



DIRECT  
FASTENING  
TECHNOLOGY  
MANUAL 01/2021







# Contents

## Hilti Direct Fastening System

<b>Part 1:</b>	<b>Direct fastening principles and technique</b>	<b>11</b>
<b>1. Introduction</b>		<b>11</b>
1.1	Definitions and general terminology	11
1.2	Reasons for using direct fastening	11
1.3	Direct fastening applications	13
<b>2. The direct fastening system</b>		<b>14</b>
2.1	Fasteners	15
2.2	Manufacturing process	16
2.3	Fastener raw material	17
2.4	Types of Hilti direct fastening tools	18
2.5	Operating principles	20
<b>3. Health and safety</b>		<b>23</b>
3.1	Operator safety	23
3.2	Fastening safety	28
3.3	Quality of installation	29
<b>4. Corrosion</b>		<b>31</b>
4.1	Corrosion protection of direct fastening systems	31
4.2	Fastener selection	33
<b>5. Steel base material</b>		<b>37</b>
5.1	Anchoring mechanisms	37
5.2	Factors influencing pull-out resistance	39
5.3	Suitability of the steel for fastening	44
5.4	Application limit diagrams	45
5.5	Thin steel base material	46
5.6	Types of load and modes of failure	47
5.7	Effect of fasteners on structural steel	54
<b>6. Concrete base material</b>		<b>59</b>
6.1	Anchoring mechanisms	59
6.2	Factors influencing resistance to pull-out	61
6.3	Effect of time on pull-out resistance	64
6.4	Effect on concrete components	65
<b>7. Masonry base material</b>		<b>66</b>
7.1	General suitability	66

<b>8. Temperature effects on the fastening</b>	<b>67</b>
8.1 Effect of low temperatures on fasteners	67
8.2 Effect of low temperatures on fastenings to steel	68
8.3 Fire rating of fastenings to steel	70
8.4 Fire rating of fastenings to concrete	72
<b>9. Design concepts</b>	<b>74</b>
<b>10. Determination of technical data for fastening design</b>	<b>76</b>
10.1 Fastenings to steel	76
10.2 Profile sheet fastenings	77
10.3 Fastenings to concrete (standard DX / GX / BX)	78
10.4 DX fastenings to concrete (DX-Kwik)	80
10.5 Fastener design in the USA and Canada	81
<b>Part 2: Fastener selection guide</b>	<b>83</b>
<b>1. Selecting the right fastener</b>	<b>84</b>
<b>2. Concrete fastener selection</b>	<b>86</b>
<b>3. Nomenclature/symbols</b>	<b>94</b>
<b>4. Tips for users</b>	<b>97</b>
<b>5. Nail and stud designation</b>	<b>103</b>
<b>Part 3: Tools and equipment</b>	<b>109</b>
<b>Powder-actuated tool</b>	<b>109</b>
DX 2                      Semi-automatic powder-actuated tool for fastening single nails	111
DX 351                    Powder-actuated tool for interior finishing applications	112
DX 351 F8                Powder-actuated tool for interior finishing, mechanical and electrical applications	112
DX 351 BT                Powder-actuated tool for fastening X-BT threaded studs	113
DX 351 BTG              Powder-actuated tool for fastening gratings	113
DX 460-MX                Powder-actuated tool for fastening collated nails	114
DX 460-F8                Powder-actuated tool for fastening single nails	114
DX 460-SM                Powder-actuated tool for fastening metal decks	117
DX 5 MX                    Digitally enabled powder-actuated tool for fastening collated nails	118
DX 5 F8                    Digitally enabled powder-actuated tool for fastening single nails	118
DX 5 IE                    Powder-actuated tool for fastening insulation	121
DX 5 GR                    Powder-actuated tool for fastening gratings	121
DX 5 SM                    Powder-actuated tool for fastening metal decks	121
DX 5 F10                   Powder-actuated tool for fastening W10 threaded studs	121
DX 76 PTR                Powder-actuated tool for fastening metal decks with collated nails	122

DX 76 PTR	Powder-actuated tool for fastening metal decks with single nails	122
DX 76 PTR	Powder-actuated tool for fastening metal decks on concrete – DX-Kwik	123
DX 76 PTR	Powder-actuated tool for fastening HVB shear connectors	123
DX 76 PTR	Powder-actuated tool for fastening gratings and checker plates	124
DX 76 PTR	Powder-actuated tool for fastening heavy duty applications	124
DX 76 MX	Powder-actuated tool for fastening metal decks with collated nails	125
DX 76	Powder-actuated tool for fastening metal decks with single nails	125
DX 76	Powder-actuated tool for fastening metal decks on concrete – DX-Kwik	126
DX 76	Powder-actuated tool for fastening HVB shear connectors	126
DX 76	Powder-actuated tool for fastening gratings and checker plates	127
DX 76	Powder-actuated tool for fastening heavy duty applications	127
DX-860-ENP	Powder-actuated tool for fastening metal decks	128
DX 860-HSN	Powder-actuated tool for fastening metal decks	128
DX 9-ENP	Digitally enabled powder-actuated tool for fastening metal decks	129
DX 9-HSN	Digitally enabled powder-actuated tool for fastening metal decks	129
Cartridges	Propellants for powder-actuated tools	130
<b>Gas-actuated tool</b>		<b>131</b>
GX 90 WF	Gas-actuated tool for wood framing	131
GX 120	Gas-actuated tool for interior finishing applications	132
GX 120-ME	Gas-actuated tool for mechanical and electrical applications	132
GX 3	Gas-actuated tool for interior finishing and building construction applications	133
GX 3-ME	Gas-actuated tool for mechanical and electrical applications	133
GX 2	Gas-actuated tool for interior finishing and building construction applications	134
GX 2	Gas cans	134
<b>Battery-actuated tool</b>		<b>135</b>
BX 3-BT	Battery-actuated tool for multi-purpose and electrical connection applications	135
BX 3-BTG	Battery-actuated tool for fastening gratings	135
BX 3-IF	Battery-actuated tool for interior finishing and building construction applications	136
BX 3-ME	Battery-actuated tool for mechanical and electrical applications	136
BX 3 02	Battery-actuated tool for mechanical and electrical applications	137
BX 3-L 02	Battery-actuated tool for interior finishing, mechanical and electrical and building construction applications	137

<b>Part 4:</b>	<b>Fasteners</b>	<b>139</b>
<b>Siding and decking nail</b>		<b>141</b>
X-ENP	Siding and decking nail	141
SDK2, PDK2	Sealing cap for cladding fastening	149
X-ENP2K	Siding and decking nail	151
X-HSN 24	Diaphragm decking nail	157
NPH	Siding and decking nail	161
<b>Shear connector</b>		<b>165</b>
X-HVB	Shear connector	165
<b>General purpose nail</b>		<b>173</b>
X-U	Nail for fastening to concrete and steel	173
X-P	Nail for fastening to concrete and steel	183
X-C	Nail for fastening to concrete and sand lime masonry	189
X-S	Nail for fastening drywall track to steel	195
EDS	Nail for fastening to steel	205
<b>Specialized nail</b>		<b>211</b>
X-R	Stainless steel nail for fastening to steel	211
X-CR	Stainless steel nail for fastening to steel	217
X-CR	Stainless steel nail for fastening to concrete, sand lime masonry and steel	221
X-CT	Nail for forming or other temporary use	227
DX-Kwik, X-M6 H, X-M8 H and DNH, X-DKH	Threaded stud and nail	231
<b>Threaded stud</b>		<b>231</b>
X-M6 H, X-M8 H, DX-Kwik	Threaded stud	231
X-M6, X-W6, X-M8, M10, W10	Threaded stud for fastening to concrete	237
X-EM6H, X-EW6H, X-EF7H, X-EM8H, X-EM10H, X-EW10H	Threaded stud for fastening to steel	241
X-BT	Stainless steel threaded stud	247
X-BT	New Generation stainless steel threaded stud	253
X-BT-MF	Composite threaded stud	261

X-BT-MR-N	Stainless steel threaded stud for narrow through hole	267
S-BT	Screw-in stainless steel and carbon steel threaded stud	275
X-ST-GR	Stainless steel threaded stud for fastening to steel	285
X-CRM	Stainless steel threaded stud for fastening to concrete and steel	291
X-BT-ER	Stainless steel threaded stud for electrical connection	297
S-BT-ER, S-BT-EF	Screw-in stainless steel and carbon steel threaded stud	303
X-FCM	Grating fastening system	317
X-FCM-R HL	Grating fastening system	329
X-FCM NG	Grating Fastening System	335
X-FCI-M	Grating fastening system	345
X-GR	Grating fastening system	353
X-FCS-R	Grating element	359
X-PGR-RU	Grating fastening system (pre-drilled)	371
X-MGR	Grating fastening system	375
X-FCP	Checker plate fastening system	379
<b>Insulation fastener</b>		<b>385</b>
X-IE-G	Insulation fastener	385
X-IE, X-IE-E	Insulation fastener	389
X-IE-H	Insulation fastener for hard board	393
XI-FV ETICS	Insulation fastener	397
X-SW 30, X-SW 60	Soft washer fastener	401
<b>Formwork fastener</b>		<b>405</b>
X-FS	Form stop	405
X-DFS	Double form stop	407
X-DFC	Double fire clip	411
<b>Gas-actuated tool fastening system</b>		<b>415</b>
X-EGN, X-GHP,		415
X-GN	Fastener for gas-actuated tool	415
GX 3 System	Fastener for interior finishing, building construction, mechanical and electrical application	421
GX 2 System	Fastener for interior finishing application	431
<b>Battery-actuated tool fastening system</b>		<b>435</b>
BX 3 System	Fastener for interior finishing, building construction, mechanical and electrical application	435
BX-Kwik	Electrical hanger system	445

<b>Hanger fastener</b>	<b>449</b>
X-HS and X-CC	Threaded hanger and loop hanger system 449
X-EHS MX, X-ECC MX	Electrical hanger system 455
X-DHS MX	Pipe support system 459
X-HS-W	Wire hanging system 463
<b>Electrical fastener</b>	<b>467</b>
X-EKB, X-ECH	Electrical fastener 467
X-MCT-FE MX	Metal cable tie holder 473
X-ECH-FE MX, X-EKB-FE MX	Circuit integrity fastener 477
X-FB, X-DFB, X-EMTC	Electrical conduit fastener 481
X-FB-E, X-DFB-E	Electrical conduit fastener 485
X-UCS MX	Universal conduit saddle 489
X-UCS-S MX	Universal conduit saddle for rigid pipe 493
X-ECT MX, X-UCT MX, X-EKS MX	Electrical cable tie and conduit clip fastener 497
X-UCT-E MX	Universal cable tie holder 503
X-ET	Nail for fastening plastic electrical cable tray and junction box 507
X-TT	Textile tape 511
<b>Wood nails</b>	<b>513</b>
GX-WF	Wood framing nail 513
<b>Summary of Approvals – Direct Fastening</b>	<b>523</b>
<b>Approvals</b>	<b>523</b>
Nails → Approvals	523
Approvals → Nails	546



Part 1:

## Direct fastening principles and technique





# 1. Introduction

## 1.1 Definitions and general terminology

Hilti direct fastening technology is a technique in which specially hardened nails or studs are driven into steel, concrete or masonry by a piston-type tool. Materials suitable for fastening by this method are steel, wood, insulation and some kinds of plastic. Fastener driving power is generated

by a power load (a cartridge containing combustible propellant powder, also known as a “booster”), combustible gas or by a battery. During the driving process, base material is displaced and not removed. In Hilti terminology, DX stands for “powder-actuated”, GX for “gas-actuated” and BX stands for “battery-actuated” systems (i.e. propellant free).”

## 1.2 Reasons for using direct fastening

“The illustrations below show some of the main reasons why many contractors take

advantage of the benefits of powder-, gas- or battery-actuated fastening.

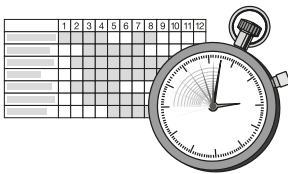

Speed is important.

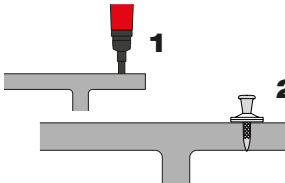

An easy-to-use, uncomplicated fastening system is required.

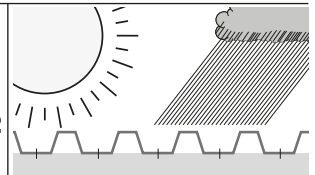

A weather-independent fastening system is required.



Electric power is not available or electric cables would hinder the work.

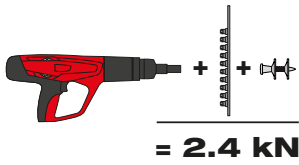

A complete fastening system with assured strength is required.



Drilling is not viable because of noise.

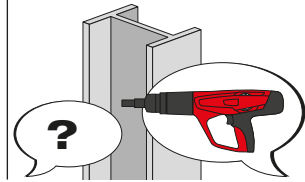

Drilling would be too difficult.

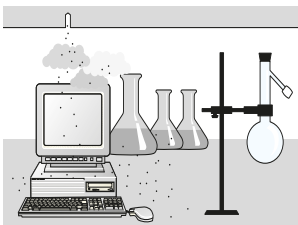

Drilling would cause too much dust.

In addition, there are specific reasons why contractors may use battery-actuated fastening:



Gas cans or combustion systems are not allowed

### 1.3 Direct fastening applications

Typical applications for powder- or gas-actuated fastening are shown in the illustrations below:

- Fastening thin metal sheets: roof decking wall liners and floor decking
- Fastening thicker steel members: e.g. metal brackets, clips
- Fastening soft materials such as wooden

battens or insulation to steel, concrete or masonry

- Threaded studs for suspended ceilings, installing building services, bar gratings or chequer plate floors
- Connections for composite structures: fastening nailed composite shear connectors

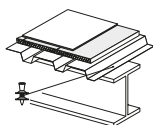

Roof decking

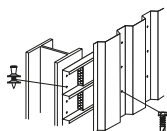

Wall liners

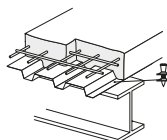

Floor decking

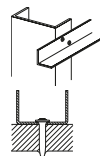

Metal brackets, clips and tracks

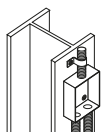

Fixtures for mechanical and electrical installations

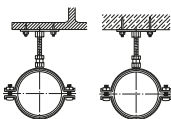

Hangers with threaded connectors

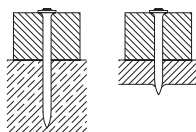

Wooden battens fastened to steel or concrete

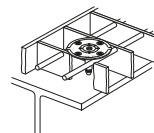

Grating fastenings

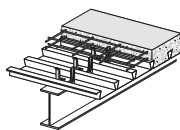

Shear connectors

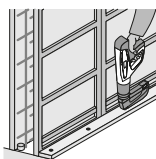

System formwork

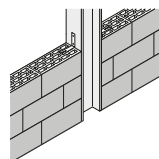

Wall-tie to steel and concrete

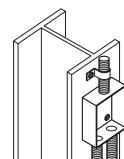

Mechanical and electrical fixtures

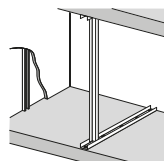



Drywall track to concrete and steel

## 2. The direct fastening system

The fastener, tool and driving energy form a fastening system with its own specific characteristics. Examples of Hilti direct

fastening system components are shown below.

Fasteners	Fastening tools	Driving energy
		
Powder-actuated tool		
		
Gas-actuated tool		
		
Battery-actuated tool		

## 2.1 Fasteners

Fasteners can be classified in three general types: nails, threaded studs and composite fasteners.

### Nails

Siding and decking nails



General purpose nails

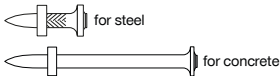

### Threaded studs

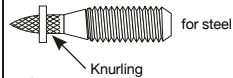

Blunt-ended fastener  
(requires pre-drilling)

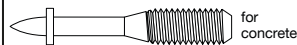

### Pre-mounted fasteners

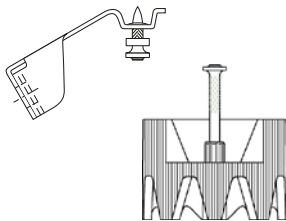

### Multi-part fasteners

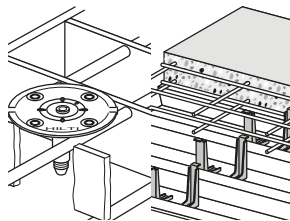

The nails used (also known as drive pins) are of a special type equipped with washers to meet the needs of the application and to provide guidance when driven. Threaded studs are essentially nails with a threaded upper section instead of a head. Composite fasteners are an assembly consisting of a nail with an application-specific fastening component such as a clip, plate or disk made of metal or plastic.

Siding and decking nails can be recognized by their washers which are specially designed to hold down the metal sheets and to absorb excess driving energy. Fasteners designed for driving into steel usually have

knurled shanks which increase their pull-out resistance. Fasteners for use on concrete have longer shanks than those for use on steel. Threaded studs may have either a metric (M6, M8 or M10) or Whitworth ( $1/16''$ ,  $5/16''$  or  $3/8''$ ) thread.

Nails and threaded studs are commonly zinc-plated for resistance to corrosion during transport, storage and construction. As this degree of protection is inadequate for long-term resistance to corrosion, use of these zinc-plated fasteners is limited to applications where they are not exposed to the weather or a corrosive atmosphere during their service life. The zinc layer on

fasteners driven into steel is, in fact, a disadvantage in that it reduces pull-out resistance. For this reason, the thickness of zinc on the fastener must be optimized to ensure good corrosion protection as well as high holding power. During production, tight control of the galvanizing process is necessary to prevent excess zinc thickness and thereby poor fastening performance. Fasteners must be 2 to 3 times harder than the material into which they are driven. The tensile strength of structural steel is

commonly between 400 and 600 MPa. Fasteners for use on steel thus require a strength of approximately 2000 MPa. As Rockwell hardness is much easier to measure than strength, but good correlation exists between hardness and strength, this characteristic is used as a parameter in the specification and manufacturing of the fasteners. In the table below, HRC hardness is given for a range of tensile strengths (DIN 50150).

Tensile strength									
(MPa)	770	865	965	1810	1920	1995	2070	2180	2215
HRC	20.5	25.5	30	52.5	54	55	56.5	58	59

## 2.2 Manufacturing process

### Standard hardened steel fasteners

Almost all power-actuated fasteners used throughout the world are manufactured from carbon steel wire which is subsequently thermally hardened to provide the strength needed for driving into steel and concrete. In nail manufacturing, shank diameter is determined by the wire diameter used. Threaded studs are made from wire corresponding to the required thread diameter. The manufacturing process, which is summarized in the diagram below, consists of cutting the wire to length, shaping the head, knurling, forging or thermo pulling the point, hardening, galvanizing and assembling with washers. The process of hardening the steel to more than HRC 50 combined with the zinc plating presents a risk of hydrogen embrittlement. This risk is mitigated by heat-treating the

galvanized product at the optimum temperature for the correct time. Galvanized and heat-treated fasteners are subjected to impact bending tests to check the effectiveness of the process. Depending on their intended application, some fasteners are additionally sampled and tested under tension and shear.

### Manufacturing Process

#### Standard zinc-coated fasteners



## Stainless steel fasteners

Hilti introduced the first powder-actuated stainless steel fastener in 1994. These fasteners, which are not thermally hardened, are manufactured from special stainless steel wire with an ultimate tensile strength of 1850 MPa. One effect of using steel of such high strength as a raw material is that the forming and forging processes present greater technical difficulties. These fasteners, on the other hand, suffer no

risk of hydrogen embrittlement and their strength decreases only very slightly when subjected to high temperatures such as in a fire.

### Manufacturing Process Stainless Steel Fasteners

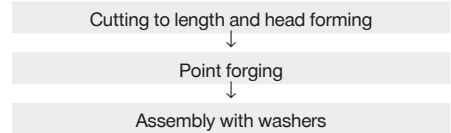

## 2.3 Fastener raw material

Hilti standard zinc plated fasteners are made from carbon steel wire with an ultimate tensile strength of 590 to 760 MPa.

Hilti X-CR / X-BT stainless steel fasteners are made from high-strength nitrogen alloyed stainless steel wire (Hilti designation CR500) or ferritic-austenitic corrosion resistant duplex steel 1.4462.

Nickel and chromium are the components of stainless steel that make it resistant to corrosion. CR500 steel is compared to commonly used stainless steels like AISI 304 and 316 (European A2 and A4) in the graph at the right. Note that CR500 steel contains considerably more nickel and chromium than both 304 and 316.

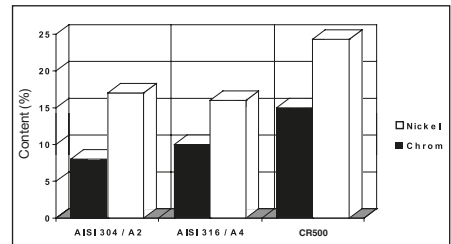

Another comparison of interest is the difference in ultimate tensile strength, as shown in the graph at the right.

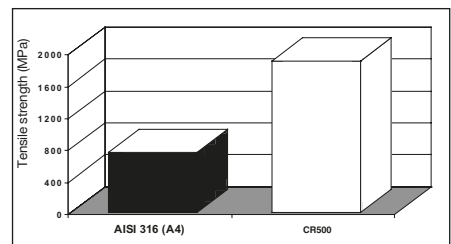

## 2.4 Types of Hilti direct fastening tools

Hilti currently offers three types of direct fastening tools: powder-actuated, gas-actuated and battery-actuated.

### 2.4.1 Powder-actuated tools



These tools rely on cartridges of different power levels as propellant. When ignited, the cartridge transfers energy to a piston which, in turn, drives the fastener into the base material.

All Hilti powder-actuated tools are classified as low-velocity tools.

Class of powder-actuated tool	Average test velocity in m/s [fps]	Maximum single test velocity in m/s [fps]
Low-velocity	100 [328]	108 [354]
Medium-velocity	150 [492]	160 [525]
High-velocity	>150 [492]	>160 [525]

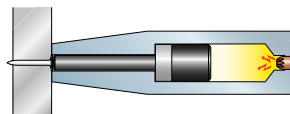



### 2.4.2 Gas-actuated tools



These tools rely on gas as propellant. Expanding the gas transfers energy to a piston which, in turn, drives the fastener into the base material.

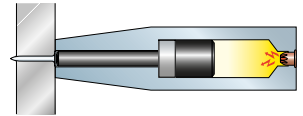

Hilti manufactures gas-actuated tools using two distinct technologies. The first (used notably in models GX 2 and GX 90 WF) uses a fan to mix the propellant with ambient air. The second (used notably in the GX 120 and GX 3) uses a Hilti-designed mechanism requiring no external power to mix the gas and air in the combustion chamber.

### 2.4.3 Battery-actuated tools



This tool is propellant-free. The energy moving the piston is generated by an electrical motor, two springs and a belt. The only source of energy required is a 22V battery which is interchangeable with other tools from the Hilti 22V platform family.



## 2.5 Operating principles

All Hilti direct fastening tools feature a piston. There are three ways the piston can come into contact with the fastener when an operator triggers a tool – referred to as operating principles. They are described in the diagram below.

It is important to bear in mind that the operating principle used for a given fastening point modifies the application's limit, particularly when fastening on steel.

Operating principle	Characteristics	
Co-acting operation	<ul style="list-style-type: none"> <li>• <math>X &gt; 0</math> ; <math>Y = 0</math></li> <li>• Highest application limit</li> <li>• Lowest recoil</li> </ul>	
Impact operation	<ul style="list-style-type: none"> <li>• <math>X = 0</math> ; <math>Y &gt; 0</math></li> <li>• Lower application limit</li> <li>• Higher recoil</li> </ul>	
Contact operation	<ul style="list-style-type: none"> <li>• <math>X = 0</math> ; <math>Y = 0</math></li> <li>• Lowest application limit</li> <li>• Highest recoil</li> </ul>	

It should be noted that 100% co-acting operation in Hilti tools can be only achieved by pushing the fastener all the way against the piston with a ramrod or, if the tool is so designed, with a built-in ramrod mechanism. Tools with nail magazines cannot operate with 100% co-action because of the need for clearance between the piston end and the collated nail strip. Some single-shot tools allow the operator to make an impact-type tool work as a co-acting tool by using a ramrod.

### 2.5.1 Cartridges (power loads, boosters)

Cartridges for powder-actuated fastening tools are available in various standard sizes and each size is available in up to 6 power levels. In the United States, the powder in a cartridge, the sensitivity of the primer, and the cartridge dimensions are governed by technical data published by the Powder-Actuated Tool Manufacturers Institute, Inc.

(PATMI). PATMI defines the power level by the velocity measured in a standard test in which a standardized 350 grain [22.7gram] cylindrical plunger is fired from a standardized apparatus. The identification and limitations of use are addressed in ANSI A10.3-2013.

#### PATMI colour codes, power levels and definition of cartridges

Size	Colour code	Power level	Velocity of 350 grain slug		Calculated energy (joules)		
			ft./sec.	[m/sec.]	minimum	average	maximum
6.8 / 11 [Cal. 27 short]	Gray	1	370 ± 45	[113 ± 13.7]	111	144	182
	Brown	2	420 ± 45	[128 ± 13.7]	148	186	228
	Green	3	480 ± 45	[146 ± 13.7]	200	243	291
	Yellow	4	560 ± 45	[171 ± 13.7]	280	331	386
	Red	5	610 ± 45	[186 ± 13.7]	337	392	452
	Purple / black	6	660 ± 45	[201 ± 13.7]	399	459	524
6.8 / 18 [Cal. 27 long]	Green	3	550 ± 45	[168 ± 13.7]	269	319	373
	Yellow	4	630 ± 45	[192 ± 13.7]	361	419	480
	Blue	4.5	725 ± 45	[221 ± 13.7]	488	554	625
	Red	5	770 ± 45	[235 ± 13.7]	554	625	700
	Purple / black	6	870 ± 45	[265 ± 13.7]	718	798	883

In Europe, the European Standard EN 16264 specifies cartridge dimensions, colour codes and power levels, which are defined in terms of energy delivered

when a cartridge is fired in a standardized apparatus. EN 16264 specifies a 80 gram plunger.



## EN 16264 colour codes, power levels and energy scale

Colour code	Power level	Energy scale
White/Brown	weakest	2
Green	weak	3
Yellow	medium	4
Blue	heavy	5
Red	very heavy	6
Black	heaviest	7

### 3. Health and safety

The safety of powder-actuated fastening systems can be clustered into two categories:

- Operator safety refers to safeguarding the operator and bystanders.
- Fastening safety refers to the adequacy of the in-place fastenings.

#### 3.1 Operator safety

This refers to the measures taken to ensure that the tool does not endanger the operator and/or bystanders by firing at an overly high velocity, firing under the wrong conditions, generating excessive noise, or being used in the wrong way.

##### The piston principle

One of the main concerns about the use of powder-filled cartridges is the risks associated with a fastener missing the base material, or with a base material too weak to absorb the nail's energy. The piston principle ensures that the energy from the propellant in the cartridge is transferred to a piston which, in turn, drives the fastener. Because the piston is captive within the tool, it will absorb app. 95% of the driving energy in case a fastener misses the base material or the material is too soft for the fastener. As a consequence, the fastener will exit the tool at a speed that is far lower and less dangerous than that of tools which are not based on a piston.

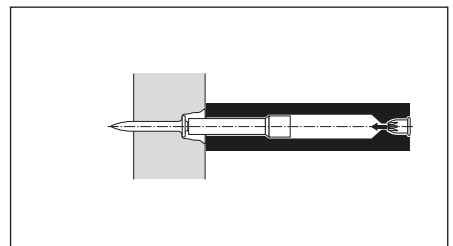
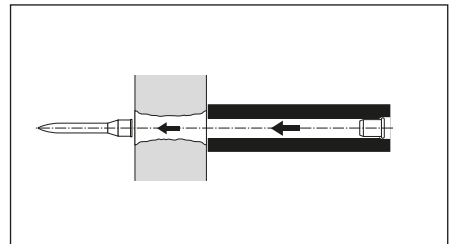

##### Tool safety mechanisms

To minimize the potential hazards during tool usage, Hilti has implemented the following safety mechanisms in all of its direct fastening tools.

### Drop-firing safety

The drop firing safety mechanism prevents the tool from firing if dropped unintentionally. This mechanism is so designed that the tool, cocked or uncocked, will not fire when dropped at any angle onto a hard surface.



### Trigger safety

The trigger in Hilti's DX- and GX-tools is uncoupled from the firing pin mechanism until the tool is fully compressed against the work surface. This mechanism ensures that pulling the trigger alone cannot cause the tool to fire.



### Contact pressure safety

Hilti's direct fastening tools can only operate when pressed against the work surface. This requires a force of at least 50 N (5.1 kg, or 11.2 pounds). Tools with large base plates, such as DX 76 and GX 120, feature an additional surface contact pin that must also be pressed to allow the tool to operate.



### Unintentional firing safety

Hilti's direct fastening tools will not operate unless first pressed against a work surface and then actioned using the trigger. This Hilti-designed feature ensures that no fastener exits a tool without the operator specifically intending it and focusing on the tool.



## Powder cartridges and operator safety

EN16264 requires submitting each cartridge to overpressure tests in each of the tools for which it is intended. This ensures that the plastic collation strip is of adequate strength. EN16264 also defines the maximum amount of unburnt powder a cartridge may leave after combustion, as this residue may explode and cause injuries to the operators and to bystanders. Meeting this requirement is a prerequisite for CE conformity.

The Hilti cartridges come in packages that address all the norms discussed above. Each package displays the cartridge's energy level through a color dot, which tools it is associated with and approved for (known as "system approvals"), a marking on a US scale and another one on the European scale, in addition to the CE and CIP logos, as the following picture illustrates in the "black" portion of the package.



The identification and limitations of cartridge use in the U.S. are addressed in the ANSI/ASSE A10.3 norm.

Finally, it is also important that, whatever the cartridge, the operator follow the ventilation instructions provided in the Operating Instructions.

## Gas cans and operator safety

Norms and standards relevant to gas cans include EN12205 and ISO 11118 as of 2018, which regulate the physical structure of gas cans. They also include the UN 1950 or UN 3150 norms, which define the conditions under which gas can shipping and distributing is considered safe. Regional regulations also apply depending on the operator’s location: ADR/RID for Europe and ORM-D for the United States. All Hilti gas cans strictly abide by these norms.

To ensure that Hilti’s gas cans are used in the appropriate conditions, each can features safety information in text and pictogram formats. In particular, it displays its expiry date, the maximum temperature it may be exposed to, its pressure level, and the “Extremely flammable” logo. The enclosing package also displays this information, in addition to recommended storage conditions. And the accompanying leaflet provides the complete list of potential hazards associated with the gas can.

### GC 42 for use with the Hilti GX 3 tool.

For professional use only. Strictly for intended use only. Read the operating instructions and the safety regulations before use. Keep out of reach of children. **See edge of can for expiration date and lot number. Extremely flammable gas. Contains gas under pressure; may explode if heated. Contains Isobutane, Propane, Propane.** Pressurized container. Do not pierce or burn, even after use. Protect from sunlight. Do not expose to temperatures exceeding 50°C/122°F. Do not spray on an open flame or other ignition source. Keep away from heat/sparks/open flames/hot surfaces. — No smoking. Store the container in a well ventilated place. Recommended storage temperature: 5°C to 25°C (41°F to 77°F).

### GC 42 Gasdose zur Verwendung im Gerät Hilti GX 3.

Nur für professionellen Gebrauch. Benutzung ausschliesslich gemäss Verwendungszweck. Vor der Inbetriebnahme Bedienungsanleitung und die Sicherheitsvorschriften lesen. Darf nicht in die Hände von Kindern gelangen. **Verfallsdatum und Abfüll-Los siehe Dosenrand. Extrem entzündbares Gas. Enthält Gas unter Druck; kann bei Erwärmung explodieren. Enthält: Isobutan, Propan, Propan.** Behälter steht unter Druck: Nicht durchstechen oder verbrennen, auch nicht nach der Verwendung. Vor Sonnenbestrahlung schützen und nicht Temperaturen von mehr als 50 °C/122°F aussetzen. Nicht gegen offene Flamme oder andere Zündquelle sprühen. Von Hitze/Funkentöffener Flamme/heißen Oberflächen fernhalten - Nicht rauchen. Nur in gut gelüfteten Bereichen verwenden. Behälter an einem gut gelüfteten Ort aufbewahren. Empfohlene Lagertemperatur 5°C bis 25°C (41°F bis 77°F).

### GC 42 pour système Hilti GX 3.

Usage réservé aux professionnels, uniquement dans le cadre d’une utilisation normale. Lire le manuel d’utilisation et toutes les instructions de sécurité avant utilisation. Tenir hors de portée des enfants. **Date d’expiration sur la bordure de la cartouche. Gaz extrêmement inflammable. Contient un gaz sous pression; peut exploser sous l’effet de la chaleur. Contient: Isobutane, Propane, Propane.** Récipient sous pression: ne pas perforez, ni brûler, même après usage. Protéger du rayonnement solaire. Ne pas exposer à une température supérieure à 50 °C/122 °F. Ne pas vaporiser sur une flamme nue ou sur toute autre source d’ignition. Tenir à l’écart de la chaleur/des étincelles/des flammes nues/des surfaces chaudes. - Ne pas fumer. Stocker les cartouches dans un endroit bien ventilés. Température recommandée pour le stockage: 5°C à 25°C (41°F à 77°F).

81 ml **115**

(2.74 fl. oz.)

Made in Germany

www.hilti.com

Hilti Corporation, FL-9494 Schaan, Tel. ++423/234 21 11

Hilti = registered trademark of Hilti Corporation, Schaan, LI



Danger  
Gefahr

2108613-10/2014



To enable the efficient tracking of any issue, the production lot number is also printed on each gas can and package.

The side illustration shows the typical graphical layout of a Hilti gas can.

The Hilti tools only operate with Hilti gas cans. This ensures that the tool receives gas in the right amount and composition, minimizing safety risks.



**Noise-related operator safety**

Hilti measures the noise its direct fastening tools emit as per the EN 15895 international standard to help operators and safety engineers plan the work in a way that minimizes risks. However, it should be noted that other ambient construction noises frequently compound with the tool's noise, which warrants additional precautions to protect operators. As a general rule, operators should always wear ear protection when operating the tools.

**Vibration-related operator safety**

Hilti direct fastening tools are not considered to produce vibrations as defined in international standards. However, as a precautionary measure, it is recommended to use the weakest possible cartridges to perform any given task, as well as to follow the instructions contained in the IFU.

**Promoting operator safety through signaling and documentation**

To ensure the safety of the operator and of bystanders, it is essential to follow the instructions contained in the Operating Instructions. Safety measures are also featured on pictograms inside the product carrying cases and on the consumables.



Hilti also covers safety measures as part of the operator training modules its local offices offer. The operators completing training receive a certificate of completion and/or an operator ID as required by local regulations. In some countries, the operators also get access to online material that serves as a refresher.

### 3.2 Fastening safety

The safety of a fastening point depends for a good part on the manufacturer correctly anticipating the conditions in which its tools and fasteners will be used on jobsites. This involves:

- 1) engineering and testing fastening systems within the framework of specific applications
- 2) ensuring that the finished products strictly match their technical specifications
- 3) ensuring that the fastening work on jobsites is performed as it is intended to be

#### Engineering and testing

Sources of information about the engineering and testing of a fastening system include the manufacturer's technical literature, official approvals and publications in technical journals. Hilti provides all of these for its products.



The use of a non-Hilti fastening system by an operator should be made contingent upon proof that the fastening system has been engineered and tested for the application the operator intends to perform.

#### Finished product quality

It is important that the manufacturer have a production quality control system. This is necessary for ISO 9001 certification. All Hilti production facilities are 9001 certified.



### 3.3 Quality of installation

Hilti contributes to the quality of the fastening work in the four following ways:

- 1) It provides application guidelines.
- 2) It provides technical advisory services.
- 3) Each box of nails designed and/or approved for specific applications comes with a plastic gauge enabling the operator to check if the nail's stand-off on the base material is within the acceptable margin
- 4) It manufactures devices enabling the tensile testing of fasteners. Threaded studs and certain decking fasteners can be tested in their final position on a jobsite. Other fasteners can be tested using a pull-over test specimen.



Checking the standoff of an ENP2 roof deck fastening with a plastic gauge



Pull-out test of an ENP fastening with a HAT28 tester and X-ENP adapter

As construction professionals demand fastening systems that are dependable without question, Hilti integrates functional reliability into the development, manufacturing, selling and servicing of its fastening systems. It does so paying particular attention to the reliability level required of each system, and the conditions in which it will be used.

During the development phase, Hilti engineers test the reliability of prototypes and system components regularly. In the plant, quality controls take place throughout the manufacturing process to ensure that the products are produced according to specifications.

When the first pilot production lots are delivered, contractors test them on jobsites. Adequate performance by the pilot production lots ensures that the products will be of good quality when mass-produced.

Hilti's sales staff gets trained to be in a position to advise customers on which system to use for their application, demonstrate how to use tools, and warn them about potential hazards.

Finally, Hilti's highly skilled tool repair and maintenance staff ensures that the fastening system functions optimally over the long run.



## 4. Corrosion

For decades, Hilti is concerned about corrosion of fastening systems and has gained a lot of experience in this area based on laboratory- and field tests. Extensive testing and research are conducted in test facilities of Hilti Corporate Research department, located around the world in different climate zones. Hilti strives to provide the best possible

support to customers for selecting the right product for safe and reliable fastening solutions.

This chapter gives an overview of corrosion protection solutions for Hilti Direct Fastening elements. More details on corrosion are described in the Hilti corrosion brochure „Corrosion handbook 2015“.

### 4.1 Corrosion protection of direct fastening systems

Carbon steel fasteners are subject to corrosion (red rust) when exposed to humidity.

Zinc is the coating most commonly applied on fasteners. Humidity attacks it before it attacks the carbon steel core. Thanks to Zinc's electro-chemical properties, this produces white rust on the coating but delays the formation of red rust on the core material.

Zinc has different removal rates depending on the surrounding environment.

The lifetime of zinc-based protection against corrosion is a function of two parameters: the environment's aggressiveness and the zinc's thickness. Depending on the degree of anti-corrosion protection required, additional layers of Zinc can be applied through passivation or organic topcoat.

Different variants of coating systems can be used to prevent fasteners from rusting. They are described in the following paragraphs.

#### **Galvanic zinc coating:**

This type of coating is generally suitable for environments with no corrosive potential. It is typically applied via an electrochemical process. Thicknesses up to 20 microns are possible, including passivation layer.

#### **Hot dip galvanizing (HDG):**

HDG is applied by dipping the parts to be protected against corrosion in a liquid zinc bath. The coating thickness can reach up to 80-100 microns, offering additional protection compared to galvanic zinc.

**Duplex coating:**

An alternative to hot dip galvanizing is duplex coating, i.e. the combination of a galvanic zinc layer with an supplemental reactive sealer the zinc in a first period. The equivalence in the protection offered by duplex coating and by HDG has been demonstrated on numerous occasions at Hilti test facilities around the world as well as at independent external labs. Duplex coating is applied to many Hilti grating fasteners, X-FCM-M.

**Mechanical zinc plating:**

Another alternative to hot dip galvanizing is mechanical plating. In this process, the zinc layer is built from zinc powder that is mechanically pressed onto the surface of the parts to protect. The equivalence in the protection offered by mechanical zinc plating and by HDG has been demonstrated on numerous occasions at Hilti test facilities around the world as well as at independent external labs.

Mechanical plating is applied on some Hilti nails and pins used in direct fastening.

**Hydrogen embrittlement:**

Hydrogen embrittlement is a specific corrosion phenomenon of zinc plated DX fastening elements, which will occur if three different conditions are present simultaneously:

- High strength carbon steel (>1000 MPa)
- Presence of hydrogen
- Tensile stresses

The combination of these three parameters leads to a decrease in the material's ductility, which may cause a sudden fastener failure even under very low static load.

The strength of fasteners is a function of its design and of the acceptable load in each application. Therefore, it is important to control the presence of hydrogen in the fasteners to prevent embrittlement from occurring. There are two main sources of hydrogen for zinc plated fasteners:

- The production process (primary hydrogen embrittlement): Hilti's power actuated fasteners are thoroughly tested and controlled during the production process to prevent primary hydrogen embrittlement.
- The corrosion process in the application (secondary hydrogen embrittlement): When zinc plated, high-strength fasteners are used in wet atmosphere, hydrogen is formed by the chemical reaction of zinc and water and diffuses into the material. To avoid secondary hydrogen embrittlement during the service life of a fastener, it is essential to follow the recommended application conditions provided for each nail in Hilti technical documents.

## Stainless steel

Stainless steel comes in many different types, each of which has different corrosion resistance properties. A stainless steel material used in a wrong environment can lead to pitting corrosion and, subsequently, sudden fastener failure. In such a situation, predicting a fastener's lifetime is not possible.

Hilti power actuated fasteners are manufactured using CR500 and 1.4462 material, similar to A4 (AISI grade 316), which offers high performance in a wide range of applications.

For higher corrosion requirements, fasteners made out of HCR (1.4529) material can be provided. The HCR (High Corrosion Resistance) material can be used in swimming pools and in road tunnels, where the performance of A4 material is not sufficient.

Stainless steel with pitting corrosion, e.g. A4 material used in a road tunnel



Suitable stainless steel used, e.g. HCR material used in a road tunnel

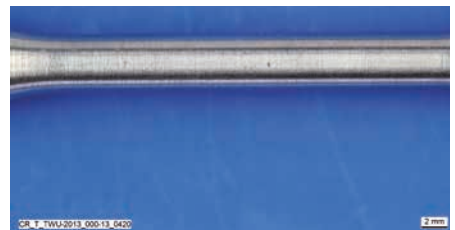

## 4.2 Fastener selection

Following table (next page) gives a general guideline of commonly-accepted applications in typical atmospheric environments. Suitability of fastening systems for a specific application can be significantly affected by localized conditions, including but not limited to:

- Elevated temperatures and humidity
- High levels of airborne pollutants
- Direct contact with corrosive products, commonly found in chemically-treated wood, waste water or salt water, concrete additives, cleaning agents, etc.

- Non-atmospheric corrosion like e.g. direct contact to soil, stagnant water
- Cyclical wetting
- Electrical current
- Contact with dissimilar metals
- Physical damage or wear

Environmental conditions		Fastened part	Carbon steel		Stainless steel		
			Galv. zinc coating	Duplex coating	CR500 or 1.4462 (A4, AISI 316)	HCR 1.4529	
			<b>Fastener</b> Galv. zinc coating   Duplex coating   CR500 or 1.4462 (A4, AISI 316)   HCR 1.4529				
			<b>Examples</b> X-ENP <sup>1)</sup> , X-U   X-FCM-M   X-BT, X-CR   On demand X-GHP   X-FCM-R				
		Dry indoor	steel (zinc coated, painted), aluminum, stainless steel, wood	■	■	■	■
		Indoor with temporary condensation	steel (zinc coated, painted), aluminum, stainless steel, wood	Consult experts for exceptions	■	■	■
		Outdoor, non-safety relevant <sup>2)</sup>	steel (zinc coated, painted), aluminum, wood	■	■	■	■
		Outdoor, rural or urban environment with low pollution	steel (zinc coated, painted)	—	■	■	■
			aluminum, stainless steel	—	Consult experts for exceptions	■	■
		Outdoor, rural or urban environment with moderate concentration of pollutants and/or salt from sea water	steel (zinc coated, painted)	—	Consult experts for exceptions	■	■
			aluminum, stainless steel	—	Consult experts for exceptions	■	■
		Coastal areas	steel (zinc coated, painted), aluminum, wood	—	—	■	■
	0-1 km	Outdoor, areas with heavy industrial pollution	steel (zinc coated, painted), aluminum, wood	—	—	■	■
	0-10 m	Close distance to streets	steel (zinc coated, painted), aluminum, wood	—	—	■	■
	Special applications	Road tunnels, indoor swimming pools, special applications in chemical industry	steel (zinc coated, painted), aluminum, wood	—	—	Consult experts for exceptions	■

■ = expected lifetime of power actuated fasteners made from this material is typically satisfactory in the specified environment based on the typically expected lifetime of a building. The assumed service life in ETA approvals for power actuated fasteners is 25 years.

— = fasteners made from this material are not suitable in the specified environment. Exceptions need a specific assessment.

1) Outdoor exposure for up to 6 months during construction is permissible for high-strength electro-galvanized siding and decking fasteners such as the X-ENP (see instructions for use for details)

2) The reference to “non-safety relevant” is intended to distinguish applications where failure of the attachment will not create any potential safety risks or significant damage.



## Remarks:

- The ultimate decision on the required corrosion protection must be made by the customer. Hilti accepts no responsibility regarding the suitability of a product for a specific application, even if informed of the applications conditions.
- This table is based on an average service life for typical applications.
- For metallic coating e.g. zinc layer systems the end of life time is the point where red rust is visible over a large percentage of the product and widespread structural deterioration can occur – the initial onset of rust will occur much sooner
- National or international codes, standards or regulations, customer and/or industry specific guidelines must be independently evaluated.
- These guidelines apply to atmospheric corrosion only. Other types of corrosion, such as crevice corrosion or stress corrosion cracking must be independently evaluated.

A typical service life of Hilti GX-WF nails in wood - wood connections is shown below:

Service Classes in accordance with EN 1995 (Eurocode 5):		Service Class 1	Service Class 1,2	Service Class 1,2,3		
Type of Corrosion Protection for Hilti GX-WF wood nails (d ≤ 4mm):		No Corrosion Protection	Zinc coated	HDG	A2 <sup>1)</sup>	A4
		Dry indoor	20 to 50 years	up to 50 years	up to 100 years	■ ■
		Indoor environments with temporary condensation	—	10 to 50 years	60 to 100 years	■ ■
		Outdoor with low pollution	—	5 to 20 years	40 to 100 years	■ ■
		Outdoor with moderate concentration of pollutants	—	2 to 10 years	20 to 40 years	■ ■
		Coastal areas	—	up to 5 years	10 to 30 years	— ■
		Outdoor, areas with heavy industrial pollution	—	up to 5 years	10 to 30 years	— ■
		Close distance to streets	—	—	—	■
	Special applications	Special applications	Consult experts for exceptions			

The table above provides typically assumed service life estimations based on corrosion considerations. Other factors determining the service life of fasteners must be evaluated separately.

- = expected lifetime of nails made from this material is typically satisfactory in the specified environment based on the typically expected lifetime of a building.
- = nails made from this material are not suitable for the environment or the typical lifetime of a building is not achieved.

1) For nails made of A2 material, discoloration of nail heads can occur before the service life in the table above is reached. To avoid this, use A4 material.

**Remarks:**

- The use of certain wood species including, but not limited to, Oak, Douglas-fir or Western Red Cedar, require the use of stainless steel nails, independent of Service Class and environmental conditions.
- The use of certain wood treatments including, but not limited to, fire retardants or preservatives can change the chemical composition of the wood and may require the use of stainless steel nails, independent of Service Class and environmental conditions.
- The evaluation of corrosive environmental conditions depends on many factors and lies within the responsibility of the customer. The planned service life of the buildings or structures can be considered according to local or national building regulations and Eurocode (EN 1990)
- The table does not contain recommendations and Hilti does not assume liability for fastener selection based on its content.
- For the typical service life, it is assumed that the nails are selected, designed, installed and otherwise treated in accordance with Hilti's published literature.
- Local building regulations and trade rules may differ from the table above. The local jurisdiction always needs to be followed.
- Wood to steel connections may require a minimum corrosion protection, independent of the environmental conditions.

## 5. Steel base material

### 5.1 Anchoring mechanisms

The following four mechanisms cause a fastener to hold when driven into steel:

- clamping
- keying
- fusing (welding)
- soldering

These mechanisms have been identified and studied by analyzing pull-out test data and by microscopic examination of fastening cross-sections.



#### Clamping

As a fastener is driven, the steel is displaced radially and towards both the entry and opposite surfaces. This results in residual pressure on the surface of the nail, which leads to friction or clamping. Clamping is the primary anchoring mechanism of through-penetrating fasteners. This is indicated by the fact that when through-penetrating fasteners are extracted, the pull-out force decreases only slowly over several millimeters of displacement.

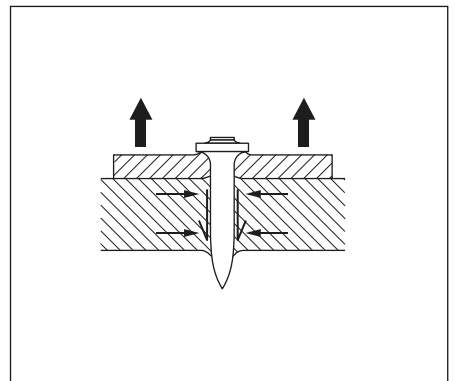

#### Keying

The keying mechanism is possible when the fastener is knurled, that is, it has fine grooves along the shank in which zinc and particles of base steel accumulate during the driving process. Microscopic examination of cross sections has shown that the grooves are not completely filled. Keying is an especially important anchoring mechanism for fasteners that do not penetrate right through the base material.

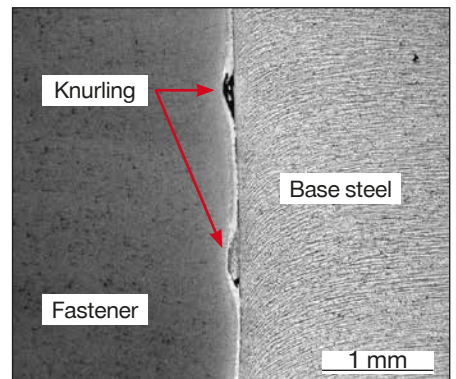

### Fusing (welding)

Complete fusing of the fastener with the base steel is indicated by portions of base material clinging to the extracted fastener. Fusing or welding is observed mostly at the point of a fastener where the temperature during driving can be expected to be the highest.

For fasteners that do not through-penetrate, this is an important anchoring mechanism. It can be relied upon only if the fastener point is manufactured without cracks and with an appropriate geometry. The thermo pulling process is ideal for achieving an optimized geometry. Control of all steps in the production process is necessary to avoid

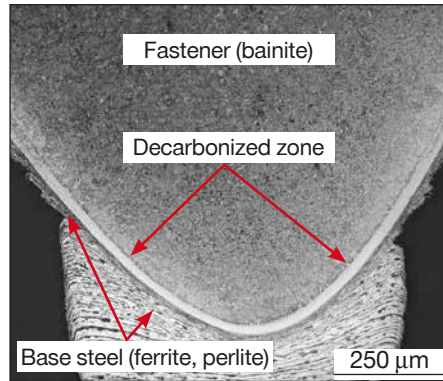

cracks in the point.

### Soldering

In the zone further from the point, there is a prominent zinc layer separating the fastener from the base steel. This zinc, soldered to the base steel, also makes a contribution to the pull-out resistance of the fastener.

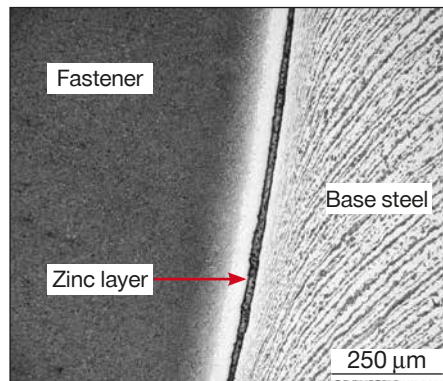

### Blunt-tipped fastener X-BT family

The X-BT fastener with a shank diameter of 4.5 mm is driven in a pre-drilled 4.0 mm diameter hole. This leads to displacement of the base material. Part of the base steel is punched down into the pre-drilled hole, generating high temperatures and causing friction welding. Due to elasticity of the base steel, additional clamping effects are also superposed.

Displaced base material can be clearly seen in the photograph. Base material adhering to the fastener shank indicates a welding effect.



## 5.2 Factors influencing pull-out resistance

Powder-actuated fastening systems must be designed and manufactured to ensure that pull-out resistance will be adequate for the applications intended. Through understanding of the anchoring mechanisms, experience and testing, factors that influence pull-out strength have been identified. Some of these factors are:

- Depth of penetration in the base material
- Surface characteristics of the fastener
- Coatings on the steel base material
- Driving velocity
- Diameter of the fastener shank

Knowledge of the influencing factors is vital to the design of fastening systems and is useful for operators in understanding the various application guidelines and restrictions that apply to a fastening system. Some of the influencing factors are discussed in the following section.

### Depth of penetration in the base material

The depth of penetration of fasteners in steel is taken as the distance that the point travels below the surface of the base steel, independent of the steel thickness. In other words the depth of penetration  $h_{ET}$  can be greater than, equal to or less than the steel thickness.

Resistance to pull-out increases with increasing depth of penetration. This is also true for through-penetrating fasteners where  $h_{ET}$  is greater than the steel thickness. The design of a powder-actuated fastener has to take into account the depth of penetration necessary to achieve the pull-out resistance required for the application. Application guidelines published for any fastener include the required nail head stand-off  $h_{NVS}$ , which corresponds to the penetration depth.

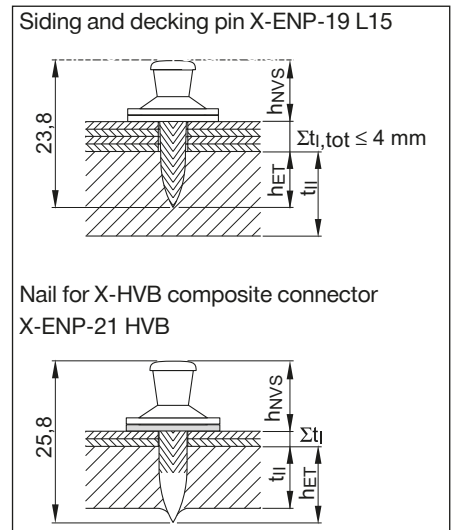

Guide values for the depth of penetration of specific fastener types are as follows:

Galvanized fastener with knurled shank:	$h_{ET} = 12$ to $18$ mm	(shank diameter 4.5 mm)
	$h_{ET} = 10$ to $14$ mm	(shank diameter 3.7 mm)
Galvanized fastener with knurled tip:	$h_{ET} = 9$ to $13$ mm	(shank diameter 4.5 mm)
Galvanized fastener with smooth shank:	$h_{ET} = 15$ to $25$ mm	
Stainless steel fastener with smooth shank:	$h_{ET} = 9$ to $14$ mm	
Blunt-ended fasteners:	$h_{ET} = 4$ to $5$ mm	

The effect of penetration depth on pull-out strength can be demonstrated in experiments in which the driving energy is varied so as to produce varying penetration. The results of a test of this kind are summarized below. The application recommendations for fasteners are based on tests like these and they clearly show the importance of carrying out the fastening installation in accordance with the recommendations of the manufacturer.

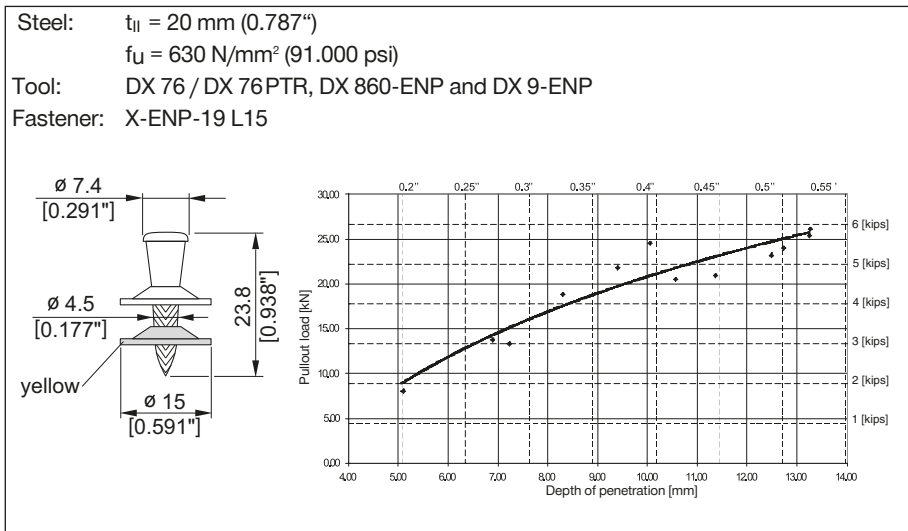

### Knurling on the fastener shank

Fasteners for use in steel base material usually have knurling on the shank so as to improve the resistance to pull-out. The effect of the knurling was shown in a test with fasteners that had knurled and unknurled shanks, but were otherwise the same.

The benefit of knurling is clearly seen from the test results. With virtually the same penetration (actually 106%), the smooth-shank fastener had only 68% of the pull-out strength of the knurled-shank type. Even with the penetration increased to 137%, the pull-out strength was still only 81% of that of the knurled-shank fastener. In this test, the steel thickness of 10 mm (0.394") allowed through penetration of the steel. If the steel is too thick for through penetration, the beneficial effect of knurling becomes even more pronounced.

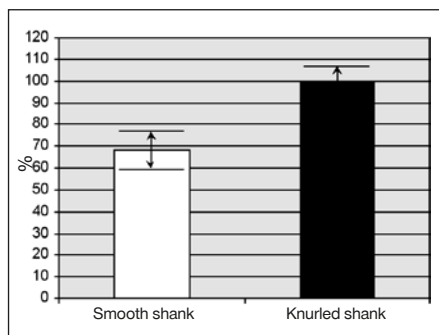

### Zinc coating on the fastener shank

Zinc on a fastener shank appears to act as a lubricant that reduces its resistance to penetration into steel. Reduced pull-out strength is the result, because the lower resistance means less heat is generated, thus reducing the welding effect between the shank and the base steel. This was shown in an experiment with fasteners that were identical except for the thickness of zinc coating.

Steel base material:  $t_{II} = 20 \text{ mm [0.787" ]}$ ,

$f_u = 440 \text{ MPa [63,817 psi]}$

Zinc thickness in mm	Average penetration		Average ultimate pull-out load		Variation CV %
	$h_{ET}$ mm / [in.]	%	$N_{u,m}$ kN / [kip]	%	
ca. 10	12.12 [0.477]	100	8.53 / [1.918]	67	25.6
2-5	11.86 [0.470]	98	12.82 / [2.882]	100	9.3

Although driving the fastener through sheet metal, as is the case when fastening siding and decking, reduces the negative effect of zinc coating on pull-out strength, the reason for tightly controlling the galvanization process is clear.

### Surface of the steel base material

Corrosion protection of structural steel is often achieved by hot-dip galvanizing. Tests have shown that if the fastener penetrates right through the steel, the galvanizing has no significant effect on pull-out strength. In the case of fasteners that do not through-penetrate, pull-out strength is reduced by about 25%. The summary of results from one test is shown below to illustrate these effects.

### Average ultimate pull-out loads

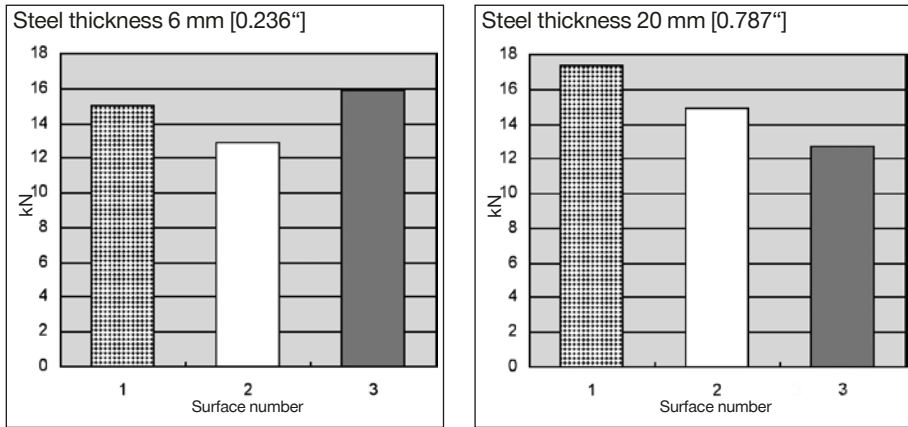

Ultimate tensile strength of steel :  
Surface of the steel :

$f_u = 430 \text{ MPa [62,366 psi]}$   
1. Rough with some slag and rust (reference)  
2. Sandblasted  
3. Pickled + hot-dip galvanized (min. 60  $\mu\text{m}$  zinc)

Several important observations can be made based on these results:

- Pull-out loads in 6 mm ( $1/4"$ ) steel base material are much less affected by the surface condition of the steel than they are in 20 mm ( $3/4"$ ) steel. The reason is that the main anchoring mechanism of through-penetration fastenings is clamping, which is not affected by the surface condition of the steel.
  - Hot-dip galvanizing appears to reduce the pull-out strength of non-through-penetrating fastenings by nearly 30%. Note, however, that even with hot-dip galvanizing, the pull-out strength was still 12.5 kN (2.8 kips).
  - The negative effect of hot-dip galvanizing is explained by the tendency of zinc on the fastener to act as a lubricant that reduces heat generation during driving. This in turn reduces the tendency of the fastener point to fuse to the base steel. Zinc from the coating on the base steel apparently becomes attached to the fastener as it enters the base steel.
- For applications where tensile strength of the fastening is critical and the steel has a heavy coating, the fastening system can be qualified by carrying out pull-out tests on site. If pull-out strength is not adequate, depth of penetration can be increased to improve the situation.



### Tensile stress in the steel

The integrity of a powder-actuated fastening is dependent on a relatively smooth pin remaining anchored in structural steel. A large amount of test data, technical assessments, approvals and practical experience with powder-actuated fastenings is available to support use of powder-actuated fastening. Performance of fasteners anchored in the steel under tension was investigated by driving fasteners into unstressed steel plates and extracting them with the plates stressed in tension. The steel plates measured 6x80x455 mm [0.236" · 3.15" · 17.9"] and possessed two different yield stresses - 328.6 MPa [47.7 ksi] and 411.7 MPa [59.7 ksi].

By expressing the steel stress in terms of % of actual yield, it was possible to combine the data for both steel grades and obtain a reasonable curve fit.

Of significance to the designer is the expected decrease in pull-out strength of the fastener at a typical maximum allowable design stress of 60 to 70 % of yield. At this stress, the pull-out strength reduction is less than 15%. The absolute value in the experiment was still greater than 2 tons.

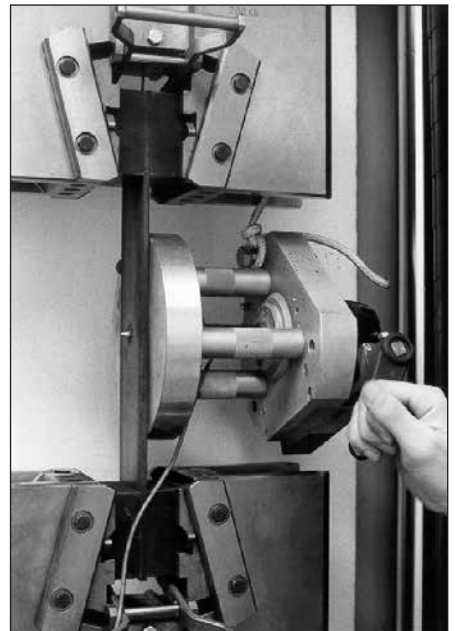
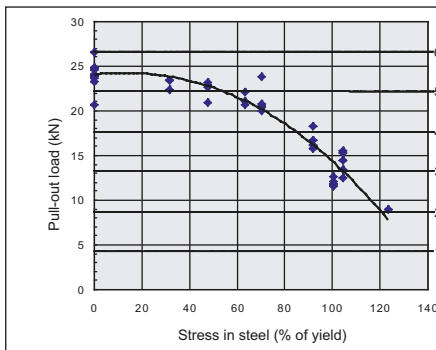

### Compressive stress in the steel

Compressive stress in the base steel has no influence on the pull-out strength of the fastener. This was demonstrated by placing fasteners in unstressed 15 mm [0.59"] thick steel plates having a yield strength of 259.3 MPa [37.6 ksi] and extracting them while the plates were compressed in a testing machine.

The minimal variation in pull-out load is simply random variation experienced in testing.

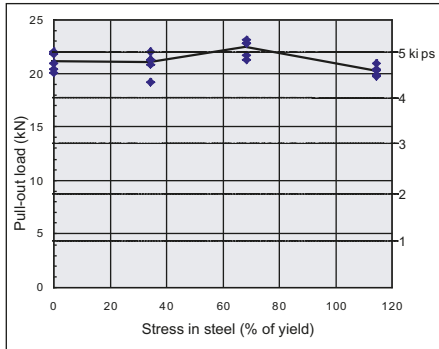

### 5.3 Suitability of the steel for fastening

There are three main factors determining the suitability of a construction grade steel member for DX fastening:

- Steel thickness
- Ultimate tensile strength
- Flexibility of the base steel member

### 5.4 Application limit diagrams

The application limit of a fastening system is a term applied to a combination of the maximum thickness  $t_{II}$  and ultimate tensile strength  $f_u$  of steel in which fastenings can be made. There are two general types of application limit diagrams:

- Short fasteners (e.g. siding and decking nails and threaded studs)
- Long fasteners (e.g. nails used to fasten wood to steel)

The application limit line for a short fastener is a plot of steel thickness versus ultimate tensile strength. In situations represented by steel thickness / ultimate tensile strength combinations above and to the right of the line, some of the fasteners may shear off during driving. The failure surface will be roughly at a 45° angle to the shank length.

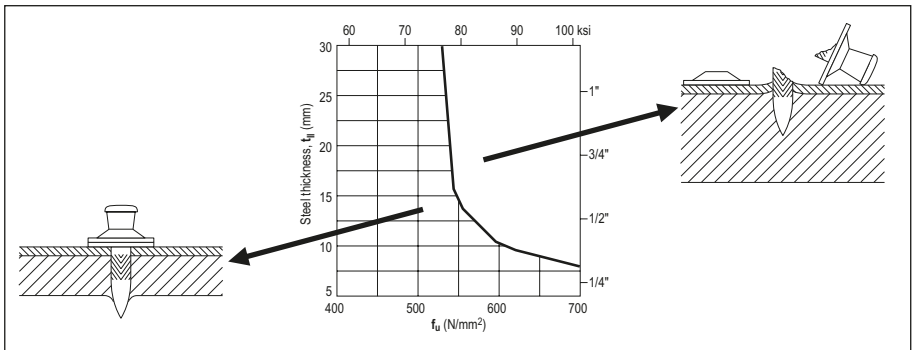

The application limit lines for long nails used to fasten wood to steel are plots of nail shank length  $L_s$  versus steel thickness  $t_{II}$ . Each line is valid only for one ultimate tensile strength of steel  $f_u$ . Attempts at working to the right of the limit line result in buckled nail shanks.

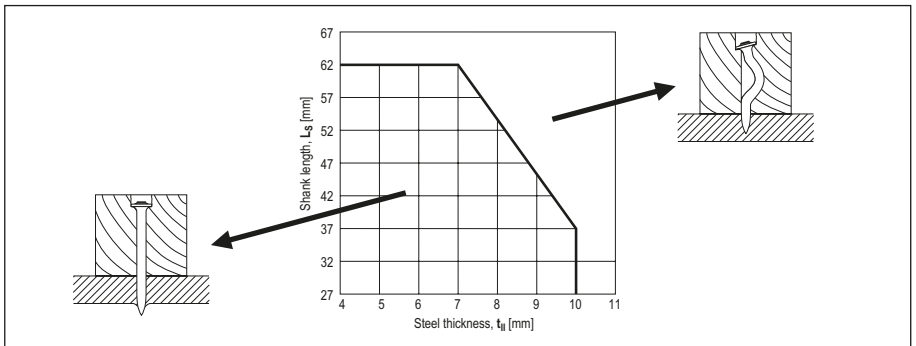

### 5.5 Thin steel base material

In the context of powder-actuated fastening, steel is considered thin when flange deformation during driving dominates fastener design. When the steel flange is thinner than about 6 mm [0.25"], flange deformation makes use of fasteners with a 4.5 mm [0.177"] shank diameter more difficult and switching to a 3.7 mm [0.145"] shank fastener leads to better results. Use of fasteners with tapered shanks and energy-absorbing washers improves performance and reliability.

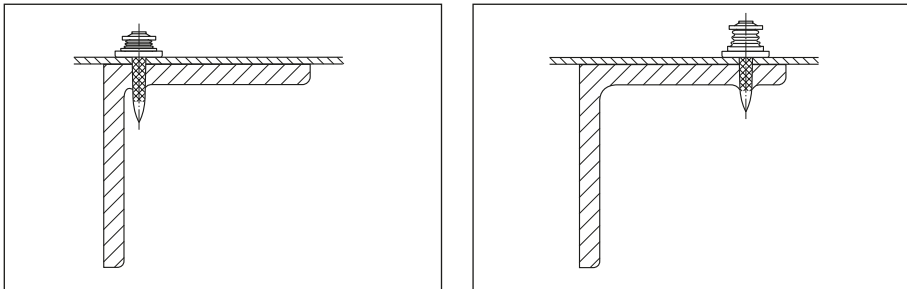

A fastener can penetrate into steel only when the steel (flange) develops a resistance greater than the force required for penetration. This implies the use of energy in excess of that required for penetrating into the steel. In fact, if the driving energy remains constant, fasteners placed closest to the web will be driven deepest. All siding and decking fasteners should have a mechanism to clamp the sheets down tightly over the entire range of allowable standoffs. This is especially critical for fasteners used for fastening to thin steel.

Obviously, under shear loading, failure of the base material is more likely with thin steel than with thick steel. When approving fastening systems for a project, it is important to consider whether the system has actually been tested with thin base steel or not.

Hilti's general recommendation for thin base steel fasteners is to place the fastenings within  $b_x = 8 \cdot t_{fl}$  of the web.

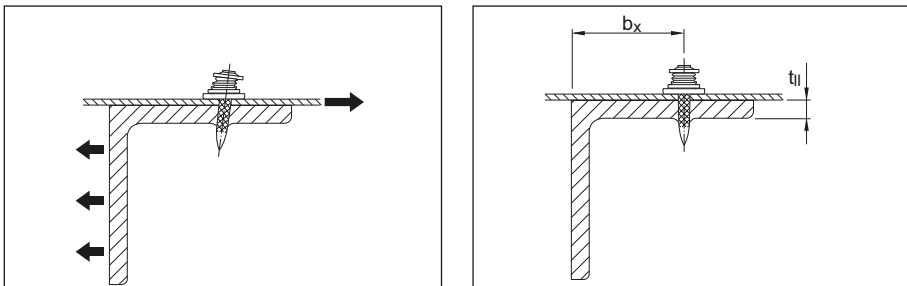

## 5.6 Types of load and modes of failure

### 5.6.1 Shear loads

The shear loads acting on siding and decking fasteners come from:

- Diaphragm action of the fastened sheets
- Forces of constraint (for example due to temperature changes)
- Self-weight of siding material

### Testing

Shear testing of siding and decking fastenings is done using specimens made up of a strip of sheet metal fastened to a steel plate. Suitable, non-slip fixtures have to be used at either end. In some cases specimens are bent up at the sides to hinder eccentricity.

### Failure of the fastened material

The load-deformation curves of shear tests with powder-actuated fasteners show a nearly ideal behavior. After an initial elastic phase during which the clamping force of the washers against the sheet metal is overcome, the sheet metal reaches its yield stress in an area where the fastener bears against it. Then the fastener shank cuts through the sheet metal until the end of the sheet is reached. The large area under the load-deformation curve represents energy absorbed, and this is what makes the fastening method ideal for diaphragms.

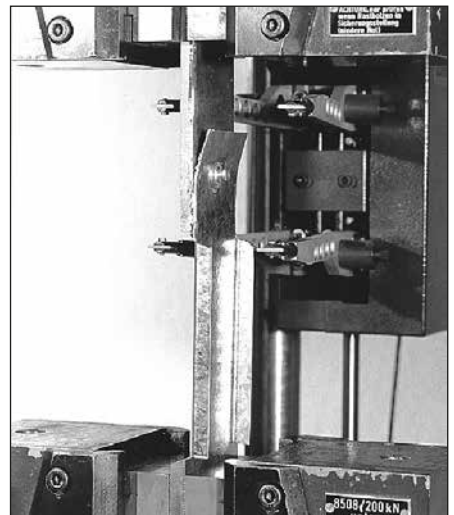

### Failure of the base steel

If the thickness of the fastened sheet metal is large compared to the base steel thickness, bearing failure of the base material is a possible mode of failure.

### Pull-out from the base steel

The unavoidable eccentricity in the shear test specimen leads to a tensile load component on the fastener. Thick fastened material and thin base material is also involved in this mode of failure. This failure mode is generally not governing for base material thickness of  $t_{fl} > 6$  mm.

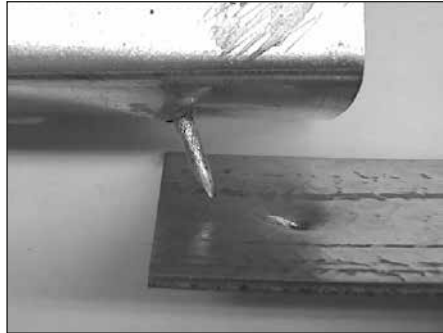

### Fracture of the fastener

About 20 kN (4.5 kips) of force is required to shear the  $\text{Ø} 4.5$  mm (0.177") shank of an X-ENP-19 L15 fastener. With about 2.5 mm (12 gauge) thick steel sheet as fastened material, a force of this magnitude could be possible. The force needed to break a  $\text{Ø} 3.7$  mm (0.145") shank of an X-ENP2K-20 L15 fastener is about 13 kN (2.9 kips). This force can be generated with 1.5 mm (16 gauge) sheet steel. In practice, this failure mode is likely only where expansion joints are not provided to relieve forces of constraint from temperature differences.

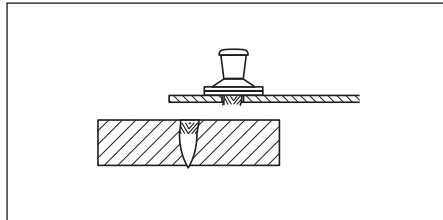

## 5.6.2 Tensile loads

The most common source of tensile loading on siding and decking fasteners comes from wind suction acting on the roof or wall cladding. In diaphragms, fasteners can be subject to tensile loads in situations where the combination of geometry and thickness of decking fastened leads to prying. In designs with very stiff decking and wide beams or unbalanced spans, prying can also be caused by concentrated loads.

## Testing

Tensile testing of siding and decking fastenings is carried out using specimens made up of a trapezoidal-shaped piece of sheet metal fastened to a steel plate. Suitable, vice-like fixtures are used to grip the specimen. This is often referred to as a pull-over test because the common failure mode is the sheet pulling over the washers or the head of the fastener. If the sheet thickness fastened is increased so that pull-over does not govern, pull-out will be the failure mode.

Some fasteners like the Hilti X-ENP have a head that can be gripped and pulled out by a suitable fixture. With these fasteners, a pull-out test can still be done even if pull-over is the original mode of failure. This fastener type has the further advantage of allowing in-place fasteners on a jobsite to be tested.

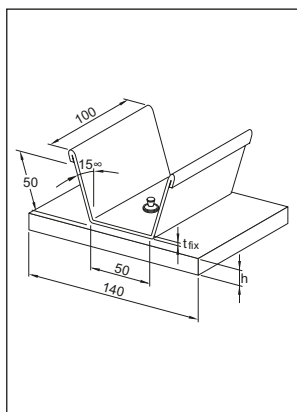

Pull-over test specimen

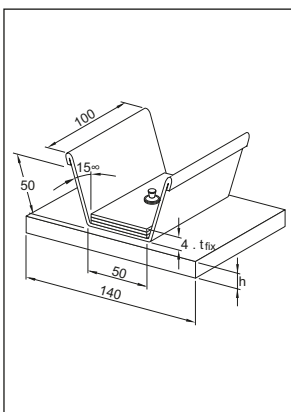

Pull-over test specimen with 3 extra layers to simulate end lap – side lap



Test setup

## Sheet pull-over

In this failure mode, the sheet tears and is lifted up over the fastener head and washers. Depending on the sheet thickness and tensile strength, the washers may be bent up.

## Washer pull-over

Another possible failure mode is that of the washers being pulled up over the head of the nail. Obviously, this happens when the sheet is somewhat stronger and /or thicker than when sheet pull-over occurs. This failure mode is also heavily dependent on fastener design.

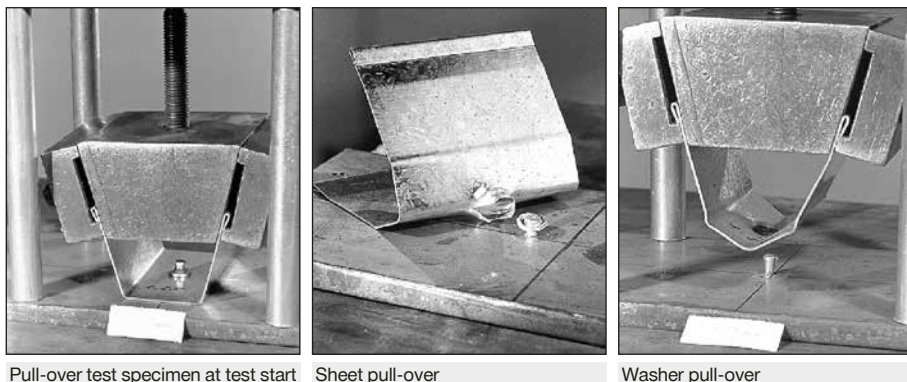

Pull-over test specimen at test start

Sheet pull-over

Washer pull-over

### Pull-out from the base steel

As sheet thickness and number of layers is increased, this failure mode becomes more likely. For a properly driven **X-ENP-19 L15** pull-out from the base steel is not a likely mode of failure. The head and washer design of the **HSN 24** or **X-ENP2K-20 L15** fasteners can allow this failure mode, especially with multiple layers of sheets.

### Fracture of the fastener

A force of more than 30 kN [6.7 kips] is required to break the  $\varnothing 4.5$  mm [0.177"] shank of an **X-ENP-19 L15** fastener and, even if sheet or washer pull-over does not govern, pull-out strengths of this magnitude are not very common. This mode of failure will therefore hardly ever occur with these heavy-duty fasteners. The  $\varnothing 3.7$  mm [0.145"] shank of an **X-HSN 24** or **X-ENP2K-20 L15** fastener may break at about 20 kN [4.5 kips] tension. Since these smaller fasteners will pull out at a force of 8 to 15 kN [1.8–3.3 kips], fractures due to tensile loads are rare. If fractured fasteners of this type are found on a jobsite, the most likely cause is that the application limit has been exceeded (the base steel is too hard and/or too thick for the pin).

### Cyclic loading

Siding and decking nails used in wall and roof construction are subject to cyclic loading from wind suction. Cyclic load testing is carried out to determine characteristic resistance and allowable (recommended) loads. The requirements of the European Technical Assessment ETA prepared by DIBt (Deutsches Institut für Bautechnik) govern the design-relevant number of load repetitions (5,000) and the necessary safety factors. Notes in this regard are found on the corresponding product data sheets.

If the fastener will be subjected to a large number of load repetitions and fatigue, we recommend carrying out a design check according to the requirements of Eurocode 3 (or similar



code). Eurocode 3 gives the characteristic fatigue resistance and safety concept for steel construction. To carry out the check according to Eurocode 3 it is necessary to have a statistical analysis of test data obtained under the application conditions. Except for siding and decking fasteners, the applicable product data sheets limit the validity of recommended loads to predominantly static loading. If a design analysis has to be carried out for true fatigue loading, test data can be obtained from Hilti. Examples of such data are shown below.

**X-EM8-15-14**  
**(standard zinc-plated fastener)**

The X-EM8-15-14 has a shank diameter of 4.5 mm and a hardness of HRC 55.5 ( $f_u = 2,000$  MPa). The  $\Delta F$ -N diagram shows the load range  $\Delta F$  for a lower load of 0.05 kN. The individual test results are displayed as points and the curves show average and characteristic (95% survival probability) values. The failure mode was shank fracture or fracture in the M8 threading.

The recommended load for predominantly static loading is 2.4 kN. Comparing this value to the  $\Delta F$ -N diagram will lead to the conclusion that X-EM8-15-14 fastenings designed for 2.4 kN static loading will survive a large number of load repetitions. The fastenings can be said to be robust, even when the actual loading turns out to be in part cyclic.

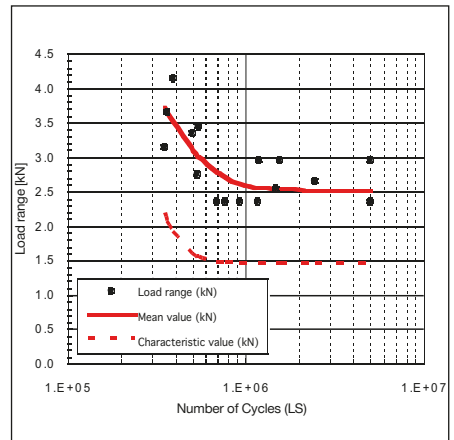



Effect of number of cycles on failure mode DX fastener in steel (correctly placed)

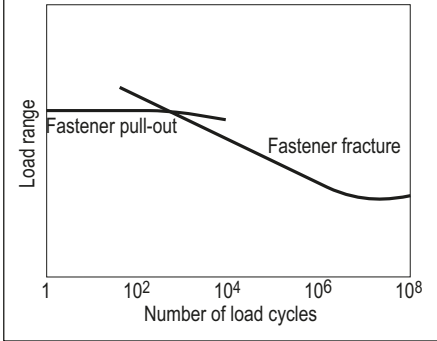

Effect of number of cycles on failure mode DX fastener in steel (incorrectly placed)

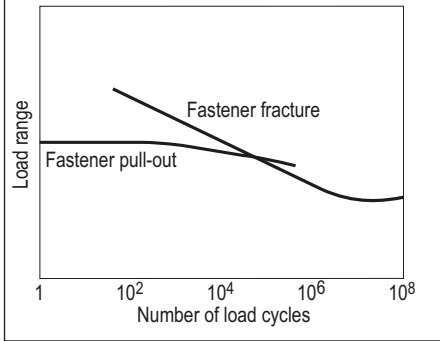

In older product information and data sheets, this basic suitability of DX fasteners for cyclic loading was emphasized by defining the recommended loads as cyclic recommended loads. At the time that this product information was assembled, a true safety concept for a strict check of DX fastenings subject to fatigue loading was not available. With Eurocode 3, this is today available. If a fatigue design analysis is carried out, it is important – as with static design – that adequate redundancy be provided.

### Failure of the sheet

In cyclic load tests, failure of the steel sheet itself is common.

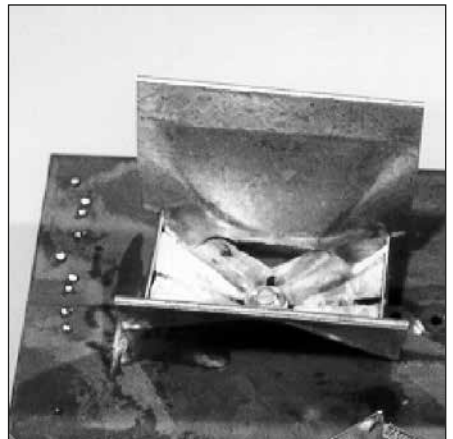

## 5.7 Effect of fasteners on structural steel

Driving powder-, gas-, or battery-actuated fasteners into a steel member does not remove steel from the cross-section, but rather displaces steel within the cross-section. It is therefore not surprising that tests like those described in following sections show that both drilled holes and screws, either self-drilling or self-tapping, reduce the strength of a cross-section more than powder-actuated fasteners.

The results of the tests can also be used to show that it is conservative to consider a powder-actuated fastener as a hole. This allows the effect of fasteners in a steel member subject to static loading to be taken into consideration.

Fatigue seldom needs to be considered in building design because the load changes are usually minor in frequency and magnitude. Full design wind and earthquake loading is so infrequent that consideration of fatigue is not required. However, fatigue may have to be considered in the design of crane runways, machinery supports, etc. The S-N curves resulting from fatigue tests of steel specimens with fasteners installed are also presented.

### 5.7.1 Effect on the stress-strain behaviour of structural steel

The effect that powder-actuated fasteners (PAF's) have on the stress-strain behaviour of structural steel was investigated in a systematic test programme using tensile test specimens containing PAF's, self-drilling screws and drilled holes. A control test was carried out using specimens without any holes or fasteners.

#### Series A:

- ASTM 607, grade 50
- Cross-section 3.42 x 74 mm [0.135 x 2.913"]
- X-EDNK22 powder-actuated fasteners, shank diameter 3.7 mm [0.145"]
- Drilled holes, diameter 3.7 mm [0.145"]
- Self-drilling screws, shank diameter 5.5 mm [0.216"]

#### Series B:

- S235 and S355 steel
- Cross-section 6 x 45 mm [0.236 x 1.772"]
- Powder-actuated fasteners, shank diameter 4.5 mm [0.177"]
- Drilled holes, diameter 4.5 mm [0.177"]

The figures below show representative stress-strain curves for the tests (the plotted stress is based on the gross cross-section). Note that the line for the powder-actuated fasteners follows the control test line more closely than the lines for drilled holes or self-drilling screws.

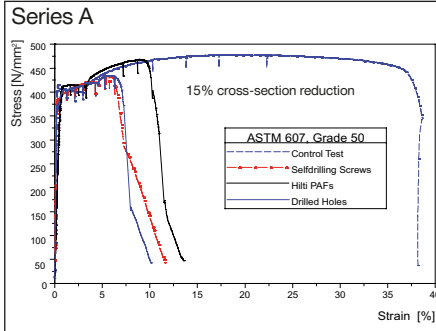

LOAD\_DEFORMATION\_SERIES\_A

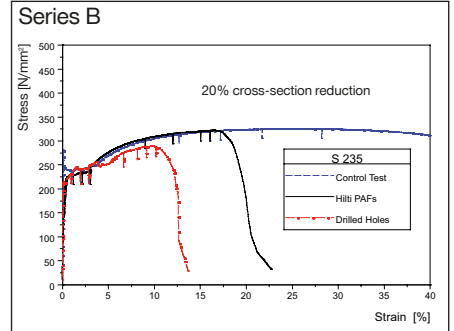

LOAD\_DEFORMATION\_SERIES\_B

The test results were evaluated in terms of utilization as a measure of ultimate strength. Utilization is the ultimate load of a sample expressed as a percent of the ultimate load of the control test.

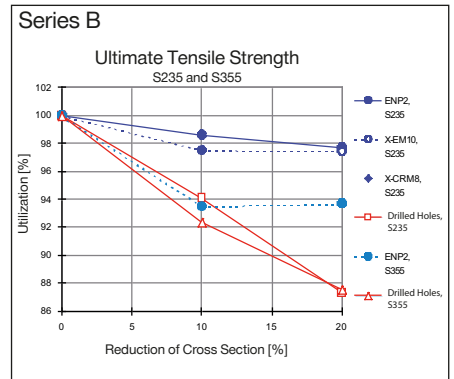
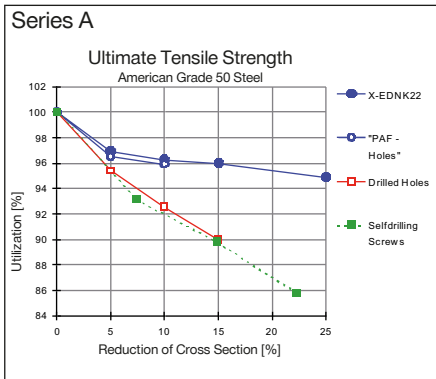

Graphs of the utilization versus cross-section reductions show that:

- The utilization for PAFs is clearly better than that of drilled holes or self-drilling screws.
- The hole left by a removed PAF has the same effect as when the PAF is left in place.
- Increasing the number of PAFs across a section from one to two or more has a proportionally smaller effect on utilization than placement of the first fastener.

More detailed information on the test program and findings is published in the paper

Powder-actuated fasteners in steel construction (and the referenced literature), published in the STAHLBAU-Kalender 2011 (Publisher Ernst & Sohn, 2011, ISBN 978-3-433-02955-8). English Reprints of the paper can be distributed per request.

### 5.7.2 Effect on the fatigue strength of structural steel

During the late 1970s and early 1980s, a fatigue testing program consisting of 58 tests with over 1,100 specimens was carried out at the University of Darmstadt in Germany. The reason for the research at that time was to support the use of powder-actuated fasteners for attaching noise-dampening cladding to railway bridges in Germany.

Parameters investigated in those tests are shown in following table:

Steel grade	Steel thicknesses	Stress ratio R	Imperfections
S 235 (St 37) / A36	6, 10, 15, 20, 26.5, 40, 50 mm	0.8, 0.5, 0.14, -1.0, -3.0	Fastener: - installed and pulled out, - inclined installation and pulled out - inclined installation
S 355 (St 52) / grade 50	[0.236, 0.394, 0.591, 1.043, 1.575, 1.969"]		

#### Loading conditions

The terminology and notation is shown in the illustration below.

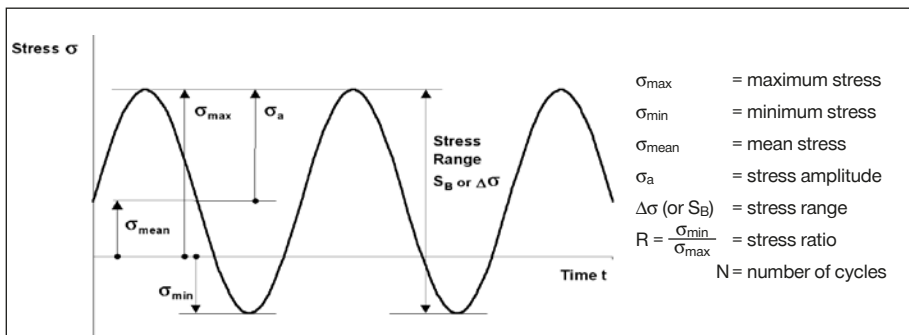

### Fasteners tested

The primary fastener used in the tests was the Hilti ENP3-21 L15, the forerunner of the ENP2-21 L15. The difference is in the head shape, which has no effect on interaction with the base steel. Tests were also performed with the ENP2-21 L15, ENP3-21 D12 and the EM8-11-14 threaded stud, all of which have 4.5 mm diameter knurled shanks.

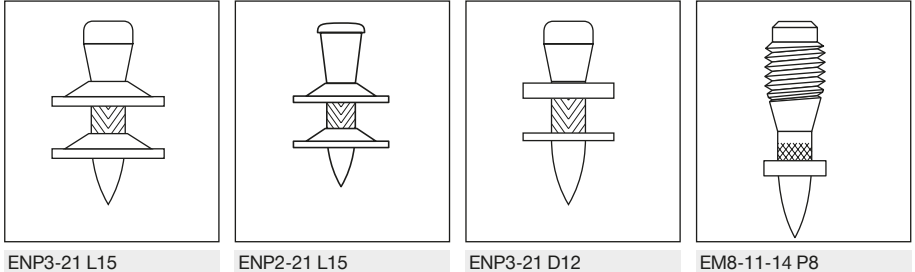

The results of the tests were evaluated by Niessner and Prof. T. Seeger from the University of Darmstadt in accordance with the provisions of Eurocode 3. An example plot of one test series is given at the right. The graph allows for a comparison with European fatigue categories 90 ( $m = 3$ ) and 100 ( $m = 5$ ) as well as American categories according to AWS-provisions.

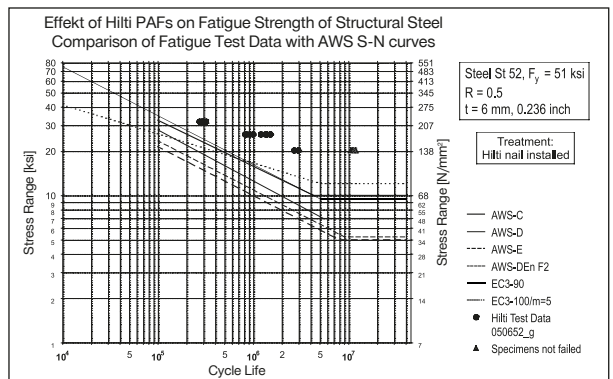

### Conclusions

- The effect of driving a Hilti powder-actuated fastener on the fatigue strength is well known and predictable.
- The constructional detail “Effect of powder-actuated fasteners on base material” (unalloyed carbon steel) was evaluated by Niessner and Seeger from the University of Darmstadt in compliance with Eurocode 3.
- The EC 3 detail category 90 with  $m = 3$  or the detail category 100 with  $m = 5$  is alternatively applicable.
- Wrong fastener installations as popped out or inclined fasteners are covered. Piston marks in the base material due to wrong use of the tool without a fastener or notches due to fasteners failed during the installation have to be removed by appropriate measures.

More detailed information on the evaluation of the test data and the test program is published in the paper “Fatigue strength of structural steel with powder-actuated fasteners according to Eurocode 3” by Niessner M. and Seeger T. (Stahlbau 68, 1999, issue 11, pp. 941-948).

English reprints of this paper can be distributed per request.



## 6. Concrete base material

### 6.1 Anchoring mechanisms

The following three mechanisms cause a powder-actuated fastener to hold in concrete:

- Bonding / sintering
- Keying
- Clamping

These mechanisms have been identified and studied by analyzing pull-out test data and by microscopic examination of pulled-out fasteners and the concrete to fastener interface.

#### Bonding / sintering

When driving a fastener into concrete, the concrete is compacted. The intense heat generated during driving causes concrete to be sintered onto the fastener. The strength of this sintered bond is actually greater than that of the clamping effect due to reactive forces of the concrete on the fastener.

The existence of the sintered bond is demonstrated by examining pulled-out fasteners. The fastener surface, especially in the region of the point, is rough due to sintered-on concrete, which can only be removed by using a grinding tool.

When performing pull-out tests, the most common failure mode is breakage of the sintered bond between the concrete and the fastener, especially at and near the point.



#### Keying

The sintered material forms ridges on the fastener surface. These ridges result in a micro-interlocking of the fastener and the concrete.

This anchoring mechanism is studied by examining pulled-out fasteners under a microscope. As in the case of sintering, keying is primarily active in the region of the fastener point.



Mechanically cleaned point of a pulled-out DX fastener

**Clamping**

The compressibility of concrete limits the buildup of compressive stress around the driven fastener. This in turn limits the effectiveness of clamping as an anchoring mechanism.

**Concrete failure**

Concrete cone failure is occasionally observed when using a testing device with widely spaced supports. The fact that the concrete failed indicates that the fastener bond to the concrete was stronger than the concrete.

The tendency of stressed concrete to relax further reduces the compressive stress and hence the clamping effect. For these reasons, clamping of the fastener shank contributes only insignificantly to the total pull-out strength.

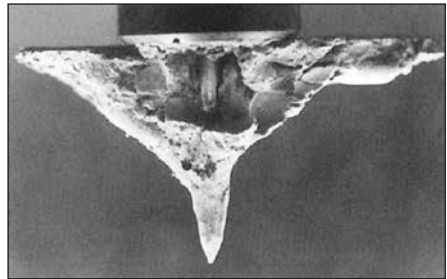

## 6.2 Factors influencing resistance to pull-out

Factors that can affect the pull-out strength of fastenings to concrete include:

- Depth of penetration into the concrete
- Concrete parameter (compressive strength, grain structure, direction of concrete placement)
- Distance to concrete edge and fastener spacing

### Depth of penetration $h_{ET}$

Fasteners that are driven deeper typically have a higher resistance to pull-out. This relation is best shown by placing groups of fasteners with different driving energy and comparing the results for each group with the others. The result of such a test is shown in the graph at the right. Note that fastener driving failures were not considered in calculation of the average ultimate load,  $N_{u,m}$ .

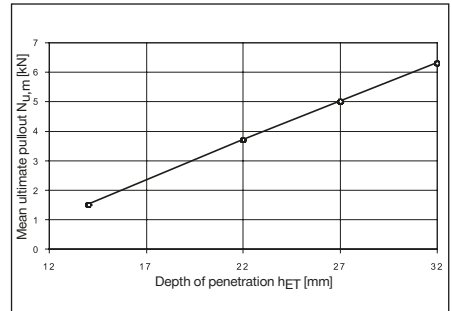

The value of increasing the depth of penetration in order to increase pull-out strength is limited by the increasing fastener driving failure rate. Provided that the penetration depth is the same, fastenings in concrete with a higher compressive strength hold better than fastenings in lower strength concrete. The ability to exploit this

characteristic is also limited by increased fastener driving failure rate with higher strength concrete.

As could be expected, the depth of penetration at which the failure rate is at a minimum decreases with increasing concrete strength.

Pull-out strength and fastener driving failure rate both increase with increasing penetration depth. The optimum depth of penetration is taken as the depth at which the yield in terms of pull-out strength begins to decrease. This is within a range of 18–32 mm depending on the grade and age of the concrete as well as the strength of the fastener.

$$\text{yield} = N_{u,m} \cdot \left( \frac{100 - p}{100} \right)$$

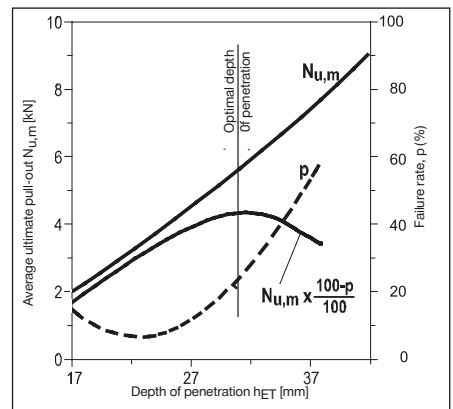

### Concrete parameters

The concrete parameters (such as the type and size of concrete aggregates, type of cement and the location on top or bottom surface of a concrete floor) do affect the fastener driving failure rate, sometimes significantly.

Fastener driving failures are caused by the fastener hitting a hard aggregate, such as granite, located close to the concrete surface. A hard aggregate can deflect the fastener and in a severe case, the fastener may bend excessively,

leading to concrete fracture in a cone shape and no hold being obtained by the fastener.

In case of slight fastener bending, concrete spalling may occur at the surface. However, because pull-out strength is obtained mostly in the area of the fastener point, concrete spalling has little effect on the permissible load of the fastening.

Softer aggregates such as limestone, sandstone or marble may be completely penetrated when hit by the fastener.

Overhead fastening is usually associated with a higher rate of fastener driving failure than floor fastening. This is due to the distribution of the aggregates within the concrete. Large aggregates tend to accumulate at the bottom of a floor slab. At the top, there is a greater concentration of small aggregates and fines.

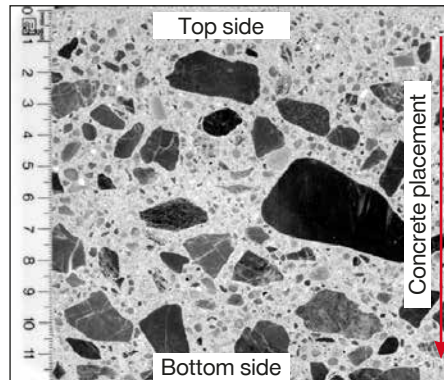

There are several possible ways of reducing the failure rate when powder-actuated fasteners are used for fastening to concrete. There are two basic ideas:

#### **Pre-drilling the concrete (DX-Kwik)**

By pre-drilling a very small hole (5mm diameter, 18 or 23 mm deep), the stresses are relocated to greater depth in the concrete. Fasteners placed with DX-Kwik are surrounded by a stress “bulb” located deep in the concrete. With this method, virtually no fastener driving failures occur.

one is to reduce concrete tensile stresses near the surface and the other is to delay the effect of these stresses.

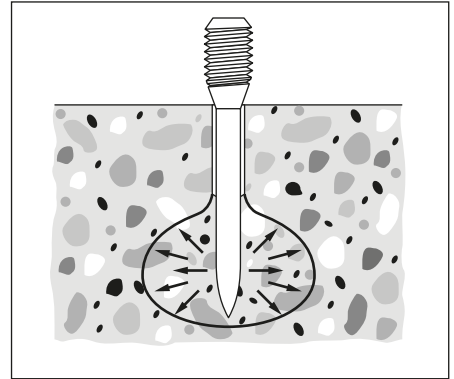

#### **Spall stop fastener guide**

A spall stop is a heavy steel fastener guide. Its weight and inertia counteract the stresses at the surface for a very short time. This allows redistribution of the stresses to other parts of the concrete.

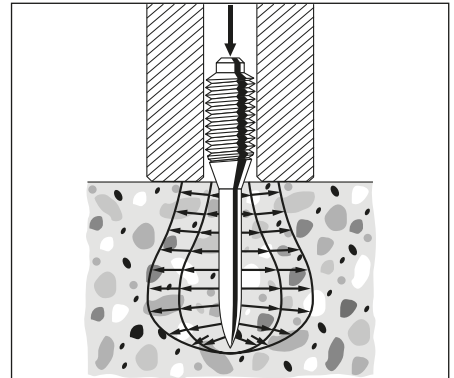

**Changing from a long to a short fastener reduces the magnitude of the stresses and thus improves stick-rate.**

### Edge distance and fastener spacing

If fasteners are placed too close to the concrete edge, pull-out load capacity will be reduced. Minimum edge distances are therefore published with a view to reducing the effect edges have on pull-out strength. The corresponding data has been obtained from tests.

Additional provision is made for fastener spacing when positioned in pairs or where fasteners are placed in rows along a concrete edge.

These edge distances and spacing also have the purpose of helping to prevent concrete spalling and/or cracking due to fastening. However, spalling has generally only an insignificant influence on pull-out strength.

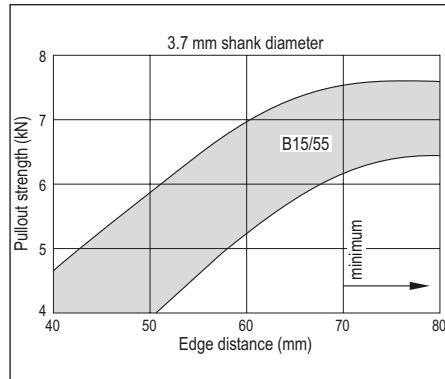

### 6.3 Effect of time on pull-out resistance

The effect of age on pull-out strength has been investigated in comprehensive tests. The main concern is, in fact, the effect of concrete relaxation in the area around the driven fastener.

This graph provides an overview of tests performed with DX-Kwik fasteners. Since standard DX fastenings have the same anchoring mechanism, this statement is also valid for standard DX fastenings. The test results indicate very strongly that relaxation of the concrete has no detrimental effect on the pull-out resistance of DX fastenings. The test data also shows that sintering and keying are the dominant anchorage mechanisms because they do not rely on friction between the fastener and the concrete.

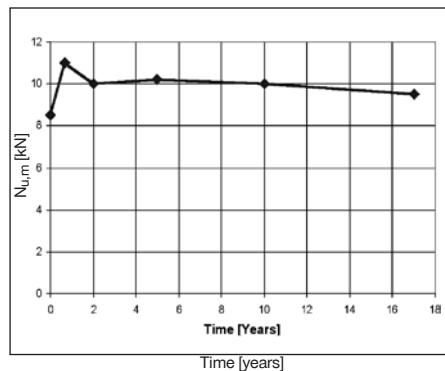

## 6.4 Effect on concrete components

Fastenings in the compression zone of the structure have no effect on concrete compressive resistance as long as detailed provisions on edge distance and spacing are complied with.

Fastenings in the tensile zone are subject to the following provisions:

- a. Installations on plain load-bearing components such as concrete walls or ceilings are generally possible without restrictions as the load-bearing behaviour of these components is only negligibly affected by the fasteners. The predominant condition is static loading. This statement is based on experimental investigations carried out at the Technical University of Braunschweig, Germany.
- b. Fastenings in reinforced concrete beams:

it has to be ensured that the main reinforcement steel will not be hit or penetrated by the DX fasteners. This measure of precaution is mainly founded on the reduction of the ultimate strain of the steel reinforcement. Exceptions are possible when the structural engineer responsible for design is consulted.

- c. Fastenings in pre-stressed concrete members:  
it has to be ensured that the pre-stressing steel reinforcement or cables will not be hit or penetrated by the DX fasteners.

If the concrete is too thin, concrete will spall off on the rear surface. The minimum thickness of concrete depends on the shank diameter of the fastener used.

Fastener shank diameter $d_{nom}$ (mm)	Minimum concrete thickness $h_{min}$ (mm)
3.0	60
3.5 / 3.7	80
4.5	100
5.2	100

## 7. Masonry base material

### 7.1 General suitability

Direct fastening technology can also be used on masonry. The joints between bricks or blocks and the covering plaster layer on virtually all types of masonry (exception for

lightweight aerated concrete blocks) provide an excellent substrate for light-duty and secondary fastenings.

**Suitability table: DX fastening on masonry**

Masonry material	Unplastered masonry Fastenings in mortar joints* (joint width ≥ 10 mm)	Fastenings in masonry blocks or bricks	Plastered masonry Fastening in plaster (thickness ≥ 20 mm)
<b>Clay brick</b>			
solid	++	+	++
vertical perforated	++	---	++
horizontally perforated	++	---	++
<b>Clay clinker</b>			
solid	++	+	++
vertical perforated	++	---	++
<b>Sand-lime block</b>			
solid	++	++	++
perforated	++	++	++
hollow	++	++	++
<b>Aerated concrete</b>	---	---	---
<b>Lightweight concrete</b>			
solid	++	-	++
hollow	++	-	++
<b>Hollow concrete</b>	++	+	++
<b>Slag aggregate</b>			
solid	++	-	-
perforated	++	-	++
hollow	++	-	++

++ suitable

+ limited suitability

- not fully investigated

--- not suitable

\*) Joints must be completely filled with mortar

The above table is based on laboratory and field experience. Because of the wide variety of types and forms of masonry in use worldwide, users are advised to carry out tests on site or on masonry of the type and form on which the fastenings are to be made.



## 8. Temperature effects on the fastening

### 8.1 Effect of low temperatures on fasteners

Steel tends to become more brittle with decreasing temperature. Increased development of natural resources in Arctic regions has led to the introduction of steels that are less susceptible to brittle failure at subzero temperatures. Most siding and decking fasteners are used to fasten the liner sheets of an insulated structure and are not exposed to extremely low

temperatures during service. Examples of situations where the fastenings are exposed to extremely low temperatures during their service life are:

- Fastenings securing cladding in single-skin construction
- Construction sites left unfinished over a winter
- Liner sheets in a cold-storage warehouse

#### Low temperature embrittlement

The susceptibility of fasteners to become brittle at low temperatures can be shown by conducting impact bending tests over a chosen temperature range. The ability

of Hilti drive pins to remain ductile over a temperature range from +20°C to -60°C is shown clearly by the fact that the impact energy required remains nearly constant throughout this temperature range.

#### Impact bending test - DSH57 (4.5 mm diameter, HRC 58 ± 1)

Temperature °F	°C	Impact energy (foot-pounds)			Impact energy (Joules)		
		minimum	maximum	mean	minimum	maximum	mean
68	20	35.1	>36.1	>36.1	47.6	>48.9	>48.9
32	0	35.8	>36.1	36.0	48.5	>48.9	48.8
- 4	-20	31.4	>36.1	34.3	42.6	>48.9	46.5
-40	-40	34.4	36.5	35.7	46.6	49.4	48.4
-76	-60	35.6	36.2	35.9	48.2	49.0	48.7

#### Impact bending test - X-CR (4.0 mm diameter)

Temperature °F	°C	Impact energy (foot-pounds)			Impact energy (Joules)		
		minimum	maximum	mean	minimum	maximum	mean
68	20	14.8	17.0	15.9	20	23	21.6
32	0	17.7	15.5	18.3	24	21	24.8
- 4	-20	14.8	15.9	15.5	20	21.6	21.0
-40	-40	16.2	17.9	16.8	21.9	24.2	22.8
-76	-60	14.2	15.6	15.1	19.2	21.1	20.5

**Impact bending test - X-CR (3.7 mm diameter)**

Temperature		Impact energy (foot-pounds)			Impact energy (Joules)		
°F	°C	minimum	maximum	mean	minimum	maximum	mean
68	20	11.5	14.8	13.2	15.6	20.0	17.9
32	0	12.9	16.3	15.1	17.5	22.1	20.4
- 4	-20	13.1	15.8	14.7	17.8	21.4	19.9
-40	-40	14.2	15.8	14.8	19.2	21.4	20.1
-76	-60	12.3	15.0	13.7	16.7	20.3	18.6

Tests conducted according to DIN EN 10045 parts 1-4

Distance between supports = 22 mm

The symbol ">" indicates no breakage of the specimens. In the other cases, about 50% of the specimens suffered breakage.

**8.2 Effect of low temperatures on fastenings to steel**
**Effect of low temperatures on pull-out strength**

Tests show that very low temperatures tend to increase pull-out strength with both standard zinc-plated fasteners and with the stainless steel. The results of two tests are summarized below. The fasteners were

driven at room temperature and tested at  $-40^{\circ}\text{C}$  to  $-70^{\circ}\text{C}$ . A control sample was tested at  $20^{\circ}\text{C}$ . Explanations for the greater strength at low temperatures include increase in the strength of the zinc that is displaced into the knurling as well as increased strength of the fusing at the point of the fastener.

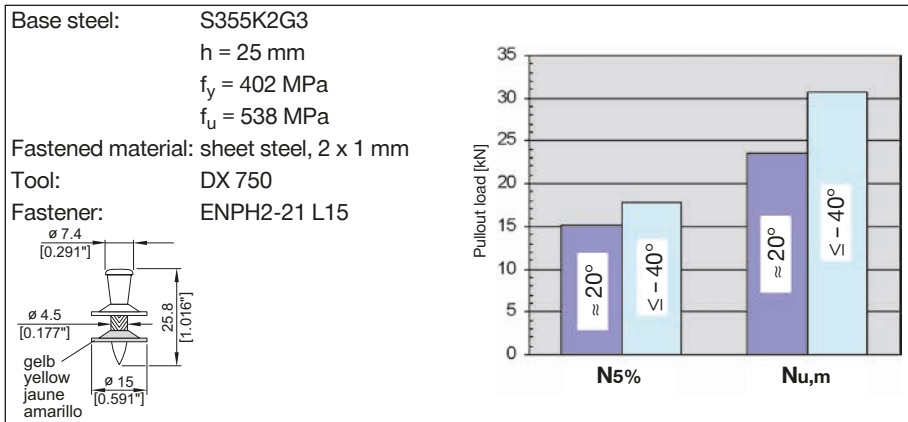

Base steel :  $h = 20 \text{ mm}$   
 $f_u = 450 \text{ MPa}$   
 Fastened material : none  
 Tool : DX 750 G  
 Fastener : X-CRM8-15-12 FP10

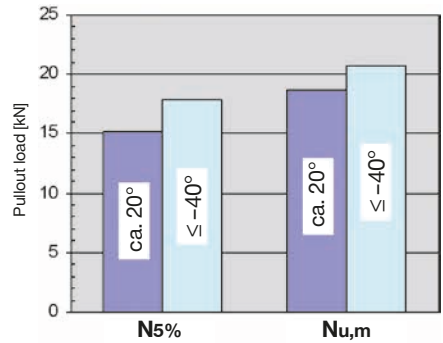
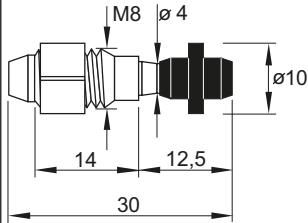

Two facts stand out from this testing:

- Pull-out strength increased as temperature decreased
- Pull-out from the base steel was the only mode of failure observed. There were no fractures!

### 8.3 Fire rating of fastenings to steel

#### Standard zinc-plated, thermally hardened steel fasteners

When subjected to high temperatures as in a fire, both powder-actuated fasteners

and structural steel lose strength. Data for standard zinc-plated, thermally hardened fasteners and structural steel are plotted in the graph below.

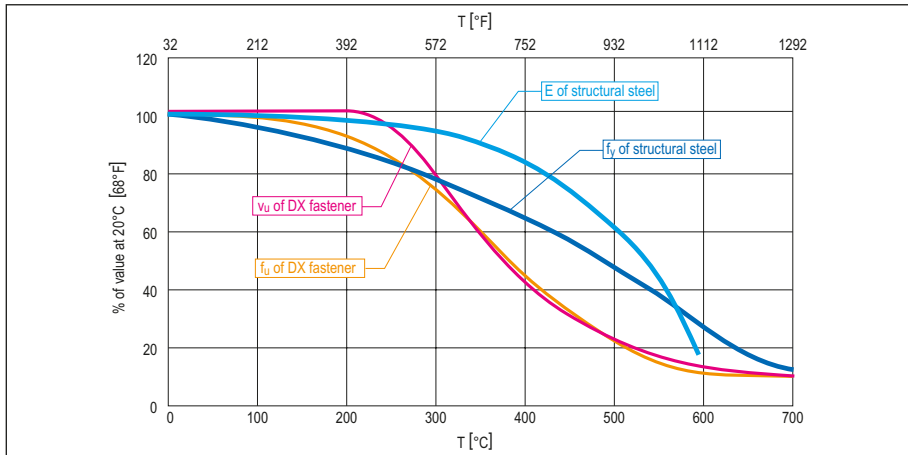

Up to about 300°C [572°F], the strength loss for DX fasteners is roughly proportional to the yield strength loss of structural steel. At 600°C [1112°F], DX fasteners have about 12% of their 20°C [68°F] strength left and structural steel about 26%. Since DX fasteners obtain their high strength through a thermal hardening process, the loss in strength at elevated temperatures is proportionally greater than for structural steel.

The relevance of different strength losses has to be evaluated in the context of the proportion of the material strengths that are actually exploited in a design. In a design calculation, it is conceivable that some steel will actually reach yield stress.

The material strengths of an X-ENP-19 L15 fastener is 30 kN [6.74 kips] in tension and 18.6 kN [4.18 kips] in shear respectively. The recommended working load in tension and shear for an X-ENP-19 L15 16 gauge (1.5 mm) fastening is 4.7 kN [1.057 kips] in tension and 4.6 kN [1.034 kips] in shear, respectively. Thus, the exploitation of the X-ENP-19 L15 strength at about 600°C is only 16 to 25% compared to about 74% for structural steel.

In a fire, powder-actuated fastenings will not be the governing factor. If the fire protection requirements permit the use of structural steel, then powder-actuated fastening can also be used without negative impact on fire protection.

CR500 stainless steel fasteners Hilti X-CR/X-CRM fasteners are much more resistant to loss of strength at high temperatures than standard fasteners. The effect of temperature on ultimate shear stress of stainless fasteners made of CR500 was determined in single lap joint shear

tests by the Swiss Federal Laboratory for Materials Testing and Research (EMPA). The results are plotted in the diagram below. This test was done by shearing 4.5 mm diameter fasteners that were inserted in steel plates with 4.6 mm diameter drilled holes.

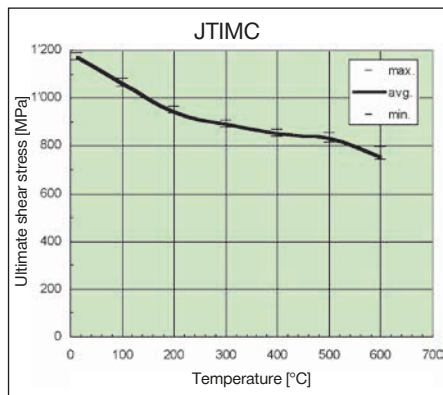
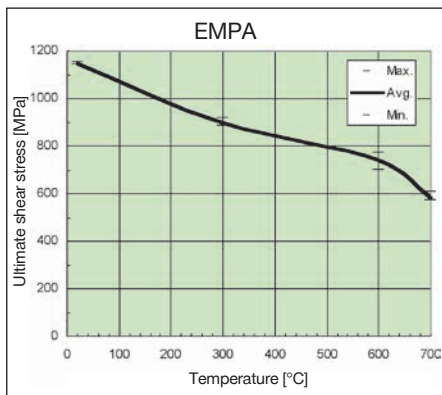

In Japan, similar tests were carried out by JTICM (Japan). These tests were done by driving a 4.5 mm diameter X-CR nail through a 6 mm steel plate into a second 6 mm thick steel plate and shearing the two plates. From the graph it is apparent that the results are nearly the same.

At 600°C, the CR500 material has 64% of its 20°C shear strength left. By comparison, standard fasteners have only 12% and structural steel only about 26%. The excellent fire resistance of the CR500 material alone justifies its use for some applications.

### 8.4 Fire rating of fastenings to concrete

Concrete is weakened and damaged by fire but not as quickly as steel. In ISO-standard fire tests conducted with DX-Kwik fastenings at the Braunschweig Technical University in Germany the only failure mode was fracture of the nails.

The actual test data are shown in the table below:

X-DKH 48 P8S15 DX-Kwik fastener, 4.0 shank

Tested in crack width $\Delta W$ (mm)	Tensile load, F (N)	Fire resistance/ time to failure (minutes)	Failure mode
0.2	250	103	Nail fracture
0.2	250	107	Nail fracture
0.2	350	73	Nail fracture
0.2	350	91	Nail fracture
0.2	500	56	Washer pullover
0.2	500	92	Nail fracture
0.2	500	93	Nail fracture

The stress in the fasteners at failure was calculated and plotted so that a plot of stress versus time resulted.

The characteristic failure stress curve from the previous graph can be used to calculate the failure load for various shank diameters with exposure to fire of different lengths of time. The calculated failure loads for 3.7, 4.0 and 4.5 mm shank diameter fasteners after 60, 90 and 120 minutes exposure to fire are shown in the table below.

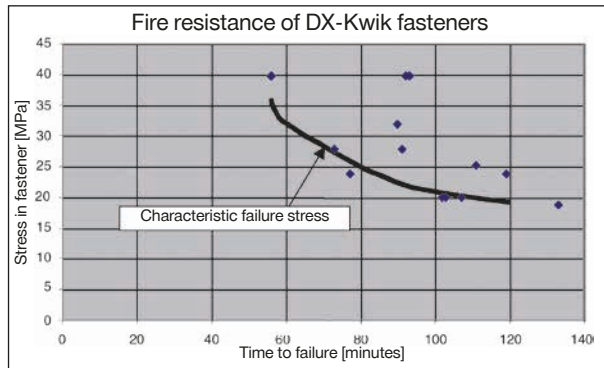

---

**Failure loads for various shank diameters and fire exposure times**

Shank diameter (mm)	Fire exposure time and failure stress		
	60 minutes	90 minutes	120 minutes
	32.1 MPa	22.3 MPa	19.1 MPa
3.7	340 N	240 N	200 N
4.0	400 N	280 N	240 N
4.5	510 N	350 N	300 N

This table can be used to determine recommended loads for the ISO fire resistance required.

## 9. Design concepts

The recommended working loads  $N_{rec}$  and  $V_{rec}$  are suitable for use in typical working load designs. If a partial factor of safety design method is to be used, the  $N_{rec}$  and  $V_{rec}$  values are conservative when used as  $N_{Rd}$  and  $V_{Rd}$ . Alternatively, the design resistance may be calculated from the recommended loads by multiplying by the factor 1.4, which considers the uncertainties from the load on the fasteners. Exact values

for  $N_{Rd}$  and  $V_{Rd}$  can be determined by using the safety factors where given and or reviewing test data. Based on cyclic tests it can be stated that DX fastenings can be said to be robust, even when the actual loading turns out to be in part cyclic. Design loads (characteristic strength, design resistance and working loads) for the **X-HVB** shear connector are listed and specified per design guideline.

The designer may encounter two main fastening design concepts:

Working load concept

$$N_S \leq N_{rec} = \frac{N_{Rk}}{\gamma_{GLOB}}$$

where  $\gamma_{GLOB}$  is an overall factor of safety including allowance for:

- errors in estimation of load
- deviations in material and workmanship

and  $N_S$  is in general a characteristic acting load.

$$N_S \equiv N_{Sk}$$

Partial factors of safety

$$N_{Sk} \cdot \gamma_F = N_{Sd} \leq \frac{N_{Rk}}{\gamma_M} = N_{Rd}$$

where:

$\gamma_F$  is a partial factor of safety to allow for errors in estimation on the acting load and

$\gamma_M$  is a partial factor of safety to allow for deviations in material and workmanship.



The characteristic strength is defined as 5 % fractile:

$$N_{Rk} = N_{u,m} - k \cdot s$$

The k factor is a function of the sample size and the accuracy required. The characteristic strength of fastenings to concrete is determined based on a 90% probability while fastenings to steel are based on a 75% probability.

Structural analysis of the fastened part (e.g. roof deck panel or pipe hung from a number of fastenings) leads to calculation of the load acting on a single fastening, which is then compared to the recommended load

(or design value of the resistance) for the fastener. In spite of this single-point design concept, it is necessary to ensure adequate redundancy so that failure of a single fastening will not lead to collapse of the entire system. The old saying “one bolt is no bolt” can also be applied to DX fastening.

For standard DX fastenings on concrete, a probability-based design concept based on multiple fastening is applied in order to allow for fastener driving failures and the large scatter in holding power observed. This concept applies to tensile as well as shear loading and is described in following chapter.

## 10. Determination of technical data for fastening design

The determination of technical data is based on the following tests:

- Application limits
- Tensile tests to determine pull-out and pull-over strength
- Shear tests to determine bearing capacity of the attached material and the base material.

These tests are described in more detail in the sections “Steel and other metal base material” and “Concrete base material”.

### 10.1 Fastenings to steel

Failure loads in tension and in shear are normally distributed and the variation coefficient is  $< 20\%$ . The test data for each test condition are evaluated for the average and characteristic values. The characteristic value is based on the 5% fractile for a 75% probability.

The application range of the fastener is determined by application limit test where fasteners are set on steel plates of thickness ranging from the minimum recommended thickness  $t_{l,min}$  to full steel ( $\geq 20$  mm) and varied plate strength.

The application limit is reached when 1 shear off failure with 30 fasteners tested occurs, or if a detrimental effect on the load values (resistance) occurs.

Due to the small scatter in failure loads fastenings in steel can thus be designed as single points, although good engineering practice should be kept in mind. System redundancy must be always ensured.

## 10.2 Profile sheet fastenings

In addition to general fastenings to steel, specific data applies to profile sheet fastenings:

### Cyclic loading

Profile sheet fastenings are subjected to repeated loading to simulate wind effects. Cyclic pull-through tests are additional optional tests where the failure load at 5,000 cycles is determined.

The design value of the pull-through resistance for repeated wind loads is the design value of the static pull-through resistance multiplied by a reduction factor of  $\alpha_{cycl}$ .

- If cyclic tests are carried out:

$$\alpha_{cycl} = 1.5 (N_{Rk,cycl} / N_{Rk,sta}) \leq 1$$

(The factor 1.5 takes the different safety levels for fatigue and predominately static design into account)

- If no cyclic tests are carried out:

$$\alpha_{cycl} = 0.5$$

### Sheet bearing capacity

Profile sheet fastenings may be subjected to shear stresses from building movements or thermal dilatation of the sheets. Tests are undertaken to prove the suitability of the fastenings to support the deformations imposed.

For this, shear tests are carried out using a substrate of the minimum and maximum thickness and 2 layers of profile sheet of the thickness specified.

The fastening is considered suitable if an elongation of 2 mm is achieved without the sheet coming loose or showing an excessive reduction in pull-out load capacity. In this case, no consideration of forces of constraint is required since sufficient ductility is provided by the fastening due to hole elongation.

### Standardization

The pull-over strength of profiled sheet fastenings is given with reference to core sheet thickness. Ultimate load data is standardized to the minimum sheet thickness and strength as specified by the relevant sheet standard. The correction applied is as follows:

$$F_{u'} = F_u \cdot \frac{t_{min}}{t_{act}} \cdot \frac{f_{u,min}}{f_{u,act}}$$

### 10.3 Fastenings to concrete (standard DX / GX / BX)

The failure loads in tension and shear show a large scatter with a variation coefficient of up to 60%. For specific applications, fastener driving failures may be detected and the fasteners replaced (e.g. threaded studs). For others, however, detection may not be possible (e.g. when fastening wooden battens) and this must be taken into consideration.

The design resistance is therefore determined for:

- failure loads without considering fastener driving failures
- failure loads considering a 20% rate of fastener driving failure

Evaluation of technical data and design according to the single point design approach based on fractiles and a safety factor is not feasible for such systems. The characteristic value would become zero at a variation coefficient of about 50%.

The evaluation of the data and the determination of the design resistance is therefore based on a multiple fastening, i.e. a redundant design, in which the failure probability not of a single, but of a number of fasteners supporting a structure is calculated. By this system, load may be transferred between the fasteners, if slip or failure of one or more of the fasteners occurs.

#### Test data

The test data for the fastener is consolidated to form a master pullout load distribution.

#### Static system

Two static systems are examined

- A suspended beam allowing unrestrained flexure of the beam
- A beam directly attached to the surface, which shows restrained flexure

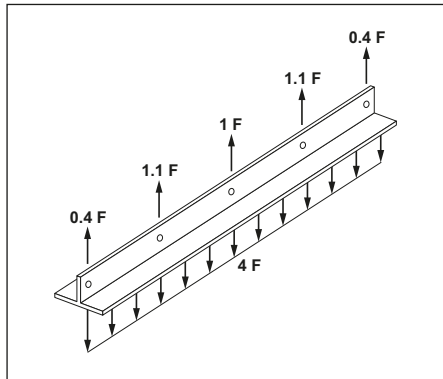

## Calculation method

The calculation method used is the Monte Carlo method, by which holding values taken stochastically from the master distribution are attributed to the individual fasteners of the system and the system is checked to determine whether the imposed line load can be supported. By performing a large number of such simulations, statistical information on the failure probability of a system under a given line load is obtained. Hidden setting failures can also be considered with this method.

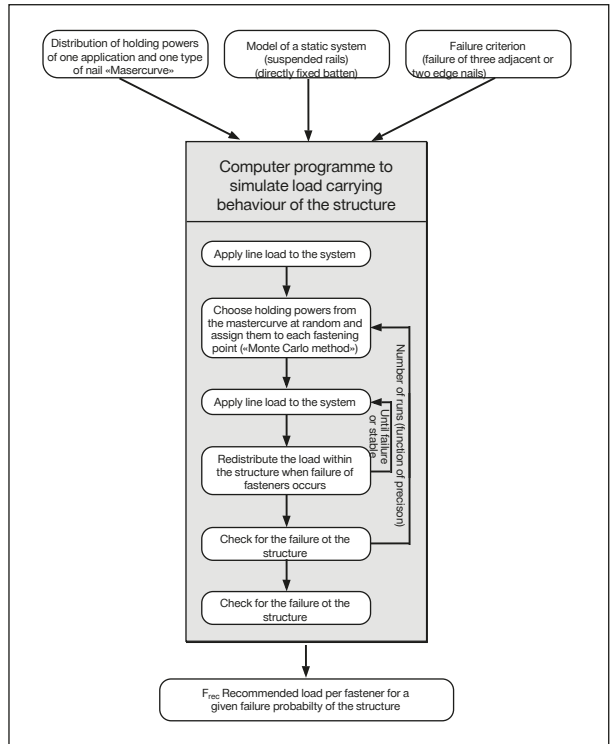

## Design parameters

The design is based on the following parameters:

- Failure probability:  $1 \cdot 10^{-6}$
- Number of fasteners: 5
- Line load uniformly distributed
- Failure criterion: 2 edge or 3 central fastenings

The result is expressed in recommended load per fastening.

### Effect on a fastening design

The overall condition for a fastening design in practice is that redundancy of the complete system has to be ensured. The effect of the Monte Carlo approach on a design is illustrated with two examples below.

#### Example:

Fastening of a plumbing with five ceiling hangers.

1. Due to the stiffness (EI) of the plumbing a redistribution of the dead load (g) to the remaining hangers is given in case of two neighbouring hangers failing.

( Fixing of each hanger with one nail is sufficient.

2. The plumbing is not stiff enough to redistribute the dead load to the neighbouring hangers in case of one fastener failing.

( Each hanger has to be fastened with five nails.

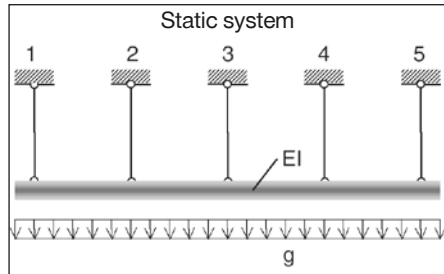

### 10.4 DX fastenings to concrete (DX-Kwik)

Failure loads in tension and shear are log-normally distributed and the variation coefficient is <20 %. The test data is evaluated to yield the 5 % fractile based on a 90% probability. The recommended working loads are obtained by applying a global safety factor of 3 for tension and shear.

The determination of technical data for cracked concrete (tensile zone) is based on tensile tests. Shear tests in cracked and uncracked concrete give similar results and are therefore not performed.

Failure loads in cracked concrete show a higher variation coefficient. Test data is also evaluated to yield the 5% fractile. The recommended load for the tensile zone is taken as the smaller of the following values:

- $N_{rec} = N_{RK} / \gamma_{GLOB}$       $\gamma_{GLOB} = 3.0$  for 0.2 mm crack width
- $N_{rec} = N_{RK} / \gamma_{GLOB}$       $\gamma_{GLOB} = 1.5$  for 0.4 mm crack width.

The application range of the fastener is determined by application limit test where fastenings are made on concrete of varying strength and age according to the application conditions specified (pre-drilling and setting). The attachment height is kept at the lower end of the range specified. The application limit is reached, if the failure rate exceeds 3% or the pull-out values strongly deviate from a lognormal distribution. The sample size is 30 per condition.

### 10.5 Fastener design in the USA and Canada

Testing of powder-actuated fasteners is carried out according to the ICC-ES AC 70 acceptance criteria and ASTM E 1190 standard test method. The test procedure covers tensile and shear testing in steel, concrete and masonry.

The determination of the allowable (recommended) load is shown below. The recommended working load is derived from the test data by taking the average failure load or the calculated characteristic load divided by a global safety factor.

$$P_a = V_a = F_{all} = \frac{F \cdot R \cdot R_f}{\Omega} \quad (3-1)$$

where:

- $F$  = Average ultimate load [lbf (N)] of the test series.
- $\Omega$  = Safety factor determined in accordance with Section 3.3.2.
- $R$  = Most severe base material reduction factor determined in accordance with Section 3.3.3.1, 3.3.3.2, or 3.3.3.3, as applicable.
- $R_f$  = Fastener based reduction factor, determined in accordance with Section 3.3.3.4, as applicable.

**Exception:** When testing satisfies the alternate sample size described in Section 8.1 of ASTM E1190 (the COV from ten tests is 15 percent or greater),  $F$  shall be taken as the lowest ultimate load of the ten tests and  $\Omega$  shall be taken as 5.

**3.3.2 Safety Factor,  $\Omega$ :** The safety factor shall be determined using Equation 3-2.

$$\Omega = \frac{3.5}{(1 - 2COV)} \geq 5 \quad (3-2)$$







**Part 2:**

## **Fastener selection guide**

## 1. Selecting the right fastener

These considerations are used to determine a suitable powder-actuated (DX), gas-actuated (GX) or battery-actuated (BX) fastener for an application.

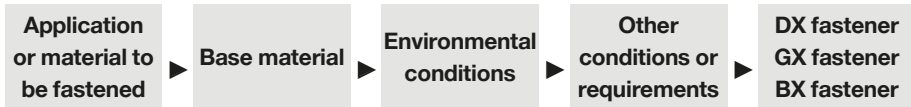

Detailed technical information for the selected fastener family is found on its product information sheet on the displayed pages.

For some applications, two or more fastener families are listed as suitable. The final selection is influenced by your specific application requirements, available tools and technical data found on the product sheets.

Regional differences in building methods, materials, trade preferences, available tools, etc. also influence fastener selection. Therefore, designers and specifiers are advised to consult the local Hilti website and make use of the local Hilti technical advisory service.

### Corrosion

Corrosion may have a major influence on the suitability of a fastener for an application and therefore also on fastener selection. In order to provide a basis for judging the suitability of fasteners, it is useful to categorise applications in three classes:

- Non-safety relevant, temporary fastenings (e.g. fastenings of wooden kickers in concrete formwork)
- Non-safety relevant, permanent fastenings (e.g. metal track fastenings for drywall)
- Safety relevant, permanent fastenings (e.g. profiled metal sheet fastenings in roof and walls)

**Non-safety-relevant , temporary and permanent fastenings:** zinc-plated fasteners made of normal carbon steel can be used without restriction. Corrosion and related damages can, however, reduce the capacity of fasteners.

**Safety-relevant, permanent fastenings:** the restrictions described below apply:

- In any case where there is a restriction to use galvanized carbon steel fasteners if they are exposed to weather or if they are inside and subject to repeated wetting as from condensation. The galvanization (typically in a range from 5 to 20 microns of Zn) provides corrosion protection during transport and construction, during which exposure to weather can never be completely prevented. If the fastenings are exposed to repeated wetting or weather during their service life, the use of galvanized carbon steel fasteners is prohibited and stainless steel fasteners must be used. This safety measure must be observed without exception because the corrosion of galvanized steel fasteners leads not just to material loss but also to hydrogen embrittlement. Hydrogen embrittlement can easily result in fracture of the fastener at very low load.
- Referring to the above-mentioned example of profiled metal sheet fastening for roofs and walls, the use of galvanized steel fasteners is allowable only where wetting of the fastener is not to be expected. This applies in general to inside skins of two skin, insulated roofs and walls enclosing dry and closed rooms. This is the classic application area for X-ENP 19 galvanized fasteners.
- For special applications like swimming pools or tunnels, highly corrosion-resistant resistant stainless steel materials are recommended. See also Part 4, Chapter 4. Please consult Hilti in such cases

**Contact corrosion** is taken into consideration by observing common rules concerning acceptable material combinations. Parts made of less noble metals are subject to increased corrosion if they are in electrochemical contact with a larger part made of a more noble metal, provided of course that an electrolyte is present. Fasteners that are used in wet areas must be at least as noble or better, nobler than the fastened part. The effect of contact corrosion is shown in the table below. This information is especially applicable to stainless steel

X-CR, X-ST and X-R fasteners because these are suitable for safety-relevant, permanent application in outdoor areas or areas otherwise exposed to corrosion.

Fastened part	<b>Powder- and gas-actuated fastener:</b>	
	Zinc-plated carbon steel	Stainless steel
Construction steel (uncoated)	s	s
Galvanized steel sheet	s	s
Aluminum alloy	d	s
Stainless steel sheet	d	s

s Negligible or no corrosion of fastener  
d Heavy corrosion of fastener

Accelerated corrosion of a fastener due to contact corrosion can take place only in the presence of an electrolyte (moisture from precipitation or condensation). Without this electrolyte – e.g. in dry inside rooms – zinc-plated fasteners can be used in connection with more noble metals.

## 2. Concrete fastener selection

### What determines nail performance

Hilti Direct Fastening systems are designed to achieve maximum performance in a wide range of applications. But there is a large variety of nails types and elements for various direct fastening concrete applications. To select the appropriate nail for an application, some important influencing parameters need to be considered:

- a) concrete properties,
- b) nail design and features
- c) the fastening system used
- d) nail embedment depth
- e) fastening tools and energy level

#### a) Concrete properties

A nail penetrating concrete needs to create a hole for the shank by crushing and compacting the concrete and also needs to withstand hitting hard aggregates. The resulting holding value achieved by the nail is linked to its diameter and embedment depth.

High penetrability and compactability lead to high stick rates and holding values.

Note: Concrete compressive strength alone is not decisive for nail performance.

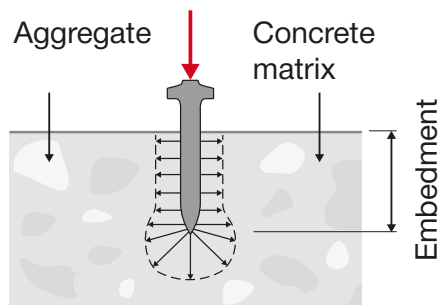

Three concrete types can be roughly distinguished:

- S**  
Soft

  - Low compressive strength, e.g.  $f_{c, cube} = 20 - 45$  MPa
  - Small to medium-size aggregates, e.g. soft limestone
  - Example: lightweight concrete
- T**  
Tough

  - Medium to high compressive strength, e.g.  $f_{c, cube} = 45 - 65$  MPa
  - Medium size aggregate, e.g. limestone, pit gravel
  - Example: normal weight concrete
- V**  
Very Tough

  - High compressive strength, e.g.  $f_{c, cube} \geq 65$  MPa
  - High proportion of large and mainly hard aggregates, e.g. quartz, granite
  - Example: high performance concrete, very old concrete.

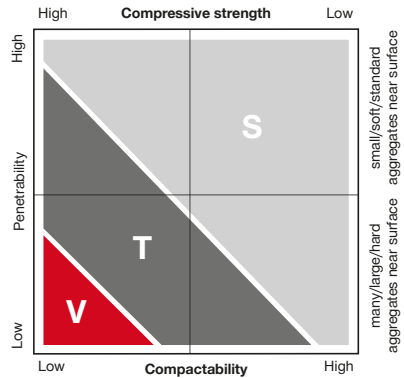

Note:  $f_{c, cube}$  = Compressive strength of concrete cube (150 mm edge length)

## b) Nail design and features

Penetrability and compactability, i.e. a nail's ability to penetrate and compact the concrete, are strongly influenced by three nail design features:

### Point type

The point type and the reduction of the diameter in the area of the tip allows a significantly improved penetration behaviour in concrete.



### Nail geometry

Length and diameter also affect how easily the nail penetrates the concrete.

### Nail hardness

A harder nail is easier to drive into tougher concrete. However, if the nail is too hard, it can break instead of bending when it hits a hard aggregate in the concrete.

### c) Fastening systems used

Hilti Direct Fastening Systems help to ensure that nails are correctly driven by achieving maximum nail perpendicularity, good nail guidance and thorough use of the appropriate driving energy.

#### Perpendicularity

Hilti Direct Fastening tools help to keep nails perpendicular to the working surface, thus reducing failures caused by nails driven at an angle. During the fastening process, Hilti Direct Fastening tools have to be maintained perpendicular to base material as much as possible. Please refer to product instructions for use and tool operation manuals for details.

#### Nail guidance

Due to excellent nail guidance in the tool and the use of solid washers, the nail leaves the tool at the intended angle.

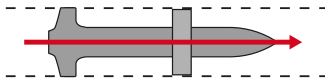

### d) Nail embedment depth

Another factor that influences nail performance is embedment depth. A nail that can be driven deeper has the ability to achieve higher loads. However, there are two side effects if a nail needs to be driven deeper.

- stick rate can decrease
- higher driving energy is required as the nail must penetrate further into the concrete

### e) Fastening tools and energy levels

Nail driving energy released by a Hilti tool is precisely controlled to help achieve the desired embedment depth reliably

#### Powder-actuated tools (DX)

Embedment depth of a nail can be influenced by selecting the right cartridge color and adjusting the power setting of powder-actuated tools (DX) on concrete, where applicable. Hence, it is crucial to understand how the different tools in combination with the various cartridges vary in terms of energy generation. Use that knowledge to pick the right tool and the right cartridge to help achieve the required embedment depth and reach the optimum nail load performance.

#### Gas-actuated tools (GX)

Embedment depth can be influenced by adjusting the slider in the front of the tool to “+” or “-” position.

#### Battery-actuated tools (BX)

Embedment depth can be influenced by selecting a different nail length.

### Choice of a nail for use on concrete

Three main factors that define the nail selection on concrete are:

- speed
- stick rate
- holding values

#### Speed

All system technologies, gas actuated-tool (GX), battery-actuated tool (BX) and powder-actuated tool (DX) offer a very high installation speed.

#### Stick rate

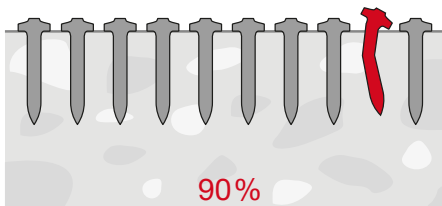

The stick rate indicates the percentage of nails that were driven correctly to carry a load.

Generally, stick rate can often be improved by combination of

- using shorter nails  
(on condition that required load can still be achieved with shorter embedment)
- selecting nails from a higher nail class  
(nail classes are described later in this chapter)
- using more energy by combination of tools, cartridges and energy setting
- using different technologies and nails from a higher nail class, i.e. switching from gas-actuated (GX) or battery-actuated tools (BX) to powder-actuated tools (DX)
- pre-drilling, see chapter Kwik

#### Holding values

Holding values provide a measure of a nail's load-bearing capability which ensures the reliable use in practical applications, consistent with their diameter and embedment depth. Nails are typically subjected to static or quasi-static actions tension, shear or combined tension and shear.

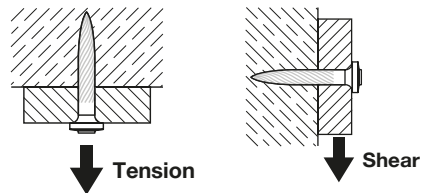

## Nail Types

Different nails have been developed for various applications and conditions.

Medium duty Class I and II nails are used for load-sensitive high performance applications in tough and very tough concrete, while medium duty Class III nails are for versatile use in soft and tough concrete. Medium duty Class I, II and III nails are generally fastened with powder-actuated tools (DX)

Light duty Class IV and V nails, generally fastened with gas-actuated (GX) and battery actuated tools (BX) are typically used for applications that have lower load requirements, hence requiring shorter embedment depth. In general, Class V nails present the most economical solution as they are the least costly.

Cost is directly related to

- the manufacturing technologies involved as well as
- the material from which the nails are made.

Each higher nail class performs better under harsher conditions than the one below, but the manufacturing costs, and thus the price of the nail, increase with each nail class.

	Nail Class	Nail featured			Concrete Class	Nail examples	Applications
		Ø [mm]	Hardness [HRC]	Tip			
Medium duty	Class I	> 4.0	> 58	Long conical		X-AL-H 1)	Load sensitive high performance and special applications in tough and some very tough concrete.
	Class II	4.0	Up to 60	Ballastic or better		X-P X-U	Load sensitive high performance applications in tough concrete.
	Class III	3.5 to 3.7	Up to 58	Mostly cut		X-C	Versatile use in soft and tough concrete.
Light duty	Class IV	3.0 to 3.2	Up to 58	Ballastic or better		X-P G2/G3/B3	Use in soft and some tough concrete with shorter embedment, e.g. for track fastening to slab underside.
	Class V	2.6 to 3.0	Up to 57	Mostly cut		X-C G2/G3/B3	Use in soft concrete with shorter embedment, e.g. for track fastening.

1) X-AL-H nail is pre-mounted to X-CX ceiling fasteners



## Nail class versus concrete type

### Stick rate versus holding values of nail classes

Nail classes are clearly differentiated when faced with tough and very tough concrete. Depth of embedment, nail geometry, hardness and tip shape vary between nail classes.

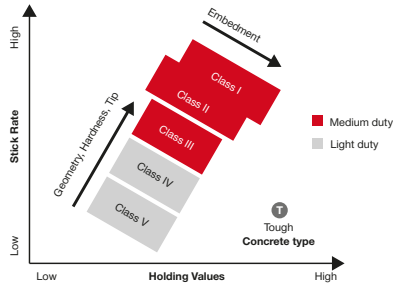

### Stick rate of nail classes in different concrete types

Nail performance varies depending on the toughness of the concrete and the distribution of its aggregates. Nails of all classes perform similarly in soft concrete, but as the concrete gets tougher, the stick rate varies.

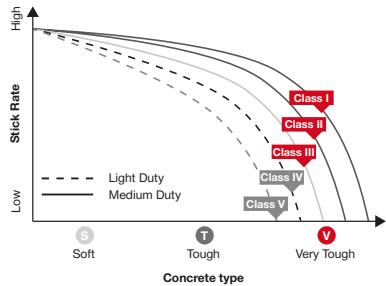

**Guidelines to selecting the right nail for concrete**

- Understand the application
- Be specific about important application requirements
- Get to know the Hilti range of nails
- Choose the right nail based on application requirements

**Improving the stick rate can be done in three different ways:**

1. Use a shorter nail (if required embedment / load still can be reached with shorter nail)
2. Select a nail from a higher nail class (move from Nail Class III to II)
3. Use more energy (energy setting) / select different technology

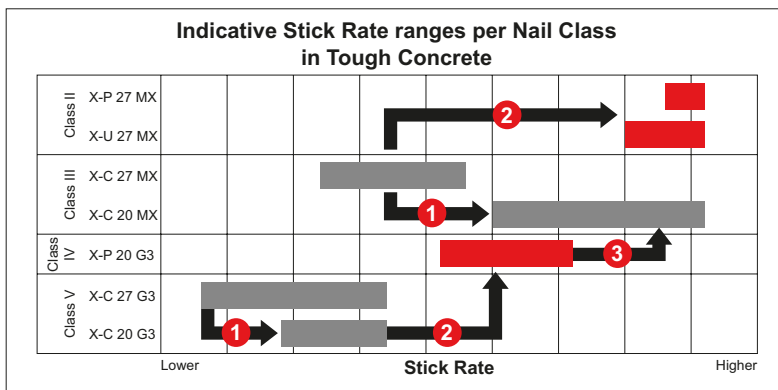
**Example of nail selection process to improve stick rate.**

- Maximize the stick rate
- Achieve the required holding values
- Select the most cost-efficient nail
- Achieve optimum embedment depth based on selecting the appropriate cartridge and adjusting the power setting for DX systems.
  - No power and cartridge selection required for GX and BX systems.
- Other application relevant requirements, e.g. environmental conditions, corrosion, etc., must be considered.

## Design concepts

The recommended working loads ( $N_{\text{rec}}$  and  $V_{\text{rec}}$ ) are suitable for use in typical working load designs. If a partial safety factor design method is to be used, the  $N_{\text{rec}}$  and  $V_{\text{rec}}$  values are conservative when used as  $N_{\text{Rd}}$  and  $V_{\text{Rd}}$ . Exact values for  $N_{\text{Rd}}$  and  $V_{\text{Rd}}$  can be determined by using the safety factors where given and/or by reviewing test data. Design loads (characteristic strength, design resistance and working loads) for the **X-HVB** shear connector are listed as per design guideline.

Worldwide the designer may encounter two main fastening design concepts:

### Working load concept

$$N_S \leq N_{\text{rec}} = \frac{N_{\text{Rk}}}{\gamma_{\text{GLOB}}}$$

where  $\gamma_{\text{GLOB}}$  is an overall factor of safety including allowance for:

- errors in estimation of load
- deviations in material and workmanship

and  $N_S$  is, in general a characteristic acting load.

$$N_S \equiv N_{\text{Sk}}$$

### Partial factors of safety

$$N_{\text{Sk}} \cdot \gamma_{\text{F}} = N_{\text{Sd}} \leq \frac{N_{\text{Rk}}}{\gamma_{\text{M}}} = N_{\text{Rd}}$$

where:

$\gamma_{\text{F}}$  is a partial factor of safety to allow for errors in estimation on the acting load.

$\gamma_{\text{M}}$  is a partial factor of safety to allow for deviations in material and workmanship.

Structural analysis of the fastened part (e.g. roof deck panel or pipe hung from a number of fastenings) leads to calculation of the load acting on a single fastening, which is then compared to the recommended load (or design value of the resistance) for the fastener. In spite of this single point design concept, it is necessary to ensure that there is sufficient redundancy that the failure of a single fastening will not lead to collapse of the entire system. The old saying “one bolt is no bolt” applies also to Direct fastening.

### 3. Nomenclature/symbols

Following is a table of symbols and nomenclature used in the technical data.

Fastener test data and performance	
<b>N</b> and <b>V</b>	Tensile and shear forces in a general sense.
<b>F</b>	Combined force (resulting from <b>N</b> and <b>V</b> ) in a general sense.
<b>N<sub>s</sub></b> and <b>V<sub>s</sub></b>	Tensile and shear forces acting on a fastening in a design calculation.
<b>F<sub>s</sub></b>	Combined force (resulting from <b>N<sub>s</sub></b> and <b>V<sub>s</sub></b> ) in a design calculation.
<b>N<sub>u</sub></b> and <b>V<sub>u</sub></b>	Ultimate tensile and shear forces that cause failure of the fastening; statistically, the reading for one specimen.
<b>N<sub>u,m</sub></b> and <b>V<sub>u,m</sub></b>	Average ultimate tensile and shear forces that cause failure of the fastening, statistically, the average for a sample of several specimens.
<b>S</b>	The standard deviation of the sample.
<b>N<sub>test,k</sub></b> and <b>V<sub>test,k</sub></b>	Characteristic tensile and shear resistance of test data, statistically, the 5 % fractile.
<b>N<sub>Rk</sub></b> and <b>V<sub>Rk</sub></b>	<p>Characteristic tensile and shear resistance of the fastening used for fastening design; statistically, the 5 % fractile. For example, the characteristic strength of a fastening whose ultimate strength can be described by a standard Gauss type distribution is calculated by:</p> $N_{Rk} = N_{u,m} - k \cdot S$ <p>where <b>k</b> is a function of the sample size <b>n</b> and the desired confidence interval.</p>
<b>N<sub>Rd</sub></b> and <b>V<sub>Rd</sub></b>	<p>Tensile and shear design resistance of the fastening</p> $N_{Rd} = \frac{N_{Rk}}{\gamma_M} \text{ and } V_{Rd} = \frac{V_{Rk}}{\gamma_M}$ <p>where <math>\gamma_M</math> is a partial safety factor for the resistance of the fastening.</p>
<b>N<sub>rec</sub></b> and <b>V<sub>rec</sub></b>	<p>Recommended tensile and shear force of the fastening</p> $N_{rec} = \frac{N_{Rk}}{\gamma_{GLOB}} \text{ and } V_{rec} = \frac{V_{Rk}}{\gamma_{GLOB}}$ <p>where <math>\gamma_{GLOB}</math> is an overall factor of safety.</p>
<b>M<sub>rec</sub></b>	<p>Recommended working moment on the fastener shank</p> $M_{rec} = \frac{M_{Rk}}{\gamma_{GLOB}}$ <p>where <b>M<sub>Rk</sub></b> is the characteristic moment resistance of the fastener shank and <math>\gamma_{GLOB}</math> is an overall factor of safety. Unless otherwise stated on the product data sheets, the <b>M<sub>rec</sub></b> values in this manual include a safety factor of "2" for static loading.</p>

**Fastening details**

<b><math>h_{ET}</math></b>	Penetration of the fastener point below the surface of the base material.
<b><math>h_{NVS}</math></b>	Nail head standoff above the surface fastened into (with nails, this is the surface of the fastened material, with threaded studs, the surface of the base material).
<b><math>t_{II}</math></b>	Thickness of the base material.
<b><math>t_I</math></b>	Thickness of the fastened material.
<b><math>\Sigma t_I</math></b>	Total thickness of the fastened material (where more than one layer is fastened).

**Characteristics of steel and other metals**

<b><math>f_y</math></b>	Yield strength of steel.
<b><math>f_u</math></b>	Tensile strength of steel.

**Characteristics of concrete and masonry**

<b><math>f_c</math></b>	Compressive strength of cylinder (150 mm diameter, 300 mm height).
<b><math>f_{cc}</math></b>	Compressive strength of cube (150 mm edge length).
<b><math>f_{c,100} / f_{c,200}</math></b>	Compressive strength of 100 mm diameter cylinder / cube with 200 mm edge length.

In some cases, building material grades are used to describe the suitable range of application. Examples of European concrete grades are C20/25, C30/35, C50/55.

Approvals, technical assessments and design guidelines are given on the product information sheets as abbreviations of the names of the issuing institutes or agencies.

Following is a list of abbreviations:

Abbreviation	Name of institute or agency / description	Country
<b>FM</b>	Factory Mutual (insurers' technical service)	USA
<b>UL</b>	Underwriters Laboratories (insurers' technical service)	USA
<b>ICC</b>	International Code Council	USA
<b>SDI</b>	Steel Deck Institute (technical trade association)	USA
<b>CSTB</b>	Centre Scientifique et Technique du Bâtiment (approval agency)	France
<b>DIBt</b>	Deutsche Institut für Bautechnik (approval agency)	Germany
<b>SOCOTEC</b>	SOCOTEC (insurers' technical service)	France
<b>ÖNORM</b>	Österreichische Norm / Austrian National Standard	Austria
<b>SCI</b>	Steel Construction Institute	Great Britain





<b>ABS</b>	American Bureau of Shipping (international classification society for ship and marine structures).
<b>LR</b>	Lloyd's Register (international classification society for ship and marine structures).
<b>DNV GL</b>	International classification society for the marine and energy industry.



## 4. Tips for users

## Tips for users (“Trouble Shooting”)

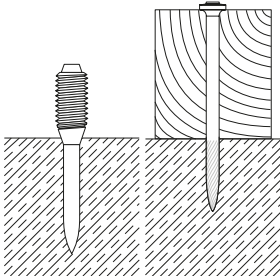
### DX fastenings on concrete

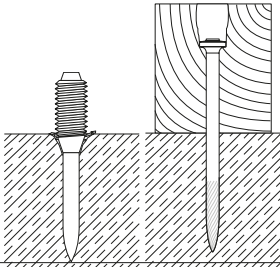
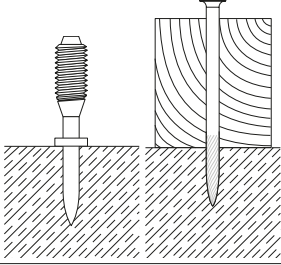
Observation	Cause	Possible remedial measures
<p><b>Fastener properly fixed</b></p> 	<ul style="list-style-type: none"> <li>• Proper*) length of fastener</li> <li>• Proper cartridge</li> <li>• Proper power setting</li> </ul>	
<p><b>Fastener penetrates too deep</b></p> 	<ul style="list-style-type: none"> <li>• Fastener too short*)</li> <li>• Too much driving power</li> </ul>	<ul style="list-style-type: none"> <li>• Use longer fastener</li> <li>• Reduce power setting</li> <li>• Use lighter cartridge</li> </ul>
<p><b>Fastener does not penetrate deep enough</b></p> 	<ul style="list-style-type: none"> <li>• Fastener too long*)</li> <li>• Too little driving power</li> </ul>	<ul style="list-style-type: none"> <li>• Use shorter fastener</li> <li>• Increase power setting</li> <li>• Use heavier cartridge</li> </ul>

\*) **Rule of thumb:** The higher the compressive strength of concrete, the shorter the fastener  
**Proper length (mm):**  $L_s = 22 + t_1$  (compare, “Fastening Technology Manual” Part Product section)

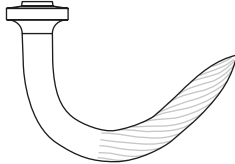
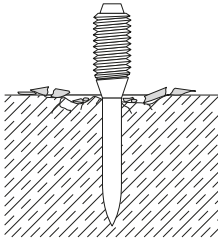
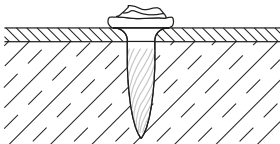

**DX fastenings on concrete**

Observation	Cause	Possible remedial measures
<p><b>Nail is bending</b></p> 	<ul style="list-style-type: none"> <li>• Hard and/or large aggregate in concrete</li> <li>• Rebar close to surface of concrete</li> <li>• Hard surface (steel)</li> </ul>	<ul style="list-style-type: none"> <li>• Use shorter nail</li> <li>• Use DX-Kwik (predrill)</li> <li>• Use stepped shank nail X-U 15</li> <li>• Change cartridge</li> </ul>
<p><b>Base material is spalling</b></p> 	<ul style="list-style-type: none"> <li>• High strength concrete</li> <li>• Hard and/or large aggregate in concrete</li> <li>• Old concrete</li> </ul>	<ul style="list-style-type: none"> <li>• Stud application: Use spall stop X-460-F8SS / - F10SS</li> <li>• Nail application: Use shorter nail Use DX-Kwik (predrill) Use X-U 15 (for highstrength precast concrete)</li> </ul>
<p><b>Damaged nail head</b></p> 	<ul style="list-style-type: none"> <li>• Too much driving power</li> <li>• Wrong piston used</li> <li>• Damaged piston</li> </ul>	<ul style="list-style-type: none"> <li>• Reduce power setting</li> <li>• Use lighter cartridge</li> <li>• Check nail-piston-combination</li> <li>• Change piston</li> </ul>

**Wrong pistons can cause all the above faults: match pistons to nails!**

Fastener	Piston	Piston tip
X-U, X-C, X-P	Use piston X-460-P8	

**DX fastenings on steel**

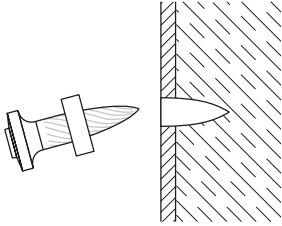
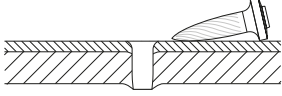
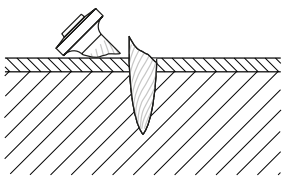
Observation	Cause	Possible remedial measures
<p><b>Nail does not penetrate surface</b></p> 	<ul style="list-style-type: none"> <li>• Too little driving power</li> <li>• Application limit exceeded (very hard surface)</li> <li>• Unsuitable system</li> </ul>	<ul style="list-style-type: none"> <li>• Try higher power setting or heavier cartridge</li> <li>• Short nail application: Try X-U 15</li> <li>• Long nail application: Try X-U</li> <li>• Use co-acting principle/ fastener guide</li> <li>• Switch to heavy system like DX 76 PTR</li> </ul>
<p><b>Nail does not hold in base material</b></p> 	<ul style="list-style-type: none"> <li>• Excess driving energy in thin steel base material (3 to 4 mm steel)</li> </ul>	<ul style="list-style-type: none"> <li>• Try different power setting or different cartridge</li> <li>• Try X-ENP2K or X-EDNK22 THQ 12 for fastening sheet metal</li> </ul>
<p><b>Nail is breaking</b></p> 	<ul style="list-style-type: none"> <li>• Too little driving power</li> <li>• Application limit exceeded (very hard surface)</li> </ul>	<ul style="list-style-type: none"> <li>• Try higher power setting or heavier cartridge</li> <li>• Use shorter nail</li> <li>• Use X-ENP19</li> <li>• Use stronger nail (X-...-H)</li> <li>• Use stepped shank nail: X-U 15</li> </ul>

### DX fastenings on steel

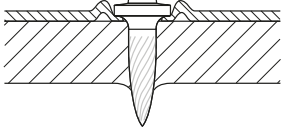
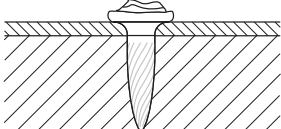
Observation	Cause	Possible remedial measures
<p><b>Nail head penetrates through material fastened (metal sheet)</b></p> 	<ul style="list-style-type: none"> <li>• Too much driving power</li> </ul>	<ul style="list-style-type: none"> <li>• Reduce power setting</li> <li>• Use lighter cartridge</li> <li>• Use nail with Top Hat</li> <li>• Use nail with washer e.g. X-U ...S12</li> </ul>
<p><b>Damaged nail head</b></p> 	<ul style="list-style-type: none"> <li>• Too much driving power</li> <li>• Wrong piston used</li> <li>• Worn-out piston</li> </ul>	<ul style="list-style-type: none"> <li>• Reduce power setting</li> <li>• Use lighter cartridge</li> <li>• Check nail-piston-combination</li> <li>• Change piston</li> </ul>

**Wrong pistons can cause all the above faults: match pistons to nails!**

Fastener	Piston	Piston tip
X-U, X-P, X-S	Use piston X-460-P8	





## 5. Nail and stud designation

## Nail designation

X-C		32	P8 S23 T	
<b>Application:</b>			<b>Washer type X (in mm):</b>	
X-ENP	Siding and Decking Nails		P	Plastic washer e.g. P8 = plastic washer Ø 8
X-ENP2K			S	Steel washer e.g. S36 = steel washer Ø 36
X-HSN	Diaphragm Decking Nails		D	Two washers
NPH	Siding and Decking Nails to Concrete		L	Two domed washers
X-U	Universal Nails		TH	Top Hat
X-P	High Performance Nail for Fastening to Concrete		THQ	Top Hat and high shear washer
X-C	Nails for Concrete and Sand lime-Masonry		MX	Collated for DX tool/ collated fasteners for GX/BX
X-S	Drywall and electrical fasteners to Steel		MXR	Collated for DX 860-ENP
X-EGN	Gas Nails for GX 120		T	For tunneling applications
X-GHP			MXR	Collated for DX 860-ENP
X-GN			T	For tunneling applications
DS	Heavy Duty Nails for Concrete and Steel		B_	For battery tools, e.g. B3
EDS	Heavy Duty Nails for Fastening Steel to Steel		G_	For gas tools, e.g. G3
X-R	Stainless Steel Nail for Fastening to Steel		<b>Dimensions:</b>	
X-CR	Stainless Steel Nails for Concrete, Sand lime Masonry and Steel. And Steel only.		Nail shank length in mm (For details, please refer to product data)	
X-CT	Nails for Forming or other Temporary uses			
DNH	DX-Kwik Nails for Concrete			
X-DKH	(pre-drilled)			

## Examples:

### X-U 52 P8

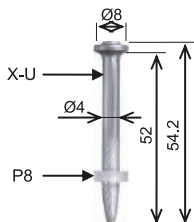

### X-U 52 MX

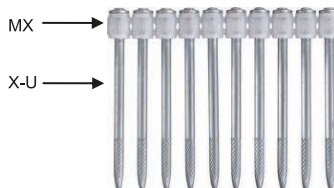

Threaded stud designation

X-M6H		10-37	FP8		
<b>Application:</b>			<b>Washer type and X (in mm):</b>		
X-M6H	DX-Kwik Threaded Studs for Concrete (pre-drilled)		P	Plastic washer e.g. P8 = plastic washer X 8	
X-M8H			S	Steel washer e.g. S8 = steel washer X 8	
X-M6		Threaded Studs for Steel	D	Two washers	
X-W6			F	Plastic guidance sleeve	
X-F7			SN12-R	Stainless steel washer for sealing purposes	
X-M8			B_	For battery tools, e.g. B3	
M10			G_	For gas tools, e.g. G3	
W10					
X-EM6H			Stainless Steel Threaded Studs		
X-EW6H					
X-EF7H					
X-EM8H					
X-EM10H					
X-EW10H					
X-BT	Stainless Steel Threaded Studs for Concrete and Steel				
X-CRM					
X-ST					
			<b>Dimensions:</b>		
			Thread Length and Shank Length in mm		

where M, W, F refer to the thread type:

M	Metric
W	Whitworth
F	French

Examples:

X-BT W10-24-6 SN12-R

X-BT M10-24-6 SN12-R

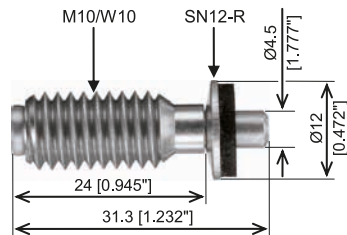

**X-BT, X-ST, S-BT Threaded studs designation**

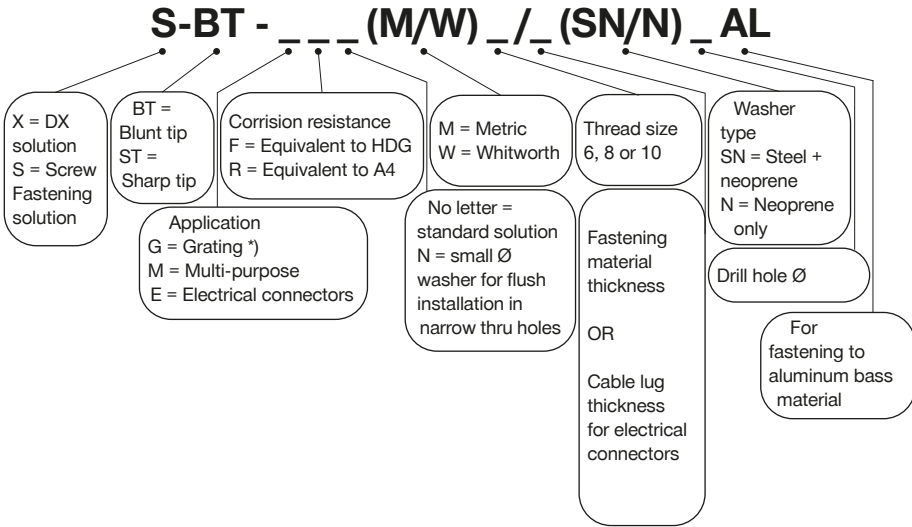

\*) X-ST-GR stainless steel threaded studs may also be used for multi-purpose applications.

**Examples**

- S-BT-MR M10/15 SN 6 AL
- S-BT-GR M8/7 SN 6
- X-BT-MF M10/10 SN 4
- X-BT-ER M8/6 SN 4



Wood nail designation

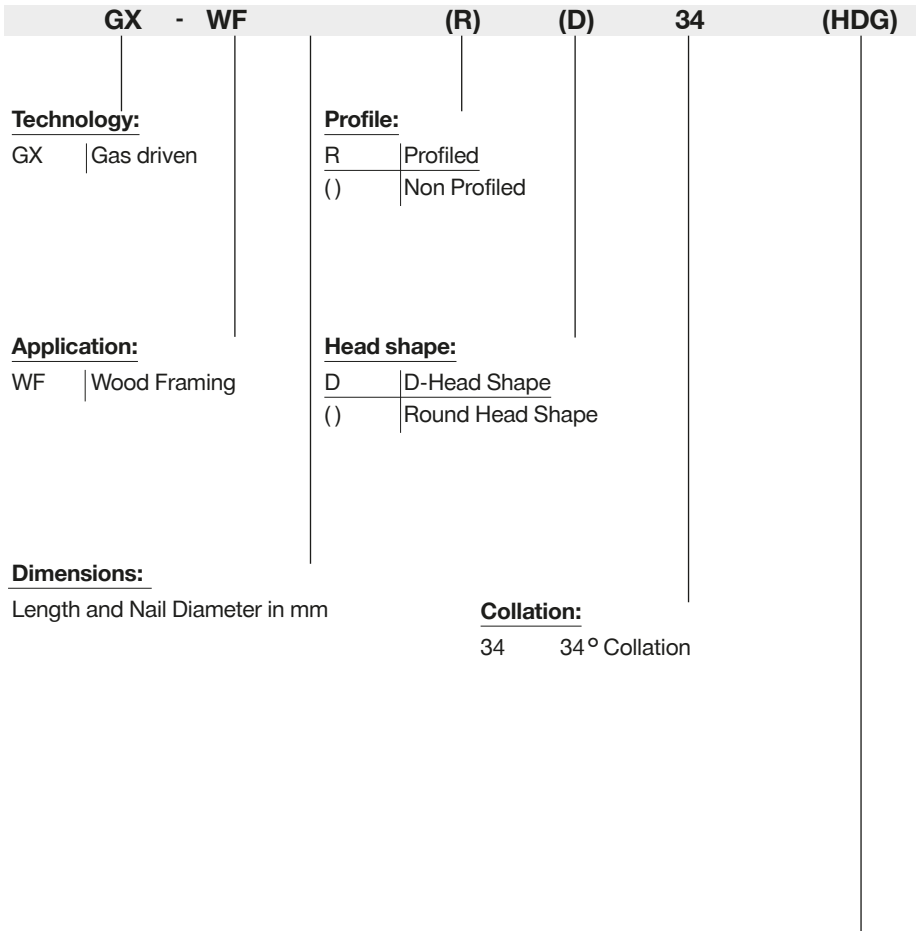

**Designation of corrosion protection on the box/label**

Suffix	Type of protection	Service Class (EN 1995-1-1)
“Bright”	no coating	1
“Galv”	12 µm zinc	1, 2
“HDG”	55 µm hot dip galvanized	1, 2, 3
“Stainless”	A2 or A4	1, 2, 3



**Part 3:**

## **Tools and equipment**



**DX 2** Semi-automatic powder-actuated tool for fastening single nails**Fastener:**

X-P  
X-U  
X-C  
X-CR  
X-CT  
X-M6/W6/F7/M8  
X-FS  
X-SW  
X-FB  
X-DNH  
X-DKH  
X-M6H, X-M8H  
X-HS  
X-CC  
X-CRM

**Cartridges:**

6.8/11M –  
red, yellow, green

**DX 351 Powder-actuated tool for interior finishing applications**

<b>Fastener:</b>
X-P_MX
X-U_MX
X-C_MX
X-S 13 MX

<b>Piston:</b>
X-P 8S-351

<b>Cartridges:</b>
6.8/11M – red, yellow, green, white

**DX 351-F8 Powder-actuated tool for interior finishing, mechanical and electrical applications**

<b>Fastener:</b>
X-P_P8
X-C_P8/TH/THP
X-U15 P8TH
X-CC-U_P8
X-HS_-U_P8S15

<b>Cartridges:</b>
6.8/11M – red, yellow, green, white

<b>Fastener guide:</b>
X-FG 8L-351 narrow access fastener guide

<b>Piston:</b>
X-P 8L-351



X-FG 8ME-351 standard fastener guide
---

<b>Piston:</b>
X-P 8S-351



**DX 351-BT** Powder-actuated tool for fastening X-BT threaded studs

**Fastener:**

X-BT M10-24-6 SN12-R  
 X-BT M10-24-6-R  
 X-BT W10-24-6 SN12-R  
 X-BT W10-24-6-R  
 X-BT M6-24-6 SN12-R  
 X-BT W6-24-6 SN12-R  
 X-BT-ER M10/3 SN4  
 X-BT-ER W10/3 SN4  
 X-BT-ER M8/7 SN4  
 X-BT-ER M6/7 SN4  
 X-BT-ER W6/7 SN4  
 X-BT-MF M/W 10

**Piston:**

X-351 BT P 1024

**Fastener guide:**

BT FG M1024 (M10)  
 BT FG W1024 (W10)  
 Fastener Guide dimensions  
 $b \times d \times L = 17.5 \times 22 \times 29.5 \text{ mm}$

**Cartridges:**

6.8/11M -  
 high precision - brown

**DX 351-BTG** Powder-actuated tool for fastening gratings

**Fastener:**

X-BT M8-15-6 SN12-R  
 X-BT M8-15-6-R

**Piston:**

X-351 BT P G

**Fastener guide:**

X-352 BT FG G (M8)  
 Fastener Guide dimensions  
 $b \times d \times L = 17.5 \times 22 \times 56 \text{ mm}$

**Cartridges:**

6.8/11M -  
 high precision - brown

**DX 351-CT** Fully automatic powder-actuated tool for fastening ceiling fasteners to concrete or steel

**Fastener:**

X-CW  
 X-CC  
 X-HS  
 X-U  
 X-C

**Piston:**

X-P8-351 CT

**Cartridges:**

6.8/11M -  
 red, yellow, green

**Fastener guide:**

X-FG8ME351

## Powder-actuated tool

### DX 460-MX Powder-actuated tool for fastening collated nails

**Fastener:**

---

X-P\_MX

---

X-U\_MX

---

X-C\_MX

---

X-CT\_MX

---

X-ET\_MX

---

X-ECT\_MX

---

X-EKS\_MX,

---

X-FB\_MX

---

X-FS\_MX,

---

X-SW\_MX

---

X-HS\_MX

---

X-CC\_MX

---

X-HS-W\_MX

---

X-EKB\_MX

**Piston:**

---

X-6-5-P8

---

X-6-5-P8W

---

for fastening wood

**Cartridges:**

---

6.8/11M -

---

black, red, yellow, green

### DX 460-F8 Powder-actuated tool for fastening single nails

**Fastener:**

---

X-P\_P8

---

X-U\_P8 / P8 TH

---

X-C\_P8

---

X-CR\_P8/ P8S12

---

X-CR M8

---

X-CT\_DP8

---

X-FS, X-SW

---

X-FB

---

X-EM6H-\_- \_FP8

---

X-EW6H-\_- \_FP8

---

X-EF7H-\_- \_FP8

---

X-M6/W6-\_- \_FP8

---

X-EM8H-\_- \_P8

---

X-M8-\_- \_P8

---

X-HS, X-CC

---

X-HS-W\_P8

**Piston:**

---

X-6-5-P8

---

X-6-5-P8W

---

for fastening wood

**Cartridges:**

---

6.8/11M -

---

black, red, yellow, green



**DX-Kwik method:**

pre-drilling into concrete

**Fastener:**

X-M6H-\_-37 FP8

X-M8H-\_37 P8

X-CRM8-\_42

**Piston:**

X-6-5-PKwik

**Fastener:**

X-DNH 37 P8S15

X-DKH 48 P8S15

**Piston:**

X-6-5-P8

**Fastener guide:**

X-5-460-F8N15

 Narrow access fastener  
guide

(Ø 15.2 mm×53.2 mm)

**Fastener:**

X-P\_P8

X-C

X-CR\_P8

X-CRM\_P8

X-ST-GR M8\_P8

**Piston:**

X-6-5-P8

**Fastener guide:**

X-5-460-F8N10

 Narrow access fastener  
guide

(b×d×L 10.4×25.9×50 mm)

**Fastener:**

X-P\_P8

X-U\_P8

X-C

X-CR\_P8

X-CRM\_P8

**Piston:**

X-6-5-P8

**Fastener guide:**

X-5-460-F8GR

Grating fastener guide

**Fastener:**

X-GR

X-PGR-RU

X-ST\_M8\_P8

X-EM 8H

**Piston:**

X-6-5-PGR

**Fastener guide:**

X-5-460-F8S12

S12 fastener guide

**Fastener:**

X-U\_S12

**Piston:**

X-6-5-P8

**Fastener guide:**

X-5-460-F8SS

8 mm stop spall fastener  
guide

**Fastener:**

X-M6-\_- \_FP8

X-W6-\_- \_FP8

X-F7-\_- \_FP8

X-M8-\_- \_P8

**Piston:**

X-6-5-P8

**Fastener guide:**

X-5-460-F10

**Fastener:**

M10 (possible)

**Piston:**

X-6-5-P10

**Fastener guide:**

X-5-460-F10SS

10 mm stop spall fastener  
guide

**Fastener:**

M10 (possible)

**Piston:**

X-6-5-P10

**Fastener guide:**

X-5-460-FIE-XL

**Fastener:**

X-IE

Insulation fastener

**Piston:**

X-6-5-PIE-XL

**DX 460-SM** Powder-actuated tool for fastening metal decks**Fastener:**

X-EDNK22-THQ12M

X-EDN19-THQ12M

X-HSN 24

**Piston:**

X-5-460-PSM

**Cartridges:**

6.8/11M –

black, red, yellow

**DX 5 MX** Digitally enabled powder-actuated tool for fastening collated nails

**Fastener:**

---

X-P\_MX

---

X-U\_MX

---

X-C\_MX

---

X-CT\_MX

---

X-ET\_MX

---

X-ECT\_MX

---

X-EKS\_MX

---

X-FB\_MX

---

X-FS\_MX

---

X-SW\_MX

---

X-HS\_MX

---

X-CC\_MX

---

X-HS-W\_MX

---

X-EKB\_MX

**Piston:**

---

X-6-5-P8

---

X-6-5-P8W

---

for fastening wood

**Cartridges:**

---

6.8/11M -

---

black, red, yellow, green

**DX 5 F8** Digitally enabled powder-actuated tool for fastening single nails

**Fastener:**

---

X-U\_P8 / P8 TH

---

X-C\_P8

---

X-CR\_P8/ P8S12

---

X-CR M8

---

X-R\_P8

---

X-ST-GR M8\_P8

---

X-CT\_DP8

---

X-FS, X-SW

---

X-FB

---

X-EM6H/EW6H-\_-FP8

---

X-EF7H/-\_-FP8

---

X-M6/W6-\_-FP8

---

X-EM8H-\_-P8

---

X-M8-\_-P8

---

X-HS, X-CC

---

X-HS-W\_P8

**Piston:**

---

X-6-5-P8

---

X-6-5-P8W

---

for fastening wood

**Cartridges:**

---

6.8/11M -

---

black, red, yellow, green

**DX-Kwik method:**

pre-drilling into concrete

**Fastener:**

X-M6H-\_-37 FP8

X-M8H-\_37 P8

X-CRM8-\_42

**Piston:**

X-6-5-Pkwik

**Fastener:**

X-DNH 37 P8S15

X-DKH 48 P8S15

**Piston:**

X-6-5-P8

**Fastener guide:**

X-5-460-F8N15

 Narrow access fastener  
guide

(∅ 15.2 mm×53.2 mm)

**Fastener:**

X-P\_P8

X-C

X-CR\_P8

X-CRM\_P8

X-ST-GR M8\_P8

**Piston:**

X-6-5-P8

**Fastener guide:**

X-5-460-F8N10

 Narrow access fastener  
guide

(b×d×L 10.4×25.9×50 mm)

**Fastener:**

X-P\_P8

X-U\_P8

X-C

X-CR\_P8

X-CRM\_P8

**Piston:**

X-6-5-P8

**Fastener guide:**

X-5-460-F8GR

Grating fastener guide

**Fastener:**

X-GR

X-PGR-RU

X-EM 8H

**Piston:**

X-6-5-PGR

**Fastener guide:**

X-5-460-F8S12

S12 fastener guide

**Fastener:**

X-U\_S12

**Piston:**

X-6-5-P8

**Fastener guide:**

X-5-460-F8SS

8 mm stop spall fastener  
guide

**Fastener:**

X-M6-\_- \_FP8

X-W6-\_- \_FP8

X-F7-\_- \_FP8

X-M8-\_- \_P8

**Piston:**

X-6-5-P8

**Fastener guide:**

X-5-460-F10

**Fastener:**

M10 (possible)

**Piston:**

X-6-5-P10

**Fastener guide:**

X-5-460-F10

10 mm stop spall fastener  
guide

**Fastener:**

M10 (possible)

**Piston:**

X-6-5-P10

**Fastener guide:**

X-5-460-FIE-XL

**Fastener:**

X-IE

Insulation fastener

**Piston:**

X-6-5-PIE-XL

**DX 5 IE** Powder-actuated tool for fastening insulation

**Fastener:**  
X-IE  
insulation fasteners

**Piston:**  
X-6-5-PIE-XL

**Cartridges:**  
6.8/11M –  
red, yellow, green

**DX 5 GR** Powder-actuated tool for fastening gratings

**Fastener:**  
X-GR  
X-PGR-RU  
X-EM 8H

**Piston:**  
X-6-5-PGR

**Cartridges:**  
6.8/11M –  
black, red

**DX 5 SM** Powder-actuated tool for fastening metal decks

**Fastener:**  
X-EDNK22-THQ12M  
X-EDN19-THQ12M  
X-HSN 24

**Piston:**  
X-5-460-PSM

**Cartridges:**  
6.8/11M –  
black, red, yellow

**DX 5 F10** Powder-actuated tool for fastening W10 threaded studs

**Fastener:**  
DS\_P10  
X-EM8H-15-12 FP10  
X-EM10H-24-12 P10

**Piston:**  
X-6-5-P10

**Cartridges:**  
6.8/11M –  
black, red, yellow, green

**DX76 PTR Powder-actuated tool for fastening metal decks with collated nails**

**Fastener:**  
 X-ENP-19 L15 MX

**Piston:**  
 X-76-P-ENP-PTR

**Piston brake:**  
 X-76-PB-PTR

**Cartridges:**  
 6.8/18M – black, red, blue

**Fastener:**  
 X-ENP2K-20 L15 MX

**Piston:**  
 X-76-P-ENP2K-PTR

**Piston brake:**  
 X-76-PB-PTR

**Cartridges:**  
 6.8/18M – red, blue, green

**DX76 PTR Powder-actuated tool for fastening metal decks with single nails**

**Fastener:**  
 X-ENP-19 L15

**Piston:**  
 X-76-P-ENP-PTR

**Fastener guide:**  
 X-76-F-15-PTR

**Piston brake:**  
 X-76-PB-PTR

**Cartridges:**  
 6.8/18M – black, red, blue

**Fastener:**  
 X-ENP2K-20 L15

**Piston:**  
 X-76-P-ENP2K-PTR

**Fastener guide:**  
 X-76-F-15-PTR

**Piston brake:**  
 X-76-PB-PTR

**Cartridges:**  
 6.8/18M – red, blue, green



**DX 76 PTR** Powder-actuated tool for fastening metal decks on concrete – DX-Kwik

**Fastener:**

NPH2-42 L15

**Piston:**

X-76-P-Kwik-PTR

**Fastener guide:**

X-76-F-Kwik-PTR

**Piston brake:**

X-76-PB-PTR

**Cartridges:**

6.8/18M – blue, yellow

**DX 76 PTR** Powder-actuated tool for fastening HVB shear connectors

**Fastener:**

X-ENP-21 HVB

**Piston:**

X-76-P-HVB-PTR

**Connector:**

X-HVB shear connectors

**Piston stop:**

X-76-PS

**Fastener guide:**

X-76-F-HVB-PTR

**Cartridges:**

6.8/18M – black, red



**DX 76 PTR** Powder-actuated tool for fastening gratings and checker plates

**Grating fastener:**

---

X-CRM8-15-12 P8

---

X-EM8H\_P8

---

X-ST-GR M8\_P8

**Chequer plate fastener**

---

X-CRM8-15-12 P8

---

X-CRM8-9-12 P8

---

X-ST-GR M8\_P8

**Fastener guide:**

---

X-76-F-8-GR-PTR

---

(Δ 19 mm×58 mm)

**Piston:**

---

X-76-P-8-GR-PTR

**Piston brake:**

---

X-76-PB-PTR

**Cartridges:**

---

6.8/18M –

---

blue, yellow

---

For X-GR and X-GRRU:

---

red, blue, yellow

**DX 76 PTR** Powder-actuated tool for fastening heavy duty applications

**Fastener:**

---

EDS19 – 22 P10

---

X-EM10H-24-12 P10

---

X-EM8H-15-12 FP10

---

X-CR M8-15-12 FP10

---

X-CR M8-9-12 FP10

---

DS27 – 37 P10

**Fastener guide:**

---

X-76-F-10-PTR

---

(Δ 19 mm×58 mm)

**Piston:**

---

X-76-P-10-PTR

**Piston brake:**

---

X-76-PB-PTR

**Cartridges:**

---

6.8/18M –

---

black, red, blue

**DX 76 MX** Powder-actuated tool for fastening metal decks with collated nails

**Fastener:**  
 X-ENP-19 L15 MX

**Piston:**  
 X-76-P-ENP

**Cartridges:**  
 6.8/18M – black, red, blue

**Fastener:**  
 X-ENP2K-20 L15 MX

**Piston:**  
 X-76-P-ENP2K

**Cartridges:**  
 6.8/18M –  
 red, blue, yellow, green

**DX 76** Powder-actuated tool for fastening metal decks with single nails

**Fastener:**  
 X-ENP-19 L15

**Piston:**  
 X-76-P-ENP

**Fastener guide:**  
 X-76-F-15

**Cartridges:**  
 6.8/18M – black, red, blue

**Fastener:**  
 X-ENP2K-20 L15

**Piston:**  
 X-76-P-ENP2K

**Fastener guide:**  
 X-76-F-15

**Cartridges:**  
 6.8/18M –  
 red, blue, yellow, green

**DX 76 Powder-actuated tool for fastening metal decks on concrete – DX-Kwik**

**Fastener:**

NPH2-42 L15

**Piston:**

X-76-P-Kwik

**Fastener guide:**

X-76-F-Kwik

**Cartridges:**

6.8/18M – blue, yellow

**DX 76 Powder-actuated tool for fastening HVB shear connectors**

**Fastener:**

X-ENP-21 HVB

**Piston:**

X-76-P-HVB

**Connector:**

X-HVB shear connectors

**Piston Stop:**

X-76-PS

**Fastener guide:**

X-76-F-HVB

**Cartridges:**

6.8/18M – black, red



**DX 76 Powder-actuated tool for fastening gratings and checker plates**

**Grating fastener:**

X-CRM8-15-12 FP10

X-EM8-15-12 FP10

**Checker plate fastener**

X-CRM8-15-12 FP10

X-CRM8-9-12 FP10

**Fastener guide:**

X-76-F-10

**Piston:**

X-76-P-GR

**Cartridges:**

6.8/18M –  
black, red, blue, yellow,  
green

**DX 76 Powder-actuated tool for fastening heavy duty applications**

**Fastener: (for nail)**

EDS 19 – 27 P10

**Fastener: (for stud)**

X-EM10-24-14 P10

**Fastener guide:**

X-76-F-10

for nails and studs

**Piston: (for nail)**

X-76-P-10

**Piston: (for stud)**

X-76-P-GR

**Cartridges:**

6.8/18M –  
black, red, blue, yellow,  
green



**DX 860-ENP Powder-actuated tool for fastening metal decks**

<b>Fastener:</b>
X-ENP-19 L15 MXR

<b>Piston:</b>
X-76-P-ENP

<b>Cartridges:</b>
6.8/18M40 – black, red, blue

**DX 860-HSN Powder-actuated tool for fastening metal decks**

<b>Fastener:</b>
X-EDNK22-THQ12M
X-EDN19-THQ12M
X-HSN 24

<b>Piston:</b>
X-860-P10

<b>Cartridges:</b>
6.8/11M40 – black, red, yellow

**DX 9-ENP** Digitally enabled powder-actuated tool for fastening metal decks

<b>Fastener:</b>
X-ENP-19 L15 MXR

<b>Piston:</b>
Piston X-9-ENP kit

<b>Nail Magazine:</b>
MX 9 - ENP packed

<b>Cartridges:</b>
6.8/18M40 – black, red, blue

**DX 9-HSN** Digitally enabled powder-actuated tool for fastening metal decks

<b>Fastener:</b>
X-EDNK22-THQ12M
X-EDN19-THQ12M
X-HSN 24

<b>Piston:</b>
X-9-HSN kit

<b>Nail Magazine:</b>
MX 9 - HSN packed

<b>Cartridges:</b>
6.8/11M40 – black, red, yellow

## Cartridges – Propellants for powder-actuated tools

### Cartridge 6.8/11M10 and 6.8/11M40<sup>1</sup> (.27 caliber short)



Color code*	Power level**	Fastening tools:			
		DX 36, DX 2	DX 460 DX 5	DX 351	DX 860-HSN <sup>1</sup> DX 9-HSN <sup>1</sup>
High precision brown	2 [2]	no	no	4	no
white [brown]	2 [2]	no	no	4	no
green	3 [3]	4	4	4	no
yellow	4 [4]	4	4	4	4
red	6 [5]	4	4	4	4
black [purple]	7 [6]	no	4	no	4

### Cartridge 6.8/18M10 (.27 caliber long)



Color code*	Power level**	Fastening tools:
		DX 76 / DX 76 PTR
green	3	4
yellow	4	4
blue	5 [4.5]	4
red	6 [5]	4
black [purple]	7 [6]	4

### Cartridge 6.8/18M40 (.27 caliber long)



Color code*	Power level**	Fastening tools:
		DX 860-ENP, DX 9-ENP
blue	5 [4.5]	4
red	6 [5]	4
black [purple]	7 [6]	4

### 6.8/18 (.27 caliber long)<sup>1</sup>



Color code*	Power level**	Fastening tools:
		DX 600N <sup>1</sup>
green	3	4
yellow	4	4
red	5	4
black [purple]	7 [6]	4

\* Color code according to EN16264, in brackets e.g. [purple] according to PATMI (USA and Canada)

\*\* Power level as used on Hilti packaging. Without brackets refers to level used in Europe, in brackets e.g. [6] refers to number according to PATMI and as used in USA and Canada.

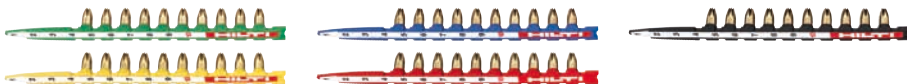

The Clean-Tec cartridges is Hilti's line of environmentally-friendly heavy metal free cartridges. All cartridges are available as Clean Tec except for 6.8/18 (.27 calibre long) for DX 600N tool.



## Gas-actuated tool

### GX 90 WF Gas-actuated tool for wood framing



#### Fastener:

- GX-WF\_
- smooth bright MX 34
- GX-WF\_
- profiled bright MX 34
- GX-WF\_
- smooth galvanized MX 34
- GX-WF\_
- profiled galvanized MX 34
- GX-WF\_
- smooth HDG MX 34
- GX-WF\_
- profiled HDG MX 34
- GX-WF\_
- profiled A2 stainless D-head

- GX-WF\_
- profiled A2 stainless full round head
- GX-WF\_
- profiled A4 stainless D-head
- GX-WF\_
- profiled A4 stainless full round head

#### Energy:

- GC 32



**GX 120 Gas-actuated tool for interior finishing applications**

**Fastener:**

X-EGN 14 MX  
 X-GHP 16 MX  
 X-GHP 17 MX  
 X-GHP 20 MX  
 X-GHP 24 MX  
 X-GN 20 MX  
 X-GN 27 MX  
 X-GN 32 MX  
 X-GN 39 MX

**Energy:**

GC20. GC 21 and GC 22

**GX 120-ME Gas-actuated tool for mechanical and electrical applications**

**Fastener:**

X-EGN 14 MX  
 X-GHP 16 MX  
 X-GHP 17 MX  
 X-GHP 20 MX  
 X-GHP 24 MX  
 X-GN 20 MX  
 X-GN 27 MX  
 X-GN 32 MX  
 X-GN 39 MX  
 X-EHS MX  
 X-ECC MX  
 X-HS-W MX  
 X-EKB MX  
 X-FB MX  
 X-DFB MX  
 X-ECT MX  
 X-ET MX  
 X-EKS MX  
 X-EMTSC  
 X-G M6/W6  
 X-UCT MX  
 X-SW 30, X-SW 60

**Energy:**

GC20. GC 21 and GC 22



**GX 3** Gas-actuated tool for interior finishing and building construction applications



**Fastener:**

- X-S 14 G3 MX
- X-P 17 G3 MX
- X-P 20 G3 MX
- X-P 24 G3 MX
- X-C 20 G3 MX
- X-C 27 G3 MX
- X-C 32 G3 MX
- X-C 39 G3 MX
- X-M6-7-14 G3 P7
- X-M6-7-24 G3 P7
- X-W6-12-20 G3 P7
- X-W6-12-14 G3 P7

**Energy:**

GC42 for international



GC41 for use in  
North America

GC40 for use in Japan

**GX 3-ME** Gas-actuated tool for mechanical and electrical applications



**Fastener:**

- X-S 14 G3 MX
- X-P 17 G3 MX
- X-P 20 G3 MX
- X-P 24 G3 MX
- X-C 20 G3 MX
- X-C 27 G3 MX
- X-C 32 G3 MX
- X-C 39 G3 MX
- X-M6-7-14 G3 P7
- X-M6-7-24 G3 P7
- X-W6-12-20 G3 P7
- X-W6-12-14 G3 P7

**Energy:**

GC42 for international



GC41 for use in  
North America

GC40 for use in Japan

**GX 2** Gas-actuated tool for interior finishing and building construction applications

**Fastener:**

X-P 14 G2 MX
X-P 17 G2 MX
X-P 20 G2 MX
X-C 20 G2 MX
X-C 27 G2 MX
X-C 32 G2 MX
X-C 39 G2 MX

**Energy:**

GC52
------



## Gas cans

The table below provides an overview of the main Hilti gas cans and their characteristics.

Model	Number of fastenings per can	Temperature range		Fuel gauge	Tool to be used with
GC 21	750	-5°C - +50°C		Yes	GX 120
GC 22	750	-10°C - +50°C		Yes	GX 120
GC 32	1000	-10°C - +50°C		No	GX 90 - WF
GC 42	1200	-10°C - +50°C		Yes	GX 3
GC 52	1100	-10°C - +50°C		Yes	GX 2

Note: The models sold in North America and Japan have slightly different characteristics.

## Battery-actuated tool

**BX 3-BT** Battery-actuated tool for multi-purpose and electrical connection applications



### Fastener:

X-BT-MR M6/10 SN 8  
 X-BT-MR W6/10 SN 8  
 X-BT-MR M8/14 N 8  
 X-BT-MR M10/15 SN 8  
 X-BT-MR W10/15 SN 8  
 X-BT-ER M6/3 SN 8  
 X-BT-ER W6/3 SN 8  
 X-BT-ER M8/7 SN 8  
 X-BT-ER M10/7 SN 8  
 X-BT-ER W10/7 SN 8  
 X-BT M10-24-6 SN12-R  
 X-BT M10-24-6-R  
 X-BT W10-24-6 SN12-R  
 X-BT W10-24-6-R  
 X-BT-ER M10/3 SN4  
 X-BT-ER W10/3 SN4  
 X-BT-ER M8/7 SN4

### Energy:

Battery

### Fastener Guide:

X-FG B3-BT M (M6/M8/M10)  
 X-FG B3-BT W (W6/W10)

**BX 3-BTG** Battery-actuated tool for fastening gratings



### Fastener:

X-BT-GR M8/7 SN 8  
 X-BT M8-15-6 SN12-R

### Energy:

Battery

### Fastener Guide:

X-FG B3-BTG (M8 short)

**BX 3-IF** Battery-actuated tool for interior finishing and building construction applications

**Fastener:**

- X-S 14 B3 MX
- X-P 17 B3 MX
- X-P 20 B3 MX
- X-P 24 B3 MX
- X-C 20 B3 MX
- X-C 24 B3 MX
- X-C 30 B3 P7
- X-C 36 B3 P7
- X-M6-7-14 B3 P7
- X-M6-7-24 B3 P7
- X-W6-12-20 B3 P7
- X-W6-12-14 B3 P7

**Energy:**

Battery

**BX 3-ME** Battery-actuated tool for mechanical and electrical applications

**Fastener:**

- X-S 14 B3 MX
- X-P 17 B3 MX
- X-P 20 B3 MX
- X-P 24 B3 MX
- X-P 30 B3 P7
- X-P 36 B3 P7
- X-C 20 B3 MX
- X-C 24 B3 MX
- X-M6-7-24 B3 P7
- X-M6-7-14 B3 P7
- X-W6-12-20 B3 P7
- X-W6-12-14 B3 P7
- X-EHS MX
- X-ECC MC
- X-HS-W MX
- X-EKB MX

- X-FB MX
- X-DFB MX
- X-ECT MX
- X-ET MX
- X-EKS MX
- X-EMTSC MC
- X-ECH MX
- X-UCT MX
- X-DHS MX
- X-ECH FE MX
- X-EKB FE MX
- X-SW MX

**Energy:**

Battery

**BX 3 02** Battery-actuated tool for mechanical and electrical applications

**Fastener:**

X-S 14 B3 MX  
 X-P 17 B3 MX  
 X-P 20 B3 MX  
 X-P 24 B3 MX  
 X-C 20 B3 MX  
 X-C 24 B3 MX  
 X-C 30 B3 MX  
 X-EHS MX  
 X-ECC MC  
 X-HS-W MX  
 X-EKB MX  
 X-FB MX  
 X-DFB MX

X-ECT MX

X-ET MX

X-EKS MX

X-EMTSC MC

X-ECH MX

X-UCT MX

X-DHS MX

X-ECH FE MX

X-EKB FE MX

X-SW MX

**Energy:**

Battery

**BX 3-L 02** Battery-actuated tool for interior finishing, mechanical and electrical and building construction applications

**Fastener:**

X-S 14 B3 MX  
 X-P 17 B3 MX  
 X-P 20 B3 MX  
 X-P 24 B3 MX  
 X-C 20 B3 MX  
 X-C 24 B3 MX  
 X-C 30 B3 MX  
 X-C 36 B3 MX  
 X-EHS MX  
 X-ECC MC  
 X-HS-W MX  
 X-EKB MX  
 X-FB MX  
 X-DFB MX  
 X-ECT MX  
 X-ET MX

X-EKS MX

X-EMTSC MC

X-ECH MX

X-UCT MX

X-DHS MX

X-ECH FE MX

X-EKB FE MX

X-SW MX

**Energy:**

Battery





**Part 4:**

## **Fasteners**



# X-ENP Siding and decking nail

## Product data

### Dimensions

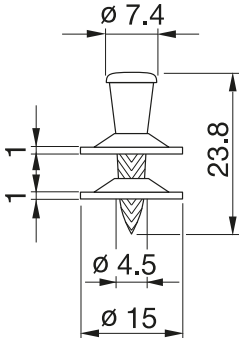

### General information

#### Material specifications

Carbon steel shank:	HRC 58
Zinc coating:	8–16 µm

#### Recommended fastening tools

DX 76 F15, DX 76 PTR with X-76-F15-PTR fastener guide	Single nail: X-ENP-19 L15
DX 76 MX, DX 76 PTR	Collated nails: X-ENP-19 L15 MX, white magazine strip
DX 860-ENP DX 9-ENP	X-ENP-19 L15 MXR, grey magazine strip

See **Tools and equipment** for more details.

### Approvals

ETA-04/0101 (Hilti-DX-DoP001), UL R13203, FM 3021719, ICC ESR-2197, ESR-2776 (USA), MLIT (Japan), ABS, LR 97/00077

## Applications

### Examples

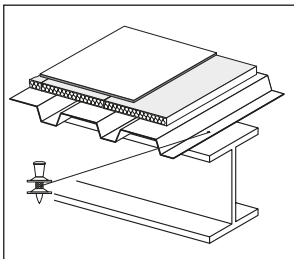

Roof decking

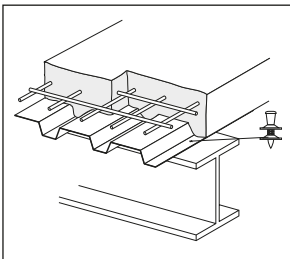

Floor decking

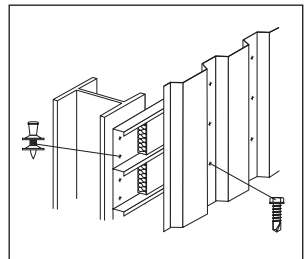

Wall liners

The intended use only comprises fastenings which are not directly exposed to external weather conditions or moist atmospheres. For out-door applications, that can be ensured by using SDK2 sealing caps. During construction exposure to external atmosphere must not exceed 6 months. Fastening of aluminum sheeting is generally recommended only for indoor conditions.

## Load data

### Characteristic loads – steel sheeting

Sheeting thickness $t_f$ [mm]	Trapezoidal profile (symmetric loading)		Liner trays <sup>1)</sup> (asymmetric loading)	
	Char. resistance according to ETA-04/0101		Char. resistance keeping to ETA-04/0101	
nominal	Shear $V_{Rk}$ [kN]	Tension $N_{Rk}$ [kN]	Shear $V_{Rk}$ [kN]	Tension $N_{Rk}$ [kN]
0.75	4.70	6.30	3.30	4.40
0.88	5.40	7.20	3.80	5.00
1.00	6.00	8.00	4.20	5.60
1.13	7.00	8.40	4.90	5.90
1.25	8.00	8.80	5.60	6.20
1.50	8.60	8.80	6.00	6.20
1.75	8.60	8.80	6.00	6.20
2.00	8.60	8.80	6.00	6.20
2.50	8.60	8.80	6.00	6.20

•  $N_{Rk}$  and  $V_{Rk}$  are valid for steel sheet with minimum tensile strength  $\geq 360$  N/mm<sup>2</sup> ( $\geq$  S280 EN 10346).

• For intermediate sheet thicknesses, use recommended load for next smaller thickness or linear interpolation.

1) Required load reduction is taken into account in accordance with EN 1993-1-3: 2006, section 8.3 (7) and fig. 8.2. See also construction rules under spacings and edge distances.

### Recommended loads – steel sheeting

Sheeting thickness $t_f$ [mm]	Trapezoidal profile (symmetric loading)		Liner trays <sup>1)</sup> (asymmetric loading)	
	Recommended loads		Recommended loads	
nominal	Shear $V_{rec}$ [kN]	Tension $N_{rec}$ [kN]	Shear $V_{rec}$ [kN]	Tension $N_{rec}$ [kN]
0.75	2.50	3.35	1.75	2.35
0.88	2.90	3.85	2.00	2.70
1.00	3.20	4.25	2.25	3.00
1.13	3.75	4.50	2.65	3.15
1.25	4.25	4.70	3.00	3.30
1.50	4.60	4.70	3.20	3.30
1.75	4.60	4.70	3.20	3.30
2.00	4.60	4.70	3.20	3.30
2.50	4.60	4.70	3.20	3.30

•  $N_{rec}$  and  $V_{rec}$  are valid for steel sheet with minimum tensile strength  $\geq 360$  N/mm<sup>2</sup> ( $\geq$  S280 EN 10346).

• For intermediate sheet thicknesses, use recommended load for next smaller thickness or linear interpolation.

• Recommended loads  $N_{rec}$  and  $V_{rec}$  are appropriate for Eurocode 1 wind loading design with a partial safety factor  $\gamma_F = 1.5$  for wind load and a partial resistance factor  $\gamma_M = 1.25$  for the fastening.

1) Required load reduction is taken into account in accordance with EN 1993-1-3: 2006, section 8.3 (7) and fig. 8.2. See also construction rules under spacings and edge distances.

**Recommended loads – aluminum sheeting<sup>1)</sup> with  $f_u \geq 210 \text{ N/mm}^2$** 

Trapezoidal profile (symmetric loading)

Thickness $t_f$ [mm]	Shear $V_{rec}$ [kN]	Tension $N_{rec}$ [kN]
0.60	0.75	0.35
0.70	0.90	0.50
0.80	1.00	0.65
0.90	1.20	0.80
1.00	1.30	0.95
1.20	1.55	1.30
1.50	1.85	1.45
2.00	2.55	1.90

- 1) Only recommended for indoor applications. Constraint forces and corrosion aspects have to be considered.
- For intermediate sheet thicknesses, use recommended load for next smaller thickness.
  - Recommended loads  $N_{rec}$  and  $V_{rec}$  are appropriate for Eurocode 1 wind loading design with a partial safety factor of  $\gamma_F = 1.5$  for wind load and a partial resistance factor  $\gamma_M = 1.25$  for the fastening.

**Recommended loads – other applications**

	$V_{rec}$ [kN]	$N_{rec}$ [kN]
	4.6	2.4

- **Fastened parts:** clips, brackets, etc.; thick steel parts ( $t_{i,max} = 2.5 \text{ mm}$ ).
- Redundancy (multiple fastening) must be provided.
- The possibility of prying effects has to be considered
- Failure of the fastened part is not considered in these values of  $N_{rec}$ ,  $V_{rec}$ .
- Valid for predominantly static loading
- Global factor of safety is  $\geq 2$  based on 5% fracture value

**Design**

Depending on the verification concept, the corresponding design criteria are given as following.

Working load concept	Partial safety concept
Tensile loads $N_{Sk} \leq N_{rec}$	$N_{Sd} \leq N_{Rd}$
Shear loads $V_{Sk} \leq V_{rec}$	$V_{Sd} \leq V_{Rd}$

**N-V Interaction**

For combined tensile and shear forces on the fastener, a linear function has to be used.

$$\left( \frac{V_{Sk}}{V_{rec}} \right) + \left( \frac{N_{Sk}}{N_{rec}} \right) \leq 1$$

with:

 $V_{Sk}$ ,  $N_{Sk}$  unfactored characteristic load acting on the fastening (= working load)

 $V_{rec}$ ,  $N_{rec}$  recommended (allowable) load with  $\gamma_{LOB} = 1.875$ 

$$\left( \frac{V_{Sd}}{V_{Rd}} \right) + \left( \frac{N_{Sd}}{N_{Rd}} \right) \leq 1$$

with:

 $V_{Sd}$ ,  $N_{Sd}$  Design load with  $\gamma_F = 1.5$ 
 $V_{Rd}$ ,  $N_{Rd}$  Design resistance of the fastening with  $\gamma_M = 1.25$ 
 $V_{Rd} = V_{Rk} / 1.25$ 
 $N_{Rd} = \alpha_{cycl} N_{Rk} / 1.25$ 
 $\alpha_{cycl} = 1.0$  according to ETA-04/0101

## Application requirements

### Thickness of base material

Steel thickness  $t_{II}$

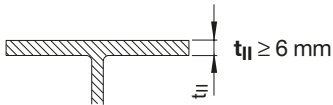

### Thickness of fastened material

$\Sigma t_{i, tot} \leq 4.0 \text{ mm}$

Sheet thicknesses and overlap types

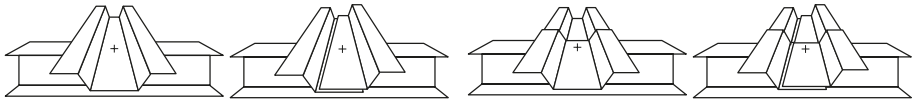

**(a)**  
single

**(b)**  
side lap

**(c)**  
end overlap

**(d)**  
side lap and end overlap

Nominal sheeting thickness  $t_i$  [mm]

Allowable overlap types

0.63–1.00

a, b, c, d

> 1.00–1.25

a, c

> 1.25–2.50

a

With the above recommended sheet thickness and overlap types, it is not necessary to take into account the effect of constraints due to temperature for steel grades up to S320 (EN 10346). For steel grade S350 (EN 10346) it shall be considered for design. Sheets of grade S350 on base material  $t_{II} \geq 8 \text{ mm}$  have been verified by Hilti, forces of constraint can be neglected.

## Spacing and edge distances (mm)

### Steel base material



### Trapezoidal profiles

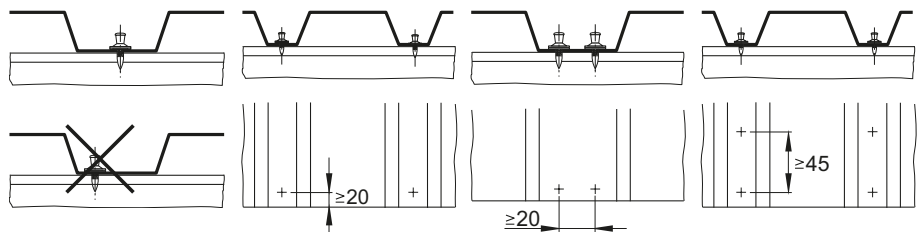

**Centre fastenings in ribs**

**Clearance to end of sheet**

**Double fastenings (asymmetric)**  
 Note:  
 Reduce tensile resistance per fastener to  $0.7 N_{Rk}$  or  $0.7 N_{rec}$ .

### Liner trays

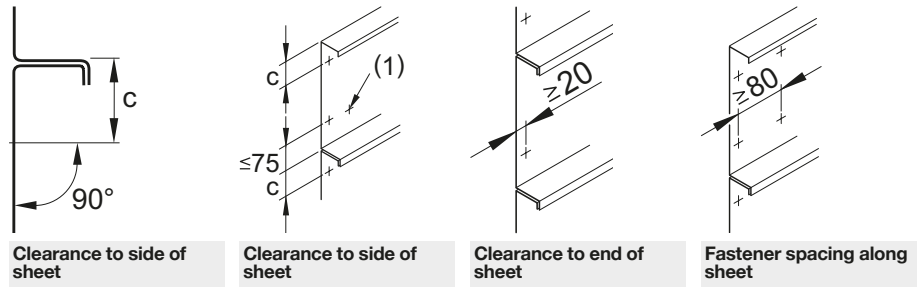

**Clearance to side of sheet**

**Clearance to side of sheet**

**Clearance to end of sheet**

**Fastener spacing along sheet**

When driving the fastener, the fastening tool needs to be positioned perpendicular to the surface.  
 If  $c > 75$  mm, it is recommended to drive an additional fastener at the other side of the tray. This additional fastener is indicated with (1) in the graph above.

## Corrosion information

The intended use only comprises fastenings which are not directly exposed to external weather conditions or moist atmospheres. For outdoor applications that can be ensured by using **SDK 2** sealing caps. During construction exposure to external atmosphere must not exceed 6 months. Fastening of aluminum sheeting is generally recommended only for indoor conditions.

## Application limit

X-ENP-19 with DX 76, DX 76 PTR, DX 860-ENP and DX 9-ENP

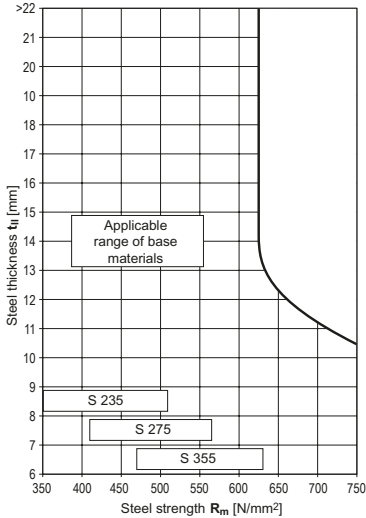

## Fastener selection and system recommendation

Fasteners			Tools	Fastener guide
	Designation	Item no.	Designation	Designation
Single nail:	X-ENP-19 L15	283506	DX 76 PTR DX 76 F15	X-76-F15-PTR
Collated nails:	X-ENP-19 L15 MX, white magazine strip	283507	DX 76 PTR DX 76 MX	
	X-ENP-19 L15 MXR, grey magazine strip	283508	DX 860-ENP	
Piston:	X-76-P-ENP-PTR		DX 76 PTR	
	X-76-P-ENP		DX 76 DX 860-ENP	
	X-9-ENP kit		DX 9-ENP	



### Cartridge selection and tool energy setting

#### DX 76, DX 860-ENP, DX 9-ENP

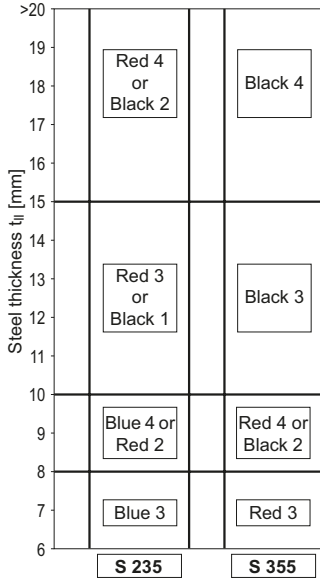

#### DX 76 PTR

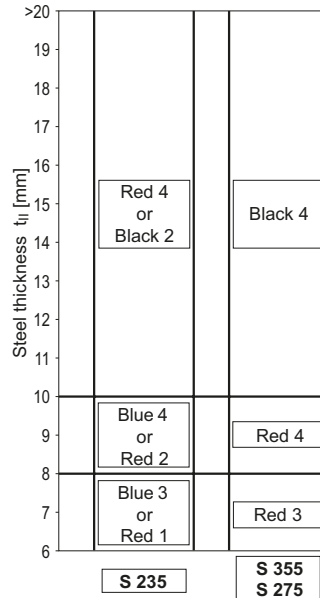

Fine adjustment by installation tests on site.

Note for S275:

Start with recommendation for S355. In case of too much energy: reduction of tool energy setting or change of cartridge colour till correct nail head stand-offs  $h_{NVS}$  are achieved.

## Fastening quality assurance

### Fastening inspection

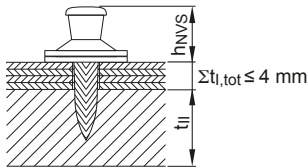

$h_{NVS} = 8.2-9.8 \text{ mm}$  for  $t_{i,tot} \leq 4 \text{ mm}$

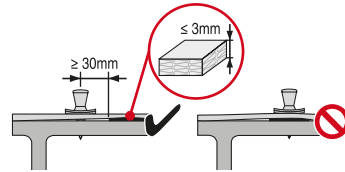

In order to allow the steel sheeting to be in direct contact with the steel supporting structure in the area of connections the X-ENP-19 fastener should be installed  $\geq 30\text{mm}$  away from the edges of insulation / isolation tapes that are  $\leq 3\text{mm}$  thick.

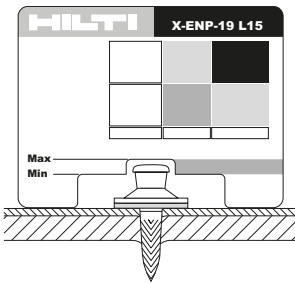

$h_{NVS} = 8.2-9.8 \text{ mm}$

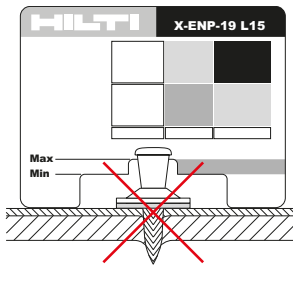

$h_{NVS} > 9.8 \text{ mm}$   
(washers are not compressed)

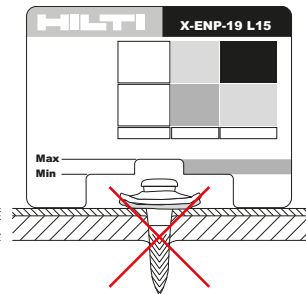

$h_{NVS} < 8.2 \text{ mm}$   
(washers are strongly damaged by the tool piston)



**Visible inspection:**  
Properly driven fastener.  
Piston mark clearly visible on the washer.

# SDK2, PDK2 Sealing cap for cladding fastening

## Product data

### Dimensions

#### SDK2 sealing cap

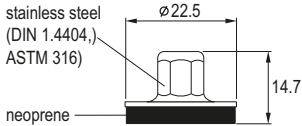

#### PDK2

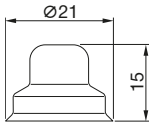

### General information

Compatible DX fasteners

X-ENP-19 L15

Base material thickness  $t_{II} \geq 6$  mm

### Fastening tool

SW/SDK2 setting tool **SDK2**

SW/PDK2 setting tool **PDK2**

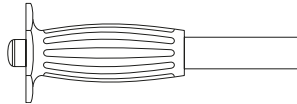

## Applications

### Examples

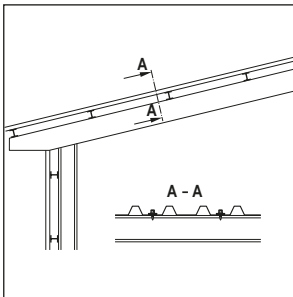

**Roof and wall cladding on single skin buildings**

#### SDK2, stainless steel sealing cap for roof and wall cladding

Stainless steel cap for mildly corrosive environments (C3)

Space under the cap isolated from the atmosphere

Neoprene washer insulates against contact corrosion and seals the space under the cap-off from the atmosphere

Pressure on the washer seals the gap between the sheet and the base steel

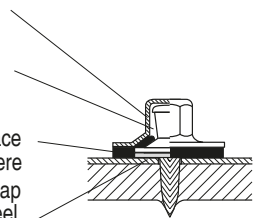

#### PDK2, plastic sealing cap for wall cladding

### Corrosion protection

**Fastening quality assurance**
**Fastening inspection**

For detailed information on X-ENP-19 L15 please see the according product pages.

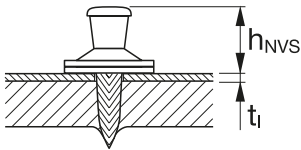
**X-ENP-19 L15**

Maximum thickness of single layer (type a):  
 $t_{i, \max} = 1.5 \text{ mm}$   
 Total thickness of end overlap (type c):  
 $\Sigma t_{i, \text{tot}} \leq 2.5 \text{ mm}$

 $h_{NVS} = 8.2\text{--}9.8 \text{ mm}$ 

Note:

It has to be ensured, that the fastened sheet is properly compressed to the base material and no gap remains at fastening point location.

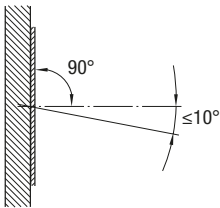
**Installation**

Position the DX tool so that nail inclination is limited to max.  $10^\circ$  from perpendicular to surface

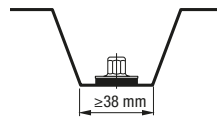
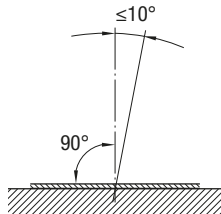

Centre fastening in valley.  
 38 mm min. valley width

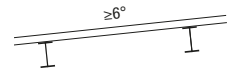

Minimum roof slope  $6^\circ$

These are abbreviated instructions which may vary by application.

**ALWAYS** review/follow the instructions accompanying the product.

# X-ENP 2K Siding and decking nail

## Product data

### Dimensions

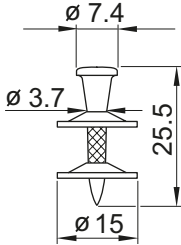

### General information

#### Material specifications

Carbon steel shank:	HRC 55.5
Zinc coating:	8–16 $\mu\text{m}$

#### Recommended fastening tools

	Single nail:
DX 76 PTR with X-76-F-15-PTR fastener guide	X-ENP 2K-20 L15
DX 76 MX with X-76-F-15 fastener guide	
	Collated nails:
DX 76 PTR	X-ENP 2K-20 L15 MX
DX 76 MX	(green magazine strip)

See **Tools and equipment** for more details.

### Approvals

BUtgb (Belgium), ABS, ETA 13/0172  
(Hilti-DX-DoP003),  
LR 97/00077



Note: technical data presented in these approvals and design guidelines reflect specific local conditions and may differ from those published in this handbook.

## Applications

### Examples

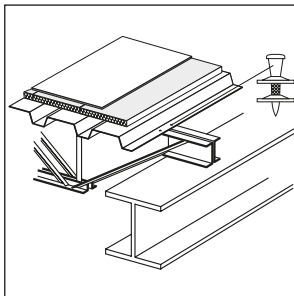

Roof and floor decking

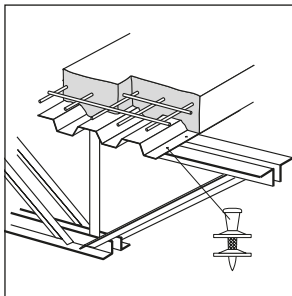

Roof and floor decking

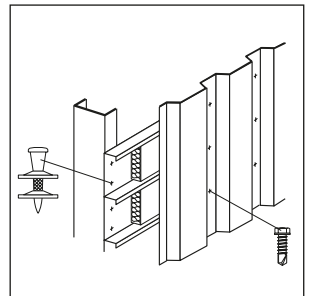

Wall liners

## Load data

### Characteristic loads

Overlap Sheeting thickness $t_l$ [mm]	$3 \text{ mm} \leq t_{ll} < 4 \text{ mm}$			$4 \text{ mm} \leq t_{ll} \leq 6 \text{ mm}$		
	$V_{Rk}$ [kN]	$N_{Rk}$ [kN]	Types of conn.	$V_{Rk}$ [kN]	$N_{Rk}$ [kN]	Types of conn.
0.75	4.70	6.00	a, c	4.70	6.30	a, b, c, d
0.88	5.40	6.00	a, c	5.40	7.20	a, (b)*, c, d
1.00	6.00	6.00	a, c	6.00	8.00	a, (b)*, c, d
1.13	–	–	–	7.00	8.40	a, c
1.25	–	–	–	8.00	8.80	a, c
1.50	–	–	–	8.60	8.80	a

\* Fastening type (b) covered for  $5 \text{ mm} \leq t_{ll} < 6 \text{ mm}$ , if  $N_{Rk}$  is reduced to 6.6 kN

Fastening type (b) fully covered for  $t_{ll} = 6 \text{ mm}$

For a, b, c, d please refer to **Application requirements, Sheet thicknesses and overlap types**

## Design

### Design shear and tension resistance $V_{Rd}$ and $N_{Rd}$

$$V_{Rd} = V_{Rk} / \gamma_M \quad N_{Rd} = \alpha_{cycl} N_{Rk} / \gamma_M \text{ with } \alpha_{cycl} = 1.0 \text{ for all sheeting thickness } t_l$$

$\alpha_{cycl}$  considers the effect of repeated wind loads

$\gamma_M = 1.25$  in the absence of national regulations

Characteristic tension resistances  $n_{Rk}$  [kN/m] and shear resistances  $v_{Rk}$  [kN/m] per unit length, taking the effect of thermal constraints into account

$N_{Rk}$  and  $V_{Rk}$  characteristic shear and tension resistance

w ... width of the panel sheet

$$n_{Rk} = 0.9 \cdot 2 \cdot N_{Rk} / w \quad v_{Rk} = 2 \cdot V_{Rk} / w$$

$$n_{Rk} = 0.9 \cdot 3 \cdot N_{Rk} / w \quad v_{Rk} = 3 \cdot V_{Rk} / w$$

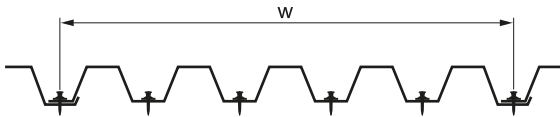

$$n_{Rk} = 0.9 \cdot 4 \cdot N_{Rk} / w \quad V_{Rk} = 4 \cdot V_{Rk} / w$$

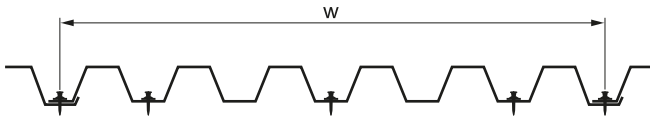

$$n_{Rk} = 0.9 \cdot 5 \cdot N_{Rk} / w \quad V_{Rk} = 5 \cdot V_{Rk} / w$$

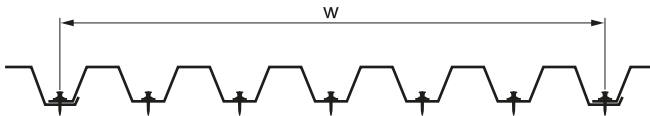

$$n_{Rk} = 3 \cdot N_{Rk} / w \quad V_{Rk} = 3 \cdot V_{Rk} / w$$

The same characteristic resistances can also be applied along supports at end-overlaps, if connection type “d” is not covered in the load table.

### Application requirements

#### Thickness of base material

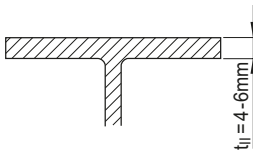

$t_{II} = 4.0 - 6.0$  mm for general shapes

**Fastening to cold-formed C- and Z-sections with a thickness from 2.9 to 4.0 mm**

**Fastening to U-shape concrete inlays with a nominal thickness  $t_{II}$  of 3 mm.**  
 $t_{II} = 3.0 \pm 0.3$  mm

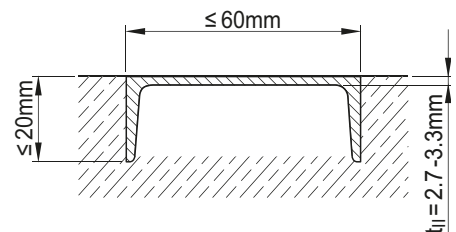
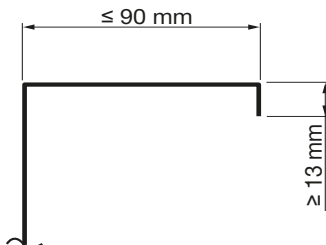

Grade:  $\geq$  S320 GD according to EN 10346

### Sheet thicknesses and overlap types

#### Type (a)

single

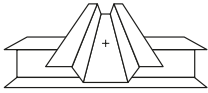

#### Type (b)

side lap

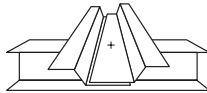

#### Type (c)

end overlap

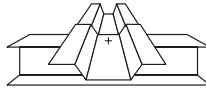

#### Type (d)

side lap and end overlap

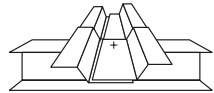

### Edge distances (mm)

#### Rolled I or wide flange shapes

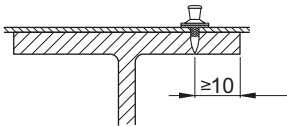

#### Angles

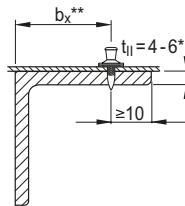

\* For  $t_{fl} = 3$  to  $4$  mm, restrictions on application. See approval or contact Hilti.

\*\* Maximum recommended  $b_x \leq 8 \times t_{fl}$  however, jobsite verification advisable.

#### Trapezoidal profiles

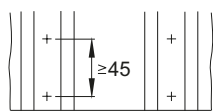
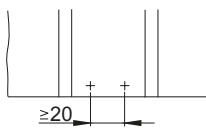
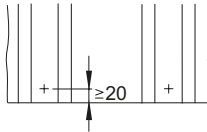
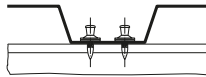
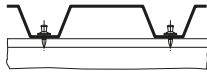
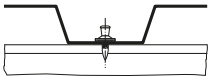

**Centre fastenings in ribs**

**Clearance to end of sheet**

**Double fastenings**

Note:  
Reduce tensile resistance per fastener to  $0.7 N_{Rk}$ .

### Corrosion information

The intended use only comprises fastenings which are not directly exposed to external weather conditions or moist atmospheres. For further detailed information on corrosion see corresponding chapter in **Direct Fastening Principles and Technique** section.



## Application limits

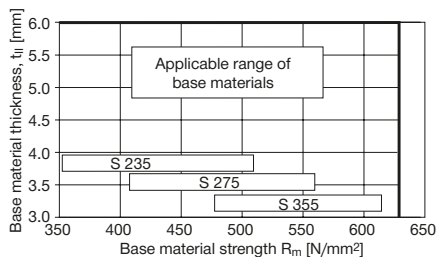

## Fastener selection and system recommendation

Fasteners			Tools	Fastener guide
	Designation	Item no.	Designation	Designation
Single nail:	X-ENP 2K-20 L15	385133	DX 76 PTR	X-76-F-15-PTR
			DX 76 MX	X-76-F-15
Collated nails:	X-ENP 2K-20 L15 MX	385134	DX 76 PTR	
			DX 76 MX	
Piston:	X-76-P-ENP2K-PTR		DX 76 PTR	
	X-76-P-ENP2K		DX 76 MX	

## Cartridge selection and tool energy setting

### DX 76 PTR

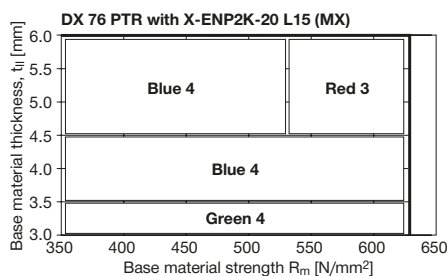

### DX 76

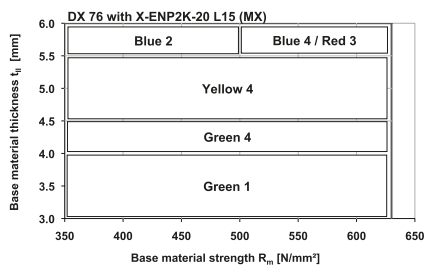

Fine adjustment by installation tests on site.

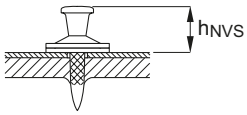
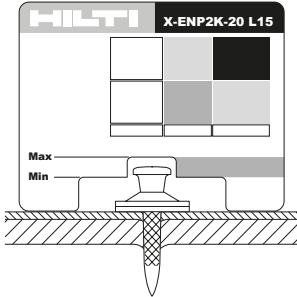
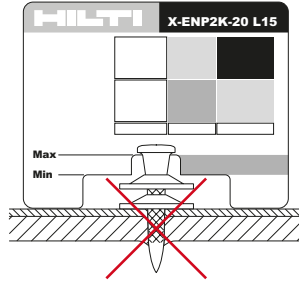
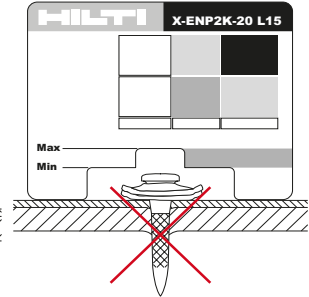
**Fastening quality assurance** $h_{NVS} = 7-11 \text{ mm}$  $h_{NVS} = 7-11 \text{ mm}$  $h_{NVS} > 11 \text{ mm}$  $h_{NVS} < 7 \text{ mm}$

# X-HSN 24 Diaphragm decking nail

## Product data

### Dimensions

#### X-HSN 24

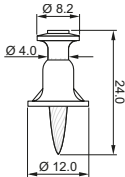

#### X-EDNK22 THQ12 M

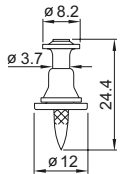

#### X-EDN19 THQ12 M

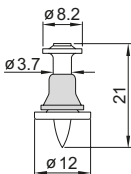

### General information

#### Material specifications

Carbon steel shank:	HRC 55.5
Zinc coating:	5–13 $\mu\text{m}$

#### Recommended fastening tool

DX 860-HSN	Collated nails:
DX 9-HSN	X-HSN 24, red magazine strip X-EDNK22 THQ12 M, grey magazine strip X-EDN19 THQ12 M, white magazine strip

See **Tools and equipment** for more details.

### Approvals

FM, SDI, UL, ICC, ABS, LR

#### Note:

Technical data presented in these approvals and design guidelines effect specific local conditions and may differ from those published in this handbook.

## Applications

### Examples

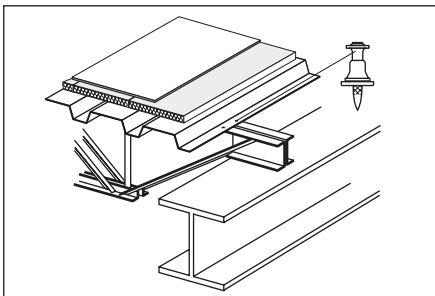

Roof decking (diaphragm design)

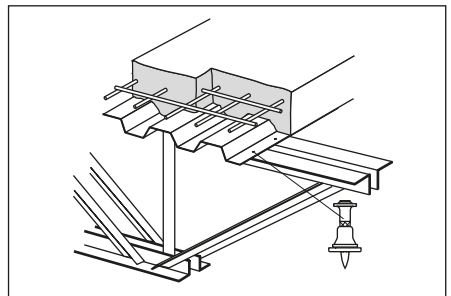

Floor decking (diaphragm design)

**Load data**
**Design data for use in the U.S.A.**
**Diaphragm strength**

Approvals provide load tables or calculation procedures for determination of the allowable strength (in lbs/ft or kN/m) of a steel deck diaphragm. The allowable diaphragm strength depends on the type, strength and thickness of the decking, the span of the decking, the type and pattern of the deck to frame fasteners (X-HSN24, X-EDNK22 or X-EDN19) and the type and spacing of the sidelap connectors (e.g. Hilti sidelap connectors S-SLC 01 and S-SLC 02).

For more details it is referred to the technical literature of Hilti North America (“Steel Deck Fastening Systems” Hilti North America Product Technical Guide) and the “Decking Design Center” offered on the website [www.us.hilti.com](http://www.us.hilti.com) as well as the respective approvals.

**Recommended shear bearing loads  $V_{rec}$** 

Sheeting thickness $t_f$		X-HSN24, X-EDNK22 and X-EDN19	
[Gauge]	[mm]	$V_{rec}$ [lbs]	[kN]
22	0.76	500	2.20
20	0.91	600	2.64
18	1.21	785	3.45
16	1.52	975	4.29

- Valid for steel sheet with a minimum tensile strength of 45 ksi (310 N/mm<sup>2</sup>). Values refer to failure controlled by the single sheet metal attached.
- For intermediate sheet thicknesses, linear interpolation is allowed.
- Recommended loads include safety factor 3.0 applied to mean shear resistance  $Q_f$ . An equation for  $Q_f$  is published in the SDI (Steel Deck Institute) Diaphragm Design Manual, 3<sup>rd</sup> edition.

**Recommended tension load  $N_{rec}$** 

Sheeting thickness $t_f$		X-HSN24, X-EDNK22		X-EDN19	
[Gauge]	[mm]	$N_{rec}$ [lbs]	[kN]	$N_{rec}$ [lbs]	[kN]
22	0.76	355	1.56	340	1.52
20	0.91	435	1.95	340	1.52
18	1.21	435	1.95	340	1.52
16	1.52	435	1.95	340	1.52

- Valid for steel sheet with minimum tensile strength of 45 ksi (310 N/mm<sup>2</sup>). Values are either controlled by pullover of sheet or by minimum value of fastener pullout of base metal.
- Values require fastener point penetration for X-EDNK22 and X-EDN19, of  $\neq 0$  (12.7 mm). Higher recommended values be applicable for X-HSN24 (see Hilti North America “Steel Deck Fastening Systems”)
- Recommended loads include a safety factor 3.0 applied to mean pullover resistance or a safety factor 5.0 applied to the mean value of pullout resistance.

**Design data for use in Europe**

Currently, the X-HSN24, X-EDNK22 and the X-EDN19 fasteners are only used in North America. Therefore, no design data is published evaluated in strict compliance with the provisions for European Technical Approvals.

For European markets, the fastener X-ENP2K-20 L15 in connection with the fastening tools DX 76 or DX 76 PTR are recommended for sheet metal fastenings to thin base materials (3 to 6 mm).

**Application limits and requirements**

**Fastening tool DX 860-HSN, DX 9-HSN**

Fastener	Base material properties		Ultimate tensile strength	
	Thickness [inch]	[mm]	[ksi]	[N/mm <sup>2</sup> ]
<b>X-EDNK22</b>	1/8"0 to 1/4"0	3.2 to 6.35	58 to 91	400-630
<b>X-EDN 19</b>	3/16"0 to 5/16"0	4.8 to 8.0	58 to 91	400-630
	5/16"0 to 3/8"0	8.0 to 9.5	58 to 68	400-470

- Comment on fastening tool DX 460-SM and DX 5-SM: This fastening tool is recommended for base material thickness from 3/16"0 to 3/8"0 (4.8 to 8.0 mm). The same strength limits apply as with the DX 860-HSN and DX 9-HSN.
- X-HSN24 covers full range of the fasteners X-EDNK22 and X-EDN19.

**Thickness of fastened material, fastener patterns, spacings and edge distance**

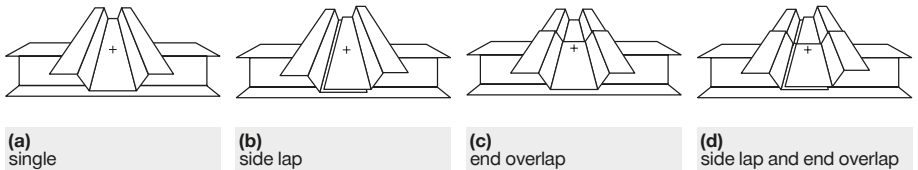

As part of a steel deck diaphragm, all four fastening types (a), (b), (c) and (d) are executed with the X-HSN 24, X-EDNK22 and the X-EDN19. The sheet metal thickness typically varies between 22 Gauge (0.76 mm) and 16 Gauge (1.52 mm).

Dependent on the base material thickness and the frame fastener pattern, restrictions on the use of thicker decking might apply. For corresponding details of these provisions, it is referred to the quoted technical literature published by Hilti North America. This literature also contains details with respect to fastener patterns, spacings and edge distance adequately addressing the specifics of the diaphragm components used in the North American market.

### Corrosion information

The intended use only comprises fastenings which are not directly exposed to external weather conditions or moist atmospheres. For further detailed information on corrosion see relevant chapter in **Direct Fastening Principles and Technique** section.

### Fastener selection and system recommendation

Fasteners	Designation	Item no.	Tool
Collated nails	X-HSN24	2042971	
	X-EDNK22 THQ12 M, grey magazine strip	34133	DX 860-HSN DX 9-HSN
	X-EDN19 THQ12 M, white magazine strip	34134	

### Cartridge selection and tool energy setting

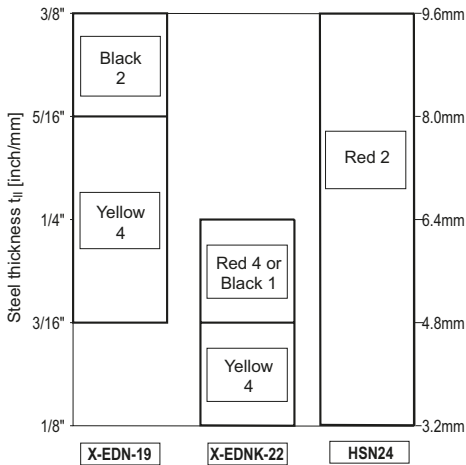

Fine adjustment by installation tests on site.

### Fastening quality assurance

#### Fastening inspection

X-HSN 24

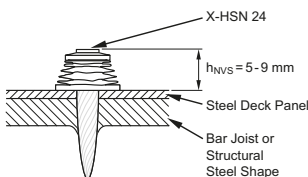

X-EDNK22 THQ12 / X-EDN19 THQ12

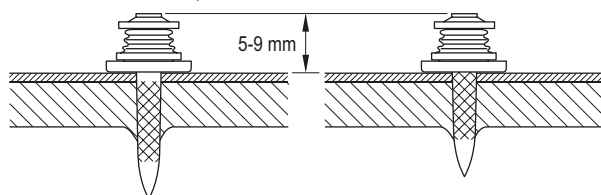

# NPH Siding and decking nail

## Product data

### Dimensions

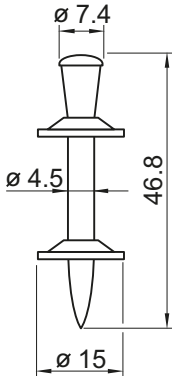

### General information

#### Material specifications

Carbon steel shank:	HRC 58
Zinc coating:	8–16 µm

#### Recommended fastening tools:

DX 76 PTR with DX 76-F-Kwik-PTR fastener guide	Cartridges: 6.8/18M blue
DX 76 with X-76-F-Kwik fastener guide	

See **Tools and equipment** for more details.

### Approvals

SOCOTEC (France)

BUTgb (Belgium)

Note:

Technical data presented in these approvals and design guidelines reflect specific local conditions and may differ from those published in this handbook.

## Applications

### Examples

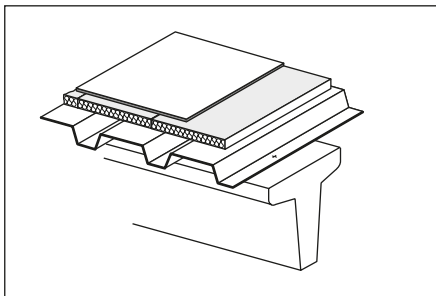

Roof decking

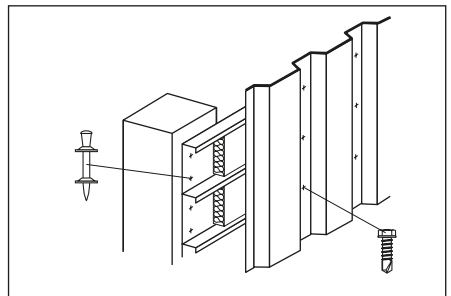

Wall liners

## Load data

### Recommended loads

Sheeting thickness $t_f$ [mm] nominal	Trapezoidal profile (symmetric)		Liner trays (asymmetric)	
	$N_{rec}$ [kN]	$V_{rec}$ [kN]	$N_{rec}$ [kN]	$V_{rec}$ [kN]
0.75	1.80	1.20	1.30	1.20
0.88	2.10	1.50	1.50	1.50
1.00	2.40	1.80	1.70	1.80
1.13	2.70	2.20	1.90	2.20
1.25	3.00	2.50	2.10	2.50
1.50	3.00	3.00	2.50	3.00
1.75	3.00	3.00	2.50	3.00
2.00	3.00	3.00	2.50	3.00

- Recommended working loads valid for steel sheets with a minimum tensile strength of  $\geq 360$  N/mm<sup>2</sup>.
- For intermediate sheet thicknesses, use recommended load for next smaller thickness.
- Recommended loads are appropriate for EC1 (or similar) wind loading designs.
- The safety factor included is at least 2.0 applied to the static 5 % fractile value and 1.3 to the cyclic (5000 cycles) 5 % fractile value.

## Application requirements

### Thickness of base material

Minimum thickness of concrete member

$h_{min} = 160$  mm

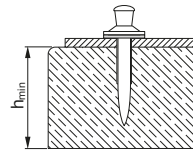

### Thickness of fastened material

#### Sheet thicknesses and overlap types

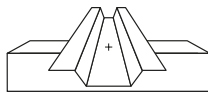

(a)  
single

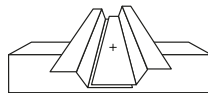

(b)  
side lap

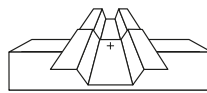

(c)  
end overlap

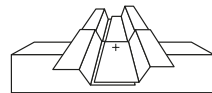

(d)  
side lap and end overlap

Nominal sheeting thickness $t_f$ [mm]	Allowable overlap types
0.63–1.13	<b>a, b, c, d</b>
> 1.13–2.50	<b>a</b>

- With the above recommended sheet thickness and overlap types, the effects of temperature induced forces of constraint during construction can be neglected.
- These recommendations are valid for sheets up to S350GD.
- With other sheets or overlaps or when unusually large forces of constraint are expected, analyse the structural system to ensure that the shear force acting on the nail does not exceed  $V_{rec}$ .



## Spacing and edge distances (mm)

### Trapezoidal profiles to girders or purlins

### Liner trays to columns

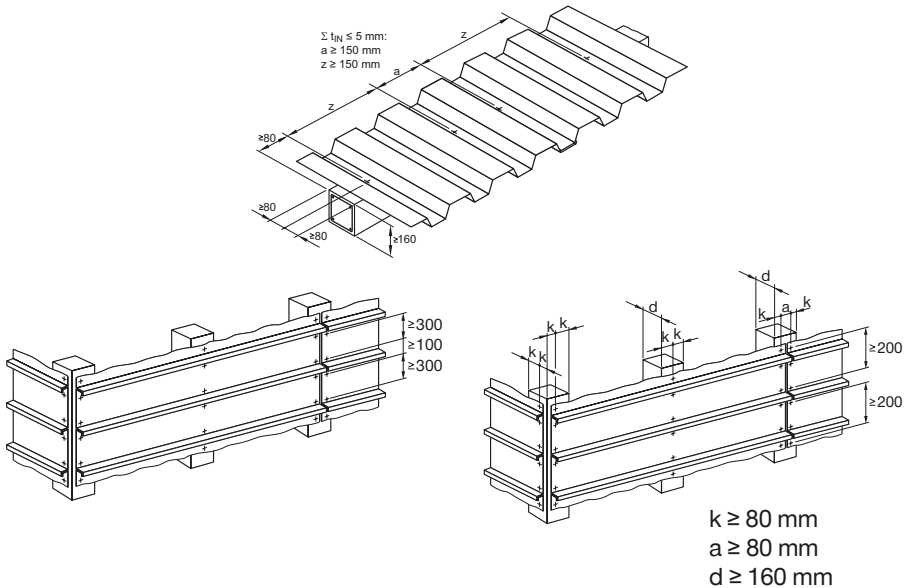

## Corrosion information

The intended use only comprises fastenings which are not directly exposed to external weather conditions or moist atmospheres. For further detailed information on corrosion see relevant chapter in **Direct Fastening Principles and Technique** section.

## Application limits

### Types of concrete

- Precast and cast-in-place pre-stressed concrete
- Precast and cast-in-place reinforced concrete

### Concrete design strength

- Minimum C20/25 ( $f_c = 20 \text{ N/mm}^2$ ,  $f_{cc} = 25 \text{ N/mm}^2$ )
- Maximum C45/55 ( $f_c = 45 \text{ N/mm}^2$ ,  $f_{cc} = 55 \text{ N/mm}^2$ )
- The **NPH/DX-Kwik** system has been successfully used in concrete having an in-place cube strength of  $70 \text{ N/mm}^2$

### Minimum strength/age at time of fastening

- C20/25 concrete must be 28 days old
- C45/55 concrete must be 15 days old

### Minimum dimensions of concrete member

- Minimum width = 180 mm
- Minimum thickness = 160 mm

### Fastener selection

Fasteners		Tool	Fastener guide	Piston
Designation	Item no.	Designation	Designation	Designation
NPH2-42 L15	40711	DX 76	X-76-F-Kwik	X-76-P-Kwik
		DX 76 PTR	X-76-F-Kwik-PTR	X-76-P-Kwik-PTR

### Cartridge selection and tool energy setting

Cartridges 6.8/18 M blue

Tool energy adjustment by setting tests on site.

### Fastening quality assurance

#### Installation

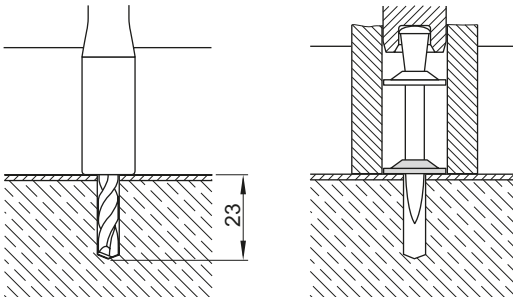

Pre-drill with TX-C-5/23 drill bit  
(Item no.: 00061787)

Place fastener with DX 76 PTR  
or DX 76

### Fastening inspection

#### NPH2-42 L15

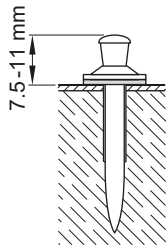

Check for conformity with recommendations  
(detailing spacing and edge distances for fastening)

Check the nailhead standoff of completed fastenings

These are abbreviated instructions which may vary by application.

**ALWAYS** review/follow the instructions accompanying the product.

# X-HVB Shear connector

## Product data

### Dimensions

#### X-HVB 140

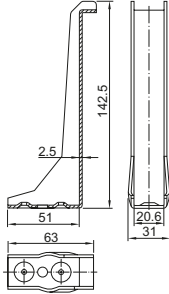

#### X-HVB 125

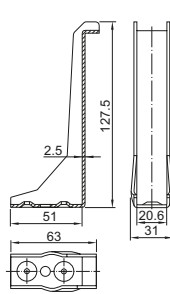

#### X-HVB 110

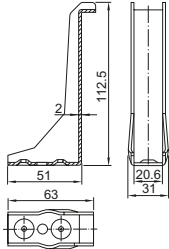

#### X-HVB 95

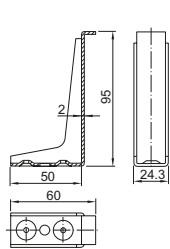

#### X-HVB 80

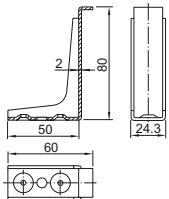

#### X-HVB 50

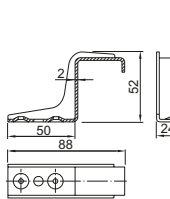

#### X-HVB 40

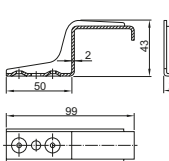

#### X-ENP-21 HVB

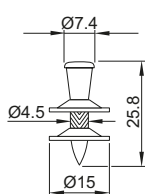

### General information

#### Material specifications

X-HVB

Carbon steel:  $R_m = 295\text{--}350\text{ N/mm}^2$

Zinc coating:  $\geq 3\ \mu\text{m}$

X-ENP-21 HVB

Carbon steel shank: HRC58

Zinc coating:  $8\text{--}16\ \mu\text{m}$

#### Recommended fastening tools

Tool	DX 76	DX 76 PTR
Fastener guide	X-76-F-HVB	X-76-F-HVB-PTR
Piston	X-76-P-HVB	X-76-P-HVB-PTR
Cartridges	6.8/18M black, red (for details see application limit X-ENP-21 HVB)	

See **Tools and equipment** for more details.

#### Approvals and design guidelines

ETA-15/0876, design according to Eurocode 4 (EN 1994-1-1, EN 1994-1-2) and Eurocode 8 (EN 1998-1)

MLIT / BCJ (Japan)

With regard to composite design according to AISC (American Institute of Steel Construction), please refer to the technical literature of Hilti North America (Product Technical Guide)

## Applications

### Examples

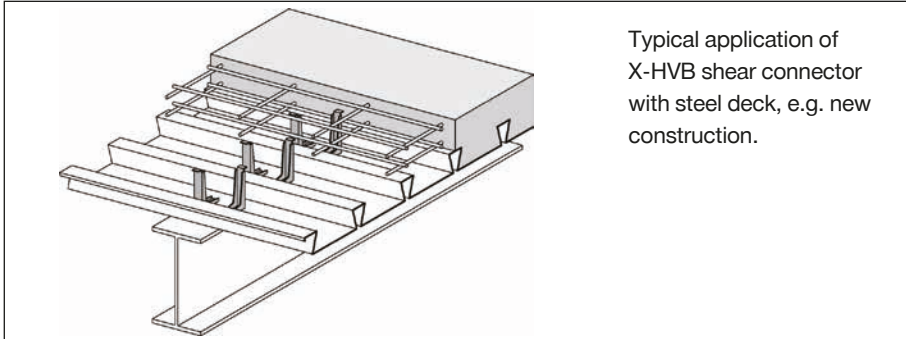

Typical application of X-HVB shear connector with steel deck, e.g. new construction.

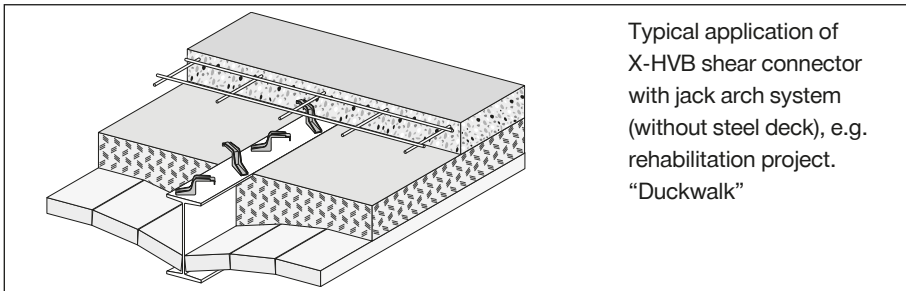

Typical application of X-HVB shear connector with jack arch system (without steel deck), e.g. rehabilitation project. "Duckwalk"

### Characteristic and design resistance (ETA-15/0876) in composite beams with solid slabs

Shear Connector	Characteristic Resistance $P_{Rk}$ [kN]	Design Resistance $P_{Rd}$ [kN]	Minimum base material thickness [mm]	X-HVB positioning	Ductility assessment
X-HVB 40	29	23	6	"duckwalk"	Ductile according to EN 1994-1-1
X-HVB 50	29	23	6		
X-HVB 80	32.5	26	8 <sup>*)</sup>	parallel with beam	
X-HVB 95	35	28			
X-HVB 110	35	28			
X-HVB 125	37.5	30			
X-HVB 140	37.5	30			

<sup>\*)</sup> Reduction to 6 mm possible, with regards to required reduction of design resistance see annex C3 of ETA-15/0876.

#### Conditions:

- Normal weight concrete C20/25 to C50/60
- Light weight concrete LC20/22 to LC50/55 with a minimum density  $\rho = 1750 \text{ kg/m}^3$

### Design resistance in composite beams with decking ribs transverse to beam axis

X-HVB positioning	Design Resistance $P_{Rd,t}$ [kN]	Ductility assessment
<p>X-HVB positioning longitudinal with the beam</p>	$P_{Rd,t,t} = k_{t,l} \cdot P_{Rd}$ $k_{t,l} = \frac{0.66}{\sqrt{n_r}} \cdot \frac{b_0}{h_p} \cdot \left( \frac{h_{SC}}{h_p} - 1 \right) \leq 1.0$	Ductile according to EN 1994-1-1
<p>X-HVB positioning transverse with the beam</p>	$P_{Rd,t,t} = 0.89 \cdot k_{t,t} \cdot P_{Rd}$ $k_{t,t} = \frac{1.18}{\sqrt{n_r}} \cdot \frac{b_0}{h_p} \cdot \left( \frac{h_{SC}}{h_p} - 1 \right) \leq 1.0$	

Conditions:

- Applicable for X-HVB 80, X-HVB 95, X-HVB 110, X-HVB 125, X-HVB 140
- $n_r$  corresponds to the number of X-HVBs per rib ( $n_r \leq 3$ )

### Design resistance in composite beams with decking ribs parallel to beam axis

X-HVB positioning	Design Resistance $P_{Rd,t}$ [kN]	Ductility assessment
<p>X-HVB positioning longitudinal with the beam</p>	$P_{Rd,t} = k_l \cdot P_{Rd}$ $k_l = 0.6 \cdot \frac{b_0}{h_p} \cdot \left( \frac{h_{SC}}{h_p} - 1 \right) \leq 1.0$	Ductile according to EN 1994-1-1

Conditions:

- Applicable for X-HVB 80, X-HVB 95, X-HVB 110, X-HVB 125, X-HVB 140
- X-HVB are to be positioned parallel with beam

### Decking geometric parameters

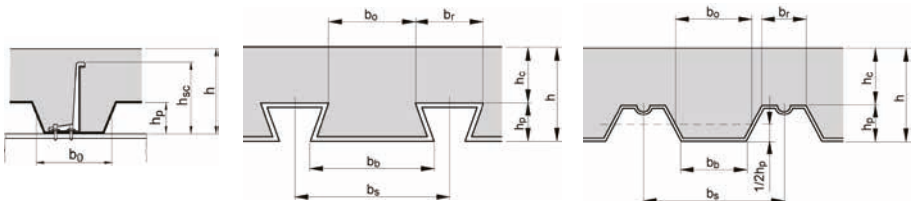

## Design information

### Connector placement along the beam

The X-HVB is a ductile shear connector according to EN 1994-1-1, section 6.6, and may be uniformly distributed between critical sections. These critical sections, where large changes in shear flow occur, may be at supporting points, points of application of point loads or areas with extreme bending moments.

### Partial shear connection

Strength:

The minimum connection depends on the design code used:

In **EN 1994-1-1** design,  $N/N_f$  must be at least 0.4. This increases depending on span length and decking geometry.

### Deflection control only

If the shear connection is needed for deflection control only, there is no minimum degree of connection. However, minimum allowable connector spacing applies and the steel beam must have enough strength to carry the self-weight and all imposed loads.

### Further specific design topics covered in the ETA-15/0876

- Coverage of seismic loading according to Eurocode 8 (EN 1998-1-1)
- Design resistance in case of use of old steel with an ultimate strength greater than 300 N/mm<sup>2</sup> and less than 360 N/mm<sup>2</sup>
- Effect of reduced base material thickness less than 8 mm for X-HVB 80 to X-HVB 140
- Design of end anchorage of composite slabs
- Design in case of a fire

## Application requirements

### Thickness of base material

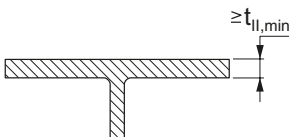

For beams with composite decking:  
minimum thickness  $t_{II} = 8$  mm.

For beams with solid concrete slabs:  
minimum thickness  $t_{II} = 6$  mm, especially relevant in renovation projects in order to take the thin flange thickness of small I-sections (e.g. IAO 100, I 100, IPE 100) into account.

### Thickness of fastened material

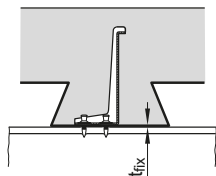

Maximum total thickness of fixed sheeting  $t_{fix}$ :

- 2.0 mm for X-HVB 80, X-HVB 95 and X-HVB 110
- 1.5 mm for X-HVB 125 and X-HVB 140

### Positioning of X-HVB connectors in solid concrete slabs

X-HVB are to be positioned parallel with beam

#### 1 row of connectors

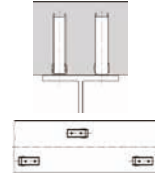
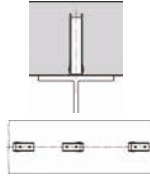
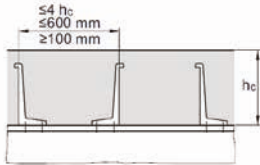

#### 2 row of connectors

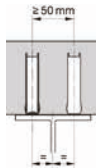
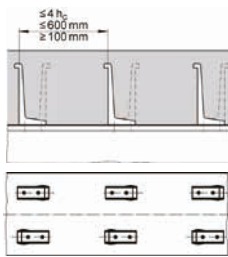

#### Maximum 3 row of connectors

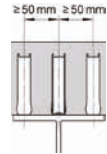
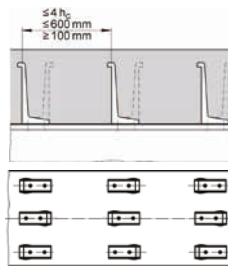

### Positioning of X-HVB connectors with composite deck (deck positioned transverse to and X-HVB positioned parallel with beam axis)

#### Spacing and positioning

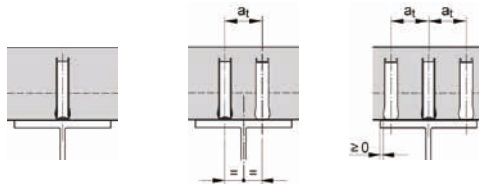

- $a_t \geq 50$  mm for compact profiled decking with  $b_0/h_p \geq 1.8$
- $a_t \geq 100$  mm for other decking

#### 1 row of connector - Minimum rib width and spacing to decking

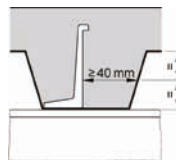
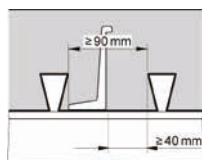

Rib width < 105mm

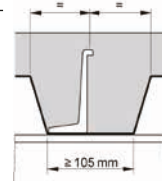

Rib width ≥ 105mm

#### Multiple rows of connector - Minimum rib width

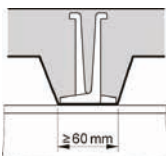

## Positioning of X-HVB connectors with composite deck (deck and X-HVB positioned transverse to beam axis)

### Spacing

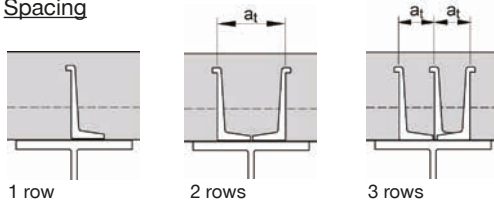

2 rows:

- $a_t \geq 100$  mm for all types decking

3 rows:

- $a_t \geq 50$  mm for compact profiled decking with  $b_0/h_p \geq 1.8$
- $a_t \geq 100$  mm for other decking

### Positioning - 1 row of connectors

Without rib stiffener

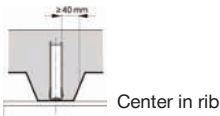

With rib stiffener (X-HVB in contact with rib stiffener)

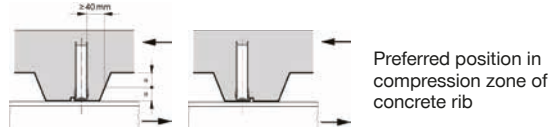

### Positioning - 2 and 3 rows of connectors

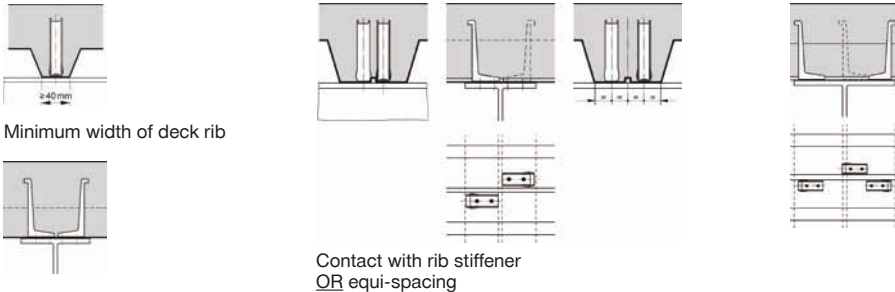

## Positioning of X-HVB connectors with composite deck (deck parallel with beam axis)

X-HVB are to be positioned parallel with beam

### Spacing and positioning

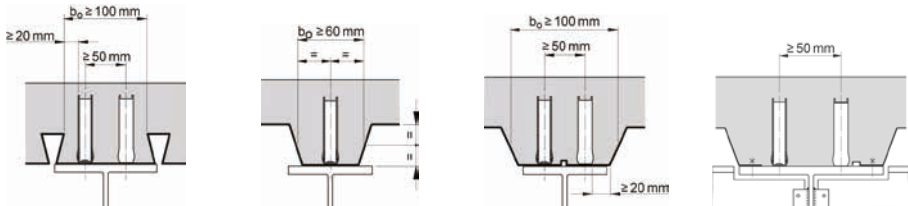

- If a centric positioning within the concrete rib is not possible due to the shape of the composite decking, the decking needs to be split.



**“Duckwalk” positioning of X-HVB 40 and 50 in combination with thin solid slabs for renovation construction**

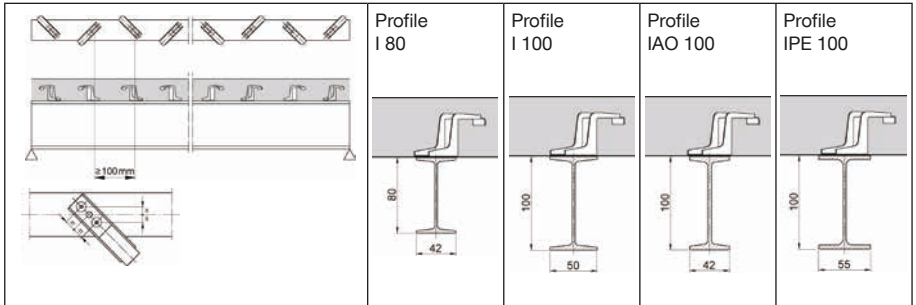

- Minimum section width = 40 mm (e.g. old section IAO 100)
- Minimum center distance of steel sections = 400 mm

**Application limits**

Application limits are valid only if correct cartridge and power setting are used!

Application limits X-ENP-21 HVB

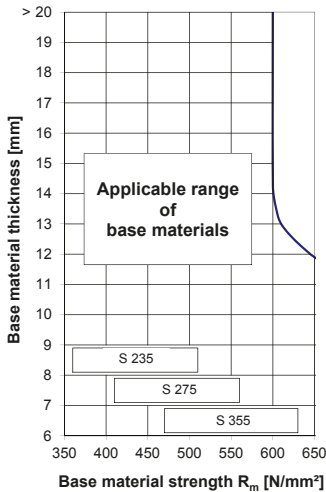

Cartridge preselection and power setting

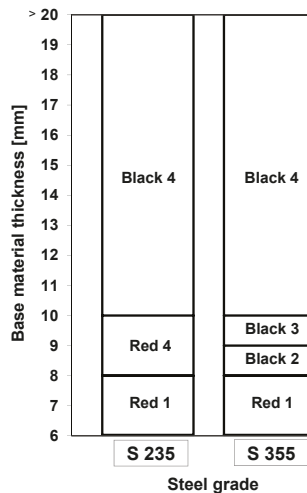

In thermo-mechanically rolled construction steel, e.g. S 355M per EN 10025-4 the application limit is reduced by 50 N/mm<sup>2</sup>

Fine adjustment by carrying out installation tests on site

- Minimum section covered: IPE 100
- Minimum base material thickness for beams with composite decking: 8 mm

**Fastener selection**
Minimum slab thickness

X-HVB	Minimum slab thickness h [mm]	
	Without effect of corrosion	With effect of corrosion
40	50	60
50	60	70
80	80	100
95	95	115
110	110	130
125	125	145
140	140	160

Maximum decking height  $h_p$ , dependent on decking geometry

X-HVB	Maximum height of composite decking $h_p$ [mm]		
	$\frac{b_o}{h_p} \geq 1.8$	$1.0 < \frac{b_o}{h_p} < 1.8$	$\frac{b_o}{h_p} \leq 1.0$ x)
80	45	45	30
95	60	57	45
110	75	66	60
125	80	75	73
140	80	80	80

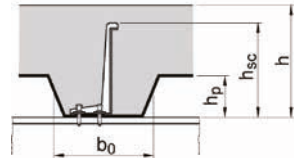

x)  $b_o / h_p \geq 1.0$  for composite decking perpendicular to beam combined with X-HVB orientation parallel with beam

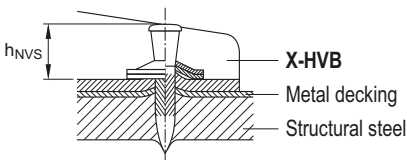
**Fastening quality assurance**
**Fastening inspection**

$$8.2 \text{ mm} \leq h_{NVS} \leq 9.8 \text{ mm}$$



Clearly visible piston mark on top washer

# X-U Nail for fastening to concrete and steel

## Product data

### Dimensions

X-U \_\_ MX

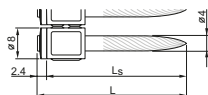

X-U \_\_ P8

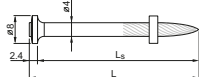

X-U \_\_ P8 S36

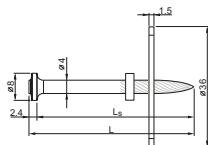

X-U \_\_ P8 S15

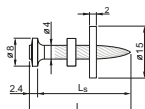

X-U 15 P8TH

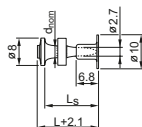

X-U \_\_ S12

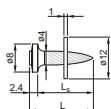

### General information

#### Material specifications

Carbon steel shank: HRC 58  
HRC 59 (X-U 15)  
Zinc coating: 5–20 µm

#### Recommended fastening tools

See **X-U fastener program** in the next pages and **Tools and equipment** chapter for more details.

#### Approvals

ICC ESR-2269 (USA)  
DIBt Z-14.4-517 (Germany), DNV-GL  
ABS, LR 97/00077, IBMB 2006/2011

Note: technical data presented in these approvals and design guidelines reflect specific local conditions and may differ from those published in this handbook.

## Applications

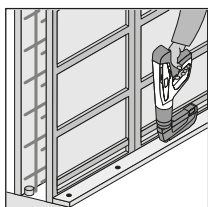

System formwork

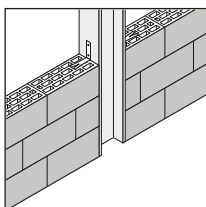

Wall-tie to steel and concrete

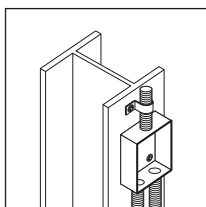

Mechanical and electrical fixtures

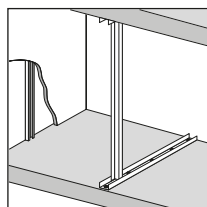

Drywall track to concrete and steel

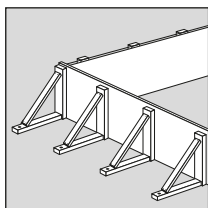

Conventional formwork

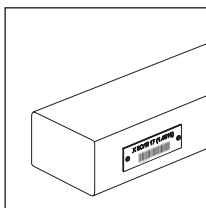

Tagging labels

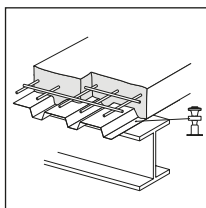

Tacking of metal decks

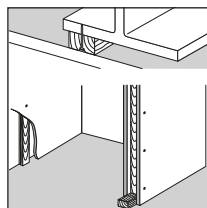

Sill plates / 2x4 wood to concrete and steel

The intended use for safety relevant and permanent applications only comprises fastenings which are not directly exposed to external weather conditions or moist atmospheres.

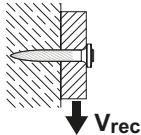
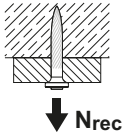
**Fastening to Concrete**
**Recommended loads**

$N_{rec}$ [kN]	$V_{rec}$ [kN]	$h_{ET}$ [mm]
0.4	0.4	$\geq 27$
0.3	0.3	$\geq 22$
0.2	0.2	$\geq 18$
0.1	0.1	$\geq 14$

**Design conditions:**

- For safety relevant fastenings sufficient redundancy of the entire system is required:  
Minimum 5 fastenings per fastened unit.
- All visible failures must be replaced.
- Valid for concrete with strength of  $f_{cc} \leq 45 \text{ N/mm}^2$ .
- Valid for predominantly static loading.
- Failure of the fastened material is not considered in recommended loads
- To limit penetration of nail and to increase pull-over load, use nails with washers.

## Fastening to Concrete

### Application requirements

#### Thickness of base material

Concrete:

$h_{\min} = 80 \text{ mm}$

#### Thickness of fastened material

Wood:

$t_1 = 15\text{--}57 \text{ mm}$

### Edge distance and fastener spacing

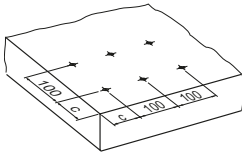

Edge distance:

$c \geq 70 \text{ mm}$

Spacing:

$s \geq 100 \text{ mm}$

### Fastener selection and system recommendation

#### Fastening to concrete

Required nail shank length:  $L_S = h_{ET} + t_1$  [mm]

Recommendation:  $h_{ET} = 22 \text{ mm}$

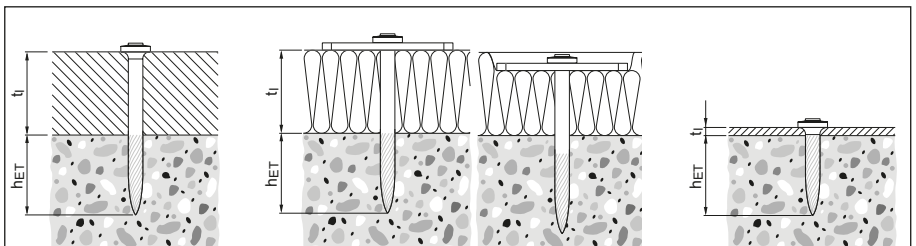

In case flush fastenings are required:

$L_S = h_{ET} + t_1 - 5$  [mm]

### Cartridge recommendation

Tool energy adjustment by setting tests on site

**Fastening to concrete:** **6.8/11M yellow cartridge** on soft and tough concrete

**6.8/11M red cartridge** on very tough concrete

## Fastening to Steel

### Recommended loads

Fastening of steel sheets and other steel parts with X-U 16 and X-U 19

Recommended loads $t_f$ [mm]	X-U_P8/MX $N_{rec}$ [kN]	X-U_S12 $N_{rec}$ [kN]	$V_{rec}$ [kN]
0.75	1.0	1.4	1.2
1.00	1.2	1.8	1.8
1.25	1.5	2.2	2.6
$\geq 2.00$	2.0	2.2	2.6

Tacking of steel sheets with X-U 15

according to ECCS-recommendation N73, „Good Construction Practice for Composite Slabs ”

Recommended loads $t_f$ [mm]	$N_{rec}$ [kN]	$V_{rec}$ [kN]
0.75–1.25	0.6	0.8

### Design conditions:

- Recommended working loads valid for steel sheet with minimum tensile strength  $\geq 360 \text{ N/mm}^2$ .
- For intermediate sheet thicknesses, use recommended load for next smaller thickness.
- In case of a design based on the characteristic resistance, recommended values have to be multiplied by two:  $\Rightarrow N_{Rk} = N_{rec} \cdot 2.0$   $V_{Rk} = V_{rec} \cdot 2.0$
- For X-U 16 S12: base material thickness  $t_{II,min} = 8 \text{ mm}$  for  $t_f \geq 1.5 \text{ mm}$  and  $t_{II,min} = 6 \text{ mm}$  for  $t_f \leq 1.25 \text{ mm}$
- Other fastened parts: clips, brackets, etc.
- Redundancy (multiple fastening) must be provided.
- Valid for predominantly static loading

### Forces of constraint

When fastening large pieces of steel, the possibility of shear loadings from forces of constraint should be considered. Avoid exceeding  $V_{rec}$  for the fastener shank!

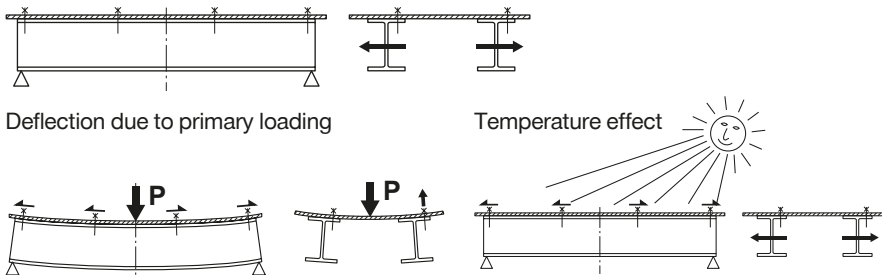

## Fastening to Steel

### Fastenings of wood to steel

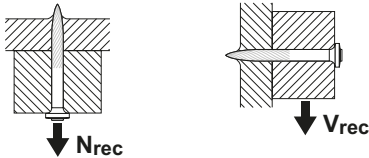

$$N_{rec} = 0.3 \text{ kN}$$

$$V_{rec} = 0.6 \text{ kN}$$

#### Design conditions:

- For safety-relevant fastenings sufficient redundancy of the entire system is required.
- In case soft material is fastened, its strength determines the loads.
- To limit penetration of nail and to increase pull-over load, use nails with washers.
- Observance of edge distance and fastener spacing in compliance with recognized standards EN 1995 (see approval).
- With respect to details of fastening wood, chipboard or OSB members to steel base material, it is referred to the German approval DIBt Z-14.4-517.

### Application requirements

#### Thickness of base material

Steel:

$$t_{II} \geq 6.0 \text{ mm (fastening steel to steel)}$$

$$t_{II} \geq 4.0 \text{ mm (fastening wood to steel)}$$

#### Thickness of fastened material

Steel:

$$t_I \leq 3 \text{ mm (fastened material not pre-drilled)}$$

$$3 \text{ mm} < t_I \leq 6 \text{ mm (fastened material pre-drilled)}$$

Wood:

$$t_I = 15\text{--}57 \text{ mm}$$

#### Condition for thick fastened steel parts ( $3 \text{ mm} < t_I \leq 6 \text{ mm}$ )

If a gap between the fastened part and the base material is unacceptable, the fastened part needs to be prepared with drilled holes.

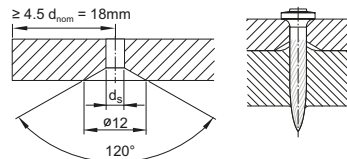

#### Edge distance and spacing

Rolled shapes:

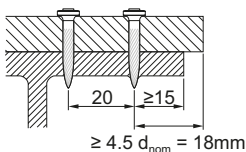

Edge distance:  $c \geq 15 \text{ mm}$

Spacing:  $a = 20 \text{ mm}$

## Fastening to Steel

### Application limits

Fastening of steel sheets and steel parts to steel

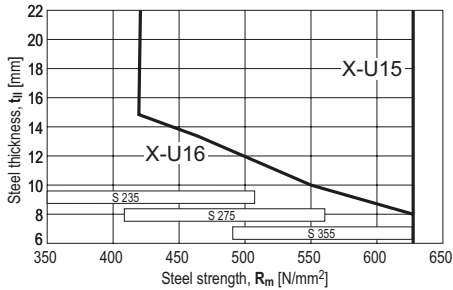

Fastening of wood and soft material to steel

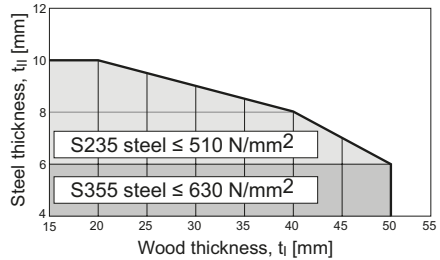

X-U 16 P8, X-U 15 P8TH: For steel sheeting with  $0.75 \text{ mm} \leq t_1 \leq 1.25 \text{ mm}$  sheets

For X-U 22 P8 to X-U 62 P8

On higher steel grades, fastening with single nails (P8 or P8TH) may yield better results (e.g. less shear brakes) than fastening with collated nails (MX or MXSP) due to better nail guidance.

### Fastener selection and system recommendation

Required nail shank length:  $L_S = h_{ET} + t_1$  [mm]

Fastening steel to steel

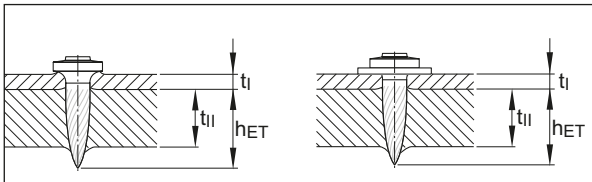

Recommendation:  $h_{ET} = 12 \pm 2 \text{ mm}$

Fastening wood to steel

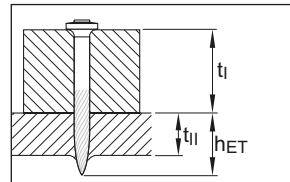

$h_{ET} \geq 8 \text{ mm}$

$h_{ET} \geq 5 \text{ mm}$  for flush installation

### Cartridge recommendation

Tool energy adjustment by setting tests on site

**Fastening wood to steel: 6.8/11M green or yellow cartridge**

on steel thickness  $t_{II} < 6 \text{ mm}$

**6.8/11M yellow, red or black cartridge**

on steel thickness  $t_{II} \geq 6 \text{ mm}$

**Fastening steel to steel: 6.8/11M yellow, red or black cartridge**



## Fastening to Steel

### X-U 16

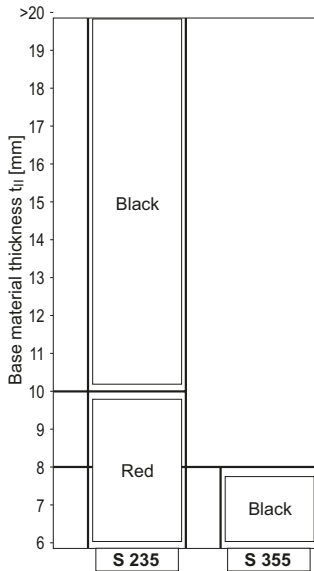

### X-U 15 P8TH

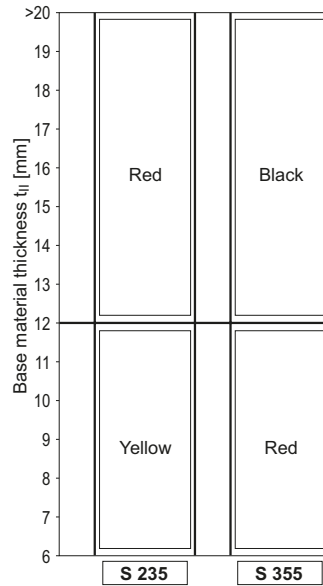

## Fastening quality assurance

### Fastening inspection

#### X-U \_\_ P8/MX

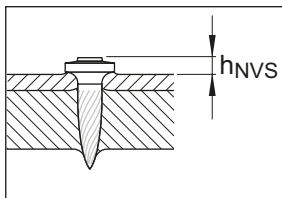

$h_{NVS} = 2.5-4.5 \text{ mm}$

#### X-U \_\_ S12

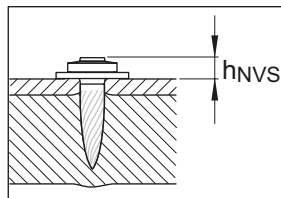

$h_{NVS} = 4.0-5.5 \text{ mm}$

#### X-U \_ P8TH / MXSP

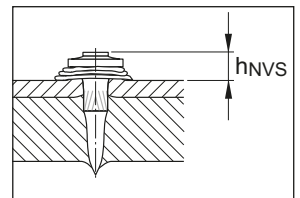

$h_{NVS} = 4.0-6.0 \text{ mm}$

## Fastener program

Fastener	Item no.	Ls [mm]	Standard tools					Special tools				Key applications
			DX 460 MX, DX 5 MX	DX 460 F8, DX 5 F8	DX 36, DX 2	DX E72	DX 351 MX	DX 351 F8	DX 35	DX 462 F8	DX 460 FR512 / DX 5 FR512 / DX 462 FR512	
<b>X-U 16 MX</b>	237344	16	■				■					Sheet metal on steel
<b>X-U 19 MX</b>	237345	19	■				■					Sheet metal on steel
<b>X-U 22 MX</b>	237346	22	■				■					Wood on concrete/steel
<b>X-U 27 MX</b>	237347	27	■				■					Wood on concrete/steel
<b>X-U 32 MX</b>	237348	32	■									Wood on concrete/steel
<b>X-U 37 MX</b>	237349	37	■									Wood on concrete/steel
<b>X-U 42 MX</b>	237350	42	■									Wood on concrete/steel
<b>X-U 47 MX</b>	237351	47	■									Wood on concrete/steel
<b>X-U 52 MX</b>	237352	52	■									Wood on concrete/steel
<b>X-U 57 MX</b>	237353	57	■									Wood on concrete/steel
<b>X-U 62 MX</b>	237354	62	■									Wood on concrete/steel
<b>X-U 72 MX</b>	237356	72	■									Wood on concrete/steel
<b>X-U 16 P8</b>	237330	16		■	■	■		■	■	■		Sheet metal on steel
<b>X-U 19 P8</b>	237331	19		■	■	■		■	■	■		Sheet metal on steel
<b>X-U 22 P8</b>	237332	22		■	■	■		■	■	■		Wood on concrete/steel
<b>X-U 27 P8</b>	237333	27		■	■	■		■	■	■		Wood on concrete/steel
<b>X-U 32 P8</b>	237334	32		■	■	■		■	■	■		Wood on concrete/steel
<b>X-U 37 P8</b>	237335	37		■	■	■		■	■	■		Wood on concrete/steel
<b>X-U 42 P8</b>	237336	42		■	■	■		■		■		Wood on concrete/steel
<b>X-U 47 P8</b>	237337	47		■	■	■		■		■		Wood on concrete/steel
<b>X-U 52 P8</b>	237338	52		■	■	■				■		Wood on concrete/steel
<b>X-U 57 P8</b>	237339	57		■	■	■				■		Wood on concrete/steel
<b>X-U 62 P8</b>	237340	62		■	■	■						Wood on concrete/steel
<b>X-U 72 P8</b>	237342	72		■	■	■						Wood on concrete/steel
<b>X-U 16 P8TH</b>	237329	16		■	■	■		■	■	■		Sheet metal on steel, *)
<b>X-U 19 P8TH</b>	385781	19		■	■	■		■	■	■		Sheet metal on steel, *)
<b>X-U 27 P8TH</b>	385782	27		■	■	■		■	■	■		Sheet metal on concrete, *)
<b>X-U 15 MXSP</b>	383466	16	■				■					Sheet metal on steel
<b>X-U 15 P8TH</b>	237328	16		■	■	■		■	■	■		Sheet metal on steel

\*) firm hold down

Fastener	Item no.	L <sub>s</sub> [mm]	Standard tools						Special tools		Key applications
			DX 460 MX, DX 5 MX	DX 460 F8, DX 5 F8	DX 36, DX 2	DX E72	DX 351 MX	DX 351 F8	DX 35	DX 462 F8 DX 460 F8S12 / DX 5 F8S12 / DX 462 F8S12	
<b>X-U 27 P8S15</b>	237371	27		■	■	■		■	■	■	High pull-over strength
<b>X-U 32 P8S15</b>	237372	32		■	■	■		■	■	■	High pull-over strength
<b>X-U 32 P8S36</b>	237374	32		■	■	■		■	■	■	Soft material on concr./steel
<b>X-U 52 P8S36</b>	237376	52		■	■	■		■		■	Soft material on concr./steel
<b>X-U 72 P8S36</b>	237379	72		■	■	■					Soft material on concr./steel
<b>X-U 16 S12</b>	237357	16								■	High pull-over strength
<b>X-U 19 S12</b>	237358	19								■	High pull-over strength
<b>X-U 22 S12</b>	237359	22								■	High pull-over strength
<b>X-U 27 S12</b>	237360	27								■	High pull-over strength
<b>X-U 32 S12</b>	237361	32								■	High pull-over strength

■ = Recommended

■ = Feasible



# X-P Nail for fastening to concrete and steel

## Product data

X-P\_MX

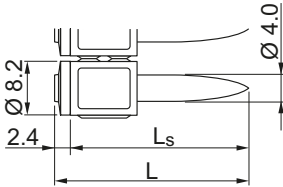

X-P\_P8

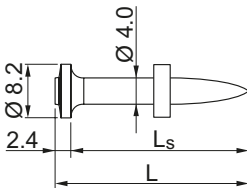

## Features and Benefits

A **specially hardened fastener** with a **long conical tip** optimized for high load and stick rate for applications on **soft & tough** concrete and wood to steel.

## General information

### Recommended fastening tools

See **X-P fastener program** in the next pages and **Tools and equipment** chapter for more details

### Approvals and Certificates

IBMB (Germany), VHT (Germany), ICC-ESR 2269 (USA), COLA RR25675 (USA)

### Material Specifications

Carbon Steel 59HRC    4mm shank diameter    Long Conical Tip  
Zinc Coating 5–20µm

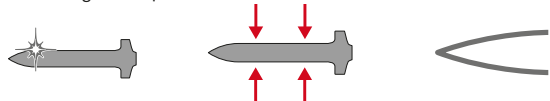

## Applications

### Example

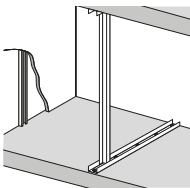

Drywall tracks

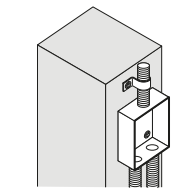

Mechanical, electrical

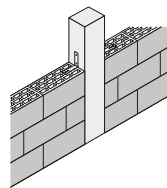

Wall ties

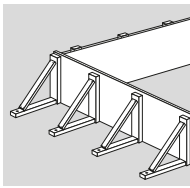

Formwork

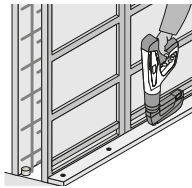

System formwork

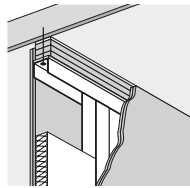

Deflection Head

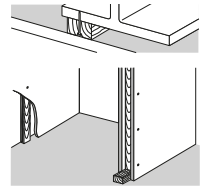

Wood Frame

The intended use for safety relevant and permanent applications only comprises fastenings which are not directly exposed to external weather conditions or moist atmospheres.

## Fastening sheet metal attachments to concrete

### Performance data

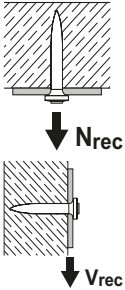

Embedment $h_{ET}$ [mm]	Recommended Loads [kN]				Typical cartridge colour selection Type 6.8/11	
	Tension $N_{rec}$		Shear $V_{rec}$			
	Concrete Toughness					
	Soft	Tough	Soft	Tough	Soft	Tough
$\geq 25$	0.40	0.20	0.80	0.40	Red	Red/ Black
$\geq 20$	0.30	0.15	0.60	0.30		
$\geq 18$	0.20	0.10	0.40	0.20	Green/ Yellow	Red

### Conditions:

- For safety relevant fastenings sufficient redundancy of the entire system is required: Minimum of 5 nails per fastened track. All visible setting failures must be replaced.
- Sheet metal failure is not considered in recommended loads and must be assessed separately
- Soft concrete up to  $f_{c,cube} = 45 \text{ N/mm}^2$ , Tough concrete up to  $f_{c,cube} = 65 \text{ N/mm}^2$ .
- Concrete with aggregate like granite or river rock or softer, and up to 16 mm diameter

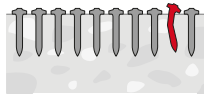

Stick rate estimation	
Soft Concrete	Tough Concrete
95% - 99%	90% - 95%

- The stick rate indicates the percentage of nails that were driven correctly to carry a load. Stick rate can vary from the above values depending on job site conditions.

### Application requirements

#### Thickness of base material

Concrete:

$h_{min} = 80 \text{ mm}$

#### Permissible sheet metal thickness

Sheet metal:

$t_1 = 0.60 - 2.00 \text{ mm}$

#### Edge distance and fastener spacing

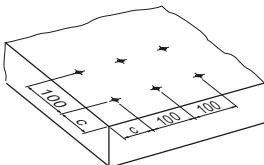

Edge distance:

$c \geq 70 \text{ mm}$

Spacing:

$s \geq 100 \text{ mm}$

For standard light partition wall track:  $s \leq 60 \text{ cm}$

For track in proprietary fire rated light partition walls:  $s \leq 30 \text{ cm}$

#### Fastener shank length ( $L_s$ ) selection

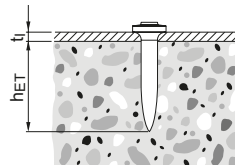

Required nail shank length:

Recommendation:

$L_s = h_{ET} + t_1$  [mm]

$h_{ET} = 20 \text{ mm}$

## Fastening Wood to concrete (Wood Framing, Formwork)

### Performance data

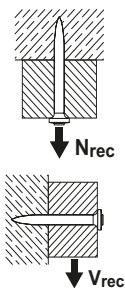

Embedment $h_{ET}$ [mm]	Recommended Loads [kN] Tension $N_{rec}$ = Shear $V_{rec}$		Typical cartridge colour selection Type 6.8/11	
	Concrete Toughness			
	Soft	Tough	Soft	Tough
$\geq 25$	0.40	0.10	Red	Red/Black
$\geq 20$	0.30	-	Red	-
$\geq 18$	0.20	-	Green/ Yellow	-
$\geq 14$	0.10	-	-	-

### Conditions:

- For safety relevant fastenings sufficient redundancy of the entire system is required: Minimum of 5 nails per fastened wood member. All visible setting failures must be replaced.
- Wood failure is not considered in recommended loads and must be assessed separately.
- Soft concrete up to  $f_{c,cube} = 45 \text{ N/mm}^2$ , Tough concrete up to  $f_{c,cube} = 65 \text{ N/mm}^2$ .
- Concrete with aggregate like granite or river rock or softer, and up to 16 mm diameter.
- To limit nail head penetration into wood or to increase pull-over load, use washer.

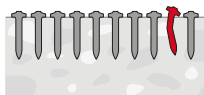

Stick rate estimation	
Soft Concrete	Tough Concrete (temporary fastenings only)
84% – 92%	80% – 90%

- The stick rate indicates the percentage of nails that were driven correctly to carry a load. Stick rate can vary from the above values depending on job site conditions.

### Application requirements

#### Thickness of base material

$h_{min} = 80 \text{ mm}$

#### Permissible wood thickness

On soft concrete:  $t_1 = 15 - 50 \text{ mm}$

On tough concrete:  $t_1 = 15 - 40 \text{ mm}$

#### Edge distance and fastener spacing

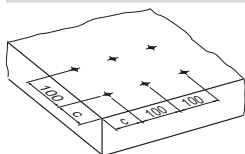

Edge distance:  
Spacing:

$c \geq 70 \text{ mm}$   
 $s \geq 100 \text{ mm}$

#### Fastener shank length ( $L_s$ ) selection

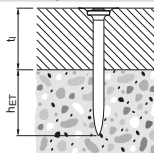
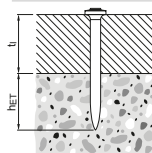

$L_s = h_{ET} + t_1$  [mm]

In case of flush fastenings:  
 $L_s = h_{ET} + t_1 - 3$  [mm]

## Fastening wood to steel base material

### Recommended loads

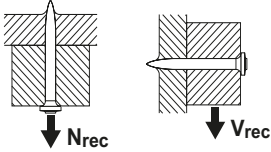

Base steel thickness	Recommended loads [kN]		Typical cartridge colour selection Type 6.8/11
	Tension $N_{rec}$	Shear $V_{rec}$	
10 mm	0.4	0.6	Red / Black
8 mm			Red
6 mm			Yellow / Red
4 mm			Green / Yellow

### Conditions:

- For safety-relevant fastenings sufficient redundancy of the entire system is required.
- The recommended loads above are conservatively controlled by wood capacity determined in accordance with EN 1995. For a more detailed design of the wood member, EN 1995 must be considered.
- Observe nail edge distance and spacing in wood required by recognized standards (e.g. EN 1995)
- To limit nail head penetration into wood or to increase pull-over load, use washers.

### Application requirements

#### Thickness of base material

Steel:

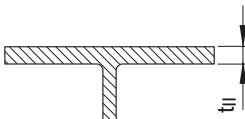

$$10 \text{ mm} \geq t_{II} \geq 4 \text{ mm}$$

#### Thickness of fastened material

Wood:

$$t_I = 15 - 50 \text{ mm}$$

#### Edge distance

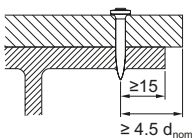

#### Fastener shank length ( $L_S$ ) selection

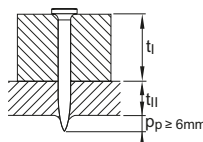

$p_p$  = penetration of nail point through base steel

$$\text{Nail shank length } L_S \sim t_I + t_{II} + 6 \text{ mm}$$

For nail installation flush with wood surface:

$$\text{Nail shank length } L_S \sim t_I + t_{II} + 3 \text{ mm}$$

#### Application limits

For X-P 22 P8 to X-P 62 P8\*

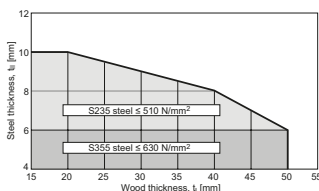

\* On higher steel grades, fastening with single nails (P8) may yield better results (e.g. less shear brakes) than fastening with collated nails (MX) due to better nail guidance.



**Corrosion information**

Zinc-coated fasteners are not suitable for long-term service outdoors or in otherwise corrosive environments.

The use of certain wood species like Oak and Douglas Fir, as well as some wood treatments can require the use of stainless steel fasteners, independent of environmental conditions. The use of carbon steel fasteners is then not permitted. Please consider relevant local regulations.

For further detailed information on corrosion see chapter **Direct Fastening Principles and Technique**.

**Fastening quality assurance**

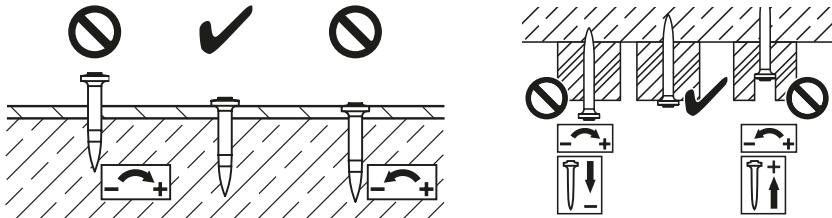

These are abbreviated instructions which may vary by application.

**ALWAYS** review / follow the instructions accompanying the product.

**Fastener selection and system recommendation**

**Fastener program**

Fastener	Item No.	L <sub>s</sub> [mm]	DX 460 MX	DX 460 F8	DX 5 MX	DX 5 F8	DX 2, DX 36	DX 351 MX	DX 351 F8	DX 462 F8	Key applications
X-P 22 MX	2150380	22	■		■			■			Track or Wall Tie to concrete
X-P 27 MX	2150381	27	■		■			■			Track or Wall Tie to concrete
X-P 34 MX	2150382	34	■		■						Track or Wall Tie to concrete
X-P 40 MX	2150383	40	■		■						Wood to concrete & steel, Deflection Head
X-P 47 MX	2173900	47	■		■						Wood to concrete & steel, Deflection Head
X-P 52 MX	2173901	52	■		■						Wood to concrete & steel, Deflection Head
X-P 57 MX	2173902	57	■		■						Wood to concrete & steel, Deflection Head

■ = Recommended

■ = Feasible

Fastener	Item No.	L <sub>S</sub> [mm]	DX 460 MX	DX 460 F8	DX 5 MX	DX 5 F8	DX 2, DX 36	DX 351 MX	DX 351 F8	DX 462 F8	Key applications
X-P 62 MX	2173903	62	■		■						Wood to concrete & steel, Deflection Head
X-P 72 MX	2173904	72	■		■						Wood to concrete, Deflection Head
X-P 22 P8	2150366	22		■		■	■		■	■	Track or Wall Tie to concrete
X-P 27 P8	2150367	27		■		■	■		■	■	Track or Wall Tie to concrete
X-P 34 P8	2150368	34		■		■	■		■	■	Track or Wall Tie to concrete
X-P 40 P8	2150369	40		■		■	■		■	■	Wood to concrete & steel, Deflection Head
X-P 47 P8	2173875	47		■		■	■		■	■	Wood to concrete & steel, Deflection Head
X-P 52 P8	2173876	52		■		■	■			■	Wood to concrete & steel, Deflection Head
X-P 57 P8	2173877	57		■		■	■			■	Wood to concrete & steel, Deflection Head
X-P 62 P8	2173878	62		■		■	■				Wood to concrete & steel, Deflection Head
X-P 72 P8	2173879	72		■		■	■				Wood to concrete, Deflection Head

■ = Recommended

■ = Feasible

# X-C Nail for fastening to concrete and sand lime masonry

## Product data

### Dimensions

X-C \_\_ P8

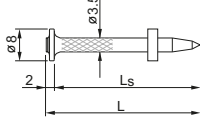

X-C \_\_ MX

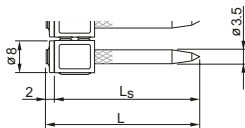

X-C \_\_ P8S23

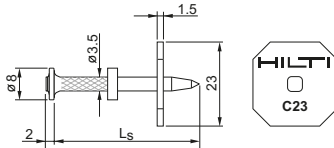

### General information

#### Material specifications

Carbon steel shank: HRC 56.5  
HRC 58 \*)

Zinc coating: 5–20  $\mu\text{m}$

\*) X-C 82, 97 and 117 P8 ( $d_{\text{nom}} = 3.7 \text{ mm}$ )

#### Recommended fastening tools

See **X-C fastener program** in the next pages and **Tools and equipment** chapter for more details.

X-C \_\_ P8S23T (for tunneling applications)

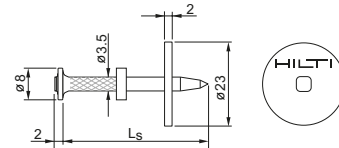

X-C \_\_ P8S36

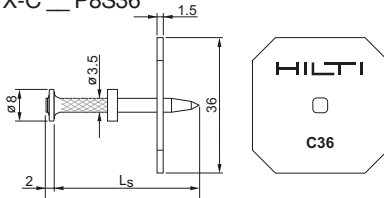

## Applications

### Examples

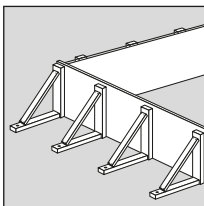

**Conventional Formwork**

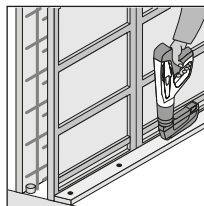

**System Formwork**

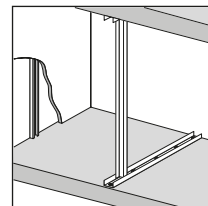

**Drywall track to concrete**

## Load data

### Recommended loads

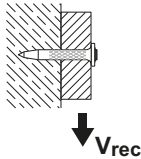
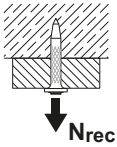

Fastening wood to concrete:

$N_{rec}$ [kN]	$V_{rec}$ [kN]	$h_{ET}$ [mm]
0.4	0.4	$\geq 27$
0.3	0.3	$\geq 22$
0.2	0.2	$\geq 18$
0.1	0.1	$\geq 14$

Fastenings to sandlime masonry:

$N_{rec} = V_{rec} = 0.4 \text{ kN}$  for  $h_{ET} \geq 27 \text{ mm}$

### Design conditions:

- For safety relevant fastenings sufficient redundancy of the entire system is required: minimum 5 fastenings per fastened unit.
- All visible failures must be replaced.
- Valid for concrete with strength of  $f_{cc} < 45 \text{ N/mm}^2$ .
- Valid for predominantly static loading.
- Failure of the fastened material is not considered in recommended loads.
- To limit penetration of nail in soft material and to increase pullover load, use nails with washers.

## Application requirements

### Thickness of base and fastened material

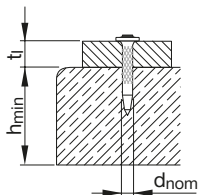

#### Concrete

$h_{min} = 80 \text{ mm}$

$t_1 \leq 50.0 \text{ mm}$

### Edge distance and fastener spacing

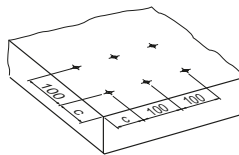

Edge distance:

Spacing:

$c \geq 70 \text{ mm}$

$s \geq 100 \text{ mm}$

### Corrosion information

The intended use for safety relevant and permanent applications only comprises fastenings which are not directly exposed to external weather conditions or moist atmospheres.

## Fastener selection and system recommendation

### Fastener selection

Required nail shank length:

$$L_S = h_{ET} + t_i \text{ [mm]}$$

Recommendation:

Concrete  $h_{ET} = 22 \text{ mm}$

Sandlime masonry  $h_{ET} = 27 \text{ mm}$

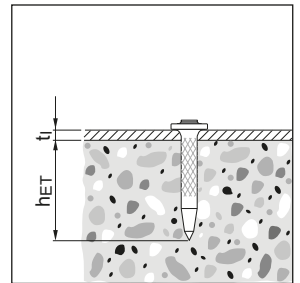
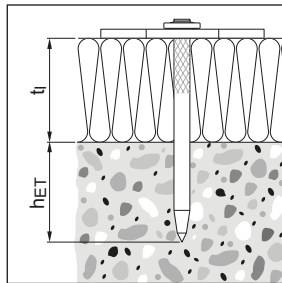
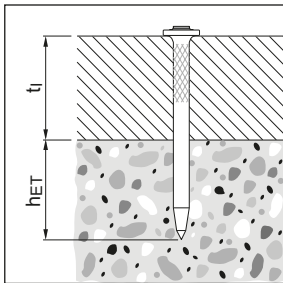

In case flush fastenings are required:

$$L_S = h_{ET} + t_i - 5 \text{ [mm]}$$

## Fastener program

Nails					Tools							Key applications
Fastener description	Item no.		Specifica-tion		DX 460 MX, DX 5 MX	DX 460 F8, DX 5 F8	DX 2, DX 36	DX E72	DX 351 MX	DX 351 F8	DX 35	
	Packs of 1000 pcs	Packs of 100 pcs	L <sub>s</sub> (mm)	d <sub>nom</sub> (mm)								
X-C 22 P8	2091378	2091377	22	3.5	■	■	■			■	■	Thin metal part to concrete
X-C 27 P8	2091380	2091379	27	3.5	■	■	■			■	■	Thin metal part to concrete
X-C 32 P8	2091382	2091381	32	3.5	■	■	■			■	■	Thin metal part to concrete
X-C 37 P8	2091384	2091383	37	3.5	■	■	■			■	■	Thin metal part to concrete
X-C 42 P8	2091386	2091385	42	3.5	■	■	■			■		Soft mat / Wood on concrete
X-C 47 P8	2091388	2091387	47	3.5	■	■	■			■	■	Soft mat / Wood on concrete
X-C 52 P8	2091390	2091389	52	3.5	■	■	■					Wood on concrete
X-C 62 P8	2091392	2091391	62	3.5	■	■	■					Wood on concrete
X-C 72 P8		2091393	72	3.5	■	■	■					Wood on concrete
X-C 82 P8		360930	82	3.7	■	■	■					Wood on concrete (with pre-hammering)
X-C 97 P8		360931	97	3.7	■	■	■					Wood on concrete (with pre-hammering)
X-C 117 P8		360933	117	3.7	■	■	■					Wood on concrete (with pre-hammering)
X-C 20 THP	2091373	2091372	20	3.5	■	■	■			■	■	Thin metal part to concrete
X-C 22 P8 S15TH		2091410	22	3.5	■	■	■					Thin metal part to concrete
X-C 22 P8TH	2091374	2091375	22	3.5	■	■	■			■	■	Thin metal part to concrete
X-C 27 P8TH		2091376	27	3.5	■	■	■			■	■	Thin metal part to concrete
X-C 27 P8S23	2091396	2091395	27	3.5	■	■	■			■	■	High pull-over strength on concrete
X-C 32 P8S23	2091399	2091397	32	3.5	■	■	■			■	■	High pull-over strength on concrete
X-C 37 P8S23	2091401	2091400	37	3.5	■	■	■			■	■	High pull-over strength on concrete
X-C 42 P8S23	2091404	2091403	42	3.5	■	■	■			■		High pull-over strength on concrete
X-C 47 P8S23	2091406	2091405	47	3.5	■	■	■			■		High pull-over strength on concrete
X-C 37 P8S36	2091407		37	3.5	■	■	■			■	■	High pull-over strength on concrete
X-C 52 P8S36	2091408		52	3.5	■	■	■			■		High pull-over strength on concrete
X-C 62 P8S36	2091409		62	3.5	■	■	■					High pull-over strength on concrete
X-C 32 P8S23T	2091398		32	3.5	■	■	■					Tunneling applications
X-C 37 P8S23T	2091402		37	3.5	■	■	■					Tunneling applications

■ recommended  
■ feasible

Nails				Tools							Key applications	
Fastener description	Item no.		Specifica-tion		DX 460 MX, DX 5 MX	DX 460 F8, DX 5 F8	DX 2, DX 36	DX E72	DX 351 MX	DX 351 F8		DX 35
	Packs of 1000 pcs	Packs of 100 pcs	L <sub>s</sub> (mm)	d <sub>nom</sub> (mm)								
X-C 20 MX	2091264	2091265	20	3.5	■							Thin metal part to concrete
X-C 27 MX	2091266	2091267	27	3.5	■				■			Thin metal part to concrete
X-C 32 MX	2091268	2091269	32	3.5	■							Thin metal part to concrete
X-C 37 MX	2091360	2091361	37	3.5	■							Thin metal part to concrete
X-C 42 MX	2091362	2091363	42	3.5	■							Soft material / Wood on concrete
X-C 47 MX	2091364	2091365	47	3.5	■							Soft material / Wood on concrete
X-C 52 MX	2091366	2091367	52	3.5	■							Wood on Concrete
X-C 62 MX	2091368	2091369	62	3.5	■							Wood on Concrete
X-C 72 MX	2091370	2091371	72	3.5	■							Wood on Concrete

MX: collated nails for magazine

■ recommended

**Cartridge recommendation:**

Green concrete: **6.8/11M green**

Normal concrete: **6.8/11M yellow**

Old/high strength concrete: **6.8/11M red**

Sandlime masonry: **6.8/11M green**

Tool energy adjustment by setting tests on site.





# X-S Nail for fastening drywall track to steel

## Product data

### Dimensions

X-S13 THP

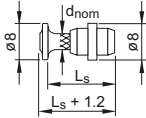

X-S16 P8TH

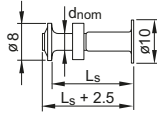

### General information

#### Material specifications

Carbon steel shank:

**X-S 16 P8 TH** HRC 55.5

**X-S 13 THP/MX** HRC 52.5

Zinc coating: 5–13  $\mu\text{m}$

#### Recommended fastening tools

**DX 460, DX 460 MX, DX 5, DX 5 MX, DX 36, DX 2, DX 351, DX 351 MX, DX-E 72**

See **X-S fastener program** in the next pages and **Tools and equipment** chapter for more details.

#### Approvals

ICC (USA): **X-S (ESR-1752)**

Note: technical data presented in these approvals and design guidelines reflect specific local conditions and may differ from those published in this handbook.

## Applications

### Examples

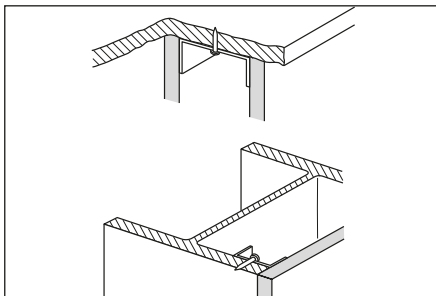

**Drywall tracks to steel**

**Load data**
**Recommended loads**

**Steel**      **0.4 kN**

**Design conditions:**

- Redundancy (multiple fastening) must be provided
- All visible failures must be replaced

**Application requirements**
**Thickness of base material**

Steel

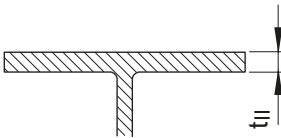

$t_{II} \geq 4 \text{ mm}$

**Thickness of fastened material**

Wooden track:       $t_I \leq 24 \text{ mm}$

Metal track:         $t_I \leq 2 \text{ mm}$

**Edge distance**

$c \geq 15 \text{ mm}$

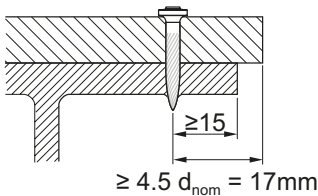
**Corrosion information**

The intended use only comprises fastenings which are not directly exposed to external weather conditions or moist atmospheres. For further detailed information on corrosion see corresponding chapter in **Direct Fastening Principles and Technique** section.

## Application limits

### Steel

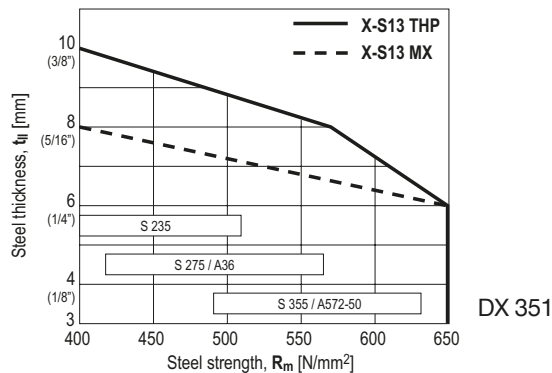

## Fastener selection and system recommendation

### Fastener selection

	Application	Base material
<b>X-S 16</b>	Metal track	Steel
<b>X-S 13</b>	Metal track	Steel

↑ Increase in strength

### Fastener program

Fastener	Item no. Packs of 1000 nails	Item no. Packs of 100 nails	$L_S$ [mm]	$d_{nom}$ [mm]	Standard tools						
					DX 460 MX, DX 5 MX	DX 460 F8, DX 5 F8	DX 2, DX 36	DX E72	DX 351 MX	DX 351 F8	DX 35
<b>X-S 13 THP</b>	274061	274059	13	3.7		■	■	■		■	■
<b>X-S 16 P8 TH</b>	388842		16	3.7		■	■	■		■	■
<b>X-S 13 MX</b>	274062	274060	13	3.7	■				■		

## Cartridge selection and tool energy setting

Cartridge recommendation:

**6.8/11M yellow or red cartridge** on steel thickness  $t_{II} \geq 6$  mm

**6.8/11M green or yellow cartridge** on steel thickness  $t_{II} < 6$  mm

Tool energy adjustment by setting tests on site.

## Fastening quality assurance

### Fastening inspection

Fastening to steel

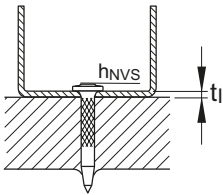

X-S:  $h_{NVS} = 2-4$  mm

# DS Heavy-duty nail for fastening to concrete and steel

## Product data

### Dimensions

DS \_\_ P10

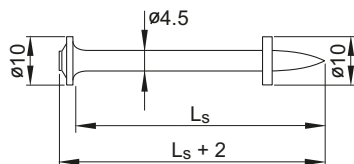

### General information

#### Material specifications

Carbon steel shank: HRC 54 (**DS**)  
HRC 58 (**DSH**)

Zinc coating: 5–20  $\mu\text{m}$

#### Recommended fastening tools

DX 460 F10, DX 5 F10, DX 76, DX 76 PTR

See **DS fastener program** in the next pages and **Tools and equipment** chapter for more details

#### Approvals

ICC (USA) LR 97/00077

Note:

Technical data presented in these approvals and design guidelines reflect specific local conditions and may differ from those published in this handbook.

## Applications

### Examples

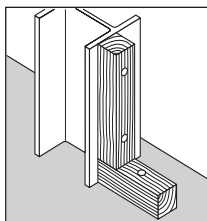

**Wood to steel and concrete**

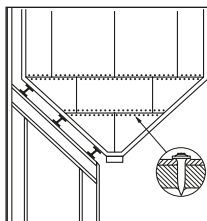

**Plastic and rubber to steel**

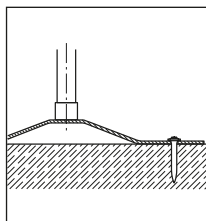

**Metal parts to concrete**

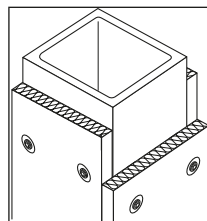

**Soft material to steel and concrete**

## Load data

### Recommended loads

Fastening wood to concrete, sandlime masonry or steel

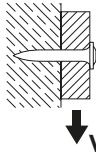
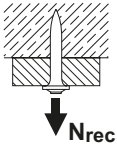

Fastening wood to concrete, sandlime masonry:

$$N_{rec} = V_{rec} = 0.4 \text{ kN}$$

Fastening wood to steel:

$$N_{rec} = V_{rec} = 0.6 \text{ kN}$$

### Design conditions:

- For safety-relevant fastenings sufficient redundancy of the entire system is required: minimum 5 fastenings per fastened unit with normal weight concrete base material.
- All visible failures must be replaced.
- Valid for concrete and sandlime masonry with strength of  $f_{cc} < 40 \text{ N/mm}^2$ .
- Fastened material:
 

wood, minimum thickness	= 24 mm
plywood, minimum thickness	= 16 mm

### Soft material:

- Working loads depend on strength and thickness of material fastened. Do not use working loads in excess of those for wood.
- Depth of penetration and other conditions same as for fastening wood.
- Use R23 or R36 ( $\varnothing 4.5 \text{ mm}$  hole) washer to control penetration and to increase pull-over strength. Separately available from Hilti.

### Metal profiles to concrete:

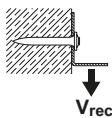
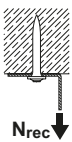

$$N_{rec} = V_{rec} = 0.4 \text{ kN}$$

- Minimum 5 fastenings per fastened unit (normal weight concrete)
- Increase to 600 N possible if 8 or more fastenings in each fastened unit.
- All visible failures must be replaced
- $t_1 = 1\text{--}4 \text{ mm}$

**Application requirements**

**Thickness of base material**

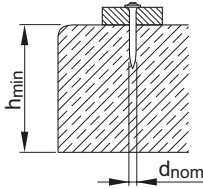

Concrete

**$h_{min} = 100 \text{ mm}$  ( $d_{nom} \geq 4.5 \text{ mm}$ )**

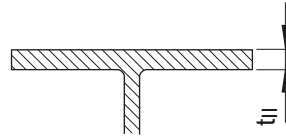

Steel

**$t_l \geq 6 \text{ mm}$**

**Thickness of fastened material**

**$t_l \leq 50.0 \text{ mm}$**

**Spacing and edge distances (mm)**

Edge distance: concrete

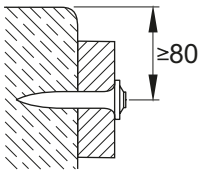

Edge distance: steel

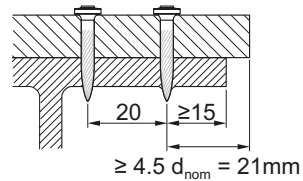

Spacing

**$a = 20 \text{ mm}$**

**Corrosion information**

The intended use for safety-relevant and permanent applications only comprises fastenings which are not directly exposed to external weather conditions or moist atmospheres. For further detailed information on corrosion see relevant chapter in **Direct Fastening Principles and Technique** section.

## Application limits

### Steel

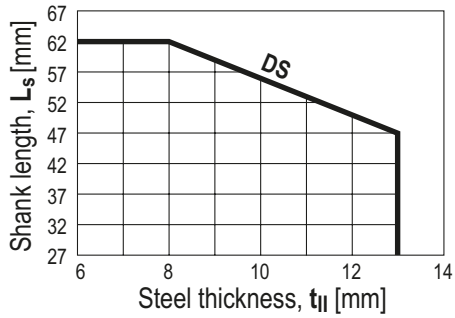

## Fastener selection

### Fastening to concrete

Required nail shank length:

Wood or

metal profiles  $L_S = h_{ET} + t_I$  [mm]

Soft material  $L_S = h_{ET} + t_I - 2 - h_{CS}$  [mm]

$h_{CS} \cong 3$  mm if possible

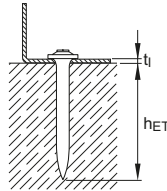

Required depth of penetration  $h_{ET}$

Select  $h_{ET}$

$h_{ET} \geq 27$  mm

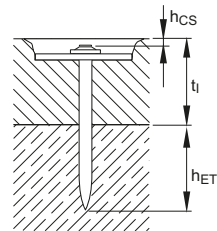
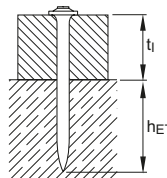

### Fastening to steel

$h_{ET} = 17-27$  mm

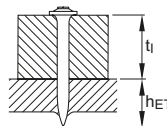



## Fastener program

### Fasteners

Designation	Item no.	L <sub>S</sub> [mm]	d <sub>nom</sub> [mm]
<b>DS 27 P10</b>	46157	27	4.5
<b>DS 32 P10</b>	46158	32	4.5
<b>DS 37 P10</b>	46159	37	4.5
<b>DS 42 P10</b>	46160	42	4.5
<b>DS 47 P10</b>	46161	47	4.5
<b>DS 52 P10</b>	46162	52	4.5
<b>DSH 57 P10</b>	40591	57	4.5
<b>DS 62 P10</b>	46164	62	4.5
<b>DS 72 P10</b>	46165	72	4.5

Nail length limits are for use without pre-driving into the wood. Hand-driving the nail into the wood and bringing the DX tool into position over the nail head extend the nail length range for the tools.

### Cartridge selection and tool energy setting

Cartridge recommendation: DX 460, DX 5

Steel: **6.8/11M red cartridge**

Concrete: **6.8/11M yellow or red cartridge**

Masonry: **6.8/11M green cartridge**

Cartridge recommendation: DX 76, DX 76 PTR

Steel: **6.8/18M red or black cartridge**

Concrete: **6.8/18M yellow or red cartridge**

Tool energy adjustment by setting tests on site.

### Fastening quality assurance

#### Fastening inspection

Fastening wood or soft material

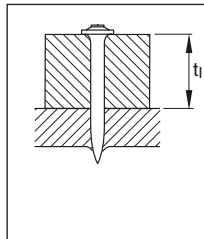
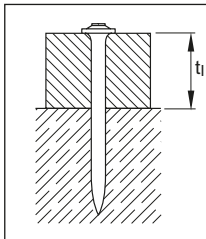

Fastening metal profiles

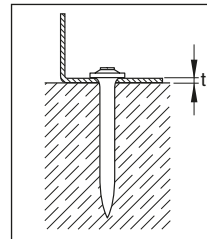

Flush setting of the nails



# EDS Nail for fastening to steel

## Product data

### Dimensions

EDS\_P10

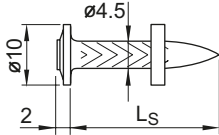

### General information

#### Material specifications

Carbon steel shank:  
 EDS 19/22 HRC 55.0  
 Zinc coating: 10–25  $\mu\text{m}$

#### Recommended fastening tools

DX 76, DX 76 PTR  
 See **EDS fastener program** in the next pages and **Tools and equipment** chapter for more details.

#### Approvals

ICC (USA)  
 ABS, LR, DNV-GL



Note:

Technical data presented in these approvals and design guidelines reflect specific local conditions and may differ from those published in this handbook.

## Applications

### Example

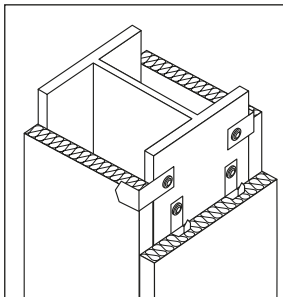

Metal clips

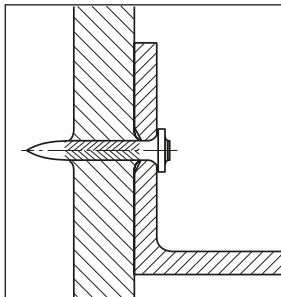

Angle bracket

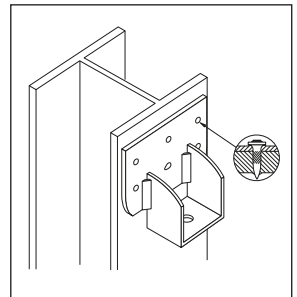

Mounting bracket

## Load data

### Recommended loads (predominantly static)

Steel sheet fastening

$t_f$ [mm]	EDS_P10	
	$N_{rec}$ [kN]	$V_{rec}$ [kN]
0.75	1.1	1.5
1.00	1.3	2.3
1.25	1.7	3.2
$\geq 2.00$	2.4	4.0

- Recommended loads valid for steel sheet with minimum tensile strength  $\geq 360$  N/mm<sup>2</sup>.
- For intermediate sheet thicknesses, use recommended load for next smaller thickness.
- $N_{rec}$  and  $V_{rec}$  include an overall safety factor of 3.0 applied to the characteristic test data.  
 Static test:  $N_{rec} = N_{test,k} / 3.0$ ,  $V_{rec} = V_{test,k} / 3.0$

### Forces of constraint

When fastening large pieces of steel, the possibility of shear loadings from forces of constraint should be considered. Avoid exceeding  $V_{rec}$  for the fastener shank!

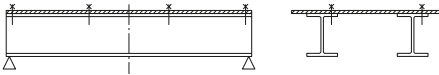

Deflection due to primary loading

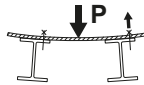
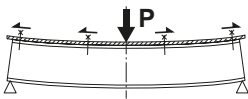

Temperature effect

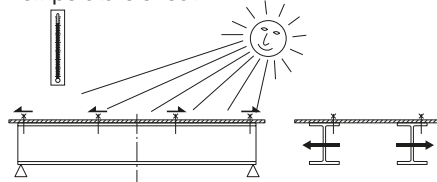

## Application requirements

### Thickness of base material

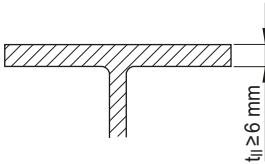

	$t_{II}$ (mm)
EDS	$\geq 6$

### Thickness of fastened material

$t_f \leq 3$  mm

Steel fastened material  $\leq 3$  mm thick, usually deforms with the displaced base material to allow a tight fit between fastened steel and base material without pre-drilling.

Because conditions may vary, trial fastenings are recommended

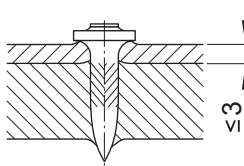

$t_f > 3$  mm

Without pre-drilling: steel fastened material  $> 3$  mm thick is too stiff to deform entirely with the displaced base material. The gap, which increases with increasing  $t_f$ , can result in bending moments being applied to the nail shank.

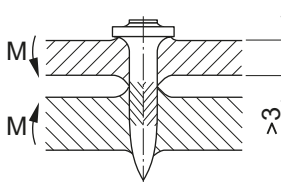

To prevent imposition of a moment on the shank of fastener, use three fasteners in a group.

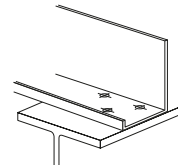

With pre-drilling:

If a gap between the fastened part and the base material is unacceptable, the fastened part can be prepared with drilled holes.

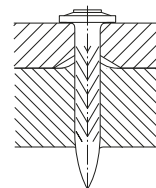
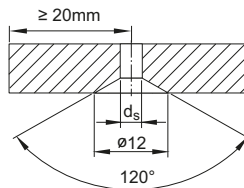

## Spacing and edge distances (mm)

Base material

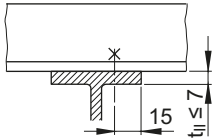

Fastened material

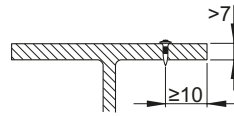
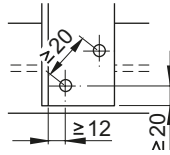

## Corrosion information

The intended use only comprises fastenings which are not directly exposed to external weather conditions or moist atmospheres. For further detailed information on corrosion see relevant chapter in **Direct Fastening Principles and Technique** section.

## Application limits

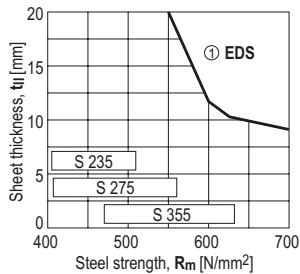

① EDS with DX76 and DX 76 PTR

- Limit line valid for steel,  $t_1 \leq 3$  mm
- For steel  $t_1 > 3$  mm and without pre-drilling, either make trial fastenings or adjust  $t_{II}$  to  $t_{II} + t_1$  before using the chart.

### Fastener program

Base material thickness	Fixed material thickness $t_f$ [mm]									Fastener	Item no.	$L_s$ [mm]	$h_{ET}$ [mm]	DX tools
	≤1	2	3	5	6	7	8	9	13					
$t_{f,min} \geq 6$ mm	■	■	■	■						EDS 19 P10	46554	19	12-17	DX 76,
				■	■	■	■			EDS 22 P10	46556	22	12-17	DX76PTR

■ recommended thickness

$$L_s = h_{ET} + t_f$$

### Cartridge recommendation

Tool energy adjustment by setting tests on site

Fastener                      Cartridge selection and tool energy setting

EDS                              Cartridge recommendation: **6.8/18M red or black**

### Fastening quality assurance

#### Fastening inspection

EDS \_\_ P10

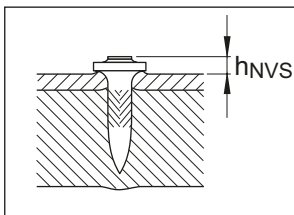

$h_{NVS} = 3.0-4.0$  mm





# X-R Stainless steel nail for fastening to steel

## Product data

### Dimensions

X-R14 P8

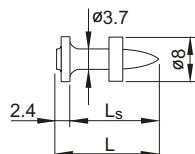

### General information

#### Material specifications

Shank: P558 (CrMnMo alloy)  
 $f_u \geq 2000 \text{ N/mm}^2$

Washer: polyethylene

#### Recommended fastening tools

DX 450, DX 460, DX 5

#### Approvals

ABS 16-HS1545447-PDA  
 DIBt Z-14.4-766  
 LR 97/00078 (E4)  
 ICC-ES ESR-1663

## Applications

### Examples

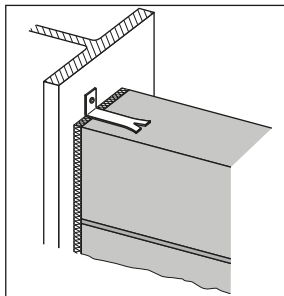

Steel to steel fastenings,  
 e.g. wall ties, struts, channels,  
 etc.

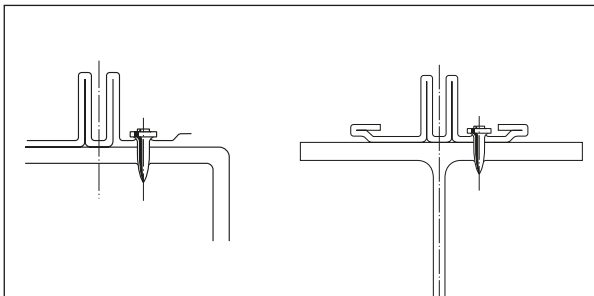

Fastening glass facade attachment profiles using the DX 450  
 (125%, 8 mm narrow access)

## Load data

### Recommended loads

Carbon steel sheet, $f_u \geq 370$ N/mm <sup>2</sup>			Aluminium sheet, $f_u \geq 210$ N/mm <sup>2</sup>		
$t_f$ [mm] <sup>1)</sup>	$N_{rec}$ [kN]	$V_{rec}$ [kN]	$t_f$ [mm]	$N_{rec}$ [kN]	$V_{rec}$ [kN]
0.75	1.0	1.1	0.8	0.4	0.4
1.00	1.2	1.4	1.0	0.6	0.6
1.25	1.5	1.7	1.2	0.8	0.9
2.00	2.2	2.0	1.5	1.1	1.4
2.50	2.2	2.0	2.0	1.6	1.7
3.00	2.2	2.0			

1) Maximum thickness of attachment profiles in glass facade applications in accordance with DIBt approval Z-14.4-766: 2.5 mm.

Conditions:

- Recommended working loads valid for fastened materials as shown above.
- For intermediate sheet thicknesses, use recommended load for next smaller thickness.
- For stainless steel sheet, use same loads as for carbon steel sheet.
- Recommended loads include an overall safety factor applied to the characteristic strength.  
Static test:  $N_{rec} = N_{test,k} / 3.0$ ,  $V_{rec} = V_{test,k} / 3.0$
- These recommended loads are appropriate for Eurocode 1 (or similar) wind loading designs.
- Forces of constraints must be observed, see section below.
- Resistances of glass facade attachment profiles: see DIBt approval Z-14.4-766

### Forces of constraint

When fastening large pieces of steel or aluminium, the possibility of shear loading due to forces of constraint must be taken into account in the fastening design. Allowance must be made for movement or, alternatively, forces of constraint must be taken into account in the design and maximum shear force limited by way of  $V_{rec}$ .

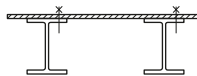
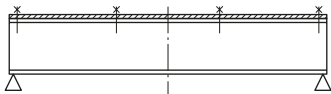

Deflection due to primary loading

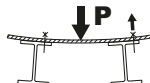
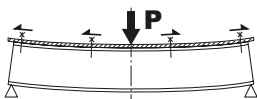

Temperature effect

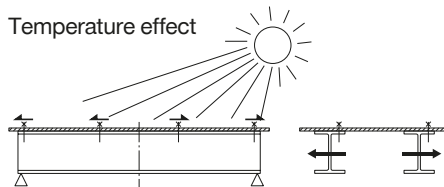

## Application requirements

### Thickness of base material

Using **DX 450** tool:  $t_{II} \geq 5.0 \text{ mm}$  <sup>1)</sup>

<sup>1)</sup>  $t_{II} \geq 4 \text{ mm}$  possible for specific types of rectangular hollow sections.

**Please refer to DIBt approval for fastening glass facade attachment profiles using the DX 450.**

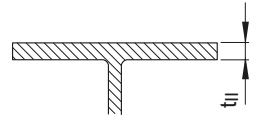

Using **DX 460, DX 5** tool:  $t_{II} \geq 6.0 \text{ mm}$

### Thickness of fastened material

Using **DX 460, DX 5** tool:  $t_I \leq 1.0 \text{ mm}$

Using **DX 450** tool:  $t_I \leq 3.0 \text{ mm}$

### Spacing and edge distances (mm)

Rolled shapes

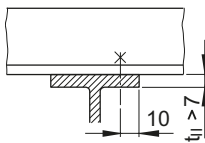

Cold-formed shapes

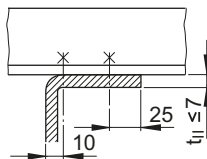

Fastened material

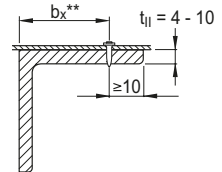
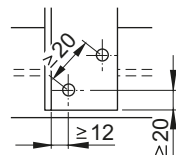

\*\* max. allowable  $b_x \leq 8 \times t_{II}$  (however, on-site trials advisable)

### Corrosion information

For fastenings exposed to outdoor environments in mildly corrosive conditions where HDG coated parts are commonly specified or used.

Not for use in atmospheres with chlorides (marine atmospheres) or in heavily polluted environments (e.g. sulphur dioxide).

## Application limits

### DX 450

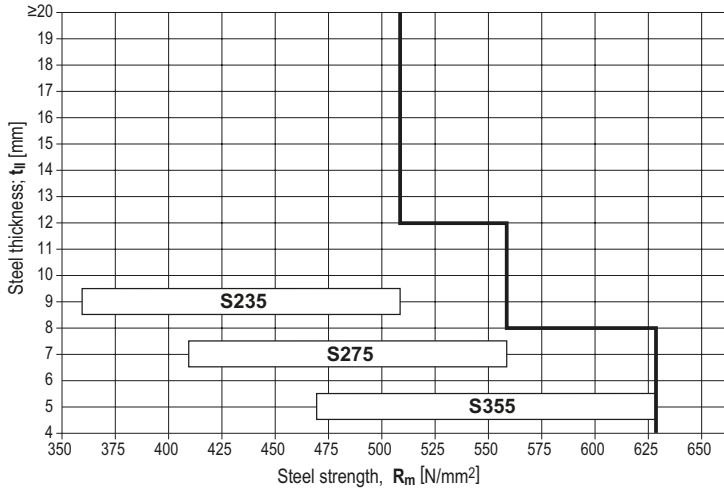

- Base material thickness 4 – 8 mm: covers base material steel grades up to grade S355
- Base material thickness 8 – 12 mm: covers base material steel grades up to grade S275
- Base material thickness > 12 mm: covers base material steel grade S235

### DX 460, DX 5

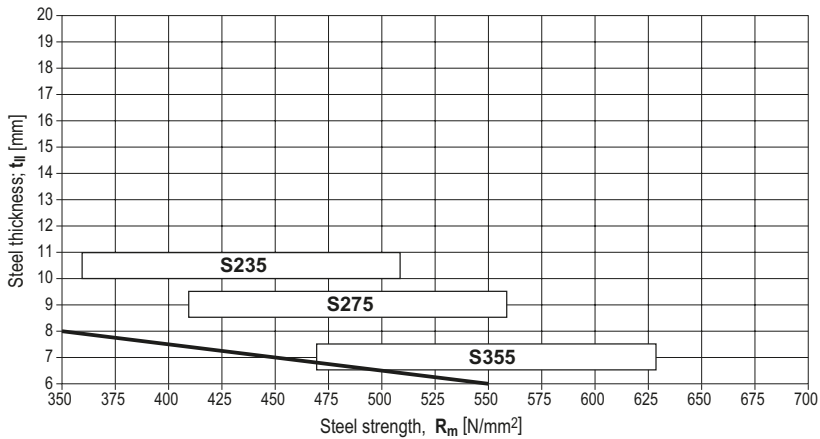

**Fastener selection**
**Fastener program**

Designation	Item no.	$L_s$ [mm]	Tools
X-R14 P8	2122461	14	DX 450, DX 460, DX 5

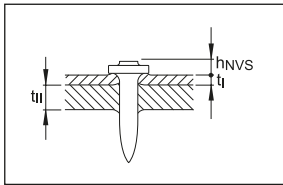
**Fastening quality assurance**
**Cartridge selection, tool energy setting and fastening inspection**

**DX 450**

Base material thickness [mm] $t_{II}$	4 - 6	6 - 8	> 8
Cartridge, 6.8/11M	Yellow	Red	
Tool energy setting	1.0 – 3.0	2.0 – 3.0	2.5 – 3.0
$h_{NVS}$ [mm]	3.0 – 4.5	3.0 – 4.5	2.0 – 3.0

**DX 460, DX 5**

Cartridge, 6.8/11M	Red
$h_{NVS}$ [mm]	3.0 – 4.5

Tool energy adjustment by setting tests on site



# X-CR Stainless steel nail for fastening to steel

## Product data

### Dimensions

X-CR\_\_ P8

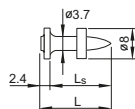

X-CR 14 D12

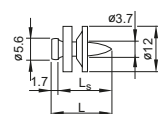

X-CR\_\_ S12

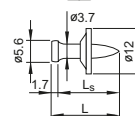

### General information

#### Material specifications

Nail shank: CR-500 (CrNiMo alloy)

$f_u \geq 1800 \text{ N/mm}^2$

Steel washers: X2CrNiMo 18143

Plastic washers: polyethylene

#### Recommended fastening tools

DX 460, DX 5, DX 450

See **X-CR fastener program** in the next pages and **Tools and equipment** chapter for more details.

#### Approvals

DIBt (Germany): X-CR 14 P8  
fastening of glass facades  
with DX 450 (125%)

ABS, LR: all types



## Applications (for fastenings exposed to weather or other corrosive conditions)

### Examples

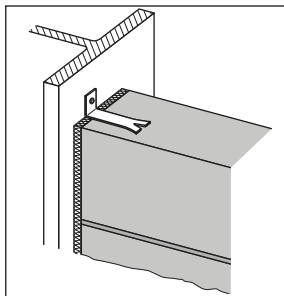

Wall ties

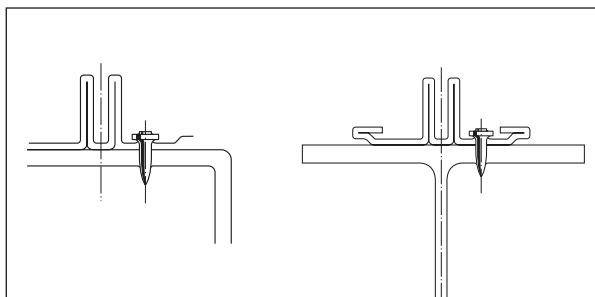

Fastening of glass facades

## Load data

## Recommended loads

### Steel sheet fastening

Carbon steel sheet,  $f_u \geq 370 \text{ N/mm}^2$

Aluminium sheet,  $f_u \geq 210 \text{ N/mm}^2$

$t_f$ [mm]	X-CR __ P8		X-CR __ D12/S12		$t_f$ [mm]	X-CR __ P8		X-CR __ D12/S12	
	$N_{rec}$ [kN]	$V_{rec}$ [kN]	$N_{rec}$ [kN]	$V_{rec}$ [kN]		$N_{rec}$ [kN]	$V_{rec}$ [kN]	$N_{rec}$ [kN]	$V_{rec}$ [kN]
0.75	1.0	1.1	1.4	1.1	0.8	0.4	0.4	0.6	0.4
1.00	1.2	1.4	1.6	1.4	1.0	0.6	0.6	0.8	0.6
1.25	1.5	1.7	1.8	1.7	1.2	0.8	0.9	1.1	0.9
2.00	2.2	2.0	2.2	2.0	1.5	1.1	1.4	1.6	1.4
					2.0	1.6	1.7	1.9	1.7

- Recommended working loads valid for fastened materials as shown above.
- For intermediate sheet thicknesses, use recommended load for next smaller thickness.
- For stainless steel sheet, use same loads as for carbon steel sheet.
- Recommended loads include an overall safety factor applied to the characteristic strength.  
Static test:  $N_{rec} = N_{test,k} / 3.0$   $V_{rec} = V_{test,k} / 3.0$
- These recommended loads are appropriate for Eurocode 1 (or similar) wind loading designs.

### Other applications\*

X-CR \_\_ P8 / X-CR 14 D12 / X-CR \_\_ S12

$N_{rec}$ [kN]	X-CR __ P8	
	$V_{rec}$ [kN]	$M_{rec}$ [Nm]
1.6	2.0	3.8

\* Fastened parts: thicker steel components (clips, brackets, etc.)

- Failure of fastened material is not considered in  $N_{rec}$  and  $V_{rec}$ .
- Loads valid for predominantly static loading.

### Forces of constraint

When fastening large pieces of steel or aluminium, the possibility of shear loadings from forces of constraint should be considered in the fastening design. Either allow for movement or avoid exceeding  $V_{rec}$ !

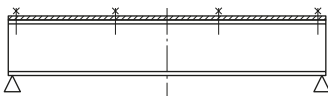

Deflection due to primary loading

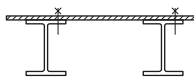

Temperature effect

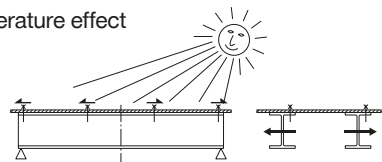
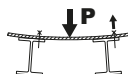
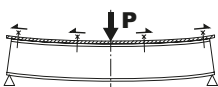



## Application requirements

### Thickness of base material

Using **DX 450** tool:  $t_{II} \geq 5.0 \text{ mm}$  <sup>1)</sup>  
 Using **DX 460, DX 5** tool:  $t_{II} \geq 6.0 \text{ mm}$  <sup>1)</sup>  $t_{II} \geq 4 \text{ mm}$  possible for specific types of hollow sections

### Thickness of fastened material

$t_I \leq 12.0 \text{ mm}$  (details see fastener selection)

### Spacing and edge distances (mm)

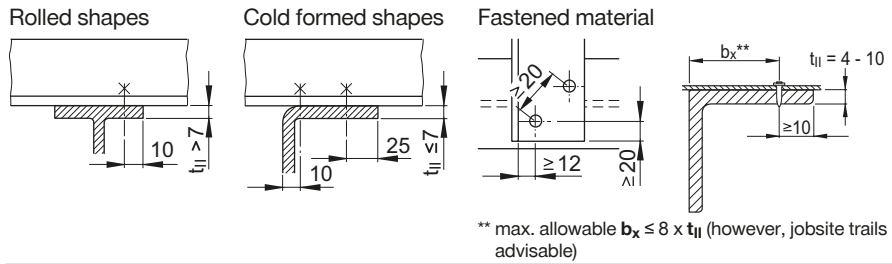

### Corrosion information

For fastenings exposed to weather or other corrosive conditions. Not for use in highly corrosive surroundings like swimming pools or highway tunnels.  
 For further detailed information on corrosion see relevant chapter in **Direct Fastening Principles and Technique** section.

### Application limits

#### DX 450, DX 460, DX 5

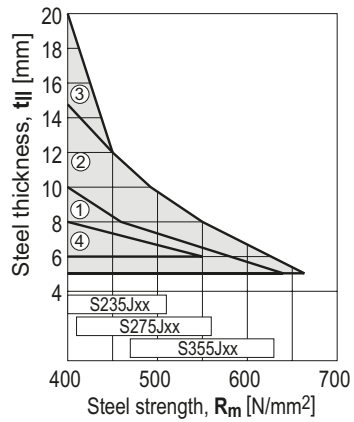

- ① **X-CR16** ( $t_I \leq 3 \text{ mm}$ ) with DX 450 tool
- ② **X-CR14** ( $t_I \leq 2 \text{ mm}$ ) with DX 450 tool
- ③ **X-CR14** ( $t_I \leq 1 \text{ mm}$ ) with DX 450 tool
- ④ **X-CR14** ( $t_I \leq 1 \text{ mm}$ ) with DX 460, DX 5 tool

**DX 450:** Steel thickness  $t_{II} \geq 5 \text{ mm}$   
**DX 460, DX 5:** Steel thickness  $t_{II} \geq 6 \text{ mm}$

## Fastener program

### Fastening of steel sheets

Fixed material thickness $t_f$ [mm]			Fastener Designation	Item no.	$L_s$ [mm]	$h_{ET}$ [mm]	Tool
≤1	2	3					
		■	X-CR 16 P8	247356	16	≥ 9	DX 450, DX 460, DX 5
■			X-CR 14 D12	244601	14	≥ 9	DX 450
	■	■	X-CR 16 S12	298855	16	≥ 9	DX 450

### Fastening of wood or soft material

Fixed material thickness $t_f$ [mm]						Fastener Designation	Item no.	$L_s$ [mm]	$h_{ET}$ [mm]	Tool
≤4	5	6	8	9	11					
	■	■				X-CR 18 P8	247357	18	≥ 9	DX 450, DX 460, DX 5
			■	■		X-CR 21 P8	247358	21	≥ 9	DX 450, DX 460, DX 5
■	■					X-CR 18 S12	298856	18	≥ 9	DX 450
		■	■			X-CR 21 S12	298857	21	≥ 9	DX 450
				■	■	X-CR 24 S12	298858	24	≥ 9	DX 450

■ = recommended thickness

$$L_s = h_{ET} + t_f$$

for X-CR \_\_P8

$$L_s = h_{ET} + t_f + 1$$

for X-CR \_\_D12/S12

## Cartridge recommendation

DX 460, DX 5 **6.8/11M red or black cartridge**

DX 450 **6.8/11M yellow cartridge** ( $t_{fl} \geq 5-6$  mm)

**6.8/11M red cartridge** ( $t_{fl} > 6$  mm)

Tool energy adjustment by setting tests on site.

## Fastening quality assurance

### Fastening inspection

#### X-CR \_\_ P8

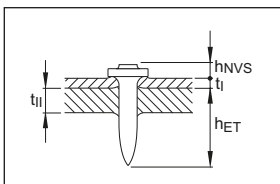

$h_{NVS} = 3.0-4.5$  mm

#### X-CR 14 D12

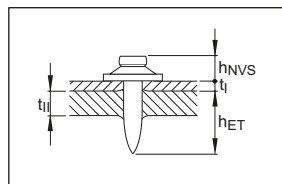

$h_{NVS} = 4-5$  mm

#### X-CR \_\_ S12

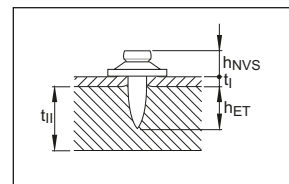

$h_{NVS} = 4-5$  mm

# X-CR Stainless steel nail for fastening to concrete, sand lime masonry and steel

## Product data

### Dimensions

X-CR \_\_ P8

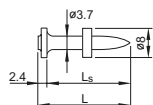

X-CR \_\_ P8

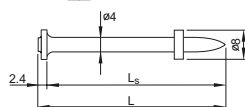

X-CR \_\_ P8 S12

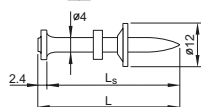

X-CR\_P8 S15

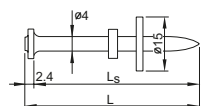

### General information

#### Material specifications

Nail shank: CrNiMo Alloy  
 $f_u \geq 1800 \text{ N/mm}^2$   
 (49 HRC)

Zinc coating: X-CR 48/52 P8 S15 has  
 5–13  $\mu\text{m}$

Zinc coating to improve anchorage in concrete

#### Recommended fastening tools

DX 460, DX 5, DX 36, DX 2, DX-E72

See **X-CR fastener program** in the next pages and **Tools and equipment** chapter for more details

#### Approvals

ABS, LR: all types



## Applications

### Examples

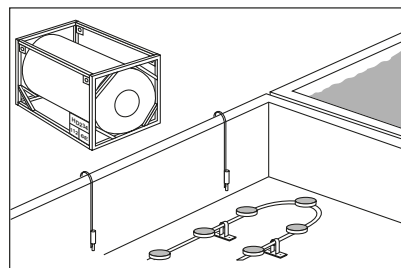

Exposure to weather or otherwise corrosive conditions

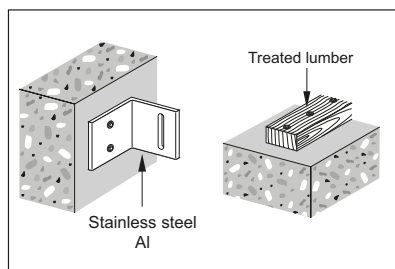

Noble or corrosive fastened material

## Load data

### DX Standard: Recommended loads

Fastening wood to concrete, sandlime masonry or steel

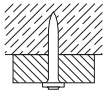

$N_{rec}$



$V_{rec}$

Fastening wood to concrete, sandlime masonry:

$$N_{rec} = V_{rec} = 0.4 \text{ kN}$$

Fastening wood to steel:

$$N_{rec} = V_{rec} = 0.6 \text{ kN}$$

### Design conditions:

- For safety relevant fastenings sufficient redundancy of the entire system is required: minimum 5 fastenings per fastened unit with normal weight concrete base material.
- All visible failures must be replaced.
- Valid for concrete and sandlime masonry with strength of  $f_{cc} < 40 \text{ N/mm}^2$ .
- Valid for predominantly static loading.

### Soft material:

- Working loads depend on strength and thickness of material fastened. Do not use working loads in excess of those for wood.
- Depth penetration and other conditions same as for fastening wood
- Use R23 or R36 ( $\varnothing 4.5 \text{ mm}$  hole) washer to control penetration and to increase pull-over strength. Separately available from Hilti.

### DX-Kwik (with pre-drilling): Recommended loads

	$N_{rec,1}$ [kN]	$N_{rec,2}$ [kN]	$V_{rec}$ [kN]	$M_{rec}$ [Nm]
X-CR 39/44	2.0	0.6	2.0	5.5
X-CR 48	3.0	0.9	3.0	5.5

### Conditions:

- $N_{rec,1}$ : concrete in compressive zone.
- $N_{rec,2}$ : concrete in tension zone.
- Static or cyclic (5000 load applications) loading.
- $f_{cc} \geq 25 \text{ N/mm}^2$ . For higher concrete strengths, higher loadings may be possible if supported by testing.
- A sufficient redundancy has to be ensured, that the failure of a single fastening will not lead to collapse of the entire system.
- Recommended loads are based on failure of the fastener anchorage in the concrete. Thickness and quality of the fastened material may lower the loadings.
- Observance of all pre-drilling requirements, fastened thickness limits, and recommended details.

## Application requirements

### Thickness of base material

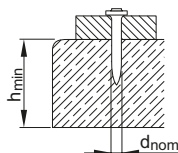

Concrete

$h_{min} = 80 \text{ mm}$  ( $d_{nom} = 3.7 \text{ mm}$ )

$h_{min} = 90 \text{ mm}$  ( $d_{nom} \geq 4.0 \text{ mm}$ )

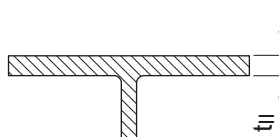

Steel

$t_{II} \geq 5 \text{ mm}$  for fastening of wood

### Thickness of fastened material

$t_1 \leq 25.0 \text{ mm}$  (detailed information see fastener selection)

### Spacing and edge distances (mm)

Pairs

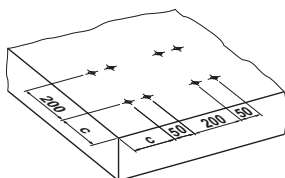

reinforced\*    non-reinforced

**c**    100            150

Row along edge

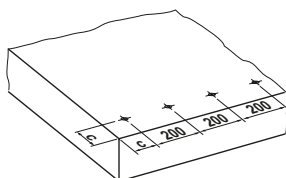

reinforced\*    non-reinforced

**c**    80            150

General

(e.g. group of fasteners)

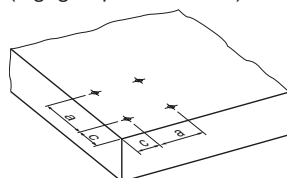

reinforced\*    non-reinforced

**c**    80            150

**a**    80            100

\* Minimum  $\varnothing 6 \text{ mm}$  reinforcing steel continuous along all edges and around all corners. Edge bar must be enclosed by stirrups.

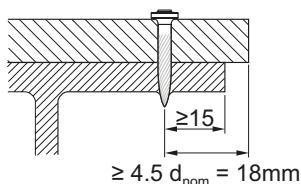

### Corrosion information

For fastenings exposed to weather or other corrosive conditions. Not for use in highly corrosive surroundings like swimming pools or highway tunnels.

For further detailed information on corrosion see relevant chapter in **Direct Fastening Principles and Technique** section.

## Application limits

Steel

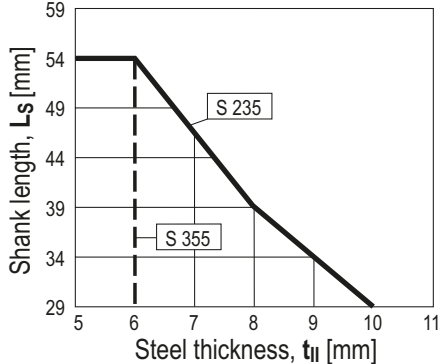

## Fastener selection

### DX Standard – fastening wood or soft material

Required nail shank length

Wood:  $L_s = h_{ET} + t_t$  [mm]

Soft material:  $L_s = h_{ET} + t_t - 2.4 - h_{CS}$  [mm]

$h_{CS} \approx 3$  mm if possible

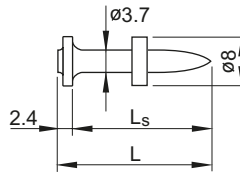

Required depth of penetration  $h_{ET}$

Normal weight concrete NWC

$h_{ET}$  according to concrete strength  $f_{cc}$

$f_{cc}$ [N/mm <sup>2</sup> ]	15	25	35
$h_{ET}$ [mm]	32	27	22

Light weight concrete LWC:

$h_{ET} = 32-37$  mm

Sandlime masonry SLM

$h_{ET}$  according to concrete strength  $f_{cc}$

$f_{cc}$ [N/mm <sup>2</sup> ]	15	25	35
$h_{ET}$ [mm]	32	27	27

Steel

$h_{ET} \geq 10$  mm

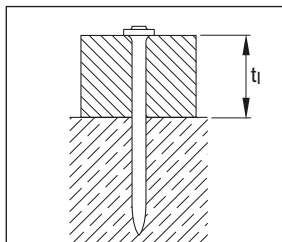

Normal weight concrete NWC

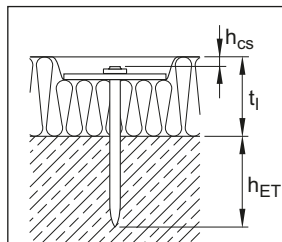

Sandlime masonry SLM

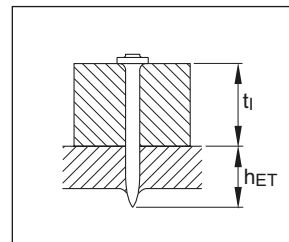

Steel

## Fastener program

Fasteners				Tool
Designation	Item no	L <sub>S</sub> [mm]	d <sub>nom</sub> [mm]	Designation
X-CR 24 P8	247359	24	3.7	DX 460, DX 5, DX 36, DX 2, DX-E 72 <sup>1)</sup>
X-CR 29 P8	247360	29	3.7	DX 460, DX 5, DX 36, DX 2, DX-E 72 <sup>1)</sup>
X-CR 34 P8	247361	34	3.7	DX 460, DX 5, DX 36, DX 2, DX-E 72 <sup>1)</sup>
X-CR 39 P8	247362	39	4.0	DX 460, DX 5, DX 36, DX 2, DX-E 72 <sup>1)</sup>
X-CR 44 P8	247363	44	4.0	DX 460, DX 5, DX 36, DX 2, DX-E 72 <sup>1)</sup>
X-CR 54 P8	247429	54	4.0	DX 460, DX 5, DX 36, DX 2, DX-E 72 <sup>1)</sup>
X-CR 39 P8 S12	247354	39	4.0	DX 460, DX 5, DX 36, DX 2 <sup>2)</sup>
X-CR 44 P8 S12	247355	44	4.0	DX 460, DX 5, DX 36, DX 2 <sup>2)</sup>
X-CR 48 P8 S15	258121	48	4.0	DX 460, DX 5, DX 36, DX 2 <sup>2)</sup>
X-CR 52 P8 S15	2052687	52	4.0	DX 460, DX 5

Method: <sup>1)</sup> **DX Standard** (without pre-drilling)

<sup>2)</sup> **DX-Kwik** (with pre-drilling)

## Cartridge selection

### DX Standard

Steel: **6.8/11M yellow, red or black cartridge**

Concrete: **6.8/11M yellow or red cartridge**

Masonry: **6.8/11M green cartridge**

### DX-Kwik

Concrete: **6.8/11M yellow or red or black cartridge**

Tool energy adjustment by setting tests on site.

## Fastening quality assurance

### Installation instruction

#### DX-Kwik

Pre-drilling details (not through fastened material)

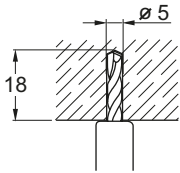

#### X-CR 39 / X-CR 44

Fastener	$t_f$ [mm]	Drill bit	Item no
X-CR 39	$\leq 2$	TX-C-5/18	00061793
X-CR 44	2-7	TX-C-5/18	

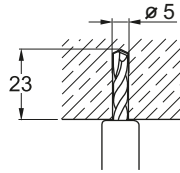

#### X-CR 48 / X-CR 52

Fastener	$t_f$ [mm]	Drill bit	Item no
X-CR 48	$\leq 5$	TX-C-5/23	00061787
X-CR 52	5-9	TX-C-5/23	00061787

Details valid for C20/25 – C45/55 ( $f_{cc} = 25-55 \text{ N/mm}^2$  /  $f_c = 20-45 \text{ N/mm}^2$ )

Pre-drilling details (through fastened material)

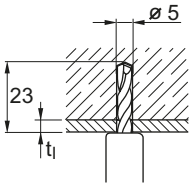

#### X-CR 48

Fastener	$t_f$ [mm]	Drill bit	Item no
X-CR 48	$\leq 2$	TX-C-5/23	00061787

Details valid for C20/25 – C50/60

These are abbreviated instructions which may vary by application.

**ALWAYS** review/follow the instructions accompanying the product.



## X-CT Nail for forming or other temporary use

### Product data

#### Dimensions

X-CT \_\_ MX, X-CT \_\_ DP8

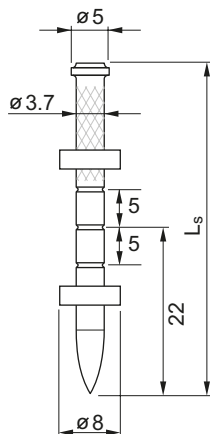

#### General information

##### Material specifications

Carbon steel shank: HRC 53

Zinc coating: 5–20 µm

##### Recommended fastening tools

DX 460-F8, DX 460 MX, DX 5-F8, DX 5 MX, DX 36, DX 2, DX-E72

See **X-CT fastener program** in the next pages and **Tools and equipment** chapter for more details.

### Applications

#### Examples

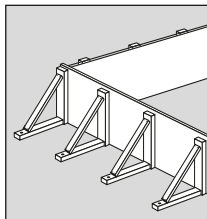

**Conventional Formwork**

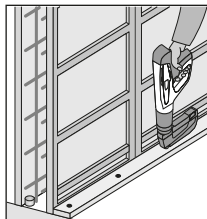

**System Formwork**

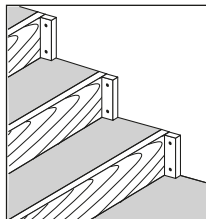

**To position and hold concrete formwork**

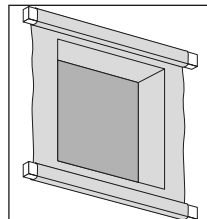

**Fasten plastic, netting, etc.**

## Load data

### Recommended loads

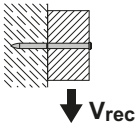

$$V_{rec} = 0.3 \text{ kN for } h_{ET} \geq 22 \text{ mm}$$

### Conditions:

- Static loading only (placing and vibration of concrete does not affect design).
- Minimum 5 fastenings per fastened unit.

## Application requirements

### Thickness of base and fastened material

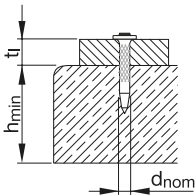

$$h_{min} = 80 \text{ mm}$$

$$t_1 = 20\text{--}50 \text{ mm}$$

### Edge distances

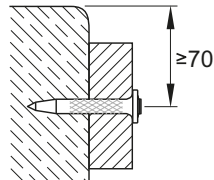

Edge distances  $c \geq 70 \text{ mm}$

## Fastener selection and system recommendation

### Fastener selection

Required nail shank length:

$$L_S = h_{ET} + t_1 \text{ [mm]}$$

Recommendation:

Concrete

$$h_{ET} = 22 \text{ mm}$$

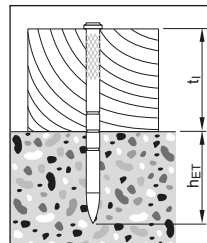

**Fastener program**
**Fasteners**

Designation	Item no. Packs of 1000 nails	100 nails	L <sub>s</sub> [mm]	d <sub>nom</sub> [mm]	Tools				Key applications
					DX-460 MX, DX-5 MX	DX-460 FR, DX-5 FB	DX-2, DX-36	DX-EF2	
<b>X-CT 47 MX</b>	383588		47	3.7	■				Wood to concrete
<b>X-CT 52 MX</b>	383589	383576	52	3.7	■				Wood to concrete
<b>X-CT 62 MX</b>	383591	383579	62	3.7	■				Wood to concrete
<b>X-CT 72 MX</b>		383580	72	3.7	■				Wood to concrete
<b>X-CT 47 DP8</b>		383582	47	3.7	■	■	■		Wood to concrete
<b>X-CT 52 DP8</b>		383583	52	3.7	■	■	■		Wood to concrete
<b>X-CT 62 DP8</b>		383585	62	3.7	■	■	■		Wood to concrete
<b>X-CT 72 DP8</b>		383586	72	3.7	■	■	■		Wood on concrete (with pre-hammering)
<b>X-CT 97 DP8</b>		383587	97	3.7	■	■	■		Wood on concrete (with pre-hammering)

■ recommended

■ feasible

**Cartridge recommendation:**

Green concrete: **6.8/11M green**

Normal concrete: **6.8/11M yellow**



# DX-Kwik X-M6 H, X-M8 H and DNH, X-DKH Threaded stud and nail

## Product data

### Dimensions

X-M6H-\_\_-37 FP8

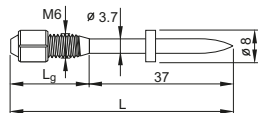

X-M8H-\_\_-37 P8

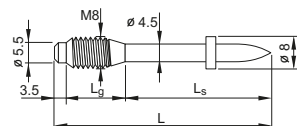

DNH 37 P8S15

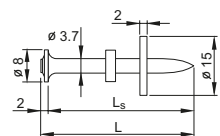

X-DKH 48 P8S15

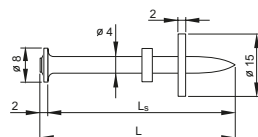

### General information

#### Material specifications

Carbon steel shank: HRC 58  
Zinc coating: 5–20 µm

#### Recommended fastening tools

DX 460, DX 5, DX 36, DXE-72

See **DX-Kwik fastener program** in the next pages and **Tools and equipment** chapter for more details.

#### Approvals

IBMB 3041/8171 X-M8H, X-DKH, X-M6H  
DIBt (Germany): X-M8H

Note:  
Technical data presented in these approvals and design guidelines reflect specific local conditions and may differ from those published in this handbook.

## Applications

### Examples

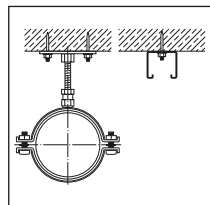

Base plates,  
rails for piping

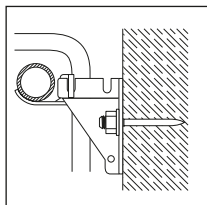

Radiator brackets

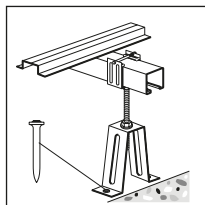

Floor stands, metal  
fixtures to concrete

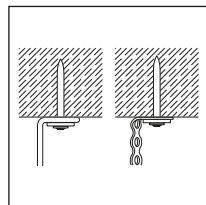

Suspended ceilings

## Load data

### Recommended loads

	$N_{rec,1}$ [kN]	$N_{rec,2}$ [kN]	$V_{rec,1}$ [kN]	$M_{rec,1}$ [Nm]
X-M6H, DNH 37	2.0	0.6	2.0	5.5
X-M8H, X-DKH 48	3.0	0.9	3.0	10.0

#### Conditions

- $N_{rec,1}$ : concrete in compressive zone.
- $N_{rec,2}$ : concrete in tension zone.
- Predominantly static loading.
- Concrete C20/25–C50/60.
- A sufficient redundancy has to be ensured, that the failure of a single fastening will not lead to collapse of the entire system.
- Recommended loads are based on failure of the fastener anchorage in the concrete. Thickness and quality of the fastened material may lower the loadings.
  - Observance of all pre-drilling requirements, fastened thickness limits, and recommended details.
  - The recommended loads in the table refer to the resistance of the individual fastening and may not be the same as the loads  $F_N$  and  $F_V$  acting on the fastened part.

Note: If relevant, prying forces need to be considered in design, see example. Moment acting on fastener shank only in case of a gap between base and fastened material.

### Arrangements to prevent moment on shank:

Coupler tight against concrete

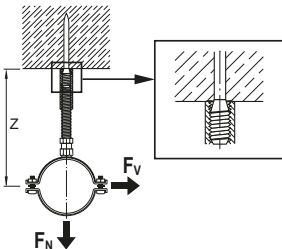

### Non-symmetric arrangement

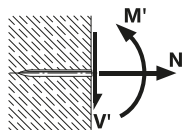
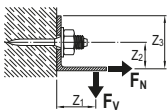

Resultant forces on nail

- Moment on fastened part
- Prying effect must be considered in determining loads acting on fastener

**Application requirements**

**Thickness of base material**

**X-M6H, DNH 37:**  $h_{min} = 100 \text{ mm}$

**X-M8H, X-DKH 48:**  $h_{min} = 100 \text{ mm}$

**Thickness of fastened material**

**X-M6H:**  $t_1 \leq L_g - t_{washer} - t_{nut} \cong \text{up to } 13.5 \text{ mm}$

**X-M8H:**  $t_1 \leq L_g - t_{washer} - t_{nut} \cong \text{up to } 14.0 \text{ mm}$

**DNH 37:**  $t_1 \leq 2.0 \text{ mm}$

**X-DKH 48:**  $t_1 \leq 5.0 \text{ mm}$  or  $t_1 \leq 2.0$  by pre-drilling through fastened material

**Spacing and edge distances (mm)**

Pairs

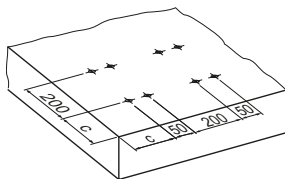

	Reinforced	Non-reinforced
<b>c</b>	100	150

Row along edge

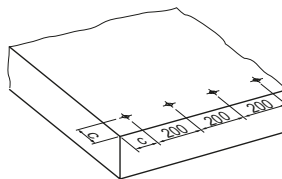

	Reinforced	Non-reinforced
<b>c</b>	80	150

General (e.g. group of fasteners)

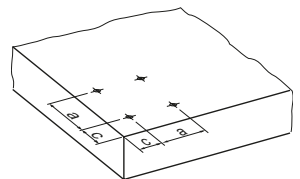

	Reinforced	Non-reinforced
<b>c</b>	80	150
<b>a</b>	80	100

**Corrosion information**

The intended use only comprises fastenings which are not directly exposed to external weather conditions or moist atmospheres. For further detailed information on corrosion see relevant chapter in **Direct Fastening Principles and Technique** section.

## Fastener program

Fastened thickness $t_{i,max}$ [mm]	Fastener				
	Designation	Item no.	$L_g$ [mm]	$L_s$ [mm]	L [mm]
-	X-M6H-10-37 FP8	40464	10	37	47
-	X-M8H-10-37 P8	20059	10	37	50.5
5.0	X-M8H/5-15-37 P8	26325	15	37	55.5
15.0	X-M8H/15-25-37 P8	20064	25	37	65.5
2.0	DNH 37 P8S15	44165	-	37	39
5.0*	X-DKH 48 P8S15	40514	-	48	50

\*) with pre-drilling through fastened material  $t_{i,max} = 2.0$  mm

## Tools, cartridge selection and tool energy setting

### DX 460, DX 5, DX 36, DXE-72: 6.8/11M yellow or red cartridge

Tool energy adjustment by setting tests on site.

## Fastening quality assurance

### Fastening inspection

X-M6H, X-M8H

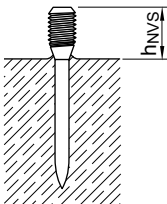

$$h_{NVS} = L - h_{ET}, \quad h_{ET} = 37-41 \text{ mm}$$

DNH 37, X-DKH 48

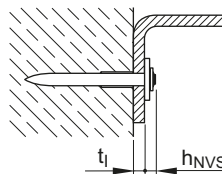

$$h_{NVS} = 4 \text{ mm}$$

Place nails so that heads and washers bear tightly against each other and against the fastened material



**Installation**

**X-M6H, X-M8H**

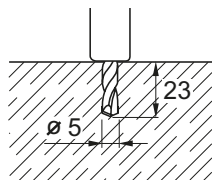

Pre-drill with drill bit  
Designation Item no

**TX-C-5/23B** 28557

or

**TX-C-5/23** 61787

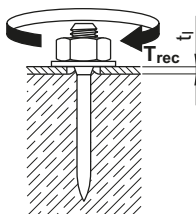

Tightening torque

Designation  $T_{rec}$  [Nm]

**X-M6H** 6.5

**X-M8H** 10.0

**DNH 37, X-DKH 48**

Pre-drilling details (not through fastened material)

**DNH 37**

$t_1$ [mm]	Drill-bit	Item no.
$\leq 2$	<b>TX-C-5/18</b>	61793

$\leq 2$  **TX-C-5/18** 61793

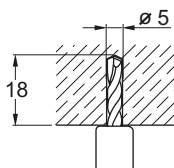

**X-DKH 48**

$t_1$ [mm]	Drill-bit	Item no.
$\leq 5$	<b>TX-C-5/23B</b>	28557

$\leq 5$  **TX-C-5/23B** 28557

or

**TX-C-5/23** 00061787

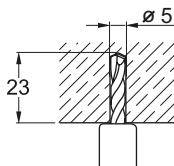

Details valid for C20/25–C50/60

Pre-drilling details (through fastened material)

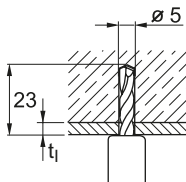

**X-DKH 48**

$t_1$ [mm]	Drill-bit	Item no.
$\leq 2$	only <b>TX-C5/23</b>	61787

$\leq 2$  only **TX-C5/23** 61787

Details valid for C20/25–C50/60

These are abbreviated instructions which may vary by application.

**ALWAYS** review/follow the instructions accompanying the product.



# X-M6, X-W6, X-M8, M10, W10

## Threaded stud for fastening to concrete

### Product data

#### Dimensions

X-M6/W6 \_\_\_\_ FP8

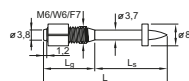

X-M8 \_\_\_\_ P8

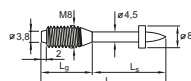

M10-24-32 P10

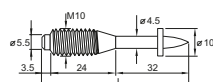

W10 \_\_\_\_ P10

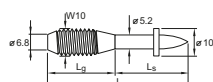

#### General information

##### Material specifications

Carbon steel shank: HRC 53.5  
Zinc coating: 5–20  $\mu\text{m}$

##### Recommended fastening tools

DX 460, DX 5, DX 351, DX 36, DX 2, DX E72,  
DX 76, DX 76 PTR, DX 600 N

See **X-M6, X-W6, X-M8, M10, W10 fastener program** in the next pages and **Tools and equipment chapter** for more details.

#### Approvals

ICC (USA): **X-W6, W10**

UL, FM: **W10**

Note:

Technical data presented in these approvals and design guidelines reflect specific local conditions and may differ from those published in this handbook.

### Applications

#### Examples

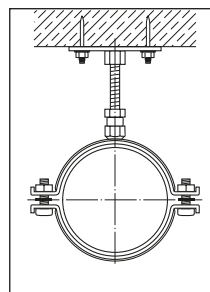

Plates for pipe rings

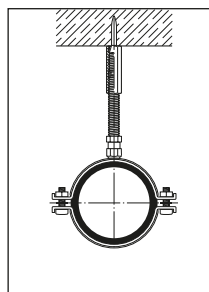

Hangings with threaded couplers

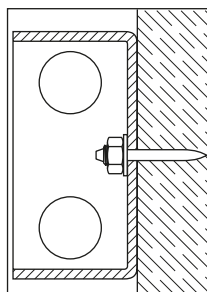

Electrical boxes

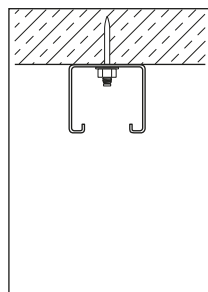

Miscellaneous attachments

**Load data**
**Recommended loads**

Fastener designation	Shank diameter $d_s$ [mm]	$M_{rec}$ [Nm]
<b>X-M6/W6</b>	3.7	5.0
<b>X-M8, M10</b>	4.5	9.0
<b>W10</b>	5.2	14.0

**X-M6/W6, X-M8, M10, W10**

$$N_{rec} = V_{rec} = 0.4 \text{ kN for } h_{ET} \geq 27 \text{ mm}$$

$$N_{rec} = V_{rec} = 0.3 \text{ kN for } h_{ET} \geq 22 \text{ mm}$$

$$N_{rec} = V_{rec} = 0.2 \text{ kN for } h_{ET} \geq 18 \text{ mm}$$

Arrangements to prevent moment on shank:

Coupler tight against concrete

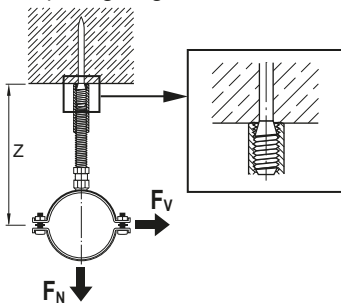

Non-symmetric arrangement:

- Moment on fastened part
- Prying effect must be considered in determining loads acting on fastener

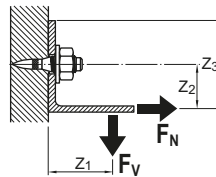
**Conditions**

- Minimum 5 fastenings per fastened unit (normal weight concrete)
- All visible failures must be replaced.
- With lightweight concrete base material and greater loading may be possible, please contact Hilti.
- Predominantly static loading.
- Observance of all application limitations and recommendations.
- The recommended loads in the table refer to the resistance of the individual fastening and may not be the same as the loads  $F_N$  and  $F_V$  acting on the fastened part.

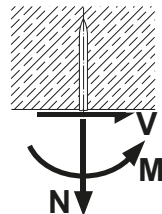

Note: If relevant, prying forces need to be considered in design, see example. Moment acting on fastener shank only in case of a gap between base and fastened material.

**Application requirements**
**Thickness of base material**

Concrete

 $h_{\min} = 80 \text{ mm}$  ( $d_{\text{nom}} = 3.7 \text{ mm}$ )

 $h_{\min} = 100 \text{ mm}$  ( $d_{\text{nom}} \geq 4.5 \text{ mm}$ )

**Thickness of fastened material**
**M6:**  $t_l \leq L_g - t_{\text{washer}} - t_{\text{nut}} \equiv$  up to 15 mm

**W6:**  $t_l \leq L_g - t_{\text{washer}} - t_{\text{nut}} \equiv$  up to 33 mm

**M8:**  $t_l \leq L_g - t_{\text{washer}} - t_{\text{nut}} \equiv$  up to 15 mm

**M10:**  $t_l \leq L_g - t_{\text{washer}} - t_{\text{nut}} \equiv$  up to 19 mm

**W10:**  $t_l \leq L_g - t_{\text{washer}} - t_{\text{nut}} \equiv$  up to 25 mm

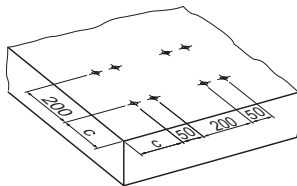
**Spacing and edge distances (mm)**
Pairs

Reinforced \* Non-reinforced

**c** 100 150

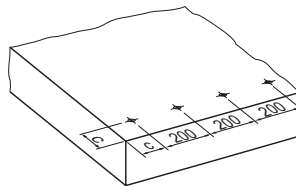
Row along edge

Reinforced \* Non-reinforced

**c** 80 150

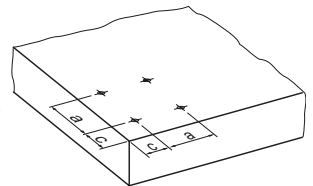
General (e.g. group of fasteners)

Reinforced \* Non-reinforced

**c** 80 150

**a** 80 100

\* Minimum  $\varnothing 6$  reinforcing steel continuous along all edges and around all corners. Edge bars must be enclosed by stirrups.

**Corrosion information**

The intended use only comprises fastenings which are not directly exposed to external weather conditions or moist atmospheres. For further detailed information on corrosion see relevant chapter in **Direct Fastening Principles and Technique** section.

**Fastener selection and system recommendation**
**Fastener selection**

Required thread length

 $L_g \geq t_l + t_{\text{washer}} + t_{\text{nut}}$  [mm]

**Fastener program**
**Fasteners**

Group <sup>1)</sup>	Designation	Item no.	Standard		Tool Designation
			threading <sup>2)</sup> L <sub>g</sub> [mm]	shank lengths <sup>2)</sup> L <sub>s</sub> [mm]	
<b>M6</b>	<b>X-M6-20-27FP8</b>	306079	20	27	<b>DX 460, DX 5, DX 351, DX 36, DX 2, DX E72</b>
<b>W6</b>	<b>X-W6-20-22FP8</b>	306073	20	22	<b>DX 460, DX 5, DX 351, DX 36, DX 2, DX E72</b>
	<b>X-W6-20-27FP8</b>	306074	20	27	<b>DX 460, DX 5, DX 351, DX 36, DX 2, DX E72</b>
	<b>X-W6-38-27FP8</b>	306075	38	27	<b>DX 460, DX 5, DX 36, DX 2, DX E72</b>
<b>M8</b>	<b>X-M8-15-27P8</b>	306092	15	27	<b>DX 460, DX 5, DX 36, DX 2, DX E72</b>
	<b>X-M8-15-42P8</b>	306094	15	42	<b>DX 460, DX 5, DX 36, DX 2, DX E72</b>
	<b>X-M8-20-32P8</b>	306096	20	32	<b>DX 460, DX 5, DX 36, DX 2, DX E72</b>
<b>M10</b>	<b>M10-24-32P10</b>	26413	24	32	<b>DX 76, DX 76 PTR</b>
<b>W10</b>	<b>W10-30-27P10</b>	26472	30	27	<b>DX 600 N</b>
	<b>W10-30-32P10</b>	26473	30	32	<b>DX 600 N</b>
	<b>W10-30-42P10</b>	26476	30	42	<b>DX 600 N</b>

<sup>1)</sup> Type threading: M = metric; W6, W10 = Whitworth 1/4"; 3/8"

<sup>2)</sup> Standard threading and shank lengths. Other lengths and combinations available on special order.

**Cartridge selection**

Cartridge recommendation:

M6, W6, M8: **6.8/11M yellow or red cartridge**

M10: **6.8/18M blue or red**

W10: **6.8/18 yellow, red or black**

Tool energy adjustment by setting tests on site.

**Fastening quality assurance**
**Fastening inspection**
**X-M6 / W6**

Penetration depth

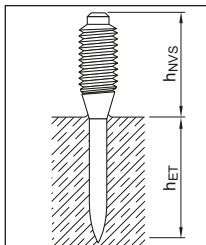

$$h_{NVS} = L_g \pm 2$$

Tightening torque

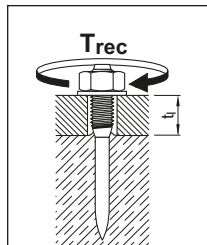

$$T_{rec} \leq 4 \text{ Nm}$$

**X-M8, M10, W10**

Penetration depth

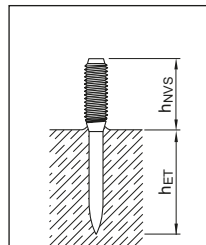

$$h_{NVS} = L_g \pm 2$$

Tightening torque

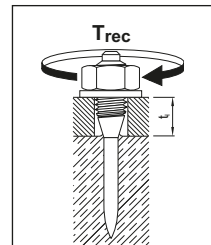

$$T_{rec} \leq 6 \text{ Nm}$$

## X-EM6H, X-EW6H, X-EF7H, X-EM8H, X-EM10H, X-EW10H Threaded stud for fastening to steel

### Product data

#### Dimension

X-EM6H/EW6H-\_\_-9 FP8

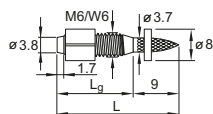

X-EF7H-7-9 FP8

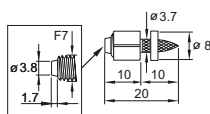

X-EM8H-\_\_-12 P8

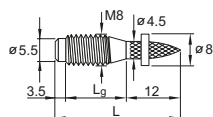

X-EM8H-15-12 FP10

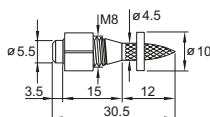

X-EM10H-24-12 P10

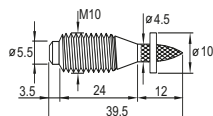

X-EW10H-30-14 P10

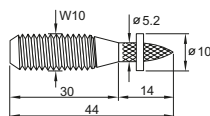

For dimension details see chapter fastener selection

#### General information

##### Material specification

Carbon steel shank: HRC 56.5

Zinc coating: 1) 5-13 µm

1) Zinc coating (electroplating for corrosion protection during construction and service in protected environment)

##### Recommended fastening tool

DX 460, DX 5, DX 76, DX 76 PTR, DX 600 N

See X-EM/ X-EW fastener program in the next pages and Tools and equipment chapter for more details.

##### Approval

ICC-ES ESR-2347 X-EW6H, X-EW10H, (USA):

FM 3026695: X-EW6H, X-EW10H

UL: EX2258: X-EW6H, X-EW10H

ABS, LR: all types



### Fastener recommendation under environmental condition

Environmental condition	Fastener X-EM6H, EW6H, X-EF7H X-EM8H, X-EW8H, X-EM10H, X-EW10H
Dry indoor non-corrosive environment	■

Further information can be found in the corrosion handbook.

## Application

Example:

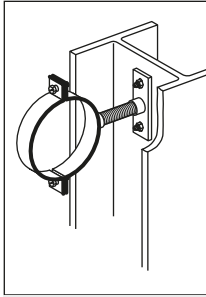

Base plates for pipe rings

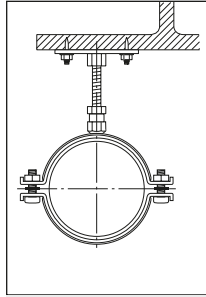

Hanging with threaded couplers

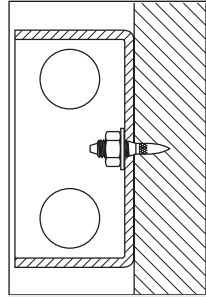

Electrical boxes

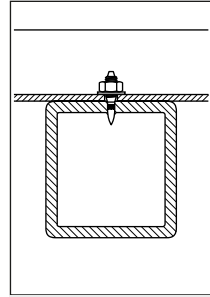

Miscellaneous attachments

## Load data

### Recommended resistance under tension load

Fastener designation	Shank $d_s \times L_s$	$N_{rec}$	$V_{rec}$	$M_{rec}$
X-EM6H, X-EW6H, X-EF7H	3.7 x 8.5 mm	1.6 kN	1.6 kN	5.0 Nm
X-EM8H, X-EM10H	4.5 x 12.0 mm	2.4 kN	2.4 kN	9.0 Nm
X-EW10H-30-14	5.2 x 15.0 mm	3.0 kN	3.0 kN	14.0 Nm

### Conditions:

- Redundancy (multiple fastening) must be provided.
- Global factor of safety for static pull-out > 3 (based on 5% fractile value).
- Predominantly static loading.
- Strength of fastened material must be considered.
- Observance of all application limitations and recommendations.
- The recommended loads in the table refer to the resistance of the individual fastening and may not be the same as the loads  $F_N$  and  $F_V$  acting on the fastened part.

Note: If relevant, prying forces need to be considered in design, see example. Moment acting on fastener shank only in case of a gap between base and fastened material.

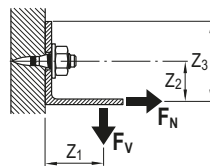
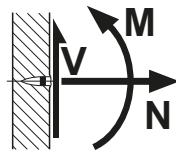



Arrangement to prevent moment on shank

Coupler tight against steel

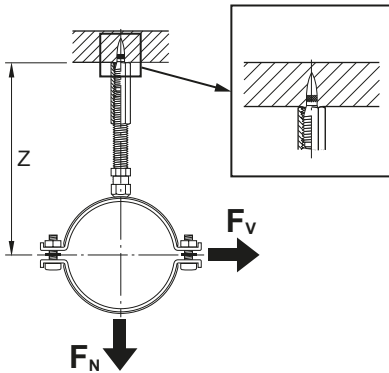

Application requirement

Thickness of base material

Fastener designation	Minimum steel thickness $t_{li}$
X-EM6H/EW6H, X-EF7H	$\geq 4$ mm
X-EM8H/EW8H, X-EM10H/X-EW10H	$\geq 6$ mm

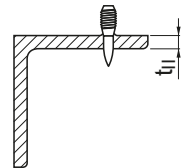

Thickness of fastened material

$$t_l \leq L_g - t_{washer} - t_{nut} \approx 1.5 - 33.0 \text{ mm}$$

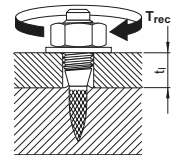

Spacing and edge distance

Edge distance and spacing:  $c = s \geq 15$  mm

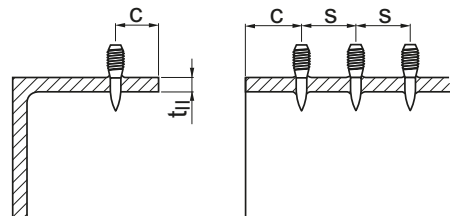

**Application limit**

**X-EM6H, X-EW6H, X-EF7H**

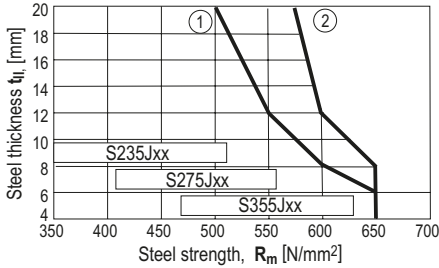

DX 460/DX 5 tool:

- ① X-EF7H-\_\_-9
- ② X-EM6H-\_\_-9,  
X-EW6H-\_\_-9

**X-EM8H**

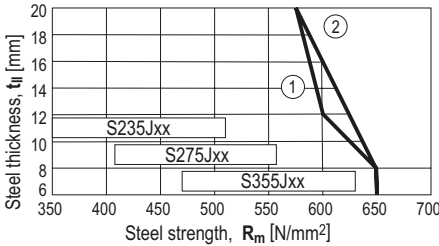

DX 460/DX 5 tool:

- ① X-EM8H-\_\_-12

DX 76/DX 76 PTR tool

with X-76-F10-PTR fastener guide:

- ② X-EM8H-15-12

**X-EM10H/X-EW10H**

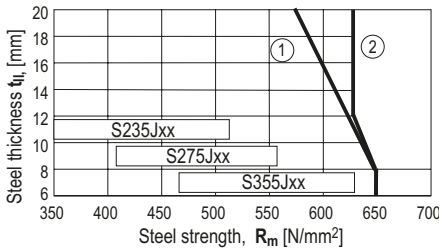

DX 76/DX 76 PTR tool:

- ① X-EM10H-24-12

DX 600 N tool:

- ② X-EW10H-30-14 P10

**Fastener selection and system recommendation**
**Fastener program**

Base material thickness $t_{l,min}$	Fastened thickness $t_{l,max}$	Fastener Designation <sup>1)</sup>	Item no.	Threading length $L_g$	Shank lengths $L_s$	DX tools
4.0 mm	1.5 mm	X-EM6H-8-9 FP8	271965	8 mm	8.5 mm	DX 460, DX 5
	4.5 mm	X-EM6H-11-9 FP8	271963	11 mm	8.5 mm	DX 460, DX 5
	13.5 mm	X-EM6H-20-9 FP8	271961	20 mm	8.5 mm	DX 460, DX 5
	4.5 mm	X-EW6H-11-9 FP8	271973	11 mm	8.5 mm	DX 460, DX 5
	13.5 mm	X-EW6H-20-9 FP8	271971	20 mm	8.5 mm	DX 460, DX 5
	21.5 mm	X-EW6H-28-9 FP8	271969	28 mm	8.5 mm	DX 460, DX 5
	31.5 mm	X-EW6H-38-9 FP8	271967	38 mm	8.5 mm	DX 460, DX 5
6.0 mm	0.5 mm	X-EF7H-7-9 FS8	271975	7 mm	10 mm	DX 460, DX 5
	2.0 mm	X-EM8H-11-12 P8	271983	11 mm	12 mm	DX 460, DX 5
	6.0 mm	X-EM8H-15-12 P8	271981	15 mm	12 mm	DX 460, DX 5
	6.0 mm	X-EM8H-15-12 FP10	271982	15 mm	12 mm	DX 76 PTR, DX 460, DX 5
	14.0 mm	X-EM10H-24-12 P10	271984	24 mm	12 mm	DX 76 PTR, DX 460, DX 5
	20.0 mm	X-EW10H-30-14 P10	271985	30 mm	14 mm	DX 600 N

<sup>1)</sup> Type of threading: M = metric; W6, W10 = Whitworth  $1/4''$ ;  $3/8''$ ; F7 = French 7 mm

**Cartridge recommendation**

Tool energy adjustment by installation tests on site

Fastener	Tool	Base material	Base material thickness	Cartridge selection
X-EM6H, X-EW6H	DX 460, DX 5	S235	4-10 mm	6.8/11M green
			10-20 mm	6.8/11M yellow
		S275	4-6 mm	6.8/11M green
			6-20 mm	6.8/11M yellow
S355	4-20 mm	6.8/11M yellow		
X-EF7H	DX 460, DX 5	S235	4-8 mm	6.8/11M green
			8-20 mm	6.8/11M yellow
		S275	4-6 mm	6.8/11M green
			6-20 mm	6.8/11M yellow
S355	4-20 mm	6.8/11M yellow		
X-EM8H	DX 460, DX 5	S235, S275	6-8 mm	6.8/11M red
			8-20 mm	6.8/11M black
		S355	6-20 mm	6.8/11M black

Fastener	Tool	Base material	Base material thickness	Cartridge selection
X-EM8H	DX 76 PTR	S235	6–8 mm	6.8/18M blue
			8–20 mm	6.8/18M red
		S275	6–7 mm	6.8/18M blue
			7–12 mm	6.8/18M red
			12–20 mm	6.8/18M black
		S355	6–10 mm	6.8/18M red
10–20 mm	6.8/18M black			
X-EM10H	DX 76 PTR	S235	6–20 mm	6.8/18M yellow
			S275	6–7 mm
		7–8 mm		6.8/18M blue
		8–20 mm		6.8/18M red
		S355	6–8 mm	6.8/18M red
			8–20 mm	6.8/18M black
X-EW10H	DX 600 N	S235	6–8 mm	6.8/18 blue
			8–15 mm	6.8/18 red
			15–20 mm	6.8/18 black
		S275	6–8 mm	6.8/18 blue
			8–12 mm	6.8/18 red
			12–20 mm	6.8/18 black
S355	6–7 mm	6.8/18 red		
7–20 mm	6.8/18 black			

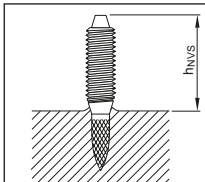
**Fastening quality assurance**
**X-EM6H, X-EW6H, X-EF7H**

Nail standoff

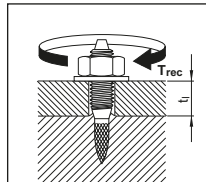

Tightening torque

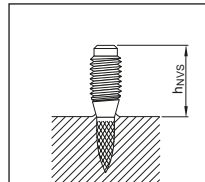
**X-EM8H, X-EM10H, X-EW10H**

Nail standoff

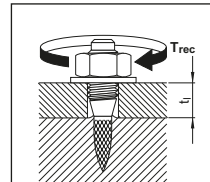

Tightening torque

Fastener	$h_{NVS}$ [mm]	$T_{rec}$ [Nm]
X-EM6H-8-9	8.0–11.0	≤ 4
X-EM6H- /X-EW6H-11-9	9.5–12.5	≤ 4
X-EM6H- /X-EW6H-20-9	18.5–21.5	≤ 4
X-EW6H-28-9	26.5–29.5	≤ 4
X-EW6H-38-9	36.5–39.5	≤ 4
X-EF7H-7-9	9.0–12.0	≤ 4

Fastener	$h_{NVS}$ [mm]	$T_{rec}$ [Nm]
X-EM8H-11-12	11.5–15.5	≤10.5
X-EM8H-15-12	15.5–19.5	≤10.5
X-EM10H-24-12	26.5–29.5	≤10.5
X-EW10H-30-14	28.0–31.0	≤15.0

# X-BT Stainless steel threaded stud

## Product data

### Dimensions

X-BT W10-24-6 SN12-R  
X-BT M10-24-6 SN12-R

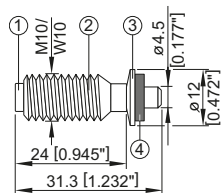

X-BT M8-15-6 SN12-R

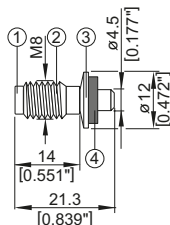

X-BT W6-24-6 SN12-R  
X-BT M6-24-6 SN12-R

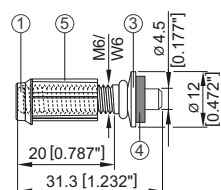

### General information

#### Material specifications

##### ① Shank:

CR 500 (CrNiMo alloy) equivalent to A4 /  
S31803 (1.4462)      AISI grade 316 material  
N 08926 (1.4529) <sup>1</sup>      Available on request

##### ② Threaded sleeve:

S31609  
(X5CrNiMo 17-12-2+2H, 1.4401)

##### ③ SN12-R washers:

S 31635  
(X2CrNiMo 17-12-2, 1.4404)

##### ④ Sealing washers:

Chloroprene rubber CR  
3.1107, black\* Resistant to UV, salt water, water, ozone, oils, etc.

<sup>1)</sup> For High Corrosion Resistance HCR material inquire at Hilti

Designation according to Unified Numbering System (UNS)

### Recommended fastening tools

BX 3-BT / BTG  
DX 351-BT / BTG

See **X-BT fastener program** in the next pages and **Tools and equipment** chapter for more details.

### Approvals

ICC ESR-2347 (USA), ABS, LR, DNV-GL, BV 23498/B0, GL 12272-10HH, Russian Maritime Register



## Applications

### Examples

Threaded stud applications especially for:

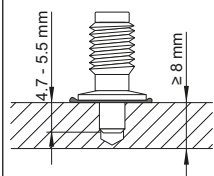

- High strength steel
- Coated steel structures
- Through penetration of base steel is not allowed

Grating with **X-FCM-R**

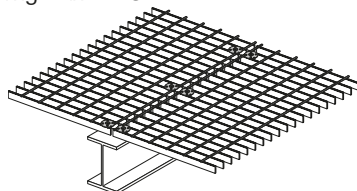

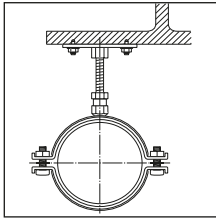

Base plates

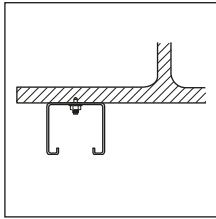

Installation rails

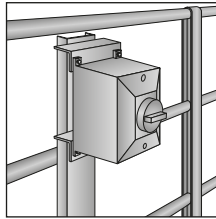

Junction box, etc.

## Load data

### Recommended loads – Steel

Steel grade: Europe, USA	S235, A36	S355, Grade 50 and stronger steel
Tension, $N_{rec}$ [kN/lb]	1.8 / 405	2.3 / 517
Shear, $V_{rec}$ [kN/lb]	2.6 / 584	3.4 / 764
Moment, $M_{rec}$ [Nm/lbft]	8.2 / 6	8.2 / 6
Torque, $T_{rec}$ [Nm/lbft]	8 / 5.9	8 / 5.9

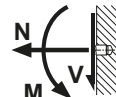

Example:

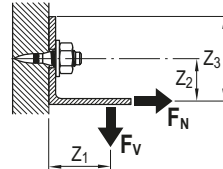

### Recommended loads – cast iron \*

Tension, $N_{rec}$ [kN/lb]	0.5 / 115
Shear, $V_{rec}$ [kN/lb]	0.75 / 170
Moment, $M_{rec}$ [Nm/lbft]	8.2 / 6

### Conditions for recommended loads:

- Global factor of safety for static pull-out > 3 (based on 5% fractile value)
- Minimum edge distance = 6 mm [1/4"].
- Effect of base metal vibration and stress considered.
- Redundancy (multiple fastening) must be provided.
- The recommended loads in the table refer to the resistance of the individual fastening and may not be the same as the loads  $F_N$  and  $F_V$  acting on the fastened part.

Note: If relevant, prying forces need to be considered in design, see example. Moment acting on fastener shank only in case of a gap between base and fastened material.

### \*Requirements of spheroidal graphite cast iron base material

Subject	Requirements
Cast iron	Spheroidal graphite cast iron according to EN 1563
Strength class	EN-GJS-400 to EN-GJS-600 according to EN 1563
Chemical analysis and amount of carbon	3.3–4.0 mass percentage
Microstructure	Form IV to VI (spherical) according to EN ISO 945-1:2010 Minimum size 7 according to Figure 4 of EN ISO 945-1:2010
Material thickness	$t_{  } \geq 20$ mm

### Design resistance – steel

Steel grade:			
Europe		S235	S355
Tension	$N_{Rd}$ [kN]	2.9	3.7
Shear	$V_{Rd}$ [kN]	4.2	5.4
Moment	$M_{Rd}$ [Nm]	18.4	18.4

### Design resistance – cast iron \*

Tension	$N_{RD}$ [kN]	0.8
Shear	$V_{RD}$ [kN]	1.2
Moment	$M_{RD}$ [Nm]	13.1

### Recommended interaction formula for combined loading

Combined loading situation	Interaction formula
----------------------------	---------------------

**V–N** (shear and tension)  $\frac{V}{V_{rec}} + \frac{N}{N_{rec}} \leq 1.2$  with  $\frac{V}{V_{rec}} \leq 1.0$  and  $\frac{N}{N_{rec}} \leq 1.0$

**V–M** (shear and bending)  $\frac{V}{V_{rec}} + \frac{M}{M_{rec}} \leq 1.2$  with  $\frac{V}{V_{rec}} \leq 1.0$  and  $\frac{M}{M_{rec}} \leq 1.0$

**N–M** (tension and bending)  $\frac{N}{N_{rec}} + \frac{M}{M_{rec}} \leq 1.0$

**V–N–M** (shear, tension and bending)  $\frac{V}{V_{rec}} + \frac{N}{N_{rec}} + \frac{M}{M_{rec}} \leq 1.0$

#### Cyclic loading:

- Anchorage of **X-BT-R** threaded stud in steel base material is not affected by cyclic loading.
- Fatigue strength is governed by fracture of the shank. Inquire at Hilti for test data if high cycle loading has to be considered in the design.

## Application requirements

### Thickness of base material

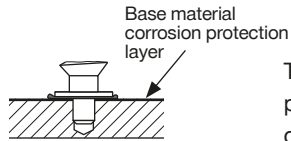
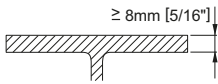

Thickness of base material corrosion protection layer  $\leq 0.4\text{mm}$ . For thicker coatings, please contact Hilti.

### Thickness of fastened material

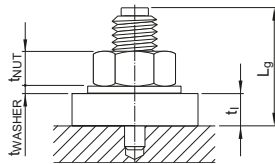

**X-BT M8:**  $2.0 \leq t_1 \leq 7.0\text{ mm}$   
**X-BT M10 / X-BT W10:**  $2.0 \leq t_1 \leq 15.0\text{ mm}$   
**X-BT M6 / X-BT W6:**  $1.0 \leq t_1 \leq 14.0\text{ mm}$

Note:

For X-BT with SN 12R sealing washer  $t_1 \geq 2.0\text{ mm}$

For X-BT M6 / W6 with SN 12R sealing washer  $t_1 \geq 1.0\text{ mm}$

### Spacing and edge distances

Edge distance:  $\geq 6\text{ mm}$

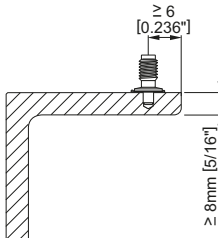

Spacing:  $\geq 15\text{ mm}$

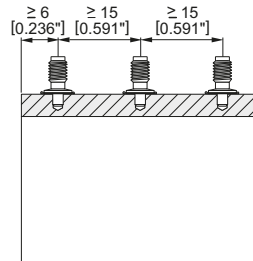

### Corrosion information

The corrosion resistance of Hilti CR500 and S31803 (1.4462) stainless steel material is equivalent to AISI 316 (A4) steel grade.

Studs made of N 08926 (HCR) material with higher corrosion resistance, e.g. for use in road tunnels or swimming pools, are available on special order.

### Application limit

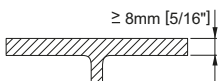

- $t_{II} \geq 8\text{ mm}$  [ $5/16$ "]  $\rightarrow$  No through penetration
- No limits with regards to steel strength



## Fastener selection and system recommendation

### Fastener program

Designation	Item no.	Tool Designation
<b>X-BT M8-15-6 SN12-R</b>	<b>377074</b>	BX 3-BTG, DX 351-BTG
<b>X-BT M10-24-6 SN12-R</b>	<b>377078</b>	BX 3-BT, DX 351-BT
<b>X-BT W10-24-6 SN12-R</b>	<b>377076</b>	BX 3-BT, DX 351-BT
<b>X-BT W10 without washer</b>	<b>377075</b>	BX 3-BT, DX 351-BT
<b>X-BT M6-24-6 SN12-R</b>	<b>432266</b>	BX 3-BT, DX 351-BT
<b>X-BT W6-24-6 SN12-R</b>	<b>432267</b>	BX 3-BT, DX 351-BT

Note: For High Corrosion Resistance HCR material inquire at Hilti

### Cartridge selection and tool energy setting

#### 6.8/11 M high precision brown cartridge

Fine adjustment by installation tests on site

### Fastening quality assurance

#### Fastening inspection

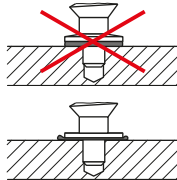
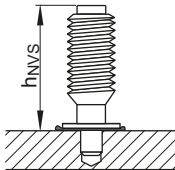

**X-BT M8**  
 $h_{NVS} = 15.7-16.8 \text{ mm}$

**X-BT M10 / X-BT W10 and  
 X-BT M6 / X-BT W6**  
 $h_{NVS} = 25.7-26.8 \text{ mm}$

### Installation

#### X-BT with washer

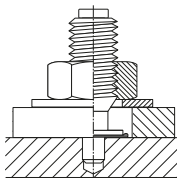

Fastened material hole  $\phi$   
 $\geq 13 \text{ mm}$

#### X-BT M6 / X-BT W6

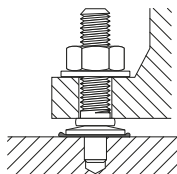

Fastened material with  
 pre-drilled hole diameter  
 $< 7 \text{ mm}$

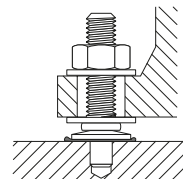

Fastened material with  
 pre-drilled hole diameter  
 $\geq 7 \text{ mm}$

Pre-drill with **TX-BT 4/7** step shank drill bit

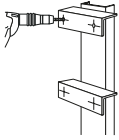

Pre-drill until the shoulder grinds a shiny ring (to ensure proper drilling depth)



**Before fastener installation:**

the drilled hole must be clear of liquids and debris. The area around the drilled hole must be free from liquids and debris.

Tighten using a screwdriver with torque clutch

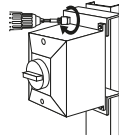

Tightening torque:  
**T<sub>rec</sub> ≤ 8 Nm (5.9 ft-lb)!**

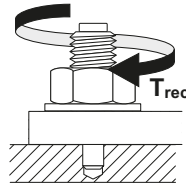

Hilti Torque tool X-BT 1/4"

Hilti screwdriver:	Torque setting:
SF 121-A	11
SF 150-A	9
SF 180-A	8
SF 144-A	9
SF 22A	9
SFC 22-A	5
SBT 4-A22	5

These are abbreviated instructions which may vary by application.  
**ALWAYS** review/follow the instructions accompanying the product.

# X-BT New Generation stainless steel threaded stud

## Product data

### Dimensions

X-BT-MR M10/15 SN 8  
X-BT-MR W10/15 SN 8

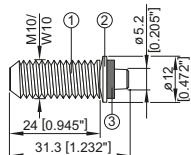

X-BT-MR M8/14 SN 8

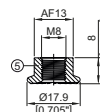
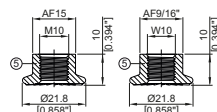
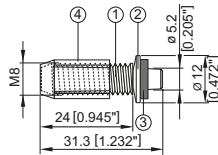

X-BT-MR M6/10 SN 8  
X-BT-MR W6/10 SN 8

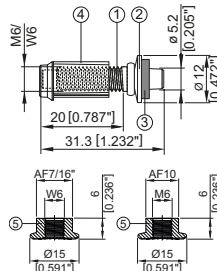

X-BT-GR M8/7 SN 8

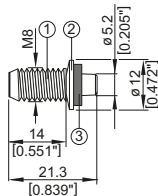

### Features and benefits

The X-BT system is an approved Fastening on Steel system for grating and multi-purpose fastening applications. Benefits include no-rework to backside of base material, not having application limits and capability to work in C5 corrosive environment. The new generation X-BT system has increased load performance compared with the previous X-BT.

### General information

#### Material specifications

- ① Shank: S31803 (1.4462) equivalent to A4 / AISI grade 316 material
- ② SN washers: S 31635 (X2CrNiMo 17-12-2, 1.4404)
- ③ Sealing washers: Elastomer, black, resistant to UV, salt water, water, ozone, oils, etc.
- ④ Guiding sleeve: Plastic
- ⑤ Flange nuts: A4 / AISI grade 316 material  
Designation according to Unified Numbering System (UNS)

### Recommended fastening tools

BX 3-BT / BTG  
DX 351-BT / BTG

See **X-BT fastener program** in the next pages and **Tools and equipment** chapter for more details.

### Fasteners approvals

ABS: 18-HS1755518, DNV-GL TAS00001SV, BV 54554, LR 19/0003, ICC-ES ESR-2347 (USA)

## Applications

### Examples

Threaded stud applications especially for:

- High strength steel
- Coated steel structures
- Through penetration of base steel is not allowed

\* Grating with X-BT-GR and X-FCM-R (HL)

\* Load data, application requirements, corrosion information, fastener selection, system recommendation, material specification and coating refer to section X-FCM-R, X-FCM-R HL or X-FCS-R Grating Fastening System in the Direct Fastening Technology Manual

Multi purpose fastening with X-BT-MR

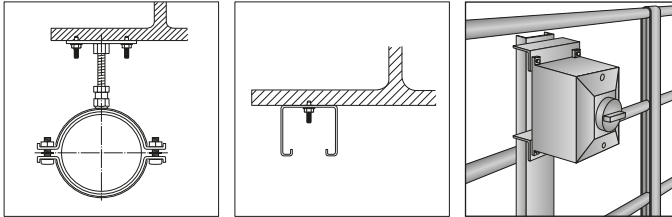

**Junction box, etc.**

### Performance data – Construction steel

#### Recommended loads – steel base material

Steel grade: Europe, USA	S235, S275 A36	S355 to S960 ≥ Grade 50
Tension, $N_{rec}$ [kN/lb]	3.6 / 810	4.6 / 1030
Shear –		
form lock $V_{rec}$ [kN/lb]	4.3 / 970	5.3 / 1190
friction lock $V_{rec}$ [kN/lb]	0.20 / 45	0.20 / 45
Moment, $M_{rec}$ [Nm/lbft]	20.0 / 14.8	20.0 / 14.8
Torque, $T_{rec}$ [Nm/lbft]	20.0 / 14.8	20.0 / 14.8

Example:

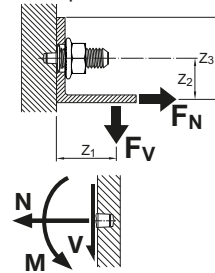

#### Conditions for recommended loads:

- Application of working load design concept (e.g. ASD)
- For unalloyed construction, off-shore and Shipbuilding steel: e.g. European grades S235, S275, S355 according to EN 10025-2, S355M, S420M, S460M according to EN 10025-4 or EN 10225, S690Q and S960Q according to EN10025-6, US steel grade A36 and Grade 50.
- Minimum base material thickness  $t_{II} = 8$  mm.
- Applicable for steel base materials up to a coating thickness of 500  $\mu$ m.
- Edge distance  $c \geq 10$  mm [3/8"].
- In case of edge distance  $6$  mm  $\leq c < 10$  mm,  $N_{rec}$ ,  $V_{rec}$  and  $M_{rec}$  need to be reduced with the reduction factor  $\alpha_c = 0.65$ .
- For group fastenings with up to 4 fasteners per group and shear force introduction via the sealing washer, the resistance of all fasteners can be added up, provided the hole in the fastened material is equal or less than 14 mm (e.g.  $V_{rec,group} = 17.2$  kN for a group with 4 fasteners fixed to S235 base material). For more details see "New Generation Hilti X-BT-GR, X-BT-MR and X-BT-ER Threaded Fastener Specification".
- Redundancy (multiple fastening) must be provided.

#### Remarks:

- The recommended loads in the table refer to the resistance of the single fastener and need to be determined by static analysis from the loads  $F_N$  and  $F_V$  acting on the fastened part. Typical example is the need of consideration of prying forces, see example.
- Moments acting on the shank only need to be considered in case of a gap between the base and the fastened material.
- Global factor of safety for tension and shear load = 2.8 related to the characteristic resistance  $N_{Rk}$  and  $V_{Rk}$
- Global factor of safety for bending moment = 1.75 related to the characteristic bending moment  $M_{R,k}$  of the shank.
- Effects of base metal vibration and stresses are considered.
- For difference of form and friction lock for shear resistance, refer to explanations at the end of this data sheet.

**Characteristic resistance – steel base material**

Steel grade: Europe, USA	S235, S275, A36	S355 to S960, ≥ Grade 50
Tension <b>N<sub>RRk</sub></b> [kN/lb]	10.0 / 2240	13.0 / 2920
Shear – form lock <b>V<sub>RRk</sub></b> [kN/lb]	12.0 / 2700	15.0 / 3360
friction lock <b>V<sub>RRk</sub></b> [kN/lb]	0.56 / 125	0.55 / 125
Moment <b>M<sub>RRk</sub></b> [Nm/lbft]	35.0 / 25.5	35.0 / 25.5

**Design resistance – steel base material**

Steel grade: Europe, USA	S235, S275, A36	S355 to S960, ≥ Grade 50
Tension <b>N<sub>Rd</sub></b> [kN/lb]	5.0 / 1120	6.5 / 1460
Shear – form lock <b>V<sub>Rd</sub></b> [kN/lb]	6.0 / 1350	7.5 / 1680
friction lock <b>V<sub>Rd</sub></b> [kN/lb]	0.28 / 62	0.28 / 62
Moment <b>M<sub>Rd</sub></b> [Nm/lbft]	28.0 / 20.5	28.0 / 20.5

**Performance data – Cast iron**
**Recommended loads – cast iron \***

Tension, <b>N<sub>rec</sub></b> [kN/lb]	1.0 / 230
Shear – form lock <b>V<sub>rec</sub></b> [kN/lb]	1.5 / 340
friction lock <b>V<sub>rec</sub></b> [kN/lb]	0.20 / 45
Moment, <b>M<sub>rec</sub></b> [Nm/lbft]	16.0 / 11.5

**Design resistance – cast iron \***

Tension <b>N<sub>Rd</sub></b> [kN/lb]	1.6 / 360
Shear form lock <b>V<sub>Rd</sub></b> [kN/lb]	2.4 / 540
friction lock <b>V<sub>Rd</sub></b> [kN/lb]	0.28 / 62
Moment <b>M<sub>Rd</sub></b> [Nm/lbft]	26.0 / 19.0

**\*Requirements of spheroidal graphite cast iron base material**

Subject	Requirements
Cast iron	Spheroidal graphite cast iron according to EN 1563
Strength class	EN-GJS-400 to EN-GJS-600 according to EN 1563
Chemical analysis and amount of carbon	3.3 – 4.0 mass percentage
Microstructure	Form IV to VI (spherical) according to EN ISO 945-1:2010 Minimum size 7 according to Figure 4 of EN ISO 945-1:2010
Material thickness	t <sub>II</sub> ≥ 20 mm

Recommended interaction formula for combined loading - steel and cast iron base material

Load combination	Interaction provision
V-N (shear and tension)	$\frac{V_{Sd}}{V_{Rd}} + \frac{N_{Sd}}{N_{Rd}} \leq 1.2$ with $\frac{V_{Sd}}{V_{Rd}} \leq 1.0$ and $\frac{N_{Sd}}{N_{Rd}} \leq 1.0$
V-M (shear and bending)	$\frac{V_{Sd}}{V_{Rd}} + \frac{M_{Sd}}{M_{Rd}} \leq 1.2$ with $\frac{V_{Sd}}{V_{Rd}} \leq 1.0$ and $\frac{M_{Sd}}{M_{Rd}} \leq 1.0$
N-M (tension and bending)	$\frac{N_{Sd}}{N_{Rd}} + \frac{M_{Sd}}{M_{Rd}} \leq 1.0$
V-N-M (shear, tension and bending)	$\frac{V_{Sd}}{V_{Rd}} + \frac{N_{Sd}}{N_{Rd}} + \frac{M_{Sd}}{M_{Rd}} \leq 1.0$

**Cyclic loading:**

- Anchorage of X-BT threaded stud in steel base material is not affected by cyclic loading.
- Fatigue strength is governed by fracture of the shank. For more details see "New Generation Hilti X-BT-GR, X-BT-MR and X-BT-ER Threaded Fastener Specification".

**Application requirements**

**Application limit and thickness of base material**

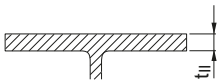

$t_{II} \geq 8 \text{ mm [5/16" ]} \rightarrow$  No through-penetration.  
No limits with regard to steel strength.

**Thickness of fastened material**

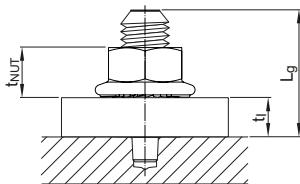

- X-BT-GR M8:  $2.0 \leq t \leq 7.0 \text{ mm}$
- X-BT-MR M10/W10:  $2.0 \leq t \leq 15.0 \text{ mm}$
- X-BT-MR M8:  $2.0 \leq t \leq 14.0 \text{ mm}$
- X-BT-MR M6/W6:  $2.0 \leq t \leq 10.0 \text{ mm}^*$

\* if base material sits on the collar of the stud  $t_{II, \min} = 1.0 \text{ mm}$

**Spacing and edge distances**

Edge distance:

- $c \geq 10 \text{ mm}$  (load reduction factor  $\alpha_c = 1.00$ )
- $6 \text{ mm} \leq c < 10 \text{ mm}$  (load reduction factor  $\alpha_c = 0.65$ )

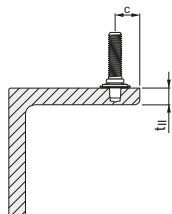

Spacing:

- $s \geq 15 \text{ mm}$

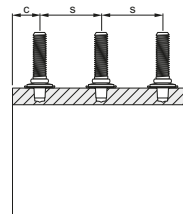

**Corrosion information**

The corrosion resistance of S31803 (1.4462) stainless steel material is equivalent to AISI 316 (A4) steel grade. For detailed information see “New Generation Hilti X-BT-GR, X-BT-MR and X-BT-ER Threaded Fastener Specification”.

**Fastener selection and system recommendation**
**Fastener program**

Designation	Item no.	Tool Designation
<b>X-BT-GR M8/7 SN 8</b>	<b>2194344</b>	BX 3-BTG, DX 351-BTG
<b>X-BT-MR M6/10 SN 8</b>	<b>2252199</b>	BX 3-BT, DX 351-BT
<b>X-BT-MR M6/14 SN8</b>	<b>2194337</b>	DX 351-BT
<b>X-BT-MR W6/10 SN 8</b>	<b>2252470</b>	BX 3-BT, DX 351-BT
<b>X-BT-MR W6/14 SN 8</b>	<b>2194338</b>	DX 351-BT
<b>X-BT-MR M8/14 SN 8</b>	<b>2194339</b>	BX 3-BT, DX 351-BT
<b>X-BT-MR M10/15 SN 8</b>	<b>2194340</b>	BX 3-BT, DX 351-BT
<b>X-BT-MR W10/15 SN 8</b>	<b>2194341</b>	BX 3-BT, DX 351-BT

**Cartridge selection and tool energy setting**

**DX 351-BTG, DX 351-BT:** 6.8/11 M high precision brown cartridge

**Battery selection and fastener guide adjustment**

**BX 3-BT, BX 3-BTG:** 22 V cordless tool battery platform

Battery recommendation: B 22/2.6, also allowed B 22/3.0, B 22/4.0, B 22/5.2

The recommended fastener guide position is “1” (if required, adjust the fastener guide position based on job site tests and IFU).

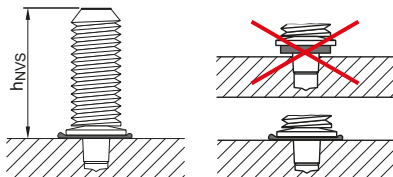
**Fastening quality assurance**
**Fastening inspection**

**X-BT-GR M8**

$h_{NVS} = 15.7-16.8 \text{ mm}$

**X-BT-MR M6/W6/M8/M10/W10**

$h_{NVS} = 25.7-26.8 \text{ mm}$

**Installation**
**X-BT-MR M8**

Fastened material:

- Hole diameter: 13 to 14 mm: Use of supplied flange nut ①
- Hole diameter: beyond 14 to 18 mm: Use of supplied flange nut with supplement washer (maximum thickness of fixed component to be reduced with thickness of washer) ②

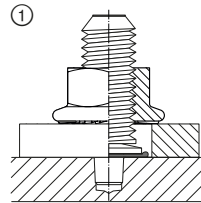
**X-BT-MR M10/W10**

Fastened material:

- Hole diameter: 13 to 18 mm: Use of supplied flange nut ①
- Hole diameter: beyond 18 to 22 mm: Use of supplied flange nut with supplement washer (maximum thickness of fixed component to be reduced with thickness of washer) ②

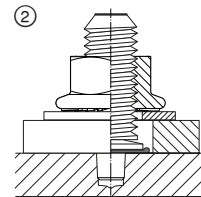
**X-BT-MR M6/W6**

Fastened material:

- Hole diameter: 6.5 – 6.7: Fastener sits on collar of stud, use of supplied flange nut ③
- Hole diameter: 6.7 to 11 mm: Use of supplied flange nut with supplement washer sitting on collar ④
- Hole diameter: > 12 mm, fixed part sits on base material, use of flange nut with supplemental washer to cover hole clearance (maximum thickness of fixed component to be reduced with thickness of washer) ②

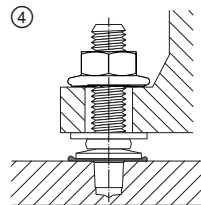
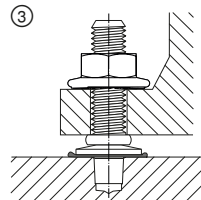
**Remarks on group fastenings**

For group fastenings with up to 4 fasteners per group and shear force introduction via the sealing washer, the resistance of all fasteners can be added up, provided the hole in the fastened material is equal or less than 14 mm. For detailed information see “New Generation Hilti X-BT-GR, X-BT-MR and X-BT-ER Threaded Fastener Specification”.



Pre-drill with **TX-BT 4.7/7** step shank drill bit

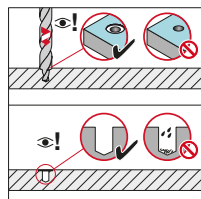
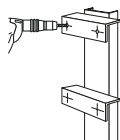

Pre-drill until shoulder grinds a shiny ring.  
The drill hole and the area around drilled hole must be clean and free from liquids and debris.

Tighten using a screwdriver with torque clutch

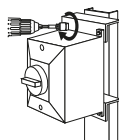

Tightening torque:  
**T<sub>rec</sub> ≤ 20 Nm (14.8 ft-lb)!**

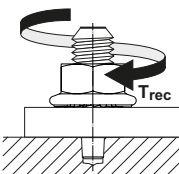

Hilti Torque tool X-BT 1/4"  
– 20 Nm / 14.8 ft-lb  
# 2212510



X-BT 1/4" 20 Nm / 14.8 lb-ft

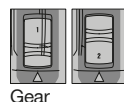

Gear

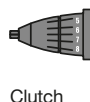

Clutch

### Hilti cordless screwdriver setting recommendations

Hilti cordless screwdriver	X-BT-MR M6/W6		X-BT-MR M8		X-BT-MR M10/W10	
	Gear	Clutch	Gear	Clutch	Gear	Clutch
SF 14-A	3	15	3	12	3	13
SF 10W-A22	4	15	4	8	4	11
SF 8M-A22	4	15	4	12	4	11
SFC 14-A	2	15	2	13	2	11
SFC 22-A	2	15	2	14	2	11
SF 6-A22	-	-	1	1	1	1

These are abbreviated instructions which may vary by application.  
**ALWAYS** review/follow the instructions accompanying the product.

**Form and friction lock for shear connection**
**Shear load transfer via friction lock is relevant if non-slip connections are required in the service state:**

- Fixing the position of channel sections with slotted holes and forces in direction of the slots
- Connections with hole clearance beyond 14 mm

Slotted holes or bigger hole clearance allow easier assembly and geometric adjustment of the fixed component. Consequently form lock mechanism by means of direct contact of the fixed component with the washer of the X-BT-MR cannot be easily ensured with little slip in those cases. The New Generation X-BT-MR fasteners allow the use higher torque of 20 Nm resulting in a friction shear connection capacity. That friction lock can be utilized to fix the position of the attached component as well as for shear load transfer if the demand is comparably small. In case of high shear demand, the form lock mechanism has to be activated and can further be optimized for group fastenings (for more details on group fastenings relying on form lock, see „New Generation Hilti X-BT-GR, X-BT-MR and X-BT-ER Threaded Fastener Specification“)

Examples of friction lock:

- MQ-41 channel with X-BT-MR M10/15 SN 8 and varying distances  $e_1$  and  $e_2$

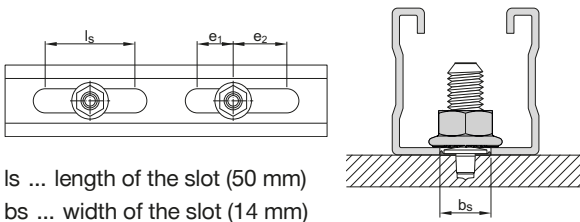

ls ... length of the slot (50 mm)  
bs ... width of the slot (14 mm)

- X-BT-MR connections with maximum hole diameter in fixed material

X-BT-MR M8/14 SN 8,

max. hole diameter = 18 mm

X-BT-MR M10/15 SN 8,

max. hole diameter = 22 mm

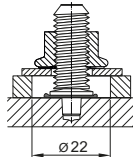
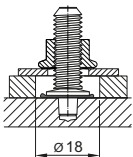
**Conditions and remarks:**

- The use of friction lock connection forces requires the application of an installation torque  $T = 20 \text{ Nm}$ .
- Friction lock not suitable in case of base material vibrations.
- The friction lock values are suitable to fix the position of components and in case of lower shear load demand. Full shear load capacity are developed by means of form lock via contact of the fixed component with the sealing washer of the X-BT-MR.

# X-BT-MF Composite threaded stud

## Product data

### Dimensions

X-BT-MF M/W 10/10 SN4

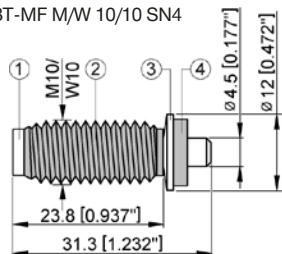

M10 nut

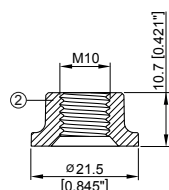

W10 nut

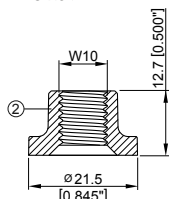

W10 = 3/8" UNC 2 thread

### General information

#### Material specifications

- ① Shank: 1.4362 according to EN 10088-2  
ASTM A240 UNS S32304
- ② Threaded sleeve and nut: Glass-fiber reinforced polyamide material - ISO 1874: PA6T/6I, MH, 12-190, GF50 (glass-fiber content: 50%), Flammability rating: UL94 HB
- ③ SN12 washer: S 31635  
(X2CrNiMo 17-12-2, 1.4404)
- ④ Sealing washer: Chloroprene rubber CR 3.1107, black

#### Recommended fastening tools

DX 351-BT

See **X-BT-MF fastener program** in the next pages and **Tools and equipment** chapter for more details.

#### Approvals

ICC ESR-2347

## Applications

### Examples

Threaded stud applications especially for:

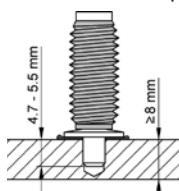

- High strength steel
- Coated steel structures
- Through penetration of base steel is not allowed

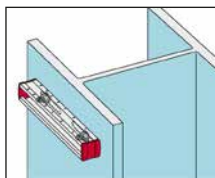

Channel installation

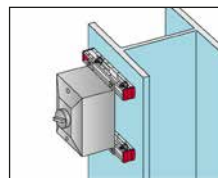

Junction box, etc.

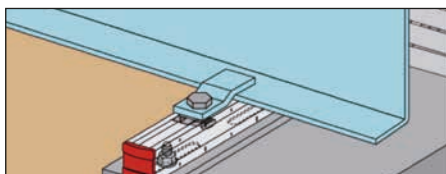

Cable ladder with hold-down/expansion-guide clip

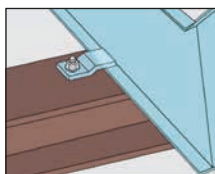

Cable ladders

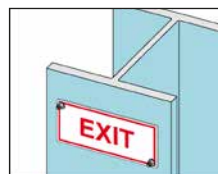

Signage

### Load data

#### Recommended loads

For structural steel (ultimate strength of base material  $R_m \geq 350$  MPa)

Service temperature	-40°C to +60°C -40°F to +140°F	+60°C to +100°C +140°F to +212°F
Tension, $N_{rec}$ [kN/lb]	1.5 / 340	1.0 / 225
Shear, $V_{rec}$ [kN/lb]	2.2 / 500	1.4 / 315
Moment, $M_{rec}$ [Nm/lbft]	8.2 / 6	8.2 / 6
Torque, $T_{rec}$ [Nm/lbft]	$\leq 8 / \leq 5.9$	
<b>During installation</b>		
In service temp. range	-40°C to +100°C / -40°F to +212°F	
Installation temperature	-10°C to +60°C / 14°F to 140°F	

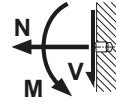

Example:

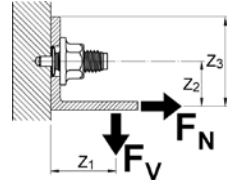

#### Conditions for recommended loads:

- Use with Hilti glass-fiber reinforced polyamide material nuts, M10 and W10 (Ⓜ according to General Information - Material specifications)
  - Not to be used with any additional washer which provide an axial force when deformed, e.g. spring or lock washer, etc.
  - Global factor of safety  $> 3$  (based on 5% fractile value)
  - Minimum edge distance = 6 mm [ $1/4"$ ].
  - Effect of base metal vibration and stress considered.
  - Redundancy (multiple fastening) must be provided.
  - The recommended loads in the table refer to the resistance of the individual fastening and may not be the same as the loads  $F_N$  and  $F_V$  acting on the fastened part.
- Note: If relevant, prying forces need to be considered in design, see example. Moment acting on fastener shank only in case of a gap between base and fastened material.
- **Minimum temperature for installation and adjustments = -10°C**

### Design loads

For structural steel (ultimate strength of base material  $R_m \geq 350$  MPa)

Service temperature	-40°C to +60°C -40°F to +140°F	+60°C to +100°C +140°F to +212°F
Tension, $N_{Rd}$ [kN/lb]	2.0 / 450	1.35 / 300
Shear, $V_{Rd}$ [kN/lb]	3.0 / 675	1.9 / 425
Moment, $M_{Rd}$ [Nm/lbft]	18.4 / 13.6	18.4 / 13.6
In service temp. range	-40°C to +100°C / -40°F to +212°F	
Installation temperature	-10°C to +60°C / 14°F to 140°F	

### Recommended interaction formula for combined loading

Combined loading situation	Interaction formula
<b>V-N</b> (shear and tension)	$\frac{V}{V_{rec}} + \frac{N}{N_{rec}} \leq 1.2$ with $\frac{V}{V_{rec}} \leq 1.0$ and $\frac{N}{N_{rec}} \leq 1.0$
<b>V-M</b> (shear and bending)	$\frac{V}{V_{rec}} + \frac{M}{M_{rec}} \leq 1.2$ with $\frac{V}{V_{rec}} \leq 1.0$ and $\frac{M}{M_{rec}} \leq 1.0$
<b>N-M</b> (tension and bending)	$\frac{N}{N_{rec}} + \frac{M}{M_{rec}} \leq 1.0$
<b>V-N-M</b> (shear, tension and bending)	$\frac{V}{V_{rec}} + \frac{N}{N_{rec}} + \frac{M}{M_{rec}} \leq 1.0$

#### Cyclic loading:

- Anchorage of **X-BT-MF** threaded stud in steel base material is not affected by cyclic loading.
- Fatigue strength is governed by fracture of the shank. Inquire at Hilti for test data if high cycle loading has to be considered in the design.

### Application requirements

#### Thickness of base material

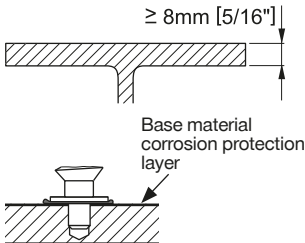

#### Where through penetration is not allowed\*

Thickness of base material corrosion protection layer  $\leq 0.4\text{ mm}$ . For thicker coatings, please contact Hilti.

\*Note: Corrosion protection may be compromised if base material thickness is less than 8mm.

Please contact Hilti for load recommendations if base material thickness is less than 8mm and through penetration allowed.

#### Thickness of fastened material

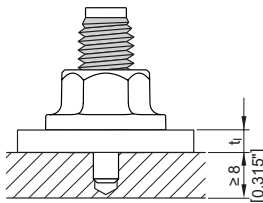

$2.0 \leq t_f \leq 10.0\text{ mm}$   
 $0.08'' \leq t_f \leq 0.39''$

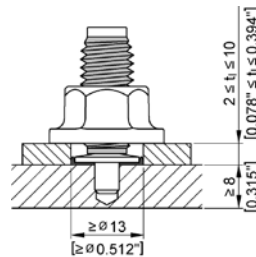

Fastened material hole  $\varnothing$   
 $\geq 13\text{ mm}$  ( $0.51''$ )

## Spacing and edge distances

Edge distance:  $\geq 6$  mm

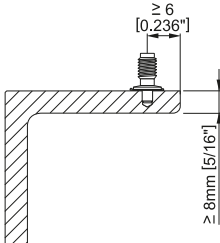

Spacing:  $\geq 15$  mm

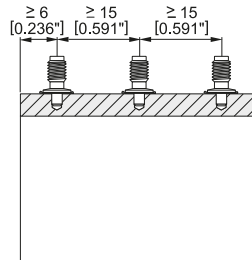

## Durability

From a durability point of view, it can be assumed that the Hilti X-BT-MF system will have a lifetime over 20 years even in mildly corrosive environment (C3 environment according to EN-ISO 12944-2).

## Corrosion information

For fastenings exposed to outdoor environments in mildly corrosive conditions where HDG coated parts are commonly specified or used.

Not for use in atmospheres with chlorides (marine atmospheres) or in heavily polluted environments (e.g. sulphur dioxide).

## Vibration (Transportation, handling and base material vibration)

When installed according to instruction for use and fastening quality assurance, the X-BT-MF system (stud and Hilti glass-fiber reinforced polyamide material nuts) is resistant to transportation, handling and base material vibration.

The use of additional lock washer is not required. Lock washer will affect the integrity and functionality of the Hilti glass-fiber reinforced polyamide material nuts. Therefore additional lock or spring washers must not be used in combination with the X-BT-MF system.

For more information regarding vibration, please refer to “X-BT-MF Additional Technical Information”.

## Application limit

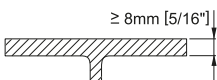

- $t_{II} \geq 8$  mm [ $5/16$ "]  $\rightarrow$  No through penetration
- No limits with regards to steel strength

## Fastener selection and system recommendation

### Fastener program

Designation	Item no.	Tool designation
<b>X-BT-MF M10/10 SN4</b>	<b>2083549</b>	DX 351-BT
<b>X-BT-MF W10/10 SN4</b>	<b>2083620</b>	DX 351-BT

### Accessories

Designation	Item no.	For use with
<b>Socket X-NSD 1/4" – 16mm</b>	<b>2097397</b>	X-BT-MF M10/10 SN4 and T-handle or Torque tool
<b>Socket X-NSD 1/4" – 9/16"</b>	<b>2107229</b>	X-BT-MF W10/10 SN4 and T-handle or Torque tool
<b>T-handle X-NSD 1/4"</b>	<b>2115130</b>	X-NSD sockets
<b>Torque tool X-BT 1/4"</b>	<b>2119272</b>	X-NSD sockets

## Cartridge selection and tool energy setting

### 6.8/11 M high precision brown cartridge

Fine adjustment by installation tests on site

## Fastening quality assurance

### Fastening inspection

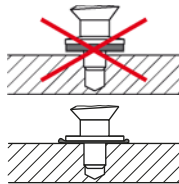
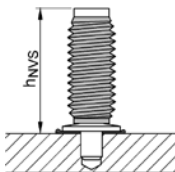

### X-BT-MF

$h_{NVS} = 25.7 - 26.8 \text{ mm}$   
 $= 1.012" - 1.055"$

## Installation

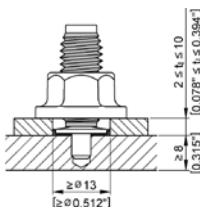

Fastened material hole  
 $\varnothing \geq 13 \text{ mm (0.51")}$

Remark: for group fastenings subjected to shear loading the fastened material hole diameter should not exceed 14mm

Pre-drill with **TX-BT 4/7** step shank drill bit

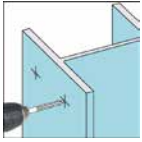

Pre-drill until the shoulder grinds a shiny ring (to ensure proper drilling depth)



**Before fastener installation:**

The drilled hole and the area around the drilled hole must be clear of liquids and debris.

Tighten using a screwdriver with torque clutch

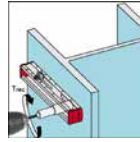

Tightening torque:  
 $T_{rec} \leq 8 \text{ Nm (5.9 ft-lb)}$

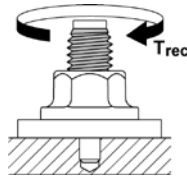

Hilti Torque tool X-BT 1/4"

Hilti screwdriver:	Torque setting:
SFC 14-A	6
SFC 18-A	3
SFC 22-A	3

These are abbreviated instructions which may vary by application.  
**ALWAYS** review/follow the instructions accompanying the product.



# X-BT-MR-N Stainless steel threaded stud for narrow through hole

## Product data

### Dimensions

X-BT-MR-N M8/14 N 4

X-BT-MR-N M8/4 N 4

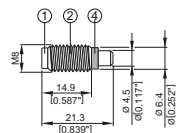
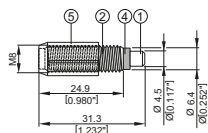

#### Note on drill-bit:

X-BT-MR-N requires the use of the specific drill bit TX-BT 4/5.5. The drill bit TX-BT 4/7, which is used for X-BT, X-BT-MF and X-BT-ER fasteners must not be used for X-BT-MR-N studs.

### General information

#### Material specifications

- ① Shank:
  - CR 500 (CrNiMo alloy) equivalent to A4 / S31803 (1.4462)
  - AISI grade 316 material N 08926 (1.4529) <sup>1</sup>
  - Available on request
- ② Threaded sleeve: S31609
  - (X5CrNiMo 17-12-2+2H, 1.4401)
- ④ Sealing washers: Chloroprene rubber CR 3.1107, black\*
- ⑤ Guide sleeve: Plastic

\* Resistant to UV, salt water, water, ozone, oils, etc.

<sup>1</sup>) For High Corrosion Resistance HCR material inquire at Hilti

Designation according to Unified Numbering System (UNS)

#### Recommended fastening tools

DX 351-BT / BTG

See **X-BT fastener program** in the next pages and **Tools and equipment** chapter for more details.

#### Approvals

ABS, LR, DNV-GL, BV



## Applications

### Examples

Threaded stud applications especially for:

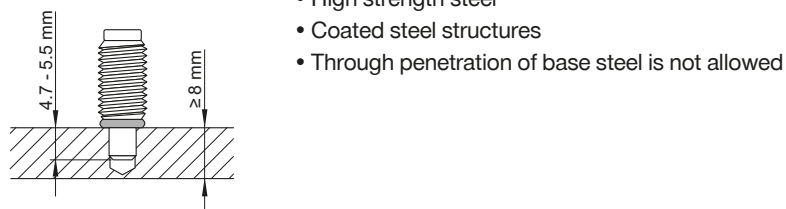

## Load data

### Recommended loads – steel

Steel grade: Europe, USA	S235, A36	S355, Grade 50 and stronger steel
Tension, $N_{rec}$ [kN/lb]	1.8 / 405	2.3 / 517
Shear, $V_{rec}$ [kN/lb]	2.6 / 584	3.4 / 764
Moment, $M_{rec}$ [Nm/lbft]	8.2 / 6	8.2 / 6
Torque, $T_{rec}$ [Nm/lbft]	8 / 5.9	8 / 5.9

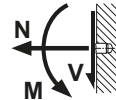

Example:

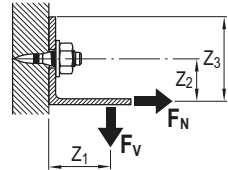

### Recommended loads – cast iron \*

Tension, $N_{rec}$ [kN/lb]	0.5 / 115
Shear, $V_{rec}$ [kN/lb]	0.75 / 170
Moment, $M_{rec}$ [Nm/lbft]	8.2 / 6

#### Conditions for recommended loads:

- Global factor of safety for static pull-out > 3 (based on 5% fractile value)
- Minimum edge distance = 6 mm [ $1/4"$ ].
- Effect of base metal vibration and stress considered.
- Redundancy (multiple fastening) must be provided.
- The recommended loads in the table refer to the resistance of the individual fastening and may not be the same as the loads  $F_N$  and  $F_V$  acting on the fastened part.  
Note: If relevant, prying forces need to be considered in design, see example. Moment acting on fastener shank only in case of a gap between base and fastened material.

#### \*Requirements of spheroidal graphite cast iron base material

Subject	Requirements
Cast iron	Spheroidal graphite cast iron according to EN 1563
Strength class	EN-GJS-400 to EN-GJS-600 according to EN 1563
Chemical analysis and amount of carbon	3.3–4.0 mass percentage
Microstructure	Form IV to VI (spherical) according to EN ISO 945-1:2010 Minimum size 7 according to Figure 4 of EN ISO 945-1:2010
Material thickness	$t_{II} \geq 20$ mm

**Design resistance – steel**

Steel grade:		S235	S355
Europe			
Tension	$N_{Rd}$ [kN]	2.9	3.7
Shear	$V_{Rd}$ [kN]	4.2	5.4
Moment	$M_{Rd}$ [Nm]	18.4	18.4

**Design resistance – cast iron \***

Tension	$N_{Rd}$ [kN]	0.8
Shear	$V_{Rd}$ [kN]	1.2
Moment	$M_{Rd}$ [Nm]	13.1

**Recommended interaction formula for combined loading - steel and cast iron base material**

Combined loading situation	Interaction formula
<b>V–N</b> (shear and tension)	$\frac{V}{V_{rec}} + \frac{N}{N_{rec}} \leq 1.2$ with $\frac{V}{V_{rec}} \leq 1.0$ and $\frac{N}{N_{rec}} \leq 1.0$
<b>V–M</b> (shear and bending)	$\frac{V}{V_{rec}} + \frac{M}{M_{rec}} \leq 1.2$ with $\frac{V}{V_{rec}} \leq 1.0$ and $\frac{M}{M_{rec}} \leq 1.0$
<b>N–M</b> (tension and bending)	$\frac{N}{N_{rec}} + \frac{M}{M_{rec}} \leq 1.0$
<b>V–N–M</b> (shear, tension and bending)	$\frac{V}{V_{rec}} + \frac{N}{N_{rec}} + \frac{M}{M_{rec}} \leq 1.0$

**Cyclic loading:**

- Anchorage of **X-BT-MR-N** threaded stud in steel base material is not affected by cyclic loading.
- Fatigue strength is governed by fracture of the shank. Inquire at Hilti for test data if high cycle loading has to be considered in the design.

## Application requirements

### Thickness of base material

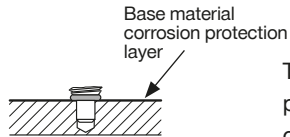
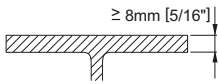

Thickness of base material corrosion protection layer  $\leq 0.4\text{mm}$ . For thicker coatings, please contact Hilti.

### Thickness of fastened material

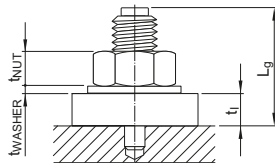

**X-BT-MR-N M8/4 N 4:**  $t_1 \leq 4\text{ mm}$

**X-BT-MR-N M8/14 N 4:**  $4\text{ mm} \leq t_1 \leq 14\text{ mm}$

For thickness less than 4 mm, reduction of shear loading is required, please contact Hilti.

### Spacing and edge distances

Edge distance:  $\geq 6\text{ mm}$

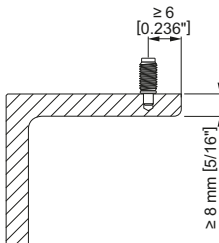

Spacing:  $\geq 15\text{ mm}$

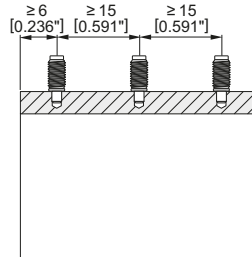

### Corrosion information

The corrosion resistance of Hilti CR500 and S31803 stainless steel material is equivalent to AISI 316 (A4) steel grade.

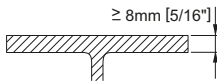
**Application limit**

- $t_{II} \geq 8 \text{ mm } [5/16"] \rightarrow$  No through penetration
- No limits with regards to steel strength

**Fastener selection and system recommendation**
**Fastener program**

Designation	Item no.	Tool Designation
<b>X-BT-MR-N M8/14 N 4</b>	<b>2112004</b>	DX 351 BT
<b>X-BT-MR-N M8/4 N 4</b>	<b>2112003</b>	DX 351 BTG

**Cartridge selection and tool energy setting**
**6.8/11 M high precision brown cartridge**

Fine adjustment by installation tests on site

### Fastening quality assurance

### Fastening inspection

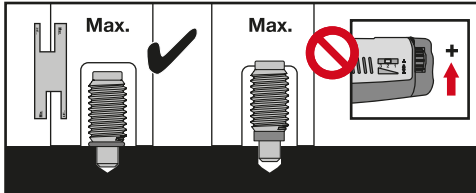

X-BT-MR-N M8/4 N 4  
 $h_{NVS} = 15.7\text{--}16.8\text{ mm}$

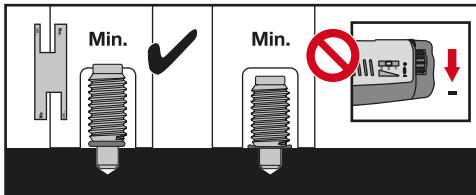

X-BT-MR-N M8/14 N 4  
 $h_{NVS} = 25.7\text{--}26.8\text{ mm}$

### Installation

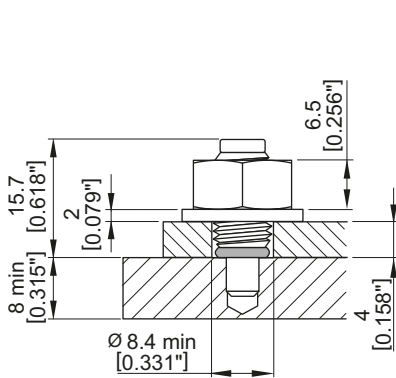

X-BT-MR-N M8/4 N 4

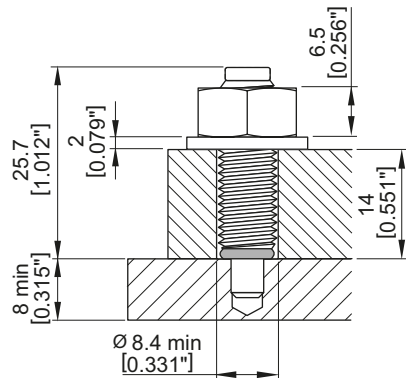

X-BT-MR-N M8/14 N 4

Pre-drill with **TX-BT 4/5.5** step shank drill bit

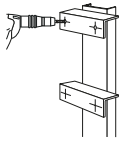

Pre-drill until the shoulder grinds a shiny ring (to ensure proper drilling depth)



**Before fastener installation:**

the drilled hole must be clear of liquids and debris. The area around the drilled hole must be free from liquids and debris.

Tighten using a screwdriver with torque clutch

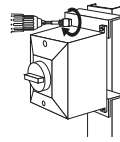

Tightening torque:  
**T<sub>rec</sub> ≤ 8 Nm (5.9 ft-lb)!**

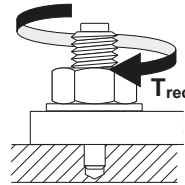

Hilti Torque tool X-BT 1/4"

Hilti screwdriver:	Torque setting:
SFC 14-A	6
SFC 18-A	3
SFC 22-A	5
SBT4-A22	5

These are abbreviated instructions which may vary by application.  
**ALWAYS** review/follow the instructions accompanying the product.





# S-BT Screw-in stainless steel and carbon steel threaded stud

## Product data

### Dimensions

S-BT-MR M10/15 SN 6  
 S-BT-MR M10/15 SN 6 AL\*\*)  
 S-BT-MR W10/15 SN 6  
 S-BT-MR W10/15 SN 6 AL\*\*)

S-BT-MF M10/15 AN 6  
 S-BT-MF W10/15 AN 6

S-BT-MR M10/15 SN 5 \*\*\*)  
 S-BT-MR W10/15 SN 5 \*\*\*)

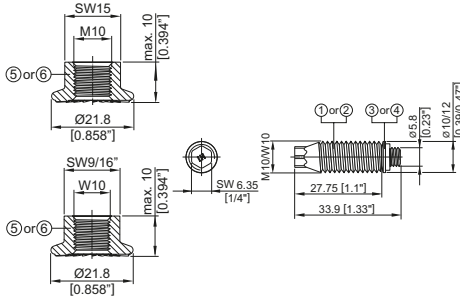

S-BT-MR M8/7 SN 6  
 S-BT-MR M8/7 SN 6 AL\*\*)  
 S-BT-GR M8/7 SN 6\*)  
 S-BT-GR M8/7 SN 6 AL\*\*\*)

S-BT-MF M8/7 AN 6  
 S-BT-GF M8/7 AN 6\*)

S-BT-MR M8/7 SN 5 \*\*\*)  
 S-BT-GR M8/7 SN 5\*) \*\*\*)

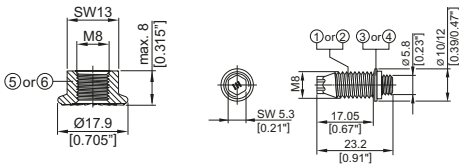

S-BT-MR M8/15 SN 6  
 S-BT-MR M8/15 SN 6 AL\*\*)

S-BT-MF M8/15 AN 6

S-BT-MR M8/15 SN 5\*\*\*)

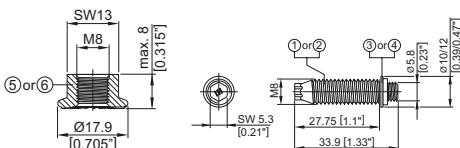

### General information

#### Material specifications

- ① Threaded shank: Stainless steel (S-BT-\_R)  
 "S 31803 (1.4462)"  
 zinc-coated
- ② Threaded shank: Carbon steel (S-BT-\_F)  
 "1038 / duplex-coated"
- ③ SN12-R washers: Stainless steel (S-BT-\_R)  
 "S 31635 (1.4404)"
- ④ AN10-F washers: Ø 10 mm [0.39"]  
 Aluminum (S-BT-\_F)
- ⑤ Serrated flange nut\*): Stainless steel (S-BT-MR)  
 grade A4 - 70/80
- ⑥ Serrated flange nut\*): Carbon steel (S-BT-MF)  
 HDG, grade 8

Sealing ring of

sealing washers:

Chloroprene rubber CR  
 3.1107, black  
 resistant to UV, salt water,  
 water, ozone, oils, etc.

### Drilling tool, setting tool, accessories and inserts

Refer to section "Fastener selection and system recommendation" for more details.

### Reports and type approvals

ICC-ES ESR-4185, ABS: 16-HS1550085-PDA, DNV-GL: TAS0000N6, LR: 16/00063, BV: 45116/A BV, Russian Maritime Register of Shipping: 16.40059.250



- \*) S-BT-GR and S-BT-GF for grating fastening: package does not include serrated flange nuts
- \*\*\*) for use in aluminum base material
- \*\*\*) this items are not available at the moment

## Applications

### Examples

Multipurpose Fastening	Grating with X-FCM and X-FCS-R *)
S-BT-MR _____	S-BT-GR _____
S-BT-MF _____	S-BT-GF _____

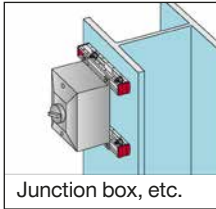

Junction box, etc.

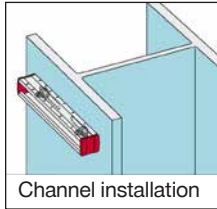

Channel installation



Signage

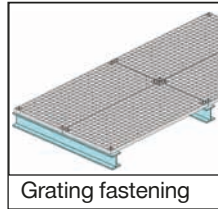

Grating fastening

\*) Load data, application requirements, corrosion information, fastener selection, system recommendation, material specification and coating refer to section X-FCM Grating Fastening System on X-FCS-R Grating Fastening System in the Direct Fastening Technology Manual.

## Load data

### Recommended loads

	S-BT-_____6			S-BT-_____5 *)			
	Steel S235 A36	Steel S355 Grade 50	Aluminum $f_u \geq 270$ MPa	Steel S235 A36	Steel S355 Grade 50	Steel S235 A36	Steel S355 Grade 50
Drill hole type and base material thickness	Pilot hole, $t_{II} \geq 6$ mm [0.24"] Drill through hole, 5 mm [0.20"] $\leq t_{II} < 6$ mm [0.24"]			Drill through hole, 3 mm [0.12"] $\leq t_{II} <$ 5 mm [0.20"]		Pilot hole, 5 mm [0.20"] $\leq t_{II} <$ 6 mm [0.24"]	
Tension, $N_{rec}$ [kN/lb]	1.8 / 405	2.3 / 520	1.0 / 225	1.0 / 225	1.3 / 290	1.0 / 225	1.3 / 290
Shear, $V_{rec}$ [kN/lb]	2.6 / 585	3.2 / 720	1.5 / 340	1.5 / 340	1.9 / 430	1.5 / 340	1.9 / 430
Moment, $M_{rec}$ [Nm/lbft]	7.0 / 5.2	7.0 / 5.2	4.8 / 3.5	7.0 / 5.2	7.0 / 5.2	6.2 / 4.6	6.2 / 4.6

## Design resistance

	S-BT-_____6			S-BT-_____5 *)			
	Steel S235 A36	Steel S355 Grade 50	Aluminum $f_u \geq 270$ MPa	Steel S235 A36	Steel S355 Grade 50	Steel S235 A36	Steel S355 Grade 50
Drill hole type and base material thickness	Pilot hole, $t_{II} \geq 6$ mm [0.24"] Drill through hole, 5 mm [0.20"] $\leq t_{II} < 6$ mm [0.24"]			Drill through hole, 3 mm [0.12"] $\leq t_{II} <$ 5 mm [0.20"]		Pilot hole, 5 mm [0.20"] $\leq t_{II} <$ 6 mm [0.24"]	
Tension, $N_{Rd}$ [kN/lb]	2.5 / 560	3.2 / 720	1.4 / 315	1.4 / 315	1.8 / 405	1.4 / 315	1.8 / 405
Shear, $V_{Rd}$ [kN/lb]	3.6 / 810	4.5 / 1010	2.1 / 470	2.1 / 470	2.7 / 610	2.1 / 470	2.7 / 610
Moment, $M_{Rd}$ [Nm/lbft]	9.8 / 7.2	9.8 / 7.2	6.7 / 4.9	9.8 / 7.2	9.8 / 7.2	8.7 / 6.4	8.7 / 6.4

\*) this items are not available at the moment

### Conditions for recommended loads:

- Use S-BT-MR and S-BT-MF (multipurpose fastening) only with the supplied Hilti serrated flange nuts M8, M10, W10 (Ⓢ or Ⓣ) as per according to General Information – Material specifications)
- Global factor of safety  $\Omega$  for static pull-out and static shear  $\geq 3$  (based on 5% fracture ultimate test value)
- Minimum edge distance = 6 mm [0.24"], spacing  $\geq 18$  mm [0.709"]
- Effect of base metal vibration and stress (e.g. areas with tensile stress) considered.
- Redundancy (multiple fastening) must be provided.
- If eccentric loading exists (e.g. use of an angle clip), moments caused by off-center loading must be considered.

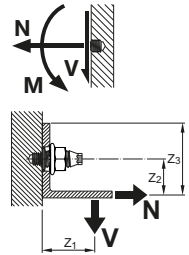

### Recommended interaction formula for combined loading – steel and aluminum base material

$$\mathbf{V-N} \text{ (shear and tension)} \quad \frac{V}{V_{rec}} + \frac{N}{N_{rec}} \leq 1.2 \text{ with } \frac{V}{V_{rec}} \leq 1.0 \text{ and } \frac{N}{N_{rec}} \leq 1.0$$

$$\mathbf{V-M} \text{ (shear and bending)} \quad \frac{V}{V_{rec}} + \frac{M}{M_{rec}} \leq 1.2 \text{ with } \frac{V}{V_{rec}} \leq 1.0 \text{ and } \frac{M}{M_{rec}} \leq 1.0$$

$$\mathbf{N-M} \text{ (tension and bending)} \quad \frac{N}{N_{rec}} + \frac{M}{M_{rec}} \leq 1.0$$

$$\mathbf{V-N-M} \text{ (shear, tension and bending)} \quad \frac{V}{V_{rec}} + \frac{N}{N_{rec}} + \frac{M}{M_{rec}} \leq 1.0$$

### Cyclic loading:

S-BT threaded studs are only to be used for fastenings subject to static or quasi-static loading. Inquire at Hilti for test data if cyclic loading has to be considered in the design.

## Application Requirements

### Base material thickness $t_{II}$ and type of bore hole

S-BT-MR M8/7 SN 6	S-BT-MR M8/15 SN 6	S-BT-MR M10/15 SN 6	S-BT-MR M8/7 SN 5 **)
S-BT-MR M8/7 SN 6 AL*)	S-BT-MR M8/15 SN 6 AL*)	S-BT-MR M10/15 SN 6 AL*)	S-BT-MR M8/15 SN 5 **)
S-BT-MF M8/7 AN 6	S-BT-MF M8/15 AN 6	S-BT-MF M10/15 AN 6	S-BT-GR M8/7 SN 5 **)
S-BT-GR M8/7 SN 6		S-BT-MR W10/15 SN 6	S-BT-MR M10/15 SN 5 **)
S-BT-GR M8/7 SN 6 AL*)		S-BT-MR W10/15 SN 6 AL*)	S-BT-MR W10/15 SN 5 **)
S-BT-GF M8/7 AN 6		S-BT-MF W10/15 AN 6	

#### Pilot hole

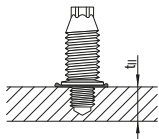

Base material thickness  
steel and aluminum:  
 $t_{II} \geq 6 \text{ mm}$

#### Drill through hole

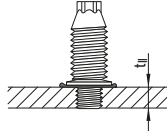

Base material thickness  
steel:  $3 \text{ mm} \leq t_{II} < 6 \text{ mm}$   
aluminum:  $5 \text{ mm} \leq t_{II} < 6 \text{ mm}$

#### Pilot hole

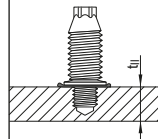

Base material thickness steel:  
 $5 \text{ mm} \leq t_{II} < 6 \text{ mm}$

\*) for use in aluminum base material

\*\*) this items are not available at the moment

Thickness of base material corrosion protection layer  $\leq 0.8 \text{ mm}$  [0.0315"].

For thicker coatings, please contact Hilti.

Base material corrosion protection layer

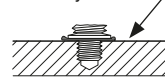

### Thickness of fastened material $t_1$

S-BT-\_\_\_\_/7\_\_\_\_  $1.6 \text{ mm}$  [0.063"]  $\leq t_1 \leq 7.0 \text{ mm}$  [0.28"]

S-BT-\_\_\_\_/15\_\_\_\_  $1.6 \text{ mm}$  [0.063"]  $\leq t_1 \leq 15.0 \text{ mm}$  [0.59"]

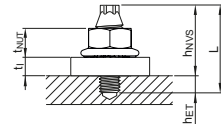

### Spacing & edge distances

Edge distance:  $\geq 6 \text{ mm}$  [0.24"]

Spacing:  $\geq 18 \text{ mm}$  [0.709"] for all S-BT M8

$\geq 22 \text{ mm}$  [0.866"] for all S-BT M10 and S-BT W10

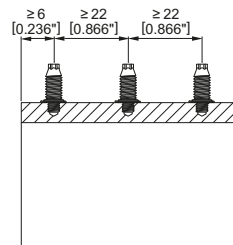
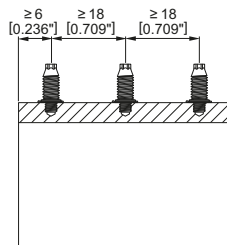
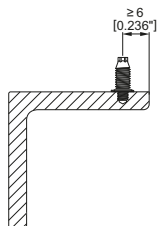

### Corrosion information

The S-BT stainless steel fasteners are made from the duplex stainless steel type 1.4462, which is equivalent to AISI 316 (A4) steel grade. This grade of stainless steel is classified in the corrosion resistance class IV according to DIN EN 1993-1-4:2015, which makes the material suitable for aggressive environments like in coastal and offshore applications.

The microstructures of duplex stainless steels consist of a mixture of austenite and ferrite phases. Compared to the austenitic stainless steel grades, duplex stainless steels are magnetic. The surface of the S-BT stainless steel fasteners is zinc-coated (anti-friction coating) in order to reduce the thread forming torque when the stud is screwed in into the base material.

The coating of the carbon steel S-BT fasteners consists of an electroplated Zn-alloy for cathodic protection and a top coat for chemical resistance (Duplex-coating). The thickness of the coating is 35 µm. The use of this coating is limited to the corrosion category C1, C2 and C3 according to the standard EN ISO 9223. For higher corrosion categories stainless steel fasteners should be used.

In case of a **drill through hole or a pilot hole in thin base material**, rework of the coating on the back side of the plate/profile may be needed.

	S-BT-_____AN 6		S-BT-_____SN 6		S-BT-_____SN 5 <sup>4)</sup>	
Corrosivity category C	C3 medium corrosive		C5 very high corrosive		C5 very high corrosive	
Drill hole type and base material thickness $t_{b1}$ <sup>1)</sup>	Topside protection	Backside protection	Topside protection	Backside protection	Topside protection	Backside protection
<b>Drill through hole</b> <b>3 mm [0.12"] ≤ <math>t_{b1}</math> &lt; 6 mm [0.24"]</b>	✓	x <sup>2)</sup>	✓	x <sup>2)</sup>	n.a.	n.a.
<b>Pilot hole</b> <b>5 mm [0.20"] ≤ <math>t_{b1}</math> &lt; 6 mm [0.24"]</b>	n.a.	n.a.	n.a.	n.a.	✓	✓ <sup>3)</sup>
<b>Pilot hole</b> <b>6 mm [0.24"] ≤ <math>t_{b1}</math> &lt; 7 mm [0.28"]</b>	✓	✓	✓	✓ <sup>3)</sup>	✓	✓
<b>Pilot hole</b> <b><math>t_{b1}</math> ≥ 7 mm [0.28"]</b>	✓	✓	✓	✓	✓	✓

<sup>1)</sup> Real base material thickness, not nominal material thickness or material thickness with coating.

<sup>2)</sup> Damage of the coating on the back side of the plate/profile require a rework of the coating.

<sup>3)</sup> Damage of the coating on the back side of the plate / profile require a rework of the coating, if the drilling tools SF BT 22-A or SF BT 18-A were used for drilling the bore hole. If the tool SBT 4-A22 was used for drilling the bore hole, no damage of the coating on the back side of the plate / profile will occur.

<sup>4)</sup> This items are not available at the moment.

### Application limit

The base material is limited to steel grade with a maximum tensile strength  $f_u = 630$  MPa [91 ksi].

The minimum tensile strength of steel is  $f_u \geq 340$  MPa [49 ksi].

The minimum tensile strength of aluminum is  $f_u \geq 270$  MPa [39 ksi].

Minimum thickness of base material  $t_{II}$ : refer to section “Application Requirements”.

Maximum thickness of base material  $t_{II}$ : no limits.

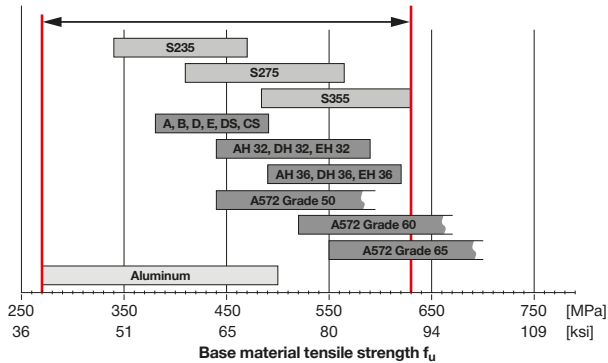

### Fastener selection and system recommendation

	Fastener	Drilling tool	Setting tool	Drill bit	Depth gauge
Stainless steel	S-BT-MR M8/7 SN 5 *)	SBT 4-A22, SF BT 18-A or SF BT 22-A	SBT 4-A22, SFC 18-A or SFC 22-A		S-DG BT M8/7 Short 5 *)
	S-BT-MR M8/15 SN 5 *)			TS-BT 4.3-74 S *)	S-DG BT M8/15 Long 5 *)
	S-BT-GR M8/7 SN 5 *)				S-DG BT M8/7 Short 5 *)
	S-BT-MR M8/7 SN 6			TS-BT 5.5-74 S	
	S-BT-MR M8/7 SN 6 AL			TS-BT 5.5-74 AL	S-DG BT M8/7 Short 6
	S-BT-MR M8/15 SN 6			TS-BT 5.5-74 S	
	S-BT-MR M8/15 SN 6 AL			TS-BT 5.5-74 AL	S-DG BT M8/15 Long 6
	S-BT-MR M8/7 SN 6			TS-BT 5.5-74 S	
	S-BT-GR M8/7 SN 6 AL			TS-BT 5.5-74 AL	S-DG BT M8/7 Short 6
	S-BT-MR M10/15 SN 5 *)				
	S-BT-MR W10/15 SN 5 *)			TS-BT 4.3-74 S *)	S-DG BT M10-W10/15 Long 5 *)
	S-BT-MR M10/15 SN 6			TS-BT 5.5-74 S	
	S-BT-MR M10/15 SN 6 AL			TS-BT 5.5-74 AL	
	S-BT-MR W10/15 SN 6			TS-BT 5.5-74 S	S-DG BT M10-W10/15 Long 6
S-BT-MR W10/15 SN 6 AL	TS-BT 5.5-74 AL				
Carbon steel	S-BT-GF M8/7 AN 6				S-DG BT M8/7 Short 6
	S-BT-MF M8/7 AN 6				
	S-BT-MF M8/15 AN 6			TS-BT 5.5-74 S	S-DG BT M8/15 Long 6
	S-BT-MF M10/15 AN 6				
	S-BT-MF W10/15 AN 6				S-DG BT M10-W10/15 Long 6

\*) this items are not available at the moment

### Fastener quality assurance

In order to ensure the exact screw-in depth and a proper compressed sealing washer, the S-BT studs have to be installed with the appropriate depth gauge. With this tool the screw-in depth can be adjusted in a range of 0 - 1.5 mm (3 steps, 0.5mm per step).

The S-CC BT calibration card is needed to check the initial stand-off of the S-BT stud and to adjust/calibrate the S-DG depth gauge. After finding the right adjustment level for the S-DG depth gauge, the gauge can be adjusted and the studs can be installed without additional check of the S-DG depth gauge.

The depth gauge has to be re-adjusted (calibrated) at following times:

- Start of the installation process
- Change of the working position (upwards, downwards, horizontal) and base material (thickness, strength, type)
- Installer change
- After each packaging respectively after the installation of 100 S-BT studs

The lifetime of the S-DG BT depth gauge is  $\geq 1000$  settings.

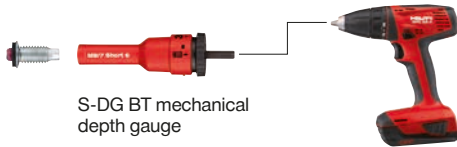

S-DG BT mechanical depth gauge

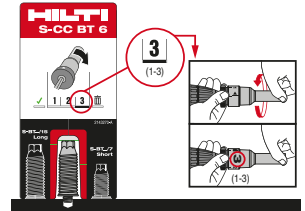

Design and functionality of the mechanical calibration card S-CC BT

### Fastening inspection

The installer is responsible for the correct setting of the S-BT studs.

For the periodical verification of the correct stud stand-off the S-CG BT check gauge can be used.

Verify stud stand-off  $h_{NVS}$  with check gauge S-CG BT

**S-BT-\_\_\_/7\_\_\_6**  $h_{NVS} = 18.6 \text{ mm to } 19.1 \text{ mm [0.732" to 0.752"]}$

**S-BT-\_\_\_/15\_\_\_6**  $h_{NVS} = 29.3 \text{ mm to } 29.8 \text{ mm [1.153" to 1.173"]}$

**S-BT-\_\_\_/7\_\_\_5\*)**  $h_{NVS} = 19.6 \text{ mm to } 20.1 \text{ mm [0.772" to 0.791"]}$

**S-BT-\_\_\_/15\_\_\_5\*)**  $h_{NVS} = 30.3 \text{ mm to } 30.8 \text{ mm [1.193" to 1.213"]}$

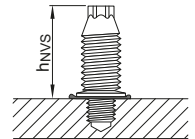

\*) this items are not available at the moment

Designation	Product name	Comment
S-DG BT M8/7 Short 6	Depth gauge	for exact setting of S-BT M8/7 _N 6
S-DG BT M8/15 Long 6	Depth gauge	for exact setting of S-BT M8/15 _N 6
S-DG BT M10-W10/15 Long 6	Depth gauge	for exact setting of S-BT M10/W10 _N 6
S-CC BT 6	Calibration card	for calibration of the depth gauge (short/long studs)
S-CG BT /7 Short 6	Check gauge	for verification of the stand-off for short studs (7 mm)
S-CG BT /15 Long 6	Check gauge	for verification of the stand-off for long studs (15 mm)

## Installation

### S-BT fasteners made of stainless steel with washer- $\varnothing$ 12mm (S-BT-\_R)

Fastened material hole  $\varnothing \geq 13$  mm [0.51"]

### S-BT fasteners made of carbon steel with washer- $\varnothing$ 10mm (S-BT-\_F)

Fastened material hole  $\varnothing \geq 11$  mm [0.43"]

**Important:** for group fastenings subjected to shear loading the fastened material hole diameter should not exceed 14 mm [0.55"] (S-BT-\_R) and 12 mm [0.47"] (S-BT-\_F) respectively.

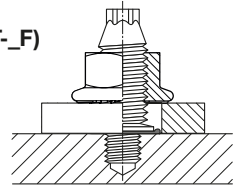

## Installation

1 Mark location for each fastening	2 Pre-drill with TS-BT stepped drill bit	3 Screw-in S-BT studs into drilled hole	4 Fasten channel on base material	5 Fasten accessory on channel																		
	<p>Usage of SBT 4-A22, SF BT 18-A or SF BT 22-A. Pre-drill until the shoulder grinds a shiny ring to assure proper drilling depth.</p> <p><b>Before fastener installation:</b> The drilled hole and the area around the drilled hole must be clear of liquids and debris.</p>	<p>Usage of SBT 4-A22, SFC 18-A or SFC 22-A in combination with the calibrated depth gauge S-DG BT.</p> <p>Verify stud stand-off <math>h_{NVS}</math> with check gauge S-CG BT</p> <p>Sealing washer must be properly compressed!</p>	<p>Position channel on S-BT studs and hold in place. Tighten the nuts with the suited tightening torque <math>T_{rec}</math>.</p> <p><math>T_{rec}</math> ref. to table below. Tighten the nuts using</p> <ul style="list-style-type: none"> <li>• SBT 4-A22, SFC 18-A / 22-A with socket S-NS</li> <li>• Torque tool X-BT 1/4" (8 Nm) or S-BT 1/4" (5 Nm)</li> <li>• Torque wrench</li> </ul> <table border="1" data-bbox="621 1109 784 1244"> <thead> <tr> <th></th> <th colspan="2"><math>T_{rec}</math></th> </tr> <tr> <th>Hilti screw-driver:</th> <th>5 Nm</th> <th>8 Nm</th> </tr> <tr> <th></th> <th colspan="2">setting:</th> </tr> </thead> <tbody> <tr> <td>SBT 4-A22</td> <td>4</td> <td>5</td> </tr> <tr> <td>SFC 18-A</td> <td>4</td> <td>5</td> </tr> <tr> <td>SFC 22-A</td> <td>4</td> <td>5</td> </tr> </tbody> </table>		$T_{rec}$		Hilti screw-driver:	5 Nm	8 Nm		setting:		SBT 4-A22	4	5	SFC 18-A	4	5	SFC 22-A	4	5	<p>Tighten the bolts with the suited tightening torque <math>T_{rec}</math> (see IFU of the Hilti wing nuts).</p>
	$T_{rec}$																					
Hilti screw-driver:	5 Nm	8 Nm																				
	setting:																					
SBT 4-A22	4	5																				
SFC 18-A	4	5																				
SFC 22-A	4	5																				
<p><b>Important:</b> These are abbreviated instructions which may vary by application. ALWAYS review / follow the instructions for use (IFU) accompanying the product. In case of a drill through hole, rework of the coating on the back side of the plate / profile may be needed.</p>																						



## Tightening torque serrated flange nut

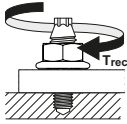

Drill hole type and base material thickness	S-BT- 6			S-BT- 5 *)			
	Pilot hole, $t_{H1} \geq 6 \text{ mm [0.24"]}$ Drill through hole, $5 \text{ mm [0.20"]} \leq t_{H1} < 6 \text{ mm [0.24"]}$			Drill through hole, $3 \text{ mm [0.12"]} \leq t_{H1} < 5 \text{ mm [0.20"]}$		Pilot hole, $5 \text{ mm [0.20"]} \leq t_{H1} < 6 \text{ mm [0.24"]}$	
Base material	Steel S235 A36	Steel S355 Grade 50	Aluminum $f_u \geq 270 \text{ MPa}$	Steel S235 A36	Steel S355 Grade 50	Steel S235 A36	Steel S355 Grade 50
Tightening torque serrated flange nut $T_{rec} \text{ [Nm/lbft]}$	8 / 5.9	8 / 5.9	5 / 3.6	5 / 3.6	5 / 3.6	5 / 3.6	5 / 3.6

**Important:** The tightening torque ( $T_{rec}$ ) for the serrated flange nut is dependent on the stud type, the base material type and thickness, and the drill hole type. Exceeding the tightening torque ( $T_{rec}$ ) leads to damage of the S-BT stud's anchorage with negative impact on the load values and the sealing function.

\*) this items are not available at the moment

## Fastener program

Designation	Item no.	Product name	Comment	Application
S-BT-GF M8/7 AN 6	2140527	Threaded stud	use with X-FCM grating disc	Grating
S-BT-MF M8/7 AN 6	2139174	Threaded stud	package includes serrated flange nut	Multipurpose
S-BT-MF M8/15 AN 6	2148618	Threaded stud	package includes serrated flange nut	Multipurpose
S-BT-MF M10/15 AN 6	2140528	Threaded stud	package includes serrated flange nut	Multipurpose
S-BT-MF W10/15 AN 6	2139173	Threaded stud	package includes serrated flange nut	Multipurpose
S-BT-GR M8/7 SN 5 *)	2149240	Threaded stud	use with X-FCM grating disc	Grating
S-BT-GR M8/7 SN 6	2140529	Threaded stud	use with X-FCM grating disc	Grating
S-BT-GR M8/7 SN 6 AL	2140742	Threaded stud	use with X-FCM grating disc	Grating
S-BT-MR M8/7 SN 5 *)	2139171	Threaded stud	package includes serrated flange nut	Multipurpose
S-BT-MR M8/7 SN 6	2139172	Threaded stud	package includes serrated flange nut	Multipurpose
S-BT-MR M8/7 SN 6 AL	2140743	Threaded stud	package includes serrated flange nut	Multipurpose
S-BT-MR M8/15 SN 5 *)	2148622	Threaded stud	package includes serrated flange nut	Multipurpose
S-BT-MR M8/15 SN 6	2148612	Threaded stud	package includes serrated flange nut	Multipurpose
S-BT-MR M8/15 SN 6 AL	2148614	Threaded stud	package includes serrated flange nut	Multipurpose
S-BT-MR M10/15 SN 5 *)	2148623	Threaded stud	package includes serrated flange nut	Multipurpose
S-BT-MR M10/15 SN 6	2140740	Threaded stud	package includes serrated flange nut	Multipurpose
S-BT-MR M10/15 SN 6 AL	2140744	Threaded stud	package includes serrated flange nut	Multipurpose
S-BT-MR W10/15 SN 5 *)	2148624	Threaded stud	package includes serrated flange nut	Multipurpose
S-BT-MR W10/15 SN 6	2140741	Threaded stud	package includes serrated flange nut	Multipurpose
S-BT-MR W10/15 SN 6 AL	2140745	Threaded stud	package includes serrated flange nut	Multipurpose
TS-BT 5.5-74 S	2143137	Stepped drill bit	for base material steel	
TS-BT 5.5-74 AL	2143138	Stepped drill bit	for base material aluminum	
TS-BT 4.3-74 S *)	2143139	Stepped drill bit	for base material steel	
S-DG BT M8/7 Short 6	2143260	Depth gauge	for exact setting of the S-BT	
S-DG BT M10-W10/15 Long 6	2143261	Depth gauge	for exact setting of the S-BT	
S-DG BT M8/15 Long 6	2148575	Depth gauge	for exact setting of the S-BT	
S-DG BT M8/7 Short 5 *)	2149241	Depth gauge	for exact setting of the S-BT	
S-DG BT M10-W10/15 Long 5 *)	2149242	Depth gauge	for exact setting of the S-BT	
S-DG BT M8/15 Long 5 *)	2149243	Depth gauge	for exact setting of the S-BT	
S-CC BT 6	2143270	Calibration card	for calibration of the depth gauge	
S-BT 1/4" - 5 Nm	2143271	Torque tool	manual torque tool (5 Nm)	
X-BT 1/4" - 8 Nm	2119272	Torque tool	manual torque tool (8 Nm)	
S-NS 13 C 95/3 3/4"	2149244	Nut setter	for serrated flange nut M8	
S-NS 15 C 95/3 3/4"	2149245	Nut setter	for serrated flange nut M10	
S-NS 9/16" C 95/3 3/4"	2149246	Nut setter	for serrated flange nut W10	

\*) this items are not available at the moment

# X-ST-GR Stainless steel threaded stud for fastening to steel

## Product data

### Dimensions

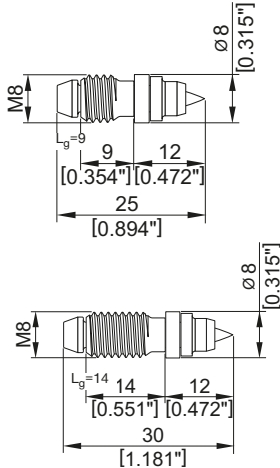

### General information

#### Material specifications

Shank: P558 (CrMnMo alloy)

$f_u \geq 2000 \text{ N/mm}^2$

Threaded sleeve: A4 (AISI 316)

Washers: polyethylene

#### Recommended fastening tools

DX 460, DX 5 with fastener guide X-5-460-F8N15

DX 76 PTR with fastener guide X-76-F-8-GR-PTR

See **X-ST-GR fastener program** in the next pages and **Tools and equipment** chapter for more details.

#### Approvals

ICC ESR-2347

ABS

## Applications

### Examples

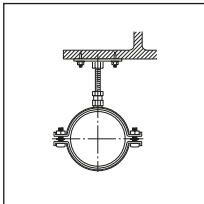

**Base plates for pipe rings**

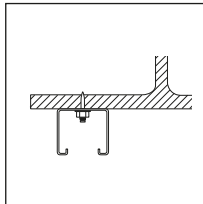

**Installation rails**

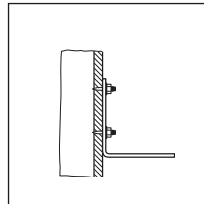

**Facade brackets**

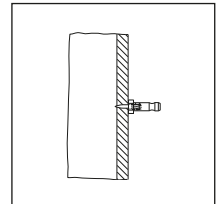

**Special purpose connections**

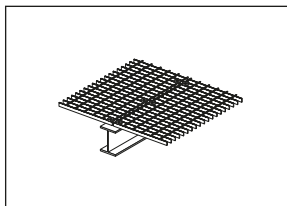

**Grating**

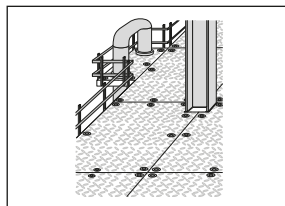

**Checker plate**

## Load data

### Recommended loads

$N_{rec}$ [kN]	$V_{rec}$ [kN]	$M_{rec}$ [Nm]
1.8	1.8	5.5

### Condition:

- For safety-relevant fastenings sufficient redundancy of the entire system is required.

Arrangements to reduce or prevent moment on shank:

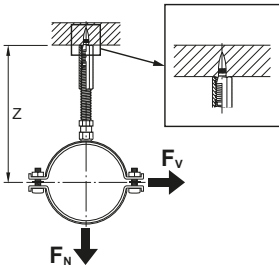

## Application requirements

### Thickness of base material

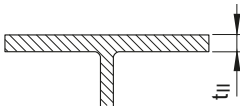

$$t_{II} \geq 6 \text{ mm}$$

### Thickness of fastened material

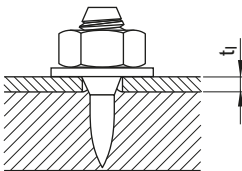

$$t_I \leq L_g - t_{\text{washer}} - t_{\text{nut}}$$

$$t_I \leq 10 \text{ mm for X-ST-GR M8/10 P8}$$

$$t_I \leq 5 \text{ mm for X-ST-GR M8/5 P8}$$

### Spacing and edge distances (mm)

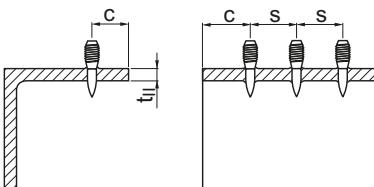

$$c, s \geq 15 \text{ mm}$$

### Corrosion information

For fastenings exposed to outdoor environments in mildly corrosive conditions where HDG coated parts are commonly specified or used. Not for use in atmospheres with chlorides (marine atmospheres) or in heavily polluted environments (e.g. sulphur dioxide).

### Application limit

**Steel: DX 460, DX 5**

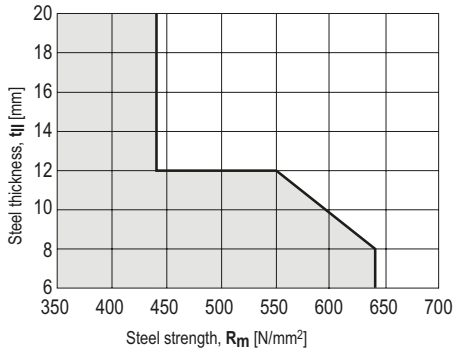

**Steel: DX 76 PTR**

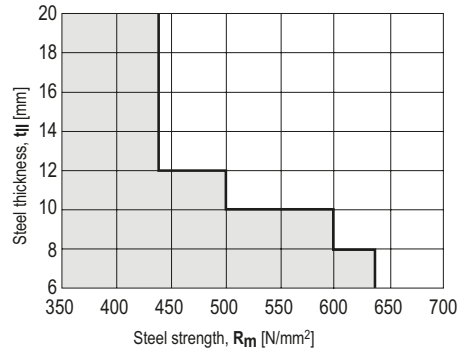

**Fastener selection and system recommendation**
**Fastener program**

Designation	Item no.	$L_g$ [mm]
<b>X-ST-GR M8/5 P8</b>	2122209	9
<b>X-ST-GR M8/10 P8</b>	2122460	14

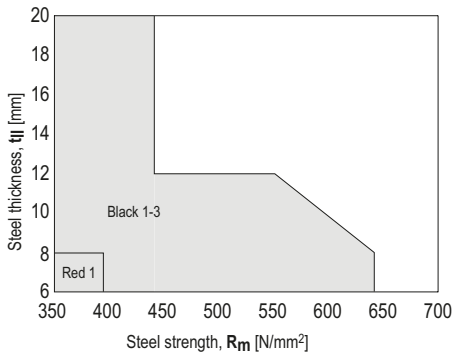
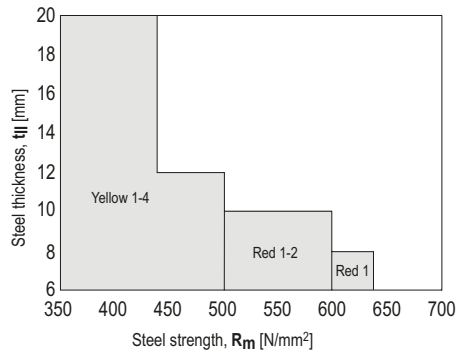
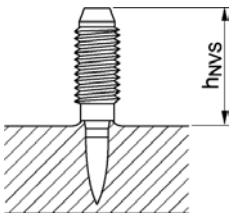
**Cartridge selection**
**DX 460, DX 5**
**6.8/11M black or red cartridge**

**DX 76 PTR**
**6.8/18M yellow or red cartridge**

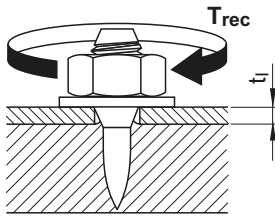
**Fastening quality assurance**
**Fastening inspection**

Fastener	$h_{NVS}$ [mm]
<b>X-ST-GR M8/5 P8</b>	12.0 – 15.0
<b>X-ST-GR M8/10 P8</b>	17.0 – 20.0

**Installation**

**Tightening torque**  
 $T_{rec} = 8.5 \text{ Nm}$





# X-CR M Stainless steel threaded stud for fastening to concrete and steel

## Product data

### Dimensions

X-CR M8-\_\_-42 P8 (DX-Kwik)

Threaded sleeve: A4 (AISI 316)

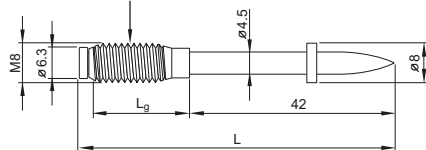

X-CR M8-15-12 FP10

Threaded sleeve: A4 (AISI 316)

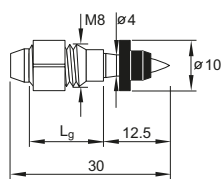

X-CRM8-9-12 P8

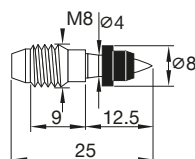

### General information

#### Material specifications

Shank:	CrNiMo alloy $f_u \geq 1800 \text{ N/mm}^2$ (49 HRC)
Threaded sleeve:	A4 (AISI 316)
Zinc coating to improve anchoring in concrete (X-CR M8-__-42):	5–13 $\mu\text{m}$
Washers/ guidance sleeve:	polyethylene

#### Recommended fastening tools

DX 460, DX 5, DX 36, DX 2,  
DX 76, DX 76 PTR

See **X-CR M fastener program** in the next pages and **Tools and equipment** chapter for more details.

#### Approvals

DIBt (Germany):	<b>X-CR M8-__-42 P8</b> (DX-Kwik)
ICC ESR-2347:	<b>X-CR M8-9-12,</b>
ABS, LR:	<b>X-CR M8-15-12</b>



Note: technical data presented in these approvals and design guidelines reflect specific local conditions and may differ from those published in this handbook.

## Applications

### Examples

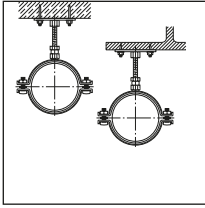

Base plates for pipe rings

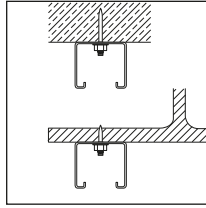

Installation rails

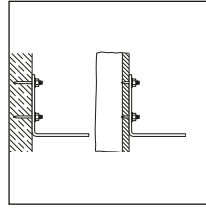

Facade brackets

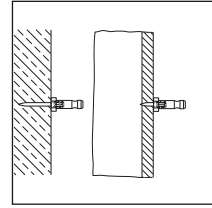

Special purpose connections

## Load data

### Recommended loads

#### Fastening to steel

	$N_{rec}$ [kN]	$V_{rec}$ [kN]	$M_{rec}$ [Nm]
<b>X-CR M8</b>	1.8	1.8	5.5

#### Conditions:

- For safety-relevant fastenings sufficient redundancy of the entire system is required.

#### Fastening to concrete – DX-Kwik method (pre-drilling)

	$N_{rec,1}$ [kN]	$N_{rec,2}$ [kN]	$V_{rec}$ [kN]	$M_{rec}$ [Nm]
<b>X-CR M8-__-42 P8</b>	3.0	0.9	3.0	5.5

#### Conditions:

- $N_{rec,1}$ : concrete in compressive zone
- $N_{rec,2}$ : concrete in tension zone
- $f_{cc} \geq 20 \text{ N/mm}^2$
- A sufficient redundancy has to be ensured, that the failure of a single fastening will not lead to collapse of the entire system.
- Observance of all pre-drilling requirements

#### Arrangements to reduce or prevent moment on shank:

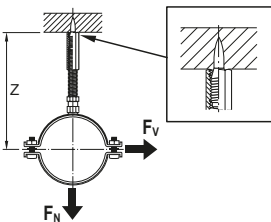

## Application requirements

### Thickness of base material

Concrete – DX-Kwik

$h_{\min} = 100 \text{ mm}$

Steel

$t_{II} \geq 6 \text{ mm}$

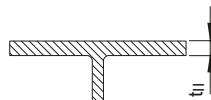

### Thickness of fastened material

X-CR M8

$t_I \leq L_g - t_{\text{washer}} - t_{\text{nut}} \approx \text{up to } 13.0 \text{ mm}$

### Spacing and edge distances (mm)

#### Fastening to steel

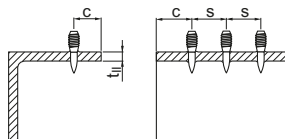

$c, s \geq 15 \text{ mm}$

#### Fastening to concrete

##### Pairs

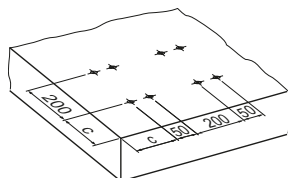

Reinforced \* Non-reinforced

**c** 100 150

##### Row along edge

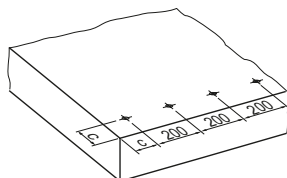

Reinforced \* Non-reinforced

**c** 80 150

##### General (e.g. group of fasteners)

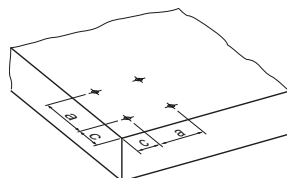

Reinforced \* Non-reinforced

**c** 80 150  
**a** 80 100

\* Minimum  $\varnothing 6$  reinforcing steel continuous along all edges and around all corners. Edge bars must be enclosed by stirrups

### Corrosion information

For fastenings exposed to weather or other corrosive conditions. Not for use in highly corrosive surroundings like swimming pools or highway tunnels.

## Application limits

### Concrete:

No general restrictions existent. Limitations are dependent on application and user requirements.

### Steel: DX 76, DX 76 PTR

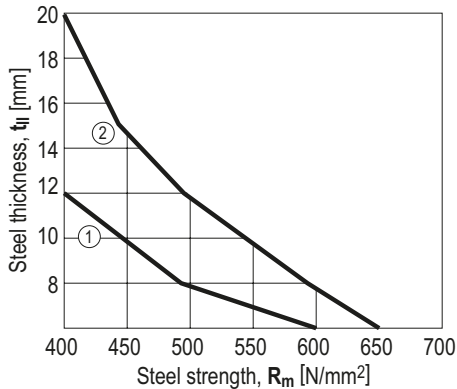

① X-CRM8-15-12 FP10 / DX 76 (impact)

② X-CRM8-15-12 FP10 / DX 76 (co-acting)

## Fastener selection and system recommendation

### Fastener program

Fastened thickness $t_{f,max}$ [mm]	Fastener Designation <sup>1)</sup>	Item no.	$L_g$ [mm]	$L_s$ [mm]	Tools
Base material concrete, DX-Kwik method					
5.0	X-CR M8-14-42 P8	255911	14	42	DX 460, DX 5, DX 36, DX 2
13.0	X-CR M8-22-42 P8	255910	22	42	DX 460, DX 5, DX 36, DX 2
Base material steel					
6.0	X-CR M8-9-12 FP10	372032	9	12.5	DX 76, DX 76 PTR, DX 5, DX 460
6.0	X-CR M8-15-12 FP10	372 034	15	12.5	DX 76, DX 76 PTR, DX 5, DX 460

<sup>1)</sup> Type threading: M = metric

### Cartridge selection and tool energy setting

Base material	Designation	Tool
Concrete	6.8/11M yellow or red cartridge	DX 460, DX 5, DX 36, DX 2
Steel	6.8/11M red cartridge	DX 460, DX 5
Steel	6.8/18M cartridge	DX 76, DX 76 PTR

Tool energy adjustment by setting tests on site.

## Fastening quality assurance

### Fastening inspection

#### Fastening to concrete

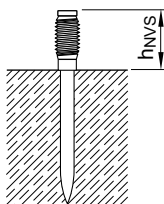

#### DX-Kwik (pre-drilling)

Fastener	$h_{NVS}$ [mm]
<b>X-CR M8-14-42 P8</b>	12.0 – 16.0
<b>X-CR M8-22-42 P8</b>	20.0 – 24.0

#### Fastening to steel

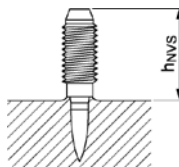

Fastener	$h_{NVS}$ [mm]
<b>X-CR M8-9-12 FP10</b>	12.0 – 15.0
<b>X-CR M8-15-12 FP10</b>	17.0 – 20.0

### Installation

#### Fastening to concrete

#### DX-Kwik (pre-drilling)

#### X-CR M8- -42 P8

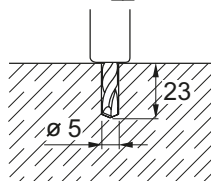

Pre-drill with drill bit  
TE-C-5/23B (Item no.  
28557) or TE-C-5/23  
(Item no. 00061787)

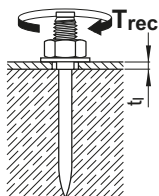

**Tightening torque**  
 $T_{rec} = 10 \text{ Nm}$

#### Fastening to steel

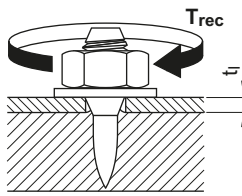

**Tightening torque**  
**X-CR M8**  $T_{rec} = 8.5 \text{ Nm}$

These are abbreviated instructions which may vary by application.

**ALWAYS** review/follow the instructions accompanying the product.



# X-BT-ER Stainless steel threaded stud for electrical connection

## Product data

### Dimensions

X-BT-ER M10/7 SN 8  
X-BT-ER W10/7 SN 8

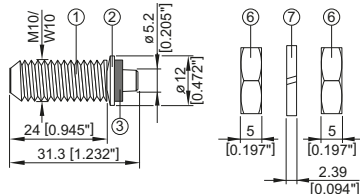

X-BT-ER M8/7 SN 8

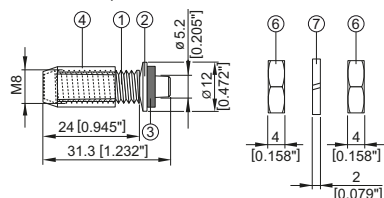

X-BT-ER M6/3 SN 8  
X-BT-ER W6/3 SN 8

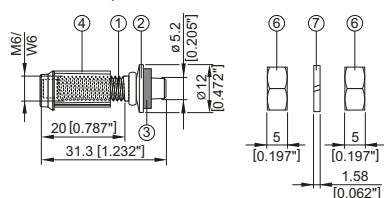

### General information

#### Material specifications

- ① Shank:  
CR 500 (CrNiMo alloy) Equivalent to A4 / AISI grade 316 material  
S31803 (1.4462)
- ② Threaded sleeve: X5CrNiMo 17-12-2+2H, 1.4401
- ③ SN washer: S 31635 (X2CrNiMo 17-12-2, 1.4404)
- ④ Sealing washer: Elastomer, black \*  
\* Resistant to UV, salt water, water, ozone, oils, etc.
- ⑤ Nuts A4 / AISI grade 316 material
- ⑥ Lock washers A4 / AISI grade 316 material
- ⑦ Guide Sleeve Plastic

#### Recommended fastening tools

BX 3-BT  
DX 351-BT

See **X-BT fastener program** in the next pages and **Tools and equipment** chapter for more details.

#### Approvals for X-BT-ER stainless steel threaded studs for electrical connections

ABS 18-HS175518, DNV-GL TAS00001 SV,  
BV 54554, LR 19/0003, UL-file E257067



## Applications

### Examples

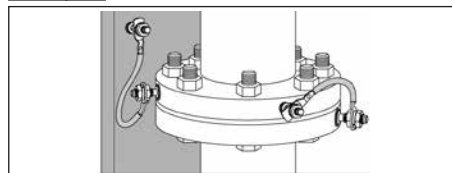

Functional and protective bonding in pipe  
(Outer diameter of installed surface  $\geq 150$  mm)

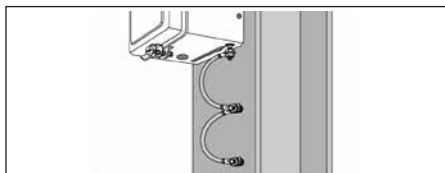

Protective bonding circuit - Double point connection

### Functional bonding and terminal connection in a circuit

For low permanent current due to static charge built up in pipes or for low permanent current when closing an electrical circuit

#### Single point connection

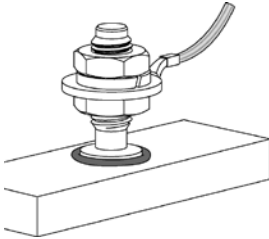

Recommended electrical connectors:

**X-BT-ER M10/7 SN 8**

**X-BT-ER W10/7 SN 8**

**X-BT-ER M8/7 SN 8**

**X-BT-ER M6/3 SN 8, X-BT-ER M6/7 SN 8**

**X-BT-ER W6/3 SN 8, X-BT-ER W6/7 SN 8**

Maximum allowable permanent current = 40 A

**Note:**

- Recommended connected cable size (tested to 40 A) according to IEC/EN 60204-1:  $\leq 10 \text{ mm}^2$  copper ( $\leq 8 \text{ AWG}$ ). Fastening of thicker cable is acceptable provided the maximum permanent current of 40 A is not exceeded and the provisions on cable lug thickness are observed.

### Protective bonding circuit

For discharging short circuit current while protecting electrical equipment or earth / ground or bonded cable trays and ladders

#### Single point connection

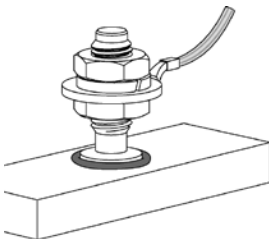

Recommended electrical connectors:

**X-BT-ER M10/7 SN 8**

**X-BT-ER W10/7 SN 8**

**X-BT-ER M8/7 SN 8**

**X-BT-ER M6/3 SN 8, X-BT-ER M6/7 SN 8**

**X-BT-ER W6/3 SN 8, X-BT-ER W6/7 SN 8**

Max. short circuit current for period of 1 s = 1250 A

**Note:**

- Recommended connected cable size (tested to 1250 A for 1 s) following IEC/EN 60947-7-2:  $\leq 10 \text{ mm}^2$  copper ( $\leq 8 \text{ AWG}$ ). Fastening of thicker cable is acceptable provided the maximum current of 1250 A for a period of 1 second is not exceeded and the provisions on cable lug thickness are observed.
- Recommended connected cable size (tested to 750 A for 4 s) according to UL 467:  $\leq 10 \text{ AWG}$



### Double point connection

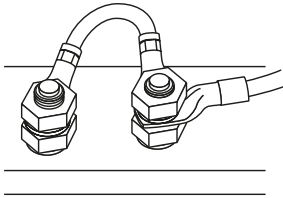

Recommended electrical connectors:

- X-BT-ER M10/7 SN 8**
- X-BT-ER W10/7 SN 8**
- X-BT-ER M8/7 SN 8**
- X-BT-ER M6/7 SN 8**
- X-BT-ER W6/7 SN 8**

Max. short circuit current for period of 1 s = 1800 A

**Note:**

- Recommended connected cable size (tested to 1800 A for 1 s) following IEC/EN 60947-7-2:  $\leq 16 \text{ mm}^2$  copper ( $\leq 6 \text{ AWG}$ ). Fastening of thicker cable is acceptable provided the maximum current of 1800 A for a period of 1 second is not exceeded and the provisions on cable lug thickness are observed.

### Lightning protection

For high temporary current due to lightning.

#### Single point connection

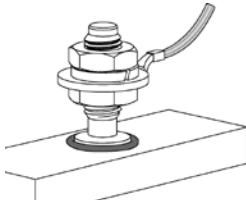

Recommended electrical connectors:

- X-BT-ER M10/7 SN 8**
- X-BT-ER W10/7 SN 8**
- X-BT-ER M8/7 SN 8**
- X-BT-ER M6/3 SN 8, X-BT-ER M6/7 SN 8**
- X-BT-ER W6/3 SN 8, X-BT-ER W6/7 SN 8**

Maximum test current (according to EN 62561-1):  
 $\leq 50 \text{ kA}$  for 2 ms

#### When one nut is utilized and cable lug is in contact with base material.

- Cable lug must be in direct contact with non-coated base material.
- Extra M10/W10 stainless steel washer to be used and installed between lock washer and cable lug.
- Base material must not contact the X-BT-ER SN washer, lock washer and nut.
- Cable lug thickness = 2 mm to 12 mm. Cable lug hole diameter  $\geq 14 \text{ mm}$ .
- **Max. tightening torque = 20 Nm.**

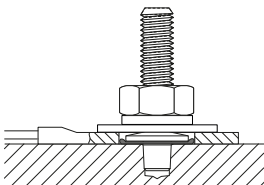

Recommended electrical connectors:

- X-BT-ER M10/7 SN 8**
- X-BT-ER W10/7 SN 8**
- X-BT-ER M8/7 SN 8**
- X-BT-ER M6/3 SN 8, X-BT-ER M6/7 SN 8**
- X-BT-ER W6/3 SN 8, X-BT-ER W6/7 SN 8**

Maximum test current:  
 $\leq 100 \text{ kA}$  for 2 ms

## Application requirements

### Thickness of base material

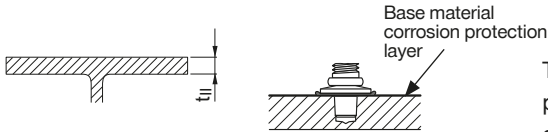

Thickness of base material corrosion protection layer  $\leq 0.4$  mm. For thicker coatings, please contact Hilti.

### Thickness of cable lug

X-BT-ER M8/M10/W10  
X-BT-ER M6/W6 /7 SN 8

$t_{cl} \leq 7$  mm (0.28")

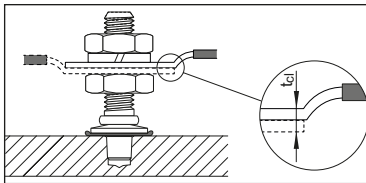

X-BT-ER M6/W6 /3 SN 8

$t_{cl} \leq 3$  mm (0.12")

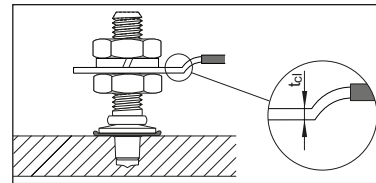

### Spacing and edge distances

Edge distance:

$c \geq 6$  mm

Spacing:

$s \geq 15$  mm

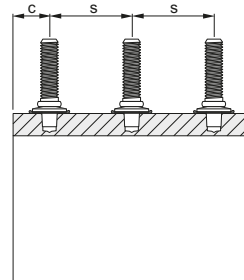
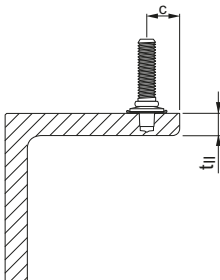

### Corrosion information

The corrosion resistance of Hilti CR500 and S31803 stainless steel material is equivalent to AISI 316 (A4) steel grade.

### Application limit

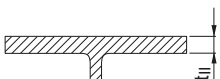

- $t_{II} \geq 8$  mm [5/16"] no through penetration
- $t_{II} \geq 6$  mm for through penetration
- No limits with regards to steel strength

### Fastener selection and system recommendation BX 3-BT

#### Fastener program

Designation	Item no.	Tool designation	Fastener Guide designation
<b>X-BT-ER M10/7 SN 8</b>	<b>2194352</b>	BX 3-BT	X-FG B3-BT M
<b>X-BT-ER M8/7 SN 8</b>	<b>2194351</b>	BX 3-BT	X-FG B3-BT M
<b>X-BT-ER M6/3 SN 8</b>	<b>2252195</b>	BX 3-BT	X-FG B3-BT M
<b>X-BT-ER W10/7 SN 8</b>	<b>2194353</b>	BX 3-BT	X-FG B3-BT W
<b>X-BT-ER W6/3 SN 8</b>	<b>2252198</b>	BX 3-BT	X-FG B3-BT W

### Fastener selection and system recommendation DX 351-BT

#### Fastener program

Designation	Item no.	Tool designation	Fastener Guide designation
<b>X-BT-ER M10/7 SN 8</b>	<b>2194352</b>	DX 351-BT	BT FG M1024
<b>X-BT-ER M8/7 SN 8</b>	<b>2194351</b>	DX 351-BT	BT FG M1024
<b>X-BT-ER M6/3 SN 8</b>	<b>2252195</b>	DX 351-BT	BT FG M1024
<b>X-BT-ER M6/7 SN 8</b>	<b>2194349</b>	DX 351-BT	BT FG M1024
<b>X-BT-ER W10/7 SN 8</b>	<b>2194353</b>	DX 351-BT	BT FG W1024
<b>X-BT-ER W6/3 SN 8</b>	<b>2252198</b>	DX 351-BT	BT FG W1024
<b>X-BT-ER W6/7 SN 8</b>	<b>2194350</b>	DX 351-BT	BT FG W1024

### Cartridge selection and tool energy setting

#### 6.8/11 M high precision brown cartridge

Fine adjustment by installation tests on site

### Fastening quality assurance

#### Fastening inspection

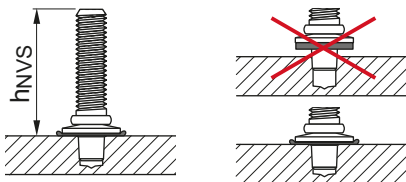

**X-BT-ER M/W10, X-BT-ER M8 and X-BT-ER M/W6**

$h_{NVS} = 25.7 - 26.8 \text{ mm}$   
 $= 1.01'' - 1.055''$

## Installation for electrical connections

### Single point connection for all X-BT-ER

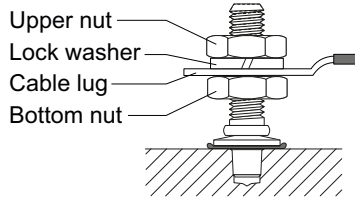
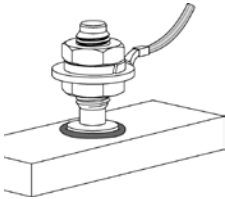

### Double point connection only for X-BT-ER M6/W6 and X-BT-ER M8

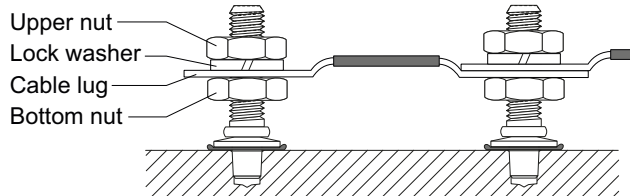
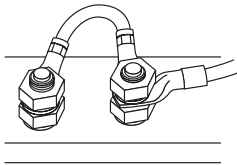

### Torque recommendation for X-BT-ER

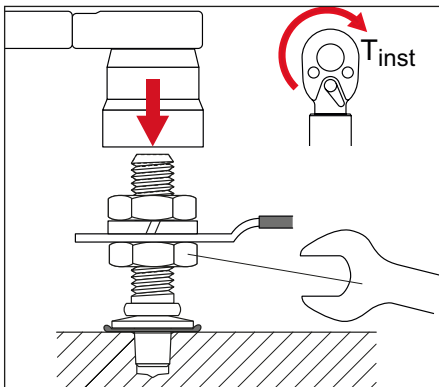

Hold the bottom nut with a spanner while tightening the upper nut.

Tightening torque:

$$T_{inst} = 8 - 20 \text{ Nm}$$

These are abbreviated instructions which may vary by application.

**ALWAYS** review/follow the instructions accompanying the product.

# S-BT-ER, S-BT-EF Screw-in stainless steel and carbon steel threaded stud

## Product data

### Dimensions

S-BT-ER M10/15 SN 6  
 S-BT-ER W10/15 SN 6  
 S-BT-EF M10/15 AN 6  
 S-BT-EF W10/15 AN 6

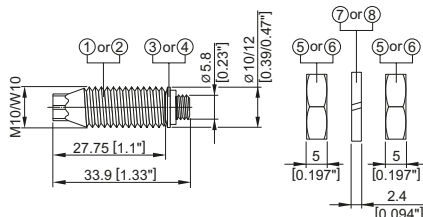

S-BT-ER M8/15 SN 6  
 S-BT-EF M8/15 AN 6

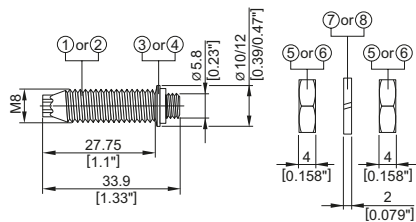

S-BT-ER M10 HC 35\*)  
 S-BT-ER W10 HC AWG2\*)  
 S-BT-ER M10 HC 120  
 S-BT-ER W10 HC AWG4/0  
 S-BT-EF M10 HC 35\*)  
 S-BT-EF W10 HC AWG2\*)  
 S-BT-EF M10 HC 120  
 S-BT-EF W10 HC AWG4/0

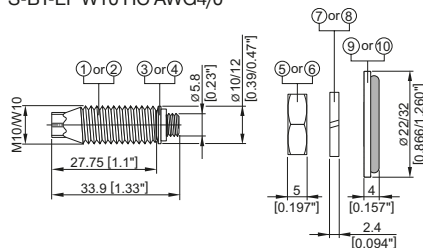

### General information

#### Material specifications

- ① Threaded shank: Stainless steel (S-BT-ER)  
"S 31803 (1.4462)"  
zinc-coated
- ② Threaded shank: Carbon steel (S-BT-EF)  
"1038 / duplex-coated"
- ③ SN12-R washers: Stainless steel (S-BT-ER)  
"S 31603 (1.4404)"
- ④ AN10-F washers: Aluminum (S-BT-EF)  
Stainless steel (S-BT-ER)  
grade A4 / AISI 316 material
- ⑤ Nut: Carbon steel (S-BT-EF)  
HDG
- ⑥ Nut: Stainless steel (S-BT-ER)  
grade A4 / AISI 316 material
- ⑦ Lock washer: Carbon steel (S-BT-EF)  
HDG
- ⑧ Lock washer: Stainless steel (S-BT-ER)  
grade A4 / AISI 316 material
- ⑨ Conductivity disc: HDG  
Ø 22 mm [0.866"]  
(HC 35/AWG2)  
Copper alloy CuSn8  
(tin-coated) with sealing ring
- ⑩ Conductivity disc: HDG  
Ø 32 mm [1.260"]  
(HC 120/AWG4/0)  
Copper alloy CuSn8  
(tin-coated) with sealing ring

Sealing ring of sealing washers: Chloroprene rubber CR 3.1107, black, resistant to UV, salt water, water, ozone, oils etc.

Conductivity discs: FKM, Resistant to UV, salt water, water, ozone, oils, etc.

### Drilling tool, setting tool, accessories and

#### inserts

Refer to section "Fastener selection and system recommendation" for more details.

### Reports and type approvals



\*) this items are available only on special request

## Applications

### Examples

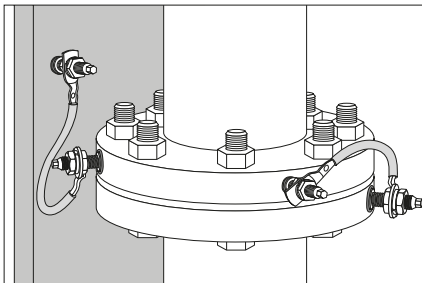

Functional and protective bonding of pipes \*)  
**(outer diameter of installed surface  $\geq 150$  mm)**

\*) only for Type A cable connections

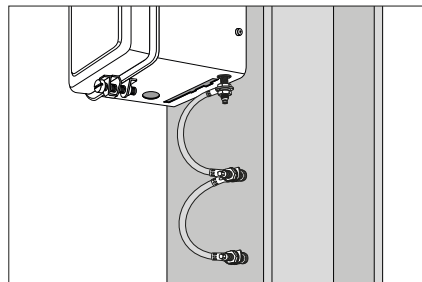

Protective bonding circuit – Double point connection

### Functional bonding and terminal connection in a circuit

For permanent current (leakage current) due to static charge built up in pipes or when closing an electrical circuit.

### Single point connection

Type A

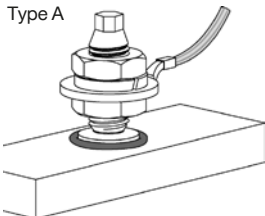

Recommended electrical connectors:

**S-BT-ER M10/15 SN 6**  
**S-BT-ER W10/15 SN 6**  
**S-BT-EF M10/15 AN 6**  
**S-BT-EF W10/15 AN 6**  
**S-BT-ER M8/15 SN 6**  
**S-BT-EF M8/15 AN 6**

Maximum allowable permanent current

$I_{th} = 57$  A

Type B

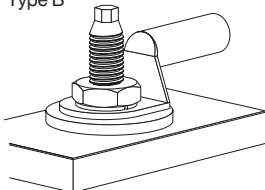

**S-BT-ER M10 HC 35\*)**  
**S-BT-ER W10 HC AWG2\*)**  
**S-BT-EF M10 HC 35\*)**  
**S-BT-EF W10 HC AWG2\*)**

$I_{th} = 125$  A

**S-BT-ER M10 HC 120**  
**S-BT-ER W10 HC AWG4/0**  
**S-BT-EF M10 HC 120**  
**S-BT-EF W10 HC AWG4/0**

$I_{th} = 269$  A

### Note:

- Recommended maximal cross section of connected cable according **IEC 60947-7-2 and IEC 60947-7-1**:  
 10 mm<sup>2</sup> (8 AWG) copper (tested permanent current  $I_{th} = 57$  A)  
 35 mm<sup>2</sup> (2 AWG) copper (tested permanent current  $I_{th} = 125$  A)  
 120 mm<sup>2</sup> (4/0 AWG) copper (tested permanent current  $I_{th} = 269$  A)
- Fastening of thicker cable is acceptable, if the maximum allowable permanent current  $I_{th}$  is not exceeded and the provisions on cable lug thickness  $t_{cl}$  are observed.

\*) this items are available only on special request

## Protective bonding circuit

For discharging short circuit current while protecting electrical equipment or earth / ground cable trays and ladders.

### Single point connection

Type A

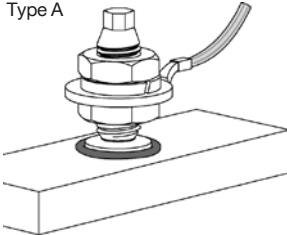

Recommended electrical connectors:

**S-BT-ER M10/15 SN 6**  
**S-BT-ER W10/15 SN 6**  
**S-BT-EF M10/15 AN 6**  
**S-BT-EF W10/15 AN 6**  
**S-BT-ER M8/15 SN 6**  
**S-BT-EF M8/15 AN 6**

Max. short circuit current according to IEC and UL

$I_{CW} = 1.20 \text{ kA (IEC)}$   
 $I_{CW} = 0.75 \text{ kA (UL)}$

Type B

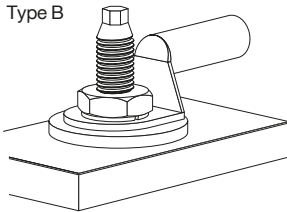

**S-BT-ER M10 HC 35\*)**  
**S-BT-ER W10 HC AWG2\*)**  
**S-BT-EF M10 HC 35\*)**  
**S-BT-EF W10 HC AWG2\*)**

$I_{CW} = 4.20 \text{ kA (IEC)}$   
 $I_{CW} = 3.90 \text{ kA (UL)}$

**S-BT-ER M10 HC 120**  
**S-BT-ER W10 HC AWG4/0**  
**S-BT-EF M10 HC 120**  
**S-BT-EF W10 HC AWG4/0**

$I_{CW} = 14.40 \text{ kA (IEC)}$   
 $I_{CW} = 10.10 \text{ kA (UL)}$

### Note:

- Recommended maximal cross section of connected cable according **IEC 60947-7-2** and **IEC 60947-7-1**:  
 10 mm<sup>2</sup> (8 AWG) copper (tested short circuit current  $I_{CW} = 1.20 \text{ kA}$  for 1 s)  
 35 mm<sup>2</sup> (2 AWG) copper (tested short circuit current  $I_{CW} = 4.20 \text{ kA}$  for 1 s)  
 120 mm<sup>2</sup> (4/0 AWG) copper (tested short circuit current  $I_{CW} = 14.40 \text{ kA}$  for 1 s)  
 according **UL 467**:  
 10 AWG copper (tested short circuit current  $I_{CW} = 0.75 \text{ kA}$  for 4 s)  
 2 AWG copper (tested short circuit current  $I_{CW} = 3.90 \text{ kA}$  for 6 s)  
 4/0 AWG copper (tested short circuit current  $I_{CW} = 10.10 \text{ kA}$  for 9 s)
- Fastening of thicker cable is acceptable, if the maximum short circuit current  $I_{CW}$  and the exposure time is not exceeded and the provisions on cable lug thickness  $t_{Cl}$  are observed.

### Double point connection

Type A

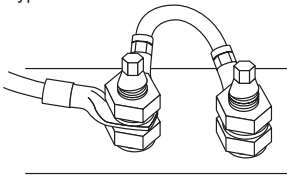

Recommended electrical connectors:

**S-BT-ER M10/15 SN 6**  
**S-BT-ER W10/15 SN 6**  
**S-BT-EF M10/15 AN 6**  
**S-BT-EF W10/15 AN 6**  
**S-BT-ER M8/15 SN 6**  
**S-BT-EF M8/15 AN 6**

Max. short circuit current according to IEC

$I_{CW} = 1.92 \text{ kA (IEC)}$

\*) this items are available only on special request

**Note:**

- Recommended maximal cross section of connected cable according **IEC 60947-7-2 and IEC 60947-7-1**:  
16 mm<sup>2</sup> (6 AWG) copper (tested short circuit current  $I_{CW} = 1.92$  kA for 1 s)
- Fastening of thicker cable is acceptable, if the maximum short circuit current  $I_{CW}$  and the exposure time is not exceeded and the provisions on cable lug thickness  $t_{Cl}$  are observed.

**Lightning protection**

For high temporary current due to lightning.

**Single point connection**
**Classification N**

(acc. IEC 62561-1)

Type A



Recommended electrical connectors:

**S-BT-ER M10/15 SN 6**  
**S-BT-ER W10/15 SN 6**  
**S-BT-EF M10/15 AN 6**  
**S-BT-EF W10/15 AN 6**  
**S-BT-ER M8/15 SN 6**  
**S-BT-EF M8/15 AN 6**

Maximum lightning current

$I_{imp} = 50$  kA for  $\leq 5$  ms  
 (according to IEC 62561-1)

Type B

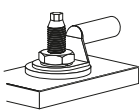

**S-BT-ER M10 HC 35\*)**  
**S-BT-ER W10 HC AWG2\*)**  
**S-BT-EF M10 HC 35\*)**  
**S-BT-EF W10 HC AWG2\*)**  
**S-BT-ER M10 HC 120**  
**S-BT-ER W10 HC AWG4/0**  
**S-BT-EF M10 HC 120**  
**S-BT-EF W10 HC AWG4/0**

**Classification H**

(acc. IEC 62561-1)

Type B

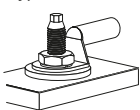

Recommended electrical connectors:

**S-BT-ER M10 HC 35\*)**  
**S-BT-ER W10 HC AWG2\*)**  
**S-BT-EF M10 HC 35\*)**  
**S-BT-EF W10 HC AWG2\*)**  
**S-BT-ER M10 HC 120**  
**S-BT-ER W10 HC AWG4/0**  
**S-BT-EF M10 HC 120**  
**S-BT-EF W10 HC AWG4/0**

$I_{imp} = 100$  kA for  $\leq 5$  ms  
 (according to IEC 62561-1)

\*) this items are available only on special request



**When S-BT-ER / -EF is used in class H applications only type B cable connection is allowed.**

**Tightening torque of 8 Nm** must be observed accurately for type B cable connection.

### Application Requirements

**Base material thickness  $t_{II} \geq 6$  mm**

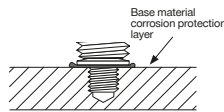
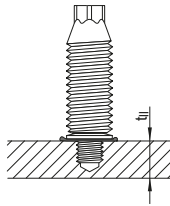

Thickness of base material corrosion protection layer  $\leq 0.8$  mm [0.0315"].

For single point connection type B conductivity disc must be in direct contact with non-coated base material.

### Cable lug characteristics and connector types

**Cable lug thickness  $t_{cl}$  and inner hole diameter  $d_2$**

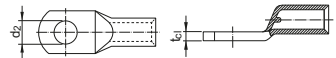

Fastener	Single point connector		Double point connector	
	Type A		Type A	
	$t_{cl}$ [mm]	$d_2$ [mm]	$t_{cl}$ [mm]	$d_2$ [mm]
<b>S-BT-ER M10/15 SN 6</b>	$\leq 7$	10.5	$\leq 7$	10.5
<b>S-BT-ER W10/15 SN 6</b>	$\leq 7$	10.5	$\leq 7$	10.5
<b>S-BT-EF M10/15 AN 6</b>	$\leq 7$	10.5	$\leq 7$	10.5
<b>S-BT-EF W10/15 AN 6</b>	$\leq 7$	10.5	$\leq 7$	10.5
<b>S-BT-ER M8/15 SN 6</b>	$\leq 7$	8.5	$\leq 7$	8.5
<b>S-BT-EF M8/15 AN 6</b>	$\leq 7$	8.5	$\leq 7$	8.5

Fastener	Single point connector	
	Type B	
	$t_{c1}$ [mm]	$d_2$ [mm]
S-BT-ER M10 HC 35*)	≤ 12	10.5
S-BT-ER W10 HC AWG2*)	≤ 12	10.5
S-BT-EF M10 HC 35*)	≤ 12	10.5
S-BT-EF W10 HC AWG2*)	≤ 12	10.5
S-BT-ER M10 HC 120	≤ 12	10.5
S-BT-ER W10 HC AWG4/0	≤ 12	10.5
S-BT-EF M10 HC 120	≤ 12	10.5
S-BT-EF W10 HC AWG4/0	≤ 12	10.5

Single point connector		Double point connector
Type A	Type B	Type A

\*) this items are available only on special request

### Spacing & edge distances

Edge distance:

Type A connector:  $\geq 6$  mm [0.236"]

Type B connector:  $\geq 20$  mm [0.787"]

Spacing:

Type A connector:  $\geq 22$  mm [0.866"]

Type B connector:  $\geq 40$  mm [1.575"]

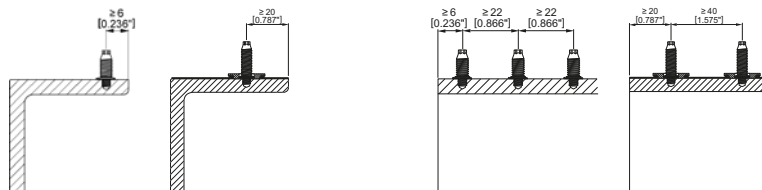

### Installation temperature and service temperature

The **installation temperature** is the temperature at which the S-BT studs are installed. A distinction is made between the temperature of the base material and the temperature of the S-BT studs, drilling and installation tools and accessories. The installation temperature range can be found in the table below.

The **service temperature** is the temperature at which the S-BT studs operate. The S-BT studs will operate effectively and without any loss in performance (loads, sealing function, etc.) within the specified service temperature range. Outside this temperature range the S-BT studs may fail.

Designation	Installation temperature		Service temperature	
	min	max	min	max
Base material	-40 °C	+60 °C	-40 °C	+100 °C
S-BT studs	-10 °C	+60 °C	-40 °C	+100 °C
Drilling & Installation tools and accessories	-10 °C	+60 °C	n.a.	n.a.

#### Note:

The service temperature range of the connected cable lugs and cables has to be observed. For details please contact the supplier of the cable lugs and cables. When using Hilti S-BT fasteners in combination with fire rated boundaries in Shipbuilding facilities, the max. service temperature for a period of 60 minutes is higher. For more details refer to section 5.10 "Fire resistance" in the S-BT Specification binder.

### Corrosion information

The S-BT-ER stainless studs are made from the duplex stainless steel type 1.4462, which is equivalent to AISI 316 (A4) steel grade. This grade of stainless steel is classified in the corrosion resistance class IV according to DIN EN 1993-1-4:2015, which makes the material suitable for aggressive environments such as coastal and offshore applications.

The microstructures of duplex stainless steels consist of a mixture of austenite and ferrite phases. Compared to the austenitic stainless steel grades, duplex stainless steels are magnetic. The surface of the S-BT-ER stainless steel fasteners is zinc-coated (anti-friction coating) in order to reduce the thread forming torque when the stud is screwed in into the base material.

The coating of the carbon steel S-BT-EF fasteners consists of an electroplated Zn-alloy for cathodic protection and a top coat for chemical resistance (Duplex-coating). The thickness of the coating is 35 µm. This product is designed for use in corrosive categories C1, C2 and C3 according to the standard EN ISO 9223.

The conductivity disc of the S-BT-ER / -EF HC is made from copper alloy CuSn8 with a tin-coating on the surface and a sealing ring on the bottom side. The copper alloy is classified as largely insensitive to stress corrosion cracking and pitting corrosion. The conductivity disc is designed for use in corrosion categories C1 - C5 according to EN ISO 9223. It is therefore suitable for use in aggressive environments like coastal and offshore applications.

To prevent corrosion of the base material due to the drilling process the following base material thickness  $t_{II}$  has to be given.

	Fastener	
	Carbon steel S-BT-EF	Stainless steel S-BT-ER
<b>Corrosivity category C</b> <b>Corrosion resistance class (CRC)</b>	C1, C2, C3	CRC III, IV
Base material thickness $t_{II}^1)$		
6 mm [0.24"] $\leq t_{II} < 7$ mm [0.28"] Pilot drill may cause damage to backside coating	✓	✓ <sup>2)</sup>
$t_{II} \geq 7$ mm [0.28"] Pilot drill will not affect backside of base material	✓	✓

1) Real base material thickness, not nominal material thickness or material thickness with coating.

2) Damage of the coating on the back side of the plate / profile require a rework of the coating, if the drilling tools SF BT 22-A or SF BT 18-A were used for drilling the bore hole. If the tool SBT 4-A22 was used for drilling the bore hole, no damage of the coating on the back side of the plate / profile will occur.

### Application limit

The base material is limited to steel grade with a maximum tensile strength  $f_u = 630$  MPa [91 ksi].

The minimum tensile strength of steel is  $f_u \geq 340$  MPa [49 ksi].

Minimum thickness of base material  $t_{II}$ : refer to section "Application Requirements".

Maximum thickness of base material  $t_{II}$ : no limits.

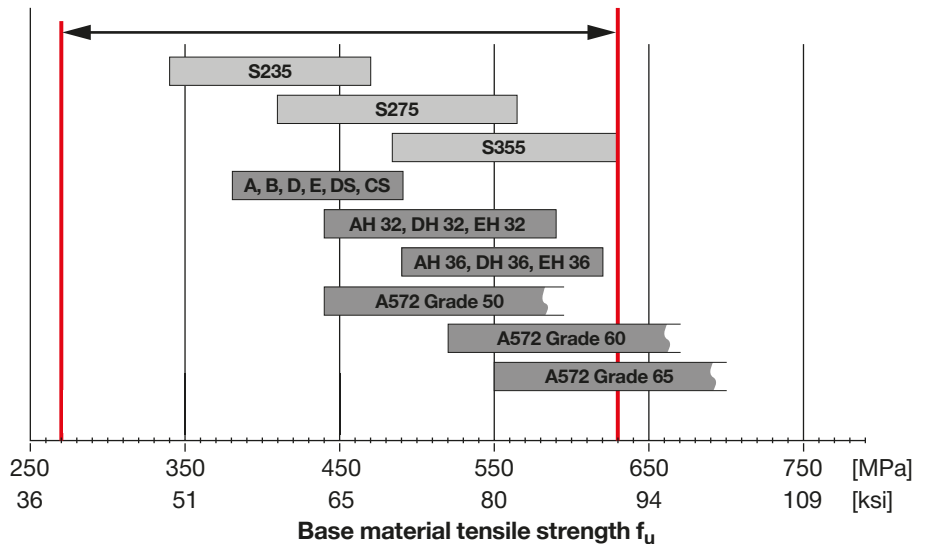

**Fastener selection and system recommendation**

Fasteners	Drilling tool	Setting tool	Stepped drill bit	Depth gauge
S-BT-ER M8/15 SN 6	SBT 4-A22, SF BT 18-A or SF BT 22-A	SBT 4-A22, SFC 18-A or SFC 22-A	TS-BT 5.5-74 S	S-DG BT M8/15 Long 6
S-BT-EF M8/15 AN 6				S-DG BT M10-W10/15 Long 6
S-BT-ER M10/15 SN 6				
S-BT-ER W10/15 SN 6				
S-BT-EF M10/15 AN 6				
S-BT-EF W10/15 AN 6				

Fasteners	Drilling tool	Setting tool	Stepped drill bit + coating removal drill bit	Depth gauge
S-BT-ER M10 HC 35*)	SBT 4-A22, SF BT 18-A or SF BT 22-A	SBT 4-A22, SFC 18-A or SFC 22-A	TS-BT 5.5-74 S TS-BT HC 35/AWG2	S-DG BT M10-W10 HC 6
S-BT-ER W10 HC AWG2*)				
S-BT-EF M10 HC 35*)				
S-BT-EF W10 HC AWG2*)				
S-BT-ER M10 HC 120			TS-BT 5.5-74 S TS-BT HC 120/AWG4/0	
S-BT-ER W10 HC AWG4/0				
S-BT-EF M10 HC 120				
S-BT-EF W10 HC AWG4/0				

**Fastener quality assurance**

In order to ensure the exact screw-in depth and a proper compressed sealing washer, the S-BT studs have to be installed with the appropriate depth gauge. With this tool the screw-in depth can be adjusted in a range of 0 - 1.5 mm (3 steps, 0.5mm per step). The S-CC BT calibration card is needed to check the initial stand-off of the S-BT stud and to adjust/calibrate the S-DG depth gauge. After finding the right adjustment level for the S-DG depth gauge, the gauge can be adjusted and the studs can be installed without additional check of the S-DG depth gauge. The depth gauge has to be re-adjusted (calibrated) at following times:

- Start of the installation process
- Change of the working position (upwards, downwards, horizontal) and base material (thickness, strength, type)
- Installer change
- After each packaging respectively after the installation of 100 S-BT studs

The lifetime of the S-DG BT depth gauge is  $\geq 1000$  settings.

The installer is responsible for the correct setting of the S-BT studs.

For the periodical verification of the correct stud stand-off the S-CG BT check gauge can be used.



S-DG BT mechanical depth gauge

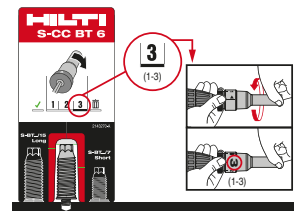

Design and functionality of the mechanical calibration card S-CC BT

\*) this items are available only on special request

**Fastening inspection**

 Verify stud stand-off  $h_{NVS}$  with check gauge S-CG BT

 $h_{NVS} = 29.3 \text{ mm to } 29.8 \text{ mm [1.153" to 1.173"]}$ 

- S-BT-ER M10/15 SN 6**
- S-BT-ER W10/15 SN 6**
- S-BT-EF M10/15 AN 6**
- S-BT-EF W10/15 AN 6**
- S-BT-ER M8/15 SN 6**
- S-BT-EF M8/15 AN 6**

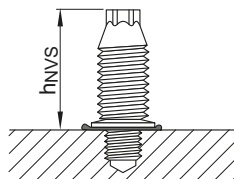

Design and functionality of the check gauge S-CG BT

 $h_{NVS} = 26.10 \text{ mm to } 26.60 \text{ mm [1.028" to 1.047"]}$ 

- S-BT-ER M10 HC \_\_\_\_**
- S-BT-ER W10 HC \_\_\_\_**
- S-BT-EF M10 HC \_\_\_\_**
- S-BT-EF W10 HC \_\_\_\_**

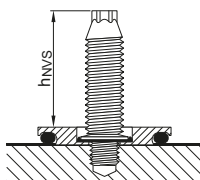

Designation	Product name	Comment
S-DG BT M8/15 Long 6	Depth gauge	for exact setting of S-BT-ER M8/15 SN 6, S-BT-EF M8/15 AN 6
S-DG BT M10-W10/15 Long 6	Depth gauge	for exact setting of S-BT-ER M10/15 SN 6, S-BT-ER W10/15 SN 6, S-BT-EF M10/15 AN 6, S-BT-EF W10/15 AN 6
S-DG BT M10-W10 HC 6	Depth gauge	for exact setting of S-BT-ER M10 HC ____, S-BT-ER W10 HC ____, S-BT-EF M10 HC ____, S-BT-EF W10 HC ____
S-CC BT 6	Calibration card	for calibration of the depth gauge for S-BT-ER and S-BT-EF
S-CC BT HC 6	Calibration card	for calibration of the depth gauge for S-BT-ER M10 HC ____, S-BT-ER W10 HC ____, S-BT-EF M10 HC ____, S-BT-EF W10 HC ____
S-CG BT /15 Long 6	Check gauge	for verification of the stand-off for S-BT-ER and S-BT-EF
S-CG BT HC	Check gauge	for verification of the stand-off for S-BT-ER M10 HC ____, S-BT-ER W10 HC ____, S-BT-EF M10 HC ____, S-BT-EF W10 HC ____

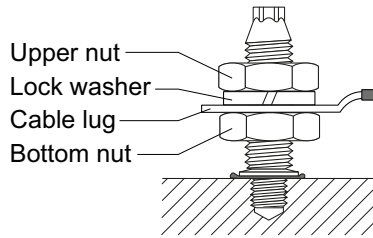
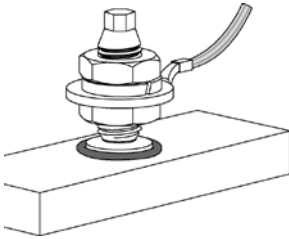
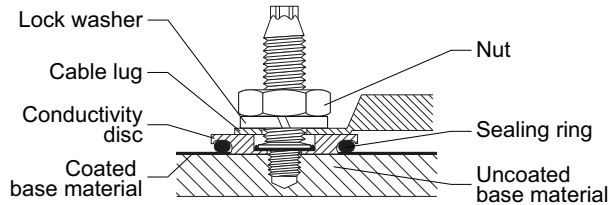
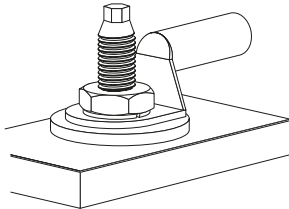
**Installation**
**Single point connection**
**Single point connection type A:**

**Single point connection type B:**

**For Type B cable connection the following requirements have to be observed:**

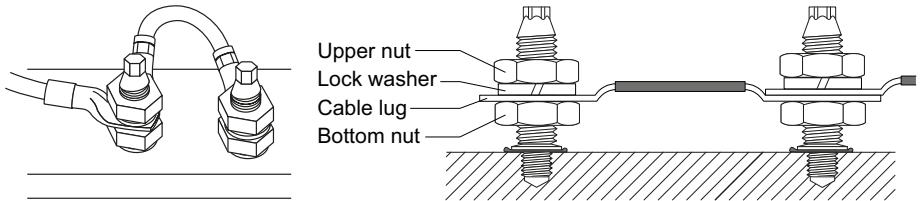
- The conductivity disc must be in direct contact with the non-coated base material.  
Coating has to be removed with the coating removal drill bit.
- **Tightening torque of 8 Nm** must be observed accurately.

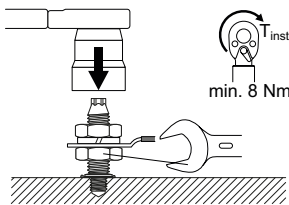

**Double point connection**
**Double point connection type A:**

Upper nut  
Lock washer  
Cable lug  
Bottom nut

**Torque recommendation for all S-BT-ER and S-BT-EF**
**Single point connection type A and double point connection type A:**

Hold the bottom nut with a spanner while tightening the upper nut.

Tightening Torque:      Min. 8 Nm  
   Max. 20 Nm

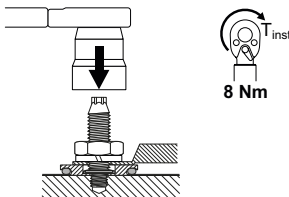
**Single point connection type B:**

The tightening torque is **8 Nm**. Exceeding or falling below this tightening torque value is not allowed. Tighten the nut using torque tool X-BT 1/4" (8 Nm), torque wrench or Hilti screw driver SBT 4-A22, SFC 18-A, SFC 22-A (torque setting 5) with socket S-NS.

**Important:** These are abbreviated instructions which may vary by application. ALWAYS review / follow the instructions for use (IFU) accompanying the product

**Fastener program**

Designation	Item no.	Product name	Comment	Application
S-BT-EF M8/15 AN 6	2186208	Threaded stud	package includes nuts and lock washers	Electrical connection
S-BT-EF M10/15 AN 6	2186204	Threaded stud		
S-BT-EF W10/15 AN 6	2186206	Threaded stud		
S-BT-ER M8/15 SN 6	2186207	Threaded stud	package includes nuts and lock washers	Electrical connection
S-BT-ER M10/15 SN 6	2186203	Threaded stud		
S-BT-ER W10/15 SN 6	2186205	Threaded stud		
S-BT-ER M10 HC 35*)	2204737	Threaded stud	package includes nuts, lock washers and conductor discs	Electrical connection
S-BT-ER W10 HC AWG2*)	2204738	Threaded stud		
S-BT-ER M10 HC 120	2204739	Threaded stud		
S-BT-ER W10 HC AWG4/0	2206611	Threaded stud		
S-BT-EF M10 HC 35*)	2204930	Threaded stud	package includes nuts, lock washers and conductor discs	Electrical connection
S-BT-EF W10 HC AWG2*)	2204931	Threaded stud		
S-BT-EF M10 HC 120	2204932	Threaded stud		
S-BT-EF W10 HC AWG4/0	2206612	Threaded stud		
TS-BT 5.5-74 S	2143137	Stepped drill bit	for base material steel	
TS-BT HC 35/AWG2	2204935	Coating removal drill bit	for removal of the coating from the base material	
TS-BT HC 120/AWG4/0	2204736	Coating removal drill bit	for removal of the coating from the base material	
S-DG BT M10-W10/15 Long 6	2143261	Depth gauge	for exact setting of the S-BT	
S-DG BT M8/15 Long 6	2148575	Depth gauge	for exact setting of the S-BT	
S-DG BT M10-W10/15 HC 6	2204933	Depth gauge	for exact setting of the S-BT ____ HC ____	
S-CC BT 6	2143270	Calibration card	for calibration of the depth gauge	
S-CC BT HC 6	2204934	Calibration card	for calibration of the depth gauge	

\*) this items are available only on special request



## Application

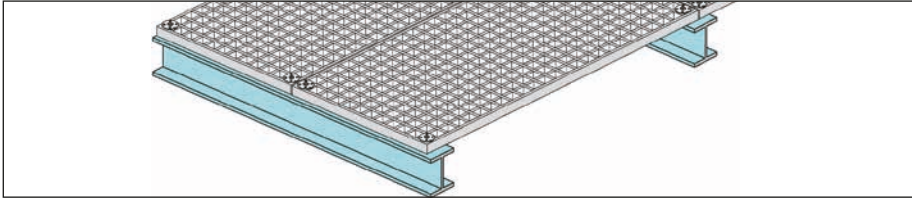

### Example



Grating (steel and fibreglass reinforced)

## Load data

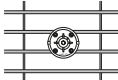
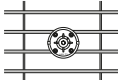
Recommended resistance under tensile load  $N_{rec}$

Grating opening type	Rectangular		Square	
				
Bar spacing	18 mm	30 mm	18 mm	30 mm
X-FCM	0.8 kN <sup>2)</sup>	0.8 kN <sup>2)</sup>	2.4 kN <sup>1)3)</sup>	0.8 kN <sup>2)</sup>
X-FCM-M	0.8 kN <sup>2)</sup>	0.8 kN <sup>2)</sup>	1.8 kN <sup>1)3)</sup>	0.8 kN <sup>2)</sup>
X-FCM-R	1.4 kN <sup>2)3)</sup>	1.0 kN <sup>2)</sup>	1.8 kN <sup>1)3)</sup>	1.0 kN <sup>2)</sup>
Bar spacing	30 mm	57 mm	30 mm	60 mm
X-FCM-M_L	0.8 kN <sup>2)</sup>	0.8 kN <sup>2)</sup>	1.8 kN <sup>1)3)</sup>	0.8 kN <sup>2)</sup>

<sup>1)</sup> Loading is limited by recommended load for threaded stud.

<sup>2)</sup> Loading is limited by elastic limit of the X-FCM disk. Exceeding recommended loads can result in plastic deformation of disk.

<sup>3)</sup> S-BT-GR M8/7 SN 6 AL in aluminum base material:  $N_{rec} = 1.0$  kN

S-BT-GR M8/7 SN 6 in steel base material  $3 \text{ mm} \leq t_{II} < 5 \text{ mm}$  (drill through hole):  $N_{rec} = 1.0$  kN

S-BT-GF M8/7 AN 6 in steel base material  $3 \text{ mm} \leq t_{II} < 5 \text{ mm}$  (drill through hole):  $N_{rec} = 1.0$  kN

S-BT-GR M8/7 SN 6, S-BT-GF M8/7 AN 6 in steel base material  $t_{II} \geq 5 \text{ mm}$ :  $N_{rec} = 1.8$  kN

**Note:**

X-FCM, X-FCM-M, X-FCM-R, X-FCM-M\_L resist shear by friction and are not suitable for explicit shear load designs, e.g. diaphragms. Depending on surface characteristics, shear loads of up to about 0.3 kN will not result in permanent deformation. Therefore small unexpected shear loads can generally be accommodated without damage.

### Characteristic resistance under tension load $N_{Rk}$

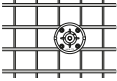
Type	Bar spacing	X-FCM-R with		
		X-BT (X-BT-GR M8/7 SN 6 for $t_{ij} \geq 6$ mm) S235 / A36 steel	S355 / Grade 50 steel	X-CRM / X-ST-GR
	Rectangle 18 mm	4.2 kN/945 lb*	4.2 kN/945 lb*	4.2 kN/945 lb*
	Rectangle 30 mm	3.0 kN/675 lb*	3.0 kN/675 lb*	3.0 kN/675 lb*
	Square 18 mm	5.4 kN/1215 lb	6.9 kN/1550 lb	5.4 kN/1215 lb
	Square 30 mm	3.0 kN/ 675 lb*	3.0 kN/ 675 lb*	3.0 kN/ 675 lb*

\* Loading is limited by elastic limit of the X-FCM-R disc.

### Characteristic resistance under tension load $N_{Rk}$

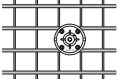
Type	Bar spacing	X-FCM-R with		
		S-BT-GR M8/7 SN 6, pilot hole, $t_{ij} \geq 6$ mm S235 / A36 steel	S355 / Grade 50 steel	Aluminum $R_m \geq 270$ N/mm <sup>2</sup>
	Rectangle 18 mm	4.2 kN/945 lb*	4.2 kN/945 lb*	3.0 kN/675 lb
	Rectangle 30 mm	3.0 kN/675 lb*	3.0 kN/675 lb*	3.0 kN/675 lb
	Square 18 mm	5.4 kN/1215 lb	6.9 kN/1550 lb	3.0 kN/675 lb
	Square 30 mm	3.0 kN/ 675 lb*	3.0 kN/ 675 lb*	3.0 kN/675 lb

\* Loading is limited by elastic limit of the X-FCM-R disc.

### Load displacement behaviour

Example:

Tensile load

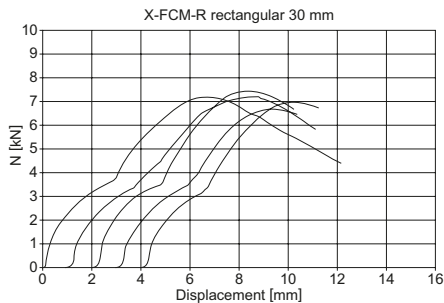

Shear load

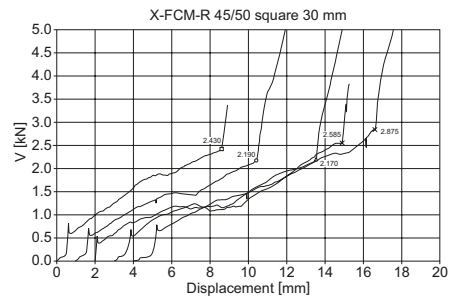

## Application requirement

### Thickness of base material

X-BT

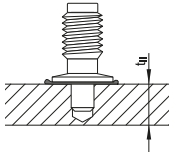

$t_{II} \geq 8 \text{ mm}$

S-BT-GF M8/7 AN 6  
S-BT-GR M8/7 SN 6  
S-BT-GR M8/7 SN 6 AL\*)

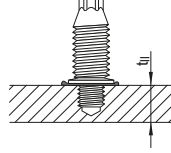

$t_{II} \geq 6 \text{ mm}$   
pilot hole

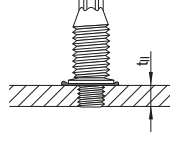

steel:  
 $3 \text{ mm} \leq t_{II} < 6 \text{ mm}$ ,  
aluminum:  
 $5 \text{ mm} \leq t_{II} < 6 \text{ mm}$  drill  
through hole

X-ST-GR,  
X-CRM and  
X-EM8H

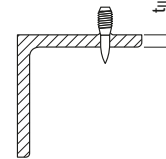

$t_{II} \geq 6 \text{ mm}$

\*) for use in aluminum base material

### Thickness of fastened material

Grating height: 25–50 mm with standard X-FCM. For other dimensions special X-FCM are available on demand.

### Spacing and edge distance

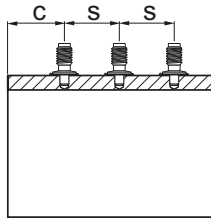
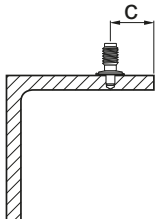

Fastener	Edge distance c	Spacing s
X-ST-GR, X-CRM, X-EM8H	$\geq 15 \text{ mm}$	$\geq 15 \text{ mm}$
X-BT, S-BT	$\geq 6 \text{ mm}$	$\geq 15 \text{ mm}$

## Corrosion information

### X-FCM

The X-FCM is Zn electroplated. The intended use of this coating is limited to corrosion category C1 according the standard EN ISO 9223 (indoors). The X-FCM carbon steel grating fasteners are to be used for fastening gratings made of coated or galvanized carbon steel or gratings made of reinforced fibreglass.

#### Note:

The X-FCM fasteners intended use only comprises fastenings which are not directly exposed to external weather conditions or moist atmospheres.

### X-FCM-M

The coating of the X-FCM-M carbon steel grating fasteners consists of an electroplated Zn-alloy for cathodic protection and a top coat for chemical resistance (duplex-coating). The intended use of this coating is limited to the corrosion category C1, C2 and C3 according the standard EN ISO 9223 (indoors, mildly corrosive environment). The X-FCM-M carbon steel grating fasteners are to be used for fastening gratings made of coated or galvanized carbon steel or gratings made of reinforced fibreglass.

#### Note:

The X-FCM-M fasteners are not for use in marine atmospheres or in heavily polluted environments.

### X-FCM-R

The X-FCM-R stainless steel grating fasteners are made from the stainless-steel type 1.4404, which is equivalent to AISI 316L (A4) steel grade. This grade of stainless steel is classified in the corrosion resistance class III according to DIN EN 1993-1-4:2015, which makes the material suitable for aggressive environments like in marine, offshore, petrochemical, caloric (coal, oil) power plants, etc. applications. The X-FCM-R stainless-steel grating fasteners are to be used for fastening gratings made of stainless steel or gratings made of reinforced fibreglass.

#### Note:

The X-FCM-R fasteners are not for use in road tunnels, indoor swimming pools or similar environments without a project specific engineering judgement.

## Application limit

### X-CRM8, X-EM8H

#### DX 460, DX 5

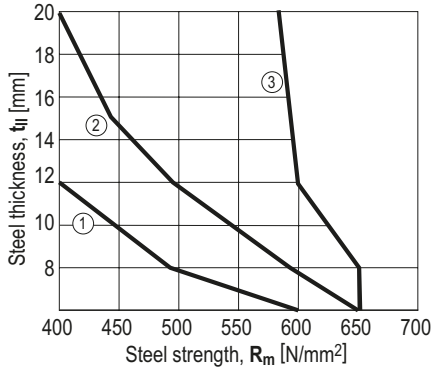

- ① X-CRM8-15-12 P8 / DX 460, DX 5 (impact)
- ② X-CRM8-15-12 P8 / DX 460, DX 5 (co-acting)
- ③ X-EM8H-15-12 P8 / DX 460, DX 5 (impact)

#### DX 76, DX 76 PTR

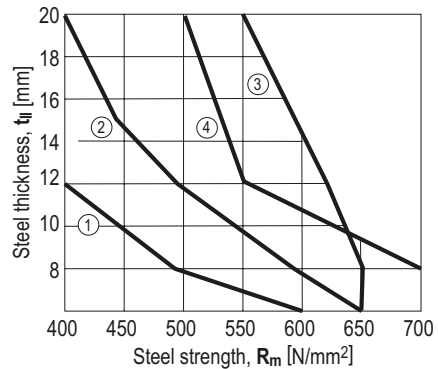

- ① X-CRM8-15-12 FP10 / DX 76, DX 76 PTR (impact)
- ② X-CRM8-15-12 FP10 / DX 76, DX 76 PTR (co-acting)
- ③ X-EM8H-15-12 FP10 / DX 76, DX 76 PTR (impact)
- ④ X-EM8H-15-12 P8 / DX 76, DX 76 PTR (impact)

### X-ST-GR

#### DX 460, DX 5

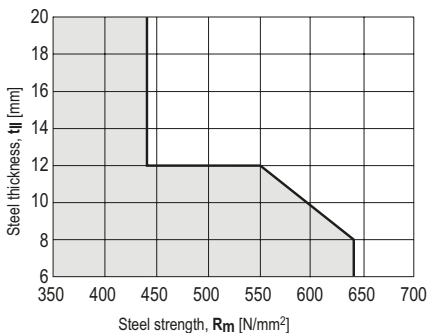

#### DX 76 PTR

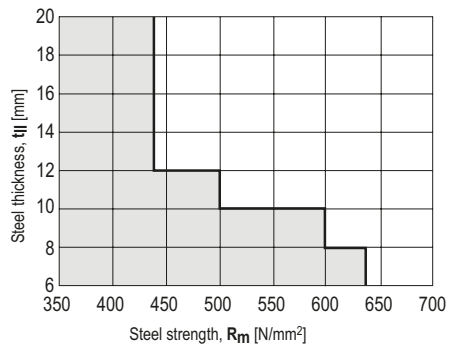

### X-BT

No application limits for use in high strength steel ( $f_u$  up to 1000 MPa)

No through penetration for base material thickness  $t_{II} \geq 8 \text{ mm}$  [ $\frac{5}{16}$ "]



### S-BT

The base material is limited to steel grade with a maximum tensile strength  $f_u = 630$  MPa (91 ksi). The minimum tensile strength of steel is  $f_u \geq 340$  MPa (49 ksi). The minimum tensile strength of aluminum is  $f_u \geq 270$  MPa (39 ksi). Minimum thickness of base material  $t_{II}$ : refer to section "Thickness of base material" Maximum thickness of base material  $t_{II}$ : no limits

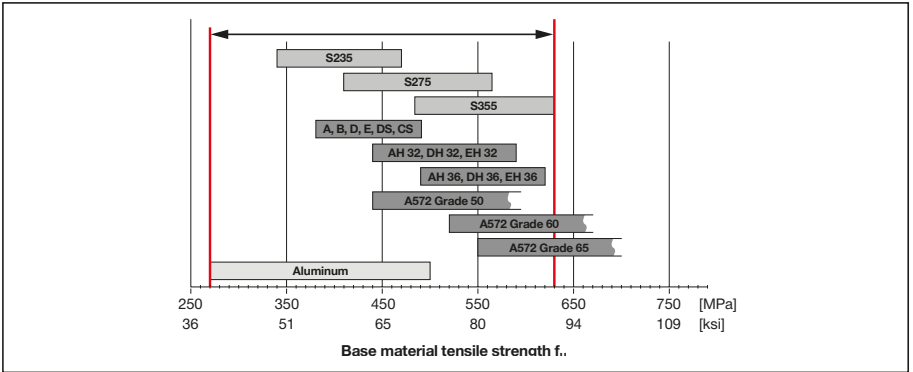

## Grating fastening system recommendation

### Application area

X-FCM	X-FCM-M	X-FCM-R
Indoors, dry and non corrosive environment	Indoors, mildly corrosive environment, or for limited lifetime use	Marine, offshore, petrochemical, calorific (coal, oil) power plants, etc.

### X-FCM grating element

X-FCM Zinc plated	Item no.	X-FCM-M Duplex coated	Item no.	X-FCM-R Stainless steel	Item no.	Grating element length L	Grating height h
X-FCM 25/30	26582 or 2117353	X-FCM-M 25/30	378683 or 2117357	X-FCM-R 25/30	247181 or 2117391	23 mm	25–30 mm
X-FCM 1"-1 1/4"	247175 or 2117354	X-FCM-M 1"-1 1/4"	378686 or 2117358	X-FCM-R 1"-1 1/4"	247184 or 2117392	27 mm	29–34 mm
X-FCM 35/40	26583 or 2117355	X-FCM-M 35/40	378684 or 2117359	X-FCM-R 35/40	247182 or 2117393	33 mm	35–40 mm
X-FCM 45/50	26584 or 2117356	X-FCM-M 45/50	378685 or 2117390	X-FCM-R 45/50	247183 or 2117394	43 mm	45–50 mm
		X-FCM-M 31/36 L	2042852*			25 mm	31–36 mm
		*For use with X-BT M8-15-6 SN12-R S-BT-GR M8					
		Note: Not for use in marine atmosphere or in heavily polluted environment.		Note: Not for use in automobile tunnels, swimming pools or similar environments			

### Tool recommendation for tightening grating element

Grating element	Tool
X-FCM X-FCM-M X-FCM-R	SF 100-A, SF 11-A, SF 150-A, SF 121-A, SF 14, SF 14-A, SF 18-A, SFC 18-A, SF 22-A, SFC 22-A, SBT 4-A22, Hilti Torque tool X-BT 1/4"

### Threaded stud

Threaded stud	Item no.	Tool
X-EM8H-15-12 P8	271981	<sup>2)</sup>
X-EM8H-15-12 FP10	271982	<sup>2)</sup>
X-BT M8-15-6 SN12-R	377074	<sup>3)</sup>
X-CR M8-15-12 P8	372033	<sup>2)</sup>
X-CR M8-15-12 FP10	372034	<sup>2)</sup>
S-BT-GF M8/7 AN 6	2140527	<sup>4), 5)</sup>
S-BT-GR M8/7 SN 6	2140529	<sup>4), 5)</sup>
S-BT-GR M8/7 SN 6 AL	2140742	<sup>4), 5)</sup>
X-ST-GR M8/10 P8	2122460	<sup>2)</sup>

<sup>2)</sup> DX 76 PTR, DX 460, DX 5

<sup>4)</sup> SF BT 18-A, SF BT 22-A and SBT 4-A22 for drilling the hole

<sup>3)</sup> BX 3-BTG, DX 351-BTG

<sup>5)</sup> SFC 18-A, SFC 22-A and SBT 4-A22 for screw-in the fastener

### Cartridge selection and tool energy setting

- X-BT: 6.8/11M high precision brown cartridges
- X-CRM: 6.8/11M yellow or red cartridges with DX 460, DX 5  
6.8/18M blue cartridges with DX 76 and DX 76 PTR
- X-ST-GR: 6.8/11M black or red cartridges with DX 460, DX 5  
6.8/18M yellow or red cartridges with DX 76 PTR
- X-EM8H: 6.8/11M red or black cartridges with DX 460, DX 5  
6.8/18M blue, red or black cartridges with DX 76 and DX 76 PTR

Tool energy adjustment by setting tests on site.

## Material specification and coating

### X-FCM grating element

	X-FCM-R		X-FCM-M+X-FCM-M_L		X-FCM		All systems ③ Absorber 1)
	① Disk	② Threaded stem	① Disk	② Threaded stem	① Disk	② Threaded stem	
Material designation	X2CrNiMo17122	X2CrNiMo17122	DC 04	11SMNPB30+C	DC 04	11SMNPB30+C	Polyurethane Black
Coating	none	none	Duplex *	Duplex *	≥ 20µm Zn	10-20 µm Zn	-

1) resistant to: UV, saltwater ozone, oil, grease

\*) comparable to 45 µm HDG steel (480 h Salt spray test per DIN 50021)

### Threaded stud

	X-BT			X-ST-GR		X-EM8H
	Shank ①	Threaded sleeve ② SN12-R washer ③	Sealing ring of sealing washer 1) ④	Shank	Threaded sleeve	
Material designation	Stainless steel CR 500 (A4 / AISI316)	X2CrNiMo17132 X5CrNiMo17122+2H (A4 / AISI316)	Elastomer, black	P558 (CrMnMo alloy)	(A4 / AISI316)	Carbon steel  Ck 67 MOD
Coating	none	none		none	none	5-13 µm Zn 2)

1) resistant to: UV, saltwater ozone, oil, grease

2) Zinc applied by electroplating. Intended for corrosion protection during shipment, storage, construction and service in protected environment. It is not adequate for protection against corrosion in outside or otherwise corrosive applications

	S-BT_R			S-BT_F		
	Threaded Shank ①	SN 12-R washer ③	Sealing ring of sealing washer 1) ③	Threaded Shank ②	AN 10-F washer ④	Sealing ring of sealing washer 1) ④
Material designation	Stainless steel 1.4462 (A4 / AISI316)	Stainless steel 1.4404 (A4 / AISI316)	Elastomer, black	Carbon steel 1038	Aluminum	Elastomer, black
Coating	Zinc	none	none	Duplex-coating	none	HDG

1) resistant to: UV, salt water, ozone, oil, grease

2) The surface of the S-BT stainless steel fasteners is zinc plated (anti-friction coating) in order to reduce the thread forming torque when the stud is screwed in into the base material.

## Fastening quality assurance

### Fastener inspection

X-BT M8-15-6 SN12-R

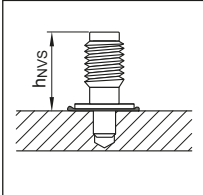

$h_{NVS} = 15.7 - 16.8 \text{ mm}$

X-BT-GR M8/7 SN8

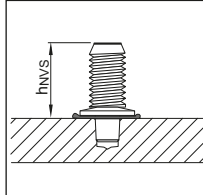

$h_{NVS} = 15.7 - 16.8 \text{ mm}$

X-CRM8-15-12

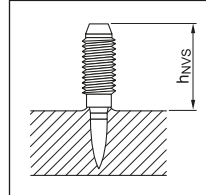

$h_{NVS} = 17 - 20 \text{ mm}$

X-EM8H-15-12

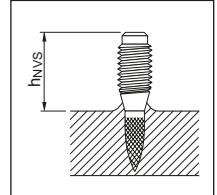

$h_{NVS} = 15.5 - 19.5 \text{ mm}$

X-ST-GR M8/10 P8

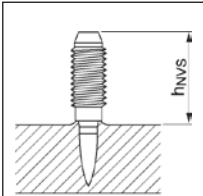

$h_{NVS} = 17.0 - 20.0 \text{ mm}$

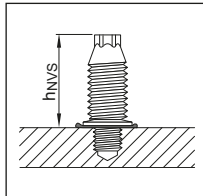

$h_{NVS} = 18.6 - 19.1 \text{ mm [0.732" - 0.752"]}$

S-BT-\_\_\_/7\_\_\_6

## Grating fastening information

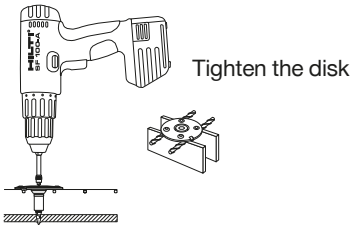

### Tightening torque

$T_{rec} = \text{max. } 8 \text{ Nm}$

$T_{rec} = \text{max. } 5 \text{ Nm}^{1)}$

<sup>1)</sup> For S-BT-GR M8/7 SN 6 AL

in aluminum base material

For S-BT-GR M8/7 SN 6 and

S-BT-GF M8/7 AN 6 in steel base material

$3 \text{ mm} \leq t_{II} < 5 \text{ mm}$  (drill through hole)

### Tightening tool

- Screwdriver with torque release coupling (TRC)
- 5 mm Allen-type bit
- Hilti Torque tool X-BT 1/4", which gives 8 Nm

### Hilti screwdriver

	$T_{rec}$	
	5 Nm	8 Nm
Torque setting		
SF 121-A	5	6
SF 150-A	4	5
SF 14	4	5
SF 14-A	5	6
SF 18-A	4	5
SFC 18-A	4	5
SF 22-A	4	5
SFC 22-A	4	5
SBT 4-A22	4	5

# X-FCM-R HL Grating fastening system

## Product data

### Dimensions

X-FCM-R HL

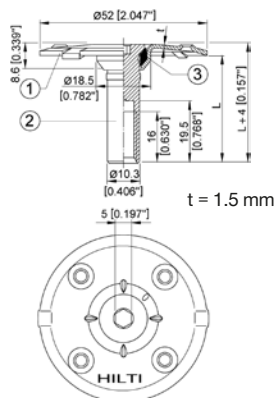

X-BT-GR M8/7 SN 8

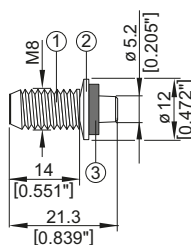

X-SEA-R30 M8

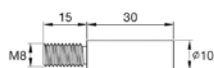

### Features and benefits

The X-FCM-R HL together with the X-BT-GR M8 threaded fasteners forms a high resistance and robust fastening system to fix grating in marine C5 corrosive environment:

- High tension resistance for use in wave zones
- Robust shear behavior
- No rework of backside of coated base material with thickness  $\geq 8$  mm
- Base material coating up to 500  $\mu\text{m}$
- No application limits in terms of base material strength and thickness
- Vibration resistant

### General information

#### Material specifications

Disk (1) and	A4 / 316
threaded stem (2):	1.4404, X2CrNiMo17-12-2
Absorber (3) <sup>1)</sup> :	TPU – thermoplastic polyurethane, red

<sup>1)</sup> resistant to: UV, saltwater, ozone, oil, grease

X-SEA-R 30 M8:	A4 / 316
	1.4401 or 1.4571

### Recommended fastening tools

See **X-FCM-R HL fastener program** in the next pages and **Tools and equipment** chapter for more details.

### Approvals

ABS, BV  
DNV GL, LR



## Application

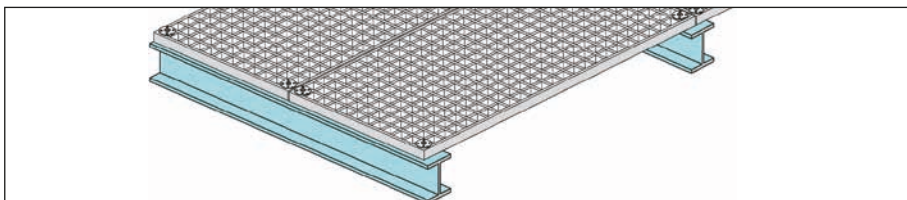

Position and fix steel or fibre-reinforced grating to steel

## Load data

### Recommended tensile loads $N_{rec}$ [kN]

#### Grating opening type

Rectangular

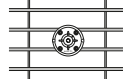

Clear bar spacing [mm] <sup>1)</sup>

18 to 24 | >24 to 30 | >30 to 35 | >35 to 44

<b>X-FCM-R HL</b>	2.8	2.1	1.4	0.7
-------------------	-----	-----	-----	-----

#### Grating opening type

Square

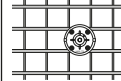

Clear mesh width [mm]

18 to 38<sup>2)</sup> | > 38 to 44<sup>1)</sup>

<b>X-FCM-R HL</b>	3.6	1.2
-------------------	-----	-----

<sup>1)</sup> Loading is limited by elastic limit of the X-FCM-R HL grating fastener.

<sup>2)</sup> Loading is limited by recommended load of threaded stud X-BT-GR M8/7 SN 8. Exceeding recommended loads might reduce the pre-tensioning of the connection.

Remark: Full utilization of X-FCM-R HL load data requires the use of the X-BT-GR M8/7 SN 8 threaded stud with  $T = 16 - 20$  Nm

Characteristic tensile loads  $N_{Rk}$  can be conservatively calculated by multiplying the recommended load values  $N_{rec}$  with the factor 2.8,  $N_{Rk} = 2.8 * N_{rec}$

### Recommended shear loads $V_{rec}$ [kN]

Without extension adapter X-SEA-R

For grating with clear rectangular mesh width from 18 to 44 mm:  $V_{rec} = 0.4$  kN

For grating with clear square mesh width from 18 to 44 mm:  $V_{rec} = 0.6$  kN

With extension adapter X-SEA-R

For grating with clear rectangular or square mesh width from 18 to 44 mm:  $V_{rec} = 0.4$  kN

#### Notes:

Those recommended loads  $V_{rec}$  are based on friction under standard conditions without the presence of lubricants (e.g. oil, grease) and require the application of an installation torque  $T = 16 - 20$  Nm. The respective slips are in the range of 0.2 mm.

Those values allow robust positioning e.g. in case of transportation of preassembled units. Structural applications – e.g. stabilizing the compression flange of a supporting beam, if the grating is used as a diaphragm – are out of scope of the X-FCM-R HL grating fastener.



## Load displacement behavior – examples:

### Tensile load

Example with square grating and a clear mesh width of 30 x 30 mm

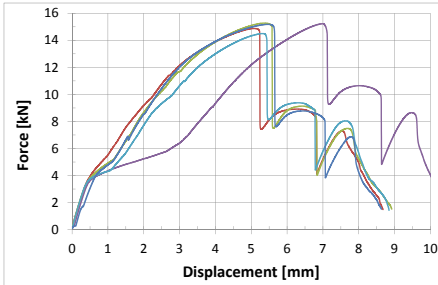

Failure mode: Pull-over of disk (1) over the threaded stem (2)

### Shear load

Example with rectangular grating and a clear bar spacing of 44 mm

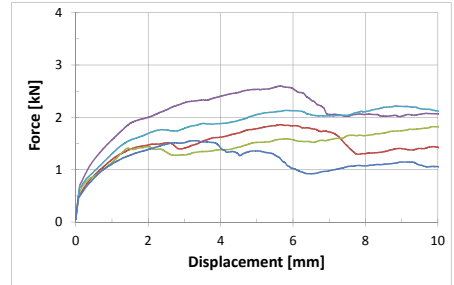

Notes:

Graph shows slipping behavior due to friction. The actual ultimate resistance will be significantly higher, as the grating itself will get into contact with the X-FCM-R HL fastener. However, those resistances are not used for design purpose due to the high deformation at those states.

## Application requirements

### Thickness of base material

#### X-BT-GR M8/7 SN8

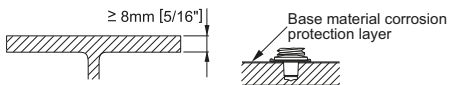

To prevent damage of back side coating: base material thickness  $\geq 8$  mm.

Thickness of base material corrosion protection considered up to 500  $\mu\text{m}$ .

### Thickness of fastened material

Grating height: 28–43 mm, 48–53 mm

Grating height: 58–73 mm, 78–83 mm with the extension adapter X-SEA-R30 M8.

### Corrosion information

X-FCM-R HL and X-BT-GR grating fastening system is intended for use in coastal and offshore applications

### Application limit

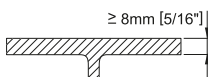

$t_{II} \geq 8$  mm [5/16"]  $\rightarrow$  No through penetration  
No limits with regards to steel strength

### Spacing and edge distance

Edge distance:  $c \geq 10$  mm

Spacing:  $\geq 15$  mm

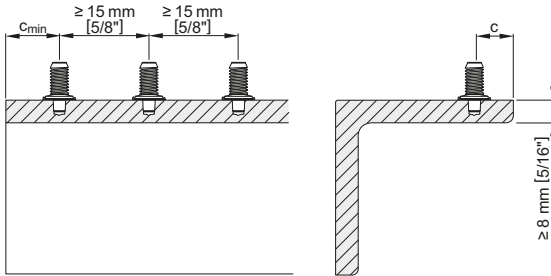

### Fastener selection and system recommendation

#### Fastener program

##### X-FCM-R HL

Designation	Item no.	Dimensions	
		L [mm]	Grating height $H_G$ [mm]
X-FCM-R HL 25/30	2194345	23	28 – 33
X-FCM-R HL 1" - 1¼"	2194346	27	32 – 37
X-FCM-R HL 35/40	2194347	33	38 – 43
X-FCM-R HL 45/50	2194348	43	48 – 53

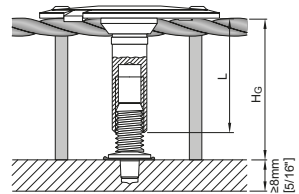

##### X-FCM-R HL in combination with X-SEA-R30 M8 (Item no. 432274)

Designation	Item no.	Dimensions	
		L [mm]	Grating height $H_G$ [mm]
X-FCM-R HL 25/30	2194345	53	58 – 63
X-FCM-R HL 1" - 1¼"	2194346	57	62 – 67
X-FCM-R HL 35/40	2194347	63	68 – 73
X-FCM-R HL 45/50	2194348	73	78 – 83

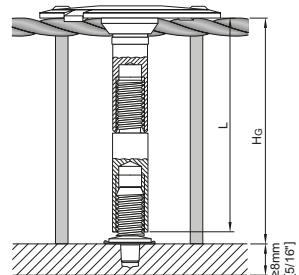

##### X-BT-GR stainless steel stud

Designation	Item no.	Tool
		Designation
X-BT-GR M8/7 SN 8	2194344	DX 351-BTG

### Cartridge selection and tool energy setting

#### 6.8/11 M10 high precision brown cartridge

The recommended tool energy setting = 1 (if required, increase of energy setting based on job site tests)

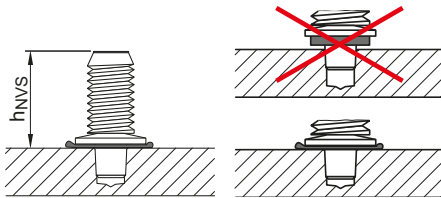
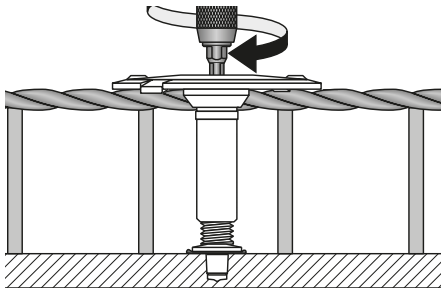
**Fastening quality assurance**
**Fastening inspection**

**X-BT-GR M8/7 SN 8**
 $h_{NVS} = 15.7-16.8 \text{ mm}$ 
**Installation**

**Tightening torque  $T = 16-20 \text{ Nm}$** 
**Tightening tool:**

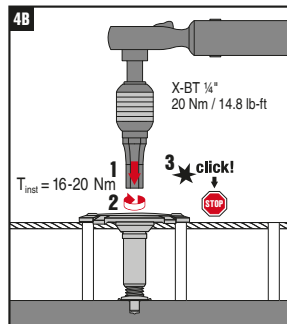
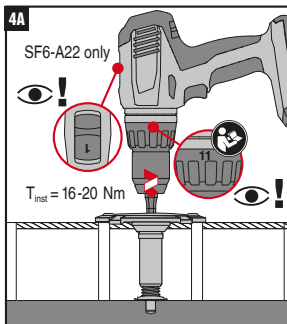
- Screwdriver (SF6, speed 1, clutch 11) with torque release coupling (TRC)
- 5 mm Allen-type bit
- Hilti torque tool X-BT ¼" 20 Nm

Details on installation are given in the instructions for use which are supplied together with the product.





# X-FCM NG Grating Fastening System

## Product data

### Dimension

X-FCM-R NG      X-FCM-M NG

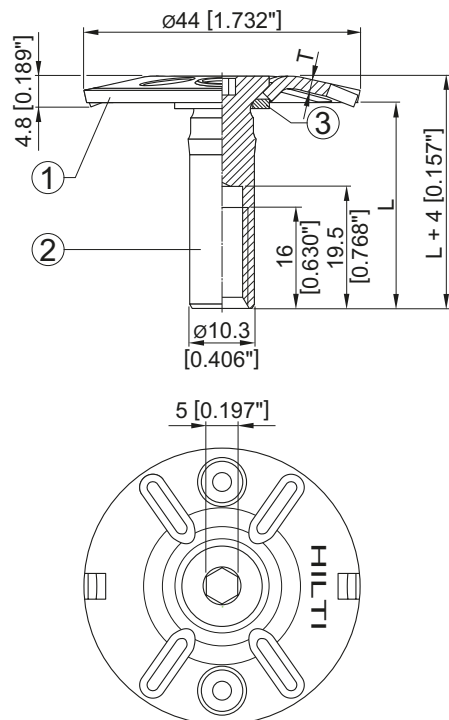

### Material specification

- |  |              |
|--|--------------|
| ① Disc: Stainless steel                  | (X-FCM-R NG) |
| X2CrNiMo17-12-2<br>S 31603 (1.4404) 316L |              |
| ① Disc: Carbon steel                     | (X-FCM-M NG) |
| DC 04/duplex coated                      |              |
| ② Threaded stem:                         |              |
| Stainless steel                          | (X-FCM-R NG) |
| X2CrNiMo17-12-2<br>S 31603 (1.4404) 316L |              |
| ② Threaded stem:                         |              |
| Carbon steel                             | (X-FCM-M NG) |
| ML08AL/duplex coated                     |              |
| ③ O-Ring                                 |              |
| Polyurethane, black                      |              |

### Recommended fastening tool

Refer to section "Fastener selection and system recommendation" for more details.

### Approval/certificate

## Application

### Securing rectangular grating

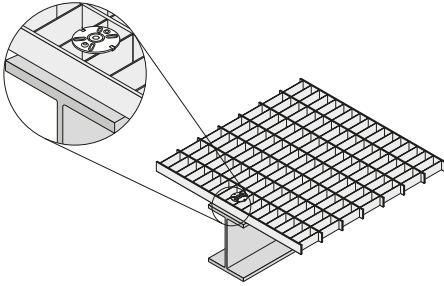

### Securing square grating

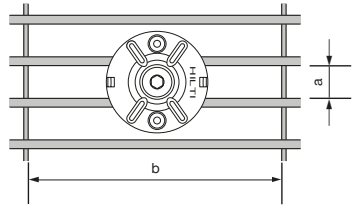
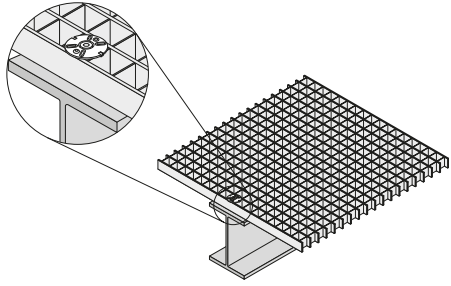

Grating with grating openings\* a = 13 mm to 22 mm and b ≥ 18 mm (steel and fibreglass reinforced)

\* Real grating opening, not nominal grating opening. If grating opening a is < 13 mm and b is < 18 mm the installation of the S-BT threaded stud is not possible.

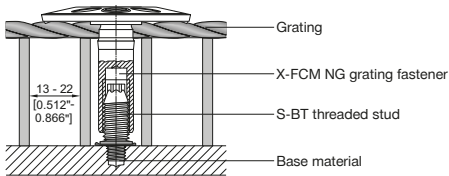

### Load Data

Recommended resistance under tension load for grating fastening system

#### Rectangular grating opening

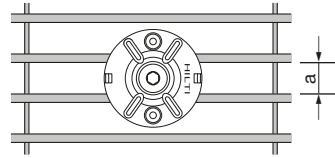

	Recommended resistance $N_{rec}$ for X-FCM-R NG + S-BT-GR NG				
Base material thickness <sup>2)</sup>	$t_{II} \geq 5 \text{ mm [0.20" ]}$			$3 \text{ mm [0.12" ]} \leq t_{II} < 5 \text{ mm [0.20" ]}$	
Base material type	Steel S235 A36	Steel S355, S420 Grade 50	Aluminum $f_u \geq 270 \text{ MPa}$	Steel S235 A36	Steel S355, S420 Grade 50
Rectangular grating Bar spacing $a = 13 \text{ mm}$	1.9 kN	2.3 kN	1.9 kN	1.8 kN	2.1 kN
Rectangular grating Bar spacing $a = 18 \text{ mm}$	1.9 kN	2.3 kN	1.9 kN	1.8 kN	2.1 kN
Rectangular grating Bar spacing $a = 22 \text{ mm}$	1.9 kN	2.1 kN <sup>1)</sup>	1.9 kN	1.8 kN	2.1 kN

	Recommended resistance $N_{rec}$ for X-FCM-M NG + S-BT-GR NG				
Base material thickness <sup>2)</sup>	$t_{II} \geq 5 \text{ mm [0.20" ]}$			$3 \text{ mm [0.12" ]} \leq t_{II} < 5 \text{ mm [0.20" ]}$	
Base material type	Steel S235 A36	Steel S355, S420 Grade 50	Aluminum $f_u \geq 270 \text{ MPa}$	Steel S235 A36	Steel S355, S420 Grade 50
Rectangular grating Bar spacing $a = 13 \text{ mm}$	1.9 kN	2.3 kN	1.9 kN	1.8 kN	2.1 kN
Rectangular grating Bar spacing $a = 18 \text{ mm}$	1.9 kN	2.1 kN <sup>1)</sup>	1.9 kN	1.8 kN	2.1 kN
Rectangular grating Bar spacing $a = 22 \text{ mm}$	1.2 kN <sup>1)</sup>	1.2 kN <sup>1)</sup>	1.2 kN <sup>1)</sup>	1.2 kN <sup>1)</sup>	1.2 kN <sup>1)</sup>

	Recommended resistance $N_{rec}$ for X-FCM-M NG + S-BT-GF NG				
Base material thickness <sup>2)</sup>	$t_{II} \geq 5 \text{ mm [0.20" ]}$			$3 \text{ mm [0.12" ]} \leq t_{II} < 5 \text{ mm [0.20" ]}$	
Base material type	Steel S235 A36	Steel S355, S420 Grade 50	Aluminum $f_u \geq 270 \text{ MPa}$	Steel S235 A36	Steel S355, S420 Grade 50
Rectangular grating Bar spacing $a = 13 \text{ mm}$	2.0 kN	2.4 kN	n.a.	1.9 kN	2.3 kN
Rectangular grating Bar spacing $a = 18 \text{ mm}$	2.0 kN	2.1 kN <sup>1)</sup>	n.a.	1.9 kN	2.1 kN <sup>1)</sup>
Rectangular grating Bar spacing $a = 22 \text{ mm}$	1.2 kN <sup>1)</sup>	1.2 kN <sup>1)</sup>	n.a.	1.2 kN <sup>1)</sup>	1.2 kN <sup>1)</sup>

<sup>1)</sup> Loading is limited by elastic limit of the X-FCM NG disk. Exceeding the load value can result in plastic deformation of the X-FCM NG disk.

<sup>2)</sup> For base material thickness  $3 \text{ mm [0.12" ]} \leq t_{II} < 6 \text{ mm [0.24" ]}$  rework of the coating on the back side of the plate/profile may be needed.

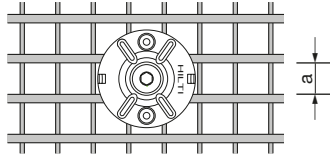
**Square grating opening**

	Recommended resistance $N_{rec}$ for X-FCM-R NG + S-BT-GR NG				
Base material thickness <sup>2)</sup>	$t_{II} \geq 5 \text{ mm [0.20" ]}$			$3 \text{ mm [0.12" ]} \leq t_{II} < 5 \text{ mm [0.20" ]}$	
Base material type	Steel S235 A36	Steel S355, S420 Grade 50	Aluminum $f_u \geq 270 \text{ MPa}$	Steel S235 A36	Steel S355, S420 Grade 50
Square grating Bar spacing $a = 18 \text{ mm}$	1.9 kN	2.3 kN	1.9 kN	1.8 kN	2.1 kN
Square grating Bar spacing $a = 22 \text{ mm}$	1.9 kN	2.3 kN	1.9 kN	1.8 kN	2.1 kN

	Recommended resistance $N_{rec}$ for X-FCM-M NG + S-BT-GR NG				
Base material thickness <sup>2)</sup>	$t_{II} \geq 5 \text{ mm [0.20" ]}$			$3 \text{ mm [0.12" ]} \leq t_{II} < 5 \text{ mm [0.20" ]}$	
Base material type	Steel S235 A36	Steel S355, S420 Grade 50	Aluminum $f_u \geq 270 \text{ MPa}$	Steel S235 A36	Steel S355, S420 Grade 50
Square grating Bar spacing $a = 18 \text{ mm}$	1.9 kN	2.3 kN	1.9 kN	1.8 kN	2.1 kN
Square grating Bar spacing $a = 22 \text{ mm}$	1.7 kN <sup>1)</sup>	1.7 kN <sup>1)</sup>	1.7 kN <sup>1)</sup>	1.7 kN <sup>1)</sup>	1.7 kN <sup>1)</sup>

	Recommended resistance $N_{rec}$ for X-FCM-M NG + S-BT-GF NG				
Base material thickness <sup>2)</sup>	$t_{II} \geq 5 \text{ mm [0.20" ]}$			$3 \text{ mm [0.12" ]} \leq t_{II} < 5 \text{ mm [0.20" ]}$	
Base material type	Steel S235 A36	Steel S355, S420 Grade 50	Aluminum $f_u \geq 270 \text{ MPa}$	Steel S235 A36	Steel S355, S420 Grade 50
Square grating Bar spacing $a = 18 \text{ mm}$	2.0 kN	2.4 kN	n.a.	1.9 kN	2.3 kN
Square grating Bar spacing $a = 22 \text{ mm}$	1.7 kN <sup>1)</sup>	1.7 kN <sup>1)</sup>	n.a.	1.7 kN <sup>1)</sup>	1.7 kN <sup>1)</sup>

<sup>1)</sup> Loading is limited by elastic limit of the X-FCM NG disk. Exceeding the load value can result in plastic deformation of the X-FCM NG disk.

<sup>2)</sup> For base material thickness  $3 \text{ mm [0.12" ]} \leq t_{II} < 6 \text{ mm [0.24" ]}$  rework of the coating on the back side of the plate/profile may be needed.

The recommended resistance under tension load  $N_{rec}$  for grating fastening system (X-FCM NG + S-BT) is determined as follows:

$$N_{rec} = \min \left\{ \begin{array}{l} N_{rec, X-FCM \text{ NG}} \\ N_{rec, S-BT} \end{array} \right.$$



Design resistance under tension load for grating fastening system

**Rectangular grating opening**

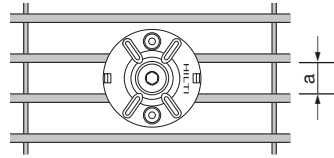

Design resistance $N_{Rd}$ for X-FCM-R NG + S-BT-GR NG					
Base material thickness <sup>2)</sup>	$t_{II} \geq 5 \text{ mm [0.20"]}$			$3 \text{ mm [0.12"]} \leq t_{II} < 5 \text{ mm [0.20"]}$	
Base material type	Steel S235 A36	Steel S355, S420 Grade 50	Aluminum $f_u \geq 270 \text{ MPa}$	Steel S235 A36	Steel S355, S420 Grade 50
Rectangular grating Bar spacing $a = 13 \text{ mm}$	2.7 kN	3.2 kN	2.7 kN	2.5 kN	3.0 kN
Rectangular grating Bar spacing $a = 18 \text{ mm}$	2.7 kN	3.2 kN	2.7 kN	2.5 kN	3.0 kN
Rectangular grating Bar spacing $a = 22 \text{ mm}$	2.7 kN	2.9 kN <sup>1)</sup>	2.7 kN	2.5 kN	3.0 kN

Design resistance $N_{Rd}$ for X-FCM-M NG + S-BT-GR NG					
Base material thickness <sup>2)</sup>	$t_{II} \geq 5 \text{ mm [0.20"]}$			$3 \text{ mm [0.12"]} \leq t_{II} < 5 \text{ mm [0.20"]}$	
Base material type	Steel S235 A36	Steel S355, S420 Grade 50	Aluminum $f_u \geq 270 \text{ MPa}$	Steel S235 A36	Steel S355, S420 Grade 50
Rectangular grating Bar spacing $a = 13 \text{ mm}$	2.7 kN	3.2 kN	2.7 kN	2.5 kN	3.0 kN
Rectangular grating Bar spacing $a = 18 \text{ mm}$	2.7 kN	2.9 kN <sup>1)</sup>	2.7 kN	2.5 kN	3.0 kN
Rectangular grating Bar spacing $a = 22 \text{ mm}$	1.7 kN	1.7 kN <sup>1)</sup>	1.7 kN <sup>1)</sup>	1.7 kN <sup>1)</sup>	1.7 kN <sup>1)</sup>

Design resistance $N_{Rd}$ for X-FCM-M NG + S-BT-GF NG					
Base material thickness <sup>2)</sup>	$t_{II} \geq 5 \text{ mm [0.20"]}$			$3 \text{ mm [0.12"]} \leq t_{II} < 5 \text{ mm [0.20"]}$	
Base material type	Steel S235 A36	Steel S355, S420 Grade 50	Aluminum $f_u \geq 270 \text{ MPa}$	Steel S235 A36	Steel S355, S420 Grade 50
Rectangular grating Bar spacing $a = 13 \text{ mm}$	2.8 kN	3.3 kN	n.a.	2.7 kN	3.2 kN
Rectangular grating Bar spacing $a = 18 \text{ mm}$	2.8 kN	2.9 kN <sup>1)</sup>	n.a.	2.7 kN	2.9 kN <sup>1)</sup>
Rectangular grating Bar spacing $a = 22 \text{ mm}$	1.7 kN <sup>1)</sup>	1.7 kN <sup>1)</sup>	n.a.	1.7 kN <sup>1)</sup>	1.7 kN <sup>1)</sup>

<sup>1)</sup> Loading is limited by elastic limit of the X-FCM NG disk. Exceeding the load value can result in plastic deformation of the X-FCM NG disk.

<sup>2)</sup> For base material thickness  $3 \text{ mm [0.12"]} \leq t_{II} < 6 \text{ mm [0.24"]}$  rework of the coating on the back side of the plate/profile may be needed.

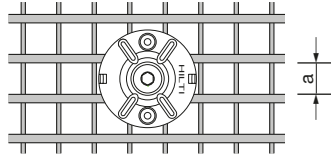
**Square grating opening**

Design resistance $N_{Rd}$ for X-FCM-R NG + S-BT-GR NG					
Base material thickness <sup>2)</sup>	$t_{II} \geq 5 \text{ mm [0.20" ]}$			$3 \text{ mm [0.12" ]} \leq t_{II} < 5 \text{ mm [0.20" ]}$	
Base material type	Steel S235 A36	Steel S355, S420 Grade 50	Aluminum $f_u \geq 270 \text{ MPa}$	Steel S235 A36	Steel S355, S420 Grade 50
Square grating Bar spacing $a = 18 \text{ mm}$	2.7 kN	3.2 kN	2.7 kN	2.5 kN	3.0 kN
Square grating Bar spacing $a = 22 \text{ mm}$	2.7 kN	3.2 kN	2.7 kN	2.5 kN	3.0 kN

Design resistance $N_{Rd}$ for X-FCM-M NG + S-BT-GR NG					
Base material thickness <sup>2)</sup>	$t_{II} \geq 5 \text{ mm [0.20" ]}$			$3 \text{ mm [0.12" ]} \leq t_{II} < 5 \text{ mm [0.20" ]}$	
Base material type	Steel S235 A36	Steel S355, S420 Grade 50	Aluminum $f_u \geq 270 \text{ MPa}$	Steel S235 A36	Steel S355, S420 Grade 50
Square grating Bar spacing $a = 18 \text{ mm}$	2.7 kN	3.2 kN	2.7 kN	2.5 kN	3.0 kN
Square grating Bar spacing $a = 22 \text{ mm}$	2.4 kN <sup>1)</sup>	2.4 kN <sup>1)</sup>	2.4 kN <sup>1)</sup>	2.4 kN <sup>1)</sup>	2.4 kN <sup>1)</sup>

Design resistance $N_{Rd}$ for X-FCM-M NG + S-BT-GF NG					
Base material thickness <sup>2)</sup>	$t_{II} \geq 5 \text{ mm [0.20" ]}$			$3 \text{ mm [0.12" ]} \leq t_{II} < 5 \text{ mm [0.20" ]}$	
Base material type	Steel S235 A36	Steel S355, S420 Grade 50	Aluminum $f_u \geq 270 \text{ MPa}$	Steel S235 A36	Steel S355, S420 Grade 50
Square grating Bar spacing $a = 18 \text{ mm}$	2.8 kN	3.3 kN	n.a.	2.7 kN	3.2 kN
Square grating Bar spacing $a = 22 \text{ mm}$	2.4 kN <sup>1)</sup>	2.4 kN <sup>1)</sup>	n.a.	2.4 kN <sup>1)</sup>	2.4 kN <sup>1)</sup>

1) Loading is limited by elastic limit of the X-FCM NG disk. Exceeding the load value can result in plastic deformation of the X-FCM NG disk.

2) For base material thickness  $3 \text{ mm [0.12" ]} \leq t_{II} < 6 \text{ mm [0.24" ]}$  rework of the coating on the back side of the plate/profile may be needed.

The design resistance under tension load  $N_{Rd}$  for grating fastening system (X-FCM NG + S-BT) is determined as follows

$$N_{Rd} = \min \left\{ \begin{array}{l} N_{Rd, X-FCM \text{ NG}} \\ N_{Rd, S-BT} \end{array} \right.$$

Note:

- X-FCM NG resist shear by friction and are not suitable for explicit shear load designs, e.g. diaphragms. Depending on surface characteristics, shear loads of up to about 0.3 kN will not result in permanent deformation. Therefore, small unexpected shear loads can generally be accommodated without damage.
- The fasteners are not to be used in wave zones due to the high load impact. For applications in wave zones please contact Hilti.

Conditions for recommended load and design load:

- Global safety factor  $\Omega$  resp. partial safety factor  $\gamma_m$  (based on 5% fractile ultimate test value):  
Recommended load:  $\Omega = 2.80$   
Design load:  $\gamma_m = 2.00$
- Effect of base metal vibration and stress (e.g. areas with tensile stress) considered.
- Redundancy (multiple fastening) must be provided.

**Application requirement****Base material**

All requirements for the base material (type, strength, thickness, spacing and edge distances, application limits, etc.) are given in the Product Data Sheet (PDS) of the S-BT fastener.

**Thickness of fastened material**

Grating height: 28–53 mm with standard X-FCM-M NG/X-FCM-R NG. For other dimensions please contact Hilti.

### Corrosion information

The coating of the X-FCM-M NG carbon steel grating fasteners consists of an electroplated Zn-alloy for cathodic protection and a top coat for chemical resistance (duplex-coating). The intended use of this coating is limited to the corrosion category C1, C2 and C3 according to the standard EN ISO 9223 (indoors, mildly corrosive environment). The carbon steel grating fasteners are to be used for fastening gratings made of coated or galvanized carbon steel or gratings made of reinforced fibreglass.

Note:

The fasteners are not for use in marine atmospheres or in heavily polluted environments.

The X-FCM-R NG stainless steel grating fasteners are made from the stainless-steel type 1.4404, which is equivalent to AISI 316L (A4) steel grade. This grade of stainless steel is classified in the corrosion resistance class III according to DIN EN 1993-1-4:2015, which makes the material suitable for aggressive environments like in marine, offshore, petrochemical, caloric (coal, oil) power plants, etc. applications.

The stainless-steel grating fasteners are to be used for fastening gratings made of stainless steel or gratings made of reinforced fibreglass.

Note:

The fasteners are not for use in automobile tunnels, swimming pools or similar environments.

**Fastener selection and system recommendation**
**Fastener program**

X-FCM NG grating fastener	Grating height	Tool	S-BT threaded studs
X-FCM-M NG 28/33	28–33 mm	SBT 4-A22	S-BT-GF NG M8/7 AN 6 S-BT-GR NG M8/7 SN 6
X-FCM-M NG 32/37	32–37 mm	SBT 4-A22	S-BT-GF NG M8/7 AN 6 S-BT-GR NG M8/7 SN 6
X-FCM-M NG 38/43	38–43 mm	SBT 4-A22	S-BT-GF NG M8/7 AN 6 S-BT-GR NG M8/7 SN 6
X-FCM-M NG 48/53	48–53 mm	SBT 4-A22	S-BT-GF NG M8/7 AN 6 S-BT-GR NG M8/7 SN 6
X-FCM-R NG 28/33	28–33 mm	SBT 4-A22	S-BT-GR NG M8/7 SN 6
X-FCM-R NG 32/37	32–37 mm	SBT 4-A22	S-BT-GR NG M8/7 SN 6
X-FCM-R NG 38/43	38–43 mm	SBT 4-A22	S-BT-GR NG M8/7 SN 6
X-FCM-R NG 48/53	48–53 mm	SBT 4-A22	S-BT-GR NG M8/7 SN 6

**Fastening quality assurance**
**Tighten the disc**
Tightening torque:
 $T_{rec} = 5 \text{ Nm}$  for X-FCM-M NG

 $T_{rec} = 8 \text{ Nm}$  for X-FCM-R NG

	$T_{rec}$	
	5 Nm	8 Nm
Hilti screwdriver*	Torque setting	
SBT 4-A22	5	7

Tightening tool:

- Torque wrench
- Torque tool S-BT ¼" – 5 Nm
- Torque tool X-BT ¼" – 8 Nm
- Screwdriver with torque release coupling (TRC)\*
- 5 mm Allen-type bit

\* The setting of the torque via the Hilti screwdriver SBT 4-A22 with torque release coupling (TRC) can change as the clutch wears over time. The specified torque setting is only a rough guide value and applies to a new Hilti screwdriver SBT 4-A22. Hilti recommends using a calibrated torque wrench or the Hilti Torque tool S-BT ¼" – 5 Nm or X-BT ¼" – 8 Nm to apply the recommended torque.

**System program**

Designation	Item no.	Product name	Comment
X-FCM-M NG 28/33	2279753	Grating Fastener	Carbon steel
X-FCM-M NG 32/37	2279754	Grating Fastener	Carbon steel
X-FCM-M NG 38/43	2279755	Grating Fastener	Carbon steel
X-FCM-M NG 48/53	2279756	Grating Fastener	Carbon steel
X-FCM-R NG 28/33	2279757	Grating Fastener	Stainless steel
X-FCM-R NG 32/37	2279758	Grating Fastener	Stainless steel
X-FCM-R NG 38/43	2279759	Grating Fastener	Stainless steel
X-FCM-R NG 48/53	2279752	Grating Fastener	Stainless steel
S-BT-GF NG M8/7 AN 6	2302143	Threaded stud	Carbon steel use with X-FCM-M NG grating disc grating
S-BT-GR NG M8/7 SN 6	2302142	Threaded stud	Stainless steel use with X-FCM-R NG grating disc or with X-FCM-M NG grating disc
TS-BT 5.5-110 S	2201685	Stepped drill bit	For use in combination with the S-CS NG centering spacer
S-CS NG	2310191	Centering Spacer	For perpendicular pilot hole drilling and precise location of studs
S-DG BT M8/7 Short 6	2279735	Depth gauge	For exact setting of the S-BT
S-BT ¼" – 5 Nm	2143271	Torque tool	Manual torque tool (5 Nm)
X-BT ¼" – 8 Nm	2119272	Torque tool	Manual torque tool (8 Nm)
5 mm Allen-type bit			

# X-FCI-M Grating fastening system

## Product data

### Dimensions

X-FCI-M and X-FCI-M L X-FCI-M C

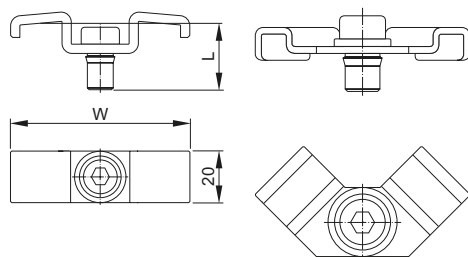

### General information

#### Dimension

See main section Fastener selection and system recommendation for dimension W and L.

#### Material specifications

See section Material specifications and coatings in the next pages for more details.

#### Recommended fastening tools

See section Fastener selection and system recommendation in the next pages and Tools and Equipment chapter for more details.

X-ST-GR M8/10 P8

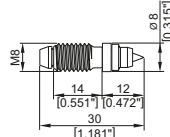

X-BT M8-15-6 SN12-R

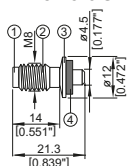

X-BT-GR M8/7 SN 8

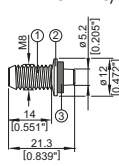

S-BT-GF M8/7 AN 6

S-BT-GR M8/7 SN 6

S-BT-GR M8/7 SN 6 AL

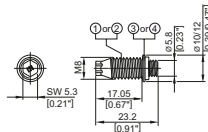

## Application

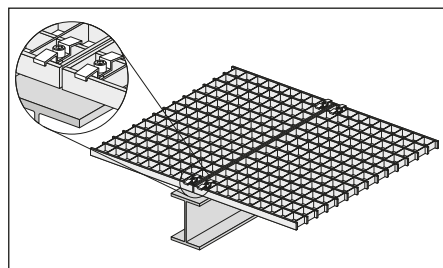

For fastenings exposed to weather and mildly corrosive conditions.

**Not for use in marine atmospheres (upstream)!**

## Load data

### Recommended tensile loads $N_{rec}$ [kN]

$N_{rec} = 0.8 \text{ kN (180 lb)}$

### Notes/Conditions:

- Tensile loading is limited by plastic deformation of the saddle clip
- X-FCI-M resists shear by friction and is not suitable for explicit shear load design

## Application requirements

### Thickness of base material

X-BT M8-15-6  
SN12-R

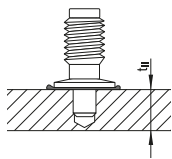

$t_{II} \geq 8 \text{ mm}$

X-BT-GR M8/7  
SN 8

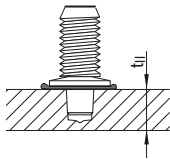

$t_{II} \geq 8 \text{ mm}$

S-BT-GF M8/7 AN 6  
S-BT-GR M8/7 SN 6  
S-BT-GR M8/7 SN 6 AL\*)

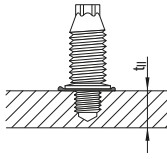

$t_{II} \geq 6 \text{ mm}$   
pilot hole

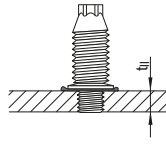

steel:  $3 \text{ mm} \leq t_{II} < 6 \text{ mm}$ , aluminum:  
 $5 \text{ mm} \leq t_{II} < 6 \text{ mm}$   
drill through hole

X-ST-GR

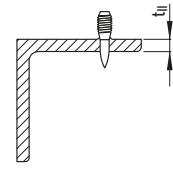

$t_{II} \geq 6 \text{ mm}$

\*) for use in aluminum base material

### Thickness of fastened material

Grating height: X-FCI-M:

HG = 28-52 mm (1.10" – 2.05"), other dimensions for X-FCI-M are available on demand.

See **Fastener selection** for detailed dimensions

### Spacing and edge distances

#### X-ST-GR

Edge distances:  $c \geq 15 \text{ mm}$

Spacing:  $s \geq 15 \text{ mm}$

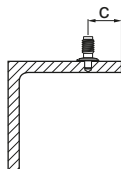

#### X-BT, X-BT-GR, S-BT

Edge distance:  $c \geq 6 \text{ mm}$

Spacing:  $s \geq 15 \text{ mm}$

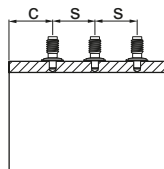



### Corrosion information

X-FCI-M is used to weather and mildly corrosive conditions, not suitable for coastal and offshore applications.

X-BT, X-BT-GR and S-BT-GR stainless steel fasteners is suitable for coastal and offshore environment. However, they can only be used for weather and mildly corrosive conditions once combining with X-FCI-M.

The coating of the carbon steel S-BT fasteners consists of an electroplated Zn-alloy for cathodic protection and a top coat for chemical resistance (Duplex-coating). The thickness of the coating is 35 µm. The use of this coating is limited to the corrosion category C1, C2 and C3 according to the standard EN ISO 9223. For higher corrosion categories stainless steel fasteners should be used. In case of a drill through hole, rework of the coating on the back side of the plate/profile may be needed.

The intended use of the X-ST-GR fasteners comprises fastenings exposed to outdoor environments in mildly corrosive conditions where HDG coated parts are commonly specified or used. Not for use in atmospheres with chlorides (marine atmospheres) or in heavily polluted environments (e.g. sulphur dioxide).

**Application limits**

**X-ST-GR:**

DX 460, DX 5

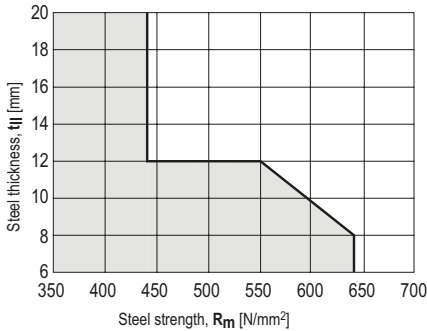

DX 76 PTR

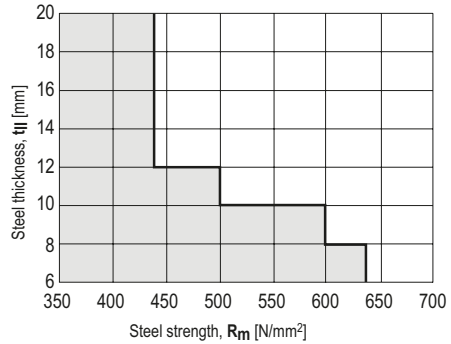

**X-BT and X-BT-GR:**

**No application limits**

→ using in high strength steel ( $f_u$  up to 1000 MPa)

**No through penetration**

→  $t_{II} \geq 8 \text{ mm}$  [<sup>5/16"</sup>]

**S-BT:**

The base material is limited to steel grade with a maximum tensile strength  $f_u = 630 \text{ MPa}$  (91 ksi). The minimum tensile strength of steel is  $f_u \geq 340 \text{ MPa}$  (49 ksi). The minimum tensile strength of aluminum is  $f_u \geq 270 \text{ MPa}$  (39 ksi). Minimum thickness of base material  $t_{II}$ : refer to section "Thickness of base material" Maximum thickness of base material  $t_{II}$ : no limits

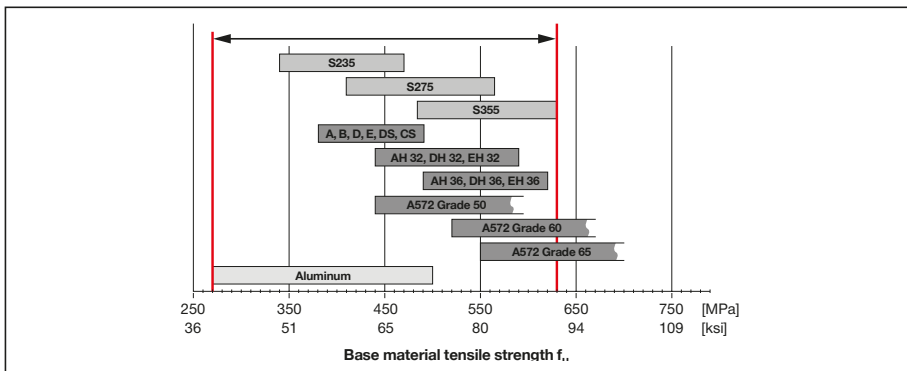

### Fastener selection

Fastener	Item no.	W	L	Grating width	Grating height
		mm (inch)	mm (inch)	a mm (inch)	H <sub>G</sub> mm (inch)
X-FCI-M 28/32	2223485	40 (1.58")	22.5 (0.89")	23-38 (0.91"-1.50")	28-32 (1.10"-1.26")
X-FCI-M 33/37	2223486	40 (1.58")	27.5 (1.08")	23-38 (0.91"-1.50")	33-37 (1.30"-1.46")
X-FCI-M 38/42	2223487	40 (1.58")	32.5 (1.30")	23-38 (0.91"-1.50")	38-42 (1.50"-1.65")
X-FCI-M 43/47	2223488	40 (1.58")	37.5 (1.48")	23-38 (0.91"-1.50")	43-47 (1.69"-1.85")
X-FCI-M 48/52	2223489	40 (1.58")	42.5 (1.67")	23-38 (0.91"-1.50")	48-52 (1.89"-2.05")
X-FCI-M 28/32 L	2223661	67 (2.64")	21 (0.83")	35-65 (1.38"-2.56")	28-32 (1.10"-1.26")
X-FCI-M 33/37 L	2223662	67 (2.64")	26 (1.02")	35-65 (1.38"-2.56")	33-37 (1.30"-1.46")
X-FCI-M 38/42 L	2223663	67 (2.64")	31 (1.22")	35-65 (1.38"-2.56")	38-42 (1.50"-1.65")
X-FCI-M 43/47 L	2223664	67 (2.64")	36 (1.42")	35-65 (1.38"-2.56")	43-47 (1.69"-1.85")
X-FCI-M 48/52 L	2223665	67 (2.64")	41 (1.61")	35-65 (1.38"-2.56")	48-52 (1.89"-2.05")
X-FCI-M 28/32 C	2223667	32 (1.26")	21 (0.83")	30 + (1.18" +)	28-32 (1.10"-1.26")
X-FCI-M 33/37 C	2223668	32 (1.26")	26 (1.02")	30 + (1.18" +)	33-37 (1.30"-1.46")
X-FCI-M 38/42 C	2223669	32 (1.26")	31 (1.22")	30 + (1.18" +)	38-42 (1.50"-1.65")
X-FCI-M 43/47 C	2223670	32 (1.26")	36 (1.42")	30 + (1.18" +)	43-47 (1.69"-1.85")
X-FCI-M 48/52 C	2223671	32 (1.26")	41 (1.61")	30 + (1.18" +)	48-52 (1.89"-2.05")

Grating width of X-FCI-M \_/\_ (L)

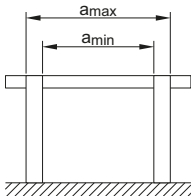

Grating height

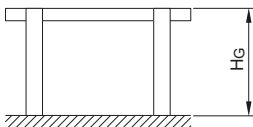

Grating width of X-FCI-M \_/\_ C

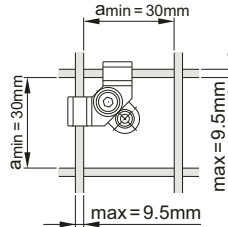

Threaded studs	Item no.
X-ST-GR M8/10 P8	2122460
X-BT M8-15-6 SN12-R	377074
X-BT-GR M8/7 SN 8	2194344
S-BT-GF M8/7 AN 6	2140527
S-BT-GR M8/7 SN 6	2140529
S-BT-GR M8/7 SN 6 AL	2140742

### Cartridge selection and tool energy setting

- X-BT, X-BT-GR:** 6.8/11M high precision brown cartridges  
**X-ST-GR:** 6.8/11M black or red cartridges with DX 460, DX 5  
 6.8/18M yellow or red cartridges with DX 76 PTR

Tool energy adjustment by setting tests on site.

### Material specifications and coatings

Fastener X-FCI-M	Saddle	Threaded stem	Washer <sup>1)</sup>
Material designation	DC0136	11SMNPB30+C	Stainless Steel 316
Coating	Duplex*	Duplex*	-

<sup>1)</sup> Metal washer only mounted on X-FCI-M L and X-FCI-M C items

\*) comparable to 45 µm HDG steel (480 h Salt spray test per DIN 50021)

### Threaded studs

	X-BT M8-15-6 SN12-R			X-ST-GR	
	Shank ①	Threaded sleeve ② SN12-R washer ③	Sealing ring of sealing washer <sup>1)</sup> ④	Shank	Threaded sleeve
Material designation	Stainless steel 1.4462, CR 500 (A4 / AISI316)	X2CrNiMo17132 X5CrNiMo17122+2H (A4 / AISI316)	Elastomer, black	P558 (CrMnMo alloy)	(A4 / AISI316)
Coating	none	none		none	none

<sup>1)</sup> resistant to: UV, saltwater ozone, oil, grease

<sup>2)</sup> Zinc applied by electroplating. Intended for corrosion protection during shipment, storage, construction and service in protected environment. It is not adequate for protection against corrosion in outside or otherwise corrosive applications

### Threaded studs

	S-BT_R, X-BT-GR			S-BT_F		
	Threaded Shank ①	SN 12-R washer ③	Sealing ring of sealing washer <sup>1)</sup> ③	Threaded Shank ②	AN 10-F washer ④	Sealing ring of sealing washer <sup>1)</sup> ④
Material designation	Stainless steel 1.4462 (A4 / AISI316)	Stainless steel 1.4404 (A4 / AISI316)	Elastomer, black	Carbon steel 1038	Aluminum	Elastomer, black
Coating	Zinc <sup>2)</sup>	none	none	Duplex-coating	none	HDG

<sup>1)</sup> resistant to: UV, salt water, ozone, oil, grease

<sup>2)</sup> The surface of the S-BT stainless steel fasteners is zinc plated (anti-friction coating) in order to reduce the thread forming torque when the stud is screwed in into the base material.

<sup>3)</sup> only S-BT is coated, X-BT-GR is uncoated

thread forming torque when the stud is screwed in into the base material.

### Fastening quality assurance

#### Fastening inspection

X-BT M8-15-6 SN12-R

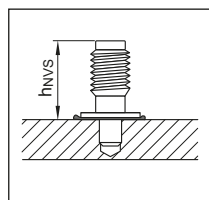

$h_{NVS} = 15.7 - 16.8 \text{ mm}$

X-BT-GR M8/7 SN 8

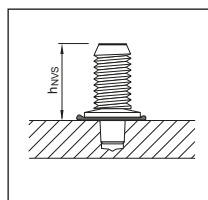

$h_{NVS} = 15.7 - 16.8 \text{ mm}$

X-ST-GR M8/10 P8

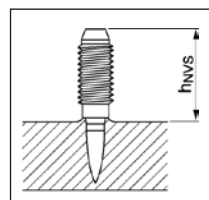

$h_{NVS} = 17.0 - 20.0 \text{ mm}$

S-BT-\_\_\_\_/7\_\_\_\_6

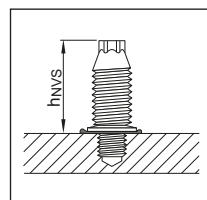

$h_{NVS} = 18.6 - 19.1 \text{ mm}$

## Fastening quality assurance

Tighten the screw

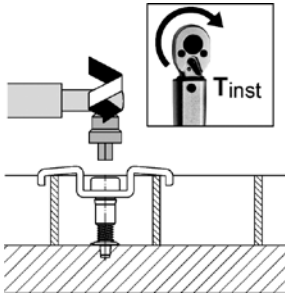

### X-FCI-M and X-FCI-M L

$T_{rec} = 4-5 \text{ Nm}$   
(3.0-3.7 ft-lb)

Tightening tool:

- Screwdriver with torque release coupling (TRC)
- 5 mm Allen-type bit

Hilti screwdriver	Gear	Torque setting
<b>SF 14</b>	2	5-6
<b>SF 8M-A22</b>	3	5
<b>SF 10W-A22</b>	4	4-5

### X-FCI-M C

$T_{rec} = 6-8 \text{ Nm}$   
(4.4-5.9 ft-lb)

Tightening tool:

- Screwdriver with torque release coupling (TRC)
- 5 mm Allen-type bit

Hilti screwdriver	Gear	Torque setting
<b>SF 14</b>	1	7
<b>SF 8M-A22</b>	3	7
<b>SF 10W-A22</b>	4	6

# X-GR Grating fastening system

## Product data

### Dimensions

X-GR an X-GR-L

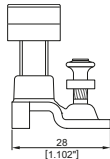
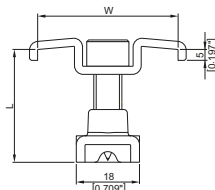

X-GR C

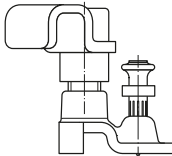

X-R 20-4.0 Zn P8

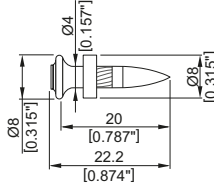

### General information

#### Material specifications

Screw:

Carbon steel

Zinc coating: Duplex\* coated

Nail:

Stainless steel: CrMnMo Alloy and zinc coated

Upper part:

Carbon steel: DD11 or DC01

Zinc coating: Duplex\* coated

Bottom part:

Carbon steel: S315MC or DC04

Zinc coating: Duplex\* coated

\*) 480 h salt spray test per DIN 50021 and 10 cycles  
Kesternich test per DIN 50018/2.0 (comparable to 45 µm HDG steel)

#### Recommended fastening tools

**DX 460 GR** and **DX 5 GR** with  
**X-5-460-F8GR** fastener guide

See **X-GR fastener program** in the next pages and **Tools and equipment** chapter for more details.

See Fastener selection for detailed dimensions

## Application

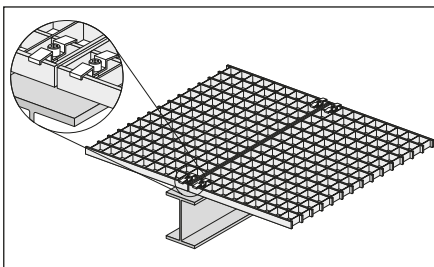

Fastening of grating

For fastenings exposed to weather and mildly corrosive conditions.

**Not for use in marine atmospheres (upstream)!**

## Load data

### Recommended tensile loads $N_{rec}$ [kN]

$N_{rec} = 0.8 \text{ kN (180 lb)}$

### Notes/Conditions:

- Tensile loading is limited by plastic deformation of the saddle clip
- X-GR resists shear by friction and is not suitable for explicit shear load designs
- For X-GR C: In case of dynamic load  $N_{rec} = 0.6 \text{ kN (135 lb)}$

## Application requirements

### Thickness of base material

$t_{II} \geq 4 \text{ mm (0.157"')}$

### Thickness of fastened material

Grating  $H_G = 23\text{-}52 \text{ mm (0.91" - 2.05"')}$

height: Standard X-GR (X-GR 25/30, X-GR 1 1/4", X-GR 35/40):

See Fastener selection for detailed dimensions

Specials X-GR (X-GR 33/37, X-GR 43/47, X-GR 48/52, X-GR \_/\_ L and X-GR \_/\_ C):

Other dimensions special X-GR are available on demand

## Grating opening types

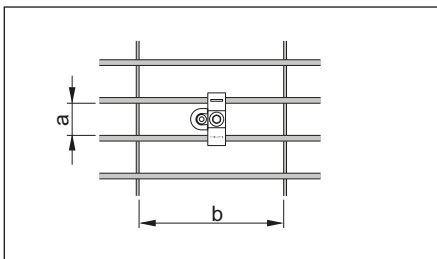

$a$  : see Fastener selection

$b \geq 30 \text{ mm (1.18"')}$

## Edge distances

$c \geq 15 \text{ mm (0.59"')}$

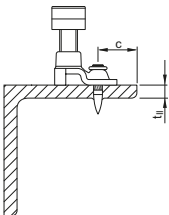

## Corrosion information

For fastenings exposed to weather and mildly corrosive conditions. **Not for use in marine atmospheres (upstream)** or in heavily polluted environments.



## Application limits

### X-GR with DX 460, DX 5

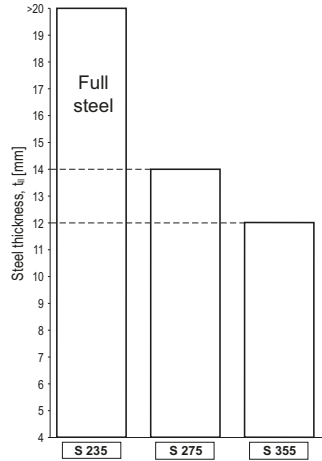
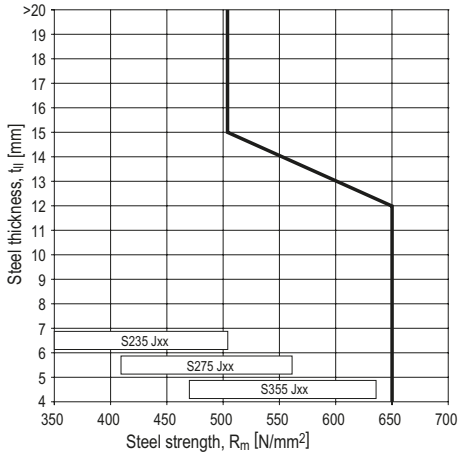

- S235: No application limit
- S275: Full coverage of grade up to 14mm base material thickness
- S355: Full coverage of grade up to 12mm base material thickness

### Fastener selection

Fastener	Item no.	W mm (inch)	L mm (inch)	Grating width a mm (inch)	Grating height H <sub>G</sub> mm (inch)
X-GR 25/30	2106415 or 2154241	40 (1.58")	32 (1.26")	23-38 (0.91"-1.50")	25-30 (0.98"-1.18")
X-GR 1 1/4"	2106416 or 2154243	40 (1.58")	34 (1.34")	23-38 (0.91"-1.50")	27-32 (1.06"-1.26")
X-GR 35/40	2106417 or 2154242	40 (1.58")	42 (1.65")	23-38 (0.91"-1.50")	35-40 (1.38"-1.57")
X-GR 33/37	2222597	40 (1.58")	32 (1.26")	23-38 (0.91"-1.50")	33-37 (1.30"-1.46")
X-GR 43/47	2222598	40 (1.58")	42 (1.65")	23-38 (0.91"-1.50")	43-47 (1.69"-1.85")
X-GR 48/52	2222599	40 (1.58")	47 (1.85")	23-38 (0.91"-1.50")	48-52 (1.89"-2.05")
X-GR 23/27 L	2222640	65 (2.56")	32 (1.26")	35-65 (1.38"-2.56")	23-27 (0.91"-1.06")
X-GR 28/32 L	2222641	65 (2.56")	37 (1.46")	35-65 (1.38"-2.56")	28-32 (1.10"-1.26")
X-GR 33/37 L	2222642	65 (2.56")	42 (1.65")	35-65 (1.38"-2.56")	33-37 (1.30"-1.46")
X-GR 38/42 L	2222643	65 (2.56")	47 (1.85")	35-65 (1.38"-2.56")	38-42 (1.50"-1.65")
X-GR 43/47 L	2222644	65 (2.56")	52 (2.05")	35-65 (1.38"-2.56")	43-47 (1.69"-1.85")
X-GR 48/52 L	2222645	65 (2.56")	57 (2.24")	35-65 (1.38"-2.56")	48-52 (1.89"-2.05")
X-GR 23/27 C	2222646	32 (1.26")	32 (1.26")	30 + (1.18" +)	23-27 (0.91"-1.06")
X-GR 28/32 C	2222647	32 (1.26")	37 (1.46")	30 + (1.18" +)	28-32 (1.10"-1.26")
X-GR 33/37 C	2222648	32 (1.26")	42 (1.65")	30 + (1.18" +)	33-37 (1.30"-1.46")
X-GR 38/42 C	2222649	32 (1.26")	47 (1.85")	30 + (1.18" +)	38-42 (1.50"-1.65")
X-GR 43/47 C	2222650	32 (1.26")	52 (2.05")	30 + (1.18" +)	43-47 (1.69"-1.85")
X-GR 48/52 C	2222651	32 (1.26")	57 (2.24")	30 + (1.18" +)	48-52 (1.89"-2.05")

Grating width of X-GR \_/\_ and X-GR \_/\_ L

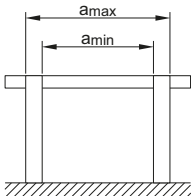

Grating height

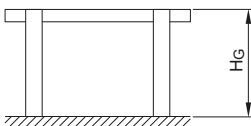

Grating width of X-GR \_/\_ C

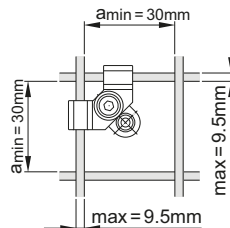

## Cartridge selection and tool energy setting

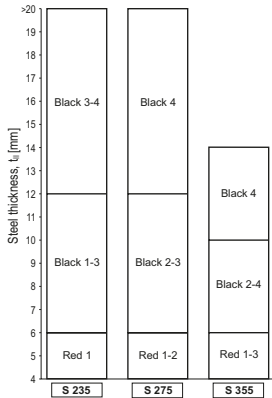

**DX 460, DX 5 with 6.8/11M cartridges**

## Fastening quality assurance

### Standard X-GR (X-GR 25/30, X-GR 1 ¼", X-GR 35/40):

Tighten the screw

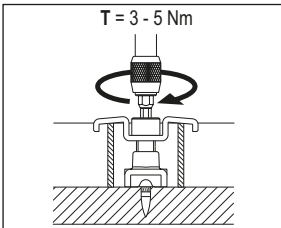

$T_{rec} = 3 - 5 \text{ Nm}$   
(4.4 - 5.9 ft-lb)

Tightening tool:

- Screwdriver with torque release coupling (TRC)
- 6 mm Allen-type bit

Hilti screwdriver	Gear	Torque setting
SF 14-A	3	5
SFC 14-A	2	6-7
SF 8M-22	4	4-6
SF 10W-22	4	4-5

### Special X-GR (X-GR 33/37, X-GR 43/47, X-GR 48/52, X-GR \_/\_ L and X-GR \_/\_ C):

Tighten the screw

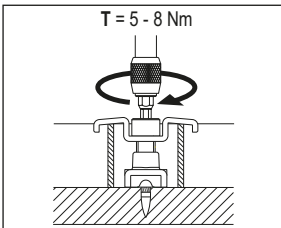

$T_{rec} = 5 - 8 \text{ Nm}$   
(3.7 - 5.9 ft-lb)

Tightening tool:

- Screwdriver with torque release coupling (TRC)
- 6 mm Allen-type bit

X-GR 33/37, X-GR 43/47, X-GR 48/52, X-GR _/_ L:		
Hilti screwdriver	Gear	Torque setting
SF 14-A	1	5-6
SF 8M-22	3	3-5
SF 10W-22	3	3-5

X-GR _/_ C:		
Hilti screwdriver	Gear	Torque setting
SF 14-A	1	3-5
SF 8M-22	4	3-5
SF 10W-22	4	3-5

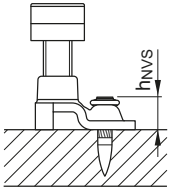
**Fastening inspection**

$$h_{NVS} = 7 - 10.5 \text{ mm } (0.28\text{v}'' - 0.41\text{v}'')$$

Observing the cartridge selection and tool energy setting typically leads to a stand-off between 9 and 10 mm.

## X-FCS-R Grating element

### X-FCS-R Grating element designation

<b>X</b>	<b>-</b>	<b>FCS</b>	<b>-</b>	<b>R</b>	<b>3</b>	<b>25</b>
Technology		Application		Material	Number of saddles	Bar spacing

#### Technology:

X | DX solution

#### Application:

FCS | Grating element

#### Material:

R | Stainless steel

#### Number of saddles:

3 | Three fastening saddles  
 4 | Four fastening saddles

#### Bar spacing:

25 | Bar spacing

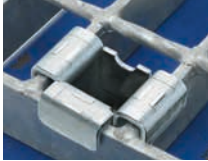
**Product data**
**X-FCS-R-3-25**

**X-FCS-R-4-25**

**Product description**

- Grating fastening system is an approved system for securing gratings under tension and shear load
- Grating element is available with three saddles for rectangular gratings and four saddles for square gratings
- Grating element X-FCS-R can be combined with various fasteners

**Grating fastening system**

Grating element	Fastener		
	X-BT M8-15-6 SN 12 R	X-BT-GR M8/7 SN 8	S-BT-GR M8/7 SN 6
X-FCS-R-3-25	●	●	●
X-FCS-R-4-25	●	●	●

**Material specification and material properties**
**Material specification and material properties for stainless steel parts**

Grating fastening system	Material	Coating	Steel grade		Corrosion resistance	
			acc. to EN 10088	acc. to ASTM AISI SAE		
X-FCS-R-3-25	Saddle	Stainless steel	none	1.4404	316 L	CRC III
X-FCS-R-3-25	Threaded nut	Stainless steel	none	1.4401	316	CRC III
X-FCS-R-4-25	Saddle	Stainless steel	none	1.4404	316 L	CRC III
X-FCS-R-4-25	Threaded nut	Stainless steel	none	1.4401	316	CRC III

### Grating fastening system recommendation under various environmental conditions

Environmental condition		Grating fastening system		
		X-FCS-R combined with X-BT M8-15-6 SN 12 R	X-FCS-R combined with X-BT-GR M8/7 SN8	X-FCS-R combined with S-BT-GR M8/7 SN6
	Dry indoor	■	■	■
	Indoor with temporary condensation	■	■	■
	Outdoor with low pollution	■	■	■
	Outdoor with moderate concentration of pollutants	■	■	■
	Coastal areas	■	■	■
	Outdoor, areas with heavy industrial pollution	■	■	■
	Close proximity to roads	■	■	■
	Special application	Please contact our Expert Hilti Engineers to support recommendation		
	Special application			

■ = Suitable for corrosion prevention

■ = Feasible for corrosion prevention

Further information can be found in following Hilti brochures:

- X-BT Threaded Fastener Specification
- New Generation X-BT-GR, X-BT-MR and X-BT-ER Threaded Fastener Specification
- S-BT Threaded Fastener Specification
- Corrosion handbook

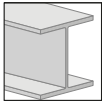
**Base material**

Steel

**Load condition**



Static/quasi static

**Approval/certificate**

Authority	American Bureau of Shipping	Bureau Veritas	Det Norske Veritas Germanischer Lloyd	Lloyd's Register	RINA

**i** Information presented in this product data sheet is based on Hilti Technical Data. For the specific application please refer to the corresponding approval/certificate.

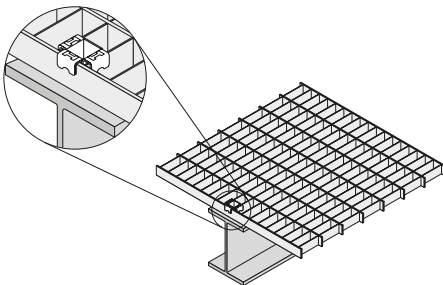
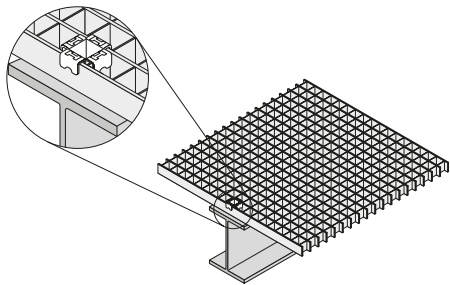
**i** Approvals/certificates available for following grating fastening systems:  
 X-FCS-R-3-25 (Saddles connected to bearing bar: 3)  
 X-FCS-R-4-25 (Saddles connected to bearing bar: 4)

**Application**
**Securing rectangular grating**

**Securing square grating**



## Grating element

### Grating element definition

X-FCS-R-3-25

X-FCS-R-4-25

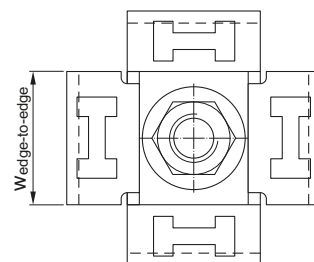
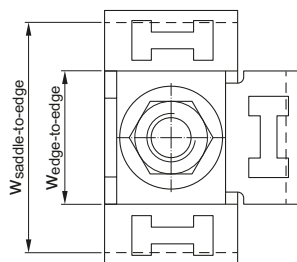
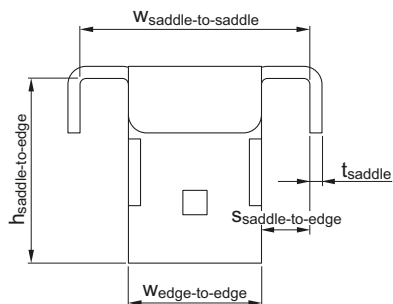
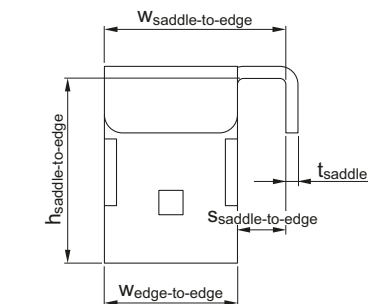

$W_{\text{saddle-to-edge}}$  = Width between saddle and edge

$W_{\text{saddle-to-saddle}}$  = Width between saddles

$W_{\text{edge-to-edge}}$  = Grating element width

$S_{\text{saddle-to-edge}}$  = Spacing between saddle and grating edge

$t_{\text{saddle}}$  = Saddle thickness

$h_{\text{saddle-to-edge}}$  = Grating element height

### Grating element definition

Grating element	Saddle width	Grating element width	Spacing between saddle and grating element	Saddle thickness	Grating element height
	$W_{\text{saddle-to-edge}}$ $W_{\text{saddle-to-saddle}}$	$W_{\text{edge-to-edge}}$	$S_{\text{saddle-to-saddle}}$	$t_{\text{saddle}}$	$h_{\text{saddle-to-edge}}$
X-FCS-R-3-25 31/35	30 mm	22 mm	8 mm	2 mm	30.5 mm
X-FCS-R-3-25 37/41	30 mm	22 mm	8 mm	2 mm	36.5 mm
X-FCS-R-4-25 31/35	38 mm	22 mm	8 mm	2 mm	30.5 mm
X-FCS-R-4-25 37/41	38 mm	22 mm	8 mm	2 mm	36.5 mm

## Grating fastening

Grating element for  
rectangular grating fastening

X-FCS-R-3-25 31/35  
X-FCS-R-3-25 37/41

3 saddles  
connected to bearing bar

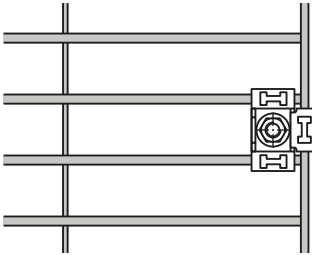

Grating element for  
square grating fastening

X-FCS-R-4-25 31/35  
X-FCS-R-4-25 37/41

4 saddles  
connected to bearing bar

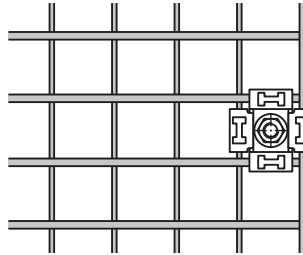

## Grating definition

Example: Fastening with X-BT

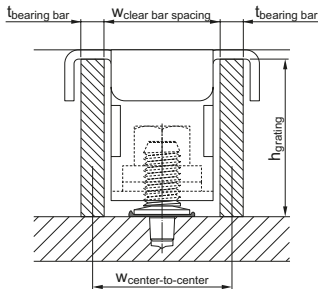

$t_{\text{bearing bar}}$  Bearing bar thickness  
 $W_{\text{clear bar spacing}}$  Clear bar spacing  
 $W_{\text{center-to-center}}$  Center-to-center bar spacing  
 $h_{\text{grating}}$  Grating height

## Grating dimension

Grating element	Bearing bar thickness	Clear bar spacing	Center-to-center bar spacing	Minimum grating height	Maximum grating height
	$t_{\text{bearing bar}}$	$W_{\text{bearing bar}}$	$W_{\text{center-to-center}}$	$h_{\text{grating, min}}$	$h_{\text{grating, max}}$
X-FCS-R-3-25 31/35	5 mm	25 mm	30 mm	31 mm	35 mm
X-FCS-R-3-25 37/41	5 mm	25 mm	30 mm	37 mm	41 mm
X-FCS-R-4-25 31/35	5 mm	25 mm	30 mm	31 mm	35 mm
X-FCS-R-4-25 37/41	5 mm	25 mm	30 mm	37 mm	41 mm

### Load data

#### Design concept for single fastening points under tension and shear load

Recommended resistance under tension load	Design resistance under tension load
$N_{rec} = \min \{N_{rec, \text{grating element}}; N_{rec, \text{fastener}}\}$	$N_{Rd} = \min \{N_{Rd, \text{grating element}}; N_{Rd, \text{fastener}}\}$
Recommended resistance under shear load	Design resistance under shear load
$V_{rec} = \min \{V_{rec, \text{grating element}}; V_{rec, \text{fastener}}\}$	$V_{Rd} = \min \{V_{Rd, \text{grating element}}; V_{Rd, \text{fastener}}\}$

#### Design concept for load interaction

Recommended resistance under combined load	Design resistance under combined load
$\frac{N}{N_{rec}} + \frac{V}{V_{rec}} \leq 1.2$	$\frac{N_{Sd}}{N_{Rd}} + \frac{V_{Sd}}{V_{Rd}} \leq 1.2$

$N_{rec}$  = Recommended resistance under tension load for grating fastening system

$N_{rec, \text{grating element}}$  = Recommended resistance under tension load for grating element

$N_{rec, \text{fastener}}$  = Recommended resistance under tension load for fastener

$V_{rec}$  = Recommended resistance under shear load for grating fastening system

$V_{rec, \text{grating element}}$  = Recommended resistance under shear load for grating element

$V_{rec, \text{fastener}}$  = Recommended resistance under shear load for fastener

$N_{Sd}$  = Design tension load

$N_{Rd}$  = Design resistance under tension load for grating fastening system

$N_{Rd, \text{grating element}}$  = Design resistance under tension load for grating element

$N_{Rd, \text{fastener}}$  = Design resistance under tension load for fastener

$V_{Sd}$  = Design shear load

$V_{Rd}$  = Design resistance under shear load for grating fastening system

$V_{Rd, \text{grating element}}$  = Design resistance under shear load for grating element

$V_{Rd, \text{fastener}}$  = Design resistance under shear load for fastener

Shear load direction definition for single fastening points

Grating element	Saddles connected to bearing bar	Shear load direction		
		Load direction a	Load direction b	Load direction c
X-FCS-R-3-25	3			
X-FCS-R-3-25	2		Not admissible	
			Not admissible	
				Contact connection of 2 saddles to the bearing bar is required
X-FCS-R-4-25	4			

**Recommended resistance under tension and shear load for single fastening points**

Grating element	Saddles connected to bearing bars	Base material (EN 10025-2)	Base material (ASTM AISI SAE)	Resistance under tension and shear load	Base material thickness		
					$t_{fl} \geq 8 \text{ mm}$	$t_{fl} \geq 8 \text{ mm}$	$t_{fl} \geq 6 \text{ mm}$
					X-BT M8-15-6 SN 12-R	X-BT-GR M8/7 SN 8	S-BT-GR M8/7 SN 6
X-FCS-R-3-25	3	S235	A36	$N_{rec}$	1.8 kN	2.6 kN	1.8 kN
				$V_{rec, \text{direction a}}$	2.6 kN	4.3 kN	2.6 kN
				$V_{rec, \text{direction b}}$	0.8 kN	0.8 kN	0.8 kN
				$V_{rec, \text{direction c}}$	2.6 kN	4.3 kN	2.6 kN
		S355	Grade 50	$N_{rec}$	2.3 kN	2.6 kN	2.3 kN
				$V_{rec, \text{direction a}}$	3.2 kN	4.3 kN	3.2 kN
				$V_{rec, \text{direction b}}$	0.8 kN	0.8 kN	0.8 kN
				$V_{rec, \text{direction c}}$	3.2 kN	4.3 kN	3.2 kN
X-FCS-R-3-25	2	S235	A36	$N_{rec}$	–	1.7 kN	–
				$V_{rec, \text{direction a}}$	–	4.3 kN	–
				$V_{rec, \text{direction b}}$	–	–	–
				$V_{rec, \text{direction c}}$	–	4.3 kN	–
		S355	Grade 50	$N_{rec}$	–	1.7 kN	–
				$V_{rec, \text{direction a}}$	–	4.3 kN	–
				$V_{rec, \text{direction b}}$	–	–	–
				$V_{rec, \text{direction c}}$	–	4.3 kN	–
X-FCS-R-4-25	4	S235	A36	$N_{rec}$	1.8 kN	2.6 kN	1.8 kN
				$V_{rec, \text{direction a}}$	2.6 kN	4.3 kN	2.6 kN
				$V_{rec, \text{direction b}}$	2.6 kN	4.3 kN	2.6 kN
				$V_{rec, \text{direction c}}$	2.6 kN	4.3 kN	2.6 kN
		S355	Grade 50	$N_{rec}$	2.3 kN	2.6 kN	2.3 kN
				$V_{rec, \text{direction a}}$	3.2 kN	4.3 kN	3.2 kN
				$V_{rec, \text{direction b}}$	3.2 kN	4.3 kN	3.2 kN
				$V_{rec, \text{direction c}}$	3.2 kN	4.3 kN	3.2 kN

**Design resistance under tension and shear load for single fastening points**

Grating element	Saddles connected to bearing bars	Base material (EN 10025-2)	Base material (ASTM AISI SAE)	Resistance under tension and shear load	Base material thickness		
					$t_{II} \geq 8 \text{ mm}$	$t_{II} \geq 8 \text{ mm}$	$t_{II} \geq 6 \text{ mm}$
					X-BT M8-15-6 SN 12-R	X-BT-GR M8/7 SN 8	S-BT-GR M8/7 SN 6
X-FCS-R-3-25	3	S235	A36	$N_{Rd}$	2.5 kN	3.6 kN	2.5 kN
				$V_{Rd, \text{direction a}}$	3.6 kN	6.0 kN	3.6 kN
				$V_{Rd, \text{direction b}}$	1.1 kN	1.1 kN	1.1 kN
				$V_{Rd, \text{direction c}}$	3.6 kN	6.0 kN	3.6 kN
		S355	Grade 50	$N_{Rd}$	3.2 kN	3.6 kN	3.2 kN
				$V_{Rd, \text{direction a}}$	4.5 kN	6.0 kN	4.5 kN
				$V_{Rd, \text{direction b}}$	1.1 kN	1.1 kN	1.1 kN
				$V_{Rd, \text{direction c}}$	4.5 kN	6.0 kN	4.5 kN
X-FCS-R-3-25	2	S235	A36	$N_{Rd}$	–	2.2 kN	–
				$V_{Rd, \text{direction a}}$	–	6.0 kN	–
				$V_{Rd, \text{direction b}}$	–	–	–
				$V_{Rd, \text{direction c}}$	–	6.0 kN	–
		S355	Grade 50	$N_{Rd}$	–	2.2 kN	–
				$V_{Rd, \text{direction a}}$	–	6.0 kN	–
				$V_{Rd, \text{direction b}}$	–	–	–
				$V_{Rd, \text{direction c}}$	–	6.0 kN	–
X-FCS-R-4-25	4	S235	A36	$N_{Rd}$	2.5 kN	3.6 kN	2.5 kN
				$V_{Rd, \text{direction a}}$	3.6 kN	6.0 kN	3.6 kN
				$V_{Rd, \text{direction b}}$	3.6 kN	6.0 kN	3.6 kN
				$V_{Rd, \text{direction c}}$	3.6 kN	6.0 kN	3.6 kN
		S355	Grade 50	$N_{Rd}$	3.2 kN	3.6 kN	3.2 kN
				$V_{Rd, \text{direction a}}$	4.5 kN	6.0 kN	4.5 kN
				$V_{Rd, \text{direction b}}$	4.5 kN	6.0 kN	4.5 kN
				$V_{Rd, \text{direction c}}$	4.5 kN	6.0 kN	4.5 kN

### Design concept for multiple fastening points under tension and shear load

Example: Recommended resistance for rectangular grating under symmetrical load in x-axis

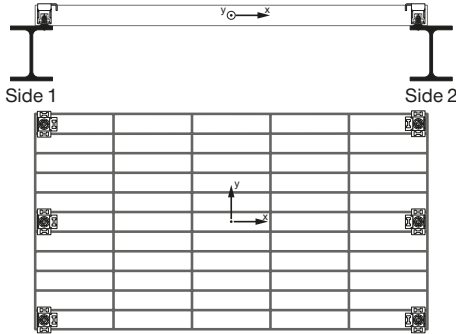

Grating element: X-FCS-R-3-25  
 Saddles connected to bearing bar: 3  
 Fastener: X-BT M8-15-6 SN 12 R  
 Base material: S235  
 Base material thickness:  $t_{II} = 8 \text{ mm}$

$$N_{\text{rec, GR}} = (n_1 + n_2) \cdot N_{\text{rec}}$$

$$= 6 \cdot 1.8 = 10.8 \text{ kN}$$

$$V_{\text{rec, GR, y}} = 2 \cdot \min\{n_1; n_2\} \cdot V_{\text{rec, a}}$$

$$= 2 \cdot 3 \cdot 2.6 = 15.6 \text{ kN}$$

$$V_{\text{rec, GR, x}} = n_1 \cdot V_{\text{rec, c}}$$

$$= 3 \cdot 2.6 = 7.8 \text{ kN}$$

X-FCS-R-3-25 per side of rectangular grating:  
 Number of X-FCS-R side 1:  $n_1 = 3$   
 Number of X-FCS-R side 2:  $n_2 = 3$

Note: Load resistance in direction b is neglected due to lower stiffness in direction b compared to direction c.

Example: Design resistance for square grating under symmetrical load in x-axis

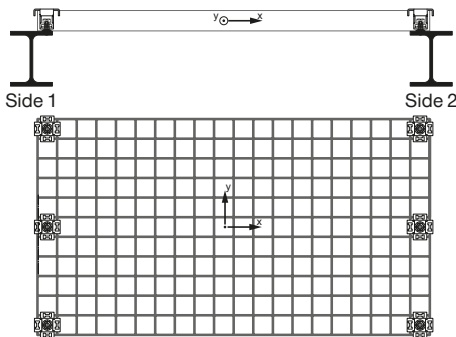

Grating element: X-FCS-R-4-25  
 Saddles connected to bearing bar: 4  
 Fastener: S-BT-GR M8/7 SN 6  
 Base material: S355  
 Base material thickness:  $t_{II} = 6 \text{ mm}$

$$N_{\text{Rd, GR}} = (n_1 + n_2) \cdot N_{\text{Rd}}$$

$$= 6 \cdot 3.2 = 19.2 \text{ kN}$$

$$V_{\text{rec, GR, y}} = 2 \cdot \min\{n_1; n_2\} \cdot V_{\text{rec, a}}$$

$$= 2 \cdot 3 \cdot 4.5 = 27.0 \text{ kN}$$

$$V_{\text{rec, GR, x}} = (n_1 + n_2) \cdot V_{\text{rec, c}}$$

$$= 6 \cdot 4.5 = 27.0 \text{ kN}$$

X-FCS-R-4-25 per side of rectangular grating:  
 Number of X-FCS-R side 1:  $n_1 = 3$   
 Number of X-FCS-R side 2:  $n_2 = 3$

Note: Load resistance in direction b is neglected due to lower stiffness in direction b compared to direction c.

## System recommendation

### System recommendation for tightening grating element

Grating element	Fastener	Torque moment	Tightening tool	Nut setter
X-FCS-R-3-25	X-BT M8-15-6 SN 12-R	8 Nm	SBT 4-A22 <sup>1)</sup> SFC 22-A <sup>1)</sup>	S-NS 12 C 95/3 3/4"
X-FCS-R-4-25	X-BT-GR M8/7 SN 8	20 Nm		
	S-BT-GR M8/7 SN 6	8 Nm		

<sup>1)</sup> Other tightening tools with torque moment control function can be used.

## Fastener setting and installation information

Fastener setting information (e.g. base material properties, fastened material properties and setting energy) and installation information (e.g. quality assurance) are part of the corresponding Product Data Sheet for fasteners.

## Grating fastening system component

Component	Designation	Item no.
Grating element	X-FCS-R-3-25 31/35	2198296
Grating element	X-FCS-R-3-25 37/41	2198297
Grating element	X-FCS-R-4-25 31/35	2198298
Grating element	X-FCS-R-4-25 37/41	2198299
Fastener	X-BT M8-15-6 SN 12 R	377074
Fastener	X-BT-GR M8/7 SN 8	2194344
Fastener	S-BT-GR M8/7 SN 6	2140529



## X-PGR-RU Grating fastening system (pre-drilled)

### Product data

#### Dimensions

X-PGR-RU

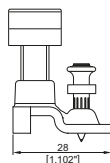
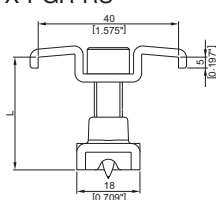

X-CR 20-4.5R P8

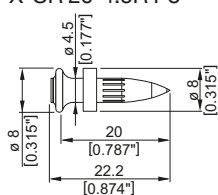

#### General information

##### Material specifications

Screw:

Carbon steel

Zinc coating: Duplex\* coated

Nail:

Stainless steel: CrNiMo Alloy

Upper part:

Carbon steel: DD11

Zinc coating: Duplex\* coated

Bottom part:

Carbon steel: S315MC

Zinc coating: Duplex\* coated

\*) 480 h salt spray test per DIN 50021 and 10 cycles  
Kesternich test per DIN 50018/2.0 (comparable to  
45 µm HDG steel)

##### Recommended fastening tools

**DX 460 GR** and **DX 5 GR** with

**X-5-460-F8GR** fastener guide

See **X-PGR-RU fastener program** in the next pages  
and **Tools and equipment** chapter for more details.

### Application

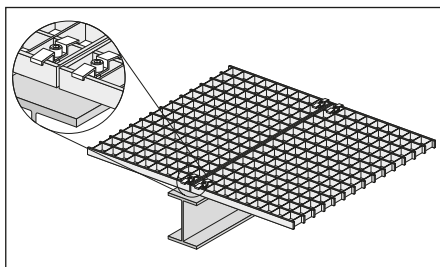

**Fastening of grating**

For fastenings exposed to weather and mildly corrosive conditions.

**Not for use in marine atmospheres (upstream)!**

## Load data

### Recommended tensile loads $N_{rec}$ [kN]

$N_{rec} = 0.8 \text{ kN (180 lb)}$

### Notes/Conditions:

- Tensile loading is limited by plastic deformation of the saddle clip
- X-PGR-RU resists shear by friction and is not suitable for explicit shear load designs

## Application requirements

### Thickness of base material

$t_{II} \geq 6 \text{ mm (0.24"')}$

### Thickness of fastened material

Grating height:  $H_G = 25\text{--}40 \text{ mm (0.98"'\text{--}1.57"')$

## Grating opening types

### Bearing bar spacing (a)

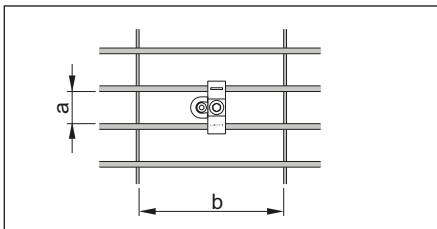

**a from 25 to 32 mm (1" to 1 1/8"')**

### Cross bar spacing (b)

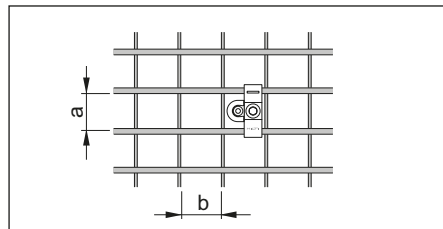

**b  $\geq 30 \text{ mm (1.18"')}$**

## Edge distances

$c \geq 15 \text{ mm (0.59"')}$

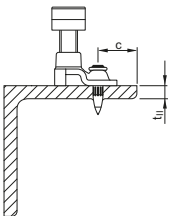

## Corrosion information

For fastenings exposed to weather and mildly corrosive conditions. **Not for use in marine atmospheres (upstream)** or in heavily polluted environments.

**Application limits**
**Application limits**

X-PGR-RU with DX 460, DX 5 (pre-drilled)

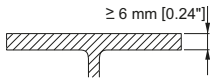

- $t_{||} \geq 6 \text{ mm [0.24" ]}$
- $350 \text{ N/mm}^2 \leq \text{Steel strength, } R_m \leq 630 \text{ N/mm}^2$

**Fastener selection and system recommendation**
**Fastener program**

Fastener	Item no.	L mm (inch)	Grating height mm (inch)
X-PGR-RU 25/30	2061313	32 (1.26 <sup>''</sup> )	25–30 (0.98 <sup>''</sup> –1.18 <sup>''</sup> )
X-PGR-RU 1 <sup>1</sup> / <sub>4</sub> ''	2061314	34 (1.34 <sup>''</sup> )	27–32 (1.06 <sup>''</sup> –1.26 <sup>''</sup> )
X-PGR-RU 35/40	2061315	42 (1.65 <sup>''</sup> )	35–40 (1.38 <sup>''</sup> –1.57 <sup>''</sup> )

**Cartridge selection and tool energy setting**

DX 460, DX 5 with 6.8/11M red cartridges, power setting 1–2

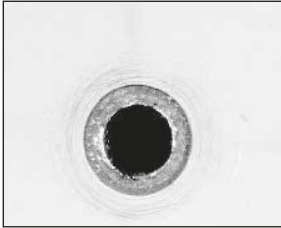
**Fastening quality assurance**
**Installation**
**Pre-drill**

Pre-drill with TX-PGR-RU-4/10-93 step shank drill bit (Item no. 2061802), until shoulder grinds a shiny ring (to ensure proper drilling depth).

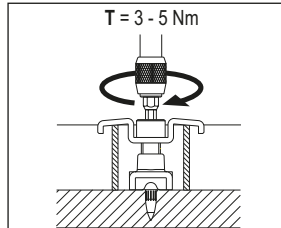
**Tighten the screw**

$T_{rec} = 3-5 \text{ Nm}$  (2.2-3.7 ft-lb)

**Tightening tool:**

- Screwdriver with torque release coupling (TRC)
- 6 mm Allen-type bit

Hilti screwdriver	Torque setting
<b>SF 121-A</b>	4-7
<b>SF 150-A</b>	3-5
<b>SF 14</b>	3-5
<b>SFC 14-A</b>	4-7
<b>SF 18-A</b>	3-5
<b>SFC 18-A</b>	3-5
<b>SFC 22-A</b>	3-5
<b>SBT 4-A22</b>	3-4

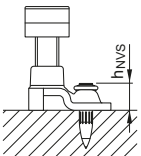
**Fastening inspection**

$h_{NVS} = 8-10 \text{ mm}$  (0.31"-0.39")

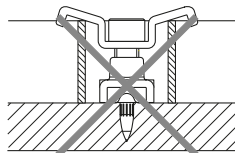

The saddle of the fastener should not be bent, see installation instruction above.

These are abbreviated instructions which may vary by application.  
**ALWAYS** review/follow the instructions accompanying the product.

# X-MGR Grating fastening system

## Product data

### Dimensions

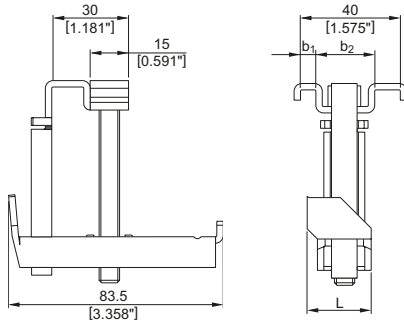

### General information

#### Material specifications

Screw:

Carbon steel

Zinc coating: 60 µm HDG

Upper part:

Carbon steel: SPCC-S

Zinc coating: 65 µm HDG

Bottom part:

Carbon steel: SPCC-S

Zinc coating: 65 µm HDG

Nut:

Carbon steel

Zinc coating: 45 µm HDG

Nut-holder:

Stainless steel: SS304

#### Recommended fastening tools

**SF 121-A, SF150-A, SF 14, SFC 14-A ,  
SF 18-A, SFC 18-A, SF 22-A**

See **X-MGR fastener program** in the next pages and **Tools and equipment** chapter for more details.

## Application

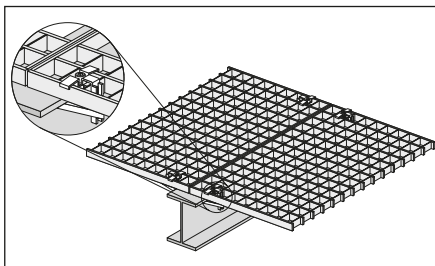

Fixing of grating

For fastenings exposed to weather and mildly corrosive conditions.

**Not for use in marine atmospheres  
(upstream)!**

**Load data**

**Recommended tensile loads  $N_{rec}$  [kN]**

$N_{rec} = 0.6 \text{ kN (135 lb)}$

**Notes/Conditions:**

- Tensile loading is limited by plastic deformation of the saddle clip
- X-MGR resists shear by friction and is not suitable for explicit shear load designs

**Application requirements**

**Thickness of base material**

$t_{II} = 3 - 25 \text{ mm (0.118 - 0.984")}$

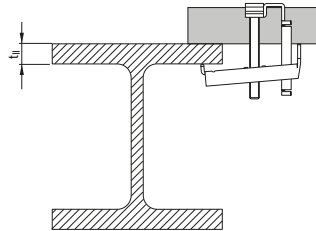

**Thickness of fastened material**

**Grating height:**

$H_G = 25 - 40 \text{ mm (0.98 - 1.57")}$

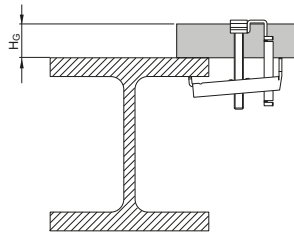

**Total fastening height**

$H_G + t_{II} \leq 65 \text{ mm (2.56")}$

**Grating opening types**

Fastener	a mm (inch)	b mm (inch)	c mm (inch)
X-MGR M60	30 (1.18")	$\geq 30 (1.18")$	$\leq 3 (0.118")$
X-MGR W60	25 (0.98")	$\geq 30 (1.18")$	$\leq 4.8 (\frac{3}{16})$

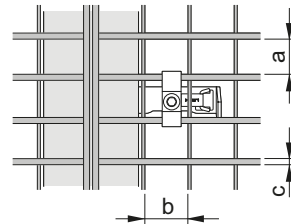

**Spacing and edge distances**

No general restriction exists.

### Corrosion information

For fastenings exposed to weather and mildly corrosive conditions. **Not for use in marine atmosphere (Upstream)** or in heavily polluted environment.

### Fastener selection and system recommendation

#### Fastener program

Fastener	Item-no.	Steel flange thickness $t_{fl}$ mm (inch)	Grating height mm (inch)	Fastening tool
X-MRG-M60	384233	3-25 (0.12"-0.98")	25-40 (0.98"-1.57")	<b>SF 121-A,</b> <b>SF 150-A</b>
X-MRG-W60	384234	3-25 (0.12"-0.98")	25-40 (0.98"-1.57")	<b>SF 121-A,</b> <b>SF 150-A</b>

### Fastening quality assurance

#### Fastening inspection

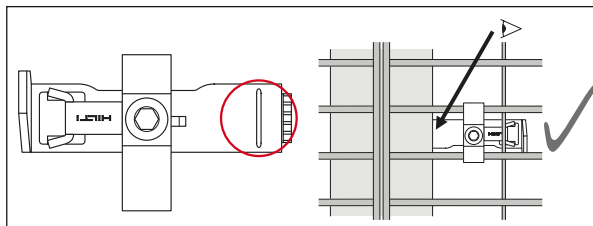

The sign on the clip has to be positioned under the steel flange

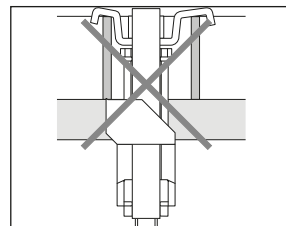

The saddle of the fastener should not be bent, see installation instructions below.

Tighten the screw

$T = 5 - 8 \text{ Nm}$

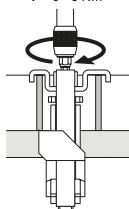

$T_{rec} = 5-8 \text{ Nm}$  (3.7-5.9 ft-lb)

Hilti Torque tool X-BT 1/4"

Hilti screwdriver

Torque setting

<b>SF 121-A</b>	6-10
<b>SF 150-A</b>	5-8
<b>SF 14</b>	5-8
<b>SFC 14-A</b>	6-10
<b>SF 18-A</b>	5-8
<b>SFC 18-A</b>	5-8
<b>SF 22-A</b>	5-8
<b>SFC 22-A</b>	4-5
<b>SBT 4-A22</b>	4-5





# X-FCP Checker plate fastening system

## Product data

### Dimensions

X-FCP-R 5/10

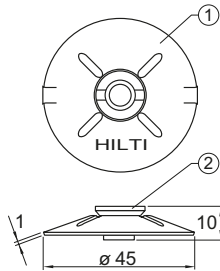

X-FCP-F 5/10

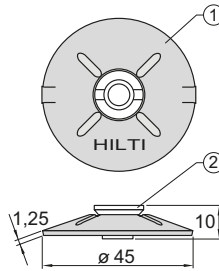

### General Information

#### Material specifications

See fastener selection for more details.

#### Recommended fastening tools

See **X-FCP fastener program** in the next pages and **Tools and equipment chapter** for more details.

#### Approvals

LR: X-FCP  
 ABS, LR: X-FCP-R  
 ABS: X-FCP-F



X-FCP Sealing ring

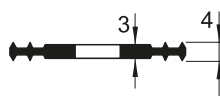
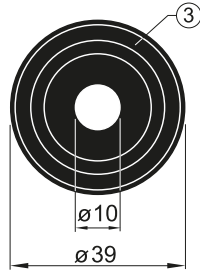

X-ST-GR M8/5 P8

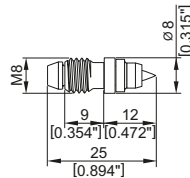

X-ST-GR M8/10 P8

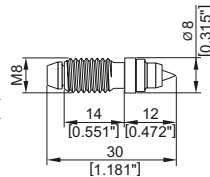

X-CRM8-15-12 FP10

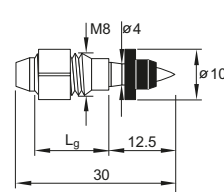

X-CRM8-9-12 P8

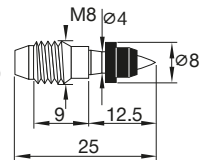

X-CRM8-9-12 FP10

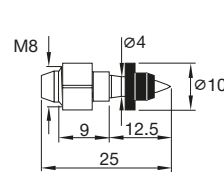

X-CRM8-15-12 P8

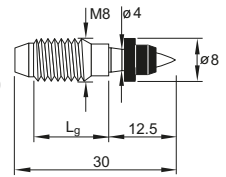

## Application

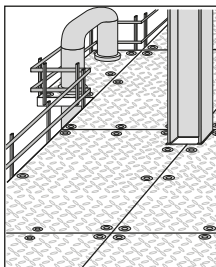

Checker plate

## Load data

### Recommended loads:

$N_{rec} = 1.8 \text{ [kN]}$

### Conditions:

- Limited by the strength of the X-CRM8 and X-ST-GR threaded stud.
- Recommended loads are valid for fastenings of steel and aluminium with 20 mm pre-drilling.
- **X-FCP-F** and **X-FCP-R** are not intended for shear loading.

## Application requirements

### Thickness of base material

X-CRM8, X-ST-GR

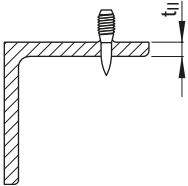

Minimum steel thickness  $t_{II} \geq 6 \text{ mm}$

### Thickness of fastened material

Thickness of chequer plates:

$t_I \approx 5.0\text{--}13.0 \text{ mm}$

## Spacing and edge distances

### X-CRM8, X-ST-GR

Edge distances:  $c \geq 15 \text{ mm}$

Spacing:  $s \geq 15 \text{ mm}$

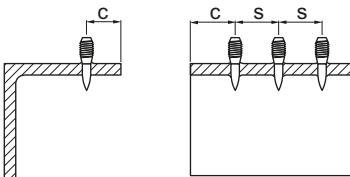

## Application limits

### DX 76, DX 76 PTR

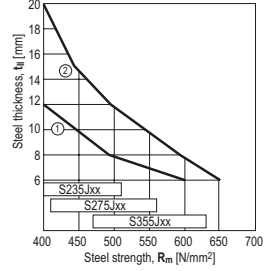

- ① **X-CRM8-\_\_-12 FP10** / DX 76 (impact)
- ② **X-CRM8-\_\_-12 FP10** / DX 76 (co-acting)

$$t_{II} \geq 6 \text{ mm}$$

### DX 460, DX 5

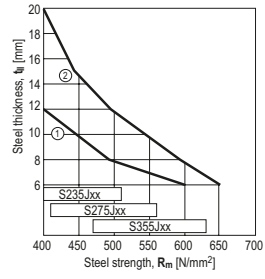

- ① **X-CRM8-\_\_-12 P8** / DX 460, DX 5 (impact)
- ② **X-CRM8-\_\_-12 P8** / DX 460, DX 5 (co-acting)

$$t_{II} \geq 6 \text{ mm}$$

**Note:**

For co-acting operation push the fastener all the way back against the piston with a ramrod.

### **X-ST-GR:**

#### **Steel: DX 76 PTR**

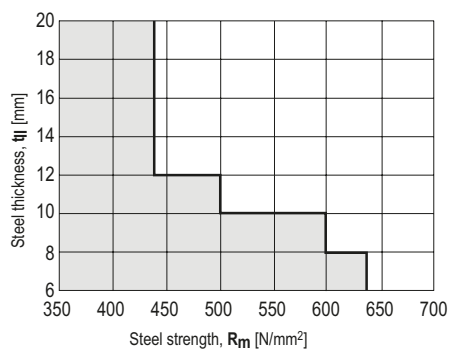

#### **Steel: DX 460, DX 5**

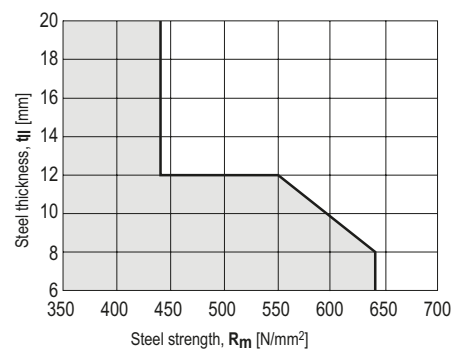

## Fastener selection and system recommendation

### Fastener program

#### Application areas

Marine, offshore, petrochemical, caloric (coal, oil) power plants, etc.	Indoors, mildly corrosive environment, or for limited lifetime use
---	--

#### X-FCP system

<b>X-FCP-R</b> Item no. 308860 Note: Not for use in automobile tunnels, swimming pools or similar environments	<b>X-FCP-F</b> Item no. 308859 Note: Not for use in marine atmosphere or in heavily polluted environment.	<b>Sealing ring</b>  Drip-through of water/oil needs to be prevented	Tools <b>SF 120-A, SF 150-A</b>
--	---	--	------------------------------------

#### Threaded studs

Designation	Chequer plate thickness	Tools
<b>X-CRM8-15-12</b>	9–13 mm	DX 460, DX 5, DX 76, DX 76 PTR
<b>X-CRM8-9-12</b>	5– 8 mm	DX 460, DX 5, DX 76, DX 76 PTR
<b>X-ST-GR M8/10 P8</b>	9–13 mm	DX 460, DX 5, DX 76 PTR
<b>X-ST-GR M8/5 P8</b>	5– 8 mm	DX 460, DX 5, DX 76 PTR

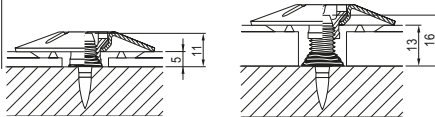

### Cartridge selection and tool energy setting

Threaded studs		Tools
X-CRM8	6.8/11M red cartridges	DX 460, DX 5
	6.8/18M yellow cartridges	DX 76, DX 76 PTR
X-ST-GR	6.8/11M black or red cartridges	DX 460, DX 5
	6.8/18M yellow or red cartridges	DX 76 PTR

Tool energy adjustment by setting tests on site.

### Material and coatings

#### X-FCP system

	X-FCP-R		X-FCP-F		All Systems
	① Disk	② Screw	① Disk	② Screw	③ Sealing ring
Material designation	X5CrNiMo17122	X2CrNiMo17132	ST2K40 BK	9SMnPb28 K	Neoprene, black
Coating	none	none	Duplex *	Duplex *	

\*) 480 h Salt spray test per DIN 50021 and 10 cycles Kesternich test per DIN 50018/2.0 (comparable to 45 µm HDG steel)

<b>X-ST-GR</b>		
	<b>Shank</b>	<b>Threaded sleeve</b>
Material designation	P558 (CrMnMo ally)	A4 (AISI316)
Coating	none	none

<b>Threaded studs X-CRM8</b>		
	<b>X-CR shank</b>	<b>CRM8 threaded sleeve</b>
Material designation	Stainless steel wire, CR 500 (A4 / AISI316)	X2CrNiMo17132 X5CrNiMo17122+2H (A4 / AISI316)
Coating	none	none

**Fastening quality assurance**

**Fastening inspection**

X-CRM8-9-12

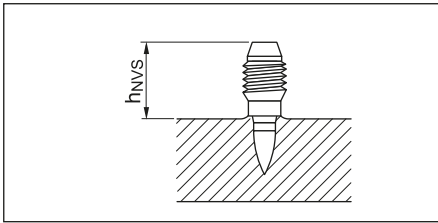

$h_{NVS} = 12.0 - 15.0 \text{ mm}$

X-CRM8-15-12

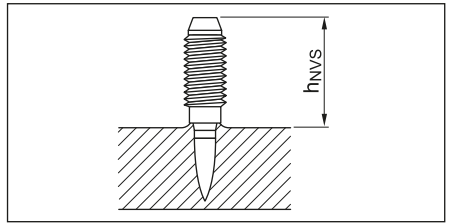

$h_{NVS} = 17.0 - 20.0 \text{ mm}$

X-ST-GR

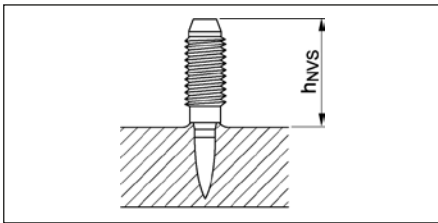

X-ST-GR M8/5 P8,  $h_{NVS} = 12.0 - 15.0 \text{ mm}$   
 X-ST-GR M8/10 P8,  $h_{NVS} = 17.0 - 20.0 \text{ mm}$

Plates must be  
pre-drilled or pre-punched

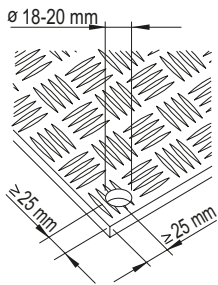

Tighten the disk

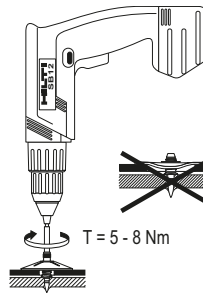

**Tightening torque**

$T_{rec} = 5-8$  Nm

**Tightening tool:**

- Screwdriver with torque release coupling (TRC)
- S-NSX 2.8 x 15 bit

Hilti	Torque
Screwdriver	setting
<b>SF 120-A</b>	TRC 5.5-7
<b>SF 150-A</b>	TRC 8-9

Hilti Torque tool X-BT 1/4"

# X-IE-G Insulation fastener

## Product data

### Dimensions

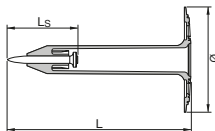
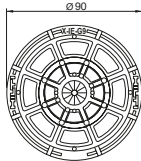
**X-IE-G 6**
**X-IE-G 9**

### Features and benefits

The GX-IE insulation fastening system comprised of gas tool and insulation fasteners for insulation application with various thicknesses of hard and soft board on soft concrete.

### General information

#### Material specifications

Plate:	X-IE-G 6 – HDPE, colorless
	X-IE-G 9 – HDPE, black (BK)
Nail:	Carbon steel shank: HRC 57.5
	Zinc coating: 2–13 µm

#### Recommended fastening tools

GX IE, GX IE XL

See **X-IE-G fastener program** in the next pages and **Tools and equipment** chapter for more details.

## Applications and suitable insulation materials

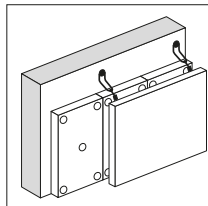
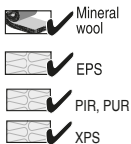

Insulation behind curtain walls

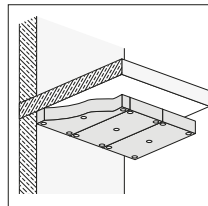

Insulation in ceilings

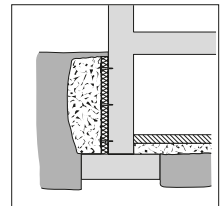

Insulation of basement perimeter/foundation walls

### In general:

the fastener is supposed to be used with insulation boards of max. tolerances of +/- 3 mm.

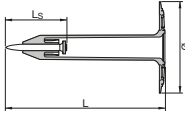
**Fastener program**
**Fastener selection**

Select fastener with designation equivalent to the insulation thickness  $t_i$ .

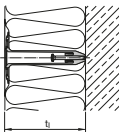
**Soft insulation boards  
(Mineral wool, EPS):**

Fasteners are allowed to be countersunk as shown in the drawing.

**Note:**

For mineral wool of intermediate thicknesses use next shorter X-IE-G. For soft mineral wool use X-IE-G 9.

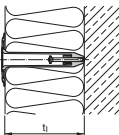
**Hard insulation boards  
(XPS, PIR, PUR):**

The fastener is not countersunk, fastener disc needs to be flush with the board prior to installation as shown in the drawing.

For convenience, pre-core the board before installation.

Designation	Fastener X-PH Ls	Item no.	Insulation thickness $t_i$ [mm]
<b>X-IE-G 6-25</b>	<b>X-P 36 G3</b>	2192914	25
<b>X-IE-G 6-30</b>	<b>X-P 36 G3</b>	2163810	30
<b>X-IE-G 6-40</b>	<b>X-P 36 G3</b>	2163811	40
<b>X-IE-G 6-50</b>	<b>X-P 36 G3</b>	2163812	50
<b>X-IE-G 6-60</b>	<b>X-P 36 G3</b>	2163813	60
<b>X-IE-G 6-70</b>	<b>X-P 36 G3</b>	2163814	70
<b>X-IE-G 6-75</b>	<b>X-P 36 G3</b>	2192915	75
<b>X-IE-G 6-80</b>	<b>X-P 36 G3</b>	2163815	80
<b>X-IE-G 6-90</b>	<b>X-P 36 G3</b>	2192916	90
<b>X-IE-G 6-100</b>	<b>X-P 36 G3</b>	2163816	100
<b>X-IE-G 6-120</b>	<b>X-P 36 G3</b>	2192917	120
<b>X-IE-G 6-130</b>	<b>X-P 36 G3</b>	2192918	130
<b>X-IE-G 6-140</b>	<b>X-P 36 G3</b>	2163817	140
<b>X-IE-G 6-150</b>	<b>X-P 36 G3</b>	2163818	150
<b>X-IE-G 6-160</b>	<b>X-P 36 G3</b>	2163819	160
<b>X-IE-G 6-180</b>	<b>X-P 36 G3</b>	2163820	180
<b>X-IE-G 6-200</b>	<b>X-P 36 G3</b>	2163821	200
<b>X-IE-G 9-40</b>	<b>X-P 36 G3</b>	2172154	40
<b>X-IE-G 9-50</b>	<b>X-P 36 G3</b>	2172155	50
<b>X-IE-G 9-60</b>	<b>X-P 36 G3</b>	2172156	60
<b>X-IE-G 9-80</b>	<b>X-P 36 G3</b>	2172157	80
<b>X-IE-G 9-100</b>	<b>X-P 36 G3</b>	2172158	100
<b>X-IE-G 9-120</b>	<b>X-P 36 G3</b>	2172159	120
<b>X-IE-G 9-140</b>	<b>X-P 36 G3</b>	2163823	140
<b>X-IE-G 9-150</b>	<b>X-P 36 G3</b>	2192919	150
<b>X-IE-G 9-160</b>	<b>X-P 36 G3</b>	2163824	160
<b>X-IE-G 9-180</b>	<b>X-P 36 G3</b>	2163825	180
<b>X-IE-G 9-200</b>	<b>X-P 36 G3</b>	2163826	200

**Note:**

For intermediate thicknesses, use the next longer X-IE-G.



### System recommendation

Tool: GX-IE , GX-IE XL

Gas can: GC52

### Application requirements

#### Thickness of base material

Concrete:  $h_{min} = 80 \text{ mm}$

#### Thickness of fastened material

##### Insulation thickness $t_i$ [mm]:

X-IE-G 6 (for the use with mineral wool, EPS, XPS, PIR, PUR): 25 – 200

X-IE-G 9 (for the use with very soft mineral wool): 40 – 200

#### Edge distances and minimum number of X-IE-G

For spacing of insulation fasteners, and minimum distances to the insulation edges, please consult with the insulation material supplier. If spacing recommendations are not available from supplier, please use a minimum of 5 X-IE G fasteners per  $m^2$

#### Performance Data (Base material: concrete)

##### Recommended load

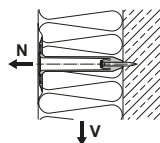

Tension (kN)	Shear (kN)
0.1	0.1

##### Conditions:

- Minimum of 5 fastenings per  $m^2$ . All visible setting failures must be replaced
- Soft concrete up to  $f_{c,cube} = 45 \text{ N/mm}^2$  (C35/45)
- When base material properties are questionable, jobsite qualification is necessary.

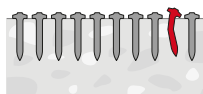

##### Stick rate estimation

	Soft Concrete
X-IE-G	Up to 90%

- The stick rate indicates the percentage of nails that were driven correctly to carry a load. Stick rate can vary from the above values depending on job site conditions.

#### Thermal efficiency

#### Point thermal transmittance [W/K]

Basement perimeter insulation	60 mm:	$\chi = 0.003$
	70 – 100mm:	$\chi = 0.002$
	120 – 200 mm:	$\chi = 0.001$
Curtain wall insulation	60 – 90 mm:	$\chi = 0.002$
	100 – 200mm:	$\chi = 0.001$

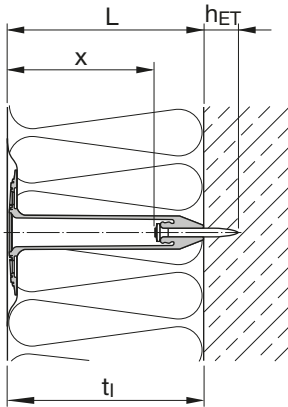
**Fastening quality assurance**
**Fastening inspection**

Insulation thickness $t_I$ [mm]								
	25/30	40	50	60	70	75	80	90

$h_{ET} = 12-19$ mm								
$x_{min}$ [mm]	3	14	24	34	44	49	54	64
$x_{max}$ [mm]	10	21	31	41	51	56	61	71

Insulation thickness $t_I$ [mm]								
	100	120	130	140	150	160	180	200

$h_{ET} = 12-24$ mm								
$x_{min}$ [mm]	74	94	104	114	124	134	154	174
$x_{max}$ [mm]	81	100	111	121	131	141	161	181

These are abbreviated instructions which may vary by application.

**ALWAYS** review/follow the instructions accompanying the product.

# X-IE, X-IE-E Insulation fastener

## Product data

### Dimensions

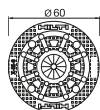
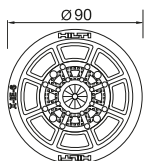
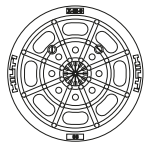
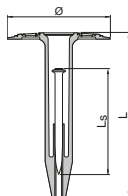
**X-IE 6**

**X-IE 9**

**HDT 90**

### General information

#### Material specifications

Plate:	X-IE 6 – HDPE, colourless
	X-IE 9 – HDPE, black (BK)
	X-IE-E 6 – HDPE, colourless
Nail:	Carbon steel shank: HRC 58
	Zinc coating: 5–20 µm

#### Recommended fastening tools

DX 460 IE, DX 460 IE XL, DX 5 IE, DX 5 IE XL

See **X-IE fastener program** in the next pages and **Tools and equipment** chapter for more details.

#### Approvals

SOCOTEC WX 1530 (France)

Note: technical data presented in these approvals and design guidelines reflect specific local conditions and may differ from those published in this handbook.

## Applications and suitable insulation materials

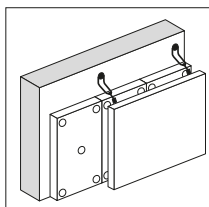
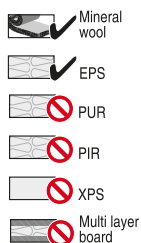

Insulation behind curtain walls

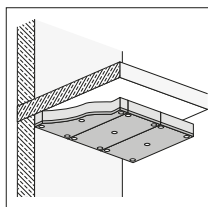

Insulation in ceilings

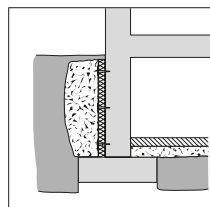

Temporary fixing of insulation of moisture barriers/drainage plates

Barriers: All materials are suitable

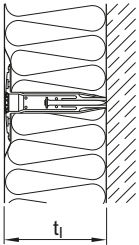
**Fastener program**
**Fastener selection**

Select Fastener Length  $L = t_i$

**In general:**

The fastener length  $L$  must be equal to the thickness  $t_i$  of mineral wool and EPS insulation material, as shown in the drawing above.

**Exceptions:**

For mineral wool of intermediate thicknesses use next shorter X-IE.  
Not for use with PUR, PIR, XPS, Multi layer boards or similar hard material not listed on this page.

**Note:**

For soft mineral wool use X-IE 9. Or X-IE 6 with HDT 90/HDT 90 BK.

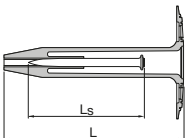

Designation	Fastener X-PH Ls	Item no.	Insulation thickness $t_i$ [mm]
<b>X-IE 6-20</b>	<b>X-PX 47</b>	2143956	20
<b>X-IE 6-25</b>	<b>X-PX 47</b>	2041714	25
<b>X-IE 6-30</b>	<b>X-PX 52</b>	2041715	30
<b>X-IE 6-35</b>	<b>X-PX 52</b>	2041716	35
<b>X-IE 6-40</b>	<b>X-PX 52</b>	2041717	40
<b>X-IE 6-50</b>	<b>X-PX 62</b>	2041718	50
<b>X-IE 6-60</b>	<b>X-PX 62</b>	2041719	60
<b>X-IE 6-70</b>	<b>X-PX 62</b>	2041740	70
<b>X-IE 6-75</b>	<b>X-PX 62</b>	2041741	75
<b>X-IE 6-80</b>	<b>X-PX 62</b>	2041742	80
<b>X-IE 6-90</b>	<b>X-PX 62</b>	2041743	90
<b>X-IE 6-100</b>	<b>X-PX 62</b>	2041744	100
<b>X-IE 6-120</b>	<b>X-PX 62</b>	2041745	120
<b>X-IE 6-140</b>	<b>X-PX 62</b>	2041393	140
<b>X-IE 6-150</b>	<b>X-PX 62</b>	2048523	150
<b>X-IE 6-160</b>	<b>X-PX 62</b>	2041394	160
<b>X-IE 6-180</b>	<b>X-PX 62</b>	2041395	180
<b>X-IE 6-200</b>	<b>X-PX 62</b>	2041396	200
<b>X-IE 9-50 BK</b>	<b>X-PX 62</b>	2092034	50
<b>X-IE 9-60 BK</b>	<b>X-PX 62</b>	2041746	60
<b>X-IE 9-80 BK</b>	<b>X-PX 62</b>	2041747	80
<b>X-IE 9-90 BK</b>	<b>X-PX 62</b>	2041748	90
<b>X-IE 9-100 BK</b>	<b>X-PX 62</b>	2041749	100
<b>X-IE 9-120 BK</b>	<b>X-PX 62</b>	2041750	120
<b>X-IE 9-140 BK</b>	<b>X-PH 62</b>	2041751	140
<b>X-IE 9-160 BK</b>	<b>X-PX 62</b>	2041752	160
<b>X-IE 9-180 BK</b>	<b>X-PX 62</b>	2041753	180
<b>X-IE 9-200 BK</b>	<b>X-PX 62</b>	2041754	200
<b>X-IE-E-6-40</b>	<b>X-U 42</b>	2143953	40
<b>X-IE-E-6-50</b>	<b>X-U 42</b>	2075810	50
<b>X-IE-E-6-60</b>	<b>X-U 42</b>	2075813	60
<b>X-IE-E-6-80</b>	<b>X-U 42</b>	2143954	80
<b>X-IE-E-6-100</b>	<b>X-U 42</b>	2075814	100
<b>X-IE-E-6-150</b>	<b>X-U 42</b>	2143955	150

## System recommendation

### Tool

DX 460 IE, DX 460 IE XL, DX 5 IE, DX 5 IE XL

### Cartridge selection and tool energy setting

#### Cartridge recommendation:

<b>X-IE:</b>	Steel:	<b>6.8/11M yellow</b> or <b>red</b> cartridge
	Concrete	<b>6.8/11M yellow</b> or <b>red</b> cartridge
	Masonry:	<b>6.8/11M yellow</b> or <b>green</b> cartridge
<b>X-IE-E:</b>	Steel:	<b>6.8/11M yellow</b> cartridge
	Concrete	<b>6.8/11M yellow</b> or <b>green</b> cartridge
	Masonry:	<b>6.8/11M green</b> cartridge

Tool energy adjustment by setting tests on site.

## Application requirements

### Thickness of base material

<b>Concrete:</b>	$h_{\min} = 80 \text{ mm}$
<b>Steel:</b>	$t_{II} \geq 4 \text{ mm}$

### Thickness of fastened material

Insulation thickness:

X-IE:  $t_I = 20 - 200 \text{ mm}$

X-IE-E:  $t_I = 40 - 150 \text{ mm}$

## Spacing and edge distances

For setting instructions please inquire at the insulation material supplier.

If recommendations from suppliers are not available, please use minimum 3 pcs of X-IE fasteners per insulation material and  $\geq 5$  pcs of X-IE fasteners per  $\text{m}^2$

## Application limits

Concrete:	$f_{cc} = 15-35/45^*) \text{ N/mm}^2$	(aggregate size $\leq 32 \text{ mm}$ )
Sand-lime masonry:	$f_{cc} = 15-45 \text{ N/mm}^2$	
Clinker brick work:	$f_{cc} = 28-45 \text{ N/mm}^2$	
Steel:	$f_u = 360-540 \text{ N/mm}^2$	( $t_{II} = 4-6 \text{ mm}$ )

\*) for X-IE-E,  $f_{cc,max} = 35 \text{ N/mm}^2$ . For X-IE,  $f_{cc,max} = 45 \text{ N/mm}^2$ .

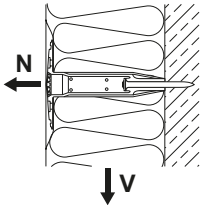
**Load data**

**Recommended loads**

	Insulation thickness $t_i$ [mm]				
	40	50	60-70	75	80-200
<b>X-IE 6, X-IE-E 6</b>	Shear, $V_{rec}$ [N]				
Polystyrol - EPS [30 kg/m <sup>3</sup> ]	150	250	300	325	350
<b>X-IE 6</b>	Pullover, $N_{rec}$ [N]				
Polystyrol - EPS [30 kg/m <sup>3</sup> ]	250	290	300	300	300
<b>X-IE-E 6</b>	Pullover, $N_{rec}$ [N]				
Polystyrol - EPS [30 kg/m <sup>3</sup> ]	-	200	200	-	200
<b>X-IE 9, HDT 90</b>	Pullover, $N_{rec}$ [N]				
Mineral wool [ $\geq 7.5$ kN/m <sup>2</sup> ]*	-	-	135	135	135
Mineral wool [ $\geq 15$ kN/m <sup>2</sup> ]*	-	-	250	250	250

\*) Tensile Strength  $\sigma_{mt}$  according to DIN EN 1607

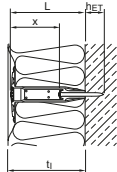
When base material properties are questionable, jobsite qualification is necessary

**Fastening quality assurance**
**Fastening inspection**

 Insulation thickness  $t_i$  [mm] for X-IE

40	50	60	70	75	80	90	100	120	140	150	160	180	200
----	----	----	----	----	----	----	-----	-----	-----	-----	-----	-----	-----

$h_{ET} = 24-29$  mm

$x_{min}$ [mm]	9	9	19	29	34	39	49	59	79	99	109	119	139	159
$x_{max}$ [mm]	14	14	24	34	39	44	54	64	84	104	114	124	144	164

 Insulation thickness  $t_i$  [mm] for X-IE-E

40	50	60	80	100	150
----	----	----	----	-----	-----

$h_{ET} = 19-24$  mm

$x_{min}$ [mm]	13.1	23.1	33.1	53.1	73.5	123.1
$x_{max}$ [mm]	18.1	28.1	38.1	58.1	78.5	128.1

# X-IE-H Insulation fastener for hard board

## Product data

### Dimensions

X-IE-H

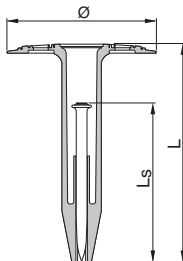
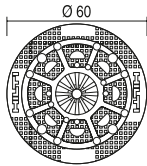

### General information

#### Material specifications

Plate: HDPE, white

Nail: Carbon steel shank: HRC 58

Zinc coating: 5–20 µm

#### Recommended fastening tools

DX 460 IE, DX 460 IE XL, DX 5 IE, DX 5 IE XL

See **X-IE fastener program** in the next pages and **Tools and equipment** chapter for more details.

## Applications and suitable insulation materials

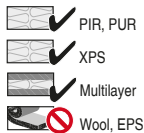

Barriers:  
All materials are suitable

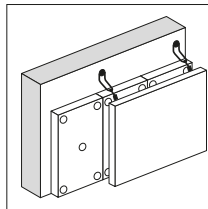

Insulation behind curtain walls

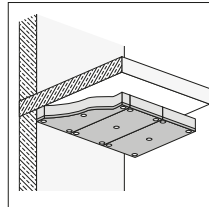

Insulation in ceilings

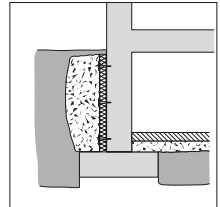

Temporary fixing of insulation of moisture barriers/drainage plates

**In general:** the fastener is intended to be used with insulation boards of type hard boards (PIR, PUR, XPS, Phenolic) produced according to the standard EN 13165 table 2 with tolerance classes T2 or T3.

## Fastener program

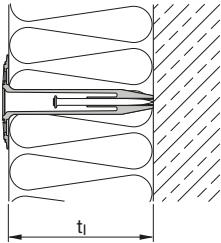

Select Fastener with Designation equivalent to the insulation thickness  $t_i$

### Exceptions:

For intermediate thicknesses, use the next longer X-IE-H.

For convenience, pre-core the insulation boards before installation.

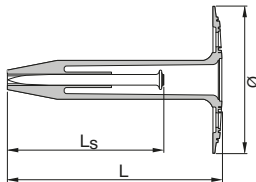

### Fastener selection table

Designation	Fastener X-PH, Ls	Item no.	Insulation thickness $t_i$ [mm]
<b>X-IE-H 40</b>	<b>X-PX 62</b>	2207195	40
<b>X-IE-H 50</b>	<b>X-PX 62</b>	2162046	50
<b>X-IE-H 60</b>	<b>X-PX 62</b>	2162047	60
<b>X-IE-H 75</b>	<b>X-PX 62</b>	2207196	75
<b>X-IE-H 80</b>	<b>X-PX 62</b>	2162048	80
<b>X-IE-H 100</b>	<b>X-PX 62</b>	2162049	100
<b>X-IE-H 125</b>	<b>X-PX 62</b>	2207197	125
<b>X-IE-H 150</b>	<b>X-PX 62</b>	2207198	150
<b>X-IE-H 175</b>	<b>X-PX 62</b>	2207194	175

**Note:** the fastener length **L** is not equal to the insulation thickness  $t_i$  due to the intention of avoiding any countersunk effect of the fastener into the insulation board,  $L = t_i + 6 \text{ mm}$ .



## System recommendation

### Tool

DX460IE, DX460IEXL, DX5IE, DX5IEXL

### Cartridge selection and tool energy setting

**Cartridge recommendation:** Steel: **6.8/11M yellow or red** cartridge  
 Concrete **6.8/11M yellow or red** cartridge

Tool energy adjustment by setting tests on site.

## Application requirements

### Thickness of base material

**Concrete:**  $h_{\min} = 80 \text{ mm}$

**Steel:**  $t_{II} \geq 4 \text{ mm}$

### Thickness of fastened material

Insulation thickness:  $t_I = 40 - 175 \text{ mm}$

### Edge distances and minimum number of X-IE-H

For minimum distances to insulation edges please inquire at the insulation material supplier. Please use minimum 4 pcs of X-IE-H fasteners per insulation plate and  $\geq 5$  pcs of X-IE-H fasteners per  $\text{m}^2$

## Application limits

**Concrete:**  $f_{cc} = 15 - 45 \text{ N/mm}^2$  (aggregate size  $\leq 32 \text{ mm}$ )

**Sand-lime masonry:**  $f_{cc} = 15 - 45 \text{ N/mm}^2$

**Clinker brick work:**  $f_{cc} = 28 - 45 \text{ N/mm}^2$

**Steel:**  $f_u = 360 - 540 \text{ N/mm}^2$  ( $t_{II} = 4 - 6 \text{ mm}$ )

## Load data

### Recommended loads

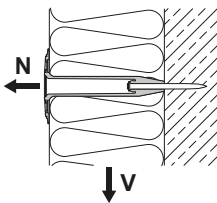

	Insulation thickness $t_I$ [mm]			
	40-50	60	75-80	100-175
Shear, $V_{\text{rec}}$ [N]	250	300	350	350
Tension, $N_{\text{rec}}$ [N]	290	300	300	300

When base material properties are questionable, jobsite qualification is necessary.



# XI-FV ETICS Insulation fastener

## Product data

### Dimensions

XI-FV

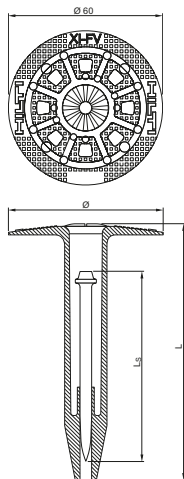

HDT-FV 90



HDT-FV 140

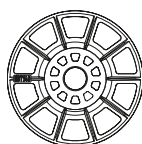

### General information

#### Material specifications

Plate: XI-FV – HDPE, Orange  
 HDT-FV – HDPE, Orange

Nail: Carbon steel shank: HRC 58  
 Zinc coating: Delta-Tone

#### Recommended fastening tools

DX 460 IE, DX 460 IE XL, DX 5 IE, DX 5 IE XL

See **XI-FV fastener program** in the next pages for more details.

#### Approvals

ETA-17/0304, DOP no. Hilti-DX-DoP-006

For more information please contact Hilti.

Note: technical data presented in these approvals and design guidelines reflect specific local conditions and may differ from those published in this handbook.

## Applications

### Examples

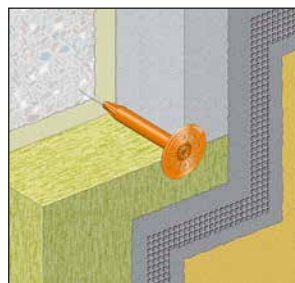

External Thermal Insulation Composite System (ETICS)

The XI-FV fastener is used to transfer wind suction loads acting on the thermal insulation composite system. The base material is normal weight concrete, which is either uncoated or coated with plaster or tiles. Coatings with plaster or tiles is often met if existing buildings are renovated and are improved with regards to their thermal insulation properties.

### Load data and application requirements

Fixing element		XI-FV
Characteristic tension resistance in uncoated concrete fastener pull-out	$N_{Rk,p} =$	1.0 kN
Partial safety factor, fastener pull-out	$\gamma_M =$	2.0
Partial safety factor for variable action of wind suction forces	$\gamma_Q =$	1.5
Mean anchorage depth	$h_V =$	30 mm
Spacing	$s_c \geq$	100 mm
Edge distance	$c_c \geq$	75 mm
Corner distance	$c_e \geq$	100 mm
Thickness of concrete member	$h \geq$	100 mm

Characteristic resistance in concrete which is coated with plaster or tiles, see ETA-17/0304

Design value of resistance:  $N_{Rd} = N_{Rk,p} / \gamma_M$

Design value of action:  $N_{Sd} = N_{Sk} \cdot \gamma_Q$   
 $N_{Sd} \leq N_{Rd}$

Please refer to ETA-17/0304 for detailed information on:

- the intended use (e.g. thickness of plaster and adhesive layer)
- verification of setting energy by means of control tests
- plate stiffness and point thermal transmittance

In case of concrete coated with plaster and tiles, the characteristic tension pull-out resistance needs in general be verified by job-site tests in accordance with EOTA Technical Report TR52: Recommendations for job-site tests of powder-actuated fasteners for ETICS for use in concrete.

Applicable insulation material are EPS and mineral wool.

Schematic illustration of spacings of fixing elements

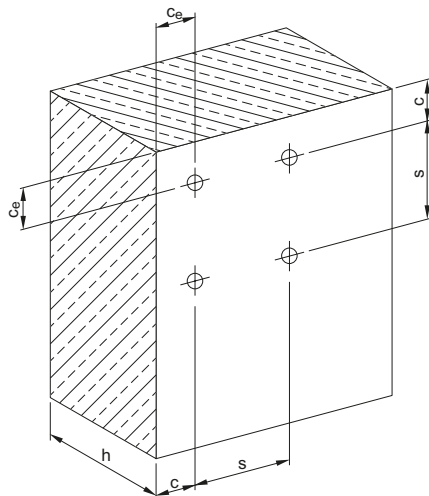

## Application requirements

### Thickness of base material

Concrete: **C12/15 to C35/45**

### Corrosion information

The intended use comprises fastenings of thermal insulation composite systems which are subject to external atmospheric exposure.

During construction, exposure to UV due to solar radiation of the fixing element not protected by rendering shall not exceed the time of 6 weeks.

The temperature during installation of the fixing element shall not be less than 5 °C.

## Fastener selection and system recommendation

### Fastener program

Designation	Fastener	Item no.	Insulation thickness $h_D$ [mm]
<b>XI-FV 60</b>	<b>X-CPH 72</b>	<b>376484</b>	<b>60</b>
<b>XI-FV 80</b>	<b>X-CPH 72</b>	<b>376485</b>	<b>80</b>
<b>XI-FV 100</b>	<b>X-CPH 72</b>	<b>376489</b>	<b>100</b>
<b>XI-FV 120</b>	<b>X-CPH 72</b>	<b>376490</b>	<b>120</b>
<b>XI-FV 140</b>	<b>X-CPH 72</b>	<b>376491</b>	<b>140</b>
<b>XI-FV 160</b>	<b>X-CPH 72</b>	<b>2069160</b>	<b>160</b>
<b>XI-FV 180</b>	<b>X-CPH 72</b>	<b>2069161</b>	<b>180</b>
<b>XI-FV 200</b>	<b>X-CPH 72</b>	<b>2069162</b>	<b>200</b>
<b>HDT-FV 90</b>	-	<b>285628</b>	-
<b>HDT-FV 140</b>	-	<b>372907</b>	-

#### Note:

For soft mineral wool use XI-FV with HDT-FV 90 and HDT-FV 140.

## System recommendation

### Tool

DX 460 IE, DX 460 IE XL, DX 5 IE, DX 5 IE XL

### Cartridge selection and tool energy setting

Concrete **6.8/11M yellow, red** or **black** cartridge

See **Fastening quality assurance** for details.

## Fastening quality assurance

### Cartridge colour and tool energy selection

Example in case of uncoated concrete (Annex B4 of ETA-17/0304: By means of the control tests made to uncoated concrete, the cartridge colour and tool energy required for driving in XI-FV for achieving the mean anchorage depth,  $h_V$ , is determined. Please refer to XI-FV ETA approval for more details.

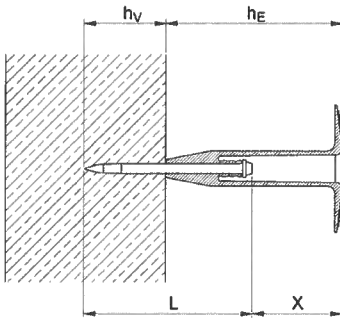

$$h_V = (\ell_N + X) - h_E = 30 \text{ mm}$$

where

$h_V$  = mean anchorage depth

$h_E$  = length of plastic part

$L$  = length of powder actuated fastener

$X$  = control dimension

Designation	Insulation thickness $t_j$ [mm]	Control dimension $X$ [mm]
<b>XI-FV 60</b>	<b>60</b>	$\geq 12.5$
<b>XI-FV 80</b>	<b>80</b>	$\geq 32.5$
<b>XI-FV 100</b>	<b>100</b>	$\geq 52.5$
<b>XI-FV 120</b>	<b>120</b>	$\geq 72.5$
<b>XI-FV 140</b>	<b>140</b>	$\geq 92.5$
<b>XI-FV 160</b>	<b>160</b>	$\geq 112.5$
<b>XI-FV 180</b>	<b>180</b>	$\geq 132.5$
<b>XI-FV 200</b>	<b>200</b>	$\geq 152.5$

These are abbreviated instructions which may vary by application.

**ALWAYS** review/follow the instructions accompanying the product.

# X-SW 30, X-SW 60 Soft washer fastener

## Product data

### Dimensions

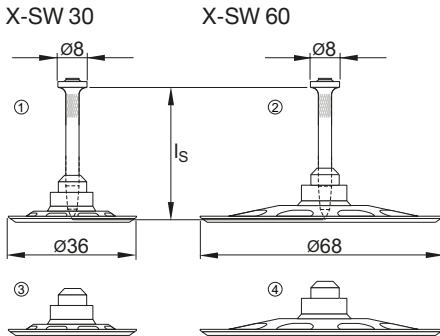

### General information

#### Material specifications

Plate:	PE
Nail:	Carbon steel shank: HRC 52.5
	Zinc coating: 5–13 $\mu\text{m}$

#### Recommended fastening tools

DX 460, DX 460 MX, DX 5, DX 5 MX,  
DX 36, DX 2, DX-E 72, GX 120 system,  
GX 2 system, GX 3 system

See **X-SW fastener program** in the next pages and  
**Tools and equipment** chapter for more details.

## Applications

### Examples

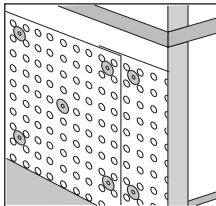

**Membranes and  
drainage plates**

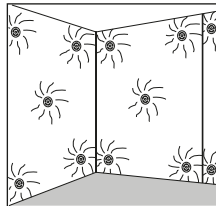

**Insulation up to 30 mm  
thick**

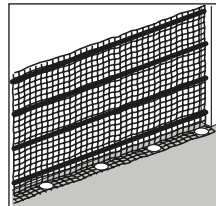

**Nets, fabric and similar**

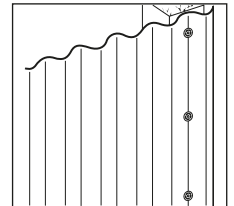

**Plastic corrugated  
sheets**

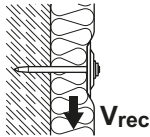
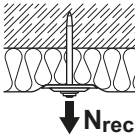
**Load data**
**Recommended loads**

**Design conditions:**

1. Minimum 5 fastenings per fastened unit.
2. Predominantly static loading.
3. Design loads valid for nail pull-out strength. Fastened material has to be considered separately.
4. Valid for concrete C 30/37.

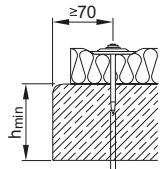
	Tension, $N_{rec}$ [kN]	Shear, $N_{rec}$ [kN]
DX	0.3	0.3
GX (with X-GN 39 MX, X-C 39 G2 MX, X-C 39 G3 MX)	0.1	0.1

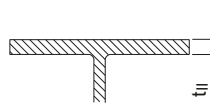
**Application requirements**
**Thickness of base material**
**Concrete:**  $h_{min} = 80$  mm

**Steel:**  $t_{II} \geq 4$  mm

 (Not recommended for X-GN 39 MX,  
X-C 39 G2 MX, X-C 39 G3 MX)

**Thickness of fastened material**

 Membranes, nets, etc.:  $t_I \leq 25$  mm (X-GN 39 MX, X-C 39 G2 MX, X-C 39 G3 MX)

 Insulation:  $t_I \leq 30$  mm (Not recommended for  
X-GN 39 MX, X-C 39 G2 MX, X-C 39 G3 MX)

**Spacing and edge distances**

For setting instructions please inquire at the supplier of fastened material.

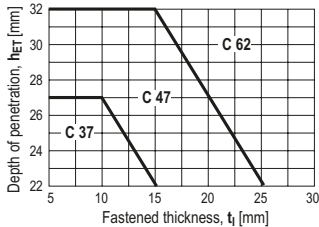

**Fastener selection and system recommendation**
**Fastening to concrete**

- **X-SW 30** for stronger, less damageable material.
- **X-SW 60** for more easily damaged material (i.e. aluminium foil, nets, paper, etc.)
- Select nail lengths (**C 37**, **C 47** and **C 62**) according to base material conditions and fastened thickness

**Fastener program**

Designation	Item no. Packs of 100/150	Packs of 400/500	$L_s$ [mm]	Tools
				Designation
① <b>X-SW 30-C 37</b>	40643	40614	37	<b>DX 460, DX 5, DX 36, DX 2, DX-E 72</b>
① <b>X-SW 30-C 47</b>	40644	40615	47	<b>DX 460, DX 5, DX 36, DX 2, DX-E 72</b>
① <b>X-SW 30-C 62</b>	40645	40616	62	<b>DX 460, DX 5, DX 36, DX 2, DX-E 72</b>
② <b>X-SW 60-C 37</b>	40617		37	<b>DX 460, DX 5, DX 36, DX 2, DX-E 72</b>
② <b>X-SW 60-C 47</b>	40618		47	<b>DX 460, DX 5, DX 36, DX 2, DX-E 72</b>
② <b>X-SW 60-C 62</b>	40619		62	<b>DX 460, DX 5, DX 36, DX 2, DX-E 72</b>
③ <b>X-SW 30</b>	371370			<b>DX 460-MX, DX 5 MX</b> with collated
③ <b>X-SW 60</b>	371371			<b>X-C</b> nails (3.5 mm shank dia.)
				<b>GX-120</b> with <b>X-GN 39 MX</b> nails
				<b>GX 2</b> with <b>X-C 39 G2 MX</b> nails
				<b>GX 3</b> with <b>X-C 39 G2 MX</b> nails

**Cartridge selection and tool energy setting**

 Cartridge recommendation: Concrete **6.8/11M yellow or red**

 Masonry: **6.8/11M green**

Tool energy adjustment by setting tests on site.



# X-FS Form stop

## Product data

### Dimensions

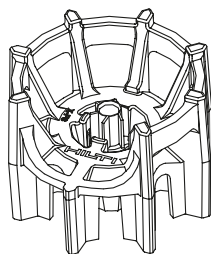
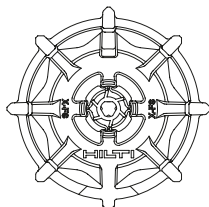
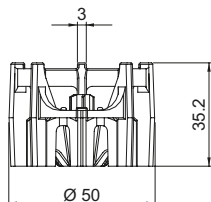

### General information

#### Material specifications

Nail: zinc coating: 5–20 µm

#### Recommended fastening tools

DX 460, DX 460 MX, DX 5, DX 5 MX, DX 36, DX 2,

See **X-FS fastener program** in the next pages and **Tools and equipment** chapter for more details.

## Applications

### Examples

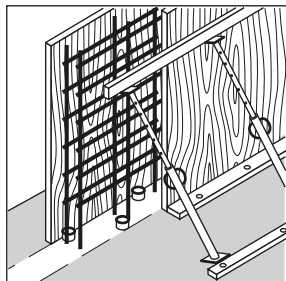

Positioning concrete forms on concrete surfaces. Leave in place, grey polyethylene is non rusting, nearly invisible and non-conductive.

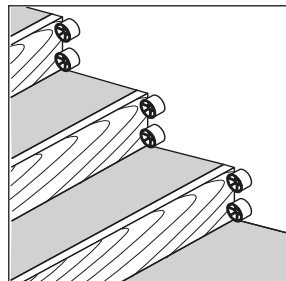
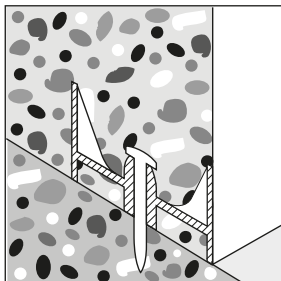

X-FS is suitable and usable for minor forming applications

### Load data

### Recommended working loads

$V_{rec} = 400 \text{ N}$

(predominantly static, however, vibration from concrete compacting is allowed)

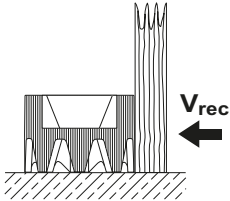

### Application requirements

#### Thickness of base material

Concrete:  $h_{min} = 80 \text{ mm}$

#### Spacing and edge distances

Spacing and edge distances depending on job site requirements.

#### Corrosion information

For temporary fixations no restrictions exist.

### Fastener program

Fastener				Tools
Designation	Item no.	$L_s$ [mm]	Nail shank diameter [mm]	Designation
① X-FS C 52 *	407346	52	3.5	DX 460, DX 5, DX 36, DX 2
② X-FS MX **	408022			DX 460-MX, DX 5 MX

\* For unusual applications, **X-FS** available with other nails on special order

\*\* **X-FS** without nail for fastening with collated nails.

### Cartridge selection and tool energy setting

<b>Cartridge recommendation:</b>	Steel:	<b>6.8/11M red</b> cartridge
	Concrete:	<b>6.8/11M yellow</b> or <b>red</b> cartridge
	Masonry:	<b>6.8/11M yellow</b> or <b>green</b> cartridge

Tool energy adjustment by setting tests on site.

# X-DFS Double form stop

## Product data

### Dimensions

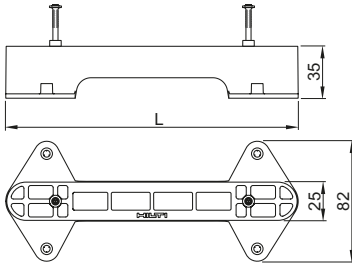

### Features and benefits

- Fixed-length form stops for soft concrete base material
- Leave in place formwork spacer

### General information

#### Material specifications

X-DFS: Polypropylene  
(halogen and silicone free)  
Grey (RAL 7030), green (RAL 6018), light brown (RAL 8001)

Nails (pre-mounted):

X-C 62 Carbon steel, HRC 56.5  
( $d_{nom} = 3.5mm$ ) zinc coating 5-20 $\mu m$

#### Recommended fastening tools

DX 5-F8, DX 2, DX 460-F8, DX 351 ME

## Applications

### Example

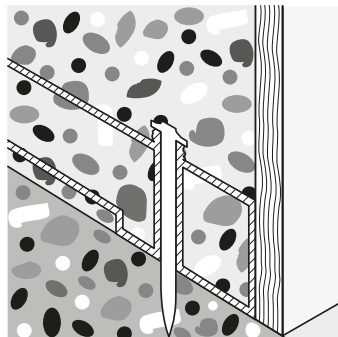
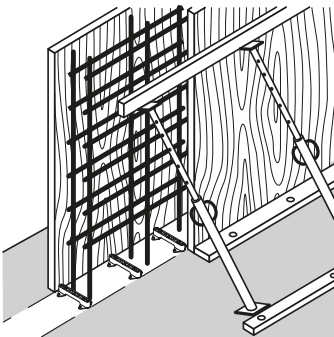

Positioning concrete forms on concrete surfaces. Leave in place, polypropylene is non rusting, nearly invisible and non-conductive.

## Recommended loads (Base material = concrete)

### Load data

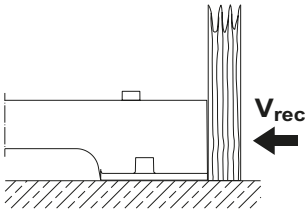

$$V_{\text{rec}} = 400 \text{ N}$$

(predominantly static, however, vibration from concrete compacting is allowed)

Valid for soft concrete with strength of  $f_{c, \text{cube}} = 25\text{-}45 \text{ N/mm}^2$ . For more details regarding concrete types, please refer to **Concrete Fastener Selection** section in Hilti Direct Fastening Technology Manual (DFTM).

### Nail recommendations

For **concrete** base material

Nail type	Length [mm]	Tip	Shank Ø [mm]	Material	Hardness [HRC]	Coating
X-C 62	62	Cut	3.5	Carbon steel	56.5	Zinc, 5-20µm

- 2 no. of X-C 62 nails are pre-mounted to each X-DFS element.

### Application requirements

#### Thickness of base material

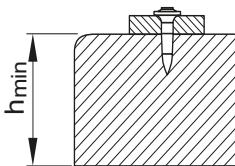

$$\text{Concrete: } h_{\text{min}} = 80 \text{ mm}$$

#### Spacing and edge distance

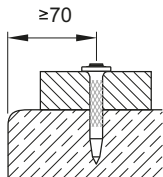

$$c \geq 70 \text{ mm}$$

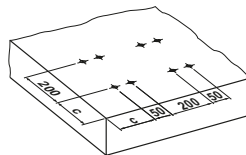

### Corrosion information

For temporary fixations no restrictions exist.

### Fastener selection and system recommendation

#### Fastener program

Designation	Item no.	L [mm]	Nail shank Ø d <sub>nom</sub> [mm]	Colour	Tool Designation
X-DFS 160 C62	2159751	160	3.5	Grey	DX 5-F8, DX 2,
X-DFS 180 C62	2159752	180	3.5	Green	DX 460-F8,
X-DFS 200 C62	2159753	200	3.5	Light brown	DX 351 ME

### Cartridge selection

Concrete: 6.8/11 M10 green or yellow cartridge

Tool energy adjustment by setting tests on site.





## X-DFC Double fire clip

### Product data

#### Dimensions

X-DFC 8 MX / X-DFC-W 8 MX

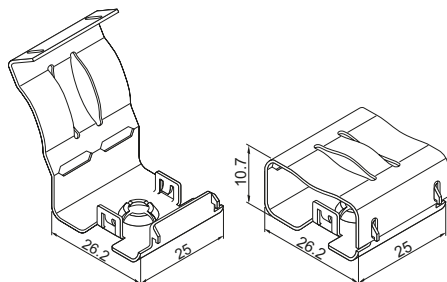

X-DFC 9 MX / X-DFC-W 9 MX

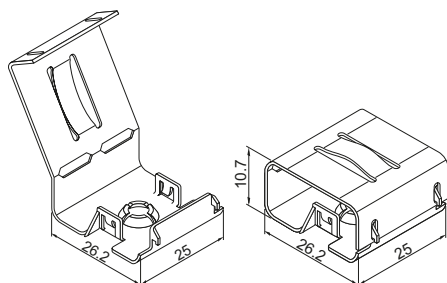

#### Features and benefits

- Easy and convenient installation to concrete (soft and some tough) and sandlime stone base material
- Quick, cost-efficient fastening
- Can be clicked on BX fastener guide, no adaptor needed
- Tested by an external, certified test institute

#### General information

##### Material specifications

X-DFC-MX: Stainless steel with 50 µm red or white colour coating

##### Approval and standards

Product qualification according to BS EN 50200, BS EN 50200 Annex E and BS 8434-2

In compliance with cable support requirements of BS 5839-1, BS 5839-8 and BS 5266-1

### Applications

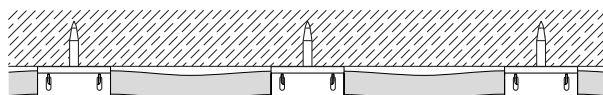

Installation of fire alarm and emergency lighting cables.

### Performance data

### Fire rating

Cable	Fastener	Cable size	Classification	Test standard
Prysmian FP200 Gold (standard)	X-DFC 8 MX / X-DFC-W 8 MX	2 core x 1.5 mm <sup>2</sup> 3 core x 1.5 mm <sup>2</sup>	PH 60	BS EN 50200 (dry)
			PH 30	BS EN 50200 Annex E (wet)
Prysmian FP plus (enhanced)	X-DFC 9 MX / X-DFC-W 9 MX	2 core x 1.5 mm <sup>2</sup>	PH 120	BS EN 50200 (dry) BS 8434-2 (wet)
Vencroft NoBurn Platinum (standard)	X-DFC 8 MX / X-DFC-W 8 MX	2 core x 1.5 mm <sup>2</sup> 4 core x 1.0 mm <sup>2</sup>	PH 60	BS EN 50200 (dry)
			PH 30	BS EN 50200 Annex E (wet)
	X-DFC 9 MX / X-DFC-W 9 MX	2 core x 2.5 mm <sup>2</sup> 4 core x 1.5 mm <sup>2</sup>	PH 60	BS EN 50200 (dry)
			PH 30	BS EN 50200 Annex E (wet)
Vencroft NoBurn plus (enhanced)	X-DFC 8 MX / X-DFC-W 8 MX	2 core x 1.5 mm <sup>2</sup>	PH 120	BS EN 50200 (dry) BS 8434-2 (wet)

### Conditions:

- Pre-loading of the elements after setting
- All visible failures must be replaced.
- Observance of all application limitations and recommendations.

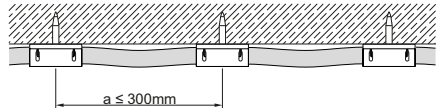

Recommended fastener spacing a:  
horizontal ≤ 300 mm, vertical ≤ 400 mm

### Fastener selection and system recommendation

### Fastener program

Designation	Item no.	Colour	Cable diameter
X-DFC 8 MX	2143695	Red	8 mm ≤ D ≤ 8.5 mm
X-DF-W 8 MX	2143699	White	
X-DFC 9 MX	2143696	Red	8.5 mm ≤ D ≤ 9 mm
X-DFC-W 9 MX	2143730	White	

### Tool selection

- |            |         |                                |
|------------|---------|--------------------------------|
| X-P B3 MX: | BX 3-ME | No gas can required            |
| X-P G3 MX: | GX 3-ME | Gas can GC 40, GC 41 and GC 42 |

### Nail recommendation

Fastening tool	Nail types	Length [mm]	Tip	Shank Ø [mm]	Material	Hardness [HRC]	Coating [µm]
BX3-ME	X-P B3 MX	17 - 20	Long-conical	3.0	Carbon steel	57.5	Zinc, 2-13
GX3-ME	X-P G3 MX					57.5	Zinc, 2-13

- For the X-DFC MX element, only 17 mm and 20 mm pin lengths are recommended in order to ensure sufficient embedment depth.
- Nails (as listed above) are recommended for wall and ceiling application (soft and some tough concrete and sandlime stone, GX/BX tools). For more details regarding nail classification and concrete types, see Concrete Fastener Selection chapter in Direct Fastening Technology Manual (DFTM).

### Application requirements

#### Thickness of base material

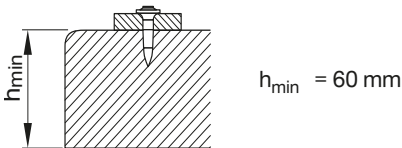

#### Edge distance

Min. edge distance = 70 mm

#### Corrosion information

Zinc-coated nails are not suitable for long-term service outdoors or in otherwise corrosive environments. For further detailed information on corrosion see relevant chapter in Direct Fastening Principles and Technique section.

#### Fastening quality assurance

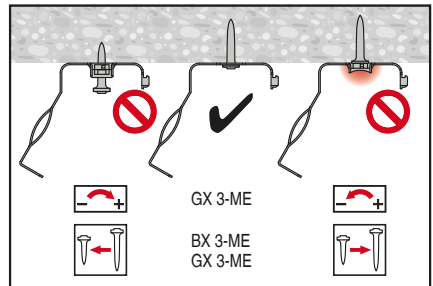
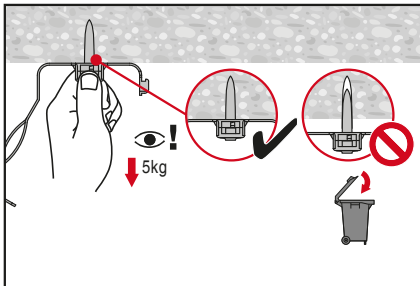



# X-EGN, X-GHP, X-GN Fastener for gas-actuated tool

## Product data

### Dimensions

#### X-EGN 14

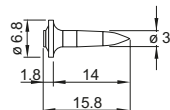

#### X-GHP 17/20/24

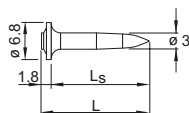

#### X-GN 20/27/32

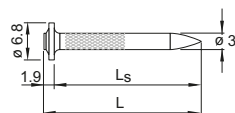

#### X-GN 39

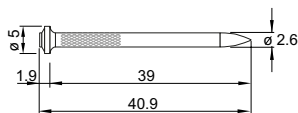

### General information

#### Material specifications

Carbon steel shank:	<b>X-EGN</b>	HRC 57.5
	<b>X-GHP</b>	HRC 57.5
	<b>X-GN</b>	HRC 53.5
Zinc coating:	2–13 $\mu\text{m}$	

#### Recommended fastening tools

**GX 120, GX 120-ME**

**GX 100, GX 100 E**

See X-EGN, X-GHP, X-GN fastener program in the next pages and Tools and equipment chapter for more details.

#### Approvals

ICC-ESR 1752 (USA):	<b>X-GN 20/27/32, X-EGN 14, X-GHP 16/17/20/24 X-GHP, X-GN</b>
IBMB	

Note: technical data presented in these approvals and design guidelines reflect specific local conditions and may differ from those published in this handbook.

## Applications

### Examples

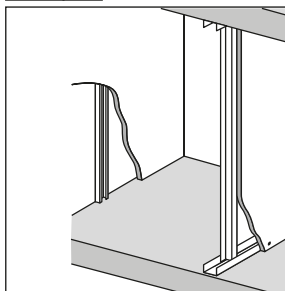

**Drywall tracks to concrete and steel**



**Electrical applications**

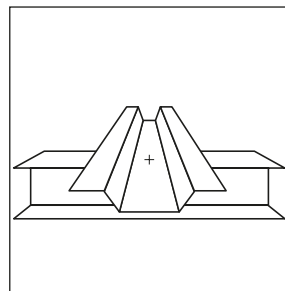

**Temporary tacking of composite deck to steel beams**

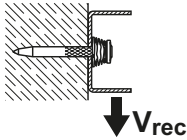
**Performance data**
**Performance data for drywall track fastening**

**X-EGN (Base material: steel)**

Tension $N_{rec}$ [kN]	Shear $V_{rec}$ [kN]
0.4	0.4

**X-GHP, X-GN (Base material: concrete / sand-lime masonry)**

Embedment [mm]	Recommended Loads [kN]					
	Tension $N_{rec}$		Shear $V_{rec}$		Tension $N_{rec}$	Shear $V_{rec}$
	Concrete Type				Sand-lime masonry	
	Soft	Tough	Soft	Tough		
$\geq 22$	-	-	-	-	0.3	0.3
$\geq 18$	0.2	-	0.2	-	0.2	0.2
$\geq 14$	0.1	0.1	0.1	0.1	0.1	0.1

**Conditions:**

- For safety relevant fastenings sufficient redundancy of the entire system is required; Minimum of 5 nails per fastened track. All visible setting failures must be replaced
- Sheet metal failure is not considered in recommended loads and must be assessed separately
- Soft concrete up to  $f_{c,cube} = 45 \text{ N/mm}^2$  (C35/45), some tough concrete up to  $f_{c,cube} = 60 \text{ N/mm}^2$  (C50/60).
- Concrete with aggregate like granite or river rock or softer, and up to 16 mm diameter



	Stick rate estimation	
	Soft Concrete	Tough concrete
X-GHP	85% - 98%	70% - 85%
X-GN	75% - 90%	55% - 70%

- The stick rate indicates the percentage of nails that were driven correctly to carry a load. Stick rate can vary from the above values depending on job site conditions.

**Recommended loads of X-EGN 14 MX for temporary tacking of composite decks**

Tension $N_{rec}$ [kN]	Shear $N_{rec}$ [kN]
0.4	0.4

**Conditions:**

- The intended use of the fastenings is to secure the deck position and to ensure a safe working platform during the erection state only. The fasteners serve as temporary fixation until the shear connectors of the composite beams are attached.
- At each permanent composite deck support, it is recommended to drive at least one fastener per trough.
- Every deck panel must be fixed at least with two fasteners at every permanent support.
- Single layer sheet with a maximum thickness of 1.25 mm.
- Sheeting grade up to S450 acc. to EN 10346.
- Minimum base material thickness: 6 mm.
- Minimum steel grade: S235 acc. to EN 10025-2.

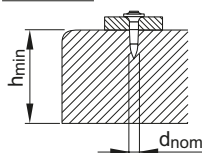
**Application requirements**
**Thickness of base material**
Concrete

$h_{min} = 60 \text{ mm}$   
 $(d_{nom} = 3.0 \text{ mm})$

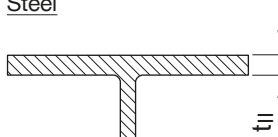
Steel

$t_{II} \geq 4 \text{ mm}$

**Thickness of fastened material**

Wooden track:  $t_1 \leq 25 \text{ mm}$   
 Metal track:  $t_1 \leq 2 \text{ mm}$

**Spacing and edge distances (mm)**

Spacing along track  
(as per U.S. Gypsum Handbook)

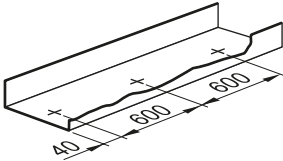

All track ends (cut-outs for doors),  
secure with 2 nails

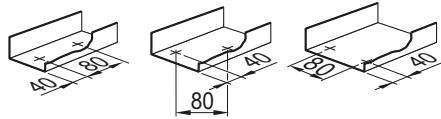

Distance to edge of concrete / Fastener spacings on wood:  
sandlime masonry

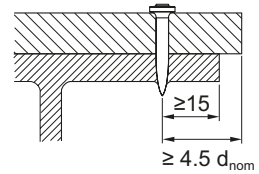
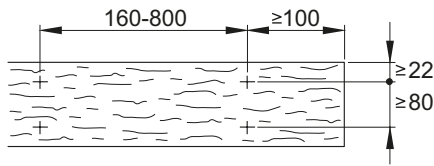
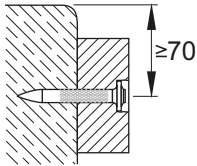
**Corrosion information**

The intended use only comprises fastenings which are not directly exposed to external weather conditions or moist atmospheres. For further detailed information on corrosion see relevant chapter in **Direct Fastening Principles and Technique** section.

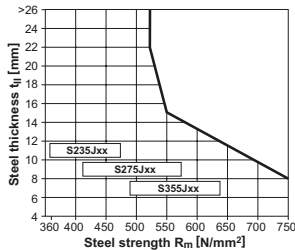
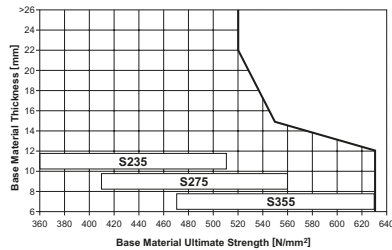

**Application limits**
**Steel**

**For temporary tacking of composite decks**

**X-EGN 14**
**Design conditions:**

- Single layer sheet with a maximum thickness of 1.25 mm.
- Sheeting grade up to S450 acc. to EN 10346.
- Minimum base material thickness: 6 mm
- Minimum steel grade: S235 acc. to EN 10025-2

**Fastener selection and system recommendation**
**Fastener selection**
Fastening to concrete / sandlime masonry

	Application	Base material	
<b>X-GN 39 MX</b>	Wooden track ( $t_1 \leq 25$ mm)	Concrete/sandlime masonry	increasing strength
<b>X-GN 27MX</b>	Metal track	Concrete/sandlime masonry	
<b>X-GN 20 MX</b>	Metal track	Concrete/sandlime masonry	
<b>X-GHP_MX</b>	Metal track	Concrete/sandlime masonry	

Fastening to steel

	Application	Base material	
<b>X-EGN 14</b>	Metal track	Steel	

**Fastener program**

	Item no.	$L_s$ [mm]	L [mm]	$d_{nom}$ [mm]
<b>X-EGN 14 MX</b>	340231	14	15.8	3.0
<b>X-GHP 16 MX</b>	2071471	16	17.8	3.0
<b>X-GHP 17 MX</b>	340228	18	19.8	3.0
<b>X-GHP 20 MX</b>	285724	20	21.8	3.0
<b>X-GHP 24 MX</b>	438945	24	25.8	3.0
<b>X-GN 20 MX</b>	340232	19	20.9	3.0
<b>X-GN 27 MX</b>	340230	27	28.9	3.0
<b>X-GN 32 MX</b>	340233	32	33.9	3.0
<b>X-GN 39 MX</b>	340234	39	40.9	2.6

**Tool and gas can**
**Designation**
**GX 120 / GX 120 ME**

with gas can GC 20, GC 21 and GC 22

**GX 100 / GX 100 E**

with gas can GC 11 and GC 12 (for USA)

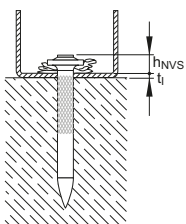
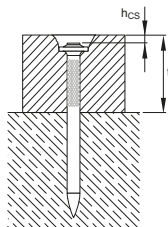
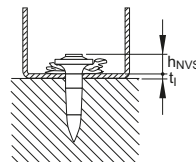
**Fastening quality assurance**
**Fastening inspection**
**Fastening to concrete / sandlime masonry**

**X-GN/GHP:  $h_{NVS} = 2-5$  mm**

**X-GN 39:  $h_{CS} = 2-3$  mm**
**Fastening to steel**

**X-EGN 14:  $h_{NVS} = 2-9$  mm**

# GX 3 System Fastener for interior finishing, building construction, mechanical and electrical application

## Product data

### GX 3 gas tool



### GX 3, GX 3-ME

### Nails (For fastening to concrete)

X-P 17/20/24 G3 MX

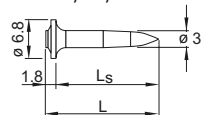

X-C 20/27/32 G3 MX

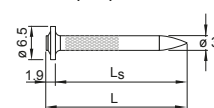

X-C 39 G3 MX

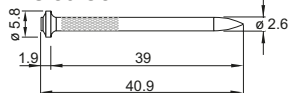

### Nails (For fastening to steel)

X-S 14 G3 MX

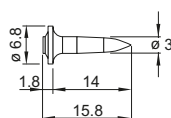

## General information

### Material specifications: B3 threaded studs

X-P G3 MX, X-S G3 MX

Carbon steel, HRC 57.5, 2-13 µm zinc coating

X-C G3 MX

Carbon steel, HRC 56.5, 2-13 µm zinc coating

### Approvals

ICC-ESR 1752 (USA)

X-P 17/20/24 G3 MX, X-C 20/27/32 G3 MX and X-S 14 G3 MX

IBMB

X-P 17/20/24 G3 MX, X-C 20/27/32/39 G3 MX

ETA-16/0301

X-P 20/24 G3 MX

## Applications

### Examples



Drywall tracks



Light-duty building construction applications

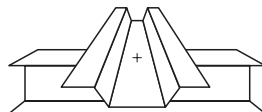

Temporary tacking of composite deck to steel beams

## Product data

### Electrical elements to be used with nails

X-ECT MX



X-UCT MX



X-EKS MX

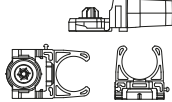

X-EKSC MX



X-FB MX

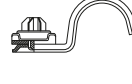

X-ECH MX

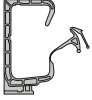

X-DFB MX



X-EKB MX



X-ECC MX



X-EHS MX



X-ET MX

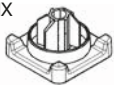

X-TT



X-ECT 40 MX



## General information

### Material specifications

XX-ECT MX, X-EKS, X-EKSC MX, ECH MX	PA, halogen free, silicone free, light grey RAL 7035
X-EKB MX	PA, halogen free, light grey RAL 7035
X-ECT-FR MX	PBT, silicone free, flame retardant, stone grey RAL 7030
X-EKB-FR MX	PBT, silicone free, flame retardant, stone grey RAL 7030
X-UCT MX, X-ET MX	HDPE, halogen free, silicone free, light grey RAL 7035
X-TT	PET
X-FB MX, X-DFB MX	Galvanized steel sheet $f_u = 270-420 \text{ N/mm}^2$ , 10-20 $\mu\text{m}$ zinc coating
X-ECC MX, X-EHS MX	Galvanized steel sheet $f_u = 270-420 \text{ N/mm}^2$ , 10-20 $\mu\text{m}$ zinc coating

## Approvals

ICC-ESR 1752 (USA), IBMB, ETA-16/0301

## Applications



Conduits and light-duty pipes



Electrical cables

## Product data

### GX 3 gas tool



### GX 3, GX 3-ME

### Studs

(For fastening to concrete)

X-M6-7-24 G3 P7

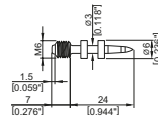

X-W6-12-20 G3 P7

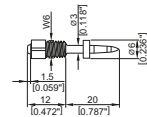

(For fastening to steel)

X-M6-7-14 G3 P7

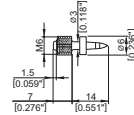

X-W6-12-14 G3 P7

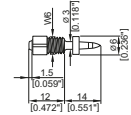

## General information

### Material specifications

Carbon steel shank

HRC 57.5

Zinc coating

2-10 µm

## Applications



Junction boxes, switch boxes, etc.



Pipe rings for light-duty pipes

## Performance data

### Performance data for drywall track fastening

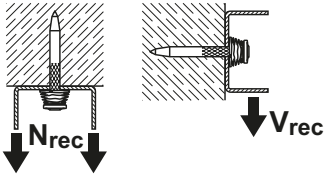

#### X-S 14 G3 MX (Base material: steel)

Tension $N_{rec}$ [kN]	Shear $V_{rec}$ [kN]
0.4	0.4

#### X-P G3, X-C G3 (Base material: concrete / sand-lime masonry)

Embedment [mm]	Recommended Loads [kN]					
	Tension $N_{rec}$		Shear $V_{rec}$		Tension $N_{rec}$	Shear $V_{rec}$
	Concrete Type				Sand-lime masonry	
	Soft	Tough	Soft	Tough		
$\geq 22$	-	-	-	-	0.3	0.3
$\geq 18$	0.2	-	0.2	-	0.2	0.2
$\geq 14$	0.1	0.1	0.1	0.1	0.1	0.1

#### Conditions:

- For safety relevant fastenings sufficient redundancy of the entire system is required; Minimum of 5 nails per fastened track. All visible setting failures must be replaced
- Sheet metal failure is not considered in recommended loads and must be assessed separately
- Soft concrete up to  $f_{c,cube} = 45 \text{ N/mm}^2$  (C35/45), some tough concrete up to  $f_{c,cube} = 60 \text{ N/mm}^2$  (C50/60).
- Concrete with aggregate like granite or river rock or softer, and up to 16 mm diameter



	Stick rate estimation	
	Soft Concrete	Tough concrete
X-P G3	85% - 98%	70% - 85%
X-C G3	75% - 90%	55% - 70%

- The stick rate indicates the percentage of nails that were driven correctly to carry a load. Stick rate can vary from the above values depending on job site conditions.

Threaded stud	Recommended loads and tightening torque			Base material
	$N_{rec}$ [kN]	$V_{rec}$ [kN]	$T_{rec}$ [Nm]	
X-M6-7-24 G3 P7	0.05	0.05	3.0	Concrete, sand-lime masonry
X-W6-12-20 G3 P7				
X-M6-7-14 G3 P7	0.2	0.2	3.0	Steel
X-W6-12-14 G3 P7				

### Recommended loads (electrical elements used with nails)

Element	Maximum service load $F_{max}$ [N]
X-ECT (FR) MX	40
X-UCT MX	40
X-EKS MX	11
X-EKSC MX	32
X-FB MX / X-DFB MX	20
X-ECC MX	50
X-EHS MX	80
X-EKB (FR) 4 MX	9
X-EKB (FR) 8 MX	14
X-EKB (FR) 16 MX	18
X-ECH MX	40
	Cable trunking
X-ET MX	100

### Application requirements

#### Thickness of base material

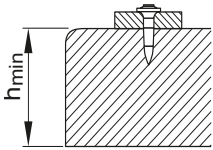

Concrete (for nails and threaded studs)  
 $h_{\min} = 60 \text{ mm}$

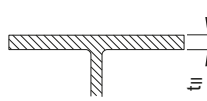

Steel  
 $t_{II} \geq 4.0 \text{ mm}$  (for nails)  
 $t_{II} \geq 6.0 \text{ mm}$  (for threaded studs)

#### Thickness of fastened material

Wooden track:  $t_I \leq 25 \text{ mm}$

Metal track:  $t_I \leq 2 \text{ mm}$

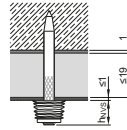

Deflection head:  
 $t_{I, \text{tot.}} \leq 21 \text{ mm}$  (gypsum strip + metal track and sealant)

#### Spacing and edge distances (mm)

##### Spacing along track

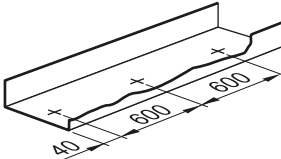

All track ends (cut-outs for doors),  
 secure with 2 nails

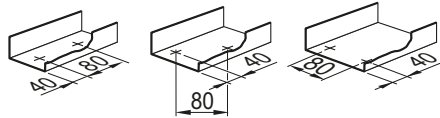

Fastener spacing max. 30 cm for proprietary light non-load-bearing partition walls with fire classification

##### Distance to edge of concrete / sand-lime masonry

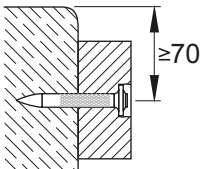

##### Spacing between nails when fastening wood to concrete

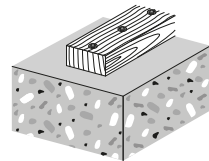
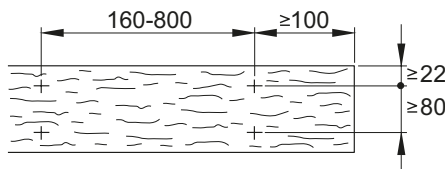

##### Distance to edge of fastened material (steel base material)

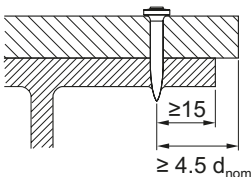



## Application limits

### X-S 14 G3 MX

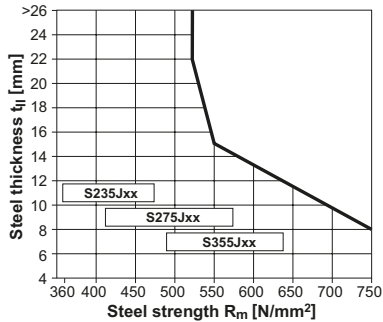

### X-M6-7-14 G3 P7, X-W6-12-14 G3 P7

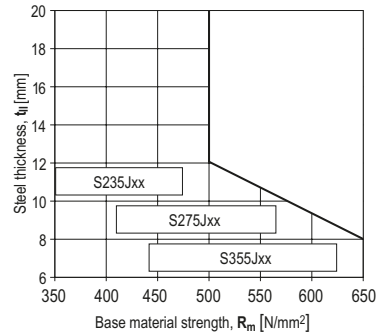

### For temporary tacking of composite decks

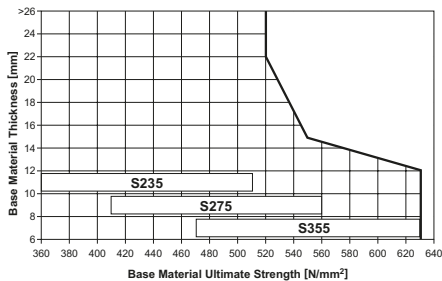

### Design conditions:

- Single layer sheet with a maximum thickness of 1.25 mm.
- Sheeting grade up to S450 acc. to EN 10346.
- Minimum base material thickness: 6 mm
- Minimum steel grade: S235 acc. to EN 10025-2

### Corrosion information

The intended use only comprises fastenings which are not directly exposed to external weather conditions or moist atmospheres, i.e. only intended for dry indoor areas.

## Fastener selection and system recommendation

Fastener program









### Nails

Nail	Item no.	Shank length (mm)	Shank diameter (mm)	Base material	Length recommendation
X-S 14 G3 MX	2101547	14	3	Steel	
X-P 17 G3 MX	2101046	17	3	Concrete / Sand-lime masonry	
X-P 20 G3 MX	2101047	20	3		
X-P 24 G3 MX	2101048	24	3		
X-C 20 G3 MX	2100955	20	3		
X-C 27 G3 MX	2100956	27	3		
X-C 32 G3 MX	2100957	32	3		
X-C 39 G3 MX	2100958	39	2.8		

### Threaded studs

Threaded studs	Item no.	Thread size	Thread length (mm)	Shank length (mm)	Shank diameter (mm)	Base material
X-M6-7-14 G3 P7	2101052	M6	7	14	3	Steel
X-M6-7-24 G3 P7	2101053	M6	7	24	3	Concrete
X-W6-12-14 G3 P7	2101054	W6	12	14	3	Steel
X-W6-12-20 G3 P7	2101055	W6	12	20	3	Concrete

### Fastener recommendations

	Nail Selector for GX 3			
	Hollow brick	Concrete		Steel
		Wall / Floor	Ceiling	
	X-C 27 G3 MX X-C 20 G3 MX	X-C 20 G3 MX	X-C 20 G3 MX X-P 17 G3 MX	X-S 14 G3 MX
	X-C 39 G3 MX X-C 32 G3 MX			
	X-C 27 G3 MX X-C 20 G3 MX	X-C 20 G3 MX	X-C 20 G3 MX X-P 17 G3 MX	X-S 14 G3 MX
	X-C 20 G3 MX		X-C 20 G3 MX X-P 17 G3 MX	X-S 14 G3 MX
	X-C 20 G3 MX		X-C 20 G3 MX X-P 17 G3 MX	X-S 14 G3 MX
	X-W6-12-20 G3 P7 X-M6-7-24 G3 P7			X-W6-12-14 G3 P7 X-M6-7-14 G3 P7
Gas can			GC 40 / GC 41 / GC 42 - For all base materials	

For more details and information, please contact your nearest Hilti representative.

Fastener guide	Item no.	Use
X-FG G3	2102280	With nails or studs only
X-FG G3-ME	2102281	With nails + elements or only studs

## Fastening quality assurance

### Fastening inspection

#### Nails and studs in concrete / sand-lime masonry

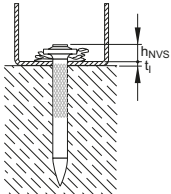

X-P\_G3 MX, X-C\_G3 MX:  
 $h_{NVS} = 2-5 \text{ mm}$

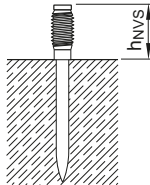

X-M6-7-24 G3 P7  
 X-W6-12-20 G3 P7  
 $h_{NVS} \geq 7 \text{ mm}$   
 $h_{NVS} \geq 12 \text{ mm}$

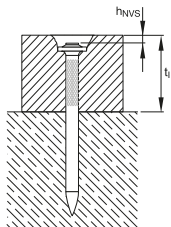

X-P\_G3 MX, X-C\_G3 MX:  
 $h_{NVS} = 2-3 \text{ mm}$

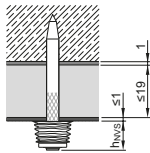

Deflection head  
 X-C 39 G3 MX  
 12.5 mm board:  $h_{NVS} \leq 15 \text{ mm}$   
 15 mm board:  $h_{NVS} \leq 12 \text{ mm}$   
 19 mm board:  $h_{NVS} \leq 8 \text{ mm}$

#### Nails and studs in steel

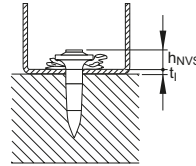

X-S 14 G3 MX:  
 $h_{NVS} = 2-9 \text{ mm}$

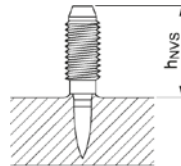

X-M6-7-14 G3 P7  
 X-W6-12-14 G3 P7  
 $h_{NVS} \geq 7 \text{ mm}$   
 $h_{NVS} \geq 12 \text{ mm}$

Element	$h_{NVS}$ (mm)	
	Concrete	Steel
X-EKB 4/8 MX	6-11	6-9
X-EKB 16 MX	6-11	6-9
X-ECT MX	6-11	6-9
X-UCT MX	6-11	6-9
X-ECH MX	6-11	6-9
X-EKS MX	6-11	6-9
X-EKSC MX	6-11	6-9
X-FB MX	7-11	7-9
X-DFB MX	7-11	7-9
X-ECC MX	7-11	7-9
X-EHS MX	7-11	7-9
X-ET MX*	5-10	5-9

#### Examples

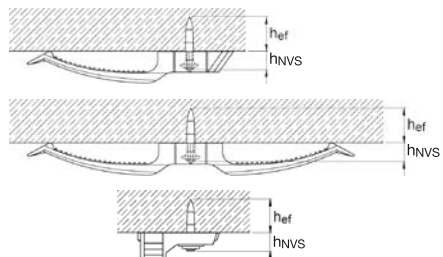

\*) With X-ET MX, the  $h_{NVS}$  is measured against the cable trunk.

## GX 2 System Fastener for interior finishing application

### Product data

#### Dimensions

X-P 14 G2 MX

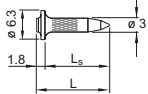

X-P 17 / 20 G2 MX

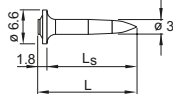

X-C 20 / 27 / 32 G2 MX

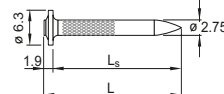

X-C 39 G2 MX

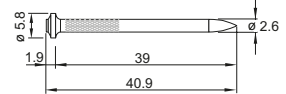

### General information

#### Material specifications

Carbon steel shank:

**X-P G2**

HRC 57.5

**X-C G2**

HRC 56.5

Zinc coating:

(X-P 14 G2 MX)

2–13 µm

up to 16 µm

### Recommended fastening tool

#### GX 2



### Approvals

ICC ESR-1752 (USA):

**X-C 20 / 27 / 32 G2, X-P 14 / 17 / 20 G2**

### Applications

#### Examples



Drywall tracks



Light-duty applications in construction

## Performance data

### Performance data for drywall track fastening

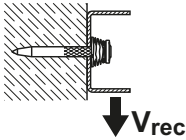

#### X-P 14 G2 MX (Base material: steel)

Tension $N_{rec}$ [kN]	Shear $V_{rec}$ [kN]
0.4	0.4

#### X-P G2, X-C G2 (Base material: concrete / sand-lime masonry)

Embedment [mm]	Recommended Loads [kN]					
	Tension $N_{rec}$		Shear $V_{rec}$		Tension $N_{rec}$	Shear $V_{rec}$
	Concrete Type				Sand-lime masonry	
	Soft	Tough	Soft	Tough		
$\geq 22$	-	-	-	-	0.3	0.3
$\geq 18$	0.2	-	0.2	-	0.2	0.2
$\geq 14$	0.1	0.1	0.1	0.1	0.1	0.1

#### Conditions:

- For safety relevant fastenings sufficient redundancy of the entire system is required; Minimum of 5 nails per fastened track. All visible setting failures must be replaced
- Sheet metal failure is not considered in recommended loads and must be assessed separately
- Soft concrete up to  $f_{c,cube} = 45 \text{ N/mm}^2$  (C35/45), some tough concrete up to  $f_{c,cube} = 60 \text{ N/mm}^2$  (C50/60).
- Concrete with aggregate like granite or river rock or softer, and up to 16 mm diameter



	Stick rate estimation	
	Soft Concrete	Tough concrete
X-P G2	85% - 98%	70% - 85%
X-C G2	75% - 90%	55% - 70%

- The stick rate indicates the percentage of nails that were driven correctly to carry a load. Stick rate can vary from the above values depending on job site conditions.

## Application requirements

### Thickness of base material

Concrete

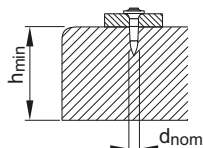

$h_{min} = 60 \text{ mm}$   
 $(d_{nom} \leq 3.0 \text{ mm})$

Steel

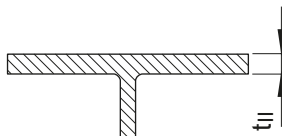

$t_{II} \geq 4.0 \text{ mm}$  (for nail)

### Thickness of fastened material

Wooden track:  $t_1 \leq 25 \text{ mm}$

Metal track:  $t_1 \leq 2 \text{ mm}$

### Spacing and edge distances (mm)

Spacing along track

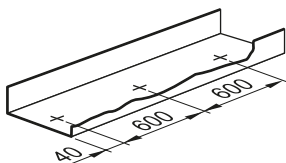

Edge distance for  
 concrete/sand-lime masonry

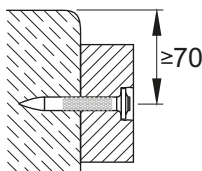

Edge distance for steel

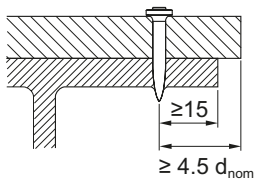

All track ends (cut-outs for doors),  
 secure with 2 nails

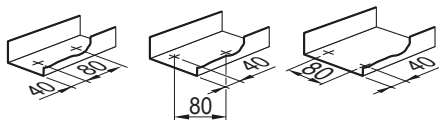

Fastener spacing on wood:

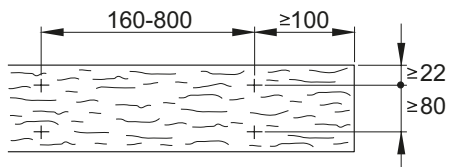

### Corrosion information

The intended use only comprises fastenings which are not directly exposed to external weather conditions or moist atmospheres. For further detailed information on corrosion see relevant chapter in **Direct Fastening Principles and Technique** section.

## Application limits

### Steel

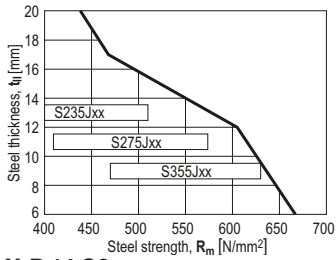

### X-P 14 G2

## Fastener selection

	Nail Selector for GX 2			
	Brick	Concrete Wall / Floor Ceiling	Steel	
	<b>X-C 27 G2 MX</b> <b>X-C 20 G2 MX</b>	<b>X-C 20 G2 MX</b>	<b>X-C 20 G2 MX</b> <b>X-P 17 G2 MX</b>	<b>X-P 14 G2 MX</b>
	<b>X-C 39 G2 MX</b> <b>X-C 32 G2 MX</b>			
<b>Gas can</b>				<b>GC 52 - For all base materials</b>

## Fastening quality assurance

### Nails in concrete / sand-lime masonry

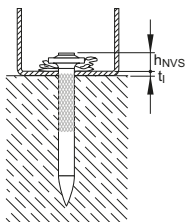

**X-C / X-P G2 MX:**  
 $h_{NVS} = 2 - 5 \text{ mm}$

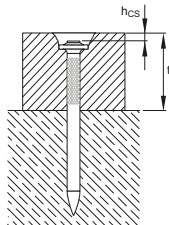

**X-C 39 G2 MX and  
 X-C 32 G2 MX:**  
 $h_{CS} = 2 - 3 \text{ mm}$

### Nails in steel

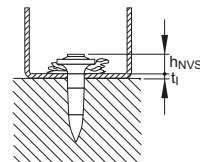

**X-P 14 G2 MX:**  
 $h_{NVS} = 2 - 9 \text{ mm}$



# BX 3 System Fastener for interior finishing, building construction, mechanical and electrical application

## Product data

### BX 3 battery-actuated direct fastening tools



BX 3-ME (02)  
BX 3-IF



BX 3 02  
BX 3-L 02

### Features and benefits

- Hilti's combustion-free direct fastening technology for driving nails into concrete, steel and some types of solid masonry
- High user comfort thanks to low levels of compression force, noise and recoil
- No disposal of (used) propellant cartridges or gas cans
- Hilti's 22V cordless tool battery platform

### Fasteners and their compatibility

#### Nails

For fastening to concrete  
X-P 17/20/24 B3 MX  
X-P 30/36 B3 P7  
X-C 20/24/27/30 B3 MX

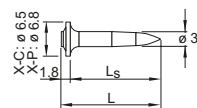

X-C 36 B3 MX

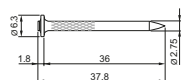

For fastening to steel  
X-S 14 B3 MX

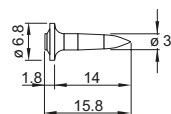

#### Threaded studs

For fastening to concrete  
X-M6-7-24 B3 P7

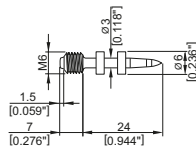

X-W6-12-20 B3 P7

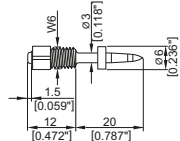

For fastening to steel  
X-M6-7-14 B3 P7

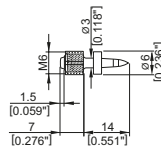

X-W6-12-14 B3 P7

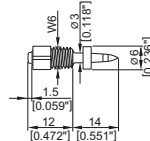

	BX 3-ME (02)	BX 3-IF	BX 3 02	BX 3-L 02
X-S 14 B3 MX	yes	yes	yes	yes
X-P 17 B3 MX	yes	yes	yes	yes
X-P 20 B3 MX	yes	yes	yes	yes
X-P 24 B3 MX	yes	yes	yes	yes
X-C 20 B3 MX	yes	yes	yes	yes
X-C 24 B3 MX	yes	yes	yes	yes
X-C 27 B3 MX	no	no	yes	yes
X-C 30 B3 MX	no	no	yes	yes
X-C 36 B3 MX	no	no	no	yes
X-M/W _ _ _ B3 P7	yes	yes	no	no
X-P _ B3 P7	yes	yes	no	no
ME MX elements	yes	with ME FG	with ME FG	with ME FG

### General information

#### Material specifications

X-P B3 MX/P7, X-S B3 MX  
X-C B3 MX

Carbon steel, HRC 57.5, 2-13 µm zinc coating  
Carbon steel, HRC 56.5, 2-13 µm zinc coating

## Electrical elements to be used with nails - examples

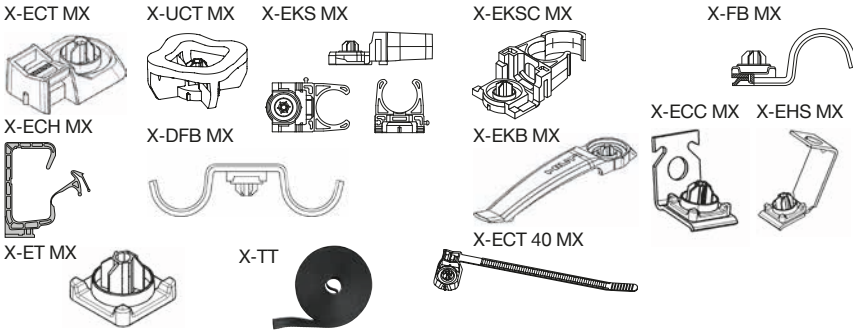

### General information

#### Material specifications

X-ECT MX, X-EKS, X-EKSC MX, ECH MX  
 X-EKB MX  
 X-ECT-FR MX  
 X-EKB-FR MX  
 X-UCT MX, X-ET MX  
 X-TT  
 X-FB MX, X-DFB MX  
 X-ECC MX, X-EHS MX

PA, halogen free, silicone free, light grey RAL 7035

PA, halogen free, light grey RAL 7035

PBT, silicone free, flame retardant, stone grey RAL 7030

PBT, silicone free, flame retardant, stone grey RAL 7030

HDPE, halogen free, silicone free, light grey RAL 7035

PET

Galvanized steel sheet,  $f_u = 270-420 \text{ N/mm}^2$ , 10–20  $\mu\text{m}$  zinc coating

Galvanized steel sheet,  $f_u = 270-420 \text{ N/mm}^2$ , 10–20  $\mu\text{m}$  zinc coating

#### Approvals

ICC-ESR 1752 (USA)  
 ETA-16/0301

X-P 20 B3 MX, X-P 24 B3 MX, various electrical elements (see ETA approval Annex A1)

### Applications

#### With nails



Drywall tracks to concrete and steel



Fastening wood, e.g. Placopan®, to concrete



Junction boxes, switch boxes, etc

#### With nails and elements



Flexible or rigid cable conduits with cable ties



Fastening cables



Cable conduits or light-duty pipes

## Performance data

### Performance data for drywall track fastening

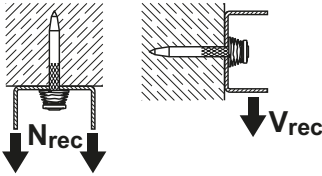

#### X-S 14 B3 MX (Base material: steel)

Tension $N_{rec}$ [kN]	Shear $V_{rec}$ [kN]
0.4	0.4

#### X-P B3, X-C B3 (Base material: concrete / sand-lime masonry)

Embedment [mm]	Recommended Loads [kN]					
	Tension $N_{rec}$		Shear $V_{rec}$		Tension $N_{rec}$	Shear $V_{rec}$
	Concrete Type				Sand-lime masonry	
	Soft	Tough	Soft	Tough		
≥ 22	-	-	-	-	0.3	0.3
≥ 18	0.2	-	0.2	-	0.2	0.2
≥ 14	0.1	0.1	0.1	0.1	0.1	0.1

#### Conditions:

- For safety relevant fastenings sufficient redundancy of the entire system is required; Minimum of 5 nails per fastened track. All visible setting failures must be replaced
- Sheet metal failure is not considered in recommended loads and must be assessed separately
- Soft concrete up to  $f_{c,cube} = 45 \text{ N/mm}^2$  (C35/45), some tough concrete up to  $f_{c,cube} = 60 \text{ N/mm}^2$  (C50/60).
- Concrete with aggregate like granite or river rock or softer, and up to 16 mm diameter



	Stick rate estimation	
	Soft Concrete	Tough concrete
X-P B3	85% - 98%	70% - 85%
X-C B3	75% - 90%	55% - 70%

- The stick rate indicates the percentage of nails that were driven correctly to carry a load. Stick rate can vary from the above values depending on job site conditions.

## Performance data

### Recommended loads (Threaded studs only)

Threaded stud	Recommended loads and tightening torque			Base material
	$N_{rec}$ [kN]	$V_{rec}$ [kN]	$T_{rec}$ [Nm]	
X-M6-7-24 B3 P7	0.05	0.05	3.0	Concrete, sand-lime masonry
X-W6-12-20 B3 P7				
X-M6-7-14 B3 P7	0.2	0.2	3.0	Steel
X-W6-12-14 B3 P7				

### Recommended loads (electrical elements used with nails)

Element	Maximum service load $F_{max}$ [N]
X-ECT (FR) MX	40
X-UCT MX	40
X-EKS MX	11
X-EKSC MX	32
X-FB MX / X-DFB MX	20
X-ECC MX	50
X-EHS MX	80
X-EKB (FR) 4 MX	9
X-EKB (FR) 8 MX	14
X-EKB (FR) 16 MX	18
X-ECH MX	40
	Cable trunking
X-ET MX	100

Conditions:

- Spacing  $\leq$  100 mm
- All visible failures must be replaced

### Nail recommendation

For **concrete** base material

Nail types	Length [mm]	Tip	Shank Ø [mm]	Material	Hardness [HRC]	Coating [µm]
X-P B3 P7/MX	17-36	Long conical	3.0	Carbon steel	57.5	Zinc, 2-10

- Premium nails (as listed above) are recommended for use on soft and some tough concrete. For more details regarding nail classification and concrete types, please refer to **Concrete Fastener Selection** section in Hilti Direct Fastening Technology Manual (DFTM)
- X-P 17/20/24 B3 MX to be used with BX 3 02, BX 3-L 02, BX 3-ME (02) and BX 3-IF
- X-P 30/36 B3 P7 to be used with BX 3-ME (02) and BX 3-IF

For **concrete** base material

Nail types	Length [mm]	Tip	Shank Ø [mm]	Material	Hardness [HRC]	Coating [µm]
X-C B3 MX	20-30 36	Cut	3.0 2.75	Carbon steel	56.5	Zinc, 5-13

- Standard nails (as listed above) are recommended for use on soft concrete only. For more details regarding nail classification and concrete types, please refer to **Concrete Fastener Selection** section in Hilti Direct Fastening Technology Manual (DFTM)
- X-C 20/24/27/30 B3 MX to be used with BX 3 02
- X-C 20/24/27/30/36 B3 MX to be used with BX 3-L 02
- X-C 20/24 B3 MX to be used with BX 3-ME (02) and BX 3-IF

For **steel** base material

Nail types	Length [mm]	Tip	Shank Ø [mm]	Material	Hardness [HRC]	Coating [µm]
X-S 14 B3 MX	14	Long conical	3.0	Carbon steel	57.5	Zinc, 2-10

- X-S 14 B3 MX to be used with BX 3 02, BX 3-L 02, BX 3-ME (02) and BX 3-IF
- Please refer to next pages for application limits on steel base material

## Application requirements

### Thickness of base material

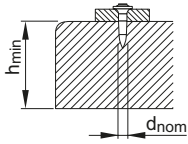

Concrete (for nails  
and threaded studs)  
 $h_{\min} = 60 \text{ mm}$   
 $d_{\text{nom}} = 3.0 \text{ mm}$

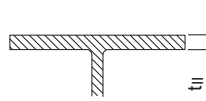

Steel  
 $t_{II} \geq 4.0 \text{ mm}$  (for nails)  
 $t_{II} \geq 6.0 \text{ mm}$  (for  
threaded studs)

### Thickness of fastened material

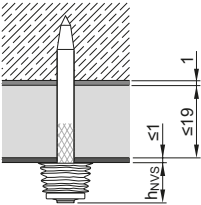

Wooden track:  $t_1 \leq 27 \text{ mm}$  (conditions: head of the nail is  
countersunk flat to the surface)  
Metal track:  $t_1 \leq 2 \text{ mm}$   
Deflection head:  $t_{1.\text{tot.}} \leq 21 \text{ mm}$  (gypsum strip +  
metal track and sealant)

### Spacing and edge distances (mm)

#### Max. spacing along track

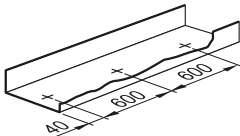

Fastener spacing max. 30 cm for proprietary  
light non-load-bearing partition walls with  
fire classification

#### All track ends (cut-outs for doors), secure with 2 nails

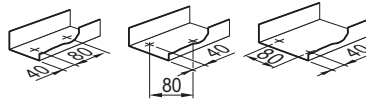

#### Distance to edge of concrete / sand-lime masonry

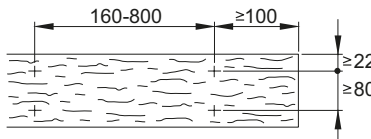
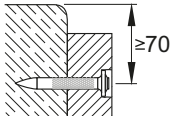

#### Spacing between nails when fastening wood to concrete

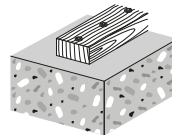

Based on common practice, spacing needs to be adjusted based on specific  
load requirement and achieved embedment depth.

#### Distance to edge of fastened material (steel base material)

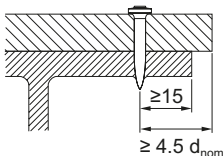

### Application limits

X-S 14 B3 MX

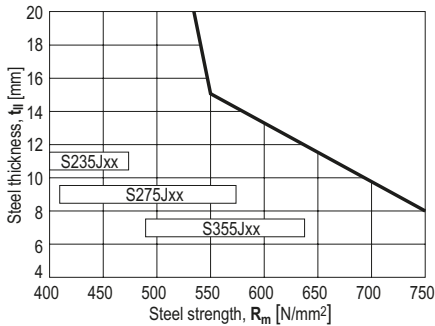

X-M6-7-14 B3 P7, X-W6-12-14 B3 P7

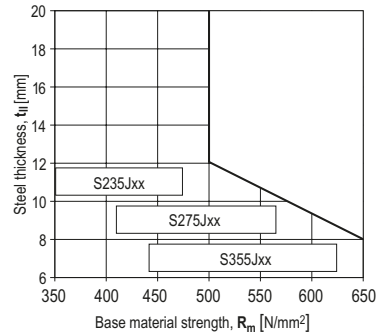

### Corrosion information

The intended use only comprises fastenings which are not directly exposed to external weather conditions or moist atmospheres, i.e. only intended for dry indoor areas.

### Fastener selection and system recommendation

Fastener program















#### Nails

Nail	Item no.	Shank length (mm)	Shank diameter (mm)	Base material	Length recommendation
X-S 14 B3 MX	2156392, 2156393	14	3	Steel	
X-P 17 B3 MX	2156216, 2156219	17	3	Concrete / Sand-lime masonry	
X-P 20 B3 MX	2156217, 2156390	20	3		
X-P 24 B3 MX	2156218, 2156391	24	3		
X-P 30 B3 P7	2105406	30	3		
X-P 36 B3 P7	2105407	36	3		
X-C 20 B3 MX	2123993	20	3		
X-C 24 B3 MX	2123994	24	3		
X-C 27 B3 MX	2224568	27	3		
X-C 30 B3 MX	2149988	30	3		
X-C 36 B3 MX	2149989	36	2.75		

### Threaded studs

Threaded studs	Item no.	Thread size	Thread length (mm)	Shank length (mm)	Shank diameter (mm)	Base material
X-M6-7-14 B3 P7	2105408	M6	7	14	3	Steel
X-M6-7-24 B3 P7	2105409	M6	7	24	3	Concrete
X-W6-12-14 B3 P7	2105800	W6	12	14	3	Steel
X-W6-12-20 B3 P7	2105801	W6	12	20	3	Concrete







### Fastener selection

	Nail Selector for BX 3-ME (02) and BX 3-IF 			
	Brick	Concrete Floor	Concrete Wall/Ceiling	Steel
 + 	<b>X-C 24 B3 MX</b>	<b>X-C 20 B3 MX</b> X-C 24 B3 MX	<b>X-C 20 B3 MX</b> X-P 17 B3 MX	<b>X-S 14 B3 MX</b>
 + 	-----	<b>X-C 36 B3 P7</b>	-----	-----
 + 	<b>X-C 24 B3 MX</b> X-C 20 B3 MX		<b>X-P 20 B3 MX</b>	<b>X-S 14 B3 MX</b>
 + 	<b>X-P 20 B3 MX</b> X-P 17 B3 MX	-----	<b>X-P 17 B3 MX</b>	<b>X-S 14 B3 MX</b>
 + 	-----	<b>X-C 24 B3 MX</b> X-C 20 B3 MX	-----	<b>X-S 14 B3 MX</b>
 + 	<b>X-W6-12-20 B3 P7</b> <b>X-M6-7-24 B3 P7</b>			<b>X-W6-12-14 B3 P7</b> <b>X-M6-7-14 B3 P7</b>
<b>Propellant-free</b>				

For more details and information, please contact your nearest Hilti representative.



## Fastener selection

	Nail Selector for BX 3 02 and BX 3-L 02			
	Brick	Concrete Floor	Concrete Wall/Ceiling	
	X-C 24-36 B3 MX*	X-C 20 B3 MX X-C 24 B3 MX	X-C 20 B3 MX X-P 17 B3 MX	X-S 14 B3 MX
	-----	X-C 36 B3 MX*	-----	-----
	X-C 24 B3 MX X-C 20 B3 MX		X-P 20 B3 MX	X-S 14 B3 MX
	X-P 20 B3 MX X-P 17 B3 MX	-----	X-P 17 B3 MX	X-S 14 B3 MX
	-----	X-C 24 B3 MX X-C 20 B3 MX	-----	X-S 14 B3 MX
Propellant-free				

\* X-C 36 B3 MX suitable for BX 3-L 02 only

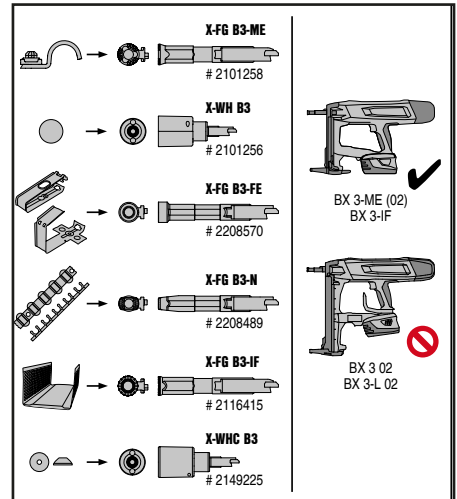
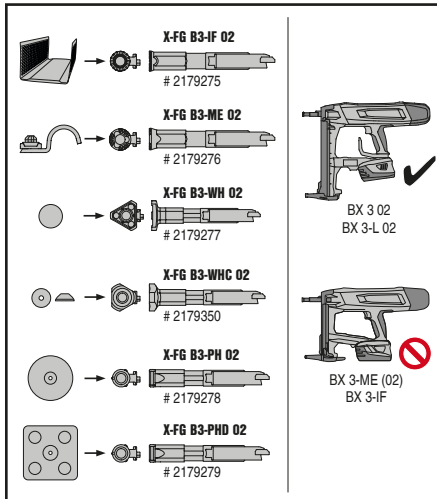

## Fastening quality assurance

### Fastening inspection

#### Nails and studs in concrete / sand-lime masonry

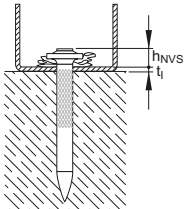

X-C\_B3, X-P\_B3:  
 $h_{NVS} = 2-5 \text{ mm}$

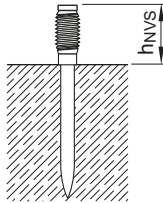

X-M6-7-24 B3 P7  
X-W6-12-20 B3 P7

$h_{NVS} \geq 7 \text{ mm}$   
 $\geq 12 \text{ mm}$

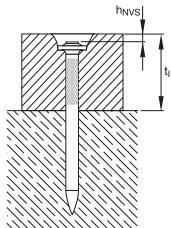

X-C\_B3, X-P\_B3:  
 $h_{NVS} = 2-3 \text{ mm}$

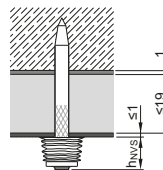

Deflection head  
X-P 36 B3 P7, X-C 36 B3 MX  
12.5 mm board:  $h_{NVS} \leq 12 \text{ mm}$   
15 mm board:  $h_{NVS} \leq 9 \text{ mm}$   
19 mm board:  $h_{NVS} \leq 5 \text{ mm}$

#### Nails and studs in steel

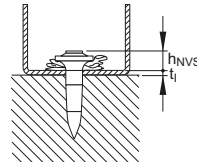

X-S\_B3:  
 $h_{NVS} = 2-9 \text{ mm}$

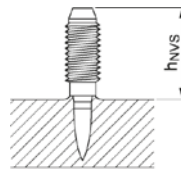

X-M6-7-14 B3 P7  
X-W6-12-14 B3 P7

$h_{NVS} \geq 7 \text{ mm}$   
 $\geq 12 \text{ mm}$

Element	$h_{NVS}$ (mm)	
	Concrete	Steel
X-EKB 4/8 MX	6-11	6-9
X-EKB 16 MX	6-11	6-9
X-ECT MX	6-11	6-9
X-UCT MX	6-11	6-9
X-ECH MX	6-11	6-9
X-EKS MX	6-11	6-9
X-EKSC MX	6-11	6-9
X-FB MX	7-11	7-9
X-DFB MX	7-11	7-9
X-ECC MX	7-11	7-9
X-EHS MX	7-11	7-9
X-ET MX*	5-10	5-9

### Examples

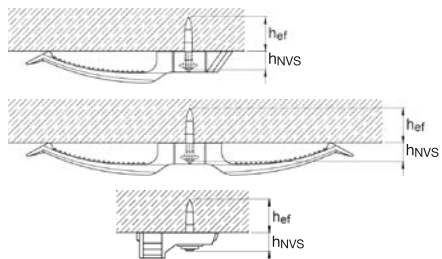

\*) With X-ET MX, the  $h_{NVS}$  is measured against the cable trunk.

# BX-Kwik Electrical hanger system

## Product data

X-EHS MX



X-P 24 B3 MX

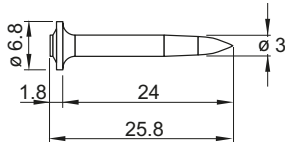

## Features and benefits

A special hanger system with pre-drilled pilot hole optimized for higher load and close to **100% stick rate** for applications on **soft & tough** concrete.

## General information

The system consists of:

- X-EHS MX hanger
- TX-C-5/10B drill bit
- X-P 24 B3 MX nail
- BX 3 ME

## Material Specifications

Hanger:

Zinc coating  $\geq 10 \mu\text{m}$

Nail:

Carbon Steel 57.5 HRC

Zinc Coating 2 – 10  $\mu\text{m}$

## Applications

### Examples



Threaded rod attachments to concrete



Cable trays

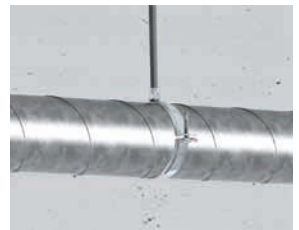

Small pipes

These zinc coated fasteners are not suitable for long-term service outdoors or in otherwise corrosive environments. For further detailed information on corrosion see chapter **Direct Fastening Principles and Technique**.

These fasteners are not recommended for fastening of suspended ceilings.

### Performance data on concrete

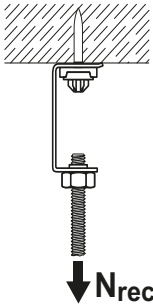

Recommended Tension Load $N_{rec}$ [kN]	
Concrete Toughness <sup>1)</sup>	
Soft 0.3	Tough 0.45

Stick rate estimation <sup>1)</sup>	
Soft Concrete	Tough Concrete
95-100 %	95-100 %

#### Conditions:

- A sufficient redundancy has to be ensured, that a failure of a single fastening will not lead to collapse of the entire system.
- Soft concrete up to  $f_{c,cube} = 45 \text{ N/mm}^2$  (C35/45).
- Tough concrete up to  $f_{c,cube} = 60 \text{ N/mm}^2$  (C50/60).
- Concrete with aggregate like granite or river rock or softer, and up to 16 mm diameter.
- Loads valid for cracked and uncracked concrete.

<sup>1)</sup> The stick rate indicates the percentage of nails that were driven correctly to carry a load. Stick rate can vary from the above value depending on job site conditions.

For more details regarding fastener behaviour and concrete types, please refer to

**Concrete Fastener Selection** section.

### Application requirements

#### Thickness of base material

Concrete:

$h_{min} = 60 \text{ mm}$

#### Edge distance and fastener spacing

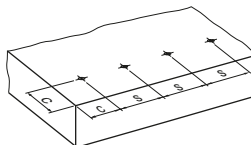

Edge distance:  $c \geq 70 \text{ mm}$

Spacing:  $s \geq 100 \text{ mm}$

## Installation

### Pre-drilling details

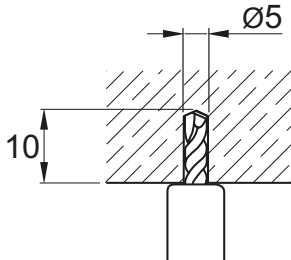

Pre-drilling with Hilti drill bit **TX-C-5/10B** until a ring on the concrete surface is visible.

## Fastener selection and system recommendation

### Fastener program

Hanger	Item no.
X-EHS M4 MX	273367
X-EHS M6 MX	272073
X-EHS M8 MX	273368

Nail	Item no.
X-P 24 B3 MX	2105405

Drill-bit	Item no.
TX-C-5/10B	2178329

## Fastening quality assurance

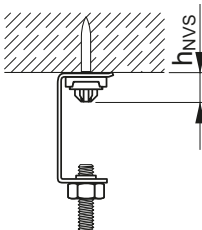

$h_{NVS} = 4.0 - 7.0 \text{ mm}$





## Approvals

Lloyds Register: X-HS

ICC, UL, FM: X-HS W6/10

Note: technical data presented in these approvals and design guidelines reflect specific local conditions and may differ from those published in this handbook.

## Applications

### Examples

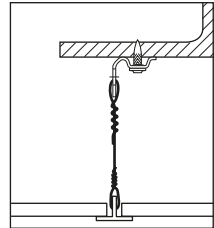
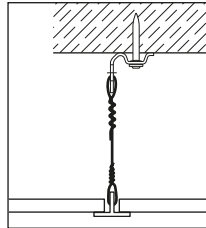
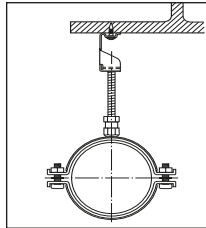
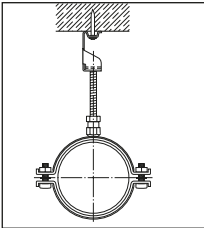

Threaded rod attachments to concrete and steel

Wire attachments to concrete and steel

## Load data

### Recommended loads

#### Concrete (DX-Kwik with pre-drilling) or steel

X-HS

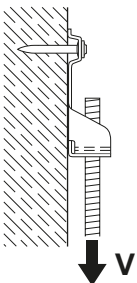
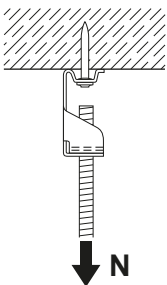

Fastener designation	$N_{rec} = V_{rec}$ [kN]	Base material
<b>X-HS __ DKH 48</b>	0.9	Concrete
<b>X-HS __ U19</b>	0.9	Steel
<b>X-CC DKH 48</b>	0.9	Concrete
<b>X-CC U16</b>	0.9	Steel

#### Conditions:

- Predominantly static loading.
- Concrete C20/25–C50/60
- Strength of fastened material is not limiting.
- Observance of all application limitations and recommendations (especially pre-drilling requirements).

X-CC

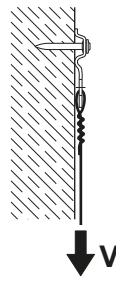
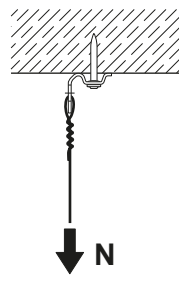



### Concrete (DX Standard without pre-drilling)

X-HS

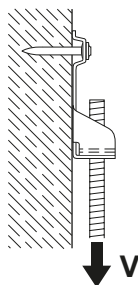
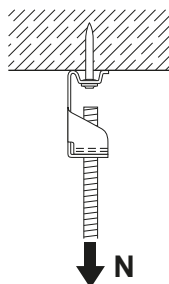

Fastener designation	$N_{rec}$ [kN]	$V_{rec}$ [kN]	$h_{ET}$ [mm]
<b>X-HS_U32</b>	0.4	0.4	27
<b>X-HS_U27</b>	0.3	0.3	22
<b>X-HS_U22</b>	0.2	0.2	18
<b>X-CC_U27</b>	0.2*	0.3	22
<b>X-CC_U22</b>	0.15*	0.2	18
<b>X-CC_CS27</b>	0.2	0.3	22
<b>X-CC_CS22</b>	0.15	0.2	18

\*) eccentric loading considered

#### Conditions:

- Minimum 5 fastenings per fastened unit (normal weight concrete).
- All visible failures must be replaced.
- With lightweight concrete base material and appropriate washers, greater loading may be possible, please contact Hilti.
- Predominantly static loading.
- Observance of all application limitations and recommendations.

X-CC

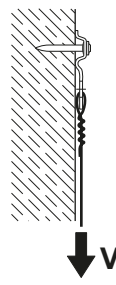
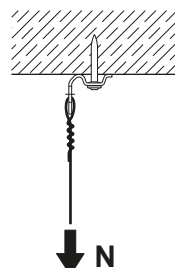

### Application requirements

#### Thickness of base material

Concrete

**DX-Kwik**

(with pre-drilling)  $h_{min} = 100 \text{ mm}$

**DX Standard**

(w/o pre-drilling)  $h_{min} = 80 \text{ mm}$

Steel

$t_{fl} \geq 4 \text{ mm}$

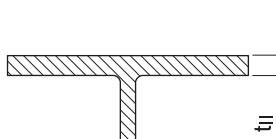

#### Spacing and edge distances

Minimum spacing and edge distances: See corresponding nail data sheet of X-U and X-DKH.

#### Corrosion information

These zinc-coated fasteners are not suitable for long-term service outdoors or in otherwise corrosive environments.

For further detailed information on corrosion see relevant chapter in **Direct Fastening Principles and Technique** section.

## Application limits

### Fastening to steel – X-HS U19 with DX351

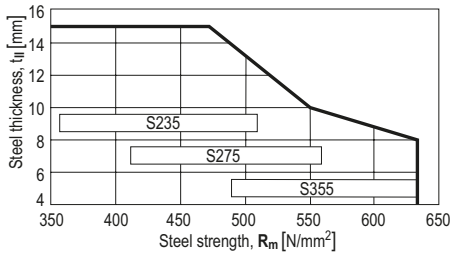

Application limit may increase in case of specific applications, like the fastening of wire mesh to steel, which is connected with X-CC U16 P8 fasteners. That wire mesh acts as reinforcement for fire protective sprayed coating. In such cases also different fastener stand-offs apply. Inquire at Hilti related with the use of X-CC U16 P8 in that specific application.

## Fastener selection

### Program, technical information

Base material	Fastener Designation	Shank Ø $d_s$ [mm]	Shank length $L_s$ [mm]	L [mm]	Tools
① Concrete pre-drilled	<b>X-HS_ DKH 48 P8S15</b>	4.0	48	50.0	<b>DX 460-F8, DX 5 F8</b>
② Concrete	<b>X-HS_ U 32 P8S15</b>	4.0	32	34.4	<b>DX 460-F8, DX 5 F8</b>
	<b>X-HS_ U 27 P8S15</b>	4.0	27	29.4	<b>DX 351-F8,</b>
	<b>X-HS_ U 22 P8S15</b>	4.0	22	24.4	<b>DX 36, DX 2</b>
Steel	<b>X-HS_ U 19 P8S15</b>	4.0	19	21.4	
③ Concrete pre-drilled	<b>X-CC DKH 48 P8S15</b>	4.0	48	50.0	<b>DX 460-F8, DX 5 F8</b>
③ Concrete	<b>X-CC U 27 P8</b>	4.0	27	29.4	<b>DX 460-F8, DX 5 F8</b>
	<b>X-CC U 22 P8</b>	4.0	22	24.4	<b>DX 351-F8,</b>
	<b>X-CC U 16 P8</b>	4.0	16	18.4	<b>DX 36, DX 2</b>
Steel					

Type of threading: M = metric; W6, W10 = Whitworth 1/4"; 3/8"

**X-HS order information**

Item no.	Designation	Item no.	Designation
361788	X-HS M6 U32 P8 S15	386214	X-HS M8 U19 P8 S15
386223	X-HS M6 U27 P8 S15	386215	X-HS M10 U19 P8 S15
361789	X-HS M8 U32 P8 S15	386217	X-HS W10 U19 P8 S15
386224	X-HS M8 U27 P8 S15	386218	X-HS M6 U22 P8 S15
361790	X-HS M10 U32 P8 S15	386219	X-HS M8 U22 P8 S15
386225	X-HS M10 U27 P8 S15	386222	X-HS W10 U22 P8 S15
386226	X-HS W6 U27 P8 S15	386216	X-HS W6 U19 P8 S15
386227	X-HS W10 U27 P8 S15	386220	X-HS M10 U22 P8 S15
386213	X-HS M6 U19 P8 S15	386221	X-HS W6 U22 P8 S15

Type of threading: M = metric; W6, W10 = Whitworth 1/4"; 3/8"

**X-CC order information**

Item no.	Designation
386229	X-CC U22 P8
386230	X-CC U27 P8
299937	X-CC DKH P8 S15
386228	X-CC U16 P8
2006454	X-CC CS22 P8
2005065	X-CC CS27 P8

**Cartridge selection**

Cartridge recommendation:

Steel:	<b>6.8/11M red cartridge</b>	$t_{II} \geq 6 \text{ mm}$
	<b>6.8/11M green cartridge</b>	$t_{II} < 6 \text{ mm}$
Concrete:	<b>6.8/11M yellow cartridge</b>	on soft and tough concrete
	<b>6.8/11M red cartridge</b>	on very tough concrete

Tool energy adjustment by setting tests on site.

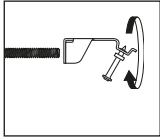
**Fastening quality assurance**
**Installation**
**X-HS**

1. Attach the threaded rod to the X-HS before fastening

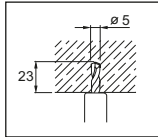

2. For **DKH 48** pre-drill ( $\varnothing 5 \times 23$ )

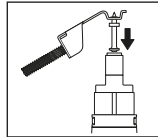

3. Load the assembly into the tool

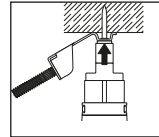

4. Locate the nail, compress the tool, pull the trigger and the fastening is complete

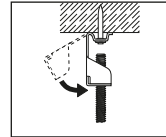

5. Bend the X-HS assembly down to the vertical position

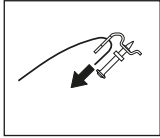
**X-CC**

1. Assemble the wire with the **X-CC**

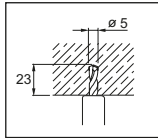

2. For **DKH 48** pre-drill ( $\varnothing 5 \times 23$ )

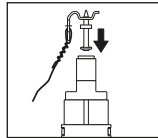

3. Load the assembly into the tool

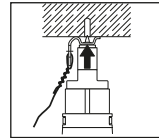

4. Locate the nail, compress the tool, pull the trigger and the fastening is complete

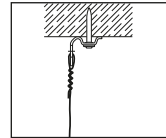

5. Adjust the wire as required

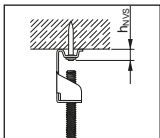
**Quality assurance**
**X-HS**

$h_{NVS} = 6-10 \text{ mm}$

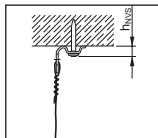
**X-CC**

$h_{NVS} = 4-7 \text{ mm}$

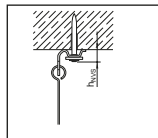
**X-CC DKH48 P8 S15**

$h_{NVS} = 6-10 \text{ mm}$

These are abbreviated instructions which may vary by application.  
**ALWAYS** review/follow the instructions accompanying the product.

## X-EHS MX, X-ECC MX Electrical hanger system

### Product data

#### Dimensions

X-EHS MX

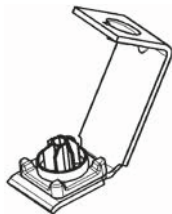

X-ECC MX

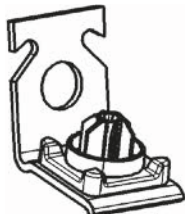

#### General information

##### Material specifications

X-EHS MX / X-ECC MX:

 Zinc coating:  $\geq 5 \mu\text{m}$ 

##### Recommended fastening tools

 DX 460 MX, DX 5 MX, DX 351 MX,  
 GX 120 ME, GX 3 ME, BX 3 ME

 See **X-EHS MX** and **X-ECC MX fastener program**  
 in the next pages and **Tools and equipment chapter**  
 for more details.

X-GHP 20/24

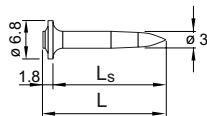

X-EGN 14

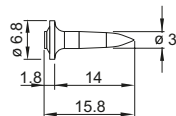

X-P 20/24 G3 MX

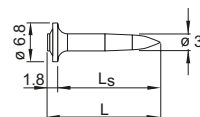

X-P 20/24 B3 MX

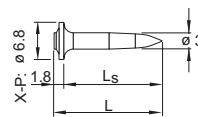

X-U 16/22

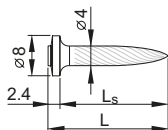

X-P 22

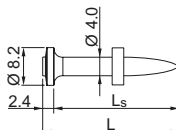

X-S 14 G3 MX

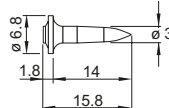

X-S 14 B3 MX

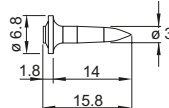

### Applications

#### Example

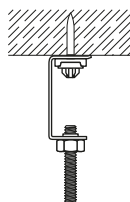

Hanger systems for light cable trays, etc.

- Threaded rod attachments
- Wire attachments

These fasteners are not recommended for fastening of suspended ceilings.

These zinc coated fasteners are not suitable for long-term service outdoors or in otherwise corrosive environments.

**Load data**
**Recommended loads on concrete**

Fastener designation	$N_{rec} = V_{rec}$ [kN]
<b>X-EHS MX</b>	0.1
<b>X-ECC MX</b>	0.05 ( $N_{rec}^*$ )
	0.1 ( $V_{rec}$ )

\*) eccentric loading considered

**Conditions:**

- Fastened with X-P 20/24 G3 MX, X-P 20/24 B3 MX, X-GHP 20/24 MX, X-U 22 or X-P 22
- Minimum 5 fastenings per fastened unit (normal weight concrete).
- All visible failures must be replaced.
- With lightweight concrete base material and appropriate washers, greater loading may be possible, please contact Hilti.
- Predominantly static loading.
- Observance of all application limitations and recommendations.

**Recommended loads on steel**

Fastener designation	$N_{rec} = V_{rec}$ [kN]
<b>X-EHS MX, X-ECC MX</b>	0.45

Fastened with X-S 14 G3 MX, X-S 14 B3 MX, X-EGN 14 or X-U 16

**Application requirements**
**Thickness of base material**

Concrete	Steel
X-U, X-P: $h_{min} = 80$ mm	$t_{fl} \geq 4$ mm
X-P G3 MX, X-P B3 MX, X-GHP: $h_{min} = 60$ mm	

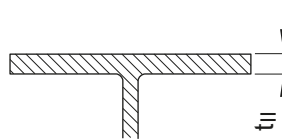
**Spacing and edge distances**

Spacing and edge distances depending on job site requirements.

**Corrosion information**

These zinc-coated fasteners are not suitable for long-term service outdoors or in otherwise corrosive environments.

For further detailed information on corrosion see relevant chapter in **Direct Fastening Principles and Technique** section.

**Application limits**

Fastening to steel

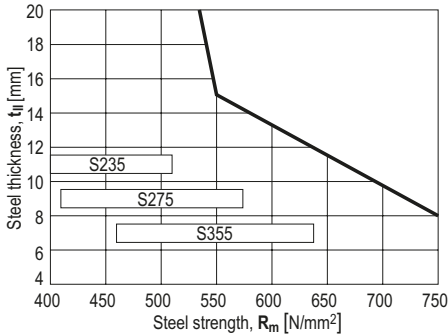
**X-EGN 14, X-S 14 G3 MX, X-S 14 B3 MX**

**Fastener program**
**Fastener selection**

Base material	Nail			
	Designation	Shank Ø $d_s$ [mm]	Shank length $L_s$ [mm]	L [mm]
Concrete	<b>X-P 20 G3 MX</b>	3.0	20	21.8
	<b>X-P 24 G3 MX</b>	3.0	24	25.8
	<b>X-P 20 B3 MX</b>	3.0	20	21.8
	<b>X-P 24 B3 MX</b>	3.0	24	25.8
	<b>X-GHP 20 MX</b>	3.0	20	21.8
	<b>X-GHP 24 MX</b>	3.0	24	25.8
	<b>X-P 22 MX</b>	4.0	22	24.4
	<b>X-U 22 MX</b>	4.0	22	24.4
Steel	<b>X-S 14 G3 MX</b>	3.0	14	15.8
	<b>X-S 14 B3 MX</b>	3.0	14	15.8
	<b>X-EGN 14 MX</b>	3.0	14	15.8
	<b>X-U 16 MX</b>	4.0	16	18.4

**Fastener selection: Order information**

Fastener	Designation	Item no.
Threaded Rod Hanger	<b>X-EHS M4 MX</b>	273367
	<b>X-EHS M6 MX</b>	272073
	<b>X-EHS W6 MX</b>	228341
	<b>X-EHS M8 MX</b>	273368
	<b>X-EHS W10 MX</b>	386468
Ceiling clip	<b>X-ECC MX</b>	228342

**System recommendation**

DX tools: Steel: **6.8/11M yellow or red cartridge**  
 Concrete: **6.8/11M yellow cartridge** on soft and tough concrete  
**6.8/11M yellow or red cartridge** on very tough concrete

GX 120-ME tool: **gas can GC 20, GC21 and GC22**

GX 3 ME tool: **gas can GC 40, GC 41 and GC42**

BX 3-ME tool: **No gas can required**

Tool energy adjustment by setting tests on site.

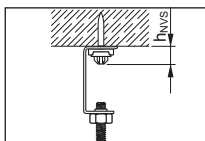
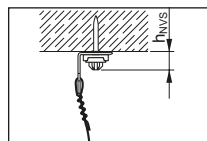
**Fastening quality assurance**
**X-EHS MX**

 $h_{NVS} = 4-8 \text{ mm}$ 
**X-ECC MX**

 $h_{NVS} = 4-8 \text{ mm}$



## X-DHS MX Pipe support system

### Product data

#### Dimensions

X-DHS 3/8" MX

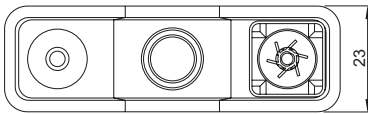
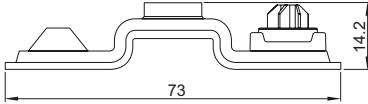

#### Features and benefits

- Securely fastened threaded rod hangers to steel and concrete (soft and tough) base material
- Easy installation of threaded rods on floors, walls and ceiling

#### General information

##### Material specification

X-DHS:

Zinc coating 10-20 µm

### Applications

#### Example



Hanger system for:

- Light-duty fastenings of pipes on ceilings
- Supporting pipes on floors
- Positioning of vertical pipes on walls

These fasteners are not recommended for fastening of suspended ceilings.

These zinc coated fasteners are not suitable for long-term service outdoors or in otherwise corrosive environments.

**Load data**
**Recommended loads (Base material = concrete)**

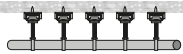
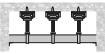
Number of X-DHS MX elements per pipe	$N_{rec}$ [kN] per X-DHS MX
$\geq 5$ 	0.2
1 to 4 with fixed end supports 	0.2

**Design conditions:**

- Each X-DHS MX element has to be fastened with 2 nails
- All visible failures must be replaced.
- Predominantly static loading.
- Valid for soft and tough concrete with strength of  $f_{c, cube} = 25-60 \text{ N/mm}^2$ . For more details regarding concrete types, please refer to **Concrete Fastener Selection** section in Hilti Direct Fastening Technology Manual (DFTM).
- Observance of all application limitations and recommendations.
- **For wall application (i.e. vertical pipes on walls), X-DHS MX is used for positioning purpose only, with NO imposed loading.**
- Maximum spacing = 100 cm

**Recommended loads (Base material = steel)**

Fastener	$N_{rec}$ [kN]
Recommended load per X-DHS MX element (fastened with 2 Nails)	0.8

## Nail recommendations

For **concrete** base material

Fastening tool	Nail types	Length [mm]	Tip	Shank Ø [mm]	Material	Hardness [HRC]	Coating [µm]
BX3	X-P B3 MX	24	Ballistic	3.0	Carbon steel	57.5	Zinc, 2-13 µm
GX3	X-P G3 MX					57.5	Zinc, 2-13 µm
GX120	X-GHP MX					57.5	Zinc, 2-13 µm

- For X-DHS MX element, only 24 mm length nails are recommended for concrete base material to ensure sufficient embedment depth.
- Premium nails (as listed above) are the only recommended nails based on intended use of X-DHS element (soft and some tough concrete, GX/BX tools). For more details regarding nail classification and concrete types, please refer to **Concrete Fastener Selection** section in Hilti Direct Fastening Technology Manual (DFTM).

For **steel** base material

Fastening tool	Nail types	Length [mm]	Tip	Shank Ø [mm]	Material	Hardness [HRC]	Coating [µm]
BX3	X-P B3 MX	17	Ballistic	3.0	Carbon steel	57.5	Zinc, 2-13 µm
GX3	X-P G3 MX	17				57.5	Zinc, 2-13 µm
GX120	X-GHP MX	18				57.5	Zinc, 2-13 µm

- For X-DHS MX element, only 17-18 mm length nails are recommended for steel base material to ensure sufficient embedment depth.

## Application requirements

### Thickness of base material

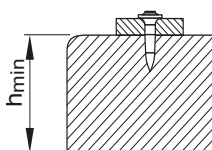

Concrete

X-GHP MX, X-P G3 MX,  
X-P B3 MX

$h_{\min} = 60 \text{ mm}$

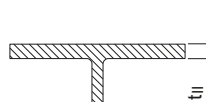

Steel

X-GHP MX, X-P G3 MX,  
X-P B3 MX

$t_{II} \geq 4.0 \text{ mm}$

### Application limits

#### X-P 17 G3 MX, X-P 17 B3 MX, X-GHP 18 MX

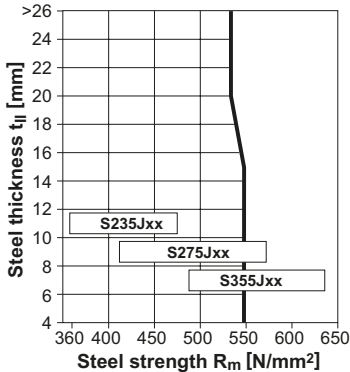

### Corrosion information

These zinc-coated fasteners are not suitable for long-term service outdoors or in otherwise corrosive environments. For further detailed information on corrosion see relevant chapter in **Direct Fastening Principles and Technique** section.

### Fastener selection and system recommendation

#### Fastener program

Designation	Item no.
X-DHS 3/8" MX	2161569

### System recommendation

GX 120-ME	Gas can GC 20, GC 21 and GC 22
GX 3-ME	Gas can GC 40, GC 41 and GC 42
BX 3-ME	No gas can required

### Fastening quality assurance

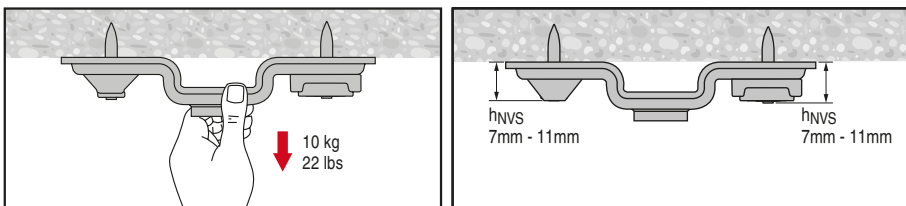

# X-HS-W Wire hanging system

## Product data

### Fasteners/Components Overview

Pre assembled

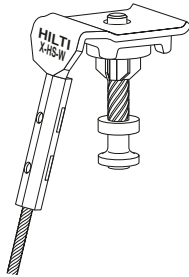

X-GHP 20/24

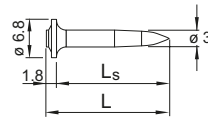

X-P 20/24 G3 MX

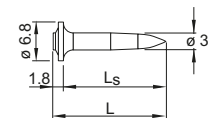

Magazined

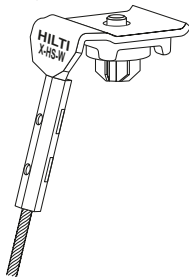

X-P 20/24 B3 MX

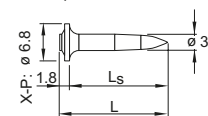

X-EGN 14

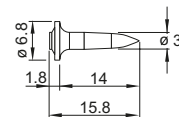

X-S 14 G3 MX

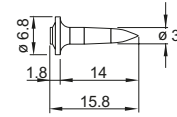

X-S 14 B3 MX

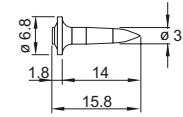

Locking Mechanism

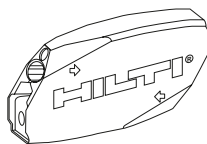

### General information

#### Material specifications

X-HS-W:  
Zinc coating  $\geq 2.5 \mu\text{m}$

#### Recommended fastening tools

DX 460F8, DX 5 F8, DX 351 F8, GX 120 ME,  
GX 3 ME, BX 3 ME

See **X-HS-W fastener program** in the next pages  
and **Tools and equipment** chapter for more details.

#### Approvals

CSTB AT 3/09-639 X-HS-W

## Applications

### Examples



Round Air Ducts



Square Air Ducts



Light weight Cable Trays / Lights

**Load data**
**Recommended loads**
**DX Standard for concrete**

Fastener designation	$N_{rec}$ [kN]	$V_{rec}$ [kN]	$h_{ET}$ [mm]
<b>X-HS-W U27</b>	0.20	0.3	22
<b>X-HS-W U22</b>	0.15	0.2	18
<b>X-HS-W MX with X-P 20/24 G3 MX, X-P 20/24 B3 MX, X-GHP 20/24 MX</b>	0.05	0.1	14

**Conditions:**

- Minimum 5 fastenings per fastened unit (normal weight concrete).
- All visible failures must be replaced.
- Predominantly static loading.
- Observance of all application limitations and recommendations.

**DX Standard for steel**

Fastener designation	$N_{rec}$	$V_{rec}$
<b>X-HS-W U16</b>	0.90	0.90
<b>X-HS-W MX with X-S 14 G3 MX, X-S 14 B3 MX, X-EGN 14 MX</b>	0.45	0.45

**Conditions:**

- Predominantly static loading.
- Observance of all application limitations and recommendations.

**Application requirements**
**Thickness of base material**

Concrete	
<b>X-U:</b>	$h_{min} = 80 \text{ mm}$
<b>X-P G3 MX, X-P B3 MX</b>	
<b>X-GHP MX</b>	$h_{min} = 60 \text{ mm}$

Steel
$t_{II} \geq 4 \text{ mm}$

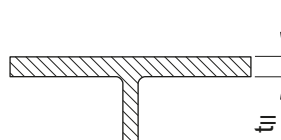

### Spacing and edge distances

Spacing and edge distances depending on job site requirements.

### Corrosion information

These zinc-coated fasteners are not suitable for long-term service outdoors or in otherwise corrosive environments.

For further detailed information on corrosion see relevant chapter in **Direct Fastening Principles and Technique** section.

### Application limits

#### Steel

#### X-HS-W MX with X-S 14 G3 MX, X-S 14 B3 MX, X-EGN 14 MX

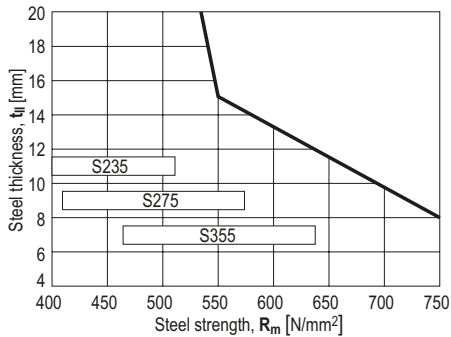

#### X-HS-W U16 P8

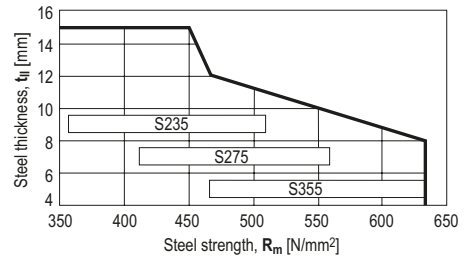

**Fastener selection: Order information**

Fastener		Designation	Item no.
X-HS-W	For DX tools	<b>X-HS-W U16 P8 1m/3ft</b>	387430
		<b>X-HS-W U22 P8 1m/3ft</b>	387431
		<b>X-HS-W U27 P8 1m/3ft</b>	387432
		<b>X-HS-W U16 P8 2m/7ft</b>	387919
		<b>X-HS-W U22 P8 2m/7ft</b>	387920
		<b>X-HS-W U27 P8 2m/7ft</b>	387921
		<b>X-HS-W U16 P8 3m/10ft</b>	387433
		<b>X-HS-W U22 P8 3m/10ft</b>	387434
		<b>X-HS-W U27 P8 3m/10ft</b>	387435
X-HS-W	For GX tools and BX tools	<b>X-HS-W MX 1m/3ft</b>	387436
		<b>X-HS-W MX 2m/7ft</b>	387922
		<b>X-HS-W MX 3m/10ft</b>	387437

**System recommendation**

DX tools: Steel: **6.8/11M red cartridge** for  $t_{ij} \geq 6$   
**6.8/11M green cartridge** for  $t_{ij} < 6$   
Concrete: **6.8/11M green or yellow cartridge** on soft and tough concrete  
**6.8/11M red cartridge** on very tough concrete

GX 120-ME tool: **gas can GC 20, GC21 and GC22**

GX 3 ME tool: **gas can GC 40, GC 41 and GC 42**

BX 3-ME tool: **no gas can required**

Tool energy adjustment by setting tests on site.

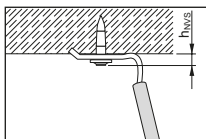
**Fastening quality assurance**
**X-HS-W**

$h_{NVS} = 5.5-8.5 \text{ mm}$

**NO LIFTING**

Do not use for lifting, such as in a crane or pulley situation.

**NO MOVEMENT**

Hilti hangers are to be used to suspend stationary loads only. Do not use to suspend moving services, or services likely to be subject to movement.

**NO JOINING**

Hilti hangers must not be used as an in-line joint using a Hilti fastener, or any other joining device. A Hilti hanger assembly must comprise one length of cable and one Hilti fastener only. If a longer length is needed, do not join two assemblies together.



# X-EKB, X-ECH Electrical fastener

## Product data

### Dimensions

#### Single Fastener

X-EKB 8/4-FR

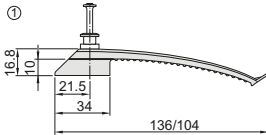

X-EKB 16 (FR)

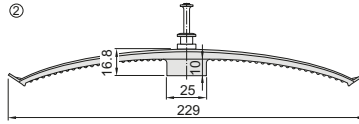

X-U 37 PH

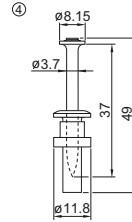

X-ECH-S (FR)

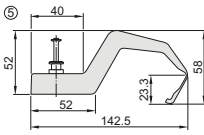

X-ECH-M (FR)

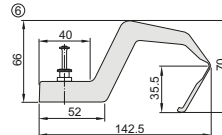

X-ECH-L (FR)

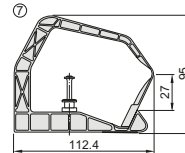

#### Magazine fastener

X-EKB 4 / 8 / 16 MX (FR)



X-EKB 4 MX (FR)

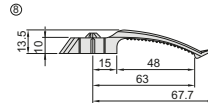

X-ECH-B MX

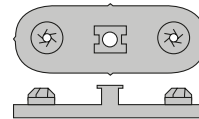

X-ECH-15/30 MX

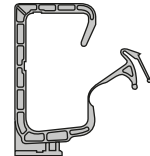

X-GHP 20/24

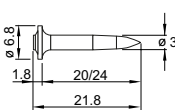

X-GN 27

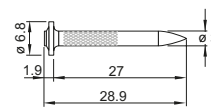

X-EGN 14

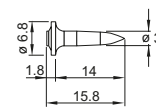

X-U 16/22/27

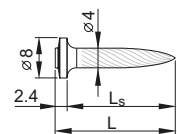

X-P 20/24 G3 MX

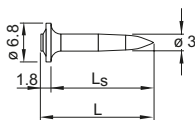

X-C 27 G3 MX

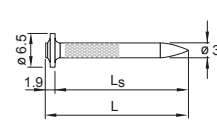

X-S 14 G3 MX

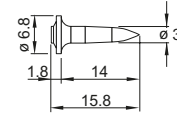

X-P 22

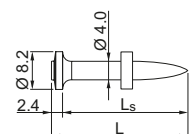

X-P 20/24 B3 MX

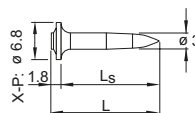

X-S 14 B3 MX

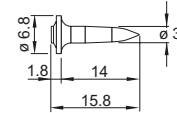

## General information

### Material specifications

See Fastener selection

### Recommended fastening tools

DX 460-F8, DX 460 MX, DX 5 F8, DX 5 MX, DX 351-F8, DX 351 MX, DX36, DX 2, GX 120 ME, GX 3 ME, BX 3 ME

See **X-EKB, X-ECH fastener program** in the next pages and **Tools and equipment chapter** for more details.

### Approvals

UL (USA): X-EKB MX, X-ECH / FR\_U37

CSTB (France): X-EKB\_U 37, X-ECH\_U37

Note: technical data presented in these approvals and design guidelines reflect specific local conditions and may differ from those published in this handbook.

## Applications

### Examples

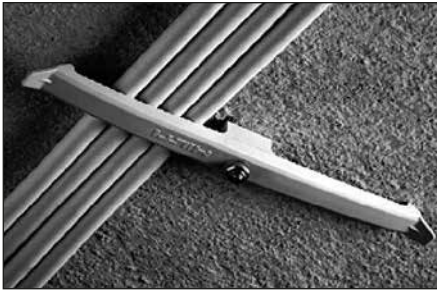

**X-EKB for fastening cables**



**X-ECH for fastening bunched cables**

### Load data

#### Fastener capacity

#### X-EKB: Securing electrical cables to concrete ceilings and walls

Max. capacity (number of cables in one **X-EKB**) at spacing of 50–100 cm

Designation	Number of wires/cables and wire sizes	
	<b>NYM 3 x 1.5 mm<sup>2</sup></b> (∅ 8 mm)	<b>NYM 5 x 1.5 mm<sup>2</sup></b> (∅ 10 mm)
<b>X-EKB 4</b> __	4	3
<b>X-EKB 8</b> __	8	5
<b>X-EKB 16</b> __	16	10

## X-ECH: Securing electrical cable to ceilings and walls

Max. capacity at spacing of 60–80 cm		
Designation	No. of nails	Number of cables
<b>X-ECH-S</b> __ and <b>X-ECH/FR-S</b> __		max. 15 NYM 5x1.5 <sup>2</sup> (Ø 10 mm)
<b>X-ECH-M</b> __ and <b>X-ECH/FR-M</b> __		max. 25 NYM 5x1.5 <sup>2</sup> (Ø 10 mm)
<b>X-ECH-L</b> __ and <b>X-ECH/FR-L</b> __		max. 35 NYM 5x1.5 <sup>2</sup> (Ø 10 mm)
<b>X-ECH-15 MX</b> and <b>X-ECH-B</b>	1 or 2	max. 15 NYM 3x1.5 <sup>2</sup> (Ø 10 mm)
<b>X-ECH-30 MX</b> and <b>X-ECH-B</b>	1 or 2	max. 30 NYM 3x1.5 <sup>2</sup> (Ø 10 mm)

### Conditions:

- For concrete C12/15 to C45/55 ( $f_{cc} = 15$  to  $55$  N/mm<sup>2</sup>)
- All visible placing failures have to be replaced
- Damaged X-ECH have to be replaced

## Application requirements

### Thickness of base material

#### Concrete

**X-U, X-P:**  $h_{\min} = 80$  mm

**X-P G3 MX, X-P B3 MX,**

**X-GHP MX, X-GN MX**  $h_{\min} = 60$  mm

#### Steel

$t_{II} \geq 4$  mm

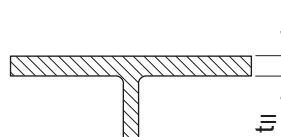

### Thickness of fastened material

Fasteners recommended for cable Ø 8 mm and 10 mm

### Spacing and edge distances

**X-EKB:** approximately 50–100 cm (Adjust as necessary to control cable sag)

**X-ECH:** approximately 60– 80 cm (Adjust as necessary to limit sagging)

### Corrosion information

These zinc-coated fasteners are not suitable for long-term service outdoors or in otherwise corrosive environments.

For further detailed information on corrosion see relevant chapter in **Direct Fastening Principles and Technique** section.

**Fastener program**
**Fastener with pre-mounted DX-nail: Technical information**

Fastener Designation	Shank		Tools
	Ø <b>d<sub>s</sub></b> [mm]	length <b>L<sub>s</sub></b> [mm]	
① <b>X-EKB8 U 37</b>	4.0	37	<b>DX 460-F8, DX 5 F8, DX351-F8, DX36, DX 2</b>
② <b>X-EKB16 U 37</b>	4.0	37	<b>DX 460-F8, DX 5 F8, DX351-F8, DX36, DX 2</b>
⑤ <b>X-ECH-S U 37</b>	4.0	37	<b>DX 460-F8, DX 5 F8, DX351-F8, DX36, DX 2</b>
⑥ <b>X-ECH-M U 37</b>	4.0	37	<b>DX 460-F8, DX 5 F8, DX351-F8, DX36, DX 2</b>
⑦ <b>X-ECH-L U 37</b>	4.0	37	<b>DX 460-F8, DX 5 F8, DX351-F8, DX36, DX 2</b>
① <b>X-EKB4-FR U 37</b>	4.0	37	<b>DX 460-F8, DX 5 F8, DX351-F8, DX36, DX 2</b>
① <b>X-EKB8-FR U 37</b>	4.0	37	<b>DX 460-F8, DX 5 F8, DX351-F8, DX36, DX 2</b>
② <b>X-EKB16-FR U 37</b>	4.0	37	<b>DX 460-F8, DX 5 F8, DX351-F8, DX36, DX 2</b>
⑤ <b>X-ECH/FR-S U 37</b>	4.0	37	<b>DX 460-F8, DX 5 F8, DX351-F8, DX36, DX 2</b>
⑥ <b>X-ECH/FR-M U 37</b>	4.0	37	<b>DX 460-F8, DX 5 F8, DX351-F8, DX36, DX 2</b>
⑦ <b>X-ECH/FR-L U 37</b>	4.0	37	<b>DX 460-F8, DX 5 F8, DX351-F8, DX36, DX 2</b>

③, ④ All nail shanks: carbon steel, HRC 58, galvanized 2–20 µm

Sleeve/thimble: carbon steel, not hardened, galvanized 5–13 µm

⊕–Δ See Product data in previous pages

**Fastener with pre-mounted DX-nail: Order information**

Designation	Item no.	Plastic material
X-EKB 4-FR U37	361581	PA ²)
X-EKB 8 U37	386231	PA ¹)
X-EKB 8-FR U37	386233	PA ²)
X-EKB 16 U37	386232	PA ¹)
X-EKB 16-FR U37	386234	PA ²)
X-ECH-S U37	386235	PA ¹)
X-ECH-M U37	386236	PA ¹)
X-ECH-L U37	386237	PA ¹)
X-ECH/FR-S U37	386238	PA ²)
X-ECH/FR-M U37	386239	PA ²)
X-ECH/FR-L U37	386240	PA ²)

¹) halogen and silicone free, light grey RAL 7035

²) halogen and silicone free, flame retardant, stone grey RAL 7030

**Fastener without pre-mounted nail: Technical information**

Base material	Cable Holder	Fastening Technology	Nail
Concrete	X-EKB 4 MX X-EKB 8 MX X-EKB 16 MX X-EKB 4 FR MX X-EKB 8 FR MX X-EKB 16 FR MX	GX	X-P 20/24 G3 MX
		GX	X-C 27 G3 MX
		GX	X-GHP 20/24 MX
		GX	X-GN 27 MX
		BX	X-P 20/24 B3 MX
		DX	X-U 22/27 MX
		DX	X-P 22/27 MX
Steel	X-ECH-15 MX* X-ECH-30 MX*	GX	X-S 14 G3 MX
		GX	X-EGN 14 MX
		BX	X-S 14 B3 MX
		DX	X-U 16 MX

\* To be used with GX or BX technology ONLY

**Fastener without pre-mounted nail: Order information**

Fastener	Plastic material	Designation	Item no.
Electrical Cable Holder	PA <sup>1)</sup>	<b>X-EKB 4 MX</b>	285712
	PA <sup>1)</sup>	<b>X-EKB 8 MX</b>	285713
	PA <sup>1)</sup>	<b>X-EKB 16 MX</b>	285714
	PBT <sup>2)</sup>	<b>X-EKB 4 FR MX</b>	285715
	PBT <sup>2)</sup>	<b>X-EKB 8 FR MX</b>	285716
	PBT <sup>2)</sup>	<b>X-EKB 16 FR MX</b>	285717
	PA <sup>3)</sup>	<b>X-ECH-15 MX</b>	2018247
	PA <sup>3)</sup>	<b>X-ECH-30 MX</b>	2018248
	PA <sup>3)</sup>	<b>X-ECH-15/B MX</b>	2018729 (kit)
	PA <sup>3)</sup>	<b>X-ECH-30/B MX</b>	2018891 (kit)
PA <sup>3)</sup>	<b>X-ECH-B MX</b>	2018391	

<sup>1)</sup> halogen free, light grey RAL 7035

<sup>2)</sup> silicone free, stone grey RAL 7030

<sup>3)</sup> halogen and silicone free, light grey RAL 7035

**System recommendation**

DX tools: Steel: **6.8/11M red cartridge**  
 Concrete: **6.8/11M yellow cartridge** on soft and tough concrete  
**6.8/11M red cartridge** on very tough concrete  
 Masonry: **6.8/11M yellow or green cartridge, green for MX Fastener**

GX 120-ME tool: **Gas can GC 20, GC21 and GC22**

GX 3 ME tool: **Gas can GC 40, GC 41 and GC 42**

BX 3-ME tool: **no gas can required**

Tool energy adjustment by setting tests on site.

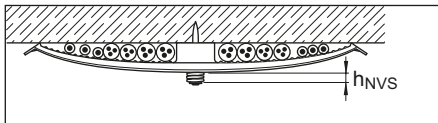
**Fastening quality assurance**
**X-EKB fastening quality**

$h_{NVS} = 7 \pm 2 \text{ mm}$

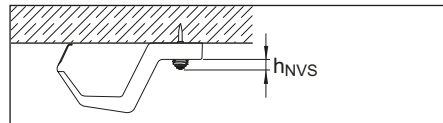
**X-ECH fastening quality**

$h_{NVS} = 7 \pm 2 \text{ mm}$

# X-MCT-FE MX Metal cable tie holder

## Product data

### Wiring system

Cable tie holder  
X-MCT-FE MX



Cable tie  
Metal cable tie  
Plastic cable tie

### Features and benefits

- Maintaining function of the fastener during fire
- Magnetic interface
- Bi-direction cable tying
- Fire test method following BS 7671
- Testing acc. to EN 1363-1: 2020-05

### Environmental condition



Dry Indoor

## Dimension

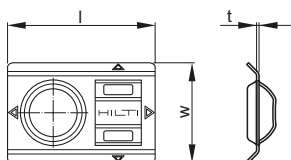

Width of the cable tie holder	Length of the cable tie holder	Thickness cable tie holder	Admissible cable tie width	
w	l	t	w <sub>min</sub>	w <sub>max</sub>
32.5 mm	48 mm	0.8 mm	4.9 mm	8 mm

w<sub>min</sub> is based on testing requirements

## Material specification and material properties

Item no.	Element	Material	Coating	Process	Minimum coating thickness
2276133	X-MCT-FE MX	DX51 D	zinc	Pre-galvanizing	5 μm

## Corrosion resistance

For fastenings not directly exposed to external weather conditions or moist atmosphere.

## Base material

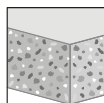

Soft concrete

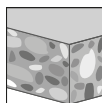

Tough concrete

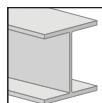

Steel

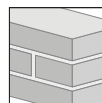

Masonry Solid brick



Static/  
quasi static



Fire resistance

## Load condition

## Application

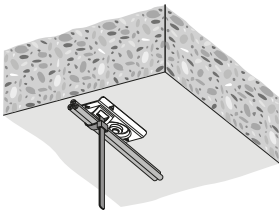

Fastening electrical installation to ceiling and wall

## Admissible electrical installation

Electrical installations      General cables

## Load data

Recommended resistance under tension and shear load  
for fastening on soft and tough concrete and steel based on working load concept

Wiring system	Tension load $N_{rec}$	Shear load $V_{rec}$	Fire rating cable tie holder	Fire rating cable tie
X-MCT-FE MX	0.04 kN	0.04 kN	120 min.	Utilization of suitable cable tie acc. to national standards

## Fastening quality assurance

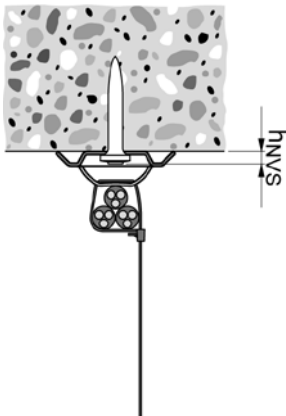

Admissible fastener stand-off

$$h_{NVS, min} = 5 \text{ mm}$$

$$h_{NVS, max} = 11 \text{ mm}$$



### System recommendation

Wiring system mounted with battery-actuated fastener

Element	Fastener						Battery-actuated tool	Base material			
	X-P 17 B3 MX	X-P 20 B3 MX	X-P 24 B3 MX	X-C 20 B3 MX	X-C 24 B3 MX	X-S 14 B3 MX		Soft concrete	Tough concrete	Steel	Masonry Solid brick
Name	X-P 17 B3 MX	X-P 20 B3 MX	X-P 24 B3 MX	X-C 20 B3 MX	X-C 24 B3 MX	X-S 14 B3 MX	BX 3-ME	Soft concrete	Tough concrete	Steel	Masonry Solid brick
X-MCT-FE MX	■	■					■	■	■		■
X-MCT-FE MX			■	■	■		■	■			■
X-MCT-FE MX						■	■			■	

■ recommended

### Setting information

- Fastener setting information (e. g. base material properties, fastened material properties and setting energy) is part of the corresponding Product Data Sheet for fastener.
- Fastener guide X-GF B3-FG required for fastener setting with battery-actuated tool.



## X-ECH-FE MX, X-EKB-FE MX Circuit integrity fastener

### Product data

#### Dimensions

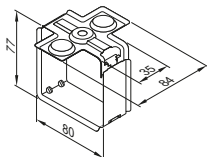
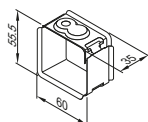
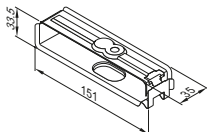
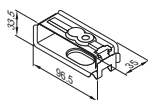
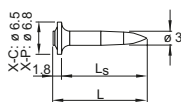
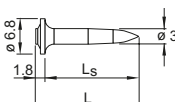
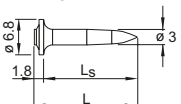
**X-ECH-FE 30 MX**

**X-ECH-FE 15 MX**

**X-EKB-FE 15 MX**

**X-EKB-FE 8 MX**

**X-P 17 B3 MX**

**X-GHP 18 MX**

**X-P 17 G3 MX**

#### General information

##### Material specifications

Galvanized steel sheet	≥ 5 μm zinc coating
X-GHP	Carbon steel, HRC 57.5, zinc coating 2-10 μm
X-P G3 MX	Carbon steel, HRC 57.5, zinc coating 2-10 μm
X-P B3 MX	Carbon steel, HRC 57.5, zinc coating 2-10 μm

##### Recommended fastening tools

GX 120-ME, GX 3-ME, BX 3-ME

##### Approval

AbP P-MPA-E-16-010  
 AbP P-2401/198/16-MPA BS  
 AbP P-1023 DMT DO

Expert review on MLAR application by MPA IBMB Braunschweig

Expert review on nail load in circuit integrity applications by MPA IBMB Braunschweig

### Applications



Circuit integrity system (CIS) application with fire rating and load data according to **AbP**

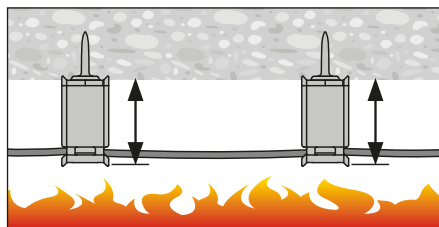

Application to non-circuit integrity cables in escape routes (according to **MLAR**)

**Load Data**
**Recommended loads (ceiling and wall application)**

Application →	Escape routes (MLAR)		Circuit integrity system		Spacing a [mm]
	Fastener ↓	Load $N_{rec}$ [kN]	Fire Rating	Cable weight [kg/m]	
X-ECH-FE 30 MX	0.04*	F90	According to AbP documents, fire rating (E30 - E90) and cable weights specific to combination of:	-	$a \leq 600$ mm
X-ECH-FE 15 MX	0.02**				
X-EKB-FE 15 MX	0.02**				
X-EKB-FE 8 MX	0.02**				

\* 6.6 kg/m with spacing  $a = 600$  mm

\*\* 3.3 kg/m with spacing  $a = 600$  mm

- Pre-loading of the elements with load  $\geq N_{rec}$  after setting
- All visible failures must be replaced (see “Fastening quality assurance”)

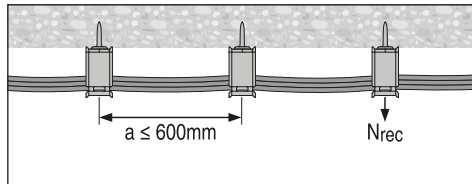
**Fastener selection and system recommendation**
**Thickness of base material**

**Corrosion Information**

The intended use only comprises fastenings which are not directly exposed to external weather conditions or moist atmospheres.

**Application requirements**
**Fastener program**

Designation	Item no.
X-ECH-FE 30 MX	2142822
X-ECH-FE 15 MX	2142823
X-EKB-FE 15 MX	2142824
X-EKB-FE 8 MX	2142825

**Fastener program**

Base material	Nail designation	Shank length Ls [mm]	Nail length L [mm]	Tool
Concrete	X-GHP 18 MX	18	19.8	GX 120-ME
	X-P 17 G3 MX	17	18.8	GX 3-ME
	X-P 17 B3 MX	17	18.8	BX 3-ME

**System recommendation**

GX 120-ME	Gas can GC 20, GC 21 and GC 22
GX 3-ME	Gas can GC 40, GC 41 and GC 42
BX 3-ME	No gas can required

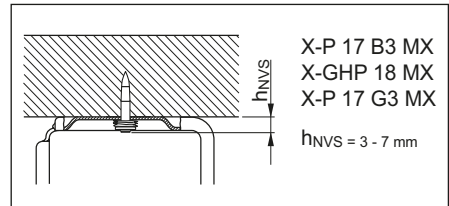
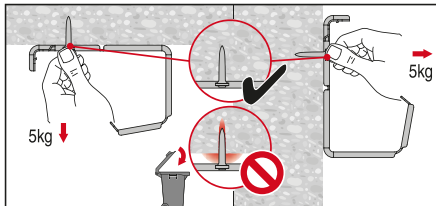
**Fastening quality assurance**



# X-FB, X-DFB, X-EMTC Electrical conduit fastener

## Product data

### Dimensions

X-FB / X-EMTC

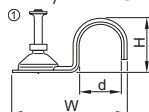

X-DFB

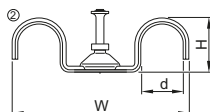

X-FB MX (X-BX/X-EMTC)

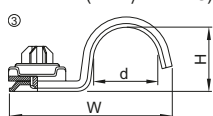

X-GN 27

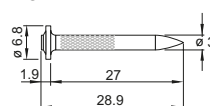

X-GHP 20/24

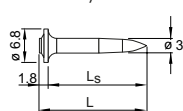

X-U 16/22/27

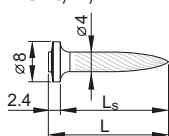

X-EGN 14

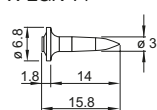

### General information

#### Material specifications

See fastener selection for more details.

#### Recommended fastening tools

DX 460 F8, DX 460 MX, DX 5 F8,  
DX 5 MX, DX 351 F8, DX 351 MX,  
GX 120 ME, GX 3 ME, BX 3 ME

See **X-FB (X-DFB/X-EMTC) fastener program** in the next pages and **Tools and equipment chapter** for more details.

X-C 27

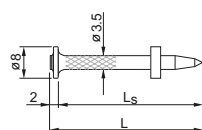

X-P 22/27

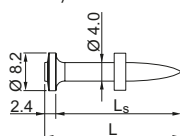

X-P 20/24 G3 MX

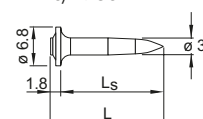

X-S 14 G3 MX

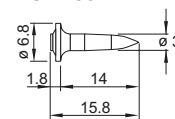

X-P 20/24 B3 MX

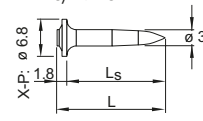

X-S 14 B3 MX

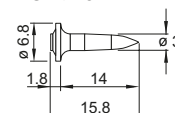

X-C 27 G3 MX

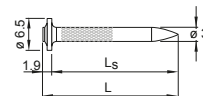

## Applications

### Example

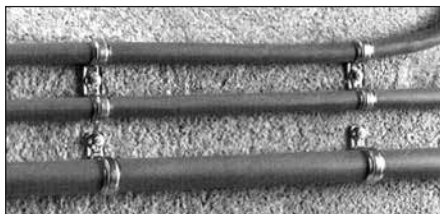

**Load data**
**Recommended loads**

Fastener	Concrete $N_{rec}$ [kN]	Sandlime stone $N_{rec}$ [kN]	Steel $N_{rec}$ [kN]
<b>X-FB / X-DFB</b> (pre-mounted)	0.06	0.06	–
<b>X-FB MX with X-U, X-P or X-C</b> ( $L_S = 22-27$ mm)	0.06	0.06	–
<b>X-FB MX with X-U 16 MX</b>	–	–	0.06
<b>X-FB MX with X-P B3 MX, X-P G3 MX or X-GHP</b> ( $L_S = 20-24$ mm)	0.02	–	–
<b>X-FB MX with X-C 27 G3 MX or X-GN 27 MX</b>	–	0.06	–
<b>X-FB MX with X-S 14 B3 MX, X-S 14 G3 MX,</b> <b>X-EGN 14 MX or X-U 16 MX</b>	–	–	0.06

**Application requirements**
**Thickness of base material**

Concrete

**X-U, X-P or X-C:**  $h_{min} = 80$  mm

**X-P B3 MX, X-P G3 MX,  
X-GHP, X-C 27 G3 MX,**
**X-GN 27 MX:**  $h_{min} = 60$  mm

Steel

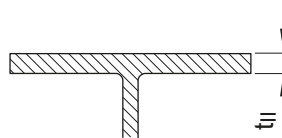
 $t_{II} \geq 4$  mm

**Thickness of fastened material**
**X-FB (X-BX, X-EMTC)** To fasten conduits, pipes and tubes of  $\varnothing 5$  mm to 50 mm

**Spacing and edge distances**

Space fastenings as needed to control sag and maintain alignment.

**Corrosion information**

These zinc-coated fasteners are not suitable for long-term service outdoors or in otherwise corrosive environments.

 For further detailed information on corrosion see relevant chapter in **Direct Fastening Principles and Technique** section.



**Fastener program**
**Technical information**

With pre-mounted nail Designation	Without pre-mounted nail Designation	d [mm]	W [mm]	H [mm]
	③ X-FB 5 MX	5		7
	③ X-FB 6 MX	6		8
	③ X-FB 7 MX	7		9
① X-FB 8-C27	③ X-FB 8 MX	8	31	10
① X-EMTC <sup>3/8"</sup> -C27/-U22	③ X-EMTC <sup>3/8"</sup> MX	10 ( <sup>3/8"</sup> )	33	12
① X-FB 11-C27	③ X-FB 11 MX	11	34	13
① X-EMTC <sup>1/2"</sup> -C27/-U22		13 ( <sup>1/2"</sup> )		
① X-FB 13-C27	③ X-EMTC <sup>1/2"</sup> MX	13 ( <sup>1/2"</sup> )	42	15
① X-FB 16-C27	③ X-FB 16 MX	16	44	18
① X-FB 18-C27		18	46	20
① X-EMTC <sup>3/4"</sup> -C27/-U22	③ X-EMTC <sup>3/4"</sup> MX	19 ( <sup>3/4"</sup> )	47	21
① X-FB 20-C27	③ X-FB 20 MX	20	48	22
① X-FB 22-C27	③ X-FB 22 MX	22	50	24
① X-FB 24-C27		24	52	26
① X-FB 25-C27	③ X-FB 25 MX, X-EMTC 1" MX	25 (1")	53	27
① X-EMTC 1"-C27/-U22		25 (1")		
① X-FB 28-C27	③ X-FB 28 MX	28	56	30
① X-FB 32-C27	③ X-FB 32 MX	32	58	34
① X-FB 35-C27		35	64	37
① X-FB 40-C27	③ X-FB 40 MX	40	69	42
① X-FB 50-C27		50	77	52
	③ X-DFB 5 MX	5	47	7
	③ X-DFB 6 MX	6	50	8
	③ X-DFB 7 MX	7	52	9
② X-DFB 8-C27	③ X-DFB 8 MX	8		9.5
② X-DFB 11-C27	③ X-DFB 11 MX	11		12.5
② X-DFB 16-C27	③ X-DFB 16 MX	16	66	15
② X-DFB 18-C27		18	70	18
② X-DFB 20-C27	③ X-DFB 20 MX	20	75	20
② X-DFB 22-C27	③ X-DFB 22 MX	22	79	22
② X-DFB 24-C27	③ X-DFB 25 MX	24	83	24
② X-DFB 25-C27		25		
② X-DFB 28-C27	③ X-DFB 28 MX	28	91	28
② X-DFB 35-C27		35	106	30
② X-DFB 40-C27		40	116	37



# X-FB-E, X-DFB-E Electrical conduit fastener

## Product data

### Dimensions

X-FB-E

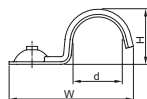

X-DFB-E

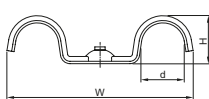

X-GN 20/27

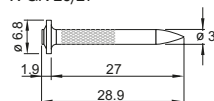

X-GHP 20

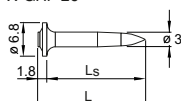

X-C 22/27

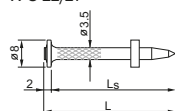

X-P 20 G3 MX

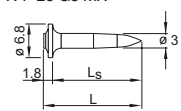

X-P 20 B3 MX

X-C 20 B3 MX

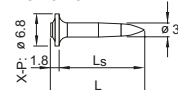

X-C 20/27 G3 MX

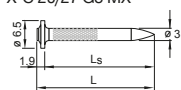

### General information

#### Material specifications

Galvanized steel sheet  $f_u = 270-420 \text{ N/mm}^2$   
10-20  $\mu\text{m}$  zinc coating

### Recommended fastening tools

GX 120-ME, GX 3 ME, BX 3 ME,  
DX 351-MX, DX 351-F8 DX 460-MX,  
DX 460-F8 DX 5 MX, DX 5 F8

See **X-FB-E fastener program** in the next pages for more details.

## Applications

### Example



**X-FB-E for rigid conduits**



**X-FB-E for flexible conduits**

## Load data

### Recommended loads

Fastener	Concrete $N_{rec}$ [kN]	Sandlime stone $N_{rec}$ [kN]
X-FB-E or X-DFB-E with X-GN 20, X-C 20 G3 MX or X-C 20 B3 MX nails	0.02	0.02
X-FB-E or X-DFB-E with X-GN 27 or X-C 27 G3 MX nails	0.06	0.06
X-FB-E or X-DFB-E with X-GHP 20, X-P 20 G3 MX or X-P 20 B3 MX nails	0.02	-
X-FB-E or X-DFB-E with X-C 22/27 nails	0.06	0.06

## Application requirements

### Thickness of base material

X-GN, X-GHP, X-C G3 MX, X-P G3 MX

X-C B3 MX, X-P B3 MX:

$h_{min} = 60$  mm

X-C:

$h_{min} = 80$  mm

### Thickness of fastened material

**X-FB-E:** To fasten conduits, pipes and tubes of  $\varnothing$  16 mm to 25 mm

**X-DFB-E:** To fasten conduits, pipes and tubes of  $\varnothing$  20 mm to 25 mm

## Spacing and edge distances

Space fastenings as needed to control sag and maintain alignment.

## Corrosion information

These zinc-coated fasteners are not suitable for long-term service outdoors or in otherwise corrosive environments.

For further detailed information on corrosion see relevant chapter in **Direct Fastening Principles and Technique** section.

**Fastener selection and system recommendation**

**Fastener program**

Designation	Item no.	d [mm]	W [mm]	H [mm]
<b>X-FB-E 16 MX</b>	<b>2112585</b>	16	44	17.5
<b>X-FB-E 20 MX</b>	<b>2112586</b>	20	48	21.5
<b>X-FB-E 25 MX</b>	<b>2112587</b>	25	55	26.5
<b>X-DFB-E 20 MX</b>	<b>2112588</b>	20	80	20
<b>X-DFB-E 25 MX</b>	<b>2112589</b>	25	90	25

**Tool selection**

<b>X-GN, X-GHP:</b>	GX 120
<b>X-C G3 MX, X-P G3 MX:</b>	GX 3 ME
<b>X-C B3 MX, X-C B3 MX</b>	BX 3 ME
<b>X-C_P8:</b>	DX 351-F8, DX 460-F8, DX 5 F8
<b>X-C_MX:</b>	DX 351-MX, DX 460-MX, DX 5 MX

**System recommendation**

DX tools	DX 351-F8 DX 460-F8 DX 5 F8	Concrete	6.8/11M yellow cartridge soft and tough concrete
	DX 351-MX DX 460-MX DX 5 MX		6.8/11M red cartridge on very tough concrete
		Masonry	6.8/11M green cartridge
GX tools	GX 120-ME	Gas can GC 20, GC 21 and GC 22	
	GX 3 ME	Gas can GC 40, GC 41 and GC 42	
BX tools	BX 3-ME	No gas can required	

**Fastening quality assurance**

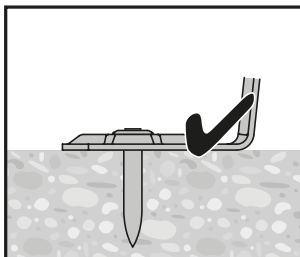

Nail head not protruding



# X-UCS MX Universal conduit saddle

## Product data

### Dimensions

X-UCS MX

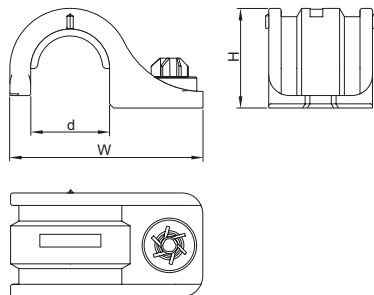

### Features and benefits

- Easy and convenient installation to concrete (soft and tough) and sandlime stone base material
- Quick, cost-efficient fastening

### General information

#### Material specification

X-UCS: PE (halogen and silicone free), light grey RAL 7035, free

## Applications

### Example



- Fastening flexible pipes and pipes with foam insulation for water and heating
- Fastening insulated injection hoses

The intended use only comprises fastenings which are not directly exposed to external weather conditions or moist atmospheres.

### Load data

#### Recommended loads (Base material = concrete)

Fastener	Concrete / Sandlime stone $N_{rec}$ [kN]
X-UCS MX	0.011

#### Design conditions:

- For pipes fastened with less than 5 fasteners and without any fixed end support, a test load has to be applied to each fastener, see Instruction For Use.
- All visible failures must be replaced.
- Predominantly static loading.
- Valid for soft and tough concrete with strength of  $f_{c, cube} = 25-60 \text{ N/mm}^2$ , that may contain medium sized aggregate e.g. limestone, pit gravel. please refer to **Concrete Fastener Selection** section in Hilti Direct Fastening Technology Manual (DFTM).
- Valid for sandlime stone.
- Observance of all application limitations and recommendations.
- Long-term behavior of X-UCS MX plastic material considered.

#### Fastener capacity

Fastening designation	Pipe diameter [mm]	Recommended fastener spacing on ceilings and walls [cm]
X-UCS 19 MX	19.0	80
X-UCS 23 MX	23.0	60
X-UCS 27.5 MX	27.5	40
X-UCS 30.5 MX	30.5	30

#### Comments:

- Recommended fastener spacing is based on recommended load and average weight of intended pipes during duty



## Nail recommendations

For **concrete** base material

Fastening tool	Nail types	Length [mm]	Tip	Shank Ø [mm]	Material	Hardness [HRC]	Coating [µm]
BX 3 ME	X-P B3 MX	20 - 24	Ballistic	3.0	Carbon steel	57.5	Zinc, 2-13 µm
GX 3 ME	X-P G3 MX					57.5	Zinc, 2-13 µm
GX120	X-GHP MX					57.5	Zinc, 2-13 µm

- For the X-UCS MX element, only 20 mm and 24 mm pin lengths are recommended in order to ensure sufficient embedment depth.
- Premium nails (as listed above) are recommended for wall and ceiling application (soft and some tough concrete and sandlime stone, GX/BX tools). For more details regarding nail classification and concrete types, please refer to **Concrete Fastener Selection** section in Hilti Direct Fastening Technology Manual (DFTM).

For **concrete** base material

Fastening tool	Nail types	Length [mm]	Tip	Shank Ø [mm]	Material	Hardness [HRC]	Coating [µm]
BX 3 ME	X-C B3 MX	20 - 24	Cut	3.0	Carbon steel	56.5	Zinc, 2-13 µm
GX 3 ME	X-C G3 MX	20 - 27				56.5	Zinc, 2-13 µm
GX120	X-GN MX	20 - 27				53.5	Zinc, 2-13 µm

- For the X-UCS MX element, only 20 mm, 24 mm and 27 mm pin lengths are recommended in order to ensure sufficient embedment depth.
- Standard nails (as listed above) are recommended for floor application (soft concrete and sandlime stone, GX/BX tools). For more details regarding nail classification and concrete types, please refer to **Concrete Fastener Selection** section in Hilti Direct Fastening Technology Manual (DFTM).

## Application requirements

### Thickness of base material

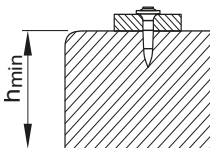

Concrete

**X-P B3 MX, X-P G3 MX,  
X-GHP MX, X-C B3 MX,  
X-C G3 MX, X-GN MX**

$h_{\min} = 60 \text{ mm}$

### Edge distance

Min. edge distance = 70 mm

### Corrosion information

Zinc-coated nails are not suitable for long-term service outdoors or in otherwise corrosive environments.

For further detailed information on corrosion see relevant chapter in **Direct Fastening Principles and Technique** section.

### Fastener selection and system recommendation

#### Fastener program

Designation	Item no.	d [mm]	W [mm]	H [mm]
X-UCS 19 MX	2161565	19.0	46.5	24.0
X-UCS 23 MX	2161566	23.0	50.5	28.0
X-UCS 27.5 MX	2161567	27.5	55.0	32.5
X-UCS 30.5 MX	2161568	30.5	58.0	35.5

#### Tool selection

X-P B3 MX, X-C B3 MX: BX 3-ME  
 X-P G3 MX, X-C G3 MX: GX 3-ME  
 X-GHP MX, X-GN MX: GX 120-ME

#### System recommendation

GX 3-ME Gas can GC 40, GC 41 and GC 42  
 GX 120-ME Gas can GC 20, GC 21 and GC 22  
 BX 3-ME No gas can required

#### Fastening quality assurance

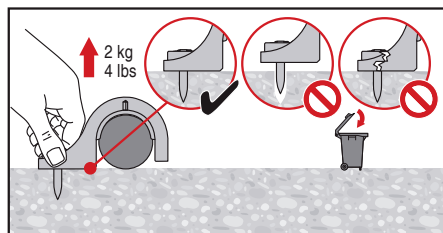
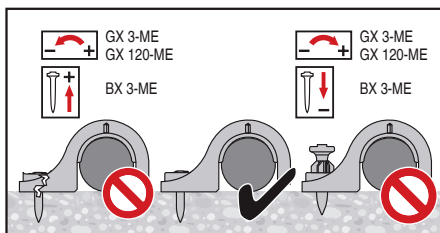

## X-UCS-S MX Universal conduit saddle for rigid pipe

### Product data

#### Dimensions

X-UCS-S MX

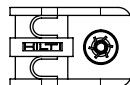
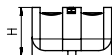
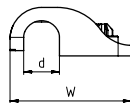

#### Features and benefits

The X-UCS-S MX enables easy and convenient installation to concrete floor (soft and some tough concrete).

#### General information

##### Material specification

X-UCS-S MX: HDPE (halogen and silicon free), light grey RAL 7035

### Applications

#### Example



- Fastening rigid pipes and smooth surface pipes (without foam or grooved protection layer) for water and heating.

The intended use only comprises fastenings which are not directly exposed to external weather conditions or moist atmospheres.

**Performance data**

Fastener	Concrete / Sandlime stone <b>V<sub>rec</sub> [kN]</b>
X-UCS-S MX	0.02

**Design conditions:**

- For pipes fastened with less than 5 fasteners and without any fixed end support, a test load has to be applied to each fastener, see Instruction For Use.
- All visible failures must be replaced.
- Predominantly static loading.
- Valid for soft and some tough concrete with strength of  $f_{c,cube} = 25-60 \text{ N/mm}^2$ , that may contain medium sized aggregate e.g. limestone, pit gravel. Please refer to **Concrete Fastener Selection** section in Hilti Direct Fastening Technology Manual (DFTM).
- Observance of all application limitations and recommendations.
- Long-term behavior of X-UCS-S MX plastic material considered.

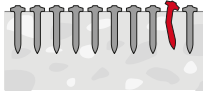

Stick rate estimation		
	Soft Concrete	Tough concrete
X-P B3	85% – 98%	70% – 85%
X-C B3	75% – 90%	55% – 70%

- The stick rate indicates the percentage of nails that were driven correctly to carry a load. Stick rate can vary from the above values depending on job site conditions.

**Nail recommendations**

For <u>concrete</u> base material							
Fastening tool	Nail types	Length [mm]	Tip	Shank Ø [mm]	Material	Hardness [HRC]	Coating [µm]
BX 3-ME (02)	X-P B3 MX	17 - 24	Long conical	3.0	Carbon steel	57.5	Zinc, 2-10
	X-C B3 MX	20 - 24	Cut			56.5	Zinc, 5-13

**Design conditions:**

- For more details regarding nail classification and concrete types, please refer to **Concrete Fastener Selection** section in Hilti Direct Fastening Technology Manual (DFTM).

### Application requirements

#### Thickness of base material

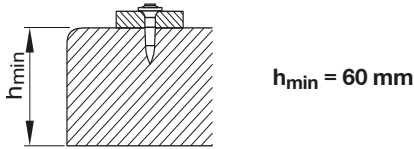

#### Edge distance

Min. edge distance = 70 mm

#### Spacing

- 50-100 cm along the pipe. Adjust spacing as needed to achieve stability of the pipe.
- At pipe turning 90 degree area, please refer to picture for distance between fasteners and orientation of fasteners.

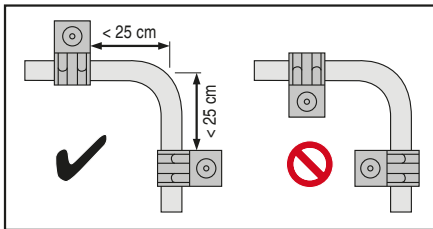

#### Corrosion information

Zinc-coated nails are not suitable for long-term service outdoors or in otherwise corrosive environments. For further detailed information on corrosion see relevant chapter in **Direct Fastening Principles and Technique** section.

**Fastener selection and system recommendation**
**Fastener program**

Designation	Item no.	Pipe Ø [mm]	d [mm]	W [mm]	H [mm]
X-UCS-S 13 MX	2212511	13.0	13.5	45.8	18.3
X-UCS-S 17 MX	2212512	17.0	17.4	49.4	22.2
X-UCS-S 21.5 MX	2212513	21.5	21.9	54.6	26.8
X-UCS-S 27 MX	2212429	27.0	27.4	59.6	32.3

**Tool selection**

X-P B3 MX, X-C B3 MX: BX 3-ME (02)

**System recommendation**

BX 3-ME (02): No gas can required

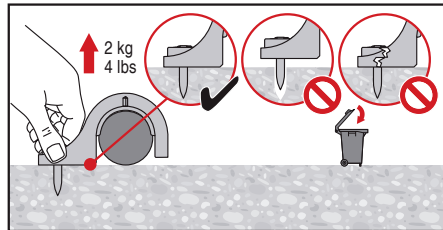
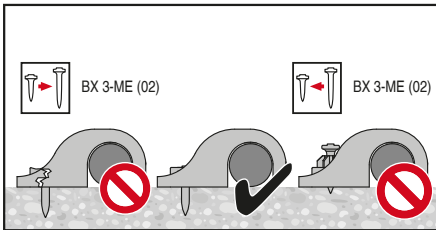
**Fastening quality assurance**

# X-ECT MX, X-UCT MX, X-EKS MX Electrical cable tie and conduit clip fastener

## Product data

### Dimensions

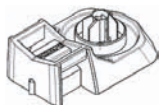
**X-ECT MX**

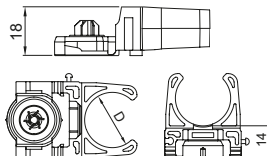
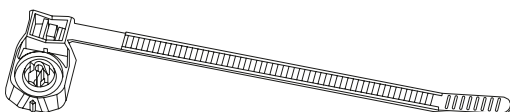
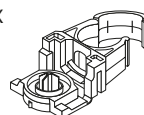
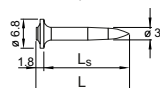
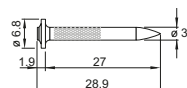
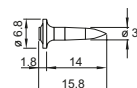
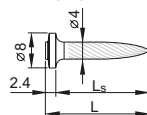
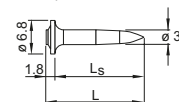
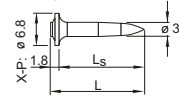
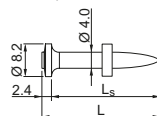
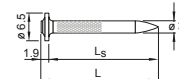
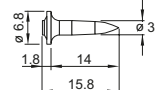
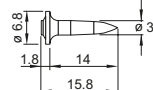
**X-UCT MX**

**X-EKS MX**

**X-ECT 40 MX**

**X-EKSC MX**

**X-GHP 20/24**

**X-GN 27**

**X-EGN 14**

**X-U 16/22/27**

**X-P 20/24 G3 MX**

**X-P 20/24 B3 MX**

**X-P 22/27**

**X-C 27 G3 MX**

**X-S 14 G3 MX**

**X-S 14 B3 MX**

## General information

## Material specifications and material properties

### X-EKS

Material specification				Material properties			
Designation	Item no.	Material	Colour	Silicone free	Halogen free	Flame retardant acc. to EN 60695-2-11, IEC 60695-2-11, VDE 0471 part 2-11 at 650°C at 960°C	UV-resistant
X-EKS 16 MX	285719	PA	light grey, RAL 7035	<input checked="" type="checkbox"/>	<input checked="" type="checkbox"/>	<input checked="" type="checkbox"/> <input type="checkbox"/>	<input checked="" type="checkbox"/> fair
X-EKS 19 MX	2105391	PA	light grey, RAL 7035	<input checked="" type="checkbox"/>	<input checked="" type="checkbox"/>	<input checked="" type="checkbox"/> <input type="checkbox"/>	<input checked="" type="checkbox"/> fair

Material specification				Material properties				
Designation	Item no.	Material	Colour	Silicone free	Halogen free	Flame retardant acc. to EN 60695-2-11, IEC 60695-2-11, VDE 0471 part 2-11 at 650°C at 960°C		UV-resistant
X-EKS 20 MX	285720	PA	light grey (RAL 7035)	<input checked="" type="checkbox"/>	<input checked="" type="checkbox"/>	<input checked="" type="checkbox"/>	<input type="checkbox"/>	<input checked="" type="checkbox"/> fair
X-EKS 25 MX	285721	PA	light grey (RAL 7035)	<input checked="" type="checkbox"/>	<input checked="" type="checkbox"/>	<input checked="" type="checkbox"/>	<input type="checkbox"/>	<input checked="" type="checkbox"/> fair
X-EKS 32 MX	285722	PA	light grey (RAL 7035)	<input checked="" type="checkbox"/>	<input checked="" type="checkbox"/>	<input checked="" type="checkbox"/>	<input type="checkbox"/>	<input checked="" type="checkbox"/> fair
X-EKS 40 MX	285723	PA	light grey (RAL 7035)	<input checked="" type="checkbox"/>	<input checked="" type="checkbox"/>	<input checked="" type="checkbox"/>	<input type="checkbox"/>	<input checked="" type="checkbox"/> fair

### X-EKSC

X-EKSC 16 MX	274083	PA	light grey (RAL 7035)	<input checked="" type="checkbox"/>	<input checked="" type="checkbox"/>	<input checked="" type="checkbox"/>	<input type="checkbox"/>	<input checked="" type="checkbox"/> fair
X-EKSC 20 MX	274086	PA	light grey (RAL 7035)	<input checked="" type="checkbox"/>	<input checked="" type="checkbox"/>	<input checked="" type="checkbox"/>	<input type="checkbox"/>	<input checked="" type="checkbox"/> fair
X-EKSC 25 MX	274087	PA	light grey (RAL 7035)	<input checked="" type="checkbox"/>	<input checked="" type="checkbox"/>	<input checked="" type="checkbox"/>	<input type="checkbox"/>	<input checked="" type="checkbox"/> fair
X-EKSC 32 MX	386469	PA	light grey (RAL 7035)	<input checked="" type="checkbox"/>	<input checked="" type="checkbox"/>	<input checked="" type="checkbox"/>	<input type="checkbox"/>	<input checked="" type="checkbox"/> fair
X-EKSC 40 MX	386470	PA	light grey (RAL 7035)	<input checked="" type="checkbox"/>	<input checked="" type="checkbox"/>	<input checked="" type="checkbox"/>	<input type="checkbox"/>	<input checked="" type="checkbox"/> fair

### X-ECT

X-ECT MX	285709	PA	light grey (RAL 7035)	<input checked="" type="checkbox"/>	<input checked="" type="checkbox"/>	<input checked="" type="checkbox"/>	<input type="checkbox"/>	<input checked="" type="checkbox"/> fair
X-ECT UV MX	285710	PA	black (RAL 9011)	<input checked="" type="checkbox"/>	<input checked="" type="checkbox"/>	<input checked="" type="checkbox"/>	<input type="checkbox"/>	<input checked="" type="checkbox"/> good
X-ECT FR MX	285711	PBT	stone grey (RAL 7030)	<input checked="" type="checkbox"/>	<input type="checkbox"/>	<input type="checkbox"/>	<input checked="" type="checkbox"/>	<input checked="" type="checkbox"/> fair
X-ECT 40 MX	432947	PA	light grey (RAL 7035)	<input checked="" type="checkbox"/>	<input checked="" type="checkbox"/>	<input checked="" type="checkbox"/>	<input type="checkbox"/>	<input checked="" type="checkbox"/> fair
X-ECT U22	288312	PA	black (RAL 9011)	<input checked="" type="checkbox"/>	<input checked="" type="checkbox"/>	<input checked="" type="checkbox"/>	<input type="checkbox"/>	<input checked="" type="checkbox"/> fair
X-ECT UV 22	288313	PA	black (RAL 9011)	<input checked="" type="checkbox"/>	<input checked="" type="checkbox"/>	<input checked="" type="checkbox"/>	<input type="checkbox"/>	<input checked="" type="checkbox"/> good



Material specification				Material properties			
Designation	Item no.	Material	Colour	Silicone free	Halogen free	Flame retardant acc. to EN 60695-2-11, IEC 60695-2-11, VDE 0471 part 2-11 at 650°C at 960°C	UV-resistant

**X-UCT MX**

X-UCT MX	2095183	HDPE	light grey (RAL 7035)	<input checked="" type="checkbox"/>	<input checked="" type="checkbox"/>	<input type="checkbox"/>	<input type="checkbox"/>	<input type="checkbox"/>
----------	---------	------	-----------------------	-------------------------------------	-------------------------------------	--------------------------	--------------------------	--------------------------

**General information**

Recommended fastening tools

DX 460 MX, DX 5 MX, DX 351 MX, GX 120 ME, GX 3 ME, BX 3 ME

See **X-ECT MX, X-UCT MX and X-EKS MX fastener program** in the next pages and **Tools and equipment** chapter for more details.

Approvals

CSTB (France) X-ECT MX, X-EKS MX, X-EKSC MX (all with X-U22 MX nail)  
 UL (USA) X-ECT MX

**Applications**

Examples



**Flexible or rigid cable conduits with cable ties**



**Rigid conduits**



**Cable conduits or light duty pipes**

**Load data**

**Recommended loads**

Fastener	Service load <sup>1)</sup> [kN]
<b>X-ECT MX / X-ECT 40 MX, X-UCT MX</b>	0.04
<b>X-EKS MX</b>	0.011

<sup>1)</sup> The recommended service load is determined by the serviceability of the plastic part.

**Application requirements**
**Thickness of base material**

Concrete

**X-U, X-P:**  $h_{\min} = 80 \text{ mm}$ 
**X-P B3 MX, X-P G3 MX, X-GHP,**
**X-C 27 G3 MX, X-GN 27 MX:**  $h_{\min} = 60 \text{ mm}$ 

Steel

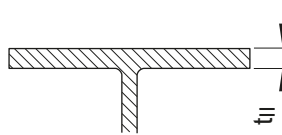
 $t_{\parallel} \geq 4 \text{ mm}$ 

**Spacing**

50–100 cm along the cable tie. Adjust spacing as needed to achieve stability of cable tie

**Corrosion information**

These zinc-coated fasteners are not suitable for long-term service outdoors or in otherwise corrosive environments.

 For further detailed information on corrosion see relevant chapter in **Direct Fastening Principles and Technique** section.

**Fastener selection**

 Suitable cables with **X-ECT MX**, **X-ECT 40 MX** and **X-UCT MX** fastener

Cable type	Cable measure $\varnothing$ [mm]	No. of cables
<b>NYM 3x1.5</b>	8	14
<b>NYM 5x1.5</b>	10	10

 Suitable conduits with **X-EKS / X-EKSC MX** fastener

Conduit type	Conduit size [mm]	No. of conduits
Plastic conduit	16–40	1

**Fastener program**

Base material	Cable Holder	Fastening Technology	Nail
Concrete or masonry	X-ECT MX X-EKS MX X-UCT MX	GX 3ME	X-P 20/24 G3 MX X-C 27 G3 MX
		GX 120 ME	X-GHP 20/24 MX X-GN 27 MX
		BX 3 ME	X-P 20/24 B3 MX
	X-ECT MX X-EKS MX	DX 460 MX, DX 5 MX, DX 351 MX	X-U 22/27 MX
			X-P 22/27 MX
	Steel	X-ECT MX X-EKS MX X-UCT MX	GX 3 ME
GX 120 ME			X-EGN 14 MX
BX 3 ME			X-S 14 B3 MX
X-ECT MX X-EKS MX		DX 460 MX, DX 5 MX, DX 351 MX	X-U 16 MX

**System recommendation**

DX tools:      Steel:      **6.8/11M yellow or red cartridge**  
                      Concrete: **6.8/11M yellow cartridge** on soft and tough concrete  
    **6.8/11M red cartridge** on very tough concrete  
                      Masonry: **6.8/11M green cartridge**

GX 120 tool:                      **Gas can GC 20, GC21 and GC22**

GX 3 ME tool:                    **Gas can GC 40, GC 41 and GC 42**

Tool energy adjustment by setting tests on site.



# X-UCT-E MX Universal cable tie holder

## Product data

### Dimensions

X-UCT-E MX

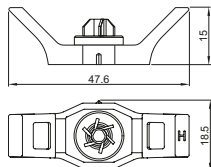

Fasteners for X-UCT-E MX  
on **concrete** base material

X-U 22/27 MX

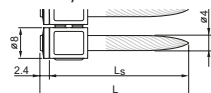

X-C 20/27 MX

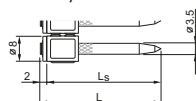

X-U 22/27 P8

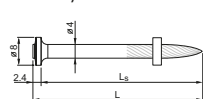

X-C 27 P8

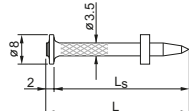

X-GHP 20/24 MX

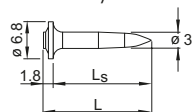

X-GN 20/27 MX

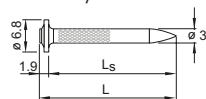

X-P 20/24 G3 MX

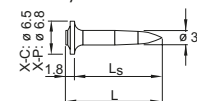

X-C 20/27 G3 MX

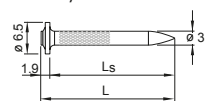

X-P 20/24 B3 MX

X-C 20/24 B3 MX

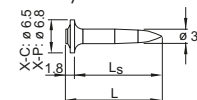

### General information

#### Material specifications:

X-UCT-E MX	PE, light grey RAL 7035
X-U P8, X-U MX	Carbon steel, HRC 58.0, zinc coating 5-20 µm
X-C P8, X-C MX	Carbon steel, HRC 56.5, zinc coating 5-20 µm
X-GHP, X-EGN	Carbon steel, HRC 57.5, zinc coating 2-13 µm
X-GN	Carbon steel, HRC 53.5, zinc coating 2-13 µm
X-P G3 MX,	Carbon steel, HRC 57.5,
X-S G3 MX	zinc coating 2-13 µm
X-C G3 MX	Carbon steel, HRC 56.5, zinc coating 2-13 µm
X-P B3 MX,	Carbon steel, HRC 57.5,
X-S B3 MX	zinc coating 2-13 µm
X-C B3 MX	Carbon steel, HRC 56.5, zinc coating 2-13 µm

#### Recommended fastening tools

DX 351 MX, DX 351-F8, GX 120-ME, GX 3-ME, BX 3-ME

#### Fasteners for X-UCT-E MX on **steel** base material

X-U 16 MX

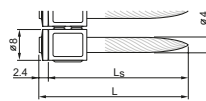

X-U 16 P8

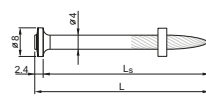

X-EGN 14 MX

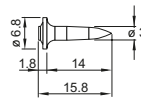

X-S 14 G3 MX / X-S 14 B3 MX

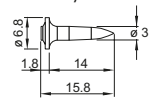

## Applications

### Examples



X-UCT-E MX with cable ties for two pipes



X-UCT-E MX with cable tie for single pipe

## Load data

### Recommended loads

Fastener	Service load <sup>1)</sup> [kN]
X-UCT-E MX	0.04
X-UCT-E MX with 1 White cable tie	
X-UCT-E MX with 1 Blue <u>AND</u> 1 Red cable ties	
X-UCT-E MX with <u>EITHER</u> 1 Blue <u>OR</u> 1 Red cable tie	0.02

<sup>1)</sup> The recommended service load is determined by the serviceability of the plastic parts.

## Application requirements

### Thickness of base material

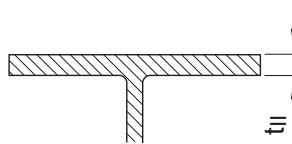
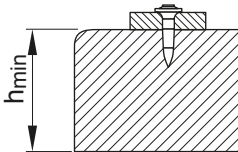

Concrete	
X-U MX, X-U P8, X-C MX, X-C P8	$h_{\min} = 80 \text{ mm}$
X-GHP MX, X-GN MX, X-P G3 MX, X-C G3 MX, X-P B3 MX, X-C B3 MX	$h_{\min} = 60 \text{ mm}$

Steel	
X-U 16 MX X-U 16 P8	$t_{II} \geq 6.0 \text{ mm}$
X-EGN 14 MX X-S 14 B3 MX	$t_{II} \geq 4.0 \text{ mm}$

## Spacing and edge distances

Space fastenings (50 – 100 cm) as needed to control sag and maintain alignment of conduits.

### Corrosion information

These zinc-coated fasteners are not suitable for long-term service outdoors or in otherwise corrosive environments.

For further detailed information on corrosion see relevant chapter in Direct Fastening Principles and Technique section.

### Application limits

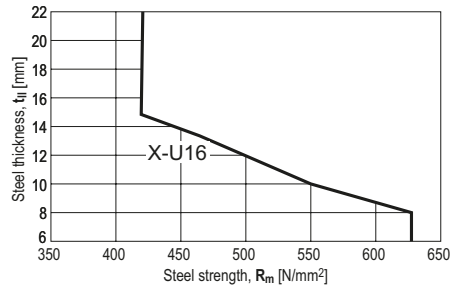
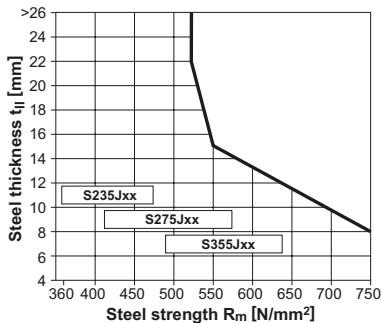

#### For fastening on steel base material

- X-EGN 14 MX
- X-S 14 B3 MX
- X-S 14 G3 MX

#### For fastening on steel base material

- X-U 16 MX

### Fastener selection and system recommendation

#### Fastener program

Designation	Item no.	
X-UCT-E MX	2149226	X-UCT-E MX element

#### Tool selection

X-U MX, X-C MX:	DX 351 MX
X-U P8, X-C P8:	DX 351-F8
X-GHP MX, X-GN MX, X-EGN 14 MX :	GX 120-ME
X-P G3 MX, X-S G3 MX, X-C G3 MX:	GX 3-ME
X-P B3 MX, X-C B3 MX, X-S B3 MX:	BX 3-ME

**System recommendation**

DX 351 MX, DX 351-F8

Soft concrete: 6.8/11M green,

Tough Concrete: 6.8/11M yellow,

Very tough concrete: 6.8/11M red

GX 120-ME

Gas can GC 20, GC 21 and GC 22

GX 3-ME

Gas can GC 40, GC 41 and GC 42

BX 3-ME

No gas can required

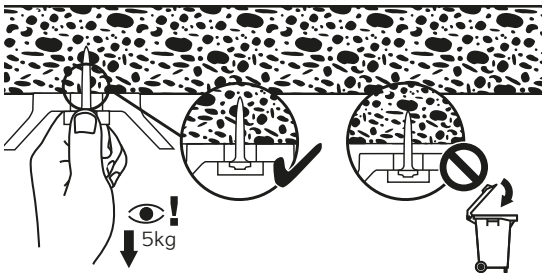
**Fastening quality assurance**



# X-ET Nail for fastening plastic electrical cable tray and junction box

## Product data

### Dimensions

X-ET UK-H27

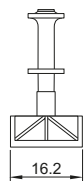
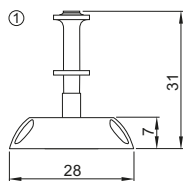

UK-H27

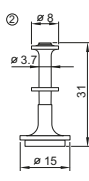

X-ET MX

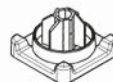

w x l x h = 16.5 x 16.5 x 12 mm

X-GHP 20/24

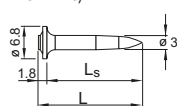

X-GN 27

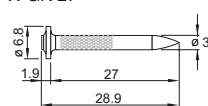

X-EGN 14

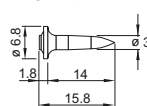

X-U 16/22/27

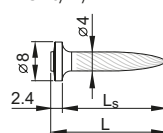

X-P 20/24 G3 MX

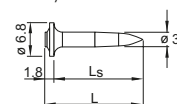

X-P 20/24 B3 MX

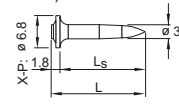

X-P 22/27

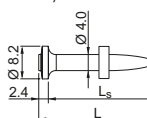

X-C 27 G3 MX

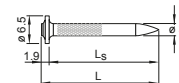

X-S 14 G3 MX

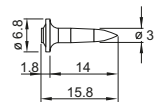

X-S 14 B3 MX

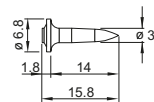

### General information

#### Material specifications

X-ET

Polyethylene

X-ET MX

Polyamide (halogen and silicone free), light grey RAL 7035

and PBT (silicone free, flame retardant), stone grey RAL 7030

#### Recommended fastening tools

DX 460 MX, DX 5 MX, DX 351 MX, GX 120 ME, GX 3 ME, BX 3 ME

See **X-ET fastener program** in the next pages and **Tools and equipment** chapter for more details.

## Applications

### Examples



Cable trunking

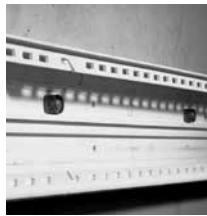

Cable trunking



Junction boxes



Conduits & pipes with metal or textile band

## Load data

### Recommended load

Fastener	Service load <sup>1)</sup> [kN]
<b>X-ET MX</b>	0.1

<sup>1)</sup> The recommended service load is controlled by serviceability of the plastic part.

## Application requirements

### Thickness of base material

#### Concrete

X-U, X-P:  $h_{\min} = 80 \text{ mm}$

X-P B3 MX, X-P G3 MX, X-GHP,

X-C 27 G3 MX, X-GN 27 MX:  $h_{\min} = 60 \text{ mm}$

#### Steel

$t_{II} \geq 4 \text{ mm}$

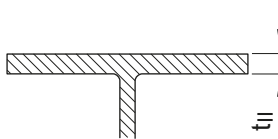

## Corrosion information

These zinc-coated fasteners are not suitable for long-term service outdoors or in otherwise corrosive environments.

For further detailed information on corrosion see relevant chapter in **Direct Fastening Principles and Technique** section.

### Fastener program

Base material	Cable Holder	Fastening Technology	Nail
Concrete or masonry	X-ET MX	GX 3ME	X-P 20/24 G3 MX X-C 27 G3 MX
		GX 120 ME	X-GHP 20/24 MX X-GN 27 MX
		BX 3 ME	X-P 20/24 B3 MX
	X-ET UK-H27	DX 460 MX, DX 5 MX, DX 351 MX	X-U 22/27 MX X-P 22/27 MX
Steel	X-ET MX	GX 3 ME	X-S 14 G3 MX
		GX 120 ME	X-EGN 14 MX
		BX 3 ME	X-S 14 B3 MX
	X-ET UK-H27	DX 460 MX, DX 5 MX, DX 351 MX	X-U 16 MX

### Order information

Fastener	Item no.	Designation
X-ET	251705	X-ET UK-H27
	285718	X-ET MX

#### Conditions for use:

- No fastenings on ribs
- Underside of trunking must be smooth
- X-ET MX only in pre-drilled holes

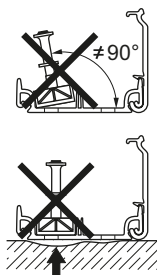

#### Trunking dimensions:

$t_1 \leq 2 \text{ mm PVC}$

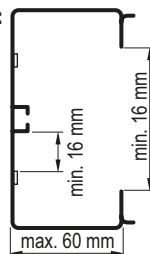

### System recommendation

DX tools:	Steel:	<b>6.8/11M yellow or red cartridge</b>
	Concrete:	<b>6.8/11M yellow cartridge</b> on soft and tough concrete <b>6.8/11M red cartridge</b> on very tough concrete
	Masonry:	<b>6.8/11M green cartridge</b>
GX 120-ME tool:		<b>Gas can GC 20, GC 21 and GC22</b>
GX 3 ME tool:		<b>Gas can GC 40, GC 41 and GC 42</b>
BX 3-ME tool:		<b>No gas can required</b>

Tool energy adjustment by setting tests on site.

## X-TT Textile tape

### Product data

X-TT



### Features and benefits

- Quick and cost efficient fastening
- No finishing required
- Several pipes or conduits can be fastened to the floor in parallel
- X-ET fastener can be used for greater stability
- No sound transmission when used to fasten metal pipes

### Environmental condition



Dry indoor  
Floor application

### Material specification and material properties

Designation	Item no.	Material	Material colour	Material width	Material thickness	Product ultimate tensile force	Temperature resistance	
							T <sub>min</sub>	T <sub>max</sub>
Textile tape	362096	PET	black	19.3 mm	1.2 mm	5000 N	-30° C	+80° C

### Base material

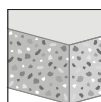

Soft concrete

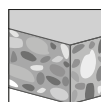

Tough concrete

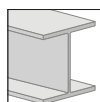

Steel



Masonry Solid brick

## Application

Textile tape for cable and conduit fastening on floors.



## Fastening quality assurance

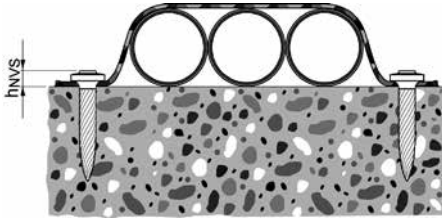

Admissible fastener stand-off

$$h_{NVS, \min} = 2.5 \text{ mm}$$

$$h_{NVS, \max} = 5.0 \text{ mm}$$

## System recommendation

Product	Fastener						Battery-actuated tool	Base material			
	X-P 17 B3 MX	X-P 20 B3 MX	X-P 24 B3 MX	X-C 20 B3 MX	X-C 24 B3 MX	X-S 14 B3 MX		BX 3-ME	Soft concrete	Tough concrete	Steel
X-TT	■	■	■	■	■	■	■	■	■	■	■

■ recommended



GX3-ME system recommendation in line with BX3-ME recommendation.

GX 120-ME, GX3-ME, DX 351 MX, DX 460 MX, DX 5 MX system recommendation is part of the corresponding chapters within the Direct Fastening Technology Manual.

## Setting information



Fastener setting information (e.g. base material properties and setting energy) is part of the corresponding Product Data Sheets for fasteners.

# GX-WF Wood framing nail

## Wood nail designation

<b>GX</b>	<b>-</b>	<b>WF</b>	<b>[l<sub>n</sub>] × [d<sub>n</sub>]</b>	<b>(R)</b>	<b>(D)</b>	<b>34</b>	<b>(HDG)</b>
Technology		Application	Dimension	Profile	Head Shape	Collation	Material

### Technology:

GX | Gas driven

### Application:

WF | Wood framing

### Dimension:

[l<sub>n</sub>] | Nail length [mm]  
 [d<sub>n</sub>] | Nail diameter [mm]

### Profile:

R | Profiled nail  
 ( ) | Smooth nail

### Head shape:

D | D-head  
 ( ) | Round head



### Collation:

34 | 34° Collation

### Material:

( ) | Bright steel  
 galv | Galvanized steel  
 HDG | Hot dip galvanized steel  
 A2 | Stainless steel

**Product data**

<b>GX-WF smooth nail</b>   (example with D-head)	<b>Product description</b>  <ul style="list-style-type: none"> <li>• Round cross-sectional smooth nails with straight shank for use in load bearing timber structures</li> <li>• In accordance with EN 1995-1-1 smooth nails can be used for short to medium term withdrawal loads &lt; 6 month or for shear loads only.</li> </ul>
<b>GX-WF profiled nail</b>   (example with round head)	<b>Product description</b>  <ul style="list-style-type: none"> <li>• Round cross-sectional profiled nails with straight shank for use in load bearing timber structures</li> <li>• Collated nail for framing application</li> <li>• In accordance with EN 1995-1-1 profiled nails can be used for permanent or long-term withdrawal loads &gt; 6 month and/or shear loads.</li> </ul>

**Recommended fastening tool**

GX 90 WF

**Material specification for GX-WF smooth nail**

Designation	Available material/coating				Minimum tensile strength
	Bright steel	Galvanized steel	Hot-dip galvanized steel	Stainless steel	
GX-WF [l <sub>n</sub> ] × 2.8 D 34	●	●	●	N/A	f <sub>u</sub> 600 N/mm <sup>2</sup>
GX-WF [l <sub>n</sub> ] × 3.1 D 34	●	●	●	N/A	600 N/mm <sup>2</sup>

**Material specification for GX-WF profiled nail**

Designation	Available material/coating				Minimum tensile strength
	Bright steel	Galvanized steel	Hot-dip galvanized steel	Stainless steel	
GX-WF [l <sub>n</sub> ] × 2.8 RD 34	●	●	●	●	f <sub>u</sub> 600 N/mm <sup>2</sup>
GX-WF [l <sub>n</sub> ] × 2.8 R 34	N/A	N/A	●	●	600 N/mm <sup>2</sup>
GX-WF [l <sub>n</sub> ] × 3.1 RD 34	●	●	●	●	600 N/mm <sup>2</sup>

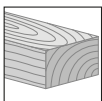
**Base material**

Wood

**Load condition**

Static/quasi static



## Application

### Examples

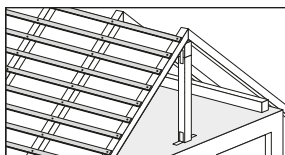

**Battens**

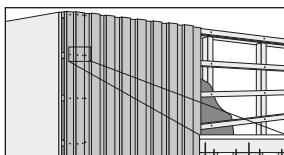

**Cladding**

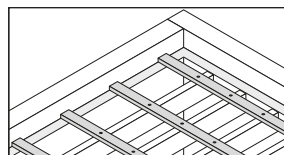

**Flat roof**

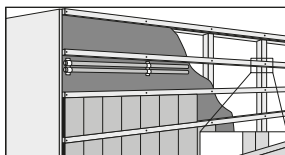

**Sub-construction**

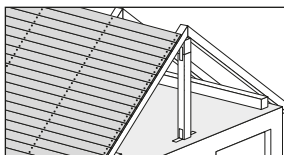

**Roof paneling**

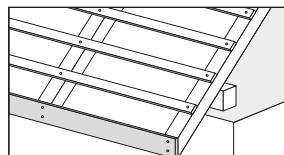

**Roof trim**

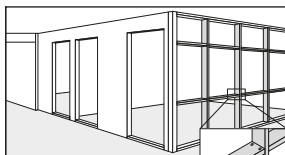

**Wall framing**

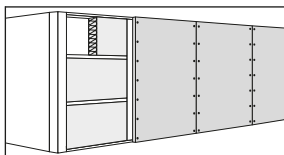

**Wall sheeting**

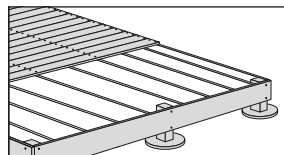

**Wood decking**

## Corrosion information

Suitable GX-WF material related to service classes according to EN 1995-1-1

Service class	1	2	3
Average moisture content of the wood specimen	≤ 12%	≤ 20%	> 20%
Designation on package/label			
Requirements for nails with $d_n \leq 4 \text{ mm}$	No coating	Fe/Zn 12c	Fe/Zn 25c <sup>1)</sup>
Suitable GX-WF material	Bright steel Galvanized steel Hot-dip galvanized steel	Stainless steel Galvanized steel Hot-dip galvanized steel	Stainless steel Hot-dip galvanized steel Stainless steel

1) according to EN 10147, for hot-dip galvanized steel nails Fe/Zn 25 c is typically substituted by Z350.



Certain wood treatments and species, like Oak, Douglas-fir or similar, require stainless steel nails due to acidity of the wood. independent of the service class.

### Mechanical strength and stiffness

Failures modes associated with design parameters, according to EN 1995-1-1



$M_y$  Yield moment

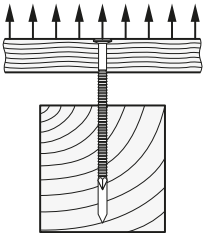

$f_{ax}$  Withdrawal parameter

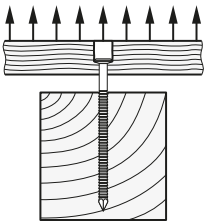

$f_{head}$  Head pull-through parameter

### Smooth nail

Designation	Available length	Tensile loading	Shear loading	Char. yield moment	Char. withdrawal parameter	Char. head pull-through parameter
	$l_n$ /mm			$M_{y,k}$	$f_{ax,k}$	$f_{head,k}$
GX-WF [I <sub>n</sub> ] × 2.8 D 34	51, 63, 70, 75, 80	Medium term (< 6 months)	Permanent (> 10 years)	2617 Nmm	2.4 N/mm <sup>2</sup>	8.5 N/mm <sup>2</sup>
GX-WF [I <sub>n</sub> ] × 2.8 D 34 gal	51, 63, 70, 75, 80			2617 Nmm	2.4 N/mm <sup>2</sup>	8.5 N/mm <sup>2</sup>
GX-WF [I <sub>n</sub> ] × 2.8 D 34 HDG	51, 63, 75			2617 Nmm	2.4 N/mm <sup>2</sup>	8.5 N/mm <sup>2</sup>
GX-WF [I <sub>n</sub> ] × 3.1 D 34	80, 90			3410 Nmm	2.0 N/mm <sup>2</sup>	8.5 N/mm <sup>2</sup>
GX-WF [I <sub>n</sub> ] × 3.1 D 34 galv	75, 80, 90			3410 Nmm	2.0 N/mm <sup>2</sup>	8.5 N/mm <sup>2</sup>
GX-WF [I <sub>n</sub> ] × 3.1 D 34 HDG	75, 80, 90			3410 Nmm	2.0 N/mm <sup>2</sup>	8.5 N/mm <sup>2</sup>

### Profiled nail

Designation	Available length	Tensile loading	Shear loading	Char. yield moment	Char. withdrawal parameter	Char. head pull-through parameter
	$l_n$ /mm			$M_{y,k}$	$f_{ax,k}$	$f_{head,k}$
GX-WF [ $l_n$ ] × 2.8 RD 34	51, 63, 70, 75, 80	Permanent (> 10 years)	Permanent (> 10 years)	2320 Nmm	6.9 N/mm <sup>2</sup>	12.5 N/mm <sup>2</sup>
GX-WF [ $l_n$ ] × 2.8 RD 34 galv	51, 63, 70, 75, 80			2320 Nmm	6.9 N/mm <sup>2</sup>	12.5 N/mm <sup>2</sup>
GX-WF [ $l_n$ ] × 2.8 RD 34 HDG	51, 63, 75, 80			2130 Nmm	6.9 N/mm <sup>2</sup>	12.5 N/mm <sup>2</sup>
GX-WF [ $l_n$ ] × 2.8 RD 34 A2	51, 63			1960 Nmm	6.8 N/mm <sup>2</sup>	12.5 N/mm <sup>2</sup>
GX-WF [ $l_n$ ] × 2.8 R 34 A2	55, 65, 80			1960 Nmm	6.8 N/mm <sup>2</sup>	15.7 N/mm <sup>2</sup>
GX-WF [ $l_n$ ] × 2.8 R 34 HDG	50, 65, 75			2130 Nmm	6.9 N/mm <sup>2</sup>	13.9 N/mm <sup>2</sup>
GX-WF [ $l_n$ ] × 3.1 RD 34 A2	80			2830 Nmm	6.2 N/mm <sup>2</sup>	13.9 N/mm <sup>2</sup>
GX-WF [ $l_n$ ] × 3.1 RD 34	70, 75, 80, 90			2772 Nmm	6.7 N/mm <sup>2</sup>	13.9 N/mm <sup>2</sup>
GX-WF [ $l_n$ ] × 3.1 RD 34 galv	70, 75, 80, 90			2772 Nmm	6.3 N/mm <sup>2</sup>	13.9 N/mm <sup>2</sup>
GX-WF [ $l_n$ ] × 3.1 RD 34 HDG	63, 75, 80, 90					2772 Nmm

### Dimension

#### Nail definition

##### Head shape

D-head

Round head



$A_h$  Head cross-sectional area  
 $d_h$  Head diameter

##### Profiled nail

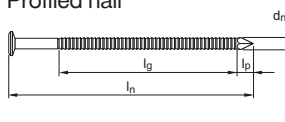

$l_n$  Nominal nail length  
 $d_n$  Nominal nail diameter  
 $l_g$  Length of profiling  
 $l_p$  Point length

#### Fastening definition

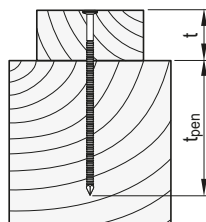

$t$  Fastening height  
 $t_{pen}$  Pointside penetration depth

### Bright steel nail, service class 1

Designation	Nominal nail length	Nominal nail diameter	Minimum head diameter	Minimum head cross-sectional area	Maximum fastening height	Length of profiling	Maximum point length
	$l_n$	$d_n$	$d_h$	$A_{h,min}$	$t$	$l_g$	$l_p$
GX-WF 51 × 2.8 D 34	51 mm	2.8 mm	7 mm	29.40 mm <sup>2</sup>	28 mm	N/A	4.6 mm
GX-WF 63 × 2.8 D 34	63 mm	2.8 mm	7 mm	29.40 mm <sup>2</sup>	40 mm	N/A	4.6 mm
GX-WF 70 × 2.8 D 34	70 mm	2.8 mm	7 mm	29.40 mm <sup>2</sup>	47 mm	N/A	4.6 mm
GX-WF 75 × 2.8 D 34	75 mm	2.8 mm	7 mm	29.40 mm <sup>2</sup>	52 mm	N/A	4.6 mm
GX-WF 80 × 2.8 D 34	80 mm	2.8 mm	7 mm	29.40 mm <sup>2</sup>	57 mm	N/A	4.6 mm
GX-WF 80 × 3.1 D 34	80 mm	3.1 mm	7.2 mm	29.40 mm <sup>2</sup>	55 mm	N/A	4.9 mm
GX-WF 90 × 3.1 D 34	90 mm	3.1 mm	7.2 mm	29.40 mm <sup>2</sup>	65 mm	N/A	4.9 mm
GX-WF 51 × 2.8 RD 34	51 mm	2.8 mm	7 mm	29.40 mm <sup>2</sup>	34 mm	34 mm	4.6 mm
GX-WF 63 × 2.8 RD 34	63 mm	2.8 mm	7 mm	29.40 mm <sup>2</sup>	46 mm	46 mm	4.6 mm
GX-WF 70 × 2.8 RD 34	70 mm	2.8 mm	7 mm	29.40 mm <sup>2</sup>	53 mm	53 mm	4.6 mm
GX-WF 75 × 2.8 RD 34	75 mm	2.8 mm	7 mm	29.40 mm <sup>2</sup>	58 mm	58 mm	4.6 mm
GX-WF 80 × 2.8 RD 34	80 mm	2.8 mm	7 mm	29.40 mm <sup>2</sup>	63 mm	63 mm	4.6 mm
GX-WF 70 × 3.1 RD 34	70 mm	3.1 mm	7.2 mm	29.40 mm <sup>2</sup>	51 mm	53 mm	4.9 mm
GX-WF 75 × 3.1 RD 34	75 mm	3.1 mm	7.2 mm	29.40 mm <sup>2</sup>	56 mm	58 mm	4.9 mm
GX-WF 80 × 3.1 RD 34	80 mm	3.1 mm	7.2 mm	29.40 mm <sup>2</sup>	61 mm	63 mm	4.9 mm
GX-WF 90 × 3.1 RD 34	90 mm	3.1 mm	7.2 mm	29.40 mm <sup>2</sup>	71 mm	73 mm	4.9 mm

### Galvanized steel nail, service class 2

Designation	Nominal nail length	Nominal nail diameter	Minimum head diameter	Minimum head cross-sectional area	Maximum fastening height	Length of profiling	Maximum point length
	$l_n$	$d_n$	$d_h$	$A_{h,min}$	$t$	$l_g$	$l_p$
GX-WF 51 × 2.8 D 34 galv	51 mm	2.8 mm	7 mm	29.40 mm <sup>2</sup>	28 mm	N/A	4.6 mm
GX-WF 63 × 2.8 D 34 galv	63 mm	2.8 mm	7 mm	29.40 mm <sup>2</sup>	40 mm	N/A	4.3 mm
GX-WF 70 × 2.8 D 34 galv	70 mm	2.8 mm	7 mm	29.40 mm <sup>2</sup>	47 mm	N/A	4.3 mm
GX-WF 75 × 2.8 D 34 galv	75 mm	2.8 mm	7 mm	29.40 mm <sup>2</sup>	52 mm	N/A	4.3 mm
GX-WF 80 × 2.8 D 34 galv	80 mm	2.8 mm	7 mm	29.40 mm <sup>2</sup>	57 mm	N/A	4.3 mm
GX-WF 75 × 3.1 D 34 galv	75 mm	3.1 mm	7.2 mm	29.40 mm <sup>2</sup>	50 mm	N/A	4.8 mm
GX-WF 80 × 3.1 D 34 galv	80 mm	3.1 mm	7.2 mm	29.40 mm <sup>2</sup>	55 mm	N/A	4.8 mm
GX-WF 90 × 3.1 D 34 galv	90 mm	3.1 mm	7.2 mm	29.40 mm <sup>2</sup>	65 mm	N/A	4.8 mm
GX-WF 51 × 2.8 RD 34 galv	51 mm	2.8 mm	7 mm	29.40 mm <sup>2</sup>	34 mm	34 mm	4.3 mm
GX-WF 63 × 2.8 RD 34 galv	63 mm	2.8 mm	7 mm	29.40 mm <sup>2</sup>	46 mm	46 mm	4.3 mm
GX-WF 70 × 2.8 RD 34 galv	70 mm	2.8 mm	7 mm	29.40 mm <sup>2</sup>	53 mm	53 mm	4.3 mm
GX-WF 75 × 2.8 RD 34 galv	75 mm	2.8 mm	7 mm	29.40 mm <sup>2</sup>	58 mm	58 mm	4.3 mm
GX-WF 80 × 2.8 RD 34 galv	80 mm	2.8 mm	7 mm	29.40 mm <sup>2</sup>	63 mm	63 mm	4.3 mm
GX-WF 70 × 3.1 RD 34 galv	70 mm	3.1 mm	7.2 mm	29.40 mm <sup>2</sup>	51 mm	53 mm	4.8 mm
GX-WF 75 × 3.1 RD 34 galv	75 mm	3.1 mm	7.2 mm	29.40 mm <sup>2</sup>	56 mm	58 mm	4.8 mm
GX-WF 80 × 3.1 RD 34 galv	80 mm	3.1 mm	7.2 mm	29.40 mm <sup>2</sup>	61 mm	63 mm	4.8 mm
GX-WF 90 × 3.1 RD 34 galv	90 mm	3.1 mm	7.2 mm	29.40 mm <sup>2</sup>	71 mm	73 mm	4.8 mm

### Hot-dip galvanized steel nail, service class 3

Designation	Nominal nail length	Nominal nail diameter	Minimum head diameter	Minimum head cross-sectional area	Maximum fastening height	Length of profiling	Maximum point length
	$l_n$	$d_n$	$d_h$	$A_{h,min}$	$t$	$l_g$	$l_p$
GX-WF 51 × 2.8 D 34 HDG	51 mm	2.8 mm	7 mm	29.40 mm <sup>2</sup>	28 mm	N/A	4.6 mm
GX-WF 63 × 2.8 D 34 HDG	63 mm	2.8 mm	7 mm	29.40 mm <sup>2</sup>	40 mm	N/A	4.6 mm
GX-WF 75 × 2.8 D 34 HDG	75 mm	2.8 mm	7 mm	29.40 mm <sup>2</sup>	52 mm	N/A	4.6 mm
GX-WF 75 × 3.1 D 34 HDG	75 mm	3.1 mm	7.2 mm	29.40 mm <sup>2</sup>	50 mm	N/A	4.9 mm
GX-WF 80 × 3.1 D 34 HDG	80 mm	3.1 mm	7.2 mm	29.40 mm <sup>2</sup>	55 mm	N/A	4.9 mm
GX-WF 90 × 3.1 D 34 HDG	90 mm	3.1 mm	7.2 mm	29.40 mm <sup>2</sup>	65 mm	N/A	4.9 mm
GX-WF 51 × 2.8 RD 34 HDG	51 mm	2.8 mm	7 mm	29.40 mm <sup>2</sup>	34 mm	34 mm	4.6 mm
GX-WF 63 × 2.8 RD 34 HDG	63 mm	2.8 mm	7 mm	29.40 mm <sup>2</sup>	46 mm	46 mm	4.6 mm
GX-WF 75 × 2.8 RD 34 HDG	75 mm	2.8 mm	7 mm	29.40 mm <sup>2</sup>	58 mm	58 mm	4.6 mm
GX-WF 80 × 2.8 RD 34 HDG	80 mm	2.8 mm	7 mm	29.40 mm <sup>2</sup>	63 mm	63 mm	4.6 mm
GX-WF 70 × 3.1 RD 34 HDG	70 mm	3.1 mm	7.2 mm	29.40 mm <sup>2</sup>	44 mm	46 mm	4.9 mm
GX-WF 75 × 3.1 RD 34 HDG	75 mm	3.1 mm	7.2 mm	29.40 mm <sup>2</sup>	56 mm	58 mm	4.9 mm
GX-WF 80 × 3.1 RD 34 HDG	80 mm	3.1 mm	7.2 mm	29.40 mm <sup>2</sup>	61 mm	63 mm	4.9 mm
GX-WF 90 × 3.1 RD 34 HDG	90 mm	3.1 mm	7.2 mm	29.40 mm <sup>2</sup>	71 mm	73 mm	4.9 mm
GX-WF 50 × 2.8 R 34 HDG	50 mm	2.8 mm	6.4 mm	32.20 mm <sup>2</sup>	33 mm	34 mm	4.6 mm
GX-WF 65 × 2.8 R 34 HDG	65 mm	2.8 mm	6.4 mm	32.20 mm <sup>2</sup>	48 mm	49 mm	4.6 mm
GX-WF 75 × 2.8 R 34 HDG	75 mm	2.8 mm	6.4 mm	32.20 mm <sup>2</sup>	59 mm	58 mm	4.6 mm

### Stainless steel nail, service class 3

Designation	Nominal nail length	Nominal nail diameter	Minimum head diameter	Minimum head cross-sectional area	Maximum fastening height	Length of profiling	Maximum point length
	$l_n$	$d_n$	$d_h$	$A_{h,min}$	$t$	$l_g$	$l_p$
GX-WF 51 × 2.8 RD 34 A2	51 mm	2.8 mm	7.0 mm	29.40 mm <sup>2</sup>	34 mm	34 mm	4.6 mm
GX-WF 63 × 2.8 RD 34 A2	63 mm	2.8 mm	7.0 mm	29.40 mm <sup>2</sup>	46 mm	46 mm	4.6 mm
GX-WF 80 × 3.1 RD 34 A2	80 mm	3.1 mm	7.2 mm	29.40 mm <sup>2</sup>	61 mm	63 mm	4.9 mm
GX-WF 55 × 2.8 R 34 A2	55 mm	2.8 mm	6.4 mm	32.20 mm <sup>2</sup>	38 mm	38 mm	4.6 mm
GX-WF 65 × 2.8 R 34 A2	65 mm	2.8 mm	6.4 mm	32.20 mm <sup>2</sup>	48 mm	48 mm	4.6 mm
GX-WF 80 × 2.8 R 34 A2	80 mm	2.8 mm	6.4 mm	32.20 mm <sup>2</sup>	63 mm	63 mm	4.6 mm

## Application requirement

### Minimum pointside penetration depth, under tension load

For smooth nail:  $t_{\text{pen}} = 8 \times d_n$

For profiled nail:  $t_{\text{pen}} = 6 \times d_n$

### Spacing and edge distance

Geometrical limitations, like spacing and edge distance, shall be in compliance with EN 1995-1-1 or other applicable regulations.

## Fastening quality assurance

### Fastening inspection for wood to wood connection

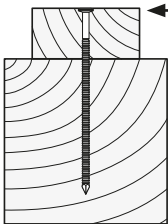

- 1 Nail head shall be flush with the wood surface
- 2 Fastened wood member should be fully in contact with the supporting wood member, if not differently required by the specific design of the connection.

## Installation information

### Pre-drilling

Pre-drilling requirements are described in EN 1995-1-1, section 8.3.1.2.

**Item no.**
**Bright steel nail, service class 1**

Designation	Item no.
GX-WF 51 × 2.8 D 34	2281814, 2083658
GX-WF 63 × 2.8 D 34	2281815, 2083659
GX-WF 70 × 2.8 D 34	2281816, 2083750
GX-WF 75 × 2.8 D 34	2281817, 2083751
GX-WF 80 × 2.8 D 34	2281818, 2083752
GX-WF 80 × 3.1 D 34	2281819, 2083753
GX-WF 90 × 3.1 D 34	2281820, 2083754
GX-WF 51 × 2.8 RD 34	2281821, 2083755
GX-WF 63 × 2.8 RD 34	2281822, 2083756
GX-WF 70 × 2.8 RD 34	2281823, 2083757
GX-WF 75 × 2.8 RD 34	2281824, 2083758
GX-WF 80 × 2.8 RD 34	2281833, 2083759
GX-WF 70 × 3.1 RD 34	2281825, 2083760
GX-WF 75 × 3.1 RD 34	2083761
GX-WF 80 × 3.1 RD 34	2281826, 2083762
GX-WF 90 × 3.1 RD 34	2281827, 2083763

**Galvanized steel nail, service class 2**

Designation	Item no.
GX-WF 51 × 2.8 D 34 galv	2281835, 2083764
GX-WF 63 × 2.8 D 34 galv	2281836, 2083765
GX-WF 70 × 2.8 D 34 galv	2281837, 2083766
GX-WF 75 × 2.8 D 34 galv	2281838, 2083767
GX-WF 80 × 2.8 D 34 galv	2281839, 2083768
GX-WF 75 × 3.1 D 34 galv	2281840, 2083769
GX-WF 80 × 3.1 D 34 galv	2281841, 2083770
GX-WF 90 × 3.1 D 34 galv	2281842, 2083771
GX-WF 51 × 2.8 RD 34 galv	2281843, 2083772
GX-WF 63 × 2.8 RD 34 galv	2281844, 2083773
GX-WF 70 × 2.8 RD 34 galv	2281845, 2083774
GX-WF 75 × 2.8 RD 34 galv	2281846, 2083775
GX-WF 80 × 2.8 RD 34 galv	2281847, 2083776
GX-WF 70 × 3.1 RD 34 galv	2281848, 2083777
GX-WF 75 × 3.1 RD 34 galv	2281849, 2083778
GX-WF 80 × 3.1 RD 34 galv	2281615, 2083779
GX-WF 90 × 3.1 RD 34 galv	2281834, 2083780

**Hot-dip galvanized steel nail, service class 3**

Designation	Item no.
GX-WF 51 × 2.8 D 34 HDG	2281616, 2083781
GX-WF 63 × 2.8 D 34 HDG	2281617, 2083782
GX-WF 75 × 2.8 D 34 HDG	2281618, 2083783
GX-WF 75 × 3.1 D 34 HDG	2281619, 2083784
GX-WF 80 × 3.1 D 34 HDG	2281800, 2083785
GX-WF 90 × 3.1 D 34 HDG	2281801, 2083786
GX-WF 51 × 2.8 RD 34 HDG	2281802, 2083787
GX-WF 63 × 2.8 RD 34 HDG	2281803, 2083788
GX-WF 75 × 2.8 RD 34 HDG	2281804, 2083789
GX-WF 80 × 2.8 RD 34 HDG	2281805, 2083790
GX-WF 70 × 3.1 RD 34 HDG	2281806, 2083791
GX-WF 75 × 3.1 RD 34 HDG	2281807, 2083792
GX-WF 80 × 3.1 RD 34 HDG	2281808, 2083793
GX-WF 90 × 3.1 RD 34 HDG	2281809, 2083794
GX-WF 50 × 2.8 R 34 HDG	2281810
GX-WF 65 × 2.8 R 34 HDG	2281811
GX-WF 51 × 2.8 R 34 HDG	2281812

**Stainless steel nail, service class 3**

Designation	Item no.
GX-WF 51 × 2.8 RD 34 A2	2281828, 2006654
GX-WF 63 × 2.8 RD 34 A2	2281829, 2006655
GX-WF 80 × 3.1 RD 34 A2	2281830, 2006656
GX-WF 55 × 2.8 R 34 A2	2281831, 2006657
GX-WF 65 × 2.8 R 34 A2	2281832, 2006658
GX-WF 80 × 2.8 R 34 A2	2281813, 2006659





## Nails → Approvals

Product	Approval	Country	Application
DNH	ITB AT-15-7696/2016	Poland	Fastening to steel and concrete
DS	ICC-ES ESR-1663	USA	Fastening to steel and concrete
	LR 97/00077(E4)	Global	Fastening to steel
	ITB AT-15-7235/2015	Poland	Fastening to steel and concrete
DX-Kwik	DIBt Z-21.7-670	Germany	Suspended ceiling fastening
	ETA-14/0426	Europe	Fastening to concrete
	IBMB 3041/8171	Germany	Fastening drywall track
	IBMB Gutachten 1498/166/13	Germany	Ceiling hanger fastening
	Rom. Ministry, ICECON: AT 016-01_389-2018	Romania	Fastening to concrete
DX-Kwik X-HS	IBMB Gutachten 1498/166/13	Germany	Ceiling hanger fastening
EDS	DNV-GL 42222-15HH	Global	Fastening to steel, Fastening to steel for shipbuilding
	ICC-ES ESR-1663	USA	Fastening to steel and concrete
	ITB AT-15-7235/2015	Poland	Fastening to steel and concrete
	LR 97/00077(E4)	Global	Fastening to steel
E-Fastener	ETA-16/0301	Europe	Cable fastening
	„Rom. Ministry, ICECON: AT 003-05/500-2016,,	Romania	Cable and conduit fastening
NPH2	BUtgb ATG 1824	Belgium	Metal deck fastening
	Socotec N 1601601R0000004	France	Deck fastening

Product	Approval	Country	Application
S-BT	ABS 16-HS1550085-2-PDA	Global	Fastening to steel, Fastening to steel for off-shore applications, Fastening to steel for shipbuilding
	BV 45116/A2 BV	Global	Fastening to steel, Fastening to steel for shipbuilding
	DNV-GL TAS00000N6	Global	Fastening to steel, Fastening to steel for off-shore applications, Fastening to steel for shipbuilding
	ETA-20/0530	Global	Fastening to steel
	ITB AT-15-7696/2016	Poland	Fastening to steel and concrete
	LR 16/00063(E1)	Global	Fastening to steel, Fastening to steel for off-shore applications, Fastening to steel for shipbuilding
	Russian Maritime Register	Global	Fastening to steel, Fastening to steel for shipbuilding
	RINA FPE278318CS	Global	Fastening to steel, Fastening to steel for off-shore applications, Fastening to steel for shipbuilding
S-BT-ER / -EF (HC)	ABS 16-HS1550085-2-PDA	Global	Fastening to steel, Fastening to steel for off-shore applications, Fastening to steel for shipbuilding
	BV 45116/A2 BV	Global	Fastening to steel, Fastening to steel for shipbuilding
	DNV-GL TAS00000N6	Global	Fastening to steel, Fastening to steel for off-shore applications, Fastening to steel for shipbuilding
	Russian Maritime Register	Global	Fastening to steel, Fastening to steel for shipbuilding
	RINA FPE278318CS	Global	Fastening to steel, Fastening to steel for off-shore applications, Fastening to steel for shipbuilding

Product	Approval	Country	Application
W10	FM Sprinkler Piper Listings	USA	Sprinkler pipe fastening
	ICC-ES ESR-1663	USA	Fastening to steel and concrete
	UL EX 2258	USA	Sprinkler pipe fastening
	UL EX 2258	Canada	Sprinkler pipe fastening
W6	ICC-ES ESR-1663	USA	Fastening to steel and concrete
Wood nails	BRANZ Appraisal 780 (2012)	New Zealand	Timber joints fastening

Product	Approval	Country	Application
X-BT	ABS 16-HS1545448-PDA	Global	Fastening to steel, Fastening to steel for off-shore applications, Fastening to steel for shipbuilding
	ABS 18-HS1755518-PDA	Global	Fastening to steel, Fastening to steel for off-shore applications, Fastening to steel for shipbuilding
	BV 23498/B0	Global	Fastening to steel, Fastening to steel for shipbuilding
	BV 54054/A0 BV	Global	Fastening to steel, Fastening to steel for shipbuilding
	Canadian Navy	Canada	Fastening to steel, Fastening to steel for shipbuilding
	DNV-GL 12272-10HH	Global	Fastening to steel, Fastening to steel for off-shore applications, Fastening to steel for shipbuilding
	DNV-GL TAS00001SV	Global	Fastening to steel, Fastening to steel for off-shore applications, Fastening to steel for shipbuilding
	ICC-ES ESR-2347 (rev. 09/2018)	USA	Fastening to steel
	ITB AT-15-7696/2016	Poland	Fastening to steel and concrete
	LR 03/00070(E4)	Global	Fastening to steel, Fastening to steel for off-shore applications, Fastening to steel for shipbuilding
	LR 19/00003	Global	Fastening to steel
	UL E 257069	Canada	Grounding
	UL E257069	USA	Grounding
	U.S. Navy 61/09-220	USA	Fastening to steel, Fastening to steel for shipbuilding

Product	Approval	Country	Application
X-BT-ER	ABS 18-HS1755518-PDA	Global	Fastening to steel, Fastening to steel for off-shore applications, Fastening to steel for shipbuilding
	BV 54054/A0 BV	Global	Fastening to steel, Fastening to steel for shipbuilding
	DNV-GL TAS00001SV	Global	Fastening to steel, Fastening to steel for off-shore applications, Fastening to steel for shipbuilding
	LR 19/00003	Global	Fastening to steel
X-BT-GR	ABS 18-HS1755518-PDA	Global	Fastening to steel, Fastening to steel for off-shore applications, Fastening to steel for shipbuilding
	BV 54054/A0 BV	Global	Fastening to steel, Fastening to steel for shipbuilding
	DNV-GL TAS00001SV	Global	Fastening to steel, Fastening to steel for off-shore applications, Fastening to steel for shipbuilding
	LR 19/00003	Global	Fastening to steel
X-BT-MF	ICC ESR 2347	USA	Fastening to steel
X-BT-MR	ABS 18-HS1755518-PDA	Global	Fastening to steel, Fastening to steel for off-shore applications, Fastening to steel for shipbuilding
	BV 54054/A0 BV	Global	Fastening to steel, Fastening to steel for shipbuilding
	DNV-GL TAS00001SV	Global	Fastening to steel, Fastening to steel for off-shore applications, Fastening to steel for shipbuilding
	LR 19/00003	Global	Fastening to steel

Product	Approval	Country	Application
X-BT-MR-N M8	ABS 16-HS1545448-PDA	Global	Fastening to steel, Fastening to steel for off-shore applications, Fastening to steel for shipbuilding
	LR 03/00070(E4)	Global	Fastening to steel, Fastening to steel for off-shore applications, Fastening to steel for shipbuilding
X-BX	UL E217969	USA	Pipe and ventilation duct fastening
	UL E217969	Canada	Pipe and ventilation duct fastening
X-C	IBMB 4850-2018	Germany	Fastening drywall track
	IBMB 4850-2018	Germany	Fastening drywall track
	IBMB 4708/2014	Germany	Fastening drywall track
	IBMB 6536/8173	Germany	Fastening drywall track
	IBMB 6537/8174	Germany	Fastening drywall track
	ICC-ES ESR-1663	USA	Fastening to steel and concrete
X-C G2	ICC-ES ESR-1752	USA	Fastening to steel and concrete
	ITB AT-15-7696/2016	Poland	Fastening to steel and concrete
	„Rom. Ministry, ICECON: AT 016-01_378-2018“	Romania	Fastening to concrete
X-C B3	IBMB 8300-2016	Germany	Fastening drywall track
	IBMB 8302-2016	Germany	Fastening drywall track
	IBMB 8304-2016	Germany	Fastening drywall track
	ICC-ES ESR-1752	USA	Fastening to steel and concrete
	ITB AT-15-7235/2015	Poland	Fastening to steel and concrete
X-C G3	ICC-ES ESR-1752	USA	Fastening to steel and concrete
	ITB AT-15-7235/2015	Poland	Fastening to steel and concrete
X-C G3	ICC-ES ESR-1752	USA	Fastening to steel and concrete
	ITB AT-15-7235/2015	Poland	Fastening to steel and concrete
	„Rom. Ministry, ICECON: AT 016-01_373-2017“	Romania	Fastening to steel and concrete

Product	Approval	Country	Application
X-CC	CSTB AT 3/16-844	France	Cable and conduit fastening
	ITB AT-15-7696/2016	Poland	Fastening to steel and concrete
	LR 97/00077(E4)	Global	Fastening to steel
	„Rom. Ministry, ICECON: AT 016-01_378-2018“	Romania	Fastening to concrete
X-CF72	ICC-ES ESR-2379	USA	Sill plate fastening
X-CP72	ICC-ES ESR-2379	USA	Sill plate fastening
X-CR	ABS 16-HS1545447-PDA	Global	Fastening to steel
	IBMB 3041/8171	Germany	Fastening drywall track
	ICC-ES ESR-1663	USA	Fastening to steel and concrete
	ITB AT-15-7235/2015	Poland	Fastening to steel and concrete
	LR 97/00078(E4)	Global	Fastening to steel, Fastening to steel for off-shore applications, Fastening to steel for shipbuilding
„Rom. Ministry, ICECON: AT 016-01_378-2018“	Romania	Fastening to concrete	
X-CR 48 (DX-Kwik)	ETA-14/0426	Europe	Fastening to concrete
X-CR 52 (DX-Kwik)	ETA-14/0426	Europe	Fastening to concrete
X-CR M8	DIBt Z-21.7-1512	Germany	Facade fastening
	DIBt Z-21.7-670	Germany	Suspended ceiling fastening
	ICC-ES ESR-2347	USA	Fastening to steel
	ITB AT-15-7235/2015	Poland	Fastening to steel and concrete
	ITB AT-15-7696/2016	Poland	Fastening to steel and concrete
X-CT	ITB AT-15-7696/2016	Poland	Fastening to steel and concrete
X-CX ALH	ICC-ES ESR-2184	USA	Suspended ceiling fastening
X-CX C27	ICC-ES ESR-2184	USA	Suspended ceiling fastening
X-DFB	ITB AT-15-7696/2016	Poland	Fastening to steel and concrete
X-DKH	IBMB 3041/8171	Germany	Fastening drywall track
	ITB AT-15-7696/2016	Poland	Fastening to steel and concrete

Product	Approval	Country	Application
X-DKH48 (DX-Kwik)	DIBt Z-21.7-670	Germany	Suspended ceiling fastening
X-DR ALH	ICC-ES ESR-2795	USA	Ceiling hanger fastening
X-DR MX	ICC-ES ESR-2795	USA	Ceiling hanger fastening
X-ECC MX	ETA-16/0301	Europe	Cable and conduit fastening
	ITB AT-15-7696/2016	Poland	Fastening to steel and concrete
X-ECH MX	ETA-16/0301	Europe	Cable and conduit fastening
X-ECH	CSTB AT 3/16-844	France	Cable and conduit fastening
	ITB AT-15-7696/2016	Poland	Fastening to steel and concrete
X-ECH/FR-L/-M/-S with X-U37	UL E201485	USA	Cable and conduit fastening
	UL E201485	Canada	Cable and conduit fastening
X-ECH-FE MX	abP P-MPA-E-16-010	Germany	Circuit integrity fastening
	abP P-2401/198/16-MPA-BS	Germany	Circuit integrity fastening
	abP P-1023 DMT DO	Germany	Circuit integrity fastening
X-ECT	CSTB AT 3/16-844	France	Cable and conduit fastening
	ITB AT-15-7235/2015	Poland	Fastening to steel and concrete
X-ECT MX	UL E201485	USA	Cable and conduit fastening
	ETA-16/0301	Europe	Cable and conduit fastening
	UL E201485	Canada	Cable and conduit fastening
X-EF	ABS 16-HS1545445-PDA	Global	Fastening to steel
	LR 97/00077(E4)	Global	Fastening to steel



Product	Approval	Country	Application
X-EGN	IBMB 4708/2014	Germany	Fastening drywall track
	IBMB 6536/8173	Germany	Fastening drywall track
	IBMB 6537/8174	Germany	Fastening drywall track
	ICC-ES ESR-1752	USA	Fastening to steel and concrete
	ITB AT-15-7235/2015	Poland	Fastening to steel and concrete
X-EHS MX	„Rom. Ministry, ICECON: AT 016-01_388-2018“	Romania	Fastening to steel and concrete
	ETA-16/0301	Europe	Cable and conduit fastening
X-EKB	ITB AT-15-7696/2016	Poland	Fastening to steel and concrete
	CSTB AT 3/16-844	France	Cable and conduit fastening
	ETA-16/0301	Europe	Cable and conduit fastening
X-EKB MX	ITB AT-15-7696/2016	Poland	Fastening to steel and concrete
	UL E201485	USA	Cable and conduit fastening
	ETA-16/0301	Europe	Cable and conduit fastening
X-EKB-FE MX	UL E201485	Canada	Cable and conduit fastening
	abP P-MPA-E-16-010	Germany	Circuit integrity fastening
	abP P-2401/198/16-MPA-BS	Germany	Circuit integrity fastening
X-EKS MX	abP P-1023 DMT DO	Germany	Circuit integrity fastening
	ETA-16/0301	Europe	Cable and conduit fastening
X-EKSC MX	CSTB AT 3/16-844	France	Cable and conduit fastening
	ITB AT-15-7235/2015	Poland	Fastening to steel and concrete
	UL E201485	USA	Cable and conduit fastening
	UL E201485	Canada	Cable and conduit fastening
X-EM	ETA-16/0301	Europe	Cable and conduit fastening
	ABS 16-HS1545445-PDA	Global	Fastening to steel
	LR 97/00077(E4)	Global	Fastening to steel

Product	Approval	Country	Application
X-EM6/8/10H	ITB AT-15-7235/2015	Poland	Fastening to steel and concrete
X-EMH	„Rom. Ministry, ICECON: AT 016-01_378-2018“	Romania	Fastening to concrete
X-EMTSC	UL E217969	USA	Pipe and ventilation duct fastening
	UL E217969	Canada	Pipe and ventilation duct fastening
X-ENK	ITB AT-15-7235/2015	Poland	Fastening to steel and concrete
X-ENP	FM 3054498	USA	Deck fastening
X-ENP-19	ABS 16-HS1545445-PDA	Global	Fastening to steel
	DIN EN 1993-1-3/NA	Germany	Deck fastening
	ETA-04/0101	Europe	Deck fastening
	FM 3029102	USA	Form deck fastening
	IAPMO ER 217, Verco Co-listing	USA	Deck fastening
	IAPMO ER 161, ASC Co-listing	USA	Deck fastening
	ICC-ES ESR-1663	USA	Deck fastening
	ICC-ES ESR-2197	USA	Deck fastening
	ICC-ES ESR-2776	USA	Deck fastening
	LR 97/00077(E4)	Global	Fastening to steel
	MLIT 2005	Japan	Deck fastening
SDI	USA	Deck fastening	
UL R 13203	USA	Deck fastening	
X-ENP2K	ABS 16-HS1545445-PDA	Global	Fastening to steel
	BUtgb ATG 1824	Belgium	Metal Deck fastening
	ETA-13/0172	Europe	Deck fastening
	ITB AT-15-7696/2016	Poland	Fastening to steel and concrete
	LR 97/00077(E4)	Global	Fastening to steel
	„Rom. Ministry, ICECON: AT 016-01_378-2018“	Romania	Fastening to concrete
X-ET	ITB AT-15-7696/2016	Poland	Fastening to concrete and steel
X-EW	ABS 16-HS1545445-PDA	Global	Fastening to steel
	LR 97/00077(E4)	Global	Fastening to steel

Product	Approval	Country	Application
X-EW10	FM Sprinkler Piper Listings	USA	Sprinkler pipe fastening
	UL EX 2258	USA	Sprinkler pipe fastening
	UL EX 2258	Canada	Sprinkler pipe fastening
	UL EX 2258	Canada	Sprinkler pipe fastening
X-EW10H	FM 3026695	USA	Fastening to steel
	ICC-ES ESR-2347	USA	Fastening to steel
	UL EX 2258	USA	Sprinkler pipe fastening
	UL EX 2258	Canada	Sprinkler pipe fastening
X-EW6H	FM 3026695	USA	Fastening to steel
	ICC-ES ESR-2347	USA	Fastening to steel
	UL EX 2258	USA	Sprinkler pipe fastening
	UL EX 2258	Canada	Sprinkler pipe fastening
X-FB	ITB AT-15-7696/2016	Poland	Fastening to steel and concrete
X-FB MX	ETA-16/0301	Europe	Cable and conduit fastening
X-FCM	ABS 15-HS1456396-3-PDA	Global	Fastening to steel, Fastening to steel for off-shore applications, Fastening to steel for shipbuilding
	ABS 16-HS1545445-PDA	Global	Fastening to steel
	ABS 18-HS1785836-PDA	Global	Fastening to steel, Fastening to steel for off-shore applications, Fastening to steel for shipbuilding
	DNV-GL TAS00001UJ	Global	Fastening to steel, Fastening to steel for off-shore applications, Fastening to steel for shipbuilding
	ITB AT-15-7235/2015	Poland	Fastening to steel and concrete
	LR 97/00077(E4)	Global	Fastening to steel
	„Rom. Ministry, ICECON: AT 016-01_378-2018“	Romania	Fastening to concrete

Product	Approval	Country	Application
X-FCM-M	ABS 15-HS1456396-3-PDA	Global	Fastening to steel, Fastening to steel for off-shore applications, Fastening to steel for shipbuilding
	ABS 16-HS1545447-PDA	Global	Fastening to steel
	ABS 16-HS1545448-PDA	Global	Fastening to steel, Fastening to steel for off-shore applications, Fastening to steel for shipbuilding
	ABS 16-HS1550085-2-PDA	Global	Fastening to steel, Fastening to steel for off-shore applications, Fastening to steel for shipbuilding
	BV 23498/B0	Global	Fastening to steel, Fastening to steel for shipbuilding
	BV 45116/A2 BV	Global	Fastening to steel, Fastening to steel for shipbuilding
	DNV-GL 12272-10HH	Global	Fastening to steel, Fastening to steel for off-shore applications, Fastening to steel for shipbuilding
	DNV-GL TAS00000N6	Global	Fastening to steel, Fastening to steel for off-shore applications, Fastening to steel for shipbuilding
	Russian Maritime Register	Global	Fastening to steel, Fastening to steel for shipbuilding
RINA FPE278318CS	Global	Fastening to steel, Fastening to steel for off-shore applications, Fastening to steel for shipbuilding	

Product	Approval	Country	Application
X-FCM-R	ABS 15-HS1456396-3-PDA	Global	Fastening to steel, Fastening to steel for off-shore applications, Fastening to steel for shipbuilding
	ABS 16-HS1545447-PDA	Global	Fastening to steel
	ABS 16-HS1545448-PDA	Global	Fastening to steel, Fastening to steel for off-shore applications, Fastening to steel for shipbuilding
	ABS 16-HS1550085-2-PDA	Global	Fastening to steel, Fastening to steel for off-shore applications, Fastening to steel for shipbuilding
	BV 23498/B0	Global	Fastening to steel, Fastening to steel for shipbuilding
	BV 45116/A2 BV	Global	Fastening to steel, Fastening to steel for shipbuilding
	DNV-GL 12272-10HH	Global	Fastening to steel, Fastening to steel for off-shore applications, Fastening to steel for shipbuilding
	DNV-GL TAS00000N6	Global	Fastening to steel, Fastening to steel for off-shore applications, Fastening to steel for shipbuilding
	LR 03/00070(E4)	Global	Fastening to steel, Fastening to steel for off-shore applications, Fastening to steel for shipbuilding
	LR 97/00078(E4)	Global	Fastening to steel, Fastening to steel for off-shore applications, Fastening to steel for shipbuilding
	LR 19/00003	Global	Fastening to steel
	Russian Maritime Register	Global	Fastening to steel, Fastening to steel for shipbuilding
RINA FPE278318CS	Global	Fastening to steel, Fastening to steel for off-shore applications, Fastening to steel for shipbuilding	

Product	Approval	Country	Application
X-FCM-R HL	ABS 18-HS1785836-PDA	Global	Fastening to steel, Fastening to steel for off-shore applications, Fastening to steel for shipbuilding
	BV 54054/A0 BV	Global	Fastening to steel, Fastening to steel for shipbuilding
X-FCP-F	ABS 15-HS1456396-3-PDA	Global	Fastening to steel, Fastening to steel for off-shore applications, Fastening to steel for shipbuilding
	ABS 16-HS1545447-PDA	Global	Fastening to steel
	ABS 18-HS1785836-PDA	Global	Fastening to steel, Fastening to steel for off-shore applications, Fastening to steel for shipbuilding
	ITB AT-15-7235/2015	Poland	Fastening to steel and concrete
	LR 97/00077(E4)	Global	Fastening to steel
X-FCP-R	ABS 15-HS1456396-3-PDA	Global	Fastening to steel, Fastening to steel for off-shore applications, Fastening to steel for shipbuilding
	ABS 16-HS1545447-PDA	Global	Fastening to steel
	ABS 18-HS1785836-PDA	Global	Fastening to steel, Fastening to steel for off-shore applications, Fastening to steel for shipbuilding
	ITB AT-15-7235/2015	Poland	Fastening to steel and concrete
	LR 97/00077(E4)	Global	Fastening to steel
	LR 97/00078(E4)	Global	Fastening to steel, Fastening to steel for off-shore applications, Fastening to steel for shipbuilding

Product	Approval	Country	Application
X-FCM-R HL	ABS 18-HS1785836-PDA	Global	Fastening to steel, Fastening to steel for off-shore applications, Fastening to steel for shipbuilding
	BV 54054/A0 BV	Global	Fastening to steel, Fastening to steel for shipbuilding
X-FCP-F	ABS 15-HS1456396-3-PDA	Global	Fastening to steel, Fastening to steel for off-shore applications, Fastening to steel for shipbuilding
	ABS 16-HS1545447-PDA	Global	Fastening to steel
	ABS 18-HS1785836-PDA	Global	Fastening to steel, Fastening to steel for off-shore applications, Fastening to steel for shipbuilding
	ITB AT-15-7235/2015	Poland	Fastening to steel and concrete
	LR 97/00077(E4)	Global	Fastening to steel
X-FCP-R	ABS 15-HS1456396-3-PDA	Global	Fastening to steel, Fastening to steel for off-shore applications, Fastening to steel for shipbuilding
	ABS 16-HS1545447-PDA	Global	Fastening to steel
	ABS 18-HS1785836-PDA	Global	Fastening to steel, Fastening to steel for off-shore applications, Fastening to steel for shipbuilding
	ITB AT-15-7235/2015	Poland	Fastening to steel and concrete
	LR 97/00077(E4)	Global	Fastening to steel
	LR 97/00078(E4)	Global	Fastening to steel, Fastening to steel for off-shore applications, Fastening to steel for shipbuilding

Product	Approval	Country	Application
X-FCS	ABS 18-HS1755527-PDA	Global	Fastening to steel, Fastening to steel for off-shore applications, Fastening to steel for shipbuilding
	BV 54054/A0 BV	Global	Fastening to steel, Fastening to steel for shipbuilding
	DNV-GL TAS00001UJ	Global	Fastening to steel, Fastening to steel for off-shore applications, Fastening to steel for shipbuilding
	LR 03/00070(E4)	Global	Fastening to steel, Fastening to steel for off-shore applications, Fastening to steel for shipbuilding
	LR 19/00003	Global	Fastening to steel
	RINA FPE278318CS	Global	Fastening to steel, Fastening to steel for off-shore applications, Fastening to steel for shipbuilding
X-FS	ITB AT-15-7696/2016	Poland	Fastening to steel and concrete
	„Rom. Ministry, ICECON: AT 016-01_378-2018“	Romania	Fastening to concrete
X-G	ITB AT-15-7696/2016	Poland	Fastening to steel and concrete
X-GHP	IBMB 4850-2018	Germany	Fastening drywall track
	IBMB 4850-2018	Germany	Fastening drywall track
	ICC-ES ESR-1752	USA	Fastening to steel and concrete
	„Rom. Ministry, ICECON: AT 016-01_388-2018“	Romania	Fastening to steel and concrete



Product	Approval	Country	Application
X-FCS	ABS 18-HS1755527-PDA	Global	Fastening to steel, Fastening to steel for off-shore applications, Fastening to steel for shipbuilding
	BV 54054/A0 BV	Global	Fastening to steel, Fastening to steel for shipbuilding
	DNV-GL TAS00001UJ	Global	Fastening to steel, Fastening to steel for off-shore applications, Fastening to steel for shipbuilding
	LR 03/00070(E4)	Global	Fastening to steel, Fastening to steel for off-shore applications, Fastening to steel for shipbuilding
	LR 19/00003	Global	Fastening to steel
	RINA FPE278318CS	Global	Fastening to steel, Fastening to steel for off-shore applications, Fastening to steel for shipbuilding
X-FS	ITB AT-15-7696/2016	Poland	Fastening to steel and concrete
	„Rom. Ministry, ICECON: AT 016-01_378-2018“	Romania	Fastening to concrete
X-G	ITB AT-15-7696/2016	Poland	Fastening to steel and concrete
X-GHP	IBMB 4850-2018	Germany	Fastening drywall track
	IBMB 4850-2018	Germany	Fastening drywall track
	ICC-ES ESR-1752	USA	Fastening to steel and concrete
	„Rom. Ministry, ICECON: AT 016-01_388-2018“	Romania	Fastening to steel and concrete

Product	Approval	Country	Application
X-GN	IBMB 4850-2018	Germany	Fastening drywall track
	IBMB 4850-2018	Germany	Fastening drywall track
	IBMB 4708/2014	Germany	Fastening drywall track
	IBMB 6536/8173	Germany	Fastening drywall track
	IBMB 6537/8174	Germany	Fastening drywall track
	ICC-ES ESR-1752	USA	Fastening to steel and concrete
	ITB AT-15-7235/2015	Poland	Fastening to steel and concrete
	„Rom. Ministry, ICECON: AT 016-01_388-2018“	Romania	Fastening to steel and concrete
X-GR	ITB AT-15-7696/2016	Poland	Fastening to steel and concrete
X-HS	CSTB AT 3/16-844	France	Cable and conduit fastening
	ITB AT-15-7696/2016	Poland	Fastening to steel and concrete
	LR 97/00077(E4)	Global	Fastening to steel
	„Rom. Ministry, ICECON: AT 016-01_378-2018“	Romania	Fastening to concrete
X-HS U19	ICC-ES ESR-2795	USA	Ceiling hanger fastening
X-HS U32	ICC-ES ESR-2795	USA	Ceiling hanger fastening
X-HS W6/10 U19	FM 3031301	USA	Sprinkler pipe fastening
X-HS W6/10 U19/22/27	UL E217969	USA	Pipe and ventilation duct fastening
	UL E217969	Canada	Pipe and ventilation duct fastening
X-HSN 24	ABS 16-HS1545445-PDA	Global	Fastening to steel
	FM 3054498	USA	Deck fastening
	IAPMO ER 217, Verco Co-listing	USA	Deck fastening
	IAPMO ER 161, ASC Co-listing	USA	Deck fastening
	ICC-ES ESR-1169	USA	Deck fastening
	ICC-ES ESR-2197	USA	Deck fastening
	ICC-ES ESR-2776	USA	Deck fastening
	SDI	USA	Deck fastening
	UL R 13203	USA	Deck fastening

Product	Approval	Country	Application
X-GN	IBMB 4850-2018	Germany	Fastening drywall track
	IBMB 4850-2018	Germany	Fastening drywall track
	IBMB 4708/2014	Germany	Fastening drywall track
	IBMB 6536/8173	Germany	Fastening drywall track
	IBMB 6537/8174	Germany	Fastening drywall track
	ICC-ES ESR-1752	USA	Fastening to steel and concrete
	ITB AT-15-7235/2015	Poland	Fastening to steel and concrete
	„Rom. Ministry, ICECON: AT 016-01_388-2018“	Romania	Fastening to steel and concrete
X-GR	ITB AT-15-7696/2016	Poland	Fastening to steel and concrete
X-HS	CSTB AT 3/16-844	France	Cable and conduit fastening
	ITB AT-15-7696/2016	Poland	Fastening to steel and concrete
	LR 97/00077(E4)	Global	Fastening to steel
	„Rom. Ministry, ICECON: AT 016-01_378-2018“	Romania	Fastening to concrete
X-HS U19	ICC-ES ESR-2795	USA	Ceiling hanger fastening
X-HS U32	ICC-ES ESR-2795	USA	Ceiling hanger fastening
X-HS W6/10 U19	FM 3031301	USA	Sprinkler pipe fastening
X-HS W6/10 U19/22/27	UL E217969	USA	Pipe and ventilation duct fastening
	UL E217969	Canada	Pipe and ventilation duct fastening
X-HSN 24	ABS 16-HS1545445-PDA	Global	Fastening to steel
	FM 3054498	USA	Deck fastening
	IAPMO ER 217, Verco Co-listing	USA	Deck fastening
	IAPMO ER 161, ASC Co-listing	USA	Deck fastening
	ICC-ES ESR-2197	USA	Deck fastening
	ICC-ES ESR-2776	USA	Deck fastening
	SDI	USA	Deck fastening
	UL R 13203	USA	Deck fastening

Product	Approval	Country	Application
X-HS-W	CSTB AT 3/16-844	France	Cable and conduit fastening
	ITB AT-15-7696/2016	Poland	Fastening to steel and concrete
X-HVB	ETA-15/0876	Europe	Composite shear connection
X-IE	ITB AT-15-7235/2015	Poland	Fastening to steel and concrete
	ITB AT-15-7696/2016	Poland	Fastening to steel and concrete
	Socotec N 1601601R0000003	France	Insulation fastening
X-IE-G	Socotec N 180668080000010	France	Insulation fastening
XI-FV	ETA-17/0304	Europe	Insulation fastening (ETICS)
X-M10	ITB AT-15-7235/2015	Poland	Fastening to steel and concrete
X-M6	„Rom. Ministry, ICECON: AT 016-01_378-2018“	Romania	Fastening to concrete
X-M6 B3	ITB AT-15-7235/2015	Poland	Fastening to steel and concrete
X-M6 G2	ITB AT-15-7235/2015	Poland	Fastening to steel and concrete
X-M6 G3	„Rom. Ministry, ICECON: AT 016-01_373-2017“	Romania	Fastening to steel and concrete
	ITB AT-15-7235/2015	Poland	Fastening to steel and concrete
X-M6H	IBMB 3041/8171	Germany	Fastening drywall track
	ITB AT-15-7696/2016	Poland	Fastening to steel and concrete
X-M8	ITB AT-15-7235/2015	Poland	Fastening to steel and concrete
X-M8H	DIBt Z-21.7-670	Germany	Suspended ceiling fastening
	IBMB 3041/8171	Germany	Fastening drywall track
	ITB AT-15-7235/2015	Poland	Fastening to steel and concrete
	ITB AT-15-7696/2016	Poland	Fastening to steel and concrete
X-MGR	ITB AT-15-7696/2016	Poland	Fastening to steel and concrete
X-NK	ITB AT-15-7235/2015	Poland	Fastening to steel and concrete

Product	Approval	Country	Application
X-P	IBMB 19210-2017	Germany	Fastening drywall track
	IBMB 19211-2017	Germany	Fastening drywall track
	IBMB 19212-2017	Germany	Fastening drywall track
	ICC-ES ESR-2269	USA	Fastening to steel and concrete
	„Rom. Ministry, ICECON: AT 016-01_378-2018“	Romania	Fastening to concrete
	VHT PZ-809-15	Germany	Deflection head fastening
X-P B3	IBMB 8300-2016	Germany	Fastening drywall track
	IBMB 8302-2016	Germany	Fastening drywall track
	IBMB 8304-2016	Germany	Fastening drywall track
	ETA-16/0301	Europe	Cable and conduit fastening
	ICC-ES ESR-1752	USA	Fastening to steel and concrete
	ITB AT-15-7235/2015	Poland	Fastening to steel and concrete
X-P G2	ICC-ES ESR-1752	USA	Fastening to steel and concrete
	ITB AT-15-7235/2015	Poland	Fastening to steel and concrete
X-P G3	ICC-ES ESR-1752	USA	Fastening to steel and concrete
	ETA-16/0301	Europe	Cable and conduit fastening
	ITB AT-15-7235/2015	Poland	Fastening to steel and concrete
	„Rom. Ministry, ICECON: AT 016-01_373-2017“	Romania	Fastening to steel and concrete
X-PGR	ITB AT-15-7696/2016	Poland	Fastening to steel and concrete
X-PN	ICC-ES ESR-3059	USA	Plywood fastening
	ITB AT-15-7696/2016	Poland	Fastening to steel and concrete
X-PN 37 G2	ICC-ES ESR-3059	USA	Plywood fastening
X-PN 37 G3	ICC-ES ESR-3059	USA	Plywood fastening

Product	Approval	Country	Application
X-R	ABS 16-HS1545447-PDA	Global	Fastening to steel
	DIBt Z-14.4-766	Germany	Glas facade fastening
	ITB AT-15-7235/2015	Poland	Fastening to steel and concrete
	LR 97/00078(E4)	Global	Fastening to steel, Fastening to steel for off-shore applications, Fastening to steel for shipbuilding
	ICC-ES ESR-1663	USA	Fastening to steel and concrete
X-S	ICC-ES ESR-1752	USA	Fastening to steel and concrete
	ITB AT-15-7235/2015	Poland	Fastening to steel and concrete
X-S B3	ICC-ES ESR-1752	USA	Fastening to steel and concrete
X-S G3	ICC-ES ESR-1752	USA	Fastening to steel and concrete
X-S G3	„Rom. Ministry, ICECON: AT 016-01_373-2017“	Romania	Fastening to steel and concrete
X-ST-GR	ABS 16-HS1545447-PDA	Global	Fastening to steel
	ICC-ES ESR-2347	USA	Fastening to steel
	ITB AT-15-7235/2015	Poland	Fastening to steel and concrete
	LR 97/00078(E4)	Global	Fastening to steel, Fastening to steel for off-shore applications, Fastening to steel for shipbuilding
X-SW	ITB AT-15-7696/2016	Poland	Fastening to steel and concrete
	„Rom. Ministry, ICECON: AT 016-01_378-2018“	Romania	Fastening to concrete

Product	Approval	Country	Application
X-U	ABS 16-HS1545445-PDA	Global	Fastening to steel
	DIBt Z-14.4-517	Germany	Fastening to steel
	DNV-GL 42222-15HH	Global	Fastening to steel, Fastening to steel for shipbuilding
	IBMB 2006/2011	Germany	Fastening drywall track
	IBMB 4708/2014	Germany	Fastening drywall track
	IBMB 6536/8173	Germany	Fastening drywall track
	IBMB 6537/8174	Germany	Fastening drywall track
	ICC-ES ESR-2269	USA	Fastening to steel and concrete
	ITB AT-15-7696/2016	Poland	Fastening to steel and concrete
	LR 97/00077(E4)	Global	Fastening to steel
	„Rom. Ministry, ICECON: AT 016-01_378-2018“	Romania	Fastening to concrete
	VHT PZ-809-15	Germany	Fastening drywall track
X-U15	ICC-ES ESR-2269	USA	Fastening to steel and concrete
X-U16 S12	ETA-16/0082	Europe	Siding
X-UCT	ITB AT-15-7235/2015	Poland	Fastening to steel and concrete
X-W6	ICC-ES ESR-1663	USA	Fastening to steel and concrete

## Approvals → Nails

Approval	Product	Country	Application
abP P-MPA-E-16-010	X-ECH-FE MX, X-EKB-FE MX	Germany	Circuit integrity fastening
abP P-2401/198/16-MPA-BS	X-ECH-FE MX, X-EKB-FE MX	Germany	Circuit integrity fastening
abP P-1023 DMT DO	X-ECH-FE MX, X-EKB-FE MX	Germany	Circuit integrity fastening
ABS 15-HS1456396-3-PDA	X-FCM, X-FCM-R, X-FCM-M, X-FCP-R, X-FCP-F	Global	Fastening to steel, Fastening to steel for off-shore applications, Fastening to steel for shipbuilding
ABS 16-HS1545445-PDA	EDS, X-U, X-ENP2K, X-ENP-19, X-HSN 24, X-EM, X-EW, X-EF, X-FCM	Global	Fastening to steel
ABS 16-HS1545447-PDA	X-CR, X-R14, X-CRM, X-CRW, X-ST-GR, X-FCM-R, X-FCM-M, X-FCP-R, X-FCP-F	Global	Fastening to steel
ABS 16-HS1545448-PDA	X-BT, X-BT-ER, X-BT-MR-N M8, X-FCM-M, X-FCM-R	Global	Fastening to steel, Fastening to steel for off-shore applications, Fastening to steel for shipbuilding
ABS 16-HS1550085-2-PDA	S-BT, S-BT-ER / -EF (HC), X-FCM-M, X-FCM-R	Global	Fastening to steel, Fastening to steel for off-shore applications, Fastening to steel for shipbuilding
ABS 18-HS1755518-PDA	X-BT-MR, X-BT-GR, X-BT-ER	Global	Fastening to steel, Fastening to steel for off-shore applications, Fastening to steel for shipbuilding
ABS 18-HS1785836-PDA	X-FCM-R HL, X-FCM, X-FCP-R, X-FCP-F	Global	Fastening to steel, Fastening to steel for off-shore applications, Fastening to steel for shipbuilding
ABS 18-HS1755527-PDA	X-FCS	Global	Fastening to steel, Fastening to steel for off-shore applications, Fastening to steel for shipbuilding
BRANZ Appraisal 780 (2012)	Wood nails	New Zealand	Timber joints fastening



Approval	Product	Country	Application
BUtgb ATG 1824	NPH2, X-ENP2K	Belgium	Metal deck fastening
BV 23498/B0	X-BT, X-FCM-M, X-FCM-R	Global	Fastening to steel, Fastening to steel for shipbuilding
BV 45116/A2 BV	S-BT, S-BT-ER / -EF (HC), X-FCM-M, X-FCM-R	Global	Fastening to steel, Fastening to steel for shipbuilding
BV 54054/A0 BV	X-BT-MR, X-BT-GR, X-BT-ER, X-FCS, X-FCM-R HL	Global	Fastening to steel, Fastening to steel for shipbuilding
Canadian Navy	X-BT	Canada	Fastening to steel, Fastening to steel for shipbuilding
CNBOP 3009/2015	E-Fasteners	Poland	Cable and conduit fastening
CNBOP_AT-0605-0430- 2014	E-Fasteners	Poland	Cable and conduit fastening
CNBOP_AT-0602-0102- 2009-2014	E-Fasteners	Poland	Cable and conduit fastening
CSTB AT 3/16-844	X-EKB, X-ECH, X-ECT, X-EKS, X-EKSC, X-CC, X-HS, X-HS-W	France	Cable and conduit fastening
DIBt Z-14.4-517	X-U	Germany	Fastening to steel
DIBt Z-14.4-766	X-R14	Germany	Glas facade fastening
DIBt Z-21.7-1512	X-CR M8, X-CR 48	Germany	Facade fastening
DIBt Z-21.7-670	X-M8H, X-CR M8, X-DKH48 (DX-Kwik)	Germany	Suspended ceiling fastening
DIN EN 1993-1-3/NA	X-ENP-19 Lateral buckling	Germany	Deck fastening
DNV-GL 12272-10HH	X-BT, X-BT-ER, X-FCM-M, X-FCM-R	Global	Fastening to steel, Fastening to steel for off-shore applications, Fastening to steel for shipbuilding
DNV-GL 42222-15HH	X-U, EDS	Global	Fastening to steel, Fastening to steel for shipbuilding
DNV-GL TAS00000N6	S-BT, S-BT-ER / -EF (HC), X-FCM-M, X-FCM-R	Global	Fastening to steel, Fastening to steel for off-shore applications, Fastening to steel for shipbuilding
DNV-GL TAS00001SV	X-BT-GR, X-BT-MR, X-BT-ER	Global	Fastening to steel, Fastening to steel for off-shore applications, Fastening to steel for shipbuilding

Approval	Product	Country	Application
DNV-GL TAS00001UJ	X-FCM, X-FCS	Global	Fastening to steel, Fastening to steel for off-shore applications, Fastening to steel for shipbuilding
ETA-04/0101	X-ENP-19	Europe	Deck fastening
ETA-13/0172	X-ENP2K, DX 76 PTR	Europe	Deck fastening
ETA-14/0426	X-CR 48 P8 S15 (DX-Kwik), X-CR 52 P8 S15 (DX-Kwik)	Europe	Fastening to concrete
ETA-15/0876	X-HVB	Europe	Composite shear connection
ETA-16/0082	X-U16 S12	Europe	Siding
ETA-16/0301	X-P 20 B3/G3, X-P 24 B3/G3, X-EKB MX, X-ECT MX, X-ECH MX, X-EKS MX, X-EKSC MX, X-(D)FB MX, X-ECC MX, X-EHS MX	Europe	Cable and conduit fastening
ETA-17/0304	XI-FV	Europe	Insulation fastening (ETICS)
ETA-20/0530	S-BT	Global	Fastening to steel
FM 3026695	X-EW6H, X-EW10H	USA	Fastening to steel
FM 3029102	X-ENP-19	USA	Form deck fastening
FM 3031301	X-HS W6/10 U19	USA	Sprinkler pipe fastening
FM 3054498	X-ENP, X-HSN 24	USA	Deck fastening
FM Sprinkler pipe fastening Listings	W10, X-EW10	USA	Sprinkler pipe fastening
IAPMO ER 217, Verco Co-listing	X-ENP-19, X-HSN 24	USA	Deck fastening
IAPMO ER 161, ASC Co-listing	X-ENP-19, X-HSN 24	USA	Deck fastening
IBMB 4850-2018	X-GN, X-GHP, X-C	Germany	Fastening drywall track
IBMB 4850-2018	X-GN, X-GHP, X-C	Germany	Fastening drywall track
IBMB 2006/2011	X-U	Germany	Fastening drywall track
IBMB 3041/8171	DX-Kwik, X-CR, X-DKH, X-M6H, X-M8H	Germany	Fastening drywall track
IBMB 19210-2017	X-P, DX5, GX3, Knauf-Trockenbauwände	Germany	Fastening drywall track
IBMB 19211-2017	X-P, DX5, GX3, Siniat-Trockenbauwände	Germany	Fastening drywall track
IBMB 19212-2017	X-P, DX5, GX3, Rigips-Trockenbauwände	Germany	Fastening drywall track

Approval	Product	Country	Application
IBMB 8300-2016	X-P B3, X-C B3 Knauf-Trockenbauwände	Germany	Fastening drywall track
IBMB 8302-2016	X-P B3, X-C B3 Siniat-Trockenbauwände	Germany	Fastening drywall track
IBMB 8304-2016	X-P B3, X-C B3 Rigips-Trockenbauwände	Germany	Fastening drywall track
IBMB 4708/2014	X-GN, X-EGN, X-C, X-U, Rigips-Trockenbauwände	Germany	Fastening drywall track
IBMB 6536/8173	X-GN, X-EGN, X-C, X-U, Knauf-Trockenbauwände	Germany	Fastening drywall track
IBMB 6537/8174	X-GN, X-EGN, X-C, X-U, Siniat-Trockenbauwände	Germany	Fastening drywall track
IBMB Gutachten 1498/166/13	DX-Kwik X-HS	Germany	Ceiling hanger fastening
ICC-ES ESR-1663	X-ENP-19 L15, EDS, DS, X-C, X-C22P8TH, X-C20THP, X-CR, X-W6, W10, X-R	USA	Fastening to steel and concrete
ICC-ES ESR-1752	X-GN, X-GHP, X-EGN, X-S, X-C, X-P G3, X-P G2, X-S G3, X-C G3, X-C G2, X-C B3, X-S B3, X-P B3	USA	Fastening to steel and concrete
ICC-ES ESR-2184	X-CX ALH, X-CX C27	USA	Suspended ceiling fastening
ICC-ES ESR-2197	X-ENP-19, X-HSN 24	USA	Deck fastening
ICC-ES ESR-2269	X-U, X-U15, X-P	USA	Fastening to steel and concrete
ICC-ES ESR-2347	X-EW6H, X-EW10H; X-CR M8, X-BT, X-ST-GR	USA	Fastening to steel
ICC-ES ESR-2379	X-CF72, X-CP72	USA	Sill plate fastening
ICC-ES ESR-2776	X-ENP-19, X-HSN 24	USA	Deck fastening
ICC-ES ESR-2795	X-HS U19, X-HS U32, X-DR ALH, X-DR MX	USA	Ceiling hanger fastening
ICC-ES ESR-3059	X-PN, X-PN 37 G2, X-PN 37 G3	USA	Plywood fastening

Approval	Product	Country	Application
ITB AT-15-7235/2015	X-CR, X-ENK, X-NK, X-CR M8, X-ECT, X-UCT, X-EKS, X-EKSC, DS, EDS, X-EGN, X-EM6/8/10H, X-FCM, X-IE, X-FCP-R, X-FCP-F, X-GN, X-M8, X-M10, X-M8H, X-P B3, X-P G3, X-P G2, X-C B3, X-C G3, X-C G2, X-M6 B3, X-M6 G3, X-M6 G2, X-S, X-ST-GR, X-R14	Poland	Fastening to steel and concrete
ITB AT-15-7696/2016	X-U, X-ENP2K, X-C, X-FS, X-SW, X-IE, X-CT, X-BT, X-GR, X-PGR, X-MGR, X-G, X-CR M8, X-HS, X-EHS, X-HS-W, X-CC, X-ECC, X-EKB, X-ECH, X-FB, X-DFB, X-M6H, X-M8H, DNH, X-DKH, X-PN, S-BT, X-ET	Poland	Fastening to steel and concrete
LR 03/00070(E4)	X-BT, X-BT-ER, X-BT- MR-N M8, X-FCM-R, X-FCS	Global	Fastening to steel, Fastening to steel for off-shore applications, Fastening to steel for shipbuilding
LR 97/00077(E4)	X-U, EDS, DS, X-ENP-19, X-ENP2K, X-EM, X-EW, X-EF, X-HS, X-CC, X-FCM, X-FCP-R, X-FCP-F	Global	Fastening to steel
LR 97/00078(E4)	X-CR, X-R14, X-CRM, X-ST-GR, X-FCM-R, X-FCP-R	Global	Fastening to steel, Fastening to steel for off-shore applications, Fastening to steel for shipbuilding
LR 16/00063(E1)	S-BT	Global	Fastening to steel, Fastening to steel for off-shore applications, Fastening to steel for shipbuilding
LR 19/00003	X-BT-GR, X-BT-MR, X-BT-ER, X-FCM-R, X-FCS	Global	Fastening to steel
MLIT 2005	X-ENP-19	Japan	Deck fastening
„Rom. Ministry, ICECON: AT 016-01_373-2017“	X-C G3, X-P G3, X-S G3, X-M6 G3	Romania	Fastening to steel and concrete
Rom. Ministry, ICECON: AT 003-05/500-2016	E-fasteners	Romania	Cable and conduit fastening

Approval	Product	Country	Application
„Rom. Ministry, ICECON: AT 016-01_378-2018“	X-U, X-C, X-P, X-CR, X-CRM, X-M6, X-ENP2K, X-EMH, X-FCM, X-SW, X-FS, X-HS, X-CC, etc.	Romania	Fastening to concrete
„Rom. Ministry, ICECON: AT 016-01_388-2018“	X-GN, X-EGN, X-GHP	Romania	Fastening to steel and concrete
„Rom. Ministry, ICECON: AT 016-01_389-2018“	DX-Kwik	Romania	Fastening to concrete
Russian Maritime Register	S-BT, S-BT-ER / -EF (HC), X-FCM-M, X-FCM-R	Global	Fastening to steel, Fastening to steel for shipbuilding
SDI	X-ENP-19, X-HSN 24	USA	Deck fastening
Socotec N 1601601R0000003	X-IE	France	Insulation fastening
Socotec N 1601601R0000004	NPH2	France	Deck fastening
Socotec N 180668080000010	X-IE-G	France	Insulation fastening
U.S. Navy 61/09-220	X-BT	USA	Fastening to steel, Fastening to steel for shipbuilding
UL E201485	X-ECH/FR-L/-M/-S with X-U37, X-EKB MX, X-ECT MX, X-EKSC MX	USA	Cable and conduit fastening
UL E201485	X-ECH/FR-L/-M/-S with X-U37, X-EKB MX, X-ECT MX, X-EKSC MX	Canada	Cable and conduit fastening
UL E217969	X-HS W6/10 U19/22/27, X-RH, X-EMTSC, X-BX	USA	Pipe and ventilation duct fastening
UL E217969	X-HS W6/10 U19/22/27, X-RH, X-EMTSC, X-BX	Canada	Pipe and ventilation duct fastening
UL EX 2258	W10, X-EW10, X-EW6H, X-EW10H	USA	Sprinkler pipe fastening
UL EX 2258	W10, X-EW10, X-EW6H, X-EW10H	Canada	Sprinkler pipe fastening
UL R 13203	X-ENP-19, X-HSN 24	USA	Deck fastening
VHT PZ-809-15	X-U, X-P	Germany	Deflection head fastening
RINA FPE278318CS	S-BT, S-BT-ER / -EF (HC), X-FCM-M, X-FCM-R, X-FCS	Global	Fastening to steel, Fastening to steel for off-shore applications, Fastening to steel for shipbuilding



Hilti Corporation  
9494 Schaan, Liechtenstein  
P +423-234 2965

[www.facebook.com/hiltigroup](https://www.facebook.com/hiltigroup)  
[www.hilti.group](https://www.hilti.group)

January 2021 / 387113