

S & R

FASTENER CO., INC.

AUTOMOTIVE CLIPS
FASTENERS
ABRASIVES
DRAIN PLUGS/GASKETS
DRILL BITS
ELECTRICAL ITEMS

SAFETY ITEMS
CAR DETAILING
TIRE REPAIR
WHEEL WEIGHTS
MINIATURE LAMPS
BUMPER BOLTS

CABINETS
FUSES
RIVETS
TAPES
AIR HOSE
AND SO MUCH MORE !



PRODUCT CATALOG

At S&R Fastener Company, our objective is to provide our customers with the highest quality products and services at the fairest prices. This is backed by a professional sales force and professional office, warehouse, manufacturing and research/development staffs, which when combined, result in an unbeatable team to serve our customers needs.

Let us know how we can help you.

S & R Fastener Co., Inc.
P.O. Box 849
San Antonio, FL 33576

Toll Free Phone: 877-773-2276

Toll Free Fax: 866-299-3563

Visit us online at:
www.srfast.com



S & R Fasteners reserves the right not to be responsible for the topicality, correctness, completeness or quality of the information provided and reserves the right to change or correct information in this catalog without prior announcement.

For the most updated information or to place an order online, please go to www.SRFast.com



Also available from S & R Fastener Co., Inc.!

International Epoxies and Sealers!

A U.S. Manufacturer of Adhesives, Sealants, Foams, Coatings and Specialty Products.



Seam Sealers

Panel Bonders

Coatings

Service Aids

Plastic Repair

Automotive Foams

Attachment Tapes

Primers

www.useies.com

ALPHABETICAL INDEX

A	
AC Parts	7
Abrasives.....	38
Absorbent Pads.....	15-5, 41-6
Acura/Honda Fastener Section	22
Acid Brushes	40-2
Aerosol Can Dispenser.....	40-2
Air Hose, Couplers & Acc	37-1 to 37-4
Assortments.....	36
Auto Body Hardware Section	16
Auto Vaccine.....	15-8
B	
BMW Fastener Section.....	18
Batteries	14-30
Battery/Starter Cable	14-15
Battery Terminals.....	14-16
Bins, Cabinets	35
Brake Cleaner.....	15-4
Brake Lathe Bits/Bands	9
Buffing Pads	42-5
Bulbs	
Miniature Lamps	14-26 to 14-27
Fluorescent 13W.....	14-30
Headlamp	14-28 to 14-29
Rough Service Bulbs	14-30
Bumper Bolts.....	16-7 to 16-8
C	
Cabinets, Bins, Etc.	35
Cable Ties.....	14-17 to 14-18
Cable Tie Mounts.....	14-19
Cap Screws	
Grade 5.....	1-11 to 1-13
Grade 8	1-14 to 1-16
18-8.....	1-23
J.I.S. Small Head	2-7
Metric Regular Pitch	2-1
Metric Fine Thread.....	2-2
Chrysler	
Fastener Section.....	19
Pigtail/Repair Harness	14-35
Specialty Elec. Conn.....	14-34
Circuit Breakers	14-23
Clearcoat, MIPA.....	43
Clip Removal Tool.....	40-2
Cold Knife	40-2
Compression Union	4-11
Contact Cleaner.....	15-4
Cotter Pins, Hammer Lock / Metric.....	4-1
Coveralls, Painting.....	41-
Cut-Off Wheels	38-5
D	
Detail Supplies.....	42
Disinfectant Spray	15-4
Door Hinge Pins, Bushing, Kits	12
Drain Plugs/Gaskets.....	5
Drill Bits	39
Drum/Barrel Pump.....	42-6
E	
E Clips	4-4 to 4-5
Ear Plugs.....	41-4
Electrical Section	
Butt Connectors	14-1 to 14-11
Chrysler Repair Harness	14-35
Chrysler Specialty Conn	14-34
Crimp & Solder	14-8 to 14-9
Electralink Terminals.....	14-7 to 14-8
Ford Repair Harness	14-39 to 14-46
Ford Specialty Conn	14-34
GM Repair Harness	14-36 to 14-38
GM Specialty Conn.....	14-31 to 14-33
Heat Shrink Tubing	14-12
Krimpa-Seal Terminals.....	14-5 to 14-6
Non-Insulated Terminals	14-11
Perma Seal Connectors.....	14-9
Quick-Connects	14-4
Quick-Lock Connectors	14-10
Solder	14-14
Solder Splice Connectors	14-11
Solderless Terminals.....	14-1 to 14-3
T Type Wire Tap.....	14-10
Tool Stripping/Crimping.....	14-6
Twist Lock Connectors.....	14-14
Universal Specialty Conn.....	14-33
Wire	14-13 to 14-14
Wire Loom	14-19
Electrical Sleeve, Expandable	14-19
Electronic Fuel Injection Hose	10-1
Eye Wash Station	41-6
F	
Fender Welt	11-2
First Aid Kit	41-4
Flashers.....	14-25
Floor Mats.....	15-5
Ford	
Fastener Section.....	20
Pigtail/Repair Harness	14-39 to 14-46
Specialty Elec. Conn.....	14-34
Frame Machine Bolt Kits	1-21
Fuel Line Hose	10-1
Fuse Assortment.....	14-25
Fuse Holders	14-23 to 14-24

ALPHABETICAL INDEX

Fuses.....	14-20 to 14-24	MBX Pneumatic Tool	38-13
G		Machine Screws	1-7
GM		Machine Screws 18-8.....	1-24
Fastener Section.....	21	Machine Screws, Metric	2-8, 2-9
Pigtail/Repair Harness	14-36 to 14-38	Markers, Panel/Glass	15-2
Specialty Elec. Conn.....	14-31 to 14-33	Mask, Protective.....	41-3
Gasket & Jointing Compound.....	15-3	Mazda Fastener Section.....	27
Gear Shift Cover.....	15-5	Mercedes Fastener Section.....	28
Glass Adhesive.....	15-3	Metric Fasteners.....	2
Glasses, Safety	41-4	Micro Torch	40-2
Gloves		Mini (BMW) Clips & Fasteners	18
Assembly	41-1	MIPA Clearcoats	43
Hybrid Vehicle, Rubber	15-6, 41-2	Mitsubishi Fastener Section	29
Latex / Nitrile.....	41-1 to 41-2	Mixing Board.....	40-1
Welding.....	41-5	Mixing Cups.....	40-1
Graphite, Powdered.....	15-3		
Greases	15-3	N	
Grease Fittings	4-11	Nissan Fastener Section	30
		Nuts	
H		Hex Grade 5	1-17
Hacksaw Blades	39-7 to 39-8	Hex Grade 8	1-17
Hairpin Retainers.....	4-2	Hex Grade 8 Nylon Insert	1-17
Handcleaner, Magic.....	15-4	Hex Machine Screw.....	1-18
Headlamps	14-28 to 14-29	J.I.S. Small.....	2-7
Headliner Clips	17-2	License Plate	1-8 to 1-10
Heat Shrink Tubing.....	14-12	Lock Flanged	1-18
Heater Hose	10-1	Lock Nylon Inserted.....	1-18
Honda/Acura Fastener Section	22	Metric	2-4 to 2-5
Hose		Mounting, Roof Rack	16-17
Air Hose	37-4 to 37-5	PAL	16-9 to 16-10
Fuel/Heater	10-1	Pushnut.....	16-10 to 16-13
Power Steering	10-2	Stainless	1-22
Transmission.....	10-2	Tubular.....	16-13 to 16-14
Vacuum/Windshield	10-1	U-Nut	16-11 to 16-16
Hose Clamps	10-4 to 10-5	Washer Lock.....	1-18
Hyundai Fastener Section	23	Wing Nuts	1-18
		Nutserts, Specialty.....	3-16
I			
Isuzu Fastener Section.....	24	O	
		O-Rings	6
J		O-Ring Assortments	6-4, 36-15
J.I.S. Small Head Flange Bolts.....	2-7	Oil Drain Plugs, Gaskets	5
J.I.S. Small Hex Nuts.....	2-7		
J.I.S. Small Head Cap Screws	2-7	P	
		Paint Suits	41-5
K		Painters Supplies.....	46
Kia Clips	25	Parts Bag.....	15-5
		Pipe Plugs	4-11
L		Plastic Spreaders	40-1
Lexus Fastener Section.....	26	Plug Buttons, Plastic.....	40-3
License Plate Screws & Nuts	1-8 to 1-10	Putty Sticks.....	40-2
M			
		R	

ALPHABETICAL INDEX

Razor Blades, Knife, Scraper 15-2
Respirator Masks..... 41-3
Retainer Pins 4-2
Retaining Rings 4-2 to 4-10

Rivets

Assortments..... 3-13
Blind Nut 3-14 to 3-15
Blind Nut, Kits, Guns..... 3-17
Gun Replacement Jaws..... 3-2
Nylon..... 3-11 to 3-12
Nylon Setter Gun 3-12
Panel Blind..... 3-1
Specialty 3-3 to 3-10
Rivet Guns 3-2
Rivet Gun Extender 3-2
Rivet Gun Nosepieces 3-2
Rivet Nuts 3-16
Self-Piercing (SPR)..... 3-10
Rubber Caps 10-3
Rubber Cord 11-2

S

Safety Equipment 41
Saw Blades..... 39-7 to 39-8
Scraper, Razor Blades, Knife 15-2
Screwdriver Bits..... 39-8

Screws

Autobody Hardware 16-1 to 16-8
Cap Screw, Metric..... 2-1 to 2-3
Cap Screw Grade 5 1-11 to 1-13
Cap Screw Grade 8 1-14 to 1-16
Cap Screws Grade 10.9 2-3
Cap Screw 18-8 1-23
J.I.S. Hex Flange Bolts 2-7
License Plate 1-8 to 1-10
Machine 1-7
Machine 18-8 1-24
Metric Machine 2-8 to 2-9
Self-Drilling 1-5
Tapping 1-1 to 1-4
Tapping 18-8..... 1-25
Torx Head 1-6
Seat Covers..... 15-5
Service Center Items 15
Shims..... 16-17 to 16-18
Spark/Welding Blankets, Gloves 41-5
Spill Pads..... 15-5, 41-6
SprayMax 44
Spreaders, Plastic 40-1
Spring Pins 4-3
Stainless Steel Fasteners..... 1-23 to 1-26
Starter Wall Lugs 14-16

Steering Wheel Cover 15-5
Superaser Wheel..... 38-12
Subaru Fasteners 31

T

T Clip Moulding Fasteners..... 17-1
Tapes 13, 15-4
Tape Dispensing Gun 13-2
Tapping Screws 1-1 to 1-4
Tapping Screws 18-8 1-25
Throttle Rod Clips..... 4-3
Tire Marking Crayon 8-8
Tire Repair Products..... 8-8 to 8-12
Tire Storage Bag 15-5
Tire Valves 8-11 to 8-12
Tire Valve Cap 8-11
Tire Valve Extenders..... 8-11
Torx Drive Screws..... 1-6
Towels/Cloths 42-6
Toyota Fastener Section..... 32
TPMS Diagnostic Tool/Sensors 8-12
Transmission Drain Plugs..... 5-5
Trim Clips, Miscellaneous..... 17-3
Tube Gripper 40-2
Tubing, Vacuum/Windshield 10-1

U

Utility Knife, Razor Blades 15-2

V

VW Fastener Section..... 33
Vacuum/Windshield Tubing 10-1
Vacuum Connectors 10-2 to 10-3
Velcro..... 11-2
Volvo Fastener Section..... 34

W

Washers

Fender 1-19
Flat SAE..... 1-19
Flat SAE Grade 8..... 1-19
Flat USS 1-19
Flat USS Grade 8 1-19
Lock External, Internal 1-20
Metric 2-4, 2-6
Spring Type Lock 1-20
Stainless 1-22
Trim..... 1-20
Weatherstrip 11-1 to 11-2
Weld Pins 40-3
Welding/Spark Blankets 41-5
Wheel Weights 8-1 to 8-6
Wheel Weight Assortments 8-7

Wheel Weight Tools 8-8
Windshield Wiper Blades..... 15-1
Windshield Wiper Blade Rack 15-1
Wire Loom 14-19
Wire, Primary & Parallel 14-13
Wire Straps, Clips..... 14-19 to 14-20

**Be sure to visit us at
www.srfast.com
for all current updates.**

ALPHABETICAL INDEX

ALPHABETICAL INDEX

BLANK

TAPPING SCREWS

TAPPING SCREWS PHILLIPS OVAL



100 Per Box
Unless Otherwise
Noted In Parenthesis

SIZE	HEAD SIZE	CHROME	ZINC CHROMATE	BLACK OXIDE
#4 x 3/8"	REG			110001
#4 x 1/2"	REG	105030		110002
#4 x 5/8"	REG			DISC
#4 x 3/4"	REG	105040		110004
#4 x 1"	REG			110005
#6 x 1/2"	REG	105070		110006
#6 x 5/8"	REG	105080		
#6 x 3/4"	REG	105090		110007
#6 x 1"	REG	105100		110008
#6 x 1-1/4"	REG	105110		110009
#8 x 3/8"	#6	105130		
#8 x 1/2"	#6	105140		110020
#8 x 1/2"	REG	105150		110030
#8 x 5/8"	#6	105120		
#8 x 3/4"	#6	105160		110040
#8 x 3/4"	REG	105170		110050
#8 x 1"	#6	105180		110060
#8 x 1"	REG	105200		110070
#8 x 1-1/4"	#6	105210		110080
#8 x 1-1/4"	REG	105220		110010
#8 x 1-1/2"	#6	105230		110090
#8 x 1-1/2"	REG	105240		110100
#8 x 1-3/4"	#6	105250		
#8 x 2"	#6		105260	
#8 x 2"	REG		105270	
#8 x 2-1/2"	#6		DISC	
#10 x 1/2"	#6	105310		
#10 x 1/2"	#8	105320		
#10 x 1/2"	REG	105330		110110
#10 x 5/8"	#8	105340		
#10 x 3/4"	#6	105360		
#10 x 3/4"	#8	105350		110130
#10 x 3/4"	REG			110180
#10 x 1"	#6	105370		
#10 x 1"	#8	105380		110150
#10 x 1"	REG	105390		110140
#10 x 1-1/4"	#8	105410		110160
#10 x 1-1/4"	REG	105420		
#10 x 1-1/2"	#6	105430		
#10 x 1-1/2"	#8			110170
#10 x 1-3/4"	REG		105440	
#12 x 3/4"	REG		105470	
#12 x 1"	#10		105480	

TAPPING SCREWS

TAPPING SCREWS PHILLIPS PAN HEAD



100 Per Box
Unless Otherwise
Noted In Parenthesis

1 General Fasteners

SIZE	ZINC CHROMATE	BLACK OXIDE
#4 x 1/4"	115010	
#4 x 3/8"	115020	115021
#4 x 1/2"	115030	
#6 x 1/4"	115040	
#6 x 3/8"	115050	
#6 x 1/2"	115060	120002
#6 x 5/8"		
#6 x 3/4"	115070	120004
#6 x 1"	115080	120005
#6 x 1-1/4"	115085	120006
#6 x 1-1/2"	115090	
#8 x 1/4"	115100	
#8 x 3/8"	115110	
#8 x 1/2"	115120	120010
#8 x 5/8"	115140	
#8 x 3/4"	115150	120020
#8 x 1"	115160	120030
#8 x 1-1/4"	115170	120040
#8 x 1-1/2"	115180	120045 (50)
#10 x 3/8"	115200	
#10 x 1/2"	115210	120050
#10 x 5/8"		120055
#10 x 3/4"	115220	120060
#10 x 1"	115230	120070 (50)
#10 x 1-1/4"	115240	120080 (50)
#10 x 1-1/2"	115250	120085 (50)
#10 x 2"	115255	
#12 x 1/2"	115260	
#12 x 5/8"	115270	
#12 x 3/4"	115280	
#12 x 1"	115290	
#12 x 1-1/4"	115295	
#12 x 1-1/2"	115300	
#14 x 1/2"	115310	
#14 x 3/4"	115340	
#14 x 1"	115360	
#14 x 1-1/4"	115370	
#14 x 1-1/2"	115380	

TAPPING SCREWS PHILLIPS FLAT HEAD ZINC PLATED



PROD#	SIZE	BOX
157040	10-12 x 2"	100
157020	14-10 x 1"	100
157030	14-10 x 1-1/2"	100
157031	14-10 x 2"	100
157032	14-10 x 2-1/2"	100

TAPPING SCREWS

SIZE x LENGTH	CHROME PLATED	BOX	BLACK PHOS	BOX
#6 x 5/8"	135010	100		
#6 x 3/4"	135020	100		
#6 x 1"	135030	100		
#8 x 5/8"	135040	100	140010	100
#8 x 3/4"	135050	100	140020	100
#8 x 1"	135060	100	140040	100
#8 x 1-1/4"	135070	50	140060	100
#10 x 1/2"			140065	50
#10 x 5/8"	135080	50		
#10 x 3/4"	135090	50	140070	50
#10 x 1"	135100	50	140080	50
#10 x 1-1/4" ..	135110	50		

SIZE x LENGTH	PROD#	BOX	PLATING
#8 x 5/8"	136010	50	Chrome
#8 x 5/8"	141010	100	Black
#8 x 11/16"	141020	100	Black
#8 x 7/8"	136020	100	Chrome
#8 x 1-1/4"	141030	100	Black

SIZE	WASHER TYPE*	CHROME	BLACK PHOSPHATE	BOX
#8 x 5/8"	FL	137005	137030	100
#8 x 5/8"	CS	137010	137035	100
#8 x 3/4"	CS	137015	137040	100
#8 x 1"	CS	137020	137045	50
#8 x 1-1/4"	CS	137025	137050	50

* FL = Flush, CS = Countersunk

PROD#	SIZE	BOX
200590	#8-18 x 1/2"	100
200591	#8-18 x 3/4"	100
200592	#8-18 x 1"	100

PHILLIPS OVAL HEAD COUNTERSUNK WASHER TAPPING SCREWS

WASHER LOOSE FROM HEAD



PHILLIPS OVAL HEAD FLUSH TYPE WASHER TAPPING SCREWS

WASHER LOOSE FROM HEAD



PHILLIPS OVAL HEAD SEMS TEK FINISHING SCREW

(With No. 2 Drill Point)



Countersunk



Flush



PHILLIPS ROUND WASHER HEAD TAPPING SCREW

PHOSPHATE AND OIL (BLACK)
TYPE "AB"
1/2" DIA. WASHER HEAD

TAPPING SCREWS/HEX HEAD SCREWS

1 General Fasteners

PHILLIPS FLAT TOP WASHER HEAD TAPPING SCREWS

WASHER SOLID TO HEAD

BLACK E-COAT (* - Black Oxide)



SIZE x LENGTH	WSHR HD OD	PROD#	BOX
#6 x 1/2"	3/8"	200406	100
#6 x 3/4"	3/8"	200408*	100
#6 x 1"	3/8"	200409*	100
#8 x 1/2"	7/16"	200410	100
#8 x 5/8"	7/16"	200420	100
#8 x 3/4"	7/16"	200430	100
#8 x 1"	7/16"	200450	100
#8 x 1"	1/2"	200455	100
#8 x 1-1/4"	7/16"	200480	100
#8 x 1-1/2"	7/16"	200490	50
#10 x 1/2"	7/16"	200456	100
#10 x 3/4"	15/32"	200453	100
#10 x 1"	1/2"	200457	100

NEW
NEW
NEW

HEX HEAD TAPPING SCREWS NO WASHER ZINC PLATED



SIZE x LENGTH	HEAD SIZE	PRODUCT NO.
#10 x 1-1/2"	5/16"	163070 (100)
#12 x 1"	5/16"	163110 (100)
#14 x 3/4"	7/16"	163015 (100)
#14 x 1-1/2"	7/16"	163130 (100)
5/16" x 3/4"	1/2"	163020 (50)

Box Qty. In Parenthesis

HEX WASHER HEAD SHEET METAL SCREWS

WASHER SOLID TO HEAD
ZINC CHROMATE



SIZE	HEAD SIZE	PROD#	SIZE	HEAD SIZE	PROD#
#8 x 1/2"	1/4"	146010 (100)	#12 x 3/4"	5/16"	150050 (100)
#8 x 1"	1/4"	146030 (100)	#12 x 1"	5/16"	150060 (100)
#8 x 1-1/4"	1/4"	146040 (100)	#12 x 1"	5/16"	150060-1000 (1000)
#8 x 1-1/2"	1/4"	146050 (100)	#14 x 1/2"	3/8"	150065 (100)
#8 x 2"	1/4"	146060 (100)	#14 x 3/4"	3/8"	150070 (100)
#10 x 1/2"	5/16"	146070 (100)	#14 x 3/4"	3/8"	150071 (500)
#10 x 3/4"	5/16"	146080 (100)	#14 x 1"	3/8"	150090 (100)
#10 x 1"	5/16"	146090 (100)	#14 x 1-1/4"	3/8"	150100 (50)
#10 x 1-1/4"	5/16"	146100 (100)	#14 x 1-1/2"	3/8"	150110 (50)
#10 x 1-1/2"	5/16"	146110 (100)	5/16" x 3/4"	7/16"	150010 (50)
#10 x 2"	5/16"	146120 (100)	5/16" x 1"	7/16"	150020 (50)
			5/16" x 1-1/2"	7/16"	150030 (50)

Box Qty. In Parenthesis

SIZE x LENGTH	HEAD SIZE	WASHER OD	PROD#
#12 x 3/4"	7/16"	5/8"	155030 (50) DISC
#14 x 3/4"	3/8"	5/8"	155071 (50)
#14 x 1"	3/8"	21/32"	155080 (50)
#14 x 1-1/2"	7/16"	21/32"	155120 (50)
5/16" x 1"	7/16"	11/16"	155010 (50)
5/16" x 1-1/2"	7/16"	11/16"	155020 (50)

Box Qty. In Parenthesis

HEX WASHER HEAD SHEET METAL SCREW

WASHER LOOSE FROM HEAD
ZINC CHROMATE



SELF DRILLING SCREWS



**SELF DRILLING SCREWS
HARDENED
ZINC PLATED**

SIZE x LENGTH	POINT	HEX WASHER HEAD	PHILLIPS PAN HEAD	PAN HEAD SQUARE	FLAT HEAD SQUARE
#8 x 1/2"	#2	165010 (100)	160010 (100)	166010 (100)	
#8 x 3/4"	#2	165020 (100)	160020 (100)	166015 (100)	166041 (100)
#8 x 1"	#2	165030 (100)	160025 (100)	166020 (100)	166042 (100)
#8 x 1-1/4"	#2	165031 (50)			
#8 x 1-1/2"	#2	165032 (50)		166030 (100)	166044 (100)
#8 x 2"	#2			166040 (100)	
#10 x 1/2"	#2	165040 (100)	160030 (100)		
#10 x 3/4"	#2	165050 (100)	160040 (100)	166050 (100)	
#10 x 1"	#2	165060 (100)	160050 (100)	166055 (100)	
#10 x 1-1/4"	#3	165061 (50)			
#10 x 1-1/2"	#3	165062 (50)		166060 (100)	
#12 x 1"	#3	165065 (25)			
#12 x 1-1/4"	#3	165066 (25)			
#12 x 1-1/2"	#3	165067 (25)			
#14 x 3/4"	#3	165070 (100)			
#14 x 1"	#3	165080 (100)			
#14 x 1-1/4"	#3	165081 (25)			
#14 x 1-1/2"	#3	165090 (100)			
#14 x 2"	#3	165100 (100)			
#14 x 2-1/2"	#3	165110 (100)			

Box Qty. In Parenthesis

NEW

**SQUARE DRIVE
SELF DRILLING SCREWS
PAINTED HEAD
ZINC PLATED
100 Per Box**



SIZE x LENGTH	WHITE HEAD	BLACK HEAD	TAN HEAD
#6 x 1/2"	115540	115560	115580
#6 x 3/4"	115541	115561	115581
#6 x 1"	115542	115562	115582
#8 x 1/2"	115545	115565	115585
#8 x 3/4"	115546	115566	115586
#8 x 1"	115547	115567	115587
#8 x 1-1/4"	115548	115568	115588
#8 x 1-1/2"	115549	115569	115589
#10 x 1/2"	115550	115570	115590
#10 x 3/4"	115551	115571	115591
#10 x 1"	115552	115572	115592
#10 x 1-1/4"	115553	115573	115593
#10 x 1-1/2"	115554	115574	115594

1
General Fasteners

TORX DRIVE SCREWS

TORX DRIVE SCREWS (STAINLESS STEEL)

RUST RESISTANT
Meets OEM Specifications



TORX OVAL HEAD SCREWS TRIM HEAD

METRIC SIZE	FINISH	PROD#
4.2mm x 20mm.....	CHROME	170080 (50)
4.2mm x 20mm.....	BLACK	170090 (50)
4.2mm x 30mm.....	CHROME	170110 (50)
4.2mm x 30mm.....	BLACK	170120 (50)
4.2mm x 35mm.....	BLACK	170135 (50)
4.2mm x 40mm.....	CHROME	170040 (50) DISC
4.2mm x 55mm.....	CHROME	170020 (50)

Box Qty. In Parenthesis



TORX PAN HEAD SCREWS

METRIC SIZE	FINISH	PROD#
4.2mm x 13mm.....	CHROME	175030 (50) DISC
4.2mm x 20mm.....	BLACK	170095 (50)
4.2mm x 25mm.....	CHROME	175050 (50) DISC
4.2mm x 25mm.....	BLACK	175060 (50) DISC
4.2mm x 55mm.....	CHROME	175090 (50)

Box Qty. In Parenthesis

TORX DRIVE SCREWS (HARDENED STEEL)



TORX OVAL HEAD SCREWS

METRIC SIZE	FINISH	PROD#
4.2mm x 16mm.....	CHROME	170060 (50)
4.2mm x 16mm.....	BLACK	170070 (50)
4.2mm x 20mm.....	CHROME	170081 (50)
4.2mm x 30mm.....	CHROME	170111 (50)
4.2mm x 30mm.....	BLACK	170121 (50)
4.2mm x 35mm.....	CHROME	170130 (50) DISC
4.2mm x 60mm.....	CHROME	170140 (50)
4.2mm x 70mm.....	BLACK	170160 (50)

Box Qty. In Parenthesis

MACHINE SCREWS

SIZE	PROD# BOX 100
6-32 x 1/2"	180050
6-32 x 3/4"	180060
6-32 x 1"	180070
6-32 x 1-1/2"	180080
8-32 x 3/8"	180090
8-32 x 1/2"	180100
8-32 x 3/4"	180110
8-32 x 1"	180120
8-32 x 1-1/4"	180130
8-32 x 1-1/2"	180140
10-32 x 3/8"	180150
10-32 x 1/2"	180160
10-32 x 3/4"	180180
10-32 x 1"	180200
10-32 x 1-1/4"	180220
10-32 x 1-1/2"	180240

SIZE	PROD# BOX 100
10-24 x 1/2"	180170
10-24 x 3/4"	180190
10-24 x 1"	180210
10-24 x 1-1/4"	180230
10-24 x 1-1/2"	180250
10-24 x 2"	180280
12-24 x 1/2"	180290
12-24 x 3/4"	180300
12-24 x 1"	180310
12-24 x 1-1/2"	180320
1/4-20 x 1/2"	180010
1/4-20 x 3/4"	180020
1/4-20 x 1"	180030
1/4-20 x 1-1/2"	180035
1/4-20 x 2"	180040

SLOTTED ROUND HEAD MACHINE SCREWS ZINC PLATED STEEL



SLOTTED FILLISTER HEAD MACHINE SCREWS ZINC PLATED STEEL

PHILLIPS PAN HEAD MACHINE SCREWS ZINC PLATED STEEL



SIZE	PROD# BOX 100
3-48 x 1/4"	190190
6-32 x 1/4"	190195
6-32 x 3/8"	190200
8-32 x 1/2"	190207
10-32 x 3/8"	190217

**NEW
NEW**

PHILLIPS TRUSS HEAD MACHINE SCREWS ZINC PLATED STEEL



SIZE	PROD# BOX 100
1/4-20 x 3/4"	190100
1/4-20 x 1"	190102
1/4-20 x 2"	190106
1/4-20 x 2-1/2"	190108

SIZE	PROD# BOX 100
4-40 x 1/4"	181016
4-40 x 3/8"	181018
4-40 x 1/2"	181020
6-32 x 1/4"	181026
6-32 x 5/16"	181027
6-32 x 3/8"	181028
6-32 x 1/2"	181030
8-32 x 3/8"	181036
8-32 x 1/2"	181038
10-32 x 1/2"	181050
10-32 x 3/4"	181052
10-32 x 1"	181054
10-32 x 1-1/4"	181055
10-32 x 1-1/2"	181056
1/4-20 x 1/2"	200235

NEW















PHILLIPS OVAL HEAD MACHINE SCREWS CHROME PLATED STEEL



HEAD SIZE	SIZE	PROD# BOX 100
8-32 x 1/2"	STD	190020
8-32 x 3/4"	#6	190030
10-24 x 1/2"	STD	190060
10-24 x 3/4"	STD	190080
10-32 x 1"	#8	190090

LICENSE SCREWS - NUTS AND OTHER FASTENERS

1 General Fasteners

 <p>85255 Stainless Steel #14 x 3/4" Phillips Truss Head Box Qty. 50</p>	<p>125261 Box 500</p>  <p>125260 Zinc #14 x 3/4" Slotted Truss Head Head Dia.: 9/16" Box Qty. 100</p>	 <p>125265 Zinc Plated #14 x 3/4" Slotted Pan Head Tapping Screw Box Qty. 100</p>	
<p>150071 Box 500</p>  <p>150070 Zinc #14 x 3/4" Slotted Hex Washer Head Washer Hd OD: 1/2" Hex: 3/8" <i>Ford</i> Box Qty. 100</p>	 <p>150075 Black E-Coat (168 Hours Salt Spray) #14 x 3/4" Slotted Hex Washer Head Washer Head O.D.: 1/2" Hex: 3/8" <i>Ford</i> Box Qty. 50</p>	 <p>150076 <i>93904-46320, 91500-SM4-999AH</i> Yellow Zinc #14 x 3/4" Phillips Hex Washer Head License Plate Screw Washer Hd OD: 12mm (1/2") Hex: 10mm <i>Honda 1990 - UP, GEO Prizm, Toyota</i> Box Qty. 50</p>	 <p>150077 Bright Zinc 6mm x 16mm Slotted Hex Washer Head License Plate Screw Washer Hd OD: 12.7mm Hex: 10mm Box Qty. 50</p>
 <p>180000 Zinc Plated M6-1.0 x 16mm Slotted Round Head Machine Screw Box Qty. 100</p>	<p>NEW</p>  <p>200001 <i>12291-06303</i> Black Zinc M6-1.0 x 29mm Phillips Round Head License Plate Screw with Sems® Flat & Lock Washer Flat Washer Dia: 13mm Lock Washer Dia: 11mm <i>Hyundai Equus 2010 - 2015 Genesis 2008 - 2014</i> Box Qty. 25</p>	 <p>200025 Zinc #14 x 1/2" Total Length: 1-1/8" Dealer License Plate Thumb Screw Box Qty. 25</p>	 <p>200030 <i>3783002</i> Zinc #10 x 5/8" Slotted Truss Washer Head Washer Head O.D.: 1/2" <i>GM</i> Box Qty. 100</p>
 <p>200192 <i>9420052, 11502483, 11503503</i> Chrome M4.2-1.41 x 20mm (#8 x 25/32") Phillips Pan Head Sems Pozi-Driv Washer O.D.: 12mm (1/2") <i>GM</i> Box Qty. 50</p>	 <p>200225 Nylon Screw, Spacer, Washer And Brass Nut License Attachment Kit M6-1.0 x 20mm Slotted Pan Head Head Dia: 12mm (15/32") Hex Width: 10mm (25/64") Washer OD: 12.5mm (1/2") Spacer OD: 19mm (3/4") <i>Toyota</i> Box Qty. 25 Sets</p>	 <p>200226 Black Nylon 6 - 1.00mm License Plate Hex Nut Hex Size: 10mm <i>GM</i> Box Qty. 100</p>	 <p>200227 Black Nylon 6 - 1.00mm x 16mm Slotted Pan Head License Plate Screw <i>GM</i> Box Qty. 100</p>

LICENSE SCREWS - NUTS AND OTHER FASTENERS

 <p>200228 Black Nylon 6 - 1.00mm x 20mm Slotted Pan Head License Plate Screw <i>GM</i> Box Qty. 100</p>	 <p>200229 Black Nylon 6 - 1.00mm x 20mm Phillips Pan Head License Plate Screw <i>GM</i> Box Qty. 100</p>	 <p>200230 Zinc Plated 1/4-20 x 1/2" Slotted Truss Head Machine Screw Box Qty. 100</p>	 <p>200231 Zinc M6-1.0 x 16mm Hex Head Flange License Plate Screw Flange O.D.: 14mm (9/16") Hex: 10mm Class 10.9 <i>Acura</i> Box Qty. 50</p>
 <p>200233 Black Finish (168 Hour Salt Spray) M6-1.0 x 20mm Phillips Pan Head <i>Import Vehicles & General Use</i> Box Qty. 50</p>	 <p>200235 Bright Zinc 1/4-20 x 1/2" Slotted Fillister Head Machine Screw Box Qty. 100</p>	 <p>200380 <i>9423101</i> Dacromet 320 Finish M6.3-1.81 x 16mm (#14 x 5/8") Duo Drive Truss Head <i>GM</i> Box Qty. 50</p>	 <p>200401 Black E-Coat #14 (1/4") x 5/8" Slotted Hex Washer Head License Plate Screw Washer Head OD: 5/8" Hex: 5/16" <i>Ford</i> Box Qty. 50</p>
 <p>200402 <i>N800369</i> Bright Zinc #14 (1/4") x 5/8" Washer Head Dia: 5/8" Hex A/F: 5/16" Slotted Indented Hex Head <i>Ford & General Purpose</i> Box Qty. 50</p>	 <p>200403 <i>N800369-S2</i> Black E-Coat #14 (1/4") x 5/8" Washer Dia: 5/8" Hex A/F: 5/16" Slotted Hex Washer Head <i>Ford & General Purpose</i> Box Qty. 50</p>	 <p>200453 Black E-Coat (168 Hours Salt Spray) #10 x 3/4" Phillips Flat Top Washer Head License Plate Screw, Trim Screw & General Purpose Washer Hd. O.D.: 1/2" <i>GM</i> Box Qty. 100</p>	 <p>200615 Black E Coat (168 Hours Salt Spray) #14 x 3/4" Slotted Truss Head License Plate Screw Head Dia: 9/16" <i>Ford</i> Box Qty. 100</p>
 <p>200616 Zinc 1/4" x 3/4" Phillips Truss Head Screw Head Dia: 6/16" <i>Ford</i> Box Qty. 50</p>	 <p>200617 Zinc 1/4-20 x 3/4" Slotted Truss Head Screw Head Dia: 9/16" <i>GM</i> Box Qty. 100</p>	 <p>200703 Black Nylon 1/4"-20 x 5/8" Slotted Truss Washer Head License Screw Washer OD: 19/32" <i>GM</i> Box Qty. 50</p>	 <p>215066 <i>3846202</i> 5/16-18 x 7/8" Indented Hex Head Sems Washer OD: 3/4" Hex: 1/2" <i>GM</i> Box Qty. 50</p>

1

General Fasteners

LICENSE SCREWS - NUTS AND OTHER FASTENERS

1 General Fasteners



216009
11508930
Black Fluorocarbon
M6-1.0 x 16mm
Hex Head Sems
Class 9.8; Hex: 10mm
Wshr O.D.: 17mm (21/32")
GM
Box Qty. 50



235030
Zinc Chromate Plated
Hardened Steel
1/4-20 Thread Size
Flanged Spin Lock Nut
Hex: 7/16"
Flange OD: 19/32"
General Purpose
Box Qty. 100



280045
Nylon
#8 Screw Size
License Plate Nut &
Headlight Door Screw
Chrysler
Box Qty. 100

280131 Box 500



280130
Nylon
Front & Rear
License Plate Nut
Split 2 Ways Under Head
Hole: 3/8" Square
(use #14 Screw)
Ford, Mercury '65 - UP
General Purpose
Box Qty. 100

280136 Box 500



280135
3907444, 4755299
Nylon
License Plate Nut
Split Four Ways Under Head
Screw Size: #14 (1/4")
Head Size: 5/8"
Stem Length: 5/16"
Hole Size: 13/32"
GM, Chrysler
Box Qty. 100



290100
6032516
Black Nylon
#12 Screw Size
License Plate Nut
Chrysler
Box Qty. 25

292005

14910-04000,
92561-25000
Natural Nylon
License Plate Grommet
Screw Size: M3.5 (#6)
Head Dia: 12mm
Stem Length: 7mm
Overall Height: 9mm
Hyundai Accent, Azera, Elantra,
Entourage, Excel, Ioniq, Santa Fe,
Scoupe, Tiburon, Tucson, Veloster,
XG300 & XG350 1985 - UP
Kia Optima & Rio 2010 - 2016
Box Qty. 25

NEW



SLOTTED PAN HEAD ZINC PLATED STEEL



PROD#	SIZE	BOX
890610	M6-1.0 x 10mm	50
890616	M6-1.0 x 16mm	50
890616-500	M6-1.0 x 16mm	500
890620	M6-1.0 x 20mm	50

PHILLIPS PAN HEAD ZINC PLATED STEEL



PROD#	SIZE	BOX
897510	M5-0.8 x 10mm	100
897610	M6-1.0 x 10mm	50
897612	M6-1.0 x 12mm	50
897616	M6-1.0 x 16mm	50
897616-1000	M6-1.0 x 16mm	1000
897620	M6-1.0 x 20mm	50

www.srfast.com

GRADE 5 CAP SCREW

**CAP SCREWS
GRADE 5
ZINC PLATED**

*120,000 P.S.I. Minimum
Tensile Strength*

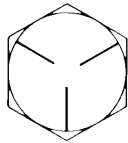

	LENGTH	USS (Coarse)		SAE (Fine)	
		PROD#	BOX	PROD#	BOX
1/4" DIA.	1/2"	205030	100	210010	100
	3/4"	205050	100	210020	100
	1"	205060	100	210030	100
	1-1/4"	205070	100	210040	100
	1-1/2"	205080	100	210050	100
	1-3/4"	205090	100	210060	100
	2"	205100	100	210070	50
	2-1/4"	205110	50	210075	50
	2-1/2"	205120	50	210080	50
	2-3/4"	205130	50	210082	50
	3"	205140	50	210084	50
	3-1/2"	205150	50	210086	50
	4"	205152	25	*	
	4-1/2"	205154	25	*	
	5"	205156	25	*	
	6"	205158	25	*	

5/16" DIA.	1/2"	205160	100	210090	100
	3/4"	205170	100	210100	100
	1"	205180	100	210110	100
	1-1/4"	205190	50	210120	50
	1-1/2"	205200	50	210130	50
	1-3/4"	205210	50	210140	50
	2"	205220	50	210150	50
	2-1/4"	205230	50	210155	50
	2-1/2"	205240	50	210160	50
	2-3/4"	205245	50	210165	50
	3"	205250	25	210170	50
	3-1/4"	205260	25	210175	50
	3-1/2"	205270	25	210180	50
	4"	205280	25	210185	50
	4-1/2"	205282	25	*	
	5"	205284	25	*	
	5-1/2"	205286	25	*	
	6"	205288	25	*	
	7"	205290	25	*	

*NOT A STOCK ITEM

GRADE 5 CAP SCREW

**CAP SCREWS
GRADE 5
ZINC PLATED**

*120,000 P.S.I. Minimum
Tensile Strength*

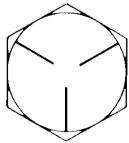

**3/8"
DIA.**

**3/8"-16
USS (Coarse)**

**3/8"-24
SAE (Fine)**

	LENGTH	USS (Coarse) PROD#	BOX	SAE (Fine) PROD#	BOX
3/8" DIA.	3/4"	205300	50	210190	50
	1"	205310	50	210200	50
	1-1/4"	205320	50	210210	50
	1-1/2"	205330	50	210220	25
	1-3/4"	205340	25	210225	25
	2"	205350	25	210230	25
	2-1/4"	205360	25	210235	25
	2-1/2"	205370	25	210240	25
	2-3/4"	*		*	
	3"	205380	25	210241	25
	3-1/2"	205390	25	210242	25
	4"	205400	25	210244	25
	4-1/2"	205405	25	210245	25
	5"	205410	25	210247	25
	5-1/2"	205412	25	210248	25
	6"	205414	25	210249	25

**7/16"
DIA.**

**7/16"-14
USS (Coarse)**

**7/16"-20
SAE (Fine)**

7/16" DIA.	3/4"	205420	25	210250	50
	1"	205430	25	210260	25
	1-1/4"	205440	25	210270	25
	1-1/2"	205450	25	210280	25
	1-3/4"	205460	25	210285	25
	2"	205470	25	210290	25
	2-1/4"	*		*	
	2-1/2"	205480	25	210291	25
	2-3/4"	205485	25	*	
	3"	205490	25	210293	25
	3-1/4"	*		*	
	3-1/2"	205500	25	210294	25
	4"	205510	25	210295	25
	4-1/2"	205515	25	210296	25
	5"	205520	25	210297	25
	5-1/2"	205522	25	210298	25
6"	205524	25	210299	25	

* NOT A STOCK ITEM

GRADE 5 CAP SCREW

CAP SCREWS GRADE 5 ZINC PLATED

120,000 P.S.I. Minimum
Tensile Strength

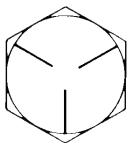

1/2" DIA.

1/2"-13
USS (Coarse)

1/2"-20
SAE (Fine)

LENGTH	USS (Coarse) PROD#	BOX	SAE (Fine) PROD#	BOX
3/4"	205530	25	210300	25
1"	205540	25	210310	25
1-1/4"	205550	25	210320	25
1-1/2"	205560	25	210330	25
1-3/4"	205570	25	210340	25
2"	205580	25	210350	25
2-1/4"	205585	25	*	
2-1/2"	205590	25	210352	25
2-3/4"	*		*	
3"	205600	25	210354	25
3-1/4"	*		*	
3-1/2"	205610	25	210356	25
3-3/4"	*		*	
4"	205620	10	210358	25
4-1/2"	205625	10	210360	25
5"	205630	10	210362	25
5-1/2"	205632	10	210364	25
6"	205634	10	210366	25

5/8" DIA.

5/8"-11
USS (Coarse)

5/8"-18
SAE (Fine)

1"	205700	10	210400	10
1-1/4"	*		*	
1-1/2"	205710	10	210410	10
1-3/4"	*		*	
2"	205720	10	210420	10
2-1/4"	*		*	
2-1/2"	205730	10	210430	10
3"	205740	10	210440	10
3-1/2"	205750	10	210450	10
4"	205760	10	210460	10
4-1/2"	205770	10	210470	10
5"	205780	10	210480	10
6"	205790	10	210500	10

3/4" DIA.

3/4"-10
USS (Coarse)

3/4"-16
SAE (Fine)

1"	205799	10	210510	10
1-1/4"	*		*	
1-1/2"	205800	10	210520	10
1-3/4"	*		*	
2"	205810	10	210530	10
2-1/2"	205820	10	210540	10
3"	205830	10	210550	10
3-1/2"	205840	10	210560	10
3-3/4"	*		*	
4"	205850	10	210570	10
4-1/2"	205860	10	210580	10
5"	205870	10	210590	10
5-1/2"	205880	10	210600	10
6"	205890	10	210610	10

* NOT A STOCK ITEM

GRADE 8 CAP SCREW

CAP SCREWS
GRADE 8
YELLOW ZINC PLATED

150,000 P.S.I. Minimum
 Tensile Strength

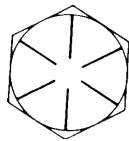

1/4"
DIA.

1/4"-20
USS (Coarse)

1/4"-28
SAE (Fine)

5/16"
DIA.

5/16"-18
USS (Coarse)

5/16"-24
SAE (Fine)

3/8"
DIA.

3/8"-16
USS (Coarse)

3/8"-24
SAE (Fine)

LENGTH	USS (Coarse)		SAE (Fine)	
	PROD#	BOX	PROD#	BOX
1/2"	810100	50	820100	50
3/4"	810101	50	820101	50
1"	810102	50	820102	50
1-1/4"	810103	50	820103	50
1-1/2"	810104	50	820104	50
1-3/4"	810105	50	820105	50
2"	810106	50	820106	50
2-1/4"	810107	25	820107	25
2-1/2"	810108	25	820108	25
2-3/4"	810109	25	820109	25
3"	810110	25	820110	25
3-1/2"*	*		*	

1/2"	810200	50	820200	50
3/4"	810201	50	820201	50
1"	810202	50	820202	50
1-1/4"	810203	50	820203	50
1-1/2"	810204	50	820204	50
1-3/4"	810205	50	820205	50
2"	810206	50	820206	50
2-1/4"	810207	25	820207	50
2-1/2"	810208	25	820208	25
2-3/4"	810209	25	820209	25
3"	810210	25	820210	25
3-1/4"	810211*	25	820211*	25
3-1/2"	810212*	25	820212*	25
4"	810213*	25	820213*	25

3/4"	810300	50	820300	50
1"	810301	50	820301	50
1-1/4"	810302	50	820302	50
1-1/2"	810303	50	820303	50
1-3/4"	810304	50	820304	50
2"	810305	50	820305	50
2-1/4"	810306	25	820306	25
2-1/2"	810307	25	820307	25
2-3/4"	810308	25	820308	25
3"	810309	25	820309	25
3-1/2"	810311	25	820311	25
4"	810313	25	820313	25
4-1/2"	*		*	
5"	*		*	
5-1/2"	*		*	
6"	*		*	

* NOT A STOCK ITEM

GRADE 8 CAP SCREW

**CAP SCREWS
GRADE 8
YELLOW ZINC PLATED**

150,000 P.S.I. Minimum
Tensile Strength



7/16"
DIA.

**7/16"-14
USS (Coarse)**

**7/16"-20
SAE (Fine)**

LENGTH	USS (Coarse) PROD#	BOX	SAE (Fine) PROD#	BOX
3/4"	810400	50	820400	25
1"	810401	50	820401	25
1-1/4"	810402	50	820402	25
1-1/2"	810403	50	820403	25
1-3/4"	810404	25	820404	25
2"	810405	25	820405	25
2-1/4"	810406	25	820406	25
2-1/2"	810407	25	820407	25
2-3/4"	810408	25	820408	25
3"	810409	25	820409	25
3-1/4"	810410	10	820410	10
3-1/2"	810411	10	820411	10
3-3/4"	810412	10	820412*	10
4"	810413	10	820413	10
4-1/2"	810415	10	820415	10
5"	810417	10	820417	10
5-1/2"	*	*	*	*
6"	*	*	*	*

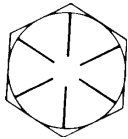

1/2"
DIA.

**1/2"-13
USS (Coarse)**

**1/2"-20
SAE (Fine)**

3/4"	*	*	*	*
1"	810500	25	820500	25
1-1/4"	810501	25	820501	25
1-1/2"	810502	25	820502	25
1-3/4"	810503	25	820503	25
2"	810504	25	820504	25
2-1/4"	810505	25	820505	25
2-1/2"	810506	25	820506	25
2-3/4"	810507	25	820507	25
3"	810508	25	820508	25
3-1/4"	810509	25	820509	10
3-1/2"	810510	10	820510	10
3-3/4"	810511	10	820511	10
4"	810512	10	820512	10
4-1/4"	810513*	10	820513*	10
4-1/2"	810514	10	820514	10
5"	810516	10	820516	10
5-1/2"	810517	10	820517	10
6"	810519	10	820519	10

* NOT A STOCK ITEM

GRADE 8 CAP SCREW

**CAP SCREWS
GRADE 8
YELLOW ZINC PLATED**

150,000 P.S.I. Minimum
Tensile Strength

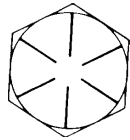

9/16"
DIA.

**9/16"-12
USS (Coarse)**

**9/16"-18
SAE (Fine)**

**5/8"-11
USS (Coarse)**

**5/8"-18
SAE (Fine)**

3/4"
DIA.

**3/4"-10
USS (Coarse)**

**3/4"-16
SAE (Fine)**

LENGTH	USS (Coarse)		SAE (Fine)	
	PROD#	BOX	PROD#	BOX
1"	810600	10	820600	10
1-1/4"	810601	10	820601	10
1-1/2"	810602	10	820602	10
1-3/4"	810603	10	820603	10
2"	810604	10	820604	10
2-1/4"	810605	10	820605	10
2-1/2"	*	10	820606	10
2-3/4"	810607	10	820607	10
3"	810608	10	820608	10
3-1/4"	810609	10	820609	10
3-1/2"	810610	10	820610	10
3-3/4"	810611*	10	820611*	10
4"	810612	10	820612	10
4-1/2"	810614	10	820614	10
5"	810616	10	820616	10
5-1/2"	810618	10	820618	10
6"	810620	10	820620	10
<hr/>				
1"	810700	10	820700	10
1-1/4"	810701	10	820701	10
1-1/2"	810702	10	820702	10
1-3/4"	810703	10	820703	10
2"	810704	10	820704	10
2-1/4"	810705	10	820705	10
2-1/2"	810706	10	820706	10
2-3/4"	810707	10	820707*	10
3"	810708	10	820708	10
3-1/4"	810709	10	820709*	10
3-1/2"	810710	10	820710	10
4"	810712	10	820712	10
4-1/2"	810714	10	820714	10
5"	810716	10	820716	10
5-1/2"	810717	10	*	
6"	810718	10	820718	10
7"	810721	10	*	
8-1/2"	810724	10	*	
<hr/>				
1"	*		*	
1-1/4"	810800	10	820800	10
1-1/2"	810801	10	820801	10
1-3/4"	810802	10	820802	10
2"	810803	10	820803	10
2-1/4"	810804	10	820804*	10
2-1/2"	810805	10	820805	10
2-3/4"	810806	10	820806*	10
3"	810807	10	820807	10
3-1/4"	810808	10	820808*	10
3-1/2"	810809	10	820809	10
3-3/4"	810810	10	820810	10
4"	810811	10	820811	10
4-1/2"	810813	10	820813	10
5"	810815	10	820815	10
5-1/2"	810816	10	820816	10
6"	810817	10	820817	10

*NOT A STOCK ITEM

HEX NUTS

GRADE 5 - HEX NUTS STANDARD FINISHED BRIGHT ZINC PLATED



DIA. THREAD	HEX WIDTH	USS PROD#	SAE PROD#	BOX		
1/4"	7/16"	USS 1/4-20	225010	SAE 1/4-28	230010	100
5/16"	1/2"	USS 5/16-18	225020	SAE 5/16-24	230020	100
3/8"	9/16"	USS 3/8-16	225030	SAE 3/8-24	230030	100
7/16"	11/16"	USS 7/16-14	225040	SAE 7/16-20	230040	100
1/2"	3/4"	USS 1/2-13	225050	SAE 1/2-20	230050	100
9/16"	7/8"	USS 9/16-12	225060	SAE 9/16-18	230060	50
5/8"	15/16"	USS 5/8-11	225070	SAE 5/8-18	230070	50
3/4"	1-1/8"	USS 3/4-10	225076	SAE 3/4-16	230080	25

HARDENED - GRADE 8 FINISHED HEX NUTS YELLOW ZINC PLATED



DIA. THREAD	HEX WIDTH	USS PROD#	SAE PROD#	BOX		
1/4"	7/16"	USS 1/4-20	830100	SAE 1/4-28	840100	100
5/16"	1/2"	USS 5/16-18	830101	SAE 5/16-24	840101	100
3/8"	9/16"	USS 3/8-16	830102	SAE 3/8-24	840102	100
7/16"	11/16"	USS 7/16-14	830103	SAE 7/16-20	840103	100
1/2"	3/4"	USS 1/2-13	830104	SAE 1/2-20	840104	100
9/16"	7/8"	USS 9/16-12	830105	SAE 9/16-18	840105	50
5/8"	15/16"	USS 5/8-11	830106	SAE 5/8-18	840106	50
3/4"	1-1/8"	USS 3/4-10	830107	SAE 3/4-16*	25

HARDENED - GRADE 8 NYLON INSERTED HEX NUTS YELLOW ZINC PLATED



DIA. THREAD	HEX WIDTH	USS PROD#	SAE PROD#	BOX		
1/4"	7/16"	USS 1/4-20	830200	SAE 1/4-28	840200	100
5/16"	1/2"	USS 5/16-18	830201	SAE 5/16-24	840201	100
3/8"	9/16"	USS 3/8-16	830202	SAE 3/8-24	840202	100
7/16"	11/16"	USS 7/16-14	830203	SAE 7/16-20	840203	100
1/2"	3/4"	USS 1/2-13	830204	SAE 1/2-20	840204	100
9/16"	7/8"	USS 9/16-12	830205	SAE 9/16-18	840205	50
5/8"	15/16"	USS 5/8-11	830206	SAE 5/8-18	840206	50
3/4"	1-1/8"	USS 3/4-10	830207	SAE 3/4-16*	25

NUTS, MISC

1 General Fasteners

MACHINE SCREW HEX NUTS ZINC PLATED



PROD#	THREAD SIZE	HEX WIDTH	BOX
225080	6-32	5/16"	100
225090	8-32	5/16"	100
225100	10-24	3/8"	100
225110	10-32	3/8"	100
225120	12-24	7/16"	100

WASHER NUTS FREE SPINNING YELLOW ZINC (*=PHOSPHATE)



PROD#	DIA.	WASHER O.D.	BOX
225130	10-24"	3/8"	100
225131	10-32"	3/8"	100
225133	1/4-20"	5/8"	100
225134*	1/4-20"	7/8"	100
225135*	5/16-18"	3/4"	100
225136*	3/8-16"	7/8"	100

HARDENED FLANGED LOCK NUTS (SERRATED) ZINC PLATED



PROD#	DESCRIPTION	BOX
235020	8-32 SAE	50
235080	10-24 USS	100
235030	1/4-20 USS	100
235035	1/4-28 SAE	100
235060	5/16-18 USS	50
235065	5/16-24 SAE	50
235070	3/8-16 USS	50
235075	3/8-24 SAE	50
235010	7/16-14 USS	25
235015	7/16-20 SAE	25

NYLON INSERTED LOCK NUTS ZINC PLATED



PROD#	DESCRIPTION	BOX
260003	8-32	100
260004	10-24 USS	100
261004	10-32 SAE	100
260005	1/4-20 USS	100
261005	1/4-28 SAE	100
260010	5/16-18 USS	50
261010	5/16-24 SAE	50
260020	3/8-16 USS	50
261020	3/8-24 SAE	50
260030	7/16-14 USS	50
261030	7/16-20 SAE	50
260040	1/2-13 USS	50
261040	1/2-20 SAE	50
260050	5/8-11 USS	50
261050	5/8-18 SAE	50
260060	3/4-10 USS	50
261060	3/4-16 SAE	50

WING NUTS ZINC PLATED



PROD#	DESCRIPTION	BOX
303190	10-24	100
303200	1/4-20	50

WASHERS



STANDARD USS FLAT WASHERS
ZINC CHROMATE
GRADE 8 USS FLAT WASHERS
YELLOW ZINC
 R/C 38-45 HARDNESS

BOLT SIZE	INSIDE DIA.	OUTSIDE DIA.	STANDARD PROD#	BOX	GRADE 8 PROD#	BOX
#10 or 3/16"	1/4"	9/16"	310010	100		
1/4"	5/16"	3/4"	310020	100	855100	100
5/16"	3/8"	7/8"	310030	100	855101	100
3/8"	7/16"	1"	310040	100	855102	100
7/16"	1/2"	1-1/4"	310050	100	855103	50
1/2"	9/16"	1-3/8"	310060	100	855104	50
9/16"	5/8"	1-1/2"	310070	100	855105	25
5/8"	11-16"	1-3/4"	310080	50	855106	25
3/4"	13/16"	2"	310090	50	855107	25



STANDARD SAE FLAT WASHERS
ZINC CHROMATE
GRADE 8 HARDNESS WASHERS
YELLOW ZINC

BOLT SIZE	INSIDE DIA.	OUTSIDE DIA.	STANDARD PROD#	BOX	GRADE 8 PROD#	BOX
#6 or 1/8"	5/32"	3/8"	311005	100		
#10 or 3/16"	7/32"	1/2"	311007	100		
1/4"	9/32"	5/8"	311010	100	850100	100
5/16"	11/32"	11/16"	311020	100	850101	100
3/8"	13/32"	13/16"	311030	100	850102	100
7/16"	15/32"	15/16"	311040	100	850103	50
1/2"	17/32"	1-1/16"	311050	100	850104	50
9/16"	19/32"	1-3/16"			850105	50
5/8"	21/32"	1-5/16"	311060	100	850106	25
3/4"	21/32"	1-5/16"			850107	25

FENDER WASHERS
ZINC CHROMATE

PROD#	BOLT SIZE	O.D.	BOX
312010	#10 or 3/16"	1"	100
312020	1/4"	1-1/4"	100
312030	5/16"	1-1/4"	100
312040	3/8"	1-1/2"	100



WASHERS

**STANDARD
SPRING TYPE
LOCK WASHER**
Grade 5
ZINC CHROMATE



**HIGH ALLOY
SPRING TYPE
LOCK WASHERS**
Grade 8
ZINC & YELLOW DICHROMATE



PROD#	SIZE	BOX
315090	#6 or 1/8"	200
315100	#8 or 5/32"	200
315110	#10 or 3/16"	200
315111	#12 or 7/32"	200
315010	1/4"	200
315020	5/16"	200
315030	3/8"	200
315040	7/16"	200
315050	1/2"	200
315060	9/16"	100
315070	5/8"	100
315080	3/4"	50

PART#	BOLT SIZE	BOX
316010	1/4"	100
316020	5/16"	100
316030	3/8"	100
316040	7/16"	50
316050	1/2"	50
316060	9/16"	50
316070	5/8"	25
316080	3/4"	25
316090	7/8"	25
316100	1"	25

1 General Fasteners

**EXTERNAL AND INTERNAL
LOCK WASHERS**
ZINC CHROMATE



INTERNAL
TYPE



EXTERNAL
TYPE

SCREW SIZE	EXTERNAL PROD#	INTERNAL PROD#	BOX
#4	325040	320010	100
#6	325050	320020	100
#8	325060	320030	100
#10	325070	320040	100
#12	325080	320050	100
1/4"	325010	320060	100
5/16"	325020	320070	100
3/8"	325030	320080	100

TRIM WASHERS
NICKEL ON BRASS



COUNTERSUNK TYPE



FLANGED TYPE



FLUSH TYPE

SIZE	COUNTERSUNK PROD#	FLANGED PROD#	FLUSH PROD#	BOX
#4	330030			100
#6	330040	330050	330005	100
#8	330070	330080	330006	100
#10	330110	330120		100
#14	330130			100

FRAME MACHINE FASTENERS

GRADE 8 HARDENED BOLTS & KITS

SIZE	BOLT ONLY PROD. #	QTY.	BOLT, WASHER & NUT KIT PROD. #
1/2-13 x 2"	81050425	610504*
1/2-13 x 2-1/2"	81050625	610506*
1/2-13 x 3"	81050825	610508*
1/2-13 x 3-1/2"	81051010	610510*
5/8-11 x 2"	81070410	610704*
5/8-11 x 2-1/2"	81070610	610706*
5/8-11 x 3"	81070810	610708*
5/8-11 x 3-1/2"	81071010	610710*
5/8-11 x 4"	81071210	610712*
3/4-10 x 5"	81081510	610815*



*Each Kit contains 10 bolts, 20 SAE washers and 10 nuts except for kit # 610815 which contains 4 bolts, 8 SAE washers and 4 nuts.



GRADE 8 HEX NUTS

SIZE	PROD. #	BOX
1/2-13	83010450
5/8-11	83010625
3/4-10	83010725

GRADE 8 HEX HARDENED SAE FLAT WASHERS

BOLT SIZE	DIMENSIONS	PROD. #	BOX QTY
1/2"	17/32" I.D. x 1-1/16" O.D.	85010450
5/8"	21/32" I.D. x 1-5/16" O.D.	85010625
3/4"	13/16" I.D. x 1-1/2" O.D.	85010725



STAINLESS STEEL FASTENERS

1 General Fasteners

ACORN NUT STAINLESS STEEL 18-8



PROD #	SIZE	BOX
86500	6-32	100
86501	8-32	100
86502	10-24	100
86503	10-32	100
86504	1/4-20	100
86505	5/16-18	100

WING NUTS STAINLESS STEEL 18-8



PROD#	SIZE	BOX
86507	10-24	100
86508	1/4-20	100

NYLON INSERT LOCK NUTS STAINLESS STEEL 18-8



PROD#	SIZE	BOX
86530	6-32	100
86531	8-32	100
86532	10-24	100
86533	10-32	100
86534	1/4-20	100
86535	5/16-18	100
86536	3/8-16	100
86537	7/16-14	100
86538	1/2-13	100

HEX MACHINE NUTS STAINLESS STEEL 18-8



PROD#	SIZE	BOX
86510	6-32	100
86511	8-32	100
86512	10-24	100
86513	10-32	100
86514	1/4-20	100

FLAT WASHERS STAINLESS STEEL 18-8



PROD#	SIZE	BOX
86550	#6	100
86551	#8	100
86552	#10	100
86553	1/4"	100
86554	5/16"	100
86555	3/8"	100
86556	7/16"	100
86557	1/2"	100

FINISHED HEX NUTS STAINLESS STEEL 18-8



PROD#	SIZE	BOX
86520	1/4-20	100
86521	5/16-18	100
86522	3/8-16	100
86523	7/16-14	100
86524	1/2-13	100

FENDER WASHERS STAINLESS STEEL 18-8



PROD#	SIZE	BOX
86570	3/16" x 1"	100
86571	1/4" x 1-1/4"	100
86572	5/16" x 1-1/4"	100
86573	3/8" x 1-1/2"	100

LOCK WASHERS STAINLESS STEEL 18-8



PROD#	SIZE	BOX
86560	# 6	100
86561	# 8	100
86562	#10	100
86563	1/4"	100
86564	5/16"	100
86565	3/8"	100
86566	7/16"	100
86567	1/2"	100

STAINLESS STEEL FASTENERS

CAP SCREWS STAINLESS STEEL 18-8



PROD#	DESCRIPTION	BOX
86001	1/4-20 x 1/2"	100
86002	1/4-20 x 3/4"	100
86003	1/4-20 x 1"	100
86004	1/4-20 x 1-1/4"	100
86005	1/4-20 x 1-1/2"	100
86006	1/4-20 x 1-3/4"	100
86007	1/4-20 x 2"	100
86008	1/4-20 x 2-1/4"	50
86009	1/4-20 x 2-1/2"	50
86010	1/4-20 x 2-3/4"	50
86011	1/4-20 x 3"	50
86012	1/4-20 x 3-1/4"	50
86013	1/4-20 x 3-1/2"	50
86014	1/4-20 x 3-3/4"	50
86015	1/4-20 x 4"	50
86016	1/4-20 x 4-1/2"	25
86017	1/4-20 x 5"	25
86018	1/4-20 x 5-1/2"	25
86019	1/4-20 x 6"	25
86020	5/16-18 x 1/2"	100
86021	5/16-18 x 3/4"	100
86022	5/16-18 x 1"	100
86023	5/16-18 x 1-1/4"	100
86024	5/16-18 x 1-1/2"	100
86025	5/16-18 x 1-3/4"	100
86026	5/16-18 x 2"	100
86027	5/16-18 x 2-1/4"	50
86028	5/16-18 x 2-1/2"	50
86029	5/16-18 x 2-3/4"	50
86030	5/16-18 x 3"	50
86031	5/16-18 x 3-1/4"	25
86032	5/16-18 x 3-1/2"	25
86033	5/16-18 x 3-3/4"	25
86034	5/16-18 x 4"	25
86035	5/16-18 x 4-1/2"	25
86036	5/16-18 x 5"	25
86037	5/16-18 x 5-1/2"	25
86038	5/16-18 x 6"	25
86114	3/8-16 x 1/2"	100
86115	3/8-16 x 3/4"	100
86116	3/8-16 x 1"	100
86117	3/8-16 x 1-1/4"	100
86099	3/8-16 x 1-1/2"	100
86100	3/8-16 x 1-3/4"	50
86101	3/8-16 x 2"	50
86102	3/8-16 x 2-1/4"	50
86103	3/8-16 x 2-1/2"	50
86104	3/8-16 x 2-3/4"	50

PROD#	DESCRIPTION	BOX
86105	3/8-16 x 3"	50
86106	3/8-16 x 3-1/4"	25
86107	3/8-16 x 3-1/2"	25
86108	3/8-16 x 3-3/4"	25
86109	3/8-16 x 4"	25
86110	3/8-16 x 4-1/2"	25
86111	3/8-16 x 5"	25
86112	3/8-16 x 5-1/2"	25
86113	3/8-16 x 6"	25
86060	7/16-14 x 3/4"	50
86061	7/16-14 x 1"	50
86062	7/16-14 x 1-1/4"	50
86063	7/16-14 x 1-1/2"	50
86064	7/16-14 x 1-3/4"	50
86065	7/16-14 x 2"	50
86066	7/16-14 x 2-1/4"	25
86067	7/16-14 x 2-1/2"	25
86068	7/16-14 x 2-3/4"	25
86069	7/16-14 x 3"	25
86070	7/16-14 x 3-1/2"	25
86071	7/16-14 x 4"	25
86072	7/16-14 x 4-1/2"	25
86073	7/16-14 x 5"	25
86074	7/16-14 x 6"	25
86081	1/2-13 x 3/4"	50
86082	1/2-13 x 1"	50
86083	1/2-13 x 1-1/4"	50
86084	1/2-13 x 1-1/2"	50
86085	1/2-13 x 1-3/4"	50
86086	1/2-13 x 2"	50
86087	1/2-13 x 2-1/4"	25
86088	1/2-13 x 2-1/2"	25
86089	1/2-13 x 2-3/4"	25
86090	1/2-13 x 3"	25
86091	1/2-13 x 3-1/4"	25
86092	1/2-13 x 3-1/2"	25
86093	1/2-13 x 3-3/4"	25
86094	1/2-13 x 4"	25
86095	1/2-13 x 4-1/2"	25
86096	1/2-13 x 5"	25
86097	1/2-13 x 5-1/2"	25
86098	1/2-13 x 6"	25

STAINLESS STEEL FASTENERS

MACHINE SCREWS STAINLESS STEEL 18-8



SIZE	PHILLIPS OVAL PROD.#	BOX
6-32 x 1/2"	86275	100
6-32 x 3/4"	86276	100
6-32 x 1"	86277	100
6-32 x 1-1/4"	86278	100
8-32 x 1/2"	86279	100
8-32 x 3/4"	86280	100
8-32 x 1"	86281	100
8-32 x 1-1/4"	86282	100
10-24 x 1/2"	86283	100
10-24 x 3/4"	86284	100
10-24 x 1"	86285	100
10-24 x 1-1/4"	86286	100
10-24 x 1-1/2"	86287	100
10-24 x 1-3/4"	86298	100
10-24 x 2"	86299	50
10-24 x 2-1/4"	86300	50
10-24 x 2-1/2"	86301	50
10-24 x 2-3/4"	86302	50
10-24 x 3"	86303	50
10-32 x 1/2"	86288	100
10-32 x 3/4"	86289	100
10-32 x 1"	86290	100
10-32 x 1-1/4"	86291	100
10-32 x 1-1/2"	86292	100
10-32 x 1-3/4"	86304	100
10-32 x 2"	86305	50
10-32 x 2-1/4"	86306	50
10-32 x 2-1/2"	86307	50
10-32 x 2-3/4"	86308	50
10-32 x 3"	86309	50
1/4-20 x 1/2"	86293	100
1/4-20 x 3/4"	86294	100
1/4-20 x 1"	86295	100
1/4-20 x 1-1/4"	86296	100
1/4-20 x 1-1/2"	86297	100
1/4-20 x 1-3/4"	86310	100
1/4-20 x 2"	86311	50
1/4-20 x 2-1/4"	86312	50
1/4-20 x 2-1/2"	86313	50
1/4-20 x 2-3/4"	86314	50
1/4-20 x 3"	86315	50

SIZE	PHILLIPS PAN PROD.#	BOX
6-32 x 1/2"	86340	100
6-32 x 3/4"	86341	100
6-32 x 1"	86342	100
6-32 x 1-1/4"	86343	100
8-32 x 1/2"	86344	100
8-32 x 3/4"	86345	100
8-32 x 1"	86346	100
8-32 x 1-1/4"	86347	100
10-24 x 1/2"	86348	100
10-24 x 3/4"	86349	100
10-24 x 1"	86350	100
10-24 x 1-1/4"	86351	100
10-24 x 1-1/2"	86352	100
10-24 x 1-3/4"	86353	100
10-24 x 2"	86354	50
10-24 x 2-1/4"	86355	50
10-24 x 2-1/2"	86356	50
10-24 x 2-3/4"	86357	50
10-24 x 3"	86358	50
10-32 x 1/2"	86359	100
10-32 x 3/4"	86360	100
10-32 x 1"	86361	100
10-32 x 1-1/4"	86362	100
10-32 x 1-1/2"	86363	100
10-32 x 1-3/4"	86364	100
10-32 x 2"	86365	50
10-32 x 2-1/4"	86366	50
10-32 x 2-1/2"	86367	50
10-32 x 2-3/4"	86368	50
10-32 x 3"	86369	50
1/4-20 x 1/2"	86370	100
1/4-20 x 3/4"	86371	100
1/4-20 x 1"	86372	100
1/4-20 x 1-1/4"	86373	100
1/4-20 x 1-1/2"	86374	100
1/4-20 x 1-3/4"	86375	100
1/4-20 x 2"	86376	50
1/4-20 x 2-1/4"	86377	50
1/4-20 x 2-1/2"	86378	50
1/4-20 x 2-3/4"	86379	50
1/4-20 x 3"	86380	50

DISC

STAINLESS STEEL FASTENERS

TAPPING SCREWS

STAINLESS STEEL

18-8



**PHILLIPS
PAN HEAD**



**PHILLIPS
OVAL**

PHILLIPS PAN		PHILLIPS OVAL	
PROD.#	BOX	PROD.#	BOX
# 6 x 1/2".....	86200 100	# 6 x 1/2".....	86250100
# 6 x 3/4".....	86201 100	# 6 x 3/4".....	86251100
# 6 x 1".....	86202 100	# 6 x 1".....	86252100
# 6 x 1-1/4".....	86203 100	# 6 x 1-1/4".....	86253100
# 8 x 1/2".....	86204 100	# 8 x 1/2".....	86254100
# 8 x 3/4".....	86205 100	# 8 x 3/4".....	86255100
# 8 x 1".....	86206 100	# 8 x 1".....	86256100
# 8 x 1-1/4".....	86207 100	# 8 x 1-1/4".....	86257100
# 8 x 1-1/2".....	86208 100	# 8 x 1-1/2".....	86258100
#10 x 1/2".....	86209 100	#10 x 1/2".....	86259100
#10 x 3/4".....	86210 100	#10 x 3/4".....	86260100
#10 x 1".....	86211 100	#10 x 1".....	86261100
#10 x 1-1/4".....	86212 100	#10 x 1-1/4".....	86262100
#10 x 1-1/2".....	86213 100	#10 x 1-1/2".....	86263100
#10 x 1-3/4".....	86214 100	#10 x 1-3/4".....	86264100
#12 x 1/2".....	86215 100	#12 x 3/4".....	86265100
#12 x 3/4".....	86216 100	#12 x 1".....	86266100
#12 x 1".....	86217 100	#12 x 1-1/4".....	86267100
#12 x 1-1/4".....	86218 100	#12 x 1-1/2".....	86268100
#12 x 1-1/2".....	86219 100		
#14 x 1/2".....	86220 100		
#14 x 3/4".....	86221 100		
#14 x 1".....	86222 100		
#14 x 1-1/4".....	86223 100		
#14 x 1-1/2".....	86224 100		

1
General Fasteners

<p>85010-100 Box 100</p>  <p>85010 1/4-20 Tee Nut Stainless Box Qty. 25</p>	 <p>85130 5/16" AN Washer ID: 11/64" OD: 9/16" Thickness: 1/16" Stainless Box Qty. 100</p>	 <p>85131 Stainless Steel 3/8" AN Washer ID: 3/8" OD: 5/8" Thickness: 1/16" Box Qty. 100</p>	 <p>85255 #14 x 3/4" Phillip Truss Head Tapping Screw Stainless Box Qty. 50</p>	 <p>85260 410 Hardened Stainless Steel Black Zinc Plated 10-16 x 1" Phillips Pan Head Self Drilling Screw Box Qty. 100</p>
 <p>85261 410 Hardened Stainless Steel 10-16 x 1" Phillips Pan Head Self Drilling Screw Box Qty. 100</p>	 <p>85574 10-32 x 1/2" Phillip Truss Head Machine Screw Stainless Box Qty. 100</p>			

STAINLESS STEEL FASTENERS

1 General Fasteners

1

BLANK

METRIC FASTENERS

REGULAR PITCH METRIC CAP SCREWS

DIN 931 & DIN 933
ZINC PLATED



8.8 Heat Treated Alloy Steel
Tensile Strength: 113,000 PSI Min. to
142,000 Max.

PROD.	DIA/PITCH	LENGTH	BOX
<i>Hex Head Size 7mm</i>			
860410	4MM-.7	10MM	50
860416	4MM-.7	16MM	50
860420	4MM-.7	20MM	50
860425	4MM-.7	25MM	50
860430	4MM-.7	30MM	50
<i>Hex Head Size 8mm</i>			
860510	5MM-.8	10MM	50
860516	5MM-.8	16MM	50
860520	5MM-.8	20MM	50
860525	5MM-.8	25MM	50
860530	5MM-.8	30MM	50
860535	5MM-.8	35MM	50
860540	5MM-.8	40MM	50
860545	5MM-.8	45MM	50
860550	5MM-.8	50MM	50
<i>Hex Head Size 10mm</i>			
860610	6MM-1.00	10MM	50
860612	6MM-1.00	12MM	50
860616	6MM-1.00	16MM	50
860620	6MM-1.00	20MM	50
860625	6MM-1.00	25MM	50
860630	6MM-1.00	30MM	50
860635	6MM-1.00	35MM	50
860640	6MM-1.00	40MM	50
860645	6MM-1.00	45MM	50
860650	6MM-1.00	50MM	50
860660	6MM-1.00	60MM	50
860665	6MM-1.00	65MM	50
<i>Hex Head Size 11mm</i>			
860716	7MM-1.00	16MM	50
860720	7MM-1.00	20MM	50
860725	7MM-1.00	25MM	50
860730	7MM-1.00	30MM	50
860735	7MM-1.00	35MM	50
860740	7MM-1.00	40MM	50
860745	7MM-1.00	45MM	50
<i>Hex Head Size 13mm</i>			
860810	8MM-1.25	10MM	50
860812	8MM-1.25	12MM	50
860816	8MM-1.25	16MM	50
860820	8MM-1.25	20MM	50
860825	8MM-1.25	25MM	50
860830	8MM-1.25	30MM	50
860835	8MM-1.25	35MM	50
860840	8MM-1.25	40MM	50
860845	8MM-1.25	45MM	25
860850	8MM-1.25	50MM	25
860855	8MM-1.25	55MM	25
860860	8MM-1.25	60MM	25
860865	8MM-1.25	65MM	25
860870	8MM-1.25	70MM	25
860875	8MM-1.25	75MM	25

NEW
NEW
NEW

NEW

NEW
NEW

PROD	DIA/PITCH	LENGTH	BOX
860890	8MM-1.25	90MM	10
860900	8MM-1.25	100MM	10
860910	8MM-1.25	110MM	10
860920	8MM-1.25	120MM	10
<i>Hex Head Size 17mm</i>			
861012	10MM-1.50	12MM	25
861016	10MM-1.50	16MM	25
861020	10MM-1.50	20MM	25
861025	10MM-1.50	25MM	25
861030	10MM-1.50	30MM	25
861035	10MM-1.50	35MM	25
861040	10MM-1.50	40MM	25
861045	10MM-1.50	45MM	25
861050	10MM-1.50	50MM	25
861055	10MM-1.50	55MM	10
861060	10MM-1.50	60MM	10
861065	10MM-1.50	65MM	10
861070	10MM-1.50	70MM	10
861075	10MM-1.50	75MM	10
861080	10MM-1.50	80MM	10
861085	10MM-1.50	85MM	10
861090	10MM-1.50	90MM	10
861110	10MM-1.50	110MM	10
861120	10MM-1.50	120MM	10
<i>Hex Head Size 19mm</i>			
861220	12MM-1.75	20MM	25
861225	12MM-1.75	25MM	25
861230	12MM-1.75	30MM	25
861235	12MM-1.75	35MM	25
861240	12MM-1.75	40MM	25
861245	12MM-1.75	45MM	10
861250	12MM-1.75	50MM	10
861255	12MM-1.75	55MM	10
861260	12MM-1.75	60MM	10
861265	12MM-1.75	65MM	10
861270	12MM-1.75	70MM	10
861275	12MM-1.75	75MM	10
861280	12MM-1.75	80MM	10
861285	12MM-1.75	85MM	10
861290	12MM-1.75	90MM	10
861300	12MM-1.75	100MM	10
861310	12MM-1.75	110MM	10
861320	12MM-1.75	120MM	10

NEW
NEW

2

Metric Fasteners

METRIC FASTENERS

FINE THREAD METRIC CAP SCREWS

DIN 960 & DIN 961
ZINC PLATED



8.8 Heat Treated Alloy Steel
Tensile Strength: 113,00 PSI Min. To
142,000 PSI Max.

Metric Fasteners

2

PRODUCT NUMBER	DIAMETER & PITCH	LENGTH	BOX QTY
<i>Hex Size 13mm</i>			
8708168MM - 1.0016MM.....	10
8708208MM - 1.0020MM.....	10
8708258MM - 1.0025MM.....	10
8708308MM - 1.0030MM.....	10
8708358MM - 1.0035MM.....	10
8708408MM - 1.0040MM.....	10
8708508MM - 1.0050MM.....	10
8708558MM - 1.0055MM.....	10
8708608MM - 1.0060MM.....	10
8708708MM - 1.0070MM.....	10
8708758MM - 1.0075MM.....	10
<i>Hex Size 17mm</i>			
87102010MM - 1.2520MM.....	10
87102510MM - 1.2525MM.....	10
87103010MM - 1.2530MM.....	10
87103510MM - 1.2535MM.....	10
87104010MM - 1.2540MM.....	10
87104510MM - 1.2545MM.....	10
87105010MM - 1.2550MM.....	10
87105510MM - 1.2555MM.....	10
87106010MM - 1.2560MM.....	10
87107010MM - 1.2570MM.....	10
87109010MM - 1.2590MM.....	10
87110010MM - 1.25100MM.....	10
<i>Hex Size 19mm</i>			
87122012MM - 1.5020MM.....	10
87122512MM - 1.5025MM.....	10
87123012MM - 1.5030MM.....	10
87123512MM - 1.5035MM.....	10
87124012MM - 1.5040MM.....	10
87124512MM - 1.5045MM.....	10
87125012MM - 1.5050MM.....	10
87125512MM - 1.5055MM.....	10
87126012MM - 1.5060MM.....	10
87127012MM - 1.5070MM.....	10
88122012MM - 1.2520MM.....	10
88122512MM - 1.2525MM.....	10
88123012MM - 1.2530MM.....	10
88123512MM - 1.2535MM.....	10
88124012MM - 1.2540MM.....	10
88124512MM - 1.2545MM.....	10
88125012MM - 1.2550MM.....	10
88125512MM - 1.2555MM.....	10
88126012MM - 1.2560MM.....	10
88128012MM - 1.2580MM.....	10
88129012MM - 1.2590MM.....	10
88130012MM - 1.25100MM.....	10

METRIC FASTENERS

NEW

REGULAR PITCH METRIC CAP SCREWS

CLASS 10.9, DIN 931 & DIN 933
YELLOW ZINC FINISH

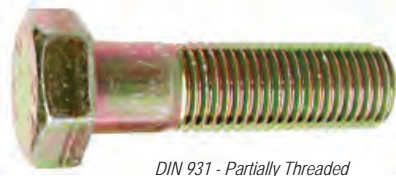

DIN 931 - Partially Threaded



DIN 933 - Full Threaded

10.9

2

Metric Fasteners

PROD. NO.	DIAMETER & PITCH	LENGTH	DIN	BOX QTY
<i>Hex Head Size: 10mm</i>				
862000	6MM-1.00	10MM	933	50
862080	6MM-1.00	12MM	933	25
862081	6MM-1.00	16MM	933	25
862001	6MM-1.00	20MM	933	25
862002	6MM-1.00	25MM	933	25
862003	6MM-1.00	30MM	933	25
862004	6MM-1.00	40MM	933	25
862005	6MM-1.00	50MM	931	25
862006	6MM-1.00	60MM	931	25
862007	6MM-1.00	70MM	931	25
862008	6MM-1.00	80MM	931	25
<i>Hex Head Size: 13mm</i>				
862082	8MM-1.25	12MM	933	25
862009	8MM-1.25	16MM	933	25
862010	8MM-1.25	20MM	933	25
862011	8MM-1.25	25MM	933	25
862012	8MM-1.25	30MM	933	25
862013	8MM-1.25	40MM	933	25
862014	8MM-1.25	50MM	931	25
862015	8MM-1.25	60MM	931	25
862016	8MM-1.25	70MM	931	25
862017	8MM-1.25	80MM	931	25
<i>Hex Head Size: 17mm</i>				
862083	10MM-1.50	16MM	933	25
862018	10MM-1.50	20MM	933	25
862019	10MM-1.50	25MM	933	25
862020	10MM-1.50	30MM	933	25
862021	10MM-1.50	40MM	933	15
862022	10MM-1.50	50MM	931	15
862023	10MM-1.50	60MM	931	10
862024	10MM-1.50	70MM	931	5
862025	10MM-1.50	80MM	931	5

PROD. NO.	DIAMETER & PITCH	LENGTH	DIN	BOX QTY
<i>Hex Head Size: 19mm</i>				
862026	12MM-1.75	20MM	933	10
862027	12MM-1.75	25MM	933	10
862028	12MM-1.75	30MM	933	10
862029	12MM-1.75	40MM	933	10
862030	12MM-1.75	50MM	933	10
862031	12MM-1.75	60MM	933	10
862032	12MM-1.75	70MM	931	10
862033	12MM-1.75	80MM	931	10
<i>Hex Head Size: 21mm</i>				
862034	14MM-2.00	25MM	933	10
862035	14MM-2.00	30MM	933	10
862036	14MM-2.00	40MM	933	5
862037	14MM-2.00	50MM	933	5
862038	14MM-2.00	60MM	933	5
862039	14MM-2.00	70MM	931	5
862040	14MM-2.00	80MM	931	5
<i>Hex Head Size: 24mm</i>				
862041	16MM-2.00	20MM	933	5
862042	16MM-2.00	30MM	933	5
862043	16MM-2.00	40MM	933	5
862044	16MM-2.00	50MM	933	5
862045	16MM-2.00	60MM	931	5
862046	16MM-2.00	70MM	931	5
862047	16MM-2.00	80MM	931	5

See Class 10.9 Flat Washers,
Lock Washers and Nuts
on the following page!

METRIC FASTENERS

NEW

METRIC FLAT WASHERS

CLASS 10.9, DIN 125-A
YELLOW ZINC FINISH



10.9

PROD. NO.	SIZE	INSIDE DIA	OUTSIDE DIA	BOX QTY
8620506MM 6.3MM15MM 100
8620518MM 8.4MM17MM 100
86205210MM 1.5MM21MM 50
86205312MM 13MM24MM 50
86205414MM 15MM28MM 25
86205516MM 17MM30MM 25

NEW

METRIC LOCK WASHERS

CLASS 10.9, DIN 127-B
YELLOW ZINC FINISH



10.9

PROD. NO.	SIZE	INSIDE DIA	OUTSIDE DIA	BOX QTY
8620606MM 6.10MM 11.50MM 100
8620618MM 8.20MM 14.40MM 100
86206210MM10.20MM 17.50MM 50
86206312MM12.20MM20.30MM 50
86206414MM14.20MM23.40MM 25
86206516MM16.20MM27.40MM 25

NEW

METRIC HEX NUTS

CLASS 10
YELLOW ZINC FINISH



10.9

PROD. NO.	SIZE	HEX SIZE	BOX QTY
862070 6-1.00MM 10MM 100
862071 8-1.25MM 13MM 100
86207210-1.50MM 17MM 50
86207312-1.75MM 19MM 50
86207414-2.00MM 21MM 25
86207516-2.00MM 24MM 25

METRIC FASTENERS



METRIC HEX NUTS

CLASS 8

DIN 934

ZINC PLATED

TENSILE STRENGTH: 116, 000 MAX.

METRIC NYLON INSERT LOCK NUTS

DIN 985
REGULAR PITCH
HEAT TREATED ALLOY STEEL
ZINC PLATED



PRODUCT NUMBER	DIAMETER & PITCH	BOX QTY
896004	4MM - .70 <i>7mm Hex Width</i>	50
896005	5MM - .80 <i>8mm Hex Width</i>	50
896006	6MM - 1.00 <i>10mm Hex Width</i>	50
896008	8MM - 1.25 <i>13mm Hex Width</i>	50
896010	10MM - 1.50 <i>17mm Hex Width</i>	50
896012	12MM - 1.75 <i>19mm Hex Width</i>	50

PRODUCT NUMBER	DIA & PITCH	WRENCH * SIZE	BOX QTY
8910033MM - .5C 50
8910044MM - .7C 7MM..... 50
8910055MM - .8C 8MM..... 50
8910066MM - 1.00C 10MM..... 50
8910077MM - 1.00C 11MM..... 50
8910088MM - 1.25C 13MM..... 50
8920088MM - 1.00F 13MM..... 50
89101010MM - 1.50C 17MM..... 25
89201010MM - 1.25F 17MM..... 25
89301010MM - 1.00F 17MM..... 10
89101212MM - 1.75C 19MM..... 25
89201212MM - 1.50F 19MM..... 25
89301212MM - 1.25F 19MM..... 10
89101414MM - 2.00C 22MM..... 25

* C = COARSE THREAD / F = FINE THREAD

METRIC SPIN LOCK NUTS

With Serrations
STANDARD FLANGE
CASE HARDENED
ZINC PLATED



PART#	THREAD SIZE	FLANGE O.D.	HEX SIZE	BOX QTY
880006M6-1.014MM10MM50
880008M8-1.2517MM12MM50
880011M10-1.2519MM14MM25

METRIC LOCK NUTS

COPPER PLATED STEEL
SLOTTED ROUND TOP



PRODUCT NUMBER	DIA. & PITCH	HEX WIDTH	BOX QTY
8961006MM - 1.0010MM25

METRIC FASTENERS

METRIC FLAT WASHERS

DIN 125
ZINC PLATED



PRODUCT NUMBER	SCREW SIZE	DIMENSION		BOX QTY
		I.D.	O.D.	
894003	3MM	3.3MM	--	100
894004	4MM	4.3MM	9MM	100
894005	5MM	5.3MM	11MM	100
894006	6MM	6.4MM	12MM	100
894007	7MM	7.4MM	14MM	100
894008	8MM	8.4MM	17MM	100
894010	10MM	10.5MM	21MM	50
894012	12MM	13MM	24MM	50
894014	14MM	15MM	28MM	50

METRIC LOCK WASHERS

SPRING STEEL
DIN 127
ZINC PLATED



PRODUCT NUMBER	SCREW SIZE	DIMENSION		BOX QTY
		I.D.	O.D.	
895003	3MM	3.1MM	--	100
895004	4MM	4.1MM	7.6MM	100
895005	5MM	5.1MM	9.2MM	100
895006	6MM	6.1MM	11.8MM	100
895007	7MM	7.1MM	12.8MM	100
895008	8MM	8.1MM	14.8MM	100
895010	10MM	10.2MM	18MM	100
895012	12MM	12.2MM	21.1MM	50
895014	14MM	14.2MM	24.1MM	50

METRIC SPRING WASHERS

SPRING STEEL
DIN 137
ZINC PLATED



PRODUCT NUMBER	SCREW SIZE	DIMENSION		THICKNESS	BOX QTY
		I.D.	O.D.		
317000	8MM	8.4MM	15MM	0.5MM	50
317010	10MM	10.5MM	18MM	0.8MM	25

METRIC FASTENERS

J.I.S. SMALL HEAD HEX FLANGE BOLTS

J.I.S. B1189, I.S.O. CLASS 10.9
ZINC PLATED



PART NO.	SIZE	HEX SIZE	FLANGE O.D.	BOX QTY
880612	M6-1.0 X 12MM	10MM	14MM	50
880616	M6-1.0 X 16MM	10MM	14MM	50
880620	M6-1.0 X 20MM	10MM	14MM	50
880625	M6-1.0 X 25MM	10MM	14MM	25
880630	M6-1.0 X 30MM	10MM	14MM	25
880635	M6-1.0 X 35MM	10MM	14MM	25
880640	M6-1.0 X 40MM	10MM	14MM	25
880645	M6-1.0 X 45MM	10MM	14MM	25
880650	M6-1.0 X 50MM	10MM	14MM	10
880655	M6-1.0 X 55MM	10MM	14MM	10
880660	M6-1.0 X 60MM	10MM	14MM	10
880812	M8-1.25 X 12MM	12MM	17.5MM	25
880816	M8-1.25 X 16MM	12MM	17.5MM	15
880817	M8-1.25 X 16MM	12MM	17.5MM	50
880820	M8-1.25 X 20MM	12MM	17.5MM	15
880821	M8-1.25 X 20MM	12MM	17.5MM	50
880825	M8-1.25 X 25MM	12MM	17.5MM	15
880830	M8-1.25 X 30MM	12MM	17.5MM	15
880835	M8-1.25 X 35MM	12MM	17.5MM	15
880840	M8-1.25 X 40MM	12MM	17.5MM	15
880845	M8-1.25 X 45MM	12MM	17.5MM	15
880850	M8-1.25 X 50MM	12MM	17.5MM	10
880855	M8-1.25 X 55MM	12MM	17.5MM	10
880860	M8-1.25 X 60MM	12MM	17.5MM	10
881016	M10-1.25 x 16MM	14MM	20MM	10
881020	M10-1.25 x 20MM	14MM	20MM	10
881025	M10-1.25 x 25MM	14MM	20MM	10
881030	M10-1.25 x 30MM	14MM	20MM	10
881035	M10-1.25 x 35MM	14MM	20MM	10
881040	M10-1.25 x 40MM	14MM	20MM	10
881045	M10-1.25 x 45MM	14MM	20MM	10
881050	M10-1.25 X 50MM	14MM	21MM	10
881055	M10-1.25 X 55MM	14MM	21MM	10
881060	M10-1.25 X 60MM	14MM	21MM	10

J.I.S. SMALL HEX NUTS

J.I.S. B1180 - STEEL
HEAT TREATED, ZINC PLATED
I.S.O. CLASS 8.8



PART NO.	PITCH DIAMETER	HEX WIDTH	BOX QTY
881008	8MM - 1.25	12MM	25
881009	8MM - 1.25	12MM	100
881010	10MM - 1.25	14MM	15
881011	10MM - 1.25	14MM	50
881012	12MM - 1.25	17MM	25

J.I.S. SMALL HEAD CAP SCREWS

J.I.S. B1180 - STEEL
HEAT TREATED
I.S.O. CLASS 8.8
ZINC PLATED

J.I.S. fasteners have a smaller hex dimension across-the-flats than DIN or ISO metric fasteners. They fit in those tight spots where the hex of an ISO or DIN fastener is too large. J. I. S. fasteners are OEM equipment on many GM and Japanese import cars.



PART NO.	DIA. & LENGTH	BOX QTY
<i>M8-1.25</i> (Across-the-Flats: 12MM)		
850816	8MM X 16MM	25
850820	8MM X 20MM	25
850825	8MM X 25MM	25
850830	8MM X 30MM	25
850835	8MM X 35MM	25
850840	8MM X 40MM	25
850845	8MM X 45MM	25
850850	8MM X 50MM	25
850870	8MM X 70MM	10
<i>M10-1.25</i> (Across-The-Flats: 14MM)		
851020	10MM X 20MM	25
851025	10MM X 25MM	25
851030	10MM X 30MM	10
851035	10MM X 35MM	10
851040	10MM X 40MM	10
851045	10MM X 45MM	10
851050	10MM X 50MM	10
851060	10MM X 60MM	10
851070	10MM X 70MM	10
<i>M12-1.25</i> (Across-The-Flats: 17MM)		
851220	12MM X 20MM	10
851225	12MM X 25MM	10
851230	12MM X 30MM	10
851235	12MM X 35MM	10
851240	12MM X 40MM	10
851245	12MM X 50MM	10

METRIC FASTENERS

METRIC MACHINE SCREWS PHILLIPS PAN HEAD

REGULAR PITCH
DIN 7985
ZINC PLATED



PROD. NO.	DIA.	LENGTH	BOX QTY.
8973063MM6MM 100
8973083MM8MM 100
8973103MM10MM 100
8973123MM12MM 100
8973163MM16MM 100
8973203MM20MM 100
8974064MM6MM 100
8974084MM8MM 100
8974104MM10MM 100
8974124MM12MM 100
8974164MM16MM 100
8974204MM20MM 100
8975085MM8MM 100
8975105MM10MM 100
8975125MM12MM 100
8975165MM16MM 100
8975205MM20MM 100
8975255MM25MM 100
8976106MM10MM 50
8976126MM12MM 50
8976166MM16MM 50
897616-10006MM16MM 1000
8976206MM20MM 50
8976256MM25MM 50
8976306MM30MM 50

METRIC MACHINE SCREWS PHILLIPS OVAL

REGULAR PITCH
DIN 966
ZINC PLATED



PRODUCT NUMBER	DESCRIPTION	BOX QTY
303310 6MM X 1.00 X 25MM 25
303317 6MM X 1.00 X 40MM 25
303318 6MM X 1.00 X 60MM 25

METRIC MACHINE SCREWS PHILLIPS FLAT HEAD

REGULAR PITCH
DIN 965
ZINC PLATED



PROD. NO.	DIA.	LENGTH	BOX QTY
8983063MM6MM 100
8983083MM8MM 100
8983103MM10MM 100
8983163MM16MM 100
8984064MM6MM 100
8984084MM8MM 100
8984104MM10MM 100
8984164MM16MM 100

METRIC FASTENERS

PRODUCT NUMBER	DIAMETER & PITCH	LENGTH	BOX QTY
890406	4MM - .7	6MM	50
890410	4MM - .7	10MM	50
890416	4MM - .7	16MM	50
890506	5MM - .8	6MM	50
890510	5MM - .8	10MM	50
890516	5MM - .8	16MM	50
890520	5MM - .8	20MM	50
890525	5MM - .8	25MM	50
890610	6MM - 1.00	10MM	50
890616	6MM - 1.00	16MM	50
890616-500	6MM - 1.00	16MM	500
890620	6MM - 1.00	20MM	50
890625	6MM - 1.00	25MM	50
890816	8MM - 1.25	16MM	50
890820	8MM - 1.25	20MM	50
890825	8MM - 1.25	25MM	50

METRIC MACHINE SCREWS
SLOTTED PAN HEAD
 DIN 85
 ZINC PLATED



DISC

DISC

DISC

METRIC FASTENERS

BLANK

PANEL BLIND RIVETS

*Aluminum Rivets:
Aluminum Rivet/Aluminum Mandrel
IFI Grade 11*

*Steel Rivets:
Plated Steel Rivet/Coated Steel Mandrel
IFI Grade 30*

PANEL BLIND RIVETS

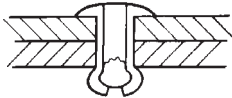

Dome Head - Most popular for industrial applications. The low profile head diameter is twice the rivet body diameter, providing adequate bearing surface for nearly all applications.

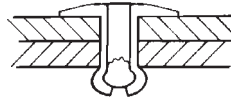

Large Flange - Provides greater bearing surface for fastening soft and brittle facing materials such as plywood and plastics including, vinyl, etc.

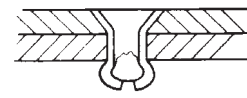

Countersunk - for applications where a flush appearance is required.

PART NO.	PKG. QUANTITY			RIVET DIA	HEAD STYLE	IND #	PANEL RANGE	RIVET LENGTH	METAL TYPE
	100	250	500						
13040	-	13041	-	3/32"	DOME	34	UP TO 1/4"	3/8"	ALUMINUM
14020	-	14021	14024	1/8"	DOME	42	UP TO 1/8"	7/32"	ALUMINUM
14022	-	14023	14025	1/8"	LG FLG	42	UP TO 1/8"	7/32"	ALUMINUM
34020	-	34021	34022	1/8"	DOME	42	UP TO 1/8"	7/32"	STEEL
14040	-	14041	14044	1/8"	DOME	44	UP TO 1/4"	3/8"	ALUMINUM
14042	-	14043	14045	1/8"	LG FLG	44	UP TO 1/4"	3/8"	ALUMINUM
34040	-	34041	34044	1/8"	DOME	44	UP TO 1/4"	3/8"	STEEL
34043	-	34042	-	1/8"	CNTRS NK	44	UP TO 1/4"	3/8"	STEEL
14060	-	14061	14062	1/8"	DOME	46	UP TO 3/8"	1/2"	ALUMINUM
34060	-	34061	34062	1/8"	DOME	46	UP TO 3/8"	1/2"	STEEL
14080	-	14081	14082	1/8"	DOME	48	UP TO 1/2"	11/16"	ALUMINUM
34080	-	34081	34082	1/8"	DOME	48	UP TO 1/2"	11/16"	STEEL
15040	15041	-	15042	5/32"	DOME	54	UP TO 1/4"	3/8"	ALUMINUM
15060	15061	-	-	5/32"	DOME	56	UP TO 3/8"	1/2"	ALUMINUM
16020	16021	-	-	3/16"	DOME	62	UP TO 1/8"	7/32"	ALUMINUM
16040	16041	-	16042	3/16"	DOME	64	UP TO 1/4"	3/8"	ALUMINUM
36041	-	-	-	3/16"	DOME	64	UP TO 1/4"	7/16"	STEEL
16060	16061	-	16064	3/16"	DOME	66	UP TO 3/8"	1/2"	ALUMINUM
36060	-	36061	-	3/16"	DOME	66	UP TO 3/8"	9/16"	STEEL
16062	16063	-	16065	3/16"	LG FLG	66	UP TO 3/8"	1/2"	ALUMINUM
16080	16081	-	16084	3/16"	DOME	68	UP TO 1/2"	11/16"	ALUMINUM
16082	16083	-	16085	3/16"	LG FLG	68	UP TO 1/2"	11/16"	ALUMINUM
16100	16101	-	16102	3/16"	DOME	610	UP TO 5/8"	3/4"	ALUMINUM
16103	-	-	16104	3/16"	LG FLG	610	UP TO 5/8"	3/4"	ALUMINUM

RIVET GUNS, PARTS, BACKUP WASHERS



17000 HEAVY DUTY RIVET GUN

For installing blind rivets ranging in size from 3/32" diameter to 3/16" diameter. Nosepieces are included. Overall length 9-1/2"

- Precision die cast body of high strength aluminum alloy.
- A steel insert into which the working nosepiece is screwed.
- Heat treated carbon steel upper handle.
- Long life jaws.
- A fulcrum pin that cannot rotate.

Box Qty. 1

REPLACEMENT NOSEPIECES & JAWS

For use with #17000 Heavy Duty Rivet Gun

Product No. Size

- | | | |
|--------------------|--|--|
| 17001 | 3/32" nosepiece | |
| 17002 | 1/8" nosepiece | |
| 17003 | 5/32" nosepiece | |
| 17004 | 3/16" nosepiece | |
| 17005 | Special Stand-Off Nosepiece
<i>Use with 1/8" stud rivets for
moulding clip installations.</i> | |
| 17008 | Replacement Jaws - one set | |

All of the above packaged 1 per box



17010 ECONOMY RIVET GUN

Lightweight, versatile and economical.

Will set 1/8" to 1/4" diameter rivets in all materials. Will also set window regulator and split-rivets with no extra nose piece needed.

Heavy Duty construction. Longer handles permit access to hard-to-reach areas. Comes with 1/4", 3/16", and 5/32" nosepieces. Box Qty. 1

BACK UP RIVET WASHERS

Steel



HOLE SIZE	DIA.	PROD NO BOX 100	PROD NO BX 1000
1/8"	3/8"	73400	34000
5/32"	7/16"	73500	35000
3/16"	1/2"	73600	36000
1/4"	1/2"	73800	38000
#10 or 3/16	1"	312010*	

(* #312010 is a zinc backup/fender washer)



17006 BIG DADDY RIVET GUN

Will set all rivets from 5/32" diameter to and including 1/4" diameter. Ideal to set window regulator rivets and glass stop rivets.

- Reduction gear design
- Die cast aluminum body
- Steel insert for nose piece

Box Qty. 1



17015 RIVET GUN NOSEPIECE EXTENDER ADAPTER KIT

For use with #17006 Big Daddy Rivet Gun.

Extends the reach by 2-1/2"

Box Qty. 1



17007

Nosepiece for setting 1/4" peel-type rivets with #17006 gun.

Box Qty. 1



17009

Replacement Jaws for #17006 rivet gun.

Box Qty. 1 set

RIVET GUNS / SPECIALTY RIVETS



41162
 ATEPRO.USA
 Heavy Duty Hand Riveter
 Ergonomic grip. Core collection bottle for safety and ease of disposal.
 Includes 5 nosepieces: 1/8" (3.2mm), 5/32" (4.0mm), 3/16" (4.8mm), 7/32" (6.0mm), 1/4" (6.4mm)
 Box Qty. 1

13001 Box 100



13000
 Stud Rivet
 Dia.: 1/8", Grip: 1/8" - 3/16"
 Flange Dia: .208
 Stainless Steel Rivet
 Steel Mandrel
 Narrow Flange for Moulding Clips
 Box Qty. 250



38505
 N805759-S100
 Dia.: 1/8", Grip: 1/8" - 3/16"
 Flange Dia: 3/8"
 Black Aluminum Rivet
 Aluminum Mandrel
 Windshield Side Rail
 Ford T-Bird & Mercury Cougar '89 - UP
 Box Qty. 50



38507
 6032856, 15622490
 Dia.: 1/8", Grip: 3/16" - 3/8"
 Flange Dia.: 5/16"
 Multi-Grip Type
 Black Aluminum Rivet
 Steel Mandrel
 Body Side Mouldings
 Universal Applications,
 Chrysler
 Box Qty. 25

NEW



38508
 Dia: 1/8"
 Grip: 1/16" - 1/8"
 Flange Dia: 3/8"
 Black Aluminum Rivet, Steel Mandrel
 Attachment of Door Glass Moulding
 Ford 1993 - UP
 Box Qty. 50



38519
 14160-03133
 Dia: 3.2mm (1/8")
 Grip: 4.0mm - 7.9mm (.158" - .311")
 Flange Dia: 6.3mm (1/4")
 Black Aluminum Rivet, Steel Mandrel
 Front/Rear Bumper
 Hyundai Accent, Azera, Elentra, Equus, Santa Fe, Santa Fe Sport, Tuscon, Veracruz & Kia Optima, Rondo, Sorento & Soul 2007 - UP
 Box Qty. 25



38530
 N803933-S101
 Dia.: 1/8" Grip: 13/64 - 9/32"
 Flange Dia.: 15/64"
 Closed End
 Black Aluminum Rivet
 Black Aluminum Mandrel
 Luggage Rack
 Ford
 Box Qty. 50



38572
 90269-04006
 Dia.: 1/8" (3.2mm)
 Grip: 3/64" - 5/32" (1.2mm - 4mm)
 Flange Dia.: 5/16" (8mm)
 Aluminum Rivet
 (Plastic Cap) /
 Steel Mandrel
 Lexus '98 - UP
 Box Qty. 10



38573
 90269-04051, 90269-A0006
 Dia.: 1/8" (3.2mm)
 Grip: 3/64" - 1/8" (1.2mm - 3.4mm)
 Flange Dia.: 15/64" (6mm)
 Aluminum Rivet (Plastic Cap) / Steel Mandrel
 Lexus '98 - UP
 Box Qty. 10

3

Rivets / Nuts / Etc.

SPECIALTY RIVETS

3 Rivets / Nuts / Etc.

1/8" Diameter (cont)



38574
 90269-04050
 Dia: 1/8" (3.2mm)
 Grip: 5/32" - 5/16" (4mm - 8mm)
 Flg Dia: 5/16" (8mm)
 Aluminum Rivet (w/ Plastic Cap),
 Steel Mandrel
 Windshield, Side & Trunk Moulding
 Lexus GS300, 400, 430 & SC430 98 - UP
 Box Qty. 15



38576
 90269-04053
 Dia: 1/8" (3.2mm)
 Grip: 1mm - 4.8mm
 Flange Dia.: 8mm
 Aluminum Rivet w/Nylon Cap
 Steel Mandrel
 Toyota Land Cruiser 1998 - UP
 Box Qty. 10



38578
 90269-04050
 Dia: 1/8" (3.2mm)
 Grip: 4mm - 8mm (5/32"-5/16")
 Flange Dia.: 8mm (5/16")
 Aluminum Rivet w/Nylon Cap
 Steel Mandrel
 Windshield, Side & Trunk Moulding
 Lexus 1998 - UP
 Toyota
 Box Qty. 15



38581
 14160-03103
 Dia: 3.2mm (1/8")
 Grip: 0.8mm-4.8mm
 (.032" - .189")
 Flange Dia: 6.3mm (1/4")
 Black Aluminum Rivet
 Steel Mandrel
 Front/Rear Bumper
 Hyundai Accent, Genesis, Santa Fe, Sonata &
 Veloster and Kia Borrego, K900, Rio, Sorrento
 & Sportage 2006 - UP
 Box Qty. 25



38751
 AD43-45BS
 Dia: 1/8" Grip: 5/32" - 5/16"
 Flange Dia: 1/4"
 Hole Size: .129"-.142"
 Multi-Grip Type
 Dome Head
 Aluminum Rivet
 Steel Mandrel
 Box Qty. 100

5/32" Diameter



38516
 6036148-AA
 Split-Type Rivet
 Dia: 5/32" G.R.: 3/64"-1/4"
 Flange Dia: 7/16"
 Aluminum Rivet (Black)
 Aluminum Mandrel
 Front Bumper, Trim Panel,
 Instrument Panel &
 Running Boards
 Chrysler 1999 - UP
 Box Qty. 25

NEW



38520
 W713819-S900
 Dia: 4mm (5/32")
 Grip Range: 1.2mm - 3.2mm
 (3/64" - 1/8")
 Flange Dia: 9mm (3/8")
 Closed End Specialty Rivet
 Black Aluminum Rivet (with
 Plastic Cap) / Steel Mandrel
 Cab & Exterior Trim
 Ford F-150 2009 - 2014
 Box Qty. 25



38522
 N807620-S100, 10131511, 11588308,
 6034212, 6036148AA
 Dia.: 5/32" Grip: 3/64" - 1/4"
 Flange Dia.: 5/16"
 Split-Type Rivet
 Black Aluminum Rivet
 Aluminum Mandrel
 Wheel Openings Lincoln '94 - UP
 Bumper Cover, Grille, Rocker Mldg.
 GM '97 - UP
 Bumper Cover Chrysler
 Box Qty. 25



38523
 9132667, 19352194
 Dia: 5/32" (4mm)
 Grip: 9/64" - 3/8" (3.6mm - 9.5mm)
 Flg Dia: 7/16" (11.1mm)
 Multi-Grip Type
 Aluminum Rivet
 Stainless Steel Mandrel
 Front & Rear Bumper
 Buick Regal & Verano; Chevy Avalanche,
 Camaro, Cruze, Malibu, Sonic & Volt 2010 - UP
 Box Qty. 25



38524
 92139150
 Dia: 5/32" (4mm)
 Grip: 11/64" - 11/32" (4.4mm - 8.5mm)
 Flg. Dia: 9/32" (7.1mm)
 Multi-Grip Type
 Aluminum Rivet
 Stainless Steel Mandrel
 Front Bumper & Grille
 Chevrolet Camaro 2012 - UP
 Box Qty. 25



38525
 9432137, 6032138
 Dia.: 5/32" Grip: 1/8" - 3/16"
 Flange Dia.: 5/16"
 Aluminum Rivet, Steel Mandrel
 Countersunk Head
 Trunk Lock Swivel Emblem Rivet
 Chrysler, GM '73 - UP
 Box Qty. 25

SPECIALTY RIVETS

5/32" Diameter (cont)



38571

GHP9-50-355
 Dia: 4mm (5/32")
 Grip: 5.6mm-9.6mm (.220" - .378")
 Flange Dia: 8mm (5/16")
 Black Aluminum Rivet
 Black Aluminum Mandrel
 Bumper, Grille & Upper Bracket
 Specialty Rivet
 Mazda 6 2014 - UP
 Box Qty. 25



38577

75547-51021
 Dia: 4mm (5/32")
 Grip: .8mm - 1.5mm
 Flange Dia.: 10.5mm
 Alum Rivet w/Nylon Cap
 Steel Mandrel
 Lexus IS250, IS350 & IS F 2006 - UP
 Toyota 2002 - UP
 Box Qty. 15



38582

BN8F-50-355
 Dia: 4mm (5/32")
 Grip: 1mm - 13mm (3/64" - 33/64")
 Flange Dia: 8mm (5/16")
 Aluminum Rivet
 Aluminum Mandrel
 Front Bumper, Grille, Specialty Rivet
 Mazda 3, 5, CX-3, CX-9, Miata &
 MX-5 2006 - UP
 Box Qty. 15



38584

11546343
 Dia: 4mm (5/32")
 Grip: 5mm - 12mm
 Flange Dia.: 8mm (5/16")
 Aluminum Rivet
 Aluminum Mandrel
 Front & Rear Bumper Cover
 Cadillac CT6 2016 - UP
 Chevrolet Camaro 2012 - UP
 Box Qty. 25



38607

N900-845-01
 Dia.: 5/32" Grip: 1/4" - 3/8"
 Flange Dia: 15/32"
 Black Aluminum Rivet,
 Steel Mandrel
 Wheel Opening Moulding Attachment
 VW Jetta, Rabbit & Golf
 Box Qty. 25



38608

16715497
 Dia.: 5/32" Grip: 3/64" - 1/4"
 Flange Dia.: 15/32"
 Multi-Grip Type
 Aluminum Rivet, Steel Mandrel
 Attaches Support Rails to Load Floor
 GM
 Box Qty. 50



38612

003-990-94-97, BBM450-355
 Dia.: 5/32" (4mm)
 Grip: 3/64" - 9/32" (1mm - 7mm)
 Flange Dia.: 5/16" (8mm)
 Split-Type Rivet
 Aluminum Rivet
 Aluminum Mandrel
 Bumpers
 Mazda 2012 - UP,
 Mercedes 2004 - UP
 Box Qty. 25



38622 Box 100

38620

979878-6
 Dia: 4mm (5/32")
 Grip: 3mm - 8.5mm (1/8" - 11/32")
 Flange: 12mm (15/32")
 Black Polyethylene Coated
 Aluminum Rivet
 Aluminum Mandrel
 Bumper & Wheel Housing
 Volvo '93 - UP
 Box Qty. 15



38714

01515-0009U
 Dia: 5/32" (4mm)
 Grip: 3/64" - 9/32" (1mm - 7mm)
 Flange Dia: 5/16" (8mm)
 Split-Type Rivet
 Black Aluminum Rivet
 Aluminum Mandrel
 Bumpers
 Nissan Pathfinder 2006 - UP
 Box Qty. 25



38756

AD53-55BS
 Dia: 5/32" Grip: 1/8" - 5/16"
 Flange Dia: 5/16"
 Hole Size: .160"-.0173
 Multi-Grip Type
 Dome Head
 Aluminum Rivet
 Steel Mandrel
 Box Qty. 50

3 Rivets / Nuts / Etc.

SPECIALTY RIVETS

3/16" Diameter

3 Rivets / Nuts / Etc.

38499 Box 25



38500

388664-S100
Dia.: 3/16" Grip: 3/8" - 1/2"
Flange Dia.: 9/16"
Black Aluminum Rivet
Aluminum Mandrel
Fascia, Bumper, Grille
Ford '82 - UP
Box Qty. 100



38506

390428-S100
Dia.: 3/16" Grip: 3/8" - 1/2"
Flange Dia.: 3/8"
Closed End
Black Aluminum Rivet
Black Aluminum Mandrel
Luggage Racks
General Purpose
Ford
Box Qty. 25



38509

9439719
Dia: 3/16" Grip: 1/4" - 3/8"
Flange Dia: 5/8"
Black Steel Rivet,
Steel Mandrel
Fascia to Underside Bumper
GM 81 - UP
Box Qty. 50

38511 Box 100



38510

25618730, N805592-S100
Dia.: 3/16" Grip: 5/64" - 15/64"
Flange Dia.: 7/16"
Split-Type Rivet
Black Aluminum Rivet
Aluminum Mandrel
Wheel House Moulding & General Purpose
Ford, GM
Box Qty. 25



38514

11516807
Split-Type Rivet
Dia: 3/16" (4.8mm)
Grip: 3/64" - 23/64" (1mm-9mm)
Flange Dia: 5/8" (16mm)
Black Aluminum Rivet
Aluminum Mandrel
Bumper Fascia & General Purpose
GM 1990 - UP
Box Qty. 25



38515

3/16" Dia. Aluminum Rivet
Grip Range: up to 1"
plus a 3/16" Back up Washer
Ford Bumper Pads
Box Qty. 25 Sets



38517

003-990-24-97
Dia: 3/16" (4.8mm)
Grip: 1/16" - 1/8"
(1.6mm - 3.2mm)
Flange Dia: 3/8" (9.5mm)
Steel Rivet, Steel Mandrel
Door Handle, Air Bag, Rocker
Moulding, Window Regulator
Mercedes-Benz 1998 - UP
Box Qty. 100

NEW



38521

W717984-S417
Dia: 4.8mm (3/16")
Grip Range: 1.6mm - 3.18mm
(.063" - .125")
Flange Dia: 9.5mm (3/8")
Closed End Specialty Rivet
Black Aluminum Rivet/Mandrel
Countersunk Head
Cab & Exterior Trim
Ford F-150 2015 - UP
Box Qty. 15



38568

90269-05054
Dia: 5mm (3/16")
Grip: 3mm - 8mm (1/8" - 5/16")
Flange: 14mm (9/16")
Aluminum Rivet w/Plastic Cap
Steel Mandrel
Windshield Side Mldg/Gas Filler Door
Toyota Camry & Sienna '97 - UP
Box Qty. 10



38569

90269-06013
Dia: 4.8mm (3/16")
Grip: 1.6mm - 6.35mm (1/16" - 1/4")
Flange: 14mm (9/16")
Aluminum Rivet w/Plastic Cap
Steel Mandrel
Gas Filler Door
Toyota Camry & Lexus IS300 2001-UP
Box Qty. 15



38575

9442361, 25609048, N804523S, N803138-S
Dia: 3/16" Grip: 3/64" - 13/64"
Flange Dia.: 9/16"
Split-Type Rivet
Black Aluminum Rivet / Steel Mandrel
Used in place of screws when attaching
new Catalytic Converter Heat Shield
Ford; Buick LeSabre & Roadmaster, Cadillac
Brougham and Oldsmobile 98 & 88 1986 - UP
Box Qty. 50



38579

90269-05065
Dia: 5mm (3/16")
Grip: 4mm - 7mm (5/32 - 9/32")
Flange Dia.: 13mm (1/2")
Aluminum Rivet w/Plastic Cap
Steel Mandrel
Bumpers/General Purpose
Lexus 2004 - UP
Box Qty. 10

SPECIALTY RIVETS

3/16" Diameter (con't)



38583
W525157-S300
 Dia: 3/16" (4.8mm)
 Grip: .126" - .250" (3.20mm - 6.35mm)
 Flange Dia: 3/8" (9.3mm)
 Aluminum Rivet
 Steele Mandrel
 Bumper & Lower Deflector
 Specialty Rivet
Ford Escape, Expedition & Taurus 2005 - UP
 Box Qty. 50



38611
90084-26001
 Dia.: 5mm (3/16")
 Grip: 3.2mm - 6.3mm
 Flange Dia.: 9.5mm
 Closed End Sealing Type Rivet
 Aluminum Rivet
 Aluminum Mandrel
 Windshield Side Moulding
Toyota Camry '97 - UP
 Box Qty. 50

NEW



38709
 Dia: 3/16"
 Grip: 1/16" - 17/64"
 Flange Dia: 3/8"
 Klik-Lock Structural Rivet
 Steel Rivet, Steel Mandrel
 Dome Head
 Box Qty. 25



38710
 Dia.: 3/16" Grip: 1/16" - 7/16"
 Klik-Lock Structural Rivet
 Steel Rivet, Steel Mandrel
 Dome Head
 Box Qty. 25



38711
 Dia: 3/16" (.187)
 Grip: .050 - .187
 Hole Size: .209 - .220
 Trifix Head
 Aluminum Rivet
 Aluminum Mandrel
 Box Qty. 100



38712
 Dia: 3/16" (.187)
 Grip: .187 - .437
 Hole Size: .177 - .433
 Trifix Head
 Aluminum Rivet
 Aluminum Mandrel
 Box Qty. 100



38713
22638717, 90671-SDA-A01
 Dia: 3/16" (4.8mm)
 Grip: 3/64" - 23/64" (1mm - 9mm)
 Flange Diameter: 5/8" (16mm)
 Split-Type Rivet
 Aluminum Rivet
 Aluminum Mandrel
 Bumper Fascia & General Purpose
GM 1987 - UP
Honda Civic 2016 - UP
 Box Qty. 100



38765
 Diameter: 3/16" Grip: 3/8 - 1/2"
 Flange Dia: 3/8"
 Length: 11/16"
 Dome Head
 Stainless Steel Rivet
 Stainless Steel Mandrel
 Blind Rivet
 Box Qty. 25

3 Rivets / Nuts / Etc.

SPECIALTY RIVETS

3 Rivets / Nuts / Etc.

1/4" Diameter

27999 Box 25



28000
6031115, 9436175, 385189-S100
Dia.: 1/4" Grip: 1/32" - 9/64"
Flange Dia.: 1/2"
Peel-Type Rivet
Aluminum Rivet
Steel Mandrel
Window Regulators
GM, Ford, Chrysler '71 - UP
Box Qty. 100

28002 Box 25



28001
6031091, 9437938, 385323-S100
Dia.: 1/4" Grip: 33/64" - 19/32"
Flange Dia.: 1/2"
Peel-Type Rivet
Aluminum Rivet
Steel Mandrel
Glass Stop, Window Regulator
GM, Ford, Chrysler '76 - UP
Box Qty. 100



38044
Dia.: 1/4" Grip: 1/4" to 3/8"
Steel Rivet
Steel Mandrel
Dome Head
Box Qty. 50



38060
AD86ABS, AB8-6A
Dia.: 1/4" Grip: 1/4" - 3/8"
Flange Dia.: 1/2"
Dome Head
Aluminum Rivet
Aluminum Mandrel
Box Qty. 25

38503 Box 25



38501
388442-S100
Dia.: 1/4" Grip: 1/8" - 1/4"
Flange Dia.: 3/4"
Black Steel Rivet
Steel Mandrel
Bumper Assembly
Ford Escort & Lynx '81 - UP
Box Qty. 100



38502
Dia.: 1/4" Grip: .080" - .375"
Flange Dia.: 33/64"
Monobolt Rivet
Aluminum Rivet
Aluminum Mandrel
Box Qty. 25



38504
388047-S102
Dia.: 1/4" Grip: 3/32" - 1/8"
Flange Dia.: 1/2"
Peel-Type Rivet
Black Aluminum Rivet
Steel Mandrel
Door Handle Assembly
Ford '81 - UP
Box Qty. 50



38512
11610383
Dia.: 1/4" Grip Range: 1/64" - 1/8"
Flange OD: 1/2"
Steel Rivet, Steel Mandrel
Step Bumper
GM Silverado & Sierra 2007 - UP
Box Qty. 50



38518
W705297-S300
Dia.: 1/4"
Grip: 3/16" - 3/8"
Flange Dia.: 11/16"
Split-Type Rivet
Aluminum Rivet
Aluminum Mandrel
Bumper Cover
Ford Fusion 2009 - UP
Box Qty. 15



38527
15022087
Dia.: 1/4" Grip: 3/64" - 5/64"
Flange Dia.: 19/32"
Shoulder Dia.: 13/32"
Steel Rivet (Zinc)
Steel Mandrel (Zinc)
Headlight Retainer
GM Trucks '98 - UP
Box Qty. 25



38545
22578214
Dia.: 1/4" Grip .086" to .129"
Flange: 1/2"
Blind Rivet
Steel Rivet
Steel Mandrel
Window Regulator
GM "N" Bodies 91 - UP
Box Qty. 15



38550
9437486, 6032926
Dia.: 1/4" Grip: 9/64" - 3/16"
Head Dia.: 1/2"
Peel-Type Rivet
Aluminum Rivet / Steel Mandrel
Window Regulators, Qtr. Vent Handles,
Assemblies & Elect. Door Lock Linkage
GM, Chrysler 1981 - UP
Box Qty. 25

SPECIALTY RIVETS

1/4" Diameter (cont)



38555

389268-S100, 20184399, 12338153
 Dia.: 1/4" Grip: 11/16" - 3/4"
 Flange Dia.: 1/2"
 Peel-Type Rivet
 Aluminum Rivet
 Steel Mandrel
 Window Regulators
 Ford & GM 1979 - UP
 Box Qty. 25

38561 Box 30



38560

N806830-S100, 6035201
 Dia.: 1/4" Grip 3/16" - 3/8"
 Flange Dia.: 11/16"
 Black Aluminum Rivet, Aluminum Mandrel
 Bumper Cover to Bumper & License Plate
 Bracket to Bumper Cover, Ford '92 - UP
 Air Dam To Fascia, Chrysler '93 - UP
 Box Qty. 15



38565

10204266
 Dia.: 1/4" Grip: 3/4" - 1"
 Head Dia.: 1/2"
 Aluminum Rivet
 Aluminum Mandrel
 Trunk Lock Cylinder
 Pontiac Firebird '94 - UP
 Box Qty. 10



38570

N804193-S100, 9441592, 15672713
 Dia.: 1/4" Grip: 3/32" - 9/64"
 Flange Dia.: 3/4"
 Peel-Type Rivet
 Black Aluminum Rivet, Steel Mandrel
 Front Door Handle & Door Lock Actuator
 Ford Tempo, Topaz, T-Bird, & Cougar '84 - UP
 Rocker Panel Mldg
 Chevrolet Beretta & Corsica 1992 - 1996
 Box Qty. 25



38580

N808426-S100
 Dia.: 1/4" Grip: 1/8" - 1/4"
 Flange Dia.: 1/2"
 Black Aluminum Rivet
 Aluminum Mandrel
 Bumper Fascia
 Ford Taurus & Mercury Sable '96 - UP
 Box Qty. 25



Recommended by Ford to replace the
 Factory Self Piercing Rivets!

38590

W702512-S900C
 Dia: 1/4" (6.3mm) Grip: 0.110" - 0.189"
 (2.79mm - 4.8mm)
 Flg Dia: 1/2" (13mm)
 Hole: 0.264-0.272" (6.71-6.91mm)
 Steel Rivet, Steel Mandrel
 Fender, Sill, Radiator Support, Cab, Rail,
 Floor, Pillar, Cowl, Box, Back Panel
 Ford F150 (Aluminum Body) 2015 - UP
 Box Qty. 10

Recommended by Ford to replace
 the Factory Self Piercing Rivets!



38591

W702554-S900C
 Dia: 1/4" (6.3mm) Grip: .268" - .346" (6.8mm - 8.8mm)
 Flange Dia: 1/2" (13mm)
 Steel Rivet, Steel Mandrel
 Cab, Floor, Door, Pillar, Box & Cowl
 Ford F150 Trucks (Aluminum Body) 2015 - UP
 Box Qty. 10

Recommended by Ford to replace the
 Factory Self Piercing Rivets!



38592

W707638-S900C
 Dia: 1/4" (6.3mm) Grip: .060" - .138" (1.5mm - 3.5mm)
 Flange Dia: 1/2" (13mm)
 Steel Rivet, Steel Mandrel
 Cab, Rear Body, Floor, Door, Box, Wheel House &
 Back Panel
 Ford F150 Trucks (Aluminum Body) 2015 - UP
 Box Qty. 10

Recommended by Ford to replace the
 Factory Self Piercing Rivets!



38595

W708777-S900C, 004-990-16-97, 11519023, 19353806
 Dia: 1/4" (6.3mm) Grip: 3/16" - 17/64" (4.8mm - 6.8mm)
 Flg Dia: 0.5" (13mm)
 Steel Rivet, Steel Mandrel
 Mercedes 2008 - UP
 Cab, Radiator, Rail, Floor, Door, Pillar, Cowl, Box, Back Panel, Fuel Door Filler
 Ford F150 (Aluminum Body) 2015 - UP; Mercedes 2008 - UP; Buick Allure, Enclave, LaCrosse, Lucerne, CadillacATS, CTS, Escalade, SRX, STS, XLR,
 XTS, Chevrolet Avalanche, Bolt EV, Camaro, Cobalt, Colorado, Corvette, Equinox, Express, HHR, Impala, Malibu, Silverado, Suburban, Tahoe, Traverse,
 GMC Acadia, Canyon, Savana, Sierra, Terrain & Yukon 2004 - UP; Chevrolet Blazer, GMC Jimmy, Oldsmobile Bravada, Pontiac G5, G6, Grand Prix,
 Pursuit, Solstice & Saturn Aura 1997 - 2009
 Box Qty. 10

3

Rivets / Nuts / Etc.

SPECIALTY RIVETS

1/4" Diameter (con't)



38603
2024778
Dia. 1/4" Grip: 1/16" - 1/4"
Flange Dia.: 1/2"
Steel Rivet
Steel Mandrel
Front Side Door Window Regulator
Chevrolet Lumina APV, Olds, Silhouette & Pontiac Trans Sport '90 - UP
Box Qty. 25



38605
22643056
Dia: 1/4" Grip: 1/16" - 5/32"
Flange Dia: 1/2"
Zinc & Yellow Dichromate
Steel Rivet / Steel Mandrel
Door Window Regulator Rivet
Buick Skylark, Chevrolet Cavalier, Olds Achieva & Aurora, and Pontiac Grand Am & Sunfire 1995-On
Box Qty. 25



38609
SD8375UG, MGLP-R8-6
Dia.: 1/4" Grip: 5/64" - 3/8"
Flange Dia.: 1/2"
All Steel, High Strength Rivet
Box Qty. 25



38720
Dia.: 1/4" Grip: 5/64" - 5/8"
Klik-Lock Structural Rivet
Steel Rivet
Steel Mandrel
Button Head
Box Qty. 100



38763
Dia: 1/4" Grip: 5/64 - 11/32"
Head Dia: 1/2"
Hole Size: .261"-.275"
Rivet Length: 39/64"
Multi-Grip Type
Dome Head
Aluminum Rivet, Steel Mandrel
Box Qty. 25



38764
90269-A0005, 90269-06017
Dia: 1/4" (6.3mm)
Grip: 1/16" - 3/16" (1.6mm - 4.8mm)
Flange Dia.: 1/2" (13mm)
Black Aluminum Rivet
Steel Mandrel
Fuel Door & General Purpose
Toyota & Lexus 2000 - UP
Scion 2005 - UP
Box Qty. 10

3 Rivets / Nuts / Etc.

SELF-PIERCING RIVETS

Silver Steel H4 ALMAC
Universal

*For Aluminum and Steel Bonding applications.
Used on Audi, BMW, Ford, Jaguar, Land Rover
and Mercedes Benz.*



Always check with your OEM or OE vendor to verify requirements for each application.

Self-Piercing Rivets

PROD	SIZE	CODE	OEM	BX QTY
38900	3.3 X 3.5MM			25
38901	3.3 X 4MM			25
38905	5.3 X 4MM			25
38906	5.3 X 5MM	AS	W708713-S900	25
38907	5.3 X 6MM	AT	W708714-S900, W712218-S900	25
38908	5.3 X 7MM	BN/DB	W710246-S900	25
38909	5.3 X 8MM	AW/EN	W708717-S900, W717186-S900	25
38910	5.3 X 9MM	QA	W717185-S900, W717184-S900	25

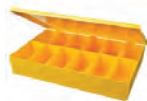

222389 SPR Assortment 1

A 99913 box that contains 25 pieces of each SPR number listed above.

NYLON RIVETS



415250
 11588308
 Nylon Rivet
 Dia: 4.95mm
 Grip Range:
 3mm - 6mm
 Flange Dia: 9mm
*Buick Lucerne; Cadillac CTS & DTS; Chevrolet
 Venture; Oldsmobile Silhouette and Pontiac
 Trans Sport 1997-UP*
 Box Qty. 25



415590
 N804583S
 Black Nylon
 Dia.: 4mm Grip: 6 - 10.5mm
 Rect. Head: 8.5mm x 15.5mm
 Cowl Vent Grille Retaining
Ford Aero Star '86 - UP
 Box Qty. 25

415595

N803739-S
 Super Tough Black Nylon
 Blind Rivet
 Flanged Button Head
 (Shoulder Forms A Seal)
 Hole: M6.3 Grip: 0.7 - .85mm
 Flange: 18mm
 Shoulder: 2.0
 Insulation Attachment
*Ford Explorer, "E" vans & Mercury
 Mountaineer & Topaz '88 - 2014*
 Box Qty. 25



415600.....Box 25
415800.....Box 100
 N803862-S, 6501559, 6506007-AA, 10184895
 1/4" Dia. Black Nylon Blind Rivet
 Panel Range: 5/32" - 13/32"
 Flange: 1/2"
GM, Ford, Chrysler, General Purpose



415601
 4630088
 Super Tough Black Nylon
 Hole: 6.3mm Grip: .7 - 4.5mm
 Flange: 17mm
 Shoulder: 2.0mm
 Countersunk Blind Rivet
 Exterior Mouldings, Body Side Mldg
 Attachment
Dodge & Eagle "LH" Models '93 - '97
 Box Qty. 25



415602.....Box 25
415802.....Box 100
 14063981, 15506827, 15506921, KA01500Z1,
 N803043-S, 6500911, 8934-201-631
 1/4" Dia. Black Nylon Blind Rivet
 Panel Range: 5/32" - 13/32"
 Flange: 21/32"
GM, Ford, Chrysler, AMC, General Purpose



415603
 4630660
 Super Tough Black Nylon
 Hole: 6.3mm Grip: .7 - 4.9mm
 Head: 17mm
 Shoulder: 9mm x 2mm
 Black Rivet / White Mandrel
 Countersunk Blind Rivet
 Exterior Mouldings
Chrysler "LH" '93 - '97
 Box Qty. 15



415604
 34202855, 6500859, 6500899, 8048635,
 20432975, 175-853-577, 175-853-57701C,
 175-852-577
 Super Tough Black Nylon
 Hole: 13/64"
 Panel Range: 1/8" - 15/64"
 Head: 15/32"
Chrysler, Ford, GM, VW, AMC
 Box Qty. 25



415605
 6501509
 Super Tough Black Nylon
 Blind Rivet w/ Shoulder
 Hole: 6.3mm (1/4")
 Grip: 1.0 - 5.0mm (3/64" - 3/16")
 Head: 17mm (11/16")
 Countersunk Shoulder: 4.5mm
 Body Side Mouldings
Chrysler "LH" '93 - UP, Various Models '87 - UP
 Box Qty. 25



415610.....Box 25
415810.....Box 100
 20421672, 15955172, 15595172
 17/64" Dia. Black Nylon Blind Rivet
 Panel Range: 3/32" - 3/16"
 Flange: 1/2"
GM, General Purpose



415620.....Box 25
415820.....Box 100
 4370132, 20433026, 14070914,
 175-553-577A, 175-853-577A
 17/64" Dia. Black Nylon Blind Rivet
 Panel Range: 3/32" - 3/16"
 Flange: 23/32"
GM, Chrysler, VW, General Purpose



415630.....Box 25
415830.....Box 100
 6500898, 15718794
 13/64" Black Nylon Blind Rivet
 Grip: 15/64" - 25/64"
 Flange: 15/32"
Chrysler, GM, General Purpose

3 Rivets / Nuts / Etc.

NYLON RIVETS



415640.....**Box 25**
415840.....**Box 100**
 20432975, 175-853-57701C, 6503800,
 N804343S
 13/64" Dia. Black Nylon Blind Rivet
 Grip: 1/8" - 15/64"
 Flange: 15/32"
 GM, VW, Chrysler, Ford, General Purpose



415645
 21094747
 Black Nylon
 Dia: 5/32"
 Grip: 7/64" - 7/32"
 Rect. Head: 5/16" x 19/32"
 GM
 Box Qty. 50



415650
 20423647, B455-56-741
 Black Nylon
 Dia: 13/64" Grip: 1/16" - 11/64"
 Flange: 11/32"
 GM, Mazda
 Box Qty. 25



415695
 N8062996-S
 Black Super Tough Nylon
 Hole: M6.3 Grip: 4 - 10mm
 Head: 17mm
 Shoulder: 9.5mm
 Front Stone Deflector
 Ford Lincoln '90 - UP
 Box Qty. 25



416053
 07147391323
 White Nylon
 Dia: 6mm
 G.R.: 6.0mm - 10.75mm
 Flange Dia: 20mm
 Wheel Arch Trim Cover
 BMW X3, X4 & X5 Series 2010-UP
 Box Qty. 25



416076
 51-71-7-002-953-2
 Black Nylon
 Dia.: 6mm Grip: 2.5 - 4.8mm
 Flange: 20mm
 BMW
 Box Qty. 25

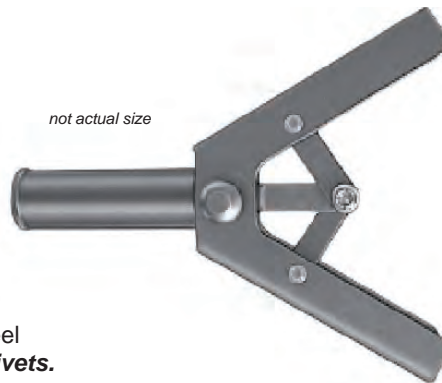

not actual size

96108
 Rivet Setter Gun (For Nylon Rivets)
 For use with nylon (plastic) blind rivets.
 A durable tool that sets all sizes. All Steel
 construction. **Not for use with metal rivets.**
 6-1/2" long
 Box Qty. 1

ASSORTMENTS

222102
Nylon Blind Rivets
w/ #96108 Rivet Gun
6 Varieties, 240 pieces



222430
Same assortment as
above but without the gun.

Includes:

415630 5mm Dia.....	6mm-10mm P.R.
415640 5mm Dia.....	3mm-6mm P.R.
415600 6.3mm Dia.....	4mm-10mm P.R.
415610 6.63mm Dia.....	2.5mm-5mm P.R.
415620 6.63mm Dia.....	2.5mm-5mm P.R.
415602 6.3mm Dia.....	4mm-10mm P.R.

(P.R.: Panel Range)



222215
Specialty Rivets
Assortment
20 Varieties, 329 pieces
*(#99905 Adjustable
Drawer included!)*

Assortment Includes:

28000	38506	38570	415630
28001	38507	38603	415640
38499	38510	38605	
38503	38530	38620	
38504	38575	415602	
38505	38561	415620	



222389
Self-Piercing Rivets
Assortment
8 Varieties, 200 pieces
*(#99913 8 Compartment
Drawer included!)*

Assortment Includes:

38900	38906	38909
38901	38907	38910
38905	38908	

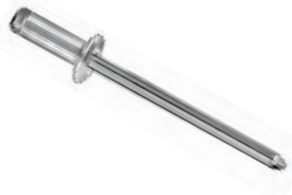

222395
Standard Blind Rivets
Aluminum Rivet & Mandrel
12 Varieties, 850 pieces
*(#99905 Adjustable
Drawer included!)*

Assortment Includes:

14021	1/8" x 1/8" Grip	16021	3/16" x 1/8" Grip
14041	1/8" x 1/4" Grip	16041	3/16" x 1/4" Grip
14061	1/8" x 3/8" Grip	16061	3/16" x 3/8" Grip
14081	1/8" x 1/2" Grip	16081	3/16" x 1/2" Grip
15041	5/32" x 1/4" Grip	16063	3/16" Lrg. Flange
15061	5/32" x 3/8" Grip	16083	3/16" Lrg. Flange



222397
Specialty Blind Rivets
Aluminum Rivet & Mandrel
12 Varieties, 400 pieces
*(#99905 Adjustable
Drawer included!)*

Assortment Includes:

13001	38505
27999	38506
28002	38507
38044	38510
38499	38520
38503	38525

3 Rivets / Nuts / Etc.

BLIND NUTS

FLUSH MOUNT BLIND NUT FASTENERS

HOW IT WORKS

The blind nut, held securely by the tool, is placed into a prepared hole. Upon the tool's actuation, the threaded portion is pulled until the fastener's wall collapse radially outward, clinching it tight against the sheet. The tool is withdrawn, leaving the blind nut ready to receive a bolt or screw. This complete operation takes only a few seconds and can be performed by anyone.



1.
INSERT BLIND NUT
INTO PREPARED
HOLE.



2.
ENGAGE THE TOOL.

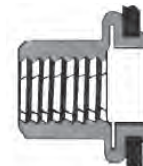

3.
BLIND NUT
INSTALLED WITH STANDARD
HEAD CONFIGURATION.

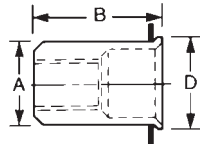

LOW CARBON STEEL, ZINC PLATED

THREAD SIZE	PRODUCT NUMBER	BOX QTY.	B MAX.	D REF.	A MAX.	GRIP RANGE	HOLE SIZE	DRILL SIZE	TYPICAL PUSHOUT (LBS.)
6-32	265150	50	.410	.287	.249	.020/.080	.250/.254	1/4"	330
6-32	265155	100	.410	.287	.249	.020/.080	.250/.254	1/4"	330
8-32	265170	50	.410	.287	.249	.020/.080	.250/.254	1/4"	330
8-32	265180	100	.410	.287	.249	.020/.080	.250/.254	1/4"	330
10-24	265200	50	.465	.320	.280	.020/.130	.281/.285	9/32"	500
10-24	265210	100	.465	.320	.280	.020/.130	.281/.285	9/32"	500
10-32	265215	50	.465	.320	.280	.020/.130	.281/.285	9/32"	500
10-32	265216	100	.465	.320	.280	.020/.130	.281/.285	9/32"	500
1/4-20	265010	25	.610	.415	.374	.030/.165	.375/.379	3/8"	510
1/4-20	265060	100	.610	.415	.374	.030/.165	.375/.379	3/8"	510
5/16-18	265020	25	.720	.540	.499	.030/.165	.500/.504	1/2"	800
5/16-18	265110	100	.720	.540	.499	.030/.165	.500/.504	1/2"	800
4MM	265300	50	.410	.287	.249	.020/.080	.250/.254	1/4"	330
4MM	265310	100	.410	.287	.249	.020/.080	.250/.254	1/4"	330
5MM	265320	50	.465	.320	.280	.020/.130	.281/.285	9/32"	500
5MM	265330	100	.465	.320	.280	.020/.130	.281/.285	9/32"	500
6MM	265340	25	.610	.415	.374	.030/.165	.375/.379	3/8"	510
6MM	265350	100	.610	.415	.374	.030/.165	.375/.379	3/8"	510
8MM	265360	25	.720	.540	.499	.030/.165	.500/.504	1/2"	800
8MM	265370	100	.720	.540	.499	.030/.165	.500/.504	1/2"	800

FLANGED BLIND NUTS

FLANGED BLIND NUT

Flanged blind nuts work the same as flush mount blind nuts, However because of their large diameter heads they offer Extra strength on softer materials.

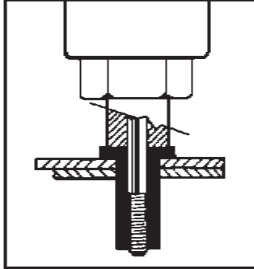

1. Drill hole to correct diameter, thread fastener onto tool mandrel and insert into hole.

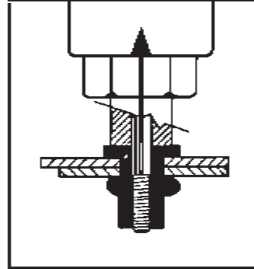

2. Actuate tool to properly set fastener into material.

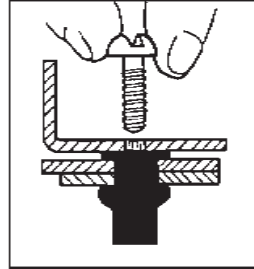

3. Complete your fastening operation with a bolt or screw with the proper thread.

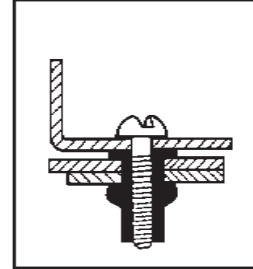

4. The positive riveting action of blind nuts provide consistent firm fastening. Push-out & shake-loose are virtually eliminated.

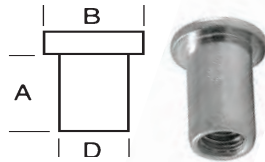

ALUMINUM ONLY

THREAD SIZE	PRODUCT NUMBER	BOX QTY.	A MAX.	B REF.	D MAX.	GRIP RANGE	HOLE SIZE	DRILL SIZE
6-32	266009	50	.438	.325	.189	.010/.075	.189/.193	#12
6-32	266010	100	.438	.325	.189	.010/.075	.189/.193	#12
8-32	266011	50	.500	.357	.221	.075/.120	.221/.226	#2
8-32	266012	100	.500	.357	.221	.075/.120	.221/.226	#2
10-24	266013	50	.594	.406	.250	.080/.130	.250/.254	1/4"
10-24	266014	100	.594	.406	.250	.080/.130	.250/.254	1/4"
10-32	266015	50	.594	.406	.250	.080/.130	.250/.254	1/4"
10-32	266016	100	.594	.406	.250	.080/.130	.250/.254	1/4"
1/4-20	266017	50	.75	.475	.332	.140/.200	.332/.338	Q
1/4-20	266018	100	.75	.475	.332	.140/.200	.332/.338	Q
5/16-18	266021	50	.875	.665	.413	.125/.200	.413/.423	Z
5/16-18	266022	100	.875	.665	.413	.125/.200	.413/.423	Z

METRIC LARGE FLANGE STEEL BLIND NUT



THREAD SIZE	PRODUCT NUMBER	BOX QTY.	A MAX	B MAX	D MAX	GRIP RANGE	HOLE SIZE
M6-1.0	265355	25	.630" 16mm	.510" 13mm	.356" 9mm	.020-.118" .5-3.0mm	.358" 9.1mm

RIVET NUTS, NUTSERTS

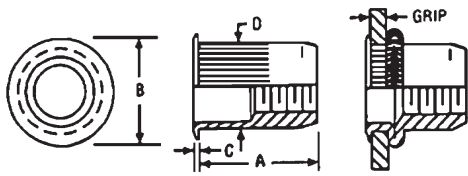

RIBBED RIVET NUTS

Steel Yellow Zinc Dichromate

After installation, these rivet nuts provide permanent, captive threads that do not allow loosening under vibration and will not rotate when attached.

Part #	Thread Size	A Body Length	B Head Dia.	C Head Height	D Body Dia.	Grip Range Min Max	Hole Size Required	
25/bx 267320 (mm)	267330 M5	.420 10.7	.932 09.9	.028 0.71	.264 06.7	.020 0.503	.130 .30	17/64
25/bx 267340 (mm)	267350 M6	.580 14.7	.500 12.7	.028 0.71	.390 09.9	.027 .068	.165 .419	25/64
25/bx 267360 (mm)	267370 M8	.690 17.5	.685 17.4	.032 0.81	.530 13.5	.027 0.683	.150 .81	17/32

3 Rivets / Nuts / Etc.

SPECIALTY NUTSERTS



266024

6506104AA
Zinc & Yellow
Roof Rack Nutsert w/Sealer
Under Head
Thread: M6 - 1.0
Grip: .7mm - 3.2mm
Head Dia.: 17mm
Hex: 9.5mm (3/8")
Jeep '99 - UP
Box Qty. 10



266025

6503812, 6504601
Tin & Zinc
Wheel Opening Moulding
Nutsert
Thread: M5 - .8
Head Dia.: 10mm
Overall Length: 12mm
Jeep '99 - UP
Box Qty. 15



266030

Zinc & Yellow
Specialty Insert
Thread: M5- .8
Grip: .5mm - 3.3mm
Head Dia.: 10mm
Hex Size: 7mm
GM
Box Qty. 15



266031

Zinc & Yellow
M4-.7 Specialty Insert
Grip: 2mm - 3.3mm
Head Dia: 9.5mm
Hex Size: 6.2mm
GM
Box Qty. 15



266032

N803763-S100,
15685099
Zinc & Yellow
M6-1.0
Grip: .65mm - 2.0mm
Head Dia.: 12mm
Hex Size: 8mm
Specialty Insert w/ Sealer
Roof Rack, Tailgate &
General Purpose
Ford Explorer 1991 - UP
GM APV Vans
Box Qty. 15



266033

10281487
Zinc & Yellow
Specialty Insert
Thread: M6-1.0
Grip: .7mm - 4.2mm
Head Dia.: 13mm
Hex Size: 9.5mm (3/8")
Front Fender
Buick, Cadillac, Corvette, L.D. Truck,
Olds Aurora & Pontiac '97 - UP
Box Qty. 15



266034

N811257-S100
M5-.8
Specialty
Insert With Sealer
Grip: .5mm-2.5mm,
Head Dia: 10mm,
Hex Size: 7mm
General Purpose
Ford Escape, Excursion, Expedition,
Explorer, Navigator & Mountaineer
2001 - UP
Box Qty. 15



266035

W708513-S437
Zinc
M8-1.25
Specialty Insert
Grip: .7mm - 3.8mm
Hd. Dia.: 22mm
Hex Size: 12.7mm
Frame Area
Ford Trucks 2004 - UP
Box Qty. 15

BLIND NUT SETTER GUN / KITS

265400

Blind Nut Setter Kit (Standard Thread)

Capable of installing all sizes of rivet nuts and threaded inserts up to 1/4-20 and 6mm threads in steel, the next-generation Rivet Nut Setter features a quick-change mandrel and longer handles for improved leverage and an adjustable stroke, positive-stop locking feature. Ergonomically designed, with a forged, heat-treated steel upper handle, precision die-cast body of high-strength aluminum alloy, patented fulcrum pin design, and comfortable hand grips. Supplied with 8-32, 10-24 and 10-32 mandrels and nosepieces.



265401

Blind Nut Setter Kit (Standard Thread)

Kit contains the 265400 Rivet Nut tool in a molded plastic case; mandrels and nosepieces for 6-32, 8-32, 10-24 and 1/4-20, instructions and wrench. The kit also includes 103 assorted Klik Rivet Nuts and Klik Poly-Nuts.



265402

Blind Nut Setter Kit (Metric Thread)

Kit contains the 265400 Rivet Nut tool in a molded plastic case with 4mm, 5mm, 6mm and 8mm mandrels and nosepieces, wrench and instructions. The kit also includes 75 assorted Klik Poly-Nuts:

3 Rivets / Nuts / Etc.

Mandrel & Nosepiece Kits

STANDARD THREAD (KITS)

Product Number	Thread Size
265405 Mandrel & Nosepiece	6-32
265406 Mandrel & Nosepiece	8-32
265407 Mandrel & Nosepiece	10-32
265408 Mandrel & Nosepiece	10-24
265409 Mandrel Only	1/4-20
265411 Mandrel Only	5/16-18

METRIC THREAD (KITS)

Product Number	Thread Size
265420 Mandrel & Nosepiece	4mm
265421 Mandrel & Nosepiece	5mm
265422 Mandrel Only	6mm
265423 Mandrel Only	8mm

RIVETS/NUTS/ETC.

BLANK

COTTER PINS

HAMMER LOCK

Plated
C 1008 Steel



METRIC COTTER PINS

Steel
DIN 94



PRODUCT NUMBER	SIZE	BOX QTY
391020	2mm x 18mm	100
391030	2mm x 20mm	100 DISC
391050	2.5mm x 25mm	100
391060	3.2mm x 20mm	100
391070	3mm x 25mm	100
391080	3mm x 30mm	100
391090	3mm x 35mm	50
391110	4mm x 30mm	50
391120	4mm x 35mm	50 DISC
391130	4mm x 40mm	50
391150	5mm x 35mm	25
391160	5mm x 40mm	25
391170	5mm x 45mm	25

PRODUCT NUMBER	SIZE	BOX QTY
390005	1/16 x 1/2"	200
390007	1/16 x 3/4"	200
390010	1/16 x 1"	200
390015	1/16 x 1-1/4"	200
390020	1/16 x 1-1/2"	200
390022	1/16 x 2"	200 DISC
390025	3/32 x 3/4"	200
390030	3/32 x 1"	200
390035	3/32 x 1-1/4"	200
390040	3/32 x 1-1/2"	200
390050	3/32 x 2"	200
390055	1/8 x 3/4"	200
390060	1/8 x 1"	200
390065	1/8 x 1-1/4"	200
390070	1/8 x 1-1/2"	200
390075	1/8 x 1-3/4"	200
390080	1/8 x 2"	200
390083	1/8 x 2-1/2"	200
390085	5/32 x 1"	100
390087	5/32 x 1-1/4"	100
390090	5/32 x 1-1/2"	100
390095	5/32 x 1-3/4"	100 DISC
390100	5/32 x 2"	100
390101	5/32 x 2-1/2"	100
390102	5/32 x 3"	100
390103	3/16 x 1"	100
390104	3/16 x 1-1/4"	100
390105	3/16 x 1-1/2"	100
390110	3/16 x 2"	100
390120	3/16 x 2-1/2"	100
390125	3/16 x 3"	100
390130	1/4 x 1-1/2"	100
390131	1/4 x 2"	100
390132	1/4 x 2-1/2"	100
390133	1/4 x 3"	100
390134	1/4 x 4"	100
390135	5/16 x 2-1/2"	100
390136	5/16 x 3"	100

HAIR PIN RETAINERS/RETAINER PINS











HAIR PIN RETAINERS



PRODUCT NUMBER	INSIDE DIAMETER	OVERALL LENGTH	BOX QTY
388010	1/32"	3/8"	100
388011	1/16"	23/64"	100
388012	5/64"	13/32"	100
388013	3/32"	3/8"	100
388015	3/32"	1/2"	100
388016	7/64"	1/2"	100
388017	1/8"	5/16"	100
388018	1/8"	31/64"	100
388019	1/8"	9/16"	100
388021	5/32"	31/64"	100
388022	5/32"	5/8"	100
388023	7/32"	3/4"	100
388024	9/32"	13/16"	100
388025	5/16"	1"	100
388026	3/8"	7/8"	100

4 Pins / Rings / Fittings

RETAINER PINS Zinc

 387010 ID: 1/16" Overall Length 3/8" Box Qty. 50	 387020 ID: 1/16" Overall Length 19/32" Box Qty. 100	 387050 ID: 3/32" Overall Length 37/64" Box Qty. 100	 387060 ID: 7/64" Overall Length 3/4" Box Qty. 100	 387030 ID: 1/8" Overall Length 1/2" Box Qty. 100
 387040 ID: 1/8" Overall Length 9/16" Box Qty. 100	 387045 ID: 1/8" Overall Length 1-1/8" Box Qty. 100	 387070 ID: 5/32" Overall Length 7/8" Box Qty. 100	 387080 ID: 3/16" Overall Length 1-3/16" Box Qty. 100	 387090 Seat Retainer Pins Ford

SPRING PINS/THROTTLE ROD CLIPS

SPRING PINS

Zinc Plated



PRODUCT NUMBER	DIA x LENGTH	BOX QTY
386010	1/16" x 1/2"	50
386020	1/16" x 3/4"	50
386030	1/16" x 1"	50
386040	5/64" x 1/2"	50
386050	5/64" x 3/4"	50
386060	5/64" x 1"	50
386070	3/32" x 1/2"	50
386080	3/32" x 3/4"	50
386090	3/32" x 1"	50
386100	1/8" x 1/2"	50
386110	1/8" x 3/4"	50
386120	1/8" x 1"	50
386125	1/8" x 1-1/4"	50
386130	5/32" x 1/2"	50
386140	5/32" x 3/4"	50
386150	5/32" x 1"	50
386155	5/32" x 1-1/4"	50
386160	3/16" x 1/2"	50
386170	3/16" x 3/4"	50
386180	3/16" x 1"	50
386190	3/16" x 1-1/2"	50

THROTTLE ROD CLIPS

Black Parkerized



Left-hand Type



Right-hand Type

PRODUCT NUMBER	ROD DIA.	SIDE	BOX QTY
490030	3/32"	R	50
490050	5/32"	R	50
490060	5/32"	L	50
490070	3/16"	R	50
490080	3/16"	L	50
490090	1/4"	R	25
490100	1/4"	L	25

DISC

O.E.M. Throttle Rod Clips may be found in each Car Manufacturer's section.

E-CLIPS

E - CLIPS - STANDARD

Phosphate & Oil Finish
DIN 6799 - 1500

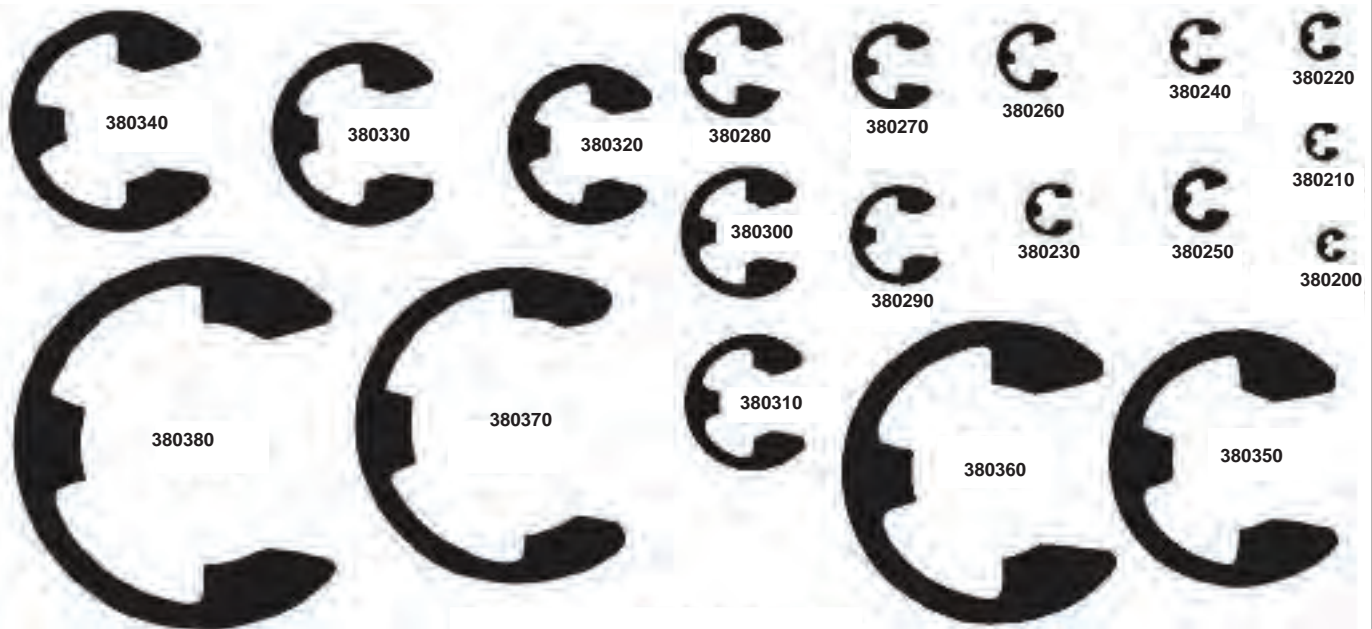

STANDARD

PRODUCT NUMBER	SHAFT DIA	GROOVE DIA	GROOVE WIDTH	BOX QTY
380200	1/16"	.052"	.012"	100
380210	3/32"	.074"	.018"	100
380220	1/8"	.095"	.018"	100
380230	9/64"	.105"	.018"	100
380240	5/32"	.116"	.029"	100
380250	11/64"	.127"	.029"	100
380260	3/16"	.147"	.029"	100
380270	7/32"	.188"	.029"	100
380280	1/4"	.210"	.029"	100
380290	5/16"	.250"	.029"	100
380300	3/8"	.303"	.039"	100
380310	7/16"	.343"	.039"	100
380320	1/2"	.396"	.046"	100
380330	5/8"	.485"	.046"	100
380340	3/4"	.580"	.056"	50
380350	7/8"	.675"	.056"	50
380360	1"	.835"	.056"	50
380370	1-3/16"	1.079"	.068"	25
380380	1-3/8"	1.230"	.068"	25

Also Available! **41093** Standard E-Clip Assortment
222028 Standard E-Clip Assortment
222027 Metric E-Clip Assortment

E - CLIPS - METRIC

Phosphate & Oil Finish
DIN 6799 - 1500



METRIC

PRODUCT NUMBER	SHAFT DIA		GROOVE DIA		GROOVE WIDTH		BOX QTY
	mm	inches	mm	inches	mm	inches	
380030	1.4	.055	1.2	.047	0.34	.0134	100
380040	2.0	.079	1.5	.059	0.44	.0173	100
380050	2.5	.098	1.9	.075	0.54	.0213	100
380060	3.0	.118	2.3	.091	0.64	.0252	100
380070	4.0	.157	3.2	.126	0.64	.0252	100
380080	5.0	.197	4.0	.157	0.74	.0291	100
380090	6.0	.236	5.0	.197	0.74	.0291	100
380100	7.0	.276	6.0	.236	0.74	.0291	100
380110	8.0	.315	7.0	.276	0.94	.0370	100
380120	9.0	.354	8.0	.315	1.05	.0413	100
380130	10.0	.394	9.0	.354	1.15	.0453	100
380150	13.0	.512	12.0	.472	1.35	.0531	100
380170	20.0	.787	19.0	.748	1.85	.0728	50

Also
Available!

41093 Standard E-Clip Assortment
222028 Standard E-Clip Assortment
222027 Metric E-Clip Assortment

RETAINING RINGS



BASIC EXTERNAL
Groove Required On Shaft
Bright Zinc

PRODUCT NUMBER	SHAFT DIA	GROOVE DIA	GROOVE WIDTH	BOX QTY
382010	1/8"	.117"	.012"	50
382020	1/4"	.230"	.029"	50
382030	9/32"	.261"	.029"	50
382040	5/16"	.290"	.029"	50
382050	11/32"	.321"	.029"	50
382060	3/8"	.352"	.029"	50
382070	13/32"	.381"	.029"	50
382080	7/16"	.412"	.029"	50
382090	1/2"	.468"	.039"	50
382100	9/16"	.530"	.039"	50
382119	9/32"	.559"	.039"	50
382120	5/8"	.588"	.039"	50
382130	11/16"	.646"	.046"	50
382140	3/4"	.704"	.046"	50
382150	13/16"	.762"	.046"	50
382160	7/8"	.821"	.046"	50
382170	15/16"	.882"	.046"	50
382180	1"	.940"	.046"	50
382190	1-1/16"	.998"	.056"	50
382200	1-1/8"	1.059"	.056"	50
382210	1-3/16"	1.118"	.056"	50
382220	1-1/4"	1.176"	.056"	50
382222	1-5/16"	1.232"	.056"	50
382224	1-3/8"	1.291"	.056"	50
382230	1-1/2"	1.406"	.056"	25
382235	1-5/8"	1.529"	.068"	25
382240	1-3/4"	1.65"	.068"	25
382245	1-7/8"	1.769"	.068"	25
382250	2"	1.88"	.068"	10
382255	2-1/8"	2.003"	.086"	10
382260	2-1/4"	2.12"	.086"	10
382265	2-3/8"	2.239"	.086"	10
382270	2-1/2"	2.36"	.086"	10

DISC

**See following page
for product illustrations.**

RETAINING RINGS

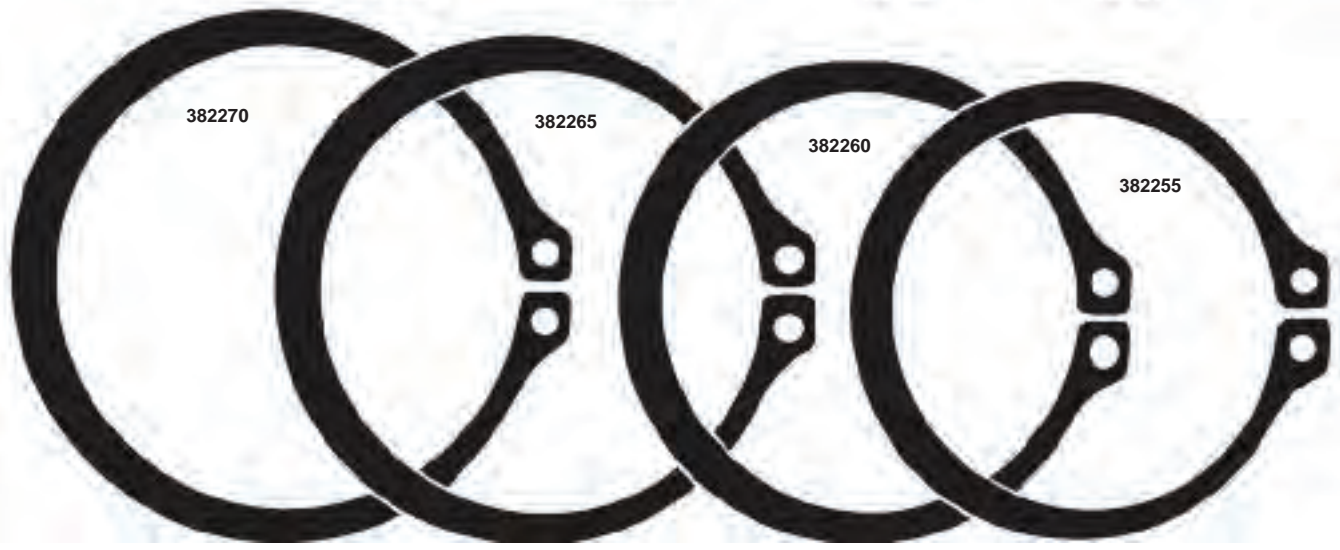
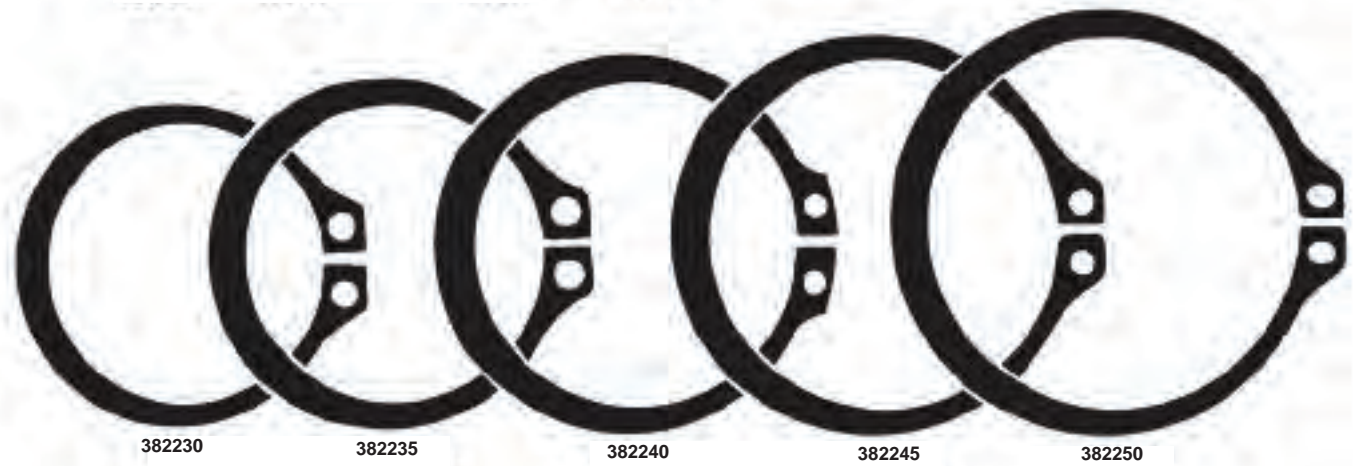
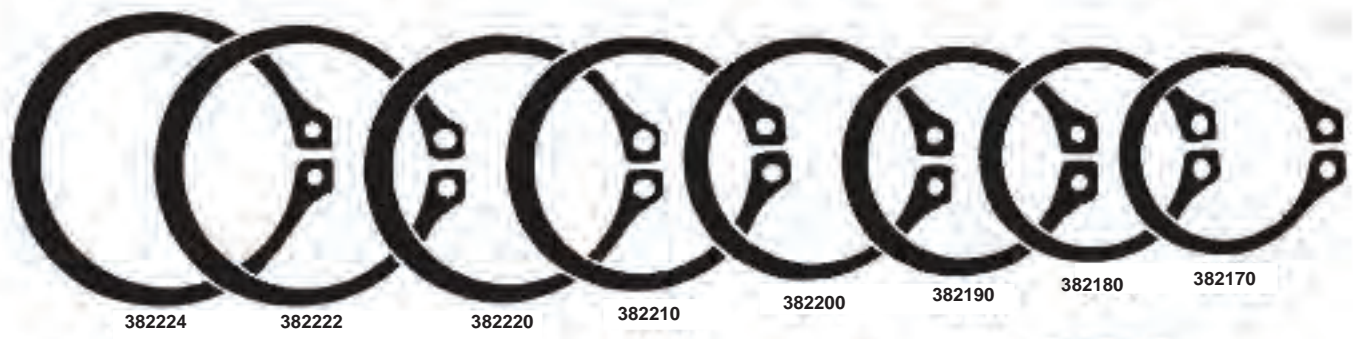

RETAINING RINGS

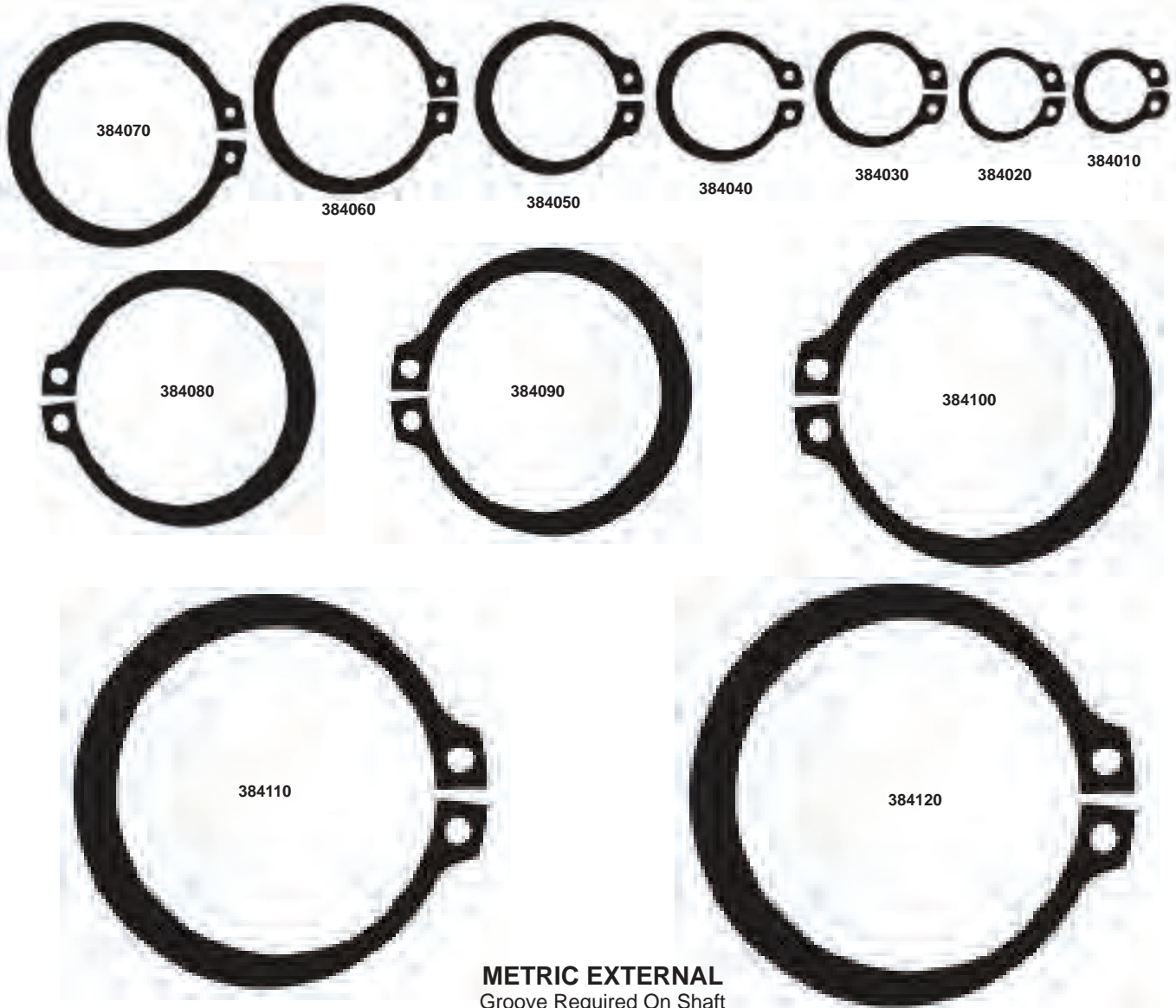

METRIC EXTERNAL
 Groove Required On Shaft
 Phosphate & Oil Finish
 DIN 471 - 1400

PRODUCT NUMBER	SHAFT DIA		GROOVE DIA		GROOVE WIDTH		BOX QTY
	mm	inches	mm	inches	mm	inches	
384010	10	.394	9.6	.378	1.10	.043	100
384020	12	.472	11.5	.452	1.10	.043	100
384030	15	.591	14.3	.563	1.10	.043	100
384040	17	.670	16.2	.637	1.10	.043	50
384050	20	.787	19.0	.748	1.30	.051	50
384060	25	.985	23.9	.941	1.30	.051	50
384070	30	1.182	28.6	1.126	1.60	.063	50
384080	35	1.378	33.0	1.299	1.60	.063	50
384090	40	1.575	37.5	1.476	1.85	.073	25
384100	50	1.969	47.0	1.850	2.15	.085	25
384110	55	2.165	52.0	2.047	2.15	.085	10
384120	60	2.362	57.0	2.244	2.15	.085	10

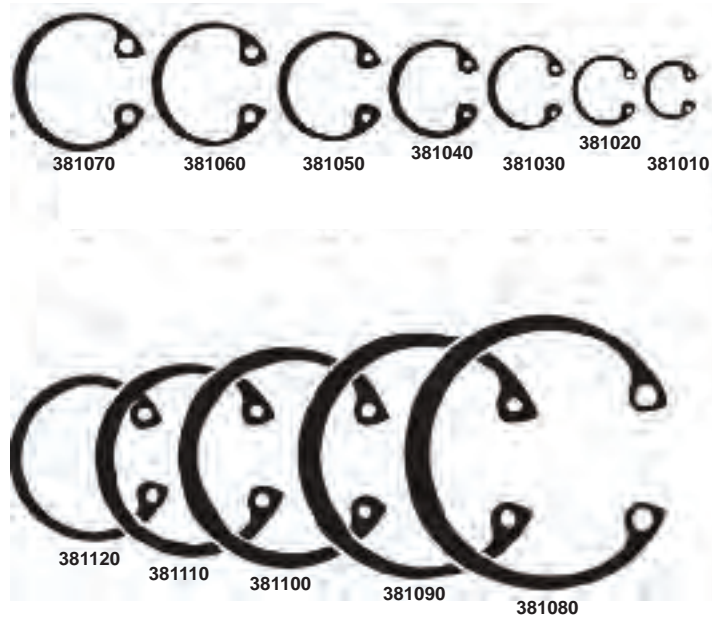

BASIC INTERNAL
Groove Required On Shaft
Bright Zinc

PRODUCT NUMBER	HOUSING DIA	GROOVE DIA	GROOVE WIDTH	BOX QTY
381010	1/4"	.268"	.020"	50
381020	5/16"	.330"	.020"	50
381030	3/8"	.397"	.029"	50
381040	7/16"	.461"	.029"	50
381050	1/2"	.530"	.039"	50
381060	9/16"	.596"	.039"	50
381070	5/8"	.665"	.039"	50
381080	3/4"	.796"	.039"	50
381090	7/8"	.931"	.046"	50
381100	1"	1.066"	.046"	50
381110	1-1/8"	1.197"	.056"	50
381120	1-1/4"	1.33"	.056"	50

RETAINING RINGS

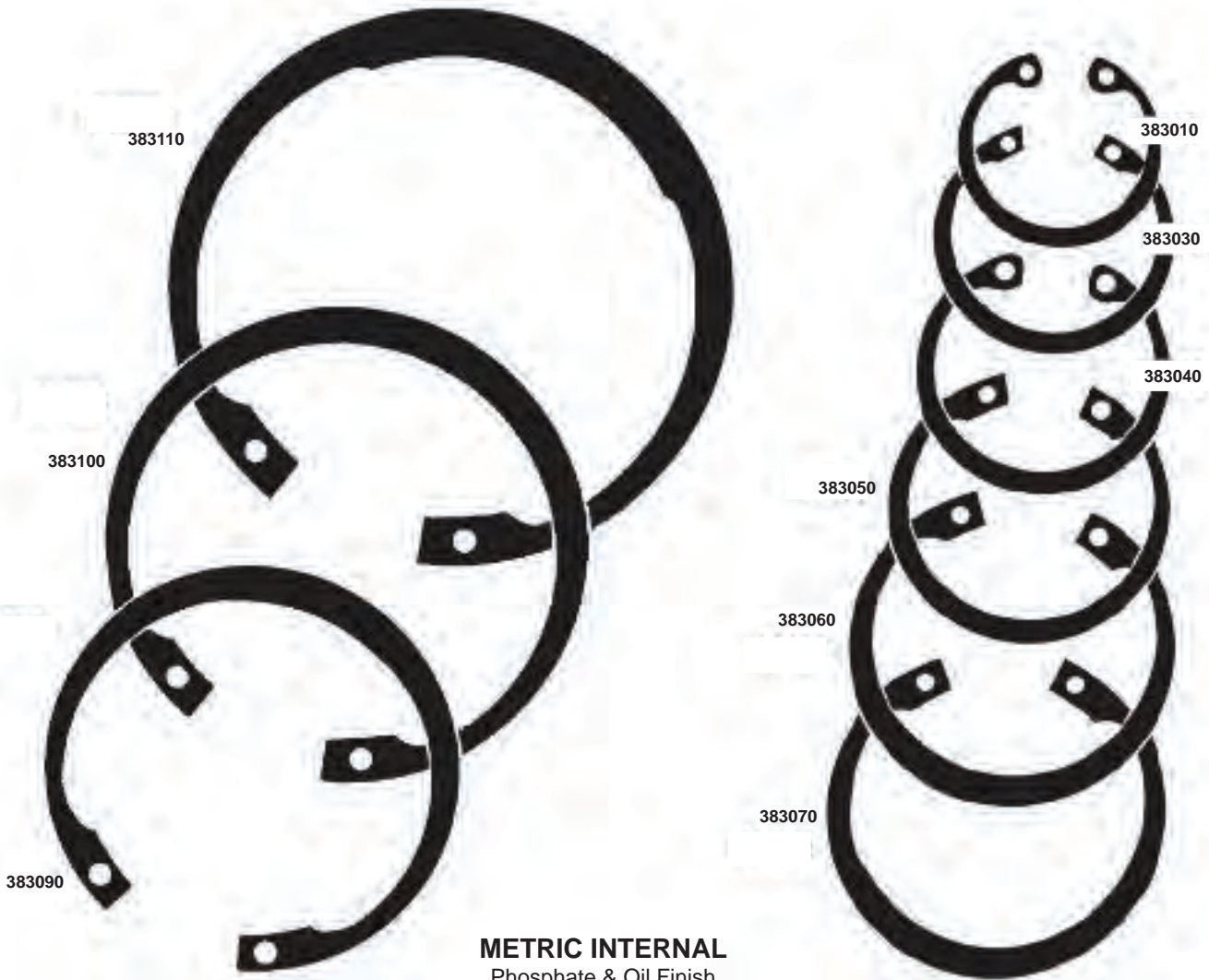

METRIC INTERNAL
 Phosphate & Oil Finish
 Groove Required In Bore
 DIN 472-1300

PRODUCT NUMBER	SHAFT DIA		GROOVE DIA		GROOVE WIDTH		BOX QTY
	mm	inches	mm	inches	mm	inches	
383010	26	1.024	27.2	1.072	1.30	.051	50
383020	28	1.102	29.4	1.157	1.30	.051	50
383030	30	1.181	31.4	1.237	1.30	.051	50
383040	32	1.260	33.7	1.328	1.30	.051	50
383050	35	1.378	37.0	1.457	1.60	.063	50
383060	40	1.575	42.5	1.675	1.85	.073	25
383070	42	1.654	44.5	1.753	1.85	.073	25
383080	47	1.850	49.5	1.948	1.85	.073	25
383090	52	2.047	55.0	2.165	2.15	.085	25
383100	62	2.441	65.0	2.559	2.15	.085	10
383110	72	2.835	75.0	2.953	2.65	.104	10
383120	80	3.149	83.5	3.287	2.65	.104	5
383130	90	3.543	93.5	3.681	3.15	.124	5

GREASE FITTINGS



45001
1/4 - 28
Straight
Box Qty. 50



45002
1/4 - 28
45 Degrees
Box Qty. 50



45003
1/4 - 28
90 Degrees
Box Qty. 50



45004
1/8"
Straight
Box Qty. 50



45005
1/8"
45 Degrees
Box Qty. 50



45006
1/8"
90 Degrees
Box Qty. 50



45007
6mm
Straight
Box Qty. 50



45008
6mm
45 Degrees
Box Qty. 50



45009
6mm
90 Degrees
Box Qty. 50

PIPE PLUGS, COMPRESSION UNION

COMPRESSION UNION

Brass



PRODUCT NUMBER	TUBE SIZE	BOX QTY
530010	1/8"	5
530020	3/16"	5
530030	1/4"	5
530040	5/16"	5
530050	3/8"	5
530060	1/2"	5

HEX PIPE PLUGS

Cold Rolled Steel
Plain Finish



PRODUCT NUMBER	OEM #	SIZE	BOX QTY
530070	444613	1/8-27 Pipe Thread	25
530080	444619, 444620	1/4-18 Pipe Thread	25

BLANK

DRAIN PLUGS / GASKETS



530205
Zinc Plate
Oil Drain Plug
Thread: 1/2-20
Hex: 9/16"
Length Under Hd: 3/4"
Box Qty. 5

Chrysler (Dom.): AMC; Ford (Linc., Merc., Fiesta); GMC (Buick, Chevrolet, Pontiac, Cadillac); Oldsmobile; Spring; Spectrum



530210
Plain Finish
Oil Drain Plug
Thread: 1/2-20
w/ Moulded Rubber
Washer Face
Hex: 5/8"
Length Under Hd: 13/16"
Box Qty. 5

Chrysler (Jeep Cherokee) Eng. 2.0, 2.4, 2.5, 2.7, 3.2, 3.3, 3.5, 3.7, 3.8, 4.7, 5.2, 5.9, 8.0



530214
Steel w/Nylon Washer
Oil Drain Plug
Thread: 1/2"-20
Hex: 7/8"
Length under Hd: 1/2"
Box Qty. 10

*AMC: 6&8 Cyl. All 64 - UP
Buick: 4, 6&8 Cyl. All [Exc. 2.5 (151), 3.0, 4.3, and 4.9 (301 Eng.)] 59 - UP; Cadillac: 6&8 Cyl. All [Exc. 4.1 Eng.] 66 - UP
Chevrolet: Includes Light Truck - 4, 6&8 Cyl. All [Exc. 1.8 (diesel), 2.5 (151), 4.3 (diesel) Eng.] 28 - UP
Chrysler: 6&8 Cyl. All 62 - UP; Ford: 4,6&8 Cyl. All [Exc. 98,122,140,171 Eng.] 57-UP; GMC: Light Truck 6&8 Cyl. All 39 - UP; Oldsmobile: 4,6&8 Cyl. All [Exc. 2.5 (151), 3.0, 4.3, (diesel), 4.3S, 4.9T (301)] 61 - UP; Pontiac: 4, 6&8 Cyl. All [Exc. 1.8 (diesel), 2.5 (151), 4.3 (diesel), 4.3S, 4.9T (301)] 60 - UP*



530216
3921988
Plain w/Nylon Washer
Oil Drain Plug
Thread: 1/2"-20
Hex: 9/16"
Length under Hd: 13/16"
Washer Hd O.D.: 7/8"
Box Qty. 15

*Buick: 4, 6&8 Cyl. All [Exc. 2.5 (151), 3.0, 4.3, 4.9 (301 Eng.)] 59 - UP
Cadillac: 6&8 Cyl. All [Exc. 4.1 Eng.] 66 - UP
Chevrolet: Includes GMC Light Truck - 4,6&8 Cyl. All [Exc. 1.8 (diesel), 2.5 (151), 4.3 (diesel) Eng.] 28 - UP
Oldsmobile: 4, 6&8 Cyl. All [Exc. 1.8 (diesel), 2.5 (151), 3.0, 4.3, (diesel), 4.3S, 4.9T (301) Eng.] 61 - UP
Pontiac: 4, 6&8 Cyl. All [Exc. 1.8 (diesel), 2.5 (151), 4.3 (diesel), 4.3S, 4.9T (301)] 60 - UP*



530215
Zinc Plate
Oil Drain Plug
Thread: 12mm-1.25
Hex: 14mm
Length Under Hd: 16mm
Box Qty. 5

Lexus; Nissan (Datsun); Toyota



530217
948187-0
Zinc
Oil Drain Plug w/Gasket
Thread: 3/4"-16
Hex: 1"
Length under Hd: 1/2"
Box Qty. 2

Volvo 4 Cyl.



530221
Zinc w/Gasket
Oil Drain Plug
Thread: 12mm-1.25
Hex: 14mm
Length Under Hd: 11mm
Washer Head O.D.: 20mm
Box Qty. 5

Nissan: Sentra, Stanza & Pulsar w/FWD 82 - UP



530226
11128-01M0B
Zinc & Yellow
Oil Drain Plug w/Gasket
Thread: 12mm-1.25
Hex: 14mm
Length under Hd: 12mm
Washer Head O.D.: 22mm
Box Qty. 2

Nissan: Sentra & 350Z and Infiniti 1992 - UP



530251
Zinc
Oil Drain Plug
Thread: 1/2"-20
Single Oversize
Box Qty. 5



530252
Zinc & Yellow
Oil Drain Plug
Thread: 1/2"-20
Double Oversize
Box Qty. 5

DRAIN PLUGS / GASKETS

530218

21006725
Black Zinc
w/Rubber Gasket
Oil Drain Plug
Thread: 12mm-1.75
Hex: 14mm
Length under Hd: 19mm
Rubber Gasket O.D.: 31mm
Box Qty. 2

GM: Saturn



530219

Zinc w/Gasket
Oil Drain Plug
Thread: 12mm-1.50
Hex: 13mm
Length under Hd: 12mm
Washer Head O.D.: 17mm
Box Qty. 5

BMW & Mercedes



530220

Zinc Plate
Oil Drain Plug
Thread: 12mm-1.75
Hex: 14mm
Length Under Hd: 12mm
Box Qty. 5

Lexus: Nissan (Datsun): Toyota



530222

F5AZ-6730
Plain w/Rubber
Washer Face Gasket
Oil Drain Plug
Thread: 12mm-1.75
Hex: 15mm
Length under Hd: 21mm
Rubber Gasket O.D.: 28mm
Box Qty. 2

Ford 2.5, 3.0 & 4.6 Eng. w/Modular &
Aluminum Pans 1993 - 1999



530223

YS4Z-6730AA
Plain w/Rubber Gasket
Oil Drain Plug
Thread: 12mm-1.75
Hex: 13mm
Length under Hd: 25mm
Washer Head O.D.: 26mm
Box Qty. 2

Ford 1993 - 1999



530224

3536964, 3538469,
11519408, 11562588,
24100042, 8-11519-408-0
Zinc w/Rubber Gasket
Oil Drain Plug
Thread: 12mm-1.75
Hex: 15mm
Length Under Hd: 25mm
Washer Head O.D.: 26mm
Box Qty. 2

GM 2.2 (4), 3.1 (M), 3.8 (K), 3.8 (1), 2.3, 4.9 &
6.0L Eng. 1985 - UP



530227

Zinc w/Gasket
Oil Drain Plug
Thread: 14mm-1.25
Hex: 13mm
Length Under Hd: 16mm
Washer Head O.D.: 23mm
Box Qty. 5

Jeep



530230

3536964
Black Oxide
w/ Inset Gasket
Oil Drain Plug
Thread: 12mm-1.75
Hex: 15mm
Length Under Hd: 25mm
Box Qty. 5

GMC Eng. 2.2(4), 3.1(m),
3.8(k), 3.8(1), 2.3



530245

Plain Finish
Oil Drain Plug
Thread: 12mm-1.75
Hex: 15mm
Length Under Hd: 26mm
Box Qty. 5

AMC; GMC (Buick, Chevrolet, Cadillac, Pontiac);
Oldsmobile; Spring; Spectrum



530265

Plain Finish
Oil Drain Plug
Thread: 14mm-1.50
Hex: 13mm
Length Under Hd: 16mm
Box Qty. 5

Jeep; Chrysler (Imp. & Dom.); AMC; Ford (Taurus);
GMC; Mazda; Opel / Isuzu



DRAIN PLUGS / GASKETS

530228

90009-PY3-000
Zinc & Yellow
w/Aluminum Gasket
Oil Drain Plug
Thread: 14mm-1.50
Hex: 17mm
Length under Hd: 15mm
Washer Head O.D.: 24mm
Box Qty. 5

Acura & Honda 2000 - UP



530229

E9DZ-6730-B
Zinc w/Gasket
Oil Drain Plug
Thread: 14mm-1.50
Hex: 13mm
Length under Hd: 16mm
Washer Head O.D.: 23mm
Box Qty. 5

Ford Escort



530233

6504018
Plain w/Rubber
Washer Face Gasket
Oil Drain Plug
Thread: 14mm-1.50
Hex: 13mm
Length Under Hd: 20mm
Rubber Gasket O.D.: 28mm
Box Qty. 2

Chrysler 2.0, 2.4, 2.7, 3.2, 3.5, 3.7 & 4.7
Eng. 2000 - UP



530234

F75Z-6730-BA
Phosphate w/Rubber Gasket
Oil Drain Plug
Thread: 14mm-1.50
Hex: 16mm
Length under Hd: 20mm
Washer Head O.D.: 28mm
Box Qty. 1

Ford Vans & Trucks with 6.8L Eng. 1996 - 2000



530236

F6TZ-6730BA
Phosphate w/Rubber Gasket
Oil Drain Plug
Thread: 14mm-1.50
Hex: 13mm
Length Under Hd: 20mm
Washer Head O.D.: 28mm
Box Qty. 2

Chrysler with 2.0(F), 2.4(B,G,8), 2.7(R,T), 3.3(G,S,3) & 3.5(G,4) Eng. 2000 - UP
Ford Aerostar, Explorer & Ranger 6 Cyl. 4 Ltr. Eng. 1996 - UP



530237

601-997-02-30
Zinc w/Gasket
Oil Drain Plug
Thread: 14mm-1.50
Hex: 13mm
Length under Hd: 24mm
Washer Head O.D.: 19mm
Box Qty. 2

Mercedes 300 Series



530238

Zinc w/Gasket
Oil Drain Plug
Thread: 14mm-1.50
Hex: 16mm
Length under Hd: 11mm
Washer Head O.D.: 25mm
Box Qty. 5

Chrysler Imports 83-UP; Honda 83-UP; Isuzu 87-UP; Mazda 72-UP; Spectrum 88-UP; VW-Audi 74-UP



530239

90009-PH1-000
Zinc & Yellow
w/Gasket
Oil Drain Plug
Thread: 14mm-1.50
Hex: 17mm
Length under Hd: 10mm
Washer Head O.D.: 24mm
Box Qty. 5

Acura & Honda



530260

Zinc Plate
Oil Drain Plug
Thread: 14mm-1.50
Hex: 16mm
Length Under Hd: 21mm
Box Qty. 5

Jeep; Chrysler (Imp. & Dom.); AMC; Ford; GMC; Mazda; Opel / Isuzu



530270

Zinc Plate
Oil Drain Plug
Thread: 14mm-1.50
Hex: 13mm
Length Under Hd: 16mm
Box Qty. 5

Jeep; Chrysler (Imp. & Dom.); AMC; Ford; GMC; Mazda; Opel / Isuzu



530273

21512-23001
Dacromet
Oil Drain Plug
with Gasket
Thread: M14-1.5
Hex: 17mm
Length Under Head: 17mm
Washer Head O.D.: 22.5mm
Box Qty. 2

Hyundai & Kia 2008 - UP



DRAIN PLUGS / GASKETS

530231

6503433

Plain
w/Rubber Washer
Face Gasket
Oil Drain Plug
Thread: 14mm-1.50
Hex: 17mm
Length under Hd: 18mm
Rubber Gasket O.D.: 28mm
Box Qty. 2

Chrysler 1.5 & 2.0 Eng.



530232

N90813201

Zinc w/ Sems®
Gasket Oil Drain Plug
Thread: 14mm-1.50
Hex: 19mm
Length under Hd: 20mm
Sems® Washer O.D.: 20mm
Box Qty. 2

Audi: Cabriolet & Quattro with 1.8, 1.9, 2.0, 2.7, 2.8 & 3.0 VW: Beetle, Eurovan, Golf, Jetta, Passat & Touareg with 1.8, 1.9, 2.0, 2.8, 3.2 & 4.0 Eng.



530241

6507741-AA

Zinc
w/Rubber Gasket
Oil Drain Plug
Thread: 14mm-1.50
Hex: 13mm
Length Under Hd: 21mm
Washer Head O.D.: 29mm
Box Qty. 2

Chrysler



530242

N90288901

Black Zinc w/Gasket
Oil Drain Plug
Thread: 14mm-1.50
Hex: 19mm
Length Under Hd: 14mm
Box Qty. 2

Volkswagen



530243

807016160,
803916010,
SU003-02194

Zinc w/Gasket
Oil Drain Plug
Thread: 16mm-1.5 x 9mm
Hex: 14mm
Washer Head Dia.: 24mm
Box Qty. 2

Subaru: Legacy & Outback 2.5L



530244

Zinc w/Gasket
Oversize Oil Drain Plug
Thread: 16.4mm-1.33
Hex: 19mm
Length under Hd: 13mm
Washer Head O.D.: 26mm
Box Qty. 5

*Nissan: All (Exc. Sentra, Stanza & Pulsar w/FWD) 62 - UP
Renault: Fuego & LeCar 80 - UP*



530246

Zinc w/Gasket
Oil Drain Plug
Thread: 18mm-1.5
Hex: 19mm
Length under Hd: 12mm
Washer Head O.D.: 29mm
Box Qty. 5

*Chrysler: All imports 70 - UP
Renault: LeCar 76 - 79
Toyota: All 75 - UP*



530248

028-103-059-A

Zinc w/Gasket
Oil Drain Plug
Thread: M24-1.5
Drive: 10mm Allen
Length under Hd: 10mm
Head Diameter: 32mm
Box Qty. 1

*Audi: Cabriolet, A6, A8, Avant, Quattro, RS6, S4, S6 & S8
VW: Phaeton 6.0L & V8 4.2L and Touareg 4.2L*

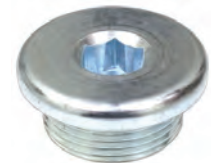

530249

Zinc w/Gasket
Oil Drain Plug
Thread: M25-1.5
Hex: 24mm
Length under Hd: 13mm
Washer Head O.D.: 35mm
Box Qty. 1

Toyota



DRAIN PLUGS / GASKETS

Magnetic Oil Drain Plugs With Gasket Zinc Plated



Type 1



Type 2



Type 3

Part No.	Type	Thread Size	Hex	Length Under Head	Finish	Bx Qty
530253	3	1/2"-20	3/4"	43/64"	Zinc	1
530254	3	1/2"-20 Single Oversize	3/4"	13/16"	Zinc	2
530256	2	1/2"-20 Double Oversize	3/4"	13/16"	Zinc & Yellow	2
530257	3	1/2"-20 Triple Oversize	3/4"	13/16"	Black Zinc	2
530258	1	12mm-1.75	13mm	19mm	Zinc	2

Oversize Oil Drain Plugs With Fibre Gasket Self-Tapping



Metric



Standard

Part No	Size	Finish	Bx Qty
530259	1/2"-20 Single Oversize	Zinc	5
530261	1/2"-20 Double Oversize	Zinc & Yellow	5
530262	1/2"-20 Triple Oversize	Black Zinc	5
530263	5/8"-18 Single Oversize	Zinc	5
530264	11/16"-20 Single Oversize	Zinc	5
530266	3/4"-16 Single Oversize	Zinc	5
530267	7/8"-14 Single Oversize	Zinc	5
530268	M12-1.25 Single Oversize	Zinc	5
530269	M12-1.50 Single Oversize	Zinc	5
530271	M12-1.75 Single Oversize	Zinc	5
530272	M14-1.5 Single Oversize	Zinc	5

Transmission



530211

F81Z-6730-AA
Plain w/Rubber
Washer Face Gasket
Trans. Drain Plug
Thread: 10mm-1.5
Hex: 13mm
Length under Hd: 15mm
Rubber Gasket O.D.: 28mm
Box Qty. 1

*Fits the following 4R100 transmission applications:
Ford: E150-450, F150-450 Excursion & Expedition
1980 - UP*

Transmission



530213

24233099
Zinc w/Rubber Gasket
Trans. Drain Plug
Thread: 12mm-1.75
Hex: 15mm
Length under Hd: 20mm
Washer Head O.D.: 32mm
Box Qty. 2

*Fits the following 4L80-E transmission applications:
Chevrolet: 2WD Full Size
Vans & Pickup Trucks 97 - UP*

DRAIN PLUGS / GASKETS



530300 Qty. 25
530301 Qty. 500
530302 Qty. 1000

Oil Drain Plug Gasket
 1/2" Fiber
 I.D. 1/2" O.D. 15/16"
 Thickness 1/16"



530305
 Oil Drain Plug Gasket
 3/4" Copper
 I.D. 3/4" O.D. 1"
 Thickness 1/16"
 Box Qty. 25



530310
GM 14090908
 Oil Drain Plug Gasket
 12mm Metal/Encasing Rubber
 I.D. 12mm O.D. 24mm
 Thickness 1mm
 Box Qty. 25



530315
GM 24571185, 14090908
 Oil Drain Plug Gasket
 12mm Metal/Encasing Rubber
 I.D. 12mm O.D. 24mm
 Thickness 1mm
 Box Qty. 25



530320
Saturn 21007240
 Oil Drain Plug Gasket
 Rubber
 I.D. 11mm O.D. 22mm
 Box Qty. 25



530321
 Rubber
 Oil Drain Plug Gasket
 I.D.: 11mm
 O.D.: 21mm
 Box Qty. 10



530322
 Rubber
 Oil Drain Plug Gasket
 I.D.: 11mm
 O.D.: 25mm
Replacement Gasket for #530218
 Box Qty. 10



530323
 Rubber
 Oil Drain Plug Gasket
 I.D.: 13mm
 O.D.: 19mm
Replacement Gasket for #530234
 Box Qty. 10



530324
 Rubber
 Oil Drain Plug Gasket
 I.D.: 13mm
 O.D.: 22mm
Replacement Gasket for #530236
 Box Qty. 10



530325 Qty. 25
530326 Qty. 500
530327 Qty. 1000
 Oil Drain Plug Gasket
 12mm Fiber
 I.D. 12mm O.D. 22mm
 Thickness 2mm



530330
 Oil Drain Plug Gasket
 12mm Fiber
 I.D. 12mm O.D. 22mm
 Thickness 2.5mm
 Box Qty. 25

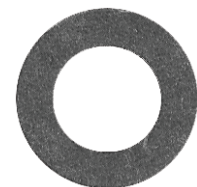

530345 Qty. 25
530346 Qty. 500
530347 Qty. 1000
 Oil Drain Plug Gasket
 12mm Fiber
 I.D. 14mm O.D. 24mm
 Thickness 2mm

DRAIN PLUGS / GASKETS



530335

Oil Drain Plug Gasket
14mm Aluminum
I.D. 14mm O.D. 24mm
Thickness 1mm
Box Qty. 25



530340

Ford F3DZ-6734A
Oil Drain Plug Gasket
14mm Metal/Encasing
I.D. 14mm O.D. 24mm
Thickness 1mm
Box Qty. 25



530350 Qty. 25
530351 Qty. 500
530352 Qty. 1000

Mazda 9956-41-800
Oil Drain Plug Gasket
18mm Aluminum
I.D. 18mm O.D. 24mm
Thickness 1mm
Box Qty. 25



530355 Qty. 25
530356 Qty. 500
530357 Qty. 1000

Oil Drain Plug Gasket
14mm Aluminum
I.D. 14mm O.D. 22mm
Thickness 2mm
Box Qty. 25



5 Drain Plugs / Gaskets

**Steel With Rubber Seal
Oil Drain Plug Gaskets**



Part No.	I.D.	O.D.	Thickness	Bx Qty
530306	1/2"	1"	3/64"	5
530307	14mm.....	25mm.....	1mm.....	10
530308	16mm.....	24mm.....	2mm.....	10
530309	18mm.....	27mm.....	2mm.....	10

DISC

**Oil Drain Plug
Crushable Gaskets**



Part No.	I.D.	O.D.	Thickness	Material	Bx Qty
530360	1/2"	3/4"	5/64"	Copper.....	10
530362	12mm	18mm.....	2mm	Copper.....	10
530363	14mm	19mm.....	2mm	Steel	10
530364	14mm	20mm.....	2mm	Copper.....	10
530365	16mm	22mm.....	2mm	Copper.....	10
530366	18mm	24mm.....	2mm	Copper.....	10
530367	18mm	24mm.....	2.5mm	Steel	10
530368	20mm	26mm.....	2mm	Copper.....	10

DISC

DRAIN PLUGS / GASKETS

OIL DRAIN PLUGS GASKETS

On vehicles equipped with aluminum gaskets, a new aluminum gasket must be installed at each oil change.



* Teflon coated steel

NEW

Part No.	I.D.	O.D.	Thick-ness	Material	Bx Qty.
530370	1/2"	3/4"	5/64"	Blk. Fibre	50
530371	1/2"	3/4"	3/32"	Nylon	25
530372	1/2"	7/8"	1/16"	Copper	25
530373	1/2"	7/8"	1/16"	Aluminum	25
530374	1/2"	15/16"	1/16"	Nylon	25
530300	1/2"	15/16"	1/16"	Fibre	25
530301	1/2"	15/16"	1/16"	Fibre	500
530302	1/2"	15/16"	1/16"	Fibre	1000
530375	1/2"	15/16"	5/64"	Fibre	50
530376	9/16"	13/16"	5/64"	Blk. Fibre	50
530377	9/16"	13/16"	3/32"	Nylon	25
530378	9/16"	13/16"	3/32"	Copper	25
530379	5/8"	1"	3/32"	Nylon	25
530305	3/4"	1"	1/16"	Copper	25
530381	3/4"	1-1/16"	3/32"	Nylon	25
530382	12mm	21mm	1.8mm	Steel*	5
530386	12mm	21mm	1.75mm	Fibre/Alum	5
530383	12mm	22mm	1.5mm	Nylon	50
530384	12mm	22mm	1.5mm	Copper	15
530385	12mm	22mm	1.5mm	Aluminum	50
530325	12mm	22mm	2mm	Blk. Fibre	25
530326	12mm	22mm	2mm	Blk. Fibre	500
530327	12mm	22mm	2mm	Blk. Fibre	1000
530330	12mm	22mm	2.5mm	Fibre	25
530387	12mm	22mm	2.5mm	Grn. Fibre	25
530388	14mm	20mm	1mm	Aluminum	50
530389	14mm	20mm	1.5mm	Copper	15
530335	14mm	24mm	1mm	Aluminum	25
530390	14mm	22mm	1.5mm	Copper	15
530355	14mm	22mm	2mm	Aluminum	25
530356	14mm	22mm	2mm	Aluminum	500
530357	14mm	22mm	2mm	Aluminum	1000
530392	14mm	24mm	1.5mm	Nylon	50
530345	14mm	24mm	2mm	Fibre	25
530346	14mm	24mm	2mm	Fibre	500
530347	14mm	24mm	2mm	Fibre	1000
530395	16mm	22mm	1.5mm	Copper	10
530396	16.7mm	27mm	2mm	Blk. Fibre	50
530397	16.5mm	27mm	1.5mm	Nylon	50
530350	18mm	24mm	1mm	Aluminum	25
530351	18mm	24mm	1mm	Aluminum	500
530352	18mm	24mm	1mm	Aluminum	1000
530399	18mm	25mm	2mm	Aluminum	50
530401	18mm	29mm	1.5mm	Nylon	50
530402	18mm	26mm	1.5mm	Copper	10
530403	18mm	29mm	1.5mm	Grn. Fibre	25
530404	20mm	26mm	2mm	Steel	10
530405	20mm	28mm	1.5mm	Nylon	50
530406	20mm	25mm	1.6mm	Copper	10
530407	20mm	28mm	1.5mm	Grn. Fibre	25
530408	25.5mm	35mm	2mm	Blk. Fibre	50

DRAIN PLUGS / GASKETS



222530
Oil Drain Plug &
Gasket Assortment
12 Varieties / 76 Pieces

Drain Plug & Gasket Assortment

Assortment Includes:

530214 1/2"-20	530224 M12-1.75
530210 1/2"-20	530260 M14-1.50
530261 1/2"-20 Double Oversize	530238 M14-1.50
530221 M12-1.25	530236 M14-1.50
530245 M12-1.75	530234 M14-1.50
530222 M12-1.75	530246 M18-1.50



222534
Oil Drain Plug &
Gasket Assortment 2
32 Varieties / 93 Pieces

Drain Plug & Gasket Assortment

Assortment Includes:

530210 1/2"-20	530229 M14-1.5
530211 M10-1.5 w/ gasket	530231 M14-1.5
530212 M10-1.5	530232 M14-1.5
530213 M12-1.75	530233 M14-1.5
530214 1/2"-20	530234 M14-1.5
530216 1/2"-20	530236 M14-1.5
530217 3/4"-16	530237 M14-1.5
530218 M12-1.75	530238 M14-1.5
530219 M12-1.5	530239 M14-1.5
530221 M12-1.25	530241 M14-1.5
530222 M12-1.75	530242 M14-1.5
530223 M12-1.75	530243 M16-1.5
530224 M12-1.75	530244 M16.4-1.33
530226 M12-1.25	530246 M18-1.5
530227 M14-1.25	530247 M20-1.5
530228 M14-1.5	530383 Nylon Gasket



222535
Oil Drain Plug
Gasket Assortment
20 Varieties / 200 Pieces

Gasket Assortment

Assortment Includes:

530384 12mm ID Copper Gasket	530305 3/4" Copper Gasket
530360 1/2" ID Copper Gasket	530371 1/2" ID Nylon Gasket
530401 18mm ID Nylon Gasket	530408 25.5mm ID Fiber Gasket
530330 12mm Fiber Gasket	530403 18mm ID Fiber Gasket
530374 1/2" ID Nylon Gasket	530376 9/16" ID Fiber Gasket
530395 16mm ID Copper Gasket	530378 9/16" ID Copper Gasket
530388 14mm ID Aluminum Gasket	530379 5/8" ID Nylon Gasket
530381 3/4" ID Nylon Gasket	530377 9/16" ID Nylon Gasket
530401 18mm ID Fiber Gasket	530315 12mm Metal/Rubber Gasket
530307 14mm ID Steel Gasket	530300 1/2" Fiber Gasket

DRAIN PLUGS / GASKETS

BLANK

BUNA "N" RUBBER "O" RINGS

Temp. Rating: 70 hours @ 100°C

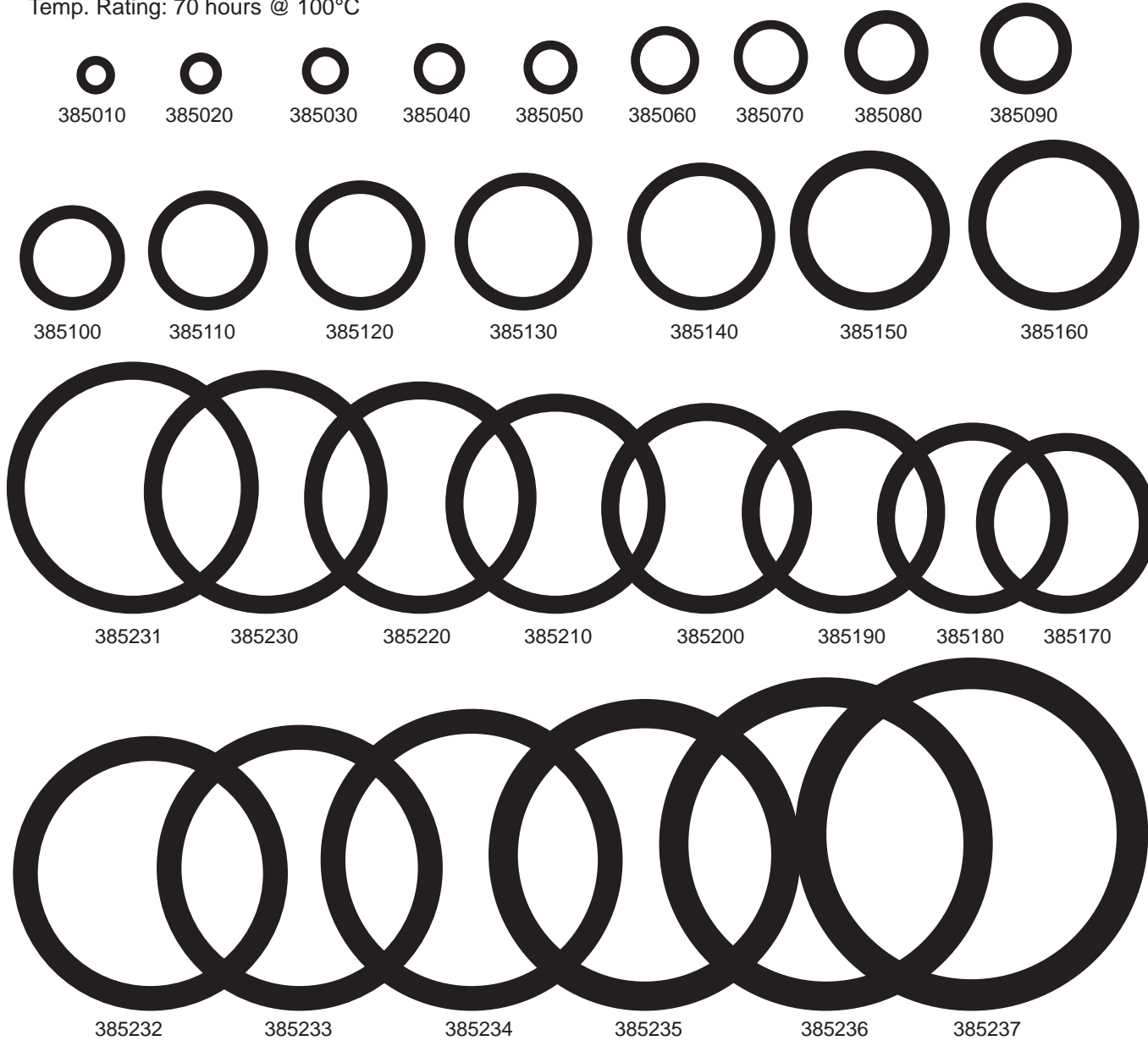

6 O-Rings

Product Number	Ind. Std.	I.D.	O.D.	Thick-ness	Box Qty.	Product Number	Ind. Std.	I.D.	O.D.	Thick-ness	Box Qty.
385010006 1/8" 1/4" 1/16"50	385160211 13/16" 1-1/16" 1/8"50
385020007 5/32" 9/32" 1/16"50	385170212 7/8" 1-1/8" 1/8"50
385030008 3/16" 5/16" 1/16"50	385180213 15/16" 1-3/16" 1/8"50
385040009 7/32" 11/32" 1/16"50	385190214 1" 1-1/4" 1/8"50
385050010 1/4" 3/8" 1/16"50	385200215 1-1/16" 1-5/16" 1/8"50
385060011 5/16" 7/16" 1/16"50	385210216 1-1/8" 1-3/8" 1/8"50
385070012 3/8" 1/2" 1/16"50	385220217 1-3/16" 1-7/16" 1/8"50
385080110 3/8" 9/16" 3/32"50	385230218 1-1/4" 1-1/2" 1/8"50
385090111 7/16" 5/8" 3/32"50	385231219 1-5/16" 1-9/16" 1/8"25
385100112 1/2" 11/16" 3/32"50	385232220 1-3/8" 1-5/8" 1/8"25
385110113 9/16" 3/4" 3/32"50	385233221 1-7/16" 1-11/16" 1/8"25
385120114 5/8" 13/16" 3/32"50	385234222 1-1/2" 1-3/4" 1/8"25
385130115 11/16" 7/8" 3/32"50	385235325 1-1/2" 1-7/8" 13/64"25
385140116 3/4" 15/16" 3/32"50	385236326 1-5/8" 2" 13/64"25
385150210 3/4" 1" 1/8"50	385237327 1-3/4" 2-1/8" 13/64"25

METRIC BUNA "N" RUBBER "O" RINGS

6 O-Rings

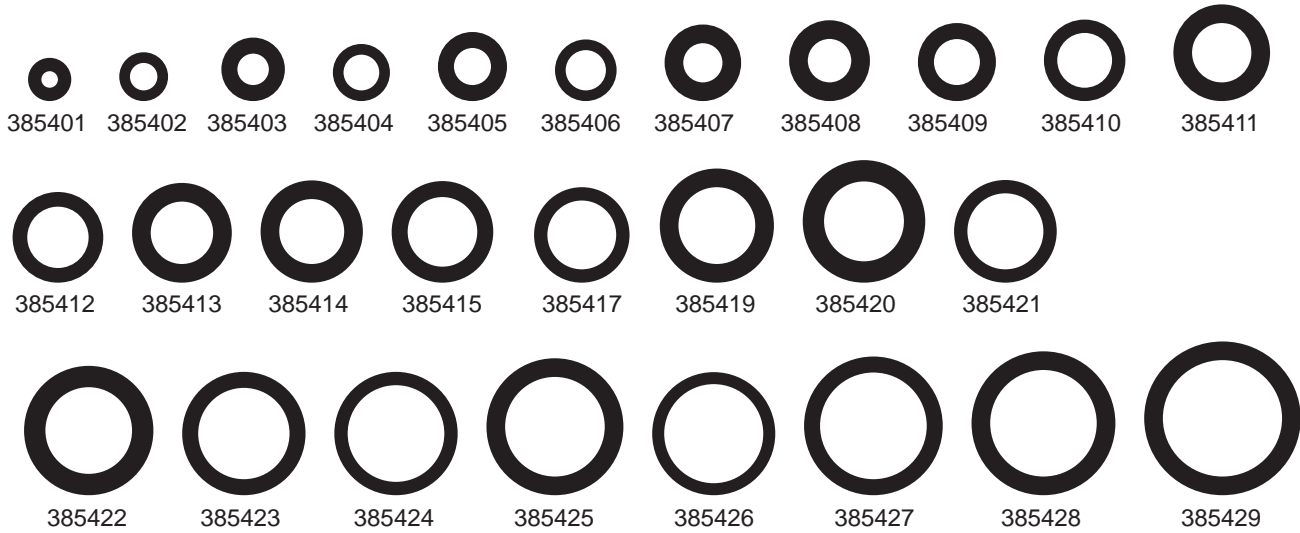

Product Number	I.D.	O.D.	Thickness	Box Qty.
385401	2.2mm	5.4mm	1.6mm	50
385402	3.1mm	6.3mm	1.6mm	50
385403	4.0mm	8.0mm	2.0mm	100
385404	4.1mm	7.3mm	1.6mm	50
385405	4.3mm	9.1mm	2.4mm	50
385406	5.0mm	8.0mm	1.5mm	50
385407	5.3mm	10.1mm	2.4mm	50
385408	5.6mm	10.4mm	2.4mm	50
385409	6.0mm	10mm	2.0mm	100
385410	7.1mm	10.3mm	1.6mm	50
385411	7.6mm	12.4mm	2.4mm	50
385412	8.0mm	12mm	2.0mm	50
385413	8.3mm	13.1mm	2.4mm	50
385414	8.6mm	13.4mm	2.4mm	50
385415	9.0mm	13mm	2.0mm	100
385417	9.1mm	12.3mm	1.6mm	50
385419	10mm	15mm	2.5mm	100
385420	10mm	16mm	3.0mm	50
385421	10.1mm	13.3mm	1.6mm	50
385422	11mm	17mm	3.0mm	50
385423	12mm	16mm	2.0mm	100
385424	13mm	16mm	1.5mm	50
385425	13mm	18mm	2.5mm	100
385426	13.1mm	16.3mm	1.6mm	25
385427	14mm	18mm	2.0mm	50
385428	14mm	19mm	2.5mm	50
385429	15mm	20mm	2.5mm	50
385431	16mm	20mm	2.0mm	50
385432	17mm	22mm	2.5mm	25
385434	19mm	23mm	2.0mm	50
385435	19mm	24mm	2.5mm	50
385436	20mm	24mm	2.0mm	50

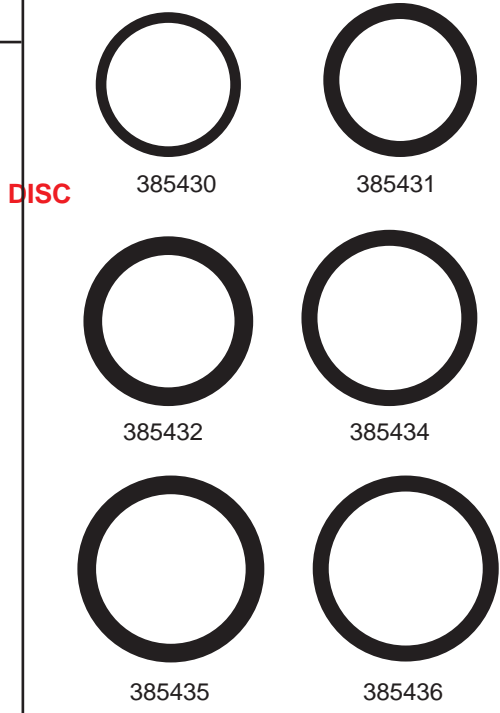

NITRILE AIR CONDITIONING "O" RINGS

For Use With R12 & R134A Refrigerant
Rings may be Green or Black with an orange dot.

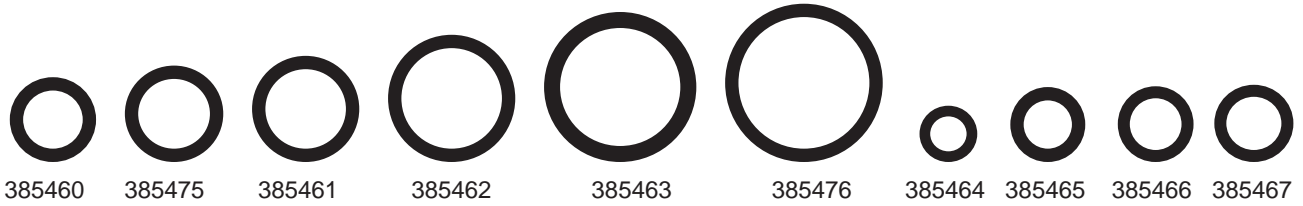

6 O-Rings

Also available: #222302 Assortment

Product Number	I.D.	O.D.	Thick-ness	OEM No.	Box Qty.
385460290"432"071"	Ford: 391396	25
385475375"500"063"	25
385461400"546"073"	Ford: 391397	25
385462509"655"073"	Ford: 391304	25
385463617"769"076"	Ford: 391305	15
385476688"813"063"	25
385464	4.5mm	7.3mm	1.4mm	Nissan: 92472-N8200	25
385465	6.0mm	9.6mm	1.8mm	Nissan: 92470-N8200	25
385466	6.5mm	9.5mm	1.5mm	Toyota: 90099-14044	25
385467	6.6mm	10.2mm	1.8mm	Acura: 80873-ST7-000	25
385468	7.7mm	11.3mm	1.8mm	Nissan: 92474-N8200	25
385469	10.7mm	15.5mm	2.4mm	Acura: 80872-ST7-000	25
				Nissan: 92475-W1000	
385470	10.8mm	14.4mm	1.8mm	Nissan: 92471-N8200	25
385471	13.3mm	18.1mm	2.4mm	Acura: 80871-ST7-000	25
385472	13.4mm	17.2mm	1.9mm	Toyota: 90099-14045	15
385473	14.0mm	17.6mm	1.8mm	Nissan: 92473-N8200	25
385474	14.8mm	19.6mm	2.4mm	Nissan: 92475-W2100	15
385477	13/16"	1-1/16"	1/8"	10

TEFLON COATED NEOPRENE "O" RINGS

For use with **ALL** refrigerant blends.

Teflon coated neoprene O-rings are generally not affected by exposure to R22, while seals made from NBR Nitrile and HNBR rubber can be damaged when exposed to R22.
Rings may be Blue or Black.

Also available: #222307 Assortment



385505
Ind. Std. 010
I.D.: 1/4"
O.D.: 3/8"
Nissan
Box Qty. 25



385510
Ind. Std. 011
I.D.: 5/16"
O.D.: 7/16"
Nissan, Hyundai
Box Qty. 25



385520
Ind. Std. 013
I.D.: 7/16"
O.D.: 9/16"
GM, Nissan, Volvo,
Mazda
Box Qty. 25



385525
Ind. Std. 014
I.D.: 1/2"
O.D.: 5/8"
GM, Mitsubishi
Box Qty. 25



385530
Ind. Std. 015
I.D.: 9/16"
O.D.: 11/16"
Ford, Toyota
Box Qty. 25

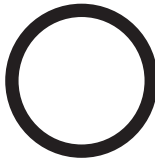

385535
Ind. Std. 017
I.D.: 11/16"
O.D.: 13/16"
Nissan
Box Qty. 25

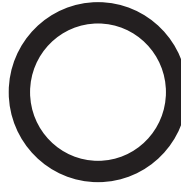

385545
Ind. Std. 116
I.D.: 3/4"
O.D.: 15/16"
Ford, Mitsubishi
Box Qty. 25

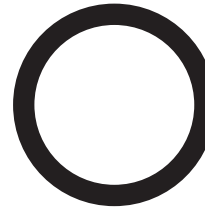

385550
Ind. Std. 118
I.D.: 7/8"
O.D.: 1-1/16"
GM, Chrysler
Box Qty. 25

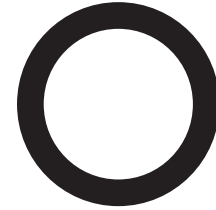

385555
Ind. Std. 211
I.D.: 5/16"
O.D.: 7/16"
GM, Ford
Box Qty. 25

"O" RING ASSORTMENTS

See pg. 36-15
for additional
info!



222302
Nitrile Air Conditioning
"O" Ring Assortment
18 different varieties, 203 pieces
Box Qty. 1

See pg. 36-15
for additional
info!



222307
Teflon Coated Neoprene
"O" Ring Assortment
12 different sizes
105 neoprene "O" rings
Box Qty. 1

- Works with R12 and R134a refrigeration systems
- Detectable when exposed to any standard black light
- Compatible with PAG, ester and mineral oils
- Does not contain solvents!!
- Will not harm A/C systems or recovery equipment
- Meets SAE J-2297 standards



3601
 Concentrated Air Conditioning U/V Leak
 Detection Dye
 1/4 oz. single application packs
 Box Qty. 12



PAG46
 AC Refrigerant Oil
 For R-134a Systems
 Box Qty. 1

3602
 Polyol Ester Oil plus UV Dye
 Net Contents: 8 oz. (237mL)
 - Provide excellent lubricity and
 compressor protection
 - Includes additives to prevent acid
 formation and corrosion
 - Includes O-ring Conditioner, Ant-Wear
 and Anti-Oxidant Additives
 - Compatible with PAG and mineral oils
 - Compatible with R-134a and R-12 refrigerant
 Box Qty. 1



**For AC "O" Ring Assortments
 See page 33-14**



3605
 Straight Low Side
 Retrofit Connector (Steel)
 7/16-20 Thread with
 Blue M8 x 1 Cap and Core
 Box Qty. 5



3610
 Straight High Side
 Retrofit Connector (Steel)
 3/8-24 Thread with
 Red M8 x 1 Cap and Core
 Box Qty. 5



3615
 Straight High Side
 Retrofit Connector (Steel)
 7/16-20 Thread with
 Red M8 x 1 Cap and Core
 Box Qty. 5



3620
 90° Low Side
 Retrofit Connector (Steel)
 7/16"-20 Thread with
 Blue M8 x 1 Cap and Core
 Box Qty. 2



3625
 90° High Side
 Retrofit Connector (Steel)
 7/16"-20 Thread with
 Red M8 x 1 Cap and Core
 Box Qty. 2



3630
 90° High Side
 Retrofit Connector (Steel)
 3/8"-24 Thread with
 Red M8 x 1 Cap and Core
 Box Qty. 2

BLANK

WHEEL WEIGHTS



See Pg. 8-8 for Wheel Weight Tools

Used on most domestic equipped with alloy rims that were manufactured prior to 1995. Fits many brands like Acura, Buick, Chevrolet, Chrysler, Dodge, Infiniti, Isuzu, Lexus, Oldsmobile & Pontiac.

UNCOATED AW WEIGHTS WILL BE DISCONTINUED WHEN OUT
ZINC WEIGHTS WILL BE REPLACED WITH COATED STEEL WEIGHTS WHEN OUT

SIZE oz.	PRODUCT NUMBER		BOX QTY
	Uncoated	Coated	
1/4	93025*	94025	25
1/2	93050	94050	25
3/4	93075	94075	25
1	93100	94100	25
1-1/4	93125	94125	25
1-1/2	93150	94150	25

* The 1/4 oz AW weight is a steel clip on weight - NOT ZINC

PASSENGER CAR WHEEL BALANCING WEIGHTS FOR ALLOY WHEELS

Zn Zinc AW Series

SIZE oz.	PRODUCT NUMBER		BOX QTY
	Uncoated	Coated	
1-3/4	93175	94175	25
2	93200	94200	25
2-1/4	93225	94225	25
2-1/2	93250	94250	25
2-3/4	93275	94275	25
3	93300	94300	25



See Pg. 8-8 for Wheel Weight Tools

Used on most domestic vehicles equipped with alloy rims. Fits many brands like Buick, Chevrolet, Chrysler, Dodge, Ford, Mazda, Oldsmobile, Pontiac & Saturn.

UNCOATED MC WEIGHTS WILL BE DISCONTINUED WHEN OUT
ZINC WEIGHTS WILL BE REPLACED WITH COATED STEEL WEIGHTS WHEN OUT

SIZE oz.	PRODUCT NUMBER		BOX QTY
	Uncoated	Coated	
1/4	89025	88025	25
1/2	89050	88050	25
3/4	89075	88075	25
1	89100	88100	25
1-1/4	89125	88125	25
1-1/2	89150	88150	25

PASSENGER CAR WHEEL BALANCING WEIGHTS FOR ALLOY WHEELS

Zn Zinc MC Series

SIZE oz.	PRODUCT NUMBER		BOX QTY
	Uncoated	Coated	
1-3/4	89175	88175	25
2	89200	88200	25
2-1/4	89225	88225	25
2-1/2	89250	88250	25
2-3/4	89275	88275	25
3	89300	88300	25



See Pg. 8-8 for Wheel Weight Tools

Used on Chrysler vehicles and is designed to fit their unique alloy rim flange. Fits all Chrysler models and some Dodge & Ram models prior to 2009.

These weights are coated, specially contoured and have a unique clip design. These weights will provide a flush appearance and are a must to balance any vehicles with flange mounted weights.

ZINC WEIGHTS WILL BE REPLACED WITH COATED STEEL WEIGHTS WHEN OUT

SIZE oz.	PRODUCT NUMBER	BOX QTY
1/4	98025	25
1/2	98050	25
3/4	98075	25
1	98100	25
1-1/4	98125	25
1-1/2	98150	25

PASSENGER CAR WHEEL BALANCING WEIGHTS FOR ALLOY WHEELS

Zn Zinc LH Series

LH WEIGHTS WILL BE DISCONTINUED WHEN OUT

SIZE oz.	PRODUCT NUMBER	BOX QTY
1-3/4	98175	25
2	98200	25
2-1/4	98225	25
2-1/2	98250	25
2-3/4	98275	25
3	98300	25

WHEEL WEIGHTS

IMPORT PASSENGER CAR WHEEL BALANCING WEIGHTS FOR ALLOY WHEELS

Designed for the thicker flange alloy wheels being used on many Japanese vehicles. Fits many brands like Acura, Honda, Infiniti, Lexus, Nissan & Toyota.

Zn Zinc FN Series

**ZINC WEIGHTS WILL BE REPLACED
WITH COATED STEEL WEIGHTS WHEN OUT**



See Pg. 8-8 for
Wheel Weight Tools

SIZE g / oz.	PRODUCT NUMBER	BOX QTY
5g/.17oz	87005*	25
7.5g/.25oz	87007 DISC	25
10g/.35oz	87010	25
12.5g/.45oz	87012	25
15g/.50oz	87015	25
17.5g/.625oz	87017	25
20g/.70oz	87020	25
22.5g/.80oz	87022	25
25g/.90oz	87025	25
27.5g/.975oz	87027	25

SIZE g / oz.	PRODUCT NUMBER	BOX QTY
30g/1.00oz	87030	25
32.5g/1.105oz	87032	25
35g/1.25oz	87035	25
37.5g/1.275oz	87037	25
40g/1.40oz	87040	25
45g/1.60oz	87045	25
50g/1.75oz	87050	25
55g/1.95oz	87055	25
60g/2.10oz	87060	25

* The 5g FN weight is a steel clip on weight - NOT ZINC

IMPORT PASSENGER CAR WHEEL BALANCING WEIGHTS FOR ALLOY WHEELS

**UNCOATED IAW WEIGHTS WILL
BE DISCONTINUED WHEN OUT**

Zn Zinc IAW Series

**ZINC WEIGHTS WILL BE REPLACED
WITH COATED STEEL WEIGHTS WHEN OUT**



See Pg. 8-8 for
Wheel Weight Tools

Used on many new Ford Models, on most European vehicles and certain Asian vehicles equipped with alloy wheels. Fits many brands like Audi, BMW, Cadillac, Jaguar, Kia, Nissan, Toyota, Volkswagen & Volvo.

SIZE oz.	PRODUCT NUMBER		BOX QTY
	Uncoated	Coated	
1/8 (5gr.)	--	92012	25
1/4 (10gr.)	91025	92025	25
1/2 (15gr.)	91050	92050	25
3/4 (20gr.)	91075	92075	25
7/8 (25gr.)	91087	92087	25
1 (30gr.)	91100	92100	25
1-1/4 (35gr.)	91125	92125	25

SIZE oz.	PRODUCT NUMBER		BOX QTY
	Uncoated	Coated	
1-3/8 (40gr.)	91137	92137	25
1-1/2 (45gr.)	91150	92150	25
1-3/4 (50gr.)	91175	92175	25
2 (55gr.)	91200	92200	25
2-1/4 (60gr.)	91225	92225	25
2-1/2	--	--	25
2-3/4	--	--	25
3	--	--	25



PASSENGER TRUCK WHEEL BALANCING WEIGHTS FOR ALUMINUM ALLOY WHEELS



Zinc TN Series

ZINC WEIGHTS WILL BE REPLACED
WITH COATED STEEL WEIGHTS WHEN OUT



Used on most domestic light trucks equipped with decorative and larger thickness steel wheels and most light-trucks equipped with alloy wheels.

Fits steel wheels with a thicker than standard rim flange and light-trucks with non-commercial alloy rims.

SIZE oz.	PRODUCT NUMBER	BOX QTY
1/4	98525	25
1/2	98550	25
3/4	98575	25
1	98600	25
1-1/4	98625	25
1-1/2	98650	25
1-3/4	98675	25
2	98700	25

SIZE oz.	PRODUCT NUMBER	BOX QTY
2-1/4	98725	25
2-1/2	98750	25
2-3/4	98775	25
3	98800	25
3-1/4	98850	25
3-1/2	98875	25
3-3/4	98900	25
4	98950	25

See Pg. 8-8 for
Wheel Weight Tools



PASSENGER TRUCK WHEEL BALANCING WEIGHTS FOR STEEL WHEELS



Zinc I7 Series

The most commonly used weight on heavy-duty trucks (larger than 26,000 lbs GVWR) with steel rims. Fits medium-duty steel wheels and older light-duty trucks with thicker than standard rim flanges.



SIZE oz.	PRODUCT NUMBER	BOX QTY
1	87100	25
1-1/2	87150	25
2	87200	25
2-1/2	87250	25
3	87300	25

SIZE oz.	PRODUCT NUMBER	BOX QTY
3-1/2	87350	25
4	87400	25
5	87500	25
6	87600	25

See Pg. 8-8 for
Wheel Weight Tools

WHEEL WEIGHTS

IMPORT PASSENGER CAR WHEEL BALANCING WEIGHTS FOR ALLOY WHEELS

Used on Audi, Mercedes-Benz, Volkswagen and very early-model Japanese vehicles equipped with alloy wheels. Fits brands like Acura, Audi, Ford, Honda, Mercedes-Benz & Volkswagen.



Zn Zinc EN Series

**ZINC WEIGHTS WILL BE REPLACED
WITH COATED STEEL WEIGHTS WHEN OUT**

SIZE oz.	PRODUCT NUMBER	BOX QTY
10g	98310	50
15g	98315	50
20g	98320	50
25g	98325	50
30g	98330	50
35g	98335	50

SIZE oz.	PRODUCT NUMBER	BOX QTY
40g	98340	50
45g	98345	50
50g	98350	50
55g	98355	50
60g	98360	50

**EN WEIGHTS WILL BE
DISCONTINUED WHEN OUT**



See Pg. 8-8 for
Wheel Weight Tools

PASSENGER CAR WHEEL BALANCING WEIGHTS FOR CONVENTIONAL STEEL RIMS

The most common weight for steel wheels. Use on all standard passenger car 13" - 17" steel wheels.



Fe Steel P Series

SIZE oz.	PRODUCT NUMBER	BOX QTY
1/4	90025	25
1/2	90050	25
3/4	90075	25
1	90100	25
1-1/4	90125	25
1-1/2	90150	25

SIZE oz.	PRODUCT NUMBER	BOX QTY
1-3/4	90175	25
2	90200	25
2-1/4	90225	25
2-1/2	90250	25
2-3/4	90275	25
3	90300	25



See Pg. 8-8 for
Wheel Weight Tools

IMPORT PASSENGER CAR WHEEL BALANCING WEIGHTS FOR ALLOY WHEELS

Zn ADHESIVE TYPE WEIGHT

Used on **AUDI, Land Rover, Mercedes Benz, Porsche, VW, Volvo**



Low-profile premium zinc adhesive weight used where standard profile does not provide sufficient clearance area to brake and steering parts. Weights of 5 gram feature a single segment; weights of 10-25 gram feature two segments; weights of 30-35 gram feature three segments; weights of 40-50 gram feature four segments; weights 55-60 gram feature five segments.

SIZE oz.	PRODUCT NUMBER	BOX QTY
5g	99105	25
10g	99110	25
15g	99115	25
20g	99120	25
25g	99125	25
30g	99130	25

SIZE oz.	PRODUCT NUMBER	BOX QTY
35g	99135	25
40g	99140	25
45g	99145	25
50g	99150	25
55g	99155	25
60g	99160	25

See Pg. 8-8 for Wheel Weight Tools

ADHESIVE WHEEL WEIGHTS

- Pre-Cut and pre-taped
- Use where wheel will not accept a clip type weight
- Use on the back side of wheel for appearance
- Clean rim with IES Super Clean or #93199 before applying

Product No. 94002 NEW
 Low Profile Adhesive Weight
 1/4 oz. (7 gram) segments
 48 - 3 oz. strips per box  **Steel**
 576 segments per box



Product No. 94011 NEW
 Black Low Profile Adhesive Weight
 1/4 oz. segments
 48 - 3 oz. strips per box  **Steel**
 576 segments per box



Product No. 94012 NEW
 Black Standard Profile Adhesive Weight
 1/2 oz. segments
 48 - 3 oz. strips per box  **Steel**
 288 segments per box



Product No. 94003 *Designed for trucks and RV's!* NEW
 Low Profile Adhesive Weight
 1/2 oz. (14 gram) segments
 48 - 3 oz. strips per box  **Steel**
 288 segments per box



Product No. 94004 *Designed for trucks and RV's!* NEW
 Standard Profile Adhesive Weight
 1 oz. (28 gram) segments
 36 - 4 oz. strips per box  **Steel**
 144 segments per box



Product No. 93010 *Designed for trucks and RV's!*
 Standard Profile Adhesive Weight
 2 oz. (56 gram) segments
 8 - 12 oz. strips per box  **Lead**
 48 segments per box



WHEEL WEIGHTS

8 Wheel Weights / Tire Repair

STEEL Pre-Segmented Adhesive Wheel Weights On A Roll

The perfect option for the environment.
 No measuring, no cutting.
 Easy to tear paper backing reduces installation time.
 OE adhesive - sticks fast and holds longer.



93005

Standard Profile
 Steel Adhesive Weight
 0.25 Ounce Increments
 20 Pounds Per Roll
 1,280 Increments Per Roll
 Box Qty. 1

93006

Low Profile
 Steel Adhesive Weight
 5 Gram Increments
 16.5 Pounds Per Roll
 1,500 Increments Per Roll
 Box Qty. 1

93008

Low Profile
 Nano Coated Adh. Weight
 1/4 oz. Increments
 20 Pounds Per Roll
 1,250 Increments Per Roll
 Box Qty. 1

93009

Standard Profile
 Nano Coated Adh. Weight
 1/2 oz. Increments
 20 Pounds Per Roll
 640 Increments Per Roll
 Box Qty. 1



93000

Wheel Weight Stand
 For Adhesive Wheel Weights
 93005, 93006, 93008, 93009
 Heavy-Duty Construction
 Holds two boxes at a time!
 Box Qty. 1

93199

Wheel Weight
 Pre-Cleaning Wipes
 For Adhesive Wheel Weights
 9" x 12" Wipes
 70 Wipes per canister.
 Box Qty. 6 canisters



***NOTE:** Use Product No. 93002, #93006, #93008 or #93011 on imports and sports cars where the brake caliper clearance knocks off standard thickness adhesive type weights.



www.srfast.com

WHEEL WEIGHTS ASSORTMENTS

The CWW155Z and CWW075Z assortments include a bin and rack storage system that is color coded to match the cataloging and packaging. This simplifies installation and storage of the installer's wheel weights.



(35.75"W x 8.25"D x 39 "H)

CWW155Z SPECIAL ORDER ONLY

The CWW155Z is the most popular OEM zinc table-top assortment. A comprehensive table-top clip-on wheel weight kit that includes all eight standard clip types needed for nearly all of today's passenger car market. It contains all seven coated alloy weights (and P steel weights) needed to balance today's passenger car market and is a practical starter kit for most installers.

TOTAL CLIP-ON WEIGHTS 1,525 pieces

Included in this assortment:

- OEM Wheel Weights
- Rack Stand and Colored Bins
- Alloy Soft-Head Wheel Weight Hammer
- OE Alloy Weight Application Guide
- OE Alloy Application Wall Chart
- Two (2) Passenger Car Rim Gauges
- Header Card and Bin Labels

CWW155NLE SPECIAL ORDER ONLY

The CWW155E is the bin and rack storage system for the CWW155. System is color coded to match the cataloging and packaging. **NO WHEEL WEIGHTS/TOOLS**
Box Qty. 1



(36"W x 14.5"D x 67"H)

CWW075Z SPECIAL ORDER ONLY

The CWW075Z is a new OEM zinc master assortment. A comprehensive floor-standing clip-on wheel weight kit that includes all eight standard clip types needed for nearly all of today's passenger car market.

TOTAL CLIP-ON WEIGHTS 2,325 pieces

Included in this assortment:

- OEM Wheel Weights
- Rack Stand and Colored Bins
- Alloy Soft-Head Wheel Weight Hammer
- OE Alloy Weight Application Guide
- OE Alloy Application Wall Chart
- Two (2) Passenger Car Rim Gauges
- Header Card and Bin Labels

CWW075E SPECIAL ORDER ONLY

The CWW075E is the bin and rack storage system for the CWW075. System is color coded to match the cataloging and packaging. **NO WHEEL WEIGHTS/TOOLS**
Box Qty. 1

WHEEL WEIGHT TOOLS/TIRE REPAIR



96116
Wheel weight installation and removal tool. Plastic coated handles.
Box Qty. 1



96118
A wheel weight hammer for coated weights. "Soft Head" design that facilitates the installation and removal of coated wheel weights without damaging the wheel or the special wheel weight coating.
Box Qty. 1



96121
Extra heavy head provides striking force needed to install TAL weights. Small diameter hammer face allows for concentration of this force precisely on the clip.
Box Qty. 1



96122
Primarily used for the large truck steel wheel weights. "Clip Claw" design is ideal for removing weights that have minimum tire/wheel flange clearance.
Box Qty. 1



96123
Heavy duty, hardened steel removal tool makes taking off even the toughest weights easy.
Box Qty. 1



96126
Adhesive wheel weight removal tool.
Box Qty. 1



KX62Y
Tire Marking Crayon (Yellow)
Use to mark on rubber tires prior to repair
Box Qty. 12



KX80221
Tire Marking Paint-stick (Yellow)
Box Qty. 12

NEW



KX1052N
Universal Mounting Paste
7.7lbs.
Box Qty. 4



KX1208
Tire / Tube Mounting Compound
8lbs.
Box Qty. 4



KX490F
Buffing Solution
Quart
Box Qty. 6



KX491F
Buffing Solution
16 oz. Aerosol
Box Qty. 12



KX507F
Tire Bead Sealer
Quart brush-top can
Box Qty. 6



KX508F
Liner Sealer
16 oz. brush-top can
Box Qty. 6



KX511F
Super Fast Drying Cement
8 oz. brush-top can
Box Qty. 10



KX73
Mounting paste brush for cars / light trucks
Box Qty. 1

TIRE REPAIR



KX81501C
Tire Mounting Lubricant
Concentrated-Gallon
Box Qty. 4



KX2990
Cotton Lube Swab
Box Qty. 1



KX101000110
REMA SHINE
Water based silicone dressing. Ideal for tires and interior and exterior mouldings. Provides high gloss restoring original beauty. Deep, long lasting shine. Convenient, ready-to-use formula. Pleasant odor and VOC Compliant.
Box Qty. 4



Double Rubber Reinforced Radial Patches
Designed for radial and bias tire repair.

Prod. #	Size		Box Qty.
44342	1-9/16" Mini Round	DISC	10
11320	1-3/4" Mini-Round		20
11321	2-3/8" Small Round		30
44344	3-1/8" Medium Round	DISC	10
11322	3-1/8" Medium Round		20



Tire Patch/Plugs

Prod. #	Size	Box Qty.
KX386	1-1/4" Dia., 1/8" Stem Dia.	24
KX387	1-7/8" Dia., 1/4" Stem Dia.	25
KX388	1-7/8" Dia., 3/8" Stem Dia.	25



KX2PCP
2-Pc Passenger Repair Kit
(50 Repairs)
*1/4" Stem units with pilot wire,
2-1/4" Medium round patches*
Box Qty. 1 kit



KX2PCT
2-Pc Truck Repair Kit
(25 Repairs)
*3/8" Stem units with pilot wire,
3-1/4" Large round patches*
Box Qty. 1 kit

KX365
**Deluxe Tire Repair Kit/
Temporary Repairs**

A popular kit that includes chrome handle spiral probe, chrome handle insertion needle, insertion lube, 50 repair plugs, razor blade, allen wrench (for tools) and instruction guide, all in a heavy-duty molded case.
Box Qty. 1



Tire Plugs

Prod. #	Size	Box Qty.
KX361	4" Brown Tire Plugs (Thick)	50
KX370	7" Black Tire Plugs (Narrow)	50



KX928
Metal T-Handle
Insertion Tool
Box Qty. 1



11331
Chrome Spiral Probe
Box Qty. 1

TIRE REPAIR

8 Wheel Weights / Tire Repair

8

	 <p>KX190 Awl Screwdriver Handle Box Qty. 1</p>	 <p>KX30 Ball Bearing Stitcher 1 1/4 x 1/8 Box Qty. 1</p>	 <p>KX929 Flexible Skiving Knife Round End Box Qty. 1</p>	 <p>KX932 Rubber Scraper Box Qty. 1</p>
 <p>KX6014 Brass Brush Stiff Box Qty. 1</p>	 <p>KX185 Tire Tread Depth Gauge Reads 0" to 1" in 1/32 increments Box Qty. 5</p>	 <p>KXCC3 Carbide Cutter 1/8" (3mm) Box Qty. 1</p>	 <p>KXCC6 Carbide Cutter 1/4" (6mm) Use with 1/4" Stems Box Qty. 1</p>	 <p>KXCC8 Carbide Cutter 5/16" (10mm) Box Qty. 1</p>
 <p>KXCC10 Carbide Cutter 3/8" (10mm) For use with 3/8" Stems Box Qty. 1</p>	 <p>KX34 Buffing Wheel 2-1/2" Dia. Fine Grit Box Qty. 1</p>	 <p>KXTCW21080 Buffing Rasp 80 Grit Box Qty. 1</p>	 <p>KXRH107 Rubber Hog Buffing Wheel 60 Grit Dia: 2-1/2" Width: 1-1/16" Bore: 3/8" Box Qty. 1</p>	
 <p>KXRH109 Rubber Hog Buffing Wheel 36 Grit Dia: 2-1/2" Width: 1-1/16" Bore: 3/8" Box Qty. 1</p>	 <p>KX6066 2-1/4" Threaded Quick Release Adapter 3/8", 24-T Box Qty. 1</p>	 <p>KX6068 For Use With KXCC6 Quick Release Adapter w/Set Screws for 1/4" Shank Box Qty. 1</p>	 <p>KX6068-125 For Use With KXCC3 Quick Release Adapter w/Set Screws for 1/8" Shank Box Qty. 1</p>	

TIRE REPAIR / VALVES



KX6069
For Use with KXCC8
Quick Release Adapter
w/Set Screws
for 5/16" Shank
Box Qty. 1



KX5196593
For Use with KXCC10
Quick Release Adapter
w/Set Screws
for 3/8" Shank
Box Qty. 1



KXCP873K
Low Speed Tire Buffer
QR Chuck
2800 RPM
Box Qty. 1



KX795
Air Vacuum Kit
For dry items,
includes bag
Box Qty. 1



KX3050-RB
Deluxe Tire Spreader Machine
Portable
Box Qty. 1



11384 Black plastic valve caps 100/Bx
11381 Black-long skirt plastic valve caps w/seal 100/Bx
11382 Gray plastic valve caps w/seal 100/Bx
11383 Green plastic valve caps w/seal 100/Bx
KX40 Chrome valve caps Hex Head 100/Bx



**Plastic
Tire Valve Extenders**

Product	Length	Qty.
41510	3/4" DISC	50
11520	1-1/4"	50

Tire Valves



Industry Number	Rim Hole Size	Length	Prod. No. Pkg. 10	Prod. No. Pkg. 25	Prod. No. Pkg. 100
TR-413	.453"	1-1/4"	11401	11385	11390
TR-418	.453"	2"	11402	11386	11391
TR-423	.453"	2-1/2"	11403	11387	11392
TR-413	.453"	1-1/4"	11401-500 (500 pack)		
TR-418	.453"	2"	11402-500 (500 pack)		

11411

High Pressure Snap-in Valve
Ind. #: TR602HP
Eff. Length: 2" Valve
Hole Dia: .453"
Max. Cold Inflation Pressure: 80 psi
Not for use on tire rims that exceed .205" in thickness.
Box Qty. 25



11413
High Pressure Snap-in Valve
Ind. #: TR802HP
Eff. Length: 2"
Valve Hole Dia: .625"
Max. Cold Inflation Pressure: 80 psi
Not for use on tire rims that exceed .205" in thickness.
Box Qty. 25



KXTR413C
Chrome Snap-in Valve
Ind. #: TR413 (Chrome)
Valve Hole Dia: .453"
Valve Size: 1-1/4" (31mm)
Box Qty. 25



11415
Tire Valve Core
High Temp
Small Bore (TRC1)
Box Qty. 25



KX36
Tire Valve Core
High Temp
Large Bore (TRC2)
Box Qty. 25



VALVES / KITS



KX6-124
TPMS Aluminum Valve Service Pack
Box Qty. 1



KX6-207A
TPMS Rubber Snap In Valve
80psi max cold inflation pressure,
Max Speed rating 115 MPH, T-10
Screw Torque 11.5in-lbs
Box Qty. 1



KX6-208
TPMS Rubber Snap In Valve
For Chrysler, Dodge, Fiat, Jeep,
Mitsubishi, Nissan
T-10 Screw Torque-12.5 in-lbs
Box Qty. 1



KX6-211
TPMS Rubber Snap In Valve
For Jeep, Chrysler, RAM, Dodge
T-10 Screw Torque-12.5 in-lbs
Box Qty. 1



KX6-234
TPMS Aluminum Clamp In Valve
115psi max cold inflation pressure,
Max Speed rating 155 MPH, TPMS
Nut Torque 62in.-lbs. T-10 Screw
Torque 11.5in-lbs
Box Qty. 1



KXPREM-TPMSB4
Prema U-Pro TPMS Starter Bundle.
Includes PREM-H46 Diagnostic Tool, OBDII Module,
20 KXPREM-ONE Sensors, User CD, Universal
Charger.
Box Qty. 1



KXPREM-ONE
Prema U-Pro Hybrid 2.0
Programmable Sensor with
Rubber Snap-In Valve.
Dual Band/Multi-Frequency
Covers 314.95, 315, 433, 433.95 &
434 MHz
Works with #KXPREM-TPMSB3 tool.
Box Qty. 2



KX104000032
Torque Valve Core Tool
Box Qty. 1



KX26KNH
Tire Repair Cabinet Kit
16 items
Heavy Duty Steel Cabinet
Box Qty. 1

- Kit Includes:**
- KX2PCP - 2 Piece Passenger Repair Kit
 - KXTCW21080 - 80 Carbide Cup Wheel
 - KX929 - Flexible Skiving Knife
 - KX190 - Awl
 - KXCP873K - Low Speed QR Tire Buffer
 - KX6068 - QR Adapter 1/4" Shank
 - KX6066 - QR Arbor (Threaded)
 - KX387 - 1/4 Stem Carbide Cutter 6mm
 - KX30 - Ball Bearing Stitcher
 - KXCC6 - 1/4 Stem Carbide Cutter
 - KX6014 - Brass Bristle Brush
 - KX932 - Rubber Tire Scraper
 - KX511F - Fast Drying Chemical Cement
 - KX508F - Liner Sealer
 - KX491F - Aerosol Buffing Solution
 - KX795 - Air Vacuum



KX10400001
TPMS TORQUE KIT
Allows the technician to
install the valve and sensor
correctly making sure all
torque settings are applied.
Box Qty. 1

Includes: Torque Wrench Kit, Torque Tool For Valve and Sensor Assembly, Valve Core Torque Tool, Rubber Grommet Removal Tool, Rubber Grommet Pick Tool, T5 and T10 Torx Head, Sleeve For Torque Wrench, Valve Core Tool.

NEW



NS03431R
Hunter Duck Head
Hunter 221-675-2, 221-675-2-B, HUR6752
Hunter Tire Changer Red Mount Head
This is for machines with plastic mount demount heads already.
Fits Hunter TC250, TC300, TC325, TC350, TC2000, TC3250, TC3305, TC3315, TC3500, TC3700, TC3715, TC3900
Box Qty. 1

BRAKE LATHE BITS

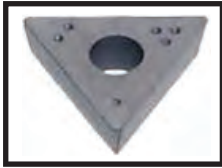

9510

Accu-Turn #40435, 433796

Accu-Turn/Bosch Style *POSITIVE* Rake Bit for Disc/Drum Lathes.

For use on Models: 7700, 8911, 8922, 8944, 8989, 8991, 8993 and 8922L.

Cutting Edges: 3 (6 by cross-indexing); Screws included: 5

Box Qty. 10

NEW



9511

Hunter #221-638-2, 6918, 8731

Hunter Style *POSITIVE* Rake Bit for Disc/Drum Lathes.

For use on Models: 500/502/505 lathes.

Cutting Edges: 3 (6 by cross-indexing); Screws included: 10

Box Qty. 10



9515

Ammco #221-580-2, 6914

Most popular - Ammco Style *NEGATIVE* Rake Bit for Disc/Drum Lathes.

For use on Models: 1000, 1001, 3000, 4000, 4100, 7000, 7700. On-The-Car brake lathe models 700, 705 & 710. Drum Side on 3850 lathes.

Cutting Edges: 6 (12 by cross-indexing); Screws included: 10

Box Qty. 10



9520

Ammco #9406

Ammco Style *POSITIVE* Rake Bit for Disc/Drum Lathes.

For use on Models: 3850, 4000, 7000, 7500. Must change tool holder.

Cutting Edges: 15-20; Screws included: 2

Box Qty. 10



9521

Pro-Cut #50741, 50742

Pro-Cut *POSITIVE* Rake Bit. For Ford lathes.

For use on Models: Pro-Cut Model 610 on-the-car brake lathes. RJ West PFM 9.2 and FM900.

Cutting Edges: 3 (6 by cross-indexing); Screws included: 10

Box Qty. 10



9525

Pro-Cut/Hoffman #D139, 90488, W139U

Pro-Cut/Hoffman Style *POSITIVE* Rake Bit for Twin Turn 400/P450 Lathes.

For use on Models: 400 & 450 Twin Turn comb. Lathes.

Cutting Edges: 3 (6 by cross-indexing); Screws included: 5

Box Qty. 10



9530

KWIK-WAY #109-1092-23, 109-1092-45, BTK10A

KWIK-WAY/SNAP-ON Style *POSITIVE* Rake Bits for Disc Rotors.

For Use On Models: SDL, DL, 850 Disc Lathes, ROTUNDA, SNAP-ON On-The-Car YA180, YA281 Bench Lathes. Kwik-Way NCL, NDL, BDL, CBL108 and Kwik-Lathe On-The-Car 108-005-04 w/000-0171-91 Screws.

Cutting Edges: 3 (6 by cross-indexing); Screws included: 10

Box Qty. 10

BRAKE LATHE BITS

Brake Lathe Silencer Bands

(Pictures are not actual size)



9540 BRAKE LATHE SILENCER BAND

Ammco #6920, FMC #90984, Van Norman #111485

Disc Style Natural Rubber Silencer - No Lead

For small and large rotors. Adjustable band has material finish on natural rubber for gripping power. 9" Diameter 32" x 1/2". Use with all vented rotors.

Box Qty. 1



9545 LARGE BRAKE SILENCER BAND

Ammco #6922, Accu-Turn #434061, FMC #90194, Performance #6922, Rels #11488

Large Neoprene Rubber Gasket Silencer.

For solid foreign car rotors - 9" Diameter.

Box Qty. 1



9550 SMALL BRAKE LATHE SILENCER BAND

Ammco #6921, Accu-Turn #433789, FMC #90196, Performance #6921, Rels #11482

Small Neoprene Rubber Gasket Silencer.

For solid foreign car rotors - 6 1/2" Diameter.

Box Qty. 1



9555 DRUM SILENCER BAND FOR PASSENGER CARS

Ammco #5280, FMC #90988, Performance #8574, Van Norman #866542

Drum Silencer Band for Passenger Cars.

Natural Rubber with riveted buckle.

6' x 1-3/4" x 1/8"

Box Qty. 1



9556 DRUM SILENCER BAND FOR LARGE DRUMS

Accu-turn 433782, FMC 90988, RELS 11486, Performance 8575

Drum Silencer Band for Large Trucks

Natural Rubber, Pressed in buckle for extra strength.

5' x 2-7/8" x 1/8"

Box Qty. 1

NEW



9557 SILENCER BAND/CHIP DEFLECTOR

Accu-Turn #434296, FMC #90198, Performance #8572, Pro-Cut #50-742

Heavy duty pads for use with any on-the-car RTI brake lathes.

Box Qty. 1





FUEL LINE HOSE

(Not For Electronic Fuel Injection)

Designed for use on all types of gasoline engines. Gives years of service for automobiles, trucks, marine engines, etc. Vapor emission properties are excellent for applications where petroleum vapors and blow-by gases are recirculated.

Meets the following O.E.M. Specifications: (SAE30R7) (GM: 6165-M) and (Chrysler: MSEA219)

Packaged on 25 Ft. spools

	1/4" I.D. 4105		3/8" I.D. 4107
	5/16" I.D. 4106		



ELECTRONIC FUEL INJECTION HOSE

Hypalon/Polyester (.030" thick) lined hose is impervious to emission and fuel penetration. Can be used with virtually all types of fuels and on all fuel systems.

Meets or exceeds performance requirements of: Chrysler MSEA 235, General Motors GM6163M, Ford ESEM2D325A, and SAE J30R9.

Boxed in 10 Ft. coils

Product Number	I.D.	O.D.	Unit Pkg.
4125	5/16" x 9/16"	10 Ft.
4130	3/8" x 5/8"	10 Ft.





VACUUM & WINDSHIELD WASHER TUBING

Ideal for windshield washer and engine vacuum applications.

Meets SAE J1037 Type 2 Specifications.

Packaged on 50 Ft. Spools.

	7/64" I.D. x 50 Ft. 4115		5/32" I.D. x 50 Ft. 4116		7/32" I.D. x 50 Ft. 4117
---	------------------------------------	---	------------------------------------	---	------------------------------------



PREMIUM QUALITY BLACK HEATER HOSE

This O.E.M. grade EPDM hose withstands the abuse of corrosive additives, heat, cold, weather and abrasion. For today's harsh engine compartment environments.

Manufactured to meet or exceed O.E.M. Specifications SAE20R3.



1/2" I.D. x 50 Ft.



5/8" I.D. x 50 Ft.



3/4" I.D. x 50 Ft.

HOSES / NYLON CONNECTORS



TRANSMISSION OIL COOLER HOSE

A special hose for circulating transmission fluid at high temperatures. The tube and cover are designed to meet OEM and SAE J1532 performance requirements. Features a polyester reinforcement for high burst protection. Will withstand fluid temperatures up to 257°F and is resistant to fuel, ozone, oil, grease and heat aging.

Prod No. **4133** 5/16" inside dia. x 25 ft. Box Qty. 1
 Prod No. **4135** 3/8" inside dia. x 25 ft. Box Qty. 1



POWER STEERING RETURN HOSE

Built of high quality nitrile tube to resist power steering fluid. Polyester reinforcement for high burst strength. Neoprene cover provides moderate oil resistance and good weather, ozone and abrasion resistance for long service life.
FOR RETURN SIDE ONLY.

Prod No. **4140** 3/8" inside dia. x 25 feet Box Qty 1



410000
 354400, 384042, 4241054
 Nylon "4-Way" Connector
 3/16" All Ends
 Box Qty. 5



410001
 10003617, 22508052, 383031,
 3236813
 Nylon "4-Way"
 Connector
 3/16" All Ends
 Box Qty. 5



410002
 10004121, 4019472, 4006848
 Nylon "Y" Connector
 1/4" All Ends
 Box Qty. 15



410003
 4179982
 Nylon "Y" Connector
 5/16" All Ends
 Box Qty. 15

NYLON VACUUM CONNECTORS



High Density Polyethylene T-Type Hose Connectors
Barbed on all sides

Product Number	Hose Size	Box Qty.
410110 1/8" x 1/8" x 1/8"	10
410070 5/32" x 5/32" x 5/32"	10
410080 3/16" x 3/16" x 3/16"	10
410090 1/4" x 1/4" x 1/4"	10
410111 5/16" x 5/16" x 5/16"	10
410220 3/8" x 3/8" x 3/8"	10
410230 1/2" x 1/2" x 1/2"	10



High Density Polyethylene Hose Connectors
Barbed on all sides

Product Number	Hose Size	Box Qty.
410010 1/8" x 1/8"	10
410020 3/16" x 3/16"	10
410030 1/4" x 1/4"	10
410040 5/16" x 5/16"	10
410045 3/8" x 3/8"	10
410046 1/2" x 1/2"	10



High Density Polyethylene Reducer Hose Connectors
Barbed on all sides

Product Number	Hose Size	Box Qty.
410050 1/4" x 3/16"	10
410060 3/8" x 1/4"	10



410105
Universal Tubing Connector
For 1/8", 1/4" or 3/8" tubing.
Break-Off Type, Butyrate Plastic
For use with Vacuum & Windshield Washer Tubing
Not For Use In Fuel Line.
Box Qty. 10



410100
3-Way
Universal Tubing Connector
For 1/8", 1/4" or 3/8" tubing.
Break-Off Type Butyrate Plastic, For use with Vacuum & Windshield Washer Tubing
Not For Use In Fuel Line.
Box Qty. 5



High Density Polyethylene Reducer Hose Connectors
Barbed on all sides

Product Number	Hose Size	Box Qty.
410120 3/8" x 3/8"	10



410015
Nylon Tubing Connector
1/8" x 1/8"
General Motors, Ford, Chrysler and General Purpose.
Box Qty. 10



Rubber Caps
(Special Heat Resistant Material)
Can be used for capping lines and hoses while testing Vacuum, Fuel, and Emission Control Systems.



410085
Nylon Tubing Connector
3-Way Type
3/16" x 3/16" x 1/8"
Box Qty. 10

Product Number	Tube Size	Box Qty.
410160 1/8"	50
410170 3/16"	25
410190 1/4"	25
410200 5/16"	25
410210 3/8"	25
410211 1/2"	10

HOSE CLAMPS

HOSE CLAMPS

5/16" (1/4" for Mini's) slotted hex head
 Housing: Zinc Plated
 Band: 201 stainless steel.

10 Hose Clamps / Vacuum Connectors



Product Number	Ind. Std. Number	Clamp Range (Min-Max)		Band Width	Box Qty.
		Inches	mm		
54004	#4-MINI	5/16" to 5/8"	8-16mm	5/16"	10
54006	#6-MINI	5/16" to 7/8"	8-22mm	5/16"	10
54106	#6	3/8" to 7/8"	10-22mm	1/2"	10
54108	#8	7/16" to 1"	11-25mm	1/2"	10
54110	#10	1/2" to 1-1/16"	13-27mm	1/2"	10
54112	#12	1/2" to 1-1/4"	13-32mm	1/2"	10
54116	#16	11/16" to 1-1/2"	18-38mm	1/2"	10
54120	#20	3/4" to 1-3/4"	19-44mm	1/2"	10
54124	#24	1" to 2"	25-51mm	1/2"	10
54128	#28	1-1/4" to 2-1/4"	32-57mm	1/2"	10
54132	#32	1-1/2" to 2-1/2"	38-63mm	1/2"	10
54136	#36	3/4" to 2-3/4"	19-70mm	1/2"	10

Also Available: **#222540** Standard Hose Clamp Assortment - 10 Items, 100 pieces

Contains #54004, #54006, #54106, #54110, #54112, #54120, #54124, #54128, #54132, #54136 and #99925 Hose Clamp Rack

ALL STAINLESS STEEL HOSE CLAMPS

304 Stainless Steel, 5/16" Slotted Hex



Product Number	Ind. Std. Number	Clamp Range (Min-Max)		Band Width	Box Qty.
		Inches	mm		
54504*	#4	7/32" to 5/8"	5.6- 6mm	5/16"	10
54506*	#6	7/16" to 25/32"	11-20mm	5/16"	10
54510	#10	9/16" to 1-1/16"	14-27mm	1/2"	10
54512	#12	11/16" to 1-1/4"	17-32mm	1/2"	10
54516	#16	13/16" to 1-1/2"	21-38mm	1/2"	10
54520	#20	13/16" to 1-3/4"	21-44mm	1/2"	10
54524	#24	1-1/16" to 2"	27-51mm	1/2"	10
54528	#28	1-5/16" to 2-1/4"	33-57mm	1/2"	10
54532	#32	1-9/16" to 2-1/2"	40-64mm	1/2"	10

* 1/4" Slotted Hex

TYPE "G" MINIATURE HOSE CLAMPS

Zinc Plated



Prod Number	Clamp Range (Min-Max)		Band Width	Box Qty.
	Inches	mm		
54200	13/32" to 1/2"	10.5-13mm	11/32" (9mm)	10
54201	1/2" to 19/32"	12.5-15mm	11/32" (9mm)	10
54203	17/32" to 5/8"	13.5-16mm	11/32" (9mm)	10

HOSE / MUFFLER CLAMPS

EUROPEAN STYLE HOSE CLAMPS



DIN3017

Stainless Steel Band & Housing

Zinc & Yellow Steel Screw

Unique offset non-welded design of the housing provides resistance to over-tightening damage to the hose. The short housing saddle gives a smooth underside ensuring high sealing efficiency. These clamps are original equipment on both domestic and import vehicles. They are particularly suited for fuel, vacuum, water, emission and heater hoses and can be used with silicone hoses.

Product Number	Clamp Range (Min-Max)		Hex Size	Band Width	Box Qty.
	Inches	mm			
54300	5/16" to 1/2"	8-12mm	6mm*	8mm (5/16")	10
54302	3/8" to 5/8"	10-16mm	6mm*	8mm (5/16")	10
54304	1/2" to 11/16"	12-18mm	6mm*	8mm (5/16")	10
54306	5/16" to 1/2"	8-12mm	6mm	9mm (11/32")	10
54308	1/2" to 13/16"	12-20mm	6mm	9mm (11/32")	10
54310	5/8" to 1"	16-25mm	6mm	9mm (11/32")	10
54312	13/16" to 1-1/4"	20-32mm	6mm	9mm (11/32")	10
54314	1" to 1-9/16"	25-40mm	6mm	9mm (11/32")	10
54316	1-3/16" to 1-3/4"	30-45mm	6mm	9mm (11/32")	10
54318	1-1/4" to 2"	32-50mm	6mm	9mm (11/32")	10
54320	1-9/16" to 2-3/8"	40-60mm	6mm	9mm (11/32")	10
54322	2" to 2-3/4"	50-70mm	6mm	9mm (11/32")	10
54324	2-3/8" to 3-1/8"	60-80mm	6mm	9mm (11/32")	10
54326	2-3/4" to 3-9/16"	70-90mm	6mm	9mm (11/32")	10

* Phillips Hex Drive

HOSE CLAMPS

BLANK

WEATHERSTRIP

SPONGE RUBBER WEATHERSTRIPS

EPDM NEOPRENE BLEND CLOSED CELL --
LIGHT WEIGHT -- WEATHER RESISTANT.



5001
Trunk Weatherstrip
Universal
35 Ft.



5002
Trunk And Rear Deck Gutter
Weatherstrip
GM And Universal
25 Ft.



5008 50 Ft.
5005
Deck Lid Weatherstrip
GM Cars 1956 - UP
25 Ft.



5006-50 50FT.
5006
Trunk And Lid Weatherstrip
GM 1959 - UP
Studebaker 1955 - '67
Ford 1949 - UP
25 Ft.

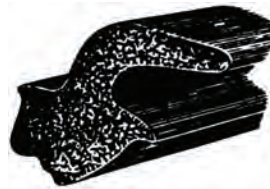

5007
C5AZ-6243720-B
Deck Lid Weatherstrip
Ford 1956 - UP
25 Ft.



5009 50 Ft.
5010
Door Flange Weatherstrip
GM, Chrysler & Ford
Cars & Trucks
25 Ft.



5011
Door Flange Weatherstrip
GM 1955 - UP
25 Ft.



5012
Door Flange Weatherstrip
Chrysler 1950 - '54
Ford 1950 - '58
25 Ft.



5013
Door Flange Weatherstrip
Ford 1955 - UP
25 Ft.



5015
Door Flange Weatherstrip
Chrysler 1958 - UP
25 Ft.



5016
Door Inner Belt Weatherstrip
All Cars 1955 - '70
25 Ft.

WEATHERSTRIP / VELCRO



5038
Roof Rail Weatherstrip.
GM 1968 - 77
25 Ft.



5180
Fender Welt
1-3/8 inch (3/16" Bead)
Bright Smooth Vinyl Bead
50 Ft.

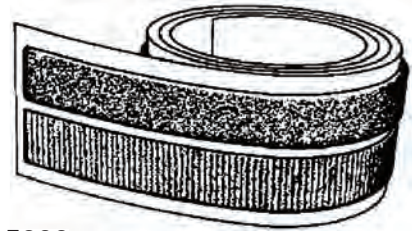

5200
Velcro Strips
5 yard long strips, 3/4" wide
Hook and Loop Material
Adhesive Backing
Box Qty. 1

Weatherstrip / Velcro

11

SPONGE WEATHERSTRIPS

Peel-Bak Adhesive
Neoprene Sponge Weatherstrip



A light-weight closed cell sponge material, Peel-Bak is an easy to apply type of weatherstrip for auto and household use. May also be used on boats, refrigerators or any place a weatherproof, permanent seal is required. Simple to use, just peel back the liner and tape and press into place. No cement or tacking required. Surface must be clean and dry. 50 ft. roll.

THICKNESS	WIDTH	PRODUCT
5/32"	3/8"	5225
5/32"	1/2"	5226
5/32"	3/4"	5227
5/32"	1"	5228
5/16"	3/8"	5229
5/16"	1/2"	5230
5/16"	3/4"	5231
5/16"	1"	5232
7/16"	3/8"	5233
7/16"	1/2"	5234
7/16"	3/4"	5235
7/16"	1"	5236

SPONGE RUBBER CORD CLOSED CELL

Flexible filler for cloth covered windlace on door and windshield pillars and door bottoms. Perfect for reinforcing weatherstrip.



Full Round	Half Round		
5023	5026	1/4" wide x 50 ft. roll	1/bx
5024	5027	3/8" wide x 50 ft. roll	1/bx
5025	5028	1/2" wide x 50 ft. roll	1/bx

TOPPER CAP WEATHERSTRIP

A closed-cell vinyl foam weatherstrip developed to provide a seal between pickup truck cabs and body side rails. One side has a permanent pressure sensitive adhesive, the other side has a polyester liner to protect against paint damage. Also provides cushioning, vibration dampening and sound deadening. Thickness: 3/16"



PROD	SIZE	BX QTY
5250	1" wide x 30 ft. roll	1
5255	1-1/2" wide x 30 ft. roll	1

www.srfast.com

DOOR HINGE REPLACEMENT PARTS



471050

6028593, 6032975
 Door Hinge Pin
 Length: 2-5/8"
 Pin Diameter: 1/4"
 Dodge, Plymouth Vans
 (Cargo Doors Side & Rear)
 1970 - UP
 Box Qty. 10



471010

6271989, 20046147
 Phosphate
 Door Hinge Pin
 Length: 4-1/16"
 Pin Diameter: 11/32"
 Head Outer Dia: 9/16"
 Buick: Estate Wagon & LeSabre Wagon 90-82, Electra 82,
 Regal 87-82, Riviera 85-82, and all exc. Skyhawk 77-76;
 Cadillac: Cimarron 88-82, Eldorado & Seville 85-82, Fleetwood
 Brougham 92-82; Chevrolet: Camaro 81-78, C & K Trucks 84 -
 73, Monte Carlo, Malibu & El Camino 88-76, Impala & Caprice
 90-82, Nova 79-77; Oldsmobile: Cutlass Supreme, Calais &
 Cruiser 88-76, Delta 88 90-77, Omega 79-77, Toronado 85-82,
 98 Recency 82-77; Pontiac: Firebird 81-78, Grand Prix 87-77,
 LeMans & Grand Am 81-77 Phoenix & Ventura 79-77,
 Safari & Parisienne 89-83
 Box Qty. 10



471020

20043351
 Phosphate
 Door Hinge Pin
 Length: 4"
 Pin Diameter: 11/32"
 Head Outer Dia: 7/16"
 Buick: Skyhawk 88-82, Skylark 85-82;
 Chevrolet: Cavalier 94-82,
 Celebrity 90-82, Chevette 87-78, and
 Citation 85-80; Oldsmobile: Cutlass
 Ciera 95-82, Firenza 88-82,
 Omega 84-80, Pontiac: Phoenix 84-80,
 Sunbird 94-82, T-1000 87-82 and 6000
 91-82
 Box Qty. 10



471217

15653790
 (For Use with 471220 & 471221)
 Zinc & Yellow
 Door Hinge Pin
 Length: 4-1/8"
 Pin Diameter: 11/32"
 Shoulder Outer Diameter: 3/8"
 Head Outer Diameter: 1/2"
 GM S & T Trucks 1994 - UP
 Box Qty. 2



471215

15591860; 15691595;
 5967691; 88891731
 (For Use with 471220 & 471221)
 Stainless Steel
 Door Hinge Pin
 Length: 5-1/4"
 Pin Diameter: 11/32"
 Shoulder Outer Dia: 3/8"
 Head Outer Dia: 9/16"
 GM Trucks C-K Models 1988 - UP
 Box Qty. 5



471015

9806723
 Door Hinge Pin
 Length: 2-13/16"
 Pin Diameter: 11/32"
 Head Outer Dia: 1/2"
 Knurl Dia: 0.351-0.357"
 GM Nova, Omega, Skylark,
 Phoenix 1971 - 1979
 Box Qty. 10



471040

6500361
 Zinc
 Spring Pin
 Length: 2-1/4"
 Pin Diameter: 1/4"
 Box Qty. 25



471030

3062243
 Spring Pin
 Length: 2"
 Pin Diameter: 5/16"
 Box Qty. 25

DOOR HINGE REPLACEMENT PARTS



222107
Hinge Pin / Bushing
Repair Kit Assortment
90 pieces total
Box Qty. 1

Each Kit Contains:
5 #471010 pins 10 #471060 bushings
5 #471020 pins 10 #471070 bushings
5 #471015 pins 10 #471080 bushings
5 #471030 pins 10 #471090 bushings
5 #471050 pins 10 #471100 bushings
5 #471040 pins 10 #471110 bushings



471224
Door Hinge Pin & Bushing
Repair Kit
GM C/K Trucks &
Full Size SUV's '99-UP
Box Qty. 1 Kit

Each Kit Contains:
2 Case hardened forged pins, with Dacromet
Finish (500 hr Salt Spray)
2 Bronze bushings
2 Thru hardened washers
2 Prevailing torque lock nuts

12 Door Hinge Parts

471100
4033711



Door Hinge Bushing
Inner Dia: 17/64"
Outer Dia: 5/16"
Length: 23/64"
Flange Outer Dia: 33/64"
Cargo doors, lift gates, rear doors and
fold-up rear seat floor hinges
*Dodge & Plymouth vans, Ramcharger and
Trailduster 1970 - UP*
Box Qty. 10

471060
9721917, D1AZ-6522841A



Inner Dia: 11/32"
Outer Dia: 27/64"
Height: 19/64"
Flange Outer Dia: 19/32"
Buick (Exc. Skyhawk) 1967 UP
*Cadillac 1946 - UP; Chevrolet: Exc. Monza & Vega
1962 - UP; Corvette 1956 - UP, GM C & K Trucks
1979 - 93; Olds Exc. Starfire 1949 - UP*
Pontiac Exc. Astre & Sunbird 1932 - UP
Box Qty. 25

471080
20429500



Inner Dia: 11/32"
Outer Dia: 31/64"
Height: 23/64"
Flange Outer Dia: 19/32"
Splined Outer Diameter
*All GM (Including Pick-Ups & Vans)
1968 - UP*
Box Qty. 25

471090
9716926, 20345137



Thick Bushing
Inner Dia: 11/32"
Outer Dia: 1/2"
Height: 3/8"
Flange Outer Dia: 19/32"
Buick 1976 - UP; Cadillac 1980 - UP;
Chevrolet: All 1976 - UP, Corvette 1973-82
Olds (Exc. Starfire) 1980 - UP;
Pontiac: Exc. Astre & Sunbird 1980 - UP
Box Qty. 25

471110
D90Z-6522841A



Inner Dia: 11/32"
Outer Dia: 31/64"
Height: 19/64"
Flange Outer Dia: 19/32"
Ford 1973 - UP
Box Qty. 10

471220
12338074, 15691493,
15964971 & 16632193



Inner Dia: 11/32"
Outer Dia: 1/2"
Height: 23/64"
Flange Outer Dia: 43/64"
Splined Outer Diameter
Side Door Upper Hinge
GM Trucks C-K Models 1988 - UP
Box Qty. 25

471070
9822198



Inner Dia: 3/8"
Outer Dia: 1/2"
Height: 15/32"
Flange Outer Dia: 5/8"
Buick 1975-82; Chevrolet: Monza & Vega 1979-80,
All (Exc. Corvette) 1962-75, Olds Starfire 1976-80,
Pontiac Astre & Sunbird 1976-80 and All 1949-75
Box Qty. 25

471221
15562609, 15964972
& 16632192



Inner Dia: 25/64"
Outer Dia: 17/32"
Height: 23/64"
Flange Outer Dia: 11/16"
Splined Outer Diameter
Side Door Lower Hinge
GM Trucks C-K Models 1988 - UP
Box Qty. 25



PROFESSIONAL MASKING TAPE

Professional masking tape for paint shops as well as construction/industrial areas. Water and moisture resistant. Thin backing. Dry natural rubber solvent based adhesive. Good adhesion on uneven surfaces. Heat resistant up to 194°F / 90°C (30 min.). Removable without breaking and can be torn by hand. Sold by the sleeve only.

PROD	SIZE	QTY
134.820	3/4" - 19mm x 50m	12/sleeve
134.822	1-1/2" - 38mm x 50m	6/sleeve



ECONOMY MASKING TAPE

General purpose applications.

705653/4" x 60 Yds 1/bx
70565-123/4" x 60 Yds 12/bx
705702" x 60 Yds 1/bx
70570-62" x 60 Yds 6/bx



DUCT TAPE

A heavy duty, weatherproof and air tight cloth tape coated with Polyethylene for heavy duty applications. For sealing air conditioning ducts, interior door panels, protecting mouldings, and other body parts when sanding or grinding nearby areas. Performance grade with higher tensile strength for holding power.

70521 Silver, 1.88" x 60yds1/bx
70522Black, 1.88" x 60yds 1/bx



WATER PROOF CLOTH TAPE (BLACK)

A high quality, strong cloth backed tape. Designed for long life applications. Provides excellent protection to auto body parts when sanding, grinding or sandblasting nearby. Moisture resistant and has instant adhesion.

705302" wide x 60 yds 1/bx
--------------	-----------------------	------------



FIBERGLASS TAPE

A fiberglass mesh tape with a high tack adhesive on one side for easy positioning. Used with Adhesive Repair Compounds to give additional strength and support.

705272" x 50 Ft. 1 roll	DISC
70528 1-7/8" x 150 Ft. 1 roll	
705356" x 75 Ft. 1 roll	DISC
70536 36" x 75 Ft. 1 roll	DISC



TEFLON TAPE

Used on pipe threads to form a leak proof seal. Resists oil, transmission fluid and freon. MIL SPEC T27730A

705901/2" x 260 inches1/bx
DISC 705911/2" x 520 inches1/bx



ALUMINUM FOIL BODY REPAIR TAPE

Ideal for reinforcing part to be repaired. Special "High-Tack Adhesive"

70525 2" x 50 Ft. 1/bx
--------------	-------------------	------------

TAPES

ELECTRICAL TAPE

PVC - Black
 (7 Mil Thickness)
 For temps up to 176°F (80°C)

705503/4" x 66 Ft..... 1/bx
70550-103/4" x 66 Ft..... 10/bx



Black Premium Electrical/
 Anti-Abrasive Polyester
 Woven Fabric Tape
 High Tear & Abrasive
 Resistance

70596 1-1/4" x 82 ft. 1/bx
70597 3/4" x 82 ft. 1/bx



70598
 3/4" x 66 ft.
 Yellow Premium Vinyl
 Electrical Tape
 Box Qty. 1

PREMIUM ELECTRICAL TAPE

"Extreme Hot/Cold Conditions"
 PVC - Black
 (7.5 Mil Thickness)
 For temps up to 220°F (105°C).

705523/4" x 66 Ft..... 1/bx
70552-103/4" x 66 Ft..... 10/bx



TRIM LIFT TAPE

A specially designed masking tape with a flexible, clear plastic edge used for masking around sunroofs, taillights and windshields. The tape is 10 meters long, 45mm wide with a clear plastic edge measuring 10mm. Perforated every 50mm to customize the amount you need for your job.

7074045mm x 10m long... 1/bx

NEW

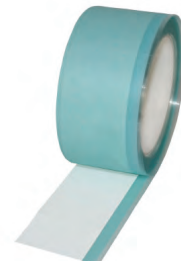

TRIM LIFT TAPE HIGH TEMP

A wash paper masking tape, with high adhesive properties, especially designed to perform well in most industrial painting and automotive masking applications. A high temperature tape where excellent holding and high temperature performance are required. The tape is 10 meters long, 45mm wide with a clear plastic edge measuring 10mm. Perforated every 50mm to customize the amount you need for your job.

7074145mm x 10m long... 1/bx



A/C INSULATION TAPE (CORK-RUBBER)

This tape eliminates sweating, condensation and dripping of refrigeration lines. Insulates A/C components to prevent dripping and ice buildup. Also improved A/C efficiency.

705951/8" x 2" x 30 ft. 1/bx
 (thick x width x length)



CARTON SEALING TAPE

A Premium class PVC (polyvinyl-chloride) tape with a natural rubber type adhesive system which provides an "Instant Stick Quality". For sealing cartons and other packaging applications. Thickness 2.3 mil

70553Clear - 55 yds..... ~~DISC~~ 1/bx
70553-6Clear - 55 yds..... ~~DISC~~ 6/bx
70551Clear - 110 yds..... ~~DISC~~ 1/bx
70551-6Clear - 110 yds..... 6/bx
70551-36Clear - 110 yds..... 36/bx

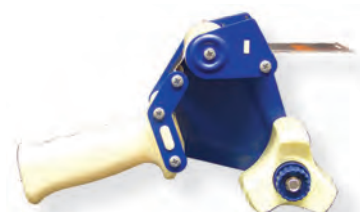

70810

CARTON SEALING TAPE DISPENSER
 Superior durable construction, will accommodate 2" x 55 Yd., 110 Yd., or 220 Yd. tape with a 3" core. Adjustable brake. 1/bx

VINYL SOLDERLESS TERMINALS

22-18 WIRE RANGE - RED Vinyl Insulated, Funnel Entry



395010
Stud Size #4-#6
Box Qty. 100



395020
Stud Size #8-#10
Box Qty. 100



395120
Stud Size #4-#6
Box Qty. 100



395130
Stud Size #8-#10
Box Qty. 100

395171 Box 500



395170
Butt Connector
Box Qty. 100



395460
Mates with #395370
Snap Plug
Box Qty. 50



395370
Mates with #395460
Snap Plug Receptacle
Box Qty. 50



395410
Female Quick-Connect
7/64" (.11") Tab Width
Box Qty. 50



395247
Male Quick-Connect
1/4" Tab Width
Box Qty. 25



395248
Female Quick-Connect
1/4" Tab Width
Box Qty. 25



395402
Female Quick-Connect
3/16" (.187) Tab Width
Box Qty. 25



395401
Male Quick-Connect
3/16" (.187) Tab Width
Box Qty. 25

16-14 WIRE RANGE - BLUE Vinyl Insulated, Funnel Entry



395040
Stud Size #4-#6
Box Qty. 100



395050
Stud Size #8-#10
Box Qty. 100



395060
Stud Size #12-1/4"
Box Qty. 100



395065
Stud Size 5/16"-3/8"
Box Qty. 100



395140
Stud Size #4-#6
Box Qty. 100



395150
Stud Size #8-#10
Box Qty. 100

395181 Box 500



395180
Butt Connector
Box Qty. 100



395220
Mates with #395360
Snap Plug
Box Qty. 100



395360
Mates with #395220
Snap Plug Receptacle
Box Qty. 50



395403
Male Quick-Connect
3/16" (.187) Tab Width
Box Qty. 25



395404
Female Quick-Connect
3/16" (.187) Tab Width
Box Qty. 50



395230
Male Quick-Connect
1/4" Tab Width
Box Qty. 100



395240
Female Quick-Connect
1/4" Tab Width
Box Qty. 100

VINYL SOLDERLESS TERMINALS

12-10 WIRE RANGE - YELLOW

Vinyl Insulated, Funnel Entry



395070
Stud Size #8-#10
Box Qty. 100



395080
Stud Size #12-1/4"
Box Qty. 100



395090
Stud Size 1/4"-5/16"
Box Qty. 100



395100
Stud Size 5/16"-3/8"
Box Qty. 100



395110
Stud Size 7/16"-1/2"
Box Qty. 100



395160
Stud Size #8-#10
Box Qty. 100



395191 Box 500
395190
Butt Connector
Box 100



395245
Female Quick-Connects
1/4" Tab Width
Box Qty. 50

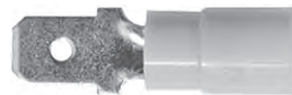

395246
Male Quick-Connects
1/4" Tab Width
Box Qty. 50

MISCELLANEOUS VINYL CONNECTORS



394010
"Red"
8 ga. Wire Size
Butt Connector
Vinyl Insulated
Box Qty. 10



395242
Quick-Connect
16-14 ga., Piggy-back
Box Qty. 100

**Need contact cleaner for your
electrical connectors?**

See page 15-4

NYLON SOLDERLESS TERMINALS

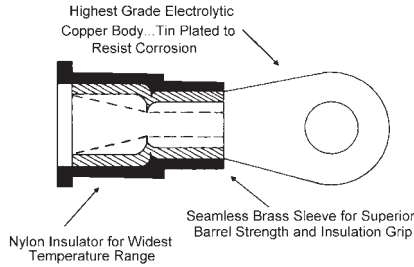

NYLON INSULATED SOLDERLESS TERMINALS

Superior vibration resistance with insulation grip.
Superior barrel strength.
Constructed to meet the highest Military and Industrial standards.

22-18 WIRE RANGE - RED

Nylon Insulated, Funnel Entry



396171
Stud Size #4-#6
Box Qty. 25



396172
Stud Size #8-#10
Box Qty. 25



396173
Stud Size #12-1/4"
Box Qty. 50



396174
Stud Size #8-#10
Box Qty. 25



396176
Stud Size #4-#6
Box Qty. 25

396170-500 Box 500



396170
Butt Connector
Box Qty. 50

16-14 WIRE RANGE - BLUE

Nylon Insulated, Funnel Entry



396178
Stud Size #4-#6
Box Qty. 25



396179
Stud Size #8-#10
Box Qty. 25



396181
Stud Size #12-1/4"
Box Qty. 25



396182
Stud Size 1/4"-5/16"
Box Qty. 25



396183
Stud Size 5/16"-3/8"
Box Qty. 25



396184
Stud Size #4-#6
Box Qty. 25



396187
Stud Size #8-#10
Box Qty. 25



396188
Stud Size #8-#10
Box Qty. 25

396180-500 Box 500



396180
Butt Connector
Box Qty. 50



396189
Female Quick-Connect
1/4" Tab Width
Box Qty. 25



396191
Male Quick-Connect
1/4" Tab Width
Box Qty. 25

12-10 WIRE RANGE - YELLOW

Nylon Insulated, Funnel Entry



396192
Stud Size #8-#10
Box Qty. 25



396193
Stud Size #12-1/4"
Box Qty. 25



396194
Stud Size 5/16"-3/8"
Box Qty. 25



396197
Stud Size #8-#10
Box Qty. 25



396190
Butt Connector
Box Qty. 50

396190-500 Box 500

NYLON QUICK CONNECTS

QUICK-CONNECTS

Fully Insulated Nylon, 1/4" Tab Width



Female



395490-500 Box 500

395480-500 Box 500

395501-500 Box 500

395490
"CLEAR RED"
22-18 Gauge Wire
Box Qty. 50

395480
"CLEAR BLUE"
16-14 Gauge Wire
Box Qty. 50

395501
"CLEAR YELLOW"
12-10 Gauge Wire
Box Qty. 50

Male



395500-500 Box 500

395470-500 Box 500

395502-500 Box 500

395500
"CLEAR RED"
22-18 Gauge Wire
Box Qty. 50

395470
"CLEAR BLUE"
16-14 Gauge Wire
Box Qty. 50

395502
"CLEAR YELLOW"
12-10 Gauge Wire
Box Qty. 50

MISCELLANEOUS NYLON CONNECTORS



Nylon Insulated
Closed End Connectors

396210
22-12 Gauge
Box Qty. 50

396215
16-10 Gauge
Box Qty. 50

KRIMPA-SEAL TERMINALS

Krimpa-Seal - "Sealed for Quality"

Our enhanced Krimpa-Seal product line is the finest line of "crimp-and-seal" connectors on the market today. New design features, the use of only the finest components, and an expanded product selection, place Krimpa-Seal squarely at the top of the class. Our line provides a quick, effective sealed connection in applications where crimping is preferred. In just a few easy steps, Krimpa-Seal will prevent corrosion and contamination in your critical wiring applications.

These connectors require the installer to insert the stripped wire(s) into the connector barrel. Using a crimping tool, crimp the barrel to the wire. Apply heat to the connector to shrink and activate sealer.

Tubing will shrink and release a sealer to completely seal the entire connection, protecting the connection from moisture, vibration, strain and unnecessary flexing.

KEY FEATURES & BENEFITS

Seamless butt connectors & brazed seam rings and spades

Prevents opening of connector barrel!

Color-coded tubing with wire gauge imprint

Provides easy identification of the correct part for the job!

Conforms to automotive manufacturers' specifications for wiring repairs

Necessary for maintaining electrical warranties!

ALL KRIMPA SEAL "-500" PACKAGES
HAVE BEEN DISCONTINUED



RING TERMINALS

Description	10 Pkg. Prod. #	50 Pkg. Prod. #
18-20 AWG #6 Stud.....	398010	398011
18-20 AWG #8 Stud.....	398015	398016
18-20 AWG #10 Stud.....	398020	398021
18-20 AWG 1/4" Stud	398025	398026
14-16 AWG #8 Stud.....	398030	398031
14-16 AWG #10 Stud.....	398035	398036
14-16 AWG 1/4" Stud	398040	398041
14-16 AWG 5/16" Stud	398042	398043
14-16 AWG 3/8" Stud	398045	398046
10-12 AWG #10 Stud.....	398050	398051
10-12 AWG 1/4" Stud	398055	398056
10-12 AWG 3/8" Stud	398060	398061
10-12 AWG 1/2" Stud	398065	398066

KRIMPA-SEAL TERMINALS

ALL KRIMPA SEAL ".500" PACKAGES
HAVE BEEN DISCONTINUED

SPADE TERMINALS



Description	10 Pkg. Prod. #	50 Pkg. Prod. #
18-20 AWG #10 Stud.....	398070	398071
14-16 AWG #10 Stud.....	398075	398076
10-12 AWG #10 Stud.....	398080	398081

BUTT CONNECTORS



Description	10 Pkg. Prod. #	50 Pkg. Prod. #
22-24 AWG CLEAR.....	398085	398086
18-20 AWG RED.....	398090	398091
14-16 AWG BLUE.....	398095	398096
10-12 AWG YELLOW.....	398100	398101
8 AWG RED.....	398105	398106

SLIP-ON CONNECTORS



Description	10 Pkg. Prod. #	50 Pkg. Prod. #
14-16 AWG .250 Fully Insulated Female.....	398110	398111
14-16 AWG .250 Fully Insulated Male.....	398115	398116

BULLET PLUG & RECEPTACLES



Description	10 Pkg. Prod. #	50 Pkg. Prod. #
14-16 AWG .157 diameter plug.....	398120	398121
14-16 AWG .157 diameter receptacle.....	398125	398126



96401
Self Adjusting
Stripping & Crimping Tool
*Features self-adjusting strip mechanism
with spring action.*
Box Qty. 1



ELECTRALINK TERMINALS

Electralink - "Sealed for Superiority"

Electralink is the clear choice of professionals that demand a superior electrical connection. Soldered connections facilitate maximum current flow with minimal resistance, provide exceptional tensile strength, and prevent reverse plating. However, with the advent of crimp connections and their ease of use, the popularity of soldering declined. Electralink has once again made soldering a viable option by providing a high quality, sealed solder connection that takes the guesswork out of installation.

These connectors require the installer to insert the stripped wire(s) into the solder barrel; Apply heat to the shrink tubing; Concentrate the heat source on the solder barrel after shrinking the tubing; When the solder flows through the wire strands, remove the heat and let the terminal cool.

Tubing will shrink to completely seal the entire connection, protecting the connection from moisture, vibration, strain and unnecessary flexing.

KEY FEATURES & BENEFITS

Translucent, adhesive-lined polyolefin tubing

Allows visual inspection, prevents corrosion & provides a waterproof seal!

Easy installation with pre-measured solder

Takes the guesswork out of the soldering process!

A soldered electrical connection

Provides superior current flow and tensile strength!

ALL ELECTRALINK "-500" PACKAGES
HAVE BEEN DISCONTINUED



RING TERMINALS

Description	10 Pkg. Prod. #	50 Pkg. Prod. #
18-20 AWG #6 Stud.....	399010	399011
18-20 AWG #8 Stud.....	399015	399016
18-20 AWG #10 Stud.....	399020	399021
18-20 AWG 1/4" Stud	399025	399026
14-16 AWG #8 Stud.....	399030	399031
14-16 AWG #10 Stud.....	399035	399036
14-16 AWG 1/4" Stud	399040	399041
14-16 AWG 3/8" Stud	399045	399046
10-12 AWG #10 Stud.....	399050	399051
10-12 AWG 1/4" Stud	399055	399056
10-12 AWG 3/8" Stud	399060	399061
10-12 AWG 1/2" Stud	399065	399066

ELECTRALINK TERMINALS

ALL ELECTRALINK "-500" PACKAGES
HAVE BEEN DISCONTINUED

14 Electrical Items

SPADE TERMINALS



Description	10 Pkg. Prod. #	50 Pkg. Prod. #
18-20 AWG #10 Stud.....	399070	399071
14-16 AWG #10 Stud.....	399075	399076
10-12 AWG #10 Stud.....	399080	399081

BUTT TERMINALS



Description	10 Pkg. Prod. #	50 Pkg. Prod. #
22-24 AWG <i>WHITE</i>	399085	399086
18-22 AWG <i>RED</i>	399090	399091
14-16 AWG <i>BLUE</i>	399095	399096
10-12 AWG <i>YELLOW</i>	399100	399101

SLIP-ON CONNECTORS



Description	10 Pkg. Prod. #	50 Pkg. Prod. #
18-20 AWG .250 Fully Insulated Female.....	399105	399106
18-20 AWG .250 Fully Insulated Male.....	399110	399111
14-16 AWG .250 Female.....	399115	399116
14-16 AWG .250 Fully Insulated Female.....	399120	399121
14-16 AWG .250 Male.....	399125	399126

CRIMP ASSORTMENTS

222033

Krimp & Seal Assortment
60 Total Pieces
Includes #99930 Drawer and
#97000 Mini Torch
Box Qty. 1



222034

Krimp & Solder Assortment
60 Total Pieces
Includes #99930 Drawer and
#97000 Mini Torch
Box Qty. 1



CRIMP & SOLDER CONNECTORS



396250
 "Clear"
 24-22 Ga.
 Crimp & Solder
 Butt Connector
 Box Qty. 10



396251
 "Red"
 22-18 Ga.
 Crimp & Solder
 Butt Connector
 Box Qty. 10



396252
 "Blue"
 16-14 Ga.
 Crimp & Solder
 Butt Connector
 Box Qty. 10



396253
 "Yellow"
 12-10 Ga.
 Crimp & Solder
 Butt Connector
 Box Qty. 10

MISC CONNECTORS

PERMA-SEAL NYLON HEAT SEALABLE BUTT CONNECTORS (With Adhesive Liner For Moisture Resistance)

Perma-Seal Connectors provide ideal protection from moisture intrusion for exposed wiring on Automobiles, Fleet Vehicles, R.V.'s, Trailers and Motorcycles. As connector is heated and begins to shrink, the adhesive liner melts and flows to encapsulate the connection.

Wire Size	Color	Product No. 10 per pkg.	Product No. 50 per pkg.
22-18	Red	396175	396177
16-14	Blue	396185	396186
12-10	Yellow	396195	396196

Simple Installation

Select the correct splice size for the wire gauge. Strip the wires 0.3" (7.6mm) from the end and insert into the crimp barrel.



Making sure the wire end is properly seated, make the crimp connection using a tool designed for insulated splices.



Apply heat directly to the splice, working from the center out to the edges, using a hot air gun or other heat source, until



the tubing shrinks and the adhesive flows. Allow to cool before inspecting splice and checking the integrity.



395202
 Tan
 Heavy Duty self-stripping connector designed for 14, 16 or 18 gauge wire connected on to 10 or 12 gauge automotive wire.
 Box Qty. 10

MISC CONNECTORS

QUICK-LOCK CONNECTOR

Connects and Insulates

Make quick, reliable pre-insulated tap splices, in-line splices, pass-through connections and pigtail connections without stripping, twisting, soldering or using special tools.

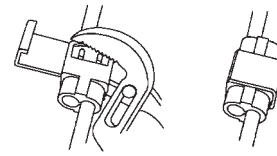

Prod No.	Description	Box Qty
395195 22-18 Ga. Wire, "Red"	50
395195-500 22-18 Ga. Wire, "Red"	500
395199 18-14 Ga. Wire, "White"	50
395199-500 18-14 Ga. Wire, "White"	500
395200 16-14 Ga. Wire, "Blue"	50
395201 16-14 Ga. Wire, "Blue"	250
395200-500 16-14 Ga. Wire, "Blue"	500
395205 12-10 Ga. Wire, "Yellow"	50
395205-500 12-10 Ga. Wire, "Yellow"	500

14 Electrical Items

T-TYPE WIRE TAP

This Tap makes tapping into an existing wire quick, easy and reliable. This Tap actually is a fully insulated female quick disconnect that can be spliced onto a wire and then mated with a .250 size male disconnect. All without stripping, twisting or soldering.

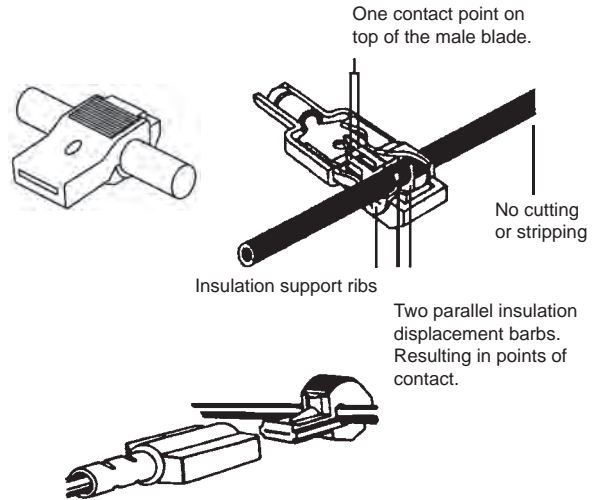

Wire Size	Color Code	Tab Size	Product No. 10 per pkg.	Product No. 50 per pkg.
26-22.....	Black.....	.250.....	395516	
22-18.....	Red.....	.250.....	395512	395513
18-14.....	Blue250.....	395510	395511
12-10.....	Yellow250.....	395514	395515

SOLDER SPLICE CONNECTORS

Our Solder Splice Connectors consist of a fluxed solder ring with a heat shrinkable insulation sleeve, when heated, provide a completely soldered, strain relieved, and encapsulated connection.

- * Clear insulation sleeve for easy inspection.
- * UL recognized.
- * One-piece design makes installation easy!
- * Temperature rating: -55° C to 125° C
- * Minimum shrink temperature: 149° C (300° F)
- * Meets or exceeds the requirements of UL486A.

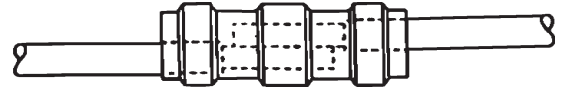
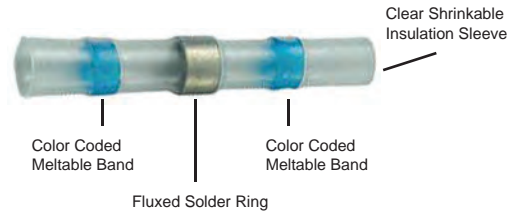









Installation:

1. Wire sizes from 26AWG to 18AWG strip 3/8" of insulation. All other size wires strip 1/2" of insulation.
2. Position the wire strands into the Solder Splice connector so that they overlap and are centered in the solder ring, See above. (The easiest method is to lay the splice connection down on a flat, heat resistant surface, then follow step 3.)
3. Apply heat, using an appropriate heat gun, directly to the solder ring until it melts, forming a solder joint. Then move the heat back & forth so that the insulation sleeve is completely shrunk.

NOTE: If the connection cannot be laid down on a flat surface, an alternate method would be to overlap the stripped wire & center in the solder ring. With your thumb & forefinger, pinch the solder ring so it deforms over the wires, this holding them in place. Then apply the heat.

Product Number	Color Code	Maximum Inside Dia.	Length (L) Approx.
397180	Blue	.175	1.5 DISC
397190	Yellow	.230	1.5

NON-INSULATED CONNECTORS

 <p>396025 22-18 Gauge Wire Non-Insulated Butt Connector Box Qty. 100</p>	 <p>396023 16-14 Gauge Wire Size Non-Insulated Butt Connector Box Qty. 25</p>	 <p>396024 12-10 Gauge Wire Size Non-Insulated Butt Connector Box Qty. 25</p>	 <p>396050 Butt Connector 8 ga. Non-Insulated Box Qty. 50</p>
 <p>396030 Ring Terminal 16-14 ga., #10 Stud Non-Insulated Box Qty. 100</p>	 <p>396033 Ring Terminal 16-14 ga., 3/8" Stud Non-Insulated Box Qty. 100</p>	 <p>396055 <i>05297428</i> Non-Insulated Solderless Terminal Splice Clips Wire Range: Max. of three #16 ga. Box Qty. 50</p>	 <p>396056 <i>1839906</i> Non-Insulated Solderless Terminal Splice Clips Wire Range: Max. of three #12 ga. Box Qty. 50</p>

HEAT SHRINK TUBING

POLYOLEFIN THIN WALL HEAT SHRINK TUBING



A thin wall high quality tubing with a wide variety of uses. It is made from flame retarded polyolefin, providing excellent physical, chemical and electrical properties that meet industrial & military requirements for highly reliable shrink tubing. Meets MIL-1-23053/5, UL and CSA Specifications. Offers excellent chemical, corrosion, oil and heat resistance. Typical uses: splices, wire bundling, markers, harnessing, stress relief, terminations, etc.

Shrink ratio: 2:1 Minimum shrink Temperature: 121°C (250°F) Continuous operating temperature: -55°C (-67°F) to 135°C (275°F)

Product Number	Expanded Diameter	Reduced Diameter	Length	Color	Box Qty
48010	3/16"	3/32"	4"	Black	12
48015	1/4"	1/8"	4"	White	12
48016	3/8"	3/16"	4"	Red	6
48017	1/2"	1/4"	4"	Black	6
48018	3/4"	3/8"	4"	White	6
48019	1"	1/2"	4"	Red	4

PERM-FIT DUAL WALL HEAT SHRINK TUBING (WITH ADHESIVE MELT LINER)



This PERM-FIT dual-wall polyolefin heat shrink tubing has an adhesive melt liner which offers excellent resistance to vibration, abrasion and corrosion while providing superior strain relief. As the tubing shrinks, the adhesive liner melts and provides a moisture-proof seal, encapsulating components or splices contained within. Meets MIL-1-23053/4 & UL224 Requirements (jacket only). Great as a moisture barrier in high humidity and corrosive environments.

Shrink ratio: 3:1 Minimum shrink temperature: 120°C (248°F) Continuous operating temperature: -55°C (-67°F) to 110°C (230°C)

Product Number	Expanded Dia.	Reduced Dia. (approx.)	Length	Color	Box Qty.
48020	1/8"	3/64"	4"	Black	12
48021	3/16"	1/16"	4"	Black	12
48025	1/4"	5/64"	4"	Black	12
48026	3/8"	1/8"	4"	Black	6
48040	1/8"	3/64"	12"	Black	12
48041	1/8"	3/64"	12"	Red	12
48042	3/16"	1/16"	12"	Black	12
48043	3/16"	1/16"	12"	Red	12
48044	1/4"	5/64"	12"	Black	12
48045	1/4"	5/64"	12"	Red	12
48046	3/8"	1/8"	12"	Black	12
48047	3/8"	1/8"	12"	Red	12
48048	1/2"	11/64"	12"	Black	12
48049	1/2"	11/64"	12"	Red	12
48050	3/4"	1/4"	12"	Black	12
48051	3/4"	1/4"	12"	Red	12

PRIMARY WIRE / MISC

PRIMARY WIRE - TXL

General purpose primary wire used where small diameter and minimal weight is desired. Type TXL wire - extra thin wall (XLP).
 Wire voltage rating: 50 Volts. Recommended temperature range: -40°C to +125°C.
 Meets SAE J-1560 requirements.
 Meets Ford (M1L-123A) and Chrysler (MS-8288) specs.
 100 Ft. Spools



Gauge	Stranding	O.D.	White	Red	Black	Green
22	7 x 30	.062	1089	1090	1091	1092

PRIMARY WIRE

For cars, trucks, marine and general purpose. General purpose thermoplastic insulation.(GPT). For use at 60 volts or less. Meets SAE J1128 specifications. Temperature rating of 80°C (176°F). RoHS compliant. Suitable for most automotive applications. Abrasion resistant and impervious to oil, grease and diesel fumes.



Gauge	Stranding	O.D.	Black	Blue	Product Number		100 ft. Spools		
					Green	Red	White	Yellow	Orange
18	16 x 30	.095	1101	1102	---	1104	1105	---	---
16	19 x 29	.102	1111	1112	1113	1114	1115	1116	1117
14	19 x 27	.117	1121	1122	1123	1124	1125	1126	---
12	19 x 25	.142	1131	1132	---	1133	1134	---	---
10	19 x 23	.174	1141	---	---	1142	1143	---	---

The lower the gauge number, the thicker the wire. (10 gauge is thicker than 16 gauge)

SPEAKER WIRE

Product No. 1170

100 Ft. Spool



Audio Cable Heavy-Duty Zip Cord (Color: Clear)

Construction: One conductor tinned copper, one conductor bare copper for polarity identification. PVC insulation, identifying ridge on one conductor, conductors laid parallel rip-type construction for easy separation of conductors when split apart. 18/2 gauge.

BONDED PARALLEL WIRE

RoHS compliant • All Copper Strand core •
 Designed especially for RV's and boat utility trailers •
 For use at 60 volts or less • Conductors meet SAE J1128 specs •
 Temp rating 80°C/176°F • Nominal cold temp rating -30°C/-22°F
 100 Ft. Roll



Prod No.	Ga.	Color
1190	16/2 ga.	Red/Black
1191	14/2 ga.	Red/Black

MISC WIRE / CONNECTORS

NEW



1177
 16 Ga. Trailer Wire Spool
 PVC Primary 4-Wire
 Color Coded and Jacketed
 Meets SAE J1128
 105°C (221°F)
 100ft. Spool
 Box Qty. 1

www.srfast.com

14 Electrical Items

14

SPOOLED FUSIBLE LINK WIRE

A fusible link is a special section of low tension wire installed by an OEM and designed to open a circuit when subjected to extreme current overload. Its purpose is to minimize wiring system damage when such an overload accidentally occurs in those circuits protected by the fusible link. Our fusible link wire meets the requirements of SAE J-156 and the insulation has the characteristics as listed for SAE J-1128 type SXL. The vehicle manufacturer should be consulted about questions on fusible link length and size. Typically fusible link wire should be 4 gauges smaller than the circuit wire.

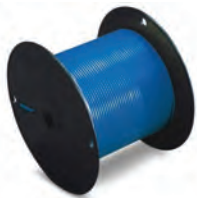

Pkg Qty.: one 25' spool

Prod. No.	Gauge	Color	Replaces	
4171	18	Green	GM:6293702	DISC
4172	16	Red	GM:6292996	DISC
4173	14	Red	GM:6292995	DISC
4174	12	Blue		DISC
1175	10	Orange		



ROSIN CORE THIN WIRE SOLDER

Very effective for general electrical soldering. Comes in a convenient reusable container that fits right in your pocket! Contains 40% Tin / 60% Lead Solder and has a rosin flux core.

Dia.: .062"
 Net Wt.: .90 oz.
 Melting Point: 460°F

	1 Bx Qty	5 Bx Qty
Prod. Number	97303	97304

TWIST LOCK WIRE CONNECTORS

Specialty wire connectors that have a cone shaped, plated steel spring that conforms to the inside contour of the insulating shell, which supports the spring as well as the conductor which is driven up into the cone. Requires no pre-twisting because the wires are automatically twisted together for a secure connection and maximum contact.



Part No.	Color	Wire Range	Description	Bx Qty.
396300	Gray	22-14	Twist Lock Connector	100
396305	Blue	22-14	Twist Lock Connector	100
396310	Orange	22-14	Twist Lock Connector	100
396315	Yellow	18-10	Twist Lock Connector	100
396320	Red	18-8	Twist Lock Connector	100

BATTERY / STARTER CABLE

BATTERY/STARTER CABLES

Rated 105°C
100 ft. rolls

11508ga.....	RED
11518ga.....	BLACK
11526ga.....	RED
11536ga.....	BLACK
11544ga.....	RED
11554ga.....	BLACK
11562ga.....	RED
11572ga.....	BLACK
11581ga.....	RED
11591ga.....	BLACK
11601/0ga.....	RED
11611/0ga.....	BLACK
11622/0ga.....	RED
11632/0ga.....	BLACK



- For uses at 60 volts or less
- Meets SAE J1128 specifications
- RoHS compliant
- Stranded annealed, single conductor copper wire
- General purpose thermoplastic (GPT) insulation
- Recommended for trucks, tractors, cars and general service
- Temperature rating of 105°C (221°F)

BATTERY/STARTER CABLES

UL Listed 1426 Tinned Wire/Cable 600V
100 ft. rolls

11808ga.....	RED
11818ga.....	BLACK
11826ga.....	RED
11836ga.....	BLACK
11844ga.....	RED
11854ga.....	BLACK
11862ga.....	RED
11872ga.....	BLACK
11881ga.....	RED
11891ga.....	BLACK
11921/0ga.....	RED
11931/0ga.....	BLACK
11942/0ga.....	RED
11952/0ga.....	BLACK



- UL Listed
- Rated 600 volts
- RoHS compliant
- Flame retardant PVC insulation
- Electro-tinned, copper strands increase corrosion protection
- Meets DOT and Coast Guard specifications for electrical systems
- Temperature ratings of 105°C (221°F) dry and 75°C (167°F) wet

www.srfast.com

BATTERY TERMINALS



STANDARD WALL STARTER LUGS

Copper, Unplated

396701 4 Ga.....	5/16" Hole	25/bx
396702 4 Ga.....	3/8" Hole	25/bx
396705 2 Ga.....	5/16" Hole	25/bx
396706 2 Ga.....	3/8" Hole	25/bx
396707 2/0 Ga.....	5/16" Hole	25/bx
396708 2/0 Ga.....	3/8" Hole	25/bx

14 Electrical Items



400520
 Universal Top Mount
 Battery Terminal
 Heavy Duty
 For Pos. & Neg. Posts
Cable Range:
 8 thru 2/0 AWG
 Card of 10



400530
 Universal Side Mount
 Battery Terminal
 Heavy Duty
 For Pos. & Neg. Posts
Cable Range:
 8 thru 2/0 AWG
 Card of 8

400542
 Wing Nut Battery Terminal
 Brass Plated
 For Positive Posts
 Terminal Stud Size 3/8"
 Box Qty. 1



400543
 Wing Nut Battery Terminal
 Brass Plated
 For Negative Posts
 Terminal Stud Size 5/16"
 Box Qty. 1

HEAVY DUTY COPPER BATTERY TERMINALS

- 93-95% Tin plated cast copper battery terminals
- Crimp or solder
- Meets TMC requirements



Part No.	Bx Qty
400537 6ga..... Universal	1
400538 4ga..... Negative	1
400539 4ga..... Positive.....	1
400540 2-1ga..... Negative	1
400541 2-1ga..... Positive.....	1
400544 1/0ga..... Negative	1
400545 1/0ga..... Positive.....	1
400546 2/0ga..... Negative	1
400547 2/0ga..... Positive.....	1

CABLE TIES

NATURAL COLOR CABLE TIES

100% VIRGIN NYLON 6/6
U.L., QPL LISTED
MIL SPECIFICATION



Rounded edges reduce insertion force and surface abrasion.
Ridges on tip allow firmer grip for pull thru.
Reinforced neck for greater strength.
Advance pawl design for superior locking power.
Low profile head for streamline appearance and snag resistance.
Smooth edges do not cut insulation.

Approx. Length	Width Inches	Max Bundle Diameter	Tensile Strength	Product No. 100 Pack	Product No. 1000 Pack
4"10	1.0"	18 lbs.	58001	58002
5"13	1.5"	40 lbs.	58035	58036
8"13	2.0"	40 lbs.	58003	58004
8"19	2.1"	50 lbs.	58037	58038
11"19	3.0"	50 lbs.	58039	58040
14"19	4.0"	50 lbs.	58005	58006

HEAVY DUTY - NATURAL COLOR CABLE TIES

100% VIRGIN NYLON 6/6
U.L., QPL LISTED
MIL SPECIFICATION



Approx. Length	Width Inches	Max Bundle Diameter	Tensile Strength	Pkg Qty.	Product No.
8"30	2.1"	120 lbs.	100	58060
14"30	4.2"	120 lbs.	100	58062
18"30	5.0"	175 lbs.	50	58064
21"31	6.5"	175 lbs.	50	58066
30"35	9.0"	175 lbs.	50	58068
36"35	11"	175 lbs.	50	58070
48"35	15"	175 lbs.	50	58072

NATURAL COLOR SCREW MOUNT CABLE TIES

SAME FEATURES AS THE ABOVE NATURAL COLOR TIES
BUT ALSO COMES WITH A MOLDED-IN SCREW MOUNT



Approx. Length	Width Inches	Max Bundle Diameter	Tensile Strength	Mounting Head Size	Product No. 100 Pack	Product No. 1000 Pack
6"14	1.5"	40 lbs.	#8	58090	
8"17	2.0"	50 lbs.	#10	58010	58011
11"19	3.0"	50 lbs.	#10	58094	
14"19	4.0"	50 lbs.	#10	58012	58013
16"31	4.0"	120 lbs.	#10	58096 DISC	

CABLE TIES

U.V. BLACK COLOR CABLE TIES

SAME FEATURES AS NATURAL TIES
BLACK AND ULTRAVIOLET RESISTANT.



Approx. Length	Width Inches	Max Bundle Diameter	Tensile Strength	Product No. 100 Pack	Product No. 1000 Pack
4"	.10	1.0"	18 lbs	58018	58019
5"	.13	1.5"	40 lbs	58045	58046
8"	.13	2.0"	40 lbs	58014	58015
8"	.13	2.1"	50 lbs	58047	58048
11"	.14	3.0"	50 lbs	58049	58050
11"	.14	3.0"	50 lbs	58023 (50 pack)	
14"	.14	4.0"	50 lbs	58016	58017

DISCONTINUED
DISCONTINUED

HEAVY DUTY - U.V. BLACK COLOR CABLE TIES

SAME FEATURES AS NATURAL TIES
BLACK AND ULTRAVIOLET RESISTANT.



Approx. Length	Width Inches	Max Bundle Diameter	Tensile Strength	Pkg. Qty.	Product No.
8"	.30	2.1"	120 lbs	100	58074
14"	.30	4.2"	120 lbs	25	58025
14"	.30	4.2"	120 lbs	100	58076
18"	.31	5.0"	175 lbs	50	58078
21"	.31	6.5"	175 lbs	50	58080
24"	.35	7.0"	175 lbs	50	58081
30"	.35	9.0"	175 lbs	50	58082
36"	.35	11"	175 lbs	50	58084
48"	.35	15"	175 lbs	50	58086

U.V. BLACK COLOR CABLE TIES

SAME FEATURES AS THE ABOVE BUT ALSO
COMES WITH A MOLDED-IN SCREW MOUNT



Approx. Length	Width Inches	Max Bundle Diameter	Tensile Strength	Mount Hd Strength	Product No. Screw Size	100 Pack
6"	.14	1.5"	40 lbs	40 lbs	#8	58098
8"	.17	2.0"	50 lbs	50 lbs	#10	58100
11"	.19	3.0"	50 lbs	50 lbs	#10	58102
14"	.19	4.0"	50 lbs	50 lbs	#10	58104

58122

Black UV Nylon
Releasable Cable Tie
PAWL Type Release
Length: 7.6"
Tensile Strength: 50lbs
Box Qty. 50



58123

Black UV Nylon
Releasable Cable Tie
PAWL Type Release
Length: 11.1"
Tensile Strength: 50lbs
Box Qty. 50



WIRE LOOM, CLIPS, STRAPS



58022
 Black Nylon
 Cable Tie Mount
 Fits Into a 1/4" or 6mm Size Hole
 Accepts up to 5/16" cable ties
 Box Qty. 25



ADHESIVE MOUNTING BASES
 For Ties Strengths 18-50 lbs.
 Size: 1" x 1"
 Pkg. Qty. 100
58110 Color: Natural
58112 Color: UV Black

WIRE LOOM (SPLIT FLEXIBLE TUBING)

Nylon 6 Black
 Maximum Temp. 345°F
 Box Qty. 1



Prod #	I.D.	O.D.	Length
5085	1/4"	3/8"	50'
5087	3/8"	9/16"	50'
5088	3/8"	9/16"	10'
5089	1/2"	11/16"	50'
5090	1/2"	11/16"	10'
5093	5/8"	13/16"	50'
5094	3/4"	15/16"	50'
5095	1"	1-1/8"	25'

NEW
NEW
NEW

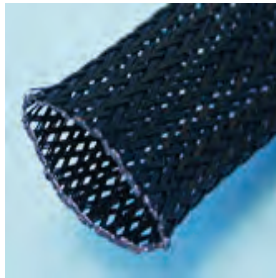

EXPANDABLE ELECTRICAL SLEEVING

A polyethylene terephthale lightweight sleeving used to cover wires, wire bundles, tubing, hoses, trailer chains, outboard motor cables, marine hoses and harness/cable assemblies. Operating temp: -75°C to 125°C (-103°F to 257°F). Manufactured to meet UL, CSA and FMVSS 302 requirements. I.D. size is measured at relaxed state, expands to 2 times original size.
 Box Qty: 1 Roll

Prod #	I.D.	O.D.	Length
5091	1/4"	3/8"	100'
5092	1/2"	9/16"	100'

WIRE LOOM ROUTING CLIPS

for wire loom
 (also called split flexible tubing, convoluted conduit)



Prod #	OEM #	I.D.	O.D.	Box Qty.
505110	8911473	11/32"	1/2"	50
505120	8911497	13/32"	19/32"	50
505130	8911472	1/2"	11/16"	50
505140	8917320, 3816659	3/4"	1"	50



505010
 Clear Color
 Adjustable Nylon Strap
 5" long
 Box Qty. 25

WIRE LOOM, CLIPS, STRAPS



505145
 Black Nylon
 Wire Loom Clips
 Fits 1/4" Tubing Size
 Push in
 Box Qty. 50



505150
 Wiring and Tube Clip
 For 1/2" O.D.
 Tube or Wire
Ford
 Box Qty. 50



505170
 Wiring and Tube Clip
 For 3/4" O.D.
 Tube or Wire
Ford
 Box Qty. 50



505195
9928-91-053,
90672-SAO-003
 Blank Nylon
 Releasable Cable Strap
 Length: 5-1/2" (140mm)
 Max Bundle Dia: 1-8/32" (30mm)
 Fits into a 7mm hole
Mazda & Honda & General Purpose
 Box Qty. 25



505197
 Push-Mount Cable Tie
 Length: 8"
 Width: 3/16"
 Max Bundle: 1-3/4"
 Fits into a 1/4" hole
 Box Qty. 25



505205
12160858
 Nylon
 Wire Loom
 Routing Clip
 I.D.: 10mm
 O.D.: 13mm
GM
 Box Qty. 15



505206
12040984
 Nylon
 Wire Loom
 Routing Clip
 Inner Dia.: 1/4"
 Outer Dia.: 3/8"
GM
 Box Qty. 15

Electrical Items

14

FUSES

AUTOMOTIVE GLASS FUSES

PACKAGED 5 FUSES PER BOX



PRODUCT NUMBER	INDUSTRIAL CODE	AMP	SIZE
46011	AGC-2	2	1/4" x 1-1/4"
46013	AGC-4	4	1/4" x 1-1/4"
46014	AGC-5	5	1/4" x 1-1/4"
46015	AGC-7-1/2	7-1/2	1/4" x 1-1/4"
46016	AGC-10	10	1/4" x 1-1/4"
46017	AGC-15	15	1/4" x 1-1/4"
46019	AGC-25	25	1/4" x 1-1/4"
46020	AGC-30	30	1/4" x 1-1/4"
46041	SFE-20	20	1/4" x 1-1/4"
46042	SFE-30	30	1/4" x 1-7/16"



LOW-PROFILE MINI FUSES

These fuses have similar performance characteristics as the standard MINI's, but have a lower overall height which allows for more space and weight savings. They require specific fuse box/terminals for installation. Most commonly found in newer vehicles.

"5 PKG." NUMBERS ARE DISCONTINUED

Amp	Color	5/Bx	25 Bx
5	Amber	48205	48205-25
7.5	Brown	48207	48207-25
10	Red	48210	48210-25
15	Blue	48215	48215-25
20	Yellow	48220	48220-25
25	Clear	48225	48225-25
30	Green	48230	48230-25



MICRO FUSES 3 BLADE

Number	Amp	Color	OEM	Box
48260	5	Tan	DG9Z-14526-N 19209797	10
48261	7.5	Brown	DG9Z-14526-S 19209798	10
48262	10	Red	DG9Z-14526-P 19209799	10
48263	15	Blue	DG9Z-14526-R 19119304	10



M CASE CARTRIDGE FUSES

Number	Amp	Color	Box
49570	15	Gray	5
49571	20	Blue	5
49572	25	Tan	5
49573	30	Pink	5
49574	40	Green	5

MICRO FUSES 2 BLADE



Number	Amp	Color	OEM	Box
48250	5	Tan	19209790	10
48251	7.5	Brown	19209791	10
48252	10	Red	19209792	10
48253	15	Blue	19209793	10
48254	20	Yellow	19209794	10
48255	25	Natural	19209795	10
48256	30	Green	19209796	10



J CASE FUSES LOW PROFILE

Number	Amp	Color	Box
49560	20	Blue	1
49561	25	White	1
49562	30	Pink	1
49563	40	Green	1
49564	50	Red	1
49565	60	Yellow	1



J-CASE FUSES FMX SERIES Female Fuse

Number	AMP	Color	Box
49540	20	Lt Blue	1
49541	30	Pink	1
49542	40	Green	1
49543	50	Red	1
49544	60	Yellow	1

FUSES

ATC BLADE FUSES

ATC fuses for marine and automotive applications. Universal color-coding to indicate amp rating. Features an enclosed element - protecting against shocks and sparks, plus corrosion resistance resulting in longer service life.

FUSE	AMPS	COLOR	5 Pkg.
ATC-3	3	VIOLET	45050
ATC-4	4	PINK	45051
ATC-5	5	TAN	45052
ATC-7.5	7.5	BROWN	45053
ATC-10	10	RED	45054
ATC-15	15	BLUE	45055
ATC-20	20	YELLOW	45056
ATC-25	25	CLEAR	45057
ATC-30	30	GREEN	45058
ATC-40	40	ORANGE	45059



Enclosed element!

**DISCONTINUED
USE ATO/ATC FUSES BELOW**

"5 PKG." NUMBERS ARE DISCONTINUED

FUSE	AMPS	COLOR	5 Pkg.	25 Pkg.
ATO-3	3	VIOLET	46050	46050-25
ATO-4	4	PINK	46051	46051-25
ATO-5	5	TAN	46052	46052-25
ATO-7.5	7.5	BROWN	46053	46053-25
ATO-10	10	RED	46054	46054-25
ATO-15	15	BLUE	46055	46055-25
ATO-20	20	YELLOW	46056	46056-25
ATO-25	25	WHITE	46057	46057-25
ATO-30	30	GREEN	46058	46058-25
ATO-40	40	ORANGE	46059	46059-25

ATO/ATC FUSES

ATO/ATC FUSE for OEM automotive applications 1977 & up



"5 PKG." NUMBERS ARE DISCONTINUED

FUSE	AMPS	COLOR	5 Pkg.	25 Pkg.
MINI-2	2	SMOKE	48102	48102-25
MINI-3	3	VIOLET	48103	48103-25
MINI-4	4	PINK	48104	48104-25
MINI-5	5	TAN	48105	48105-25
MINI-7.5	7.5	BROWN	48107	48107-25
MINI-10	10	RED	48110	48110-25
MINI-15	15	BLUE	48115	48115-25
MINI-20	20	YELLOW	48120	48120-25
MINI-25	25	WHITE	48125	48125-25
MINI-30	30	GREEN	48130	48130-25

MINI-FUSES

Replacement fuses for late model automotive O.E.M applications.



FUSES / CIRCUIT BREAKERS

MAXI-FUSES

Used on automotive vehicles since 1989
1 Per Box



PROD NO.	FUSE NO.	AMPS	COLOR
49020	MAX-20	20	YELLOW
49030	MAX-30	30	GREEN
49040	MAX-40	40	ORANGE
49050	MAX-50	50	RED
49060	MAX-60	60	BLUE
49070	MAX-70	70	BROWN
49080	MAX-80	80	CLEAR

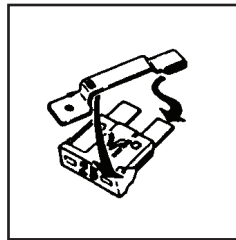

395435

Can be used with #395410
Blade Type Fuse Tap
For Quick Connect & Disconnect of Accessories, for ATO or ATC Fuses, Installed in Fuse Block
Box Qty. 25

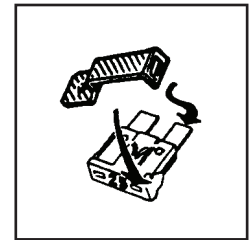

395436

Can be used with #395410
Mini Fuse Blade Type Fuse Tap
For Tapping "Hot Side" of Mini Fuse Type Fuse Block
Box Qty. 50

CIRCUIT BREAKER FUSE CLIP TYPE

Fits 1-1/4" fuse clips
1 Per Box



PROD NUMBER	AMP RATING
47010	10
47015	15
47020	20
47025	25
47030	30
47035	35
47040	40

CIRCUIT BREAKER STUD TYPE

(6-24 volts)
Conforms to SAE J553
1 Per Box



PROD NUMBER	AMP RATING
47115	15
47120	20
47125	25
47130	30
47135	35
47140	40

48031

THERMAL LIMITER SWITCH

For GM Air Conditioners
1 Per Box



Need contact cleaner for your electrical connectors?

See page 15-4

CARTRIDGE FUSES



**PAL - FEMALE TYPE
AUTO LINK FUSE**
1 Per Box

PROD NO.	FUSE NO.	AMP	COLOR
49001	PAL-030	30	PINK
49002	PAL-040	40	GREEN
49007	PAL-050	50	RED
49003	PAL-060	60	YELLOW



**PAL - MALE TYPE
AUTO LINK FUSE**
1 Per Box

PROD NO.	FUSE NO.	AMP	COLOR
49004	PAL-130	30	PINK
49005	PAL-160	60	YELLOW
49006	PAL-180	80	BLACK

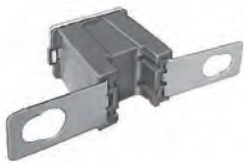

**PAL- 13/16" BENT
MALE TYPE
AUTO LINK FUSE**
1 Per Box

PROD NO.	FUSE NO.	AMP	COLOR
48990	PAL-230	30	PINK
48991	PAL-240	40	GREEN
48992	PAL-250	50	RED
48993	PAL-260	60	YELLOW

14 Electrical Items

FUSEHOLDERS

48001
Universal
Bayonet Knob
In-line Fuse Holder



Supplied with a 15" loop of 14 ga. wire and three springs to accommodate SFE 7-1/2,9,14,20, AGA, AGW, and AGX fuses.
Box Qty. 1

48002
Heavy Duty 30 Amp
In-line Fuse Holder



Supplied with 2-4" leads of 12 Ga. wire
AGC 30 amp fuse included.
Box Qty. 1

48004
Heavy Duty In-line
ATO Fuse Holder



Supplied with an 8" loop of 12 Ga. orange wire for use with ATO 25 and ATO 30 amp fuses.
Box Qty. 1

48006
Mini-Fuse Easy Crimp Fuseholder
Use with MINI Blade fuses.
30 amp max., #10-14 AWG wire.
Quickly and easily crimps stranded copper wire to fuseholder terminals using a standard crimping tool.
Box Qty. 1



48007
Water Tight
Sealed Fuseholder - ATO
Use with ATO fuses.
Rated 1-30 amps
9" 12 ga (3.0mm) Type GXL leads
Designed for automotive/marine engine compartment conditions, and provides the highest reliability in the harshest environments.
Box Qty. 1



FUSE HOLDERS/FLASHERS



48008
Add-A-Circuit Fuse Holder
10 Amp Mini Fuse
16 Ga. Wire
Box Qty. 1



48552
INDUSTRY #536/552
Replaces 12-volt,
two-terminal flashers.
Flashes two to three 32 C.P.
Standard or long-life lamps for turn signals.
Flashes two to six lamps for hazard warning.
Box Qty. 1

2-Prong

FUSE ASSORTMENTS

48600
AUTOFUSE 80 Piece Fuse Assortment

Contents:
(10) ATO 3 (10) ATO 15
(10) ATO 5 (10) ATO 20
(10) ATO 7.5 (10) ATO 25
(10) ATO 10 (10) ATO 30



48601
ATO/MINI 80 Piece Fuse Assortment
(w/ #48603 Fuse Puller)

Contents:
(10) ATO 15 (10) MIN 15
(10) ATO 20 (10) MIN 20
(10) ATO 25 (10) MIN 25
(10) ATO 30 (10) MIN 30
(1) 48603 Fuse Puller



48605
Micro2 / Micro3
Fuse Assortment
56 pieces
Box Qty. 1



48603
Fuse Puller
For easy fuse removal and replacement
of Glass, ATO and MINI Fuses.
Box Qty. 1



48604
J Case
Fuse Puller
Box Qty. 1



MINIATURE LAMPS

MINIATURE LAMPS - DOMESTIC

All Bulbs are packaged in boxes of 10,
except for *, which is packaged in a box of 2

TO BE DISCONTINUED WHEN OUT - REFER TO IMPORT BULBS

Prod No.	Bulb No.	Bulb Type	Prod No.	Bulb No.	Bulb Type
1995	DISC.....24.....	10	2280	DISC..... 2057.....	1
1996	DISC..... 24NA.....	10	2285	DISC..... 2057NA.....	1
2010	DISC..... 53.....	4	2286	DISC..... 2357.....	1
2020	DISC..... 63.....	4	2287	DISC..... 2357NA.....	1
2025	DISC..... 67.....	4	2305	DISC..... 2721.....	5
2030	DISC..... 74.....	10	2288	DISC..... 3057.....	17
2035	DISC..... 89.....	5	2289	DISC..... 3057NA.....	7
2055	DISC..... 97.....	4	2303	DISC..... 3156.....	17
2085	DISC..... 194.....	2	2304	DISC..... 3156A.....	17
2095	DISC..... 194NA.....	2	2290	DISC..... 3157.....	17
2100	DISC..... 211-2.....	6	2294	DISC..... 3157NA.....	7
2105	DISC..... 212-2.....	6	2308	DISC..... 3157NALL	
2120	DISC..... 561.....	12		4157NALL.....	17
2135	DISC..... 631.....	4	2299	DISC..... DE-3022.....	9
2140	DISC..... 904.....	10	2300	DISC..... DE-3175.....	9
2145	DISC..... 906.....	10	2306	DISC..... 3357/3457.....	17
2150	DISC..... 912.....	10	2307	DISC..... 3357A/3457A.....	17
2146	DISC..... 916.....	10	2340* 3496.....	1
2147	DISC..... 916NA.....	10	2341	DISC..... 3496.....	1
2155	DISC..... 1003.....	3	2345	DISC..... 3497.....	5
2160	DISC..... 1004.....	1	2347	DISC..... 3757KA.....	17
2180	DISC..... 1141.....	3	2346* 4114LL.....	17
2190	DISC..... 1154.....	1	2348	DISC..... 4157LL.....	17
2200	DISC..... 1156.....	3	2315	DISC..... 6411.....	9
2201	DISC..... 1156NA.....	3	2310	DISC..... 6418.....	9
2205	DISC..... 1157.....	1	2320* 7225.....	1
2215	DISC..... 1157NA.....	1	2325*	DISC..... 7440.....	2
2238	DISC..... 1295NA.....	3	2330*	DISC..... 7443.....	2
2250	DISC..... 1816.....	5	2331 7444LL.....	2
2260	DISC..... 1891.....	5	2332 7444NALL.....	2
2270	DISC..... 1893.....	5			
2275	DISC..... 1895.....	4			



Type 1



Type 2



Type 3



Type 4



Type 5



Type 6



Type 7



Type 9



Type 12



Type 17



Type 10

TO BE DISCONTINUED WHEN OUT - REFER TO IMPORT BULBS

IMPORT MINIATURE LAMPS

Prod No.	Bulb No.	Bulb Type
2604	24	2
2605	24NA	2
2606	53	4
2607	63	4
2600	67	4
2608	74	10
2609	89	4
2611	97	4
2610	194	2
2612	194A	2
2620	194NA	2
2621	211-2	6
2622	212-2	6
2623	561	12
2624	631	4
2627	904	10
2625	906	10
2628	912	10
2629	916	10
2626	916NA	10
2631	921	2
2632	1003	3
2633	1004	1
2634	1141	3
2636	1154	1
2630	1156	3
2637	1156A	3
2635	1156NA	3
2640	1157	1
2650	1157NA	1
2651	1295NA	3
2652	1816	5
2653	1891	5

Prod No.	Bulb No.	Bulb Type
2654	1893	5
2660	1895	4
2670	2057	1
2671	2057A	1
2680	2057NA	1
2681	2357	1
2682	2357A	1
2683	2721	2
2693	DE-3022	9
2684	3057	17
2688	3057A	17
2685	3057NA	17
2687	3156	17
2686	3156A	17
2690	3157	7
2697	3157A	7
2691	3157NA	17
2694	DE-3175	9
2695	3357/3457	17
2696	3357/3457NA	17
2698	3496	1
2699	3497	5
2712	3757	17
2713	3757A	17
2706	3757KA	7
2707	4114LL	17
2709	6411	9
2710	6418	9
2711	7225	1
2700	7440	10
2701	7440NA	10
2703	7443	10
2704	7443NA	10



10 Lamps Per Box

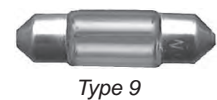

HEADLAMPS - DOMESTIC

AERODYNAMIC HALOGEN HEADLAMPS DOMESTIC



2294
9007 BULB
High-Low Beam
In Single Headlight
Assemblies
Box Qty. 1



2295
9004 BULB
High-Low Beam
In Single Headlight
Assemblies
Box Qty. 1



2296
9005 BULB
High Beam
In Dual Headlight
Assemblies
Box Qty. 1



2297
9006 BULB
Low Beam
In Dual Headlight
Assemblies
Box Qty. 1



2350
12 Volt
55 Watt
H1 Halogen Lamp
Box Qty. 1



2355
12 Volt
55 Watt
H3 Halogen Lamp
Used in Fog Lamps
Box Qty. 1

TO BE DISCONTINUED WHEN OUT - REFER TO IMPORT BULBS

HEADLAMPS - IMPORT

AERODYNAMIC HALOGEN HEADLAMPS IMPORT



2714
9004 BULB (Import)
High-Low Beam
In Single Headlight
Assemblies
Box Qty. 1



2715
9005 BULB (Import)
High Beam
In Dual Headlight
Assemblies
Box Qty. 1



2716
9006 BULB (Import)
Low Beam
In Dual Headlight
Assemblies
Box Qty. 1



2717
9007 BULB (Import)
High-Low Beam
In Single Headlight
Assemblies
Box Qty. 1



2719
9008 / H13 BULB
55/65 W, 12.8V
Halogen Light Bulb
Box Qty. 1

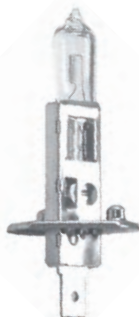

2720
(Import)
12 Volt
H1 Halogen Lamp
Box Qty. 1



2725
(Import)
12 Volt
H3 Halogen Lamp
Used in Fog Lamps
Box Qty. 1



2730
(Import)
H7
Halogen Lamp
Box Qty. 1



2731
H8 Bulb (Import)
H8 Halogen Fog Lamp Bulb
12V, 35Watt
Box Qty. 1



2732
H9 Bulb (Import)
H9 Halogen Headlight Bulb
12V, 65Watt
Box Qty. 1



2733
H10 (9145) Bulb (Import)
H10 Halogen Fog Lamp Bulb
12V, 45Watt
Box Qty. 1



2735
H11 Bulb (Import)
H11 Halogen Fog &
Headlight Bulb
12V, 55Watt
Box Qty. 1

14

Electrical Items

MISCELLANEOUS

Electrical Items

14

ROUGH SERVICE BULBS HEAVY DUTY

- * Brass Base resists corrosion in socket
- * Vibration resistant, reinforced element withstands unusual shock and abuse
- * Long Life 5000 Hours
- * 120/130 volt



SAFETY COATED ROUGH SERVICE BULBS

Same features as our Heavy Duty Rough Service Bulbs but are Rubber Coated to eliminate potential flying glass fragments due to accidental breakage. They also have thermal shock resistance to extreme temperature changes from water sprays, weld spatter or melting snows.

Prod. No.	Watts	Qty.
2500	50	6
2510	75	6

Prod. No.	Watts	Qty.
2520	50	6
2530	75	6



2535
F13BX, SPX41, 840
Twin-tube, Compact
Rough service replacement fluorescent light bulb
13 Watt, 110 Volts
GX23 Base (2 Pin)
Box Qty. 1

ALKALINE BATTERIES



Prod. No.	Description	Bx Qty
3507	AAA 1.5 Volt	4
3505	AA 1.5 Volt	4
3510	9 Volt	1
3515	C 1.5 Volt	2
3520	D 1.5 Volt	2
3521	A23 12 Volt	5



97000
Micro-Torch
Jet Flame, Wind-proof
45° Angle, Refillable
Box Qty. 1



**3 VOLT
LITHIUM BATTERY**
Used with various **Keyless Remote Entry Systems** and other various small electronic devices.

Prod. No.	Industry No.	Qty.
3525	2016	5
3530	2032	5
3522	1616	5
3523	1620	5
3524	1632	5
3527	2025	5
3531	2450	4 NEW

GM SPECIALTY CONNECTORS

GM 56 SERIES



396681
2962984
Insulates #396686, #396680
Mates w/Shell #396682
Box Qty. 25



395590
2084421, 2962447
Insulated w/Shell #396682
Mates with #396686
Unplated Brass
16-14 Gauge Wire
Box Qty. 50



396660
2965142
Insulated w/Shell #396682
Mates with #396680
Tin Plated
16-14 Gauge Wire
Box Qty. 25



396680
2971962
Insulated w/Shell #396681
Mates w/Terminal #396660
Tin Plated
16-14 Gauge
Box Qty. 25



396682
2962448
Insulates #395590, #396660
Mates w/Shell #396681
Box Qty. 25



396686
2962987
Insulated w/Shell #396681
Mates w/Terminal #395590
Tin Plated
16-14 Gauge
Box Qty. 25



396688
8917283, 12015878
Insulated w/Shell #396681
Tin Plated Copper
12-10 Gauge Wire
Box Qty. 25

GM WEATHER PACK SERIES



395610
12033674, 12089040
Mates with #395620
Tin Plated
20-18 Gauge
Box Qty. 25



395620
12034051, 12089188
Mates with #395610
Tin Plated
20-18 Gauge
Box Qty. 25



395650
12015323
Use with #'s 395610, 395620,
396622, 396021
Green Silicone
Cable Seal
Box Qty. 10



396021
12010085, 12089305
Mates with #396622-DISC
Tin Plated
16-14 Gauge
Box Qty. 25



396690
12010300
Silicone
Cavity Plug
Used to Plug Empty
Cavities in Connector Shells
Box Qty. 25



396691
12014836
Connector and Seal Set
Set of 395610 & 395650
20-18 Gauge
Box Qty. 25 Sets



396692
12014837
Connector and Seal Set
Set of 395620 & 395650
20-18 Gauge
Box Qty. 25 Sets

GM SPECIALTY CONNECTORS

GM MICRO-PACK TERMINALS



395112
 12040902
 Tin Plated
 22 Gauge
 Box Qty. 25



395624
 12020757
 Tin Plated
 Electronic Control Module
 Terminals Short
 20-18 Gauge
 Box Qty. 10

GM PACK-CON I SERIES TERMINALS



395113
 12020347
 Mates with #395637
 16-14 Gauge
 Box Qty. 25



395637
 8900524, 12020320
 Mates with #395113
 Tin Plated
 16-14 Gauge
 Box Qty. 25

GM PACK-CON H.D. I SERIES TERMINALS



395115
 12033817
 Tin Plated
 12-10 Gauge
 Box Qty. 10

GM METRI-PACK 150.1 SERIES TERMINAL



396693
 12052922, 12089340
 Not for use w/150.2 Series
 20-18 Gauge
 Box Qty. 25

GM METRI-PACK 150 SERIES TERMINALS



395118
 12047680
 Mates with #395119
 Tin-Plated
 20-18 Gauge
 Box Qty. 10



395119
 12047581
 Mates with #395118
 Tin-Plated
 20-18 Gauge
 Box Qty. 25



396000
 12047767, 4368618
 Tin Plated
 20-16 Gauge
 Box Qty. 25

GM SPECIALTY CONNECTORS

GM METRI-PACK 280 SERIES TERMINALS



395621
12020116
Mates with #395622
Tin Plated
16-14 Gauge
Box Qty. 10



395622
12015857
Mates with #395621
Tin Plated
16-14 Gauge
Box Qty. 10



396002
12034047
Mates with #396003
Tin Plated
20-18 Gauge
Box Qty. 25



396003
12034046
Mates with #396002
Tin Plated
20-18 Gauge
Box Qty. 25

GM METRI-PACK 480 SERIES TERMINALS



396005
12015861
Tin Plated
16-14 Gauge Wire
Box Qty. 25



396020
2965580, 2096467,
C1SF-14474-A
Unplated Brass
Female Terminal 1/4" Tab
14-12 Gauge
GM, Ford, Chrysler
Box Qty. 25

GM METRI-PACK 630 SERIES TERMINALS



396006
12020126
Mates with #396007
Tin Plated
1/4" Blade Width
16-14 Gauge Wire
Box Qty. 25



396007
12015870
Mates with #396006
Tin Plated
16-14 Gauge Wire
Box Qty. 25



UNIVERSAL CONNECTORS



396020
2965580, 2096467,
C1SF-14474-A
Unplated Brass
Female Terminal 1/4" Tab
14-12 Gauge
GM, Ford, Chrysler
Box Qty. 25



395640
2984172, C8AB-14463N, 4274166
Tin Plated
1/4" (6.2mm) Stud Size
Locking Type
16-14 Gauge
GM, Ford, Chrysler
Box Qty. 25

Need contact cleaner
for your
electrical connectors?

See page 15-4

FORD/CHRYSLER SPECIALTY CONNECTORS

FORD WEDGELOCK PIN TYPE TERMINALS



395627

D1AB-14461-AA
Mates With #395628
.110" Dia. Pin
20-18 Gauge
Box Qty. 10



395628

D1AB-14488-CA
Mates With #395627
.110" Dia. Pin
20-18 Gauge
Box Qty. 10

FORD STANDARD BOX TERMINALS



395629

D8BB-14474-BA,
D3AB-14474-DA
20-18 Gauge
Box Qty. 25



396011

D20B-14421-CB
3/16" Blade Width
16-14 Gauge
Box Qty. 10

FORD MINI-BLOCK TERMINALS



396018

E7EB-14421-EA
1/8" Blade Width
20-18 Gauge
Box Qty. 10

FORD TERMINALS



395638

Terminal, Female
Mates w/Pin Style
Male Terminal
Fuel Tank Sending Unit
16-14 Gauge
Ford and General Purpose
Box Qty. 25



395639

Terminal, Female
Mates w/Pin Style
Male Terminal
Fuel Tank Sending Unit
20-18 Gauge
Ford & General Purpose
Box Qty. 25



396020

2965580, 2096467,
C1SF-14474-A
Unplated Brass
Female Terminal 1/4" Tab
14-12 Gauge
Box Qty. 25



396700

101028
E7EB-14487-6A
Mini Female Pin Receptacle
16 Ga., 4" SXL Lead
Ford Products
Box Qty. 10

CHRYSLER QUICK CONNECT ELECTRICAL TERMINALS



396013

3843386
1/4" Blade Width
16-14 Gauge
Box Qty. 10



396695

7368261
Male Pin Type Terminal
3/32" Dia. Pin
20-18 Gauge
Box Qty. 25



396698

4304729
Double Cantilever
Spring Terminal
used on PC Board
Connections and General Purpose
24-18 Gauge
Box Qty. 25

CHRYSLER PIGTAIL SOCKET ASSEMBLIES



400110
 Repair Harness -
 Ignition
 10 Leads, 6" Length
 Chevrolet "C", "G" & "P" Trucks '67 - '93
 Box Qty. 1



400130
 2962510
 Repair Harness -
 Air-Conditioner
 Blower Relay
 18 Ga. Wire
 GM, AMC & Chrysler
 Box Qty. 10



400481
 Repair Harness - Headlamp Socket
 For #9004 & #9007 Halogen Bulb
 3 Prong, GM Style
 3 - 10" leads, 18 Ga. wire
 GM, Ford, Chrysler
 Box Qty. 5



400482
 12101898, PT168
 Repair Harness - Headlamp Socket
 For #9005 Halogen Bulb (High Beam)
 2 Prong, Two Indexing Grooves
 2 - 10" Leads, 18 Ga. Wire
 GM, Ford, AMC & Imports
 Box Qty. 5



400483
 12101897, PT167
 Repair Harness - Headlamp Socket
 For #9006 Halogen Bulb (Low Beam)
 2 Prong, One Indexing Groove
 2 - 10" Leads, 16 Ga. Wire
 GM '86 - UP, Ford, AMC, Imports
 Also #899 Fog Lamp Bulb
 Ford Explorer '97 - UP
 Box Qty. 5



400635
 12085491, PT113
 Repair Harness - Fuel Injector
 2 - 18 Ga. GXL 8" Leads
 Lucas & Bosch Injectors
 w/ External Spring Clip Retainer
 Domestic & Import Vehicles
 Box Qty. 1



400684
 Rep: 12102696, PT363
 Repair Harness -
 Various Accessory Relays
 5-16 GA GXL 8" Leads
 General Purpose
 Ford, Chrysler, GM '80 - UP
 Box Qty. 1



400705
 Use with #400635
 Rubber Boot (Neoprene)
 Fuel Injector Connector,
 Protects Against Moisture
 Domestic & Import Vehicles
 Box Qty. 10

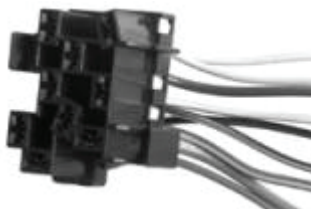

400725
 4728204
 Repair Harness - Headlamp Switch
 Switch # 56007043
 9 Leads: 1 - 12 Ga., 2 - 14 Ga.,
 6 - 18 Ga.
 Dodge Dakota, "B" Van &
 Full Size Pickup '90 - UP
 Box Qty. 1

GM PIGTAIL SOCKET ASSEMBLIES



400090

Not Supplied by OEM
Voltage Regulator Pigtail
4-Leads
GM Cars
Box Qty. 12



400100

6298886, 6298892,
88860426, LS101, LS124
Repair Harness -
Marker Light
12" Leads
Use with Bulb's #194, 194A
GM & Ford Cars '68-UP
Box Qty. 1



400130

2962510
Repair Harness -
Air-Conditioner
Blower Relay
18 Ga. Wire
GM, AMC & Chrysler
Box Qty. 10



400135

Headlamp Harness Connector
Gauge: 14
Three 8" Leads

Acura 2003-2005, Audi 1994-1998, Chevrolet 1999-2011, Daewoo 1999-2002, Eagle 1993-1996, Ford 1994-2004, Honda 1992-2018, Hyundai 1999-2018, Infiniti 1993-2005, Isuzu 1996-2013, Jeep 1958-1974, Kia 1996-2018, Land Rover 1989-2003, Lexus 1994-1997, Mazda 1993-2014, Mercedes 1991-2010, Mini 2015-2018, Mitsubishi 1983-2018, Nissan 1993-2018, Pontiac 2005-2010, Porsche 1992-1995, Saab 1994-2003, Scion 2004-2014, Smart 2016-2018, Subaru 1992-2005, Suzuki 1995-2009, Toyota 1993-2018, Volkswagen 1992-2018
Box Qty. 1



400140

19179280: AC Delco: PT2427
Cam/Crank Sensor, Ignition Coil, MAP
Sensor, Oil Pressure Switch & Throttle
Position Sensor Harness Connector
Gauge: 22

Three 8" Leads
Cadillac DeVille, Eldorado, Fleetwood & Seville 1980 - 1988, Chevrolet Express 1500-3500 & Silverado 1500, GMC Savanna 1500-3500, Silverado 1500 2007 - 2014, Pontiac Gran Prix 1984, Acura CL, MDX, RDX, RL, RSX, TL & TSX 2001 - 2012, Honda Accord, Civic, CR-V, Element, Fit, Insight, Odyssey, Pilot & Ridgeline 2003 - 2011, Scion FR-S, iA 2013 - 2016, Toyota Yaris 2017 - 2018
Box Qty. 1



400145

12117369, PT2468
90° Headlight
Harness Connector
Gauge: 16
Three 8" Leads

Cadillac Escalade 1999-2000, Chevrolet Astro, Blazer, C/K1500 - C/K3500, Express, G10 - G30, Impala, P30, S10, Suburban & Tahoe 1991-2017, GMC C/K1500 - C/K3500, G1500 - G3500, Jimmy, Safari, Savana, Samona, Suburban, Typhoon & Yukon 1992-2017, Oldsmobile Bravada 1996-1997
Box Qty. 1



400150

12126461, PT731
Blower Motor & Power Door Lock
Actuator Harness Connector
Gauge: 16
Two 8" Leads

Buick Allure, Century, Enclave, LaCrosse, Park Avenue, Regal, Rendezvous, Roadmaster & Terraza 1993-2008, Cadillac DTS & Escalade 2008-2008, Chevrolet Avalanche, C/K2500 - C/K3500, Caprice, Express 1500-3500, Impala, Monte Carlo, Silverado 1500-3500, Suburban, Tahoe, Uplander & Venture 1993-2008, GMC Acadia, C/K2500-C/K3500, Savanna 1500-3500, Sierra 1500-3500 & Yukon 2000-2008, Oldsmobile Silhouette 1999-2004, Pontiac Grand Prix, Montana, & Transport 1997-2008, Saturn Outlook & Relay 2005-2008
Box Qty. 1



400155

88987992, PT1795
Ignition Coil & Flex Fuel Sensor
Harness Connector
Gauge: 18
Three 8" Leads

Buick LeSabre, Park Avenue & Roadmaster 1996-2005, Cadillac DeVille, Eldorado, Fleetwood & Seville 1999-2005, Chevrolet Astro, Avalanche, Blazer, C/K1500-C/K3500, Camaro, Caprice, Corvette, Express 1500-3500, G30, Impala, P30, S-10 Silverado 1500-3500, Sonoma, Suburban, Tahoe 1995-2007, GMC C/K1500-C/K3500, G3500, Jimmy, P3500, Safari Savana, Sierra 1500-3500, Sonora & Yukon 1996-2007, Oldsmobile Auror & Bravada 1996-2003, Pontiac Bonneville, Firebird, & Sunbird 1994-2005, Isuzu Hombre & NPR 2002-2006
Box Qty. 1

14 Electrical Items

GM PIGTAIL SOCKET ASSEMBLIES



400360
 Repair Harness -
 Alternator Leads Extender
GM Cars and Trucks
 Box Qty. 12

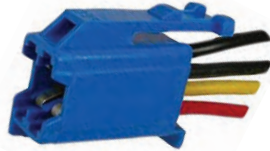

400400
 "Blue"
 Repair Harness-Radio Rear Speaker
GM '78 - UP
 Box Qty. 6



400420
 "White"
 Repair Harness-Radio Front Speaker
GM '78 - UP
 Box Qty. 6

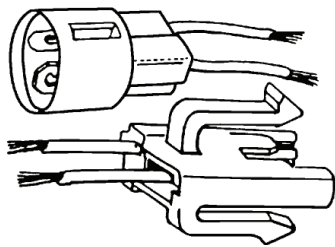

400460
 Repair Harness -
 Power Window Regulator Motor
GM Products
 Box Qty. 1



400481
 Repair Harness - Headlamp Socket
 For #9004 & #9007 Halogen Bulb
 3 Prong, GM Style
 3 - 10" leads, 18 Ga. wire
GM, Ford, Chrysler
 Box Qty. 5



400482
12101898, PT168
 Repair Harness - Headlamp Socket
 For #9005 Halogen Bulb (High Beam)
 2 Prong, Two Indexing Grooves
 2 - 10" Leads, 18 Ga. Wire
GM '86 - UP, Ford, Chrysler
 Box Qty. 5



400483
12101897, PT167
 Repair Harness -
 Headlamp Socket
 For #9006 Halogen Bulb (Low Beam)
 2 Prong, One Indexing Groove
 2 - 10" Leads, 16 Ga. Wire
GM '86 - UP, Ford, Chrysler
 Also #899 Fog Lamp Bulb
Ford Explorer '97 - UP
 Box Qty. 5



400484
12043215, 12085498
 Cornering & Fog Light Socket
 For #881 & #H1 Bulbs
GM
 Box Qty. 1



400495
12046623, 12101899, PT169
 Repair Harness -
 Coolant Temp. Sensor
 Crank Sensor #'s 1103703, 1103661
 & 10456043
 2-18 Ga. 12" Leads
GM '85 - UP
 Box Qty. 1

GM PIGTAIL SOCKET ASSEMBLIES



400505
 12117385, PT517
 Repair Harness -
 Exhaust Oxygen Sensor (O²)
 (For Single Wire Harness)
 1-18 Ga. GXL 8" Lead
 GM '82 - UP, AMC, Jeep, Isuzu
 Box Qty. 1



400506
 Repair Harness -
 Idle Air Control Valve
 4-18 Ga. 10" Leads w/Seal
 GM '82 - UP w/Fuel Injection
 Box Qty. 1



400508
 12085525, 26, 27, 28, 12101895,
 1217361, PT494
 Repair Harness -
 Voltage Regulator Module
 Reg. #'s 1116411, 1116408
 2-18 Ga., 1-12 Ga. 3" Leads
 GM '86 - UP w/Internal Regulators
 Box Qty. 1



400509
 Repair Harness - Distributor Module
 2-18 Ga. GXL 8" Leads
 GM '85 - UP w/6 Cyl. Engines
 Also Chrysler Horns '91 - '95
 Box Qty. 1



400510
 8915135
 14 Gauge Wire Size
 Fusible Link
 G.M. Products
 Box Qty. 10



400511
 Repair Harness - Distributor Module
 Module # 1987466; Crank Sensor #'s
 25526124, 25535481, 25526122
 4-18 Ga. GXL 8" Leads
 GM w/2.8 Eng. '85 - UP
 GM w/3.8 Eng. '88 - UP
 Also IAC Valves:
 GM '87 - '95, Chrysler '86 - '95
 Box Qty. 1



400512
 12085521, PT131
 Repair Harness - A/C Compressor
 High Pressure Switch
 2-18 Ga. 7" Leads
 (Index Slot at 1 o'clock)
 GM all w/ V-5 Compressor
 Box Qty. 1



400513
 12085503, PT124
 Repair Harness - A/C Compressor
 Low Pressure Switch
 2-18 Ga. 7" Leads
 (Index Slot at 3 o'clock)
 GM all w/ V-5 Compressor
 Box Qty. 1



400579
 12085491
 Repair Harness -
 Fuel Injector Plug
 2 - 18 Ga. SXL 8" Leads
 Lucas & Bosch Injectors
 w/ External Spring Clip Retainer
 Domestic & Import Vehicles
 Box Qty. 1



400585
 Fits Assy. #'s 17079129, 17079121
 Repair Harness - Idle Speed Control
 4-18 Ga. GXL 8" Leads
 GM Products '81 - '87
 V6 & V8 Engines, w/Carburetors
 Box Qty. 1

14 Electrical Items

GM PIGTAIL SOCKET ASSEMBLIES



400625
 12051234, 12102621, PT308
 Repair Harness - A/C Compressor Coolant, cooling Fan Temp Switch & Knock Sensor
 10" Lead
 GM Products '82 - UP
 Box Qty. 1



400635
 12085491, PT113
 Repair Harness - Fuel Injector
 2 - 18 Ga. GXL 8" Leads
 Lucas & Bosch Injectors
 w/ External Spring Clip Retainer
 Domestic & Import Vehicles
 Box Qty. 1



400650
 12029960, 12102568, PT285
 Repair Harness - Throttle Body Fuel Injectors
 2-18 Ga. GPT 8" Leads
 GM '82 - UP
 Box Qty. 1



400660
 12085488, PT110
 Repair Harness - Coolant Temp Sensor (#25036628)
 2-18 Ga. GXL 8" Leads
 GM '84 - UP
 Box Qty. 1



400665
 12083007, LS13
 Repair Harness - Side Marker Lamp
 Accepts #24 Bulb
 2-18 Ga. 12" Leads
 GM '88 - UP
 Box Qty. 1



400671
 12101907, PT179
 Repair Harness - A/C Compressor
 2-18 Ga. GXL Leads w/Diode & 1 Molded Pin Grip 90° Term. End
 GM '83 - '89
 Box Qty. 1



400672
 12085524, PT134
 Repair Harness - Manifold Absolute Temperature (M.A.T.) Sensor
 2-16 Ga. GXL 8" Leads
 GM Vehicles '90 - UP
 Box Qty. 1



400679
 12085507
 Repair Harness - A/C Pressure Switch Fits #25527510 3-18 Gauge (GXL) 8" Leads
 GM Vehicles '84 - 89
 Box Qty. 1



400680
 12101937
 Repair Harness - A/C Compressor Clutch
 2-18 Ga. 8" GPT Leads
 GM '89 - UP
 Box Qty. 1



400684
 Rep: 12102696, 88861106, 89057715, 88862254
 PT363, PT1842, PT2163, PT2335
 Repair Harness - Various Accessory Relays
 5-16 GA GXL 8" Leads
 General Purpose, Ford, Chrysler,
 GM '80 - UP
 Box Qty. 1



400711
 Rep: 88860491, PT1936
 Repair Harness - Fan Speed Switch
 Switch #'s 16015256, 16032480 & 16033615
 4 Leads: 1-14 Ga.;
 2-16 Ga.; 1-18 Ga.
 8" GPT Wire Leads
 GM '77 - UP
 Box Qty. 1

FORD PIGTAIL SOCKET ASSEMBLIES



400100

6298886, 6298892,
88860426, LS101, LS124
Repair Harness -
Marker Light
12" Leads
Use with Bulb's #194, 194A
GM & Ford Cars '68-UP
Box Qty. 1

400135

Headlamp Harness Connector
Gauge: 14
Three 8" Leads

Acura 2003-2005, Audi 1994-1998, Chevrolet 1999-2011, Daewoo 1999-2002, Eagle 1993-1996, Ford 1994-2004, Honda 1992-2018, Hyundai 1999-2018, Infiniti 1993-2005, Isuzu 1996-2013, Jeep 1958-1974, Kia 1996-2018, Land Rover 1989-2003, Lexus 1994-1997, Mazda 1993-2014, Mercedes 1991-2010, Mini 2015-2018, Mitsubishi 1983-2018, Nissan 1993-2018, Pontiac 2005-2010, Porsche 1992-1995, Saab 1994-2003, Scion 2004-2014, Smart 2016-2018, Subaru 1992-2005, Suzuki 1995-2009, Toyota 1993-2018, Volkswagen 1992-2018
Box Qty. 1



14 Electrical Items

Need contact cleaner for your
electrical connectors?

See page 15-4



400165

Repair Harness -
Heater Blower Motor
2 - 12" Leads
Ford Trucks '82 - '86
Radiator Cooling Fan Motor
Ford 4 Cyl. Engines '79 - UP
Box Qty. 3



400315

Repair Harness -
Vehicle Speed Sensor
(Base #9E731)
A.B.S. Wheel Speed Sensor
(Base #2L373)
2-18 ga. GXL 8" Leads
Ford Various Models '93 - UP
Box Qty. 1

400317

F2AZ-14489-W
Repair Harness Kit -
Ignition Switches
Switch #F2DZ-11572-A &
F4DZ-11572-B
3 - 10 ga. GPT 4" Leads
3 - 12 ga. GPT 4" Leads
1 - 20 ga. TWP 4" Lead
Ford, Lincoln, Mercury,
Lt. Duty Trucks '90 - UP
Box Qty. 1

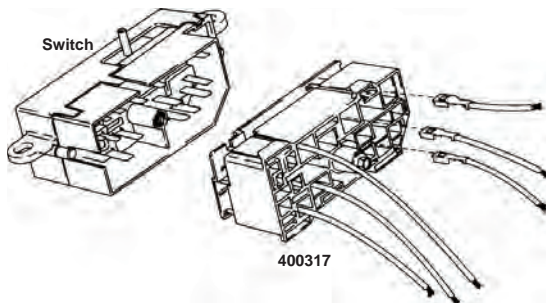

400320

Not Supplied By OEM
Repair Harness - 100 Amp Alternator
2 - 16 ga., 5 1/2" Leads
Ford Products '75 - UP
Box Qty. 10

400322

Repair Harness -
Blower Motor Switch
Switch #F5RZ-18578-A, F7RZ-18578-DA
2 - 10 ga. GXL 8" Leads
2 - 12 ga. GXL 8" Leads
Ford Contour & Merc. Mystique '95 - UP
Box Qty. 1

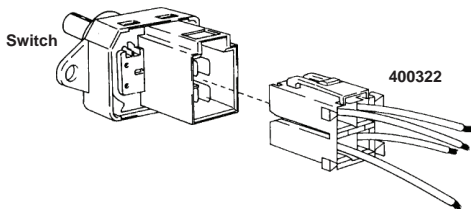

400325

Repair Harness -
Radiator Cooling Fan Motor
Fan & Shroud Assy. #F4DZ-8C607B, F5CZ-8C607-A
2 - 12 ga. GXL 8" Leads
1 - 10 ga. GXL 8" Lead
Ford Taurus, Sable, Cont. Escort '90 - '96
Contour, Mystique w/1 Motor 2.0 '95 - '97
Box Qty. 1



FORD PIGTAIL SOCKET ASSEMBLIES



400327

Repair Harness Kit -
Blower Motor Resistor
Resistor #'s F1CZ-19A706-A & F7CZ-19A706-AA
Kit Contains: 2 Repair Harnesses, 1 With 1 ea. of
20, 16, 14 & 12 ga. GXL 8" Leads &
1 With 1, 12 ga. GXL 8" Lead
Ford Escort & Merc. Tracer '91 - UP
Box Qty. 1 (1 of Each)

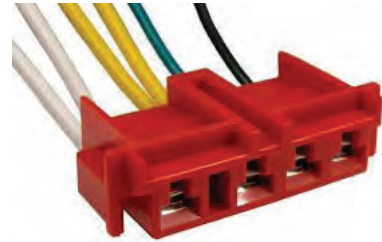

400330

Not Supplied By OEM
Repair Harness - Voltage Regulator
Ford Products '75 - UP
Box Qty. 5



400332

Repair Harness -
Mass Air Flow Sensor
Sensors With Base #12B579
1 - 16 ga., 3 - 18 ga. GXL 8" Leads
Also: Fits Coil F0TZ-12029-A,
F1SZ-12029-A
Ford Vehicles '89 - '92
Box Qty. 1



400337

Harness Connector
Master Cylinder, Door Jamb Switch,
& Power Mirror
Ford '87 - UP
Box Qty. 1



400340

Repair Harness - Alternator
3 - 10" Color coded Leads:
2 - 10 Ga., 1 - 20 Ga.
Ford Products
6 Cyl. Engine w/75 Amp '89 - UP
4 Cyl. Engine '85 - UP
Box Qty. 1



400380

Not Supplied By OEM
Repair Harness - Coil To Ignition
2 - 18 Ga., 8" Leads
Ford Products '77 - UP
Box Qty. 10



400455

Repair Harness -
Air Conditioner Clutch Field Coil
Socket w/12" Leads
Ford Products
Box Qty. 10



400456

Repair Harness - Heater & A/C
Blower Switch
Fits Most Base #19986 Switches
5 - 12 Ga., 5" Leads w/Butt Conn.
Most Ford Products '73 - UP
Box Qty. 1



400470

18 Gauge Wire - Red
Fusible Link
Ford Products '73 - UP
Box Qty. 10



400481

Repair Harness - Headlamp Socket
For #9004 & #9007 Halogen Bulb
3 Prong, GM Style
3 - 10" leads, 18 Ga. wire
GM, Ford, Chrysler
Box Qty. 5



400482

12101898, PT168
Repair Harness - Headlamp Socket
For #9005 Halogen Bulb (High Beam)
2 Prong, Two Indexing Grooves
2 - 10" Leads, 18 Ga. Wire
GM '86 - UP, Ford, Chrysler
Box Qty. 5

FORD PIGTAIL SOCKET ASSEMBLIES



400483

12101897, PT167
 Repair Harness - Headlamp Socket
 For #9006 Halogen Bulb (Low Beam)
 2 Prong, One Indexing Groove
 2 - 10" Leads, 16 Ga. Wire
 GM '86 - UP, Ford, Chrysler
 Also #899 Fog Lamp Bulb
 Ford Explorer '97 - UP
 Box Qty. 5



400516

Repair Harness Kit - Ignition Switch
 Fits Switch #E6FZ-11572-A, SW1774B
 Contains: 1 Socket, 4 - 12 Ga.,
 3 - 10 Ga. 4" GPT Leads
 Ford Products '80 - UP
 Box Qty. 1



400550

Repair Harness -
 Air Charge Temp. Sensor
 2 - 18 Ga. GXL 8" Leads
 Ford Product w/Fuel Injection
 '81 - UP
 Box Qty. 1



400560

E4FZ-8C290-A
 Repair Harness Kit -
 Engine Cooling Fan Module
 1 - 8 Pos. & 1 - 10 Pos. Connector
 5 - 12 Ga., 4" Leads
 Ford 4 & 6 Cyl. '83 - UP
 Box Qty. 1



400590

Repair Harness -
 Engine Fan Switch
 Fits Switch #'s E5SZ-
 8B607-A, E4FZ-8B607-A
 2 - 14 Ga., 7" Leads
 Black Connector
 Ford Products '85 - UP
 Box Qty. 1



400595

88860480, PT1925
 Repair Harness -
 Windshield Washer
 Pump Assy.
 Pump #'s E3AZ-17664-A,
 E0AZ-17664-A
 Ford Products '68 - UP
 Box Qty. 1

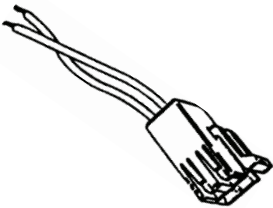

400600

Repair Harness -
 Radio Speaker
 2 - 18 Ga. 8" GPT Leads
 Ford Products '80 - '89
 Box Qty. 5

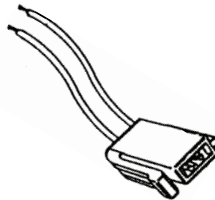

400601

3U2Z-14S411-GJA, 5U2Z-
 14S411-DA, WPT-416, WPT-843
 Repair Harness -
 Radio Speaker
 3 - 18 Ga. 8" GPT Leads
 Ford Products '89 - UP
 Box Qty. 5



400605

Repair Harness - EGR Sensor
 Sensor #E6AZ-9J460-A
 3 - 18 Ga. GLX 10" Leads
 Ford Products '88 - UP
 Box Qty. 1



400615

E5ZZ-12A209-A
 Repair Harness -
 Electronic Module EEC IV IGN.
 6 - 14 Ga. GXL 8" Leads
 Gray
 Ford '83 - UP
 Box Qty. 1



400620

Repair Harness -
 Regulators & Coolant Level Sensors
 Sensor Base #10D968
 3 - 16 Ga. Lead
 Ford
 Box Qty. 1



400630

Repair Harness - Headlamp Switch
 Fits most switches with Base #11654
 9 - 8" Leads: 3 - 20 Ga., 4 - 8 Ga.,
 1 - 16 Ga. & 1 - 12 Ga.
 Ford Cars & Trucks '84 - UP
 Box Qty. 1

FORD PIGTAIL SOCKET ASSEMBLIES



400635

12085491, PT113
 Repair Harness - Fuel Injector
 2 - 18 Ga. GXL 8" Leads
 Lucas & Bosch Injectors
 w/ External Spring Clip Retainer
 Domestic & Import Vehicles
 Box Qty. 1



400640

Repair Harness -
 Exhaust Oxygen Sensor
 Sensor #'s F0TZ-9F472-A & C,
 F09Z-A & C, F1SZ-A, F1UZ-C, F9UZ-B
 3 - 18 Ga., & 1 - 16 Ga.
 (GXL) 8" Leads, Gray Connector
 Ford '89 - UP
 Box Qty. 1



400645

Repair Harness -
 Exhaust Oxygen Sensor
 Sensor #'s F0TZ-9, F472-B, F02Z-C,
 F03Z-A, F0SZ-A & B, F0TZ-E
 3 - 18 Ga., & 1 - 16 Ga.
 (GXL) 8" Leads, Black Connector
 Ford '89 - UP
 Box Qty. 1



400655

E6DZ-14A411-A
 Repair Harness - Ignition Switch
 Switch # E7DZ-11572-A, SW1991
 Contains: 1 Socket, 4 - 10 Ga. GPT
 Terminated Leads
 Ford Taurus & Sable '86 - UP
 Box Qty. 1



400670

Repair Harness -
 Coolant Temp Sensor
 Fits Sensor #E1AZ-12A648-A,
 F2AZ-12A648-A
 2 - 18 Ga. GXL 8" Leads
 Ford '81 - UP
 Box Qty. 1



400674

Repair Harness -
 Turn Signal Switch
 Switch #'s E7FZ-13341-A,
 F33Z-13341-B
 5 - 18 Ga. GPT 8" Leads
 Ford '85 - UP
 Box Qty. 1



400676

Repair Harness -
 Headlamp Switch
 Fits #E6DZ-11654-A
 & F2DZ-A
 (Motorcraft SW-1976)
 6 - 18 Ga., 1 - 16 Ga., 1 - 12 Ga. GXL
 8" Leads
 Mercury Sable '90 - UP,
 Ford Taurus '86 - UP
 Box Qty. 1



400677

Repair Harness - Headlamp Switch
 Fits #E64Y-11654-A
 (Motorcraft SW-1975)
 5 - 18 Ga., 2 - 14 Ga., 1 - 12 Ga. GXL 8"
 Leads
 Mercury Sable '86 - '99
 Box Qty. 1



400678

Repair Harness -
 Fan Speed Switch
 Switch #E6DZ-19986-A &
 E9SZ-A, F2DZ-A, F2UZ-A & B
 2 - 12 Ga., 1 - 14 1 - 16 Gauge
 GPT 8" Leads
 Ford Taurus/Sable '86 - '93,
 T-Bird/Cougar '89 - '93
 Box Qty. 1



400681

Repair Harness -
 A/C Blower Motor Resistor
 #E7TZ19A706-A
 4 - 18 Ga. 8" Leads
 Ford Trucks '86 - UP
 Box Qty. 1

FORD PIGTAIL SOCKET ASSEMBLIES



400682
 Repair Harness -
 A/C Cycling Switch
 Fits Switch #E35Y-19E561-A
 2 - 16 Ga. 8" PVC Wire Leads
 Ford '83 - UP
 Box Qty. 1



400683
 Repair Harness - EEC IV Test Plug
 (2 Connectors)
 7 - 18 Ga. Leads PLUS
 1 - 18 Ga. Lead 8" GXL Wire
 Ford Products '83 - UP
 Box Qty. 1



400684
 Rep: 12102696, PT363
 Repair Harness -
 Various Accessory Relays
 5-16 GA GXL 8" Leads
 General Purpose
 Ford, Chrysler,
 GM '80 - UP
 Box Qty. 1



400685
 OEM # Not Available
 Harness Connector
 Plugs Into Light Socket Base For
 Double Filament Wedge Type Bulbs
 Stop, Tail, Turn & Parking Lights
 Ford Ranger, Explorer &
 Econoline '91 - UP
 Box Qty. 1



400687
 OEM # Not Available
 Straight Lamp Socket Base
 Repair Harness
 Wedge Bulb
 Three 18 gauge TXL 8" Leads
 Ford Windstar '95 - UP
 Box Qty. 1



400690
 Shielded License/ Utility Light
 Sealed Socket Assembly
 w/ Chrome Plastic Shield
 14" Sealed Plastic Boot
 28" Lead w/ Male Spade Terminal
 Bulb Included - Mounts In 1-1/4" Hole
 Universal
 Box Qty. 1



400701
 Not Supplied by OEM
 Power Brake Pigtail. 12" Leads
 Eliminates Removing & Replacing
 Entire Wiring Harness
 Ford '65/
 Box Qty. 5



400702
 Not Supplied by OEM
 Repair Harness - Ignition Coil
 Fits Coil E73Z-12029A
 w/Color Coded Wires
 2-18 Ga., 1-16 Ga. 10" Leads
 Ford Models '86 - UP
 Box Qty. 6



400710
 Repair Harness - Fuel Pump Relay
 E3FZ-9345-B
 4 Leads: 1 - 18 Ga., 2 - 16 Ga.,
 1 - 14 Ga. 8" GPT Wire Leads
 Ford '82 - UP
 Box Qty. 1



400712
 Repair Harness - EEC Relay
 Relay E3AZ-12A646-A
 5 Leads: 2 - 18 Ga., 2 - 16 Ga.,
 1 - 14 Ga. GPT 8" Leads
 Ford '83 - UP
 Box Qty. 1



400713
 Repair Harness -
 Engine Fan Switch
 Switch #E43Z8B607-A
 2 - 14 Ga. 7" Leads
 Gray Connector
 Ford '84 - UP
 Box Qty. 1 Kit



400714
 Repair Harness - Rear Lamps
 For #3156 Wedge-Style Bulb
 2 - 18 Ga. 8" GPT Wire Leads
 Ford '87 - UP
 Box Qty. 1

FORD PIGTAIL SOCKET ASSEMBLIES



400715
 Repair Harness -
 Idle Air By-Pass Valves
 w/ Base #PF715
 1 - 18 Ga., 1 - 16 Ga. GPT 8" Leads
 Ford
 Also Headlamp Switch
 Switch #E7ZZ-11654-B (SW2106)
 Ford Mustang '88-'93 w/Fog Lamps
 Box Qty. 1



400716
 Repair Harness -
 Throttle Position Sensor
 3 - 18 Ga. GPT 8" Leads
 Sensor Base #9B989
 Ford Taurus, Sable '90 - UP;
 Ranger, Explorer, Escort '91 - UP;
 Crown Victoria, Marquis '92 - UP
 Box Qty. 1



400717
 Repair Harness -
 Headlamp Switch
 Switch #E7ZZ-11654-A
 8 Leads: 6 - 18 Ga.,
 2 - 12 Ga.
 GPT 8" Leads
 Ford Mustang '87 - '93
 Also Switch #E7ZZ-11654-B (SW2106)
 w/ Fog Use #400715
 Box Qty. 1



400718
 Repair Harness -
 Alternator Regulator,
 A/C Clutch Field
 1 - 16 Ga. GPT 8" Lead
 Ford Various Models '94 - UP
 Box Qty. 10



400719
 88860566, PT2011
 (Use with #400630)
 Repair Harness - Headlight Switch
 Switch #'s F2AZ,-11654-A,
 F3VY-11654-A, F2AZ-11654B
 1 - 16 Ga., 1 - 18 Ga., 1 - 20 Ga.
 GPT 8" Leads
 Ford & Lincoln '92 - '94
 Box Qty. 1



400720
 Repair Harness -
 Aux. Blower Switch
 Switch #F2UZ-19986-C, YH-538
 3 - 12 Ga. GPT 8" Leads
 1 - 14 Ga. GPT 8" Lead
 1 - 18 Ga. GPT 8" Lead
 Ford Full Size Vans '92 - UP
 Box Qty. 1 Kit



400721
 Repair Harness -
 Starter Solenoid In-line Repair
 1 - 12 Ga. GXL 8" Lead
 Ford & Lincoln T.C. '91 - '97
 Box Qty. 1



400722
 F6HZ-14A464-FUA
 Repair Harness -
 Ignition Switch
 Switch # D7AZ-11572-A, SW 1379
 15 Leads: 2 - 8 Ga., 4 - 12 Ga., 1 - 14 Ga.,
 2 - 16 Ga., 5 - 18 Ga., 1 - 24 Ga.
 Ford Cars & Trucks '70 - '77
 Box Qty. 1



400723
 Repair Kit -
 Horn & Blower Relays
 Relay #FOA8-14B193-AB
 Kit Contains: 1 Connector, 1 Lock &
 1 Each: 10 Ga., 12 Ga., 14 Ga., 16 Ga.,
 18 Ga. SXL 4" Leads
 Wire Position is Based On Existing
 Wire Configuration
 Ford Cars and Trucks
 Box Qty. 1 Kit

14 Electrical Items

FORD PIGTAIL SOCKET ASSEMBLIES



400724
In-Tank Fuel Pump &
Sending Unit Connector
Ford '85 - UP
Box Qty. 1



400726
Repair Harness -
Radiator Cooling Motor & Resistor
Resistor # *F5RZ-8L603-AC*
Motor #'s *F5RZ-8C607-B, F8RZ-8C607-
GC, F8RZ-8C607-GE, RF28, RF76, RF81,*
2 - 12 Ga. GXL 8" Leads
*Ford Contour, Mystique,
Mercury Cougar '95 - UP*
Box Qty. 1



400727
Repair Harness -
Cam Shaft & Crank Shaft Sensors
Sensor #'s *F0CZ-6B288A, F1AZ-6C315-A,
F1AZ-6B288-A, XC3Z-6B288-AA*
2 - 18 Ga. GXL 8" Leads
Ford Cars & Lt. Duty Trucks '91 - UP
Box Qty. 1



400731
Injector/
Glow Plug Pass Through
At Valve Cover Gasket
(1/HEAD) Valve Cover Gasket
#*F81Z-6584-AA*
5-18 ga. & 4-14 ga. TXL 8" Leads
*Ford E & F Series Trucks 7.3 Diesel '98 &
Excursion 2000 '95 - 97*
Box Qty. 1



400732
Injector/Glow Plug Pass
Through At Valve Cover Gasket
(2/HEAD) Valve Cover Gasket
#*F4TZ-6584-A*
2-16 ga. & 3-18 ga. TXL 8" Leads
*Ford E & F Super Duty & Excursion Trucks
7.3 Diesel '95 - 97*
Box Qty. 1



400733
F81Z-13411-AA
(Use w/ #*400734*)
License, Side Marker &
Back Up - Socket
Straight Housing,
Bulb's #194 & #17177
*Ford Lincoln, Mercury Cars
& Lt. Duty Trucks '99 - UP*
Box Qty. 1



400734
1U2Z-14S411-BEA, WPT-150
(Use w/ #*400733*)
Marker, Signal, License, Back Up & Lift Gate
Lamp Sockets Repair Harness
2-18 Ga. GXL 8" Leads
Bulb's #194 & #17177
Ford Cars & Trucks '98 - UP
Box Qty. 1

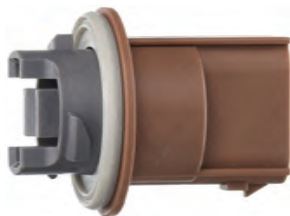

400735
2U5Z-13411-SA
(Use w/ #*400736*)
Park, Turn Signal, Tail & Side
Marker Lamps - Socket
Straight Housing,
Bulb #3157
Ford Cars & Trucks '98 - UP
Box Qty. 1

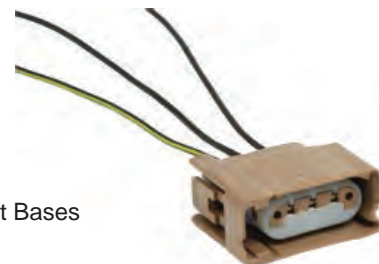

400736
88988117, PT1774
(Use w/ #*400735*)
Straight Lamp Socket Bases
Repair Harness
Wedge Bulb
3-18 Ga. TXL 8" Leads
*Ford Focus, Escape, Ranger, Explorer, Mountaineer, F150 &
F-Super Duty '98 - UP*
Box Qty. 1

14 Electrical Items

14

FORD PIGTAIL SOCKET ASSEMBLIES

REPAIR HARNESSES FOR FORD MULTI-FUNCTION SWITCHES

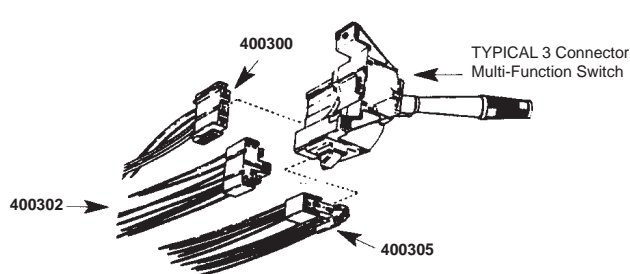
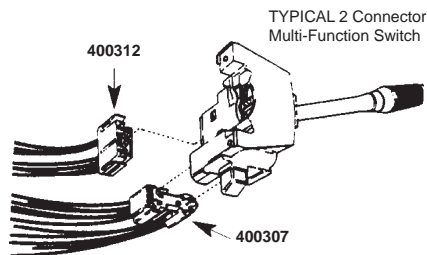

400300

Rep. 3U2Z-14S411-MVA, WPT-453,
88860510, PT1955
2-16 Ga. (GPT) & 2-12 Ga. (GPT)
Leads 8" Length
Box Qty. 1



400302

Rep. 3U2Z-14S411-MYA, WPT-
472, 88860511, PT1956
9-16 Ga. (GPT)
Leads 8" Length
Box Qty. 1



400305

Rep. 3U2Z-14S411-YHA, WPT-
607, 88860512, PT1957
10-16 Ga. (GPT)
Leads 8" Length
Box Qty. 1



400307

Rep. 1U2Z-14S411-APA,
WPT-178, 88860514, PT1959
11-18 Ga. (TXL) Leads 8" Length
Box Qty. 1



400312

Rep. 1U2Z-14S411-ARA,
WPT-179, 88860515, PT1960
3-20 Ga. & 4-16 Ga. (TXL) Leads 8" Length
Box Qty. 1

FORD MULTI FUNCTION SWITCH BASE NO. 13K359			REPAIR HARNESS
No. 13K359	M/C No.	APPLICATION	UNIT PACKAGE 1
E8DZ-B	SW-2441	86/89 Taurus, Sable W/O Intermittent	400300.....400302.....400305
E8ZZ-B	SW-2443	87/89 Mustang	400300.....400302.....400305
E9DZ-A	SW-2444	86/89 Taurus, Sable W/ Intermittent	400300.....400302.....400305
E9DZ-B	SW-2444	86/89 Taurus, Sable W/ Intermittent	400300.....400302.....400305
E9DZ-C	SW-2444	86/89 Taurus, Sable W/ Intermittent	400300.....400302.....400305
E9OY-D	SW-2446	88/90 Continental, Town Car	400300.....400302.....400305
E9SZ-B	SW-2447	89/93 T. Bird, Cougar, W/O Auto Dimmer	400300.....400302.....400305
E9SZ-D	SW-2447	89/93 T. Bird, Cougar, W/O Auto Dimmer	400300.....400302.....400305
E9SZ-E	SW-2448	89/93 T. Bird, Cougar, W/ Auto Dimmer	400300.....400302.....400305
FOZZ-A	SW-2453	90/93 Mustang	400300.....400302.....400305
FOZZ-B	SW-2453	90/93 Mustang	400300.....400302.....400305
F1AZ-A	SW-2454	91-94 Ford, Merc, Continental T. Car	400305.....400312
F1AZ-B	SW-2454	91-94 Ford, Merc, Continental T. Car	400305.....400312
F1DZ-B	SW-2461	90/ Taurus, Sable	400307.....400312
F1LY-B	SW-2466	90/92 Lincoln Mark	400305.....400312
F1OY-D	SW-2468	91/95 Lincoln Continental	400305.....400312
F1VY-C	SW-2469	90/94 Lincoln T. Car	400305.....400312
F3TZ-B	SW-2485	92/95 F Pickup, Bronco, Aerostar	400305.....400312
F3UZ-C	SW-2484	92/95 E Van, Aerostar W/ Auto Dimmer	400307.....400312
F6DZ-A	SW-5083	96 Taurus, Sable	400307.....400312

MISC PIGTAIL SOCKET ASSEMBLIES

HONDA, KIA, LEXUS, MAZDA, MERCEDES, MITSUBISHI, NISSAN, SUBARU, TOYOTA, VW

400135

Headlamp Harness Connector

Gauge: 14

Three 8" Leads

Acura 2003-2005, Audi 1994-1998, Chevrolet 1999-2011, Daewoo 1999-2002, Eagle 1993-1996, Ford 1994-2004, Honda 1992-2018, Hyundai 1999-2018, Infiniti 1993-2005, Isuzu 1996-2013, Jeep 1958-1974, Kia 1996-2018, Land Rover 1989-2003, Lexus 1994-1997, Mazda 1993-2014, Mercedes 1991-2010, Mini 2015-2018, Mitsubishi 1983-2018, Nissan 1993-2018, Pontiac 2005-2010, Porsche 1992-1995, Saab 1994-2003, Scion 2004-2014, Smart 2016-2018, Subaru 1992-2005, Suzuki 1995-2009, Toyota 1993-2018, Volkswagen 1992-2018

Box Qty. 1



400140

19179280: AC Delco: PT2427

Cam/Crank Sensor, Ignition Coil, MAP Sensor, Oil Pressure Switch & Throttle Position Sensor Harness Connector

Gauge: 22

Three 8" Leads

Cadillac DeVille, Eldorado, Fleetwood & Seville 1980 - 1988, Chevrolet Express 1500-3500 & Silverado 1500, GMC Savanna 1500-3500, Silverado 1500 2007 - 2014, Pontiac Gran Prix 1984, Acura CL, MDX, RDX, RL, RSX, TL & TSX 2001 - 2012, Honda Accord, Civic, CR-V, Element, Fit, Insight, Odyssey, Pilot & Ridgeline 2003 - 2011, Scion FR-S, iA 2013 - 2016, Toyota Yaris 2017 - 2018

Box Qty. 1



SERVICE CENTER ITEMS



Premium Grade Wiper Blades

Premium Wiping Edge
 Stainless Steel Blade Backing
 All Metal, Rust Resistant Frame
 Adapters For Universal Coverage
 Packed In A Re-Closable Hanging Sleeve
 Box Qty. 1

Part No.	Description
PV13	13" Blade
PV14	14" Blade
PV15	15" Blade
PV16	16" Blade
PV17	17" Blade
PV18	18" Blade
PV19	19" Blade
PV20	20" Blade
PV21	21" Blade
PV22	22" Blade
PV24	24" Blade
PV26	26" Blade
PV28	28" Blade



ELEMENT BEAM WIPER BLADES

O.E. fit, form & function
 Designed to provide maximum windshield contact
 Frame less wiper blade
 Smooth, quiet operation
 Quick & easy installation
 Aerodynamic design ensures optimal pressure
 All weather!

Part No.	Description
OE16	16" Element Blade
OE17	17" Element Blade
OE18	18" Element Blade
OE19	19" Element Blade
OE20	20" Element Blade
OE21	21" Element Blade
OE22	22" Element Blade
OE24	24" Element Blade
OE26	26" Element Blade
OE28	28" Element Blade

99821

Wall Rack For Premium Grade Wiper Blades

A great way to present your wiper blades.
 Holds up to 63 blades on 7 hooks.
 Tough, coated steel.
 Box Qty. 1



SERVICE CENTER ITEMS



97069 100/BX
97069-50 5000/BX

INDUSTRIAL SINGLE EDGE BLADES

These single faceted blades provide durability for more abusive applications. Fabricated from surgical steel and are made specifically for auto trim, glass and auto body applications.



97070 100/BX
97070-50 5000/BX

KEEN EDGE - INDUSTRIAL SINGLE EDGE BLADES

These double faceted blades provide exceptional sharpness for those hard to cut applications. Fabricated from surgical steel and are made specifically for auto trim, glass and auto body applications.



97071
DELUXE HAND RAZOR BLADE SCRAPER

For use with single edge blades.
 Metal.
 Box Qty. 1



97072
HEAVY DUTY UTILITY KNIFE BLADES
 Two-Notch replacement blades for #97073 Patriot Utility Knife.
 Box Qty. 100



97073
PATRIOT UTILITY KNIFE WITH RETRACTABLE BLADE
 Button retracts blade to 3 positions. Lightweight die cast construction.
 Box Qty. 1

AUTO BODY PANEL & GLASS MARKER

The Auto Body Panel & Glass marker writes on the painted surfaces of cars and windows.

- Marks are removed with a damp cloth and glass cleaner.
- Marks will not be removed by rain or snow.
- Safe to use. Meets ASTM D-4236.
- Excellent for making fine, medium or broad sharp lines when needed.
 (9.0mm Extra Wide Chisel Tip when rotated makes Fine (1.5mm), Medium (5.0mm) or Broad (9.0mm) lines.



FM00254	Blue Flowmaster Panel/Glass Marker	12/box
FM00554	Green Flowmaster Panel/Glass Marker	12/box
FM00854	Orange Flowmaster Panel/Glass Marker	12/box
FM01054	Pink Flowmaster Panel/Glass Marker	12/box
FM01154	Red Flowmaster Panel/Glass Marker	12/box
FM01354	White Flowmaster Panel/Glass Marker	12/box
FM01454	Yellow Flowmaster Panel/Glass Marker	12/box
FM05406	Assorted Colors (6 markers per box)	1/box

(Assortment contains one each of the following: Pink, White, Green, Red, Blue, Yellow)

SERVICE CENTER ITEMS



3576

Dry Powdered Graphite Lubricant
Designed to lubricate locking mechanisms, bolt and screw threads, and much more. When a wet lubricant or grease won't work, Tube-O-Lube is the perfect solution. Packaged in a 0.21 oz squeeze bottle.
Box Qty. 1



3175

SUPER GLUE
Easy to apply and works on both porous and non-porous materials for a strong, tight bond. Super Fast and Strong. Long lasting bond. Works on most surfaces.
.07 oz tube
Box Qty. 12

3210

SUPER GLUE GEL
"Stays put", will not run on vertical overhead or hard to reach surfaces. Specially formulated to fill gaps. Works on both porous and non-porous materials. Super Fast and Strong. Long lasting bond. Works on most surfaces. .07 oz tube
Box Qty. 12



U428

Quick Cure
Primerless to Auto Glass
Urethane Adhesive
Box Qty. 10



3575

White Lithium Grease for door latches, strikers, hood hinges, window gears, etc.
14 oz. size tub
Box Qty. 12



3577

Ultralube High Temperature Wheel Bearing Grease For all automotive wheel bearings including cars with disc brakes.
16 oz. size tub
Box Qty. 12



3578

Lubrimatic (LMX) Red Grease
Rated GC-LB by NLGI.
NLGI #2, drop point 510°F
14 oz. Cartridge
Box Qty. 10



3579

Lubrimatic Disc/Drum Wheel Bearing Grease
14 oz. Cartridge
Rated GC-LB by NLGI.
NLGI #2, drop point 510°F
Meets Ford Spec.
MIC 198-A 14 oz. Cartridge
Box Qty. 10

SERVICE CENTER ITEMS

15 Service Center

Z495525

ZENATIZE

Country Disinfectant
Disinfects and deodorizes surfaces. Prevents mold and mildew on environmental surfaces in your home and in public places. Meets AOAC Efficacy Standards for hospital aerosol disinfectants.

Net Wt. 15 oz. Aerosol

Box Qty. 12



Z496525

ZenLektrix Contact Cleaner

This non-conductive, non-corrosive aerosol removes all types of contamination (grease, oil, dust) from operating electrical equipment. It will not harm most plastics, paint or wire insulation like other chlorinated substances. Product has high dielectric strength. Cleans, restores and protects.

Box Qty. 12

NEW



PAINTER'S PUNCH

Superior heavy duty paint removing hand cleaner. Quickly removes oil based paints, lacquers, and enamels. Melts adhesives, sealers, primers and resins from your skin.

Fortified with superior skin conditioners to help promote good hand health.

400ml bottle

Box Qty. 12

NEW



NEW

2413

Johnsen's Non-Chlorinated Brake & Parts Cleaner
Removes oil, grease, brake fluid and contaminants quickly and with no residue.

Box Qty. 12



2413HP

Johnsen's Non-Chlorinated Brake & Parts Cleaner
Removes oil, grease, brake fluid and contaminants quickly and with no residue.

One Half-Pallet - 36 cases

2413P

Johnsen's Non-Chlorinated Brake & Parts Cleaner
Removes oil, grease, brake fluid and contaminants quickly and with no residue.

One Pallet - 72 cases

BAZOOKABLAST

Bazooka Blast is a free rinsing, heavy duty hand cleaner designed for industrial, automotive and manufacturing applications. Fortified with emollients to help against drying and cracking. Pleasant berry cherry fragrance. Use half the soap, get twice the results. *Dispenses with the MAGICDISP soap dispenser.*

Box Qty. 4



Item No.	Desc	Bx. Qty.
BAZOOKABLAST	3.55 Liter Jug	4
MAGICDISP	Wall Dispenser	1

MAGIC All Natural Industrial Hand Cleaner

Non-solvent formula eliminates drying and cracking. Contains superior skin emollients and skin conditioners. No dyes or perfume. Contains natural walnut shell scrubbers. Thick concentrated formula reduces hand soap use by up to 75%. Contains the antibacterial ingredient "PCMX". Washes away with no greasy residue. No phosphates. *Dispenses with "MAGICDISP" wall dispenser (not included).*



Item No.	Description	Bx. Qty.
MAGIC	3.55 Liter Jug	4
MAGICDISP	Wall Dispenser	1

MAGIC HAND / SURFACE TOWELS

A multi-purpose, pre-moistened towel formulated to remove grease, oil, dirt, tar and asphalt, brake dust and grime. Perfect for use anywhere. Clean hands, tools, machinery, equipment, pipes and a variety of nonporous surfaces

9" X 12" Heavy-Duty Waterless, two-sided wipes. 70 wipes per container.



Item No.	Description	Bx. Qty.
MAGICTOWEL	9" x 12" Wipes	6

PREMIUM ELECTRICAL TAPE

"Extreme Hot/Cold Conditions"

PVC - Black

(7.5 Mil Thickness)

For temps up to 220°F (105°C).

705523/4" x 66 Ft. 1/bx

70552-103/4" x 66 Ft. 10/bx



3M-33

3M SUPER 33+

VINYL ELECTRICAL TAPE

Super strong adhesion. Withstands harsh conditions. Protects and insulates.

Each roll: 3/4" x 66 ft. (.007" thick).

Box Qty. 1



SERVICE CENTER ITEMS

NEW



9738
Prime Paper Floor Mats
Durable coating for heavy traffic. Premium quality. Size: 17" x 19"
Box Qty. 500

NEW

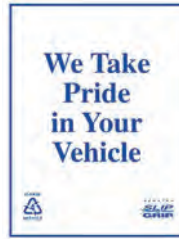

9741
Plastic Floor Mats
Impervious to water, oil, grease and most shop chemicals. Size: 16.5" x 21", 2 mil. thickness. On a roll.
Box Qty. 500

NEW



9740
Slip-N-Grip Clear Seat Cover
Keeps vehicle clean during the service process. Size: 32" x 56". On a roll.
Qty. 250

NEW



9742
Tire Storage Bag
Three layer construction for superior strength and durability. Ideal for transporting or storing tires. Size: 36" x 40". On a roll.
Qty. 100

NEW



9743
Parts Bag
High strength, impervious to most chemicals. Used for purchases, worn parts and customer's personal items. Size: 11" x 17". On a roll.
Qty. 500

NEW



9744
Steering Wheel Cover
Elastic design is easy to apply versus stretch wrap covers. Size: 24"
Box Qty. 250

NEW



9745
Wall Rack Start-Up Kit
Perfect kit to get your shop up and running! Includes: Sturdy dispensing rack with shelf, 500 plastic floor mats, 250 seat covers, 500 parts bags, and 250 Steering wheel covers.
Size: 28" x 18" x 11"
Box Qty. 1

NEW



9746
Gear Shift Cover
Size: 5" x 17"
Box Qty. 500

UNIVERSAL SORBENT PADS
Used to clean up both water and oil based fluid leaks, drips or spills. Made from meltblown polypropylene allowing them to soak up oil, water and even aggressive chemicals. 200 per bag

Part no. Description
97078 Pad Size: 15" x 18"



NEW



97079
Heavy duty barrel top absorbent pads.
For use with 55 gal drums.
Box Qty. 10

SERVICE CENTER ITEMS

Nitrile Gloves - Black **NEW**

6 mil nitrile gloves. Superior puncture & abrasion resistance. Textured grip. Beaded cuff. Powder-free.

KX9943	Medium	100/BX
KX9944	Large	100/BX
KX9945	X-Large	100/BX



**POWDER FREE
NITRILE
6 MIL**

Qualakote® Assembly Gloves

Gray nylon. Light weight. Dipped palm & fingers repels oils & cleaners. Open knit back breaths for day-long comfort. Washable, reusable for economy.

96315	Medium	1 Pair/pkg
96316	Large	1 Pair/pkg
96317	X-Large	1 Pair/pkg



**GREY NYLON
OPEN KNIT
REUSABLE**

15 Service Center

HYBRID VEHICLE SERVICE GLOVES

Safety glove system used for protection against the high voltage batteries used in todays Hybrid cars.

RUBBER INSULATING GLOVES

Class 0 Type I. Natural rubber, designed for maximum comfort and protection. 12" long with rolled cuff for easy pull-on and pull-off.

*Maximum use 1000 volts AC / 1500 volts DC
Meets ASTM D 120 Standard.*



96335	Medium	1 Pair	DISC
96336	Large	1 Pair	DISC
96337	Extra Large	1 Pair	DISC

PROTECTIVE OVER GLOVES

Wear over Hybrid Service Gloves to protect rubber insulating gloves from punctures and abrasion.

Meets ASTM F696 Standards.



96338	Fits Over Medium	1 Pair	DISC
96339	Fits Over Large	1 Pair	DISC
96340	Fits Over Extra Large	1 Pair	DISC

PROTECTIVE GLOVES BAG

Heavy-duty canvas bag allows storage for both the service gloves and the protective over gloves.

96341	Protective Gloves Bag	1/box	DISC
--------------	-----------------------	-------	-------------



SERVICE CENTER ITEMS

SURFACE PREP DISCS



A durable non-woven web coated with tough aluminum oxide grit for longer life and faster stock removal.

- Removes rust, paint and oxidation
- Removes gasket residue
- Excellent for surface blending
- Twist-On

Prod. No.	Description-Color	Box Qty.
7100	2" Coarse-Gold	50
7105	2" Medium-Maroon	50
7110	2" Fine-Blue	50
7115	3" Coarse-Gold	25
7120	3" Medium-Maroon	25
7125	3" Fine-Blue	25



HOLDERS FOR SURFACE PREP AND MINI GRINDING DISCS

7130	2" Disc Holder	1
7135	3" Disc Holder	1



GEMTEX® BRITE PREP NON-WOVEN 6 x 9 HAND SCUFF PADS

Our 6 x 9 Hand Scuff Pads are manufactured from synthetic fibers, bonded together with specially formulated resins and impregnated throughout the web with mineral grain creating an open, three dimensional structure. These products are designed for a broad range of jobs including light duty cleaning, polishing, scuffing, finishing and for heavy duty jobs including paint, rust and corrosion removal. Manufactured from tough synthetic fibers that will not rust, they can be used for dry scuffing and finishing or may be used with water or chemical solvents. They are flexible enough to be used in hard to reach spots, yet strong enough for continuous use. They are produced in a variety of grades ranging from hand cleaning to high-speed machine use. "A Steel Wool Substitute".

Item No.	Description	Bx. Qty.
7185	Fine - Gray	20
7180	Medium - Maroon	20
7179	Super Medium - Green	20

CLOTH UTILITY ROLLS

Rolls are packaged in handy box dispenser. Used for smoothing rough spots, deburring and cleaning metal surfaces.



- Aluminum Oxide Grain
- Resin Over Resin Construction
- Egyptian Cloth Backing
- Use on Ferrous & Non-Ferrous Surfaces

Prod #	Grit	Size
7030	80	1-1/2" x 50 Yds.
7031	100	1-1/2" x 50 Yds.
7032	120	1-1/2" x 50 Yds.
7033	150	1-1/2" x 50 Yds.
7034	180	1-1/2" x 50 Yds.
7035	240	1-1/2" x 50 Yds.
7036	320	1-1/2" x 50 Yds.

SERVICE CENTER ITEMS

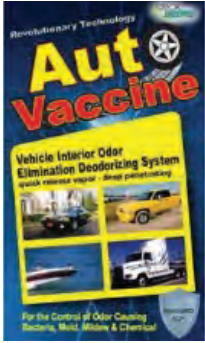

AUTO VACCINE Odor Eliminating, Deodorizing, Decontaminate Delivery System

Your car is your second home - Keep it clean with Auto Vaccine!

- Safe, Powerful & Effective
- Eliminates all odors, smoke, mold, mildew, pet smells, bacteria
- Not a Cover-up or Mask
- Safe for all interior materials

Auto Vaccine can quickly treat enclosed spaces with the most powerful penetrating technology available. Released as a vapor, our broad spectrum biocide products are safe, powerful and very effective!

Prod No. **3500** Box Qty. 1 kit





ODOR ELIMINATOR & AIR PURIFIER















- Quickly eliminates odors caused by tobacco smoke, animals, decay, mold, mildew, fungus and more!
- Refreshing scent helps to neutralize odors
- Great for eliminating odors in vehicles, home or office
- Use as needed to quickly eliminate odors

Prod No. **3603** Aerosol, Net Weight 10oz. Box Qty. 1

AUTO BODY HARDWARE - SCREWS, BOLTS

 <p>170018 Bright Zinc M6-1.0 x 20mm w/18mm Dia. Washer Torx Washer Head Bolt w/Starter Point <i>GM, General Purpose</i> Box Qty. 25</p>	 <p>170025 <i>14044408</i> Black 4.2mm - 1.41 x 20mm Torx Drive Knurled Socket Head Dash Pad Retaining Screw <i>GM Firebird, Camaro '82 - UP</i> Box Qty. 25</p>	 <p>170210 M6-1.0 x 20mm Torx Drive Body Bolt w/ Dog Point T-30 Torx Drive 18mm Plastic Washer 9.5mm x 5mm Shoulder <i>GM Saturn '91 - UP</i> Box Qty. 15</p>	 <p>200000 <i>12210-06203, 12342-06203</i> Black Zinc M6-1.0 x 19mm Phillips Round Head Thread Cutting Screw with Sems® Flat & Lock Washer Flat Washer Dia: 13mm Lock Washer Dia: 11mm <i>Hyundai Elantra, Genesis, Scoupe, Santa Fe & Tiburon 1990 - 2014</i> Box Qty. 50</p>
 <p>200001 <i>12291-06303</i> Black Zinc M6-1.0 x 29mm Phillips Round Head License Plate Screw with Sems® Flat & Lock Washer Flat Washer Dia: 13mm Lock Washer Dia: 11mm <i>Hyundai Equus 2010 - 2015 Genesis 2008 - 2014</i> Box Qty. 25</p>	 <p>200010 <i>W704874-S439</i> Zinc Organic Hex Washer Head Screw M4.8-1.59 x 16mm (Special Hi-Lo Thread) Hex: 7mm Washer Dia: 12.5mm <i>Ford Escape, Expedition, Explorer, Fusion, Taurus, T-bird, Lincoln Aviator, Continental, LS, MKC, MKZ, Navigator, Town Car, Merc. Mariner, Mountaineer & Sable 2000 - UP</i> Box Qty. 25</p>	 <p>200011 <i>W704875-S439</i> Zinc Organic M4.2-1.41 x 19mm Hex Washer Head Tapping Screw Hex: 7mm Washer Dia: 12.5mm <i>Ford Escape, Explorer, Edge, Expedition, F-150/250/350/450/550, Flex, Taurus & Thunderbird and Lincoln LS, Mark LT, MKX & MKZ 1999 - UP</i> Box Qty. 25</p>	 <p>200040 Bright Zinc #8-18 x 3/8" Phillips Round Washer Head Tapping Screw Head Dia.: 9/32" <i>Chrysler, General Purpose</i> Box Qty. 100</p>
 <p>200045 <i>20423550, 381801-S2, 390017-S2</i> Black Phosphate #8 x 1/2" Phillips Washer Head w/Teks® Point Washer Head O.D.: 7/16" <i>GM, Ford</i> Box Qty. 100</p>	 <p>200050 Black Phosphate M4.8-1.6 x 15mm (#10 x 19/32") Phillips TrussHead Tapping Screw Head O.D.: 14mm (9/16") <i>Nissan Bumpers</i> Box Qty. 50</p>	 <p>200055 Black Oxide M4.8-1.81 x 16mm (#10 x 5/8") Phillips Truss Head Tapping Screw Head Dia.: 11mm (7/16") <i>Imports</i> Box Qty. 100</p>	 <p>200070 Stainless Steel #4-24 x 3/8" Special Phillips Flat Head Head Dia.: 7/32" Used for Attaching Mldg Clips to Body, Shorter Length for Shallow Areas Box Qty. 100</p>
 <p>200075 10 x 1/2" Head Dia: 1/2" Phillips Tapping Screw Boot Well/Weatherstrip Rails <i>GM & Ford Convertible & Hardtops</i> Box Qty. 100</p>	 <p>200090 <i>9616231</i> Chrome #8-18 x 3/8" Phillips Round Washer Head Tapping Screw Head Dia.: 7/16" For Wheel House Mldg Box Qty. 50</p>	 <p>200095 <i>1651249</i> Zinc #10 x 9/16" Phillips Round Washer Head Tapping Screw Head Dia.: 7/16" For Larger Wheel House Moulding Box Qty. 50</p>	 <p>200101 Zinc & Yellow Dichromate M6.3-1.81 x 20mm (#14 x 25/32") Hex Head SEMS® Washer O.D.: 18mm (45/64") 10mm Hex <i>Honda, Nissan, Toyota</i> Box Qty. 25</p>

AUTO BODY HARDWARE - SCREWS, BOLTS

 <p>200170 367292, 367291 Chrome Plated Steel Outside Rearview Mirror Mounting Nut & Bolt 1/4"-20 x 1" Chrysler & GM Trucks & Vans Box Qty. 10</p>	 <p>200175 367291, 14007511, 474821 Chrome Plated Steel Screw 1/4"-20 x 1" Hex Washer Head Hex: 3/8" Wshr O.D.: 5/8" Truck Mirror Mounting Screw Chrysler & GM Trucks/Vans Box Qty. 10</p>	 <p>200177 11503578, 11503785 Black Phosphate M4.2-1.41 x 16mm (#8 x 5/8") Hex: 7mm Washer O.D.: 12mm (1/2") Hex Washer Head Screw W/ Teks® Point GM & General Purpose Box Qty. 50</p>	 <p>200188 Black M4.2-1.41 x 20MM Hex Head Tapping Screw w/SEMS Washer OD: 17mm Box Qty. 50</p>
<p>200191 Box 250</p>  <p>200190 11500434, 11503892 Phosphate M4.2-1.41 x 20mm (#8 x 25/32") Hex Head Sems® Tapping Screw Washer Hd.: 16mm (5/8") Hex: 7mm GM Box Qty. 50</p>	 <p>200192 9420052, 11502483, 11503503 Chrome M4.2-1.41 x 20mm (#8 x 25/32") Phillips Pan Head Sems Pozi-Drive Washer O.D.: 12mm (1/2") GM Box Qty. 50</p>	 <p>200193 90103-SDA-A00 Black Phosphate M5-1.81 x 20mm Phillips Flat Head Tapping Screw Head Diameter: 13mm Front & Rear Bumper Honda Civic, Pilot & Ridgeline 2006 - UP Box Qty. 100</p>	 <p>200280 10120517, 10155743 Black M4.2-0.79 x 15mm Phillips Round Washer Head Drill Point Screw Head Dia.: 11mm GM Cars, General Purpose Box Qty. 100</p>
 <p>200281 11609457 Black Zinc M4.2-1.41 x 20mm Round Washer Hd Pozi-Drive Tap Screw Head Dia: 11mm Tail Lamp Assembly Buick Cascada, Enclave, Encore, Cadillac CTS, Chevrolet Avalanche, Camaro, Caprice, Corvette, Impala, Monte Carlo & Trax and Pontiac G6 2000 - UP Box Qty. 25</p>	 <p>200285 Zinc & Yellow Dichromate Hex Head Washer Screw M5.5-1.81 x 18mm (#12 x 45/65") Washer O.D.:15mm (19/32") Hex: 8mm Imports Box Qty. 50</p>	<p>200291 Box 250</p>  <p>200290 11504056, 11513801 Phosphate M4.2-1.41 x 20mm (#8 x 25/32") Hex Washer Head Sems® Tapping Screw Washer O.D.: 12mm (1/2") Hex: 7mm GM Cars, Ford Box Qty. 50</p>	 <p>200292 Phosphate M4.2-1.41 x 20mm (#8 x 25/32") Hex Washer Head Sems® w/Teks® Point Tapping Screw Washer O.D.: 12mm (1/2") Hex: 7mm Box Qty. 50</p>
 <p>200293 Black Phosphate Screw, Hex Washer Head W/ Loose Washer M4.2 - 1.41 x 20mm W/ Drill Point 7mm Across Flats Washer Dia.: 17mm GM & General Purpose Box Qty. 50</p>	 <p>200294 11589012 Black Zinc M4.2-1.41 x 25mm Indented Hex Flange Head Sems® Tapping Screw Hex: 7mm Washer Dia: 12.5mm Signal Lamp Mounting, Interior Door Trim, Instrument Panel, Radio & Speaker Mounting, Rear Bumper & Liftgate Buick Allure, Cascada, Enclave, Encore, Envision, LaCrosse, Lesabre, Lucerne, Park Avenue, Rainier, Regal & Verano and Cadillac ATS, CT6, CTS, Deville, DTS, Eldorado, ELR, Escalade, Seville, SRX, STS, XT5 & XTS and Chevrolet Avalanche, Blazer, Bolt EV, Camaro, Captiva Sport, Cobalt, Colorado, Corvette, Cruze, Equinox, Express, HHR, Impala, Lumina, Malibu, Monte Carlo, Orlando, S10, Silverado, Sonic, Spark, SS, SSR, Suburban, Tahoe, Trailblazer, Traverse, Trax & Volt and GMC Acadia, Canyon, Envoy, Savana, Sierra, Sonoma, Terrain & Yukon and Hummer H2 & H3 and Pontiac Bonneville, G5, Grand Am, Pursuit, Solstice & Torrent and Saturn Ion, Outlook & Sky 1987 - UP Box Qty. 50</p>		

AUTO BODY HARDWARE - SCREWS, BOLTS

<p>200295 11547420 Black Zinc M4.2-1.41 x 20mm Bumper, Grille, Fog Lamp Hex Head Sems Tapping Screw Hex: 7mm Washer OD: 17mm Point Type: BR Grade: 2 <i>Buick Enclave, Cadillac XT6, Chevrolet Blazer, Equinox, Express, Silverado, Traverse, GMC Savana, Sierra & Terrain 2018 - UP; Malibu 2016 - 2018</i> Box Qty. 25</p> 	<p>200313 11501903 Black Oxide M4.2-1.41 x 10mm (#8 x 13/32") Phillips Washer Head w/Pozi-Drive Tapping Screw Wshr Hd O.D.: 11mm (7/16") <i>GM</i> Box Qty. 100</p> 	<p>200315 11501884 Black Oxide M4.2-1.41 x 20mm (#8 x 25/32") Phillips Washer Head w/Pozi-Drive Tapping Screw Washer O.D.: 11mm(7/16") <i>GM</i> Box Qty. 100</p> 	
<p>200325 Phosphate #8 x 3/4" Phillips Round Washer Head Tapping Screw w/Teks® Point Washer Hd. O.D.: 7/16" Box Qty. 50</p> 	<p>200350 Phosphate M4.2-1.41 x 20mm (#8 x 25/32") Phillips Pan Head Sems® Tapping Screw Wshr Hd. O.D.: 16mm (5/8") <i>Ford</i> Box Qty. 50</p> 	<p>200355 Phosphate M4.2-1.41 x 25mm (#8 x 1") Round Washer Head Pozi-Drive w/Teks® Point Tapping Screw Wshr Hd. O.D.: 11mm (7/16") Box Qty. 100</p> 	<p>200357 Zinc #8 x 1-1/4" Phillips Round Washer Head w/Teks® Point Tapping Screw Washer Hd. O.D.: (7/16") Box Qty. 50</p> 
<p>200360 Chrome #8 x 7/16" Phillips Truss Head Tapping Screws Head Dia.: 13/32" Box Qty. 100</p> 	<p>NEW</p> <p>200361 11503395 Black Finish Indeneted Hex Head Sems Screw, Loose Washer M4.2-1.41 x 16mm (#8 x 5/8") Indeneted Hex Head: 7mm Washer Dia: 12mm (15/32") <i>GM</i> Box Qty. 50</p> 	<p>200363 14090382, 6506161-AA Black Phosphate M4.2-1.41 x 20mm (#8 x 25/32") Hex Head Tapping Screw w/SEMS Washer OD: 20mm Hex: 7mm <i>GM</i> Box Qty. 50</p> 	<p>200364 201-990-05-36 Black E-Coat M4.8-1.61 x 20mm (#10 x 25/32") Hex Head Tapping Screw w/ SEMS Washer OD: 26mm Hex: 8mm Front Bumper & Mldg. Strip <i>Mercedes '93 - 2014</i> Box Qty. 25</p> 
<p>200365 N811534-S61 M4.2-1.41 x 30mm (#8 x 1-3/16") Hex Head Sems® Tapping Screw Washer Hd. O.D.: 17mm(11/16") Hex: 7mm <i>Ford</i> Box Qty. 15</p> 	<p>200366 6509539-AA Phosphate Hex Head Sems® Tapping Screw M4.8-1.61 x 32mm (#10 x 1-1/4") Washer OD:19mm (3/4") Hex: 8mm <i>Chrysler Town & Country and Dodge Ram 2009 - 14</i> Box Qty. 50</p> 		

AUTO BODY HARDWARE - SCREWS, BOLTS

200368

N801169-S900,
W710763-S901

Hex Head Sems®
Tapping Screw
M4.2 - 1.41 x 22mm
Hex Size: 5.5mm
Washer Dia: 16mm
Front Bumper, Exterior Trim &
Front Fender
Ford Edge & Expedition And Lincoln
MKT & MKX 1997 - UP
Box Qty. 50



200370

6104374AA
Zinc Finish
M6-1.0 x 40mm
Hex Head Sems®
Body Bolt with Dog Point
Washer Outer Dia: 20mm
Hex: 10mm
Headlamp Bracket
Chrysler, Dodge & Jeep 2008 - UP
Box Qty. 10



200371

6105103AA
Zinc Finish
M8-1.25 x 30mm
Hex Head Sems®
Body Bolt with Dog Point
Washer Outer Dia: 24mm
Hex: 13mm
Chrysler, Dodge & Jeep 2007 - UP
Box Qty. 5



200375

9422202
Zinc
#8 x 1/2"
Phillips Flat Top
Washer Head Tapping Screw
Washer Hd Dia.: 13/32"
Chrysler, General Purpose
Box Qty. 100



200380-500 Box 500



200380

9423101
Dacromet 320 Finish
M6.3-1.81 x 16mm
(#14 x 5/8")
Duo Drive Truss Head
License Plate Screw
GM Cars & Trucks '65 - UP
Box Qty. 50

200385

Black Phosphate
M6.3-1.81 x 16mm
(#14 x 5/8")
Phillips Truss Head
Tapping Screw
Hd. O.D.: 15.5mm (39/64")
Japanese Imports, Universal
Box Qty. 50



200395

11570637
Black
M4.2-1.41 x 20MM
(#8 x 25/32")
Torx Pan Head Tapping Screw
w/SEMS Round Dog Point
Washer OD: 17mm (11/16")
Bumper, Fender Apron, Rad. Grille,
Rocker, Back-up Lamp
GM Encore, Enclave, Verano, ATS, Camaro,
Caprice, Cruze, Impala, Malibu, Silverado,
Sonic, Volt, Terrain, Arcadia 2007 - UP
Box Qty. 50



200396

Black Zinc
M4.2-1.41 x 25mm
(#8 x 1")
T-15 Drive Torx Pan Head
Sems Tapping Screw
Washer Dia: 12mm (1/2")
Box Qty. 50



200397

N90892001,
N90775001
Black Zinc
M5-2.12 x 19mm
Torx® Truss Head
Tapping Screw, T25 Drive
Head Diameter: 14mm
Audi, Porsche & VW 2007 - 14
Box Qty. 25



200398

13144822
Black Zinc
M5.5 x 20mm
(#12 x 25/32")
Torx Truss Head T-20 Drive
Head O.D.: 15mm (19/32")
GM 2011 - UP, Saab 2003 - UP
Box Qty. 25



APPLICATION UPDATED

200399

W702413-S450B,
W702413-S307
Black Finish
M5-2.2 x 20mm
Torx® Pan Head Sems®
T30 Torx® Drive
Washer Dia: 20mm
Ford C-Max, Escape, Focus &
Transit Connect 2013 - UP; Edge
& F-150 and Lincoln MKC & MKX
2015 - UP
Box Qty. 15



200401

Black E-Coat
#14 (1/4") x 5/8"
Slotted Hex Washer Head
License Plate Screw
Washer OD: 5/8"
Hex: 5/16"
Ford
Box Qty. 50





200411

Black Oxide
M4.2-1.41 x 16mm
(#8 x 5/8")
Phillips Truss Head
Tapping Screw
Head Dia.: 9.5mm (3/8)
Honda
Box Qty. 100



AUTO BODY HARDWARE - SCREWS, BOLTS

 <p>200413 90114-SE0-000, 90114-SZ3-000 Black Finish M4.8 x 19mm (#10 x 3/4") Phillips Truss Head Sems Tapping Screw Washer OD: 16mm (5/8") Splash Shield & General Purpose Honda '86 - UP Box Qty. 25</p>	 <p>200415 1689827 Zinc #8 x 1/2" Phillips Washer Head w/Teks® Point Washer Hd. Dia.: 7/16" Reveal Mldg. to Panel GM Box Qty. 100</p>	 <p>200416 Zinc #8 x 1/2" Phillips Flat Top Washer Head w/ #2 TekS® Point Washer Hd. Dia.: 12/32" Box Qty. 100</p>	 <p>200425 Black Zinc M5-1.59 x 16mm Phillips Hex Head Sems® Tapping Screw Washer O.D.: 16mm Hex: 8mm Box Qty. 50</p>
<p>NEW</p>  <p>200426 90159-60525 Black E-Coat Phillips Hex Head Sems Screw, Loose Washer M6.5-2.5 x 19mm (#14 x 3/4") Indented Hex Head: 10mm Washer Dia: 20mm (25/32") Floor Pan & Lower Back Panel Moulding, Rear Bumper Stay, Suspension Cross Member and Under Cover Toyota 1998 - UP Box Qty. 25</p>	 <p>200600 07119-916-646 Zinc CR3 Finish Indented Hex Head Washer Screw M4.8-1.61 x 16mm Washer Dia.: 15mm Type "AB" BMW Box Qty. 50</p>	 <p>215014 57030-S36 Zinc & Yellow Dichromate 1/4"-20 x 7/8" Hex Head Sems® With Dog Point Washer O.D.: 3/4" Hex: 7/16" Ford Box Qty. 50</p>	 <p>215015 57472-S2 Black Phosphate 1/4-20 x 3/4" Hex Head Body Bolt w/Dog Point, Washer Washer O.D.: 3/4" Hex: 7/16" Ford Products Box Qty. 50</p>
 <p>215020 Phosphate 1/4-20 x 1" Hex Head Sems® Body Bolt Washer O.D.: 1" Hex: 3/8" GM, Ford Box Qty. 25</p>	 <p>215040 6025329 1/4-20 x 1" Hex Head Body Bolt w/Free Spinning Washer Washer OD: 5/8" Hex: 7/16" Chrysler Box Qty. 50</p>	<p>NEW</p>  <p>215041 Black Phosphate 1/4-20 x 1-3/16" Hex Head Body Bolt w/Free Spinning Washer Washer OD: 3/4" Hex: 7/16" Box Qty. 50</p>	 <p>215045 Black Phosphate 5/16-18 x 3/4" Hex Head Body Bolt Washer Hd. O.D.: 21/32" Hex: 1/2" GM Box Qty. 50</p>
 <p>215050 57039-S2 Black Phosp 5/16-18 x 1" Hex Head Body Bolt w/Dog Point, Loose Washer Washer O.D.: 7/8" Hex: 1/2" Ford, GM Box Qty. 25</p>	 <p>215055 57041-S2 Black Phosphate 5/16-18 x 1-3/16" Hex Head Body Bolt w/Dog Point, Loose Washer Washer O.D.: 7/8" Hex: 1/2" Ford Box Qty. 50</p>	 <p>215060 9796223 Phosphate 5/16-12 x 1" Hex Washer Head Tapping Screw Washer Hd. O.D.: 21/32" Hex: 1/2 GM Box Qty. 50</p>	 <p>215065 Black Phosphate 5/16-18 x 13/16" Hex Head Body Bolt Washer Hd. O.D.: 41/64" Hex: 1/2" GM Box Qty. 50</p>

AUTO BODY HARDWARE - SCREWS, BOLTS



215066
3846202
5/16-18 x 7/8"
Indented Hex Head Sems
Washer OD: 3/4"
Hex: 1/2"
GM
Box Qty. 50



215067
2968521
Black
#5/16-18 x 1"
Hex Washer Head
Flange: 5/8"
Hex: 1/2"
Radiator Shroud & Grille
Headlamps
GM '73 - UP
Box Qty. 50



215090
3986997,
14011722
Black Finish
3/8"-16 x 1"
Indented Hex Head Bolt
Washer OD: 1"
Hex: 9/16"
Fender to Hood Hinge
General Purpose
GM '71 - UP
Box Qty. 25



215100
407217, 1564180
Black Finish
3/8"-16 x 1-1/2"
Indented Hex Head
Washer OD: 1-1/8"
Hex: 9/16"
General Purpose
GM & Ford '71 - UP
Box Qty. 10



215130
11503982
Class 9.8
Phosphate
M6-1.0 x 25mm
Hex Head Sems®
Body Bolt
Wshr O.D.: 24mm(15/16")
Hex: 10mm
GM
Box Qty. 50



216000
W711390-S900
Black Zinc
Hex Head Sems
Body Bolt with Threaded Patch
M6-1.0 x 30mm
Washer O.D.: 18mm (23/32")
Hex: 10mm
Ford F-150 Trucks With Aluminum
Body 2015 - UP
Box Qty. 25



216002
W717793-S439
Zinc Finish
M8-1.25 x 31mm
Hex Washer Head
Sems® Body Bolt
with Dog Point
Class 10.9
Washer O.D.: 24mm
Hex: 13mm
Fender & Hood Hinge
Ford Expedition & Lincoln
Navigator 2018 - UP
Ford F-150 2015 - UP
Box Qty. 10



216009
11508930
Black Fluorocarbon
M6-1.0 x 16mm
Hex Head Sems
Class 9.8; Hex: 10mm
Wshr O.D.: 17mm (21/32")
GM
Box Qty. 50



216010
11500969
Class 9.8
M8-1.25 x 20mm
Indented Hex Flange Head
Bolt w/Starter Point
Flange: 16mm
Hex: 13mm
GM
Box Qty. 50



216110
6100568
Class 9.8
Phosphate
M6-1.0 x 30mm
Hex Head Sems® Bolt
w/Dog Point
Washer O.D. 19mm (3/4")
Hex: 10mm
Chrysler
Box Qty. 25



216115
11503619, 11501102
Class 9.8
M8-1.25 x 25mm
Hex Head Sems® Body Bolt
Washer O.D.: 24mm
Hex: 13mm
GM
Box Qty. 25



216129
N606677-S
Class 9.8
Phosphate
M6-1.0 x 28mm
Hex Head Sems® Body Bolt
w/Dog Point
Washer O.D.: 19mm (3/4")
Hex: 8mm
Chrysler
Box Qty. 25



216130
N-606676-S2,
N-606676-S100
Class 9.8
Phosphate
M6-1.0 x 22mm
High Hex Head Sems®
w/Dog Point
Washer O.D.: 19mm (3/4")
Hex: 8mm
Ford
Box Qty. 50



216132
N606676-S36
Class 9.8
Zinc & Yellow
M6-1.0 x 23mm
Hex Head Sems®
w/ Dog Point
Washer O.D.: 19mm (3/4")
Hex: 8mm
Ford
Box Qty. 50



216133
N606677-S36
Class 9.8
Zinc & Yellow
M6-1.0 x 28mm
Hex Head Sems®
w/ Dog Point
Washer O.D.: 19mm (3/4")
Hex: 8mm
Ford
Box Qty. 25



216137 Box 500
216135
11503834,
20351035
Class 9.8
Phosphate
M6-1.0 x 25mm
Hex Head Sems® Body Bolt
Wshr O.D.: 17mm (21/32")
Hex: 10mm
GM
Box Qty. 50

AUTO BODY HARDWARE - SCREWS, BOLTS

 <p>216140 11503800 Class 9.8 Black M6-1.0 x 20mm Hex Washer Head Wshr Hd O.D.: 13mm (1/2") Hex: 10mm GM Box Qty. 50</p>	 <p>216141 MS452348 Black E-Coat M6-1.81 x 20MM Phillips Hex Head Sems, Hex: 10mm Washer OD: 13mm (1/2") Bumper, Ext. Trim, Fender Shield and Qtr. Panel <i>Mitsubishi Diamante, Eclipse, Galant, Lancer, Mirage, Montero, 3000GT 1991-2012</i> Box Qty. 25</p>	 <p>216145 11503958 Class 9.8 Phosphate M6-1.0 x 25mm Hex Washer Head Wshr Hd O.D.: 13mm (1/2") Hex: 10mm Class 9.8 GM Box Qty. 50</p>	 <p>216148 11505044 Class 9.8 Black Phosphate M6-1.0 x 35mm Hex Head Sems® Wshr O.D.: 17mm (21/32") Hex: 10mm GM Box Qty. 50</p>
 <p>216155 34201287, 8934201287 Zinc M6-1.0 x 20mm Slotted Hex Washer Head Body Bolt Wshr Hd O.D.: 13mm (1/2") Hex: 10mm <i>Chrysler, Honda, AMC</i> Box Qty. 50</p>	 <p>216195 11505022 Black Phosphate M6.3-1.81 x 20MM (#14 x 25/32") Hex Washer Head SEMS Washer OD: 17mm (11/16") Hex: 10mm GM Box Qty. 50</p>	 <p>216196 Black Zinc M6.3-1.81 x 20MM (#14 x 25/32") Phillips Hex Head SEMS Washer OD: 20mm (25/32") Hex: 10mm <i>Imports</i> Box Qty. 50</p>	 <p>216200 11500996, 11505023, 11508430 Phosphate M6.3-1.81 x 25mm (#14 x 1") Hex Head Sems® Tapping Screw Wshr O.D.: 17mm (21/32") Hex: 10mm GM Box Qty. 50</p>
 <p>216205 N800312-S2 Phosphate M6.3-1.81 x 16mm (#14 x 41/64") Hex Head Sems® Tapping Screw Washer O.D.: 16mm (5/8") Hex: 8mm <i>Ford</i> Box Qty. 50</p>	 <p>216210 11504981 Phosphate M6.3-1.81 x 30mm (#14 x 1-3/16") Hex Head Sems® Wshr O.D.: 24mm (15/16") Hex: 10mm GM Box Qty. 25</p>	 <p>216215 11500994, 11509371 Phosphate M6.3-1.81 x 16mm (#14 x 41/64") Hex Head SEMS® Wshr O.D.: 17mm (11/16") Hex: 10mm GM Box Qty. 50</p>	 <p>216225 60324703 Zinc Plated #14-14 x 7/8" Indented Hex Washer Head Body Bolt Serrated Wshr Hd. OD: 13/16" Hex: 3/8" Front Fender & Fascia Attachment <i>Chrysler '93 - UP</i> Box Qty. 25</p>
 <p>216235 N606690-S2 Class 9.8 Black Phosphate M8-1.25 x 30mm Hex Head Sems® w/Dog Point Washer O.D.: 22mm (7/8") Hex: 10mm <i>Ford</i> Box Qty. 25</p>	 <p>216240 11501188 Class 9.8 Phosphate M8-1.25 x 30mm Hex Head Sems® w/Starter Point Wshr O.D.: 24mm (15/16") Hex: 13mm GM Box Qty. 25</p>	 <p>216250 11503632, 11500970 Class 9.8 Black M8-1.25 x 25mm Hex Washer Head Washer OD: 16mm Hex: 13mm GM Box Qty. 25</p>	 <p>216252 11500971, 11504492, 11515619 Class 9.8 Black Organic M8-1.25 x 30mm Hex Flange Head w/Starter Point Flange: 17mm (21/32") Hex: 13mm GM Box Qty. 50</p>

AUTO BODY HARDWARE - SCREWS, BOLTS

216290

6100539
Phosphate
M5-0.8 x 20mm
Hex Head Sems®
Thread Cutting Screw
w/Dog Point
Washer O.D.: 12mm (1/2")
Hex: 8mm
Chrysler
Box Qty. 50



216294

11503668
Class 9.8
Phosphate
M8-1.25 x 35mm
Hex Head Sems®
w/Starter Point
Wshr OD: 24mm (15/16")
Hex: 13mm
GM
Box Qty. 25



216295

11504982
Class 9.8
Phosphate
M8-1.25 x 35mm
Hex Flange Head
Washer OD:
17mm(21/32")
Hex: 13mm
GM
Box Qty. 25



216296

11502941,
11506174
Class 9.8
Phosphate
M6-1.0 x 20mm
Hex Head Sems®
Wshr O.D.: 17mm (21/32")
Hex: 10mm
GM
Box Qty. 25



216297

11504570,
11509816,
11514623
Class 9.8
Phosphate
M6-1.0 x 20mm
(#14 x 25/32")
Hex Head Sems®
Washer OD: 17mm (21/32")
Hex: 10mm
GM
Box Qty. 50



216310 Box 25

216300

11501193
Class 9.8
Phosphate
M10-1.50 x 40mm
Hex Head Sems®
Wshr OD: 29mm (1-5/32")
Hex: 15mm
GM
Box Qty. 10



216358

11589031
Class 9.8
Black Zinc
Hex Head Sems
Body Bolt
M6-1.0 x 20mm
Hex: 10mm
Washer Dia: 24mm
Front Bumper Support,
Fender Liner, Grille &
Headlamp Adjusting
*Cadillac Escalade, Chevrolet
Camero, Silverado, GMC Sierra and
Pontiac Solstice 2006 - UP*
Box Qty. 15



216360

N800947-S,
AB-181-GG
Class 9.8
Phosphate
M6-1.0 x 28mm,
Hex Head
Sems® w/ Dog Point
Washer O.D.: 25mm (1")
Hex: 8mm
Ford
Box Qty. 25



220040

376337-S100
Zinc
Stainless Steel Cap
5/16"-18 x 3/4"
Bumper Bolt w/ Nuts
Head Dia.: 3/4"
Shoulder Length: 3/16"
Ford
Box Qty. 25



220050

6026723
Zinc
Stainless Steel Cap
3/8"-16 x 1"
Pan Head Bumper Bolt
w/ Hex Nuts
Head Dia.: 7/8"
Shoulder Length: 3/32"
Chrysler
Box Qty. 25



220060

Stainless Steel Cap
3/8"-16 x 1"
Round Head Bumper Bolt
w/ Hex Nuts
General Purpose
Box Qty. 10



220069

7/16"-14 x 1"
Round Head Bumper Bolt
w/ Nuts
General Purpose
Box Qty. 10



220070

9786454
Stainless Steel Cap
7/16"-14 x 1-3/8"
Pan Head Bumper Bolt
w/ Hex Nuts
Head Dia.: 29/32"
Shoulder Length: 5/32"
GM
Box Qty. 10



220075

490067
Stainless Steel Cap
7/16"-14 x 1-1/2"
Round Head Bumper Bolt
w/ Lock Nuts
Head Dia.: 31/32"
Shoulder Length: 3/16"
GM
Box Qty. 10



220100

Stainless Steel Cap
1/2"-13 x 1-1/2"
Round Head Bumper Bolt
w/ Nuts
Box Qty. 10



220130

11502479,
11502480,
12338141
Zinc
Stainless Steel Cap
M8-1.25 x 20mm
Pan Head Bumper Bolt
w/ Nuts
Head Dia.: 19mm
Shoulder Length; 2mm
GM
Box Qty. 25



AUTO BODY HARDWARE - SCREWS, BOLTS



220135
Stainless Steel Cap
M8-1.25 x 28mm
Flat Head Bumper Bolt
Chrysler, General Purpose
Box Qty. 25



220138
90111-SM4-003
Black
Bumper Bolt
Size: M6 - 1.0 x 8mm
Shoulder Dia: 9mm
Shoulder Length: 6.5mm
Washer Outer Dia: 18mm
Hex: 10mm, Hex Height: 7mm
Acura CL 2003-1997; ILX 2013-2019; Integra 1986-2001; Legend 1987-1995; MDX 2014-2019; NSX 1991-2005; RDX 2007-2019; RL 2009-2012; RLX 2014-2019; RSX 2002 - 2004; TL 1996 - 2014; TLX 2015-2019; TSX 2004-2014; Vigor 1992-1994; ZDX 2010-2013 Honda Accord 1990-2020; Civic 1984-2020; CR-V 1997-2020; CR-Z 2011-2016; Crosstour 2010-2015; CRX 1984-1991; Element 2007-2008; Fit 2007-2020; Insight 2000-2020; Odyssey 1995-2020; Passport 2019-2020; Pilot 2012-2020; Prelude 1992-2001; Ridgeline 2006-2020
Box Qty. 15



220140
11502480
M8 x 20mm
Bumper Bolt
Uncapped Metric
GM '76 - UP
Box Qty. 25



220145
14003784
Zinc
Stainless Steel Cap
M8-1.25 x 25mm
Pan Head Bumper Bolt
Head Dia.: 19mm
Shoulder Length: 3mm
GM
Box Qty. 25



220175
01135-00201
Bright Chrome Finish
Bumper Bolt
M6-1.0 x 12mm
Head: 14mm
Imports,
Nissan Truck '82 - UP
Box Qty. 10



220176
01135-00511
Black Chrome Finish
Bumper Bolt
M6-1.0 x 12mm
Head: 14mm
Imports
Nissan Truck '82 - UP
Box Qty. 10



236004
N621900, N800466
Phosphate
Free Spinning Washer Nut
Thread: M4-0.7
Washer O.D.: 12mm
Hex: 9mm
Height: 4.5mm
Box Qty. 50



236005
11502722, 11502702
Black Finish
Hex Flange Nut
Thread: M5-0.8
Flange Dia.: 11.8mm
Hex: 8mm
Height: 5mm
GM
Box Qty. 50



236006
11504614
Phosphate
Free Spinning Washer Nut
Thread: M5-0.8
Washer O.D.: 19mm
Hex: 10mm
Height: 7mm
Box Qty. 25



236010
11505329, 11503752, N90100001
Phosphate
Free Spinning Washer Nut
Thread: M6-1.0
Washer O.D.: 16mm
Hex: 10mm
Height: 7mm
GM, VW
Box Qty. 50



236012
11508275
Zinc
Free Spinning Washer Nut
Thread: M6-1.0
Washer O.D.: 19mm
Hex: 10mm
Height: 8mm
Box Qty. 25



236015
6100049
Phosphate
Free Spinning Washer Nut
Thread: M6-1.0
Washer O.D.: 20mm
Hex: 10mm
Height: 9mm
Box Qty. 50



236020
11503754, 11503756
Phosphate
Free Spinning Washer Nut
Thread: M6-1.0
Washer O.D.: 19mm
Hex: 11mm
Height: 9.5mm
Box Qty. 50



236060
11503695, 11506117, 11516780, 11500401, N621940-S424
Phosphate
Free Spinning Washer Nut
Thread: M8-1.25
Washer OD: 24mm
Hex: 13mm
GM, Ford
Box Qty. 50

AUTO BODY HARDWARE - SCREWS, BOLTS, NUTS

16 Autobody Hardware



236070
 11502609, 11501889,
 11507036, 11514518, 11514596
 Phosphate
 Hex Flange Nut
 Thread: M8-1.25
 Flange Dia.: 17mm
 Hex: 13mm
 Height: 8mm
 Box Qty. 50



236090
 11501850
 Grade 9
 Phosphate
 Hex Flange Nut
 Thread: M10-1.5
 Flange Dia.: 21mm
 Hex: 15mm
 Height: 10mm
 Box Qty. 25



236100
 N621942
 Grade 9
 Phosphate
 Free Spinning Washer Nut
 Thread: M10-1.5
 Washer O.D.: 24mm
 Hex: 15mm
 Height: 13mm
 Box Qty. 25



236116
 Zinc
 12mm-1.75 Flange Nut
 Hex: 18mm
 Flange: 26mm
 Box Qty. 10



236120
 11503745
 Grade 9
 Black
 Hex Flange Nut
 Thread: M6-1.0
 Flange Dia.: 14mm
 Hex: 10mm
 Box Qty. 50



236125
 Grade 9
 Black
 Free Spinning Washer Nut
 Thread: M8-1.25
 Washer O.D.: 19mm
 Hex: 13mm
 Box Qty. 25



240020
 Zinc
 Thread Cutting Nut
 Stud Size: 1/8"
 Hex: 5/16"
 Washer Dia.: 7/16"
 Box Qty. 100



240030
 Zinc
 Thread Cutting Nut
 Stud Size: 5/32"
 Hex: 3/8"
 Washer Dia.: 9/16"
 Box Qty. 100



240040
 Zinc
 Thread Cutting Nut
 Stud Size: 3/16"
 Hex: 3/8"
 Washer Dia.: 1/2"
 Box Qty. 100



240050
 Zinc
 Thread Cutting Nut
 Stud Size: 1/4"
 Hex: 7/16"
 Washer Dia.: 11/16"
 Box Qty. 100



240070
 Zinc
 Thread Cutting Nut
 Stud Size: 5/16"
 Washer Dia.: 3/4"
 Hex: 1/2"
 Box Qty. 100



240090
 Zinc Plated
 Washer Lock Nut
 Thread: 10-24
 Hex Width: 3/8"
 O.D.: 1/2"
 Box Qty. 100



240100
 Zinc Plated
 Washer Lock Nut
 Thread: 10-24
 Hex Width: 3/8"
 O.D.: 3/4"
 Box Qty. 50



245020
 Plated
 M3.2 Stud x 8mm Hex
 Self Threading PAL Nut
 w/14mm Integral Washer
 Box Qty. 100

















245040
 11502549
 Plated
 M4 Stud x 9mm Hex
 Self Threading PAL Nut
 w/15mm Integral Washer
 GM
 Box Qty. 100

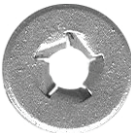

245080
 11501937
 M5 Stud x 10mm Hex
 Self Threading PAL Nut
 w/15mm Integral Washer
 GM '77 - UP
 Box Qty. 100

AUTO BODY HARDWARE - NUTS

<p>245085 <i>W706675-S439</i> Zinc Finish Self Threaded Emblem Nut with Locking Teeth Stud Size: 5mm Flange O.D.: 15mm Hex: 10mm Height: 5.5mm <i>Ford Crown Victoria, E-150, E-250, E-350, E-450, Edge, Escape, Explorer, F-150, F-250, F-350, F-450, F-550, Flex, Mustang, Ranger and Lincoln Mark LT, MKC, MKS, MKX, Navigator, Mariner & Sable 2008 - UP</i> Box Qty. 50</p> 	 <p>245099 Zinc Plated M6.3 Stud x 11mm Hex Self Threading PAL Nut w/15mm Integral Washer Box Qty. 100</p>	 <p>245100 <i>11501836</i> M6.3 Stud x 11mm Hex Self Threading PAL Nut w/18mm Integral Washer <i>GM '77 - UP</i> Box Qty. 100</p>	 <p>250010 Black Pushnut For Threaded Fasteners Bolt Dia.: 1/4" O.D.: 1/2" <i>General Purpose</i> Box Qty. 100</p>
 <p>250020 Zinc Pushnut For Threaded Fasteners Bolt Dia.: 5/16" O.D.: 5/8" <i>General Purpose</i> Box Qty. 100</p>	 <p>250030 Black Pushnut For Threaded Fasteners Bolt Dia.: 3/8" O.D.: 25/32" <i>General Purpose</i> Box Qty. 100</p>	 <p>250040 Black Pushnut For Threaded Fasteners Bolt Dia.: 7/16" O.D.: 27/32" <i>General Purpose</i> Box Qty. 100</p>	 <p>250050 Black Pushnut For Threaded Fasteners Bolt Dia.: 1/2" O.D.: 15/16" <i>General Purpose</i> Box Qty. 100</p>
 <p>255030 <i>11504119</i> Black Pushnut For Threaded Fasteners Bumper Rub Strip Stud: 14mm O.D.: 25mm <i>GM '81 - UP</i> Box Qty. 50</p>	 <p>255040 <i>11502794</i> Zinc Pushnut For Non-Threaded Fasteners Stud: 3.2mm O.D.: 9.5mm <i>GM '81 - UP</i> Box Qty. 10</p>	 <p>255050 <i>11501937</i> Zinc Pushnut For Non-Threaded Fasteners Stud: 4.0mm O.D.: 11mm <i>GM '77 - UP</i> Box Qty. 100</p>	 <p>255060 <i>11501927</i> Zinc Finish Pushnut For Non-Threaded Fasteners Stud: 3/16" O.D.: 7/16" <i>GM '78 - UP</i> Box Qty. 100</p>
 <p>255065 <i>11503736</i> Dachromet Pushnut For Threaded Fasteners Stud: M6 O.D.: 13mm <i>GM</i> Box Qty. 100</p>	 <p>255066 <i>6501178, 6501192, N801192S36, 11503736, 11609738, 14093869</i> Dichromate Finish Pushnut For Threaded Fasteners Fascia Attachments Stud: M6 O.D.: 17mm <i>Chrysler, Ford, GM</i> Box Qty. 100</p>	 <p>255070 <i>11503698</i> Phosphate Pushnut Stud: M6.3 O.D.: 13mm <i>GM '78 - UP</i> Box Qty. 100</p>	 <p>255080 <i>11502504, 11502853</i> Dachromet Pushnut For Threaded Fasteners Stud: M8 O.D.: 16mm <i>GM</i> Box Qty. 100</p>

AUTO BODY HARDWARE - NUTS

255095 Box 250

255090

10009923
6501825
Dachromet
Pushnut For
Threaded Fasteners
Stud: M8
O.D.: 25mm
GM, Chrysler
Box Qty. 50



255120

11501849
Dachromet
Pushnut For
Threaded Fasteners
Stud: M10
O.D.: 24mm
Box Qty. 100



255130

11502737
Phosphate
Pushnut For
Threaded Fasteners
Stud: M12
O.D.: 21mm
GM '77
Box Qty. 100



266024

6506104AA
Zinc & Yellow
Roof Rack Nutsert
w/ Sealer Under Head
Thread: M6 - 1.0
Grip: .7mm - 3.2mm
Head Dia.: 17mm
Hex Size: 9.5mm (3/8")
Jeep '99 - 2001
Box Qty. 10



266025

6503812, 6504601
Zinc & Yellow
Wheel Opening
Moulding Nutsert
Thread: M5 - .8
Head Dia.: 10mm
Hex Size: 10mm
Overall Length: 12mm
Jeep '99 - UP
Box Qty. 15



266030

Zinc & Yellow
Specialty Insert
Thread: M5- .8
Grip: .5mm - 3.3mm
Head Dia.: 10mm
Hex Size: 7mm
GM
Box Qty. 15



266032

N803763-S100,
15685099
Zinc & Yellow
M6-1.0
Grip: .65mm - 2.0mm
Head Dia.: 12mm
Hex Size: 8mm
Specialty Insert w/ Sealer
Roof Rack, Tailgate &
General Purpose
Ford Explorer 1991 - UP
GMAPV Vans
Box Qty. 15



266033

10281487
Zinc & Yellow
Specialty Insert
Thread: M6-1.0
Grip: .7mm - 4.2mm
Head Dia.: 13mm
Hex Size: 9.5mm (3/8")
Front Fender
Buick, Cadillac, Corvette, L.D.
Truck, Olds Aurora & Pontiac
'97 - UP
Box Qty. 15



266034

N811257-S100
M5-.8
Specialty
Insert With Sealer
Grip: .5mm-2.5mm,
Head Dia: 10mm,
Hex Size: 7mm
General Purpose
Ford Escape, Excursion, Ex-
pedition, Explorer, Navigator &
Mountaineer 2001 - UP
Box Qty. 15



266035

W708513-S437
Zinc
M8-1.25
Specialty Insert
Grip: .7mm - 3.8mm
Hd. Dia.: 22mm
Hex Size: 12.7mm
Frame Area
Ford Trucks 2004 - UP
Box Qty. 15



270003

6506955AA
Zinc Finish
Door & Fender Panel Nut
Screw Size: M6-1.0
Head Size: 14.5mm x 21mm
Stem Length: 10mm
Fits into 15mm Square Hole
Chrysler Pacifica 2017 - UP, Town & Country, Dodge Caliber, Caravan &
Grand Caravan 2005 - 2012; Dodge Durango & Journey and Jeep Com-
pass, Grand Cherokee, Patriot & Wrangler 2007 - 2017
Dodge Ram 2008 - 2009
Box Qty. 10



270004

11570015
Zinc Organic
Front/Rear Bumper &
Headlamp Assembly
Specialty Push-In Nut
Thread Size: M6-1.0
Overall Height: 11.6mm
Buick Cascada, Envision, LaCrosse
& Regal, Cadillac ATS, CT6, CTS,
ELR, Escalade & XTS, Chevrolet
Camero, Colorado, Cruze, Malibu,
Silverado, Sonic, Suburban, Tahoe &
Volt and GMC Arcadia 2011 - UP
Box Qty. 10



270005

Phosphate
"J" Nut
Screw Size: #8
P.R.: .090" - .110"
Center Hole To Edge: 9/32"
Box Qty. 50













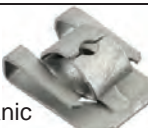

270009

1570654, 6509432AA, W716529-S900
Blue Finish
Radiator Grille Nut
Screw Size: #8 (4.20mm)
Head Size: 6mm x 16mm
Panel Range: .70 - 2.30mm
Hole Size: 8.7mm
Buick Allure, Enclave, Encore, LaCrosse, Lesabre, Lucerne, Rainer,
Regal & Verano and Cadillac ATS, CTS, Deville, DTS, ELR, Escalade,
SRX & STS 2000 - UP; Chrysler 200, 300, PT Cruiser, Sebring, Town
& Country and Dodge Avenger, Caliber, Charger, Dart, Grand Caravan,
Ram 2500 & Ram 3500 2006 - 2015; Ford 250, 350, 450 & 550 Super
Duty Trucks 2013 - 2015
Box Qty. 25



AUTO BODY HARDWARE - NUTS

 <p>270010 Phosphate "U" Nut Screw Size: #8 P.R.: .025" - .040" Ctr to Edge: 9/32" Box Qty. 50</p>	 <p>270011 11547582 Zinc Organic Air Duct & Rear Bumper Bracket Nut Thread Size: M6-1.0 Head Size: 8mm x 18mm Overall Height: 11mm <i>Cadillac CT6, Chevrolet Silverado and GMC Acadia & Sierra 2016 - UP</i> Box Qty. 25</p>	 <p>270012 11546868 Zinc Organic Door Panel, Bumper, Lamps & Deck Lid Nut with Silicone Pad Screw Size: M4.2-1.41 (#8) Head Size: 12mm x 16mm Stem Length: 6.5mm <i>Buick Allure, Enclave, Encore, Envision, LaCrosse, Rainier, & Regal, Cadillac ATS, CT6, CTS, ELR, Escalade, SRX, XT5 & XTS, Chevrolet Bolt EV, Camaro, Cobalt, Colorado, Cruze, Equinox, HHR, Impala, Malibu, Orlando, Silverado, Sonic, Spark, Spark EV, SS, Suburban, Tahoe, Trailblazer, Tra- verse, Trax & Volt, GMC Acadia, Canyon, Envoy, Sierra, Terrain & Yukon 2008 - UP; Hummer H2, H3 & H3T 2003-2010; Pontiac G5 & Saturn Outlook 2007-2010</i> Box Qty. 15</p>	
 <p>270020 N802538-S100 Green Phosphate "U" Nut Screw Size: #8 P.R.: 1/16" - 5/32" Center Hole To Edge: 5/16" Width: 17/32" Length: 51/64" <i>Ford</i> Box Qty. 50</p>	 <p>270021 W708991-S439 Silver Zinc Organic Metric U-Nut Screw Size: M4.2-1.41 (#8) PR: 2mm - 3.4mm (.079" - .137") Center of Hole to Edge: 9.5mm (3/8") Fender Apron & Mud Flap <i>Ford Expedition, F150/250/350/ 450/550, Transit and Lincoln Mark LT & Navigator 2005 - UP</i> Box Qty. 25</p>	 <p>270025 9424837, 9431530, 15650655 381818-S2, 15650655 Phosphate "U" Nut Screw Size: #8 P.R.: .025" - .150" Center Hole To Edge: 3/8" <i>GM, Ford</i> Box Qty. 50</p>	 <p>270030 9440178, 11504531, 9433155, 381863-S2 Phosphate "U" Nut Screw Size: #8 P.R.: .025" - .150" Center Hole To Edge: 5/8" <i>GM, Ford</i> Box Qty. 50</p>
 <p>270040 9431532 "U" Nut Screw Size: #14 (6.3mm) P.R.: .025" - .150" Center Of Hole To Edge: 3/8" <i>Chevrolet, Pontiac '71 - '75</i> Box Qty. 50</p>	 <p>270060 Black Finish "U" Nut Screw Size: #10 (4.8mm) P.R.: .025" - .150" Center Hole To Edge: 11/32" Box Qty. 50</p>	 <p>270070 Black Finish "U" Nut Screw Size: #10 (4.8mm) P.R.: 0.25" - .150" Center Hole To Edge: 19/32" Box Qty. 50</p>	 <p>270071 Zinc & Yellow "U" Type Nut Screw Size: 3.5mm (#6) PR: .5mm - 1.5mm Center Hole To Edge: 8mm <i>BMW, Mercedes</i> Box Qty. 50</p>
 <p>270072 123-994-08-45 Zinc & Yellow "U" Type Nut Screw Size: 4.2mm (#8) PR: .5mm - 2.5mm Center Hole To Edge: 14mm <i>Mercedes</i> Box Qty. 25</p>	 <p>270073 "U" Type Nut Screw Size: #8 (4.2mm) P.R.: .5mm - 2.5mm Width: 11mm Length: 16.5mm Center Hole to Edge: 8mm <i>Honda</i> Box Qty. 50</p>	 <p>270075 000-994-04-45 Plated "U" Type Nut Screw Size: 4.2mm (#8) Panel Range: .5mm-1.7mm Center Hole To Edge: 8mm <i>Mercedes Benz</i> Box Qty. 50</p>	 <p>270077 0712-9-925-737, 000-994-06-45 Plated "U" Type Nut Screw Size: 4.8mm (#10) Panel Range: .5mm -1.7mm Center Hole to Edge: 7mm <i>BMW, Mercedes Benz</i> Box Qty. 50</p>

AUTO BODY HARDWARE - NUTS



270078
 000-994-09-14,
 946-418, 20-72-175
 Plated "U" Type Nut
 Screw Size: 6.5mm (#14)
 Panel Range: .7mm-1.5mm
 Center Hole to Edge: 13mm
Mercedes, Opel, Volvo
 Box Qty. 50



270080
 "U" Type Nut
 Screw Size: #1/4 (6.3mm)
 P.R.: .025" - .150"
 Center Hole To Edge: 5/8"
Chevrolet, GMC Trucks '71 - '75
General Purpose
 Box Qty. 50



270081
 Zinc
 "U" Type Nut
 Screw Size: 4.8mm (#10)
 Panel Range: .9mm-2.0mm
 Center Hole To Edge: 8mm
Mercedes Benz, BMW, Subaru,
SAAB, VW & Opel
 Box Qty. 25



270082
 000-994-14-45,
 0711-9-916-945
 Plated
 "U" Type Nut
 Screw Size: 4.8mm (#10)
 Panel Range: .8mm-1.7mm
 Center Hole To Edge: 11mm
BMW, Mercedes Benz
 Box Qty. 50



270085
 000-994-25-45,
 0712-9-925-708
 "U" Type Nut
 Screw Size: 4.2mm (#8)
 Panel Range: 3mm-4mm
 Center of Hole to Edge: 7mm
BMW, Mercedes Benz
 Box Qty. 50



270089
 0712-9-925-720
 Plated
 "U" Type Nut
 Screw Size: 5.6mm
 Panel Range: 1.2mm-2.0mm
 Center Hole To Edge: 10mm
BMW
 Box Qty. 50



270170
 Phosphate
 "U" Nut
 Screw Size: #10-24
 Panel Range: .045" - .062"
 Center Hole To Edge: 17/32"
 Box Qty. 50



270195
 10005510
 Bumper Impact Strip
 Retainer
 Fits 3/16" Rod
GM '78 - UP
 Box Qty. 50



270230
 14083996
 "U" Type Nut
 Screw Size: #8-18
 Adjustable Range
 Panel Range: 1/16" - 1/8"
GM, General Purpose
 Box Qty. 50



275010
 Phosphate
 Flat Push Nuts
 Stud Size: 1/16"
 7/32" x 3/8"
General Purpose
 Box Qty. 100



275030
 Phosphate
 Flat Push Nut
 Stud Size: 3/32"
 1/4" x 7/16"
General Purpose
 Box Qty. 100



275040
 Phosphate
 Flat Push Nuts
 Stud Size: 1/8"
 5/16" x 9/16"
General Purpose
 Box Qty. 100



275060
 Phosphate
 Flat Push Nuts
 Stud Size: 5/32"
 3/8" x 9/16"
General Purpose
 Box Qty. 100



275070
 Phosphate
 Flat Push Nuts
 Stud Size: 3/16"
 3/8" x 5/8"
General Purpose
 Box Qty. 100



275180
 Phosphate
 Flat Push Nuts
 Stud Size: #10-24
 7/16" x 3/4"
General Purpose
 Box Qty. 100



295140
 375890-S100
 Phosphate
 Barrel Nut
 Stud Size: 1/8"
 Panel Range: .040" - .045"
 Fits Into 3/16" Hole
Ford
 Box Qty. 100

AUTO BODY HARDWARE - NUTS



295150
Phosphate
Barrel Nut
Stud Size: 1/8"
P.R.: .030" - .036"
Fits Into 5/32" Hole
Box Qty. 100



295160
375480-S100, 3783794
Phosphate
Barrel Nut
Stud Size: 1/8"
Panel Range: .036" - .046"
Fits Into 1/4" Hole
Box Qty. 100



295200
Phosphate
Barrel Nut
Stud Size: 5/32"
P.R.: .062" - .068"
Fits Into 7/32"
General Purpose
Box Qty. 50



295220
354341-S
Phosphate
Barrel Nut
Stud Size: 1/4"
P.R.: .034" - .040"
Fits Into 9/32" Hole
Ford, General Purpose
Box Qty. 50



300070
45263-S2, 1494252,
1480627
Phosphate
Extruded "U" Nut
Thread Size: 1/4"-20
Panel Range: .025" - .150"
Cntr Hole to Edge: 17/32"
Ford, GM
Box Qty. 25



300080
45267, 1494257
Phosphate
Extruded "U" Nut
Thread Size: 1/4"-20
Panel Range: .025" - .150"
Cntr Hole to Edge 25/32"
Ford, GM
Box Qty. 50



300120
1480909
Phosphate
Thread Size: 5/16"-18
Panel Range: .060" - .090"
Cntr Hole to Edge: 9/16"
GM
Box Qty. 50

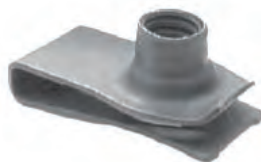

300130
379831-S, 1494258
Phosphate
Extruded "U" Nut
Thread Size: 5/16"-18
P.R.: .010" - .170"
Cntr Hole to Edge: 27/32"
GM, Ford
Box Qty. 25



300135
1494254,
12337873, 45265-S2
Phosphate
Screw Size: 3/8"-16
Panel Range: .050" - .200"
Cntr Hole To Edge: 3/4"
GM, Ford
Box Qty. 25



300136
45269, 45269-S
Phosphate
Screw Size: 3/8"-16
Panel Range: .050" - .200"
Cntr Hole To Edge: 1-1/8"
Ford
Box Qty. 25



302000
W713617-S439
Zinc
Push-In Nut w/Sealer
Screw Size: M4.2-1.41
Width: 11.7mm
Length: 16.5mm
Overall Height: 8mm
Ford Escape, Explorer, Flex, Fusion,
Mustang, Ranger & Taurus and
Lincoln MKS, MKT, MKZ, Milan &
Zephyr 2009 - UP
Box Qty. 15



302002
6105242-AA
Magni-554 Silver
Extruded "U" Nut
Thread Size: M6 -1.0
P.R.: 0.5mm - 4.00mm
Center Hole To Edge: 13mm
Quarter Panel & Fender
Chrysler 200 & Pacifica, Dodge
Challenger, Charger, Dart & Ram and
Jeep Cherokee, Grand Cherokee &
Renegade 2009 - UP
Box Qty. 25



302003
6509799-AA
Zinc Organic
Metric Extruded U-Nut
Screw Size: M4.8-1.6 (#10)
Panel Range: .61mm - 3.8mm
(.024" - .149")
Center of Hole to Edge:
11.5mm (.452")
Chrysler 200 & Pacifica and Dodge
Dart & Ram and Jeep Cherokee
2010 - UP
Box Qty. 25



302004
11548579
Zinc Organic
Metric Extruded U-Nut
Screw Size: M4.2-1.41 (#8)
Panel Range: 2.0mm - 3.0mm
(.078" - .118")
Center of Hole to Edge:
9.5mm (3/8")
Buick Cascada, Encore, Envision,
LaCrosse, Cadillac ATS, CTS, XTS,
Chevrolet Camaro, Cruze, Equinox,
Malibu, Sonic, Traverse, Trax & GMC
Terrain 2017 - UP
Box Qty. 25











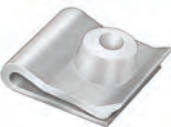

302005
11548580
Zinc Organic
Metric Extruded U-Nut
Screw Size: M4.2-1.41 (#8)
Panel Range: .65mm - 3.8mm
(.026" - .149")
Center of Hole to Edge: 15mm
(19/32")
Cadillac XTS and Conv/Camaro,
Chevrolet Cruze, Equinox, &
Traverse 2017 - UP
Box Qty. 25

AUTO BODY HARDWARE - NUTS

 <p>302006 W716567-S439 Zinc Organic Metric U-Nut Screw Size: M4.2-1.41 Panel Range: 1.8mm-3.50mm (.071" - .137") Center of Hole to Edge: 9.5mm (3/8") Ford Escape & Lincoln MKC 2013 - UP Box Qty. 25</p>	 <p>302007 11515638 Zinc Metric Extruded U-Nut W/ Locking Thread Screw Size: M4.2-1.41 PR: .65mm - 3.8mm (1/32" - 5/32") Center of Hole to Edge: 15mm (19/32") Bumper Cover GM Box Qty. 25</p>	 <p>302010 11500654, 11588415, N623330-S2 Zinc Organic Extruded "U" Nut Thread Size: M4-0.7 P.R.: .60mm - 3.8mm Cntr Hole To Edge: 9.5mm GM, Ford Box Qty. 50</p>	 <p>302011 11516397 Zinc Organic U-Nut Screw: M4.2 - 1.41 (#8) P.R.: .5mm - 2.0mm (1/32" - 5/64") Center of Hole To Edge: 10mm (25/64") GM 1997 - UP Box Qty. 25</p>
 <p>302015 15707256 Zinc Organic Front Fender Extension & License Plate Bracket Retainer Nut Screw Size: M6 - 1.0 GM Express & Savanna '96 - UP Box Qty. 10</p>	 <p>302020 11500655 Black Phosphate Extruded "U" Nut Thread Size: M4-0.7 P.R.: .80mm - 4mm Cntr Hole To Edge: 13.5mm GM, Ford Box Qty. 50</p>	 <p>302030 11500657 Black Phosphate Extruded "U" Nut Thread Size: M5-0.8 P.R.: .80mm - 4mm Cntr. Hole To Edge: 15.8mm GM, Ford Box Qty. 50</p>	 <p>302035 N623332, N623332-S2, N623332-S53, N623332-S100, 11503957, 11503716, 1016937 Black Extruded "U" Nut Thread Size: M6-1.0 P.R.: .80mm - 4.0mm Cntr. Hole To Edge: 13.5mm GM, Ford Box Qty. 50</p>
 <p>302036 W520822-S439, 6510185-AA, 6101956, 6503694 Zinc Organic Metric Extruded U-Nut Screw Size: M6-1.0 Panel Range: .8mm - 4.0mm (.030" - .160") Center of Hole to Edge: 13.5mm (17/32") Chrysler 300, Pacifica, Prowler, PT Cruiser, Sebring & Town & Country and Dodge Caravan, Challenger, Charger, Durango, Magnum, Nitro, Ram, Stratus & Viper and Jeep Commander, Grand Cherokee & Wrangler 1996 - UP Box Qty. 25</p>	 <p>302037 11611321 Zinc Organic Metric Extruded U-Nut Screw Size: M6-1.0 Panel Range: .70mm - 2.0mm Center of Hole to Edge: 14mm Buick Envision, LaCrosse, Cadillac XTS, Chevrolet Bolt EV, Colorado, Cruze, Equinox, Impala, Traverse, Volt & GMC Acadia Canyon & Terrain 2017 - UP Box Qty. 10</p>	 <p>302038 W712324-S439 Zinc Organic Bumper Deflector U-Nut Screw Size: M6-1.0 Panel Range: 0.7mm-2.0mm Center Hole to Edge: 12mm Ford Ranger 2019 - UP Box Qty. 10</p>	 <p>302040 11503715, 11508241, 11609385 Black Extruded "U" Nut Thread Size: M6-1.0 P.R.: .80mm - 4.0mm Cntr. Hole To Edge: 19.5mm GM Express & Savana Vans 2001- UP & Various other GM Box Qty. 50</p>
 <p>302044 53879-14010-A, 53879-14020, 53879-22030, 94841226, LA01-56-135 Black Nylon Inner Fender "U" Nut Screw Size: #10 (4.8mm) Center Hole To Edge: 11mm Toyota, GM, Mazda Box Qty. 10</p>	 <p>302045 53879-22010 Black Nylon Fender "U" Nut Screw Size: #14 (1/4") Center Hole To Edge: 15mm Toyota Box Qty. 10</p>	 <p>302047 63848-D4000 Black Nylon Fender/Wheel Housing U-Nut Screw Size: M5.5 (#12) Width: 31mm Length: 22mm Panel Range: Up to 2mm Center of Hole to Edge: 9mm Nissan Sentra & Infinity '89 - UP Box Qty. 15</p>	<p>302055 Box 25</p>

AUTO BODY HARDWARE - GENERAL

 <p>302048 63848-35F00 (63848-35F00) Black Nylon Fender Clip U-Nut Screw Size: M4.8 (#10) Width: 20mm Length: 32mm Panel Range: Up to 2mm Center of Hole to Edge: 8mm <i>Nissan Maxima & 240SX 1994-UP</i> Box Qty. 15</p>	 <p>302049 76882-0M000 White Nylon Nylon "U" Nut M4.8 (#10) Screw Size Panel Range: Up To 1.5mm Center Hole To Edge: 8mm <i>Nissan & Infiniti 1995 - UP</i> Box Qty. 15</p>	 <p>302050 90179-05060 Black Nylon "U" Nut Screw Size: #10 18mm Wide, 27mm Long Panel Range: Up To 3mm Cntr Hole to Edge: 14mm <i>Lexus '90 - UP</i> Box Qty. 10</p>	 <p>302051 97086AA000 Black Nylon Splash Guard Nylon "U" Nut With Metal Insert Nut Thread: M5-.80 (Internal Steel Nut) Panel Range: Up To 3mm Cntr Hole to Edge: 10mm <i>Subaru 2008 - UP</i> Box Qty. 10</p>
 <p>302057 51-12-7-070-202 Zinc Organic Metric Extruded U-Nut Screw Size: M6-1.0 Panel Range: .5mm Max. Center Hole to Edge: 11.5mm <i>BMW 321i, 328d, 328i, 328i GT, 330e, 330i, 330i GT, 335d, 335i, 335 GT, 335is, 340i, 340i GT, 428i, 428i Gran Coupe, 430i, 430i Gran Coupe, 435i, 435i Gran Coupe, 440i, 440i Gran Coupe, 528i, 535i, 550i, 645Ci, 650i, 740Li, 750Li, 750i, 760Li, M3, M4, M6, X3 & X5 2006 - UP</i> Box Qty. 25</p>	 <p>302058 W714171-S439 Zinc Organic Door & Under Cover Nut with Silicon Rubber Sealer Screw Size: M4.2-1.41 Head Size: 12mm x 16mm Stem Length: 6.5mm <i>Ford Edge, Expedition & Focus and Lincoln MKC, MKX & Navigator 2015 - UP</i> <i>Escape 2013 - UP</i> Box Qty. 25</p>	 <p>302059 W705958-S439 Zinc Organic Metric Extruded U-Nut with Locking Thread Screw Size: M6-1.0 Panel Range: .5mm - 2.3mm (.019" - .090") Center of Hole to Edge: 14.5mm (9/16") <i>Ford F-150 & F350 2018 - UP</i> Box Qty. 10</p>	 <p>302060 W715197-S439 Zinc Organic Front & Rear Bumper Specialty Nut with Pastiol Pad Screw Size: M4.8-1.6 Head Size: 14mm x 23mm Stem Length: 7mm <i>Ford Edge, Escape, Expedition, Explorer, Fusion, Mustang & Transit and Lincoln Continental, MKC, MKS, MKX, MKZ & Navigator 2011 - UP</i> Box Qty. 10</p>
 <p>302080 11508923, 11500660, 11502617, N623333-S2, N623333-S100, 6100042, 6101283 Black Phosphate Extruded "U" Nut Thread Size: M8-1.25 P.R.: .80mm - 4.0mm Cntr. Hole To Edge: 14.5mm <i>GM, Ford, Chrysler</i> Box Qty. 50</p>	 <p>302081 N800296-S439, W520823-S439 Zinc Metric Extruded U-Nut W/ Locking Thread Screw Size: M8-1.25 PR: .80mm - 4.00mm (.030" - .160") Center of Hole to Edge: 14.5mm (9/16") <i>Ford Expedition, Explorer, Explorer Sport, F-150/250/350/450/550, Freestar, Mustang & Taurus and Lincoln MKT & Navigator and Mercury Monterey & Mountaineer 2002 - UP</i> Box Qty. 15</p>		
 <p>302082 W520813-S439, 11516150 Zinc Metric Extruded U-Nut Screw Size: M8-1.25 PR: .80mm - 4.00mm (.030" - .160") Center of Hole to Edge: 21mm (13/16") Fender Liner <i>Ford F-150/250/350 & Mustang 2015 - UP</i> <i>Chevrolet Colorado &, Express Van and GMC Canyon & Savana Van 2015 - UP</i> Box Qty. 15</p>	 <p>302090 11500661, 11503317, 11516150 N623343-S2, N623343-S100 Black Phosphate Extruded "U" Nut Thread Size: M8-1.25 P.R.: .80mm - 4.5mm Cntr. Hole To Edge: 20mm <i>GM, Ford</i> Box Qty. 50</p>	 <p>302100 11500662, 22531616 Black Phosphate Extruded "U" Nut Thread Size: M10-1.5 P.R.: 1.0mm - 6.0mm Cntr. Hole To Edge: 19mm <i>GM</i> Box Qty. 25</p>	

AUTOBODY HARDWARE - GENERAL



303120
 367292, 6031438
 Zinc w/ Sealer
 Mirror Mounting Retainer
 Thread: 1/4-20
 Stem Length: 5/8"
 Grip Range: 3/16" - 3/8"
 GM, Chrysler
 Box Qty. 25



303125
 14007940
 Zinc w/ Raintite
 Roof Rack Mounting Nut
 Thread: M6-1.0
 GM "X" & "Y" Bodies
 Box Qty. 10



303310
 Zinc Plated
 DIN 966
 6mm - 1.00 x 25mm
 Phillips Oval Head
 Machine Screw
 For Luggage Racks & Mirrors
 Box Qty. 25



303325
 528846, 342271,
 4003120, 2094869,
 6033705
 Neoprene Captive Brass
 Well Nut
 Screw Size: 1/4" - 20
 Hole Size: 1/2"
 Length: 19/32"
 Grip Range: .015" - .111"
 Luggage Rack Mount
 GM, AMC, Chrysler
 Box Qty. 25



303326
 20130258, 14002811
 Neoprene Captive Brass
 Well Nut
 Screw Size: M6 - 1.0
 Hole Size: 12.70mm
 Length: 15mm
 Flange Dia: 20mm
 Grip Range: .015" - .094"
 Roof Rack & General Purpose
 GM
 Box Qty. 25

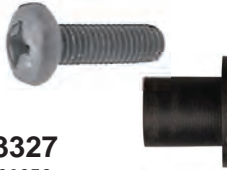

303327
 20130258
 Roof Rack Well Nut & Screw
 Thread: M6 x 1.0
 w/ #10 Stainless Screw
 Hole Size: 1/2"
 GM & General Purpose
 Box Qty. 10

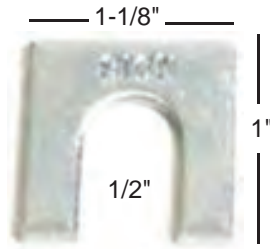

PRODUCT NUMBER	THICKNESS
335050	1/64"
335170	1/16"
335280	1/8"
Box Qty. 50	

C-TYPE SHIMS

These C-Type body shims work well in areas that require the shim to remain virtually unseen.

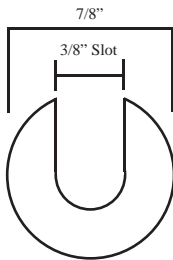

Prod. No.	Size*	Pkg Qty
335285	1/16"	50
335286	1/16"	250
335287	1/16"	500

* Thickness

Prod. No.	Size*	Pkg Qty
335290	1/8"	50
335291	1/8"	250
335292	1/8"	500

* Thickness

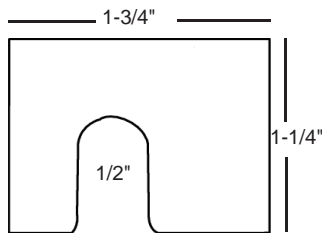

PRODUCT NUMBER	THICKNESS
335010	1/8"
Box Qty. 50	

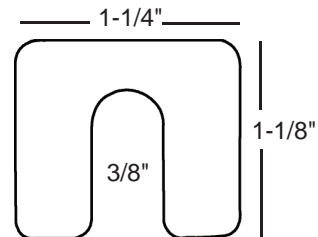

PRODUCT NUMBER	THICKNESS
335150	1/16"
335270	1/8"
Box Qty. 100	

SHIMS

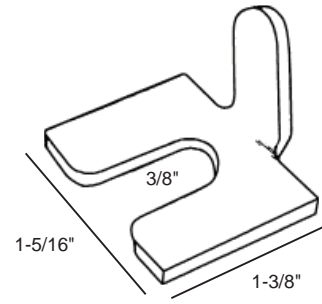
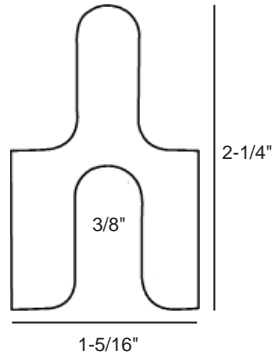
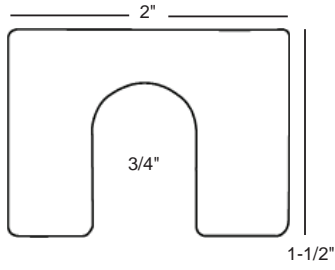

PRODUCT NUMBER	THICKNESS
335260	1/8"
Box Qty. 50	

PRODUCT NUMBER	THICKNESS
335025	1/16"
335030	1/8"
Box Qty. 50	

PRODUCT NUMBER	THICKNESS
335250	1/16"
Box Qty. 50	

T-CLIP MOULDING FASTENERS



235080

Zinc Plated
10-24 Spin Lock Nut
Flanged With Serrations
used with T-Clips
General Purpose
Box Qty. 100



440020

358560, 1560058,
6010029, 568792,
574355, 1165051
Universal Type "T" Clip
Screw Size: 10-24 x 3/4"
Plate Length: 1"
Plate Width: 1/2"
Ford, GM, Chrysler
Box Qty. 25



440040

6000705, 6013029,
3722635
Universal Type "T" Clip
Screw Size: 10-24 x 3/4"
Plate Length: 1-11/32"
Plate Width: 1/2"
Chrysler, GM & General Purpose
Box Qty. 25



440050

1624705, 6010093,
4689929, 4778814
Universal Type "T" Clip
Screw Size: 10-24 x 3/4"
Plate Length: 23/32"
Plate Width: 11/32"
GM, Ford & Chrysler
Box Qty. 25



440060

3744999, 1758099,
6000720, 6010046
Universal Type "T" Clip
Screw Size: 10-24 x 3/4"
Plate Length: 1 - 25/32"
Plate Width: 9/16"
GM, Chrysler, General Purpose
Box Qty. 25



440070

575411, 4723818
Universal Type "T" Clip
Screw Size: 10-24 x 5/8"
Plate Length: 1 - 5/8"
Plate Width: 9/16"
GM
Box Qty. 25



440120

4853108
Nylon
Front & Rear Door & Quarter
Panel Moulding Fastener
For 3/4" to 1" Moulding
GM
Box Qty. 25



440130

4883164
Nylon
Rear Fender
Lower Moulding Fastener
For 7/8" to 1 - 1/4" Mouldings
GM, General Purpose
Box Qty. 25



440140

Nylon
Universal Moulding Fastener
1-1/4" to 1-3/4" Moulding
All Cars, All Models
Box Qty. 25



440150

Nylon
Moulding Fastener
Fits 1/2" - 5/8" Mouldings
All Models
Box Qty. 50



440170

1244839, 3944866
Push In Type
Moulding Fastener, "T" Clip
GM, General Purpose
Box Qty. 25



440175

Zinc
Universal Moulding Clip
Screw Size: #10-24 x 3/4"
Plate Size: 2-1/2" x 3/4"
Break Off Plate At 1/16"
Perforations To Fit Moulding
Box Qty. 25

GM HEADLINER CLIPS

17 T-Clips / Headliner / Misc. Trim

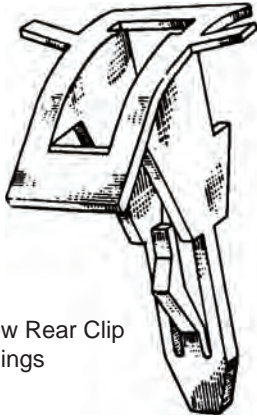

445530
 20009204
 Quarter Window Rear Clip
 Garnish Mouldings
 GM '77 - UP
 Box Qty. 10



445666
 1708675
 Headlining
 Moulding Clip
 GM '76
 Box Qty. 25



445789
 20462090
 Nylon
 Garnish Moulding Clip
 Buick Century & Regal, Chevrolet Camaro,
 Celebrity, Monte Carlo & Malibu, Oldsmobile
 Cutlass & Ciera, Pontiac Firebird Grand Prix &
 6000 1978 - UP
 Box Qty. 25



445920
 20058837
 Nylon
 Windshield Upper Garnish Clip
 GMA & G Models 1978 - 1988
 Box Qty. 10



MISC. TRIM CLIPS

17 T-Clip / Headliner / Misc. Trim



303350
Zinc Plated Steel
10-24 T-Nuts
(3-Prong)
3/16" Prong Depth
Box Qty. 50



445030
Sandstone
Push-Type Trim Fastener
Head OD: 17/32"
Prong Length: 1-17/64"
Hole Size: 9/32"
Width of Diamond: 7/16"
General Purpose
All Cars, All Models
Box Qty. 50



445140
Hog Rings Medium Size
Wire Dia: .080"
To attach Seat Covers to
Cushions and Seat Bottoms
Also Cushion Spring Clip
Box Qty. 500



445200
Cloth Lined
Cushion Spring Clips
Length: 7/8"
For 1/4" or two 8ga. wires
To fasten springs to each
other or border wire.
Box Qty. 100



445270
4495047
Arm Support (Front Seat)
Hinge Pin Retainer:
GM
Box Qty. 100



445280
Snap On Trim Fastener
Panel Range .060 - .090
General Purpose
All Cars, All Models
Box Qty. 100



445250
4000155
Nickel
Front Seat Inner
Bracket Nut
Outer Dia: 11/16"
Stud Size: 3/8"
General Purpose
Box Qty. 100

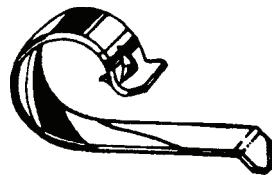

445330
Zinc Plated
Seat Cover Clip
For Use with Seat Covers
All Late Model Cars
Box Qty. 100



445335
Zinc Plated
Seat Cover Clip
GM Cars '78 - '80
Box Qty. 100

445938 Box 100

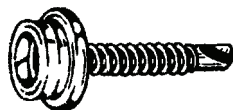

445937
#8 X 1" Self Drilling Stud
Nickel on Brass Stud
Black Zinc Plated Steel Screw
Standard Size Stud
Box Qty. 50















445942
Stud
Nickel on Brass
Box Qty 100

BLANK













BMW CLIPS & FASTENERS

 <p>200600 07119-916-946 Zinc CR3 Finish Indented Hex Head Washer Screw M4.8-1.61 x 16mm Washer Dia.: 15mm Hex: 8mm Type "AB" BMW Box Qty. 50</p>	<p>NEW</p>  <p>270071 Zinc & Yellow U Type Nut 3.5mm (#6) Screw Size PR: .5mm - 1.5mm Center Hole To Edge: 8mm BMW, Mercedes Box Qty. 50</p>	 <p>270077 0712-9-925-737, 000-994-06-45 Plated "U" Type Nut Screw Size: 4.8mm (#10) Panel Range: .5mm -1.7mm Center Hole to Edge: 7mm BMW, Mercedes Benz Box Qty. 50</p>	 <p>270082 000-994-14-45, 0711-9-916-945 Plated "U" Type Nut Screw Size: 4.8mm (#10) Panel Range: .8mm-1.7mm Center Hole To Edge: 11mm BMW, Mercedes Benz Box Qty. 50</p>
 <p>270085 000-994-25-45, 0712-9-925-708 "U" Type Nut Screw Size: 4.2mm (#8) Panel Range: 3mm-4mm Center of Hole to Edge: 7mm BMW, Mercedes Benz Box Qty. 50</p>	 <p>270089 0712-9-925-720 Plated "U" Type Nut Screw Size: 5.6mm Panel Range: 1.2mm-2.0mm Center Hole To Edge: 10mm BMW Box Qty. 50</p>	<p>NEW</p>  <p>292002 16-13-1-176-747, 003-990-02-51 Black Nylon Nylon Flange Nut Stud Size: 5mm Hex: 10mm Flange Dia: 16mm Overall Height: 11mm BMW & Mercedes 1997 - UP Box Qty. 25</p>	 <p>292156 51711-916-199 Nylon Headlight Cover Grommet BMW Series 3, 5 & 7 '84 - UP Box Qty. 25</p>
<p>NEW </p>  <p>292157 07-14-7-306-224 Natural Nylon Skid Plate & Under Cover Grommet Head Dia: 26mm Stem Length: 16mm Overall Height: 20mm Fits into 9mm Square Hole BMW 230i, 320i, 328d, 330e, 330i, 340i, 430i, 440i, 530e, 530i, 540i, M240i, M3 & M4 2018 - UP Mini-Cooper, Clubman & Countryman 2015 - UP Box Qty. 20</p>	<p>NEW</p>  <p>292158 07-14-7-169-847, 07-14-7-166-870, 002-990-53-50 Black Nylon Fender Liner, Wheel Apron & Rocker Moulding Nut Screw Size: M4.8-1.61 (#10) Hex Size: 10mm Flange Dia: 22mm BMW 230i, 320i, 328d, 330e, 330i, 330i GT, 340i, 340i GT, 430i, 430i Gran Coupe, 440i, 440i Gran Coupe & M2 2018-UP; Mini-Cooper, Clubman, Countryman & Paceman 2011-UP; Mercedes CL550, CL600 2007-2014, CL63 1500, 2500, 3500 2019-UP, S350 2012-2013, S400 2010-2013, S550, S600 2007-2013, S63 AMG, S65 AMG 2008-2013 Box Qty. 25</p>	<p>NEW </p>  <p>292159 07-14-7-336-362 Black Nylon Fender Liner & Wheel Apron Nut Screw Size: M4.8-1.61 (#10) Hex Size: 10mm Flange Dia: 18mm BMW X3, X4, i3 & i3s 2011 - UP Box Qty. 25</p>	
<p>NEW </p>  <p>292160 51-12-7-046-911 White Nylon Bumper Screw Grommet with Sealer Screw Size: M4.2 (#8) Head Dia: 15mm Stem Length: 19mm Fits into 8mm Square Hole BMW 528i, 640i, 640i Gran Coupe, 650i, 650i Gran Coupe, M6 & M6 Gran Coupe 2016 - UP Mini-Cooper Countryman & Paceman 2011 - 2016 Box Qty. 25</p>	 <p>295250 5141-1-802-258 Natural Nylon Plastic Barrel Nut For 7mm Stud Fits Into 8mm Hole Overall Length: 20mm BMW Box Qty. 50</p>	 <p>295271 51-21-6-442-159, 52-20-8-238-999 Nylon Moulding Insert BMW Box Qty. 100</p>	 <p>295272 51-14-1-902-279, 51-14-1-807-495 Natural Nylon Emblem Grommet Head Dia.: 12mm Stem Length: 8mm Fits Into 6.8mm Hole BMW Series 3, 5, 6 & 7 1986-2001 Box Qty. 15</p>

BMW CLIPS & FASTENERS

<p>NEW</p>  <p>295273 51-13-8-124-389 Black Plastic (Use with 416112) Cowl Panel Mldg Insert Head Dia: 13mm Stem Length: 11mm Stem Dia: 9mm BMW Series 3 & 5 '89 - UP Box Qty. 50</p>	<p>NEW</p>  <p>295274 51-44-7-780-15, 108-988-00-27 Natural Nylon Tubular Nut Stud Size: 7mm Head Dia: 16mm Stem Length: 16mm Fits Into 8.5mm Hole BMW, Mercedes, Universal Box Qty. 25</p>	<p>NEW</p>  <p>295277 07-14-7-265-039 Natural Nylon Door & Quarter Panel Screw Grommet with Sealer Screw Size: M5 Head Size: 23mm Stem Length: 19mm BMW 740e, 740i, 745e, 750i, M760i & Z4 2016 - UP; i3 2014 - 2018 Mini Cooper 2014 - UP Box Qty. 25</p>	
	<p>NEW</p>  <p>302057 51-12-7-070-202 Zinc Organic Metric Extruded U-Nut Screw Size: M6-1.0 Panel Range: .5mm Max. Center Hole to Edge: 11.5mm BMW 321i, 328d, 328i, 328i GT, 330e, 330i, 330i GT, 335d, 335i, 335 GT, 335is, 340i, 340i GT, 428i, 428i Gran Coupe, 430i, 430i Gran Coupe, 435i, 435i Gran Coupe, 440i, 440i Gran Coupe, 528i, 535i, 550i, 645Ci, 650i, 740Li, 750Li, 750i, 760Li, M3, M4, M6, X3 & X5 2006 - UP Box Qty. 25</p>		<p>NEW</p>  <p>302091 07-14-7-212-877 Yellow Nylon Bumper Cover U-Nut Screw Size: M5 Panel Range: 2.5mm Max. Center of Hole to Edge: 8mm BMW 535i GT, 550i GT, 640i, 640i Gran Coupe, 650i, 650i Gran Coupe, 740e, 740i, 750i, M6 & X6 2017 - UP Box Qty. 25</p>
<p>302092 07-14-7-311-312 Natural Nylon Rocker & Fender Moulding U-Nut Screw Size: M4.2 (#8) Width: 15mm, Length: 22mm Height: 13.5mm, Panel Range: 1mm Center of Hole to Edge: 11mm BMW 428i, 428i Gran Coupe, 430i, 430i Gran Coupe, 435i, 435i Gran Coupe, 440i, 440i Gran Coupe, 528i, 530e, 530i, 535d, 535i, 535i GT, 540i, 550i, 550i GT, 640i, 640i Gran Coupe, 650i, 650i Gran Coupe, 740Ld, 740Li, 740i, 750Li, 750i, 760Li, ActiveHybrid 5 & 7, M4, M5, M550i, M6, M6 Gran Coupe, M760i, X1, X2, X3, X5, X6, i3, i3s & i8 2012 - UP Mini Cooper, Clubman & Countryman 2014 - UP Box Qty. 25</p>	<p>NEW</p>  	<p>416001-100 Box 100</p> <p>416001 91503-SP0-003, 07-13-0-702-966, 94530623 Plastic Front/Rear Bumper Screw-Type Rivet Hole: 10mm Washer Face: 20mm Stem Length: 15mm GM: BMW: Acura CL, Integra, Legend RL & TL '91 - 2004 and Honda Accord, Civic, Del Sol, Odyssey, Passport, Pilot, Prelude & Ridgeline '92 - UP Box Qty. 10</p> 	
<p>NEW</p>  <p>416053 07147391323 White Nylon Dia: 6mm G.R.: 6.0mm - 10.75mm Flange Dia: 20mm Wheel Arch Trim Cover BMW X3, X4 & X5 Series 2010-UP Box Qty. 25</p>	 <p>416076 51-71-7-002-953-2 Black Nylon Dia.: 6mm Grip: 2.5 - 4.8mm Flange: 20mm BMW Box Qty. 25</p>	 <p>416077 51111-964-186 Plastic Push-Type Retainer Hole Size: 6mm, Flange: 14.5mm, GR: 8-15mm Front Spoiler BMW 3 Series '89 - UP Box Qty. 25</p>	 <p>416078 51-11-1-944-537 Black Nylon Push-Type Retainer Hole: M6 (1/4") Flange: 20mm Stem Length: 15mm Front Bumper, Scuff Plate, Wheel Opening, Interior Trim BMW 3,5,7 and X5 Series '89 - UP Box Qty. 50</p>

BMW CLIPS & FASTENERS

<p>416079 51-11-8-174-185 Plastic Push-Type Retainer Hole M6, Flange: 20mm Stem Length: 17mm Front/Rear Bumper Cover, Front Bumper Grille BMW 3,5,7 Series '95 - UP Box Qty. 50</p> 	<p>416100 51-48-1-938-725, 51-48-1-915-464 Push-Type Retainer Hole: M7 (9/32") Flange: 20mm Stem Length: 9mm Hood & Trunk Insulation BMW 7 Series Box Qty. 25</p> 	<p>416104 51-11-1-908-077, 00-990-54-92 Black Nylon Push-Type Retainer Head Dia.: 15mm Stem Length: 15mm Fits Into 6.3mm Hole Scuff Plate BMW 3,5 and 7 Series '84 - UP Mercedes 1994 - 2014 Box Qty. 50</p> 	<p>416105 51-71-1-928-946 Plastic Push-Type Retainer Hole: M6 Head: 10 x 12mm P.R.: 3.5mm Cowl Vent BMW 5 & 7 Series Box Qty. 25</p> 
<p>416110 000-990-34-92, 51-16-1-881-149, N-102-593-01 Black Nylon Radiator Housing Push-Type Retainer Head Dia: 10mm Stem Length: 10mm Fits Into 6mm Hole Mercedes Benz Body Styles 116, 123, 124, 126, 129, 140, 170, 201, 208 & 210 1974-UP BMW, VW Box Qty. 15</p> 	<p>NEW</p> <p>416112 51-21-8-205-295 Black Nylon (Use with 295273) Cowl Vent Push-Type Retainer Head Dia: 20mm Stem Length: 16mm Fits Into 7mm (9/32") Hole BMW Series 5 '97 - UP Box Qty. 50</p> 	<p>NEW</p> <p>416230 51-47-8-166-992 Black Nylon Trunk Lid Compartment Trim & Wheel Well Push-Type Retainer Head Dia: 9mm Stem Length: 7mm Hole Size: 5mm BMW 3, 5, 7 & Z Series 1997 - UP Box Qty. 25</p> 	<p>NEW</p> <p>416231 51-46-7-002-606 Black Nylon Front Bumper, Grille, Trunk Panel & Rear Window Push-Type Retainer Head Dia: 10mm Stem Length: 11mm Hole Size: 6.3mm BMW 3, 5, 7 & Z Series 1997 - UP Box Qty. 25</p> 
<p> 416271 51-43-7-001-491-2 White Nylon Headliner Retainer Top Hd Diameter: 14mm Middle Hd Diameter: 15mm Bottom Hd Diameter: 18mm Stem Diameter: 9mm Stem Length: 14mm Mini-Cooper 2005 - UP Box Qty. 25</p> 	<p>416285 201-990-02-92, 51471911992, 51470146782, 54170390017 Black Nylon Push-Type Retainer Head Dia: 20mm Stem Length: 14mm Fits Into 8.5mm Hole Mercedes Benz; BMW 1, 2, 3, 4, 5, 7, i3, i8, X & Z Series 1988 - UP Box Qty. 25</p> 	<p>NEW</p> <p>416297 Black Nylon Bumper & Wheel Opening Push-Type Retainer Head Dia: 15mm Stem Length: 15mm Fits Into 6.3mm Hole BMW 2004 - UP Box Qty. 15</p> 	<p>NEW</p> <p> 416303 17-11-1-712-963 Black Nylon Bumper Side Support & Fan Shroud Push-Type Retainer Head Dia: 15mm Stem Length: 11mm Fits Into 8mm Hole BMW 3, 5, 7, 8, X, Z Series & i8 1990 - UP Mini-Cooper 2007 - 2010 Box Qty. 25</p> 
<p>416307 51-48-1-915-964 Black Nylon Hood Insulator & Rear Bumper Push-Type Retainer Head Diameter: 20mm Stem Diameter: 6.8mm Stem Length: 11mm Fits into 7mm Hole BMW 128i, 135i, 135is, 318i, 318is, 323i, 323is, 325Ci, 325i, 325is, 325xi, 328Ci, 328i, 328is, 328xi, 330Ci, 330i, 330xi, 335d, 335i, 335is, 335xi, 525i, 525xi, 528i, 530i, 530xi, 535i, 535xi, 540i, 545i, 550i, 645Ci, 650i, 735iL, 740i, 740iL, 750iL, M3, M5, M6, X3, X4, X5, X6, Z3, Z4 & Z8 1991-2017 Mini-Cooper, Countryman & Paceman 2011-2016 Box Qty. 50</p>  	<p>416351 51-49-8-166-702 Trim Panel Push-Type Retainer Head Diameter: 12.5mm Stem Length: 12mm Fits Into 8.5mm Hole BMW 1, 2, 3, 5, 6, 7, X & Z Series 1995 - UP Box Qty. 15</p> 	<p>416353  51-49-8-237-075 Dark Gray Nylon Trunk Lid, Quarter Trim & Control Module Push-Type Retainer Head Dia: 15.5mm Stem Length: 13mm Fits into 8mm Hole BMW 128i, 135i, 323i, 325Ci, 325i, 325xi, 328i, 328xi, 330Ci, 330i, 330xi, 335d, 335i, 335is, 335xi, M3, X3, & X4 1999 - 2018; Mini-Cooper 2007 - UP Box Qty. 25</p> 	

18 BMW Clips

BMW CLIPS & FASTENERS

18 BMW Clips

NEW



416354
52-20-8-133-466
Black Nylon
Motion Sensor Retainer
Head Dia: 18mm
Stem Dia: 5.7mm
Stem Length: 12mm
BMW 1, 2, 3, 4, 5, 6, 7, 8, i3, i8 X & Z Series 1992 - UP
Box Qty. 30

NEW



416355
51-48-9-119-216,
51-48-7-273-379
Black Nylon
Hood Insulator Retainer
Head Dia: 21mm
Stem Dia: 10.8mm
Stem Length: 9.5mm
BMW 230i, 320i, 328d, 330e, 330i, 330i GT, 340i, 340i GT, 430i, 430i Gran Coupe, 440i, 440i Gran Coupe & 530e 2018 - UP; Mini-Cooper & Countryman 2015 - UP
Box Qty. 50

NEW



416356
07-14-7-281-961
Black Nylon
Rocker Moulding
Push-Type Retainer
Head Dia: 25mm
Stem Length: 19mm
Fits into 8mm Hole
BMW X3 2011 - 2017
X4 2015 - UP
Box Qty. 25

NEW



435009
51-71-8-259-025
Black & White Nylon
Wheel Flare & Rocker
Moulding Clip
Top Head: 20mm x 30mm
Grommet Head Dia: 12mm
Grommet Stem Dia: 7.4mm
Grommet Length: 15mm
BMW 7 Series 1998 - 2001
X Series 2011 - UP
Box Qty. 25



435390
51-13-1-849-724
Nylon
Moulding Fastener
BMW
Box Qty. 10



435392
51-13-1-804-205
Nylon
Moulding Clip
with Sealer
BMW
Box Qty. 50



435395
51-13-1-848-664
Plastic
Body Side Moulding Clip
BMW 320i
Box Qty. 25



435396
51-13-1-816-019
Plastic
Body Side Moulding Clip
BMW 2002
Box Qty. 25



435397
51-13-1-808-841
Plastic
Body Side Moulding Clip
BMW 528, 530 & Bavaria
Box Qty. 50



435398
51-13-1-876-128
Plastic
Body Side Moulding Clip
BMW 218i, 325e 1983 - UP
Box Qty. 25



435399
51-13-1-946-258
Plastic
Drive Type
Side Moulding Clip
Hole: M7, P.R.: 2mm
BMW 5 Series
Box Qty. 25

NEW



435418
51-13-1-960-054
White Nylon With
Rubber Boot
Moulding Clip
Width: 22mm
Length: 35mm
Hole Size: 10mm
BMW 1992 - 1999
Box Qty. 25

NEW



435419
51-13-2-251-394
White Nylon With
Rubber Boot
Moulding Clip
Width: 18mm
Length: 30.5mm
Stem Length: 10mm
Hole Size: 10mm
BMW 1992 - 1999
Box Qty. 25

NEW



435420
51-13-8-166-675
White Nylon With
Rubber Boot
Moulding Clip
Width: 25.5mm
Length: 34mm
Stem Length: 11mm
Hole Size: 9.5mm
BMW 1995 - 2003
Box Qty. 25

NEW



435421
51-13-8-231-130
White Nylon With
Rubber Boot
Moulding Clip
Width: 20.5mm
Length: 32mm
Stem Length: 9.5mm
BMW 3 Series 1991 - 2009
Box Qty. 25

NEW



435532
07-13-0-702-516
Black Nylon
Rear Quarter
Wheel Opening
Moulding Clip
Top Hd Dia: 13mm
Middle Hd Dia: 15mm
Bottom Hd Dia: 15mm
Stem Dia: 10mm
Fits Into 8mm Hole
Stem Length: 8mm
Mini-Cooper 2002 - UP
Box Qty. 25

BMW CLIPS & FASTENERS

  <p>435534 07-13-7-073-915 White Nylon Trim Panel & Fender Flare Moulding Clip Top Hd: 11.5mm x 19mm Bottom Hd Dia: 21mm Stem Length: 13mm Fits Into 8mm Hole <i>Mini Cooper S 2002 - UP</i> Box Qty. 15</p>	  <p>435535 51-71-1-496-621 Black Nylon Rocker Moulding Retainer Head Size: 8.5mm x 14mm Stem Size: 5mm x 7.5mm Stem Length: 14mm <i>Mini-Cooper 2002 - UP</i> Box Qty. 25</p>	 <p>440221 51-13-1-869-959 Nylon with Zinc & Yellow Screw Moulding Clip 13mm Wide, 35mm Long Bolt: M4 - .7 x 11mm Box Qty. 25</p>	<p>NEW</p>  <p>445001 07-14-7-133-419 Beige Nylon Door Trim Panel Retainer Top Head Dia: 14mm Middle Head Dia: 15mm Bottom Head Dia: 18mm Stem Dia: 9mm Stem Length: 12mm <i>BMW 128i, 135i, 135is, 328i, X3 & X4 2011 - UP</i> Box Qty. 25</p>



BMW CLIPS & FASTENERS

BMW Clips

18

BLANK

CHRYSLER CLIPS & FASTENERS

27999 Box 25



28000

6031115, 9436175, 385189-S100
Peel-Type Rivet
Dia.: 1/4" Grip: 1/32" - 9/64"
Flange Dia.: 1/2"
Aluminum Rivet, Steel Mandrel
Window Regulators
GM, Ford, Chrysler '71 - UP
Box Qty. 100

28002 Box 25



28001

6031091, 9437938, 385323-S100
Dia.: 1/4" Grip: 33/64" - 19/32"
Flange Dia.: 1/2"
Peel-Type Rivet
Aluminum Rivet
Steel Mandrel
Glass Stop, Window Regulator
GM, Ford, Chrysler '76 - UP
Box Qty. 100



38507

6032856, 15622490
Dia.: 1/8", Grip: 3/16" - 3/8"
Flange Dia.: 5/16"
Multi-Grip Type
Black Aluminum Rivet
Steel Mandrel
Body Side Mouldings
Universal Applications,
Chrysler
Box Qty. 25



38516

6036148-AA
Split-Type Rivet
Dia: 5/32" G.R.: 3/64"-1/4"
Flange Dia: 7/16"
Aluminum Rivet (Black)
Aluminum Mandrel
Front Bumper, Trim Panel,
Instrument Panel &
Running Boards
Chrysler 1999 - UP
Box Qty. 25



38522

N807620-S100, 10131511, 11588308,
6034212, 6036148AA
Dia.: 5/32" Grip: 3/64" - 1/4"
Flange Dia.: 5/16"
Split-Type Rivet
Black Aluminum Rivet
Aluminum Mandrel
Wheel Openings Lincoln '94 - UP
Bumper Cover, Grille, Rocker Mldg. GM
'97 - UP
Bumper Cover Chrysler
Box Qty. 25



38525

9432137, 6032138
Dia.: 5/32" Grip: 1/8" - 3/16"
Flange Dia.: 5/16"
Aluminum Rivet,
Steel Mandrel
Countersunk Head
Trunk Lock Swivel
Emblem Rivet
Chrysler, GM '73 - UP
Box Qty. 25



38550

9437486, 6032926
Dia.: 1/4" Grip: 9/64" - 3/16"
Head Dia.: 1/2"
Alum. Rivet, Steel Mandrel
Window Regulator Rivet
GM, Chrysler
Box Qty. 25



38555

389268-S100, 20184399,
12338153
Dia.: 1/4" Grip: 11/16" - 3/4"
Flange Dia.: 1/2"
Peel-Type Rivet
Aluminum Rivet
Steel Mandrel
Window Regulators
Ford & GM 1979 - UP
Box Qty. 25



38560

N806830-S100, N806830-S100, 6035201
Dia.: 1/4" Grip 3/16" - 3/8"
Flange Dia.: 11/16"
Black Aluminum Rivet
Aluminum Mandrel
Bumper Covers, License Plate Bracket
Ford '92 - UP
Air Dam To Fascia Chrysler '93 - UP
Box Qty. 15



200170

367292, 367291
Chrome Plated Steel
Outside Rearview Mirror
Mounting Nut & Bolt
1/4"-20 x 1"
Chrysler & GM Trucks & Vans
Box Qty. 10



200175

367291, 14007511,
474821
Chrome Plated
Steel Screw
1/4"-20 x 1"
Hex Washer Head
Hex: 3/8"
Wshr O.D.: 5/8"
Truck Mirror Mounting Screw
Chrysler & GM Trucks/Vans
Box Qty. 10



200366

6509539-AA
Phosphate
Hex Head Sems®
Tapping Screw
M4.8-1.61 x 32mm
(#10 x 1-1/4")
Washer OD:19mm (3/4")
Hex: 8mm
Chrysler Town & Country
and Dodge Ram 2009 - 14
Box Qty. 50

NEW



200370

6104374AA
Zinc Finish
M6-1.0 x 40mm
Hex Head Sems®
Body Bolt with Dog Point
Washer Outer Dia: 20mm
Hex: 10mm
Headlamp Bracket
Chrysler, Dodge & Jeep 2008 - UP
Box Qty. 10

CHRYSLER CLIPS & FASTENERS

<p>NEW</p>  <p>200371 6105103AA Zinc Finish M8-1.25 x 30mm Hex Head Sems® Body Bolt with Dog Point Washer Outer Dia: 24mm Hex: 13mm Chrysler, Dodge & Jeep 2007 - UP Box Qty. 5</p>	 <p>216155 34201287, 8934201287 Zinc M6-1.0 x 20mm Slotted Hex Washer Head Body Bolt Wshr Hd O.D.: 13mm (1/2") Hex: 10mm Chrysler, Honda, AMC Box Qty. 50</p>	 <p>266024 6506104AA Zinc & Yellow Roof Rack Nutsert w/ Sealer Under Head Thread: M6 - 1.0 Grip: .7mm - 3.2mm Head Dia.: 17mm Hex Size: 9.5mm (3/8") Jeep '99 - 2001 Box Qty. 10</p>	 <p>266025 6503812, 6504601 Zinc & Yellow Wheel Opening Moulding Nutsert Thread: M5 - .8 Head Dia.: 10mm Hex Size: 10mm Overall Length: 12mm Jeep '99 - UP Box Qty. 15</p>
 <p>270006 4806226-AA, 11562364 Zinc Front & Rear Bumper and Grille Fastener Screw Size: #6 Width: 10mm Overall Height: 18mm Buick Lucerne and Cadillac CTS & STS 2005 - UP Chrysler 300, Dodge Nitro and Jeep Commander 2005 - UP Box Qty. 15</p>	<p>NEW</p>  <p>270003 6506955AA Zinc Finish Door & Fender Panel Nut Screw Size: M6-1.0 Head Size: 14.5mm x 21mm Stem Length: 10mm Fits into 15mm Square Hole Chrysler Pacifica 2017 - UP, Town & Country, Dodge Caliber, Caravan & Grand Caravan 2005 - 2012; Dodge Durango & Journey and Jeep Compass, Grand Cherokee, Patriot & Wrangler 2007 - 2017 Dodge Ram 2008 - 2009 Box Qty. 10</p>	 <p>270009 1570654, 6509432AA, W716529-S900 Blue Finish Radiator Grille Nut Screw Size: #8 (4.20mm) Head Size: 6mm x 16mm Panel Range: .70 - 2.30mm Hole Size: 8.7mm Buick Allure, Enclave, Encore, LaCrosse, Lesabre, Lucerne, Rainer, Regal & Verano and Cadillac ATS, CTS, Deville, DTS, ELR, Escalade, SRX & STS 2000 - UP; Chrysler 200, 300, PT Cruiser, Sebring, Town & Country and Dodge Avenger, Caliber, Charger, Dart, Grand Caravan, Ram 2500 & Ram 3500 2006 - 2015; Ford 250, 350, 450 & 550 Super Duty Trucks 2013 - 2015 Box Qty. 25</p>	
	 <p>280040 8934-201-263, 6000943 White Nylon Radiator Grille Nut Screw Size: #8 (4.2mm) Stem Length: 9mm Head Size: 10mm AMC-Renault, Chrysler Box Qty. 50</p>	 <p>280045 Nylon #8 Screw Size License Plate Nut & Headlight Door Screw Chrysler Box Qty. 100</p>	<p>280136 Box 500</p>  <p>280135 3907444, 4755299 Nylon License Plate Nut Split Four Ways Under Head Screw Size: #14 (1/4") Head Size: 5/8" Stem Length: 5/16" Hole Size: 13/32" GM, Chrysler Box Qty. 100</p>
 <p>280250 1386805, 6032676 Nylon Radiator Grille Nut Screw Size: #8 or #10 Chrysler Truck '85, Buick & General Purpose Box Qty. 100</p>	 <p>285036 6031869, 10032838, 1264963, 8934-201-602 Black Nylon High Torque Screw Grommet Head Size: 14.7 x 20.8mm Hole Size: 7.10 x 20.30mm Stem Length: 16.5mm GM, Chrysler, AMC-Renault Box Qty. 25</p>	 <p>285100 N806624-S191 6502776 Rear Light Assembly Retainer Ford Explorer '91 - UP Chrysler Box Qty. 25</p>	 <p>290000 55156879-AB Black Nylon Tail Light Grommet Head Size: 20mm x 31mm Hole Size: 14mm x 26mm Receives 10mm Ball Stud Jeep Commander 2006 - UP Box Qty. 25</p>

CHRYSLER CLIPS & FASTENERS

 <p>290002 4805119 Natural Nylon Cowl Vent Nut Screw Size: 4.8mm (#10) Hole: 9mm x 13mm Flange: 14mm x 17mm <i>Chrysler LH, Neon & 300M</i> '98 - UP Box Qty. 25</p>	 <p>290005 6505161AA White Nylon Bumper Fascia Grommet Screw Size: M4.2 (#8) Hd Dia: 14mm x 18mm Snaps Into 9mm x 11mm Hole <i>Chrysler LH & LHS Series</i> '98 - UP Box Qty. 25</p>	 <p>290010 6504072 Black Nylon Tail Light Housing Grommet Hole Size: 12mm (15/32") Head Dia.: 16mm Stem Length: 10mm <i>Dodge Dakota, Ram Trucks</i> '97 - UP Box Qty. 25</p>	 <p>290041 68084593-AA Black Nylon Tail Light Assembly Grommet Head Dia: 19mm Stem Length: 11mm Fits Into 12mm Hole <i>Dodge Pick-Ups 1500 & 2500</i> Series 2006 - UP Box Qty. 25</p>
 <p>290070 6031138 Nylon Headlight Grommet Screw Size: #6 or #8 <i>Chrysler</i> Box Qty. 50</p>	 <p>290090 6501699 Black Nylon Cowl Screen Grommet Hole: M7 Square Screw Size: M4.2 (#8) <i>Chrysler Minivans & Various Cars</i> '90 - UP Box Qty. 25</p>	 <p>290100 6032516 Black Nylon #12 Screw Size License Plate Nut <i>Chrysler</i> Box Qty. 25</p>	 <p>295090 D7VY-6050074-A, 1259296, 3201767, 15964853, 8934-201-767 Plastic Barrel Nut Hole: 1/4" <i>Ford, GM, Chrysler</i> Box Qty. 50</p>
 <p>302002 6105242-AA Magni-554 Silver Extruded "U" Nut Thread Size: M6 -1.0 P.R.: 0.5mm - 4.00mm Center Hole To Edge: 13mm Quarter Panel & Fender <i>Chrysler 200 & Pacifica, Dodge Challenger, Charger, Dart & Ram and Jeep Cherokee, Grand Cherokee & Renegade</i> 2009 - UP Box Qty. 25</p>	<p>NEW</p>  <p>302003 6509799-AA Zinc Organic Metric Extruded U-Nut Screw Size: M4.8-1.6 (#10) Panel Range: .61mm - 3.8mm (.024" - .149") Center of Hole to Edge: 11.5mm (.452") <i>Chrysler 200 & Pacifica and Dodge Dart & Ram and Jeep Cherokee</i> 2010 - UP Box Qty. 25</p>	<p>NEW</p>  <p>302036 W520822-S439, 6510185-AA, 6101956, 6503694 Zinc Organic Metric Extruded U-Nut Screw Size: M6-1.0 Panel Range: .8mm - 4.0mm (.030" - .160") Center of Hole to Edge: 13.5mm (17/32") <i>Chrysler 300, Pacifica, Prowler, PT Cruiser, Sebring & Town & Country and Dodge Caravan, Challenger, Charger, Durango, Magnum, Nitro, Ram, Stratus & Viper and Jeep Commander, Grand Cherokee & Wrangler</i> 1996 - UP Box Qty. 25</p>	
	 <p>303120 367292, 6031438 Zinc w/ Sealer Mirror Mounting Retainer Thread: 1/4-20 Stem Length: 5/8" Grip Range: 3/16" - 3/8" <i>GM, Chrysler</i> Box Qty. 25</p>	 <p>303130 6510123AA Black Nylon Rocker Panel & Splash Shield Screw Grommet w/Specialty Screw Grommet Hd Dia: 18mm Length Under Head: 36mm Black Hx Wshr Head Sems Screw Assembled in Grommet <i>Chrysler Pacifica, Dodge Challenger & Ram and Jeep Cherokee</i> 2011 - UP Box Qty. 5</p>	 <p><small>not actual size</small></p> <p>350080 5201269, 5201359, 4270581, 4334140, 4334141, 4334142 Headlight Adjusting Nut & Screw Assembly Screw: 12-28 x 2-1/8" <i>Chrysler</i> '78 - UP Box Qty. 25</p>

CHRYSLER CLIPS & FASTENERS

 <p>415040 2988430 Black Nylon Radiator Grille Retainer Hole Size: 1/4" (6.3mm) Head Dia: 1-1/4" Stem Length: 1/2" Chrysler, Ford, GM Box Qty. 25</p>	<p>415051 Box 250 415050 1631564, N804379-S, 3420287 W706358-S300 Black Plastic Bumper Fascia Retainer Head Dia: 22mm Hole Size: 11mm Length: 28mm Buick, Cadillac & Olds. '81 - UP Ford Taurus & Merc. Sable '86-UP Chrysler Box Qty. 25</p> 	<p>415072 Box 250 415071 Box 500 415070 11569768, 15958694, 1605396, 6030441, 388577S, W705589-S300 Black Nylon Radiator Yolk, Fender & Bumper Shield Retainer Hole Size: 1/4" (6.3mm) Stem Length: 20mm Head Dia: 25.5mm GM, Ford, Chrysler Box Qty. 50</p> 	<p>415076 Box 250 415075 21094146, 21110201, 6501301 Black Nylon Hole Size: 5/16" (8mm) Stem Length: 19/32" Head Dia: 33/64" Trim Panel Retainer GM Saturn '91 - UP Sliding Door & Lift Gate Trim Panel Retainer Chrysler Mini Vans '87 - UP Box Qty. 50</p> 
<p>415077 N807721-S, 6504043, 650403 Black Nylon Hole Size: 23/64" (9mm) Stem Length: 15mm Head Dia: 18mm Trim Panel Retainer Ford Explorer '93 - UP Trunk Lid Latch Chrysler '96 - UP Box Qty. 50</p> 	<p>415100 20413107, 388246S, 4006516 Black Nylon Weatherstrip Retainer Hole Size: 3/16" (4.5mm) Stem Length: 21/32" Head Dia: 7/16" GM, Ford, AMC Box Qty. 50</p> 	<p>415107 MB020923 Gray Nylon Hood Insulation Retainer Head Dia: 26mm Stem Dia: 10mm Stem Length: 8mm Jeep Eagle and Mitsubishi Eclipse '92 - UP Box Qty. 10</p> 	<p>415124 Box 100 415123 N802781-S, 802781-S, W704340-S300, 14093088, 55176248 Splash Shield & Facia Retainer Flange Dia: 1" (25.4mm) Stem Length: 7/8" (22mm) Fits into 1/4" (6.3mm) Hole Ford, GM, Chrysler Box Qty. 25</p> 
<p>415125 N803362-S, 20510029, 34202672 Black Nylon Body Retainer Flange Dia: 11/16" Stem Length: 7/8" Fits Into 1/4" Hole Ford, GM, Chrysler '84 - UP Box Qty. 25</p> 	<p>415129 Box 50 415126 N803421-S, 6501590, 6500725 Black Nylon Splash Shield & Fascia Retainer Head Dia: 1" Shoulder Length: 1/8" Stem Length: 7/8" Fits Into 5/16" Hole Ford, Chrysler Box Qty. 25</p> 	<p>415128 N803946-S, 6502871, 20664091 Black Nylon Push-Type Retainer Head Dia: 19/32" Stem Length: 29/32" Fits Into 1/4" Hole GM, Chrysler, Ford '87 - UP Box Qty. 25</p> 	<p>415165 D30Z-16776-A, 385330-S, 6003351 Black Nylon Hole Size: 1/4" (6.3mm) Stem Length: 5/8" Head Size: 1/2" x 1/2" Hood Insulation Retainer Chrysler '72 - UP Grille to Radiator Retainer Ford '73 - UP Box Qty. 25</p> 
<p>415190 2898909, 382570-S Black Nylon Dash & Cowl Panel Retainer Hole Size: M6.3 Head Dia: 12.4mm Stem Length: 13mm GM, Chrysler, Ford '70 Box Qty. 50</p> 	<p>415221 Box 250 415222 Box 500 415220 3977775, 3078511 Hood Insulation Clip Hole Size: 1/4" Head Dia.: 2" Stem Length: 3/4" GM, Chrysler, Ford Box Qty. 50</p> 	<p>415225 6505302AA, N803387, N803387-S, N803387-S300 Black Nylon Trim Panel Retainer Head Dia.: 1-3/4" Stem Length: 1" Fits 9/32" Hole Ford, Chrysler Box Qty. 25</p> 	

CHRYSLER CLIPS & FASTENERS

 <p>415229 6504098, N808842-S Black Nylon Hood Insulation Retainer Hole Size: 1/4" (6.3mm) Head Dia: 1-1/4" Stem Dia: 5/16" Stem Length: 11/16" Chrysler Sebring '96 - UP Ford Taurus, Sable & Mark VIII '96 - UP Box Qty. 50</p>	 <p>415232 4341060 Black Nylon Hood Insulation / Fender Shield Retainer Hole Size: 1/4" (6.3mm) Stem Length: 13/16" Head Dia.: 1-5/16" Chrysler '85 - UP Box Qty. 25</p>	 <p>415236 6502842, 21039129 Black Nylon Hood Insulation Retainer Hole: 1/4" Head Dia.: 1-3/16" Chrysler Concorde, Dodge Intrepid, Eagle Vision '93 - UP GM Corvette, Equinox & Saturn '92 - UP Box Qty. 50</p>	 <p>415245 10195515, N805026S, 4696488, 6503163 Black Nylon Screw-Type Retainer Head Diameter: 1/2" Stem Length: 1-13/64" Fits Into 9/32" Hole GM, Ford & Chrysler 1987 - UP Box Qty. 25</p>
 <p>415251 6502328, 20699808 Black Nylon Door Weatherstrip Retainer Hole Size: 13/64" (5mm) Stem Length: 11.5mm Head Dia: 10mm Dodge Ram 1994 - UP GM 1974 - UP Box Qty. 100</p>	 <p>415254 4806110-AA Front Bumper Push-Type Retainer Hole Size: 11mm (7/16") Head Dia: 24mm Shoulder Length: 3mm Stem Length: 20mm Fits Into 11mm Hole Chrysler 300 & Magnum 2005 - UP Box Qty. 15</p>	 <p>415305 6502545 Nylon Headlight Side Shield Retainer Dodge Daytona '92 - UP Box Qty. 25</p>	 <p>415505 14019206, 14019205, 16514113, 34201621, 6504090, 8934-201-621, 6503454, E308-4A163CA Black Nylon Front Fender Mud Skirt & Fender Liner Retainer Head Dia: 11/16" Stem Length: 9/16" Fits Into 1/4" Hole GM, AMC, Chrysler, Ford Box Qty. 50</p>
 <p>415524 6507669-AA Black Nylon Radiator Grille Push-Type Retainer Head Dia: 20mm Stem Length: 16mm Fits Into 10mm Hole Dodge Durango 2004 - UP Box Qty. 25</p>	<p>415597-500 Box 500</p>  <p>415597 N804570-S, 4638136, 20664092, 15773445, 20452072, 6502790, 22538004 Black Plastic Radiator Shield & Trim Screw-Type Retainer Hole: 1/4" Flange Dia: 11/16" Stem Length: 29/32" Ford, GM, Chrysler & Cadillac '98-UP Box Qty. 25</p>		 <p>415600.....Box 25 415800.....Box 100 N803862-S, 6501559, 6506007-AA, 10184895 1/4" Dia. Black Nylon Blind Rivet Panel Range: 5/32" - 13/32" Flange: 1/2" GM, Ford, Chrysler, General Purpose</p>
 <p>415601 4630088, 15732202 Super Tough Black Nylon Hole: 1/4" Grip: 1/32" - 11/64" Flange: 21/32" Shoulder: 5/64" Countersunk Blind Rivet Exterior Mouldings, Body Side Mldg Attachment GM Dodge & Eagle "LH" Models '93 - '97 Box Qty. 25</p>	 <p>415602.....Box 25 415802.....Box 100 14063981, 15506827, 15506921, KA01500Z1, N803043-S, 6500911, 8934-201-631 1/4" Dia. Black Nylon Blind Rivet Panel Range: 5/32" - 13/32" Flange: 21/32" GM, Ford, Chrysler, AMC, General Purpose</p>	 <p>415603 4630660 Super Tough Black Nylon Hole: 6.3mm Grip: .7 - 4.9mm Head: 17mm Shoulder: 9mm x 2mm Black Rivet / White Mandrel Countersunk Blind Rivet Exterior Mouldings Chrysler "LH" '93 - '97 Box Qty. 15</p>	

CHRYSLER CLIPS & FASTENERS

19 Chrysler Clips



415604
 34202855, 6500859, 6500899, 8048635,
 20432975, 175-853-577, 175-853-57701C,
 175-852-577
 Super Tough Black Nylon
 Hole: 13/64"
 Panel Range: 1/8" - 15/64"
 Head: 15/32"
 Chrysler, Ford, GM, VW, AMC
 Box Qty. 25



415605
 6501509
 Super Tough Black Nylon
 Blind Rivet w/ Shoulder
 Hole: 6.3mm (1/4")
 Grip: 1.0 - 5.0mm (3/64" - 3/16")
 Head: 17mm (11/16")
 Countersunk Shoulder: 4.5mm
 Body Side Mouldings
 Chrysler "LH" '93 - UP, Various Models '87 - UP
 Box Qty. 25



415610.....Box 25
415810.....Box 100
 20421672, 15955172, 15595172
 17/64" Dia. Black Nylon Blind Rivet
 Panel Range: 3/32" - 3/16"
 Flange: 1/2"
 GM, General Purpose



415620.....Box 25
415820.....Box 100
 4370132, 20433026, 14070914,
 175-553-577A, 175-853-577A
 17/64" Dia. Black Nylon Blind Rivet
 Panel Range: 3/32" - 3/16"
 Flange: 23/32"
 GM, Chrysler, VW, General Purpose



415630.....Box 25
415830.....Box 100
 6500898, 15718794
 13/64" Black Nylon Blind Rivet
 Panel Range: 15/64" - 25/64"
 Flange: 15/32"
 Chrysler, GM, General Purpose



415640.....Box 25
415840.....Box 100
 20432975, 175-853-57701C, 6503800,
 N804343S
 13/64" Dia. Black Nylon Blind Rivet
 Panel Range: 1/8" - 15/64"
 Flange: 15/32"
 GM, VW, Chrysler, Ford, General Purpose

415652
 6503106
 Lower Rear
 Moulding
 Push-Type
 Retainer
 Hole: M6.3 (1/4")
 Head: 22mm (7/8")
 Stem Length: 25.4mm (1")
 Chrysler "LH" Models '93 - UP
 Jeep Grand Cherokee Laredo
 '94-UP
 Box Qty. 15



415653
 25612415,
 6509761-AA
 Plastic
 Front Bumper
 Push-Type
 Retainer
 Head Dia: 20mm
 Stem Length: 13.5mm
 Fits into 10mm Hole
 Dodge Ram & Jeep Cherokee
 2010-UP
 Box Qty. 15



415664 Box 100
415663
 16500308, 6500787
 Black Nylon
 Tail Light Push-Type Retainer
 Hole: 13/64" (5mm)
 Stem Length: 15/32"
 Head Dia: 3/8
 GM, Chrysler
 Box Qty. 25



415759 Box 50
415761
 94218027,
 H200-50-715,
 8942180270,
 58974-00008, B092-50-715,
 BF67-S0715, MB153825,
 90467-13011, 90467-12020
 Black Nylon
 Grille Headlight Clip
 Width: 13mm Length: 22mm
 Ford, GM, Toyota, Mitsubishi, Isuzu,
 Honda, Plymouth, Mazda
 Box Qty. 25



415781 Box 100
415780
 10053182,
 6503163
 Body Splash Shield
 Screw-Type Retainer
 Flange Dia: 19/32"
 Stem Length: 13/16"
 Fits Into 5/16" Hole
 GM '87 - UP
 Chrysler
 Box Qty. 25



415785
 10140480, 6502625
 Black Nylon
 Rear Bumper Fascia
 Screw-Type Retainer
 Head Dia.: 21mm (27/32")
 Panel Range: 3mm (1/8")
 Stem Length: 25mm (1")
 Fits Into 12mm (1/2") Hole
 GM, Chrysler
 Box Qty. 25















415790
 6501544, N803170-S,
 5017410-AA
 Black Nylon
 Fascia Shield Retainer
 Hole: 13/64" (M5)
 Stem Length: 1/2" (12.7mm)
 Head: 7/16" (10mm)
 Ford Mustang, Capri '84 - UP,
 Chrysler
 Box Qty. 50



415851
 6502573
 Black Nylon
 Screw-Type Retainer
 Cowl Screen Attachment
 Head Size: 15/32" (11.9mm)
 Stem Length: 9/16" (14.3mm)
 Fits 1/4" (6.4mm) Sq. Hole
 Chrysler Concorde & LHS
 Dodge Intrepid & Eagle Vision
 '93 - UP
 Box Qty. 15



CHRYSLER CLIPS & FASTENERS

 <p>415881 Black Nylon Cowl Screen Retainer <i>Chrysler New Yorker, LHS, Dodge Intrepid, Eagle Concorde & Vision '93 - UP</i> Box Qty. 15</p>	 <p>415883 <i>W709176-S300, 15149708, 6506008AA</i> Radiator, Wheelhouse, Fender & Bumper Cover Push-Type Retainer Hole: M6 Flange: 17mm Stem Length: 16mm <i>Chrysler, Ford, GM</i> Box Qty. 25</p>	 <p>415888 <i>21075686, 6504555</i> <i>F3LY-14570-B, F3LB-14K056-AA</i> Black Nylon Rocker Panel, Wheel Liner, Air Inlet Duct Push-Type Retainer Hole: M8 Flange: 15mm Stem Length: 20mm <i>Ford, Chrysler, GM</i> Box Qty. 25</p>	<p style="text-align: right;">415891 Box 100 415891-500 Box 500</p>  <p>415889 <i>21030249, N807389S, 6503598</i> Black Nylon Air Baffle To Under Carriage Push-Type Rivet Head Dia: 20mm Stem Length: 20mm Fits Into 8mm Hole <i>GM, Ford, Chrysler</i> Box Qty. 25</p>
 <p>415892 <i>6509103AA, 6509103-AA, W705436-S300, 21077123, 20730531</i> Plastic Wheel Mldg. Push-Type Retainer Hole: 1/4" (6.4mm) Flange: 19/32" (15mm) Stem Length: 3/4" (19mm) <i>GM, Ford, Chrysler</i> Box Qty. 25</p>	 <p>415893 <i>21077123, 20730531, 6509103AA, 6509103-AA, W705436-S300</i> Black Nylon Wheel Opening Mldg Push-Type Retainer Head Dia: 19/32" (15mm) Stem Length: 3/4" (19mm) Fits Into 1/4" (6mm) Hole <i>Saturn 91 - UP, Ford 2002 - UP, Chrysler 2010 - UP</i> Box Qty. 25</p>		 <p>415992 <i>4001916</i> Black Nylon Weatherstrip Retainer Hole: 5/16" Head: 3/16" x 9/16" P.R.: .050 <i>Jeep Wrangler 1991 - UP</i> <i>GM Trucks</i> Box Qty. 50</p>
 <p>415994 <i>4696129, 21077575</i> Weatherstrip Retainer Front and Rear Doors Hole: M5 Head: 6.5 x 16.5mm P.R.: 1.5mm <i>Chrysler Concorde & LHS</i> <i>Dodge Intrepid & Eagle Vision 1993 - UP</i> <i>Oldsmobile Alero & Pontiac Grand Am 1999 - UP</i> Box Qty. 100</p>	 <p>416011 <i>N803946S, 000-991-52-40, 20664091, 6502871, W706350-S300</i> Black Nylon Rear Quarter Trim Panel Screw-Type Retainer Head Dia: 19/32" (15mm) Stem Length: 29/32" (23mm) Fits Into 1/4" (6.4mm) Hole <i>Ford & Chrysler '97 - UP, GM, Mercedes Metris 2016-20, Sprinter 1500, 2500, 3500 2019-UP</i> Box Qty. 50</p>	 <p>416040 <i>6503453</i> Black Nylon Bumper Fascia Push-Type Ret. Head Dia.: 1" Stem length: 1-1/8" Fits Into 1/4" Hole <i>Jeep Grand Cherokee '94 - UP</i> Box Qty. 25</p>	 <p>416042 <i>94530438, B040-68-865-A96</i> Plastic Fender Liner Screw-Type Retainer Head Dia: 15mm Stem Length: 14mm Fits Into 6mm Hole <i>Ford Probe '88 - UP</i> <i>Mazda MX6 '88 - UP</i> <i>Chevrolet Aveo 2004 - UP</i> Box Qty. 25</p>
 <p>416046 <i>14019226, 14071289, 04388293, 175720B010</i> Black Nylon Radiator Overflow Bottle/Windshield Washer Bottle Retainer Head Dia: 21/32" Stem Length: 9/16" Fits Into 5/16" Hole <i>Ford, Chrysler, GM '81-UP</i> Box Qty. 50</p>	 <p>416047 <i>6033082, 6033840, W709346-S300, 39001S, 10121502, 10077401, 390018-S</i> Black Nylon Shield Retainer Battery Post Shield, Engine Splash Shield Radiator Side Air Baffle Hole Size: 1/4" (6.3mm) Head Dia: 23/32" Stem Length: 1-1/16" <i>Ford, Chrysler, GM, GM Express & Savana Vans 1996-UP</i> Box Qty. 50</p>	 <p>416055 <i>MB888869, 90505-SLO-003, 90467-08155, 9485236</i> Plastic Bumper Cover Screw-Type Ret. Hole: M8, Stem: 21mm Flange Dia: 20mm <i>Chrysler, GM, Acura, Toyota '93 - UP</i> Box Qty. 15</p>	 <p>416057 <i>6504521</i> Black Nylon Fascia Push-Type Retainer Hole Size: 8mm Flange Dia.: 18mm Stem Length: 23mm <i>Chrysler LHS, Concorde, Dodge Intrepid & Eagle Vision '98 - UP</i> Box Qty. 25</p>

CHRYSLER CLIPS & FASTENERS



416060
4676356
Phosphate
Grille to Fascia Retainer
Width: 1/2"
Height: 23/32"
Chrysler Minivan '97 - UP
Box Qty. 25



416097
MR-1388107
Bumper Cover
Screw-Type Retainer
Hole: 8mm (5/16")
Flange Dia: 20mm
Stem Length: 26mm
Chrysler Sebring '96 - UP
Mitsubishi Eclipse '94 - UP
Box Qty. 5



416102
6503819,
6503401, 25631448
Black Nylon
M7.5 x 35mm
Square Drive
Truss Head
Tapping Screw
Head Dia.: 22mm
Shoulder Dia.: 9mm
Foam To Bumper Fascia
GM '97 - UP, Chrysler '93 - UP
Box Qty. 15



416123
MR478262
Black Nylon
(Use w/416125)
Bumper Cover/
Garnish Moulding
Push-Type Retainer
Top Hd Dia: 15mm
Bottom Hd Dia: 14mm
Stem Length: 12mm
Fits Into 7mm Hole
Chrysler Sebring & Stratus 2000-UP,
Mitsubishi Eclipse 2000 - UP
Box Qty. 15



416125
MR478263
Black Rubber
(Use w/416123)
Bumper Cover &
Garnish Moulding
Grommet With Sealer
Head Dia: 16mm
Stem Length: 20mm
Fits Into 9mm Hole
Chrysler Sebring & Stratus 2000-UP,
Mitsubishi Eclipse 2000 - UP
Box Qty. 15



416138
Black Nylon
Shroud Retainer
High Retention Capability
GM, Ford, Chrysler
Box Qty. 50



416140
22547243, 11610086,
6501916
Black Nylon
Push Retainer
Hole Size: 1/4" (6.3mm)
Head Dia: 7/8"
Stem Length: 1-3/32"
Splash Shield &
Wheel Well Cover
Chrysler 1988 - UP
Hood Seal Retainer
GM 1989 - UP
Box Qty. 50



416144
6031383
Black Nylon
Grille Push-Type Retainer
Head Dia: 11/16" (17.5mm)
Stem Length: 7/16" (11mm)
Fits Into 9/32" (7.1mm) Hole
Chrysler '78 - UP
Box Qty. 25



416146
F50C-9E728-AA,
6501925, 10134407,
15990756,
Black Nylon
Push-Type Retainer
Hole Size: 1/4"
Flange Dia: 11/16"
Stem Length: 13/16"
Chrysler Concorde & LHS, Dodge
Intrepid & Eagle Vision '93 - UP
Coolant Recovery Reservoir
GM '92 - UP
Ford
Box Qty. 25



416148
6503339
(Use w/ #416150)
Black Nylon
Cowl Top Stud
Retainer Cover
Torx Recess
Head Dia.: 13/16"
Dodge Ram '94 - UP
Jeep Grand Cherokee '99 - UP
Box Qty. 25



416150
6503336
(Use w/ #416148)
Cowl Screen Retainer
Flange Dia.: 9/16"
Stem Dia.: 19/64"
Stem Length: 13/32"
Dodge Ram '94 - UP
Jeep Grand Cherokee '99 - UP
Box Qty. 25



416152
25535963,
N811772S
Black Nylon
Twist Lock
Inst. Panel, Front Comp.
Rear Site Shield Retainer
Buick Electra, LeSabre, Park Ave. &
Skylark, Cadillac DeVille, Oldsmobile
Achieva, Cutlass, Delta 88, 88
Royale & 98 Regency And Pontiac
Bonneville & Grand Am 1991 - UP
Upper Deflector Shield
Ford
Box Qty. 15

not actual size



416154
4805405AA,
1L5Z-17K826AA
Front Fascia
Push-Type Ret.
Hole: M8
Flange Dia: 34mm
Stem Length: 20.5mm
Shoulder: 3.5mm
Chrysler Concorde
Dodge Intrepid, 300M '98 - UP
Ford Trucks 2005 - UP
Box Qty. 15

not actual size



416155
4389947-AA
Bumper Cover
Ret. w/ Sealer
Head Dia: 24mm
Shoulder Length: 3mm
Stem Length: 20mm
Fits Into 11mm Hole
Chrysler Avenger, Journey
& Sebring 2008 - UP
Box Qty. 15









416169
14045480,
55074801
Black Nylon
Fascia Retainer
Head Dia: 1"
Stem Length: 11/16"
Fits Into 3/8" Hole
Chrysler 2009-UP, GM '82-UP
Box Qty. 25

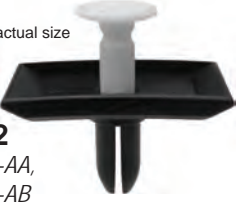

416171
15056810, 65058686AA
Black Nylon
Bumper Fascia Retainer
Hole Size: 12.5mm (1/2")
Head Dia.: 25mm
Stem Length: 15mm
GM S & T Trucks 2002 - UP
Chrysler
Box Qty. 25

CHRYSLER CLIPS & FASTENERS

<p>416172 4857345-AA Black Nylon Tail Light Housing Push-Type Retainer Lg Head Dia.: 21mm Stem Length: 23mm Fits Into 9.5mm Hole <i>Chrysler Caravan, T&C, Voyager Mini Vans 2002 - UP</i> Box Qty. 25</p> 	<p>416177 20551451, 20511451, 36003452 Black Nylon Cowl Vent Retainer Head Dia: 21/32" Stem Dia: 15/32" Fits Into 7/32" Hole <i>Chrysler, GM '84 - UP</i> Box Qty. 25</p> 	<p>416179 6506132-AA Black Nylon Side Radiator Shield Push-Type Retainer Head Dia.: 20mm Stem Length: 17mm Fits Into 7mm Hole <i>Chrysler Sebring, Stratus '2001 - UP</i> Box Qty. 25</p> 	<p>416181 WX68DX9-AA Black Nylon Door Trim Panel Retainer Head Dia.: 22mm Stem Length: 10mm Fits Into 9mm Hole <i>Chrysler 300M and Dodge Magnum & Charger 2005 - UP</i> Box Qty. 25</p> 
<p>416182 55157112-AA, 55157112-AB Black & Natural Nylon Bumper Cover Retainer Head Size: 25mm x 45mm Shoulder Length: 3mm Stem Length: 20mm Fits Into 9.5mm Hole <i>Jeep Liberty 2005 - UP</i> Box Qty. 15</p> <p>not actual size</p> 	<p>416183 OWX68BD5-AA Gray Nylon Door Trim Panel Push-Type Retainer Head Dia.: 22mm Stem Length: 10mm Fits Into 9mm Hole <i>Chrysler 300M and Dodge Charger & Magnum 2005 - UP</i> Box Qty. 25</p> 	<p>416184 11561368, 6508712AA Black Nylon Fender, Wheel & Bumper Push-Type Retainer Flange Dia.: 18mm Stem Length: 20mm P.R.: 3mm - 5.8mm Fits Into 9.5mm Hole <i>Chevrolet Impala & Monte Carlo and Pontiac Grand Prix & Solstice 2004 - UP Jeep Wrangler 2000 - UP</i> Box Qty. 15</p> 	<p>416187 OWX68BD1-AA Tan Nylon Door Trim Panel Push-Type Retainer Head Dia.: 22mm Stem Length: 10mm Fits Into 9mm Hole <i>Chrysler 300M and Dodge Charger & Magnum 2005 - UP</i> Box Qty. 25</p> 
<p>416190 06508863-AA, W713610-S300, 11589289 Black Nylon Air Distributor/ Windshield Defroster Push-Type Retainer Flange Dia.: 18mm Stem Length: 17.5mm PR: 2.0mm - 4.5mm Fits Into 6.5mm Hole <i>GM, Chrysler, Ford</i> Box Qty. 25</p> 	<p>416192 11589290, 6509049-AA, W714040-S300 Black Nylon Air Inlet Grille/ Bumper Fascia/Front Brake Caliper Cooling Duct Push-Type Retainer Flange Dia: 18mm Stem Length: 20mm PR: 4.5mm - 7.0mm Fits Into 6.5mm Hole <i>Buick Enclave, Cadillac, CTS & STS, Chevrolet Cobalt, Equinox & SSR, GM Trucks and Pontiac G5 & Torrent 2002-UP Chrysler Charger & 300 2011-UP, Ford</i> Box Qty. 50</p> 	<p>416196 5116530-AA, 15296830 Black Nylon Fascia/General Purpose Push-Type Retainer Flange Dia.: 19mm Stem Length: 16mm PR: 5.0mm - 7.0mm Fits Into 8mm Hole <i>GM, Chrysler</i> Box Qty. 25</p> 	<p>416196 5116530-AA, 15296830 Black Nylon Fascia/General Purpose Push-Type Retainer Flange Dia.: 19mm Stem Length: 16mm PR: 5.0mm - 7.0mm Fits Into 8mm Hole <i>GM, Chrysler</i> Box Qty. 25</p> 
<p>416206 6509960AA Black Nylon Bumper Push-Type Retainer Flange Dia: 18mm Stem Length: 10mm Fits Into 8mm Hole <i>Chrysler 300 2011 - UP</i> Box Qty. 25</p> 	<p>416207 6509590-AA Black Nylon Bumper Retainer Head Dia: 19mm Stem Length: 26mm Fits Into 7.50mm Hole <i>Chrysler 300 & Charger 2011 - UP</i> Box Qty. 25</p> 	<p>416208 W712665-S300, 11589295, 5GUU9K11BA Black Nylon Fender, Flare, Gas Tank & Panel Attchmnt Push-Type Ret. Flange Dia.: 25mm Stem Length: 20mm PR: 3.0mm - 6.0mm Fits Into 10.5mm Hole <i>GM, Ford, Chrysler</i> Box Qty. 15</p> 	<p>416215 6509761-AA, 24512415 Black Nylon Front Bumper Retainer Head Dia: 20mm Stem Length: 13.5mm Fits Into 10mm Hole <i>Dodge Ram & Jeep Cherokee 2010 - UP</i> Box Qty. 15</p> 

CHRYSLER CLIPS & FASTENERS

<p>NEW</p>  <p>416232 4878883AA Black Nylon Hood Insulation Retainer Head Dia: 30mm Stem Dia: 8mm Stem Length: 12mm Chrysler LH & LHS Series 1997 - UP Box Qty. 50</p>	<p>NEW</p>  <p>416234 6504135 Black Nylon Hood Insulation Retainer Head Dia: 1" Stem Dia: 9/32" Stem Length: 5/8" Chrysler Mini-Vans & Durango 1997 - UP Box Qty. 50</p>	 <p>416261 11561438 Black Nylon M14 x 34mm Bumper and Door Insulator Nylon Screw No. 3 Square Drive Head O.D.: 22mm Fits Into 12mm Hole GM, Ford, Chrysler 2005 - UP Box Qty. 25</p>	 <p>416270 230-990-01-92, 6104900-A Black Nylon Hood Insulation/Cowl Grille Push-Type Retainer Head Diameter: 20mm Stem Length: 10mm Fits Into 8mm Hole Mercedes Benz GL, M, R, SL & SLK 2005 - UP; Chrysler 2010-UP Box Qty. 15</p>
 <p>416273 55055098 Black Nylon Headlight Grille Retainer Head Dia: 7/16" Stem Length: 3/8" Fits Into 1/8" Hole Dodge Ram 1994 - UP Box Qty. 25</p>	 <p>416274 4806334-AA Rear Bumper Push-Type Retainer With Sealer Head Dia: 34mm Shoulder Length: 3.5mm Stem Length: 17mm Fits In 8.5mm Hole Dodge Caliber and Jeep Compass & Patriot 2007 - UP Box Qty. 10</p>	 <p>416275 5160260-AA Black Nylon Rear Bumper And Fender Push-Type Retainer Bottom Head Dia: 18mm Stem Length: 20mm Fits Into 8mm Hole Dodge Caliber and Jeep Compass & Patriot 2007 - UP Box Qty. 15</p>	 <p>416276 6508197-AA, W706092-S300 Black Nylon Front Air Shield, Splash Guard & Heat Shield Push-Type Retainer Head Dia: 18mm Stem Length: 18mm Fits Into 6.4mm Hole Dodge Ram 2006 - UP Ford Taurus 2008 - UP Box Qty. 25</p>
 <p>416277 6501067 Black Nylon Fascia Retainer Head Dia: 25mm Stem Length: 20mm Fits Into 7.5mm Hole Chrysler 1985 - UP Box Qty. 50</p>	 <p>416280 22512276, 6503221 Black Nylon Front End Stone Shield Retainer Head Dia: 7/8" Stem Length: 7/16" Fits Into 3/8" Hole Chrysler, GM 1981 - UP Box Qty. 25</p>	 <p>416281 10185925, 6503768 Black Nylon Bumper Fascia Retainer Head Dia: 3/4" Stem Length: 1-3/16" Fits Into 11/32" Hole Chevy Lumina APV, Olds Silhouette & Pontiac Transport 1993 - UP Chrysler Box Qty. 25</p>	 <p>416322 68033045AA Black Nylon Front & Rear Fender Flare Retainer Head Diameter: 20mm Stem Length: 19mm Fits Into 9mm Hole Jeep Wrangler 2007 - UP Box Qty. 15</p>
 <p>421401 11571175, 68172491-AA Gray Nylon Rocker Clip w/ Sealer Top Hd Size: 12mm x 20mm Bottom Hd: 12mm x 20mm Stem Length: 11mm Fits Into 9mm Hole Chevrolet Traverse 2010-UP Chrysler 200 2015-UP Jeep Grand Cherokee 2015 - 2012 Box Qty. 15</p>	 <p>430000 55157070-AC Black Nylon Rocker Moulding Clip Head Dia: 25mm Overall Length: 31mm Fits Into 8mm Hole Jeep Liberty 2002 - UP Box Qty. 10</p>	 <p>430001 1BA41AX1-AA Black Nylon Rocker Panel Moulding Clip Head Size: 12mm x 20mm Stem Length: 13mm Chrysler 300, Dodge Magnum 2005 - UP Box Qty. 15</p>	 <p>430002 55157069-AB White Nylon Rocker Moulding Clip Top Head: 14mm x 27mm Bottom Head: 13mm x 26mm Stem Length: 15mm Fits Into 9mm Hole Jeep Liberty 2002 - UP Box Qty. 25</p>

CHRYSLER CLIPS & FASTENERS



430003
 55157055-AA,
 55157065-AA
 Gray Nylon
 Fender Flare Moulding Clip
 Top Head: 14mm x 38mm
 Bottom Head: 16mm x 38mm
 Stem Length: 15mm
 Fits Into 9mm Hole
Jeep Liberty 2005 - UP
 Box Qty. 15



430004
 1BA41XWG-AA
 Cream Color Nylon
 Rocker Panel Moulding Clip
 Head Size: 12mm x 20mm
 Stem Length: 13mm
 Fits Into 9mm Hole
Chrysler 300 2006 - UP
 Box Qty. 15



430005
 5189181-AA
 Black Nylon
 Fender Flare
 Moulding Clip With Sealer
 Top Head: 14mm x 40mm
 Bottom Head: 14mm x 18mm
 Stem Length: 15mm
 Fits Into 9mm Hole
Jeep Commander 2006-UP
 Box Qty. 10



430006
 6508947-AA
 Front Bumper Moulding Clip
 Top Head: 11mm x 32mm
 Bottom Head: 15mm x 20mm
 Stem Length: 20mm
 Fits Into 15mm Hole
Jeep Patriot 2007 - UP
 Box Qty. 10



430007
 Not Available From O.E.M.
 White Nylon
 Fender & Wheel Flare
 Moulding Clip
 Top Head: 14mm x 18mm
 Bottom Head: 17mm x 21mm
 Stem Length: 13mm
 Fits Into 9mm Hole
Jeep Commander 2006 - UP
 Box Qty. 25



430008
 5189180-AA
 Front Fender Moulding Clip
 Top Head: 13mm x 31mm
 Bottom Head: 14mm x 22mm
 Stem Length: 22mm
Jeep Commander 2006 - UP
 Box Qty. 15



430009
 6509288AA
 Black Nylon
 Rocker Mldg Clip with Sealer
 Upper Head: 21mm x 22mm
 Bottom Head: 22mm x 22mm
 Stem Length: 9mm
 Fits Into 7mm Hole
*Grand Caravan and Town
 & Country 2008 - UP*
 Box Qty. 10



430010
 68092697AA
 White Nylon
 Rocker Panel Moulding Clip
 Top Head: 9/16" x 13/16"
 Bottom Head: 9/16" x 23/32"
 Stem Length: 5/8"
 Fits Into 23/64" Hole
*Dodge Dakota & Durango and
 Jeep Liberty 2000 - UP*
 Box Qty. 15



430011
 68225214AA,
 11547341
 White Nylon
 Bumper Moulding Clip
 Head Size: 11.5mm x 21mm
 Stem Length: 11mm
 Overall Height: 17mm
*Jeep Cherokee 2014 - UP; Buick
 Enclave & Envision, Cadillac ATS,
 CT6, CTS, ELR, Escalade, XT4
 & XT5, Chevrolet Blazer, Bolt EV,
 Camaro, Corvette, Cruze, Equinox,
 Impala, Malibu, Silverado, Sonic,
 Suburban, Tahoe, Traverse, Trax &
 Volt, GMC Acadia, Sierra 2500/3500,
 Terrain & Yukon 2018 - UP*
 Box Qty. 50



430012
 68283229AA
 Black Nylon
 Rocker Moulding Clip
 w/Sealer
 Top Hd: 14mm x 20mm
 Bottom Hd: 14mm x 32mm
 Stem Length: 15mm
 Fits Into 9mm Hole
*Chrysler 300 & Dodge Charger
 2015 - UP*
 Box Qty. 10



430090
 6003219
 Side Moulding Clip
Chrysler Cars & Trucks '71 - UP
 Box Qty. 25



430095
 5FR56DX9
 Black Nylon
 Rocker Moulding Retainer
 Hole: M11 Square
 Head: 11 x 20mm
 Length: 16mm
Jeep Grand Cherokee '99 - UP
 Box Qty. 15



430240
 6003632
 Nylon
 Fender Wheel Opening
 Moulding Clip
Chrysler Products '78-UP
 Box Qty. 50



not actual size

430290
 6003685
 Quarter Panel Outside
 Moulding Clip
Chrysler Products '78 - UP
 Box Qty. 10



430480
 6003856
 Deck Lid
 Moulding Clip
Dodge Van '84 - UP
 Box Qty. 25



430482
 55156429-AA
 Rocker Panel &
 Bumper Fascia Retainer
 Top Head: 1/2" x 1-3/16"
 Stem Length: 27/32"
Jeep Liberty 2002 - UP
 Box Qty. 10

CHRYSLER CLIPS & FASTENERS



430485
55156447-AB
Fender Flare Retainer
Head Width: 1/2"
Head Length: 1-1/2"
Stem Length: 1/2"
Fits Into 10mm Hole
Jeep Liberty 2002
Box Qty. 10



445032
385661-S,
6032363, N989022
Black Nylon
Door Trim Panel Retainer
Head Dia: 15/16"
Stem Length: 11/16"
Fits Into 5/16" Hole
Ford, Chrysler, VW '75 - UP
Box Qty. 25



445038
(Use With #445039)
White Nylon
Door Panel Retainer
Top Head Dia.: 13mm
Bottom Head Dia.: 23mm
Stem Dia.: 6.5mm
Stem Length: 20mm
Chrysler LH Series 2000 - UP
Box Qty. 25



445039
6506655AA
(Use With #445038)
White Nylon
Door Panel Grommet
Head Dia.: 19mm
Stem Length: 12mm
Fits Into 9mm Hole
Chrysler LH Series 2000 - UP
Box Qty. 25



445040
55350747AB
White Nylon
Door Trim Panel Retainer w/Sealer
Top Hd Dia.: 13mm
Bottom Hd Dia.: 18mm
Stem Dia.: 8mm
Stem Length: 18mm
Chrysler Minivans '99 - UP
Box Qty. 15



445042
MB566719
Plastic
Door Cladding Retainer
Hole: M7
Head: 12mm
P.R.: 2mm
Chrysler Sebring, Concorde & Eagle Talon '96 - UP
Box Qty. 15



445044
6505539AA,
5012874AA
Plastic
Door Trim Panel Retainer (Used On Plastic Panels)
Hole: M7
Stem Length: 15mm
P.R.: 1.7mm - 2.25mm
Jeep Grand Cherokee '99 - UP
Box Qty. 25



445046
6503709
Plastic-Natural
Door & Quarter Trim Panel Retainer
Hole: 5/16"
G.R.: 1/16" - 9/16"
Minivans, Pick-ups
Sebring Convertible
Dodge Viper '94 - UP
Box Qty. 50

Upholstery And Trim Clips

5mm Hole Size
Chrysler Products, Japanese Models,
Mitsubishi Models
Box Qty. 25



Part No.	OEM No.	Color
445178	MB178893	Black
445180	MB222647	Burgundy
445182	MB178894	Blue
445184	MB178899	Off White
445186	MB178896	Lt. Blue



445350
4114785
Zinc Plated
Trim Panel Retainer
Fits Into 5/16" Hole
Chrysler Products '86 - UP
Box Qty. 50



445565
N802734S,
22718305,
6506788
Black Nylon
Interior Trim Panel/
Hood Insulation Retainer
Head Dia: 25mm
Stem Length: 20mm
Fits Into 7mm Hole
Ford '83 - UP
GM & Chrysler
Box Qty. 50



445585
6003349, 9685057,
4005470, N98905101
White Nylon
Door Trim Panel Retainer
Hole Size: 7mm
Top Head Size: 20mm
Stem Length: 18mm
Chrysler, GM, AMC, VW '76 - UP
Box Qty. 50



445623
20298365, 6013122
Natural Nylon
Trim Panel Retainer
Top Head: 3/8" x 9/16"
Bottom Head: 9/16"
Stem Length: 11/16"
Fits Into 11/32" Hole
GM '82 - UP
Chrysler '76 - UP
Box Qty. 50













445624
6033862, 796255,
4005099, 0501094C1
Black Nylon
Door Trim Panel Retainer
Hole: 5/16"
Top Head: 19/32"
Bottom Head: 3/4"
Stem Length: 11/16"
AMC '76 - UP and GM '81 - '88
and Jeep Wrangler '91 - UP
Box Qty. 25



445632
6502991
Yellow Nylon
Tail Gate & Door Trim Panel Retainer
Hole Size: 7.5mm
Top Head: 13mm
Bottom Head: 18mm
Stem Length: 25mm
Jeep Cherokee '93 - UP
Box Qty. 25

CHRYSLER CLIPS & FASTENERS

<p>NEW</p>  <p>445633 68087885AA Turquoise Nylon Lift Gate Retainer Top Head Dia: 13mm Middle Head Dia: 16mm Bottom Head Dia: 18mm Stem Dia: 8mm Stem Length: 27.5mm Overall Length: 31.5mm Dodge Durango & Jeep Grand Cherokee 2011 - UP Box Qty. 25</p>	 <p>445760 385188-S, 6032235 Door & Interior Trim Panel Retainer Hole: M7.2 Top Head: 12.6mm x 15mm Stem Length: 15mm Ford '75 Chrysler '81 Box Qty. 50</p>	 <p>445792 6034336, 6034812, 6035807 Phosphate Door Panel Nut #6 Screw Size Chrysler Cirrus, Concorde, LHS, Dodge Intrepid, Stratus & Eagle Vision '93 - UP Box Qty. 25</p>	 <p>445797 6505292AA, W706812S300 Natural Nylon Door Trim Panel Retainer Top Head: 15mm Bottom Head: 20mm Stem Length: 14mm Stem Dia: 9.5mm Chrysler Vans '98 - UP Ford Box Qty. 25</p>
 <p>445818 95008221, 67771-30090, MB608104 Yellow Nylon Door Trim & Back Panel Lower Garnish Retainer Top Head Dia: 13mm Stem Length: 15mm Fits Into 9mm Hole Toyota Land Cruiser & 2WD Truck 1991 - UP Geo Prizm 1993 - 97 Box Qty. 50</p>	 <p>445882 6504014, 6503896, 6542907 White Nylon Door Trim Panel Retainer Hole: M7 Top Head Dia: 13mm Stem Length: 15mm Chrysler Neon, Cirrus, Caravan, Stratus & Voyager '95 - UP Dodge Pick-Up '94 - UP Box Qty. 100</p>	 <p>445883 91560-SM4-003, 6502907 White Nylon Door Trim Panel Retainer Hole Size: 9mm Top Head: 13mm Middle Head: 18mm Bottom Head: 16mm Stem Length: 15mm Honda Accord '90 - UP Dodge Pick-ups '94 - UP Box Qty. 25</p>	 <p>445890 6503204 Green Nylon Trim Panel Retainer Hole: 5/16" Top Head: 19/32" Bottom Head: 23/32" Stem Length: 5/8" Chrysler Cirrus & Stratus '95 - UP Box Qty. 50</p>
 <p>475075 4805570-AA Black Radiator Grille Cover Clip Width: 26mm Length: 26mm Caravan, Town & Country and Voyager Mini-Vans '96- UP Box Qty. 10</p>	 <p>475155 14083173, 17988488, 17997722, 25536302, N803685-S Zinc Organic Windshield/Rear Side Door Garnish Moulding & Liftgate Trim Panel Fastener Height: 9/16" Width: 1/2" Chevrolet Camaro, Corvette, & Venture; Oldsmobile Silhouette and Pontiac Firebird, Grand Prix & Trans Sport 1993 - UP Chrysler 1996 - UP Box Qty. 15</p>	<p>475705 16662182, 6502988, 25580123 Zinc Organic Windshield/Rear Side Door Garnish Moulding & Liftgate Trim Panel Fastener Height: 9/16" Width: 1/2" Chevrolet Camaro, Corvette, & Venture; Oldsmobile Silhouette and Pontiac Firebird, Grand Prix & Trans Sport 1993 - UP Chrysler 1996 - UP Box Qty. 15</p>	

CHYSLER GLASS SHOP SUPPLIES

19 Chrysler Clips



460000
3767196
Windshield Setting Block
Lower Spacer
Chrysler Caravan,
Plymouth Voyager,
Town & Country '84 - UP
Box Qty. 15



460110
6003238
Windshield Reveal
Moulding Clip
Chrysler
Box Qty. 50



471200
Windshield Wiper
Linkage Cap
Groove Dia.: 9/16"
Chrysler Products '74 - UP
Box Qty. 50



480515
4339372
Black Nylon
Door Glass Slide Guide
w/Rivets
Chrysler Acclaim, GTS, Lancer,
LeBaron, Shadow, Spirit &
Sundance 1989 - UP
Box Qty. 25



480531
69951-12180
not actual size
Nylon
w/ Steel Threaded Insert
Glass Mount
M6-1.0 Thread
Ford, Nissan and Imports
Box Qty. 5



486015
Torque Pin Kit
For Window Gears
Pin Dia: 1/2"
Pin Length: 13/32"
Ford & Chrysler '64 - UP
Box Qty. 15 pins

not actual size



486050
Power Window
Regulator Gear
(9-Tooth)
Chrysler Products '75 - UP
Box Qty. 1

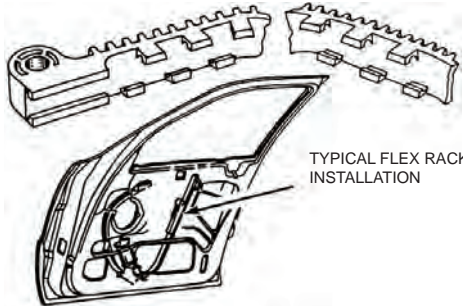

TYPICAL FLEX RACK
INSTALLATION

486110
Flex Rack,
Used on Flex-Drive Window Regulators
O/L 54", Cut to Fit
Chrysler Products
Box Qty. 1



FORD CLIPS & FASTENERS

20 Ford Clips

27999 Box 25



28000

6031115, 9436175, 385189-S100
Peel-Type Rivet
Dia: 1/4" Grip: 1/32" - 9/64"
Flange Dia: 1/2"
Aluminum Rivet, Steel Mandrel
Window Regulators
GM, Ford Chrysler '71 - UP
Box Qty. 100

28002 Box 25



28001

6031091, 9437938, 385323-S100
Peel-Type Rivet
Dia: 1/4" Grip: 33/64" - 19/32"
Flange Dia: 1/2"
Aluminum Rivet, Steel Mandrel
Window Regulator
GM, Ford, Chrysler '76 - UP
Box Qty. 100

38499 Box 25



38500

388664-S100
Dia: 3/16" Grip: 3/8" - 1/2"
Flange Dia: 9/16"
Black Aluminum Rivet
w/ Aluminum Mandrel
Fascia, Bumper, Grille
Ford Products 1982 - UP
Box Qty. 100

38503 Box 25



38501

388442-S100
Dia: 1/4" Grip: 1/8" - 1/4"
Flange Dia: 3/4"
Black Steel Rivet
Steel Mandrel
Bumper Assembly
Ford Escort & Lynx '81 - UP
Box Qty. 100

38504

388047-S102
Dia: 1/4" Grip: 3/32" - 1/8"
Flange Dia: 1/2"
Peel-Type Rivet
Black Aluminum Rivet
Steel Mandrel
Door Handle Assembly
Ford '81 - UP
Box Qty. 50

38505

N805759-S100
Dia: 1/8", Grip: 1/8" - 3/16"
Flange Dia: 3/8"
Black Aluminum Rivet
Aluminum Mandrel
Windshield Side Rail
Ford T-Bird
Mercury Cougar '89 - UP
Box Qty. 50

38506

390428-S100
Dia: 3/16" Grip: 3/8" - 1/2"
Flange Dia: 3/8"
Black Aluminum Rivet
Black Aluminum Mandrel
Closed End
Luggage Racks &
General Purpose
Ford
Box Qty. 25

38507

6032856
Dia: 1/8" Grip: 5/16" - 3/8"
Flange Dia: 3/8"
Aluminum Rivet (Black)
Aluminum Mandrel
Body Side Moulding &
Universal Applications
Chrysler
Box Qty. 25

NEW

38508

Dia: 1/8"
Grip: 1/16" - 1/8"
Flange Dia: 3/8"
Black Aluminum Rivet
Steel Mandrel
Attachment of Door Glass
Moulding
Ford 1993 - UP
Box Qty. 50

38511 Box 100

38510

25618730, N805592-S100
Dia: 3/16"
Grip: 5/64" - 15/64"
Flange Dia: 7/16"
Black Aluminum Rivet
Aluminum Mandrel
Split-Type Rivet
Wheel House Moulding &
General Purpose
Ford, GM
Box Qty. 25



NEW

38520

W713819-S900
Dia: 4mm (5/32")
Grip Range: 1.2mm - 3.2mm
(3/64" - 1/8")
Flange Dia: 9mm (3/8")
Closed End Specialty Rivet
Black Aluminum Rivet (with
Plastic Cap) / Steel Mandrel
Cab & Exterior Trim
Ford F-150 2009 - 2014
Box Qty. 25



NEW

38521

W717984-S417
Dia: 4.8mm (3/16")
Grip Range: 1.6mm - 3.18mm
(.063" - .125")
Flange Dia: 9.5mm (3/8")
Closed End Specialty Rivet
Black Aluminum Rivet/Mandrel
Countersunk Head
Cab & Exterior Trim
Ford F-150 2015 - UP
Box Qty. 15



FORD CLIPS & FASTENERS



38515
 Aluminum Rivet
 Dia: 3/16"
 Grip Range: Up To 1"
 plus a 3/16"
 Back up Washer
Ford Bumper Pads
 Box Qty. 25 Sets



38518
W705297-S300
 Dia: 1/4"
 Grip: 3/16" - 3/8"
 Flange Dia: 11/16"
 Split-Type Rivet
 Aluminum Rivet
 Aluminum Mandrel
 Bumper Cover
Ford Fusion 2009 - UP
 Box Qty. 15



38522
N807620-S100, 10131511, 11588308, 6034212, 6036148AA
 Dia: 5/32" Grip: 3/64" - 1/4"
 Flange Dia: 5/16"
 Split-Type Rivet
 Black Aluminum Rivet
 Aluminum Mandrel
 Wheel Openings *Lincoln '94 - UP*
 Bumper Cover, Grille, Rocker Mldg.
GM '97 - UP
 Bumper Cover *Chrysler*
 Box Qty. 25



38530
N803933-S101
 Dia: 1/8" Grip: 13/64-9/32"
 Flange Dia: 15/64"
 Closed End
 Black Aluminum Rivet
 Black Aluminum Mandrel
 Luggage Rack
Ford
 Box Qty. 50



38555
389268-S100, 20184399, 12338153
 Dia: 1/4" Grip: 11/16" - 3/4"
 Flange Dia: 1/2"
 Peel-Type Rivet
 Aluminum Rivet
 Steel Mandrel
 Window Regulators
Ford & GM 1979 - UP
 Box Qty. 25



38561 Box 30
38560
N806830-S100, N806830-S100, 6035201
 Dia: 1/4" Grip 3/16" - 3/8"
 Flange Dia: 11/16"
 Black Aluminum Rivet
 Aluminum Mandrel
 Bumper Covers, License Plate Bracket
Ford '92 - UP
 Air Dam To Fascia *Chrysler '93 - UP*
 Box Qty. 15



38570
N804193-S100, 9441592, 15672713
 Dia: 1/4" Grip: 3/32" - 9/64"
 Flange Dia: 3/4"
 Peel-Type Rivet
 Black Aluminum Rivet, Steel Mandrel
 Front Door Handle & Door Lock Actuator
Ford Tempo, Topaz, T-Bird, & Cougar '84 - UP
 Rocker Panel Mldg
Chevrolet Beretta & Corsica 1992 - 1996
 Box Qty. 25



38575
9442361, 25609048, N804523S, N803138-S
 Dia: 3/16" Grip: 3/64" - 13/64"
 Flange Dia.: 9/16"
 Split-Type Rivet
 Black Aluminum Rivet / Steel Mandrel
 Used in place of screws when attaching
 new Catalytic Converter Heat Shield
Ford; Buick LeSabre & Roadmaster, Cadillac Brougham and Oldsmobile 98 & 88 1986 - UP
 Box Qty. 50



38580
N808426-S100
 Dia: 1/4"
 Grip: 1/8" - 1/4"
 Flange Dia: 1/2"
 Black Aluminum Rivet
 Aluminum Mandrel
 Bumper Fascia
Ford Taurus & Mercury Sable '96 - UP
 Box Qty. 25



38583
W525157-S300
 Dia: 4.8mm (3/16")
 Grip: 3.20mm - 6.35mm
 (.126" - .250")
 Flange Dia: 9.3mm (3/8")
 Aluminum Rivet
 Steele Mandrel
 Bumper & Lower Deflector
Ford Escape, Expedition & Taurus 2005 - UP
 Box Qty. 50

*Recommended by Ford to replace
 the Factory Self Piercing Rivets!*



38590
W702512-S900C
 Dia: 1/4" (6.3mm) Grip: 0.110" - 0.189" (2.79mm - 4.8mm)
 Flg Dia: 1/2" (13mm)
 Hole: 0.264-0.272" (6.71-6.91mm)
 Steel Rivet, Steel Mandrel
 Fender, Sill, Radiator Support, Cab, Rail, Floor, Pillar, Cowl,
 Box, Back Panel
Ford F150 (Aluminum Body) 2015 - UP
 Box Qty. 10

FORD CLIPS & FASTENERS

Recommended by Ford to replace
the Factory Self Piercing Rivets!



38591

W702554-S900C
Dia: 1/4" (6.3mm) Grip: .268" - .346" (6.8mm - 8.8mm)
Flange Dia: 1/2" (13mm)
Steel Rivet, Steel Mandrel
Cab, Floor, Door, Pillar, Box & Cowl
Ford F150 Trucks (Aluminum Body) 2015 - UP
Box Qty. 10

Recommended by Ford to replace
the Factory Self Piercing Rivets!



38592

W707638-S900C
Dia: 1/4" (6.3mm)
Grip: .060" - .138" (1.5mm - 3.5mm)
Flange Dia: 1/2" (13mm)
Steel Rivet, Steel Mandrel
Cab, Rear Body, Floor, Door, Box,
Wheel House & Back Panel
Ford F150 Trucks (Aluminum Body) 2015 - UP
Box Qty. 10

Recommended by Ford to replace
the Factory Self Piercing Rivets!

38595

W708777-S900C, 004-990-16-97, 11519023, 19353806
Dia: 1/4" (6.3mm) Grip: 3/16" - 17/64" (4.8mm - 6.8mm)
Flg Dia: 0.5" (13mm)
Steel Rivet, Steel Mandrel
Mercedes 2008 - UP
Cab, Radiator, Rail, Floor, Door, Pillar, Cowl, Box, Back Panel, Fuel Door
Filler Ford F150 (Aluminum Body) 2015 - UP; Mercedes 2008 - UP; Buick Allure,
Enclave, LaCrosse, Lucerne, Cadillac ATS, CTS, Escalade, SRX, STS, XLR, XTS,
Chevrolet Avalanche, Bolt EV, Camaro, Cobalt, Colorado, Corvette, Equinox, Express,
HHR, Impala, Malibu, Silverado, Suburban, Tahoe, Traverse, GMC Acadia, Canyon,
Savana, Sierra, Terrain & Yukon 2004 - UP; Chevrolet Blazer, GMC Jimmy, Oldsmobile
Bravada, Pontiac G5, G6, Grand Prix, Pursuit, Solstice & Saturn Aura 1997 - 2009
Box Qty. 10



270009

1570654, 6509432AA, W716529-S900
Blue Finish
Radiator Grille Nut
Screw Size: #8 (4.20mm), Head Size: 6mm x 16mm
Panel Range: .70 - 2.30mm, Hole Size: 8.7mm
Buick Allure, Enclave, Encore, LaCrosse, Lesabre, Lucerne,
Rainer, Regal & Verano and Cadillac ATS, CTS, Deville, DTS,
ELR, Escalade, SRX & STS 2000 - UP; Chrysler 200, 300, PT
Cruiser, Sebring, Town & Country and Dodge Avenger, Caliber,
Charger, Dart, Grand Caravan, Ram 2500 & Ram 3500 2006
- 2015; Ford 250, 350, 450 & 550 Super Duty Trucks 2013 -
2015
Box Qty. 25



20 Ford Clips

200010

W704874-S439
Zinc Organic
M4.8-1.59 x 16mm
(Special Hi-Lo Thread)
Hex Washer
Head Screw
Hex: 7mm
Washer Dia: 12.5mm
Ford Escape, Expedition, Explorer,
Fusion, Taurus, Thunderbird, Lincoln
Aviator, Continental, LS, MKC, MKZ,
Navigator, Town Car, Mercury Mariner,
Mountaineer & Sable 2000 - UP
Box Qty. 25



NEW

200011

W704875-S439
Zinc Organic
M4.2-1.41 x 19mm
Hex Washer
Head Tapping Screw
Hex: 7mm
Washer Dia: 12.5mm
Ford Escape, Explorer, Edge,
Expedition, F-150/250/350/450/550,
Flex, Taurus & Thunderbird and
Lincoln LS, Mark LT, MKX & MKZ
1999 - UP
Box Qty. 25



200075

10 x 1/2"
Head Dia: 1/2"
Phillips Tapping Screw
Boot Well & Weatherstrip
Rails
GM & Ford Convertible & Hardtops
Box Qty. 100



200368

N801169-S900,
W710763-S901
Hex Head Sems®
Tapping Screw
M4.2 - 1.41 x 22mm
Hex Size: 5.5mm
Washer Dia: 16mm
Front Bumper,
Exterior Trim & Front Fender
Ford Edge & Expedition And Lincoln
MKT & MKX 1997 - UP
Box Qty. 50



APPLICATION UPDATED

200399

W702413-S450B,
W702413-S307
Black Finish
M5-2.2 x 20mm
Torx® Pan Head Sems®
T30 Torx® Drive
Washer Dia: 20mm
Ford C-Max, Escape, Focus &
Transit Connect 2013 - UP; Edge
& F-150 and Lincoln MKC & MKX
2015 - UP
Box Qty. 15



200402

N800369
Zinc
License Plate Screw
(#14) 1/4 - 14 x 5/8"
Slotted Hex Washer Head
Washer Head OD: 5/8"
Hex A/F: 5/16"
Ford
Box Qty. 50



200403-1M Box 1000

200403

N800369-S2
Black E-Coat
License Plate Screw
(#14) 1/4 - 14 x 5/8"
Slotted Hex Washer Head
Washer Head OD: 5/8"
Hex A/F: 5/16"
Ford
Box Qty. 50



215014

57030-S36
Zinc & Yellow Dichromate
1/4"-20 x 7/8"
Hex Head Sems®
With Dog Point
Washer OD: 3/4"
Hex: 7/16"
Ford
Box Qty. 50



FORD CLIPS & FASTENERS

20 Ford Clips



216000
W711390-S900
Black Zinc
Hex Head Sems Body Bolt
w/Threaded Locking Patch
M6-1.0 x 30mm
Washer OD: 18mm (23/32")
Hex: 10mm
Ford F-150 Trucks With Aluminum
Body 2015 - UP
Box Qty. 25



NEW
216002
W717793-S439
Zinc Finish
M8-1.25 x 31mm
Hex Washer Head
Sems® Body Bolt
with Dog Point
Class 10.9
Washer O.D.: 24mm
Hex: 13mm
Fender & Hood Hinge
Ford Expedition & Lincoln
Navigator 2018 - UP
Ford F-150 2015 - UP
Box Qty. 10

245085
W706675-S439
Zinc Finish
Self Threaded Emblem Nut
with Locking Teeth
Stud Size: 5mm
Flange O.D.: 15mm
Hex: 10mm
Height: 5.5mm
Ford Crown Victoria, E-150, E-250,
E-350, E-450, Edge, Escape,
Explorer, F-150, F-250, F-350, F-450,
F-550, Flex, Mustang, Ranger and
Lincoln Mark LT, MKC, MKS, MKX,
Navigator, Mariner & Sable 2008 - UP
Box Qty. 50



NEW

266032
N803763-S100,
15685099
Zinc & Yellow
M6-1.0
Grip: .65mm - 2.0mm
Head Dia: 12mm
Hex Size: 8mm
Specialty Insert w/ Sealer
Roof Rack, Tailgate &
General Purpose
Ford Explorer 1991 - UP
GM APV Vans
Box Qty. 15



266034
N811257-S100
M5-.8
Specialty
Insert With Sealer
Grip: .5mm-2.5mm,
Head Dia: 10mm,
Hex Size: 7mm
General Purpose
Ford Escape, Excursion, Ex-
pedition, Explorer, Navigator &
Mountaineer 2001 - UP
Box Qty. 15



266035
W708513-S437
Zinc
M8-1.25
Specialty Insert
Grip: .7mm - 3.8mm
Hd. Dia: 22mm
Hex Size: 12.7mm
Frame Area
Ford Trucks 2004 - UP
Box Qty. 15



NEW
270021
W708991-S439
Silver Zinc Organic
Metric U-Nut
Screw Size: M4.2-1.41 (#8)
PR: 2mm - 3.4mm
(.079" - .137")
Center of Hole to Edge:
9.5mm (3/8")
Fender Apron & Mud Flap
Ford Expedition, F150/250/350/
450/550, Transit and Lincoln Mark LT
& Navigator 2005 - UP
Box Qty. 25



280031
25649667,
W705590-S300,
W710459-S300
Natural Nylon
Screw Grommet with Sealer
Screw Size: M4.2 (#8)
Head Size: 13mm x 22mm
Stem Length: 18mm
Back Glass Moulding &
Interior Trim
Cadillac & Ford Windstar 1998 - UP
Box Qty. 15



280131 Box 500
280130
Nylon
Front & Rear
License Plate Nut
Split 2 Ways Under Head
Hole: 3/8" Square
(use #14 Screw)
Ford, Mercury '65 - UP
General Purpose
Box Qty. 100



280240
1255823, 389360S
Nylon
Screw Size #6 or #8
Front End Bezel Nut
GM '79 - UP
Tail Light Nut
Ford '81 - UP
Box Qty. 50



285010
379830-S
Nylon
Side Mirror, Headlamp Door
Attaching Nut
Ford, Mercury '67 - UP
Mercury Comet '66
General Usage
Box Qty. 50



NEW
285011
W711612-S300
White Nylon
Grille Trim Screw Grommet
Screw Size: M4.2 (#8)
Head Dia: 12.75mm
Stem Length: 5mm
Fits Into 7.87mm Square Hole
Overall Height: 9mm
Ford Ranger 2004 - 2011
F150 2015 - UP
Box Qty. 25



285035
D9BZ-5402316-A
Dash Panel &
Grille Retaining Grommet
Screw: M4.2
Hole: M7
Ford Full Size Cars, Aerostar,
Ranger, Explorer & "E" Vans '79-UP
Box Qty. 25



285040
N-800503S
Black Nylon
Front Fender
Screw Grommet
Screw Size: 3.5mm (#6)
Head Size: 9mm x 13mm
Stem Length: 8.5mm
Ford Products '78 - UP
Box Qty. 50



285050
N-800841-S
Nylon
Grille Retaining Grommet
Screw: M4.2
Ford Mustang '80 - UP
Box Qty. 25



285055
W701650S, F6DZ-5402316-A,
F7DZ-5402316-AA
Plastic
(Use with #416090)
Cowl Grommet
Hole: 9 x 12.1mm
Ford Taurus, Mercury Sable
'96 - UP
Box Qty. 50



FORD CLIPS & FASTENERS



285060
N804775-S32B
 Black Finish
 Parking Lamp Retaining Clip
Ford Escort & Lynx '88 - UP
 Box Qty. 25

285071 Box 50



285070
E9DZ-13N129A,
E9DB-13N020AA,
F2AB-13N020-AA
 Zinc
 Headlamp Adjusting Bar
 To Header Panel Retainer
Ford Products w/ Aerodynamic
Headlight Designs '89 - UP
 Box Qty. 15



285090
N803768-S
 Nylon
 Door Arm Rest Nut
 Screw Size: #8
Ford Mustang & Capri '87 - UP
 Box Qty. 15



285100
N806624-S191
6502776
 Rear Light Assembly
 Retainer
Ford Explorer '91 - UP
Chrysler
 Box Qty. 25



285102
W717970-S300
 Black Nylon
 Rear Lamp Grommet
 Head Dia: 18mm
 Stem Length: 16mm
 Overall Length: 18mm
Ford F150 2015 - UP
 Box Qty. 10



285103
F50Y-14603-A
 Black Nylon
 Headlight &
 Tail Light Grommet
 Hd Size: 18.5mm x 21.5mm
 Stem Length: 18mm
 Fits 9.5mm x 21.5mm Hole
Ford Explorer, Navigator &
Super Duty Pick-Up 2003 - UP
 Box Qty. 25



285110
N807994-S, N811169S,
W704740-S300, W705550S300
 Black Nylon
 Grille & Side Marker
 Light Grommet
 Hole: M10 (25/64")
 Head Dia: 13mm
 Stem Length: 9mm
Ford Mustang '94 - UP
 Box Qty. 25



285111
W712160-S300
 Black Nylon
 Headlight Grommet
 Screw Size: M6 (1/4")
 Head Size: 22mm x 23.5mm
 Overall Height: 18mm
Expedition, F150 and Navigator
2003 - UP
 Box Qty. 15



285112
W711079-S300
 Black Nylon
 Tail Light Grommet
 Head Size: 13mm x 17mm
 Stem Length: 10mm
Ford Explorer, Mountaineer &
Pick-Up Trucks 2006 - UP
 Box Qty. 25



285115
N811169-S,
W705550-S300,
90189-06111,
90075-10801, 10423331
 White Nylon
 Headlamp Mounting /
 Turn Signal Retainer
 Head Dia: 13mm
 Stem Length: 9mm
 Fits Into 11mm Hole
Ford F250-F550 '99 - UP
Toyota/Lexus '89 - UP
GM
 Box Qty. 50



285200
N804765-S
 Nylon
 Wheel Opening
 Screw Grommet
 Screw Size: #8 (M4.2)
 Head Size: 3/8" x 3/8"
 Stem Length: 78"
Ford Mustang, T-Bird, Mercury
Cougar, Lincoln Continental
'93 - UP
 Box Qty. 50



NEW
285201
W706436-S300
 White Nylon
 Tail Lamp Screw Grommet
 With Sealer
 Screw Size: M4.8 (#10)
 Head Dia: 16mm
 Stem Length: 27mm
 Overall Height: 28.5mm
 Fits Into 8mm Square Hole
Ford Focus & Transit 2013 - UP
 Box Qty. 25



285202
N807189-S100,
N811353-S100
 Nylon
 Cowl Vent Grommet
 Screw Size: M4.2 (#8)
 Fits In 10mm x 14mm Hole
 Stem Length: 13mm
Ford F150 Pickup, Expedition,
Windstar '95 - UP
 Box Qty. 10



285204
F5RZ-17K657-A
 Nylon
 Windshield Washer
 Reservoir Screw Grommet
 Screw Size: #12
 Head Dia: 1/2"
 Overall Length: 13/16"
 Fits In 3/8" sq. Hole
Ford Contour, Focus,
Mystique '95 - UP
 Box Qty. 25



285212
W700158-S300
 Nylon
 Door Trim Grommet
 Screw Size: 4.2mm
 Washer Face: 22mm
 Hole: M12
Ford Contour, Mystique '95 - UP
 Box Qty. 25

FORD CLIPS & FASTENERS

20 Ford Clips

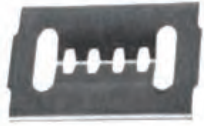

285290
Bumper Cover Retainer
Front & Rear Bumpers
Ford Festiva '88 - UP
Box Qty. 50



292265
9991-00-501
Natural Nylon
Screw Grommet
Screw Size: 4.8mm (#10)
Width: 12mm
Length: 12mm
Snaps Into 8mm x 8mm Hole
Ford Probe '88
Mazda MX6 '88 - UP
Box Qty. 25



292300
GJ21-50-H81
Nylon
Cowl Screen Grommet
Right Side, Round Opening
Ford Probe and Mazda 626 & MX6 '88 - UP
Box Qty. 25



292310
GJ21-50-H82
Natural Nylon
Cowl Screen Grommet
Ford Probe and Mazda 626 & MX6 '88 - UP
Box Qty. 25



295090
D7VY-6050074-A, 1259296, 3201767, 15964853, 8934-201-767
Plastic Barrel Nut
Hole: 1/4"
Ford, GM, Chrysler
Box Qty. 50



295145
Plastic
Pivot Socket
Headlamp Adjuster
Ford Aerostar '92 - UP
Box Qty. 10



295165
Green Plastic
Lower Body Side
Moulding Tubular Nut
Hole Size: 3/8"
Lincoln Town Car '90 - UP
Box Qty. 25



295280
Natural Plastic
Tubular Nut
Body Side Moulding
Ford Taurus, Sable '86 - UP
Box Qty. 100



302000
W713617-S439
Zinc
Push-In Nut w/Sealer
Screw Size: M4.2-1.41
Width: 11.7mm
Length: 16.5mm
Overall Height: 8mm
Ford Escape, Explorer, Flex, Fusion, Mustang, Ranger & Taurus and Lincoln MKS, MKT, MKZ, Milan & Zephyr 2009 - UP
Box Qty. 15

NEW



302006
W716567-S439
Zinc Organic
Metric U-Nut
Screw Size: M4.2-1.41
Panel Range: 1.8mm-3.50mm (.071" - .137")
Center of Hole to Edge: 9.5mm (3/8")
Ford Escape & Lincoln MKC 2013 - UP
Box Qty. 25

NEW



302038
W712324-S439
Zinc Organic
Bumper Deflector U-Nut
Screw Size: M6-1.0
Panel Range: 0.7mm-2.0mm
Center Hole to Edge: 12mm
Ford Ranger 2019 - UP
Box Qty. 10

NEW



302058
W714171-S439
Zinc Organic
Door & Under Cover Nut with Silicon Rubber Sealer
Screw Size: M4.2-1.41
Head Size: 12mm x 16mm
Stem Length: 6.5mm
Ford Edge, Expedition & Focus and Lincoln MKC, MKX & Navigator 2015 - UP
Escape 2013 - UP
Box Qty. 25

NEW



302059
W705958-S439
Zinc Organic
Metric Extruded U-Nut with Locking Thread
Screw Size: M6-1.0
Panel Range: .5mm - 2.3mm (.019" - .090")
Center of Hole to Edge: 14.5mm (9/16")
Ford F-150 & F350 2018 - UP
Box Qty. 10

NEW



302060
W715197-S439
Zinc Organic
Front & Rear Bumper Specialty Nut with Pastisol Pad
Screw Size: M4.8-1.6
Head Size: 14mm x 23mm
Stem Length: 7mm
Ford Edge, Escape, Expedition, Explorer, Fusion, Mustang & Transit and Lincoln Continental, MKC, MKS, MKX, MKZ & Navigator 2011 - UP
Box Qty. 10

NEW



302081
N800296-S439, W520823-S439
Zinc
Metric Extruded U-Nut W/ Locking Thread
Screw Size: M8-1.25
PR: .80mm - 4.00mm (.030" - .160")
Center of Hole to Edge: 14.5mm (9/16")
Ford Expedition, Explorer, Explorer Sport, F-150/250/350/450/550, Freestar, Mustang & Taurus and Lincoln MKT & Navigator and Mercury Monterey & Mountaineer 2002 - UP
Box Qty. 15

FORD CLIPS & FASTENERS

NEW

302082

W520813-S439, 11516150

Zinc

Metric Extruded U-Nut

Screw Size: M8-1.25

PR: .80mm - 4.00mm (.030" - .160")

Center of Hole to Edge: 21mm (13/16")

Fender Liner

Ford F-150/250/350 & Mustang 2015 - UP

Chevrolet Colorado &, Express Van and

GMC Canyon & Savana Van 2015 - UP

Box Qty. 15



303210

N-803719-S

Black Finish

Parking Lamp

Retaining Fastener

Ford '85 - UP

Box Qty. 50

303285

386285, 3230375

Nylon

Air Cleaner Wing Nut

Self Threading

Size: 1/4", 6mm

Ford & AMC Products

Box Qty. 10



345070

DITZ-13032B,

D70Z-13032B,

D7SZ-13032A,

D70B-13A-093-AA

Phosphate Headlamp

Adjusting Screw & Nut

Assembly

1/4"-28 x 2"

Ford Products '73 - UP

Box Qty. 10



345110

D8BZ-13032A, D8BZ-13032B,

D8BB-13M-093AA

Zinc

Headlamp Adjusting Screw

& Nut Assembly

#12-28 x 1-3/4"

Ford Products '78 - UP

Box Qty. 10



345125

E7SZ-13032C

Zinc Finish (Screw),

Gray Plastic Nut

Headlamp Adj. Assembly

R.H. Lower, L.H. Upper

12-28 x 2-1/2"

Ford T-Bird, Cougar '87-'88

Lincoln Continental

Box Qty. 5



345135

E7SZ-13032D

Zinc Finish (Screw),

Gray Plastic Nut

Headlamp Adj. Assembly

R.H. Upper, L.H. Lower

12-28 x 2"

Ford T-Bird, Cougar '87-'88

Lincoln Continental

Box Qty. 5

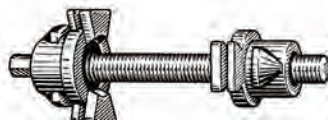

345175

E8FZ-13032A,

E8EB-13A093AA or

E8EB-13A093-AB

Headlamp Vertical Adjuster

Ford Escort & Lynx '88 - '90

Box Qty. 5

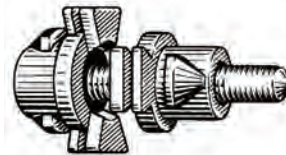

345178

E9TZ-13032B,

E97B-13A093BA

Black Screw

Headlamp Adjuster

Bronco and Ranger '89 - UP

Box Qty. 5

345190

E9WY-13032C,

E9WB-13A093CA

Black Chromate

Finish, Black Nut,

White Pivot w/ Ret.

Pivot Point

Headlamp Adjuster

Screw: M6 x 47.5mm O/L

Mercury Cougar '89 - UP

Grand Marquis '92 - UP

Box Qty. 5

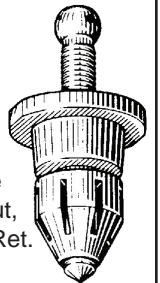

415020

383142-S

Front License Plate

Push-Type Retainer

Grille To Headlight Bracket

Hole: 1/4 (6.3mm)

Head Dia: 5/8" (16mm)

Stem Length: 7/16" (11mm)

Ford Products

Box Qty. 50



415040

2988430

Black Nylon

Radiator Grille Retainer

Hole Size: 1/4" (6.3mm)

Head Dia: 1-1/4"

Stem Length: 1/2"

Chrysler, Ford, GM

Box Qty. 25



FORD CLIPS & FASTENERS

20 Ford Clips

415051 Box 250

415050

1631564,
N804379-S, 3420287
W706358-S300

Black Plastic
Bumper Fascia
Retainer

Head Dia: 22mm
Hole Size: 11mm
Length: 28mm

*Buick, Cadillac & Olds '81 - UP
Ford Taurus & Merc. Sable '86-UP
Chrysler*

Box Qty. 25



415072 Box 250

415071 Box 500

415070

11569768,
15958694, 1605396,
6030441, 388577S,
W705589-S300

Black Nylon
Radiator Yolk, Fender &
Bumper Shield Retainer

Hole Size: 1/4" (6.3mm)
Stem Length: 20mm

Head Dia: 25.5mm
GM, Ford, Chrysler

Box Qty. 50



415076 Box 250

415075

21094146,
6501301

Black Nylon
Trim Panel Retainer
GM Saturn '91 - UP
Sliding Door & Lift Gate
Trim Panel Retainer

Chrysler Mini Vans '87 - UP
Box Qty. 50



415077

N807721-S, 6504043,
650403

Black Nylon
Hole Size: 23/64" (9mm)

Stem Length: 15mm
Head Dia: 18mm

Trim Panel Retainer
Ford Explorer '93 - UP

Trunk Lid Latch
Chrysler '96 - UP

Box Qty. 50



415100

20413107, 388246S,
4006516

Black Nylon
Weatherstrip Fastener
Hole Size: 3/16" (4.5mm)
Stem Length: 21/32"
Head Dia: 7/16"

GM, Ford, AMC
Box Qty. 50



415110

387843-S
Black Nylon
Fender Shield Retainer

Head Dia: 19/32"
Stem Length: 5/8"
Fits Into 1/4" Hole

Ford '78 - UP
Box Qty. 50



415120

387944-S
Nylon
Grille to Metal
Stamping Retainer

Head Dia: 3/4"
Shoulder Length: 1/4"
Stem Length: 11/16"
Fits Into 1/4" Wide Slot
Ford Truck '78 - UP
Box Qty. 25



415124 Box 100

415123

N802781-S,
802781-S,
W704340-S300,
14093088, 55176248

Splash Shield &
Facia Retainer
Flange Dia: 1" (25.4mm)
Stem Length: 7/8" (22mm)
Fits into 1/4" (6.3mm) Hole

Ford, GM, Chrysler
Box Qty. 25



415125

N803362-S,
20510029, 34202672

Black Nylon
Body Retainer
Flange Dia: 11/16"
Stem Length: 7/8"
Fits Into 1/4" Hole

Ford, GM, Chrysler '84 - UP
Box Qty. 25



415129 Box 50

415126

N803421-S,
6501590,
6500725

Black Nylon
Splash Shield &
Fascia Retainer
Head Dia: 1"
Shoulder Length: 1/8"
Stem Length: 7/8"
Fits Into 5/16" Hole

Ford, Chrysler
Box Qty. 25



415128

N803946-S,
6502871, 20664091

Black Nylon
Screw-Type Retainer
Head Dia: 19/32"
Stem Length: 29/32"
Fits Into 1/4" Hole
GM, Chrysler, Ford '87 - UP
Box Qty. 25



415130

N803494S,
15679091

Black Nylon
Fascia, Trim & Grille Retainer
Head Size: 15/32" x 15/32"
Stem Length: 21/32"
Fits Into 1/4" Square Hole

*Ford '85 - UP
GM '84 - UP*
Box Qty. 25



415138

20570245,
20635065,
N804614S,
N803934-S

Black Nylon
Splash Shield,
Seat Cushion & Spare Tire
Push-Type Retainer
Head Dia: 1"
Stem Length: 7/8"
Fits Into 5/16" Hole

Ford & GM '84 - UP
Box Qty. 25



415139

N804674-S
Nylon
Push-Type Retainer
Head Dia: 25mm
Stem Length: 27mm
Fits Into 7mm Hole
Ford Mustang & Capri
Box Qty. 50



415150

389809, C6GY-16776-A
Plastic
Hood Insulation Retainer
1-1/2" x 1-1/2"
GM, Ford
Box Qty. 50



415165

D30Z-16776-A, 385330-S, 6003351

Black Nylon
Hole Size: 1/4" (6.3mm)
Stem Length: 5/8"
Head Size: 1/2" x 1/2"
Hood Insulation Retainer
Chrysler '72 - UP

Grille to Radiator Retainer
Ford '73 - UP
Box Qty. 25



FORD CLIPS & FASTENERS



415190
 2898909, 382570-S
 Black Nylon
 Dash & Cowl Panel Retainer
 Hole Size: M6.3
 Head Dia: 12.4mm
 Stem Length: 13mm
 GM, Chrysler, Ford '70
 Box Qty. 50

415221 Box 250
415222 Box 500

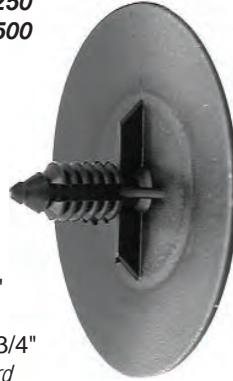

415220
 3977775,
 3078511
 Hood
 Insulation Clip
 Hole Size: 1/4"
 Head Dia: 2"
 Stem Length: 3/4"
 GM, Chrysler, Ford
 Box Qty. 50



415225
 6505302AA, N803387,
 N803387-S, N803387-S300
 Black Nylon
 Trim Panel Retainer
 Head Dia: 1-3/4"
 Stem Length: 1"
 Fits 9/32" Hole
 Ford, Chrysler
 Box Qty. 25



415228
 388908-S
 Black Nylon
 Hood Insulation Retainer
 Head Dia: 1-3/4"
 Stem Length: 3/4"
 Fits Into 3/8" Hole
 Ford '75 - UP
 Box Qty. 50



415229
 6504098,
 N808842-S
 Black Nylon
 Hood Insulation Retainer
 Hole Size: 1/4" (6.3mm)
 Head Dia: 1-1/4"
 Stem Dia: 5/16"
 Stem Length: 11/16"
 Chrysler Sebring '96 - UP
 Ford Taurus, Sable & Mark VIII '96 - UP
 Box Qty. 50



415238
 W700671-S300
 Black Plastic
 Hood Insulation Retainer
 Head Dia: 25mm
 Stem Length: 12.5mm
 Hole: 8.5mm
 Ford Contour & Mercury '95 - UP
 Box Qty. 15



415245
 10195515, N805026S,
 4696488, 6503163
 Black Nylon
 Screw-Type Retainer
 Head Dia: 1/2"
 Stem Length: 1-13/64"
 Fits Into 9/32" Hole
 GM, Ford & Chrysler 1987 - UP
 Box Qty. 25



415249
 W711687-S300,
 11589181
 Black Nylon
 Bumper and
 Fender Apron Retainer
 Head Diameter: 18mm
 Stem Diameter: 7.5mm
 Stem Length: 20mm
 Ford Focus 2007 - UP
 GM Full Size Pick-Ups 2007 - UP
 Box Qty. 25



415253
 W713202-S300
 W713445-S300
 Black Nylon
 Bumper Screw-Type
 Retainer
 Flange Dia: 13mm
 Stem Length: 18mm
 Fits Into 8mm Hole
 Ford Fusion 2006 - UP
 Box Qty. 15



415255
 E7GZ-6120586-B,
 G031-58-762,
 67868-89101, 67867-28030,
 67867-89103, 86438-2B000
 Natural Nylon
 Weatherstrip Retainer
 Head Size: 5mm x 15mm
 Stem Length: 10mm
 Fits Into 5mm Hole
 Toyota 4-Runner 1983 - 89,
 Mazda 1996 - UP, Ford 1996 - UP,
 Hyundai 2007-UP and Kia 2009-UP
 Box Qty. 50



415256
 W718033-S300
 Black Nylon
 Rear Bumper Retainer
 w/Sealer
 Top Head: 13mm
 Bottom Head: 18mm
 Stem Length: 10.8mm
 Fits Into 14.5mm Hole
 Ford Edge 2015 - UP
 Box Qty. 15



415257
 Yellow Nylon
 Door & Hood Seal
 Weatherstrip Retainer
 Top Head Dia: 5mm x 15mm
 Bottom Hd: 10mm
 Stem Length: 8.60mm
 Hole Size: 5.3mm (13/64")
 Ford
 Box Qty. 100



415259
 Yellow Nylon
 Door & Hood Seal
 Weatherstrip Retainer
 Top Head Dia: 5mm x 15mm
 Bottom Hd: 8mm
 Stem Length: 7.80mm
 Hole Size: 5mm (13/64")
 Ford, Acura, Honda
 Box Qty. 100

FORD CLIPS & FASTENERS

20 Ford Clips

415440

388930-A, 391039-S
Black Nylon
Trim Panel
Push-Type Retainer
Head Dia: 1"
Stem Length: 1-3/32"
Fits Into 1/4" Hole
Ford '80 - UP
Box Qty. 50



415465

N803857S
Black Nylon
Front End Fascia Retainer
Head Dia: 14mm
Stem Length: 8.70mm
Fits Into 6.3mm Hole
Ford Aero Star, Marquis, LTD '85-UP
Box Qty. 50



415505

14019206, 14019205,
16514113, 34201621,
6504090, 8934-201-621,
6503454, E308-4A163CA
Black Nylon
Front Fender Mud Skirt &
Fender Liner Retainer
Head Dia: 11/16"
Stem Length: 9/16"
Fits Into 1/4" Hole
GM, AMC, Chrysler, Ford
Box Qty. 50



415523

XL3Z-17E971-AA
Natural Nylon
Front Bumper Cover
Push-Type Retainer
Head Dia: 16mm
Stem Length: 12mm
Fits Into 10mm Hole
Ford F-150 & F-250 Trucks
'99 - UP
Box Qty. 25



415590

N804583S
Black Nylon
Dia: 4mm Grip: 6 - 10.5mm
Rect. Head: 8.5mm x 15.5mm
Cowl Vent Grille Retaining
Ford Aero Star '86 - UP
Box Qty. 25



415595

N803739-S
Super Tough Nylon
Blind Rivet
Flanged Button Head
(Shoulder Forms A Seal)
Hole: M6.3,
Flange: 18mm
Shoulder: 2.0
Grip: 0.7 - 7mm
Insulation Attachment
Ford Explorer & Vans,
Mercury Mountaineer
'88 - 2014
Box Qty. 25



415596

25612368,
N807673-S
Black Nylon
Dash & Tailgate
Push-Type Retainer
Head Dia: 14mm
Stem Length: 9mm
Fits Into 7mm Hole
GM Saturn '95 - UP,
Ford Explorer Sport Trac, F150,
F250, F350 2007 - UP
Box Qty. 10



415597-500 Box 500

415597

N804570-S,
4638136, 20664092,
15773445, 20452072,
6502790, 22538004
Black Plastic
Radiator Shield & Trim
Screw-Type Retainer
Hole: 1/4"
Flange Dia: 11/16"
Stem Length: 29/32"
Ford, GM, Chrysler & Cadillac '98-UP
Box Qty. 25



415598

W705532-S300,
N808048S
Black Plastic
Front Bumper Stone
Deflector Push-Type Retainer
Hole: M6.4 Square
Flange Dia: 18mm
Stem Length: 18mm
Ford Bronco, Ranger & Explorer
'89 - UP
Box Qty. 25



415600.....Box 25

415800.....Box 100
N803862-S, 6501559, 6506007-AA, 10184895
1/4" Dia. Black Nylon Blind Rivet
Panel Range: 5/32" - 13/32"
Flange: 1/2"
GM, Ford, Chrysler, General Purpose



415602.....Box 25

415802.....Box 100
14063981, 15506827, 15506921, KA01500Z1,
N803043-S, 6500911, 8934-201-631
1/4" Dia. Black Nylon Blind Rivet
Panel Range: 5/32" - 13/32"
Flange: 21/32"
GM, Ford, Chrysler, AMC, General Purpose



415604

34202855, 6500859, 6500899, 8048635,
20432975, 175-853-577, 175-853-57701C,
175-852-577
Super Tough Black Nylon
Hole: 13/64"
Panel Range: 1/8" - 15/64"
Head: 15/32"
Chrysler, Ford, GM, VW, AMC
Box Qty. 25



415610.....Box 25

415810.....Box 100
20421672, 15955172
17/64" Dia. Black Nylon Blind Rivet
Panel Range: 3/32" - 3/16"
Flange: 1/2"
G.M., General Purpose



415620.....Box 25

415820.....Box 100
4370132, 20433026, 14070914,
175-553-577A, 175-853-577A
17/64" Dia. Black Nylon Blind Rivet
Panel Range: 3/32" - 3/16"
Flange: 23/32"
GM, Chrysler, VW, General Purpose



FORD CLIPS & FASTENERS



415630.....Box 25
415830.....Box 100
 6500898, 15718794
 13/64" Black Nylon Blind Rivet
 Panel Range: 15/64" - 25/64"
 Flange: 15/32"
 Chrysler, GM, General Purpose



415640.....Box 25
415840.....Box 100
 20432975, 175-853-57701C, 6503800,
 N804343S
 13/64" Dia. Black Nylon Blind Rivet
 Panel Range: 1/8" - 15/64"
 Flange: 15/32"
 GM, VW, Chrysler, Ford, General Purpose



415650
 20423647, N804189-S, B455-56-741
 Super Tough Black Nylon
 Blind Rivet
 Dia: 13/64"
 Grip: 1/16" - 11-64"
 Flange Dia: 11/32"
 Ford, GM, Mazda
 Box Qty. 25



415695
 N8062996-S
 Super Tough
 Black Nylon
 Hole: M6.3
 Grip: 4 - 10mm
 Head: 17mm
 Front Stone Deflector
 Lincoln '90 - UP
 Box Qty. 25

415751 Box 50



415750
 63844-01A00;
 MNA01-56-145;
 NA01-56-145;
 MNA01-56145,
 NA01-56145
 Black Nylon
 Inner Fender Retainer
 Head Dia: 20mm (25/32")
 Stem Length: 18mm (23/32")
 Fits Into 8mm (5/16") Hole
 Ford, Mazda, Kia and Nissan '80-UP
 Box Qty. 10

415759 Box 50



415761
 94218027,
 H200-50-715
 8942180270,
 58974-00008, B092-50-715,
 BF67-S0715, MB153825,
 90467-13011, 90467-12020
 Black Nylon
 Grille Headlight Clip
 Width: 13mm Length: 22mm
 Ford, GM, Toyota, Mitsubishi, Isuzu,
 Honda, Plymouth, Mazda
 Box Qty. 25

415781 Box 100



415780
 10053182,
 6503163
 Body Splash Shield
 Screw-Type Retainer
 Flange Dia: 19/32"
 Stem Length: 13/16"
 Fits Into 5/16" Hole
 GM '87 - UP
 Chrysler
 Box Qty. 25



415790
 6501544, N803170-S,
 5017410-AA
 Black Nylon
 Fascia Shield Retainer
 Hole: 13/64" (M5)
 Stem Length: 1/2" (12.7mm)
 Head: 7/16" (10mm)
 Ford Mustang, Capri '84 - UP,
 Chrysler
 Box Qty. 50



415798
 15686142, N802865-S100,
 11561448
 Zinc Phosphate
 Grille, Bumper &
 Radiator Support Nut
 Screw: M4.2 or #8
 Ford Lincoln '83 - UP
 GM Trucks '93 - UP
 Box Qty. 25



415883
 W709176-S300,
 15149708, 6506008AA
 Radiator, Wheelhouse,
 Fender & Bumper Cover
 Push-Type Retainer
 Hole: M6
 Flange: 17mm
 Stem Length: 16mm
 Chrysler, Ford, GM
 Box Qty. 25

415888 415891 Box 100



21075686,
 6504555
 F3LY-14570-B,
 F3LB-14K056-AA
 Black Nylon
 Rocker Panel,
 Wheel Liner,
 Air Inlet Duct
 Push-Type Retainer
 Hole: M8
 Flange: 15mm
 Stem Length: 20mm
 Ford, Chrysler, GM
 Box Qty. 25

415891 Box 100
415891-500 Box 500

415889
 21030249,
 N807389S,
 6503598
 Black Nylon
 Air Baffle To
 Under Carriage
 Push-Type Rivet
 Head Dia: 20mm
 Stem Length: 20mm
 Fits Into 8mm Hole
 GM, Ford, Chrysler
 Box Qty. 25



415892
 6509103AA,
 6509103-AA,
 W705436-S300,
 21077123, 20730531
 Plastic
 Wheel Mldg.
 Push-Type Retainer
 Hole: 1/4" (6.4mm)
 Flange: 19/32" (15mm)
 Stem Length: 3/4" (19mm)
 GM, Ford, Chrysler
 Box Qty. 25



415893
 21077123,20730531
 6509103AA,
 6509103-AA
 W705436-S300
 Black Nylon
 Wheel Opening Mldg
 Push-Type Retainer
 Head Dia: 19/32" (15mm)
 Stem Length: 3/4" (19mm)
 Fits Into 1/4" (6.4mm) Hole
 Saturn 91 - UP, Ford 2002 - UP,
 Chrysler 2010 - UP
 Box Qty. 25



415910
 BF67-50-033,
 E7GZ-17A904-B
 Black Nylon
 Bumper Retainer
 Head Size: 20mm x 30mm
 Stem Length: 11mm
 Fits Into 10mm Hole
 Mercury Tracer '87 - UP, Mazda
 Box Qty. 15



FORD CLIPS & FASTENERS



415935

G030-68-885-B-38, F22Z-16774-A, GA2A-56694
 Nylon
 Hood Insulation Retainer
 Head Dia: 20mm
 Stem Length: 9mm
 Fits into a 6mm Hole
Ford, Mazda
 Box Qty. 25



415975

E92Z-17C756C, GJ21-50-034
 Nylon
 Bumper Cover Retainer
 Head Size: 20mm x 30mm
 Stem Length: 20mm
 Fits Into 10mm Hole
Ford Probe, Mazda MX6 '89 - UP
 Box Qty. 15

NEW



415976

W718046-S300
 Black Nylon
 Bumper & Mud Guard Retainer
 Head Diameter: 12.5mm
 Stem Diameter: 7mm
 Stem Length: 9mm
Ford Edge 2015 - 2018, Ranger 2019 - UP
 Box Qty. 25



415993

F4XY-1200586-A, N806289-S
 Plastic
 Weatherstrip Retainer
 Head Size: 5mm x 15mm
 Stem Length: 12mm
 Fits Into 4mm Hole
Lincoln '89 - UP
 Box Qty. 50



415997

Yellow Nylon
 Weatherstrip Retainer
 Head Dia: 9mm
 Stem Length: 14.5mm
 Hole Size: 6.8mm
Ford
 Box Qty. 100



416003

W705957-S300, W706519-S300
 Black Nylon
 Radiator Site Shield Push-Type Retainer
 Head Dia: 24.5mm
 Stem Length: 14mm
 Fits Into 9mm Hole
Lincoln LS 2000 - UP
 Box Qty. 10



416004

3M8Z-1502316-A, GJ6E-50-715A
 Black Nylon
 Cowl Screw-Type Retainer
 Head Size: 8.5mm x 12mm
 Stem Length: 9mm
 Fits Into 5mm Hole
Fusion, Milan & Zephyr 2006 - UP, Mazda 5 & 6 2003 - UP
 Box Qty. 15



416011

N803946S, 000-991-52-40, 20664091, 6502871, W706350-S300
 Black Nylon
 Rear Quarter Trim Panel Screw-Type Retainer
 Head Dia: 19/32" (15mm)
 Stem Length: 29/32" (23mm)
 Fits Into 1/4" (6.4mm) Hole
Ford & Chrysler '97 - UP, GM, Mercedes Metris 2016-20, Sprinter 1500, 2500, 3500 2019-UP
 Box Qty. 50



416013

1009864S, 390964-S
 Black Nylon
 Front Door Lower Moulding Retainer
 Head Dia: 1/2"
 Stem Length: 3/4"
 Fits into 1/4" Hole
Pontiac Grand Prix '94-UP, Ford
 Box Qty. 50



416016

W716510-S300, W716969-S300
 Black Nylon
 Low Radiator Shield Push-Type Retainer
 Head Dia: 18mm
 Stem Length: 12mm
 Fits Into 7mm Hole
Ford Fusion 2013 - UP
 Box Qty. 10



416018

91530-SP1-003, 91530-SPL-003, W704643, N807438S
 Nylon
 Weatherstrip Retainer
 Head Size: 5mm x 15mm
 Stem Length: 10mm
 Fits Into 6mm Hole
Ford; Acura 3.5 RL & Honda Accord, Civic & Odyssey '92 - UP
 Box Qty. 25



416025

B092-51-833, MB-455-56143, W705845-S300, 86590-28000
 Black Nylon
 Screw-Type Retainer
 Head Dia: 18mm
 Stem length: 12mm
 Fits Into 8mm Hole
Mazda & Ford Aspire, Hyundai
 Box Qty. 10



416039

B003-68-865-96
 Nylon
 Rear Compartment Interior Trim Retainer
 Head Dia: 15mm
 Stem Length: 14mm
 Stem Dia: 6.5mm
Ford Probe '88 - UP, Mazda MX6 '88 - UP
 Box Qty. 50



416041

F1CZ-16774-A, B455-56-741
 Black Plastic
 Hood Insulation Retaining Clip
 Head Dia: 14mm
 Length: 10mm
 Stem Dia: 6mm
Ford Probe and Mazda MX6 '88-'92
 Box Qty. 25



416042

94530438, B040-68-865-A96
 Plastic
 Fender Liner Screw-Type Retainer
 Head Dia: 15mm
 Stem Length: 14mm
 Fits Into 6mm Hole
Ford Probe '88 - UP, Mazda MX6 '88 - UP, Chevrolet Aveo 2004 - UP
 Box Qty. 25



416045

N804837-S
 Black Nylon
 Trim Attachment Screw-Type Retainer
 Flange Dia: 1" (25.4mm)
 Stem Length: 29/32" (23mm)
 Fits Into 1/4" (6.4mm) Hole
Ford '87 - UP
 Box Qty. 25

20 Ford Clips

FORD CLIPS & FASTENERS

<p>416046 14019226, 14071289, 04388293, 175720B010 Black Nylon Radiator Overflow Bottle/Windshield Washer Bottle Retainer Head Dia: 21/32" Stem Length: 9/16" Fits Into 5/16" Hole Ford, Chrysler, GM '81-UP Box Qty. 50</p> 	<p>416047 6033082, 6033840, W709346-S300, 39001S, 10121502, 10077401, 390018-S Black Nylon Shield Retainer Battery Post Shield, Engine Splash Shield Radiator Side Air Baffle Hole Size: 1/4" (6.3mm) Head Dia: 23/32" Stem Length: 1-1/16" Ford, Chrysler, GM, GM Express & Savana Vans 1996-UP Box Qty. 50</p> 	<p>416062 W707889-S300 Black Nylon Mud Flap Retainer Head Dia: 11/16" Stem Dia: 5/16" Stem Length: 1-3/4" Ford Expedition & F-150 '97 - 2001 Box Qty. 25</p> 	<p>416063 W710532-S300 Black Nylon Rocker Moulding Retainer Head Dia: 18mm Stem Length: 44mm Fits Into 6.3mm Hole Ford Mustang 2005 - UP Box Qty. 25</p> 
<p>416065 F1TZ-7810182-A Black Nylon Rocker Panel & Ground Effects Mldg. Clip Top Head: 9/16" x 2" Stem Length: 11/16" Fits Into 8mm Hole Ford Explorer, Expedition & F150 '91 - UP Box Qty. 25</p> 	<p>416066 F57Z-16241-AB, W709767-S300 Black Nylon Rocker Panel Moulding Clip Head: 14mm x 40mm Stem Length: 11mm Mustang 2001 - UP Box Qty. 15</p> 	<p>416067 N803716-S Black Nylon Fascia Retainer Head Dia: 18mm Stem Length: 23mm Fits Into 7mm Hole Ford Mustang, Capri '85 - UP Box Qty. 25</p> 	<p>416090 W701649-S, W704881-S300 (Use with #285055) Plastic Cowl Top Vent Grille Nylon Screw Head Dia: 18mm Head Dia: 9/16" Ford Taurus & Mercury Sable '96 - UP Box Qty. 50</p> 
<p>416118 11518017, W708530-S300 Black Nylon Bumper Cover & Fender Shield Retainer Flange Dia: 20mm Stem Length: 26mm Fits Into 8mm Hole GM, Ford '97 - UP Box Qty. 15</p> 	<p>416131 W707365-S300 Black Nylon Front Fender Screw-Type Retainer Head Diameter: 13mm Stem Length: 10mm Fits Into 7mm Hole Ford Edge 2015 - UP Box Qty. 10</p> 	<p>416138 Black Nylon Shroud Retainer High Retention Capability GM, Ford, Chrysler Box Qty. 50</p> 	<p>416146 F50C-9E728-AA, 6501925, 10134407, 15990756, Black Nylon Push-Type Retainer Hole Size: 1/4" Flange Dia: 11/16" Stem Length: 13/16" Chrysler Concorde & LHS, Dodge Intrepid & Eagle Vision '93 - UP Coolant Recovery Reservoir GM '92 - UP Ford Box Qty. 25</p> 
<p>416152 25535963, N811772S Black Nylon Twist Lock Inst. Panel, Front Comp. Rear Site Shield Retainer Buick Electra, LeSabre, Park Ave. & Skylark, Cadillac DeVille, Oldsmobile Achieva, Cutlass, Delta 88, 88 Royale & 98 Regency And Pontiac Bonneville & Grand Am 1991 - UP Upper Deflector Shield Ford Box Qty. 15</p> 	<p>416153 W706494-S300 Black Nylon & Santoprene Rubber Bumper Screw-Type Retainer Flange Dia: 18mm Stem Length: 18mm Fits Into 8mm Hole Ford 2000 - UP Box Qty. 25</p> 	<p>not actual size</p> <p>416154 4805405AA, 1L5Z-17K826AA Front Fascia Push-Type Ret. Hole: M8 Flange Dia: 34mm Stem Length: 20.5mm Shoulder: 3.5mm Chrysler Concorde Dodge Intrepid, 300M '98 - UP Ford Trucks 2005 - UP Box Qty. 15</p> 	

FORD CLIPS & FASTENERS

20 Ford Clips

416157

W706182-S300

Nylon
Deck Lid Ret. &
Headlight Mounting
Head Dia: 20mm
Hex: 10mm
Stem Length: 13mm
Fits Into 8mm Hole

*Ford Expedition, Focus, Explorer
2000 - UP*

Box Qty. 25



416180

Nylon

Radiator Shroud
Air Deflector Retainer
Head Dia: 20mm
Stem Dia: 13mm
Stem Length: 16mm

Ford Expedition 2003 - UP

Box Qty. 50



416186-500 Box 500

416186

11589293, W712196-S300

Black Nylon
Cowl Vent &
Fender Retainer
Flange Dia: 20mm
Stem Length: 22mm
P.R.: 4.5mm - 7.0mm
Fits Into 8.5mm Hole

*Buick Century, LaCrosse & Regal,
Cadillac, Chevrolet Equinox, GM
Trucks, Hummer H3 and Pontiac
Grand Prix & Torrent 1997 - UP
Ford 2006 - UP*

Box Qty. 25



416190

06508863-AA,

W713610-S300,

11589289

Black Nylon
Air Distributor/
Windshield Defroster
Push-Type Retainer
Flange Dia: 18mm

Stem Length: 17.5mm

PR: 2.0mm - 4.5mm

Fits Into 6.5mm Hole

GM, Chrysler, Ford

Box Qty. 25



416192

11589290, 6509049-AA,

W714040-S300

Black Nylon

Air Inlet Grille/ Bumper
Fascia /Front Brake Caliper
Cooling Duct Push-Type Ret.
Flange Dia: 18mm
Stem Length: 20mm
PR: 4.5mm - 7.0mm

Fits Into 6.5mm Hole

*Buick Enclave, Cadillac, CTS & STS,
Chevrolet Cobalt, Equinox & SSR, GM Trucks
and Pontiac G5 & Torrent 2002-UP
Chrysler Charger & 300 2011-UP, Ford*

Box Qty. 50



416194

W713331-S300,

11589291

Black Nylon

Air Dam/Grille
Push-Type Retainer
Head Dia: 18mm
Stem Length: 22mm
PR: 7.0mm - 9.5mm

Fits Into 6.5mm Hole

*GM Cadillac CTS, SRX and STS 2003 - UP
Ford*

Box Qty. 25



416200

11609417,

W715537-S300

Black Nylon

Fender Apron

Push-Type Retainer

Flange Dia: 19mm

Stem Length: 14mm

PR: 2.7mm - 5.3mm

Fits Into 8.5mm Hole

*Buick Enclave & LaCrosse, Cadillac
CTS, SRX & STS, Chevrolet Cobalt,
Equinox & Malibu, GM Trucks and
Pontiac G5, G6 & Torrent 2003-UP,
Ford*

Box Qty. 50



416204

11589294,

W714975-S300

Black Nylon

Bumper Fascia,

Fender, Toe/
Floor Panel

Push-Type Ret.

Head Dia: 20mm

Stem Length: 24mm

PR: 7.0mm - 10.0mm

Fits Into 8.5mm Hole

*Buick Enclave & LaCrosse, Chev-
rolet & GMC C & K Trucks, GMC
Acadia, Hummer H3 and Saturn
Outlook 2005-UP, Ford*

Box Qty. 25



416208

W712665-S300,

11589295,

5GUU9K11BA

Black Nylon

Fender, Flare,

Gas Tank &

Panel Attchmnt

Push-Type Ret.

Flange Dia: 25mm

Stem Length: 20mm

PR: 3.0mm - 6.0mm

Fits Into 10.5mm Hole

GM, Ford, Chrysler

Box Qty. 15



416209

W718088-S300

Black Nylon

Fender Apron

Push-Type Retainer

Head Diameter: 18mm

Stem Length: 20mm

Fits Into 7mm Hole

Ford Fusion 2015 - UP

Box Qty. 15



416212

W713579-S300

White Nylon

Tail Light Mounting

Retainer w/Sealer

Top Head Dia: 15mm

Bottom Head Dia: 18mm

Stem Length: 12mm

Fits Into 8mm Square Hole

*Ford Escape, Explorer, Focus, MKZ
& Zephyr 2006 - UP*

Box Qty. 10



416222

W716783-S300

Black Nylon

Hood Insulation Retainer

Head: 25mm x 30mm

Stem Length: 15mm

Overall Height: 17mm

Ford C-Max & Escape 2013 - UP

Lincoln MKC 2016 - UP

Box Qty. 25



416223

W717823-S300

Black Nylon

Splash/Heat Shield Retainer

Head Dia: 25mm

Stem Length: 11mm

Fits Into 6.5mm Hole

Ford Mustang 2014 - UP

Box Qty. 15



416260

N803709S,

15681408

Black Nylon

Fascia Retainer

Head Dia: 15mm

Stem Length: 23mm

Fits Into 6mm Hole

GM & Ford 1986 - UP

Box Qty. 50



416261

11561438

Black Nylon

M14 x 34mm

Bumper and Door Insulator

Nylon Screw

No. 3 Square Drive

Head O.D.: 22mm











Fits Into 12mm Hole

GM, Ford, Chrysler 2005 - UP

Box Qty. 25

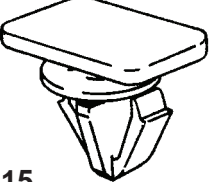

FORD CLIPS & FASTENERS

<p>416276 6508197-AA, W706092-S300 Black Nylon Front Air Shield, Splash Guard & Heat Shield Push-Type Retainer Head Dia: 18mm Stem Length: 18mm Fits Into 6.4mm Hole <i>Dodge Ram 2006 - UP</i> <i>Ford Taurus 2008 - UP</i> Box Qty. 25</p> 	<p>416278 W706635-SSW Black Nylon Rocker, Pillar & Fender Liner Retainer Head Dia: 26mm Stem Length: 28mm Stem Dia: 7.5mm <i>Ford Fusion & Taurus 2009 - UP</i> Box Qty. 50</p> 	<p>NEW</p> <p>416290 480534, 384051-S Black Nylon Head Dia: 13/32 x 1" Stem Dia: 9/32" Stem Length: 9/16" Cowl Insulation Retainer <i>GM</i> Splash Shield/ Wire Retainer <i>Ford</i> Box Qty. 25</p> 	<p>425202 4L3Z-1510182-AA Black Nylon Rook & Garnish Moulding Clip Tip to Tip: 42mm Front to Back: 12mm Height: 21mm <i>Ford F150 2005 - UP</i> Box Qty. 15</p> 
<p>425203 F57B-16241-AA White Nylon Fender Moulding Clip Head Size: 15mm x 51mm Stem Length: 11mm Fits Into 8mm Hole <i>Explorer & Others 2005 - UP</i> Box Qty. 15</p> 	<p>425204 F6DZ-5410182-AA Black Nylon Rocker Panel Moulding Clip Head Size: 13mm x 39mm Stem Length: 14mm Fits Into 9mm Hole <i>Sable, Taurus, Lincoln LS2000 1996 - UP</i> Box Qty. 10</p> 	<p>425205 6G1Z-5410182-A, W716350-S300 Gray Nylon Rocker Panel Moulding Clip Top Head Size: 22mm x 30mm Overall Height: 18mm <i>Ford 500 2005 - UP</i> Box Qty. 15</p> 	<p>425206 <i>Not Available From O.E.M.</i> White Nylon Drip Rail Moulding Clip With Sealer Width: 1-11/32" Overall Height: 11/16" <i>Ford 500, Montego, Sable & Taurus 2005 - UP</i> Box Qty. 10</p> 
<p>425207 W713590-S300 Windshield Moulding Clip With Sealer Top Head Size: 14mm x 18mm Bottom Head Size: 15mm x 18mm Stem Length: 11mm Fits Into 9mm Hole <i>Ford Flex 2009 - UP</i> Box Qty. 15</p> 	<p>425208 <i>N/A From O.E.M.</i> Door Cladding Moulding Clip With Sealer Top Head Size: 15mm x 20mm Bottom Head Size: 20mm x 24mm Stem Length: 11mm Fits Into 11mm Hole <i>Ford Edge and Lincoln MKX 2007 - UP</i> Box Qty. 10</p> 	<p>425209 W790173-S900 Windshield Moulding Clip With Sealer Top Head: 14mm x 18mm Bottom Head: 19mm x 18mm Stem Length: 10mm Fits Into 9mm Hole <i>Ford Flex 2009 - UP</i> Box Qty. 10</p> 	<p>425210 <i>N/A From O.E.M.</i> Fender Flare Moulding Clip Top Head: 14mm x 34mm Bottom Head: 14mmx33mm Stem Length: 14mm Fits Into 9mm Hole <i>Ford Explorer 2007 - UP</i> Box Qty. 25</p> 
<p>425211 <i>Not Available From O.E.M.</i> Plastic Belt Moulding Retainer <i>Ford Taurus 2010 - UP</i> Box Qty. 10</p> 	<p>425212 W716352-S300 White Nylon Rocker Panel & Door Mldg Clip With Sealer Top Head: 12mm x 20mm Bottom Hd: 12mm x 20mm Stem Length: 14mm Fits Into 9mm Hole <i>Ford Edge, Mustang 2015 - UP</i> Box Qty. 25</p> 	<p>425515 Plastic Fender Lip Moulding Retainer Hole: M10 Head: 12 x 20mm <i>Ford Expedition, Navigator '98 - UP</i> Box Qty. 25</p> 	<p>425516 White Nylon Moulding Clip Head Dia: 3/4" Stem Length: 15/32" Fits Into 5/16" Hole <i>Ford Expedition, Explorer & Mountaineer 2001 - UP</i> Box Qty. 10</p> 

FORD CLIPS & FASTENERS

20 Ford Clips



425517
W703507-S300
 Plastic
 Wheel Opening Mldg. Clip
 Hole: M9 Sq.
 Flange: 18mm, P.R.: 18mm
 Stud Dia: 4.5mm
Ford Focus 2000, Fiesta 2011 - UP, C-Max 2013 - UP
 Box Qty. 25



425520
 Plastic
 Belt Moulding Clip
 Width: 18.50mm
 Length: 34.50mm
Ford Taurus, Mercury Sable '97 - UP
 Box Qty. 25



425522
 Nylon
 Wheel Flare Moulding Clip w/Sealer
 Hd Size: 14mm x 29mm
 Stem Length: 16mm
 Fits Into 9mm Hole
Ford Explorer 2006 - UP
 Box Qty. 15



425523
OEM Not Available
 Fender Flare Moulding Clip
 Top Head: 14.5mm x 33.5mm
 Bottom Head: 15mm x 45mm
 Stem Length: 14mm
 Fits Into 11mm Hole
F-450 & F-550 Trucks 2009 - UP
 Box Qty. 10



425525
W705849-S300, 9XG0-73-88X0
 Nylon
 Front End Moulding Clip
 Top Hd. Size: 1/2" x 13/16"
 Bottom Hd Size: 11/16" x 25/32"
 Stem Length: 3/8"
Mazda, Ford 2000 - UP
 Box Qty. 10



445032
385661-S, 6032363, N989022
 Black Nylon
 Black Nylon
 Trim Panel Retainer
 Head Dia: 15/16"
 Stem Length: 11/16"
 Fits Into 5/16" Hole
Ford, Chrysler, VW '75 - UP
 Box Qty. 25



445161
9XG0-75-93X0, W706738-S300, W708621-S300
 Caramel & Natural Nylon
 Trim Panel Retainer
 Top Head Dia: 13mm
 Bottom Head Dia: 20mm
 Stem Length: 16mm
 Fits Into 8.5mm Hole
Ford 2000 - UP, Mazda
 Box Qty. 25



445230
 Door Trim Panel Fastener
Ford Products
 Box Qty. 100



445510
W704958-S300
 Plastic
 Door Trim Panel Retainer
 Round Head Dia: 23mm
 Wedge Shaped Head
 Diameter: 29/32"
 Stem Length: 11/16"
 Fits Into 3/8" Hole
Lincoln Town Car '99 - UP
 Box Qty. 10



445565
N802734S, 22718305, 6506788
 Black Nylon
 Interior Trim Panel/
 Hood Insulation Retainer
 Head Dia: 25mm
 Stem Length: 20mm
 Fits Into 7mm Hole
Ford '83 - UP, GM & Chrysler
 Box Qty. 50



445570
387477-S
 White Nylon
 Interior Trim Panel Retainer
 Top Head Dia: 1/2"
 Stem Length: 21/32"
 Fits Into 5/16" Hole
Ford '77 - UP
 Box Qty. 50



445720
387496-S, 12084605
 White Nylon
 Door Trim Panel Retainer
 Top Head Size: 20mm
 Stem Length: 24mm
 Fits Into 7mm Hole
Ford '76 - UP, GM
 Box Qty. 50



445725
N801925-S
 Black or White Nylon
 Door Trim Panel Retainer
 Flange Dia: 25/32"
 Stem Length: 5/8"
 Fits Into 5/16" Hole
Ford '81 - UP
 Box Qty. 25



445760
385188-S, 6032235
 Door & Interior
 Trim Panel Retainer
 Hole: M7.2
 Top Head: 12.6mm x 15mm
 Stem Length: 15mm
Ford '75, Chrysler '81
 Box Qty. 50





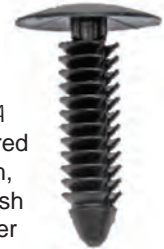











445765
N804349S
 Black Nylon
 Interior Trim Retainer
 Hole: M8
 Head Dia: 26mm
 Stem Length: 38mm
Ford '86 - UP
 Box Qty. 25

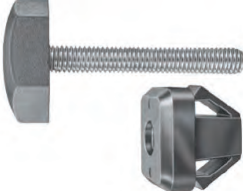

445766
W714076-SS3JA
 Plastic, Textured
 Cowl, Int. Trim,
 Radiator Splash
 Shield Retainer
 Head Dia: 23mm
 Stem Length: 30mm
 Hole: M7
Ford Mustang & F150 Pick Up 2015 - UP
 Box Qty. 25

FORD CLIPS & FASTENERS

 <p>445797 6505292AA, W706812S300 Natural Nylon Door Trim Panel Retainer Top Head: 15mm Bottom Head: 20mm Stem Length: 14mm Stem Dia: 9.5mm Chrysler Vans '98 - UP Ford Box Qty. 25</p>	 <p>445837 11519032, W711513-S300 Door/Trim Panel Retainer Top Head Dia: 20mm Bottom Head Dia: 19mm Stem Length: 16mm Overall Length: 28mm Trim Thk: 4.5mm Fits Into 11mm Hole Buick Lucerne & Rainier, Cadillac DTS, Escalade & SPX, Chevrolet Avalanche, Malibu, Silverado, Tahoe & Trailblazer, GMC Envoy, Sierra, Suburban & Yukon, Hummer H2, H3 & H3T, Oldsmobile Bravada and Pontiac G6 2002 - UP Box Qty. 10</p>	 <p>445838 11519031, W711521-S300 White Nylon Door Trim Panel Retainer With Sealer Top Head Dia: 19.5mm Stem Length: 17mm Fits Into 9.5mm Hole Hummer H2 2003-UP Lincoln 2007-UP Box Qty. 15</p>	
 <p>445839 N811283-S Black Nylon & Santoprene Rubber Trim Panel Screw-Type Retainer Head Dia: 18mm Stem Length: 18mm Fits Into 6.3mm Hole Expedition & Navigator 1997 - UP Box Qty. 25</p>	 <p>445842 F7UZ-1513284-BA Zinc Organic Front Door Scuff Plate Retainer Econoline Van E150/350 1997 - UP Box Qty. 25</p>	<p>445898-100 Box 100</p>  <p>445898 25670009, F58Z-16237A02-A Yellow Nylon Door Trim Panel Retainer Hole: 5/16" Flange Dia: 1/2" Stem Length: 3/4" Ford Windstar '95 - UP GM Box Qty. 25</p>	 <p>445945 N805315 N805315-S Gray Plastic (Paint To Match) Headliner Retainer Hole: M7, Head: 32mm Stem Length: 20mm Ford Aerostar '86 - UP Box Qty. 15</p>
 <p>445946 W713297-S300 White Nylon Door Trim Panel Retainer With Sealer Top & Middle Head Diameter: 16mm Bottom Head Dia: 22mm Stem Diameter: 11mm Stem Length: 17mm Ford Flex 2009 Box Qty. 25</p>	 <p>445947 W709995-S300 Green Nylon Lift Gate Trim Retainer Top Hd Dia: 15mm Middle Hd Dia: 19mm Bottom Hd Dia: 18mm Stem Dia: 12mm Stem Length: 14mm Ford Flex 2009 - UP Box Qty. 25</p>	<p>NEW</p>  <p>445949 Blue Nylon Lower Cab Moulding Clip with Sealer Top Head Size: 9.5mm x 20mm Bottom Head Size: 14mm x 20mm Stem Length: 21.9mm Overall Height: 27mm Fits into 9mm Hole Ford F-150 & F-250 2015 - UP Box Qty. 10</p>	
 <p>445986 B101-68-252-00 Black Plastic Various Interior Trim Push-Type Retainer Head Dia: 14mm Stem Length: 16mm Fits Into 6mm Hole Ford Probe '88 - UP Mazda MX6 '88 - UP Box Qty. 25</p>	 <p>445995 GJ21-68-885B-02, 5R3Z-54310D12-AAA, 6E5Z-7850980-AAA Black Nylon Trim Panel Push-Type Retainer Head Diameter: 18mm Stem Length: 10mm Fits into 6mm Hole Fusion & Mustang 2005 - UP Mazda 1992 - UP Box Qty. 25</p>	 <p>470110 E83Z-16758-A Hood Bumper Kit (Consists of 1-470115 and 1-470120) Ford '89 - UP Box Qty. 5 Kits</p>	 <p>470115 Zinc (Use with #470120) Hood Adjuster Bumper M6 - 1.00 x 44mm Hex: 23mm Ford '89 - UP Box Qty. 5</p>

FORD CLIPS & FASTENERS



470120
 (Use with #470115)
 Hood Adjuster Bumper Nut
 Threaded Insert: M6-1.0
 Ford '89 - UP
 Box Qty. 15

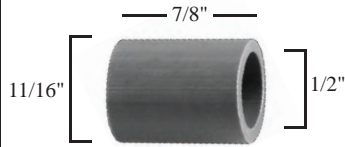

471120
 Plastic
 Door Latch Striker Bushing
 ID: 1/2", OD: 11/16"
 Length: 7/8"
 Ford Cars & Trucks '72 - UP
 Box Qty. 10



475001
 W710793-S439
 Zinc Organic
 Headlight Mounting Clip
 Thread: M6-1.0
 Ford Super Duty Pick-Up 2008-9
 Box Qty. 10



475090
 380340-S
 Transmission Control Clip
 Ford Products
 Box Qty. 10



475155
 14083173,
 17988488,
 17997722, 25536302,
 N803685-S
 Frt Bumper, Side/High Stop
 Lamps, Rear Wheel Flare &
 Int. Trim/Dash Mounting Nut
 Screw: M4.2 (#8)
 Hole: 9 x 11mm
 GM, Saturn, Hummer, Ford,
 Jeep '82 - UP
 Box Qty. 25



475420
 386299-S
 Plastic
 Hood Prop Rod Clip
 Rod Dia: 5/16"
 Ford & Mercury
 Passenger Cars '75 - UP
 "E" Vans '80 - '91
 Box Qty. 50

**Clip Should Be Replaced
 Whenever A Connector Is Removed**

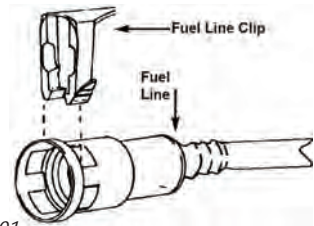

475715
 N802239-S,
 N806191-S1901
 Natural Nylon
 Fuel Line Clip
 Fits 5/16" Fuel Line
 Ford w/Fuel Injection
 '80 - UP
 Box Qty. 25

475720
 N802241-S,
 N806190-S1901
 Black Plastic
 Fuel Line Clip
 Fits 3/8" Fuel Line
 Ford w/Fuel Injection
 '80 - UP
 Box Qty. 25



GLASS SHOP SUPPLIES



455005
 C5ZZ-6503178-B
 Windshield & Rear Window
 Moulding Clip
 Mustang '64 - '65
 Box Qty. 50



455010
 D1AZ-6542413-B,
 D1AB-6542413-AB,
 C8AZ-6364243-A
 Windshield & Back Glass
 Moulding Fastener
 Ford & Mercury Products '71 - UP
 Box Qty. 100



455011
 C5ZZ-6543413-B
 Windshield & Rear Window
 Reveal Moulding Fastener
 Ford '66 - '80
 Box Qty. 100



455140
 D9AZ-5403178-A
 Windshield Top Reveal
 Moulding Retainer
 Ford Products
 Box Qty. 100



455180
 E3SZ-6342413-A,
 E3SB-6342413-AB
 Windshield & Rear Glass
 Reveal Moulding Clip
 Ford Topaz, Tempo, T-Bird
 Box Qty. 50



465150
 B092-50-609
 Gray Plastic
 Back Glass
 Moulding Clip
 Ford Probe '88 - UP,
 Mazda MX6 '88 - UP,
 Mercury Tracer '87 - UP
 Box Qty. 25

FORD GLASS SHOP SUPPLIES

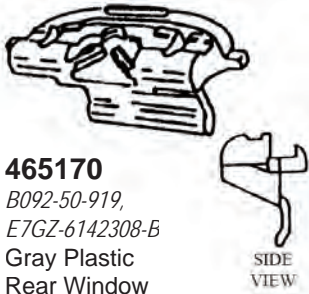

465170
 B092-50-919,
 E7GZ-6142308-B
 Gray Plastic
 Rear Window
 Moulding Clip
 Mazda 323 '88 - UP,
 Mercury Tracer '88 - UP
 Box Qty. 15



480010
 Door & Window Crank
 Handle Retaining Clip
 Ford, GM, Toyota
 Box Qty. 100



480040
 COAB-6423240-B,
 B9A-6423240-A,
 Window Regulator Roller
 Ford & Mercury Products '59 - '70
 Box Qty. 25



480531
 69951-12180
 Nylon
 with Steel Threaded Insert
 Glass Mount
 M6-1.0 Thread
 Ford, Nissan and Imports
 Box Qty. 5

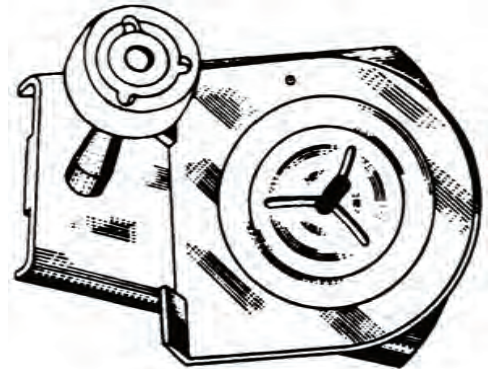

485340
 D3AZ-5726106-A
 Window Track
 Roller &
 Slide Assembly
 Ford '73 - UP
 Box Qty. 1

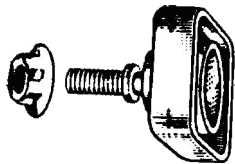

485390
 D6AZ-5323240-A
 Window Guide Roller & Nut
 Square with Rounded Corners
 Ford Products '74 - UP
 Pick-Up '90 - UP
 Box Qty. 10



486010
 D0AZ-62234A24
 Power Window
 Regulator Gear (9-Tooth)
 Ford Products '64 - UP
 Box Qty. 1



not actual size
486012
 Power Window Regulator
 Contains: one 2-1/2" O.D.
 Nylon Gear &
 3-486015 Torque Pins
 Ford '89 - UP
 Box Qty. 1 Kit



486015
 Torque Pin Kit
 For Window Gears
 Pin Dia: 1/2"
 Pin Length: 13/32"
 Ford & Chrysler '64 - UP
 Box Qty. 15 pins



BLANK

GM CLIPS & FASTENERS

<p>27999 Box 25</p>  <p>28000 6031115, 9436175, 385189-S100 Dia.: 1/4" Grip: 1/32" - 9/64" Flange Dia: 1/2" Peel-Type Rivet Aluminum Rivet Steel Mandrel Window Regulators GM, Ford, Chrysler '71 - UP Box Qty. 100</p>	<p>28002 Box 25</p>  <p>28001 6031091, 9437938, 385323-S100 Dia.: 1/4" Grip: 33/64" - 19/32" Flange Dia: 1/2" Peel-Type Rivet Aluminum Rivet Steel Mandrel Glass Stop, Window Regulator GM, Ford, Chrysler '76 - UP Box Qty. 100</p>	 <p>38509 9439719 Dia: 3/16" Grip: 1/4" - 3/8" Flange Dia: 5/8" Black Steel Rivet, Steel Mandrel Fascia to Underside Bumper GM 81 - UP Box Qty. 50</p>
<p>38511 Box 100</p>  <p>38510 25618730, N805592-S100 Dia.: 3/16" Grip: 5/64" - 15/64" Flange Dia: 7/16" Split-Typr Rivet Black Aluminum Rivet Aluminum Mandrel Wheel House Moulding & General Purpose Ford, GM Box Qty. 25</p>	 <p>38512 11610383 Dia: 1/4" Grip Range: 1/64" - 1/8" Flange OD: 1/2" Steel Rivet, Steel Mandrel Step Bumper GM Silverado & Sierra 2007 - UP Box Qty. 50</p>	 <p>38514 11516807 Split-Type Rivet Dia: 3/16" (4.8mm) Grip: 3/64" - 23/64" (1mm-9mm) Flange Dia: 5/8" (16mm) Black Aluminum Rivet Aluminum Mandrel Bumper Fascia & General Purpose GM 1990 - UP Box Qty. 25</p>
 <p>38522 N807620-S100, 10131511, 11588308, 6034212, 6036148AA Dia.: 5/32" Grip: 3/64" - 1/4" Flange Dia: 5/16" Split-Type Rivet Black Aluminum Rivet Aluminum Mandrel Wheel Openings Lincoln '94 - UP Bumper Cover, Grille, Rocker Mldg. GM '97 - UP Bumper Cover Chrysler Box Qty. 25</p>	 <p>38523 9132667, 19352194 Dia: 5/32" (4mm) Grip: 9/64" - 3/8" (3.6mm - 9.5mm) Flg Dia: 7/16" (11.1mm) Multi-Grip Type Aluminum Rivet Stainless Steel Mandrel Front & Rear Bumper Buick Regal & Verano; Chevy Avalanche, Camaro, Cruze, Malibu, Sonic & Volt 2010 - UP Box Qty. 25</p>	 <p>38524 92139150 Dia: 5/32" (4mm) Grip: 11/64" - 11/32" (4.4mm - 8.5mm) Flg. Dia: 9/32" (7.1mm) Multi-Grip Type Aluminum Rivet Stainless Steel Mandrel Front Bumper & Grille Chevrolet Camaro 2012 - UP Box Qty. 25</p>
 <p>38525 9432137, 6032138 Dia.: 5/32" Grip: 1/8" - 3/16" Flange Dia.: 5/16" Aluminum Rivet, Steel Mandrel Countersunk Head Trunk Lock Swivel Emblem Rivet Chrysler, GM '73 - UP Box Qty. 25</p>	 <p>38527 15022087 Dia.: 1/4" Grip: 3/64" - 5/64" Flange Dia.: 19/32" Shoulder Dia.: 13/32" Steel Rivet (Zinc) Steel Mandrel (Zinc) Headlight Retainer GM Trucks '98 - UP Box Qty. 25</p>	 <p>38545 22578214 Dia: 1/4" Grip .086" to .129" Flange: 1/2" Blind Rivet Steel Rivet Steel Mandrel Window Regulator GM "N" Bodies 91 - UP Box Qty. 15</p>

GM CLIPS & FASTENERS

21 GM Clips



38550
 9437486, 6032926
 Dia: 1/4" Grip: 9/64" - 3/16"
 Head Dia.: 1/2"
 Aluminum Rivet, Steel Mandrel
 Window Regulator Rivet
 GM, Chrysler
 Box Qty. 25



38555
 389268-S100, 201843399,
 12338153
 Dia: 1/4" Grip: 11/16" - 3/4"
 Flange Dia.: 1/2"
 Peel-Type Rivet
 Aluminum Rivet
 Steel Mandrel
 Window Regulators
 Ford & GM
 Box Qty. 25



38565
 10204266
 Dia.: 1/4" Grip: 3/4" - 1"
 Flange Dia: 1/2"
 Aluminum Rivet
 Aluminum Mandrel
 Trunk Lock Cylinder
 Pontiac Firebird '94 - UP
 Box Qty. 10



38570
 N804193-S100, 9441592, 15672713
 Dia.: 1/4" Grip: 3/32" - 9/64"
 Flange Dia.: 3/4"
 Peel-Type Rivet
 Black Aluminum Rivet, Steel Mandrel
 Front Door Handle & Door Lock Actuator
 Ford Tempo, Topaz, T-Bird, & Cougar '84 - UP
 Rocker Panel Mldg
 Chevrolet Beretta & Corsica 1992 - 1996
 Box Qty. 25

NEW



38575
 9442361, 25609048, N804523S, N803138-S
 Dia: 3/16" Grip: 3/64" - 13/64"
 Flange Dia.: 9/16"
 Split-Type Rivet
 Black Aluminum Rivet / Steel Mandrel
 Used in place of screws when attaching
 new Catalytic Converter Heat Shield
 Ford; Buick LeSabre & Roadmaster, Cadillac
 Brougham and Oldsmobile 98 & 88 1986 - UP
 Box Qty. 50

NEW



38584
 11546343
 Dia: 4mm (5/32")
 Grip: 5mm - 12mm
 Flange Dia.: 8mm (5/16")
 Aluminum Rivet
 Aluminum Mandrel
 Front & Rear Bumper Cover
 Cadillac CT6 2016 - UP
 Chevrolet Camaro 2012 - UP
 Box Qty. 25



38603
 2024778
 Dia: 1/4" Grip: 1/16" - 1/4"
 Flange Dia: 1/2"
 Steel Rivet (Zinc)
 Steel Mandrel (Zinc)
 Front Side Door Window Regulator
 Chevrolet Lumina APV, Olds Silhouette &
 Pontiac Trans Sport '90 - UP
 Box Qty. 25



38605
 22643056
 Dia: 1/4" Grip: 1/16" - 5/32"
 Flange Dia: 1/2"
 Zinc & Yellow Dichromate
 Steel Rivet, Steel Mandrel
 Door Window Regulator Rivet
 Buick Skylark, Chevrolet Cavalier, Olds Achieva
 & Aurora, and Pontiac Grand Am & Sunfire
 1995-On
 Box Qty. 25



38608
 16715497
 Dia: 5/32" Grip: 3/64" - 1/4"
 Flange Dia: 15/32"
 Aluminum Rivet, Steel Mandrel
 Attaches Support Rails to Load Floor
 GM
 Box Qty. 50



38713
 22638717, 90671-SDA-A01
 Dia: 3/16" (4.8mm)
 Grip: 3/64" - 23/64" (1mm - 9mm)
 Flange Dia: 5/8" (16mm)
 Aluminum Rivet,
 Aluminum Mandrel
 Bumper Fascia & General Purpose
 GM 1987 - UP and Honda Civic 2016 - UP
 Box Qty. 100



170025
 14044408
 Black
 4.2mm - 1.41 x 20mm
 Torx Drive
 Knurled Socket Head
 Dash Pad Retaining Screw
 Firebird, Camaro '82 - UP
 Box Qty. 25



170210
 M6-1.0 x 20mm
 Torx Drive Bolt w/Dog Point
 T-30 Torx Drive
 18mm Plastic Washer
 9.5mm x 5mm Shoulder
 GM Saturn '91 - UP
 Box Qty. 15









200075
 10 x 1/2"
 Head Dia: 1/2"
 Phillips Tapping Screw
 Boot Well & Weatherstrip
 Rails
 GM & Ford Convertible & Hardtops
 Box Qty. 100

GM CLIPS & FASTENERS













 <p>200170 367292 & 367291 Chrome Plated Steel Outside Rearview Mirror 1/4"-20 x 1" Bolt & Mounting Nut <i>Chrysler & GM Trucks & Vans</i> Box Qty. 10</p>	 <p>200175 367291, 14007511 Chrome Plated Steel 1/4"-20 x 1" Hex Washer Head Hex: 3/8" Wshr OD: 5/8" Truck Mirror Mounting Screw <i>Chrysler & GM Trucks/Vans</i> Box Qty. 10</p>	 <p>200177 11503578, 11503785 Black Phosphate M4.2-1.41 x 16mm (#8 x 5/8") Hex: 7mm Washer OD: 12mm (1/2") Hex Washer Head Screw W/ Teks® Point <i>GM & General Purpose</i> Box Qty. 50</p>	<p>NEW</p>  <p>200281 11609457 Black Zinc M4.2-1.41 x 20mm Round Washer Hd Pozi-Drive Tap Screw Head Dia: 11mm Tail Lamp Assembly <i>Buick Cascada, Enclave, Encore, Cadillac CTS, Chevrolet Avalanche, Camaro, Caprice, Corvette, Impala, Monte Carlo & Trax and Pontiac G6 2000 - UP</i> Box Qty. 25</p>
 <p>200293 Black Phosphate Hex Washer Head w/ Loose Washer M4.2 - 1.41 x 20mm w/ Drill Point 7mm Indented Hex Head Washer Dia: 17mm <i>GM & General Purpose</i> Box Qty. 50</p>	 <p>200294 11589012 Black Zinc M4.2-1.41 x 25mm Indented Hex Flange Head Sems® Tapping Screw Hex: 7mm Washer Dia: 12.5mm Signal Lamp Mounting, Interior Door Trim, Instrument Panel, Radio & Speaker Mounting, Rear Bumper & Liftgate <i>Buick Allure, Cascada, Enclave, Encore, Envision, LaCrosse, Lesabre, Lucerne, Park Avenue, Rainier, Regal & Verano and Cadillac ATS, CT6, CTS, Deville, DTS, Eldorado, ELR, Escalade, Seville, SRX, STS, XT5 & XTS and Chevrolet Avalanche, Blazer, Bolt EV, Camaro, Captiva Sport, Cobalt, Colorado, Corvette, Cruze, Equinox, Express, HHR, Impala, Lumina, Malibu, Monte Carlo, Orlando, S10, Silverado, Sonic, Spark, SS, SSR, Suburban, Tahoe, Trailblazer, Traverse, Trax & Volt and GMC Acadia, Canyon, Envoy, Savana, Sierra, Sonoma, Terrain & Yukon and Hummer H2 & H3 and Pontiac Bonneville, G5, Grand Am, Pursuit, Solstice & Torrent and Saturn Ion, Outlook & Sky 1987 - UP</i> Box Qty. 50</p>		
<p>200295 11547420 Black Zinc M4.2-1.41 x 20mm Bumper, Grille, Fog Lamp Hex Head Sems Tapping Screw Hex: 7mm Washer OD: 17mm Point Type: BR Grade: 2 <i>Buick Enclave, Cadillac XT6, Chevrolet Blazer, Equinox, Express, Silverado, Traverse, GMC Savana, Sierra & Terrain 2018 - UP; Malibu 2016 - 2018</i> Box Qty. 25</p> 	<p>NEW</p>  <p>200361 11503395 Black Finish Indented Hex Head Sems Screw, Loose Washer M4.2-1.41 x 16mm (#8 x 5/8") Indented Hex Head: 7mm Washer Dia: 12mm (15/32") <i>GM</i> Box Qty. 50</p>		<p>21 GM Clips</p>
	 <p>200363 14090382, 6506161-AA Black Phosphate M4.2-1.41 x 20MM (#8 x 25/32") Hex Head Tapping Screw w/SEMS Washer OD: 20mm Hex: 7mm <i>GM</i> Box Qty. 50</p>	<p>200380-500 Box 500</p>  <p>200380 9423101 Dacromet 320 Finish License Plate Screw M6.3-1.81 x 16mm (#14 x 5/8") Duo Drive Truss Head <i>GM Cars & Trucks '65 - UP</i> Box Qty. 50</p>	 <p>200395 11570637 Black Zinc M4.2-1.41 x 20mm Torx Pan Head Tapping Screw w/SEMS Round Dog Point Washer OD: 17mm (11/16") Bumper, Fender Apron, Rad. Grille, Rocker, Back-up Lamp <i>GM Encore, Enclave, Verano, ATS, Camaro, Caprice, Cruze, Impala, Malibu, Silverado, Sonic, Volt, Terrain, Arcadia 2007 - UP</i> Box Qty. 50</p>

GM CLIPS & FASTENERS

21 GM Clips

 <p>200398 13144822 Black Zinc M5.5 x 20mm (#12 x 25/32") Torx Truss Head T-20 Drive Head OD: 15mm (19/32") GM 2011 - UP, Saab 2003 - UP Box Qty. 25</p>	 <p>215067 2968521 Black #5/16-18 x 1" Hex Washer Head Flange: 5/8" A/F: 1/2" Radiator Shroud & Grille Headlamps GM '73 - UP Box Qty. 50</p>	 <p>216195 11505022 Black Phosphate M6.3-1.81 x 20mm (#14 x 25/32") Hex Washer Head SEMS Hex: 10mm Washer OD: 17mm (11/16") GM Box Qty. 50</p>	 <p>216297 11504570, 11509816, 11514623 Phosphate Class 9.8 M6-1.0 x 20mm (#14 x 25/32") Hex Head SEMS Hex: 10mm Washer OD: 17mm (21/32") GM Box Qty. 50</p>
 <p>216358 NEW 11589031 Black Zinc Class 9.8 Hex Head Sems Body Bolt M6-1.0 x 20mm Hex: 10mm Washer Dia: 24mm Front Bumper Support, Fender Liner, Grille & Headlamp Adjusting <i>Cadillac Escalade, Chevrolet Camero, Silverado, GMC Sierra and Pontiac Solstice 2006 - UP</i> Box Qty. 15</p>	 <p>266030 Zinc & Yellow M5-.8 Specialty Insert Grip: .5mm - 3.3mm Head Dia.: 10mm Hex Size: 7mm GM Box Qty. 15</p>	 <p>266031 Zinc & Yellow M4-.7 Specialty Insert Grip: 2mm - 3.3mm Head Dia: 9.5mm Hex Size: 6.2mm Box Qty. 15</p>	 <p>266032 N803763-S100, 15685099 Zinc & Yellow M6-1.0 Grip: .65mm - 2.0mm Head Dia: 12mm Hex Size: 8mm Specialty Insert w/ Sealer Roof Rack, Tailgate & General Purpose <i>Ford Explorer 1991 - UP GM APV Vans</i> Box Qty. 15</p>
 <p>266033 10281487 Zinc & Yellow M6-1.0 Specialty Insert Grip: .7mm - 4.2mm Head Dia: 13mm Hex Size: 9.5mm (3/8") Front Fender <i>Buick, Cadillac, Corvette, L.D. Pontiac, Olds Aurora & Pontiac '97 - UP</i> Box Qty. 15</p>	 <p>270004 NEW 11570015 Zinc Organic Front/Rear Bumper & Headlamp Assembly Specialty Push-In Nut Thread Size: M6-1.0 Overall Height: 11.6mm <i>Buick Cascada, Envision, LaCrosse & Regal, Cadillac ATS, CT6, CTS, ELR, Escalade & XTS, Chevrolet Camero, Colorado, Cruze, Malibu, Silverado, Sonic, Suburban, Tahoe & Volt and GMC Acadia 2011 - UP</i> Box Qty. 10</p>	 <p>270006 4806226-AA, 11562364 Zinc Front & Rear Bumper and Grille Fastener Screw Size: #6 Width: 10mm Overall Height: 18mm <i>Buick Lucerne and Cadillac CTS & STS 2005 - UP Chrysler 300, Dodge Nitro and Jeep Commander 2005 - UP</i> Box Qty. 15</p>	 <p>270007 11518531 Zinc Organic Fender Bracket Interior Trim Door, Bumper & Hood Retainer Nut #8 (M4.2-1.41) Screw Size <i>Buick Enclave & Lucerne, Hummer and Pontiac G5, G6, G8 & Solstice 2003 - UP</i> Box Qty. 15</p>
 <p>270008 11609952 Magni-565 Plating Front Bumper Specialty Nut Screw Size: M4.2-1.41 (#8) Head Size: 6mm x 16mm Overall Height: 7mm <i>Cadillac Escalade, Chevrolet Tahoe and GMC Yukon 2007 - UP</i> Box Qty. 25</p>	 <p>270009 1570654, 6509432AA, W716529-S900 Blue Finish Radiator Grille Nut Screw Size: #8 (4.20mm) Head Size: 6mm x 16mm Panel Range: .70 - 2.30mm Hole Size: 8.7mm <i>Buick Allure, Enclave, Encore, LaCrosse, Lesabre, Lucerne, Rainer, Regal & Verano and Cadillac ATS, CTS, Deville, DTS, ELR, Escalade, SRX & STS 2000 - UP; Chrysler 200, 300, PT Cruiser, Sebring, Town & Country and Dodge Avenger, Caliber, Charger, Dart, Grand Caravan, Ram 2500 & Ram 3500 2006 - 2015; Ford 250, 350, 450 & 550 Super Duty Trucks 2013 - 2015</i> Box Qty. 25</p>	 <p>270011 11547582 Zinc Organic Air Duct & Rear Bumper Bracket Nut Thread Size: M6-1.0 Head Size: 8mm x 18mm Overall Height: 11mm <i>Cadillac CT6, Chevrolet Silverado and GMC Acadia & Sierra 2016 - UP</i> Box Qty. 25</p>	

GM CLIPS & FASTENERS

<p>270012 11546868 Zinc Organic Door Panel, Bumper, Lamps & Deck Lid Nut with Silicone Pad Screw Size: M4.2-1.41 (#8) Head Size: 12mm x 16mm Stem Length: 6.5mm <i>Buick Allure, Enclave, Encore, Envision, LaCrosse, Rainier, & Regal, Cadillac ATS, CT6, CTS, ELR, Escalade, SRX, XT5 & XTS, Chevrolet Bolt EV, Camaro, Cobalt, Colorado, Cruze, Equinox, HHR, Impala, Malibu, Orlando, Silverado, Sonic, Spark, Spark EV, SS, Suburban, Tahoe, Trailblazer, Traverse, Trax & Volt, GMC Acadia, Canyon, Envoy, Sierra, Terrain & Yukon 2008 - UP; Hummer H2, H3 & H3T 2003-2010; Pontiac G5 & Saturn Outlook 2007-2010</i> Box Qty. 15</p> 	<p>280031 25649667, W705590-S300, W710459-S300 Natural Nylon Screw Grommet with Sealer Screw Size: M4.2 (#8) Head Size: 13mm x 22mm Stem Length: 18mm Back Glass Moulding & Interior Trim <i>Cadillac & Ford Windstar 1998 - UP</i> Box Qty. 15</p> 			
<p>280032 11610157 Center Console Door, Front Lights, Grille, Instrument Panel & Lift Gate Nut With Silicone Pad Screw Size: M4.2-1.41 (#8) <i>Cadillac CTS, Chevrolet Corvette, Equinox, Malibu & Traverse, Hummer H3, Pontiac G6 and Saturn Ion 2003-UP</i> Box Qty. 10</p> 	<p>280033 11562503 Zinc Organic w/ Plastisol Pad Specialty Nut Screw Size: M6-1.0 Head Size: 13mm x 13mm Stem Length: 8mm <i>Chevrolet Truck & GMC 2008-UP</i> Box Qty. 10</p> 	<p>NEW</p> <p>280035 84221533 Orange Nylon Tail Lamp Grommet with Sealer Head Dia: 19mm Fits into 10mm Hole Overall Length: 17.5mm <i>Cadillac XT5, Chevrolet Silverado & Traverse and GMC Acadia 2018 - UP</i> Box Qty. 10</p> 	<p>280040 8934-201-263, 6000943 White Nylon Radiator Grille Nut Screw Size: #8 (4.2mm) Stem Length: 9mm Head Size: 10mm <i>AMC-Renault, Chrysler</i> Box Qty. 50</p> 	
<p>280070 3893980, 347347 Nylon Front End & Instrument Panel Nut Screw Size: #8 Head Size: 7/16" Stem Length: 9/32" Hole Size: 5/16" <i>GM '67 - UP</i> Box Qty. 50</p> 	<p>280080 1377030 Nylon Valance Panel To Rear Bumper Bar Grommet Screw Size: #6 or #8 Head Size: 14mm x 21mm Stem Length: 9mm Hole Size: 7mm x 18.5mm <i>GM '71 - UP</i> Box Qty. 50</p> 	<p>280100 3986978 Headlight Bezel Nut 8 Used Per Car <i>Chevrolet '71 - UP</i> Box Qty. 25</p> 	<p>280135 3907444, 4755299 Nylon License Plate Nut Split Four Ways Under Head Screw Size: #14 (1/4") Head Size: 5/8" Stem Length: 5/16" Hole Size: 13/32" <i>GM, Chrysler</i> Box Qty. 100</p> <p>280136 Box 500</p> 	
<p>280210 3919773, 22649878, 22649879 White Nylon Headlamp Bezel Nut Screw Size: #8 Head Size: 7/16" Stem Length: 9/32" Hole Size: 5/16" <i>GM '74 - UP</i> Box Qty. 50</p> 	<p>280220 Nylon Nut Headlamp Bezel Screw Size: #8 or #10 Head Size: 1/2" <i>GM Cars & General Purpose</i> Box Qty. 50</p> 	<p>280230 1254815 Nylon Fenders, Cornering Lights Screw Grommet Screw Size: #6 Hole: 1/4" Panel Range: .060" - .150" <i>GM '77 - UP</i> Box Qty. 50</p> 	<p>280240 1255823, 389360S Nylon Screw Size #6 or #8 Front End Bezel Nut <i>GM '79 - UP</i> Tail Light Nut <i>Ford '81 - UP</i> Box Qty. 50</p> 	<p>280250 1386805, 6032676 Nylon Radiator Grille Nut Screw Size: #8 or #10 <i>Chrysler Truck '85, Buick & General Purpose</i> Box Qty. 100</p> 

GM CLIPS & FASTENERS

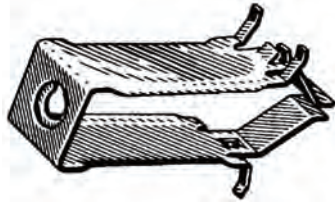

280295
22514924
Headlight Mounting
Bezel Nut
Screw Size: #8 (M4.2-1.41)
2" Long
Oldsmobile '82 - UP
Box Qty. 25



280315
15078238
Black
Radiator Grille & Bumper
Cover Retainer
Width: 5/8"
Length: 1"
Overall Height: 5/8"
GM Trucks/Vans '99-UP
Box Qty. 15



280320
14013246
Nylon
Headlight Bezel Nut
Screw Size: #8
Head Size: 31/64"
Stem Length: 17/64"
Fits Into 5/16" Hole
GM '67 - UP
Box Qty. 50



280360
22529009
Side Marker Grommet
Marker & Headlight
Bezel Nut
M4.2 or #8 Screw
GM 'J' & 'N' Bodies '84 - UP
Box Qty. 50



280380
Plastic
Front Side Marker
Lamp Grommet
Screw Size: M4.2
Rect. Hole: 8.0 x 6.0mm
Cadillac "C" Body (Fwd.) '86 - UP
Box Qty. 50



280381
11610748
(Use with #415011)
Black Nylon
Grille Retainer Nut
Hex: 13mm
Washer Dia: 25mm
Overall Height: 7mm
Cadillac SRS & SRX and
Chevrolet Camaro 2010 - UP
Box Qty. 25



280400
16503548
Nylon & Stainless Steel
Nut & Spring Grommet
Provides Tension on
Headlamp
Various GM '83 - UP
Box Qty. 25



280405
16507939
Nut & Spring Grommet
with Drive Pin
Provides Tension on
Headlamp
GM C-K Truck
Box Qty. 15



285036
6031869, 10032838,
1264963, 8934-201-602
Black Nylon
High Torque
Screw Grommet
Head Size: 14.7 x 20.8mm
Hole Size: 7.10 x 20.30mm
Stem Length: 16.5mm
GM, Chrysler, AMC-Renault
Box Qty. 25



285115
N811169-S,
W705550-S300,
90189-06111,
90075-10801, 10423331
White Nylon
Headlamp Mounting /
Turn Signal Retainer
Head Dia.: 13mm
Stem Length: 9mm
Fits Into 11mm Hole
Ford F250-F550 '99 - UP
Toyota/Lexus '89 - UP
GM
Box Qty. 50



NEW
292007
25704358
White Nylon
Rear Bumper
Screw Grommet With Sealer
Screw Size: M6.3 (1/4" or #14)
Head: 15mm x 18mm
Stem Length: 23mm
Cadillac CTS & SRX and
Pontiac Grand Prix 2004 - UP
Box Qty. 10



NEW
292011
11547637
Natural Nylon
Bumper Deflector Flange Nut
Thread Size: M4.2 (#8)
Flange OD: 20mm
Hex Size: 10mm
Height: 13.5mm
Buick Regal & Verano 2014 - 2017
Cadillac CT6, Chevrolet Cruze,
Equinox & GMC Terrain 2016 - UP
Cadillac ATS, CTS, XTS & Chevrolet
Malibu 2014 - 2018; Chevrolet Cruze
2014 - 2019
Box Qty. 25



292050
90189-05013, MS480009
MS-480002, 94841764
Nylon Nut
Headlamp Bezel & Grille
Screw Size: #10
Width: 12mm, Length: 12mm
Fits into 8mm x 9mm Hole
Toyota, Mitsubishi, GM
Box Qty. 50



292060
90189-04008,
MB029111,
90467-12096,
94841130
Nylon Grille Nut
Screw Size: #8
Length 16mm, Width 12mm
Height 15mm
Fits Into 10mm Square Hole
GM Nova '85 - UP
Toyota, Mitsubishi
Box Qty. 25



292218
90189-06028, 94854203
Black Nylon
Front & Rear Wheel
Fender Liner Screw Grommet
Screw Size: #12
Head Dia: 16mm
Stem Length: 19mm
Fits into 9mm Square Hole
Toyota Tacoma, T100 & 4 Runner
1992-UP; Chevrolet Nova & Prizm
and Pontiac Vibe 1985-UP
Box Qty. 15



295090
D7VY-6050074-A, 1259296,
3201767, 15964853, 8934-201-767
Plastic Barrel Nut
Hole: 1/4"
Ford, GM, Chrysler
Box Qty. 50

GM CLIPS & FASTENERS

 <p>300185 22529957 Nylon Front Bumper Fascia Nut Screw Size: M4.2 (#8) Washer Face: 25mm Head Dia.: 25mm (1") Hole: 7mm Sq. Oldsmobile Cutlass Ciera '85 - UP Box Qty. 25</p>	<p>NEW</p>  <p>302004 11548579 Zinc Organic Metric Extruded U-Nut Screw Size: M4.2-1.41 (#8) Panel Range: 2.0mm - 3.0mm (.078" - .118") Center of Hole to Edge: 9.5mm (3/8") Buick Cascada, Encore, Envision, LaCrosse, Cadillac ATS, CTS, XTS, Chevrolet Camaro, Cruze, Equinox, Malibu, Sonic, Traverse, Trax & GMC Terrain 2017 - UP Box Qty. 25</p>	<p>NEW</p>  <p>302005 11548580 Zinc Organic Metric Extruded U-Nut Screw Size: M4.2-1.41 (#8) Panel Range: .65mm - 3.8mm (.026" - .149") Center of Hole to Edge: 15mm (19/32") Cadillac XTS and Conv/Camaro, Chevrolet Cruze, Equinox, & Traverse 2017 - UP Box Qty. 25</p>	<p>NEW</p>  <p>302007 11515638 Zinc Metric Extruded U-Nut W/ Locking Thread Screw Size: M4.2-1.41 PR: .65mm - 3.8mm (1/32" - 5/32") Center of Hole to Edge: 15mm (19/32") Bumper Cover GM Box Qty: 25</p>
 <p>302011 11516397 Zinc Organic U-Nut Screw: M4.2 - 1.41 (#8) P.R.: .5mm - 2.0mm (1/32" - 5/64") Center of Hole To Edge: 10mm (25/64") GM 1997 - UP Box Qty. 25</p>	 <p>302015 15707256 Zinc Organic Front Fender Extension & License Plate Bracket Retainer Nut Screw Size: M6 - 1.0 GM Express & Savanna '96 - UP Box Qty. 10</p>	<p>NEW</p>  <p>302037 11611321 Zinc Organic Metric Extruded U-Nut Screw Size: M6-1.0 Panel Range: .70mm - 2.0mm Center of Hole to Edge: 14mm Buick Envision, LaCrosse, Cadillac XTS, Chevrolet Bolt EV, Colorado, Cruze, Equinox, Impala, Traverse, Volt & GMC Acadia Canyon & Terrain 2017 - UP Box Qty. 10</p>	<p>302055 Box 25</p>  <p>302044 53879-14010-A, 53879-14020, 53879-22030, 94841226, LA01-56-135 Black Nylon U-Nut Wheel Housing Applications Screw Size: 4.8mm (#10) Panel Range: Up to 1mm Center of Hole to Edge: 11mm Toyota, GM, Mazda Box Qty. 10</p>
<p>NEW</p>  <p>302082 W520813-S439, 11516150 Zinc Metric Extruded U-Nut Screw Size: M8-1.25 PR: .80mm - 4.00mm (.030" - .160") Center of Hole to Edge: 21mm (13/16") Fender Liner Ford F-150/250/350 & Mustang 2015 - UP Chevrolet Colorado &, Express Van and GMC Canyon & Savana Van 2015 - UP Box Qty. 15</p>	 <p>303120 367292, 6031438 Zinc w/ Sealer Mirror Mounting Retainer Thread: 1/4-20 Stem Length: 5/8" Grip Range: 3/16" - 3/8" GM, Chrysler Box Qty. 25</p>	 <p>303125 14007940 Zinc w/ Raintite Roof Rack Mounting Nut Thread: M6-1.0 GM "X" & "Y" Bodies Box Qty. 10</p>	 <p>303260 20180178 Plastic Rear Speaker Cover Wing Nut Thread: M6 GM Box Qty. 25</p>
 <p>303325 528846, 4003120 Luggage Rack Mount Well Nut Thread: 1/4" - 20 Hole Size: 1/2" GM & AMC Box Qty. 25</p>	 <p>303326 20130258, 14002811 Neoprene Captive Brass Roof Rack & General Purpose Well Nut Thread: M6 - 1.0 Hole Size: 1/2" Box Qty. 25</p>		

GM CLIPS & FASTENERS

21 GM Clips

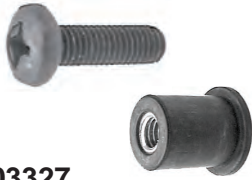

303327
20130258
Roof Rack Well Nut
Thread M6 x 1.0
w/ #10 Stainless Screw
Hole Size: 1/2"
GM & General Purpose
Box Qty. 10



340010
5949838
Headlight Adjusting Screw
& Nut assembly
Chevrolet, Buick & Pontiac
Box Qty. 10 Sets



340030
5953005
Nylon
Headlight Adjusting Nut
Chevrolet all early Models
Box Qty. 50



340230
343543
White
Headlamp Adjusting
Screw & Nut Assembly
1/4 - 28 x 2" Screw
Chevette '76 - UP
Mini Van '85 - UP
Box Qty. 25

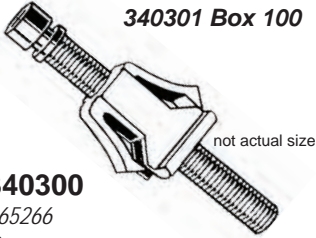

340300
365266
Green
Headlamp
Screw & Nut Assembly
1/4" - 28 x 2" Screw
Chevy Caprice '75 - UP
Full Size Cars '76 - UP
Box Qty. 25

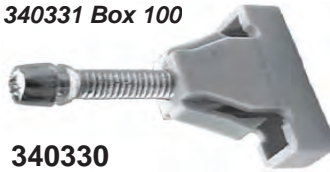

340331 Box 100
340330
557057
Blue
Headlamp Adjusting
Screw & Nut Assembly
12 - 28 x 1-1/4" Screw
Pontiac '77 - UP
'A' Body '82 - UP
'P', 'C' Body '85 - UP
Box Qty. 25



340350
9436928
Headlamp Adjusting
Screw
1/4 - 28 x 2-1/4"
GM '76
Box Qty. 50



350020
16507452
Headlamp Adjusting
Screw & Nut Assembly
M5 x 34mm
Slotted Torx Screw
Horizontal &
Vertical Adjustment
GM 'J' Bodies '87 - UP
Box Qty. 10



360290
555388
Headlight Adjusting Spring
Oldsmobile '76 - UP
'C' Bodies '85 - UP
Box Qty. 10



415010
4801268, 8731909
Black Nylon
Door Flange
Weatherstrip Fastener
Flange Dia: 13/32"
Stem Length: 7/16"
Stem Dia: 9/64"
GM
Box Qty. 100



415011
11610747
(Use with #280381)
Black Nylon Grille Retainer
Flang Dia: 25mm
Stem Length: 25.5mm
Stem Dia: 5.8mm
Cadillac SRS & SRX and
Chevrolet Camaro 2010 - UP
Box Qty. 25



415040
2988430
Black Nylon
Radiator Grille Retainer
Hole Size: 1/4" (6.3mm)
Head Dia: 1-1/4"
Stem Length: 1/2"
Chrysler, Ford, GM
Box Qty. 25



415051 Box 100
415050
1631564,
N804379-S, 3420287
W706358-S300
Black Plastic
Bumper Fascia
Retainer
Head Dia: 22mm
Hole Size: 11mm
Length: 28mm
Buick, Cadillac & Olds. '81 - UP
Ford Taurus & Merc. Sable '86-UP
Chrysler
Box Qty. 25



415052
22536642
Black Nylon
Rear Bumper
Fascia Retainer
Head Dia: 1/2"
Stem Length: 11/16"
Stem Dia: 5/16"
Chevy Cavalier, Olds Calais, Pontiac
Grand Prix, Sun Bird & 6000
1988 - UP
Box Qty. 50

















415060
4876498
Black Nylon
Weatherstrip Retainer
Head Size: 3/16" x 1/2"
Stem Length: 7/16"
Stem Dia: 3/16"
GM
Box Qty. 50



415072 Box 250
415071 Box 500
415070
11569768,
15958694, 1605396,
6030441, 388577S,
W705589-S300
Black Nylon
Radiator Yolk, Fender &
Bumper Shield Retainer
Hole Size: 1/4" (6.3mm)
Stem Length: 20mm
Head Dia: 25.5mm
GM, Ford, Chrysler
Box Qty. 50

GM CLIPS & FASTENERS

<p>415076 Box 250</p>  <p>415075 21094146, 21110201, 6501301 Black Nylon Hole Size: 5/16" (8mm) Stem Length: 19/32" Head Dia: 33/64" Trim Panel Retainer GM Saturn '91 - UP Sliding Door & Lift Gate Trim Panel Retainer Chrysler Mini Vans '87 - UP Box Qty. 50</p>	 <p>415080 8731909, 4841194 Black Nylon Door Weatherstrip Retainer Head Size: 13/32" Stem Length: 3/8" Stem Dia: 5/32" GM '63 - UP Box Qty. 100</p>	 <p>415100 20413107, 388246S, 4006516 Black Nylon Weatherstrip Fastener Hole Size: 3/16" (4.5mm) Stem Length: 21/32" Head Dia: 7/16" GM, Ford, AMC Box Qty. 50</p>	<p>415124 Box 100</p>  <p>415123 N802781-S, 802781-S, W704340-S300, 14093088, 55176248 Splash Shield & Facia Retainer Flange Dia: 1" (25.4mm) Stem Length: 7/8" (22mm) Fits into 1/4" (6.3mm) Hole Ford, GM, Chrysler Box Qty. 25</p>
 <p>415125 N803362-S, 20510029, 34202672 Black Nylon Body Retainer Flange Dia: 11/16" Stem Length: 7/8" Fits Into 1/4" Hole Ford, GM, Chrysler '84 - UP Box Qty. 25</p>	 <p>415127 10089262, 21042098, 55075139 Black Nylon Screw-Type Retainer Torx Screw Drive Head Dia: 7/16" (11mm) Stem Length: 11/16" (18mm) Fits Into 15/64" (6mm) Hole GM & Saturn 4 Door & Station Wagon 87 - UP Box Qty. 25</p>	 <p>415128 N803946-S, 6502871, 20664091 Black Nylon Push-Type Retainer Head Dia: 19/32" Stem Length: 29/32" Fits Into 1/4" Hole GM, Chrysler, Ford '87 - UP Box Qty. 25</p>	 <p>415130 N803494S, 15679091 Black Nylon Fascia, Trim & Grille Retainer Head Size: 15/32" x 15/32" Stem Length: 21/32" Fits Into 1/4" Square Hole Ford '85 - UP GM '84 - UP Box Qty. 25</p>
 <p>415131 21047094, 21110145 Black Nylon Push-Type Retainer Top Head Dia: 14mm Stem Length: 14mm Fits Into 6mm Hole GM Saturn '91 - UP Box Qty. 25</p>	 <p>415135 10157900 11517803 15993201 Black Nylon Front Bumper Fascia Retainer Head Dia: 18mm Stem Length: 23mm Fits Into 9.5mm Hole (3/8") Oldsmobile Cutlass '90-UP, GM truck '96-UP Box Qty. 25</p>	 <p>415138 20570245, 20635065, N804614S, N803934-S Black Nylon Splash Shield, Seat Cushion & Spare Tire Push-Type Retainer Head Dia: 1" Stem Length: 7/8" Fits Into 5/16" Hole Ford & GM '84 - UP Box Qty. 25</p>	<p><i>not actual size</i></p>  <p>415150 389809, C6GY-16776-A Plastic Hood Insulation Retainer 1-1/2" x 1-1/2" GM, Ford Box Qty. 50</p>
 <p>415190 2898909, 382570-S Black Nylon Dash & Cowl Panel Retainer Hole Size: M6.3 Head Dia: 12.4mm Stem Length: 13mm GM, Chrysler, Ford '70 Box Qty. 50</p>	 <p>415210 411700 Black Nylon Trim Panel Retainer Head Dia: 1/2" Stem Length: 3/4" Fits Into 9/32" Hole GM 1968-UP Box Qty. 50</p>	<p>415221 Box 250 415222 Box 500</p>  <p>415220 3977775, 3078511 Hood Insulation Clip Hole Size: 1/4" Head Dia.: 2" Stem Length: 3/4" GM, Chrysler, Ford Box Qty. 50</p>	

GM CLIPS & FASTENERS

 <p>415235 21039141, 15678493 Plastic Hood Insulation Retainer Head Dia: 40mm Length: 13mm Fits Into 8mm Hole GM Saturn '91 - UP Box Qty. 25</p>	 <p>415245 10195515, N805026S, 4696488, 6503163 Black Nylon Screw-Type Retainer Head Dia: 1/2" Stem Length: 1-13/64" Fits Into 9/32" Hole GM, Ford & Chrysler 1987 - UP Box Qty. 25</p>	 <p>415246 21035345 Black Nylon Liftgate Upper Window & Lower Garnish Moulding Push-Type Retainer Head Dia: 16mm Stem Length: (Excl. Pin): 12mm Fits Into 7mm Hole GM Saturn 1993 - 98 Box Qty. 10</p>	 <p>415247 15153415 Black Nylon Rear Bumper Cover Push-Type Retainer Large Head Dia: 20mm Stem Length: 21mm Fits Into 9mm Hole C & K Trucks 1999 - UP Box Qty. 25</p>
	 <p>415249 W711687-S300, 11589181 Black Nylon Bumper and Fender Apron Retainer Head Diameter: 18mm Stem Diameter: 7.5mm Stem Length: 20mm Ford Focus 2007 - UP GM Full Size Pick-Ups 2007 - UP Box Qty. 25</p>	 <p>415250 11588308 Nylon Rivet Dia: 4.95mm Grip Range: 3mm - 6mm Flange Dia: 9mm Buick Lucerne; Cadillac CTS & DTS; Chevrolet Venture; Oldsmobile Silhouette and Pontiac Trans Sport 1997- UP Box Qty. 25</p>	 <p>415251 6502328, 20699808 Black Nylon Door Weatherstrip Retainer Hole Size: 13/64" (5mm) Stem Length: 11.5mm Head Dia: 10mm Dodge Ram 1994 - UP GM 1974 - UP Box Qty. 100</p>
<p>415451 Box 250</p>  <p>415450 1619321 Black Nylon Radiator Apron Panel Retainer Head Dia: 1" Stem Length: 27/32" Fits Into 3/8" Hole GM '77 - UP & General Purpose Box Qty. 50</p>	 <p>415480 5973996 Brown Nylon Fascia Retainer Head Dia: 1" Shoulder Length: 1/4" Stem Length: 7/8" Fits Into 1/2" Hole GM Cars '82 - UP Box Qty. 25</p>	 <p>415490 5973400 Black Nylon Fascia Retainer Head Dia: 1" Shoulder Length: 1/8" Stem Length: 3/4" Fits Into 1/2" Hole GM Cars '79 - UP Box Qty. 25</p>	 <p>415503 175-853-695, 14015161 Black Plastic Grille Attaching Drive-Type Retainer Hole: 5/16" Flange: 5/16" x 1-1/16" GM & VW Box Qty. 50</p>
 <p>415505 14019206, 14019205, 16514113, 34201621, 6504090, 8934-201-621, 6503454, E308-4A163CA Black Nylon Front Fender Mud Skirt & Fender Liner Retainer Head Dia: 11/16" Stem Length: 9/16" Fits Into 1/4" Hole GM, AMC, Chrysler, Ford Box Qty. 50</p>	 <p>415525 10053388, 22542705 Black Nylon Bumper Fascia Retainer Head Dia: 1" Panel Range: 1/8" Stem Length: 1-7/64" Fits into 1/2" Hole GM '87 - UP Box Qty. 25</p>	 <p>415596 25612368, N807673-S Black Nylon Dash & Tailgate Push-Type Retainer Head Dia: 14mm Stem Length: 9mm Fits Into 7mm Hole GM Saturn 95 - UP, Ford Explorer Sport Trac, F150, F250, F350 2007 - UP Box Qty. 10</p>	<p>415597-500 Box 500</p>  <p>415597 N804570-S, 4638136, 20664092, 15773445, 20452072, 6502790, 22538004 Black Plastic Radiator Shield & Trim Screw-Type Retainer Hole: 1/4" Flange Dia: 11/16" Stem Length: 29/32" Ford, GM, Chrysler & Cadillac '98-UP Box Qty. 25</p>

GM CLIPS & FASTENERS



415600.....Box 25
415800.....Box 100
 N803862-S, 6501559, 6506007-AA, 10184895
 1/4" Dia. Black Nylon Blind Rivet
 Panel Range: 5/32" - 13/32"
 Flange: 1/2"
 GM, Ford, Chrysler, General Purpose



415602.....Box 25
415802.....Box 100
 14063981, 15506827, 15506921, KA01500Z1,
 N803043-S, 6500911, 8934-201-631
 1/4" Dia. Black Nylon Blind Rivet
 Panel Range: 5/32" - 13/32"
 Flange: 21/32"
 GM, Ford, Chrysler, AMC, General Purpose



415604
 34202855, 6500859, 6500899, 8048635,
 20432975, 175-853-577, 175-853-57701C,
 175-852-577
 Super Tough Black Nylon
 Hole: 13/64"
 Panel Range: 1/8" - 15/64"
 Head: 15/32"
 Chrysler, Ford, GM, VW, AMC
 Box Qty. 25



415610.....Box 25
415810.....Box 100
 20421672, 15955172, 15595172
 17/64" Dia. Black Nylon Blind Rivet
 Panel Range: 3/32" - 3/16"
 Flange: 1/2"
 GM, General Purpose



415620.....Box 25
415820.....Box 100
 4370132, 20433026, 14070914,
 175-553-577A, 175-853-577A
 17/64" Dia. Black Nylon Blind Rivet
 Panel Range: 3/32" - 3/16"
 Flange: 23/32"
 GM, Chrysler, VW, General Purpose



415630.....Box 25
415830.....Box 100
 6500898, 15718794
 13/64" Dia. Black Nylon Blind Rivet
 Panel Range: 15/64" - 25/64"
 Flange: 15/32"
 Chrysler, GM, General Purpose



415640.....Box 25
415840.....Box 100
 20432975, 175-853-57701C, 6503800,
 N804343S
 13/64" Dia. Black Nylon Blind Rivet
 Panel Range: 1/8" - 15/64"
 Flange: 15/32"
 GM, VW, Chrysler, Ford, General Purpose



415645
 21094747
 Black Nylon
 Dia: 5/32"
 Grip: 7/64" - 7/32"
 Rect. Head: 5/16" x 19/32"
 GM
 Box Qty. 50



415650
 20423647, N804189-S,
 B455-56-741
 Super Tough Black Nylon
 Blind Rivet
 Dia: 13/64"
 Grip: 1/16" - 11-64"
 Flange Dia: 11/32"
 Ford, GM, Mazda
 Box Qty. 25



415651
 10108746
 Black Nylon
 Front Bumper Fascia Retainer
 Head Dia: 20mm
 Stem Length: 20mm
 Fits Into 10mm Hole
 GM '91 - UP
 Box Qty. 25

415653
 25612415,
 6509761-AA
 Plastic
 Front Bumper
 Push-Type
 Retainer
 Head Dia: 20mm
 Stem Length: 13.5mm
 Fits into 10mm Hole
 Dodge Ram & Jeep Cherokee
 2010-UP
 Box Qty. 15



415664 Box 100

415663
 16500308, 6500787
 Black Nylon
 Tail Light Push-Type Retainer
 Hole: 13/64" (5mm)
 Stem Length: 15/32"
 Head Dia: 3/8
 GM, Chrysler
 Box Qty. 25



415666
 20514862
 Plastic
 Shroud Vent Grille to
 Panel Retainer
 Hole Size: 13/64"
 Head Dia: 19/32"
 Stem Length: 3/4"
 GM '85 - UP
 Box Qty. 100



GM CLIPS & FASTENERS

21 GM Clips

415740

66860-01W01,
94051993

Nylon
Cowl Panel to
Reinforcement Plate &
Engine Splash Shield Ret.
Head Dia: 14mm (9/16")
Stem Length: 16mm (5/8")
Fits Into 6mm (1/4") Hole
Geo Storm '90 - UP
Nissan '80 - UP
Box Qty. 25



415759 Box 50

415761

94218027,
H200-50-715
8942180270,
58974-00008, B092-50-715,
BF67-S0715, MB153825,
90467-13011, 90467-12020
Black Nylon
Grille Headlight Clip
Width: 13mm Length: 22mm
Ford, GM, Toyota, Mitsubishi, Isuzu,
Honda, Plymouth, Mazda
Box Qty. 25



415781 Box 100

415780

10053182,
6503163
Body Splash Shield
Screw-Type Retainer
Flange Dia: 19/32"
Stem Length: 13/16"
Fits Into 5/16" Hole
GM '87 - UP
Chrysler
Box Qty. 25



415782

22718369
Black Nylon
Fuel Tank Shield
Push-Type Retainer
Head Dia: 26mm
Stem Length: 12mm
Fits Into 10mm Hole
Chevrolet Malibu &
Trail Blazer 2004 - UP
Box Qty. 25



415785

10140480, 6502625

Black Nylon
Rear Bumper Fascia
Screw-Type Retainer
Head Dia.: 21mm (27/32")
Panel Range: 3mm (1/8")
Stem Length: 25mm (1")
Fits Into 12mm (1/2") Hole
GM, Chrysler
Box Qty. 25



415790

6501544, N803170-S,
5017410-AA
Black Nylon
Fascia Shield Retainer
Hole: 13/64" (M5)
Stem Length: 1/2" (12.7mm)
Head: 7/16" (10mm)
Ford Mustang, Capri '84 - UP,
Chrysler
Box Qty. 50



415795

14103435, 12337900
Nylon
Upper Radiator
Shield Retainer
Chevrolet Corsica & Beretta '87-UP
Box Qty. 15



415798

15686142, N802865-S100,
11561448
Zinc Phosphate
Grille, Bumper & Radiator
Support Nut
Screw: M4.2 or #8
Ford Lincoln '83 - UP
GM Trucks '93 - UP
Box Qty. 25



NEW

415799

11548673
Green Metallic Finish
Bracket Retainer Nuts
Screw: #8 (4.20-1.41mm)
Panel Range: 1.40 - 5mm
Hole Size: 10.90 x 13mm
Buick Cascada, Enclave, Envision &
LaCrosse, Cadillac CT6, XT5 & XTS
2016 - UP
Box Qty. 25



415883

W709176-S300,
15149708, 6506008AA
Radiator, Wheelhouse,
Fender & Bumper Cover
Push-Type Retainer
Hole: M6
Flange: 17mm
Stem Length: 16mm
Chrysler, Ford, GM
Box Qty. 25



415886

21077131,
214077131,
01553-0161U
Black Nylon
Bumper Fascia
Push-Type
Retainer
Head Dia: 1-3/16"
Stem Length: 2"
Fits Into 7/16" Hole
Nissan, GM Saturn '91 - UP
Box Qty. 10



415888

21075686,
6504555
F3LY-14570-B,
F3LB-14K056-AA
Black Nylon
Rocker Panel,
Wheel Liner,
Air Inlet Duct
Push-Type Retainer
Hole: M8
Flange: 15mm
Stem Length: 20mm
Ford, Chrysler, GM
Box Qty. 25



415891 Box 100
415891-500 Box 500

415889

21030249,
N807389S,
6503598

Black Nylon
Air Baffle To
Under Carriage
Push-Type Ret.
Head Dia: 20mm
Stem Length: 20mm
Fits Into 8mm Hole
GM, Ford, Chrysler
Box Qty. 25



415892

6509103AA,
6509103-AA,
W705436-S300,
21077123, 20730531
Plastic
Wheel Mldg.
Push-Type Retainer
Hole: 1/4" (6.4mm)
Flange: 19/32" (15mm)
Stem Length: 3/4" (19mm)
GM, Ford, Chrysler
Box Qty. 25



415893

21077123, 20730531
6509103AA,
6509103-AA
W705436-S300
Black Nylon
Wheel Opening Mldg
Push-Type Retainer
Head Dia: 19/32" (15mm)
Stem Length: 3/4" (19mm)
Fits Into 1/4" (6mm) Hole
Saturn 91 - UP, Ford 2002 - UP,
Chrysler 2010 - UP
Box Qty. 25





415916 Box 50

415915

90657-SA6-0030,
N304-13-356-A,
94198687
Nylon
Screw-Type Retainer
Head Dia: 14mm
Stem Length: 11mm
Fits into 7mm Hole
Honda & Mazda, GM
Box Qty. 25



GM CLIPS & FASTENERS

<p>415920 94221150, 63844-D0100, 8942211500 Nylon Screw-Type Retainer Screw: 5mm x 14mm Head Size: 14mm x 22mm Stem Length: 9mm Fits into a 7mm Hole GM, Nissan, Isuzu Box Qty. 25</p> 	<p>415922 15959832 Black Nylon Front License Plate Push-Type Retainer Head Dia: 1" Stem Length: 1-5/8" Fits Into 1/2" Hole GM Truck '94 - UP Box Qty. 10</p> 	<p>415925 30012018, 90684-SA5-0030, 90684-SA5-003, 874-298-1190, 8942981190, 10998-30880 Nylon Screw-Type Retainer Head Dia: 15mm Stem Length: 11mm Fits in a 6mm Hole Nissan, Honda, Isuzu, GM Box Qty. 25</p> 	<p>416050 Box 5 415926 Box 25 415928 Box 50 415927 52161-02020, 52161-16010, 52161-02030, 94858566 Black Nylon Rear Bumper Cover Push-Type Retainer Head Dia: 18mm Stem Length: 28mm Fits Into 9mm Hole Toyota Tercel '88 - UP Box Qty. 10</p> 
<p>415960 94847334, 96057847, 90467-07066, 09409-07313 Black Nylon Radiator Grille & Trim Panel Push-Type Retainer Head Dia: 11mm Stem Length: 14mm Fits Into 7mm Hole GM, Toyota, Suzuki, Geo Tracker & Prizm '89 - '92 Box Qty. 10</p> 	<p>415963 25695687 Black Nylon Radiator Support Sight Shield Retainer Flange Dia: 27mm Shoulder Length: 7mm Stem Length: 18mm Fits Into 10mm Hole Cadillac DeVille & Seville '2000 - UP Box Qty. 15</p> 	<p>415965 96057846, 90467-07041, 90467-07041-B2, 90467-07076-C0, 86155-2200 Black Nylon Push-Type Retainer Head Dia: 15mm Stem Length: 8mm (ex pin) Fits Into 6.3mm Hole Geo Metro & Tracker '89 - UP Toyota & Hyundai Box Qty. 10</p> 	<p>415992 4001916 Black Nylon Weatherstrip Retainer Hole: 5/16" Head: 3/16" x 9/16" P.R.: .050 Jeep Wrangler 1991 - UP GM Trucks Box Qty. 50</p> 
<p>415994 4696129, 21077575 Weatherstrip Retainer Front and Rear Doors Hole: M5 Head: 6.5 x 16.5mm P.R.: 1.5mm Chrysler Concorde & LHS Dodge Intrepid & Eagle Vision 1993 - UP Oldsmobile Alero & Pontiac Grand Am 1999 - UP Box Qty. 100</p> 	<p>415996 15672328 Black Nylon Radiator Grille Retainer Flange Dia: 3/4" Stem Length: 11/16" Head Dia: 9/32" x 11/32" GM S-10 & S-15 Pick-ups '91 - UP Box Qty. 25</p> 	<p>416001-100 Box 100 416001 91503-SP0-003, 07-13-0-702-966, 94530623 Plastic Front/Rear Bumper Screw-Type Rivet Hole: 10mm Washer Face: 20mm Stem Length: 15mm GM; BMW; Acura CL, Integra, Leg- end RL & TL '91 - 2004 and Honda Accord, Civic, Del Sol, Odyssey, Passport, Pilot, Prelude & Ridgeline '92 - UP Box Qty. 10</p> 	<p>416005 15682898, 15002520, 15709521, Zinc Organic Radiator Grille Clip GM Pickup, Van, Blazer, Jimmy '94-UP Box Qty. 25</p> 
<p>416008 22587036 Nylon Rear Bumper Fascia Push-Type Retainer Head Dia: 1" Stem Length: 15/16" Fits into 3/8" Hole Chevrolet Cavalier & Pontiac Sunfire '95-UP Box Qty. 25</p> 	<p>416010 14074081, 15552345, 1699250 Black Nylon Hood Seal Retainer Head Dia: 3/4" Stem Length: 1-3/8" Hole Size: 5/16" GM '83 - UP Box Qty. 25</p> 	<p>416011 N803946S, 000-991-52-40, 20664091, 6502871, W706350-S300 Black Nylon Rear Quarter Trim Panel Screw-Type Retainer Head Dia: 19/32" (15mm) Stem Length: 29/32" (23mm) Fits Into 1/4" (6.4mm) Hole Ford & Chrysler '97 - UP, GM, Mercedes Metris 2016-20, Sprinter 1500, 2500, 3500 2019-UP Box Qty. 50</p> 	

GM CLIPS & FASTENERS

21 GM Clips

416013

10098645, 390964-S
Black Nylon
Front Door Lower
Moulding Retainer
Head Dia: 1/2"
Stem Length: 3/4"
Fits into 1/4" Hole
Pontiac Grand Prix '94-UP
Ford
Box Qty. 50



416014

10158124
Natural Nylon
Trim Panel Retainer
Flange Dia: 15/16"
Stem Length: 15/16"
Fits Into 5/16" Hole
GM, Chrysler '92 - UP
Box Qty. 50



416015

21095797,
11519807
Black Nylon
Bumper Fascia
Push Retainer
Head Dia: 20mm
Stem Length: 28mm
Fits Into 8mm (5/16) Hole
GM Saturn '96-UP
Box Qty. 25



416023

91512-SX0-003,
11519949, MU000319
Black Nylon
Front Bumper
Push-Type Retainer
Flange Dia: 20mm
Stem Length: 11mm
Fits Into 8mm Hole
Buick, Cadillac, Chevrolet & GMC
'97-UP; Mitsubishi Lancer; Acura
3.5RL, Honda Accord, Prelude &
Odyssey '94-UP
Box Qty. 25



416035

3540858
Nylon
Radiator Air Baffle
Push-Type Retainer
Head Dia: 3/4"
Stem Length: 1-1/8"
Fits In 1/4" Hole
Cadillac Eldorado & Seville '93-UP
Box Qty. 25



416046

14019226,
14071289, 04388293,
175720B010
Black Nylon
Radiator Overflow
Bottle/Windshield Washer
Bottle Retainer
Head Dia: 21/32"
Stem Length: 9/16"
Fits Into 5/16" Hole
Ford, Chrysler, GM '81-UP
Box Qty. 50



416047

6033082, 6033840,
W709346-S300,
39001S, 10121502,
10077401, 390018-S
Black Nylon
Shield Retainer
Battery Post Shield,
Engine Splash Shield
Radiator Side Air Baffle
Hole Size: 1/4" (6.3mm)
Head Dia: 23/32"
Stem Length: 1-1/16"
Ford, Chrysler, GM, GM Express &
Savana Vans 1996-UP
Box Qty. 50



416055

MB888869,
90505-SL0-003,
90467-08155,
9485236
Plastic
Bumper Cover
Screw-Type Ret.
Hole: M8, Stem: 21mm
Flange Dia: 20mm
Chrysler, GM, Acura,
Toyota '93 - UP
Box Qty. 15



416098

62955-20020,
94848834
Nylon
Retainer with Sealer
Head Dia: 15mm
Stem Length: 9mm
Fits Into 8mm Hole
Toyota Pick-Up Truck;
Pontiac Vibe
Box Qty. 25



416102

6503819,
6503401, 25631448
Black Nylon
M7.5 x 35mm
Square Drive
Truss Head
Tapping Screw
Head Dia.: 22mm
Shoulder Dia.: 9mm
Foam To Bumper Fascia
GM '97 - UP, Chrysler '93 - UP
Box Qty. 15



416103

90467-06017,
9926-50-625,
20426301
Black Nylon
Screw-Type Retainer
Head Dia: 15mm
Stem Length: 12mm
Fits Into 7mm Hole
Toyota, Mazda, GM
Box Qty. 15



416118

11518017,
W708530-S300
Black Nylon
Bumper Cover &
Fender Shield
Retainer
Flange Dia: 20mm
Stem Length: 26mm
Fits Into 8mm Hole
GM, Ford '97 - UP
Box Qty. 15



416138

Black Nylon
Shroud Retainer
High Retention Capability
GM, Ford, Chrysler
Box Qty. 50



416140

22547243, 11610086,
6501916
Black Nylon
Push Retainer
Hole Size: 1/4" (6.3mm)
Head Dia: 7/8"
Stem Length: 1-3/32"
Splash Shield &
Wheel Well Cover
Chrysler 1988 - UP
Hood Seal Retainer
GM 1989 - UP
Box Qty. 50



416146

F50C-9E728-AA,
6501925, 10134407,
15990756,
Black Nylon
Push-Type Retainer
Hole Size: 1/4"
Flange Dia: 11/16"
Stem Length: 13/16"
Chrysler Concorde & LHS, Dodge
Intrepid & Eagle Vision '93 - UP
Coolant Recovery Reservoir
GM '92 - UP
Ford
Box Qty. 25



















416152

25535963,
N811772S
Black Nylon
Twist Lock
Inst. Panel, Front Comp.
Rear Site Shield Retainer
Buick Electra, LeSabre, Park Ave. &
Skylark, Cadillac DeVille, Oldsmobile
Achieva, Cutlass, Delta 88, 88
Royale & 98 Regency And Pontiac
Bonneville & Grand Am 1991 - UP
Upper Deflector Shield
Ford
Box Qty. 15



GM CLIPS & FASTENERS

 <p>416156 20064875 Black Nylon Hood Insulation Retainer Head: 1-21/32" Stem 13/16" Hole Size: 5/16" GM '80 - UP Box Qty. 25</p>	 <p>416158 (Use with #416160) 15733971 Black Nylon Front Air Deflector Ret. Sm Head Dia.: 18mm Lg Head Dia.: 26mm Flange Dia.: 30mm Stem Length: 24mm GM C & K Trucks '99 - UP, Express & Savana Vans 2003-UP Box Qty. 15</p>	 <p>416160 (Use with #416158) 15733970 Black Nylon Front Air Deflector Grommet Head Dia.: 28mm Stem Length: 13mm GM C & K Trucks '99 - UP Express & Savana Vans 2003-UP Box Qty. 25</p>	 <p>416161 15989431 Black Nylon Hood Insulation Retainer Head Dia: 28mm Stem Dia: 8mm Stem Length: 17mm Chevrolet Traverse 2010 - UP Box Qty. 25</p>
 <p>416163 11609483 Black Nylon Rear Hatch Sill Plate Retainer Top Head Dia: 12mm Bottom Head Size: 17mm x 34mm Stem Length: 15mm Chevrolet HHR 2006 - UP Box Qty. 10</p>	 <p>416164 22657634, 10246149 Black Nylon Fender & Rocker Panel Screw-Type Retainer Head Dia: 12mm Stem Length: 17mm Fits into 6mm hole Achieva, Cutlass, Grand Am & Malibu '99 - UP Box Qty. 25</p>	 <p>416166 1636632, 20687704 Black Nylon Front Bumper Fascia Retainer Flange Dia: 17mm Stem Length: 18mm Fits Into 9.5mm (3/8") Hole Buick Riviera/Reatta '88 - UP Box Qty. 25</p>	 <p>416168 25663903 Black Nylon Upper Radiator Shield Screw-Type Retainer Head Dia: 1" Stem Length: 1" Fits Into 1/4" Hole Cadillac DeVille & Seville '98 - UP Box Qty. 15</p>
 <p>416169 14045480, 55074801 Black Nylon Fascia Retainer Head Dia: 1" Stem Length: 11/16" Fits Into 3/8" Hole Chrysler 2009-UP, GM '82-UP Box Qty. 25</p>	 <p>416170 10283414, 10405030 Door Weatherstrip Retainer Head: 5mm x 15mm Stem Length: 9mm Fits Into 5mm Hole Buick Century & Regal and Oldsmobile Intrigue '97-UP Box Qty. 50</p>	 <p>416171 15056810, 65058686-AA Black Nylon Bumper Fascia Retainer Hole Size: 12.5mm (1/2") Head Dia: 25mm Stem Length: 15mm GM S & T Trucks 2002 - UP Chrysler Box Qty. 25</p>	 <p>416175 10287971 Plastic Door Panel Retainer Top Head Dia: 18mm Bottom Head: 20mm Stem Length: 13mm Fits Into 8mm Hole Buick Century & Regal, Chevrolet Venture, Olds Silhouette and Pontiac Trans Sport 1997-UP Box Qty. 50</p>
 <p>416177 20551451, 20511451, 36003452 Black Nylon Cowl Vent Retainer Head Dia: 21/32" Stem Dia: 15/32" Fits Into 7/32" Hole Chrysler, GM '84 - UP Box Qty. 25</p>	 <p>416184 11561368, 6508712AA Black Nylon Fender, Wheel & Bumper Push-Type Retainer Flange Dia: 18mm Stem Length: 20mm P.R.: 3mm - 5.8mm Fits Into 9.5mm Hole Chevrolet Impala & Monte Carlo and Pontiac Grand Prix & Solstice 2004 - UP Jeep Wrangler 2000 - UP Box Qty. 15</p>	 <p>416186-500 Box 500 416186 11589293, W712196-S300 Black Nylon Cowl Vent & Fender Retainer Flange Dia: 20mm Stem Length: 22mm P.R.: 4.5mm - 7.0mm Fits Into 8.5mm Hole Buick Century, LaCrosse & Regal, Cadillac, Chevrolet Equinox, GM Trucks, Hummer H3 and Pontiac Grand Prix & Torrent 1997 - UP Ford 2006 - UP Box Qty. 25</p>	 <p>416190 06508863-AA, W713610-S300, 11589289 Black Nylon Air Distributor/ Windshield Defroster Push-Type Retainer Flange Dia: 18mm Stem Length: 17.5mm PR: 2.0mm - 4.5mm Fits Into 6.5mm Hole GM, Chrysler, Ford Box Qty. 25</p>

GM CLIPS & FASTENERS

21 GM Clips

416192

11589290, 6509049-AA, W714040-S300

Black Nylon
Air Inlet Grille/ Bumper Fascia/Front Brake
Caliper Cooling Duct Push-Type Retainer

Flange Dia: 18mm
Stem Length: 20mm
PR: 4.5mm - 7.0mm

Fits Into 6.5mm Hole

Buick Enclave, Cadillac, CTS & STS, Chevrolet Cobalt, Equinox & SSR, GM Trucks and Pontiac G5 & Torrent 2002-UP Chrysler Charger & 300 2011-UP, Ford

Box Qty. 50



E r g o
T u f l o k

416194

W713331-S300,
11589291

Black Nylon
Air Dam/Grille
Push-Type Retainer

Flange Dia: 18mm
Stem Length: 22mm
PR: 7.0mm - 9.5mm

Fits Into 6.5mm Hole

GM Cadillac CTS, SRX and STS 2003 - UP, Ford

Box Qty. 25



E r g o
T u f l o k

416196

5116530-AA,
15296830

Black Nylon
Fascia/General
Purpose

Push-Type Retainer
Flange Dia: 19mm
Stem Length: 16mm

PR: 5.0mm - 7.0mm

Fits Into 8mm Hole

GM, Chrysler

Box Qty. 25



E r g o
T u f l o k

416198

11589292

Black Nylon
Bumper Fascia,
Flares & Air Dam
Push-Type Retainer

Flange Dia: 20mm
Stem Length: 20.5mm
PR: 2.0mm - 4.5mm

Fits Into 8.5mm Hole

Chevrolet and GMC C & K Trucks 2007-UP

Box Qty. 25



E r g o
T u f l o k

416200

11609417,
W715537-S300

Black Nylon
Fender Apron
Push-Type Retainer

Flange Dia: 19mm
Stem Length: 14mm
PR: 2.7mm - 5.3mm

Fits Into 8.5mm Hole

Buick Enclave & LaCrosse, Cadillac CTS, SRX & STS, Chevrolet Cobalt, Equinox & Malibu, GM Trucks and Pontiac G5, G6 & Torrent 2003-UP, Ford

Box Qty. 50



E r g o
T u f l o k

416204

11589294,
W714975-S300

Black Nylon
Bumper Fascia,
Fender, Toe/
Floor Panel

Push-Type Ret.
Head Dia: 20mm
Stem Length: 24mm
PR: 7.0mm - 10.0mm

Fits Into 8.5mm Hole

Buick Enclave & LaCrosse, Chevrolet & GMC C & K Trucks, GMC Acadia, Hummer H3 and Saturn Outlook 2005-UP, Ford

Box Qty. 25



E r g o
T u f l o k

416208

W712665-S300,
11589295,
5GUU9K11BA

Black Nylon
Fender, Flare,
Gas Tank &
Panel Attchmnt

Push-Type Ret.
Flange Dia: 25mm
Stem Length: 20mm

PR: 3.0mm - 6.0mm

Fits Into 10.5mm Hole

GM, Ford, Chrysler

Box Qty. 15

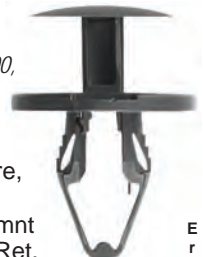

E r g o
T u f l o k

416210

11589296

Black Nylon
Panel Attchmnt
Gen. Purpose
Push-Type Ret.

Head Dia: 25mm
Stem Length: 23mm
PR: 6.0mm - 9.0mm

Fits Into 10.5mm Hole

Buick Enclave and GMC Acadia 2007-UP

Box Qty. 15



E r g o
T u f l o k

416211

14027471

Black Nylon
Trim Panel
Retainer

Head Dia: 1"

Stem Length: 1-7/16"

Stem Dia: 9/32"

GM Trucks 1981 - UP

Box Qty. 25



NEW

416233

11571159

Black Nylon
Hood Insulation Retainer

Head Dia: 30mm
Stem Dia: 7.8mm
Stem Length: 15mm

Fits Into 7mm Hole

Buick Enclave, Envision & LaCrosse 2012 - UP; Allure 2012 - 2015; Cadillac ATS, CTS, CT6 & XTS 2012 - UP; Escalade 2019 - UP; Chevrolet Bolt, Camaro, Cruze, Impala, Malibu, Silverado, Sonic, Spark, Suburban, Tahoe, Traverse, Trax & Volt 2011 - UP; Equinox 2010 - 2017; SS 2014 - 2017; GMC Acadia, Sierra & Yukon 2013 - UP; Terrain 2010 - 2017

Box Qty. 25



416259

20478294

Black Nylon
Carpet Retainer

Head Dia: 30mm

Fits Onto 6mm Stud

GM 1984 - UP

Box Qty. 25



416260

N803709S,
15681408

Black Nylon
Fascia Retainer

Head Dia: 15mm
Stem Length: 23mm

Fits Into 6mm Hole

GM & Ford 1986 - UP

Box Qty. 50



416261

11561438

Black Nylon
M14 x 34mm
Bumper and Door Insulator
Nylon Screw

No. 3 Square Drive
Head O.D.: 22mm

Fits Into 12mm Hole

GM, Ford, Chrysler 2005 - UP

Box Qty. 25



416279

15944588

Tan Nylon
Headliner Retainer

Head Dia: 25mm
Stem Length: 22mm

Stem Dia: 7.5mm

Chevrolet Malibu 2004 - UP

Box Qty. 25









GM CLIPS & FASTENERS

 <p>416280 22512276, 6503221 Black Nylon Bumper Fascia Retainer Front End Stone Shield Retainer Head Dia: 7/8" Stem Length: 7/16" Fits Into 3/8" Hole Chrysler, GM 1981 - UP Box Qty. 25</p>	 <p>416281 10185925, 6503768 Black Nylon Bumper Fascia Retainer Head Dia: 3/4" Stem Length: 1-3/16" Fits Into 11/32" Hole Chevy Lumina APV, Olds Silhouette & Pontiac Transport 1993 - UP Chrysler Box Qty. 25</p>	 <p>416282 25749564 Tan Nylon Headliner Retainer Head Dia: 45mm Stem Length: 20mm Stem Dia: 9.5mm Chevrolet Express Van & GMC Savana Van 2004 - UP Box Qty. 15</p>	 <p>416283 22690838 Black Nylon Door Trim Push-Type Ret. Head Dia: 12mm Stem Length: 14mm (ex pin) Fits Into 6mm Hole Chevrolet Malibu & Pontiac G6 2004 - UP Box Qty. 25</p>
	<p>NEW</p>  <p>416290 480534, 384051-S Black Nylon Head Dia: 13/32 x 1" Stem Dia: 9/32" Stem Length: 9/16" Cowl Insulation Retainer GM Splash Shield/ Wire Retainer Ford Box Qty. 25</p>	 <p>420000 11570512 Yellow Nylon Side Window Reveal Moulding Clip w/Sealer Length: 28mm Width: 12.5mm Overall Height: 13mm Fits Into 6mm Hole Buick Lucerne 2006 - UP Box Qty. 10</p>	 <p>420001 11610522, 10383817 White Nylon Side Window (Rear) Reveal Moulding Clip w/Sealer Top Hd Size: 6mm x 11mm Bottom Hd: 10mm x 17mm Stem Length: 20mm Fits Into 8mm Hole Buick Lucerne 2006 - UP Box Qty. 10</p>
 <p>420002 11569920 Green Nylon Fender Mldg Clip w/Sealer Top Hd: 7.5mm x 11mm Bottom Hd: 15mm x 15mm Stem Length: 13mm Fits Into 7mm Hole Buick Enclave, Cadillac CTS, Chevrolet Traverse & GMC Acadia 2003 - UP Box Qty. 10</p>	 <p>420003 22691056 Black Nylon Tail Gate Moulding Retainer w/Sealer Flange Dia: 25mm Stem Length: 14mm Fits Into 10.5mm Hole Cadillac Escalade EXT and Chevrolet Avalanche 2007-UP Pkg Qty. 15</p>	 <p>420004 11547581 White Nylon Body Side & Exterior Trim Moulding Clip w/Sealer Top Head: 12mm x 20mm Bottom Head Dia: 19mm Stem Length: 11mm Fits Into 9mm Hole Cadillac XT5, Chevrolet Cruze & Impala 2014 - UP Box Qty. 25</p>	
<p>NEW</p>  <p>420005 24405740 Blue Nylon Windshield Pillar, Interior & Trunk Trim Moulding Clip w/ Metal Reinforcement Top Hd: 17mm x 20mm Bottom Hd: 14mm x 28mm Stem Length: 11mm Buick Allure, Encore, Lacrosse, Regal & Verano, Cadillac XTS, Chevrolet Camaro, Caprice, Cruze, Malibu & Sonic 2010 - UP Box Qty. 15</p>	<p>NEW</p>  <p>420006 24405739 Black Nylon Windshield Pillar, Interior Trim Moulding Clip w/ Metal Reinforcement Top Hd: 17mm x 20mm Bottom Hd: 14mm x 28mm Stem Length: 12mm Buick Allure, Encore, Lacrosse, Regal & Verano, Cadillac XTS, Chevrolet Camaro, Caprice, Cruze, Malibu & Sonic 2010 - UP Box Qty. 15</p>	<p>NEW</p>  <p>420007 11611623 Blue Nylon Windshield Pillar, Interior Trim Moulding Clip w/ Metal Reinforcement Top Hd: 17mm x 24mm Bottom Hd: 14mm x 28mm Stem Length: 10mm Cadillac ATS & Escalade, Chevrolet Corvette, Impala & Malibu, GMC Sierra & Yukon 2013 - UP Box Qty. 10</p>	<p>NEW</p>  <p>420008 11547026 Red Nylon Windshield Garnish, Interior Trim Moulding Clip w/ Metal Reinforcement Top Hd: 17mm x 24mm Bottom Hd: 14mm x 28mm Stem Length: 10mm Cadillac ATS & CTS, Chevrolet Impala, GMC Yukon 2013 - UP Box Qty. 10</p>

GM CLIPS & FASTENERS

21 GM Clips

<p>NEW 420009 11611367 Blue Nylon Scuff Plate & Trim Panel Moulding Clip w/Sealer & Metal Reinforcement Top Hd: 17mm x 24mm Bottom Hd: 10mm x 24mm Stem Length: 10mm Overall Height: 16mm <i>Buick Verano, Cadillac ATS, CTS & XTS, Chevrolet Camaro, Impala, Malibu & Volt 2011 - UP</i> Box Qty. 10</p> 	 <p>420010 7731589 Nylon Qtr. Panel & Reveal Mldg & Landau Top Mldg Clip Length: 25/32" Width: 7/16" GM Box Qty. 100</p>	<p>NEW 420011 11547024 Red Nylon Door Sill Plate Moulding Clip w/Sealer & Metal Reinforcement Top Hd: 17mm x 24mm Bottom Hd: 10mm x 24mm Stem Length: 10mm Overall Height: 16mm <i>Cadillac ELR & XTS 2013 - UP</i> <i>Chevrolet Camaro & Malibu 2016 - UP</i> Box Qty. 10</p> 	
 <p>420015 10323057 White Nylon Rocker Moulding Clip Top Head: 12mm x 20mm Bottom Head: 12mm x 24mm Stem Length: 14mm Fits Into 9mm Hole <i>Pontiac Grand Prix 2004 - UP</i> Box Qty. 15</p>	 <p>420016 25774893 Yellow Nylon Door Moulding Clip Top Head: 12mm x 16mm Bottom Head: 12mm x 20mm Stem Length: 24mm Fits Into 9mm Hole <i>Chevy Traverse 2010 - UP</i> Box Qty. 15</p>		 <p>420018 94530742 White Nylon Fender, Wheel, Side & Bumper Mldg. Clip w/Sealer Top Head: 11mm x 15mm Bottom Head Dia: 16mm Stem Length: 10mm Fits Into 8mm Hole <i>Saturn Vue 2008-UP</i> <i>Chevrolet Captiva & Cruze 2011-UP</i> Box Qty. 15</p>
 <p>420019 11588818 White Nylon Wheel Opening Mldg Clip Top Hd: 16mm x 26mm Bottom Hd: 14mm x 20mm Stem Length: 16mm Fits Into 9mm Hole <i>Buick Encore, Cadillac XT5, Chevrolet Bolt & Trax and GMC Arcadia & Hummer H3 2007 - UP</i> Box Qty. 25</p>	 <p>420030 8733059, 4492962, 9838109, 8933059 Nylon Body Side, Wheel Opening Moulding Clip <i>Buick, Chevrolet & Oldsmobile '68-UP</i> Box Qty. 100</p>		
 <p>420110 8799350 Nylon Door, Quarter Panel & Rear End Moulding Clip Length: 57/64" Width: 31/64" <i>GM '70 - UP</i> Box Qty. 100</p>	 <p>420280 1688094 Nylon Vinyl Top Moulding Clip (Narrow mldg, roof top) <i>Chevrolet, Cadillac & Oldsmobile '74 - UP</i> Box Qty. 50</p>	 <p>420290 1660123 Nylon Belt Moulding Clip <i>GM '75 - UP</i> Box Qty. 100</p>	 <p>420860 20175051, 15633873, 6003737 Nylon Quarter Belt Reveal Moulding Clip <i>GM '80 - UP</i> Box Qty. 50</p>

GM CLIPS & FASTENERS



420940
20071874
Belt Moulding Clip
Used on Vinyl Tops
GM '78 - UP
Box Qty. 50



420950
20171942, 12338089
Nylon
Moulding Clip
(6 Used Per Car)
GM '80 - UP
Box Qty. 25



421000
20237057
Rear Belt Reveal
Moulding Clip
GM '80 - UP
Box Qty. 50



421001
11589176
White Nylon
Rocker Panel Moulding Clip
Top Hd Size: 3/4" x 1-1/32"
Bottom Hd: 19/32" x 1-1/32"
Stem Length: 9/16"
Fits Into 3/8" Hole
Chevrolet Malibu 2004 - UP
Box Qty. 15



421002
15236894
White Nylon
Rocker Panel Mldg. Clip
Top Hd Size: 9/16" x 23/32"
Overall Height: 5/8"
Stem Length: 7/16"
Fits Into 3/8" Hole
Buick Lucerne and Cadillac CTS &
STS 2003 - UP
Box Qty. 10



421003
10442914, 10300287
White Nylon
Rocker Panel Moulding Clip
Top Head Size: 1/2" x 9/16"
Bottom Hd Size: 9/16" x 5/8"
Stem Length: 9/16"
Fits Into 7/16" Hole
Buick Rendezvous 2002 - UP
Box Qty. 15

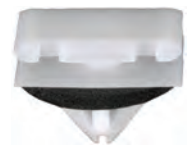

421005
11562250
White Nylon
Rocker Panel
Moulding Clip w/Sealer
Top Head: 12mm x 20mm
Bottom Head: 12mm x 20mm
Stem Length: 11mm
Fits Into 9mm Hole
GMC Acadia 2007 - UP
Box Qty. 15



421006
11588818,
11561329
Front Bumper,
Rocker Moulding Clip
Top Hd Size: 18mm x 26mm
Bottom Hd: 14mm x 20mm
Stem Length: 15mm
Fits Into 10mm Hole
Cadillac STS & Corvette 2005 - UP
Box Qty. 10

NEW



421013
11569921
Yellow Nylon
Rocker, Wheel Opening &
Spoiler Moulding Clip
Top Head: 9.5mm x 20mm
Bottom Head: 14mm x 20mm
Stem Length: 20mm
Fits into 9mm Hole
Buick Enclave & Envision, Cadillac
XTS, Chevrolet Bolt EV, Equinox,
Traverse and GMC Acadia & Terrain
2017 - UP
Box Qty. 10



421050
20199675
White Nylon
Belt Moulding Clip
Width: 7/16"
Length: 31/32
GM '80 - UP
Box Qty. 100

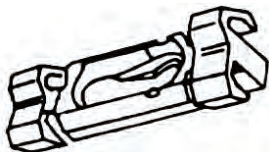

421122
20766166
Plastic
Roof Moulding Clip
Cadillac Sedan DeVille '89 - UP
Box Qty. 25



421130
22512114
Nylon
Rocker Panel
Moulding Clip
GM '82 - UP
Box Qty. 50



421150
20481545
Plastic
Body Side Moulding Clip
Oldsmobile "C" Body (FWD) '85-UP
Box Qty. 50

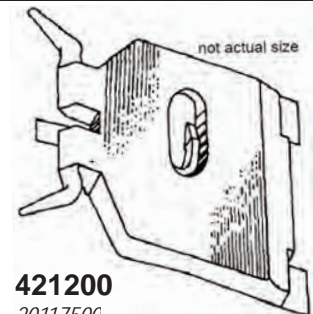

421200
20117500
Front, Rear Door & Side
Moulding Clip
GM '80 - UP
Box Qty. 25

GM CLIPS & FASTENERS

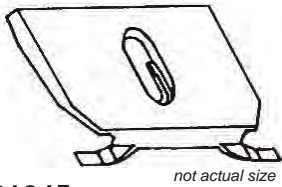

not actual size

421245

20766166

Plastic

Roof Transverse
Moulding Clip

Buick Century & Regal '78 - '80

Oldsmobile Cutlass '78-'80

Box Qty. 25



421278

20356051

Plastic

Fender & Quarter
Mouldings Clip

GM '84 - UP

Box Qty. 25

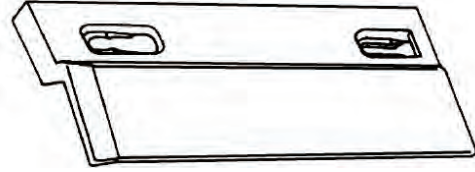

421305

20641048, 10091280

Plastic

Rocker Panel
Moulding Clip (*Right Hand*)
Accent Moulding

Pontiac Grand Prix '88 - UP

Box Qty. 15

421310

20641049, 10091281

Plastic

Rocker Panel
Moulding Clip (*Left Hand*)
Accent Moulding

Pontiac Grand Prix '88 - UP

Box Qty. 15



421360

21093588

Nylon

Roof Drip Moulding Clip

2 Dr & 4 Dr Models

GM Saturn '91 - UP

Box Qty. 25



421361

25744385

Green Nylon

Rocker Moulding Clip

Head Size: 22mm x 46mm

Stem Length: 17mm

Fits Into 10mm Hole

Cadillac 1998 - UP

Box Qty. 15



421362

11611435

White Nylon

Moulding Clip w/Sealer

Top Head Size: 22mm x 45mm

Bottom Hd Size: 25mm x 37mm

Stem Length: 15mm

Fits Into 10mm Hole

Cadillac, Chevrolet & GMC 2013 - 14

Box Qty. 10



421375

22603384

White Nylon

Rocker Panel

Moulding Clip

Head Size: 3/4" x 1-3/16"

Stem Length: 19/32"

Fits Into 7/16" Hole

Oldsmobile Alero &

Pontiac Grand Am '99 - UP

Box Qty. 15



421376

10431524

Black Nylon

Rocker Panel Mldg. Clip

Head Size: 11/16" x 1-5/16"

Stem Length: 9/16"

Snaps Into 5/16" Hole

GM 2000 - UP

Box Qty. 15



421377

10437565, 10352803

Black Nylon

Rocker Panel Mldg. Clip

Head Size: 15/32" x 1-5/16"

Stem Length: 9/16"

Snaps Into 5/16" Hole

Chevrolet Impala, Lumina

& Monte Carlo 2000 - UP

Box Qty. 10



421378

10431761,

10411395

Gray Nylon

Rocker Panel Mldg. Clip

Top Hd: 11/16" x 1-1/2"

Bottom Hd: 7/8 x 1-9/16"

Stem Length: 1-1/4"

Snaps Into 7/16" Hole

Chevrolet Impala, Lumina &

Monte Carlo 2000-UP

Box Qty. 15



421379

25693852

Gray Nylon

Rocker Panel

Mldg. Clip

Top Hd: 9/16" x 3/4"

Bottom Hd: 5/8" x 3/4"

Stem Length: 9/16"

Snaps Into 7/16" Hole

Buick LeSabre; Cadillac Concours,

DeVille, Eldorado & Seville;

Chevrolet Impala, Lumina & Monte

Carlo; Oldsmobile Aurora and

Pontiac Bonneville 1995-UP

Box Qty. 25

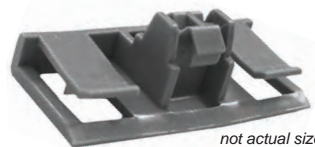

not actual size

421380

25722671

Gray Nylon

Rocker Panel Mldg. Clip

Width: 7/8, Length: 2"

Buick LeSabre, Cadillac DeVille &

Seville, Oldsmobile Aurora and

Pontiac Bonneville 2000-UP

Box Qty. 10



421381

10443956

11518357

Nylon

Rocker Panel Moulding

Clip with Sealer

Top Hd: 9/16" x 13/16"

Bottom Hd: 13/16 x 13/16"

Stem Length: 9/16"













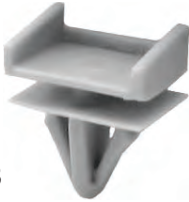

Snaps Into 7/16" Hole

Chevrolet Impala, Lumina, Monte

Carlo and C & K Trucks 2000-UP

Box Qty. 25

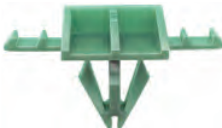
GM CLIPS & FASTENERS

 <p>421382 Rocker Panel Moulding Clip Upper Hd: 12mm x 20mm Bottom Hd: 12mm x 24mm Stem Length: 15mm Fits Into 9mm Hole <i>Saturn Aura 2007 - UP</i> Box Qty. 15</p>	 <p>421383 <i>5480852</i> Yellow Nylon Rocker Panel Moulding Clip with Sealer Top Hd Size: 9/16" x 25/32" Bottom Hd: 5/8" x 13/16" Stem Length: 9/16" Hole Size: 23/64" <i>Chevy Equinox 2005 - UP</i> Box Qty. 10</p>	 <p>421384 <i>15127746</i> White Nylon Body Side Mldg Clip Head Size: 12mm x 20mm Stem Length: 11mm Fits Into 9mm Hole <i>Buick Terraza, Chevrolet Uplander, GMC Acadia, Pontiac Montana SV6 and Saturn Relay 2005 - UP</i> Box Qty. 15</p>	 <p>421385 <i>11561491, 15872008</i> Black Nylon Rocker Panel Moulding Clip with Sealer Top Hd Size: 20mm x 30mm Overall Length: 28mm Fits Into 17mm Hole <i>Chevrolet Equinox and Pontiac Torrent 2005 - UP</i> Box Qty. 10</p>
 <p>421386 <i>25724529</i> White Nylon Rocker / Grille Mldg. Clip Top Hd: 9/16"x13/16" Bottom Hd: 5/8"x13/16" Stem Length: 9/16" Fits Into 3/8" Hole <i>Buick LeSabre & Rainier; Cadillac Concours, CTS, DeVille, Eldorado, Escalade, Seville, SRX & STS; Chevrolet Avalanche, Impala, Lumina, Monte Carlo, SSR, Vans & Trucks; Oldsmobile Aurora & Bravada and Pontiac Bonneville 1992-UP</i> Box Qty. 15</p>	 <p>421387 <i>11562563</i> White Nylon Rocker Mldg Clip Upper Hd: 12mm x 20mm Bottom Hd: 12mm x 32mm Stem Length: 15mm Fits Into 10mm Hole <i>Chevy Malibu 2008 - UP</i> Box Qty. 15</p>	 <p>421388 <i>10242298</i> Black Nylon Front Fender Flare Retainer Top Head: 9/16" x 13/16" Stem Length: 9/16" Hole Size: 7/16" <i>GM 'U' Body Vans '97 - UP</i> Box Qty. 15</p>	 <p>421389 <i>10297368</i> White Nylon Rear Wheel Opening Moulding Clip w/Sealer Top Hd: 15/32" x 25/32" Bottom Hd: 1/2" x 25/32" Stem Length: 9/16" Fits Into 7/16" Hole <i>Pontiac Transport, Montana (with short wheel base) '97 - UP</i> Box Qty. 10</p>
 <p>421390 <i>10297371</i> Yellow Nylon Rear Wheel Opening Moulding Clip w/Sealer Top Hd: 19/32" x 25/32" Stem Length: 9/16" Fits Into 7/16" Hole <i>Pontiac Transport, Montana (with long wheel base) '97 - UP</i> Box Qty. 15</p>	 <p>421391 <i>15221959</i> Gray Nylon Rocker Panel Mldg. Clip Top Head: 9/16" x 1-1/8" Stem Length: 9/16" Fits Into 7/16" Hole <i>Chevrolet Cobalt & HHR 2005 - UP</i> Box Qty. 15</p>	 <p>421392 <i>10423553</i> Green Nylon Side Mldg., Fender & Rocker Panel Mldg. Clip Top Hd: 1/2" x 13/16" Bottom Hd: 19/32" x 13/16" Stem Length: 9/16" Fits Into 7/16" Hole <i>Pontiac Aztek and GM C & K Trucks 2001 - UP</i> Box Qty. 15</p>	
 <p>421394 <i>10431523</i> Tan Nylon Rocker Panel Mldg Clip Head Size: 11/16" x 1-5/16" Stem Length: 9/16" Fits Into 5/16" Hole <i>Chevrolet Impala, Lumina & Monte Carlo 2000 - UP</i> Box Qty. 15</p>	 <p>421395 <i>10352797</i> Gray Nylon Rocker Panel Mldg Clip Head Size: 11/16" x 1-5/16" Stem Length: 11/16" Fits Into 5/16" Hole <i>Chevrolet Impala, Lumina & Monte Carlo 2000 - UP</i> Box Qty. 15</p>	 <p>421396 <i>15116576, 15282120, 11516656</i> Green Nylon Body Side Mldg Clip Head Size: 16mm x 38mm Stem Length: 15mm Fits Into 10mm Hole <i>Buick Terraza, Cadillac C & K Truck, Chevrolet C, K Truck & Uplander, GMC Arcadia, C & K Truck, Pontiac Montana SV6 and Saturn Relay 2005-UP</i> Box Qty. 15</p>	 <p>421397 <i>25648693</i> Gray Nylon Rocker Panel Mldg Clip Width: 7/8" Length: 2" <i>Cadillac Deville & Seville '98 - UP</i> Box Qty. 10</p>

GM CLIPS & FASTENERS

21 GM Clips

421398

10443956
White Nylon
Rocker Panel Mldg Clip
Top Hd: 9/16" x 13/16"
Bottom Hd: 13/16" x 13/16"
Stem Length: 9/16"
Fits Into 7/16" Hole
Chevrolet Impala, Lumina, Monte Carlo and C & K Trucks 2000-UP
Box Qty. 15



421399

15288146,
15893516
Gray Nylon
Windshield Pillar Mldg Clip
Top Hd: 12mm x 20mm
Bottom Hd: 14mm x 20mm
Stem Length: 15mm
Fits Into 9mm Hole
Chevrolet Equinox & Pontiac Torrent 2005 - UP
Box Qty. 15



421400

25922739
Green Nylon
Rocker Moulding Clip
Top Hd: 12mm x 29mm
Bottom Hd: 12mm x 20mm
Stem Length: 10mm
Fits Into 9mm Hole
Buick Enclave, Cadillac SRX, Chevrolet Tahoe, Traverse & GMC Acadia, Yukon 2009-UP
Box Qty. 25



421401

11571175,
68172491-AA
Gray Nylon
Rocker Clip w/ Sealer
Top Hd Size: 12mm x 20mm
Bottom Hd: 12mm x 20mm
Stem Length: 11mm
Fits Into 9mm Hole
*Chevrolet Traverse 2010-UP
Chrysler 200 2015-UP
Jeep Grand Cherokee 2015 - 2012*
Box Qty. 15



430011

68225214AA,
11547341
White Nylon
Bumper Moulding Clip
Head Size: 11.5mm x 21mm
Stem Length: 11mm
Overall Height: 17mm
Jeep Cherokee 2014 - UP; Buick Enclave & Envision, Cadillac ATS, CT6, CTS, ELR, Escalade, XT4 & XT5, Chevrolet Blazer, Bolt EV, Camaro, Corvette, Cruze, Equinox, Impala, Malibu, Silverado, Sonic, Suburban, Tahoe, Traverse, Trax & Volt, GMC Acadia, Sierra 2500/3500, Terrain & Yukon 2018 - UP
Box Qty. 50



435494

90467-10161,
94858299, 94178705
White Nylon
Trim Board Retainer
Top Head Dia: 13mm
Middle Head Dia: 16mm
Bottom Head Dia: 18mm
Stem Dia: 9mm x 9mm
Stem Length: 14mm
Overall Length: 20mm
Toyota Sienna, Solara & Tercel 1990 -UP and Geo Prizm & Pontiac Vibe 1998-UP
Box Qty. 50



NEW

445002

11549307
Natural Nylon
Door Trim Panel Retainer with Sealer
Top Head Dia: 15mm
Bottom Head Dia: 18mm
Stem Dia: 8.75mm
Stem Length: 17mm
Chevrolet Silverado 2019 - UP
Box Qty. 15



445360

9818648,
9883583,
2064891
White Nylon
Door Trim Panel & Headlight Retainer
Top Head Dia: 11/16"
Bottom Head Dia: 3/4"
Stem Length: 1/2"
Stem Dia: 5/16"
GM '71 - UP
Box Qty. 100



445361

13252119
Green Nylon
Door Panel Retainer
Top Head Dia: 15mm
Bottom Head Dia: 17mm
Stem Length: 14mm
Stem Dia: 9mm
Buick, Cadillac, Chevrolet and GMC 2010 - UP
Box Qty. 25



445362

13252118
Blue Nylon
Door Panel Retainer
Top Head Dia: 13mm
Bottom Head Dia: 17mm
Stem Length: 13mm
Stem Dia: 9mm
Cadillac, Chevrolet & GMC 2010-UP
Box Qty. 25



445363

11561499
(Use with #445364)
White Nylon
Door Trim Panel Retainer
Top Head Dia: 19.5mm
Pin Length: 28.3mm
Chevrolet Traverse 2010 - UP
Box Qty. 25



445364

11561500
(Use with #445363)
Yellow Nylon
Door Panel Grommet w/Sealer
Hole Size: 9mm
Chevy Traverse 2010 - UP
Box Qty. 25



445365

20421800,
15600382,
10073833
White Nylon
Door Trim Panel Retainer
Top Head: 9/32" x 19/32"
Bottom Head: 3/4" x 7/8"
Stem Length: 3/4"
Fits Into 5/16" Hole
GM '83 - UP
Box Qty. 25



445375

11588650
Zinc
Garnish, Interior Trim Bezel & Scuff Plate Fastener
Width: 15/32"
Height: 11/16"
GM Cars / Light Trucks 2002-UP
Box Qty. 10



445376

Zinc
Interior Panel Fastener
Width: 10mm
Height: 12mm
GM Silverado 2014 - UP
Box Qty. 15

















445565

N802734S,
22718305,
6506788
Black Nylon
Interior Trim Panel/ Hood Insulation Retainer
Head Dia: 25mm
Stem Length: 20mm
Fits Into 7mm Hole
*Ford '83 - UP
GM & Chrysler*
Box Qty. 50



GM CLIPS & FASTENERS

 <p>445585 6003349, 9685057, 4005470, N98905101 White Nylon Door Trim Panel Retainer Top Head Size: 20mm Stem Length: 18mm Hole Size: 7mm Chrysler, GM, AMC, VW '76 - UP Box Qty. 50</p>	 <p>445590 363137 White Nylon Trim Panel Retainer Top Head Size: 17mm Stem Length: 25mm Hole Size: 7mm Chevrolet & GMC Pick-Up Trucks '76 - UP Box Qty. 25</p>	 <p>445595 20451401 White Nylon Conduit to Sheet Metal In Doors Retainer Length: 1-1/8" Head Dia: 15/16" Stud Dia: 1/4" GM "C" Bodies '85 - UP Box Qty. 25</p>	 <p>445620 3065575, 16656935X White Nylon Door Trim Panel Retainer Top Head: 29/32" Stem Length: 29/32" Fits Into 1/4" Hole GM '77 - UP Box Qty. 50</p>
 <p>445622 15545202 White Nylon Door Trim Panel Retainer Top Head: 1/4" x 29/64" Bottom Head: 1/2" Stem Length: 3/4" Fits Into 5/16" Hole GM Trucks '88 - UP Box Qty. 50</p>	 <p>445623 20298365, 6013122 Natural Nylon Trim Panel Retainer Top Head: 3/8" x 9/16" Bottom Head: 9/16" Stem Length: 11/16" Fits Into 11/32" Hole GM '82 - UP Chrysler '76 - UP Box Qty. 50</p>	<p>445635 Box 50</p>  <p>445624 6033862, 796255, 4005099, 0501094C1 Black Nylon Door Trim Panel Retainer Hole: 5/16" Top Head: 19/32" Bottom Head: 3/4" Stem Length: 11/16" AMC '76 - UP and GM '81 - '88 and Jeep Wrangler '91 - UP Box Qty. 25</p>	 <p>445625 1699250 Natural Plastic Trim Panel Retainer Head: 19mm Overall Length: 34mm Fits Into 7mm Hole GM '77 - UP Box Qty. 50</p>
 <p>445629 10153057 Door & Qtr. Trim Panel Clip Top Head Dia: 18mm Overall Length: 30mm Hole Dia: 7mm GM '82 - UP Box Qty. 50</p>	 <p>445645 10285935 White Nylon Trim Retainer Top Head: 18mm Bottom Head: 20mm Stem Length: 24mm Fits Into 8mm Hole Buick Century & Regal, Chevrolet Venture, GM Truck, Express/ Savana, Olds Silhouette & Pontiac Trans Sport '97 - UP Box Qty. 50</p>	 <p>445655 15607165, 15612948 White Nylon Front Door Trim Panel Retainer Top Head: 9/32" x 1/2" Bottom Head: 9/16" x 11/16" Stem Length: 3/4" Fits Into 5/16" Hole GM Trucks '76 - UP Box Qty. 25</p>	 <p>445720 387496-S, 12084605 White Nylon Door Trim Panel Retainer Top Head Size: 20mm Stem Length: 24mm Fits Into 7mm Hole Ford '76 - UP GM Box Qty. 50</p>
 <p>445801 1644290 Black Nylon Hood Insulation, Rear Bumper Fascia & Door Trim Plate Retainer Head Dia: 11mm Stem Length: 17.8mm Fits Into 5mm Hole GM 1991-UP, Nissan 2002-UP Box Qty. 25</p>	 <p>445815 67771-01010, 67771-12010, 8942264920, 9927-40-825, 95005064 White Nylon Door Panel Retainer Top Head Dia: 13mm Bottom Head Dia: 18mm Stem Length: 14mm Overall Length: 21mm Fits Into 9mm Hole GM, Isuzu, Mazda, Toyota Box Qty. 25</p>	 <p>445818 95008221, 67771-30090, MB608104 Yellow Nylon Door Trim & Back Panel Lower Garnish Retainer Top Head Dia: 13mm Stem Length: 15mm Fits Into 9mm Hole Toyota Land Cruiser & 2WD Truck 1991 - UP Geo Prizm 1993 - 97 Box Qty. 50</p>	 <p>445819 15076791 White Nylon Trim Panel Retainer Top Head Dia: 20mm Bottom Head Dia: 19mm Overall Length: 26mm Stem Length: 17mm Stem Dia: 11mm GM Trucks: Rendezvous, S & T 2002 - UP Box Qty. 15</p>

GM CLIPS & FASTENERS

21 GM Clips

445833

82315-38000,
94530565

Natural Nylon
Door Trim Panel Retainer
Hole Size: 11/32" (9mm)
Top Head Dia.: 13mm
Stem Length: 10mm

Hyundai Accent, Santa Fe, Sonata
Tiburon & XG300/350 1999-UP
Kia Optima, Rio & Sorrento 2001-UP
Chevrolet Aveo 2004-UP

Box Qty. 25



445836

15748479, 11588650

Zinc
Garnish Moulding Fastener
Width: 1/2"
Height: 5/8"

GM Cars & Trucks 1994 - UP

Box Qty. 25

445837

11519032, W711513-S300

Door/Trim Panel Retainer
Top Head Dia: 20mm
Bottom Head Dia: 19mm
Stem Length: 16mm
Overall Length: 28mm
Trim Thk: 4.5mm
Fits Into 11mm Hole

Buick Lucerne & Rainier, Cadillac DTS, Escalade & SPX, Chevrolet
Avalanche, Malibu, Silverado, Tahoe & Trailblazer, GMC Envoy, Sierra,
Suburban & Yukon, Hummer H2, H3 & H3T, Oldsmobile Bravada and
Pontiac G6 2002 - UP

Box Qty. 10



445838

11519031,
W711521-S300

White Nylon
Door Trim Panel Retainer
With Sealer

Top Head Dia: 19.5mm
Stem Length: 17mm
Fits Into 9.5mm Hole

Hummer H2 2003-UP
Lincoln 2007-UP

Box Qty. 15



445884

22651066, 22600612,
22595723

Yellow Nylon
Trim Panel Retainer
Top Head Dia: 13mm
Bottom Head: 18mm
Stem Length: 18mm
Fits Into 9mm Hole

GM '96 - UP
Box Qty. 25



445895

15960325

White Nylon
Door Trim Panel
Push-Type
Retainer

Head Dia. 9/16"
Stem Length: 41/64"

Fits Into 1/4" Hole
GM Trucks C,K 1,2,3 '95 - UP
Box Qty. 50



445896

25704141,
25762391

Green Nylon
Trim Panel Retainer
with Sealer

Hole: M9, Head: 19.5mm
O/L: 27.8mm

Buick LeSabre & Pontiac Bonneville
2000 - UP
Box Qty. 10



445897

25696693

White Nylon
Door Trim Panel Retainer
with Sealer

Hole: M9, Head: 19.5mm
O/L: 31.6mm

Cadillac '98 - UP
Box Qty. 10



445898-100 Box 100

445898

25670009,
F58Z-16237A02-A

Yellow Nylon
Door Trim Panel
Retainer
Hole: 5/16"
Flange Dia: 1/2"
Stem Length: 3/4"

Ford Windstar '95 - UP
GM
Box Qty. 25



445948

10382313

Sight Shield & Trim
Push-Type Retainer
Head Dia: 24.5mm
Stem Length: 13mm

Fits In 9mm Hole
Cadillac STS, Pontiac Solstice
Saturn Sky 2009 - 05
Box Qty. 10



445978 Box 50

445977

90467-08004, 90467-08011,
94842841, 94849113

Black Nylon
Hood Seal Retaining Clip
Head Dia.: 13mm
Stem Length: 11mm

Fits Into 6mm Hole
Lexus, Toyota, Geo Prizm & Nova
1985-UP
Box Qty. 25



470070

1717924

Trunk Lid Bumper
Dia.: 11/16"
Length: 3/4"

GM '79 - UP
Box Qty. 10



470090

4272450

Hood Bumper
Dia.: 15/16"
Length: 1-5/16"
GM 'X' Cars '80 - UP
Saturn '91 - UP
Box Qty. 10



470125

Hood Bumper
M8-1.25 x 38mm
GM '78 - UP
Box Qty. 5













471115

PVC Plastic
Door Lock
Striker Bushing
I.D.: 9/16"
O.D.: 11/16"
Length: 3/4"
GM '77 - UP
Box Qty. 10



GM CLIPS & FASTENERS

<p>471215 not actual size  15591860, 15691595, 15691595X, 15967691, 15685040, 88891731, 5967691 (Use With #471220, #471221 & #471222) Stainless Steel Door Hinge Pin Pin Length: 5-1/4" Pin Dia. 11/32" Shoulder OD: 3/8" Hd OD: 9/16" GM Trucks C-K Models '88-UP Box Qty. 5</p>	<p>471216 not actual size  12540326 Zinc Door Pin Assembly Diameter: 9/16" Length: 5-1/2" Roller O.D.: 3/4" Roller Groove Dia: 5/8" Knurl Dia: 19/32" GM C & K Light Trucks '88 - 2000 Box Qty. 1</p>	<p>471217 not actual size  15653790 (Use With #471220, #471221 & #471222) Zinc & Yellow Door Hinge Pin Length: 4-1/8" Pin Dia: 11/32" Shoulder O.D.: 3/8" Head O.D.: 1/2" GM S & T Trucks '94 - UP Box Qty. 2</p>	<p>471220  12338074, 16632193 15691493, 15964971 Side Door Upper Hinge Bushing (Splined O.D.) Inner Dia: 11/32" Outer Dia: 1/2" Height" 23/64" Flanged Outside Dia: 43/64" GM Trucks, C-K Models '88 - UP Box Qty. 25</p>
<p>471221  15562609, 15964972, 16632192 Side Door Lower Hinge Bushing (Splined O.D.) Inner Dia: 25/64" Outer Dia: 17/32" Height: 23/64" Flange Outer Dia: 11/16" GM Trucks, C-K Models '88 - UP Box Qty. 25</p>		<p>471224  Door Hinge Pin & Bushing Repair Kit GM C/K Trucks & Full Size SUV's '99-UP Box Qty. 1 Kit</p> <p>Each Kit Contains: 2 Case hardened forged pins, with Dacromet Finish (500 hr Salt Spray) 2 Bronze bushings 2 Thru hardened washers 2 Prevailing torque lock nuts</p>	
<p>475080  1241972, 554343, 562327 Bumper Fastener GM '73 - UP Box Qty. 50</p>	<p>475155  14083173, 17988488, 17997722, 25536302, N803685-S Front Bumper, Side/High Stop Lamps, Rear Wheel Flare & Interior Trim/Dash Mounting Nut Screw: M4.2 (#8) Hole: 9 x 11mm GM, Saturn, Hummer, Ford, Jeep '82 - UP Box Qty. 25</p>	<p>475180  383212-S-2 Transmission Clip GM '54 - UP Box Qty. 50</p>	<p>475200  3979975 Hood Release Cable Clip GM Cars Box Qty. 15</p>
<p>475440  561258 Tee Bolt and Nut Kit Bumper Strips and End Attaching 6mm Oldsmobile '78 - UP Box Qty. 25</p>	<p>475455  1613543 Headlight Door Clip GM '79 - UP Box Qty. 25</p>	<p>475470  1612276 Headlamp Door Stud Cadillac '77 - UP Box Qty. 25</p>	<p>475700  15632790 Zinc Organic Grille Clip GM S10, S15 Pick-ups '91-UP Box Qty. 5</p> <p>not actual size</p>

GM CLIPS & FASTENERS

475705

16662182,
6502988, 25580123

Zinc Organic
Windshield/Rear Side Door
Garnish Moulding & Liftgate
Trim Panel Fastener

Height: 9/16"

Width: 1/2"

*Chevrolet Camaro, Corvette, &
Venture; Oldsmobile Silhouette and
Pontiac Firebird, Grand Prix &
Trans Sport 1993 - UP
Chrysler 1996 - UP*

Box Qty. 15



475706

10150076

Black Nylon
Hood Latch &
Cable Clip
Inside Dia of Hole: 15.7mm
Width Across Bottom: 26mm
Stem Length: 11mm
Fits Into 6.3mm (1/4") Hole

*Chevrolet Camaro, Canyon, Equinox,
Malibu, Silverado, GMC Colorado &
Sierra and Olds. Cutlass 1997 - UP*

Box Qty. 25



475707

22581725

Black Nylon
Hood Release
Cable Clip
Will Hold
4.76mm - 6.35mm
Diameter Cable
Bottom Hd Dia: 17mm
Stem Dia: 8mm
Stem Length: 16mm
*Chevrolet Equinox, Silverado,
Traverse, GMC Terrain and Pontiac
Solstice 2006 - UP*

Box Qty. 25



21 GM Clips

475708

11546500

Black Phosphate
Grille Assembly Clip
Head Size: 17.5mm x 25mm
Overall Height: 19mm

*Chevrolet Canyon, Colorado &
Silverado and GMC Sierra
2015 - UP*

Box Qty. 10



490010

1247872, 15567924

Throttle Rod Retaining Clip
For 1/4" Rod w/ 5/32" Groove
O.D.: 19/32"

GM '75 - UP

Box Qty. 100



495050

4234830, 12337868

Door Lock Rod Clip

GM '64 - UP

Box Qty. 50



495210

3081052, 469716

Door Lock Rod End Clip
Rod Dia: 3/16"

GM '78 - UP

Box Qty. 50



495290

20633148

Door Lock Rod End Clip
Left Hand

GM '86 - UP

Box Qty. 25



505205

12160858

Nylon
Wire Loom
Routing Clip
I.D.: 10mm
O.D.: 13mm

GM

Box Qty. 15



505206

12040984

Nylon
Wire Loom
Routing Clip
Inner Dia.: 1/4"
Outer Dia.: 3/8"

GM

Box Qty. 15



GM GLASS SHOP SUPPLIES

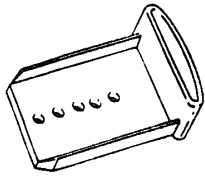

435351
Plastic
Windshield Glass Support
5 Holes for Universal Use
GM Products
Box Qty. 10

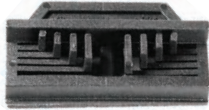

450001
15061964
Windshield Glass Setting Block
w/Adhesive Backing
Overall Length: 51mm
Buick Rainier; Cadillac Escalade;
Chevrolet Avalanche, Colorado,
Silverado, Suburban, Tahoe &
Trailblazer; GMC Canyon, Envoy,
Sierra & Yukon; Hummer H2 & H3
Oldsmobile Bravada and Saab 9-7
1999 - UP
Box Qty. 10



450120
1654048
Rear Window Reveal
Moulding Fastener
GM Cars '75-UP
Box Qty. 50



450140
4506041, 4533699
Windshield, Rear Window,
Station Wagon
Quarter Window
Slip On Clip
GM
Box Qty. 100



450220
9895598
Windshield Reveal
Moulding Fastener
GM '71 - UP
Box Qty. 100



450230
9662950, 9606232,
20603072
Windshield & Rear Window
Moulding Fastener
GM Cars '73 - UP
Box Qty. 100



450270
4005540, 9731301
Nylon
Windshield Reveal
Moulding Fastener
GM Cars & AMC '75 - 'UP
Box Qty. 50



450290
1654047
Windshield Reveal
Moulding Clip
GM '74 - UP
Box Qty. 50

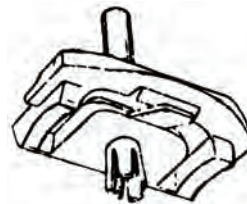

450340
20113224
Plastic
Windshield Reveal
Moulding Clip
GM '79 - UP
Box Qty. 50

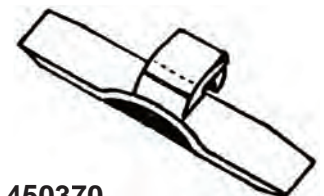

450370
94842802
Orange Plastic
Windshield Reveal
Moulding Clip
Self Adhesive
GM Nova '85 - UP
Box Qty. 10

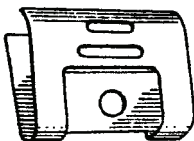

450400
Windshield Reveal
Moulding Clip
Chevy Corvette '64 - '67
Box Qty. 25



480010
Door & Window Crank
Handle Retaining Clip
Ford, GM, Toyota
Box Qty. 100

not actual size



480500
20123070, 20328600
Front Door Window Guide
GM '80 - UP
Buick, Cadillac,
Olds "B", "C" & "X" Bodies
Box Qty. 25

not actual size



480501
10087223
Plastic Front Door
Window Guide (Rear)
Chevrolet Corsica '87 - UP
Box Qty. 25

GM GLASS SHOP SUPPLIES

21 GM Clips

not actual size



480510
20160591
Rear Door Window Guide
GM Wagons "B", "C",
& "X" Bodies '80 - UP
Box Qty. 25

not actual size



480513
20487630
Plastic Guide Front Door
Window Guide
GM Olds & Buick
"C" Bodies '85 - UP
Box Qty. 25

480512
20477850
Plastic Rear Door
Window Guide
GM "C" Bodies '85 - UP
Box Qty. 25

not actual size



480514
20478733
Plastic Front Door
Window Guide (Rear)
GM Olds & Buick
"C" Bodies '85 - UP
Box Qty. 25

not actual size



480516
20478732
Plastic Front Door
Window Guide
GM Cars Type "C" & "H" Body
'85 - UP
Box Qty. 10

not actual size



480517
20162174
Plastic Front Door
Window Guide
GM Cars Type "J" Body '82 - UP
Box Qty. 10

not actual size



480518
20493450
Plastic Rear Door
Window Guide (Upper)
Chevrolet Corsica '87 - UP
Box Qty. 25

not actual size



480519
20747508, 20487631
Plastic Front Door
Window Guide
GM "C" Bodies '85 - UP
Box Qty. 25

not actual size

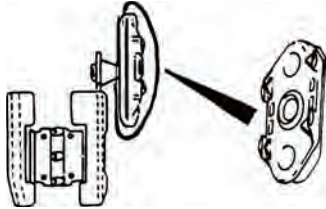

480524
Plastic Guide Front Door
Window Regulator
Guide Only (No Stud)
GM '85 - UP
Box Qty. 5

not actual size



480525
10051034, 10114597
Plastic Front Door
Window Guide
w/Adhesive Gasket
GM "A" Bodies & "S" Trucks
Box Qty. 10



480526
115647709
Plastic
Rear Side Door
Window Guide
GM S-10 Blazer 4 Dr.
Box Qty. 15

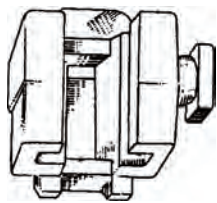

480530
20085730
Guide for Tape Controlled
Window Regulators
(Right Hand)
GM '80 - UP
Box Qty. 10

not actual size



480531
69951-12180
Plastic
Door Window Bracket
w/M6-1.0 Steel Insert.
Imports & Various Domestic Vehicles
Box Qty. 5



480545
10142872
Plastic Front Door Window
Guide
GM "A" Bodies '90 - UP
Box Qty. 10



480550
20085729
Tape Control Window
Regulator Block
GM '80 - UP
Box Qty. 25

GM GLASS SHOP SUPPLIES



480578
Upper Ventilator Pivot
Shoulder Rivet
GM Cars '691 - 72
Box Qty. 25



480580
Ventilator Window Handle
Bracket & Shaft
Right Hand
GM '71 - UP
Box Qty. 1



480585
Ventilator Window Handle
Bracket & Shaft
Left Hand
GM '71 - UP
Box Qty. 1

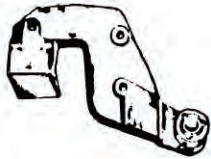

485480
7682226
Right Front Window
Guide Plate (Rear)
*GM Full Size Sport Coupes &
Convertibles*
Box Qty. 1

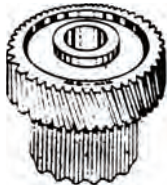

486070
Power Window
Motor Gear
GM '80 - UP
Box Qty. 1

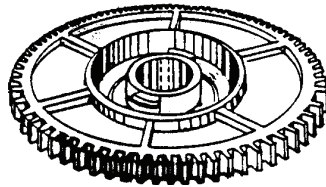

486080
Power Window Motor Gear
GM '80 - UP
Box Qty. 1

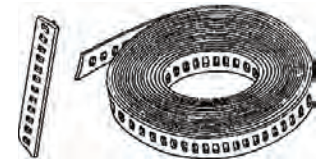

486100
20435391, 20161228
Window Regulator
Elastomeric Tape Provides
Strength & Flexibility
GM '80 - UP
Box Qty. 1



GM CLIPS & FASTENERS

21 GM Clips

BLANK

HONDA / ACURA CLIPS & FASTENERS



38713
 22638717, 90671-SDA-A01
 Dia: 3/16" (4.8mm)
 Grip: 3/64" - 23/64"
 (1mm - 9mm)
 Flange Dia: 5/8" (16mm)
 Aluminum Rivet,
 Aluminum Mandrel
 Bumper Fascia &
 General Purpose
*GM 1987 - UP and
 Honda Civic 2016 - UP*
 Box Qty. 100



200101
 Zinc & Yellow
 Dichromate
 M6.3-1.81 x 20mm
 (#14 x 25/32")
 Hex Head SEMS®
 Washer OD: 18mm (45/64")
 Hex: 10mm
Honda, Nissan, Toyota
 Box Qty. 25



200193
 90103-SDA-A00
 Black Phosphate
 M5-1.81 x 20mm
 Phillips Flat Head
 Tapping Screw
 Head Dia: 13mm
 Front & Rear Bumper
*Honda Civic, Pilot & Ridgeline
 2006 - UP*
 Box Qty. 100



200411
 Black Oxide
 M4.2-1.41 x 16mm
 (#8 x 5/8")
 Phillips Truss Head
 Head Dia: 9.5mm (3/8")
 Tapping Screw
Honda
 Box Qty. 100



200413
 90114-SE0-000,
 90114-SZ3-000
 Black E Coat
 M4.8 x 19mm
 w/ 16mm Loose Washer
 Phillips Truss Head
 Tapping Screw
*Honda '86 - UP
 & General Purpose*
 Box Qty. 25



220138
 90111-SM4-003
 Black
 Bumper Bolt
 Size: M6 - 1.0 x 8mm
 Shoulder Dia: 9mm
 Shoulder Length: 6.5mm
 Washer Outer Dia: 18mm
 Hex: 10mm, Hex Height: 7mm
*Acura CL 2003-1997; ILX 2013-2019; Integra 1986-2001; Legend 1987-1995; MDX 2014-2019; NSX 1991-
 2005; RDX 2007-2019; RL 2009-2012; RLX 2014-2019; RSX 2002 - 2004; TL 1996 - 2014; TLX 2015-2019;
 TSX 2004-2014; Vigor 1992-1994; ZDX 2010-2013 Honda Accord 1990-2020; Civic 1984-2020; CR-V
 1997-2020; CR-Z 2011-2016; Crosstour 2010-2015; CRX 1984-1991; Element 2007-2008; Fit 2007-2020;
 Insight 2000-2020; Odyssey 1995-2020; Passport 2019-2020; Pilot 2012-2020; Prelude 1992-2001; Ridgeline
 2006-2020*
 Box Qty. 15



292040
 75522-611-000, 75522-611-0000
 9991-00-412, MS-480001,
 96706-B0700, 97606-B0700,
 90189-04042, 95900-04036
 Grommet Nut
 Screw Size: #8
 Width: 9.5mm, Length: 9.5mm
 Fits into 7mm x 7mm Hole
*Honda, Toyota, Nissan, Mazda,
 Mitsubishi*
 Box Qty. 50



292050
 90189-05013, MS480009
 MS-480002, 94841764
 Nylon Nut
 Headlamp Bezel & Grille
 Screw Size: #10
 Width: 12mm, Length: 12mm
 Fits into 8mm x 9mm Hole
Toyota, Mitsubishi, GM
 Box Qty. 50



292071
 68425-H5000, 62698-V7000,
 9991-00-503, 90662-671-0030,
 90662-671-003, 90662-SB-003
 Nylon Nut
 Screw Size: #10
 Width: 17mm, Length: 17mm
 Fits Into 8mm x 8.5mm Hole
Honda, Mazda, Nissan
 Box Qty. 25



292075
 96706-H9400,
 96706-K1351,
 96706-K1300,
 MB106212, 90672-671-811
 Screw Grommet
 Screw Size: #8
 Head Dia: 13.5mm
 Stem Length: 16mm
 Fits Into 6mm x 6mm Hole
Honda, Nissan, Mitsubishi
 Box Qty. 25



292076
 90603-S7S-003
 (Use with #416059)
 Blue Nylon
 With Sealer
 Cowl Vent Grommet
 Flange Size: 10mm x 24mm
 Stem Length: 6mm
Accord 2003 - UP
 Box Qty. 15



292077
 90670-SG0-003,
 91626-SH3-003
 Plastic w/Seal
 Front Door Panel, Speakers &
 Door Lock Control Grommet
 Screw: M4.2
 Head: 12mm
 Stem Length: 16mm
 Fits Into 7mm x 7mm Hole
Honda Civic, CRV '93 - UP
 Box Qty. 15



292086
 90662-693-003, 90662-693-0030
 90189-04066, 90662-693-0031
 Nylon Screw Grommet
 Screw Size: #6
 Head Dia: 14mm
 Stem Length: 10mm
 Fits Into 7mm x 7mm Hole
Honda, Toyota
 Box Qty. 25



292101
 90601-S30-003
 (Use with 416229)
 White Nylon
 Cowl & Wheelhouse
 Screw Grommet w/ Sealer
 Head Size: 13mm x 13mm
 Stem Length: 13mm
 Overall Height: 14mm
 Fits into 8mm x 8mm Hole
*Acura MDX, RDX, RL, RLX, TL,
 TLX, TSX & ZDX 2001 - 2019
 Honda Accord, Civic, Clarity, CR-V, Fit,
 HR-V, Insight, Odyssey, Passport, Pilot,
 Prelude, Ridgeline & S2000 1997 - UP*
 Box Qty. 25

HONDA / ACURA CLIPS & FASTENERS



292087
 90656-671-6310M1
 Nylon
 Screw Grommet
 Screw Size: #14 (6.3mm)
 Head Size: 13mm x 15mm
 Snaps Into 8.5 x 10.5mm Hole
 Honda
 Box Qty. 50



292098
 91601-STX-A00
 Gray Nylon
 Rear Hatch Screw Grommet
 With Sealer
 Screw Size: M3.5 (#6)
 Top Head Dia: 12mm
 Bottom Head Dia: 14mm
 Stem Length: 10mm
 Acura MDX 2009 - UP
 Box Qty. 10



292105
 78856-R4301,
 90683-693-0000
 Nylon Screw Grommet
 Screw Size: #10
 Width: 12mm, Length: 19mm
 Stem Length: 17mm
 Fits Into 8mm x 15mm Hole
 Honda & Nissan
 Box Qty. 10



292115
 90669-SA5-6720
 Plastic Screw Anchor
 Adjustable, Grille to Body
 Honda Accord '82 - UP
 Box Qty. 10



292210
 90189-06010,
 75521-611-0000,
 9991-00-601, 96706-P0105
 Nylon
 Screw Grommet
 Screw Size: #10
 Width 13mm, Length 13mm
 Snaps Into 8.5mm Sq. Hole
 Toyota, Honda, Mazda, Nissan
 Box Qty. 25



292225
 90672-671-8110M1,
 90189-04013
 Nylon Screw Grommet
 Screw Size: #6
 Head Dia: 14mm
 Stem Length: 15mm
 Fits Into 7mm x 7mm Hole
 Honda & Toyota
 Box Qty. 25



292233
 90107-S10-003
 Black Nylon
 Wheel Well Mldg.
 Screw Grommet
 #10 Screw Size: #10
 Head Size: 16mm
 Stem Length: 10mm
 Honda CRV '97-UP
 Box Qty. 25



292237
 90682-SB0-003,
 90676-SA7-003
 Plastic
 Grille Grommet Nut
 Screw: M5-.80
 Head Size: 13mm
 Stem Length: 8mm
 Hole Size: 8mm
 Honda Prelude & Accord '84 - UP
 Box Qty. 25



292270
 90661-SC7-0030,
 90661-SC7-003,
 H001-50-841, MS-480012,
 01651-00481, 74798-S9000,
 90189-06042
 Nylon Screw Grommet
 Screw Size: #8 (M4.2)
 Head Dia: 16mm
 Stem Length: 17mm
 Fits a 8mm x 8mm Hole
 Honda, Toyota, Nissan,
 Mitsubishi, Mazda
 Box Qty. 25



292330
 34355-SD2-003
 Nylon
 Side Marker Clip
 Honda Accord '86-UP
 Box Qty. 10



292402
 91635-SM4-003
 Nylon
 Headlight to Grille
 Spacer Bracket Grommet
 Screw Size: #10
 Honda Accord '90 - UP
 Box Qty. 10



292405
 91619-SM4-003,
 91619-SM4-0030
 Natural Nylon
 Center Pillar Garnish
 Moulding (Oval)
 Screw Grommet
 Screw Size: #4
 Honda Odyssey &
 Accord Wagon '91 - UP
 Box Qty. 25



292420
 71144-SR3-A00
 Natural Nylon
 Bumper Grommet
 Screw Size: M4.2 (#8)
 Honda Civic '93 - UP
 Box Qty. 25



292421
 90682-SDA-A01
 Black Nylon
 Rear Bumper
 Screw Grommet
 Screw Size: M4.8 (#10)
 Head Size: 14mm x 14mm
 Stem Length: 14mm
 Honda Civic 2009 - UP
 Box Qty. 15



292422
 90682-SEA-003
 Nylon
 Fender Apron Grommet
 Screw Size: #8 (4.2mm)
 Hd. Dia: 20mm
 Stem Length: 12mm
 Fits Into 9mm Sq. Hole
 Acura TSX, Honda Civic, Odyssey
 2004 - UP
 Box Qty. 25

HONDA / ACURA CLIPS & FASTENERS

 <p>295275 Plastic M4 Screw Wheel House Fender Moulding Grommet Nut <i>Honda Accord '86 - UP</i> Box Qty. 25</p>	<p>NEW</p>  <p>295276 <i>91626-STK-A01</i> Gray Nylon Taillight Screw Grommet with Sealer Head Dia: 18mm Stem Length: 14mm Overall Length: 16mm <i>Acura MDX & RDX and Honda Accord, Civic, Crosstour & Odyssey 2007 - UP</i> Box Qty. 25</p>	<p>415072 Box 250 415071 Box 500</p>  <p>415070 <i>11569768, 15958694, 1605396, 6030441, 388577S, W705589-S300</i> Black Nylon Radiator Yolk, Fender & Bumper Shield Retainer Hole Size: 1/4" (6.3mm) Stem Length: 20mm Head Dia: 25.5mm <i>GM, Ford, Chrysler</i> Box Qty. 50</p>	 <p>415073 <i>91501-S1K-003, 91501-STK-003</i> Black Nylon Hood Insulation Retainer Hd Dia: 30mm Stem Length: 14mm Hole Size: 7mm (17/64") <i>Acura 3.5RL & RSX and Honda Civic & CR-V 2000 - UP</i> Box Qty. 25</p>
<p>415076 Box 250</p>  <p>415075 <i>21094146, 21110201, 6501301</i> Black Nylon Hole Size: 5/16" (8mm) Stem Length: 19/32" Head Dia: 33/64" Trim Panel Retainer <i>GM Saturn '91 - UP</i> Sliding Door & Lift Gate Trim Panel Retainer <i>Chrysler Mini Vans '87 - UP</i> Box Qty. 50</p>	 <p>415239 <i>90700-SB2-003</i> Plastic Hood Insulation Clip Hole: M6 Head Dia: 30mm Stem Length: 9mm <i>Honda Prelude '85 - UP</i> Box Qty. 15</p>	 <p>415240 <i>74842-659-0030, 74842-659-003</i> <i>90467-12078, 90467-12078-01</i> Black Nylon Retaining Clip Head Dia: 18mm Stem Length: 15mm Hole Size: 8mm (5/16") <i>Honda & Toyota</i> Box Qty. 25</p>	 <p>415259 Yellow Nylon Door & Hood Seal Weatherstrip Retainer Top Head Dia: 5mm x 15mm Bottom Hd: 8mm Stem Length: 7.8mm Hole Size: 5mm (13/64") <i>Ford, Acura, Honda</i> Box Qty. 100</p>
 <p>415263 <i>90687-SA5-003, 90687-SA5-0030</i> Black Plastic Cowl Top Clip Head Dia: 13mm Stem Length: 15mm Fits Into 5mm Hole <i>Honda Accord '87 - UP</i> Box Qty. 25</p>	 <p>415268 <i>66435-648-0000</i> Nylon Retaining Clip Head Dia: 11mm Stem Length: 13mm Panel Thickness: 5mm Fits Into 5.5mm Hole <i>Honda</i> Box Qty. 50</p>	 <p>415668 <i>90688-SB0-003, 90688SB0-013</i> Air Scoop Grille Cowl Vent Panel Screw-Type Retainer Head Dia: 18mm Stem Length: 11mm Fits Into 6mm Hole <i>Acura, Honda</i> Box Qty. 25</p>	<p>415759 Box 50</p>  <p>415761 <i>94218027, H200-50-715, 8942180270, 58974-00008, B092-50-715, BF67-S0715, MB153825, 90467-13011, 90467-12020</i> Black Nylon Grille Headlight Clip Width: 13mm Length: 22mm <i>Ford, GM, Toyota, Mitsubishi, Isuzu, Honda, Plymouth, Mazda</i> Box Qty. 25</p>
<p>415776 Box 25</p>  <p>415775 <i>8942431900, 9841690750, 1395-68-676, 9926-50-635, 75775-41300, 23270-3895, 80915-29A66</i> Screw-Type Drive Retainer Flange Dia: 20mm Stem Length: 9mm Fits Into 6mm Hole <i>Honda, Nissan, Isuzu</i> Box Qty. 10</p>	<p>415778 Box 25 415779 Box 100</p>  <p>415777 <i>90675-SB3-003, FB01-56-964, 63876-95596</i> Cowl Vent, Air Ducts & Fender Splash Shield Screw Type Retainer Head Dia: 20mm Stem Length: 9mm Fits Into 8m Hole <i>Honda, Nissan, Mazda</i> Box Qty. 10</p>	<p>415865</p>  <p><i>91545-SE0-003, 91545-SE0-0030-W1, 63848-01G00, 63848-01G00-A</i> Nylon Push-Type Retainer Flange Dia: 20mm Stem Length: 8mm (excluding the pin) Fits Into 8mm Hole <i>Honda, Nissan</i> Box Qty. 25</p>	<p>415866</p>  <p><i>91561-S84-A00-M1, 91561-S84-A21ZB</i> Black Nylon Rear Panel Assembly Screw-Type Retainer Head Dia: 16mm Stem Length: 21mm Fits Into 8mm Hole <i>Honda Accord & Civic 2001 - 07, Fit 2009 - 14</i> Box Qty. 10</p>

HONDA / ACURA CLIPS & FASTENERS

415880-150 Box 150



415880
91512-SM4-003
Nylon
Fender Splash Shield
Screw-Type Retainer
Head Dia: 20mm
Stem Length: 9mm
Fits Into 8mm Hole
Honda Accord '90 - UP
Box Qty. 15

415885



91508-SM4-003
Plastic
Cowl Panel Retainer
Head Dia: 18mm
Stem Length: 14mm
Fits Into 8mm Hole
Honda Accord '90 - UP
Box Qty. 10

415916 Box 50



415915
90657-SA6-0030,
N304-13-356-A,
94198687
Nylon
Screw-Type Retainer
Head Dia: 14mm
Stem Length: 11mm
Fits into 7mm Hole
Honda & Mazda, GM
Box Qty. 25

415925



30012018,
90684-SA5-0030,
90684-SA5-003,
874-298-1190,
8942981190,
10998-30880
Nylon
Push-Type Retainer
Head Dia: 15mm
Stem Length: 11mm
Fits in a 6mm Hole
Nissan, Honda, Isuzu, GM
Box Qty. 25

415971 Box 25



415970
91504-SM4-000
Nylon
Bumper Fascia
Screw-Type Retainer
Flange Dia: 20mm
Stem Length: 24mm
Fits Into 10mm Hole
Honda Accord '90 - UP
Box Qty. 10

415981 Box 25



415980
91502-SM4-0000,
86590-35000
Nylon
Bumper Fascia
Screw-Type Ret.
Flange Dia: 20mm
Stem Length: 27mm
Fits Into 10mm Hole
Honda Accord '90-UP
Hyundai 2005-UP
Box Qty. 15

415982



91501-SM4-003
Plastic
Cowl Top Retainer
Head Dia: 14mm
Stem Length: 15mm
Fits Into 6mm Hole
Honda Accord '90 - UP
Box Qty. 15

415983 Box 25



415984
91516-SK7-013,
01553-0034U
Nylon
Splash Shield
Screw-Type Ret.
Flange Dia: 20mm
Stem Length: 15mm
Hex: 10mm
Fits Into 8mm Hole
Honda Civic '92-UP; Nissan XTerra,
Frontier, Quest '99-UP
Box Qty. 10

415995



90505-SM4-003,
90505-SM-003
Nylon
Screw-Type Retainer
Head Dia: 18mm
Stem Length: 21mm
Fits Into 8mm Hole
Honda Accord '90 - UP
Box Qty. 10

416000-50 Box 50



416000
91502-SP0-003
Plastic
Front Bumper
Screw-Type Rivet
Hole: 10mm
Flange Dia: 20mm
Stem Length: 25mm
Honda '90 - UP
Box Qty. 5

416001-100 Box 100



416001
91503-SP0-003,
07-13-0-702-966,
94530623
Plastic
Front/Rear Bumper
Screw-Type Rivet
Hole: 10mm
Washer Face: 20mm
Stem Length: 15mm
GM; BMW; Acura CL, Integra,
Legend RL & TL '91 - 2004 and
Honda Accord, Civic, Del Sol,
Odyssey, Passport, Pilot, Prelude &
Ridgeline '92 - UP
Box Qty. 10

416002



91578-SV4-003
Plastic
Radiator Grille Retainer
Head Size: 18.5mmx23.5mm
Stem Length: 23mm
Overall Length: 40mm
Honda Accord '94
Box Qty. 5

416006



90667-SA7-0030,
90667-SA7-003,
90667-SA7-003ZB, 89427-98070
Black Nylon
Door Trim Panel Retainer
Head Dia: 20mm
Stem Length: 15mm
Fits Into 5mm Hole
Honda & Nissan
Box Qty. 25

416026 Box 100



416018
91530-SP1-003,
91530-SPL-003,
W704643, N807438S
Nylon
Weatherstrip Retainer
Head Size: 5mm x 15mm
Stem Length: 10mm
Fits Into 6mm Hole
Ford; Acura 3.5 RL & Honda
Accord, Civic & Odyssey '92 - UP
Box Qty. 25

416024 Box 50



416021
91501-S04-003
Black Nylon
Front Fender
Push-Type Retainer
Flange Dia: 20mm
Stem Length: 10mm
Fits Into 8mm Hole
Honda Civic, De Sol '93 - UP
Box Qty. 15

416023



91512-SX0-003,
11519949, MU000319
Black Nylon
Front Bumper
Push-Type Retainer
Flange Dia: 20mm
Stem Length: 11mm
Fits Into 8mm Hole
Buick, Cadillac, Chevrolet & GMC
'97-UP; Mitsubishi Lancer; Acura
3.5RL, Honda Accord, Prelude &
Odyssey '94-UP
Box Qty. 25



HONDA / ACURA CLIPS & FASTENERS

 <p>416027 91501-TR0-003 Black Nylon Fender Push-Type Retainer Head Dia: 20mm Stem Length: 10mm Fits Into 8mm Hole Honda Civic 2012 - UP Box Qty. 25</p>	<p>416033 Box 100</p>  <p>416030 91520-SM4-C01 Nylon Hood Insulation Retaining Clip Head Dia: 10mm Stem length: 10mm Stem Dia: 7.5mm Fits Into 6mm Hole Honda & Acura '90 - UP Box Qty. 25</p>	<p>416044 Box 50</p>  <p>416032 91503-SZ3-003, 909140054 Plastic Bumper & Front Grille Push-Type Retainer Hole: M10 Flange Dia: 20mm P.R.: 5mm Stem Length: 13mm Honda Cars & Odyssey, Acura 3.5RL Sedan '96 - UP Box Qty. 15</p>	<p>416036 Box 50</p>  <p>416034 91503-SZ5-003 Plastic Front & Rear Bumper Push-Type Retainer Hole: M10 Flange Dia: 20mm P.R.: 7mm Stem Length: 18mm Honda Accord & Odyssey, Acura 3.5RL Sedan '96 - UP Box Qty. 15</p>
 <p>416048 91506-S9A-003 Bumper & Splash Shield Retainer w/Metal Insert Flange Dia: 20mm Stem Length: 16mm Fits Into 10mm Hole Acura MDX, RDX & TSX; Honda Accord, Civic, CR-V & Fit 2004-2009 Box Qty. 10</p>	 <p>416055 MB888869, 90505-SL0-003, 90467-08155, 9485236 Plastic Bumper Cover Screw-Type Rivet Hole: M8, Stem: 21mm Flange Dia: 20mm Chrysler, GM, Acura, Toyota '93 - UP Box Qty. 15</p>	 <p>416058 91505-S9A-003 Nylon Front Bumper Push-Type Retainer Hd Dia: 20mm Stem Length: 13mm Fits Into 10mm Hole Honda 2006 - UP Box Qty. 10</p>	 <p>416059 90602-S7S-003 (Use with #292076) Blue Nylon Cowl Vent Retainer Top Head: 12mm Bottom Head: 16mm Stem Length: 7mm Stem Dia: 3mm Honda Accord 2003 - UP Box Qty. 25</p>
 <p>416061 90602-SAA-003 Orange Nylon Cowl Vent & Radiator Support Retainer Top Head Dia: 12mm Bottom Head Dia: 18mm Stem Length: 14mm Hole Size: 9mm Honda Fit & CRV 2003 - UP Box Qty. 15</p>	 <p>416068 91501-SEA-003 Black Nylon Cowl & Garnish Retainer Head Dia: 20mm Stem Length: 15mm Stem Dia: 7mm Honda Civic 2006 - UP Box Qty. 15</p>	 <p>416069 91501-SL4-003 Black Nylon Front Cowl Retaining Clip Head Dia: 13mm Stem Length: 10mm Stem Dia: 6mm Acura 3.5 RL 1996 - UP Box Qty. 25</p>	 <p>416070 90108-SW3-003, 90108-SW3-003, 90418-SW3-003 Plastic Rear Bumper Retainer Head: 16mm Stem Length: 21mm Hole Size: 6mm Honda Accord, Prelude, Odyssey '95 - UP Box Qty. 10</p>
 <p>416072 91508-SR3-000 Black Plastic Cowl Grill Retainer Head Dia: 17mm Stem Length: 9mm Fits Into 8mm Hole Honda '90 - UP Box Qty. 10</p>	 <p>416074 91530-ST5-003, 91516-SM4-013 Front & Rear Door Weatherstrip Retainer Head Size: 5mm x 15mm Stem Length: 10mm Hole: M6 Honda Civic '95 - UP Box Qty. 10</p>	 <p>416075 91524-SE0-003 Plastic Cowl Vent Screw-Type Retainer Head Dia: 18mm Stem Length: 12mm Fits into 6mm Hole Honda Accord '86-UP, Accord & Odyssey '95-UP Acura Vigor '92-'98 Box Qty. 25</p>	 <p>416082 90700-SJ4-000 Black Plastic Hood Insulation Retainer Head Dia: 30mm Panel Range: 1.5 - 5.0mm Stem Length: 6mm Hole Size: 7.5mm Acura Legend '91-UP Honda Accord '98-UP Box Qty. 15</p>

HONDA / ACURA CLIPS & FASTENERS

<p>416083 90467-09139 Black Nylon Bumper Cover & Wheel Housing Push-Type Retainer Head Dia: 18mm Stem Length: 15mm Fits Into 9mm Hole <i>Honda, Mazda 626 & Toyota Corolla '92 - UP</i> Box Qty. 15</p> 	<p>416084 90505-SX0-003 Black Nylon Garnish Side Prot. Push-Type Retainer Head Dia: 18mm Stem Length: 15mm (Not Including The Pin) Fits Into 8mm Hole <i>Honda Odyssey '95 - UP</i> Box Qty. 15</p> 	<p>416085 91518-SM4-003 Black Nylon Hood & Trunk Moulding Retaining Clip Head Dia: 12mm Stem Length: 9mm Stem Dia: 8.5mm Fits Into 6mm Hole <i>Honda Civic & Acura Integra '94-UP</i> Box Qty. 15</p> 	<p>416087 91568-SR2-003 Green Nylon Weatherstrip Retainer Head Size: 5mm x 15mm Stem Length: 10mm Fits Into 5mm Hole <i>Honda Odyssey '95 - UP</i> Box Qty. 100</p> 
<p>416088 91502-S84-A11 Black Nylon Cowl Vent/Rear Hood Seal Retaining Clip Head Dia: 6mm x 16mm Stem Length: 14mm Fits Into 6mm Hole <i>Honda Odyssey '99 - UP</i> Box Qty. 15</p> 	<p>416089 91570-SK7-003ZF Black Nylon Tailgate Lining Screw-Type Retainer Head Dia: 17mm Stem Length: 16mm Fits Into 7mm Square Hole <i>Honda Prelude '97 - UP</i> Box Qty. 10</p> 	<p>416091 90666-SA7-003ZW Black Nylon Trunk Lining Retainer Head Dia: 16mm Stem Dia: 5mm Square Stem Length: 16mm <i>Acura 2.5TL, 3.2TL, 3.5, Integra & Legend; Honda Accord Wagon & Prelude '87 - UP</i> Box Qty. 15</p> 	<p>416092 91515-SR3-000 Black Plastic Rear Hood Cowl Weatherstrip Retaining Clip Head: 8mm x 18mm Stem Length: 15mm Fits Into 7mm Hole <i>Honda Civic '93-UP, CRV '97-UP</i> Box Qty. 25</p> 
<p>416093 90657-SB0-003 Bumper Covers & Fender Wells Drive-Type Retainer Flange: 11mm Stem Length: 10mm Head Size: 8mm <i>Acura Legend; Honda Accord, Pre- lude, Legend, Odyssey '83 - UP</i> Box Qty. 10</p> 	<p>416094 91508-S50-003 Black Nylon Cowl Top Retainer Head Dia: 17mm Stem Length: 13mm (excl pin) Fits Into 9mm Hole <i>Honda '98 - UP</i> Box Qty. 5</p> 	<p>416126 90602-SX0-003 Cowl Vent Retainer Top Hd: 13mm Bottom Head: 16mm Stem Length: 13mm Stem Dia: 4mm <i>Acura MDX; Honda Civic, Insight, Odyssey, Prelude '95 - UP</i> Box Qty. 10</p> 	<p>416127-50 Box 50 416127 91505-TM8-003 Black Nylon Bumper & Wheel Well Liner Push-Type Retainer Head Dia: 20mm Stem Length: 14mm Fits Into 10mm Hole <i>Acura ILX and Honda Insight '12-UP</i> Box Qty. 15</p> 
<p>416133 MR200300 Black Nylon Fender & Bumper Push-Type Retainer Head Dia: 18mm Stem Length: 13mm Fits Into 9mm Hole <i>Honda & Mitsubishi 1998 - UP</i> Box Qty. 15</p> 	<p>416201 90602-SLJ-003, 90603-SLJ-003, 90602-TA0-003 Nylon Cowl Vent Retainer Top Head: 10mm x 14mm Bottom Head Dia: 16mm Stem Length: 13mm Stem Dia: 8mm <i>Acura MDX & Honda CR-V 2007 - UP, Accord & Fit 2008 - UP</i> Box Qty. 10</p> 	<p>416213 91563-SCV-003, 67867-52010, 67867-0D060 White Nylon Weatherstrip Retainer Head Size: 5mm x 15mm Bottom Head Dia: 6.5mm Stem Dia: 7mm Stem Length: 8.5mm <i>Acura TL and Honda Element, Odyssey & Pilot 2003-UP; Toyota Echo, Land Cruiser, Prius, Tacoma & Yaris and Lexus GS 450, GX 460 & LX 430 and Scion xA & xD 2000 - UP</i> Box Qty. 25</p> 	

HONDA / ACURA CLIPS & FASTENERS

<p>416220 90667-TC0-U01-ZA Black Nylon Trunk Interior & Side Trim Push-Type Retainer Top Head Dia: 15.5mm Bottom Head Dia: 16mm Stem Length: 15mm Fits Into 7mm Hole <i>Acura ILX & TSX and Honda Accord, HR-V & Insight 2012 - UP</i> Box Qty. 25</p> 	<p>416229 91512-SED-003 Black Nylon Inner Fender Wheel Well Retainer Head Dia: 18mm Stem Dia: 4.1mm Stem Length: 16mm <i>Honda Civic, Odyssey & Pilot 2005 - UP</i> Box Qty. 25</p> 	<p>416266 91518-S10-003 Black Nylon Hood Seal Retaining Clip Head Dia: 11mm Stem Length: 8mm Stem Dia: 7mm <i>Honda Odyssey 1999 - UP</i> Box Qty. 25</p> 	
<p>NEW</p> <p>416298 91563-TG7-A00 Black Nylon Weatherstrip Retainer Head Dia: 12mm Stem Dia: 8mm Stem Length: 10mm <i>Acura NSX 2017 - UP</i> <i>Honda CR-V, Pilot & Ridgeline 2016 - UP</i> Box Qty. 100</p> 	<p>416321 90657-SA5-003 Black Nylon Bumper & Splash Shield Screw-Type Retainer Head Dia: 15mm Stem Length: 12mm Fits Into 6.3mm Hole <i>Acura TL 2004 - 08: Honda Accord, CR-V, Insight & Pilot 1997 - 2007</i> Box Qty. 15</p> 	<p>NEW</p> <p>416352 91505-TY2-003 Black Nylon Engine Cover Push-Type Retainer Head Dia: 30mm Stem Length: 12mm Fits Into 10mm Hole <i>Honda Accord, Civic, Clarity, CR-V & Fit 2017 - UP</i> Box Qty. 15</p> 	<p>NEW</p> <p>421012 91512-TZ5-A01 White Nylon Rocker Moulding Retainer Top Head: 18mm x 18mm Bottom Head: 20mm x 22mm Stem Dia: 9.8mm Stem Length: 22.5mm <i>Acura MDX & NSX 2014 - UP</i> <i>Honda Odyssey, Pilot & Ridgeline 2016 - UP</i> Box Qty. 15</p> 
<p>421350 91528-SR4-003, 91528-S01-A01 Blue Drip Rail Moulding Clip With Sealer Head Size: 10.3mm x 43mm Stem Length: 10mm Hole Size: 6mm <i>Honda Accord, Civic '95 - UP</i> Box Qty. 15</p> 	<p>435002 91560-TX4-A01 Yellow Nylon Garnish Retainer w/Sealer Top Head Dia: 13mm Middle Head Dia: 16.3mm Bottom Head Dia: 18mm Stem Length: 13mm Stem Dia: 9.5mm <i>Acura ILX, MDX, RDX, RLX & TLX and Honda Civic, Clarity, CR-V, Fit, HR-V, Honda Odyssey, Pilot & Ridgeline 2013 - UP</i> Box Qty. 25</p> 	<p>NEW</p> <p>435003 91560-TG1-T01 Green Nylon Garnish Retainer w/Sealer Top Head: 13mm Middle Head: 16.5mm Bottom Head: 18mm Stem Dia: 9.3mm Stem Length: 12mm <i>Honda Accord, Civic, CR-V, Fit, HR-V, Odyssey & Pilot 2013 - UP</i> Box Qty. 15</p> 	<p>NEW</p> <p>435006 91560-TL0-G21 Tan Nylon Garnish Retainer w/Sealer Top Head: 13mm Middle Head: 16.5mm Bottom Head: 18mm Stem Dia: 9mm Stem Length: 9mm <i>Acura RDX, TSX, ILX, RLX & TLX and Honda Accord, CR-V & Odyssey 2007 - UP</i> Box Qty. 15</p> 
<p>NEW</p> <p>435007 90666-SDA-A01 White Nylon Grille Clip Width Across Center Ears: 9mm Width Across Bottom Ears: 11mm Overall Height: 16.5mm <i>Acura RDX, ILX, TL & TSX and Honda Accord, Civic, CR-V, Fit, Odyssey & Pilot 2003 - UP</i> Box Qty. 25</p> 	<p>NEW</p> <p>435008 90651-TA0-003 Natural Nylon Door Panel & Weatherstrip Retainer Top Head: 5mm x 12mm Bottom Head Dia: 12mm Stem Dia: 6mm Stem Length: 4.5mm <i>Acura ILX, MDX, RDX, RLX & ZDX 2010 - UP</i> <i>Honda Accord, CR-V, Pilot & Ridgeline 2008 - UP</i> Box Qty. 50</p> 	<p>435181 91506-SD4-921 Lower Moulding Door Retainer Narrow Chrome Mldg <i>Acura Legend '86 - '88</i> Box Qty. 25</p> 	<p>435184 75305-S0A-003 Body Side Moulding Clip Head Size: 6.5mm & 13mm x 18mm Stem Length: 12mm Hole Size: 11mm x 10mm <i>Honda Civic, CR-V, Odyssey & Pilot 1999 - UP</i> Box Qty. 10</p> 

HONDA / ACURA CLIPS & FASTENERS

22 Honda / Acura Clips

435185

91558-SE3-003
Hood Release Cable
Fuel Door Release Cable
Max Cable Dia: 5mm
Overall Height Closed: 17mm
Fits Into 7mm Hole
Acura CL, Legend, NSX, RL, TI, TL, TSX & Vigor and Honda Accord, Civic, CR-V, Insight, Odyssey, Pilot, Prelude & Ridgeline 1991 - UP
Box Qty. 25



435381

91534-SE0-000,
91534-SE0-003
Nylon
Body Side Moulding Clip
Head Size: 8.5mm
Stem Length: 11mm
Hole Size: 8mm
Honda Accord '86 - UP
Box Qty. 25



435425

90652-692-003
Plastic
Grille Lower Moulding Clip
Honda Prelude '79 - '82
Box Qty. 10



435427

91527-SM4-003,
91527-SZ3-003,
91561-S84-A01,
91561-S84-A01-M1, 91527-S23-003
White Nylon
Belt Moulding Clip
Length: 1-5/32"
Width: 51/64"
Honda Accord & Odyssey '90-UP
Box Qty. 25



435428

90604-SH3-014
Plastic Door Belt
Moulding Clip
Honda Civic '88-UP
Box Qty. 15



435429

75329-SM4-013
Red Plastic
Door Moulding Clip
Honda Accord '90
Box Qty. 15



435440

90662-692-003
Plastic
Body Side Moulding Clip
Honda Prelude '79-'82
Box Qty. 25

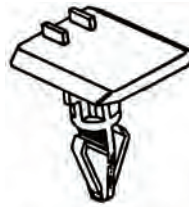

435460

90680-SA5-003
Body Moulding Clip
Honda Accord
Box Qty. 10



435475

90675-692-0031
Body Side Moulding Clip
Length: 15mm
Width: 18mm
Snaps Into 10mm Hole
Honda
Box Qty. 10



435477

90676-SR4-003
(Use with #435478)
Plastic
Rear Window
Lower Moulding Pin Retainer
Head Dia: 12mm
Honda Accord '94, Civic '93 - UP
Box Qty. 15



435481

90679-692-0030
Body Side Moulding Clip
Head Size: 10mm
Stem Length: 12mm
Hole Size: 10mm
*Honda '79 - '83
Prelude and other Models*
Box Qty. 10



435495

91531-ST0-003
Lime Green Plastic
Door Moulding Clip
Honda Civic '95 - UP
Box Qty. 15



435498

91513-SM4-000
Plastic
Rocker Panel
Moulding Retainer w/ Sealer
Length: 20mm, Width: 20mm
Fits Into 12mm Hole
Honda Accord '91 - UP, Civic '92
Box Qty. 15



435502

91526-SM4-004
Black Plastic
Rear Window Holder
With Screw & Sealer
Honda Accord 4 Door 1990 - UP
Box Qty. 5

















435505

90661-ST7-003
Nylon
Bumper Clip
Acura Integra '94 - UP
Box Qty. 5



HONDA / ACURA CLIPS & FASTENERS

 <p>435527 91561-SJD-003 Black & White Nylon Pillar, Rocker Panel & Floor Retainer Top Head Dia: 15mm Middle Hd Dia: 16mm Bottom Hd Dia: 18mm Stem Length: 13mm Fits Into 8mmHole Honda Civic & Pilot 2004 - UP Box Qty. 10</p>	 <p>435528 75305-SHJ-003 White Nylon Front and Side Door Exterior Trim Moulding Clip Width: 13mm Length: 14mm Height: 13mm Honda Odyssey 2005 - UP Box Qty. 15</p>	 <p>435529 75315-STK-A01 White Nylon Front & Rear Door Exterior Trim Moulding Clip Top Hd Size: 12mm x 15mm Bottom Hd: 14mm x 20mm Stem Length: 9mm Hole Size: 8mm Acura RDX 2007 - 09 Box Qty. 15</p>	 <p>435530 91502-S9A-003 White Nylon Front & Rear Bumper Moulding Clip with Sealer Head Size: 14mm x 26mm Stem Length: 15mm Height: 28mm Honda CR-V 2002 - UP Box Qty. 10</p>
 <p>435531 91513-SMG-E11 White Nylon Fender Moulding Clip Top Head: 7mm x 7mm Bottom Head: 10mm x 19mm Stem Length: 6mm Honda CR-V 2009 - UP Box Qty. 25</p>	 <p>435539 90651-T3L-003 Black Nylon Rear Bumper Garnish Ret. Top Head Dia: 13mm Middle Head Dia: 16.5mm Bottom Head Dia: 18mm Stem Dia: 9.3mm Stem Length: 14mm Acura NSX & RDX 2016 - UP Honda Accord & Civic 2013 - 2017 Box Qty. 25</p>	 <p>435560 91527-SM4-003, 91561-S84-A01-M1, 91527-SZ3-003, 91561-S84-A01 White Nylon Belt Moulding Clip Length: 1-5/32" Width: 51/64" Honda Accord, Odyssey '90 - UP Box Qty. 10</p>	<p>NEW</p>  <p>445804 90651-T2M-003 Black Nylon Weatherstrip Retainer Head: 4mm x 10mm Stem Dia: 6.5mm Stem Length: 7mm Honda Accord & Clarity 2014 - UP Box Qty. 25</p>
 <p>445805 90467-11005, 89421-76980, 9926-40-658, 76906-T3000, 76916-T3000 Black Nylon Weatherstrip Clip Head Dia: 14mm Stem Length: 16mm Stem Dia: 10mm Honda, Isuzu, Mazda, Nissan Box Qty. 25</p>	 <p>445806 91560-SP0-003 Front & Rear Door Trim Panel Retainer Top Head Dia: 13mm Stem Length: 12mm Hole Size: 8.5mm Acura Integra & Legend; Honda Accord, Civic, Prelude, Odyssey & Del Sol 1991 - UP Box Qty. 50</p>	 <p>445807 91560-S9A-A01 Blue Nylon Door Panel Retainer Top Head Dia: 13mm Bottom Head: 15mm Stem Length: 13mm Hole Size: 9.5mm Acura TL & TSX; Honda Accord, Civic, CRV & Odyssey 2002 - UP Box Qty. 25</p>	 <p>445883 91560-SM4-003, 6502907 White Nylon Door Trim Panel Retainer Hole Size: 9mm Top Head: 13mm Middle Head: 18mm Bottom Head: 16mm Stem Length: 15mm Honda Accord '90 - UP Dodge Pick-ups '94 - UP Box Qty. 25</p>
 <p>445892 90602-S5A-003 Blue Nylon Cowl Vent Retainer Top Head: 12mm x 13mm Middle Head Dia: 16mm Bottom Head Dia: 18mm Stem Length: 14mm Stem Dia: 8.5mm x 8.5mm Acura RSX; Honda Civic & CR-V 2001 - UP Box Qty. 15</p>	 <p>445893 90602-TA0-003 Blue Nylon Cowl Vent Retainer Top Head: 10mm x 14mm Bottom Head Dia: 16mm Stem Length: 13mm Stem Dia: 8mm Acura TSK & ZDX and Honda Accord & Fit 2008 - UP Box Qty. 10</p>		 <p>445965 67771-22020 Natural & Yellow Nylon Door Panel Retainer Top Head Dia: 12.5mm Bottom head Dia: 16mm Stem Length: 11mm Overall Length: 20mm Stem Dia: 8.5mm Honda, Toyota Box Qty. 25</p>

HONDA / ACURA CLIPS & FASTENERS

22 Honda / Acura Clips



445967
 91566-SP0-003
 Nylon
 Door Trim Panel Retainer
 Top Head Dia: 13mm
 Bottom Head Dia: 18mm
 Stem Length: 14mm
 Fits Into 9mm Hole
 Honda '90 - UP
 Box Qty. 15



465219
 90672-671-003
 Gray Plastic
 Cowl Grille &
 Headliner Clip
 Head Dia: 13mm
 Stem Length: 16mm
 Stem Dia: 5mm
 Honda Accord '86 - UP
 Box Qty. 25



475430
 90677-SE0-003
 Plastic
 Hood Prop Rod Clip
 Rod Size: 8mm
 Honda Accord '86 - UP
 Box Qty. 5



475435
 91604-SD2-013
 Nylon
 Hood Prop Rod Grommet
 Head Dia: 19.94mm
 Stem Length: 6.9mm
 Hole Size: 12.5mm
 Honda Civic '89 - UP
 Box Qty. 5



475438
 91504-SDA-003
 Black Nylon
 Hood Release Cable Clip
 Holds 5mm Dia Cable
 Stem Length: 6.5mm
 Fits Into 7mm Hole
 Honda Accord, Civic & Clarity
 2003 - UP
 Box Qty. 25



475610
 90652-SB2-023
 Nylon
 Windshield Washer
 Hose Retainer
 For 3mm (7/64") I.D.,
 5mm (13/64") O.D. Hose
 Fits Into 7mm (9/32") Square
 Hole
 Honda '86 - UP
 Box Qty. 15



495003
 91591-SJ6-013
 Natural Nylon
 Door Lock Rod Clip
 Rod Size: 5mm
 Fits Into 7mm Hole
 Overall Height: 17mm
 Acura TSX and Honda Accord,
 Odyssey & Ridgeline 2003 - UP
 Box Qty. 15

not actual size



505195
 90672-SAO-0030,
 9928-91-053
 Nylon
 Releasable Cable Strap
 Length: 140mm (5-1/2")
 Max. Bundle Dia.: 30mm
 Fits Into 7mm Hole
 Honda, Mazda
 Box Qty. 25

HONDA / ACURA GLASS SHOP SUPPLIES



465086
 90677-SA6-003
 Plastic Front Windshield
 Pillar Moulding Clip
 Honda Accord '84 - UP
 Box Qty. 10

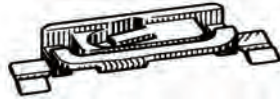

465087
 90694-SB0-0030
 Plastic
 Windshield Moulding Clip
 Honda Prelude '83 - UP
 Box Qty. 25



465089
 91534-SM4-003
 White Plastic
 Windshield Upper
 Moulding Clip
 Honda Accord '90 - UP
 Acura Legend '91 - UP
 Box Qty. 15



465200
 90672-SD2-003
 Plastic
 Front Door Sash
 Moulding Clip w/Sealer
 Acura Integra '88 - UP
 Box Qty. 15













465204
 90652-SD4-003
 Plastic
 Front Door Reveal
 Moulding Clip
 Acura Legend '86 - UP
 Box Qty. 15

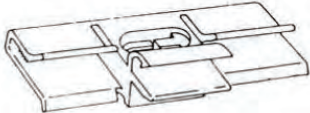

465205
 90651-SD4-003
 Plastic
 Front Door Sash
 Moulding Clip w/Sealer
 Acura Legend '86 - UP
 Box Qty. 15

HONDA / ACURA GLASS SHOP SUPPLIES

		 <p>465209 60658-SB3-000 Black Plastic Cowl Screen Screw Cover Honda Civic '84 - UP Box Qty. 15</p>	 <p>465210 91525-SM4-003 (Use with #465211) Pink Plastic Windshield Side Moulding Clip Honda Accord '90 - UP Box Qty. 15</p>
 <p>465213 90683-SD2-003, 67811-SG-003 Plastic Windshield Moulding Clip Narrow Groove Acura Integra '86 - UP Box Qty. 10</p>	 <p>465214 90658-SB0-0030 Reveal Moulding Clip Quarter Window Self Adhesive Plastic Honda Prelude '83 - UP Box Qty. 10</p>	 <p>465243 91573-SV4-003 (Use with #465244) Blue Plastic Windshield Side Moulding Clip Honda Accord '94 Box Qty. 10</p>	 <p>465244 91528-SP0-003 (Use with #465243) Yellow Plastic Windshield Side Moulding Clip Acura Legend 2 & 4 DR, Honda Accord '94 - UP Box Qty. 10</p>
 <p>465253 91511-SR3-003 (Use with #465400) Orange Plastic Windshield Side Moulding Clip Honda Civic '92 - UP Box Qty. 15</p>	 <p>465256 91572-SV2-003 White Plastic Windshield Front Side Moulding Clip Honda Accord '94 - UP Box Qty. 10</p>	 <p>465257 91570-SZA-305 Windshield Mldg. Clip w/Sealer Width: 8mm Length: 82mm Acura ZDX, Honda Odyssey and Pilot 2009 - UP Box Qty. 5</p>	 <p>465400 91520-SR3-003 (Use with #465253) Red Nylon Windshield Side Moulding Clip Honda Civic '92 - UP Box Qty. 15</p>
 <p>505210 91512-SE0-003 Gray Nylon Windshield Washer Hose Clip Honda Accord '86 - UP Box Qty. 15</p>	 <h1>HONDA</h1>		

BLANK

HYUNDAI CLIPS & FASTENERS

<p>NEW</p>  <p>HY18R-P <i>HY18R-P</i> Key Blank for Kia and Hyundai automobiles. <i>Hyundai, Kia</i> Box Qty. 5</p>	<p>NEW</p>  <p>KK10-P <i>KK10-P</i> Key Blank for Kia and Hyundai automobiles. <i>Hyundai, Kia</i> Box Qty. 5</p>	<p>NEW</p> <p>38519 <i>14160-03103</i> Dia: 3.2mm (1/8") Grip: 4.0mm - 7.9mm (.158" - .311") Flange Dia: 6.3mm (1/4") Black Aluminum Rivet Steel Mandrel Front/Rear Bumper <i>Hyundai Accent, Azera, Elentra, Equus, Santa Fe, Santa Fe Sport, Tuscon, Veracruz & Kia Optima, Rondo, Sorento & Soul 2007 - UP</i> Box Qty. 25</p> 	<p>38581 <i>14160-03133</i> Dia: 3.2mm (1/8") Grip: 0.8mm-4.8mm (.032" - .189") Flange Dia: 6.3mm (1/4") Black Aluminum Rivet Steel Mandrel Front/Rear Bumper <i>Hyundai Accent, Genesis, Santa Fe, Sonata & Veloster and Kia Borrego, K900, Rio, Sorento & Sportage 2006 - UP</i> Box Qty. 25</p> 
<p>NEW</p>  <p>200000 <i>12210-06203, 12342-06203</i> Black Zinc M6-1.0 x 19mm Phillips Round Head Thread Cutting Screw with Sems® Flat & Lock Washer Flat Washer Dia: 13mm Lock Washer Dia: 11mm <i>Hyundai Elantra, Genesis, Scoupe, Santa Fe & Tiburon 1990 - 2014</i> Box Qty. 50</p>	<p>NEW</p>  <p>200001 <i>12291-06303</i> Black Zinc M6-1.0 x 29mm Phillips Round Head License Plate Screw with Sems® Flat & Lock Washer Flat Washer Dia: 13mm Lock Washer Dia: 11mm <i>Hyundai Equus 2010 - 2015 Genesis 2008 - 2014</i> Box Qty. 25</p>	 <p>200196 Black Zinc M6-1.0 x 16mm Phillips Round Washer Head Thread Cutting License Plate Screw Washer Head O.D.:14mm <i>Hyundai</i> Box Qty. 50</p>	<p>NEW</p>  <p>292003 <i>97519-22000</i> White Nylon Bumper & Side Marker Lamp Screw Grommet w/Sealer Screw Size: M3.5 (#6) Head Dia: 14mm Stem Length: 16mm Fits Into 7mm x 7mm Hole <i>Hyundai Accent, Elantra, Excel, Santa Fe, Scoupe, Sonata, Tiburon, Tuscon & Veloster 1985 - UP</i> Box Qty. 50</p>
<p>NEW</p>  <p>292004 <i>86699-1E010</i> Gray Nylon Bumper Screw Grommet Screw Size: M4.8 (#10) Head Size: 12mm x 12mm Stem Length: 8mm Overall Height: 10mm <i>Hyundai Accent, Tucson & Veloster 2009 - UP: Kia Optima & Optima Hybrid 2010 - 2013</i> Box Qty. 25</p>	<p>NEW</p>  <p>292005 <i>14910-04000, 92561-25000</i> Natural Nylon License Plate Grommet Screw Size: M3.5 (#6) Head Dia: 12mm Stem Length: 7mm Overall Height: 9mm <i>Hyundai Accent, Azera, Elantra, Entourage, Excel, Ioniq, Santa Fe, Scoupe, Tiburon, Tucson, Veloster, XG300 & XG350 1985 - UP Kia Optima & Rio 2010 - 2016</i> Box Qty. 25</p>	 <p>292041 <i>87714-FD200, 87756-1C000</i> White Nylon Body Side Moulding Nut Screw Size: M4.2 (#8) Head Size: 13mm x 13mm Stem Length: 10mm <i>Hyundai Veracruz and Kia Rio 2009 - UP</i> Box Qty. 15</p>	 <p>292043 <i>81385-38000</i> Yellow Nylon Interior Trim Grommet Screw Size: 4.8mm (#10) Head Dia: 14.7mm Stem Length: 8mm <i>Hyundai</i> Box Qty. 25</p>
 <p>292044 <i>87758-37000</i> White Nylon w/Sealer Fender & Rocker Moulding Screw Grommet Screw Size: 4.2mm (#8) Head Dia.: 17mm x 17mm Stem Length: 14mm <i>Hyundai Accent & Sonata 99 - UP Kia 2001 - UP</i> Box Qty. 25</p>	 <p>292045 <i>87756-35000</i> White Nylon Body Side Rocker Moulding Grommet Screw Size: 5.5mm (#12) Head Size: 13mm x 13mm Stem Length: 8.5mm Fits Into 9mm Hole <i>Hyundai Accent, Santa Fe, Sonata, Tiburon</i> Box Qty. 25</p>	 <p>292051 <i>84219-3L000</i> Black Nylon Engine Under Cover/Rear Bumper Moulding Grommet Screw Size: M6-1.0 Head Dia: 20mm Stem Dia: 14mm Stem Length: 7mm Overall Length: 9.5mm <i>Hyundai Azera, Equus, Genesis, Santa Fe, Sonata and Kia Forte, Optima & Rio 2010 - UP</i> Box Qty. 25</p>	 <p>292094 <i>86848-22000, 86848-C8000</i> Fender Apron Nylon Nut Screw Size: M4.8 (#10) Head Dia: 16mm Stem Length: 11mm Fits Into 8.5mm Square Hole <i>Hyundai Accent, Elantra, Ioniq, Sonata & Tiburon 1995 - UP Kia Cadenza & Optima 2016 - UP</i> Box Qty. 25</p>

HYUNDAI CLIPS & FASTENERS

Hyundai Clips

23



292095
86910-21010
Bumper Screw
Grommet With Sealer
Screw Size: M4.8 (#10)
Head Dia: 18mm
Stem Length: 21mm
Hyundai Azera 2009 - UP
Box Qty. 15



292100
92351-37000
Natural Nylon
Headlight Grommet
Head Dia: 15mm
Stem Length: 8mm
Fits Into 10mm Hole
Hyundai XG300/350 2001 - UP
Kia Rio & Spectra 2000 - UP
Box Qty. 25



292102
14913-05010
White Nylon
Front & Rear
Bumper/Fender Nut
Screw Size: M4.8 (#10)
Head Size: 12mm x 12mm
Stem Length: 11mm
Hyundai Elantra, Sonata, XG300 & XG350 1992 - UP
Kia Magentis & Optima 1992 - UP
Box Qty. 25



292103
86625-3S000
White Nylon
Bumper Cover
Screw Grommet w/Sealer
Screw Size: M4.8 (#10)
Top Head Size: 14mm x 18mm
Bottom Head Dia: 18mm
Stem Length: 18mm
Hyundai Santa Fe 2013 - UP
Box Qty. 25



292106
87756-26900
White Nylon
Emblem & Rocker
Moulding Nut w/Sealer
Screw Size: M3.5 (#6)
Head Size: 13mm x 13mm
Stem Dia: 12mm
Stem Length: 10mm
Hyundai Genesis & Santa Fe 2007 - UP
Box Qty. 50



292107
87756-34520
Green Nylon
Fender & Door
Moulding Nut
Screw Size: M3.5 (#6)
Head Size: 13mm x 13mm
Stem Dia: 13.5mm
Stem Length: 8mm
Hyundai Tuscon 2005 - 2009
Kia Optima 2001 - 2006
Box Qty. 50



292111
86518-3M000
Plastic
Bumper Grommet
Screw Size: M3.5 (#6)
Head Size: 8mm x 10mm
Stem Length: 12mm
Hyundai Azera, Sonata 2012-UP
Kia Cadenza 2014-UP
Box Qty. 25

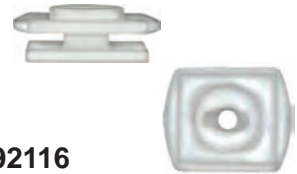

292116
87701-3B000
Plastic
Body Side Moulding Nut
Screw Size: M3.5 (#6)
Top Head: 16mm x 20mm
Bottom Head: 16mm x 16mm
Hyundai Tuscon 2004-09
Box Qty. 50



NEW
292122
84145-26000
Black Nylon
Wheel Well Liner &
Splash Shield Nylon Nut
Hex Size: 14mm
Flange Dia: 30mm
Overall Height: 10mm
Hyundai Accent, Elentra, Equus,
Genesis, Genesis Coupe, Genesis
G90, Santa Fe, Sonata, Tuscon,
Veloster & Veracruz 2000 - UP
Box Qty. 15



NEW
292123
86625-1E000
White Nylon
Bumper Bracket Screw
Grommet With Sealer
Screw Size: M4.8 (#10)
Top Head: 14mm x 18mm
Bottom Head Dia: 18mm
Stem Size: 8.5mm x 8.5mm
Stem Length: 18mm
Hyundai Elantra GT 2013 - UP
Kia Niro & Sorento 2016 - UP
Box Qty. 25



302053
86825-28000
Nylon "U" Nut
Screw Size: M6 (#14)
Panel Range: Up To 1.5mm
Center Of Hole
to Edge: 8mm
Hyundai Accent & Elantra 1995-UP
Kia 1995-UP
Box Qty. 25



415255
E7GZ-6120586-B,
G031-58-762,
67868-89101, 67867-28030,
67867-89103, 86438-2B000
Natural Nylon
Weatherstrip Retainer
Head Size: 5mm x 15mm
Stem Length: 10mm
Fits Into 5mm Hole
Toyota 4-Runner 1983 - 89
Mazda 1996 - UP, Ford 1996 - UP
Hyundai 2007-UP and Kia 2009-UP
Box Qty. 50



415965
96057846,
90467-07041,
90467-07041-B2,
90467-07076-C0, 86155-2200
Black Nylon
Push-Type Retainer
Head Dia: 15mm
Stem Length: 8mm (ex pin)
Fits Into 6.3mm Hole
Geo Metro & Tracker '89 - UP
Toyota & Hyundai
Box Qty. 10



415981 Box 25
415980
91502-SM4-0000,
86590-35000
Nylon
Bumper Fascia
Screw-Type Ret.
Flange Dia: 20mm
Stem Length: 27mm
Fits Into 10mm Hole
Honda Accord '90-UP
Hyundai 2005-UP
Box Qty. 15







NEW
415999
0B102-68865
Black Nylon
Trunk Trim Retainer
Head Dia: 20mm
Stem Dia: 7mm
Stem Length: 13mm
Hyundai Accent, Genesis & Tuscon
2005 - 2017
Kia Rio, Rondo, Sedona, Sorento,
Soul & Sportage 2000 - 2017
Box Qty. 25



416049 Box 25
416025
B092-51-833,
MB-455-56143,
W705845-S300, 86590-28000
Black Nylon
Screw-Type Retainer
Head Dia.: 18mm
Stem length: 12mm
Fits Into 8mm Hole
Mazda & Ford Aspire,
Hyundai
Box Qty. 10

HYUNDAI CLIPS & FASTENERS

 <p>416185 81126-37010 Black Nylon Hood Insulation Retainer Head Dia.: 26mm Stem Dia.: 12mm Stem Length: 14mm <i>Hyundai Elantra, Sonata 1995-UP Kia Optima 1995-UP</i> Box Qty. 15</p>	 <p>416203 87378-3N000 Blue Nylon License Plate Panel Retainer w/Sealer Top Head Dia: 15mm Middle Hd Dia: 16mm Bottom Hd Dia: 18mm Stem Dia: 10.5mm Stem Length: 39mm <i>Hyundai Equus 2011 - UP</i> Box Qty. 25</p>	 <p>416205 85495-2E050 Black Nylon Headliner Retainer Top Head Dia: 14mm Middle Head Dia: 15mm Bottom Head Dia: 16mm Stem Dia: 10.3mm Stem Length: 10mm <i>Hyundai & Kia</i> Box Qty. 50</p>	 <p>416255 86157-37000 Black Nylon Hood Mounting Screw-Type Retainer Head Diameter: 10mm Stem Length: 13mm Fits Into 5mm Hole <i>Hyundai Azera 2009 - UP</i> Box Qty. 25</p>
 <p>416256 86155-2H100 Black Nylon Cowl & Bumper Push-Type Retainer Head Diameter: 15mm Stem Length: 10mm Fits Into 7mm Hole <i>Hyundai Genesis & Veracruz; Kia Rio 2009-UP</i> Box Qty. 15</p>	 <p>416257 86434-4A000 Black Nylon Hood Seal Retainer Head Size: 6mm x 16mm Stem Diameter: 8mm Stem Length: 14mm <i>Hyundai Elantra, Sonata & Tucson; Kia Sportage 2009-UP</i> Box Qty. 50</p>	 <p>416258 86438-4A100 Black Nylon Hood Seal Retainer Head Size: 5mm x 13mm Stem Diameter: 8mm Stem Length: 11mm <i>Hyundai Elantra & Tucson and Kia Forte & Sportage 2009-UP</i> Box Qty. 50</p>	 <p>416286 86438-1R000 Plastic Hood Seal Retainer Hole: M6 Head: 5mm x 13mm Stem Lgth: 10mm O/L: 12mm <i>Hyundai Accent 2011-UP</i> Box Qty. 50</p>
<p>416287 86595-2T500, 14206-08250-B Bumper, Engine Under Cover & Fender Liner Push-Type Retainer Hole: M8, Flange: 18mm Stem Length: 14mm, P.R: 8mm <i>Hyundai Elantra, Equus, Genesis, Santa Fe & Sonata; Kia Forte, K900, Optima, Sedona & Sorento 2013-UP</i> Box Qty. 50</p>		<p>416289 87756-2W000 Plastic Door Moulding Retainer Hole: M5 Head: 5mm x15mm Stem Dia: 7mm Stem Length: 8mm <i>Hyundai Santa Fe; Kia Sorento 2013-UP</i> Box Qty. 100</p> 	<p>416337 909130067, 86590-3S000 Black Nylon Engine Cover and Fender Liner Screw-Type Retainer Head Dia: 18mm Stem Length: 10mm Fits Into 8mm Hole <i>Subaru B9 Tribeca, Forester, Legacy & Outback & Tribeca 2005 - UP Hyundai Azera, Elantra, Genesis & Sonata and Kia Cadenza & Optima 2011-UP</i> Box Qty. 15</p> 
<p>NEW</p> <p>416302 86590-1W000 Black Nylon Bumper Cover Push-Type Retainer Head Dia: 18mm Stem Length: 11mm Fits Into 8mm Hole <i>Hyundai Equus & Genesis 2014 - 2016 Kia Rio & Sedona 2012 - UP</i> Box Qty. 25</p> 	<p>435004 87756-2J000 Pink Nylon Side Garnish Mldg Clip w/Sealer Head Size: 13mm x 16mm Stem Dia: 11.5mm Stem Length: 9mm <i>Hyundai Santa Fe & Tuscon 2013 - UP</i> Box Qty. 15</p> 	<p>NEW</p> <p>435473 85818-37000 White Nylon Moulding Clip With Sealer Top Head: 12.5mm x 14mm Bottom Head Dia: 16mm Stem Dia: 10mm Stem Length: 12.5mm <i>Hyundai Accent, Elantra & Tucson and Kia Optima & Rio 2012 - UP</i> Box Qty. 25</p> 	<p>NEW</p> <p>435474 87715-3S000 White Nylon Waist Line Moulding Trim Clip With Sealer Head Size: 5mm x 14mm Stem Size: 5mm x 11mm Stem Length: 9mm <i>Hyundai Sonata & Sonata Hybrid 2009 - UP</i> Box Qty. 25</p> 

HYUNDAI CLIPS & FASTENERS



435497
87758-35000
Rocker Moulding Clip
Top Head: 10mm x 11mm
Bottom Head: 14mm x 19mm
Stem Length: 10mm
Hyundai Accent, Santa Fe & Tiburon 1995-UP
Box Qty. 15



435499
87756-2G000
Black Nylon
Body Side Moulding Clip with Sealer
Head Size: 8mm x 22mm
Stem Length: 10mm
Hyundai Sonata; Kia Magentis & Optima 2006-UP
Box Qty. 15



435501
87758-3L000
Blue Nylon
Moulding Clip with Sealer
Top Head: 16mm x 18mm
Bottom Head: 18mm x 20mm
Stem Length: 15mm
Hyundai Azera & Genesis 2009-UP
Box Qty. 15



435503
87759-27000
Yellow Nylon
Rocker Moulding Grommet w/ Sealer
Screw Size: M4.2 (#8)
Head Size: 17mm x 25mm
Stem Length: 16mm
Hyundai Accent, Genesis, Santa Fe, Sonata, Tiburon & Veracruz 1995 - UP
Box Qty. 25



435504
87702-H1000
Rocker Moulding Clip
Top Head: 11mm x 15.5mm
Bottom Head Dia: 16mm
Stem Length: 12mm
Hyundai Genesis & Sonata; Kia Sorento 2009-UP
Box Qty. 15



435512
87756-2E000
Moulding Clip w/Sealer
Top Head: 10mm x 12mm
Bottom Head: 14mm x 20mm
Stem Length: 10mm
Hyundai Entourage, Tucson & Veracruz; Kia Optima, Sedona, Spectra & Sportage 2005-UP
Box Qty. 15



435537
87719-3D000
Natural Nylon
Body Side Moulding Clip
Head Size: 6mm x 14mm
Base Diameter: 14mm
Overall Height: 6mm
Hyundai Elantra & Sonata 2004-UP
Box Qty. 15



435600
87756-3D000
White Nylon
Body Side Moulding Clip with Sealer
Screw Size: M4.2 (#8)
Head Size: 14mm x 14mm
Stem Length: 10mm
Hyundai Elantra, Sonata 2002 - UP
Box Qty. 15



435601
87756-38000
Black Nylon
Body Side Moulding Clip with Sealer
Top Head: 8mm x 9mm
Bottom Head: 14mm x 18mm
Stem Length: 10mm
Hyundai Elantra & Sonata 2002-UP; Kia Rio 2010-UP
Box Qty. 15



435602
87758-3D000
Yellow Nylon
Rocker Panel Mldg. Clip with Sealer
Top Hd Size: 16mm x 20mm
Bottom Head: 14mm x 18mm
Stem Length: 10mm
Hyundai Elantra & Sonata 2002-UP
Box Qty. 15



435603
86360-3L000
White Nylon
Front Hood Moulding Clip w/Sealer
Top Head: 10mm x 12mm
Bottom Head: 13mm x 15mm
Stem Length: 11mm
Hyundai Azera, Equus & Sonata 2006 - UP
Box Qty. 25



435604
87703-H1000
Yellow Nylon
Hood Moulding Clip w/Sealer
Top Head: 12mm x 16mm
Bottom Head Dia: 16mm
Stem Dia: 9.5mm
Stem Length: 10mm
Hyundai Elantra 2001-2006
Box Qty. 25



435606
87756-1F000
Blue Nylon
Fender Flare, Rocker, Door & Exterior Mldg Clip w/Sealer
Top Head: 10mm x 12mm
Bottom Head: 14mm x 20mm
Stem Dia: 14mm
Stem Length: 10mm
Hyundai Santa Fe 2013-UP; Kia Sportage 2011-UP
Box Qty. 25















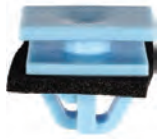



435607
87756-37000
White Nylon
Rocker Moulding Clip w/Sealer
Top Head: 16mm x 20mm
Bottom Head Dia: 15mm
Stem Length: 10mm
Fits Into 9mm Hole
Hyundai Sonata 2002-2005
Box Qty. 25



435608
87770-27000
White Nylon
Rocker Moulding Clip w/Sealer
Top Head: 12mm x 15mm
Bottom Head: 14mm x 36mm
Stem Dia: 14mm
Stem Length: 10mm
Hyundai Tiburon 1997-2001
Box Qty. 25

HYUNDAI CLIPS & FASTENERS

 <p>435610 86179-2V000 White Nylon Garnish Moulding Retainer with Sealer Top Head: 13mm x 13mm Bottom Head Dia: 20mm Stem Length: 11mm Fits into 7.5mm Hole Hyundai Veloster 2012-UP Box Qty. 25</p>	 <p>435611 86179-2V020 Blue Nylon Garnish Moulding Retainer with Sealer Top Head: 10.5mm x 12mm Bottom Head Dia: 12mm Stem Length: 11mm Fits into 7.5mm Hole Hyundai Veloster 2012-UP Kia Soul 2014-UP Box Qty. 25</p>	 <p>435612 86438-2T000 Black Nylon Hood/Bumper Seal Retainer Head Size: 4.5mm x 13mm Stem Diameter: 7.6mm Stem Length: 7.5mm Hyundai Elantra, Genesis 2013-UP Kia K900, Optima 2011-UP Box Qty. 50</p>	 <p>435613 87716-2W000 White Nylon Fender, Body Side & Rocker Moulding Clip with Sealer Top Head: 10mm x 12mm Bottom Head: 14mm x 20mm Stem Length: 11mm Hyundai Santa Fe 2012-UP Kia Borrego 2007-2011 & Kia Niro 2017-UP Box Qty. 50</p>
 <p>435614 87756-D300 Blue Nylon Door Moulding Clip with Sealer Top Head: 14mm x 18mm Bottom Head: 16mm x 20mm Stem Length: 10mm Hyundai Tucson 2016-UP Box Qty. 25</p>	 <p>435615 87758-2S000 White Nylon Rocker Moulding Clip with Sealer Head Size: 17mm x 25mm Stem Length: 14mm Hyundai Tucson 2016-UP Box Qty. 25</p>	 <p>435616 87758-38000 White Nylon Rocker Moulding Clip with Sealer Top Head: 10mm x 13mm Bottom Head: 7mm x 16mm Stem Length: 9mm Hyundai Sonata '99-2001 Kia Optima & Sorento 2001-2009 Box Qty. 50</p>	 <p>435617 87759-2M000 Red Nylon Rocker Panel Moulding Clip with Sealer Head Size: 17mm x 25mm Stem Length: 13mm Hyundai Genesis 2008-UP Box Qty. 50</p>
 <p>435618 87759-3V000 Yellow Nylon Rocker Panel Moulding Clip with Sealer Top Head: 12mm x 12mm Bottom Head: 14mm x 20mm Stem Length: 17mm Hyundai Azera 2012-UP Kia K900 2015-UP Box Qty. 50</p>	 <p>445833 82315-38000, 94530565 Natural Nylon Door Trim Panel Retainer Hole Size: 11/32" (9mm) Top Head Dia.: 13mm Stem Length: 10mm Hyundai Accent, Santa Fe, Sonata Tiburon & XG300/350 1999-UP Kia Optima, Rio & Sorento 2001-UP Chevrolet Aveo 2004-UP Box Qty. 25</p>	 <p>445834 85849-3B000 White Nylon Headliner & Trim Panel Retainer Top Head Dia: 13mm Middle Head Dia: 16mm Bottom Head Dia: 16mm Stem Dia: 10mm Stem Length: 12mm Hyundai 2001 - UP Box Qty. 25</p>	 <p>445840 82315-2P000 White Nylon Trim Panel Retainer Top Head Dia: 13mm Middle Head Dia: 15mm Bottom Head Dia: 18mm Stem Dia: 11mm Stem Length: 13mm Hyundai & Kia 1999 - UP Box Qty. 50</p>
 <p>445835 82315-27000 Pink Nylon Trim Panel Retainer Top Head Dia: 15mm Middle Head Dia: 16mm Bottom Head Dia: 18mm Stem Dia: 10mm Stem Length: 12mm Hyundai & Kia 2003 - UP Box Qty. 25</p>	 <p>445843 82315-22000 White Nylon Trim Panel Retainer Top Head Dia: 13mm Middle Head Dia: 16mm Bottom Head Dia: 18mm Stem Dia: 9mm Stem Length: 15mm Hyundai Accent 1995 - 1999 Box Qty. 50</p>	 <p>445844 82315-33020 White Nylon Trim Panel Retainer Top Head Dia: 15mm Middle Head Dia: 16mm Bottom Head Dia: 18mm Stem Dia: 10.7mm Stem Length: 12mm Hyundai & Kia 1995 - UP Box Qty. 50</p>	 <p>445840 82315-2P000 White Nylon Trim Panel Retainer Top Head Dia: 13mm Middle Head Dia: 15mm Bottom Head Dia: 18mm Stem Dia: 11mm Stem Length: 13mm Hyundai & Kia 1999 - UP Box Qty. 50</p>

HYUNDAI CLIPS & FASTENERS

Hyundai Clips

23

445845

82315-36000
92552-36000

White Nylon
Trim Panel Retainer w/ Sealer
Top Head Dia: 13mm
Middle Head Dia: 15mm
Bottom Head Dia: 18.5mm
Stem Dia: 10.3mm
Stem Length: 15mm
Hyundai Accent & Elantra
1995 - 2000
Box Qty. 25



445846

84747-2L000

White Nylon
Trim Panel &
Dash Console Clip
Overall Length: 21mm
Hyundai Elantra, Entourage, Sonata
& *Volster* 2006 - UP,
Kia Forte, Sorrento & Soul 2010-UP
Box Qty. 50



445847

85506-4A000

White Nylon
Trim Panel &
Window Garnish Retainer
Top Head Dia: 13mm
Middle Head Dia: 16mm
Bottom Head Dia: 15mm
Stem Dia: 9.6mm
Stem Length: 13mm
Hyundai Tuscon &
Kia Sorrento 2003 - UP
Box Qty. 50



445849

82315-2W000

Green Nylon
Door Panel, Interior
Trim & Garnish Retainer
Top Head Dia: 13mm
Middle Head Dia: 16mm
Bottom Head Dia: 18mm
Stem Dia: 10mm
Stem Length: 10mm
Overall Length: 17mm
Hyundai Santa Fe, Sonata 2013-UP
Kia Forte & K900 2014-UP
Box Qty. 25



445850

85849-3L000

Gray Nylon
Garnish & Interior
Moulding Retainer
Top Head Dia: 13mm
Middle Head Dia: 16.5mm
Bottom Head Dia: 18mm
Stem Length: 15mm
Overall Length: 21mm
Fits into 9mm Hole
Hyundai Azera, Sonata, Tuscon,
2006 - UP; *Kia Forte* 2010-UP
Box Qty. 50



445851

85858-3S000

Black Nylon
Interior Trim Clip
Overall Height: 16mm
Width at Bottom: 11mm
Hyundai Azera, Sonata 2011-UP
Kia Optima, Soul 2011-UP
Box Qty. 100



445852

85859-3S100

Black Nylon
Interior Trim Clip
Overall Height: 19mm
Width at Bottom: 15mm
Hyundai Accent, Azera, Elantra,
Sonata 2011-UP
Kia Optima, Rio 2011-UP
Box Qty. 100



NEW

445861

82134-22000

Black Nylon
Door Weatherstrip Clip
Height: 14mm
Length: 20mm
Hyundai Accent, Elantra, Sante Fe,
Sonata, Tucson & Veloster
1993 - UP; *Kia Forte* 2014 - 2017
Box Qty. 25



NEW

445862

82134-3L000

Black Nylon
Weatherstrip Clip
Width: 12mm
Length: 18mm
Hyundai Azera, Elantra, Equus,
Genesis, Santa Fe & Sonata and
Kia Optima & Sedona 2005 - 2017
Box Qty. 50



NEW

465000

86143-3S000

White Nylon
Windshield Moulding Clip
Overall Length: 60mm
Hyundai Sonata 2011 - 2015
Box Qty. 25



475076

86593-24000

Stainless Steel
Bumper & Grille Retainer
Width: 13mm
Length: 30mm
Hyundai Accent, Santa Fe & Sonata
1995 - UP
Box Qty. 25



475201

81174-2L000

Black Nylon
Hood Prop Rod Clip
Holds 8mm Rod
Width: 20mm
Length: 24mm
Hyundai Accent & Elantra 2008 - UP
Kia Forte & Soul 2009 - 2013
Box Qty. 15



475202

81174-21000,
81174-11011,
81174-21010

Black Nylon
Hood Prop Rod Clip
Holds 8mm Rod
Bottom Base: 20mm x 20mm
Stem Length: 9mm
Overall Length: 25mm
Hyundai Elantra, Sonata, Tucson &
Veloster 1997 - UP
Box Qty. 15



HYUNDAI

BLANK

BLANK









ISUZU CLIPS & FASTENERS

 <p>292215 90189-05012, 8-94134-027-0 Nylon Screw Grommet Screw Size: #6 Width: 16mm Length: 12mm Snaps Into 6mm x 10mm Hole <i>Toyota, Isuzu</i> Box Qty. 25</p>	<p>415759 Box 50</p>  <p>415761 94218027, H200-50-715 8942180270, 58974-00008, B092-50-715, BF67-S0715, MB153825, 90467-13011, 90467-12020 Black Nylon Grille Headlight Clip Width: 13mm Length: 22mm <i>Ford, GM, Toyota, Mitsubishi, Isuzu, Honda, Plymouth, Mazda</i> Box Qty. 25</p>	<p>415776 Box 25</p>  <p>415775 8942431900, 9841690750, 1395-68-676, 9926-50-635, 75775-41300, 23270-3895, 80915-29A66 Screw-Type Drive Retainer Flange Dia: 20mm Stem Length: 9mm Fits Into 6mm Hole <i>Honda, Nissan, Isuzu</i> Box Qty. 10</p>	 <p>415920 94221150, 63844-D0100, 8942211500 Nylon Screw-Type Retainer Screw: 5mm x 14mm Head Size: 14mm x 22mm Stem Length: 9mm Fits into a 7mm Hole <i>GM, Nissan, Isuzu</i> Box Qty. 25</p>
<p>415925 30012018, 90684-SA5-0030, 90684-SA5-003, 874-298-1190, 8942981190, 10998-30880 Nylon Push-Type Retainer Head Dia: 15mm Stem Length: 11mm Fits in a 6mm Hole <i>Nissan, Honda, Isuzu, GM</i> Box Qty. 25</p> 	<p>416130 94145515, 89414-55150 Black Nylon Inner Fender Shield & Bumper Fascia Retainer Head Dia: 18mm Stem Length: 23mm Stem Dia: 7mm <i>Geo Storm & Isuzu '90 - UP</i> Box Qty. 25</p> 	<p>445815 67771-01010, 67771-12010, 8942264920, 9927-40-825 White Nylon Door Panel Retainer Top Head Dia.: 13mm Bottom Head Dia.: 18mm Stem Length: 14mm Overall Length: 21mm Fits Into 9mm Hole <i>Isuzu, Mazda, Toyota</i> Box Qty. 25</p> 	

ISUZU

BLANK

KIA CLIPS & FASTENERS

<p>NEW</p>  <p>HY18R-P HY18R-P Key Blank for Kia and Hyundai automobiles. Hyundai, Kia Box Qty. 5</p>	<p>NEW</p>  <p>KK10-P KK10-P Key Blank for Kia and Hyundai automobiles. Hyundai, Kia Box Qty. 5</p>	<p>NEW</p> <p>38519 14160-03103 Dia: 3.2mm (1/8") Grip: 4.0mm - 7.9mm (.158" - .311") Flange Dia: 6.3mm (1/4") Black Aluminum Rivet Steel Mandrel Front/Rear Bumper Hyundai Accent, Azera, Elantra, Equus, Santa Fe, Santa Fe Sport, Tuscon, Veracruz & Kia Optima, Rondo, Sorento & Soul 2007 - UP Box Qty. 25</p> 	<p>38581 14160-03103 Dia: 3.2mm (1/8") Grip: 0.8mm-4.8mm (.032" - .189") Flange Dia: 6.3mm (1/4") Black Aluminum Rivet Steel Mandrel Front/Rear Bumper Hyundai Accent, Genesis, Santa Fe, Sonata & Veloster and Kia Borrego, K900, Rio, Sorento & Sportage 2006 - UP Box Qty. 25</p> 
<p>NEW</p> <p>292004 86699-1E010 Gray Nylon Bumper Screw Grommet Screw Size: M4.8 (#10) Head Size: 12mm x 12mm Stem Length: 8mm Overall Height: 10mm Hyundai Accent, Tucson & Veloster 2009 - UP Kia Optima & Optima Hybrid 2010 - 2013 Box Qty. 25</p> 	<p>NEW</p> <p>292005 14910-04000, 92561-25000 Natural Nylon License Plate Grommet Screw Size: M3.5 (#6) Head Dia: 12mm Stem Length: 7mm Overall Height: 9mm Hyundai Accent, Azera, Elantra, Entourage, Excel, Ioniq, Santa Fe, Scoupe, Tiburon, Tucson, Veloster, XG300 & XG350 1985 - UP Kia Optima & Rio 2010 - 2016 Box Qty. 25</p> 	<p>292041 87714-FD200, 87756-1C000 White Nylon Body Side Moulding Nut Screw Size: M4.2 (#8) Head Size: 13mm x 13mm Stem Length: 10mm Hyundai Veracruz and Kia Rio 2009 - UP Box Qty. 15</p> 	<p>292042 86699-2D000 White Nylon Front / Rear Bumper Cover Grommet Head Size: 11mm x 11mm Stem Length: 9mm Overall Length: 13.5mm Kia Forte 2010-UP Box Qty. 25</p> 
<p>292044 87758-37000 White Nylon w/Sealer Fender & Rocker Moulding Grommet Screw Size: 4.2mm (#8) Head Dia.: 17mm x 17mm Stem Length: 14mm Hyundai Accent & Sonata 99 - UP Kia 2001 - UP Box Qty. 25</p> 	<p>292051 84219-3L000 Black Nylon Engine Under Cover/Rear Bumper Moulding Grommet Screw Size: M6-1.0 Head Dia: 20mm Stem Dia: 14mm Stem Length: 7mm Overall Length: 9.5mm Hyundai Azera, Equus, Genesis, Santa Fe, Sonata and Kia Forte, Optima & Rio 2010 - UP Box Qty. 25</p> 	<p>292094 86848-22000, 86848-C8000 Fender Apron Nylon Nut Screw Size: M4.8 (#10) Head Diameter: 16mm Stem Length: 11mm Fits Into 8.5mm Square Hole Accent, Elantra, Ioniq, Sonata & Tiburon 1995 - UP Kia Cadenza & Optima 2016 - UP Box Qty. 25</p> 	<p>292100 92351-37000 Natural Nylon Headlight Grommet Head Dia: 15mm Stem Length: 8mm Fits Into 10mm Hole Hyundai XG300/350 2001 - UP Kia Rio & Spectra 2000 - UP Box Qty. 25</p> 
<p>292102 14913-05010 White Nylon Front & Rear Bumper/Fender Nut Screw Size: M4.8 (#10) Head Size: 12mm x 12mm Stem Length: 11mm Hyundai Elantra, Sonata, XG300 & XG350 1992 - UP Kia Magentis & Optima 1992 - UP Box Qty. 25</p> 	<p>292107 87756-34520 Green Nylon Fender & Door Moulding Nut Screw Size: M3.5 (#6) Head Size: 13mm x 13mm Stem Dia: 13.5mm Stem Length: 8mm Hyundai Tucson 2005 - 2009 Kia Optima 2001 - 2006 Box Qty. 50</p> 	<p>292111 86518-3M000 Plastic Bumper Grommet Screw Size: M3.5 (#6) Head Size: 8mm x 10mm Stem Length: 12mm Hyundai Azera, Sonata 2012-UP Kia Cadenza 2014-UP Box Qty. 25</p> 	<p>292113 86625-1M000 White Nylon Bumper Grommet Screw Size: M4.8 (#10) Head Size: 8mm x 10mm Stem Length: 12mm Kia Optima 2011-UP Box Qty. 25</p> 

KIA CLIPS & FASTENERS

25 Kia clips

NEW

292123

86625-1E000
White Nylon
Bumper Bracket Screw
Grommet With Sealer
Screw Size: M4.8 (#10)
Top Head: 14mm x 18mm
Bottom Head Dia: 18mm
Stem Size: 8.5mm x 8.5mm
Stem Length: 18mm
Hyundai Elantra GT 2013 - UP
Kia Niro & Sorento 2016 - UP
Box Qty. 25



302053

86825-28000
Nylon "U" Nut
Screw Size: M6 (#14)
Panel Range: Up To 1.5mm
Center Of Hole
to Edge: 8mm
Hyundai Accent & Elantra 1995-UP
Kia 1995-UP
Box Qty. 25



415255

E7GZ-6120586-B,
G031-58-762,
67868-89101, 67867-28030,
67867-89103, 86438-2B000
Natural Nylon
Weatherstrip Retainer
Head Size: 5mm x 15mm
Stem Length: 10mm
Fits Into 5mm Hole
Toyota 4-Runner 1983 - 89
Mazda 1996 - UP, Ford 1996 - UP
Hyundai 2007-UP and Kia 2009-UP
Box Qty. 50



415751 Box 50

415750

63844-01A00;
MNA01-56-145;
NA01-56-145;
MNA01-56145,
NA01-56145
Black Nylon
Inner Fender Retainer
Head Dia.: 20mm (25/32")
Stem Length: 18mm (23/32")
Fits Into 8mm (5/16") Hole
Ford, Mazda, Kia and Nissan '80-UP
Box Qty. 10



NEW

415999

0B102-68865
Black Nylon
Trunk Trim Retainer
Head Dia: 20mm
Stem Dia: 7mm
Stem Length: 13mm
Hyundai Accent, Genesis & Tuscon
2005 - 2017
Kia Rio, Rondo, Sedona, Sorento,
Soul & Sportage 2000 - 2017
Box Qty. 25



416185

81126-37010
Black Nylon
Hood Insulation Retainer
Head Dia.: 26mm
Stem Dia.: 12mm
Stem Length: 14mm
Hyundai Elantra, Sonata 1995-UP
Kia Optima 1995-UP
Box Qty. 15



416205

85495-2E050
Black Nylon
Headliner Retainer
Top Head Dia: 14mm
Middle Head Dia: 15mm
Bottom Head Dia: 16mm
Stem Dia: 10.3mm
Stem Length: 10mm
Hyundai & Kia
Box Qty. 50



416256

86155-2H100
Black Nylon
Cowl & Bumper
Push-Type Retainer
Head Diameter: 15mm
Stem Length: 10mm
Fits Into 7mm Hole
Hyundai Genesis & Veracruz;
Kia Rio 2009-UP
Box Qty. 15



416257

86434-4A000
Black Nylon
Hood Seal Retainer
Head Size: 6mm x 16mm
Stem Diameter: 8mm
Stem Length: 14mm
Hyundai Elantra, Sonata &
Tucson; Kia Sportage 2009-UP
Box Qty. 50



416258

86438-4A100
Hood Seal Retainer
Head Size: 5mm x 13mm
Stem Diameter: 8mm
Stem Length: 11mm
Hyundai Elantra & Tucson and
Kia Forte & Sportage 2009-UP
Box Qty. 50



416262

85746-06000LX
Gray Nylon
Headliner Retainer
Head Dia: 18mm
Stem Dia: 8mm
Stem Length: 16mm
Kia Rio 2010-UP
Box Qty. 25



416263

85746-06000RU
Tan Nylon
Headliner Retainer
Head Dia: 18mm
Stem Dia: 8mm
Stem Length: 16mm
Kia Rio 2010-UP
Box Qty. 25



416272

86591-25000
Black Nylon
Bumper Cover Clip
w/ Sealer
Head Size: 25mm x 30mm
Stem Length: 15mm
Overall Length: 35mm
Kia Rio 2010 - UP
Box Qty. 5



416287

86595-2T500, 14206-08250-B
Bumper, Engine Under Cover &
Fender Liner Push-Type Retainer
Hole: M8, Flange: 18mm
Stem Length: 14mm, P.R: 8mm
Hyundai Elantra, Equus, Genesis,
Santa Fe & Sonata;
Kia Forte, K900, Optima, Sedona & Sorento 2013-UP
Box Qty. 50



416289

87756-2W000
Plastic
Door Moulding Retainer
Hole: M5
Head: 5mm x 15mm
Stem Dia: 7mm
Stem Length: 8mm
Hyundai Santa Fe;
Kia Sorento 2013-UP
Box Qty. 100



KIA CLIPS & FASTENERS

<p>416300 0G032-50037-A Black Nylon Bumper, Fender, Grille, Interior & Exterior Trim and Pillar Screw-Type Retainer Head Dia: 18mm Stem Length: 12mm Fits into 8mm Hole <i>Kia Amanti, Magentis, Optima, Rio, Sedona, Sephia, Sorento, Spectra & Sportage 2000-UP</i> Box Qty. 15</p> 	<p>NEW</p> <p>416302 86590-1W000 Black Nylon Bumper Cover Push-Type Retainer Head Dia: 18mm Stem Length: 11mm Fits Into 8mm Hole <i>Hyundai Equus & Genesis 2014 - 2016</i> <i>Kia Rio & Sedona 2012 - UP</i> Box Qty. 25</p> 	<p>416337 909130067, 86590-3S000 Black Nylon Engine Cover and Fender Liner Screw-Type Retainer Head Dia: 18mm Stem Length: 10mm Fits Into 8mm Hole <i>Subaru B9 Tribeca, Forester, Legacy & Outback & Tribeca 2005 - UP</i> <i>Hyundai Azera, Elantra, Genesis & Sonata and Kia Cadenza & Optima 2011-UP</i> Box Qty. 15</p> 	<p>NEW</p> <p>435473 85818-37000 White Nylon Moulding Clip With Sealer Top Head: 12.5mm x 14mm Bottom Head Dia: 16mm Stem Dia: 10mm Stem Length: 12.5mm <i>Hyundai Accent, Elantra & Tucson and Kia Optima & Rio 2012 - UP</i> Box Qty. 25</p> 
<p>435499 87756-2G000 Black Nylon Body Side Moulding Clip with Sealer Head Size: 8mm x 22mm Stem Length: 10mm <i>Hyundai Sonata;</i> <i>Kia Magentis & Optima 2006-UP</i> Box Qty. 15</p> 	<p>435504 87702-H1000 Rocker Moulding Clip Top Head: 11mm x 15.5mm Bottom Head Dia: 16mm Stem Length: 12mm <i>Hyundai Genesis & Sonata;</i> <i>Kia Sorento 2009-UP</i> Box Qty. 15</p> 	<p>435512 87756-2E000 Moulding Clip w/Sealer Top Head: 10mm x 12mm Bottom Head: 14mm x 20mm Stem Length: 10mm <i>Hyundai Entourage, Tucson & Veracruz;</i> <i>Kia Optima, Sedona, Spectra & Sportage 2005-UP</i> Box Qty. 15</p> 	<p>435513 86359-33500 Front Bumper Moulding Clip Top Head: 10mm x 15mm Bottom Head: 16mm x 18mm Stem Length: 9mm <i>Kia Spectra 2004-2009</i> Box Qty. 25</p> 
<p>435514 87756-3E500 Red Nylon Wheel Flare & Body Side Moulding Clip with Sealer Top Head: 11mm x 13mm Bottom Head: 12mm x 20mm Stem Length: 10mm <i>Kia Forte Koup & Sorento 2009-UP</i> Box Qty. 15</p> 	<p>435601 87756-38000 Black Nylon Body Side Moulding Clip with Sealer Top Head: 8mm x 9mm Bottom Head: 14mm x 18mm Stem Length: 10mm <i>Hyundai Elantra & Sonata 2002-UP</i> <i>Kia Rio 2010-UP</i> Box Qty. 15</p> 	<p>435605 87758-3E000, 87759-3E000, 87719-02500 White Nylon Fender Flare & Door Moulding Clip with Sealer Top Head: 10.5mm x 9.5mm Bottom Head: 14mm x 17.5mm Stem Dia: 14.3mm Stem Length: 10mm <i>Kia Sorento 2003 - 2009</i> Box Qty. 25</p> 	<p>435606 87756-1F000 Blue Nylon Fender Flare, Rocker, Door & Exterior Mldg Clip w/Sealer Top Head: 10mm x 12mm Bottom Head: 14mm x 20mm Stem Dia: 14mm Stem Length: 10mm <i>Hyundai Santa Fe 2013-UP</i> <i>Kia Sportage 2011-UP</i> Box Qty. 25</p> 
<p>435611 86179-2V020 Blue Nylon Garnish Moulding Retainer with Sealer Top Head: 10.5mm x 12mm Bottom Head Dia: 12mm Stem Length: 11mm Fits into 7.5mm Hole <i>Hyundai Veloster 2012-UP</i> <i>Kia Soul 2014-UP</i> Box Qty. 25</p> 	<p>435612 86438-2T000 Black Nylon Hood/Bumper Seal Retainer Head Size: 4.5mm x 13mm Stem Diameter: 7.6mm Stem Length: 7.5mm <i>Hyundai Elantra, Genesis 2013-UP</i> <i>Kia K900, Optima 2011-UP</i> Box Qty. 50</p> 	<p>435613 87716-2W000 White Nylon Fender, Body Side & Rocker Moulding Clip with Sealer Top Head: 10mm x 12mm Bottom Head: 14mm x 20mm Stem Length: 11mm <i>Hyundai Santa Fe 2012-UP</i> <i>Kia Borrego 2007-2011 & Kia Niro 2017-UP</i> Box Qty. 50</p> 	<p>435616 87758-38000 White Nylon Rocker Moulding Clip with Sealer Top Head: 10mm x 13mm Bottom Head: 7mm x 16mm Stem Length: 9mm <i>Hyundai Sonata '99-2001</i> <i>Kia Optima & Sorento 2001-2009</i> Box Qty. 50</p> 

KIA CLIPS & FASTENERS



435618
87759-3V000
Yellow Nylon
Rocker Panel Moulding Clip with Sealer
Top Head: 12mm x 12mm
Bottom Head: 14mm x 20mm
Stem Length: 17mm
Hyundai Azera 2012-UP
Kia K900 2015-UP
Box Qty. 50



435619
87756-C5000
Red Nylon
Fender, Rocker & Wheel Moulding Clip with Sealer
Top Head: 10mm x 12mm
Bottom Head: 14mm x 20mm
Stem Length: 10mm
Kia Sorento 2016-UP
Box Qty. 25



445366
OK95A-68615
Black Nylon
Cowl Trim Retainer
Flange Dia: 25mm
Hex Size: 14mm
Overall Height: 10mm
Kia Forte Koup 2010 - UP
Box Qty. 25



445833
82315-38000,
94530565
Natural Nylon
Door Trim Panel Retainer
Hole Size: 11/32" (9mm)
Top Head Dia: 13mm
Stem Length: 10mm
Hyundai Accent, Santa Fe, Sonata
Tiburon & XG300/350 1999-UP
Kia Optima, Rio & Sorento 2001-UP
Chevrolet Aveo 2004-UP
Box Qty. 25



445835
82315-27000
Pink Nylon
Trim Panel Retainer
Top Head Dia: 15mm
Middle Head Dia: 16mm
Bottom Head Dia: 18mm
Stem Dia: 10mm
Stem Length: 12mm
Hyundai & Kia 2003 - UP
Box Qty. 25



445840
82315-2P000
White Nylon
Trim Panel Retainer
Top Head Dia: 13mm
Middle Head Dia: 15mm
Bottom Head Dia: 18mm
Stem Dia: 11mm
Stem Length: 13mm
Hyundai & Kia 1999 - UP
Box Qty. 50



445844
82315-33020
White Nylon
Trim Panel Retainer
Top Head Dia.: 15mm
Middle Head Dia: 16mm
Bottom Head Dia.: 18mm
Stem Dia: 10.7mm
Stem Length: 12mm
Hyundai & Kia 1995 - UP
Box Qty. 50



445846
84747-2L000
White Nylon
Trim Panel & Dash Console Clip
Overall Length: 21mm
Hyundai Elantra, Entourage,
Sonata & Volster 2006 - UP
Kia Forte, Sorento & Soul 2010 - UP
Box Qty. 50



445847
85506-4A000
White Nylon
Trim Panel & Window Garnish Retainer
Top Head Dia.: 13mm
Middle Head Dia: 16mm
Bottom Head Dia.: 15mm
Stem Dia: 9.6mm
Stem Length: 13mm
Hyundai Tuscon & Kia Sorento 2003 - UP
Box Qty. 50



445849
82315-2W000
Green Nylon
Door Panel, Interior Trim & Garnish Retainer
Top Head Dia: 13mm
Middle Head Dia: 16mm
Bottom Head Dia: 18mm
Stem Dia: 10mm
Stem Length: 10mm
Overall Length: 17mm
Hyundai Santa Fe, Sonata 2013-UP
Kia Forte & K900 2014-UP
Box Qty. 25



445850
85849-3L000
Gray Nylon
Garnish & Interior Moulding Retainer
Top Head Dia: 13mm
Middle Head Dia: 16.5mm
Bottom Head Dia: 18mm
Stem Length: 15mm
Overall Length: 21mm
Fits into 9mm Hole
Hyundai Azera, Sonata, Tuscon, 2006 - UP; Kia Forte 2010-UP
Box Qty. 50



445851
85858-3S000
Black Nylon
Interior Trim Clip
Overall Height: 16mm
Width at Bottom: 11mm
Hyundai Azera, Sonata 2011-UP
Kia Optima, Soul 2011-UP
Box Qty. 100



445852
85859-3S100
Black Nylon
Interior Trim Clip
Overall Height: 19mm
Width at Bottom: 15mm
Hyundai Accent, Azera, Elantra, Sonata 2011-UP
Kia Optima, Rio 2011-UP
Box Qty. 100



445853
OK95-A-68401
Gray Nylon
Exterior & Interior Moulding Retainer
Top Head Dia: 13mm
Middle Head Dia: 16mm
Bottom Head Dia: 15mm
Stem Dia: 9.5mm
Stem Length: 12mm
Overall Length: 18mm
Kia Soul, Sedona, Sportage 2010
Box Qty. 50

NEW



445861
82134-22000
Black Nylon
Door Weatherstrip Clip
Height: 14mm
Length: 20mm
Hyundai Accent, Elantra, Santa Fe, Sonata, Tuscon & Veloster 1993 - UP
Kia Forte 2014 - 2017
Box Qty. 25

NEW



445862
82134-3L000
Black Nylon
Weatherstrip Clip
Width: 12mm
Length: 18mm
Hyundai Azera, Elantra, Equus, Genesis, Santa Fe & Sonata and Kia Optima & Sedona 2005 - 2017
Box Qty. 50

KIA CLIPS & FASTENERS



475201

81174-2L000

Black Nylon

Hood Prop Rod Clip

Holds 8mm Rod

Width: 20mm

Length: 24mm

Hyundai Accent & Elantra 2008-UP

Kia Forte & Soul 2009 - 2013

Box Qty. 15



25

Kia Clips

KIA CLIPS & FASTENERS

Kia clips

25

BLANK

LEXUS CLIPS & FASTENERS



38569

90269-06013

Dia: 4.8mm (3/16")

Grip: 1.6mm - 6.35mm (1/16" - 1/4")

Flange: 14mm (9/16")

Aluminum Rivet w/Plastic Cap

Steel Mandrel

Gas Filler Door

Toyota Camry & Lexus IS300

2001-UP

Box Qty. 15



38572

90269-04006

Dia: 1/8" (3.2mm)

Grip: 3/64" - 5/32" (1.2mm - 4mm)

Flange Dia: 5/16" (8mm)

Aluminum Rivet w/Plastic Cap

Steel Mandrel

Lexus '98 - UP

Box Qty. 10



38573

90269-04051, 90269-A0006

Dia.: 1/8" (3.2mm)

Grip: 3/64" - 1/8" (1.2mm - 3.4mm)

Flange Dia.: 15/64" (6mm)

Aluminum Rivet (Plastic Cap)

Steel Mandrel

Lexus '98 - UP

Box Qty. 10



38574

90269-04050

Dia: 1/8" (3.2mm)

Grip: 5/32" - 5/16" (4mm - 8mm)

Flg Dia: 5/16" (8mm)

Aluminum Rivet w/Plastic Cap

Steel Mandrel

Windshield, Side & Trunk Moulding

Lexus GS300, 400, 430 &

SC430 '98 - UP

Box Qty. 15



38577

75547-51021

Dia: 4mm (5/32")

Grip: .8mm - 1.5mm

Flange Dia.: 10.5mm

Alum Rivet w/Nylon Cap

Steel Mandrel

Lexus IS250, IS350 & IS F 2006-UP

Toyota 2002 - UP

Box Qty. 15



38578

90269-04050

Dia: 3.2mm (1/8")

Grip: 4mm-8mm (5/32"-5/16")

Flange Dia.: 8mm (5/16")

Aluminum Rivet w/Nylon Cap

Steel Mandrel

Windshield, Side & Trunk Moulding

Lexus 1998 - UP

Toyota

Box Qty. 15



38579

90269-05065

Dia: 5mm (3/16")

Grip: 4mm-7mm (5/32-9/32")

Flange Dia.: 13mm (1/2")

Aluminum Rivet w/Plastic Cap

Steel Mandrel

Bumpers/General Purpose

Lexus 2004 - UP

Box Qty. 10



38764

90269-A0005, 90269-06017

Dia: 1/4" (6.3mm)

Grip: 1/16" - 3/16" (1.6mm - 4.8mm)

Flange Dia: 1/2" (13mm)

Black Aluminum Rivet

Steel Mandrel

Fuel Door & General Purpose

Toyota & Lexus 2000-UP

Scion 2005-UP

Box Qty. 10

285115

N811169-S,

W705550-S300,

90189-06111,

90075-10801, 10423331

White Nylon

Headlamp Mounting /

Turn Signal Retainer

Head Dia.: 13mm

Stem Length: 9mm

Fits Into 11mm Hole

Ford F250-F550 '99 - UP

Toyota/Lexus '89 - UP

GM

Box Qty. 50



292057 Box 50

292055

96706-W1000,

90189-06013

Screw Grommet

Screw Size: #14 (1/4") or

M6.3-1.81

Head Dia: 20mm

Stem Length: 17mm

Fits Into 8mm x 8mm Hole

Toyota & Lexus

Box Qty. 25



292097

90189-04059

White Nylon

Rocker, Pillar, Floor &

Exterior Trim Screw Grommet

Screw Size: M3.5 (#6)

Head Size: 12mm x 18mm

Stem Length: 7mm

Lexus ES300, ES330, RX330,

RX400, SC300, SC400 and Toyota

Scion, Avalon & FJ Cruiser 1992-UP

Box Qty. 25



292108

52197-22020

Black Nylon

Rear Bumper

Side Bracket Screw

Grommet With Sealer

Screw Size: M6.3 (#14)

Head Size: 16mm x 18mm

Stem Length: 19mm

Lexus ES 350 & HS 250H 2007-2012

Toyota Avalon & Camry 2012-UP

Box Qty. 15



LEXUS CLIPS & FASTENERS

 <p>292263 52197-30040 White Nylon Front Bumper Screw Grommet with Sealer Screw Size: M5.5 (#12) Head Size: 22mm x 18mm Overall Length: 24mm <i>Lexus CT200h, GS300, 350, 430, 460, GS450h, HS250h, LS460, 600h, RX350 & RX450h 2006 - UP</i> Box Qty. 15</p>	 <p>292216 90189-06162 Natural Nylon Front Clearance Lamp Nut <i>Toyota Camry 1991-1994</i> Headlight Adjusting Nut <i>Lexus</i> Box Qty. 10</p>	 <p>292262 81496-52020, 81496-0E020 Natural Nylon Rear Combo Tail Light Guide Grommet w/Sealer Head Dia: 16mm Stem Length: 14mm Overall Length: 15mm <i>Lexus CT 200h, ES 300h, ES 350, GX 460, IS 200t, IS 250, IS 300, IS 350, LC 500h, LX 570, NX 200t, NX 300h, RC F, RC 200h, RC 300, RC 350, RX 350 & RX 450h and Toyota 4Runner, C-HR, Corolla, Corolla iM, Highlander, Land Cruiser, Mirai, Prius, Prius Prime, Prius V, RAV4, Sequoia, Venza & Yaris 2006 - UP Scion iM & xD 2016 - 2008</i> Box Qty. 25</p>	
 <p>302050 90179-05060 Black Nylon U- Nut Screw Size: #10 Width: 18mm, Length: 27mm Panel Range: Up To 3mm Center Hole to Edge: 14mm <i>Lexus '90 - UP</i> Box Qty. 10</p>	 <p>302052 90467-05114 Black Nylon U- Nut Bumper/Fender Apron Screw Size: M5.5 (#12) Width: 20mm, Length: 36mm Panel Range: Up To 1mm Center Hole to Edge: 14mm <i>Lexus, Toyota 2000 - UP</i> Box Qty. 10</p>	 <p>355020 53271-44010 Black Nylon Headlight Bracket Clip Width: 25mm Length: 40.5mm <i>Toyota Camry, RAV 4 2001-UP</i> <i>Lexus IS300 2001 - UP</i> Box Qty. 4</p>	 <p>415234 90467-A0008 Black Nylon Bumper Cover Retainer Head Diameter: 19mm Stem Diameter: 7.5mm Stem Length: 16mm <i>Toyota, Lexus & Scion 1995 - UP</i> Box Qty. 50</p>
 <p>415242 90467-06192 Black Nylon Fender Liner Clip Head Size: 14.5mm x 16mm Stem Dia: 10.5mm Stem Length: 10mm Fits Into 8mm Hole <i>Lexus ES 300h, ES 350, GS 200h, GS 350, GS F, GS 450h, IS 200t, IS 300, IS 350, LS 460, LS 600h L & RC F and Toyota Camry & RAV4 2006 - UP</i> Box Qty. 25</p>	 <p>415977 90467-09093 Nylon Bumper Cover Screw-Type Retainer Head Dia: 15mm Stem Length: 27mm Fits Into 9mm Hole <i>Lexus LS-400</i> Box Qty. 10</p>	 <p>416022 90467-08124 Black Nylon Hood Insulation Retainer Head Dia: 25mm Stem Dia: 8mm Stem Length: 12mm <i>Toyota Supra '93 - UP,</i> <i>Lexus '89 - '94</i> Box Qty. 15</p>	 <p>416028 90467-09096 Black Nylon Front Bumper Push-Type Retainer Head Dia: 15mm Stem Length: 27mm Fits Into 9mm Hole <i>Toyota Celica, Supra and Lexus LS400 '89 - UP</i> Box Qty. 10</p>
 <p>416029 90467-09128 Plastic Bumper Cover Screw-Type Ret. Hole Dia.: M9 Stem Length: 26.5mm Washer Dia.: 20mm <i>Lexus 1995-2000</i> Box Qty. 10</p>	 <p>416031 90467-09050, 90467-A0003 Black Nylon Hood Insulation Retainer Head Dia: 25mm Stem Length: 10mm Fits Into 7mm Hole <i>Lexus</i> <i>Toyota Camry & Solara '98-UP</i> Box Qty. 15</p>	 <p>416071 90467-07138 Black Nylon Push-Type Retainer Head Dia: 20mm Stem Length: 12mm Fits Into 7mm Hole <i>Lexus 1990 - UP</i> Box Qty. 10</p>	 <p>416073 90467-07117 Black Nylon Push-Type Retainer Head Dia: 17mm Stem Length: 9mm Fits Into 7mm Hole <i>Lexus 1990 - UP</i> Box Qty. 10</p>

LEXUS CLIPS & FASTENERS

 <p>416129 90467-09006 Black Nylon Hood Insulation Retainer Head Dia: 30mm Stem Length: 17mm Fits Into 7mm Hole <i>Toyota Avalon, Camry & Lexus '88 - UP</i> Box Qty. 15</p>	 <p>416135 01553-09611, 90467-08185 Black Nylon Bumper Push-Type Retainer Head Dia: 18mm Stem Length: 10mm Fits Into 8mm Hole <i>Lexus and Toyota 2002-UP Nissan 1994-UP</i> Box Qty. 15</p>	<p>416147-50 Bx 50</p>  <p>416147 90467-07201 Black Nylon Engine Under Cover Push-Type Retainer Head Dia: 20mm Stem Length: 10mm Fits Into 7mm Hole <i>Toyota Avalon, Camry, Solara and Lexus ES300/330 2002 - UP</i> Box Qty. 10</p>	 <p>416165 75867-AA010 Black Nylon Rocker Panel & Scuff Plate Retainer <i>Lexus ES300 & ES330 2002-UP Toyota Avalon, Camry, Scion & Solara 2004-UP</i> Box Qty. 15</p>
 <p>416173 47749-58010 (use with #416174) Black Nylon Front Fender & Bumper Cover Pin Retainer Head Dia: 15mm Stem Length: 25mm <i>Lexus and Toyota 4 Runner, Sienna, Highlander & Solara 2000 - UP</i> Box Qty. 10</p>	 <p>416174 53879-58010 (use with #416173) Black Nylon Front Fender & Bumper Cover Clip Width: 25mm, Length: 34mm <i>Lexus and Toyota 4 Runner, Sienna, Highlander & Solara 2000 - UP</i> Box Qty. 5</p>	 <p>416176 90467-10183, 88970767 Black Nylon Front Fender Liner Push-Type Retainer Head Dia: 18mm Stem Length: 7.5mm Fits Into 7mm Hole <i>Lexus, Pontiac Vibe, and Toyota Celica, Corolla, Matrix & Solara 1999 -UP</i> Box Qty. 10</p>	 <p>416193 90467-07211 Black Nylon Bumper, Radiator Cover and Grille Push-Type Retainer Head Dia: 19mm Stem Length: 8mm Fits Into 7mm Hole <i>Lexus IS & LS, Scion and Toyota Avalon, Camry & Highlander 2005-UP</i> Box Qty. 10</p>
<p>416213 91563-SCV-003, 67867-52010, 67867-0D060 White Nylon Weatherstrip Retainer Head Size: 5mm x 15mm Bottom Head Dia: 6.5mm Stem Dia: 7mm Stem Length: 8.5mm <i>Acura TL and Honda Element, Odyssey & Pilot 2003-UP; Toyota Echo, Land Cruiser, Prius, Tacoma & Yaris and Lexus GS 450, GX 460 & LX 430 and Scion xA & xD 2000 - UP</i> Box Qty. 25</p> 	<p>416217 90467-06205-C0 Black Nylon Front Fender Retaining Clip w/Sealer Head Dia: 20mm Stem Dia: 8mm Stem Length: 9mm <i>Lexus GS F, GS 350, GS 450h, GX 460, HS 250h, IS 200t, IS 250, IS 300, IS 350, LC 500h, RC F, RC 200t, RC 300, RC 350, RX 350 & RX 450h 2010 - UP and Scion iQ & xD and Toyota 4Runner & Highlander 2008 - 2015</i> Box Qty. 25</p> 	<p>416218 65487-60010 Black Nylon Hood Seal Retaining Clip Head: 5mm x 13mm Stem Dia: 7mm Stem Length: 8mm <i>Lexus CT 200h, ES 300h, ES 350, GS F, GS 200t, GS 350, GS 450h, LC 500h & LX 570 and Toyota Landcruiser & Mirai 2008 - UP</i> Box Qty. 25</p> 	
 <p>416225 47749-50090 (Use with #416226, 416227) Black Nylon Front Bumper Cover Pin Head Dia: 10mm Stem Length: 24mm <i>Lexus GS, IS, LS 2007 - UP</i> Box Qty. 15</p>	 <p>416226 53879-30040 (Use with #416225) Black Nylon Front Bumper Cover Clip Width: 32mm Length: 39mm <i>Lexus CT200h, HS250h 2010 - UP Toyota Camry 2012 - UP</i> Box Qty. 5</p>	 <p>416227 53879-50020 (Use with #416225) Black Nylon Front Bumper Clip Width: 35mm Length: 25mm <i>Lexus GS, IS, LS 2007 - UP</i> Box Qty. 10</p>	 <p>416228 53879-30050 Black Nylon Fender Liner Clip Width: 42mm Length: 29.5mm <i>Lexus GS F, GS 200t, GS 350, GS 450h, IS 200t, IS 250, IS 300, IS 350, RC F, RC 200t, RC 300 & RC 350 2013 - UP and Toyota C-HR, Prius, Prius Prime & Prius V 2016-UP</i> Box Qty. 15</p>

LEXUS CLIPS & FASTENERS

NEW

416299

90467-07220

Black Nylon
Bumper Cover, Radiator Support,
Under Cover & Wheel Opening
Push-Type Retainer
Head Dia: 20mm
Stem Length: 12mm

Fits into 7mm Hole

*Lexus CT 200h, GX 460, IS 300, IS 350, LC 500h, NX 200t, NX 300h,
RX 350 & RX 450h and Toyota 4Runner, C-HR, Camry, Corolla,
Corolla iM, Prius, Prius Prime, Prius V & RAV4 2013 - UP
Scion iM, tC & xB 2008 - 2016*

Box Qty. 25



416242

53879-02150

53879-33030

Black Nylon
Bumper to Fender Liner Clip
Overall Length: 43mm
Overall Width: 39mm

*Lexus ES300 & ES350 2019 - UP
Toyota Camry & Corolla 2018 - UP*

Box Qty. 5



NEW

416304

90467-07208

Black Nylon
Fender Seal Retainer
Head Dia: 16mm
Stem Dia: 8mm
Stem Length: 16mm

Fits Into 8mm Hole

*Lexus ES 300h, ES 350, IS F,
LS 460 & LS 600h 2013 - UP*

Box Qty. 25



NEW

416305

90467-09242

Black Nylon
Cowl Grille
Push-Type Retainer
Head Dia: 22mm
Stem Length: 15mm

Fits into 9mm Hole

*Lexus RX 350 & RX 450h and
Toyota C-HR, Camry, Prius, Prius
Prime & Yaris 2016 - UP*

Box Qty. 15



416323

90467-07137

Black Nylon
Fender Panel Retaining Clip
Head Size: 4.5mm x 11mm
Stem Dia: 6.5mm
Stem Length: 9mm

*Lexus ES 350, GS 300,
GS 450h & IS 250 2006 - UP*

Box Qty. 25



416324

90467-05125

Black Nylon
Front Bumper
Bracket Retainer
Head Diameter: 16mm
Stem Dia: 4.7mm x 4.7mm
Stem Length: 12mm

*Lexus GS 300, GS 450h
& LS 400 1995 - UP*

Box Qty. 25



416325

53145-60030

Black Nylon
Front Bumper, Grille &
Hood Seal Retaining Clip
Head Size: 4.3mm x 11mm
Stem Dia: 6.2mm
Stem Length: 10mm

*Toyota Avalon, Camry, Highlander, Land Cruiser, Prius & Venza and
Lexus GS 350, GS 450h, IS 250, IS 350, LX 570, NX 200t, NX 300h,
RX 350 & RX 450h and Scion iQ & tC 2008 - UP*

Box Qty. 100



435435

75394-60060

Yellow Nylon
Fender Moulding Clip
w/Sealer
Head Dia: 18mm
Stem Length: 20mm

Lexus 2000 - UP

Box Qty. 10



435436

75492-60030

Gray Nylon
Fender Mldg Clip w/Sealer
Head Dia: 18mm
Stem Length: 20mm

Lexus 2000 - UP

Box Qty. 10



435437

75395-33030

Pink Nylon
Moulding Clip
Lexus ES300 & RX300 '99 - UP

Box Qty. 15



435438

75392-60030, 75392-60031

Gray Nylon
Rocker Panel Mldg Clip
Head Dia: 18mm
Overall Length: 19mm

Lexus 2000 - UP

Box Qty. 15



435441

52535-0E030

White Nylon
Bumper/Various Trim
Moulding Clip
Top Head: 13mm x 13mm
Stem Length: 22mm
Overall Length: 25mm

*Lexus LS600h & RX450h and
Toyota RAV4 & 4Runner 2006 - UP*

Box Qty. 15



435480

90189-06005,
098-145,
01281-00023

White Nylon
Screw Grommet
Screw Size: #14 (1/4") or
M6.3-1.81
Head Diameter: 18mm
Stem Length: 16mm
Fits into 8mm x 8mm Hole

Lexus, Toyota, Mitsubishi, Datsun

Box Qty. 25



LEXUS CLIPS & FASTENERS



435507
75397-48010
Red Nylon
Moulding Clip
Lexus ES300 & RX300 '99-UP
Box Qty. 15



435508
75039-33010
Brown & White Nylon
Front Door Outside
Moulding Clip
Lexus ES300 1991-UP
Box Qty. 5



435509
75039-33060
Brown & White Nylon
Door Lower Moulding Clip
Lexus ES300 1991-UP
Box Qty. 5



435510
75049-33020,
75049-33010
Plastic
Side Moulding Retainer
Lexus '90 - UP
Box Qty. 10



435517
75867-30120
Rocker Moulding
Push-Type Retainer
Head Dia: 18mm
Stem Length: 19mm
Fits Into 8mm Hole
Lexus GS350, GS430, GS460 &
LS460 and Toyota Camry 2007-UP
Box Qty. 15

NEW
445006
90467-09232
Red Nylon
Trim Panel Retainer
Top Head Dia: 13mm
Middle Head Dia: 16mm
Bottom Head Dia: 18mm
Stem Dia: 9mm
Stem Length: 15mm
Lexus IS 250 & IS 350 2015 - 2010
LC 500, LC 500h, LS 500, LS 500h,
NX 200t, NX 300 & NX 300h and
Toyota Highlander & Tacoma
2014 - UP
Box Qty. 25



445816
62217-13010
White Nylon
Garnish Moulding Retainer
Top Head Dia: 13mm
Middle Head Dia: 16mm
Bottom Head Dia: 15mm
Stem Dia: 10mm
Stem Length: 11mm
Lexus and Toyota Corolla, Matrix &
4 Runner 2003-UP
Box Qty. 25



445817
67771-12070
Door Panel & Rocker
Moulding Retainer w/Sealer
Top Head Dia: 13mm
Bottom Head Dia: 18mm
Stem Dia: 11mm
Stem Length: 14mm
Lexus SC300/400
Toyota Avalon & Corolla 1992 - UP
Box Qty. 15



445820
90467-A0005
White Nylon
Door Trim Panel
Retainer with Sealer
Top Head Dia: 13mm
Middle Head Dia: 16mm
Bottom Head Dia: 18mm
Stem Diameter: 8.5mm
Stem Length: 14mm
Lexus ES 350, GX 470, IS 250, IS
350, IS F, LS 460 & LS 600HL and
Toyota Camry, FJ Cruiser, Highlan-
der, RAV 4 & 4-Runner 2001-UP
Box Qty. 15



445854
90467-06015-C0
Black Nylon
Front & Rear Bumper
Retaining Clip
Head Dia: 7.5mm
Stem Dia: 5.5mm
Stem Length: 10mm
Lexus GS 300, GS 400 &
GS 430 1998 - 2005
Box Qty. 25



445950
75392-35220
White Nylon
Front & Rear Spoiler
Moulding Clip
Head Size: 10mm x 20mm
Stem Length: 24mm
Overall Length: 27mm
Lexus HS250 & RX350 and Toyota
Camry, Corolla, FJ Cruiser &
Highlander 2010 - UP
Box Qty. 25



445978 Box 50
445977
90467-08004, 90467-08011,
94842841, 94849113
Black Nylon
Hood Seal Retaining Clip
Head Dia.: 13mm
Stem Length: 11mm
Fits Into 6mm Hole
Lexus, Toyota, Geo Prizm & Nova
1985-UP
Box Qty. 25



495002
69293-12040
Door Lock Rod Clip
Rod Size: 5mm
Left (Driver) Side
Lexus ES 300 2001 - 97
Toyota Camry, Celica, Corolla,
Echo, Highlander, MR2, RAV 4,
Tundra and 4-Runner 1994 - UP
Box Qty. 10



MAZDA CLIPS & FASTENERS



38571
GHP9-50-355
 Dia: 4mm (5/32")
 Grip: 5.6mm-9.6mm (.220" - .378")
 Flange Dia: 8mm (5/16")
 Black Aluminum Rivet
 Black Aluminum Mandrel
 Bumper, Grille & Upper
 Bracket Specialty Rivet
Mazda 6 2014 - UP
 Box Qty. 25



38582
BN8F-50-355
 Dia: 4mm (5/32")
 Grip: 1mm - 13mm (3/64" - 33/64")
 Flange Dia: 8mm (5/16")
 Aluminum Rivet
 Aluminum Mandrel
 Front Bumper, Grille
 Specialty Rivet
*Mazda 3, 5, CX-3, CX-9, Miata &
 MX-5 2006 - UP*
 Box Qty. 15



292040
75522-611-000, 75522-611-0000
9991-00-412, MS-480001,
96706-B0700, 97606-B0700,
90189-04042, 95900-04036
 Grommet Nut
 Screw Size: #8
 Width: 9.5mm, Length: 9.5mm
 Fits into 7mm x 7mm Hole
Honda, Toyota, Nissan, Mazda,
Mitsubishi
 Box Qty. 50



292071
68425-H5000, 62698-V7000,
9991-00-503, 90662-671-0030,
90662-671-003, 90662-SB-003
 Nylon Nut
 Screw Size: #10
 Width: 17mm, Length: 17mm
 Fits Into 8mm x 8.5mm Hole
Honda, Mazda, Nissan
 Box Qty. 25



292080
96706-89901,
9991-00-402
 Nylon
 Screw Grommet
 Screw Size: #6
 Width 9.5mm, Length 9.5mm
 Stem Length: 16mm
 Fits Into 7mm x 7mm Hole
Mazda, Nissan
 Box Qty. 25



292200
9991-00-403
 Nylon
 Headlamp, Door & Grille Nut
 Screw Size: #8
 Head Dia.: 13mm
 Fits into 7mm x 7mm Hole
Mazda
 Box Qty. 25



292203
KA78-50-AF4
 Black Nylon
 Splash Shield
 Screw Grommet
 Screw Size: #12 (M5.5)
 Head Dia.: 18mm x 20mm
 Stem Length: 15mm
Mazda 626 1998-UP
 Box Qty. 10



292210
90189-06010,
75521-611-0000,
9991-00-601, 96706-P0105
 Nylon
 Screw Grommet
 Screw Size: #10
 Width 13mm, Length 13mm
 Snaps Into 8.5mm Sq. Hole
Toyota, Honda, Mazda, Nissan
 Box Qty. 25



292265
9991-00-501
 Natural Nylon
 Screw Grommet
 Screw Size: #10
 Width 12mm, Length 12mm
 Snaps Into 8mm x 8mm Hole
Ford Probe '88
Mazda MX6 '88 - UP
 Box Qty. 25



292270
90661-SC7-0030,
90661-SC7-003,
H001-50-841, MS-480012,
01651-00481, 74798-S9000,
90189-06042
 Nylon Screw Grommet
 Screw Size: #8 (M4.2)
 Head Dia: 16mm
 Stem Length: 17mm
 Fits a 8mm x 8mm Hole
Honda, Toyota, Nissan,
Mitsubishi, Mazda
 Box Qty. 25



292300
GJ21-50-H81
 Natural Nylon
 Cowl Screen Grommet
Ford Probe
Mazda 626 & MX6 '88 - UP
 Box Qty. 25



292310
GJ21-50-H82
 Natural Nylon
 Cowl Screen Grommet
Ford Probe and
Mazda 626 & MX6 '88 - UP
 Box Qty. 25



302001
C274-50-133
 Gray Nylon
 Front Bumper Retainer Nut
 Screw Size: M4.8 (#10)
 Center Hole To Edge: 11mm
 Panel Range: Up to 1mm
Mazda 2, 5, 6, CX-5, CX-7 & CX-9
2010 - 2014
 Box Qty. 25



302055 Box 25
302044
53879-14010-A, 53879-14020,
53879-22030, 94841226,
LA01-56-135
 Black Nylon U-Nut
 Wheel Housing Applications
 Screw Size: 4.8mm (#10)
 Panel Range: Up to 1mm
 Center of Hole to Edge: 11mm
Toyota, GM, Mazda
 Box Qty. 10



415255
E7GZ-6120586-B,
G031-58-762,
67868-89101, 67867-28030,
67867-89103, 86438-2B000
 Natural Nylon
 Weatherstrip Retainer
 Head Size: 5mm x 15mm
 Stem Length: 10mm
 Fits Into 5mm Hole
Toyota 4-Runner 1983 - 89
Mazda 1996 - UP, Ford 1996 - UP
Hyundai 2007-UP and Kia 2009-UP
 Box Qty. 50

MAZDA CLIPS & FASTENERS

415650

20423647,
N804189-S,
B455-56-741
Super Tough
Black Nylon
Blind Rivet
Dia: 13/64"
Grip: 1/16" - 11-64"
Flange Dia: 11/32"
Ford, GM, Mazda
Box Qty. 25



415751 Box 50

415750

63844-01A00;
MNA01-56-145;
NA01-56-145;
MNA01-56145,
NA01-56145
Black Nylon
Inner Fender Retainer
Head Dia.: 20mm (25/32")
Stem Length: 18mm (23/32")
Fits Into 8mm (5/16") Hole
Ford, Mazda, Kia and Nissan '80-UP
Box Qty. 10



415759 Box 50

415761

94218027,
H200-50-715
8942180270,
58974-00008, B092-50-715,
BF67-S0715, MB153825,
90467-13011, 90467-12020
Black Nylon
Grille Headlight Clip
Width: 13mm Length: 22mm
Ford, GM, Toyota, Mitsubishi, Isuzu,
Honda, Plymouth, Mazda
Box Qty. 25



415778 Box 25 415779 Box 100

415777

90675-SB3-003
FB01-56-964, 63876-95596
Cowl Vent, Air Ducts &
Fender Splash Shield
Screw Type Retainer
Head Dia: 20mm
Stem Length: 9mm
Fits Into 8mm Hole
Honda, Nissan, Mazda
Box Qty. 10



415910

E7GZ-17A904-B,
BF67-50-033
Black Nylon
Bumper Retainer
Head Size: 20mm x 30mm
Stem Length: 11mm
Fits Into 10mm Hole
Mercury Tracer '87 - UP,
Mazda
Box Qty. 15



415916 Box 50

415915

90657-SA6-0030,
N304-13-356-A,
94198687
Nylon
Push-Type Retainer
Head Dia: 14mm
Stem Length: 11mm
Fits into 7mm Hole
Honda & Mazda, GM
Box Qty. 25



415935

G030-68-885-B-38,
F22Z-16774-A,
GA2A-56694
Nylon
Hood Insulation Retainer
Head Dia: 20mm
Stem Length: 9mm
Fits into a 6mm Hole
Ford, Mazda
Box Qty. 25



415975

E92Z-17C756C,
GJ21-50-034
Nylon
Bumper Cover Retainer
Head Size: 20mm x 30mm
Stem Length: 20mm
Fits Into 10mm Hole
Ford Probe, Mazda MX6 '89 - UP
Box Qty. 15



416004

3M8Z-1502316-A
GJ6E-50-715A
Black Nylon
Cowl Screw-Type Retainer
Head Size: 8.5mm x 12mm
Stem Length: 9mm
Fits Into 5mm Hole
Fusion, Milan & Zephyr 2006 - UP
Mazda 5 & 6 2003 - UP
Box Qty. 15



416049 Box 25

416025

B092-51-833,
MB-455-56143,
W705845-S300, 86590-28000
Black Nylon
Screw-Type Retainer
Head Dia.: 18mm
Stem length: 12mm
Fits Into 8mm Hole
Mazda & Ford Aspire,
Hyundai
Box Qty. 10



416038

GA2A-58-762
Blue Nylon
Weatherstrip Retainer
Head Size: 5mm x 15mm
Stem Length: 8mm
Fits Into 6mm Hole
Front & Rear Door and Hood
Mazda 626, Millenia '95 - UP
Box Qty. 50



416039

B003-68-865-96
Nylon
Rear Compartment
Interior Trim Retainer
Head Dia.: 15mm
Stem Length: 14mm
Stem Dia.: 6.5mm
Ford Probe '88 - UP,
Mazda MX6 '88 - UP
Box Qty. 50



416041

F1CZ-16774-A,
B455-56-741
Black Plastic
Hood Insulation Retaining Clip
Head Dia: 14mm
Length: 10mm
Stem Dia: 6mm
Ford Probe and Mazda MX6 '88-'92
Box Qty. 25



416042

94530438,
B040-68-865-A96
Plastic
Fender Liner
Screw-Type Retainer
Head Dia: 15mm
Stem Length: 14mm
Fits Into 6mm Hole
Ford Probe '88 - UP
Mazda MX6 '88 - UP
Chevrolet Aveo 2004 - UP
Box Qty. 25



MAZDA CLIPS & FASTENERS

 <p>416043 GA2A-56-399A Black Nylon Front Fender Plate Seal Clip Head Dia: 18mm Stem Length: 26mm Mazda 626 '98 - '2000 Box Qty. 10</p>	 <p>416083 90467-09139 Black Nylon Bumper Cover & Wheel Housing Push-Type Retainer Head Dia: 18mm Stem Length: 15mm Fits Into 9mm Hole Honda, Mazda 626 & Toyota Corolla '92 - UP Box Qty. 15</p>	 <p>416103 90467-06017, 9926-50-625, 20426301 Black Nylon Screw-Type Retainer Head Dia: 15mm Stem Length: 12mm Fits Into 7mm Hole Toyota, Mazda, GM Box Qty. 15</p>	 <p>416107 BC1D-56-145 Black Nylon Mud Guard Screw-Type Retainer Head Dia: 20mm Stem Length: 9mm (Excluding the Pin) Fits into 8mm Hole Mazda Protege '96 - UP Box Qty. 25</p>
 <p>416202 01553-05323, L33X13209 Black Nylon Cowl, Bumper & Fender Liner Push-Type Retainer Head Dia: 20mm Stem Length: 12mm Fits Into 8mm Hole Infiniti FX35, FX45, G35 and Nissan 2003-UP; Mazda 2, 3, 5, 6, CX-5, CX-7 & CX-9 2007-UP Box Qty. 10</p>	 <p>416219 B45A-56-146A, 90118-WB048 Black Nylon Bumper, Fender, Engine Cover & Qtr. Panel Push-Type Retainer Head Dia: 20mm Stem Length: 13mm Fits Into 8mm Hole Mazda 3, 5, 6, CX-3, CX-5, CX-9 & MX-5 Miata 2012 - UP Scion iA 2016 - UP Box Qty. 25</p>	 <p>416221 BGV4-56-145 Black Nylon Bumper Cover/Fender Liner Retainer Head Dia: 20mm Stem Length: 14mm Fits Into 8mm Hole Mazda 2, 3, 6, CX-9 & Miata 2010 - UP Box Qty. 25</p>	<p>NEW</p>  <p>416224 GD7A-50-EA1 Black Nylon Bumper Cover & Grille Push-Type Retainer Head Dia: 19.5mm Stem Length: 15mm Fits Into 10mm Hole Mazda '99 - UP Box Qty. 10</p>
 <p>425525 W705849-S300, 9XG0-73-88X0 Nylon Front End Moulding Clip Top Hd. Size: 1/2" x 13/16" Bottom Hd Size: 11/16" x 25/32" Stem Length: 3/8" Mazda, Ford 2000 - UP Box Qty. 10</p>	 <p>435187 D10E-51-SJ3 Green Nylon Rocker Panel Mldg Retainer With Sealer Top Head: 13mm x 17mm Bottom Head Dia: 18.5mm Stem Dia: 11.7mm Stem Length: 12mm Mazda 3, 5, CX-3, CX-9, Miata & MX-5 2016 - UP Box Qty. 15</p>	 <p>435536 BP4L-51-SJ3 Gray Nylon Moulding Clip W/Sealer Top Head: 14mm x 20mm Bottom Head Dia: 36.5mm Stem Length: 10mm Mazda 3, 5, 6, CX-7, CX-9 & RX-8 2004 - UP Box Qty. 10</p>	<p>NEW</p>  <p>435540 KD45-51-W24 White Nylon Fender & Wheel Apron Moulding Clip With Sealer Top Head: 14mm x 18mm Bottom Head Dia: 18mm Stem Length: 12mm Stem Dia: 11mm Mazda CX-5 2013 - 2016 Box Qty. 25</p>
 <p>435561 KD53-51-SJ3A Gray Nylon Stone Guard Moulding Clip with Sealer Top Head: 10mm x 15mm Bottom Head Dia: 18mm Stem Dia: 12mm Stem Length: 9mm Mazda CX-5 2016 - UP Box Qty. 25</p>	 <p>445161 9XG0-75-93X0, W706738-S300, W708621-S300 Caramel & Natural Nylon Trim Panel Retainer Top Head Dia: 13mm Bottom Head Dia: 20mm Stem Length: 16mm Fits Into 8.5mm Hole Ford 2000 - UP Mazda Box Qty. 25</p>	 <p>445805 90467-11005, 89421-76980, 9926-40-658, 76906-T3000, 76916-T3000 Black Nylon Weatherstrip Clip Head Dia: 14mm Stem Length: 16mm Stem Dia: 10mm Honda, Isuzu, Mazda, Nissan Box Qty. 25</p>	 <p>445811 G18K-51-SJ3 White Nylon Door Trim Panel Retainer with Sealer Mazda 3, 5, 6, CX-7, Miata & Protege 2001 - UP Box Qty. 10</p>

MAZDA CLIPS & FASTENERS

445814

9927-40-822,
62581-14020

Natural Nylon

Trim Panel Retainer
Top Head Dia: 14mm
Bottom Head Dia: 18.5mm
Stem Dia: 11.5mm
Stem Length: 14mm
Overall Length: 20mm

Mazda & Toyota

Box Qty. 25



445815

67771-01010,
67771-12010,
8942264920,
9927-40-825,
95005064

White Nylon

Door Panel Retainer
Top Head Dia: 13mm
Bottom Head Dia: 18mm
Stem Length: 14mm
Overall Length: 21mm

Fits Into 9mm Hole

GM, Isuzu, Mazda, Toyota

Box Qty. 25



445985

9927-40-821

Nylon

Door Panel Retainer
Top Head Dia:
Bottom Head Dia: 17mm
Stem Length: 14mm
Overall Length: 20mm

Fits Into 8mm Hole

Mazda

Box Qty. 25



445986

B101-68-252-00

Black Plastic

Interior Trim
Push-Type Retainer
Head Dia: 14mm
Stem Length: 16mm
Fits Into 6mm Hole

Ford Probe and Mazda MX6 '88 - UP

Box Qty. 25



445991

BP4K-58-762

Black Nylon

Weatherstrip Retainer

Hole: M4

Head: 9mm

Stem Length: 7mm

Mazda 2007 - UP

Box Qty. 25

445995

GJ21-68-885B-02
5R3Z-54310D12-AAA,
6E5Z-7850980-AAA;

Black Nylon

Trim Panel

Push-Type Retainer

Head Diameter: 18mm

Stem Length: 10mm

Fits into 6mm Hole

Fusion & Mustang 2005 - UP

Mazda 1992 - UP

Box Qty. 25



475439

D001-56-731

Black Nylon

Hood Release Cable Clip

Holds 5mm Dia Cable

Stem Length: 9mm

Fits Into 6mm Hole

Mazda 2, 3, 5, 6, 323, 626, CX-5,

CX-7, CX-9, Miata, Millenia, MPV,

MX-3, MX-6, Protege, RX-7 & RX-8

1989 - 2013

Box Qty. 25



495000

9927-80-405

Door Lock Rod Clip

Hole: M6

Rod: 4mm

Mazda 323, 626 & 929 '76 - '95

Box Qty. 25

505195

9928-91-053,
90672-SAO-0030

Nylon

Releasable

Cable Strap

Length: 5-1/2"

(140mm)

Fits a 7mm Hole

Mazda & Honda

Box Qty. 25

not actual size



MAZDA GLASS SHOP SUPPLIES



465040
72825-47400
Plastic Windshield Reveal
Moulding Clip
Datsun, Mazda
Box Qty. 25



465140
HA01-50-609
Plastic
Windshield Reveal
Moulding Clip
Mazda Truck '86 - UP
Mercury Tracer '87 - UP
Box Qty. 25



465145
H-0015609
Plastic
Windshield Reveal
Moulding Clip
Mazda 626 '83 - UP
Box Qty. 25



465150
B092-50-609
Gray Plastic
Back Glass
Moulding Clip
Ford Probe '88 - UP,
Mazda MX6 '88 - UP,
Mercury Tracer '87 - UP
Box Qty. 25

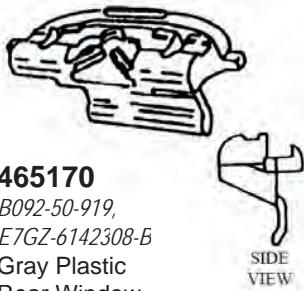

465170
B092-50-919,
E7GZ-6142308-B
Gray Plastic
Rear Window
Moulding Clip
Mazda 323 '88 - UP,
Mercury Tracer '88 - UP
Box Qty. 15

MAZDA CLIPS & FASTENERS

Mazda Clips

27

BLANK

MERCEDES CLIPS & FASTENERS

 <p>38517 003-990-24-97 Dia: 3/16" (4.8mm) Grip: 1/16" - 1/8" (1.6mm - 3.2mm) Flange Dia: 3/8" (9.5mm) Steel Rivet, Steel Mandrel Door Handle, Air Bag, Rocker Moulding, Window Regulator Mercedes-Benz 1998 - UP Box Qty. 100</p>	<p>38595 W708777-S900C, 004-990-16-97, 11519023, 19353806 Dia: 1/4" (6.3mm) Grip: 3/16" - 17/64" (4.8mm - 6.8mm) Flg Dia: 0.5" (13mm) Steel Rivet, Steel Mandrel Mercedes 2008 - UP Cab, Radiator, Rail, Floor, Door, Pillar, Cowl, Box, Back Panel, Fuel Door Filler Ford F150 (Aluminum Body) 2015 - UP; Mercedes 2008 - UP; Buick Allure, Enclave, LaCrosse, Lucerne, Cadillac ATS, CTS, Escalade, SRX, STS, XLR, XTS, Chevrolet Avalanche, Bolt EV, Cobalt, Camaro, Colorado, Corvette, Equinox, Express, HHR, Impala, Malibu, Silverado, Suburban, Tahoe, Traverse, GMC Acadia, Canyon, Savana, Sierra, Terrain & Yukon 2004 - UP; Chevrolet Blazer, GMC Jimmy, Oldsmobile Bravada, Pontiac G5, G6, Grand Prix, Pursuit, Solstice & Saturn Aura 1997 - 2009 Box Qty. 10</p>	<p>Recommended by Ford to replace the Factory Self Piercing Rivets!</p> 	
 <p>38612 003-990-94-97, BBM450-355 Dia.: 5/32" (4mm) Grip: 3/64" - 9/32" (1mm-7mm) Flange Dia.: 5/16" (8mm) Split-Type Rivet Aluminum Rivet Aluminum Mandrel Bumpers Mazda 2012 - UP, Mercedes 2004 - UP Box Qty. 25</p>	 <p>200364 201-990-05-36 Black E-Coat M4.8-1.61 x 20MM (#10 x 25/32") Hex Head Tapping Screw w/ SEMS Washer OD: 26mm Hex: 8mm Front Bumper & Mldg. Strip Mercedes '93 - 2014 Box Qty. 25</p>	<p>NEW</p>  <p>270071 Zinc & Yellow U Type Nut 3.5mm (#6) Screw Size PR: .5mm - 1.5mm Center Hole To Edge: 8mm BMW, Mercedes Box Qty. 50</p>	<p>NEW</p>  <p>270072 123-994-08-45 Zinc & Yellow U Type Nut 4.2mm (#8) Screw Size PR: .5mm - 2.5mm Center Hole To Edge: 14mm Mercedes Box Qty. 25</p>
 <p>270074 001-990-00-91 Zinc & Yellow Screw Size: M6-1.0 Panel Range: .5mm - 1.7mm Center Hole to Edge: 15mm Mercedes Benz Box Qty. 10</p>	 <p>270075 000-994-04-45 Plated "U" Type Nut Screw Size: 4.2mm (#8) Panel Range: .5mm-1.7mm Center Hole To Edge: 8mm Mercedes Benz Box Qty. 50</p>	 <p>270077 0712-9-925-737, 000-994-06-45 Plated "U" Type Nut Screw Size: 4.8mm (#10) Panel Range: .5mm -1.7mm Center Hole to Edge: 7mm BMW, Mercedes Benz Box Qty. 50</p>	 <p>270078 000-994-09-14, 946-418, 20-72-175 Plated "U" Type Nut Screw Size: 6.5mm (#14) Panel Range: .7mm-1.5mm Center Hole to Edge: 13mm Mercedes, Opel, Volvo Box Qty. 50</p>
 <p>270081 Zinc "U" Type Nut Screw Size: 4.8mm (#10) Panel Range: .9mm-2.0mm Center Hole To Edge: 8mm Mercedes Benz, BMW, Subaru, SAAB, VW & Opel Box Qty. 25</p>	 <p>270082 000-994-14-45, 0711-9-916-945 Plated "U" Type Nut Screw Size: 4.8mm (#10) Panel Range: .8mm-1.7mm Center Hole To Edge: 11mm BMW, Mercedes Benz Box Qty. 50</p>	 <p>270085 000-994-25-45, 0712-9-925-708 "U" Type Nut Screw Size: 4.2mm (#8) Panel Range: 3mm-4mm Center of Hole to Edge: 7mm BMW, Mercedes Benz Box Qty. 50</p>	<p>NEW</p>  <p>292002 16-13-1-176-747, 003-990-02-51 Black Nylon Nylon Flange Nut Stud Size: 5mm Hex: 10mm Flange Dia: 16mm Overall Height: 11mm BMW & Mercedes 1997 - UP Box Qty. 25</p>

MERCEDES CLIPS & FASTENERS

NEW



292008

000-988-16-25
Nylon
Cowl Vent Nut
M3.5 (#6) Screw Size
Head: 9.5mm x 9.5mm
Stem Length: 14mm
Fits Into 6.5mm x 7mm Hole
Mercedes
Box Qty. 25

NEW



292012

003-994-75-45
Black Nylon
Bumper, Spoiler & License Mount
Screw Grommet
Screw Size: M4.2 (#8)
Head Size: 14mm
Stem Length: 8mm
Mercedes-Benz A 220, CLA 250 & CLA 45 AMG 2019 - UP;
CLK 320, CLK 500 & CLK 55 AMG 2003 - 2005;
CLK 350, CLK 550 & CLK 63 AMG 2006 - 2009;
E 350 & E 550 2010 - 2013; GLA 250 2015 - 2017;
GLA 45 AMG 2015 - UP; S 63 AMG 2014 - 2016;
SLC 300 & SLC 43 AMG 2017 - UP
Box Qty. 50

NEW



292158

07-14-7-169-847,
07-14-7-166-870, 002-990-53-50
Black Nylon
Fender Liner, Wheel Apron & Rocker Moulding Nut
Screw Size: M4.8-1.61 (#10)
Hex Size: 10mm
Flange Dia: 22mm
BMW 230i, 320i, 328d, 330e, 330i, 330i GT, 340i, 340i GT, 430i, 430i
Gran Coupe, 440i, 440i Gran Coupe & M2 2018-UP; Mini-Cooper,
Clubman, Countryman & Paceman 2011-UP; Mercedes CL550,
CL600 2007-2014, CL63 1500, 2500, 3500 2019-UP; S350 2012-
2013, S400 2010-2013, S550, S600 2007-2013, S63 AMG, S65 AMG
2008-2013
Box Qty. 25



295040

000-988-15-81
Red Nylon
Moulding Insert
Mercedes Benz
Box Qty. 50



295045

000-988-55-81
Blue Nylon
Moulding Insert
Mercedes Benz
Box Qty. 50



295046

000-987-10-81
White Nylon
Moulding Insert
Mercedes Benz
Box Qty. 50



295047

001-988-20-81
Red
Nylon Tubular Nut
I.D.: 4.5 mm
Length: 14mm
Fits Into 9mm Hole
Mercedes Benz
Box Qty. 50

NEW



295274

51-44-7-780-15,
108-988-00-27
Natural Nylon
Tubular Nut
Stud Size: 7mm
Head Dia: 16mm
Stem Length: 16mm
Fits Into 8.5mm Hole
BMW, Mercedes, Universal
Box Qty. 25

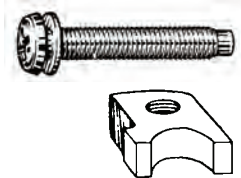

355055

Headlamp Adjusting Screw
and Nut Assembly
Mercedes Benz
Box Qty. 10



415710

000-990-03-92, 947-098
Black Nylon
Push-Type Retainer
Head Dia: 10mm
Stem Length: 7mm
Fits into 5mm Hole
Mercedes Benz, Volvo
Box Qty. 50

NEW

415711

000-990-37-92
Black Nylon
Trunk Trim &
General Purpose
Push-Type Retainer
Head Dia: 13mm
Stem Length: 14mm
Fits Into 8mm Hole
Mercedes SL500 & SL600
Convertible '99 - UP
Box Qty. 15



416011

NEW

N803946S, 000-991-52-40,
20664091, 6502871,
W706350-S300
Black Nylon
Rear Quarter
Trim Panel
Screw-Type Retainer
Head Dia: 19/32" (15mm)
Stem Length: 29/32" (23mm)
Fits Into 1/4" (6.4mm) Hole
Ford & Chrysler '97 - UP, GM,
Mercedes Metris 2016-20, Sprinter
1500, 2500, 3500 2019-UP
Box Qty. 50



416081

001-988-03-25
Black Nylon
Hood Insulation Retainer
Mercedes 2002-UP
Box Qty. 15



MERCEDES CLIPS & FASTENERS

 <p>416101 123-990-00-92 Dark Gray Nylon Push-Type Retainer Head Dia: 12mm Stem Length: 10mm Fits Into 8.5mm Hole Mercedes Benz Box Qty. 10</p>	 <p>416104 51-11-1-908-077, 00-990-54-92 Black Nylon Push-Type Retainer Head Dia.: 15mm Stem Length: 15mm Fits Into 6.3mm Hole Scuff Plate BMW 3,5 and 7 Series '84 - UP Mercedes 1994 - 2014 Box Qty. 50</p>	 <p>416110 000-990-34-92, 51-16-1-881-149, N-102-593-01 Black Nylon Radiator Housing Push-Type Retainer Head Dia: 10mm Stem Length: 10mm Fits Into 6mm Hole Mercedes Benz Body Styles 116, 123, 124, 126, 129, 140, 170, 201, 208 & 210 1974-UP BMW, VW Box Qty. 15</p>	 <p>416111 Grille Clip Mercedes Benz Box Qty. 50</p>
 <p>416119 123-990-02-92 Black Nylon Push-Type Retainer Head Dia: 20mm Stem Length: 9mm Fits Into 8mm Hole Mercedes Benz Box Qty. 10</p>	 <p>416121 201-990-00-50 Black Nylon Rear Compartment Carpet Retainer Stud Size: 5mm Head Dia: 24mm Hex: 10mm Mercedes Benz Box Qty. 25</p>	 <p>416270 230-990-01-92, 6104900-A Black Nylon Hood Insulation/Cowl Grille Push-Type Retainer Head Diameter: 20mm Stem Length: 10mm Fits Into 8mm Hole Mercedes Benz GL, M, R, SL & SLK 2005 - UP; Chrysler 2010-UP Box Qty. 15</p>	 <p>416285 201-990-02-92, 51471911992, 51470146782, 54170390017 Black Nylon Push-Type Retainer Head Dia: 20mm Stem Length: 14mm Fits Into 8.5mm Hole Mercedes Benz, BMW 1, 2, 3, 4, 5, 7, i3, i8, X & Z Series 1988 - UP Box Qty. 25</p>
<p>NEW</p>  <p>416292 000-990-44-92 Black Nylon Push-Type Retainer Head Dia: 12mm Stem Length: 11mm Fits Into 5mm x 5mm Hole Mercedes Box Qty. 25</p>	<p>NEW</p>  <p>416293 000-990-40-92, 124-990-05-92-9051 Black Nylon Push-Type Retainer Head Dia: 12mm Stem Length: 11mm Fits Into 5mm Hole Mercedes Box Qty. 25</p>	<p>NEW</p>  <p>416294 000-990-46-92 Black Nylon Push-Type Retainer Head Dia: 17mm Stem Length: 15mm Fits Into 6mm Hole Mercedes Box Qty. 10</p>	
<p>NEW</p>  <p>416296 000-990-84-92 Black Nylon Push-Type Retainer Head Dia: 10mm Stem Length: 10mm Fits Into 6mm Hole Mercedes 2005 - UP Box Qty. 25</p>	 <p>416306 000-991-41-40 Black Nylon Rear Fender Liner Push-Type Retainer Head Diameter: 20mm Stem Length: 19mm Fits into 7mm Hole Mercedes-Benz A 220, C 300, C 350e, C 400, AMG® C 43, AMG® C 450, AMG® C 63, E 300, AMG® E 63, S 550, S 550e, S 560, S 600, AMG® S 63 & AMG® S 65 2015 - UP Box Qty. 25</p>	<p>NEW</p>  <p>421007 000-988-86-25 Natural Nylon Rocker Panel Moulding Screw Grommet Stem Length: 16mm Flange Dia: 18mm Use with M4.2 (#8) Screw Mercedes CL, E, & S '96 - UP Box Qty. 25</p>	 <p>435401 001-988-51-81 White Nylon Body Side Moulding Clip Mercedes Benz Body Styles 124 & 201 1986-95 Box Qty. 15</p>

MERCEDES CLIPS & FASTENERS

Mercedes Clips

28



435402
201-986-07-78
Black Nylon
Body Side Moulding Clip
Mercedes Benz Body Style 201
1993-94
Box Qty. 10

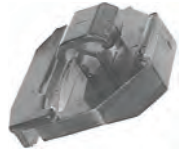

435403
006-988-35-78
White Nylon
Body Side Moulding Clip
Mercedes Benz
Body Style 201 1987-93
Box Qty. 10



435406
201-988-03-78
Nylon
Moulding Clip
16.5mm Wide, 18mm Long
Fits Into 6mm Hole
Mercedes Benz
Box Qty. 25



435408
002-988-09-78
Grille Moulding Clip
Mercedes Benz
Box Qty. 50



435411
004-988-94-78
Moulding Clip
Mercedes Benz
Box Qty. 50



435412
000-988-78-81
Moulding Clip
Mercedes Benz
Box Qty. 50



435413
000-988-75-81
Rocker Panel Moulding Clip
Mercedes Benz Styles 115-123
Box Qty. 25



435417
124-990-04-92
Plastic
Fender/Grille
Push-Type Retainer
Head Dia: 16mm
Stem Length: 18mm
Fits Into 7mm Hole
Mercedes Benz C, CLK, CLS, E, M
& R Class 2001 - UP
Box Qty. 15



435515
002-988-51-81
Black Nylon
Grille Moulding Clip
Fits Into 7mm Hole
Mercedes Benz CLK320, CLK500 &
ML350 2003 - UP
Box Qty. 10



435516
007-988-99-78,
007-988-34-78
Green Nylon
Door Trim Panel Retainer
Top Head Dia: 13mm
Bottom Head Dia: 17mm
Stem Dia: 9mm
Stem Length: 14mm
Mercedes-Benz 1996 - UP
Box Qty. 10



445036
003-988-41-78
White Nylon
Trim Panel Retainer
Small Head Dia.: 13mm
Large Head Dia.: 18mm
Stem Dia.: 8.5mm
Stem Length: 11mm
Mercedes Benz
Body Styles 107, 108, 109, 114,
115, 123 & 124 1968 - 95
Box Qty. 10













445813
123-990-05-92,
126-990-03-92
Black Nylon
Cowl Screen Cover
Push-Type Retainer
Head Diameter: 16mm
Stem Length: 11mm
Fits Into 6.3mm Hole
Mercedes Benz E, CL & S Class
2000 - UP
Box Qty. 15



Mercedes-Benz

MITSUBISHI CLIPS & FASTENERS

<p>216141 MS452348 Black E-Coat M6-1.81 x 20MM Phillips Hex Head SEMS, Hex: 10mm Washer OD: 13mm (1/2") Bumper, Ext. Trim, Fender Shield and Qtr. Panel <i>Mitsubishi Diamante, Eclipse, Galant, Lancer, Mirage, Montero & 3000GT 1991-2012</i> Box Qty. 25</p> 	<p>292040 75522-611-000, 75522-611-0000 9991-00-412, MS-480001, 96706-B0700, 97606-B0700, 90189-04042, 95900-04036 Grommet Nut Screw Size: #8 Width: 9.5mm, Length: 9.5mm Fits into 7mm x 7mm Hole <i>Honda, Toyota, Nissan, Mazda, Mitsubishi</i> Box Qty. 50</p> 	<p>292050 90189-05013, MS480009 MS-480002, 94841764 Nylon Nut Headlamp Bezel & Grille Screw Size: #10 Width: 12mm, Length: 12mm Fits into 8mm x 9mm Hole <i>Toyota, Mitsubishi, GM</i> Box Qty. 50</p> 	<p>292060 90189-04008, MB029111, 90467-12096, 94841130 Nylon Grille Nut Screw Size: #8 Length 16mm, Width 12mm Height 15mm Fits Into 10mm Square Hole <i>GM Nova '85 - UP Toyota, Mitsubishi</i> Box Qty. 25</p> 
<p>292075 96706-H9400, 96706-K1351, 96706-K1300, MB106212, 90672-671-811 Screw Grommet Screw Size: #8 Head Dia: 13.5mm Stem Length: 16mm Fits Into 6mm x 6mm Hole <i>Honda, Nissan, Mitsubishi</i> Box Qty. 25</p> 	<p>292260 90189-06001, MB-098145, 01281-00023, 01281-00231 White Nylon Screw Grommet Screw Size: #10 Head Dia.: 18mm Stem Length: 17mm Fits Into 8.5mm Square Hole <i>Toyota, Mitsubishi, Nissan</i> Box Qty. 25</p> 	<p>292270 90661-SC7-0030, 90661-SC7-003, H001-50-841, MS-480012, 01651-00481, 74798-S9000, 90189-06042 Nylon Screw Grommet Screw Size: #8 (M4.2) Head Dia: 16mm Stem Length: 17mm Fits a 8mm x 8mm Hole <i>Honda, Toyota, Nissan, Mitsubishi, Mazda</i> Box Qty. 25</p> 	<p>415107 MB020923 Gray Nylon Hood Insulation Retainer Head Dia: 26mm Stem Dia: 10mm Stem Length: 8mm <i>Jeep Eagle and Mitsubishi Eclipse '92 - UP</i> Box Qty. 10</p> 
<p>415112 MU481187 Black Nylon Hood Insulation Retainer Head Dia: 26mm Stem Dia: 10mm Stem Length: 8mm <i>Mitsubishi Diamante '93 - UP</i> Box Qty. 15</p> 	<p>415759 Box 50 415761 94218027, H200-50-715 8942180270, 58974-00008, B092-50-715, BF67-S0715, MB153825, 90467-13011, 90467-12020 Black Nylon Grille Headlight Clip Width: 13mm Length: 22mm <i>Ford, GM, Toyota, Mitsubishi, Isuzu, Honda, Plymouth, Mazda</i> Box Qty. 25</p> 	<p>416023 91512-SX0-003, 11519949, MU000319 Black Nylon Front Bumper Push-Type Retainer Flange Dia: 20mm Stem Length: 11mm Fits Into 8mm Hole <i>Buick, Cadillac, Chevrolet & GMC '97-UP; Mitsubishi Lancer; Acura 3.5RL, Honda Accord, Prelude & Odyssey '94-UP</i> Box Qty. 25</p> 	<p>416055 MB888869, 90505-SL0-003, 90467-08155 Plastic Bumper Cover Screw-Type Rivet Hole: M8, Stem: 20.5mm Panel: 13mm, HD: 20mm <i>Chrysler, Mitsubishi, Acura, Toyota '93 - UP</i> Box Qty. 15</p> 
<p>416097 MR138807 Black Nylon Bumper Cover Screw Type Rivet Hole: M8, Flange: 20mm Max G.R.: 20mm <i>Chrysler Sebring '96 - UP Mitsubishi Eclipse '94 - UP</i> Box Qty. 5</p> 	<p>416123 MR478262 Black Nylon (Use w/416125) Bumper Cover/ Garnish Moulding Push-Type Retainer Top Hd Dia: 15mm Bottom Hd Dia: 14mm Stem Length: 12mm Fits Into 7mm Hole <i>Chrysler Sebring & Stratus 2000-UP, Mitsubishi Eclipse 2000 - UP</i> Box Qty. 15</p> 	<p>416125 MR478263 Black Rubber (Use w/416123) Bumper Cover & Garnish Moulding Grommet With Sealer Head Dia: 16mm Stem Length: 20mm Fits Into 9mm Hole <i>Chrysler Sebring & Stratus 2000-UP, Mitsubishi Eclipse 2000 - UP</i> Box Qty. 15</p> 	<p>416133 MR200300 Black Nylon Fender & Bumper Push-Type Retainer Head Dia: 18mm Stem Length: 13mm Fits Into 9mm Hole <i>Honda & Mitsubishi 1998 - UP</i> Box Qty. 15</p> 

MITSUBISHI CLIPS & FASTENERS

29 Mitsubishi Clips

416134

63854-01A00,
MB547806
Black Nylon
Front Bumper Fascia
Screw-Type Retainer
Head Dia: 20mm
Stem Length: 20mm
Fits Into 8mm Hole
Mitsubishi and Nissan 300ZX
'90 - UP
Box Qty. 15



NEW

416243

MR288150,
909130013
Black Nylon
Bumper Fender Liner
Push-Type Retainer
Head Diameter: 15mm
Stem Length: 11mm
Fits into 6mm Hole
Mitsubishi Endeavor, Galant, Lancer, Mirage, Montero & Outlander 1997 - UP; Subaru BRZ, Forester, Impreza, Legacy, Outback, & XV Crosstrek 2004 - UP
Box Qty. 10



435480

90189-06005,
098-145, 01281-00023
White Nylon
Screw Grommet
Screw Size: #14 (1/4") or M6.3-1.81
Head Dia: 18mm
Stem Length: 16mm
Fits into 8mm x 8mm Hole
Lexus, Toyota, Mitsubishi, Datsun
Box Qty. 25



445188

HB-121467
Black Nylon
Screw Grommet
Retaining Clip
Head Dia: 18mm
Shank Length: 15mm
Panel Thickness: 5mm
Snaps into 8mm Hole
Mitsubishi
Box Qty. 25



445944

MB619582
Black Nylon
Interior Trim,
Bumper & Grille
Push-Type Retainer
Head Dia: 15mm
Stem Length: 12mm
Fits Into 6.3mm Hole
Mitsubishi Eclipse, Endeavor,
Lancer & Outlander 2002 - UP
Box Qty. 25



465107

MB880455
Nylon
Windshield Moulding Clip
Mitsubishi Montero 1992-UP
Box Qty. 10



465112

MR313985
Natural Nylon
Windshield Clip
Mitsubishi Montero '92 - '99
Box Qty. 15



Upholstery And Trim Clips

5mm Hole Size
Chrysler Products, Japanese Models,
Mitsubishi Models



445178

MB178893
Black
Box Qty. 25

445180

MB222647
Burgundy
Box Qty. 25

445182

MB178894
Blue
Box Qty. 25

445184















MB178899
Off White
Box Qty. 25

445186

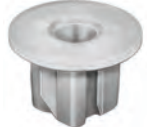
MB178896
Light Blue
Box Qty. 25



NISSAN CLIPS & FASTENERS

 <p>DA-34 DA-34, X237 Key Blanks Nissan, Infinity Box Qty. 10</p>	 <p>38714 01515-0009U Dia: 5/32" (4mm) Grip: 3/64" - 9/32" (1mm-7mm) Flange Dia: 5/16" (8mm) Split-Type Rivet Black Aluminum Rivet Aluminum Mandrel Bumpers Nissan Pathfinder 2006 - UP Box Qty. 25</p>	 <p>200101 Zinc & Yellow Dichromate M6.3-1.81 x 20mm (#14 x 25/32") Hex Head SEMS® Washer OD: 18mm (45/64") Hex: 10mm Honda, Nissan, Toyota Box Qty. 25</p>	 <p>220175 01135-00201 Bright Chrome Finish Bumper Bolt M6-1.0 x 12mm Head: 14mm Imports, Nissan Truck '82 - UP Box Qty. 10</p>
 <p>220176 01135-00511 Black Chrome Finish Bumper Bolt M6-1.0 x 12mm Head: 14mm Imports Nissan Truck '82 - UP Box Qty. 10</p>	 <p>292000 01281-00111 Natural Nylon Screw Grommet Screw Size: M5.5 (#12) Head Dia: 16mm Stem Length: 11mm Infiniti FX35, FX45, G20, G25, G35, G37, I30, J30, Q40, Q45, Q60, QX4 & QX56 1997 - UP Nissan 200SX, 240SX, 300ZX, Altima, Armada, Cube, Frontier, GT-R, Juke, Maxima, Murano, Pathfinder, Leaf, Quest, Rogue & Sentra 1987 - UP Box Qty. 25</p>	 <p>292001 85099-1MA0A Yellow Nylon Front & Rear Bumper Scuw Grommet Screw Size: M5.5 (#12) Top Hd Size: 10mm x 10mm Bottom Hd: 15mm x 16mm Stem Length: 9mm Nissan Pathfinder, Sentra, Versa & Versa Note 2012 - UP Box Qty. 25</p>	 <p>292040 75522-611-000, 75522-611-0000 9991-00-412, MS-480001, 96706-B0700, 97606-B0700, 90189-04042, 95900-04036 Grommet Nut Screw Size: #8 Width: 9.5mm, Length: 9.5mm Fits into 7mm x 7mm Hole Honda, Toyota, Nissan, Mazda, Mitsubishi Box Qty. 50</p>
 <p>292071 68425-H5000, 62698-V7000, 9991-00-503, 90662-671-0030, 90662-671-003, 90662-SB-003 Nylon Nut Screw Size: #10 Width: 17mm, Length: 17mm Fits Into 8mm x 8.5mm Hole Honda, Mazda, Nissan Box Qty. 25</p>	 <p>292072 01281-00831 Natural Nylon Bumper, Fender & Light Screw Grommet Screw Size: M4.2 (#8) Head Dia: 16mm Stem Length: 10mm Fits Into 9mm x 9mm Hole Nissan 240SX, Altima, Frontier, Maxima, Pathfinder, Quest & Xterra and Infiniti 1989 - UP Box Qty. 25</p>	 <p>292073 62319-0W000 Natural Nylon Front Bumper Nylon Nut Screw Size: M5.5 (#12) Head Dia: 16mm Stem Length: 11mm Nissan Frontier Truck 1997 - UP Box Qty. 10</p>	 <p>292074 01281-00691 Natural Nylon Screw Grommet Screw Size: M4.2 (#8) Head Dia: 16mm Stem Length: 20mm Nissan 240SX, Altima, Frontier, Maxima, Pathfinder & Titan, Infiniti I30, I35 & Q45 1989 - UP Box Qty. 15</p>
 <p>292075 96706-H9400, 96706-K1351, 96706-K1300, MB106212, 90672-671-811 Screw Grommet Screw Size: #8 Head Dia: 13.5mm Stem Length: 16mm Fits Into 6mm x 6mm Hole Honda, Nissan, Mitsubishi Box Qty. 25</p>	 <p>292080 96706-89901, 9991-00-402 Nylon Screw Grommet Screw Size: #6 Width 9.5mm, Length 9.5mm Stem Length: 16mm Fits Into 7mm x 7mm Hole Mazda, Nissan Box Qty. 25</p>	 <p>292105 78856-R4301, 90683-693-000 Nylon Screw Grommet Screw Size: #10 Width: 12mm, Length: 19mm Stem Length: 17mm Fits Into 8mm x 15mm Hole Honda & Nissan Box Qty. 10</p>	 <p>292074 01281-00691 Natural Nylon Screw Grommet Screw Size: M4.2 (#8) Head Dia: 16mm Stem Length: 20mm Nissan 240SX, Altima, Frontier, Maxima, Pathfinder & Titan, Infiniti I30, I35 & Q45 1989 - UP Box Qty. 15</p>

NISSAN CLIPS & FASTENERS



292110
62318-U7400
Grille Retainer
Datsun
Box Qty. 25



292112
62318-H8500,
01553-03831
Nylon
Grille Retainer
Overall Height: 22mm (7/8")
Nissan Maxima, Stanza '82 - UP
Box Qty. 25

NEW



292161
01651-00491
White Nylon
Trunk & Liftgate Moulding
Screw Grommet with Sealer
Screw Size: M6
Head Dia: 20mm
Stem Length: 17.5mm
Fits into 10mm x 10mm Hole
Nissan 200SX 1995 - 1998
Altima, Juke, Maxima, Murano,
Quest, Rogue, Rogue Sport, Sentra
& Titan 2007 - 2018
Box Qty. 25

NEW



292162
85099-1EAOA
Yellow Nylon
Bumper Screw Grommet
Screw Size: M5
Head Diameter: 14mm
Stem Length: 15.5mm
Overall Length: 18.5mm
Infiniti Q50 & QX80 2014 - UP
QX56 2011 - 2013
Nissan 370Z 2009 - UP
Armada & Quest 2017 - UP
Box Qty. 25



292210
90189-06010,
75521-611-0000,
9991-00-601, 96706-P0105
Nylon
Screw Grommet
Screw Size: #10
Width 13mm, Length 13mm
Snaps Into 8.5mm Sq. Hole
Toyota, Honda, Mazda, Nissan
Box Qty. 25



292260
90189-06001,
MB-098145,
01281-00023, 01281-00231
White Nylon
Screw Grommet
Screw Size: #10
Head Dia.: 18mm
Stem Length: 17mm
Fits Into 8.5mm Square Hole
Toyota, Mitsubishi, Nissan
Box Qty. 25



292261
01281-01431
Nylon
Front Bumper
Screw Grommet
Screw Size: M5.5 (#12)
Head Dia: 14mm
Stem Length: 17mm
Overall Length: 20mm
Infiniti Q30 2017 - UP; Nissan
Altima, Cube, Maxima, Murano,
NV, Quest, Sentra, Titan & Versa
2009 - UP
Box Qty. 25

292270
90661-SC7-0030,
90661-SC7-003,
H001-50-841, MS-480012,
01651-00481, 74798-S9000,
90189-06042
Nylon Screw Grommet
Screw Size: #8 (M4.2)
Head Dia: 16mm
Stem Length: 17mm
Fits a 8mm x 8mm Hole
Honda, Toyota, Nissan,
Mitsubishi, Mazda
Box Qty. 25



292295
96706-N8000
Nylon
Screw Grommet
Screw Size: #8
Width: 12mm, Length: 15mm
Fits 8mm x 12mm Hole
Nissan
Box Qty. 25



302047
63848-D4000
Black Nylon
Fender/Wheel Housing U-Nut
Screw Size: M5.5 (#12)
Width: 31mm
Length: 22mm
Panel Range: Up to 2mm
Center of Hole to Edge: 9mm
Nissan Sentra & Infiniti '89 - UP
Box Qty. 15



302048
63848-35F00
Black Nylon
Fender Clip U-Nut
Screw Size: M4.8 (#10)
Width: 20mm
Length: 32mm
Panel Range: Up to 2mm
Center of Hole to Edge: 8mm
Nissan Maxima & 240SX 1994-UP
Box Qty. 15



302049
76882-0M000
White Nylon
Nylon "U" Nut
M4.8 (#10) Screw Size
Panel Range: Up To 1.5mm
Center Hole To Edge: 8mm
Nissan & Infiniti 1995 - UP
Box Qty. 15



415237
01553-06721
Black Nylon
Front & Rear Bumper Cover
Push-Type Retainer
Head Diameter: 20mm
Stem Length: 11mm (Exclud-
ing the Pin)
Fits into 8mm Hole
Nissan Maxima '90 - UP,
Infiniti Q45 (Rear) '90 - UP
Box Qty. 25



















415243
66814-01A00
Plastic
Cowl Grille
Screw-Type Retainer
Hole: M6 Sq.
Head: 8mm x 12mm
G.R.: 5 - 7mm
Nissan 300 ZX '90 - UP
Box Qty. 25



415260
90467-07050,
90467-08008,
01553-00172
Weatherstrip &
Trim Panel Clip
Head Dia: 13mm
Stem Length: 15mm
Panel Thickness: 3mm
Fits Into 5mm Hole
Toyota, Nissan
Box Qty. 50

NISSAN CLIPS & FASTENERS

 <p>415278 01553-00545 Nylon Bumper Fascia Retainer Head Dia: 13mm Stem Length: 15mm Fits 5mm Hole Nissan Sentra '90 - UP Box Qty. 25</p>	 <p>415295 65832-F5000, 65846-30F00 Nylon Hood Insulation Retainer O.D.: 29.5mm Stem Dia: 7mm Stem Length: 9mm Nissan, Datsun '81 - UP Box Qty. 15</p>	 <p>415413 62089-N8520 Bumper Cover Retainer Datsun '80 - UP Box Qty. 25</p>	<p>415917 Box 25</p>  <p>415509 76882-57A00 Black Nylon Body Side Moulding Push-Type Retainer Head Dia: 16mm Stem Length: 20mm Fits into 8mm Hole Nissan Sentra '86 - UP Box Qty. 10</p>
 <p>415730 66824-W1000 Black Nylon Screw-Type Retainer Head Size: 12mm x 18mm Stem Length: 10mm Fits into 6mm Hole Nissan Box Qty. 10</p>	 <p>415740 66860-01W01, 94051993 Nylon Cowl Panel to Reinforcement Plate & Engine Splash Shield Ret. Head Dia: 14mm (9/16") Stem Length: 16mm (5/8") Fits Into 6mm (1/4") Hole Geo Storm '90 - UP Nissan '80 - UP Box Qty. 25</p>	<p>415751 Box 50</p>  <p>415750 63844-01A00; MNA01-56-145; NA01-56-145; MNA01-56145, NA01-56145 Black Nylon Inner Fender Retainer Head Dia.: 20mm (25/32") Stem Length: 18mm (23/32") Fits Into 8mm (5/16") Hole Ford, Mazda, Kia and Nissan '80-UP Box Qty. 10</p>	 <p>415772 66814-01G00 Black Nylon Cowl Grille Retainer Head Size: 8mm x 12mm Stem Length: 8mm Fits into 6mm Sq. Hole Nissan Pick-Up Truck '86 - UP Box Qty. 25</p>
<p>415776 Box 25</p>  <p>415775 8942431900, 9841690750, 1395-68-676, 9926-50-635, 75775-41300, 23270-3895, 80915-29A66 Screw-Type Drive Retainer Flange Dia: 20mm Stem Length: 9mm Fits Into 6mm Hole Honda, Nissan, Isuzu Box Qty. 10</p>	<p>415778 Box 25 415779 Box 100</p>  <p>415777 90675-SB3-003 FB01-56-964, 63876-95596 Cowl Vent, Air Ducts & Fender Splash Shield Screw-Type Retainer Head Dia: 20mm Stem Length: 9mm Fits Into 8mm Hole Honda, Nissan, Mazda Box Qty. 10</p>	 <p>415865 91545-SEO-003, 91545-SEO-0030-W1, 63848-01G00, 63848-01G00-A Nylon Push-Type Retainer Flange Dia: 20mm Stem Length: 8mm (Excluding the pin) Fits Into 8mm Hole Honda, Nissan Box Qty. 25</p>	 <p>415867 66824-01G00 Black Nylon Push-Type Retainer Head Dia: 12mm Stem Length: 8mm (Excluding The Pin) Fits Into 6mm Hole Nissan Box Qty. 25</p>
 <p>415886 21077131, 214077131, 01553-0161U Black Nylon Bumper Fascia Push-Type Retainer Head Dia: 1-3/16" Stem Length: 2" Fits Into 7/16" Hole Nissan, GM Saturn '91 - UP Box Qty. 10</p>	 <p>415905 63844-01A99 Nylon Screw-Type Retainer Head Dia: 17mm Stem Length: 18mm Fits into an 8mm Hole Nissan Box Qty. 25</p>	 <p>415920 94221150, 63844-D0100, 8942211500 Nylon Screw-Type Retainer Screw: 5mm x 14mm Head Size: 14mm x 22mm Stem Length: 9mm Fits into a 7mm Hole GM, Nissan, Isuzu Box Qty. 25</p>	 <p>415925 30012018, 90684-SA5-0030, 90684-SA5-003, 874-298-1190, 8942981190, 10998-30880 Nylon Push-Type Retainer Head Dia: 15mm Stem Length: 11mm Fits in a 6mm Hole Nissan, Honda, Isuzu, GM Box Qty. 25</p>

NISSAN CLIPS & FASTENERS



415940
62869-N4700
Black Nylon
Retaining Clip
Head Dia: 14mm
Stem Length: 11mm
Panel Thickness: 4mm
Fits in a 6mm Hole
Nissan
Box Qty. 25

415983 Box 25



415984
91516-SK7-013,
01553-0034U
Nylon
Splash Shield
Screw-Type Ret.
Flange Dia: 20mm
Stem Length: 15mm
Hex: 10mm
Fits Into 8mm Hole
Honda Civic '92-UP; Nissan XTerra,
Frontier, Quest '99-UP
Box Qty. 10



416006
90667-SA7-0030,
90667-SA7-003,
90667-SA7-003ZB, 89427-98070
Black Nylon
Door Trim Panel Retainer
Head Dia: 20mm
Stem Length: 15mm
Fits Into 5mm Hole
Honda & Nissan
Box Qty. 25



416007
80875-85E00
Black Nylon
Trim Panel Retainer
Head Dia: 10mm
Stem Length: 10mm
Stem Diameter: 4mm
Nissan Maxima '89 - UP
Box Qty. 25



416009
65810-K2009
White Nylon
Hood to Cowl Seal Retainer
Head Size: 6mm x 16mm
Stem Length: 15mm
Fits into 5mm Hole
Infiniti & Nissan Pathfinder 1992-UP
Box Qty. 25



416054
63848-9E001
Black Nylon
Bumper Fascia
Push-Type Retainer
Head Dia: 18mm
Stem Length: 19mm
(Excluding the pin)
Fits Into 9mm Hole
Nissan Altima 1997 - UP
Box Qty. 15



416056
63878-01E10
Black Nylon
Screw-Type Retainer
Head Dia: 20mm
Stem Length: 22mm
Fits Into 8mm Hole
Nissan Maxima 1994 - UP
Box Qty. 15



416064
01553-0038U
Gray Nylon
Bumper Screw-Type Retainer
Head Dia: 18mm
Stem Length: 12mm
Fits Into 8mm Hole
Nissan Frontier, Pathfinder & Xterra
2005 - UP
Box Qty. 10

416096 Box 25
416099 Box 50



416095
01553-09321
Black Nylon
Front Fender
Push-Type Retainer
Head Dia: 20mm
Stem Length: 9mm
(Excluding The Pin)
Fits Into 8mm Hole
Nissan Maxima, 300ZX '94 - UP
Box Qty. 15



416108
90467-07043,
80999-05N07
Nylon
Push-Type Retainer
Head Dia: 18mm
Stem Length: 11mm
(Excluding The Pin)
Fits Into 7mm Hole
Toyota, Nissan
Box Qty. 15



416134
63854-01A00,
MB547806
Black Nylon
Front Bumper Fascia
Screw-Type Retainer
Head Dia: 20mm
Stem Length: 20mm
Fits Into 8mm Hole
Mitsubishi and Nissan 300ZX
'90 - UP
Box Qty. 15



416135
01553-09611,
90467-08185
Black Nylon
Bumper Push-Type Retainer
Head Dia: 18mm
Stem Length: 10mm
Fits Into 8mm Hole
Lexus and Toyota 2002-UP
Nissan 1994-UP
Box Qty. 15

416137 Box 25



416136
01553-09241
Push-Type
Bumper Push-Type Retainer
Head Dia: 18mm
Stem Length: 15mm
Fits Into 10mm Hole
Nissan 240SX & Maxima '94 - UP
Box Qty. 10



416139
11296-AG000
Front Bumper and
Radiator Support
Push-Type Retainer
Head Dia: 20mm
Stem Length: 13mm
Fits Into 8mm Hole
Infiniti FX 35/45; Nissan Altima,
Maxima & Quest 2002 - UP
Box Qty. 25









416159
66820-3S500-C1
White Nylon
Cowl Vent Retainer
Top Head Dia: 13mm
Bottom Head Dia: 16mm
Stem Dia: 4mm
Stem Length: 13mm
Nissan Frontier, Xterra '98 - UP
Box Qty. 25



416202
01553-05323,
L33X13209
Black Nylon
Cowl, Bumper & Fender Liner
Push-Type Retainer
Head Dia: 20mm
Stem Length: 12mm
Fits Into 8mm Hole
Infiniti FX35, FX45, G35 and Nissan
2003-UP; Mazda 2, 3, 5, 6, CX-5,
CX-7 & CX-9 2007-UP
Box Qty. 10

NISSAN CLIPS & FASTENERS

 <p>416216 01553-0170U Black Nylon Front Bumper Cover Retainer Head Dia: 18mm Stem Dia: 8.5mm Stem Length: 19mm Nissan Altima 2015 - UP Box Qty. 25</p>	<p>NEW</p>  <p>416235 80850-89916 Black Nylon Door Weatherstrip Retainer Head Size: 4mm x 10mm Stem Dia: 5.4mm Stem Length: 10mm Infiniti I30 1996 - 2001 I35 2002 - 2004 Nissan Juke 2011 - 2015 Maxima 1995 - 2003 Box Qty. 50</p>	<p>NEW</p>  <p>416236 01553-05891 Dark Gray Nylon Bumper Bracket Retainer Head Dia: 26mm Stem Dia: 8.6mm Stem Length: 39mm Nissan Altima 2013 - UP Box Qty. 25</p>	<p>NEW</p>  <p>416237 01658-01361 24253-M9400 Black Rubber Hole Plug Head Dia: 17mm Overall Height: 6mm Fits into 12mm Hole Nissan 200SX 1997 - 1995 350Z, 370Z, Altima, Armada, Cube, Frontier, GT-R, Juke, Lead, Maxima, Pathfinder, Quest, Rogue, Sentra, Vera Note & Xterra 1999 - UP Box Qty. 30</p>
<p>NEW</p>  <p>416238 62828-AG000 Black Nylon Wheel Wind Deflector Push-Type Retainer Head Dia: 26mm Stem Length: 9mm (Not Including Pin) Fits into 16mm Hole Nissan Versa 2013 - UP Box Qty. 15</p>	 <p>416268 66820-AX020 Black Nylon Cowl Vent & Outside Mirror Push-Type Retainer Head Dia: 14mm Stem Length: 10mm Fits Into 6mm Hole Nissan Pathfinder & Versa 2005 - UP Box Qty. 15</p>		 <p>416350 01553-2DR9A Black Nylon Push-Type Retainer Top Head Dia: 16mm x 19mm Bottom Head Dia: 20mm Stem Length: 12mm Fits Into 8mm Hole Infiniti G20, JX35, Q45 & QX60 & Nissan Frontier, Maxima, NV, Pathfinder, Sentra, Versa & Xterra 2002 - UP Box Qty. 50</p>
 <p>435480 90189-06005, 098-145, 01281-00023 White Nylon Screw Grommet Screw Size: #14 (1/4") or M6.3-1.81 Head Dia: 18mm Stem Length: 16mm Fits into 8mm x 8mm Hole Lexus, Toyota, Mitsubishi, Datsun Box Qty. 25</p>	 <p>435482 N/A From O.E.M. White Nylon Drip Moulding Clip W/ Sealer Top Width: 25mm Overall Height: 16mm Fits Into 5mm Hole Infiniti M45, I30 & G35 2005-UP Nissan Altima, Maxima & 350Z 2002 - UP Box Qty. 15</p>	 <p>435489 01281-00711 Natural Nylon Rocker Moulding Screw Grommet Screw Size: M4.2 (#8) & M4.8 (#10) Head Dia: 20mm Stem Length: 15mm Nissan & Infiniti 1995 - UP NV200 2013-UP Box Qty. 10</p>	 <p>435492 76882-EG01A Black Nylon Rocker Panel Moulding Clip With Sealer Head Size: 10mm x 15mm Bottom Head Dia: 18mm Stem Length: 12mm Fits into 8mm Hole Nissan Altima, Maxima 2010 Box Qty. 15</p>
 <p>435623 26398-ED000 White Nylon Tail Light Clip Top Hd Size: 13mm x 13mm Bottom Hd Dia: 19mm Stem Length: 10mm Infiniti M37, M56 & M Hybrid 2013-UP; Nissan Armada, Juke, Pathfinder, Sentra & Versa 2006-UP Box Qty. 25</p>	 <p>435624 76847-1JB0A White Nylon Moulding Clip With Sealer Top Head Dia: 13mm Bottom Head Dia: 13mm Stem Length: 11mm Nissan Altima, Quest & Sentra 2011 - UP Box Qty. 15</p>	<p>NEW</p>  <p>435630 76882-EW00B White Nylon Rocker Moulding & Exterior Trim Moulding Clip W/Sealer Top Head: 6mm x 9mm Bottom Head: 13mm Stem Length: 7mm Fits Into 8mm Hole Nissan Altima & Juke 2011 - UP Box Qty. 10</p>	<p>NEW</p>  <p>445003 84915-0W010 White Nylon Wheelhouse, Trunk Trim & Package Tray Retainer Top Head Dia: 14mm Middle Head Dia: 16mm Bottom Head Dia: 18mm Stem Dia: 9mm Stem Length: 10mm Overall Length: 16.5mm Infiniti QX4 1997 - 2003 Nissan Pathfinder 1996 - 2004 Sentra 2013 - UP Box Qty. 25</p>

NISSAN CLIPS & FASTENERS

30 Nissan Clips

<p>NEW</p>  <p>445004 63848-AQ100 Red Nylon Wheel Opening Moulding & Lift-gate Trim Retainer Top Head Dia: 13mm Middle Head Dia: 16mm Bottom Head Dia: 18mm Stem Dia: 9mm Stem Length: 11.5mm Nissan Murano 2008 - 2013 Nissan Rogue 2014 - 2017 Box Qty. 20</p>	 <p>445800 01553-00042 Nylon Door Trim Panel Clip Nissan Box Qty. 25</p>	 <p>445801 1644290 Black Nylon Hood Insulation, Rear Bumper Fascia & Door Trim Plate Retainer Head Dia: 11mm Stem Length: 17.8mm Fits Into 5mm Hole GM 1991-UP, Nissan 2002-UP Box Qty. 25</p>	<p>NEW</p>  <p>445802 01553-0162U White Nylon Liftgate, Pillar & Quarter Panel Trim Retainer Top Head Dia: 13mm Middle Head Dia: 16mm Bottom Head Dia: 18mm Stem Dia: 10mm Stem Length: 14mm Overall Length: 21mm Nissan Frontier, Maxima, Murano, Pathfinder & Xterra 2007 - UP Box Qty. 25</p>
 <p>445805 90467-11005, 89421-76980, 9926-40-658, 76906-T3000, 76916-T3000 Black Nylon Weatherstrip Clip Head Dia: 14mm Stem Length: 16mm Stem Dia: 10mm Honda, Isuzu, Mazda, Nissan Box Qty. 25</p>	<p>445808 NEW 01553-09131 Blue Nylon Quarter Trim Panel Retainer Top Head Diameter: 13mm Middle Head Dia: 16mm Bottom Head Dia: 18mm Stem Dia: 9mm Stem Length: 10mm Infiniti G35, I30, I35 & M45 2000-2007; Q50 & Q60 2014-UP Nissan 200SX & Sentra 1995-1999; 350Z, Altima & Quest 1999-2008; GT-R, Maxima & Xterra 2005-UP Box Qty. 25</p> 	 <p>445970 01553-00051 Black Nylon Retaining Clip Head Dia: 20mm Stem Length: 16mm Panel Thickness: 7mm Snaps into 7mm Hole Nissan Box Qty. 25</p>	 <p>465040 72825-47400 Plastic Windshield Reveal Moulding Clip Datsun, Mazda Box Qty. 25</p>
 <p>465041 Black Nylon Windshield Moulding Clip Width: 22mm Length: 46mm Nissan Altima 2004 - UP Box Qty. 25</p>	 <p>465061 72727-W1000 White Nylon Windshield Reveal Moulding Clip Width: 21mm Length: 40mm Datsun, Nissan Box Qty. 25</p>	 <p>465100 80866-01A00 Windshield Reveal Moulding Clip Datsun Box Qty. 25</p>	 <p>475605 Metal Front Bumper Cushion Retainer Infinity Q45 '91 - UP Nissan Sentra '87-UP Box Qty. 15</p>
 <p>475606 85284-AD000 White Nylon Rear Bumper Clip Width: 20mm Height: 29mm Length: 35mm Infiniti G20, I30, I35, Q45 & QX56 and Nissan 350Z, Altima, Maxima & Murano 1999 - UP Box Qty. 10</p>	 <p>475607 85284-AL510 Gray Nylon Rear Bumper Cover Moulding Clip Width: 20mm Length: 32mm Overall Height: 20.5mm Infiniti G35, FX35, & FX45 2003 - 2008 Nissan Pathfinder 2005 - 2012 Box Qty. 5</p>	 <p>475710 62228-51S00 Front Bumper Retainer Nissan 300ZX '92 - UP Box Qty. 10</p>	<p>NEW</p>  <p>475711 65625-8J000 Black Nylon Hood Release Cable Clip Holds 6mm Dia. Cable Fits into 6mm Hole Nissan Altima, Maxima, Murano, NV1500, NV2500, NV3500, Pathfinder, Rogue, Sentra, Versa & Versa Note 2016 - UP Box Qty. 50</p>

NISSAN CLIPS & FASTENERS



480035
542290201P
 Window Crank Handle
 Retaining Clip
Datsun
 Box Qty. 50



480531
69951-12180
 Nylon
 w/ Steel Threaded Insert
 Glass Mount
 M6-1.0 Thread
Ford, Nissan and Imports
 Box Qty. 5

not actual size



NISSAN CLIPS & FASTENERS

30 Nissan Clips

BLANK

SUBARU CLIPS & FASTENERS

 <p>292121 91167AA000 Black Nylon Cowl Top, Quarter Glass, Exterior Trim, Belt Moulding, Trunk Lid & Rear Light Grommet w/ Sealer Head Diameter: 17.5mm Stem Length: 15mm Fits Into 8mm Hole <i>Subaru Baja, Forester, Impreza, Legacy, Outback & SVX 1991-2006</i> Box Qty. 25</p>	 <p>292117 62731FA010 Blue Nylon Screw Size: M3.5 (#6) Head Size: 11mm x 11mm Stem Length: 10mm Fits Into 8mm Sq Hole <i>Subaru 1993 - UP</i> Box Qty. 25</p>	 <p>292118 62731FA000 White Nylon Screw Size: M3.5 (#6) Head Size: 10mm x 10mm Stem Length: 5mm Fits Into 7mm x 7mm Hole <i>Subaru Forester, Impreza, Legacy & Outback 2005 - 2009</i> Box Qty. 25</p>	 <p>292119 94081FA010 White Nylon Screw Grommet Screw Size: M4.8 (#10) Head Dia: 13mm Stem Length: 8mm Fits Into 8mm Square Hole <i>Subaru 1992 - UP</i> Box Qty. 25</p>
 <p>292120 909300015 White Nylon Rear Bumper Screw Grommet Screw Size: M4.8 (#10) Head Dia: 12mm Stem Length: 15mm Fits Into 7mm Square Hole <i>Subaru Impreza, Legacy, Outback & SVX 1995 - 2009</i> Box Qty. 25</p>	 <p>302051 91086AA000 Black Nylon Splash Guard Nylon "U" Nut With Metal Insert Nut Thread: M5-.80 (Internal Steel Nut) Panel Range: Up To 3mm Center of Hole to Edge: 10mm <i>Subaru 2008 - UP</i> Box Qty. 10</p>	<p>NEW</p>  <p>416243 MR288150, 909130013 Black Nylon Bumper Fender Liner Push-Type Retainer Head Diameter: 15mm Stem Length: 11mm Fits into 6mm Hole <i>Mitsubishi Endeavor, Galant, Lancer, Mirage, Montero & Outlander 1997 - UP; Subaru BRZ, Forester, Impreza, Legacy, Outback, & XV Crossstre 2004 - UP</i> Box Qty. 10</p>	 <p>416320 909140065 Black Nylon Front Fender Liner, Engine Cover, Hood & Quarter Panel Push-Type Retainer Head Dia: 18mm Stem Length: 10mm Fits Into 8mm Hole <i>Subaru BRZ, Crosstrek, Forester, Impreza, Legacy, Outback & WRX 2008 - UP</i> Box Qty. 15</p>
 <p>416326 909207031 Black Nylon Hood Insulation Retainer Head Dia: 23mm Stem Dia: 8mm Stem Length: 15mm <i>Subaru BRZ, Forester, Impreza, WRX & XV Crossstre 2012 - UP</i> Box Qty. 50</p>	 <p>416327 909140059 Black Nylon Front/Rear Bumper Push-Type Retainer Head Dia: 10mm Stem Length: 8.5mm Fits Into 5mm Hole <i>Subaru Forester, Impreza, Legacy, Outback, WRX, XV Crossstre 2008 - UP</i> Box Qty. 50</p>	 <p>416328 91059FC090 Black Nylon Grille Clip Top Head: 15.5mm x 11mm Bottom Head: 19.5mm x 14mm Stem Length: 11mm <i>Subaru Forester & Legacy 1991 - 2008</i> Box Qty. 25</p>	 <p>416329 91017FA080 Gray Nylon Grille Clip Overall Height: 27mm <i>Subaru Forester Impreza & SVX 1993 - 2008</i> Box Qty. 25</p>
 <p>416330 90814FC001 Black Nylon Hood Insulation Retainer Head Dia: 30mm Stem Dia: 6.5mm Stem Length: 13mm <i>Subaru 1998 - UP</i> Box Qty. 10</p>	 <p>416331 909130074 Black Nylon Hood Insulation Retainer Head Dia: 30mm Stem Dia: 7.7mm Stem Length: 13mm <i>Subaru Baja, Forester, Impreza, Legacy, Outback & Tribeca 1998 - UP</i> Box Qty. 15</p>	 <p>416332 90331AA050 White Nylon Weatherstrip Retaining Clip Head Size: 5mm x 14mm Stem Dia: 7mm Stem Length: 8.5mm <i>Subaru Forester 2003 - 2008</i> Box Qty. 10</p>	 <p>416333 909130003 Black Nylon Upper Grille Push-Type Retainer Head Dia: 9mm Stem Length: 7mm Fits Into 4mm Hole <i>Subaru Baja, Legacy & Outback 2000-2006</i> Box Qty. 25</p>

SUBARU CLIPS & FASTENERS

416334

46064AE000
Black Nylon
Front Fender,
Bumper & Quarter Panel
Screw-Type Retainer
Head Dia: 15mm
Stem Length: 8mm
Fits Into 7mm Hole
Baja, Forester, Impreza, Legacy & Outback, 2003 - UP
Box Qty. 10



416335

909140012
Black Nylon
Rear Light Reflector
& Roof Spoiler
Screw-Type Retainer
Head Dia: 16mm
Stem Length: 11mm
Fits Into 6mm Hole
Subaru B9 Tribeca, Impreza, Legacy & Outback 2005 - UP
Box Qty. 25



416336

91085TA030
Black Nylon
Mud Flap/Splash Guard
Screw-Type Retainer
Head Dia: 16mm
Stem Length: 13mm
Fits Into 7mm Hole
Subaru Baja, Impreza, Legacy & Outback 2000 - UP
Box Qty. 25



416337

909130067,
86590-3S000
Black Nylon
Engine Cover and Fender
Liner Screw-Type Retainer
Head Dia: 18mm
Stem Length: 10mm
Fits Into 8mm Hole
Subaru B9 Tribeca, Forester, Legacy & Outback & Tribeca 2005 - UP
Hyundai Azera, Elantra, Genesis & Sonata and Kia Cadenza & Optima 2011-UP
Box Qty. 15



416338

909140051
Black Nylon
Front Bumper & Qtr Panel
Push-Type Retainer
Head Dia: 20mm
Stem Length: 9mm
Fits Into 7mm Hole
Subaru Impreza, Legacy, Outback & Tribeca 2005 - UP
Box Qty. 15



416339

59122FA010
Black Nylon
Front Bumper,
Fender, Windshield Washer
& Rocker Moulding,
Screw-Type Retainer
Head Dia: 20mm
Stem Length: 10mm
Fits Into 8mm Hole
Subaru B9 Tribeca, Baja, Forester, Impreza, Legacy & Outback 1998-UP
Box Qty. 25



416340

909140052
Black Nylon
Screw-Type Retainer
Head Dia: 20mm
Stem Length: 11mm
Fits Into 7mm Hole
Subaru B9 Tribeca, Impreza, Legacy & Outback 2005 - UP
Box Qty. 25



416341

909130051
Black Nylon
Fender Liner, Duct & Lower
Moulding Screw-Type Ret.
Head Dia: 20mm
Stem Length: 11mm
Fits Into 7mm Hole
Subaru B9 Tribeca, Forester, Impreza, Legacy, Outback 2005-UP
Box Qty. 15



416342

59122AC030
Black Nylon
Front Fender
Screw-Type Retainer
Head Dia: 20mm
Stem Length: 12mm
Fits Into 7mm Hole
Subaru B9 Tribeca, Baja, Forester, Legacy & Outback 1995 - UP
Box Qty. 15



416343

909140063
Black Nylon
Cowl Vent
Screw-Type Retainer
Head Dia: 20mm
Stem Length: 12mm
Fits Into 7mm Hole
Subaru Legacy & Outback 2010-UP
Box Qty. 10



416344

909130059
Black Nylon
Front Bumper & Fender
Push-Type Retainer
Head Dia: 20mm
Stem Length: 15mm
Fits Into 10mm Hole
Subaru Forester, Impreza, & Outback 2002 - 06
Box Qty. 25



416345

909140007
Black Nylon
Bumper, Engine
Cover, Fender & Grille
Push-Type Retainer
Head Dia: 21mm
Stem Length: 15mm
Fits Into 10mm Hole
Subaru Tribeca, Baja, Forester, Impreza, Legacy & Outback 2000-UP
Box Qty. 15



416346

57750AA090
Black Nylon
Front & Rear Bumper
Screw-Type Retainer
Head Dia: 22mm
Stem Length: 28mm
Fits Into 10mm Hole
Subaru Impreza & Legacy 1993 - 2001
Box Qty. 25



416347

909140055
Black Nylon
Push-Type Retainer
With Sealer
Head Dia: 25mm
Shoulder Length: 3mm
Shoulder Dia: 16.5mm
Stem Length: 16mm
Fits Into 11mm Hole
Subaru 2006 - UP
Box Qty. 5



416348

909140002
Black Nylon
Rocker, Pillar,
Floor & Exterior Trim Push-
Type Retainer With Sealer
Head Dia: 25mm
Shoulder Dia: 17mm
Shoulder Length: 3mm
Stem Length: 14mm
Fits Into 11mm Hole
Subaru B9 Tribeca, Baja, Legacy & Outback 2000 - UP
Box Qty. 25



416349

57160FC000
Black Nylon
Front Fender
Push-Type Retainer
Top Head Length: 19.5mm
Bottom Head Dia: 14mm
Stem Length: 15mm
Fits Into 10mm Hole
Subaru Forester 1998 - 2008
Box Qty. 25



SUBARU CLIPS & FASTENERS

 <p>435625 57750FC010 White Nylon Rear Bumper Reinforcement Beam Grommet With Sealer Screw Size: M4.8 (#10) Head Size: 16mm x 16mm Stem Length: 19mm Subaru Forester 1998 - 2008 Box Qty. 25</p>	 <p>435626 909130109 Black Nylon Front & Rear Door, Fender, Quarter Panel and Rocker Panel Moulding Clip Top Head: 11mm x 14mm Bottom Head Dia: 17mm Stem Dia: 9.7mm Stem Length: 12mm Subaru B9 Tribeca, Forester, Impreza, Legacy & Outback 2003-UP Box Qty. 25</p>	 <p>435627 909130007 Gray Nylon Pillar & Door Moulding Trim & Rear Light Retainer With Sealer Top Head: 11mm x 15mm Bottom Head Dia: 18mm Stem Dia: 9.7mm Stem Length: 12mm Subaru B9 Tribeca, Forester, Impreza, Legacy & Outback 2005 - UP Box Qty. 25</p>	
 <p>435628 91059FC030 White Nylon Front & Rear Door Fender, Quarter Panel and Lift Gate Moulding Clip With Sealer Top Head: 11mm x 14mm Bottom Head Dia: 17mm Stem Length: 12mm Fits Into 9mm Hole Subaru B9 Tribeca, Forester, Impreza, Outback 1998 - UP Box Qty. 25</p>	 <p>435629 909130088 Black Nylon, Fender, Rocker, Garnish, Pillar, Floor & Exterior Trim Retainer With Sealer Top Hd Size: 11mm x 14mm Bottom Head Dia: 17mm Stem Dia: 9.7mm Stem Length: 12mm Subaru Forester, Impreza, Legacy, Outback, B9 Tribeca & WRX 2005-UP Box Qty. 25</p>	 <p>445855 909130105 White Nylon Front & Rear Door, Headliner, Interior Trim, Liftgate & Qtr. Panel Retainer Top Head Dia: 13mm Middle Head Dia: 16mm Bottom Head Dia: 15mm Stem Dia: 9.6mm x 9.6mm Stem Length: 14mm Subaru BRZ, Forester, Impreza, Legacy, Outback, B9 Tribeca, WRX & XV Crosstrek 2002 - UP Box Qty. 50</p>	
 <p>445856 99045AE03AMA Black Nylon Trim Panel Retainer Head Dia: 18mm Stem Dia: 7.7mm Stem Length: 15mm Subaru B9 Tribeca, Impreza, Legacy & Outback 2005 - UP Box Qty. 25</p>	 <p>445857 95022AC040ML Black Nylon Headliner & Trim Space Retainer Head Dia: 20mm Stem Dia: 6mm Stem Length: 22mm Subaru Forester, Impreza, Legacy & Outback 1998 - UP Box Qty. 25</p>	 <p>445858 909130034 White Nylon Door, Pillar, Rocker, Floor & Interior Trim Retainer Top Head Dia: 13mm Middle Head Dia: 16mm Bottom Head Dia: 15mm Stem Dia: 9.5mm Stem Length: 11mm Subaru Baja, Forester, Legacy & Outback 2003 - 2008 Box Qty. 25</p>	 <p>445859 909130213 White Nylon Door Trim Panel Retainer With Sealer Top Head Dia: 13mm Middle Head Dia: 16mm Bottom Head Dia: 15mm Stem Dia: 9.5mm Stem Length: 14mm Subaru Legacy & Outback 2010-UP Box Qty. 10</p>
 <p>445860 693005370 White Nylon Front Door & Lift Gate, Trim Panel Retainer Top Head Dia: 13mm Middle Head Dia: 16mm Bottom Head Dia: 18mm Stem Dia: 9.3mm Stem Length: 10mm Subaru Impreza, Justy, Legacy & Outback 1987 - 2007 Box Qty. 25</p>	 <p>505155 57371GA070 Natural Nylon Tube/Cable Routing Clip Holds 5mm Dia. Tube/Cable Snaps Into 6mm Hole Overall Height: 15mm Subaru BRZ, Forester, Impreza, Legacy, Outback, B9 Tribeca & WRX 1995 - UP Box Qty. 25</p>		



BLANK

TOYOTA CLIPS & FASTENERS



38568

90269-05054
 Dia: 5mm (3/16")
 Grip: 3mm - 8mm (1/8"-5/16")
 Flange: 14mm (9/16")
 Aluminum Rivet w/Plastic Cap
 Steel Mandrel
 Windshield Side Moulding/
 Gas Filler Door
 Toyota Camry & Sienna '97 - UP
 Box Qty. 10



38569

90269-06013
 Dia: 4.8mm (3/16")
 Grip: 1.6mm - 6.35mm (1/16" - 1/4")
 Flange: 14mm (9/16")
 Aluminum Rivet w/Plastic Cap
 Steel Mandrel
 Gas Filler Door
 Toyota Camry & Lexus IS300
 2001-UP
 Box Qty. 15



38576

90269-04053
 Dia: 3.2mm (1/8")
 Grip: 1mm - 4.8mm (3/64" - 3/16")
 Flange Dia: 8mm (5/16")
 Aluminum Rivet w/Nylon Cap
 Steel Mandrel
 Toyota Land Cruiser 1998 - UP
 Box Qty. 10



38577

75547-51021
 Dia: 4mm (5/32")
 Grip: .8mm - 1.5mm
 Flange Dia: 10.5mm
 Alum Rivet w/Nylon Cap
 Steel Mandrel
 Lexus IS250, IS350 & IS F 2006-UP
 Toyota 2002 - UP
 Box Qty. 15



38578

90269-04050
 Dia: 3.2mm (1/8")
 Grip: 4mm-8mm (5/32"-5/16")
 Flange Dia.: 8mm (5/16")
 Aluminum Rivet w/Nylon Cap
 Steel Mandrel
 Windshield, Side &
 Trunk Moulding
 Lexus 1998 - UP
 Toyota
 Box Qty. 15



38611

90084-26001
 Dia: 5mm
 Grip: 3.2mm - 6.3mm
 Flange Dia: 9.5mm
 Closed End Sealing
 Type Rivet
 Aluminum Rivet & Mandrel
 Windshield Side Moulding
 Toyota Camry '97 - UP
 Box Qty. 50



38764

90269-A0005, 90269-06017
 Dia: 1/4" (6.3mm)
 Grip: 1/16" - 3/16" (1.6mm - 4.8mm)
 Flange Dia: 1/2" (13mm)
 Black Aluminum Rivet
 Steel Mandrel
 Fuel Door & General Purpose
 Toyota & Lexus 2000-UP
 Scion 2005-UP
 Box Qty. 10



200101

Zinc & Yellow
 Dichromate
 M6.3-1.81 x 20mm
 (#14 x 25/32")
 Hex Head SEMS®
 Washer OD: 18mm (45/64")
 Hex: 10mm
 Honda, Nissan, Toyota
 Box Qty. 25

NEW



200426

90159-60525
 Black E-Coat
 Phillips Hex Head
 Sems Screw, Loose Washer
 M6.5-2.5 x 19mm (#14 x 3/4")
 Indented Hex Head: 10mm
 Washer Dia: 20mm (25/32")
 Floor Pan & Lower Back Panel
 Moulding, Rear Bumper Stay,
 Suspension Cross Member and
 Under Cover Toyota 1998 - UP
 Box Qty. 25



280294

90468-04030
 Bumper Strip Retainer
 Toyota '84 - UP
 Box Qty. 50



















285115















N811169-S,
 W705550-S300,
 90189-06111,
 90075-10801, 10423331
 White Nylon
 Headlamp Mounting /
 Turn Signal Retainer
 Head Dia.: 13mm
 Stem Length: 9mm
 Fits Into 11mm Hole
 Ford F250-F550 '99 - UP
 Toyota/Lexus '89 - UP
 GM
 Box Qty. 50

TOYOTA CLIPS & FASTENERS

32 Toyota Clips

<p>NEW</p>  <p>292006 90189-06238 Neon Yellow Nylon Headlamp Assembly Grommet Screw Size: M4.8 (#8) Head Dia: 17mm Stem Length: 8mm Fits into 9mm x 9mm Hole Toyota C-HR, Camry, Prius C & Prius Prime 2017 - UP Box Qty. 25</p>	 <p>292040 75522-611-000, 75522-611-0000 9991-00-412, MS-480001, 96706-B0700, 97606-B0700, 90189-04042, 95900-04036 Grommet Nut Screw Size: #8 Width: 9.5mm, Length: 9.5mm Fits into 7mm x 7mm Hole Honda, Toyota, Nissan, Mazda, Mitsubishi Box Qty. 50</p>	 <p>292050 90189-05013, MS-480002, 94841764 Nylon Nut Headlamp Bezel & Grille #10 Screw Size 12mm Wide, 12mm Long Fits into 8mm x 9mm Hole G.M. Nova '85 - UP Toyota, Mitsubishi, GM Box Qty. 50</p>	<p>292057 Box 50</p>  <p>292055 96706-W1000, 90189-06013 Screw Grommet Screw Size: #14 (1/4") or M6.3-1.81 Head Dia: 20mm Stem Length: 17mm Fits Into 8mm x 8mm Hole Toyota & Lexus Box Qty. 25</p>
 <p>292060 90189-04008, MB029111, 90467-12096, 94841130 Nylon Grille Nut Screw Size: #8 Length 16mm, Width 12mm Height 15mm Fits Into 10mm Square Hole GM Nova '85 - UP Toyota, Mitsubishi Box Qty. 25</p>	 <p>292082 90189-06006 Natural Nylon Screw Size: #10 (M4.8) Head Dia: 17mm Fits Into 9mm x 9mm Hole Toyota Box Qty. 25</p>	 <p>292083 90189-06214 Black Nylon Fender Liner Screw Grommet Screw Size: #12 (M5.5) Head Dia: 16mm Stem Length: 18mm Toyota Sienna, Tacoma & Tundra Pick-Up 1999 - UP Box Qty. 15</p>	 <p>292084 90189-06157 Black Nylon Fender Lining Screw Grommet Screw Size: #12 Head Dia: 20mm Stem Length: 22mm Fits Into 8mm x 8mm Hole Toyota Avalon, Camry, Rav 4, Solara & Tacoma 1995-UP Box Qty. 15</p>
 <p>292085 90189-06065 Black Nylon Hood & Fender Screw Grommet Screw Size: M5.5 (#12) Head Dia: 20mm Stem Length: 18mm Fits Into 9mm x 9mm Hole Toyota Camry & RAV 4 1995 - 99 Box Qty. 25</p>	 <p>292086 90662-693-003, 90662-693-0030 90189-04066, 90662-693-0031 Natural Nylon Nylon Screw Grommet Screw Size: #6 Head Dia: 14mm Stem Length: 10mm Fits Into 7mm x 7mm Hole Honda, Toyota Box Qty. 25</p>	 <p>292088 90189-05142 Natural Nylon Headlight Mounting Nut Screw Size: M4.2 (#8) Head Dia: 17mm Stem Length: 8mm Fits Into 9mm Square Hole Toyota & Scion 2001 - UP Box Qty. 25</p>	 <p>292096 90189-09002 Natural Nylon Screw Grommet Screw Size: M4.2 (#8) Head Diameter: 18mm Stem Length: 8mm Fits into 9mm Square Hole Toyota Corolla 2003 - 2008 Box Qty. 25</p>
 <p>292097 90189-04059 White Nylon Rocker, Pillar, Floor & Exterior Trim Screw Grommet Screw Size: M3.5 (#6) Head Size: 12mm x 18mm Stem Length: 7mm Lexus ES300, ES330, RX330, RX400, SC300, SC400 and Toyota Scion, Avalon & FJ Cruiser 1992-UP Box Qty. 25</p>	 <p>292108 52197-22020 Black Nylon Rear Bumper Side Bracket Screw Grommet With Sealer Screw Size: M6.3 (#14) Head Size: 16mm x 18mm Stem Length: 19mm Lexus ES 350 & HS 250H 2007-2012 Toyota Avalon & Camry 2012-UP Box Qty. 15</p>	 <p>292114 52188-06030 Yellow Nylon Rear Bumper Screw Grommet With Sealer Screw Size: M6 (#14) Head Dia: 20mm Stem Length: 22mm Fits Into 9mm x 9mm Sq Hole Toyota Camry 2007 - 11 Box Qty. 15</p>	 <p>292207 90189-06193 Natural Nylon Front Bumper Nut Screw Size: M5.5 (#12) Head Size: 14mm x 16mm Stem Length: 10mm Toyota Camry & Avalon 2002-UP Box Qty. 25</p>

TOYOTA CLIPS & FASTENERS

 <p>292210 90189-06010, 75521-611-0000, 9991-00-601, 96706-P0105 Nylon Screw Grommet Screw Size: #10 Width 13mm, Length 13mm Snaps Into 8.5mm Sq. Hole <i>Toyota, Honda, Mazda, Nissan</i> Box Qty. 25</p>	 <p>292215 90189-05012, 8-94134-027-0 Nylon Screw Grommet Screw Size: #6 Width: 16mm Length: 12mm Snaps Into 6mm x 10mm Hole <i>Toyota, Isuzu</i> Box Qty. 25</p>	 <p>292216 90189-06162 Natural Nylon Front Clearance Lamp Nut <i>Toyota Camry 1991-1994</i> Headlight Adjusting Nut <i>Lexus</i> Box Qty. 10</p>	 <p>292218 90189-06028, 94854203 Black Nylon Front & Rear Wheel Fender Liner Screw Grommet Screw Size: #12 Head Dia: 16mm Stem Length: 19mm Fits into 9mm Square Hole <i>Toyota Tacoma, T100 & 4 Runner 1992-UP; Chevrolet Nova & Prizm and Pontiac Vibe 1985-UP</i> Box Qty. 15</p>
 <p>292220 90189-04011 Natural Nylon Screw Grommet Screw Size: #6 Width: 12mm, Length: 12mm Snaps Into 7mm x 7.5mm Hole <i>Toyota</i> Box Qty. 25</p>	 <p>292225 90672-671-8110M1, 90189-04013 Nylon Screw Grommet Screw Size: #6 Head Dia: 14mm Stem Length: 15mm Fits Into 7mm x 7mm Hole <i>Honda & Toyota</i> Box Qty. 25</p>	 <p>292240 90189-04019 Natural Nylon Screw Grommet Screw Size: #8 Width: 12mm, Length: 14mm Fits Into 6.5mm x 8.5mm Hole <i>Toyota</i> Box Qty. 25</p>	 <p>292255 90189-04014 Natural Nylon Screw Grommet Screw Size: #8 Width: 10mm, Length: 10mm Snaps Into 7mm x 7mm Hole <i>Toyota</i> Box Qty. 50</p>
 <p>292260 90189-06001, MB-098145, 01281-00023, 01281-00231 White Nylon Screw Grommet Screw Size: #10 Head Dia.: 18mm Stem Length: 17mm Fits Into 8.5mm Square Hole <i>Toyota, Mitsubishi, Nissan</i> Box Qty. 25</p>	 <p>292262 81496-52020, 81496-0E020 Natural Nylon Rear Combo Tail Light Guide Grommet w/Sealer Head Dia: 16mm Stem Length: 14mm Overall Length: 15mm <i>Lexus CT 200h, ES 300h, ES 350, GX 460, IS 200t, IS 250, IS 300, IS 350, LC 500h, LX 570, NX 200t, NX 300h, RC F, RC 200h, RC 300, RC 350, RX 350 & RX 450h and Toyota 4Runner, C-HR, Corolla, Corolla iM, Highlander, Land Cruiser, Mirai, Prius, Prius Prime, Prius V, RAV4, Sequoia, Venza & Yaris 2006 - UP Scion iM & xD 2016 - 2008</i> Box Qty. 25</p>	 <p>292270 90661-SC7-0030, 90661-SC7-003, H001-50-841, MS-480012, 01651-00481, 74798-S9000, 90189-06042 Nylon Screw Grommet Screw Size: #8 (M4.2) Head Dia: 16mm Stem Length: 17mm Fits a 8mm x 8mm Hole <i>Honda, Toyota, Nissan, Mitsubishi, Mazda</i> Box Qty. 25</p>	
 <p>292285 90189-06018 Black Nylon Screw Grommet Screw Size: #10 Width: 14mm, Length: 14mm Snaps Into 9mm Square Hole <i>Toyota</i> Box Qty. 25</p>	 <p>292425 90189-06114 White Nylon Front Fender Liner Screw Grommet Screw Size: M5.5 (#12) Head Dia: 18mm Stem Length: 15mm Fits into 9mm Square Hole <i>Toyota RAV 4 '96 - 2002</i> Box Qty. 15</p>	<p>302055 Box 25</p>  <p>302044 53879-14010-A, 53879-14020, 53879-22030, 94841226, LA01-56-135 Black Nylon U-Nut Wheel Housing Applications Screw Size: 4.8mm (#10) Panel Range: Up to 1mm Center of Hole to Edge: 11mm <i>Toyota, GM, Mazda</i> Box Qty. 10</p>	 <p>302045 53879-22010 Black Nylon U-Nut Housing Applications Size: #14 (1/4") Width: 20mm Length: 29mm Panel Range: Up to 1mm Center of Hole to Edge: 15mm <i>Toyota</i> Box Qty. 10</p>

TOYOTA CLIPS & FASTENERS



302052
90467-05114
Black Nylon U- Nut
Bumper/Fender Apron
Screw Size: M5.5 (#12)
Width: 20mm, Length: 36mm
Panel Range: Up To 1mm
Center Hole to Edge: 14mm
Lexus, Toyota 2000 - UP
Box Qty. 10



302056
53879-0R010, 53879-28010
Black Nylon
Front Fender Liner Clip
Slotted Head Dia: 15.3mm
Body Width: 35mm
*Toyota Highlander, RAV4 & Tacoma
and Scion iQ & xD 2008 - UP*
Box Qty. 25



355020
53271-44010
Black Nylon
Headlight Bracket Clip
Width: 25mm
Length: 40.5mm
*Toyota Camry, RAV 4 2001-UP
Lexus IS300 2001 - UP*
Box Qty. 4

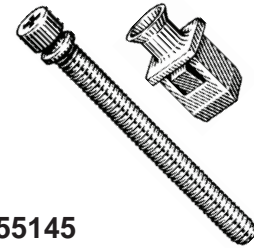

355145
81195-89101
Headlamp Adjusting
Assembly Screw w/ Nut
M5 x 50mm
Toyota Pickup '84 - UP
Box Qty. 10



355160
81124-89101
Nylon
Headlamp Spacer
Width: 15mm
Length: 18mm
Fits into 7mm Square Hole
Toyota Pickup '84 - UP
Box Qty. 25



415234
90467-A0008
Black Nylon
Bumper Cover Retainer
Head Diameter: 19mm
Stem Diameter: 7.5mm
Stem Length: 16mm
Toyota, Lexus & Scion 1995 - UP
Box Qty. 50



415240
74842-659-0030, 74842-659-003
90467-12078, 90467-12078-01
Black Nylon
Retaining Clip
Head Dia: 18mm
Stem Length: 15mm
Hole Size: 8mm (5/16")
Honda & Toyota
Box Qty. 25



415242
90467-06192
Black Nylon
Fender Liner Clip
Head Size: 14.5mm x 16mm
Stem Dia: 10.5mm
Stem Length: 10mm
Fits Into 8mm Hole
*Lexus ES 300h, ES 350, GS 200h,
GS 350, GS F, GS 450h, IS 200i,
IS 300, IS 350, LS 460, LS 600h L
& RC F; and Toyota Camry & RAV4
2006 - UP*
Box Qty. 25



415255
E7GZ-6120586-B,
G031-58-762,
67868-89101, 67867-28030,
67867-89103, 86438-2B000
Natural Nylon
Weatherstrip Retainer
Head Size: 5mm x 15mm
Stem Length: 10mm
Fits Into 5mm Hole
*Toyota 4-Runner 1983 - 89
Mazda 1996 - UP, Ford 1996 - UP
Hyundai 2007-UP and Kia 2009-UP*
Box Qty. 50



415260
90467-07050,
90467-08008,
01553-00172
Weatherstrip &
Trim Panel Clip
Head Dia: 13mm
Stem Length: 15mm
Panel Thickness: 3mm
Fits Into 5mm Hole
Toyota, Nissan
Box Qty. 50



415269
90467-06161-01
Nylon
Retaining Clip
Head Dia: 14mm
Stem Length: 10mm
Panel Thickness: 3mm
Fits Into 5mm Hole
Toyota
Box Qty. 25



415755
10116-41810
Trim Attaching Retainer
Toyota
Box Qty. 10



415759 Box 50
415761
94218027,
H200-50-715
8942180270,
58974-00008, B092-50-715,
BF67-S0715, MB153825,
90467-13011, 90467-12020
Black Nylon
Grille Headlight Clip
Width: 13mm Length: 22mm
*Ford, GM, Toyota, Mitsubishi, Isuzu,
Honda, Plymouth, Mazda*
Box Qty. 25



415763 Box 25
415762
90467-17004
Nylon
Radiator Grille Clip
Width: 21mm
Length: 22mm
Toyota Cressida '84 - '87
Box Qty. 10



415860
90467-09145
Black Nylon
Bumper Cover
Screw-Type Retainer
Head Dia: 15mm
Stem Length: 12mm
Fits Into 9mm Hole
Toyota Camry '92 - UP
Box Qty. 15



416050 Box 5
415926 Box 25
415928 Box 50
415927
52161-02020,
52161-16010,
52161-02030, 94858560
Black Nylon
Rear Bumper Cover
Push-Type Retainer
Head Dia: 18mm
Stem Length: 28mm
Fits Into 9mm Hole
Toyota Tercel '88 - UP
Box Qty. 10

TOYOTA CLIPS & FASTENERS

 <p>415930 90467-09008 Black Nylon Hood Insulation Retaining Clip Head Dia: 30mm Stem Length: 17mm Panel Thickness: 6mm Fits Into 7mm Hole Toyota Cressida, Supra Box Qty. 25</p>	 <p>415960 94847334, 96057847, 90467-07066, 09409-07313 Black Nylon Radiator Grille & Trim Panel Push-Type Retainer Head Dia: 11mm Stem Length: 14mm Fits Into 7mm Hole GM, Toyota, Suzuki, Geo Tracker & Prizm '89 - '92 Box Qty. 10</p>	 <p>415965 96057846, 90467-07041, 90467-07041-B2, 90467-07076-C0, 86155-2200 Black Nylon Push-Type Retainer Head Dia: 15mm Stem Length: 8mm (ex pin) Fits Into 6.3mm Hole Geo Metro & Tracker '89 - UP Toyota & Hyundai Box Qty. 10</p>	 <p>416019 90467-07059-22 Black Nylon Rear Door Trim & Luggage Compartment Push-Type Retainer Head Dia: 15mm Stem Length: 10mm Fits Into 7mm Hole Toyota Camry & Celica '90 - UP Box Qty. 15</p>
 <p>416022 90467-08124 Black Nylon Hood Insulation Retainer Head Dia: 25mm Stem Dia: 8mm Stem Length: 12mm Toyota Supra '93 - UP, Lexus '89 - '94 Box Qty. 15</p>	 <p>416028 90467-09096 Black Nylon Front Bumper Push-Type Retainer Head Dia: 15mm Stem Length: 27mm Fits Into 9mm Hole Toyota Celica, Supra and Lexus LS400 '89 - UP Box Qty. 10</p>	 <p>416031 90467-09050, 90467-A0003 Black Nylon Hood Insulation Retainer Head Dia: 25mm Stem Length: 10mm Fits Into 7mm Hole Lexus Toyota Camry & Solara '98-UP Box Qty. 15</p>	 <p>416051 90467-05090-B1 Black Nylon Bumper Fascia Screw-Type Retainer Head Dia: 10mm Stem Length: 12mm Fits Into 5mm Hole Toyota Corolla, Matrix & Scion 2008 - UP Box Qty. 25</p>
 <p>416055 MB888869, 90505-SL0-003, 90467-08155, 9485236 Plastic Bumper Cover Screw-Type Rivet Hole: M8, Stem: 21mm Flange Dia: 20mm Chrysler, GM, Acura, Toyota '93 - UP Box Qty. 15</p>	 <p>416083 90467-09139 Black Nylon Bumper Cover & Wheel Housing Push-Type Retainer Head Dia: 18mm Stem Length: 15mm Fits Into 9mm Hole Honda, Mazda 626 & Toyota Corolla '92 - UP Box Qty. 15</p>	 <p>416098 62955-20020, 94848834 Nylon Retainer with Sealer Head Dia: 15mm Stem Length: 9mm Fits Into 8mm Hole Toyota Pick-Up Truck; Pontiac Vibe Box Qty. 25</p>	 <p>416103 90467-06017, 9926-50-625, 20426301 Black Nylon Screw-Type Retainer Head Dia: 15mm Stem Length: 12mm Fits Into 7mm Hole Toyota, Mazda, GM Box Qty. 15</p>
 <p>416106 90467-07146 Black Nylon Cowl Panel & Luggage Comp. Screw-Type Retainer Head Dia: 16mm Stem Length: 9mm Fits into 7mm Hole Toyota Avalon, Camry, Celica & Solara '93-UP Box Qty. 10</p>	 <p>416108 90467-07043, 80999-05N07 Nylon Push-Type Retainer Head Dia: 18mm Stem Length: 11mm (Excluding The Pin) Fits Into 7mm Hole Toyota, Nissan Box Qty. 15</p>	 <p>416109 90467-05063-C0 Black Nylon Front Bumper Screw-Type Retainer Head Dia: 11mm Stem Length: 8mm Fits Into 5mm Hole Toyota Corolla 2009 - UP Box Qty. 15</p>	 <p>416113 53879-60010 Black Nylon Fender Liner Push-Type Retainer Head Dia: 18mm Stem Length: 7mm Fits Into 7mm Hole Toyota Land Cruiser, RAV 4 1998 - UP Box Qty. 15</p>

TOYOTA CLIPS & FASTENERS

416115 Box 50
416117 Box 500



416114
90467-07166
Black Nylon
Front Fender Splash Shield
Push-Type Retainer
Head Dia: 20mm
Stem Length: 8mm
(Excluding the Pin)
Fits into 7mm Hole
Toyota Tercel '94 - UP
Box Qty. 15



416116
90467-09004,
90467-09004-01
Plastic
Hood Insulation Retainer
Hole: 6.50mm (1/4")
Head Dia: 30mm
Stem Length: 16mm
Toyota Tacoma '95 - UP
Box Qty. 15



416120
90467-10107
Black Nylon
Fender Apron Seal Clip
Hole: M8
Head Dia: 17mm
Stem Length: 12mm
Toyota Truck '88 - UP
Box Qty. 10



416122
90467-06175
Black Nylon
Luggage Compartment
Retainer
Head Dia: 16mm
Stem Dia: 6mm
Stem Length: 16mm
Toyota Solara '98 - UP
Box Qty. 15



416124
90467-10077
Butterscotch Nylon
Door Moulding Clip
with Sealer
Head Size: 15mm Square
Stem Length: 9mm
Fits Into 8mm Hole
Toyota Avalon & Corolla '98 - UP
Box Qty. 15



416128
67921-32010
White Nylon
Scuff Plate Retainer
Top Head Dia: 13mm
Bottom Head Dia: 18mm
Stem Dia: 10mm
Stem Length: 11mm
Toyota Avalon, Camry & Corolla '97 - UP
Box Qty. 15



416129
90467-09006
Black Nylon
Hood Insulation Retainer
Head Dia: 30mm
Stem Length: 17mm
Fits Into 7mm Hole
Toyota Avalon, Camry & Lexus '88 - UP
Box Qty. 15



416135
01553-09611,
90467-08185
Black Nylon
Bumper Push-Type Retainer
Head Dia: 18mm
Stem Length: 10mm
Fits Into 8mm Hole
Lexus and Toyota 2002-UP
Nissan 1994-UP
Box Qty. 15



416141
75392-35200,
75392-04010
Blue Nylon
Fender Flare &
Bumper Clip
Head Size: 13mm x 26mm
Stem Length: 24mm
Toyota Camry, FJ, RAV 4 & Tacoma 2005 - UP
Box Qty. 15

416143 Box 100
416145 Box 25



416142
90467-07164,
09409-07332
Fender Splash Shield
Push-Type Retainer
Head Dia: 20mm
Stem Length: 10mm
Fits into 7mm Hole
Toyota Camry, Echo, MR2 & Sienna 1997 - UP; Suzuki 1999 - UP
Box Qty. 10

416147-50 Bx 50



416147
90467-07201
Black Nylon
Engine Under Cover
Push-Type Retainer
Head Dia: 20mm
Stem Length: 10mm
Fits Into 7mm Hole
Toyota Avalon, Camry, Solara and Lexus ES300/330 2002 - UP
Box Qty. 10



416149
90467-08186
Black Nylon
Luggage Compartment
Trim Retainer
Head Dia: 16mm
Stem Dia: 8mm
Stem Length: 16mm
Toyota Camry 1999 - UP
Box Qty. 15



416151
52161-20010
Black Nylon
Bumper Cover &
Grille Push-Type
Retainer
Head Dia: 18mm
Stem Length: 31mm
Fits Into 9mm Hole
Toyota 2000 - UP
Box Qty. 15



416165
75867-AA010
Black Nylon
Rocker Panel &
Scuff Plate Retainer
Lexus ES300 & ES330 2002-UP
Toyota Avalon, Camry, Scion & Solara 2004-UP
Box Qty. 15

















416167
90467-07188
Black Nylon
Push-Type Retainer
Head Dia: 15mm
Stem Length: 17mm
Fits Into 7mm Hole
Toyota Camry, Tundra & 4-Runner 2002 - UP
Box Qty. 15



416173
47749-58010
(use with #416174)
Black Nylon
Front Fender &
Bumper Cover Pin Retainer
Head Dia: 15mm
Stem Length: 25mm
Lexus and Toyota 4 Runner, Sienna, Highlander & Solara 2000 - UP
Box Qty. 10

TOYOTA CLIPS & FASTENERS

 <p>416174 53879-58010 (use with #416173) Black Nylon Front Fender & Bumper Cover Clip Width: 25mm, Length: 34mm Lexus and Toyota 4 Runner, Sienna, Highlander & Solara 2000 - UP Box Qty. 5</p>	 <p>416176 90467-10183, 88970767 Black Nylon Front Fender Liner Push-Type Retainer Head Dia: 18mm Stem Length: 7.5mm Fits Into 7mm Hole Lexus, Pontiac Vibe, and Toyota Celica, Corolla, Matrix & Solara 1999 -UP Box Qty. 10</p>	 <p>416178 90467-07044 Black Nylon Quarter Panel Wheel Opening Moulding Screw-Type Retainer Head Dia: 20mm Stem Length: 9mm Fits Into 7mm Hole Toyota T-100 1992 - UP Box Qty. 10</p>	 <p>416188 90467-09166 Black Nylon Screw-Type Retainer Head Dia: 20mm Stem Length: 9mm Fits Into 9mm Square Hole Toyota Camry 2006 - UP Box Qty. 15</p>
 <p>416189 90467-07192 Black Nylon Cowl Vent Push-Type Retainer Head Dia: 15mm Stem Length: 14mm Fits Into 7mm Hole Toyota RAV 4 2002 - UP Box Qty. 15</p>	 <p>416191 53326-08010 Black Nylon Hood Insulation Retainer Head Dia: 24mm Stem Length: 12mm Hole Size: 17/64" (7mm) Toyota Sienna 2009 - UP Box Qty. 25</p>	 <p>416193 90467-07211 Black Nylon Bumper, Radiator Cover and Grille Push-Type Retainer Head Dia: 19mm Stem Length: 8mm Fits Into 7mm Hole Lexus IS & LS, Scion and Toyota Avalon, Camry & Highlander 2005-UP Box Qty. 10</p>	 <p>416195 90467-07214 Radiator Splash Shield Push-Type Retainer Head Dia: 20mm Stem Length: 9mm Fits Into 7mm Hole Toyota Camry 2007 - UP Box Qty. 15</p>
 <p>416197 90467-10146 Black Nylon Cowl Panel Retainer Head Size: 8mm x 17mm Stem Length: 14mm Fits into 7mm Hole Toyota Sienna Van 1997 - UP Box Qty. 25</p>	 <p>416199 90467-09206 White Nylon Trim Panel Retainer Top Head Dia: 13mm Middle Head Dia: 16mm Bottom Head Dia: 18mm Stem Dia: 8.5mm x 8.5mm Stem Length: 15mm Overall Length: 20mm Toyota RAV 4 & Tundra 2000 - UP Box Qty. 15</p>	 <p>416213 91563-SCV-003, 67867-52010, 67867-0D060 White Nylon Weatherstrip Retainer Head Size: 5mm x 15mm Bottom Head Dia: 6.5mm Stem Dia: 7mm Stem Length: 8.5mm Acura TL and Honda Element, Odyssey & Pilot 2003-UP; Toyota Echo, Land Cruiser, Prius, Tacoma & Yaris and Lexus GS 450, GX 460 & LX 430 and Scion xA & xD 2000 - UP Box Qty. 25</p>	
 <p>416214 90467-07215 Black Nylon Fender Liner Retainer Head Dia: 20mm Stem Length: 10mm Fits Into 7mm Hole Scion iC and Toyota 4Runner, Avalon, Camry, Corolla, Highlander, Land Cruiser, Prius, RAV4, Tacoma & Tundra 2010 - UP Box Qty. 25</p>	 <p>416217 90467-06205-C1 Black Nylon Front Fender Retaining Clip w/Sealer Head Dia: 20mm Stem Dia: 8mm Stem Length: 9mm Lexus GS F, GS 350, GS 450h, GX 460, HS 250h, IS 200t, IS 250, IS 300, IS 350, LC 500h, RC F, RC 200t, RC 300, RC 350, RX 350 & RX 450h 2010 - UP Scion iQ & xD and Toyota 4Runner & Highlander 2008 - 2015 Box Qty. 25</p>	 <p>416218 65487-60010 Black Nylon Hood Seal Retaining Clip Head: 5mm x 13mm Stem Dia: 7mm Stem Length: 8mm Lexus CT 200h, ES 300h, ES 350, GS F, GS 200t, GS 350, GS 450h, LC 500h & LX 570 and Toyota Landcruiser & Mirai 2008 - UP Box Qty. 25</p>	 <p>416219 B45A-56-146A, 90118-WB048 Black Nylon Bumper, Fender, Engine Cover & Qtr. Panel Push-Type Retainer Head Dia: 20mm Stem Length: 13mm Fits Into 8mm Hole Mazda 3, 5, 6, CX-3, CX-5, CX-9 & MX-5 Miata 2012 - UP Scion iA 2016 - UP Box Qty. 25</p>

TOYOTA CLIPS & FASTENERS



416225
47749-50090
(Use with #416226, 416227)
Black Nylon
Front Bumper Cover Pin
Head Dia: 10mm
Stem Lgth: 24mm
Lexus GS, IS, LS 2007 - UP
Box Qty. 15



416226
53879-30040
(Use with #416225)
Black Nylon
Front Bumper Cover Clip
Width: 32mm
Length: 39mm
Lexus CT200h, HS250h 2010 - UP
Toyota Camry 2012 - UP
Box Qty. 5



416228
53879-30050
Black Nylon
Fender Liner Clip
Width: 42mm
Length: 29.5mm
Lexus GS F, GS 200t, GS 350, GS 450h, IS 200t, IS 250, IS 300, IS 350, RC F, RC 200t, RC 300 & RC 350 2013 - UP and Toyota C-HR, Prius, Prius Prime & Prius V 2016-UP
Box Qty. 15

NEW



416242
53879-02150
53879-33030
Black Nylon
Bumper to Fender Liner Clip
Overall Length: 43mm
Overall Width: 39mm
Lexus ES300 & ES350 2019 - UP
Toyota Camry & Corolla 2018 - UP
Box Qty. 5



416264
53935-35020
Black Nylon
Bumper Filler Clip
Overall Length: 30mm
Overall Height: 17mm
Toyota 4 Runner 2003 - UP
Box Qty. 10



416265
53888-48010
Black Nylon
Wheel Opening Push-Type Retainer
Head Dia: 18mm
Stem Length: 14mm
Fits Into 7mm Hole
Toyota Highlander 2001 - UP
Box Qty. 5



416288
90080-46327
Black Nylon
Fender Apron Seal Retainer
Head Dia: 17mm
Stem Length: 15mm
Fits Into 7mm Hole
Toyota Sequoia, Tacoma & Tundra 2000 - UP
Box Qty. 50

NEW

416299
90467-07220
Black Nylon
Bumper Cover, Radiator Support, Under Cover & Wheel Opening Push-Type Retainer
Head Dia: 20mm
Stem Length: 12mm
Fits into 7mm Hole
Lexus CT 200h, GX 460, IS 300, IS 350, LC 500h, NX 200t, NX 300h, RX 350 & RX 450h and Toyota 4Runner, C-HR, Camry, Corolla, Corolla iM, Prius, Prius Prime, Prius V & RAV4 2013 - UP
Scion iM, iC & xB 2008 - 2016
Box Qty. 25



NEW

416305
90467-09242
Black Nylon
Cowl Grille Push-Type Retainer
Head Dia: 22mm
Stem Length: 15mm
Fits into 9mm Hole
Lexus RX 350 & RX 450h and Toyota C-HR, Camry, Prius, Prius Prime & Yaris 2016 - UP
Box Qty. 15



416325
53145-60030
Black Nylon
Front Bumper, Grille & Hood Seal Retaining Clip
Head Size: 4.3mm x 11mm
Stem Diameter: 6.2mm
Stem Length: 10mm
Toyota Avalon, Camry, Highlander, Land Cruiser, Prius & Venza and Lexus GS 350, GS 450h, IS 250, IS 350, LX 570, NX 200t, NX 300h, RX 350 & RX 450h and Scion iQ & iC 2008 - UP
Box Qty. 100

NEW



421008
90467-22014
Black Nylon
Rocker Moulding Retainer with Sealer
Head Dia: 38mm
Stem Length: 11mm
Fits into 22mm Hole
Toyota Camry 2018 - UP
Prius & Prius Prime 2016 - UP
Box Qty. 10

NEW



421009
90467-22015
Black Nylon
Rocker Moulding Retainer with Sealer
Head Dia: 47mm
Stem Length: 35mm
Fits into 22mm Hole
Toyota Camry 2018 - UP
Prius & Prius Prime 2016 - UP
Box Qty. 10

NEW



421011
75867-68010
White Nylon
Rocker Panel & Wheel Opening Moulding Retainer
Top Head Dia: 13mm
Bottom Head Dia: 18mm
Stem Length: 14.5mm
Stem Dia: 9.5mm
Toyota C-HR, Camry, Prius, Prius C, Prius Prime, Prius V & RAV4 2012 - UP
Box Qty. 50



435439
75498-42010
White Nylon
Garnish Clip
Head Dia: 20mm
Stem Length: 20mm
Toyota RAV4 '96 - UP
Box Qty. 10

TOYOTA CLIPS & FASTENERS

 <p>435441 52535-0E030 White Nylon Bumper/Various Trim Moulding Clip Top Head: 13mm x 13mm Stem Length: 22mm Overall Length: 25mm <i>Lexus LS600h & RX450h and Toyota RAV4 & 4Runner 2006 - UP</i> Box Qty. 15</p>	 <p>435480 90189-06005, 098-145, 01281-00023 White Nylon Screw Grommet Screw Size: #14 (1/4") or M6.3-1.81 Head Dia: 18mm Stem Length: 16mm Fits into 8mm x 8mm Hole <i>Lexus, Toyota, Mitsubishi, Datsun</i> Box Qty. 25</p>	 <p>435483 90467-11063 White Nylon Rocker Panel Moulding Clip Head Dia: 18mm Stem Length: 9mm <i>Toyota Previa '90 - UP</i> Box Qty. 15</p>	 <p>435484 90904-67036 Blue Nylon Fender Moulding Clip Head Dia: 17mm Stem Length: 17mm <i>Toyota Highlander, Land Cruiser, Tacoma & Tundra 2001 - UP</i> Box Qty. 10</p>
 <p>435486 90904-67037 Red Nylon Fender Moulding Clip Head Dia: 17mm Stem Length: 13mm <i>Toyota Highlander, Land Cruiser, Tacoma & Tundra 2001 - '02</i> Box Qty. 10</p>	 <p>435487 90467-11100 Yellow Nylon Fender & Wheel Flare Moulding Clip Head Dia: 17mm Stem Length: 17mm <i>Toyota Highlander, Land Cruiser, Tacoma & Tundra 2000 - UP</i> Box Qty. 10</p>	 <p>435488 75867-30110 Black Nylon Rocker Panel Moulding Clip Head Dia: 18mm Stem Length: 22mm Fits Into 9mm Hole <i>Toyota Corolla '97 - UP</i> Box Qty. 15</p>	 <p>435491 75397-35010 Orange Nylon Wheel Flare Moulding Clip with Sealer Head Dia: 17mm Stem Length: 17mm <i>Toyota 4-Runner 2003 - UP</i> Box Qty. 10</p>
 <p>435493 75495-35010, 75396-35020 Blue Nylon Rocker Moulding Clip with Sealer Head Dia: 17mm Stem Length: 10mm <i>Toyota 4-Runner 2003 - UP</i> Box Qty. 10</p>	 <p>435494 90467-10161, 94858299, 94178705 White Nylon Trim Board Retainer Top Head Dia: 13mm Middle Head Dia: 16mm Bottom Head Dia: 18mm Stem Dia: 9mm x 9mm Stem Length: 14mm Overall Length: 20mm <i>Toyota Sienna, Solara & Tercel 1990 -UP and Geo Prizm & Pontiac Vibe 1998-UP</i> Box Qty. 50</p>	 <p>435500 75494-42010, 75395-42020 Yellow Nylon Rocker Moulding Clip w/Sealer Top Hd: 10.3mm x 16.5mm Bottom Hd: 13.5mm x 17.5mm Stem Length: 19mm <i>Toyota FJ Cruiser & RAV4 2001 - 2014</i> Box Qty. 25</p>	 <p>435517 75867-30120 Black Nylon Rocker Moulding Push-Type Retainer Head Dia: 18mm Stem Length: 19mm Fits Into 8mm Hole <i>Lexus GS350, GS430, GS460 & LS460 and Toyota Camry 2007-UP</i> Box Qty. 15</p>
 <p>435518 76924-47010 Black Nylon Rocker Panel Moulding Clip Head Size: 43mm x 54mm Overall Height: 26mm <i>Toyota Prius 2009 - UP</i> Box Qty. 5</p>	 <p>435519 75867-02010 Black Nylon Rocker Moulding Retainer Top Head Dia: 13mm Bottom Head Dia: 18mm Stem Dia: 9mm Stem Length: 10mm <i>Toyota Corolla 2009 - UP</i> Box Qty. 25</p>	 <p>435520 90467-06133-CO Black Nylon Rocker Panel Screw-Type Retainer Head Dia: 14mm Stem Length: 8mm Fits Into 6mm Hole <i>Toyota 4-Runner 1998 - UP</i> Box Qty. 15</p>	 <p>435521 52115-48040 Gray Nylon Front Bumper Moulding Clip Overall Length: 47mm Stem Length: 8mm <i>Toyota Highlander 2001 - UP</i> Box Qty. 10</p>

TOYOTA CLIPS & FASTENERS



435522
52197-52010
Black Nylon
Front Bumper
Moulding Clip With Sealer
Overall Width: 30mm
Overall Height: 25mm
Stem Length: 13mm
Toyota Highlander 2001 - UP
Box Qty. 10



435523
61118-35010
Black Nylon
Front Fender Upper Seal
Moulding Clip
Head Size: 18mm x 18mm
Stem Length: 13mm
Fits Into 9mm Hole
Toyota FJ Cruiser 2007-UP
Box Qty. 15



435524
52115-0C090
Black Nylon
Front Bumper Moulding Clip
Head Size: 25mm x 74mm
Overall Height: 17mm
Stem Length: 15mm
Toyota Tundra 2009 - UP
Box Qty. 10



435525
61991-35010
Black Nylon
Front Fender/Sheet Metal
Upper Seal Moulding Clip
Top Head: 9mm x 31mm
Overall Height: 30mm
Toyota FJ Cruiser 2007 - UP
Box Qty. 10



435526
61992-35010
Black Nylon
Front Fender/Sheet Metal
Upper Seal Moulding Clip
Top Head: 13mm x 31mm
Overall Height: 34mm
Toyota FJ Cruiser 2007 - UP
Box Qty. 10



435538
90467-10186
Black Nylon
Fender Apron Seal Clip
Head Dia: 17mm
Stem Length: 12mm
Toyota 2WD & 4WD Truck 1988-UP
Box Qty. 10



435620
53145-12010
Black Nylon
Grille Clip
Overall Length: 38mm
Toyota Corolla, FJ Cruiser & Tacoma 1993 - UP
Box Qty. 15



435621
75397-42010
White Nylon
Moulding Clip With Sealer
Top Head: 14.5mm x 17mm
Bottom Head: 12mm x 18mm
Stem Length: 9mm
Toyota RAV4 2001 - 2005
Box Qty. 25



435622
90467-08225
White Nylon
Moulding Clip w/Sealer
Top Head: 10mm x 10mm
Bottom Head: 15mm
Stem Dia: 8mm x 8mm
Stem Length: 8mm
Toyota Corolla, Highlander & RAV4 2014 - UP
Box Qty. 15

NEW

445006
90467-09232
Red Nylon
Trim Panel Retainer
Top Head Dia: 13mm
Middle Head Dia: 16mm
Bottom Head Dia: 18mm
Stem Dia: 9mm
Stem Length: 15mm
*Lexus IS 250 & IS 350 2015 - 2010
LC 500, LC 500h, LS 500, LS 500h,
NX 200t, NX 300 & NX 300h and
Toyota Highlander & Tacoma
2014 - UP*
Box Qty. 25



445814
9927-40-822,
62581-14020
Natural Nylon
Trim Panel Retainer
Top Head Dia: 14mm
Bottom Head Dia: 18.5mm
Stem Dia: 11.5mm
Stem Length: 14mm
Overall Length: 20mm
Mazda & Toyota
Box Qty. 25



445815
67771-01010,
67771-12010,
8942264920,
9927-40-825,
95005064
White Nylon
Door Panel Retainer
Top Head Dia: 13mm
Bottom Head Dia: 18mm
Stem Length: 14mm
Overall Length: 21mm
Fits Into 9mm Hole
GM, Isuzu, Mazda, Toyota
Box Qty. 25



445816
62217-13010
White Nylon
Garnish Moulding Retainer
Top Head Dia: 13mm
Middle Head Dia: 16mm
Bottom Head Dia: 15mm
Stem Dia: 10mm
Stem Length: 11mm
*Lexus and Toyota Corolla, Matrix &
4 Runner 2003-UP*
Box Qty. 25



445817
67771-12070
Door Panel & Rocker
Moulding Retainer w/Sealer
Top Head Dia: 13mm
Bottom Head Dia: 18mm
Stem Dia: 11mm
Stem Length: 14mm
*Lexus SC300/400
Toyota Avalon & Corolla 1992 - UP*
Box Qty. 15

















445818
95008221,
67771-30090,
MB608104
Yellow Nylon
Door Trim & Back Panel
Lower Garnish Retainer
Top Head Dia: 13mm
Stem Length: 15mm
Fits Into 9mm Hole
*Toyota Land Cruiser & 2WD Truck
1991 - UP
Geo Prizm 1993 - 97*
Box Qty. 50



445820
90467-A0005
White Nylon
Door Trim Panel
Retainer with Sealer
Top Head Dia: 13mm
Middle Head Dia: 16mm
Bottom Head Dia: 18mm
Stem Diameter: 8.5mm
Stem Length: 14mm
*Lexus ES 350, GX 470, IS 250, IS
350, IS F, LS 460 & LS 600HL and
Toyota camry, FJ Cruiser, Highlan-
der, RAV 4 & 4-Runner 2001-UP*
Box Qty. 15

TOYOTA CLIPS & FASTENERS

<p>445889 Box 25</p>  <p>445881 67771-16080 Natural Nylon Door Trim Panel & Back Panel Upper Garnish Retainer Top Head Dia: 13mm Middle Head Dia: 16mm Bottom Head Dia: 18mm Stem Dia: 9.5mm Stem Length: 14mm Toyota Truck '88 - UP Box Qty. 10</p>	 <p>445885 67771-30070 Natural Nylon Door Trim Panel & Garnish Retainer Small Head Dia: 13mm Large Head Dia: 16mm Stem Diameter: 9mm Stem Length: 11mm Toyota Corolla Wagon, Tercel, T-100 & Tacoma 2WD '92 - UP Box Qty. 25</p>	 <p>445886 67771-16120 Gray Nylon Front & Rear Door Trim Panel Retainer Top Head Dia: 13mm Bottom Head Dia: 18mm Stem Length: 15mm Fits Into a 9mm Hole Toyota Tercel '94 - UP Box Qty. 15</p>	 <p>445887 90467-10188 Turquoise Nylon Trim Panel Retainer Top Head Dia: 13mm Middle Head Dia: 16mm Bottom Head Dia: 18mm Stem Dia: 8.5mm x 9mm Stem Length: 14mm Toyota Sienna 2004 - UP Box Qty. 25</p>
 <p>445888 67771-03030 Gray Nylon Door Trim Retainer Top Head Dia: 13mm Middle Head Dia: 16mm Bottom Head: 17.5mm Stem Length: 14mm Stem Diameter: 10mm Toyota Camry '88 - UP Box Qty. 50</p>	 <p>445891 67771-22010 Blue & Natural Nylon Door Panel Retainer Top Head Dia: 13mm Bottom Head Dia: 18mm Stem Length: 14mm Stem Dia: 9.5mm Box Qty. 25</p>	<p>NEW</p>  <p>445950 75392-35220 White Nylon Front & Rear Spoiler Moulding Clip Head Size: 10mm x 20mm Stem Length: 24mm Overall Length: 27mm Lexus HS250 & RX350 and Toyota Camry, Corolla, FJ Cruiser & Highlander 2010 - UP Box Qty. 25</p>	 <p>445965 67771-22020 Natural & Yellow Nylon Door Panel Retainer Top Head Dia: 12.5mm Bottom head Dia: 16mm Stem Length: 11mm Overall Length: 20mm Stem Dia: 8.5mm Honda, Toyota Box Qty. 25</p>
<p>445978 Box 50</p>  <p>445977 90467-08004, 90467-08011, 94842841, 94849113 Black Nylon Hood Seal Retaining Clip Head Dia.: 13mm Stem Length: 11mm Fits Into 6mm Hole Lexus, Toyota, Geo Prizm & Nova 1985-UP Box Qty. 25</p>	 <p>475085 90183-03001 Nylon Front Bumper Cushion Clip Toyota '82 - UP Box Qty. 25</p>	 <p>475530 53455-14020 Nylon Hood Prop Rod Clip Holds 8mm Dia. Rod Snaps Into 14mm Hole Box Qty. 15</p>	 <p>480010 Door & Window Crank Handle Retaining Clip Ford, GM, Toyota Box Qty. 100</p>
 <p>495002 69293-12040 Door Lock Rod Clip Rod Size: 5mm Left (Driver) Side Lexus ES 300 2001 - 97 Toyota Camry, Celica, Corolla, Echo, Highlander, MR2, RAV 4, Tundra and 4-Runner 1994 - UP Box Qty. 10</p>	 <p>TR47-P Code Series: 10001-15000 One Key System Toyota Avalon, Camry, Celica, Corolla, RAV4, Sienna, Solara, Tacoma & Tundra 1992 - UP Box Qty. 5</p>	<p>NEW</p>  <p>530386 90430-12031, 90430-12018, 90430-12027 & 90430-C0005 Fibre & Aluminum Oil & Transmission Drain Plug Gasket Inner Dia: 12mm Outer Dia: 21mm Thickness: 1.75mm Toyota 4Runner, Avalon, Camry, Celica, Corolla, Echo, FJ Cruiser, Highlander, Land Cruiser, Matrix, MR2, Paseo, Previa, Prius, RAV4, Sequoia, Sienna, Solara, Supra, T100, Tacoma, Tercel, Tundra, Venza & Yaris 1991 - UP Box Qty. 5</p>	

TOYOTA GLASS SHOP SUPPLIES

32 Toyota Clips



465050
75545-12030A
Nylon
Windshield Reveal
Moulding Clip
9mm Wide, 26mm Long
Toyota
Box Qty. 50



465070
75546-22021B
Windshield Reveal
Moulding Clip
Toyota
Box Qty. 25



465073
75546-12010
Nylon
Windshield Moulding Clip
20mm Wide, 40mm Long
Fits Into 8mm Hole
Box Qty. 10

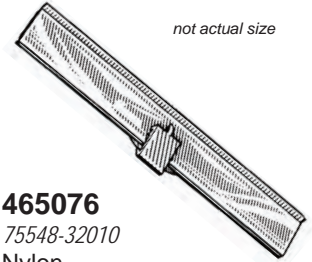

465076
75548-32010
Nylon
Windshield Midg Clip
w/ Self Adhesive Backing
14.5mm Wide, 70mm Long
Box Qty. 25

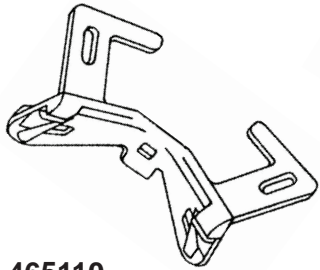

465110
75546-22030
Windshield Moulding Clip
Toyota Cressida '81 - '82
Box Qty. 10

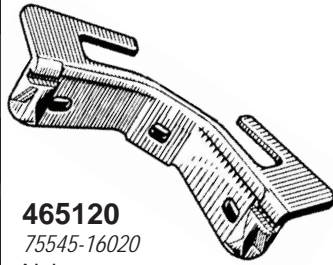

465120
75545-16020
Nylon
Windshield Moulding Clip
18mm Wide, 49mm Long,
13mm High
Toyota Corolla, Tercel '83
Box Qty. 10

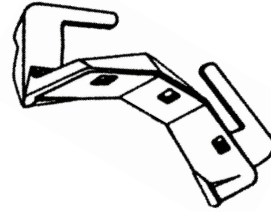

465129
75545-14060
Plastic
Windshield Moulding Clip
Toyota Celica '82 - '85
Box Qty. 10

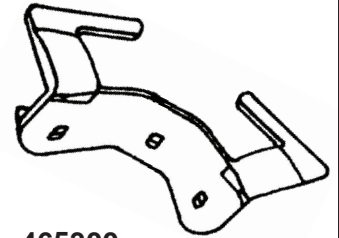

465300
75545-12040
Plastic
Windshield Moulding Clip
Toyota Corolla '84 - UP
Box Qty. 25

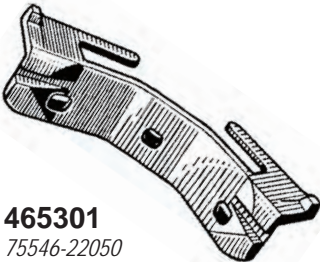

465301
75546-22050
Plastic
Windshield Moulding Clip
14mm Wide, 47mm Long,
12mm High
Toyota Cressida '85 - UP
Box Qty. 25

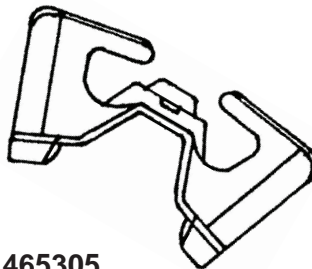

465305
75546-28010
Plastic
Windshield Moulding Clip
Toyota Van '85 - UP
Box Qty. 25

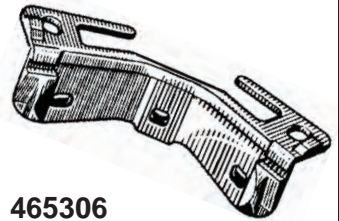

465306
75545-28010-B, 75545-88080
Nylon
Windshield Moulding Clip
18mm Wide, 49mm Long,
16mm High
Toyota Van '84
Box Qty. 25

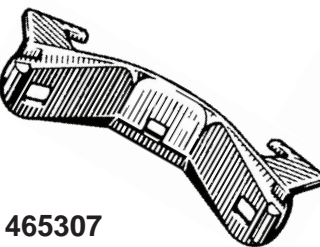

465307
75545-89101
Windshield Moulding Clip
15mm Wide, 47mm Long,
13mm High
Toyota Pick-Up Trucks '84 - UP
Box Qty. 25

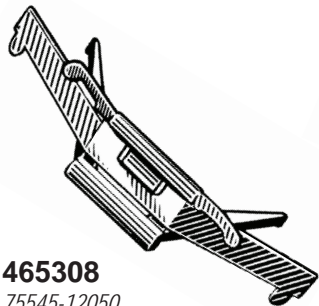

465308
75545-12050
White Plastic
Windshield Moulding Clip
Toyota Corolla '84 - UP
Box Qty. 10

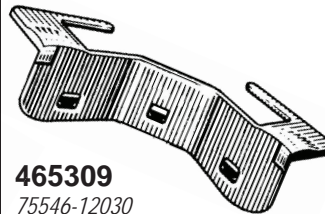

465309
75546-12030
Plastic
Windshield Moulding Clip
21mm Wide, 54mm Long,
15mm High
Toyota Corolla '84 - UP
Box Qty. 10

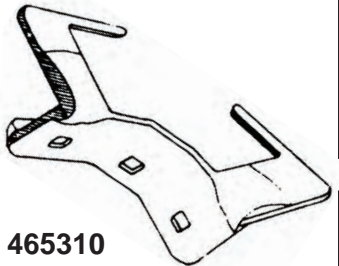

465310
75546-14080
Plastic
Windshield Moulding Clip
Toyota Celica '81 - '87
Box Qty. 25

TOYOTA GLASS SHOP SUPPLIES

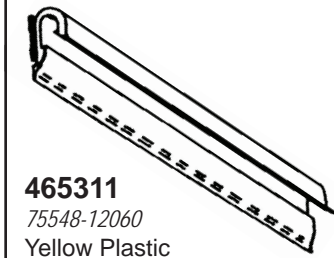

465311
75548-12060
Yellow Plastic
Upper & Side Back Glass
Moulding Clip
Overall Length 60mm
Plastic w/ Self Adhesive
Toyota Corolla '87 - '91
Box Qty. 10



465312
75547-32010
Yellow Plastic
Upper & Side
Back Glass
Moulding Clip
Toyota Camry '87 - UP
Box Qty. 15

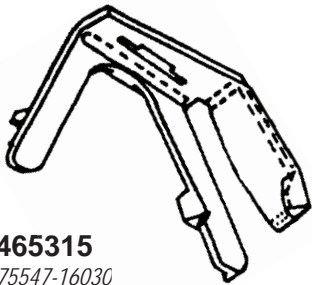

465315
75547-16030
White Plastic
Windshield Moulding Clip
Right
Toyota Tercel '83 - '88
Box Qty. 10

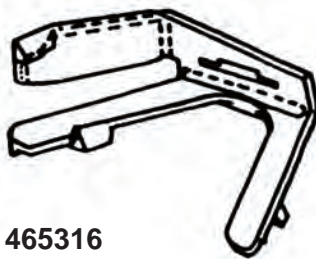

465316
75546-16030
White Plastic
Windshield Moulding Clip
Left
Toyota Tercel '83 - '88
Box Qty. 10



465317
75545-20060
Green Plastic
Windshield Moulding Clip
Toyota Celica '86 - UP
Box Qty. 25

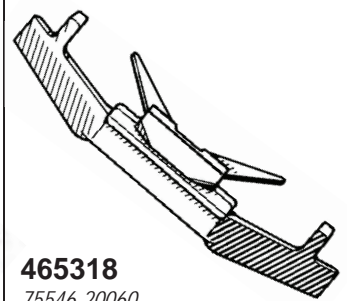

465318
75546-20060
Blue Plastic
Windshield Moulding Clip
Toyota Celica '86 - UP
Box Qty. 25

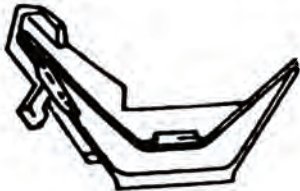

465319
75547-89105
Yellow Plastic
Windshield Chrome
Moulding Clip
Upper L.H. Corner
Toyota Truck '88 - UP
Box Qty. 10



465320
75545-89103
White Plastic
Windshield Chrome
Moulding Clip
Side L.H. & R.H.
without Center Tab
Toyota Truck '88 - UP
Box Qty. 15

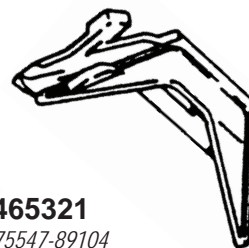

465321
75547-89104
White Plastic
Windshield Chrome
Moulding Clip
Upper R.H. Corner
Toyota Truck '88 - UP
Box Qty. 10

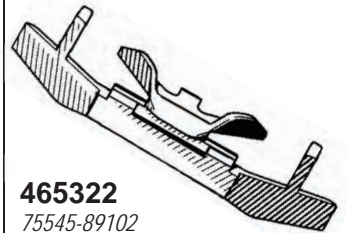

465322
75545-89102
White Plastic
Windshield Chrome
Moulding Clip
Side L.H. & R.H.
with Center Tab
Toyota Truck '88 - UP
Box Qty. 15



465323
75961-22030
Plastic
Windshield Moulding Clip
Top Corner R.H.
Toyota Cressida '88 - UP
Box Qty. 10

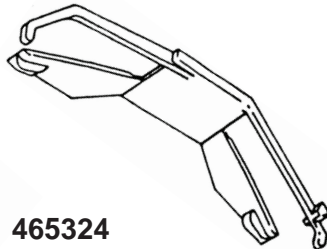

465324
75962-22040
Plastic
Windshield Moulding Clip
Top Corner
Toyota Cressida '88 - UP
Box Qty. 10



465325
75546-22060
Plastic
Windshield Sides
Moulding Clip
Toyota Cressida '88 - UP
Box Qty. 15

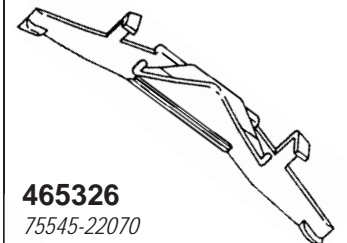

465326
75545-22070
Plastic
Windshield Top
Moulding Clip
Toyota Cressida '88 - UP
Box Qty. 15

TOYOTA GLASS SHOP SUPPLIES



465327
 75547-89106
 Black Plastic
 Windshield Chrome
 Moulding Clip
 Lower R.H. Corner
Toyota Truck '88 - UP
 Box Qty. 10



465328
 75547-89107
 Gray Plastic
 Windshield Chrome
 Moulding Clip
 Lower L.H. Corner
Toyota Truck '88 - UP
 Box Qty. 10

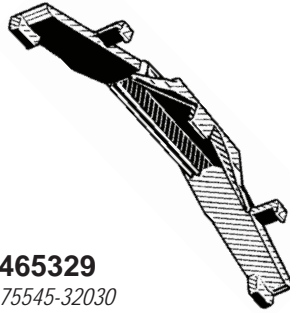

465329
 75545-32030
 Natural Nylon
 Windshield Moulding Clip
Camry '92 - UP
 Box Qty. 15

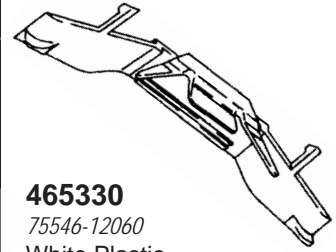

465330
 75546-12060
 White Plastic
 Side Windshield
 Moulding Clip
*Toyota Corolla Sedan
 & Wagon '88 - '92*
 Box Qty. 15















32 Toyota Clips

32



TOYOTA

VOLKSWAGEN / AUDI CLIPS

<p>38607 N900-845-01 Dia.: 5/32" Grip: 1/4" - 3/8" Flange O.D.: 15/32" Black Aluminum Rivet Steel Mandrel Wheel Opening Moulding Attachment VW Jetta, Rabbit & Golf Box Qty. 25</p> 	<p>200397 N90892001, N90775001 Black Zinc M5-2.12 x 19mm Head Dia: 14mm Torx® Truss Head Tapping Screw, T25 Drive Audi, Porsche & VW 2007 - 14 Box Qty. 25</p> 	<p>270081 Zinc "U" Type Nut Screw Size: 4.8mm (#10) Panel Range: .9mm-2.0mm Center Hole To Edge: 8mm Mercedes Benz, BMW, Subaru, SAAB, VW & Opel Box Qty. 25</p> 	<p>292089 N908-338-01 Black Nylon Fender Apron Screw Grommet Scew Size: M4.2 (#8) Head Dia: 15mm Stem Length: 12mm VW Cabrio, Golf, Jetta & Phaeton 1999 - UP Box Qty. 15</p> 
<p>292090 N908-214-01 Bumper & Fender Apron Screw Grommet Screw Size: M4.2 (#8) Head Dia: 15mm Stem Length: 20mm Audi A4/S4 and A6/S6 1996-UP; VW Cabrio, Golf, Jetta & Phaeton 1999-UP Box Qty. 15</p> 	<p>292091 1H0-853-586 Blue Rubber Moulding Clip Grommet I.D.: 7mm Flange O.D.: 13mm Overall Length: 12mm Audi and VW Cabrio, Golf, Jetta, Passat & Touareg 1990-2007 Box Qty. 50</p> 		<p>NEW 292093 N105-073-01 Brown Nylon Bumper & Fender Apron Screw Grommet With Sealer Screw Size: M4.8 (#10) Head Dia: 13mm Stem Length: 17mm Fits Into 7.5mm Square Hole Audi A3, A4, A5, RS 5, S4 & S5 2009 - 2015 VW Phaeton 2004 - 2006 Box Qty. 25</p> 
<p>292099 357-827-998 Black Nylon Front & Rear Door Panel Screw Grommet Screw Size: M4.8 (#10) Head Dia: 16mm Stem Length: 20mm VW Cabrio, Golf, Jetta & Passat 1993 - UP Box Qty. 15</p> 	<p>292163 NEW N-103-180-01 Natural Nylon Fender Liner, Grille, Engine Under Cover & Rocker Moulding Screw Grommet Screw Size: M4.2 (#8) Head Dia: 14.5mm Stem Length: 16mm Fits into 7.5mm Hole Overall Height: 18mm Audi TT 2012 - 2015 Porsche Cayenne 2006 - 2010 Volkswagen Phaeton 2004 - 2006 Box Qty. 50</p> 	<p>NEW 292164 5Z0-853-695 Clear Nylon Corner Cover Grommet With Steel Reinforcement Head Dia: 14mm Stem Length: 5.5mm Overall Height: 7mm Fits into 7mm Hole Volkswagen Beetle 2012 - UP Box Qty. 25</p> 	<p>415241 1H5-863-849-A-01C Hood Insulation Retainer Head Size: 20mm x 25mm Stem Length: 13mm Fits Into 12mm Hole Audi A4, A6, Cabriolet, Quattro, S4 & S6 and VW Beetle, Golf, Jetta, Passat, Rabbit & Touareg 1998-UP Box Qty. 15</p> 
<p>415503 175-853-695, 14015161 Black Plastic Grille Attaching Drive-Type Rivet Hole: 5/16" Flange: 5/16" x 1-1/16" GM & Volkswagen Box Qty. 50</p> 	<p>415604 34202855, 6500859, 6500899, 8048635, 20432975, 175-853-577, 175-853-57701C, 175-852-577 Super Tough Black Nylon Hole: 13/64" Panel Range: 1/8" - 15/64" Head: 15/32" Chrysler, Ford, GM, VW, AMC Box Qty. 25</p> 	<p>415620.....Box 25 415820.....Box 100 4370132, 20433026, 14070914, 175-553-577A, 175-853-577A 17/64" Dia. Black Nylon Blind Rivet Panel Range: 3/32" - 3/16" Flange: 23/32" GM, Chrysler, VW, General Purpose</p> 	

VOLKSWAGEN / AUDI CLIPS

VW / Audi Clips

33



415640.....**Box 25**
415840.....**Box 100**
 20432975, 175-853-57701C,
 6503800, N804343S
 Black Nylon Blind Rivet
 Dia: 13/64"
 Grip: 1/8" - 15/64"
 Flange: 15/32"
 GM, VW, Chrysler, Ford, General
 Purpose



416017
 4D0-807-300
 Black Nylon
 Bumper, Fender & Hood
 Insulation Push-Type Retainer
 Head Dia: 22mm
 Stem Length: 12mm
 Fits Into 7.5mm Hole
 Audi A4, A5, A8, Q3, Q5 & S8
 1997 - UP
 Box Qty. 15

416110
 000-990-34-92,
 51-16-1-881-149,
 N-102-593-01



Black Nylon
 Radiator Housing
 Push-Type Retainer
 Head Dia: 10mm
 Stem Length: 10mm
 Fits Into 6mm Hole
 Mercedes Benz Body Styles 116,
 123, 124, 126, 129, 140, 170, 201,
 208 & 210 1974-UP
 BMW, VW
 Box Qty. 15

NEW



416240
 N-105-835-01-9B9
 Black Nylon
 Bumper, Fender,
 Interior Trim & Seat
 Release Handle
 Push-Type Retainer
 Top Head Dia: 17mm
 Bottom Head Dia: 13mm
 Stem Length: 12mm
 Fits into 8mm Hole
 Audi A3, A4, A5, A8, Allroad, Q3,
 RS5, S3, S4, S5 & S8 2009 - UP
 Volkswagen Beetle 2013 - UP
 Box Qty. 25



416250
 6Q0-868-243
 Black & White Nylon
 Nylon Trim Panel
 Push-Type Retainer
 Head Dia: 22.5mm
 Stem Length: 12mm
 Fits Into 8mm Hole
 VW Golf, Jetta, Passat, Phaeton,
 Rabbit & Tiguan 2004-UP
 Box Qty. 15



416251
 1H0-819-055-B01C
 Black Nylon
 Instrument Panel, Cowl Vent,
 Defroster Grille & Ducts
 Retainer - Phillips Drive
 Head Dia: 23mm
 Stem Dia: 6.5mm
 Stem Length: 16mm
 Audi and VW Cabrio, Golf & Jetta
 1993-2002
 Box Qty. 25



416252
 701-867-299
 Gray Nylon
 Front Bumper &
 Interior Trim
 Push-Type Retainer
 With 3mm Allen Head Drive
 Head Dia: 18.5mm
 Stem Length: 11mm
 Fits Into 9mm Hole
 VW Jetta & Passat 99-UP
 Box Qty. 25



416253
 N90-335-006
 Dacromet
 Splash Shield & Wheel
 Well Push-On Retainer
 Stud Size 5mm
 O.D.: 30mm
 VW & Audi
 Box Qty. 25



416254
 4A0-805-121-A
 Black Nylon
 Front Fender, Bumper
 & Engine Cover
 Retainer - Slotted Drive
 Head Dia: 25mm
 Stem Length: 22mm
 Audi and VW Passat 1992 - 2011
 Box Qty. 25



NEW
416291
 N90-796-501,
 N90-796-502
 Dacromet
 Radiator Support & Splash
 Shield Push-On Retainer
 Stud Size: 5mm
 OD: 30mm
 VW 1999 - 2006
 Box Qty. 25



NEW
416301
 6N0-129-355
 Black Nylon
 Bumper Clamping Washer
 Outside Dia: 18mm
 Thickness: 1mm
 Hole Dia: 5.5mm
 Audi Q3, Q5, SQ5 & TT
 2000 - 2017
 Volkswagen CC, Passat & Touareg
 2004 - 2010
 Box Qty. 25

NEW



435010
 N-911-829-01
 Black Nylon
 Rocker Moulding
 Push-Type Retainer
 Head Dia: 18mm
 Stem Length: 13mm
 Fits into 10mm Hole
 Volkswagen 2000 - UP
 Box Qty. 15



















435230
 321-853-139
 Side Moulding Clip
 Volkswagen Dasher '78 - UP
 Box Qty. 50



435301
 803-853-577
 Natural Nylon
 Body Moulding Clip
 Volkswagen
 Box Qty. 50

VOLKSWAGEN / AUDI CLIPS

 <p>435496 7L0-839-069 White Nylon Rocker Panel Moulding Clip Width: 10mm Length: 28.5mm Stem Length: 11mm Fits Into 10mm Hole VW Touareg 2005 - 10 Box Qty. 25</p>	<p>NEW</p>  <p>445005 3AA-868-243-A Black Nylon Door Trim Panel Retainer with Rubber Seal Top Head: 10mm x 18.5mm Bottom Head Dia: 21mm Stem Length: 12mm Fits into 12mm Hole Volkswagen Atlas, Beetle, e-Golf, GTI, Golf, Golf Alltrack, Golf R, Golf Sportwagen, Passat & Tiguan 2016 - UP Box Qty. 15</p>	 <p>445032 385661-S, 6032363, N989022 Black Nylon Door Trim Panel Retainer Head Dia: 15/16" Stem Length: 11/16" Fits Into 5/16" Hole Ford, Chrysler, VW '75 - UP Box Qty. 25</p>	 <p>445585 6003349, 9685057, 4005470, N98905101 White Nylon Door Trim Panel Retainer Hole Size: 7mm Top Head Size: 20mm Stem Length: 18mm Chrysler, GM, AMC, VW '76 - UP Box Qty. 50</p>
 <p>445821 3B0-868-243 Black Nylon Door Trim Panel Retainer Head Dia: 22mm Stem Length: 10mm Fits into 10mm Hole VW Beetle, Golf, Jetta & Passat 1998 - UP Box Qty. 25</p>	 <p>445822 N14389.3, 3104-426 Metal Door Panel Clip VW, Volvo Box Qty. 50</p>	 <p>445823 8934-201-681, 175-867-299 White Nylon Trim Panel Retainer Head Diameter: 19mm Stem Length: 18mm Stem Diameter: 9mm AMC-Renault 1984-UP; VW 1982-UP Box Qty. 50</p>	 <p>445824 8E0-868-243 Interior Trim Panel Retainer with Sealer Top Head Dia: 21.5mm Bottom Head Dia: 27mm Stem Dia: 11mm Stem Length: 19mm Audi A4 & S4, Avant, Cabriolet, Quattro & Sedan Wagon, 2005-UP Box Qty. 25</p>
 <p>445825 1H0-868-243 Blue & Black Nylon Trim Retainer Top Head Dia: 28mm Bottom Head Dia: 19mm Overall Length: 31mm Audi & VW Cabrio, Golf & Jetta 1993 - 1999 Box Qty. 25</p>	 <p>445826 1H0-853-585 Door Moulding Clip Width: 34mm Length: 38.5mm Stem Length: 10mm Audi & VW Cabrio, Golf & Jetta 1993 - 2002 Box Qty. 15</p>	 <p>445827 1H0-853-585-B Door Moulding Clip Width: 34mm Length: 38.5mm Stem Length: 18mm Audi & VW Cabrio 1999 - 2002 Box Qty. 15</p>	 <p>445828 1H0-853-585-A Quarter Panel Moulding Clip Width: 23mm Length: 40mm Stem Length: 11mm Audi & VW Cabrio, Golf & Jetta 1993 - 2002 Box Qty. 15</p>
 <p>445829 6K0-868-243-C Black Nylon Trim Panel Retainer Top Head Dia: 22mm Bottom Head Dia: 18mm Stem Length: 11mm Fits Into 8mm Hole Audi & VW Touareg 2004-2010 Box Qty. 25</p>	 <p>445831 3B0-853-575 Moulding Clip Width: 17.5mm Length: 21mm Stem Length: 12mm VW Passat 1998-2005 Box Qty. 25</p>	 <p>445832 3A0-853-575 Door, Fender & Quarter Panel Moulding Clip Width: 35mm Length: 38mm Stem Length: 14mm Volkswagen 1990-1997 Box Qty. 15</p>	 <p>445848 1J6-867-276 Zinc Finish Door Trim Clip Overall Height: 22.5mm Width at Bottom Base: 13.5mm Audi & VW 2004 - UP Box Qty. 25</p>

VOLKSWAGEN / AUDI CLIPS

VW / Audi Clips

33

BLANK

VOLVO CLIPS & FASTENERS

<p>38622 Box 100</p>  <p>38620 979878-6 Dia: 4mm (5/32") Grip: 3mm - 8.5mm (1/8" - 11/32") Flange: 12mm (15/32") Black Polyethylene Coated Aluminum Rivet Aluminum Mandrel Bumper & Wheel Housing Volvo '93 - UP Box Qty. 15</p>	 <p>270078 000-994-09-14, 946-418, 20-72-175 Plated "U" Type Nut Screw Size: 6.5mm (#14) Panel Range: .7mm-1.5mm Center Hole to Edge: 13mm Mercedes, Opel, Volvo Box Qty. 50</p>	 <p>415710 000-990-03-92, 947-098 Black Nylon Push-Type Retainer Head Diameter: 10mm Stem Length: 7mm Fits into 5mm Hole Mercedes Benz, Volvo Box Qty. 50</p>	
	 <p>416132 1268176-3 Black Plastic Lower Bumper Push-Type Retainer Hole: 6mm Head: 15.8mm Stem Length: 14mm Volvo 740 & 760 Box Qty. 25</p>	<p>NEW</p>  <p>416239 3541113 Black Nylon Bumper, Windshield Trim, Trunk Trim & Mud Flap Push-Type Retainer Head Dia: 20mm Stem Length: 8.3mm (Not Including Pin) Fits into 8mm Hole Volvo 940 & 960 1991 - 1993 C30, C70, S40, S60, S80, S90, V50, V60, V70, V90, XC60, XC70 & XC90 2000 - UP Box Qty. 25</p>	 <p>435112 1304-967 Nylon Bumper Cover Moulding Clip w/Metal Retainer 10mm Wide, 23mm Long Fits Into 6mm Hole Volvo 240 & 260 '83 - UP Box Qty. 25</p>
 <p>445822 N14389.3, 3104-426 Metal Door Panel Clip VW, Volvo Box Qty. 50</p>	 <p>465031 1246934 Green/White Windshield Moulding Clip Sliding Center Volvo Box Qty. 10</p>	 <p>465032 1246926 Gray Windshield Moulding Clip Stationary Center Volvo Box Qty. 10</p>	 <p>465033 1254849 White Windshield Moulding Clip Sliding Center Volvo Box Qty. 10</p>
 <p>465035 1-325-285, 1-268-566-5 Plastic Upper & Side Windshield Moulding Clip Front & Rear Volvo '83 - UP Box Qty. 25</p>	 <p>465036 1342150 Plastic Lower Windshield Moulding Clip Volvo 740 & 760 '85 - UP Box Qty. 25</p>		

BLANK

CABINETS AND BINS



99902 6 Drawer Cabinet with 12 Dividers

Overall Size: 33-3/4" Wide x 11-5/8" Deep x 4" High
 Drawer Size: 4-7/8" Wide x 11-1/4" Deep x 2-3/4" High
 Made of Prime Cold Rolled Steel. The Finish is Rust & Acid Resistant.
 Blue Powder Coated, Baked Enamel.



99901 18 Drawer Cabinet with 36 Dividers

Overall Size: 33-3/4" Wide x 11-3/4" Deep x 12-7/8" High
 Drawer Size: 4-7/8" Wide x 11-1/4" Deep x 3-1/2" High
 Made of Prime Cold Rolled Steel. The Finish is Rust & Acid Resistant.
 Blue Powder Coated, Baked Enamel. Weight 50 Lbs.



99900 Additional Dividers for #99901 or #99902 Bin 12/Box

99815 40 Compartment Open Slot Parts Bin

Made of prime cold roll steel and will not warp, twist or sag. Two of these bins will bolt together to make an 80 compartment bin.
 33-3/4" Wide x 8-1/2" Deep x 22-1/4" High
 Bin slot size: 4-1/2" Wide x 4" High x 8-3/8" Deep.
 Weight 40 Lbs. Gray Powder Coated, Baked Enamel



99807 Base Stand For Bins #99901, #99902 or #99815.

Made of prime cold roll steel.
 Blue Powder Coated, Baked Enamel
 34-1/8" Wide x 12-1/4" Deep x 5-3/4" High



99808 Base Stand For Bins #99901, #99902 or #99815.

Made of prime cold roll steel.
 Blue Powder Coated, Baked Enamel
 34-1/8" Wide x 12-1/4" Deep x 15" High



99817 Aerosol/Epoxy Utility Cabinet

Made of prime cold rolled steel. Comes with one slotted shelf and two solid shelves. Both are adjustable with 8 different height positions. Will store from 38-44 aerosol cans. Doors lock for added security.
 30" Wide x 20 High x 13" Deep
 Blue and White Powder Coated, Baked Enamel
 1 - Cabinet per box Weight 38 Lbs.



99816

Aerosol/Utility Cabinet
 Two adjustable shelves.
 Lock attachment for padlock.
 Inside door literature holder.
 Keyhole slots allow hanging.
 Box Qty. 1

Dimensions: Height: 32-3/4",
 Width: 19-7/8", Depth: 14-1/4",

99819 Aerosol/Epoxy Utility Cabinet Legs

Leg set for the #99817 Aerosol/Utility Cabinet.
 Allows the cabinet to be free standing.
 Blue Powder Coated
 1 set (4 legs) per box.



99820

Mini Cabinet
 One adjustable shelf
 (11 adjustable positions)
 Door lock for added security
 Keyhole slots allow hanging.
 Box Qty. 1



Dimensions: Height: 24",
 Width: 13-7/8", Depth: 12-3/4",

CABINETS AND BINS



99904 - 24 Compartment Drawer

This large 24 compartment portable, heavy-duty plastic compartment box is great for storage of nuts, bolts, connectors or any other assortment of small parts. Comes with double latched cover and a handle. Gray in color.

*Overall dimensions: 18-1/4" Wide x 12-1/4" Deep x 3-1/8" High
20 small (2-13/16" x 2-5/8") and 4 large (4-1/4" x 2-3/4") fixed compartments*



99905 - Large Adjustable Drawer

This large adjustable, heavy-duty plastic compartment box is great for storage of nuts, bolts, connectors or any other assortment of small parts. Comes with double latched cover and a handle. Gray in color.

*Overall dimensions: 18-1/4" Wide x 12-1/4" Deep x 3-1/8" High
Up to 32 compartments - Includes 28 dividers - fully adjustable to your needs!*

99905DIV - Additional dividers for #99905 drawer. Pkg. Qty. 25



99907S-NBK

Nut and Bolt Kit for joining two 99907's or 99901's together.
Pkg. Qty. 1 set



99907

4- Drawer Slide Rack For Scoop Compartment Boxes.
Made of Prime Cold Rolled All Welded Steel Construction. Blue Powder Coated, Baked Enamel
20" Wide x 15" High x 15-3/4" Deep
Weight 37 Lbs. 1 Per Box

99805

Base Stand For Rack #99907
20-3/8" W x 15-1/8" H x 16" D
Blue Powder Coated, Baked Enamel
Weight 13 Lbs. 1 Per Box



99911

Wire/Hose Spool Rack

Made of prime cold rolled steel.
Comes with 4 Plated steel rods.
For Spools up to 10" in diameter
26-1/8" Wide x 37-1/8" High x 6" Deep
Gray Baked Enamel
Weight 25 Lbs. 1 Per Box



99925

Hose Clamp Rack

Rack provides easy access to adjustable hose clamps. Holds up to 10 clamps. For countertop use or may be wall-mounted. Powder coated.
Dimensions: 23-5/16" x 5-1/2" x 14-5/16"
1 Per Box

6 - PACK CLEAR "K - RESIN" POLYSTYRENE BOX

Product Number	Description	Number of Compartments
999124" x 8" x 1-3/16"	6

1 Per Package



YELLOW OPAQUE POLYPROPYLENE BOXES

Product Number	Description	Number of Compartments
99913 6-3/16" x 10-1/2" x 1-9/16"	12

1 Per Package



99906 - Miniature Bulb Storage Cabinet

This easily accessible Mini Lamp Storage Bin makes storing and retrieving items a snap. It has a steel frame with a Black Powder Coated Finish. Each of the four Durable Clear Plastic Trays have seven adjustable dividers to make 8 total compartments per tray. Storage trays tip forward for easy retrieval of products. This unit also has a top storage compartment that measures 3" D x 6" H x 18" W with two shelves and a hinged door. Can stand on bench or be wall mounted. 15 lbs. Made in the U.S.A.

Features

- 19" Wide x 26.75" High x 4" Deep
- High-Impact Clear Polystyrene Tip-Out Trays
- 4 Tip-Out Tray Cabinet with 7 Adjustable Removable Clear Dividers per Tray
- Upper Storage with 2 Shelves & Hinged Door

TRANSLUCENT DURABLE POLYPROPYLENE BOXES

6-3/16" x 10-1/2" x 1-9/16"

- Extremely Durable
- Heavy Duty Heat-Sealed Hinges
- Resists Solvents

99930	6 Compartment Box	1 Per Box
99931	12 Compartment Box	1 Per Box
99932	18 Compartment Box	1 Per Box
99933	8 Compartment Box Adj.	1 Per Box



99930



99931



99932



99933

CABINETS AND BINS

Cabinets / Bins

35

BLANK

BRONZECLASS

Body Shop Fastener
Starter Assortment
71 of the most popular items - Over 1700 pieces.
Fasteners Only - No Bins
Box Qty. 1 Assortment



Inside of drawer



"BRONZECLASSWB" Shown above
#99901 Cabinet Size
33-3/4" Wide x 11-5/8" Deep x 10-7/8" High
Drawer Size
5-3/8" Wide x 11-1/4" Deep x 2-3/4" High

INCLUDES:

- BODY BOLTS
- BODY NUTS
- U NUTS
- SHIMS
- RIVETS
- SCREWS
- X-MAS CLIPS
- PUSH PINS
- TRIM CLIPS
- NYLON NUTS
- MINIATURE BULBS

BRONZECLASSWB

Above assortment with one #99901 Cabinet,
17 extra 99900 dividers, all drawers pre-labeled inside and out.

SILVERCLASS

Body Shop Assortment
181 of the most popular items.
Over 6200 pieces.
Fasteners Only - No Bins
Box Qty. 1 Assortment



Inside of drawer



"SILVERCLASSWB" Shown above
#99901 Cabinet Size (Qty.: 2)
33-3/4" Wide x 11-5/8" Deep x 10-7/8" High
Drawer Size
5-3/8" Wide x 11-1/4" Deep x 2-3/4" High
Stand Size
34-1/8" Wide x 12-1/4" Deep x 5-3/4" High

INCLUDES:

- BODY BOLTS
- BODY NUTS
- U NUTS
- SHIMS
- RIVETS
- SCREWS
- X-MAS CLIPS
- PUSH PINS
- TRIM CLIPS
- NYLON NUTS
- MINIATURE BULBS
- SPEED CLIPS
- PAL NUTS
- PUSH NUTS
- FUSES
- ELECTRICAL CONNECTORS

SILVERCLASSWB

Above assortment with two #99901 Cabinets,
73 extra 99900 dividers, one #99807 Stand, all draw-
ers pre-labeled inside and out.

GOLDCLASS

Body Shop Fastener
Master Assortment
252 of the most popular items.
Over 11,700 pieces.
Fasteners Only - No Bins
Box Qty. 1 Assortment



Inside of drawer



"GOLDCLASSWB" Shown above
#99901 Cabinet Size (Qty.: 3)
33-3/4" Wide x 11-5/8" Deep x 10-7/8" High
Drawer Size
5-3/8" Wide x 11-1/4" Deep x 2-3/4" High
Stand Size
34-1/8" Wide x 12-1/4" Deep x 5-3/4" High

INCLUDES:

- BODY BOLTS
- BODY NUTS
- U NUTS
- SHIMS
- RIVETS
- SCREWS
- X-MAS CLIPS
- PUSH PINS
- TRIM CLIPS
- NYLON NUTS
- MINIATURE BULBS
- SPEED CLIPS
- PAL NUTS
- PUSH NUTS
- WASHERS
- CABLE TIES
- FUSES
- ELECTRICAL CONNECTORS

GOLDCLASSWB

Above assortment with three #99901 Cabinets, 96
extra 99900 dividers, one #99807 Stand, all drawers
pre-labeled inside and out.

ASSORTMENTS



SIX - PACK ASSORTMENTS

The S & R SIX-PACK ASSORTMENT is a six compartment, easy to open, durable translucent Plastic Box. The items in each compartment have been carefully selected to provide the customer maximum coverage for a minimum cost.

Please view the detailed descriptions of these assortments on pages 2 and 3.













Size of Box: 8-1/4" x 4-1/2" x 1-3/8"

ASSORTMENT	DESCRIPTION
222000.....	Phillips Oval Head Tapping Screws (Black)
222002.....	Phillips Oval Head Tapping Screws (Chrome)
222008.....	Phillips Pan Head Tapping Screws (Black)
222012.....	Self Threading Nuts (Standard)
222013.....	Self Threading Nuts (Metric)
222014.....	Round Push Nuts (Standard)
222016.....	Round Push Nuts (Metric)
222017.....	U-Type Speed Nuts
222018.....	G.M. Nylon Nuts
222020.....	Barrel Nuts
222027.....	E - Clips Metric
222028.....	E - Clips Standard
222032.....	Solderless Terminals
222033.....	Krimp & Seal Assortment
222034.....	Krimp & Solder Assortment
222046.....	Door Lock Rod Clips
222050.....	USS Flat Washers
222051.....	SAE Flat Washers
222054.....	Cotter Pins
222095.....	Nylon Cable Ties
222102*.....	Nylon Blind Rivets
222107#.....	Hinge Pin & Bushing Repair Kit
222200*.....	Shrink Tubing (Polyolefin Thin Wall)
222201*.....	Perm-Fit Dual Wall Shrink Tubing

* in 99930 Box, measures 6-3/16" x 10-1/2" x 1-9/16"









special box measures 11-3/4" x 6-1/2" x 1-3/4" (Not a #99912 Box)

SIX-PACK ASSORTMENTS

 <p>222000 Phillips Oval Head Tapping Screws "Black " 210 Pieces</p> <p>Prod. No. Size</p>	 <p>222002 Phillips Oval Head Tapping Screws 180 Pieces</p> <p>Prod. No. Size</p>	 <p>222008 Phillips Pan Head Tapping Screws "Black" 180 Pieces</p> <p>Prod. No. Size</p>
<p>110030..... 8 x 1/2" 110050..... 8 x 3/4" 110070..... 8 x 1" 110110..... 10 x 1/2" 110180..... 10 x 3/4" 110140..... 10 x 1"</p>	<p>105150.....8 x 1/2" Chrome 105170.....8 x 3/4" Chrome 105200.....8 x 1" Chrome 105220.....8 x 1-1/4" Chrome 105240.....8 x 1-1/2" Chrome 105270.....8 x 2" Zinc</p>	<p>120010..... 8 x 1/2" 120020..... 8 x 3/4" 120030..... 8 x 1" 120050..... 10 x 1/2" 120060..... 10 x 3/4" 120070..... 10 x 1"</p>
 <p>222012 Self Threading Pal Nuts "Zinc Plated" 210 Pieces</p> <p>Prod. No. Stud Size</p>	 <p>222013 Self Threading Pal Nuts (<i>Metric</i>) 180 Pieces</p> <p>Prod. No. Stud Size</p>	 <p>222014 Push Nuts Standard 230 Pieces</p> <p>Prod. No. Size</p>
<p>240020.....1/8" 240030.....5/32" 240040.....3/16" 240050.....1/4" 240070.....5/16" 240090.....10-24 <i>Machine Thread</i></p>	<p>245020.....3.2mm 245040.....4mm 245080.....5mm 245100.....6.3mm 245060.....5mm <i>Machine Thread</i> 245099.....6mm <i>Machine Thread</i></p>	<p>255050.....#10 or 3/16" 250010.....1/4" 250020.....5/16" 250030.....3/8" 250040.....7/16" 250050.....1/2"</p>
 <p>222016 Push Nuts Metric 275 Pieces</p> <p>Prod. No. Size</p>	 <p>222017 U-Type Speed Nuts 125 Pieces</p> <p>Prod. No. Size</p>	 <p>222018 G.M. Nylon Nuts 120 Pieces</p> <p>Prod. No. Description</p>
<p>255040.....3.2mm 255050.....4mm 255060.....5mm 255070.....6.3mm 255090.....8mm 255120.....10mm</p>	<p>270025.....#8 Short Range 270030.....#8 Long Range 270170.....#10 Speed Nut 270070.....#10 Cage Clip 270040.....#14 Short Range 270080.....#14 Long Range</p>	<p>280040 #8 Screw Size, Radiator 280070 #8 Screw Size, Inst. Panel 280080 #6 or #8, Valance 280100 Headlamp Bezel Nut 280320 5/16" or #8 Headlamp Nut 280220 Headlamp Nut</p>
 <p>222020 Barrel Clips 150 Pieces</p> <p>Prod. No. Size</p>	 <p>222027 E - Clips Metric 275 Pieces</p> <p>Prod. No. Shaft Size</p>	 <p>222028 E - Clips Standard 275 Pieces</p> <p>Prod. No. Shaft Size</p>
<p>295140..... 1/8" 295150..... 1/8" 295160..... 1/8" 295090..... 5/32" 295200..... 5/32" 295220..... 1/4"</p>	<p>380070.....4mm 380080.....5mm 380090.....6mm 380100.....7mm 380110.....8mm 380130.....10mm</p>	<p>380220.....1/8" 380240.....5/32" 380260.....3/16" 380280.....1/4" 380290.....5/16" 380300.....3/8"</p>

SIX-PACK ASSORTMENTS

36 Assortments

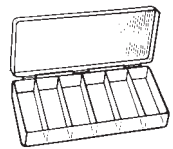
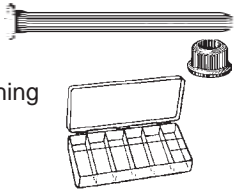
 <p>222032 Solderless Terminals 197 Pieces</p> <p>Prod. No. Size</p>	 <p>222033 Krimp & Seal 60 Pieces</p> <p>Prod No. Size</p>	 <p>222034 Krimp & Solder 60 Pieces</p> <p>Prod No. Size</p>
<p>395170..... 22-18 Butt Connectors 395180..... 16-14 Butt Connectors 395190..... 12-10 Butt Connectors 395200..... Blue Quick-Lock 395230..... 16-14 Quick Slide Male 395240..... 16-14 Quick Slide Fem.</p>	<p>99930..... Drawer 97000..... Mini Torch 398100..... 12-10 Connectors (yellow) 398095..... 16-14 Connectors (blue) 398090..... 22-18 Connectors (red)</p>	<p>99930..... Drawer 97000..... Mini Torch 396253..... 12-10 Connectors (yellow) 396252..... 16-14 Connectors (blue) 396251..... 22-18 Connectors (red)</p>
	 <p>222050 USS Flat Washers "Zinc Plated" 345 Pieces</p> <p>Prod. No. Bolt Size</p>	 <p>222051 SAE Flat Washers "Zinc Plated" 405 Pieces</p> <p>Prod. No. Bolt Size</p>
	<p>310010..... 3/16" or # 10 310020..... 1/4" 310030..... 5/16" 310040..... 3/8" 310050..... 7/16" 310060..... 1/2"</p>	<p>311007..... 3/16" or #10 311010..... 1/4" 311020..... 5/16" 311030..... 3/8" 311040..... 7/16" 311050..... 1/2"</p>
 <p>222054 Cotter Pins -Hammer Lock Plated 385 Pieces</p> <p>Prod. No. Size</p>	 <p>222095 Nylon Cable Ties 230 Pieces</p> <p>Prod. No.</p>	
<p>390030..... 3/32" x 1" 390040..... 3/32" x 1-1/2" 390070..... 1/8" x 1-1/2" 390080..... 1/8" x 2" 390090..... 5/32" x 1-1/2" 390100..... 5/32" x 2"</p>	<p>58001..... 4" Natural 58018..... 4" Black 58003..... 8-1/2" Natural 58014..... 8-1/2" Black 505195..... 5-1/2" Releasable 505197..... 8" Push Mount</p>	
 <p>222102 Nylon Blind Rivets w/ #96108 Rivet Gun 6 Varieties, 240 pieces</p> <p>222430 Same assortment as above but without the gun.</p>  <p>Storage Box #99930 Size 6-3/16" x 10-1/2" x 19/16"</p> <p>4156305mm Dia..... 6mm-10mm P.R. 4156405mm Dia..... 3mm-6mm P.R. 4156006.3mm Dia..... 4mm-10mm P.R. 4156106.63mm Dia..... 2.5mm-5mm P.R. 4156206.63mm Dia..... 2.5mm-5mm P.R. 4156026.3mm Dia..... 4mm-10mm P.R.</p> <p>(P.R.: Panel Range)</p>	 <p>222107 Hinge Pin & Bushing Repair Kit 90 Pieces</p> <p>Prod. No.</p> <p>471010 471070 471020 471080 471015 471090 471030 471100 471050 471110 471060 471040</p>	

SIX-PACK ASSORTMENTS

Standard



4" Lengths



Storage Box #99930
Size 6-3/16" x 10-1/2 x 1-9/16"

222200

Shrink Tubing
Polyolefin Thin Wall
Shrink Ratio 2:1
6 Varieties, 76 pieces

48010	3/16"
48015	1/4"
48016	3/8"
48017	1/2"
48018	3/4"
48019	1"

With Adhesive Liner



4" Lengths



Storage Box #99930
Size 6-3/16" x 10-1/2 x 1-9/16"

222201

Perm-Fit Dual Wall
Shrink Tubing With
Non-Insulated Terminals
Shrink Ratio 3:1
6 Varieties, 111 pieces

48021	3/16"
48025	1/4"
48026	3/8"
396025	22-18 ga.
396023	16-14 ga.
396024	12-10 ga.

ASSORTMENTS

CAP SCREWS - NUTS - WASHERS FASTENER ASSORTMENTS GRADE 5 - GRADE 8 - METRIC 8.8

Each assortment includes a #99815
40 compartment steel bin and
bin labels with product number and
description for easy reordering.

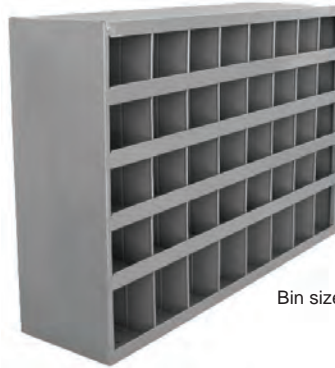

Bin size: 33-3/4" wide
22-1/4" high
8-1/2" deep

222303 USS Grade 5 Coarse Thread Fastener Assortment

222308 Same as 222303 except without bin.

Over 1,200 pieces of Grade 5 USS Cap Screws, Hex Nuts, Flat Washers and Lock Washers.
Diameters: 1/4"-20, 5/16"-18, 3/8"-16, 7/16"-14 and 1/2"-13.
Lengths 1/2" through 3".
All fasteners are zinc plated.

222304 SAE Grade 5 Fine Thread Fastener Assortment

222309 Same as 222304 except without bin.

Over 2,100 pieces of Grade 5 SAE Cap Screws, Hex Nuts, Flat Washers and Lock Washers.
Diameters: 1/4"-28, 5/16"-24, 3/8"-24, 7/16"-20 and 1/2"-20.
Lengths 1/2" through 4".
All fasteners are zinc plated.

222310 USS Grade 8 Coarse Thread Fastener Assortment

222312 Same as 222310 except without bin.

Over 2,600 pieces of Grade 8 USS Cap Screws, Hex Nuts, Flat Washers and Lock Washers.
Diameters: 1/4"-20, 5/16"-18, 3/8"-16, 7/16"-14, 1/2"-13 and 5/8"-11..
Lengths 1/2" through 4".
All fasteners are zinc plated.

222322 METRIC Regular Pitch Fastener Assortment

222323 Same as 222322 except without bin.

Over 840 pieces of Metric Cap Screws, Hex Nuts, Flat Washers and Lock Washers.
Diameters: 5mm-.8, 6mm-1.00, 8mm-1.25, 10mm-1.50 and 12mm-1.75.
Lengths 10mm through 50mm.
All fasteners are zinc plated.

222324 METRIC Class 10.9 Regular Pitch Fastener Assortment

222325 Same as 222324 except without bin.

1465 pieces of Class 10.9 Metric Cap Screws, Hex Nuts, Flat Washers and Lock Washers.
Diameters: 6mm-1.00, 8mm-1.25, 10mm-1.50 and 12mm-1.75, 14mm-2.00.
Lengths 10mm through 60mm.
All fasteners are yellow zinc plated.

LARGE DRAWER ASSORTMENT KITS

LARGE DRAWER ASSORTMENT KITS

The S & R Large Drawer Assortments are a valuable item to fit your needs. Depending on each assortment, they have 12, 20 or 24 compartments. They fit rack #99907.

Please view the detailed descriptions of these assortments on the following pages.

Bin Size: 18-1/4" Wide x 12-1/4" Deep x 3-1/8" High



ASSORTMENT	DESCRIPTION
222110	Plastic Retainers, Nylon Rivets
222111	X-Mas Tree Retainers NEW
222112	Various Push-Type Retainers NEW
222113	Various Scre-Type Retainers NEW
222115	Body Shop Hardware
222117	License Plate Screw & Nut
222209	GM Rocker Panel Mldg. Clips
222210	Tapping Screws #1
222211	Tapping Screws #2
222212	Body Hardware
222213	PAL/Push Nuts
222214	Nylon Fasteners
222215	Specialty Rivets
222217	Chrysler Retainers #2
222218	Ford Retainers #1
222228	Ford Retainers #2
222219	GM Retainers #1
222220	GM Retainers #2
222221	Honda Retainers #1
222222	Honda Retainers #2
222223	Mazda Retainers

ASSORTMENT	DESCRIPTION
222224	Nissan Retainers #1
222225	Toyota Retainers #1
222226	Toyota Retainers #2
222227	Miniature Bulbs (Domestic)
222230	Hyundai/Kia Retainers
222238	Ford F150 Retainers (w/SPR Tool)
222239	Ford F150 Retainers (no tool)
222360	Solderless Terminals
222370	Phillips Oval Sheet Metal Screws (Chrome, Black)
222380	Cotter Pins
222395	Standard Blind Rivets
222397	Specialty Blind Rivets
222409	Ergo Tuflock Retainers (small)
222410	Ergo Tuflock Retainers (large)
222530	Oil Drain Plugs #1
222534	Oil Drain Plugs #2
222535	Oil Drain Plug Gaskets
222537	Splash Shield Retainers NEW

LARGE DRAWER ASSORTMENT KITS



222110
X-Mas Tree Retainers
Assortment
24 Varieties, 570 pieces

Assortment Includes:

415050	415135	415600	415663
415070	415220	415602	415780
415075	415440	415610	415790
415125	415490	415620	415751
415126	415505	415630	415889
415128	415597	415640	416010

NEW



222111
Plastic Retainers &
Nylon Rivets Assortment
24 Varieties, 1,155 pieces

Assortment Includes:

415050	415210	416010	416140
415070	415251	416013	416149
415075	415440	416039	416171
415077	415450	416047	416277
415080	415666	416062	416281
415190	415790	416122	445565

NEW



222112
Push-Type Retainer
Assortment
24 Varieties, 595 pieces

Assortment Includes:

415125	416032	416139	416196
415883	416034	416186	416198
415927	416057	416190	416200
416021	416095	416192	416202
416023	416114	416193	416287
416027	416135	416194	416350

NEW



222113
Screw-Type Retainer
Assortment
23 Varieties, 450 pieces

Assortment Includes:

415128	415880	416025	416107
415597	415915	416045	416109
415740	415925	416051	416134
415750	415977	416055	416276
415780	416001	416056	416300
415860	416004	416103	



222115
Body Shop Hardware
Bolts, U-Nuts, Push Nuts
24 Varieties, 680 pieces

Assortment Includes:

215130	216252	255040	270080
216200	216300	255070	302035
216129	236015	255090	302040
216135	236060	270025	302080
216140	236070	270030	302090
216240	236090	270060	302100



222117
License Plate Screw
& Nut Assortment
20 Varieties, 520 pieces

Assortment Includes:

125260	200227	200616	897616
150070	200228	200617	897620
150075	200229	200703	
150076	200380	280135	
150077	200403	280137	
200226	200615	897612	

LARGE DRAWER ASSORTMENTS

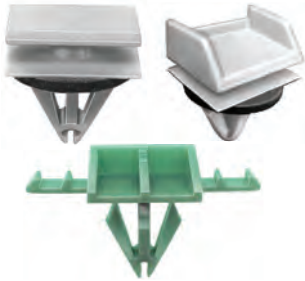

222209
GM Rocker Panel / Mldg.
Clips Assortment
24 Varieties, 220 pieces

Assortment Includes:

420015	421382	421388	421394
421375	421383	421389	421395
421376	421384	421390	421396
421377	421385	421391	421397
421378	421386	421392	421398
421380	421387	421393	421399



222210
Tapping Screw #1
Assortment
23 Varieties, 588 pieces

Assortment Includes:

200045	200290	200413	216215
200101	200292	200415	216225
200177	200293	200425	270025
200190	200350	216200	270030
200280	200365	216205	270040
200285	200385	216210	



222211
Tapping Screw #2
Assortment
24 Varieties, 949 pieces

Assortment Includes:

160010	200095	200400	200430
200045	200313	200410	200450
200050	200315	200411	200480
200055	200325	200413	200590
200070	200380	200415	200591
200090	200385	200420	200592



222212
Body Hardware
Assortment
19 Varieties, 382 pieces

Assortment Includes:

215130	216296	236060	302090
216115	216300	236100	
216135	236005	236125	
216148	236006	302035	
216290	236010	302040	
216294	236015	302080	



222213
PAL / Push nut
Assortment
23 Varieties, 362 pieces

Assortment Includes:

240020	245100	255030	255070
240030	250010	255040	255090
240040	250020	255050	255120
240050	250030	255060	
240070	250040	255065	
245090	250050	255066	



222214
Nylon Fasteners
Assortment
16 Varieties, 330 pieces

Assortment Includes:

415050	415450	415790
415070	415525	416138
415075	445565	416062
415077	415666	416047
415165	445765	
415220	415780	

LARGE DRAWER ASSORTMENTS

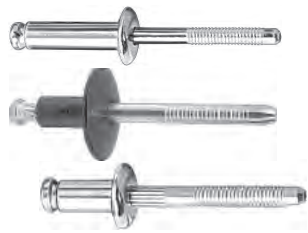

222215
Specialty Rivets
Assortment
20 Varieties, 329 pieces

Assortment Includes:

28000	38506	38575	415630
28001	38507	38603	415640
38499	38510	38605	
38503	38522	38620	
38504	38561	415602	
38505	38570	415620	



222217
Chrysler Retainers
Assortment
19 Varieties, 285 pieces

Assortment Includes:

280040	416140	445039	445883
415785	416144	445040	
415992	416146	445044	
416040	416152	445046	
416057	416154	445785	
416102	445038	445797	



222218
Ford Retainers #1
Assortment
24 Varieties, 419 pieces

Assortment Includes:

38575	285035	285110	415126
38580	285040	285200	415128
200402	285060	415070	415130
200403	285070	415110	415138
280130	285115	415123	415139
280135	285100	415125	416152



222219
GM Retainers #1
Assortment
20 Varieties, 405 pieces

Assortment Includes:

200380	292007	415490	415889
280040	415010	415505	415892
280070	415060	415653	
280135	415131	415798	
280210	415135	415883	
280220	415235	415888	



222220
GM Retainers #2
Assortment
20 Varieties, 272 pieces

Assortment Includes:

415922	416015	421375	480524
416005	416146	445365	495195
416010	416158	445629	
416012	416160	445655	
416013	416162	445884	
416014	416164	445895	



222221
Honda Retainers #1
Assortment
19 Varieties, 220 pieces

Assortment Includes:

292040	415268	415981	416058
292050	415777	415982	
292233	415865	415995	
292421	415880	416018	
292422	415970	416021	
415263	415971	416030	

LARGE DRAWER ASSORTMENTS



222222
Honda Retainers #2
Assortment
22 Varieties, 176 pieces

Assortment Includes:

416000	416070	416093	475430
416001	416074	421350	475610
416002	416084	435560	416083
416030	416085	445805	505210
416032	416087	445883	
416034	416088	465219	



222223
Mazda Retainers
Assortment
20 Varieties, 210 pieces

Assortment Includes:

292203	415890	416038	435187
292265	415910		416219
292270	415915	416041	416188
292300	415935	416083	416025
292310	415975	416103	445818
415107	416037		



222224
Nissan Retainers
Assortment
20 Varieties, 203 pieces

Assortment Includes:

292071	292270	415509	416134
292072	302047	415740	416136
292112	302049	415751	
292161	415237	415775	
292162	415260	416007	
292260	415295	416095	



222225
Toyota Retainers #1
Assortment
20 Varieties, 160 pieces

Assortment Includes:

292084	415930	416106	435493
415755	416022	416114	445815
415761	416051	416124	
415762	416083	416128	
415860	416098	416151	
415927	416103	435483	



222226
Toyota Retainers #2
Assortment
20 Varieties, 175 pieces

Assortment Includes:

38568	292220	416188	445881
280294	292285	416219	445977
292040	302050	435507	
292055	416029	435517	
292215	416114	445006	
292218	416122	445818	



222227
Miniature Bulb (*Domestic*)
Assortment
12 Varieties, 74 pieces

Assortment Includes:

2085	194	2215	1157A
2095	194A	2303	2456
2145	906	2325	7440
2200	1156	2330	7443
2201	1156A	2290	2458/3157
2205	1157	2291	2458A/3157A

LARGE DRAWER ASSORTMENTS



222228
 Ford Retainers #2
 Assortment
 21 Varieties, 296 pieces

Assortment Includes:

285055	415597	416045	445946
415070	415598	416065	470110
415229	415976	416090	471120
415440	416011	425515	
415935	416025	425520	
415993	416042	445725	



222230
 Hyundai / Kia Retainers
 Assortment
 23 Varieties, 405 Pieces

Assortment Includes:

416258	435497	435503	292045
416257	435602	435600	435537
445834	435601	292044	292094
445835	435512	292043	292102
445833	415965	292100	475076
302053	416025	416185	



222238
 2015 Ford F150 Assortment
 20 Varieties, 490 Pieces
 With SPR Tool
Includes Large Drawer
 Box Qty. 1

Assortment Includes:

ST21970	400734	415596	416192
38590	400735	415893	445766
38591	400736	416003	445946
38592	415070	416047	
38595	415229	416180	
400733	415524	416186	



222239
 2015 Ford F150 Assortment
 20 Varieties, 489 Pieces
Without SPR tool
Includes Large Drawer
 Box Qty. 1

Assortment Includes:

38590	400735	415893	445766
38591	400736	416003	445946
38592	415070	416047	
38595	415229	416180	
400733	415524	416186	
400734	415596	416192	

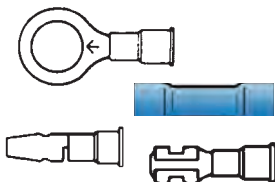

222360
 Electrical Connectors
 24 Varieties, 1175 pieces

Assortment Includes:

395020	395080	395180	395245
395040	395090	395190	395246
395050	395100	395200	395360
395060	395130	395220	395410
395065	395150	395230	395470
395070	395170	395240	395480

LARGE DRAWER ASSORTMENTS



222370

Phillips Oval
Sheet Metal Screws
Chrome & Black
Dia. #6 - #10
20 Varieties, 1000 pieces

Assortment Includes:

105070	105220	105420	110180
105090	105240	105440	110140
105100	105270	110030	
105150	105330	110050	
105170	105350	110070	
105200	105390	110010	



222380

Cotter Pins Assortment
Dia.: 1/16", 1/8", 5/32",
3/16", 1/4"
Lengths: 1/2" to 2-1/2"
17 Varieties, 1350 pieces

Assortment Includes:

390005	390050	390100
390010	390060	390105
390020	390070	390110
390025	390080	390120
390030	390085	390130
390040	390090	



222395

Standard Blind Rivets
Aluminum Rivet & Mandrel
12 Varieties, 850 pieces

Assortment Includes:

14021	1/8" x 1/8" Grip	16021	3/16" x 1/8" Grip
14041	1/8" x 1/4" Grip	16041	3/16" x 1/4" Grip
14061	1/8" x 3/8" Grip	16061	3/16" x 3/8" Grip
14081	1/8" x 1/2" Grip	16081	3/16" x 1/2" Grip
15041	5/32" x 1/4" Grip	16063	3/16" Lrg. Flange
15061	5/32" x 3/8" Grip	16083	3/16" Lrg. Flange



222397

Specialty Blind Rivets
Aluminum Rivet & Mandrel
12 Varieties, 400 pieces

Assortment Includes:

13001	38505
27999	38506
28002	38507
38044	38510
38499	38520
38503	38525



222409

Small Ergo Tuflok
Assortment
11 Varieties, 110 Pieces
Includes Small Drawer
Box Qty. 1

Assortment Includes:

416184	416198
416186	416200
416190	416204
416192	416208
416194	416210
416196	

LARGE DRAWER ASSORTMENTS



222410
 Large Ergo Tuflok
 Assortment
 11 Varieties, 280 Pieces
 Includes #99905
 Large Drawer

Assortment Includes:
 416184 416198
 416186 416200
 416190 416204
 416192 416208
 416194 416210
 416196



222530
 Oil Drain Plug #1
 (w/gaskets) Assortment
 12 Varieties, 76 pieces

Assortment Includes:
 530210 530236 530383
 530214 530238 530392
 530221 530245
 530222 530246
 530224 530260
 530234 530261



222534
 Oil Drain Plug #2
 (w/gaskets) Assortment
 32 Varieties, 93 pieces

Assortment Includes:
 530210 530217 530224 530232 530241
 530211 530218 530226 530233 530242
 530212 530219 530227 530234 530243
 530213 530221 530228 530236 530244
 530214 530222 530229 530265 530246
 530216 530223 530231 530238 530247
 530239 530383



222535
 Oil Drain Plug Gasket
 Assortment
 20 Varieties, 200 pieces

Assortment Includes:
 530300 530371 530381 530403
 530305 530374 530384 530408
 530307 530376 530388
 530315 530377 530395
 530330 530378 530400
 530360 530379 530401



NEW

222537
 Splash Shield
 Assortment
 24 Varieties, 355 pieces

Assortment Includes:
 200413 415138 416048 416223
 292122 415740 416114 416253
 303130 415880 416140 416290
 415070 415889 416142 416291
 415123 415984 416147 416321
 415126 416047 416195 445766

SMALL DRAWER ASSORTMENTS



222208
Toyota/Lexus Mldg.
Clip Assortment
11 Varieties, 154 pieces

Assortment Includes:
435435 435484
435436 435486
435437 435487
435438 435491
435439 435493
435483



(Includes small drawer: 6-3/16" x 10-1/2" x 1-9/16")



222398
Nylon-Capped Rivet
(Toyota/Lexus) Assortment
8 Varieties, 120 pieces

Assortment Includes:
38573 38578
38576 38568
38572 38579
38577 38569



(Includes 99933 drawer: 6-3/16" x 10-1/2" x 1-9/16")

MISC ASSORTMENTS



222540
Hose Clamp (w/rack)
Assortment
10 Varieties, 100 pieces

Assortment Includes:
54004 54120
54006 54128
54106 54132
54110 54136
54112
54116



(Includes #99925 rack!)



222250
Automotive Lamp
Assortment
13 Varieties, 112 pieces

Assortment Includes:
2610 2670 2717
2620 2684
2625 2687
2630 2690
2640 2691
2650 2714



(Includes #99906 cabinet!)



222389
Self Piercing Rivets
Assortment
8 Varieties, 200 pieces

Assortment Includes:
38900 38907
38901 38908
38905 38909
38906 38910



(Includes #99913 box!)

MISC ASSORTMENTS



41093
E-Clip Assortment
9 Varieties, 300 pieces

Assortment Includes:

- | | |
|-------|------|
| 1/16" | 1/2" |
| 1/8" | 5/8" |
| 3/16" | 3/4" |
| 1/4" | 7/8" |
| 3/8" | |



"O" RING ASSORTMENTS

222302
NITRILE AIR CONDITIONING "O" RING ASSORTMENT
This kit contains various quantities of the 18 different sizes illustrated in our catalog, for a total of 203 nitrile rubber "O" rings in a see thru durable plastic box. The lid label lists the I.D. and thickness dimensions of each "O" ring as well as actual size illustrations. For illustrations of the contents, please refer to our catalog page on "Nitrile A/C O-Rings".
*Rings may be green or black.

For use with R134A & R12 refrigerant systems.

Unit Package 1



222307
TEFLON COATED NEOPRENE "O" RING ASSORTMENT
This kit contains various quantities of the 12 different sizes illustrated in our catalog, for a total of 105 blue neoprene "O" rings in a "see-thru" durable plastic box. The lid label lists the I.D. and thickness dimensions of each "O" ring as well as actual size illustrations. For illustrations of the contents, please refer to our catalog page on "Neoprene O Rings".
*Rings may be blue or black.

Unit Package 1

AIR HOSE / COUPLERS



3536
For Use with 3538, 3539
 ColorConnex Green Coupler
 Type B, 1/4 in FNPT
 Steel/Aluminum
 Max Pressure: 300 psi
 Box Qty. 1



3537
For Use with 3538, 3539
 ColorConnex Green Coupler
 Type B, 1/4 in MNPT
 Steel/Aluminum
 Max Pressure: 300 psi
 Box Qty. 1



3538
For Use with 3536, 3537
 ColorConnex Green Plug
 Type B, 1/4 in FNPT
 6061-T6 Aircraft Aluminum
 Max Pressure: 300 psi
 Box Qty. 1



3539
For Use with 3536, 3537
 ColorConnex Green Plug
 Type B, 1/4 in MNPT
 6061-T6 Aircraft Aluminum
 Max Pressure: 300 psi
 Box Qty. 1



3541
For Use with 3543, 3544
 ColorConnex Blue Coupler
 Type C, 1/4 in FNPT
 Steel/Aluminum
 Max Pressure: 300 psi
 Box Qty. 1



3542
For Use with 3543, 3544
 ColorConnex Blue Coupler
 Type C, 1/4 in MNPT
 Steel/Aluminum
 Max Pressure: 300 psi
 Box Qty. 1



3543
For Use with 3541, 3542
 ColorConnex Blue Plug
 Type C, 1/4 in FNPT
 6061-T6 Aircraft Aluminum
 Max Pressure: 300 psi
 Box Qty. 1



3544
For Use with 3541, 3542
 ColorConnex Blue Plug
 Type C, 1/4 in MNPT
 6061-T6 Aircraft Aluminum
 Max Pressure: 300 psi
 Box Qty. 1



3551
For Use with 3553, 3554
 ColorConnex Red Coupler
 Type D, 1/4 in FNPT
 Steel/Aluminum
 Max Pressure: 300 psi
 Box Qty. 1



3552
For Use with 3553, 3554
 ColorConnex Red Coupler
 Type D, 1/4 in MNPT
 Steel/Aluminum
 Max Pressure: 300 psi
 Box Qty. 1



3553
For Use with 3551, 3552
 ColorConnex Red Plug
 Type D, 1/4 in FNPT
 6061-T6 Aircraft Aluminum
 Max Pressure: 300 psi
 Box Qty. 1



3554
For Use with 3551, 3552
 ColorConnex Red Plug
 Type D, 1/4 in MNPT
 6061-T6 Aircraft Aluminum
 Max Pressure: 300 psi
 Box Qty. 1



3556
For Use with 3558, 3587, 3588
 Flexzilla High Flow Coupler
 1/4 in. MNPT
 Steel/Aluminum
 Max Pressure: 300 psi
 Box Qty. 1



3558
For Use with 3556, 3586
 Flexzilla High Flow
 Ball Swivel Plug
 1/4 in. MNPT
 Nickel Plated Steel
 Max Pressure: 300 psi
 Box Qty. 1



3566
 H Style Coupler
 3/8 in. FNPT
 With Buna-N seal
 Max Pressure: 300 psi
 Box Qty. 1



3567
 H Style Plug
 1/4 in. MNPT
 Max Pressure: 300 psi
 Box Qty. 1

AIR HOSE / COUPLERS

37 Air Hose / Couplers



FLEXZILLA® PRO HIGH FLOW INTERCHANGE

FLEXZILLA® Pro High Flow couplers and plugs allows Twice The Flow to your air tools. Connect Flexzilla High Flow fittings from your tool all the way to the compressor. This ensures the best performance your air system can provide. For maximum efficiency, use Flexzilla Pro High Flow! Maximum Torque - Maximum RPM - Push Connect System. Maximum Working Pressure: 300 PSI

- 3585** High Flow Kit *Includes (1) 3586, (1) 3587, (1) 3588* Box Qty. 1
- 3586** High Flow Coupler 1/4" FNPT Box Qty. 1
- 3587** High Flow Plug 1/4" FNPT Box Qty. 1
- 3588** High Flow Plug 1/4" MNPT Box Qty. 1

AIR HOSE COUPLERS

(Coupler/Plug drawings are not actual size)

- Precision engineered for maximum performance.....*longer life!*
- Tougher wear resistant, anti-corrosion materials throughout.
- They swivel to prevent air line kinks! • Fully automatic. • Permits 45 cfm air flow at 100 p.s.i.g.
- Operating pressure up to 250 p.s.i.g. • Operating temperature range: -40½ F. To +250½ F.

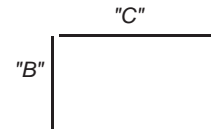

3550
Coupler
1/4" Female NPT
Mates with #3555 & #3560
B = 1-1/16"
C = 1-31/32"
Box Qty. 1



3555
Male Nipple
1/4" NPT
Mates with #3550
B = 9/16"
C = 1-11/16"
Box Qty. 1



3560
Female Nipple
1/4" NPT
Mates with 3550
B = 5/8"
C = 1-3/4"
Box Qty. 1



3535
Coupler
1/4" Female NPT
Mates with #3540 & #3545
B = 1-1/16"
C = 1-11/16"
Box Qty. 1



3540
Male Nipple
1/4" NPT
Mates with #3535, #3599
B = 9/16"
C = 1-25/32"
Box Qty. 1



3545
Female Nipple
1/4" NPT
Mates with #3535, #3599
B = 5/8"
C = 1-9/16"
Box Qty. 1



3565
Coupler
1/4" Female NPT
Mates with #3570 & #3572
B = 1-1/16"
C = 2-13/32"
Box Qty. 1



3570
Male Nipple
1/4" NPT
Mates with #3565
B = 9/16"
C = 2-5/32"
Box Qty. 1



3572
Female Nipple
1/4" NPT
Mates with #3565
B = 5/8"
C = 2-1/16"
Box Qty. 1

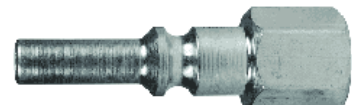

AIR HOSE / COUPLERS



HVLV EURO Coupler & Plugs

To achieve optimum atomization, an HVLV Spray Gun requires sufficient air transfer through the gun to produce the necessary air pressure at the air cap and attain the proper CFM (cubic feet per minute). This is accomplished by using the new quick converting HVLV EURO Coupler that provides a larger inside diameter enabling more CFM to pass through the connection. The design of this system also enables complete insertion of the plug into the coupler before air is activated thus eliminating air pressure resistance during the plug connection.

- 3591** 1/4" Quick Converting Coupler - Female, NPT 1 Per Pkg.
- 3592** 1/4" Plug - Female, NPT 1 Per Pkg.
- 3593** 1/4" Plug - Male, NPT 1 Per Pkg.
- 3590** Coupler Set Contains: 1 - #3592, 1 - #3591 1 Set Per Pkg.



UNIVERSAL BRASS COUPLER

A coupler to fit all your needs! 1/4" Female Universal coupler that fits most ARO, MILTON, TOMCO, TRU-FLATE and INDUSTRIAL INTERCHANGE type mating nipples. Brass Body, NBR seal, Stainless Steel spring, Steel locking balls. Maximum operating pressure up to 220 psi. *Mates with #3540, #3545, #3555, #3560, but NOT #3570 and #3572.*

- 3595** 1/4" NPT Female Universal Brass Coupler 1 Per Pkg.

PUSH BUTTON SAFETY COUPLERS

Reduces the risk of possible injury due to accidental air line disconnect.

Double click to engage properly. First click locks coupler and plug; the second click engages the air pressure. To disconnect push button twice. First push relieves air pressure; second push allows plug and coupler to be disengaged.

Max. Inlet Pressure: 225 psi
 Max. Temperature: -60°F to 140°F
 Air Flow: 36 SCFM @ 90 psi
 Coupler Body Shell Material: Fiberglass filled nylon 66
 Rubber Seal: NBR 80



3535SC
Mates with #3540, #3545
 1/4" Female
 M Style Safety Coupler
 Box Qty. 1



3550SC
Mates with #3555, #3560
 1/4" Female
 A Style Safety Coupler
 Box Qty. 1

3599
Mates with #3540, #3545
 Industrial Non-Marring
 Composite Coupler
 1/4 in. FNPT
 Maximum Input Pressure: 175 psi
 Temp Range: 5°F to 160°F
 Box Qty. 1



REPAIR FITTINGS FOR AIR HOSE

A 3/8" MPT Reusable Hose Coupling. Use on 3/8" rubber/wire braided hose. Reverse thread female section onto your hose, thread male section into female to secure coupling to hose. You can connect the hose coupling directly to a variety of female threaded guns, sockets, or swivels. Adapt and repair hoses in the field. Extend the life of damaged hoses. Easy to repair. No crimps required.

- Prod No. **3596** 3/8" ID x 5/8" OD (two-piece stem/ferrule) 1 per box
- Prod No. **3597** 3/8" ID x 3/4" OD (two-piece stem/ferrule) 1 per box

AIR HOSE / COUPLERS



3573
Brass
Hose Splicer
For 3/8" I.D. Air Hose
Barbed Type
Box Qty. 10

3574
Brass
Hose Splicer
For 1/4" I.D. Air Hose
Barbed Type
Box Qty. 10



3580
Safety blow gun.
Meets all federal standards relating to OSHA.
Maximum inlet pressure 150 P.S.I.
Inlet size 1/4" NPT.
Box Qty. 1



3581
Brass Hose Barb
3/8" I.D.
1/4" MNPT
Box Qty. 1



3583
Brass Hose Ferrule
5/8" (.625) I.D.
1" Length
Box Qty. 10



3584
Brass Hose Ferrule
3/4" (.750) I.D.
1" Length
Box Qty. 10

37 Air Hose / Couplers

37

10 Pc. Blow Gun Kit

Features an ergonomically superior gun body for maximum comfort and control which reduces operator fatigue. A variable flow trigger regulates air volume precisely with maximum flow, equal to or greater than the competition. The exclusive modular accessories system allows the Flexzilla blow guns to be customized for extension length and tips needed for any job. Flexzilla safety nozzles are labeled to meet or exceed OSHA standards.

3571
Blow Gun Kit
Includes: (2) 6" Extensions
(3) Needle Tips
Xtreme-Flo Safety Nozzle
Quiet-Flo Safety Nozzle
Rubber Tip
Tip Adapter
Box Qty. 1



"FLEXZILLA®" PRO (REPAIRABLE) AIR HOSE

"FLEXZILLA®" is a revolutionary hose featuring a Premium Hybrid Polymer material that redefines flexibility. Flexzilla® hose characteristics offer zero memory allowing it to lay-flat exactly where you drop it and will not work against you during operation or coiling after use. Extreme all-weather flexibility, even in subzero conditions (-40° to 140°F). Permits use in environments where general purpose PVC and rubber hoses may become too stiff. Kink resistant under pressure. Excellent abrasion-resistant outer cover. Includes bend restrictor that reduces wear and tear, prolonging the life of the hose. Flexzilla® Hi-Vis color, safety green, makes hose more visible in the workplace. This hose is field repairable with reusable aircraft aluminum fittings.



Maximum Working Pressure..... 300 PSI



Product No.	I.D.	Length	Fittings
4080	3/8"	x 25 Ft. 1/4" MNPT
4081	3/8"	x 35 Ft. 1/4" MNPT
4082	3/8"	x 50 Ft. 1/4" MNPT

AIR HOSE / COUPLERS

"BIG RED AIR HOSE"

"BIG RED" is an extremely flexible, durable hose for use with air, water or mild chemicals. It is resistant to oil and gasoline and with it's high flexibility you have an ideal hose for lube and repair bays. Both the inner hose and cover are made of Prime PVC, and cord-reinforced for added strength. Big Red is far more resistant to oil and gasoline than rubber, and offers three times the life under normal conditions. It is more flexible and weighs only half as much as comparable rubber hose.



Maximum Working Pressure..... 300 PSI
Burst Pressure.....1200 PSI

Product No.	I.D.	Length	Fittings
4099	3/8"	35 Ft.	1/4" NPT

"FLEXZILLA®" PRO WATER HOSE

FLEXZILLA® is a revolutionary hose featuring a Premium Hybrid Polymer material that redefines flexibility. Flexzilla® hose characteristics offer zero memory allowing it to lay-flat exactly where you drop it and will not work against you during operation or coiling after use. Extreme all-weather flexibility. Kink resistant under pressure. Excellent abrasion-resistant outer cover. Flexzilla® Hi-Vis color, safety green, makes hose more visible in the workplace. Includes bend restrictors that reduces wear and tear, prolonging the life of the hose. Anodized aircraft aluminum ends. Drinking water safe! This hose is field repairable!
Maximum Working Pressure: 150 PSI



4070
5/8" x 50 ft.
Flexzilla Garden Hose
Box Qty. 1



4084
Reusable End
Used With 3/8" Flexzilla Pro
Box Qty. 1



4085
Reusable Splicer
Used With 3/8" Flexzilla Pro
Box Qty. 1



4086
1/4" NPT
Swivel Connector
Bx. Qty. 1



9710 DeVilbiss 3 Stage Desiccant Filter/Dryer
9711 Replacement Filter Cartridges

Box Qty. 1
Box Qty. 1

Cost effective. Use anywhere. Complete air control. A perfect solution for restoration shops, customizing shops and hobbyist. High performance filtration with only 2 PSI pressure drop. Three-stage filtering with 0.1 micron rating produces clean, oil and humidity free air resulting in outstanding paint finishes by removing water particulates, oil and humidity. Quick change filter cartridge is easy to maintain. Bowl removal tool included. Larger filter media and longer life desiccant than disposable dryers: 4X more filter area, 16X more desiccant. Low life-cycle costs. Complete air control enabling better color match and coating thickness. Inlet shut off valve, regulator and gauge, humidity indicator, bowl drain.

AIR HOSE / COUPLERS

Air Hose / Couplers

37

BLANK

The Strip Away® Disc is made from a tough, synthetic fiber impregnated with abrasive grit. They are a safer alternative to wire bristle tools. These unique discs provide fast cutting action with virtually no heat build-up. The open coat design quickly cleans surfaces without damage.

Cleans and prepares awkward and uneven surfaces.

One step stripping and cleaning, no additional finishing required for painting.

USE WITH

- Electric Drills
- Air Tools
- Angle Grinders
- Bench Grinders

USE ON

- Aluminum
- Stainless Steel
- Fiberglass
- Brick & Stone
- Cement & Concrete

IDEAL FOR REMOVING

- Rust & Scale
- Paint
- Oxidation and Corrosion
- Plastic Edging
- Undercoatings, Stone Guards and Seam Sealers
- Varnish & Epoxy Paints
- Light Weld Splatter



7302
Mandrel
For #7301 or
#7304 Discs
Box Qty. 1



7130
Roll On Adapter
For #7300 or
#7303 Discs
Box Qty. 1

7300

4" **BLACK - STANDARD**
Standard Strip Away®
Roll-On Type
Box Qty. 10



7301

4" **BLACK - STANDARD**
Standard Strip Away®
Mandrel Type
Box Qty. 10



For more aggressive applications.

7303

4" **BLUE - HEAVY DUTY**
Ultra Fast Cutting Strip Away®
Roll-On Type
Box Qty. 5

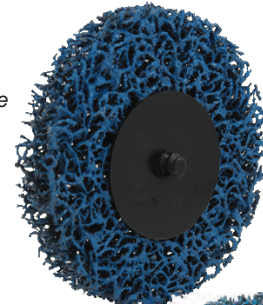

7304

4" **BLUE - HEAVY DUTY**
Ultra Fast Cutting Strip Away®
Mandrel Type
Box Qty. 5

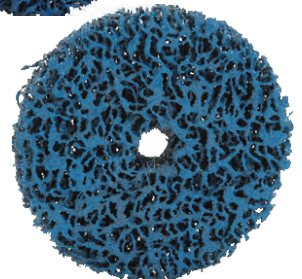

*RPM Rating: Roll On Type - 6000, Mandrel Type - 3900.
When grinding or sanding with power tools
always wear proper protective equipment.*



Flap Discs (Zirconia)

Design allows flap to conform to curved surfaces resulting in excellent blending and contouring results. The flaps extend beyond the edge of the disc allowing smooth operation close to awkward spaces. Spacing of flaps allows operation with less heat build-up for long life and consistent finish.

Box Qty. 10



Part No.

Description

7310	2" Dia., 36 Grit
7311	2" Dia., 40 Grit
7312	2" Dia., 60 Grit
7314	2" Dia., 80 Grit
7316	2" Dia., 120 Grit
7320	3" Dia., 36 Grit
7321	3" Dia., 40 Grit
7322	3" Dia., 60 Grit
7324	3" Dia., 80 Grit
7326	3" Dia., 120 Grit

ABRASIVES



side view

The **Trim-Kut® Abrasive Disc** is a versatile tool used for grinding, sanding, cleaning and general surface preparation in Autobody Repair. It can be used for rust/paint removal, leveling welded seams and MIG-weld residue removal.

Trim-Kut® Abrasive Discs are a unique one-piece design, with the grinding surface bonded to a hard copolymer backing. It is a highly durable grinding unit that will not fly-off during use and eliminates the need for additional backing pads. The disc can be trimmed when the outside edge has been sufficiently "loaded" to the point where it is not grinding effectively, by simply placing the back of the disc against a sharp edge or object and with activation of the electric/air tool, the "loaded" portion on the outside edge can be removed from the rest of the disc creating a new edge ready for use. **Trim-Kut® Abrasive Discs** can be trimmed in such a manner right up to the mandrel.

Each box of 25 **Trim-Kut® Abrasive Discs** comes with 1 mandrel.

Maximum operating speed for a 3" disc is 21,000 RPM
 Maximum operating speed for a 5" disc is 12,000 RPM

7050

3" 120 Grit
 "Green"
 Box Qty. 25

7055

3" 60 Grit
 "Orange"
 Box Qty. 25

7060

3" 36 Grit
 "Red"
 Box Qty. 25

7065

3" 24 Grit
 "Black"
 Box Qty. 25

7085

5" 36 Grit
 Box Qty. 25

7090

5" 24 Grit
 Box Qty. 25

7070

1/4" Mandrel for
 Trim-Kut Discs
 Box Qty. 1



7073

7/16-20 Mandrel for
 Trim-Kut Discs
 Box Qty. 1



SURFACE PREP DISCS



A durable non-woven web coated with tough aluminum oxide grit for longer life and faster stock removal.

- Removes rust, paint and oxidation
- Removes gasket residue
- Excellent for surface blending
- Twist-On

Prod. No.	Description-Color	Box Qty.
7100	2" Coarse-Gold	50
7105	2" Medium-Maroon	50
7110	2" Fine-Blue	50
7115	3" Coarse-Gold	25
7120	3" Medium-Maroon	25
7125	3" Fine-Blue	25

HOLDERS FOR SURFACE PREP AND MINI GRINDING DISCS



Prod. No.	Description-Color	Box Qty.
7130	2" Disc Holder	1
7135	3" Disc Holder	1

MINI GRINDING DISCS

These discs are covered with a specially formulated bond coat to resist loading, glazing and grain stripping.



- Weld removal, blending and removal of imperfections.
- For use on wood, ferrous and non ferrous metals, plastics, fiberglass, paint and coatings.
- Twist-On

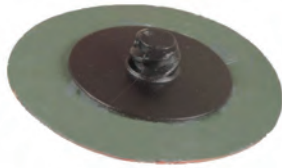

Prod. No.	Size-Grit	Box Qty.
7140	2" 24 Grit	50
7145	2" 36 Grit	50
7150	2" 80 Grit	50
7155	2" 120 Grit	50
7160	3" 24 Grit	25
7165	3" 36 Grit	25
7170	3" 80 Grit	25
7175	3" 120 Grit	25

*Maximum operating speed for a 2" disc is 25,000 RPM
Maximum operating speed for a 3" disc is 20,000 RPM*

MINI GRINDING DISCS - Ceramic!

These discs are made with ceramic grit and that means easy cutting and long life. Use these discs to remove rust, grind away and shape metal, composites and plastic. A multi use product in all body shops. Twist-On.



COLOR MAY VARY

Prod. No.	Size-Grit		Box Qty.
7141	2" 24 Grit	<i>Ceramic</i>	50
7142	2" 36 Grit	<i>Ceramic</i>	50
7143	2" 50 Grit	<i>Ceramic</i>	50
7144	2" 80 Grit	<i>Ceramic</i>	50
7176	3" 24 Grit	<i>Ceramic</i>	25
7177	3" 36 Grit	<i>Ceramic</i>	25
7178	3" 50 Grit	<i>Ceramic</i>	25
7174	3" 80 Grit	<i>Ceramic</i>	25

*Maximum operating speed for a 2" disc is 25,000 RPM
Maximum operating speed for a 3" disc is 20,000 RPM*



HOLDERS FOR SURFACE PREP AND MINI GRINDING DISCS

Prod. No.	Size-Grit	Box Qty.
7130	2" Disc Holder	1
7135	3" Disc Holder	1

ABRASIVES

38 Abrasives

5" GRINDING DISCS



"C" Type: Aluminum Oxide. Economical general purpose industrial quality disc. Clean bonding system promotes a safer, healthier working environment.

- Excellent for metal grinding
- Fast cutting
- Long lasting

Prod. No.	Grit	Box Qty.
7190	24 Grit	25
7195	36 Grit	25

Maximum operating speed for this disc is 11,900 RPM

5" BLUE ZIRCONIUM GRINDING DISCS



"Z" Type: Zirconium. Five inch, 7/8" center hole.

- Increased Productivity
- Longer Life
- Cooler Cutting
- Lower Grinding Cost Per Working Hour

Prod. No.	Grit	Box Qty.
7295	24 Grit	25
7290	36 Grit	25

SUPERTRON III FILE BELTS



Prod. No.	Description	Box Qty
7444	3/8" x 13" 40Grit	10
7445	3/8" x 13" 60Grit	10
7446	3/8" x 13" 80Grit	10
7450	1/2" x 18" 40Grit	10
7451	1/2" x 18" 60Grit	10
7452	1/2" x 18" 80Grit	10
7455	3/4" x 20-1/2" 40Grit	10
7456	3/4" x 20-1/2" 60Grit	10
7457	3/4" x 20-1/2" 80Grit	10

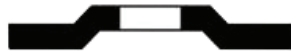

side view

“ZIP” High Performance Cutting Wheels

- General purpose cutting of all types of steel and stainless steel.
- Fast, cool and free cutting allowing the operator to work with minimal pressure for best control.
- Excellent wheel life. Fewer changes of the wheel - increasing productivity.
- Metal hub provides greater safety and straighter cuts.
- “Type 27” hub - allows for perfectly flush cutting.

Item No.	Dia.	Thick.	Arbor	Grit	Max RPM	Box Qty.
7008	3"	1/32"	3/8"	60	25,470	10
7009	4"	1/32"	3/8"	60	19,100	10

CERAMIC CUT-OFF WHEELS

A super premium long-life cutting wheel specifically designed to cut all forms of stainless steel, high tensile alloys, chrome and Inconel® alloys. Contaminate-free cutting of stainless steel & aluminum. No iron, sulfur or chlorine. Fast cutting with minimal wear. Lasts up to 8x longer than conventional aluminum oxide products. Made in the USA.



Maximum operating speed: 3" disc - 20,372 RPM 4" disc - 19,000 RPM

APPLICATIONS: Stainless Steel, Aluminum, High Tensile Alloys

Diameter: 3", 4" Center Hole: 3/8" Thickness: 1/32" (.035) and 1/16"

Item No.	Description	Bx. Qty.
7025	3" x 1/32" x 3/8"	5/Box
7026	3" x 1/16" x 3/8"	5/Box
7027	3" x 3/16" x 3/8"	5/Box
7028	4" x 1/16" x 3/8"	5/Box
7001	Arbor (1/4" Shank)	1/Box

SUPERTRON III CUT-OFF WHEELS

Space-age grain technology that is designed to stay sharper and last 3 to 4 times longer than the competition! Cuts faster and stays cooler, saving you time and money! SUPERTRON eats Boron! Great for cutting all forms of metal, including Boron, aluminum, steel and galvanized steel. Made in the USA.



Maximum operating speed: 3" disc - 25,000 RPM

APPLICATIONS: Boron, Steel, Galvanized Steel

Diameter: 3" Center Hole: 3/8" Thickness: 1/32" (.035) and 1/16"

Item No.	Description	Bx. Qty.
7015	3" x 1/32" x 3/8"	5/Box
7016	3" x 1/16" x 3/8"	5/Box
7001	Arbor (1/4" Shank)	1/Box

ABRASIVES

NEW



FLEXIBLE SURFACE PREP SANDING PAD SPONGES

Coated on one side with an Aluminum Oxide abrasive. Flexible hand held sponges for hard to reach places. Can be used on wood, metal and painted surfaces. Great for general polishing in the woodworking, cabinetry and automotive industries. Pads are 5-1/2" x 4-1/4" x 3/16" in size.

7196	Medium, Gray	20/bx
7197	Fine, Blue	20/bx
7198	Very Fine, Red	20/bx
7199	Super Fine, Yellow	20/bx
7194	Assortment (20 pads)	1/bx

7194 Assortment includes 5 each of 7196, 7197, 7198, 7199

GEMTEX® BRITE PREP NON-WOVEN 6 x 9 HAND SCUFF PADS

Our 6 x 9 Hand Scuff Pads are manufactured from synthetic fibers, bonded together with specially formulated resins and impregnated throughout the web with mineral grain creating an open, three dimensional structure. These products are designed for a broad range of jobs including light duty cleaning, polishing, scuffing, finishing and for heavy duty jobs including paint, rust and corrosion removal. Manufactured from tough synthetic fibers that will not rust, they can be used for dry scuffing and finishing or may be used with water or chemical solvents. They are flexible enough to be used in hard to reach spots, yet strong enough for continuous use. They are produced in a variety of grades ranging from hand cleaning to high-speed machine use. "A Steel Wool Substitute".



Item No.	Description	Bx. Qty.
7185	Fine - Gray	20
7180	Medium - Maroon	20
7179	Super Medium - Green	20

GEMTEX® BRITE PREP NON-WOVEN 6" SCUFF DISCS

Manufactured from synthetic fibers, bonded together with specially formulated resins and impregnated throughout the web with mineral grain creating an open, three dimensional structure. These products are designed for a broad range of jobs including light duty cleaning, polishing, scuffing, finishing and for heavy duty jobs including paint, rust and corrosion removal. Manufactured from tough synthetic fibers that will not rust, they can be used for dry scuffing and finishing or may be used with water or chemical solvents. They are flexible enough to be used in hard to reach spots, yet strong enough for continuous use. They are produced in a variety of grades ranging from hand cleaning to high-speed machine use. "A Steel Wool Substitute".



Item No.	Description	Bx. Qty.
7187	Gen. Purpose - Maroon	10
7188	Fine - Gray	10

CLOTH UTILITY ROLLS

Rolls are packaged in handy box dispenser. Used for smoothing rough spots, deburring and cleaning metal surfaces.



- Aluminum Oxide Grain
- Resin Over Resin Construction
- Egyptian Cloth Backing
- Use on Ferrous & Non-Ferrous Surfaces

Prod #	Grit	Size
7030	80	1-1/2" x 50 Yds.
7031	100	1-1/2" x 50 Yds.
7032	120	1-1/2" x 50 Yds.
7033	150	1-1/2" x 50 Yds.
7034	180	1-1/2" x 50 Yds.
7035	240	1-1/2" x 50 Yds.
7036	320	1-1/2" x 50 Yds.



6" GOLD PREMIUM PSA ABRASIVE DISCS *(Aluminum Oxide paper)*

A great Pressure Sensitive Adhesive-backed abrasive disc used in the automotive industry for dry sanding. One hundred discs on a convenient roll. Each disc is 6" and is available in a variety of grits. A dust-repellent additive is incorporated to the top of the disc to prevent premature clogging of the grain surface. Flexible latex paper, tear resistant. Aluminum oxide grain type. 100 discs per roll - except #7338 which is 50 discs per roll.

Item No.	Description	Qty.
7338*	40 grit	1
7339	60 grit	1
7340	80 grit	1
7345	120 grit	1
7348	180 grit	1
7349	220 grit	1
7355	320 grit	1
7356	400 grit	1
7358	600 grit	1
7336	Back Up Pad	1
7045	Mandrel	1



PREMIUM GOLD PSA ABRASIVES *(Aluminum Oxide paper)*



A great Pressure Sensitive Adhesive-backed abrasive used in the automotive industry for dry sanding. The Premium Gold PSA Sheet Rolls and the Premium Gold PSA File Strips are available in a variety of grits. A dust repellent additive is incorporated to the top of the paper to prevent premature clogging of the grain surface. Flexible latex paper, tear resistant. Aluminum oxide grain type.

Premium Gold PSA Sheet Rolls

Item No.	Description	Qty.
7200	40 grit, 2-3/4" x 20 yds.	1 roll
7202	80 grit, 2-3/4" x 20 yds.	1 roll
7204	100 grit, 2-3/4" x 25 yds.	1 roll
7206	120 grit, 2-3/4" x 25 yds.	1 roll
7208	150 grit, 2-3/4" x 25 yds.	1 roll
7210	180 grit, 2-3/4" x 25 yds.	1 roll
7212	220 grit, 2-3/4" x 25 yds.	1 roll
7214	240 grit, 2-3/4" x 25 yds.	1 roll
7218	320 grit, 2-3/4" x 25 yds.	1 roll



ABRASIVES - PSA



PREMIUM GOLD PSA ABRASIVES *(Aluminum Oxide paper)*

A great Pressure Sensitive Adhesive-backed abrasive used in the automotive industry for dry sanding. The Premium Gold PSA Sheet Rolls and the Premium Gold PSA File Strips are available in a variety of grits. A dust repellent additive is incorporated to the top of the paper to prevent premature clogging of the grain surface. Flexible latex paper, tear resistant. Aluminum oxide grain type.

Premium Gold PSA File Strips



Item No.	Description	Qty.
7230	40 grit, 2-3/4" x 16-1/2"	25
7232	60 grit, 2-3/4" x 16-1/2"	50
7234	80 grit, 2-3/4" x 16-1/2"	50
7236	100 grit, 2-3/4" x 16-1/2"	50
7238	120 grit, 2-3/4" x 16-1/2"	50
7240	150 grit, 2-3/4" x 16-1/2"	50
7242	180 grit, 2-3/4" x 16-1/2"	50
7244	220 grit, 2-3/4" x 16-1/2"	50
7246	320 grit, 2-3/4" x 16-1/2"	50
7248	400 grit, 2-3/4" x 16-1/2"	50

38 Abrasives

38



8" GOLD PREMIUM PSA TAB DISCS

Adhesive back design.
Aluminum Oxide paper.

Item No.	Description	Qty.
7360	8" PSA Tab Disc, 40 grit	25
7361	8" PSA Tab Disc, 80 grit	25



7336
Backing Pad.
For use with
6" PSA discs.
Box Qty. 1



7045
Mandrel for
Back Up Pads
Box Qty. 1



PREMIUM GOLD GRIP FILE STRIPS *(Aluminum Oxide paper)*

Item No.	Description	Qty.
7250	40 grit, 2-3/4" x 16-1/2"	25
7251	80 grit, 2-3/4" x 16-1/2"	50
7253	120 grit, 2-3/4" x 16-1/2"	50
7255	180 grit, 2-3/4" x 16-1/2"	50
7257	320 grit, 2-3/4" x 16-1/2"	50



GOLD PREMIUM GRIP DISCS *(Aluminum Oxide paper)*

3" Grip Discs



Item No.	Description	Qty.
7600	3" Grip Disc, 80 grit	50
7602	3" Grip Disc, 100 grit	50
7604	3" Grip Disc, 120 grit	50
7606	3" Grip Disc, 150 grit	50
7608	3" Grip Disc, 180 grit	50
7610	3" Grip Disc, 220 grit	50
7614	3" Grip Disc, 320 grit	50
7616	3" Grip Disc, 400 grit	50
7618	3" Grip Disc, 600 grit	50
7619	3" Grip Disc, 800 grit	50
7601	3" Backing Pad for Grip Discs	1
7045	Mandrel	1

6" Grip Discs



Item No.	Description	Qty.
7362	6" Grip Disc, 40 grit	50
7363	6" Grip Disc, 60 grit	50
7365	6" Grip Disc, 80 grit	100
7367	6" Grip Disc, 120 grit	100
7369	6" Grip Disc, 180 grit	100
7370	6" Grip Disc, 220 grit	100
7373	6" Grip Disc, 320 grit	100
7374	6" Grip Disc, 400 grit	100
7364	6" Backing Pad for Grip Discs	1
7045	Mandrel	1

8" Grip Discs



Item No.	Description	Qty.
7380	8" Grip Disc, 40 grit	25
7381	8" Grip Disc, 80 grit	25



ABRASIVES - GRIP

38 Abrasives

BLUE FILM GRIP DISCS (Aluminum Oxide Film)

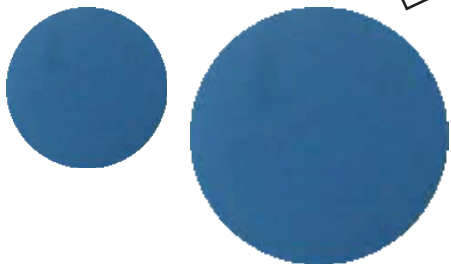

3" Grip Discs

Item No.	Description	Qty.
7620	3" Grip Disc, 600 grit	50
7623	3" Grip Disc, 1200 grit	50
7601	3" Backing Pad for Grip Discs	1
7045	Mandrel	1

6" Grip Discs

Item No.	Description	Qty.
7656	6" Grip Disc, 1200 grit	100
7364	6" Backing Pad for Grip Discs	1
7045	Mandrel	1

WHITE FILM GRIP DISCS (White Aluminum Oxide Film)



Item No.	Description	Qty.
7640	3" Grip Disc, 600 grit	50
7641	3" Grip Disc, 800 grit	50
7642	3" Grip Disc, 1000 grit	50
7643	3" Grip Disc, 1200 grit	50
7644	3" Grip Disc, 1500 grit	50
7645	3" Grip Disc, 2000 grit	50
7651	6" Grip Disc, 600 grit	50
7653	6" Grip Disc, 800 grit	50
7655	6" Grip Disc, 1000 grit	50
7657	6" Grip Disc, 1200 grit	50
7659	6" Grip Disc, 1500 grit	50
7661	6" Grip Disc, 2000 grit	50
7663	6" Grip Disc, 2500 grit	50
7665	6" Grip Disc, 3000 grit	50
7364	6" Backing Pad for Grip Discs	1
7045	Mandrel	1

GRIP DISK WITH VACUUM HOLES

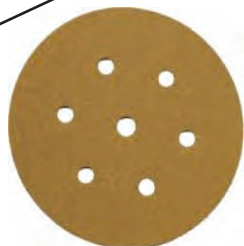

Item No.	Description	Qty
7680	40 Grit - 6" Grip Disc w/Vac Holes	50
7681	60 Grit - 6" Grip Disc w/Vac Holes	50
7683	80 Grit - 6" Grip Disc w/Vac Holes	100
7685	120 Grit - 6" Grip Disc w/Vac Holes	100
7687	180 Grit - 6" Grip Disc w/Vac Holes	100
7688	220 Grit - 6" Grip Disc w/Vac Holes	100
7691	320 Grit - 6" Grip Disc w/Vac Holes	100
7692	400 Grit - 6" Grip Disc w/Vac Holes	100

NEW



6" SPECTRUM ABRASIVE DISCS FOAM BACKED HOOK & LOOP DISCS

Soft foam abrasive hook & loop discs with a revolutionary patented cloth backing that is laminated to ultra-breathable flexible foam. This foam "cushions" the abrasive grains facilitating a high quality, even, fine finish. Anti-clogging features reduce the temperature of the work surface to grant a longer life and enhanced finish quality.

Specifically designed for automotive paint applications, but also proven effective on non-ferrous metals, steel, fiberglass, solid surface, plastic & hardwoods. Can be used wet or dry.

Item No.	Description	Box Qty.
7220	6" White - 500 Grit	10
7221	6" Blue - 800 Grit	10
7222	6" Purple - 1000 Grit	10
7223	6" Orange - 2000 Grit	10
7224	6" Red - 3000 Grit	10
7225	6" Green - 4000 Grit	10
7226	Assortment (2 each 800-4000 grit)	1
7364	6" Flexible Foam Grip Disc	1



9" x 11" SANDING SHEETS



Item No.	Description	Qty.
7378	9" x 11" Dry Sanding Sheet, 320 grit <i>-Super Sharp, Easy Cutting</i>	50
7385	9" x 11" Waterproof Sheet, 400 grit	50
7386	9" x 11" Waterproof Sheet, 600 grit	50
7388	9" x 11" Waterproof Sheet, 800 grit	50
7389	9" x 11" Waterproof Sheet, 1000 grit	50
7390	9" x 11" Waterproof Sheet, 1200 grit	50
7391	9" x 11" Waterproof Sheet, 1500 grit	50
7392	9" x 11" Waterproof Sheet, 2000 grit	50
7393	9" x 11" Waterproof Sheet, 2500 grit	50
7394	9" x 11" Waterproof Sheet, 3000 grit <i>-Remains flexible. Will not crack or curl. Offers uniform sanding results</i>	50

MISCELLANEOUS ABRASIVES



7603
3" Interface Grip Pad
For use with
standard grip
back-up pads.
Box Qty. 1



7366
6" Interface Grip Pad
For use with
standard grip
back-up pads.
Box Qty. 1



7368
6" Grip Conversion Pad
Converts PSA pads to a grip pad.
Box Qty. 3



7601
Backing Pad.
5/16-24 male thread
For use with
3" grip discs.
Box Qty. 1



7336
Backing Pad.
5/16-24 male thread
For use with 6" PSA
discs.
Box Qty. 1



7364
Backing Pad.
5/16-24 male thread
For use with 6" grip
discs.
Box Qty. 1



7045
Mandrel for
Back Up Pads
Box Qty. 1

NEW



7359
Backing Pad.
5/16-24 male thread
For use with 6" grip
discs.
Box Qty. 1



SUPERASER™ ABRASIVE WHEEL KIT

For quick and easy removal of decals, pinstripes, bumper stickers, reflective tapes, double-faced tape from the back side of mouldings, from glass and OEM painted surfaces without any damage. Long lasting. Will not leave a sticky adhesive residue. Without mandrel, wheel fits on other popular pneumatic tools.

Wider than the standard solid disc = FASTER
Toothed wheel works cooler = Less smearing
Easier to control = Less user fatigue
Longer Life!

Item No.	Description	Box Qty.
7044	4" wheel w/mandrel	1

WARNING: DO NOT exceed 4000 RPM. Wheel could break apart and cause serious injury. Not recommended for use on lacquer paints, non-OEM finished surfaces, acrylic, lexan, plexi-glass and soft plastic substrates.



7460

File Belt Grinder (w/belts!)
Great for spot welds, welding seams, soldered connections, rust, deburring, etc.
Swiveling belt finger for narrow spaces.
For use with 13" Belts
Comes with (2) #7444 belts, (2) #7445 belts and (2) #7446 belts.
1/Box



7460-ARM-ASSEMBLY

Replacement arm for #7460 File Belt Grinder
Box Qty. 1



3M ROLOC™ BRISTLE DISC

Super tough plastic bristle brush, embedded with abrasive, wear as they clean continually exposing fresh abrasive. Bristles ride over surface cleaning contaminates without gouging surface. Use green on steel parts, yellow on aluminum parts.

Item No.	Description	Box Qty.	
3M-7524	2" Green Bristle Disc	10	
3M-7525	2" Yellow Bristle Disc	10	
3M-7528	2" White Bristle Disc	10	NEW

MISCELLANEOUS ABRASIVES



MBX PNEUMATIC TOOL - with speed control/reverse rotation

The MBX Pneumatic Tool is a lightweight air grinder that, depending on which wheel you use, can be used for the removal of: seam sealer, undercoating, urethane, paint, rust, decals, adhesives, pinstripes, moulding tape and much more without damaging the metal surface. Specifically designed for the applications in car repair shops.

Features:

- Fast! Saves time and increases productivity
- Compact, slim design adapts well to hard-to-reach edges and contours
- Extra handle for control and safety
- Speed control switch and reverse rotation
- Safety guard
- Steady torque at a safe speed

7400 MBX Pneumatic Tool (tool only)

Includes: MBX Tool, #7415 Housing, #7416 Housing

7411 MBX Belt/Wheel Assortment

Includes: #7405 Belt, #7406 Belt, #7407 Belt, #7410 Wheel

ABRASIVE BELTS / WHEELS

Steel Belts

7412	11mm Coarse Abrasive Steel Belt	Box Qty. 1
7413	11mm Medium Abrasive Steel Belt	Box Qty. 1
7414	11mm Fine Abrasive Steel Belt	Box Qty. 1
7405	23mm Coarse Abrasive Steel Belt	Box Qty. 1
7406	23mm Medium Abrasive Steel Belt	Box Qty. 1
7407	23mm Fine Abrasive Steel Belt	Box Qty. 1
7402	43mm Coarse Abrasive Steel Belt	Box Qty. 1
7403	43mm Medium Abrasive Steel Belt	Box Qty. 1
7404	43mm Fine Abrasive Steel Belt	Box Qty. 1

Stainless Steel Belts

7417	11mm Medium Abrasive Stainless Steel	Box Qty. 1
7419	11mm Fine Abrasive Stainless Steel	Box Qty. 1
7418	23mm Medium Abrasive Stainless Steel	Box Qty. 1
7420	23mm Fine Abrasive Stainless Steel	Box Qty. 1
7421	43mm Medium Abrasive Stainless Steel	Box Qty. 1
7422	43mm Fine Abrasive Stainless Steel	Box Qty. 1



REPLACEMENT BELTS - TOOL

7408	Belt for MBX Tool - Red	Box Qty. 1
7409	Belt for MBX Tool - Blue	Box Qty. 1
7423	Belt for MBX Tool - Black	Box Qty. 1



Vinyl Zapper Wheel



7410
Removes Decals, Adhesives, Etc.
(uses #7415 Housing)
Box Qty. 1

HOUSINGS / ADAPTERS

7416	For 11mm Belts	Box Qty. 1
7415	For 23mm Belts & #7410 Wheel	Box Qty. 1
7401	For 43mm Belts	Box Qty. 1



Made in U.S.A.

Double Ended Drill Bits

Made of High Speed Steel for superb durability. 135° Split Point prevents the drill bit from walking. Long life. Won't break under normal use. *Please use #12020 Boron Buster when drilling Boron.*

Size	12/pkg	144/pkg
1/8" dia.	12000	12000-144
3/16" dia.	12018	12018-144
1/4" dia.	12019	12019-144

222402 Double-Ended Drill Bit Assortment
12 Double-Ended Drill Bits *Four each of 12000, 12018, 12019* Box Qty. 1

12027 Box Qty 5
12029 Box Qty 25



12026
8mm x 1.69"

Made in U.S.A.

Cobalt Spotweld Replacement Bit

Very popular replacement bit for some pneumatic spot weld removal tools. Top quality. *Please use #12020 Boron Buster when drilling Boron.* (.75 Flat On Shank)
Box Qty. 1

12047 Box Qty 5
12049 Box Qty 25



12046
8mm x 1.49"

Made in U.S.A.

Cobalt Spotweld Replacement Bit

Very popular replacement bit for some pneumatic spot weld removal tools. Top quality. *Please use #12020 Boron Buster when drilling Boron.* (.44 Flat On Shank)
Pkg Qty. 1



12020
BORON BUSTER

Extends the life of drill bits and saw blades. Reduces friction and heat on cutting edge for longer tool life and better finish. For use when drilling or cutting Boron and Hi-Strength Steel. *30g Tin Can*
Box Qty. 1

SUPER - COBALT Spot Weld Cutting Bits

A premium quality spot weld bit designed to remove spot welds from sheet metal by drilling through the outside panel with little or no damage to the inside panel.

Please use #12020 Boron Buster when drilling Boron.

- Eliminates pilot hole
- 135° Self - Centering Split Point
- Made of Super Cobalt Steel
- Performs best at low RPM
- Cuts extremely fast

Description	1 pkg	5 pkg	10 pkg	25 pkg
6.5mm (1/4" dia.)	12070	12071	12072	12073
8mm (5/16" dia.)	12030	12031	12033	12032
10mm (3/8" dia.)	12035	12036	12038	12037

Also available:

222400 Cobalt Assortment (includes 5 - 8mm bits and 5 - 10mm bits).



Made in U.S.A.

SUPER M7 High Speed Spot Weld Cutting Bits

A premium quality spot weld bit designed to remove spot welds from sheet metal by drilling through the outside panel with little or no damage to the inside panel.

Please use #12020 Boron Buster when drilling Boron.

- Eliminates pilot hole
- 135° Self - Centering Split Point
- Made of Super M7 High Speed Steel
- Performs best at low RPM
- Cuts extremely fast

Description	1 pkg	5 pkg	10 pkg	25 pkg
8mm (5/16" dia.)	12086	12085	12080	12087
10mm (3/8" dia.)	12096	12095	12090	12097



Made in U.S.A.

HIGH SPEED SCREW MACHINE DRILL BITS

135° Split Point



Made in U.S.A.

Product Number	Size Dia.	Dec. Equiv.	Flute Length	Overall Length	Pkg. Qty.
12001	1/16"	.0625	5/8"	1-5/8"	12
12002	5/64"	.0781	11/16"	1-11/16"	12
12003	3/32"	.0938	3/4"	1-3/4"	12
12004	7/64"	.1094	13/16"	1-13/16"	12
12005	1/8"	.1250	7/8"	1-7/8"	12
12006	9/64"	.1406	15/16"	1-15/16"	12
12007	5/32"	.1562	1"	2-1/16"	12

Boron Buster #12020 is recommended when drilling Boron.

DRILL BITS

MAGNUM Jobber Drill Bits

135° Split Point, Black & Gold



Special Hi-Molybdenum tool steel. 135° split point for fast penetration and accurate starting without a center punch. Precision ground point, flute, body, clearance and drill diameter for the ultimate in accuracy and performance. Body and clearance are gold surface treated for maximum lubricity. Harder than high-speed steel. Withstands substantially higher drilling temperatures while maintaining sharpness. Recommended for use in work hardening grades of stainless steel and other hard metal drilling applications.

Item No.	Dia.	Overall Length	Box Qty.	Item No.	Dia.	Overall (mm) Length	Box Qty.
12260	1/16"	1-7/8"	12	12296	5/8"	7-1/8"	1
12261	5/64"	2"	12	12297	41/64"	7-1/8"	1
12262	3/32"	2-1/4"	12	12298	21/32"	7-1/8"	1
12263	7/64"	2-5/8"	12	12299	43/64"	7-3/8"	1
12264	1/8"	2-3/4"	12	12300	11/16"	7-3/8"	1
12265	9/64"	2-7/8"	12	12301	45/64"	7-3/8"	1
12266	5/32"	3-1/8"	12	12302	23/32"	7-3/8"	1
12267	11/64"	3-1/4"	12	12303	47/64"	7-3/8"	1
12268	3/16"	3-1/2"	12	12304	3/4"	7-3/8"	1
12269	13/64"	3-5/8"	12				
12270	7/32"	3-3/4"	12	12401	1.0	41mm (1-5/8")	10
12271	15/64"	3-7/8"	12	12404	1.5	48mm (1-7/8")	10
12272	1/4"	4"	12	12406	2.0	51mm (2")	10
12273	17/64"	4-1/8"	12	12408	2.5	60mm (2-23/64")	10
12274	9/32"	4-1/4"	12	12410	3.0	70mm (2-3/4")	10
12275	19/64"	4-3/8"	6	12412	3.5	73mm (2-7/8")	10
12276	5/16"	4-1/2"	6	12414	4.0	83mm (3-1/4")	10
12277	21/64"	4-5/8"	6	12416	4.5	86mm (3-3/8")	10
12278	11/32"	4-3/4"	6	12418	5.0	92mm (3-5/8")	10
12279	23/64"	4-7/8"	6	12420	5.5	95mm (3-3/4")	10
12280	3/8"	5"	6	12422	6.0	102mm (4")	10
12281	25/64"	5-1/8"	6	12424	6.5	105mm (4-1/8")	10
12282	13/32"	5-1/4"	6	12426	7.0	105mm (4-1/8")	10
12283	27/64"	5-3/8"	6	12428	7.5	111mm (4-3/8")	5
12284	7/16"	5-1/2"	6	12430	8.0	114mm (4-1/2")	5
12285	29/64"	5-5/8"	6	12432	8.5	121mm (4-3/4")	5
12286	15/32"	5-3/4"	6	12434	9.0	124mm (4-7/8")	5
12287	31/64"	5-7/8"	6	12436	9.5	127mm (5")	5
12288	1/2"	6"	6	12438	10.0	130mm (5-1/8")	5
12289	33/64"	6-5/8"	1	12440	10.5	133mm (5-15/64")	5
12290	17/32"	6-5/8"	1	12442	11.0	140mm (5-1/2")	5
12291	35/64"	6-5/8"	1	12444	11.5	143mm (5-5/8")	5
12292	9/16"	6-5/8"	1	12446	12.0	149mm (5-7/8")	5
12293	37/64"	6-5/8"	1	12448	12.5	152mm (6")	5
12294	19/32"	7-1/8"	1	12450	13.0	152mm (6")	5
12295	39/64"	7-1/8"	1				



SUPER PREMIUM COBALT Spot Weld Drill Bits - w/TiCN Coating

Shallow Point

Packaged in a 10-pack plastic sleeve to protect bits!



A premium quality spot weld bit designed to remove spot welds from sheet metal by drilling through the outside panel with little or no damage to the inside panel. Eliminates pilot hole. Self-centered shallow point. Performs best at low RPM (100-400). Includes Titanium CarboNitride (TiCN)* coating. Longer life. For use by hand drilling machines. For increased drill bit life, use with IES Boron Buster (#12020).

**TiCN is an excellent all purpose coating that helps tools typically last 3 to 10 times longer than uncoated tools.*

Item No.	Description	Box Qty.
12225	6mm x 70mm	1
12226	6mm x 70mm	5
12227	6mm x 70mm	10
12228	6mm x 70mm	20
12229	6mm x 70mm	30
12235	8mm x 80mm	1
12236	8mm x 80mm	5
12237	8mm x 80mm	10
12238	8mm x 80mm	20
12239	8mm x 80mm	30
12245	10mm x 90mm	1
12246	10mm x 90mm	5
12247	10mm x 90mm	10
12248	10mm x 90mm	20
12249	10mm x 90mm	30

SUPER COBALT Spot Weld Replacement Drill Bits - w/TiCN Coating

Shallow Point

A very popular replacement bit for pneumatic spot weld removal tools like Spottle & Spitznagel. Top quality replacement drill bits. Includes Titanium CarboNitride (TiCN)* coating. Longer life. For use by hand drilling machines. For increased drill bit life, use with IES Boron Buster (#12020).

**TiCN is an excellent all purpose coating that helps tools typically last 3 to 10 times longer than uncoated tools.*



8mm x 39mm



8mm x 45mm

Item No.	Description	Box Qty.
12250	8mm x 39mm	1
12251	8mm x 39mm	5
12252	8mm x 39mm	10
12253	8mm x 39mm	20
12254	8mm x 39mm	30
12255	8mm x 45mm	1
12256	8mm x 45mm	5
12257	8mm x 45mm	10
12258	8mm x 45mm	20
12259	8mm x 45mm	30

DRILL BITS

IES™ Boron Buster Carbide Spot Weld Bit w/ TiCN or AlTiN Coating

Finally a drill bit designed to cut spotwelds from Boron Steel! The Boron Buster Carbide Spotweld Bit has an TiCN coating (Titanium CarboNitride) that creates a protective oxide layer that keeps its hardness at higher temperatures and also improves lubricity. Tools coated in TiCN typically last 3-10 times longer than uncoated tools. Comes with a "Tri-flute" head. #12210 has three flat sides and #12205 has one .75 flat side on the shank that can be used in most conventional electric and pneumatic drills.



"Tri-Flute"

- Designed to cut spot welds from Boron Steel
- High Temperature Applications
- Recommended 900RPM-1,000RPM
- Best When Used With #12020 Boron Buster Cutting Tool Lubricant/ Coolant

Carbide bits are brittle and may break due to the angle, pressure and speed being exerted by the operator. We will not warranty broken bits.

TiCN - Titanium CarboNitride

AlTiN - Aluminum Titanium Nitride

12210 3 Flats on Shank



Overall Length: 50mm

12205 .750 Flat on Shank



Overall Length: 46mm

Prod No.	Description	Bx Qty.
12210	8mm (5/16") w/ 3 Flats On Shank (TiCN Coating)	1
12205	8mm (5/16") w/ .75 Flat On Shank (AlTiN Coating)	1



12213
8 x 44mm
Cobalt Spot Weld Bit
w/TiCN Coating
For use with #12214 Drill
Box Qty. 1



12215
8 x 44mm
Carbide Spot Weld Bit
w/TiCN Coating
For use with #12214 Drill
Box Qty. 1

DRILL BITS

HIGH SPEED JOBBER LENGTH DRILL BITS

135° Split Point



Made in U.S.A.

Product Number	Size Dia.	Dec. Equiv.	Flute Length	Overall Length	Pkg. Qty.
12008	11/64"	.1719	2-1/8"	3-1/4"	12
12009	3/16"	.1875	2-5/16"	3-1/2"	6
12010	13/64"	.2031	2-7/16"	3-5/8"	6
12011	7/32"	.2188	2-1/2"	3-3/4"	6
12012	1/4"	.250	2-3/4"	4"	6
12013	9/32"	.2812	2-15/16"	4-1/4"	6
12014	5/16"	.3125	3-3/16"	4-1/2"	6
12015	11/32"	.3438	3-7/16"	4-3/4"	6
12016	3/8"	.3750	3-5/8"	5"	6
12017	13/32"	.4062	3-7/8"	5-1/4"	6



12025

Drill Tree
High Speed Steel
Drills Holes 1/8" To 1/2" In 1/32" Increments
13 different sizes
Self starting point
Automatically deburrs holes with next cutting edge
Box Qty. 1

222401

Body Shop Drill Assortment
Box Qty. 1

Now you can have the drill bit you need - when you need it!
All of these high quality drills are "Made In The U.S.A."!

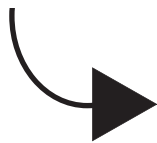

1/8" Double-end Drill Bit	1/8" - 1/2" Step Point Drill Bit	5/16" (8mm) 3/8" (10mm) Spot Weld Bit	1/4" (6.5mm) Spot Weld Bit	8mm (5/16") Spot Weld Bit	10mm (3/8") Spot Weld Bit
HIGH SPEED STEEL	HIGH SPEED STEEL	HIGH SPEED STEEL	SUPER COBALT	SUPER COBALT	SUPER COBALT
Qty. 6	Qty. 1	Qty. 1 each	Qty. 1	Qty. 2	Qty. 1

Drawings are not actual size

Here's what you get!

Description	Qty.
1. 1/8" Double-end Drill Bit	6
2. 1/8-1/2 Step Point Drill Bit	1
3. 5/16" HSS Spot Weld Bit	1
3/8" HSS Spot Weld Bit	1
4. 1/4" Super Cobalt Spot Weld Bit	1
5. 8mm Super Cobalt Spot Weld Bit	2
6. 10mm Super Cobalt Spot Weld Bit	1

13 Total Pcs.

DRILL BITS

Product #	Size	Box Qty.
12100	1/16"	12
12102	5/64"	12
12104	3/32"	12
12106	7/64"	12
12108	1/8"	12
12110	9/64"	12
12112	5/32"	12
12114	11/64"	12
12116	3/16"	12
12118	13/64"	6
12120	7/32"	6
12122	15/64"	6
12124	1/4"	6
12128	9/32"	3
12132	5/16"	3
12136	11/32"	3
12140	3/8"	3
12144	13/32" *	1
12148	7/16" *	1
12152	15/32" *	1
12156	1/2" *	1

* 3/8" shank



SUPER PREMIUM MAGNUM DRILL BITS

Mechanics Length

Super Premium Magnum, mechanics length drill bits are made of Hi- Molybdenum tool steel, recommended for the toughest metal drilling applications. Their 135° split point prevents walking and also runs cooler - meaning a substantially longer cutting life. Sizes 3/16" diameter and larger have 3 flats to prevent slippage and are ideal for keyless chucks. All drills over 3/8" will fit a 3/8" chuck.

NEW PKG QUANTITIES

12170

13 piece Super Premium
Magnum Drill Set
(includes: 1/16" thru 1/4 by 64^{ths}.)
Box Qty. 1 Set



12171

21 piece Super Premium
Magnum Drill Bit Set
(includes: 1/16" thru 1/4 by 64^{ths},
9/32" thru 1/2" by 32^{nds}.)
Box Qty. 1 Set



Left hand spiral cobalt drills and
bolt extractors for fast, easy stud
removal. Drill may loosen bolt with
counterclockwise rotation. 135° split
point will cut work hardened metals.
Durable metal case included.

12174

Studout Bolt Remover Set
Box Qty. 1



Special Hi-Molybdenum and Hi-
Tungsten tool steels, gold surface
treated for maximum lubricity.
Precision ground tap threads.
Designed for hard metal applications
for the ultimate in accuracy and
performance. 18 pieces. Durable
metal case included.

12172 (English) Super Premium Tap & Drill Set

12173 (Metric) Super Premium Tap & Drill Set



12020

BORON BUSTER

Extends the life of drill bits and saw blades. Reduces friction
and heat on cutting edge for longer tool life and better finish.
For use when drilling or cutting Boron and Hi-Strength Steel.
30g Tin Can
Box Qty. 1



STERLING® Hacksaw Blades

Bimetal, Shatterproof 10 per pkg.

Shatter resistant bi-metal construction allows blades to bend and flex. The high hardness tool steel cutting edge provides extended tool life compared to other hacksaw blades. The original varied pitch tooth design was patented and introduced in 1937, on hand hacksaw blades.

Item No.	Length x Width x Thickness	TPI	Recommended Uses
510280	12" x 1/2" x .025	24/20	Varied pitch mitigates tooth strippage problems and allows faster cuts in a wider variety of applications
510290	12" x 1/2" x .025	32	For very thin gauge sheet metal, tubing, trim, etc.



STERLING® Reciprocating Saw Blades

Universal 1/2" Shank Metal Cutting 5 per pkg.

Tough, shatterproof bi-metal reciprocating blades. Fits all popular machines and out performs standard blades by a wide margin. The teeth retain their hardness and stay sharper longer. Breakage is eliminated because of bi-metal construction.

Item No.	Length x Width x Thickness	TPI	Recommended Uses
510381	6" x 3/4" x .035	18	For heavy gauge sheet metal, conduit, pipe, tubing, thin fiberglass.
510382	8" x 3/4" x .035	18	For heavy gauge sheet metal, conduit, pipe, tubing, thin fiberglass.
510383	6" x 3/4" x .035	24	For metals lighter than 18 gauge, thin wall tubing, formed sheet, trim, etc.
510384	4" x 3/4" x .035	32	For very thin gauge metals, sheet, tubing, trim, etc.



STERLING® RUFF-NECK™ - DEMOLITION BLADES Reciprocating Saw Blades

Universal 1/2" Shank Metal Cutting 2 per pkg.

Tough, shatterproof bi-metal reciprocating blades. Fits all popular machines and out performs standard blades by a wide margin. The teeth retain their hardness and stay sharper longer. Breakage is eliminated because of bi-metal construction.

Item No.	Length x Width x Thickness	TPI	Recommended Uses
510385	6" x 1" x .062	12/8	Wavy set for metal lath, thin steel plate, metal demolition work and nail embedded wood.
510386	9" x 1" x .062	12/8	



STERLING® METAL SCROLL CUTTING Reciprocating Saw Blades

Universal 1/2" Shank Metal Cutting 5 per pkg.

Tough, shatterproof bi-metal reciprocating blades. Fits all popular machines and out performs standard blades by a wide margin. The teeth retain their hardness and stay sharper longer. Breakage is eliminated because of bi-metal construction.

Item No.	Length x Width x Thickness	TPI	Recommended Uses
510387	3" x 1/4" x .035	18	For scroll cutting metals lighter than 14 gauge.

SAW BLADES / SCREWDRIVER BITS



STERLING® Jig Saw Blades

Durable, high performance bi-metal jig/sabre saw blades outlast all other types of carbon and high speed steel blades. These shatter proof metal cutting blades are available in "T" style Universal and 1/4" Style Universal.

T STYLE UNIVERSAL 5 per pkg.

Item No.	Length x Width x Thickness	TPI	Recommended Uses
510389	3" x 5/16" x .042	18	Mild steel up to 3/16", nonferrous up to 1/4".
510390	3" x 5/16" x .042	24	Thin wall tubing and metal under 1/8".

1/4" STYLE UNIVERSAL 5 per pkg

Item No.	Length x Width x Thickness	TPI	Recommended Uses
510391	3-1/2" x 5/16" x .042	18	1/16" - 1/8" steel, conduit, plastics. etc.
510392	3-1/2" x 5/16" x .042	24	1/16" steel and under thin metals, formica, etc.



STERLING® Air Saw Blades Universal 1/2" Shank 5 per pkg.

Bi-metals blades to fit popular pneumatic saw machines. High-speed cutting edge welded to tough, shatter resistant back makes this the ideal blade for air saw applications. The bi-metal construction obsoletes solid high-speed steel blades previously available. Fits all standard air saws.

PROD NO.	Length x Width x Thickness	TPI	Recommended Uses
510379	3-5/8" x 1/2" x .025	18	For scroll cutting metals lighter than 14 gauge.
510380	3-5/8" x 1/2" x .025	24	For scroll cutting metals lighter than 18 gauge.

SCREWDRIVER BITS

Hardened
Made in U.S.A
Box Qty. 1



Slotted Head

Torx Head

Product	Description	Shank
95005 #5 Slotted.....	1/4"
95006 #6 Slotted.....	1/4"
95010 #10 Slotted.....	1/4"
95014 T-10 Torx.....	1/4"
95015 T-15 Torx.....	1/4"
95040 T-40 Torx.....	1/4"
95130 T-30 Torx.....	5/16"
95140 T-40 Torx.....	5/16"
95150 T-50 Torx.....	5/16"

MISCELLANEOUS

PLASTIC SPREADERS

Spreaders are available in 3 different sizes. All spreaders are available in either a 12 or 100 package quantity only. Broken package quantities are not available.



4" Plastic Spreaders

Part No.	Qty.
97150	100
97151	12

5" Plastic Spreaders

Part No.	Qty.
97160	100
97161	12

6" Plastic Spreaders

Part No.	Qty.
97180	100
97181	12

Also available: Part No. **97185** Spreader Assortment (4 each of the above sizes)



DISPOSABLE MIXING BOARDS

High quality mixing boards. Masonite board with strap on back for easy holding. Mix on top sheet, then remove for next mixing - 100 sheets per pad. No cleaning required. Save time and money!

Item No.	Description	Bx Qty.
97145	12" x 12" sheets, 100 sheets	1

MEASURING / MIXING CUPS AND LIDS

Great mixing cups for all your mixing needs. Available in all major brand measurements. Transparent plastic with easy to read measurements. Reusable - print on cups will not wash off. Lids sold separately.



Item No.	Description	Bx Qty.
908	8 oz. Mixing Cup	100
908L	8 oz. Cup Lid	100
916	16 oz. Mixing Cup	100
916L	16 oz. Cup Lid	100
932	32 oz. Mixing Cup	100
932L	32 oz. Cup Lid	100
980	80 oz. (2-1/2 Qt) Mixing Cup	50
980L	80 oz. (2-1/2 Qt) Cup Lid	50

MISCELLANEOUS

Miscellaneous

40



PLASTIC PUTTY STICK / WINDSHIELD SETTING TOOL

These multi-purpose tools are molded from break-resistant, self-lubricating plastic. The #96111 is beveled to a chisel on one end that can also be used as a scraper.

Can be used as: a putty knife, a paddle for backfilling windshields, a pry bar for removing and installing glass that's set in a rubber channel.

- 96110** Plastic Putty Stick 6/box
- 96111** Plastic Putty Stick w/Chisel 6/box



- 277-004**
Clip/Trim Combo Wedge
Removal Tool
Width: 1"
Length: 8-1/4"
Box Qty. 1



- 96074**
Cut - Out Cold Knife. For cutting sealants from windshields and back-lites.
1 per pkg

Replacement Blades

- DISC 96066** Heavy Duty Blades (6 pkg.)
- 96075** Cold Knife Blades (6 pkg.)
- DISC 96067** Urethane Blades (1 pkg.)



- 96203**
TUBE GRIPPER
A 14-gauge steel tool which will enable you to dispense and apply material supplied in plastic or aluminum tubes. 2-1/2" wide.
Box Qty. 1



- 97100**
3/8" (Brush Width) x 6" Long
Acid Brushes
Tin Handle with Horse Hair Bristles
Box Qty. 144

- 97101**
1/2" (Brush Width) x 6" Long
Acid Brushes
Tin Handle with Horse Hair Bristles
Box Qty. 144



- 97000**
Micro-Torch
Jet Flame, Wind-proof
45° Angle, Refillable
Box Qty. 1



- 97135**
Aerosol Can Dispenser.
Spray Can Trigger Handle.
Snaps onto most spray cans.
Box Qty. 1



- 3M-33**
3M SUPER 33+
VINYL ELECTRICAL TAPE
Super strong adhesion. Withstands harsh conditions. Protects and insulates.
Each roll: 3/4" x 66 ft. (.007" thick).
Box Qty. 10

MISCELLANEOUS

Part No.	Hole Size	Head Dia.	Working Thickness	Unit Pkg.
405030	1/2"	7/8"02-.07".....	100
405040	3/4"	1-1/8".....	.02-.14".....	100
405050	7/8"	1-1/4".....	.02-.10".....	100
405060	1"	1-3/8".....	.04-.10".....	100
405010	1-1/4"	1-5/8".....	.04-.10".....	100
405070	1-1/2"	1-7/8".....	.04-.10".....	100

PLASTIC PLUG BUTTONS Depressed Center



WELD PINS

Lo-oval Copper Plated Steel

By welding these pins to a damaged body panel, a body shop technician can use a gripping tool to pull the dent out of the panel.



Pin Diameter: 2mm (.080")
Length: 2"
Head Diameter: .150"

~~12060~~ Box Qty. 100 **DISC**
~~12064~~ Box Qty. 250 **DISC**
12065 Box Qty. 500

Pin Diameter: 2.5mm (.098")
Length: 2"
Head Diameter: .150"

~~12061~~ Box Qty. 100 **DISC**
~~12062~~ Box Qty. 250 **DISC**
12063 Box Qty. 500

DFK-2

DeFroster Pro's Tab Bonding adhesive is over 80% silver. High silver content is needed for highly conductive tab bonding required in defroster repair. Two part adhesive cures quickly, bonds aggressively and makes the electrical and structural connection to the defroster one simple operation.

Contents: 2 part adhesive (7g total net weight), Sandpaper, Stir sticks, Instructions

Box Qty. 1



BLANK

SAFETY EQUIPMENT

TBD

Nitrile Gloves - Black

6 mil nitrile gloves. Superior puncture & abrasion resistance. Textured grip. Beaded cuff. Powder-free.

KX9943	Medium	100/BX
KX9944	Large	100/BX
KX9945	X-Large	100/BX



**POWDER FREE
NITRILE
6 MIL**

Nitrile Gloves (Powder-Free) **NEW**

Powder-free. Superior puncture and abrasion resistance. Latex-free textured grip. Beaded cuff & ambidextrous. 6 Mil Nitrile.

96325	Medium	120/BX
96326	Large	120/BX
96327	X-Large	120/BX



**POWDER FREE
NITRILE
6 MIL**

Assembly Gloves

Gray nylon. Light weight. Dipped palm & fingers repels oils & cleaners. Open knit back breaths for day-long comfort. Washable, reusable for economy.

96315	Medium	1 Pair/pkg
96316	Large	1 Pair/pkg
96317	X-Large	1 Pair/pkg



**GREY NYLON
OPEN KNIT
REUSABLE**

Qualatex® Latex Gloves "Miracle Grip, High Risk Series"

Super 14 mil latex gloves. Unequaled wet/dry grip, easy on/off, clean and powder-free.

96321	Large	50/BX
96322	X-Large	50/BX



**POWDER FREE
LATEX
14 MIL!**

41

Safety Equipment

SAFETY EQUIPMENT

HYBRID VEHICLE SERVICE GLOVES

Safety glove system used for protection against the high voltage batteries used in today's Hybrid cars.



RUBBER INSULATING GLOVES

Class 0 Type I. Natural rubber, designed for maximum comfort and protection. 12" long with rolled cuff for easy pull-on and pull-off.

Maximum use 1000 volts AC / 1500 volts DC
Meets ASTM D 120 Standard.

- 96335** ————— Medium ————— 1 Pair **DISC**
- 96336** ————— Large ————— 1 Pair **DISC**
- 96337** ————— Extra Large ————— 1 Pair **DISC**



PROTECTIVE OVER GLOVES

Wear over Hybrid Service Gloves to protect rubber insulating gloves from punctures and abrasion.

Meets ASTM F696 Standards.

- 96338** ————— Fits Over Medium ————— 1 Pair **DISC**
- 96339** ————— Fits Over Large ————— 1 Pair **DISC**
- 96340** ————— Fits Over Extra Large ————— 1 Pair **DISC**



PROTECTIVE GLOVES BAG

Heavy-duty canvas bag allows storage for both the service gloves and the protective over gloves.

- 96341** ————— Fits Over Medium ————— 1/box **DISC**

SAFETY EQUIPMENT

MEETS REQUIREMENTS
FOR OSHA & NIOSH N95



FOLDING PARTICULATE RESPIRATOR MASK

3D cup shape can also fold flat for easy storage and portability. Can be folded and placed in your pocket! Incredible comfort. Adjustable integrated nosepiece. Fluid resistant.

96500 Folding Mask Bx Qty. 20

MEETS REQUIREMENTS
FOR OSHA & NIOSH N95



PARTICULATE RESPIRATOR MASK

Durable, latex-free ultrasonically welded headstraps withstand tough use. Adjustable contoured nosepiece and soft open cell foam nose cushion ensure proper fit and increased comfort.

96505 Particulate Dusk Mask Bx Qty. 20

MEETS REQUIREMENTS
FOR OSHA & NIOSH N95



PARTICULATE RESPIRATOR MASK WITH EXHALATION VALVE

Durable, latex-free ultrasonically welded headstraps withstand tough use. Adjustable contoured nosepiece and soft open cell foam nose cushion ensure proper fit and increased comfort. Includes an added feature of our LPD (low pressure drop) exhalation valve for easy breathing and increased worker comfort. Prevents safety glasses from clouding or fogging up.

96510 Mask w/Valve Bx Qty. 10

MEETS REQUIREMENTS
NIOSH N95



DUAL CARTRIDGE RESPIRATOR MASK

Disposable

Maintenance free half mask comes completely and permanently assembled with cartridges. Ready to use. No spare parts to stock. No cartridges to replace. Soft, lightweight thermoplastic elastomer facepiece, cradle suspension and easy-adjust headstraps facilitate proper and comfortable fit. Disposable. NIOSH approved.

96520 Medium Respirator Mask Bx Qty. 1

96521 Large Respirator Mask Bx Qty. 1



96700 OPTI-FIT Full Face Cartridge Respirator - Medium 1 per pkg.

96701 OPTI-FIT Full Face Cartridge Respirator - Large 1 per pkg.

96702 Replacement Organic Vapors Cartridge & N95 Filters Combo Kit

96704 Clear Peel-Off Lens Covers 25 per pkg.

NIOSH Approved TC-84A-1420 Silicone skirt offers exceptional durability and comfort. Nose cup prevents fogging. Wide viewing area offering distortion free visibility and optical clarity. Five-point head strap. Polycarbonate lens treated with anti-scratch coating.

ORGANIC VAPOR CARTRIDGE, N95 PARTICULATE FILTER, NIOSH APPROVED



9715 Deluxe Spray Sock

Lightweight, breathable Lycra fits snugly around head and neck. One size fits all. One per pkg.

SAFETY EQUIPMENT

Meets
ANSI Z87.1+
Standards



Anti-Scratch

96606

Lightweight Safety Glasses

- High Impact Clear Polycarbonate Lens
- Lightweight Wrap Around Lens
- Anti-Scratch
- 99.9% UVA, UVB Protection
- Distortion Free Lens
- Soft & Lightweight Temples
- Soft Rubber Nose Piece For Comfort

Box Qty. 12

Meets
ANSI Z87.1+
Standards



Anti-Scratch, Anti-Fog

96607

Lightweight Safety Glasses

- High Impact Clear Polycarbonate Lens
- Lightweight Wrap Around Lens
- Anti-Scratch, Anti-Fog
- 99.9% UVA, UVB Protection
- Distortion Free Lens
- Soft & Lightweight Temples
- Soft Rubber Nose Piece For Comfort

Box Qty. 12



96610

Tapered, Polyurethane Foam, Uncorded Ear plugs. 31 Noise Deduction Rating (NRR). CSA Class AL. Super Soft, comfortable polyurethane foam exerts very low pressure on ear canal. Each pair individually packaged. Box opens on front for easy dispensing. 200 Pair per Box



96611

EP6 Earplugs (Medium)
Protects against loud harmful noises without interfering with the hearing of routing sounds or conversations. Comes with protective case. Box Qty. 12 pairs



96620

10 Person First Aid Kit Assortment
Plastic case (gasketed) for protection.
Meets ANSI Z308.1 Standards.
Box Qty. 1



- 9720** GEN-NEX Painters Coverall - Medium
- 9721** GEN-NEX Painters Coverall - Large
- 9722** GEN-NEX Painters Coverall - X-Large
- 9723** GEN-NEX Painters Coverall - XX-Large

Anti-static. Cloth-like fiber. Full zipper front and elastic wrists. Non-elastic ankle cuffs. Excellent protection against isocyanate based coatings. One per pkg.



- 9728** LACKIER Painters Coverall - Medium
- 9729** LACKIER Painters Coverall - Large
- 9730** LACKIER Painters Coverall - X-Large
- 9731** LACKIER Painters Coverall - XX-Large
- 9732** LACKIER Painters Coverall - XXX-Large

Anti-static. Tear resistant. Fire resistant. Impermeable to paint. 100% Polyester. Full zipper front and elastic wrists. Elastic bands on the cuffs and trouser legs. Excellent protection against isocyanate based coatings. Machine washable at 60°. One per pkg.

SPARK / WELDING BLANKET

Made from heat cleaned uncoated fiberglass for light to medium duty welding. Protects fabric, glass, trim and painted surfaces from sparks. Weight: 18 oz/yd².



- Features:
- 1000° F Constant Heat
 - 100% Fiberglass Yarn
 - Abrasion Resistant

Part no.	Description	
70506	6 ft. x 6 ft.	1/box
70508	6 ft. x 8 ft.	1/box
70510	5 ft. x 10 ft.	1/box DISC

NEW SIZE



SLAG BUSTER WELDING BLANKET

Made from a carbon fiber fabric that withstands intermittent temperatures to 3000°F. Protects from sparks, spatter and small slag. 100% flame resistant. Heat and tear resistant. Soft, flexible and lightweight (16 oz/yd²). Non-abrasive, will not scratch clearcoats. For heavy duty welding.

Part no.	Description	
70580	6 ft. x 6 ft. 8 in. (72" x 72", 3/16" thick)	1/box



70505 WELDING GLOVES

Cotton lined for added comfort. Shoulder split cowhide. Durable lock stitching with polyester thread. Stitching protected by welted fingers and seams. Wing thumb for natural feel and versatile movement. Length: 14". Size: Large. Box Qty. 1 pair

SAFETY EQUIPMENT



PORTABLE EYE WASH STATION

Portable eye wash station meets OSHA requirements. Includes mounting bracket, inspection tag and water preservative. Water should be changed every 90 days. NO PLUMBING REQUIRED. (unit measures 9-1/2" x 16-1/2" x 20")

- 1-Hand Operation
- Gravity-Fed - no plumbing required
- Locking cap prevents leaks
- 0.4 Gallons Per Minute (GPM) for 15 Minutes
- ANSI Z358.1-2014 Compliant

Item No.	Description	Bx. Qty.
96649	Eye Wash Station	1
96650	Water Preservative 8 fl. oz.	4
96651	Inspection Tag	5



UNIVERSAL SORBENT PADS

Used to clean up both water and oil based fluid leaks, drips or spills. Made from meltblown polypropylene allowing them to soak up oil, water and even aggressive chemicals

Part no.	Description	
97078	Pad Size: 15" x 18"	200/bag



BARREL TOP ABSORBENT PADS

Heavy-Duty Barrel Top Absorbent Pads soak up both oil and water as well as grease, transmission fluid, hydraulic fluid, diesel fuel, coolants and many other fluids. Pads are 22" in diameter and fit standard 55 gallon drums. Sold in pack quantity only (10 pads).

Part no.	Description	
97079	Pad Size: 22"	10/box

Visit
www.srfast.com
for current updates.

AUTOMOTIVE DETAIL SUPPLIES



VAL34
3/4" Plastic Valve
For use with 5 gallon containers
Box Qty. 1



1824
Spray Bottle w/Trigger Sprayer
32 oz. Bottle
Box Qty. 1

*Professional quality.
High Density
Polyethylene bottle with
chemical resistant trigger
sprayer.
32 oz. bottle.
Adjust from a wide mist
to a sharp stream.
No molded-in dilution
scales or markings on
outside of bottle.*

NEW



1827
Pressure Pump Spray Can.
A pressurized atomizer spray can for
applying and atomizing liquids evenly
and consistently. Solvent resistant due
to viton seals. 1 Liter.
Box Qty. 1



9738
Prime Paper Floor Mats
Durable coating for heavy
traffic. Premium quality. Size:
17" x 19"
Box Qty. 500



*Great for hard to reach areas!
Easy removal of decals and stickers.
Use on windshields, windows and glass.
Screwdriver style handle.
Store extra blades in handle (one
replacement blade included).*

97074
Screwdriver Style Scraper
Box Qty. 1



*Thumb feature offers better
control. Easy to maneuver
- for washing and cleaning
surfaces without scratching.*

97080
Wash Mitt - with Thumb
Box Qty. 1



97081
Bug Sponge
Poly sponge encased in
nylon mesh
7.25" x 4.25" x 1.00"
Box Qty. 1



*Remove dust from crevasses of console,
dash, gear shift, vents and more. Remove
wax and polish residue from emblems and
side mouldings.*

97082
Cotton Detailing Sticks
100% Cotton, Dual Tipped - 3" Long
Box Qty. 100

AUTOMOTIVE DETAIL SUPPLIES

Steel Wool



97083
Steel Wool
Grade 000 Extra Fine
5 lb. Reel
Box Qty. 1



97084
Small Wire Wheel Spoke Brush
Easy grip plastic handle.
Length: 7.25"
Bristle Length Dia.: 2.00" to 1.00"
Box Qty. 1



97085
Large Wire Wheel Spoke Brush
Plain sanded wood handle.
Length: 17"
Bristle Length Dia.: 3.00" to 1.25"
Box Qty. 1



97086
Vent & Dash Brush
Filament Type: Black China
Length: 6.5"
Bristle Length: .62"
Box Qty. 1



97087
Vent & Dash Brush
Filament Type: Black China
Length: 6.5"
Bristle Length: .75"
Box Qty. 1



97088
Vent & Dash Brush
Filament Type: Gray China
Length: 7"
Bristle Length: 1.00" Dbl Thick
Box Qty. 1



97089
Dual Purpose Detail Brush
Filament Type: White Nylon
Length: 7"
Bristle Length: .43" & .18"
Box Qty. 1



97090
Iron Style Scrub Brush
Filament Type: White
Polypropylene
Length: 6.5"
Bristle Length: 1.12"
Box Qty. 1



97091
For Use With Standard Wood Handle
Bi-Level Vehicle Brush
Filament Type: Green Nylon
Length: 10"
Bristle Length: 2.50"
Box Qty. 1

AUTOMOTIVE DETAIL SUPPLIES



97092

For Use With Standard Wood Handle
 Bristle Vehicle Wash Brush
 Filament Type: Green Nylon
 Length: 10"
 Bristle Length: 2.50"
 Box Qty. 1



97093

Pet Hair Removal Brush
 Filament Type: Rubber
 Length: 10.25"
 Bristle Length: .875"
 Box Qty. 1



97094

Carpet & Mat Scrub Brush
 Filament Type: Black Nylon
 Length: 8.50"
 Bristle Length: 1.00"
 Box Qty. 1



97095

Car Wash Body Brush
 Filament Type: Polystyrene
 Length: 8.50"
 Bristle Length: 2.00"
 Box Qty. 1



97096

Car Wash Body Brush
 Filament Type: Polystyrene
 Length: 20.00"
 Bristle Length: 2.00"
 Box Qty. 1



97097

1-1/2" Width
 Paint Brushes
 Box Qty. 36



97098

2" Width
 Paint Brushes
 Box Qty. 24



97099

2-1/2" Width
 Paint Brushes
 Box Qty. 12



97103

Stainless Steel Bristle
 Detail Brush
 Box Qty. 1

AUTOMOTIVE DETAIL SUPPLIES



9735 Rubble Wrap Self-Adhesive Plastic Film (36" x 100 ft.)

Used to seal broken windows and uncloseable doors of vehicles exposed to weather following a collision or vandalism. Coated with a light tack adhesive designed to grip the surface then be removed without leaving adhesive residue on the surface. The film features UV inhibitors to prevent damage when exposed to sunlight for lengthy periods of time. Thickness: 3 mil. One per pkg.

**Always check online for the most
updated information!**

www.srfast.com

AUTOMOTIVE DETAIL SUPPLIES

TP1WR - Buff and Shine Kit

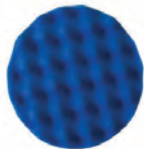
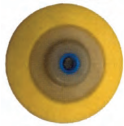

Buff and Shine Kit includes three pads and a backing plate. The three pads are: #752R for heavy compounding, #830WR for polishing and #820WR for finishing along with a grip backing plate #658Y. The three pads have a patented Center Tee for fast easy pad loading and centering every time. The Buff and Shine Kit was designed for the body shop technician in mind. This kit was designed to keep a simple set of pads in the shop for the technician and speed up the return of the vehicle to the owner. Each kit has the necessary pads needed in a body shop after a vehicle is painted and color sanded which will eliminate cross contamination. A high quality design - made in the USA!

- 8" diameter of contact surface ensures faster detailing jobs
- Centers backing plate every time
- Center ring ensures wobble-free buffing
- Center ring is fully washable
- Waffle pattern keeps pad life up and heat friction down and allows air to flow in and out of the pad for a smoother, cooler buffing experience.

Item No.	Description	Application	Qty.
TP1WR	KIT - Contains 1 each: 752R, 830WR, 820WR, 658Y	Kit	1
752R	100% 4-ply twisted wool Grip-Pad w/center ring	Heavy Cutting	1
830WR	Yellow foam Grip-Pad, waffle pattern w/center ring	Lt Cut/Polishing	1
820WR	Black foam Grip-Pad, waffle pattern w/center ring	Finishing	1
658Y	Grip Backing Plate with 5/8 x 11 thread	Backing Plate	1
850WR	Blue Foam Grip-Pad, waffle pattern w/ center ring	Soft Polishing	1



TP-4

Mini Buffing Kit
Designed for small buffing areas. 3" dia. pads.
Contains four pads, backing plate, two adapters.
Box Qty. 1

AUTOMOTIVE DETAIL SUPPLIES

42 Auto Detail Supplies



97105
12" x 12"
Speedy Surface Prep Towel
Medium Grade - Blue
For medium to heavy surface
contaminants.
Box Qty. 1



97106
Speedy Surface Prep
Decontamination Kit
*Contains: one 6" x 6" Surface Prep Mini Towel, one 4
oz. bottle of Speedy Surface Prep and one 16" x 16"
Microfiber Towel.*
Box Qty. 1

NEW



KX101000110
REMA SHINE
Water based silicone
dressing. Ideal for tires
and interior and exterior
mouldings. Provides high
gloss restoring original
beauty. Deep, long lasting
shine. Convenient, ready-
to-use formula. Pleasant
odor and VOC Compliant.
Box Qty. 4

NEW



PUMP4540-55
STANDARD DUTY LEVER
BARREL PUMP
A standard duty pump
designed for use with our
#4540-55. Fits 15 to 55 gallon
drums with Standard Bung.
Ideal for lubricants, solvents,
industrial chemicals. Self-
adjusting telescoping suction
tube; removable spout,
comfort-grip vinyl handle.
Dispenses approx. 350cc per
stroke.
Box Qty. 1

NEW



PUMP55GAL
Pump used for 55 gallon plastic
drums. Pump is constructed of
polyethylene & polypropylene and
resists corrosion from commercial
grade soap and detergents.
For use with a wide range of
chemicals including Industrial
Grade Degreasers / Cleaners,
Detergents, Detailing Soaps, All
Purpose Cleaners, Lightweight
Lubricants and Low Viscosity
Oils. Total length 43". Dispenses
approx. 1-1/2 pints (24 oz.) per
stroke. Box Qty. 1

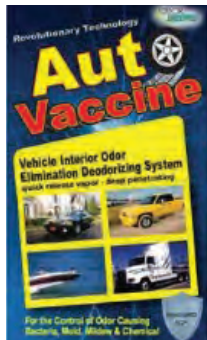

AUTO VACCINE Odor Eliminating, Deodorizing, Decontaminate Delivery System

Your car is your second home - Keep it clean with Auto Vaccine!

- Safe, Powerful & Effective
- Not a Cover-up or Mask
- Eliminates all odors, smoke, mold, mildew, pet smells, bacteria
- Safe for all interior materials

Auto Vaccine can quickly treat enclosed spaces with the most powerful penetrating technology available. Released as a vapor, our broad spectrum biocide products are safe, powerful and very effective!

Prod No. **3500** Box Qty. 1 kit

MADE IN GERMANY - MIPA IS THE THIRD LARGEST PAINT COMPANY IN GERMANY

C210 CLEARCOAT

Meets all demands on quick, high-quality paint jobs. C210 is a medium-solids clearcoat that is a thinner viscosity than the C75, but still thicker than most clearcoats. Ideal for high-production shops.

- Excellent Gloss
- Low 3.5 VOC
- Quick dry
- Fast Buffing Time
- Easiest Clear To Buff
- Best UV Protection and No Yellowing

C210 CLEARCOAT

- C210-1L** Clearcoat 1 liter
- C210-5L** Clearcoat 5 liters

MS HARDENER Low VOC

MS HARDENERS

- MS10-2.5L** Fast Hardener 2.5 liter
- MS25-2.5L** Normal Hardener 2.5 liter
- MS35-2.5L** Slow Hardener 2.5 liter
- MS40-2.5L** Extra Slow 2.5 liter



- Reduce: 0-10%
- Coats: 2-3
- Coat Thickness: 1.5 mils per coat
- Mix Ratio: 2:1
- Use 1.3 - 1.5 nozzle gravity HVLP @ 8-10psi

- Flash Time @ 68°F: 5-20 min
- Flash Time @ 140°F: 5 min.
- Handable @ 68°F: 20-30 min.
- Handable @ 140°F: 15 min.
- Complete Dry @ 68°F: Overnight
- Complete Dry @ 140°F: 30 min.

All times are dependant upon temperature, humidity, air circulation and hardener used.

C75 CLEARCOAT

Ideal for extra high-quality orientated shops and is a high-viscosity, high-solids clearcoat.

A urethane clearcoat for clear over base process, with active UV protection and short drying time.

Universally suitable for two-coat painting. Excellent resistance against weathering and yellowing, very high gloss and good build.

- Brilliant Surface
- Excellent Drying
- High UV protection, No Yellowing
- High Solid Content and Environmental Protection

C75 CLEARCOAT

- C75-1L** Clearcoat 1 liter
- C75-5L** Clearcoat 5 liters

MS HARDENER Low VOC

MS HARDENERS

- MS10-2.5L** Fast Hardener 2.5 liter
- MS25-2.5L** Normal Hardener 2.5 liter
- MS35-2.5L** Slow Hardener 2.5 liter
- MS40-2.5L** Extra Slow 2.5 liter



- Reduce: 0-10%
- Coats: 2
- Coat Thickness: 2 mils per coat
- Mix Ratio: 2:1
- Flash time between coats: 5-10 min.
- Use 1.3 - 1.5 nozzle gravity HVLP @ 8-10psi

- Flash Time @ 68°F: 10-40 min
- Flash Time @ 140°F: 5-10 min.
- Handable @ 68°F: 4-5 min.
- Handable @ 140°F: 15-30 min.
- Complete Dry @ 68°F: Overnight
- Complete Dry @ 140°F: 30-40 min.

All times are dependant upon temperature, humidity, air circulation and hardener used.

MIPA COATINGS

MADE IN GERMANY - MIPA IS THE THIRD LARGEST PAINT COMPANY IN GERMANY

4+1 PRIMER

The absolute filler used as the basis for excellent paintwork. Will fill and cover 80 grit sandpaper scratches.

- High Filling Power
- Fast Drying
- Excellent Sanding Ability
- High Solid Content - HS Quality

URETHANE PRIMER FILLER

- ~~4-1PRIMER-1L~~ Primer 1 liter **DISC**
- 4-1PRIMER-3L Primer 3 liters

H5/H10 HARDENER

H5/H10 HARDENERS

- H5-1L** Extra Fast Hardener 1 liter
- H10-1L** Fast Hardener 1 liter



- Reduce: 0-10%
- Mix Ratio: 4:1

Use 1.5 - 1.7 nozzle in spray gun

- Flash-Off Time: 15 min
- Recoat Time @ 68°F: 3-5 hours
- Recoat Time @ 140°F: 30-40 min

All times are dependant upon temperature, humidity, air circulation and hardener used.



REDUCER

- REDUCER-N-1L** Normal 1 liter
- REDUCER-F-5L** Fast 5 liter
- REDUCER-N-5L** Normal 5 liter
- REDUCER-S-5L** Slow 5 liter

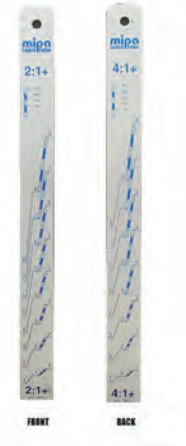

MIPA STICK

MIPA Paint Mixing Stick. Includes 2:1 ratios on one side and 4:1 ratios on the other side. Aluminum. Sold as eaches.

- MIPASTICK** Mixing Stick 1/bx

Surface Prep



1K SOLVENT WASH

Application: A mild cleaning agent rich in active ingredients for the efficient removal of silicone, grease, oil, wax, dirt, tar, and soot.

Advantages: Excellent cleaning and degreasing properties and improves the adhesion to any paint coat. The product is used for the application of solvent-based paints.



SPRAY PASS
2 spray passes,
each 0.6 - 0.8 mil



CLEANING
wipe with a dry &
clean cloth

PROD NO.	DESCRIPTION	BX QTY
3680090	1K Solvent Wash	3/bx



GUN CLEANER

Application: Rich in active cleaning solvents for the thorough cleaning of the variator nozzle or conventional spray guns.

Advantages: Suitable for solvent and waterborne basecoats. Equipped with lancet. Cleans variator nozzle.



PROTECTIVE
GLOVES



PROTECTIVE
EYEWEAR

PROD NO.	DESCRIPTION	BX QTY
3680095	Gun Cleaner	3/bx

Primer / Primer Filler

1K E-COAT PRIMER



Application: A true direct to metal coating matching the color and gloss of factory primers and e-coat colors. Provides superior corrosion protection. Perfect color and gloss match for restoring the original appearance and gloss of factory e-coats. Use E-COAT on any e-coated panel, vehicle floor, engine bay, core support, trunk area, any inner body panel.

Advantages: Superior corrosion protection. Excellent color and gloss match to OEM factory coatings. Direct to steel and aluminum. Good hiding. Available in 6 popular OEM colors. Compatible with most automotive basecoats

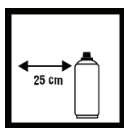

SPRAY DISTANCE
6 - 8 inches
(15 - 20 cm)



SPRAY PASS
Dry film thickness
1 - 2 spray passes,
each 1.2 - 1.8 mil

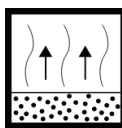

FLASH OFF TIME
Flash off time: 5 - 10
min. between each
spray coat



DRYING "DUST DRY"
TG1 dust dry: 25 min.



Variable
spray
nozzle!

PROD NO.	DESCRIPTION	BX QTY
3680230	1K E-Coat Primer White	3/bx
3680231	1K E-Coat Primer Light Green	3/bx
3680232	1K E-Coat Primer Olive Green	3/bx
3680233	1K E-Coat Primer Gray	3/bx
3680234	1K E-Coat Primer Black	3/bx
3680235	1K E-Coat Primer Tan	3/bx

1K ACRYLIC PRIMER FILLER - MEDIUM GRAY



Application: Acrylic filler with good stability, fast drying time and excellent dry-sanding properties. Ideal for spot repairs. Can be used on steel, galvanized steel, aluminum and various plastics.

Advantages: Excellent filling properties. Sag resistant. Excellent dry-sanding properties. Recoatable with all standard solvent-/ water borne basecoats or single stage topcoats.



SPRAY PASS
2 - 3 spray passes,
each approx. 0.8 mil

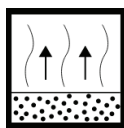

FLASH-OFF TIME
5 min
Top coat in 10-15 min / 68°F



DRYING INFRARED DEVICE
15 min / 68°F
IR: 3 min



**SANDING WET/DRY
MANUALLY**
P400 - P500
P800



Variable
spray
nozzle!

PROD NO.	DESCRIPTION	BX QTY
3680282	1K Acrylic Primer Filler	3/bx

Primer / Primer Filler

1K SELF ETCH WELD THRU PRIMER RED BROWN



Application: Corrosion protection primer with very good adhesion properties. Suitable for bare, sanded and unsanded surfaces. Cannot be retouched with polyester materials.

Advantages: Excellent corrosion protection. Good adhesion. Welding test certificate: repels welding beads. Can also be used on old paint coatings as a sealer.



SPRAY PASS
2-3 spray passes,
each 0.4 - 0.6 mil

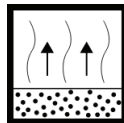

FLASH-OFF TIME
3 - 5 min
overcoatable:
10 - 15min / 68°F



DRYING INFRARED DEVICE
15-60 min / 68°F
IR: 7 min



SANDING "WET/DRY"
(Manually)
P400 - 500
P800



Variable
spray
nozzle!

PROD NO.	DESCRIPTION	BX QTY
3680001	1K Self Etch Weld Thru Primer	3/bx

1K SELF ETCH PRIMER FILLER LIGHT GRAY



Application: Can be used as a wash primer with good adhesion properties or as a filler primer with good filling volume depending on the thickness of application. Ideal for subsequent waterborne basecoats.

Advantages: Excellent corrosion protection. Fast drying. Welding certificate. Can be overcoated with all solvent based and waterborne base coats and 2K topcoat systems.



SPRAY PASS
2-3 spray passes,
each 0.4 - 0.6 mil

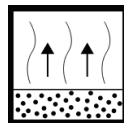

FLASH-OFF TIME
3 - 5 min
overcoatable:
10 - 15min / 68°F



DRYING INFRARED DEVICE
60 min / 68°F
30 min / 140°F
IR: 7 min



SANDING "WET/DRY"
(Manually)
P400 - 500
P800 - 1200



Variable
spray
nozzle!

PROD NO.	DESCRIPTION	BX QTY
3680003	1K Self Etch Primer Filler	3/bx

Primer / Primer Filler

2K EPOXY PRIMER - BEIGE 2K EPOXY PRIMER - GRAY 2K EPOXY PRIMER - BLACK

Application: Universal 2K epoxy primer filler for all problematic surfaces; for example, metal, non-ferrous metal, galvanized sheet steel, or anodized aluminum.

Advantages: Excellent adhesion and corrosion protection properties, even critical surfaces such as aluminum. Very smooth flow. Outstanding insulating & sealing properties. Recoatable with all standard solvent-/ water borne basecoats or single stage topcoats. For cleaned and sanded surfaces.



SPRAY PASS
2 - 3 spray passes,
each 1.2 - 1.4 mil

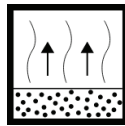

FLASH-OFF TIME
5 min.
Top coat in
15 min-12 hours / 68°F



DRYING INFRARED DEVICE
12 hours / 68°F
30 min / 120°F
IR: 20 min



SANDING WET/DRY MANUALLY
P400 - 500
P800 - 1200

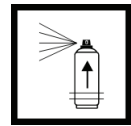

2K POTLIFE
4 days / 68°F

PROD NO.	DESCRIPTION	BX QTY
3680032	2K Epoxy Primer - Beige	3/bx
3680033	2K Epoxy Primer - Gray	3/bx
3680034	2K Epoxy Primer - Black	3/bx



Variable
spray
nozzle!

2K RAPID PRIMER FILLER - GRAY, NON-ISOCYANATE

Application: Universal, quick-drying 2K primer for high quality automotive paint jobs. Ideal for partial paint jobs and spot repair.

Advantages: Free from isocyanates and resistant to solvents. Quick drying (1 hour at 68°F). Good sandability. High filling capacity (up to 4 mil). Excellent adhesion, including on bare sheet and galvanized surfaces as well as existing sanded paint finishes. Recoatable with all standard solvent/water borne basecoats or single stage topcoats.



SPRAY PASS
2 - 3 spray passes,
each approx. 1.2 mil

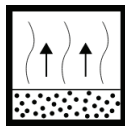

FLASH-OFF TIME
5-10 min
Top coat in 20 min / 68°F



DRYING
60 min / 68°F
30 min / 140°F
IR: 15 min



SANDING WET/DRY MANUALLY
P400 - 500
P800 - 1200

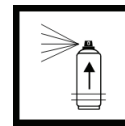

2K POTLIFE
24 hours / 68°F

PROD NO.	DESCRIPTION	BX QTY
3680031	2K Rapid Primer Filler	3/bx



Variable
spray
nozzle!

Primer / Primer Filler

2K WASH PRIMER



Application: 2K primer for fast insulation of sanded through areas as part of car repair paintwork. For cleaned and sanded surfaces such as steel, aluminum, hardened surfaces, 2K body fillers and old paintwork.

Advantages: Very good adhesion. Excellent anti-corrosion protection, in particular on aluminum. Must be recoated with 2K Urethane Acrylic Filler. Fast drying. (Do not overcoat with water-based paints or 2K epoxy primer surfacers. Do not overcoat with 2K UP putties.)



SPRAY PASS
1 - 2 spray passes,
0.4 - 0.6 mil

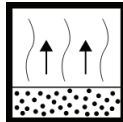

FLASH-OFF TIME
5 min



DRYING
10 min / 68°F

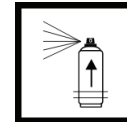

2K POTLIFE
96 hours / 68°F

PROD NO.	DESCRIPTION	BX QTY
3684029	2K Wash Primer	3/bx

Top Coats

NEW



1K TEXTURE COATING BLACK

Application: Special product for imitation of automotive plastic textured surfaces, particularly for plastic bumpers, trim strips and various plastic parts..

Advantages: Different kinds of patterns can be achieved. Easy to use. Dries very quickly. Can be topcoated with all conventional 1K basecoat solventborne and waterborne and 2K topcoat systems.

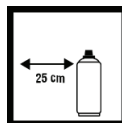

SPRAY DISTANCE
6 - 8 inches
(15 - 20 cm) Depending
on the desired pattern.
Spray distance and
speed should be varied.



SPRAY PASS
Dry film thickness
1.2 - 1.6 mil (approx 2-3
spray coats)

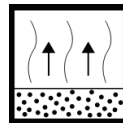

FLASH-OFF TIME
5-10 min / 68°F
between each spray coat



DRYING
TG1 dust dry: 15 min



Variable
spray
nozzle!

PROD NO.	DESCRIPTION	BX QTY
3680224	1K Texture Coating Black	3/bx

Top Coats

1K TRIM PAINT - BLACK SATIN



Application: For high-quality topcoat paint jobs and spot repairs on cars, motorcycles and other applications.

Advantages: Easy to use. High yield. Excellent coverage due to high solid matter content. Dries quickly. Very good flow.



SPRAY PASS
2 - 3 spray passes,
each 0.6 - 0.8 mil

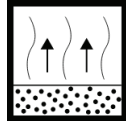

FLASH-OFF TIME
1 - 5 min / 68°F



DRYING INFRARED DEVICE
3 hours / 68°F
30 min / 140°F
IR: approx. 7 min



Variable
spray
nozzle!

PROD NO.	DESCRIPTION	BX QTY
3680102	1K Trim Paint - Satin Black	3/bx

2K HOT ROD BLACK SATIN



Application: For small damage repair jobs on existing semi gloss Hot Rod Back parts/surfaces or for an easy and fast paint job of a newer restored part.

Advantages: Easy to use. High quality two component coating. Very good flow. Highest chemical and weather resistance. Long lasting and very durable finish.



SPRAY PASS
2 - 3 spray passes,
each approx. 1 mil

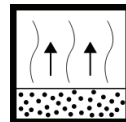

FLASH-OFF TIME
25 min / 68°F

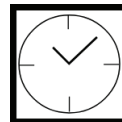

DRYING INFRARED DEVICE
3 hours / 68°F
35 min / 140°F

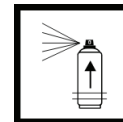

2K POTLIFE
24 hours / 68°F



Variable
spray
nozzle!

PROD NO.	DESCRIPTION	BX QTY
3680212	2K Hot Rod Black	3/bx

Clear Coats & Spot Blender



1K SPOT BLENDER

Application: 1K Spot Blender is a special product for homogeneous paint transitions in the blending area of 2K clearcoats as well as of single stage topcoats with outstanding blending results. The Spot Blender is used immediately after the clear- / topcoat is applied.

Advantages: Seamless edge transitions in the blending area. Superior blending ability. No color deviations. Ideal for spot repairs.



SPRAY PASS
2-3 very light
spray passes

PROD NO.	DESCRIPTION	BX QTY
3680093	1K Spot Blender	3/bx



1K CLEAR ACRYLIC

Application: 1K clear coat for quick coating and longterm sealing of repair paint jobs and new paint jobs on cars and motorcycles.

Advantages: Easy to use. Dries quickly. High gloss level. No color deviation. Good weathering resistance. Very good flow. Very good polishing ability.



SPRAY PASS
2 - 3 spray passes,
each 0.6 - 0.8 mil

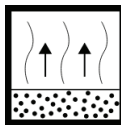

FLASH-OFF TIME
5 - 10 min / 68°F



DRYING INFRARED DEVICE
12 hours / 68°F
60 min / 140°F
IR: approx. 7 min

PROD NO.	DESCRIPTION	BX QTY
3680058	1K Clear Acrylic	3/bx

Clear Coats & Spot Blender



2K CLEAR GLAMOUR

Application: 2K clear coat with very high chemical, gasoline, and weather resistance for high-quality and long-term sealing of repair paint jobs and new paint jobs on cars and motorcycles.

Advantages: Maximum resistance to abrasion and scratching. Very smooth flow. Lasting high gloss. Very good polishing ability. No color deviation. Outstanding painting surface. Suitable even at higher ambient temperatures.



SPRAY PASS
2 spray passes,
each 0.6 - 0.8 mil

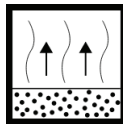

FLASH-OFF TIME
5 - 10 min / 68°F



DRYING INFRARED DEVICE
18 hours / 68°F
60 min / 140°F
IR: approx. 15 min

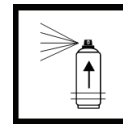

2K POTLIFE
48 hours / 68°F

PROD NO.	DESCRIPTION	BX QTY
3680061	2K Clear Glamour	3/bx

2K CLEAR RAPID

Application: 2K clear coat with very short drying time and very high chemical, gasoline and weathering resistance for high quality and longterm sealing of repair paint jobs and new paint jobs on cars and motorcycles. Ideally suited for spot repairs.

Advantages: Very fast drying. Very smooth flow. Lasting high gloss. Maximum resistance to abrasion and scratching. No color deviation. Outstanding painting surface. Very good polish ability. Suitable even at lower ambient temperatures. Ideally suited for small surfaces.



SPRAY PASS
2 spray passes,
each 0.6 - 0.8 mil

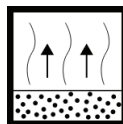

FLASH-OFF TIME
5 min / 68°F



DRYING INFRARED DEVICE
60 min / 68°F
30 min / 140°F
IR: approx. 15 min

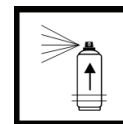

2K POTLIFE
14 hours / 68°F

PROD NO.	DESCRIPTION	BX QTY
3684064	2K Clear Rapid	3/bx

Clear Coats & Spot Blender

2K CLEAR MATTE



Application: Developed for the Small Damage Repair Process or complete painting of mounting parts.
Advantages: Very fast drying. Excellent flow. Highest chemical and weathering resistance.
 Gloss units @ 85°: Matte 12±3



SPRAY PASS
 2 spray passes,
 each 0.6 - 0.8 mil

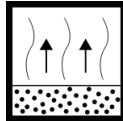

FLASH-OFF TIME
 5 - 10 min / 68°F



DRYING INFRARED DEVICE
 18 hours / 68°F
 60 min / 140°F
 IR: approx. 15 min

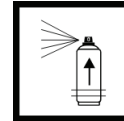

2K POTLIFE
 48 hours / 68°F

PROD NO.	DESCRIPTION	BX QTY
3680065	2K Clear Matte	3/bx

NEW

2K CLEAR SATIN



Application: Developed for the small damage repair process or completing painting of mounting parts.
Advantages: Very fast drying. Excellent flow. Highest chemical and weathering resistance.

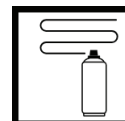

SPRAY PASS
 2 spray passes,
 each 0.6 - 0.8 mil

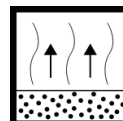

FLASH-OFF TIME
 5-10 min / 68°F



DRYING
 12 hours / 68°F
 60 min / 140°F
 IR: approx. 15 min

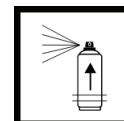

2K POTLIFE
 48 hours / 68°F

PROD NO.	DESCRIPTION	BX QTY
3680067	2K Clear Satin	3/bx

BLANK PAGE



PROFESSIONAL MASKING TAPE

Professional masking tape for paint shops as well as construction/industrial areas. Water and moisture resistant. Thin backing. Dry natural rubber solvent based adhesive. Good adhesion on uneven surfaces. Heat resistant up to 194°F / 90°C (30 min.). Removable without breaking and can be torn by hand. Sold by the sleeve only.

PROD	SIZE	QTY
134.820	3/4" - 19mm x 50m	12/sleeve
134.822	1-1/2" - 38mm x 50m	6/sleeve

DISCONTINUED

138.843

Euro 843 Liquid Putty.

A high viscosity liquid putty designed for easy sanding. Will not clog sandpaper and adheres to fillers, painted surfaces and metals including galvanized metal and steel. 1 oz. cream hardener included. Box Qty. 6



1827

Pressure Pump Spray Can.

A pressurized atomizer spray can for applying and atomizing liquids evenly and consistently. Solvent resistant due to viton seals. 1 Liter. Box Qty. 1



NEW

138.844

Euro 844 Liquid Putty.

Two-component polyester finishing putty designed for the professional. Excellent adhesion to metal, body filler, wood, fiberglass, and old/sanded OEM topcoats. Provides an ultra-smooth finish that is easy to sand while preventing sandpaper clogging. Includes BPO Pink Hardener. Box Qty. 8



BLANK

PAINTERS SUPPLIES

White Film Grip Discs White Aluminum Oxide Film



Item No.	Description	Qty.
7640	3" Grip Disc, 600 grit	50
7641	3" Grip Disc, 800 grit	50
7642	3" Grip Disc, 1000 grit	50
7643	3" Grip Disc, 1200 grit	50
7644	3" Grip Disc, 1500 grit	50
7645	3" Grip Disc, 2000 grit	50
7651	6" Grip Disc, 600 grit	50
7653	6" Grip Disc, 800 grit	50
7655	6" Grip Disc, 1000 grit	50
7657	6" Grip Disc, 1200 grit	50
7659	6" Grip Disc, 1500 grit	50
7661	6" Grip Disc, 2000 grit	50
7663	6" Grip Disc, 2500 grit	50
7665	6" Grip Disc, 3000 grit	50
7364	6" Backing Pad for Grip Discs	1
7045	Mandrel	1

9" x 11" Sanding Sheets Waterproof

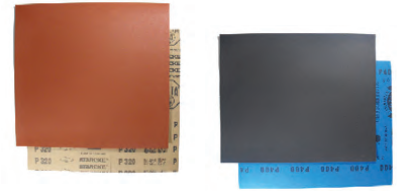

Item No.	Description	Qty.
7378	9" x 11" Dry Sanding Sheet, 320 grit <i>-Super Sharp, Easy Cutting</i>	50
7385	9" x 11" Waterproof Sheet, 400 grit	50
7386	9" x 11" Waterproof Sheet, 600 grit	50
7388	9" x 11" Waterproof Sheet, 800 grit	50
7389	9" x 11" Waterproof Sheet, 1000 grit	50
7390	9" x 11" Waterproof Sheet, 1200 grit	50
7391	9" x 11" Waterproof Sheet, 1500 grit	50
7392	9" x 11" Waterproof Sheet, 2000 grit	50
7393	9" x 11" Waterproof Sheet, 2500 grit	50
7394	9" x 11" Waterproof Sheet, 3000 grit <i>-Remains flexible. Will not crack or curl. Offers uniform sanding results</i>	50

GEMTEX® BRITE PREP NON-WOVEN 6 x 9 HAND SCUFF PADS



Manufactured from synthetic fibers, bonded together with specially formulated resins and impregnated throughout the web with mineral grain creating an open, three dimensional structure. These products are designed for a broad range of jobs including light duty cleaning, polishing, scuffing, finishing and for heavy duty jobs including paint, rust and corrosion removal. Will not rust, and can be used for dry scuffing and finishing or may be used with water or chemical solvents. They are flexible enough to be used in hard to reach spots, yet strong enough for continuous use. They are produced in a variety of grades ranging from hand cleaning to high-speed machine use. "A Steel Wool Substitute".

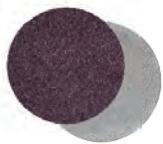

Item No.	Description	Bx. Qty.
7185	6" x 9", Fine - Gray	20
7180	6" x 9", Medium - Maroon	20
7179	6" x 9", Super Medium - Green	20
7187	6" Round, Gen. Purpose - Maroon	10
7188	6" round, Fine - Gray	10

FLEXIBLE SURFACE PREP SANDING PAD SPONGES



Coated on one side with an Aluminum Oxide abrasive. Flexible hand held sponges for hard to reach places. Can be used on wood, metal and painted surfaces. Great for general polishing in the woodworking, cabinetry and automotive industries. Pads are 5-1/2" x 4-1/4" x 3/16" in size.

7196	Medium, Gray	20/bx
7197	Fine, Blue	20/bx
7198	Very Fine, Red	20/bx
7199	Super Fine, Yellow	20/bx
7194	Assortment (20 pads)	1/bx

7194 Assortment includes 5 each of 7196, 7197, 7198, 7199

PAINTERS SUPPLIES



- 9710 DeVilbiss 3 Stage Desiccant Filter/Dryer Box Qty. 1
- 9711 Replacement Filter Cartridges Box Qty. 1

Cost effective. Use anywhere. Complete air control. A perfect solution for restoration shops, customizing shops and hobbyist. High performance filtration with only 2 PSI pressure drop. Three-stage filtering with 0.1 micron rating produces clean, oil and humidity free air resulting in outstanding paint finishes by removing water particulates, oil and humidity. Quick change filter cartridge is easy to maintain. Bowl removal tool included. Larger filter media and longer life desiccant than disposable dryers: 4X more filter area, 16X more desiccant. Low life-cycle costs. Complete air control enabling better color match and coating thickness. Inlet shut off valve, regulator and gauge, humidity indicator, bowl drain.



FLEXZILLA® PRO HIGH FLOW INTERCHANGE

FLEXZILLA® Pro High Flow couplers and plugs allows Twice The Flow to your air tools. Connect Flexzilla High Flow fittings from your tool all the way to the compressor. This ensures the best performance your air system can provide. For maximum efficiency, use Flexzilla Pro High Flow! Maximum Torque - Maximum RPM - Push Connect System.

Maximum Working Pressure: 300 PSI

- 3585 High Flow Kit Includes (1) 3586, (1) 3587, (1) 3588 Box Qty. 1

"FLEXZILLA®" PRO (REPAIRABLE) AIR HOSE

"FLEXZILLA™" is a revolutionary hose featuring a Premium Hybrid Polymer material that redefines flexibility. Flexzilla® hose characteristics offer zero memory allowing it to lay-flat exactly where you drop it and will not work against you during operation or coiling after use. Extreme all-weather flexibility, even in subzero conditions (-40° to 140°F). Permits use in environments where general purpose PVC and rubber hoses may become too stiff. Kink resistant under pressure. Excellent abrasion-resistant outer cover. Includes bend restrictor that reduces wear and tear, prolonging the life of the hose. Flexzilla® Hi-Vis color, safety green, makes hose more visible in the workplace. This hose is field repairable with reusable aircraft aluminum fittings. Maximum Working Pressure..... 300 PSI



- 4080 3/8" x 25 ft. 1/4" MNPT
- 4081 3/8" x 35 ft. 1/4" MNPT <--- Most popular paint booth length!!
- 4082 3/8" x 50 ft. 1/4" MNPT



- 4084 Reusable End
Used With 3/8" Flexzilla Pro
Box Qty. 1



- 4085 Reusable Splicer
Used With 3/8" Flexzilla Pro
Box Qty. 1



- 4086 1/4" NPT
Swivel Connector
Bx. Qty. 1

"FLEXZILLA®" PRO WATER HOSE

FLEXZILLA® is a revolutionary hose featuring a Premium Hybrid Polymer material that redefines flexibility. Flexzilla® hose characteristics offer zero memory allowing it to lay-flat exactly where you drop it and will not work against you during operation or coiling after use. Extreme all-weather flexibility. Kink resistant under pressure. Excellent abrasion-resistant outer cover. Flexzilla® Hi-Vis color, safety green, makes hose more visible in the workplace. Includes bend restrictors that reduces wear and tear, prolonging the life of the hose. Anodized aircraft aluminum ends. Drinking water safe! This hose is field repairable! Maximum Working Pressure: 150 PSI



- 4070 5/8" x 50 ft. Flexzilla Pro Water Hose Box Qty. 1

MEASURING / MIXING CUPS AND LIDS

Great mixing cups for all your mixing needs. Available in all major brand measurements. Transparent plastic with easy to read measurements. Reusable - print on cups will not wash off. Lids sold separately.



Item No.	Description	Bx Qty.
908	8 oz. Mixing Cup	100
908L	8 oz. Cup Lid	100
916	16 oz. Mixing Cup	100
916L	16 oz. Cup Lid	100
932	32 oz. Mixing Cup	100
932L	32 oz. Cup Lid	100
980	80 oz. (2 1/2 Qt) Mixing Cup	50
980L	80 oz. (2 1/2 Qt) Cup Lid	50

INDUSTRIAL SINGLE EDGE RAZOR BLADES



These single faceted blades provide durability for more abusive applications. Fabricated from surgical steel and are made specifically for auto trim, glass and auto body applications.

97069	100/BX
97069-50	5000/BX



ACID BRUSHES

Tin Handle with Horse Hair Bristles
Box Qty. 144

97100	3/8" (Brush Width) x 6" Long
97101	1/2" (Brush Width) x 6" Long



RUBBLE WRAP SELF-ADHESIVE PLASTIC FILM

Used to seal broken windows and uncloseable doors of vehicles exposed to weather following a collision or vandalism. Coated with a light tack adhesive designed to grip the surface then be removed without leaving adhesive residue on the surface. The film features UV inhibitors to prevent damage when exposed to sunlight for lengthy periods of time. Thickness: 3 mil. One per pkg.

9735	36" x 100 ft.	Box Qty. 1
------	---------------	------------



PROFESSIONAL MASKING TAPE

Professional masking tape for paint shops as well as construction/ industrial areas. Water and moisture resistant. Thin backing. Dry natural rubber solvent based adhesive. Good adhesion on uneven surfaces. Heat resistant up to 194°F / 90°C (30 min.). Removable without breaking and can be torn by hand. Sold by the sleeve only.

PROD	SIZE	QTY
134.820	3/4" - 19mm x 50m	12/sleeve
134.822	1-1/2" - 38mm x 50m	6/sleeve

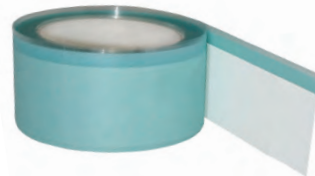

TRIM MASKING TAPE - HIGH TEMP, ACRYLIC

A wash paper masking tape, with high adhesive properties, especially designed to perform well in most industrial painting and automotive masking applications. A high temperature tape where excellent holding and high temperature performance are required.

70741 45mm x 10mm long	1/bx
-------	------------------------------	------

PAINTERS SUPPLIES



BUFF AND SHINE KIT

Buff and Shine Kit includes three pads and a backing plate. The three pads are: #752R for heavy compounding, #830WR for polishing and #820WR for finishing along with a grip backing plate #658Y. The three pads have a patented Center Tee for fast easy pad loading and centering every time. The Buff and Shine Kit was designed for the body shop technician in mind. This kit was designed to keep a simple set of pads in the shop for the technician and speed up the return of the vehicle to the owner. Each kit has the necessary pads needed in a body shop after a vehicle is painted and color sanded which will eliminate cross contamination. A high quality design - made in the USA!

- 8" diameter of contact surface ensures faster detailing jobs
- Centers backing plate every time
- Center ring ensures wobble-free buffing
- Center ring is fully washable
- Waffle pattern keeps pad life up and heat friction down and allows air to flow in and out of the pad for a smoother, cooler buffing experience.

Item No.	Description	Application	Qty.
TP1WR	KIT - Contains 1 each: 752R, 830WR, 820WR, 658Y	Kit	1
752R	100% 4-ply twisted wool Grip-Pad w/center ring	Heavy Cutting	1
830WR	Yellow foam Grip-Pad, waffle pattern w/center ring	Lt Cut/Polishing	1
820WR	Black foam Grip-Pad, waffle pattern w/center ring	Finishing	1
658Y	Grip Backing Plate with 5/8 x 11 thread	Backing Plate	1
850WR	Blue Foam Grip-Pad, waffle pattern w/ center ring	Soft Polishing	1



MINI BUFFING KIT

Designed for small buffing areas. 3" dia. pads. Contains a total of 7 pieces: four pads, grip backing plate, two adapters.

- Heavy compounding pad - 100% 4Ply Twisted Wool.
- Medium compounding pad - Wool Blend 4Ply Twist.
- Polishing pad - Reticulated Polyester Foam.
- Finishing pad - Reticulated Polyester Foam.
- Grip backing plate - 5/8"x11 thread grip pad.
- Two adapters (one for a pneumatic polisher, one for a drill).

TP-4 Mini Buffing Kit Box Qty. 1



SPEEDY SURFACE PREP TOWEL

12" x 12", Medium grade - Blue. For medium to heavy surface contaminates.

97105 Box Qty. 1



SPEEDY SURFACE PREP KIT

Contains one mini towel, one 4 oz. bottle of prep spray and one microfiber towel.

97106 Box Qty. 1.



Meets
ANSI Z87.1+
Standards
Anti-Scratch

96606

- Lightweight Safety Glasses
- High Impact Clear Polycarbonate Lens
 - Lightweight Wrap Around Lens
 - Anti-Scratch
 - 99.9% UVA, UVB Protection
 - Distortion Free Lens
 - Soft & Lightweight Temples
 - Soft Rubber Nose Piece For Comfort
- Box Qty. 12



Meets
ANSI Z87.1+
Standards
Anti-Scratch,
Anti-Fog

96607

- Lightweight Safety Glasses
- High Impact Clear Polycarbonate Lens
 - Lightweight Wrap Around Lens
 - Anti-Scratch, Anti-Fog
 - 99.9% UVA, UVB Protection
 - Distortion Free Lens
 - Soft & Lightweight Temples
 - Soft Rubber Nose Piece For Comfort
- Box Qty. 12

NEW



**POWDER FREE
NITRILE
6 MIL**

Nitrile Gloves (Powder-Free)

Powder-free. Superior puncture and abrasion resistance. Latex-free textured grip. Beaded cuff & ambidextrous. 6 Mil Nitrile.

96325	Medium	120/BX
96326	Large	120/BX
96327	X-Large	120/BX

NEW



**POWDER FREE
NITRILE
6 MIL**

Nitrile Gloves - Black

6 mil nitrile gloves. Superior puncture & abrasion resistance. Textured grip. Beaded cuff. Powder-free.

KX9943	Medium	100/BX
KX9944	Large	100/BX
KX9945	X-Large	100/BX



**GRAY NYLON
OPEN KNIT
REUSABLE**

QUALAKOTE® ASSEMBLY GLOVES

Gray nylon. Light weight. Dipped palm & fingers repels oils & cleaners. Open knit back breaths for day-long comfort. Washable, reusable for economy.

96315	Medium	1 Pair/pkg
96316	Large	1 Pair/pkg
96317	X-Large	1 Pair/pkg



FOAM EAR PLUGS

Tapered, Polyurethane Foam, Uncorded Ear plugs. 31 Noise Deduction Rating (NRR). CSA Class AL. Super Soft, comfortable polyurethane foam exerts very low pressure on ear canal. Each pair individually packaged. Box opens on front for easy dispensing.

96610 200 Pair per Box



EP6 EARPLUGS (MEDIUM)

Protects against loud harmful noises without interfering with the hearing of routing sounds or conversations. Comes with a protective case.

96611 Box Qty. 12 pairs



FIRST AID KIT ASSORTMENT

Plastic case (gasketed) for protection. Meets ANSI Z308.1 Standards. Ten person kit.

96620 Box Qty. 1

PORTABLE EYE WASH STATION

Portable eye wash station meets OSHA requirements. Includes mounting bracket, inspection tag and water preservative. Change water every 90 days. NO PLUMBING REQUIRED. (unit measures 25" x 19-1/2" x 11-1/2")



- 1-Hand Operation
- No Plumbing
- Gravity Fed
- 0.4 Gallons Per Minute (GPM) for 15 Minutes
- ANSI Z358.1 Compliant
- Built-in Handles & Wall Mount
- Double Latch Tray for Secure Hold

Item No.	Description	Bx. Qty.
96649	Eye Wash Station	1
96650	Water Preservative 8 fl. oz.	4
96651	Inspection Tag	5

PAINTERS SUPPLIES



FOLDING PARTICULATE RESPIRATOR MASK

3D cup shape can also fold flat for easy storage and portability. Can be folded and placed in your pocket! Incredible comfort. Adjustable integrated nose-piece. Fluid resistant.

96500 Folding Mask Bx Qty. 20



PARTICULATE RESPIRATOR MASK WITH EXHALATION VALVE

All the features of the #96505 mask with the added feature of our LPD (low pressure drop) exhalation valve for easy breathing and increased worker comfort. Prevents safety glasses from clouding or fogging up.

96510 Mask w/Valve Bx Qty. 10



PARTICULATE RESPIRATOR MASK

Durable, latex-free ultrasonically welded head straps withstand tough use. Adjustable contoured nose-piece and soft open cell foam nose cushion ensure proper fit and increased comfort.

96505 Particulate Dusk Mask Bx Qty. 20



- 9728 LACKIER Painters Coverall - Medium
- 9729 LACKIER Painters Coverall - Large
- 9730 LACKIER Painters Coverall - X-Large
- 9731 LACKIER Painters Coverall - XX-Large
- 9732 LACKIER Painters Coverall - XXX-Large

Anti-static. Tear resistant. Fire resistant. Impermeable to paint. 100% Polyester. Full zipper front and elastic wrists. Elastic bands on the cuffs and trouser legs. Excellent protection against isocyanate based coatings. Machine washable at 60°. One per pkg.



DELUXE SPRAY SOCK

Lightweight, breathable Lycra fits snugly around head and neck. One size fits all.

9715 Deluxe Spray Sock 1 per pkg.



- 9720 GEN-NEX Painters Coverall - Medium
- 9721 GEN-NEX Painters Coverall - Large
- 9722 GEN-NEX Painters Coverall - X-Large
- 9723 GEN-NEX Painters Coverall - XX-Large

Anti-static. Cloth-like fiber. Full zipper front and elastic wrists. Non-elastic ankle cuffs. Excellent protection against isocyanate based coatings. One per pkg.



UNIVERSAL SORBENT PADS

Used to clean up both water and oil based fluid leaks, drips or spills. Made from meltblown polypropylene allowing them to soak up oil, water and even aggressive chemicals. Pad Size: 15" x 18"

97078 200 pads per bag



BARREL TOP ABSORBENT PADS

Heavy-Duty Barrel Top Absorbent Pads soak up both oil and water as well as grease, transmission fluid, hydraulic fluid, diesel fuel, coolants and many other fluids. Pads are 22" in diameter and fit standard 55 gallon drums. Sold in pack quantity only (10 pads).

Part no.	Description	
97079	Pad Size: 22"	10/box

OPTI-FIT FULL FACE CARTRIDGE RESPIRATOR

NIOSH Approved TC-84A-1420 Silicone skirt offers exceptional durability and comfort. Nose cup prevents fogging. Wide viewing area offering distortion free visibility and optical clarity. Five-point head strap. Polycarbonate lens treated with anti-scratch coating.



96700 Full Face Cartridge Respirator - Medium 1 per pkg.

96701 Full Face Cartridge Respirator - Large 1 per pkg.

96702 Replacement Cartridge & N95 Filters Combo Kit

96704 Clear Peel-Off Lens Covers 25 per pkg.

DUAL CARTRIDGE RESPIRATOR MASK

Maintenance free half mask comes completely and permanently assembled with cartridges. Ready to use. No spare parts to stock. No cartridges to replace. Soft, lightweight thermoplastic elastomer face piece, cradle suspension and easy-adjust head straps facilitate proper and comfortable fit. NIOSH approved.



96520 Medium Respirator Bx Qty. 1

96521 Large Respirator Bx Qty. 1

Disposable



FLEXIBLE PRIMER SURFACER (GRAY)

A fast drying, easy sanding, flexible primer formulated for all flexible/rigid plastic autobody parts. Good filling and easy sanding. Dries in 5-10 minutes and can be feathered. High solids content. Compatible with most automotive paint.

4185 20 oz. aerosol can 12/Box
Net Weight 15 oz.



INTER-BOND ADHESION PROMOTER

A specially designed formula to promote super strong adhesion to all TPO-polyolefin based materials before painting or repairing. Seals in oils and plasticizers that are an integral part of any polyolefin based substrate. Fast tacking. Non isocyanate.

4182 16 oz. aerosol can 12/Box
Net Weight 12 oz.



INTER-BOND LOW VOC ADHESION PROMOTER

Designed to improve adhesion and help prevent paint peeling on new unfinished plastic parts and previously painted surfaces. It modifies the surface properties of "difficult" polyolefin plastics like polypropylene, TPO, TPE, EDPM and other plastics, creating a tie coat between the plastic and the top coat. Works equally well on fiberglass, aluminum, vinyl, galvanized metal and painted surfaces. Clear in color.

*Prevents paint peeling on new unfinished plastic parts and previously painted surfaces.
 Easy to use and cost efficient.
 Can be topcoated with any type of paint system.
 Works on flexible and rigid surfaces.*

1809 4 fl. oz. pump spray bottle 6/Box
1810 1 Quart (0.95L) 6/Box
1811 1 Gallon Can (3.75L) 4/Box



QUICKIE 5000 ADHESIVE / CEMENT REMOVER

An extra strength, fast acting solvent for removing dried rubber cement, sealers, overspray, undercoating, tar, silicone and wax. Fast drying. Non-staining. Film free. Contains no Chlorinated Solvents or CFC'S.

Does not meet California & OTC regulations.

4750 24 oz. aerosol can 12/Box
Net Weight 16 oz.
1750 32 fl. oz. can 12/Box
1752 5 gallon pail 1/Box



ALL-IN-ONE IES SELF-ETCHING PRIMER

This primer chemically etches the surface of bare metal to replace the "metal conditioning" step needed for corrosion resistance. Ideal for small rub-throughs. This product can also be used to prime aluminum and galvanized surfaces to prevent top coats from peeling off. This new improved formula works well on plastics, SMC and fiberglass! Professional fan spray. Corrosion resistant. Excellent adhesion. Dries fast. Easy to use. No measuring, mixing or gun cleaning. Net Weight 14 oz.

*For Steel, Aluminum and Plastic Parts!
 For Rigid or Flexible Surfaces!*

4186 GREEN 20 oz. aerosol can 12/Box
4188 GRAY 20 oz. aerosol can 12/Box



INTER-CLAD "DOUBLE-DUTY" 1K ADHESION PRIMER & SEALER

A 2 in 1 elastomeric coating that facilitates adhesion to TPO, TEO and PP substrates. Has a built in adhesion promoter that saves you time and money. Topcoat can be applied without the need of sanding or scuffing as soon as it is dry. Ideal for easy refinishing of new unprimed OEM replacement bumpers as well as reconditioned bumpers. Gray in color.

*Provides superior adhesion to TPO, TEO & PP plastics
 Works on flexible or rigid substrates
 No sanding or scuffing is required
 Outstanding flexibility
 Ideal for easy refinishing of new, unprimed
 OEM replacement bumpers*

1815 1 Quart (0.95L) 4/Box
1816 1 Gallon Can (3.75L) 1/Box



SUPER CLEANING SOLVENT

A quick, safe, multi-purpose virgin solvent. Excellent for removing silicone wax, adhesives, tar, undercoating, sealers, paint overspray and bugs. Safe on most fully cured paints, fabric, vinyl, glass and most plastics. Non-staining. Film free. Contains no Chlorinated Solvents or CFC'S.

Does not meet California & OTC regulations.

4700 24 oz. aerosol can 12/Box
Net Weight 16 oz.
1700 32 fl. oz. can 12/Box
1701 1 gallon can 4/Box
1702 5 gallon pail 1/Box

PAINTERS SUPPLIES

SUPER CLEAN 2

Waterborne Plastic Prep Anti-Static!

IES Super Clean 2 is a water based cleaner and paint prep all in one! Suitable for cleaning metal (including aluminum and galvanized), old paint finishes, transport coatings, primers, glass, fiberglass and plastics. Removes dirt, bugs, sanding dust, grease, finger prints, salt, soap rests, silicone, etc.. Improves adhesion before applying primers, paints, coatings, and adhesives. Eliminates static. NOTE: Not recommended to remove tar or glue. 50 State Compliant!



1790	quart	6/Box
1791	gallon	4/Box
1792	5 gallon	1/Box

PAINT GUN PAINT REMOVER NON-CHLORINATED

A heavy-duty cleaning solvent that is great as a paint gun cleaner. Quickly removes paint overspray from metal surfaces and spray equipment. Also works great for removing grease, adhesives, dirt, and grime. Quick Action Formula. Heavy Duty. Leaves No Residue.



*High Pressure
Quick Action Formula
Heavy Duty
Leaves No Residue*

4545	20 oz. aerosol can	12/Box
	<i>Net Weight 14 oz.</i>	

NEW

PAINTER'S PUNCH

Superior heavy duty paint removing hand cleaner. Quickly removes oil based paints, lacquers, and enamels. Melts adhesives, sealers, primers and resins from your skin. Fortified with superior skin conditioners to help promote good hand health. 400ml bottle.



PAINTER'S PUNCH	400ml bottle	1/Box
-----------------	--------------	-------

MADE IN GERMANY - MIPA IS THE THIRD LARGEST PAINT COMPANY IN GERMANY

C210 CLEARCOAT

Meets all demands on quick, high-quality paint jobs. C210 is a medium-solids clearcoat that is a thinner viscosity than the C75, but still thicker than most clearcoats. Ideal for high-production shops.

- Excellent Gloss
- Low 3.5 VOC
- Quick dry
- Fast Buffing Time
- Easiest Clear To Buff
- Best UV Protection and No Yellowing

C210 CLEARCOAT

C210-1L Clearcoat 1 liter

C210-5L Clearcoat 5 liters

MS HARDENER Low VOC

MS HARDENERS

MS10-2.5L	Fast Hardener	2.5 liter
MS25-2.5L	Normal Hardener	2.5 liter
MS35-2.5L	Slow Hardener	2.5 liter
MS40-2.5L	Extra Slow	2.5 liter



Reduce:	0-10%
Coats:	2-3
Coat Thickness:	1.5 mils per coat
Mix Ratio:	2:1
Use 1.3 - 1.5 nozzle gravity HVLP @ 8-10psi	

Flash Time @ 68°F:	5-20 min
Flash Time @ 140°F:	5 min.
Handable @ 68°F:	20-30 min.
Handable @ 140°F:	15 min.
Complete Dry @ 68°F:	Overnight
Complete Dry @ 140°F:	30 min.

All times are dependant upon temperature, humidity, air circulation and hardener used.

C75 CLEARCOAT

Ideal for extra high-quality orientated shops and is a high-viscosity, high-solids clearcoat.

A urethane clearcoat for clear over base process, with active UV protection and short drying time.

Universally suitable for two-coat painting. Excellent resistance against weathering and yellowing, very high gloss and good build.

- Brilliant Surface
- Excellent Drying
- High UV protection, No Yellowing
- High Solid Content and Environmental Protection

C75 CLEARCOAT

C75-1L Clearcoat 1 liter

C75-5L Clearcoat 5 liters

MS HARDENER Low VOC

MS HARDENERS

MS10-2.5L	Fast Hardener	2.5 liter
MS25-2.5L	Normal Hardener	2.5 liter
MS35-2.5L	Slow Hardener	2.5 liter
MS40-2.5L	Extra Slow	2.5 liter



Reduce:	0-10%
Coats:	2
Coat Thickness:	2 mils per coat
Mix Ratio:	2:1
Flash time between coats:	5-10 min.
Use 1.3 - 1.5 nozzle gravity HVLP @ 8-10psi	

Flash Time @ 68°F:	10-40 min
Flash Time @ 140°F:	5-10 min.
Handable @ 68°F:	4-5 min.
Handable @ 140°F:	15-30 min.
Complete Dry @ 68°F:	Overnight
Complete Dry @ 140°F:	30-40 min.

All times are dependant upon temperature, humidity, air circulation and hardener used.

PAINTERS SUPPLIES

MADE IN GERMANY - MIPA IS THE THIRD LARGEST PAINT COMPANY IN GERMANY

4+1 PRIMER

The absolute filler used as the basis for excellent paintwork.
Will fill and cover 80 grit sandpaper scratches.

- High Filling Power
- Fast Drying
- Excellent Sanding Ability
- High Solid Content - HS Quality

URETHANE PRIMER FILLER

- 4-1PRIMER-1L — Primer — 1 liter **DISC**
- 4-1PRIMER-3L — Primer — 3 liters

H5/H10 HARDENER

H5/H10 HARDENERS

- H5-1L — Extra Fast Hardener — 1 liter
- H10-1L — Fast Hardener — 1 liter



- Reduce: 0-10%
- Mix Ratio: 4:1
- Use 1.5 - 1.7 nozzle in spray gun
- Flash-Off Time: 15 min
- Recoat Time @ 68°F: 3-5 hours
- Recoat Time @ 140°F: 30-40 min

All times are dependant upon temperature, humidity, air circulation and hardener used.



REDUCER

- REDUCER-N-1L — Normal — 1 liter
- REDUCER-F-5L — Fast — 5 liter
- REDUCER-N-5L — Normal — 5 liter
- REDUCER-S-5L — Slow — 5 liter



MIPA STICK

MIPA Paint Mixing Stick. Includes 2:1 ratios on one side and 4:1 ratios on the other side. Aluminum. Sold as eaches.

- MIPASTICK — Mixing Stick — 1/bx

Surface Prep



1K SOLVENT WASH

Application: A mild cleaning agent rich in active ingredients for the efficient removal of silicone, grease, oil, wax, dirt, tar, and soot.

Advantages: Excellent cleaning and degreasing properties and improves the adhesion to any paint coat. The product is used for the application of solvent-based paints.



SPRAY PASS
2 spray passes,
each 0.6 - 0.8 mil



CLEANING
wipe with a dry &
clean cloth

PROD NO.	DESCRIPTION	BX QTY
3680090	1K Solvent Wash	3/bx



GUN CLEANER

Application: Rich in active cleaning solvents for the thorough cleaning of the variator nozzle or conventional spray guns.

Advantages: Suitable for solvent and waterborne basecoats. Equipped with lancet. Cleans variator nozzle.



PROTECTIVE GLOVES



PROTECTIVE EYEWEAR

PROD NO.	DESCRIPTION	BX QTY
3680095	Gun Cleaner	3/bx

Primer / Primer Filler

1K E-COAT PRIMER

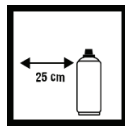

SPRAY DISTANCE
6 - 8 inches
(15 - 20 cm)



SPRAY PASS
Dry film thickness
1 - 2 spray passes,
each 1.2 - 1.8 mil

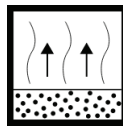

FLASH OFF TIME
Flash off time: 5 - 10
min. between each
spray coat



DRYING "DUST DRY"
TG1 dust dry: 25 min.



Variable
spray
nozzle!

PROD NO.	DESCRIPTION	BX QTY
3680230	1K E-Coat Primer White	3/bx
3680231	1K E-Coat Primer Light Green	3/bx
3680232	1K E-Coat Primer Olive Green	3/bx
3680233	1K E-Coat Primer Gray	3/bx
3680234	1K E-Coat Primer Black	3/bx
3680235	1K E-Coat Primer Tan	3/bx

1K ACRYLIC PRIMER FILLER - MEDIUM GRAY



SPRAY PASS
2 - 3 spray passes,
each approx. 0.8 mil

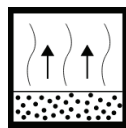

FLASH-OFF TIME
5 min
Top coat in 10-15 min / 68°F



DRYING INFRARED DEVICE
15 min / 68°F
IR: 3 min



**SANDING WET/DRY
MANUALLY**
P400 - P500
P800



Variable
spray
nozzle!

PROD NO.	DESCRIPTION	BX QTY
3680282	1K Acrylic Primer Filler	3/bx

Primer / Primer Filler

1K SELF ETCH WELD THRU PRIMER RED BROWN



Application: Corrosion protection primer with very good adhesion properties. Suitable for bare, sanded and unsanded surfaces. Cannot be retouched with polyester materials.
Advantages: Excellent corrosion protection. Good adhesion. Welding test certificate: repels welding beads. Can also be used on old paint coatings as a sealer.



SPRAY PASS
2-3 spray passes,
each 0.4 - 0.6 mil

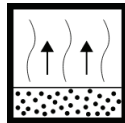

FLASH-OFF TIME
3 - 5 min
overcoatable:
10 - 15min / 68°F



DRYING INFRARED DEVICE
15-60 min / 68°F
IR: 7 min



SANDING "WET/DRY"
(Manually)
P400 - 500
P800



Variable
spray
nozzle!

PROD NO.	DESCRIPTION	BX QTY
3680001	1K Self Etch Weld Thru Primer	3/bx

1K SELF ETCH PRIMER FILLER LIGHT GRAY



Application: Can be used as a wash primer with good adhesion properties or as a filler primer with good filling volume depending on the thickness of application. Ideal for subsequent waterborne basecoats.

Advantages: Excellent corrosion protection. Fast drying. Welding certificate. Can be overcoated with all solvent based and waterborne base coats and 2K topcoat systems.



SPRAY PASS
2-3 spray passes,
each 0.4 - 0.6 mil

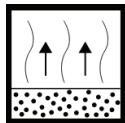

FLASH-OFF TIME
3 - 5 min
overcoatable:
10 - 15min / 68°F



DRYING INFRARED DEVICE
60 min / 68°F
30 min / 140°F
IR: 7 min



SANDING "WET/DRY"
(Manually)
P400 - 500
P800 - 1200



Variable
spray
nozzle!

PROD NO.	DESCRIPTION	BX QTY
3680003	1K Self Etch Primer Filler	3/bx

Primer / Primer Filler

2K EPOXY PRIMER - BEIGE 2K EPOXY PRIMER - GRAY 2K EPOXY PRIMER - BLACK

Application: Universal 2K epoxy primer filler for all problematic surfaces; for example, metal, non-ferrous metal, galvanized sheet steel, or anodized aluminum.

Advantages: Excellent adhesion and corrosion protection properties, even critical surfaces such as aluminum. Very smooth flow. Outstanding insulating & sealing properties. Recoatable with all standard solvent-/ water borne basecoats or single stage topcoats. For cleaned and sanded surfaces.



SPRAY PASS
2 - 3 spray passes,
each 1.2 - 1.4 mil

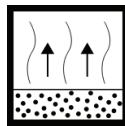

FLASH-OFF TIME
5 min.
Top coat in
15 min-12 hours / 68°F



DRYING INFRARED DEVICE
12 hours / 68°F
30 min / 120°F
IR: 20 min



SANDING WET/DRY
MANUALLY
P400 - 500
P800 - 1200

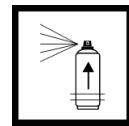

2K POTLIFE
4 days / 68°F

PROD NO.	DESCRIPTION	BX QTY
3680032	2K Epoxy Primer - Beige	3/bx
3680033	2K Epoxy Primer - Gray	3/bx
3680034	2K Epoxy Primer - Black	3/bx



Variable
spray
nozzle!

2K RAPID PRIMER FILLER - GRAY, NON-ISOCYANATE

Application: Universal, quick-drying 2K primer for high quality automotive paint jobs. Ideal for partial paint jobs and spot repair.

Advantages: Free from isocyanates and resistant to solvents. Quick drying (1 hour at 68°F). Good sandability. High filling capacity (up to 4 mil). Excellent adhesion, including on bare sheet and galvanized surfaces as well as existing sanded paint finishes. Recoatable with all standard solvent/water borne basecoats or single stage topcoats.



SPRAY PASS
2 - 3 spray passes,
each approx. 1.2 mil

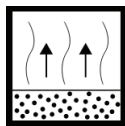

FLASH-OFF TIME
5-10 min
Top coat in 20 min / 68°F



DRYING
60 min / 68°F
30 min / 140°F
IR: 15 min



SANDING WET/DRY
MANUALLY
P400 - 500
P800 - 1200

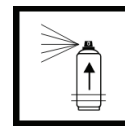

2K POTLIFE
24 hours / 68°F

PROD NO.	DESCRIPTION	BX QTY
3680031	2K Rapid Primer Filler	3/bx



Variable
spray
nozzle!

Primer / Primer Filler

2K WASH PRIMER



Application: 2K primer for fast insulation of sanded through areas as part of car repair paintwork. For cleaned and sanded surfaces such as steel, aluminum, hardened surfaces, 2K body fillers and old paintwork.

Advantages: Very good adhesion. Excellent anti-corrosion protection, in particular on aluminum. Must be recoated with 2K Urethane Acrylic Filler. Fast drying. (Do not overcoat with water-based paints or 2K epoxy primer surfacers. Do not overcoat with 2K UP putties.)



SPRAY PASS
1 - 2 spray passes,
0.4 - 0.6 mil

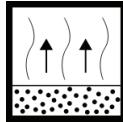

FLASH-OFF TIME
5 min

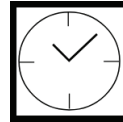

DRYING
10 min / 68°F

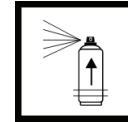

2K POTLIFE
96 hours / 68°F

PROD NO.	DESCRIPTION	BX QTY
3684029	2K Wash Primer	3/bx

Top Coats

NEW



1K TEXTURE COATING BLACK

Application: Special product for imitation of automotive plastic textured surfaces, particularly for plastic bumpers, trim strips and various plastic parts..

Advantages: Different kinds of patterns can be achieved. Easy to use. Dries very quickly. Can be topcoated with all conventional 1K basecoat solventborne and waterborne and 2K topcoat systems.

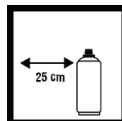

SPRAY DISTANCE
6 - 8 inches
(15 - 20 cm) Depending
on the desired pattern.
Spray distance and
speed should be varied.

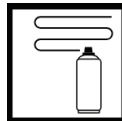

SPRAY PASS
Dry film thickness
1.2 - 1.6 mil (approx 2-3
spray coats)

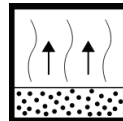

FLASH-OFF TIME
5-10 min / 68°F
between each spray coat



DRYING
TG1 dust dry: 15 min



Variable
spray
nozzle!

PROD NO.	DESCRIPTION	BX QTY
3680224	1K Texture Coating Black	3/bx

PAINTERS SUPPLIES

Top Coats

1K TRIM PAINT - BLACK SATIN



Application: For high-quality topcoat paint jobs and spot repairs on cars, motorcycles and other applications.

Advantages: Easy to use. High yield. Excellent coverage due to high solid matter content. Dries quickly. Very good flow.



SPRAY PASS
2 - 3 spray passes,
each 0.6 - 0.8 mil

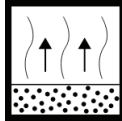

FLASH-OFF TIME
1 - 5 min / 68°F



DRYING INFRARED DEVICE
3 hours / 68°F
30 min / 140°F
IR: approx. 7 min



Variable
spray
nozzle!

PROD NO.	DESCRIPTION	BX QTY
3680102	1K Trim Paint - Satin Black	3/bx

2K HOT ROD BLACK SATIN



Application: For small damage repair jobs on existing semi gloss Hot Rod Back parts/surfaces or for an easy and fast paint job of a newer restored part.

Advantages: Easy to use. High quality two component coating. Very good flow. Highest chemical and weather resistance. Long lasting and very durable finish.



SPRAY PASS
2 - 3 spray passes,
each approx. 1 mil

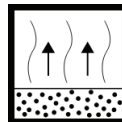

FLASH-OFF TIME
25 min / 68°F

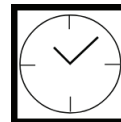

DRYING INFRARED DEVICE
3 hours / 68°F
35 min / 140°F

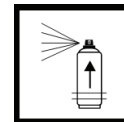

2K POTLIFE
24 hours / 68°F



Variable
spray
nozzle!

PROD NO.	DESCRIPTION	BX QTY
3680212	2K Hot Rod Black	3/bx

Clear Coats & Spot Blender



1K SPOT BLENDER

Application: 1K Spot Blender is a special product for homogeneous paint transitions in the blending area of 2K clearcoats as well as of single stage topcoats with outstanding blending results. The Spot Blender is used immediately after the clear- / topcoat is applied.

Advantages: Seamless edge transitions in the blending area. Superior blending ability. No color deviations. Ideal for spot repairs.



SPRAY PASS
2-3 very light
spray passes

PROD NO.	DESCRIPTION	BX QTY
3680093	1K Spot Blender	3/bx



1K CLEAR ACRYLIC

Application: 1K clear coat for quick coating and longterm sealing of repair paint jobs and new paint jobs on cars and motorcycles.

Advantages: Easy to use. Dries quickly. High gloss level. No color deviation. Good weathering resistance. Very good flow. Very good polishing ability.



SPRAY PASS
2 - 3 spray passes,
each 0.6 - 0.8 mil

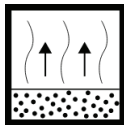

FLASH-OFF TIME
5 - 10 min / 68°F



DRYING INFRARED DEVICE
12 hours / 68°F
60 min / 140°F
IR: approx. 7 min

PROD NO.	DESCRIPTION	BX QTY
3680058	1K Clear Acrylic	3/bx

Clear Coats & Spot Blender

2K CLEAR GLAMOUR



Application: 2K clear coat with very high chemical, gasoline, and weather resistance for high-quality and long-term sealing of repair paint jobs and new paint jobs on cars and motorcycles.

Advantages: Maximum resistance to abrasion and scratching. Very smooth flow. Lasting high gloss. Very good polishing ability. No color deviation. Outstanding painting surface. Suitable even at higher ambient temperatures.



SPRAY PASS
2 spray passes,
each 0.6 - 0.8 mil

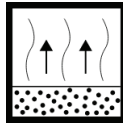

FLASH-OFF TIME
5 - 10 min / 68°F



DRYING INFRARED DEVICE
18 hours / 68°F
60 min / 140°F
IR: approx. 15 min

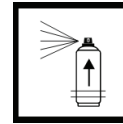

2K POTLIFE
48 hours / 68°F

PROD NO.	DESCRIPTION	BX QTY
3680061	2K Clear Glamour	3/bx

2K CLEAR RAPID



Application: 2K clear coat with very short drying time and very high chemical, gasoline and weathering resistance for high quality and longterm sealing of repair paint jobs and new paint jobs on cars and motorcycles. Ideally suited for spot repairs.

Advantages: Very fast drying. Very smooth flow. Lasting high gloss. Maximum resistance to abrasion and scratching. No color deviation. Outstanding painting surface. Very good polish ability. Suitable even at lower ambient temperatures. Ideally suited for small surfaces.



SPRAY PASS
2 spray passes,
each 0.6 - 0.8 mil

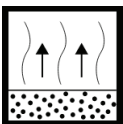

FLASH-OFF TIME
5 min / 68°F



DRYING INFRARED DEVICE
60 min / 68°F
30 min / 140°F
IR: approx. 15 min

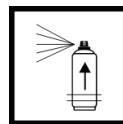

2K POTLIFE
14 hours / 68°F

PROD NO.	DESCRIPTION	BX QTY
3684064	2K Clear Rapid	3/bx

Clear Coats & Spot Blender

2K CLEAR MATTE



Application: Developed for the Small Damage Repair Process or complete painting of mounting parts.
Advantages: Very fast drying. Excellent flow. Highest chemical and weathering resistance.
 Gloss units @ 85°: Matte 12±3



SPRAY PASS
 2 spray passes,
 each 0.6 - 0.8 mil

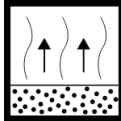

FLASH-OFF TIME
 5 - 10 min / 68°F



DRYING INFRARED DEVICE
 18 hours / 68°F
 60 min / 140°F
 IR: approx. 15 min

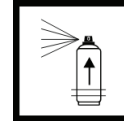

2K POTLIFE
 48 hours / 68°F

PROD NO.	DESCRIPTION	BX QTY
3680065	2K Clear Matte	3/bx

NEW

2K CLEAR SATIN



Application: Developed for the small damage repair process or completing painting of mounting parts.
Advantages: Very fast drying. Excellent flow. Highest chemical and weathering resistance.

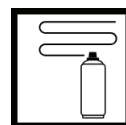

SPRAY PASS
 2 spray passes,
 each 0.6 - 0.8 mil

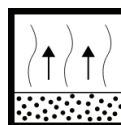

FLASH-OFF TIME
 5-10 min / 68°F



DRYING
 12 hours / 68°F
 60 min / 140°F
 IR: approx. 15 min

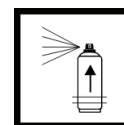

2K POTLIFE
 48 hours / 68°F

PROD NO.	DESCRIPTION	BX QTY
3680067	2K Clear Satin	3/bx

BLANK PAGE

INDEX

INDEX

Item No.	Section No.	Item No.	Section No.	Item No.	Section No.	Item No.	Section No.
134.820	13-1, 45-1, 46-3	1190	14-13	2320	14-26	2699	14-27
134.822	13-1, 45-1, 46-3	1191	14-13	2325	DISC	2700	14-27
138.843	DISC	1192	14-15	2330	DISC	2701	14-27
138-844	45-1	1193	14-15	2331	14-26	2703	14-27
277-004	40-2	1194	14-15	2332	14-26	2704	14-27
658Y	45-5, 46-4	1195	14-15	2340	14-26	2706	14-27
752R	45-5, 46-4	1401	DISC	2341	DISC	2707	14-27
820WR	45-5, 46-4	1700	46-7	2345	DISC	2709	14-27
830WR	45-5, 46-4	1701	46-7	2346	14-26	2710	14-27
850WR	45-5, 46-4	1702	46-7	2347	DISC	2711	14-27
908	40-1, 46-3	1750	46-7	2348	DISC	2712	14-27
908L	40-1, 46-3	1752	46-7	2350	14-28	2713	14-27
916	40-1, 46-3	1790	46-8	2355	14-28	2714	14-29
916L	40-1, 46-3	1791	46-8	2356	DISC	2715	14-29
932	40-1, 46-3	1792	46-8	2360	DISC	2716	14-29
932L	40-1, 46-3	1809	46-7	2413	15-4	2717	14-29
980	40-1, 46-3	1810	46-7	2413HP	15-4	2719	14-29
980L	40-1, 46-3	1811	46-7	2413P	15-4	2720	14-29
1089	14-13	1815	46-7	2500	14-30	2725	14-29
1090	14-13	1816	46-7	2510	14-30	2730	14-29
1091	14-13	1824	42-1	2520	14-30	2731	14-29
1092	14-13	1825	DISC	2530	14-30	2732	14-29
1101	14-13	1827	42-1, 45-1	2535	14-30	2733	14-29
1102	14-13	1995	DISC	2600	14-27	2735	14-29
1104	14-13	1996	DISC	2604	14-27	3175	15-3
1105	14-13	2010	DISC	2605	14-27	3210	15-3
1111	14-13	2020	DISC	2606	14-27	3500	15-8, 42-6
1112	14-13	2025	DISC	2607	14-27	3505	14-30
1113	14-13	2030	DISC	2608	14-27	3507	14-30
1114	14-13	2035	DISC	2609	14-27	3510	14-30
1115	14-13	2055	DISC	2610	14-27	3515	14-30
1116	14-13	2085	DISC	2611	14-27	3520	14-30
1117	14-13	2095	DISC	2612	14-27	3521	14-30
1121	14-13	2100	DISC	2620	14-27	3522	14-30
1122	14-13	2105	DISC	2621	14-27	3523	14-30
1123	14-13	2120	DISC	2622	14-27	3524	14-30
1124	14-13	2135	DISC	2623	14-27	3525	14-30
1125	14-13	2140	DISC	2624	14-27	3527	14-30
1126	14-13	2145	DISC	2625	14-27	3530	14-30
1131	14-13	2146	DISC	2626	14-27	3531	14-30
1132	14-13	2147	DISC	2627	14-27	3535	37-2
1133	14-13	2150	DISC	2628	14-27	3535SC	37-3
1134	14-13	2155	DISC	2629	14-27	3550SC	37-3
1141	14-13	2160	DISC	2630	14-27	3536	37-1
1142	14-13	2180	DISC	2631	14-27	3537	37-1
1143	14-13	2190	DISC	2632	14-27	3538	37-1
1150	14-15	2200	DISC	2633	14-27	3539	37-1
1151	14-15	2201	DISC	2634	14-27	3540	37-2
1152	14-15	2205	DISC	2635	14-27	3541	37-1
1153	14-15	2215	DISC	2636	14-27	3542	37-1
1154	14-15	2238	DISC	2637	14-27	3543	37-1
1155	14-15	2250	DISC	2640	14-27	3544	37-1
1156	14-15	2260	DISC	2650	14-27	3545	37-2
1157	14-15	2270	DISC	2651	14-27	3550	37-2
1158	14-15	2275	DISC	2652	14-27	3551	37-1
1159	14-15	2280	DISC	2653	14-27	3552	37-1
1160	14-15	2285	DISC	2654	14-27	3553	37-1
1161	14-15	2286	DISC	2660	14-27	3554	37-1
1162	14-15	2287	DISC	2670	14-27	3555	37-2
1163	14-15	2288	DISC	2671	14-27	3556	37-1
1170	14-13	2289	DISC	2680	14-27	3558	37-1
1171	DISC	2290	DISC	2681	14-27	3560	37-2
1172	DISC	2291	DISC	2682	14-27	3565	37-2
1173	DISC	2294	14-28	2683	14-27	3566	37-1
1174	DISC	2295	14-28	2684	14-27	3567	37-1
1175	14-14	2296	14-28	2685	14-27	3570	37-2
1177	14-14	2297	14-28	2686	14-27	3571	37-4
1180	14-15	2299	DISC	2687	14-27	3572	37-2
1181	14-15	2300	DISC	2688	14-27	3573	37-4
1182	14-15	2303	DISC	2690	14-27	3574	37-4
1183	14-15	2304	DISC	2691	14-27	3575	15-3
1184	14-15	2305	DISC	2693	14-27	3576	15-3
1185	14-15	2306	DISC	2694	14-27	3577	15-3
1186	14-15	2307	DISC	2695	14-27	3578	15-3
1187	14-15	2308	DISC	2696	14-27	3579	15-3
1188	14-15	2310	DISC	2697	14-27	3580	37-4
1189	14-15	2315	DISC	2698	14-27	3581	37-4

INDEX

INDEX

Item No.	Section No.	Item No.	Section No.	Item No.	Section No.	Item No.	Section No.
3583.....	37-4	5090.....	14-19	7190.....	38-4	7370.....	38-9
3584.....	37-4	5091.....	14-19	7194.....	38-6, 46-1	7373.....	38-9
3585.....	37-2, 46-2	5092.....	14-19	7195.....	38-4	7374.....	38-9
3586.....	37-2	5093.....	14-19	7196.....	38-6, 46-1	7378.....	38-11, 46-1
3587.....	37-2	5094.....	14-19	7197.....	38-6, 46-1	7380.....	38-9
3588.....	37-2	5095.....	14-19	7198.....	38-6, 46-1	7381.....	38-9
3590.....	37-3	5180.....	11-2	7199.....	38-6, 46-1	7385.....	38-11, 46-1
3591.....	37-3	5200.....	11-2	7200.....	38-7	7386.....	38-11, 46-1
3592.....	37-3	5225.....	11-2	7202.....	38-7	7388.....	38-11, 46-1
3593.....	37-3	5226.....	11-2	7204.....	38-7	7389.....	38-11, 46-1
3595.....	37-3	5227.....	11-2	7206.....	38-7	7390.....	38-11, 46-1
3596.....	37-3	5228.....	11-2	7208.....	38-7	7391.....	38-11, 46-1
3597.....	37-3	5229.....	11-2	7210.....	38-7	7392.....	38-11, 46-1
3599.....	37-3	5230.....	11-2	7212.....	38-7	7393.....	38-11, 46-1
3601.....	7-1	5231.....	11-2	7214.....	38-7	7394.....	38-11, 46-1
3602.....	7-1	5232.....	11-2	7218.....	38-7	7399.....	DISC
3603.....	15-8	5233.....	11-2	7220.....	38-11	7400.....	38-14
3605.....	7-1	5234.....	11-2	7221.....	38-11	7401.....	38-14
3610.....	7-1	5235.....	11-2	7222.....	38-11	7402.....	38-14
3615.....	7-1	5236.....	11-2	7223.....	38-11	7403.....	38-14
3620.....	7-1	5250.....	11-2	7224.....	38-11	7404.....	38-14
3625.....	7-1	5255.....	11-2	7225.....	38-11	7405.....	38-14
3630.....	7-1	7001.....	38-5	7226.....	38-11	7406.....	38-14
4070.....	37-5, 46-2	7008.....	38-5	7230.....	38-8	7407.....	38-14
4080.....	37-4, 46-2	7009.....	38-5	7232.....	38-8	7408.....	38-14
4081.....	37-4, 46-2	7015.....	38-5	7234.....	38-8	7409.....	38-14
4082.....	37-4, 46-2	7016.....	38-5	7236.....	38-8	7410.....	38-14
4084.....	37-5, 46-2	7025.....	38-5	7238.....	38-8	7411.....	38-14
4085.....	37-5, 46-2	7026.....	38-5	7240.....	38-8	7412.....	38-14
4086.....	37-5, 46-2	7027.....	38-5	7242.....	38-8	7413.....	38-14
4099.....	37-5	7028.....	38-5	7244.....	38-8	7414.....	38-14
4105.....	10-1	7030.....	15-7, 38-6	7246.....	38-8	7415.....	38-14
4106.....	10-1	7031.....	15-7, 38-6	7248.....	38-8	7416.....	38-14
4107.....	10-1	7032.....	15-7, 38-6	7250.....	38-9	7417.....	38-14
4109.....	10-1	7033.....	15-7, 38-6	7251.....	38-9	7418.....	38-14
4110.....	10-1	7034.....	15-7, 38-6	7253.....	38-9	7419.....	38-14
4111.....	10-1	7035.....	15-7, 38-6	7255.....	38-9	7420.....	38-14
4115.....	10-1	7036.....	15-7, 38-6	7257.....	38-9	7421.....	38-14
4116.....	10-1	7044.....	38-13	7290.....	38-4	7422.....	38-14
4117.....	10-1	7045.....	38-7, 38-8, 38-9, 38-10	7295.....	38-4	7423.....	38-14
4125.....	10-1	38-12, 46-1	7300.....	38-1	7444.....	38-4
4130.....	10-1	7050.....	38-2	7301.....	38-1	7445.....	38-4
4133.....	10-2	7055.....	38-2	7302.....	38-1	7446.....	38-4
4135.....	10-2	7060.....	38-2	7303.....	38-1	7450.....	38-4
4140.....	10-2	7065.....	38-2	7304.....	38-1	7451.....	38-4
4182.....	46-7	7070.....	38-2	7310.....	38-1	7452.....	38-4
4185.....	46-7	7073.....	38-2	7311.....	38-1	7455.....	38-4
4186.....	46-7	7085.....	38-2	7312.....	38-1	7456.....	38-4
4188.....	46-7	7090.....	38-2	7314.....	38-1	7457.....	38-4
4545.....	46-8	7100.....	15-7, 38-2	7316.....	38-1	7460.....	38-13
4700.....	46-7	7105.....	15-7, 38-2	7320.....	38-1	7460-ARM-ASSEMBLY...38-13	
4750.....	46-7	7110.....	15-7, 38-2	7321.....	38-1	7600.....	38-9
5001.....	11-1	7115.....	15-7, 38-2	7322.....	38-1	7601.....	38-9, 38-10, 38-12
5002.....	11-1	7120.....	15-7, 38-2	7324.....	38-1	7602.....	38-9
5005.....	11-1	7125.....	15-7, 38-2	7326.....	38-1	7603.....	38-12
5006.....	11-1	7130.....	15-7, 38-1, 38-2, 38-3	7336.....	38-7, 38-8, 38-12	7604.....	38-9
5006-50.....	11-1	7135.....	15-7, 38-2, 38-3	7338.....	38-7	7606.....	38-9
5007.....	11-1	7140.....	38-3	7339.....	38-7	7608.....	38-9
5008.....	11-1	7141.....	38-3	7340.....	38-7	7610.....	38-9
5010.....	11-1	7142.....	38-3	7345.....	38-7	7614.....	38-9
5011.....	11-1	7143.....	38-3	7348.....	38-7	7616.....	38-9
5012.....	11-1	7144.....	38-3	7349.....	38-7	7618.....	38-9
5013.....	11-1	7145.....	38-3	7355.....	38-7	7619.....	38-9
5014.....	DISC	7150.....	38-3	7356.....	38-7	7620.....	38-10
5015.....	11-1	7155.....	38-3	7358.....	38-7	7623.....	38-10
5016.....	11-1	7160.....	38-3	7359.....	38-12	7640.....	38-10, 46-1
5023.....	11-2	7165.....	38-3	7360.....	38-8	7641.....	38-10, 46-1
5024.....	11-2	7170.....	38-3	7361.....	38-8	7642.....	38-10, 46-1
5025.....	11-2	7174.....	38-3	7362.....	38-9	7643.....	38-10, 46-1
5026.....	11-2	7175.....	38-3	7363.....	38-9	7644.....	38-10, 46-1
5027.....	11-2	7176.....	38-3	7364.....	38-9, 38-10, 38-12,	7645.....	38-10, 46-1
5028.....	11-2	7177.....	38-3	46-1	7651.....	38-10, 46-1
5038.....	11-2	7178.....	38-3	7365.....	38-9	7653.....	38-10, 46-1
5085.....	14-19	7179.....	15-7, 38-6, 46-1	7366.....	38-12	7655.....	38-10, 46-1
5087.....	14-19	7180.....	15-7, 38-6, 46-1	7367.....	38-9	7656.....	38-10
5088.....	14-19	7185.....	15-7, 38-6, 46-1	7368.....	38-12	7657.....	38-10, 46-1
5089.....	14-19	7187.....	38-6, 46-1, 38-6, 46-1	7369.....	38-9	7659.....	38-10, 46-1

INDEX

INDEX

Item No.	Section No.	Item No.	Section No.	Item No.	Section No.	Item No.	Section No.
7661	38-10, 46-1	12001	39-1	12170	39-6	12303	39-2
7663	38-10, 46-1	12002	39-1	12171	39-6	12304	39-2
7665	38-10, 46-1	12003	39-1	12172	39-6	12401	39-2
7680	38-10	12004	39-1	12173	39-6	12404	39-2
7681	38-10	12005	39-1	12174	39-6	12406	39-2
7683	38-10	12006	39-1	12205	39-4	12408	39-2
7685	38-10	12007	39-1	12210	39-4	12410	39-2
7687	38-10	12008	39-5	12213	39-4	12412	39-2
7688	38-10	12009	39-5	12215	39-4	12414	39-2
7691	38-10	12010	39-5	12225	39-3	12416	39-2
7692	38-10	12011	39-5	12226	39-3	12418	39-2
9425	8-1	12012	39-5	12227	39-3	12420	39-2
9510	9-1	12013	39-5	12228	39-3	12422	39-2
9511	9-1	12014	39-5	12229	39-3	12424	39-2
9515	9-1	12015	39-5	12235	39-3	12426	39-2
9520	9-1	12016	39-5	12236	39-3	12428	39-2
9521	9-1	12017	39-5	12237	39-3	12430	39-2
9525	9-1	12018	39-1	12238	39-3	12432	39-2
9530	9-1	12018-144	39-1	12239	39-3	12434	39-2
9540	9-2	12019	39-1	12245	39-3	12436	39-2
9545	9-2	12019-144	39-1	12246	39-3	12438	39-2
9550	9-2	12020	39-1, 39-6	12247	39-3	12440	39-2
9555	9-2	12025	39-5	12248	39-3	12442	39-2
9556	9-2	12026	39-1	12249	39-3	12444	39-2
9557	9-2	12027	39-1	12250	39-3	12446	39-2
9706	DISC	12029	39-1	12251	39-3	12448	39-2
9710	37-5, 46-2	12030	39-1	12252	39-3	12450	39-2
9711	37-5, 46-2	12031	39-1	12253	39-3	13000	3-3
9715	41-3, 46-6	12032	39-1	12254	39-3	13001	3-3
9720	41-5, 46-6	12033	39-1	12255	39-3	13040	3-1
9721	41-5, 46-6	12035	39-1	12256	39-3	13041	3-1
9722	41-5, 46-6	12036	39-1	12257	39-3	14020	3-1
9723	41-5, 46-6	12037	39-1	12258	39-3	14021	3-1
9728	41-5, 46-6	12038	39-1	12259	39-3	14022	3-1
9729	41-5	12046	39-1	12260	39-2	14023	3-1
9730	41-5, 46-6	12047	39-1	12261	39-2	14024	3-1
9731	41-5, 46-6	12049	39-1	12262	39-2	14025	3-1
9732	41-5, 46-6	12060	DISC	12263	39-2	14040	3-1
9735	42-4, 46-3	12061	DISC	12264	39-2	14041	3-1
9738	15-5, 42-1	12062	DISC	12265	39-2	14042	3-1
9740	15-5	12063	40-3	12266	39-2	14043	3-1
9741	15-5	12064	DISC	12267	39-2	14044	3-1
9742	15-5	12065	40-3	12268	39-2	14045	3-1
9743	15-5	12070	39-1	12269	39-2	14060	3-1
9744	15-5	12071	39-1	12270	39-2	14061	3-1
9745	15-5	12072	39-1	12271	39-2	14062	3-1
9746	15-5	12073	39-1	12272	39-2	14080	3-1
11312	DISC	12080	39-1	12273	39-2	14081	3-1
11314	DISC	12085	39-1	12274	39-2	14082	3-1
11320	8-9	12086	39-1	12275	39-2	15040	3-1
11321	8-9	12087	39-1	12276	39-2	15041	3-1
11322	8-9	12090	39-1	12277	39-2	15042	3-1
11331	8-9	12095	39-1	12278	39-2	15060	3-1
11381	8-11	12096	39-1	12279	39-2	15061	3-1
11382	8-11	12097	39-1	12280	39-2	16020	3-1
11383	8-11	12100	39-6	12281	39-2	16021	3-1
11384	8-11	12102	39-6	12282	39-2	16040	3-1
11385	8-11	12104	39-6	12283	39-2	16041	3-1
11386	8-11	12106	39-6	12284	39-2	16042	3-1
11387	8-11	12108	39-6	12285	39-2	16060	3-1
11390	8-11	12110	39-6	12286	39-2	16061	3-1
11391	8-11	12112	39-6	12287	39-2	16062	3-1
11392	8-11	12114	39-6	12288	39-2	16063	3-1
11401	8-11	12116	39-6	12289	39-2	16064	3-1
11401-500	8-11	12118	39-6	12290	39-2	16065	3-1
11402	8-11	12120	39-6	12291	39-2	16080	3-1
11402-500	8-11	12122	39-6	12292	39-2	16081	3-1
11403	8-11	12124	39-6	12293	39-2	16082	3-1
11410	DISC	12126	39-6	12294	39-2	16083	3-1
11411	8-11	12128	39-6	12295	39-2	16084	3-1
11412	DISC	12132	39-6	12296	39-2	16085	3-1
11413	8-11	12136	39-6	12297	39-2	16100	3-1
11415	8-11	12140	39-6	12298	39-2	16101	3-1
11510	DISC	12144	39-6	12299	39-2	16102	3-1
11520	8-11	12148	39-6	12300	39-2	16103	3-1
12000	39-1	12152	39-6	12301	39-2	16104	3-1
12000-144	39-1	12156	39-6	12302	39-2	17000	3-2



INDEX

INDEX

Item No.	Section No.	Item No.	Section No.	Item No.	Section No.	Item No.	Section No.
17001	3-2	38570	3-9, 20-2, 21-2	46016	14-20	48107-25	14-22
17002	3-2	38571	3-5, 27-1	46017	14-20	48110	DISC
17003	3-2	38572	3-3, 26-1	46019	14-20	48110-25	14-22
17004	3-2	38573	3-3, 26-1	46020	14-20	48115	DISC
17005	3-2	38574	3-4, 26-1	46041	14-20	48115-25	14-22
17006	3-2	38575	3-6, 20-2, 21-2	46042	14-20	48120	DISC
17007	3-2	38576	3-4, 32-1	46050	DISC	48120-25	14-22
17008	3-2	38577	3-5, 26-1, 32-1	46050-25	14-22	48125	DISC
17009	3-2	38578	3-4, 26-1, 32-1	46051	DISC	48125-25	14-22
17010	3-2	38579	3-6, 26-1	46051-25	14-22	48130	DISC
17015	3-2	38580	3-9, 20-2	46052	DISC	48130-25	14-22
27999	3-8, 19-1, 20-1, 21-1	38581	3-4, 23-1, 25-2	46052-25	14-22	48205	DISC
28000	3-8, 19-1, 20-1, 21-1	38582	3-5, 27-1	46053	DISC	48205-25	14-21
28001	3-8, 19-1, 20-1, 21-1	38583	3-7, 20-2	46053-25	14-22	48207	DISC
28002	3-8, 19-1, 20-1, 21-1	38584	3-5, 21-2	46054	DISC	48207-25	14-21
34000	3-2	38585	DISC	46054-25	14-22	48210	DISC
34020	3-1	38590	3-9, 20-2	46055	DISC	48210-25	14-21
34021	3-1	38591	3-9, 20-3	46055-25	14-22	48215	DISC
34022	3-1	38592	3-9, 20-3	46056	DISC	48215-25	14-21
34040	3-1	38595	3-9, 20-3, 28-1	46056-25	14-22	48220	DISC
34041	3-1	38603	3-10, 21-2	46057	DISC	48220-25	14-21
34042	3-1	38605	3-10, 21-2	46057-25	14-22	48225	DISC
34043	3-1	38607	3-5, 33-1	46058	DISC	48225-25	14-21
34044	3-1	38608	3-5, 21-2	46058-25	14-22	48230	DISC
34060	3-1	38609	3-10	46059	DISC	48230-25	14-21
34061	3-1	38610	DISC	46059-25	14-22	48250	14-21
34062	3-1	38611	3-7, 32-1	47010	14-23	48251	14-21
34080	3-1	38612	3-5, 28-1	47015	14-23	48252	14-21
34081	3-1	38620	3-5, 34-1	47020	14-23	48253	14-21
34082	3-1	38622	3-5	47025	14-23	48254	14-21
35000	3-2	38709	3-7	47030	14-23	48255	14-21
36000	3-2	38710	3-7	47035	14-23	48256	14-21
36041	3-1	38711	3-7	47040	14-23	48260	14-21
36060	3-1	38712	3-7	47115	14-23	48261	14-21
36061	3-1	38713	3-7, 21-2, 22-1	47120	14-23	48262	14-21
38000	3-2	38714	3-5, 30-1	47125	14-23	48263	14-21
38044	3-8	38720	3-10	47130	14-23	48552	14-25
38060	3-8	38751	3-4	47135	14-23	48600	14-25
38499	3-6, 20-1	38756	3-5	47140	14-23	48601	14-25
38500	3-6, 20-1	38763	3-10	48001	14-24	48603	14-25
38501	3-8, 20-1	38764	3-10, 26-1, 32-1	48002	14-24	48604	14-25
38502	3-8	38765	3-7	48004	14-24	48605	14-25
38503	3-8, 20-1	38900	3-10	48006	14-24	48990	14-24
38504	3-8, 20-1	38901	3-10	48007	14-24	48991	14-24
38505	3-3, 20-1	38905	3-10	48008	14-25	48992	14-24
38506	3-6, 20-1	38906	3-10	48010	14-12	48993	14-24
38507	3-3, 19-1, 20-1	38907	3-10	48015	14-12	49001	14-24
38508	3-3, 20-1	38908	3-10	48016	14-12	49002	14-24
38509	3-6, 21-1	38909	3-10	48017	14-12	49003	14-24
38510	3-6, 20-1, 21-1	38910	3-10	48018	14-12	49004	14-24
38511	3-6, 20-1, 21-1	395200-500	14-10	48019	14-12	49005	14-24
38512	3-8, 21-1	41093	36-16	48020	14-12	49006	14-24
38514	3-6, 21-1	41162	3-3	48021	14-12	49007	14-24
38515	3-6, 20-2	45001	4-11	48025	14-12	49020	14-23
38516	3-4, 19-1	45002	4-11	48026	14-12	49030	14-23
38517	3-6, 28-1	45003	4-11	48031	14-23	49040	14-23
38518	3-8, 20-2, 25-2	45004	4-11	48040	14-12	49050	14-23
38519	3-3, 23-1	45005	4-11	48041	14-12	49060	14-23
38520	3-4, 20-1	45006	4-11	48042	14-12	49070	14-23
38521	3-6, 20-1	45007	4-11	48043	14-12	49080	14-23
38522	3-4, 19-1, 20-2, 21-1	45008	4-11	48044	14-12	49540	14-21
	34-1	45009	4-11	48045	14-12	49541	14-21
38523	3-4, 21-1	45050	DISC	48046	14-12	49542	14-21
38524	3-4, 21-1	45051	DISC	48047	14-12	49543	14-21
38525	3-4, 19-1, 21-1	45052	DISC	48048	14-12	49544	14-21
38527	3-8, 21-1	45053	DISC	48049	14-12	49560	14-21
38530	3-3, 20-2	45054	DISC	48050	14-12	49561	14-21
38535	DISC	45055	DISC	48051	14-12	49562	14-21
38545	3-8, 21-1	45056	DISC	48102	DISC	49563	14-21
38550	3-8, 19-1, 21-2	45057	DISC	48102-25	14-22	49564	14-21
38555	3-9, 19-1, 20-2, 21-2	45058	DISC	48103	DISC	49565	14-21
38556	DISC	45059	DISC	48103-25	14-22	49570	14-21
38560	3-9, 19-1, 20-2	45862	23-6	48104	DISC	49571	14-21
38561	3-9, 19-1, 20-2	46011	14-20	48104-25	14-22	49572	14-21
38565	3-9, 21-2	46013	14-20	48105	DISC	49573	14-21
38568	3-6, 32-1	46014	14-20	48105-25	14-22	49574	14-21
38569	3-6, 26-1, 32-1	46015	14-20	48107	DISC	54004	10-4

INDEX

Item No.	Section No.	Item No.	Section No.	Item No.	Section No.	Item No.	Section No.
54006	10-4	58049	14-18	86001	1-23	86105	1-23
54106	10-4			86002	1-23	86106	1-23
54108	10-4	58050	14-18	86003	1-23	86107	1-23
54110	10-4	58060	14-17	86004	1-23	86108	1-23
54112	10-4	58062	14-17	86005	1-23	86109	1-23
54116	10-4	58064	14-17	86006	1-23	86110	1-23
54120	10-4	58066	14-17	86007	1-23	86111	1-23
54124	10-4	58068	14-17	86008	1-23	86112	1-23
54128	10-4	58070	14-17	86009	1-23	86113	1-23
54132	10-4	58072	14-17	86010	1-23	86114	1-23
54136	10-4	58074	14-18	86011	1-23	86115	1-23
54200	10-4	58076	14-18	86012	1-23	86116	1-23
54201	10-4	58078	14-18	86013	1-23	86117	1-23
54203	10-4	58080	14-18	86014	1-23	86200	1-25
54300	10-5	58081	14-18	86015	1-23	86201	1-25
54302	10-5	58082	14-18	86016	1-23	86202	1-25
54304	10-5	58084	14-18	86017	1-23	86203	1-25
54306	10-5	58086	14-18	86018	1-23	86204	1-25
54308	10-5	58090	14-17	86019	1-23	86205	1-25
54310	10-5	58094	14-17	86020	1-23	86206	1-25
54312	10-5	58096	DISC	86021	1-23	86207	1-25
54314	10-5	58098	14-18	86022	1-23	86208	1-25
54316	10-5	58100	14-18	86023	1-23	86209	1-25
54318	10-5	58102	14-18	86024	1-23	86210	1-25
54320	10-5	58104	14-18	86025	1-23	86211	1-25
54322	10-5	58110	14-19	86026	1-23	86212	1-25
54324	10-5	58112	14-19	86027	1-23	86213	1-25
54326	10-5	58122	14-18	86028	1-23	86214	1-25
54504	10-4	58123	14-18	86029	1-23	86215	1-25
54506	10-4	70505	41-5	86030	1-23	86216	1-25
54510	10-4	70506	41-5	86031	1-23	86217	1-25
54512	10-4	70508	41-5	86032	1-23	86218	1-25
54516	10-4	70510	DISC	86033	1-23	86219	1-25
54520	10-4	70521	13-1	86034	1-23	86220	1-25
54524	10-4	70522	13-1	86035	1-23	86221	1-25
54528	10-4	70525	13-1	86036	1-23	86222	1-25
54532	10-4	70527	DISC	86037	1-23	86223	1-25
55112	DISC	70528	13-1	86038	1-23	86224	1-25
55134	DISC	70530	13-1	86060	1-23	86250	1-25
55178	DISC	70535	DISC	86061	1-23	86251	1-25
55200	DISC	70536	DISC	86062	1-23	86252	1-25
55212	DISC	70550	13-2	86063	1-23	86253	1-25
55214	DISC	70550-10	13-2	86064	1-23	86254	1-25
56178	DISC	70551	DISC	86065	1-23	86255	1-25
56200	DISC	70551-36	13-2	86066	1-23	86256	1-25
56212	DISC	70551-6	13-2	86067	1-23	86257	1-25
56214	DISC	70552	15-4	86068	1-23	86258	1-25
56218	DISC	70552-10	15-4	86069	1-23	86259	1-25
58001	14-17	70553	DISC	86070	1-23	86260	1-25
58002	14-17	70553-6	DISC	86071	1-23	86261	1-25
58003	14-17	70565	13-1	86072	1-23	86262	1-25
58004	14-17	70565-12	13-1	86073	1-23	86263	1-25
58005	14-17	70570	13-1	86074	1-23	86264	1-25
58006	14-17	70570-6	13-1	86081	1-23	86265	1-25
58010	14-17	70580	41-5	86082	1-23	86266	1-25
58011	14-17	70590	13-1	86083	1-23	86267	1-25
58012	14-17	70591	DISC	86084	1-23	86268	1-25
58013	14-17	70595	13-2	86085	1-23	86275	1-24
58014	DISC	70596	13-2	86086	1-23	86276	1-24
58015	DISC	70597	13-2	86087	1-23	86277	1-24
58016	14-18	70598	13-2	86088	1-23	86278	1-24
58017	14-18	70740	13-2	86089	1-23	86279	1-24
58018	14-18	70741	13-2, 46-3	86090	1-23	86280	1-24
58019	14-18	70810	13-2	86091	1-23	86281	1-24
58022	14-19	73400	3-2	86092	1-23	86282	1-24
58023	14-18	73500	3-2	86093	1-23	86283	1-24
58025	14-18	73600	3-2	86094	1-23	86284	1-24
58035	14-17	73800	3-2	86095	1-23	86285	1-24
58036	14-17	75010	41-5	86096	1-23	86286	1-24
58037	14-17	85010	1-25	86097	1-23	86287	1-24
58038	14-17	85010-100	1-25	86098	1-23	86288	1-24
58039	14-17	85130	1-25	86099	1-23	86289	1-24
58040	14-17	85131	1-25	86100	1-23	86290	1-24
58045	DISC	85255	1-8, 1-25	86101	1-23	86291	1-24
58046	DISC	85260	1-25	86102	1-23	86292	1-24
58047	14-18	85261	1-25	86103	1-23	86293	1-24
58048	14-18	85574	1-25	86104	1-23	86294	1-24

INDEX

INDEX

Item No.	Section No.	Item No.	Section No.	Item No.	Section No.	Item No.	Section No.
86295	1-24	86522	1-22	89250	DISC	94250	8-1
86296	1-24	86523	1-22	89275	8-1	94275	8-1
86297	1-24	86524	1-22	89300	DISC	94300	8-1
86298	1-24	86530	1-22	90025	8-4	95005	39-8
86299	1-24	86531	1-22	90050	8-4	95006	39-8
86300	1-24	86532	1-22	90075	8-4	95010	39-8
86301	1-24	86533	1-22	90100	8-4	95014	39-8
86302	DISC	86534	1-22	90125	8-4	95015	39-8
86303	1-24	86535	1-22	90150	8-4	95040	39-8
86304	1-24	86536	1-22	90175	8-4	95130	39-8
86305	1-24	86537	1-22	90200	8-4	95140	39-8
86306	1-24	86538	1-22	90225	8-4	95150	39-8
86307	1-24	86550	1-22	90250	8-4	96066	DISC
86308	1-24	86551	1-22	90275	8-4	96067	DISC
86309	1-24	86552	1-22	90300	8-4	96074	40-2
86310	1-24	86553	1-22	91025	8-2	96075	40-2
86311	1-24	86554	1-22	91050	8-2	96108	3-12
86312	1-24	86555	1-22	91075	8-2	96110	40-2
86313	1-24	86556	1-22	91087	8-2	96111	40-2
86314	1-24	86557	1-22	91100	DISC	96116	8-8
86315	1-24	86560	1-22	91125	8-2	96118	8-8
86340	1-24	86561	1-22	91137	8-2	96121	8-8
86341	1-24	86562	1-22	91150	8-2	96122	8-8
86342	1-24	86563	1-22	91175	8-2	96123	8-8
86343	1-24	86564	1-22	91200	8-2	96126	8-8
86344	1-24	86565	1-22	91225	DISC	96203	40-2
86345	1-24	86566	1-22	92012	8-2	96296	DISC
86346	1-24	86567	1-22	92025	8-2	96297	DISC
86347	1-24	87005	8-2	92050	8-2	96298	DISC
86348	1-24	87007	DISC	92075	8-2	96300	DISC
86349	1-24	87010	8-2	92087	8-2	96301	DISC
86350	1-24	87012	8-2	92100	8-2	96302	DISC
86351	1-24	87015	8-2	92125	8-2	96305	DISC
86352	1-24	87017	8-2	92137	8-2	96306	DISC
86353	1-24	87020	8-2	92150	8-2	96307	DISC
86354	1-24	87022	8-2	92175	8-2	96309	DISC
86355	1-24	87025	8-2	92200	8-2	96310	DISC
86356	1-24	87027	8-2	92225	8-2	96311	DISC
86357	1-24	87030	8-2	93000	8-6	96312	DISC
86358	1-24	87032	8-2	93001	DISC	96315	15-6, 41-1, 46-5
86359	1-24	87035	8-2	93002	DISC	96316	15-6, 41-1, 46-5
86360	1-24	87037	8-2	93003	DISC	96317	15-6, 41-1, 46-5
86361	1-24	87040	8-2	93004	DISC	96321	41-1
86362	1-24	87045	8-2	93005	8-6	96322	41-1
86363	1-24	87050	8-2	93006	8-6	96325	41-1, 46-5
86364	1-24	87055	8-2	93007	DISC	96326	41-1, 46-5
86365	1-24	87060	8-2	93008	8-6	96327	41-1, 46-5
86366	1-24	87100	8-3	93009	8-6	96330	DISC
86367	1-24	87150	8-3	93010	8-5	96331	DISC
86368	1-24	87200	8-3	93011	DISC	96332	DISC
86369	1-24	87250	8-3	93012	DISC	96335	DISC
86370	1-24	87300	8-3	93025	DISC	96336	DISC
86371	1-24	87350	8-3	93050	8-1	96337	DISC
86372	1-24	87400	8-3	93075	8-1	96338	DISC
86373	1-24	87500	8-3	93100	8-1	96339	DISC
86374	1-24	87600	8-3	93125	DISC	96340	DISC
86375	1-24	88025	8-1	93150	8-1	96341	DISC
86376	1-24	88050	8-1	93175	8-1	96349	DISC
86377	1-24	88075	8-1	93199	8-6	96350	DISC
86378	1-24	88100	8-1	93200	8-1	96351	DISC
86379	1-24	88125	8-1	93225	8-1	96352	DISC
86380	1-24	88150	8-1	93250	8-1	96353	DISC
86500	1-22	88175	8-1	93275	8-1	96401	14-6
86501	1-22	88200	8-1	93300	8-1	96500	41-3, 46-6
86502	1-22	88225	8-1	94002	8-5	96505	41-3, 46-6
86503	1-22	88250	8-1	94003	8-5	96510	41-3, 46-6
86504	1-22	88275	8-1	94004	8-5	96520	41-3, 46-6
86505	1-22	88300	DISC	94011	8-5	96521	41-3, 46-6
86507	1-22	89025	DISC	94012	8-5	96606	41-4, 46-4
86508	1-22	89050	DISC	94025	8-1	96607	41-4, 46-4
86510	1-22	89075	DISC	94050	8-1	96610	41-4, 46-5
86511	1-22	89100	DISC	94075	8-1	96611	41-4, 46-5
86512	1-22	89125	DISC	94100	8-1	96620	41-4, 46-5
86513	1-22	89150	DISC	94150	8-1	96649	41-4, 46-5
86514	1-22	89175	8-1	94175	8-1	96650	41-4, 46-5
86520	1-22	89200	8-1	94200	8-1	96651	41-4, 46-5
86521	1-22	89225	DISC	94225	8-1	96700	41-3, 46-6

INDEX

Item No.	Section No.	Item No.	Section No.	Item No.	Section No.	Item No.	Section No.
96701	41-3, 46-6	98550	8-3	105320	1-1	115540	1-5
96702	41-3, 46-6	98575	8-3	105330	1-1	115541	1-5
96704	41-3, 46-6	98600	8-3	105340	1-1	115542	1-5
97000	14-30, 40-2	98625	8-3	105350	1-1	115545	1-5
97069	15-2, 46-3	98650	8-3	105360	1-1	115546	1-5
97069-50	15-2, 46-3	98675	8-3	105370	1-1	115547	1-5
97070	15-2	98700	8-3	105380	1-1	115548	1-5
97070-50	15-2	98725	8-3	105390	1-1	115549	1-5
97071	15-2	98750	8-3	105410	1-1	115550	1-5
97072	15-2	98775	8-3	105420	1-1	115551	1-5
97073	15-2	98800	8-3	105430	1-1	115552	1-5
97074	42-1	98850	8-3	105440	1-1	115553	1-5
97075B	DISC	98875	8-3	105470	1-1	115554	1-5
97075G	DISC	98900	8-3	105480	1-1	115560	1-5
97075Y	DISC	98950	8-3	110001	1-1	115561	1-5
97076	42-6, 46-4	99105	8-4	110002	1-1	115562	1-5
97077	42-6, 46-4	99110	8-4	110003	DISC	115565	1-5
97078	15-5, 41-6, 46-6	99115	8-4	110004	1-1	115566	1-5
97079	15-5, 41-6, 46-6	99120	8-4	110005	1-1	115567	1-5
97080	42-1	99125	8-4	110006	1-1	115568	1-5
97081	42-1	99130	8-4	110007	1-1	115569	1-5
97082	42-1	99135	8-4	110008	1-1	115570	1-5
97083	42-2	99140	8-4	110009	1-1	115571	1-5
97084	42-2	99145	8-4	110010	1-1	115572	1-5
97085	42-2	99150	8-4	110020	1-1	115573	1-5
97086	42-2	99155	8-4	110030	1-1	115574	1-5
97087	42-2	99160	8-4	110040	1-1	115580	1-5
97088	42-2	99805	35-2	110050	1-1	115581	1-5
97089	42-2	99807	35-1	110060	1-1	115582	1-5
97090	42-2	99808	35-1	110070	1-1	115585	1-5
97091	42-2	99815	35-1	110080	1-1	115586	1-5
97092	42-3	99816	35-1	110090	1-1	115587	1-5
97093	42-3	99817	35-1	110100	1-1	115588	1-5
97094	42-3	99819	35-1	110110	1-1	115589	1-5
97095	42-3	99820	35-1	110130	1-1	115590	1-5
97096	42-3	99821	15-1	110140	1-1	115591	1-5
97097	42-3	99900	35-1	110150	1-1	115592	1-5
97098	42-3	99901	35-1	110160	1-1	115593	1-5
97099	42-3	99902	35-1	110170	1-1	115594	1-5
97100	40-2, 46-3	99904	35-2	110180	1-1	120002	1-2
97101	40-2, 46-3	99905	35-2	115010	1-2	120004	1-2
97103	42-3	99905DIV	35-2	115020	1-2	120005	1-2
97105	42-6, 46-4	99906	35-3	115021	1-2	120006	1-2
97106	42-6, 46-4	99907	35-2	115030	1-2	120010	1-2
97135	40-2	99907S-NBK	35-2	115040	1-2	120020	1-2
97145	40-1	99911	35-2	115050	1-2	120030	1-2
97150	40-1	99912	35-3	115060	1-2	120040	1-2
97151	40-1	99913	35-3	115070	1-2	120045	1-2
97160	40-1	99925	35-2	115080	1-2	120050	1-2
97161	40-1	99930	35-3	115085	1-2	120055	1-2
97180	40-1	99931	35-3	115090	1-2	120060	1-2
97181	40-1	99932	35-3	115100	1-2	120070	1-2
97303	14-14	99933	35-3	115110	1-2	120080	1-2
97304	14-14	105030	1-1	115120	1-2	120085	1-2
98025	DISC	105040	1-1	115140	1-2	125260	1-8
98050	DISC	105070	1-1	115150	1-2	125261	1-8
98075	8-1	105080	1-1	115160	1-2	125265	1-8
98100	DISC	105090	1-1	115170	1-2	135010	1-3
98150	DISC	105100	1-1	115180	1-2	135020	1-3
98175	DISC	105110	1-1	115200	1-2	135030	1-3
98200	DISC	105120	1-1	115210	1-2	135040	1-3
98225	8-1	105130	1-1	115220	1-2	135050	1-3
98250	8-1	105140	1-1	115230	1-2	135060	1-3
98275	8-1	105150	1-1	115240	1-2	135070	1-3
98300	DISC	105160	1-1	115250	1-2	135080	1-3
98310	8-4	105170	1-1	115255	1-2	135090	1-3
98315	8-4	105180	1-1	115260	1-2	135100	1-3
98320	8-4	105200	1-1	115270	1-2	135110	1-3
98325	8-4	105210	1-1	115280	1-2	136010	1-3
98330	8-4	105220	1-1	115290	1-2	136020	1-3
98335	8-4	105230	1-1	115295	1-2	137005	1-3
98340	8-4	105240	1-1	115300	1-2	137010	1-3
98345	8-4	105250	1-1	115310	1-2	137015	1-3
98350	DISC	105260	1-1	115340	1-2	137020	1-3
98355	8-4	105270	1-1	115360	1-2	137025	1-3
98360	8-4	105280	DISC	115370	1-2	137030	1-3
98525	8-3	105310	1-1	115380	1-2	137035	1-3

INDEX

INDEX

Item No.	Section No.	Item No.	Section No.	Item No.	Section No.	Item No.	Section No.
137040.....	1-3	165081.....	1-5	181036.....	1-7	200370.....	16-4, 19-1
137045.....	1-3	165090.....	1-5	181038.....	1-7	200371.....	16-4, 19-2
137050.....	1-3	165100.....	1-5	181050.....	1-7	200375.....	16-4
140010.....	1-3	165110.....	1-5	181052.....	1-7	200380.....	1-9, 16-4, 21-3
140020.....	1-3	166010.....	1-5	181054.....	1-7	200380-500.....	1-9, 16-4, 21-3
140040.....	1-3	166015.....	1-5	181055.....	1-7	200385.....	16-4
140060.....	1-3	166020.....	1-5	181056.....	1-7	200395.....	16-4, 21-3
140065.....	1-3	166030.....	1-5	190020.....	1-7	200396.....	16-4
140070.....	1-3	166040.....	1-5	190030.....	1-7	200397.....	16-4, 33-1
140080.....	1-3	166041.....	1-5	190060.....	1-7	200398.....	16-4, 21-4
141010.....	1-3	166042.....	1-5	190080.....	1-7	200399.....	16-4, 20-3
141020.....	1-3	166044.....	1-5	190090.....	1-7	200401.....	1-9, 16-4
141030.....	1-3	166050.....	1-5	190100.....	1-7	200402.....	1-9, 20-3
146010.....	1-4	166055.....	1-5	190102.....	1-7	200403.....	1-9, 20-3
146030.....	1-4	166060.....	1-5	190106.....	1-7	200403-1M.....	1-9, 20-3
146040.....	1-4	170018.....	16-1	190108.....	1-7	200406.....	1-4
146050.....	1-4	170020.....	1-6	190190.....	1-7	200407.....	DISC
146060.....	1-4	170025.....	16-1, 21-2	190195.....	1-7	200408.....	1-4
146070.....	1-4	170040.....	DISC	190200.....	1-7	200409.....	1-4
146080.....	1-4	170060.....	1-6	190207.....	1-7	200410.....	1-4
146090.....	1-4	170070.....	1-6	190217.....	1-7	200411.....	16-4, 22-1
146100.....	1-4	170080.....	1-6	200000.....	16-1, 23-1	200413.....	16-5
146110.....	1-4	170081.....	1-6	200001.....	1-8, 16-1, 23-1	200415.....	16-5
146120.....	1-4	170090.....	1-6	200010.....	16-1, 20-3	200416.....	16-5
150000.....	DISC	170095.....	1-6	200011.....	16-1, 20-3	200420.....	1-4
150010.....	1-4	170110.....	1-6	200025.....	1-8	200425.....	16-5
150020.....	1-4	170111.....	1-6	200030.....	1-8	200426.....	16-5, 32-1
150030.....	DISC	170120.....	1-6	200040.....	16-1	200430.....	1-4
150050.....	1-4	170121.....	1-6	200045.....	16-1	200450.....	1-4
150060.....	1-4	170130.....	DISC	200050.....	16-1	200453.....	1-4, 1-9
150060-1000.....	1-4	170135.....	1-6	200055.....	16-1	200455.....	1-4
150065.....	1-4	170140.....	1-6	200070.....	16-1	200456.....	1-4
150070.....	1-4, 1-8	170160.....	1-6	200075.....	16-1, 20-3, 21-2	200457.....	1-4
150071.....	1-4, 1-8	170210.....	16-1, 21-2	200090.....	16-1	200480.....	1-4
150075.....	1-8	175030.....	DISC	200091.....	16-1	200490.....	1-4
150076.....	1-8	175050.....	DISC	200095.....	16-1	200590.....	1-3
150077.....	1-8	175060.....	DISC	200101.....	16-1, 22-1, 30-1, 32-1	200591.....	1-3
150090.....	1-4	175090.....	1-6	200170.....	16-2, 19-1, 21-3	200592.....	1-3
150100.....	1-4	180000.....	1-8	200175.....	16-2, 19-1, 21-3	200600.....	16-5, 18-1
150110.....	1-4	180010.....	1-7	200177.....	16-2, 21-3	200605.....	DISC
155010.....	1-4	180020.....	1-7	200188.....	16-2	200615.....	1-9
155020.....	1-4	180030.....	1-7	200190.....	16-2	200616.....	1-9
155030.....	1-4	180035.....	1-7	200191.....	16-2	200617.....	1-9
155071.....	1-4	180040.....	1-7	200192.....	1-8, 16-2	200703.....	1-9
155080.....	1-4	180050.....	1-7	200193.....	16-2, 22-1	205030.....	1-11
155120.....	1-4	180060.....	1-7	200196.....	23-1	205050.....	1-11
157020.....	1-2	180070.....	1-7	200225.....	1-8	205060.....	1-11
157030.....	1-2	180080.....	1-7	200226.....	1-8	205070.....	1-11
157031.....	1-2	180090.....	1-7	200227.....	1-8	205080.....	1-11
157032.....	1-2	180100.....	1-7	200228.....	1-9	205090.....	1-11
157040.....	1-2	180110.....	1-7	200229.....	1-9	205100.....	1-11
160010.....	1-5	180120.....	1-7	200230.....	1-9	205110.....	1-11
160020.....	1-5	180130.....	1-7	200231.....	1-9	205120.....	1-11
160025.....	1-5	180140.....	1-7	200233.....	1-9	205130.....	1-11
160030.....	1-5	180150.....	1-7	200235.....	1-7, 1-9	205140.....	1-11
160040.....	1-5	180160.....	1-7	200280.....	16-2	205150.....	1-11
160050.....	1-5	180170.....	1-7	200281.....	16-2, 21-3	205152.....	1-11
163015.....	1-4	180180.....	1-7	200285.....	16-2	205154.....	1-11
163020.....	1-4	180190.....	1-7	200290.....	16-2	205156.....	1-11
163070.....	1-4	180200.....	1-7	200291.....	16-2	205158.....	1-11
163110.....	1-4	180210.....	1-7	200292.....	16-2	205160.....	1-11
163130.....	1-4	180220.....	1-7	200293.....	16-2, 21-3	205170.....	1-11
165010.....	1-5	180230.....	1-7	200294.....	16-2, 21-3	205180.....	1-11
165020.....	1-5	180240.....	1-7	200295.....	16-3, 21-3	205190.....	1-11
165030.....	1-5	180250.....	1-7	200313.....	16-3	205200.....	1-11
165031.....	1-5	180280.....	1-7	200315.....	16-3	205210.....	1-11
165032.....	1-5	180290.....	1-7	200325.....	16-3	205220.....	1-11
165040.....	1-5	180300.....	1-7	200350.....	16-3	205230.....	1-11
165050.....	1-5	180310.....	1-7	200355.....	16-3	205240.....	1-11
165060.....	1-5	180320.....	1-7	200357.....	16-3	205245.....	1-11
165061.....	1-5	181016.....	1-7	200360.....	16-3	205250.....	1-11
165062.....	1-5	181018.....	1-7	200361.....	16-3, 21-3	205260.....	1-11
165065.....	1-5	181020.....	1-7	200363.....	16-3, 21-3	205270.....	1-11
165066.....	1-5	181026.....	1-7	200364.....	16-3, 28-1	205280.....	1-11
165067.....	1-5	181027.....	1-7	200365.....	16-3	205282.....	1-11
165070.....	1-5	181028.....	1-7	200366.....	16-3, 19-1	205284.....	1-11
165080.....	1-5	181030.....	1-7	200368.....	16-4, 20-3	205286.....	1-11

Item No.	Section No.	Item No.	Section No.	Item No.	Section No.	Item No.	Section No.
205288.....	1-11	210086.....	1-11	210600.....	1-13	222018.....	36-3
205290.....	1-11	210090.....	1-11	210610.....	1-13	222020.....	36-3
205300.....	1-12	210100.....	1-11	215014.....	16-5, 20-3	222027.....	4-4, 4-5, 36-3
205310.....	1-12	210110.....	1-11	215015.....	16-5	222028.....	4-4, 4-5, 36-3
205320.....	1-12	210120.....	1-11	215020.....	16-5	222032.....	36-4
205330.....	1-12	210130.....	1-11	215040.....	16-5	222033.....	14-8, 36-4
205340.....	1-12	210140.....	1-11	215041.....	16-5	222034.....	14-8, 36-4
205350.....	1-12	210150.....	1-11	215045.....	16-5	222046.....	DISC
205360.....	1-12	210155.....	1-11	215050.....	16-5	222050.....	36-4
205370.....	1-12	210160.....	1-11	215055.....	16-5	222051.....	36-4
205400.....	1-12	210165.....	1-11	215060.....	16-5	222054.....	36-4
205405.....	1-12	210170.....	1-11	215065.....	16-5	222095.....	36-4
205410.....	1-12	210175.....	1-11	215066.....	1-9, 16-6	222102.....	3-13, 36-4
205412.....	1-12	210180.....	1-11	215067.....	16-6, 21-4	222107.....	12-2, 36-4
205414.....	1-12	210185.....	1-11	215090.....	16-6	222110.....	36-8
205420.....	1-12	210190.....	1-12	215100.....	16-6	222111.....	36-8
205430.....	1-12	210200.....	1-12	215130.....	16-6	222112.....	36-8
205440.....	1-12	210210.....	1-12	216000.....	16-6, 20-4	222113.....	36-8
205450.....	1-12	210220.....	1-12	216002.....	16-6, 20-4	222115.....	36-8
205460.....	1-12	210225.....	1-12	216009.....	1-10, 16-6	222117.....	36-8
205470.....	1-12	210230.....	1-12	216010.....	16-6	222200.....	36-5
205480.....	1-12	210235.....	1-12	216080.....	DISC	222201.....	36-5
205485.....	1-12	210240.....	1-12	216110.....	16-6	222208.....	36-15
205490.....	1-12	210241.....	1-12	216115.....	16-6	222209.....	36-9
205500.....	1-12	210242.....	1-12	216129.....	16-6	222210.....	36-9
205510.....	1-12	210244.....	1-12	216130.....	16-6	222211.....	36-9
205515.....	1-12	210245.....	1-12	216132.....	16-6	222212.....	36-9
205520.....	1-12	210247.....	1-12	216133.....	16-6	222213.....	36-9
205522.....	1-12	210248.....	1-12	216135.....	16-6	222214.....	36-9
205524.....	1-12	210249.....	1-12	216137.....	16-6	222215.....	3-13, 36-10
205530.....	1-13	210250.....	1-12	216140.....	16-7	222217.....	36-10
205540.....	1-13	210260.....	1-12	216141.....	16-7, 29-1	222218.....	36-10
205550.....	1-13	210270.....	1-12	216145.....	16-7	222219.....	36-10
205560.....	1-13	210280.....	1-12	216148.....	16-7	222220.....	36-10
205570.....	1-13	210285.....	1-12	216155.....	16-7, 19-2	222221.....	36-10
205580.....	1-13	210290.....	1-12, 39-7	216195.....	16-7, 21-4	222222.....	36-11
205585.....	1-13	210291.....	1-12	216196.....	16-7	222223.....	36-11
205590.....	1-13	210293.....	1-12	216200.....	16-7	222224.....	36-11
205600.....	1-13	210294.....	1-12	216205.....	16-7	222225.....	36-11
205610.....	1-13	210295.....	1-12	216210.....	16-7	222226.....	36-11
205620.....	1-13	210296.....	1-12	216215.....	16-7	222227.....	36-11
205625.....	1-13	210297.....	1-12	216225.....	16-7	222228.....	36-12
205630.....	1-13	210298.....	1-12	216235.....	16-7	222230.....	36-12
205632.....	1-13	210299.....	1-12	216240.....	16-7	222238.....	36-12
205634.....	1-13	210300.....	1-13	216250.....	16-7	222239.....	36-12
205700.....	1-13	210310.....	1-13	216252.....	16-7	222250.....	36-15
205710.....	1-13	210320.....	1-13	216290.....	16-8	222302.....	6-4, 36-16
205720.....	1-13	210330.....	1-13	216294.....	16-8	222303.....	36-6
205730.....	1-13	210340.....	1-13	216295.....	16-8	222304.....	36-6
205740.....	1-13	210350.....	1-13	216296.....	16-8	222307.....	6-4, 36-16
205750.....	1-13	210352.....	1-13	216297.....	16-8, 21-4	222308.....	36-6
205760.....	1-13	210354.....	1-13	216300.....	16-8	222309.....	36-6
205770.....	1-13	210356.....	1-13	216310.....	16-8	222310.....	36-6
205780.....	1-13	210358.....	1-13	216358.....	16-8, 21-4	222312.....	36-6
205790.....	1-13	210360.....	1-13	216360.....	16-8	222322.....	36-6
205799.....	1-13	210362.....	1-13	220040.....	16-8	222323.....	36-6
205800.....	1-13	210364.....	1-13	220050.....	16-8	222324.....	36-6
205810.....	1-13	210366.....	1-13	220060.....	16-8	222325.....	36-6
205820.....	1-13	210400.....	1-13	220069.....	16-8	222360.....	36-12
205830.....	1-13	210410.....	1-13	220070.....	16-8	222370.....	36-13
205840.....	1-13	210420.....	1-13	220075.....	16-8	222380.....	36-13
205850.....	1-13	210430.....	1-13	220100.....	16-8	222389.....	3-10, 3-13, 36-15
205860.....	1-13	210440.....	1-13	220130.....	16-8	222395.....	3-13, 36-13
205870.....	1-13	210450.....	1-13	220135.....	16-9	222397.....	3-13, 36-13
205880.....	1-13	210460.....	1-13	220138.....	16-9, 22-1	222398.....	36-15
205890.....	1-13	210470.....	1-13	220140.....	16-9	222400.....	39-1
210010.....	1-11	210480.....	1-13	220145.....	16-9	222401.....	39-5
210020.....	1-11	210500.....	1-13	220175.....	16-9, 30-1	222402.....	39-1
210030.....	1-11	210510.....	1-13	220176.....	16-9, 30-1	222409.....	36-13
210040.....	1-11	210520.....	1-13	222000.....	36-3	222410.....	36-14
210050.....	1-11	210530.....	1-13	222002.....	36-3	222430.....	3-13, 36-4
210060.....	1-11	210540.....	1-13	222008.....	36-3	222530.....	5-9, 36-14
210070.....	1-11	210550.....	1-13	222012.....	36-3	222534.....	5-9, 36-14
210075.....	1-11	210560.....	1-13	222013.....	36-3	222535.....	5-9, 36-14
210080.....	1-11	210570.....	1-13	222014.....	36-3	222537.....	36-14
210082.....	1-11	210580.....	1-13	222016.....	36-3	222540.....	10-4, 36-15
210084.....	1-11	210590.....	1-13	222017.....	36-3	225010.....	1-17

INDEX

INDEX

Item No.	Section No.	Item No.	Section No.	Item No.	Section No.	Item No.	Section No.
225020.....	1-17	255080.....	16-11	267330.....	3-16	285036.....	19-2, 21-6
225030.....	1-17	255090.....	16-12	267340.....	3-16	285040.....	20-4
225040.....	1-17	255095.....	16-12	267350.....	3-16	285050.....	20-4
225050.....	1-17	255120.....	16-12	267360.....	3-16	285055.....	20-4
225060.....	1-17	255130.....	16-12	267370.....	3-16	285060.....	20-5
225070.....	1-17	260003.....	1-18	270003.....	16-12, 19-2	285070.....	20-5
225076.....	1-17	260004.....	1-18	270004.....	16-12, 21-4	285071.....	20-5
225080.....	1-18	260005.....	1-18	270005.....	16-12	285090.....	20-5
225090.....	1-18	260010.....	1-18	270006.....	19-2, 21-4	285100.....	19-2, 20-5
225100.....	1-18	260020.....	1-18	270007.....	21-4	285102.....	20-5
225110.....	1-18	260030.....	1-18	270008.....	21-4	285103.....	20-5
225120.....	1-18	260040.....	1-18	270009.....	16-12, 19-2, 20-3, 21-4	285110.....	20-5
225130.....	1-18	260050.....	1-18	270010.....	16-13	285111.....	20-5
225131.....	1-18	260060.....	1-18	270011.....	16-13, 21-4	285112.....	20-5
225133.....	1-18	261004.....	1-18	270012.....	16-13, 21-5	285115.....	20-5, 21-6, 26-1, 32-1
225134.....	1-18	261005.....	1-18	270020.....	16-13	285200.....	20-5
225135.....	1-18	261010.....	1-18	270021.....	16-13, 20-4	285201.....	20-5
225136.....	1-18	261020.....	1-18	270025.....	16-13	285202.....	20-5
230010.....	1-17	261030.....	1-18	270030.....	16-13	285204.....	20-5
230020.....	1-17	261040.....	1-18	270040.....	16-13	285209.....	DISC
230030.....	1-17	261050.....	1-18	270060.....	16-13	285212.....	20-5
230040.....	1-17	261060.....	1-18	270070.....	16-13	285290.....	20-6
230050.....	1-17	265010.....	3-14	270071.....	16-13, 18-1, 28-1	290000.....	19-2
230060.....	1-17	265020.....	3-14	270072.....	16-13, 28-1	290001.....	DISC
230070.....	1-17	265060.....	3-14	270073.....	16-13	290002.....	19-3
230080.....	1-17	265110.....	3-14	270074.....	28-1	290005.....	19-3
235010.....	1-18	265150.....	3-14	270075.....	16-13, 28-1	290010.....	19-3
235015.....	1-18	265155.....	3-14	270077.....	16-13, 18-1, 28-1	290041.....	19-3
235020.....	1-18	265170.....	3-14	270078.....	16-14, 28-1, 34-1	290070.....	DISC
235030.....	1-10, 1-18	265180.....	3-14	270080.....	16-14	290080.....	DISC
235035.....	1-18	265200.....	3-14	270081.....	16-14, 28-1, 33-1	290090.....	19-3
235060.....	1-18	265210.....	3-14	270082.....	16-14, 18-1, 28-1	290100.....	1-10, 19-3
235065.....	1-18	265215.....	3-14	270085.....	16-14, 18-1, 28-1	292000.....	30-1
235070.....	1-18	265216.....	3-14	270088.....	DISC	292001.....	30-1
235075.....	1-18	265300.....	3-14	270089.....	16-14, 18-1	292002.....	18-1, 28-1
235080.....	1-18, 17-1	265310.....	3-14	270140.....	DISC	292003.....	23-1
236004.....	16-9	265320.....	3-14	270170.....	16-14	292004.....	23-1, 25-2
236005.....	16-9	265330.....	3-14	270195.....	16-14	292005.....	1-10, 23-1, 25-2
236006.....	16-9	265340.....	3-14	270230.....	16-14	292006.....	32-2
236007.....	16-9	265350.....	3-14	275010.....	16-14	292007.....	21-6
236010.....	16-9	265355.....	3-15	275030.....	16-14	292008.....	28-2
236012.....	16-9	265360.....	3-14	275040.....	16-14	292010.....	DISC
236015.....	16-9	265370.....	3-14	275060.....	16-14	292011.....	21-6
236020.....	16-9	265400.....	3-17	275070.....	16-14	292012.....	28-2
236060.....	16-9	265401.....	3-17	275180.....	16-14	292040.....	22-1, 27-1, 29-1, 30-1
236070.....	16-10	265402.....	3-17	280030.....	DISC	32-2
236090.....	16-10	265405.....	3-17	280031.....	20-4, 21-5	292041.....	23-1, 25-2
236100.....	16-10	265406.....	3-17	280032.....	21-5	292042.....	25-2
236116.....	16-10	265407.....	3-17	280033.....	21-4	292043.....	23-1
236120.....	16-10	265408.....	3-17	280035.....	21-5	292044.....	23-1, 25-2
236125.....	16-10	265409.....	3-17	280040.....	19-2, 21-5	292045.....	23-1
240020.....	16-10	265411.....	3-17	280045.....	1-10, 19-2	292050.....	21-6, 22-1, 29-1, 32-2
240030.....	16-10	265420.....	3-17	280070.....	21-5	292051.....	23-1, 25-2
240040.....	16-10	265421.....	3-17	280080.....	21-5	292055.....	26-1, 32-2
240050.....	16-10	265422.....	3-17	280100.....	21-5	292057.....	26-1, 32-2
240070.....	16-10	265423.....	3-17	280130.....	1-10, 20-4	292060.....	21-6, 29-1, 32-2
240090.....	16-10	266009.....	3-15	280131.....	1-10, 20-4	292070.....	30-1
240100.....	16-10	266010.....	3-15	280135.....	1-10, 19-2, 21-5	292071.....	22-1, 27-1, 30-1
245020.....	16-10	266011.....	3-15	280136.....	1-10, 19-2, 21-5	292072.....	30-1
245040.....	16-10	266012.....	3-15	280210.....	21-5	292073.....	30-1
245060.....	DISC	266013.....	3-15	280220.....	21-5	292074.....	30-1
245080.....	16-10	266014.....	3-15	280230.....	21-5	292075.....	22-1, 29-1, 30-1
245085.....	16-11, 20-4	266015.....	3-15	280240.....	20-4, 21-5	292076.....	22-1
245099.....	16-11	266016.....	3-15	280250.....	19-2, 21-5	292077.....	22-1
245100.....	16-11	266017.....	3-15	280294.....	32-1	292080.....	27-1, 30-1
250010.....	16-11	266018.....	3-15	280295.....	21-6	292082.....	32-2
250020.....	16-11	266021.....	3-15	280315.....	21-6	292083.....	32-2
250030.....	16-11	266022.....	3-15	280320.....	21-6	292084.....	32-2
250040.....	16-11	266024.....	3-16, 16-12, 19-2	280350.....	DISC	292085.....	32-2
250050.....	16-11	266025.....	3-16, 16-12, 19-2	280360.....	21-6	292086.....	22-1, 32-2
255030.....	16-11	266030.....	3-16, 16-12, 21-4	280380.....	21-6	292087.....	22-2
255040.....	16-11	266031.....	3-16, 21-4	280381.....	21-6	292088.....	32-2
255050.....	16-11	266032.....	3-16, 16-12, 20-4, 21-4	280400.....	21-6	292089.....	33-1
255060.....	16-11	266033.....	3-16, 16-12, 21-4	280405.....	21-6	292090.....	33-1
255065.....	16-11	266034.....	3-16, 16-12, 20-4	285010.....	20-4	292091.....	33-1
255066.....	16-11	266035.....	3-16, 16-12, 20-4	285011.....	20-4	292092.....	DISC
255070.....	16-11	267320.....	3-16	285035.....	20-4	292093.....	33-1

Item No.	Section No.	Item No.	Section No.	Item No.	Section No.	Item No.	Section No.
292094	23-1, 25-2	295145	20-6	303325	16-18, 21-7	335025	16-20
292095	23-2	295150	16-15	303326	16-18, 21-7	335030	16-20
292096	32-2	295160	16-15	303327	16-18, 21-8	335050	16-19
292097	26-1, 32-2	295165	20-6	303350	17-3	335090	DISC
292098	22-2	295200	16-15	303360	DISC	335150	16-19
292099	33-1	295220	16-15	310010	1-19	335170	16-19
292100	23-2, 25-2	295250	18-1	310020	1-19	335185	DISC
292101	22-1	295271	18-1	310030	1-19	335250	16-20
292102	23-2, 25-2	295272	18-1	310040	1-19	335260	16-20
292103	23-2	295273	18-2	310050	1-19	335270	16-19
292104	DISC	295274	18-2, 28-2	310060	1-19	335280	16-19
292105	22-2, 30-1	295275	22-3	310070	1-19	335285	16-19
292106	23-2	295276	22-3	310080	1-19	335286	16-19
292107	23-2, 25-2	295277	18-2	310090	1-19	335287	16-19
292108	26-1, 32-2	295280	20-6	311005	1-19	335290	16-19
292110	30-2	295285	DISC	311007	1-19	335291	16-19
292111	23-2, 25-2	300070	16-15	311010	1-19	335292	16-19
292112	30-2	300080	16-15	311020	1-19	340010	21-8
292113	25-2	300120	16-15	311030	1-19	340030	21-8
292114	32-2	300130	16-15	311040	1-19	340050	DISC
292115	22-2	300135	16-15	311050	1-19	340230	21-8
292116	23-2	300136	16-15	311060	1-19	340300	21-8
292117	31-1	300185	21-7	312010	1-19, 3-2	340301	21-8
292118	31-1	302000	16-15, 20-6	312020	1-19	340310	DISC
292119	31-1	302001	27-1	312030	1-19	340330	21-8
292120	31-1	302002	16-15, 19-3	312040	1-19	340331	21-8
292121	31-1	302003	16-15, 19-3	315010	1-20	340350	21-8
292122	23-2	302004	16-15, 21-7	315020	1-20	345070	20-7
292123	23-2, 25-2	302005	16-15, 21-7	315030	1-20	345110	20-7
292130	DISC	302006	16-16, 20-6	315040	1-20	345120	DISC
292156	18-1	302007	16-16, 21-7	315050	1-20	345125	20-7
292157	18-1	302010	16-16	315060	1-20	345135	20-7
292158	18-1, 28-2	302011	16-16, 21-7	315070	1-20	345175	20-7
292159	18-1	302015	16-16, 21-7	315080	1-20	345178	20-7
292160	18-1	302020	16-16	315090	1-20	345190	20-7
292161	30-2	302030	16-16	315100	1-20	350020	21-8
292162	30-2	302035	16-16	315110	1-20	350050	DISC
292163	33-1	302036	16-16, 19-3	315111	1-20	350080	19-3
292164	33-1	302037	16-16, 21-7	316010	1-20	355020	26-2, 32-4
292200	27-1	302038	16-16	316020	1-20	355055	28-2
292203	27-1	302040	16-16	316030	1-20	350085	DISC
292207	32-2	302044	16-16, 21-7, 27-1, 32-3	316040	1-20	355145	32-4
292210	22-2, 27-1, 30-2, 32-3	302045	16-16, 32-3	316050	1-20	355160	32-4
292215	24-1, 32-3	302046	DISC	316060	1-20	360080	DISC
292216	26-2, 32-3	302047	16-16, 30-2	316070	1-20	360290	21-8
292218	21-6, 32-3	302048	16-17, 30-2	316080	1-20	380030	4-5
292220	32-3	302049	16-17, 30-2	316090	1-20	380040	4-5
292225	22-2, 32-3	302050	16-17, 26-2	316100	1-20	380050	4-5
292232	DISC	302051	16-17, 31-1	317000	2-6	380060	4-5
292233	22-2	302052	26-2 32-4	317010	2-6	380070	4-5
292237	22-2	302053	23-2 25-2	320010	1-20	380080	4-5
292240	32-3	302055	16-16, 21-7, 27-1, 32-3	320020	1-20	380090	4-5
292255	32-3	302056	32-4	320030	1-20	380100	4-5
292260	29-1, 30-2, 32-3	302057	16-17, 18-2	320040	1-20	380110	4-5
292261	30-2	302058	16-17, 20-6	320050	1-20	380120	4-5
292262	26-2, 32-3	302059	16-17, 20-6	320060	1-20	380130	4-5
292263	26-2	302060	16-17, 20-6	320070	1-20	380150	4-5
292265	20-6, 27-1	302080	16-17	320080	1-20	380170	4-5
292270	22-2, 27-1, 29-1, 30-2	302081	16-17, 20-6	325010	1-20	380200	4-4
	32-3	302082	16-17, 20-6, 21-7	325020	1-20	380210	4-4
292285	32-3	302090	16-17	325030	1-20	380220	4-4
292295	30-2	302091	18-2	325040	1-20	380230	4-4
292300	20-6, 27-1	302092	18-2	325050	1-20	380240	4-4
292310	20-6, 27-1	302100	16-17	325060	1-20	380250	4-4
292330	22-2	303120	16-18, 19-3, 21-7	325070	1-20	380260	4-4
292402	22-2	303125	16-18, 21-7	325080	1-20	380270	4-4
292405	22-2	303130	19-3	330005	1-20	380280	4-4
292420	22-2	303190	1-18	330006	1-20	380290	4-4
292421	22-2	303200	1-18	330030	1-20	380300	4-4
292422	22-2	303210	20-7	330040	1-20	380310	4-4
292425	32-3	303255	DISC	330050	1-20	380320	4-4
295040	28-2	303260	21-7	330070	1-20	380330	4-4
295045	28-2	303280	DISC	330080	1-20	380340	4-4
295046	28-2	303285	20-7	330110	1-20	380350	4-4
295047	28-2	303310	2-8, 16-18	330120	1-20	380360	4-4
295090	19-3, 20-6, 21-6	303317	2-8	330130	1-20	380370	4-4
295140	16-14	303318	2-8	335010	16-19	380380	4-4

INDEX

INDEX

Item No.	Section No.	Item No.	Section No.	Item No.	Section No.	Item No.	Section No.
381010.....	4-9	385080.....	6-1	385530.....	6-4	390104.....	4-1
381020.....	4-9	385090.....	6-1	385535.....	6-4	390105.....	4-1
381030.....	4-9	385100.....	6-1	385545.....	6-4	390110.....	4-1
381040.....	4-9	385110.....	6-1	385550.....	6-4	390120.....	4-1
381050.....	4-9	385120.....	6-1	385855.....	6-4	390125.....	4-1
381060.....	4-9	385130.....	6-1	386010.....	4-3	390130.....	4-1
381070.....	4-9	385140.....	6-1	386020.....	4-3	390131.....	4-1
381080.....	4-9	385150.....	6-1	386030.....	4-3	390132.....	4-1
381090.....	4-9	385160.....	6-1	386040.....	4-3	390133.....	4-1
381100.....	4-9	385170.....	6-1	386050.....	4-3	390134.....	4-1
381110.....	4-9	385180.....	6-1	386060.....	4-3	390135.....	4-1
381120.....	4-9	385190.....	6-1	386070.....	4-3	390136.....	4-1
382010.....	4-6	385200.....	6-1	386080.....	4-3	391020.....	4-1
382020.....	4-6	385210.....	6-1	386090.....	4-3	391030.....	4-1
382030.....	4-6	385220.....	6-1	386100.....	4-3	391050.....	4-1
382040.....	4-6	385230.....	6-1	386110.....	4-3	391060.....	4-1
382050.....	4-6	385231.....	6-1	386120.....	4-3	391070.....	4-1
382060.....	4-6	385232.....	6-1	386125.....	4-3	391080.....	4-1
382070.....	4-6	385233.....	6-1	386130.....	4-3	391090.....	4-1
382080.....	4-6	385234.....	6-1	386140.....	4-3	391110.....	4-1
382090.....	4-6	385235.....	6-1	386150.....	4-3	391120.....	DISC
382100.....	4-6	385236.....	6-1	386155.....	4-3	391130.....	4-1
382119.....	DISC	385237.....	6-1	386160.....	4-3	391150.....	4-1
382120.....	4-6	385401.....	6-2	386170.....	4-3	391160.....	4-1
382130.....	4-6	385402.....	6-2	386180.....	4-3	391170.....	4-1
382140.....	4-6	385403.....	6-2	386190.....	4-3	394010.....	14-2
382150.....	4-6	385404.....	6-2	387010.....	4-2	395010.....	14-1
382160.....	4-6	385405.....	DISC	387020.....	4-2	395020.....	14-1
382170.....	4-6	385406.....	6-2	387030.....	4-2	395040.....	14-1
382180.....	4-6	385407.....	6-2	387040.....	4-2	395050.....	14-1
382190.....	4-6	385408.....	6-2	387045.....	4-2	395060.....	14-1
382200.....	4-6	385409.....	6-2	387050.....	4-2	395065.....	14-1
382210.....	4-6	385410.....	6-2	387060.....	4-2	395070.....	14-2
382220.....	4-6	385411.....	6-2	387070.....	4-2	395080.....	14-2
382222.....	4-6	385412.....	6-2	387080.....	4-2	395090.....	14-2
382224.....	4-6	385413.....	6-2	387090.....	4-2	395100.....	14-2
382230.....	4-6	385414.....	6-2	388010.....	4-2	395110.....	14-2
382235.....	4-6	385415.....	6-2	388011.....	4-2	395112.....	14-32
382240.....	4-6	385417.....	6-2	388012.....	4-2	395113.....	14-32
382245.....	4-6	385419.....	6-2	388013.....	4-2	395114.....	DISC
382250.....	4-6	385420.....	6-2	388015.....	4-2	395115.....	14-32
382255.....	4-6	385421.....	6-2	388016.....	4-2	395117.....	DISC
382260.....	4-6	385422.....	6-2	388017.....	4-2	395118.....	14-32
382265.....	4-6	385423.....	6-2	388018.....	4-2	395119.....	14-32
382270.....	4-6	385424.....	DISC	388019.....	4-2	395120.....	14-1
383010.....	4-10	385425.....	6-2	388021.....	4-2	395130.....	14-1
383020.....	4-10	385426.....	6-2	388022.....	4-2	395140.....	14-1
383030.....	4-10	385427.....	6-2	388023.....	4-2	395150.....	14-1
383040.....	4-10	385428.....	6-2	388024.....	4-2	395160.....	14-2
383050.....	4-10	385429.....	6-2	388025.....	4-2	395170.....	14-1
383060.....	4-10	385431.....	6-2	388026.....	4-2	395171.....	14-1
383070.....	4-10	385432.....	6-2	390005.....	4-1	395180.....	14-1
383080.....	4-10	385434.....	6-2	390007.....	4-1	395181.....	14-1
383090.....	4-10	385435.....	6-2	390010.....	4-1	395190.....	14-2
383100.....	4-10	385436.....	6-2	390015.....	4-1	395191.....	14-2
383110.....	4-10	385460.....	6-3	390020.....	4-1	395195.....	14-10
383120.....	4-10	385461.....	6-3	390022.....	DISC	395195-500.....	14-10
383130.....	4-10	385462.....	6-3	390025.....	4-1	395199.....	14-10
384010.....	4-8	385463.....	6-3	390030.....	4-1	395199-500.....	14-10
384020.....	4-8	385464.....	6-3	390035.....	4-1	395200.....	14-10
384030.....	4-8	385465.....	6-3	390040.....	4-1	395201.....	14-10
384040.....	4-8	385466.....	6-3	390050.....	4-1	395202.....	14-9
384050.....	4-8	385467.....	6-3	390055.....	4-1	395205.....	14-10
384060.....	4-8	385468.....	6-3	390060.....	4-1	395205-500.....	14-10
384070.....	4-8	385469.....	6-3	390065.....	4-1	395220.....	14-1
384080.....	4-8	385470.....	6-3	390070.....	4-1	395230.....	14-1
384090.....	4-8	385471.....	6-3	390075.....	4-1	395240.....	14-1
384100.....	4-8	385472.....	6-3	390080.....	4-1	395242.....	14-2
384110.....	4-8	385473.....	6-3	390083.....	4-1	395245.....	14-2
384120.....	4-8	385474.....	6-3	390085.....	4-1	395246.....	14-2
385010.....	6-1	385475.....	6-3	390087.....	4-1	395247.....	14-1
385020.....	6-1	385476.....	6-3	390090.....	4-1	395248.....	14-1
385030.....	6-1	385477.....	6-3	390095.....	DISC	395360.....	14-1
385040.....	6-1	385505.....	6-4	390100.....	4-1	395370.....	14-1
385050.....	6-1	385510.....	6-4	390101.....	4-1	395401.....	14-1
385060.....	6-1	385520.....	6-4	390102.....	4-1	395402.....	14-1
385070.....	6-1	385525.....	6-4	390103.....	4-1	395403.....	14-1

INDEX

Item No.	Section No.	Item No.	Section No.	Item No.	Section No.	Item No.	Section No.
395404.....	14-1	396183.....	14-3	398075.....	14-6	400150.....	14-36
395410.....	14-1	396184.....	14-3	398076.....	14-6	400155.....	14-36
395435.....	14-23	396185.....	14-9	398080.....	14-6	400165.....	14-3, 14-40
395436.....	14-23	396186.....	14-9	398081.....	14-6	400300.....	14-47
395460.....	14-1	396187.....	14-3	398085.....	14-6	400302.....	14-47
395470.....	14-4	396188.....	14-3	398086.....	14-6	400305.....	14-47
395470-500.....	14-4	396189.....	14-3	398090.....	14-6	400307.....	14-47
395480.....	14-4	396190.....	14-3	398091.....	14-6	400312.....	14-47
395480-500.....	14-4	396190-500.....	14-3	398095.....	14-6	400315.....	14-40
395490.....	14-4	396191.....	14-3	398096.....	14-6	400317.....	14-40
395490-500.....	14-4	396192.....	14-3	398100.....	14-6	400320.....	14-40
395500.....	14-4	396193.....	14-3	398101.....	14-6	400322.....	14-40
395500-500.....	14-4	396194.....	14-3	398105.....	14-6	400325.....	14-40
395501.....	14-4	396195.....	14-9	398106.....	14-6	400327.....	14-41
395501-500.....	14-4	396196.....	14-9	398110.....	14-6	400330.....	14-41
395502.....	14-4	396197.....	14-3	398111.....	14-6	400332.....	14-41
395502-500.....	14-4	396210.....	14-4	398115.....	14-6	400337.....	14-41
395510.....	14-10	396215.....	14-4	398116.....	14-6	400340.....	14-41
395511.....	14-10	396250.....	14-9	398120.....	14-6	400360.....	14-37
395512.....	14-10	396251.....	14-9	398121.....	14-6	400380.....	14-41
395513.....	14-10	396252.....	14-9	398125.....	14-6	400400.....	14-37
395514.....	14-10	396253.....	14-9	398126.....	14-6	400420.....	14-37
395515.....	14-10	396300.....	14-14	399010.....	14-7	400455.....	14-41
395516.....	14-10	396305.....	14-14	399011.....	14-7	400456.....	14-41
395590.....	14-31	396310.....	14-14	399015.....	14-7	400460.....	14-37
395610.....	14-31	396315.....	14-14	399016.....	14-7	400470.....	14-41
395620.....	14-31	396320.....	14-14	399020.....	14-7	400481.....	14-35, 14-37, 14-41
395621.....	14-33	396622.....	DISC	399021.....	14-7	400482.....	14-35, 14-37, 14-41
395622.....	14-33	396660.....	14-31	399025.....	14-7	400483.....	14-35, 14-37, 14-42
395624.....	14-32	396680.....	14-31	399026.....	14-7	400484.....	14-37
395627.....	14-34	396681.....	14-31	399030.....	14-7	400495.....	14-37
395628.....	14-34	396682.....	14-31	399031.....	14-7	400505.....	14-38
395629.....	14-34	396686.....	14-31	399035.....	14-7	400506.....	14-38
395637.....	14-32	396688.....	14-31	399036.....	14-7	400508.....	14-38
395638.....	14-34	396690.....	14-31	399040.....	14-7	400509.....	14-38
395639.....	14-34	396691.....	14-31	399041.....	14-7	400510.....	14-38
395640.....	14-33	396692.....	DISC	399045.....	14-7	400511.....	14-38
395650.....	14-31	396693.....	14-32	399046.....	14-7	400512.....	14-38
395659.....	DISC	396695.....	14-34	399050.....	14-7	400513.....	14-38
396000.....	14-32	396698.....	14-34	399051.....	14-7	400516.....	14-42
396002.....	14-33	396700.....	14-34	399055.....	14-7	400520.....	14-16
396003.....	14-33	396701.....	14-16	399056.....	14-7	400530.....	14-16
396005.....	14-33	396702.....	14-16	399060.....	14-7	400537.....	14-16
396006.....	14-33	396705.....	14-16	399061.....	14-7	400538.....	14-16
396007.....	14-33	396706.....	14-16	399065.....	14-7	400539.....	14-16
396009.....	DISC	396707.....	14-16	399066.....	14-7	400540.....	14-16
396011.....	14-34	396708.....	14-16	399070.....	14-8	400541.....	14-16
396013.....	14-34	397180.....	DISC	399071.....	14-8	400542.....	14-16
396016.....	DISC	397190.....	14-11	399075.....	14-8	400543.....	14-16
396017.....	DISC	398010.....	14-5	399076.....	14-8	400544.....	14-16
396018.....	14-34	398011.....	14-5	399080.....	14-8	400545.....	14-16
396019.....	DISC	398015.....	14-5	399081.....	14-8	400546.....	14-16
396020.....	14-33, 14-34	398016.....	14-5	399085.....	14-8	400547.....	14-16
396021.....	14-31	398020.....	14-5	399086.....	14-8	400550.....	14-42
396023.....	14-11	398021.....	14-5	399090.....	14-8	400560.....	14-42
396024.....	14-11	398025.....	14-5	399091.....	14-8	400579.....	14-38
396025.....	14-11	398026.....	14-5	399095.....	14-8	400582.....	DISC
396030.....	14-11	398030.....	14-5	399096.....	14-8	400585.....	14-38
396033.....	14-11	398031.....	14-5	399100.....	14-8	400590.....	14-42
396050.....	14-11	398035.....	14-5	399101.....	14-8	400595.....	14-42
396055.....	14-11	398036.....	14-5	399105.....	14-8	400600.....	14-42
396056.....	14-11	398040.....	14-5	399106.....	14-8	400601.....	14-42
396170.....	14-3	398041.....	14-5	399110.....	14-8	400605.....	14-42
396170-500.....	14-3	398042.....	14-5	399111.....	14-8	400610.....	DISC
396171.....	14-3	398043.....	14-5	399115.....	14-8	400615.....	14-42
396172.....	14-3	398045.....	14-5	399116.....	14-8	400620.....	14-42
396173.....	14-3	398046.....	14-5	399120.....	14-8	400625.....	14-39
396174.....	14-3	398050.....	14-5	399121.....	14-8	400630.....	14-42
396175.....	14-9	398051.....	14-5	399125.....	14-8	400635.....	14-35, 14-39, 14-43
396176.....	14-3	398055.....	14-5	399126.....	14-8	400640.....	14-43
396177.....	14-9	398056.....	14-5	400090.....	14-36	400645.....	14-43
396178.....	14-3	398060.....	14-5	400100.....	14-36, 14-40	400650.....	14-39
396179.....	14-3	398061.....	14-5	400110.....	14-35	400655.....	14-43
396180.....	14-3	398065.....	14-5	400130.....	14-35, 14-36	400660.....	14-39
396180-500.....	14-3	398066.....	14-5	400135.....	14-36, 14-40, 14-48	400665.....	14-39
396181.....	14-3	398070.....	14-6	400140.....	14-36, 14-48	400670.....	14-43
396182.....	14-3	398071.....	14-6	400145.....	14-36	400671.....	14-39

INDEX

INDEX

Item No.	Section No.	Item No.	Section No.	Item No.	Section No.	Item No.	Section No.
400672	14-39	410230	10-3	415305	19-5		33-1
400674	14-43	415010	21-8	415413	30-3	415830	3-11, 19-6, 20-11, 21-11
400676	14-43	415011	21-8	415440	20-10	415840	3-12, 19-6, 20-11, 21-11
400677	14-43	415020	20-7	415450	21-10		33-2
400678	14-43	415040	19-4, 20-7, 21-8	415451	21-10	415851	19-6
400679	14-39	415049	DISC	415465	20-10	415860	32-4
400680	14-39	415050	19-4, 20-8, 21-8	415480	21-10	415865	22-3, 30-3
400681	14-43	415051	19-4, 20-8, 21-8	415490	21-10	415866	22-3
400682	14-44	415052	21-8	415503	21-10, 33-1	415867	30-3
400683	14-44	415060	21-8	415505	19-5, 20-10, 21-10	415880	22-4
400684	14-35, 14-39, 14-44	415070	19-4, 20-8, 21-8, 22-3	415509	30-3	415880-150	22-4
400685	14-44	415071	19-4, 20-8, 21-8, 22-3	415518	DISC	415881	19-7
400687	14-44	415072	19-4, 20-8, 21-8, 22-3	415523	20-10	415883	19-7, 20-11, 21-12
400690	14-44	415073	22-3	415524	19-5	415885	22-4
400701	14-44	415075	19-4, 20-8, 21-9, 22-3	415525	21-10	415886	21-12, 30-3
400702	14-44	415076	19-4, 20-8, 21-9, 22-3	415590	3-11, 20-10	415888	19-7, 20-11, 21-12
400705	14-35	415077	19-4, 20-8	415595	3-11, 20-10	415889	19-7, 20-11, 21-12
400710	14-44	415080	21-9	415596	20-10, 21-10	415890	DISC
400711	14-39	415100	19-4, 20-8, 21-9	415597	19-5, 20-10, 21-10	415891	19-7, 20-11, 21-12
400712	14-44	415107	19-4, 29-1	415597-500	19-5, 20-10, 21-10	415891-500	19-7, 20-11, 21-12
400713	14-44	415110	20-8	415598	20-10	415892	19-7, 20-11, 21-12
400714	14-44	415112	29-1	415600	3-11, 19-5, 20-10, 21-11	415893	19-7, 20-11, 21-12
400715	14-45	415120	20-8	415601	3-11, 19-5	415905	30-3
400716	14-45	415123	19-4, 20-8, 21-9	415602	3-11, 19-5, 20-10, 21-11	415910	20-11, 27-2
400717	14-45	415124	19-4, 20-8, 21-9	415603	3-11, 19-5	415915	21-12, 22-4, 27-2
400718	14-45	415125	19-4, 20-8, 21-9	415604	3-11, 19-6, 20-10, 21-11	415916	21-12, 22-4, 27-2
400719	14-45	415126	19-4, 20-8		33-1	415917	30-3
400720	14-45	415127	21-9	415605	3-11, 19-6	415920	21-13, 24-1, 30-3
400721	14-45	415128	19-4, 20-8, 21-9, 19-4	415610	3-11, 19-6, 20-10, 21-11	415922	21-13
400722	14-45		20-8	415620	3-11, 19-6, 20-10, 21-11	415925	21-13, 22-4, 24-1, 30-3
400723	14-45	415130	20-8, 21-9		33-1	415926	32-4, 21-13
400724	14-46	415131	21-9	415630	3-11, 19-6, 20-11, 21-11	415927	32-4, 21-13
400725	14-35	415135	21-9	415640	3-12, 19-6, 20-11, 21-11	415928	32-4, 21-13
400726	14-46	415138	20-8, 21-9		33-2	415930	32-5
400727	14-46	415139	20-8	415645	3-12, 21-11	415935	20-12, 27-2
400731	14-46	415147-50	26-3	415650	3-12, 20-11, 21-11, 27-2	415940	30-4
400732	14-46	415150	20-8, 21-9	415651	21-11	415950	DISC
400733	14-46	415165	19-4, 20-8	415652	19-6	415960	21-13, 32-5
400734	14-46	415190	19-4, 20-9, 21-9	415653	19-6, 21-11	415963	21-13
400735	14-46	415210	21-9	415663	19-6, 21-11	415965	21-13, 23-2, 32-5
400736	14-46	415220	19-4, 20-9, 21-9	415664	19-6, 21-11	415970	22-4
405010	40-3	415221	19-4, 20-9, 21-9	415666	21-11	415971	22-4
405030	40-3	415222	19-4, 20-9, 21-9	415668	22-3	415975	20-12, 27-2
405040	40-3	415225	19-4, 20-9	415695	3-12, 20-11	415976	20-12
405050	40-3	415228	20-9	415710	28-2, 34-1	415977	26-2
405060	40-3	415229	19-5, 20-9	415711	28-2	415978	26-2
405070	40-3	415232	19-5	415730	30-3	415980	22-4, 23-2
410000	10-2	415234	26-2, 32-4	415740	21-12, 30-3	415981	22-4, 23-2
410001	10-2	415235	21-10	415750	20-11, 25-2, 27-2, 30-3	415982	22-4
410002	10-2	415236	19-5	415751	20-11, 25-2, 27-2, 30-3	415983	22-4, 30-4
410003	10-2	415237	30-2	415755	32-4	415984	22-4, 30-4
410010	10-3	415238	20-9	415759	19-6, 20-11, 21-12, 22-3	415991	DISC
410015	10-3	415239	22-3		24-1	415992	19-7, 21-13
410020	10-3	415240	22-3, 32-4	415759	27-2, 29-1, 32-4	415993	20-11
410030	10-3	415241	33-1	415761	19-6, 20-11, 21-12, 22-3	415994	19-7, 21-13
410040	10-3	415242	26-2, 32-4		24-1	415995	22-4
410045	10-3	415243	30-2	415761	27-2, 29-1, 32-4	415996	21-13
410046	10-3	415245	19-5, 20-9, 21-10	415762	32-4	415997	20-12
410050	10-3	415246	21-10	415763	32-4	415999	23-2, 25-2
410060	10-3	415247	21-10	415772	30-3	416000	22-4
410070	10-3	415248	DISC	415775	22-3, 24-1, 30-3	416000-50	22-4
410080	10-3	415249	20-9, 21-10	415776	22-3, 24-1, 30-3	416001	18-2, 21-13, 22-4
410085	10-3	415250	3-11, 21-10	415777	22-3, 27-2, 30-3	416001-100	18-2, 21-13, 22-4
410090	10-3	415251	19-5, 21-10	415778	22-3, 27-2, 30-3	416002	22-4
410100	10-3	415252	DISC	415779	22-3, 27-2, 30-3	416003	20-12
410105	10-3	415253	20-9	415780	19-6, 20-11, 21-12	416004	20-12, 27-2
410110	10-3	415254	19-5	415781	19-6, 20-11, 21-12	416005	21-13
410111	10-3	415255	20-9, 23-2, 25-2, 27-1	415782	21-12	416006	22-4, 30-4
410120	10-3		32-4	415785	19-6, 21-12	416007	30-4
410130	DISC	415256	20-9	415790	19-6, 20-11, 21-12	416008	21-13
410160	10-3	415257	20-9	415795	21-12	416009	30-4
410170	10-3	415259	20-9, 22-3, 30-2, 32-4	415798	20-11, 21-12	416010	21-13
410190	10-3	415263	22-3	415799	21-12	416011	19-7, 20-12, 21-13,
410200	10-3	415268	22-3	415800	3-11, 19-5, 20-10, 21-11		28-2
410210	10-3	415269	32-4	415802	3-11, 19-5, 20-10, 21-11	416012	DISC
410211	10-3	415278	30-3	415810	3-11, 19-6, 20-10, 21-11	416013	20-12, 21-14
410220	10-3	415295	30-3	415820	3-11, 19-6, 20-10, 21-11	416014	21-14

INDEX

INDEX

Item No.	Section No.	Item No.	Section No.	Item No.	Section No.	Item No.	Section No.
416015.....	21-14	416091.....	22-6	416167.....	32-6	416250.....	33-2
416016.....	20-12	416092.....	22-6	416168.....	21-15	416251.....	33-2
416017.....	33-2	416093.....	22-6	416169.....	19-8, 21-15	416252.....	33-2
416018.....	20-12, 22-4	416094.....	22-6	416170.....	21-15	416253.....	33-2
416019.....	32-5	416095.....	30-4	416171.....	19-8, 21-15	416254.....	33-2
416020.....	DISC	416096.....	30-4	416172.....	19-9	416255.....	23-3
416021.....	22-4	416097.....	19-8, 29-1	416173.....	26-3, 32-6	416256.....	23-3, 25-2
416022.....	26-2, 32-5	416098.....	21-14, 32-5	416174.....	26-3, 32-7	416257.....	23-3, 25-2
416023.....	21-14, 22-4, 29-1	416099.....	30-4	416175.....	21-15	416258.....	23-3, 25-2
416024.....	22-4	416100.....	18-3	416176.....	26-3, 32-7	416259.....	21-16
416025.....	20-12, 23-2, 27-2	416101.....	28-3	416177.....	19-9, 21-15	416260.....	20-14, 21-16
416026.....	20-12, 22-4	416102.....	19-8, 21-14	416178.....	32-7	416261.....	19-10, 20-14, 21-16
416027.....	22-5	416103.....	21-14, 27-3, 32-5	416179.....	19-9	416262.....	25-2
416028.....	26-2, 32-5	416104.....	18-3, 28-3	416180.....	20-14	416263.....	25-2
416029.....	26-2	416105.....	18-3	416181.....	19-9	416264.....	32-8
416030.....	22-5	416106.....	32-5	416182.....	19-9	416265.....	32-8
416031.....	26-2, 32-5	416107.....	27-3	416183.....	19-9	416266.....	22-7
416032.....	22-5	416108.....	30-4, 32-5	416184.....	19-9, 21-15	416268.....	30-5
416033.....	22-5	416109.....	32-5	416185.....	23-3, 25-2	416269.....	DISC
416034.....	22-5	416110.....	18-3, 28-3, 33-2	416186.....	20-14, 21-15	416270.....	19-10, 28-3
416035.....	21-14	416111.....	28-3	416186-500.....	20-14, 21-15	416271.....	18-3
416036.....	22-5	416112.....	18-3	416187.....	19-9	416272.....	25-2
416037.....	DISC	416113.....	32-5	416188.....	32-7	416273.....	19-10
416038.....	27-2	416114.....	32-6	416189.....	32-7	416274.....	19-10
416039.....	20-12, 27-2	416115.....	32-6	416190.....	19-9, 20-14, 21-15	416275.....	19-10
416040.....	19-7	416116.....	32-6	416191.....	32-7	416276.....	19-10, 20-15
416041.....	20-12, 27-2	416117.....	32-6	416192.....	19-9, 20-14, 21-16	416277.....	19-10
416042.....	19-7, 20-12, 27-2	416118.....	20-13, 21-14	416193.....	26-3, 32-7	416278.....	20-15
416043.....	27-3	416119.....	28-3	416194.....	20-14, 21-16	416279.....	21-16
416044.....	22-5	416120.....	32-6	416195.....	32-7	416280.....	19-10, 21-17
416045.....	20-12	416121.....	28-3	416196.....	19-9, 21-16	416281.....	19-10, 21-17
416046.....	19-7, 20-13, 21-14	416122.....	32-6	416197.....	32-7	416282.....	21-17
416047.....	19-7, 20-13, 21-14	416123.....	19-8, 29-1	416198.....	21-16	416283.....	21-17
416048.....	22-5	416124.....	32-6	416199.....	32-7	416284.....	DISC
416049.....	20-12, 23-2, 27-2	416125.....	19-8, 29-1	416200.....	20-14, 21-16	416285.....	18-3, 28-3
416050.....	32-4, 21-13	416126.....	22-6	416201.....	22-6	416286.....	23-3
416051.....	32-5	416127.....	22-6	416202.....	27-3, 30-4	416287.....	23-3, 25-2
416052.....	DISC	416127-50.....	22-6	416203.....	23-3	416288.....	32-8
416053.....	3-12, 18-2	416128.....	32-6	416204.....	20-14, 21-16	416289.....	23-3, 25-2
416054.....	30-4	416129.....	26-3, 32-6	416205.....	23-3, 25-2	416290.....	20-15, 21-17
416055.....	19-7, 21-14, 22-5, 29-1	416130.....	24-1	416206.....	19-9	416291.....	33-2
.....	32-5	416131.....	20-13	416207.....	19-9	416292.....	28-3
416056.....	30-4	416132.....	34-1	416208.....	19-9, 20-14, 21-16	416293.....	28-3
416057.....	19-7	416133.....	22-6, 29-1	416209.....	20-14, 27-3	416294.....	28-3
416058.....	22-5	416134.....	29-2, 30-4	416210.....	21-16	416296.....	28-3
416059.....	22-5	416135.....	26-3, 30-4, 32-6	416211.....	21-16	416297.....	18-3
416060.....	19-8	416136.....	30-4	416212.....	20-14	416298.....	22-7
416061.....	22-5	416137.....	30-4	416213.....	22-6, 26-3, 32-7	416299.....	26-4, 32-8
416062.....	20-13	416138.....	19-8, 20-13, 21-14	416214.....	32-7	416300.....	25-3
416063.....	20-13	416139.....	30-4	416215.....	19-9	416301.....	33-2
416064.....	30-4	416140.....	19-8, 21-14	416216.....	30-5	416302.....	23-3, 25-3
416065.....	20-13	416141.....	32-6	416217.....	26-3, 32-7	416303.....	18-3
416066.....	20-13	416142.....	32-6	416218.....	26-3, 32-7	416304.....	26-4
416067.....	20-13	416143.....	32-6	416219.....	32-7	416305.....	26-4, 32-8
416068.....	22-5	416144.....	19-8	416220.....	22-7	416306.....	28-3
416069.....	22-5	416145.....	32-6	416221.....	27-3	416320.....	31-1
416070.....	22-5	416146.....	19-8, 20-13, 21-14	416222.....	20-14	416321.....	22-7
416071.....	26-2	416147.....	26-3, 32-6	416223.....	20-14	416322.....	19-10
416072.....	22-5	416148.....	19-8	416224.....	27-3	416323.....	26-4
416073.....	26-2	416149.....	32-6	416225.....	26-3, 32-8	416324.....	26-4
416074.....	22-5	416150.....	19-8	416226.....	26-3, 32-8	416325.....	26-4, 32-8
416075.....	22-5	416151.....	32-6	416227.....	26-3	416326.....	31-1
416076.....	3-12, 18-2	416152.....	19-8, 20-13, 1-14	416228.....	26-3, 32-8	416327.....	31-1
416077.....	18-2	416153.....	20-13	416229.....	22-7	416328.....	31-1
416078.....	18-2	416154.....	19-8, 20-13	416230.....	18-3	416329.....	31-1
416079.....	18-3	416155.....	19-8	416231.....	18-3	416330.....	31-1
416080.....	DISC	416156.....	21-15	416232.....	19-10	416331.....	31-1
416081.....	28-2	416157.....	20-14	416233.....	21-16	416332.....	31-1
416082.....	22-5	416158.....	21-15	416234.....	19-10	416333.....	31-1
416083.....	22-6, 27-3, 32-5	416159.....	30-4	416235.....	30-5	416334.....	31-2
416084.....	22-6	416160.....	21-15	416236.....	30-5	416335.....	31-2
416085.....	22-6	416161.....	21-15	416237.....	30-5	416336.....	31-2
416086.....	22-6	416162.....	DISC	416238.....	30-5	416337.....	23-3, 25-3, 31-2
416087.....	22-6	416163.....	21-15	416239.....	34-1	416338.....	31-2
416088.....	22-6	416164.....	21-15	416240.....	33-2	416339.....	31-2
416089.....	22-6	416165.....	26-3, 32-6	416242.....	32-8	416340.....	31-2
416090.....	20-13	416166.....	21-15	416243.....	29-2, 31-1	416341.....	31-2

INDEX

INDEX

Item No.	Section No.	Item No.	Section No.	Item No.	Section No.	Item No.	Section No.
416342.....	31-2	421381.....	21-20	435351.....	21-27	435516.....	28-4
416343.....	31-2	421382.....	21-21	435381.....	22-8	435517.....	26-5, 32-9
416344.....	31-2	421383.....	21-21	435390.....	18-4	435518.....	32-9
416345.....	31-2	421384.....	21-21	435392.....	18-4	435519.....	32-9
416346.....	31-2	421385.....	21-21	435395.....	18-4	435520.....	32-9
416347.....	31-2	421386.....	21-21	435396.....	18-4	435521.....	32-9
416348.....	31-2	421387.....	21-21	435397.....	18-4	435522.....	32-10
416349.....	31-2	421388.....	21-21	435398.....	18-4	435523.....	32-10
416350.....	30-5	421389.....	21-21	435399.....	18-4	435524.....	32-10
416351.....	18-3	421390.....	21-21	435401.....	28-3	435525.....	32-10
416352.....	22-7	421391.....	21-21	435402.....	28-4	435526.....	32-10
416353.....	18-3	421392.....	21-21	435403.....	28-4	435527.....	22-9
416354.....	18-4	421393.....	DISC	435405.....	DISC	435528.....	22-9
416355.....	18-4	421394.....	21-21	435406.....	28-4	435529.....	22-9
416356.....	18-4	421395.....	21-21	435408.....	28-4	435530.....	22-9
416417-50.....	32-6	421396.....	21-21	435409.....	DISC	435531.....	22-9
420000.....	21-17	421397.....	21-21	435411.....	28-4	435532.....	18-4
420001.....	21-17	421398.....	21-22	435412.....	28-4	435533.....	DISC
420002.....	21-17	421399.....	21-22	435413.....	28-4	435534.....	18-5
420003.....	21-17	421400.....	21-22	435414.....	DISC	435535.....	18-5
420004.....	21-17	421401.....	19-10, 21-22	435417.....	28-4	435536.....	27-3
420005.....	21-17	425200.....	DISC	435418.....	18-4	435537.....	23-4
420006.....	21-17	425202.....	20-15	435419.....	18-4	435538.....	32-10
420007.....	21-17	425203.....	20-15	435420.....	18-4	435539.....	22-9
420008.....	21-17	425204.....	20-15	435421.....	18-4	435540.....	27-3
420009.....	21-18	425205.....	20-15	435425.....	22-8	435560.....	22-9
420010.....	21-18	425206.....	20-15	435427.....	22-8	435561.....	27-3
420011.....	21-18	425207.....	20-15	435428.....	22-8	435600.....	23-4
420015.....	21-18	425208.....	20-15	435429.....	22-8	435601.....	23-4, 25-3
420016.....	21-18	425209.....	20-15	435430.....	DISC	435602.....	23-4
420017.....	DISC	425210.....	20-15	435435.....	26-4	435603.....	23-4
420018.....	21-18	425211.....	20-15	435436.....	26-4	435604.....	23-4
420019.....	21-18	425212.....	20-15	435437.....	26-4	435605.....	25-3
420030.....	21-18	425515.....	20-15	435438.....	26-4	435606.....	23-4, 25-3
420070.....	DISC	425516.....	20-15	435439.....	32-8	435607.....	23-4
420090.....	DISC	425517.....	20-16	435440.....	22-8	435608.....	23-4
420110.....	21-18	425520.....	20-16	435441.....	26-4, 32-9	435609.....	DISC
420280.....	21-18	425522.....	20-16	435460.....	22-8	435610.....	23-5
420290.....	21-18	425523.....	20-16	435473.....	23-3, 25-3	435611.....	23-5, 25-3
420860.....	21-18	425525.....	20-16, 27-3	435474.....	23-3	435612.....	23-5, 25-3
420940.....	21-19	430000.....	19-10	435475.....	22-8	435613.....	23-5, 25-3
420950.....	21-19	430001.....	19-10	435477.....	22-8	435614.....	23-5
421000.....	21-19	430002.....	19-10	435478.....	DISC	435615.....	23-5
421001.....	21-19	430003.....	19-11	435479.....	DISC	435616.....	23-5, 25-3
421002.....	21-19	430004.....	19-11	435480.....	26-4, 29-2, 30-5, 32-9	435617.....	23-5
421003.....	21-19	430005.....	19-11	435481.....	22-8	435618.....	23-5, 25-4
421004.....	DISC	430006.....	19-11	435482.....	30-5	435619.....	25-4
421005.....	21-19	430007.....	19-11	435483.....	32-9	435620.....	32-10
421006.....	21-19	430008.....	19-11	435484.....	32-9	435621.....	32-10
421007.....	28-3	430009.....	19-11	435486.....	32-9	435622.....	32-10
421008.....	32-8	430010.....	19-11	435487.....	32-9	435623.....	30-5
421009.....	32-8	430011.....	19-11, 21-22	435488.....	32-9	435624.....	30-5
421010.....	DISC	430012.....	19-11	435489.....	30-5	435625.....	31-3
421011.....	32-8	430090.....	19-11	435491.....	32-9	435626.....	31-3
421012.....	22-7	430095.....	19-11	435492.....	30-5	435627.....	31-3
421013.....	21-19	430240.....	19-11	435493.....	32-9	435628.....	31-3
421050.....	21-19	430290.....	19-11	435494.....	21-22, 32-9	435629.....	31-3
421122.....	21-19	430480.....	19-11	435495.....	22-8	435630.....	30-5
421130.....	21-19	430482.....	19-11	435496.....	33-3	440020.....	17-1
421150.....	21-19	430485.....	19-12	435497.....	23-4	440040.....	17-1
421200.....	21-19	435002.....	22-7	435498.....	22-8	440050.....	17-1
421245.....	21-20	435003.....	22-7	435499.....	23-4, 25-3	440060.....	17-1
421278.....	21-20	435004.....	23-3	435500.....	32-9	440070.....	17-1
421305.....	21-20	435006.....	22-7	435501.....	23-4	440120.....	17-1
421310.....	21-20	435007.....	22-7	435502.....	22-8	440130.....	17-1
421350.....	22-7	435008.....	22-7	435503.....	23-4	440140.....	17-1
421351.....	DISC	435009.....	18-4	435504.....	23-4, 25-3	440150.....	17-1
421360.....	21-20	435010.....	33-2	435505.....	22-8	440170.....	17-1
421361.....	21-20	435075.....	DISC	435506.....	DISC	440175.....	17-1
421362.....	21-20	435112.....	34-1	435507.....	26-5	440221.....	18-5
421365.....	DISC	435181.....	22-7	435508.....	26-5	445001.....	18-5
421375.....	21-20	435184.....	22-7	435509.....	26-5	445002.....	21-22
421376.....	21-20	435185.....	22-8	435510.....	26-5	445003.....	30-5
421377.....	21-20	435187.....	27-3	435512.....	23-4, 25-3	445004.....	30-6
421378.....	21-20	435230.....	33-2	435513.....	25-3	445005.....	33-3
421379.....	21-20	435301.....	33-2	435514.....	25-3	445006.....	26-5, 32-10
421380.....	21-20	435302.....	DISC	435515.....	28-4	445030.....	17-3

Item No.	Section No.	Item No.	Section No.	Item No.	Section No.	Item No.	Section No.
445032.....	19-12, 20-16, 33-3	445802.....	30-6	445927.....	DISC	465207.....	DISC
445035.....	DISC	445804.....	22-9	445935.....	DISC	465209.....	22-11
445036.....	28-4	445805.....	22-9, 27-3, 30-6	445937.....	17-3	465210.....	22-11
445038.....	19-12	445806.....	22-9	445938.....	17-3	465213.....	22-11
445039.....	19-12	445807.....	22-9	445940.....	DISC	465214.....	22-11
445040.....	19-12	445808.....	30-6	445941.....	DISC	465219.....	22-10
445042.....	19-12	445811.....	27-3	445942.....	17-3	465243.....	22-11
445044.....	19-12	445812.....	DISC	445943.....	DISC	465244.....	22-11
445046.....	19-12	445813.....	28-4	445944.....	29-2	465253.....	22-11
445060.....	DISC	445814.....	27-4, 32-10	445945.....	20-17	465256.....	22-11
445100.....	DISC	445815.....	21-23, 24-1, 27-4,	445946.....	20-17	465257.....	22-11
445130.....	DISC	32-10	445947.....	20-17	465300.....	32-12
445140.....	17-3	445816.....	26-5, 32-10	445948.....	21-24	465301.....	32-12
445161.....	20-16, 27-3	445817.....	26-5, 32-10	445949.....	20-17	465303.....	DISC
445178.....	19-12, 29-2	445818.....	19-13, 21-23, 32-10	445950.....	26-5, 32-11	465305.....	32-12
445180.....	19-12, 29-2	445819.....	21-23	445965.....	22-9, 32-11	465306.....	32-12
445182.....	19-12, 29-2	445820.....	26-5, 32-10	445967.....	22-10	465307.....	32-12
445184.....	19-12, 29-2	445821.....	33-3	445970.....	30-6	465308.....	32-12
445186.....	19-12, 29-2	445822.....	33-3, 34-1	445977.....	21-24, 26-5, 32-11	465309.....	32-12
445188.....	29-2	445823.....	33-3	445978.....	21-24, 26-5, 32-11	465310.....	32-12
445200.....	17-3	445824.....	33-3	445985.....	27-4	465311.....	32-13
445220.....	DISC	445825.....	33-3	445986.....	20-17, 27-4	465312.....	32-13
445230.....	20-16	445826.....	33-3	445990.....	DISC	465313.....	DISC
445250.....	17-3	445827.....	33-3	445991.....	27-4	465314.....	DISC
445270.....	17-3	445828.....	33-3	445995.....	20-17, 27-4	465315.....	32-13
445280.....	17-3	445829.....	33-3	450001.....	21-27	465316.....	32-13
445290.....	DISC	445831.....	33-3	450010.....	DISC	465317.....	32-13
445291.....	DISC	445832.....	33-3	450030.....	DISC	465318.....	32-13
445330.....	17-3	445833.....	21-24, 23-5, 25-4	450120.....	21-27	465319.....	32-13
445335.....	17-3	445834.....	23-5	450140.....	21-27	465320.....	32-13
445350.....	19-12	445835.....	23-5, 25-4	450220.....	21-27	465321.....	32-13
445360.....	21-22	445836.....	21-24	450230.....	21-27	465322.....	32-13
445361.....	21-22	445837.....	20-17, 21-24	450270.....	21-27	465323.....	32-13
445362.....	21-22	445838.....	20-17, 21-24	450290.....	21-27	465324.....	32-13
445363.....	21-22	445839.....	20-17	450340.....	21-27	465325.....	32-13
445364.....	21-22	445840.....	23-5, 25-4	450370.....	21-27	465326.....	32-13
445365.....	21-22	445841.....	DISC	450400.....	21-27	465327.....	32-14
445366.....	25-4	445842.....	20-17	455000.....	DISC	465328.....	32-14
445370.....	DISC	445843.....	23-5	455005.....	20-18	465329.....	32-14
445375.....	21-22	445844.....	23-5, 25-4	455010.....	20-18	465330.....	32-14
445376.....	21-22	445845.....	23-6	455011.....	20-18	465400.....	22-11
445390.....	17-2	445846.....	23-6, 25-4	445080.....	DISC	470070.....	21-24
445440.....	DISC	445847.....	23-6, 25-4	455140.....	20-18	470090.....	21-24
445490.....	DISC	445848.....	33-3	455180.....	20-18	470110.....	20-17
445510.....	20-16	445849.....	23-6, 25-4	460000.....	19-14	470115.....	20-17
445530.....	17-2	445850.....	23-6, 25-4	460110.....	19-14	470120.....	20-18
445565.....	19-12, 20-16, 21-22	445851.....	23-6, 25-4	460140.....	DISC	470125.....	21-24
445570.....	20-16	445852.....	23-6, 25-4	465000.....	23-6	471010.....	12-1
445585.....	19-12, 21-23, 33-3	445853.....	25-4	465031.....	34-1	471015.....	12-1
445590.....	21-23	445854.....	26-5	465032.....	34-1	471020.....	12-1
445595.....	21-23	445855.....	31-3	465033.....	34-1	471030.....	12-1
445620.....	21-23	445856.....	31-3	465035.....	34-1	471040.....	12-1
445622.....	21-23	445857.....	31-3	465036.....	34-1	471050.....	12-1
445623.....	19-12, 21-23	445858.....	31-3	465040.....	27-5, 30-6	471060.....	12-2
445624.....	19-12, 21-23	445859.....	31-3	465041.....	30-6	471070.....	12-2
445625.....	21-23	445860.....	31-3	465050.....	32-12	471080.....	12-2
445629.....	21-23	445861.....	23-6, 25-4	465061.....	30-6	471090.....	12-2
445632.....	19-12	445862.....	25-4	465070.....	32-12	471100.....	12-2
445633.....	19-13	445881.....	32-11	465073.....	32-12	471110.....	12-2
445635.....	19-12, 21-23	445882.....	19-13	465076.....	32-12	471115.....	21-24
445640.....	DISC	445883.....	19-13, 22-9	465086.....	22-10	471120.....	20-18
445645.....	21-23	445884.....	21-24	465087.....	22-10	471200.....	19-14
445655.....	21-23	445885.....	32-11	465088.....	DISC	471215.....	12-1, 21-25
445666.....	17-2	445886.....	32-11	465089.....	22-10	471216.....	21-25
445685.....	DISC	445887.....	32-11	465100.....	30-6	471217.....	12-1, 21-25
445720.....	20-16, 21-23	445888.....	32-11	465107.....	29-2	471220.....	12-2, 21-25
445725.....	20-16	445889.....	32-10	465110.....	32-12	471221.....	12-2, 21-25
445760.....	19-13, 20-16	445890.....	19-13	465112.....	29-2	471222.....	DISC
445765.....	20-16	445891.....	32-11	465120.....	32-12	471224.....	12-2, 21-25
445766.....	20-16	445892.....	22-9	465129.....	32-12	475001.....	20-18
445770.....	DISC	445893.....	22-9	465140.....	27-5	475075.....	19-13
445785.....	DISC	445895.....	21-24	465145.....	27-5	475076.....	23-6
445789.....	17-2	445896.....	21-24	465150.....	20-18, 27-5	475080.....	21-25
445792.....	19-13	445897.....	21-24	465170.....	20-19, 27-5	475085.....	32-11
445797.....	19-13, 20-17	445898.....	20-17, 21-24	465200.....	22-10	475090.....	20-18
445800.....	30-6	445898-100.....	20-17, 21-24	465204.....	22-10	475155.....	19-13, 20-18, 21-25
445801.....	21-23, 30-6	445920.....	17-2	465205.....	22-10	475180.....	21-25

INDEX

INDEX

Item No.	Section No.	Item No.	Section No.	Item No.	Section No.	Item No.	Section No.
475200	21-25	490100	4-3	530234	5-3	530371	5-8
475201	23-6, 25-5	495000	27-4	530235	DISC	530372	5-8
475202	23-6	495001	DISC	530236	5-3	530373	5-8
475420	20-18	495002	26-5, 32-11	530237	5-3	530374	5-8
475430	22-10	495003	22-10	530238	5-3	530375	5-8
475435	22-10	495050	21-26	530239	5-3	530376	5-8
475437	DISC	495195	DISC	530240	5-2	530377	5-8
475438	22-10	495210	DISC	530241	5-4	530378	5-8
475439	27-4	495230	DISC	530242	5-4	530379	5-8
475440	21-25	495250	DISC	530243	5-4	530381	5-8
475455	21-25	495260	DISC	530244	5-4	530382	5-8
475470	21-25	495285	DISC	530245	5-2	530383	5-8
475530	32-11	495290	21-26	530246	5-4	530384	5-8
475540	DISC	495300	DISC	530247	DISC	530385	5-8
475605	30-6	505010	14-19	530248	5-4	530386	5-8, 32-11
475606	30-6	505020	DISC	530249	5-4	530387	5-8
475607	30-6	505110	14-19	530251	5-1	530388	5-8
475610	22-10	505120	14-19	530252	5-1	530389	5-8
475700	21-25	505130	14-19	530253	5-5	530390	5-8
475705	19-13, 21-26	505140	14-19	530254	5-5	530392	5-8
475706	21-26	505145	14-20	530256	5-5	530395	5-8
475707	21-26	505150	14-20	530257	5-5	530396	5-8
475708	21-26	505155	31-3	530258	5-5	530397	5-8
475710	30-6	505170	14-20	530259	5-5	530399	5-8
475711	30-6	505195	14-20, 22-10, 27-4	530260	5-3	530401	5-8
475715	20-18	505197	14-20	530261	5-5	530402	5-8
475720	20-18	505200	DISC	530262	5-5	530403	5-8
480010	20-19, 21-27, 32-11	505205	14-20, 21-26	530263	5-5	530404	5-8
480035	30-7	505206	14-20, 21-26	530264	5-5	530405	5-8
480040	20-19	505210	22-11	530265	5-2	530406	5-8
480360	DISC	510280	39-7	530266	5-5	530407	5-8
480500	21-27	510379	39-8	530267	5-5	530408	5-8
480501	21-27	510380	39-8	530268	5-5	610504	1-21
480510	DISC	510381	39-7	530269	5-5	610506	1-21
480512	21-28	510382	39-7	530270	5-3	610508	1-21
480513	21-28	510383	39-7	530271	5-5	610510	1-21
480514	21-28	510384	39-7	530272	5-5	610704	1-21
480515	19-14	510385	39-7	530273	5-3	610706	1-21
480516	21-28	510386	39-7	530300	5-6, 5-8	610708	1-21
480517	21-28	510387	39-7	530301	5-6, 5-8	610710	1-21
480518	21-28	510388	DISC	530302	5-6, 5-8	610712	1-21
480519	21-28	510389	39-8	530305	5-6, 5-8	610815	1-21
480524	21-28	510390	39-8	530306	5-7	810100	1-14
480525	21-28	510391	39-8	530307	5-7	810101	1-14
480526	21-28	510392	39-8	530308	DISC	810102	1-14
480530	21-28	530010	4-11	530309	5-7	810103	1-14
480531	19-14, 20-19, 21-28	530020	4-11	530310	5-6	810104	1-14
		530030	4-11	530315	5-6	810105	1-14
		530040	4-11	530320	5-6	810106	1-14
480545	21-28	530050	4-11	530321	5-6	810107	1-14
480550	21-28	530060	4-11	530322	5-6	810108	1-14
480560	DISC	530070	4-11	530323	5-6	810109	1-14
480578	21-29	530080	4-11	530324	5-6	810110	1-14
480580	21-29	530205	5-1	530325	5-6, 5-8	810200	1-14
480585	21-29	530210	5-1	530326	5-6, 5-8	810201	1-14
485340	20-19	530211	5-5	530327	5-6, 5-8	810202	1-14
485390	20-19	530212	5-5	530330	5-6, 5-8	810203	1-14
485480	21-29	530213	5-5	530335	5-7, 5-8	810204	1-14
485500	DISC	530214	5-1	530340	5-7	810205	1-14
485501	DISC	530215	5-1	530345	5-6, 5-8	810206	1-14
486010	20-19	530216	5-1	530346	5-6, 5-8	810207	1-14
486012	20-19	530217	5-1	530347	5-6, 5-8	810208	1-14
486015	19-14, 20-19	530218	5-2	530350	5-7, 5-8	810209	1-14
486040	20-19	530219	5-2	530351	5-7, 5-8	810210	1-14
486050	19-14	530220	5-2	530352	5-7, 5-8	810211	1-14
486051	DISC	530221	5-1	530355	5-7, 5-8	810212	1-14
486070	21-29	530222	5-2	530356	5-7, 5-8	810213	1-14
486080	21-29	530223	5-2	530357	5-7, 5-8	810300	1-14
486090	DISC	530224	5-2	530360	5-7	810301	1-14
486100	21-29	530226	5-1	530362	5-7	810302	1-14
486110	19-14	530227	5-2	530363	DISC	810303	1-14
490010	21-26	530228	5-3	530364	5-7	810304	1-14
490030	DISC	530229	5-3	530365	5-7	810305	1-14
490050	4-3	530230	5-2	530366	5-7	810306	1-14
490060	4-3	530231	5-4	530367	5-7	810307	1-14
490070	4-3	530232	5-4	530368	5-7	810308	1-14
490080	4-3	530233	5-3	530370	5-8	810309	1-14
490090	4-3						

INDEX

INDEX

Item No.	Section No.	Item No.	Section No.	Item No.	Section No.	Item No.	Section No.
810311.....	1-14	810807.....	1-16	820516.....	1-15	840203.....	1-17
810313.....	1-14	810808.....	1-16	820517.....	1-15	840204.....	1-17
810400.....	1-15	810809.....	1-16	820519.....	1-15	840205.....	1-17
810401.....	1-15	810810.....	1-16	820600.....	1-16	840206.....	1-17
810402.....	1-15	810811.....	1-16	820601.....	1-16	850100.....	1-19
810403.....	1-15	810813.....	1-16	820602.....	1-16	850101.....	1-19
810404.....	1-15	810815.....	1-16, 1-21	820603.....	1-16	850102.....	1-19
810405.....	1-15	810816.....	1-16	820604.....	1-16	850103.....	1-19
810406.....	1-15	810817.....	1-16	820605.....	1-16	850104.....	1-19, 1-21
810407.....	1-15	820100.....	1-14	820606.....	1-16	850105.....	1-19
810408.....	1-15	820101.....	1-14	820607.....	1-16	850106.....	1-19, 1-21
810409.....	1-15	820102.....	1-14	820608.....	1-16	850107.....	1-19, 1-21
810410.....	1-15	820103.....	1-14	820609.....	1-16	850816.....	2-7
810411.....	1-15	820104.....	1-14	820610.....	1-16	850820.....	2-7
810412.....	1-15	820105.....	1-14	820611.....	1-16	850825.....	2-7
810413.....	1-15	820106.....	1-14	820612.....	1-16	850830.....	2-7
810415.....	1-15	820107.....	1-14	820614.....	1-16	850835.....	2-7
810417.....	1-15	820108.....	1-14	820616.....	1-16	850840.....	2-7
810500.....	1-15	820109.....	1-14	820618.....	1-16	850845.....	2-7
810501.....	1-15	820110.....	1-14	820620.....	1-16	850850.....	2-7
810502.....	1-15	820200.....	1-14	820700.....	1-16	850870.....	2-7
810503.....	1-15	820201.....	1-14	820701.....	1-16	851020.....	2-7
810504.....	1-15, 1-21	820202.....	1-14	820702.....	1-16	851025.....	2-7
810505.....	1-15	820203.....	1-14	820703.....	1-16	851030.....	2-7
810506.....	1-15, 1-21	820204.....	1-14	820704.....	1-16	851035.....	2-7
810507.....	1-15	820205.....	1-14	820705.....	1-16	851040.....	2-7
810508.....	1-15, 1-21	820206.....	1-14	820706.....	1-16	851045.....	2-7
810509.....	1-15	820207.....	1-14	820707.....	1-16	851050.....	2-7
810510.....	1-15, 1-21	820208.....	1-14	820708.....	1-16	851060.....	2-7
810511.....	1-15	820209.....	1-14	820709.....	1-16	851070.....	2-7
810512.....	1-15	820210.....	1-14	820710.....	1-16	851220.....	2-7
810513.....	1-15	820211.....	1-14	820712.....	1-16	851225.....	2-7
810514.....	1-15	820212.....	1-14	820714.....	1-16	851230.....	2-7
810516.....	1-15	820213.....	1-14	820716.....	1-16	851235.....	2-7
810517.....	1-15	820300.....	1-14	820718.....	1-16	851240.....	2-7
810519.....	1-15	820301.....	1-14	820800.....	1-16	851245.....	2-7
810600.....	1-16	820302.....	1-14	820801.....	1-16	855100.....	1-19
810601.....	1-16	820303.....	1-14	820802.....	1-16	855101.....	1-19
810602.....	1-16	820304.....	1-14	820803.....	1-16	855102.....	1-19
810603.....	1-16	820305.....	1-14	820804.....	1-16	855103.....	1-19
810604.....	1-16	820306.....	1-14	820805.....	1-16	855104.....	1-19
810605.....	1-16	820307.....	1-14	820806.....	1-16	855105.....	1-19
810607.....	1-16	820308.....	1-14	820807.....	1-16	855106.....	1-19
810608.....	1-16	820309.....	1-14	820808.....	1-16	855107.....	1-19
810609.....	1-16	820311.....	1-14	820809.....	1-16	860410.....	2-1
810610.....	1-16	820313.....	1-14	820810.....	1-16	860416.....	2-1
810611.....	1-16	820400.....	1-15	820811.....	1-16	860420.....	2-1
810612.....	1-16	820401.....	1-15	820813.....	1-16	860425.....	2-1
810614.....	1-16	820402.....	1-15	820815.....	1-16	860430.....	2-1
810616.....	1-16	820403.....	1-15	820816.....	1-16	860510.....	2-1
810618.....	1-16	820404.....	1-15	820817.....	1-16	860516.....	2-1
810620.....	1-16	820405.....	1-15	830100.....	1-17	860520.....	2-1
810700.....	1-16	820406.....	1-15	830101.....	1-17	860525.....	2-1
810701.....	1-16	820407.....	1-15	830102.....	1-17	860530.....	2-1
810702.....	1-16	820408.....	1-15	830103.....	1-17	860535.....	2-1
810703.....	1-16	820409.....	1-15	830104.....	1-17, 1-21	860540.....	2-1
810704.....	1-16, 1-21	820410.....	1-15	830105.....	1-17	860545.....	2-1
810705.....	1-16	820411.....	1-15	830106.....	1-17, 1-21	860550.....	2-1
810706.....	1-16, 1-21	820412.....	1-15	830107.....	1-17, 1-21	860610.....	2-1
810707.....	1-16	820413.....	1-15	830200.....	1-17	860612.....	2-1
810708.....	1-16, 1-21	820415.....	1-15	830201.....	1-17	860616.....	2-1
810709.....	1-16	820417.....	1-15	830202.....	1-17	860620.....	2-1
810710.....	1-16, 1-21	820500.....	1-15	830203.....	1-17	860625.....	2-1
810712.....	1-16, 1-21	820501.....	1-15	830204.....	1-17	860630.....	2-1
810714.....	1-16	820502.....	1-15	830205.....	1-17	860635.....	2-1
810716.....	1-16	820503.....	1-15	830206.....	1-17	860640.....	2-1
810717.....	1-16	820504.....	1-15	830207.....	1-17	860645.....	2-1
810718.....	1-16	820505.....	1-15	840100.....	1-17	860650.....	2-1
810721.....	1-16	820506.....	1-15	840101.....	1-17	860660.....	2-1
810724.....	1-16	820507.....	1-15	840102.....	1-17	860665.....	2-1
810800.....	1-16	820508.....	1-15	840103.....	1-17	860716.....	2-1
810801.....	1-16	820509.....	1-15	840104.....	1-17	860720.....	2-1
810802.....	1-16	820510.....	1-15	840105.....	1-17	860725.....	2-1
810803.....	1-16	820511.....	1-15	840106.....	1-17	860730.....	2-1
810804.....	1-16	820512.....	1-15	840200.....	1-17	860735.....	2-1
810805.....	1-16	820513.....	1-15	840201.....	1-17	860740.....	2-1
810806.....	1-16	820514.....	1-15	840202.....	1-17	860745.....	2-1

INDEX

INDEX

Item No.	Section No.	Item No.	Section No.	Item No.	Section No.	Item No.	Section No.
860810.....	2-1	862021.....	2-3	871245.....	2-2	891005.....	2-5
860812.....	2-1	862022.....	2-3	871250.....	2-2	891006.....	2-5
860816.....	2-1	862023.....	2-3	871255.....	2-2	891007.....	2-5
860820.....	2-1	862024.....	2-3	871260.....	2-2	891008.....	2-5
860825.....	2-1	862025.....	2-3	871270.....	2-2	891010.....	2-5
860830.....	2-1	862026.....	2-3	880006.....	2-5	891012.....	2-5
860835.....	2-1	862027.....	2-3	880008.....	2-5	891014.....	2-5
860840.....	2-1	862028.....	2-3	880011.....	2-5	891425.....	DISC
860845.....	2-1	862029.....	2-3	880612.....	2-7	892008.....	2-5
860850.....	2-1	862030.....	2-3	880616.....	2-7	892010.....	2-5
860855.....	2-1	862031.....	2-3	880620.....	2-7	892012.....	2-5
860860.....	2-1	862032.....	2-3	880625.....	2-7	893010.....	2-5
860865.....	2-1	862033.....	2-3	880630.....	2-7	893012.....	2-5
860870.....	2-1	862034.....	2-3	880635.....	2-7	894003.....	2-6
860875.....	2-1	862035.....	2-3	880640.....	2-7	894004.....	2-6
860890.....	2-1	862036.....	2-3	880645.....	2-7	894005.....	2-6
860900.....	2-1	862037.....	2-3	880650.....	2-7	894006.....	2-6
860910.....	2-1	862038.....	2-3	880655.....	2-7	894007.....	2-6
860920.....	2-1	862039.....	2-3	880660.....	2-7	894008.....	2-6
861012.....	2-1	862040.....	2-3	880812.....	2-7	894010.....	2-6
861016.....	2-1	862041.....	2-3	880816.....	2-7	894012.....	2-6
861020.....	2-1	862042.....	2-3	880817.....	2-7	894014.....	2-6
861025.....	2-1	862043.....	2-3	880820.....	2-7	895003.....	2-6
861030.....	2-1	862044.....	2-3	880821.....	2-7	895004.....	2-6
861035.....	2-1	862045.....	2-3	880825.....	2-7	895005.....	2-6
861040.....	2-1	862046.....	2-3	880830.....	2-7	895006.....	2-6
861045.....	2-1	862047.....	2-3	880835.....	2-7	895007.....	2-6
861050.....	2-1	862050.....	2-4	880840.....	2-7	895008.....	2-6
861055.....	2-1	862051.....	2-4	880845.....	2-7	895010.....	2-6
861060.....	2-1	862052.....	2-4	880850.....	2-7	895012.....	2-6
861065.....	2-1	862053.....	2-4	880855.....	2-7	895014.....	2-6
861070.....	2-1	862054.....	2-4	880860.....	2-7	896004.....	2-5
861075.....	2-1	862055.....	2-4	881008.....	2-7	896005.....	2-5
861080.....	2-1	862060.....	2-4	881009.....	2-7	896006.....	2-5
861085.....	2-1	862061.....	2-4	881010.....	2-7	896008.....	2-5
861090.....	2-1	862062.....	2-4	881011.....	2-7	896010.....	2-5
861110.....	2-1	862063.....	2-4	881012.....	2-7	896012.....	2-5
861120.....	2-1	862064.....	2-4	881016.....	2-7	896100.....	2-5
861220.....	2-1	862065.....	2-4	881020.....	2-7	897306.....	2-8
861225.....	2-1	862070.....	2-4	881025.....	2-7	897308.....	2-8
861230.....	2-1	862071.....	2-4	881030.....	2-7	897310.....	2-8
861235.....	2-1	862072.....	2-4	881035.....	2-7	897312.....	2-8
861240.....	2-1	862073.....	2-4	881040.....	2-7	897316.....	2-8
861245.....	2-1	862074.....	2-4	881045.....	2-7	897320.....	2-8
861250.....	2-1	862075.....	2-4	881050.....	2-7	897406.....	2-8
861255.....	2-1	862080.....	2-3	881055.....	2-7	897408.....	2-8
861260.....	2-1	862081.....	2-3	881060.....	2-7	897410.....	2-8
861265.....	2-1	862082.....	2-3	881220.....	2-2	897412.....	2-8
861270.....	2-1	862083.....	2-3	881225.....	2-2	897416.....	2-8
861275.....	2-1	870816.....	2-2	881230.....	2-2	897420.....	2-8
861280.....	2-1	870820.....	2-2	881235.....	2-2	897508.....	2-8
861285.....	2-1	870825.....	2-2	881240.....	2-2	897510.....	1-10, 2-8
861290.....	2-1	870830.....	2-2	881245.....	2-2	897512.....	2-8
861300.....	2-1	870835.....	2-2	881250.....	2-2	897516.....	2-8
861310.....	2-1	870840.....	2-2	881255.....	2-2	897520.....	2-8
861320.....	2-1	870850.....	2-2	881260.....	2-2	897525.....	2-8
862000.....	2-3	870855.....	2-2	881280.....	2-2	897610.....	1-10, 2-8
862001.....	2-3	870860.....	2-2	881290.....	2-2	897612.....	1-10, 2-8
862002.....	2-3	870870.....	2-2	881300.....	2-2	897616.....	1-10, 2-8
862003.....	2-3	870875.....	2-2	890406.....	2-9	897616-1000.....	1-10, 2-8
862004.....	2-3	871020.....	2-2	890410.....	2-9	897620.....	1-10, 2-8
862005.....	2-3	871025.....	2-2	890416.....	2-9	897625.....	2-8
862006.....	2-3	871030.....	2-2	890506.....	2-9	897630.....	2-8
862007.....	2-3	871035.....	2-2	890510.....	2-9	898306.....	2-8
862008.....	2-3	871040.....	2-2	890516.....	2-9	898308.....	2-8
862009.....	2-3	871045.....	2-2	890520.....	2-9	898310.....	2-8
862010.....	2-3	871050.....	2-2	890525.....	2-9	898316.....	2-8
862011.....	2-3	871055.....	2-2	890610.....	1-10, 2-9	898406.....	2-8
862012.....	2-3	871060.....	2-2	890616.....	1-10, 2-9	898408.....	2-8
862013.....	2-3	871070.....	2-2	890616-500.....	1-10, 2-9	898410.....	2-8
862014.....	2-3	871090.....	2-2	890620.....	1-10, 2-9	898416.....	2-8
862015.....	2-3	871100.....	2-2	890625.....	2-9	3680001.....	44-3, 46-13
862016.....	2-3	871220.....	2-2	890816.....	2-9	3680003.....	44-3, 46-13
862017.....	2-3	871225.....	2-2	890820.....	2-9	3680031.....	44-4, 46-14
862018.....	2-3	871230.....	2-2	890825.....	2-9	3680032.....	44-4, 46-14
862019.....	2-3	871235.....	2-2	891003.....	2-5	3680033.....	44-4, 46-14
862020.....	2-3	871240.....	2-2	891004.....	2-5	3680034.....	44-4, 46-14

Item No.	Section No.	Item No.	Section No.	Item No.	Section No.	Item No.	Section No.
3680058.....	44-7, 46-17	KX40	8-11	REDUCER-N-5L. 43-2, 46-10			
3680061.....	44-8, 46-18	KX490F.....	8-8	REDUCER-S-5L. 43-2, 46-10			
3680065.....	44-9, 46-19	KX491F.....	8-8	SILVERCLASS... 36-1			
3680067.....	44-9, 46-19	KX507F.....	8-8	SILVERCLASSWB...36-1			
3680090.....	44-1, 46-11	KX508F.....	8-8	TP1WR	45-5, 46-4		
3680093.....	44-7, 46-17	KX511F	8-8	TP-4	45-5, 46-4		
3680095.....	44-1, 46-11	KX5196593.....	8-11	TR47-P	32-11		
3680102.....	44-6, 46-16	KX6014	8-10	U428	15-3		
3680212.....	44-6, 46-16	KX6066.....	8-10	VAL34	42-1		
3680224.....	44-5, 46-15	KX6068.....	8-10	Z495525	15-4		
3680230.....	44-2, 46-12	KX6068-125	8-10	Z496515	DISC		
3680231.....	44-2, 46-12	KX6069.....	8-11	Z496525	15-4		
3680232.....	44-2, 46-12	KX6-124.....	8-12				
3680233.....	44-2, 46-12	KX6-207A	8-12				
3680234.....	44-2, 46-12	KX6-208.....	8-12				
3680235.....	44-2, 46-12	KX6-211.....	8-12				
3680282.....	44-2, 46-12	KX6-234.....	8-12				
3684026.....	DISC	KX62Y.....	8-8				
3684029.....	44-5, 46-15	KX73	8-8				
3684064.....	44-8, 46-18	KX795	8-11				
2K-ELASTIC-1L	DISC	KX80221	8-8				
3M-33.....	15-4, 40-2	KX81501C	8-9				
3M-7524	38-13	KX928	8-9				
3M-7525	38-13	KX929	8-10				
3M-7528	38-13	KX932	8-10				
4-1PRIMER-1L....	DISC	KX9943	15-6, 41-1, 46-5				
4-1PRIMER-3L....	43-2, 46-10	KX9944	15-6, 41-1, 46-5				
BAZOOKABLAST.15-4		KX9945.....	15-6, 41-1, 46-5				
BRONZECLASS.36-1		KXCC10.....	8-10				
BRONZECLASSWB...36-1		KXCC3.....	8-10				
C210-1L.....	43-1, 46-9	KXCC6.....	8-10				
C210-5L.....	43-1, 46-9	KXCC8.....	8-10				
C75-1L	43-1, 46-9	KXCP873K.....	8-11				
C75-5L.....	43-1, 46-9	KXPREM-ONE...8-12					
CWW075E	8-7	KXPREM-TPMSB4...8-12					
CWW075Z.....	DISC	KXRH107	8-10				
CWW155NLE.....	8-7	KXRH109	8-10				
CWW155Z.....	DISC	KXTCW21080.....	8-10				
DA-34.....	30-1	KXTR413C	8-11				
DFK-2.....	40-3	MAGIC	15-4				
EAP5-140G	DISC	MAGICDISP	15-4				
FM00254	15-2	MAGICTOWEL	15-4				
FM00554	15-2	MIPASTICK	43-2, 46-10				
FM00854	15-2	MS10-2.5L.....	43-1, 46-9				
FM01054	15-2	MS25-2.5L.....	43-1, 46-9				
FM01154.....	15-2	MS35-2.5L.....	43-1, 46-9				
FM01354	15-2	MS40-2.5L.....	43-1, 46-9				
FM01454	15-2	NS03431R.....	8-12				
FM05406	15-2	OE16.....	15-1				
GOLDCLASS.....	36-1	OE17	15-1				
GOLDCLASSWB..36-1		OE18	15-1				
H10-1L.....	43-2, 46-10	OE19.....	15-1				
H5-1L.....	43-2, 46-10	OE20.....	15-1				
HY18R-P	23-1, 25-2	OE21	15-1				
HYRF3.....	DISC	OE22.....	15-1				
KK10-P	23-1, 25-2	OE24.....	15-1				
KX101000110.....	8-9, 42-6	OE26.....	15-1				
KX10400001	8-12	OE28.....	15-1				
KX104000032	8-12	PAG46	7-1				
KX1052N	8-8	PAINTERSPUNCH...15-4, 46-8					
KX1208.....	8-8	PUPMP4540-55..42-6					
KX185	8-10	PUMP55GAL.....	42-6				
KX190.....	8-10	PV13	15-1				
KX26KNH.....	8-12	PV14	15-1				
KX2990	8-9	PV15	15-1				
KX2PCP	8-9	PV16	15-1				
KX2PCT.....	8-9	PV17	15-1				
KX30	8-10	PV18	15-1				
KX3050-RB	8-11	PV19	15-1				
KX34	8-10	PV20	15-1				
KX36	8-11	PV21	15-1				
KX361	8-9	PV22	15-1				
KX365.....	8-9	PV24	15-1				
KX370	8-9	PV26	15-1				
KX386.....	8-9	PV28	15-1				
KX387.....	8-9	REDUCER-F-5L. 43-2, 46-10					
KX388.....	8-9	REDUCER-N-1L. 43-2, 46-10					

Visit us online at:
www.srfast.com

Over 40 years of serving the automotive aftermarket!



An AMERICAN Company!

*S&R Fastener Co., Inc. | P.O. Box 849
San Antonio, FL 33576 | Phone 877-773-2276
www.srfast.com*

#985217