



Descriptive bulletin

FT Flexitest family

FT-1, FT-1F, FT-1X, FT-14, FT-19R,
FT-19RX, FT-19RS, FT-22RS, & test plugs

Index

1. Application	3	5. Test plugs	13
2. The most complete family of test switches	4	5.1. In-service series test plug.....	13
2.1. FT-1.....	4	5.2. Individual current circuit test plug	13
2.2. FT-1F.....	4	5.3. Individual current circuit test plug with open CT protection	13
2.3. FT-1X.....	4	5.4. Separate source test plug.....	14
2.4. FT-14.....	4	5.5. Flexitest test kit	14
2.5. The FT-19R and FT-19RX	4	6. FT Flexitest switches ordering information	17
2.6. The FT-19RS	5	6.1. FT-1, FT-1F and FT-1X switches	18
2.7. FT-22RS	5	6.1.1. Terminal connections	18
3. Advantages	6	6.1.2. Cover	18
3.1. Safe and convenient	6	6.1.3. Depth	18
3.2. Fast and reliable	6	6.1.4. Front connected.....	18
3.3. Maximum flexibility	6	6.2. FT-14.....	18
3.4. Security.....	6	6.2.1. Terminal connections	18
3.5. Quality.....	6	6.2.2. Cover	18
3.6. Technical and application engineering support	6	6.3 FT-19 and FT-22 test switch assemblies	19
4. Specifications	7	6.3.1 Terminal connections	19
4.1. Certifications	7	6.3.2 Panel height	19
4.2. Ratings.....	7	6.3.3 Panel color & material.....	19
4.3. Mounting.....	7	6.3.4 Flexitest switch code numbers (positions A, B, and C).....	19
4.4. Construction	8	6.3.5 Switch replacement	19
4.5. Cover	8	6.3.6 Cover	19
4.6. Poles	9	6.3.7 Additional features.....	19
4.6.1. Potential poles	9	7. Test plugs & accessories - ordering information	27
4.6.2. Current poles	9	8. Warranty	29
4.7. Switch handles	11		
4.8. Terminal connections	11		
4.9. Switch arrangement.....	12		

1. Application

ABB Flexitest switches, types FT-1 (10 pole, rear connected), FT-1F (10 pole, front connected), FT-1X (10 pole, extended terminals, rear connected), FT-14 (14 pole, rear connected), and associated Test Plugs, provide a safe, simple, fast and reliable method to isolate, test, and service installed equipment without disturbing the system.

FT-19R, FT-19RX, FT-19RS, and FT-22RS Flexitest switch assemblies for rack and switchboard mounting also permit convenient isolation of switchboard relays, meters, and instruments allowing quick and easy multi-circuit testing by any conventional test method. These assemblies utilize FT-1 and/or FT-14 switches, depending on customer's requirements.



2. The most complete family of test switches

2.1. FT-1 Standard 10 pole, rear connected test switch.

2.2. FT-1F Surface mount switch allows the user to make the same connections as with FT-1 but on the front of the switch.

2.3. FT-1X Extended length test switch brings the rear terminal connections to the same depth as most panel mounted protective relays and equipment for easier and faster access to wiring points. Extended 8 inches or 10 inches depth is available.

2.4. FT-14 Provides the same features and reliability as FT-1 but with a maximum of 14 individual poles. Although supplying 40% more capacity than the FT-1, the FT-14 only requires 18% more space.

2.5. The FT-19R and FT-19RX assemblies accommodate up to three FT-1 switches mounted on a 19" wide, and two-rack unit (2RU), three-rack unit (3RU), or four-rack unit (4RU) high panel suitable for rack or switchboard mounting. These assemblies can be ordered with a full-length clear cover (standard), or optional individual clear covers for each switch.

The FT-19RX extends the rear terminals of the FT-1 switches to the same depth as most 19" rack mounted equipment thereby providing improved access to the rear terminals. FT-19RX two-rack unit assemblies (2RU) allow the user to mount protective relays or other equipment in the racks directly above and below the FT-19RX, optimizing the space in the rack and reducing the amount of wire required.

1 FT-1 | 2 FT-1F | 3 FT-1X | 4 FT-14 | 5 FT-19R 2RU with Full Length Clear Cover

1



2



3



4



5



2.6. FT-19RS assemblies consist of up to two FT-1 switches, two FT-14 switches, or the combination of one FT-1 and one FT-14 switch mounted on a 19" wide, and two-rack unit (2RU), three-rack unit (3RU), or four-rack unit (4RU) high panel suitable for rack or switchboard mounting. Any combination of FT-1 or FT-14 switches styles may be selected with individual black or clear covers. Non-ABB equipment is not included with the assembly (see circle in picture 9 below).

Mounting panels for these assemblies may be of steel or aluminum. Steel panels are commonly available in gray, beige and black; although panel color or finish, as well as panel height, can be customized to meet the user's necessities. The three rack unit (3RU) assembly also allows switches to be positioned off-center, in either low or high upper mounting positions in the rack panel, allowing room for special label requirements, as shown on page 5, figure 7.

2.7. FT-22RS assemblies consists of up to three FT-1 or two FT-14 switches mounted on a 22" wide, two-rack unit (2RU), three-rack unit (3RU), or four-rack unit (4RU) high mounting panel suitable for rack or switchboard mounting. Any combination of FT-1 or FT-14 switches styles may be selected with individual black or clear covers.

6 FT-19 3RU lockable version | 7 FT-19R 3RU with Full Length Clear Cover. Switches mounted in the lower position, with special customer labels | 8 FT-19RX 3RU with Full Length Clear Cover | 9 FT-19RS | 10 FT-22RS



3. Advantages

Flexitest test switches provide a safe, reliable, and cost-effective means to wire the output of relays, meters, and other associated equipment to external devices for in-service testing.

3.1. Safe and convenient

All measurements and tests can be performed at the front of the switchboard, without taking any devices out of service, and without the need to access wiring at the rear of the devices.

Flexitest switches and test plugs have all the features necessary for applications involving the safe measurement and isolation of individual currents, voltages, and digital I/O signals to facilitate testing of substation instrumentation and protection devices.

The make-before-break current shorting feature allows test personnel to quickly and safely isolate equipment from current transformer (CT) circuits.

Voltage measurements can also be made directly on Flexitest switches, without disturbing existing connections. There is a test clip located on the top of each pole that allows connection with standard spring clip test leads.

3.2. Fast and reliable

When test plugs are used, any number of circuits may be tested in rapid succession. One plug properly connected can test all instruments or meters of a particular type.

3.3. Maximum flexibility

Test switches can be assembled in a variety of different arrangements, to match customer requirements. To build new or view existing Flexitest Switches and FT-19R panels, please visit our interactive FT-1 Configurator website at <http://ft1switch.com> (see page 15).

3.4. Security

With the cover in place, a meter seal can be placed through either of the cover studs of any Flexitest switch to prevent unauthorized access to the switch. As an additional feature, a clear cover is available that can also be installed with the switch-blades in the fully open or closed positions. In addition, a barrier has been incorporated into the cover to prevent knife switches from being left partially open. Optional padlocking provisions are available for most covers allowing access to authorized personnel only.

3.5. Quality

With over 50 years of field proven applications, ABB is the test switch manufacturer with the highest quality and largest installed base in North America. ABB's Flexitest test switches have been an industry standard for years.

3.6. Technical and application engineering support

Available 24/7 at +1 800 HELP 365, option 8; or +1 440 585 7804.

4. Specifications

4.1. Certifications

All Flexitest Switches meet or exceed all requirements of ANSI/IEEE Standard C37.90. Class 1E switches meet IEEE C37.98, C37.105, 323-1983 and 344-1987 Standards.

UL and CUL file number E103204, CSA, and 1E certification are available for most test switches. Contact your ABB representative for more details.

4.2. Ratings

All Flexitest switches are rated at 600 Volts AC and 30 Amps.

4.3. Mounting

The FT-1, FT-14, and FT-1X switches are designed for semi-flush mounting on the front of switchboard panels, facilitating inspection and accessibility. The FT-1F is designed for surface mounting and can also be mounted on a unistrut with the use of a unistrut adapter plate. Refer to figures 7 to 9 beginning on page 30 for the specific outline and drilling plan information of each switch.

The FT-19R, FT-19RX, and FT-19RS are designed for mounting on 19-inch rack structures or conventional panels. The FT-22RS are designed for mounting on 22-inch rack structures.

Connections, dimensions and layout are shown on pages 30-37.

Approximate shipping weight and dimensions

Device type	Net lbs (kg)	Shipping lbs (kg)	Shipping container L x W x H in (mm)
FT-1 and FT-1F	1.75 (0.79)	3 (1.4)	4 (100) x 7 (177) x 5 (126)
FT-1X	2.7 (1.25)	3.75 (1.7)	4 (100) x 12 (300) x 7 (177)
FT-14	2.5 (1.5)	3.25 (1.5)	4 (100) x 9 (225) x 5 (126)
FT-19R	7.0 (3.18)	12 (6)	10 (254) x 21 (534) x 10 (254)
FT-19RX	9.0 (4.08)	17 (8)	10 (254) x 21 (534) x 16 (407)
FT-19RS	7.0 (3.18)	12 (6)	10 (254) x 21 (534) x 10 (254)
FT-22RS	7.0 (3.18)	12 (6)	10 (254) x 24 (610) x 10 (254)
Separate Source Test Plug (10 position)	1.5 (0.68)	3 (1.4)	10 (253) x 7 (177) x 5 (126) For up to 4 pieces
In-Service Series Test Plug (10 position)	1.5 (0.68)	3 (1.4)	10 (253) x 7 (177) x 5 (126) For up to 4 pieces
Individual Current Circuit Test Plug	0.1 (0.045)	1 (0.45)	10 (253) x 7 (177) x 5 (126) For up to 30 pieces

4.4. Construction

The base of all Flexitest switches is made of a high grade molded thermo-plastic which provides a tough, insulated enclosure. Barriers are molded into the base (front and rear) to separate the switch units from one another. The barriers provide insulation between poles, and also ample wiring space between terminals. The terminals of the FT-1X are extended either 8 or 10 inches beyond the switch blades located on the front of the switch. The back of the terminals is marked with a white raised 3-D numbering, which allows easier identification of poles and helps prevent inadvertent upside down installation.

4.5. Cover

All Flexitest switch covers provide a tough insulated enclosure for the switch and are made from a durable thermoplastic material. Covers are fastened to the switches with thumbnuts on either end that can be loosened and tightened by hand, or with a 1/4" nut driver. This is the same size nut driver used on the hex head terminal screws of all Flexitest Switches. All covers have the provision to accept meter seals.

All switches may be purchased with a black opaque cover or a clear cover. The clear cover offers the user the unique option of intentionally leaving switch handles in the open position with the cover in place, maintaining the provision for a meter seal. This allows the user to service electrical equipment while still complying with OSHA tag and lockout procedures.

Lockable covers (in black or clear) are also available upon request.

Any cover can be ordered separately to retrofit any existing switch, maintaining the same ease of use and accessibility. See ordering information on page 28.



Figure 1. FT switch terminal numbering, rear view.

FT Cover selection samples (a) Black; (b) Clear; (c) Lockable



4.6. Poles

FT-1, FT-1F and FT-1X switches are available in combinations of 1 to a maximum of 10 individual poles or switch units. FT-14 switches are available in combinations of 1 to a maximum of 14 poles or switch units. Each pole is identified by a letter (A to J or A to N) visible along the top of the base from left to right (front view).

Individual pole designations are used to identify each pole according to its type or function. In order to develop a complete Switch Arrangement, pole designations should be listed sequentially from left to right to account for every pole position on the switch. Unused poles are identified by the letter X.

Each individual pole is of a knife blade type. There are two different types of poles, Potential and Current.

For quick, easy, user friendly configuration of flexitest switches, please visit www.ft1switch.com.

4.6.1. Potential poles

Potential poles (P) are configured as single, non-shorting knife blades for use in potential, trip, or control circuits. P designates a potential, trip, or control circuit with a black handle. Potential poles with other color handles are available by replacing the "P" with the appropriate designation per chart on page 10.

Each potential pole can also be described with 2 characters (P1 to P9). P indicates Potential and the second character is a numeric color code for the switch handle.

4.6.2. Current poles

Current poles are typically configured in sets of two (C-C), for use with current circuits, and consist of a current test jack, a shorting spring, a shorting blade, and a non-shorting blade (see Figure 2) The positions of the short circuit springs are always visible from the front of the switch.

C designates a single Current circuit, non-shorting pole, with a current test jack and a black handle. Current poles with other color handles are available by replacing the "C" with the appropriate designation per chart on page 10.



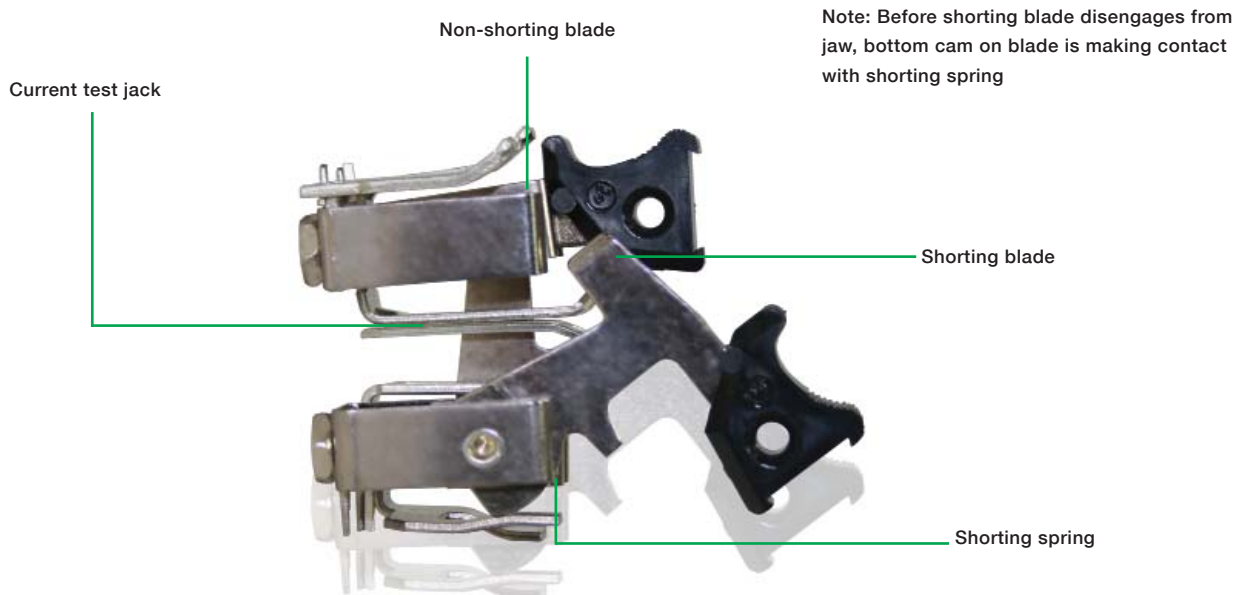

Each current pole can also be described with 2 characters (C1 to C9). C indicates Current and the second character is a numeric color code for the switch handle.

Current poles typically span more than one pole position. Pole designations C-C, C-C-C, C-C-C-C and C-C-C-C-C indicate current shorting poles (make-before-break) with black handles. Note that any color handle may be selected for any pole position by using the appropriate pole designation, ex: 5-R or C-9-7 (alternately C5-C2 or C1-C9-C7).

Figure 2. Blade assembly of 2 position pole "C-C"

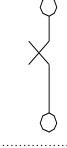
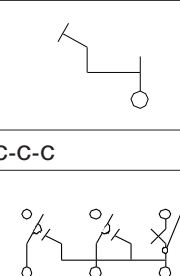

Visit www.ft1switch.com to build any complete FT switch arrangement, select options, view schematic details and get style number information.

Pole type	Potential pole designation	Handle color	Description & schematic symbol	Schematic legend	
Potential	P	P1	Black		Non-shorting blade
	T	P2	Red		
	H	P3	Brown		
	V	P4	Purple		
	G	P5	Green		
	Y	P6	Yellow		
	Z	P7	Blue		
	W	P8	White		
	O	P9	Orange		
L	L1	Black ††	Potential, shorting blade		Shorting blade
Current	C	C1	Black		
	R	C2	Red		
	3	C3	Brown		
	4	C4	Purple		
	5	C5	Green		
	6	C6	Yellow		
	7	C7	Blue		
	8	C8	White		
	9	C9	Orange		
D	D0	N/A	Current test jack, no switch blade		Shorting spring
Current Shorting†	C-C	C1-C1	Black ††	Current shorting (make-before-break), with test jack and blade	
	C-A	C1-A1	Black ††	Current shorting (make-before-break), with standard blade, no current test jack	
	C-B	C1-B1	Black ††	Current shorting (make-before-break), with stud only, no current jack, no switch blade	
	C-D	C1-D1	Black ††	Current shorting (make-before-break), with current test jack, no switch blade	
	C-E	C1-E1	Black ††	Current shorting (make-before-break), with shorting blade, no current test jack	
	C-S	C1-S1	Black ††	Current shorting (make-before-break), with fixed shorting strap	
	Miscellaneous	S	S0	None	
J		J0	None	Current jaw, no blade	
N		N0	None	Terminal stud in blade location, no jaw	
U		U0	None	Stud and test clip in jaw location, no blade	
X		X0	None	Empty pole position	

† = Current shorting poles are also available spanning up to 5 positions (ex: C-C-C-C-C or alternately C1-C1-C1-C1-C1)

†† = Every color handle is available by substituting appropriate pole color designation in desired location



Switch handles with interlocking bar

4.7. Switch handles

Switch handles are made of a molded thermoplastic material. They are typically black for potential and current circuits, red for trip circuits. In addition to black and red, switch handles are also available in various other colors (brown, purple, green, yellow, blue, white, and orange) for simple circuit identification. Each handle has a dovetail indentation that can hold a circuit identification label.

Knife blade switches can be operated independently, or ganged together with a horizontal interlocking bar to suit testing needs. A hole runs through the middle of each switch handle to allow insertion of interlocking bars that can mechanically tie 2, 3, 4, 5, 6, 8, 10, or 14 adjacent switch handles together. Interlocking bars are ordered as a separate line item and installed by the customer ; see “Test plug & accessories – ordering information” on page 28.

4.8. Terminal connections

Connection terminals are located at the rear of the switch (except on the front connected FT-1F). Most Flexitest switch terminals are marked with a white raised 3-D numbering, which allows easier identification of poles along the rear of the switch (1 to 20 on FT-1 and 1 to 28 on FT-14), as shown on Figure 1, page 8). Each pair of numbered terminals is associated with a matching pole designated by a letter on the front of the switch.

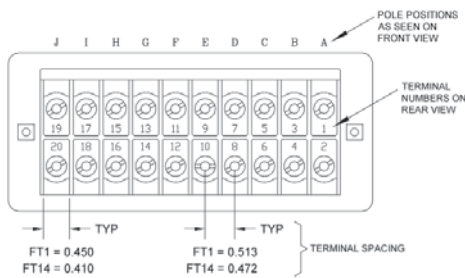

Figure 3. FT Switch terminals, rear view (FT-1 shown)

All required terminal hardware is supplied with every Flexitest switch (see Figure 4).

Screw terminals are provided standard with all Flexitest switches. Connections are made with a hex washer head screw - #8 thread size (0.164-32), 1/4" hex head.

Stud and nut terminals are an optional feature. Connections are made with two washers and a nut. A special (5/16") nut driver can be purchased from ABB to connect to stud terminals, see “Test plug & accessories - ordering information” on page 28.

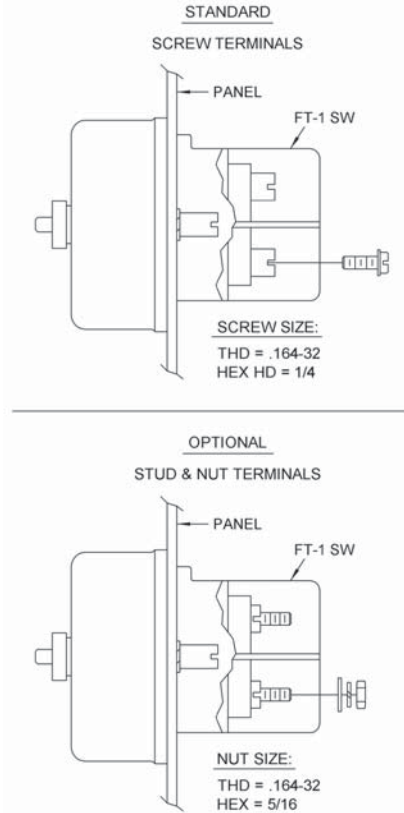

Figure 4. FT Switch terminals, rear view (FT-1 shown)

! Warning

Connections to ALL equipment should be made using standard and safe connection practices.

Torque values for all Flexitest switch terminals are 16-20 in-lbs, 25 in-lbs maximum. Exceeding this torque may result in damage to terminal threads.

Even number terminals (bottom row) of Flexitest switches should be connected to voltage transformers and current transformers, while odd number terminals (top row) should be connected to equipment that is to be isolated, such as meters and relays.

Max Lug Size = Yellow 12-10 ga. Ring Terminal

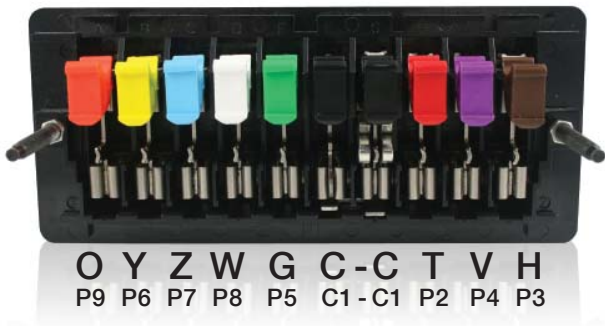

Figure 5. FT Switch arrangement, front view (FT-1 shown)

4.9. Switch arrangement

Pole positions are identified from left to right on the front view of the switch by the letters “A” through “J” or “A” through “N”. Individual pole designations are used to identify each pole according to its type or function. In order to develop a complete Switch Arrangement, pole designations should be listed sequentially from left to right to account for every pole position on the switch. Unused poles are identified by the letter X.

! Warning

All switch arrangements should be checked for adequate current transformer shorting when applied to current transformer circuits.



5. Test plugs



Figure 6. SafePlug with open CT protection

Test plugs used in conjunction with Flexitest switches enable easy measurement, calibration, verification and maintenance of relays, meters and instruments.

5.1. In-Service Series Test Plug

The “In-Service” Series Test Plug with a maximum of 10 positions is designed to match the pole configurations of specific styles of FT Flexitest devices (either FT-1, FT-1F, FT-1X switches or FT case relays).

This test plug is typically used to connect devices measuring the currents and voltages being applied to the switchboard relays, meters and instruments without interrupting or short-circuiting the circuit. Only current test switches with a current test jack must be opened before inserting the Series test plug. Connections to the test plug must be made before inserting the test plug into a Flexitest switch or relay.

Not every switch or relay pole configuration is suitable to accept an In-Service Series Test Plug. For available styles, see table 1, FT-1 switch selection guide 1VAC397062-SG. You may also refer to your ABB representative or ABB FT-1 configurator at www.ft1switch.com.

WARNING

When using an In-Service Series Test Plug for current measurements, connections from the test plug to the measuring instruments must be made before inserting the test plug in place.

5.2. Individual Current Circuit Test Plug

This plug consists of two conducting strips separated by an insulating strip. The ammeter is connected to these strips by terminal screws and leads carried out through holes in the back of the insulated handle. (See figures 2 and 4 on page 14).

The standard test plug inserts into the current test jack with the red part of the handle facing up allowing the alignment nipple and tab to guide the connector into the test jack.

5.3. SafePlug with open CT protection

The SafePlug is an individual current circuit test plug with open current transformer (CT) protection provides a safe, simple, fast, and reliable method to test and service installed equipment while reducing risks due to operator error, incorrect equipment settings, or deviation from correct test procedures. Its design prevents shock hazards, outages, and erroneous meter readings all associated with open CTs.

If a CT opens during operation, the test plug shorts the CT to protect the operator, typically within 100 microseconds or less (6/1000th of a cycle). At the same time a red LED provides visual indication of the fault.

! Warning

Complete CT secondary circuit connections from the Individual Current Circuit Test Plug to the measuring instrument must be made before inserting the Test Plug in place.

5.4. Separate Source Test Plug

The 10 Position and the 14 Position Separate Source Test Plugs isolate the external connections from the relay or equipment under test. The test plug accepts all common size banana plugs, ring wire connectors, spade lugs and has a through hole for meter probe or wire connections.

This test plug provides quick circuit testing by fitting into the stationary contact jaws of any Flexitest Type FT Case or Switch. The L-shaped test blades assure quick, accurate alignment between the Test Plug and the stationary contact jaws. The blades connect the relay inputs and outputs to a set of binding banana posts on the top of the Test Plug. An insulated barrier along the bottom of the blades isolates the relay circuits from external connections. Test circuits can then be connected to these binding posts, which are staggered for easy accessibility.

Before inserting the Separate Source Test Plug into service, all switchblades must be placed in the full open position. In a Flexitest Type FT Case, the plug is inserted in the bottom switch jaw with the binding posts up and in the top test switch jaw with the binding posts down.

! Warning

Provision is made only on current poles with shorting springs to automatically short-circuit current transformer circuits when the knife switches are opened prior to inserting the Test Plug.

5.5. Flexitest test kit

The ABB Flexitest test kit comes with a convenient carrying case to hold your hand held meter, test plugs, patch cords, test clips, and test probes in neat order. Flexitest Test Kits can be ordered with your selected quantities of test plugs, safety patch cords, test clips, and test probes. Patch cords are highly durable and flexible. Contact your local ABB representative for a quotation. For more information see "Test Plugs & Accessories - Ordering Information" on pages 27-28.

1 In-service Series Test Plug | 2 Individual Current Circuit Test Plug | 3 Separate Source Test Plug | 4 Individual Current Circuit Test Plug inserted in Flexitest relay case | 5 Separate Source Test Plug | 6 FT test kit

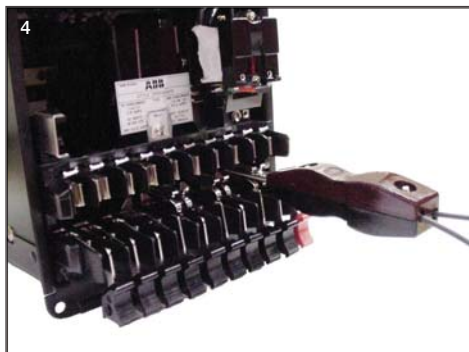

6. FT Flexitest switches ordering information

FT-1 Configurator

ABB has a web based tool to help build any complete FT Switch Arrangement, select options, view schematic details and get style number information. We strongly recommend the use of the web based tool for quick, easy, and user-friendly configuration of Flexitest switches.

The following products can be easily configured:

- FT-1 (10 Pole)
- Front connected FT-1F
- Extended terminals FT-1X
- Replacement switches for FT-19R
- FT-14 (14 Pole)
- FT-19R switch panel assemblies
- FT-19RX switch panel assemblies

Please visit ABB's FT-1 Configurator website at www.ft1switch.com.

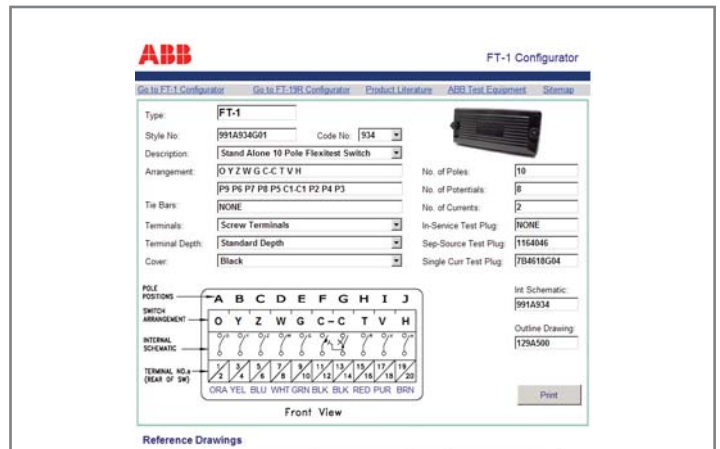
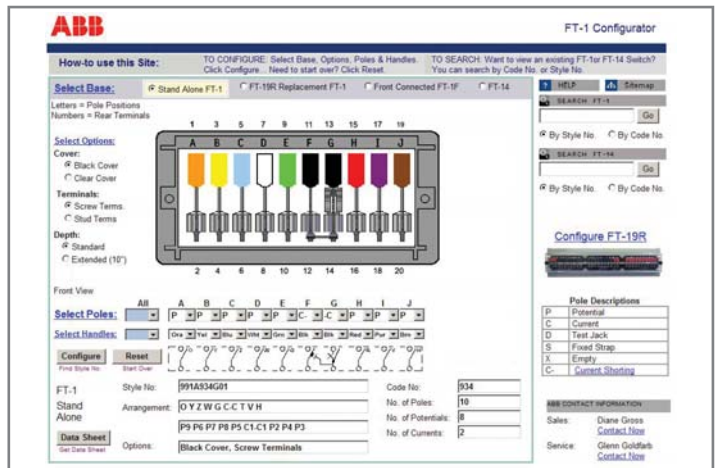
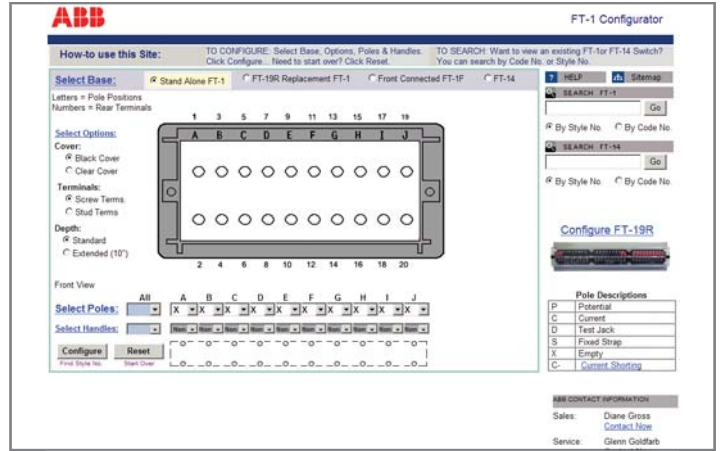

Flexitest switch ordering information

FT-1

10 pole - Flexitest switch

Style numbers are assigned by the factory.

Choose from available options by adding style prefix as shown.

Individual covers for FT-1 to be used on FT-19R application should be ordered as a separate item. See ordering information table on page 28.

Example style number

1 2 9 A 5 0 1 G 0 1



- None** = Black cover, screw terminals.
- S** = Black cover, stud & nut terminals
- C** = Clear cover, screw terminals
- CS** = Clear cover, stud & nut terminals
- L** = Lockable black cover, screw terminals, rear connected
- LS** = Lockable black cover, stud & nut, rear connected
- LC** = Lockable clear cover, screw terminals, rear connected
- LCS** = Lockable clear cover, stud & nut, rear connected
- R** = FT-19R application, screw terminals
- RS** = FT-19R application, stud & nut terminals

FT-1X

10 pole - extended terminals

Style numbers same as FT-1.

Choose from available options by adding style prefix as shown.

Choose extended length as shown.

Individual covers for FT-1 to be used on FT-19R application should be ordered as a separate item. See ordering information table on page 28.

Example style number

1 2 9 A 5 0 1 G 01

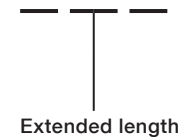

Same as FT-1

X10 = 10.25 inches

X08 = 8.25 inches

FT-1F
10 pole - front connected

Example style number

1 2 9 A 5 0 1 G 0 1

Style numbers are assigned by the factory.

Choose from available options by adding style prefix as shown.



Style prefix

- F** = Black cover, screw terminals
- SF** = Black cover, stud & nut terminals

- CF** = Clear cover, screw terminals
- CSF** = Clear cover, stud & nut terminals

- LF** = Lockable black cover, screw terminals, rear connected
- LSF** = Lockable black cover, stud & nut, rear connected
- LCF** = Lockable clear cover, screw terminals, rear connected
- LCSF** = Lockable clear cover, stud & nut, rear connected

FT-14
14 pole Flexitest switch

FT4 A 14 T 14 C N 4001

Base type:

FT4 = FT14

Depth:

A = Standard depth (rear connected)

No. of poles:

01-14 = Total number of poles used

Terminals:

T = Standard screw terminals

S = Stud and nut terminals

No. of potentials:

00-14 = Total number of potential poles

Cover:

C = Clear cover

B = Black cover

L = Lockable clear cover

R = Lockable black cover

Special features:

N = None

Code no.:

4001-4999 = Unique code number assigned by the factory

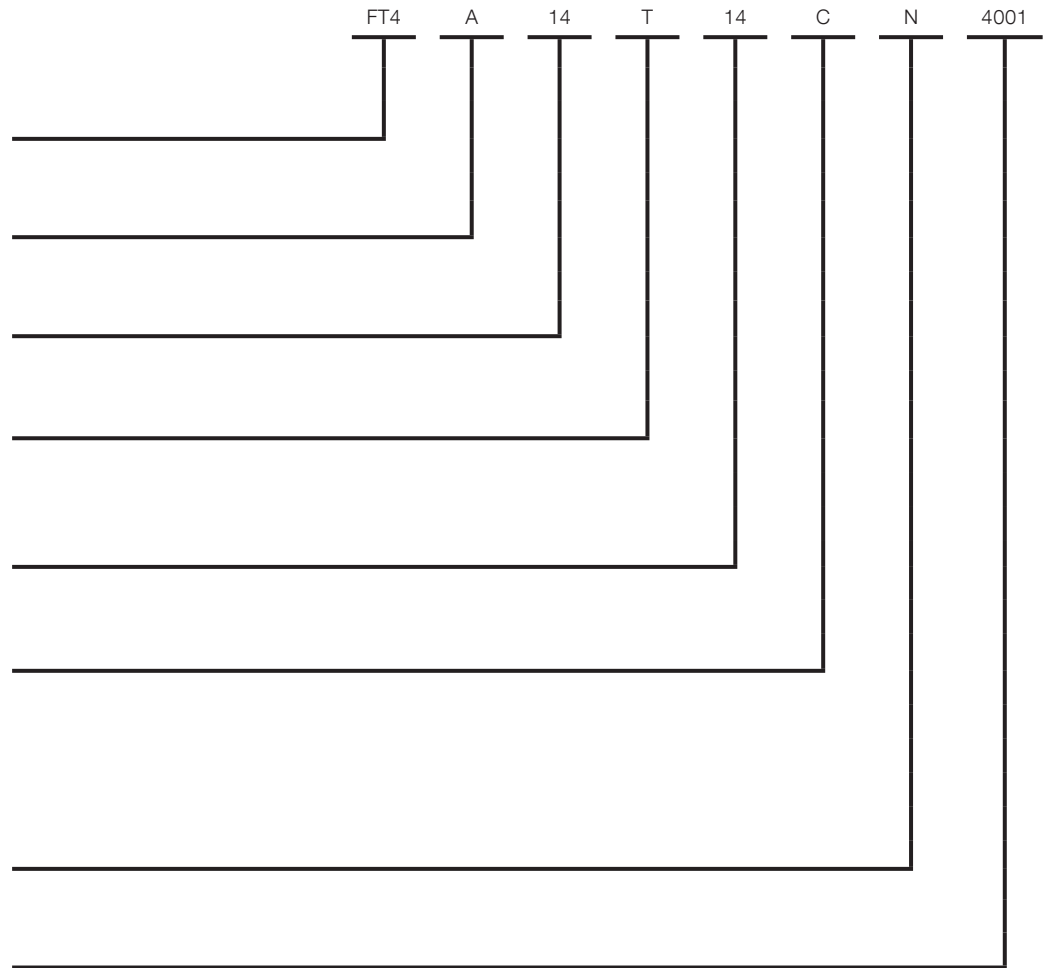

6.1. FT-1, FT-1F and FT-1X switches are available in any combination of 1 to 10 poles. Each different configuration of poles is assigned a unique part number or style number by the factory. See ordering information chart for FT-1, FT-1X, and FT-1F on pages 16-17.

The standard FT-1 Style Number defines a unique pole configuration with black cover and screw terminals ex: 129A501G01. Adding a prefix and/or suffix to the standard Style Number allows the selection of options for FT-1 as well as the ability to create complete FT-1F and FT-1X style numbers.

Customers may also place an order by providing a complete switch arrangement definition as well as the selected options. ex: P X P C-C C-C C-C P (P1 X0 P1 C1-C1 C1-C1 C1-C1 P1), clear cover, screw terminals.

6.1.1. Terminal connections

An optional FT-1 Switch with stud and nut termination can be supplied at no additional charge. Style Number prefix “S” is used for this option, ex: S129A501G01. For optional clear cover with stud and nut terminals use style number prefix “CS”, ex: CS129A501G01. See pages 16-17 for more ordering details.

6.1.2. Cover

An optional clear cover will be supplied instead of the black cover by using style number prefix “C,” ex: C129A501G01.

6.1.3. Depth

An FT-1X extended switch with black cover will be supplied by using suffix “X08” for 8 inches and “X10” for 10 inches, ex: 129A501G01X08 or 129A501G01X10.

An FT-1X extended switch with clear cover will be supplied by using prefix “C” and suffix “X10”, ex: C129A501G01X10

6.1.4. Front connected

Adding a prefix “F” to the standard style number is used for a front connected FT-1F switch, which allows the user to make the connections on the front of the switch.

6.2. FT-14 switch is available in any combination up to 14 poles. Each different style number is based on a smart part number system. See ordering information chart on page 17.

6.2.1. Terminal connections

A standard FT-14 Switch with screw termination will be supplied when using the normal style number. An optional FT-14 switch with stud and nut termination can be supplied at no additional charge provided when the seventh character on the smart part number is changed from “T” to “S.”

6.2.2. Cover

A standard FT-14 Switch with clear cover will be supplied when using the normal style number. An optional FT-14 switch with black cover can be supplied at no additional charge provided the tenth character in the above styles is changed from “C” to “B”. An optional FT-14 switch with lockable clear or black cover can be supplied at no additional charge provided the tenth character changed from “C” to either “L” (lockable clear) or “R” (lockable black).

6.3 FT-19 and FT-22 test switch assemblies.

The FT-19R and FT-19RX assemblies accommodate up to two FT-1 switches. The FT-19RS and FT-22RS assemblies accommodate up to two FT-1 switches, two FT-14 switches, or the combination of one FT-1 and one FT-14 switch.

Each different style number is based on a smart part number system. See page 20-22 for more ordering details.

6.3.1 Terminal connections

The Flexitest Switches for FT-19R, FT-19RX, FT-19RS, and FT-22RS assemblies can be ordered with standard (# 8) screw terminals or optional stud & nut terminals. The type of terminal connection is represented by the second character of the style number.

6.3.2 Panel height

The 19" as well as 22" wide mounting panel can be ordered in different rack unit (RU) heights: 2RU, 3RU or 4RU. The 3RU assembly is available with switch positions centered, mounted high or mounted low. The 4RU is available with switches mounted low or high.

6.3.3 Panel color & material

Panels are available in the following colors and materials: ANSI 61 gray - steel; ANSI 70 gray - steel; RAL7035 gray - steel; beige - steel; black - steel; Light Sandlewood (RAL1019) - steel; Thunder Blue (textured) - steel ; and brushed finish aluminum.

For visual representation of the panel colors, please visit www.ft1switch.com.

6.3.4 Flexitest switch code numbers (positions A, B, and C)

Each FT-1 switch is identified by a unique three-digit code number. FT-14 switches are identified by a unique four digit code number. These "code numbers" are required for each of the positions in the assembly (positions A, B and C).

To obtain the FT-1 or FT-14 switch style number and the three or four digit code number refer to the ABB FT-1 configurator at www.ft1switch.com or FT switch selection guide (document 1VAC397062-SG). A cover plate will be provided for unused FT-1 or FT-14 switch positions (A, B, or C) by using code number "000" or "0000" respectively.

If a particular arrangement is not listed, contact the ABB Coral Springs factory.

6.3.5 Switch replacement

To add an FT-1 switch in an unused position or to replace a switch in an FT-19R assembly, the required FT-1 switch style(s) will need to be provided. These numbers differ from the individual FT-1 style numbers by including the prefix "R" to represent screw terminals (e.g., R129A501G01) or the prefix "RS" to represent stud type terminals (e.g., RS129A501G01). For FT-19RX assemblies provide the required FT-1 switch style with an "R" or "RS" prefix plus the X08 or X10 length suffix (e.g., R129A501G01X10).

It is not necessary to add "R" prefix to the standard style number of FT-1 or FT-14 switches to be used as replacement on FT-19RS assemblies.

6.3.6 Cover

For FT-19R assemblies, the cover field should be left BLANK to order the unit with the standard full length clear cover. Optional full length black, individual clear, individual black, lockable full length clear or lockable full length black cover can be requested by indicating the assigned letter on the cover field on the smart part number.

The cover field is always required on FT-19RX, FT-19RS and FT-22RS part numbers.

6.3.7 Additional features

When ordering the "Flat panel" version, please note this is meant for applications where flush panel or cabinet mounting is required.

FT-19R

Flexitest switch assembly

		Typical catalog number		
		Pos A	Pos B	Pos C
		014	014	014
		F	R	2
		B		
Terminal connections				
Screw type (Standard)	R			
Stud and nut type (optional)	S			
Panel height				
Two rack units	2			
Three rack units (switches centered)	3			
Three rack units (switches low)	X			
Three rack units (switches high)	Y			
Four rack units (switches low)	4			
Four rack units (switches high)	Z			
Color and material				
Brushed finish aluminum	A			
Beige (textured surface) steel	B			
Gray (ANSI 61 smooth surface) steel	G			
Gray (ANSI 70 smooth surface) steel	H			
Gray (RAL7035 smooth surface) steel	J			
Black (smooth surface) steel	K			
Light Sandlewood (RAL1019) Steel	D			
Thunder Blue (Textured) Steel	E			
FT-1 switch code numbers				
Position A				
Position B				
Position C				
000 = No switch (cover plate provided over switch cutout)				
3-Digit FT-1 code number				
Cover				
Full length clear cover (standard)	Blank			
Full length clear cover (use with additional features only) ¹	N			
Full length black cover	A			
Individual clear covers	C			
Individual black covers	B			
Lockable full length clear cover	L			
Lockable full length black cover	R			
Additional features				
None	Blank			
Flat panel (panel and cabinet mount only)	F			

¹ The cover option "N" only applies when additional features are required.

For special configurations, please contact the factory.

FT-19RX

Flexitest switch assembly

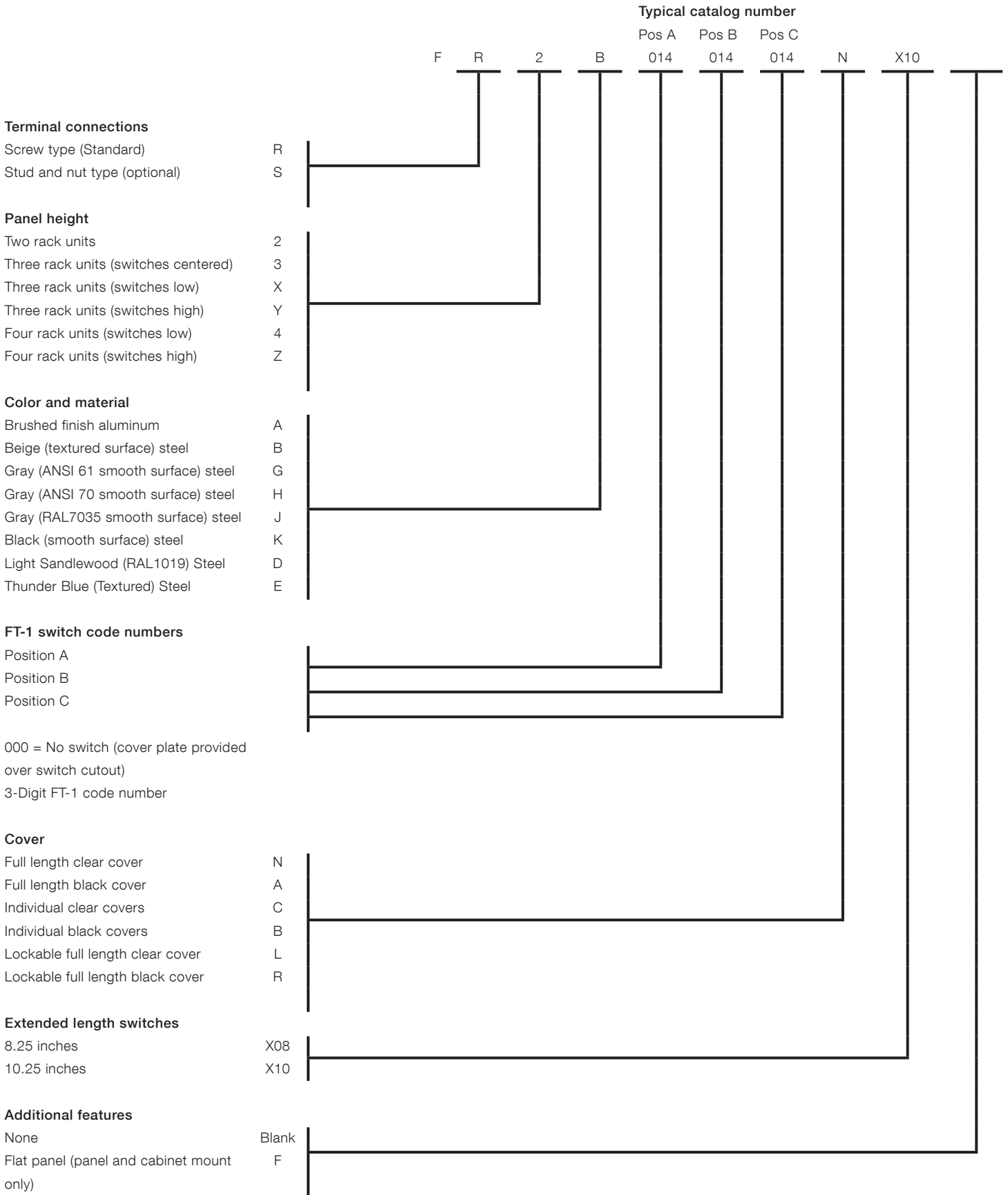

For special configurations, please contact the factory.

FT-19RS and FT-22RS
Flexitest switch assembly

Typical catalog number

Pos A Pos B Pos C
 014 - N - 4025 B

Assembly type

19 inch mounting panel
 22 inch mounting panel



Terminal connections:

Screw type (Standard)
 Stud and nut type (optional)



Panel height

Two rack units
 Three rack units (switches centered)
 Three rack units (switches low)
 Three rack units (switches high)
 Four rack units (switches low)
 Four rack units (switches high)



Color and material

Brushed finish aluminum
 Beige (textured surface) steel
 Gray (ANSI 61 smooth surface) steel
 Gray (ANSI 70 smooth surface) steel
 Gray (RAL7035 smooth surface) steel
 Black (smooth surface) steel
 Light Sandlewood (RAL1019) Steel
 Thunder Blue (Textured) Steel

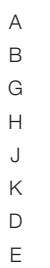

Positions A, B, C

001-999, A01-Z99 = 3-Digit FT-1 switch code number
 4001-4999 = 4-Digit FT-14 switch code number
 S01-S99 = Special equipment code (see table 1, page 24)
 N = Unused panel position

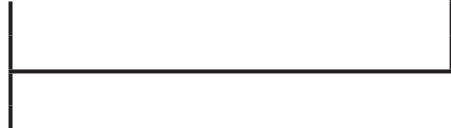

000 = No switch (cover plate provided over FT-1 switch cutout)
 4000 = No switch (cover plate provided over FT-14 switch cutout)

Cover

Individual clear covers
 Individual black covers (standard)
 Lockable individual clear cover
 Lockable individual black cover

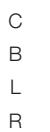

Additional features

None
 8.25 inches extended terminals (FT-1 only)
 10.25 inches extended terminals (FT-1 only)
 Flat panel
 8.25 inches extended terminals (FT-1 only), Flat panel
 10.25 inches extended terminals (FT-1 only), Flat panel



For special configurations, please contact the factory.

Possible combinations of FT-1 and FT-14 switches on FT-19RS and FT-22RS assemblies, when space for special equipment is not required

Fig.	Pos. A	Pos. B	Pos. C
1	FT1	N	FT1
2	FT14	N	FT14
3	FT14	N	FT1
4	FT1	N	FT14

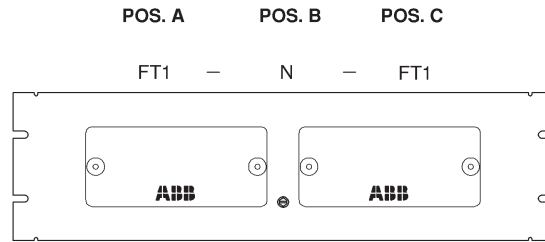

FIGURE 1

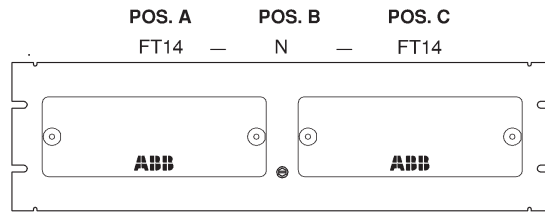

FIGURE 2

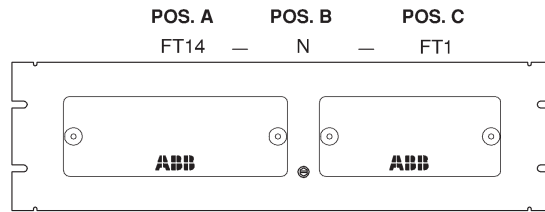

FIGURE 3

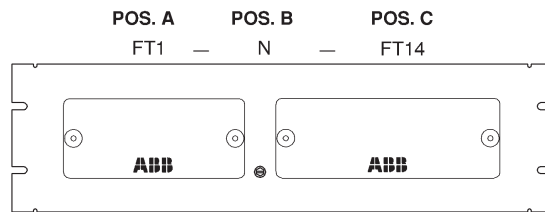

FIGURE 4

Possible configuration of FT-19RS and FT-22RS assemblies, when space for special equipment is required

Fig.	Pos. A	Pos. B	Pos. C
5	FT1	FT1	Sxx
6	FT1	Sxx	FT1
7	Sxx	FT1	FT1

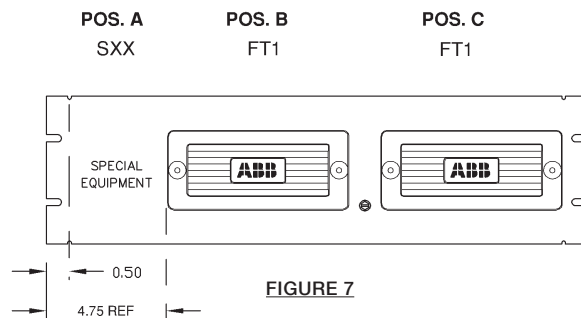
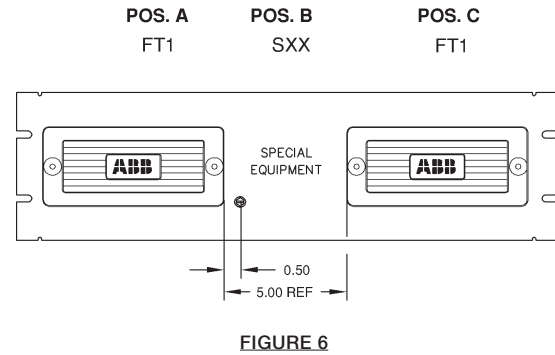
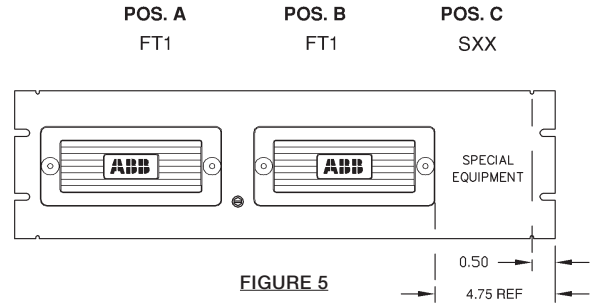

Table 1

AVAILABLE SPECIAL EQUIPMENT CODES

CODE	DETAIL DRAWING	MANUFACTURER	DESCRIPTION
S01	PNL-DRL-S01	—	TOGGLE SWITCH
S02	PNL-DRL-S02	ELECTROSWITCH	SERIES 24 LOCK-OUT RELAY
S03	PNL-DRL-S03	G.E.	GE TYPE SBM CONTROL SWITCH
S24	PNL-DRL-S24	ELECTROSWITCH	SERIES 24 CONTROL TRANSFER SWITCH

Note: Special equipment not included with assembly.

Most popular FT switches

Table 1 - FT-1 Switch selection guide

Poles	Potential	Current	A	B	C	D	E	F	G	H	I	J	Style number	Code	Options	In-Service Test Plug
10	10	0	P	P	P	P	P	P	P	P	P	P	129A501G01	001	Black Cover, Screw Terminals	129A062G10
10	10	0	T	T	T	T	T	T	T	T	T	T	129A539G01	036	Black Cover, Screw Terminals	129A062G10
10	10	0	P	T	T	T	T	T	T	T	T	T	9688A17G01	584	Black Cover, Screw Terminals	129A062G10
10	10	0	P	P	P	P	P	P	P	P	T	T	1586C42G23	212	Black Cover, Screw Terminals	129A062G10
10	10	0	P	P	P	P	T	T	T	P	P	P	9676A14G01	452	Black Cover, Screw Terminals	129A062G10
10	10	0	T	T	P	P	P	P	P	P	P	P	1586C42G45	262	Black Cover, Screw Terminals	129A062G10
10	4	6	P	P	P	C	-	C	C	-	C	-	129A514G01	014	Black Cover, Screw Terminals	292B319G23
10	4	6	P	C	-	C	P	C	-	C	P	C	129A528G01	026	Black Cover, Screw Terminals	NONE
10	4	6	C	-	C	C	-	C	C	-	C	P	774B430G20	171	Black Cover, Screw Terminals	NONE
10	4	6	T	T	T	T	C	-	C	C	-	C	498A010G01	065	Black Cover, Screw Terminals	NONE
10	4	6	P	P	P	P	C	-	C	C	-	C	670B197G18	119	Black Cover, Screw Terminals	NONE
10	4	6	T	T	T	C	-	C	C	-	C	C	714B325G32	137	Black Cover, Screw Terminals	292B319G23
10	4	6	C	-	C	C	-	C	C	T	T	T	774B430G24	183	Black Cover, Screw Terminals	NONE
10	3	7	P	P	C	C	-	C	C	-	C	C	129A535G01	033	Black Cover, Screw Terminals	292B319G22
10	2	8	P	C	-	C	C	-	C	C	-	C	129A518G01	018	Black Cover, Screw Terminals	292B319G22
10	2	8	C	-	C	C	-	C	C	-	C	P	837A407G01	083	Black Cover, Screw Terminals	NONE
10	2	8	C	-	C	C	-	C	C	-	C	T	774B430G22	173	Black Cover, Screw Terminals	NONE
10	0	10	C	-	C	C	-	C	C	-	C	C	498A020G01	073	Black Cover, Screw Terminals	NONE
8	0	8	.	C	-	C	C	-	C	C	-	C	129A517G01	017	Black Cover, Screw Terminals	292B319G22
8	0	8	X	R	-	R	R	-	R	R	-	R	9660A84G01	266	Black Cover, Screw Terminals	292B319G22
6	0	6	.	.	.	C	-	C	C	-	C	C	129A516G01	016	Black Cover, Screw Terminals	292B319G23

Table 2 - FT-14 Switch selection guide

Poles	Potential	Current	A	B	C	D	E	F	G	H	I	J	K	L	M	N	Style number	Code	Options
14	14	0	P	P	P	P	P	P	P	P	P	P	P	P	P	P	FT4A14T14CN4001	4001	Clear Cover, Screw Terminals
14	14	0	T	T	T	T	T	T	T	T	T	T	T	T	T	T	FT4A14T14CN4018	4018	Clear Cover, Screw Terminals
14	6	8	P	P	P	P	P	P	C	-	C	C	-	C	C	-	FT4A14T06CN4046	4046	Clear Cover, Screw Terminals
14	6	8	P	P	P	C	-	C	C	-	C	C	-	C	P	P	FT4A14T06CN4044	4044	Clear Cover, Screw Terminals
14	6	8	C	-	C	C	-	C	C	-	C	P	P	P	P	P	FT4A14T06CN4068	4068	Clear Cover, Screw Terminals
14	6	8	C	-	C	C	-	C	C	-	C	P	P	P	T	T	FT4A14T06CN4035	4035	Clear Cover, Screw Terminals
14	6	8	T	T	T	T	C	-	C	C	-	C	C	-	T	T	FT4A14T06CN4052	4052	Clear Cover, Screw Terminals
14	4	10	P	P	P	P	C	-	C	C	-	C	C	-	C	C	FT4A14S04BN4151	4151	Black Cover, Stud Terminals
14	2	12	C	-	C	C	-	C	C	-	C	P	P	C	-	C	FT4A14S02BN4177	4177	Black Cover, Stud Terminals
14	0	14	C	-	C	C	-	C	C	-	C	C	-	C	C	C	FT4A14T00CN4063	4063	Clear Cover, Screw Terminals
12	4	8	T	P	Z	W	.	R	-	R	C	-	C	7	-	7	FT4A12T04CN4163	4163	Clear Cover, Screw Terminals
11	3	8	P	P	P	.	C	-	C	C	-	C	.	C	-	C	FT4A11S03BN4127	4127	Black Cover, Stud Terminals



The above are the most popular FT configurations. For more styles please visit www.ft1switch.com.

Table 3 - FT-19R switch assemblies

Style number	Position A	Position B	Position C	Options
FR3G001001001	001	001	001	3RU (centered), Steel, Ansi 61 Gray, Screw Terminals
FR3G171001001	171	001	001	3RU (centered), Steel, Ansi 61 Gray, Screw Terminals
FR2G001001001	001	001	001	2RU, Steel, Ansi 61 Gray, Screw Terminals
FR3H014001001	014	001	001	3RU (centered), Steel, Ansi 70 Gray, Screw Terminals
FR3H001001001	001	001	001	3RU (centered), Steel, Ansi 70 Gray, Screw Terminals
FR3G073001001	073	001	001	3RU (centered), Steel, Ansi 61 Gray, Screw Terminals
FRXG001001001	001	001	001	3RU (low), Steel, Ansi 61 Gray, Screw Terminals
FR3G014001001	014	001	001	3RU (centered), Steel, Ansi 61 Gray, Screw Terminals
FR3G001001262	001	001	262	3RU (centered), Steel, Ansi 61 Gray, Screw Terminals
FR3G183001262	183	001	262	3RU (centered), Steel, Ansi 61 Gray, Screw Terminals
FR4G001001001	001	001	001	4RU, Steel, Ansi 61 Gray, Screw Terminals
FR3G073212036	073	212	036	3RU (centered), Steel, Ansi 61 Gray, Screw Terminals
FR3G183001001	183	001	001	3RU (centered), Steel, Ansi 61 Gray, Screw Terminals
FR4G171001001	171	001	001	4RU, Steel, Ansi 61 Gray, Screw Terminals
FR3G083001001	083	001	001	3RU (centered), Steel, Ansi 61 Gray, Screw Terminals
FR3G083452000	083	452	000	3RU (centered), Steel, Ansi 61 Gray, Screw Terminals
FR2G014001001	014	001	001	2RU, Steel, Ansi 61 Gray, Screw Terminals
FR3G036036036	036	036	036	3RU (centered), Steel, Ansi 61 Gray, Screw Terminals
FR2G026001001	026	001	001	2RU, Steel, Ansi 61 Gray, Screw Terminals
FR3G026001026	026	001	026	3RU (centered), Steel, Ansi 61 Gray, Screw Terminals
FR3G171171001	171	171	001	3RU (centered), Steel, Ansi 61 Gray, Screw Terminals
FR2G001001000	001	001	000	2RU, Steel, Ansi 61 Gray, Screw Terminals
FR2G001000000	001	000	000	2RU, Steel, Ansi 61 Gray, Screw Terminals
FR3H014014014	014	014	014	3RU (centered), Steel, Ansi 70 Gray, Screw Terminals
FR3G026001001	026	001	001	3RU (centered), Steel, Ansi 61 Gray, Screw Terminals

The above are the most popular FT configurations. For more styles please visit www.ft1switch.com.

7. Test plugs & accessories - ordering information

Test Plugs	Style Number		
	In-Service Series Test Plug (Order to match Flexitest FT-1 switch arrangement or FT relay case)	See FT switch selection guide (document 1VAC397062-SG) page 4	
	Standard Individual Current Circuit Test Plug - leads not included	7B4618G04	
	Standard Individual Current Circuit Test Plug - leads included	7B4618G05	
	SafePlug - Individual Current Circuit Test Plug with open CT protection - leads not included	1VAC391001P001	
	SafePlug - Individual Current Circuit Test Plug with open CT protection - leads included	1VAC391001P002	
	Separate Source Test Plug (10 position)	1164046	
	Separate Source Test Plug (14 position)	1355D32G04	
Complete FT test kit (Includes ABB bag)		9688A68G18	
	Items in test kit 9688A68G18 1 Red 6' safety patch cord with retractable sleeve banana plug on both ends 1 Black 6' safety patch cord with retractable sleeve banana plug on both ends 1 Red 10' UTP cable with RJ-45 male connector on both ends. 1 Red safety plug-on test probe 1 Black safety plug-on test probe 1 Red safety plug-on alligator test clip 1 Black safety plug-on alligator test clip FT separate source test plug - 1164046 FT individual series test plug - 7B4618G04	Rated voltage 600 VDC 600 VDC 600V 1000V 1000V 1000V 1000V 600V 600V	Rated current 32A 32A 30A 10A 10A 10A 10A 30A 30A

Complete FT test kit (includes ABB Bag)

9688A68G24

Items in test kit 9688A68G24	Rated	Rated
	Voltage	Current
1 red 6' safety patch cord with retractable sleeve banana plug on both ends	600 VDC	32A
1 black 6' safety patch cord with retractable sleeve banana plug on both ends	600 VDC	32A
1 red 10' UTP cable with RJ-45 male connector on both ends	600V	30A
1 red safety plug-on test probe	1000V	10A
1 black safety plug-on test probe	1000V	10A
1 red safety plug-on alligator test clip	1000V	10A
1 black safety plug-on alligator test clip	1000V	10A
FT separate source test plug - 1164046	600V	30A
FT individual current circuit test plug with open CT protection - 1VAC391001P001	600V	20A





Cover	FT-1	FT-14	FT-19R
	Standard individual cover w/ thumb nuts - BLACK	128A973G01	128A973G03
Standard individual cover w/ thumb nuts - CLEAR	9676A32G01	9676A32G02	9683A78G01
Full length cover w/ thumb nuts - BLACK	Not applicable	Not applicable	9676A28G02
Full length cover w/ thumb nuts - CLEAR	Not applicable	Not applicable	9676A28G01
Lockable cover w/ thumb nuts & bracket- BLACK	9669A49G01	9669A49G03	Not Applicable
Lockable cover w/ thumb nuts & bracket - CLEAR	9669A49G02	9669A49G04	Not Applicable
Lockable full length cover w/thumb nuts & bracket- BLACK	Not applicable	Not applicable	9669A52G02
Lockable full length cover w/thmb nuts & bracket - CLEAR	Not applicable	Not applicable	9669A52G01



Interlocking bars	FT-1	FT-14
	2 Positions	1270547
3 Positions	1164048	9669A19G03
4 Positions	02C9834G03	9669A19G04
5 Positions	02C9834G04	9669A19G05
6 Positions	02C9834G06	9669A19G06
7 Positions	Not Applicable	9669A19G07
8 Positions	02C9834G07	9669A19G08
10 Positions	02C9834G05	9669A19G10
14 Positions	Not Applicable	9669A19G14



Miscellaneous	Style number
 <p>FT-1 & FT-14 nut driver For stud & nut terminals</p>	877A821G02
 <p>Unistrut adapter plate for railmount of FT-1F</p>	9666A15H01
 <p>Label Holder Sleeve (gloss polycarbonate) for FT-1 SW</p> <p>*To create and print custom labels, please use the template found on our website www.abb.com/substationautomation under Distribution Automation subheading Test Equipment</p>	1506B81H01

8. Warranty

All ABB Flexitest switches and assemblies are backed by a 12-YEAR warranty. The quality of ABB products comes from years of experience and rigorous quality testing programs.

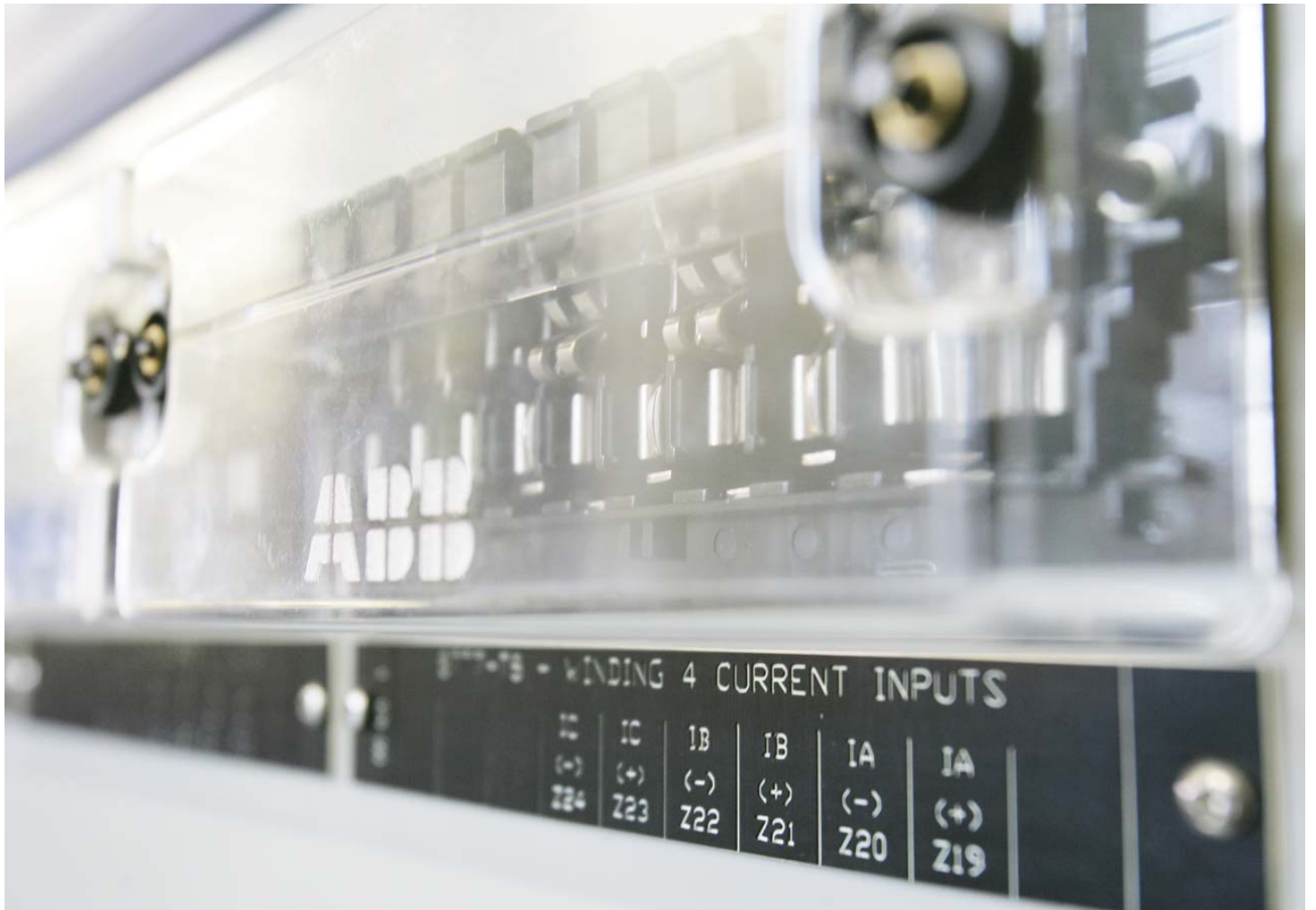
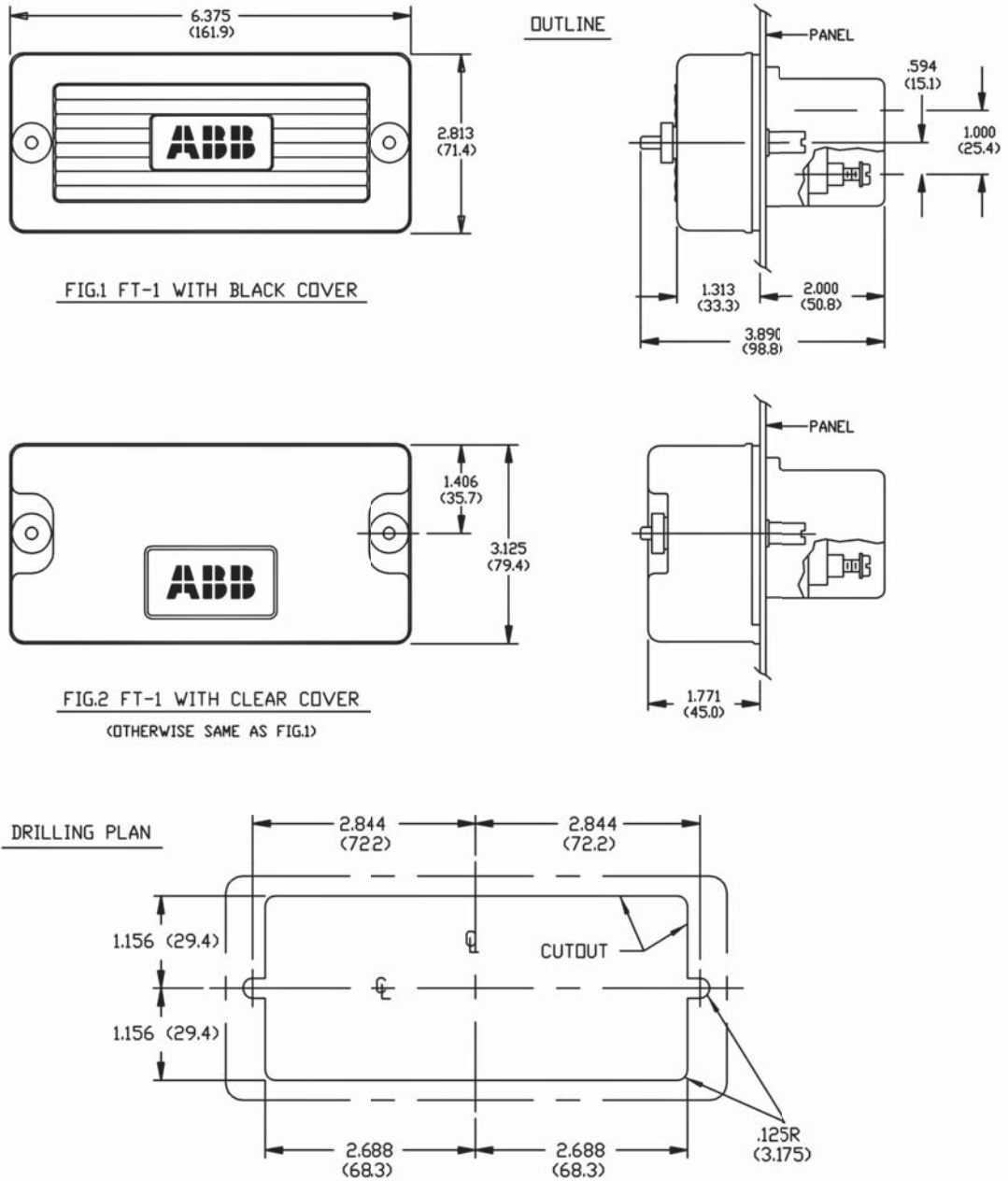

Figure 7 - FT-1 and FT-1X switch outline and drilling plan

FT-1



FT-1X

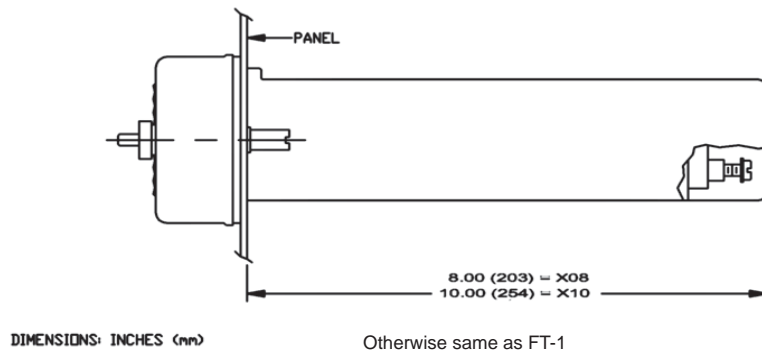
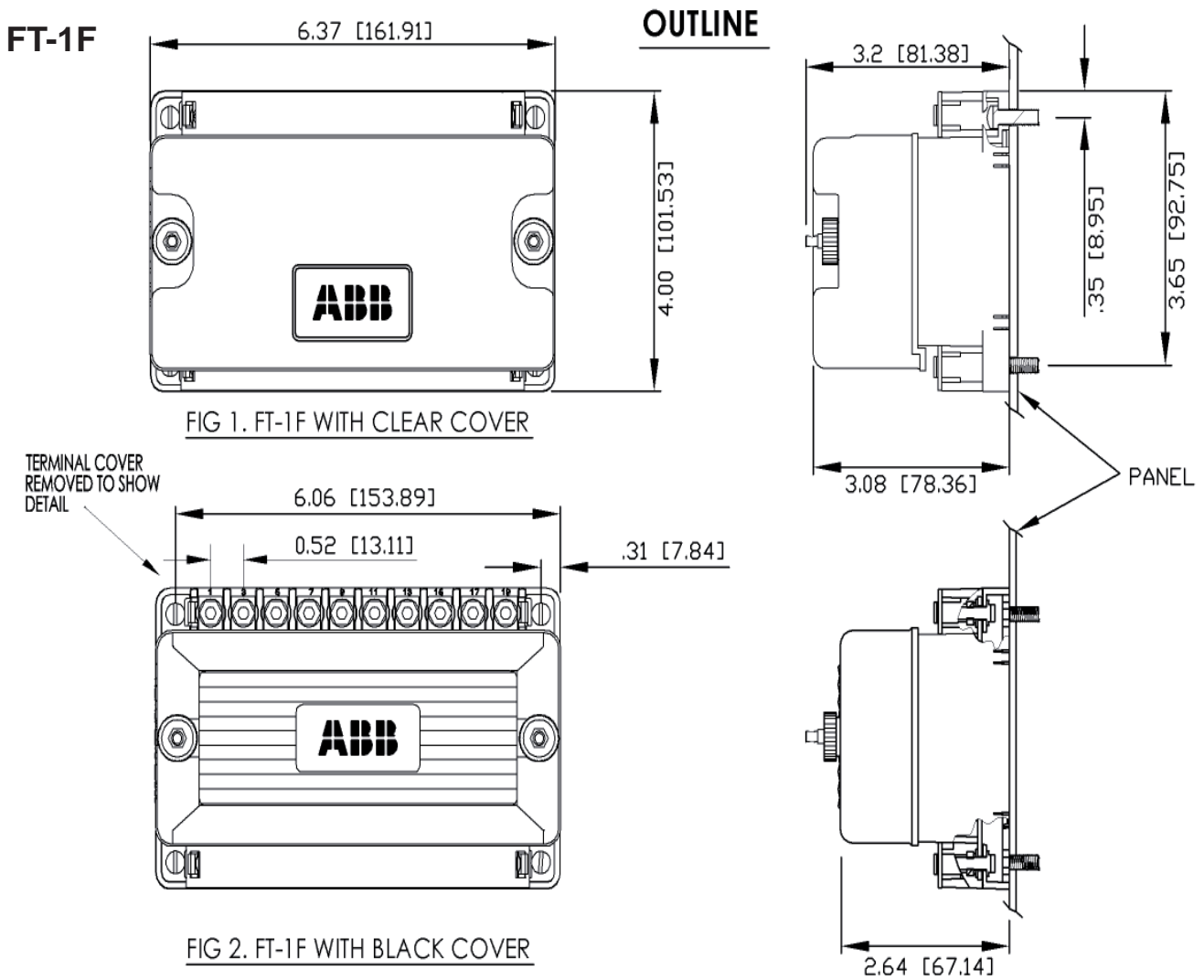
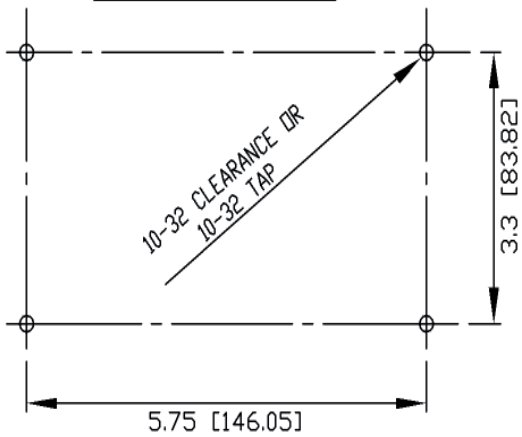

Figure 8 - FT-1F switch outline and drilling plan



DRILLING PLAN



DIMENSIONS: INCHES [mm]

Figure 9 - FT-14 switch outline and drilling plan

FT-14

OUTLINE

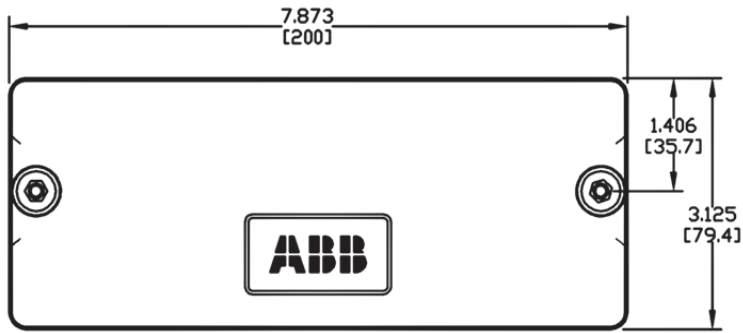
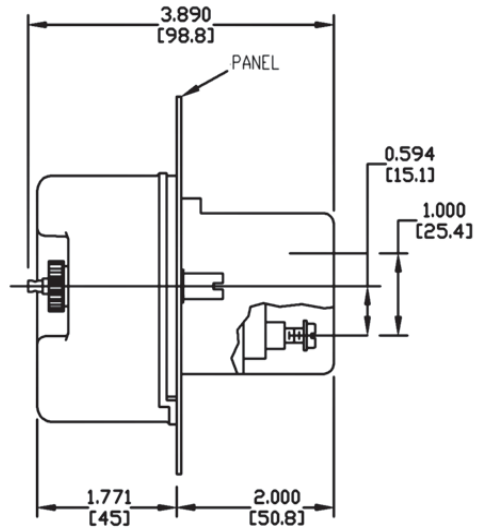
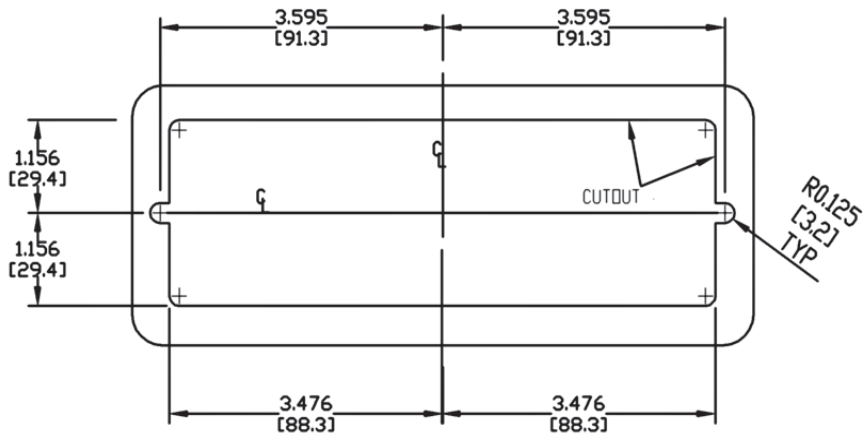

FIG 1. FT-14 WITH CLEAR COVER



DRILLING PLAN



DIMENSIONS: INCHES [mm]

Figure 10 - FT-19R dimensions and layout for rack mounting

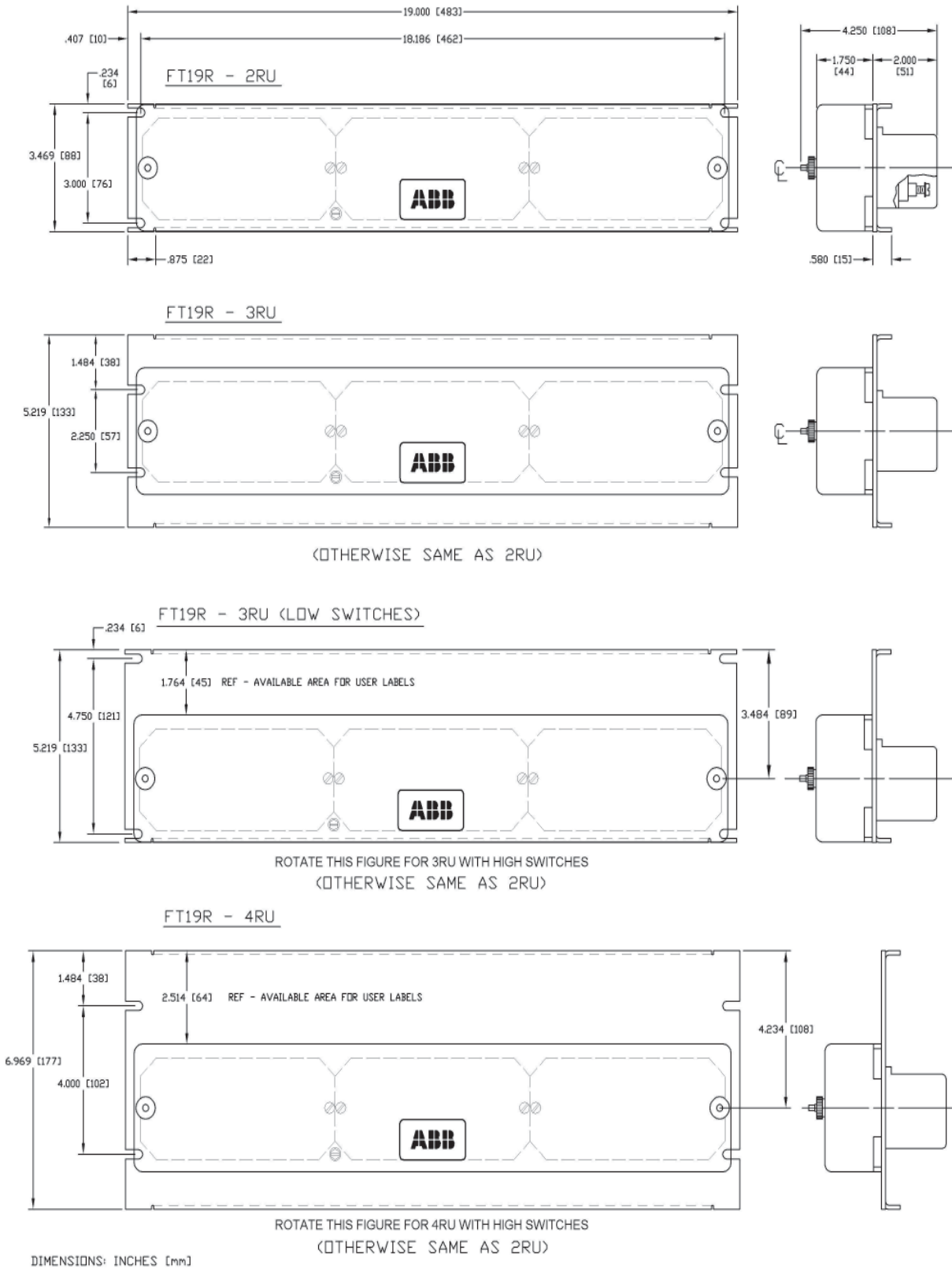
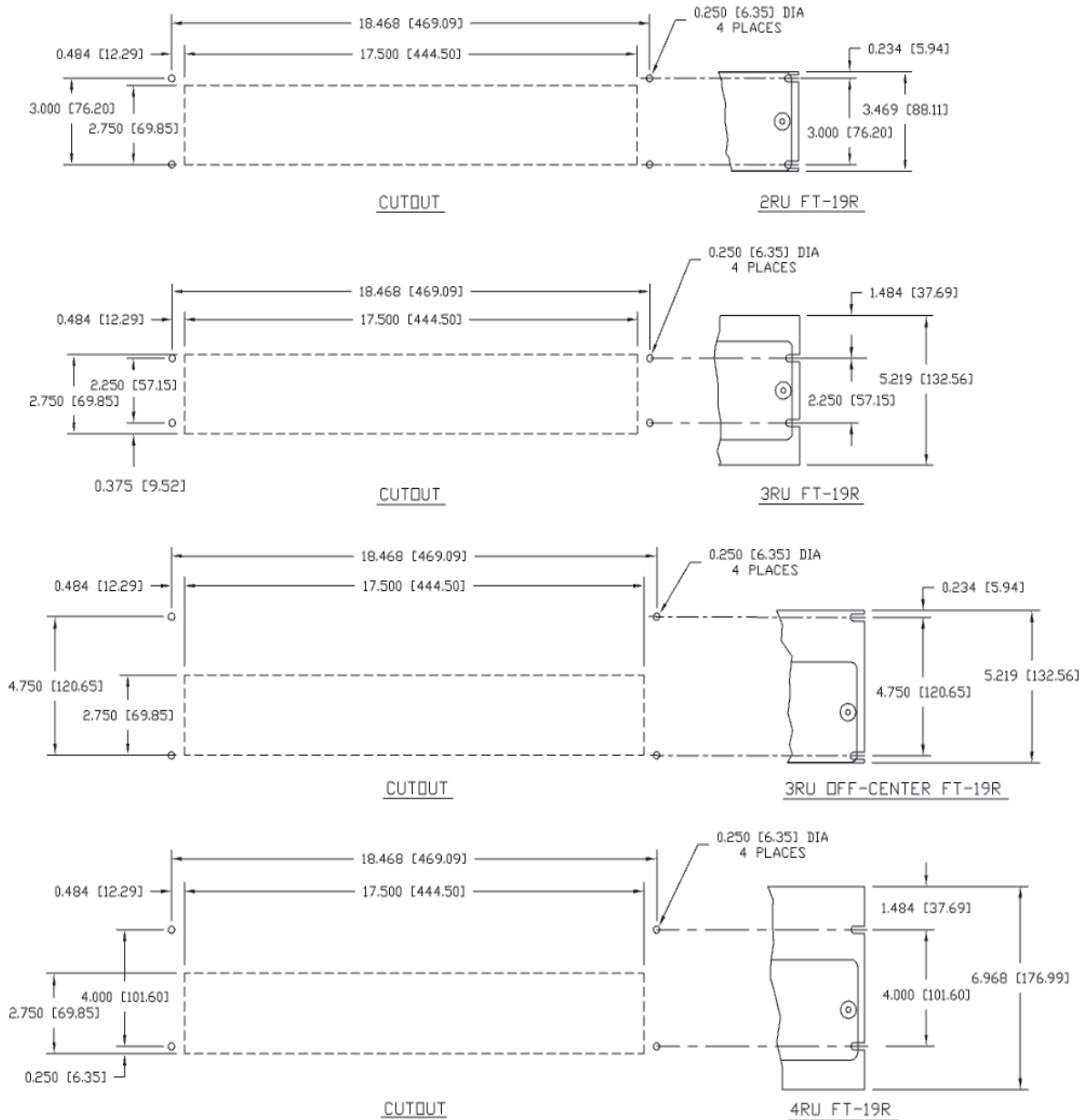

Figure 11 - Outline and drilling plan for FT-19R with flat panels (no rolled edges), rack or flush mounting for panels or cabinets



REF:
 DIMENSIONS: INCHES [mm]
 ALL FIGURES SHOW FRONT VIEW FT19R PANELS AND CUTOUTS.

Figure 12 - FT-22RS dimensions and layout for rack mounting

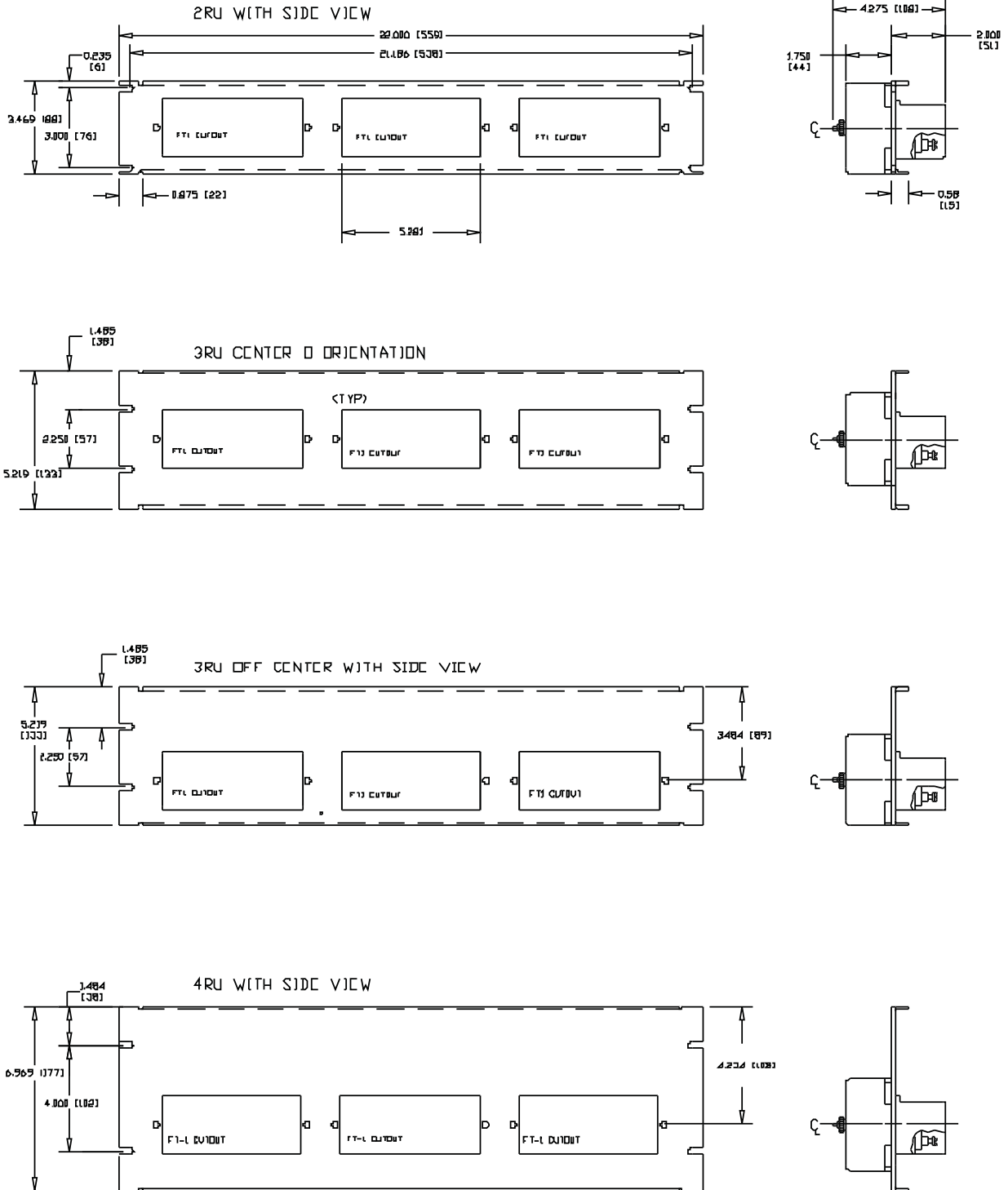

Figure 13 - Outline and drilling plan for FT-22RS with flat panels (no rolled edges), rack or flush mounting for panels or cabinets

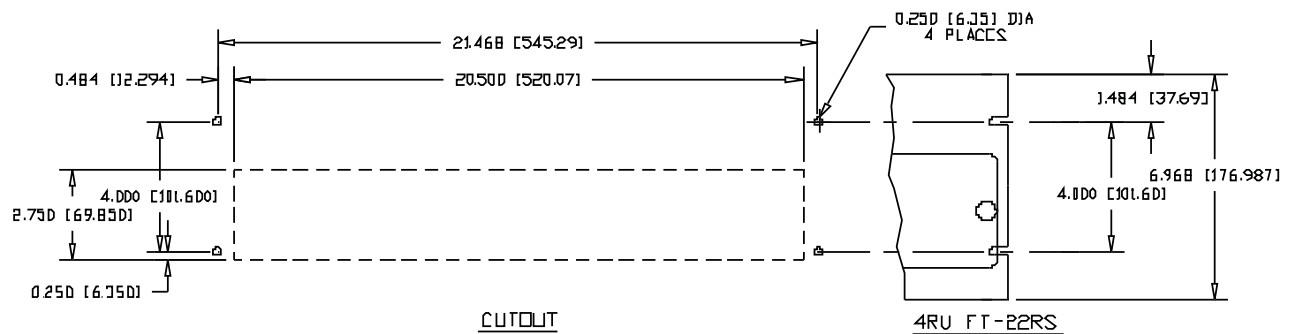
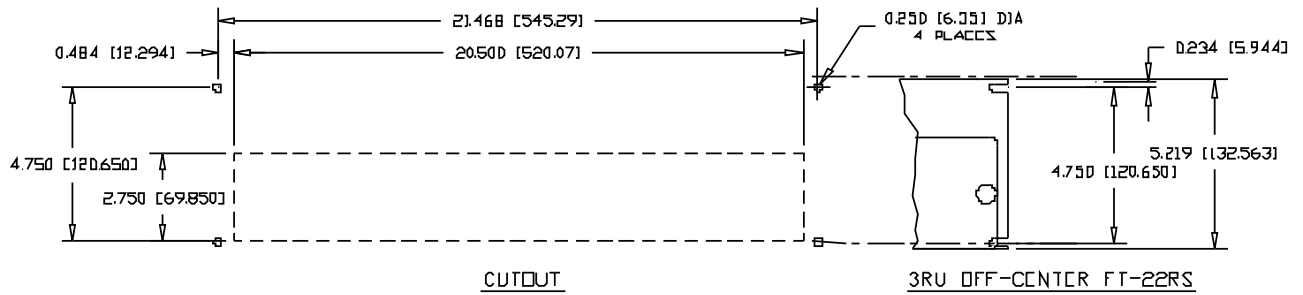
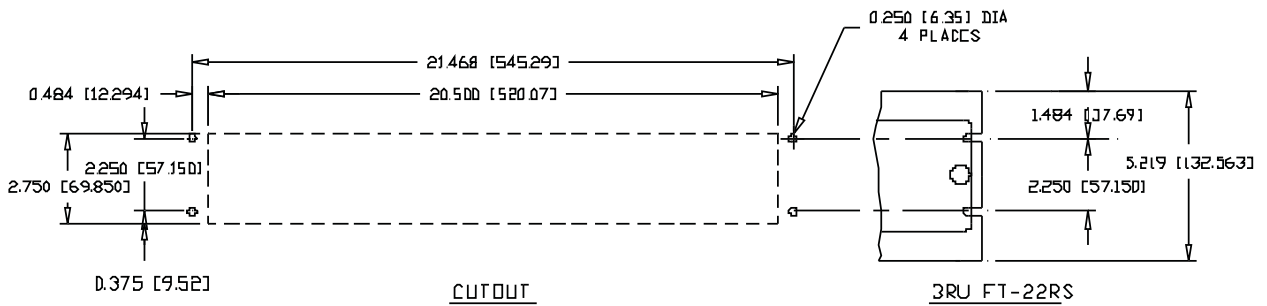
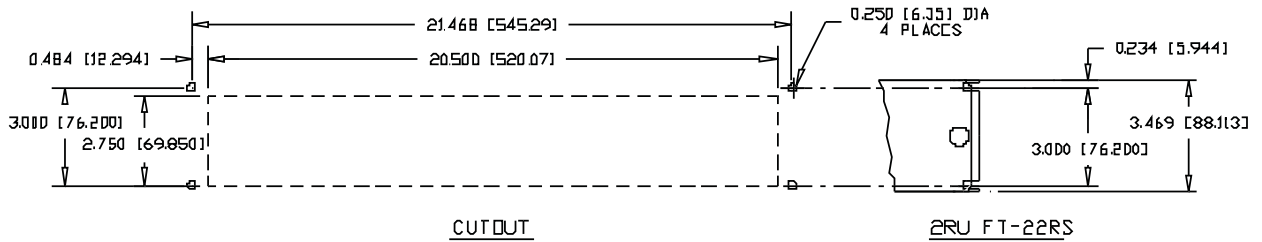
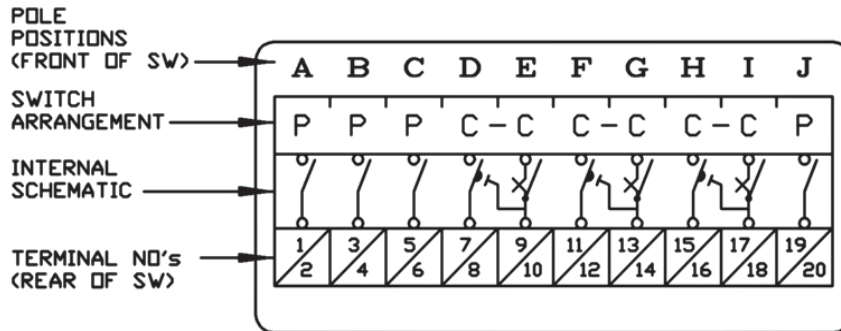
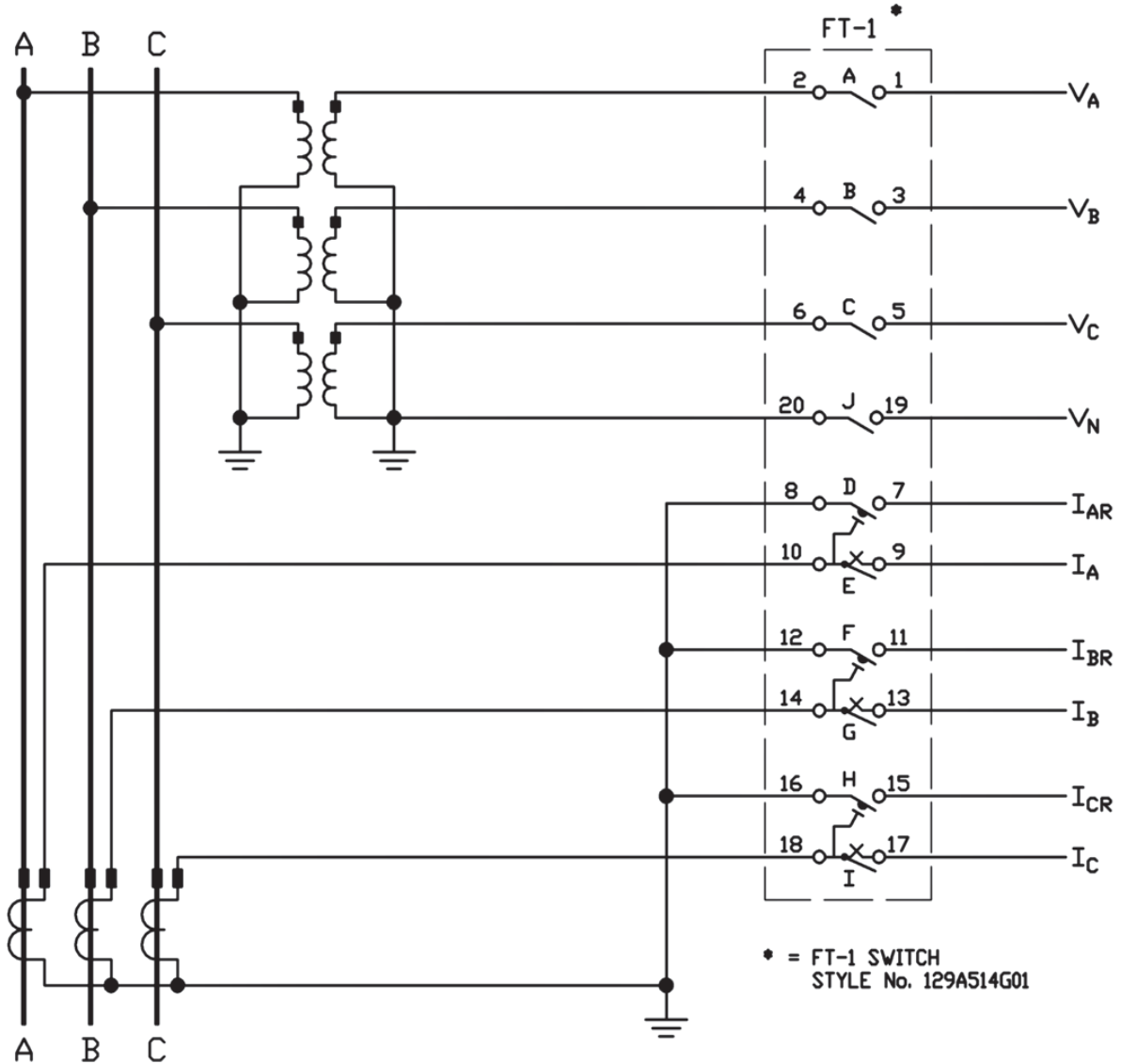

Figure 14- FT-1 switch connection schematic

TYPICAL FT-1 SWITCH CONNECTION SCHEMATIC



FT-1 STYLE No. 129A514G01
(SWITCH LAYOUT)

Notes

Contact us

ABB Inc.

Distibution Automation

4300 Coral Ridge Drive

Coral Springs, Florida 33065

Telephone: +1 954-752-6700

Fax: +1 954-345-5329

www.abb.com/substationautomation

All sales are subject to ABB Inc.
General Terms and Conditions of Sale.

While every effort has been made to assure accuracy, the
information in this document is subject to change without
notice.

© Copyright 2011 ABB Inc. All rights reserved.

DB 41-077 Rev.D March 2011