



MES3500 Series

Layer 2 Management Switch

Version 4.00
Edition 2, 01/2016

User's Guide

Default Login Details

LAN IP Address	http://192.168.1.1
User Name	admin
Password	1234

IMPORTANT!

READ CAREFULLY BEFORE USE.

KEEP THIS GUIDE FOR FUTURE REFERENCE.

Screenshots and graphics in this book may differ slightly from your product due to differences in your product firmware or your computer operating system. Every effort has been made to ensure that the information in this manual is accurate.

Related Documentation

- Quick Start Guide

The Quick Start Guide shows how to connect the Switch and access the Web Configurator.

- CLI Reference Guide

The CLI Reference Guide explains how to use the Command-Line Interface (CLI) and CLI commands to configure the Switch.

Note: It is recommended you use the Web Configurator to configure the Switch.

- Web Configurator Online Help

Click the help icon in any screen for help in configuring that screen and supplementary information.

- More Information

Go to support.zyxel.com to find other information on the Switch.



Contents Overview

User's Guide	17
Getting to Know Your Switch	18
Hardware Installation and Connection	22
Hardware Overview	26
The Web Configurator	35
Initial Setup Example	43
Tutorials	47
Technical Reference	72
System Status and Port Statistics	73
Basic Setting	77
VLAN	88
Static MAC Forward Setup	108
Static Multicast Forward Setup	110
Filtering	113
Spanning Tree Protocol	115
Bandwidth Control	134
Broadcast Storm Control	137
Mirroring	139
Link Aggregation	145
Port Authentication	152
Port Security	160
Range Profile	163
Classifier	168
Policy Rule	174
Queuing Method	179
VLAN Stacking	182
Multicast	189
AAA	203
IP Source Guard	216
Loop Guard	236
VLAN Mapping	239
Layer 2 Protocol Tunneling	242
sFlow	246
PPPoE	250
Error Disable	258
Private VLAN	264
Static Route	266

Differentiated Services	269
DHCP	276
ARP Learning	290
Maintenance	294
Access Control	303
Diagnostic	325
Syslog	326
Cluster Management	329
MAC Table	336
ARP Table	339
Configure Clone	341
Troubleshooting	344

Table of Contents

Contents Overview	3
Table of Contents	5
Part I: User's Guide	17
Chapter 1	
Getting to Know Your Switch.....	18
1.1 Introduction	18
1.1.1 Backbone Application	18
1.1.2 Bridging Example	19
1.1.3 High Performance Switching Example	19
1.1.4 IEEE 802.1Q VLAN Application Examples	20
1.1.5 IPv6 Support	21
1.2 Ways to Manage the Switch	21
1.3 Good Habits for Managing the Switch	21
Chapter 2	
Hardware Installation and Connection	22
2.1 Installation Scenarios	22
2.2 Desktop Installation	22
2.3 Rack Mounting	22
2.3.1 Rack-mounted Installation Requirements	22
2.3.2 Attaching the Mounting Brackets to the Switch	23
2.3.3 Mounting the Switch on a Rack	23
2.4 Wall Mounting	24
Chapter 3	
Hardware Overview	26
3.1 Front Panel	26
3.1.1 Console Port	28
3.1.2 Ethernet Ports	28
3.1.3 Transceiver Slots	29
3.1.4 Power Connector	30
3.1.5 Signal Slot	31
3.2 LEDs	33

Chapter 4	
The Web Configurator	35
4.1 Introduction	35
4.2 System Login	35
4.3 The Web Configurator Layout	36
4.3.1 Change Your Password	40
4.4 Saving Your Configuration	40
4.5 Switch Lockout	40
4.6 Resetting the Switch	41
4.6.1 Reload the Configuration File	41
4.7 Logging Out of the Web Configurator	42
4.8 Help	42
Chapter 5	
Initial Setup Example.....	43
5.1 Overview	43
5.1.1 Creating a VLAN	43
5.1.2 Setting Port VID	44
5.2 Configuring Switch Management IP Address	45
Chapter 6	
Tutorials.....	47
6.1 How to Use DHCP Snooping on the Switch	47
6.2 How to Use DHCP Relay on the Switch	50
6.2.1 DHCP Relay Tutorial Introduction	50
6.2.2 Creating a VLAN	51
6.2.3 Configuring DHCPv4 Relay	53
6.2.4 Troubleshooting	54
6.3 How to Use PPPoE IA on the Switch	54
6.3.1 Configuring Switch A	55
6.3.2 Configuring Switch B	57
6.4 How to Use Error Disable and Recovery on the Switch	60
6.5 How to Set Up a Guest VLAN	62
6.5.1 Creating a Guest VLAN	62
6.5.2 Enabling IEEE 802.1x Port Authentication	65
6.5.3 Enabling Guest VLAN	66
6.6 How to Do Port Isolation in a VLAN	67
6.6.1 Creating a VLAN	68
6.6.2 Creating a Private VLAN Rule	70
Part II: Technical Reference.....	72

Chapter 7	
System Status and Port Statistics	73
7.1 Overview	73
7.2 Port Status Summary	73
7.2.1 Status: Port Details	74
Chapter 8	
Basic Setting	77
8.1 System Information	77
8.2 General Setup	78
8.3 Introduction to VLANs	80
8.3.1 Smart Isolation	80
8.4 Switch Setup	82
8.5 IP Setup	83
8.5.1 Management IP Addresses	83
8.6 Port Setup	85
Chapter 9	
VLAN	88
9.1 Introduction to IEEE 802.1Q Tagged VLANs	88
9.1.1 Forwarding Tagged and Untagged Frames	88
9.2 Automatic VLAN Registration	89
9.2.1 GARP	89
9.2.2 GVRP	89
9.3 Port VLAN Trunking	90
9.4 Select the VLAN Type	90
9.5 Static VLAN	90
9.5.1 VLAN Status	91
9.5.2 VLAN Details	91
9.5.3 Configure a Static VLAN	92
9.5.4 Configure VLAN Port Settings	94
9.6 Subnet Based VLANs	95
9.6.1 Configuring Subnet Based VLAN	96
9.7 Protocol Based VLANs	98
9.7.1 Configuring Protocol Based VLAN	99
9.7.2 Create an IP-based VLAN Example	100
9.8 MAC Based VLAN	101
9.9 VLAN MAC Learning	102
9.10 Port-based VLAN Setup	104
9.10.1 Configure a Port-based VLAN	105
Chapter 10	
Static MAC Forward Setup	108

10.1 Overview	108
10.2 Configuring Static MAC Forwarding	108
Chapter 11	
Static Multicast Forward Setup	110
11.1 Static Multicast Forwarding Overview	110
11.2 Configuring Static Multicast Forwarding	111
Chapter 12	
Filtering.....	113
12.1 Configure a Filtering Rule	113
Chapter 13	
Spanning Tree Protocol.....	115
13.1 STP/RSTP Overview	115
13.1.1 STP Terminology	115
13.1.2 How STP Works	116
13.1.3 STP Port States	116
13.1.4 Multiple RSTP	116
13.1.5 Multiple STP	117
13.2 Spanning Tree Protocol Status Screen	120
13.3 Spanning Tree Configuration	120
13.4 Configure Rapid Spanning Tree Protocol	121
13.5 Rapid Spanning Tree Protocol Status	124
13.6 Configure Multiple Rapid Spanning Tree Protocol	125
13.7 Multiple Rapid Spanning Tree Protocol Status	127
13.8 Configure Multiple Spanning Tree Protocol	128
13.8.1 Multiple Spanning Tree Protocol Port Configuration	130
13.9 Multiple Spanning Tree Protocol Status	132
Chapter 14	
Bandwidth Control.....	134
14.1 Bandwidth Control Overview	134
14.1.1 CIR and PIR	134
14.2 Bandwidth Control Setup	134
Chapter 15	
Broadcast Storm Control	137
15.1 Broadcast Storm Control Setup	137
Chapter 16	
Mirroring	139
16.1 Port Mirroring Overview	139

16.2 Local Port Mirroring Screen	141
16.3 RMirror-Source Screen	142
16.4 RMirror-Destination Screen	143
Chapter 17	
Link Aggregation	145
17.1 Link Aggregation Overview	145
17.2 Dynamic Link Aggregation	145
17.2.1 Link Aggregation ID	146
17.3 Link Aggregation Status	146
17.4 Link Aggregation Setting	147
17.5 Link Aggregation Control Protocol	149
17.6 Static Trunking Example	150
Chapter 18	
Port Authentication	152
18.1 Port Authentication Overview	152
18.1.1 IEEE 802.1x Authentication	152
18.1.2 MAC Authentication	153
18.2 Port Authentication Configuration	154
18.2.1 Activate IEEE 802.1x Security	154
18.2.2 Guest VLAN	156
18.2.3 Activate MAC Authentication	158
Chapter 19	
Port Security	160
19.1 About Port Security	160
19.2 Port Security Setup	160
Chapter 20	
Range Profile.....	163
20.1 Range Profile Overview	163
20.2 Range Profile Screen	163
20.3 VLAN Range Profile	163
20.4 Port Range Profile	164
20.5 IP Address Range Profile	165
20.6 Socket-Port Range Profile	166
Chapter 21	
Classifier.....	168
21.1 About the Classifier and QoS	168
21.2 Configuring the Classifier	168
21.3 Viewing and Editing Classifier Configuration	171

21.4 Classifier Example	172
Chapter 22	
Policy Rule	174
22.1 Policy Rules Overview	174
22.1.1 DiffServ	174
22.1.2 DSCP and Per-Hop Behavior	174
22.2 Configuring Policy Rules	174
22.3 Viewing and Editing Policy Configuration	176
22.4 Policy Example	177
Chapter 23	
Queuing Method	179
23.1 Queuing Method Overview	179
23.1.1 Strictly Priority Queuing	179
23.1.2 Weighted Fair Queuing	179
23.1.3 Weighted Round Robin Scheduling (WRR)	180
23.2 Configuring Queuing	180
Chapter 24	
VLAN Stacking	182
24.1 VLAN Stacking Overview	182
24.1.1 VLAN Stacking Example	182
24.2 VLAN Stacking Port Roles	183
24.3 VLAN Tag Format	183
24.3.1 Frame Format	184
24.4 Configuring VLAN Stacking	184
24.4.1 Port-based Q-in-Q	186
24.4.2 Selective Q-in-Q	187
Chapter 25	
Multicast	189
25.1 Multicast Overview	189
25.1.1 IP Multicast Addresses	189
25.1.2 IGMP Filtering	189
25.1.3 IGMP Snooping	189
25.1.4 IGMP Snooping and VLANs	190
25.2 Multicast Status	190
25.2.1 Multicast Setting	190
25.2.2 IGMP Snooping VLAN	193
25.2.3 IGMP Filtering Profile	195
25.3 MVR Overview	196
25.3.1 Types of MVR Ports	196

25.3.2 MVR Modes	197
25.3.3 How MVR Works	197
25.4 General MVR Configuration	197
25.4.1 MVR Group Configuration	199
25.4.2 MVR Configuration Example	200
Chapter 26	
AAA	203
26.1 Authentication, Authorization and Accounting (AAA)	203
26.1.1 Local User Accounts	203
26.1.2 RADIUS and TACACS+	204
26.2 AAA Screens	204
26.2.1 RADIUS Server Setup	204
26.2.2 TACACS+ Server Setup	206
26.2.3 AAA Setup	208
26.2.4 Vendor Specific Attribute	211
26.2.5 Tunnel Protocol Attribute	212
26.3 Supported RADIUS Attributes	212
26.3.1 Attributes Used for Authentication	213
26.3.2 Attributes Used for Accounting	213
Chapter 27	
IP Source Guard.....	216
27.1 IP Source Guard Overview	216
27.1.1 DHCP Snooping Overview	216
27.1.2 ARP Inspection Overview	218
27.2 IP Source Guard	220
27.3 IP Source Guard Static Binding	220
27.4 DHCP Snooping	222
27.5 DHCP Snooping Configure	224
27.5.1 DHCP Snooping Port Configure	226
27.5.2 DHCP Snooping VLAN Configure	227
27.5.3 DHCP Snooping VLAN Port Configure	228
27.6 ARP Inspection Status	229
27.6.1 ARP Inspection VLAN Status	230
27.6.2 ARP Inspection Log Status	231
27.6.3 ARP Inspection Configure	232
27.6.4 ARP Inspection Port Configure	233
27.6.5 ARP Inspection VLAN Configure	234
Chapter 28	
Loop Guard	236
28.1 Loop Guard Overview	236

28.2 Loop Guard Setup	238
Chapter 29	
VLAN Mapping	239
29.1 VLAN Mapping Overview	239
29.1.1 VLAN Mapping Example	239
29.2 Enabling VLAN Mapping	239
29.3 Configuring VLAN Mapping	240
Chapter 30	
Layer 2 Protocol Tunneling.....	242
30.1 Layer 2 Protocol Tunneling Overview	242
30.1.1 Layer-2 Protocol Tunneling Mode	243
30.2 Configuring Layer 2 Protocol Tunneling	243
Chapter 31	
sFlow.....	246
31.1 sFlow Overview	246
31.2 sFlow Port Configuration	246
31.2.1 sFlow Collector Configuration	248
Chapter 32	
PPPoE	250
32.1 PPPoE Intermediate Agent Overview	250
32.1.1 PPPoE Intermediate Agent Tag Format	250
32.1.2 Sub-Option Format	250
32.1.3 Port State	251
32.2 PPPoE Screen	252
32.3 PPPoE Intermediate Agent	252
32.3.1 PPPoE IA Per-Port	254
32.3.2 PPPoE IA Per-Port Per-VLAN	255
32.3.3 PPPoE IA for VLAN	257
Chapter 33	
Error Disable	258
33.1 CPU Protection Overview	258
33.2 Error-Disable Recovery Overview	258
33.3 Error Disable Screen	258
33.4 Error-Disable Status	259
33.5 CPU Protection Configuration	260
33.6 Error-Disable Detect Configuration	261
33.7 Error-Disable Recovery Configuration	262

Chapter 34	
Private VLAN	264
34.1 Private VLAN Overview	264
34.2 Configuring Private VLAN	264
Chapter 35	
Static Route	266
35.1 Static Routing Overview	266
35.2 Configuring Static Routing	266
Chapter 36	
Differentiated Services	269
36.1 DiffServ Overview	269
36.1.1 DSCP and Per-Hop Behavior	269
36.1.2 DiffServ Network Example	269
36.2 Two Rate Three Color Marker Traffic Policing	270
36.2.1 TRTCM-Color-blind Mode	271
36.2.2 TRTCM-Color-aware Mode	271
36.3 Activating DiffServ	271
36.3.1 Configuring 2-Rate 3 Color Marker Settings	272
36.3.2 Configuring DSCP Profiles	274
36.4 DSCP-to-IEEE 802.1p Priority Settings	275
36.4.1 Configuring DSCP Settings	275
Chapter 37	
DHCP	276
37.1 DHCP Overview	276
37.1.1 DHCP Modes	276
37.1.2 DHCP Configuration Options	276
37.2 DHCP Configuration	276
37.3 DHCPv4 Status	277
37.4 DHCPv4 Relay	277
37.4.1 DHCPv4 Relay Agent Information	277
37.4.2 DHCPv4 Option 82 Profile	278
37.4.3 Configuring DHCPv4 Global Relay	279
37.4.4 DHCPv4 Global Relay Port Configure	280
37.4.5 Global DHCPv4 Relay Configuration Example	281
37.4.6 Configuring DHCPv4 VLAN Settings	282
37.4.7 DHCPv4 VLAN Port Configure	283
37.4.8 Example: DHCPv4 Relay for Two VLANs	284
37.5 DHCPv6 Relay	285
37.5.1 DHCPv6 Options Profile	287
37.5.2 DHCPv6 Port Configure	288

Chapter 38	
ARP Learning	290
38.1 ARP Overview	290
38.2 ARP Learning	292
Chapter 39	
Maintenance	294
39.1 The Maintenance Screen	294
39.2 Load Factory Default	295
39.3 Save Configuration	295
39.4 Reboot System	295
39.5 Firmware Upgrade	297
39.6 Restore a Configuration File	297
39.7 Backup a Configuration File	298
39.8 Tech-Support	298
39.9 FTP Command Line	300
39.9.1 Filename Conventions	300
39.9.2 FTP Command Line Procedure	301
39.9.3 GUI-based FTP Clients	301
39.9.4 FTP Restrictions	302
Chapter 40	
Access Control	303
40.1 Access Control Overview	303
40.2 The Access Control Main Screen	303
40.3 About SNMP	303
40.3.1 SNMP v3 and Security	304
40.3.2 Supported MIBs	305
40.3.3 SNMP Traps	305
40.3.4 Configuring SNMP	309
40.3.5 Configuring SNMP Trap Group	311
40.3.6 Enabling/Disabling Sending of SNMP Traps on a Port	312
40.3.7 Configuring SNMP User	313
40.4 Setting Up Login Accounts	315
40.5 SSH Overview	316
40.6 How SSH works	316
40.7 SSH Implementation on the Switch	317
40.7.1 Requirements for Using SSH	318
40.8 Introduction to HTTPS	318
40.9 HTTPS Example	319
40.9.1 Internet Explorer Warning Messages	319
40.9.2 Mozilla Firefox Warning Messages	320
40.9.3 The Main Screen	322

40.10 Service Port Access Control	322
40.11 Remote Management	323
Chapter 41	
Diagnostic	325
41.1 Diagnostic	325
Chapter 42	
Syslog	326
42.1 Syslog Overview	326
42.2 Syslog Setup	326
42.3 Syslog Server Setup	327
Chapter 43	
Cluster Management	329
43.1 Cluster Management Status Overview	329
43.2 Cluster Management Status	330
43.2.1 Cluster Member Switch Management	331
43.3 Clustering Management Configuration	333
Chapter 44	
MAC Table	336
44.1 MAC Table Overview	336
44.2 Viewing the MAC Table	337
Chapter 45	
ARP Table	339
45.1 ARP Table Overview	339
45.1.1 How ARP Works	339
45.2 The ARP Table Screen	339
Chapter 46	
Configure Clone	341
46.1 Configure Clone	341
Chapter 47	
Troubleshooting.....	344
47.1 Power, Hardware Connections, and LEDs	344
47.2 Switch Access and Login	345
47.3 Switch Configuration	347
Appendix A Customer Support	348
Appendix B Common Services	354

Appendix C Legal Information 357

Index 362

PART I

User's Guide

Getting to Know Your Switch

This chapter introduces the main features and applications of the Switch.

1.1 Introduction

The Switch is a layer-2 standalone Ethernet switch. The Switch has two or four GbE dual personality interfaces with each interface comprising one mini-GBIC slot and one 100/1000 Mbps RJ-45 port, with either port or slot active at a time.

This User's Guide covers the following models: MES3500-24, MES3500-24F, and MES3500-10.

Table 1 Switch Comparison Table

FEATURES	MES3500-24	MES3500-24F	MES3500-10
8 10/100Base-T Ethernet Ports			✓
24 10/100Base-T Ethernet Ports	✓		
24 100BASE-FX SFP Slots		✓	
4 Dual Personality Interfaces	✓	✓	
2 Dual Personality Interfaces			✓
Rack-Mounting	✓	✓	✓
Wall-Mounting			✓

With its built-in web configurator, managing and configuring the Switch is easy. In addition, the Switch can also be managed via Telnet, any terminal emulator program on the console port, or third-party SNMP management.

This section shows a few examples of using the Switch in various network environments.

1.1.1 Backbone Application

The Switch is an ideal solution for small networks where rapid growth can be expected in the near future. The Switch can be used standalone for a group of heavy traffic users. You can connect computers and servers directly to the Switch's port or connect other switches to the Switch.

In this example, all computers can share high-speed applications on the server. To expand the network, simply add more networking devices such as switches, routers, computers, print servers etc.

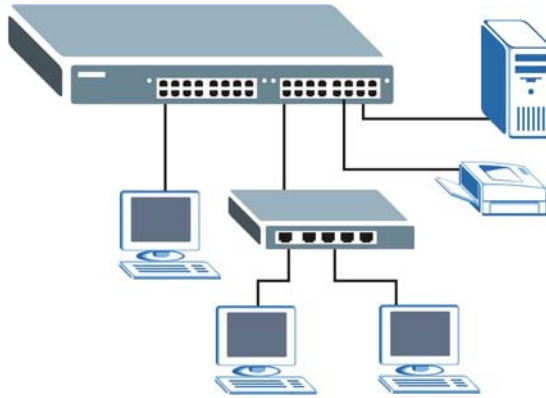
Figure 1 Backbone Application

1.1.2 Bridging Example

In this example, the Switch connects different company departments (**RD** and **Sales**) to the corporate backbone. It can alleviate bandwidth contention and eliminate server and network bottlenecks. All users that need high bandwidth can connect to high-speed department servers via the Switch. You can provide a super-fast uplink connection by using a Gigabit Ethernet/mini-GBIC port on the Switch.

Moreover, the Switch eases supervision and maintenance by allowing network managers to centralize multiple servers at a single location.

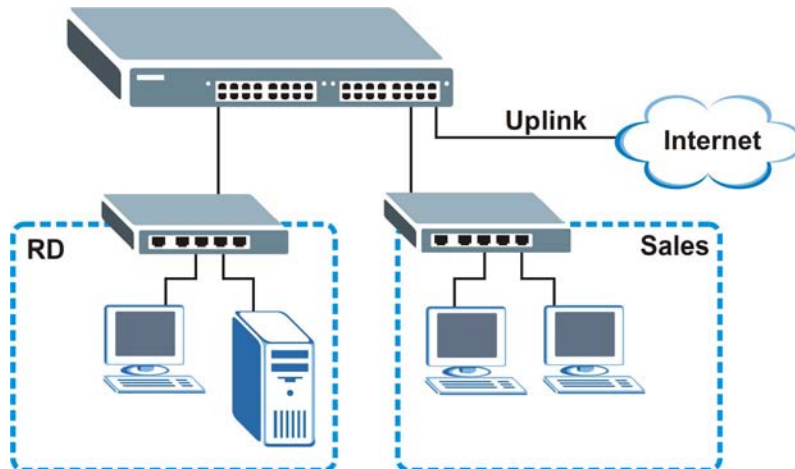
Figure 2 Bridging Application

1.1.3 High Performance Switching Example

The Switch is ideal for connecting two networks that need high bandwidth. In the following example, use trunking to connect these two networks.

Switching to higher-speed LANs such as ATM (Asynchronous Transmission Mode) is not feasible for most people due to the expense of replacing all existing Ethernet cables and adapter cards, restructuring your network and complex maintenance. The Switch can provide the same bandwidth

as ATM at much lower cost while still being able to use existing adapters and switches. Moreover, the current LAN structure can be retained as all ports can freely communicate with each other.

Figure 3 High Performance Switched Workgroup Application

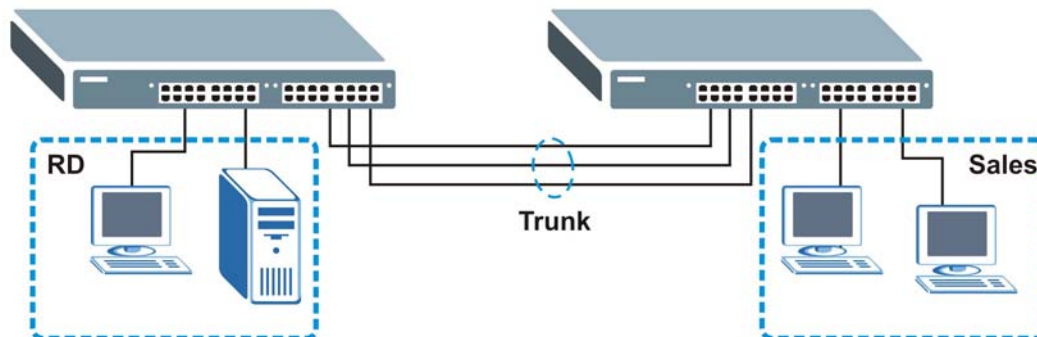

1.1.4 IEEE 802.1Q VLAN Application Examples

A VLAN (Virtual Local Area Network) allows a physical network to be partitioned into multiple logical networks. Stations on a logical network belong to one group. A station can belong to more than one group. With VLAN, a station cannot directly talk to or hear from stations that are not in the same group(s) unless such traffic first goes through a router.

For more information on VLANs, refer to [Chapter 9 on page 88](#).

1.1.4.1 Tag-based VLAN Example

Ports in the same VLAN group share the same frame broadcast domain thus increase network performance through reduced broadcast traffic. VLAN groups can be modified at any time by adding, moving or changing ports without any re-cabling.

Shared resources such as a server can be used by all ports in the same VLAN as the server. In the following figure only ports that need access to the server need to be part of VLAN 1. Ports can belong to other VLAN groups too.

Figure 4 Shared Server Using VLAN Example

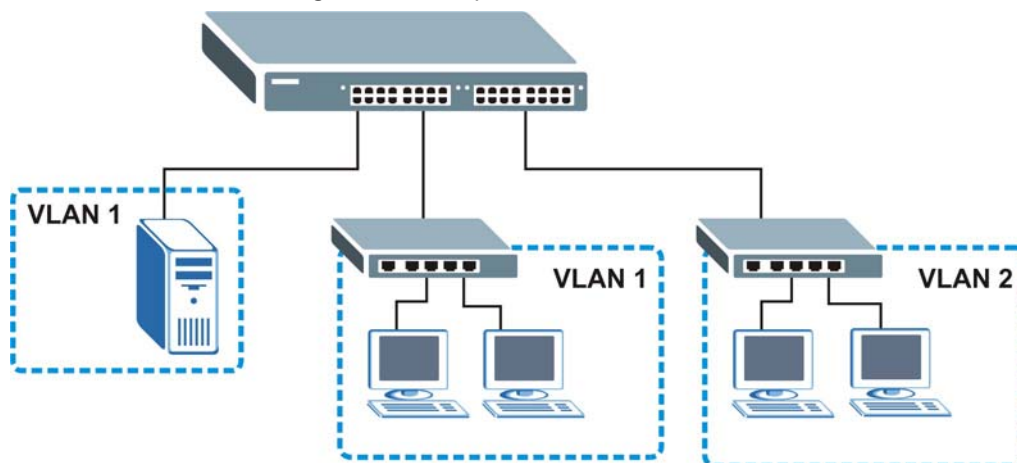

1.1.5 IPv6 Support

IPv6 (Internet Protocol version 6), is designed to enhance IP address size and features. The increase in IPv6 address size to 128 bits (from the 32-bit IPv4 address) allows up to 3.4×10^{38} IP addresses. At the time of writing, the Switch supports the following features.

- Static address assignment and stateless auto-configuration
- Neighbor Discovery Protocol (a protocol used to discover other IPv6 devices in a network)
- Remote Management using ping SNMP, telnet, HTTP and FTP services
- ICMPv6 to report errors encountered in packet processing and perform diagnostic functions, such as "ping"
- IPv4/IPv6 dual stack; the Switch can run IPv4 and IPv6 at the same time
- DHCPv6 client and relay
- Multicast Listener Discovery (MLD) snooping and proxy

For more information on IPv6, refer to the CLI Reference Guide.

1.2 Ways to Manage the Switch

Use any of the following methods to manage the Switch.

- Web Configurator. This is recommended for everyday management of the Switch using a (supported) web browser. See [Chapter 4 on page 35](#).
- Command Line Interface. Line commands offer an alternative to the web configurator and in some cases are necessary to configure advanced features. See the CLI Reference Guide.
- FTP. Use FTP for firmware upgrades and configuration backup/restore. See [Section 39.9 on page 300](#).
- SNMP. The Switch can be monitored by an SNMP manager. See [Section 40.3 on page 303](#).
- Cluster Management. Cluster Management allows you to manage multiple switches through one switch, called the cluster manager. See [Chapter 43 on page 329](#).

1.3 Good Habits for Managing the Switch

Do the following things regularly to make the Switch more secure and to manage the Switch more effectively.

- Change the password. Use a password that's not easy to guess and that consists of different types of characters, such as numbers and letters.
- Write down the password and put it in a safe place.
- Back up the configuration (and make sure you know how to restore it). Restoring an earlier working configuration may be useful if the device becomes unstable or even crashes. If you forget your password, you will have to reset the Switch to its factory default settings. If you backed up an earlier configuration file, you would not have to totally re-configure the Switch. You could simply restore your last configuration.

Hardware Installation and Connection

This chapter shows you how to install and connect the Switch.

2.1 Installation Scenarios

The Switch can be placed on a desktop or mounted on a standard EIA rack. Some models can even be mounted on a wall. Use the rubber feet in a desktop installation and the brackets in a rack-mounted installation.

Note: For proper ventilation, allow at least 4 inches (10 cm) of clearance at the front and 3.4 inches (8 cm) at the back of the Switch. This is especially important for enclosed rack installations.

2.2 Desktop Installation

- 1 Make sure the Switch is clean and dry.
- 2 Set the Switch on a smooth, level surface strong enough to support the weight of the Switch and the connected cables. Make sure there is a power outlet nearby.
- 3 Make sure there is enough clearance around the Switch to allow air circulation and the attachment of cables and the power cord.

2.3 Rack Mounting

The Switch can be mounted on an EIA standard size, 19-inch rack or in a wiring closet with other equipment. Follow the steps below to mount your Switch on a standard EIA rack using a rack-mounting kit.

2.3.1 Rack-mounted Installation Requirements

- Two mounting brackets.
- Eight M3 flat head screws and a #2 Philips screwdriver.
- Four M5 flat head screws and a #2 Philips screwdriver.

Failure to use the proper screws may damage the unit.

2.3.1.1 Precautions

- Make sure the rack will safely support the combined weight of all the equipment it contains.
- Make sure the position of the Switch does not make the rack unstable or top-heavy. Take all necessary precautions to anchor the rack securely before installing the unit.

2.3.2 Attaching the Mounting Brackets to the Switch

- 1 Position a mounting bracket on one side of the Switch, lining up the four screw holes on the bracket with the screw holes on the side of the Switch.

Figure 5 Attaching the Mounting Brackets

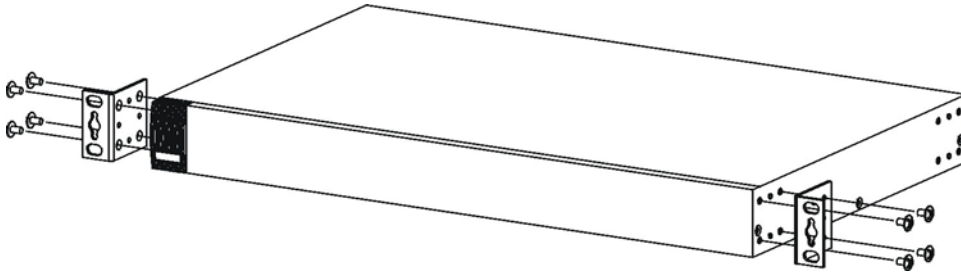

- 2 Using a #2 Philips screwdriver, install the M3 flat head screws through the mounting bracket holes into the Switch.
- 3 Repeat steps 1 and 2 to install the second mounting bracket on the other side of the Switch.
- 4 You may now mount the Switch on a rack. Proceed to the next section.

2.3.3 Mounting the Switch on a Rack

- 1 Position a mounting bracket (that is already attached to the Switch) on one side of the rack, lining up the two screw holes on the bracket with the screw holes on the side of the rack.

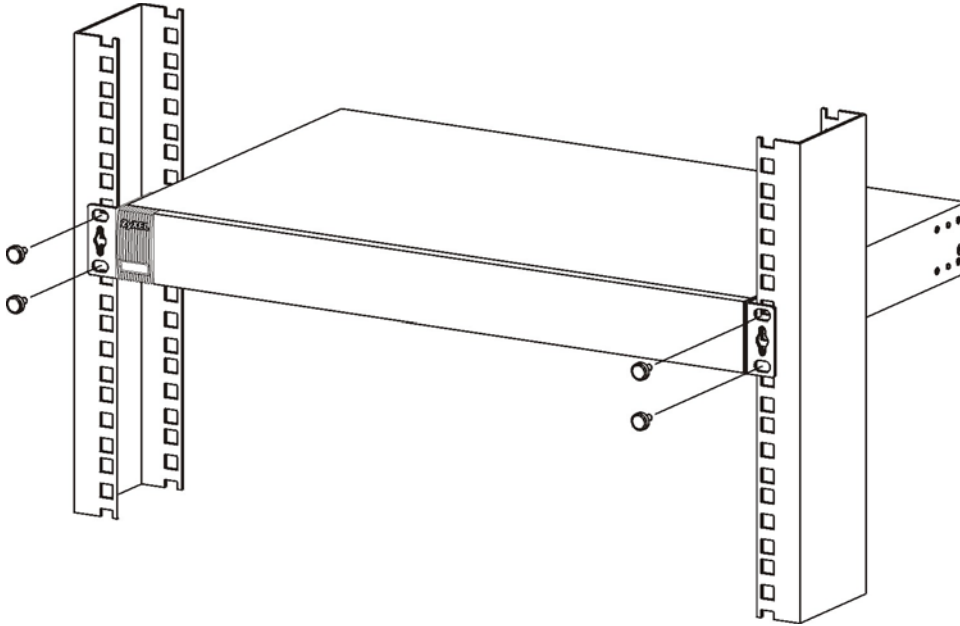
Figure 6 Mounting the Switch on a Rack

- 2 Using a #2 Philips screwdriver, install the M5 flat head screws through the mounting bracket holes into the rack.
- 3 Repeat steps 1 and 2 to attach the second mounting bracket on the other side of the rack.

2.4 Wall Mounting

See [Table 1 on page 18](#) for the Switch models that can be wall-mounted. Do the following to attach your Switch to a wall.

You may need screw anchors if mounting on a concrete or brick wall.

Table 2 Wall Mounting Information

Distance between holes	198 mm
Self-tapping screws (Diameter: 3 mm)	Two
Screw anchors (optional)	Two

- 1 Select a position free of obstructions on a wall strong enough to hold the weight of the device.
- 2 Mark two holes on the wall at the appropriate distance apart for the screws.

Be careful to avoid damaging pipes or cables located inside the wall when drilling holes for the screws.

- 3 If using screw anchors, drill two holes for the screw anchors into the wall. Push the anchors into the full depth of the holes, then insert the screws into the anchors. Do not insert the screws all the way in - leave a small gap of about 0.5 cm.

If not using screw anchors, use a screwdriver to insert the screws into the wall. Do not insert the screws all the way in - leave a gap of about 0.5 cm.

- 4 Make sure the screws are fastened well enough to hold the weight of the Switch with the connection cables.
- 5 Align the holes on the back of the Switch with the screws on the wall. Hang the Switch on the screws.

Figure 7 Wall Mounting Example

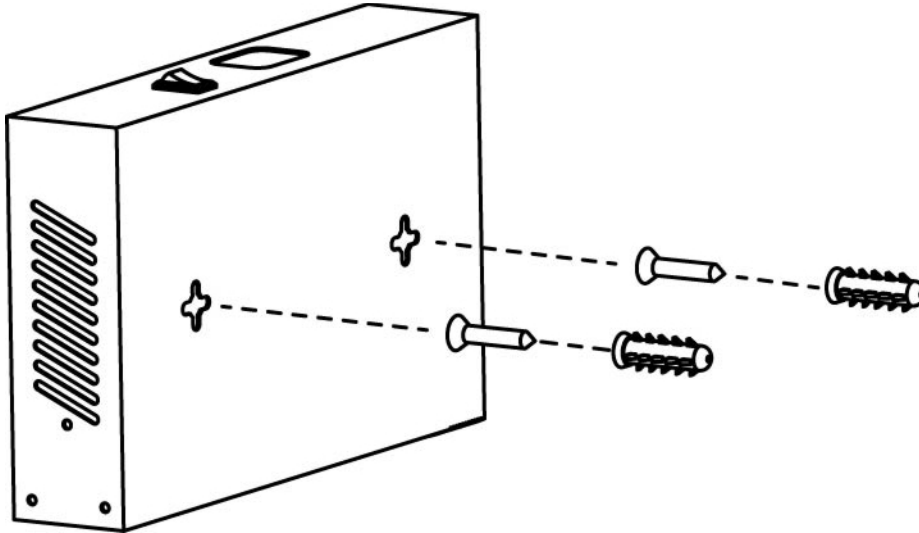

Hardware Overview

This chapter describes the front panel and rear panel of the Switch and shows you how to make the hardware connections.

3.1 Front Panel

The following figure shows the front panel of the Switch.

Figure 8 MES3500-24 Front Panel: AC Model

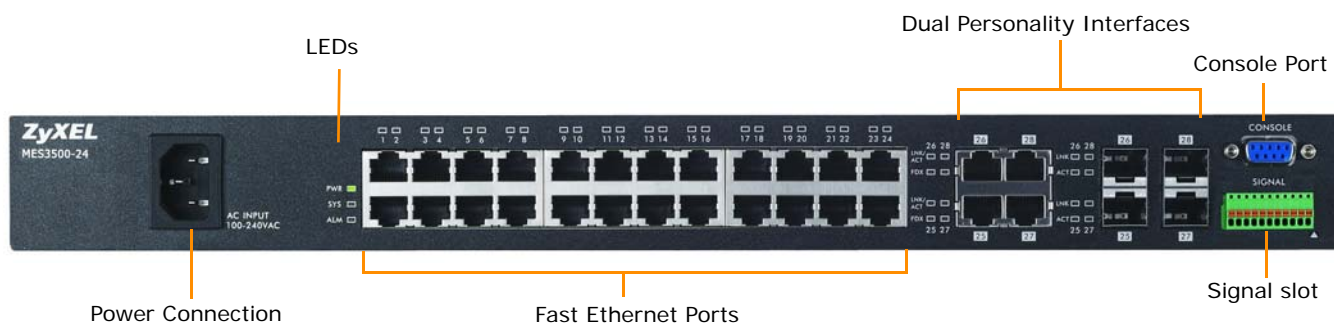

Figure 9 MES3500-24 Front Panel: DC Model

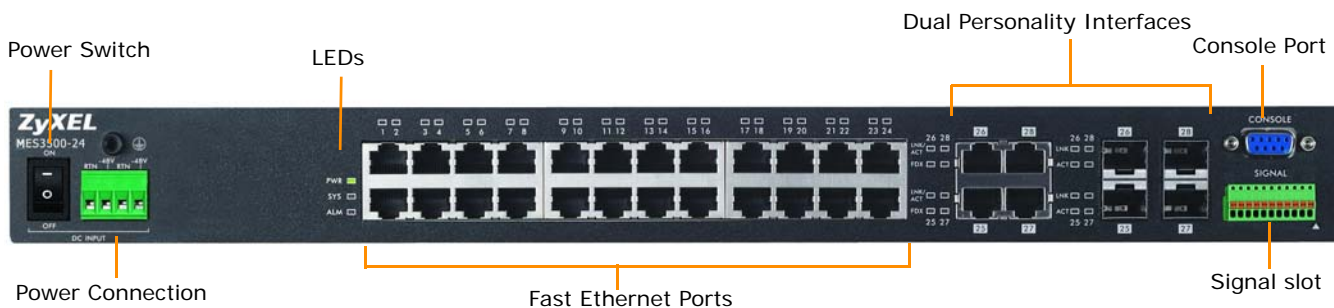

Figure 10 MES3500-24F Front Panel: AC Model



Figure 11 MES3500-24F Front Panel: DC Model

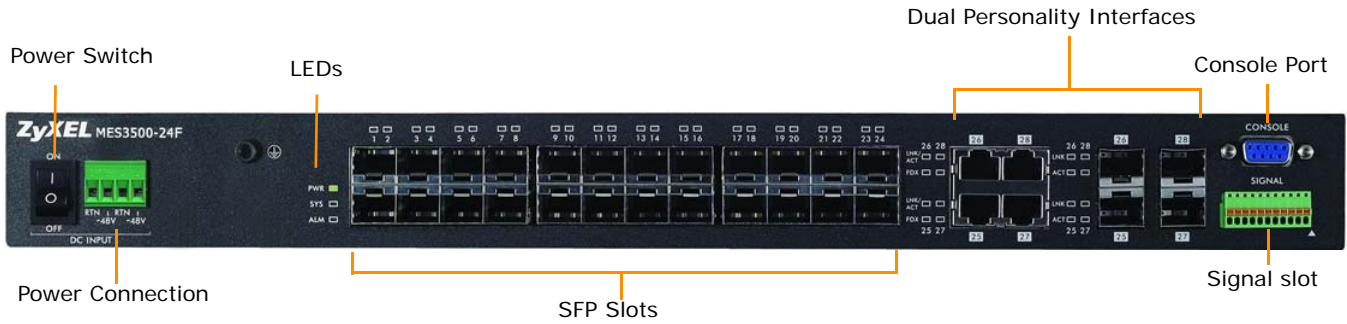
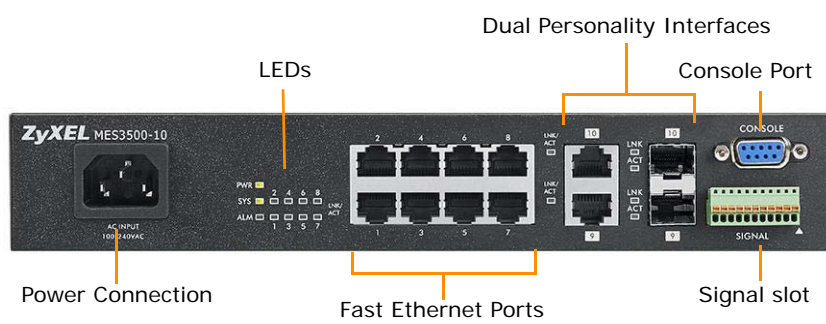

Figure 12 MES3500-10 Front Panel: AC Model



The following table describes the port labels on the front panel.

Table 3 Front Panel Connections

LABEL	DESCRIPTION
Power Switch	This is for DC model only. After you connect the DC power properly (see Section 3.1.4.2 on page 31.), put the power switch in the ON position to turn on the Switch.
Power Connection	Connect an appropriate power supply to this port.
RJ-45 Ethernet Ports	Connect these ports to a computer, a hub, an Ethernet switch or router.
SFP Slots	Use transceivers in these slots for fiber-optic or copper connections to a computer, a hub, a switch or router.
Four or Two Dual Personality Interfaces	<p>Each interface has one 1000BASE-T RJ-45 port and one transceiver slot, with one port or transceiver active at a time.</p> <ul style="list-style-type: none"> Four 10/100/1000 Mbps RJ-45 Ports: Connect these ports to high-bandwidth backbone network Ethernet switches using 1000BASE-T compatible Category 5/5e/6 copper cables. Four Transceiver Slots: Use mini-GBIC or SFP transceivers in these slots for connections to backbone Ethernet switches.
Console Port	The console port is for local configuration of the Switch.
Signal slot	<p>Connect the signal input pins to signal output terminals on other pieces of equipment.</p> <p>Connect the signal output pins to a signal input terminal on another piece of equipment.</p>

3.1.1 Console Port

For local management, you can use a computer with terminal emulation software configured to the following parameters:

- VT100
- Terminal emulation
- 9600 bps
- No parity, 8 data bits, 1 stop bit
- No flow control

Connect the male 9-pin end of the console cable to the console port of the Switch. Connect the female end to a serial port (COM1, COM2 or other COM port) of your computer.

3.1.2 Ethernet Ports

The Switch has 8 or 24 10/100 Mbps and 2 or 4 10/100/1000 Mbps auto-negotiating, auto-crossover Ethernet ports. In 10/100 Mbps Fast Ethernet, the speed can be 10 Mbps or 100 Mbps and the duplex mode can be half duplex or full duplex. In 10/100/1000 Mbps Gigabit Ethernet, the speed can be 10 Mbps, 100 Mbps or 1000 Mbps and the duplex mode can be half duplex or full duplex.

An auto-negotiating port can detect and adjust to the optimum Ethernet speed (10/100 Mbps or 10/100/1000 Mbps) and duplex mode (full duplex or half duplex) of the connected device.

An auto-crossover (auto-MDI/MDI-X) port automatically works with a straight-through or crossover Ethernet cable.

The Switch has two or four 1000Base-T Ethernet ports, which are paired with a mini-GBIC slot to create a dual personality interface. The Switch uses up to one connection for each mini-GBIC and 1000Base-T Ethernet pair. The mini-GBIC slots have priority over the Gigabit ports. This means that if a mini-GBIC slot and the corresponding GbE port are connected at the same time, the GbE port will be disabled.

When auto-negotiation is turned on, an Ethernet port negotiates with the peer automatically to determine the connection speed and duplex mode. If the peer Ethernet port does not support auto-negotiation or turns off this feature, the Switch determines the connection speed by detecting the signal on the cable and using half duplex mode. When the Switch's auto-negotiation is turned off, an Ethernet port uses the pre-configured speed and duplex mode when making a connection, thus requiring you to make sure that the settings of the peer Ethernet port are the same in order to connect.

3.1.2.1 Default Ethernet Negotiation Settings

The factory default negotiation settings for the Gigabit ports on the Switch are:

- Speed: Auto
- Duplex: Auto
- Flow control: Off
- Link Aggregation: Disabled

3.1.2.2 Auto-crossover

All ports are auto-crossover, that is auto-MDIX ports (Media Dependent Interface Crossover), so you may use either a straight-through Ethernet cable or crossover Ethernet cable for all Gigabit port connections. Auto-crossover ports automatically sense whether they need to function as crossover or straight ports, so crossover cables can connect both computers and switches/hubs.

3.1.3 Transceiver Slots

These are slots for mini-GBIC (Gigabit Interface Converter) transceivers or 100 Mbps Small Form-factor Pluggable (SFP) transceivers. A transceiver is a single unit that houses a transmitter and a receiver. The Switch does not come with transceivers. You must use transceivers that comply with the SFP Transceiver MultiSource Agreement (MSA). See the SFF committee's INF-8074i specification Rev 1.0 for details.

You can change transceivers while the Switch is operating. You can use different transceivers to connect to Ethernet switches with different types of fiber-optic or even copper cable connectors.

To avoid possible eye injury, do not look into an operating fiber-optic module's connectors.

- Type: SFP connection interface
- Connection speed: 1 Gigabit per second (Gbps) or 1 Megabit per second (Mbps)

3.1.3.1 Transceiver Installation

Use the following steps to install a mini-GBIC transceiver (SFP module).

- 1 Insert the transceiver into the slot with the exposed section of PCB board facing down.
- 2 Press the transceiver firmly until it clicks into place.
- 3 The Switch automatically detects the installed transceiver. Check the LEDs to verify that it is functioning properly.
- 4 Close the transceiver's latch (latch styles vary).
- 5 Connect the fiber optic cables to the transceiver.

Figure 13 Transceiver Installation Example

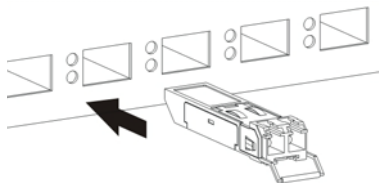
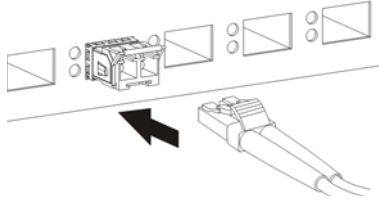
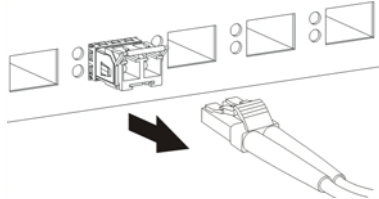
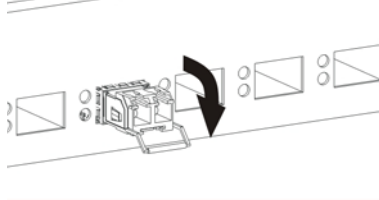
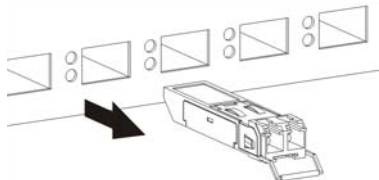

Figure 14 Connecting the Fiber Optic Cables

3.1.3.2 Transceiver Removal

Use the following steps to remove a mini-GBIC transceiver (SFP module).

- 1 Remove the fiber optic cables from the transceiver.
- 2 Open the transceiver's latch (latch styles vary).
- 3 Pull the transceiver out of the slot.

Figure 15 Removing the Fiber Optic Cables**Figure 16** Opening the Transceiver's Latch Example**Figure 17** Transceiver Removal Example

3.1.4 Power Connector

Make sure you are using the correct power source as shown on the panel and that no objects obstruct the airflow of the fans.

Use the following procedures to connect the Switch to a power source after you have installed it.

Note: Check the power supply requirements on the panel, and make sure you are using an appropriate power source.

Keep the power supply switch and the Switch's power switch in the OFF position until you come to the procedure for turning on the power.

Use only power wires of the required diameter for connecting the Switch to a power supply.

3.1.4.1 AC Power Connection

Connect the female end of the power cord to the power socket of your Switch. Connect the other end of the cord to a power outlet.

3.1.4.2 DC Power Connection

The Switch uses a single ETB series terminal block plug with four pins which allows you to connect up to two separate power supplies. If one power supply fails the system can operate on the remaining power supply. Use two wires to connect to a single terminal pair, one wire for the positive terminal and one wire for the negative terminal.

Note: The current rating of the power wires must be greater than 20 Amps. The power supply to which the Switch connects must have a built-in circuit breaker or switch to toggle the power.

Note: When installing the power wire, push it wire firmly into the terminal as deep as possible and make sure that no exposed (bare) wire can be seen or touched.

Exposed power wire is dangerous. Use extreme care when connecting a DC power source to the device.

To connect a power supply:

- 1 Use a screwdriver to loosen the terminal block captive screws.
- 2 Connect one end of a power wire to the Switch's **RTN** (return) pin and tighten the captive screw.
- 3 Connect the other end of the power wire to the positive terminal on the power supply.
- 4 Connect one end of a power wire to the Switch's **-48V** (input) pin and tighten the captive screw.
- 5 Connect the other end of the power wire to the negative terminal on the power supply.
- 6 Insert the terminal block plug in the Switch's terminal block header.

3.1.5 Signal Slot

The **Signal** slot (fitted with the signal connector) allows you to connect devices to the Switch, such as sensors or other ZyXEL switches which support the external alarm feature. This feature is in addition to the system alarm, which detects abnormal temperatures, and voltage levels on the Switch.

Your Switch can respond to an external signal in four ways.

- The **ALM** LED shows an alert.

- The **Signal** slot can send an external alarm on to another device. By daisy-chaining the signal sensor cables from one Switch to another ZyXEL switch which supports this feature, the external alarm alert (but not the system alarm) is received on each Switch.
- The Switch can be configured to send an SNMP trap to the SNMP server. See [Section 40.3 on page 303](#) for more information on using SNMP.
- The Switch can be configured to create an error log of the alarm. See [Section 42.1 on page 326](#) for more information on using the system log.

3.1.5.1 Connect a Sensor to the Signal Slot

This section shows you how to connect an external sensor device to the Switch.

- 1 Use a connector to connect wires of the correct gauge (18 AWG or larger) to the sensor's signal output pins. Check the sensor's documentation to identify its two signal output pins.
- 2 Connect these two wires to any one of the following pairs of signal input pins on the Switch's **Signal** connector--(4,5) (6,7) (8,9) (10,11). The pin numbers run from the right side of the connector to the left.
 - 2a Connect each of the sensor's two signal output wires to the **Signal** connector by depressing the spring clip corresponding to the pin you are connecting to.
 - 2b Insert the wire and release the spring clip.
 - 2c Repeat the process for the sensor's other signal output wire. A total of four sensors may be connected to the **Signal** connector in this way using the remaining signal input pins.
- 3 Insert the alarm connector into the **Signal** slot.

Figure 18 Connecting a Sensor to the **Signal** Slot

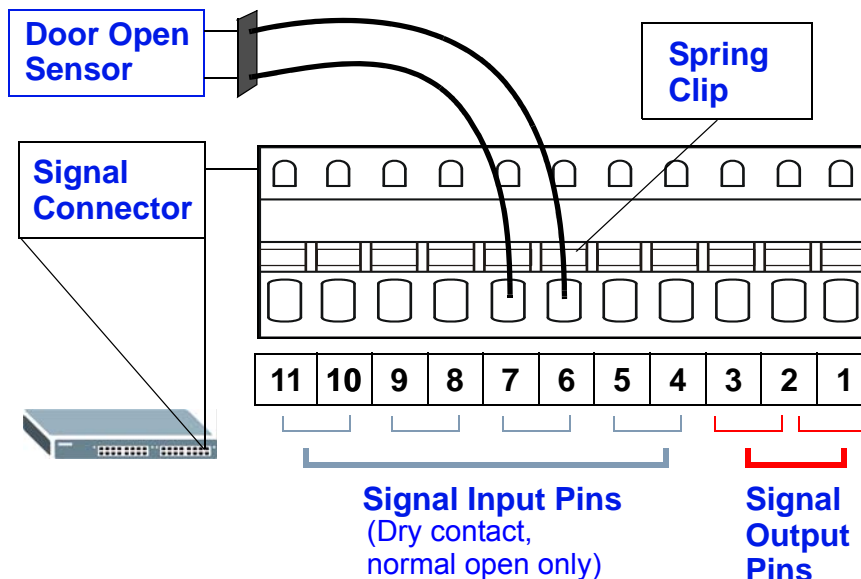

- 4 To connect an output device, repeat the previous steps but this time connect to either pins (1,2) or (2,3) on the **Signal** connector.

You can also daisy-chain the external alarm to another ZyXEL Switch which supports the external alarm feature. If daisy-chaining to a ZyXEL switch that is a different model, check your switch's documentation for the correct pin assignments.

- 1 Use wires of the correct gauge to connect either of the signal output pin pairs (1-*normal close*, 2-*common*) or (2-*common*, 3-*normal open*) on the **Signal** connector to the input signal pin pairs of an **Signal** connector on another ZyXEL Switch.
- 2 When daisy-chaining further Switches ensure that the signal output pins you use are the same as those you used when connecting to the first switch, as shown in the diagram below.

Figure 19 Daisy-chaining an External Alarm Sensor to Other Switches of the Same Model

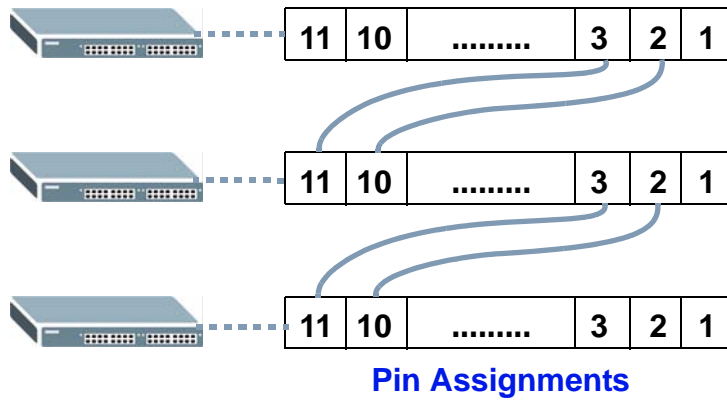

3.2 LEDs

After you connect the power to the Switch, view the LEDs to ensure proper functioning of the Switch and as an aid in troubleshooting.

Table 4 LED Descriptions

LED	COLOR	STATUS	DESCRIPTION
PWR	Green	On	The system is turned on.
		Off	The system is off.
SYS	Green	On	The system is on and functioning properly.
		Blinking	The system is rebooting and performing self-diagnostic tests.
		Off	The power is off or the system is not ready/malfunctioning.
ALM	Red	On	A hardware failure is detected, or an external alarm is active.
		Off	The system is functioning normally.
10/100 Mbps Fast Ethernet Ports (MES3500-24 & MES3500-10)			
1 ~ 24 1 ~ 8	Green	Blinking	The system is transmitting/receiving to/from a 10 Mbps Ethernet network.
		on	The link to a 10 Mbps Ethernet network is up.
	Amber	Blinking	The system is transmitting/receiving to/from a 100 Mbps Ethernet network.
		On	The link to a 100 Mbps Ethernet network is up.
		Off	The link to an Ethernet network is down.

Table 4 LED Descriptions (continued)

LED	COLOR	STATUS	DESCRIPTION
100 Mbps SFP Slots (MES3500-24F)			
1 ~ 24	Amber	On	The port has a successful connection.
		Off	No Ethernet device is connected to this port.
		Blinking	This port is receiving or transmitting data.
1000Base-T Ethernet Ports (in Dual Personality Interface)			
LNK/ACT	Green	Blinking	The system is transmitting/receiving to/from a 10 Mbps or a 1000 Mbps Ethernet network.
		On	The link to a 10 Mbps or a 1000 Mbps Ethernet network is up.
	Amber	Blinking	The system is transmitting/receiving to/from a 100 Mbps Ethernet network.
		On	The link to a 100 Mbps Ethernet network is up.
	Off	The link to an Ethernet network is down.	
FDX	Amber	On	The Gigabit port is negotiating in full-duplex mode.
		Off	The Gigabit port is negotiating in half-duplex mode.

The Web Configurator

This section introduces the configuration and functions of the web configurator.

4.1 Introduction

The web configurator is an HTML-based management interface that allows easy Switch setup and management via Internet browser. Use Internet Explorer 6.0 and later or Firefox 2.0 and later versions. The recommended screen resolution is 1024 by 768 pixels.

In order to use the web configurator you need to allow:

- Web browser pop-up windows from your device. Web pop-up blocking is enabled by default in Windows XP SP (Service Pack) 2.
- JavaScript (enabled by default).
- Java permissions (enabled by default).

4.2 System Login

- 1 Start your web browser.
- 2 Type "http://" and the IP address of the Switch (for example, the default management IP address is 192.168.1.1) in the Location or Address field. Press [ENTER].
- 3 The login screen appears. The default username is **admin** and associated default password is **1234**. The date and time display as shown if you have not configured a time server nor manually entered a time and date in the **General Setup** screen.

Figure 20 Web Configurator: Login



- 4 Click **OK** to view the first web configurator screen.

4.3 The Web Configurator Layout

The **Status** screen is the first screen that displays when you access the web configurator. This guide uses the MES3500-24 screens as an example. The screens may vary slightly for different models.

The following figure shows the navigating components of a web configurator screen.

Figure 21 The Web Configurator Layout

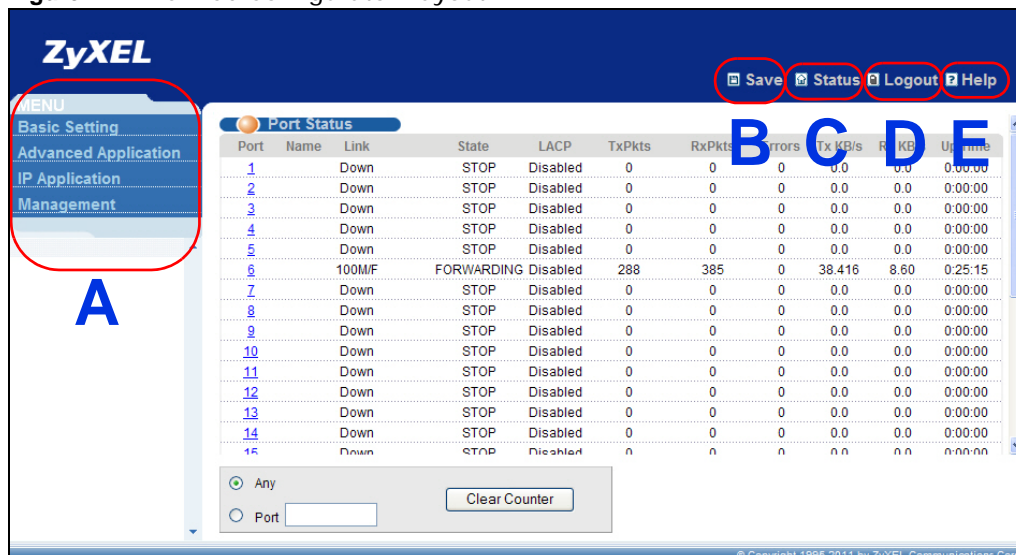

A - Click the menu items to open submenu links, and then click on a submenu link to open the screen in the main window.

B, C, D, E - These are quick links which allow you to perform certain tasks no matter which screen you are currently working in.

B - Click this link to save your configuration into the Switch's nonvolatile memory. Nonvolatile memory is saved in the configuration file from which the Switch booted from and it stays the same even if the Switch's power is turned off. See [Section 39.3 on page 295](#) for information on saving your settings to a specific configuration file.



C - Click this link to go to the status page of the Switch.

D - Click this link to log out of the web configurator.

E - Click this link to display web help pages. The help pages provide descriptions for all of the configuration screens.

In the navigation panel, click a main link to reveal a list of submenu links.

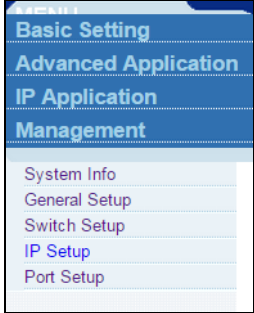
Table 5 Navigation Panel Sub-links Overview

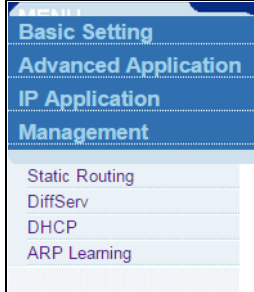
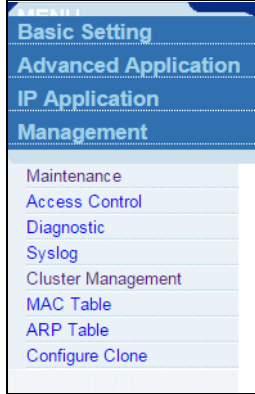
BASIC SETTING	ADVANCED APPLICATION	IP APPLICATION	MANAGEMENT
			

The following table describes the links in the navigation panel.

Table 6 Navigation Panel Links

LINK	DESCRIPTION
Basic Settings	
System Info	This link takes you to a screen that displays general system and hardware monitoring information.
General Setup	This link takes you to a screen where you can configure general identification information and time settings for the Switch.
Switch Setup	This link takes you to a screen where you can set up global Switch parameters such as VLAN type, smart isolation, MAC address learning, GARP and priority queues.
IP Setup	This link takes you to a screen where you can configure the management IP address, subnet mask (necessary for Switch management) and DNS (domain name server).
Port Setup	This link takes you to screens where you can configure speed, flow control and priority settings for individual Switch ports.
Advanced Application	
VLAN	This link takes you to screens where you can configure port-based or 802.1Q VLAN (depending on what you configured in the Switch Setup menu). You can also configure a protocol based VLAN or a subnet based VLAN in these screens.
Static MAC Forwarding	This link takes you to screens where you can configure static MAC addresses for a port. These static MAC addresses do not age out.
Static Multicast Forwarding	This link takes you to a screen where you can configure static multicast MAC addresses for port(s). These static multicast MAC addresses do not age out.
Filtering	This link takes you to a screen to set up filtering rules.
Spanning Tree Protocol	This link takes you to screens where you can configure the RSTP/MRSTP/MSTP to prevent network loops.
Bandwidth Control	This link takes you to screens where you can cap the maximum bandwidth allowed on a port.
Broadcast Storm Control	This link takes you to a screen to set up broadcast filters.
Mirroring	This link takes you to screens where you can copy traffic from one port or ports to another port in order that you can examine the traffic from the first port without interference.
Link Aggregation	This link takes you to screen where you can logically aggregate physical links to form one logical, higher-bandwidth link.
Port Authentication	This link takes you to a screen where you can configure IEEE 802.1x port authentication as well as MAC authentication for clients communicating via the Switch.
Port Security	This link takes you to a screen where you can activate MAC address learning and set the maximum number of MAC addresses to learn on a port.
Range Profile	This link takes you to screens where you can configure profiles for a range of VLANs, IP addresses, ports and socket ports.
Classifier	This link takes you to a screen where you can configure the Switch to group packets based on the specified criteria.
Policy Rule	This link takes you to a screen where you can configure the Switch to perform special treatment on the grouped packets.
Queuing Method	This link takes you to a screen where you can configure queuing with associated queue weights for each port.
VLAN Stacking	This link takes you to screens where you can activate and configure VLAN stacking.
Multicast	This link takes you to screen where you can configure various multicast features, IGMP snooping and create multicast VLANs.

Table 6 Navigation Panel Links (continued)

LINK	DESCRIPTION
AAA	This link takes you to a screen where you can configure authentication, authorization and accounting services via external servers. The external servers can be either RADIUS (Remote Authentication Dial-In User Service) or TACACS+ (Terminal Access Controller Access-Control System Plus).
IP Source Guard	This link takes you to screens where you can configure filtering of unauthorized DHCP and ARP packets in your network.
Loop Guard	This link takes you to a screen where you can configure protection against network loops that occur on the edge of your network.
VLAN Mapping	This link takes you to screens where you can configure VLAN mapping settings on the Switch.
Layer 2 Protocol Tunneling	This link takes you to a screen where you can configure L2PT (Layer 2 Protocol Tunneling) settings on the Switch.
sFlow	This link takes you to screens where you can configure sFlow settings on the Switch.
PPPoE	This link takes you to screens where you can configure how the Switch gives a PPPoE termination server additional subscriber information that the server can use to identify and authenticate a PPPoE client.
Errdisable	This link takes you to a screen where you can configure CPU protection and error disable recovery.
Private VLAN	This link takes you to a screen where you can block traffic between ports in a VLAN on the Switch.
IP Application	
Static Routing	This link takes you to a screen where you can configure static routes. A static route defines how the Switch should forward traffic by configuring the TCP/IP parameters manually.
DiffServ	This link takes you to screens where you can enable DiffServ, configure marking rules and set DSCP-to-IEEE802.1p mappings.
DHCP	This link takes you to screens where you can configure the DHCP settings.
ARP Learning	This link takes you to screens where you can configure the ARP learning settings for each port.
Management	
Maintenance	This link takes you to screens where you can perform firmware and configuration file maintenance as well as reboot the system.
Access Control	This link takes you to screens where you can change the system login password and configure SNMP and remote management.
Diagnostic	This link takes you to screens where you can view system logs and can test port(s).
Syslog	This link takes you to screens where you can setup system logs and a system log server.
Cluster Management	This link takes you to a screen where you can configure clustering management and view its status.
MAC Table	This link takes you to a screen where you can view the MAC address and VLAN ID of a device attached to a port. You can also view what kind of MAC address it is.
ARP Table	This link takes you to a screen where you can view the MAC address – IP address resolution table.
Configure Clone	This link takes you to a screen where you can copy attributes of one port to (an)other port(s).

4.3.1 Change Your Password

After you log in for the first time, it is recommended you change the default administrator password. Click **Management** > **Access Control** > **Logins** to display the next screen.

Figure 22 Change Administrator Login Password

The screenshot shows the 'Logins Administrator' page. At the top, there are tabs for 'Logins' and 'Access'. Below the tabs, there are three input fields: 'Old Password', 'New Password', and 'Retype to confirm'. A red box highlights these three fields. Below the input fields, there is a red warning message: 'Please record your new password whenever you change it. The system will lock you have forgotten your password.' Below the warning, there is a table titled 'Edit Logins' with columns: 'Login', 'User Name', 'Password', and 'Retype to'. The table has four rows, numbered 1 to 4. At the bottom of the page, there are 'Apply' and 'Cancel' buttons.

Old Password	New Password	Retype to confirm
<input type="text"/>	<input type="text"/>	<input type="text"/>

Please record your new password whenever you change it. The system will lock you have forgotten your password.

Login	User Name	Password	Retype to
1			
2			
3			
4			

Apply Cancel

4.4 Saving Your Configuration

When you are done modifying the settings in a screen, click **Apply** to save your changes back to the run-time memory. Settings in the run-time memory are lost when the Switch's power is turned off.

Click the **Save** link in the upper right hand corner of the web configurator to save your configuration to nonvolatile memory. Nonvolatile memory refers to the Switch's storage that remains even if the Switch's power is turned off.

Note: Use the **Save** link when you are done with a configuration session.

4.5 Switch Lockout

You could block yourself (and all others) from using in-band-management (managing through the data ports) if you do one of the following:

- 1 Delete the management VLAN (default is VLAN 1).
- 2 Delete all port-based VLANs with the CPU port as a member. The "CPU port" is the management port of the Switch.
- 3 Filter all traffic to the CPU port.

- 4 Disable all ports.
- 5 Misconfigure the text configuration file.
- 6 Forget the password and/or IP address.
- 7 Prevent all services from accessing the Switch.
- 8 Change a service port number but forget it.

Note: Be careful not to lock yourself and others out of the Switch. If you do lock yourself out, try using out-of-band management (via the management port) to configure the Switch.

4.6 Resetting the Switch

If you lock yourself (and others) from the Switch or forget the administrator password, you will need to reload the factory-default configuration file or reset the Switch back to the factory defaults.

4.6.1 Reload the Configuration File

Uploading the factory-default configuration file replaces the current configuration file with the factory-default configuration file. This means that you will lose all previous configurations and the speed of the console port will be reset to the default of 9600bps with 8 data bit, no parity, one stop bit and flow control set to none. The password will also be reset to "1234" and the IP address to 192.168.1.1.

To upload the configuration file, do the following:

- 1 Connect to the console port using a computer with terminal emulation software. See [Section 3.1 on page 26](#) for details.
- 2 Disconnect and reconnect the Switch's power to begin a session. When you reconnect the Switch's power, you will see the initial screen.
- 3 When you see the message "Press any key to enter Debug Mode within 3 seconds ..." press any key to enter debug mode.
- 4 Type `atlc` after the "Enter Debug Mode" message.
- 5 Wait for the "Starting XMODEM upload" message before activating XMODEM upload on your terminal.
- 6 After a configuration file upload, type `atgo` to restart the Switch.

Figure 23 Resetting the Switch: Via the Console Port

```

Bootbase Version: V1.00 | 11/02/2011 11:09:37
RAM: Size = 65536 Kbytes
DRAM POST: Testing: 65536K
OK
DRAM Test SUCCESS !

ZyNOS Version: MES3500-24_4.00 (AABB.0)b1 | 11/04/2011 17:32:28

Press any key to enter debug mode within 3 seconds.
.....
Enter Debug Mode
ras> atlc
Starting XMODEM upload (CRC mode)....
CCCCCCCCCCCCCCCC
Total 393216 bytes received.
Erasing..
.....
OK
ras> atgo

```

The Switch is now reinitialized with a default configuration file including the default password of "1234".

4.7 Logging Out of the Web Configurator

Click **Logout** in a screen to exit the web configurator. You have to log in with your password again after you log out. This is recommended after you finish a management session for security reasons.

Figure 24 Web Configurator: Logout Screen

4.8 Help

The web configurator's online help has descriptions of individual screens and some supplementary information.

Click the **Help** link from a web configurator screen to view an online help description of that screen.

Initial Setup Example

This chapter shows how to set up the Switch for an example network.

5.1 Overview

The following lists the configuration steps for the initial setup:

- Create a VLAN
- Set port VLAN ID
- Configure the Switch IP management address

5.1.1 Creating a VLAN

VLANs confine broadcast frames to the VLAN group in which the port(s) belongs. You can do this with port-based VLAN or tagged static VLAN with fixed port members.

In this example, you want to configure port 1 as a member of VLAN 2.

Figure 25 Initial Setup Network Example: VLAN

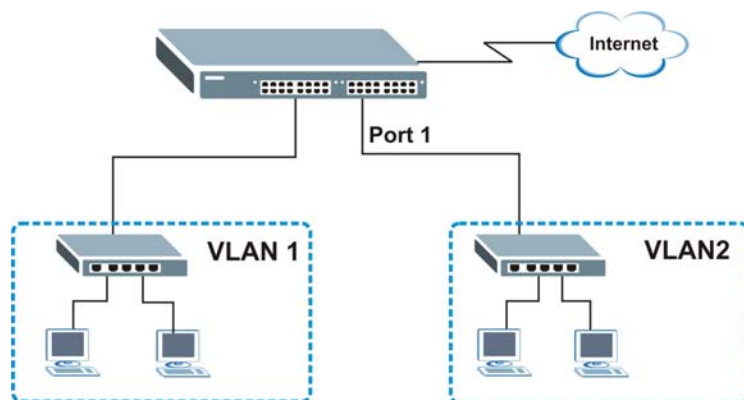

- 1 Click **Advanced Application** > **VLAN** in the navigation panel and click the **Static VLAN** link.

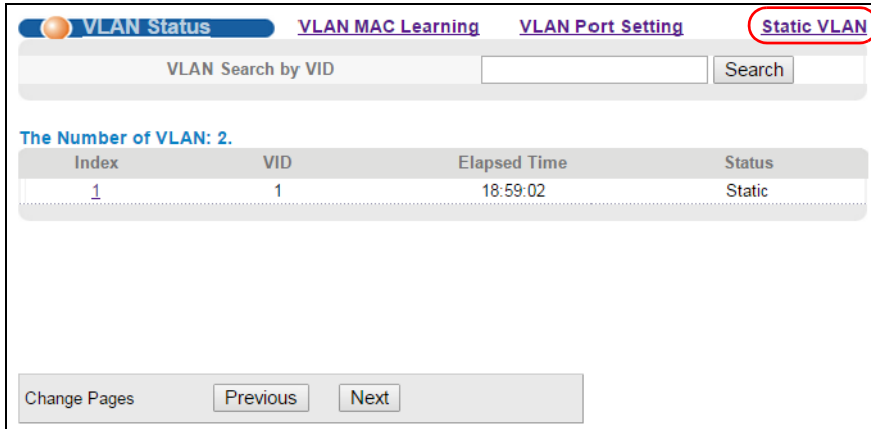

- In the **Static VLAN** screen, select **ACTIVE**, enter a descriptive name in the **Name** field and enter 2 in the **VLAN Group ID** field for the **VLAN2** network.

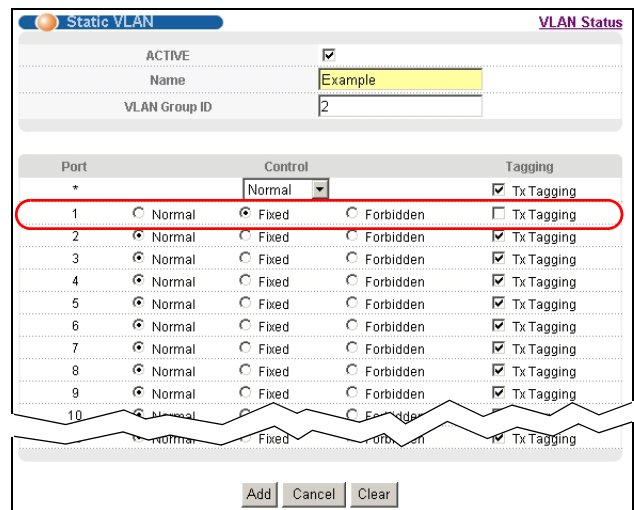

Note: The **VLAN Group ID** field in this screen and the **VID** field in the **IP Setup** screen refer to the same VLAN ID.

- Since the **VLAN2** network is connected to port 1 on the Switch, select **Fixed** to configure port 1 to be a permanent member of the VLAN only.
- To ensure that VLAN-unaware devices (such as computers and hubs) can receive frames properly, clear the **TX Tagging** check box to set the Switch to remove VLAN tags before sending.
- Click **Add** to save the settings to the run-time memory. Settings in the run-time memory are lost when the Switch's power is turned off.

5.1.2 Setting Port VID

Use PVID to add a tag to incoming untagged frames received on that port so that the frames are forwarded to the VLAN group that the tag defines.

In the example network, configure 2 as the port VID on port 1 so that any untagged frames received on that port get sent to VLAN 2.

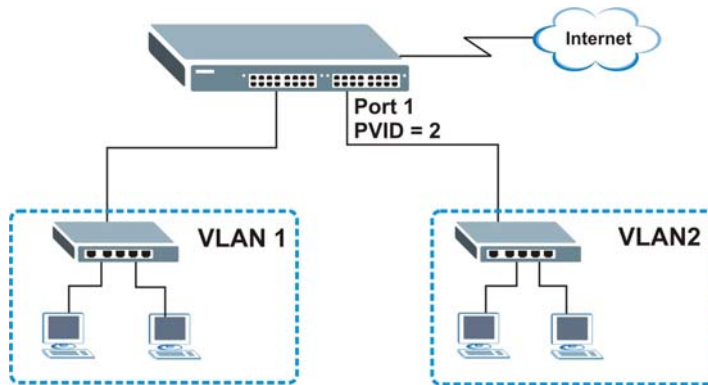
Figure 26 Initial Setup Network Example: Port VID

- 1 Click **Advanced Applications** > **VLAN** in the navigation panel. Then click the **VLAN Port Setting** link.
- 2 Enter 2 in the **PVID** field for port 1 and click **Apply** to save your changes back to the run-time memory. Settings in the run-time memory are lost when the Switch's power is turned off.

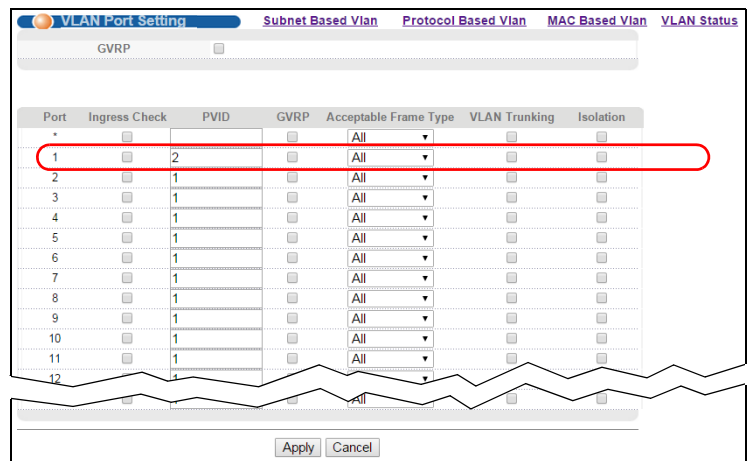

5.2 Configuring Switch Management IP Address

The default management IP address of the Switch is 192.168.1.1. You can configure another IP address in a different subnet for management purposes. The following figure shows an example.

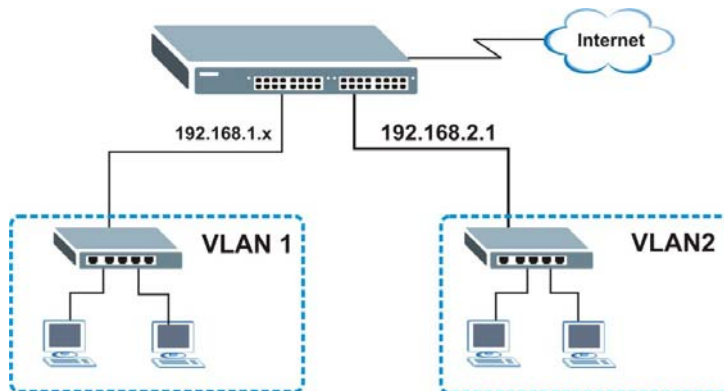
Figure 27 Initial Setup Example: Management IP Address

- 1 Connect your computer to the Switch's port which is not in VLAN 2.
- 2 Open your web browser and enter 192.168.1.1 (the default management IP address) in the address bar to access the web configurator. See [Section 4.2 on page 35](#) for more information.
- 3 Click **Basic Setting** > **IP Setup** in the navigation panel.
- 4 Configure the related fields in the **IP Setup** screen.
- 5 For the **VLAN2** network, enter 192.168.2.1 as the IP address and 255.255.255.0 as the subnet mask.
- 6 In the **VID** field, enter the ID of the VLAN group to which you want this management IP address to belong. This is the same as the VLAN ID you configure in the **Static VLAN** screen.
- 7 Click **Add** to save your changes back to the run-time memory. Settings in the run-time memory are lost when the Switch's power is turned off.

The screenshot displays the 'IP Setup' configuration page. At the top, there is a 'Domain Name Server' field set to '0.0.0.0'. Below this, the 'Default Management IP Address' section is configured for a 'Static IP Address' with the following values: IP Address: 192.168.1.1, IP Subnet Mask: 255.255.255.0, and Default Gateway: 0.0.0.0. The 'VID' field is set to '1'. 'Apply' and 'Cancel' buttons are visible below this section.

The 'Management IP Addresses' section is highlighted with a red rounded rectangle. It contains a table with the following data:

Index	IP Address	IP Subnet Mask	VID	Default Gateway	Delete
	192.168.2.1	255.255.255.0	2	0.0.0.0	

Below the table are 'Add' and 'Cancel' buttons. At the bottom of the page, there are 'Delete' and 'Cancel' buttons.

Tutorials

This chapter provides some examples of using the web configurator to set up and use the Switch. The tutorials include:

- [How to Use DHCP Snooping on the Switch](#)
- [How to Use DHCP Relay on the Switch](#)
- [How to Use PPPoE IA on the Switch](#)
- [How to Use Error Disable and Recovery on the Switch](#)
- [How to Set Up a Guest VLAN](#)
- [How to Do Port Isolation in a VLAN](#)

6.1 How to Use DHCP Snooping on the Switch

You only want DHCP server **A** connected to port 5 to assign IP addresses to all devices in VLAN 100. Create a VLAN containing ports 5, 6 and 7. Connect a computer (**M**) to the Switch's port which is not in VLAN 100.

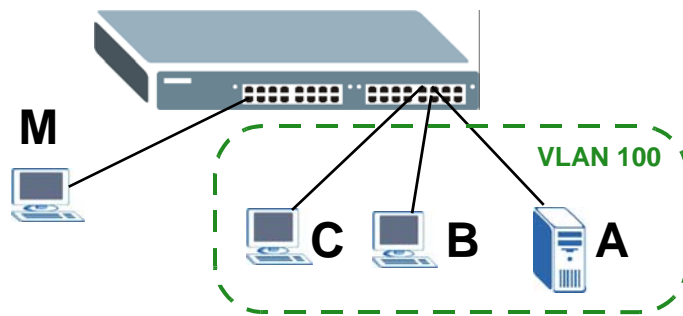

Note: For related information about DHCP snooping, see [Section 27.1 on page 216](#).

The settings in this tutorial are as the following.

Table 7 Settings in this Tutorial

HOST	PORT CONNECTED	VLAN	PVID	DHCP SNOOPING PORT TRUSTED
DHCP Server (A)	5	1 and 100	100	Yes
DHCP Client (B)	6	1 and 100	100	No
DHCP Client (C)	7	1 and 100	100	No

- 1 Access the Switch through **http://192.168.1.1**. Log into the Switch by entering the username (default: **admin**) and password (default: **1234**).

- 2 Go to **Advanced Application > VLAN > Static VLAN**, and create a VLAN with ID of 100. Add ports 5, 6 and 7 in the VLAN by selecting **Fixed** in the **Control** field as shown.

Deselect **Tx Tagging** because you don't want outgoing traffic to contain this VLAN tag.

Click **Add**.

Static VLAN [VLAN Status](#)

ACTIVE

Name

VLAN Group ID

Port	Control			Tagging
*	<input checked="" type="radio"/> Normal	<input type="radio"/> Fixed	<input type="radio"/> Forbidden	<input checked="" type="checkbox"/> Tx Tagging
1	<input checked="" type="radio"/> Normal	<input type="radio"/> Fixed	<input type="radio"/> Forbidden	<input checked="" type="checkbox"/> Tx Tagging
2	<input checked="" type="radio"/> Normal	<input type="radio"/> Fixed	<input type="radio"/> Forbidden	<input checked="" type="checkbox"/> Tx Tagging
3	<input checked="" type="radio"/> Normal	<input type="radio"/> Fixed	<input type="radio"/> Forbidden	<input checked="" type="checkbox"/> Tx Tagging
4	<input checked="" type="radio"/> Normal	<input type="radio"/> Fixed	<input type="radio"/> Forbidden	<input checked="" type="checkbox"/> Tx Tagging
5	<input type="radio"/> Normal	<input checked="" type="radio"/> Fixed	<input type="radio"/> Forbidden	<input type="checkbox"/> Tx Tagging
6	<input type="radio"/> Normal	<input checked="" type="radio"/> Fixed	<input type="radio"/> Forbidden	<input type="checkbox"/> Tx Tagging
7	<input type="radio"/> Normal	<input checked="" type="radio"/> Fixed	<input type="radio"/> Forbidden	<input type="checkbox"/> Tx Tagging
8	<input checked="" type="radio"/> Normal	<input type="radio"/> Fixed	<input type="radio"/> Forbidden	<input checked="" type="checkbox"/> Tx Tagging
9	<input checked="" type="radio"/> Normal	<input type="radio"/> Fixed	<input type="radio"/> Forbidden	<input checked="" type="checkbox"/> Tx Tagging

- 3 Go to **Advanced Application > VLAN > VLAN Port Setting**, and set the PVID of the ports 5, 6 and 7 to 100. This tags untagged incoming frames on ports 5, 6 and 7 with the tag 100.

VLAN Port Setting [Subnet Based Vlan](#) [Protocol Based Vlan](#) [VLAN Status](#)

GVRP

Port	Ingress Check	PVID	GVRP	Acceptable Frame Type	VLAN Trunking	Isolation
*	<input type="checkbox"/>	<input type="text"/>	<input type="checkbox"/>	All	<input type="checkbox"/>	<input type="checkbox"/>
1	<input type="checkbox"/>	1	<input type="checkbox"/>	All	<input type="checkbox"/>	<input type="checkbox"/>
2	<input type="checkbox"/>	1	<input type="checkbox"/>	All	<input type="checkbox"/>	<input type="checkbox"/>
3	<input type="checkbox"/>	1	<input type="checkbox"/>	All	<input type="checkbox"/>	<input type="checkbox"/>
4	<input type="checkbox"/>	1	<input type="checkbox"/>	All	<input type="checkbox"/>	<input type="checkbox"/>
5	<input type="checkbox"/>	100	<input type="checkbox"/>	All	<input type="checkbox"/>	<input type="checkbox"/>
6	<input type="checkbox"/>	100	<input type="checkbox"/>	All	<input type="checkbox"/>	<input type="checkbox"/>
7	<input type="checkbox"/>	100	<input type="checkbox"/>	All	<input type="checkbox"/>	<input type="checkbox"/>
8	<input type="checkbox"/>	1	<input type="checkbox"/>	All	<input type="checkbox"/>	<input type="checkbox"/>

- 4 Go to **Advanced Application > IP Source Guard > DHCP snooping > Configure**, activate and specify VLAN 100 as the DHCP VLAN as shown. Click **Apply**.

DHCP Snooping Configure [Port](#) [VLAN](#) [DHCP Snooping](#)

Active Disable
 DHCP Vlan

Database

Agent URL

Timeout interval seconds
 Write delay interval seconds

Renew DHCP Snooping URL

5 Click the **Port** link at the top right corner.



6 The **DHCP Snooping Port Configure** screen appears.

Select **Trusted** in the **Server Trusted state** field for port 5 because the DHCP server is connected to port 5. Keep ports 6 and 7 **Untrusted** because they are connected to DHCP clients. Click **Apply**.

DHCP Snooping Port Configure [Configure](#)

Port	Server Trusted state	Rate (pps)
*	Untrusted	<input type="text"/>
1	Untrusted	<input type="text" value="0"/>
2	Untrusted	<input type="text" value="0"/>
3	Untrusted	<input type="text" value="0"/>
4	Untrusted	<input type="text" value="0"/>
5	Trusted	<input type="text" value="0"/>
6	Untrusted	<input type="text" value="0"/>
7	Untrusted	<input type="text" value="0"/>
8	Untrusted	<input type="text" value="0"/>

7 Go to **Advanced Application > IP Source Guard > DHCP snooping > Configure > VLAN**, show VLAN 100 by entering 100 in the **Start VID** and **End VID** fields and click **Apply**. Then select **Yes** in the **Enabled** field of the VLAN 100 entry shown at the bottom section of the screen.

If you want to add more information in the DHCP request packets such as source VLAN ID or system name, you can also select the **Option82** and **Information** fields in the entry. See [Section 27.1.1.3 on page 218](#).

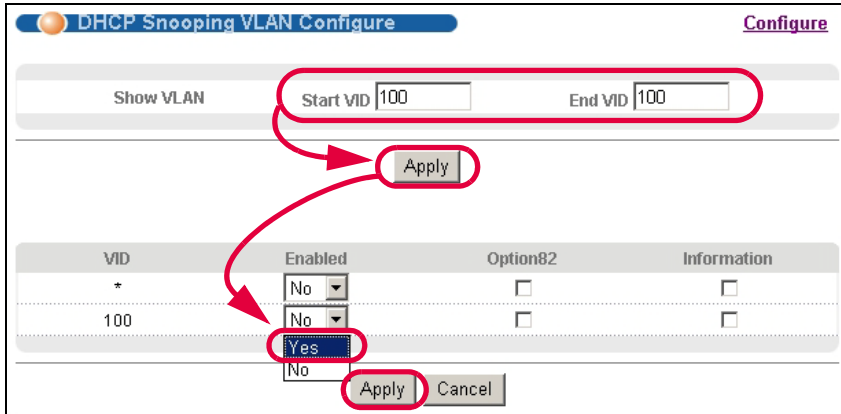

- 8 Click **Save** at the top right corner of the web configurator to save the configuration permanently.

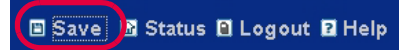

- 9 Connect your DHCP server to port 5 and a computer (as DHCP client) to either port 6 or 7. The computer should be able to get an IP address from the DHCP server. If you put the DHCP server on port 6 or 7, the computer will not be able to get an IP address.
- 10 To check if DHCP snooping works, go to **Advanced Application > IP Source Guard**, you should see an IP assignment with the type **dhcp-snooping** as shown.

Index	MAC Address	IP Address	Lease	Type	VID	Port
1	00:02:00:00:00:1c	10.10.1.16	6d23h17m 0s	dhcp-snooping	100	7

You can also telnet or log into the Switch's console. Use the command "show dhcp snooping binding" to see the DHCP snooping binding table as shown next.

```
sysname# show dhcp snooping binding
-----
      MacAddress      IpAddress      Lease      Type      VLAN      Port
-----
00:02:00:00:00:1c   10.10.1.16    6d23h59m20s  dhcp-snooping  100      7
Total number of bindings: 1
```

6.2 How to Use DHCP Relay on the Switch

This tutorial describes how to configure your Switch to forward DHCP client requests to a specific DHCP server. The DHCP server can then assign a specific IP address based on the information in the DHCP requests.

6.2.1 DHCP Relay Tutorial Introduction

In this example, you have configured your DHCP server (192.168.2.3) and want to have it assign a specific IP address (say 172.16.1.18) and gateway information to DHCP client **A** based on the system name, VLAN ID and port number in the DHCP request. Client **A** connects to the Switch's port 2 in VLAN 102.

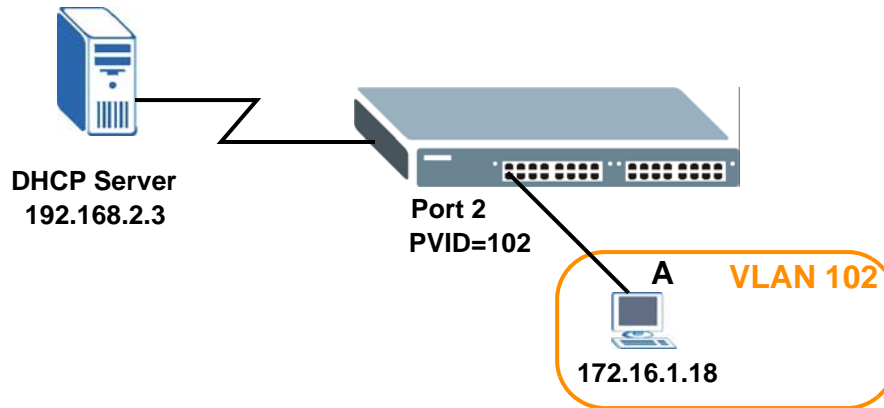

6.2.2 Creating a VLAN

Follow the steps below to configure port 2 as a member of VLAN 102.

- 1 Access the web configurator through the Switch's port which is not in VLAN 102.
- 2 Go to **Basic Setting > Switch Setup** and set the VLAN type to **802.1Q**. Click **Apply** to save the settings to the run-time memory.

The screenshot shows the 'Switch Setup' web interface. The 'VLAN Type' is set to '802.1Q'. The 'Bridge Control Protocol Transparency' is set to 'Active'. The 'MAC Address Learning' section includes 'Aging Time' (300 seconds), 'Join Timer' (200 milliseconds), 'Leave Timer' (600 milliseconds), and 'Leave All Timer' (10000 milliseconds). The 'Priority Queue Assignment' section shows a list of levels from level7 to level0, with dropdown menus for each level.

Section	Parameter	Value	Unit
MAC Address Learning	Aging Time	300	seconds
	Join Timer	200	milliseconds
	Leave Timer	600	milliseconds
	Leave All Timer	10000	milliseconds
Priority Queue Assignment	level7	7	
	level6	6	
	level5	5	
	level4	4	
	level3	3	
	level2	1	
	level1	0	
	level0	2	

- 3 Click **Advanced Application > VLAN > Static VLAN**.
- 4 In the **Static VLAN** screen, select **ACTIVE**, enter a descriptive name (VLAN 102 for example) in the **Name** field and enter 102 in the **VLAN Group ID** field.
- 5 Select **Fixed** to configure port 2 to be a permanent member of this VLAN.
- 6 Clear the **TX Tagging** check box to set the Switch to remove VLAN tags before sending.

- 7 Click **Add** to save the settings to the run-time memory. Settings in the run-time memory are lost when the Switch's power is turned off.

Static VLAN [VLAN Status](#)

ACTIVE

Name

VLAN Group ID

Port	Control			Tagging
*	Normal			<input checked="" type="checkbox"/> Tx Tagging
1	<input checked="" type="radio"/> Normal	<input type="radio"/> Fixed	<input type="radio"/> Forbidden	<input checked="" type="checkbox"/> Tx Tagging
2	<input type="radio"/> Normal	<input checked="" type="radio"/> Fixed	<input type="radio"/> Forbidden	<input type="checkbox"/> Tx Tagging
3	<input checked="" type="radio"/> Normal	<input type="radio"/> Fixed	<input type="radio"/> Forbidden	<input checked="" type="checkbox"/> Tx Tagging
4	<input checked="" type="radio"/> Normal	<input type="radio"/> Fixed	<input type="radio"/> Forbidden	<input checked="" type="checkbox"/> Tx Tagging
5	<input checked="" type="radio"/> Normal	<input type="radio"/> Fixed	<input type="radio"/> Forbidden	<input checked="" type="checkbox"/> Tx Tagging
24	<input checked="" type="radio"/> Normal	<input type="radio"/> Fixed	<input type="radio"/> Forbidden	<input checked="" type="checkbox"/> Tx Tagging
25	<input checked="" type="radio"/> Normal	<input type="radio"/> Fixed	<input type="radio"/> Forbidden	<input checked="" type="checkbox"/> Tx Tagging
26	<input checked="" type="radio"/> Normal	<input type="radio"/> Fixed	<input type="radio"/> Forbidden	<input checked="" type="checkbox"/> Tx Tagging
27	<input checked="" type="radio"/> Normal	<input type="radio"/> Fixed	<input type="radio"/> Forbidden	<input checked="" type="checkbox"/> Tx Tagging
28	<input checked="" type="radio"/> Normal	<input type="radio"/> Fixed	<input type="radio"/> Forbidden	<input checked="" type="checkbox"/> Tx Tagging

- 8 Click the **VLAN Status** link in the **Static VLAN** screen and then the **VLAN Port Setting** link in the **VLAN Status** screen.

VLAN Status [VLAN Port Setting](#) [Static VLAN](#)

VLAN Search by VID

The Number of VLAN: 2.

Index	VID	Elapsed Time	Status
1	1	49:52:07	Static
2	102	0:00:15	Static

Change Pages

- 9 Enter 102 in the **PVID** field for port 2 to add a tag to incoming untagged frames received on that port so that the frames are forwarded to the VLAN group that the tag defines.
- 10 Click **Apply** to save your changes back to the run-time memory.

VLAN Port Setting Subnet Based Vlan Protocol Based Vlan VLAN Status

GVRP

Port	Ingress Check	PVID	GVRP	Acceptable Frame Type	VLAN Trunking	Isolation
*	<input type="checkbox"/>		<input type="checkbox"/>	All	<input type="checkbox"/>	<input type="checkbox"/>
1	<input type="checkbox"/>	1	<input type="checkbox"/>	All	<input type="checkbox"/>	<input type="checkbox"/>
2	<input type="checkbox"/>	102	<input type="checkbox"/>	All	<input type="checkbox"/>	<input type="checkbox"/>
3	<input type="checkbox"/>	1	<input type="checkbox"/>	All	<input type="checkbox"/>	<input type="checkbox"/>
4	<input type="checkbox"/>	1	<input type="checkbox"/>	All	<input type="checkbox"/>	<input type="checkbox"/>
5	<input type="checkbox"/>	1	<input type="checkbox"/>	All	<input type="checkbox"/>	<input type="checkbox"/>
6	<input type="checkbox"/>	1	<input type="checkbox"/>	All	<input type="checkbox"/>	<input type="checkbox"/>
7	<input type="checkbox"/>	1	<input type="checkbox"/>	All	<input type="checkbox"/>	<input type="checkbox"/>

Apply Cancel

- 11 Click the **Save** link in the upper right corner of the web configurator to save your configuration permanently.

6.2.3 Configuring DHCPv4 Relay

Follow the steps below to enable DHCPv4 relay on the Switch and allow the Switch to add relay agent information (such as the VLAN ID) to DHCP requests.

- 1 Click **IP Application > DHCP > DHCPv4** and then the **Global** link to open the **DHCP Relay** screen.
- 2 Select the **Active** check box.
- 3 Enter the DHCP server's IP address (192.168.2.3 in this example) in the **Remote DHCP Server 1** field.
- 4 Select a pre-defined **Option 82 Profile** that includes the system name, VLAN ID and port number in the client DHCP requests (default2 in this example).
- 5 Click **Apply** to save your changes back to the run-time memory.

DHCP Relay		Port	Status
Active	<input checked="" type="checkbox"/>		
Remote DHCP Server 1	192.168.2.3		
Remote DHCP Server 2	0.0.0.0		
Remote DHCP Server 3	0.0.0.0		
Option 82 Profile	default2		

- 6 Click the **Save** link in the upper right corner of the web configurator to save your configuration permanently.
- 7 The DHCP server can then assign a specific IP address based on the DHCP request.

6.2.4 Troubleshooting

Check the client **A**'s IP address. If it did not receive the IP address 172.16.1.18, make sure:

- 1 Client **A** is connected to the Switch's port 2 in VLAN 102.
- 2 You configured the correct VLAN ID, port number and system name for DHCP relay on both the DHCP server and the Switch.
- 3 You clicked the **Save** link on the Switch to have your settings take effect.

6.3 How to Use PPPoE IA on the Switch

You want to configure PPPoE Intermediate Agent on the Switch (**A**) to pass a subscriber's information to a PPPoE server (**S**). There is another switch (**B**) between switch **A** and server **S**. Switch **B** is connected to switch **A**. In this way, PPPoE server **S** can identify subscriber **C** and may apply different settings to it.

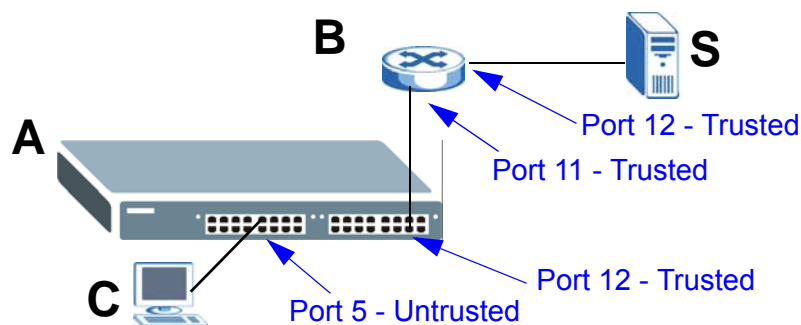

Note: For related information about PPPoE IA, see [Section 32.3 on page 252](#).

The settings in this tutorial are as follows:

Table 8 Settings in this Tutorial

SWITCH	PORT CONNECTED	VLAN	CIRCUIT-ID	REMOTE-ID	PPPOE IA PORT TRUSTED
A	Port 5 (to C)	1	userC	00134900000A	Untrusted
	Port 12 (to B)	1	N/A	N/A	Trusted
B	Port 11 (to A)	1	N/A	N/A	Trusted
	Port 12 (to S)	1	N/A	N/A	Trusted

6.3.1 Configuring Switch A

- 1 Click **Advanced Application > PPPoE > Intermediate Agent**. Select **Active** then click **Apply**.

The screenshot shows the configuration interface for the Intermediate Agent. At the top, there are tabs for 'Port', 'VLAN', and 'PPPoE'. The 'Active' checkbox is highlighted with a red circle. Below it, the 'access-node-identifier' field is set to 'MES3500'. The 'circuit-id' section includes an 'Active' checkbox (unchecked), an empty 'identifier-string' field, an 'option' dropdown set to 'spv', and a 'delimiter' dropdown set to '/'. At the bottom, there are 'Apply' and 'Cancel' buttons.

Click **Port** on the top of the screen.

- 2 Select **Untrusted** for port 5 and enter **userC** as **Circuit-id** and **00134900000A** as **Remote-id**. Select **Trusted** for port 12 and then leave the other fields empty. Click **Apply**.

Port	Server Trusted State	Circuit-id	Remote-id
*	Untrusted		
1	Untrusted		
2	Untrusted		
3	Untrusted		
4	Untrusted		
5	Untrusted	userC	00134900000A
6	Untrusted		
7	Untrusted		
8	Untrusted		
9	Untrusted		
10	Untrusted		
11	Untrusted		
12	Trusted		
13	Untrusted		
14	Untrusted		

Then Click **Intermediate Agent** on the top of the screen.

- 3 The **Intermediate Agent** screen appears. Click **VLAN** on the top of the screen.

Intermediate Agent	Port	VLAN	PPPoE
Active	<input type="checkbox"/>		
access-node-identifier	MES3500		
circuit-id			
Active	<input type="checkbox"/>		
identifier-string			
option	spv		
delimiter	/		
<input type="button" value="Apply"/> <input type="button" value="Cancel"/>			

- 4 Enter 1 for both **Start VID** and **End VID** since both the Switch and PPPoE server are in VLAN 1 in this example. Click **Apply**.

VLAN Intermediate Agent

Show VLAN Start VID 1 End VID 1

Apply

VID	Enabled	Circuit-id	Remote-id
*	No	<input type="checkbox"/>	<input type="checkbox"/>

Apply Cancel

- Then select **Yes** to enable PPPoE IA in VLAN 1 and also select **Circuit-id** and **Remote-id** to allow the Switch to add these two strings to frames tagged with VLAN 1 and pass to the PPPoE server. Click **Apply**.

VLAN Intermediate Agent

Show VLAN Start VID End VID

Apply

VID	Enabled	Circuit-id	Remote-id
*	No	<input type="checkbox"/>	<input type="checkbox"/>
1	Yes	<input checked="" type="checkbox"/>	<input checked="" type="checkbox"/>

Apply Cancel

6.3.2 Configuring Switch B

The example uses another MES3500-24/24F as switch **B**.

- Click **Advanced Application > PPPoE > Intermediate Agent**. Select **Active** then click **Apply**.

Intermediate Agent Port VLAN PPPoE

Active

access-node-identifier

circuit-id

Active

identifier-string

option

delimiter

Click **Port** on the top of the screen.

- 2 Select **Trusted** for ports 11 and 12 and then click **Apply**.

Port VLAN Intermediate Agent

Port	Server Trusted State	Circuit-id	Remote-id
*	Untrusted		
1	Untrusted		
2	Untrusted		
3	Untrusted		
4	Untrusted		
5	Untrusted		
6	Untrusted		
7	Untrusted		
8	Untrusted		
9	Untrusted		
10	Untrusted		
11	Trusted		
12	Trusted		
13	Untrusted		
14	Untrusted		

Then Click **Intermediate Agent** on the top of the screen.

- 3 The **Intermediate Agent** screen appears. Click **VLAN** on the top of the screen.

Intermediate Agent Port VLAN PPPoE

Active

access-node-identifier

circuit-id

Active

identifier-string

option

delimiter

- 4 Enter 1 for both **Start VID** and **End VID**. Click **Apply**.

VLAN Intermediate Agent

Show VLAN Start VID End VID

VID	Enabled	Circuit-id	Remote-id
*	No <input type="text"/>	<input type="checkbox"/>	<input type="checkbox"/>

- 5 Then select **Yes** to enable PPPoE IA in VLAN 1 and also select **Circuit-id** and **Remote-id** to allow the Switch to add these two strings to frames tagged with VLAN 1 and pass to the PPPoE server. Click **Apply**.

VLAN Intermediate Agent

Show VLAN Start VID End VID

VID	Enabled	Circuit-id	Remote-id
*	No <input type="text"/>	<input type="checkbox"/>	<input type="checkbox"/>
1	Yes <input type="text"/>	<input checked="" type="checkbox"/>	<input checked="" type="checkbox"/>

The settings are completed now. If you miss some settings above, subscriber C could not successfully receive an IP address assigned by the PPPoE Server. If this happens, make sure you follow the steps exactly in this tutorial.

6.4 How to Use Error Disable and Recovery on the Switch

This tutorial shows you how to shut down a port when:

- there is a loop occurred

or

- too many ARP requests (over 100 packets per second) received on a port

You also want the Switch to wait for a period of time (10 minutes) before resuming the port automatically, after the problem(s) are gone. Loop guard and Errdisable features are helpful for this demand.

Note: Refer to [Section 28.2 on page 238](#) and [Section 33.3 on page 258](#) for more information about Loop Guard and Errdisable.

To configure the settings:

- 1 First, click **Advanced Application > Loop Guard**. Select the **Active** option in the first section to enable loop guard on the Switch. Then select the **Active** option of the first entry (port *) to enable loop guard for all ports. Click **Apply**.

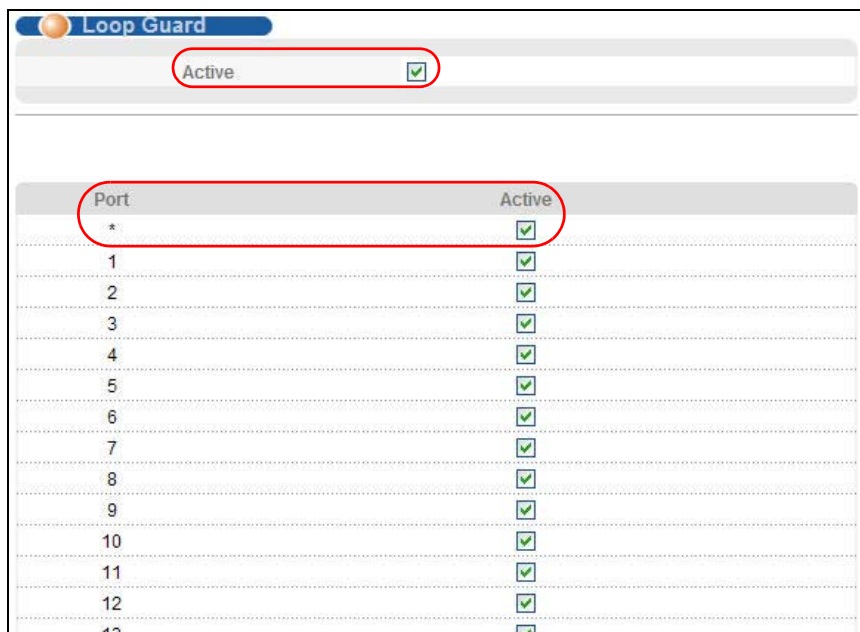

- 2 Click **Advanced Application > Errdisable > CPU Protection**, select **ARP** as the reason, enter 100 as the rate limit (packets per second) for the first entry (port *) to apply the setting to all ports. Then click **Apply**.

CPU protection Errdisable

Reason: ARP

Port	Rate Limit (pkt/s)
*	100
1	100
2	100
3	100
4	100
5	100
6	100
7	100
8	100
9	100
10	100
11	100
12	100
13	100

- 3 Click **Advanced Application > Errdisable > Errdisable Detect**, select **Active** for cause **ARP** and **inactive-port** as the mode. Then click **Apply**.

Errdisable Detect Errdisable

Cause	Active	Mode
*	<input type="checkbox"/>	inactive-port
ARP	<input checked="" type="checkbox"/>	inactive-port
BPDU	<input type="checkbox"/>	inactive-port
IGMP	<input type="checkbox"/>	inactive-port

Apply Cancel

- 4 Click **Advanced Application > Errdisable > Errdisable Recovery**, select **Active** and **Timer Status** for **loopguard** and **ARP** entries. Also enter 180 (180 seconds = 3 minutes) in the **Interval** field for both entries. Then click **Apply**.

Errdisable Recovery Errdisable

Active

Reason	Timer Status	Interval
*	<input type="checkbox"/>	
loopguard	<input checked="" type="checkbox"/>	180
ARP	<input checked="" type="checkbox"/>	180
BPDU	<input type="checkbox"/>	300
IGMP	<input type="checkbox"/>	300

Apply Cancel

6.5 How to Set Up a Guest VLAN

All ports on the Switch are in VLAN 1 by default. Say you enable IEEE 802.1x authentication on ports 1 to 8. Clients that connect to these ports should provide the correct user name and password in order to access the ports. You want to assign clients that connect to ports 1, 2 or 3 to a guest VLAN (200 for example) before they can authenticate with the authentication server. In this guest VLAN, clients can surf the Internet through the default gateway attached to port 10, but are not allowed to access other network resources, such as the mail server or local data base.

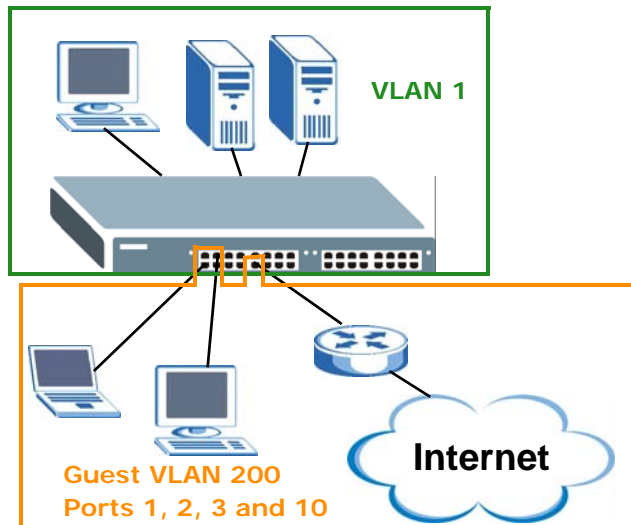

6.5.1 Creating a Guest VLAN

Follow the steps below to configure port 1, 2, 3 and 10 as a member of VLAN 200.

- 1 Access the web configurator through the Switch's port which is not in VLAN 200.
- 2 Go to **Basic Setting** > **Switch Setup** and set the VLAN type to **802.1Q**. Click **Apply** to save the settings to the run-time memory.

Switch Setup		
VLAN Type	<input checked="" type="radio"/> 802.1Q <input type="radio"/> Port Based	
Bridge Control Protocol Transparency	Active	<input type="checkbox"/>
MAC Address Learning	Aging Time	300 seconds
	Join Timer	200 milliseconds
GARP Timer	Leave Timer	600 milliseconds
	Leave All Timer	10000 milliseconds
	Priority Queue Assignment	
	level7	7
	level6	6
	level5	5
	level4	4
	level3	3
	level2	1
	level1	0
	level0	2

Apply Cancel

- 3 Click **Advanced Application > VLAN > Static VLAN**.
- 4 In the **Static VLAN** screen, select **ACTIVE**, enter a descriptive name (VLAN 200 for example) in the **Name** field and enter 200 in the **VLAN Group ID** field.
- 5 Select **Fixed** to configure ports 1, 2, 3 and 10 to be permanent members of this VLAN.
- 6 Clear the **TX Tagging** check box to set the Switch to remove VLAN tags before sending frames out of these ports.
- 7 Click **Add** to save the settings to the run-time memory. Settings in the run-time memory are lost when the Switch's power is turned off.

Static VLAN VLAN Status

ACTIVE

Name

VLAN Group ID

Port	Control			Tagging
*		Normal		<input checked="" type="checkbox"/> Tx Tagging
1	<input type="radio"/> Normal	<input checked="" type="radio"/> Fixed	<input type="radio"/> Forbidden	<input type="checkbox"/> Tx Tagging
2	<input type="radio"/> Normal	<input checked="" type="radio"/> Fixed	<input type="radio"/> Forbidden	<input type="checkbox"/> Tx Tagging
3	<input type="radio"/> Normal	<input checked="" type="radio"/> Fixed	<input type="radio"/> Forbidden	<input type="checkbox"/> Tx Tagging
4	<input checked="" type="radio"/> Normal	<input type="radio"/> Fixed	<input type="radio"/> Forbidden	<input checked="" type="checkbox"/> Tx Tagging
5	<input checked="" type="radio"/> Normal	<input type="radio"/> Fixed	<input type="radio"/> Forbidden	<input checked="" type="checkbox"/> Tx Tagging
6	<input checked="" type="radio"/> Normal	<input type="radio"/> Fixed	<input type="radio"/> Forbidden	<input checked="" type="checkbox"/> Tx Tagging
7	<input checked="" type="radio"/> Normal	<input type="radio"/> Fixed	<input type="radio"/> Forbidden	<input checked="" type="checkbox"/> Tx Tagging
8	<input checked="" type="radio"/> Normal	<input type="radio"/> Fixed	<input type="radio"/> Forbidden	<input checked="" type="checkbox"/> Tx Tagging
9	<input checked="" type="radio"/> Normal	<input type="radio"/> Fixed	<input type="radio"/> Forbidden	<input checked="" type="checkbox"/> Tx Tagging
10	<input type="radio"/> Normal	<input checked="" type="radio"/> Fixed	<input type="radio"/> Forbidden	<input type="checkbox"/> Tx Tagging
11	<input checked="" type="radio"/> Normal	<input type="radio"/> Fixed	<input type="radio"/> Forbidden	<input checked="" type="checkbox"/> Tx Tagging

- 8 Click the **VLAN Status** link in the **Static VLAN** screen and then the **VLAN Port Setting** link in the **VLAN Status** screen.

VLAN Status VLAN Port Setting Static VLAN

VLAN Search by VID

The Number of VLAN: 4.

Index	VID	Elapsed Time	Status
1	1	2:59:05	Static
2	102	2:59:05	Static
3	123	2:59:05	Static
4	200	0:00:07	Static

Change Pages

- 9 Enter 200 in the **PVID** field for ports 1, 2, 3 and 10 to add a tag to incoming untagged frames received on these ports so that the frames are forwarded to the VLAN group that the tag defines.
- 10 Click **Apply** to save your changes back to the run-time memory.

VLAN Port Setting Subnet Based Vlan Protocol Based Vlan VLAN Status

GVRP

Port	Ingress Check	PVID	GVRP	Acceptable Frame Type	VLAN Trunking	Isolation
*	<input type="checkbox"/>		<input type="checkbox"/>	All	<input type="checkbox"/>	<input type="checkbox"/>
1	<input type="checkbox"/>	200	<input type="checkbox"/>	All	<input type="checkbox"/>	<input type="checkbox"/>
2	<input type="checkbox"/>	200	<input type="checkbox"/>	All	<input type="checkbox"/>	<input type="checkbox"/>
3	<input type="checkbox"/>	200	<input type="checkbox"/>	All	<input type="checkbox"/>	<input type="checkbox"/>
4	<input type="checkbox"/>	1	<input type="checkbox"/>	All	<input type="checkbox"/>	<input type="checkbox"/>
5	<input type="checkbox"/>	1	<input type="checkbox"/>	All	<input type="checkbox"/>	<input type="checkbox"/>
6	<input type="checkbox"/>	1	<input type="checkbox"/>	All	<input type="checkbox"/>	<input type="checkbox"/>
7	<input type="checkbox"/>	1	<input type="checkbox"/>	All	<input type="checkbox"/>	<input type="checkbox"/>
8	<input type="checkbox"/>	1	<input type="checkbox"/>	All	<input type="checkbox"/>	<input type="checkbox"/>
9	<input type="checkbox"/>	1	<input type="checkbox"/>	All	<input type="checkbox"/>	<input type="checkbox"/>
10	<input type="checkbox"/>	200	<input type="checkbox"/>	All	<input type="checkbox"/>	<input type="checkbox"/>
11	<input type="checkbox"/>	1	<input type="checkbox"/>	All	<input type="checkbox"/>	<input type="checkbox"/>

- 11 Click the **Save** link in the upper right corner of the web configurator to save your configuration permanently.

6.5.2 Enabling IEEE 802.1x Port Authentication

Follow the steps below to enable port authentication to validate access to ports 1~8 to clients based on a RADIUS server.

- 1 Click **Advanced Application > Port Authentication** and then the **Click Here** link for **802.1x**.

Port Authentication

802.1x [Click here](#)

MAC Authentication [Click here](#)

- 2 Select the first **Active** checkbox to enable 802.1x authentication on the Switch.
Select the **Active** checkboxes for ports 1 to 8 to turn on 802.1x authentication on the selected ports.
Click **Apply**.

802.1x
Port Authentication [Guest Vlan](#)

Active

Port	Active	Max-Req	Reauth	Reauth-period secs	Quiet-period secs	Tx-period secs	Supp-Timeout secs
*	<input type="checkbox"/>		On ▼				
1	<input checked="" type="checkbox"/>	2	On ▼	3600	60	30	30
2	<input checked="" type="checkbox"/>	2	On ▼	3600	60	30	30
3	<input checked="" type="checkbox"/>	2	On ▼	3600	60	30	30
4	<input checked="" type="checkbox"/>	2	On ▼	3600	60	30	30
5	<input checked="" type="checkbox"/>	2	On ▼	3600	60	30	30
6	<input checked="" type="checkbox"/>	2	On ▼	3600	60	30	30
7	<input checked="" type="checkbox"/>	2	On ▼	3600	60	30	30
8	<input checked="" type="checkbox"/>	2	On ▼	3600	60	30	30
9	<input type="checkbox"/>	2	On ▼	3600	60	30	30
10	<input type="checkbox"/>	2	On ▼	3600	60	30	30

6.5.3 Enabling Guest VLAN

- 1 Click the **Guest Vlan** link in the **802.1x** screen.
- 2 Select **Active** and enter the guest VLAN ID (200 in this example) on ports 1, 2 and 3. The Switch puts unauthenticated clients in the specified guest VLAN.

Set **Host-mode** to **Multi-Secure** to have the Switch authenticate each client that connects to one of these ports, and specify the maximum number of clients that the Switch will authenticate on each of these port (5 in this example).

Click **Apply**.

Guest Vlan 802.1x

Port	Active	Guest Vlan	Host-mode	Multi-Secure Num
*	<input type="checkbox"/>		Multi-Host	
1	<input checked="" type="checkbox"/>	200	Multi-Secure	5
2	<input checked="" type="checkbox"/>	200	Multi-Secure	5
3	<input checked="" type="checkbox"/>	200	Multi-Secure	5
4	<input type="checkbox"/>	1	Multi-Host	1
5	<input type="checkbox"/>	1	Multi-Host	1
6	<input type="checkbox"/>	1	Multi-Host	1
7	<input type="checkbox"/>	1	Multi-Host	1
8	<input type="checkbox"/>	1	Multi-Host	1
9	<input type="checkbox"/>	1	Multi-Host	1
28	<input type="checkbox"/>	1	Multi-Host	1

Apply Cancel

- Click the **Save** link in the upper right corner of the web configurator to save your configuration permanently.

Clients that attach to port 1, 2 or 3 and fail to authenticate with the RADIUS server now should be in VLAN 200 and can access the Internet, but cannot communicate with devices in VLAN 1.

6.6 How to Do Port Isolation in a VLAN

You want to prevent communications between ports in a VLAN but still allow them to access the Internet or network resources through the uplink port in the same VLAN. You use private VLAN to do port isolation in a VLAN instead of assigning each port to a separate VLAN and creating a different IP routing domain for each individual port.

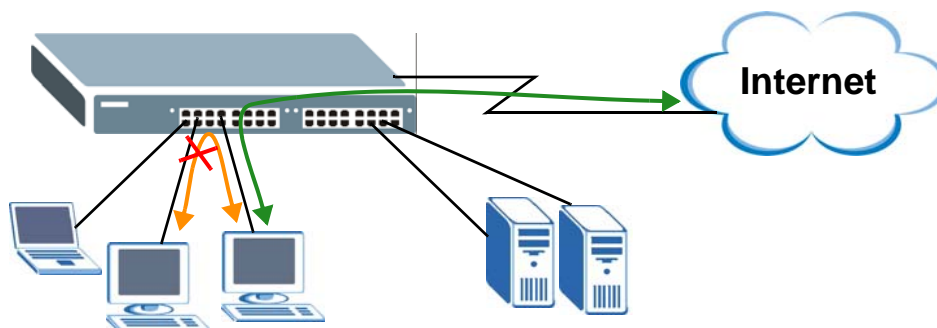

In this example, you put ports 2 to 4 and 25 in VLAN 123 and create a private VLAN rule for VLAN 123 to block traffic between ports 2, 3 and 4.

6.6.1 Creating a VLAN

Follow the steps below to configure port 2, 3, 4 and 25 as a member of VLAN 123.

- 1 Access the web configurator through the Switch's port which is not in VLAN 123.
- 2 Go to **Basic Setting > Switch Setup** and set the VLAN type to **802.1Q**. Click **Apply** to save the settings to the run-time memory.

The screenshot shows the 'Switch Setup' configuration page. A red circle highlights the 'VLAN Type' section, where '802.1Q' is selected with a radio button, and 'Port Based' is unselected. Below this, the 'Bridge Control Protocol Transparency' is set to 'Active' with an unchecked checkbox. The 'MAC Address Learning' section includes 'Aging Time' set to 300 seconds, 'Join Timer' set to 200 milliseconds, and 'GARP Timer' with 'Leave Timer' set to 600 milliseconds and 'Leave All Timer' set to 10000 milliseconds. The 'Priority Queue Assignment' section shows a list of levels from level7 to level0, each with a dropdown menu. The values are: level7 (7), level6 (6), level5 (5), level4 (4), level3 (3), level2 (1), level1 (0), and level0 (2). At the bottom, there are 'Apply' and 'Cancel' buttons.

- 3 Click **Advanced Application > VLAN > Static VLAN**.
- 4 In the **Static VLAN** screen, select **ACTIVE**, enter a descriptive name (VLAN 123 for example) in the **Name** field and enter 123 in the **VLAN Group ID** field.
- 5 Select **Fixed** to configure ports 2, 3, 4 and 25 to be permanent members of this VLAN.
- 6 Clear the **TX Tagging** check box to set the Switch to remove VLAN tags before sending frames out of these ports.
- 7 Click **Add** to save the settings to the run-time memory. Settings in the run-time memory are lost when the Switch's power is turned off.

Static VLAN VLAN Status

ACTIVE

Name

VLAN Group ID

Port	Control			Tagging
*	Normal			<input checked="" type="checkbox"/> Tx Tagging
1	<input checked="" type="radio"/> Normal	<input type="radio"/> Fixed	<input type="radio"/> Forbidden	<input checked="" type="checkbox"/> Tx Tagging
2	<input type="radio"/> Normal	<input checked="" type="radio"/> Fixed	<input type="radio"/> Forbidden	<input type="checkbox"/> Tx Tagging
3	<input type="radio"/> Normal	<input checked="" type="radio"/> Fixed	<input type="radio"/> Forbidden	<input type="checkbox"/> Tx Tagging
4	<input type="radio"/> Normal	<input checked="" type="radio"/> Fixed	<input type="radio"/> Forbidden	<input type="checkbox"/> Tx Tagging
5	<input checked="" type="radio"/> Normal	<input type="radio"/> Fixed	<input type="radio"/> Forbidden	<input checked="" type="checkbox"/> Tx Tagging
6	<input checked="" type="radio"/> Normal	<input type="radio"/> Fixed	<input type="radio"/> Forbidden	<input checked="" type="checkbox"/> Tx Tagging
7	<input checked="" type="radio"/> Normal	<input type="radio"/> Fixed	<input type="radio"/> Forbidden	<input checked="" type="checkbox"/> Tx Tagging
8	<input checked="" type="radio"/> Normal	<input type="radio"/> Fixed	<input type="radio"/> Forbidden	<input checked="" type="checkbox"/> Tx Tagging
9	<input checked="" type="radio"/> Normal	<input type="radio"/> Fixed	<input type="radio"/> Forbidden	<input checked="" type="checkbox"/> Tx Tagging
24	<input checked="" type="radio"/> Normal	<input type="radio"/> Fixed	<input type="radio"/> Forbidden	<input checked="" type="checkbox"/> Tx Tagging
25	<input type="radio"/> Normal	<input checked="" type="radio"/> Fixed	<input type="radio"/> Forbidden	<input type="checkbox"/> Tx Tagging
26	<input type="radio"/> Normal	<input type="radio"/> Fixed	<input type="radio"/> Forbidden	<input checked="" type="checkbox"/> Tx Tagging
27	<input checked="" type="radio"/> Normal	<input type="radio"/> Fixed	<input type="radio"/> Forbidden	<input checked="" type="checkbox"/> Tx Tagging
28	<input checked="" type="radio"/> Normal	<input type="radio"/> Fixed	<input type="radio"/> Forbidden	<input checked="" type="checkbox"/> Tx Tagging

- 8 Click the **VLAN Status** link in the **Static VLAN** screen and then the **VLAN Port Setting** link in the **VLAN Status** screen.

VLAN Status VLAN Port Setting Static VLAN

VLAN Search by VID

The Number of VLAN: 3.

Index	VID	Elapsed Time	Status
1	1	5:19:47	Static
2	102	5:19:47	Static
3	123	0:05:28	Static

Change Pages

- 9 Enter 123 in the **PVID** field for ports 2, 3, 4 and 25 to add a tag to incoming untagged frames received on these ports so that the frames are forwarded to the VLAN group that the tag defines.
- 10 Click **Apply** to save your changes back to the run-time memory.

VLAN Port Setting Subnet Based Vlan Protocol Based Vlan VLAN Status

GVRP

Port	Ingress Check	PVID	GVRP	Acceptable Frame Type	VLAN Trunking	Isolation
*	<input type="checkbox"/>		<input type="checkbox"/>	All	<input type="checkbox"/>	<input type="checkbox"/>
1	<input type="checkbox"/>	1	<input type="checkbox"/>	All	<input type="checkbox"/>	<input type="checkbox"/>
2	<input type="checkbox"/>	123	<input type="checkbox"/>	All	<input type="checkbox"/>	<input type="checkbox"/>
3	<input type="checkbox"/>	123	<input type="checkbox"/>	All	<input type="checkbox"/>	<input type="checkbox"/>
4	<input type="checkbox"/>	123	<input type="checkbox"/>	All	<input type="checkbox"/>	<input type="checkbox"/>
5	<input type="checkbox"/>	1	<input type="checkbox"/>	All	<input type="checkbox"/>	<input type="checkbox"/>
6	<input type="checkbox"/>	1	<input type="checkbox"/>	All	<input type="checkbox"/>	<input type="checkbox"/>
7	<input type="checkbox"/>	1	<input type="checkbox"/>	All	<input type="checkbox"/>	<input type="checkbox"/>
8	<input type="checkbox"/>	1	<input type="checkbox"/>	All	<input type="checkbox"/>	<input type="checkbox"/>
9	<input type="checkbox"/>	1	<input type="checkbox"/>	All	<input type="checkbox"/>	<input type="checkbox"/>
25	<input type="checkbox"/>	123	<input type="checkbox"/>	All	<input type="checkbox"/>	<input type="checkbox"/>
26	<input type="checkbox"/>	1	<input type="checkbox"/>	All	<input type="checkbox"/>	<input type="checkbox"/>
27	<input type="checkbox"/>	1	<input type="checkbox"/>	All	<input type="checkbox"/>	<input type="checkbox"/>
28	<input type="checkbox"/>	1	<input type="checkbox"/>	All	<input type="checkbox"/>	<input type="checkbox"/>

Apply Cancel

- 11 Click the **Save** link in the upper right corner of the web configurator to save your configuration permanently.

6.6.2 Creating a Private VLAN Rule

Follow the steps below to configure private VLAN for VLAN 123.

- 1 Click **Advanced Application > Private VLAN**.

- 2 In the **Private VLAN** screen, select **Active**.

Enter a descriptive name (PrivateVLAN123 for example) in the **Name** field and enter 123 in the **VLAN ID** field.

Click **Add**.

Private VLAN

Active

Name PrivateVLAN123

VLAN ID 123

Add Cancel Clear

Index	Active	Name	VLAN	Delete
-------	--------	------	------	--------

Delete Cancel

- 3 Click the **Save** link in the upper right corner of the web configurator to save your configuration permanently.

Ports 2, 3 and 4 in this VLAN will be added to the isolated port list automatically and cannot send traffic to each other.

From port 2, 3, or 4, you should be able to access the device that attaches to port 25, such as a server or default gateway.

PART II

Technical Reference

System Status and Port Statistics

This chapter describes the system status (web configurator home page) and port details screens.

7.1 Overview

The home screen of the web configurator displays a port statistical summary with links to each port showing statistical details.

7.2 Port Status Summary

To view the port statistics, click **Status** in all web configurator screens to display the **Status** screen as shown next.

Figure 28 Status

Port	Name	Link	State	LACP	TxPkts	RxPkts	Errors	Tx KB/s	Rx KB/s	Up Time
1		Down	STOP	Disabled	0	0	0	0.0	0.0	0:00:00
2		Down	STOP	Disabled	0	0	0	0.0	0.0	0:00:00
3		Down	STOP	Disabled	0	0	0	0.0	0.0	0:00:00
4		Down	STOP	Disabled	0	0	0	0.0	0.0	0:00:00
5		Down	STOP	Disabled	0	0	0	0.0	0.0	0:00:00
6		Down	STOP	Disabled	0	0	0	0.0	0.0	0:00:00
7		Down	STOP	Disabled	0	0	0	0.0	0.0	0:00:00
8		Down	STOP	Disabled	0	0	0	0.0	0.0	0:00:00
9		Down	STOP	Disabled	0	0	0	0.0	0.0	0:00:00
10		Down	STOP	Disabled	0	0	0	0.0	0.0	0:00:00
11		Down	STOP	Disabled	0	0	0	0.0	0.0	0:00:00
12		Down	STOP	Disabled	0	0	0	0.0	0.0	0:00:00
13		Down	STOP	Disabled	0	0	0	0.0	0.0	0:00:00
14		Down	STOP	Disabled	0	0	0	0.0	0.0	0:00:00
15		Down	STOP	Disabled	0	0	0	0.0	0.0	0:00:00
16		Down	STOP	Disabled	0	0	0	0.0	0.0	0:00:00

Any
 Port

The following table describes the labels in this screen.

Table 9 Status

LABEL	DESCRIPTION
Port	This identifies the Ethernet port. Click a port number to display the Port Details screen (refer to Figure 29 on page 75).
Name	This is the name you assigned to this port in the Basic Setting > Port Setup screen.

Table 9 Status (continued)

LABEL	DESCRIPTION
Link	This field displays the speed (either 10M for 10Mbps, 100M for 100Mbps or 1000M for 1000Mbps) and the duplex (F for full duplex or H for half). It also shows the cable type (Copper or Fiber) for the combo ports. This field displays Down if the port is not connected to any device.
State	If STP (Spanning Tree Protocol) is enabled, this field displays the STP state of the port (see Section 13.1 on page 115 for more information). If STP is disabled, this field displays FORWARDING if the link is up, otherwise, it displays STOP .
LACP	This field displays whether LACP (Link Aggregation Control Protocol) has been enabled on the port.
TxPkts	This field shows the number of transmitted frames on this port.
RxBkts	This field shows the number of received frames on this port.
Errors	This field shows the number of received errors on this port.
Tx KB/s	This field shows the number of kilobytes per second transmitted on this port.
Rx KB/s	This field shows the number of kilobytes per second received on this port.
Up Time	This field shows the total amount of time in hours, minutes and seconds the port has been up.
Clear Counter	Enter a port number and then click Clear Counter to erase the recorded statistical information for that port, or select Any to clear statistics for all ports.

7.2.1 Status: Port Details

Click a number in the **Port** column in the **Status** screen to display individual port statistics. Use this screen to check status and detailed performance data about an individual port on the Switch.

Figure 29 Status > Port Details

Port Details		Port Status
Port Info	Port NO.	3
	Name	
	Link	100MF
	State	FORWARDING
	LACP	Disabled
	TxPkts	984269
	RxPkts	438864
	Errors	0
	Tx KBs/s	0.256
	Rx KBs/s	0.0
	Up Time	6:58:27
TX Packet	Unicast	598015
	Multicast	268290
	Broadcast	117964
	Pause	0
RX Packet	Unicast	436765
	Multicast	800
	Broadcast	1299
	Pause	0
TX Collision	Single	0
	Multiple	0
	Excessive	0
	Late	0
Error Packet	RX CRC	0
Distribution	64	570667
	65 to 127	206782
	128 to 255	46306
	256 to 511	120074
	512 to 1023	34762
	1024 to 1518	444542
	Giant	0

The following table describes the labels in this screen.

Table 10 Status: Port Details

LABEL	DESCRIPTION
Port Info	
Port NO.	This field displays the port number you are viewing.
Name	This field displays the name of the port.
Link	This field displays the speed (either 10M for 10Mbps, 100M for 100Mbps or 1000M for 1000Mbps) and the duplex (F for full duplex or H for half duplex). It also shows the cable type (Copper or Fiber). This field displays Down if the port is not connected to any device.
Status	If STP (Spanning Tree Protocol) is enabled, this field displays the STP state of the port (see Section 13.1 on page 115 for more information). If STP is disabled, this field displays FORWARDING if the link is up, otherwise, it displays STOP .
LACP	This field shows if LACP is enabled on this port or not.
TxPkts	This field shows the number of transmitted frames on this port
RxPkts	This field shows the number of received frames on this port
Errors	This field shows the number of received errors on this port.
Tx KB/s	This field shows the number kilobytes per second transmitted on this port.

Table 10 Status: Port Details (continued)

LABEL	DESCRIPTION
Rx KB/s	This field shows the number of kilobytes per second received on this port.
Up Time	This field shows the total amount of time the connection has been up.
Tx Packet	
The following fields display detailed information about packets transmitted.	
Unicast	This field shows the number of good unicast packets transmitted.
Multicast	This field shows the number of good multicast packets transmitted.
Broadcast	This field shows the number of good broadcast packets transmitted.
Pause	This field shows the number of 802.3x Pause packets transmitted.
Rx Packet	
The following fields display detailed information about packets received.	
Unicast	This field shows the number of good unicast packets received.
Multicast	This field shows the number of good multicast packets received.
Broadcast	This field shows the number of good broadcast packets received.
Pause	This field shows the number of 802.3x Pause packets received.
TX Collision	
The following fields display information on collisions while transmitting.	
Single	This is a count of successfully transmitted packets for which transmission is inhibited by exactly one collision.
Multiple	This is a count of successfully transmitted packets for which transmission was inhibited by more than one collision.
Excessive	This is a count of packets for which transmission failed due to excessive collisions. Excessive collision is defined as the number of maximum collisions before the retransmission count is reset.
Late	This is the number of times a late collision is detected, that is, after 512 bits of the packets have already been transmitted.
Error Packet	
The following fields display detailed information about packets received that were in error.	
RX CRC	This field shows the number of packets received with CRC (Cyclic Redundant Check) error(s).
Distribution	
64	This field shows the number of packets (including bad packets) received that were 64 octets in length.
65-127	This field shows the number of packets (including bad packets) received that were between 65 and 127 octets in length.
128-255	This field shows the number of packets (including bad packets) received that were between 128 and 255 octets in length.
256-511	This field shows the number of packets (including bad packets) received that were between 256 and 511 octets in length.
512-1023	This field shows the number of packets (including bad packets) received that were between 512 and 1023 octets in length.
1024-1518	This field shows the number of packets (including bad packets) received that were between 1024 and 1518 octets in length.
Giant	This field shows the number of packets (including bad packets) received that were between 1519 octets and the maximum frame size. The maximum frame size varies depending on your switch model.

Basic Setting

This chapter describes how to configure the **Basic Setting** screens.

8.1 System Information

In the navigation panel, click **Basic Setting** > **System Info** to display the screen as shown. You can check the firmware version number and monitor the Switch temperature and voltage in this screen.

Figure 30 Basic Setting > System Info

System Name		MES3500				
Product Model		MES3500-24				
ZyNOS F/W Version		VMES3500-24_4.00(AABB.3)b10 08/26/201				
Ethernet Address		fc:f5:28:4e:1c:6e				
Hardware Monitor						
Temperature Unit <input type="button" value="C"/>						
Temperature (C)	Current	MAX	MIN	Threshold	Status	
BOARD	41.0	44.0	40.0	75.0	Normal	
MAC	51.0	54.0	50.0	85.0	Normal	
PHY	38.0	41.0	36.0	85.0	Normal	
Voltage (V)	Current	MAX	MIN	Threshold	Status	
1.2VIN	1.204	1.204	1.204	+/-6%	Normal	
1.8VIN	1.843	1.843	1.843	+/-6%	Normal	
3.3VIN	3.257	3.274	3.257	+/-6%	Normal	
2.5VIN	2.486	2.513	2.486	+/-6%	Normal	

The following table describes the labels in this screen.

Table 11 Basic Setting > System Info

LABEL	DESCRIPTION
System Name	This field displays the descriptive name of the Switch for identification purposes.
Product Model	This field displays the model number of the Switch.
ZyNOS F/W Version	This field displays the version number of the Switch 's current firmware including the date created.
Ethernet Address	This field refers to the Ethernet MAC (Media Access Control) address of the Switch.
Hardware Monitor	
Temperature Unit	The Switch has temperature sensors that are capable of detecting and reporting if the temperature rises above the threshold. You may choose the temperature unit (Centigrade or Fahrenheit) in this field.

Table 11 Basic Setting > System Info (continued)

LABEL	DESCRIPTION
Temperature	BOARD , MAC and PHY refer to the location of the temperature sensors on the Switch printed circuit board.
Current	This shows the current temperature at this sensor.
MAX	This field displays the maximum temperature measured at this sensor.
MIN	This field displays the minimum temperature measured at this sensor.
Threshold	This field displays the upper temperature limit at this sensor.
Status	This field displays Normal for temperatures below the threshold and Error for those above.
Voltage(V)	The power supply for each voltage has a sensor that is capable of detecting and reporting if the voltage falls out of the tolerance range.
Current	This is the current voltage reading.
MAX	This field displays the maximum voltage measured at this point.
MIN	This field displays the minimum voltage measured at this point.
Threshold	This field displays the percentage tolerance of the voltage with which the Switch still works.
Status	Normal indicates that the voltage is within an acceptable operating range at this point; otherwise Error is displayed.

8.2 General Setup

Use this screen to configure general settings such as the system name and time. Click **Basic Setting** > **General Setup** in the navigation panel to display the screen as shown.

Figure 31 Basic Setting > General Setup

The screenshot shows the 'General Setup' configuration page. It includes the following fields and options:

- System Name:** MES3500
- Location:** (empty text field)
- Contact Person's Name:** (empty text field)
- Use Time Server when Bootup:** NTP(RFC-1305) (dropdown menu)
- Time Server Address:**
 - Server 1: 0.tw.pool.ntp.org
 - Server 2: 0.0.0.0
 - Server 3: 0.0.0.0
- Current Time:** 07 : 04 : 25 UTC
- New Time (hh:mm:ss):** 07 : 04 : 25
- Current Date:** 1970 - 01 - 02
- New Date (yyyy-mm-dd):** 1970 - 01 - 02
- Time Zone:** UTC (dropdown menu)
- Daylight Saving Time:**
- Start Date:** First of January at 0:00
- End Date:** First of January at 0:00

At the bottom of the page, there is a blue warning message: "It will take 60 seconds if time server is unreachable." and two buttons: "Apply" and "Cancel".

The following table describes the labels in this screen.

Table 12 Basic Setting > General Setup

LABEL	DESCRIPTION
System Name	Choose a descriptive name for identification purposes. This name consists of up to 64 printable characters; spaces are allowed.
Location	Enter the geographic location of your Switch. You can use up to 32 printable ASCII characters; spaces are allowed.
Contact Person's Name	Enter the name of the person in charge of this Switch. You can use up to 32 printable ASCII characters; spaces are allowed.
Use Time Server when Bootup	<p>Enter the time service protocol that your timeserver uses. Not all time servers support all protocols, so you may have to use trial and error to find a protocol that works. The main differences between them are the time format.</p> <p>When you select the Daytime (RFC 867) format, the Switch displays the day, month, year and time with no time zone adjustment. When you use this format it is recommended that you use a Daytime timeserver within your geographical time zone.</p> <p>Time (RFC-868) format displays a 4-byte integer giving the total number of seconds since 1970/1/1 at 0:0:0.</p> <p>NTP (RFC-1305) is similar to Time (RFC-868).</p> <p>None is the default value. Enter the time manually. Each time you turn on the Switch, the time and date will be reset to 1970-1-1 0:0.</p>
Time Server Address	<p>Enter the IP address or domain name of your timeserver. You can enter up to three time server addresses. The Switch tries to synchronize with the first server. If the synchronization fails, then the Switch goes through the rest of the list in order.</p> <p>The Switch attempts to connect to the timeserver for up to 60 seconds. If you specify a timeserver that is unreachable, then this screen will appear locked for 60 seconds. Please wait.</p>
Current Time	This field displays the time you open this menu (or refresh the menu).
New Time (hh: min: ss)	Enter the new time in hour, minute and second format. The new time then appears in the Current Time field after you click Apply .
Current Date	This field displays the date you open this menu.
New Date (yyyy-mm-dd)	Enter the new date in year, month and day format. The new date then appears in the Current Date field after you click Apply .
Time Zone	Select the time difference between UTC (Universal Time Coordinated, formerly known as GMT, Greenwich Mean Time) and your time zone from the drop-down list box.
Daylight Saving Time	<p>Daylight saving is a period from late spring to early fall when many countries set their clocks ahead of normal local time by one hour to give more daytime light in the evening.</p> <p>Select this option if you use Daylight Saving Time.</p>
Start Date	<p>Configure the day and time when Daylight Saving Time starts if you selected Daylight Saving Time. The time is displayed in the 24 hour format. Here are a couple of examples:</p> <p>Daylight Saving Time starts in most parts of the United States on the second Sunday of March. Each time zone in the United States starts using Daylight Saving Time at 2 A.M. local time. So in the United States you would select Second, Sunday, March and 2:00.</p> <p>Daylight Saving Time starts in the European Union on the last Sunday of March. All of the time zones in the European Union start using Daylight Saving Time at the same moment (1 A.M. GMT or UTC). So in the European Union you would select Last, Sunday, March and the last field depends on your time zone. In Germany for instance, you would select 2:00 because Germany's time zone is one hour ahead of GMT or UTC (GMT+1).</p>

Table 12 Basic Setting > General Setup (continued)

LABEL	DESCRIPTION
End Date	<p>Configure the day and time when Daylight Saving Time ends if you selected Daylight Saving Time. The time field uses the 24 hour format. Here are a couple of examples:</p> <p>Daylight Saving Time ends in the United States on the first Sunday of November. Each time zone in the United States stops using Daylight Saving Time at 2 A.M. local time. So in the United States you would select First, Sunday, November and 2:00.</p> <p>Daylight Saving Time ends in the European Union on the last Sunday of October. All of the time zones in the European Union stop using Daylight Saving Time at the same moment (1 A.M. GMT or UTC). So in the European Union you would select Last, Sunday, October and the last field depends on your time zone. In Germany for instance, you would select 2:00 because Germany's time zone is one hour ahead of GMT or UTC (GMT+1).</p>
Apply	Click Apply to save your changes to the Switch's run-time memory. The Switch loses these changes if it is turned off or loses power, so use the Save link on the top navigation panel to save your changes to the non-volatile memory when you are done configuring.
Cancel	Click Cancel to begin configuring this screen afresh.

8.3 Introduction to VLANs

A VLAN (Virtual Local Area Network) allows a physical network to be partitioned into multiple logical networks. Devices on a logical network belong to one group. A device can belong to more than one group. With VLAN, a device cannot directly talk to or hear from devices that are not in the same group(s); the traffic must first go through a router.

In MTU (Multi-Tenant Unit) applications, VLAN is vital in providing isolation and security among the subscribers. When properly configured, VLAN prevents one subscriber from accessing the network resources of another on the same LAN, thus a user will not see the printers and hard disks of another user in the same building.

VLAN also increases network performance by limiting broadcasts to a smaller and more manageable logical broadcast domain. In traditional switched environments, all broadcast packets go to each and every individual port. With VLAN, all broadcasts are confined to a specific broadcast domain.

Note: VLAN is unidirectional; it only governs outgoing traffic.

See [Chapter 9 on page 88](#) for information on port-based and 802.1Q tagged VLANs.

8.3.1 Smart Isolation

To block traffic between two specific ports within the Switch, you can use port isolation or private VLAN (see [Chapter 34 on page 264](#) for more information). However, it does not work across

multiple switches. For example, broadcast traffic from isolated ports on a switch (say **B**) can be forwarded to all ports on other switches (**A** and **C**), including the isolated ports.

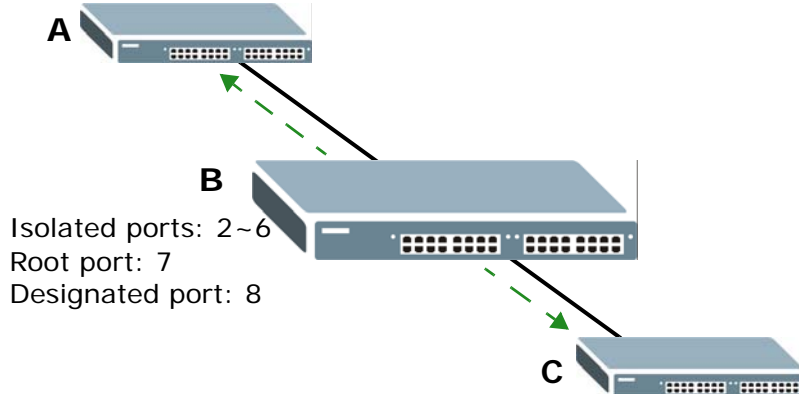

Smart isolation allows you to prevent isolated ports on different switches from transmitting traffic to each other. After you enable RSTP/MRSTP and smart isolation on the Switch, the designated port(s) will be added to the isolated port list. In the following example, switch **A** is the root bridge. Switch **B**'s root port **7** connects to switch **A** and switch **B**'s designated port **8** connects to switch **C**. Traffic from isolated ports on switch **B** can only be sent through non-isolated port **1** or root port **7** to switch **A**. This prevents isolated ports on switch **B** sending traffic through designated port **8** to switch **C**. Traffic received on designated port **8** from switch **C** will not be forwarded to any other isolated ports on switch **B**.

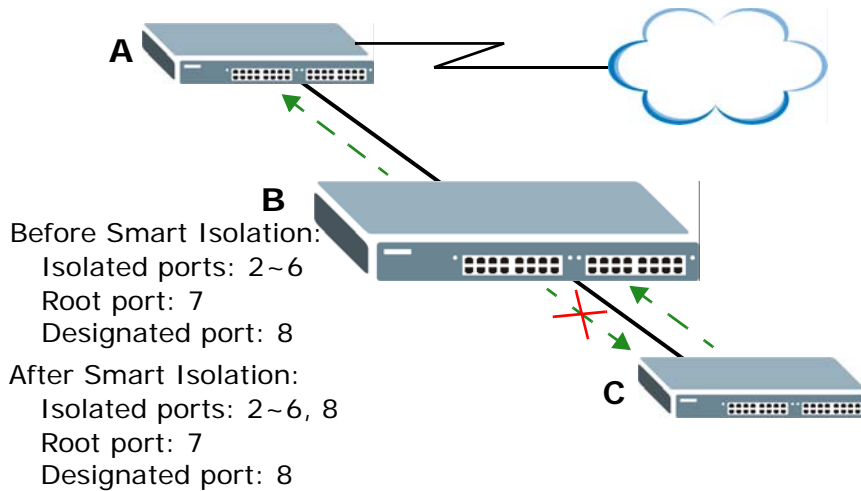

You should enable RSTP or MRSTP before you can use smart isolation on the Switch. If the network topology changes, the Switch automatically updates the isolated port list with the latest designated port information.

Note: The uplink port connected to the Internet should be the root port. Otherwise, with smart isolation enabled, the isolated ports cannot access the Internet.

8.4 Switch Setup

Click **Basic Setting** > **Switch Setup** in the navigation panel to display the screen as shown. The VLAN setup screens change depending on whether you choose **802.1Q** or **Port Based** in the **VLAN Type** field in this screen. Refer to the chapter on VLAN.

Figure 32 Basic Setting > Switch Setup

VLAN Type	
<input checked="" type="radio"/>	802.1Q
<input type="radio"/>	Port Based
Smart Isolation	
Active	<input type="checkbox"/>
MAC Address Learning	
Aging Time	300 seconds
Join Timer	200 milliseconds
GARP Timer	
Leave Timer	600 milliseconds
Leave All Timer	10000 milliseconds
Priority Queue Assignment	
Level7	7 ▼
Level6	6 ▼
Level5	5 ▼
Level4	4 ▼
Level3	3 ▼
Level2	1 ▼
Level1	0 ▼
Level0	2 ▼

The following table describes the labels in this screen.

Table 13 Basic Setting > Switch Setup

LABEL	DESCRIPTION
VLAN Type	Choose 802.1Q or Port Based . The VLAN Setup screen changes depending on whether you choose 802.1Q VLAN type or Port Based VLAN type in this screen. See Chapter 9 on page 88 for more information.
Smart Isolation	Select Active to enable smart isolation on the Switch. The designated port(s) then becomes the isolated port. Smart isolation allows you to prevent isolated ports on different switches from transmitting traffic to each other. Note: To use smart isolation, you should have configured 802.1Q VLAN port isolation or private VLAN and (M)RSTP on the Switch. Smart isolation does not work with MSTP and/or port-based VLAN.
MAC Address Learning	MAC address learning reduces outgoing traffic broadcasts. For MAC address learning to occur on a port, the port must be active.
Aging Time	Enter a time from 10 to 3000 seconds. This is how long all dynamically learned MAC addresses remain in the MAC address table before they age out (and must be relearned).
GARP Timer: Switches join VLANs by making a declaration. A declaration is made by issuing a Join message using GARP. Declarations are withdrawn by issuing a Leave message. A Leave All message terminates all registrations. GARP timers set declaration timeout values. See the chapter on VLAN setup for more background information.	
Join Timer	Join Timer sets the duration of the Join Period timer for GVRP in milliseconds. Each port has a Join Period timer. The allowed Join Time range is between 100 and 65535 milliseconds; the default is 200 milliseconds. See the chapter on VLAN setup for more background information.

Table 13 Basic Setting > Switch Setup (continued)

LABEL	DESCRIPTION
Leave Timer	Leave Time sets the duration of the Leave Period timer for GVRP in milliseconds. Each port has a single Leave Period timer. Leave Time must be two times larger than Join Timer ; the default is 600 milliseconds.
Leave All Timer	Leave All Timer sets the duration of the Leave All Period timer for GVRP in milliseconds. Each port has a single Leave All Period timer. Leave All Timer must be larger than Leave Timer.
Priority Queue Assignment	
IEEE 802.1p defines up to eight separate traffic types by inserting a tag into a MAC-layer frame that contains bits to define class of service. Frames without an explicit priority tag are given the default priority of the ingress port. Use the next fields to configure the priority level-to-physical queue mapping.	
The Switch has eight physical queues that you can map to the 8 priority levels. On the Switch, traffic assigned to higher index queues gets through faster while traffic in lower index queues is dropped if the network is congested.	
Priority Level (The following descriptions are based on the traffic types defined in the IEEE 802.1d standard (which incorporates the 802.1p).	
Level 7	Typically used for network control traffic such as router configuration messages.
Level 6	Typically used for voice traffic that is especially sensitive to jitter (jitter is the variations in delay).
Level 5	Typically used for video that consumes high bandwidth and is sensitive to jitter.
Level 4	Typically used for controlled load, latency-sensitive traffic such as SNA (Systems Network Architecture) transactions.
Level 3	Typically used for "excellent effort" or better than best effort and would include important business traffic that can tolerate some delay.
Level 2	This is for "spare bandwidth".
Level 1	This is typically used for non-critical "background" traffic such as bulk transfers that are allowed but that should not affect other applications and users.
Level 0	Typically used for best-effort traffic.
Apply	Click Apply to save your changes to the Switch's run-time memory. The Switch loses these changes if it is turned off or loses power, so use the Save link on the top navigation panel to save your changes to the non-volatile memory when you are done configuring.
Cancel	Click Cancel to reset the fields.

8.5 IP Setup

Use the **IP Setup** screen to configure the Switch IP address, default gateway device, the default domain name server and the management VLAN ID. The default gateway specifies the IP address of the default gateway (next hop) for outgoing traffic.

8.5.1 Management IP Addresses

The Switch needs an IP address for it to be managed over the network. The factory default in-band IP address is 192.168.1.1. The subnet mask specifies the network number portion of an IP address. The factory default subnet mask is 255.255.255.0.

You can configure up to 64 IP addresses which are used to access and manage the Switch from the ports belonging to the pre-defined VLAN(s).

Note: You must configure a VLAN first.

Figure 33 Basic Setting > IP Setup

The following table describes the labels in this screen.

Table 14 Basic Setting > IP Setup

LABEL	DESCRIPTION
Domain Name Server	DNS (Domain Name System) is for mapping a domain name to its corresponding IP address and vice versa. Enter a domain name server IP address in order to be able to use a domain name instead of an IP address.
Default Management IP Address	
DHCP Client	Select this option if you have a DHCP server that can assign the Switch an IP address, subnet mask, a default gateway IP address and a domain name server IP address automatically.
Static IP Address	Select this option if you don't have a DHCP server or if you wish to assign static IP address information to the Switch. You need to fill in the following fields when you select this option.
IP Address	Enter the IP address of your Switch in dotted decimal notation for example 192.168.1.1.
IP Subnet Mask	Enter the IP subnet mask of your Switch in dotted decimal notation for example 255.255.255.0.

Table 14 Basic Setting > IP Setup (continued)

LABEL	DESCRIPTION
Default Gateway	Enter the IP address of the default outgoing gateway in dotted decimal notation, for example 192.168.1.254.
VID	Enter the VLAN identification number associated with the Switch IP address. This is the VLAN ID of the CPU and is used for management only. The default is "1". All ports, by default, are fixed members of this "management VLAN" in order to manage the device from any port. If a port is not a member of this VLAN, then users on that port cannot access the device. To access the Switch make sure the port that you are connected to is a member of Management VLAN.
Apply	Click Apply to save your changes to the Switch's run-time memory. The Switch loses these changes if it is turned off or loses power, so use the Save link on the top navigation panel to save your changes to the non-volatile memory when you are done configuring.
Cancel	Click Cancel to begin configuring the fields again.
Management IP Addresses	
You can create up to 64 IP addresses, which are used to access and manage the Switch from the ports belonging to the pre-defined VLAN(s). You must configure a VLAN first.	
IP Address	Enter the IP address for managing the Switch by the members of the VLAN specified in the VID field below.
IP Subnet Mask	Enter the IP subnet mask in dotted decimal notation.
VID	Type the VLAN group identification number.
Default Gateway	Enter the IP address of the default outgoing gateway in dotted decimal notation.
Add	Click Add to insert the entry to the summary table below and save your changes to the Switch's run-time memory. The Switch loses these changes if it is turned off or loses power, so use the Save link on the top navigation panel to save your changes to the non-volatile memory when you are done configuring.
Cancel	Click Cancel to reset the fields to your previous configuration.
Index	This field displays the index number of the rule. Click an index number to edit the rule.
IP Address	This field displays the IP address.
IP Subnet Mask	This field displays the subnet mask.
VID	This field displays the ID number of the VLAN group.
Default Gateway	This field displays the IP address of the default gateway.
Delete	Check the management IP addresses that you want to remove in the Delete column, then click the Delete button.
Cancel	Click Cancel to clear the selected check boxes in the Delete column.

8.6 Port Setup

Use this screen to configure Switch port settings. Click **Basic Setting** > **Port Setup** in the navigation panel to display the configuration screen.

Figure 34 Basic Setting > Port Setup

Port	Active	Name	Type	Speed / Duplex	Flow Control	802.1p Priority
*	<input type="checkbox"/>		-	Auto	<input type="checkbox"/>	0
1	<input checked="" type="checkbox"/>		10/100M	Auto	<input type="checkbox"/>	0
2	<input checked="" type="checkbox"/>		10/100M	Auto	<input type="checkbox"/>	0
3	<input checked="" type="checkbox"/>		10/100M	Auto	<input type="checkbox"/>	0
4	<input checked="" type="checkbox"/>		10/100M	Auto	<input type="checkbox"/>	0
27	<input checked="" type="checkbox"/>		10/100/1000M	Auto	<input type="checkbox"/>	0
28	<input checked="" type="checkbox"/>		10/100/1000M	Auto	<input type="checkbox"/>	0

Apply Cancel

The following table describes the labels in this screen.

Table 15 Basic Setting > Port Setup

LABEL	DESCRIPTION
Port	This is the port index number.
*	Settings in this row apply to all ports. Use this row only if you want to make some settings the same for all ports. Use this row first to set the common settings and then make adjustments on a port-by-port basis. Note: Changes in this row are copied to all the ports as soon as you make them.
Active	Select this check box to enable a port. The factory default for all ports is enabled. A port must be enabled for data transmission to occur.
Name	Enter a descriptive name that identifies this port. You can enter up to 64 alpha-numerical characters. Note: Due to space limitation, the port name may be truncated in some web configurator screens.
Type	This field displays 10/100M for Fast Ethernet connections and 10/100/1000M for Gigabit connections.
Speed/Duplex	Select the speed and the duplex mode of the Ethernet connection on this port. Choices are Auto , 10M/Half Duplex , 10M/Full Duplex , 100M/Half Duplex , 100M/Full Duplex and 1000M/Full Duplex (Gigabit connections only). Selecting Auto (auto-negotiation) allows one port to negotiate with a peer port automatically to obtain the connection speed and duplex mode that both ends support. When auto-negotiation is turned on, a port on the Switch negotiates with the peer automatically to determine the connection speed and duplex mode. If the peer port does not support auto-negotiation or turns off this feature, the Switch determines the connection speed by detecting the signal on the cable and using half duplex mode. When the Switch's auto-negotiation is turned off, a port uses the pre-configured speed and duplex mode when making a connection, thus requiring you to make sure that the settings of the peer port are the same in order to connect.

Table 15 Basic Setting > Port Setup (continued)

LABEL	DESCRIPTION
Flow Control	<p>A concentration of traffic on a port decreases port bandwidth and overflows buffer memory causing packet discards and frame losses. Flow Control is used to regulate transmission of signals to match the bandwidth of the receiving port.</p> <p>The Switch uses IEEE802.3x flow control in full duplex mode and backpressure flow control in half duplex mode.</p> <p>IEEE802.3x flow control is used in full duplex mode to send a pause signal to the sending port, causing it to temporarily stop sending signals when the receiving port memory buffers fill.</p> <p>Back Pressure flow control is typically used in half duplex mode to send a "collision" signal to the sending port (mimicking a state of packet collision) causing the sending port to temporarily stop sending signals and resend later. Select Flow Control to enable it.</p>
802.1p Priority	This priority value is added to incoming frames without a (802.1p) priority queue tag. See Priority Queue Assignment in Table 13 on page 82 for more information.
Apply	Click Apply to save your changes to the Switch's run-time memory. The Switch loses these changes if it is turned off or loses power, so use the Save link on the top navigation panel to save your changes to the non-volatile memory when you are done configuring.
Cancel	Click Cancel to begin configuring this screen afresh.

The type of screen you see here depends on the **VLAN Type** you selected in the **Switch Setup** screen. This chapter shows you how to configure 802.1Q tagged and port-based VLANs.

9.1 Introduction to IEEE 802.1Q Tagged VLANs

A tagged VLAN uses an explicit tag (VLAN ID) in the MAC header to identify the VLAN membership of a frame across bridges - they are not confined to the switch on which they were created. The VLANs can be created statically by hand or dynamically through GVRP. The VLAN ID associates a frame with a specific VLAN and provides the information that switches need to process the frame across the network. A tagged frame is four bytes longer than an untagged frame and contains two bytes for the TPID (Tag Protocol Identifier, residing within the type/length field of the Ethernet frame) and two bytes for the TCI (Tag Control Information, starting after the source address field of the Ethernet frame).

The CFI (Canonical Format Indicator) is a single-bit flag, always set to zero for Ethernet switches. If a frame received at an Ethernet port has a CFI set to 1, then that frame should not be forwarded as it is to an untagged port. The remaining twelve bits define the VLAN ID, giving a possible maximum number of 4,096 VLANs. Note that user priority and VLAN ID are independent of each other. A frame with VID (VLAN Identifier) of null (0) is called a priority frame, meaning that only the priority level is significant and the default VID of the ingress port is given as the VID of the frame. Of the 4096 possible VIDs, a VID of 0 is used to identify priority frames and the value 4095 (FFF) is reserved, so the maximum possible number of VLAN configurations is 4,094.

TPID	User Priority	CFI	VLAN ID
2 Bytes	3 Bits	1 Bit	12 bits

9.1.1 Forwarding Tagged and Untagged Frames

Each port on the Switch is capable of passing tagged or untagged frames. To forward a frame from an 802.1Q VLAN-aware switch to an 802.1Q VLAN-unaware switch, the Switch first decides where to forward the frame and then strips off the VLAN tag. To forward a frame from an 802.1Q VLAN-unaware switch to an 802.1Q VLAN-aware switch, the Switch first decides where to forward the frame, and then inserts a VLAN tag reflecting the ingress port's default VID. The default PVID is VLAN 1 for all ports, but this can be changed.

A broadcast frame (or a multicast frame for a multicast group that is known by the system) is duplicated only on ports that are members of the VID (except the ingress port itself), thus confining the broadcast to a specific domain.

9.2 Automatic VLAN Registration

GARP and GVRP are the protocols used to automatically register VLAN membership across switches.

9.2.1 GARP

GARP (Generic Attribute Registration Protocol) allows network switches to register and de-register attribute values with other GARP participants within a bridged LAN. GARP is a protocol that provides a generic mechanism for protocols that serve a more specific application, for example, GVRP.

9.2.1.1 GARP Timers

Switches join VLANs by making a declaration. A declaration is made by issuing a Join message using GARP. Declarations are withdrawn by issuing a Leave message. A Leave All message terminates all registrations. GARP timers set declaration timeout values.

9.2.2 GVRP

GVRP (GARP VLAN Registration Protocol) is a registration protocol that defines a way for switches to register necessary VLAN members on ports across the network. Enable this function to permit VLAN groups beyond the local Switch.

Please refer to the following table for common IEEE 802.1Q VLAN terminology.

Table 16 IEEE 802.1Q VLAN Terminology

VLAN PARAMETER	TERM	DESCRIPTION
VLAN Type	Permanent VLAN	This is a static VLAN created manually.
	Dynamic VLAN	This is a VLAN configured by a GVRP registration/deregistration process.
VLAN Administrative Control	Registration Fixed	Fixed registration ports are permanent VLAN members.
	Registration Forbidden	Ports with registration forbidden are forbidden to join the specified VLAN.
	Normal Registration	Ports dynamically join a VLAN using GVRP.
VLAN Tag Control	Tagged	Ports belonging to the specified VLAN tag all outgoing frames transmitted.
	Untagged	Ports belonging to the specified VLAN don't tag all outgoing frames transmitted.
VLAN Port	Port VID	This is the VLAN ID assigned to untagged frames that this port received.
	Acceptable Frame Type	You may choose to accept both tagged and untagged incoming frames, just tagged incoming frames or just untagged incoming frames on a port.
	Ingress filtering	If set, the Switch discards incoming frames for VLANs that do not have this port as a member.

9.3 Port VLAN Trunking

Enable **VLAN Trunking** on a port to allow frames belonging to unknown VLAN groups to pass through that port. This is useful if you want to set up VLAN groups on end devices without having to configure the same VLAN groups on intermediary devices.

The following figure describes **VLAN Trunking**. Suppose you want to create VLAN groups 1 and 2 (V1 and V2) on devices A and B. Without **VLAN Trunking**, you must configure VLAN groups 1 and 2 on all intermediary switches C, D and E; otherwise they will drop frames with unknown VLAN group tags. However, with **VLAN Trunking** enabled on a port(s) in each intermediary switch you only need to create VLAN groups in the end devices (A and B). C, D and E automatically allow frames with VLAN group tags 1 and 2 (VLAN groups that are unknown to those switches) to pass through their VLAN trunking port(s).

Figure 35 Port VLAN Trunking

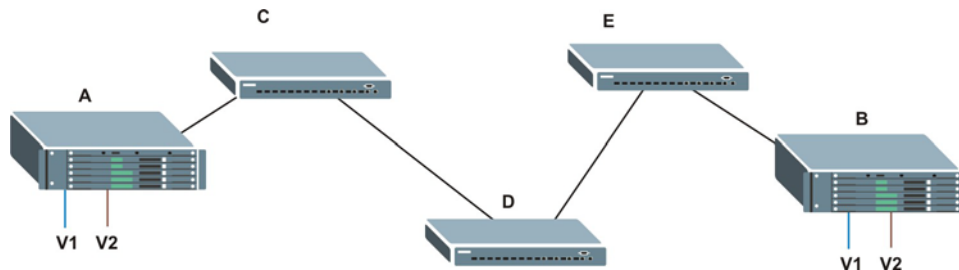

9.4 Select the VLAN Type

Select a VLAN type in the **Basic Setting > Switch Setup** screen.

Figure 36 Switch Setup: Select VLAN Type

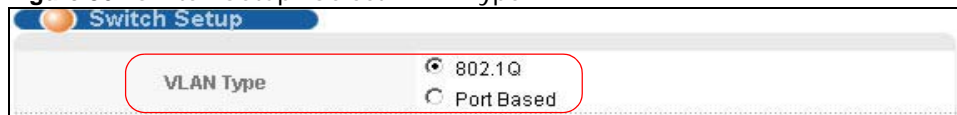

9.5 Static VLAN

Use a static VLAN to decide whether an incoming frame on a port should be

- sent to a VLAN group as normal depending on its VLAN tag.
- sent to a group whether it has a VLAN tag or not.
- blocked from a VLAN group regardless of its VLAN tag.

You can also tag all outgoing frames (that were previously untagged) from a port with the specified VID.

9.5.1 VLAN Status

See [Section 9.1 on page 88](#) for more information on Static VLAN. Click **Advanced Application > VLAN** from the navigation panel to display the **VLAN Status** screen as shown next.

Figure 37 Advanced Application > VLAN: VLAN Status

Index	VID	Elapsed Time	Status
1	1	8:27:49	Static

The following table describes the labels in this screen.

Table 17 Advanced Application > VLAN: VLAN Status

LABEL	DESCRIPTION
VLAN Search by VID	Enter an existing VLAN ID number(s) (separated by a comma) and click Search to display only the specified VLAN(s) in the list below. Leave this field blank and click Search to display all VLANs configured on the Switch.
The Number of VLAN	This is the number of VLANs configured on the Switch.
The Number of Search Results	This is the number of VLANs that match the searching criteria and display in the list below. This field displays only when you use the Search button to look for certain VLANs.
Index	This is the VLAN index number. Click on an index number to view more VLAN details.
VID	This is the VLAN identification number that was configured in the Static VLAN screen.
Elapsed Time	This field shows how long it has been since a normal VLAN was registered or a static VLAN was set up.
Status	This field shows how this VLAN was added to the Switch. <ul style="list-style-type: none"> • Dynamic - using GVRP • Static - manually added as a normal VLAN • RMirror - manually added as a remote port mirroring VLAN • MVR - added via Multicast VLAN Registration (MVR)
Change Pages	Click Previous or Next to show the previous/next screen if all status information cannot be seen in one screen.

9.5.2 VLAN Details

Use this screen to view detailed port settings and status of the VLAN group. See [Section 9.1 on page 88](#) for more information on static VLAN. Click on an index number in the **VLAN Status** screen to display VLAN details.

Figure 38 Advanced Application > VLAN > VLAN Detail

VLAN Detail														VLAN Status		
VID	Port Number														Elapsed Time	Status
	2	4	6	8	10	12	14	16	18	20	22	24	26	28		
1	U	U	U	U	U	U	U	U	U	U	U	U	U	U	3:22:07	Static
	U	U	U	U	U	U	U	U	U	U	U	U	U	U		

The following table describes the labels in this screen.

Table 18 Advanced Application > VLAN > VLAN Detail

LABEL	DESCRIPTION
VLAN Status	Click this to go to the VLAN Status screen.
VID	This is the VLAN identification number that was configured in the Static VLAN screen.
Port Number	This column displays the ports that are participating in a VLAN. A tagged port is marked as T , an untagged port is marked as U and ports not participating in a VLAN are marked as “—”.
Elapsed Time	This field shows how long it has been since a normal VLAN was registered or a static VLAN was set up.
Status	This field shows how this VLAN was added to the Switch. <ul style="list-style-type: none"> • Dynamic - using GVRP • Static - manually added as a normal VLAN • RMirror - manually added as a remote port mirroring VLAN • MVR - added via Multicast VLAN Registration (MVR)

9.5.3 Configure a Static VLAN

Use this screen to configure and view 802.1Q VLAN parameters for the Switch. See [Section 9.1 on page 88](#) for more information on static VLAN. To configure a static VLAN, click **Static VLAN** in the **VLAN Status** screen to display the screen as shown next.

Figure 39 Advanced Application > VLAN > Static VLAN

Static VLAN VLAN Status

ACTIVE

Name

VLAN Group ID

Port	Control			Tagging
*	Normal			<input checked="" type="checkbox"/> Tx Tagging
1	<input checked="" type="radio"/> Normal	<input type="radio"/> Fixed	<input type="radio"/> Forbidden	<input checked="" type="checkbox"/> Tx Tagging
2	<input checked="" type="radio"/> Normal	<input type="radio"/> Fixed	<input type="radio"/> Forbidden	<input checked="" type="checkbox"/> Tx Tagging
3	<input checked="" type="radio"/> Normal	<input type="radio"/> Fixed	<input type="radio"/> Forbidden	<input checked="" type="checkbox"/> Tx Tagging
4	<input checked="" type="radio"/> Normal	<input type="radio"/> Fixed	<input type="radio"/> Forbidden	<input checked="" type="checkbox"/> Tx Tagging
5	<input checked="" type="radio"/> Normal	<input type="radio"/> Fixed	<input type="radio"/> Forbidden	<input checked="" type="checkbox"/> Tx Tagging
6	<input checked="" type="radio"/> Normal	<input type="radio"/> Fixed	<input type="radio"/> Forbidden	<input checked="" type="checkbox"/> Tx Tagging
7	<input checked="" type="radio"/> Normal	<input type="radio"/> Fixed	<input type="radio"/> Forbidden	<input checked="" type="checkbox"/> Tx Tagging
8	<input checked="" type="radio"/> Normal	<input type="radio"/> Fixed	<input type="radio"/> Forbidden	<input checked="" type="checkbox"/> Tx Tagging
9	<input checked="" type="radio"/> Normal	<input type="radio"/> Fixed	<input type="radio"/> Forbidden	<input checked="" type="checkbox"/> Tx Tagging
10	<input checked="" type="radio"/> Normal	<input type="radio"/> Fixed	<input type="radio"/> Forbidden	<input checked="" type="checkbox"/> Tx Tagging
11	<input checked="" type="radio"/> Normal	<input type="radio"/> Fixed	<input type="radio"/> Forbidden	<input checked="" type="checkbox"/> Tx Tagging
12	<input checked="" type="radio"/> Normal	<input type="radio"/> Fixed	<input type="radio"/> Forbidden	<input checked="" type="checkbox"/> Tx Tagging
13	<input checked="" type="radio"/> Normal	<input type="radio"/> Fixed	<input type="radio"/> Forbidden	<input checked="" type="checkbox"/> Tx Tagging
14	<input checked="" type="radio"/> Normal	<input type="radio"/> Fixed	<input type="radio"/> Forbidden	<input checked="" type="checkbox"/> Tx Tagging

Add Cancel Clear

Rule Usage: 1 / 4094

VID	Active	Name	Delete
1	Yes	1	<input type="checkbox"/>

Delete Cancel

The following table describes the related labels in this screen.

Table 19 Advanced Application > VLAN > Static VLAN

LABEL	DESCRIPTION
ACTIVE	Select this check box to activate the VLAN settings.
Name	Enter a descriptive name for the VLAN group for identification purposes. This name consists of up to 64 printable characters; spaces are allowed.
VLAN Group ID	Enter the VLAN ID for this static entry; the valid range is between 1 and 4094.
Port	The port number identifies the port you are configuring.
*	Settings in this row apply to all ports. Use this row only if you want to make some settings the same for all ports. Use this row first to set the common settings and then make adjustments on a port-by-port basis. Note: Changes in this row are copied to all the ports as soon as you make them.

Table 19 Advanced Application > VLAN > Static VLAN (continued)

LABEL	DESCRIPTION
Control	Select Normal for the port to dynamically join this VLAN group using GVRP. This is the default selection. Select Fixed for the port to be a permanent member of this VLAN group. Select Forbidden if you want to prohibit the port from joining this VLAN group.
Tagging	Select TX Tagging if you want the port to tag all outgoing frames transmitted with this VLAN Group ID.
Add	Click Add to save your changes to the Switch's run-time memory. The Switch loses these changes if it is turned off or loses power, so use the Save link on the top navigation panel to save your changes to the non-volatile memory when you are done configuring.
Cancel	Click Cancel to begin configuring this screen afresh.
Clear	Click Clear to start configuring the screen again.
VID	This field displays the ID number of the VLAN group. Click the number to edit the VLAN settings.
Active	This field indicates whether the VLAN settings are enabled (Yes) or disabled (No).
Name	This field displays the descriptive name for this VLAN group.
Delete	Click Delete to remove the selected entry from the summary table.
Cancel	Click Cancel to clear the Delete check boxes.

9.5.4 Configure VLAN Port Settings

Use the VLAN Port Setting screen to configure the static VLAN (IEEE 802.1Q) settings on a port. See [Section 9.1 on page 88](#) for more information on static VLAN. Click the **VLAN Port Setting** link in the **VLAN Status** screen.

Figure 40 Advanced Application > VLAN > VLAN Port Setting

Port	Ingress Check	PVID	GVRP	Acceptable Frame Type	VLAN Trunking	Isolation
*	<input type="checkbox"/>		<input type="checkbox"/>	All	<input type="checkbox"/>	<input type="checkbox"/>
1	<input type="checkbox"/>	1	<input type="checkbox"/>	All	<input type="checkbox"/>	<input type="checkbox"/>
2	<input type="checkbox"/>	1	<input type="checkbox"/>	All	<input type="checkbox"/>	<input type="checkbox"/>
3	<input type="checkbox"/>	1	<input type="checkbox"/>	All	<input type="checkbox"/>	<input type="checkbox"/>
4	<input type="checkbox"/>	1	<input type="checkbox"/>	All	<input type="checkbox"/>	<input type="checkbox"/>
5	<input type="checkbox"/>	1	<input type="checkbox"/>	All	<input type="checkbox"/>	<input type="checkbox"/>
6	<input type="checkbox"/>	1	<input type="checkbox"/>	All	<input type="checkbox"/>	<input type="checkbox"/>
7	<input type="checkbox"/>	1	<input type="checkbox"/>	All	<input type="checkbox"/>	<input type="checkbox"/>
8	<input type="checkbox"/>	1	<input type="checkbox"/>	All	<input type="checkbox"/>	<input type="checkbox"/>
9	<input type="checkbox"/>	1	<input type="checkbox"/>	All	<input type="checkbox"/>	<input type="checkbox"/>
10	<input type="checkbox"/>	1	<input type="checkbox"/>	All	<input type="checkbox"/>	<input type="checkbox"/>
11	<input type="checkbox"/>	1	<input type="checkbox"/>	All	<input type="checkbox"/>	<input type="checkbox"/>
12	<input type="checkbox"/>	1	<input type="checkbox"/>	All	<input type="checkbox"/>	<input type="checkbox"/>
13	<input type="checkbox"/>	1	<input type="checkbox"/>	All	<input type="checkbox"/>	<input type="checkbox"/>

The following table describes the labels in this screen.

Table 20 Advanced Application > VLAN > VLAN Port Setting

LABEL	DESCRIPTION
GVRP	GVRP (GARP VLAN Registration Protocol) is a registration protocol that defines a way for switches to register necessary VLAN members on ports across the network. Select this check box to permit VLAN groups beyond the local Switch.
Port	This field displays the port number.
*	Settings in this row apply to all ports. Use this row only if you want to make some settings the same for all ports. Use this row first to set the common settings and then make adjustments on a port-by-port basis. Note: Changes in this row are copied to all the ports as soon as you make them.
Ingress Check	If this check box is selected for a port, the Switch discards incoming frames for VLANs that do not include this port in its member set. Clear this check box to disable ingress filtering.
PVID	A PVID (Port VLAN ID) is a tag that adds to incoming untagged frames received on a port so that the frames are forwarded to the VLAN group that the tag defines. Enter a number between 1 and 4094 as the port VLAN ID.
GVRP	Select this check box to allow GVRP on this port.
Acceptable Frame Type	Specify the type of frames allowed on a port. Choices are All , Tag Only and Untag Only . Select All from the drop-down list box to accept all untagged or tagged frames on this port. This is the default setting. Select Tag Only to accept only tagged frames on this port. All untagged frames will be dropped. Select Untag Only to accept only untagged frames on this port. All tagged frames will be dropped.
VLAN Trunking	Enable VLAN Trunking on ports connected to other switches or routers (but not ports directly connected to end users) to allow frames belonging to unknown VLAN groups to pass through the Switch.
Isolation	Select this to allow this port to communicate only with the CPU management port and the ports on which the isolation feature is not enabled.
Apply	Click Apply to save your changes to the Switch's run-time memory. The Switch loses these changes if it is turned off or loses power, so use the Save link on the top navigation panel to save your changes to the non-volatile memory when you are done configuring.
Cancel	Click Cancel to begin configuring this screen afresh.

9.6 Subnet Based VLANs

Subnet based VLANs allow you to group traffic into logical VLANs based on the source IP subnet you specify. When a frame is received on a port, the Switch checks if a tag is added already and the IP subnet it came from. The untagged packets from the same IP subnet are then placed in the same subnet based VLAN. One advantage of using subnet based VLANs is that priority can be assigned to traffic from the same IP subnet.

For example, an ISP (Internet Service Provider) may divide different types of services it provides to customers into different IP subnets. Traffic for voice services is designated for IP subnet

172.16.1.0/24, video for 192.168.1.0/24 and data for 10.1.1.0/24. The Switch can then be configured to group incoming traffic based on the source IP subnet of incoming frames.

You can then configure a subnet based VLAN with priority 6 and VID of 100 for traffic received from IP subnet 172.16.1.0/24 (voice services). You can also have a subnet based VLAN with priority 5 and VID of 200 for traffic received from IP subnet 192.168.1.0/24 (video services). Lastly, you can configure VLAN with priority 3 and VID of 300 for traffic received from IP subnet 10.1.1.0/24 (data services). All untagged incoming frames will be classified based on their source IP subnet and prioritized accordingly. That is, video services receive the highest priority and data the lowest.

Figure 41 Subnet Based VLAN Application Example

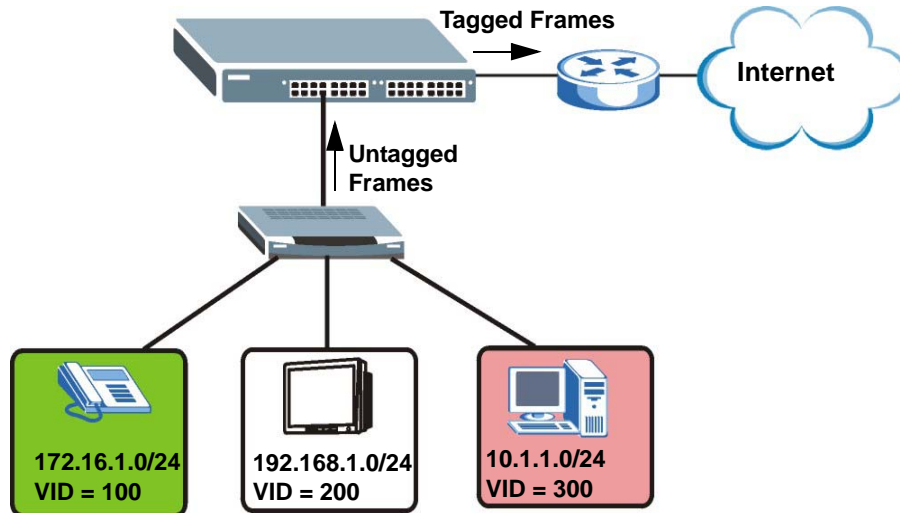

9.6.1 Configuring Subnet Based VLAN

Click **Subnet Based VLAN** in the **VLAN Port Setting** screen to display the configuration screen as shown.

Note: Subnet based VLAN applies to un-tagged packets and is applicable only when you use IEEE 802.1Q tagged VLAN.

Figure 42 Advanced Application > VLAN > VLAN Port Setting > Subnet Based VLAN

The screenshot shows the configuration interface for Subnet Based VLAN. It includes a top navigation bar with 'Subnet Based VLAN' and 'VLAN Port Setting'. Below this, there are two main configuration panels. The first panel has 'Active' and 'DHCP-Vlan Override' checkboxes and an 'Apply' button. The second panel has a form with fields for 'Active' (checkbox), 'Name', 'IP', 'Mask-Bits', 'VID', and 'Priority', followed by 'Add' and 'Cancel' buttons. At the bottom, there is a table with columns: Index, Active, Name, IP, Mask-Bits, VID, Priority, Delete, and 'Delete' and 'Cancel' buttons below it.

The following table describes the labels in this screen.

Table 21 Advanced Application > VLAN > VLAN Port Setting > Subnet Based VLAN

LABEL	DESCRIPTION
Active	Check this box to activate this subnet based VLANs on the Switch.
DHCP-Vlan Override	When DHCP snooping is enabled DHCP clients can renew their IP address through the DHCP VLAN or via another DHCP server on the subnet based VLAN. Select this checkbox to force the DHCP clients in this IP subnet to obtain their IP addresses through the DHCP VLAN.
Apply	Click Apply to save your changes to the Switch's run-time memory. The Switch loses these changes if it is turned off or loses power, so use the Save link on the top navigation panel to save your changes to the non-volatile memory when you are done configuring.
Active	Check this box to activate the IP subnet VLAN you are creating or editing.
Name	Enter up to 32 alphanumeric characters to identify this subnet based VLAN.
IP	Enter the IP address of the subnet for which you want to configure this subnet based VLAN.
Mask-Bits	Enter the bit number of the subnet mask. To find the bit number, convert the subnet mask to binary format and add all the 1's together. Take "255.255.255.0" for example. 255 converts to eight 1s in binary. There are three 255s, so add three eights together and you get the bit number (24).
VID	Enter the ID of a VLAN with which the untagged frames from the IP subnet specified in this subnet based VLAN are tagged. This must be an existing VLAN which you defined in the Advanced Applications > VLAN screens.
Priority	Select the priority level that the Switch assigns to frames belonging to this VLAN.
Add	Click Add to save your changes to the Switch's run-time memory. The Switch loses these changes if it is turned off or loses power, so use the Save link on the top navigation panel to save your changes to the non-volatile memory when you are done configuring.
Cancel	Click Cancel to begin configuring this screen afresh.

Table 21 Advanced Application > VLAN > VLAN Port Setting > Subnet Based VLAN (continued)

LABEL	DESCRIPTION
Index	This is the index number identifying this subnet based VLAN. Click on any of these numbers to edit an existing subnet based VLAN.
Active	This field shows whether the subnet based VLAN is active or not.
Name	This field shows the name the subnet based VLAN.
IP	This field shows the IP address of the subnet for this subnet based VLAN.
Mask-Bits	This field shows the subnet mask in bit number format for this subnet based VLAN.
VID	This field shows the VLAN ID of the frames which belong to this subnet based VLAN.
Priority	This field shows the priority which is assigned to frames belonging to this subnet based VLAN.
Delete	Click this to delete the subnet based VLANs which you marked for deletion.
Cancel	Click Cancel to begin configuring this screen afresh.

9.7 Protocol Based VLANs

Protocol based VLANs allow you to group traffic into logical VLANs based on the protocol you specify. When an upstream frame is received on a port (configured for a protocol based VLAN), the Switch checks if a tag is added already and its protocol. The untagged packets of the same protocol are then placed in the same protocol based VLAN. One advantage of using protocol based VLANs is that priority can be assigned to traffic of the same protocol.

Note: Protocol based VLAN applies to un-tagged packets and is applicable only when you use IEEE 802.1Q tagged VLAN.

For example, ports 1, 2, 3 and 4 belong to static VLAN 100, and ports 4, 5, 6, 7 belong to static VLAN 120. You can configure a protocol based VLAN A with priority 3 for ARP traffic received on port 1, 2 and 3. You can also have a protocol based VLAN B with priority 2 for Apple Talk traffic received on port 6 and 7. All upstream ARP traffic from port 1, 2 and 3 will be grouped together, and all upstream Apple Talk traffic from port 6 and 7 will be in another group and have higher priority than ARP traffic when they go through the uplink port to a backbone switch C.

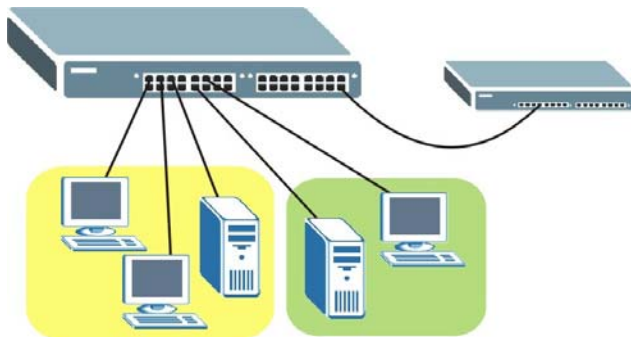
Figure 43 Protocol Based VLAN Application Example

9.7.1 Configuring Protocol Based VLAN

Click **Protocol Based VLAN** in the **VLAN Port Setting** screen to display the configuration screen as shown.

Figure 44 Advanced Application > VLAN > VLAN Port Setting > Protocol Based VLAN

The following table describes the labels in this screen.

Table 22 Advanced Application > VLAN > VLAN Port Setting > Protocol Based VLAN

LABEL	DESCRIPTION
Active	Check this box to activate this protocol based VLAN.
Port	Type a port number to be included in this protocol based VLAN. This port must belong to a static VLAN in order to participate in a protocol based VLAN. See Chapter 9 on page 88 for more details on setting up VLANs.
Name	Enter up to 32 alphanumeric characters to identify this protocol based VLAN.
Ethernet-type	Use the drop down list box to select a predefined protocol to be included in this protocol based VLAN or select Others and type the protocol number in hexadecimal notation. For example, the IP protocol in hexadecimal notation is 0800, and Novell IPX protocol is 8137. Note: Protocols in the hexadecimal number range of 0x0000 to 0x05ff are not allowed to be used for protocol based VLANs.
VID	Enter the ID of a VLAN to which the port belongs. This must be an existing VLAN which you defined in the Advanced Applications > VLAN screens.
Priority	Select the priority level that the Switch will assign to frames belonging to this VLAN.
Add	Click Add to save your changes to the Switch's run-time memory. The Switch loses these changes if it is turned off or loses power, so use the Save link on the top navigation panel to save your changes to the non-volatile memory when you are done configuring.
Cancel	Click Cancel to begin configuring this screen afresh.
Index	This is the index number identifying this protocol based VLAN. Click on any of these numbers to edit an existing protocol based VLAN.
Active	This field shows whether the protocol based VLAN is active or not.
Port	This field shows which port belongs to this protocol based VLAN.

Table 22 Advanced Application > VLAN > VLAN Port Setting > Protocol Based VLAN (continued)

LABEL	DESCRIPTION
Name	This field shows the name the protocol based VLAN.
Ethernet-type	This field shows which Ethernet protocol is part of this protocol based VLAN.
VID	This field shows the VLAN ID of the port.
Priority	This field shows the priority which is assigned to frames belonging to this protocol based VLAN.
Delete	Click this to delete the protocol based VLANs which you marked for deletion.
Cancel	Click Cancel to begin configuring this screen afresh.

9.7.2 Create an IP-based VLAN Example

This example shows you how to create an IP VLAN which includes ports 1, 4 and 8. Follow these steps using the screen below:

- 1 Activate this protocol based VLAN.
- 2 Type the port number you want to include in this protocol based VLAN. Type **1**.
- 3 Give this protocol-based VLAN a descriptive name. Type **IP-VLAN**.
- 4 Select the protocol. Leave the default value **IP**.
- 5 Type the VLAN ID of an existing VLAN. In our example we already created a static VLAN with an ID of 5. Type **5**.
- 6 Leave the priority set to **0** and click **Add**.

Figure 45 Protocol Based VLAN Configuration Example

The screenshot shows the 'Protocol Based VLAN' configuration interface. The 'Active' checkbox is checked. The 'Port' field is set to 1, 'Name' is IP-VLAN, 'Ethernet-type' is IP, 'VID' is 5, and 'Priority' is 0. There are 'Add' and 'Cancel' buttons below the form. Below the form is a table with columns: Index, Active, Port, Name, Ethernet-type, VID, Priority, Delete. The table is currently empty. Below the table are 'Delete' and 'Cancel' buttons. A red 'EXAMPLE' stamp is in the bottom right corner.

To add more ports to this protocol based VLAN.

- 1 Click the index number of the protocol based VLAN entry. Click **1**
- 2 Change the value in the **Port** field to the next port you want to add.

- 3 Click **Add**.

9.8 MAC Based VLAN

The MAC-based VLAN feature assigns incoming untagged packets to a VLAN and classifies the traffic based on the source MAC address of the packet. When untagged packets arrive at the switch, the source MAC address of the packet is looked up in a MAC to VLAN mapping table. If an entry is found, the corresponding VLAN ID is assigned to the packet. The assigned VLAN ID is verified against the VLAN table. If the VLAN is valid, ingress processing on the packet continues; otherwise, the packet is dropped.

This feature allows users to change ports without having to reconfigure the VLAN. You can assign priority to the MAC-based VLAN and define a MAC to VLAN mapping table by entering a specified source MAC address in the MAC-based VLAN setup screen. You can also delete a MAC-based VLAN entry in the same screen.

Click **MAC Based VLAN** in the **VLAN Port Setting** screen to see the following screen.

Figure 46 Advanced Application > VLAN > VLAN Port Setting > MAC Based VLAN

The following table describes the fields in the above screen.

Table 23 Advanced Application > VLAN > VLAN Port Setting > MAC Based VLAN

LABEL	DESCRIPTION
Active	Check this box to activate this MAC based VLAN.
Name	Type a name up to 32 alpha numeric characters for the MAC-based VLAN entry.
MAC Address	Type a MAC address that is bind to the MAC-based VLAN entry. This is the source MAC address of the data packet that is looked up when untagged packets arrive at the Switch.

Table 23 Advanced Application > VLAN > VLAN Port Setting > MAC Based VLAN (continued)

LABEL	DESCRIPTION
Mask-Bits	Type the mask for the specified MAC address to determine which bits a packet's MAC address should match. Enter "f" for each bit of the specified source MAC address that the traffic's MAC address should match. Enter "0" for the bit(s) of the matched traffic's MAC address, which can be of any hexadecimal character(s). For example, if you set the MAC address to 00:13:49:00:00:00 and the mask to ff:ff:ff:00:00:00, a packet with a MAC address of 00:13:49:12:34:56 matches this criteria.
VID	Type an ID (from 1 to 4094) for the VLAN ID that is associated with the MAC-based VLAN entry.
Priority	Type a priority (0-7) for the MAC-based VLAN entry. The higher the numeric value you assign, the higher the priority for this MAC-based VLAN entry.
Add	Click Add to save the new MAC-based VLAN entry.
Cancel	Click Cancel to clear the fields in the MAC-based VLAN entry.
Index	This field displays the index number of the MAC-based VLAN entry.
Active	This field shows whether the MAC-based VLAN is active or not.
Name	This field displays the name of the MAC-based VLAN entry.
MAC Address	This field displays the source MAC address that is bind to the MAC-based VLAN entry.
Mask-Bits	This field shows the MAC mask in bit number format for this MAC-based VLAN.
VID	This field displays the VLAN ID of the MAC-based VLAN entry.
Priority	This field displays the priority level of the MAC-based VLAN entry.
Delete	Click this to delete the MAC-based VLANs which you marked for deletion.
Cancel	Click Cancel to clear the check boxes.

9.9 VLAN MAC Learning

Use this screen to set the MAC address learning limit on per-port and per-VLAN basis. Click **VLAN MAC Learning** in the **VLAN Status** screen to display the screen as shown next.

Figure 47 Advanced Application > VLAN > VLAN MAC Learning

The following table describes the related labels in this screen.

Table 24 Advanced Application > VLAN > VLAN MAC Learning

LABEL	DESCRIPTION
Active	Select this check box to enable the MAC address learning limit on the Switch.
Action when MAC Limit Number reached	Specify the action the Switch takes when the the maximum number of MAC addresses which a port can learn in a VLAN is reached. Select Forward packets with new source MAC to allow the Switch to forward new packets even when the packet's MAC address is not learned. Select Drop packets with new source MAC to have the Switch discard any packet whose MAC address is not learned.
Apply	Click Apply to save your changes to the Switch's run-time memory. The Switch loses these changes if it is turned off or loses power, so use the Save link on the top navigation panel to save your changes to the non-volatile memory when you are done configuring.
Active	Select this option to activate this rule.
VID	Enter the identification number of the VLAN to which the port belongs.
Port	Select Any to apply the rule to all ports in the specified VLAN. To specify a port, select the second choice and enter the number of the port to which this rule is applied.
MAC Learning	Select this option to enable the MAC address learning limit in this rule.

Table 24 Advanced Application > VLAN > VLAN MAC Learning (continued)

LABEL	DESCRIPTION
MAC Limit Number	Use this field to limit the number of (dynamic) MAC addresses that may be learned on a port in a specified VLAN. For example, if you set this field to "5" on port 2, then only the devices with these five learned MAC addresses may access port 2 at any one time. A sixth device would have to wait until one of the five learned MAC addresses aged out. MAC address aging out time can be set in the Switch Setup screen. The valid range is from "0" to "16384". If you enter 0 here, the Switch automatically changes to use the maximum value (16384). Note: You also set the MAC address learning limit in the Port Security screen. If you configure two different limits, the Switch bases on the smaller one.
Add	Click Add to save your changes to the Switch's run-time memory. The Switch loses these changes if it is turned off or loses power, so use the Save link on the top navigation panel to save your changes to the non-volatile memory when you are done configuring.
Cancel	Click Cancel to begin configuring this screen afresh.
Index	This field displays the index number of the rule. Click an index number to change the settings.
Active	This field displays Yes when the rule is activated and No when is it deactivated.
VID	This field displays the ID number of the VLAN to which the port belongs.
Port	This field displays the number of the port to which this rule is applied.
MAC Learning	This field displays Y when the MAC address learning limit is enabled in this rule. Otherwise, it displays N .
MAC Limit Number	This is the maximum number of MAC addresses which a port can learn in a VLAN.
Delete	Check the rule(s) that you want to remove in the Delete column and then click the Delete button.
Cancel	Click Cancel to clear the Delete check boxes.

9.10 Port-based VLAN Setup

Port-based VLANs are VLANs where the packet forwarding decision is based on the destination MAC address and its associated port.

Port-based VLANs require allowed outgoing ports to be defined for each port. Therefore, if you wish to allow two subscriber ports to talk to each other, for example, between conference rooms in a hotel, you must define the egress (an egress port is an outgoing port, that is, a port through which a data packet leaves) for both ports.

Port-based VLANs are specific only to the Switch on which they were created.

Note: When you activate port-based VLAN, the Switch uses a default VLAN ID of 1. You cannot change it.

Note: In screens (such as **IP Setup** and **Filtering**) that require a VID, you must enter 1 as the VID.

The port-based VLAN setup screen is shown next. The **CPU** management port forms a VLAN with all Ethernet ports.

9.10.1 Configure a Port-based VLAN

Select **Port Based** as the **VLAN Type** in the **Switch Setup** screen and then click **VLAN** from the navigation panel to display the following screen. Select either **All Connected** or **Port Isolated** from the drop-down list depending on your VLAN and VLAN security requirements. If VLAN members need to communicate directly with each other, then select **All Connected**. Select **Port Isolated** if you want to restrict users from communicating directly. Click **Apply** to save your settings.

The following screen shows users on a port-based, all-connected VLAN configuration.

Figure 48 Advanced Application > VLAN > Port Based VLAN Setup (All Connected)

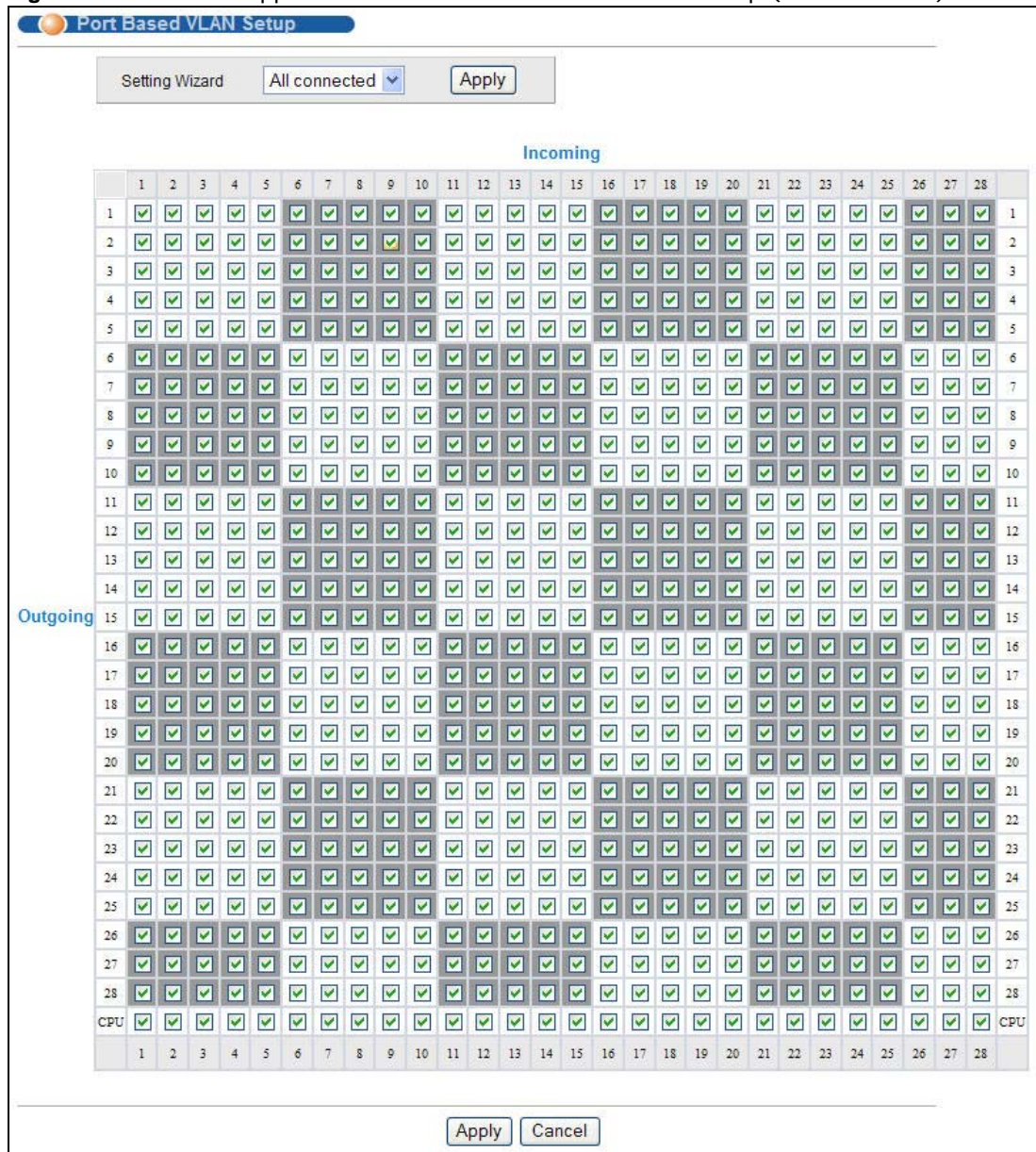

The following screen shows users on a port-based, port-isolated VLAN configuration.

Figure 49 Advanced Application > VLAN: Port Based VLAN Setup (Port Isolation)

Port Based VLAN Setup

Setting Wizard
Port isolation ▼
Apply

Incoming

	1	2	3	4	5	6	7	8	9	10	11	12	13	14	15	16	17	18	19	20	21	22	23	24	25	26	27	28	
1	<input checked="" type="checkbox"/>	<input type="checkbox"/>	<input type="checkbox"/>	<input type="checkbox"/>	<input type="checkbox"/>	<input type="checkbox"/>	<input type="checkbox"/>	<input type="checkbox"/>	<input type="checkbox"/>	<input type="checkbox"/>	<input type="checkbox"/>	<input type="checkbox"/>	<input type="checkbox"/>	<input type="checkbox"/>	<input type="checkbox"/>	<input type="checkbox"/>	<input type="checkbox"/>	<input type="checkbox"/>	<input type="checkbox"/>	<input type="checkbox"/>	<input type="checkbox"/>	<input type="checkbox"/>	<input type="checkbox"/>	<input type="checkbox"/>	<input type="checkbox"/>	<input type="checkbox"/>	<input type="checkbox"/>	1	
2	<input type="checkbox"/>	<input checked="" type="checkbox"/>	<input type="checkbox"/>	<input type="checkbox"/>	<input type="checkbox"/>	<input type="checkbox"/>	<input type="checkbox"/>	<input type="checkbox"/>	<input type="checkbox"/>	<input type="checkbox"/>	<input type="checkbox"/>	<input type="checkbox"/>	<input type="checkbox"/>	<input type="checkbox"/>	<input type="checkbox"/>	<input type="checkbox"/>	<input type="checkbox"/>	<input type="checkbox"/>	<input type="checkbox"/>	<input type="checkbox"/>	<input type="checkbox"/>	<input type="checkbox"/>	<input type="checkbox"/>	<input type="checkbox"/>	<input type="checkbox"/>	<input type="checkbox"/>	<input type="checkbox"/>	<input type="checkbox"/>	2
3	<input type="checkbox"/>	<input type="checkbox"/>	<input checked="" type="checkbox"/>	<input type="checkbox"/>	<input type="checkbox"/>	<input type="checkbox"/>	<input type="checkbox"/>	<input type="checkbox"/>	<input type="checkbox"/>	<input type="checkbox"/>	<input type="checkbox"/>	<input type="checkbox"/>	<input type="checkbox"/>	<input type="checkbox"/>	<input type="checkbox"/>	<input type="checkbox"/>	<input type="checkbox"/>	<input type="checkbox"/>	<input type="checkbox"/>	<input type="checkbox"/>	<input type="checkbox"/>	<input type="checkbox"/>	<input type="checkbox"/>	<input type="checkbox"/>	<input type="checkbox"/>	<input type="checkbox"/>	<input type="checkbox"/>	<input type="checkbox"/>	3
4	<input type="checkbox"/>	<input type="checkbox"/>	<input type="checkbox"/>	<input checked="" type="checkbox"/>	<input type="checkbox"/>	<input type="checkbox"/>	<input type="checkbox"/>	<input type="checkbox"/>	<input type="checkbox"/>	<input type="checkbox"/>	<input type="checkbox"/>	<input type="checkbox"/>	<input type="checkbox"/>	<input type="checkbox"/>	<input type="checkbox"/>	<input type="checkbox"/>	<input type="checkbox"/>	<input type="checkbox"/>	<input type="checkbox"/>	<input type="checkbox"/>	<input type="checkbox"/>	<input type="checkbox"/>	<input type="checkbox"/>	<input type="checkbox"/>	<input type="checkbox"/>	<input type="checkbox"/>	<input type="checkbox"/>	<input type="checkbox"/>	4
5	<input type="checkbox"/>	<input type="checkbox"/>	<input type="checkbox"/>	<input type="checkbox"/>	<input checked="" type="checkbox"/>	<input type="checkbox"/>	<input type="checkbox"/>	<input type="checkbox"/>	<input type="checkbox"/>	<input type="checkbox"/>	<input type="checkbox"/>	<input type="checkbox"/>	<input type="checkbox"/>	<input type="checkbox"/>	<input type="checkbox"/>	<input type="checkbox"/>	<input type="checkbox"/>	<input type="checkbox"/>	<input type="checkbox"/>	<input type="checkbox"/>	<input type="checkbox"/>	<input type="checkbox"/>	<input type="checkbox"/>	<input type="checkbox"/>	<input type="checkbox"/>	<input type="checkbox"/>	<input type="checkbox"/>	<input type="checkbox"/>	5
6	<input type="checkbox"/>	<input type="checkbox"/>	<input type="checkbox"/>	<input type="checkbox"/>	<input type="checkbox"/>	<input checked="" type="checkbox"/>	<input type="checkbox"/>	<input type="checkbox"/>	<input type="checkbox"/>	<input type="checkbox"/>	<input type="checkbox"/>	<input type="checkbox"/>	<input type="checkbox"/>	<input type="checkbox"/>	<input type="checkbox"/>	<input type="checkbox"/>	<input type="checkbox"/>	<input type="checkbox"/>	<input type="checkbox"/>	<input type="checkbox"/>	<input type="checkbox"/>	<input type="checkbox"/>	<input type="checkbox"/>	<input type="checkbox"/>	<input type="checkbox"/>	<input type="checkbox"/>	<input type="checkbox"/>	<input type="checkbox"/>	6
7	<input type="checkbox"/>	<input type="checkbox"/>	<input type="checkbox"/>	<input type="checkbox"/>	<input type="checkbox"/>	<input type="checkbox"/>	<input checked="" type="checkbox"/>	<input type="checkbox"/>	<input type="checkbox"/>	<input type="checkbox"/>	<input type="checkbox"/>	<input type="checkbox"/>	<input type="checkbox"/>	<input type="checkbox"/>	<input type="checkbox"/>	<input type="checkbox"/>	<input type="checkbox"/>	<input type="checkbox"/>	<input type="checkbox"/>	<input type="checkbox"/>	<input type="checkbox"/>	<input type="checkbox"/>	<input type="checkbox"/>	<input type="checkbox"/>	<input type="checkbox"/>	<input type="checkbox"/>	<input type="checkbox"/>	<input type="checkbox"/>	7
8	<input type="checkbox"/>	<input type="checkbox"/>	<input type="checkbox"/>	<input type="checkbox"/>	<input type="checkbox"/>	<input type="checkbox"/>	<input type="checkbox"/>	<input checked="" type="checkbox"/>	<input type="checkbox"/>	<input type="checkbox"/>	<input type="checkbox"/>	<input type="checkbox"/>	<input type="checkbox"/>	<input type="checkbox"/>	<input type="checkbox"/>	<input type="checkbox"/>	<input type="checkbox"/>	<input type="checkbox"/>	<input type="checkbox"/>	<input type="checkbox"/>	<input type="checkbox"/>	<input type="checkbox"/>	<input type="checkbox"/>	<input type="checkbox"/>	<input type="checkbox"/>	<input type="checkbox"/>	<input type="checkbox"/>	<input type="checkbox"/>	8
9	<input type="checkbox"/>	<input type="checkbox"/>	<input type="checkbox"/>	<input type="checkbox"/>	<input type="checkbox"/>	<input type="checkbox"/>	<input type="checkbox"/>	<input type="checkbox"/>	<input checked="" type="checkbox"/>	<input type="checkbox"/>	<input type="checkbox"/>	<input type="checkbox"/>	<input type="checkbox"/>	<input type="checkbox"/>	<input type="checkbox"/>	<input type="checkbox"/>	<input type="checkbox"/>	<input type="checkbox"/>	<input type="checkbox"/>	<input type="checkbox"/>	<input type="checkbox"/>	<input type="checkbox"/>	<input type="checkbox"/>	<input type="checkbox"/>	<input type="checkbox"/>	<input type="checkbox"/>	<input type="checkbox"/>	<input type="checkbox"/>	9
10	<input type="checkbox"/>	<input type="checkbox"/>	<input type="checkbox"/>	<input type="checkbox"/>	<input type="checkbox"/>	<input type="checkbox"/>	<input type="checkbox"/>	<input type="checkbox"/>	<input type="checkbox"/>	<input checked="" type="checkbox"/>	<input type="checkbox"/>	<input type="checkbox"/>	<input type="checkbox"/>	<input type="checkbox"/>	<input type="checkbox"/>	<input type="checkbox"/>	<input type="checkbox"/>	<input type="checkbox"/>	<input type="checkbox"/>	<input type="checkbox"/>	<input type="checkbox"/>	<input type="checkbox"/>	<input type="checkbox"/>	<input type="checkbox"/>	<input type="checkbox"/>	<input type="checkbox"/>	<input type="checkbox"/>	<input type="checkbox"/>	10
11	<input type="checkbox"/>	<input type="checkbox"/>	<input type="checkbox"/>	<input type="checkbox"/>	<input type="checkbox"/>	<input type="checkbox"/>	<input type="checkbox"/>	<input type="checkbox"/>	<input type="checkbox"/>	<input type="checkbox"/>	<input checked="" type="checkbox"/>	<input type="checkbox"/>	<input type="checkbox"/>	<input type="checkbox"/>	<input type="checkbox"/>	<input type="checkbox"/>	<input type="checkbox"/>	<input type="checkbox"/>	<input type="checkbox"/>	<input type="checkbox"/>	<input type="checkbox"/>	<input type="checkbox"/>	<input type="checkbox"/>	<input type="checkbox"/>	<input type="checkbox"/>	<input type="checkbox"/>	<input type="checkbox"/>	<input type="checkbox"/>	11
12	<input type="checkbox"/>	<input type="checkbox"/>	<input type="checkbox"/>	<input type="checkbox"/>	<input type="checkbox"/>	<input type="checkbox"/>	<input type="checkbox"/>	<input type="checkbox"/>	<input type="checkbox"/>	<input type="checkbox"/>	<input type="checkbox"/>	<input checked="" type="checkbox"/>	<input type="checkbox"/>	<input type="checkbox"/>	<input type="checkbox"/>	<input type="checkbox"/>	<input type="checkbox"/>	<input type="checkbox"/>	<input type="checkbox"/>	<input type="checkbox"/>	<input type="checkbox"/>	<input type="checkbox"/>	<input type="checkbox"/>	<input type="checkbox"/>	<input type="checkbox"/>	<input type="checkbox"/>	<input type="checkbox"/>	<input type="checkbox"/>	12
13	<input type="checkbox"/>	<input type="checkbox"/>	<input type="checkbox"/>	<input type="checkbox"/>	<input type="checkbox"/>	<input type="checkbox"/>	<input type="checkbox"/>	<input type="checkbox"/>	<input type="checkbox"/>	<input type="checkbox"/>	<input type="checkbox"/>	<input type="checkbox"/>	<input checked="" type="checkbox"/>	<input type="checkbox"/>	<input type="checkbox"/>	<input type="checkbox"/>	<input type="checkbox"/>	<input type="checkbox"/>	<input type="checkbox"/>	<input type="checkbox"/>	<input type="checkbox"/>	<input type="checkbox"/>	<input type="checkbox"/>	<input type="checkbox"/>	<input type="checkbox"/>	<input type="checkbox"/>	<input type="checkbox"/>	<input type="checkbox"/>	13
14	<input type="checkbox"/>	<input type="checkbox"/>	<input type="checkbox"/>	<input type="checkbox"/>	<input type="checkbox"/>	<input type="checkbox"/>	<input type="checkbox"/>	<input type="checkbox"/>	<input type="checkbox"/>	<input type="checkbox"/>	<input type="checkbox"/>	<input type="checkbox"/>	<input type="checkbox"/>	<input checked="" type="checkbox"/>	<input type="checkbox"/>	<input type="checkbox"/>	<input type="checkbox"/>	<input type="checkbox"/>	<input type="checkbox"/>	<input type="checkbox"/>	<input type="checkbox"/>	<input type="checkbox"/>	<input type="checkbox"/>	<input type="checkbox"/>	<input type="checkbox"/>	<input type="checkbox"/>	<input type="checkbox"/>	<input type="checkbox"/>	14
15	<input type="checkbox"/>	<input type="checkbox"/>	<input type="checkbox"/>	<input type="checkbox"/>	<input type="checkbox"/>	<input type="checkbox"/>	<input type="checkbox"/>	<input type="checkbox"/>	<input type="checkbox"/>	<input type="checkbox"/>	<input type="checkbox"/>	<input type="checkbox"/>	<input type="checkbox"/>	<input type="checkbox"/>	<input checked="" type="checkbox"/>	<input type="checkbox"/>	<input type="checkbox"/>	<input type="checkbox"/>	<input type="checkbox"/>	<input type="checkbox"/>	<input type="checkbox"/>	<input type="checkbox"/>	<input type="checkbox"/>	<input type="checkbox"/>	<input type="checkbox"/>	<input type="checkbox"/>	<input type="checkbox"/>	<input type="checkbox"/>	15
16	<input type="checkbox"/>	<input type="checkbox"/>	<input type="checkbox"/>	<input type="checkbox"/>	<input type="checkbox"/>	<input type="checkbox"/>	<input type="checkbox"/>	<input type="checkbox"/>	<input type="checkbox"/>	<input type="checkbox"/>	<input type="checkbox"/>	<input type="checkbox"/>	<input type="checkbox"/>	<input type="checkbox"/>	<input type="checkbox"/>	<input checked="" type="checkbox"/>	<input type="checkbox"/>	<input type="checkbox"/>	<input type="checkbox"/>	<input type="checkbox"/>	<input type="checkbox"/>	<input type="checkbox"/>	<input type="checkbox"/>	<input type="checkbox"/>	<input type="checkbox"/>	<input type="checkbox"/>	<input type="checkbox"/>	<input type="checkbox"/>	16
17	<input type="checkbox"/>	<input type="checkbox"/>	<input type="checkbox"/>	<input type="checkbox"/>	<input type="checkbox"/>	<input type="checkbox"/>	<input type="checkbox"/>	<input type="checkbox"/>	<input type="checkbox"/>	<input type="checkbox"/>	<input type="checkbox"/>	<input type="checkbox"/>	<input type="checkbox"/>	<input type="checkbox"/>	<input type="checkbox"/>	<input type="checkbox"/>	<input checked="" type="checkbox"/>	<input type="checkbox"/>	<input type="checkbox"/>	<input type="checkbox"/>	<input type="checkbox"/>	<input type="checkbox"/>	<input type="checkbox"/>	<input type="checkbox"/>	<input type="checkbox"/>	<input type="checkbox"/>	<input type="checkbox"/>	<input type="checkbox"/>	17
18	<input type="checkbox"/>	<input type="checkbox"/>	<input type="checkbox"/>	<input type="checkbox"/>	<input type="checkbox"/>	<input type="checkbox"/>	<input type="checkbox"/>	<input type="checkbox"/>	<input type="checkbox"/>	<input type="checkbox"/>	<input type="checkbox"/>	<input type="checkbox"/>	<input type="checkbox"/>	<input type="checkbox"/>	<input type="checkbox"/>	<input type="checkbox"/>	<input type="checkbox"/>	<input checked="" type="checkbox"/>	<input type="checkbox"/>	<input type="checkbox"/>	<input type="checkbox"/>	<input type="checkbox"/>	<input type="checkbox"/>	<input type="checkbox"/>	<input type="checkbox"/>	<input type="checkbox"/>	<input type="checkbox"/>	<input type="checkbox"/>	18
19	<input type="checkbox"/>	<input type="checkbox"/>	<input type="checkbox"/>	<input type="checkbox"/>	<input type="checkbox"/>	<input type="checkbox"/>	<input type="checkbox"/>	<input type="checkbox"/>	<input type="checkbox"/>	<input type="checkbox"/>	<input type="checkbox"/>	<input type="checkbox"/>	<input type="checkbox"/>	<input type="checkbox"/>	<input type="checkbox"/>	<input type="checkbox"/>	<input type="checkbox"/>	<input type="checkbox"/>	<input checked="" type="checkbox"/>	<input type="checkbox"/>	<input type="checkbox"/>	<input type="checkbox"/>	<input type="checkbox"/>	<input type="checkbox"/>	<input type="checkbox"/>	<input type="checkbox"/>	<input type="checkbox"/>	<input type="checkbox"/>	19
20	<input type="checkbox"/>	<input type="checkbox"/>	<input type="checkbox"/>	<input type="checkbox"/>	<input type="checkbox"/>	<input type="checkbox"/>	<input type="checkbox"/>	<input type="checkbox"/>	<input type="checkbox"/>	<input type="checkbox"/>	<input type="checkbox"/>	<input type="checkbox"/>	<input type="checkbox"/>	<input type="checkbox"/>	<input type="checkbox"/>	<input type="checkbox"/>	<input type="checkbox"/>	<input type="checkbox"/>	<input type="checkbox"/>	<input checked="" type="checkbox"/>	<input type="checkbox"/>	<input type="checkbox"/>	<input type="checkbox"/>	<input type="checkbox"/>	<input type="checkbox"/>	<input type="checkbox"/>	<input type="checkbox"/>	<input type="checkbox"/>	20
21	<input type="checkbox"/>	<input type="checkbox"/>	<input type="checkbox"/>	<input type="checkbox"/>	<input type="checkbox"/>	<input type="checkbox"/>	<input type="checkbox"/>	<input type="checkbox"/>	<input type="checkbox"/>	<input type="checkbox"/>	<input type="checkbox"/>	<input type="checkbox"/>	<input type="checkbox"/>	<input type="checkbox"/>	<input type="checkbox"/>	<input type="checkbox"/>	<input type="checkbox"/>	<input type="checkbox"/>	<input type="checkbox"/>	<input type="checkbox"/>	<input checked="" type="checkbox"/>	<input type="checkbox"/>	<input type="checkbox"/>	<input type="checkbox"/>	<input type="checkbox"/>	<input type="checkbox"/>	<input type="checkbox"/>	<input type="checkbox"/>	21
22	<input type="checkbox"/>	<input type="checkbox"/>	<input type="checkbox"/>	<input type="checkbox"/>	<input type="checkbox"/>	<input type="checkbox"/>	<input type="checkbox"/>	<input type="checkbox"/>	<input type="checkbox"/>	<input type="checkbox"/>	<input type="checkbox"/>	<input type="checkbox"/>	<input type="checkbox"/>	<input type="checkbox"/>	<input type="checkbox"/>	<input type="checkbox"/>	<input type="checkbox"/>	<input type="checkbox"/>	<input type="checkbox"/>	<input type="checkbox"/>	<input type="checkbox"/>	<input checked="" type="checkbox"/>	<input type="checkbox"/>	<input type="checkbox"/>	<input type="checkbox"/>	<input type="checkbox"/>	<input type="checkbox"/>	<input type="checkbox"/>	22
23	<input type="checkbox"/>	<input type="checkbox"/>	<input type="checkbox"/>	<input type="checkbox"/>	<input type="checkbox"/>	<input type="checkbox"/>	<input type="checkbox"/>	<input type="checkbox"/>	<input type="checkbox"/>	<input type="checkbox"/>	<input type="checkbox"/>	<input type="checkbox"/>	<input type="checkbox"/>	<input type="checkbox"/>	<input type="checkbox"/>	<input type="checkbox"/>	<input type="checkbox"/>	<input type="checkbox"/>	<input type="checkbox"/>	<input type="checkbox"/>	<input type="checkbox"/>	<input type="checkbox"/>	<input checked="" type="checkbox"/>	<input type="checkbox"/>	<input type="checkbox"/>	<input type="checkbox"/>	<input type="checkbox"/>	<input type="checkbox"/>	23
24	<input type="checkbox"/>	<input type="checkbox"/>	<input type="checkbox"/>	<input type="checkbox"/>	<input type="checkbox"/>	<input type="checkbox"/>	<input type="checkbox"/>	<input type="checkbox"/>	<input type="checkbox"/>	<input type="checkbox"/>	<input type="checkbox"/>	<input type="checkbox"/>	<input type="checkbox"/>	<input type="checkbox"/>	<input type="checkbox"/>	<input type="checkbox"/>	<input type="checkbox"/>	<input type="checkbox"/>	<input type="checkbox"/>	<input type="checkbox"/>	<input type="checkbox"/>	<input type="checkbox"/>	<input type="checkbox"/>	<input checked="" type="checkbox"/>	<input type="checkbox"/>	<input type="checkbox"/>	<input type="checkbox"/>	<input type="checkbox"/>	24
25	<input type="checkbox"/>	<input type="checkbox"/>	<input type="checkbox"/>	<input type="checkbox"/>	<input type="checkbox"/>	<input type="checkbox"/>	<input type="checkbox"/>	<input type="checkbox"/>	<input type="checkbox"/>	<input type="checkbox"/>	<input type="checkbox"/>	<input type="checkbox"/>	<input type="checkbox"/>	<input type="checkbox"/>	<input type="checkbox"/>	<input type="checkbox"/>	<input type="checkbox"/>	<input type="checkbox"/>	<input type="checkbox"/>	<input type="checkbox"/>	<input type="checkbox"/>	<input type="checkbox"/>	<input type="checkbox"/>	<input type="checkbox"/>	<input checked="" type="checkbox"/>	<input type="checkbox"/>	<input type="checkbox"/>	<input type="checkbox"/>	25
26	<input type="checkbox"/>	<input type="checkbox"/>	<input type="checkbox"/>	<input type="checkbox"/>	<input type="checkbox"/>	<input type="checkbox"/>	<input type="checkbox"/>	<input type="checkbox"/>	<input type="checkbox"/>	<input type="checkbox"/>	<input type="checkbox"/>	<input type="checkbox"/>	<input type="checkbox"/>	<input type="checkbox"/>	<input type="checkbox"/>	<input type="checkbox"/>	<input type="checkbox"/>	<input type="checkbox"/>	<input type="checkbox"/>	<input type="checkbox"/>	<input type="checkbox"/>	<input type="checkbox"/>	<input type="checkbox"/>	<input type="checkbox"/>	<input type="checkbox"/>	<input checked="" type="checkbox"/>	<input type="checkbox"/>	<input type="checkbox"/>	26
27	<input type="checkbox"/>	<input type="checkbox"/>	<input type="checkbox"/>	<input type="checkbox"/>	<input type="checkbox"/>	<input type="checkbox"/>	<input type="checkbox"/>	<input type="checkbox"/>	<input type="checkbox"/>	<input type="checkbox"/>	<input type="checkbox"/>	<input type="checkbox"/>	<input type="checkbox"/>	<input type="checkbox"/>	<input type="checkbox"/>	<input type="checkbox"/>	<input type="checkbox"/>	<input type="checkbox"/>	<input type="checkbox"/>	<input type="checkbox"/>	<input type="checkbox"/>	<input type="checkbox"/>	<input type="checkbox"/>	<input type="checkbox"/>	<input type="checkbox"/>	<input type="checkbox"/>	<input checked="" type="checkbox"/>	<input type="checkbox"/>	27
28	<input type="checkbox"/>	<input type="checkbox"/>	<input type="checkbox"/>	<input type="checkbox"/>	<input type="checkbox"/>	<input type="checkbox"/>	<input type="checkbox"/>	<input type="checkbox"/>	<input type="checkbox"/>	<input type="checkbox"/>	<input type="checkbox"/>	<input type="checkbox"/>	<input type="checkbox"/>	<input type="checkbox"/>	<input type="checkbox"/>	<input type="checkbox"/>	<input type="checkbox"/>	<input type="checkbox"/>	<input type="checkbox"/>	<input type="checkbox"/>	<input type="checkbox"/>	<input type="checkbox"/>	<input type="checkbox"/>	<input type="checkbox"/>	<input type="checkbox"/>	<input type="checkbox"/>	<input type="checkbox"/>	<input checked="" type="checkbox"/>	28
CPU	<input checked="" type="checkbox"/>	<input checked="" type="checkbox"/>	<input checked="" type="checkbox"/>	<input checked="" type="checkbox"/>	<input checked="" type="checkbox"/>	<input checked="" type="checkbox"/>	<input checked="" type="checkbox"/>	<input checked="" type="checkbox"/>	<input checked="" type="checkbox"/>	<input checked="" type="checkbox"/>	<input checked="" type="checkbox"/>	<input checked="" type="checkbox"/>	<input checked="" type="checkbox"/>	<input checked="" type="checkbox"/>	<input checked="" type="checkbox"/>	<input checked="" type="checkbox"/>	<input checked="" type="checkbox"/>	<input checked="" type="checkbox"/>	<input checked="" type="checkbox"/>	<input checked="" type="checkbox"/>	<input checked="" type="checkbox"/>	<input checked="" type="checkbox"/>	<input checked="" type="checkbox"/>	<input checked="" type="checkbox"/>	<input checked="" type="checkbox"/>	<input checked="" type="checkbox"/>	<input checked="" type="checkbox"/>	<input checked="" type="checkbox"/>	CPU

Apply
Cancel

The following table describes the labels in this screen.

Table 25 Advanced Application > VLAN: Port Based VLAN Setup

LABEL	DESCRIPTION
Setting Wizard	<p>Choose All connected or Port isolation.</p> <p>All connected means all ports can communicate with each other, that is, there are no virtual LANs. All incoming and outgoing ports are selected. This option is the most flexible but also the least secure.</p> <p>Port isolation means that each port can only communicate with the CPU management port and cannot communicate with each other. All incoming ports are selected while only the CPU outgoing port is selected. This option is the most limiting but also the most secure.</p> <p>After you make your selection, click Apply (top right of screen) to display the screens as mentioned above. You can still customize these settings by adding/deleting incoming or outgoing ports, but you must also click Apply at the bottom of the screen.</p>
Incoming	<p>These are the ingress ports; an ingress port is an incoming port, that is, a port through which a data packet enters. If you wish to allow two subscriber ports to talk to each other, you must define the ingress port for both ports. The numbers in the top row denote the incoming port for the corresponding port listed on the left (its outgoing port). CPU refers to the Switch management port. By default it forms a VLAN with all Ethernet ports. If it does not form a VLAN with a particular port then the Switch cannot be managed from that port.</p>
Outgoing	<p>These are the egress ports. An egress port is an outgoing port, that is, a port through which a data packet leaves. If you wish to allow two subscriber ports to talk to each other, you must define the egress port for both ports. CPU refers to the Switch management port. By default it forms a VLAN with all Ethernet ports. If it does not form a VLAN with a particular port then the Switch cannot be managed from that port.</p>
Apply	<p>Click Apply to save your changes to the Switch's run-time memory. The Switch loses these changes if it is turned off or loses power, so use the Save link on the top navigation panel to save your changes to the non-volatile memory when you are done configuring.</p>
Cancel	<p>Click Cancel to begin configuring this screen afresh.</p>

Static MAC Forward Setup

Use these screens to configure static MAC address forwarding.

10.1 Overview

This chapter discusses how to configure forwarding rules based on MAC addresses of devices on your network.

10.2 Configuring Static MAC Forwarding

A static MAC address is an address that has been manually entered in the MAC address table. Static MAC addresses do not age out. When you set up static MAC address rules, you are setting static MAC addresses for a port. This may reduce the need for broadcasting.

Static MAC address forwarding together with port security allows only computers in the MAC address table on a port to access the Switch. See [Chapter 19 on page 160](#) for more information on port security.

Click **Advanced Applications > Static MAC Forwarding** in the navigation panel to display the configuration screen as shown.

Figure 50 Advanced Application > Static MAC Forwarding

The screenshot shows the configuration interface for Static MAC Forwarding. It includes a form with the following fields:

- Active:** A checkbox.
- Name:** A text input field.
- MAC Address:** Six input boxes separated by colons, representing the MAC address format (XX:XX:XX:XX:XX:XX).
- VID:** A text input field.
- Port:** A text input field.

Below the form are three buttons: **Add**, **Cancel**, and **Clear**. At the bottom of the screen, there is a table with the following columns: **Index**, **Active**, **Name**, **MAC Address**, **VID**, **Port**, and **Delete**. Below the table are two buttons: **Delete** and **Cancel**.

The following table describes the labels in this screen.

Table 26 Advanced Application > Static MAC Forwarding

LABEL	DESCRIPTION
Active	Select this check box to activate your rule. You may temporarily deactivate a rule without deleting it by clearing this check box.
Name	Enter a descriptive name for identification purposes for this static MAC address forwarding rule.
MAC Address	Enter the MAC address in valid MAC address format, that is, six hexadecimal character pairs. Note: Static MAC addresses do not age out.
VID	Enter the VLAN identification number.
Port	Enter the port where the MAC address entered in the previous field will be automatically forwarded.
Add	Click Add to save your rule to the Switch's run-time memory. The Switch loses this rule if it is turned off or loses power, so use the Save link on the top navigation panel to save your changes to the non-volatile memory when you are done configuring.
Cancel	Click Cancel to begin configuring this screen afresh.
Clear	Click Clear to reset the fields to the factory defaults.
Index	Click an index number to modify a static MAC address rule for a port.
Active	This field displays whether this static MAC address forwarding rule is active (Yes) or not (No). You may temporarily deactivate a rule without deleting it.
Name	This field displays the descriptive name for identification purposes for this static MAC address-forwarding rule.
MAC Address	This field displays the MAC address that will be forwarded and the VLAN identification number to which the MAC address belongs.
VID	This field displays the ID number of the VLAN group.
Port	This field displays the port where the MAC address shown in the next field will be forwarded.
Delete	Click Delete to remove the selected entry from the summary table.
Cancel	Click Cancel to clear the Delete check boxes.

Static Multicast Forward Setup

Use these screens to configure static multicast address forwarding.

11.1 Static Multicast Forwarding Overview

A multicast MAC address is the MAC address of a member of a multicast group. A static multicast address is a multicast MAC address that has been manually entered in the multicast table. Static multicast addresses do not age out. Static multicast forwarding allows you (the administrator) to forward multicast frames to a member without the member having to join the group first.

If a multicast group has no members, then the switch will either flood the multicast frames to all ports or drop them. You can configure this in the **Advanced Application > Multicast > Multicast Setting** screen (see [Section 25.2.1 on page 190](#)). [Figure 51](#) shows such unknown multicast frames flooded to all ports. With static multicast forwarding, you can forward these multicasts to port(s) within a VLAN group. [Figure 52](#) shows frames being forwarded to devices connected to port 3. [Figure 53](#) shows frames being forwarded to ports 2 and 3 within VLAN group 4.

Figure 51 No Static Multicast Forwarding

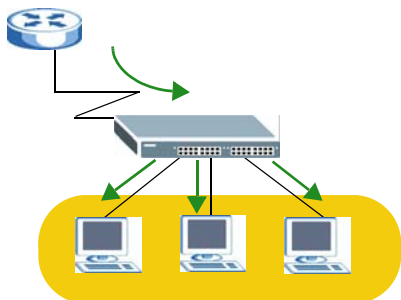

Figure 52 Static Multicast Forwarding to A Single Port

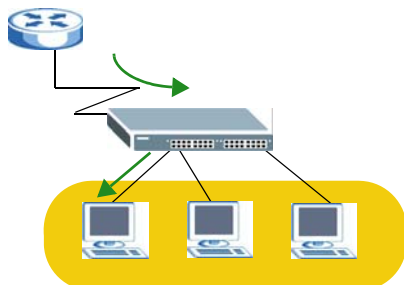
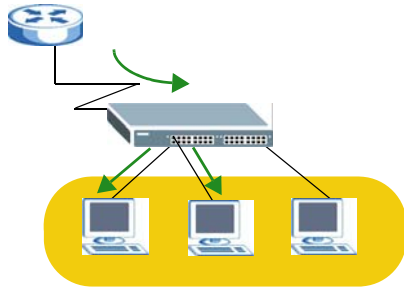

Figure 53 Static Multicast Forwarding to Multiple Ports

11.2 Configuring Static Multicast Forwarding

Use this screen to configure rules to forward specific multicast frames, such as streaming or control frames, to specific port(s).

Click **Advanced Application > Static Multicast Forwarding** to display the configuration screen as shown.

Figure 54 Advanced Application > Static Multicast Forwarding

The following table describes the labels in this screen.

Table 27 Advanced Application > Static Multicast Forwarding

LABEL	DESCRIPTION
Active	Select this check box to activate your rule. You may temporarily deactivate a rule without deleting it by clearing this check box.
Name	Type a descriptive name (up to 32 printable ASCII characters) for this static multicast MAC address forwarding rule. This is for identification only.
MAC Address	Enter a multicast MAC address which identifies the multicast group. The last binary bit of the first octet pair in a multicast MAC address must be 1. For example, the first octet pair 00000001 is 01 and 00000011 is 03 in hexadecimal, so 01:00:5e:00:00:0A and 03:00:5e:00:00:27 are valid multicast MAC addresses.

Table 27 Advanced Application > Static Multicast Forwarding (continued)

LABEL	DESCRIPTION
VID	You can forward frames with matching destination MAC address to port(s) within a VLAN group. Enter the ID that identifies the VLAN group here. If you don't have a specific target VLAN, enter 1.
Port	Enter the port(s) where frames with destination MAC address that matched the entry above are forwarded. You can enter multiple ports separated by (no space) comma (,) or hyphen (-). For example, enter "3-5" for ports 3, 4, and 5. Enter "3,5,7" for ports 3, 5, and 7.
Add	Click Add to save your rule to the Switch's run-time memory. The Switch loses this rule if it is turned off or loses power, so use the Save link on the top navigation panel to save your changes to the non-volatile memory when you are done configuring.
Cancel	Click Cancel to reset the fields to their last saved values.
Clear	Click Clear to begin configuring this screen afresh.
Index	Click an index number to modify a static multicast MAC address rule for port(s).
Active	This field displays whether a static multicast MAC address forwarding rule is active (Yes) or not (No). You may temporarily deactivate a rule without deleting it.
Name	This field displays the descriptive name for identification purposes for a static multicast MAC address-forwarding rule.
MAC Address	This field displays the multicast MAC address that identifies a multicast group.
VID	This field displays the ID number of a VLAN group to which frames containing the specified multicast MAC address will be forwarded.
Port	This field displays the port(s) within a identified VLAN group to which frames containing the specified multicast MAC address will be forwarded.
Delete	Click Delete to remove the selected entry from the summary table.
Cancel	Click Cancel to clear the Delete check boxes.

Filtering

This chapter discusses MAC address port filtering.

12.1 Configure a Filtering Rule

Configure the Switch to filter traffic based on the traffic's source, destination MAC addresses and/or VLAN group (ID).

Click **Advanced Application > Filtering** in the navigation panel to display the screen as shown next.

Figure 55 Advanced Application > Filtering

The following table describes the related labels in this screen.

Table 28 Advanced Application > Filtering

LABEL	DESCRIPTION
Active	Make sure to select this check box to activate your rule. You may temporarily deactivate a rule without deleting it by deselecting this check box.
Name	Type a descriptive name (up to 32 printable ASCII characters) for this rule. This is for identification only.

Table 28 Advanced Application > Filtering (continued)

LABEL	DESCRIPTION
Action	<p>Select Discard source to drop frames from the source MAC address (specified in the MAC field). The Switch can still send frames to the MAC address.</p> <p>Select Discard destination to drop frames to the destination MAC address (specified in the MAC address). The Switch can still receive frames originating from the MAC address.</p> <p>Select Discard source and Discard destination to block traffic to/from the MAC address specified in the MAC field.</p>
MAC	Type a MAC address in a valid MAC address format, that is, six hexadecimal character pairs.
VID	Type the VLAN group identification number.
Add	Click Add to save your changes to the Switch's run-time memory. The Switch loses these changes if it is turned off or loses power, so use the Save link on the top navigation panel to save your changes to the non-volatile memory when you are done configuring.
Cancel	Click Cancel to begin configuring this screen afresh.
Clear	Click Clear to clear the fields to the factory defaults.
Index	This field displays the index number of the rule. Click an index number to change the settings.
Active	This field displays Yes when the rule is activated and No when is it deactivated.
Name	This field displays the descriptive name for this rule. This is for identification purposes only.
MAC Address	This field displays the source/destination MAC address with the VLAN identification number to which the MAC address belongs.
VID	This field displays the VLAN group identification number.
Delete	Check the rule(s) that you want to remove in the Delete column and then click the Delete button.
Cancel	Click Cancel to clear the selected checkbox(es) in the Delete column.

Spanning Tree Protocol

The Switch supports Spanning Tree Protocol (STP), Rapid Spanning Tree Protocol (RSTP) and Multiple Spanning Tree Protocol (MSTP) as defined in the following standards.

- IEEE 802.1D Spanning Tree Protocol
- IEEE 802.1w Rapid Spanning Tree Protocol
- IEEE 802.1s Multiple Spanning Tree Protocol

The Switch also allows you to set up multiple STP configurations (or trees). Ports can then be assigned to the trees.

13.1 STP/RSTP Overview

(R)STP detects and breaks network loops and provides backup links between switches, bridges or routers. It allows a Switch to interact with other (R)STP-compliant switches in your network to ensure that only one path exists between any two stations on the network.

The Switch uses IEEE 802.1w RSTP (Rapid Spanning Tree Protocol) that allows faster convergence of the spanning tree than STP (while also being backwards compatible with STP-only aware bridges). In RSTP, topology change information is directly propagated throughout the network from the device that generates the topology change. In STP, a longer delay is required as the device that causes a topology change first notifies the root bridge and then the root bridge notifies the network. Both RSTP and STP flush unwanted learned addresses from the filtering database. In RSTP, the port states are Discarding, Learning, and Forwarding.

Note: In this user's guide, "STP" refers to both STP and RSTP.

13.1.1 STP Terminology

The root bridge is the base of the spanning tree.

Path cost is the cost of transmitting a frame onto a LAN through that port. The Switch supports both the short and the long path cost methods. The original short path cost method uses a 16-bit value. The long path cost method allows the Switch to use longer path length (32-bit values) for high-speed links. The default cost is assigned according to the speed of the link to which a port is attached. The slower the media, the higher the cost.

Table 29 STP Path Costs

	LINK SPEED	DEFAULT VALUE (SHORT)	DEFAULT VALUE (LONG)	ALLOWED RANGE
Path Cost	10Mbps	100	2,000,000	1 to 200,000,000
Path Cost	100Mbps	19	200,000	1 to 200,000,000

Table 29 STP Path Costs

	LINK SPEED	DEFAULT VALUE (SHORT)	DEFAULT VALUE (LONG)	ALLOWED RANGE
Path Cost	1Gbps	4	20,000	1 to 200,000,000
Path Cost	10Gbps	2	2,000	1 to 200,000,000

On each bridge, the bridge communicates with the root through the root port. The root port is the port on this Switch with the lowest path cost to the root (the root path cost). If there is no root port, then this Switch has been accepted as the root bridge of the spanning tree network.

For each LAN segment, a designated bridge is selected. This bridge has the lowest cost to the root among the bridges connected to the LAN.

13.1.2 How STP Works

After a bridge determines the lowest cost-spanning tree with STP, it enables the root port and the ports that are the designated ports for connected LANs, and disables all other ports that participate in STP. Network packets are therefore only forwarded between enabled ports, eliminating any possible network loops.

STP-aware switches exchange Bridge Protocol Data Units (BPDUs) periodically. When the bridged LAN topology changes, a new spanning tree is constructed.

Once a stable network topology has been established, all bridges listen for Hello BPDUs (Bridge Protocol Data Units) transmitted from the root bridge. If a bridge does not get a Hello BPDU after a predefined interval (Max Age), the bridge assumes that the link to the root bridge is down. This bridge then initiates negotiations with other bridges to reconfigure the network to re-establish a valid network topology.

13.1.3 STP Port States

STP assigns five port states to eliminate packet looping. A bridge port is not allowed to go directly from blocking state to forwarding state so as to eliminate transient loops.

Table 30 STP Port States

PORT STATE	DESCRIPTION
Disabled	STP is disabled (default).
Blocking	Only configuration and management BPDUs are received and processed.
Listening	All BPDUs are received and processed. Note: The listening state does not exist in RSTP.
Learning	All BPDUs are received and processed. Information frames are submitted to the learning process but not forwarded.
Forwarding	All BPDUs are received and processed. All information frames are received and forwarded.

13.1.4 Multiple RSTP

MRSTP (Multiple RSTP) is ZyXEL's proprietary feature that is compatible with RSTP and STP. With MRSTP, you can have more than one spanning tree on your Switch and assign port(s) to each tree. Each spanning tree operates independently with its own bridge information.

In the following example, there are two RSTP instances (**MRSTP 1** and **MRSTP2**) on switch **A**.

Figure 56 MRSTP Network Example

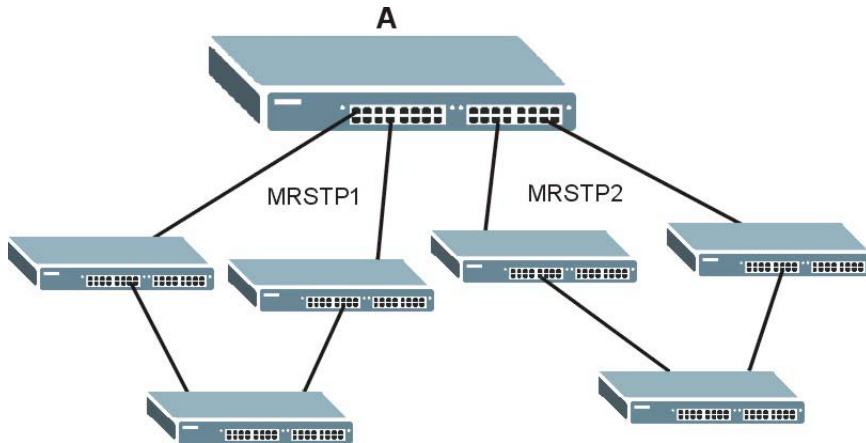

To set up MRSTP, activate MRSTP on the Switch and specify which port(s) belong to which spanning tree.

Note: Each port can belong to one STP tree only.

13.1.5 Multiple STP

Multiple Spanning Tree Protocol (IEEE 802.1s) is backwards compatible with STP/RSTP and addresses the limitations of existing spanning tree protocols (STP and RSTP) in networks to include the following features:

- One Common and Internal Spanning Tree (CIST) that represents the entire network's connectivity.
- Grouping of multiple bridges (or switching devices) into regions that appear as one single bridge on the network.
- A VLAN can be mapped to a specific Multiple Spanning Tree Instance (MSTI). MSTI allows multiple VLANs to use the same spanning tree.
- Load-balancing is possible as traffic from different VLANs can use distinct paths in a region.

13.1.5.1 MSTP Network Example

The following figure shows a network example where two VLANs are configured on the two switches. If the switches are using STP or RSTP, the link for VLAN 2 will be blocked as STP and RSTP allow only one link in the network and block the redundant link.

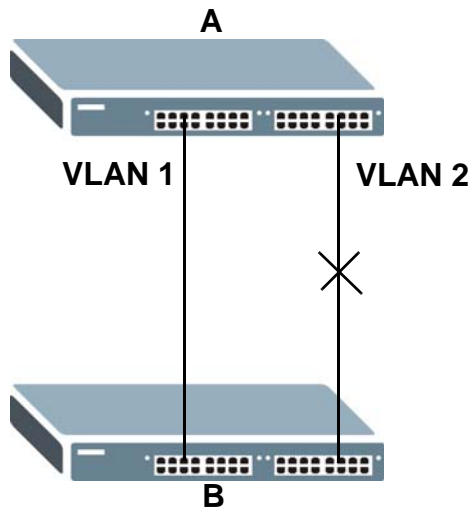
Figure 57 STP/RSTP Network Example

With MSTP, VLANs 1 and 2 are mapped to different spanning trees in the network. Thus traffic from the two VLANs travel on different paths. The following figure shows the network example using MSTP.

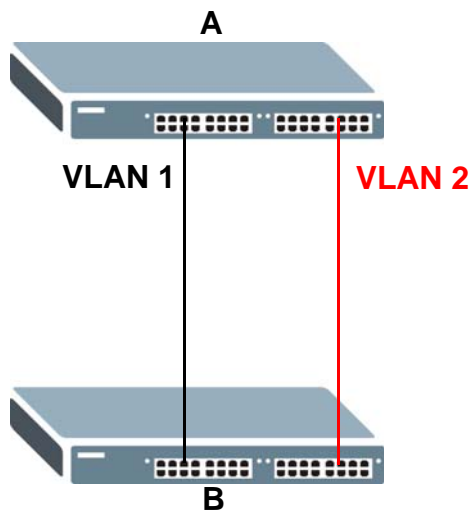
Figure 58 MSTP Network Example

13.1.5.2 MST Region

An MST region is a logical grouping of multiple network devices that appears as a single device to the rest of the network. Each MSTP-enabled device can only belong to one MST region. When BPDUs enter an MST region, external path cost (of paths outside this region) is increased by one. Internal path cost (of paths within this region) is increased by one when BPDUs traverse the region.

Devices that belong to the same MST region are configured to have the same MSTP configuration identification settings. These include the following parameters:

- Name of the MST region
- Revision level as the unique number for the MST region
- VLAN-to-MST Instance mapping

13.1.5.3 MST Instance

An MST Instance (MSTI) is a spanning tree instance. VLANs can be configured to run on a specific MSTI. Each created MSTI is identified by a unique number (known as an MST ID) known internally to a region. Thus an MSTI does not span across MST regions.

The following figure shows an example where there are two MST regions. Regions 1 and 2 have 2 spanning tree instances.

Figure 59 MSTIs in Different Regions

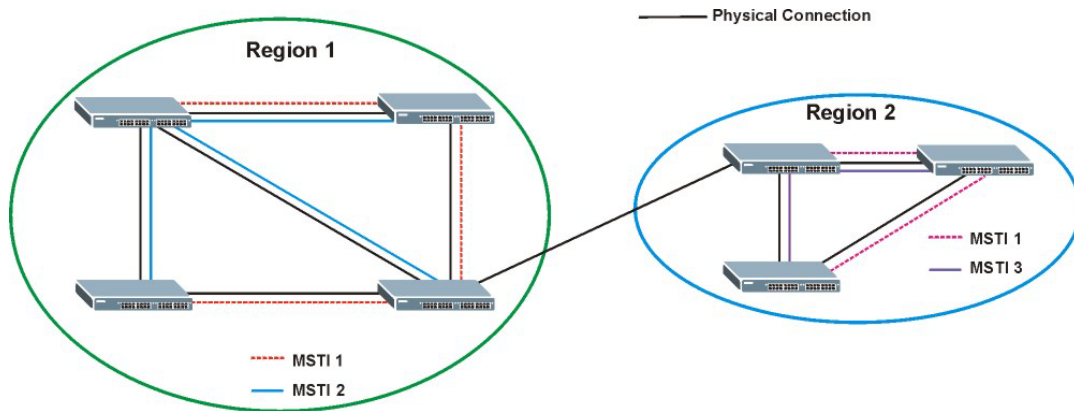

13.1.5.4 Common and Internal Spanning Tree (CIST)

A CIST represents the connectivity of the entire network and it is equivalent to a spanning tree in an STP/RSTP. The CIST is the default MST instance (MSTID 0). Any VLANs that are not members of an MST instance are members of the CIST. In an MSTP-enabled network, there is only one CIST that runs between MST regions and single spanning tree devices. A network may contain multiple MST regions and other network segments running RSTP.

Figure 60 MSTP and Legacy RSTP Network Example

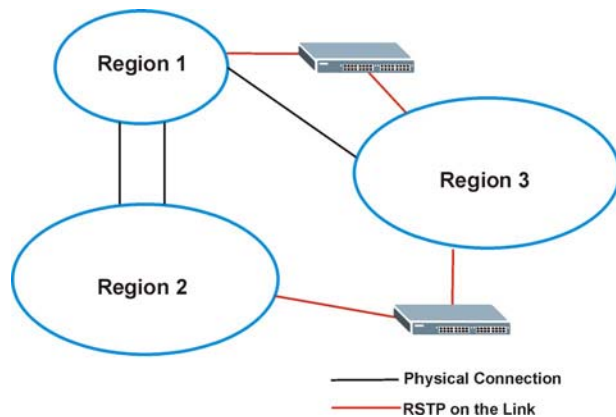

13.2 Spanning Tree Protocol Status Screen

The Spanning Tree Protocol status screen changes depending on what standard you choose to implement on your network. Click **Advanced Application > Spanning Tree Protocol** to see the screen as shown.

Figure 61 Advanced Application > Spanning Tree Protocol

The screenshot shows the 'Spanning Tree Protocol Status' screen with the 'RSTP' mode selected. The screen has a header with 'Spanning Tree Protocol Status' and navigation links for 'Configuration', 'RSTP', 'MRSTP', and 'MSTP'. Below the header, it says 'Spanning Tree Protocol: RSTP'. A table displays the following data:

Bridge	Root	Our Bridge
Bridge ID	0000-000000000000	0000-000000000000
Hello Time (second)	0	0
Max Age (second)	0	0
Forwarding Delay (second)	0	0
Cost to Bridge	0	
Port ID	0x0000	
Topology Changed Times		0
Time Since Last Change		0:00:00

This screen differs depending on which STP mode (RSTP, MRSTP or MSTP) you configure on the Switch. This screen is described in detail in the section that follows the configuration section for each STP mode. Click **Configuration** to activate one of the STP standards on the Switch.

13.3 Spanning Tree Configuration

Use the **Spanning Tree Configuration** screen to activate one of the STP modes on the Switch. Click **Configuration** in the **Advanced Application > Spanning Tree Protocol**.

Figure 62 Advanced Application > Spanning Tree Protocol > Configuration

The screenshot shows the 'Spanning Tree Configuration' screen. It has a header with 'Spanning Tree Configuration' and a 'Status' link. The main area contains the following configuration options:

- Spanning Tree Mode:** Three radio buttons are present:
 - Rapid Spanning Tree
 - Multiple Rapid Spanning Tree
 - Multiple Spanning Tree
- Type of Default Path Cost:** A dropdown menu is set to 'Short'.

At the bottom of the screen, there are two buttons: 'Apply' and 'Cancel'.

The following table describes the labels in this screen.

Table 31 Advanced Application > Spanning Tree Protocol > Configuration

LABEL	DESCRIPTION
Spanning Tree Mode	You can activate one of the STP modes on the Switch. Select Rapid Spanning Tree , Multiple Rapid Spanning Tree or Multiple Spanning Tree . See Section 13.1 on page 115 for background information on STP.
Type of Default Path Cost	Select the default path cost method (Short or Long) you want the Switch to use in each STP mode. Note: If you select Long , all the switches in your network also need to use the long path cost method. Otherwise, the spanning tree may not converge properly.
Apply	Click Apply to save your changes to the Switch's run-time memory. The Switch loses these changes if it is turned off or loses power, so use the Save link on the top navigation panel to save your changes to the non-volatile memory when you are done configuring.
Cancel	Click Cancel to begin configuring this screen afresh.

13.4 Configure Rapid Spanning Tree Protocol

Use this screen to configure RSTP settings, see [Section 13.1 on page 115](#) for more information on RSTP. Click **RSTP** in the **Advanced Application > Spanning Tree Protocol** screen.

Figure 63 Advanced Application > Spanning Tree Protocol > RSTP

Port	Active	Edge	Root Guard	Priority	Path Cost
*	<input type="checkbox"/>	<input type="checkbox"/>	<input type="checkbox"/>		
1	<input type="checkbox"/>	<input checked="" type="checkbox"/>	<input type="checkbox"/>	128	4
2	<input type="checkbox"/>	<input checked="" type="checkbox"/>	<input type="checkbox"/>	128	4
3	<input type="checkbox"/>	<input checked="" type="checkbox"/>	<input type="checkbox"/>	128	4
4	<input type="checkbox"/>	<input checked="" type="checkbox"/>	<input type="checkbox"/>	128	4
5	<input type="checkbox"/>	<input checked="" type="checkbox"/>	<input type="checkbox"/>	128	4
6	<input type="checkbox"/>	<input checked="" type="checkbox"/>	<input type="checkbox"/>	128	4
7	<input type="checkbox"/>	<input checked="" type="checkbox"/>	<input type="checkbox"/>	128	4
8	<input type="checkbox"/>	<input checked="" type="checkbox"/>	<input type="checkbox"/>	128	4
9	<input type="checkbox"/>	<input checked="" type="checkbox"/>	<input type="checkbox"/>	128	4
10	<input type="checkbox"/>	<input checked="" type="checkbox"/>	<input type="checkbox"/>	128	4
11	<input type="checkbox"/>	<input checked="" type="checkbox"/>	<input type="checkbox"/>	128	4

The following table describes the labels in this screen.

Table 32 Advanced Application > Spanning Tree Protocol > RSTP

LABEL	DESCRIPTION
Status	Click Status to display the RSTP Status screen (see Figure 64 on page 124).
Active	Select this check box to activate RSTP. Clear this checkbox to disable RSTP. Note: You must also activate Rapid Spanning Tree in the Advanced Application > Spanning Tree Protocol > Configuration screen to enable RSTP on the Switch.
Bridge Priority	Bridge priority is used in determining the root switch, root port and designated port. The switch with the highest priority (lowest numeric value) becomes the STP root switch. If all switches have the same priority, the switch with the lowest MAC address will then become the root switch. Select a value from the drop-down list box. The lower the numeric value you assign, the higher the priority for this bridge. Bridge Priority determines the root bridge, which in turn determines Hello Time, Max Age and Forwarding Delay.
Hello Time	This is the time interval in seconds between BPDU (Bridge Protocol Data Units) configuration message generations by the root switch. The allowed range is 1 to 10 seconds.

Table 32 Advanced Application > Spanning Tree Protocol > RSTP (continued)

LABEL	DESCRIPTION
Max Age	This is the maximum time (in seconds) a switch can wait without receiving a BPDU before attempting to reconfigure. All switch ports (except for designated ports) should receive BPDUs at regular intervals. Any port that ages out STP information (provided in the last BPDU) becomes the designated port for the attached LAN. If it is a root port, a new root port is selected from among the switch ports attached to the network. The allowed range is 6 to 40 seconds.
Forwarding Delay	This is the maximum time (in seconds) a switch will wait before changing states. This delay is required because every switch must receive information about topology changes before it starts to forward frames. In addition, each port needs time to listen for conflicting information that would make it return to a blocking state; otherwise, temporary data loops might result. The allowed range is 4 to 30 seconds. As a general rule: Note: $2 * (\text{Forward Delay} - 1) \geq \text{Max Age} \geq 2 * (\text{Hello Time} + 1)$
Port	This field displays the port number.
*	Settings in this row apply to all ports. Use this row only if you want to make some settings the same for all ports. Use this row first to set the common settings and then make adjustments on a port-by-port basis. Note: Changes in this row are copied to all the ports as soon as you make them.
Active	Select this check box to activate RSTP on this port.
Edge	Select this check box to configure a port as an edge port when it is directly attached to a computer. An edge port changes its initial STP port state from blocking state to forwarding state immediately without going through listening and learning states right after the port is configured as an edge port or when its link status changes. Note: An edge port becomes a non-edge port as soon as it receives a Bridge Protocol Data Unit (BPDU).
Root Guard	Select this check box to enable root guard on this port in order to prevent the switch(es) attached to the port from becoming the root bridge. With root guard enabled, a port is blocked when the Switch receives a superior BPDU on it. The Switch allows traffic to pass through this port again when the switch connected to the port stops to send superior BPDUs.
Priority	Configure the priority for each port here. Priority decides which port should be disabled when more than one port forms a loop in a switch. Ports with a higher priority numeric value are disabled first. The allowed range is between 0 and 255 and the default value is 128.
Path Cost	Path cost is the cost of transmitting a frame on to a LAN through that port. It is recommended to assign this value according to the speed of the bridge. The slower the media, the higher the cost - see Table 29 on page 115 for more information. The default path cost value varies depending on the default path cost method you selected.
Apply	Click Apply to save your changes to the Switch's run-time memory. The Switch loses these changes if it is turned off or loses power, so use the Save link on the top navigation panel to save your changes to the non-volatile memory when you are done configuring.
Cancel	Click Cancel to begin configuring this screen afresh.

13.5 Rapid Spanning Tree Protocol Status

Click **Advanced Application** > **Spanning Tree Protocol** in the navigation panel to display the status screen as shown next. See [Section 13.1 on page 115](#) for more information on RSTP.

Note: This screen is only available after you activate RSTP on the Switch.

Figure 64 Advanced Application > Spanning Tree Protocol > Status: RSTP

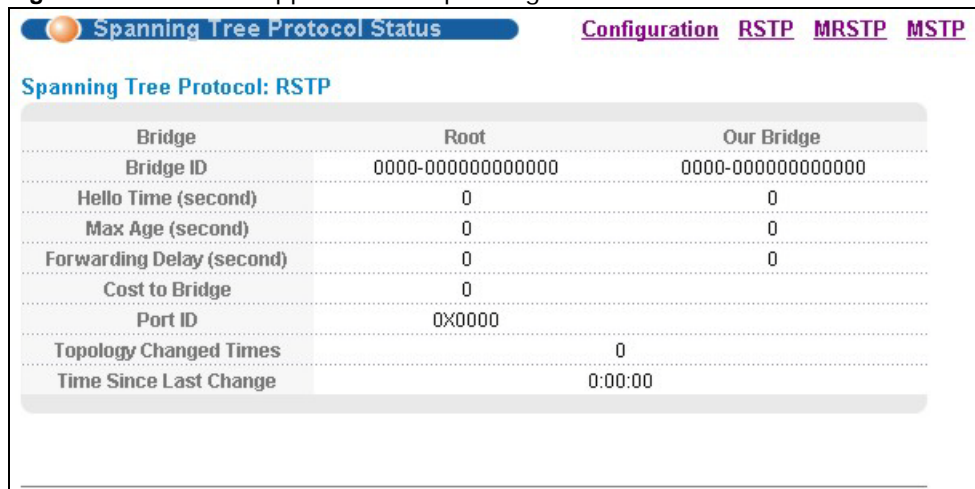

Bridge	Root	Our Bridge
Bridge ID	0000-000000000000	0000-000000000000
Hello Time (second)	0	0
Max Age (second)	0	0
Forwarding Delay (second)	0	0
Cost to Bridge	0	
Port ID	0x0000	
Topology Changed Times		0
Time Since Last Change		0:00:00

The following table describes the labels in this screen.

Table 33 Advanced Application > Spanning Tree Protocol > Status: RSTP

LABEL	DESCRIPTION
Configuration	Click Configuration to specify which STP mode you want to activate. Click RSTP to edit RSTP settings on the Switch.
Bridge	Root refers to the base of the spanning tree (the root bridge). Our Bridge is this Switch. This Switch may also be the root bridge.
Bridge ID	This is the unique identifier for this bridge, consisting of the bridge priority plus the MAC address. This ID is the same for Root and Our Bridge if the Switch is the root switch.
Hello Time (second)	This is the time interval (in seconds) at which the root switch transmits a configuration message. The root bridge determines Hello Time, Max Age and Forwarding Delay.
Max Age (second)	This is the maximum time (in seconds) a switch can wait without receiving a configuration message before attempting to reconfigure.
Forwarding Delay (second)	This is the time (in seconds) the root switch will wait before changing states (that is, listening to learning to forwarding). See Section 13.1.3 on page 116 for information on port states. Note: The listening state does not exist in RSTP.
Cost to Bridge	This is the path cost from the root port on this Switch to the root switch.
Port ID	This is the priority and number of the port on the Switch through which this Switch must communicate with the root of the Spanning Tree.
Topology Changed Times	This is the number of times the spanning tree has been reconfigured.
Time Since Last Change	This is the time since the spanning tree was last reconfigured.

13.6 Configure Multiple Rapid Spanning Tree Protocol

To configure MRSTP, click **MRSTP** in the **Advanced Application > Spanning Tree Protocol** screen. See [Section 13.1 on page 115](#) for more information on MRSTP.

Figure 65 Advanced Application > Spanning Tree Protocol > MRSTP

Tree	Active	Bridge Priority	Hello Time	MAX Age	Forwarding Delay
1	<input type="checkbox"/>	32768	2 seconds	20 seconds	15
2	<input type="checkbox"/>	32768	2 seconds	20 seconds	15

Port	Active	Edge	Root Guard	Priority	Path Cost	Tree
*	<input type="checkbox"/>	<input type="checkbox"/>	<input type="checkbox"/>			1
1	<input type="checkbox"/>	<input checked="" type="checkbox"/>	<input type="checkbox"/>	128	4	1
2	<input type="checkbox"/>	<input checked="" type="checkbox"/>	<input type="checkbox"/>	128	4	1
3	<input type="checkbox"/>	<input checked="" type="checkbox"/>	<input type="checkbox"/>	128	4	1
4	<input type="checkbox"/>	<input checked="" type="checkbox"/>	<input type="checkbox"/>	128	4	1
5	<input type="checkbox"/>	<input checked="" type="checkbox"/>	<input type="checkbox"/>	128	4	1
6	<input type="checkbox"/>	<input checked="" type="checkbox"/>	<input type="checkbox"/>	128	4	1
7	<input type="checkbox"/>	<input checked="" type="checkbox"/>	<input type="checkbox"/>	128	4	1
8	<input type="checkbox"/>	<input checked="" type="checkbox"/>	<input type="checkbox"/>	128	4	1
9	<input type="checkbox"/>	<input checked="" type="checkbox"/>	<input type="checkbox"/>	128	4	1

The following table describes the labels in this screen.

Table 34 Advanced Application > Spanning Tree Protocol > MRSTP

LABEL	DESCRIPTION
Status	Click Status to display the MRSTP Status screen (see Figure 64 on page 124).
Tree	This is a read-only index number of the STP trees.
Active	Select this check box to activate an STP tree. Clear this checkbox to disable an STP tree. Note: You must also activate Multiple Rapid Spanning Tree in the Advanced Application > Spanning Tree Protocol > Configuration screen to enable MRSTP on the Switch.
Bridge Priority	Bridge priority is used in determining the root switch, root port and designated port. The switch with the highest priority (lowest numeric value) becomes the STP root switch. If all switches have the same priority, the switch with the lowest MAC address will then become the root switch. Select a value from the drop-down list box. The lower the numeric value you assign, the higher the priority for this bridge. Bridge Priority determines the root bridge, which in turn determines Hello Time, Max Age and Forwarding Delay.
Hello Time	This is the time interval in seconds between BPDUs (Bridge Protocol Data Units) configuration message generations by the root switch. The allowed range is 1 to 10 seconds.

Table 34 Advanced Application > Spanning Tree Protocol > MRSTP (continued)

LABEL	DESCRIPTION
Max Age	This is the maximum time (in seconds) a switch can wait without receiving a BPDU before attempting to reconfigure. All switch ports (except for designated ports) should receive BPDUs at regular intervals. Any port that ages out STP information (provided in the last BPDU) becomes the designated port for the attached LAN. If it is a root port, a new root port is selected from among the Switch ports attached to the network. The allowed range is 6 to 40 seconds.
Forwarding Delay	This is the maximum time (in seconds) a switch will wait before changing states. This delay is required because every switch must receive information about topology changes before it starts to forward frames. In addition, each port needs time to listen for conflicting information that would make it return to a blocking state; otherwise, temporary data loops might result. The allowed range is 4 to 30 seconds. As a general rule: Note: $2 * (\text{Forward Delay} - 1) \geq \text{Max Age} \geq 2 * (\text{Hello Time} + 1)$
Port	This field displays the port number.
*	Settings in this row apply to all ports. Use this row only if you want to make some settings the same for all ports. Use this row first to set the common settings and then make adjustments on a port-by-port basis. Note: Changes in this row are copied to all the ports as soon as you make them.
Active	Select this check box to activate STP on this port.
Edge	Select this check box to configure a port as an edge port when it is directly attached to a computer. An edge port changes its initial STP port state from blocking state to forwarding state immediately without going through listening and learning states right after the port is configured as an edge port or when its link status changes. Note: An edge port becomes a non-edge port as soon as it receives a Bridge Protocol Data Unit (BPDU).
Root Guard	Select this check box to enable root guard on this port in order to prevent the switch(es) attached to the port from becoming the root bridge. With root guard enabled, a port is blocked when the Switch receives a superior BPDU on it. The Switch allows traffic to pass through this port again when the switch connected to the port stops to send superior BPDUs.
Priority	Configure the priority for each port here. Priority decides which port should be disabled when more than one port forms a loop in the Switch. Ports with a higher priority numeric value are disabled first. The allowed range is between 0 and 255 and the default value is 128.
Path Cost	Path cost is the cost of transmitting a frame on to a LAN through that port. It is recommended that you assign this value according to the speed of the bridge. The slower the media, the higher the cost - see Table 29 on page 115 for more information. The default path cost value varies depending on the default path cost method you selected.
Tree	Select which STP tree configuration this port should participate in.
Apply	Click Apply to save your changes to the Switch's run-time memory. The Switch loses these changes if it is turned off or loses power, so use the Save link on the top navigation panel to save your changes to the non-volatile memory when you are done configuring.
Cancel	Click Cancel to begin configuring this screen afresh.

13.7 Multiple Rapid Spanning Tree Protocol Status

Click **Advanced Application** > **Spanning Tree Protocol** in the navigation panel to display the status screen as shown next. See [Section 13.1 on page 115](#) for more information on MRSTP.

Note: This screen is only available after you activate MRSTP on the Switch.

Figure 66 Advanced Application > Spanning Tree Protocol > Status: MRSTP

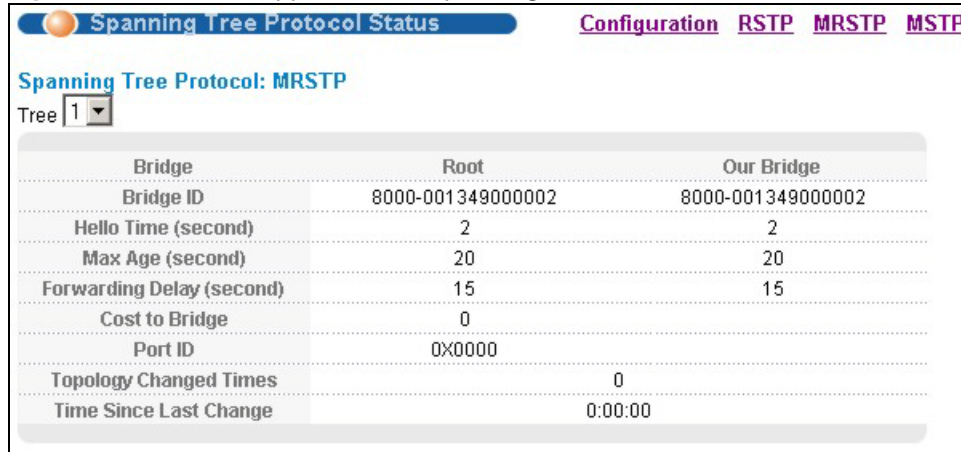

Bridge	Root	Our Bridge
Bridge ID	8000-001349000002	8000-001349000002
Hello Time (second)	2	2
Max Age (second)	20	20
Forwarding Delay (second)	15	15
Cost to Bridge	0	
Port ID	0X0000	
Topology Changed Times	0	
Time Since Last Change	0:00:00	

The following table describes the labels in this screen.

Table 35 Advanced Application > Spanning Tree Protocol > Status: MRSTP

LABEL	DESCRIPTION
Configuration	Click Configuration to specify which STP mode you want to activate. Click MRSTP to edit MRSTP settings on the Switch.
Tree	Select which STP tree configuration you want to view.
Bridge	Root refers to the base of the spanning tree (the root bridge). Our Bridge is this Switch. This Switch may also be the root bridge.
Bridge ID	This is the unique identifier for this bridge, consisting of bridge priority plus MAC address. This ID is the same for Root and Our Bridge if the Switch is the root switch.
Hello Time (second)	This is the time interval (in seconds) at which the root switch transmits a configuration message. The root bridge determines Hello Time, Max Age and Forwarding Delay.
Max Age (second)	This is the maximum time (in seconds) a switch can wait without receiving a configuration message before attempting to reconfigure.
Forwarding Delay (second)	This is the time (in seconds) the root switch will wait before changing states (that is, listening to learning to forwarding). Note: The listening state does not exist in RSTP.
Cost to Bridge	This is the path cost from the root port on this Switch to the root switch.
Port ID	This is the priority and number of the port on the Switch through which this Switch must communicate with the root of the Spanning Tree.
Topology Changed Times	This is the number of times the spanning tree has been reconfigured.
Time Since Last Change	This is the time since the spanning tree was last reconfigured.

13.8 Configure Multiple Spanning Tree Protocol

To configure MSTP, click **MSTP** in the **Advanced Application > Spanning Tree Protocol** screen. See [Section 13.1.5](#) on page 117 for more information on MSTP.

Figure 67 Advanced Application > Spanning Tree Protocol > MSTP

Multiple Spanning Tree Protocol
[Port](#) [Status](#)

Bridge:

Active	<input type="checkbox"/>
Hello Time	<input type="text" value="2"/> seconds
MAX Age	<input type="text" value="20"/> seconds
Forwarding Delay	<input type="text" value="15"/> seconds
Maximum hops	<input type="text" value="20"/>
Configuration Name	<input type="text" value="0019cb004701"/>
Revision Number	<input type="text" value="0"/>

Instance:

Instance	<input type="text"/>
Bridge Priority	<input type="text" value="32768"/> ▼
VLAN Range	Start <input type="text"/> End <input type="text"/> <input type="button" value="Add"/> <input type="button" value="Remove"/> <input type="button" value="Clear"/>
Enabled VLAN(s)	<div style="border: 1px solid gray; height: 40px; width: 100%;"></div>

Port	Active	Priority	Path Cost
*	<input type="checkbox"/>	<input type="text"/>	<input type="text"/>
1	<input type="checkbox"/>	<input type="text" value="128"/>	<input type="text" value="19"/>
2	<input type="checkbox"/>	<input type="text" value="128"/>	<input type="text" value="19"/>
3	<input type="checkbox"/>	<input type="text" value="128"/>	<input type="text" value="19"/>
4	<input type="checkbox"/>	<input type="text" value="128"/>	<input type="text" value="19"/>
5	<input type="checkbox"/>	<input type="text" value="128"/>	<input type="text" value="19"/>
6	<input type="checkbox"/>	<input type="text" value="128"/>	<input type="text" value="19"/>
7	<input type="checkbox"/>	<input type="text" value="128"/>	<input type="text" value="19"/>

Instance	VLAN	Active Port	Delete
0	1-4094	-	<input type="button" value="Delete"/>

The following table describes the labels in this screen.

Table 36 Advanced Application > Spanning Tree Protocol > MSTP

LABEL	DESCRIPTION
Port	Click Port to display the MSTP Port Configuration screen (see Figure 68 on page 131).
Status	Click Status to display the MSTP Status screen (see Figure 69 on page 132).
Active	Select this check box to activate MSTP on the Switch. Clear this checkbox to disable MSTP on the Switch. Note: You must also activate Multiple Spanning Tree in the Advanced Application > Spanning Tree Protocol > Configuration screen to enable MSTP on the Switch.
Hello Time	This is the time interval in seconds between BPDU (Bridge Protocol Data Units) configuration message generations by the root switch. The allowed range is 1 to 10 seconds.
MaxAge	This is the maximum time (in seconds) a switch can wait without receiving a BPDU before attempting to reconfigure. All switch ports (except for designated ports) should receive BPDUs at regular intervals. Any port that ages out STP information (provided in the last BPDU) becomes the designated port for the attached LAN. If it is a root port, a new root port is selected from among the Switch ports attached to the network. The allowed range is 6 to 40 seconds.
Forwarding Delay	This is the maximum time (in seconds) a switch will wait before changing states. This delay is required because every switch must receive information about topology changes before it starts to forward frames. In addition, each port needs time to listen for conflicting information that would make it return to a blocking state; otherwise, temporary data loops might result. The allowed range is 4 to 30 seconds. As a general rule: Note: $2 * (\text{Forward Delay} - 1) \geq \text{Max Age} \geq 2 * (\text{Hello Time} + 1)$
Maximum hops	Enter the number of hops (between 1 and 255) in an MSTP region before the BPDU is discarded and the port information is aged.
Configuration Name	Enter a descriptive name (up to 32 characters) of an MST region.
Revision Number	Enter a number to identify a region's configuration. Devices must have the same revision number to belong to the same region.
Apply	Click Apply to save your changes to the Switch's run-time memory. The Switch loses these changes if it is turned off or loses power, so use the Save link on the top navigation panel to save your changes to the non-volatile memory when you are done configuring.
Cancel	Click Cancel to begin configuring this screen afresh.
Instance	Use this section to configure MSTI (Multiple Spanning Tree Instance) settings.
Instance	Enter the number you want to use to identify this MST instance on the Switch. The Switch supports instance numbers 0-64.
Bridge Priority	Set the priority of the Switch for the specific spanning tree instance. The lower the number, the more likely the Switch will be chosen as the root bridge within the spanning tree instance. Enter priority values between 0 and 61440 in increments of 4096 (thus valid values are 4096, 8192, 12288, 16384, 20480, 24576, 28672, 32768, 36864, 40960, 45056, 49152, 53248, 57344 and 61440).

Table 36 Advanced Application > Spanning Tree Protocol > MSTP (continued)

LABEL	DESCRIPTION
VLAN Range	Enter the start of the VLAN ID range that you want to add or remove from the VLAN range edit area in the Start field. Enter the end of the VLAN ID range that you want to add or remove from the VLAN range edit area in the End field. Next click: <ul style="list-style-type: none"> • Add - to add this range of VLAN(s) to be mapped to the MST instance. • Remove - to remove this range of VLAN(s) from being mapped to the MST instance. • Clear - to remove all VLAN(s) from being mapped to this MST instance.
Enabled VLAN(s)	This field displays which VLAN(s) are mapped to this MST instance.
Port	This field displays the port number.
*	Settings in this row apply to all ports. Use this row only if you want to make some settings the same for all ports. Use this row first to set the common settings and then make adjustments on a port-by-port basis. Note: Changes in this row are copied to all the ports as soon as you make them.
Active	Select this check box to add this port to the MST instance.
Priority	Configure the priority for each port here. Priority decides which port should be disabled when more than one port forms a loop in the Switch. Ports with a higher priority numeric value are disabled first. The allowed range is between 0 and 255 and the default value is 128.
Path Cost	Path cost is the cost of transmitting a frame on to a LAN through that port. It is recommended to assign this value according to the speed of the bridge. The slower the media, the higher the cost - see Table 29 on page 115 for more information. The default path cost value varies depending on the default path cost method you selected.
Add	Click Add to save this MST instance to the Switch's run-time memory. The Switch loses this change if it is turned off or loses power, so use the Save link on the top navigation panel to save your changes to the non-volatile memory when you are done configuring.
Cancel	Click Cancel to begin configuring this screen afresh.
Instance	This field displays the ID of an MST instance.
VLAN	This field displays the VID (or VID ranges) to which the MST instance is mapped.
Active Port	This field display the ports configured to participate in the MST instance.
Delete	Check the rule(s) that you want to remove in the Delete column and then click the Delete button.
Cancel	Click Cancel to begin configuring this screen afresh.

13.8.1 Multiple Spanning Tree Protocol Port Configuration

To configure MSTP ports, click **Port** in the **Advanced Application > Spanning Tree Protocol > MSTP** screen.

Figure 68 Advanced Application > Spanning Tree Protocol > MSTP > Port

Port	Edge	Root Guard
*	<input type="checkbox"/>	<input type="checkbox"/>
1	<input checked="" type="checkbox"/>	<input type="checkbox"/>
2	<input checked="" type="checkbox"/>	<input type="checkbox"/>
3	<input checked="" type="checkbox"/>	<input type="checkbox"/>
4	<input checked="" type="checkbox"/>	<input type="checkbox"/>
5	<input checked="" type="checkbox"/>	<input type="checkbox"/>
6	<input checked="" type="checkbox"/>	<input type="checkbox"/>
7	<input checked="" type="checkbox"/>	<input type="checkbox"/>
8	<input checked="" type="checkbox"/>	<input type="checkbox"/>
9	<input checked="" type="checkbox"/>	<input type="checkbox"/>
10	<input checked="" type="checkbox"/>	<input type="checkbox"/>
11	<input checked="" type="checkbox"/>	<input type="checkbox"/>
12	<input checked="" type="checkbox"/>	<input type="checkbox"/>
13	<input checked="" type="checkbox"/>	<input type="checkbox"/>
14	<input checked="" type="checkbox"/>	<input type="checkbox"/>
15	<input checked="" type="checkbox"/>	<input type="checkbox"/>

Apply Cancel

The following table describes the labels in this screen.

Table 37 Advanced Application > Spanning Tree Protocol > MSTP > Port

LABEL	DESCRIPTION
Port	This field displays the port number.
*	Settings in this row apply to all ports. Use this row only if you want to make some settings the same for all ports. Use this row first to set the common settings and then make adjustments on a port-by-port basis. Note: Changes in this row are copied to all the ports as soon as you make them.
Edge	Select this check box to configure a port as an edge port when it is directly attached to a computer. An edge port changes its initial STP port state from blocking state to forwarding state immediately without going through listening and learning states right after the port is configured as an edge port or when its link status changes. Note: An edge port becomes a non-edge port as soon as it receives a Bridge Protocol Data Unit (BPDU).
Root Guard	Select this check box to enable root guard on this port in order to prevent the switch(es) attached to the port from becoming the root bridge. With root guard enabled, a port is blocked when the Switch receives a superior BPDU on it. The Switch allows traffic to pass through this port again when the switch connected to the port stops to send superior BPDUs.
Apply	Click Apply to save your changes to the Switch's run-time memory. The Switch loses these changes if it is turned off or loses power, so use the Save link on the top navigation panel to save your changes to the non-volatile memory when you are done configuring.
Cancel	Click Cancel to begin configuring this screen afresh.

13.9 Multiple Spanning Tree Protocol Status

Click **Advanced Application** > **Spanning Tree Protocol** in the navigation panel to display the status screen as shown next. See [Section 13.1.5 on page 117](#) for more information on MSTP.

Note: This screen is only available after you activate MSTP on the Switch.

Figure 69 Advanced Application > Spanning Tree Protocol > Status: MSTP

The screenshot shows the 'Spanning Tree Protocol Status' page with tabs for Configuration, RSTP, MRSTP, and MSTP. The 'Spanning Tree Protocol: MSTP' section is active. It displays two tables: one for CST (Common Spanning Tree) and one for MSTI 1 (Multiple Spanning Tree Instance 1).

Bridge	Root	Our Bridge
Bridge ID	0000-000000000000	8000-000000000000
Hello Time (second)	0	2
Max Age (second)	0	20
Forwarding Delay (second)	0	15
Cost to Bridge	0	0
Port ID	0x0000	0x0000
Configuration Name	001349000002	
Revision Number	0	
Configuration Digest	A317523DB32DA2D62	
Topology Changed Times	0	
Time Since Last Change	0	

Instance	VLAN
0	1-4093

Bridge	Regional Root	Our Bridge
Bridge ID	0000-000000000000	8001-000000000000
Internal Cost	0	0
Port ID	0x0000	0x0000

The following table describes the labels in this screen.

Table 38 Advanced Application > Spanning Tree Protocol > Status: MSTP

LABEL	DESCRIPTION
Configuration	Click Configuration to specify which STP mode you want to activate. Click MSTP to edit MSTP settings on the Switch.
CST	This section describes the Common Spanning Tree settings.
Bridge	Root refers to the base of the spanning tree (the root bridge). Our Bridge is this Switch. This Switch may also be the root bridge.
Bridge ID	This is the unique identifier for this bridge, consisting of bridge priority plus MAC address. This ID is the same for Root and Our Bridge if the Switch is the root switch.
Hello Time (second)	This is the time interval (in seconds) at which the root switch transmits a configuration message.
Max Age (second)	This is the maximum time (in seconds) a switch can wait without receiving a configuration message before attempting to reconfigure.
Forwarding Delay (second)	This is the time (in seconds) the root switch will wait before changing states (that is, listening to learning to forwarding).
Cost to Bridge	This is the path cost from the root port on this Switch to the root switch.

Table 38 Advanced Application > Spanning Tree Protocol > Status: MSTP (continued)

LABEL	DESCRIPTION
Port ID	This is the priority and number of the port on the Switch through which this Switch must communicate with the root of the Spanning Tree.
Configuration Name	This field displays the configuration name for this MST region.
Revision Number	This field displays the revision number for this MST region.
Configuration Digest	A configuration digest is generated from the VLAN-MSTI mapping information. This field displays the 16-octet signature that is included in an MSTP BPDU. This field displays the digest when MSTP is activated on the system.
Topology Changed Times	This is the number of times the spanning tree has been reconfigured.
Time Since Last Change	This is the time since the spanning tree was last reconfigured.
Instance:	These fields display the MSTI to VLAN mapping. In other words, which VLANs run on each spanning tree instance.
Instance	This field displays the MSTI ID.
VLAN	This field displays which VLANs are mapped to an MSTI.
MSTI	Select the MST instance settings you want to view.
Bridge	Root refers to the base of the MST instance. Our Bridge is this Switch. This Switch may also be the root bridge.
Bridge ID	This is the unique identifier for this bridge, consisting of bridge priority plus MAC address. This ID is the same for Root and Our Bridge if the Switch is the root switch.
Internal Cost	This is the path cost from the root port in this MST instance to the regional root switch.
Port ID	This is the priority and number of the port on the Switch through which this Switch must communicate with the root of the MST instance.

Bandwidth Control

This chapter shows you how you can cap the maximum bandwidth using the **Bandwidth Control** screen.

14.1 Bandwidth Control Overview

Bandwidth control means defining a maximum allowable bandwidth for incoming and/or out-going traffic flows on a port.

14.1.1 CIR and PIR

The Committed Information Rate (CIR) is the guaranteed bandwidth for the incoming traffic flow on a port. The Peak Information Rate (PIR) is the maximum bandwidth allowed for the incoming traffic flow on a port when there is no network congestion.

The CIR and PIR should be set for all ports that use the same uplink bandwidth. If the CIR is reached, packets are sent at the rate up to the PIR. When network congestion occurs, packets through the ingress port exceeding the CIR will be marked for drop.

Note: The CIR should be less than the PIR.

Note: The sum of CIRs cannot be greater than or equal to the uplink bandwidth.

14.2 Bandwidth Control Setup

Click **Advanced Application** > **Bandwidth Control** in the navigation panel to bring up the screen as shown next.

Figure 70 Advanced Application > Bandwidth Control

Port	Active	Ingress Rate			Active	Egress Rate	
		Commit Rate	Kbps	Active		Peak Rate	Kbps
*	<input type="checkbox"/>		Kbps	<input type="checkbox"/>		Kbps	<input type="checkbox"/>
1	<input type="checkbox"/>	1	Kbps	<input type="checkbox"/>	1	Kbps	<input type="checkbox"/>
2	<input type="checkbox"/>	1	Kbps	<input type="checkbox"/>	1	Kbps	<input type="checkbox"/>
3	<input type="checkbox"/>	1	Kbps	<input type="checkbox"/>	1	Kbps	<input type="checkbox"/>
4	<input type="checkbox"/>	1	Kbps	<input type="checkbox"/>	1	Kbps	<input type="checkbox"/>
5	<input type="checkbox"/>	1	Kbps	<input type="checkbox"/>	1	Kbps	<input type="checkbox"/>
6	<input type="checkbox"/>	1	Kbps	<input type="checkbox"/>	1	Kbps	<input type="checkbox"/>
7	<input type="checkbox"/>	1	Kbps	<input type="checkbox"/>	1	Kbps	<input type="checkbox"/>
8	<input type="checkbox"/>	1	Kbps	<input type="checkbox"/>	1	Kbps	<input type="checkbox"/>
9	<input type="checkbox"/>	1	Kbps	<input type="checkbox"/>	1	Kbps	<input type="checkbox"/>
10	<input type="checkbox"/>	1	Kbps	<input type="checkbox"/>	1	Kbps	<input type="checkbox"/>
11	<input type="checkbox"/>	1	Kbps	<input type="checkbox"/>	1	Kbps	<input type="checkbox"/>
12	<input type="checkbox"/>	1	Kbps	<input type="checkbox"/>	1	Kbps	<input type="checkbox"/>
13	<input type="checkbox"/>	1	Kbps	<input type="checkbox"/>	1	Kbps	<input type="checkbox"/>
14	<input type="checkbox"/>	1	Kbps	<input type="checkbox"/>	1	Kbps	<input type="checkbox"/>

Apply Cancel

The following table describes the related labels in this screen.

Table 39 Advanced Application > Bandwidth Control

LABEL	DESCRIPTION
Active	Select this check box to enable bandwidth control on the Switch.
Port	This field displays the port number.
*	Settings in this row apply to all ports. Use this row only if you want to make some settings the same for all ports. Use this row first to set the common settings and then make adjustments on a port-by-port basis. Note: Changes in this row are copied to all the ports as soon as you make them.
Ingress Rate	
Active	Select this check box to activate commit rate limits on this port.
Commit Rate	Specify the guaranteed bandwidth allowed in kilobits per second (Kbps) for the incoming traffic flow on a port. The commit rate should be less than the peak rate. The sum of commit rates cannot be greater than or equal to the uplink bandwidth.
Active	Select this check box to activate peak rate limits on this port.
Peak Rate	Specify the maximum bandwidth allowed in kilobits per second (Kbps) for the incoming traffic flow on a port.
Active	Select this check box to activate egress rate limits on this port.
Egress Rate	Specify the maximum bandwidth allowed in kilobits per second (Kbps) for the out-going traffic flow on a port.

Table 39 Advanced Application > Bandwidth Control (continued)

LABEL	DESCRIPTION
Apply	Click Apply to save your changes to the Switch's run-time memory. The Switch loses these changes if it is turned off or loses power, so use the Save link on the top navigation panel to save your changes to the non-volatile memory when you are done configuring.
Cancel	Click Cancel to begin configuring this screen afresh.

Broadcast Storm Control

This chapter introduces and shows you how to configure the broadcast storm control feature.

15.1 Broadcast Storm Control Setup

Broadcast storm control limits the number of broadcast, multicast and destination lookup failure (DLF) packets the Switch receives per second on the ports. When the maximum number of allowable broadcast, multicast and/or DLF packets is reached per second, the subsequent packets are discarded. Enable this feature to reduce broadcast, multicast and/or DLF packets in your network. You can specify limits for each packet type on each port.

Click **Advanced Application > Broadcast Storm Control** in the navigation panel to display the screen as shown next.

Figure 71 Advanced Application > Broadcast Storm Control

Port	Broadcast (pkt/s)	Multicast (pkt/s)	DLF (pkt/s)	Shutdown
*	<input type="checkbox"/>	<input type="checkbox"/>	<input type="checkbox"/>	<input type="checkbox"/>
1	<input type="checkbox"/> 0	<input type="checkbox"/> 0	<input type="checkbox"/> 0	<input type="checkbox"/>
2	<input type="checkbox"/> 0	<input type="checkbox"/> 0	<input type="checkbox"/> 0	<input type="checkbox"/>
3	<input type="checkbox"/> 0	<input type="checkbox"/> 0	<input type="checkbox"/> 0	<input type="checkbox"/>
4	<input type="checkbox"/> 0	<input type="checkbox"/> 0	<input type="checkbox"/> 0	<input type="checkbox"/>
5	<input type="checkbox"/> 0	<input type="checkbox"/> 0	<input type="checkbox"/> 0	<input type="checkbox"/>
6	<input type="checkbox"/> 0	<input type="checkbox"/> 0	<input type="checkbox"/> 0	<input type="checkbox"/>
7	<input type="checkbox"/> 0	<input type="checkbox"/> 0	<input type="checkbox"/> 0	<input type="checkbox"/>
8	<input type="checkbox"/> 0	<input type="checkbox"/> 0	<input type="checkbox"/> 0	<input type="checkbox"/>
9	<input type="checkbox"/> 0	<input type="checkbox"/> 0	<input type="checkbox"/> 0	<input type="checkbox"/>
10	<input type="checkbox"/> 0	<input type="checkbox"/> 0	<input type="checkbox"/> 0	<input type="checkbox"/>
11	<input type="checkbox"/> 0	<input type="checkbox"/> 0	<input type="checkbox"/> 0	<input type="checkbox"/>

The following table describes the labels in this screen.

Table 40 Advanced Application > Broadcast Storm Control

LABEL	DESCRIPTION
Active	Select this check box to enable traffic storm control on the Switch. Clear this check box to disable this feature.
Errdisable	<p>Select this option to turn on error disable for traffic storm control on the Switch. The Switch shuts down a port when the maximum number of allowable broadcast, multicast and/or DLF packets is reached on the port.</p> <p>Click the Errdisable link to go to the Errdisable Recovery screen where you can set the port to become active automatically after a specified time interval.</p>
Port	This field displays a port number.
*	<p>Settings in this row apply to all ports.</p> <p>Use this row only if you want to make some settings the same for all ports. Use this row first to set the common settings and then make adjustments on a port-by-port basis.</p> <p>Note: Changes in this row are copied to all the ports as soon as you make them.</p>
Broadcast (pkt/s)	Select this option and specify how many broadcast packets the port receives per second.
Multicast (pkt/s)	Select this option and specify how many multicast packets the port receives per second.
DLF (pkt/s)	Select this option and specify how many destination lookup failure (DLF) packets the port receives per second.
Shutdown	Select this option to allow the Switch to shut down the port when the specified number of allowable broadcast, multicast and/or DLF packets is reached.
Apply	Click Apply to save your changes to the Switch's run-time memory. The Switch loses these changes if it is turned off or loses power, so use the Save link on the top navigation panel to save your changes to the non-volatile memory when you are done configuring.
Cancel	Click Cancel to begin configuring this screen afresh.

Mirroring

This chapter discusses port mirroring setup screens.

16.1 Port Mirroring Overview

Port mirroring allows you to copy a traffic flow to a monitor port (the port you copy the traffic to) in order that you can examine the traffic from the monitor port without interference.

The Switch supports both local port mirroring and remote port mirroring.

Local Port Mirroring

In local port mirroring, the mirrored ports (through which traffic you copy passes) and the monitor port are on the same device.

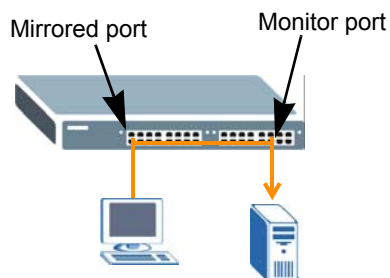

Remote Port Mirroring

In remote port mirroring (RMirror), the mirroring ports and monitor port can be on different devices in a network. You can use it to monitor multiple switches across your network. Traffic from the source device's mirrored port(s) is sent to a mirroring port for VLAN tagging and forwarded to other switch(es) in the same remote port mirroring (RMirror) VLAN. Traffic are then carried over the specified RMirror VLAN and sent to the destination device's monitor port.

Note: If the Switch is not acting as a source or destination device in remote port mirroring, you need to enable port VLAN trunking to allow traffic belonging to the specific RMirror VLAN to pass through it. Alternatively, you can configure a VLAN group for the mirrored traffic.

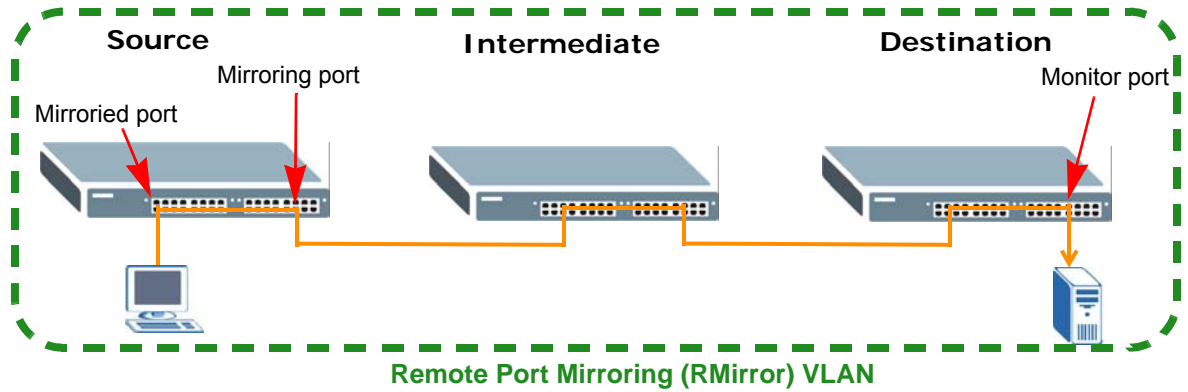

Port Rules in Port Mirroring

The following table shows the rule for a port in remote port mirroring. For example, a port on the source device can be a mirrored port in both RMirror VLAN 1 and RMirror VLAN 2. But when the port is the source device's mirrored port in RMirror VLAN 1, it cannot be the mirroring port or monitor port in another RMirror VLAN.

Table 41 Port Rules between Different Remote Port Mirroring VLANs

		RMirror VLAN 1		
		Source Mirrored Port	Source Mirroring Port	Destination Monitor Port
RMirror VLAN 2	Source Mirrored Port	Y	N	N
	Source Mirroring Port	N	N	N
	Destination Monitor Port	N	N	N

The following table shows the rule for a port used in both local port mirroring and remote port mirroring. For example, the RMirror mirroring port on the source device can also be used as the mirroring port in local port mirroring. But it cannot be the monitor port in local port mirroring.

Table 42 Port Rules between Remote and Local Port Mirroring

		RMirror		
		Source Mirrored Port	Source Mirroring Port	Destination Monitor Port
Local Port Mirroring	Mirrored Port	Y	N	N
	Monitor Port	N	N	N

16.2 Local Port Mirroring Screen

Click **Advanced Application > Mirroring** in the navigation panel to display the **Mirroring** screen. Use this screen to select a monitor port and specify the traffic flow to be copied to the monitor port.

Figure 72 Advanced Application > Mirroring

Port	Mirrored	Direction
*	<input type="checkbox"/>	Ingress ▼
1	<input type="checkbox"/>	Ingress ▼
2	<input type="checkbox"/>	Ingress ▼
3	<input type="checkbox"/>	Ingress ▼
4	<input type="checkbox"/>	Ingress ▼
5	<input type="checkbox"/>	Ingress ▼
6	<input type="checkbox"/>	Ingress ▼
7	<input type="checkbox"/>	Ingress ▼
8	<input type="checkbox"/>	Ingress ▼
9	<input type="checkbox"/>	Ingress ▼
10	<input type="checkbox"/>	Ingress ▼
11	<input type="checkbox"/>	Ingress ▼
12	<input type="checkbox"/>	Ingress ▼
13	<input type="checkbox"/>	Ingress ▼
14	<input type="checkbox"/>	Ingress ▼

The following table describes the labels in this screen.

Table 43 Advanced Application > Mirroring

LABEL	DESCRIPTION
Active	Select this check box to activate port mirroring on the Switch. Clear this check box to disable the feature.
Monitor Port	The monitor port is the port you copy the traffic to in order to examine it in more detail without interfering with the traffic flow on the original port(s). Type the port number of the monitor port.
Port	This field displays the port number.
*	Settings in this row apply to all ports. Use this row only if you want to make some settings the same for all ports. Use this row first to set the common settings and then make adjustments on a port-by-port basis. Note: Changes in this row are copied to all the ports as soon as you make them.
Mirrored	Select this option to mirror the traffic on a port.
Direction	Specify the direction of the traffic to mirror by selecting from the drop-down list box. Choices are Egress (outgoing), Ingress (incoming) and Both .

Table 43 Advanced Application > Mirroring (continued)

LABEL	DESCRIPTION
Apply	Click Apply to save your changes to the Switch's run-time memory. The Switch loses these changes if it is turned off or loses power, so use the Save link on the top navigation panel to save your changes to the non-volatile memory when you are done configuring.
Cancel	Click Cancel to begin configuring this screen afresh.

16.3 RMirror-Source Screen

Use this screen to set the RMirror VLAN ID, configure the mirroring port and specify the traffic flow to be copied when the Switch is the source device in remote port mirroring.

Click the **RMirror-Source** link in the **Mirroring** screen. The following screen opens.

Figure 73 Advanced Application > Mirroring > RMirror-Source

RMirror-Source [Mirroring](#) [RMirror-Destination](#)

Active

RMirror VLAN ID

Mirroring Port

802.1 Priority

Port	Mirrored	Direction
*	<input type="checkbox"/>	Both ▼
1	<input type="checkbox"/>	Both ▼
2	<input type="checkbox"/>	Both ▼
3	<input type="checkbox"/>	Both ▼
4	<input type="checkbox"/>	Both ▼
5	<input type="checkbox"/>	Both ▼
6	<input type="checkbox"/>	Both ▼
7	<input type="checkbox"/>	Both ▼
8	<input type="checkbox"/>	Both ▼
9	<input type="checkbox"/>	Both ▼
10	<input type="checkbox"/>	Both ▼
11	<input type="checkbox"/>	Both ▼
12	<input type="checkbox"/>	Both ▼

Rule Usage: 1 / 2

VLAN	Active	802.1 Priority	Mirrored Port			Mirroring Port	Delete
			Ingress	Egress	Both		
1122	Yes	2	3	4	2	1	<input type="checkbox"/>

The following table describes the labels in this screen.

Table 44 Advanced Application > Mirroring > RMirror-Source

LABEL	DESCRIPTION
Active	Select this check box to enable the rule. Clear this check box to disable it.
RMirror VLAN ID	Enter the ID number of the RMirror VLAN over which the mirrored traffic is forwarded.
Mirroring Port	Select the number of the port that adds the RMirror VLAN tag to all mirrored traffic and forwards traffic to other switch(es) in the same RMirror VLAN.
802.1 Priority	Specify the priority of the mirrored traffic.
Port	This field displays the port number.
*	Settings in this row apply to all ports. Use this row only if you want to make some settings the same for all ports. Use this row first to set the common settings and then make adjustments on a port-by-port basis. Note: Changes in this row are copied to all the ports as soon as you make them.
Mirrored	Select this option to mirror the traffic on a port.
Direction	Specify the direction of the traffic to mirror by selecting from the drop-down list box. Choices are Egress (outgoing), Ingress (incoming) and Both .
Apply	Click Apply to save your changes to the Switch's run-time memory. The Switch loses these changes if it is turned off or loses power, so use the Save link on the top navigation panel to save your changes to the nonvolatile memory when you are done configuring.
Cancel	Click Cancel to begin configuring this screen afresh.
VLAN	This field displays the ID number of RMirror VLAN over which the mirrored traffic is forwarded.
Active	This field shows whether the rule is active or not.
802.1 Priority	This field displays the priority of the mirrored traffic.
Mirrored Port	
Ingress	This field displays the number of port(s) on which the incoming traffic is mirrored.
Egress	This field displays the number of port(s) on which the outgoing traffic is mirrored.
Both	This field displays the number of port(s) on which the incoming and outgoing traffic is mirrored.
Mirroring Port	This field displays the number of the mirroring port in this RMirror VLAN.
Delete	Check the rule(s) that you want to remove in the Delete column and then click the Delete button.
Cancel	Click Cancel to begin configuring this screen afresh.

16.4 RMirror-Destination Screen

Use this screen to specify the RMirror VLAN ID and configure the monitor port when the Switch is the destination device in remote port mirroring.

Click the **RMirror-Destination** link in the **Mirroring** screen. The following screen opens.

Figure 74 Advanced Application > Mirroring > RMirror-Destination

The following table describes the labels in this screen.

Table 45 Advanced Application > Mirroring > RMirror-Destination

LABEL	DESCRIPTION
Active	Select this check box to enable the rule. Clear this check box to disable it.
RMirror VLAN ID	Enter the ID number of the RMirror VLAN over which the mirrored traffic is forwarded.
Monitor Port	Specify the port to which you copy the traffic in order to examine it in more detail without interfering with the traffic flow on the original port(s).
Tagging	Select whether to add the RMirror VLAN tag to mirrored traffic on the monitor port.
Apply	Click Apply to save your changes to the Switch's run-time memory. The Switch loses these changes if it is turned off or loses power, so use the Save link on the top navigation panel to save your changes to the nonvolatile memory when you are done configuring.
Cancel	Click Cancel to begin configuring this screen afresh.

Link Aggregation

This chapter shows you how to logically aggregate physical links to form one logical, higher-bandwidth link.

17.1 Link Aggregation Overview

Link aggregation (trunking) is the grouping of physical ports into one logical higher-capacity link. You may want to trunk ports if for example, it is cheaper to use multiple lower-speed links than to under-utilize a high-speed, but more costly, single-port link.

However, the more ports you aggregate then the fewer available ports you have. A trunk group is one logical link containing multiple ports.

The beginning port of each trunk group must be physically connected to form a trunk group.

The Switch supports both static and dynamic link aggregation.

Note: In a properly planned network, it is recommended to implement static link aggregation only. This ensures increased network stability and control over the trunk groups on your Switch.

See [Section 17.6 on page 150](#) for a static port trunking example.

17.2 Dynamic Link Aggregation

The Switch adheres to the IEEE 802.3ad standard for static and dynamic (LACP) port trunking.

The Switch supports the link aggregation IEEE802.3ad standard. This standard describes the Link Aggregation Control Protocol (LACP), which is a protocol that dynamically creates and manages trunk groups.

When you enable LACP link aggregation on a port, the port can automatically negotiate with the ports at the remote end of a link to establish trunk groups. LACP also allows port redundancy, that is, if an operational port fails, then one of the “standby” ports become operational without user intervention. Please note that:

- You must connect all ports point-to-point to the same Ethernet switch and configure the ports for LACP trunking.
- LACP only works on full-duplex links.
- All ports in the same trunk group must have the same media type, speed, duplex mode and flow control settings.

Configure trunk groups or LACP before you connect the Ethernet switch to avoid causing network topology loops.

17.2.1 Link Aggregation ID

LACP aggregation ID consists of the following information¹:

Table 46 Link Aggregation ID: Local Switch

SYSTEM PRIORITY	MAC ADDRESS	KEY	PORT PRIORITY	PORT NUMBER
0000	00-00-00-00-00-00	0000	00	0000

Table 47 Link Aggregation ID: Peer Switch

SYSTEM PRIORITY	MAC ADDRESS	KEY	PORT PRIORITY	PORT NUMBER
0000	00-00-00-00-00-00	0000	00	0000

17.3 Link Aggregation Status

Click **Advanced Application > Link Aggregation** in the navigation panel. The **Link Aggregation Status** screen displays by default. See [Section 17.1 on page 145](#) for more information.

Figure 75 Advanced Application > Link Aggregation Status

Group ID	Enabled Ports	Synchronized Ports	Aggregator ID	Criteria	Status
T1	1,2,3	-	-	src-dst-mac	Static
T2	4,5	-	[[0000,00-00-00-00-00-00,0000,00,0000]]	src-dst-mac	LACP
T3	-	-	-	src-dst-mac	-
T4	-	-	-	src-dst-mac	-
T5	-	-	-	src-dst-mac	-
T6	-	-	-	src-dst-mac	-
T7	-	-	-	src-dst-mac	-
T8	-	-	-	src-dst-mac	-

The following table describes the labels in this screen.

Table 48 Advanced Application > Link Aggregation Status

LABEL	DESCRIPTION
Group ID	This field displays the group ID to identify a trunk group, that is, one logical link containing multiple ports.
Enabled Port	These are the ports you have configured in the Link Aggregation screen to be in the trunk group. The port number(s) displays only when this trunk group is activated and there is a port belonging to this group.
Synchronized Ports	These are the ports that are currently transmitting data as one logical link in this trunk group.

1. Port Priority and Port Number are 0 as it is the aggregator ID for the trunk group, not the individual port.

Table 48 Advanced Application > Link Aggregation Status (continued)

LABEL	DESCRIPTION
Aggregator ID	<p>Link Aggregator ID consists of the following: system priority, MAC address, key, port priority and port number. Refer to Section 17.2.1 on page 146 for more information on this field.</p> <p>The ID displays only when there is a port belonging to this trunk group and LACP is also enabled for this group.</p>
Criteria	<p>This shows the outgoing traffic distribution algorithm used in this trunk group. Packets from the same source and/or to the same destination are sent over the same link within the trunk.</p> <p>src-mac means the Switch distributes traffic based on the packet's source MAC address.</p> <p>dst-mac means the Switch distributes traffic based on the packet's destination MAC address.</p> <p>src-dst-mac means the Switch distributes traffic based on a combination of the packet's source and destination MAC addresses.</p> <p>src-ip means the Switch distributes traffic based on the packet's source IP address.</p> <p>dst-ip means the Switch distributes traffic based on the packet's destination IP address.</p> <p>src-dst-ip means the Switch distributes traffic based on a combination of the packet's source and destination IP addresses.</p>
Status	<p>This field displays how these ports were added to the trunk group. It displays:</p> <ul style="list-style-type: none"> • Static - if the ports are configured as static members of a trunk group. • LACP - if the ports are configured to join a trunk group via LACP.

17.4 Link Aggregation Setting

Click **Advanced Application > Link Aggregation > Link Aggregation Setting** to display the screen shown next. See [Section 17.1 on page 145](#) for more information on link aggregation.

Figure 76 Advanced Application > Link Aggregation > Link Aggregation Setting

Group ID	Active	Criteria
T1	<input checked="" type="checkbox"/>	src-dst-mac ▼
T2	<input checked="" type="checkbox"/>	src-ip ▼
T3	<input type="checkbox"/>	src-dst-mac ▼
T4	<input type="checkbox"/>	src-dst-mac ▼
T5	<input type="checkbox"/>	src-dst-mac ▼
T6	<input type="checkbox"/>	src-dst-mac ▼
T7	<input type="checkbox"/>	src-dst-mac ▼
T8	<input type="checkbox"/>	src-dst-mac ▼

Port	Group
1	T1 ▼
2	T1 ▼
3	T1 ▼
4	T2 ▼
5	T2 ▼
6	None ▼
7	None ▼
8	None ▼

The following table describes the labels in this screen.

Table 49 Advanced Application > Link Aggregation > Link Aggregation Setting

LABEL	DESCRIPTION
Link Aggregation Setting	This is the only screen you need to configure to enable static link aggregation.
Group ID	The field identifies the link aggregation group, that is, one logical link containing multiple ports.
Active	Select this option to activate a trunk group.
Criteria	<p>Select the outgoing traffic distribution type. Packets from the same source and/or to the same destination are sent over the same link within the trunk. By default, the Switch uses the src-dst-mac distribution type. If the Switch is behind a router, the packet's destination or source MAC address will be changed. In this case, set the Switch to distribute traffic based on its IP address to make sure port trunking can work properly.</p> <p>Select src-mac to distribute traffic based on the packet's source MAC address.</p> <p>Select dst-mac to distribute traffic based on the packet's destination MAC address.</p> <p>Select src-dst-mac to distribute traffic based on a combination of the packet's source and destination MAC addresses.</p> <p>Select src-ip to distribute traffic based on the packet's source IP address.</p> <p>Select dst-ip to distribute traffic based on the packet's destination IP address.</p> <p>Select src-dst-ip to distribute traffic based on a combination of the packet's source and destination IP addresses.</p>

Table 49 Advanced Application > Link Aggregation > Link Aggregation Setting (continued)

LABEL	DESCRIPTION
Port	This field displays the port number.
Group	Select the trunk group to which a port belongs. Note: When you enable the port security feature on the Switch and configure port security settings for a port, you cannot include the port in an active trunk group.
Apply	Click Apply to save your changes to the Switch's run-time memory. The Switch loses these changes if it is turned off or loses power, so use the Save link on the top navigation panel to save your changes to the non-volatile memory when you are done configuring.
Cancel	Click Cancel to begin configuring this screen afresh.

17.5 Link Aggregation Control Protocol

Click in the **Advanced Application > Link Aggregation > Link Aggregation Setting > LACP** to display the screen shown next. See [Section 17.2 on page 145](#) for more information on dynamic link aggregation.

Figure 77 Advanced Application > Link Aggregation > Link Aggregation Setting > LACP

Link Aggregation Control Protocol [Link Aggregation Setting](#)

Active

System Priority

Group ID	LACP Active
T1	<input type="checkbox"/>
T2	<input checked="" type="checkbox"/>
T3	<input type="checkbox"/>
T4	<input type="checkbox"/>
T5	<input type="checkbox"/>
T6	<input type="checkbox"/>
T7	<input type="checkbox"/>
T8	<input type="checkbox"/>

Port	LACP Timeout
*	30 seconds
1	30 seconds
2	30 seconds
3	30 seconds
4	30 seconds
5	30 seconds
6	30 seconds
7	30 seconds
8	30 seconds
9	30 seconds

Apply Cancel

The following table describes the labels in this screen.

Table 50 Advanced Application > Link Aggregation > Link Aggregation Setting > LACP

LABEL	DESCRIPTION
Link Aggregation Control Protocol	Note: Do not configure this screen unless you want to enable dynamic link aggregation.
Active	Select this checkbox to enable Link Aggregation Control Protocol (LACP).
System Priority	LACP system priority is a number between 1 and 65,535. The switch with the lowest system priority (and lowest port number if system priority is the same) becomes the LACP "server". The LACP "server" controls the operation of LACP setup. Enter a number to set the priority of an active port using Link Aggregation Control Protocol (LACP). The smaller the number, the higher the priority level.
Group ID	The field identifies the link aggregation group, that is, one logical link containing multiple ports.
LACP Active	Select this option to enable LACP for a trunk.
Port	This field displays the port number.
*	Settings in this row apply to all ports. Use this row only if you want to make some settings the same for all ports. Use this row first to set the common settings and then make adjustments on a port-by-port basis. Note: Changes in this row are copied to all the ports as soon as you make them.
LACP Timeout	Timeout is the time interval between the individual port exchanges of LACP packets in order to check that the peer port in the trunk group is still up. If a port does not respond after three tries, then it is deemed to be "down" and is removed from the trunk. Set a short timeout (one second) for busy trunked links to ensure that disabled ports are removed from the trunk group as soon as possible. Select either 1 second or 30 seconds.
Apply	Click Apply to save your changes to the Switch's run-time memory. The Switch loses these changes if it is turned off or loses power, so use the Save link on the top navigation panel to save your changes to the non-volatile memory when you are done configuring.
Cancel	Click Cancel to begin configuring this screen afresh.

17.6 Static Trunking Example

This example shows you how to create a static port trunk group for ports 2-5.

- 1 **Make your physical connections** - make sure that the ports that you want to belong to the trunk group are connected to the same destination. The following figure shows ports 2-5 on switch **A** connected to switch **B**.

Figure 78 Trunking Example - Physical Connections

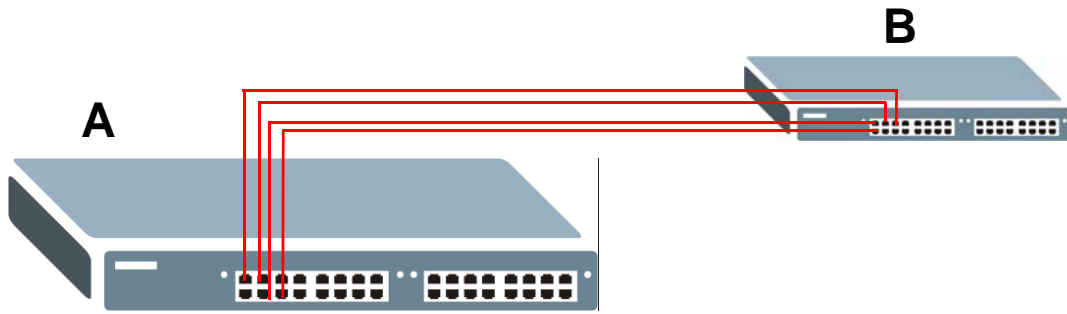

- 2 **Configure static trunking** - Click **Advanced Application** > **Link Aggregation** > **Link Aggregation Setting**. In this screen activate trunk group T1, select the traffic distribution algorithm used by this group and select the ports that should belong to this group as shown in the figure below. Click **Apply** when you are done.

Figure 79 Trunking Example - Configuration Screen

Link Aggregation Setting Status LACP

Group ID	Active	Criteria
T1	<input checked="" type="checkbox"/>	src-dst-mac
T2	<input type="checkbox"/>	src-dst-mac
T3	<input type="checkbox"/>	src-dst-mac
T4	<input type="checkbox"/>	src-dst-mac
T5	<input type="checkbox"/>	src-dst-mac
T6	<input type="checkbox"/>	src-dst-mac
T7	<input type="checkbox"/>	src-dst-mac
T8	<input type="checkbox"/>	src-dst-mac

Port	Group
1	None
2	T1
3	T1
4	T1
5	T1
6	None
7	None
8	None
9	None
10	None

EXAMPLE

Apply Cancel

Your trunk group 1 (T1) configuration is now complete.

Port Authentication

This chapter describes the IEEE 802.1x and MAC authentication methods.

18.1 Port Authentication Overview

Port authentication is a way to validate access to ports on the Switch to clients based on an external server (authentication server). The Switch supports the following methods for port authentication:

- **IEEE 802.1x²** - An authentication server validates access to a port based on a username and password provided by the user.
- **MAC Authentication** - An authentication server validates access to a port based on the MAC address and password of the client.

Both types of authentication use the RADIUS (Remote Authentication Dial In User Service, RFC 2138, 2139) protocol to validate users. See [Section 26.1.2 on page 204](#) for more information on configuring your RADIUS server settings.

Note: If you enable IEEE 802.1x authentication and MAC authentication on the same port, the Switch performs IEEE 802.1x authentication first. If a user fails to authenticate via the IEEE 802.1x method, then access to the port is denied.

18.1.1 IEEE 802.1x Authentication

The following figure illustrates how a client connecting to an IEEE 802.1x authentication enabled port goes through a validation process. The Switch prompts the client for login information in the form of a user name and password after the client responds to its identity request. When the client provides the login credentials, the Switch sends an authentication request to a RADIUS server. The RADIUS server validates whether this client is allowed access to the port.

2. At the time of writing, IEEE 802.1x is not supported by all operating systems. See your operating system documentation. If your operating system does not support 802.1x, then you may need to install 802.1x client software.

Figure 80 IEEE 802.1x Authentication Process

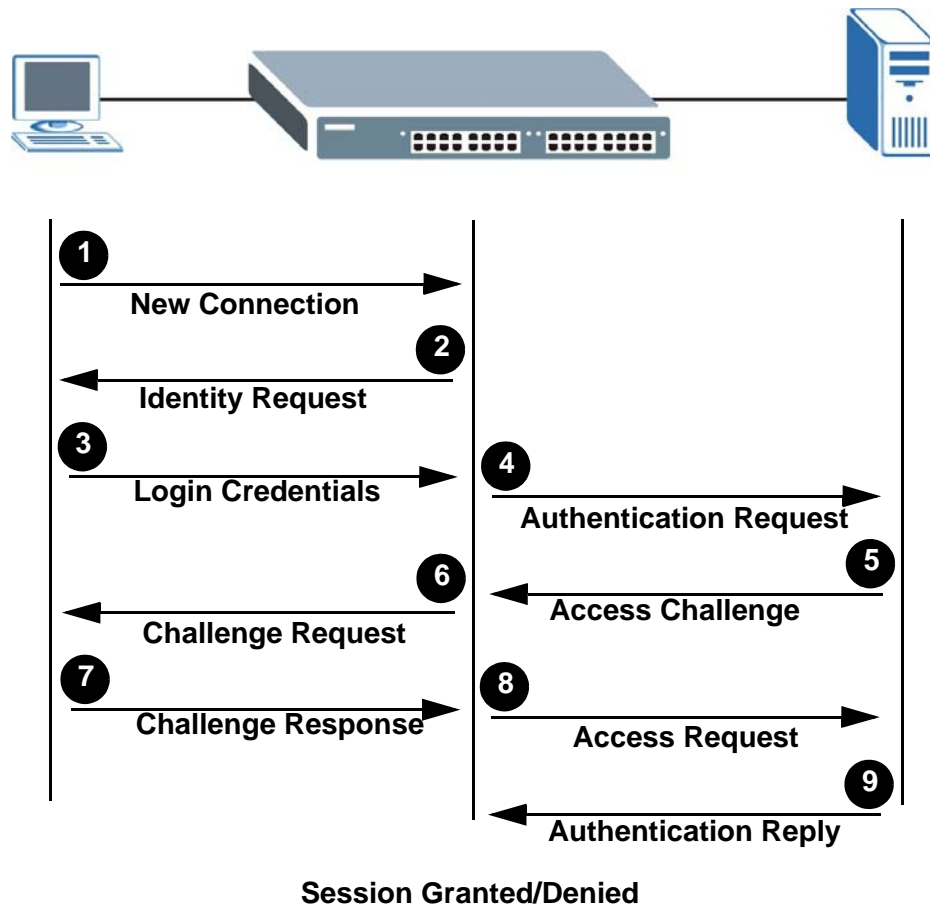

18.1.2 MAC Authentication

MAC authentication works in a very similar way to IEEE 802.1x authentication. The main difference is that the Switch does not prompt the client for login credentials. The login credentials are based on the source MAC address of the client connecting to a port on the Switch along with a password configured specifically for MAC authentication on the Switch.

Figure 81 MAC Authentication Process

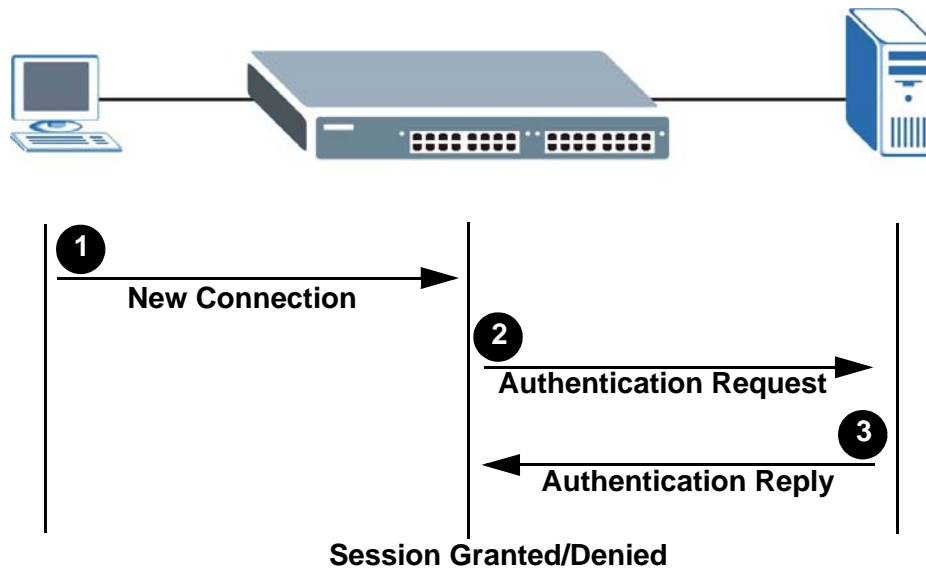

18.2 Port Authentication Configuration

To enable port authentication, first activate the port authentication method(s) you want to use (both on the Switch and the port(s)), then configure the RADIUS server settings in the **AAA > Radius Server Setup** screen.

To activate a port authentication method, click **Advanced Application > Port Authentication** in the navigation panel. Select a port authentication method in the screen that appears.

Figure 82 Advanced Application > Port Authentication



18.2.1 Activate IEEE 802.1x Security

Use this screen to activate IEEE 802.1x security. In the **Port Authentication** screen click **802.1x** to display the configuration screen as shown.

Figure 83 Advanced Application > Port Authentication > 802.1x

Port	Active	Max-Req	Reauth	Reauth-period secs	Quiet-period secs	Tx-period secs	Supp-Timeout secs
*	<input type="checkbox"/>		On ▼				
1	<input type="checkbox"/>	2	On ▼	3600	60	30	30
2	<input type="checkbox"/>	2	On ▼	3600	60	30	30
3	<input type="checkbox"/>	2	On ▼	3600	60	30	30
4	<input type="checkbox"/>	2	On ▼	3600	60	30	30
5	<input type="checkbox"/>	2	On ▼	3600	60	30	30
6	<input type="checkbox"/>	2	On ▼	3600	60	30	30
7	<input type="checkbox"/>	2	On ▼	3600	60	30	30
8	<input type="checkbox"/>	2	On ▼	3600	60	30	30
9	<input type="checkbox"/>	2	On ▼	3600	60	30	30
27	<input type="checkbox"/>	2	On ▼	3600	60	30	30
28	<input type="checkbox"/>	2	On ▼	3600	60	30	30

The following table describes the labels in this screen.

Table 51 Advanced Application > Port Authentication > 802.1x

LABEL	DESCRIPTION
Active	Select this check box to permit 802.1x authentication on the Switch. Note: You must first enable 802.1x authentication on the Switch before configuring it on each port.
Port	This field displays a port number.
*	Settings in this row apply to all ports. Use this row only if you want to make some settings the same for all ports. Use this row first to set the common settings and then make adjustments on a port-by-port basis. Note: Changes in this row are copied to all the ports as soon as you make them.
Active	Select this checkbox to permit 802.1x authentication on this port. You must first allow 802.1x authentication on the Switch before configuring it on each port.
Max-Req	Specify the number of times the Switch tries to authenticate client(s) before sending unresponsive ports to the Guest VLAN. This is set to 2 by default. That is, the Switch attempts to authenticate a client twice. If the client does not respond to the first authentication request, the Switch tries again. If the client still does not respond to the second request, the Switch sends the client to the Guest VLAN. The client needs to send a new request to be authenticated by the Switch again.
Reauth	Specify if a subscriber has to periodically re-enter his or her username and password to stay connected to the port.
Reauth-period	Specify the length of time required to pass before a client has to re-enter his or her username and password to stay connected to the port.

Table 51 Advanced Application > Port Authentication > 802.1x (continued)

LABEL	DESCRIPTION
Quiet-period	Specify the number of seconds the port remains in the HELD state and rejects further authentication requests from the connected client after a failed authentication exchange.
Tx-period	Specify the number of seconds the Switch waits for client's response before re-sending an identity request to the client.
Supp-Timeout	Specify the number of seconds the Switch waits for client's response to a challenge request before sending another request.
Apply	Click Apply to save your changes to the Switch's run-time memory. The Switch loses these changes if it is turned off or loses power, so use the Save link on the top navigation panel to save your changes to the non-volatile memory when you are done configuring.
Cancel	Click Cancel to begin configuring this screen afresh.

18.2.2 Guest VLAN

When 802.1x port authentication is enabled on the Switch and its ports, clients that do not have the correct credentials are blocked from using the port(s). You can configure your Switch to have one VLAN that acts as a guest VLAN. If you enable the guest VLAN (**102** in the example) on a port (**2** in the example), the user (**A** in the example) that is not IEEE 802.1x capable or fails to enter the correct username and password can still access the port, but traffic from the user is forwarded to the guest VLAN. That is, unauthenticated users can have access to limited network resources in the same guest VLAN, such as the Internet. The rights granted to the Guest VLAN depends on how the network administrator configures switches or routers with the guest network feature.

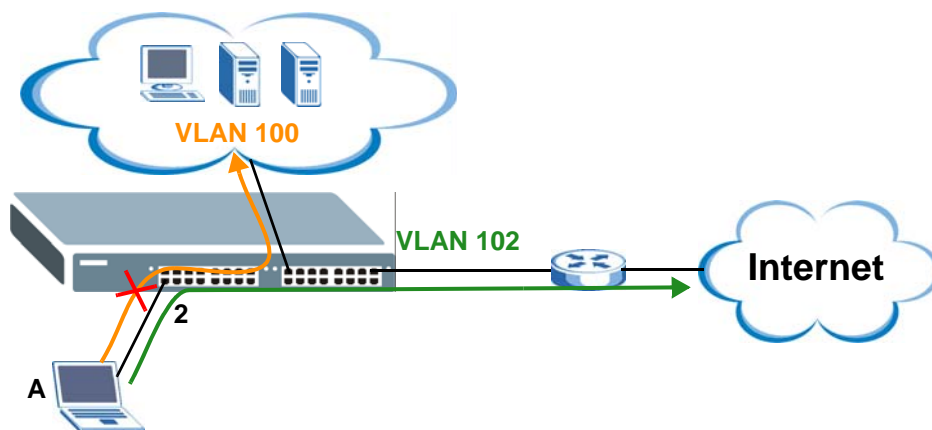
Figure 84 Guest VLAN Example

Use this screen to enable and assign a guest VLAN to a port. In the **Port Authentication > 802.1x** screen click **Guest Vlan** to display the configuration screen as shown.

Figure 85 Advanced Application > Port Authentication > 802.1x > Guest VLAN

Port	Active	Guest Vlan	Host-mode	Multi-Secure Num
*	<input type="checkbox"/>	1	Multi-Host	1
1	<input type="checkbox"/>	1	Multi-Host	1
2	<input type="checkbox"/>	1	Multi-Host	1
3	<input type="checkbox"/>	1	Multi-Host	1
4	<input type="checkbox"/>	1	Multi-Host	1
5	<input type="checkbox"/>	1	Multi-Host	1
6	<input type="checkbox"/>	1	Multi-Host	1
7	<input type="checkbox"/>	1	Multi-Host	1
8	<input type="checkbox"/>	1	Multi-Host	1
9	<input type="checkbox"/>	1	Multi-Host	1
10	<input type="checkbox"/>	1	Multi-Host	1
...				
27	<input type="checkbox"/>	1	Multi-Host	1
28	<input type="checkbox"/>	1	Multi-Host	1

Apply Cancel

The following table describes the labels in this screen.

Table 52 Advanced Application > Port Authentication > 802.1x > Guest VLAN

LABEL	DESCRIPTION
Port	This field displays a port number.
*	Settings in this row apply to all ports. Use this row only if you want to make some settings the same for all ports. Use this row first to set the common settings and then make adjustments on a port-by-port basis. Note: Changes in this row are copied to all the ports as soon as you make them.
Active	Select this checkbox to enable the guest VLAN feature on this port. Clients that fail authentication are placed in the guest VLAN and can receive limited services.
Guest Vlan	A guest VLAN is a pre-configured VLAN on the Switch that allows non-authenticated users to access limited network resources through the Switch. You must also enable IEEE 802.1x authentication on the Switch and the associated ports. Enter the number that identifies the guest VLAN. Make sure this is a VLAN recognized in your network.
Host-mode	Specify how the Switch authenticates users when more than one user connect to the port (using a hub). Select Multi-Host to authenticate only the first user that connects to this port. If the first user enters the correct credential, any other users are allowed to access the port without authentication. If the first user fails to enter the correct credential, they are all put in the guest VLAN. Once the first user who did authentication logs out or disconnects from the port, rest of the users are blocked until a user does the authentication process again. Select Multi-Secure to authenticate each user that connects to this port.
Multi-Secure Num	If you set Host-mode to Multi-Secure , specify the maximum number of users (between 1 and 5) that the Switch will authenticate on this port.

Table 52 Advanced Application > Port Authentication > 802.1x > Guest VLAN (continued)

LABEL	DESCRIPTION
Apply	Click Apply to save your changes to the Switch's run-time memory. The Switch loses these changes if it is turned off or loses power, so use the Save link on the top navigation panel to save your changes to the non-volatile memory when you are done configuring.
Cancel	Click Cancel to begin configuring this screen afresh.

18.2.3 Activate MAC Authentication

Use this screen to activate MAC authentication. In the **Port Authentication** screen click **MAC Authentication** to display the configuration screen as shown.

Figure 86 Advanced Application > Port Authentication > MAC Authentication

Port	Active
*	<input type="checkbox"/>
1	<input type="checkbox"/>
2	<input type="checkbox"/>
3	<input type="checkbox"/>
4	<input type="checkbox"/>
5	<input type="checkbox"/>
6	<input type="checkbox"/>
7	<input type="checkbox"/>
8	<input type="checkbox"/>

The following table describes the labels in this screen.

Table 53 Advanced Application > Port Authentication > MAC Authentication

LABEL	DESCRIPTION
Active	Select this check box to permit MAC authentication on the Switch. Note: You must first enable MAC authentication on the Switch before configuring it on each port.
Name Prefix	Type the prefix that is appended to all MAC addresses sent to the RADIUS server for authentication. You can enter up to 32 printable ASCII characters. If you leave this field blank, then only the MAC address of the client is forwarded to the RADIUS server.
Password	Type the password the Switch sends along with the MAC address of a client for authentication with the RADIUS server. You can enter up to 32 printable ASCII characters.

Table 53 Advanced Application > Port Authentication > MAC Authentication (continued)

LABEL	DESCRIPTION
Timeout	<p>Specify the amount of time before the Switch allows a client MAC address that fails authentication to try and authenticate again. Maximum time is 3000 seconds.</p> <p>When a client fails MAC authentication, its MAC address is learned by the MAC address table with a status of denied. The timeout period you specify here is the time the MAC address entry stays in the MAC address table until it is cleared. If you specify 0 for the timeout value, then this entry will not be deleted from the MAC address table.</p> <p>Note: If the Aging Time in the Switch Setup screen is set to a lower value, then it supersedes this setting. See Section 8.4 on page 82.</p>
Port	This field displays a port number.
*	<p>Use this row to make the setting the same for all ports. Use this row first and then make adjustments on a port-by-port basis.</p> <p>Note: Changes in this row are copied to all the ports as soon as you make them.</p>
Active	Select this checkbox to permit MAC authentication on this port. You must first allow MAC authentication on the Switch before configuring it on each port.
Apply	Click Apply to save your changes to the Switch's run-time memory. The Switch loses these changes if it is turned off or loses power, so use the Save link on the top navigation panel to save your changes to the non-volatile memory when you are done configuring.
Cancel	Click Cancel to begin configuring this screen afresh.

Port Security

This chapter shows you how to set up port security.

19.1 About Port Security

Port security allows only packets with dynamically learned MAC addresses and/or configured static MAC addresses to pass through a port on the Switch. The Switch can learn up to 16K MAC addresses in total with no limit on individual ports other than the sum cannot exceed 16K.

For maximum port security, enable this feature, disable MAC address learning and configure static MAC address(es) for a port. It is not recommended you disable port security together with MAC address learning as this will result in many broadcasts. By default, MAC address learning is still enabled even though the port security is not activated.

19.2 Port Security Setup

Click **Advanced Application > Port Security** in the navigation panel to display the screen as shown.

Figure 87 Advanced Application > Port Security

Port Security
MAC Freeze :

Port List MAC freeze

Port Security :

Active

[Errdisable](#) Shutdown the port when the learned MAC is out of limit

Port	Active	Address Learning	Limited Number of Learned MAC Address	Shutdown
*	<input type="checkbox"/>	<input checked="" type="checkbox"/>	<input type="text"/>	<input type="checkbox"/>
1	<input type="checkbox"/>	<input checked="" type="checkbox"/>	0	<input type="checkbox"/>
2	<input type="checkbox"/>	<input checked="" type="checkbox"/>	0	<input type="checkbox"/>
3	<input type="checkbox"/>	<input checked="" type="checkbox"/>	0	<input type="checkbox"/>
4	<input type="checkbox"/>	<input checked="" type="checkbox"/>	0	<input type="checkbox"/>
5	<input type="checkbox"/>	<input checked="" type="checkbox"/>	0	<input type="checkbox"/>
6	<input type="checkbox"/>	<input checked="" type="checkbox"/>	0	<input type="checkbox"/>
7	<input type="checkbox"/>	<input checked="" type="checkbox"/>	0	<input type="checkbox"/>
8	<input type="checkbox"/>	<input checked="" type="checkbox"/>	0	<input type="checkbox"/>
9	<input type="checkbox"/>	<input checked="" type="checkbox"/>	0	<input type="checkbox"/>
10	<input type="checkbox"/>	<input checked="" type="checkbox"/>	0	<input type="checkbox"/>
11	<input type="checkbox"/>	<input checked="" type="checkbox"/>	0	<input type="checkbox"/>

Apply Cancel

The following table describes the labels in this screen.

Table 54 Advanced Application > Port Security

LABEL	DESCRIPTION
Port List	Enter the number of the port(s) (separated by a comma) on which you want to enable port security and disable MAC address learning. After you click MAC freeze , all previously learned MAC addresses on the specified port(s) will become static MAC addresses and display in the Static MAC Forwarding screen.
MAC freeze	Click MAC freeze to have the Switch automatically select the Active check boxes and clear the Address Learning check boxes only for the ports specified in the Port list .
Active	Select this option to enable port security on the Switch.
Errdisable	Select this option to turn on error disable for port security on the Switch. The Switch shuts down a port when the maximum number of MAC addresses that may be learned on a port is reached. Click the Errdisable link to go to the Errdisable Recovery screen where you can set the port to become active automatically after a specified time interval.
Port	This field displays a port number.

Table 54 Advanced Application > Port Security (continued)

LABEL	DESCRIPTION
*	<p>Settings in this row apply to all ports.</p> <p>Use this row only if you want to make some of the settings the same for all ports. Use this row first to set the common settings and then make adjustments on a port-by-port basis.</p> <p>Note: Changes in this row are copied to all the ports as soon as you make them.</p>
Active	<p>Select this check box to enable the port security feature on this port. The Switch forwards packets whose MAC address(es) is in the MAC address table on this port. Packets with no matching MAC address(es) are dropped.</p> <p>Clear this check box to disable the port security feature. The Switch forwards all packets on this port.</p>
Address Learning	<p>MAC address learning reduces outgoing broadcast traffic. For MAC address learning to occur on a port, the port itself must be active with address learning enabled.</p>
Limited Number of Learned MAC Address	<p>Use this field to limit the number of (dynamic) MAC addresses that may be learned on a port. For example, if you set this field to "5" on port 2, then only the devices with these five learned MAC addresses may access port 2 at any one time. A sixth device must wait until one of the five learned MAC addresses ages out. MAC address aging out time can be set in the Switch Setup screen. The valid range is from "0" to "16384". "0" means this feature is disabled.</p>
Shutdown	<p>Select this option to allow the Switch to shut down the port when the specified number of MAC addresses that may be learned on a port is reached.</p>
Apply	<p>Click Apply to save your changes to the Switch's run-time memory. The Switch loses these changes if it is turned off or loses power, so use the Save link on the top navigation panel to save your changes to the non-volatile memory when you are done configuring.</p>
Cancel	<p>Click Cancel to begin configuring this screen afresh.</p>

Range Profile

This chapter shows you how to create range profiles.

20.1 Range Profile Overview

A profile represents a group of saved settings that you can use across any number of screens. A range profile allows you to define a specific range of ports, IP addresses, VLANs or socket ports.

20.2 Range Profile Screen

The **Range Profile** screens allow you to access and configure profiles for a range of VLANs, IP addresses, ports and socket ports. Click **Advanced Application > Range Profile** in the navigation panel to display the screen as shown.

Figure 88 Advanced Application > Range Profile

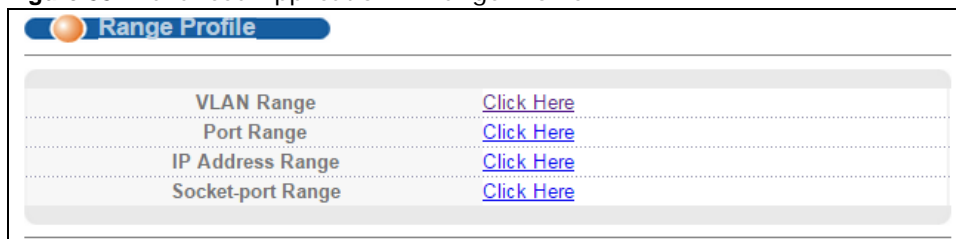

20.3 VLAN Range Profile

Use this screen to view, manage and create VLAN range profiles. In the **Range Profile** screen, click **VLAN Range** to display the screen as shown.

Figure 89 Advanced Application > Range Profile > VLAN Range

The following table describes the labels in this screen.

Table 55 Advanced Application > Range Profile > VLAN Range

LABEL	DESCRIPTION
Name	Enter a descriptive name for this profile for identifying purposes.
VLAN-ID	Enter the first and last VLAN ID number to specify a range of VLANs.
Add	Click Add to save your changes to the Switch's run-time memory. The Switch loses this change if it is turned off or loses power, so use the Save link on the top navigation panel to save your changes to the non-volatile memory when you are done configuring.
Cancel	Click Cancel to begin configuring this screen afresh.
Index	This field displays the index number of the profile. Click an index number to change the settings.
Name	This field displays the descriptive name for this profile.
VLAN-ID	This field displays the ID number of the VLANs in this profile.
Referenced	This field displays whether this profile is in use by a feature, such as classifier.
Delete	Check the profile(s) that you want to remove in the Delete column and then click the Delete button.
Cancel	Click Cancel to begin configuring this screen afresh.

20.4 Port Range Profile

Use this screen to view, manage and create port range profiles. In the **Range Profile** screen, click **Port Range** to display the screen as shown.

Figure 90 Advanced Application > Range Profile > Port Range

Port Range Range Profile

Name

Port Number

1	2	3	4	5	6	7	8	9	10	11	12	13	14	15	16	17	18	19	20	21	22	23	24	25	26	27	28
<input type="checkbox"/>	<input type="checkbox"/>	<input type="checkbox"/>	<input type="checkbox"/>	<input type="checkbox"/>	<input type="checkbox"/>	<input type="checkbox"/>	<input type="checkbox"/>	<input type="checkbox"/>	<input type="checkbox"/>	<input type="checkbox"/>	<input type="checkbox"/>	<input type="checkbox"/>	<input type="checkbox"/>	<input type="checkbox"/>	<input type="checkbox"/>	<input type="checkbox"/>	<input type="checkbox"/>	<input type="checkbox"/>	<input type="checkbox"/>	<input type="checkbox"/>	<input type="checkbox"/>	<input type="checkbox"/>	<input type="checkbox"/>	<input type="checkbox"/>	<input type="checkbox"/>	<input type="checkbox"/>	<input type="checkbox"/>

Add Cancel

Rule Usage: 1 / 10

Index	Name	Port Number	Referenced	Delete
1	portrange1	25-28	No	<input type="checkbox"/>

Delete Cancel

The following table describes the labels in this screen.

Table 56 Advanced Application > Range Profile > Port Range

LABEL	DESCRIPTION
Name	Enter a descriptive name for this profile for identifying purposes.
Port Number	Select the number of ports you want to include in this profile.
Add	Click Add to save your changes to the Switch's run-time memory. The Switch loses this change if it is turned off or loses power, so use the Save link on the top navigation panel to save your changes to the non-volatile memory when you are done configuring.
Cancel	Click Cancel to begin configuring this screen afresh.
Index	This field displays the index number of the profile. Click an index number to change the settings.
Name	This field displays the descriptive name for this profile.
Port Number	This field displays the number of ports in this profile.
Referenced	This field displays whether this profile is in use by a feature, such as classifier.
Delete	Check the profile(s) that you want to remove in the Delete column and then click the Delete button.
Cancel	Click Cancel to begin configuring this screen afresh.

20.5 IP Address Range Profile

Use this screen to view, manage and create IP address range profiles. In the **Range Profile** screen, click **IP Address Range** to display the screen as shown.

Figure 91 Advanced Application > Range Profile > IP Address Range

The following table describes the labels in this screen.

Table 57 Advanced Application > Range Profile > IP Address Range

LABEL	DESCRIPTION
Name	Enter a descriptive name for this profile for identifying purposes.
Type	Select to specify the source or destination IP addresses.
IP Address	Enter the first and last IP address to specify a range of IP addresses.
Add	Click Add to save your changes to the Switch's run-time memory. The Switch loses this change if it is turned off or loses power, so use the Save link on the top navigation panel to save your changes to the non-volatile memory when you are done configuring.
Cancel	Click Cancel to begin configuring this screen afresh.
Index	This field displays the index number of the profile. Click an index number to change the settings.
Name	This field displays the descriptive name for this profile.
Type	This field displays the type of the IP address(es) in this profile.
IP Address	This field displays the range of IP addresses defined in this profile.
Referenced	This field displays whether this profile is in use by a feature, such as classifier.
Delete	Check the profile(s) that you want to remove in the Delete column and then click the Delete button.
Cancel	Click Cancel to begin configuring this screen afresh.

20.6 Socket-Port Range Profile

Use this screen to view, manage and create socket port range profiles. In the **Range Profile** screen, click **Socket-port Range** to display the screen as shown.

Figure 92 Advanced Application > Range Profile > Socket-port Range

The following table describes the labels in this screen.

Table 58 Advanced Application > Range Profile > Socket-port Range

LABEL	DESCRIPTION
Name	Enter a descriptive name for this profile for identifying purposes.
Type	Select to specify the source or destination socket port numbers.
IP Address	Enter the first and last socket port numbers to specify a range of socket port numbers.
Add	Click Add to save your changes to the Switch's run-time memory. The Switch loses this change if it is turned off or loses power, so use the Save link on the top navigation panel to save your changes to the non-volatile memory when you are done configuring.
Cancel	Click Cancel to begin configuring this screen afresh.
Index	This field displays the index number of the profile. Click an index number to change the settings.
Name	This field displays the descriptive name for this profile.
Type	This field displays the type of the socket ports in this profile.
Socket-Port	This field displays the range of socket ports defined in this profile.
Referenced	This field displays whether this profile is in use by a feature, such as classifier.
Delete	Check the profile(s) that you want to remove in the Delete column and then click the Delete button.
Cancel	Click Cancel to begin configuring this screen afresh.

Classifier

This chapter introduces and shows you how to configure the packet classifier on the Switch.

21.1 About the Classifier and QoS

Quality of Service (QoS) refers to both a network's ability to deliver data with minimum delay, and the networking methods used to control the use of bandwidth. Without QoS, all traffic data is equally likely to be dropped when the network is congested. This can cause a reduction in network performance and make the network inadequate for time-critical application such as video-on-demand.

A classifier groups traffic into data flows according to specific criteria such as the source address, destination address, source port number, destination port number or incoming port number. For example, you can configure a classifier to select traffic from the same protocol port (such as Telnet) to form a flow.

Configure QoS on the Switch to group and prioritize application traffic and fine-tune network performance. Setting up QoS involves two separate steps:

- 1 Configure classifiers to sort traffic into different flows.
- 2 Configure policy rules to define actions to be performed for a classified traffic flow (refer to [Chapter 22 on page 174](#) to configure policy rules).

21.2 Configuring the Classifier

Use the **Classifier** screen to define the classifiers. After you define the classifier, you can specify actions (or policy) to act upon the traffic that matches the rules. To configure policy rules, refer to [Chapter 22 on page 174](#).

Click **Advanced Application > Classifier** in the navigation panel to display the configuration screen as shown.

Figure 93 Advanced Application > Classifier

The screenshot shows the 'Classifier' configuration page. At the top, there is a title bar with 'Classifier' and a 'Range Profile' link. Below this is an 'Active' checkbox and a 'Name' input field. The configuration is divided into two main sections: 'Layer 2' and 'Layer 3'.
Layer 2 Section:
 - **VLAN:** Radio buttons for 'Any', 'Single' (with an input field), and 'Range' (with a dropdown menu and a link '(See VLAN Range)').
 - **Priority:** Radio buttons for 'Any' and '0' (with a dropdown menu).
 - **Ethernet Type:** Radio buttons for 'All' (with a dropdown menu) and 'Others' (with an input field and '(Hex)').
Source Section:
 - **MAC Address:** Radio buttons for 'Any' and 'MAC' (with six input fields for hex digits and a '/Mask' field with six input fields).
 - **Port:** Radio buttons for 'Any', 'Single' (with an input field), and 'Range' (with a dropdown menu and a link '(See Port Range)').
Destination Section:
 - **MAC Address:** Radio buttons for 'Any' and 'MAC' (with six input fields for hex digits and a '/Mask' field with six input fields).
Layer 3 Section:
 - **DSCP/ToS:** Radio buttons for 'DSCP' (with a dropdown menu 'Any'), 'ToS' (with dropdown menus 'Any' and 'Any' and '(Precedence, ToS)'), and 'Establish Only (Valid for TCP)'.
 - **IP Protocol:** Radio buttons for 'All' (with a dropdown menu and 'Establish Only (Valid for TCP)'), and 'Others' (with an input field and '(Dec)').
Source Section:
 - **IP Address:** Radio buttons for 'Prefix' (with '0.0.0.0' and a slash and input field) and 'Range' (with a dropdown menu and a link '(See IP Address Range)').
 - **Socket Number:** Radio buttons for 'Any', 'Single' (with an input field), and 'Range' (with a dropdown menu and a link '(See Socket Port Range)').
Destination Section:
 - **IP Address:** Radio buttons for 'Prefix' (with '0.0.0.0' and a slash and input field) and 'Range' (with a dropdown menu and a link '(See IP Address Range)').
 - **Socket Number:** Radio buttons for 'Any', 'Single' (with an input field), and 'Range' (with a dropdown menu and a link '(See Socket Port Range)').
 At the bottom of the configuration area are 'Add', 'Cancel', and 'Clear' buttons. Below this is a 'Rule Usage: 0 / 192' indicator and a table with columns 'Index', 'Active', 'Name', 'Rule', and 'Delete'. At the very bottom are 'Delete' and 'Cancel' buttons.

The following table describes the labels in this screen.

Table 59 Advanced Application > Classifier

LABEL	DESCRIPTION
Active	Select this option to enable this rule.
Name	Enter a descriptive name for this rule for identifying purposes.
Layer 2	Specify the fields below to configure a layer-2 classifier.

Table 59 Advanced Application > Classifier (continued)

LABEL	DESCRIPTION
VLAN	Select Any to classify traffic from any VLAN. Select Single and specify a source VLAN ID in the field provided. Select Range and choose a pre-defined VLAN range profile.
Priority	Select Any to classify traffic from any priority level or select the second option and specify a priority level in the field provided.
Ethernet Type	Select an Ethernet type or select Others and enter the Ethernet type number in hexadecimal value. Refer to Table 61 on page 172 for information.
Source	
MAC Address	Select Any to apply the rule to all MAC addresses. To specify a source, select MAC/Mask to enter the source MAC address of the packet in valid MAC address format (six hexadecimal character pairs) and type the mask for the specified MAC address to determine which bits a packet's MAC address should match. Enter "f" for each bit of the specified MAC address that the traffic's MAC address should match. Enter "0" for the bit(s) of the matched traffic's MAC address, which can be of any hexadecimal character(s). For example, if you set the MAC address to 00:13:49:00:00:00 and the mask to ff:ff:ff:00:00:00, a packet with a MAC address of 00:13:49:12:34:56 matches this criteria. If you leave the Mask field blank, the Switch automatically sets the mask to ff:ff:ff:ff:ff:ff.
Port	Select Any to apply the rule to all ports. Select Single and specify a port number to which the rule should be applied. Select Range and choose a pre-defined port range profile to apply the rule to the ports defined in the profile.
Destination	
MAC Address	Select Any to apply the rule to all MAC addresses. To specify a destination, select MAC/Mask to enter the destination MAC address of the packet in valid MAC address format (six hexadecimal character pairs) and type the mask for the specified MAC address to determine which bits a packet's MAC address should match. Enter "f" for each bit of the specified MAC address that the traffic's MAC address should match. Enter "0" for the bit(s) of the matched traffic's MAC address, which can be of any hexadecimal character(s). For example, if you set the MAC address to 00:13:49:00:00:00 and the mask to ff:ff:ff:00:00:00, a packet with a MAC address of 00:13:49:12:34:56 matches this criteria. If you leave the Mask field blank, the Switch automatically sets the mask to ff:ff:ff:ff:ff:ff.
Layer 3 Specify the fields below to configure a layer-3 classifier.	
DSCP/ToS	Select DSCP and Any to classify traffic from any DSCP or select a DSCP (DiffServ Code Point) number between 0 and 63 in the field provided. Select ToS and Any to classify traffic from any ToS or select an IP Precedence (the first 3 bits of the 8-bit ToS field) value in the first field next to the ToS option and a Type of Service (the last 5 bits of the 8-bit ToS field) value in the second field.
IP Protocol	Select an IP protocol type or select Other and enter the protocol number in decimal value. Refer to Table 62 on page 172 for more information. You may select Establish Only for TCP protocol type. This means that the Switch will pick out the packets that are sent to establish TCP connections.
Source	
IP Address	Select Prefix to enter a source IP address and specify the address prefix by entering the number of ones in the subnet mask. Otherwise, select Range and choose a predefined source IP address range profile.

Table 59 Advanced Application > Classifier (continued)

LABEL	DESCRIPTION
Socket Number	Note: You must select either UDP or TCP in the IP Protocol field before you configure the socket numbers. Select Any to apply the rule to all TCP/UDP protocol port numbers. Select Single and enter a TCP/UDP protocol port number. Select Range and choose a pre-defined socket port range profile.
Destination	
IP Address	Select Prefix to enter a destination IP address and specify the address prefix by entering the number of ones in the subnet mask. Otherwise, select Range and choose a predefined destination IP address range profile.
Socket Number	Note: You must select either UDP or TCP in the IP Protocol field before you configure the socket numbers. Select Any to apply the rule to all TCP/UDP protocol port numbers. Select Single and enter a TCP/UDP protocol port number. Select Range and choose a pre-defined socket port range profile.
Add	Click Add to insert the entry in the summary table below and save your changes to the Switch's run-time memory. The Switch loses these changes if it is turned off or loses power, so use the Save link on the top navigation panel to save your changes to the non-volatile memory when you are done configuring.
Cancel	Click Cancel to begin configuring this screen afresh.
Clear	Click Clear to set the above fields back to the factory defaults.

21.3 Viewing and Editing Classifier Configuration

To view a summary of the classifier configuration, scroll down to the summary table at the bottom of the **Classifier** screen. To change the settings of a rule, click a number in the **Index** field.

Note: When two rules conflict with each other, a higher layer rule has priority over a lower layer rule.

Figure 94 Advanced Application > Classifier: Summary Table

Index	Active	Name	Rule	Delete

The following table describes the labels in this screen.

Table 60 Classifier: Summary Table

LABEL	DESCRIPTION
Rule Usage	This field displays how many rules have been configured on the Switch.
Index	This field displays the index number of the rule. Click an index number to edit the rule.

Table 60 Classifier: Summary Table

LABEL	DESCRIPTION
Active	This field displays Yes when the rule is activated and No when it is deactivated.
Name	This field displays the descriptive name for this rule. This is for identification purposes only.
Rule	This field displays a summary of the classifier rule's settings.
Delete	Click Delete to remove the selected entry from the summary table.
Cancel	Click Cancel to clear the Delete check boxes.

The following table shows some other common Ethernet types and the corresponding protocol number.

Table 61 Common Ethernet Types and Protocol Number

ETHERNET TYPE	PROTOCOL NUMBER
IP ETHII	0800
X.75 Internet	0801
NBS Internet	0802
ECMA Internet	0803
Chaosnet	0804
X.25 Level 3	0805
XNS Compat	0807
Banyan Systems	0BAD
BBN Simnet	5208
IBM SNA	80D5
AppleTalk AARP	80F3

Some of the most common IP ports are:

Table 62 Common IP Ports

PORT NUMBER	PORT NAME
21	FTP
23	Telnet
25	SMTP
53	DNS
80	HTTP
110	POP3

21.4 Classifier Example

The following screen shows an example of configuring a classifier that identifies all traffic from MAC address 00:50:ba:ad:4f:81 on port 2.

Figure 95 Classifier: Example

Classifier
[Range Profile](#)

Active

Name

VLAN Any
 Single
 Range (See [VLAN Range](#))

Priority Any
 0

Ethernet Type All
 Others (Hex)

Layer 2

Source

MAC Address Any
 MAC : : : : :
 /Mask : : : : :

Port Any
 Single
 Range (See [Port Range](#))

Destination

MAC Address Any
 MAC : : : : :
 /Mask : : : : :

DSCP/ToS DSCP
 ToS (Precedence, ToS)

IP Protocol All Establish Only (Valid for TCP)
 Others (Dec)

Layer 3

Source

IP Address Prefix /
 Range (See [IP Address Range](#))

Socket Number Any
 Single
 Range (See [Socket Port Range](#))

Destination

IP Address Prefix /
 Range (See [IP Address Range](#))

Socket Number Any
 Single
 Range (See [Socket Port Range](#))

After you have configured a classifier, you can configure a policy to define action(s) on the classified traffic flow. See [Chapter 22 on page 174](#) for information on configuring a policy rule.

Policy Rule

This chapter shows you how to configure policy rules.

22.1 Policy Rules Overview

A classifier distinguishes traffic into flows based on the configured criteria (refer to [Chapter 21 on page 168](#) for more information). A policy rule ensures that a traffic flow gets the requested treatment in the network.

22.1.1 DiffServ

DiffServ (Differentiated Services) is a class of service (CoS) model that marks packets so that they receive specific per-hop treatment at DiffServ-compliant network devices along the route based on the application types and traffic flow. Packets are marked with DiffServ Code Points (DSCPs) indicating the level of service desired. This allows the intermediary DiffServ-compliant network devices to handle the packets differently depending on the code points without the need to negotiate paths or remember state information for every flow. In addition, applications do not have to request a particular service or give advanced notice of where the traffic is going.

22.1.2 DSCP and Per-Hop Behavior

DiffServ defines a new DS (Differentiated Services) field to replace the Type of Service (TOS) field in the IP header. The DS field contains a 2-bit unused field and a 6-bit DSCP field which can define up to 64 service levels. The following figure illustrates the DS field.

DSCP is backward compatible with the three precedence bits in the ToS octet so that non-DiffServ compliant, ToS-enabled network device will not conflict with the DSCP mapping.

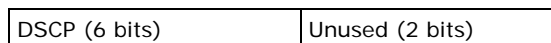

The DSCP value determines the forwarding behavior, the PHB (Per-Hop Behavior), that each packet gets across the DiffServ network. Based on the marking rule, different kinds of traffic can be marked for different kinds of forwarding. Resources can then be allocated according to the DSCP values and the configured policies.

22.2 Configuring Policy Rules

You must first configure a classifier in the **Classifier** screen. Refer to [Section 21.2 on page 168](#) for more information.

Click **Advanced Applications > Policy Rule** in the navigation panel to display the screen as shown.

Figure 96 Advanced Application > Policy Rule

The screenshot shows the 'Policy Rule' configuration interface. It includes the following elements:

- Active:** A checkbox to enable the policy.
- Name:** A text input field for the policy name.
- Classifier(s):** A list box to select one or more classifiers.
- Parameters:**
 - General:** Includes 'Egress Port' (input: 1), 'Priority' (dropdown: 0), 'DSCP' (input), and 'TOS' (dropdown: 0).
 - Bandwidth:** A section with 'Rate Limit' (input) and 'Kbps' label.
- Action:**
 - Forwarding:** Radio buttons for 'No change', 'Discard the packet', and 'Do not drop the matching frame previously marked for dropping'.
 - Priority:** Radio buttons for 'No change', 'Set the packet's 802.1p priority and send the packet to priority queue', and 'Replace the 802.1p priority field with the IP TOS value and send the packet to priority queue'.
 - Diffserv:** Radio buttons for 'No change', 'Set the packet's TOS field', and 'Set the Diffserv Codepoint field in the frame'.
 - Outgoing:** A checkbox for 'Send the packet to the egress port'.
 - Rate Limit:** A checkbox for 'Enable'.
- Buttons:** 'Add', 'Cancel', and 'Clear' buttons at the bottom.

The following table describes the labels in this screen.

Table 63 Advanced Application > Policy Rule

LABEL	DESCRIPTION
Active	Select this option to enable the policy.
Name	Enter a descriptive name for identification purposes.
Classifier(s)	This field displays the active classifier(s) you configure in the Classifier screen. Select the classifier(s) to which this policy rule applies. To select more than one classifier, press [SHIFT] and select the choices at the same time.

Table 63 Advanced Application > Policy Rule (continued)

LABEL	DESCRIPTION
Parameters	Set the fields below for this policy. You only have to set the field(s) that is related to the action(s) you configure in the Action field.
General	
Egress Port	Type the number of an outgoing port.
Priority	Specify a priority level.
DSCP	Specify a DSCP (DiffServ Code Point) number between 0 and 63.
TOS	Specify the type of service (TOS) priority level.
Rate Limit	You can configure the desired bandwidth available to a traffic flow.
Bandwidth	Specify the bandwidth in kilobit per second (Kbps). Enter a number between 1 and 1000000.
Action	Specify the action(s) the Switch takes on the associated classified traffic flow.
Forwarding	Select No change to forward the packets. Select Discard the packet to drop the packets. Select Do not drop the matching frame previously marked for dropping to retain the frames that were marked to be dropped before.
Priority	Select No change to keep the priority setting of the frames. Select Set the packet's 802.1p priority and send the packet to priority queue to replace the packet's 802.1p priority field with the value you set in the Priority field. Then put the packets in the designated queue. Select Replace the 802.1p priority field with the IP TOS value and send the packet to priority queue to replace the packet's 802.1p priority field with the value you set in the TOS field. Then put the packets in the designated queue.
Diffserv	Select No change to keep the TOS and/or DSCP fields in the packets. Select Set the packet's TOS field to set the TOS field with the value you configure in the TOS field. Select Set the Diffserv Codepoint field in the frame to set the DSCP field with the value you configure in the DSCP field.
Outgoing	Select Send the packet to the egress port to send the packet to the egress port.
Rate Limit	Select Enable to activate bandwidth limitation on the traffic flow(s).
Add	Click Add to insert the entry in the summary table below and save your changes to the Switch's run-time memory. The Switch loses these changes if it is turned off or loses power, so use the Save link on the top navigation panel to save your changes to the non-volatile memory when you are done configuring.
Cancel	Click Cancel to begin configuring this screen afresh.
Clear	Click Clear to set the above fields back to the factory defaults.

22.3 Viewing and Editing Policy Configuration

To view a summary of the classifier configuration, scroll down to the summary table at the bottom of the **Policy** screen. To change the settings of a rule, click a number in the **Index** field.

Figure 97 Advanced Application > Policy Rule: Summary Table

Index	Active	Name	Classifier(s)	Delete
<input type="button" value="Delete"/> <input type="button" value="Cancel"/>				

The following table describes the labels in this screen.

Table 64 Policy: Summary Table

LABEL	DESCRIPTION
Rule Usage	This field displays how many rules have been configured on the Switch.
Index	This field displays the policy index number. Click an index number to edit the policy.
Active	This field displays Yes when policy is activated and No when is it deactivated.
Name	This field displays the name you have assigned to this policy.
Classifier(s)	This field displays the name(s) of the classifier to which this policy applies.
Delete	Click Delete to remove the selected entry from the summary table.
Cancel	Click Cancel to clear the Delete check boxes.

22.4 Policy Example

The figure below shows an example **Policy** screen where you configure a policy to limit bandwidth on a traffic flow classified using the **Example** classifier (refer to [Section 21.4 on page 172](#)).

Figure 98 Policy Example

Policy		
Active	<input checked="" type="checkbox"/>	
Name	Test	
Classifier(s)	Example	
Parameters	General	
	Egress Port	1
	Priority	0 ▾
	DSCP	
	TOS	0 ▾
Action	Rate Limit	Bandwidth 10000 Kbps
	Forwarding	<input checked="" type="radio"/> No change <input type="radio"/> Discard the packet <input type="radio"/> Do not drop the matching frame previously marked for dropping
	Priority	<input checked="" type="radio"/> No change <input type="radio"/> Set the packet's 802.1p priority and send the packet to priority queue <input type="radio"/> Replace the 802.1p priority field with the IP TOS value and send the packet to priority queue
	Diffserv	<input checked="" type="radio"/> No change <input type="radio"/> Set the packet's TOS field <input type="radio"/> Set the Diffserv Codepoint field in the frame
	Outgoing	<input type="checkbox"/> Send the packet to the egress port
	Rate Limit	<input type="checkbox"/> Enable
	EXAMPLE	
	<input checked="" type="button" value="Add"/> <input type="button" value="Cancel"/> <input type="button" value="Clear"/>	

Queuing Method

This chapter introduces the queuing methods supported.

23.1 Queuing Method Overview

Queuing is used to help solve performance degradation when there is network congestion. Use the **Queuing Method** screen to configure queuing algorithms for outgoing traffic. See also **Priority Queue Assignment** in **Switch Setup** and **802.1p Priority** in **Port Setup** for related information.

Queuing algorithms allow switches to maintain separate queues for packets from each individual source or flow and prevent a source from monopolizing the bandwidth.

23.1.1 Strictly Priority Queuing

Strictly Priority Queuing (SPQ) services queues based on priority only. As traffic comes into the Switch, traffic on the highest priority queue, Q7 is transmitted first. When that queue empties, traffic on the next highest-priority queue, Q6 is transmitted until Q6 empties, and then traffic is transmitted on Q5 and so on. If higher priority queues never empty, then traffic on lower priority queues never gets sent. SP does not automatically adapt to changing network requirements.

23.1.2 Weighted Fair Queuing

Weighted Fair Queuing is used to guarantee each queue's minimum bandwidth based on its bandwidth weight (the number you configure in the **Weight** field) when there is traffic congestion. WFQ is activated only when a port has more traffic than it can handle. Queues with larger weights get more guaranteed bandwidth than queues with smaller weights. By default, the weight for Q0 is 1, for Q1 is 2, for Q2 is 3, and so on.

The weights range from 1 to 15 and the actual guaranteed bandwidth is calculated as follows:

$$2^{(\text{Weight} - 1)} \times 10 \text{ KB}$$

If the weight setting is 5, the actual quantum guaranteed to the associated queue would be as follows:

$$2^4 \times 10\text{KB} = 160 \text{ KB}$$

23.1.3 Weighted Round Robin Scheduling (WRR)

Round Robin Scheduling services queues on a rotating basis and is activated only when a port has more traffic than it can handle. A queue is given an amount of bandwidth irrespective of the incoming traffic on that port. This queue then moves to the back of the list. The next queue is given an equal amount of bandwidth, and then moves to the end of the list; and so on, depending on the number of queues being used. This works in a looping fashion until a queue is empty.

Weighted Round Robin Scheduling (WRR) uses the same algorithm as round robin scheduling, but services queues based on their priority and queue weight (the number you configure in the queue **Weight** field) rather than a fixed amount of bandwidth. WRR is activated only when a port has more traffic than it can handle. Queues with larger weights get more service than queues with smaller weights. This queuing mechanism is highly efficient in that it divides any available bandwidth across the different traffic queues and returns to queues that have not yet emptied.

23.2 Configuring Queuing

Click **Advanced Application > Queuing Method** in the navigation panel.

Figure 99 Advanced Application > Queuing Method

Port	Method	Weight								Hybrid-SPQ Lowest-Queue
		Q0	Q1	Q2	Q3	Q4	Q5	Q6	Q7	
*	SPQ									None
1	<input checked="" type="radio"/> SPQ <input type="radio"/> WFQ <input type="radio"/> WRR	1	2	3	4	5	6	7	8	None
2	<input checked="" type="radio"/> SPQ <input type="radio"/> WFQ <input type="radio"/> WRR	1	2	3	4	5	6	7	8	None
3	<input checked="" type="radio"/> SPQ <input type="radio"/> WFQ <input type="radio"/> WRR	1	2	3	4	5	6	7	8	None
4	<input checked="" type="radio"/> SPQ <input type="radio"/> WFQ <input type="radio"/> WRR	1	2	3	4	5	6	7	8	None
5	<input checked="" type="radio"/> SPQ <input type="radio"/> WFQ <input type="radio"/> WRR	1	2	3	4	5	6	7	8	None
6	<input checked="" type="radio"/> SPQ <input type="radio"/> WFQ <input type="radio"/> WRR	1	2	3	4	5	6	7	8	None
7	<input checked="" type="radio"/> SPQ <input type="radio"/> WFQ <input type="radio"/> WRR	1	2	3	4	5	6	7	8	None
8	<input checked="" type="radio"/> SPQ <input type="radio"/> WFQ <input type="radio"/> WRR	1	2	3	4	5	6	7	8	None

The following table describes the labels in this screen.

Table 65 Advanced Application > Queuing Method

LABEL	DESCRIPTION
Port	This label shows the port you are configuring.
*	<p>Settings in this row apply to all ports.</p> <p>Use this row only if you want to make some settings the same for all ports. Use this row first to set the common settings and then make adjustments on a port-by-port basis.</p> <p>Note: Changes in this row are copied to all the ports as soon as you make them.</p>
Method	<p>Select SPQ (Strictly Priority Queuing), WFQ (Weighted Fair Queuing) or WRR (Weighted Round Robin).</p> <p>Strictly Priority services queues based on priority only. When the highest priority queue empties, traffic on the next highest-priority queue begins. Q7 has the highest priority and Q0 the lowest.</p> <p>Weighted Fair Queuing is used to guarantee each queue's minimum bandwidth based on their bandwidth weight (the number you configure in the Weight field). Queues with larger weights get more guaranteed bandwidth than queues with smaller weights.</p> <p>Weighted Round Robin Scheduling services queues on a rotating basis based on their queue weight (the number you configure in the queue Weight field). Queues with larger weights get more service than queues with smaller weights.</p>
Weight Q0-Q7	When you select WFQ or WRR enter the queue weight here. Bandwidth is divided across the different traffic queues according to their weights.
Hybrid- SPQ Lowest- Queue	<p>This field is applicable only when you select WFQ or WRR.</p> <p>Select a queue (Q0 to Q7) to have the Switch use SPQ to service the subsequent queue(s) after and including the specified queue. For example, if you select Q5, the Switch services traffic on Q5, Q6 and Q7 using SPQ.</p> <p>Select None to always use WFQ or WRR.</p>
Apply	Click Apply to save your changes to the Switch's run-time memory. The Switch loses these changes if it is turned off or loses power, so use the Save link on the top navigation panel to save your changes to the non-volatile memory when you are done configuring.
Cancel	Click Cancel to begin configuring this screen afresh.

VLAN Stacking

This chapter shows you how to configure VLAN stacking on your Switch. See the chapter on VLANs for more background information on Virtual LAN.

24.1 VLAN Stacking Overview

A service provider can use VLAN stacking to allow it to distinguish multiple customers VLANs, even those with the same (customer-assigned) VLAN ID, within its network.

Use VLAN stacking to add an outer VLAN tag to the inner IEEE 802.1Q tagged frames that enter the network. By tagging the tagged frames (“double-tagged” frames), the service provider can manage up to 4,094 VLAN groups with each group containing up to 4,094 customer VLANs. This allows a service provider to provide different service, based on specific VLANs, for many different customers.

A service provider’s customers may require a range of VLANs to handle multiple applications. A service provider’s customers can assign their own inner VLAN tags on ports for these applications. The service provider can assign an outer VLAN tag for each customer. Therefore, there is no VLAN tag overlap among customers, so traffic from different customers is kept separate.

24.1.1 VLAN Stacking Example

In the following example figure, both **A** and **B** are Service Provider’s Network (SPN) customers with VPN tunnels between their head offices and branch offices respectively. Both have an identical VLAN tag for their VLAN group. The service provider can separate these two VLANs within its network by adding tag 37 to distinguish customer **A** and tag 48 to distinguish customer **B** at edge device **1** and then stripping those tags at edge device **2** as the data frames leave the network.

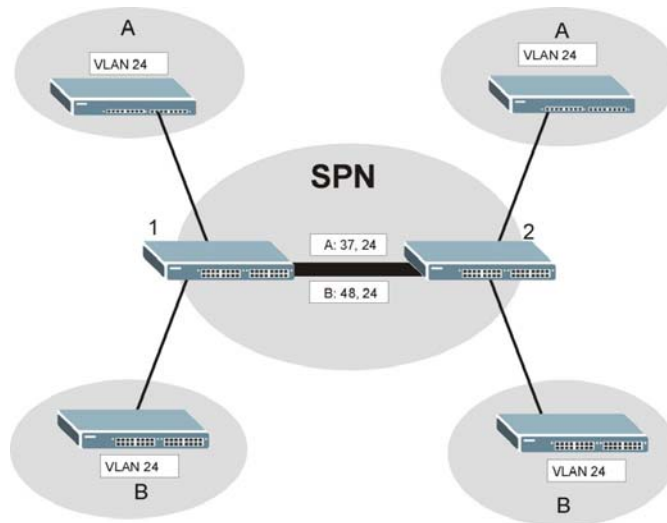
Figure 100 VLAN Stacking Example

24.2 VLAN Stacking Port Roles

Each port can have three VLAN stacking “roles”, **Normal**, **Access Port** and **Tunnel Port** (the latter is for Gigabit ports only).

- Select **Normal** for “regular” (non-VLAN stacking) IEEE 802.1Q frame switching.
- Select **Access Port** for ingress ports on the service provider's edge devices (1 and 2 in the VLAN stacking example figure). The incoming frame is treated as “untagged”, so a second VLAN tag (outer VLAN tag) can be added.

Note: Static VLAN Tx Tagging MUST be disabled on a port where you choose **Normal** or **Access Port**.

- Select **Tunnel Port** (available for Gigabit ports only) for egress ports at the edge of the service provider's network. All VLANs belonging to a customer can be aggregated into a single service provider's VLAN (using the outer VLAN tag defined by the Service Provider's (SP) VLAN ID (VID)).

Note: Static VLAN Tx Tagging MUST be enabled on a port where you choose **Tunnel Port**.

24.3 VLAN Tag Format

A VLAN tag (service provider VLAN stacking or customer IEEE 802.1Q) consists of the following three fields.

Table 66 VLAN Tag Format

Type	Priority	VID
------	----------	-----

Type is a standard Ethernet type code identifying the frame and indicates that whether the frame carries IEEE 802.1Q tag information. **SP TPID** (Service Provider Tag Protocol Identifier) is the service provider VLAN stacking tag type. Many vendors use 0x8100 or 0x9100.

TPID (Tag Protocol Identifier) is the customer IEEE 802.1Q tag.

- If the VLAN stacking port role is **Access Port**, then the Switch adds the **SP TPID** tag to all incoming frames on the service provider's edge devices (1 and 2 in the VLAN stacking example figure).
- If the VLAN stacking port role is **Tunnel Port**, then the Switch only adds the **SP TPID** tag to all incoming frames on the service provider's edge devices (1 and 2 in the VLAN stacking example figure) that have an **SP TPID** different to the one configured on the Switch. (If an incoming frame's **SP TPID** is the same as the one configured on the Switch, then the Switch will not add the tag.)

Priority refers to the IEEE 802.1p standard that allows the service provider to prioritize traffic based on the class of service (CoS) the customer has paid for.

- On the Switch, configure priority level of the inner IEEE 802.1Q tag in the **Port Setup** screen.
- "0" is the lowest priority level and "7" is the highest.

VID is the VLAN ID. **SP VID** is the VID for the second (service provider's) VLAN tag.

24.3.1 Frame Format

The frame format for an untagged Ethernet frame, a single-tagged 802.1Q frame (customer) and a "double-tagged" 802.1Q frame (service provider) is shown next.

Configure the fields as highlighted in the Switch **VLAN Stacking** screen.

Table 67 Single and Double Tagged 802.1Q Frame Format

						DA	SA	Len/Etype	Data	FCS	Untagged Ethernet frame
			DA	SA	TPID	Priority	VID	Len/Etype	Data	FCS	IEEE 802.1Q customer tagged frame
DA	SA	SPTPID	Priority	VID	TPID	Priority	VID	Len/Etype	Data	FCS	Double-tagged frame

Table 68 802.1Q Frame

DA	Destination Address	Priority	802.1p Priority
SA	Source Address	Len/Etype	Length and type of Ethernet frame
(SP)TPID	(Service Provider) Tag Protocol Identifier	Data	Frame data
VID	VLAN ID	FCS	Frame Check Sequence

24.4 Configuring VLAN Stacking

Click **Advanced Applications > VLAN Stacking** to display the screen as shown.

Figure 101 Advanced Application > VLAN Stacking

Port	Role	Tunnel TPID
*	Normal	
1	Normal	8100
2	Normal	8100
3	Normal	8100
4	Normal	8100

The following table describes the labels in this screen.

Table 69 Advanced Application > VLAN Stacking

LABEL	DESCRIPTION
Active	Select this checkbox to enable VLAN stacking on the Switch.
Port	The port number identifies the port you are configuring.
*	Settings in this row apply to all ports. Use this row only if you want to make some settings the same for all ports. Use this row first to set the common settings and then make adjustments on a port-by-port basis. Note: Changes in this row are copied to all the ports as soon as you make them.
Role	Select Normal to have the Switch ignore frames received (or transmitted) on this port with VLAN stacking tags. Anything you configure in SPVID and Priority of the Port-based QinQ or the Selective QinQ screen are ignored. Select Access Port to have the Switch add the SP TPID tag to all incoming frames received on this port. Select Access Port for ingress ports at the edge of the service provider's network. Select Tunnel Port (available for Gigabit ports only) for egress ports at the edge of the service provider's network. Select Tunnel Port to have the Switch add the Tunnel TPID tag to all outgoing frames sent on this port. In order to support VLAN stacking on a port, the port must be able to allow frames of 1526 Bytes (1522 Bytes + 4 Bytes for the second tag) to pass through it.
Tunnel TPID	TPID is a standard Ethernet type code identifying the frame and indicates whether the frame carries IEEE 802.1Q tag information. Enter a four-digit hexadecimal number from 0000 to FFFF that the Switch adds in the outer VLAN tag of the frames sent on the tunnel port(s). The Switch also uses this to check if the received frames are double-tagged. The value of this field is 0x8100 as defined in IEEE 802.1Q. If the Switch needs to communicate with other vendors' devices, they should use the same TPID. Note: You can define up to four different tunnel TPIDs (including 8100) in this screen at a time.
Apply	Click Apply to save your changes to the Switch's run-time memory. The Switch loses these changes if it is turned off or loses power, so use the Save link on the top navigation panel to save your changes to the non-volatile memory when you are done configuring.
Cancel	Click Cancel to begin configuring this screen afresh.

24.4.1 Port-based Q-in-Q

Port-based Q-in-Q lets the Switch treat all frames received on the same port as the same VLAN flows and add the same outer VLAN tag to them, even they have different customer VLAN IDs.

Click **Port-based QinQ** in the **Advanced Application > VLAN Stacking** screen to display the screen as shown.

Figure 102 Advanced Application > VLAN Stacking > Port-based QinQ

Port	SPVID	Priority
*		0
1	1	0
2	1	0
3	1	0
4	1	0
5	1	0
6	1	0
7	1	0
8	1	0
9	1	0
10	1	0
11	1	0
12	1	0
13	1	0
14	1	0
15	1	0
16	1	0
17	1	0

Apply Cancel

The following table describes the labels in this screen.

Table 70 Advanced Application > VLAN Stacking > Port-based QinQ

LABEL	DESCRIPTION
Port	The port number identifies the port you are configuring.
SPVID	SPVID is the service provider's VLAN ID (the outer VLAN tag). Enter the service provider ID (from 1 to 4094) for frames received on this port. See Chapter 9 on page 88 for more background information on VLAN ID.
Priority	Select a priority level (from 0 to 7). This is the service provider's priority level that adds to the frames received on this port. "0" is the lowest priority level and "7" is the highest.
Apply	Click Apply to save your changes to the Switch's run-time memory. The Switch loses these changes if it is turned off or loses power, so use the Save link on the top navigation panel to save your changes to the non-volatile memory when you are done configuring.
Cancel	Click Cancel to begin configuring this screen afresh.

24.4.2 Selective Q-in-Q

Selective Q-in-Q is VLAN-based. It allows the Switch to add different outer VLAN tags to the incoming frames received on one port according to their inner VLAN tags.

Note: Selective Q-in-Q rules are only applied to single-tagged frames received on the access ports. If the incoming frames are untagged or single-tagged but received on a tunnel port or cannot match any selective Q-in-Q rules, the Switch applies the port-based Q-in-Q rules to them.

Click **Selective QinQ** in the **Advanced Application > VLAN Stacking** screen to display the screen as shown.

Figure 103 Advanced Application > VLAN Stacking > Selective QinQ

The following table describes the labels in this screen.

Table 71 Advanced Application > VLAN Stacking > Selective QinQ

LABEL	DESCRIPTION
Active	Check this box to activate this rule.
Name	Enter a descriptive name (up to 32 printable ASCII characters) for identification purposes.
Port	The port number identifies the port you are configuring.
CVID	Enter a customer VLAN ID (the inner VLAN tag) from 1 to 4094. This is the VLAN tag carried in the packets from the subscribers.
SPVID	SPVID is the service provider's VLAN ID (the outer VLAN tag). Enter the service provider ID (from 1 to 4094) for frames received on this port. See Chapter 9 on page 88 for more background information on VLAN ID.
Priority	Select a priority level (from 0 to 7). This is the service provider's priority level that adds to the frames received on this port. "0" is the lowest priority level and "7" is the highest.
Add	Click Add to save your changes to the Switch's run-time memory. The Switch loses these changes if it is turned off or loses power, so use the Save link on the top navigation panel to save your changes to the non-volatile memory when you are done configuring.
Cancel	Click Cancel to begin configuring this screen afresh.
Index	This is the number of the selective VLAN stacking rule.

Table 71 Advanced Application > VLAN Stacking > Selective QinQ (continued)

LABEL	DESCRIPTION
Active	This shows whether this rule is activated or not.
Name	This is the descriptive name for this rule.
Port	This is the port number to which this rule is applied.
CVID	This is the customer VLAN ID in the incoming packets.
SPVID	This is the service provider's VLAN ID that adds to the packets from the subscribers.
Priority	This is the service provider's priority level in the packets.
Delete	Check the rule(s) that you want to remove in the Delete column and then click the Delete button.
Cancel	Click Cancel to clear the Delete check boxes.

This chapter shows you how to configure various multicast features.

25.1 Multicast Overview

Traditionally, IP packets are transmitted in one of either two ways - Unicast (1 sender to 1 recipient) or Broadcast (1 sender to everybody on the network). Multicast delivers IP packets to just a group of hosts on the network.

IGMP (Internet Group Management Protocol) is a network-layer protocol used to establish membership in a multicast group - it is not used to carry user data. Refer to RFC 1112, RFC 2236 and RFC 3376 for information on IGMP versions 1, 2 and 3 respectively.

25.1.1 IP Multicast Addresses

In IPv4, a multicast address allows a device to send packets to a specific group of hosts (multicast group) in a different subnetwork. A multicast IP address represents a traffic receiving group, not individual receiving devices. IP addresses in the Class D range (224.0.0.0 to 239.255.255.255) are used for IP multicasting. Certain IP multicast numbers are reserved by IANA for special purposes (see the IANA website for more information).

25.1.2 IGMP Filtering

With the IGMP filtering feature, you can control which IGMP groups a subscriber on a port can join. This allows you to control the distribution of multicast services (such as content information distribution) based on service plans and types of subscription.

You can set the Switch to filter the multicast group join reports on a per-port basis by configuring an IGMP filtering profile and associating the profile to a port.

25.1.3 IGMP Snooping

The Switch can passively snoop on IGMP packets transferred between IP multicast routers/switches and IP multicast hosts to learn the IP multicast group membership. It checks IGMP packets passing through it, picks out the group registration information, and configures multicasting accordingly. IGMP snooping allows the Switch to learn multicast groups without you having to manually configure them.

The Switch forwards multicast traffic destined for multicast groups (that it has learned from IGMP snooping or that you have manually configured) to ports that are members of that group. IGMP snooping generates no additional network traffic, allowing you to significantly reduce multicast traffic passing through your Switch.

25.1.4 IGMP Snooping and VLANs

The Switch can perform IGMP snooping on up to 16 VLANs. You can configure the Switch to automatically learn multicast group membership of any VLANs. The Switch then performs IGMP snooping on the first 16 VLANs that send IGMP packets. This is referred to as auto mode. Alternatively, you can specify the VLANs that IGMP snooping should be performed on. This is referred to as fixed mode. In fixed mode the Switch does not learn multicast group membership of any VLANs other than those explicitly added as an IGMP snooping VLAN.

25.2 Multicast Status

Click **Advanced Application > Multicast** to display the screen as shown. This screen shows the multicast group information. See [Section 25.1 on page 189](#) for more information on multicasting.

Figure 104 Advanced Application > Multicast

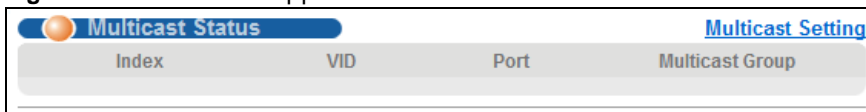

The following table describes the labels in this screen.

Table 72 Advanced Application > Multicast

LABEL	DESCRIPTION
Index	This is the index number of the entry.
VID	This field displays the multicast VLAN ID.
Port	This field displays the port number that belongs to the multicast group.
Multicast Group	This field displays IP multicast group addresses.

25.2.1 Multicast Setting

Click the **Multicast Setting** link in the **Advanced Application > Multicast** screen to display the screen as shown. See [Section 25.1 on page 189](#) for more information on multicasting.

Figure 105 Advanced Application > Multicast > Multicast Setting

Multicast Setting [Multicast Status](#) [IGMP Snooping VLAN](#) [IGMP Filtering Profile](#) [MVR](#)

IGMP Snooping

Mode: (dropdown)

Querier:

Host Timeout:

802.1p Priority: (dropdown)

IGMP Filtering

Active:

Unknown Multicast Frame: Flooding Drop

Reserved Multicast Group: Flooding Drop

Port	Immed. Leave	Normal Leave	Fast Leave	Group Limited	Max Group Num.	Throttling	IGMP Filtering Profile	IGMP Querier Mode
*	<input type="radio"/>	<input checked="" type="radio"/>	<input type="radio"/>	<input type="checkbox"/>	<input type="text" value=""/>	Deny (dropdown)	Default (dropdown)	Auto (dropdown)
1	<input type="radio"/>	<input checked="" type="radio"/> 4000	<input type="radio"/> 200	<input type="checkbox"/>	<input type="text" value="0"/>	Deny (dropdown)	Default (dropdown)	Auto (dropdown)
2	<input type="radio"/>	<input checked="" type="radio"/> 4000	<input type="radio"/> 200	<input type="checkbox"/>	<input type="text" value="0"/>	Deny (dropdown)	Default (dropdown)	Auto (dropdown)
3	<input type="radio"/>	<input checked="" type="radio"/> 4000	<input type="radio"/> 200	<input type="checkbox"/>	<input type="text" value="0"/>	Deny (dropdown)	Default (dropdown)	Auto (dropdown)
4	<input type="radio"/>	<input checked="" type="radio"/> 4000	<input type="radio"/> 200	<input type="checkbox"/>	<input type="text" value="0"/>	Deny (dropdown)	Default (dropdown)	Auto (dropdown)
5	<input type="radio"/>	<input checked="" type="radio"/> 4000	<input type="radio"/> 200	<input type="checkbox"/>	<input type="text" value="0"/>	Deny (dropdown)	Default (dropdown)	Auto (dropdown)
6	<input type="radio"/>	<input checked="" type="radio"/> 4000	<input type="radio"/> 200	<input type="checkbox"/>	<input type="text" value="0"/>	Deny (dropdown)	Default (dropdown)	Auto (dropdown)
7	<input type="radio"/>	<input checked="" type="radio"/> 4000	<input type="radio"/> 200	<input type="checkbox"/>	<input type="text" value="0"/>	Deny (dropdown)	Default (dropdown)	Auto (dropdown)
8	<input type="radio"/>	<input checked="" type="radio"/> 4000	<input type="radio"/> 200	<input type="checkbox"/>	<input type="text" value="0"/>	Deny (dropdown)	Default (dropdown)	Auto (dropdown)
9	<input type="radio"/>	<input checked="" type="radio"/> 4000	<input type="radio"/> 200	<input type="checkbox"/>	<input type="text" value="0"/>	Deny (dropdown)	Default (dropdown)	Auto (dropdown)

Apply Cancel

The following table describes the labels in this screen.

Table 73 Advanced Application > Multicast > Multicast Setting

LABEL	DESCRIPTION
IGMP Snooping	Use these settings to configure IGMP Snooping.
Mode	The Switch supports IGMP version 1, IGMP version 2 and IGMP version 3. Select the version of the IGMP packets that the Switch should use (Version2 or Version3) to enable IGMP Snooping to forward group multicast traffic only to ports that are members of that group. Otherwise, select Disable .
Querier	Select this option to allow the Switch to send IGMP General Query messages to the VLANs with the multicast hosts attached.
Host Timeout	Specify the time (from 1 to 16 711 450) in seconds that elapses before the Switch removes an IGMP group membership entry if it does not receive report messages from the port.
802.1p Priority	Select a priority level (0-7) to which the Switch changes the priority in outgoing IGMP control packets. Otherwise, select No-Change to not replace the priority.

Table 73 Advanced Application > Multicast > Multicast Setting (continued)

LABEL	DESCRIPTION
IGMP Filtering	<p>Select Active to enable IGMP filtering to control which IGMP groups a subscriber on a port can join.</p> <p>Note: If you enable IGMP filtering, you must create and assign IGMP filtering profiles for the ports that you want to allow to join multicast groups.</p>
Unknown Multicast Frame	<p>Specify the action to perform when the Switch receives an unknown multicast frame. Select Drop to discard the frame(s). Select Flooding to send the frame(s) to all ports.</p>
Reserved Multicast Group	<p>The IP address range of 224.0.0.0 to 224.0.0.255 are reserved for multicasting on the local network only. For example, 224.0.0.1 is for all hosts on a local network segment and 224.0.0.9 is used to send RIP routing information to all RIP v2 routers on the same network segment. A multicast router will not forward a packet with the destination IP address within this range to other networks. See the IANA web site for more information.</p> <p>The layer-2 multicast MAC addresses used by Cisco layer-2 protocols, 01:00:0C:CC:CC:CC and 01:00:0C:CC:CC:CD, are also included in this group.</p> <p>Specify the action to perform when the Switch receives a frame with a reserved multicast address. Select Drop to discard the frame(s). Select Flooding to send the frame(s) to all ports.</p>
Port	<p>This field displays the port number.</p>
*	<p>Settings in this row apply to all ports.</p> <p>Use this row only if you want to make some settings the same for all ports. Use this row first to set the common settings and then make adjustments on a port-by-port basis.</p> <p>Note: Changes in this row are copied to all the ports as soon as you make them.</p>
Immed. Leave	<p>Select this option to set the Switch to remove this port from the multicast tree when an IGMP version 2 leave message is received on this port.</p> <p>Select this option if there is only one host connected to this port.</p>
Normal Leave	<p>Enter an IGMP normal leave timeout value (from 200 to 6,348,800) in milliseconds. Select this option to have the Switch use this timeout to update the forwarding table for the port.</p> <p>In normal leave mode, when the Switch receives an IGMP leave message from a host on a port, the Switch waits for IGMP reports after the multicast router sends out an IGMP Group-Specific Query (GSQ) message to determine whether other hosts connected to the port should remain in the specific multicast group.</p> <p>This defines how many seconds the Switch waits for an IGMP report before removing an IGMP snooping membership entry when an IGMP leave message is received on this port from a host.</p> <p>Note: The timeout value for each IGMP report will be halved automatically by the Switch because the robustness variable value (the number of query messages) is set to two by default to cover the possibility of an IGMP GSQ being missed by IGMP host(s) or an IGMP report being missed by the multicast router(s) due to network congestion.</p>
Fast Leave	<p>Enter an IGMP fast leave timeout value (from 200 to 6,348,800) in milliseconds. Select this option to have the Switch use this timeout to update the forwarding table for the port.</p> <p>In fast leave mode, right after receiving an IGMP leave message from a host on a port, the Switch sends out an IGMP Group-Specific Query (GSQ) message to determine whether other hosts connected to the port should remain in the specific multicast group. This helps speed up the leave process.</p> <p>This defines how many seconds the Switch waits for an IGMP report before removing an IGMP snooping membership entry when an IGMP leave message is received on this port from a host.</p>

Table 73 Advanced Application > Multicast > Multicast Setting (continued)

LABEL	DESCRIPTION
Group Limited	Select this option to limit the number of multicast groups this port is allowed to join.
Max Group Num.	Enter the number of multicast groups this port is allowed to join. Once a port is registered in the specified number of multicast groups, any new IGMP join report frame(s) is dropped on this port.
Throttling	<p>IGMP throttling controls how the Switch deals with the IGMP reports when the maximum number of the IGMP groups a port can join is reached.</p> <p>Select Deny to drop any new IGMP join report received on this port until an existing multicast forwarding table entry is aged out.</p> <p>Select Replace to replace an existing entry in the multicast forwarding table with the new IGMP report(s) received on this port.</p>
IGMP Filtering Profile	<p>Select the name of the IGMP filtering profile to use for this port. Otherwise, select Default to prohibit the port from joining any multicast group.</p> <p>You can create IGMP filtering profiles in the Multicast > Multicast Setting > IGMP Filtering Profile screen.</p>
IGMP Querier Mode	<p>The Switch treats an IGMP query port as being connected to an IGMP multicast router (or server). The Switch forwards IGMP join or leave packets to an IGMP query port.</p> <p>Select Auto to have the Switch use the port as an IGMP query port if the port receives IGMP query packets.</p> <p>Select Fixed to have the Switch always use the port as an IGMP query port. Select this when you connect an IGMP multicast server to the port.</p> <p>Select Edge to stop the Switch from using the port as an IGMP query port. The Switch will not keep any record of an IGMP router being connected to this port. The Switch does not forward IGMP join or leave packets to this port.</p>
Apply	Click Apply to save your changes to the Switch's run-time memory. The Switch loses these changes if it is turned off or loses power, so use the Save link on the top navigation panel to save your changes to the non-volatile memory when you are done configuring.
Cancel	Click Cancel to begin configuring this screen afresh.

25.2.2 IGMP Snooping VLAN

Click **Advanced Application > Multicast** in the navigation panel. Click the **Multicast Setting** link and then the **IGMP Snooping VLAN** link to display the screen as shown. See [Section 25.1.4 on page 190](#) for more information on IGMP Snooping VLAN.

Figure 106 Advanced Application > Multicast > Multicast Setting > IGMP Snooping VLAN

The screenshot shows the configuration interface for IGMP Snooping VLAN. It includes a mode selector (auto/fixed), a list of configured VLANs, and a table for adding new VLANs. The 'Apply' and 'Cancel' buttons are used to save or discard changes, while 'Add', 'Clear', and 'Delete' buttons manage the VLAN list.

The following table describes the labels in this screen.

Table 74 Advanced Application > Multicast > Multicast Setting > IGMP Snooping VLAN

LABEL	DESCRIPTION
Mode	<p>Select auto to have the Switch learn multicast group membership information of any VLANs automatically.</p> <p>Select fixed to have the Switch only learn multicast group membership information of the VLAN(s) that you specify below.</p> <p>In either auto or fixed mode, the Switch can learn up to 16 VLANs (including up to five VLANs you configured in the MVR screen). For example, if you have configured one multicast VLAN in the MVR screen, you can only specify up to 15 VLANs in this screen.</p> <p>The Switch drops any IGMP control messages which do not belong to these 16 VLANs.</p> <p>Note: You must also enable IGMP snooping in the Multicast Setting screen first.</p>
Apply	Click Apply to save your changes to the Switch's run-time memory. The Switch loses these changes if it is turned off or loses power, so use the Save link on the top navigation panel to save your changes to the non-volatile memory when you are done configuring.
Cancel	Click Cancel to begin configuring this screen afresh.
VLAN	Use this section of the screen to add VLANs upon which the Switch is to perform IGMP snooping.
Name	Enter the descriptive name of the VLAN for identification purposes.
VID	<p>Enter the ID of a static VLAN; the valid range is between 1 and 4094.</p> <p>Note: You cannot configure the same VLAN ID as in the MVR screen.</p>
Add	Click Add to insert the entry in the summary table below and save your changes to the Switch's run-time memory. The Switch loses these changes if it is turned off or loses power, so use the Save link on the top navigation panel to save your changes to the non-volatile memory when you are done configuring.
Cancel	Click Cancel to reset the fields to your previous configuration.
Clear	Click this to clear the fields.
Index	This is the number of the IGMP snooping VLAN entry in the table.

Table 74 Advanced Application > Multicast > Multicast Setting > IGMP Snooping VLAN (continued)

LABEL	DESCRIPTION
Name	This field displays the descriptive name for this VLAN group.
VID	This field displays the ID number of the VLAN group.
Delete	Check the rule(s) that you want to remove in the Delete column, then click the Delete button.
Cancel	Click Cancel to clear the Delete check boxes.

25.2.3 IGMP Filtering Profile

An IGMP filtering profile specifies a range of multicast groups that clients connected to the Switch are able to join. A profile contains a range of multicast IP addresses which you want clients to be able to join. Profiles are assigned to ports (in the **Multicast Setting** screen). Clients connected to those ports are then able to join the multicast groups specified in the profile. Each port can be assigned a single profile. A profile can be assigned to multiple ports.

Click **Advanced Application > Multicast > Multicast Setting > IGMP Filtering Profile** to display the screen as shown.

Figure 107 Advanced Application > Multicast > Multicast Setting > IGMP Filtering Profile

The following table describes the labels in this screen.

Table 75 Advanced Application > Multicast > Multicast Setting > IGMP Filtering Profile

LABEL	DESCRIPTION
Profile Name	Enter a descriptive name for the profile for identification purposes. To configure additional rule(s) for a profile that you have already added, enter the profile name and specify a different IP multicast address range.
Start Address	Type the starting multicast IP address for a range of multicast IP addresses that you want to belong to the IGMP filter profile.
End Address	Type the ending multicast IP address for a range of IP addresses that you want to belong to the IGMP filter profile. If you want to add a single multicast IP address, enter it in both the Start Address and End Address fields.

Table 75 Advanced Application > Multicast > Multicast Setting > IGMP Filtering Profile (continued)

LABEL	DESCRIPTION
Add	Click Add to save the profile to the Switch's run-time memory. The Switch loses these changes if it is turned off or loses power, so use the Save link on the top navigation panel to save your changes to the non-volatile memory when you are done configuring.
Clear	Click Clear to clear the fields to the factory defaults.
Profile Name	This field displays the descriptive name of the profile.
Start Address	This field displays the start of the multicast address range.
End Address	This field displays the end of the multicast address range.
Delete	To delete the profile(s) and all the accompanying rules, select the profile(s) that you want to remove in the Delete Profile column, then click the Delete button. To delete a rule(s) from a profile, select the rule(s) that you want to remove in the Delete Rule column, then click the Delete button.
Cancel	Click Cancel to clear the Delete Profile/Delete Rule check boxes.

25.3 MVR Overview

Multicast VLAN Registration (MVR) is designed for applications (such as Media-on-Demand (MoD)) that use multicast traffic across an Ethernet ring-based service provider network.

MVR allows one single multicast VLAN to be shared among different subscriber VLANs on the network. While isolated in different subscriber VLANs, connected devices can subscribe to and unsubscribe from the multicast stream in the multicast VLAN. This improves bandwidth utilization with reduced multicast traffic in the subscriber VLANs and simplifies multicast group management.

MVR only responds to IGMP join and leave control messages from multicast groups that are configured under MVR. Join and leave reports from other multicast groups are managed by IGMP snooping.

The following figure shows a network example. The subscriber VLAN (**1**, **2** and **3**) information is hidden from the streaming media server, **S**. In addition, the multicast VLAN information is only visible to the Switch and **S**.

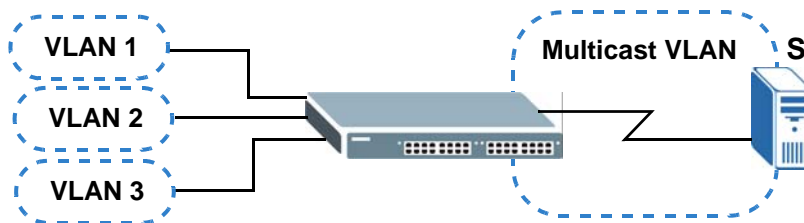
Figure 108 MVR Network Example

25.3.1 Types of MVR Ports

In MVR, a source port is a port on the Switch that can send and receive multicast traffic in a multicast VLAN while a receiver port can only receive multicast traffic. Once configured, the Switch maintains a forwarding table that matches the multicast stream to the associated multicast group.

25.3.2 MVR Modes

You can set your Switch to operate in either dynamic or compatible mode.

In dynamic mode, the Switch sends IGMP leave and join reports to the other multicast devices (such as multicast routers or servers) in the multicast VLAN. This allows the multicast devices to update the multicast forwarding table to forward or not forward multicast traffic to the receiver ports.

In compatible mode, the Switch does not send any IGMP reports. In this case, you must manually configure the forwarding settings on the multicast devices in the multicast VLAN.

25.3.3 How MVR Works

The following figure shows a multicast television example where a subscriber device (such as a computer) in VLAN 1 receives multicast traffic from the streaming media server, **S**, via the Switch. Multiple subscriber devices can connect through a port configured as the receiver on the Switch.

When the subscriber selects a television channel, computer **A** sends an IGMP report to the Switch to join the appropriate multicast group. If the IGMP report matches one of the configured MVR multicast group addresses on the Switch, an entry is created in the forwarding table on the Switch. This maps the subscriber VLAN to the list of forwarding destinations for the specified multicast traffic.

When the subscriber changes the channel or turns off the computer, an IGMP leave message is sent to the Switch to leave the multicast group. The Switch sends a query to VLAN 1 on the receiver port (in this case, an uplink port on the Switch). If there is another subscriber device connected to this port in the same subscriber VLAN, the receiving port will still be on the list of forwarding destination for the multicast traffic. Otherwise, the Switch removes the receiver port from the forwarding table.

Figure 109 MVR Multicast Television Example

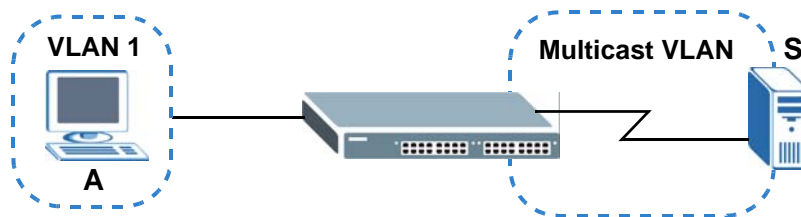

25.4 General MVR Configuration

Use the **MVR** screen to create multicast VLANs and select the receiver port(s) and a source port for each multicast VLAN. Click **Advanced Application > Multicast > Multicast Setting > MVR** to display the screen as shown next.

Note: You can create up to five multicast VLANs and up to 256 multicast rules on the Switch.

Note: Your Switch automatically creates a static VLAN (with the same VID) when you create a multicast VLAN in this screen.

Figure 110 Advanced Application > Multicast > Multicast Setting > MVR

The following table describes the related labels in this screen.

Table 76 Advanced Application > Multicast > Multicast Setting > MVR

LABEL	DESCRIPTION
Active	Select this check box to enable MVR to allow one single multicast VLAN to be shared among different subscriber VLANs on the network.
Name	Enter a descriptive name (up to 32 printable ASCII characters) for identification purposes.
Multicast VLAN ID	Enter the VLAN ID (1 to 4094) of the multicast VLAN.
802.1p Priority	Select a priority level (0-7) with which the Switch replaces the priority in outgoing IGMP control packets (belonging to this multicast VLAN).
Mode	Specify the MVR mode on the Switch. Choices are Dynamic and Compatible . Select Dynamic to send IGMP reports to all MVR source ports in the multicast VLAN. Select Compatible to set the Switch not to send IGMP reports.
Port	This field displays the port number on the Switch.

Table 76 Advanced Application > Multicast > Multicast Setting > MVR (continued)

LABEL	DESCRIPTION
*	Settings in this row apply to all ports. Use this row only if you want to make some settings the same for all ports. Use this row first to set the common settings and then make adjustments on a port-by-port basis. Note: Changes in this row are copied to all the ports as soon as you make them.
Source Port	Select this option to set this port as the MVR source port that sends and receives multicast traffic. All source ports must belong to a single multicast VLAN.
Receiver Port	Select this option to set this port as a receiver port that only receives multicast traffic.
None	Select this option to set the port not to participate in MVR. No MVR multicast traffic is sent or received on this port.
Tagging	Select this checkbox if you want the port to tag the VLAN ID in all outgoing frames transmitted.
Add	Click Add to save your changes to the Switch's run-time memory. The Switch loses these changes if it is turned off or loses power, so use the Save link on the top navigation panel to save your changes to the non-volatile memory when you are done configuring.
Cancel	Click Cancel to begin configuring this screen afresh.
VLAN	This field displays the multicast VLAN ID.
Active	This field displays whether the multicast group is enabled or not.
Name	This field displays the descriptive name for this setting.
Mode	This field displays the MVR mode.
Source Port	This field displays the source port number(s).
Receiver Port	This field displays the receiver port number(s).
802.1p	This field displays the priority level.
Delete	To delete a multicast VLAN(s), select the rule(s) that you want to remove in the Delete column, then click the Delete button.
Cancel	Click Cancel to clear the Delete check boxes.

25.4.1 MVR Group Configuration

All source ports and receiver ports belonging to a multicast group can receive multicast data sent to this multicast group.

Configure MVR IP multicast group address(es) in the **Group Configuration** screen. Click **Group Configuration** in the **MVR** screen.

Note: A port can belong to more than one multicast VLAN. However, IP multicast group addresses in different multicast VLANs cannot overlap.

Figure 111 Advanced Application > Multicast > Multicast Setting > MVR: Group Configuration

The following table describes the labels in this screen.

Table 77 Advanced Application > Multicast > Multicast Setting > MVR: Group Configuration

LABEL	DESCRIPTION
Multicast VLAN ID	Select a multicast VLAN ID (that you configured in the MVR screen) from the drop-down list box.
Name	Enter a descriptive name for identification purposes.
Start Address	Enter the starting IP multicast address of the multicast group in dotted decimal notation. Refer to Section 25.1.1 on page 189 for more information on IP multicast addresses.
End Address	Enter the ending IP multicast address of the multicast group in dotted decimal notation. Enter the same IP address as the Start Address field if you want to configure only one IP address for a multicast group. Refer to Section 25.1.1 on page 189 for more information on IP multicast addresses.
Add	Click Add to save your changes to the Switch's run-time memory. The Switch loses these changes if it is turned off or loses power, so use the Save link on the top navigation panel to save your changes to the non-volatile memory when you are done configuring.
Cancel	Click Cancel to begin configuring this screen afresh.
MVLAN	This field displays the multicast VLAN ID.
Name	This field displays the descriptive name for this setting.
Start Address	This field displays the starting IP address of the multicast group.
End Address	This field displays the ending IP address of the multicast group.
Delete	Select Delete All or Delete Group and click Delete to remove the selected entry(ies) from the table. If you delete a multicast VLAN, all multicast groups in this VLAN will also be removed.
Cancel	Select Cancel to clear the checkbox(es) in the table.

25.4.2 MVR Configuration Example

The following figure shows a network example where ports 1, 2 and 3 on the Switch belong to VLAN 1. In addition, port 7 belongs to the multicast group with VID 200 to receive multicast traffic (the

News and **Movie** channels) from the remote streaming media server, **S**. Computers A, B and C in VLAN 1 are able to receive the traffic.

Figure 112 MVR Configuration Example

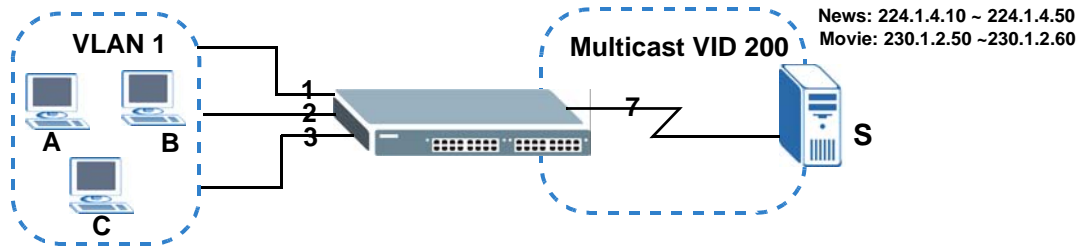

To configure the MVR settings on the Switch, create a multicast group in the **MVR** screen and set the receiver and source ports.

Figure 113 MVR Configuration Example

Port	Source Port	Receiver Port	None	Tagging
*		Receiver Port ▼		<input type="checkbox"/>
1	<input type="radio"/>	<input type="radio"/>	<input type="radio"/>	<input type="checkbox"/>
2	<input type="radio"/>	<input type="radio"/>	<input type="radio"/>	<input type="checkbox"/>
3	<input type="radio"/>	<input type="radio"/>	<input type="radio"/>	<input type="checkbox"/>
4	<input type="radio"/>	<input type="radio"/>	<input type="radio"/>	<input type="checkbox"/>
5	<input type="radio"/>	<input type="radio"/>	<input type="radio"/>	<input type="checkbox"/>
6	<input type="radio"/>	<input type="radio"/>	<input type="radio"/>	<input type="checkbox"/>
7	<input checked="" type="radio"/>	<input type="radio"/>	<input type="radio"/>	<input checked="" type="checkbox"/>
8	<input type="radio"/>	<input type="radio"/>	<input type="radio"/>	<input type="checkbox"/>
9	<input type="radio"/>	<input type="radio"/>	<input type="radio"/>	<input type="checkbox"/>
10	<input type="radio"/>	<input type="radio"/>	<input type="radio"/>	<input type="checkbox"/>
11	<input type="radio"/>	<input type="radio"/>	<input type="radio"/>	<input type="checkbox"/>
12	<input type="radio"/>	<input type="radio"/>	<input type="radio"/>	<input type="checkbox"/>

To set the Switch to forward the multicast group traffic to the subscribers, configure multicast group settings in the **Group Configuration** screen. The following figure shows an example where two multicast groups (**News** and **Movie**) are configured for the multicast VLAN 200.

Figure 114 MVR Group Configuration Example-1

Group Configuration MVR

Multicast VLAN ID: 200

Name	Start Address	End Address
Movie	230.1.2.50	230.1.2.60

Add Cancel **EXAMPLE**

MVLAN	Name	Start Address	End Address	Delete All	Delete Group
200	News	224.1.4.10	224.1.4.50	<input type="checkbox"/>	<input type="checkbox"/>

Delete Cancel

Figure 115 MVR Group Configuration Example-2

Group Configuration MVR

Multicast VLAN ID: 200

Name	Start Address	End Address
	0.0.0.0	0.0.0.0

Add Cancel **EXAMPLE**

MVLAN	Name	Start Address	End Address	Delete All	Delete Group
200	Movie	230.1.2.50	230.1.2.60	<input type="checkbox"/>	<input type="checkbox"/>
	News	224.1.4.10	224.1.4.50	<input type="checkbox"/>	<input type="checkbox"/>

Delete Cancel

This chapter describes how to configure authentication, authorization and accounting settings on the Switch.

26.1 Authentication, Authorization and Accounting (AAA)

Authentication is the process of determining who a user is and validating access to the Switch. The Switch can authenticate users who try to log in based on user accounts configured on the Switch itself. The Switch can also use an external authentication server to authenticate a large number of users.

Authorization is the process of determining what a user is allowed to do. Different user accounts may have higher or lower privilege levels associated with them. For example, user A may have the right to create new login accounts on the Switch but user B cannot. The Switch can authorize users based on user accounts configured on the Switch itself or it can use an external server to authorize a large number of users.

Accounting is the process of recording what a user is doing. The Switch can use an external server to track when users log in, log out, execute commands and so on. Accounting can also record system related actions such as boot up and shut down times of the Switch.

The external servers that perform authentication, authorization and accounting functions are known as AAA servers. The Switch supports RADIUS (Remote Authentication Dial-In User Service, see [Section 26.1.2 on page 204](#)) and TACACS+ (Terminal Access Controller Access-Control System Plus, see [Section 26.1.2 on page 204](#)) as external authentication, authorization and accounting servers.

Figure 116 AAA Server

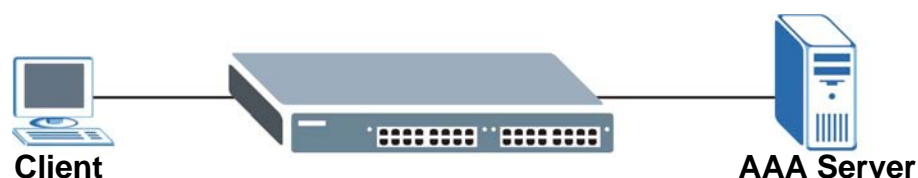

26.1.1 Local User Accounts

By storing user profiles locally on the Switch, your Switch is able to authenticate and authorize users without interacting with a network AAA server. However, there is a limit on the number of users you may authenticate in this way (See [Chapter 40 on page 303](#)).

26.1.2 RADIUS and TACACS+

RADIUS and TACACS+ are security protocols used to authenticate users by means of an external server instead of (or in addition to) an internal device user database that is limited to the memory capacity of the device. In essence, RADIUS and TACACS+ authentication both allow you to validate an unlimited number of users from a central location.

The following table describes some key differences between RADIUS and TACACS+.

Table 78 RADIUS vs TACACS+

	RADIUS	TACACS+
Transport Protocol	UDP (User Datagram Protocol)	TCP (Transmission Control Protocol)
Encryption	Encrypts the password sent for authentication.	All communication between the client (the Switch) and the TACACS server is encrypted.

26.2 AAA Screens

The **AAA** screens allow you to enable authentication, authorization, accounting or all of them on the Switch. First, configure your authentication and accounting server settings (RADIUS, TACACS+ or both) and then set up the authentication priority, activate authorization and configure accounting settings.

Click **Advanced Application > AAA** in the navigation panel to display the screen as shown.

Figure 117 Advanced Application > AAA



26.2.1 RADIUS Server Setup

Use this screen to configure your RADIUS server settings. See [Section 26.1.2 on page 204](#) for more information on RADIUS servers and [Section 26.3 on page 212](#) for RADIUS attributes utilized by the authentication and accounting features on the Switch. Click on the **RADIUS Server Setup** link in the **AAA** screen to view the screen as shown.

Figure 118 Advanced Application > AAA > RADIUS Server Setup

The following table describes the labels in this screen.

Table 79 Advanced Application > AAA > RADIUS Server Setup

LABEL	DESCRIPTION
Authentication Server	Use this section to configure your RADIUS authentication settings.
Mode	This field only applies if you configure multiple RADIUS servers. Select index-priority and the Switch tries to authenticate with the first configured RADIUS server, if the RADIUS server does not respond then the Switch tries to authenticate with the second RADIUS server. Select round-robin to alternate between the RADIUS servers that it sends authentication requests to.
Timeout	Specify the amount of time in seconds that the Switch waits for an authentication request response from the RADIUS server. If you are using index-priority for your authentication and you are using two RADIUS servers then the timeout value is divided between the two RADIUS servers. For example, if you set the timeout value to 30 seconds, then the Switch waits for a response from the first RADIUS server for 15 seconds and then tries the second RADIUS server.
Index	This is a read-only number representing a RADIUS server entry.
IP Address	Enter the IP address of an external RADIUS server in dotted decimal notation.
UDP Port	The default port of a RADIUS server for authentication is 1812 . You need not change this value unless your network administrator instructs you to do so.
Shared Secret	Specify a password (up to 32 alphanumeric characters) as the key to be shared between the external RADIUS server and the Switch. This key is not sent over the network. This key must be the same on the external RADIUS server and the Switch. Note that as you type a password, the screen displays an asterisk (*) for each character you type.

Table 79 Advanced Application > AAA > RADIUS Server Setup (continued)

LABEL	DESCRIPTION
Delete	Check this box if you want to remove an existing RADIUS server entry from the Switch. This entry is deleted when you click Apply .
Apply	Click Apply to save your changes to the Switch's run-time memory. The Switch loses these changes if it is turned off or loses power, so use the Save link on the top navigation panel to save your changes to the non-volatile memory when you are done configuring.
Cancel	Click Cancel to begin configuring this screen afresh.
Accounting Server	Use this section to configure your RADIUS accounting server settings.
Timeout	Specify the amount of time in seconds that the Switch waits for an accounting request response from the RADIUS accounting server.
Index	This is a read-only number representing a RADIUS accounting server entry.
IP Address	Enter the IP address of an external RADIUS accounting server in dotted decimal notation.
UDP Port	The default port of a RADIUS accounting server for accounting is 1813 . You need not change this value unless your network administrator instructs you to do so.
Shared Secret	Specify a password (up to 32 alphanumeric characters) as the key to be shared between the external RADIUS accounting server and the Switch. This key is not sent over the network. This key must be the same on the external RADIUS accounting server and the Switch. Note that as you type a password, the screen displays an asterisk (*) for each character you type.
Delete	Check this box if you want to remove an existing RADIUS accounting server entry from the Switch. This entry is deleted when you click Apply .
Apply	Click Apply to save your changes to the Switch's run-time memory. The Switch loses these changes if it is turned off or loses power, so use the Save link on the top navigation panel to save your changes to the non-volatile memory when you are done configuring.
Cancel	Click Cancel to begin configuring this screen afresh.

26.2.2 TACACS+ Server Setup

Use this screen to configure your TACACS+ server settings. See [Section 26.1.2 on page 204](#) for more information on TACACS+ servers. Click on the **TACACS+ Server Setup** link in the **Authentication and Accounting** screen to view the screen as shown.

Figure 119 Advanced Application > AAA > TACACS+ Server Setup

TACACS+ Server Setup Auth and Acct

Authentication Server

Mode:

Timeout: seconds

Index	IP Address	TCP Port	Shared Secret	Delete
1	<input type="text" value="0.0.0.0"/>	<input type="text" value="49"/>	<input type="text"/>	<input type="checkbox"/>
2	<input type="text" value="0.0.0.0"/>	<input type="text" value="49"/>	<input type="text"/>	<input type="checkbox"/>

Accounting Server

Timeout: seconds

Index	IP Address	TCP Port	Shared Secret	Delete
1	<input type="text" value="0.0.0.0"/>	<input type="text" value="49"/>	<input type="text"/>	<input type="checkbox"/>
2	<input type="text" value="0.0.0.0"/>	<input type="text" value="49"/>	<input type="text"/>	<input type="checkbox"/>

The following table describes the labels in this screen.

Table 80 Advanced Application > AAA > TACACS+ Server Setup

LABEL	DESCRIPTION
Authentication Server	Use this section to configure your TACACS+ authentication settings.
Mode	This field is only valid if you configure multiple TACACS+ servers. Select index-priority and the Switch tries to authenticate with the first configured TACACS+ server, if the TACACS+ server does not respond then the Switch tries to authenticate with the second TACACS+ server. Select round-robin to alternate between the TACACS+ servers that it sends authentication requests to.
Timeout	Specify the amount of time in seconds that the Switch waits for an authentication request response from the TACACS+ server. If you are using index-priority for your authentication and you are using two TACACS+ servers then the timeout value is divided between the two TACACS+ servers. For example, if you set the timeout value to 30 seconds, then the Switch waits for a response from the first TACACS+ server for 15 seconds and then tries the second TACACS+ server.
Index	This is a read-only number representing a TACACS+ server entry.
IP Address	Enter the IP address of an external TACACS+ server in dotted decimal notation.
TCP Port	The default port of a TACACS+ server for authentication is 49 . You need not change this value unless your network administrator instructs you to do so.
Shared Secret	Specify a password (up to 32 alphanumeric characters) as the key to be shared between the external TACACS+ server and the Switch. This key is not sent over the network. This key must be the same on the external TACACS+ server and the Switch. Note that as you type a password, the screen displays an asterisk (*) for each character you type.

Table 80 Advanced Application > AAA > TACACS+ Server Setup (continued)

LABEL	DESCRIPTION
Delete	Check this box if you want to remove an existing TACACS+ server entry from the Switch. This entry is deleted when you click Apply .
Apply	Click Apply to save your changes to the Switch's run-time memory. The Switch loses these changes if it is turned off or loses power, so use the Save link on the top navigation panel to save your changes to the non-volatile memory when you are done configuring.
Cancel	Click Cancel to begin configuring this screen afresh.
Accounting Server	Use this section to configure your TACACS+ accounting settings.
Timeout	Specify the amount of time in seconds that the Switch waits for an accounting request response from the TACACS+ server.
Index	This is a read-only number representing a TACACS+ accounting server entry.
IP Address	Enter the IP address of an external TACACS+ accounting server in dotted decimal notation.
TCP Port	The default port of a TACACS+ accounting server is 49 . You need not change this value unless your network administrator instructs you to do so.
Shared Secret	Specify a password (up to 32 alphanumeric characters) as the key to be shared between the external TACACS+ accounting server and the Switch. This key is not sent over the network. This key must be the same on the external TACACS+ accounting server and the Switch. Note that as you type a password, the screen displays an asterisk (*) for each character you type.
Delete	Check this box if you want to remove an existing TACACS+ accounting server entry from the Switch. This entry is deleted when you click Apply .
Apply	Click Apply to save your changes to the Switch's run-time memory. The Switch loses these changes if it is turned off or loses power, so use the Save link on the top navigation panel to save your changes to the non-volatile memory when you are done configuring.
Cancel	Click Cancel to begin configuring this screen afresh.

26.2.3 AAA Setup

Use this screen to configure authentication, authorization and accounting settings on the Switch. Click on the **AAA Setup** link in the **AAA** screen to view the screen as shown.

Figure 120 Advanced Application > AAA > AAA Setup

AAA Setup AAA

Authentication

Type	Method 1	Method 2	Method 3
Privilege Enable	local	-	-
Login	local	-	-

Authorization

Type	Active	Method
Exec	<input type="checkbox"/>	radius
Dot1x	<input type="checkbox"/>	radius

Accounting

Update Period: minutes

Type	Active	Broadcast	Mode	Method	Privilege
System	<input type="checkbox"/>	<input type="checkbox"/>	-	radius	-
Exec	<input type="checkbox"/>	<input type="checkbox"/>	start-stop	radius	-
Dot1x	<input type="checkbox"/>	<input type="checkbox"/>	start-stop	radius	-
Commands	<input type="checkbox"/>	<input type="checkbox"/>	stop-only	tacacs+	0

Apply Cancel

The following table describes the labels in this screen.

Table 81 Advanced Application > AAA > AAA Setup

LABEL	DESCRIPTION
Authentication	Use this section to specify the methods used to authenticate users accessing the Switch.
Privilege Enable	<p>These fields specify which database the Switch should use (first, second and third) to authenticate access privilege level for administrator accounts (users for Switch management).</p> <p>Configure the access privilege of accounts via commands (see the Ethernet Switch CLI Reference Guide) for local authentication. The TACACS+ and RADIUS are external servers. Before you specify the priority, make sure you have set up the corresponding database correctly first.</p> <p>You can specify up to three methods for the Switch to authenticate the access privilege level of administrators. The Switch checks the methods in the order you configure them (first Method 1, then Method 2 and finally Method 3). You must configure the settings in the Method 1 field. If you want the Switch to check other sources for access privilege level specify them in Method 2 and Method 3 fields.</p> <p>Select local to have the Switch check the access privilege configured for local authentication.</p> <p>Select radius or tacacs+ to have the Switch check the access privilege via the external servers.</p>

Table 81 Advanced Application > AAA > AAA Setup (continued)

LABEL	DESCRIPTION
Login	<p>These fields specify which database the Switch should use (first, second and third) to authenticate administrator accounts (users for Switch management).</p> <p>Configure the local user accounts in the Access Control > Logins screen. The TACACS+ and RADIUS are external servers. Before you specify the priority, make sure you have set up the corresponding database correctly first.</p> <p>You can specify up to three methods for the Switch to authenticate administrator accounts. The Switch checks the methods in the order you configure them (first Method 1, then Method 2 and finally Method 3). You must configure the settings in the Method 1 field. If you want the Switch to check other sources for administrator accounts, specify them in Method 2 and Method 3 fields.</p> <p>Select local to have the Switch check the administrator accounts configured in the Access Control > Logins screen.</p> <p>Select radius to have the Switch check the administrator accounts configured via the RADIUS Server.</p> <p>Select tacacs+ to have the Switch check the administrator accounts configured via the TACACS+ Server.</p>
Authorization	Use this section to configure authorization settings on the Switch.
Type	<p>Set whether the Switch provides the following services to a user.</p> <ul style="list-style-type: none"> • Exec: Allow an administrator which logs in the Switch through Telnet or SSH to have different access privilege level assigned via the external server. • Dot1x: Allow an IEEE 802.1x client to have different bandwidth limit or VLAN ID assigned via the external server.
Active	Select this to activate authorization for a specified event types.
Method	<p>Select whether you want to use RADIUS or TACACS+ for authorization of specific types of events.</p> <p>RADIUS is the only method for IEEE 802.1x authorization.</p>
Accounting	Use this section to configure accounting settings on the Switch.
Update Period	This is the amount of time in minutes before the Switch sends an update to the accounting server. This is only valid if you select the start-stop option for the Exec or Dot1x entries.
Type	<p>The Switch supports the following types of events to be sent to the accounting server(s):</p> <ul style="list-style-type: none"> • System - Configure the Switch to send information when the following system events occur: system boots up, system shuts down, system accounting is enabled, system accounting is disabled • Exec - Configure the Switch to send information when an administrator logs in and logs out via the console port, telnet or SSH. • Dot1x - Configure the Switch to send information when an IEEE 802.1x client begins a session (authenticates via the Switch), ends a session as well as interim updates of a session. • Commands - Configure the Switch to send information when commands of specified privilege level and higher are executed on the Switch.
Active	Select this to activate accounting for a specified event types.
Broadcast	<p>Select this to have the Switch send accounting information to all configured accounting servers at the same time.</p> <p>If you don't select this and you have two accounting servers set up, then the Switch sends information to the first accounting server and if it doesn't get a response from the accounting server then it tries the second accounting server.</p>

Table 81 Advanced Application > AAA > AAA Setup (continued)

LABEL	DESCRIPTION
Mode	The Switch supports two modes of recording login events. Select: <ul style="list-style-type: none"> • start-stop - to have the Switch send information to the accounting server when a user begins a session, during a user's session (if it lasts past the Update Period), and when a user ends a session. • stop-only - to have the Switch send information to the accounting server only when a user ends a session.
Method	Select whether you want to use RADIUS or TACACS+ for accounting of specific types of events. TACACS+ is the only method for recording Commands type of event.
Privilege	This field is only configurable for Commands type of event. Select the threshold command privilege level for which the Switch should send accounting information. The Switch will send accounting information when commands at the level you specify and higher are executed on the Switch.
Apply	Click Apply to save your changes to the Switch's run-time memory. The Switch loses these changes if it is turned off or loses power, so use the Save link on the top navigation panel to save your changes to the non-volatile memory when you are done configuring.
Cancel	Click Cancel to begin configuring this screen afresh.

26.2.4 Vendor Specific Attribute

RFC 2865 standard specifies a method for sending vendor-specific information between a RADIUS server and a network access device (for example, the Switch). A company can create Vendor Specific Attributes (VSAs) to expand the functionality of a RADIUS server.

The Switch supports VSAs that allow you to perform the following actions based on user authentication:

- Limit bandwidth on incoming or outgoing traffic for the port the user connects to.
- Assign account privilege levels (see the CLI Reference Guide for more information on account privilege levels) for the authenticated user.

The VSAs are composed of the following:

- **Vendor-ID**: An identification number assigned to the company by the IANA (Internet Assigned Numbers Authority). ZyXEL's vendor ID is 890.
- **Vendor-Type**: A vendor specified attribute, identifying the setting you want to modify.
- **Vendor-data**: A value you want to assign to the setting.

Note: Refer to the documentation that comes with your RADIUS server on how to configure VSAs for users authenticating via the RADIUS server.

The following table describes the VSAs supported on the Switch. Note that these attributes only work when you enable authorization (see [Section 26.2.3 on page 208](#)).

Table 82 Supported VSAs

FUNCTION	ATTRIBUTE
Ingress Bandwidth Assignment	Vendor-Id = 890 Vendor-Type = 1 Vendor-data = ingress rate (Kbps in decimal format)
Egress Bandwidth Assignment	Vendor-Id = 890 Vendor-Type = 2 Vendor-data = egress rate (Kbps in decimal format)
Privilege Assignment	Vendor-ID = 890 Vendor-Type = 3 Vendor-Data = " shell:priv-lvl=N " or Vendor-ID = 9 (CISCO) Vendor-Type = 1 (CISCO-AVPAIR) Vendor-Data = " shell:priv-lvl=N " where N is a privilege level (from 0 to 14). Note: If you set the privilege level of a login account differently on the RADIUS server(s) and the Switch, the user is assigned a privilege level from the database (RADIUS or local) the Switch uses first for user authentication.

26.2.5 Tunnel Protocol Attribute

You can configure tunnel protocol attributes on the RADIUS server (refer to your RADIUS server documentation) to assign a port on the Switch to a VLAN based on IEEE 802.1x authentication. The port VLAN settings are fixed and untagged. This will also set the port's VID. The following table describes the values you need to configure. Note that these attributes only work when you enable authorization (see [Section 26.2.3 on page 208](#)).

Table 83 Supported Tunnel Protocol Attribute

FUNCTION	ATTRIBUTE
VLAN Assignment	Tunnel-Type = VLAN (13) Tunnel-Medium-Type = 802 (6) Tunnel-Private-Group-ID = VLAN ID Note: You must also create a VLAN with the specified VID on the Switch. Note: The bolded values in this table are fixed values as defined in RFC 3580.

26.3 Supported RADIUS Attributes

Remote Authentication Dial-In User Service (RADIUS) attributes are data used to define specific authentication, and accounting elements in a user profile, which is stored on the RADIUS server. This section lists the RADIUS attributes supported by the Switch.

Refer to RFC 2865 for more information about RADIUS attributes used for authentication. Refer to RFC 2866 and RFC 2869 for RADIUS attributes used for accounting.

This section lists the attributes used by authentication and accounting functions on the Switch. In cases where the attribute has a specific format associated with it, the format is specified.

26.3.1 Attributes Used for Authentication

The following sections list the attributes sent from the Switch to the RADIUS server when performing authentication.

26.3.1.1 Attributes Used for Authenticating Privilege Access

User-Name

- the format of the User-Name attribute is **\$enab#\$**, where # is the privilege level (1-14)

User-Password

NAS-Identifier

NAS-IP-Address

26.3.1.2 Attributes Used to Login Users

User-Name

User-Password

NAS-Identifier

NAS-IP-Address

26.3.1.3 Attributes Used by the IEEE 802.1x Authentication

User-Name

NAS-Identifier

NAS-IP-Address

NAS-Port

NAS-Port-Type

- This value is set to **Ethernet(15)** on the Switch.

Calling-Station-Id

Frame-MTU

EAP-Message

State

Message-Authenticator

26.3.2 Attributes Used for Accounting

The following sections list the attributes sent from the Switch to the RADIUS server when performing authentication.

26.3.2.1 Attributes Used for Accounting System Events

NAS-IP-Address

NAS-Identifier

Acct-Status-Type

Acct-Session-ID

- The format of Acct-Session-Id is **date+time+8-digit sequential number**, for example, 2007041917210300000001. (date: 2007/04/19, time: 17:21:03, serial number: 00000001)

Acct-Delay-Time

26.3.2.2 Attributes Used for Accounting Exec Events

The attributes are listed in the following table along with the time that they are sent (the difference between Console and Telnet/SSH Exec events is that the Telnet/SSH events utilize the Calling-Station-Id attribute):

Table 84 RADIUS Attributes - Exec Events via Console

ATTRIBUTE	START	INTERIM-UPDATE	STOP
User-Name	✓	✓	✓
NAS-Identifier	✓	✓	✓
NAS-IP-Address	✓	✓	✓
Service-Type	✓	✓	✓
Acct-Status-Type	✓	✓	✓
Acct-Delay-Time	✓	✓	✓
Acct-Session-Id	✓	✓	✓
Acct-Authentic	✓	✓	✓
Acct-Session-Time		✓	✓
Acct-Terminate-Cause			✓

Table 85 RADIUS Attributes - Exec Events via Telnet/SSH

ATTRIBUTE	START	INTERIM-UPDATE	STOP
User-Name	✓	✓	✓
NAS-Identifier	✓	✓	✓
NAS-IP-Address	✓	✓	✓
Service-Type	✓	✓	✓
Calling-Station-Id	✓	✓	✓
Acct-Status-Type	✓	✓	✓
Acct-Delay-Time	✓	✓	✓
Acct-Session-Id	✓	✓	✓
Acct-Authentic	✓	✓	✓
Acct-Session-Time		✓	✓
Acct-Terminate-Cause			✓

26.3.2.3 Attributes Used for Accounting IEEE 802.1x Events

The attributes are listed in the following table along with the time of the session they are sent:

Table 86 RADIUS Attributes - Exec Events via Console

ATTRIBUTE	START	INTERIM-UPDATE	STOP
User-Name	✓	✓	✓
NAS-IP-Address	✓	✓	✓
NAS-Port	✓	✓	✓
Class	✓	✓	✓
Called-Station-Id	✓	✓	✓
Calling-Station-Id	✓	✓	✓
NAS-Identifier	✓	✓	✓
NAS-Port-Type	✓	✓	✓
Acct-Status-Type	✓	✓	✓
Acct-Delay-Time	✓	✓	✓
Acct-Session-Id	✓	✓	✓
Acct-Authentic	✓	✓	✓
Acct-Input-Octets		✓	✓
Acct-Output-Octets		✓	✓
Acct-Session-Time		✓	✓
Acct-Input-Packets		✓	✓
Acct-Output-Packets		✓	✓
Acct-Terminate-Cause			✓
Acct-Input-Gigawords		✓	✓
Acct-Output-Gigawords		✓	✓

IP Source Guard

Use IP source guard to filter unauthorized DHCP and ARP packets in your network.

27.1 IP Source Guard Overview

IP source guard uses a binding table to distinguish between authorized and unauthorized DHCP and ARP packets in your network. A binding contains these key attributes:

- MAC address
- VLAN ID
- IP address
- Port number

When the Switch receives a DHCP or ARP packet, it looks up the appropriate MAC address, VLAN ID, IP address, and port number in the binding table. If there is a binding, the Switch forwards the packet. If there is not a binding, the Switch discards the packet.

The Switch builds the binding table by snooping DHCP packets (dynamic bindings) and from information provided manually by administrators (static bindings).

IP source guard consists of the following features:

- Static bindings. Use this to create static bindings in the binding table.
- DHCP snooping. Use this to filter unauthorized DHCP packets on the network and to build the binding table dynamically.
- ARP inspection. Use this to filter unauthorized ARP packets on the network.

If you want to use dynamic bindings to filter unauthorized ARP packets (typical implementation), you have to enable DHCP snooping before you enable ARP inspection.

27.1.1 DHCP Snooping Overview

Use DHCP snooping to filter unauthorized DHCP packets on the network and to build the binding table dynamically. This can prevent clients from getting IP addresses from unauthorized DHCP servers.

27.1.1.1 Trusted vs. Untrusted Ports

Every port is either a trusted port or an untrusted port for DHCP snooping. This setting is independent of the trusted/untrusted setting for ARP inspection. You can also specify the maximum number for DHCP packets that each port (trusted or untrusted) can receive each second.

Trusted ports are connected to DHCP servers or other switches. The Switch discards DHCP packets from trusted ports only if the rate at which DHCP packets arrive is too high. The Switch learns dynamic bindings from trusted ports.

Note: The Switch will drop all DHCP requests if you enable DHCP snooping and there are no trusted ports.

Untrusted ports are connected to subscribers. The Switch discards DHCP packets from untrusted ports in the following situations:

- The packet is a DHCP server packet (for example, OFFER, ACK, or NACK).
- The source MAC address and source IP address in the packet do not match any of the current bindings.
- The packet is a RELEASE or DECLINE packet, and the source MAC address and source port do not match any of the current bindings.
- The rate at which DHCP packets arrive is too high.

27.1.1.2 DHCP Snooping Database

The Switch stores the binding table in volatile memory. If the Switch restarts, it loads static bindings from permanent memory but loses the dynamic bindings, in which case the devices in the network have to send DHCP requests again. As a result, it is recommended you configure the DHCP snooping database.

The DHCP snooping database maintains the dynamic bindings for DHCP snooping and ARP inspection in a file on an external TFTP server. If you set up the DHCP snooping database, the Switch can reload the dynamic bindings from the DHCP snooping database after the Switch restarts.

You can configure the name and location of the file on the external TFTP server. The file has the following format:

Figure 121 DHCP Snooping Database File Format

```
<initial-checksum>
TYPE DHCP-SNOOPING
VERSION 1
BEGIN
<binding-1> <checksum-1>
<binding-2> <checksum-1-2>
...
...
<binding-n> <checksum-1-2-..-n>
END
```

The <initial-checksum> helps distinguish between the bindings in the latest update and the bindings from previous updates. Each binding consists of 72 bytes, a space, and another checksum that is used to validate the binding when it is read. If the calculated checksum is not equal to the checksum in the file, that binding and all others after it are ignored.

27.1.1.3 DHCP Relay Option 82 Information

The Switch can add information to DHCP requests that it does not discard. This provides the DHCP server more information about the source of the requests. The Switch can add the following information:

- Slot ID (1 byte), port ID (1 byte), and source VLAN ID (2 bytes)
- System name (up to 32 bytes)

This information is stored in an Agent Information field in the option 82 field of the DHCP headers of client DHCP request frames. See [Chapter 37 on page 276](#) for more information about DHCP relay option 82.

When the DHCP server responds, the Switch removes the information in the Agent Information field before forwarding the response to the original source.

You can configure this setting for each source VLAN. This setting is independent of the DHCP relay settings ([Chapter 37 on page 276](#)).

27.1.1.4 Configuring DHCP Snooping

Follow these steps to configure DHCP snooping on the Switch.

- 1 Enable DHCP snooping on the Switch.
- 2 Enable DHCP snooping on each VLAN, and configure DHCP relay option 82.
- 3 Configure trusted and untrusted ports, and specify the maximum number of DHCP packets that each port can receive per second.
- 4 Configure static bindings.

27.1.2 ARP Inspection Overview

Use ARP inspection to filter unauthorized ARP packets on the network. This can prevent many kinds of man-in-the-middle attacks, such as the one in the following example.

Figure 122 Example: Man-in-the-middle Attack

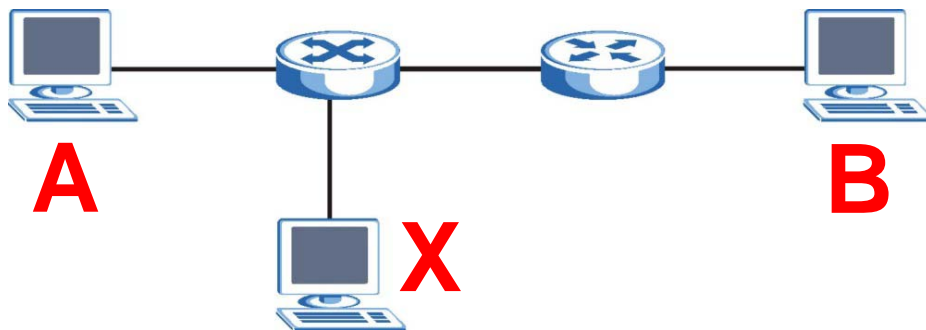

In this example, computer **B** tries to establish a connection with computer **A**. Computer **X** is in the same broadcast domain as computer **A** and intercepts the ARP request for computer **A**. Then, computer **X** does the following things:

- It pretends to be computer **A** and responds to computer **B**.
- It pretends to be computer **B** and sends a message to computer **A**.

As a result, all the communication between computer **A** and computer **B** passes through computer **X**. Computer **X** can read and alter the information passed between them.

27.1.2.1 ARP Inspection and MAC Address Filters

When the Switch identifies an unauthorized ARP packet, it automatically creates a MAC address filter to block traffic from the source MAC address and source VLAN ID of the unauthorized ARP packet. You can configure how long the MAC address filter remains in the Switch.

These MAC address filters are different than regular MAC address filters ([Chapter 12 on page 113](#)).

- They are stored only in volatile memory.
- They do not use the same space in memory that regular MAC address filters use.
- They appear only in the **ARP Inspection** screens and commands, not in the **MAC Address Filter** screens and commands.

27.1.2.2 Trusted vs. Untrusted Ports

Every port is either a trusted port or an untrusted port for ARP inspection. This setting is independent of the trusted/untrusted setting for DHCP snooping. You can also specify the maximum rate at which the Switch receives ARP packets on untrusted ports.

The Switch does not discard ARP packets on trusted ports for any reason.

The Switch discards ARP packets on untrusted ports in the following situations:

- The sender's information in the ARP packet does not match any of the current bindings.
- The rate at which ARP packets arrive is too high.

27.1.2.3 Syslog

The Switch can send syslog messages to the specified syslog server ([Chapter 42 on page 326](#)) when it forwards or discards ARP packets. The Switch can consolidate log messages and send log messages in batches to make this mechanism more efficient.

27.1.2.4 Configuring ARP Inspection

Follow these steps to configure ARP inspection on the Switch.

- 1 Configure DHCP snooping. See [Section 27.1.1.4 on page 218](#).

Note: It is recommended you enable DHCP snooping at least one day before you enable ARP inspection so that the Switch has enough time to build the binding table.

- 2 Enable ARP inspection on each VLAN.
- 3 Configure trusted and untrusted ports, and specify the maximum number of ARP packets that each port can receive per second.

27.2 IP Source Guard

Use this screen to look at the current bindings for DHCP snooping and ARP inspection. Bindings are used by DHCP snooping and ARP inspection to distinguish between authorized and unauthorized packets in the network. The Switch learns the bindings by snooping DHCP packets (dynamic bindings) and from information provided manually by administrators (static bindings). To open this screen, click **Advanced Application > IP Source Guard**.

Figure 123 Advanced Application > IP Source Guard

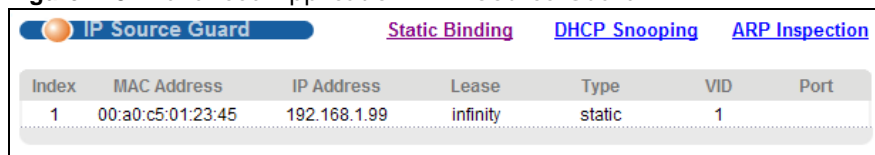

The screenshot shows the 'IP Source Guard' configuration page with tabs for 'Static Binding', 'DHCP Snooping', and 'ARP Inspection'. A table displays the following binding:

Index	MAC Address	IP Address	Lease	Type	VID	Port
1	00:a0:c5:01:23:45	192.168.1.99	infinity	static	1	

The following table describes the labels in this screen.

Table 87 Advanced Application > IP Source Guard

LABEL	DESCRIPTION
Index	This field displays a sequential number for each binding.
MAC Address	This field displays the source MAC address in the binding.
IP Address	This field displays the IP address assigned to the MAC address in the binding.
Lease	This field displays how many days, hours, minutes, and seconds the binding is valid; for example, 2d3h4m5s means the binding is still valid for 2 days, 3 hours, 4 minutes and 5 seconds. This field displays infinity if the binding is always valid (for example, a static binding).
Type	This field displays how the Switch learned the binding. static : This binding was learned from information provided manually by an administrator. dhcp-snooping : This binding was learned by snooping DHCP packets.
VID	This field displays the source VLAN ID in the binding.
Port	This field displays the port number in the binding. If this field is blank, the binding applies to all ports.

27.3 IP Source Guard Static Binding

Use this screen to manage static bindings for DHCP snooping and ARP inspection. Static bindings are uniquely identified by the MAC address and VLAN ID. Each MAC address and VLAN ID can only be in one static binding. If you try to create a static binding with the same MAC address and VLAN ID as an existing static binding, the new static binding replaces the original one. To open this screen, click **Advanced Application > IP Source Guard > Static Binding**.

Figure 124 Advanced Application > IP Source Guard > Static Binding

IP Source Guard Static Binding IPSG

MAC Address: [] : [] : [] : [] : [] : []

IP Address: []

VLAN: []

Port: [] Any

[Add] [Cancel] [Clear]

Index	MAC Address	IP Address	Lease	Type	VLAN	Port	Delete
1	00:a0:c5:01:23:48	192.168.1.99	infinity	static	1		<input checked="" type="checkbox"/>

[Delete] [Cancel]

The following table describes the labels in this screen.

Table 88 Advanced Application > IP Source Guard > Static Binding

LABEL	DESCRIPTION
MAC Address	Enter the source MAC address in the binding.
IP Address	Enter the IP address assigned to the MAC address in the binding.
VLAN	Enter the source VLAN ID in the binding.
Port	Specify the port(s) in the binding. If this binding has one port, select the first radio button and enter the port number in the field to the right. If this binding applies to all ports, select Any .
Add	Click this to create the specified static binding or to update an existing one.
Cancel	Click this to reset the values above based on the last selected static binding or, if not applicable, to clear the fields above.
Clear	Click this to clear the fields above.
Index	This field displays a sequential number for each binding.
MAC Address	This field displays the source MAC address in the binding.
IP Address	This field displays the IP address assigned to the MAC address in the binding.
Lease	This field displays how many days, hours, minutes, and seconds the binding is valid; for example, 2d3h4m5s means the binding is still valid for 2 days, 3 hours, 4 minutes and 5 seconds. This field displays infinity if the binding is always valid (for example, a static binding).
Type	This field displays how the Switch learned the binding. static : This binding was learned from information provided manually by an administrator.
VLAN	This field displays the source VLAN ID in the binding.
Port	This field displays the port number in the binding. If this field is blank, the binding applies to all ports.
Delete	Check the entry(ies) that you want to remove and then click the Delete button to remove the selected entry(ies) from the summary table.
Cancel	Click this to clear the Delete check boxes above.

27.4 DHCP Snooping

Use this screen to look at various statistics about the DHCP snooping database. To open this screen, click **Advanced Application > IP Source Guard > DHCP Snooping**.

Figure 125 Advanced Application > IP Source Guard > DHCP Snooping

DHCP Snooping		Configure	IPSG
Database Status			
Description	Status		
Agent URL			
Write delay timer	300	seconds	
Abort timer	300	seconds	
Agent running	None		
Delay timer expiry	Not Running		
Abort timer expiry	Not Running		
Last succeeded time	None		
Last failed time	None		
Last failed reason	No failure recorded		
Times			
Total attempts	0		
Startup failures	0		
Successful transfers	0		
Failed transfers	0		
Successful reads	0		
Failed reads	0		
Successful writes	0		
Failed writes	0		
Database detail			
Description	Status		
First successful access	None		
Last ignored bindings counters			
Binding collisions	0		
Invalid interfaces	0		
Parse failures	0		
Expired leases	0		
Unsupported vlans	0		
Last ignored time	None		
Total ignored bindings counters			
Binding collisions	0		
Invalid interfaces	0		
Parse failures	0		
Expired leases	0		
Unsupported vlans	0		

The following table describes the labels in this screen.

Table 89 Advanced Application > IP Source Guard > DHCP Snooping

LABEL	DESCRIPTION
Database Status	
	This section displays the current settings for the DHCP snooping database. You can configure them in the DHCP Snooping Configure screen. See Section 27.5 on page 224 .
Agent URL	This field displays the location of the DHCP snooping database.

Table 89 Advanced Application > IP Source Guard > DHCP Snooping (continued)

LABEL	DESCRIPTION
Write delay timer	This field displays how long (in seconds) the Switch tries to complete a specific update in the DHCP snooping database before it gives up.
Abort timer	This field displays how long (in seconds) the Switch waits to update the DHCP snooping database after the current bindings change.
	This section displays information about the current update and the next update of the DHCP snooping database.
Agent running	<p>This field displays the status of the current update or access of the DHCP snooping database.</p> <p>none: The Switch is not accessing the DHCP snooping database.</p> <p>read: The Switch is loading dynamic bindings from the DHCP snooping database.</p> <p>write: The Switch is updating the DHCP snooping database.</p>
Delay timer expiry	This field displays how much longer (in seconds) the Switch tries to complete the current update before it gives up. It displays Not Running if the Switch is not updating the DHCP snooping database right now.
Abort timer expiry	This field displays when (in seconds) the Switch is going to update the DHCP snooping database again. It displays Not Running if the current bindings have not changed since the last update.
	This section displays information about the last time the Switch updated the DHCP snooping database.
Last succeeded time	This field displays the last time the Switch updated the DHCP snooping database successfully.
Last failed time	This field displays the last time the Switch updated the DHCP snooping database unsuccessfully.
Last failed reason	This field displays the reason the Switch updated the DHCP snooping database unsuccessfully.
	This section displays historical information about the number of times the Switch successfully or unsuccessfully read or updated the DHCP snooping database.
Total attempts	This field displays the number of times the Switch has tried to access the DHCP snooping database for any reason.
Startup failures	This field displays the number of times the Switch could not create or read the DHCP snooping database when the Switch started up or a new URL is configured for the DHCP snooping database.
Successful transfers	This field displays the number of times the Switch read bindings from or updated the bindings in the DHCP snooping database successfully.
Failed transfers	This field displays the number of times the Switch was unable to read bindings from or update the bindings in the DHCP snooping database.
Successful reads	This field displays the number of times the Switch read bindings from the DHCP snooping database successfully.
Failed reads	This field displays the number of times the Switch was unable to read bindings from the DHCP snooping database.
Successful writes	This field displays the number of times the Switch updated the bindings in the DHCP snooping database successfully.
Failed writes	This field displays the number of times the Switch was unable to update the bindings in the DHCP snooping database.
Database detail	
First successful access	This field displays the first time the Switch accessed the DHCP snooping database for any reason.

Table 89 Advanced Application > IP Source Guard > DHCP Snooping (continued)

LABEL	DESCRIPTION
Last ignored bindings counters	This section displays the number of times and the reasons the Switch ignored bindings the last time it read bindings from the DHCP binding database. You can clear these counters by restarting the Switch or using CLI commands. See the Ethernet Switch CLI Reference Guide.
Binding collisions	This field displays the number of bindings the Switch ignored because the Switch already had a binding with the same MAC address and VLAN ID.
Invalid interfaces	This field displays the number of bindings the Switch ignored because the port number was a trusted interface or does not exist anymore.
Parse failures	This field displays the number of bindings the Switch ignored because the Switch was unable to understand the binding in the DHCP binding database.
Expired leases	This field displays the number of bindings the Switch ignored because the lease time had already expired.
Unsupported vlans	This field displays the number of bindings the Switch ignored because the VLAN ID does not exist anymore.
Last ignored time	This field displays the last time the Switch ignored any bindings for any reason from the DHCP binding database.
Total ignored bindings counters	This section displays the reasons the Switch has ignored bindings any time it read bindings from the DHCP binding database. You can clear these counters by restarting the Switch or using CLI commands. See the Ethernet Switch CLI Reference Guide.
Binding collisions	This field displays the number of bindings the Switch has ignored because the Switch already had a binding with the same MAC address and VLAN ID.
Invalid interfaces	This field displays the number of bindings the Switch has ignored because the port number was a trusted interface or does not exist anymore.
Parse failures	This field displays the number of bindings the Switch has ignored because the Switch was unable to understand the binding in the DHCP binding database.
Expired leases	This field displays the number of bindings the Switch has ignored because the lease time had already expired.
Unsupported vlans	This field displays the number of bindings the Switch has ignored because the VLAN ID does not exist anymore.

27.5 DHCP Snooping Configure

Use this screen to enable DHCP snooping on the Switch (not on specific VLAN), specify the VLAN where the default DHCP server is located, and configure the DHCP snooping database. The DHCP snooping database stores the current bindings on a secure, external TFTP server so that they are still available after a restart. To open this screen, click **Advanced Application > IP Source Guard > DHCP Snooping > Configure**.

Figure 126 Advanced Application > IP Source Guard > DHCP Snooping Configure

The following table describes the labels in this screen.

Table 90 Advanced Application > IP Source Guard > DHCP Snooping Configure

LABEL	DESCRIPTION
Active	Select this to enable DHCP snooping on the Switch. You still have to enable DHCP snooping on specific VLAN and specify trusted ports. Note: The Switch will drop all DHCP requests if you enable DHCP snooping and there are no trusted ports.
DHCP Vlan	Select the second option and specify a VLAN ID if you want the Switch to forward DHCP packets to DHCP servers on a specific VLAN. Note: You have to enable DHCP snooping on the DHCP VLAN too. You can enable Option82 in the DHCP Snooping VLAN Configure screen (Section 27.5.2 on page 227) to help the DHCP servers distinguish between DHCP requests from different VLAN. Select Disable if you do not want the Switch to forward DHCP packets to a specific VLAN.
Database	If Timeout interval is greater than Write delay interval , it is possible that the next update is scheduled to occur before the current update has finished successfully or timed out. In this case, the Switch waits to start the next update until it completes the current one.
Agent URL	Enter the location of the DHCP snooping database. The location should be expressed like this: tftp://{domain name or IP address}/directory, if applicable/file name ; for example, tftp://192.168.10.1/database.txt .
Timeout interval	Enter how long (10-65535 seconds) the Switch tries to complete a specific update in the DHCP snooping database before it gives up.
Write delay interval	Enter how long (10-65535 seconds) the Switch waits to update the DHCP snooping database the first time the current bindings change after an update. Once the next update is scheduled, additional changes in current bindings are automatically included in the next update.

Table 90 Advanced Application > IP Source Guard > DHCP Snooping Configure (continued)

LABEL	DESCRIPTION
Renew DHCP Snooping URL	Enter the location of a DHCP snooping database, and click Renew if you want the Switch to load it. You can use this to load dynamic bindings from a different DHCP snooping database than the one specified in Agent URL . When the Switch loads dynamic bindings from a DHCP snooping database, it does not discard the current dynamic bindings first. If there is a conflict, the Switch keeps the dynamic binding in volatile memory and updates the Binding collisions counter in the DHCP Snooping screen (Section 27.4 on page 222).
Apply	Click Apply to save your changes to the Switch's run-time memory. The Switch loses these changes if it is turned off or loses power, so use the Save link on the top navigation panel to save your changes to the non-volatile memory when you are done configuring.
Cancel	Click this to reset the values in this screen to their last-saved values.

27.5.1 DHCP Snooping Port Configure

Use this screen to specify whether ports are trusted or untrusted ports for DHCP snooping.

Note: The Switch will drop all DHCP requests if you enable DHCP snooping and there are no trusted ports.

You can also specify the maximum number for DHCP packets that each port (trusted or untrusted) can receive each second. To open this screen, click **Advanced Application > IP Source Guard > DHCP Snooping > Configure > Port**.

Figure 127 Advanced Application > IP Source Guard > DHCP Snooping Port Configure

Port	Server Trusted state	Rate (pps)
*	Untrusted ▼	<input type="text"/>
1	Untrusted ▼	0
2	Untrusted ▼	0
3	Untrusted ▼	0
4	Untrusted ▼	0
5	Untrusted ▼	0
6	Untrusted ▼	0
7	Untrusted ▼	0
8	Untrusted ▼	0
9	Untrusted ▼	0

Apply Cancel

The following table describes the labels in this screen.

Table 91 Advanced Application > IP Source Guard > DHCP Snooping Port Configure

LABEL	DESCRIPTION
Port	This field displays the port number. If you configure the * port, the settings are applied to all of the ports.
Server Trusted state	Select whether this port is a trusted port (Trusted) or an untrusted port (Untrusted). Trusted ports are connected to DHCP servers or other switches, and the Switch discards DHCP packets from trusted ports only if the rate at which DHCP packets arrive is too high. Untrusted ports are connected to subscribers, and the Switch discards DHCP packets from untrusted ports in the following situations: <ul style="list-style-type: none"> The packet is a DHCP server packet (for example, OFFER, ACK, or NACK). The source MAC address and source IP address in the packet do not match any of the current bindings. The packet is a RELEASE or DECLINE packet, and the source MAC address and source port do not match any of the current bindings. The rate at which DHCP packets arrive is too high.
Rate (pps)	Specify the maximum number for DHCP packets (1-2048) that the Switch receives from each port each second. The Switch discards any additional DHCP packets. Enter 0 to disable this limit, which is recommended for trusted ports.
Apply	Click Apply to save your changes to the Switch's run-time memory. The Switch loses these changes if it is turned off or loses power, so use the Save link on the top navigation panel to save your changes to the non-volatile memory when you are done configuring.
Cancel	Click this to reset the values in this screen to their last-saved values.

27.5.2 DHCP Snooping VLAN Configure

Use this screen to enable DHCP snooping on each VLAN and to specify whether or not the Switch adds DHCP relay agent option 82 information ([Chapter 37 on page 276](#)) to DHCP requests that the Switch relays to a DHCP server for each VLAN. To open this screen, click **Advanced Application > IP Source Guard > DHCP Snooping > Configure > VLAN**.

Figure 128 Advanced Application > IP Source Guard > DHCP Snooping VLAN Configure

The screenshot shows the 'DHCP Snooping VLAN Configure' interface. At the top, there's a title bar with an orange circle icon and the text 'DHCP Snooping VLAN Configure'. To the right of the title bar is a link labeled 'Port Configure'. Below the title bar is a section labeled 'Show VLAN' containing two input fields: 'Start VID' and 'End VID'. Below these fields is an 'Apply' button. The main configuration area is a table with three columns: 'VID', 'Enabled', and 'Option 82 Profile'. The first row of the table has the following values: '*' in the 'VID' column, 'No' in the 'Enabled' column, and a dropdown menu in the 'Option 82 Profile' column. At the bottom of the screen are two buttons: 'Apply' and 'Cancel'.

The following table describes the labels in this screen.

Table 92 Advanced Application > IP Source Guard > DHCP Snooping VLAN Configure

LABEL	DESCRIPTION
Show VLAN	Use this section to specify the VLANs you want to manage in the section below.
Start VID	Enter the lowest VLAN ID you want to manage in the section below.
End VID	Enter the highest VLAN ID you want to manage in the section below.
Apply	Click this to display the specified range of VLANs in the section below.
VID	This field displays the VLAN ID of each VLAN in the range specified above. If you configure the * VLAN, the settings are applied to all VLANs.
Enabled	Select Yes to enable DHCP snooping on the VLAN. You still have to enable DHCP snooping on the Switch and specify trusted ports. Note: The Switch will drop all DHCP requests if you enable DHCP snooping and there are no trusted ports.
Option 82 Profile	Select a pre-defined DHCP option 82 profile that the Switch applies to all ports in the specified VLAN(s). The Switch adds the information (such as slot number, port number, VLAN ID and/or system name) specified in the profile to DHCP requests that it broadcasts to the DHCP VLAN, if specified, or VLAN. You can specify the DHCP VLAN in the DHCP Snooping Configure screen (see Section 27.5 on page 224) and the DHCP option 82 profile in the IP Application > DHCP > DHCPv4 > Option 82 Profile screen (see Section 37.4.2 on page 278).
Apply	Click Apply to save your changes to the Switch's run-time memory. The Switch loses these changes if it is turned off or loses power, so use the Save link on the top navigation panel to save your changes to the non-volatile memory when you are done configuring.
Cancel	Click this to reset the values in this screen to their last-saved values.

27.5.3 DHCP Snooping VLAN Port Configure

Use this screen to apply a different DHCP option 82 profile to certain ports in a VLAN. To open this screen, click **Advanced Application > IP Source Guard > IPv4 Source Guard Setup > DHCP Snooping > Configure > VLAN > Port**.

Figure 129 Advanced Application > IP Source Guard > DHCP Snooping > Configure > VLAN > Port

The screenshot shows the 'Port' configuration screen for DHCP Snooping. The top navigation bar includes 'Port' and 'DHCP Snooping VLAN Configure'. The main form contains three input fields: 'VID', 'Port', and 'Option 82 Profile'. Below these fields are three buttons: 'Add', 'Cancel', and 'Clear'. At the bottom of the screen, there is a table with the following columns: 'Index', 'VID', 'Port', 'Profile Name', and 'Delete'. Below the table are two buttons: 'Delete' and 'Cancel'.

The following table describes the labels in this screen.

Table 93 Advanced Application > IP Source Guard > DHCP Snooping > Configure > VLAN > Port

LABEL	DESCRIPTION
VID	Enter the ID number of the VLAN you want to configure here.
Port	Enter the number of port(s) to which you want to apply the specified DHCP option 82 profile. You can enter multiple ports separated by (no space) comma (,) or hyphen (-). For example, enter "3-5" for ports 3, 4, and 5. Enter "3,5,7" for ports 3, 5, and 7.
Option 82 Profile	Select a pre-defined DHCP option 82 profile that the Switch applies to the specified port(s) in this VLAN. The Switch adds the information (such as slot number, port number, VLAN ID and/or system name) specified in the profile to DHCP requests that it broadcasts to the DHCP VLAN, if specified, or VLAN. You can specify the DHCP VLAN in the DHCP Snooping Configure screen (see Section 27.5 on page 224). The profile you select here has priority over the one you select in the DHCP Snooping > Configure > VLAN screen.
Add	Click this to create a new entry or to update an existing one. This saves your changes to the Switch's run-time memory. The Switch loses these changes if it is turned off or loses power, so use the Save link on the top navigation panel to save your changes to the non-volatile memory when you are done configuring.
Cancel	Click this to reset the values above based on the last selected entry or, if not applicable, to clear the fields above.
Clear	Click Clear to reset the fields to the factory defaults.
Index	This field displays a sequential number for each entry. Click an index number to change the settings.
VID	This field displays the VLAN to which the port(s) belongs.
Port	This field displays the port(s) to which the Switch applies the settings.
Profile Name	This field displays the DHCP option 82 profile that the Switch applies to the port(s).
Delete	Select the entry(ies) that you want to remove in the Delete column, then click the Delete button to remove the selected entry(ies) from the table.
Cancel	Click this to clear the Delete check boxes above.

27.6 ARP Inspection Status

Use this screen to look at the current list of MAC address filters that were created because the Switch identified an unauthorized ARP packet. When the Switch identifies an unauthorized ARP packet, it automatically creates a MAC address filter to block traffic from the source MAC address and source VLAN ID of the unauthorized ARP packet. To open this screen, click **Advanced Application > IP Source Guard > ARP Inspection**.

Figure 130 Advanced Application > IP Source Guard > ARP Inspection Status

Index	MAC Address	VID	Port	Expiry (sec)	Reason	Delete
*	-	-	-	-	-	<input type="checkbox"/>

The following table describes the labels in this screen.

Table 94 Advanced Application > IP Source Guard > ARP Inspection Status

LABEL	DESCRIPTION
Total number of filters	This field displays the current number of MAC address filters that were created because the Switch identified unauthorized ARP packets.
Index	This field displays a sequential number for each MAC address filter.
MAC Address	This field displays the source MAC address in the MAC address filter.
VID	This field displays the source VLAN ID in the MAC address filter.
Port	This field displays the source port of the discarded ARP packet.
Expiry (sec)	This field displays how long (in seconds) the MAC address filter remains in the Switch. You can also delete the record manually (Delete).
Reason	This field displays the reason the ARP packet was discarded. MAC+VLAN: The MAC address and VLAN ID were not in the binding table. IP: The MAC address and VLAN ID were in the binding table, but the IP address was not valid. Port: The MAC address, VLAN ID, and IP address were in the binding table, but the port number was not valid.
Delete	Select the entry(ies) that you want to remove in the Delete column, then click the Delete button to remove the selected entry(ies) from the table.
Cancel	Click this to clear the Delete check boxes above.

27.6.1 ARP Inspection VLAN Status

Use this screen to look at various statistics about ARP packets in each VLAN. To open this screen, click **Advanced Application > IP Source Guard > ARP Inspection > VLAN Status**.

Figure 131 Advanced Application > IP Source Guard > ARP Inspection VLAN Status

The following table describes the labels in this screen.

Table 95 Advanced Application > IP Source Guard > ARP Inspection VLAN Status

LABEL	DESCRIPTION
Show VLAN range	Use this section to specify the VLANs you want to look at in the section below.
Enabled VLAN	Select this to look at all the VLANs on which ARP inspection is enabled in the section below.

Table 95 Advanced Application > IP Source Guard > ARP Inspection VLAN Status

LABEL	DESCRIPTION
Selected VLAN	Select this to look at all the VLANs in a specific range in the section below. Then, enter the lowest VLAN ID (Start VID) and the highest VLAN ID (End VID) you want to look at.
Apply	Click this to display the specified range of VLANs in the section below.
VID	This field displays the VLAN ID of each VLAN in the range specified above.
Received	This field displays the total number of ARP packets received from the VLAN since the Switch last restarted.
Request	This field displays the total number of ARP Request packets received from the VLAN since the Switch last restarted.
Reply	This field displays the total number of ARP Reply packets received from the VLAN since the Switch last restarted.
Forwarded	This field displays the total number of ARP packets the Switch forwarded for the VLAN since the Switch last restarted.
Dropped	This field displays the total number of ARP packets the Switch discarded for the VLAN since the Switch last restarted.

27.6.2 ARP Inspection Log Status

Use this screen to look at log messages that were generated by ARP packets and that have not been sent to the syslog server yet. To open this screen, click **Advanced Application > IP Source Guard > ARP Inspection > Log Status**.

Figure 132 Advanced Application > IP Source Guard > ARP Inspection Log Status

The following table describes the labels in this screen.

Table 96 Advanced Application > IP Source Guard > ARP Inspection Log Status

LABEL	DESCRIPTION
Clearing log status table	Click Apply to remove all the log messages that were generated by ARP packets and that have not been sent to the syslog server yet.
Total number of logs	This field displays the number of log messages that were generated by ARP packets and that have not been sent to the syslog server yet. If one or more log messages are dropped due to unavailable buffer, there is an entry called overflow with the current number of dropped log messages.
Index	This field displays a sequential number for each log message.
Port	This field displays the source port of the ARP packet.
VID	This field displays the source VLAN ID of the ARP packet.
Sender Mac	This field displays the source MAC address of the ARP packet.
Sender IP	This field displays the source IP address of the ARP packet.

Table 96 Advanced Application > IP Source Guard > ARP Inspection Log Status (continued)

LABEL	DESCRIPTION
Num Pkts	This field displays the number of ARP packets that were consolidated into this log message. The Switch consolidates identical log messages generated by ARP packets in the log consolidation interval into one log message. You can configure this interval in the ARP Inspection Configure screen. See Section 27.6.3 on page 232 .
Reason	<p>This field displays the reason the log message was generated.</p> <p>dhcp deny: An ARP packet was discarded because it violated a dynamic binding with the same MAC address and VLAN ID.</p> <p>static deny: An ARP packet was discarded because it violated a static binding with the same MAC address and VLAN ID.</p> <p>deny: An ARP packet was discarded because there were no bindings with the same MAC address and VLAN ID.</p> <p>dhcp permit: An ARP packet was forwarded because it matched a dynamic binding.</p> <p>static permit: An ARP packet was forwarded because it matched a static binding.</p> <p>In the ARP Inspection VLAN Configure screen, you can configure the Switch to generate log messages when ARP packets are discarded or forwarded based on the VLAN ID of the ARP packet. See Section 27.6.5 on page 234.</p>
Time	This field displays when the log message was generated.

27.6.3 ARP Inspection Configure

Use this screen to enable ARP inspection on the Switch. You can also configure the length of time the Switch stores records of discarded ARP packets and global settings for the ARP inspection log. To open this screen, click **Advanced Application > IP Source Guard > ARP Inspection > Configure**.

Figure 133 Advanced Application > IP Source Guard > ARP Inspection Configure

The screenshot shows the 'ARP Inspection Configure' configuration page. At the top, there is a navigation bar with 'ARP Inspection Configure' selected, and tabs for 'Port', 'VLAN', and 'ARP Inspection'. Below the navigation bar, there is a section for 'Active' with a checkbox. The 'Filter Aging Time' section has a 'Filter aging time' field set to '300' seconds. The 'Log Profile' section has three fields: 'Log buffer size' set to '32' entries, 'Syslog rate' set to '5' entries, and 'Log interval' set to '1' seconds. At the bottom, there are 'Apply' and 'Cancel' buttons.

The following table describes the labels in this screen.

Table 97 Advanced Application > IP Source Guard > ARP Inspection Configure

LABEL	DESCRIPTION
Active	Select this to enable ARP inspection on the Switch. You still have to enable ARP inspection on specific VLAN and specify trusted ports.
Filter Aging Time	
Filter aging time	This setting has no effect on existing MAC address filters. Enter how long (1-2147483647 seconds) the MAC address filter remains in the Switch after the Switch identifies an unauthorized ARP packet. The Switch automatically deletes the MAC address filter afterwards. Type 0 if you want the MAC address filter to be permanent.
Log Profile	
Log buffer size	Enter the maximum number (1-1024) of log messages that were generated by ARP packets and have not been sent to the syslog server yet. Make sure this number is appropriate for the specified Syslog rate and Log interval . If the number of log messages in the Switch exceeds this number, the Switch stops recording log messages and simply starts counting the number of entries that were dropped due to unavailable buffer. Click Clearing log status table in the ARP Inspection Log Status screen to clear the log and reset this counter. See Section 27.6.2 on page 231 .
Syslog rate	Type the maximum number of syslog messages the Switch can send to the syslog server in one batch. This number is expressed as a rate because the batch frequency is determined by the Log Interval . You must configure the syslog server (Chapter 42 on page 326) to use this. Enter 0 if you do not want the Switch to send log messages generated by ARP packets to the syslog server. The relationship between Syslog rate and Log interval is illustrated in the following examples: <ul style="list-style-type: none"> 4 invalid ARP packets per second, Syslog rate is 5, Log interval is 1: the Switch sends 4 syslog messages every second. 6 invalid ARP packets per second, Syslog rate is 5, Log interval is 2: the Switch sends 5 syslog messages every 2 seconds.
Log interval	Type how often (1-86400 seconds) the Switch sends a batch of syslog messages to the syslog server. Enter 0 if you want the Switch to send syslog messages immediately. See Syslog rate for an example of the relationship between Syslog rate and Log interval .
Apply	Click Apply to save your changes to the Switch's run-time memory. The Switch loses these changes if it is turned off or loses power, so use the Save link on the top navigation panel to save your changes to the non-volatile memory when you are done configuring.
Cancel	Click this to reset the values in this screen to their last-saved values.

27.6.4 ARP Inspection Port Configure

Use this screen to specify whether ports are trusted or untrusted ports for ARP inspection. You can also specify the maximum rate at which the Switch receives ARP packets on each untrusted port. To open this screen, click **Advanced Application > IP Source Guard > ARP Inspection > Configure > Port**.

Figure 134 Advanced Application > IP Source Guard > ARP Inspection Port Configure

Port	Trusted State	Limit	
		Rate (pps)	Burst interval (seconds)
*	Untrusted		
1	Untrusted	15	1
2	Untrusted	15	1
3	Untrusted	15	1
4	Untrusted	15	1
5	Untrusted	15	1
6	Untrusted	15	1
7	Untrusted	15	1
8	Untrusted	15	1

Apply Cancel

The following table describes the labels in this screen.

Table 98 Advanced Application > IP Source Guard > ARP Inspection Port Configure

LABEL	DESCRIPTION
Port	This field displays the port number. If you configure the * port, the settings are applied to all of the ports.
Trusted State	Select whether this port is a trusted port (Trusted) or an untrusted port (Untrusted). The Switch does not discard ARP packets on trusted ports for any reason. The Switch discards ARP packets on untrusted ports in the following situations: <ul style="list-style-type: none"> The sender's information in the ARP packet does not match any of the current bindings. The rate at which ARP packets arrive is too high. You can specify the maximum rate at which ARP packets can arrive on untrusted ports.
Limit	Rate and Burst Interval settings have no effect on trusted ports.
Rate (pps)	Specify the maximum rate (1-2048 packets per second) at which the Switch receives ARP packets from each port. The Switch discards any additional ARP packets. Enter 0 to disable this limit.
Burst interval (seconds)	The burst interval is the length of time over which the rate of ARP packets is monitored for each port. For example, if the Rate is 15 pps and the burst interval is 1 second, then the Switch accepts a maximum of 15 ARP packets in every one-second interval. If the burst interval is 5 seconds, then the Switch accepts a maximum of 75 ARP packets in every five-second interval. Enter the length (1-15 seconds) of the burst interval.
Apply	Click Apply to save your changes to the Switch's run-time memory. The Switch loses these changes if it is turned off or loses power, so use the Save link on the top navigation panel to save your changes to the non-volatile memory when you are done configuring.
Cancel	Click this to reset the values in this screen to their last-saved values.

27.6.5 ARP Inspection VLAN Configure

Use this screen to enable ARP inspection on each VLAN and to specify when the Switch generates log messages for receiving ARP packets from each VLAN. To open this screen, click **Advanced Application > IP Source Guard > ARP Inspection > Configure > VLAN**.

Figure 135 Advanced Application > IP Source Guard > ARP Inspection VLAN Configure

The following table describes the labels in this screen.

Table 99 Advanced Application > IP Source Guard > ARP Inspection VLAN Configure

LABEL	DESCRIPTION
VLAN	Use this section to specify the VLANs you want to manage in the section below.
Start VID	Enter the lowest VLAN ID you want to manage in the section below.
End VID	Enter the highest VLAN ID you want to manage in the section below.
Apply	Click this to display the specified range of VLANs in the section below.
VID	This field displays the VLAN ID of each VLAN in the range specified above. If you configure the * VLAN, the settings are applied to all VLANs.
Enabled	Select Yes to enable ARP inspection on the VLAN. Select No to disable ARP inspection on the VLAN.
Log	Specify when the Switch generates log messages for receiving ARP packets from the VLAN. None: The Switch does not generate any log messages when it receives an ARP packet from the VLAN. Deny: The Switch generates log messages when it discards an ARP packet from the VLAN. Permit: The Switch generates log messages when it forwards an ARP packet from the VLAN. All: The Switch generates log messages every time it receives an ARP packet from the VLAN.
Apply	Click Apply to save your changes to the Switch's run-time memory. The Switch loses these changes if it is turned off or loses power, so use the Save link on the top navigation panel to save your changes to the non-volatile memory when you are done configuring.
Cancel	Click this to reset the values in this screen to their last-saved values.

Loop Guard

This chapter shows you how to configure the Switch to guard against loops on the edge of your network.

28.1 Loop Guard Overview

Loop guard allows you to configure the Switch to shut down a port if it detects that packets sent out on that port loop back to the Switch. While you can use Spanning Tree Protocol (STP) to prevent loops in the core of your network. STP cannot prevent loops that occur on the edge of your network.

Figure 136 Loop Guard vs STP

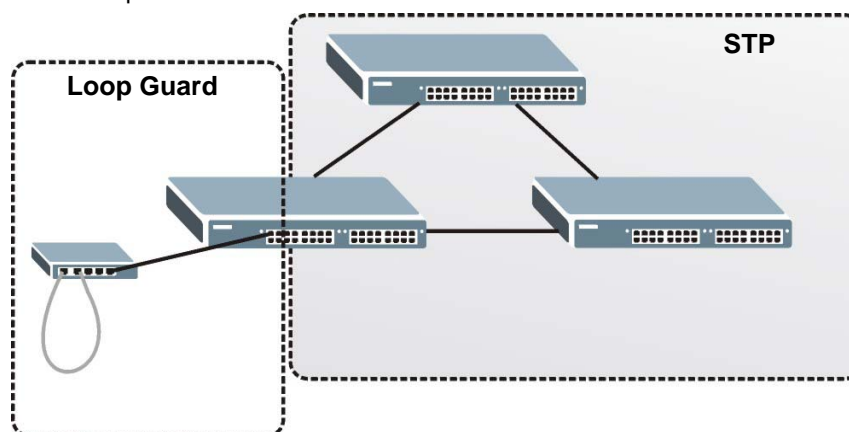

Loop guard is designed to handle loop problems on the edge of your network. This can occur when a port is connected to a Switch that is in a loop state. Loop state occurs as a result of human error. It happens when two ports on a switch are connected with the same cable. When a switch in loop state sends out broadcast messages the messages loop back to the switch and are re-broadcast again and again causing a broadcast storm.

If a switch (not in loop state) connects to a switch in loop state, then it will be affected by the switch in loop state in the following way:

- It will receive broadcast messages sent out from the switch in loop state.
- It will receive its own broadcast messages that it sends out as they loop back. It will then re-broadcast those messages again.

The following figure shows port **N** on switch **A** connected to switch **B**. Switch **B** is in loop state. When broadcast or multicast packets leave port **N** and reach switch **B**, they are sent back to port **N** on **A** as they are rebroadcast from **B**.

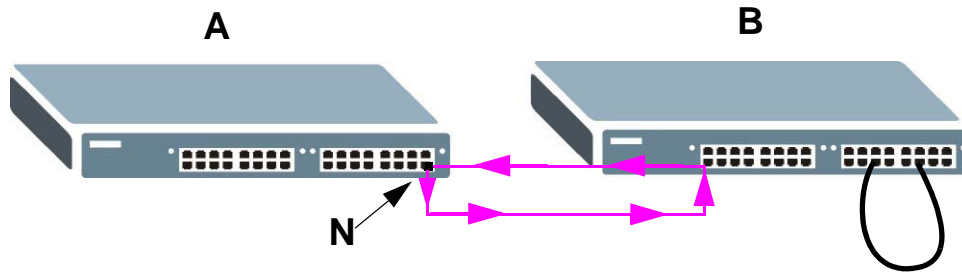
Figure 137 Switch in Loop State

The loop guard feature checks to see if a loop guard enabled port is connected to a switch in loop state. This is accomplished by periodically sending a probe packet and seeing if the packet returns on the same port. If this is the case, the Switch will shut down the port connected to the switch in loop state.

The following figure shows a loop guard enabled port **N** on switch **A** sending a probe packet **P** to switch **B**. Since switch **B** is in loop state, the probe packet **P** returns to port **N** on **A**. The Switch then shuts down port **N** to ensure that the rest of the network is not affected by the switch in loop state.

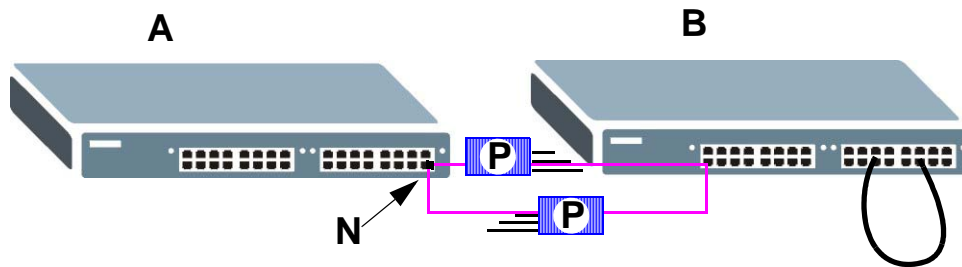
Figure 138 Loop Guard - Probe Packet

The Switch also shuts down port **N** if the probe packet returns to switch **A** on any other port. In other words loop guard also protects against standard network loops. The following figure illustrates three switches forming a loop. A sample path of the loop guard probe packet is also shown. In this example, the probe packet is sent from port **N** and returns on another port. As long as loop guard is enabled on port **N**. The Switch will shut down port **N** if it detects that the probe packet has returned to the Switch.

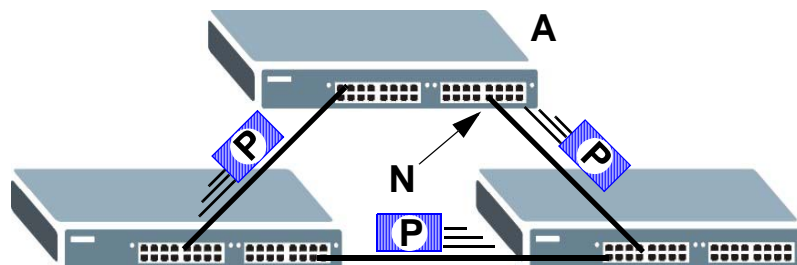
Figure 139 Loop Guard - Network Loop

Note: After resolving the loop problem on your network you can re-activate the disabled port via the web configurator (see [Section 8.6 on page 85](#)) or via commands (see the Ethernet Switch CLI Reference Guide).

28.2 Loop Guard Setup

Click **Advanced Application > Loop Guard** in the navigation panel to display the screen as shown.

Note: The loop guard feature can not be enabled on the ports that have Spanning Tree Protocol (RSTP, MRSTP or MSTP) enabled.

Figure 140 Advanced Application > Loop Guard

Port	Active
*	<input type="checkbox"/>
1	<input type="checkbox"/>
2	<input type="checkbox"/>
3	<input type="checkbox"/>
4	<input type="checkbox"/>
5	<input type="checkbox"/>
6	<input type="checkbox"/>
7	<input type="checkbox"/>
8	<input type="checkbox"/>

The following table describes the labels in this screen.

Table 100 Advanced Application > Loop Guard

LABEL	DESCRIPTION
Active	Select this option to enable loop guard on the Switch. The Switch generates syslog, internal log messages as well as SNMP traps when it shuts down a port via the loop guard feature.
Port	This field displays a port number.
*	Use this row to make the setting the same for all ports. Use this row first and then make adjustments on a port-by-port basis. Note: Changes in this row are copied to all the ports as soon as you make them.
Active	Select this check box to enable the loop guard feature on this port. The Switch sends probe packets from this port to check if the Switch it is connected to is in loop state. If the Switch that this port is connected is in loop state the Switch will shut down this port. Clear this check box to disable the loop guard feature.
Apply	Click Apply to save your changes to the Switch's run-time memory. The Switch loses these changes if it is turned off or loses power, so use the Save link on the top navigation panel to save your changes to the non-volatile memory when you are done configuring.
Cancel	Click Cancel to begin configuring this screen afresh.

VLAN Mapping

This chapter shows you how to configure VLAN mapping on the Switch.

29.1 VLAN Mapping Overview

With VLAN mapping enabled, the Switch can map the VLAN ID and priority level of packets received from a private network to those used in the service provider's network.

The Switch checks incoming traffic from the switch ports (non-management ports) against the VLAN mapping table first, the MAC learning table and then the VLAN table before forwarding them through the Gigabit uplink port. When VLAN mapping is enabled and incoming tagged packets do not match any entry in the VLAN mapping table, the Switch forwards the tagged packets according to its VLAN tag that do not match an entry in the VLAN mapping table. If the incoming packets are untagged, the Switch adds a PVID based on the VLAN setting.

Note: You can not enable VLAN mapping and VLAN stacking at the same time.

29.1.1 VLAN Mapping Example

In the following example figure, packets that carry VLAN ID 12 and are received on port 3 match a pre-configured VLAN mapping rule. The Switch translates the VLAN ID from 12 into 123 before forwarding the packets. Any packets carrying a VLAN tag other than 12 (such as 10) and received on port 3 will be forwarded in the individual VLAN network respectively (such as VLAN 10).

Figure 141 VLAN mapping example

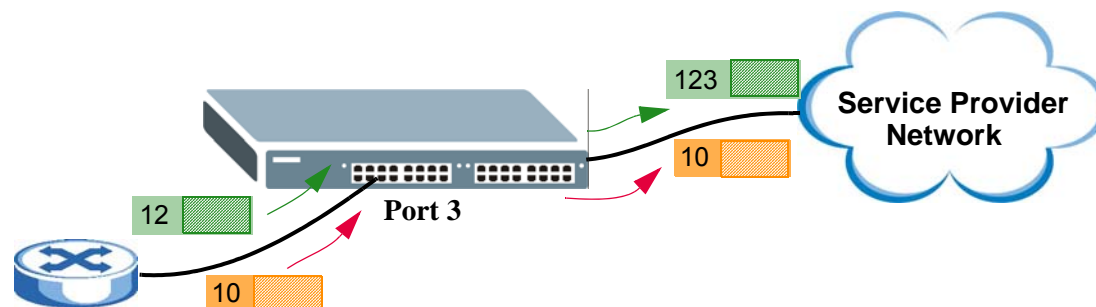

29.2 Enabling VLAN Mapping

Click **Advanced Application** and then **VLAN Mapping** in the navigation panel to display the screen as shown.

Figure 142 Advanced Application > VLAN Mapping

Port	Active
*	<input type="checkbox"/>
1	<input type="checkbox"/>
2	<input type="checkbox"/>
3	<input type="checkbox"/>
4	<input type="checkbox"/>
5	<input type="checkbox"/>
6	<input type="checkbox"/>
7	<input type="checkbox"/>
8	<input type="checkbox"/>
9	<input type="checkbox"/>
10	<input type="checkbox"/>
11	<input type="checkbox"/>

The following table describes the labels in this screen.

Table 101 Advanced Application > VLAN Mapping

LABEL	DESCRIPTION
Active	Select this option to enable VLAN mapping on the Switch.
Port	This field displays the port number.
*	Use this row to make the setting the same for all ports. Use this row first and then make adjustments on a port-by-port basis. Changes in this row are copied to all the ports as soon as you make them.
Active	Select this check box to enable the VLAN mapping feature on this port. Clear this check box to disable the VLAN mapping feature.
Apply	Click Apply to save your changes to the Switch's run-time memory. The Switch loses these changes if it is turned off or loses power, so use the Save link on the top navigation panel to save your changes to the non-volatile memory when you are done configuring.
Cancel	Click Cancel to begin configuring this screen afresh.

29.3 Configuring VLAN Mapping

Click the **VLAN Mapping Configure** link in the **VLAN Mapping** screen to display the screen as shown. Use this screen to enable and edit the VLAN mapping rule(s).

Figure 143 Advanced Application > VLAN Mapping > VLAN Mapping Configuration

The following table describes the labels in this screen.

Table 102 Advanced Application > VLAN Mapping > VLAN Mapping Configuration

LABEL	DESCRIPTION
Active	Check this box to activate this rule.
Name	Enter a descriptive name (up to 32 printable ASCII characters) for identification purposes.
Port	Type a port to be included in this rule.
VID	Enter a VLAN ID from 1 to 4094. This is the VLAN tag carried in the packets and will be translated into the VID you specified in the Translated VID field.
Translated VID	Enter a VLAN ID (from 1 to 4094) into which the customer VID carried in the packets will be translated.
Priority	Select a priority level (from 0 to 7). This is the priority level that replaces the customer priority level in the tagged packets or adds to the untagged packets.
Direction	Specify the direction of the traffic to which the rule is applied. Choices are Egress (outgoing), Ingress (incoming) and Both .
Add	Click Add to insert the entry in the summary table below and save your changes to the Switch's run-time memory. The Switch loses these changes if it is turned off or loses power, so use the Save link on the top navigation panel to save your changes to the non-volatile memory when you are done configuring.
Cancel	Click Cancel to reset the fields to your previous configuration.
Index	This is the number of the VLAN mapping entry in the table.
Active	This shows whether this entry is activated or not.
Name	This is the descriptive name for this rule.
Port	This is the port number to which this rule is applied.
VID	This is the customer VLAN ID in the incoming packets.
Translated VID	This is the VLAN ID that replaces the customer VLAN ID in the tagged packets.
Priority	This is the priority level that replaces the customer priority level in the tagged packets.
Direction	This is the direction of the traffic to which the rule is applied.
Delete	Check the rule(s) that you want to remove in the Delete column and then click the Delete button.
Cancel	Click Cancel to clear the Delete check boxes.

Layer 2 Protocol Tunneling

This chapter shows you how to configure layer-2 protocol tunneling on the Switch.

30.1 Layer 2 Protocol Tunneling Overview

Layer-2 protocol tunneling (L2PT) is used on the service provider's edge devices. L2PT allows edge switches (**1** and **2** in the following figure) to tunnel layer-2 STP (Spanning Tree Protocol), CDP (Cisco Discovery Protocol) and VTP (VLAN Trunking Protocol) packets between customer switches (**A**, **B** and **C** in the following figure) connected through the service provider's network. The edge switch encapsulates layer-2 protocol packets with a specific MAC address before sending them across the service provider's network to other edge switches.

Figure 144 Layer-2 Protocol Tunneling Network Scenario

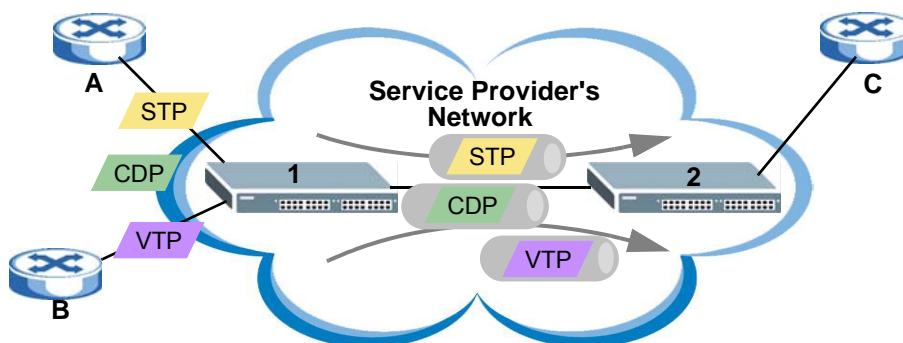

In the following example, if you enable L2PT for STP, you can have switches **A**, **B**, **C** and **D** in the same spanning tree, even though switch **A** is not directly connected to switches **B**, **C** and **D**. Topology change information can be propagated throughout the service provider's network.

To emulate a point-to-point topology between two customer switches at different sites, such as **A** and **B**, you can enable protocol tunneling on edge switches **1** and **2** for PAgP (Port Aggregation Protocol), LACP or UDLD (UniDirectional Link Detection).

Figure 145 L2PT Network Example

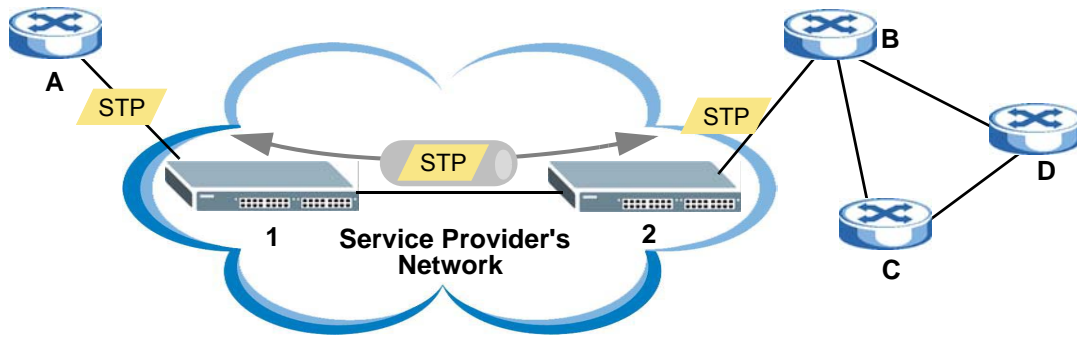

30.1.1 Layer-2 Protocol Tunneling Mode

Each port can have two layer-2 protocol tunneling modes, **Access** and **Tunnel**.

- The **Access** port is an ingress port on the service provider's edge device (**1** or **2** in [Figure 145 on page 243](#)) and connected to a customer switch (**A** or **B**). Incoming layer-2 protocol packets received on an access port are encapsulated and forwarded to the tunnel ports.
- The **Tunnel** port is an egress port at the edge of the service provider's network and connected to another service provider's switch. Incoming encapsulated layer-2 protocol packets received on a tunnel port are decapsulated and sent to an access port.

30.2 Configuring Layer 2 Protocol Tunneling

Click **Advanced Application** > **Layer 2 Protocol Tunneling** in the navigation panel to display the screen as shown.

Figure 146 Advanced Application > Layer 2 Protocol Tunneling

Port	CDP	STP	VTP	Point to Point			Mode
				PAGP	LACP	UDLD	
*	<input type="checkbox"/>	<input type="checkbox"/>	<input type="checkbox"/>	<input type="checkbox"/>	<input type="checkbox"/>	<input type="checkbox"/>	Access
1	<input type="checkbox"/>	<input type="checkbox"/>	<input type="checkbox"/>	<input type="checkbox"/>	<input type="checkbox"/>	<input type="checkbox"/>	Access
2	<input type="checkbox"/>	<input type="checkbox"/>	<input type="checkbox"/>	<input type="checkbox"/>	<input type="checkbox"/>	<input type="checkbox"/>	Access
3	<input type="checkbox"/>	<input type="checkbox"/>	<input type="checkbox"/>	<input type="checkbox"/>	<input type="checkbox"/>	<input type="checkbox"/>	Access
4	<input type="checkbox"/>	<input type="checkbox"/>	<input type="checkbox"/>	<input type="checkbox"/>	<input type="checkbox"/>	<input type="checkbox"/>	Access
5	<input type="checkbox"/>	<input type="checkbox"/>	<input type="checkbox"/>	<input type="checkbox"/>	<input type="checkbox"/>	<input type="checkbox"/>	Access
6	<input type="checkbox"/>	<input type="checkbox"/>	<input type="checkbox"/>	<input type="checkbox"/>	<input type="checkbox"/>	<input type="checkbox"/>	Access
7	<input type="checkbox"/>	<input type="checkbox"/>	<input type="checkbox"/>	<input type="checkbox"/>	<input type="checkbox"/>	<input type="checkbox"/>	Access
8	<input type="checkbox"/>	<input type="checkbox"/>	<input type="checkbox"/>	<input type="checkbox"/>	<input type="checkbox"/>	<input type="checkbox"/>	Access
9	<input type="checkbox"/>	<input type="checkbox"/>	<input type="checkbox"/>	<input type="checkbox"/>	<input type="checkbox"/>	<input type="checkbox"/>	Access
10	<input type="checkbox"/>	<input type="checkbox"/>	<input type="checkbox"/>	<input type="checkbox"/>	<input type="checkbox"/>	<input type="checkbox"/>	Access
11	<input type="checkbox"/>	<input type="checkbox"/>	<input type="checkbox"/>	<input type="checkbox"/>	<input type="checkbox"/>	<input type="checkbox"/>	Access
12	<input type="checkbox"/>	<input type="checkbox"/>	<input type="checkbox"/>	<input type="checkbox"/>	<input type="checkbox"/>	<input type="checkbox"/>	Access
13	<input type="checkbox"/>	<input type="checkbox"/>	<input type="checkbox"/>	<input type="checkbox"/>	<input type="checkbox"/>	<input type="checkbox"/>	Access

The following table describes the labels in this screen.

Table 103 Advanced Application > Layer 2 Protocol Tunneling

LABEL	DESCRIPTION
Active	Select this to enable layer-2 protocol tunneling on the Switch.
Destination MAC Address	Specify an MAC address with which the Switch uses to encapsulate the layer-2 protocol packets by replacing the destination MAC address in the packets. Note: The MAC address can be either a unicast MAC address or multicast MAC address. If you use a unicast MAC address, make sure the MAC address does not exist in the address table of a switch on the service provider's network. Note: All the edge switches in the service provider's network should be set to use the same MAC address for encapsulation.
Port	This field displays the port number.
*	Use this row to make the setting the same for all ports. Use this row first and then make adjustments on a port-by-port basis. Note: Changes in this row are copied to all the ports as soon as you make them.
CDP	Select this option to have the Switch tunnel CDP (Cisco Discovery Protocol) packets so that other Cisco devices can be discovered through the service provider's network.
STP	Select this option to have the Switch tunnel STP (Spanning Tree Protocol) packets so that STP can run properly across the service provider's network and spanning trees can be set up based on bridge information from all (local and remote) networks.
VTP	Select this option to have the Switch tunnel VTP (VLAN Trunking Protocol) packets so that all customer switches can use consistent VLAN configuration through the service provider's network.

Table 103 Advanced Application > Layer 2 Protocol Tunneling (continued)

LABEL	DESCRIPTION
Point to Point	<p>The Switch supports PAGP (Port Aggregation Protocol), LACP (Link Aggregation Control Protocol) and UDLD (UniDirectional Link Detection) tunneling for a point-to-point topology.</p> <p>Both PAGP and UDLD are Cisco's proprietary data link layer protocols. PAGP is similar to LACP and used to set up a logical aggregation of Ethernet ports automatically. UDLD is to determine the link's physical status and detect a unidirectional link.</p>
PAGP	Select this option to have the Switch send PAGP packets to a peer to automatically negotiate and build a logical port aggregation.
LACP	Select this option to have the Switch send LACP packets to a peer to dynamically creates and manages trunk groups.
UDLD	Select this option to have the Switch send UDLD packets to a peer's port it connected to monitor the physical status of a link.
Mode	<p>Select Access to have the Switch encapsulate the incoming layer-2 protocol packets and forward them to the tunnel port(s). Select Access for ingress ports at the edge of the service provider's network.</p> <p>Note: You can enable L2PT services for STP, LACP, VTP, CDP, UDLD, and PAGP on the access port(s) only.</p> <p>Select Tunnel for egress ports at the edge of the service provider's network. The Switch decapsulates the encapsulated layer-2 protocol packets received on a tunnel port by changing the destination MAC address to the original one, and then forward them to an access port. If the service(s) is not enabled on an access port, the protocol packets are dropped.</p>
Apply	Click Apply to save your changes to the Switch's run-time memory. The Switch loses these changes if it is turned off or loses power, so use the Save link on the top navigation panel to save your changes to the non-volatile memory when you are done configuring.
Cancel	Click Cancel to begin configuring this screen afresh.

This chapter shows you how to configure sFlow to have the Switch monitor traffic in a network and send information to an sFlow collector for analysis.

31.1 sFlow Overview

sFlow (RFC 3176) is a standard technology for monitoring switched networks. An sFlow agent embedded on a switch or router gets sample data and packet statistics from traffic forwarded through its ports. The sFlow agent then creates sFlow data and sends it to an sFlow collector. The sFlow collector is a server that collects and analyzes sFlow datagram. An sFlow datagram includes packet header, input and output interface, sampling process parameters and forwarding information.

sFlow minimizes impact on CPU load of the Switch as it analyzes sample data only. sFlow can continuously monitor network traffic and create reports for network performance analysis and troubleshooting. For example, you can use it to know which IP address or which type of traffic caused network congestion.

Figure 147 sFlow Application

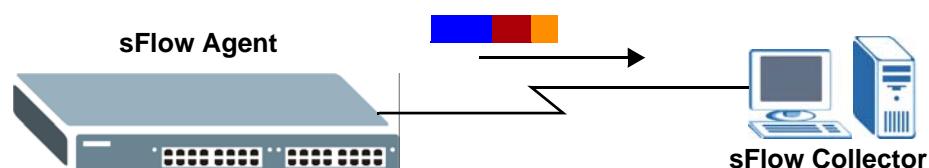

31.2 sFlow Port Configuration

Click **Advanced Application** > **sFlow** in the navigation panel to display the screen as shown.

Figure 148 Advanced Application > sFlow

Port	Active	Sample-rate	poll-interval	Collector Address
*	<input type="checkbox"/>			
1	<input type="checkbox"/>	32768	120	
2	<input type="checkbox"/>	32768	120	
3	<input type="checkbox"/>	32768	120	
4	<input type="checkbox"/>	32768	120	
5	<input type="checkbox"/>	32768	120	
6	<input type="checkbox"/>	32768	120	
7	<input type="checkbox"/>	32768	120	
27	<input type="checkbox"/>	32768	120	
28	<input type="checkbox"/>	32768	120	

The following table describes the labels in this screen.

Table 104 Advanced Application > sFlow

LABEL	DESCRIPTION
Active	Select this to enable the sFlow agent on the Switch.
Apply	Click Apply to save your changes to the Switch's run-time memory. The Switch loses these changes if it is turned off or loses power, so use the Save link on the top navigation panel to save your changes to the non-volatile memory when you are done configuring.
Cancel	Click Cancel to begin configuring this screen afresh.
Port	This field displays the port number.
*	Use this row to make the setting the same for all ports. Use this row first and then make adjustments on a port-by-port basis. Note: Changes in this row are copied to all the ports as soon as you make them.
Active	Select this to allow the Switch to monitor traffic on this port and generate and send sFlow datagram to the specified collector.
Sample-rate	Enter a number (N) from 256 to 65535. The Switch captures every one out of N packets for this port and creates sFlow datagram.
poll-interval	Specify a time interval (from 20 to 120 in seconds) the Switch waits before sending the sFlow datagram and packet counters for this port to the collector.

Table 104 Advanced Application > sFlow (continued)

LABEL	DESCRIPTION
Collector Address	Enter the IP address of the sFlow collector. Note: You must have the sFlow collector already configured in the sFlow > Collector screen. The sFlow collector does not need to be in the same subnet as the Switch, but it must be accessible from the Switch. Note: Configure UDP port 6343 (the default) on a NAT router to allow port forwarding if the collector is behind a NAT router. Configure a firewall rule for UDP port 6343 (the default) to allow incoming traffic if the collector is behind a firewall.
Apply	Click Apply to save your changes to the Switch's run-time memory. The Switch loses these changes if it is turned off or loses power, so use the Save link on the top navigation panel to save your changes to the non-volatile memory when you are done configuring.
Cancel	Click Cancel to begin configuring this screen afresh.

31.2.1 sFlow Collector Configuration

Click the **Collector** link in the **sFlow** screen to display the screen as shown. You can configure up to four sFlow collectors in this screen. You may want to configure more than one collector if the traffic load to be monitored is more than one collector can manage.

Figure 149 Advanced Application > sFlow > Collector

The screenshot shows the 'sflow Collector' configuration page. At the top, there's a 'Collector' section with two input fields: 'Collector Address' (containing '0.0.0.0') and 'UDP Port' (containing '6343'). Below these fields are three buttons: 'Add', 'Cancel', and 'Clear'. A horizontal line separates this from a table below. The table has four columns: 'Index', 'Collector Address', 'UDP Port', and 'Delete'. The first row contains the values '1', '1.2.3.4', '6343', and a checkbox. Below the table are two buttons: 'Delete' and 'Cancel'.

The following table describes the labels in this screen.

Table 105 Advanced Application > sFlow > Collector

LABEL	DESCRIPTION
Collector Address	Enter the IP address of the sFlow collector.
UDP Port	Enter a UDP port number the Switch uses to send sFlow datagram to the collector. If you change the port here, make sure you change it on the collector, too. The default port is 6343.
Add	Click Add to save your changes to the Switch's run-time memory. The Switch loses these changes if it is turned off or loses power, so use the Save link on the top navigation panel to save your changes to the non-volatile memory when you are done configuring.
Cancel	Click Cancel to reset the fields to your previous configuration.

Table 105 Advanced Application > sFlow > Collector (continued)

LABEL	DESCRIPTION
Clear	Click Clear to clear the fields to the factory defaults.
Index	This field displays the index number of this entry.
Collector Address	This field displays IP address of the sFlow collector.
UDP Port	This field displays port number the Switch uses to send sFlow datagram to the collector.
Delete	Check the rule(s) that you want to remove in the Delete column and then click the Delete button.
Cancel	Click Cancel to begin configuring this screen afresh.

This chapter describes how the Switch gives a PPPoE termination server additional information that the server can use to identify and authenticate a PPPoE client.

32.1 PPPoE Intermediate Agent Overview

A PPPoE Intermediate Agent (PPPoE IA) is deployed between a PPPoE server and PPPoE clients. It helps the PPPoE server identify and authenticate clients by adding subscriber line specific information to PPPoE discovery packets from clients on a per-port or per-port-per-VLAN basis before forwarding them to the PPPoE server.

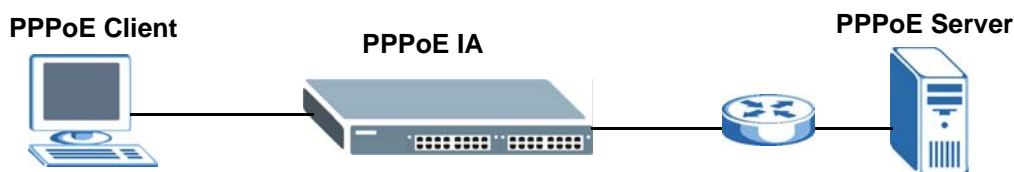

32.1.1 PPPoE Intermediate Agent Tag Format

If the PPPoE Intermediate Agent is enabled, the Switch adds a vendor-specific tag to PADI (PPPoE Active Discovery Initialization) and PADR (PPPoE Active Discovery Request) packets from PPPoE clients. This tag is defined in RFC 2516 and has the following format for this feature.

Table 106 PPPoE Intermediate Agent Vendor-specific Tag Format

Tag_Type (0x0105)	Tag_Len	Value	i1	i2
----------------------	---------	-------	----	----

The Tag_Type is 0x0105 for vendor-specific tags, as defined in RFC 2516. The Tag_Len indicates the length of Value, i1 and i2. The Value is the 32-bit number 0x00000DE9, which stands for the “ADSL Forum” IANA entry. i1 and i2 are PPPoE intermediate agent sub-options, which contain additional information about the PPPoE client.

32.1.2 Sub-Option Format

There are two types of sub-option: “Agent Circuit ID Sub-option” and “Agent Remote ID Sub-option”. They have the following formats.

Table 107 PPPoE IA Circuit ID Sub-option Format: User-defined String

SubOpt	Length	Value
0x01 (1 byte)	N (1 byte)	String (63 bytes)

Table 108 PPPoE IA Remote ID Sub-option Format

SubOpt	Length	Value
0x02 (1 byte)	N (1 byte)	MAC Address or String (63 bytes)

The 1 in the first field identifies this as an Agent Circuit ID sub-option and 2 identifies this as an Agent Remote ID sub-option. The next field specifies the length of the field. The Switch takes the Circuit ID string you manually configure for a VLAN on a port as the highest priority and the Circuit ID string for a port as the second priority. In addition, the Switch puts the PPPoE client's MAC address into the Agent Remote ID Sub-option if you do not specify any user-defined string.

32.1.2.1 Flexible Circuit ID Syntax with Identifier String and Variables

If you do not configure a Circuit ID string for a VLAN on a specific port or for a specific port, the Switch adds the user-defined identifier string and variables into the Agent Circuit ID Sub-option. The variables can be the slot ID of the PPPoE client, the port number of the PPPoE client and/or the VLAN ID on the PPPoE packet.

The identifier-string, slot ID, port number and VLAN ID are separated from each other by a pound key (#), semi-colon (;), period (.), comma (,), forward slash (/) or space. An Agent Circuit ID Sub-option example is "Switch/07/0123" and indicates the PPPoE packets come from a PPPoE client which is connected to the Switch's port 7 and belong to VLAN 123.

Table 109 PPPoE IA Circuit ID Sub-option Format: Using Identifier String and Variables

SubOpt	Length	Value						
0x01 (1 byte)	N (1 byte)	Identifier String (53 byte)	delimiter (1 byte)	Slot ID (1 byte)	delimiter (1 byte)	Port No (2 byte)	delimiter (1 byte)	VLAN ID (4 bytes)

32.1.2.2 WT-101 Default Circuit ID Syntax

If you do not configure a Circuit ID string for a specific VLAN on a port or for a specific port, and disable the flexible Circuit ID syntax in the **PPPoE > Intermediate Agent** screen, the Switch automatically generates a Circuit ID string according to the default Circuit ID syntax which is defined in the DSL Forum Working Text (WT)-101. The default access node identifier is the host name of the PPPoE intermediate agent and the eth indicates "Ethernet".

Table 110 PPPoE IA Circuit ID Sub-option Format: Defined in WT-101

SubOpt	Length	Value								
0x01 (1 byte)	N (1 byte)	Access Node Identifier (20 byte)	Space (1 byte)	eth (3 byte)	Space (1 byte)	Slot ID (1 byte)	/ (1 byte)	Port No (2 byte)	: (1 byte)	VLAN ID (4 bytes)

32.1.3 Port State

Every port is either a trusted port or an untrusted port for the PPPoE intermediate agent. This setting is independent of the trusted/untrusted setting for DHCP snooping or ARP inspection. You can also specify the agent sub-options (circuit ID and remote ID) that the Switch adds to PADI and PADR packets from PPPoE clients.

Trusted ports are connected to PPPoE servers.

- If a PADO (PPPoE Active Discovery Offer), PADS (PPPoE Active Discovery Session-confirmation), or PADT (PPPoE Active Discovery Terminate) packet is sent from a PPPoE server and received on a trusted port, the Switch forwards it to all other ports.
- If a PADI or PADR packet is sent from a PPPoE client but received on a trusted port, the Switch forwards it to other trusted port(s).

Note: The Switch will drop all PPPoE discovery packets if you enable the PPPoE intermediate agent and there are no trusted ports.

Untrusted ports are connected to subscribers.

- If a PADI, PADR, or PADT packet is sent from a PPPoE client and received on an untrusted port, the Switch adds a vendor-specific tag to the packet and then forwards it to the trusted port(s).
- The Switch discards PADO and PADS packets which are sent from a PPPoE server but received on an untrusted port.

32.2 PPPoE Screen

Use this screen to configure the PPPoE Intermediate Agent on the Switch.

Click **Advanced Application** > **PPPoE** in the navigation panel to display the screen as shown. Click **Click Here** to go to the **Intermediate Agent** screen.

Figure 150 Advanced Application > PPPoE Intermediate Agent

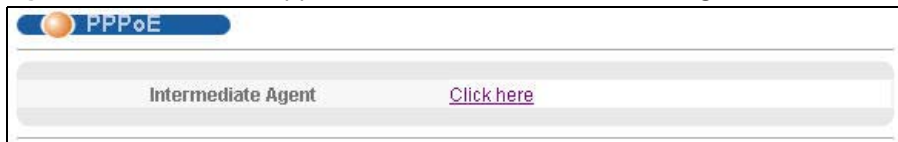

32.3 PPPoE Intermediate Agent

Use this screen to configure the Switch to give a PPPoE termination server additional subscriber information that the server can use to identify and authenticate a PPPoE client.

Click **Advanced Application** > **PPPoE** > **Intermediate Agent** in the navigation panel to display the screen as shown.

Figure 151 Advanced Application > PPPoE > Intermediate Agent

The following table describes the labels in this screen.

Table 111 Advanced Application > PPPoE > Intermediate Agent

LABEL	DESCRIPTION
Active	Select this option to enable the PPPoE intermediate agent globally on the Switch.
access-node-identifier	Enter up to 20 ASCII characters to identify the PPPoE intermediate agent. Hyphens (-) and spaces are also allowed. The default is the Switch's host name.
circuit-id	Use this section to configure the Circuit ID field in the PADI and PADR packets. The Circuit ID you configure for a specific port or for a specific VLAN on a port has priority over this. The Circuit ID you configure for a specific port (in the Advanced Application > PPPoE > Intermediate Agent > Port screen) or for a specific VLAN on a port (in the Advanced Application > PPPoE > Intermediate Agent > Port > VLAN screen) has priority over this. That means, if you also want to configure PPPoE IA Per-Port or Per-Port Per-VLAN setting, leave the fields here empty and configure circuit-id and remote-id in the Per-Port or Per-Port Per-VLAN screen.
Active	Select this option to have the Switch add the user-defined identifier string and variables (specified in the option field) to PADI or PADR packets from PPPoE clients. If you leave this option unselected and do not configure any Circuit ID string (using CLI commands) on the Switch, the Switch will use the string specified in the access-node-identifier field.
hostname	Select this option to have the Switch add the Switch's host name to PADI or PADR packets from PPPoE clients.
identifier-string	Specify a string that the Switch adds in the Agent Circuit ID sub-option. You can enter up to 53 ASCII characters. Spaces are allowed.
option	Select the variables that you want the Switch to generate and add in the Agent Circuit ID sub-option. The variable options include s , p , v , sp , sv , pv and spv which indicate slot, port, vlan or combinations of slot-port, slot-VLAN, port-VLAN and slot-port-VLAN respectively. The Switch enters a zero into the PADI and PADR packets for the slot value.
delimiter	Select a delimiter to separate the identifier-string, slot ID, port number and/or VLAN ID from each other. You can use a pound key (#), semi-colon (;), period (.), comma (,), forward slash (/) or space.

Table 111 Advanced Application > PPPoE > Intermediate Agent (continued)

LABEL	DESCRIPTION
Apply	Click Apply to save your changes to the Switch's run-time memory. The Switch loses these changes if it is turned off or loses power, so use the Save link on the top navigation panel to save your changes to the non-volatile memory when you are done configuring.
Cancel	Click Cancel to begin configuring this screen afresh.

32.3.1 PPPoE IA Per-Port

Use this screen to specify whether individual ports are trusted or untrusted ports and have the Switch add extra information to PPPoE discovery packets from PPPoE clients on a per-port basis.

Note: The Switch will drop all PPPoE packets if you enable the PPPoE Intermediate Agent on the Switch and there are no trusted ports.

Click the **Port** link in the **Intermediate Agent** screen to display the screen as shown.

Figure 152 Advanced Application > PPPoE > Intermediate Agent > Port

Port	Server Trusted State	Circuit-id	Remote-id
*	Untrusted		
1	Untrusted		
2	Untrusted		
3	Untrusted		
4	Untrusted		
5	Untrusted		
6	Untrusted		
7	Untrusted		
8	Untrusted		
9	Untrusted		
10	Untrusted		
11	Untrusted		

Apply Cancel

The following table describes the labels in this screen.

Table 112 Advanced Application > PPPoE > Intermediate Agent > Port

LABEL	DESCRIPTION
Port	This field displays the port number.
*	Use this row to make the setting the same for all ports. Use this row first and then make adjustments on a port-by-port basis. Note: Changes in this row are copied to all the ports as soon as you make them.

Table 112 Advanced Application > PPPoE > Intermediate Agent > Port (continued)

LABEL	DESCRIPTION
Server Trusted State	<p>Select whether this port is a trusted port (Trusted) or an untrusted port (Untrusted).</p> <p>Trusted ports are uplink ports connected to PPPoE servers.</p> <ul style="list-style-type: none"> • If a PADO (PPPoE Active Discovery Offer), PADS (PPPoE Active Discovery Session-confirmation), or PADT (PPPoE Active Discovery Terminate) packet is sent from a PPPoE server and received on a trusted port, the Switch forwards it to all other ports. • If a PADI or PADR packet is sent from a PPPoE client but received on a trusted port, the Switch forwards it to other trusted port(s). <p>Untrusted ports are downlink ports connected to subscribers.</p> <ul style="list-style-type: none"> • If a PADI, PADR, or PADT packet is sent from a PPPoE client and received on an untrusted port, the Switch adds a vendor-specific tag to the packet and then forwards it to the trusted port(s). • The Switch discards PADO and PADS packets which are sent from a PPPoE server but received on an untrusted port.
Circuit-id	<p>Enter a string of up to 63 ASCII characters that the Switch adds into the Agent Circuit ID sub-option for PPPoE discovery packets received on this port. Spaces are allowed.</p> <p>The Circuit ID you configure for a specific VLAN on a port (in the Advanced Application > PPPoE > Intermediate Agent > Port > VLAN screen) has the highest priority.</p>
Remote-id	<p>Enter a string of up to 63 ASCII characters that the Switch adds into the Agent Remote ID sub-option for PPPoE discovery packets received on this port. Spaces are allowed.</p> <p>If you do not specify a string here or in the Remote-id field for a VLAN on a port, the Switch automatically uses the PPPoE client's MAC address.</p> <p>The Remote ID you configure for a specific VLAN on a port (in the Advanced Application > PPPoE > Intermediate Agent > Port > VLAN screen) has the highest priority.</p>
Apply	<p>Click Apply to save your changes to the Switch's run-time memory. The Switch loses these changes if it is turned off or loses power, so use the Save link on the top navigation panel to save your changes to the non-volatile memory when you are done configuring.</p>
Cancel	<p>Click Cancel to begin configuring this screen afresh.</p>

32.3.2 PPPoE IA Per-Port Per-VLAN

Use this screen to configure PPPoE IA settings that apply to a specific VLAN on a port.

Click the **VLAN** link in the **Intermediate Agent > Port** screen to display the screen as shown.

Figure 153 Advanced Application > PPPoE > Intermediate Agent > Port > VLAN

The following table describes the labels in this screen.

Table 113 Advanced Application > PPPoE > Intermediate Agent > Port > VLAN

LABEL	DESCRIPTION
Show Port	Enter a port number to show the PPPoE Intermediate Agent settings for the specified VLAN(s) on the port.
Show VLAN	Use this section to specify the VLANs you want to configure in the section below.
Start VID	Enter the lowest VLAN ID you want to configure in the section below.
End VID	Enter the highest VLAN ID you want to configure in the section below.
Apply	Click Apply to display the specified range of VLANs in the section below.
Port	This field displays the port number specified above.
VID	This field displays the VLAN ID of each VLAN in the range specified above. If you configure the * VLAN, the settings are applied to all VLANs.
*	Use this row to make the setting the same for all VLANs. Use this row first and then make adjustments on a VLAN-by-VLAN basis. Note: Changes in this row are copied to all the VLANs as soon as you make them.
Circuit-id	Enter a string of up to 63 ASCII characters that the Switch adds into the Agent Circuit ID sub-option for this VLAN on the specified port. Spaces are allowed. The Circuit ID you configure here has the highest priority.
Remote-id	Enter a string of up to 63 ASCII characters that the Switch adds into the Agent Remote ID sub-option for this VLAN on the specified port. Spaces are allowed. If you do not specify a string here or in the Remote-id field for a specific port, the Switch automatically uses the PPPoE client's MAC address. The Remote ID you configure here has the highest priority.
Apply	Click Apply to save your changes to the Switch's run-time memory. The Switch loses these changes if it is turned off or loses power, so use the Save link on the top navigation panel to save your changes to the non-volatile memory when you are done configuring.
Cancel	Click Cancel to begin configuring this screen afresh.

32.3.3 PPPoE IA for VLAN

Use this screen to set whether the PPPoE Intermediate Agent is enabled on a VLAN and whether the Switch appends the Circuit ID and/or Remote ID to PPPoE discovery packets from a specific VLAN.

Click the **VLAN** link in the **Intermediate Agent** screen to display the screen as shown.

Figure 154 Advanced Application > PPPoE > Intermediate Agent > VLAN

VID	Enabled	Circuit-id	Remote-id
*	No	<input type="checkbox"/>	<input type="checkbox"/>
123	No	<input type="checkbox"/>	<input type="checkbox"/>
124	Yes	<input checked="" type="checkbox"/>	<input checked="" type="checkbox"/>
125	No	<input type="checkbox"/>	<input type="checkbox"/>
126	No	<input type="checkbox"/>	<input type="checkbox"/>
127	No	<input type="checkbox"/>	<input type="checkbox"/>
128	No	<input type="checkbox"/>	<input type="checkbox"/>

The following table describes the labels in this screen.

Table 114 Advanced Application > PPPoE > Intermediate Agent > VLAN

LABEL	DESCRIPTION
Show VLAN	Use this section to specify the VLANs you want to configure in the section below.
Start VID	Enter the lowest VLAN ID you want to configure in the section below.
End VID	Enter the highest VLAN ID you want to configure in the section below.
Apply	Click Apply to display the specified range of VLANs in the section below.
VID	This field displays the VLAN ID of each VLAN in the range specified above. If you configure the * VLAN, the settings are applied to all VLANs.
*	Use this row to make the setting the same for all VLANs. Use this row first and then make adjustments on a VLAN-by-VLAN basis. Note: Changes in this row are copied to all the VLANs as soon as you make them.
Enabled	Select this option to turn on the PPPoE Intermediate Agent on a VLAN.
Circuit-id	Select this option to make the Circuit ID settings for a specific VLAN take effect.
Remote-id	Select this option to make the Remote ID settings for a specific VLAN take effect.
Apply	Click Apply to save your changes to the Switch's run-time memory. The Switch loses these changes if it is turned off or loses power, so use the Save link on the top navigation panel to save your changes to the non-volatile memory when you are done configuring.
Cancel	Click Cancel to begin configuring this screen afresh.

Error Disable

This chapter shows you how to configure the rate limit for control packets on a port, and set the Switch to take an action (such as to shut down a port or stop sending packets) on a port when the Switch detects a pre-configured error. It also shows you how to configure the Switch to automatically undo the action after the error is gone.

33.1 CPU Protection Overview

Switches exchange protocol control packets in a network to get the latest networking information. If a switch receives large numbers of control packets, such as ARP, BPDU or IGMP packets, which are to be processed by the CPU, the CPU may become overloaded and be unable to handle regular tasks properly.

The CPU protection feature allows you to limit the rate of ARP, BPDU and IGMP packets to be delivered to the CPU on a port. This enhances the CPU efficiency and protects against potential DoS attacks or errors from other network(s). You then can choose to drop control packets that exceed the specified rate limit or disable a port on which the packets are received.

33.2 Error-Disable Recovery Overview

Some features, such as loop guard or CPU protection, allow the Switch to shut down a port or discard specific packets on a port when an error is detected on the port. For example, if the Switch detects that packets sent out the port(s) loop back to the Switch, the Switch can shut down the port(s) automatically. After that, you need to enable the port(s) or allow the packets on a port manually via the web configurator or the commands. With error-disable recovery, you can set the disabled port(s) to become active or start receiving the packets again after the time interval you specify.

33.3 Error Disable Screen

Use this screen to configure error disable related settings. Click **Advanced Application > Errdisable** in the navigation panel to open the following screen.

Figure 155 Advanced Application > Errdisable



33.4 Error-Disable Status

Use this screen to view whether the Switch detected that control packets exceeded the rate limit configured for a port or a port is disabled according to the feature requirements and what action you configure, and related information. Click the **Click here** link next to **Errdisable Status** in the **Advanced Application > Errdisable** screen to display the screen as shown.

Figure 156 Advanced Application > Errdisable > Errdisable Status

Errdisable Status

Inactive-reason mode reset:

Port List Cause

Port	Cause	Active	Mode	Rate	Status	Recovery Time Left (secs)	Total Dropped
1	ARP	NO	inactive-port	0	Forwarding	-	-
	BPDU	NO	inactive-port	0	Forwarding	-	-
	IGMP	NO	inactive-port	0	Forwarding	-	-
	Loop Guard	NO	inactive-port	-	Forwarding	-	-
	Storm Control	NO	inactive-port	-	Forwarding	-	-
	Port Security	NO	inactive-port	-	Forwarding	-	-
2	ARP	NO	inactive-port	0	Forwarding	-	-
	BPDU	NO	inactive-port	0	Forwarding	-	-
	IGMP	NO	inactive-port	0	Forwarding	-	-
	Loop Guard	NO	inactive-port	-	Forwarding	-	-
	Storm Control	NO	inactive-port	-	Forwarding	-	-
3	Port Security	NO	inactive-port	-	Forwarding	-	-
	ARP	NO	inactive-port	0	Forwarding	-	-
	BPDU	NO	inactive-port	0	Forwarding	-	-
	IGMP	NO	inactive-port	0	Forwarding	-	-
	Loop Guard	NO	inactive-port	-	Forwarding	-	-
4	Storm Control	NO	inactive-port	-	Forwarding	-	-
	Port Security	NO	inactive-port	-	Forwarding	-	-
	ARP	NO	inactive-port	0	Forwarding	-	-
	BPDU	NO	inactive-port	0	Forwarding	-	-
	IGMP	NO	inactive-port	0	Forwarding	-	-
	Loop Guard	NO	inactive-port	-	Forwarding	-	-
	Storm Control	NO	inactive-port	-	Forwarding	-	-

The following table describes the labels in this screen.

Table 115 Advanced Application > Errdisable > Errdisable Status

LABEL	DESCRIPTION
Inactive-reason mode reset	
Port List	Enter the number of the port(s) (separated by a comma) on which you want to reset inactive-reason status.
Cause	Select the cause of inactive-reason mode you want to reset here.
Reset	Press to reset the specified port(s) to handle ARP, BPDU or IGMP packets instead of ignoring them, if the port(s) is in inactive-reason mode.
Errdisable Status	
Port	This is the number of the port on which you want to configure Errdisable Status.
Cause	This displays the type of the control packet received on the port or the feature enabled on the port and causing the Switch to take the specified action.
Active	This field displays whether the control packets (ARP, BPDU, and/or IGMP) on the port is being detected or not. It also shows whether loop guard, anti-arp scanning, BPDU guard or ZULD is enabled on the port.
Mode	This field shows the action that the Switch takes for the cause. <ul style="list-style-type: none"> • inactive-port - The Switch disables the port. • inactive-reason - The Switch drops all the specified control packets (such as BPDU) on the port. • rate-limitation - The Switch drops the additional control packets the port(s) has to handle in every one second.
Rate	This field displays how many control packets this port can receive or transmit per second. It can be adjusted in CPU Protection . 0 means no rate limit.
Status	This field displays the errdisable status. <ul style="list-style-type: none"> • Forwarding: The Switch is forwarding packets. Rate-limitation mode is always in Forwarding status. • Err-disable: The Switch disables the port on which the control packets are received (inactive-port) or drops specified control packets on the port (inactive-reason)
Recovery Time Left	This field displays the time (seconds) left before the port(s) becomes active of Errdisable Recovery.
Total Dropped	This field displays the total packet number dropped by this port where the packet rate exceeds the rate of mode rate-limitation.

33.5 CPU Protection Configuration

Use this screen to limit the maximum number of control packets (ARP, BPDU and/or IGMP) that the Switch can receive or transmit on a port. Click the **Click Here** link next to **CPU protection** in the **Advanced Application > Errdisable** screen to display the screen as shown.

Note: After you configure this screen, make sure you also enable error detection for the specific control packets in the **Advanced Application > Errdisable > Errdisable Detect** screen.

Figure 157 Advanced Application > Errdisable > CPU protection

Port	Rate Limit (pkt/s)
*	
1	0
2	0
3	0
4	0
5	0
6	0
7	0
8	0
9	0

The following table describes the labels in this screen.

Table 116 Advanced Application > Errdisable > CPU protection

LABEL	DESCRIPTION
Reason	Select the type of control packet you want to configure here.
Port	This field displays the port number.
*	Use this row to make the setting the same for all ports. Use this row first and then make adjustments to each port if necessary. Note: Changes in this row are copied to all the ports as soon as you make them.
Rate Limit (pkt/s)	Enter a number from 0 to 256 to specify how many control packets this port can receive or transmit per second. 0 means no rate limit. You can configure the action that the Switch takes when the limit is exceeded. See Section 33.6 on page 261 for detailed information.
Apply	Click Apply to save your changes to the Switch's run-time memory. The Switch loses these changes if it is turned off or loses power, so use the Save link on the top navigation panel to save your changes to the non-volatile memory when you are done configuring.
Cancel	Click Cancel to begin configuring this screen afresh.

33.6 Error-Disable Detect Configuration

Use screen to have the Switch detect whether the control packets exceed the rate limit configured for a port and configure the action to take once the limit is exceeded. Click the **Click Here** link next to **Errdisable Detect** link in the **Advanced Application > Errdisable** screen to display the screen as shown.

Figure 158 Advanced Application > Errdisable > Errdisable Detect

Cause	Active	Mode
*	<input type="checkbox"/>	inactive-port
ARP	<input type="checkbox"/>	inactive-port
BPDU	<input type="checkbox"/>	inactive-port
IGMP	<input type="checkbox"/>	inactive-port

The following table describes the labels in this screen.

Table 117 Advanced Application > Errdisable > Errdisable Detect

LABEL	DESCRIPTION
Cause	This field displays the types of control packet that may cause CPU overload.
*	Use this row to make the setting the same for all entries. Use this row first and then make adjustments to each entry if necessary. Note: Changes in this row are copied to all the entries as soon as you make them.
Active	Select this option to have the Switch detect if the configured rate limit for a specific control packet is exceeded and take the action selected below.
Mode	Select the action that the Switch takes when the number of control packets exceed the rate limit on a port, set in the Advanced Application > Errdisable > CPU protection screen. <ul style="list-style-type: none"> inactive-port - The Switch disables the port on which the control packets are received. inactive-reason - The Switch drops all the specified control packets on the port. rate-limitation - The Switch drops the additional control packets the port has to handle in every one second.
Apply	Click Apply to save your changes to the Switch's run-time memory. The Switch loses these changes if it is turned off or loses power, so use the Save link on the top navigation panel to save your changes to the non-volatile memory when you are done configuring.
Cancel	Click Cancel to begin configuring this screen afresh.

33.7 Error-Disable Recovery Configuration

Use this screen to configure the Switch to automatically undo an action after the error is gone. Click the **Click Here** link next to **Errdisable Recovery** in the **Advanced Application > Errdisable** screen to display the screen as shown.

Figure 159 Advanced Application > Errdisable > Errdisable Recovery

Reason	Timer Status	Interval
*	<input type="checkbox"/>	
loopguard	<input type="checkbox"/>	300
ARP	<input type="checkbox"/>	300
BPDU	<input type="checkbox"/>	300
IGMP	<input type="checkbox"/>	300
stormcontrol	<input type="checkbox"/>	300
portsecurity	<input type="checkbox"/>	300

The following table describes the labels in this screen.

Table 118 Advanced Application > Errdisable > Errdisable Recovery

LABEL	DESCRIPTION
Active	Select this option to turn on the error-disable recovery function on the Switch.
Reason	This field displays the supported features that allow the Switch to shut down a port or discard packets on a port according to the feature requirements and what action you configure.
*	Use this row to make the setting the same for all entries. Use this row first and then make adjustments to each entry if necessary. Note: Changes in this row are copied to all the entries as soon as you make them.
Timer Status	Select this option to allow the Switch to wait for the specified time interval to activate a port or allow specific packets on a port, after the error was gone. Deselect this option to turn off this rule.
Interval	Enter the number of seconds (from 30 to 2592000) for the time interval.
Apply	Click Apply to save your changes to the Switch's run-time memory. The Switch loses these changes if it is turned off or loses power, so use the Save link on the top navigation panel to save your changes to the non-volatile memory when you are done configuring.
Cancel	Click Cancel to begin configuring this screen afresh.

Private VLAN

This chapter shows you how to configure the Switch to prevent communications between ports in a VLAN.

34.1 Private VLAN Overview

Private VLAN allows you to do port isolation within a VLAN in a simple way. If you enable a private VLAN rule for a VLAN on the Switch, the Switch automatically adds all ports (except the uplink port(s)) in this VLAN to the isolated port list and blocks traffic between the isolated ports. The uplink ports (25 to 28 on the MES3500-24(F) or 9 to 10 on the MES3500-10) are always in the promiscuous port list. A promiscuous port can communicate with any port in the same VLAN. An isolated port can communicate with the promiscuous port(s) only.

Note: You can have up to one private VLAN rule for each VLAN.

In the following example, ports 1, 2, 3 and 25 belong to VLAN 123. You configure and enable private VLAN for VLAN 123 on the Switch. Then ports 1, 2 and/or 3 cannot send traffic to each other, but they all can talk to the uplink port 25.

Figure 160 Private VLAN Example

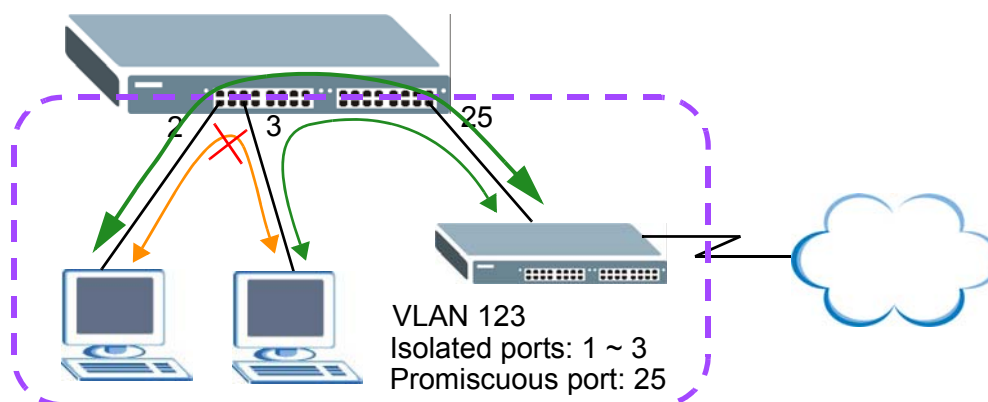

Note: Make sure you keep at least one port in the promiscuous port list for a VLAN with private VLAN enabled. Otherwise, this VLAN is blocked from the whole network.

34.2 Configuring Private VLAN

Click **Advanced Application** > **Private VLAN** in the navigation panel to display the screen as shown.

Figure 161 Advanced Application > Private VLAN

The following table describes the labels in this screen.

Table 119 Advanced Application > Private VLAN

LABEL	DESCRIPTION
Active	Check this box to enable private VLAN in a VLAN.
Name	Enter a descriptive name (up to 32 printable ASCII characters) for identification purposes.
VLAN ID	Enter a VLAN ID from 1 to 4094. This is the VLAN to which this rule applies.
Add	Click Add to insert the entry in the summary table below and save your changes to the Switch's run-time memory. The Switch loses these changes if it is turned off or loses power, so use the Save link on the top navigation panel to save your changes to the non-volatile memory when you are done configuring.
Cancel	Click Cancel to reset the fields to your previous configuration.
Clear	Click Clear to clear the fields to the factory defaults.
Index	This is the index number of the rule.
Active	This shows whether this rule is activated or not.
Name	This is the descriptive name for this rule.
VLAN	This is the VLAN to which this rule is applied.
Delete	Check the rule(s) that you want to remove in the Delete column and then click the Delete button.
Cancel	Click Cancel to clear the Delete check boxes.

Static Route

This chapter shows you how to configure static routes.

35.1 Static Routing Overview

The Switch uses IP for communication with management computers, for example using HTTP, Telnet, SSH, or SNMP. Use IP static routes to have the Switch respond to remote management stations that are not reachable through the default gateway. The Switch can also use static routes to send data to a server or device that is not reachable through the default gateway, for example when sending SNMP traps or using ping to test IP connectivity.

This figure shows a **Telnet** session coming in from network **N1**. The Switch sends reply traffic to default gateway **R1** which routes it back to the manager's computer. The Switch needs a static route to tell it to use router **R2** to send traffic to an SNMP trap server on network **N2**.

Figure 162 Static Routing Overview

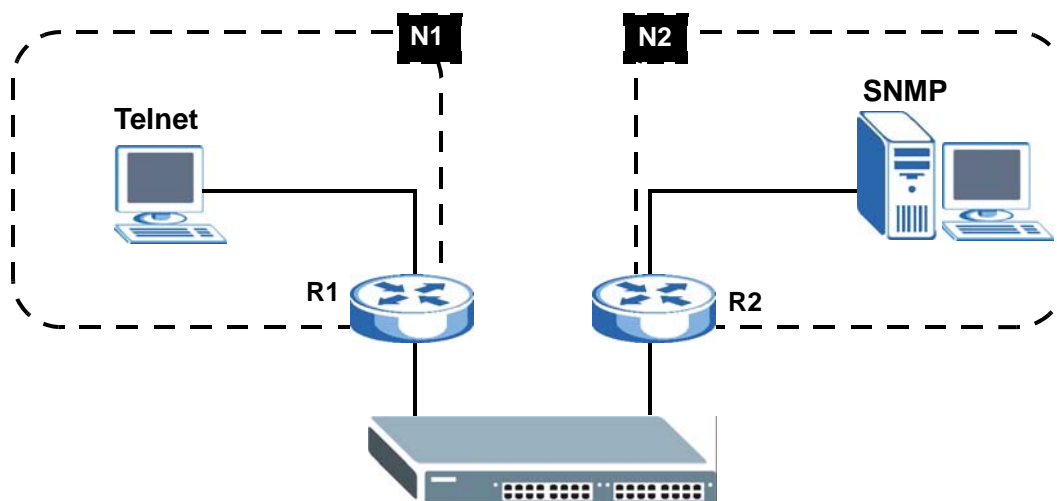

35.2 Configuring Static Routing

Click **IP Application** > **Static Routing** in the navigation panel to display the screen as shown.

Figure 163 IP Application > Static Routing

The screenshot shows the 'Static Routing' configuration page. At the top, there is a title bar with an orange circle and the text 'Static Routing'. Below this is a form with the following fields:

- Active:** A checkbox that is currently unchecked.
- Name:** An empty text input field.
- Destination IP Address:** A text input field containing '0.0.0.0'.
- IP Subnet Mask:** A text input field containing '0.0.0.0'.
- Gateway IP Address:** A text input field containing '0.0.0.0'.
- Metric:** An empty text input field.

Below the form are three buttons: 'Add', 'Cancel', and 'Clear'. At the bottom of the page, there is a table header with the following columns: 'Index', 'Active', 'Name', 'Destination Address', 'Subnet Mask', 'Gateway Address', 'Metric', and 'Delete'. Below the header are two buttons: 'Delete' and 'Cancel'.

The following table describes the related labels you use to create a static route.

Table 120 IP Application > Static Routing

LABEL	DESCRIPTION
Active	This field allows you to activate/deactivate this static route.
Name	Enter a descriptive name (up to 10 printable ASCII characters) for identification purposes.
Destination IP Address	This parameter specifies the IP network address of the final destination.
IP Subnet Mask	Enter the subnet mask for this destination. Routing is always based on network number. If you need to specify a route to a single host, use a subnet mask of 255.255.255.255 in the subnet mask field to force the network number to be identical to the host ID.
Gateway IP Address	Enter the IP address of the gateway. The gateway is an immediate neighbor of your Switch that will forward the packet to the destination. The gateway must be a router on the same segment as your Switch.
Metric	The metric represents the "cost" of transmission for routing purposes. IP routing uses hop count as the measurement of cost, with a minimum of 1 for directly connected networks. Enter a number that approximates the cost for this link. The number need not be precise, but it must be between 1 and 15. In practice, 2 or 3 is usually a good number.
Add	Click Add to insert a new static route to the Switch's run-time memory. The Switch loses these changes if it is turned off or loses power, so use the Save link on the top navigation panel to save your changes to the non-volatile memory when you are done configuring.
Cancel	Click Cancel to reset the above fields to your previous configuration.
Clear	Click Clear to set the above fields back to the factory defaults.
Index	This field displays the index number of the route. Click a number to edit the static route entry.
Active	This field displays Yes when the static route is activated and No when it is deactivated.
Name	This field displays the descriptive name for this route. This is for identification purposes only.
Destination Address	This field displays the IP network address of the final destination.
Subnet Mask	This field displays the subnet mask for this destination.

Table 120 IP Application > Static Routing (continued)

LABEL	DESCRIPTION
Gateway Address	This field displays the IP address of the gateway. The gateway is an immediate neighbor of your Switch that will forward the packet to the destination.
Metric	This field displays the cost of transmission for routing purposes.
Delete	Click Delete to remove the selected entry from the summary table.
Cancel	Click Cancel to clear the Delete check boxes.

Differentiated Services

This chapter shows you how to configure Differentiated Services (DiffServ) on the Switch.

36.1 DiffServ Overview

Quality of Service (QoS) is used to prioritize source-to-destination traffic flows. All packets in the flow are given the same priority. You can use CoS (class of service) to give different priorities to different packet types.

DiffServ is a class of service (CoS) model that marks packets so that they receive specific per-hop treatment at DiffServ-compliant network devices along the route based on the application types and traffic flow. Packets are marked with DiffServ Code Points (DSCPs) indicating the level of service desired. This allows the intermediary DiffServ-compliant network devices to handle the packets differently depending on the code points without the need to negotiate paths or remember state information for every flow. In addition, applications do not have to request a particular service or give advanced notice of where the traffic is going.

36.1.1 DSCP and Per-Hop Behavior

DiffServ defines a new DS (Differentiated Services) field to replace the Type of Service (ToS) field in the IP header. The DS field contains a 6-bit DSCP field which can define up to 64 service levels and the remaining 2 bits are defined as currently unused (CU). The following figure illustrates the DS field.

Figure 164 DiffServ: Differentiated Service Field

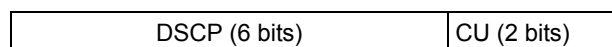

DSCP is backward compatible with the three precedence bits in the ToS octet so that non-DiffServ compliant, ToS-enabled network device will not conflict with the DSCP mapping.

The DSCP value determines the PHB (Per-Hop Behavior), that each packet gets as it is forwarded across the DiffServ network. Based on the marking rule different kinds of traffic can be marked for different priorities of forwarding. Resources can then be allocated according to the DSCP values and the configured policies.

36.1.2 DiffServ Network Example

The following figure depicts a DiffServ network consisting of a group of directly connected DiffServ-compliant network devices. The boundary node (**A** in [Figure 165](#)) in a DiffServ network classifies (marks with a DSCP value) the incoming packets into different traffic flows (**Platinum, Gold, Silver, Bronze**) based on the configured marking rules. A network administrator can then apply

various traffic policies to the traffic flows. An example traffic policy, is to give higher drop precedence to one traffic flow over others. In our example, packets in the **Bronze** traffic flow are more likely to be dropped when congestion occurs than the packets in the **Platinum** traffic flow as they move across the DiffServ network.

Figure 165 DiffServ Network

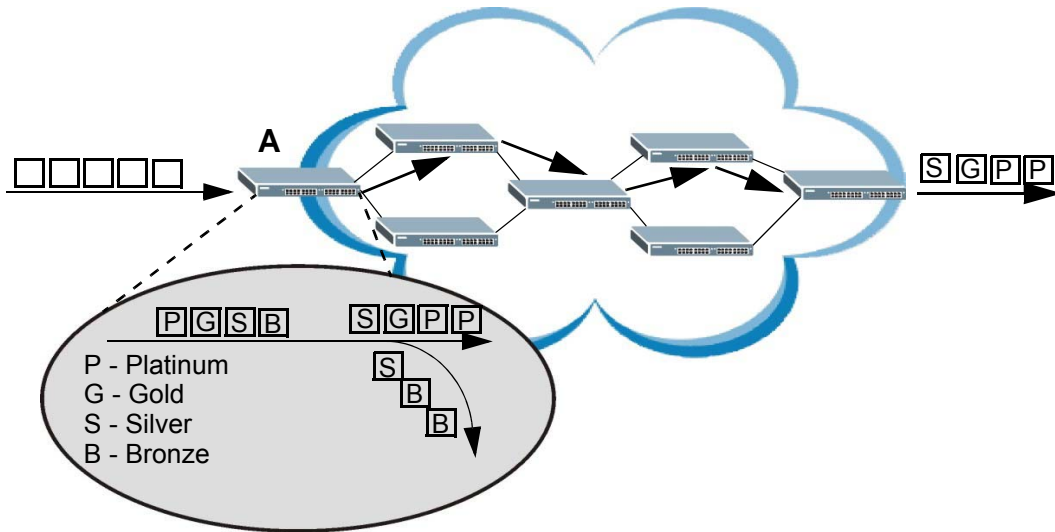

36.2 Two Rate Three Color Marker Traffic Policing

Traffic policing is the limiting of the input or output transmission rate of a class of traffic on the basis of user-defined criteria. Traffic policing methods measure traffic flows against user-defined criteria and identify it as either conforming, exceeding or violating the criteria.

Two Rate Three Color Marker (TRTCM, defined in RFC 2698) is a type of traffic policing that identifies packets by comparing them to two user-defined rates: the Committed Information Rate (CIR) and the Peak Information Rate (PIR). The CIR specifies the average rate at which packets are admitted to the network. The PIR is greater than or equal to the CIR. CIR and PIR values are based on the guaranteed and maximum bandwidth respectively as negotiated between a service provider and client.

Two Rate Three Color Marker evaluates incoming packets and marks them with one of three colors which refer to packet loss priority levels. High packet loss priority level is referred to as red, medium is referred to as yellow and low is referred to as green. After TRTCM is configured and DiffServ is enabled the following actions are performed on the colored packets:

- Red (high loss priority level) packets are dropped.
- Yellow (medium loss priority level) packets are dropped if there is congestion on the network.
- Green (low loss priority level) packets are forwarded.

TRTCM operates in one of two modes: color-blind or color-aware. In color-blind mode, packets are marked based on evaluating against the PIR and CIR regardless of if they have previously been marked or not. In the color-aware mode, packets are marked based on both existing color and evaluation against the PIR and CIR. If the packets do not match any of colors, then the packets proceed unchanged.

36.2.1 TRTCM-Color-blind Mode

All packets are evaluated against the PIR. If a packet exceeds the PIR it is marked red. Otherwise it is evaluated against the CIR. If it exceeds the CIR then it is marked yellow. Finally, if it is below the CIR then it is marked green.

Figure 166 TRTCM-Color-blind Mode

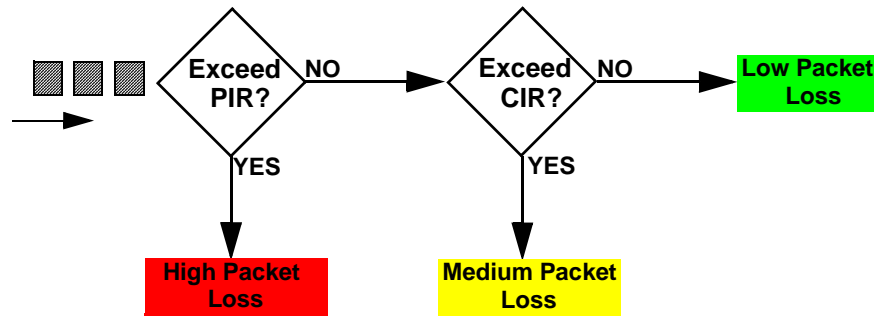

36.2.2 TRTCM-Color-aware Mode

In color-aware mode the evaluation of the packets uses the existing packet loss priority. TRTCM can increase a packet loss priority of a packet but it cannot decrease it. Packets that have been previously marked red or yellow can only be marked with an equal or higher packet loss priority.

Packets marked red (high packet loss priority) continue to be red without evaluation against the PIR or CIR. Packets marked yellow can only be marked red or remain yellow so they are only evaluated against the PIR. Only the packets marked green are first evaluated against the PIR and then if they don't exceed the PIR level are they evaluated against the CIR.

Figure 167 TRTCM-Color-aware Mode

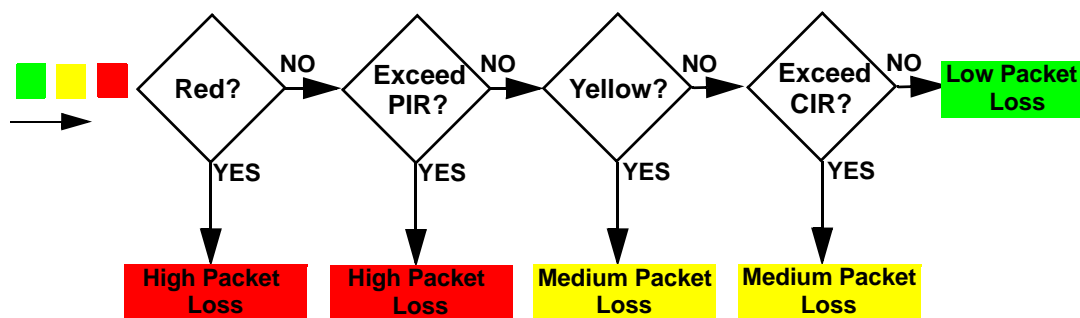

36.3 Activating DiffServ

Activate DiffServ to apply marking rules or IEEE 802.1p priority mapping on the selected port(s).

Click **IP Application** > **DiffServ** in the navigation panel to display the screen as shown.

Figure 168 IP Application > DiffServ

Port	Active
*	<input type="checkbox"/>
1	<input checked="" type="checkbox"/>
2	<input type="checkbox"/>
3	<input type="checkbox"/>
4	<input type="checkbox"/>
5	<input type="checkbox"/>
6	<input type="checkbox"/>
7	<input type="checkbox"/>
8	<input type="checkbox"/>
9	<input type="checkbox"/>
10	<input type="checkbox"/>
11	<input type="checkbox"/>
12	<input type="checkbox"/>

The following table describes the labels in this screen.

Table 121 IP Application > DiffServ

LABEL	DESCRIPTION
Active	Select this option to enable DiffServ on the Switch.
Port	This field displays the index number of a port on the Switch.
*	Settings in this row apply to all ports. Use this row only if you want to make some settings the same for all ports. Use this row first to set the common settings and then make adjustments on a port-by-port basis. Note: Changes in this row are copied to all the ports as soon as you make them.
Active	Select Active to enable DiffServ on the port.
Apply	Click Apply to save your changes to the Switch's run-time memory. The Switch loses these changes if it is turned off or loses power, so use the Save link on the top navigation panel to save your changes to the non-volatile memory when you are done configuring.
Cancel	Click Cancel to begin configuring this screen afresh.

36.3.1 Configuring 2-Rate 3 Color Marker Settings

Use this screen to configure TRTCM settings. Click the **2-rate 3 Color Marker** link in the **DiffServ** screen to display the screen as shown next.

Note: You cannot enable both TRTCM and Bandwidth Control at the same time.

Figure 169 IP Application > DiffServ > 2-rate 3 Color Marker

Port	Active	Commit Rate	Peak Rate	DSCP
*	<input type="checkbox"/>	<input type="text" value="1"/> Kbps	<input type="text" value="1"/> Kbps	Default ▼
1	<input type="checkbox"/>	<input type="text" value="1"/> Kbps	<input type="text" value="1"/> Kbps	Default ▼
2	<input type="checkbox"/>	<input type="text" value="1"/> Kbps	<input type="text" value="1"/> Kbps	Default ▼
3	<input type="checkbox"/>	<input type="text" value="1"/> Kbps	<input type="text" value="1"/> Kbps	Default ▼
4	<input type="checkbox"/>	<input type="text" value="1"/> Kbps	<input type="text" value="1"/> Kbps	Default ▼
5	<input type="checkbox"/>	<input type="text" value="1"/> Kbps	<input type="text" value="1"/> Kbps	Default ▼
6	<input type="checkbox"/>	<input type="text" value="1"/> Kbps	<input type="text" value="1"/> Kbps	Default ▼
7	<input type="checkbox"/>	<input type="text" value="1"/> Kbps	<input type="text" value="1"/> Kbps	Default ▼
8	<input type="checkbox"/>	<input type="text" value="1"/> Kbps	<input type="text" value="1"/> Kbps	Default ▼
9	<input type="checkbox"/>	<input type="text" value="1"/> Kbps	<input type="text" value="1"/> Kbps	Default ▼
10	<input type="checkbox"/>	<input type="text" value="1"/> Kbps	<input type="text" value="1"/> Kbps	Default ▼
11	<input type="checkbox"/>	<input type="text" value="1"/> Kbps	<input type="text" value="1"/> Kbps	Default ▼
12	<input type="checkbox"/>	<input type="text" value="1"/> Kbps	<input type="text" value="1"/> Kbps	Default ▼
13	<input type="checkbox"/>	<input type="text" value="1"/> Kbps	<input type="text" value="1"/> Kbps	Default ▼

The following table describes the labels in this screen.

Table 122 IP Application > DiffServ > 2-rate 3 Color Marker

LABEL	DESCRIPTION
Active	Select this to activate TRTCM (Two Rate Three Color Marker) on the Switch. The Switch evaluates and marks the packets based on the TRTCM settings. Note: You must also activate DiffServ on the Switch and the individual ports for the Switch to drop red (high loss priority) colored packets.
Mode	Select color-blind to have the Switch treat all incoming packets as uncolored. All incoming packets are evaluated against the CIR and PIR. Select color-aware to treat the packets as marked by some preceding entity. Incoming packets are evaluated based on their existing color. Incoming packets that are not marked proceed through the Switch.
Port	This field displays the index number of a port on the Switch.
*	Settings in this row apply to all ports. Use this row only if you want to make some settings the same for all ports. Use this row first to set the common settings and then make adjustments on a port-by-port basis. Note: Changes in this row are copied to all the ports as soon as you make them.
Active	Select this to activate TRTCM on the port.
Commit Rate	Specify the Commit Information Rate (CIR) for this port.
Peak Rate	Specify the Peak Information Rate (PIR) for this port.

Table 122 IP Application > DiffServ > 2-rate 3 Color Marker (continued)

LABEL	DESCRIPTION
DSCP	Select the DSCP profile that you want to apply to packets on this port. In a DSCP profile you can specify the DSCP values to assign to packets based on the color they are marked via TRTCM.
Apply	Click Apply to save your changes to the Switch's run-time memory. The Switch loses these changes if it is turned off or loses power, so use the Save link on the top navigation panel to save your changes to the non-volatile memory when you are done configuring.
Cancel	Click Cancel to begin configuring this screen afresh.

36.3.2 Configuring DSCP Profiles

Use this screen to configure DSCP profiles. Click the **DSCP Profile** link in the **2-Rate 3 Color Marker** screen to display the screen as shown next.

Figure 170 IP Application > DiffServ > 2-rate 3 Color Marker > DSCP Profile

The screenshot shows the 'DSCP Profile' configuration interface. At the top, there's a navigation bar with 'DSCP Profile' and 'Two-Rate Three Color Marker'. Below that, the 'DSCP Setup' section contains a table for adding a new profile. The table has columns for 'Profile Name', 'Green', 'Yellow', and 'Red'. The 'Profile Name' field contains 'Default', and the other three fields contain '0'. Below this table are 'Add' and 'Cancel' buttons. Below that, there's another table for existing profiles. This table has columns for 'Profile Name', 'Green', 'Yellow', 'Red', and 'Delete Profile'. The 'Profile Name' field contains 'Default', and the other three fields contain '0'. The 'Delete Profile' field contains an unchecked checkbox. Below this table are 'Delete' and 'Cancel' buttons.

The following table describes the labels in this screen.

Table 123 IP Application > DiffServ > 2-rate 3 Color Marker > DSCP Profile

LABEL	DESCRIPTION
Profile Name	Type a descriptive name (up to 32 printable ASCII characters) for this profile. This is for identification only.
Green	Specify the DSCP value to use for packets with low packet loss priority.
Yellow	Specify the DSCP value to use for packets with medium packet loss priority.
Red	Specify the DSCP value to use for packets with high packet loss priority.
Add	Click Add to insert a new DSCP profile to the Switch's run-time memory. The Switch loses these changes if it is turned off or loses power, so use the Save link on the top navigation panel to save your changes to the non-volatile memory when you are done configuring.
Cancel	Click Cancel to reset the above fields to your previous configuration.
Profile Name	This field displays the name of the DSCP profile. Click the name to edit the profile settings.
Green	This field displays the DSCP value to use for packets with low packet loss priority in this profile.
Yellow	This field displays the DSCP value to use for packets with medium packet loss priority in this profile.

Table 123 IP Application > DiffServ > 2-rate 3 Color Marker > DSCP Profile (continued)

LABEL	DESCRIPTION
Red	This field displays the DSCP value to use for packets with high packet loss priority in this profile.
Delete Profile	Select the profile(s) that you want to remove.
Delete	Click Delete to remove the selected profile(s) from the summary table.
Cancel	Click Cancel to clear the Delete check boxes.

36.4 DSCP-to-IEEE 802.1p Priority Settings

You can configure the DSCP to IEEE 802.1p mapping to allow the Switch to prioritize all traffic based on the incoming DSCP value according to the DiffServ to IEEE 802.1p mapping table.

The following table shows the default DSCP-to-IEEE802.1p mapping.

Table 124 Default DSCP-IEEE 802.1p Mapping

DSCP VALUE	0 – 7	8 – 15	16 – 23	24 – 31	32 – 39	40 – 47	48 – 55	56 – 63
IEEE 802.1p	0	1	2	3	4	5	6	7

36.4.1 Configuring DSCP Settings

To change the DSCP-IEEE 802.1p mapping click the **DSCP Setting** link in the **DiffServ** screen to display the screen as shown next.

Figure 171 IP Application > DiffServ > DSCP Setting

The following table describes the labels in this screen.

Table 125 IP Application > DiffServ > DSCP Setting

LABEL	DESCRIPTION
0 ... 63	This is the DSCP classification identification number. To set the IEEE 802.1p priority mapping, select the priority level from the drop-down list box.
Apply	Click Apply to save your changes to the Switch's run-time memory. The Switch loses these changes if it is turned off or loses power, so use the Save link on the top navigation panel to save your changes to the non-volatile memory when you are done configuring.
Cancel	Click Cancel to begin configuring this screen afresh.

This chapter shows you how to configure the DHCP feature.

37.1 DHCP Overview

DHCP (Dynamic Host Configuration Protocol RFC 2131 and RFC 2132) allows individual computers to obtain TCP/IP configuration at start-up from a server. You can configure the Switch as a DHCP server or a DHCP relay agent. When configured as a server, the Switch provides the TCP/IP configuration for the clients. If you configure the Switch as a relay agent, then the Switch forwards DHCP requests to DHCP server on your network. If you don't configure the Switch as a DHCP server or relay agent then you must have a DHCP server in the broadcast domain of the client computers or else the client computers must be configured manually.

37.1.1 DHCP Modes

If there is already a DHCP server on your network, then you can configure the Switch as a DHCP relay agent. When the Switch receives a request from a computer on your network, it contacts the DHCP server for the necessary IP information, and then relays the assigned information back to the computer.

37.1.2 DHCP Configuration Options

The DHCP configuration on the Switch is divided into **Global** and **VLAN** screens. The screen you should use for configuration depends on the DHCP services you want to offer the DHCP clients on your network. Choose the configuration screen based on the following criteria:

- **Global**: The Switch forwards all DHCP requests to the same DHCP server.
- **VLAN**: The Switch is configured on a VLAN by VLAN basis. The Switch can be configured to relay DHCP requests to different DHCP servers for clients in different VLAN.

37.2 DHCP Configuration

Click **IP Application** > **DHCP** in the navigation panel to display the screen as shown. Click the link next to **DHCPv4** to open screens where you can enable and configure DHCPv4 relay settings and create option 82 profiles. Click the link next to **DHCPv6** to open a screen where you can configure DHCPv6 relay settings.

Figure 172 IP Application > DHCP



37.3 DHCPv4 Status

Click **IP Application > DHCP > DHCPv4** in the navigation panel. The **DHCP Status** screen displays.

Figure 173 IP Application > DHCP > DHCPv4

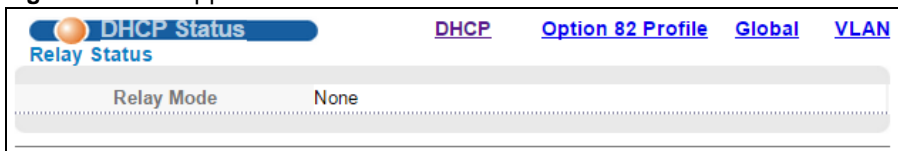

The following table describes the labels in this screen.

Table 126 IP Application > DHCP > DHCPv4

LABEL	DESCRIPTION
Relay Status	This section displays configuration settings related to the Switch's DHCP relay mode.
Relay Mode	This field displays: <ul style="list-style-type: none"> • None: if the Switch is not configured as a DHCP relay agent. • Global: if the Switch is configured as a DHCP relay agent only. • VLAN: followed by a VLAN ID or multiple VLAN IDs if it is configured as a relay agent for specific VLAN(s).

37.4 DHCPv4 Relay

Configure DHCP relay on the Switch if the DHCP clients and the DHCP server are not in the same broadcast domain. During the initial IP address leasing, the Switch helps to relay network information (such as the IP address and subnet mask) between a DHCP client and a DHCP server. Once the DHCP client obtains an IP address and can connect to the network, network information renewal is done between the DHCP client and the DHCP server without the help of the Switch.

The Switch can be configured as a global DHCP relay. This means that the Switch forwards all DHCP requests from all domains to the same DHCP server. You can also configure the Switch to relay DHCP information based on the VLAN membership of the DHCP clients.

37.4.1 DHCPv4 Relay Agent Information

The Switch can add information about the source of client DHCP requests that it relays to a DHCP server by adding **Relay Agent Information**. This helps provide authentication about the source of the requests. The DHCP server can then provide an IP address based on this information. Please refer to RFC 3046 for more details.

The DHCP **Relay Agent Information** feature adds an Agent Information field to the **Option 82** field. The **Option 82** field is in the DHCP headers of client DHCP request frames that the Switch relays to a DHCP server.

Relay Agent Information can include the **System Name** of the Switch if you select this option. You can change the **System Name** in **Basic Settings > General Setup**.

The following describes the DHCP relay information that the Switch sends to the DHCP server:

Table 127 Relay Agent Information

FIELD LABELS	DESCRIPTION
Slot ID	(1 byte) This value is always 0 for stand-alone switches.
Port ID	(1 byte) This is the port that the DHCP client is connected to.
VLAN ID	(2 bytes) This is the VLAN that the port belongs to.
Information	(up to 64 bytes) This optional, read-only field is set according to system name set in Basic Settings > General Setup .

37.4.2 DHCPv4 Option 82 Profile

Use this screen to create DHCPv4 option 82 profiles. Click **IP Application > DHCP > DHCPv4** in the navigation panel and click the **Option 82 Profile** link to display the screen as shown.

Figure 174 IP Application > DHCP > DHCPv4 > Option 82 Profile

DHCP Option 82 Profile [DHCP Setting](#)

Profile Setup

Name:

Circuit-ID: Enable
 slot-port vlan hostname
 string:

Remote-ID: Enable
 mac
 string:

Profile Name	Circuit-ID		Remote-ID		Delete
	Enable	Field	Enable	Field	
default1	Yes	slot-port, vlan	No	-	<input type="checkbox"/>
default2	Yes	slot-port, vlan, hostname	No	-	<input type="checkbox"/>
default3	Yes	slot-port, vlan	Yes	mac	<input type="checkbox"/>

The following table describes the labels in this screen.

Table 128 IP Application > DHCP > DHCPv4 > Option 82 Profile

LABEL	DESCRIPTION
Name	Enter a descriptive name for the profile for identification purposes. You can use up to 32 ASCII characters. Spaces are allowed.
Circuit-ID	Use this section to configure the Circuit ID sub-option to include information that is specific to the relay agent (the Switch).
Enable	Select this option to have the Switch add the Circuit ID sub-option to client DHCP requests that it relays to a DHCP server.
slot-port	Select this option to have the Switch add the number of port that the DHCP client is connected to.
vlan	Select this option to have the Switch add the ID of VLAN which the port belongs to.
hostname	This is the system name you configure in the Basic Setting > General Setup screen. Select this option for the Switch to add the system name to the client DHCP requests that it relays to a DHCP server.
string	Enter a string of up to 64 ASCII characters that the Switch adds into the client DHCP requests. Spaces are allowed.
Remote-ID	Use this section to configure the Remote ID sub-option to include information that identifies the relay agent (the Switch).
Enable	Select this option to have the Switch append the Remote ID sub-option to the option 82 field of DHCP requests.
mac	Select this option to have the Switch add its MAC address to the client DHCP requests that it relays to a DHCP server.
string	Enter a string of up to 64 ASCII characters for the remote ID information in this field. Spaces are allowed.
Add	Click this to create a new entry or to update an existing one. This saves your changes to the Switch's run-time memory. The Switch loses these changes if it is turned off or loses power, so use the Save link on the top navigation panel to save your changes to the non-volatile memory when you are done configuring.
Cancel	Click Cancel to reset the fields to their last saved values.
Profile Name	This field displays the descriptive name of the profile. Click the name to change the settings.
Circuit-ID	
Enable	This field displays whether the Circuit ID sub-option is added to client DHCP requests.
Field	This field displays the information that is included in the Circuit ID sub-option.
Remote-ID	
Enable	This field displays whether the Remote ID sub-option is added to client DHCP requests.
Field	This field displays the information that is included in the Remote ID sub-option.
Delete	Check the entry(ies) that you want to remove in the Delete column and then click the Delete button.
Cancel	Click Cancel to clear the selected checkbox(es) in the Delete column.

37.4.3 Configuring DHCPv4 Global Relay

Configure global DHCP relay in this screen. Click **IP Application > DHCP > DHCPv4** in the navigation panel and click the **Global** link to display the screen as shown.

Figure 175 IP Application > DHCP > DHCPv4 > Global

The following table describes the labels in this screen.

Table 129 IP Application > DHCP > DHCPv4 > Global

LABEL	DESCRIPTION
Active	Select this check box to enable DHCP relay.
Remote DHCP Server 1 .. 3	Enter the IP address of a DHCP server in dotted decimal notation.
Option 82 Profile	Select a pre-defined DHCPv4 option 82 profile that the Switch applies to all ports. The Switch adds the Circuit ID sub-option and/or Remote ID sub-option specified in the profile to DHCP requests that it relays to a DHCP server.
Apply	Click Apply to save your changes to the Switch's run-time memory. The Switch loses these changes if it is turned off or loses power, so use the Save link on the top navigation panel to save your changes to the non-volatile memory when you are done configuring.
Cancel	Click Cancel to begin configuring this screen afresh.

37.4.4 DHCPv4 Global Relay Port Configure

Use this screen to apply a different DHCP option 82 profile to certain ports on the Switch. To open this screen, click **IP Application > DHCP > DHCPv4 > Global > Port**.

Figure 176 IP Application > DHCP > DHCPv4 > Global > Port

The following table describes the labels in this screen.

Table 130 IP Application > DHCP > DHCPv4 > Global > Port

LABEL	DESCRIPTION
Port	Enter the number of port(s) to which you want to apply the specified DHCP option 82 profile. You can enter multiple ports separated by (no space) comma (,) or hyphen (-). For example, enter "3-5" for ports 3, 4, and 5. Enter "3,5,7" for ports 3, 5, and 7.
Option 82 Profile	Select a pre-defined DHCP option 82 profile that the Switch applies to the specified port(s). The Switch adds the Circuit ID sub-option and/or Remote ID sub-option specified in the profile to DHCP requests that it relays to a DHCP server. The profile you select here has priority over the one you select in the DHCP > DHCPv4 > Global screen.
Add	Click this to create a new entry or to update an existing one. This saves your changes to the Switch's run-time memory. The Switch loses these changes if it is turned off or loses power, so use the Save link on the top navigation panel to save your changes to the non-volatile memory when you are done configuring.
Cancel	Click this to reset the values above based on the last selected entry or, if not applicable, to clear the fields above.
Clear	Click Clear to reset the fields to the factory defaults.
Index	This field displays a sequential number for each entry. Click an index number to change the settings.
Port	This field displays the port(s) to which the Switch applies the settings.
Profile Name	This field displays the DHCP option 82 profile that the Switch applies to the port(s).
Delete	Select the entry(ies) that you want to remove in the Delete column, then click the Delete button to remove the selected entry(ies) from the table.
Cancel	Click this to clear the check boxes in the Delete column.

37.4.5 Global DHCPv4 Relay Configuration Example

The follow figure shows a network example where the Switch is used to relay DHCP requests for the **VLAN1** and **VLAN2** domains. There is only one DHCP server that services the DHCP clients in both domains.

Figure 177 Global DHCP Relay Network Example

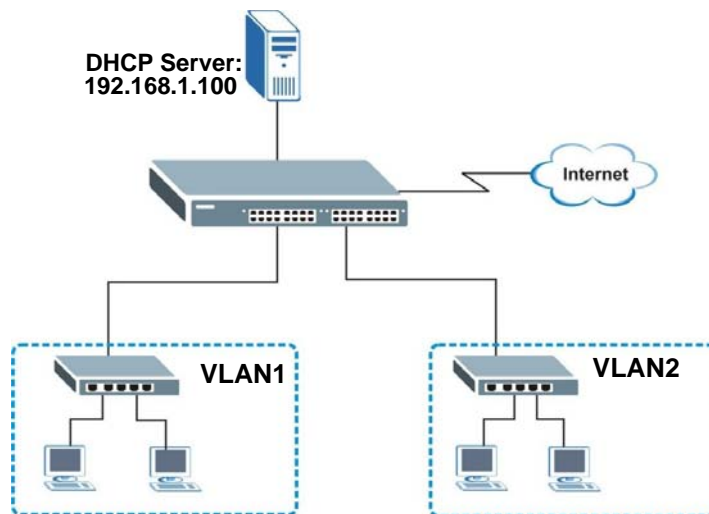

Configure the **DHCP Relay** screen as shown. Make sure you select a DHCP option 82 profile (**default1** in this example) to set the Switch to send additional information (such as the VLAN ID) together with the DHCP requests to the DHCP server. This allows the DHCP server to assign the appropriate IP address according to the VLAN ID.

Figure 178 DHCP Relay Configuration Example

The screenshot shows the DHCP Relay configuration interface. The 'Active' checkbox is checked. The configuration table is as follows:

Remote DHCP Server 1	192.168.1.100
Remote DHCP Server 2	0.0.0.0
Remote DHCP Server 3	0.0.0.0
Option 82 Profile	default1

A red stamp with the word 'EXAMPLE' is located at the bottom right of the configuration area. Below the configuration area are 'Apply' and 'Cancel' buttons.

37.4.6 Configuring DHCPv4 VLAN Settings

Use this screen to configure your DHCP settings based on the VLAN domain of the DHCP clients. Click **IP Application > DHCP > DHCPv4** in the navigation panel, then click the **VLAN** link in the **DHCP Status** screen that displays.

Note: You must set up a management IP address for each VLAN that you want to configure DHCP settings for on the Switch. See [Section 8.5 on page 83](#) for information on how to set up management IP addresses for VLANs.

Figure 179 IP Application > DHCP > DHCPv4 > VLAN

The screenshot shows the 'VLAN Setting' configuration page. It includes a title bar with 'VLAN Setting' and a 'Port Status' link. The main configuration area contains a form with the following fields: 'VID', 'Remote DHCP Server 1' (0.0.0.0), 'Remote DHCP Server 2' (0.0.0.0), 'Remote DHCP Server 3' (0.0.0.0), and 'Option 82 Profile' (a dropdown menu). Below the form are 'Add', 'Cancel', and 'Clear' buttons. At the bottom, there is a 'Rule Usage: 0 / 16' indicator and a table with columns 'VID', 'Type', 'DHCP Status', and 'Delete'. Below the table are 'Delete' and 'Cancel' buttons.

The following table describes the labels in this screen.

Table 131 IP Application > DHCP > DHCPv4 > VLAN

LABEL	DESCRIPTION
VID	Enter the ID number of the VLAN to which these DHCP settings apply.
Remote DHCP Server 1 .. 3	Enter the IP address of a DHCP server in dotted decimal notation.
Option 82 Profile	Select a pre-defined DHCP option 82 profile that the Switch applies to all ports in this VLAN. The Switch adds the Circuit ID sub-option and/or Remote ID sub-option specified in the profile to DHCP requests that it relays to a DHCP server.
Add	Click Add to save your changes to the Switch's run-time memory. The Switch loses these changes if it is turned off or loses power, so use the Save link on the top navigation panel to save your changes to the non-volatile memory when you are done configuring.
Cancel	Click Cancel to begin configuring this screen afresh.
Clear	Click this to clear the fields above.
Rule Usage	This field displays how many rules have been configured on the Switch.
VID	This field displays the ID number of the VLAN group to which this DHCP settings apply.
Type	This field displays the DHCP mode (Relay).
DHCP Status	For DHCP relay configuration, this field displays the first remote DHCP server IP address.
Delete	Select the configuration entries you want to remove in the Delete column and click the Delete button to remove them.
Cancel	Click Cancel to clear the Delete check boxes.

37.4.7 DHCPv4 VLAN Port Configure

Use this screen to apply a different DHCP option 82 profile to certain ports in a VLAN. To open this screen, click **IP Application > DHCP > DHCPv4 > VLAN > Port**.

Figure 180 IP Application > DHCP > DHCPv4 > VLAN > Port

The following table describes the labels in this screen.

Table 132 IP Application > DHCP > DHCPv4 > VLAN > Port

LABEL	DESCRIPTION
VID	Enter the ID number of the VLAN you want to configure here.
Port	Enter the number of port(s) to which you want to apply the specified DHCP option 82 profile. You can enter multiple ports separated by (no space) comma (,) or hyphen (-). For example, enter "3-5" for ports 3, 4, and 5. Enter "3,5,7" for ports 3, 5, and 7.
Option 82 Profile	Select a pre-defined DHCP option 82 profile that the Switch applies to the specified port(s) in this VLAN. The Switch adds the Circuit ID sub-option and/or Remote ID sub-option specified in the profile to DHCP requests that it relays to a DHCP server. The profile you select here has priority over the one you select in the DHCP > DHCPv4 > VLAN screen.
Add	Click this to create a new entry or to update an existing one. This saves your changes to the Switch's run-time memory. The Switch loses these changes if it is turned off or loses power, so use the Save link on the top navigation panel to save your changes to the non-volatile memory when you are done configuring.
Cancel	Click this to reset the values above based on the last selected entry or, if not applicable, to clear the fields above.
Clear	Click Clear to reset the fields to the factory defaults.
Index	This field displays a sequential number for each entry. Click an index number to change the settings.
VID	This field displays the VLAN to which the port(s) belongs.
Port	This field displays the port(s) to which the Switch applies the settings.
Profile Name	This field displays the DHCP option 82 profile that the Switch applies to the specified port(s) in this VLAN.
Delete	Select the entry(ies) that you want to remove in the Delete column, then click the Delete button to remove the selected entry(ies) from the table.
Cancel	Click this to clear the check boxes in the Delete column.

37.4.8 Example: DHCPv4 Relay for Two VLANs

The following example displays two VLANs (VIDs 1 and 2) for a campus network. Two DHCP servers are installed to serve each VLAN. The system is set up to forward DHCP requests from the

dormitory rooms (VLAN 1) to the DHCP server with an IP address of 192.168.1.100. Requests from the academic buildings (VLAN 2) are sent to the other DHCP server with an IP address of 172.16.10.100.

Figure 181 DHCP Relay for Two VLANs

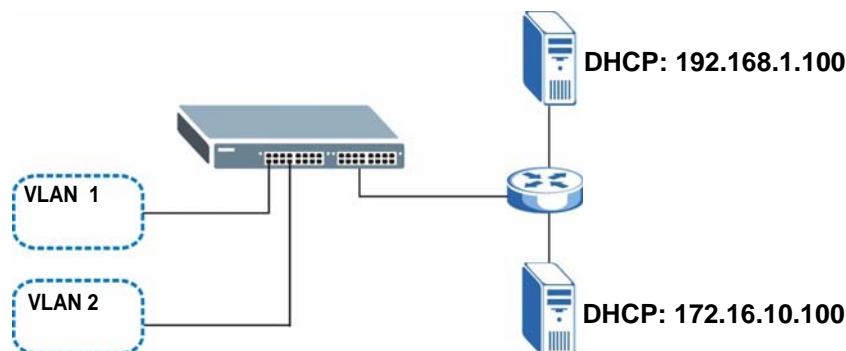

For the example network, configure the **VLAN Setting** screen as shown.

Figure 182 DHCPv4 Relay for Two VLANs Configuration Example

The screenshot shows the 'VLAN Setting' configuration screen. The top section is for configuring DHCP relay for a specific VLAN. The 'VID' field is set to 2. The 'Remote DHCP Server 1' field is set to 172.16.10.100, 'Remote DHCP Server 2' is set to 0.0.0.0, and 'Remote DHCP Server 3' is set to 0.0.0.0. There are 'Add', 'Cancel', and 'Clear' buttons below this section. The bottom section shows a table of existing configurations:

VID	Type	DHCP Status	Delete
1	Relay	192.168.1.100	<input type="checkbox"/>

There are 'Delete' and 'Cancel' buttons below the table.

37.5 DHCPv6 Relay

A DHCPv6 relay agent is on the same network as the DHCPv6 clients and helps forward messages between the DHCPv6 server and clients. When a client cannot use its link-local address and a well-known multicast address to locate a DHCPv6 server on its network, it then needs a DHCPv6 relay agent to send a message to a DHCPv6 server that is not attached to the same network.

The DHCPv6 relay agent can add the remote identification (remote-ID) option and the interface-ID option to the Relay-Forward DHCPv6 messages. The remote-ID option carries a user-defined string, such as the system name. The interface-ID option provides slot number, port information and the VLAN ID to the DHCPv6 server. The remote-ID option (if any) is stripped from the Relay-Reply messages before the relay agent sends the packets to the clients. The DHCPv6 server copies the interface-ID option from the Relay-Forward message into the Relay-Reply message and sends it to the relay agent. The interface-ID should not change even after the relay agent restarts.

Use this screen to configure DHCPv6 relay settings for a specific VLAN on the Switch. Click **IP Application > DHCP > DHCPv6** in the navigation panel to display the screen as shown.

Figure 183 IP Application > DHCP > DHCPv6

The following table describes the labels in this screen.

Table 133 IP Application > DHCP > DHCPv6

LABEL	DESCRIPTION
VID	Enter the ID number of the VLAN you want to configure here.
Helper Address	Enter the remote DHCPv6 server address for the specified VLAN.
Options Profile	Select a pre-defined DHCPv6 options profile that the Switch applies to all ports in this VLAN. The Switch adds the interface-ID sub-option, remote-ID sub-option and/or subscriber-ID sub-option specified in the profile to DHCP requests that it relays to a DHCP server.
Add	Click this to create a new entry or to update an existing one. This saves your changes to the Switch's run-time memory. The Switch loses these changes if it is turned off or loses power, so use the Save link on the top navigation panel to save your changes to the non-volatile memory when you are done configuring.
Cancel	Click Cancel to reset the fields to their last saved values.
Clear	Click Clear to reset the fields to the factory defaults.
VID	This field displays the VLAN ID number. Click the VLAN ID to change the settings.
Helper Address	This field displays the IPv6 address of the remote DHCPv6 server for this VLAN.
Profile Name	This field displays the DHCPv6 options profile that the Switch applies to the port(s) in this VLAN.
Delete	Select the entry(ies) that you want to remove in the Delete column, then click the Delete button to remove the selected entry(ies) from the table.
Cancel	Click this to clear the check boxes in the Delete column.

37.5.1 DHCPv6 Options Profile

Use this screen to create DHCPv6 options profiles. Click **IP Application > DHCP > DHCPv6** in the navigation panel and click the **Options Profile** link to display the screen as shown.

Figure 184 IP Application > DHCP > DHCPv6 > Options Profile

DHCPv6 Options Profile [DHCPv6 Relay](#)

Profile Setup

Name

Option18 Interface-ID Enable

Option37 Remote-ID Enable
 mac

Option38 Subscriber-ID Enable
 slot-port

Rule Usage: 1 / 64

Profile Name	Option18	Option37	Option38	Referenced	Delete
default	Disable	-	-	No	<input type="checkbox"/>

The following table describes the labels in this screen.

Table 134 IP Application > DHCP > DHCPv6 > Options Profile

LABEL	DESCRIPTION
Name	Enter a descriptive name for the profile for identification purposes. You can use up to 32 ASCII characters. Spaces are allowed.
Option 18 Interface ID	Select Enable to have the Switch add the interface-ID option in the DHCPv6 requests from the clients before the Switch forwards them to a DHCPv6 server. Enter a string of up to 64 printable characters to be carried in the interface-ID option.
Option 37 Remote ID	Select Enable to have the Switch add the remote-ID option in the DHCPv6 requests from the clients before the Switch forwards them to a DHCPv6 server. Select mac to have the Switch add its MAC address to the client DHCPv6 requests that it relays to a DHCP server. Enter a string of up to 64 printable characters to be carried in the remote-ID option.
Option 38 Subscriber-ID	Select Enable to have the Switch add the Subscriber-ID option to client DHCPv6 requests that it relays to a DHCPv6 server. Select slot-port to have the Switch add the number of port that the DHCPv6 client is connected to. Enter a string of up to 64 printable characters to be carried in the subscriber-ID option.

Table 134 IP Application > DHCP > DHCPv6 > Options Profile (continued)

LABEL	DESCRIPTION
Add	Click this to create a new entry or to update an existing one. This saves your changes to the Switch's run-time memory. The Switch loses these changes if it is turned off or loses power, so use the Save link on the top navigation panel to save your changes to the non-volatile memory when you are done configuring.
Cancel	Click Cancel to reset the fields to their last saved values.
Profile Name	This field displays the descriptive name of the profile. Click the name to change the settings.
Option18	This field displays whether the Interface-ID option is added to client DHCP requests.
Option37	This field displays the information that is included in the Remote-ID option.
Option38	This field displays the information that is included in the Subscriber-ID option.
Referenced	This field displays whether this profile is in use by a feature, such as DHCPv6 relay.
Delete	Check the entry(ies) that you want to remove in the Delete column and then click the Delete button.
Cancel	Click Cancel to clear the selected checkbox(es) in the Delete column.

37.5.2 DHCPv6 Port Configure

Use this screen to apply a different DHCPv6 options profile to certain ports in a VLAN. To open this screen, click **IP Application > DHCP > DHCPv6 > Port**.

Figure 185 IP Application > DHCP > DHCPv6 > Port

The following table describes the labels in this screen.

Table 135 IP Application > DHCP > DHCPv6 > Port

LABEL	DESCRIPTION
VID	Enter the ID number of the VLAN you want to configure here.
Port	Enter the number of port(s) to which you want to apply the specified DHCPv6 options profile. You can enter multiple ports separated by (no space) comma (,) or hyphen (-). For example, enter "3-5" for ports 3, 4, and 5. Enter "3,5,7" for ports 3, 5, and 7.
Options Profile	Select a pre-defined DHCPv6 options profile that the Switch applies to the specified port(s) in this VLAN. The profile you select here has priority over the one you select in the DHCP > DHCPv6 screen.

Table 135 IP Application > DHCP > DHCPv6 > Port (continued)

LABEL	DESCRIPTION
Add	Click this to create a new entry or to update an existing one. This saves your changes to the Switch's run-time memory. The Switch loses these changes if it is turned off or loses power, so use the Save link on the top navigation panel to save your changes to the non-volatile memory when you are done configuring.
Cancel	Click this to reset the values above based on the last selected entry or, if not applicable, to clear the fields above.
Clear	Click Clear to reset the fields to the factory defaults.
Index	This field displays a sequential number for each entry. Click an index number to change the settings.
VID	This field displays the VLAN to which the port(s) belongs.
Port	This field displays the port(s) to which the Switch applies the settings.
Profile Name	This field displays the DHCPv6 options profile that the Switch applies to the specified port(s) in this VLAN.
Delete	Select the entry(ies) that you want to remove in the Delete column, then click the Delete button to remove the selected entry(ies) from the table.
Cancel	Click this to clear the check boxes in the Delete column.

ARP Learning

38.1 ARP Overview

Address Resolution Protocol (ARP) is a protocol for mapping an Internet Protocol address (IP address) to a physical machine address, also known as a Media Access Control or MAC address, on the local area network.

An IP (version 4) address is 32 bits long. In an Ethernet LAN, MAC addresses are 48 bits long. The ARP table maintains an association between each MAC address and its corresponding IP address.

38.1.0.1 How ARP Works

When an incoming packet destined for a host device on a local area network arrives at the Switch, the Switch looks in the ARP Table and if it finds the address, it sends it to the device.

If no entry is found for the IP address, ARP broadcasts the request to all the devices on the LAN. The Switch fills in its own MAC and IP address in the sender address fields, and puts the known IP address of the target in the target IP address field. In addition, the Switch puts all ones in the target MAC field (FF.FF.FF.FF.FF.FF is the Ethernet broadcast address). The replying device (which is either the IP address of the device being sought or the router that knows the way) replaces the broadcast address with the target's MAC address, swaps the sender and target pairs, and unicasts the answer directly back to the requesting machine. ARP updates the ARP Table for future reference and then sends the packet to the MAC address that replied.

38.1.0.2 ARP Learning Mode

The Switch supports three ARP learning modes: ARP-Reply, Gratuitous-ARP, and ARP-Request.

ARP-Reply

The Switch in ARP-Reply learning mode updates the ARP table only with the ARP replies to the ARP requests sent by the Switch. This can help prevent ARP spoofing.

In the following example, the Switch does not have IP address and MAC address mapping information for hosts **A** and **B** in its ARP table, and host **A** wants to ping host **B**. Host **A** sends an ARP request to the Switch and then sends an ICMP request after getting the ARP reply from the Switch. The Switch finds no matched entry for host **B** in the ARP table and broadcasts the ARP request to all the devices on the LAN. When the Switch receives the ARP reply from host **B**, it updates its ARP table and also forwards host **A**'s ICMP request to host **B**. After the Switch gets the

ICMP reply from host **B**, it sends out an ARP request to get host **A**'s MAC address and updates the ARP table with host **A**'s ARP reply. The Switch then can forward host **B**'s ICMP reply to host **A**.

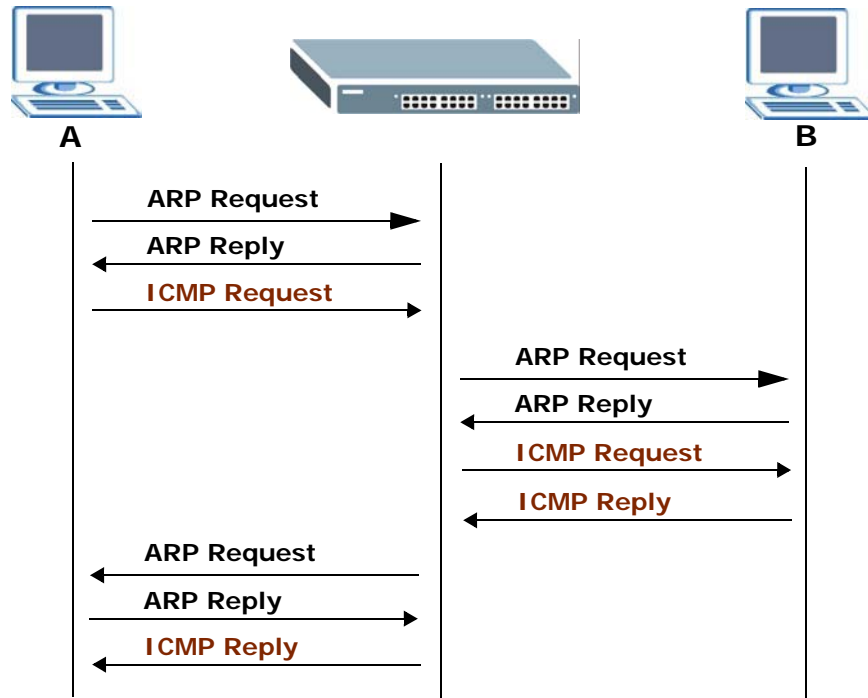

Gratuitous-ARP

A gratuitous ARP is an ARP request in which both the source and destination IP address fields are set to the IP address of the device that sends this request and the destination MAC address field is set to the broadcast address. There will be no reply to a gratuitous ARP request.

A device may send a gratuitous ARP packet to detect IP collisions. If a device restarts or its MAC address is changed, it can also use gratuitous ARP to inform other devices in the same network to update their ARP table with the new mapping information.

In Gratuitous-ARP learning mode, the Switch updates its ARP table with either an ARP reply or a gratuitous ARP request.

ARP-Request

When the Switch is in ARP-Request learning mode, it updates the ARP table with both ARP replies, gratuitous ARP requests and ARP requests.

Therefore in the following example, the Switch can learn host **A**'s MAC address from the ARP request sent by host **A**. The Switch then forwards host **B**'s ICMP reply to host **A** right after getting host **B**'s MAC address and ICMP reply.

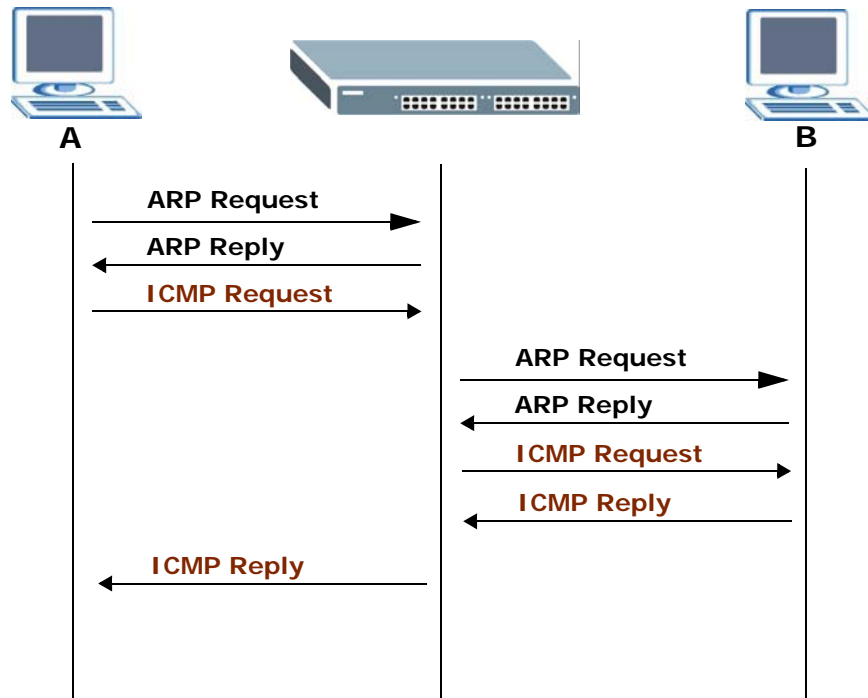

38.2 ARP Learning

Use this screen to configure each port's ARP learning mode. Click **IP Application > ARP Learning** in the navigation panel to display the screen as shown next.

Figure 186 IP Application > ARP Learning

Port	ARP Learning Mode
*	ARP-Reply ▼
1	ARP-Reply ▼
2	ARP-Reply ▼
3	ARP-Reply ▼
4	ARP-Reply ▼
5	ARP-Reply ▼
6	ARP-Reply ▼
7	ARP-Reply ▼
8	ARP-Reply ▼
9	ARP-Reply ▼
10	ARP-Reply ▼
11	ARP-Reply ▼
12	ARP-Reply ▼
13	ARP-Reply ▼
14	ARP-Reply ▼
15	ARP-Reply ▼
16	ARP-Reply ▼

Apply Cancel

The following table describes the labels in this screen.

Table 136 IP Application > ARP Learning

LABEL	DESCRIPTION
Port	This field displays the port number.
*	Settings in this row apply to all ports. Use this row only if you want to make some settings the same for all ports. Use this row first to set the common settings and then make adjustments on a port-by-port basis. Changes in this row are copied to all the ports as soon as you make them.
ARP Learning Mode	Select the ARP learning mode the Switch uses on the port. Select ARP-Reply to have the Switch update the ARP table only with the ARP replies to the ARP requests sent by the Switch. Select Gratuitous-ARP to have the Switch update its ARP table with either an ARP reply or a gratuitous ARP request. Select ARP-Request to have the Switch update the ARP table with both ARP replies, gratuitous ARP requests and ARP requests.
Apply	Click Apply to save your changes to the Switch's run-time memory. The Switch loses these changes if it is turned off or loses power, so use the Save link on the top navigation panel to save your changes to the non-volatile memory when you are done configuring.
Cancel	Click Cancel to begin configuring this screen afresh.

Maintenance

This chapter explains how to configure the screens that let you maintain the firmware and configuration files.

39.1 The Maintenance Screen

Use this screen to manage firmware and your configuration files. Click **Management > Maintenance** in the navigation panel to open the following screen.

Figure 187 Management > Maintenance



The following table describes the labels in this screen.

Table 137 Management > Maintenance

LABEL	DESCRIPTION
Current	This field displays which configuration (Configuration 1 or Configuration 2) is currently operating on the Switch.
Firmware Upgrade	Click Click Here to go to the Firmware Upgrade screen.
Restore Configuration	Click Click Here to go to the Restore Configuration screen.
Backup Configuration	Click Click Here to go to the Backup Configuration screen.
Load Factory Default	Click Click Here to reset the configuration to the factory default settings.
Save Configuration	Click Config 1 to save the current configuration settings to Configuration 1 on the Switch. Click Config 2 to save the current configuration settings to Configuration 2 on the Switch.
Reboot System	Click Click Here to go to the Reboot System screen.
Tech-Support	Click Click Here to see the Tech-Support screen. You can set CPU and memory thresholds for log reports and download related log reports for issue analysis. Log reports include CPU history and utilization, crash and memory.

39.2 Load Factory Default

Follow the steps below to reset the Switch back to the factory defaults.

- 1 In the **Maintenance** screen, click the **Click Here** button next to **Load Factory Default** to clear all Switch configuration information you configured and return to the factory defaults.
- 2 Click **OK** to reset all Switch configurations to the factory defaults.

Figure 188 Load Factory Default: Start

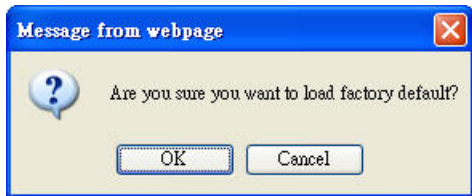

- 3 In the web configurator, click the **Save** button in the top of the screen to make the changes take effect. If you want to access the Switch web configurator again, you may need to change the IP address of your computer to be in the same subnet as that of the default Switch IP address (192.168.1.1).

39.3 Save Configuration

Click **Config 1** to save the current configuration settings permanently to **Configuration 1** on the Switch.

Click **Config 2** to save the current configuration settings to **Configuration 2** on the Switch.

Alternatively, click **Save** on the top right-hand corner in any screen to save the configuration changes to the current configuration.

Note: Clicking the **Apply** or **Add** button does NOT save the changes permanently. All unsaved changes are erased after you reboot the Switch.

39.4 Reboot System

Reboot System allows you to restart the Switch without physically turning the power off. It also allows you to load configuration one (**Config 1**) or configuration two (**Config 2**) when you reboot. You can restart the Switch immediately or set the Switch to restart at a specific time.

Click **Management** > **Maintenance** > **Reboot System** to view the screen as shown next.

Figure 189 Management > Maintenance > Reboot System

Reboot System Maintenance

Reboot Scheduled in	0 days : 22 hours : 59 minutes : 55 seconds (approximately at 21:44:47 UTC, Fri 1970-01-02)	
Reboot Reason	Example	
Boot Image	Config: 1	Current: 1
Configuration File	Config: 2	Current: 1

Refresh Cancel

Reboot System

Immediately
 Delayed (in 24 days)

Time(hh:mm) in [] : []
Time(hh:mm) at [] : []
Date(mm-dd) [] - [] (Optional)

Reason []

Configuration File 1 ▾

Apply

The following table describes the labels in this screen.

Table 138 Management > Maintenance > Reboot System

LABEL	DESCRIPTION
Reboot Scheduled in	This displays the number of days, hours, minutes and/or seconds remaining before the Switch restarts. It also shows the date and time at which the Switch is scheduled to restart automatically.
Reboot Reason	This shows the reason for the restart.
Boot Image	This displays which firmware (1 or 2) should load when the Switch restarts and which firmware is currently in use on the Switch (1 or 2).
Configuration File	This displays which configuration file (1 or 2) should load when the Switch restarts and which configuration file is currently in use on the Switch (1 or 2).
Refresh	Click Refresh to update the time information in the Reboot Scheduled in field.
Cancel	Click Cancel to begin configuring this screen afresh.
Reboot System	Select Immediately to have the Switch restart right after you click Apply . Select Delayed (in 24 days) to schedule a time for the restart to happen. <ul style="list-style-type: none"> Select in to specify how many hours and minutes remain for the restart. Select at to configure a specific time of the day, at which the Switch restarts. You can also specify a date within 24 days of today's date.
Reason	Enter a description for the restart.
Configuration File	Select the configuration files you want the Switch to use when it restarts.
Apply	Click Apply to save your changes to the Switch's run-time memory. The Switch loses these changes if it is turned off or loses power, so use the Save link on the top navigation panel to save your changes to the non-volatile memory when you are done configuring.

39.5 Firmware Upgrade

Make sure you have downloaded (and unzipped) the correct model firmware and version to your computer before uploading to the device.

Firmware is uploaded to the current image. See [Section 39.9 on page 300](#) for more information about images and uploading firmware to a different image.

Be sure to upload the correct model firmware as uploading the wrong model firmware may damage your device.

Click **Management** > **Maintenance** > **Firmware Upgrade** to view the screen as shown next.

Figure 190 Management > Maintenance > Firmware Upgrade

Type the path and file name of the firmware file you wish to upload to the Switch in the **File Path** text box or click **Browse** to locate it. Select the **Rebooting** check box if you want to reboot the Switch and apply the new firmware immediately. (Firmware upgrades are only applied after a reboot). Click **Upgrade** to load the new firmware.

After the firmware upgrade process is complete, see the **System Info** screen to verify your current firmware version number.

39.6 Restore a Configuration File

Restore a previously saved configuration from your computer to the Switch using the **Restore Configuration** screen.

Figure 191 Management > Maintenance > Restore Configuration

Type the path and file name of the configuration file you wish to restore in the **File Path** text box or click **Browse** to locate it. After you have specified the file, click **Restore**. "config" is the name of

the configuration file on the Switch, so your backup configuration file is automatically renamed when you restore using this screen.

39.7 Backup a Configuration File

Backing up your Switch configurations allows you to create various “snap shots” of your device from which you may restore at a later date.

Back up your current Switch configuration to a computer using the **Backup Configuration** screen.

Figure 192 Management > Maintenance > Backup Configuration

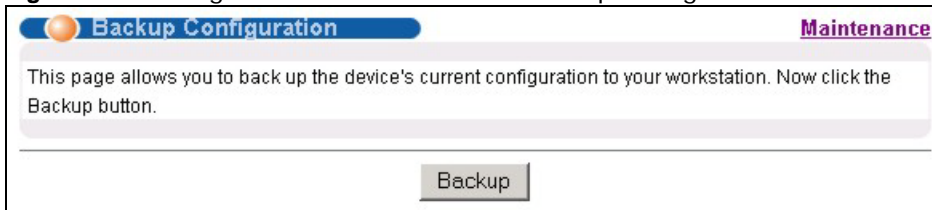

Follow the steps below to back up the current Switch configuration to your computer in this screen.

- 1 Click **Backup**.
- 2 Click **Save** to display the **Save As** screen.
- 3 If the current configuration file is open and/or downloaded to your computer automatically, you can click **File > Save As** to save the file to a specific place.

If a dialog box pops up asking whether you want to open or save the file, click **Save** or **Save File** to download it to the default downloads folder on your computer. If a **Save As** screen displays after you click **Save** or **Save File**, choose a location to save the file on your computer from the **Save in** drop-down list box and type a descriptive name for it in the **File name** list box. Click **Save** to save the configuration file to your computer.

39.8 Tech-Support

The Tech-Support feature is a log enhancement tool that logs useful information such as CPU utilization history, memory and Mbuf (Memory Buffer) log and crash reports for issue analysis by customer support should you have difficulty with your Switch. The Tech Support menu eases your effort in obtaining reports and it is also available in CLI command by typing “Show tech-support” command.

Click **Management > Maintenance > Tech-Support** to see the following screen.

Figure 193 Management > Maintenance > Tech-Support

Tech-Support	
CPU Loading	threshold 80 keep 5 seconds
Mbuf Usage	threshold 50 %
<input type="button" value="Apply"/> <input type="button" value="Cancel"/>	
All	Download
Crash Dump	Download
CPU Loading History	Download
Memory Usage	Download
Mbuf Usage	Download
ROM File	Download

You may need WordPad or similar software to see the log report correctly. The table below describes the fields in the above screen.

Table 139 Management > Maintenance > Tech-Support

LABEL	DESCRIPTION
CPU Loading	Type a number ranging from 50 to 100 in the CPU threshold box, and type another number ranging from 5 to 60 in the seconds box then click Apply . For example, 80 for CPU threshold and 5 for seconds means a log will be created when CPU utilization reaches over 80% and lasts for 5 seconds. The log report holds 7 days of CPU log data and is stored in volatile memory (RAM). The data is lost if the Switch is turned off or in event of power outage. After 7 days, the logs wrap around and new ones and replace the earliest ones. The higher the CPU threshold number, the fewer logs will be created, and the less data technical support will have to analyze and vice versa.
Mbuf Usage	Type a number ranging from 50 to 100 in the Mbuf (Memory Buffer) threshold box. The Mbuf log report is stored in flash (permanent) memory. For example, Mbuf 50 means a log will be created when the Mbuf utilization is over 50%. The higher the Mbuf threshold number, the fewer logs will be created, and the less data technical support will have to analyze and vice versa.
Apply	Click Apply to save your changes to the Switch's run-time memory. The Switch loses these changes if it is turned off or loses power, so use the Save link on the top navigation panel to save your changes to the non-volatile memory when you are done configuring.
Cancel	Click Cancel to begin configuring this screen afresh.
All	Click Download to see all the log report and system status. This log report is stored in flash memory. If the All log report is too large, you can download the log reports separately below.
Crash Dump	Click Download to see the crash log report. The log will include information of the last crash and is stored in flash memory.
CPU Loading History	Click Download to see the CPU loading history log report. The 7-days log is stored in RAM and you will need to save it, otherwise it will be lost when the Switch is shutdown or during power outage.
Memory Usage	Click Download to see the memory usage log report. This log report is stored in flash memory.

Table 139 Management > Maintenance > Tech-Support

LABEL	DESCRIPTION
Mbuf Usage	Click Download to see the Mbuf usage log report. The log includes Mbuf over threshold information. This log report is stored in flash memory.
ROM File	Click Download to see the Read Only Memory (ROM) log report. This report is stored in flash memory.

39.9 FTP Command Line

This section shows some examples of uploading to or downloading files from the Switch using FTP commands. First, understand the filename conventions.

39.9.1 Filename Conventions

The configuration file (also known as the romfile or ROM) contains the factory default settings in the screens such as password, Switch setup, IP Setup, and so on. Once you have customized the Switch's settings, they can be saved back to your computer under a filename of your choosing.

ZyNOS (ZyXEL Network Operating System sometimes referred to as the "ras" file) is the system firmware and has a "bin" filename extension.

Table 140 Filename Conventions

FILE TYPE	INTERNAL NAME	EXTERNAL NAME	DESCRIPTION
Configuration File	config	*.cfg	This is the configuration filename on the Switch. Uploading the config file replaces the specified configuration file system, including your Switch configurations, system-related data (including the default password), the error log and the trace log.
Firmware	ras-0 ras-1	*.bin	This is the generic name for the ZyNOS firmware on the Switch. <i>ras-0</i> is image 1; <i>ras-1</i> is image 2.

You can store up to two images, or firmware files of the same device model, on the Switch. Only one image is used at a time.

- Run the `boot image <1|2>` command to specify which image is updated when firmware is loaded using the web configurator and to specify which image is loaded when the Switch starts up.
- You can also use FTP commands to upload firmware to any image.

The Switch supports dual firmware images, *ras-0* and *ras-1*. You can switch from one to the other by using the `boot image <index>` command, where *<index>* is 1 (*ras-0*) or 2 (*ras-1*). See the CLI Reference Guide for more information about using commands. The system does not reboot after it switches from one image to the other.

39.9.1.1 Example FTP Commands

```
ftp> put firmware.bin ras-0
```

This is a sample FTP session showing the transfer of the computer file "firmware.bin" to the Switch.

```
ftp> get config config.cfg
```

This is a sample FTP session saving the current configuration to a file called "config.cfg" on your computer.

If your (T)FTP client does not allow you to have a destination filename different than the source, you will need to rename them as the Switch only recognizes "config", "ras-0", and "ras-1". Be sure you keep unaltered copies of all files for later use.

Be sure to upload the correct model firmware as uploading the wrong model firmware may damage your device.

39.9.2 FTP Command Line Procedure

- 1 Launch the FTP client on your computer.
- 2 Enter `open`, followed by a space and the IP address of your Switch.
- 3 Press [ENTER] when prompted for a username.
- 4 Enter your password as requested (the default is "1234").
- 5 Enter `bin` to set transfer mode to binary.
- 6 Use `put` to transfer files from the computer to the Switch, for example, `put firmware.bin ras-0` transfers the firmware on your computer (firmware.bin) to the Switch and renames it to "ras-0". Similarly, `put config.cfg config` transfers the configuration file on your computer (config.cfg) to the Switch and renames it to "config". Likewise `get config config.cfg` transfers the configuration file on the Switch to your computer and renames it to "config.cfg". See [Table 140 on page 300](#) for more information on filename conventions.
- 7 Enter `quit` to exit the ftp prompt.

39.9.3 GUI-based FTP Clients

The following table describes some of the commands that you may see in GUI-based FTP clients.

General Commands for GUI-based FTP Clients

COMMAND	DESCRIPTION
Host Address	Enter the address of the host server.
Login Type	Anonymous. This is when a user I.D. and password is automatically supplied to the server for anonymous access. Anonymous logins will work only if your ISP or service administrator has enabled this option. Normal. The server requires a unique User ID and Password to login.
Transfer Type	Transfer files in either ASCII (plain text format) or in binary mode. Configuration and firmware files should be transferred in binary mode.
Initial Remote Directory	Specify the default remote directory (path).
Initial Local Directory	Specify the default local directory (path).

39.9.4 FTP Restrictions

FTP will not work when:

- FTP service is disabled in the **Service Access Control** screen.
- The IP address(es) in the **Remote Management** screen does not match the client IP address. If it does not match, the Switch will disconnect the FTP session immediately.

Access Control

This chapter describes how to control access to the Switch.

40.1 Access Control Overview

A console port and FTP are allowed one session each, Telnet and SSH share nine sessions, up to five Web sessions (five different user names and passwords) and/or limitless SNMP access control sessions are allowed.

Table 141 Access Control Overview

Console Port	SSH	Telnet	FTP	Web	SNMP
One session	Share up to nine sessions		One session	Up to five accounts	No limit

A console port access control session and Telnet access control session cannot coexist when multi-login is disabled. See the CLI Reference Guide for more information on disabling multi-login.

40.2 The Access Control Main Screen

Click **Management** > **Access Control** in the navigation panel to display the main screen as shown.

Figure 194 Management > Access Control

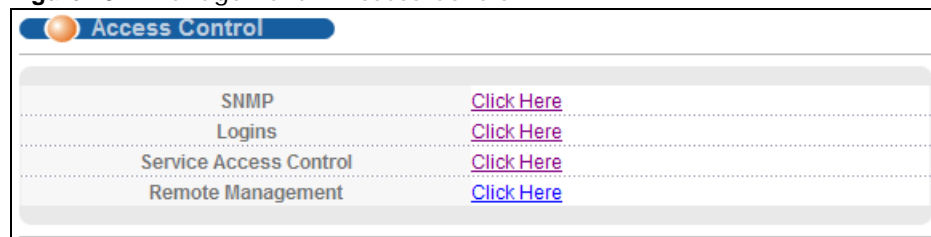

40.3 About SNMP

Simple Network Management Protocol (SNMP) is an application layer protocol used to manage and monitor TCP/IP-based devices. SNMP is used to exchange management information between the network management system (NMS) and a network element (NE). A manager station can manage and monitor the Switch through the network via SNMP version one (SNMPv1), SNMP version 2c or

SNMP version 3. The next figure illustrates an SNMP management operation. SNMP is only available if TCP/IP is configured.

Figure 195 SNMP Management Model

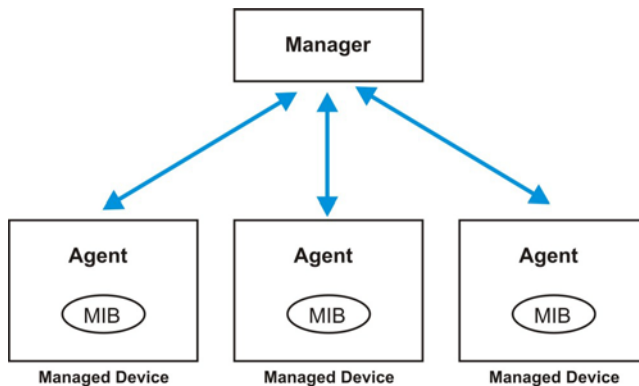

An SNMP managed network consists of two main components: agents and a manager.

An agent is a management software module that resides in a managed switch (the Switch). An agent translates the local management information from the managed switch into a form compatible with SNMP. The manager is the console through which network administrators perform network management functions. It executes applications that control and monitor managed devices.

The managed devices contain object variables/managed objects that define each piece of information to be collected about a switch. Examples of variables include number of packets received, node port status and so on. A Management Information Base (MIB) is a collection of managed objects. SNMP allows a manager and agents to communicate for the purpose of accessing these objects.

SNMP itself is a simple request/response protocol based on the manager/agent model. The manager issues a request and the agent returns responses using the following protocol operations:

Table 142 SNMP Commands

COMMAND	DESCRIPTION
Get	Allows the manager to retrieve an object variable from the agent.
GetNext	Allows the manager to retrieve the next object variable from a table or list within an agent. In SNMPv1, when a manager wants to retrieve all elements of a table from an agent, it initiates a Get operation, followed by a series of GetNext operations.
Set	Allows the manager to set values for object variables within an agent.
Trap	Used by the agent to inform the manager of some events.

40.3.1 SNMP v3 and Security

SNMP v3 enhances security for SNMP management. SNMP managers can be required to authenticate with agents before conducting SNMP management sessions.

Security can be further enhanced by encrypting the SNMP messages sent from the managers. Encryption protects the contents of the SNMP messages. When the contents of the SNMP messages are encrypted, only the intended recipients can read them.

40.3.2 Supported MIBs

MIBs let administrators collect statistics and monitor status and performance.

The Switch supports the following MIBs:

- SNMP MIB II (RFC 1213)
- RFC 1157 SNMP v1
- RFC 1493 Bridge MIBs
- RFC 1643 Ethernet MIBs
- RFC 1155 SMI
- RFC 2674 SNMPv2, SNMPv2c
- RFC 1757 RMON
- SNMPv2, SNMPv2c or later version, compliant with RFC 2011 SNMPv2 MIB for IP, RFC 2012 SNMPv2 MIB for TCP, RFC 2013 SNMPv2 MIB for UDP

40.3.3 SNMP Traps

The Switch sends traps to an SNMP manager when an event occurs. The following tables outline the SNMP traps by category.

An OID (Object ID) that begins with “**1.3.6.1.4.1.890.1.5.8**” is defined in private MIBs. Otherwise, it is a standard MIB OID.

The OIDs beginning with “**1.3.6.1.4.1.890.1.5.8.68**” are specific to the MES3500-24 switch.

The OIDs beginning with “**1.3.6.1.4.1.890.1.5.8.57**” are specific to the MES3500-24F switch.

The OIDs beginning with “**1.3.6.1.4.1.890.1.5.8.80**” are specific to the MES3500-10 switch.

Table 143 SNMP System Traps

OPTION	OBJECT LABEL	OBJECT ID	DESCRIPTION
coldstart	coldStart	1.3.6.1.6.3.1.1.5.1	This trap is sent when the Switch is turned on.
warmstart	warmStart	1.3.6.1.6.3.1.1.5.2	This trap is sent when the Switch restarts.
temperature	TemperatureEventOn	1.3.6.1.4.1.890.1.5.8.68.27.2.1	This trap is sent when the temperature goes above or below the normal operating range.
		1.3.6.1.4.1.890.1.5.8.57.27.2.1	
		1.3.6.1.4.1.890.1.5.8.80.27.2.1	
TemperatureEventClear	TemperatureEventClear	1.3.6.1.4.1.890.1.5.8.68.27.2.2	This trap is sent when the temperature returns to the normal operating range.
		1.3.6.1.4.1.890.1.5.8.57.27.2.2	
		1.3.6.1.4.1.890.1.5.8.80.27.2.2	

Table 143 SNMP System Traps (continued)

OPTION	OBJECT LABEL	OBJECT ID	DESCRIPTION
voltage	VoltageEventOn	1.3.6.1.4.1.890.1.5.8.68.27.2.1 1.3.6.1.4.1.890.1.5.8.57.27.2.1 1.3.6.1.4.1.890.1.5.8.80.27.2.1	This trap is sent when the voltage goes above or below the normal operating range.
	VoltageEventClear	1.3.6.1.4.1.890.1.5.8.68.27.2.2 1.3.6.1.4.1.890.1.5.8.57.27.2.2 1.3.6.1.4.1.890.1.5.8.80.27.2.2	This trap is sent when the voltage returns to the normal operating range.
reset	UncontrolledResetEventOn	1.3.6.1.4.1.890.1.5.8.68.27.2.1 1.3.6.1.4.1.890.1.5.8.57.27.2.1 1.3.6.1.4.1.890.1.5.8.80.27.2.1	This trap is sent when the Switch automatically resets.
	ControlledResetEventOn	1.3.6.1.4.1.890.1.5.8.68.27.2.1 1.3.6.1.4.1.890.1.5.8.57.27.2.1 1.3.6.1.4.1.890.1.5.8.80.27.2.1	This trap is sent when the Switch resets by an administrator through a management interface.
	RebootEvent	1.3.6.1.4.1.890.1.5.0.1	This trap is sent when the Switch reboots by an administrator through a management interface.
timesync	RTCNotUpdatedEventOn	1.3.6.1.4.1.890.1.5.8.68.27.2.1 1.3.6.1.4.1.890.1.5.8.57.27.2.1 1.3.6.1.4.1.890.1.5.8.80.27.2.1	This trap is sent when the Switch fails to get the time and date from a time server.
	RTCNotUpdatedEventClear	1.3.6.1.4.1.890.1.5.8.68.27.2.2 1.3.6.1.4.1.890.1.5.8.57.27.2.2 1.3.6.1.4.1.890.1.5.8.80.27.2.2	This trap is sent when the Switch gets the time and date from a time server.
intrusionlock	IntrusionLockEventOn	1.3.6.1.4.1.890.1.5.8.68.27.2.1 1.3.6.1.4.1.890.1.5.8.57.27.2.1 1.3.6.1.4.1.890.1.5.8.80.27.2.1	This trap is sent when intrusion lock occurs on a port.
loopguard	LoopguardEventOn	1.3.6.1.4.1.890.1.5.8.68.27.2.2 1.3.6.1.4.1.890.1.5.8.57.27.2.2 1.3.6.1.4.1.890.1.5.8.80.27.2.2	This trap is sent when loopguard shuts down a port.
errdisable	errdisableDetectTrap	1.3.6.1.4.1.890.1.5.8.68.130.4.1 1.3.6.1.4.1.890.1.5.8.57.130.4.1 1.3.6.1.4.1.890.1.5.8.80.130.4.1	This trap is sent when an error is detected on a port, such as a loop occurs or the rate limit for specific control packets is exceeded.
	errdisableRecoveryTrap	1.3.6.1.4.1.890.1.5.8.68.130.4.2 1.3.6.1.4.1.890.1.5.8.57.130.4.2 1.3.6.1.4.1.890.1.5.8.80.130.4.2	This trap is sent when the Switch ceases the action taken on a port, such as shutting down the port or discarding packets on the port, after the specified recovery interval.

Table 143 SNMP System Traps (continued)

OPTION	OBJECT LABEL	OBJECT ID	DESCRIPTION
externalalarm	ExternalAlarmEventOn	1.3.6.1.4.1.890.1.5.8.68.27.2.1 1.3.6.1.4.1.890.1.5.8.57.27.2.1 1.3.6.1.4.1.890.1.5.8.80.27.2.1	This trap is sent when the external alarm is received.
	ExternalAlarmEventClear	1.3.6.1.4.1.890.1.5.8.68.27.2.2 1.3.6.1.4.1.890.1.5.8.57.27.2.2 1.3.6.1.4.1.890.1.5.8.80.27.2.2	This trap is sent when the external alarm stops sending an alert.
dyinggasp	DyingGaspEventOn	1.3.6.1.4.1.890.1.5.8.68.27.2.1 1.3.6.1.4.1.890.1.5.8.57.27.2.1 1.3.6.1.4.1.890.1.5.8.80.27.2.1	The trap is sent when the device power goes below the normal value.

Table 144 SNMP Interface Traps

OPTION	OBJECT LABEL	OBJECT ID	DESCRIPTION
linkup	linkUp	1.3.6.1.6.3.1.1.5.4	This trap is sent when the Ethernet link is up.
	LinkDownEventClear	1.3.6.1.4.1.890.1.5.8.68.27.2.2 1.3.6.1.4.1.890.1.5.8.57.27.2.2 1.3.6.1.4.1.890.1.5.8.80.27.2.2	This trap is sent when the Ethernet link is up.
linkdown	linkDown	1.3.6.1.6.3.1.1.5.3	This trap is sent when the Ethernet link is down.
	LinkDownEventOn	1.3.6.1.4.1.890.1.5.8.68.27.2.1 1.3.6.1.4.1.890.1.5.8.57.27.2.1 1.3.6.1.4.1.890.1.5.8.80.27.2.1	This trap is sent when the Ethernet link is down.
lldp	LLDPRemoteTopologyChange	1.0.8802.1.1.2.0.0.1	This trap is sent when the LLDP (Link Layer Discovery Protocol) remote topology changes.
transceiver-ddmi	transceiverddmiEventOn	1.3.6.1.4.1.890.1.5.8.68.27.2.1 1.3.6.1.4.1.890.1.5.8.57.27.2.1 1.3.6.1.4.1.890.1.5.8.80.27.2.1	This trap is sent when one of the device operating parameters (such as transceiver temperature, laser bias current, transmitted optical power, received optical power and transceiver supply voltage) is above or below a factory set normal range.
	transceiverddmiEventClear	1.3.6.1.4.1.890.1.5.8.68.27.2.2 1.3.6.1.4.1.890.1.5.8.57.27.2.2 1.3.6.1.4.1.890.1.5.8.80.27.2.2	This trap is sent when all device operating parameters return to the normal operating range.

Table 145 AAA Traps

OPTION	OBJECT LABEL	OBJECT ID	DESCRIPTION
authentication	authenticationFailure	1.3.6.1.6.3.1.1.5.5	This trap is sent when authentication fails due to incorrect user name and/or password.
	AuthenticationFailureEventOn	1.3.6.1.4.1.890.1.5.8.68.27.2.1 1.3.6.1.4.1.890.1.5.8.57.27.2.1 1.3.6.1.4.1.890.1.5.8.80.27.2.1	This trap is sent when authentication fails due to incorrect user name and/or password.
	RADIUSNotReachableEventOn	1.3.6.1.4.1.890.1.5.8.68.27.2.1 1.3.6.1.4.1.890.1.5.8.57.27.2.1 1.3.6.1.4.1.890.1.5.8.80.27.2.1	This trap is sent when there is no response message from the RADIUS server.
	RADIUSNotReachableEventClear	1.3.6.1.4.1.890.1.5.8.68.27.2.2 1.3.6.1.4.1.890.1.5.8.57.27.2.2 1.3.6.1.4.1.890.1.5.8.80.27.2.2	This trap is sent when the RADIUS server can be reached.
accounting	RADIUSNotReachableEventOn	1.3.6.1.4.1.890.1.5.8.68.27.2.1 1.3.6.1.4.1.890.1.5.8.57.27.2.1 1.3.6.1.4.1.890.1.5.8.80.27.2.1	This trap is sent when there is no response message from the RADIUS accounting server.
	RADIUSNotReachableEventClear	1.3.6.1.4.1.890.1.5.8.68.27.2.2 1.3.6.1.4.1.890.1.5.8.57.27.2.2 1.3.6.1.4.1.890.1.5.8.80.27.2.2	This trap is sent when the RADIUS accounting server can be reached.

Table 146 SNMP IP Traps

OPTION	OBJECT LABEL	OBJECT ID	DESCRIPTION
ping	pingProbeFailed	1.3.6.1.2.1.80.0.1	This trap is sent when a single ping probe fails.
	pingTestFailed	1.3.6.1.2.1.80.0.2	This trap is sent when a ping test (consisting of a series of ping probes) fails.
	pingTestCompleted	1.3.6.1.2.1.80.0.3	This trap is sent when a ping test is completed.
traceroute	traceRoutePathChange	1.3.6.1.2.1.81.0.1	This trap is sent when a path to a target changes.
	traceRouteTestFailed	1.3.6.1.2.1.81.0.2	This trap is sent when a traceroute test fails.
	traceRouteTestCompleted	1.3.6.1.2.1.81.0.3	This trap is sent when a traceroute test is completed.

Table 147 SNMP Switch Traps

OPTION	OBJECT LABEL	OBJECT ID	DESCRIPTION
stp	STPNewRoot	1.3.6.1.2.1.17.0.1	This trap is sent when the STP root switch changes.
	MRSTPNewRoot	1.3.6.1.4.1.890.1.5.8.68.36.2.1	This trap is sent when the MRSTP root switch changes.
		1.3.6.1.4.1.890.1.5.8.57.36.2.1	
		1.3.6.1.4.1.890.1.5.8.80.36.2.1	
	MSTPNewRoot	1.3.6.1.4.1.890.1.5.8.68.107.70.1	This trap is sent when the MSTP root switch changes.
		1.3.6.1.4.1.890.1.5.8.57.107.70.1	
		1.3.6.1.4.1.890.1.5.8.80.107.70.1	
STPTopologyChange	1.3.6.1.2.1.17.0.2	This trap is sent when the STP topology changes.	
MRSTPTopologyChange	1.3.6.1.4.1.890.1.5.8.68.36.2.2	This trap is sent when the MRSTP topology changes.	
	1.3.6.1.4.1.890.1.5.8.57.36.2.2		
	1.3.6.1.4.1.890.1.5.8.80.36.2.2		
MSTPTopologyChange	1.3.6.1.4.1.890.1.5.8.68.107.70.2	This trap is sent when the MSTP root switch changes.	
	1.3.6.1.4.1.890.1.5.8.57.107.70.2		
	1.3.6.1.4.1.890.1.5.8.80.107.70.2		
mactable	MacTableFullEventOn	1.3.6.1.4.1.890.1.5.8.68.27.2.1	This trap is sent when more than 99% of the MAC table is used.
		1.3.6.1.4.1.890.1.5.8.57.27.2.1	
1.3.6.1.4.1.890.1.5.8.80.27.2.1			
MacTableFullEventClear	1.3.6.1.4.1.890.1.5.8.68.27.2.2	This trap is sent when less than 95% of the MAC table is used.	
	1.3.6.1.4.1.890.1.5.8.57.27.2.2		
	1.3.6.1.4.1.890.1.5.8.80.27.2.2		
rmon	RmonRisingAlarm	1.3.6.1.2.1.16.0.1	This trap is sent when a variable goes over the RMON "rising" threshold.
	RmonFallingAlarm	1.3.6.1.2.1.16.0.2	This trap is sent when the variable falls below the RMON "falling" threshold.
cfm	dot1agCfmFaultAlarm	1.3.111.2.802.1.1.8.0.1	The trap is sent when the Switch detects a connectivity fault.

40.3.4 Configuring SNMP

Click **Management** > **Access Control** > **SNMP** to view the screen as shown. Use this screen to configure your SNMP settings.

Figure 196 Management > Access Control > SNMP

SNMP [Access Control](#) [Trap Group](#) [User](#)

General Setting

Version	v2c
Get Community	public
Set Community	public
Trap Community	public

Trap Destination

Version	IP	Port	Username
v2c	0.0.0.0	162	
v2c	0.0.0.0	162	
v2c	0.0.0.0	162	
v2c	0.0.0.0	162	

Apply Cancel

The following table describes the labels in this screen.

Table 148 Management > Access Control > SNMP

LABEL	DESCRIPTION
General Setting	Use this section to specify the SNMP version and community (password) values.
Version	Select the SNMP version for the Switch. The SNMP version on the Switch must match the version on the SNMP manager. Choose SNMP version 2c (v2c), SNMP version 3 (v3) or both (v3v2c). Note: SNMP version 2c is backwards compatible with SNMP version 1.
Get Community	Enter the Get Community string, which is the password for the incoming Get- and GetNext- requests from the management station. The Get Community string is only used by SNMP managers using SNMP version 2c or lower. Note that as you type a password, the screen displays an asterisk (*) for each character you type.
Set Community	Enter the Set Community , which is the password for incoming Set- requests from the management station. The Set Community string is only used by SNMP managers using SNMP version 2c or lower. Note that as you type a password, the screen displays an asterisk (*) for each character you type.
Trap Community	Enter the Trap Community string, which is the password sent with each trap to the SNMP manager. The Trap Community string is only used by SNMP managers using SNMP version 2c or lower. Note that as you type a password, the screen displays an asterisk (*) for each character you type.
Trap Destination	Use this section to configure where to send SNMP traps from the Switch.

Table 148 Management > Access Control > SNMP (continued)

LABEL	DESCRIPTION
Version	Specify the version of the SNMP trap messages.
IP	Enter the IP addresses of up to four managers to send your SNMP traps to.
Port	Enter the port number upon which the manager listens for SNMP traps.
Username	Enter the username to be sent to the SNMP manager along with the SNMP v3 trap. Note: This username must match an existing account on the Switch (configured in the Management > Access Control > SNMP > User screen).
Apply	Click Apply to save your changes to the Switch's run-time memory. The Switch loses these changes if it is turned off or loses power, so use the Save link on the top navigation panel to save your changes to the non-volatile memory when you are done configuring.
Cancel	Click Cancel to begin configuring this screen afresh.

40.3.5 Configuring SNMP Trap Group

Click **Management > Access Control > SNMP > Trap Group** to view the screen as shown. Use the **Trap Group** screen to specify the types of SNMP traps that should be sent to each SNMP manager.

Figure 197 Management > Access Control > SNMP > Trap Group

Type	Options
System <input type="checkbox"/> *	<input type="checkbox"/> coldstart <input type="checkbox"/> warmstart <input type="checkbox"/> temperature <input type="checkbox"/> voltage <input type="checkbox"/> reset <input type="checkbox"/> timesync <input type="checkbox"/> intrusionlock <input type="checkbox"/> loopguard <input type="checkbox"/> erddisable <input type="checkbox"/> externalalarm <input type="checkbox"/> dyinggasp
Interface <input type="checkbox"/> *	<input type="checkbox"/> linkup <input type="checkbox"/> linkdown <input type="checkbox"/> lldp <input type="checkbox"/> oam <input type="checkbox"/> transceiver-ddm
AAA <input type="checkbox"/> *	<input type="checkbox"/> authentication <input type="checkbox"/> accounting
IP <input type="checkbox"/> *	<input type="checkbox"/> ping <input type="checkbox"/> traceroute
Switch <input type="checkbox"/> *	<input type="checkbox"/> stp <input type="checkbox"/> mactable <input type="checkbox"/> rmon <input type="checkbox"/> cfm

The following table describes the labels in this screen.

Table 149 Management > Access Control > SNMP > Trap Group

LABEL	DESCRIPTION
Trap Destination IP	Select one of your configured trap destination IP addresses. These are the IP addresses of the SNMP managers. You must first configure a trap destination IP address in the SNMP Setting screen. Use the rest of the screen to select which traps the Switch sends to that SNMP manager.
Type	Select the categories of SNMP traps that the Switch is to send to the SNMP manager.

Table 149 Management > Access Control > SNMP > Trap Group (continued)

LABEL	DESCRIPTION
Options	Select the individual SNMP traps that the Switch is to send to the SNMP station. See Section 40.3.3 on page 305 for individual trap descriptions. The traps are grouped by category. Selecting a category automatically selects all of the category's traps. Clear the check boxes for individual traps that you do not want the Switch to send to the SNMP station. Clearing a category's check box automatically clears all of the category's trap check boxes (the Switch only sends traps from selected categories).
Apply	Click Apply to save your changes to the Switch's run-time memory. The Switch loses these changes if it is turned off or loses power, so use the Save link on the top navigation panel to save your changes to the non-volatile memory when you are done configuring.
Cancel	Click Cancel to begin configuring this screen afresh.

40.3.6 Enabling/Disabling Sending of SNMP Traps on a Port

From the **SNMP > Trap Group** screen, click **Port** to view the screen as shown. Use this screen to set whether a trap received on the port(s) would be sent to the SNMP manager.

Figure 198 Management > Access Control > SNMP > Trap Group > Port

Port	Active
*	<input type="checkbox"/>
1	<input checked="" type="checkbox"/>
2	<input checked="" type="checkbox"/>
3	<input checked="" type="checkbox"/>
4	<input checked="" type="checkbox"/>
5	<input checked="" type="checkbox"/>
6	<input checked="" type="checkbox"/>
7	<input checked="" type="checkbox"/>
8	<input checked="" type="checkbox"/>
9	<input checked="" type="checkbox"/>

The following table describes the labels in this screen.

Table 150 Management > Access Control > SNMP > Trap Group > Port

LABEL	DESCRIPTION
Option	Select the trap type you want to configure here.
Port	This field displays a port number.
*	Settings in this row apply to all ports. Use this row only if you want to make some of the settings the same for all ports. Use this row first to set the common settings and then make adjustments on a port-by-port basis. Note: Changes in this row are copied to all the ports as soon as you make them.

Table 150 Management > Access Control > SNMP > Trap Group > Port (continued)

LABEL	DESCRIPTION
Active	Select this check box to enable the sending of SNMP traps on this port. The Switch sends the related traps received on this port to the SNMP manager. Clear this check box to disable the sending of SNMP traps on this port.
Apply	Click Apply to save your changes to the Switch's run-time memory. The Switch loses these changes if it is turned off or loses power, so use the Save link on the top navigation panel to save your changes to the non-volatile memory when you are done configuring.
Cancel	Click Cancel to begin configuring this screen afresh.

40.3.7 Configuring SNMP User

From the **SNMP** screen, click **User** to view the screen as shown. Use the **User** screen to create SNMP users for authentication with managers using SNMP v3 and associate them to SNMP groups. An SNMP user is an SNMP manager.

Figure 199 Management > Access Control > SNMP > User

Index	Username	SecurityLevel	Authentication	Privacy	Group	Delete
1	admin	noauth	MD5	DES	admin	<input type="checkbox"/>

The following table describes the labels in this screen.

Table 151 Management > Access Control > SNMP > User

LABEL	DESCRIPTION
User Information	Note: Use the username and password of the login accounts you specify in this screen to create accounts on the SNMP v3 manager.
Username	Specify the username of a login account on the Switch.

Table 151 Management > Access Control > SNMP > User (continued)

LABEL	DESCRIPTION
Security Level	<p>Select whether you want to implement authentication and/or encryption for SNMP communication from this user. Choose:</p> <ul style="list-style-type: none"> • noauth - to use the username as the password string to send to the SNMP manager. This is equivalent to the Get, Set and Trap Community in SNMP v2c. This is the lowest security level. • auth - to implement an authentication algorithm for SNMP messages sent by this user. • priv - to implement authentication and encryption for SNMP messages sent by this user. This is the highest security level. <p>Note: The settings on the SNMP manager must be set at the same security level or higher than the security level settings on the Switch.</p>
Authentication	<p>Select an authentication algorithm. MD5 (Message Digest 5) and SHA (Secure Hash Algorithm) are hash algorithms used to authenticate SNMP data. SHA authentication is generally considered stronger than MD5, but is slower.</p>
Password	<p>Enter the password of up to 32 ASCII characters for SNMP user authentication.</p> <p>Note that as you type a password, the screen displays an asterisk (*) for each character you type.</p>
Privacy	<p>Specify the encryption method for SNMP communication from this user. You can choose one of the following:</p> <ul style="list-style-type: none"> • DES - Data Encryption Standard is a widely used (but breakable) method of data encryption. It applies a 56-bit key to each 64-bit block of data. • AES - Advanced Encryption Standard is another method for data encryption that also uses a secret key. AES applies a 128-bit key to 128-bit blocks of data.
Password	<p>Enter the password of up to 32 ASCII characters for encrypting SNMP packets.</p> <p>Note that as you type a password, the screen displays an asterisk (*) for each character you type.</p>
Group	<p>SNMP v3 adopts the concept of View-based Access Control Model (VACM) group. SNMP managers in one group are assigned common access rights to MIBs. Specify in which SNMP group this user is.</p> <p>admin - Members of this group can perform all types of system configuration, including the management of administrator accounts.</p> <p>readwrite - Members of this group have read and write rights, meaning that the user can create and edit the MIBs on the Switch, except the user account and AAA configuration.</p> <p>readonly - Members of this group have read rights only, meaning the user can collect information from the Switch.</p>
Add	<p>Click Add to insert the entry in the summary table below and save your changes to the Switch's run-time memory. The Switch loses these changes if it is turned off or loses power, so use the Save link on the top navigation panel to save your changes to the non-volatile memory when you are done configuring.</p>
Cancel	<p>Click Cancel to reset the fields to your previous configuration.</p>
Clear	<p>Click Clear to reset the fields to the factory defaults.</p>
Index	<p>This is a read-only number identifying a login account on the Switch. Click on an index number to view more details and edit an existing account.</p>
Username	<p>This field displays the username of a login account on the Switch.</p>
Security Level	<p>This field displays whether you want to implement authentication and/or encryption for SNMP communication with this user.</p>
Authentication	<p>This field displays the authentication algorithm used for SNMP communication with this user.</p>
Privacy	<p>This field displays the encryption method used for SNMP communication with this user.</p>
Group	<p>This field displays the SNMP group to which this user belongs.</p>

Table 151 Management > Access Control > SNMP > User (continued)

LABEL	DESCRIPTION
Delete	Click Delete to remove the selected entry from the summary table.
Cancel	Click Cancel to begin configuring this screen afresh.

40.4 Setting Up Login Accounts

Up to five people (one administrator and four non-administrators) may access the Switch via web configurator at any one time.

- An administrator is someone who can both view and configure Switch changes. The username for the Administrator is always **admin**. The default administrator password is **1234**.

Note: It is highly recommended that you change the default administrator password (**1234**).

- A non-administrator (username is something other than **admin**) is someone who can view but not configure Switch settings.

Click **Management > Access Control > Logins** to view the screen as shown next.

Figure 200 Management > Access Control > Logins

The screenshot shows the 'Logins' configuration page under 'Access Control'. At the top, there is a 'Logins' header and a link to 'Access Control'. Below this is the 'Administrator' section, which contains three password input fields: 'Old Password', 'New Password', and 'Retype to confirm'. A red warning message states: 'Please record your new password whenever you change it. The system will lock you out if you have forgotten your password.' Below the warning is a horizontal line. The 'Edit Logins' section features a table with four columns: 'Login', 'User Name', 'Password', and 'Retype to confirm'. The table has four rows, numbered 1 to 4. At the bottom of the page are 'Apply' and 'Cancel' buttons.

Old Password	New Password	Retype to confirm
<input type="text"/>	<input type="text"/>	<input type="text"/>

Please record your new password whenever you change it. The system will lock you out if you have forgotten your password.

Login	User Name	Password	Retype to confirm
1	<input type="text"/>	<input type="text"/>	<input type="text"/>
2	<input type="text"/>	<input type="text"/>	<input type="text"/>
3	<input type="text"/>	<input type="text"/>	<input type="text"/>
4	<input type="text"/>	<input type="text"/>	<input type="text"/>

Apply Cancel

The following table describes the labels in this screen.

Table 152 Management > Access Control > Logins

LABEL	DESCRIPTION
Administrator	This is the default administrator account with the "admin" user name. You cannot change the default administrator user name. Only the administrator has read/write access.
Old Password	Type the existing system password (1234 is the default password when shipped).
New Password	Enter your new system password.
Retype to confirm	Retype your new system password for confirmation
Edit Logins	You may configure passwords for up to four users. These users have read-only access. You can give users higher privileges via the CLI. For more information on assigning privileges see the Ethernet Switch CLI Reference Guide.
User Name	Set a user name (up to 32 ASCII characters long).
Password	Enter your new system password.
Retype to confirm	Retype your new system password for confirmation
Apply	Click Apply to save your changes to the Switch's run-time memory. The Switch loses these changes if it is turned off or loses power, so use the Save link on the top navigation panel to save your changes to the non-volatile memory when you are done configuring.
Cancel	Click Cancel to begin configuring this screen afresh.

40.5 SSH Overview

Unlike Telnet or FTP, which transmit data in clear text, SSH (Secure Shell) is a secure communication protocol that combines authentication and data encryption to provide secure encrypted communication between two hosts over an unsecured network.

Figure 201 SSH Communication Example



40.6 How SSH works

The following table summarizes how a secure connection is established between two remote hosts.

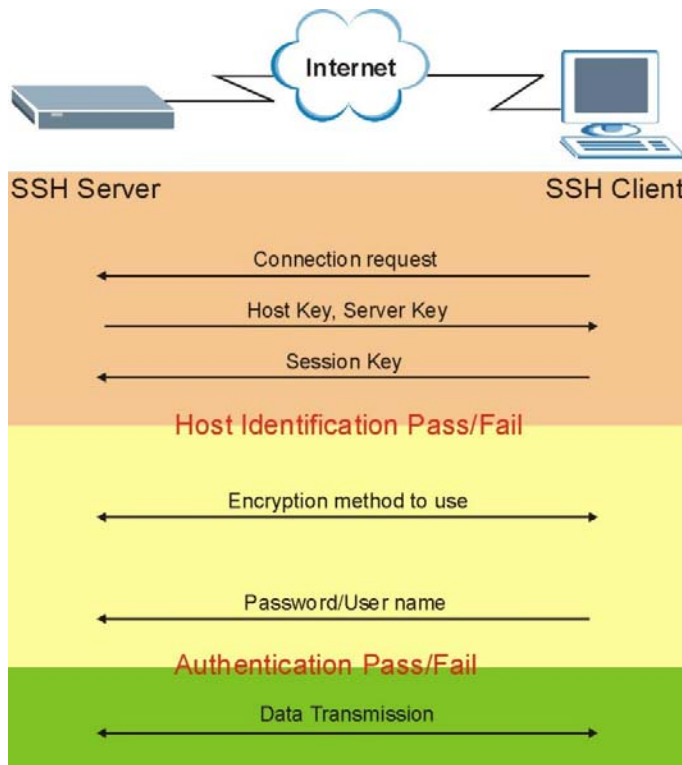
Figure 202 How SSH Works**1** Host Identification

The SSH client sends a connection request to the SSH server. The server identifies itself with a host key. The client encrypts a randomly generated session key with the host key and server key and sends the result back to the server.

The client automatically saves any new server public keys. In subsequent connections, the server public key is checked against the saved version on the client computer.

2 Encryption Method

Once the identification is verified, both the client and server must agree on the type of encryption method to use.

3 Authentication and Data Transmission

After the identification is verified and data encryption activated, a secure tunnel is established between the client and the server. The client then sends its authentication information (user name and password) to the server to log in to the server.

40.7 SSH Implementation on the Switch

Your Switch supports SSH version 2 using RSA authentication and three encryption methods (DES, 3DES and Blowfish). The SSH server is implemented on the Switch for remote management and file transfer on port 22. Only one SSH connection is allowed at a time.

40.7.1 Requirements for Using SSH

You must install an SSH client program on a client computer (Windows or Linux operating system) that is used to connect to the Switch over SSH.

40.8 Introduction to HTTPS

HTTPS (HyperText Transfer Protocol over Secure Socket Layer, or HTTP over SSL) is a web protocol that encrypts and decrypts web pages. Secure Socket Layer (SSL) is an application-level protocol that enables secure transactions of data by ensuring confidentiality (an unauthorized party cannot read the transferred data), authentication (one party can identify the other party) and data integrity (you know if data has been changed).

It relies upon certificates, public keys, and private keys.

HTTPS on the Switch is used so that you may securely access the Switch using the web configurator. The SSL protocol specifies that the SSL server (the Switch) must always authenticate itself to the SSL client (the computer which requests the HTTPS connection with the Switch), whereas the SSL client only should authenticate itself when the SSL server requires it to do so. Authenticating client certificates is optional and if selected means the SSL-client must send the Switch a certificate. You must apply for a certificate for the browser from a CA that is a trusted CA on the Switch.

Please refer to the following figure.

- 1 HTTPS connection requests from an SSL-aware web browser go to port 443 (by default) on the Switch's WS (web server).
- 2 HTTP connection requests from a web browser go to port 80 (by default) on the Switch's WS (web server).

Figure 203 HTTPS Implementation

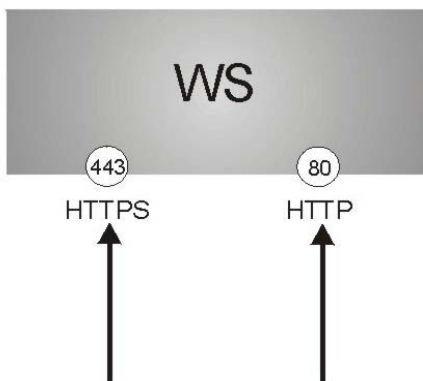

Note: If you disable **HTTP** in the **Service Access Control** screen, then the Switch blocks all HTTP connection attempts.

40.9 HTTPS Example

If you haven't changed the default HTTPS port on the Switch, then in your browser enter "https:// Switch IP Address/" as the web site address where "Switch IP Address" is the IP address or domain name of the Switch you wish to access.

40.9.1 Internet Explorer Warning Messages

40.9.1.1 Internet Explorer 6

When you attempt to access the Switch HTTPS server, a Windows dialog box pops up asking if you trust the server certificate.

You see the following **Security Alert** screen in Internet Explorer. Select **Yes** to proceed to the web configurator login screen; if you select **No**, then web configurator access is blocked.

Figure 204 Security Alert Dialog Box (Internet Explorer 6)

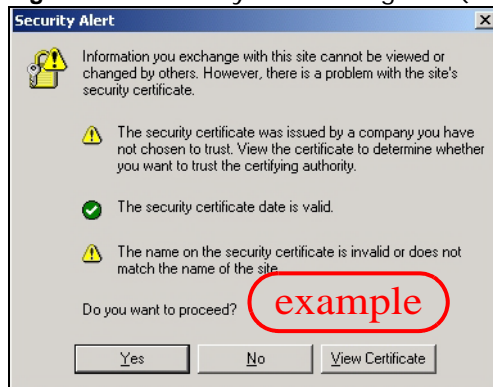

40.9.1.2 Internet Explorer 7 or 8

When you attempt to access the Switch HTTPS server, a screen with the message "There is a problem with this website's security certificate." may display. If that is the case, click **Continue to this website (not recommended)** to proceed to the web configurator login screen.

Figure 205 Security Certificate Warning (Internet Explorer 7 or 8)

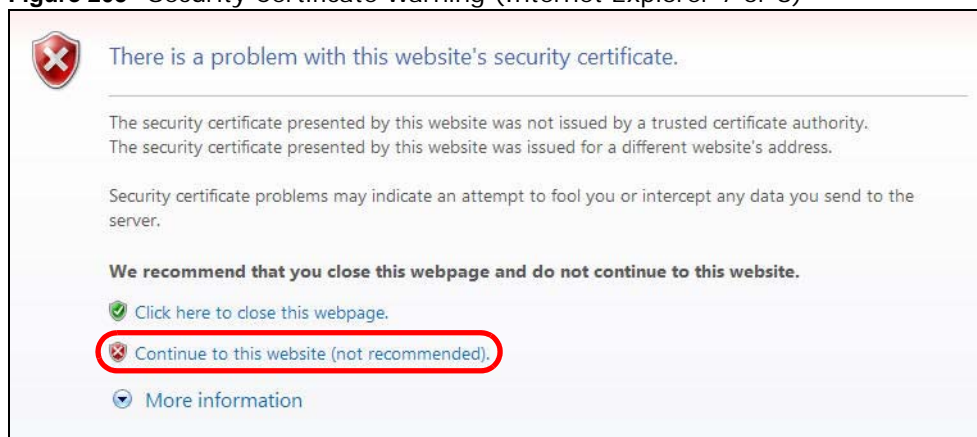

After you log in, you will see the red address bar with the message **Certificate Error**. Click on **Certificate Error** next to the address bar and click **View certificates**.

Figure 206 Certificate Error (Internet Explorer 7 or 8)

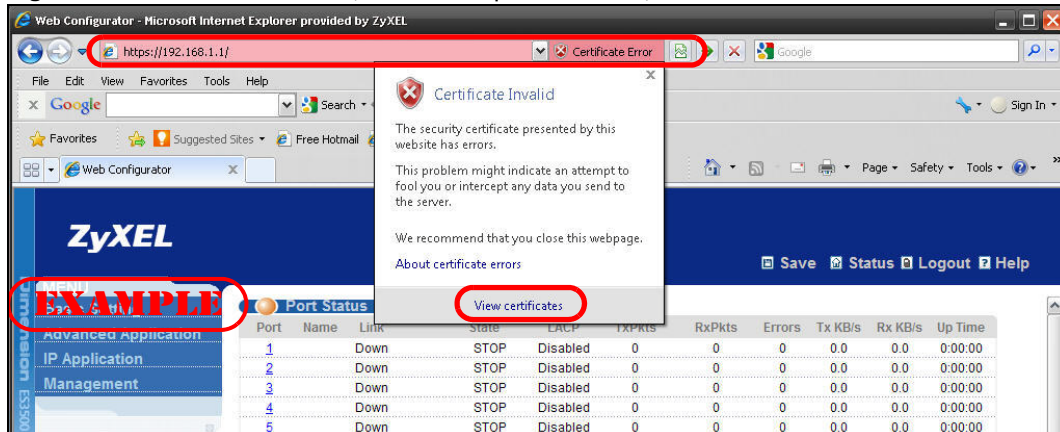

Click **Install Certificate...** and follow the on-screen instructions to install the certificate in your browser.

Figure 207 Certificate (Internet Explorer 7 or 8)



40.9.2 Mozilla Firefox Warning Messages

When you attempt to access the Switch HTTPS server, a **This Connection is Unstructured** screen may display. If that is the case, click **I Understand the Risks** and then the **Add Exception...** button.

Figure 208 Security Alert (Mozilla Firefox)

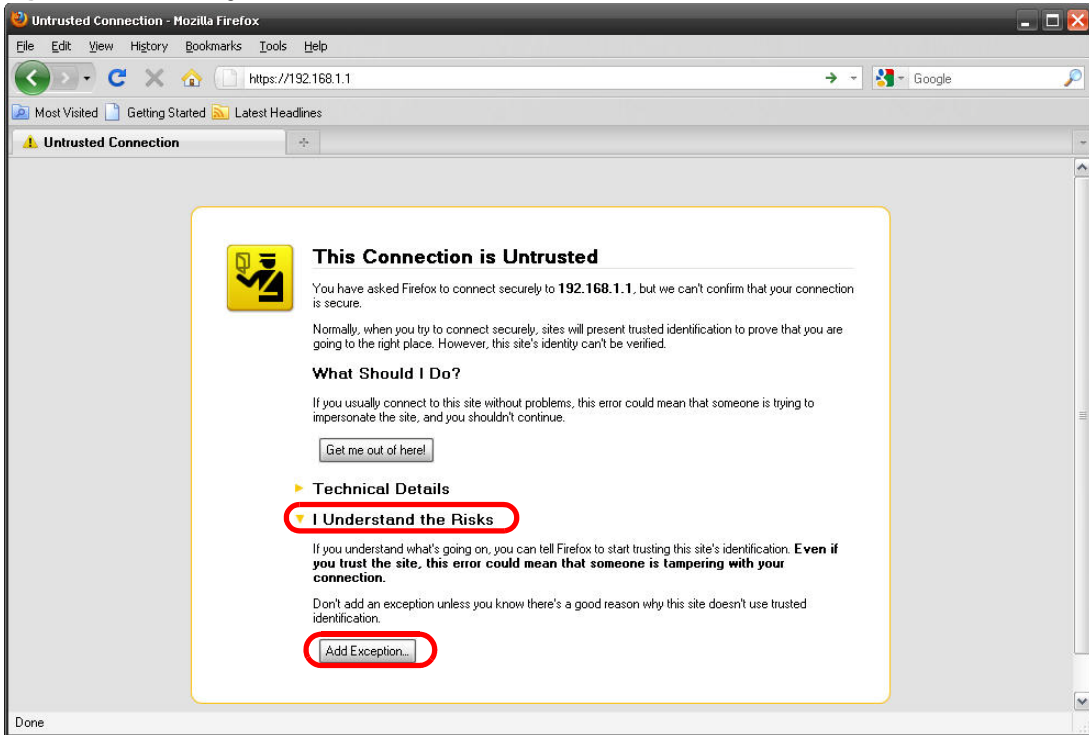

Confirm the HTTPS server URL matches. Click **Confirm Security Exception** to proceed to the web configurator login screen.

Figure 209 Security Alert (Mozilla Firefox)

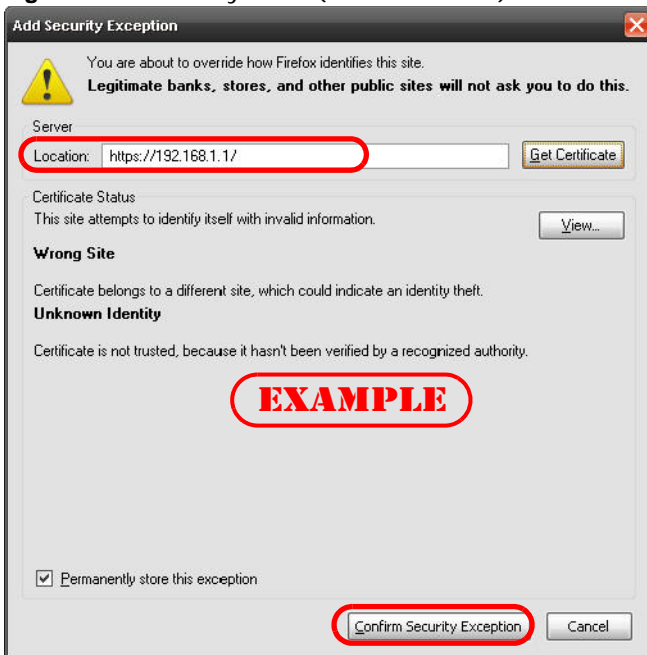

40.9.3 The Main Screen

After you accept the certificate and enter the login username and password, the Switch main screen appears. The lock displayed in the bottom right of the browser status bar or next to the website address denotes a secure connection.

Figure 210 Example: Lock Denoting a Secure Connection

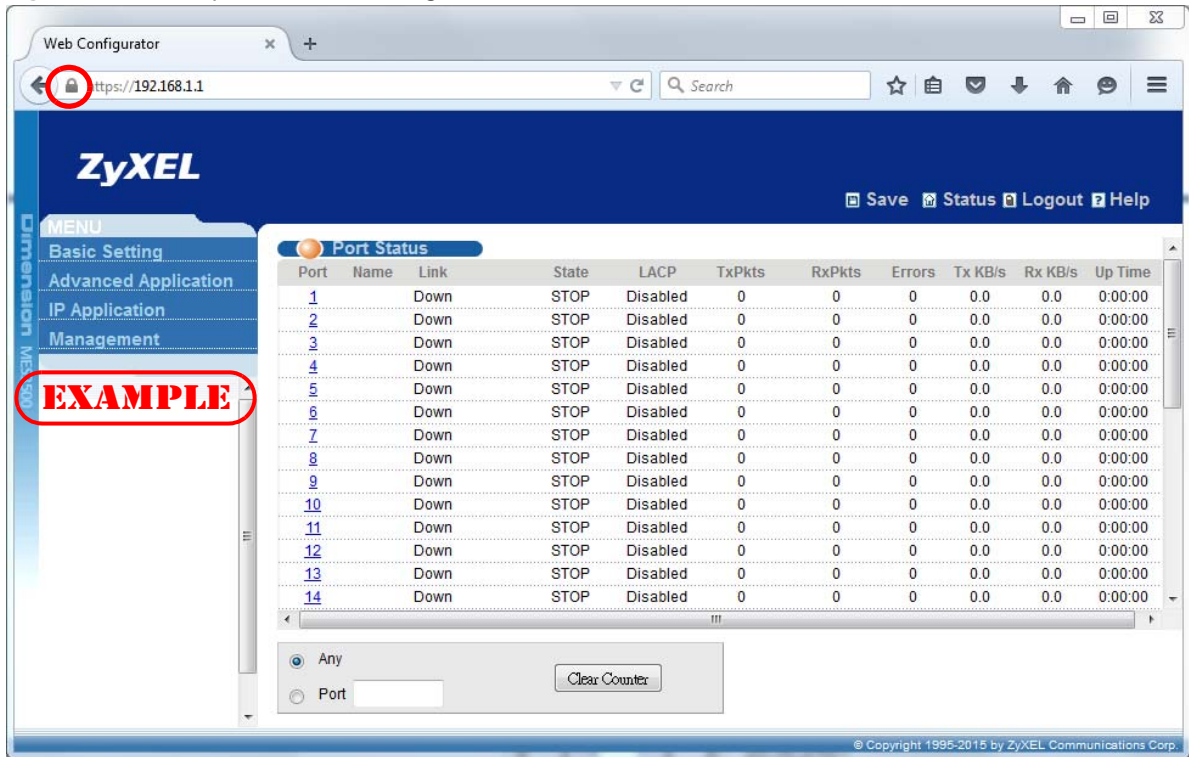

40.10 Service Port Access Control

Service Access Control allows you to decide what services you may use to access the Switch. You may also change the default service port and configure "trusted computer(s)" for each service in the **Remote Management** screen (discussed later). Click **Management > Access Control > Service Access Control** to view the screen as shown.

Figure 211 Management > Access Control > Service Access Control

Services	Active	Service Port	Timeout
Console			5 Minutes
Telnet	<input checked="" type="checkbox"/>	23	5 Minutes
SSH	<input checked="" type="checkbox"/>	22	
FTP	<input checked="" type="checkbox"/>	21	5 Minutes
HTTP	<input checked="" type="checkbox"/>	80	3 Minutes
HTTPS	<input checked="" type="checkbox"/>	443	
ICMP	<input checked="" type="checkbox"/>		
SNMP	<input checked="" type="checkbox"/>		

The following table describes the fields in this screen.

Table 153 Management > Access Control > Service Access Control

LABEL	DESCRIPTION
Services	Services you may use to access the Switch are listed here.
Active	Select this option for the corresponding services that you want to allow to access the Switch.
Service Port	For Telnet, SSH, FTP, HTTP or HTTPS services, you may change the default service port by typing the new port number in the Server Port field. If you change the default port number then you will have to let people (who wish to use the service) know the new port number for that service.
Timeout	Type how many minutes (from 1 to 255) a management session can be left idle before the session times out. After it times out you have to log in with your password again. Very long idle timeouts may have security risks.
Apply	Click Apply to save your changes to the Switch's run-time memory. The Switch loses these changes if it is turned off or loses power, so use the Save link on the top navigation panel to save your changes to the non-volatile memory when you are done configuring.
Cancel	Click Cancel to begin configuring this screen afresh.

40.11 Remote Management

Click **Management > Access Control > Remote Management** to view the screen as shown next.

You can specify a group of one or more “trusted computers” from which an administrator may use a service to manage the Switch. Click **Access Control** to return to the **Access Control** screen.

Figure 212 Management > Access Control > Remote Management

Entry	Active	Start Address	End Address	Telnet	FTP	HTTP	ICMP	SNMP	SSH	HTTPS
1	<input checked="" type="checkbox"/>	0.0.0.0	0.0.0.0	<input checked="" type="checkbox"/>	<input checked="" type="checkbox"/>	<input checked="" type="checkbox"/>	<input checked="" type="checkbox"/>	<input checked="" type="checkbox"/>	<input checked="" type="checkbox"/>	<input checked="" type="checkbox"/>
2	<input type="checkbox"/>	0.0.0.0	0.0.0.0	<input type="checkbox"/>	<input type="checkbox"/>	<input type="checkbox"/>	<input type="checkbox"/>	<input type="checkbox"/>	<input type="checkbox"/>	<input type="checkbox"/>
3	<input type="checkbox"/>	0.0.0.0	0.0.0.0	<input type="checkbox"/>	<input type="checkbox"/>	<input type="checkbox"/>	<input type="checkbox"/>	<input type="checkbox"/>	<input type="checkbox"/>	<input type="checkbox"/>
4	<input type="checkbox"/>	0.0.0.0	0.0.0.0	<input type="checkbox"/>	<input type="checkbox"/>	<input type="checkbox"/>	<input type="checkbox"/>	<input type="checkbox"/>	<input type="checkbox"/>	<input type="checkbox"/>
5	<input type="checkbox"/>	0.0.0.0	0.0.0.0	<input type="checkbox"/>	<input type="checkbox"/>	<input type="checkbox"/>	<input type="checkbox"/>	<input type="checkbox"/>	<input type="checkbox"/>	<input type="checkbox"/>
6	<input type="checkbox"/>	0.0.0.0	0.0.0.0	<input type="checkbox"/>	<input type="checkbox"/>	<input type="checkbox"/>	<input type="checkbox"/>	<input type="checkbox"/>	<input type="checkbox"/>	<input type="checkbox"/>
7	<input type="checkbox"/>	0.0.0.0	0.0.0.0	<input type="checkbox"/>	<input type="checkbox"/>	<input type="checkbox"/>	<input type="checkbox"/>	<input type="checkbox"/>	<input type="checkbox"/>	<input type="checkbox"/>
8	<input type="checkbox"/>	0.0.0.0	0.0.0.0	<input type="checkbox"/>	<input type="checkbox"/>	<input type="checkbox"/>	<input type="checkbox"/>	<input type="checkbox"/>	<input type="checkbox"/>	<input type="checkbox"/>
9	<input type="checkbox"/>	0.0.0.0	0.0.0.0	<input type="checkbox"/>	<input type="checkbox"/>	<input type="checkbox"/>	<input type="checkbox"/>	<input type="checkbox"/>	<input type="checkbox"/>	<input type="checkbox"/>
10	<input type="checkbox"/>	0.0.0.0	0.0.0.0	<input type="checkbox"/>	<input type="checkbox"/>	<input type="checkbox"/>	<input type="checkbox"/>	<input type="checkbox"/>	<input type="checkbox"/>	<input type="checkbox"/>
11	<input type="checkbox"/>	0.0.0.0	0.0.0.0	<input type="checkbox"/>	<input type="checkbox"/>	<input type="checkbox"/>	<input type="checkbox"/>	<input type="checkbox"/>	<input type="checkbox"/>	<input type="checkbox"/>
12	<input type="checkbox"/>	0.0.0.0	0.0.0.0	<input type="checkbox"/>	<input type="checkbox"/>	<input type="checkbox"/>	<input type="checkbox"/>	<input type="checkbox"/>	<input type="checkbox"/>	<input type="checkbox"/>
13	<input type="checkbox"/>	0.0.0.0	0.0.0.0	<input type="checkbox"/>	<input type="checkbox"/>	<input type="checkbox"/>	<input type="checkbox"/>	<input type="checkbox"/>	<input type="checkbox"/>	<input type="checkbox"/>
14	<input type="checkbox"/>	0.0.0.0	0.0.0.0	<input type="checkbox"/>	<input type="checkbox"/>	<input type="checkbox"/>	<input type="checkbox"/>	<input type="checkbox"/>	<input type="checkbox"/>	<input type="checkbox"/>
15	<input type="checkbox"/>	0.0.0.0	0.0.0.0	<input type="checkbox"/>	<input type="checkbox"/>	<input type="checkbox"/>	<input type="checkbox"/>	<input type="checkbox"/>	<input type="checkbox"/>	<input type="checkbox"/>
16	<input type="checkbox"/>	0.0.0.0	0.0.0.0	<input type="checkbox"/>	<input type="checkbox"/>	<input type="checkbox"/>	<input type="checkbox"/>	<input type="checkbox"/>	<input type="checkbox"/>	<input type="checkbox"/>

The following table describes the labels in this screen.

Table 154 Management > Access Control > Remote Management

LABEL	DESCRIPTION
Entry	This is the client set index number. A "client set" is a group of one or more "trusted computers" from which an administrator may use a service to manage the Switch.
Active	Select this check box to activate this secured client set. Clear the check box if you wish to temporarily disable the set without deleting it.
Start Address End Address	Configure the IP address range of trusted computers from which you can manage this Switch. The Switch checks if the client IP address of a computer requesting a service or protocol matches the range set here. The Switch immediately disconnects the session if it does not match.
Telnet/FTP/ HTTP/ICMP/ SNMP/SSH/ HTTPS	Select services that may be used for managing the Switch from the specified trusted computers.
Apply	Click Apply to save your changes to the Switch's run-time memory. The Switch loses these changes if it is turned off or loses power, so use the Save link on the top navigation panel to save your changes to the non-volatile memory when you are done configuring.
Cancel	Click Cancel to begin configuring this screen afresh.

Diagnostic

This chapter explains the **Diagnostic** screen. You can use this screen to help you identify problems

41.1 Diagnostic

Click **Management** > **Diagnostic** in the navigation panel to open this screen. Use this screen to check system logs, ping IP addresses or perform port tests.

Figure 213 Management > Diagnostic

The screenshot shows the 'Diagnostic' screen with a blue header bar containing an orange circle icon and the text 'Diagnostic'. Below the header is a large, empty text area with the text '- Info -' at the top left. At the bottom of the screen, there are three diagnostic tool sections, each with a label and a button:

- System Log**: Includes 'Display' and 'Clear' buttons.
- IP Ping**: Includes an 'IP Address' text input field and a 'Ping' button.
- Ethernet Port Test**: Includes a 'Port' text input field and a 'Port Test' button.

The following table describes the labels in this screen.

Table 155 Management > Diagnostic

LABEL	DESCRIPTION
System Log	Click Display to display a log of events in the multi-line text box. Click Clear to empty the text box and reset the syslog entry.
IP Ping	Type the IP address of a device that you want to ping in order to test a connection. Click Ping to have the Switch ping the IP address (in the field to the left).
Ethernet Port Test	Enter a port number and click Port Test to perform an internal loopback test.

This chapter explains the syslog screens.

42.1 Syslog Overview

The syslog protocol allows devices to send event notification messages across an IP network to syslog servers that collect the event messages. A syslog-enabled device can generate a syslog message and send it to a syslog server.

Syslog is defined in RFC 3164. The RFC defines the packet format, content and system log related information of syslog messages. Each syslog message has a facility and severity level. The syslog facility identifies a file in the syslog server. Refer to the documentation of your syslog program for details. The following table describes the syslog severity levels.

Table 156 Syslog Severity Levels

CODE	SEVERITY
0	Emergency: The system is unusable.
1	Alert: Action must be taken immediately.
2	Critical: The system condition is critical.
3	Error: There is an error condition on the system.
4	Warning: There is a warning condition on the system.
5	Notice: There is a normal but significant condition on the system.
6	Informational: The syslog contains an informational message.
7	Debug: The message is intended for debug-level purposes.

42.2 Syslog Setup

Click **Management** > **Syslog** in the navigation panel to display this screen. The syslog feature sends logs to an external syslog server. Use this screen to configure the device's system logging settings.

Figure 214 Management > Syslog

Logging type	Active	Facility	Privilege
System	<input type="checkbox"/>	local use 0	-
Interface	<input type="checkbox"/>	local use 0	-
Switch	<input type="checkbox"/>	local use 0	-
AAA	<input type="checkbox"/>	local use 0	-
IP	<input type="checkbox"/>	local use 0	-
Commands	<input type="checkbox"/>	local use 0	2

The following table describes the labels in this screen.

Table 157 Management > Syslog

LABEL	DESCRIPTION
Syslog	Select Active to turn on syslog (system logging) and then configure the syslog setting.
Logging Type	This column displays the names of the categories of logs that the device can generate.
Active	Select this option to set the device to generate logs for the corresponding category.
Facility	The log facility allows you to send logs to different files in the syslog server. Refer to the documentation of your syslog program for more details.
Privilege	Select a command privilege level. The Switch will only generate logs for commands that have a privilege level greater than or equal to the specified privilege level.
Apply	Click Apply to save your changes to the Switch's run-time memory. The Switch loses these changes if it is turned off or loses power, so use the Save link on the top navigation panel to save your changes to the non-volatile memory when you are done configuring.
Cancel	Click Cancel to begin configuring this screen afresh.

42.3 Syslog Server Setup

Click **Management > Syslog > Syslog Server Setup** to view the screen as shown next. Use this screen to configure a list of external syslog servers.

Figure 215 Management > Syslog > Syslog Server Setup

The following table describes the labels in this screen.

Table 158 Management > Syslog > Syslog Server Setup

LABEL	DESCRIPTION
Active	Select this check box to have the device send logs to this syslog server. Clear the check box if you want to create a syslog server entry but not have the device send logs to it (you can edit the entry later).
Server Address	Enter the IP address of the syslog server.
Log Level	Select the severity level(s) of the logs that you want the device to send to this syslog server. The lower the number, the more critical the logs are.
Add	Click Add to save your changes to the Switch's run-time memory. The Switch loses these changes if it is turned off or loses power, so use the Save link on the top navigation panel to save your changes to the non-volatile memory when you are done configuring.
Cancel	Click Cancel to begin configuring this screen afresh.
Clear	Click Clear to return the fields to the factory defaults.
Index	This is the index number of a syslog server entry. Click this number to edit the entry.
Active	This field displays Yes if the device is to send logs to the syslog server. No displays if the device is not to send logs to the syslog server.
IP Address	This field displays the IP address of the syslog server.
Log Level	This field displays the severity level of the logs that the device is to send to this syslog server.
Delete	Select an entry's Delete check box and click Delete to remove the entry.
Cancel	Click Cancel to begin configuring this screen afresh.

Cluster Management

This chapter introduces cluster management.

43.1 Cluster Management Status Overview

Cluster Management allows you to manage switches through one Switch, called the cluster manager. The switches must be directly connected and be in the same VLAN group so as to be able to communicate with one another.

Table 159 ZyXEL Clustering Management Specifications

Maximum number of cluster members	24
Cluster Member Models	Must be compatible with ZyXEL cluster management implementation.
Cluster Manager	The switch through which you manage the cluster member switches.
Cluster Members	The switches being managed by the cluster manager switch.

In the following example, switch **A** in the basement is the cluster manager and the other switches on the upper floors of the building are cluster members.

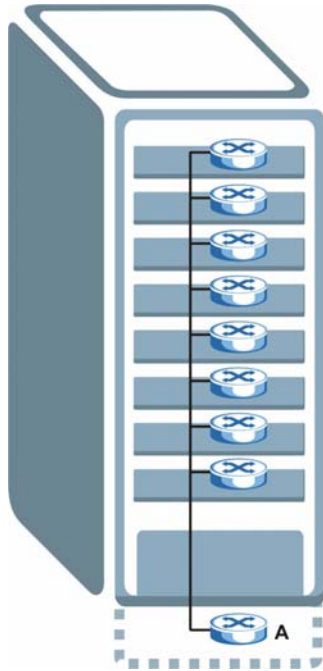
Figure 216 Clustering Application Example

43.2 Cluster Management Status

Click **Management** > **Cluster Management** in the navigation panel to display the following screen.

Note: A cluster can only have one manager.

Figure 217 Management > Cluster Management: Status

Clustering Management Status		Configuration		
Status	Manager			
Manager	00:13:49:00:00:02			
The Number Of Member = 1				
Index	MacAddr	Name	Model	Status
1	00:a0:c5:01:23:46		GS-2024	Online

The following table describes the labels in this screen.

Table 160 Management > Cluster Management: Status

LABEL	DESCRIPTION
Status	This field displays the role of this Switch within the cluster. Manager Member (you see this if you access this screen in the cluster member switch directly and not via the cluster manager) None (neither a manager nor a member of a cluster)
Manager	This field displays the cluster manager switch's hardware MAC address.
The Number of Member	This field displays the number of switches that make up this cluster. The following fields describe the cluster member switches.
Index	You can manage cluster member switches via the cluster manager switch. Each number in the Index column is a hyperlink leading to the cluster member switch's web configurator (see Figure 218 on page 332).
MacAddr	This is the cluster member switch's hardware MAC address.
Name	This is the cluster member switch's System Name .
Model	This field displays the model name.
Status	This field displays: Online (the cluster member switch is accessible) Error (for example the cluster member switch password was changed or the switch was set as the manager and so left the member list, etc.) Offline (the switch is disconnected - Offline shows approximately 1.5 minutes after the link between cluster member and manager goes down)

43.2.1 Cluster Member Switch Management

Go to the **Clustering Management Status** screen of the cluster manager switch and then select an **Index** hyperlink from the list of members to go to that cluster member switch's web configurator home page. This cluster member web configurator home page and the home page that you'd see if you accessed it directly are different.

Figure 218 Cluster Management: Cluster Member Web Configurator Screen

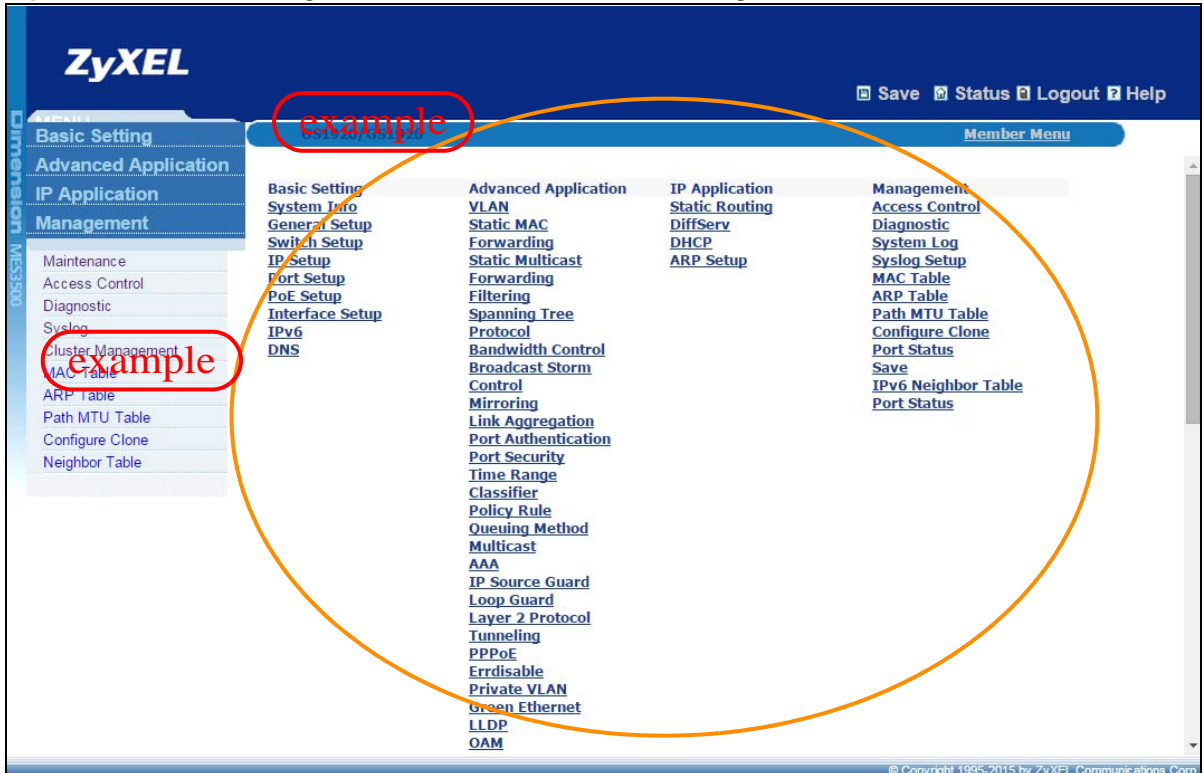

43.2.1.1 Uploading Firmware to a Cluster Member Switch

You can use FTP to upload firmware to a cluster member switch through the cluster manager switch as shown in the following example.

Figure 219 Example: Uploading Firmware to a Cluster Member Switch

```

C:\>ftp 192.168.1.1
Connected to 192.168.1.1.
220 Switch FTP version 1.0 ready at Thu Jan  1 00:58:46 1970
User (192.168.0.1:(none)): admin
331 Enter PASS command
Password:
230 Logged in
ftp> ls
200 Port command okay
150 Opening data connection for LIST
--w--w--w-  1 owner   group           3082906 Jul  01 12:00 ras-0
--w--w--w-  1 owner   group           3082906 Jul  01 12:00 ras-1
-rw-rw-rw-  1 owner   group           8388608 Jul  01 12:00 config
226 File sent OK
ftp: 297 bytes received in 0.00Seconds 297000.00Kbytes/sec.
ftp> bin
200 Type I OK
ftp> put 400AABB0B1.bin ras-0
200 Port command okay
150 Opening data connection for STOR ras-0
226 File received OK
ftp: 262144 bytes sent in 0.63Seconds 415.44Kbytes/sec.
ftp>

```

The following table explains some of the FTP parameters.

Table 161 FTP Upload to Cluster Member Example

FTP PARAMETER	DESCRIPTION
User	Enter "admin".
Password	The web configurator password default is 1234.
ls	Enter this command to list the name of cluster member switch's firmware and configuration file.
400AABB0B1.bin	This is the name of the firmware file you want to upload to the cluster member switch.
ras-0	This is the cluster member switch's firmware name as seen in the cluster manager switch.
config	This is the cluster member switch's configuration file name as seen in the cluster manager switch.

43.3 Clustering Management Configuration

Use this screen to configure clustering management. Click **Management > Cluster Management > Configuration** to display the next screen.

Figure 220 Management > Cluster Management > Configuration

Clustering Management Configuration [Status](#)

Clustering Manager:

Active	<input checked="" type="checkbox"/>
Name	Master
VID	1

Apply Cancel

Clustering Candidate:

List	00:a0:c5:01:23:46/GS-2024/
Password	

Add Cancel Refresh

Index	MacAddr	Name	Model	Remove

Remove Cancel

The following table describes the labels in this screen.

Table 162 Management > Cluster Management > Configuration



LABEL	DESCRIPTION
Clustering Manager	
Active	Select Active to have this Switch become the cluster manager switch. A cluster can only have one manager. Other (directly connected) switches that are set to be cluster managers will not be visible in the Clustering Candidates list. If a switch that was previously a cluster member is later set to become a cluster manager, then its Status is displayed as Error in the Cluster Management Status screen and a warning icon () appears in the member summary list below.
Name	Type a name to identify the Clustering Manager . You may use up to 32 printable characters (spaces are allowed).
VID	This is the VLAN ID and is only applicable if the Switch is set to 802.1Q VLAN. All switches must be directly connected and in the same VLAN group to belong to the same cluster. Switches that are not in the same VLAN group are not visible in the Clustering Candidates list. This field is ignored if the Clustering Manager is using Port-based VLAN.
Apply	Click Apply to save your changes to the Switch's run-time memory. The Switch loses these changes if it is turned off or loses power, so use the Save link on the top navigation panel to save your changes to the non-volatile memory when you are done configuring.

Table 162 Management > Cluster Management > Configuration (continued)

LABEL	DESCRIPTION
Cancel	Click Cancel to begin configuring this screen afresh.
Clustering Candidate	The following fields relate to the switches that are potential cluster members.
List	A list of suitable candidates found by auto-discovery is shown here. The switches must be directly connected. Directly connected switches that are set to be cluster managers will not be visible in the Clustering Candidate list. Switches that are not in the same management VLAN group will not be visible in the Clustering Candidate list.
Password	Each cluster member's password is its web configurator password. Select a member in the Clustering Candidate list and then enter its web configurator password. If that switch administrator changes the web configurator password afterwards, then it cannot be managed from the Cluster Manager . Its Status is displayed as Error in the Cluster Management Status screen and a warning icon () appears in the member summary list below. If multiple devices have the same password then hold [SHIFT] and click those switches to select them. Then enter their common web configurator password.
Add	Click Add to save your changes to the Switch's run-time memory. The Switch loses these changes if it is turned off or loses power, so use the Save link on the top navigation panel to save your changes to the non-volatile memory when you are done configuring.
Cancel	Click Cancel to begin configuring this screen afresh.
Refresh	Click Refresh to perform auto-discovery again to list potential cluster members.
The next summary table shows the information for the clustering members configured.	
Index	This is the index number of a cluster member switch.
MacAddr	This is the cluster member switch's hardware MAC address.
Name	This is the cluster member switch's System Name .
Model	This is the cluster member switch's model name.
Remove	Select this checkbox and then click the Remove button to remove a cluster member switch from the cluster.
Cancel	Click Cancel to begin configuring this screen afresh.

MAC Table

This chapter introduces the **MAC Table** screen.

44.1 MAC Table Overview

The **MAC Table** screen (a MAC table is also known as a filtering database) shows how frames are forwarded or filtered across the Switch's ports. It shows what device MAC address, belonging to what VLAN group (if any) is forwarded to which port(s) and whether the MAC address is dynamic (learned by the Switch) or static (manually entered in the **Static MAC Forwarding** screen).

The Switch uses the MAC table to determine how to forward frames. See the following figure.

- 1 The Switch examines a received frame and learns the port on which this source MAC address came.
- 2 The Switch checks to see if the frame's destination MAC address matches a source MAC address already learned in the MAC table.
 - If the Switch has already learned the port for this MAC address, then it forwards the frame to that port.
 - If the Switch has not already learned the port for this MAC address, then the frame is flooded to all ports. Too much port flooding leads to network congestion.
 - If the Switch has already learned the port for this MAC address, but the destination port is the same as the port it came in on, then it filters the frame.

Figure 221 MAC Table Flowchart

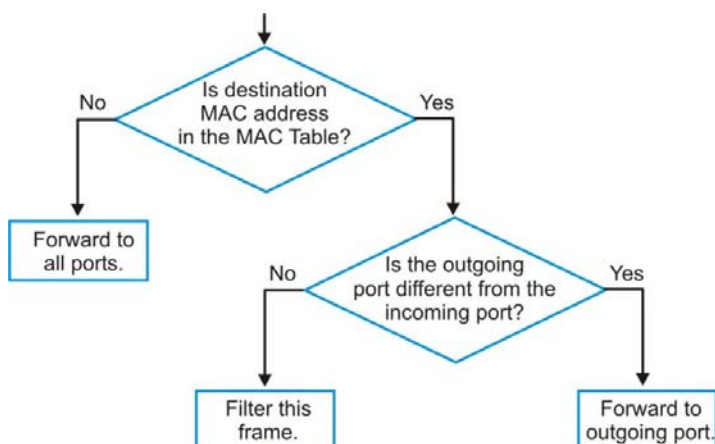

44.2 Viewing the MAC Table

Click **Management > MAC Table** in the navigation panel to display the following screen.

Figure 222 Management > MAC Table

Index	MAC Address	VID	Port	Type
1	00:00:aa:10:01:73	1	27	dynamic
2	00:00:e8:7c:14:80	1	28	dynamic
3	00:02:e3:56:16:9d	1	27	dynamic
4	00:02:e3:57:ea:1c	1	27	dynamic
5	00:04:80:9b:78:00	1	27	dynamic
6	00:0d:88:ca:af:b2	1	27	dynamic
7	00:0e:7b:e4:17:19	1	27	dynamic
8	00:0f:b0:80:e7:56	1	27	dynamic

The following table describes the labels in this screen.

Table 163 Management > MAC Table

LABEL	DESCRIPTION
Condition	<p>Select one of the buttons and click Search to only display the data which matches the criteria you specified.</p> <p>Select All to display any entry in the MAC table of the Switch.</p> <p>Select Static to display the MAC entries manually configured on the Switch.</p> <p>Select MAC and enter a MAC address in the field provided to display a specified MAC entry.</p> <p>Select VID and enter a VLAN ID in the field provided to display the MAC entries belonging to the specified VLAN.</p> <p>Select Port and enter a port number in the field provided to display the MAC addresses which are forwarded on the specified port.</p>
Sort by	<p>Define how the Switch displays and arranges the data in the summary table below.</p> <p>Select MAC to display and arrange the data according to MAC address.</p> <p>Select VID to display and arrange the data according to VLAN group.</p> <p>Select PORT to display and arrange the data according to port number.</p>

Table 163 Management > MAC Table (continued)

LABEL	DESCRIPTION
Transfer Type	<p>Select Dynamic to MAC forwarding and click the Transfer button to change all dynamically learned MAC address entries in the summary table below into static entries. They also display in the Static MAC Forwarding screen.</p> <p>Select Dynamic to MAC filtering and click the Transfer button to change all dynamically learned MAC address entries in the summary table below into MAC filtering entries. These entries will then display only in the Filtering screen and the default filtering action is Discard source.</p>
Cancel	Click Cancel to change the fields back to their last saved values.
Index	This is the incoming frame index number.
MAC Address	This is the MAC address of the device from which this incoming frame came.
VID	This is the VLAN group to which this frame belongs.
Port	This is the port where the above MAC address is forwarded.
Type	This shows whether the MAC address is dynamic (learned by the Switch) or static (manually entered in the Static MAC Forwarding screen).

ARP Table

This chapter introduces ARP Table.

45.1 ARP Table Overview

Address Resolution Protocol (ARP) is a protocol for mapping an Internet Protocol address (IP address) to a physical machine address, also known as a Media Access Control or MAC address, on the local area network.

An IP (version 4) address is 32 bits long. In an Ethernet LAN, MAC addresses are 48 bits long. The ARP Table maintains an association between each MAC address and its corresponding IP address.

45.1.1 How ARP Works

When an incoming packet destined for a host device on a local area network arrives at the Switch, the Switch's ARP program looks in the ARP Table and, if it finds the address, sends it to the device.

If no entry is found for the IP address, ARP broadcasts the request to all the devices on the LAN. The Switch fills in its own MAC and IP address in the sender address fields, and puts the known IP address of the target in the target IP address field. In addition, the Switch puts all ones in the target MAC field (FF.FF.FF.FF.FF.FF is the Ethernet broadcast address). The replying device (which is either the IP address of the device being sought or the router that knows the way) replaces the broadcast address with the target's MAC address, swaps the sender and target pairs, and unicasts the answer directly back to the requesting machine. ARP updates the ARP Table for future reference and then sends the packet to the MAC address that replied.

45.2 The ARP Table Screen

Click **Management** > **ARP Table** in the navigation panel to open the following screen. Use the ARP table to view IP-to-MAC address mapping(s) and remove specific dynamic ARP entries.

Figure 223 Management > ARP Table

Index	IP Address	MAC Address	VID	Port	Type
1	172.16.13.10	00:21:85:0c:44:4b	1	24	dynamic
2	172.16.13.255	ff:ff:ff:ff:ff:ff	1	CPU	static
3	192.168.1.255	ff:ff:ff:ff:ff:ff	1	CPU	static

The following table describes the labels in this screen.

Table 164 Management > ARP Table

LABEL	DESCRIPTION
Condition	Specify how you want the Switch to remove ARP entries when you click Flush . Select All to remove all of the dynamic entries from the ARP table. Select IP Address and enter an IP address to remove the dynamic entries learned with the specified IP address. Select Port and enter a port number to remove the dynamic entries learned on the specified port.
Flush	Click Flush to remove the ARP entries according to the condition you specified.
Cancel	Click Cancel to return the fields to the factory defaults.
Index	This is the ARP table entry number.
IP Address	This is the learned IP address of a device connected to a Switch port with the corresponding MAC address below.
MAC Address	This is the MAC address of the device with the corresponding IP address above.
VID	This field displays the VLAN to which the device belongs.
Port	This field displays the port to which the device connects. CPU means this learned IP address is the Switch's management IP address.
Type	This shows whether the MAC address is dynamic (learned by the Switch) or static (manually entered in the Static MAC Forwarding screen).

Configure Clone

This chapter shows you how you can copy the settings of one port onto other ports.

46.1 Configure Clone

Cloning allows you to copy the basic and advanced settings from a source port to a destination port or ports. Click **Management** > **Configure Clone** to open the following screen.

Figure 224 Management > Configure Clone

The following table describes the labels in this screen.

Table 165 Management > Configure Clone

LABEL	DESCRIPTION
Source/ Destination	Enter the source port under the Source label. This port's attributes are copied.
Port	<p>Enter the destination port or ports under the Destination label. These are the ports which are going to have the same attributes as the source port. You can enter individual ports separated by a comma or a range of ports by using a dash.</p> <p>Example:</p> <ul style="list-style-type: none"> • 2, 4, 6 indicates that ports 2, 4 and 6 are the destination ports. • 2-6 indicates that ports 2 through 6 are the destination ports.
Basic Setting	Select which port settings (you configured in the Basic Setting menus) should be copied to the destination port(s).

Table 165 Management > Configure Clone (continued)

LABEL	DESCRIPTION
Advanced Application	Select which port settings (you configured in the Advanced Application menus) should be copied to the destination ports.
Apply	Click Apply to save your changes to the Switch's run-time memory. The Switch loses these changes if it is turned off or loses power, so use the Save link on the top navigation panel to save your changes to the non-volatile memory when you are done configuring.
Cancel	Click Cancel to begin configuring this screen afresh.

Troubleshooting

This chapter offers some suggestions to solve problems you might encounter. The potential problems are divided into the following categories.

- [Power, Hardware Connections, and LEDs](#)
- [Switch Access and Login](#)
- [Switch Configuration](#)

47.1 Power, Hardware Connections, and LEDs

The Switch does not turn on. None of the LEDs turn on.

- 1 Make sure the Switch is turned on (in DC models or if the DC power supply is connected in AC/DC models).
- 2 Make sure you are using the power adaptor or cord included with the Switch.
- 3 Make sure the power adaptor or cord is connected to the Switch and plugged in to an appropriate power source. Make sure the power source is turned on.
- 4 Turn the Switch off and on (in DC models or if the DC power supply is connected in AC/DC models).
- 5 Disconnect and re-connect the power adaptor or cord to the Switch (in AC models or if the AC power supply is connected in AC/DC models).
- 6 If the problem continues, contact the vendor.

The **ALM** LED is on.

- 1 Turn the Switch off and on (in DC models or if the DC power supply is connected in AC/DC models).
- 2 Disconnect and re-connect the power adaptor or cord to the Switch (in AC models or if the AC power supply is connected in AC/DC models).
- 3 If the problem continues, contact the vendor.

One of the LEDs does not behave as expected.

- 1 Make sure you understand the normal behavior of the LED. See [Section 3.2 on page 33](#).
- 2 Check the hardware connections. See [Section 3.1 on page 26](#).
- 3 Inspect your cables for damage. Contact the vendor to replace any damaged cables.
- 4 Turn the Switch off and on (in DC models or if the DC power supply is connected in AC/DC models).
- 5 Disconnect and re-connect the power adaptor or cord to the Switch (in AC models or if the AC power supply is connected in AC/DC models).
- 6 If the problem continues, contact the vendor.

47.2 Switch Access and Login

I forgot the IP address for the Switch.

- 1 The default management IP address is **192.168.1.1**.
- 2 Use the console port to log in to the Switch.
- 3 If this does not work, you have to reset the device to its factory defaults. See [Section 4.6 on page 41](#).

I forgot the username and/or password.

- 1 The default username is **admin** and the default password is **1234**.
- 2 If this does not work, you have to reset the device to its factory defaults. See [Section 4.6 on page 41](#).

I cannot see or access the **Login** screen in the web configurator.

- 1 Make sure you are using the correct IP address.
 - The default management IP address is [192.168.1.1](#).
 - If you changed the IP address, use the new IP address.

- If you changed the IP address and have forgotten it, see the troubleshooting suggestions for [I forgot the IP address for the Switch](#).
- 2 Check the hardware connections, and make sure the LEDs are behaving as expected. See [Section 3.2 on page 33](#).
 - 3 Make sure your Internet browser does not block pop-up windows and has JavaScripts and Java enabled.
 - 4 Make sure your computer is in the same subnet as the Switch. (If you know that there are routers between your computer and the Switch, skip this step.)
 - 5 Reset the device to its factory defaults, and try to access the Switch with the default IP address. See [Section 4.6 on page 41](#).
 - 6 If the problem continues, contact the vendor, or try one of the advanced suggestions.

Advanced Suggestions

- Try to access the Switch using another service, such as Telnet. If you can access the Switch, check the remote management settings to find out why the Switch does not respond to HTTP.

I can see the **Login** screen, but I cannot log in to the Switch.

- 1 Make sure you have entered the user name and password correctly. The default user name is **admin**, and the default password is **1234**. These fields are case-sensitive, so make sure [Caps Lock] is not on.
- 2 You may have exceeded the maximum number of concurrent Telnet sessions. Close other Telnet session(s) or try connecting again later.

Check that you have enabled logins for HTTP or Telnet. If you have configured a secured client IP address, your computer's IP address must match it. Refer to the chapter on access control for details.
- 3 Disconnect and re-connect the cord to the Switch.
- 4 If this does not work, you have to reset the device to its factory defaults. See [Section 4.6 on page 41](#).

Pop-up Windows, JavaScripts and Java Permissions

In order to use the web configurator you need to allow:

- Web browser pop-up windows from your device.
- JavaScripts (enabled by default).
- Java permissions (enabled by default).

I cannot see some of **Advanced Application** submenus at the bottom of the navigation panel.

The recommended screen resolution is 1024 by 768 pixels. Adjust the value in your computer and then you should see the rest of **Advanced Application** submenus at the bottom of the navigation panel.

There is unauthorized access to my Switch via telnet, HTTP and SSH.

Click the **Display** button in the **System Log** field in the **Management > Diagnostic** screen to check for unauthorized access to your Switch. To avoid unauthorized access, configure the secured client setting in the **Management > Access Control > Remote Management** screen for telnet, HTTP and SSH (see [Section 40.11 on page 323](#)). Computers not belonging to the secured client set cannot get permission to access the Switch.

47.3 Switch Configuration

I lost my configuration settings after I restart the Switch.

Make sure you save your configuration into the Switch's nonvolatile memory each time you make changes. Click **Save** at the top right corner of the web configurator to save the configuration permanently. See also [Section 39.3 on page 295](#) for more information about how to save your configuration.



Customer Support

In the event of problems that cannot be solved by using this manual, you should contact your vendor. If you cannot contact your vendor, then contact a ZyXEL office for the region in which you bought the device.

See <http://www.zyxel.com/homepage.shtml> and also http://www.zyxel.com/about_zyxel/zyxel_worldwide.shtml for the latest information.

Please have the following information ready when you contact an office.

Required Information

- Product model and serial number.
- Warranty Information.
- Date that you received your device.
- Brief description of the problem and the steps you took to solve it.

Corporate Headquarters (Worldwide)

Taiwan

- ZyXEL Communications Corporation
- <http://www.zyxel.com>

Asia

China

- ZyXEL Communications (Shanghai) Corp.
- ZyXEL Communications (Beijing) Corp.
- ZyXEL Communications (Tianjin) Corp.
- <http://www.zyxel.cn>

India

- ZyXEL Technology India Pvt Ltd
- <http://www.zyxel.in>

Kazakhstan

- ZyXEL Kazakhstan
- <http://www.zyxel.kz>

Korea

- ZyXEL Korea Corp.
- <http://www.zyxel.kr>

Malaysia

- ZyXEL Malaysia Sdn Bhd.
- <http://www.zyxel.com.my>

Pakistan

- ZyXEL Pakistan (Pvt.) Ltd.
- <http://www.zyxel.com.pk>

Philippines

- ZyXEL Philippines
- <http://www.zyxel.com.ph>

Singapore

- ZyXEL Singapore Pte Ltd.
- <http://www.zyxel.com.sg>

Taiwan

- ZyXEL Communications Corporation
- <http://www.zyxel.com/tw/zh/>

Thailand

- ZyXEL Thailand Co., Ltd
- <http://www.zyxel.co.th>

Vietnam

- ZyXEL Communications Corporation-Vietnam Office
- <http://www.zyxel.com/vn/vi>

Europe

Austria

- ZyXEL Deutschland GmbH
- <http://www.zyxel.de>

Belarus

- ZyXEL BY
- <http://www.zyxel.by>

Belgium

- ZyXEL Communications B.V.
- <http://www.zyxel.com/be/nl/>
- <http://www.zyxel.com/be/fr/>

Bulgaria

- ZyXEL България
- <http://www.zyxel.com/bg/bg/>

Czech Republic

- ZyXEL Communications Czech s.r.o
- <http://www.zyxel.cz>

Denmark

- ZyXEL Communications A/S
- <http://www.zyxel.dk>

Estonia

- ZyXEL Estonia
- <http://www.zyxel.com/ee/et/>

Finland

- ZyXEL Communications
- <http://www.zyxel.fi>

France

- ZyXEL France
- <http://www.zyxel.fr>

Germany

- ZyXEL Deutschland GmbH
- <http://www.zyxel.de>

Hungary

- ZyXEL Hungary & SEE
- <http://www.zyxel.hu>

Italy

- ZyXEL Communications Italy
- <http://www.zyxel.it/>

Latvia

- ZyXEL Latvia
- <http://www.zyxel.com/lv/lv/homepage.shtml>

Lithuania

- ZyXEL Lithuania
- <http://www.zyxel.com/lt/lt/homepage.shtml>

Netherlands

- ZyXEL Benelux
- <http://www.zyxel.nl>

Norway

- ZyXEL Communications
- <http://www.zyxel.no>

Poland

- ZyXEL Communications Poland
- <http://www.zyxel.pl>

Romania

- ZyXEL Romania
- <http://www.zyxel.com/ro/ro>

Russia

- ZyXEL Russia
- <http://www.zyxel.ru>

Slovakia

- ZyXEL Communications Czech s.r.o. organizacna zlozka
- <http://www.zyxel.sk>

Spain

- ZyXEL Communications ES Ltd
- <http://www.zyxel.es>

Sweden

- ZyXEL Communications
- <http://www.zyxel.se>

Switzerland

- Studerus AG

- <http://www.zyxel.ch/>

Turkey

- ZyXEL Turkey A.S.
- <http://www.zyxel.com.tr>

UK

- ZyXEL Communications UK Ltd.
- <http://www.zyxel.co.uk>

Ukraine

- ZyXEL Ukraine
- <http://www.ua.zyxel.com>

Latin America

Argentina

- ZyXEL Communication Corporation
- <http://www.zyxel.com/ec/es/>

Brazil

- ZyXEL Communications Brasil Ltda.
- <https://www.zyxel.com/br/pt/>

Ecuador

- ZyXEL Communication Corporation
- <http://www.zyxel.com/ec/es/>

Middle East

Israel

- ZyXEL Communication Corporation
- <http://il.zyxel.com/homepage.shtml>

Middle East

- ZyXEL Communication Corporation
- <http://www.zyxel.com/me/en/>

North America

USA

- ZyXEL Communications, Inc. - North America Headquarters
- <http://www.zyxel.com/us/en/>

Oceania

Australia

- ZyXEL Communications Corporation
- <http://www.zyxel.com/au/en/>

Africa

South Africa

- Nology (Pty) Ltd.
- <http://www.zyxel.co.za>

Common Services

The following table lists some commonly-used services and their associated protocols and port numbers. For a comprehensive list of port numbers, ICMP type/code numbers and services, visit the IANA (Internet Assigned Number Authority) web site.

- **Name:** This is a short, descriptive name for the service. You can use this one or create a different one, if you like.
- **Protocol:** This is the type of IP protocol used by the service. If this is **TCP/UDP**, then the service uses the same port number with TCP and UDP. If this is **User-Defined**, the **Port(s)** is the IP protocol number, not the port number.
- **Port(s):** This value depends on the **Protocol**. Please refer to RFC 1700 for further information about port numbers.
 - If the **Protocol** is **TCP, UDP, or TCP/UDP**, this is the IP port number.
 - If the **Protocol** is **USER**, this is the IP protocol number.
- **Description:** This is a brief explanation of the applications that use this service or the situations in which this service is used.

Table 166 Commonly Used Services

NAME	PROTOCOL	PORT(S)	DESCRIPTION
AH (IPSEC_TUNNEL)	User-Defined	51	The IPSEC AH (Authentication Header) tunneling protocol uses this service.
AIM/New-ICQ	TCP	5190	AOL's Internet Messenger service. It is also used as a listening port by ICQ.
AUTH	TCP	113	Authentication protocol used by some servers.
BGP	TCP	179	Border Gateway Protocol.
BOOTP_CLIENT	UDP	68	DHCP Client.
BOOTP_SERVER	UDP	67	DHCP Server.
CU-SEEME	TCP UDP	7648 24032	A popular videoconferencing solution from White Pines Software.
DNS	TCP/UDP	53	Domain Name Server, a service that matches web names (for example www.zyxel.com) to IP numbers.
ESP (IPSEC_TUNNEL)	User-Defined	50	The IPSEC ESP (Encapsulation Security Protocol) tunneling protocol uses this service.
FINGER	TCP	79	Finger is a UNIX or Internet related command that can be used to find out if a user is logged on.
FTP	TCP TCP	20 21	File Transfer Program, a program to enable fast transfer of files, including large files that may not be possible by e-mail.
H.323	TCP	1720	NetMeeting uses this protocol.

Table 166 Commonly Used Services (continued)

NAME	PROTOCOL	PORT(S)	DESCRIPTION
HTTP	TCP	80	Hyper Text Transfer Protocol - a client/server protocol for the world wide web.
HTTPS	TCP	443	HTTPS is a secured http session often used in e-commerce.
ICMP	User-Defined	1	Internet Control Message Protocol is often used for diagnostic or routing purposes.
ICQ	UDP	4000	This is a popular Internet chat program.
IGMP (MULTICAST)	User-Defined	2	Internet Group Multicast Protocol is used when sending packets to a specific group of hosts.
IKE	UDP	500	The Internet Key Exchange algorithm is used for key distribution and management.
IRC	TCP/UDP	6667	This is another popular Internet chat program.
MSN Messenger	TCP	1863	Microsoft Networks' messenger service uses this protocol.
NEW-ICQ	TCP	5190	An Internet chat program.
NEWS	TCP	144	A protocol for news groups.
NFS	UDP	2049	Network File System - NFS is a client/server distributed file service that provides transparent file sharing for network environments.
NNTP	TCP	119	Network News Transport Protocol is the delivery mechanism for the USENET newsgroup service.
PING	User-Defined	1	Packet INternet Groper is a protocol that sends out ICMP echo requests to test whether or not a remote host is reachable.
POP3	TCP	110	Post Office Protocol version 3 lets a client computer get e-mail from a POP3 server through a temporary connection (TCP/IP or other).
PPTP	TCP	1723	Point-to-Point Tunneling Protocol enables secure transfer of data over public networks. This is the control channel.
PPTP_TUNNEL (GRE)	User-Defined	47	PPTP (Point-to-Point Tunneling Protocol) enables secure transfer of data over public networks. This is the data channel.
RCMD	TCP	512	Remote Command Service.
REAL_AUDIO	TCP	7070	A streaming audio service that enables real time sound over the web.
REXEC	TCP	514	Remote Execution Daemon.
RLOGIN	TCP	513	Remote Login.
RTELNET	TCP	107	Remote Telnet.
RTSP	TCP/UDP	554	The Real Time Streaming (media control) Protocol (RTSP) is a remote control for multimedia on the Internet.
SFTP	TCP	115	Simple File Transfer Protocol.

Table 166 Commonly Used Services (continued)

NAME	PROTOCOL	PORT(S)	DESCRIPTION
SMTP	TCP	25	Simple Mail Transfer Protocol is the message-exchange standard for the Internet. SMTP enables you to move messages from one e-mail server to another.
SNMP	TCP/UDP	161	Simple Network Management Program.
SNMP-TRAPS	TCP/UDP	162	Traps for use with the SNMP (RFC:1215).
SQL-NET	TCP	1521	Structured Query Language is an interface to access data on many different types of database systems, including mainframes, midrange systems, UNIX systems and network servers.
SSH	TCP/UDP	22	Secure Shell Remote Login Program.
STRM WORKS	UDP	1558	Stream Works Protocol.
SYSLOG	UDP	514	Syslog allows you to send system logs to a UNIX server.
TACACS	UDP	49	Login Host Protocol used for (Terminal Access Controller Access Control System).
TELNET	TCP	23	Telnet is the login and terminal emulation protocol common on the Internet and in UNIX environments. It operates over TCP/IP networks. Its primary function is to allow users to log into remote host systems.
TFTP	UDP	69	Trivial File Transfer Protocol is an Internet file transfer protocol similar to FTP, but uses the UDP (User Datagram Protocol) rather than TCP (Transmission Control Protocol).
VDOLIVE	TCP	7000	Another videoconferencing solution.

Legal Information

Copyright

Copyright © 2016 by ZyXEL Communications Corporation.

The contents of this publication may not be reproduced in any part or as a whole, transcribed, stored in a retrieval system, translated into any language, or transmitted in any form or by any means, electronic, mechanical, magnetic, optical, chemical, photocopying, manual, or otherwise, without the prior written permission of ZyXEL Communications Corporation.

Published by ZyXEL Communications Corporation. All rights reserved.

Disclaimer

ZyXEL does not assume any liability arising out of the application or use of any products, or software described herein. Neither does it convey any license under its patent rights nor the patent rights of others. ZyXEL further reserves the right to make changes in any products described herein without notice. This publication is subject to change without notice.

Regulatory Notice and Statement

United States of America



The following information applies if you use the product within USA area.

Federal Communications Commission (FCC) EMC Statement

- This device complies with Part 15 of FCC rules. Operation is subject to the following two conditions:
 - (1) This device may not cause harmful interference.
 - (2) This device must accept any interference received, including interference that may cause undesired operations.
- Changes or modifications not expressly approved by the party responsible for compliance could void the user's authority to operate the device.
- This device has been tested and found to comply with the limits for a Class A digital device, pursuant to part 15 of the FCC Rules. These limits are designed to provide reasonable protection against harmful interference when the device is operated in a commercial environment. This device generates, uses, and can radiate radio frequency energy and, if not installed and used in accordance with the instruction manual, may cause harmful interference to radio communications. Operation of this device in a residential area is likely to cause harmful interference in which case the user will be required to correct the interference at his own expense.

Canada

The following information applies if you use the product within Canada area

Industry Canada ICES statement

CAN ICES-3 (A)/NMB-3(A)

European Union



The following information applies if you use the product within the European Union.

CE EMC statement

This is Class A Product. In domestic environment this product may cause radio interference in which case the user may be required to take adequate measures.

List of National Codes

COUNTRY	ISO 3166 2 LETTER CODE	COUNTRY	ISO 3166 2 LETTER CODE
Austria	AT	Liechtenstein	LI
Belgium	BE	Lithuania	LT
Bulgaria	BG	Luxembourg	LU
Croatia	HR	Malta	MT
Cyprus	CY	Netherlands	NL
Czech Republic	CR	Norway	NO
Denmark	DK	Poland	PL
Estonia	EE	Portugal	PT
Finland	FI	Romania	RO
France	FR	Serbia	RS
Germany	DE	Slovakia	SK
Greece	GR	Slovenia	SI
Hungary	HU	Spain	ES
Iceland	IS	Sweden	SE
Ireland	IE	Switzerland	CH
Italy	IT	Turkey	TR
Latvia	LV	United Kingdom	GB

Safety Warnings

- Do not use this product near water, for example, in a wet basement or near a swimming pool.
- Do not expose your device to dampness, dust or corrosive liquids.
- Do not store things on the device.
- Do not install, use, or service this device during a thunderstorm. There is a remote risk of electric shock from lightning.
- Connect ONLY suitable accessories to the device.
- Do not open the device or unit. Opening or removing covers can expose you to dangerous high voltage points or other risks. Only qualified service personnel should service or disassemble this device. Please contact your vendor for further information.
- Make sure to connect the cables to the correct ports.
- Place connecting cables carefully so that no one will step on them or stumble over them.
- Always disconnect all cables from this device before servicing or disassembling.
- Do not remove the plug and connect it to a power outlet by itself; always attach the plug to the power adaptor first before connecting it to a power outlet.
- Do not allow anything to rest on the power adaptor or cord and do NOT place the product where anyone can walk on the power adaptor or cord.
- Please use the provided or designated connection cables/power cables/ adaptors. Connect it to the right supply voltage (for example, 110V AC in North America or 230V AC in Europe). If the power adaptor or cord is damaged, it might cause electrocution. Remove it from the device and the power source, repairing the power adapter or cord is prohibited. Contact your local vendor to order a new one.
- Do not use the device outside, and make sure all the connections are indoors. There is a remote risk of electric shock from lightning.
- Caution: Risk of explosion if battery is replaced by an incorrect type, dispose of used batteries according to the instruction. Dispose them at the applicable collection point for the recycling of electrical and electronic device. For detailed information about recycling of this product, please contact your local city office, your household waste disposal service or the store where you purchased the product.
- Use ONLY power wires of the appropriate wire gauge for your device. Connect it to a power supply of the correct voltage.
- Fuse Warning! Replace a fuse only with a fuse of the same type and rating.
- The POE (Power over Ethernet) devices that supply or receive power and their connected Ethernet cables must all be completely indoors.
- Do not obstruct the device ventilation slots as insufficient airflow may harm your device.
- The following warning statements apply, where the disconnect device is not incorporated in the device or where the plug on the power supply cord is intended to serve as the disconnect device,
 - For permanently connected devices, a readily accessible disconnect device shall be incorporated external to the device;
 - For pluggable devices, the socket-outlet shall be installed near the device and shall be easily accessible.
- This device must be grounded. Never defeat the ground conductor or operate the device in the absence of a suitably installed ground conductor. Contact the appropriate electrical inspection authority or an electrician if you are uncertain that suitable grounding is available.
- When connecting or disconnecting power to hot-pluggable power supplies, if offered with your system, observe the following guidelines:
 - Install the power supply before connecting the power cable to the power supply.
 - Unplug the power cable before removing the power supply.
 - If the system has multiple sources of power, disconnect power from the system by unplugging all power cables from the power supply.

Environment Statment

European Union - Disposal and Recycling Information

The symbol below means that according to local regulations your product and/or its battery shall be disposed of separately from domestic waste. If this product is end of life, take it to a recycling station designated by local authorities. At the time of disposal, the separate collection of your product and/or its battery will help save natural resources and ensure that the environment is sustainable development.

Die folgende Symbol bedeutet, dass Ihr Produkt und/oder seine Batterie gemäß den örtlichen Bestimmungen getrennt vom Hausmüll entsorgt werden muss. Wenden Sie sich an eine Recyclingstation, wenn dieses Produkt das Ende seiner Lebensdauer erreicht hat. Zum Zeitpunkt der Entsorgung wird die getrennte Sammlung von Produkt und/oder seiner Batterie dazu beitragen, natürliche Ressourcen zu sparen und die Umwelt und die menschliche Gesundheit zu schützen.

El símbolo de abajo indica que según las regulaciones locales, su producto y/o su batería deberán depositarse como basura separada de la doméstica. Cuando este producto alcance el final de su vida útil, llévelo a un punto limpio. Cuando llegue el momento de desechar el producto, la recogida por separado éste y/o su batería ayudará a salvar los recursos naturales y a proteger la salud humana y medioambiental.

Le symbole ci-dessous signifie que selon les réglementations locales votre produit et/ou sa batterie doivent être éliminés séparément des ordures ménagères. Lorsque ce produit atteint sa fin de vie, amenez-le à un centre de recyclage. Au moment de la mise au rebut, la collecte séparée de votre produit et/ou de sa batterie aidera à économiser les ressources naturelles et protéger l'environnement et la santé humaine.

Il simbolo sotto significa che secondo i regolamenti locali il vostro prodotto e/o batteria deve essere smaltito separatamente dai rifiuti domestici. Quando questo prodotto raggiunge la fine della vita di servizio portarlo a una stazione di riciclaggio. Al momento dello smaltimento, la raccolta separata del vostro prodotto e/o della sua batteria aiuta a risparmiare risorse naturali e a proteggere l'ambiente e la salute umana.

Symbolen innebär att enligt lokal lagstiftning ska produkten och/eller dess batteri kastas separat från hushållsavfallet. När den här produkten når slutet av sin livslängd ska du ta den till en återvinningsstation. Vid tiden för kasseringen bidrar du till en bättre miljö och mänsklig hälsa genom att göra dig av med den på ett återvinningsställe.



Environmental Product Declaration

Български (Bulgarian)	Čeština (Czech)	Dansk (Danish)	Deutsch (German)
<p>Екологична продуктова декларация</p> <p>RoHS Директива 2011/65/EC WEEE Директива 2012/19/EC PPW Директива 94/62/EC REACH РЕГЛАМЕНТ (ЕО) № 1907/2006</p> <p>Име/ титла : Richard Hsu / Quality Management Подпис : Division Senior Manager Дата (dd/mm/yyyy): 01/10/2014</p>  	<p>Environmentální prohlášení o produktu</p> <p>RoHS Směrnice 2011/65/EU WEEE Směrnice 2012/19/EU PPW Směrnice 94/62/ES REACH Nařízení (ES) č. 1907/2006</p> <p>Jméno/ titul : Richard Hsu / Quality Management Podpis : Division Senior Manager Datum (dd/mm/yyyy): 01/10/2014</p>  	<p>Miljøvederklæring</p> <p>RoHS Direktiv 2011/65/EU WEEE Direktiv 2012/19/EU PPW Direktiv 94/62/EF REACH Forordning (EF) nr. 1907/2006</p> <p>Navn/ titel : Richard Hsu / Quality Management Underskrift : Division Senior Manager Dato (dd/mm/åååå): 01/10/2014</p>  	<p>Produkt-Umweltdeklaration</p> <p>RoHS Richtlinie 2011/65/EU WEEE Richtlinie 2012/19/EU PPW Richtlinie 94/62/EG REACH VERORDNUNG (EG) Nr.1907/2006</p> <p>Name/ titel : Richard Hsu / Quality Management Unterschrift : Division Senior Manager Datum (jjj/mm/tt): 2014/10/01</p>  
Eesti keel (Estonian)	English	Español (Spanish)	Français (French)
<p>Toote keskkonnadeklaratsiooni</p> <p>RoHS Direktiiv 2011/65/EL WEEE Direktiiv 2012/19/EU PPW Direktiiv 94/62/EU REACH MÄÄRUS (EÜ) nr 1907/2006</p> <p>Nimi/ pealkiri : Richard Hsu / Quality Management Allkiri : Division Senior Manager Kuupäev (pp/kk/aaaa): 01/10/2014</p>  	<p>Environmental product declaration</p> <p>RoHS Directive 2011/65/EU WEEE Directive 2012/19/EU PPW Directive 94/62/EC REACH Regulation (EC) No 1907/2006</p> <p>Name/ title : Richard Hsu / Quality Management Signature : Division Senior Manager Date (dd/mm/yyyy): 01/10/2014</p>  	<p>Declaraciones Ambientales de Producto</p> <p>RoHS Directiva 2011/65/UE WEEE Directiva 2012/19/UE PPW Directiva 94/62/CE REACH REGLAMENTO (CE) nº 1907/2006</p> <p>Nombre/ título : Richard Hsu / Quality Management Firma : Division Senior Manager Fecha (aaaa/mm/dd): 2014/10/01</p>  	<p>Profil environnemental de produit</p> <p>RoHS Directive 2011/65/UE WEEE Directive 2012/19/UE PPW Directive 94/62/CE REACH REGLEMENT (CE) N° 1907/2006</p> <p>Nom/ titre : Richard Hsu / Quality Management Signature : Division Senior Manager Date (aaaa/mm/jj): 2014/10/01</p>  
Hrvatski (Croatian)	Italiano (Italian)	Latviešu valoda (Latvian)	Lietuvių kalba (Lithuanian)
<p>Deklaraciju o zbrinjavanju proizvoda</p> <p>RoHS Direktiva 2011/65/EU WEEE Direktiva 2012/19/EU PPW Direktiva 94/62/EZ REACH Uredbe (EZ) br. 1907/2006</p> <p>Ime/ naslov : Richard Hsu / Quality Management Potpis : Division Senior Manager Datum (dd/mm/yyyy): 01/10/2014</p>  	<p>Dichiarazione ambientale di prodotto</p> <p>RoHS Direttiva 2011/65/UE WEEE Direttiva 2012/19/UE PPW Direttiva 94/62/CE REACH REGOLAMENTO (CE) n. 1907/2006</p> <p>Nome/ titolo : Richard Hsu / Quality Management Firma : Division Senior Manager Data (aaaa/mm/gg): 2014/10/01</p>  	<p>Produkta vides ietekmējuma deklarācija</p> <p>RoHS Direktīva 2011/65/ES WEEE Direktīva 2012/19/ES PPW Direktīva 94/62/EK REACH Regula (EK) Nr. 1907/2006</p> <p>Nosaukum s/ tītuls : Richard Hsu / Quality Management Paraksts : Division Senior Manager Datums(dd/mm/gggg): 01/10/2014</p>  	<p>Aplinkosauginę gaminių deklaraciją</p> <p>RoHS Direktyva 2011/65/ES WEEE Direktyva 2012/19/ES PPW Direktyva 94/62/EB REACH REGLAMENTAS (EB) Nr. 1907/2006</p> <p>Vardas/ titulas : Richard Hsu / Quality Management Parašas : Division Senior Manager Data (dd/mm/mmmmm): 01/10/2014</p>  
Magyar (Hungarian)	Malta (Maltese)	Nederlands (Dutch)	Polski (Polish)
<p>Környezetvédelmi terméknyilatkozatot</p> <p>RoHS 2011/65/EU irányelve WEEE 2012/19/EU irányelve PPW 94/62/EK irányelve REACH 1907/2006/EK Rendelet</p> <p>Név/ cím : Richard Hsu / Quality Management Aláírás : Division Senior Manager Dátum (éééé/hh/nn): 2014/10/01</p>  	<p>Dikjarazzjoni Ambjentali dwar il-Prodott</p> <p>RoHS Direttiva 2011/65/UE WEEE Direttiva 2012/19/UE PPW Direttiva 94/62/KE REACH REGOLAMENTO (KE) NRU 1907/2006</p> <p>Isem/ titolu : Richard Hsu / Quality Management Firma : Division Senior Manager Data (ssss/xx/jj): 2014/10/01</p>  	<p>Milieuproductverklaring</p> <p>RoHS Richtlijn 2011/65/EU WEEE Richtlijn 2012/19/EU PPW Richtlijn 94/62/EG REACH Verordening (EG) nr. 1907/2006</p> <p>Naam/ titel : Richard Hsu / Quality Management Handtekening : Division Senior Manager Datum (dd/mm/jaar): 01/10/2014</p>  	<p>Deklarację środowiskową produktu</p> <p>RoHS Dyrektywa 2011/65/UE WEEE Dyrektywa 2012/19/UE PPW Dyrektywa 94/62/WE REACH Rozporządzenie (WE) nr 1907/2006</p> <p>Nazwisko /tytuł : Richard Hsu / Quality Management Podpis : Division Senior Manager Data (rrr/mm/vdd): 2014/10/01</p>  
Português (Portuguese)	Română (Romanian)	Slovenčina (Slovak)	Slovenščina (Slovene)
<p>Declaração ambiental do produto</p> <p>RoHS Directiva 2011/65/UE WEEE Directiva 2012/19/UE PPW Directiva 94/62/CE REACH Regulamento (CE) n.º 1907/2006</p> <p>Nome/ título : Richard Hsu / Quality Management Assinatura : Division Senior Manager Data (dd/mm/aaaa): 01/10/2014</p>  	<p>Declarație de mediu privind produsele</p> <p>RoHS Directiva 2011/65/UE WEEE Directiva 2012/19/UE PPW Directiva 94/62/CE REACH REGULAMENTUL (CE) NR 907/2006</p> <p>Numele/ titlu : Richard Hsu / Quality Management Semnătura : Division Senior Manager Data (zz/ll/aaaa): 01/10/2014</p>  	<p>Vyhlasenie o environmentálnom výrobku</p> <p>RoHS Smernica 2011/65/EU WEEE Smernica 2012/19/EU PPW Smernica 94/62/ES REACH Nariadenie (ES) č. 1907/2006</p> <p>Menó/ titul : Richard Hsu / Quality Management Podpis : Division Senior Manager Dátum (dd/mm/yyyy): 01/10/2014</p>  	<p>Okoljsko deklaracija izdelka</p> <p>RoHS Direktiva 2011/65/UE WEEE Direktiva 2012/19/EU PPW Direktiva 94/62/ES REACH Uredba (ES) št. 1907/2006</p> <p>Ime/ naziv : Richard Hsu / Quality Management Podpis : Division Senior Manager Datum (dd/mm/llll): 01/10/2014</p>  
Suomi (Finnish)	Svenska (Swedish)	Ελληνικά (Greek)	Norsk (Norwegian)
<p>Standardiin perustuva ympäristötuoteseloste</p> <p>RoHS Direktiivi 2011/65/EU WEEE Direktiivi 2012/19/EU PPW Direktiivi 94/62/EU REACH ASETUS (EY) N:o 1907/2006</p> <p>Nimi/ otsikko : Richard Hsu / Quality Management Allekirjoitus : Division Senior Manager Päivämäärä (pp/kk/vvvv): 01/10/2014</p>  	<p>Miljöproduktdeklaration</p> <p>RoHS Direktiv 2011/65/EU WEEE Direktiv 2012/19/EU PPW Direktiv 94/62/EG REACH Förordning (EG) nr 1907/2006</p> <p>Namn/ titel : Richard Hsu / Quality Management Namnteckning : Division Senior Manager Datum (dd/mm/åååå): 01/10/2014</p>  	<p>Περιβαλλοντική δήλωση προϊόντος</p> <p>RoHS Οδηγία 2011/65/ΕΕ WEEE Οδηγία 2012/19/ΕΕ PPW Οδηγία 94/62/ΕΚ REACH Κανονισμός (ΕΚ) αριθ. 1907/2006</p> <p>Όνομα/ τίτλος : Richard Hsu / Quality Management Υπογραφή : Division Senior Manager Ημερομηνία (ηη/μμ/εεεε): 01/10/2014</p>  	<p>Miljødeklarasjon</p> <p>RoHS Direktiv 2011/65/EU WEEE Direktiv 2012/19/EU PPW Direktiv 94/62/EF REACH Forordning (EF) nr. 1907/2006</p> <p>Navn/ tittel : Richard Hsu / Quality Management Signatur : Division Senior Manager Dato (dd/mm/åååå): 01/10/2014</p>  

台灣

警告使用者：
這是甲類的資訊產品，在居住的環境中使用時，可能會造成射頻干擾，在這種情況下，使用者會被要求採取某些適當的對策。」

安全警告

為了您的安全，請先閱讀以下警告及指示：

- 請勿將此產品接近水、火焰或放置在高溫的環境。
- 避免設備接觸
任何液體 - 切勿讓設備接觸水、雨水、高濕度、污水腐蝕性的液體或其他水份。
灰塵及污物 - 切勿接觸灰塵、污物、沙土、食物或其他不合適的材料。
- 雷雨天氣時，不要安裝、使用或維修此設備。有遭受電擊的風險。
- 切勿重摔或撞擊設備，並勿使用不正確的電源變壓器。
- 若接上不正確的電源變壓器會有爆炸的風險。
- 請勿隨意更換產品內的電池。
- 如果更換不正確之電池型式，會有爆炸的風險，請依製造商說明書處理使用過之電池。
- 請將廢電池丟棄在適當的電器或電子設備回收處。
- 請勿將設備解體。
- 請勿阻礙設備的散熱孔，空氣對流不足將會造成設備損害。
- 請插在正確的電壓供給插座 (如：北美 / 台灣電壓 110V AC，歐洲是 230V AC)。
- 假若電源變壓器或電源變壓器的纜線損壞，請從插座拔除，若您還繼續插電使用，會有觸電死亡的風險。
- 請勿試圖修理電源變壓器或電源變壓器的纜線，若有毀損，請直接聯絡您購買的店家，購買一個新的電源變壓器。
- 請勿將此設備安裝於室外，此設備僅適合放置於室內。
- 請勿隨一般垃圾丟棄。
- 請參閱產品背貼上的設備額定功率。
- 請參考產品型錄或是彩盒上的作業溫度。
- 設備必須接地，接地導線不允許被破壞或沒有適當安裝接地導線，如果不確定接地方式是否符合要求可聯繫相應的電氣檢驗機構檢驗。
- 如果您提供的系統中有提供熱插拔電源，連接或斷開電源請遵循以下指導原則
 - 先連接電源線至設備連，再連接電源。
 - 先斷開電源再拔除連接至設備的電源線。
 - 如果系統有多個電源，需拔除所有連接至電源的電源線再關閉設備電源。
- 產品沒有斷電裝置或者採用電源線的插頭視為斷電裝置的一部分，以下警語將適用：
 - 對永久連接之設備，在設備外部須安裝可觸及之斷電裝置；
 - 對插接式之設備，插座必須接近安裝之地點而且是易於觸及的。

Viewing Certifications

Go to <http://www.zyxel.com> to view this product's documentation and certifications.

ZyXEL Limited Warranty

ZyXEL warrants to the original end user (purchaser) that this product is free from any defects in material or workmanship for a specific period (the Warranty Period) from the date of purchase. The Warranty Period varies by region. Check with your vendor and/or the authorized ZyXEL local distributor for details about the Warranty Period of this product. During the warranty period, and upon proof of purchase, should the product have indications of failure due to faulty workmanship and/or materials, ZyXEL will, at its discretion, repair or replace the defective products or components without charge for either parts or labor, and to whatever extent it shall deem necessary to restore the product or components to proper operating condition. Any replacement will consist of a new or re-manufactured functionally equivalent product of equal or higher value, and will be solely at the discretion of ZyXEL. This warranty shall not apply if the product has been modified, misused, tampered with, damaged by an act of God, or subjected to abnormal working conditions.

Note

Repair or replacement, as provided under this warranty, is the exclusive remedy of the purchaser. This warranty is in lieu of all other warranties, express or implied, including any implied warranty of merchantability or fitness for a particular use or purpose. ZyXEL shall in no event be held liable for indirect or consequential damages of any kind to the purchaser.

To obtain the services of this warranty, contact your vendor. You may also refer to the warranty policy for the region in which you bought the device at http://www.zyxel.com/web/support_warranty_info.php.

Registration

Register your product online to receive e-mail notices of firmware upgrades and information at www.zyxel.com for global products, or at www.us.zyxel.com for North American products.

Trademarks

ZyNOS (ZyXEL Network Operating System) and ZON (ZyXEL One Network) are registered trademarks of ZyXEL Communications, Inc. Other trademarks mentioned in this publication are used for identification purposes only and may be properties of their respective owners.

Open Source Licenses

This product contains in part some free software distributed under GPL license terms and/or GPL like licenses. Open source licenses are provided with the firmware package. You can download the latest firmware at www.zyxel.com. To obtain the source code covered under those Licenses, please contact support@zyxel.com.tw to get it.

Numbers

802.1P priority [87](#)

A

access control

limitations [303](#)

login account [315](#)

remote management [323](#)

service port [322](#)

SNMP [303](#)

accounting

setup [208](#)

address learning, MAC [96, 99](#)

Address Resolution Protocol (ARP) [290, 339, 341, 342](#)

administrator password [316](#)

age [129](#)

aggregator ID [147, 149](#)

aging time [82](#)

applications

backbone [18](#)

bridging [19](#)

IEEE 802.1Q VLAN [20](#)

switched workgroup [19](#)

ARP

how it works [290, 339](#)

learning mode [290](#)

overview [290](#)

table [339](#)

ARP (Address Resolution Protocol) [339](#)

ARP inspection [216, 218](#)

and MAC filter [219](#)

configuring [219](#)

syslog messages [219](#)

trusted ports [219](#)

ARP-Reply [290](#)

ARP-Request [291](#)

authentication

and RADIUS [204](#)

setup [208](#)

authorization

privilege levels [211](#)

setup [208](#)

auto-crossover [29](#)

automatic VLAN registration [89](#)

B

back up, configuration file [298](#)

basic settings [77](#)

basic setup tutorial [47](#)

binding [216](#)

binding table [216](#)

building [216](#)

BPDUs (Bridge Protocol Data Units) [116](#)

Bridge Protocol Data Units (BPDUs) [116](#)

C

CDP [244](#)

certifications

viewing [361](#)

CFI (Canonical Format Indicator) [88](#)

changing the password [40](#)

Cisco Discovery Protocol, see CDP

CIST [119](#)

CIST (Common and Internal Spanning Tree) [117](#)

Class of Service (CoS) [269](#)

classifier [168, 171](#)

and QoS [168](#)

editing [171](#)

example [172](#)

overview [168](#)

setup [168, 171](#)

viewing [171](#)

CLI

- Reference Guide [2](#)
- cloning a port See port cloning [342](#)
- cluster management [329](#)
 - and switch passwords [335](#)
 - cluster manager [329, 334](#)
 - cluster member [329, 335](#)
 - cluster member firmware upgrade [332](#)
 - network example [329](#)
 - setup [333](#)
 - specification [329](#)
 - status [330](#)
 - switch models [329](#)
 - VID [334](#)
 - web configurator [331](#)
- cluster manager [329](#)
- cluster member [329](#)
- Common and Internal Spanning Tree (CIST) [117](#)
- Common and Internal Spanning Tree, See CIST [119](#)
- configuration [268](#)
 - change running config [295](#)
 - file names [300](#)
- configuration file [41](#)
 - backup [298](#)
 - restore [41, 297](#)
 - saving [295](#)
- configuration, saving [40](#)
- console port [28](#)
- contact information [348](#)
- copying port settings, See port cloning [342](#)
- copyright [357](#)
- CPU management port [104](#)
- CPU protection
 - configuration [260](#)
 - overview [258](#)
- current date [79](#)
- current time [79](#)
- customer support [348](#)

D

- daylight saving time [79](#)
- default Ethernet settings [28](#)
- DHCP [276](#)
 - configuration options [276](#)

- modes [276](#)
 - relay agent [276](#)
 - relay example [284](#)
 - setup [276, 282](#)
- DHCP (Dynamic Host Configuration Protocol) [276](#)
- DHCP relay option 82 [218](#)
- DHCP snooping [47, 216](#)
 - configuring [218](#)
 - DHCP relay option 82 [218](#)
 - trusted ports [217](#)
 - untrusted ports [217](#)
- DHCP snooping database [217](#)
- DHCPv6 relay [285](#)
 - interface-ID [285](#)
 - remote-ID [285](#)
- diagnostics [325](#)
 - Ethernet port test [325](#)
 - ping [325](#)
 - system log [325](#)
- Differentiated Service (DiffServ) [269](#)
- DiffServ [269](#)
 - activate [271](#)
 - and TRTCM [273](#)
 - DS field [269](#)
 - DSCP [269](#)
 - network example [269](#)
 - PHB [269](#)
- disclaimer [357](#)
- documentation
 - related [2](#)
- double-tagged frames [182](#)
- DS (Differentiated Services) [269](#)
- DSCP
 - service level [269](#)
 - what it does [269](#)
- DSCP (DiffServ Code Point) [269](#)
- dynamic link aggregation [145](#)

E

- egress port [107](#)
- errdisable status [260](#)
- Error Disable [60](#)
- error disable
 - control packets [260](#)

- status [259](#)
- error disable detect [261](#)
- error disable recovery
 - configuration [262](#)
 - overview [258](#)
- Ethernet broadcast address [290, 339](#)
- Ethernet port test [325](#)
- external authentication server [204](#)

F

- FCC interference statement [357](#)
- file transfer using FTP
 - command example [300](#)
- filename convention, configuration [300](#)
- filtering [113](#)
 - rules [113](#)
- filtering database, MAC table [336](#)
- firmware [77](#)
 - upgrade [297, 332](#)
- flow control [87](#)
 - back pressure [87](#)
 - IEEE802.3x [87](#)
- forwarding
 - delay [129](#)
- frames
 - tagged [95](#)
 - untagged [95](#)
- front panel [26](#)
- FTP [300](#)
 - file transfer procedure [301](#)
 - restrictions over WAN [302](#)

G

- GARP [89](#)
- GARP (Generic Attribute Registration Protocol) [89](#)
- GARP terminology [89](#)
- GARP timer [82, 89](#)
- general setup [78](#)
- getting help [42](#)
- Gigabit ports [28](#)
- GMT (Greenwich Mean Time) [79](#)

- gratuitous ARP [291](#)
- Guide
 - CLI Reference [2](#)
 - Quick Start [2](#)
- GVRP [89, 95](#)
 - and port assignment [95](#)
- GVRP (GARP VLAN Registration Protocol) [89](#)

H

- hardware installation [22](#)
- hardware monitor [77](#)
- hardware overview [26](#)
- hello time [129](#)
- hops [129](#)
- HTTPS [318](#)
 - certificates [318](#)
 - implementation [318](#)
 - public keys, private keys [318](#)
- HTTPS example [319](#)

I

- IEEE 802.1p, priority [83](#)
- IEEE 802.1x
 - activate [154, 158, 206](#)
 - reauthentication [155](#)
- IEEE 802.1x, port authentication [152](#)
- IGMP
 - version [189](#)
- IGMP (Internet Group Management Protocol) [189](#)
- IGMP filtering [189](#)
 - profile [195](#)
 - profiles [191](#)
- IGMP leave timeout
 - fast [192](#)
 - normal [192](#)
- IGMP snooping [189](#)
 - MVR [196](#)
- IGMP throttling [193](#)
- ingress port [107](#)
- installation
 - desktop [22](#)

- precautions [23](#)
 - rack-mounting [22](#)
 - transceivers [29](#)
- installation scenarios [22](#)
- Internet Protocol version 6, see IPv6
- introduction [18](#)
- IP address [84](#)
- IP interface [83](#)
- IP setup [83](#)
- IP source guard [216](#)
- ARP inspection [216, 218](#)
 - DHCP snooping [216](#)
 - static bindings [216](#)
- IP subnet mask [84](#)
- IPv6 [21](#)
- Neighbor Discovery Protocol [21](#)
 - ping [21](#)
- ## L
- L2PT [242](#)
- access port [243](#)
 - CDP [242](#)
 - configuration [243](#)
 - encapsulation [242](#)
 - LACP [242](#)
 - MAC address [242](#)
 - mode [243](#)
 - overview [242](#)
 - PAgP [242](#)
 - point to point [242](#)
 - STP [242](#)
 - tunnel port [243](#)
 - UDLD [242](#)
 - VTP [242](#)
- LACP [145, 245](#)
- system priority [150](#)
 - timeout [150](#)
- Layer 2 protocol tunneling, see L2PT
- LEDs [33](#)
- limit MAC address learning [162](#)
- Link Aggregate Control Protocol (LACP) [145](#)
- link aggregation [145](#)
- dynamic [145](#)
 - ID information [146](#)
 - setup [147, 149](#)
- status [146](#)
 - traffic distribution algorithm [147](#)
 - traffic distribution type [148](#)
- local port mirroring [139](#)
- lockout [40](#)
- log [325](#)
- login [35](#)
- password [40](#)
- login account
- Administrator [315](#)
 - non-administrator [315](#)
- login accounts [315](#)
- configuring via web configurator [315](#)
 - multiple [315](#)
 - number of [315](#)
- login password [316](#)
- loop guard [236](#)
- how it works [237](#)
 - port shut down [237](#)
 - probe packet [237](#)
- loop guard, vs STP [236](#)
- ## M
- MAC (Media Access Control) [77](#)
- MAC address [77, 339](#)
- maximum number per port [162](#)
- MAC address learning [82, 96, 99, 108, 162](#)
- specify limit [162](#)
- MAC authentication [153](#)
- aging time [159](#)
- MAC filter
- and ARP inspection [219](#)
- MAC freeze [161](#)
- MAC table [336](#)
- display criteria [337](#)
 - how it works [336](#)
 - sorting criteria [337](#)
 - transfer type [338](#)
 - viewing [337](#)
- MAC-based VLAN [101](#)
- maintenance [294](#)
- configuration backup [298](#)
 - current configuration [294](#)
 - firmware [297](#)

- main screen [294](#)
 - restoring configuration [297](#)
 - Management Information Base (MIB) [304](#)
 - management port [107](#)
 - managing the device
 - good habits [21](#)
 - using FTP. See [FTP](#). [21](#)
 - using Telnet. See [command interface](#). [21](#)
 - using the command interface. See [command interface](#). [21](#)
 - man-in-the-middle attacks [218](#)
 - max
 - age [129](#)
 - hops [129](#)
 - MDIX (Media Dependent Interface Crossover) [29](#)
 - Metric [267](#)
 - MIB
 - and SNMP [304](#)
 - supported MIBs [305](#)
 - MIB (Management Information Base) [304](#)
 - mirroring ports [139](#)
 - monitor port [141](#)
 - mounting brackets [23](#)
 - MST Instance, See [MSTI](#) [119](#)
 - MST region [118](#)
 - MSTI [119](#)
 - MST ID [119](#)
 - MSTI (Multiple Spanning Tree Instance) [117](#)
 - MSTP [115, 117](#)
 - bridge ID [132, 133](#)
 - configuration [128, 130](#)
 - configuration digest [133](#)
 - forwarding delay [129](#)
 - Hello Time [132](#)
 - hello time [129](#)
 - Max Age [132](#)
 - max age [129](#)
 - max hops [129](#)
 - MST region [118](#)
 - network example [117](#)
 - path cost [130](#)
 - port priority [130](#)
 - revision level [129](#)
 - MSTP (Multiple Spanning Tree Protocol) [115](#)
 - MTU (Multi-Tenant Unit) [80](#)
 - multicast [189](#)
 - 802.1 priority [191](#)
 - and IGMP [189](#)
 - IGMP throttling [193](#)
 - IP addresses [189](#)
 - overview [189](#)
 - setup [190, 191](#)
 - multicast group [195](#)
 - multicast VLAN [199](#)
 - Multiple Spanning Tree Instance, See [MSTI](#) [117](#)
 - Multiple Spanning Tree Protocol [116](#)
 - Multiple Spanning Tree Protocol, See [MSTP](#). [115](#)
 - Multiple STP [116](#)
 - Multiple STP, see [MSTP](#) [117](#)
 - MVR [196](#)
 - configuration [197](#)
 - group configuration [199](#)
 - network example [196](#)
 - MVR (Multicast VLAN Registration) [196](#)
- ## N
- network applications [18](#)
 - network management system (NMS) [303](#)
 - NTP (RFC-1305) [79](#)
- ## O
- other documentation [2](#)
- ## P
- PAGP [245](#)
 - password [40](#)
 - administrator [316](#)
 - PHB (Per-Hop Behavior) [269](#)
 - ping, test connection [325](#)
 - policy [175, 177](#)
 - and classifier [175](#)
 - and DiffServ [174](#)
 - configuration [175](#)
 - example [177](#)
 - overview [174](#)
 - rules [174](#)

- viewing [176](#)
 - policy configuration [177](#)
 - Port Aggregation Protocol, see [PAgP](#)
 - port authentication [152](#)
 - and RADIUS [204](#)
 - IEEE802.1x [154, 158, 206](#)
 - MAC authentication [153](#)
 - port based VLAN type [82](#)
 - port cloning [341, 342](#)
 - advanced settings [341, 342](#)
 - basic settings [341, 342](#)
 - port details [74](#)
 - port isolation [107](#)
 - port mirroring [139, 141](#)
 - direction [141, 143](#)
 - egress [141, 143](#)
 - ingress [141, 143](#)
 - port redundancy [145](#)
 - port security [160](#)
 - address learning [162](#)
 - limit MAC address learning [162](#)
 - MAC address learning [160](#)
 - overview [160](#)
 - setup [160, 238, 243](#)
 - port setup [85](#)
 - port status [73](#)
 - port VLAN trunking [90](#)
 - port-based VLAN [104](#)
 - all connected [107](#)
 - port isolation [107](#)
 - settings wizard [107](#)
 - ports
 - "standby" [145](#)
 - diagnostics [325](#)
 - mirroring [139](#)
 - speed/duplex [86](#)
 - power connector [30](#)
 - power module
 - current rating [31](#)
 - power wire [31](#)
 - power status [78](#)
 - power voltage [78](#)
 - power wires [31](#)
 - PPPoE IA [54](#)
 - trusted ports [252](#)
 - untrusted ports [252](#)
 - priority level [83](#)
 - priority, queue assignment [83](#)
 - private VLAN [264](#)
 - configuration [264](#)
 - isolated port [264](#)
 - overview [264](#)
 - promiscuous port [264](#)
 - product registration [361](#)
 - protocol based VLAN [98](#)
 - and IEEE 802.1Q tagging [98](#)
 - example [100](#)
 - hexadecimal notation for protocols [97, 99](#)
 - isolate traffic [98](#)
 - priority [97, 99](#)
 - PVID [88, 95](#)
 - PVID (Priority Frame) [88](#)
- ## Q
- QoS
 - and classifier [168](#)
 - queue weight [180](#)
 - queuing [179](#)
 - SPQ [180](#)
 - WRR [180](#)
 - queuing method [179, 181](#)
 - Quick Start Guide [2](#)
- ## R
- rack-mounting [22](#)
 - RADIUS [204](#)
 - advantages [204](#)
 - and authentication [204](#)
 - Network example [203](#)
 - server [204](#)
 - settings [204](#)
 - setup [204](#)
 - Rapid Spanning Tree Protocol, See [RSTP](#). [115](#)
 - reboot
 - load configuration [295](#)
 - reboot system [295](#)
 - Reference Guide, CLI [2](#)
 - reflector port [139](#)

- registration
 - product [361](#)
 - related documentation [2](#)
 - remote management [323](#)
 - service [324](#)
 - trusted computers [324](#)
 - remote port mirroring [139](#)
 - resetting [41, 295](#)
 - to factory default settings [295](#)
 - restoring configuration [41, 297](#)
 - RFC 3164 [326](#)
 - RMirror [139](#)
 - monitor port [142](#)
 - reflector port [142](#)
 - source [142](#)
 - Round Robin Scheduling [180](#)
 - RSTP [115](#)
- S**
- save configuration [40, 295](#)
 - service access control [322](#)
 - service port [323](#)
 - sFlow [246](#)
 - collector [248](#)
 - configuration [246](#)
 - datagram [246](#)
 - overview [246](#)
 - poll interval [247](#)
 - sample rate [247](#)
 - UDP port [248](#)
 - sFlow agent [246](#)
 - sFlow collector [246](#)
 - Simple Network Management Protocol, see SNMP [303](#)
 - Small Form-factor Pluggable (SFP) [29](#)
 - SNMP [303](#)
 - agent [304](#)
 - and MIB [304](#)
 - and security [304](#)
 - authentication [314](#)
 - communities [310](#)
 - management model [304](#)
 - manager [304](#)
 - MIB [305](#)
 - network components [304](#)
 - object variables [304](#)
 - protocol operations [304](#)
 - security [314](#)
 - setup [309, 311](#)
 - users [313](#)
 - version 3 [304](#)
 - versions supported [303](#)
 - SNMP traps [305](#)
 - setup [311](#)
 - supported [305, 307, 309](#)
 - Spanning Tree Protocol, See STP. [115](#)
 - SPQ (Strict Priority Queuing) [180](#)
 - SSH
 - encryption methods [317](#)
 - how it works [316](#)
 - implementation [317](#)
 - SSH (Secure Shell) Secure Shell, See SSH [316](#)
 - SSL (Secure Socket Layer) [318](#)
 - standby ports [145](#)
 - static bindings [216](#)
 - static MAC address [108](#)
 - static MAC forwarding [96, 99, 108](#)
 - static multicast address [110](#)
 - static multicast forwarding [110](#)
 - Static route
 - Setup [266](#)
 - static routes [268](#)
 - static trunking example [150](#)
 - Static VLAN [92](#)
 - static VLAN
 - control [94](#)
 - tagging [94](#)
 - status [73](#)
 - link aggregation [146](#)
 - port [73](#)
 - port details [74](#)
 - power [78](#)
 - STP [124, 127, 132](#)
 - VLAN [91](#)
 - STP [115, 244](#)
 - bridge ID [124, 127](#)
 - bridge priority [122, 125](#)
 - configuration [121, 125, 128](#)
 - designated bridge [116](#)
 - forwarding delay [123, 126](#)
 - Hello BPDU [116](#)
 - Hello Time [122, 124, 125, 127](#)

- how it works [116](#)
- Max Age [123, 124, 126, 127](#)
- path cost [115, 123, 126](#)
- port priority [123, 126](#)
- port state [116](#)
- root port [116](#)
- status [124, 127, 132](#)
- terminology [115](#)
- vs loop guard [236](#)
- subnet based VLANs [95](#)
 - and DHCP VLAN [97](#)
 - and priority [96](#)
 - configuration [96](#)
- switch lockout [40](#)
- switch reset [41](#)
- switch setup [82](#)
- syslog [219, 326](#)
 - protocol [326](#)
 - server setup [327](#)
 - settings [326](#)
 - setup [326](#)
 - severity levels [326](#)
- system information [77](#)
- system log [325](#)
- system reboot [295](#)
- transceiver MultiSource Agreement (MSA) [29](#)
- transceivers [29](#)
 - installation [29](#)
 - removal [30](#)
- traps
 - destination [310](#)
- TRTCM
 - and bandwidth control [272](#)
 - and DiffServ [273](#)
 - color-aware mode [271](#)
 - color-blind mode [271](#)
 - setup [272](#)
- trunk group [145](#)
- trunking [145](#)
 - example [150](#)
- trusted ports
 - ARP inspection [219](#)
 - DHCP snooping [217](#)
 - PPPoE IA [252](#)
- Tunnel Protocol Attribute, and RADIUS [212](#)
- tutorials [47](#)
 - DHCP snooping [47](#)
 - Error Disable [60](#)
 - PPPoE IA [54](#)
- Two Rate Three Color Marker (TRTCM) [270](#)
- Type of Service (ToS) [269](#)

T

- TACACS+ [204](#)
 - setup [206](#)
- TACACS+ (Terminal Access Controller Access-Control System Plus) [203](#)
- tagged VLAN [88](#)
- Tech-Support [298](#)
 - log enhancement [298](#)
- temperature indicator [78](#)
- terminal emulation [28](#)
- time
 - current [79](#)
 - time zone [79](#)
- Time (RFC-868) [79](#)
- time server [79](#)
- time service protocol [79](#)
 - format [79](#)
- trademarks [361](#)

U

- UDLD [245](#)
- UniDirectional Link Detection, see UDLD
- untrusted ports
 - ARP inspection [219](#)
 - DHCP snooping [217](#)
 - PPPoE IA [252](#)
- user profiles [203](#)

V

- Vendor Specific Attribute See VSA
- ventilation [22](#)
- VID [88, 91, 92, 184](#)
 - number of possible VIDs [88](#)
 - priority frame [88](#)

VID (VLAN Identifier) [88](#)

VLAN [80, 88](#)

acceptable frame type [95](#)

automatic registration [89](#)

ID [88](#)

ingress filtering [95](#)

introduction [80](#)

number of VLANs [91](#)

port number [92](#)

port settings [94](#)

port-based VLAN [104](#)

port-based, all connected [107](#)

port-based, isolation [107](#)

port-based, wizard [107](#)

static VLAN [92](#)

status [91, 92](#)

tagged [88](#)

trunking [90, 95](#)

type [82, 90](#)

VLAN (Virtual Local Area Network) [80](#)

VLAN ID [85](#)

VLAN mapping [239](#)

activating [239](#)

configuration [240](#)

example [239](#)

priority level [239](#)

tagged [239](#)

traffic flow [239](#)

untagged [239](#)

VLAN ID [239](#)

VLAN stacking [182, 184](#)

configuration [184](#)

example [182](#)

frame format [184](#)

port roles [183, 185](#)

port-based Q-in-Q [186](#)

priority [184](#)

selective Q-in-Q [187](#)

VLAN Trunking Protocol, see VTP

VLAN, protocol based, See protocol based VLAN

VLAN, subnet based, See subnet based VLANs [95](#)

VSA [211](#)

VT100 [28](#)

VTP [244](#)

W

warranty [361](#)

note [361](#)

web configurator [35](#)

getting help [42](#)

layout [36](#)

login [35](#)

logout [42](#)

navigation panel [37](#)

weight, queuing [180](#)

Weighted Round Robin Scheduling (WRR) [180](#)

WRR (Weighted Round Robin Scheduling) [180](#)

Z

ZyNOS (ZyXEL Network Operating System) [300](#)