

CATALOG
14

Section A



SPAENAU

Fasteners Right Now[®]

CATALOG
14

CATALOG 14

SPAENAUR

P: 1-800-265-8772 F: 1-888-252-6380 service@spenaar.com



© 2018 Spenaar Inc. All rights reserved. Catalog may not be reproduced, in whole or in part, without the written permission of Spenaar Inc. Subject to Catalog Terms and Conditions of Use available at Spenaar.com and on page TC2 and TC3 at the back of this catalog. © 2018 Spenaar Inc. Tous droits réservés. Le catalogue ne peut être reproduit, en tout ou en partie, sans l'autorisation écrite de Spenaar Inc. L'utilisation est soumise aux Conditions d'utilisation du Catalogue disponibles sur Spenaar.com et à la page TC4 et TC5 à la fin de ce catalogue.

Assortments, Plastikits & Storage Products



Assortiments, plastikits et produits d'entreposage

A

Assortment & Plastikit Container Specifications Storage Slide Racks, Empty Assortment & Plastikit Containers	Inch A2	Pouce	Spécifications du conteneur d'assortiment et plastikit Supports de rangement coulissant, conteneur d'assortiment et plastikit vide
Spaenaur Assortments & Plastikits Visual Assortment Index	Inch & Metric A5	Pouce et métrique	Assortiments et plastikits Spaenaur Référence rapide du produit
Spaenaur Assortments & Plastikits Full Product Details	Inch & Metric A25	Pouce et métrique	Informations sur le contenu du produit Détails complets du produit
Durham Organizers, Storage & Display Solutions Cases, Drawers, Cabinets, Bins, Racks, Literature Racks, Spool Racks, Plastic Compartment Boxes, Tool Boxes & Accessories	Inch A120	Pouce	Organiseurs, solutions de rangement et d'affichage Durham Caisnes, tiroirs, armoires, bacs, supports, supports de documentation, supports de bobines, boîtes à compartiments en plastique, boîtes à outils et accessoires
Section Index	 A141 A142		Index de section

SPAENAUR**REGULAR SIZE
Assortments****13-3/8" x 9-1/4" x 2"**

- All "REGULAR SIZE" Assortments are put up in durable, welded STEEL drawers with hinged lid, and are finished in Grey enamel.
- Inside lid label shows stock numbers and size data.
- All drawers have SCOOPED bins, for easy removal of contents.
- Individual refill items always available in Unit Packages, as catalogued.
- SPAENAUR Regular Size Assortments are ideal for garages, industrial plants, service trades, schools, etc.
- Matching empty drawers are also available. (See pages A120 and A121.)



Typical
**"REGULAR SIZE"
Assortment**

(See page A3 for
"Large Size" Assortments.)

PKG QTY. 1

STORAGE - SLIDE RACKS

For Organized Storage of Your

SPAENAUR**"REGULAR SIZE" Assortments Only****No. 814-406****15-1/4" W x 11-3/4" D x 16-3/8" H**Shipping weight **14.5 kg** (32 lbs.)**Accommodates 6 Drawers - Regular size**

13-3/8" W x 9-1/4" D x 2" H

No. 814-404**15-1/4" W x 11-3/4" D x 11-1/4" H**Shipping weight **10 kg** (22 lbs.)**Accommodates 4 Drawers - Regular size**

13-3/8" W x 9-1/4" D x 2" H

No. 814-751**15-1/4" W x 11-3/4" D x 6-1/4" H**Shipping weight **5.5 kg** (12 lbs.)**Accommodates 2 Drawers - Regular size**

13-3/8" W x 9-1/4" D x 2" H

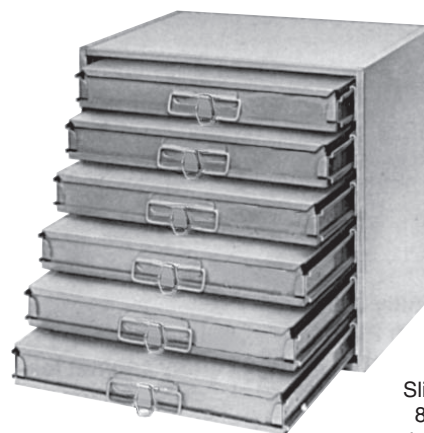

Slide Rack
814-406
is shown.

SLIDE RACK

(Drawers not included)

- Heavy-duty Steel
- All Welded Construction
- Grey Enamel Finish

SPAENAUR
REGULAR SIZE ASSORTMENTS
are for YOU!



PKG QTY. 1

Typical
"LARGE SIZE"
Assortment

Roomy compartments provide generous storage space.
(See also page A2 for "Regular Size" Assortments.)

SPAENAUR
LARGE SIZE
Assortments

18" x 12" x 3"

- All "LARGE SIZE" Assortments are put up in welded STEEL drawers with hinged lid, and finished in Grey enamel.
- Inside lid label shows stock numbers and size data.
- All drawers have SCOOPED bins, for easy removal of contents.
- Individual refill items always available in Unit Packages, as catalogued.
- Matching empty drawers are also available. See pages A120 - A123.

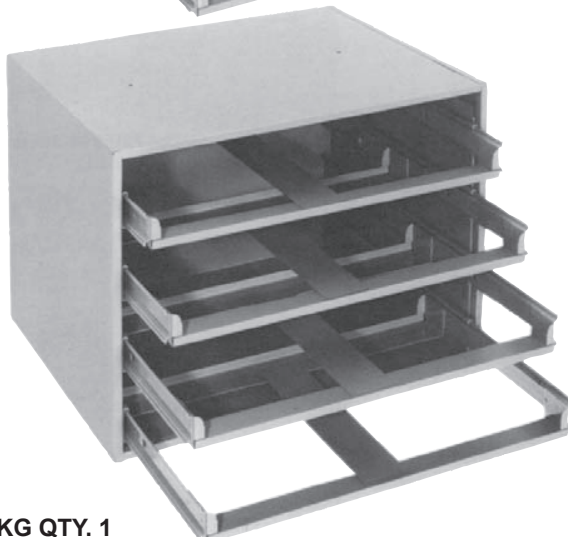
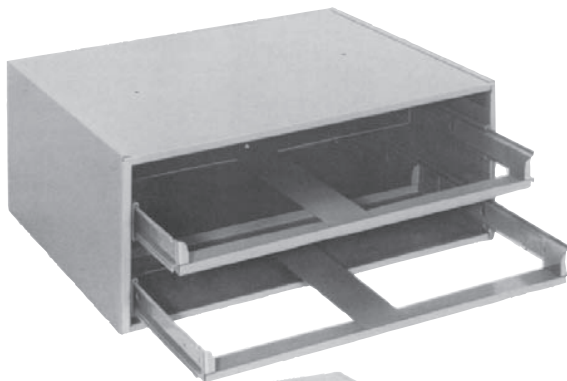

PKG QTY. 1

STORAGE - SLIDE RACKS

(Drawers not included)

For Organized Storage of Your
SPAENAUR
"LARGE SIZE" Assortments.

No. 814-754

20" W x 15-3/4" D x 8-1/8" H

Shipping weight **9.5 kg** (21 lbs.)

Accommodates 2 "LARGE SIZE" Drawers

18" W x 12" D x 3" H

No. 814-604

20" W x 15-3/4" D x 15" H

Shipping weight **13.2 kg** (29 lbs.)

Accommodates 4 "LARGE SIZE" Drawers

18" W x 12" D x 3" H

STEEL SLIDE RACK ONLY (Drawers not included)

A

EMPTY PLASTIKITS

CLEAR PLASTIC CONTAINERS - Durable and practical. Hinged lids - all plastic - no metal pins to rust or break. Positive gripping clasp - no spilling of contents.

Visible stock. Easy storage of parts. Neat! Clean! Handy!

SPAENAUR No. 176-E

Size: 4-1/2" x 2-3/4" x 1"
Weight .041 kg (0.09lbs.)

PKG QTY. 1



SPAENAUR No. 181-E

PKG QTY. 1

Size: 5-1/2" x 1-13/16" x 1/2"
Weight .027 kg (0.0616 lbs.)



For more storage units used to make our Assortments see pages A120 - A125

Used to assemble our REGULAR SIZE ASSORTMENTS.

Drawer Size: 13-3/8" W x 9-1/4" D x 2" H

Fits #814-751, #814-404, and #814-406
Slide Racks shown on page A75.



814-408
8 Compartments
(*814-408T)



814-412
12 Compartments
(*814-412T)

**Assortment Box
Heavy Duty Steel
All Welded Construction
Finish: Grey Enamel**



814-416
16 Compartments
(*814-416T)



814-420
20 Compartments
(*814-420T)

Includes Interior Tray of High-Impact Styrene

(*Replacement Insert Trays are available.
Use number with "T" suffix to order tray only.)

All drawers on this page,
Approx. Shipping Weight **1.8 kg** (4 lbs.)

All drawers on this page have "SCOOPED" bins

SPAENAUR CATALOG 14

A4

P: 1-800-265-8772 F: 1-888-252-6380 service@spaenaur.com

Spaenaur reserves the right to substitute parts in any assortment without notice. For any questions or suggestions about our Assortments and Plastikits, please contact us 1-800-265-8772. © 2018 Spaenaur Inc. All rights reserved. Catalog may not be reproduced, in whole or in part, without the written permission of Spaenaur Inc. Subject to Catalog Terms and Conditions of Use available at Spaenaur.com and on page TC2 and TC3 at the back of this catalog. Spaenaur se réserve le droit de remplacer des pièces dans n'importe quel assortiment sans préavis. Pour toute question ou suggestion concernant nos Assortiments et Plastikits, veuillez nous contacter au 1-800-265-8772. © 2018 Spaenaur Inc. Tous droits réservés. Le catalogue ne peut être reproduit, en tout ou en partie, sans l'autorisation écrite de Spaenaur Inc. L'utilisation est soumise aux Conditions d'utilisation du Catalogue disponibles sur Spaenaur.com et à la page TC4 et TC5 à la fin de ce catalogue.

B SECTION Assortments

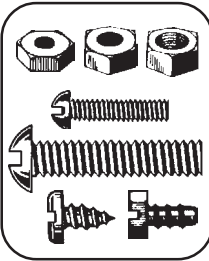

B-576-M-C
Steel, Plated
SLOTTED SCREWS & HEX NUTS
 For Radio, Television & Electronics Shops
 1477 Pieces - 42 Sizes
 Regular Box
 Inch Sizes
 See page A25

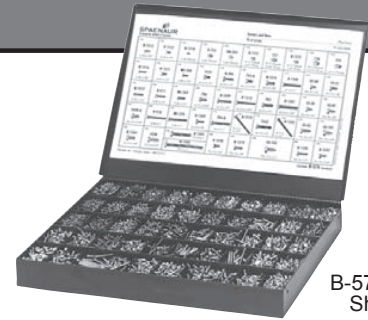

B-576-M-C Shown

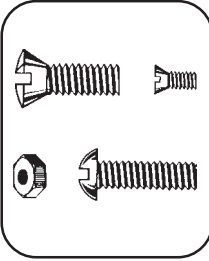

1285M-F
Steel, Plated
SLOT DRIVE MACHINE SCREWS & HEX NUTS
 Oval, Round, Flat Slot Head
 72 Sizes - 1043 Pieces
 Regular Box
 Inch Sizes
 See page A26

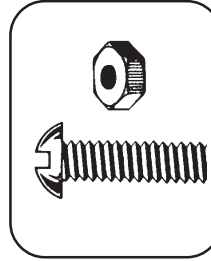

1140
Steel, Plated
MACHINE SCREWS
 Slot Round Head with Hexagon Nuts
 27 Sizes - 175 Pieces
 Plastikitt
 Inch Sizes
 See page A27

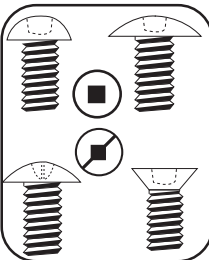

805-535C
Steel, Plated
MACHINE SCREWS Square Socket and Socket/Slot Drive
 30 Sizes - 1080 Pieces
 Regular Box
 Inch Sizes
 See Page A29

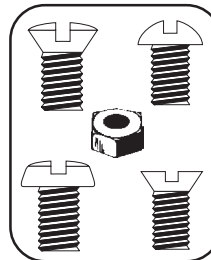

805-534A
Brass, Unplated
SLOTTED MACHINE SCREWS AND HEX NUTS
 945 pieces, 74 sizes
 Regular Box
 Inch Sizes
 See page A28

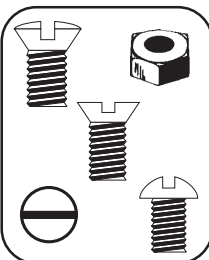

805-525
18-8 Stainless Steel
MACHINE SCREWS AND HEX NUTS
 1043 pieces, 72 sizes
 Regular Box
 Inch Sizes
 See page A29

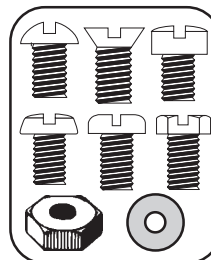

805-641
6/6 Nylon
MACHINE SCREWS, HEX NUTS AND FLAT WASHERS
 Round, Flat, Fillister, Pan, Binding, Hex Slotted Head
 3475 pieces - 71 sizes
 Large Box
 Inch Sizes
 See page A27

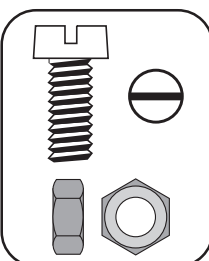

805-A04-1W
Unplated, or Zinc Plated
SLOTTED CHEESE HEAD MACHINE SCREWS & NUTS
 1200 Pieces - 24 Sizes
 Coarse Thread
 Regular Box
Metric Sizes
 See page A30

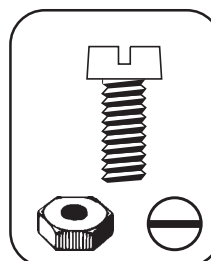

805-400
Steel, Zinc Plated
SLOT DRIVE MACHINE SCREWS & HEX NUTS
 24 Sizes - 1385 Pieces
 Regular Box
Metric Sizes
 See page A30

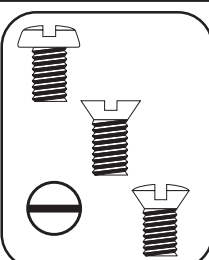

805-401
Steel, Zinc Plated
SLOT DRIVE MACHINE SCREWS
 Pan, Flat and Oval Heads
 24 Sizes - 1100 Pieces
 Regular Box
Metric Sizes
 See page A30

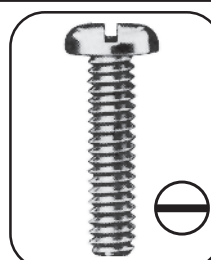

805-439C
Steel, Zinc Plated
METRIC NORTH AMERICAN STYLE SLOTTED PAN HEAD MACHINE SCREWS
 24 Sizes - 1000 Pieces, Coarse Thread
 Regular Box
Metric Sizes
 See page A31

B SECTION Assortments

Continues on next page

Visual Assortment Index

Index des assortiments virtuels

A

B SECTION Assortments



805-429
Shown

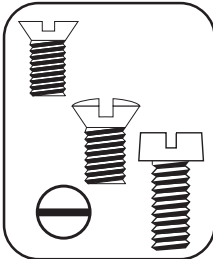

805-429
A2 Stainless Steel
METRIC MACHINE SCREWS
Slotted Cheese, Oval & Flat Heads
24 Sizes - 215 Pieces, Coarse Thread
Regular Box
Metric Sizes
See page A31

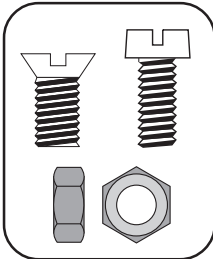

805-536A
Brass, Unplated
METRIC MACHINE SCREWS
& HEX NUTS - Slotted Flat
and Cheese Head
1245 Pieces - 62 Sizes
Coarse Thread, Regular Box
Metric Sizes See page A32

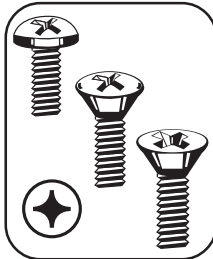

805-483B
Low Carbon Steel, Plated
MACHINE SCREWS - (Phillips)
Pan, Oval and Flat Heads
24 Sizes - 990 Pieces
Coarse Thread
Regular Box
Metric Sizes See page A33

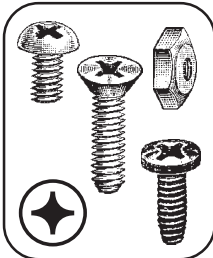

805-614D
Steel with Plated Finish
PHILLIPS DRIVE
MACHINE SCREWS
42 Sizes - 1900 Pieces
Large Box
Inch Sizes See page A33

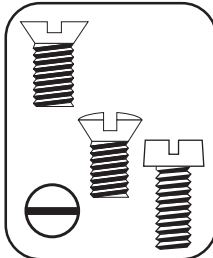

805-431
6/6 Nylon
METRIC MACHINE SCREWS
Cheese, Oval & Flat Slot Head
24 Sizes - 188 Pieces
Coarse Thread
Regular Box
Metric Sizes See page A34

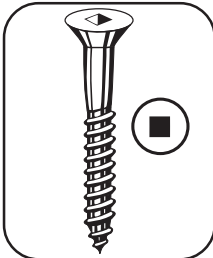

805-661-A
Steel, Zinc Plated
WOOD SCREWS
Square Socket Drive
24 Sizes - 1150 Pieces
Large Box
Inch Sizes See page A34

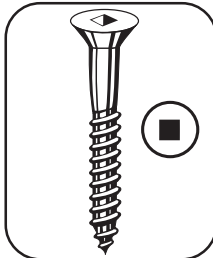

805-541A
Brass
WOOD SCREWS -
Square Socket Drive
24 Sizes - 1125 Pieces
Regular Box
Inch Sizes See page A34



B-573
Steel, Plated
TAPPING SCREWS (Type AB)
Slotted & Phillips Pan Head
36 Sizes - 1000 Pieces
Large Box 18" x 12" x 3"
Inch Sizes See page A35

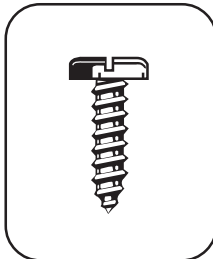

A-5
Steel, Plated
TYPE AB TAPPING SCREWS
Pan Slot Head
20 Sizes - 140 Pieces
Plastikit
Inch Sizes See page A35

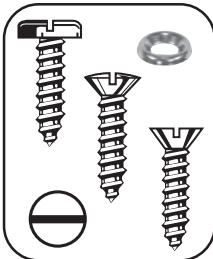

1268M
Steel, Plated
TAPPING SCREWS (Type AB)
Slotted Pan, Oval & Flat Head
36 Sizes - 995 Pieces
Regular Box
Inch Sizes See page A36

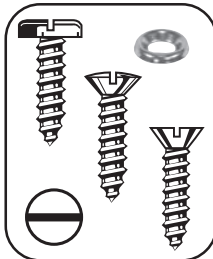

1268R
Steel, Plated
TAPPING SCREWS (Type AB)
Slotted Pan, Oval & Flat Head
36 Sizes - 1025 Pieces
Special Box 16-1/4" x 11-3/4" x 2"
Inch Sizes See page A36

B SECTION Assortments

Continues on next page

A6

P: 1-800-265-8772 F: 1-888-252-6380 service@spenaaur.com

Spenaaur reserves the right to substitute parts in any assortment without notice. For any questions or suggestions about our Assortments and Plastikits, please contact us 1-800-265-8772. © 2018 Spenaaur Inc. All rights reserved. Catalog may not be reproduced, in whole or in part, without the written permission of Spenaaur Inc. Subject to Catalog Terms and Conditions of Use available at Spenaaur.com and on page TC2 and TC3 at the back of this catalog. Spenaaur se réserve le droit de remplacer des pièces dans n'importe quel assortiment sans préavis. Pour toute question ou suggestion concernant nos Assortiments et Plastikits, veuillez nous contacter au 1-800-265-8772. © 2018 Spenaaur Inc. Tous droits réservés. Le catalogue ne peut être reproduit, en tout ou en partie, sans l'autorisation écrite de Spenaaur Inc. L'utilisation est soumise aux Conditions d'utilisation du Catalogue disponibles sur Spenaaur.com et à la page TC4 et TC5 à la fin de ce catalogue.

SPENAUR
CATALOG 14.03
2019/04/18

B SECTION Assortments

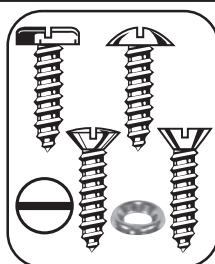

805-526
 18-8 Stainless Steel
TAPPING SCREWS (Type AB)
 Slotted Oval, Flat, Pan and Truss Head
 34 Sizes of Screws, 2 Sizes of Countersunk
 Finishing Washers – 1000 Pieces
 Regular Box
 Inch Sizes

See page A37



805-526
 Shown

A

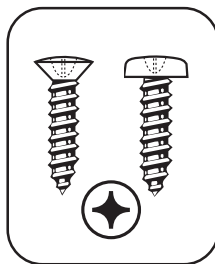

B-570B
 Steel, Plated
TAPPING SCREWS (Type AB)
 Phillips Drive -
 Oval, Pan & Flat Head
 36 Sizes - 1095 Screws
 Special Box 16-1/4" x 11-3/4" x 2"
 Inch Sizes

See page A37

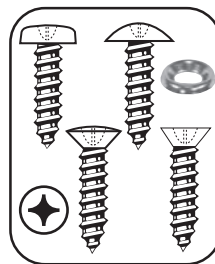

805-546
 18-8 Stainless Steel
TAPPING SCREWS
 (Type A – AB)
 Phillips Oval, Flat, Pan, and Truss Head
 34 Varieties - 900 Screws
 2 Varieties - 100 Ctsk. Finishing Washers
 Regular Box
 Inch Sizes

See page A38

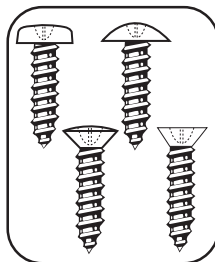

804-080
 18-8 Stainless Steel
TAPPING SCREWS Type A-AB
 Phillips Drive - Oval, Flat, Pan
 and Truss Heads
 20 Varieties - 200 Pieces
 Plastikit
 Inch Sizes

See page A38

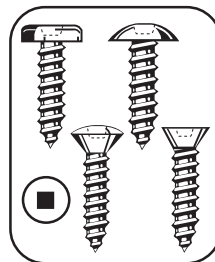

805-531A
 Steel, Plated
TAPPING SCREWS (Type AB)
 Square Socket Oval, Flat, Pan
 and Truss Head
 32 Varieties - 1000 Pieces
 Regular Box
 Inch Sizes

See page A39

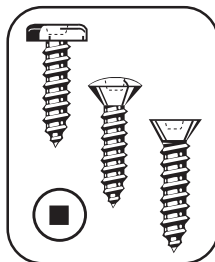

805-530
 18-8 Stainless Steel
TAPPING SCREWS (Type AB)
 Square Socket Oval, Flat,
 Pan Head
 30 Varieties - 690 Pieces
 Regular Box
 Inch Sizes

See page A39

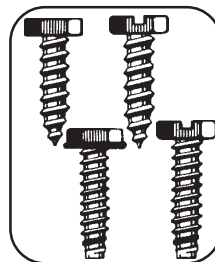

B-575C
 Steel, Plated
HEXAGON HEAD
TAPPING SCREWS
 (Type AB, Type B)
 36 Sizes - 716 Screws
 Large Box 18" x 12" x 3"
 Inch Sizes

See page A40

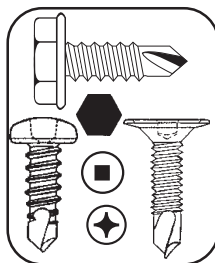

805-532
 Carbon Steel, Plated
TEKS® Self-Drilling Screws
 Hex Washer Head, Square Socket Pan
 Head, Phillips Pan Head, Square Socket
 Wafer Head
 26 Sizes - 575 Pieces, Regular Box
 Inch Sizes

See page A40

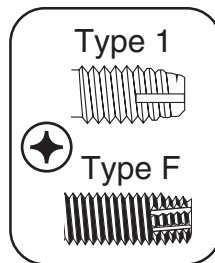

805-540
 Steel, Plated
THREAD-CUTTING SCREWS
 Fillister, Flat, Oval, Pan, Round, and Truss
 Head, Phillips Drive, Type 1, F, and 23
 24 Sizes, 1270 Pieces
 Regular Box
 Inch Sizes

See page A41



805-433
 Steel, Plated
"TAMPRUF" SCREWS
 239 Pieces, 25 Sizes
 Screw Driver and Bits
 Regular Box
 Inch Sizes

See page A41



805-548
 Alloy Steel, Plain
TORX® TAMPER-RESISTANT
MACHINE SCREWS
 507 Pieces - 27 Items
 Button Head, Flat Head, Inserts Bits, Driver
 Regular Box
 Inch Sizes

See page A42

B SECTION Assortments



Continues on next page

CATALOG 14.03
 2019/04/18
 SPAENAUR

Visual Assortment Index

Index des assortiments virtuels

A

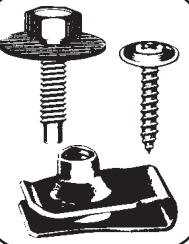
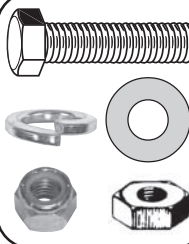
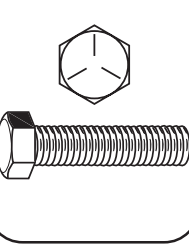
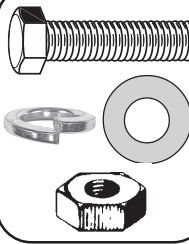
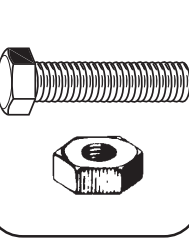
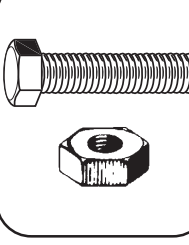
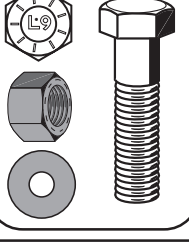
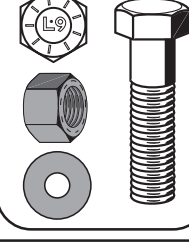
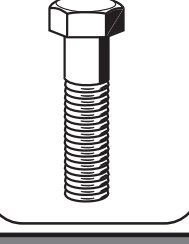
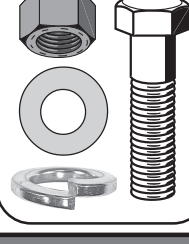
B SECTION Assortments	
 <p>805-547A <i>Alloy Steel, Plain</i> TORX® TAMPER-RESISTANT SHEET METAL SCREWS 507 Pieces - 27 Items Button Head, Flat Head, Inserts Bits, Driver Regular Box Inch Sizes See page A42</p>	 <p>805-543 <i>18-8 Stainless Steel</i> TORX® TAMPER-RESISTANT SHEET METAL SCREWS 507 Pieces - 27 Items Button Head, Flat Head, Inserts Bits, Driver Regular Box Inch Sizes See page A42</p>
 <p>805-513A <i>Steel</i> AUTOMOTIVE SPECIAL SCREWS & NUTS 26 Sizes - 321 Pieces Regular Box Inch & Metric Sizes See page A43</p>	 <p>805-001B <i>Steel, Zinc Plated</i> HEX CAP SCREWS, NUTS, SPLIT LOCK & FLAT WASHERS Coarse Thread (UNC) Bin with 41 Sizes - 2950 Pieces 40 compartments 33-3/4" W x 22-1/4" H x 8-3/4" D See page A44 Inch Sizes</p>
 <p>805-515 <i>SAE Grade 5 Steel, Plated</i> HEXAGON CAP SCREWS Coarse Thread 24 Sizes - 180 Pieces Regular Box Inch Sizes See page A45</p>	 <p>805-657B <i>SAE Grade 5 Steel, Plated</i> HEX CAP SCREWS, NUTS, SPLIT LOCK & FLAT WASHERS Coarse Thread (UNC) 23 Sizes - 1170 Pieces Large Box Inch Sizes See page A45</p>
 <p>805-660 <i>SAE Grade 8 Steel, Plated</i> HEX CAP SCREWS & NUTS Coarse Thread 20 Sizes of Screws - 750 pieces, 4 Sizes of Nuts - 350 Pieces Large Box Inch Sizes See page A46</p>	 <p>805-650 <i>SAE Grade 8 Steel, Plated</i> HEX CAP SCREWS & NUTS Fine Thread 20 Sizes of Screws - 750 pieces, 4 Sizes of Nuts - 350 Pieces Large Box Inch Sizes See page A46</p>
 <p>805-648 <i>Steel, Plated</i> L9® FASTENING SYSTEM Coarse Thread (UNC) 24 Sizes - 1115 Pieces Large Box Inch Sizes See page A47</p>	 <p>805-649 <i>Steel, Plated</i> L9® FASTENING SYSTEM Fine Thread (UNF) 24 Sizes - 1115 Pieces Large Box Inch Sizes See page A47</p>
 <p>805-549 <i>18-8 Stainless Steel</i> HEXAGON HEAD CAP SCREWS Coarse Thread (UNC) 24 Sizes - 192 Pieces Regular Box Inch Sizes See page A48</p>	 <p>805-608 <i>18-8 Stainless Steel,</i> HEX CAP SCREWS, NUTS, SPLIT LOCK & FLAT WASHERS Coarse Thread (UNC) 24 Sizes - 1430 Pieces Large Box Inch Sizes See page A48</p>

B SECTION Assortments

Continues on next page

A8

P: 1-800-265-8772 F: 1-888-252-6380 service@spenaaur.com

Spenaaur reserves the right to substitute parts in any assortment without notice. For any questions or suggestions about our Assortments and Plastikits, please contact us 1-800-265-8772. © 2018 Spenaaur Inc. All rights reserved. Catalog may not be reproduced, in whole or in part, without the written permission of Spenaaur Inc. Subject to Catalog Terms and Conditions of Use available at Spenaaur.com and on page TC2 and TC3 at the back of this catalog. Spenaaur se réserve le droit de remplacer des pièces dans n'importe quel assortiment sans préavis. Pour toute question ou suggestion concernant nos Assortiments et Plastikits, veuillez nous contacter au 1-800-265-8772. © 2018 Spenaaur Inc. Tous droits réservés. Le catalogue ne peut être reproduit, en tout ou en partie, sans l'autorisation écrite de Spenaaur Inc. L'utilisation est soumise aux Conditions d'utilisation du Catalogue disponibles sur Spenaaur.com et à la page TC4 et TC5 à la fin de ce catalogue.

B SECTION Assortments

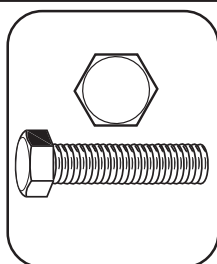

805-494
Nylon
HEXAGON CAP SCREWS
 Coarse Thread
 24 Sizes - 180 Pieces
 Regular Box
 Inch Sizes
 See page A49



805-494
 Shown

A

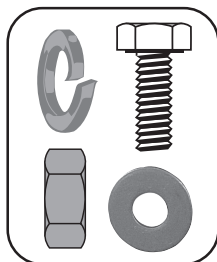

805-612
Property Class 8.8 Carbon Steel, Plated
METRIC HEXAGON CAP SCREWS, NUTS & WASHERS
 Coarse Thread DIN 933
 32 Sizes - 1840 Pieces
 Large Box
Metric Sizes See page A49

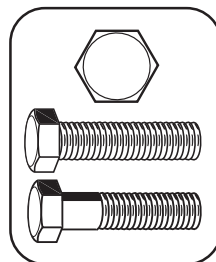

805-402
Property Class 8.8 Carbon Steel, Plated
METRIC HEXAGON HEAD CAP SCREWS
 Coarse Thread
 DIN 931 / DIN 933
 24 Sizes - 636 Pieces
 Regular Box
Metric Sizes See page A50

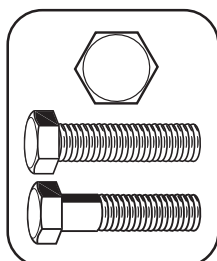

805-537A
Property Class 8.8 Carbon Steel, Plated
METRIC HEXAGON HEAD CAP SCREWS
 Fine Thread
 DIN 960 / DIN 961
 24 Sizes - 294 Pieces
 Regular Box
Metric Sizes See page A50

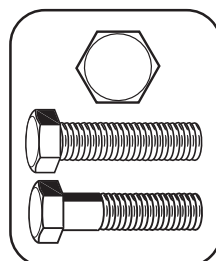

805-472
Property Class 10.9 Carbon Steel, Plated
METRIC HEXAGON HEAD CAP SCREWS
 Coarse Thread
 DIN 933 / DIN 931
 24 Sizes - 550 Pieces
 Regular Box
Metric Sizes See page A51

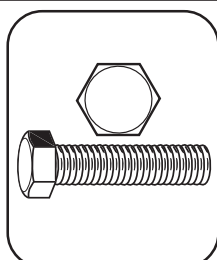

805-434
A2 Stainless Steel
METRIC HEXAGON HEAD CAP SCREWS
 Coarse Thread
 DIN 933
 24 Sizes - 180 Pieces
 Regular Box
Metric Sizes See page A51



805-454A
Alloy Steel, Unplated
HEX SOCKET CAP SCREWS
 Coarse Thread
 22 Sizes - 600 Pieces
 Regular Box
 Inch Sizes
 See page A52

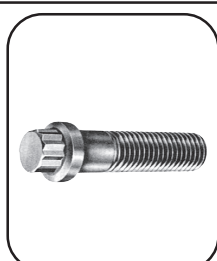

805-652
Alloy Steel, Black Satin Finish
"COUNTR-BOR" SCREWS
 Flanged - 12 point
 Coarse and Fine Thread
 24 Sizes - 455 Pieces
 Large Box
 Inch Sizes
 See page A52



805-498
Property Class 8.8 Carbon Steel, Unplated
METRIC HEX SOCKET CAP SCREWS
 Coarse Thread, DIN 912
 24 Sizes - 500 Pieces
 Regular Box
Metric Sizes See page A52



805-435
Property Class 8.8 Carbon Steel, Unplated
METRIC HEX SOCKET CAP SCREWS
 Coarse Thread
 Low (Cylinder) Head Style (DIN 7984)
 22 Cap Screw Sizes, plus 6 Hex Key Sizes
 Total Contents - 585 Pieces
 Regular Box
Metric Sizes See page A53



805-500
Property Class 12.9 Alloy Steel, Not Plated
METRIC HEX SOCKET CAP SCREWS
 DIN 912 Metric Coarse Thread
 24 Sizes - 500 Pieces
 Regular Box
Metric Sizes See page A53

B SECTION Assortments

Continues on next page

CATALOG 14 SPAENAUR

Visual Assortment Index

Index des assortiments virtuels

A

B SECTION Assortments	
 <p>805-467 A2 (304) Stainless Steel METRIC HEX SOCKET CAP SCREWS (DIN 912) plus Alloy Steel Hex Keys 27 Varieties - 580 Pieces (incl. keys) Regular Box Metric Sizes See page A54</p>	 <p>805-477 Property Class 10.9 Steel, Unplated METRIC BUTTON HEAD HEX CAP SCREWS, ISO 7380 24 Sizes - 720 Pieces Regular Box Metric Sizes See page A54</p>
 <p>805-538 Property Class 10.9 Plain Steel HEX SOCKET CAP SCREWS COUNTERSUNK FLAT HEAD - DIN 7991 Coarse Thread 22 Sizes - 545 Pieces, Regular Box Metric Sizes See page A55</p>	 <p>805-489 Property Class 12.9 Plain Steel METRIC HEX SOCKET SHOULDER SCREWS, DIN 7379 Coarse Thread 24 Sizes - 107 Pieces Regular Box Metric Sizes See page A55</p>
 <p>B-583 Alloy Steel, Unplated HEX SOCKET SET SCREWS Cup Point Style 905 Set Screws - 14 Sizes, 35 Hex Keys - 7 Sizes Regular Box Inch Sizes See page A55</p>	 <p>804-085 Alloy Steel, Unplated HEX SOCKET SET SCREWS Cup Point 10 Each of 15 Set Screw Sizes 1 Each of 5 Hex Key Sizes Plastikit Inch Sizes See page A56</p>
 <p>805-517 18-8 Stainless Steel HEX SOCKET SET SCREWS Cup Point Style 905 Set Screws - 14 Sizes 35 Hex Keys - 7 Sizes Regular Box Inch Sizes See page A56</p>	 <p>805-488 Alloy Steel, Unplated HEX SOCKET SET SCREWS with "Half-Dog" Point 500 Pieces - 24 Sizes Regular Box Inch Sizes See page A56</p>
 <p>B-582 Steel, Unplated SQUARE HEAD SET SCREWS Cup Point / UNC 18 Varieties - 491 Pieces Regular Box Inch Sizes See page A57</p>	 <p>805-468 A2 Stainless Steel HEX SOCKET SET SCREWS Cup Point - Coarse Thread DIN 916 24 Sizes - 410 Pieces (plus Alloy Steel Hex Keys) Regular Box Metric Sizes See page A57</p>
 <p>805-405 Alloy Steel, Unplated METRIC HEX SOCKET SET SCREWS - Cup Point - Coarse Thread, DIN 916 Total Contents - 464 Pieces, 20 Set Screw Sizes - 7 Hex Key Sizes Regular Box Metric Sizes See page A57</p>	 <p>804-086 45H Steel, Plain DIN 916, METRIC HEX SOCKET SET SCREWS 10 Each of 15 Set Screw Sizes 1 Each of 5 Hex Keys Plastikit Metric Sizes See page A58</p>

B SECTION Assortments

Continues on next page

A10

P: 1-800-265-8772 F: 1-888-252-6380 service@spenaaur.com

Spenaaur reserves the right to substitute parts in any assortment without notice. For any questions or suggestions about our Assortments and Plastikits, please contact us 1-800-265-8772. © 2018 Spenaaur Inc. All rights reserved. Catalog may not be reproduced, in whole or in part, without the written permission of Spenaaur Inc. Subject to Catalog Terms and Conditions of Use available at Spenaaur.com and on page TC2 and TC3 at the back of this catalog. Spenaaur se réserve le droit de remplacer des pièces dans n'importe quel assortiment sans préavis. Pour toute question ou suggestion concernant nos Assortiments et Plastikits, veuillez nous contacter au 1-800-265-8772. © 2018 Spenaaur Inc. Tous droits réservés. Le catalogue ne peut être reproduit, en tout ou en partie, sans l'autorisation écrite de Spenaaur Inc. L'utilisation est soumise aux Conditions d'utilisation du Catalogue disponibles sur Spenaaur.com et à la page TC4 et TC5 à la fin de ce catalogue.

CATALOG 14
SPAENAUR

A

B SECTION Assortments

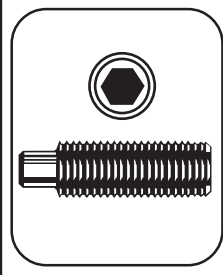

805-490
 Alloy Steel, Unplated
METRIC SOCKET SET SCREWS
 with Dog Point, Coarse Thread
 DIN 915
 24 Sizes - 500 Pieces
 Regular Box
Metric Sizes See page A58

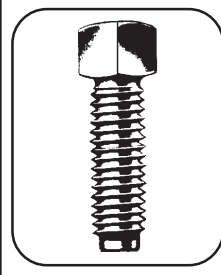

805-495
 Property Class 8.8 Carbon Steel, Unplated
METRIC SQUARE HEAD SET SCREW
 with Short Dog Point,
 DIN 479, Coarse Thread
 24 Sizes - 500 Pieces
 Regular Box
Metric Sizes See page A58

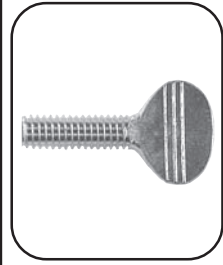

804-089
 Steel, Plated
THUMB SCREWS - Cold Forged
 9 Sizes - 85 Thumb Screws
 Plastikkit
 Inch Sizes
 See page A59



805-418
 Delrin Plastic
SHEAR-LOC®
THUMBSCREW KNOBS
 24 Kinds - 507 Pieces
 Regular Box
 Inch Sizes
 See page A59



805-419
 Delrin Plastic
SHEAR-LOC®
THUMBSCREW KNOBS
 22 Items - 456 Pieces
 Regular Box
Metric Sizes See page A59

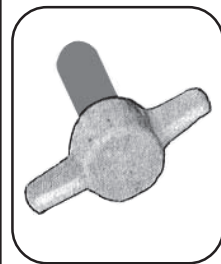

805-445
 Delrin Plastic
SHEAR-LOC® TEE STYLE
THUMBSCREW KNOBS
 24 Items - 510 Pieces
 Regular Box
 Inch and **Metric** Sizes
 See page A60

C SECTION Assortments Continues on next page

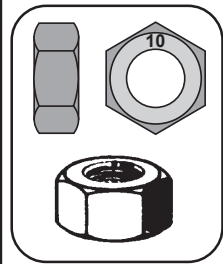

805-407
 Property Classes 5, 8 and 10 Steel
 Plain and Plated
METRIC HEXAGON NUTS
 (Standard) DIN 934, Coarse Thread
 24 Sizes - 922 Pieces
 Regular Box
Metric Sizes See page A61

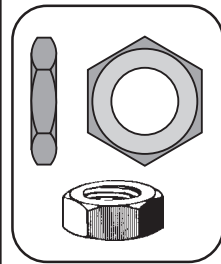

805-409A
 DIN 439B (Property Class 4),
 DIN 936 (Property Class. 17H)
METRIC HEXAGON NUTS
 (Low Style) Plain and Plated Steel
 Coarse and Fine Thread
 24 Sizes - 1108 Pieces
 Regular Box
Metric Sizes See page A60

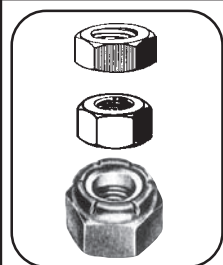

805-658B
 Steel, Plated
HEX NUTS & LOCKNUTS
 Coarse (UNC) and
 Fine (UNF) Thread
 32 Sizes - 2140 Pieces
 Large Box
 Inch Sizes
 See page A60

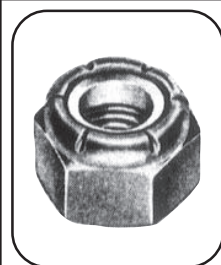

805-521A
 Steel, Plated
NYLON INSERT LOCKNUTS
 Natural Nylon Locking Insert
 (Zytel - 101), Coarse (UNC)
 and Fine (UNF) Thread
 24 Sizes - 979 Pieces, Regular Box
 Inch Sizes
 See page A61

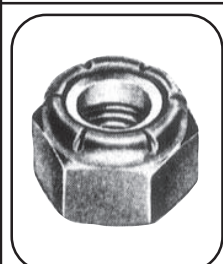

805-522
 Stainless Steel 18-8
NYLON INSERT LOCKNUTS
 Natural Nylon Locking Insert
 (Zytel - 101), Coarse (UNC)
 and Fine (UNF) Thread
 16 Sizes - 805 Pieces, Regular Box
 Inch Sizes
 See page A61

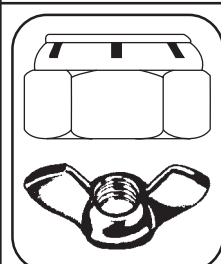

805-410A
 Cold Forged Steel, Plated
METRIC NYLON INSERT
LOCKNUTS & WING NUTS
 14 Sizes of Nylon Insert Hex Locknuts
 plus 6 Sizes of Wing Nuts
 Total Contents - 300 Pieces
 Regular Box
Metric Sizes See page A62



CATALOG 14 SPAENAUR

Spaenaur reserves the right to substitute parts in any assortment without notice. For any questions or suggestions about our Assortments and Plastikits, please contact us 1-800-265-8772. © 2018 Spaenaur Inc. All rights reserved. Catalog may not be reproduced, in whole or in part, without the written permission of Spaenaur Inc. Subject to Catalog Terms and Conditions of Use available at Spaenaur.com and on page T02 and T03 at the back of this catalog. Spaenaur se réserve le droit de remplacer des pièces dans n'importe quel assortiment sans préavis. Pour toute question ou suggestion concernant nos Assortiments et Plastikits, veuillez nous contacter au 1-800-265-8772. © 2018 Spaenaur Inc. Tous droits réservés. Le catalogue ne peut être reproduit, en tout ou en partie, sans l'autorisation écrite de Spaenaur Inc. L'utilisation est soumise aux Conditions d'utilisation du Catalogue disponibles sur Spaenaur.com et à la page TC4 et TC5 à la fin de ce catalogue.

Visual Assortment Index

Index des assortiments virtuels

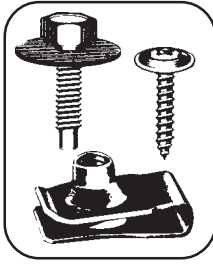
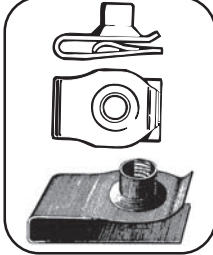
A

C SECTION Assortments	
 <p>A-16 <i>Cold Forged Steel, Plated</i> WING NUTS 9 Sizes - 62 Pieces Plastikit Inch Sizes</p> <p>See page A62</p>	 <p>804-068 <i>Stamped Steel, Plated</i> STAMPED WING NUTS Style 1 - Type D 7 Sizes - 70 Pieces Plastikit Inch Sizes</p> <p>See page A62</p>
 <p>805-640G <i>Spring Steel - Heat Treated</i> Tinnerman® SPRING NUTS AND TUBULAR STUD RETAINERS Flat, U and J Type Spring Nuts and Tubular Stud Retainers 65 Varieties - 875 Pieces, Large Box Inch Sizes</p> <p>See page A63</p>	 <p>805-513A <i>Steel</i> AUTOMOTIVE SPECIAL SCREWS & NUTS 26 Sizes - 321 Pieces Regular Box Inch & Metric Sizes</p> <p>See page A43</p>
 <p>805-511A <i>Spring Steel - Heat Treated</i> METRIC EXTRUDED PANEL NUTS For automotive and industrial use. 15 Sizes - 205 Pieces Regular Box Metric Sizes</p> <p>See page A64</p>	 <p>805-512D <i>Spring Steel - Heat Treated</i> EXTRUDED PANEL NUTS & U-TYPE SPRING NUTS For Automotive Service and Industrial use 6 Extruded Panel Nuts 17 U-Type Spring Nuts Total Pieces - 650 Regular Box Inch Sizes</p> <p>See page A65</p>
 <p>805-544 <i>Neoprene</i> WELL NUT™ SCREW ANCHORS 130 Pieces, 15 Sizes Regular Box Inch Sizes</p> <p>See page A65</p>	 <p>805-A06-1X <i>Carbon Steel, Plated</i> WEDGE ANCHORS Assorted Head Styles 16 Sizes - 116 Pieces Large Box Inch Sizes</p> <p>See page A66</p>
 <p>805-663A <i>Steel, Plated</i> AVK INDUSTRIAL PRODUCTS A-K™ SERIES INSERTS 16 Sizes - 331 Pieces including insert tool TAA170. Large Box Inch Sizes</p> <p>See page A67</p>	 <p>805-664B <i>Steel, Plated</i> AVK INDUSTRIAL PRODUCTS A-L™ SERIES INSERTS 16 Sizes - 331 Pieces including insert tool TAA170. Large Box Inch Sizes</p> <p>See page A67</p>
 <p>805-665 <i>Steel, Plated</i> AVK A-O, A-T & A-W SERIES INSERTS 399 Pieces, 29 Sizes also contains 8 Conversion Kits and insert tool TAA170. Large Box Inch Sizes</p> <p>See page A68</p>	 <p>805-493 <i>Brass</i> BARB-SERT BRASS INSERTS Ideal for Prototype Work 25 Sizes - 475 Pieces Regular Box Inch and Metric Sizes</p> <p>See page A68</p>

C SECTION Assortments

Continues on next page

A12

P: 1-800-265-8772 F: 1-888-252-6380 service@spenaaur.com

Spenaaur reserves the right to substitute parts in any assortment without notice. For any questions or suggestions about our Assortments and Plastikits, please contact us 1-800-265-8772. © 2018 Spenaaur Inc. All rights reserved. Catalog may not be reproduced, in whole or in part, without the written permission of Spenaaur Inc. Subject to Catalog Terms and Conditions of Use available at Spenaaur.com and on page TC2 and TC3 at the back of this catalog. Spenaaur se réserve le droit de remplacer des pièces dans n'importe quel assortiment sans préavis. Pour toute question ou suggestion concernant nos Assortiments et Plastikits, veuillez nous contacter au 1-800-265-8772. © 2018 Spenaaur Inc. Tous droits réservés. Le catalogue ne peut être reproduit, en tout ou en partie, sans l'autorisation écrite de Spenaaur Inc. L'utilisation est soumise aux Conditions d'utilisation du Catalogue disponibles sur Spenaaur.com et à la page TC4 et TC5 à la fin de ce catalogue.

SPENAUR CATALOG 14.10

A

C SECTION Assortments



805-425-B
Steel, Black Oxide
“E-Z LOK”™ THREAD INSERTS
 Coarse and Fine Thread
 21 Sizes - 60 Pieces
 Regular Box
 Inch Sizes

See page A69



805-422A
Steel, Black Oxide
“E-Z LOK”™ THREAD INSERTS
 15 Sizes - 60 Pieces
 Regular Box
 Inch & **Metric** Sizes

See page A69



805-423A
303 Stainless Steel
“E-Z LOK”™ THREAD INSERTS
 12 Sizes - 42 Pieces
 Regular Box
 Inch Sizes

See page A69

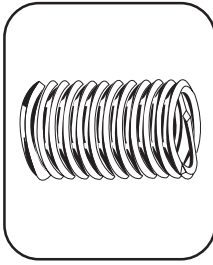

805-545
18-8 Stainless Steel
HELICOIL® THREAD REPAIR INSERTS, Coarse (UNC) and Fine (UNF)
 4 UNC Sizes - 87 Inserts, 4 UNF Sizes - 87 Inserts Plus 8 Taps and 8 Installation Tools
 Regular Box
 Inch Sizes

See page A70

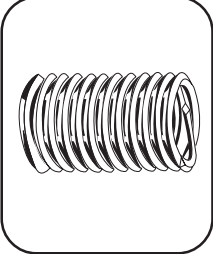

805-463A
18-8 Stainless Steel
HELICOIL® THREAD REPAIR INSERTS, Coarse Thread (UNC)
 8 Sizes - 88 Inserts Plus 8 Taps and 8 Installation Tools
 Regular Box
 Inch Sizes

See page A70

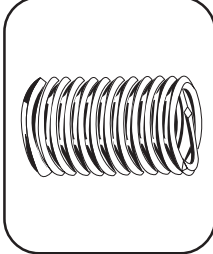

805-464
18-8 Stainless Steel
HELICOIL® THREAD REPAIR INSERTS, Fine Thread (UNF)
 8 Sizes - 88 Inserts Plus 8 Taps and 8 Installation Tools
 Regular Box
 Inch Sizes

See page A70

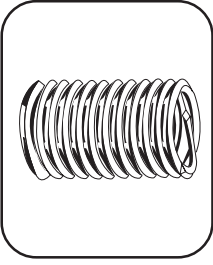

805-465
18-8 Stainless Steel
METRIC HELICOIL® THREAD REPAIR INSERTS
 108 Pieces, 22 Sizes
 Plus 7 Taps and 7 Installation Tools
 Regular Box
Metric Sizes

See page A71

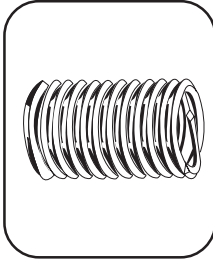

805-466
18-8 Stainless Steel
METRIC HELICOIL® THREAD REPAIR INSERTS
 10 Sizes - 60 Inserts
 Plus 5 Taps and 5 Installation Tools
 Regular Box
Metric Sizes

See page A71

D SECTION Assortments Continues on next page

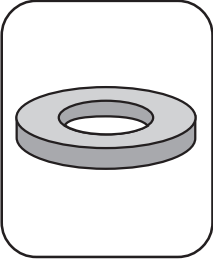

B-558C
Steel, Plated
STEEL FLAT WASHERS
 17 Sizes - 1190 Pieces
 Regular Box
 Inch Sizes

See page A72

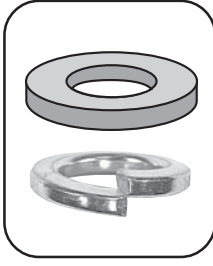

804-081
Steel, Plated
FLAT & HELICAL WASHERS
 14 Sizes - 280 Pieces
 Plastikit
 Inch Sizes

See page A72

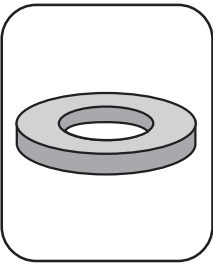

805-520
18-8 Stainless Steel
FLAT WASHERS
 16 Sizes - 967 Pieces
 Regular Box
 Inch Sizes

See page A72

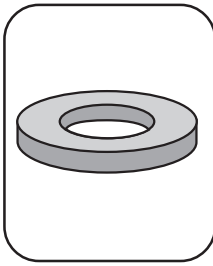

805-519
Brass
FLAT WASHERS
 16 Sizes - 1315 Pieces
 Regular Box
 Inch Sizes

See page A73





CATALOG 14 SPAENAUR

Spaenaur reserves the right to substitute parts in any assortment without notice. For any questions or suggestions about our Assortments and Plastikits, please contact us 1-800-265-8772. © 2018 Spaenaur Inc. All rights reserved. Catalog may not be reproduced, in whole or in part, without the written permission of Spaenaur Inc. Subject to Catalog Terms and Conditions of Use available at Spaenaur.com and on page TC2 and TC3 at the back of this catalog. Spaenaur se réserve le droit de remplacer des pièces dans n'importe quel assortiment sans préavis. Pour toute question ou suggestion concernant nos Assortiments et Plastikits, veuillez nous contacter au 1-800-265-8772. © 2018 Spaenaur Inc. Tous droits réservés. Le catalogue ne peut être reproduit, en tout ou en partie, sans l'autorisation écrite de Spaenaur Inc. L'utilisation est soumise aux Conditions d'utilisation du Catalogue disponibles sur Spaenaur.com et à la page TC4 et TC5 à la fin de ce catalogue.

Visual Assortment Index

Index des assortiments virtuels

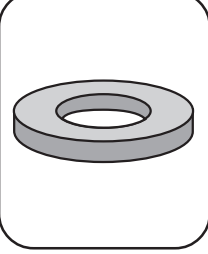
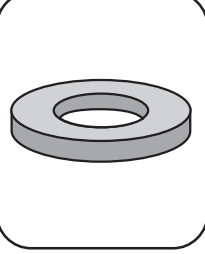
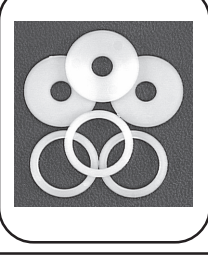
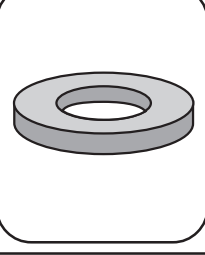
A

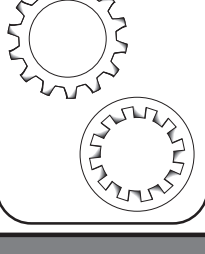
D SECTION Assortments	
	<p>B-584A <i>Red Vulcanized Fibre</i> FIBRE WASHERS 24 Sizes - 1000 Pieces Regular Box Inch Sizes</p> <p style="text-align: right;">See page A73</p>
	<p>804-082 <i>Steel, Plated</i> METRIC FLAT & HELICAL WASHERS, DIN 125 14 Sizes - 280 Pieces Plastikit Metric Sizes</p> <p style="text-align: right;">See page A73</p>
	<p>805-446 <i>A2 Stainless Steel</i> METRIC FLAT WASHERS DIN 125 20 Sizes - 893 Pieces Regular Box Metric Sizes</p> <p style="text-align: right;">See page A74</p>
	<p>805-447 <i>Brass</i> METRIC FLAT WASHERS DIN 125 20 Sizes - 940 Pieces Regular Box Metric Sizes</p> <p style="text-align: right;">See page A74</p>
	<p>805-448 <i>6/6 Nylon</i> FLAT WASHERS 18 Sizes - 1000 Pieces Regular Box Inch and Metric (DIN 125A) Sizes</p> <p style="text-align: right;">See page A74</p>
	<p>805-411 <i>Steel, Plated & Plain</i> METRIC FLAT WASHERS 21 Sizes - 943 Pieces Regular Box Metric Sizes</p> <p style="text-align: right;">See page A75</p>
	<p>A-203 <i>Steel, Plated</i> SPLIT LOCKWASHERS Helical, "Regular" and "Light" Styles 14 Sizes - 582 Pieces Regular Box Inch Sizes</p> <p style="text-align: right;">See page A75</p>
	<p>805-528 <i>18-8 Stainless Steel</i> SPLIT LOCKWASHERS Helical, "Regular" Styles 16 Sizes 1000 Pieces Regular Box Inch Sizes</p> <p style="text-align: right;">See page A75</p>
	<p>805-449 <i>A2 Stainless Steel</i> METRIC SPLIT LOCKWASHERS DIN 127B 20 Sizes - 950 Pieces Regular Box Metric Sizes</p> <p style="text-align: right;">See page A76</p>
	<p>805-413 <i>Steel, Plated</i> METRIC SPLIT LOCKWASHERS DIN 127B for use with Hex Head Cap Screws DIN 7980 for use with Hex Socket Head Cap Screws 24 Sizes - 1381 Pieces Regular Box Metric Sizes</p> <p style="text-align: right;">See page A76</p>
	<p>4640-S <i>Steel, Plated</i> TOOTH LOCKWASHERS 30 Varieties - 877 Pieces 12 Sizes of External Tooth Flat Lockwashers 9 Sizes of Internal Tooth Flat Lockwashers 9 Sizes of External Tooth 82° Countersunk Lockwashers Regular Box Inch Sizes</p> <p style="text-align: right;">See page A77</p>
	<p>805-529 <i>410 Stainless Steel</i> TOOTH LOCKWASHERS 18 Varieties - 1050 Pieces 9 Sizes of External Tooth Flat Lockwashers 9 Sizes of Internal Tooth Flat Lockwashers Regular Box Inch Sizes</p> <p style="text-align: right;">See page A77</p>

D SECTION Assortments

Continues on next page

A14

P: 1-800-265-8772 F: 1-888-252-6380 service@spenaaur.com

Spenaaur reserves the right to substitute parts in any assortment without notice. For any questions or suggestions about our Assortments and Plastikits, please contact us 1-800-265-8772. © 2018 Spenaaur Inc. All rights reserved. Catalog may not be reproduced, in whole or in part, without the written permission of Spenaaur Inc. Subject to Catalog Terms and Conditions of Use available at Spenaaur.com and on page TC2 and TC3 at the back of this catalog. Spenaaur se réserve le droit de remplacer des pièces dans n'importe quel assortiment sans préavis. Pour toute question ou suggestion concernant nos Assortiments et Plastikits, veuillez nous contacter au 1-800-265-8772. © 2018 Spenaaur Inc. Tous droits réservés. Le catalogue ne peut être reproduit, en tout ou en partie, sans l'autorisation écrite de Spenaaur Inc. L'utilisation est soumise aux Conditions d'utilisation du Catalogue disponibles sur Spenaaur.com et à la page TC4 et TC5 à la fin de ce catalogue.

A

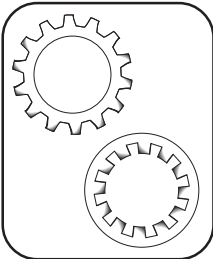
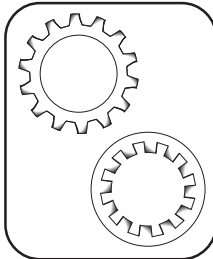

D SECTION Assortments

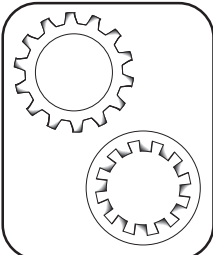
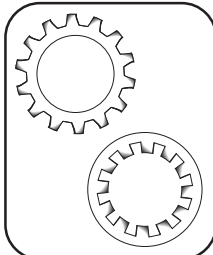

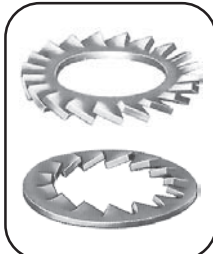
	<p>805-533 <i>Phosphor Bronze</i> TOOTH LOCKWASHERS 16 Varieties - 1000 Pieces 11 Sizes of External Tooth Flat Lockwashers 5 Sizes of Internal Tooth Flat Lockwashers Regular Box Inch Sizes</p> <p style="text-align: right;">See page A78</p>		<p>1706 <i>Steel, Plated</i> TOOTH LOCKWASHERS Internal & External 19 Varieties - 188 Pieces Plastikit</p> <p style="text-align: right;">See page A78</p>
---	--	--	--

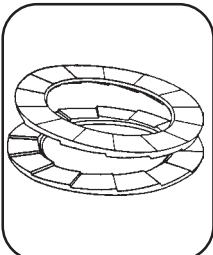
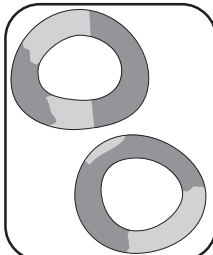
	<p>805-437A <i>Steel, Plated</i> METRIC TOOTH LOCKWASHERS - FLAT 24 Varieties - 850 Pieces 13 Sizes of External Tooth Lockwashers DIN 6797A, 11 Sizes of Internal Tooth Lockwashers DIN 6797J, Regular Box Metric Sizes</p> <p style="text-align: right;">See page A78</p>		<p>805-451 <i>A2 Stainless Steel</i> METRIC TOOTH LOCKWASHERS - FLAT 24 Varieties - 850 Pieces, 12 Sizes of External Tooth Lockwashers DIN 6797A 12 Sizes of Internal Tooth Lockwashers DIN 6797J, Regular Box Metric Sizes</p> <p style="text-align: right;">See page A79</p>
---	--	--	--

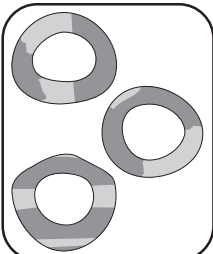
	<p>805-438 <i>Spring Steel, Plated</i> METRIC OVERLAP TOOTH LOCKWASHERS - FLAT 24 Varieties - 730 Pieces 12 Sizes of External Tooth Lockwashers DIN 6798A, 12 Sizes of Internal Tooth Lockwashers DIN 6798J, Regular Box Metric Sizes</p> <p style="text-align: right;">See page A79</p>		<p>805-470 <i>A2 Stainless Steel</i> METRIC OVERLAP TOOTH LOCKWASHERS - FLAT 22 Varieties - 760 Pieces 11 Sizes of External Tooth Lockwashers DIN 6798A, 11 Sizes of Internal Tooth Lockwashers DIN 6798J, Regular Box Metric Sizes</p> <p style="text-align: right;">See page A80</p>
--	--	---	--

	<p>805-516C <i>Steel, Plated</i> NORD-LOCK® VIBRATION PROOF FASTENERS 14 Sizes - 361 Pairs Regular Box Inch & Metric Sizes</p> <p style="text-align: right;">See page A80</p>		<p>805-527 <i>Steel, Plain</i> SPRING TENSION WASHERS Bowed and Wave 29 Sizes - 1175 Washers Regular Box Inch & Metric Sizes</p> <p style="text-align: right;">See page A81</p>
---	--	--	--

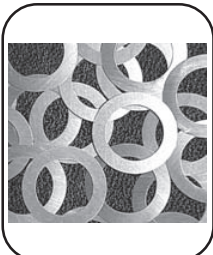
	<p>805-417A Metric <i>Spring Steel, Unplated</i> SPRING TENSION WASHERS Bowed Spring DIN 137A Single Wave Spring DIN 137B Flat-Face Bowed Spring Style C 24 Sizes - 1800 Pieces Regular Box Metric Sizes</p> <p style="text-align: right;">See page A82</p>		<p>B-598 <i>Steel, Stainless Steel & Brass Plated</i> FINISHING WASHERS 20 Sizes - 1700 Pieces Regular Box Inch Sizes</p> <p style="text-align: right;">See page A82</p>
---	---	--	---

	<p>805-629 <i>Steel, Unplated</i> SHIM RINGS (without Keyway) 73 Sizes - 730 Pieces Large Box Inch Sizes</p> <p style="text-align: right;">See page A83</p>		<p>805-630 <i>Steel, Unplated</i> SHIM RINGS (with Keyway) 64 Sizes - 490 Pieces Large Box Inch Sizes</p> <p style="text-align: right;">See page A84</p>
---	--	--	---

D SECTION Assortments

CATALOG 14.09 SPAENAUR

Visual Assortment Index

Index des assortiments virtuels

A

E SECTION Assortments

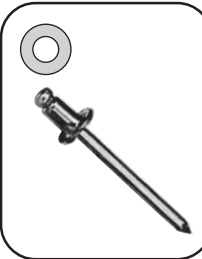

805-637C
Aluminum, Steel and Monel
POP® RIVETS & BACK-UP WASHERS
 21 Varieties, 2700 Pieces
 Large Box
 Inch Sizes
 See page A85

805-637C
 Shown

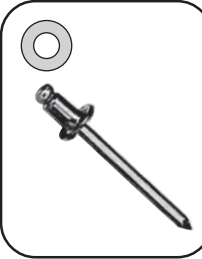

805-671D
Aluminum Rivet, Steel Mandrel
DOME-HEAD POP® RIVETS
 22 Sizes, 2701 Pieces
 Large Box
 Inch Sizes
 See page A85

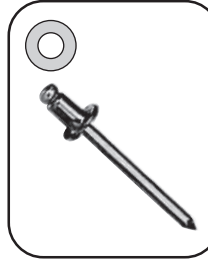

805-672A
Aluminum, Plain
DOME-HEAD POP® RIVETS
 21 Sizes - 1851 Pieces
 Large Box
 Inch Sizes
 See page A86

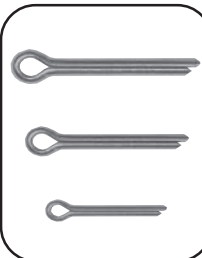

805-A03-1K
Brass, Plain
COTTER PINS
 Round, Extended, Prong Type
 16 Sizes - 1075 Pieces
 Regular Box
 Inch Sizes
 See page A86



B-585
Steel, Plain
HAMMER-LOK COTTER PINS
 14 Sizes - 1445 Pieces
 Regular Box
 Inch Sizes
 See page A86

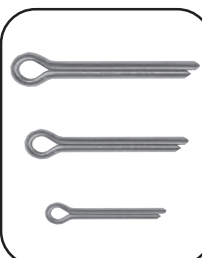

805-523
18-8 Stainless Steel
COTTER PINS
 Round, Extended, Prong Type
 20 Sizes - 1400 Pieces
 Regular Box
 Inch Sizes
 See page A87

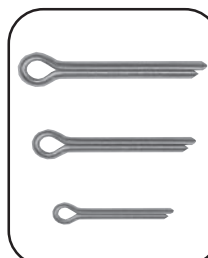

B-581
Steel, Plain
COTTER PINS
 Round, Extended, Prong Type
 14 Sizes - 1575 Pieces
 Regular Box
 Inch Sizes
 See page A87

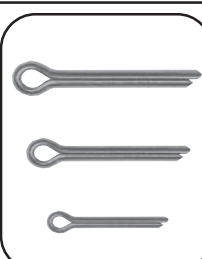

A-44
Steel, Plain
COTTER PINS
 14 Sizes - 250 Pieces
 Plastikit
 Inch Sizes
 See page A87

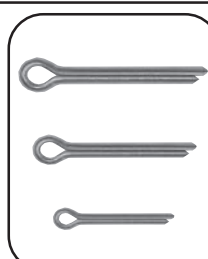

805-475
Steel, Plain
METRIC COTTER PINS
DIN 94
 24 Sizes - 1473 Pieces
 Regular Box
Metric Sizes
 See page A87

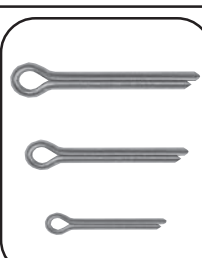

805-508
A2 Stainless Steel
METRIC COTTER PINS
DIN 94
 24 Sizes - 1473 Pieces
 Regular Box
Metric Sizes
 See page A88

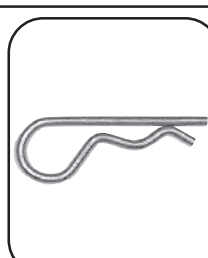

A-212
Steel, Plated
HITCH PIN CLIPS
 Internal Type (Hairpin Cotters)
 20 Sizes - 444 Pieces
 Large Box
 Inch Sizes
 See page A88

E SECTION Assortments

Continues on next page





A16

P: 1-800-265-8772 F: 1-888-252-6380 service@spaenaur.com

Spaenaur reserves the right to substitute parts in any assortment without notice. For any questions or suggestions about our Assortments and Plastikits, please contact us 1-800-265-8772. © 2018 Spaenaur Inc. All rights reserved. Catalog may not be reproduced, in whole or in part, without the written permission of Spaenaur Inc. Subject to Catalog Terms and Conditions of Use available at Spaenaur.com and on page TC2 and TC3 at the back of this catalog. Spaenaur se réserve le droit de remplacer des pièces dans n'importe quel assortiment sans préavis. Pour toute question ou suggestion concernant nos Assortiments et Plastikits, veuillez nous contacter au 1-800-265-8772. © 2018 Spaenaur Inc. Tous droits réservés. Le catalogue ne peut être reproduit, en tout ou en partie, sans l'autorisation écrite de Spaenaur Inc. L'utilisation est soumise aux Conditions d'utilisation du Catalogue disponibles sur Spaenaur.com et à la page TC4 et TC5 à la fin de ce catalogue.

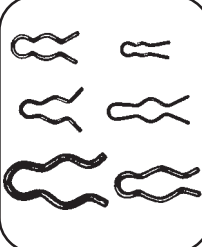
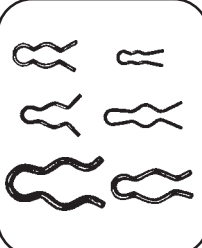
SPAENAUR CATALOG 14

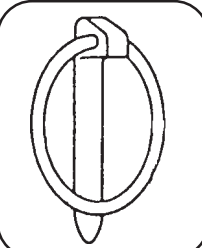
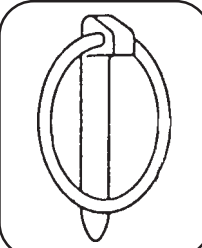
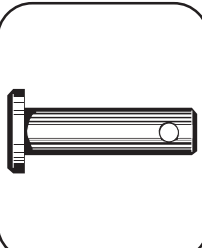
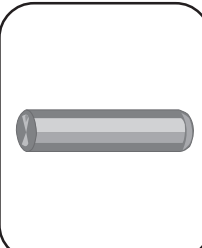
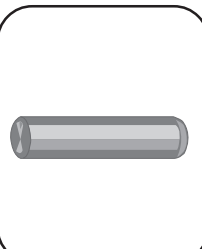
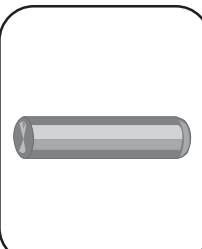
E SECTION Assortments











 <p>805-509 <i>Steel, Plated</i> METRIC HITCH PIN CLIPS Internal Type (Hairpin Cotter) Single and Double Loop Style 14 Sizes 150 Pieces Regular Box Metric Sizes</p> <p>See page A88</p>	 <p>B-597 <i>Steel, Plated</i> HAIR PIN COTTERS External Type 11 Sizes, 1300 Pieces Regular Box Inch Sizes</p> <p>See page A89</p>
 <p>A-45 <i>Steel, Plated</i> HAIR PIN COTTERS External Type 7 Sizes - 140 Pieces Plastikit Inch Sizes</p> <p>See page A89</p>	 <p>A-62 <i>Steel, Plated</i> HITCH PIN CLIPS Internal Type 14 Sizes - 40 Pieces Plastikit Inch Sizes</p> <p>See page A89</p>
 <p>805-503A <i>Steel, Plated</i> LYNCH PIN 11 Sizes - 70 Pieces Regular Box Inch Sizes</p> <p>See page A89</p>	 <p>805-510A <i>Steel, Plated</i> METRIC LYNCH PIN 10 Sizes - 110 Pieces Regular Box Metric Sizes</p> <p>See page A89</p>
 <p>B-555D <i>Steel, Plated</i> CLEVIS PINS 32 Sizes - 340 Pieces Large Box Inch Sizes</p> <p>See page A90</p>	 <p>805-476 <i>Alloy Steel, Unplated</i> DOWEL PINS Precision ground - case hardened 24 Sizes - 410 Pieces Regular Box Inch Sizes</p> <p>See page A90</p>
 <p>805-473 <i>Steel, Unplated</i> METRIC DOWEL PINS - DIN 7 Tolerance m6 - Not Hardened 24 Sizes - 410 Pieces Regular Box Metric Sizes</p> <p>See page A90</p>	 <p>805-484 <i>Steel, Unplated</i> METRIC DOWEL PINS DIN 6325 Precision ground - m6 - Hardened HRC 60 ±2 24 Sizes - 410 Pieces Regular Box Metric Sizes</p> <p>See page A91</p>
 <p>A-218 <i>Steel, Unplated</i> TAPER PINS 23 Sizes - 186 Pieces Regular Box Inch Sizes</p> <p>See page A91</p>	 <p>805-474 <i>Steel, Unplated</i> METRIC TAPER PINS - DIN 1B 24 Sizes - 200 Pieces Regular Box Metric Sizes</p> <p>See page A91</p>

E SECTION Assortments Continues on next page

Visual Assortment Index

Index des assortiments virtuels

A

E SECTION Assortments	
	<p>805-479 <i>Stainless Steel</i> METRIC SLOTTED SPRING TENSION PINS – DIN 1481 24 Sizes - 355 Pieces Regular Box Metric Sizes</p> <p>See page A92</p>
	<p>805-480 <i>Spring Steel, Unplated</i> METRIC SLOTTED SPRING TENSION PINS – ISO 8752 24 Sizes - 350 Pieces Regular Box Metric Sizes</p> <p>See page A92</p>
	<p>A-211 <i>Steel, Plain</i> TENSION PINS (Slotted Spring Pins) 24 Sizes - 335 Pieces Regular Box Inch Sizes</p> <p>See page A93</p>
	<p>804-002 <i>Spring Steel, Plain</i> METRIC TENSION PINS (Slotted Spring Pins) – ISO 8752 24 Sizes - 180 Pieces Plastikit Metric Sizes</p> <p>See page A93</p>
	<p>804-004 <i>Carbon Steel, Plain</i> COILED SPRING PINS 25 Sizes - 210 Pieces Plastikit Inch Sizes</p> <p>See page A94</p>
	<p>804-003A <i>Carbon Steel, Plain</i> METRIC COILED SPRING PINS 25 Sizes - 205 Pieces Plastikit Metric Sizes</p> <p>See page A95</p>
	<p>805-518A <i>Chrome Stainless Steel</i> SLOTTED SPRING TENSION PINS 335 Tension Pins - 24 Sizes Regular Box Inch Sizes</p> <p>See page A92</p>
	<p>A-61 <i>Steel, Plain</i> TENSION PINS (Slotted Spring Pins) 24 Sizes - 123 Pieces Plastikit Inch Sizes</p> <p>See page A93</p>
	<p>805-491 <i>Carbon Steel, Plain</i> COILED SPRING PINS 24 Sizes - 350 Pieces Regular Box Inch Sizes</p> <p>See page A94</p>
	<p>805-440A <i>Carbon Steel - Plain</i> METRIC COILED SPRING PINS 24 Sizes - 350 Pieces Regular Box Metric Sizes</p> <p>See page A94</p>
	<p>A-207 <i>Carbon Steel, Unplated</i> WOODRUFF KEYS 16 Sizes - 210 Pieces Regular Box Inch Sizes</p> <p>See page A95</p>



E SECTION Assortments

Continues on next page

A18

P: 1-800-265-8772 F: 1-888-252-6380 service@spaenaur.com

Spaenaur reserves the right to substitute parts in any assortment without notice. For any questions or suggestions about our Assortments and Plastikits, please contact us 1-800-265-8772. © 2018 Spaenaur Inc. All rights reserved. Catalog may not be reproduced, in whole or in part, without the written permission of Spaenaur Inc. Subject to Catalog Terms and Conditions of Use available at Spaenaur.com and on page TC2 and TC3 at the back of this catalog. Spaenaur se réserve le droit de remplacer des pièces dans n'importe quel assortiment sans préavis. Pour toute question ou suggestion concernant nos Assortiments et Plastikits, veuillez nous contacter au 1-800-265-8772. © 2018 Spaenaur Inc. Tous droits réservés. Le catalogue ne peut être reproduit, en tout ou en partie, sans l'autorisation écrite de Spaenaur Inc. L'utilisation est soumise aux Conditions d'utilisation du Catalogue disponibles sur Spaenaur.com et à la page TC4 et TC5 à la fin de ce catalogue.

E SECTION Assortments



A-56
SAE 1035 Carbon Steel, Unplated
WOODRUFF KEYS
12 Sizes - 100 Keys
Plastikit
Inch Sizes
See page A95



A-56 Shown



805-469
Carbon Steel, Unplated
METRIC WOODRUFF KEYS
DIN 6888
21 Sizes - 280 Pieces
Regular Box
Metric Sizes See page A95



804-070
Carbon Steel, Unplated
METRIC WOODRUFF KEYS
DIN 6888
11 Sizes - 100 Keys
Plastikit
Metric Sizes See page A96

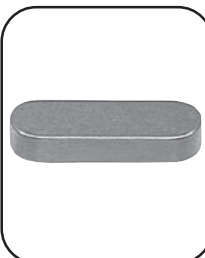

805-471
Steel, Unplated
METRIC SHAFT KEYS
DIN 6885-A, Oblong - Rounded
24 Sizes - 345 Pieces
Regular Box
Metric Sizes See page A96



805-404
Carbon Spring Steel
ROTOR CLIP® RETAINING RINGS
External - Radial Assembly
795 Rings - 20 Sizes
Regular Box
Inch Sizes See page A96

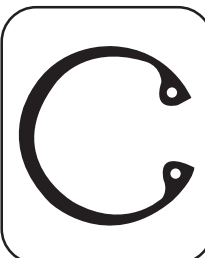

805-406
Carbon Spring Steel
ROTOR CLIP® RETAINING RINGS
Internal - Axial Assembly
336 Rings - 16 Sizes
Regular Box
Inch Sizes See page A97

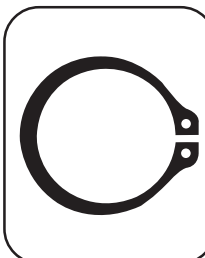

805-430A
Carbon Spring Steel
ROTOR CLIP® RETAINING RINGS
External - Axial Assembly
225 Rings - 26 Sizes
Regular Box
Inch Sizes See page A97



A-58
Carbon Spring Steel
RETAINING RINGS - R1000 and R1200 Series
External - Radial Assembly
169 Rings - 19 Sizes
Plastikit
Inch Sizes See page A97



804-075
Stainless Steel
RETAINING RINGS - R1000 & R1200 Series
External - Radial Assembly
90 Rings - 18 Sizes
Plastikit
Inch Sizes See page A98

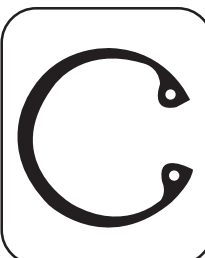

A-59
Carbon Spring Steel
RETAINING RINGS - R3000 Series
Internal - Axial Assembly
88 Rings in 16 Sizes
Plastikit
Inch Sizes See page A98

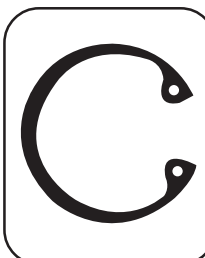

804-076
Stainless Steel
RETAINING RINGS - R3000 Series
Internal Axial Assembly
43 Rings - 14 Sizes
Plastikit
Inch Sizes See page A98

E SECTION Assortments Continues on next page

CATALOG 14 SPAENAUR

Visual Assortment Index

Index des assortiments virtuels

A

E SECTION Assortments

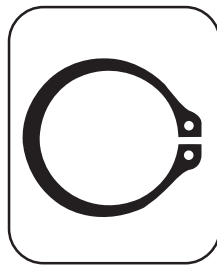

A-60
Carbon Spring Steel
RETAINING RINGS - R3100 Series
External - Axial Assembly
100 Rings - 26 Sizes
Plastikit
Inch Sizes See page A98

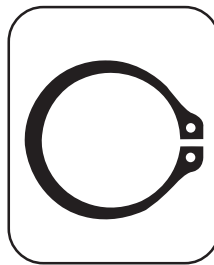

804-074
Stainless Steel
RETAINING RINGS - R3100 Series
External - Axial Assembly
46 Rings - 23 Sizes
Plastikit
Inch Sizes See page A98

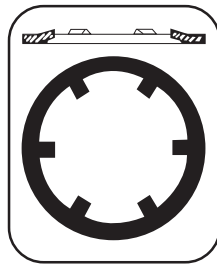

804-077
Carbon Spring Steel
RETAINING RINGS R6100 Series Self-Seating
245 Rings - 16 Sizes
Plastikit
Inch Sizes See page A98



805-441A
Carbon Spring Steel, Plain
METRIC EXTERNAL RETAINING RINGS - DIN 471
28 Sizes - 300 Pieces
Regular Box
Metric Sizes See page A99



805-442
Carbon Spring Steel, Plain
METRIC INTERNAL RETAINING RINGS - DIN 472
28 Sizes - 300 Pieces
Regular Box
Metric Sizes See page A99



805-443
Carbon Spring Steel
METRIC EXTERNAL RETAINING RINGS - DIN 6799
17 Sizes - 450 Pieces
Regular Box
Metric Sizes See page A99

See Pages E140 & E141 for our Retaing Ring Pliers

F SECTION Assortments



805-505
Tempered Steel
GRIPPER CLIPS
11 Clip No's. 125 Pieces,
plus 131 Mounting Screws
Regular Box
Inch Sizes See page A100

G SECTION Assortments



805-623
Stainless Steel Band
and Housing
GEAR-TYPE HOSE CLAMPS
10 Sizes - 58 Clamps
Large Box
Inch Sizes See page A100



805-639
All Stainless Steel
GEAR-TYPE HOSE CLAMPS
10 Sizes - 58 Clamps
Large Box
Inch Sizes See page A100

A20

P: 1-800-265-8772 F: 1-888-252-6380 service@spenaaur.com

Spenaaur reserves the right to substitute parts in any assortment without notice. For any questions or suggestions about our Assortments and Plastikits, please contact us 1-800-265-8772. © 2018 Spenaaur Inc. All rights reserved. Catalog may not be reproduced, in whole or in part, without the written permission of Spenaaur Inc. Subject to Catalog Terms and Conditions of Use available at Spenaaur.com and on page TC2 and TC3 at the back of this catalog. Spenaaur se réserve le droit de remplacer des pièces dans n'importe quel assortiment sans préavis. Pour toute question ou suggestion concernant nos Assortiments et Plastikits, veuillez nous contacter au 1-800-265-8772. © 2018 Spenaaur Inc. Tous droits réservés. Le catalogue ne peut être reproduit, en tout ou en partie, sans l'autorisation écrite de Spenaaur Inc. L'utilisation est soumise aux Conditions d'utilisation du Catalogue disponibles sur Spenaaur.com et à la page TC4 et TC5 à la fin de ce catalogue.

A

G SECTION Assortments



805-645
Stainless Steel Band and Housing Only
INNER SHIELD HOSE CLAMPS
 Micro and Full Series
 16 Sizes - 94 Clamps
 Large Box
 Inch Sizes
 See page A100

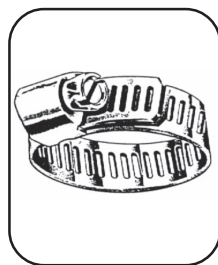

805-646
All 316 Stainless Steel
HOSE CLAMPS
 Micro and Full Series
 15 Sizes - 133 Clamps
 Large Box
 Inch Sizes
 See page A101



805-656
Stainless Steel
WORM DRIVE HOSE CLAMPS
 Acid-Resistant
 12 Sizes - 88 Clamps plus 1 Flexible Hex Socket Driver
 Large Box
 Inch and **Metric** Sizes
 See page A101

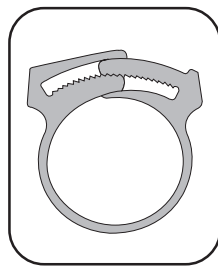

805-514
Nylon 6/6
HOSE CLAMPS
 17 Sizes - 120 Clamps
 Regular Box
 Inch Sizes
 See page A101



805-655
Steel, Plated - 23 Sizes
OETIKER 2-EAR CLAMPS
 Each assortment contains 241 2-Ear Clamps plus Installation Tool
 Large Box
 Inch Sizes
 See page A102

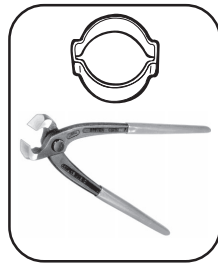

805-654
Stainless Steel - 23 Sizes
OETIKER 2-EAR CLAMPS
 Each assortment contains 241 2-Ear Clamps plus Installation Tool
 Large Box
 Inch Sizes
 See page A102

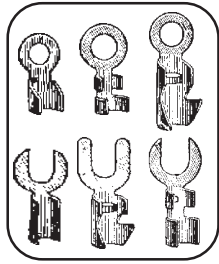

A-49A
Non-Insulated
GENERAL PURPOSE SOLDERING WIRING TERMINALS
 Ring Type and Spade Type
 13 Varieties - 100 Pieces
 Plastikit
 Inch Sizes
 See page A103

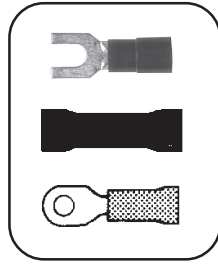

804-083
Insulated
SOLDERLESS TERMINALS
 16 Sizes - 160 Pieces
 Put up in a translucent polypropylene container.
 Special Size: 7" x 3-1/2" x 1-5/16"
 Plastikit
 Inch Sizes
 See page A103

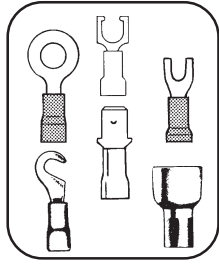

805-628A
Insulated Type
SOLDERLESS TERMINALS
 67 Sizes - Total: 1010 Terminals
 Large Box
 Inch Sizes
 See page A104

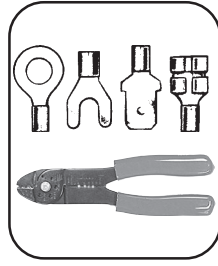

A-200-B
Non-Insulated Type
SOLDERLESS TERMINALS
 24 Sizes - 478 Pieces plus Crimper Tool
 Regular Box
 Inch Sizes
 See page A105

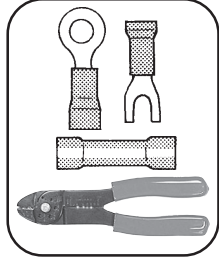

A-215
Plastic Insulated
SOLDERLESS TERMINALS
 21 Sizes - 541 Pieces
 Regular Box
 Inch Sizes
 See page A106

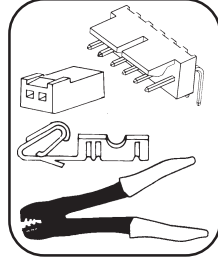

805-502
Nylon
MOLEX® KK® INTERCONNECTION SYSTEM
 .100" Centre Spacing
 235 Connectors - 350 Terminals, 1 Hand Crimper & 1 Extraction Tool, Regular Box
 Inch Sizes
 See page A106







G SECTION Assortments

CATALOG 14 SPAENAUR

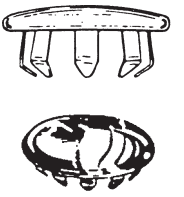
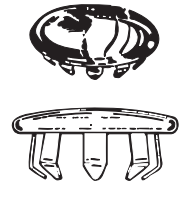
Visual Assortment Index

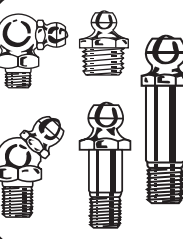
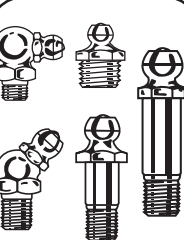
Index des assortiments virtuels

A

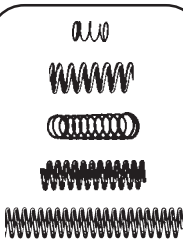
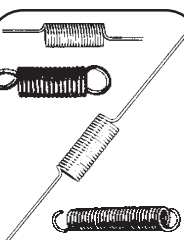
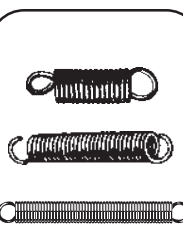
H SECTION Assortments	
	<p>A-206A <i>Brass and Steel, Plated</i> PLUG BUTTONS 14 Sizes - 312 Pieces Regular Box Inch Sizes</p> <p style="text-align: right;">See page A107</p>
	<p>804-084 <i>Steel, Nickel Plated</i> PLUG BUTTONS Standard Type 7 Sizes - 56 Plugs Plastikit Inch Sizes</p> <p style="text-align: right;">See page A107</p>
	<p>A-202 <i>Low Carbon Steel, Plated</i> SELF-TAPPING DRAIN AND FILLER PLUGS Each Drain Plug is supplied with a Fibre Gasket - Crankcase, Transmission and Differential, 7 Sizes - 17 Plugs Special Polypropylene Box 7" x 3-1/2" x 1-5/16" Inch Sizes</p> <p style="text-align: right;">See page A107</p>
	<p>B-599 <i>Steel, Plated</i> GREASE FITTINGS 12 Sizes - 145 Fittings Regular Box Inch Sizes</p> <p style="text-align: right;">See page A107</p>
	<p>804-079 <i>303/404 Stainless Steel</i> GREASE FITTINGS 7 Sizes - 19 Fittings Plastikit Inch Sizes</p> <p style="text-align: right;">See page A108</p>
	<p>A-55 <i>Steel, Plated</i> GREASE FITTINGS 9 Sizes - 52 Fittings Plastikit Inch Sizes</p> <p style="text-align: right;">See page A108</p>
	<p>805-444 <i>Steel, Plated</i> METRIC GREASE FITTINGS DIN 71412, Fine Thread 12 Sizes - 120 Pieces Includes Conversion Fittings Regular Box Metric Sizes</p> <p style="text-align: right;">See page A108</p>
	<p>804-078 <i>Steel, Plated</i> METRIC GREASE FITTINGS DIN 71412 Styles H1, H2, & H3 Coarse & Fine Thread 11 Sizes - 77 Pieces Plastikit Metric Sizes</p> <p style="text-align: right;">See page A108</p>
	<p>B-550-M-A <i>Steel, Plated</i> EXTENSION & COMPRESSION SPRINGS 57 Sizes, 264 Pieces Large Adjusta-Bin Box Inch Sizes</p> <p style="text-align: right;">See page A109</p>
	<p>805-632A <i>Steel, Plated</i> COMPRESSION SPRINGS 30 Sizes - 435 Pieces Large Box Inch Sizes</p> <p style="text-align: right;">See page A110</p>
	<p>805-633 <i>Steel, Plated</i> EXTENSION SPRINGS 29 Sizes - 268 Pieces Large Box Inch Sizes</p> <p style="text-align: right;">See page A110</p>
	<p style="text-align: right;"><i>H Section</i></p> <p>A-26 <i>Steel, Plated</i> EXTENSION SPRINGS 10 Sizes - 45 Pieces Plastikit Inch Sizes</p> <p style="text-align: right;">See page A111</p>

H SECTION Assortments

Continues on next page

A22

P: 1-800-265-8772 F: 1-888-252-6380 service@spenaaur.com

Spenaaur reserves the right to substitute parts in any assortment without notice. For any questions or suggestions about our Assortments and Plastikits, please contact us 1-800-265-8772. © 2018 Spenaaur Inc. All rights reserved. Catalog may not be reproduced, in whole or in part, without the written permission of Spenaaur Inc. Subject to Catalog Terms and Conditions of Use available at Spenaaur.com and on page TC2 and TC3 at the back of this catalog. Spenaaur se réserve le droit de remplacer des pièces dans n'importe quel assortiment sans préavis. Pour toute question ou suggestion concernant nos Assortiments et Plastikits, veuillez nous contacter au 1-800-265-8772. © 2018 Spenaaur Inc. Tous droits réservés. Le catalogue ne peut être reproduit, en tout ou en partie, sans l'autorisation écrite de Spenaaur Inc. L'utilisation est soumise aux Conditions d'utilisation du Catalogue disponibles sur Spenaaur.com et à la page TC4 et TC5 à la fin de ce catalogue.

SPAENAUR CATALOG 14.09

H SECTION Assortments



A-27
Steel, Plated
COMPRESSION SPRINGS
17 Sizes - 44 Pieces
Plastikit
Inch Sizes

See page A111



A-28
Steel, Plated
EXTENSION & COMPRESSION SPRINGS
25 Sizes - 54 Pieces
Plastikit
Inch Sizes

See page A111

J SECTION Assortments Continues on next page



805-642
Nylon 6/6
HOLE PLUGS
Smooth or Matte Finish,
Black or White (Natural)
64 Items - 860 Pieces
Large Box
Inch Sizes

See page A112



805-627
Nylon
HOLE PLUGS & BUSHINGS
22 Sizes - 475 Pieces
Large Box
Inch Sizes

See page A113



805-626
Black Nylon
SNAP BUSHINGS
32 Sizes - 693 Pieces
Large Box
Inch Sizes

See page A113



805-621A
Rubber
GENERAL PURPOSE RUBBER BUMPERS
30 Sizes, 655 Pieces
Large Box
Inch Sizes

See page A114



B-580
Rubber
GROMMETS & BUSHINGS
32 Sizes - 687 Pieces
Large Box
Inch Sizes

See page A115



A-32
SBR
RUBBER GROMMETS
12 Sizes - 52 Pieces
Plastikit
Inch Sizes

See page A116



805-A05-2M
Nitrile Compound
O-RING SPLICING KIT
8 Pieces, 8 Sizes
Regular Box
Inch Sizes

See page A117



A-216
Nitrile Compound
O-RING SEALS
36 Varieties - 428 Pieces
Large Box
Inch Sizes

See page A116



805-606
Viton Compound
O-RING SEALS
36 Varieties - 428 Pieces
Large Box
Inch Sizes

See page A116



804-069
Nitrile
O-RING SEALS
19 Sizes - 78 Pieces
Plastikit
Inch Sizes

See page A117

CATALOG 14 SPAENAUR

Visual Assortment Index

Index des assortiments virtuels

A

J SECTION Assortments

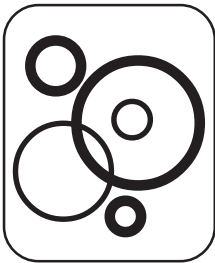

804-001
Viton
O-RING SEALS
 19 Sizes - 78 Pieces
 Plastikits
 Inch Sizes

See page A117

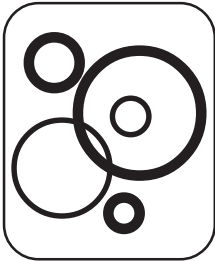

805-625
Nitrile Compound
METRIC O-RING SEALS
 36 Sizes - 439 Pieces
 Large Box
Metric Sizes

See page A117

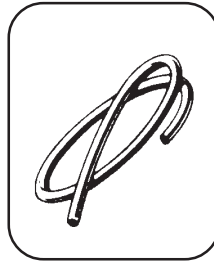

805-455 *German Metric O-Rings*
 6 Diameters, 5 feet of each
METRIC O-RING SPLICING CORD
Nitrile Compound Regular Box
Metric Sizes

See page A118

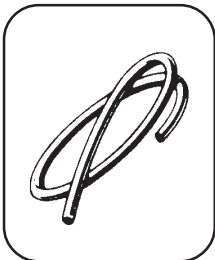

805-456 *Swedish Metric O-Rings*
 5 Diameters, 5 feet of each
METRIC O-RING SPLICING CORD
Nitrile Compound
 Regular Box
Metric Sizes

See page A118

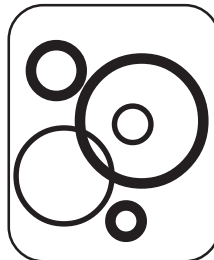

804-071
Nitrile
GERMAN METRIC O-RING SEALS
 28 Sizes - 128 Pieces
 Plastikits
Metric Sizes

See page A118



805-455 Shown

M SECTION Assortments



805-499A
Anti-Corrosive
"MARINE" FASTENERS
 19 Sizes, 636 Pieces plus 3 tools.
 Large Box
 Inch Sizes
 See page A119

805-499A Shown



Inch
Pouce



Machine / Tapping / Hex Washer Screws / Hex Nuts

Vis mécaniques/Vis autotaraudeuses/Vis à tête rondelle hexagonale/Écrous hexagonaux

ASSORTMENT B-576-M-C

SLOTTED SCREWS & HEX NUTS For Radio, Television & Electronics Shops, Etc.

Steel, Zinc and Nickel Plated.

42 SIZES - 1477 PIECES

Regular drawer has scooped compartments, and is finished in grey enamel. Fits into our Slide Racks shown on page A2.

13-3/8" x 9-1/4" x 2"

Shipping weight **3.63 kg** (8 lbs.)



A



Name	Head Type	Thread Size	Spaenaur No.	Screw Length	Qty.	Page	
Machine Screw Slot Drive	Flat 82° Countersunk	#4-40	B-1512	1/4"	20	B6	
			B-1515		50	B5	
	#2-56	B-1516	3/8"	40			
		380-F09-1T	1/2"	30			
		380-F26-1M	1/4"				
	#4-40	Round	B-411	1/2"	25	B6	
			380-F53-1X	1"	30		
	#5-40	MS-268	1/4"	20			
		MS-270	1"	30			
	#6-32	380-F37-1W	1/4"		15		
		B-1509	3/8"				
		380-F22-1N	1/2"				
		B-1499	3/4"				
	#8-32	Round	786A	1"	12		B7
			380-F42-1A	1-1/4"	20		
			380-F69-1C	1-1/2"	30		
			785A	5/16"			
			785	1/2"			
			1042	3/4"	20		
	#10-32	Round	B-1500	1"	15		
B-1501			1-1/4"				
B-1502			1-3/4"				
B-1503			2"				
#10-32	Round	1028-A	5/16"	25	B8		
		1028	1/2"	20			
		380-F25-1W	1"	15			
		#4	Indented Hex Washer	525-172	1/4"	30	B88
				B-1098	3/8"	35	
B-1519	1/2"						
B-1520	5/16"			30			
#6	525-D04-1T	1/2"					
	#8	ST-6H	3/8"	25	B89		
ST-7H		1/2"					
#10	Indented Hex Washer	525-D30-1T	1/2"	75	C2		
		#2-56	155-P07-1N			50	
			155-P11-1K				
		#4-40	HN-205				
			B-1521				
		#6-32	155-P03-2A				
155-P05-1Y							
#8-32	155-P04-1P						
	#10-32	155-P02-1X					

CATALOG 14

SPAENAUR

P: 1-800-265-8772 F: 1-888-252-6380 service@spaenaur.com

A25

Spaenaur reserves the right to substitute parts in any assortment without notice. For any questions or suggestions about our Assortments and Plastikits, please contact us 1-800-265-8772. © 2018 Spaenaur Inc. All rights reserved. Catalog may not be reproduced, in whole or in part, without the written permission of Spaenaur Inc. Subject to Catalog Terms and Conditions of Use available at Spaenaur.com and on page TC2 and TC3 at the back of this catalog. Spaenaur se réserve le droit de remplacer des pièces dans n'importe quel assortiment sans préavis. Pour toute question ou suggestion concernant nos Assortiments et Plastikits, veuillez nous contacter au 1-800-265-8772. © 2018 Spaenaur Inc. Tous droits réservés. Le catalogue ne peut être reproduit, en tout ou en partie, sans l'autorisation écrite de Spaenaur Inc. L'utilisation est soumise aux Conditions d'utilisation du Catalogue disponibles sur Spaenaur.com et à la page TC4 et TC5 à la fin de ce catalogue.



ASSORTMENT **1285M-F**
ASSORTIMENT

SLOT DRIVE MACHINE SCREWS & HEX NUTS

Slot & Phillips Drive, Steel, Head: Round / Flat / Oval

Zinc / Zinc Chromate
Trivalent Zinc / Nickel

72 VARIETIES
1043 PIECES

Regular drawer has 20 scooped compartments and is finished in grey enamel. Fits into our Slide Racks shown on page A2

13-3/8" x 9-1/4" x 2"

Shipping Weight **4.54 kg** (10 lbs.)

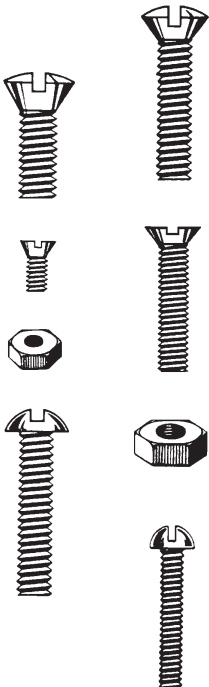
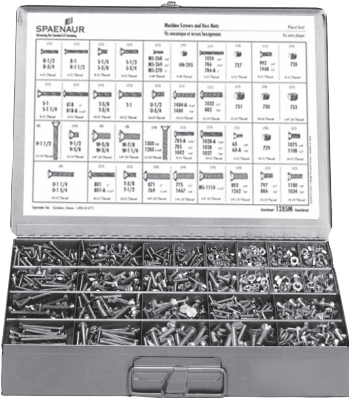

Name	Thread Size	Head Type	Spaenaur No.	Screw Length	Qty.	Page		
Machine Screw Steel	#5-40	Round	MS-268	1/4"	12	B6		
			MS-269	1/2"				
			MS-270	1"				
			380-F37-1W	1/4"	15			
			786	5/16"				
	786A	1"	12	B26				
	R-1/2	1/2"						
	R-3/4	3/4"						
	385-258	1"						
	MS-29	2"						
	#6-32	Flat	Flat 82° Countersunk	380-F84-1N	3/8"	12	B6	
				63-A	3/4"			
		Round	785A	5/16"	15	B7		
			785	1/2"				
			MS-58	5/8"				
	#8-32	Oval	Oval with 80° to 82° Countersunk	1042	3/4"	12	B8	
				MS-1244	7/8"			
		Flat	Flat 82° Countersunk	B-1500	1"	15	B7	
				380-F83-1C	1-1/2"			
		Oval	Oval with 80° to 82° Countersunk	1809	1"	12	B26	
				S-3/8	3/8"			
		Flat	Flat 82° Countersunk	S-1-1/4	1-1/4"	12	B7	
				992	1/4"			
		#10-24	Round	Round	380-F92-1A	1/2"	6	B7
					1468-A	3/4"		
	Oval		Oval with 80° to 82° Countersunk	380-F49-1W	5/16"	12	B7	
				1484	7/8"			
	Flat		Flat 82° Countersunk	380-F34-1N	1/2"	12	B7	
		U-7/8		7/8"				
		MS-160		1"				
	#10-32	Round	Round	1180	3/8"	12	B8	
				886	3/4"			
		Oval	Oval with 80° to 82° Countersunk	797	1/2"	10	B8	
				1034	5/8"			
		Flat	Flat 82° Countersunk	MS-1108	2"	6	B8	
				1028-A	5/16"			
		#12-24	Round	Round	1028	1/2"	12	B27
					1027	7/8"		
			Oval	Oval with 80° to 82° Countersunk	380-F25-1W	1"	10	B8
					801-A	1-1/2"		
	Flat		Flat 82° Countersunk	MS-1184P	3/8"	10	B9	
		T-1/2		1/2"				
		T-5/8		5/8"				
	1/4"-20	Round	Round	T-7/8	7/8"	6	B8	
				T-1	1"			
		Oval	Oval with 80° to 82° Countersunk	1075	1/4"	8	B9	
				1108	1/2"			
		Flat	Flat 82° Countersunk	1032	1/2"	10	B9	
	380-F07-1C			7/8"				
	Hex Nut Machine Screw Steel	#5-40	Round	V-1/2	1/2"	10	B8	
				2034	5/8"			
		#6-32	Oval	Oval with 80° to 82° Countersunk	1303	1-3/8"	10	B8
					1283	1-3/8"		
		#8-32	Flat	Flat with 80° to 82° Countersunk	775	1/2"	6	B9
					1467	3/4"		
		#10-24	Round	Round	871	1"	8	B9
					380-F08-1N	1-1/4"		
		#10-32	Oval	Oval with 80° to 82° Countersunk	W-5/8	5/8"	6	B9
					W-3/4	3/4"		
	#12-24	Flat	Flat 82° Countersunk	MS-33	1"	10	B9	
				W-1-1/4	1-1/4"			
	1/4"-20	Round	Round	380-F39-2X	3/4"	10	B9	
				1262	7/8"			
	#10-24	Flat	Flat 82° Countersunk	MS-1110	1-1/2"	25	C2	
				HN-205				
	#10-32	Oval	Oval with 80° to 82° Countersunk	155-P03-2A		50	C2	
				155-P04-1P				
	#12-24	Flat	Flat 82° Countersunk	155-P08-1T		25	C2	
				155-P02-1X				
	1/4"-20	Round	Round	155-P22-1T		25	C2	
				155-P06-1C				

Inch

Pouce



Machine Screws / Hex Nuts / Flat Washers

Vis mécaniques / Écrous hexagonaux / Rondelles plates

PLASTIKIT
«PLASTIKIT» **1140**

MACHINE SCREWS WITH HEXAGON NUTS

Steel, Zinc Plated
Round Slot Head

27 Sizes - 175 Pieces

Handy size, hinged lid and positive clasp
1" x 2-3/4" x 4-1/2"



Name	Head Type	Spaenaur No.	Thread Size	Screw Length	Qty.	Page
Machine Screw Slot Drive Steel ASME/ANSI B18.6.3	Round	380-F10-1N	#4-40	3/8"	6	B6
		380-F53-1X		1"		
		786	#6-32	5/16"	12	B6
		786A		1"		
		785	#8-32	1/2"	10	B7
		1042		3/4"		
		B-1500		1"		
		380-F83-1C		1-1/2"		
		1484	#10-24	7/8"	8	B8
		1027				
		1028	#10-32	1/2"	6	B8
		801-A				
		1032	#12-24	1/2"	2	B8
		1153				
		380-F07-1C				
		775	1/4"-20	3/4"	1	B9
		1467				
		871				
		380-F08-1N				
		Hex Nut Machine Screw Steel Zinc Plated		155-P11-1K	#4-40	5
155-P03-2A	#6-32			18		
155-P04-1P	#8-32			8	B273 C2	
155-P08-1T	#10-24			10	C2	
155-P02-1X	#10-32			6		
155-P22-1T	#12-24	6				

A

ASSORTMENT
ASSORTIMENT **805-641**

Machine Screws with Hex Nuts & Flat Washers

71 SIZES - 3475 PIECES

6/6 Nylon Slot Drive

Furnished in Large Size, Grey Enamelled STEEL Drawer, with scooped bins.
Drawer will fit into the Slide Racks shown on page A3
18" x 12" x 3" Shipping weight **4.5 kg** (10 lbs.)

Name	Spaenaur No.	Thread	Screw	Qty.	Page
Slotted Round Head Nylon Machine Screws	445-052	#2-56	1/2"	50	B23
	445-007		3/4"		
	445-B06-1K	1/4"			
	445-013	5/16"			
	MS-5007	#4-40	3/8"		
	445-029		1/2"		
	445-053		3/4"		
	MS-5009		1"		
	MS-5008	#6-32	1/4"		
	445-030		3/8"		
	MS-5012		1/2"		
	MS-5011		5/8"		
	445-054	#8-32	3/4"		
	MS-5010		1"		
	445-111		1/4"		
	445-112		5/16"		
	445-031	#10-24	3/8"		
	445-032		1/2"		
	445-033		3/4"		
	MS-5001		1"		
	445-136	#10-32	1/4"		
	445-137		5/16"		
	445-058		3/8"		
	445-059		1/2"		
	445-060	#10-32	3/4"		
	445-056		1"		
	445-155		1/4"		
	445-161		5/16"		
	445-034	#10-32	3/8"		
	445-035		1/2"		
	445-036		3/4"		
	MS-5005		1"		
	445-062	1/4"-20	1-1/4"		
	445-179		1-1/2"		
	445-186		5/16"		
	445-190		3/8"		
	445-055	1/4"-20	1/2"		
	MS-5004		3/4"		
	445-024		1"		
	445-063		1-1/4"		

Name	Spaenaur No.	Thread	Screw	Qty.	Page
Slotted Flat Head Nylon Machine Screws	445-037	#4-40	1/4"	50	B23
	MS-5018		1/2"		
	445-038		3/4"		
Slotted Fillister Head Nylon Machine	445-039	#6-32	1"	50	B23
	MS-5003		1/4"		
	MS-5014		1/2"		
Slotted Pan Head Nylon Machine Screws	MS-5015	#8-32	3/4"	50	B23
	445-083		1"		
	445-124		1/4"		
Slotted Binding Head Nylon Machine Screws	445-B01-1A	#10-32	1/2"	50	B24
	445-126		1"		
	445-159		1/4"		
Slotted Hex Head Nylon Machine Screws	445-077	#10-32	1/2"	25	B24
	445-078		3/4"		
	445-079		1"		
Hex Nuts Nylon	445-196	1/4"-20	1/2"	50	C8
	445-200		1"		
	445-204	1-1/2"			
	HN-5000	#2-56			
	163-A01-1P	#4-40			
	HN-5002	#6-32			
Flat Washers Nylon	HN-5003	#8-32	50	D10	
	HN-5004	#10-24			
	HN-5005	#10-32			
	HN-5006	1/4"-20			
	654-001	#2			
	654-G02-1A	#4			
	W-5001	#6			
654-G06-1N	#8				
W-5003	#10	100	D10		
W-5004	1/4"	50	H34		



CATALOG 14

SPAENAUR

P: 1-800-265-8772 F: 1-888-252-6380 service@spaenaur.com

A27

Spaenaur reserves the right to substitute parts in any assortment without notice. For any questions or suggestions about our Assortments and Plastikits, please contact us 1-800-265-8772. © 2018 Spaenaur Inc. All rights reserved. Catalog may not be reproduced, in whole or in part, without the written permission of Spaenaur Inc. Subject to Catalog Terms and Conditions of Use available at Spaenaur.com and on page TC2 and TC3 at the back of this catalog. Spaenaur se réserve le droit de remplacer des pièces dans n'importe quel assortiment sans préavis. Pour toute question ou suggestion concernant nos Assortiments et Plastikits, veuillez nous contacter au 1-800-265-8772. © 2018 Spaenaur Inc. Tous droits réservés. Le catalogue ne peut être reproduit, en tout ou en partie, sans l'autorisation écrite de Spaenaur Inc. L'utilisation est soumise aux Conditions d'utilisation du Catalogue disponibles sur Spaenaur.com et à la page TC4 et TC5 à la fin de ce catalogue.



ASSORTMENT **805-534A**
ASSORTIMENT

Made to ASME/ANSI B18.6.3

SLOTTED MACHINE SCREWS AND HEX NUTS

Brass, Unplated

74 SIZES
945 TOTAL PIECES

Regular Size welded steel drawer has hinged lid and is finished in grey enamel. Will fit into Slide Racks shown on A2.

13-3/8" x 9-1/4" x 2"
Shipping Weight: **4.54 kg** (10 lbs.)



Name	Spaenaur No.	Thread Size	Screw Length	Qty.	Page			
Slotted Oval Head	MS-531	#6-32	3/4"	10	B15			
	MS-728		1"					
	MS-532		1-1/2"					
	MS-820	#8-32	1/4"			B16		
	MS-908		1/2"					
	MS-678	#10-24	1"				B14	
	MS-744		1-1/2"					
	MS-904		1/2"					
	MS-544	#12-24	1-1/4"					B15
	MS-758	1/4"-20	1"					
MS-517	#4-36	3/4"	B15					
400-B05-1K	#4-40	1"						
MS-520		1/4"						
400-B49-1Y	#6-32	3/4"		B16				
400-B02-1C		1-1/2"						
400-B10-1X		1/2"						
MS-524	#8-32	1"			B15			
MS-525		1-1/2"						
400-B20-1W		2"						
400-B52-1C	#10-24	1/2"				B16		
MS-801		3/8"						
MS-788		1"						
MS-746	#10-24	1-1/2"	B16					
MS-747		2"						
MS-748		1/2"						
400-B29-1K	#10-32	1/4"		B15				
MS-912		1"						
MS-528		2"						
400-B58-1X	#12-24	1-1/2"			B14			
MS-666		3/4"						
MS-878		1/2"						
MS-856	1/4"-20	1"				B16		
400-B22-1X		1-1/2"						
MS-810		2"						
MS-761	#4-40	1/4"	B15					
MS-763		1/2"						
MS-653		1"						
MS-577	#6-32	1-1/2"		B16				
MS-510		1"						
MS-665		1-1/2"						
MS-918	#8-32	1/4"			B15			
400-B06-1W		1/2"						
MS-724		1"						
400-B44-1W	#10-24	1-1/2"				B16		
MS-585		3/8"						
MS-586		3/4"						
MS-741	#10-32	1"	B14					
400-628		1-1/2"						
400-B07-1M		1/4"						
400-B47-1A	#10-32	3/4"		B15				
400-B28-1T		1"						
MS-587		1-1/2"						
MS-588	#12-24	1/2"			B16			
400-B53-1N		1"						
MS-826		1/2"						
400-B01-1Y	1/4"-20	3/8"				B15		
MS-659		1/4"						
400-B17-1K		1/2"						
400-B31-1K	#6-32	1"	B16					
400-B13-1Y		1/4"						
MS-795		3/4"						
MS-830	#8-32	1-1/2"		C2				
400-B11-1A		1"						
MS-516		1/2"						
MS-900	#10-32	3/4"			25			
MS-655		1-1/2"						
HN-5B		1"						
157-T14-1W	#4-40	50				10		
HN-10B		#6-32						
157-T17-1A		#8-32						
HN-15B	#10-24	25						
157-T01-2K		#10-32						
157-T04-1X		#12-24						
157-T10-1C	1/4"-20	10						

Inch
Pouce



Machine Screws / Hex Nuts
Vis mécaniques / Écrous hexagonaux

ASSORTMENT
ASSORTIMENT **805-525**

MACHINE SCREWS and HEX NUTS
18-8 STAINLESS STEEL

72 SIZES - 1043 PIECES

Furnished in a regular size grey enamelled drawer, with hinged lid and scoop bins.
Drawer will fit Slide Racks shown on page A2.
Shipping Weight **4.19 kg** (9-1/4 lbs.)

A

Name	Thread Size	Spaenaur No.	Screw Length	Qty.	Page
Flat Head					
1/4"-20		MS-2003	3/4"	10	B21
		420-B03-1K	1"		
		420-462	1-1/2"		
#6-32		MS-2129	3/8"	12	B19
		420-A64-1A	3/4"		
#8-32		MS-2168	1/4"	12	B20
		MS-2016	1/2"		
#10-24		MS-2017	3/8"	10	B20
		MS-2207	1/2"		
		420-A80-1Y	5/8"		
#10-32		420-A95-1T	3/4"	10	B20
		420-A15-1P	1/4"		
#12-24		MS-2018	1/2"	8	B20
		420-A57-1T	1/2"		
		*MS-2285	5/8"		
		MS-2289	1"		
*80° - 82° Countersunk					
Oval Head					
1/4"-20		MS-2304	5/8"	6	B20
		MS-2306	3/4"		
		420-B04-1W	1"		
#6-32		MS-2314	1-1/4"	8	B21
		420-A96-1K	1/2"		
		MS-2148	3/4"		
		MS-2155	1"		
		MS-2159	1-1/4"		
#8-32		420-A98-1M	3/8"	12	B19
		MS-2200	1/2"		
		420-A99-1X	3/4"		
#10-32		MS-2197	1"	15	B20
		MS-2193	1-1/4"		
		MS-2188	1-1/2"		
#10-24		MS-2249	3/8"	12	B20
		*MS-2253	1/2"		
		MS-2260	3/4"		
		MS-2270	1"		
		MS-2273	1-1/4"		
		MS-2209	1/2"		
		MS-2219	3/4"		
420-A26-1A	1"				
		MS-2232	1-1/4"	6	
*80° - 82° Countersunk					

Name	Thread Size	Spaenaur No.	Screw Length	Qty.	Page
Round Head					
Machine Screw 18-8 Stainless Steel Slot Drive	1/4"-20	MS-2298	1/2"	10	B20
		MS-2005	3/4"		
		420-A59-1W	1"		B21
		420-A60-1K	1-1/4"		
		420-A19-1T	5/16"		
#8-32		MS-2013	1/2"	12	B19
		MS-2187	3/4"		
		420-A79-1C	1"		
#6-32		MS-2199	1-1/2"	15	B19
		MS-2120	1/4"		
		420-A94-1N	1/2"		
#4-40		MS-2154	1"	12	B20
		420-A52-1A	1/4"		
		420-A61-1W	1/2"		
		420-A93-1C	1"		
		420-A16-1Y	5/16"		
		420-A63-1X	1/2"		
		MS-2264	7/8"		
		MS-2269	1"		
		MS-2246	1-1/2"		
		MS-2223	3/8"		
#10-24		MS-2204	7/8"	10	B20
		MS-2288	7/8"		
		MS-2284	1/2"		
		MS-2286	5/8"		
		420-B10-1P	1-1/4"		
Hex Nut Machine Screw 18-8 Stainless Steel		#4-40	159-W03-2P	50	C2
		#6-32	HN-2003		
		#8-32	159-W04-1T		
		#10-24	159-W19-1T		
		#10-32	159-W15-1P		
		#12-24	159-W28-1Y		
		1/4"-20	159-W21-1T		
				25	C2

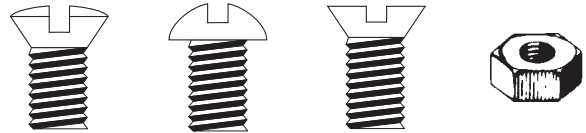

ASSORTMENT
ASSORTIMENT **805-535C**

MACHINE SCREWS
Inch Sizes - PLATED STEEL
Square Socket and Socket/Slot Drive

30 SIZES - 1080 PIECES

Furnished in a regular size grey enamelled steel drawer, with hinged lid and scoop bins. Drawer will fit Slide Racks shown on page A2
Shipping Weight **5.89 kg** (13 lbs.)

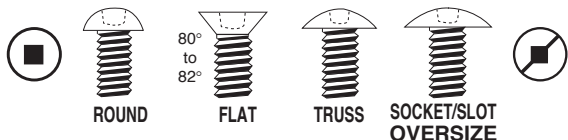

Name	Spaenaur No.	Thread Size	Screw Size	Qty.	Page
Square Socket Drive Flat Head	395-063	#6-32	1/2"	30	B33
	395-065		1-1/2"		
	395-067	#8-32	3/4"	50	
	395-070		1-1/2"		
	395-071	#10-24	3/4"	30	
	395-072		1-1/2"		
	395-075	#10-32	3/4"	30	
Square Socket Drive Truss Head	395-H17-1Y	1/4"-20	3/4"	50	B34
	MS-427	#8-32	1-1/2"	30	B33
Square Socket Drive Round Head	MS-1018	#10-24	3/4"	40	
	395-H51-1M	#4-40	1"	15	
	395-H38-1X		1/4"		
	395-H55-1Y	#6-32	1/2"	30	
	395-H53-1A		1"		
	395-051	#8-32	2"	50	
	395-H34-1T		1/2"		
	395-H02-1X	#10-24	1"	40	
	395-H71-1N		1-1/2"		
	395-H16-1P	#10-32	1/2"	30	
	395-H50-1W		1-1/2"		
	395-H41-1A	#10-24	1"	25	
	395-H29-1Y		1/2"		
	395-060	1/4"-20	2"	30	
395-H36-1W	1"				
395-H44-1C	#8-32	1"	30		
395-H54-1P		2"			
Slot/Square Socket Drive Truss Head	395-081	#8-32	5/8"	30	B35
395-H15-1A	1-1/4"				
Slot/Square Drive Flat Head	395-211	#10-24	2"	50	
	395-147R				

CATALOG 14.10 SPAENAUR

P: 1-800-265-8772 F: 1-888-252-6380 service@spaenaur.com

A29

Spaenaur reserves the right to substitute parts in any assortment without notice. For any questions or suggestions about our Assortments and Plastikits, please contact us 1-800-265-8772. © 2018 Spaenaur Inc. All rights reserved. Catalog may not be reproduced, in whole or in part, without the written permission of Spaenaur Inc. Subject to Catalog Terms and Conditions of Use available at Spaenaur.com and on page TC2 and TC3 at the back of this catalog. Spaenaur se réserve le droit de remplacer des pièces dans n'importe quel assortiment sans préavis. Pour toute question ou suggestion concernant nos Assortiments et Plastikits, veuillez nous contacter au 1-800-265-8772. © 2018 Spaenaur Inc. Tous droits réservés. Le catalogue ne peut être reproduit, en tout ou en partie, sans l'autorisation écrite de Spaenaur Inc. L'utilisation est soumise aux Conditions d'utilisation du Catalogue disponibles sur Spaenaur.com et à la page TC4 et TC5 à la fin de ce catalogue.



A

ASSORTMENT **805-A04-1W**
ASSORTIMENT

DIN 84 Screws
DIN 934 Nuts

**METRIC COARSE THREAD
SLOTTED CHEESE
HEAD SCREWS & NUTS**

Plain and Plated Finishes

1,200 PIECES, 24 SIZES

Furnished in Regular Size grey enamel steel drawer with hinged lid and catch. Drawer will fit into Slide Racks shown on page A2

Shipping Weight: **2.58 kg** (5.7 lbs.)

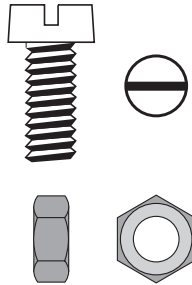

Name	Spaenaur No.	Diameter x Length	Qty.	Page
Machine Screw Slot Drive	382-B01-1T	M1.0 x 2mm	50	B37
	382-004	M1.0 x 5mm		
	382-870	M1.2 x 2mm		B44
	382-872	M1.2 x 4mm		
	382-B18-1A	M1.2 x 6mm		
	382-875	M1.4 x 2mm		B37
	382-020	M1.4 x 4mm		
	382-878	M1.4 x 6mm		B44
	382-029NP	M1.7 x 2mm		
	382-883	M1.7 x 10mm		B44
	382-039	M2 x 3mm		B38
	382-042	M2 x 12mm		
	382-049	M2.3 x 4mm		
	382-051	M2.3 x 8mm		B38
	382-053	M2.3 x 16mm		
382-063	M2.5 x 10mm			
382-067	M2.5 x 20mm	B38		
Nut Hexagon	156-001ZP	M1.0	C9	
	156-002ZP	M1.2		
	156-003ZP	M1.4		
	156-005	M1.7		
	156-006	M2		
	156-007ZP	M2.3		
156-008	M2.5			

**METRIC THREADED
SLOT DRIVE MACHINE
SCREWS & HEX NUTS**

STEEL, Zinc Plated

Slot Head Style, With Hex Nuts

DIN 84

Regular Size welded steel drawers have hinged lids and are finished in grey enamel.

Drawers will fit into Slide Racks shown on page A2

Shipping Weight: **4.54 kg** (10 lbs.)

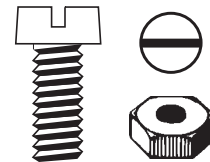

ASSORTMENT **805-400**
ASSORTIMENT

**24 SIZES
1,385 PIECES**

Name	Spaenaur No.	Thread Size	Screw Length	Qty.	Page
Machine Screw Slot Drive Cheese Head	382-041	M2 x 0.40	8mm	80	B38
	382-074		6mm		
	382-B20-1A	M3 x 0.50	8mm		B39
	382-B26-1K		10mm		
	382-289		16mm	50	
	382-190		6mm		
	382-102		8mm		
	382-B17-1X	M4 x 0.70	10mm	40	B40
	382-B22-1Y		12mm		
	382-105		16mm		
	382-192		20mm	40	
	382-116		10mm		
	382-117		16mm		
	382-118	M5 x 0.80	20mm	30	B41
	382-119		25mm		
	382-131		10mm		
	382-133	M6 x 1.00	16mm	25	
	382-210		20mm		
382-135		25mm			
Hex Nut	156-006ZP	M2 x 0.40		80	C9
	156-010ZP	M3 x 0.50			
	156-012ZP	M4 x 0.70		100	
	156-013ZP	M5 x 0.80			C10
	156-014ZP	M6 x 1.00		80	

ASSORTMENT **805-401**
ASSORTIMENT

**24 SIZES
1,100 PIECES**

Name	Head Type	Spaenaur No.	Thread Size	Screw Length	Qty.	Page
Machine Screw Slot Drive Head Style Flat Metric DIN 963	Flat	382-082	M3 x 0.50	6mm	80	B39
		382-084		10mm		
		382-239		20mm		
		382-110	M4 x 0.70	8mm	50	B40
		382-112		12mm		
		382-128	M5 x 0.80	16mm	30	
		382-246		30mm	40	
		382-145		M6 x 1.00	20mm	30
		382-159	M8 x 1.25		20	B42
		Machine Screw Slot Drive Head Style Pan Metric DIN 85	Pan	382-078	M3 x 0.50	6mm
382-079	10mm					
382-106	M4 x 0.70			8mm	50	B40
382-107				12mm		
382-120				6mm		
382-122	M5 x 0.80			10mm	40	
382-123				20mm		
382-137	M6 x 1.00			10mm	30	B41
382-138				16mm		
Machine Screw Slot Drive Head Style Oval Metric DIN 964	Oval			382-081	M3 x 0.50	12mm
		382-109	M4 x 0.70		50	
		382-124	M5 x 0.80	10mm	40	B40
		382-126		25mm		
		382-141	M6 x 1.00	16mm	30	B41
		382-157	M8 x 1.25	30mm	20	B42

A30

P: 1-800-265-8772 F: 1-888-252-6380 service@spaenaur.com

Spaenaur reserves the right to substitute parts in any assortment without notice. For any questions or suggestions about our Assortments and Plastikits, please contact us 1-800-265-8772. © 2018 Spaenaur Inc. All rights reserved. Catalog may not be reproduced, in whole or in part, without the written permission of Spaenaur Inc. Subject to Catalog Terms and Conditions of Use available at Spaenaur.com and on page TC2 and TC3 at the back of this catalog. Spaenaur se réserve le droit de remplacer des pièces dans n'importe quel assortiment sans préavis. Pour toute question ou suggestion concernant nos Assortiments et Plastikits, veuillez nous contacter au 1-800-265-8772. © 2018 Spaenaur Inc. Tous droits réservés. Le catalogue ne peut être reproduit, en tout ou en partie, sans l'autorisation écrite de Spaenaur Inc. L'utilisation est soumise aux Conditions d'utilisation du Catalogue disponibles sur Spaenaur.com et à la page TC4 et TC5 à la fin de ce catalogue.



ASSORTMENT
ASSORTIMENT **805-439C**

Metric
North American Style
Metric Slotted Pan Head
MACHINE SCREWS

DIN 84 / DIN 85

STEEL - Zinc Plated
24 SIZES - 1,000 PIECES

REGULAR SIZE welded STEEL drawer has hinged lid, "Scooped" bins, and is finished in grey enamel. Drawer will fit into slide racks shown on page A2



Name	Spaenaur No.	Thread Size	Screw Length	Qty.	Page								
Machine Screw Slot Drive Head Style Cheese Metric DIN 84	382-063	M2.5 x 0.45	10mm	50									
Machine Screw Slot Drive Head Style Pan Metric DIN 85	382-517	M3.5 x 0.60	8mm	50	B39								
	382-554	M6 x 1.00	30mm		B41								
	382-556		45mm		B41								
	382-300	M2 x 0.40	3mm		50	B38							
	382-302		8mm										
	382-308	M2.5 x 0.45	20mm			50	B38						
	382-B10-1Y		25mm										
	382-311	M3 x 0.50	5mm				50	B39					
	382-313		8mm										
	382-B12-1N	M3.5 x 0.60	16mm					50	B39				
	382-325		20mm										
	382-326	M3.5 x 0.60	20mm						50	B39			
	382-B16-1M		35mm										
	382-332	M4 x 0.70	8mm							50	B40		
	382-334		13mm										
	382-337	M4 x 0.70	25mm								50	B40	
	382-343		10mm										
	382-B13-1T	M5 x 0.80	16mm									50	B40
	382-348		30mm										
	382-386	M6 x 1.00	16mm										50
382-387	20mm												
382-370	M8 x 1.25	25mm	50	B42									
382-372		35mm											

A

ASSORTMENT
ASSORTIMENT **805-429**

METRIC
Standard (Coarse) Thread

A2 Stainless Steel
MACHINE SCREWS
24 SIZES-215 PIECES

Contains slotted Cheese, Oval and Flat heads, in Metric diameters M3 to M10.

REGULAR SIZE grey enamelled STEEL Drawer has "scooped" bins. Will fit the Slide Racks shown on page A2

Shipping Weight: **2.72 kg** (6 lbs.)



Head	Spaenaur No.	Thread Size	Screw Length	Qty.	Page
Pan	421-021	M5 x 0.80	30mm	6	B47
Flat	421-093	M3 x 0.50	8mm	20	B46
	421-096		20mm		
	421-101	M4 x 0.70	8mm	10	B47
	421-103		16mm		
	421-108	M5 x 0.80	20mm	8	B48
	421-113	M6 x 1.00	25mm	6	
	421-114	M8 x 1.25	20mm	4	
	421-118	M10 x 1.50		3	
Oval	421-065	M3 x 0.50	12mm	15	B46
	421-070	M4 x 0.70	10mm	10	B47
	421-072		20mm		
	421-076	M5 x 0.80	16mm	8	B48
	421-081	M6 x 1.00	20mm	6	
Cheese	421-A08-1T	M3 x 0.50	12mm	15	B46
	421-005		16mm		
	421-008	M3.5 x 0.60	12mm	10	B47
	421-012		16mm		
	421-014	M4 x 0.70	25mm	8	B47
	421-018		M5 x 0.80		
	421-024	M6 x 1.00	30mm	5	B48
	421-027		16mm		
	421-032	M8 x 1.25	20mm	4	B48
	421-037	M10 x 1.50	30mm	3	



A

ASSORTMENT 805-536A
ASSORTIMENT 805-536A

**METRIC STANDARD
COARSE THREAD**

**MACHINE SCREWS
AND HEX NUTS**

BRASS - Unplated

**62 SIZES
1245 PIECES**

Furnished in a Regular Size grey
enamelled steel drawer.

Shipping Weight **4.08** kg (9 lbs.)



Name	Thread Size	Compatible Hole Size	Head Diameter / Width Across Flats	Head Height	Spaenaur No.	Screw Length	Qty.	Page		
Machine Screw Metric (Flat)	M2 x 0.40	1.60mm	3.8mm	1.20mm	401-044	8mm	20	B49		
					401-046	18mm				
					401-042	30mm				
					401-047	4mm				
					401-050	10mm				
	M2.3 x 0.40	1.90mm				401-052	20mm			
						401-053	6mm			
						401-054	12mm			
						401-137	10mm			
						401-138	16mm			
	M2.5 x 0.45	2.05mm	4.7mm	1.50mm		401-197	4mm		B50	
						401-141	10mm			
	M3 x 0.50	2.50mm	5.6mm	1.65mm		401-143	25mm		B50	
						401-199	10mm			
	M3.5 x 0.60	2.90mm	6.5mm	1.93mm		401-146	20mm	15	B51	
						401-348	35mm			
						401-148	10mm			
						401-150	20mm			
						401-151	30mm			
	M4 x 0.70	3.30mm	7.5mm	2.20mm		401-152	40mm		B52	
401-364						10mm				
401-153						16mm				
401-154						20mm				
401-155						30mm				
M5 x 0.80	4.20mm	9.2mm	2.50mm		401-205	40mm		B52		
					401-206	60mm				
					401-182	4mm				
					401-019	5mm				
					401-020	12mm				
Machine Screw Metric (Cheese)	M2 x 0.40	1.60mm	3.8mm	1.30mm	401-021	18mm	20	B49		
					401-024	15mm				
					401-022	8mm				
	M2.3 x 0.40	1.90mm	4.4mm	1.50mm		401-025	4mm		B50	
						401-211	10mm			
						401-027	16mm			
	M2.5 x 0.45	2.05mm	4.5mm	1.60mm		401-182	4mm		B50	
						401-059	12mm			
	M3 x 0.50	2.50mm	5.5mm	2.00mm		401-062	25mm		B50	
						401-064	10mm			
	M3.5 x 0.60	2.90mm	6.0mm	2.40mm		401-065	16mm	15	B51	
						401-067	25mm			
						401-068	6mm			
						401-069	10mm			
						401-070	16mm			
	M4 x 0.70	3.30mm	7.0mm	2.60mm		401-071	20mm		B52	
						401-072	25mm			
						401-184	6mm			
						401-074	16mm			
						401-075	20mm			
M5 x 0.80	4.20mm	8.5mm	3.30mm		401-076	25mm		B52		
					401-077	35mm				
					401-079	1mm				
					401-P03-1C	10mm				
					401-081	25mm				
M6 x 1.00	5.00mm	10.0mm	3.90mm		401-082	35mm		C12		
					158-001					
					158-023					
					158-002					
					158-003					
					158-004					
					158-005					
Hexagon Nut Metric	M2 x 0.40	1.60mm	3.8mm				25	C12		
									M2.3 x 0.40	
									M2.5 x 0.45	
									M3 x 0.50	
									M3.5 x 0.60	
									M4 x 0.70	
									M5 x 0.80	
M6 x 1.00										

CATALOG 14

SPAENAUR

A32

P: 1-800-265-8772 F: 1-888-252-6380 service@spaenaur.com

Spaenaur reserves the right to substitute parts in any assortment without notice. For any questions or suggestions about our Assortments and Plastikits, please contact us 1-800-265-8772. © 2018 Spaenaur Inc. All rights reserved. Catalog may not be reproduced, in whole or in part, without the written permission of Spaenaur Inc. Subject to Catalog Terms and Conditions of Use available at Spaenaur.com and on page TC2 and TC3 at the back of this catalog. Spaenaur se réserve le droit de remplacer des pièces dans n'importe quel assortiment sans préavis. Pour toute question ou suggestion concernant nos Assortiments et Plastikits, veuillez nous contacter au 1-800-265-8772. © 2018 Spaenaur Inc. Tous droits réservés. Le catalogue ne peut être reproduit, en tout ou en partie, sans l'autorisation écrite de Spaenaur Inc. L'utilisation est soumise aux Conditions d'utilisation du Catalogue disponibles sur Spaenaur.com et à la page TC4 et TC5 à la fin de ce catalogue.



SPAENAU

Fasteners Right Now[®]

NEW

CONTINENTAL[®] ABRASIVES

Abrasives Cut Off & Grinding Wheels

High-quality materials & world class performance now available in Canada



From CONTINENTAL ABRASIVES

Pg. P146

Pour la version française, voir la page suivante

T: 1-800-265-8772 F: 1-888-252-6380 service@spaenaur.com



SPAENAU

Fasteners Right Now[®]

Nouveau

BLOQUEURS DE FILETAGE ET PRODUITS
D'ÉTANCHÉITÉ VIBRA-TITE^{MD}

Des produits sur lesquels vous pouvez compter

Répondez à vos besoins de verrouillage,
de collage et d'étanchéité avec des
produits de haute qualité.



Vibra-TITE

De ND INDUSTRIES INC.

Pg. C218

For the English version, see previous page

T: 1-800-265-8772 F: 1-888-252-6380 service@spaenaur.com



ASSORTMENT 805-483B

METRIC PHILLIPS DRIVE

**Machine Screws
Coarse Thread**

Low Carbon STEEL, Plated Finish

PAN (IFI 513), OVAL (DIN 966)
AND FLAT (DIN 965) Heads

24 SIZES - 990 PIECES

Furnished in REGULAR SIZE
grey enamelled steel drawer.

Shipping Weight **4.3 kg** (9.5 lbs.)



Head Type	Spaenaur No.	Thread Size	Screw Length	Qty.	Page
Oval	388-050	M3 x 0.50	5mm	65	B56
	388-052		12mm	60	
	388-A20-1X	M4 x 0.70	6mm	50	
	388-058		16mm		
	388-062	M5 x 0.80	20mm	40	
	388-066	M6 x 1.00	16mm	30	
	388-067		25mm	20	
	388-071	M8 x 1.25	30mm	20	
Flat	388-074	M3 x 0.50	8mm	65	
	388-076		16mm	60	
	388-079	M4 x 0.70	10mm	50	
	388-081		25mm		
	388-083	M5 x 0.80	12mm	40	
	388-088	M6 x 1.00	16mm	30	
	388-089		25mm	20	
	388-092	M8 x 1.25	16mm	20	
Pan	388-A01-1N	M3 x 0.50	12mm	60	B57
	388-253	M3	20mm		
	388-020	M3.5 x 0.60	16mm	50	
	388-126		M4 x 0.70		
	388-285	M5	30mm	40	
	388-293	M6	25mm	20	
	388-302	M8 x 1.25	16mm	30	
388-305	30mm		20		

ASSORTMENT 805-614D

**INCH SIZES
PHILLIPS DRIVE
MACHINE SCREWS
with Hexagon Nuts**

STEEL - with Plated Finish

42 SIZES - 1900 PIECES

Put up in a large grey enamelled steel
drawer, with hinged lid and catch.

Shipping Weight: **8.17 kg** (18 lbs.)

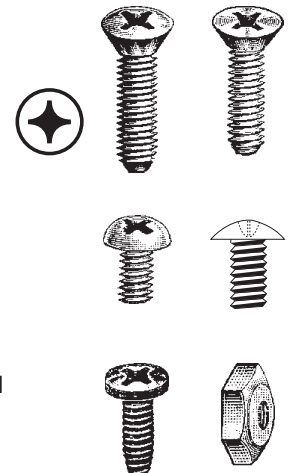

Name	Head Type	Spaenaur No.	Thread Size	Screw Length	Qty.	Page			
Machine Screw Phillips Drive	Round	385-C34-1N	#6-32	3/8"	50	B26			
		MS-423P		1/2"					
		B-339	#8-32	3/4"					
		385-B99-1Y							
		1873	#10-24	1/2"		25	B27		
		385-B10-1X		#10-32				3/4"	
		B-342							
		2035-A	#12-24						
		MS-1210P	1/4"-20	1/2"			B28		
		2016		7/8"					
		Oval	Oval	B-416		#6-32	1/2"	50	B26
				1405			3/4"		
	1407			3/8"					
	1881			#8-32	5/8"				
	B-332				3/4"				
	1809			1"	B26				
	1870-S		#10-24	5/8"	B27				
	MS-2384P			1"					
	1882		#10-32	7/16"	25	B27			
	1810			5/8"					
	1811			3/4"					
	2034			#12-24		5/8"	B8		
	B-922	1/2"							
	2036	1/4"-20		1-1/4"		B28			
	Flat	Flat	385-043	#8-32	1-3/4"	50	B26		
			385-B61-1A		1/2"				
			385-046	3/4"					
		385-B16-1T	#10-32	1/2"	25		B27		
		385-B64-1C		1"					
		1814	1/4"-20	5/8"	B28				
	1887								
	Binding	Binding	2209	#8-32	5/16"	50	B26		
			385-C11-1T		3/8"				
		MS-156P	1"						
	Truss	Truss	385-B04-1T	1/4"-20	3/4"	25	B28		
			385-B51-1Y		#8-32			1"	50
	Nut Hex Machine Screw Steel Zinc Plated	Pan	155-P03-2A	#6-32		100	C2		
			155-P04-1P		#8-32				
			155-P08-1T	#10-24					
			155-P02-1X		#10-32				
			155-P22-1T	#12-24					
			155-P06-1C		1/4"-20				



ASSORTMENT **805-431**
ASSORTIMENT

Metric Standard
6/6 Nylon Coarse Thread
Metric Machine Screws
NATURAL COLOUR

24 SIZES
188 PIECES

Shipping Weight:
2.38 kg (5-1/4 lbs.)

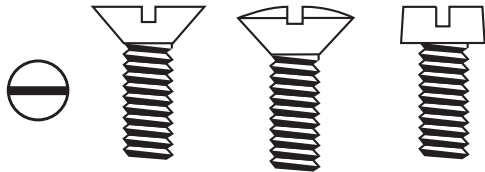
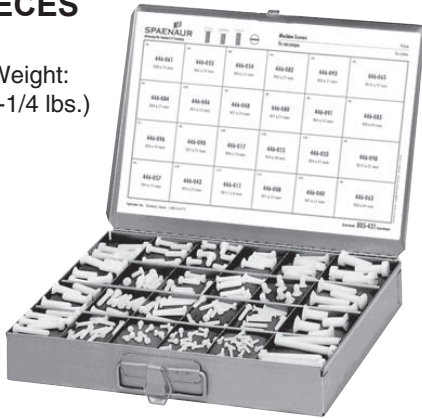

Head Type	Thread Size	Spaenaur No.	Screw Length	Qty.	Page
Cheese	M3 x 0.50	446-008	10mm	15	B53
	M3.5 x 0.60	446-011	8mm	12	
	M4 x 0.70	446-015	18mm	10	
		446-017	30mm	10	
	M5 x 0.80	446-046	10mm	8	B54
		446-048	20mm	8	
		446-054	12mm	6	
		446-055	20mm	6	
	M6 x 1.00	446-057	35mm	6	B54
		446-061	30mm	5	
446-063		60mm	4		
446-065		30mm	4		
Flat	M3 x 0.50	446-040	12mm	15	B53
	M4 x 0.70	446-043	20mm	10	
	M5 x 0.80	446-090	25mm	8	
		446-091	10mm	8	
	M6 x 1.00	446-093	35mm	6	B54
		446-096	60mm	5	
Oval	M10 x 1.50	446-098	25mm	4	B53
	M4 x 0.70	446-035	25mm	10	
	M5 x 0.80	446-080	25mm	8	
	M6 x 1.00	446-082	25mm	6	
446-084		25mm	6		
M8 x 1.25	446-085	40mm	4	B54	

ASSORTMENT **805-661-A**
ASSORTIMENT

STEEL
Wood Screws
Zinc Plated

SQUARE SOCKET DRIVE
24 SIZES
1150 PIECES

Furnished in Large Size grey enamel drawer with scooped bins for easy access.
Drawers will fit into Slide Racks shown on page A3

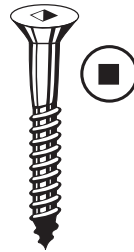

Shipping Weight:
7.71 kg (17 lbs)

Head Type	Spaenaur No.	Dia. X Lgth.	Qty.	Page		
Flat	WS-56	6 x 3/4"	50	B68		
	593-K02-1Y	6 x 1"				
	593-005	6 x 1-1/2"				
	WS-94	6 x 2"				
	WS-63	8 x 3/4"				
	WS-20	8 x 1"				
	WS-65	8 x 1-1/4"				
	593-K05-1T	8 x 1-1/2"				
	WS-80	8 x 2"				
	WS-81	8 x 2-1/2"				
	WS-40	10 x 1"				
	WS-41	10 x 1-1/4"				
	WS-42	10 x 1-1/2"				
	593-K23-1X	10 x 2"				
	WS-136	10 x 2-1/2"				
	WS-96	10 x 3"			25	B69
	WS-139	10 x 3-1/2"				
	WS-46	12 x 1-1/2"				
WS-48	12 x 2"					
Round	WS-50	12 x 2-1/2"	50	B68		
	593-K01-1P	6 x 3/8"				
	WS-126	8 x 1-1/4"				
	WS-157	8 x 2"				
WS-128	10 x 3/4"					

ASSORTMENT **805-541A**
ASSORTIMENT

BRASS
Wood Screws

SQUARE SOCKET DRIVE
24 SIZES
1125 PIECES

Furnished in Regular Size grey enamel drawer with scooped bins for easy access.
Drawers will fit into Slide Racks shown on page A2

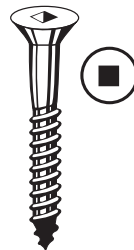

Shipping Weight:
5.18 kg (11.42 lbs)

Head Type	Spaenaur No.	Thread Diameter	Screw Length	Qty.	Page	
Flat	WS-555	#4	1/2"	50	B68	
	WS-558	#5	3/4"			
	WS-538	#6	1"			
	592-A06-1W		1-1/2"			
	WS-646	#8	3/4"			
	WS-543		1-1/4"			
	WS-546		1-1/2"			
	WS-547		1-3/4"			
	WS-652	#10	2"			40
	WS-627		1-1/4"			50
	WS-549	1-1/2"	30			
	WS-550	#12	1-3/4"			35
	WS-567		2"			40
	WS-553	M6	40mm			40
701-529						
Round	592-A03-1N	#6	3/4"	50	B68	
	WS-577	#8	1-1/4"			
	WS-583		3/4"			
	WS-586	1-1/4"				
	592-001	2-1/2"				
	WS-590	#10	3/4"			
Oval	WS-616	#8	1"	30	B69	
	WS-617	#10	1-1/4"			
	WS-621		1-1/2"			

Inch
Pouce

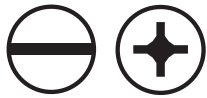

Tapping Screws
Vis autotaraudeuses

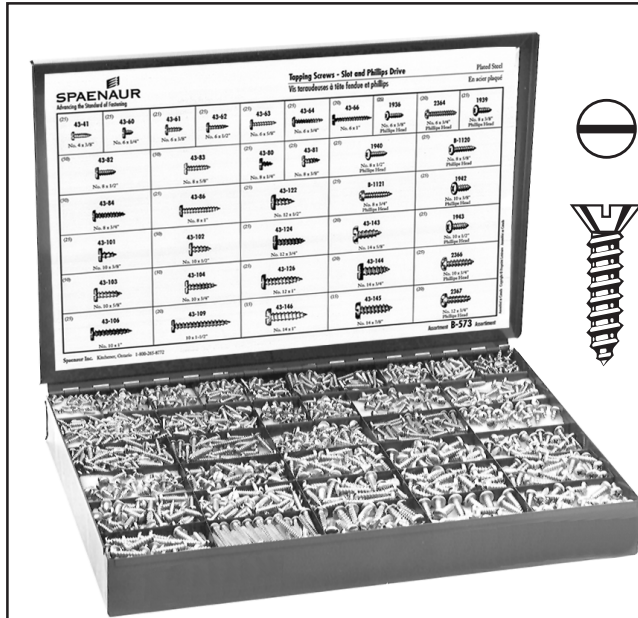

ASSORTMENT B-573

**Slotted & Phillips Pan Head
TAPPING SCREWS (Type AB)**
ALL SCREWS ZINC PLATED

36 SIZES - 1000 PIECES

18" x 12" x 3"

Grey enamelled metal box.
Hinged lid, scooped bins & dividers.
Shipping weight **5.6 kg** (12.35 lbs.)



PLASTIKIT
«PLASTIKIT» **A-5**

**Pan Slot Head
TYPE AB
TAPPING SCREWS**
STEEL, Zinc Plated
20 SIZES - 140 PIECES
Shipping weight **0.34 kg** (0.75 lbs.)

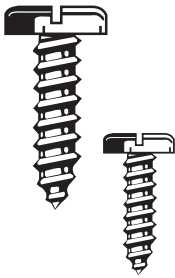

Head Type	Thread Diameter	Spaenaur No.	Screw Length	Qty.	Page
Pan	#4	43-41	3/8"	5	B79
		43-61		10	
	#6	43-62	1/2"	5	
		43-64	3/4"		
		43-66	1"		
		43-80	1/4"		
	#8	43-81	3/8"	12	
		43-82	1/2"		
		43-83	5/8"		
		43-84	3/4"		
		43-86	1"		
		43-101	3/8"		
	#10	43-102	1/2"	12	
		43-104	3/4"		
		43-106	1"		
		43-108	1-1/4"		
	#12	43-122	1/2"	5	
		43-126	1"		
	#14	43-144	3/4"	5	
		43-146	1"		

Drive	Thread Diameter	Spaenaur No.	Screw Length	Qty.	Page	
Slot	#4	43-41	3/8"	25	B79	
		43-60	1/4"			
	#6	43-61	3/8"			20
		43-62	1/2"			
		43-63	5/8"			
		43-64	3/4"			
	#8	43-66	1"			50
		43-80	1/4"			
		43-81	3/8"			
		43-82	1/2"			
		43-83	5/8"			
		43-84	3/4"			
	#10	43-86	1"			25
		43-101	3/8"			
		43-102	1/2"			
		43-104	3/4"			
	#12	43-105	7/8"			25
		43-106	1"			
		43-122	1/2"			
		43-124	3/4"			
#14	43-126	1"	20			
	43-143	5/8"				
	43-144	3/4"				
	43-145	7/8"				
Phillips	#6	43-146	1"	20	B79	
		530-B02-1N	3/8"			
	#8	2364	3/4"	25	B81	
		530-B14-1N	3/8"			
		530-B60-1A	1/2"			
		B-1120	5/8"			
	#10	B-1121	3/4"	20		
		1942	3/8"			
		1943	1/2"			
		530-B30-1K	3/4"			
#12	1943-B	1-1/2"	20			
	2367	3/4"				

CATALOG 14.03
2019/04/18

SPAENAUR

P: 1-800-265-8772 F: 1-888-252-6380 service@spaenaur.com

A35

Spaenaur reserves the right to substitute parts in any assortment without notice. For any questions or suggestions about our Assortments and Plastikits, please contact us 1-800-265-8772. © 2018 Spaenaur Inc. All rights reserved. Catalog may not be reproduced, in whole or in part, without the written permission of Spaenaur Inc. Subject to Catalog Terms and Conditions of Use available at Spaenaur.com and on page TC2 and TC3 at the back of this catalog. Spaenaur se réserve le droit de remplacer des pièces dans n'importe quel assortiment sans préavis. Pour toute question ou suggestion concernant nos Assortiments et Plastikits, veuillez nous contacter au 1-800-265-8772. © 2018 Spaenaur Inc. Tous droits réservés. Le catalogue ne peut être reproduit, en tout ou en partie, sans l'autorisation écrite de Spaenaur Inc. L'utilisation est soumise aux Conditions d'utilisation du Catalogue disponibles sur Spaenaur.com et à la page TC4 et TC5 à la fin de ce catalogue.



A

**Slotted Pan, Oval, & Flat Head
TAPPING SCREWS (Type AB)**
ALL SCREWS NICKEL OR ZINC PLATED



**SPECIAL
ASSORTMENT**

**36 Sizes
1025 Pieces**

16-1/4" x 11-3/4" x 2"

Red enamelled metal box. Hinged lid, 12 SCOOPED bins, 24 regular bins & dividers.

ASSORTMENT 1268R

Shipping weight:
5.22 kg (11-1/2 lbs.)



**REGULAR
ASSORTMENT**

**36 Sizes
995 Pieces**

13-3/8" x 9-1/4" x 2"

Grey enamelled metal box. Hinged lid, SCOOPED bins & dividers.

ASSORTMENT 1268M

Shipping weight:
4.08 kg (9 lbs.)

Head Type	Thread Diameter	Spaenaur No.	Screw Length	Qty.	Page
Type AB					
Oval	#6	ST-115	1/2"	30	B79
		52-64	3/4"		
		ST-117	7/8"		
		52-68	1-1/4"		
	#8	52-83	5/8"	30	B79
		52-84	3/4"		
		52-85	7/8"		
		1435	7/8"		
		52-86	1"		
		1246	1-1/8"		
	#10	52-88	1-1/4"	25	B79
		52-104	3/4"		
		1398	7/8"		
		1442	1"		
1443		1-1/4"			
#12	520-001	1"	20	B79	
	52-148	1-1/4"			
Flat	#6	63-61	3/8"	25	B79
		63-65	7/8"		
	#10	63-104	3/4"		
		63-105	7/8"		
Pan	#6	43-61	3/8"	30	B79
		43-81	3/8"		
	#8	43-82	1/2"		
		43-84	3/4"		
	#10	43-102	1/2"		
43-108	1-1/4"				
Type A					
Oval	#10	52-105	7/8"	25	B79
Flat	#4-24	63-41	3/8"	25	
Pan	#8	43-83	5/8"	40	
	#10	43-104	3/4"	25	
Truss	#10	ST-107	5/8"	25	
Washer for Finishing Screw Countersunk & Flush Type					
	Compatible Bolt Size	Spaenaur No.	Outer Diameter	Qty.	Page
Flush	#6	7137	11/32"	50	D68
	#8	7138	3/8"		

Head Type	Thread Diameter	Spaenaur No.	Screw Length	Qty.	Page		
Flat	#4	63-41	3/8"	25	B79		
		63-61					
	#6	63-65	7/8"				
		63-104	3/4"				
Oval	#10	63-105	7/8"	30	B79		
		52-64	3/4"				
	#6	ST-117	7/8"				
		52-68	1-1/4"				
		52-83	5/8"				
		52-84	3/4"				
	#8	52-85	7/8"			25	B79
		1435	7/8" (#6 Trim Head)				
		1246	1-1/8"				
		52-88	1-1/4"				
52-102		1/2"					
52-104		3/4"					
#10	1398	7/8"	25	B79			
	1442	1"					
	52-106	1"					
	1443	1-1/4"					
	1277	1-1/2"					
	1448	1"					
Pan	#12	52-148	1-1/4"	20	B79		
		52-145	7/8"				
	#6	43-61	3/8"				
		43-82	1/2"				
	#8	43-83	5/8"				
		43-84	3/4"				
		43-89	1-1/2"				
		43-102	1/2"				
	#10	43-104	3/4"			25	B79
		43-108	1-1/4"				
ST-148		1-1/4"					
Truss		ST-148	1-1/4"				
Washer Type							
Flush	Compatible Bolt Size	Spaenaur No.	Outer Diameter	Qty.	Page		
	#6	7137	11/32"	50	D68		
#8	7138	3/8"					

CATALOG 14.03
2019/04/18

SPAENAUER

Inch
Pouce



Tapping Screws / Countersunk Washers

Vis autotaraudeuses / Rondelles fraisées

ASSORTMENT
ASSORTIMENT **805-526**

TYPE "AB"



18-8 Stainless Steel TAPPING SCREWS

36 SIZES - 1,000 PIECES

Furnished in a REGULAR SIZE drawer, with lid and scooped bin.
Fits the slide racks shown on Page A2

Shipping Weight: **3.40 kg** (7-1/2 lbs.)



Name	Thread Diameter	Spaenaur No.	Screw Length	Qty.	Page
Slotted Pan Head	#4	ST-2033	3/8"	25	B80
		ST-2035	1/2"	25	
	#6	ST-2042	3/8"	30	
		ST-2045	1/2"		
		ST-2048	3/4"		
	#8	ST-2049	1"	25	
		ST-2061	1/2"		
		ST-2068	3/4"		
		ST-2004	1"		
	#10	ST-2098	1-1/4"	30	
		ST-2072	1/2"		
		ST-2076	3/4"		
#12	ST-2079	1"	25		
	ST-2082	3/4"	25		
#14	521-A04-1N	1"	20		
	ST-2099				
Slotted Flat Head	#4	ST-2032	3/8"	25	
		ST-2129			
	#6	521-A03-1C	1/2"	30	
		ST-2132	5/8"	25	
	#8	ST-2133	3/4"	30	
		521-A02-1Y	5/8"		
		ST-2066	3/4"		
	#10	ST-2015	1"	25	
521-A06-1K		3/4"	25		
Slotted Oval Head	#6	ST-2077	1"	30	
		ST-2131	1/2"		
	ST-2059	3/4"			
#8	ST-2062	1/2"	25		
	ST-2065	5/8"			
	521-A05-1T	3/8"			
Slotted Truss Head	#6	ST-2104	1/2"	25	
		ST-2014	3/4"		
	#8	521-A07-1W	1"		
Countersunk Washers	#6	W-2010	7/16"	50	D68
	#8	W-2011	17/32"		

ASSORTMENT
ASSORTIMENT **B-570B**

TYPE "AB"

PHILLIPS DRIVE (Oval, Pan and Flat Head) Steel, Nickel Plated (Or Zinc) TAPPING SCREWS

36 SIZES - 1,095 PIECES



16-1/4" x 11-1/4" x 2"

Red enamelled, all steel container

Shipping Weight: **5.90 kg** (13 lbs.)



Head Type	Thread Diameter	Spaenaur No.	Screw Length	Qty.	Page
Flat	#8	1711	1/2"	30	B81
		530-743	1"		
		530-B58-1A	1-1/4"		
Oval	#6	1794	3/4"	20	
		1796	1"		
		2358	1/2"		
	#8	1421	5/8"	30	
		2359	3/4"		
		530-B68-1M	3/4"		
		ST-14P	7/8"		
		1483	1"		
		530-B65-1T	1-1/8"		
	Pan	#6	2361	1-1/4"	30
			ST-32P	1-3/8"	
			2362	1-1/2"	
		#8	1933	1-3/4"	50
			1717	3/4"	
			1804	1"	
1807			1-1/8"		
2046			1-1/2"		
ST-69P			1-1/2"		
2047			1-3/4"		
Pan			#6	530-B02-1N	
	530-B80-1K	1/2"			
	ST-41P	5/8"			
	#8	530-B14-1N	3/8"	50	
		530-B60-1A	1/2"		
		B-1121	3/4"		
		2088	1-3/4"		
		1942	3/8"		
	#10	1943	1/2"	50	
		1943-A	5/8"		
		530-B30-1K	3/4"		
2367		3/4"			
#12	B-1336	2-1/4"	15		
	ST-11P	2-1/2"			
#14			15		

CATALOG 14.03
2019/04/18

SPAENAUR

P: 1-800-265-8772 F: 1-888-252-6380 service@spaenaur.com

A37

Spaenaur reserves the right to substitute parts in any assortment without notice. For any questions or suggestions about our Assortments and Plastikits, please contact us 1-800-265-8772. © 2018 Spaenaur Inc. All rights reserved. Catalog may not be reproduced, in whole or in part, without the written permission of Spaenaur Inc. Subject to Catalog Terms and Conditions of Use available at Spaenaur.com and on page TC2 and TC3 at the back of this catalog. Spaenaur se réserve le droit de remplacer des pièces dans n'importe quel assortiment sans préavis. Pour toute question ou suggestion concernant nos Assortiments et Plastikits, veuillez nous contacter au 1-800-265-8772. © 2018 Spaenaur Inc. Tous droits réservés. Le catalogue ne peut être reproduit, en tout ou en partie, sans l'autorisation écrite de Spaenaur Inc. L'utilisation est soumise aux Conditions d'utilisation du Catalogue disponibles sur Spaenaur.com et à la page TC4 et TC5 à la fin de ce catalogue.



A

ASSORTIMENT 805-546

Made to ASME/ANSI B18.6.3

18-8 STAINLESS STEEL TAPPING SCREWS

PHILLIPS DRIVE

36 SIZES - 1000 PIECES

Furnished in Regular Size Steel drawer which will fit into Slide Racks shown on page A2

Shipping Wght: **3.60 kg** (7.95 lbs.)

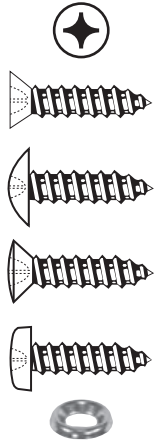

PLASTIKIT «PLASTIKIT» 804-080

Type A-AB

TAPPING SCREWS

18-8 Stainless Steel

20 Varieties - 200 Pieces

Phillips Drive

Oval, Flat, Pan and Truss Heads

Clear durable, plastic container

1" x 2-3/4" x 4-1/2"

Shipping Weight: **0.48 kg** (1.05 lbs.)

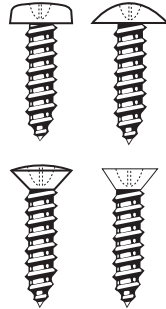

Head Type	Spaenaur No.	Thread Diameter	Screw Length	Qty.	Page
Oval	531-A54-1A	#4	3/4"	10	B83
	531-A28-1A	#6	5/8"		
	531-044		1"		
	531-072	#8	3/4"		
	531-073		1"		
	531-A63-1W		1-1/4"		
	531-075	#10	1-1/2"		
	531-110		1"		
	531-111	#10	1-1/4"		
531-112		1-1/2"			
Pan	531-A41-1X	#6	1/4"	10	B83
	531-025		3/8"		
	531-053	#8	1/2"		
	531-055		3/4"		
Truss	531-A40-1M	#10	1/2"	10	B83
	531-080	#8	3/4"		
Flat	531-A66-1A	#8	1-1/4"	10	B83
	531-A38-1M	#10	1"		
Flat	531-A26-1M	#6	3/8"	10	B83
	531-A17-1P	#10	1"		

Head Type	Thread Diameter	Spaenaur No.	Screw Length	Qty.	Page
Flat	#4	531-A46-1N	3/8"	25	B83
		531-A26-1M			
	#6	531-034	1/2"	30	
		531-A64-1M	5/8"	25	
		531-036	3/4"		
	#8	531-063	5/8"	30	
		531-064	3/4"		
	#8	531-A24-1K	1"	25	
		531-099	3/4"		
	#10	531-A17-1P	1"	25	
Oval	#4	531-A54-1A	3/4"	30	
	#6	531-A58-1N	1/2"		
	#8	531-A25-1W	5/8"		
Truss	#6	ST-2086P	3/8"	25	
	#8	531-001	1/2"		
		531-080	3/4"		
		531-081	1"		
Pan	#4	531-A22-1N	3/8"	30	
		531-A02-2A	1/2"		
	#6	531-025	3/8"		
		531-A14-1M	1/2"		
		531-A11-1T	3/4"		
	#8	531-029	1"		25
		531-053	1/2"		
	#8	531-055	3/4"		25
		531-A45-1C	1"		
	#8	531-057	1-1/4"		25
		531-A40-1M	1/2"		
	#10	531-088	3/4"		30
		531-090	1"		
	#12	531-128	3/4"		25
531-129		1"			
#14	531-145	1"	20		
Name	Compatible Bolt Size	Spaenaur No.	Outer Diameter	Qty.	Page
Counter sunk Washer	#6	W-2010	7/16"	50	D68
	#8	W-2011	17/32"		

CATALOG 14

SPAENAUER

A38

P: 1-800-265-8772 F: 1-888-252-6380 service@spaenaur.com

Spaenaur reserves the right to substitute parts in any assortment without notice. For any questions or suggestions about our Assortments and Plastikits, please contact us 1-800-265-8772. © 2018 Spaenaur Inc. All rights reserved. Catalog may not be reproduced, in whole or in part, without the written permission of Spaenaur Inc. Subject to Catalog Terms and Conditions of Use available at Spaenaur.com and on page TC2 and TC3 at the back of this catalog. Spaenaur se réserve le droit de remplacer des pièces dans n'importe quel assortiment sans préavis. Pour toute question ou suggestion concernant nos Assortiments et Plastikits, veuillez nous contacter au 1-800-265-8772. © 2018 Spaenaur Inc. Tous droits réservés. Le catalogue ne peut être reproduit, en tout ou en partie, sans l'autorisation écrite de Spaenaur Inc. L'utilisation est soumise aux Conditions d'utilisation du Catalogue disponibles sur Spaenaur.com et à la page TC4 et TC5 à la fin de ce catalogue.



ASSORTMENT 805-531A

Tapping Screws

Low Carbon Hardened Steel

32 SIZES - 1000 PIECES

TYPE AB

SQUARE SOCKET OVAL, FLAT, PAN & TRUSS HEAD

Regular Size grey enamelled steel drawer.

Shipping Wt. **4.39 kg** (9.7 lbs.)



ASSORTMENT 805-530

Tapping Screws

18-8 Stainless Steel

30 SIZES - 690 PIECES

TYPE AB

SQUARE SOCKET OVAL, FLAT, PAN HEAD

Regular Size grey enamelled steel drawer.

Shipping Wt. **4.19 kg** (9.24 lbs.)



Head Type	Spaenaur No.	Thread Diameter	Screw Length	Qty.	Page	
Square Socket Oval Head	ST-228	#8	5/8"	30	B84	
	ST-231		1"			
	ST-233	#10	1/2"			
	ST-235		1"			
Square Socket Flat Head	535-A02-1N	#6	3/8"	25		
	ST-257		1/2"			
	ST-258		3/4"			
	Square Socket Pan Head	ST-259	#8	1"		30
		ST-664		1-1/2"		
		ST-260	#10	1/2"		50
		ST-264		1-1/2"		
		ST-95R		3/4"		
		Square Socket Truss Head	ST-267	#10	1-1/2"	30
ST-270			#14		1"	
Square Socket Flat Head	535-A09-1P		#4	3/8"	20	
	535-A22-1W			1/4"		
	ST-275		#6	1/2"	15	
		535-A30-1K		2"		
	Square Socket Pan Head	535-A38-1N	#8	1/4"	50	
		535-A37-1C		1"		
		ST-287	#10	1/2"	30	
				ST-482		1"
				ST-288		2"
		ST-290	#12	1/2"	50	
ST-290				1"		
535-A04-1K				#14		3/4"
ST-203		1-1/2"				
Square Socket Truss Head		535-A21-1X	#6	5/8"	25	
	ST-298	3/4"				
	ST-628	#8	2"	25		
			535-A10-1A		3/4"	
	ST-302	#10	1-1/4"	25		

Head Type	Thread Diameter	Spaenaur No.	Screw Length	Qty.	Page		
Square Socket Oval Head	#6	536-024	1/2"	25	B85		
		536-A20-1W	3/4"				
		536-026	1"				
	#8	536-027	3/4"				
		536-A18-1W	1"				
		536-029	1-1/4"				
		536-032	1"				
	Square Socket Flat Head	#10	536-034			1-1/2"	15
			536-039			1/2"	
		#8	536-A06-1W			1"	
536-043			1-1/2"				
536-047			3/4"				
536-A27-1N			1-1/4"				
#12	536-052	2"					
	536-065	1"					
	536-056	1-1/2"					
	536-058	2"					
Square Socket Pan Head	#14	536-061	1-1/2"	15			
		536-A13-1Y	2"				
	#6	536-001	1/2"	25			
		536-A22-1X	3/4"				
		536-A10-1X	1/2"				
		536-005	1"				
		536-A05-1K	1-1/2"				
		536-A25-1Y	3/4"				
	#8	536-A12-1P	1-1/4"	20			
		536-A03-1N	2"				
536-020		3/4"					
536-A17-1K		1"					
536-022		1-1/2"					



ASSORTMENT **B-575C**
ASSORTIMENT

HEXAGON HEAD TAPPING SCREWS

Hardened Steel Inch Sizes

36 SIZES - 716 SCREWS

Grey enamelled, all-steel box. Hinged lid with illustrated chart. Smaller screws are in SCOOPED bottom bins for easy removal.

18" x 12" x 3"

Shipping weight: **7.57 kg** (16.69 lbs.)

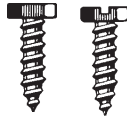

TYPE AB



TYPE B

Name	Spaenaur No.	Thread Diameter	Screw Length	Qty.	Page	
Regular Hex Head Type AB	525-D37-1Y	3/8"	1"	10	B89	
	525-D22-1X		5/8"	15		
	525-D23-1A		3/4"	20		
	2268	5/16"	1"	15	B88	
	2269		1-1/4"			
	ST-616H	#6	1/4"	25	B89	
	2368	#8	3/8"			
	2389	#10	1/2"			
	2388	#12	5/8"	20	B89	
	1780	#14	1/2"	25		
	2012		5/8"			
	2179		3/4"			
ST-622H	#14	3/4"	15	B89		
525-152		1-1/2"				
Slotted Hex Head Type B	B-1098	#6	1/4"	25	B88	
	525-D04-1T	#8	5/16"	20		
	2011	#10	1/2"			
Hex Washer Head Type AB	525-D24-1P	#8	3/4"	25	B89	
	2369	#10	1/2"	20		
	2330	#14	3/4"	25		
	525-D07-1M		5/8"			
	525-D11-1A		1"			
	525-163	#14	1-1/4"	20		
Hex Washer Head Type B	T-60	#10	1"	15	B88	
	ST-85H	#14	9/16"	25		
Slot Hex Washer Head Type AB	ST-625H	#12	3/4"	15	B93	
ACME Thread	1916	5/16"	7/8"	15		
Slotted Hex Head Type A	525-D01-1Y	#8	1/2"	25	B88 B94	
Indented Hex Head Type 1	Name	Spaenaur No.	Thread Size	Screw Length	Qty.	Page
	Indented Hex Head Type 1	2013	1/4"-20	3/4"	15	B98
		491-P31-1X	5/16"-18	1"	10	
		491-P10-1Y	3/8"-16	1"	10	
Indented Hex Washer Head Type 1	491-P03-2W	1/4"-20	1/2"	25	B98	
	491-P22-1Y	5/16"-18	1/2"	15		
	491-P06-1A			6		
	B-1063	3/8"-16	5/8"	15		
	491-P05-2X	#10 - 24	5/8"	15		

ASSORTMENT **805-532**
ASSORTIMENT

TEKS® SELF-DRILLING SCREWS

Carbon Steel Hardened - Plated

26 SIZES, 575 PIECES

Furnished in a REGULAR SIZE grey enamelled steel drawer that will fit slide racks shown on page A2

Shipping Weight **4.03 kg** (8.88 lbs.)



Head Type	Thread Size	Spaenaur No.	Screw Length	Qty.	Page	
Hex Washer	#8-18	ST-668H	1/2"	25	B93	
		508-013	3/4"			
	#10-16	508-001	1/2"			
		508-T23-1T	5/8"			
		508-005	3/4"			
		508-006	1"			
	#12-14	508-007	3/4"			
		508-018	1"			
		508-019	1-1/2"			
		508-020	2"			
	1/4"-14	508-008	3/4"			15
		508-021	1"			
		508-022	1-1/2"			
		508-023	2"			
		508-024	2"			
Square Socket Pan Head	#6-20	508-101	1/2"	50	B93	
		ST-727T	1/2"			
	#8-18	508-102	5/8"	25		
		508-103	3/4"			
		508-104	1"			
	#10-16	508-105	1/2"	20		
508-106		3/4"				
508-107		1"				
508-108		1-1/4"				
Square Socket Wafer Head	#10-24	508-T20-1Y	3/4"	20		
		508-011	1-1/4"			
#11-16	508-200	3/4"	15			

Inch
Pouce



Thread Cutting Screws / Tampruf™ Screws / Driver / Bits

Vis à filets coupants / Vis Tampruf^{MC} / Embouts

ASSORTMENT
ASSORTIMENT **805-540**

THREAD-CUTTING SCREWS

**PHILLIPS DRIVE
CASE-HARDENED STEEL
Zinc Plated**

24 SIZES — 1270 PIECES

Furnished in Regular Size grey enamel Steel drawer with scooped bins for easy access. Drawer will fit into Slide Racks shown on page A2
Shipping Weight: **4.96 kg** (10.94 lbs.)



Type 1



Type F



Type 23



Head Style	Spaenaur No.	Size	Thread Type	Qty.	Page
Pan	492-C12-1M	#4-40 x 1/4"	Type F	50	B95
	ST-477P	#6-32 x 1/4"	Type 1		
	ST-399P	#6-32 x 1/2"	Type F		
	ST-657P	#8-32 x 1/2"	Type 1		
	492-C27-1P	#8-32 x 3/4"	Type F		
Truss	492-C18-1N	#10-24 x 3/4"	Type 1	50	B95
	492-C04-1Y	#10-32 x 5/8"			
	492-C03-1P	#6-32 x 3/8"			
	ST-185P	#6-32 x 1/2"			
Flat	492-C24-1X	#10-24 x 3/8"	Type 23	50	B95 H34
	492-073	#10-24 x 1/2"			
	ST-207P	#10-32 x 1/2"			
Round	ST-714P	#2-56 x 1/4"	Type F	40	B95
	492-C10-1K	#8-32 x 7/16"			
	492-C40-1A	#10-32 x 1-1/2"			
Oval	492-C41-1P	#12-24 x 1/2"	Type 1	50	B95
	492-C42-1Y	#8-32 x 1/4"			
	ST-66P	#8-32 x 7/8"			
Fillister	492-C14-1A	1/4"-20 x 5/8"	Type F	60	B95
	492-C32-1N	1/4"-20 x 3/4"			
	ST-56P	#8-32 x 1/2"		50	
	492-C35-1W	1/4"-20 x 1"		50	B95
	ST-618P	#8-32 x 1-1/4"		40	

ASSORTMENT
ASSORTIMENT **805-433**

**"TAMPRUF™" SCREWS
STEEL, Zinc Plated
239 PIECES - 25 SIZES**

Plus Screw Driver and Bits

Furnished in Regular Size grey enamel Steel drawer with scooped bins for easy access. Drawer will fit into Slide Racks shown on page A2
Shipping Wt. **2.95 kg** (6-1/2 lbs.)



Name	Head Type	Spaenaur No.	Thread Diameter	Screw Length	Qty.	Page		
TAMPRUF Wood / Metal Screw	Countersunk	381-067	#8	1"	12	B103		
		381-069	#10		10			
	Tampruf Standard	381-064	#6	1/2"	12			
		381-065	#8	3/4"	12			
		381-066	#10	1"	10			
TAMPRUF Machine Screw	80° Countersunk	381-086	1/4"-20	1/2"	12	B103		
		Countersunk	381-054	#8-32	1"		6	
	Round	381-062	1/4"-20	1-1/4"	6			
		381-053	#8-32	1"	12			
	Tampruf Standard	381-050	#4-40	1/2"	15		B103	
		381-051	#6-32	5/8"				
		381-052	#8-32	3/4"				
		381-055	#8-32	1-1/4"				
		381-056	#10-24	5/8"				12
		381-057	#10-24	1"				8
		381-059	#10-24	1-1/2"				8
		381-060	#10-24	3/4"				12
381-061	1/4"-20	1"	10					
381-063	1/4"-20	1-1/2"	8					
Name	Tip Width	Spaenaur No.	Socket / Bit Size	Qty.	Page			
TAMPRUF Drive Bit	1/4"	876-533	#4	1	B103			
		876-534	#6					
		876-789	#10					
Name	Drive Type	Spaenaur No.	Tip Width	End Type	Qty.	Page		
Driver Handle Spinner	Square	876-536	1/4"	Single Ended	1	B103 C62 P017		

CATALOG 14.07 SPAENAUR

P: 1-800-265-8772 F: 1-888-252-6380 service@spaenaur.com

A41

Spaenaur reserves the right to substitute parts in any assortment without notice. For any questions or suggestions about our Assortments and Plastikits, please contact us 1-800-265-8772. © 2018 Spaenaur Inc. All rights reserved. Catalog may not be reproduced, in whole or in part, without the written permission of Spaenaur Inc. Subject to Catalog Terms and Conditions of Use available at Spaenaur.com and on page TC2 and TC3 at the back of this catalog. Spaenaur se réserve le droit de remplacer des pièces dans n'importe quel assortiment sans préavis. Pour toute question ou suggestion concernant nos Assortiments et Plastikits, veuillez nous contacter au 1-800-265-8772. © 2018 Spaenaur Inc. Tous droits réservés. Le catalogue ne peut être reproduit, en tout ou en partie, sans l'autorisation écrite de Spaenaur Inc. L'utilisation est soumise aux Conditions d'utilisation du Catalogue disponibles sur Spaenaur.com et à la page TC4 et TC5 à la fin de ce catalogue.



TORX® TAMPER-RESISTANT SHEET METAL SCREWS

Alloy Steel

27 Items - 507 Pieces

13-3/8" W x 9-1/4" D x 2" H

Furnished in a REGULAR SIZE grey enamelled steel drawer. Drawer will fit into Slide Racks shown on page A2

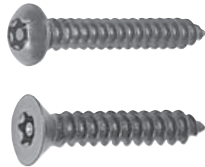

ASSORTMENT 805-548

Machine Screws

Spaenaur No.	Size	Qty.	Page		
Button Head					
381-600	#6-32 x 3/8"	25	B111		
381-601	#6-32 x 1/2"				
381-602	#6-32 x 3/4"				
381-606	#8-32 x 1/2"				
381-608	#8-32 x 1"				
381-612	#10-24 x 3/4"				
381-613	#10-24 x 1"				
381-617	#10-32 x 3/4"				
381-618	#10-32 x 1"				
381-624	1/4"-20 x 1"				
381-626	1/4"-20 x 1-1/2"				
Flat Head					
381-627	#6-32 x 3/8"	25	B111		
381-633	#8-32 x 1/2"				
381-634	#8-32 x 3/4"				
381-638	#10-24 x 1/2"				
381-639	#10-24 x 3/4"				
381-640	#10-24 x 1"				
381-645	#10-32 x 1"				
381-650	1/4"-20 x 3/4"				
381-651	1/4"-20 x 1"				
Insert Bits					
876-348	TR10			1	B113 P16
876-349	TR15				
876-823	TR20				
876-350	TR25				
876-351	TR27				
876-892	TR30				
Driver					
876-124	1/4"	1	P17		

Shipping weight: 3.64 kg (8.04 lbs.)

ASSORTMENT 805-547A

Sheet Metal Screws

Spaenaur No.	Size	Qty.	Page
Button Head			
516-200	#6 x 1/2"	25	B112
516-202	#6 x 1"		
516-204	#8 x 1/2"		
516-206	#8 x 1"		
516-208	#8 x 1-1/2"		
516-209	#10 x 1/2"		
516-211	#10 x 1"		
516-213	#10 x 1-1/2"		
516-216	#14 x 1"		
516-218	#14 x 1-1/2"		
Flat Head			
516-026	#6 x 1/2"	25	B112
516-221	#6 x 1"		
516-237	#8 x 1/2"		
516-240	#8 x 1"		
516-242	#8 x 1-1/2"		
516-228	#10 x 1/2"		
516-230	#10 x 1"		
516-232	#10 x 1-1/2"		
516-234	#14 x 1"		
516-236	#14 x 1-1/2"		
Insert Bits			
876-348	TR10	1	B113 P16
876-349	TR15		
876-823	TR20		
876-350	TR25		
876-351	TR27		
876-892	TR30		
Driver			
876-124	1/4"	1	P17

Shipping weight: 3.61 kg (7.97 lbs.)

ASSORTMENT 805-543

TORX® TAMPER-RESISTANT SCREWS

18-8 Stainless Steel

27 SIZES - 507 PIECES

Furnished in a REGULAR SIZE grey enamelled steel drawer. Drawer will fit into Slide Racks shown on page A2

13-3/8" W x 9-1/4" D x 2" H

Shipping Weight: 3.5 kg (7-3/4 lbs.)

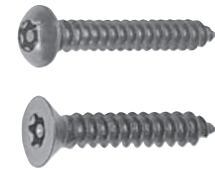

Spaenaur No.	Size	Qty.	Page
Button Head			
516-921	#6 x 1/2"	25	B112
516-923	#6 x 1"		
516-925	#8 x 1/2"		
516-927	#8 x 1"		
516-929	#8 x 1-1/2"		
516-930	#10 x 1/2"		
516-932	#10 x 1"		
516-934	#10 x 1-1/2"		
516-937	#14 x 1"		
516-939	#14 x 1-1/2"		
Flat Head			
516-940	#6 x 1/2"	25	B112
516-942	#6 x 1"		
516-944	#8 x 1/2"		
516-946	#8 x 1"		
516-948	#8 x 1-1/2"		
516-949	#10 x 1/2"		
516-951	#10 x 1"		
516-953	#10 x 1-1/2"		
516-956	#14 x 1"		
516-958	#14 x 1-1/2"		
Insert Bits			
876-348	TR10	1	B113 P16
876-349	TR15		
876-823	TR20		
876-350	TR25		
876-351	TR27		
876-892	TR30		
Driver			
876-124	1/4"	1	P17



ASSORTMENT **805-513A**
ASSORTIMENT

AUTOMOTIVE SPECIAL SCREWS & NUTS WITH TINNERMAN® FASTENERS

Panel Nuts & Automotive Screws
Steel

26 SIZES — 321 PIECES

Furnished in Regular Size, Grey enamelled STEEL
Drawer with scooped bins. Drawer will fit into Slide
Racks shown on page A2

Size: 13-3/8" x 9-1/4" x 2"

Shipping Wt. **4.88 kg** (10-3/4 lbs.)

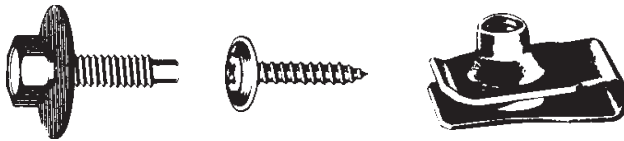

Name	Spaenaur No.	Centre of Hole to Panel Edge	Compatible Material Thickness	Thread Size	Length x Width	Qty.	Page
Extruded Panel Nuts							
Type U	N-256U	9/16"	0.025" - 0.150"	5/16"-18	1" x 11/16"	20	C104
	202-P14-1T	27/32"		1/4"-20	1-3/16" x 9/16"	10	C106
Metric Type U	202-504	13.5mm	0.8mm - 4.0mm	M6.3 x 1.0		10	C105
	202-513	15.0mm		M8 x 1.25		10	C104
	202-505	20.0mm	0.8mm - 4.5mm	M6 x 1.00		20	C105
	202-P11-1Y	19.0mm	1.0mm - 6.0mm	M10 x 1.50		5	
Tinnerman Fasteners							
J-Type (Threaded Shaft, Corner Cut Off)	B-1166	0.36"	0.093" - 0.105"	#14	0.56" x 0.87"	10	C75
U-Type Panel Clip	TN-186	0.40"	0.112" - 0.140"	5/16"-18	1.04" x 0.63"		C80
Type J	202-400	1/2"	0.032" - 0.093"	1/4"-20			C104
Screws							
Name	Spaenaur No.	Head Type	Drive Type	Thread Size	Screw Length	Qty.	Page
SEMS Tapping Screw-Phillips Drive	SE-29	Oval Washer	Phillips	#8	5/8"	25	B117
	SE-30				3/4"	20	
	SE-31				1"		
SEMS Automotive & Special Screw	391-C16-1A	Hex Washer	Hex	1/4"-20	5/8"	10	B119
	MS-243	Indented Hex Washer	Unslotted Hex	5/16"-18	3/4"		
	391-C11-1T		Slot		1"		
SEMS Automotive & Special - Metric	461-A01-1Y	Hex w/ Flat Washer	Hex	M6 x 1.00	25mm	10	B121
	461-A02-1C			M6.3 x 1.00			
	461-005			M10 x 40			
	461-019	Hex w/ Conical Washer		M6 x 1.00	18mm	15	
	466-001	Hex w/ Washer		M6.3 x 1.81	22mm	10	
	461-012	Indented Hex w/ Conical Washer		M8 x 1.25	25mm	6	
Automotive & Special - Inch & Metric	542-004	Indented Hex Washer	Slot	M8 x 1.25	25mm	10	B123
	542-002		Hex	M8 X 2.12	20mm		
	392-002		Hex Washer	M8 x 1.26	30mm		
Machine Screw	460-009	Hex Head Dog Point	Hex	5/16"-18	1-3/16"		B119
Flange Screw	328-F13-1C	Serrated Hex Washer			1"	15	B120

CATALOG 14.03
2019/04/18

SPAENAUR



ASSORTMENT **805-001B**

HEX CAP SCREWS, NUTS, SPLIT LOCK & FLAT WASHERS

2950 PIECES
41 SIZES

ASME B18.21.1 ASME/ANSI B18.2.1 ASME/ANSI B18.2.2

A

The perfect choice for easily accessible storage in parts departments, tool crib areas, maintenance and repair shops, garages, and for the handyman.

About the Storage Bin!

The grey baked enamel Durham bin is extremely sturdy. Produced from prime cold rolled steel - interlocked and welded construction, it will not warp, twist or sag. Each shelf has a fully hemmed 1-1/8" turn on the front providing space for labelling contents. It has 40 compartments for assortment contents. Overall bin measurements are width 33-3/4", height 22-1/4", depth 8-3/4", minimizing premium floor space requirements.

Reordering Stock - EASY!

When stock items are getting low, simply contact our Order Desk, identify the items you require by **SPAENAUR Number** and we'll send you the unit package quantities to refill your bin.

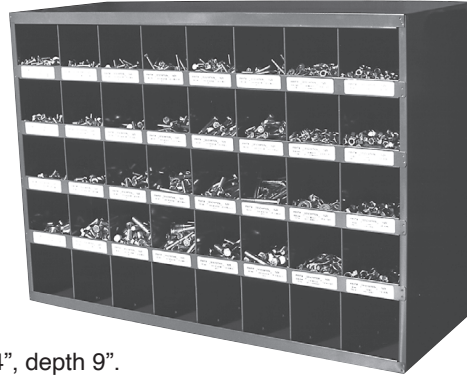

SPAENAUR No. 814-040 BASE STAND

Sturdy all-steel construction. Overall measurements: height 5-3/4", width 34", depth 9".

Name	Compatible Bolt Size	Spaenaur No.	Inner Diameter	Outer Diameter	Thickness	Qty.	Page		
Flat Washer S.A.E Zinc Plated	1/4"	656-B33-1M	9/32"	5/8"	0.051" - 0.080"	100	D2		
	5/16"	656-B47-1A	11/32"	11/16"					
	3/8"	656-B02-1Z	13/32"	13/16"					
	7/16"	656-B09-1A	15/32"	59/64"					
Name	Compatible Bolt Size	Spaenaur No.	Width	Thickness		Qty.	Page		
Washer Lockwasher Helical Spring Split Plain & Zinc Plated ASME B18.21.1	1/4"	16-SN	0.109"	0.062"		100	D22		
	5/16"	17-SN	0.125"	0.078"					
	3/8"	663-W06-1P	0.141"	0.094"					
	7/16"	19-SN	0.156"	0.109"					
Name	Thread Size	Spaenaur No.	Length Under Head			Qty.	Page		
Cap Screw Partial Thread Hexagon Head Bright Zinc Chromate Finish ASME/ANSI B18.2.1	1/4"-20	HC-8	1/2"			100	B138		
		HC-10	3/4"			50			
		HC-12	1"			100	B139 L93		
		HC-14	1-1/2"						
		HC-15	1-3/4"						
	5/16"-18	HC-16	2"				B139		
		HC-18	2-1/2"						
		HC-25	3/4"				B138		
		HC-27	1"						
		HC-29	1-1/2"						
		HC-31	2"				B139		
		HC-33	2-1/2"						
		HC-35	3"						
		3/8"-16	HC-41			3/4"		50	B138
			HC-43			1"			
	HC-45		1-1/2"						
	HC-47		2"				B139		
	HC-49		2-1/2"						
	7/16"-14	HC-51	3"						
		HC-58	1"				B138		
HC-59		1-1/2"							
HC-61		2"							
HC-63		2-1/2"		B139					
HC-65		3"							
HC-66		3-1/2"		25					
Name	Thread Size	Spaenaur No.				Qty.	Page		
Nut Steel Hex Finished Full SAE Grade 5 ASME/ANSI B18.2.2	5/16"-18	B-92			100	C3			
	3/8"-16	B-93							
	1/4"-20	B-91							
	7/16"-14	155-P39-1A							
Locknut Cap Screw Sizes Regular Hex Standard Height	1/4"-20	178-C03-1N				C26 L93 C26			
	5/16"-18	178-C26-1C							
	3/8"-16	178-C05-2P							
	7/16"-14	HN-181							

SPAENAUR CATALOG 14.06

A44

P: 1-800-265-8772 F: 1-888-252-6380 service@spaenaur.com

Spaenaur reserves the right to substitute parts in any assortment without notice. For any questions or suggestions about our Assortments and Plastikits, please contact us 1-800-265-8772. © 2018 Spaenaur Inc. All rights reserved. Catalog may not be reproduced, in whole or in part, without the written permission of Spaenaur Inc. Subject to Catalog Terms and Conditions of Use available at Spaenaur.com and on page TC2 and TC3 at the back of this catalog. Spaenaur se réserve le droit de remplacer des pièces dans n'importe quel assortiment sans préavis. Pour toute question ou suggestion concernant nos Assortiments et Plastikits, veuillez nous contacter au 1-800-265-8772. © 2018 Spaenaur Inc. Tous droits réservés. Le catalogue ne peut être reproduit, en tout ou en partie, sans l'autorisation écrite de Spaenaur Inc. L'utilisation est soumise aux Conditions d'utilisation du Catalogue disponibles sur Spaenaur.com et à la page TC4 et TC5 à la fin de ce catalogue.

Inch

Pouce



Hex Cap Screws / Nuts / Washers

Vis à tête hexagonale / Écrous / Rondelles

ASSORTMENT **805-515**
ASSORTIMENT

Hexagon CAP SCREWS

SAE GRADE 5 STEEL - For Extra Strength
Bright Zinc Chromate Plated

ALL COARSE THREAD INCH SIZES

12 sizes **PARTIALLY THREADED**

* 12 sizes **FULLY THREADED**

24 SIZES - 180 PIECES

Regular Size grey enamelled drawer fits the
Slide Racks shown on page A2

Shipping Wt: **5.78 kg** (12-3/4 lbs.)

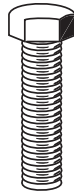

ASSORTMENT **805-657B**
ASSORTIMENT

**HEX CAP SCREWS, NUTS,
SPLIT LOCK & FLAT WASHERS**

SAE GRADE 5 STEEL - For Extra Strength
Bright Zinc Chromate Plated

COARSE THREAD (UNC)

SAE GR. 5 STEEL For Extra Strength

23 SIZES - 1170 PIECES

Furnished in a Large Size welded metal drawer with hinged lid
and catch. Drawer will fit into Slide Racks shown on page A3
Shipping Wt: **15.9 kg** (35 lbs.)

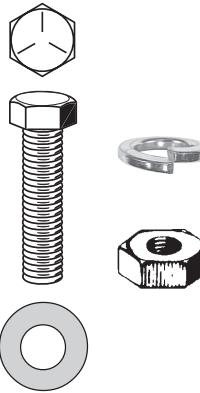

Thread Size	Spaenaur No.	Length Under Head	Qty.	Page	
1/4"-20	*HC-8	1/2"	15	B138	
	*HC-10	3/4"			
	*HC-12	1"			
	HC-14	1-1/2"			B139
	HC-16	2"			L93
	HC-18	2-1/2"			B139
5/16"-18	*HC-24	5/8"	10	B138	
	*HC-25	3/4"			
	*HC-27	1"			
	HC-28	1-1/4"			
3/8"-16	*HC-43	1"	4	B139	
	HC-45	1-1/2"			
	HC-47	2"			
	HC-48	2-1/4"			
7/16"-14	*HC-58	1"	5	B138	
	*HC-59	1-1/2"			
	HC-60	1-3/4"			
	HC-61	2"			B139
	HC-63	2-1/2"			
1/2"-13	*HC-73	1"	5	B138	
	*HC-74	1-1/4"			
	*HC-75	1-1/2"			
	HC-77	2"			B139
	HC-79	2-1/2"			

Name	Spaenaur No.	Thread Size	Length Under Head	Qty.	Page
Hexagon Cap Screw	HC-8	1/4"-20	1/2"	30	B138
	HC-10		3/4"		
	HC-12		1"		
	HC-13		1-1/4"		B139
	HC-14	1-1/2"	L93		
	HC-43	3/8"-16	1"		20
	HC-44		1-1/4"		
	HC-45		1-1/2"		
	HC-47		2"	B139	
	HC-49	1/2"-13	2-1/2"	15	B138
	HC-74		1-1/4"		
	HC-75		1-1/2"		
	HC-77		2"		
Hex Nut	B-93	3/8"-16		100	B265
	B-91	1/4"-20			B273
	B-95	1/2"-13			C3
				75	B265
					C3
Name	Spaenaur No.	Compatible Bolt Size	Qty.	Page	
Flat Washer	656-B33-1M	1/4"	100	D2	
	656-B02-1Z	3/8"			
	656-B05-1G	1/2"			
Split Lockwasher	16-SN	1/4"	100	D2	
	663-W06-1P	3/8"			
	20-SN	1/2"			

A

CATALOG 14

SPAENAUR

P: 1-800-265-8772 F: 1-888-252-6380 service@spaenaur.com

A45

Spaenaur reserves the right to substitute parts in any assortment without notice. For any questions or suggestions about our Assortments and Plastikits, please contact us 1-800-265-8772. © 2018 Spaenaur Inc. All rights reserved. Catalog may not be reproduced, in whole or in part, without the written permission of Spaenaur Inc. Subject to Catalog Terms and Conditions of Use available at Spaenaur.com and on page TC2 and TC3 at the back of this catalog. Spaenaur se réserve le droit de remplacer des pièces dans n'importe quel assortiment sans préavis. Pour toute question ou suggestion concernant nos Assortiments et Plastikits, veuillez nous contacter au 1-800-265-8772. © 2018 Spaenaur Inc. Tous droits réservés. Le catalogue ne peut être reproduit, en tout ou en partie, sans l'autorisation écrite de Spaenaur Inc. L'utilisation est soumise aux Conditions d'utilisation du Catalogue disponibles sur Spaenaur.com et à la page TC4 et TC5 à la fin de ce catalogue.



HEX CAP SCREWS & NUTS

Each assortment contains:
20 Sizes — 750 Pieces Hex Cap Screws
4 Sizes — 350 Pieces Hex Nuts

Zinc Plated & Dichromate Dipped
 Golden Alloy Finish

Each Assortment is furnished in a Large Size grey enamel steel drawer with hinged lid and catch.

Drawers have scooped bins for easy access and will fit into Slide Racks shown on page A3

**SAE
 GR. 8**

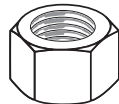

ASSORTMENT 805-660
ASSORTIMENT 805-660

COARSE (UNC) THREAD

Shipping Weight: **20.86 kg** (46 lbs.)

ASSORTMENT 805-650
ASSORTIMENT 805-650

FINE (UNF) THREAD

Shipping Weight : **21.27 kg** (46.9 lbs.)

Name	Spaenaur No.	Thread Size	Length Under Head	Qty.	Page	
Hex Head Coarse Thread Cap Screw	SA-1	1/4"-20	1/2"	50	B144	
	SA-5		3/4"			
	SA-7		1"			
	SA-11		1-1/2"			
	SA-15		2"			
	SA-27	5/16"-18	5/8"	50		
	SA-29		3/4"			
	SA-31		1"			
	SA-33		1-1/4"			
	SA-39		2"			
	327-D12-1C	3/8"-16	1"	40		
	SA-65		1-1/2"	25		
	SA-69		2"			
	SA-71		2-1/4"			20
	SA-73		2-1/2"			30
	SA-121		1/2"-13			1"
SA-123	1-1/4"				20	
SA-125	1-1/2"				15	
SA-129	2"					
SA-133	2-1/2"					
Hex Nut	SAN-1	1/4"-20	100		C3	
	SAN-3	5/16"-18				
	SAN-5	3/8"-16				
	SAN-9	1/2"-13		50		

Name	Spaenaur No.	Thread Size	Length Under Head	Qty.	Page		
Hex Head Fine Thread Cap Screw	SA-2	1/4"-28	1/2"	50	B146		
	SA-6		3/4"				
	SA-8		1"				
	SA-12	5/16"-24	1-1/2"	50			
	SA-16		2"				
	SA-26		1/2"				
	SA-30		3/4"				
	SA-32		1"				
	SA-34	3/8"-24	1-1/4"	40			
	SA-40		2"				
	SA-62		1"			25	
	327-D10-1P		1-1/2"				
	SA-70		2"				
	SA-72		2-1/4"				20
	SA-74		2-1/2"				30
	SA-122		1/2"-20				1"
SA-124	1-1/4"				20		
SA-126	1-1/2"				15		
SA-130	2"						
SA-134	2-1/2"						
Hex Nut	SAN-2	1/4"-28	100	C3			
	SAN-4	5/16"-24					
	SAN-6	3/8"-24					
	SAN-10	1/2"-20			50		



A

L•9® Fastening System

Zinc Plated
Yellow Dichromate Finish

24 Sizes — 1,115 Pieces

Furnished in LARGE SIZE grey enamel drawer with hinged lid and catch.

Drawer will fit into Slide Racks shown on A3

Shipping Weight: **15.79 kg** (34.8 lbs.)

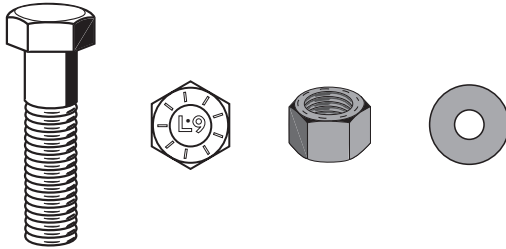

ASSORTMENT 805-648

Coarse (UNC) Thread

Name	Spaenaur No.	Thread Size	Length Under Head	Qty.	Page
Coarse Thread Hexagon Bolt	329-002	1/4"-20	3/4"	35	B147
	329-003		1"		
	329-005		1-1/2"		
	329-007	2"			
	329-012	3/4"			
	329-013	5/16"-18	1"		
	329-015	1-1/2"			
	329-017	2"			
	329-024	3/8"-16	1"	25	
	329-026		1-1/2"		
	329-028		2"		
	329-030	1/2"-13	2-1/2"	15	
	329-050		1"		
	329-052		1-1/2"		
	329-054	2"	10		
329-056	2-1/2"				
Hex Nut	155-400	1/4"-20		100	B150
	155-401	5/16"-18			
	155-402	3/8"-16			
	155-404	1/2"-13			
Name	Spaenaur No.	Compatible Thread Size	Qty.	Page	
Flat Washer	656-400	1/4"	100	B150	
	656-401	5/16"			
	656-402	3/8"			
	656-404	1/2"			

ASSORTMENT 805-649

Fine (UNF) Thread

Name	Spaenaur No.	Thread Size	Length Under Head	Qty.	Page
Fine Thread Hexagon Bolt	329-172	1/4"-28	3/4"	35	B148
	329-173		1"		
	329-175		1-1/2"		
	329-176	2"			
	329-179	3/4"			
	329-180	5/16"-24	1"		
	329-182	1-1/2"			
	329-184	2"			
	329-188	3/8"-24	1"	25	
	329-190		1-1/2"		
	329-192		2"		
	329-194	1/2"-20	2-1/2"	15	
	329-207		1"		
	329-209		1-1/2"		
	329-211	2"	10		
329-213	2-1/2"				
Hex Nut	155-413	1/4"-28	100	B150	
	155-414	5/16"-24			
	155-415	3/8"-24			
	155-417	1/2"-20			
Name	Spaenaur No.	Compatible Bolt Size	Qty.	Page	
Flat Washer	656-400	1/4"	100	B150	
	656-401	5/16"			
	656-402	3/8"			
	656-404	1/2"			



ASSORTMENT **805-549**
ASSORTIMENT

HEXAGON HEAD CAP SCREWS

Coarse (UNC) Thread
18-8 Stainless Steel

24 Sizes — 192 Pieces

Furnished in REGULAR SIZE grey enamel drawer with hinged lid and catch.

Drawer will fit into Slide Racks shown on A2

Shipping Weight: **5-3/4 kg** (13 lbs.)



Thread Size	Spaenaur No.	Length Under Head	Qty.	Page
1/4"-20	343-C14-1K	1/2"	15	B151
	CS-2001	3/4"	10	
	343-C05-1X	1"	15	
	343-C17-1X	1-1/2"	10	
	CS-2008	2"		
CS-2010	2-1/2"			
343-C28-1M	5/8"	10		
343-C19-1P	3/4"			
CS-2015	1"			
CS-2017	1-1/2"			
343-C18-1A	2"			
343-C48-1N	2-1/2"	5		
343-C03-2W	1"			
343-C42-1M	1-1/4"		5	
343-C47-1C	1-3/4"		10	
343-C46-1Y	2"		4	
343-C12-1N	2-1/4"			
343-C09-1C	2-1/2"			
343-C04-1M	1"	5		
343-C08-1Y	1-1/4"			
343-C06-1A	1-1/2"			
CS-2044	1-3/4"		4	
343-C01-2T	2"			
1/2"-13	CS-2046	2-1/2"	5	

ASSORTMENT **805-608**
ASSORTIMENT

HEAD CAP SCREWS, NUTS, SPLIT LOCKS & WASHERS

Coarse (UNC) Thread
18-8 Stainless Steel

24 Sizes — 1,430 Pieces

Furnished in LARGE SIZE grey enamel drawer with hinged lid and catch.

Drawer will fit into Slide Racks shown on A3

Shipping Weight: **15-1/2 kg** (34 lbs.)

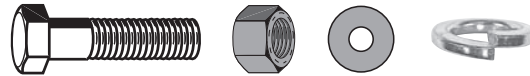

Washer Lockwasher Helical Split								
Spaenaur No.	Compatible Bolt Size	Width	Thickness	Qty.	Page			
667-P06-1W	1/4"	0.109"	0.062"	100	D23			
667-P24-1K	5/16"	0.125"	0.078"					
667-P01-2W	3/8"	0.141"	0.094"					
667-P11-1T	1/2"	0.171"	0.125"	75				
Washer Flat 18-8 Stainless Steel								
Spaenaur No.	Compatible Bolt Size	Thickness	Outer Diameter	Qty.	Page			
658-015	1/4"	0.034" - 0.068"	5/8"	100	D6			
658-B26-1P	5/16"		3/4"					
W-2039	3/8"	0.040" - 0.075"	1"					
658-B21-1K	1/2"	0.056" - 0.112"	1-1/4"	75				
Cap Screw Hex Head								
Spaenaur No.	Thread Size	Length Under Head		Qty.	Page			
343-C14-1K	1/4"-20	1/2"	30	20	B151			
CS-2001		1"						
343-C17-1X		1-1/2"						
CS-2015	5/16"-18	1"						
CS-2017		1-1/2"						
343-C18-1A		2"						
343-C47-1C	3/8"-16	1"						
343-C03-2W		1-1/4"						
343-C09-1C		2-1/2"						
343-C06-1A	1/2"-13	1-1/2"						
343-C01-2T		2"						
343-C21-1P		3"						
15								
Nut Hexagon 18-8 Stainless Steel								
Spaenaur No.	Thread Size						Qty.	Page
159-W02-2A	1/4"-20			100	C7			
HN-2011	5/16"-18							
159-W17-1C	3/8"-16							
HN-2014	1/2"-13					75		



ASSORTMENT **805-494**
ASSORTIMENT

**NYLON
HEXAGON CAP SCREWS**
INCH SIZES COARSE THREAD

24 SIZES - 180 PIECES

REGULAR SIZE grey enamelled drawer fits the Slide Racks shown on page A2.

Shipping Weight: **2.38 kg** (5.25 lbs.)

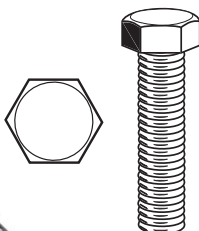

Name	Length Under Head	Spaenaur No.	Thread Size	Qty.	Page	
Hexagon Cap Screws Nylon Zytel 101 UL 94V2	1/4"-20	352-008	1/2"	10	B155	
		352-006	3/4"			
		352-A07-1T	1"			
		352-011	1-1/4"			
		352-012	1-1/2"			
		352-013	2"			
		352-014	2-1/2"			5
		352-016	1/2"			10
	352-002	3/4"				
	352-004	1"				
	352-017	1-1/4"				
	352-018	1-1/2"				
	352-019	2"	5			
	352-020	2-1/2"	4			
	352-022	3/4"	10			
	352-005	1"				
	352-023	1-1/4"				
	352-024	1-1/2"		5		
	352-025	2"		4		
	352-026	2-1/2"				
	352-029	1"				5
	352-030	1-1/2"				
	352-007	2"	3			
	352-001	2-1/2"	4			

ASSORTMENT **805-612**
ASSORTIMENT

DIN 933

**METRIC HEXAGON CAP SCREWS,
NUTS AND WASHERS**

Property Class 8.8, Zinc Plated
REGULAR COARSE METRIC THREAD

32 SIZES - 1840 PIECES

Furnished in a LARGE SIZE grey enamelled steel drawer, with hinged lid and scooped bins. Drawer will fit Slide Racks shown on page A3.

Shipping Weight: **8.85 kg** (19.5 lbs.)



Name	Spaenaur No.	Thread Size	Length Under Head	Qty.	Page	
Cap Screw Hexagon Head Coarse Thread	330-H23-1T	M4 x 0.70	12mm	50	B160	
	330-023ZP		16mm			
	330-H32-1Y		20mm			
	330-342ZP		25mm			
	330-032ZP	M5 x 0.80	12mm	25		
	330-033ZP		16mm			
	330-035ZP		20mm			
	330-037ZP	M6 x 1.00	25mm	50		
	330-045ZP		12mm			
	330-046ZP		16mm			
	330-048ZP		20mm			
	330-050ZP	M8 x 1.25	25mm	25		
	330-052ZP		30mm			
	330-077ZP		30mm			
330-079ZP	M10 x 1.50	40mm	15			
330-098ZP		30mm				
330-100ZP		40mm	10			
Name	Spaenaur No.	Compatible Bolt Size	Inner Diameter	Qty.	Page	
Washers Metric	664-C07-1P	M4	4.1mm	100	D25	
	657-W03-1M		4.3mm		D12	
	664-007ZP	M5	5.1mm		D25	
	657-008ZP		5.3mm		D12	
	664-008ZP	M6	6.1mm		D25	
	657-W04-1Y		6.4mm		D12	
	664-C10-1Y	M8	8.1mm		50	D25
	657-011ZP		8.4mm			D12
	664-011ZP	M10	10.2mm			D25
	657-012ZP		10.5mm			D12
Name	Spaenaur No.	Thread Size	Qty.	Page		
Hexagon Nut Property Class 8	156-F07-1C	M4 x 0.70	100	C10		
	156-013ZP	M5 x 0.80				
	156-014ZP	M6 x 1.00				
	156-016ZP	M8 x 1.25				
	156-017ZP	M10 x 1.50			50	



ASSORTMENT
ASSORTIMENT **805-402**

HEXAGON HEAD CAP SCREWS

Metric - Property Class 8.8

REGULAR COARSE THREAD

DIN 931 / DIN 933

Medium Carbon Steel, Quenched & Tempered
Zinc Plated

24 SIZES - 636 PIECES

Furnished in a REGULAR SIZE grey enamelled steel drawer, with hinged lid and scoop bins. Drawer will fit Slide Racks shown on page A2
Shipping Weight: **5.49 kg** (12.1 lbs.)

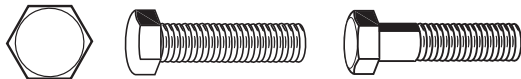

Thread Type	Thread Size	Spaenaur No.	Length Under Head	Qty.	Page
Fully Threaded	M4 x 0.70	330-023ZP	16mm	40	B160
		330-H32-1Y	20mm		
	M5 x 0.80	330-033ZP	16mm		
		330-035ZP	20mm		
		330-038ZP	30mm		
		330-040ZP	40mm		
	M6 x 1.00	330-046ZP	16mm	40	
		330-050ZP	25mm	35	
		330-053ZP	35mm	20	
		330-055ZP	45mm	25	
	M8 x 1.25	330-H09-1T	20mm	20	
		330-075ZP	25mm	20	
330-078ZP		35mm	15		
M10 x 1.50	330-081ZP	50mm	12		
	330-H33-1C	20mm	10		
	330-098ZP	30mm	8		
	330-099ZP	35mm	10		
M12 x 1.75	330-102ZP	50mm	6		
	330-122ZP	30mm	10		
Partially Threaded	M4 x 0.70	330-128ZP	60mm	40	B161
		330-025ZP	25mm		
M8 x 1.25	330-026ZP	30mm	10		
	330-027ZP	35mm			
M12 x 1.75	330-083ZP	60mm	10		
	330-028ZP	35mm			

ASSORTMENT
ASSORTIMENT **805-537A**

DIN 960 / DIN 961

HEXAGON HEAD CAP SCREWS

Metric - Property Class 8.8 FINE THREAD

Medium Carbon Steel, Quenched & Tempered Zinc Plated

24 SIZES - 294 PIECES

Furnished in a REGULAR SIZE grey enamelled steel drawer, with hinged lid and scoop bins. Drawer will fit Slide Racks shown on page A2

Shipping Weight: **10.2 kg** (22-1/2 lbs.)

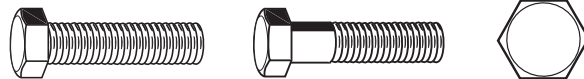

Name	Thread Size	Spaenaur No.	Length Under Head	Qty.	Page		
Cap Screw Hexagon Head Partial Thread Zinc Plated	M8 x 1.00	330-287ZP	35mm	20	B167		
		330-H13-1W	40mm	15			
		330-289ZP	45mm	10			
	M10 x 1.25	330-295ZP	40mm	6			
		330-296ZP	45mm	20			
		330-303ZP	60mm	15			
	Cap Screw Full Thread Zinc Plated	M8 x 1.00	330-306ZP	60mm		20	B166
			330-250ZP	16mm			
			330-251ZP	20mm			
330-253ZP			25mm				
M10 x 1.25		330-254ZP	30mm	15			
		330-255ZP	18mm				
		330-256ZP	20mm				
		330-258ZP	25mm				
M12 x 1.25		330-259ZP	30mm	10			
		330-260ZP	35mm				
		330-261ZP	20mm				
		330-262ZP	25mm				
M14 x 1.50	330-263ZP	30mm	8				
	330-264ZP	35mm					
	330-265ZP	40mm					
	330-267ZP	30mm					
M16 x 1.50	330-271ZP	40mm	6				
	330-273ZP	40mm					



ASSORTMENT 805-472
ASSORTIMENT 805-472

Metric HEXAGON HEAD CAP SCREWS

**Property Class 10.9
Regular COARSE Thread**

DIN 933 / DIN 931

**Medium Carbon Steel, Quenched & Tempered
Zinc Plated and Dichromate Dipped (Gold Colour)**

24 SIZES — 550 PIECES

Furnished in a regular size grey enamelled steel drawer, with hinged lid and scoop bins. Drawer will fit slide racks shown on page A2

Shipping Weight: **10.4 kg** (23 lbs.)

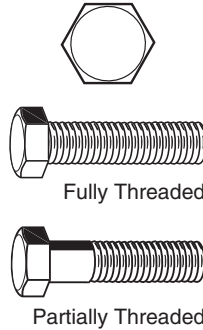

Name	Thread Size	Spaenaur No.	Length Under Head	Qty.	Page
Cap Screw Hexagon Head Partial Thread	M6 x 1.00	332-008YZ	40mm	40	B171
		332-010YZ	50mm	20	
		332-018YZ	35mm	18	
	M8 x 1.25	332-019YZ	40mm	18	
		332-020YZ	45mm	15	
		332-021YZ	50mm	10	
	M10 x 1.50	332-033YZ	40mm	6	
		332-034YZ	45mm	6	
		332-035YZ	50mm	8	
	M12 x 1.75	332-052YZ	55mm	8	
		332-053YZ	60mm	6	
	Cap Screw Hexagon Head Full Thread	M6 x 1.00	332-002YZ	12mm	
332-003YZ			16mm	60	
332-004YZ			20mm	50	
332-B14-1K			25mm	35	
M8 x 1.25		332-015YZ	20mm	25	
		332-B06-1A	25mm	20	
		332-017YZ	30mm	15	
M10 x 1.50		332-029YZ	20mm	15	
		332-030YZ	25mm	10	
		332-031YZ	30mm	10	
		332-032YZ	35mm	10	
M12 x 1.75		332-B13-1T	35mm	10	
		332-049YZ	40mm	10	

ASSORTMENT 805-434
ASSORTIMENT 805-434

Metric HEXAGON HEAD CAP SCREWS

**A2 STAINLESS STEEL
Regular COARSE Metric Thread**

DIN 933

24 SIZES — 180 PIECES

Furnished in Regular Size grey enamelled steel drawer.
Shipping Wt: **4.31 kg** (9-1/2 lbs.)

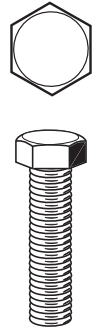

Thread Size	Spaenaur No.	Length Under Head	Qty.	Page
M4 x 0.70	344-001	10mm	15	B172
	344-002	12mm		
	344-003	16mm		
	344-004	20mm		
	344-006	30mm		
M5 x 0.80	344-009	12mm	10	
	344-010	16mm		
	344-011	20mm		
	344-013	30mm		
M6 x 1.00	344-W10-1P	16mm	5	
	344-018	25mm		
	344-020	35mm		
M8 x 1.25	344-027	20mm	5	
	344-W15-1K	30mm		
	344-031	40mm		
	344-033	50mm		
M10 x 1.50	344-037	25mm	3	
	344-039	35mm		
	344-041	45mm		
M12 x 1.75	344-043	60mm	5	
	344-W12-1C	25mm		
M16 x 2.00	344-W01-1N	35mm	3	
	344-051	50mm		
	344-064			



A

ASSORTMENT 805-454A Inch Sizes

HEX SOCKET CAP SCREWS

Alloy Steel, Not Plated
22 SIZES - 600 PIECES

Coarse Thread - 1960 Series
10-24 to 1/2"-13

(Includes Hex Keys)

Grey Enamelled Drawer 13-3/8" x 9-1/4" x 2"
fits the Slide Racks shown on page A2.

Shipping Wt: **8.9 kg** (19.75 lbs.)



Name	Spaenaur No.	Thread Size	Bolt Length	Qty.	Page
Cap Screw Hex Socket	HX-11	#10-24	1/2"	50	B196
	HX-12		3/4"		
	HX-13		1"		
	HX-41		1-1/4"		
	HX-42		1-1/2"		
	HX-16	1/4"-20	1"	40	
	363-A22-1N		3/4"		
	HX-17		1-1/4"		
	HX-18		1-1/2"		
	HX-19		1"		
	HX-20	5/16"-18	3/4"	30	
	HX-34		1-1/4"		
	HX-21		1-1/2"		
	HX-30	3/8"-16	3/4"	25	
	HX-22		1"		
	363-A01-1W		1-1/4"		
	HX-249	7/16"-14	3/4"	15	B197
	HX-276		1"		
	HX-277		1-1/2"		
	HX-126		3/4"		
HX-127	1"				
HX-25	1/2"-13	1-1/2"	10		
Hex Key	SS-66K	5/32"	5	P7	
	SS-67K	3/16"	3		
	SS-68K	1/4"			
	SS-69K	5/16"			
	SS-104K	3/8"	2		

ASSORTMENT 805-652

12 point Flanged Head
ALLOY STEEL

COUNTR-BOR SCREWS

Coarse and Fine Thread

24 Sizes
455 Pieces



Furnished in Large Size grey enamelled steel drawer with hinged lid and catch. Drawer will fit into Slide Racks shown on page A3

Shipping Weight: **13.33 kg** (29.4 lbs.)

Thread Type	Spaenaur No.	Thread Size	Length	Qty.	Page
Coarse	CS-153	1/4"-20	3/4"	30	B210
	CS-154		7/8"		
	CS-155		1"		
	CS-168	5/16"-18	1-1/2"	25	
	CS-170		2"		
	CS-172		1"		
	CS-182	3/8"-16	1-1/4"	20	
	CS-183		1-1/2"		
	CS-184		1-1/4"		
	CS-200	7/16"-14	1-1/4"	15	
	CS-203		2"		
	CS-205		2-1/2"		
	CS-212	1/2"-13	3/4"	10	
	CS-215		1-1/4"		
	CS-216		1-1/2"		
CS-218	1/4"-28	2"	30		
CS-304		7/8"			
CS-309		1-1/4"			
CS-311	5/16"-24	1-1/4"	25		
CS-312		1-1/2"			
CS-321		1"			
CS-329	3/8"-24	1-1/4"	20		
CS-334		1-1/2"			
CS-338		1-1/2"			
Fine	CS-329	7/16"-20	1-1/4"	15	
	CS-334	1/2"-20	1-1/2"	10	
	CS-338	1/2"-20	2-1/2"	5	

ASSORTMENT 805-498

Regular (Coarse) Thread
FULL Cylinder Head

METRIC Hex Socket Cap Screws

Property Class 8.8 Med. Carbon Steel Not Plated

DIN 912

24 Sizes
500 Pieces



Put up in REGULAR SIZE grey enamelled STEEL drawer. Drawer will fit the Slide Racks on page A2.

Shipping Weight: **5.53 kg** (12.2 lbs.)

Name	Spaenaur No.	Size	Qty.	Page
Fully Threaded Hex Socket Cap Screws	367-B04-1P	M3 x 10mm	30	B212
	367-012	M3 x 16mm		
	367-019	M4 x 12mm		
	367-021	M4 x 20mm	25	
	367-034	M5 x 8mm		
	367-B05-1Y	M5 x 12mm		
	367-038	M5 x 20mm	20	
	367-039	M5 x 25mm		
	367-055	M6 x 10mm		
	367-B07-1N	M6 x 16mm	15	
	367-059	M6 x 25mm		
	367-075	M8 x 12mm		
	367-077	M8 x 20mm	10	
	367-079	M8 x 30mm		
	367-100	M10 x 16mm		
367-102	M10 x 25mm	30		
367-132	M12 x 30mm			
367-134	M12 x 40mm			
Partially Threaded Hex Socket Cap Screws	367-014	M3 x 25mm	25	B214
	367-023	M4 x 30mm		
	367-025	M4 x 40mm		
	367-040	M5 x 30mm		
	367-061	M6 x 35mm		
367-081	M8 x 40mm	10		

A52

P: 1-800-265-8772 F: 1-888-252-6380 service@spaenaur.com

Spaenaur reserves the right to substitute parts in any assortment without notice. For any questions or suggestions about our Assortments and Plastikits, please contact us 1-800-265-8772. © 2018 Spaenaur Inc. All rights reserved. Catalog may not be reproduced, in whole or in part, without the written permission of Spaenaur Inc. Subject to Catalog Terms and Conditions of Use available at Spaenaur.com and on page TC2 and TC3 at the back of this catalog. Spaenaur se réserve le droit de remplacer des pièces dans n'importe quel assortiment sans préavis. Pour toute question ou suggestion concernant nos Assortiments et Plastikits, veuillez nous contacter au 1-800-265-8772. © 2018 Spaenaur Inc. Tous droits réservés. Le catalogue ne peut être reproduit, en tout ou en partie, sans l'autorisation écrite de Spaenaur Inc. L'utilisation est soumise aux Conditions d'utilisation du Catalogue disponibles sur Spaenaur.com et à la page TC4 et TC5 à la fin de ce catalogue.



ASSORTMENT 805-435 DIN 7984
ASSORTIMENT 805-435 DIN 7984

METRIC Hex Socket Cap Screws

LOW Cylinder Head Style

Regular COARSE Metric Thread

Med. Carbon Steel, Metric
Property Class 8.8 Not Plated

Total Contents: 28 Sizes - 585 Pieces

REGULAR SIZE welded STEEL drawer
with Hinged Lid & Scooped Bins.
Drawer fits the Slide Racks
shown on Page A2

Shipping Weight: 9.41 kg (20-3/4 lbs.)



Name	Thread Size	Spaenaur No.	Bolt Length	Qty.	Page
Cap Screws	M5 x 0.80	366-403	16mm	50	B217
		366-405	20mm		
		366-407	25mm		
	M6 x 1.00	366-409	12mm	40	
		366-411	16mm		
		366-413	20mm		
		366-415	25mm		
		366-416	30mm		
		366-418	16mm		
	M8 x 1.25	366-420	20mm	30	
		366-422	25mm		
		366-423	30mm		
		366-426	20mm		
	M10 x 1.50	366-428	25mm	20	
		366-429	30mm		
		366-431	40mm		
	M12 x 1.75	366-433	25mm	10	
		366-434	30mm		
366-435		35mm			
366-440		40mm			
M16 x 2.00	366-442	50mm	5		
	366-444	60mm			
Name	Key Size	Spaenaur No.		Qty.	Page
Hex Keys	3mm	130-206		3	P9
	4mm	130-207			
	5mm	130-208			
	7mm	130-210		2	
	8mm	130-211			
	12mm	130-214		1	

ASSORTMENT 805-500 DIN 912
ASSORTIMENT 805-500 DIN 912

METRIC

Hex Socket Cap Screws

Property Class 12.9

Alloy Steel Not Plated

Contains Full and Partial
Metric Regular Coarse Threads

24 Sizes — 500 Pieces

Put up in Grey Enamelled Steel Drawer. Drawer will fit
into Slide Racks shown on page A2

Shipping Weight: 5.44 kg (12 lbs.)



Thread Type	Spaenaur No.	Thread Size	Bolt Length	Qty.	Page
Partial Thread	366-711	M3 x 0.50	25mm	30	B223
	366-720	M4 x 0.70	30mm	25	
	366-722	M4 x 0.70	40mm	30	
	366-731	M5 x 0.80	30mm	25	
	366-743	M6 x 1.00	35mm	20	
	366-759	M8 x 1.25	40mm	15	
Full Thread	366-707	M3 x 0.50	10mm	30	B221
	366-709		16mm		
	366-716		12mm		
	366-718	M4 x 0.70	20mm	25	
	366-725	M5 x 0.80	8mm		
	366-727		12mm		
	366-729		20mm		
	366-730	M5 x 0.80	25mm	20	
	366-737	M6 x 1.00	10mm		
	366-739		16mm		
	366-741		25mm		
	366-753	M8 x 1.25	12mm	15	
	366-755		20mm		
	366-757		30mm		
	366-771	M10 x 1.50	16mm	10	
	366-773		25mm		
	366-794	M12 x 1.75	20mm		
	366-798		40mm		



ASSORTMENT 805-467
ASSORTIMENT 805-467

METRIC HEX SOCKET CAP SCREWS

A2 Stainless Steel

(with Alloy Steel Keys)

Metric, Type **DIN 912**

27 KINDS - 580 PIECES (incl. Keys)

REGULAR SIZE grey enamelled steel drawer will fit Slide Racks shown page A2.

Shipping weight: **9.3 kg** (20.5 lbs.)



Name	Thread Size	Compatible Key Size	Spaenaur No.	Bolt Length	Qty.	Page
Cap Screw Hex Socket	M5 x 0.80	4mm	373-017	16mm	50	B227
			373-B12-1W	20mm		
			373-019	25mm	40	
			373-020	30mm		
	M6 x 1.00	5mm	373-B24-1W	35mm	35	
			373-028	20mm		
			373-029	25mm	30	
			373-030	30mm		
	M8 x 1.25	6mm	373-031	35mm	25	
			373-038	16mm		
			373-039	20mm	15	
			373-040	25mm		
	M10 x 1.50	8mm	373-041	30mm	10	
			373-042	35mm		
			373-053	20mm	10	
			373-054	25mm		
	M12 x 1.75	10mm	373-055	30mm	5	
			373-067	25mm		
			373-068	30mm	3	
			373-069	35mm		
Hex Key			373-070	40mm	2	
			373-072	50mm		
Name			Spaenaur No.	Key Size	Qty.	Page
Hex Key			130-207	4mm	5	P9
			130-208	5mm	3	
			130-209	6mm		
			130-211	8mm		
			130-213	10mm		

ASSORTMENT 805-477
ASSORTIMENT 805-477

METRIC BUTTON HEAD

Hex Socket Cap Screws

Property Class 10.9 Steel

Not Plated

24 Sizes - 720 Pieces **ISO 7380**

Regular Coarse Thread

REGULAR SIZE grey enamelled steel drawer will fit Slide Racks shown page A2.

Shipping weight: **6.8 kg** (15 lbs.)



Product Type	Thread Size	Spaenaur No.	Length Under Head	Qty.	Page	
Cap Screw Hex Socket Button Head	M5 x 0.80	366-600	10mm	50	B229	
		366-603	16mm			
		366-605	20mm			40
		366-606	25mm			
	M6 x 1.00	6mm	366-607	30mm		35
			366-613	12mm		
			366-615	16mm		30
			366-W02-1T	20mm		
	M8 x 1.25	8mm	366-618	25mm		25
			366-619	30mm		
			366-620	35mm		20
			366-621	40mm		
			366-624	10mm		15
			366-626	14mm		
			366-627	16mm		10
			366-629	20mm		
	M10 x 1.50	10mm	366-622	10mm		10
			366-624	14mm		
			366-627	16mm		10
			366-629	20mm		
M12 x 1.75	12mm	366-630	25mm	10		
		366-631	30mm			
		366-633	40mm	10		
		366-634	45mm			
M10 x 1.50	10mm	366-636	16mm	10		
		366-639	25mm			
		366-641	35mm	10		
		366-644	50mm			



ASSORTMENT **805-489**
ASSORTIMENT

Metric **DIN 7379**

Hex Socket Shoulder Screws

Property Class 12.9
Alloy Steel - Plain Finish
Metric Regular
(Coarse) Thread

24 Sizes — 107 Pieces

Furnished in Regular Size grey enamelled steel drawer with hinged lid and catch.

Drawer will fit into Slide Racks shown on page A2.

Shipping Weight: **4.19 kg** (9-1/4 lbs.)

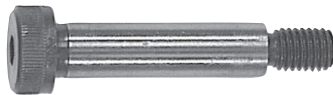

Thread Size	Thread Length	Shoulder Diameter	Spaenaur No.	Shoulder Length	Qty.	Page
M5 x 0.80mm	9.5mm	6mm	365-001	10mm	5	B233
			365-002	12mm		
			365-003	16mm		
			365-004	20mm		
			365-005	25mm		
			365-006	30mm		
			365-007	40mm		
M6 x 1.00mm	11.0mm	8mm	365-009	12mm		
			365-010	16mm		
			365-012	25mm		
			365-011	20mm		
			365-013	30mm		
			365-014	40mm		
			365-017	16mm		
M8 x 1.25mm	13.0mm	10mm	365-018	20mm		
			365-019	25mm		
			365-020	30mm		
			365-021	40mm		
			365-022	50mm		
			365-026	16mm		
			365-027	20mm		
M10 x 1.50mm	16.0mm	12mm	365-028	25mm	3	
			365-029	30mm		
			365-P02-1P	40mm		
					2	

ASSORTMENT **805-538**
ASSORTIMENT

DIN 7991

Hex Socket Flat Head Cap Screws
Property Class 10.9

Fully Threaded Metric Coarse Thread
Countersunk Flat Head

Furnished in Regular Size grey enamel steel drawer with hinged drawer with hinged lid and catch.

Drawer will fit into Slide Racks shown on page A2.

22 Sizes
545 Pieces

Not Plated

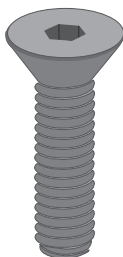

Spaenaur No.	Thread Size	Bolt Length	Qty.	Page	
366-566	M3 x 0.50	10mm	50	B230	
366-568		16mm			
366-571		25mm			
366-574	M4 x 0.70	12mm			25
366-577		20mm			
366-579		30mm			
366-581		40mm			
366-583	M5 x 0.80	8mm	20		
366-501		12mm			
366-505		20mm			
366-506		25mm			
366-507	M6 x 1.00	30mm	25		
366-509		10mm			
366-512		16mm			
366-515		25mm			
366-517	M8 x 1.25	35mm	20		
366-519		16mm			
366-520		18mm			
366-521		20mm			
366-523	M10 x 1.50	30mm	15		
366-526		16mm			
366-529		25mm			

ASSORTMENT **B-583**
ASSORTIMENT

CUP POINT

Hex Socket Set Screws

21 SIZES - 940 PIECES



Regular Size welded Steel Drawer has hinged lid and is finished in grey enamel.

Will fit into the Slide Racks, shown on page A2.

Shipping Weight: **2.95 kg** (7 lbs.)

Name	Spaenaur No.	Thread Size	Screw Length	Qty.	Page
Hex Socket Set Screw	SS-34	#6-32	3/16"	100	B234
	SS-35		1/4"		
	SS-40	#8-32	3/8"	75	
	SS-42		1/2"		
	SS-43	#10-24	3/16"	100	
	SS-45		5/16"		
	SS-48	#10-32	1/4"	50	
	SS-50		3/8"		
	SS-51	1/4"-20	5/16"	40	
	SS-53		3/8"		
	SS-54	5/16"-18	1/2"	35	
	SS-56		3/8"		
	478-E10-1M	3/8"-16	1/2"	30	
	SS-58		1/2"-13		
				25	B235
Name	Spaenaur No.	Key Size		Qty.	Page
Hex Key	SS-62K	1/16"		6	P7
	SS-63K	5/64"			
	SS-64K	3/32"			
	SS-65K	1/8"		4	P7
	SS-66K	5/32"			
	SS-67K	3/16"			
	SS-68K	1/4"			



PLASTIKIT
«PLASTIKIT» **804-085**

CUP POINT
HEX SOCKET SET SCREWS



ALLOY STEEL - NOT PLATED
20 Sizes, 155 Pieces

Put up in a clear, durable plastic container with hinged lid. Size: 1" x 2-3/4" x 4-1/2"

Name	Spaenaur No.	Thread Size	Screw Length	Qty.	Page
Set Screw Hex Socket	SS-28	#4-40	1/8"	10	B234
	SS-35	#6-32	1/4"		
	SS-39	#8-32	3/16"		
	SS-40		1/4"		
	SS-42		3/8"		
	SS-85		1/2"		
	SS-43	#10-24	3/16"		
	SS-47	#10-32	1/4"		
	SS-48		3/8"		
	SS-181		1/4"		
	478-E19-1W		5/16"		
	SS-189		3/8"		
	SS-51		1/2"		
	SS-52		1"		
	SS-86				
	Name	Spaenaur No.	Key Size		
Hex Key	SS-61K	0.050"	1	P7	
	SS-62K	1/16"			
	SS-63K	5/64"			
	SS-64K	3/32"			
	SS-65K	1/8"			B75 P7

ASSORTMENT
ASSORTIMENT **805-517**

Cup Point
Hex Socket Set Screws
18-8 Stainless Steel



940 Pieces, 21 Sizes

Furnished in a grey enamelled REGULAR SIZE steel drawer
Will fit slide racks shown on page A2.

Shipping Weight: **2.94 kg** (6-1/2 lbs.)

Name	Spaenaur No.	Thread Size	Screw Length	Qty.	Page
Hex Socket Set Screw	479-D07-1P	#6-32	3/16"	100	B238
	SS-2001		1/4"	60	
	SS-2023	#8-32	3/8"	75	
	SS-2024		3/16"	100	
	479-D16-1M	#10-24	1/4"	50	
	SS-2028		3/8"	40	
	479-D33-1P	#10-32	5/16"	35	
	479-D34-1Y		1/4"-20	30	
	479-D29-1X	5/16"-18	3/8"	25	
	479-D25-1T		3/8"		
	479-D21-1P	3/8"-16	1/2"		
	479-D30-1M		1/2"-13		
	SS-2052				
	SS-2056				
Name	Spaenaur No.	Key Size	Qty.	Page	
Hex Key	SS-62K	1/16"	6	P7	
	SS-63K	5/64"		B75 P7	
	SS-64K	3/32"			
	SS-65K	1/8"	4	P7	
	SS-66K	5/32"	3		
	SS-67K	3/16"			
SS-68K	1/4"				

ASSORTMENT
ASSORTIMENT **805-488**

ALLOY STEEL - NOT PLATED - INCH SIZES
HEX SOCKET SET SCREWS

24 SIZES - 500 PIECES

Put up in a REGULAR SIZE grey enamelled STEEL drawer, which fits slide racks shown on page A2.

Shipping Weight **2.49 kg** (5.5 lbs.)

"Half-Dog" Point



Name	Thread Size	Spaenaur No.	Screw Length	Qty.	Page	
Set Screw Hex Socket With Half Dog Point	#4-40	478-100	1/4"	40	B243	
		478-102	3/8"			
	#6-32	478-104	3/16"	30		
		478-105	5/16"			
	#8-32	478-107	1/2"	20		
		478-109	1/4"			
	#10-24	478-112	3/8"	15		
		478-114	5/8"			
	#10-32	478-116	3/16"	10		
		478-117	5/16"			
	1/4"-20	478-119	1/2"	5		
		478-121	1/4"			
	1/4"-28	478-122	3/8"			
		478-124	5/8"			
	5/16"-18	478-126	1"			
		478-128	1/4"			
	5/16"-24	478-130	3/8"			
		478-132	5/8"			
	3/8"-16	478-134	1"			
		478-136	3/8"			
			478-138			
			478-140			
			478-143			
			478-145			



ASSORTMENT B-582
ASSORTIMENT

SQUARE HEAD SET SCREWS

CUP POINT / UNC

STEEL - Case Hardened - Not Plated

18 Varieties - 491 pieces.

Furnished in Regular Size Steel drawer which will fit into Slide Racks shown on page A2.

Shipping Weight: **7.37 kg** (16-1/4 lbs.)

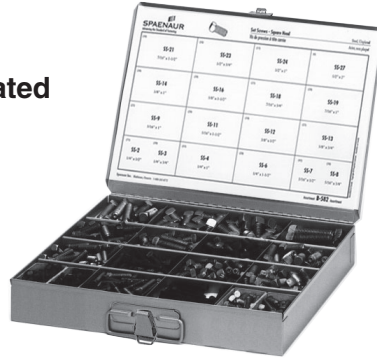

Thread Size	Spaenaur No.	Screw Length	Qty.	Page
1/4"-20	SS-2	1/2"	75	B244
	SS-3	3/4"	50	
	SS-4	1"	35	
5/16"-18	SS-6	1-1/2"	20	
	SS-7	1/2"	45	
	SS-8	3/4"	30	
3/8"-16	SS-9	1"	25	
	SS-11	1-1/2"	20	
	SS-12	1/2"	30	
7/16"-14	SS-13	3/4"	25	
	SS-14	1"	30	
	SS-16	1-1/2"	20	
1/2"-13	SS-18	3/4"	25	
	SS-19	1"	20	
	SS-21	1-1/2"	10	
1/2"-13	SS-23	3/4"	15	
	SS-24	1"	15	
1/2"-13	SS-27	2"	6	

ASSORTMENT 805-468 **DIN 916** ~ ISO 4029 **DIN 911**

METRIC Hex Socket Set Screws
Regular Coarse Thread **CUP POINT**

304 STAINLESS STEEL
24 Sizes - 410 Pieces

REGULAR SIZE welded steel drawer with hinged lid and scooped bins, finished in grey enamel. Fits the Slide Racks shown on page A2
Shipping Weight: **2.49 kg** (5.5 lbs.)



Name	Thread Size	Screw Length	Spaenaur No.	Qty.	Page
Set Screw Hex Socket Cup Point 304 Stainless Steel DIN 916 Metric	M4 x 0.70	6mm	482-004	30	B249
		8mm	482-005		
		10mm	482-006		
		12mm	482-007		
		16mm	482-008		
		8mm	482-010		
	M5 x 0.80	10mm	482-W05-1W	25	
		12mm	482-012		
		16mm	482-013		
		20mm	482-014		
	M6 x 1.00	8mm	482-016	20	
		10mm	482-017		
		12mm	482-018		
		16mm	482-W04-1K		
		20mm	482-020		
	M8 x 1.25	8mm	482-054	15	
		10mm	482-055		
		12mm	482-022		
		16mm	482-023		
		20mm	482-024		
Hex Key Alloy Steel DIN 911 Metric	Key Size	2.0mm	130-204	3	P9
		2.5mm	130-205		
		3.0mm	130-206		
		4.0mm	130-207		

ASSORTMENT 805-405 **DIN 916** ~ ISO 4029

METRIC Hex Socket Set Screws
Metric Coarse Thread **CUP POINT**
ALLOY STEEL - Not Plated

Total Contents - 464 Pieces - 27 Sizes

REGULAR SIZE welded steel drawer with hinged lid and scooped bins, finished in grey enamel. Fits the Slide Racks shown on page A2.

Shipping Weight: **3.06 kg** (6-3/4 lbs.)

Name	Spaenaur No.	Thread Size	Screw Length	Qty.	Page	
Set Screw Hex Socket	481-013	M3 x 0.50	5mm	30	B248	
	481-015		8mm			
	481-020	M4 x 0.70	5mm			
	481-C06-1X		6mm			
	481-023		10mm			
	481-024		12mm			
	481-029	M5 x 0.80	6mm			25
	481-031		10mm			
	481-032		12mm			
	481-034	M6 x 1.00	16mm			15
	481-039		8mm			
	481-041	M8 x 1.25	12mm			10
	481-044		20mm			
	481-048	M10 x 1.50	8mm			8
	481-050		12mm			
	481-053	M12 x 1.75	25mm			5
	481-056		10mm			
	481-081		16mm			
	481-058	M12 x 1.75	20mm			3
	481-062		16mm			
Hex Key	Spaenaur No.	Key Size		5	P9	
		130-203	1.5mm			
		130-204	2.0mm			
		130-205	2.5mm			
		130-206	3.0mm			
		130-207	4.0mm			
130-208	5.0mm	3				
130-209	6.0mm					



A

PLASTIKIT
«PLASTIKIT» **804-086**

METRIC
Hex Socket Set
Screws with Keys

DIN 916

45H STEEL , Not Plated
15 Sizes - 150 Pieces



Size: 1" x 2-3/4" x 4-1/2"
Clear durable, plastic container



Name	Spaenaur No.	Thread Size	Screw Length	Qty.	Page
Set Screw Hex Socket 45H Steel Cup Point DIN 916 Metric	481-011	M3 x 0.50	3mm	10	B248
	481-013		5mm		
	481-014		6mm		
	481-019	M4 x 0.70	4mm		
	481-020		5mm		
	481-C06-1X		6mm		
	481-024		12mm		
	481-028	M5 x 0.80	5mm		
	481-029		6mm		
	481-038	M6 x 1.00	8mm		
	481-039		10mm		
	481-041		12mm		
	481-048	M8 x 1.25	8mm		
	481-049		10mm		
	Name	Spaenaur No.	Key Length		
Hex Key Alloy Steel DIN 911 Metric	130-203	1.5mm		1	P9
	130-204	2.0mm			
	130-205	2.5mm			
	130-207	3.0mm			
	130-206	4.0mm			

ASSORTMENT
ASSORTIMENT **805-490** **DIN 915**

METRIC "REGULAR" (COARSE) THREAD
HEX SOCKET SET SCREWS

Grade 45H
ALLOY
STEEL
Not Plated

24
Sizes
500
Pieces

With
DOG
POINT



Thread Size	Spaenaur No.	Screw Length	Qty.	Page
M3 x 0.50	481-136	4mm	40	B252
	481-138	6mm		
	481-139	8mm		
	481-140	10mm		
	481-141	12mm		
M4 x 0.70	481-142	5mm	30	
	481-144	8mm		
	481-146	12mm		
M5 x 0.80	481-147	16mm	20	
	481-148	6mm		
	481-150	10mm		
	481-152	16mm		
	481-153	20mm		
M6 x 1.00	481-154	6mm	15	
	481-156	10mm		
	481-158	16mm		
	481-159	20mm		
	481-160	25mm		
M8 x 1.25	481-161	8mm	10	
	481-163	12mm		
	481-165	20mm		
	481-167	30mm		
M10 x 1.50	481-169	12mm	5	
	481-170	16mm		

REGULAR SIZE grey enamelled STEEL. Drawer has "Scooped" bins. Drawer fits Slide Racks shown on page A2
Shipping weight: **2.49 kg** (5.5 lbs.)

ASSORTMENT
ASSORTIMENT **805-495** **DIN 479**

METRIC "REGULAR" (COARSE) THREAD
SQUARE HEAD SET SCREWS

STEEL
Property
Class 8.8
Not Plated

24
Sizes
500
Pieces

With
DOG
SHORT
POINT



Thread Size	Spaenaur No.	Screw Length	Qty.	Page
M5 x 0.80	487-009	8mm	40	B253
	487-003	16mm		
	487-005	25mm		
	487-006	30mm		
	487-007	35mm		
	487-010	12mm		
	487-B01-1C	16mm		
M6 x 1.00	487-012	20mm	30	
	487-013	25mm		
	487-014	30mm		
	487-016	40mm		
	487-019	12mm		
M8 x 1.25	487-020	16mm	15	
	487-021	20mm		
	487-022	25mm		
	487-023	30mm		
	487-024	35mm		
	487-032	20mm		
	487-034	30mm		
M10 x 1.50	487-036	40mm	10	
	487-041	25mm		
M12 x 1.75	487-042	35mm	5	
	487-046	40mm		

REGULAR SIZE grey enamelled STEEL. Drawer has "Scooped" bins. Drawer fits Slide Racks shown on page A2
Shipping weight: **5.60 kg** (12.25 lbs.)

PLASTIKIT
«PLASTIKIT» **804-089**

THUMBSCREWS

Cold Forged Steel

Zinc Plated

9 SIZES - 85 PIECES

Size: 1" x 2-3/4" x 4-1/2"
Clear durable, plastic container



Spaenaur No.	Thread Size	Thread Length	Qty.	Page
Thumbscrew Without Shoulder				
TS-1000	#6-32	5/8"	10	B279
TS-512	#10-24	1/2"		
TS-516		1"		
TS-524	1/4"-20	3/4"		
TS-526		1"		
TS-530		1-1/2"		
TS-536	5/16"-18	1"	5	
Thumbscrew With Shoulder				
TS-525	1/4"-20	3/4"	10	B279

REGULAR and LARGE Size Thumbscrew Knob Assortments

ASSORTMENT
ASSORTIMENT **805-418**

Inch SHEAR-LOC® THUMBSCREW KNOBS

24 VARIETIES - 507 PIECES

For use with Hex Socket Cap Screws in inch sizes #4 to 3/8" dia.
Delrin Plastic - Black, Grey, Red

REGULAR SIZE Drawer:
13-5/16" x 9-1/4" x 2"

805-418



ASSORTMENT
ASSORTIMENT **805-419**

Metric SHEAR-LOC® THUMBSCREW KNOBS

22 VARIETIES - 456 PIECES

For use with Metric Hex Socket Cap Screws in diameters M3 to M10.
Delrin Plastic - Black, Grey, Red

REGULAR SIZE Drawer:
13-5/16" x 9-1/4" x 2"

Shipping weight: **2.9 kg** (6.5 lbs.)

Knob Diameter	Knob Height	Spaenaur No.	Colour	Qty.	Page
5/16"	11/64"	134-074	Black	35	B285
		134-075	Gray		
		134-076	Red		
3/8"	3/16"	134-077	Black	30	
		134-078	Gray		
		134-079	Red		
		134-080	Black		
1/2"	7/32"	134-081	Gray	25	
		134-082	Red		
		134-083	Black		
5/8"	1/4"	134-084	Gray	20	
		134-085	Red		
		134-086	Black		
3/4"	5/16"	134-087	Gray	15	
		134-088	Red		
		134-089	Black		
		134-090	Gray		
		134-091	Red		
1"	13/32"	134-092	Black	9	
		134-093	Gray		
		134-094	Red		
		134-095	Black		
		134-096	Gray		
1-1/2"	15/32"	134-097	Black		

Shipping weight: **2.9 kg** (6.5 lbs.)

Fits Screw	Knob Diameter	Spaenaur No.	Colour	Qty.	Page
M3	9.6mm	134-500	Black	35	B285
		134-501	Gray		
		134-502	Red		
M4	13.0mm	134-503	Black	30	
		134-504	Gray		
		134-505	Red		
M5	16.0mm	134-506	Black	25	
		134-507	Gray		
		134-508	Red		
M6	19.0mm	134-509	Black	20	
		134-510	Gray		
		134-511	Red		
		134-512	Black		
		134-513	Gray		
M6	26.0mm	134-514	Red	15	
		134-515	Black		
		134-516	Gray		
		134-517	Red		
		134-518	Black		
M8	38.0mm	134-519	Gray	9	
		134-520	Black		
		134-521	Gray		
M10					

A

ASSORTMENT **805-445** KNOBS – Inch and Metric

SHEAR-LOC® TEE STYLE THUMBSCREW
24 VARIETIES - 510 PIECES

REGULAR SIZE gray enamelled drawer.

Shipping weight: **2.7 kg** (6 lbs.)

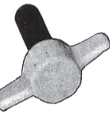

Delrin Plastic

Name	Fits Screw	Spaenaur No.	Colour	Qty.	Page
Shear-Loc® Tee Knob	#10	134-099	Black	30	B285
		134-100	Gray		
		134-107	Red		
	1/4"	134-101	Black	25	
		134-102	Gray		
		134-108	Red		
	5/16"	134-103	Black	20	
		134-104	Gray		
		134-109	Red		
	3/8"	134-105	Black	10	
		134-106	Gray		
		134-110	Red		
134-522		Black			
Shear-Loc® Tee Knob-Metric	M5	134-523	Gray	30	
		134-530	Red		
		134-524	Black		
	M6	134-525	Gray	25	
		134-531	Red		
		134-526	Black		
	M8	134-527	Gray	20	
		134-532	Red		
		134-528	Black		
	M10	134-529	Gray	10	
		134-533	Red		

ASSORTMENT **805-409A**

Metric HEXAGON NUTS (Low Style)

Coarse and Fine Thread Plain and Plated Steel

24 SIZES - 1108 PIECES

DIN 439 (Property Class 4)

Shipping Weight: **4.676 kg** (10.5 lbs.)

DIN 936 (Property Class 17H)

Name	Finish	Spaenaur No.	Thread Size	Qty.	Page
Nut Hexagon Low Profile Property Class 4 DIN 439B	Zinc Plated	156-055ZP	M2 x 0.40	80	C13
		156-167ZP	M2.3 x 0.40		
		156-F04-1A	M2.5 x 0.45		
		156-059ZP	M3 x 0.50	100	
		156-060ZP	M3.5 x 0.60	80	
		156-061ZP	M4 x 0.70	100	
		156-F12-1K	M5 x 0.80	90	
		156-063ZP	M6 x 1.00	80	
		156-064ZP	M7 x 1.00	60	
		156-058NP	M2.6 x 0.45	80	
Nut Hexagon Low Fine Thread Property Class 4 DIN 439B	Zinc Plated	156-134ZP	M8 x 1.00	50	C14
	Plain	156-139	M10 x 1.25	40	
		156-141	M12 x 1.25	20	
Nut Hexagon Coarse Thread Class 17H DIN 936	Zinc Plated	156-F11-1T	M8 x 1.25	50	C15
		156-066ZP	M10 x 1.50	40	
		156-067ZP	M12 x 1.75	20	
		156-068ZP	M14 x 2.00	15	
		156-069ZP	M16 x 2.00	12	
		156-070ZP	M18 x 2.50	8	
		156-071ZP	M20 x 2.50	6	
		156-072ZP	M22 x 2.50	5	
		156-073ZP	M24 x 3.00	5	
		156-074ZP	M27 x 3.00	4	
		156-075ZP	M30 x 3.50	3	

ASSORTMENT **805-658B**

HEX NUTS & NYLON INSERT LOCKNUTS

STEEL, ZINC PLATED

COARSE (UNC) and FINE (UNF)

All Inch Sizes

32 Sizes – 2,140 Pieces

Furnished in Large Size grey enamel steel drawer with scooped bins for easy access.

Drawer will fit into Slide Racks shown on page A3.

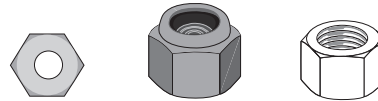

Name	Spaenaur No.	Thread Size	Qty.	Page	
Hex Nuts	B-91	1/4"-20	75	B265	
	155-P36-1W	1/4"-28		C3	
	B-92	5/16"-18	75	B265	
	155-P31-1Y	5/16"-24		B273	
	B-93	3/8"-16	50	C3	
	155-P23-1K	3/8"-24		B265	
	155-P39-1A	7/16"-14	30	B273	
	B-104	7/16"-20		C3	
	B-95	1/2"-13	20	B265	
	B-105	1/2"-20		C3	
	B-96	9/16"-12	25	C3	
	155-P16-1P	5/8"-11	20		
Machine Screw Nuts	155-P11-1K	#4-40	100	C2	
	155-P03-2A	#6-32			
	155-P04-1P	#8-32			
	155-P08-1T	#10-24			
155-P02-1X	#10-32	75	B273		
155-P22-1T	#12-24		C2		
Nylon Insert Locknuts	178-C01-1Y	#4-40	75	C26	
	178-C02-1C	#6-32			
	HN-171	#8-32			
	HN-172	#10-24			
	178-C06-2X	#10-32			
	178-C03-1N	1/4"-20			
	HN-176	1/4"-28		50	C26
	178-C26-1C	5/16"-18			
	HN-178	5/16"-24		30	C26
	178-C05-2P	3/8"-16			
	HN-180	3/8"-24		15	C26
	HN-181	7/16"-14			
178-C23-1A	1/2"-13				
178-C27-1N	5/8"-11				

ASSORTMENT **805-407**
ASSORTIMENT

Metric
HEXAGON NUTS
(Standard)

DIN 934, Coarse Thread

Property Classes 5, 8 and 10
Steel Plain and Plated

24 Sizes - 922 Pieces

Furnished in REGULAR SIZE
grey enamelled drawer.
Drawer will fit into Slide Racks

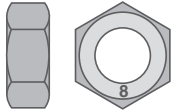

Spaenaur No.	Thread Size	Qty.	Page
156-001ZP	M1.0 x 0.25	20	C9
156-002ZP	M1.2 x 0.25	35	
156-003ZP	M1.4 x 0.30	30	
156-004ZP	M1.6 x 0.35	30	
156-005ZP	M1.7 x 0.35	50	
156-006ZP	M2 x 0.40	100	
156-007ZP	M2.3 x 0.40		
156-008ZP	M2.5 x 0.45		
156-010ZP	M3 x 0.50		
156-011ZP	M3.5 x 0.60	C10	
156-012ZP	M4 x 0.70	80	C9
156-013ZP	M5 x 0.80	50	C10
156-014ZP	M6 x 1.00	30	
156-016ZP	M8 x 1.25	25	
156-017ZP	M10 x 1.50	20	
156-F09-1T	M12 x 1.75	12	
156-019ZP	M14 x 2.00	10	
156-F10-1N	M16 x 2.00	8	
156-021ZP	M18 x 2.50	6	
156-022ZP	M20 x 2.50	3	
156-023ZP	M22 x 2.50	2	
156-024ZP	M24 x 3.00		
156-025ZP	M27 x 3.00		
156-026ZP	M30 x 3.50		

ASSORTMENT **805-521A**
ASSORTIMENT

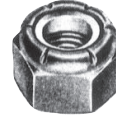

Natural Nylon Locking Insert (Zytel-101)

Steel, Zinc Plated

NYLON INSERT LOCKNUTS

24 SIZES - 979 PIECES

Furnished in regular size grey enamelled steel
drawer, with hinged lid and scoop bins.

Drawer will fit Slide Racks shown on page A2

Shipping Weight: **5.90 kg** (13 lbs.)

Name	Spaenaur No.	Thread Size	Qty.	Page
Locknut (Machine Screw)	HN-248	#2-56	100	C26
	178-C01-1Y	#4-40		
	178-004	#5-40		
	178-C02-1C	#6-32		
	HN-171	#8-32		
	HN-172	#10-24		
	178-C06-2X	#10-32		
178-C25-1Y	#12-24			
Locknut (Cap Screw)	178-C03-1N	1/4"-20	50	C26 L93
	HN-176	1/4"-28	25	C26
	178-C26-1C	5/16"-18		
	HN-178	5/16"-24		C26 L93
	178-C05-2P	3/8"-16	20	C26
	HN-180	3/8"-24		
	HN-181	7/16"-14	10	C26
	178-C23-1A	1/2"-13		
	HN-184	1/2"-20		
	HN-185	9/16"-12	5	C26
	178-C27-1N	5/8"-11		
	HN-188	5/8"-18		
	HN-189	3/4"-10		
HN-190	3/4"-16	2	C26	
HN-191	7/8"-9			
178-018	1"-8			

ASSORTMENT **805-522**
ASSORTIMENT

Natural Nylon Locking
Insert (Zytel-101)

Stainless Steel 18-8

**NYLON INSERT
LOCKNUTS**

16 SIZES
805 PIECES



Furnished in
REGULAR SIZE grey
enamelled drawer.
Drawer will fit into
Slide Racks shown
on A2

Shipping Weight:
4.99 kg (11 lbs.)

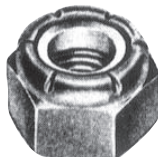

Name	Spaenaur No.	Thread Size	Qty.	Page
Locknut Machine Screw	179-005	#2-56	100	C26
	179-W15-1C	#4-40		
	179-W08-2M	#6-32		
	179-W07-1K	#8-32		
	179-W12-1A	#10-24		
	179-003	#10-32		
Locknut Cap Screw	179-W04-2N	1/4"-20	50	C26
	179-W02-2Y	5/16"-18	25	
	179-W05-2M	3/8"-16		
	179-007	3/8"-24		
	HN-2038	7/16"-14	10	
	179-W03-2C	1/2"-13		
	179-W18-1K	5/8"-11	5	
	179-008	5/8"-18		
	179-W17-1T	3/4"-10		
	HN-2043	3/4"-16		

ASSORTMENT 805-410A



NYLON INSERT LOCKNUTS

Contains 14 METRIC SIZES

- plus -
6 sizes of

METRIC WING NUTS

Cold Forged Steel Bright Zinc Plated

Style 220 Medium Pattern

Dia. Range **M4 - M12** Regular Thread

Total 300 Pieces

Regular Size Welded Steel Drawer,
will fit into Slide Racks shown on page A2.

Shipping Wt. **4.31 kg** (9-1/2 lbs.)

Product Type	Spaenaur No.	Thread Size	Qty.	Page
Locknut Metric (Nylon Insert)	178-523	M2.5 x 0.45	15	C30
	178-C29-1K	M3 x 0.50	30	
	178-510	M4 x 0.70	40	
	178-511	M5 x 0.80	30	
	178-C20-1W	M6 x 1.00	20	
	178-514	M8 x 1.25	10	
	178-516	M12 x 1.75	8	
	178-517	M14 x 2.00	6	
	178-518	M16 x 2.00	3	
	178-519	M18 x 2.50	2	
	178-520	M20 x 2.50	2	
178-521	M22 x 2.50	2		
178-522	M24 x 3.00	2		
Wing Nut Metric	211-W01-1K	M4 x 0.70	15	C52
	211-101	M5 x 0.80	10	
	211-102	M6 x 1.00	8	
	211-103	M8 x 1.25	8	
	211-104	M10 x 1.50	6	
	211-105	M12 x 1.75	6	

PLASTIKIT «PLASTIKIT» A-16

WING NUTS

Cold Forged Steel
Zinc Plated

62 WING NUTS - 9 INCH SIZES

Clear durable, plastic container



Spaenaur No.	Thread Size	Wing Span	Qty.	Page
WN-1	#6-32	21/32"	10	C50
WN-2	#8-32	27/32"	12	
WN-3	#10-24		10	
WN-4	#10-32		15	
WN-6	1/4"-20	1-1/16"	8	
WN-7	5/16"-18	1-7/32"	3	
WN-8	3/8"-16	1-13/32"	2	
WN-9	7/16"-14	1-13/16"	1	
WN-10	1/2"-13	1-7/8"		

PLASTIKIT «PLASTIKIT» 804-068

STAMPED WING NUTS

Zinc Plated Steel

Style 1 - Type D

70 Pieces - 7 Sizes

Size: 1" x 2-3/4" x 4-1/2"
Clear durable, plastic container



Spaenaur No.	Thread Size	Wing Span	Qty.	Page
211-020	#6-32	3/4"	15	C50
211-021	#8-32		12	
211-018	#10-24	7/8"	10	
211-022	#10-32		8	
211-019	1/4"-20	1-1/16"	6	
211-023	5/16"-18	1-1/4"	4	
211-024	3/8"-16	1-3/8"	4	

ASSORTIMENT 805-640G



Tinnerman® Spring Nuts and Tubular Stud Retainers

SPRING STEEL - HEAT TREATED

An excellent kit for general industrial maintenance, electronics, repair shops, etc. as well as for automotive general use. Inside label shows illustrations and size data.

Separate refill items available in "Unit Packages"

65 Varieties 875 Pieces

Contains a full range of all most popular sizes, in Flat, U and J Type Spring Nuts, and Tubular Stud Retainers.

Furnished in Large Size grey enamel drawer with scooped bins for easy access. Drawers will fit into Slide Racks shown on page A3

Shipping Weight: **4.31 kg** (9.5 lbs.)



Name	Spaenaur No.	Thread Size	Nut Thickness	Qty.	Page	
Flat Type Fastener Rectangular	1896	#2-56	0.010"	25	C72	
	1898	#6-32	0.017"			
	TN-7	#8-32	0.033"			
	J Type Fasteners	202-203	#8B	0.033"	15	C72
		202-029	#10-24	0.022"		
		1901	#10-24	0.017"	25	C72
		TN-9	#10-32	0.031"		
		1900	#10A	0.031"	15	
		B-1170	#10A	0.031"		
		2064		0.025"	10	
		202-001	1/4"-20	0.025"	15	
		202-401	1/4"-20	0.025"		
Flat Type Fasteners Round Zip-On Fit		202-064	#6-32	0.017"	10	C75
	B-1131	#8	0.028"	8		
	202-P42-1W	#10	0.031"	10		
	202-P23-1Y					
	B-1155					
	2055	#14	0.034"	12		
	TN-38					
	B-1186					
	2059	1/4"-20	0.025"	8		
	B-1166					
	B-1173					
202-044						
Name	Spaenaur No.	Compatible Stud ø	Speed Nut Shape	Qty.	Page	
Push-On Type Fasteners Round Studs	B-1167	0.062"	Rectangular	10	C88	
	TN-13	0.093"		15		
	1909	0.100"		40		
	1906	0.125"		25	C88	
	1914	0.125"		10	C89	
	1897	0.153" - 0.157"	Round	15	C90	
	202-159	0.156"	Rectangular	12		
	TN-99	0.187"	Rectangular	25		
	1905	0.187"	Rectangular	10		
	2102	0.187"	Round	15		
	202-071	0.250"	Rectangular	10		
	TN-171	0.250"	Rectangular	12		
	2104	0.250"	Round	15		
	202-057	0.250"	Rectangular	10		
	B-1182	0.357"	Rectangular	12		
	2106	0.357"	Round	15		
	TN-146	0.500"	Rectangular	22		
202-P02-1T	0.625"	Rectangular	10			
TN-184	0.625"	Rectangular	10			
Name	Spaenaur No.	Compatible Stud ø	Compatible Panel Thickness	Qty.	Page	
Tubular Type Fasteners	TN-125	0.062"	0.025" - 0.125"	10	C95	
	TN-95	0.088"	0.032" - 0.040"			
	TN-54	0.090"	0.031" - 0.041"	12	C77	
	TN-254	0.093" - 0.105"	0.031" - 0.042"			
	TN-5	1/8"	0.038" - 0.044"	15	C94	
	B-1190	0.180"	0.050" - 0.060"			
	B-1380	0.180"	0.020" - 0.032"	10	C104	
	TN-229	0.184" - 0.190"	0.036" - 0.042"			
	2066	3/16"	0.038" - 0.044"	12		
	TN-66	1/4"	0.034" - 0.040"	10	C77	
Name	Spaenaur No.	Compatible Stud ø	Nut Thickness	Qty.	Page	
Push-On Type Rectangular Studs Special	2060	0.250"	0.017"	10		
Name	Spaenaur No.	Compatible Screw Size	Compatible Panel Thickness	Qty.	Page	
U Type Fasteners	202-193	#8A or B	0.025" - 0.040"	8	C78	
	B-993	#8A	0.040" - 0.051"			
	2062	#10A	0.030" - 0.043"	8		
	TN-149	#10A or B	0.040" - 0.051"			
	TN-131	#10A or B	0.051" - 0.064"	10		
	202-202	#10A or B	0.102" - 0.125"			
	2293	1/4"-20	0.064" - 0.125"	12	C79 H34	

A

ASSORTMENT **805-511A**
ASSORTIMENT

Extruded Panel Nuts
METRIC RANGE

SPRING STEEL
HEAT TREATED

15 SIZES
205 PIECES

Regular size grey enamelled drawer fits the Slide Racks shown on page A2
 Shipping weight: **2.95 kg** (6.5 lbs)

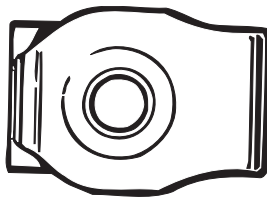

Product Type	Spaenaur No.	Thread Size	Compatible Material Thickness	Centre of Hole to Panel Edge	OEM Part Number	Qty.	Page	
Extruded Panel Nut	202-P17-1M	M4 x 0.70	0.8mm - 4.0mm	9.5mm	11500654	20	C105	
	202-501			13.5mm	11500655			
	202-503			15.8mm	11500657			
	202-512	M6 x 1.00	0.6mm - 4.0mm	13.5mm	11503957	15		
	202-509			13.0mm	11503455			
	202-506			14.0mm	11503716			
	202-505	M6.3 x 1.00	0.8mm - 4.5mm	20.0mm	11503715	10		
	202-504			13.5mm	11500658			
	202-502			11502785				
	202-511	M8 x 1.25	0.8mm - 4.0mm	14.5mm	11500660	10		C104
	202-513			15.0mm	11500662			
	202-508			20.0mm	11503719			
202-P11-1Y	M10 x 1.50		1.0mm - 6.0mm	19.0mm	11500662	20	C105	

CATALOG 14.02
 2018/12/05

SPAENAUR

ASSORTMENT **805-512D**
ASSORTIMENT

EXTRUDED PANEL NUTS & U-TYPE SPRING NUTS

Spring Steel Heat Treated
For **AUTOMOTIVE** service
and **INDUSTRIAL** use.

23 SIZES, 650 PIECES

Regular size grey enamelled drawer fits the
Slide Racks shown on page A2

Shipping Weight: **3.06 kg** (6-3/4 lbs.)



Name	Thread Size	Spaenaur No.	Overall Length	Qty.	Page
Extruded Panel Nut Type U	1/4"-20	202-395	15/16"	10	C104 C106
		202-P14-1T	1-3/16"		
	5/16"-18	N-256U	1"	5	
		202-396	1-1/4"		
	3/8"-16	202-392	1-5/16"		
		202-385	1-11/16"		
Name	Compatible Screw Size	Spaenaur No.	Overall Length	Qty.	Page
Tinnerman U Type Fasteners	#6-32	TN-226	0.360"	50	C76
		202-151	0.380"		
		202-P12-1C	0.450"		
		TN-225	0.510"		
	#6A or B	202-027	0.810"		C77
	#8-32	TN-195	0.440"	25	C77 C78
		TN-256	0.740"		
	#8A	TN-232	0.830"	25	
		TN-101	0.710"		
	#8A or B	TN-118	0.620"	50	
		TN-257	0.630"		
		TN-188	0.840"		
	1/4"-20	B-1154	0.890"	20	C79
		#14B	TN-133	0.900"	10
Name	Thread Size	Spaenaur No.	Overall Length	Qty.	
Tinnerman U Type Fasteners Special	#10A or AB	202-194	0.093"	25	
		TN-127	0.760"		

A

ASSORTMENT **805-544**
ASSORTIMENT

INCH & METRIC SIZES
WELL NUT® SCREW ANCHORS
Neoprene

15 SIZES — 130 PIECES

Furnished in Regular Size grey
enamel Steel drawer with scooped
bins for easy access. Drawer will fit
into Slide Racks shown on page A2

Shipping Weight:
2.43 kg (5.36 lbs.)



Thread Size	Spaenaur No.	Compatible Material Thickness	Qty.	Page
#6-32	102-200	0.015"-0.156"	10	C109
	102-201	0.375"-0.607"		
#8-32	102-202	0.015"-0.156"	5	
#10-32	102-204	0.015"-0.192"		
	102-207	0.030"-0.277"		
	102-209	0.035"-0.232"		
	102-210	0.312"-0.450"		
1/4"-20	102-205	0.312"-0.645"	5	
	102-211	0.015"-0.111"		
	102-212	0.031"-0.187"		
5/16"-18	102-213	0.250"-0.457"	10	
	102-214	0.015"-0.156"		
3/8"-16	102-215	0.015"-0.125"		
M6 x 1.00	102-217	0.031"-0.187"	10	

CATALOG 14

SPAENAUR

ASSORTMENT
ASSORTIMENT **805-A06-1X**

Concrete Anchoring System

WEDGE ANCHORS

Carbon Steel Zinc Plated

16 SIZES - 116 PIECES



Furnished in Large Size 'Adjusta-bin' grey enameled steel drawer.
Drawer will fit into Slide Racks shown on page A3.
Shipping Weight: **11.34 kg** (25 lbs.)

Name	Head Type	Thread Size	Drill Size	Spaenaur No.	Bolt Length	Max Fixture Thickness	Type	Qty.	Page	
Carbon Steel Zinc Plated	Hex Nut	1/4"	1/4"	102-W01-1K	1-3/4"	1-1/4"	Wedge	8	C117.2	
			1/4"	102-W02-1W	2-1/4"	1-3/4"	Wedge			
			1/4"	102-W03-1M	3-1/4"	2-3/4"	Wedge			
		3/8"	3/8"	102-W04-1X	2-1/4"	1-5/8"	Wedge			
			3/8"	102-W05-1A	2-3/4"	2"	Wedge			
			3/8"	102-W06-1P	3"	2-1/4"	Wedge			
		1/2"	3/8"	102-W07-1Y	3-3/4"	2-3/8"	Wedge			
			1/2"	102-W09-1N	2-3/4"	2-1/2"	Wedge			
			1/2"	102-W10-1C	3-3/4"	2-7/8"	Wedge			
		5/8"	1/2"	102-W11-1N	4-1/4"	3-1/2"	Wedge			
			5/8"	102-W14-1W	3-1/2"	2-7/8"	Wedge			
			5/8"	102-W37-1K	4-1/2"	3"	Wedge			
		3/4"	5/8"	102-W15-1M	5"	3-1/2"	Wedge			
			3/4"	3/4"	102-W19-1Y	4-1/4"	3-3/8"	Wedge		4
				3/4"	102-W20-1P	4-3/4"	4"	Wedge		
		3/4"		102-W21-1Y	5-1/2"	4-3/4"	Wedge			

Inch

Pouce



ASSORTMENT 805-663A

A-K™ SERIES INSERTS
16 SIZES — 331 PIECES



Shipping Weight: **2.6 kg** (5.75 lbs.)

Name	Thread Size	Spaenaur No.	Grip Range	Qty.	Page
A-K Inserts	#6-32	215-A72-1X	0.020"-0.080"	25	C131
		215-A26-1C	0.080"-0.130"		
	#8-32	215-A18-1W	0.020"-0.080"		C131
		215-A23-1A	0.080"-0.130"		
	#10-24	215-A43-1K	0.020"-0.130"		C131
		215-A47-2A	0.130"-0.225"		
	#10-32	215-A04-1T	0.020"-0.130"		C131
		215-A13-1Y	0.130"-0.225"		
	1/4"-20	215-A34-1X	0.027"-0.165"		C131
		215-A38-1C	0.165"-0.260"		
	1/4"-28	215-A29-1K	0.027"-0.165"		C131
		215-A51-1Y	0.165"-0.260"		
5/16"-18	215-A37-1Y	0.027"-0.165"	C131		
	215-058				
3/8"-16	215-A41-1N	0.027"-0.150"	C131		
	215-060				
AVK Conversion Kit For A-H, A-K, A-L, A-O Series Hand Installation Tool	#6-32	TAA271-632		1	
	#8-32	TAA271-832			
	#10-24	TAA271-1024			
	#10-32	TAA271-1032			
	1/4"-20	TAA271-420			
	1/4"-28	TAA271-428			
	5/16"-18	TAA271-518			
	5/16"-24	TAA271-524			
Installation Tool	3/8"-16	TAA271-616	TAA170		
	3/8"-24	TAA271-624			

Both assortments furnished in LARGE SIZE Steel drawer which will fit into Slide Racks shown on page A3



ASSORTMENT 805-664B

A-L™ SERIES INSERTS
16 SIZES — 331 PIECES



Shipping Weight: **5.5 kg** (12.1 lbs.)

Name	Thread Size	Spaenaur No.	Grip Range	Qty.	Page	
A-L Inserts	#6-32	215-A49-1Y	0.020" - 0.080"	25	C133	
		215-A07-1M	0.080" - 0.130"			
	#8-32	215-A10-1X	0.020" - 0.080"			C133
		215-A17-1K	0.080" - 0.130"			
	#10-24	215-A21-1M	0.020" - 0.130"			C133
		215-A03-1N	0.130" - 0.225"			
	#10-32	215-A22-1X	0.020" - 0.130"			C133
		215-A35-1A	0.130" - 0.225"			
	1/4"-20	215-A32-1W	0.027" - 0.165"			C133
		215-A50-1P	0.165" - 0.260"			
	1/4"-28	215-A48-1P	0.027" - 0.165"			C133
		215-A60-1X	0.165" - 0.260"			
5/16"-18	215-A40-1C	0.027" - 0.165"	C133			
	215-A68-1W					
5/16"-24	215-A52-2C	0.027" - 0.150"	C133			
	215-080					
AVK Conversion Kit For A-H, A-K, A-L, A-O Series Hand Installation Tool	For Thread Size	Spaenaur No.		1		
	#6-32	TAA271-632				
	#8-32	TAA271-832				
	#10-24	TAA271-1024				
	#10-32	TAA271-1032				
	1/4"-20	TAA271-420				
	1/4"-28	TAA271-428				
	5/16"-18	TAA271-518				
Installation Tool	5/16"-24	TAA271-524	TAA170			
	3/8"-16	TAA271-616				
Installation Tool	3/8"-24	TAA271-624	TAA170			

CATALOG 14

SPAENAUR

Spaenaur reserves the right to substitute parts in any assortment without notice. For any questions or suggestions about our Assortments and Plastikits, please contact us 1-800-265-8772. © 2018 Spaenaur Inc. All rights reserved. Catalog may not be reproduced, in whole or in part, without the written permission of Spaenaur Inc. Subject to Catalog Terms and Conditions of Use available at Spaenaur.com and on page TC2 and TC3 at the back of this catalog. Spaenaur se réserve le droit de remplacer des pièces dans n'importe quel assortiment sans préavis. Pour toute question ou suggestion concernant nos Assortiments et Plastikits, veuillez nous contacter au 1-800-265-8772. © 2018 Spaenaur Inc. Tous droits réservés. Le catalogue ne peut être reproduit, en tout ou en partie, sans l'autorisation écrite de Spaenaur Inc. L'utilisation est soumise aux Conditions d'utilisation du Catalogue disponibles sur Spaenaur.com et à la page TC4 et TC5 à la fin de ce catalogue.



ASSORTMENT
ASSORTIMENT **805-665**

A-O™, A-T™ & A-W™
SERIES INSERTS

399 PIECES, 29 SIZES



Assortment also contains
8 Conversion Kits from 6-32
to 3/8-16 thread size, & 1
installation tool TAA170.

Furnished in LARGE SIZE Steel
drawer which will fit into Slide Racks
shown on page A3.

Shipping Weight: **5.3 kg** (11.6 lbs.)

Name	Spaenaur No.	Thread Size	Compatible Hole Size	Grip Range	Qty.	Page
Threaded Insert A-O Series	215-A88-1C	#6-32	1/4"	0.020" - 0.080"	25	C134
	215-A53-1N	#8-32				
	215-A11-1A	#10-24	9/32"	0.020" - 0.130"		
	215-A71-1M	#10-32	3/8"	0.030" - 0.165"	20	C134
	215-A39-1N	1/4"-20				
	215-A46-1X	5/16"-18	1/2"	0.040" - 0.200"	10	C134
	215-A25-1Y	3/8"-16				
Threaded Insert A-T Series	215-A45-2M	#6-32	7/32"	0.385"	25	C136
	215-A42-2T	#8-32	1/4"			
	215-A63-1T	#10-24	9/32"			C136
	215-A64-1C	#10-32				
	215-A20-2W	1/4"-20	3/8"	0.530"	20	C136
	215-A31-1K	1/4"-28				
	215-A14-2C	5/16"-18	1/2"	0.630"	10	C136
	215-A06-2W	3/8"-16	9/16"	0.760"		
Threaded Insert A-W Series	215-A24-2P	#8-32	17/64"	0.385"	25	C137
	215-A15-1N	#10-32	19/64"	0.390"		
	215-A19-1M	1/4"-20		0.530"	20	
	215-A28-1T	5/16"-18	17/32"	0.630"	10	
	215-A12-2P	3/8"-16	19/32"	0.755"		
AVK Conversion Kits	TAA271-632	#6-32			1	
	TAA271-832	#8-32				
	TAA271-1024	#10-24				
	TAA271-1032	#10-32				
	TAA271-420	1/4"-20				
	TAA271-428	1/4"-28				
	TAA271-518	5/16"-18				
TAA271-616	3/8"-16					
Plier Type Hand Installation Tool	TAA170	4mm; 5mm; 6mm; 8mm				

ASSORTMENT
ASSORTIMENT **805-493**

25 SIZES - 475 PIECES

INCH & METRIC
Barb-Sert®
Brass Inserts

Ideal for prototype work

Put up in a regular size grey
Enamelled Steel Drawer.

Fits the Slide Racks shown
on page A2.

Shipping Weight: **2.72 kg** (6 lbs.)



Thread Size	Spaenaur No.	Overall Length	Qty.	Page
#2-56	628-501	0.160"	20	C202
	628-500	0.205"	25	
#4-40	628-503	0.160"	20	
	628-502	0.205"		
#6-32	628-B77-1N	0.160"	20	
	628-504	0.276"		
#8-32	628-507	0.217"	20	
	628-B79-1K	0.335"		
#10-24	628-509	0.257"	15	
	628-508	0.395"		
#10-32	628-511	0.257"	15	
	628-B81-1K	0.395"		
1/4"-20	628-513	0.296"	20	
	628-512	0.500"		
M2.5 x 0.45	628-550	0.205"	20	
M3 x 0.50	628-553	0.160"		
	628-552	0.205"		
M3.5 x 0.60	628-555	0.160"	20	
	628-554	0.276"		
M4 x 0.70	628-557	0.217"	20	
	628-556	0.335"		
M5 x 0.80	628-559	0.257"	15	
	628-558	0.395"		
M6 x 1.00	628-561	0.296"	15	
	628-560	0.500"		

E-Z LOK® Inch & Metric
STANDARD ASSORTMENTS



ASSORTMENT
ASSORTIMENT **805-425B**

STEEL
21 SIZES - 60 PIECES
Coarse & Fine Thread

ASSORTMENT
ASSORTIMENT **805-423A**

303 STAINLESS STEEL
12 SIZES - 42 PIECES

Steel Drawer Size:
13-5/16" W. x 9-1/4" D. x 2" H.

Spaenaur No.	Internal Thread Size	External Thread Size	Internal Thread Depth	Qty.	Page
627-020	#4-40	#10-32	9/32"	4	C184
627-021	#6-32	1/4"-20	11/32"		
627-022	#8-32	5/16"-18	7/16"		
627-001	#10-24	3/8"-16	15/32"		
627-B93-1W	#10-32				
627-002	1/4"-20	7/16"-14	1/2"		
627-B89-1T	1/4"-28				
627-003	5/16"-18	1/2"-13	9/16"		
627-013	5/16"-24				
627-B04-1G	3/8"-16	9/16"-12	19/32"	3	
627-014	3/8"-24				
627-005	7/16"-14				
627-B80-1G	7/16"-20	5/8"-11	23/32"	2	
627-B81-1W	1/2"-13				
627-016	1/2"-20	3/4"-10	3/4"	1	
627-B05-1W	5/8"-11				
627-008		7/8"-9	13/16"		
627-B09-1P	5/8"-18	1"-8	7/8"	2	
627-B06-1M	3/4"-10				
627-018	3/4"-16	1"-8	1-3/8"	1	
627-B07-1X	1"-8				

Thread Type	Spaenaur No.	Internal Thread Size	External Thread Size	Overall Length	Qty.	Page		
Coarse	627-800	#10 - 24	3/8"-16	0.406"	6	C186		
	627-801	1/4"-20	7/16"-14	0.437"	5			
	627-802	5/16"-18	1/2"-13	0.484"	4			
	627-803	3/8"-16	9/16"-12	0.515"	2			
	627-804	7/16"-14	5/8"-11	0.656"				
Fine	627-805	1/2"-13	3/4"-10	0.656"	2	C186		
	627-806	#10 - 32	3/8"-16				0.406"	6
	627-807	1/4"-28	7/16"-14				0.437"	5
	627-808	5/16"-24	1/2"-13				0.484"	4
	627-B25-1Z	3/8"-24	9/16"-12				0.515"	2
	627-810	7/16"-20	5/8"-11				0.656"	
627-811	1/2"-20	3/4"-10						

E-Z LOK® **ASSORTMENT** **ASSORTIMENT** **805-422A**

Inch & Metric
STANDARD ASSORTMENT

STEEL
15 SIZES - 60 PIECES

Internal threads are Metric,
External are Inch

13-5/16" W. x 9-1/4" D. x 2" H.



Name	Spaenaur No.	Internal Thread	External Thread	Length	Qty.	Page	
Carbon Steel Inserts for Metal - Fine Thread	627-200	M6-1.00	3/8"-16	0.406"	5	C185	
	627-201	M8-1.25	1/2"-13	0.484"			
	627-202	M10-1.50	9/16"-12	0.515"	4		
	627-203	M12-1.75	3/4"-10	0.656"			
	627-204	M14-2.00	7/8"-9	0.687"	3		
627-B97-1P	M16-2.00	1"-8	0.781"				
Carbon Steel Inserts - Automotive	627-206	M10-1.00	9/16"-18	0.453"	4		C185
	627-207	M12-1.25	5/8"-18	0.453"			
	627-B18-1M			0.703"			
	627-209	M14-1.25	3/4"-16	0.328"			
	627-B82-1M			0.453"			
	627-B83-1X			0.703"			
	627-B85-1P	M18-1.50	1"-12	0.453"			
Carbon Steel Inserts - Automotive VW Case Savers	627-214	M10-1.50	9/16"-12	1.000"			
	627-B84-1A						



A

HeliCoil ASSORTIMENT ASSORTIMENT **805-545**

**INCH COARSE (U.N.C.) AND FINE (U.N.F)
REPAIR INSERT ASSORTMENT
24 SIZES - 174 PIECES**

4 U.N.C. Sizes — 87 Inserts. (2-56, 4-40, 6-32 and 8-32)
4 U.N.F. Sizes— 87 Inserts. (3-56, 4-48, 6-40 and 8-36)
Plus 8 Taps and 8 Installation Tools.

Furnished in REGULAR SIZE Steel drawer. Drawer will fit into Slide Racks shown on page A2

Shipping Weight: **2.5 kg** (5.52 lbs)

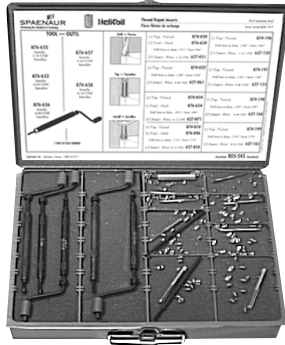
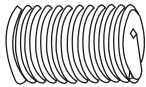

Name	Spaenaur No.	Thread Size	Qty.	Page
HeliCoil Industrial Screw Threaded Insert Tap Plug	874-034	#2-56	1	C209
	874-030	#3-48		
	874-032	#5-40		
	874-010	#8-32		
HeliCoil Industrial Screw Threaded Insert 304 Stainless Steel	874-046	#10-24	25	C211
	627-051	#2-56		
	627-150	#3-56		
	627-061	#4-40		
	627-155	#4-48	12	C209
	627-071	#6-32		
	627-160	#6-40		
	627-850	#8-32		
HeliCoil Threaded Insert Tap Finishing Plug For Aluminum or Steel	627-165	#8-36	1	C208
	874-196	#3-56		
	874-197	#4-48		
	874-198	#6-40		
HeliCoil Installation Tool	874-199	#8-36	1	C208
	876-650	#2-56		
	876-655	#3-56		
	876-652	#4-40		
	876-656	#4-48		
	876-654	#6-32		
	876-657	#6-40		
	876-658	#8-36		

HeliCoil ASSORTIMENT ASSORTIMENT **805-463A**

**Inch Coarse (U.N.C.)
24 sizes - 88 only HeliCoil Inserts**

Shipping Weight **3.18 kg** (7 lbs.)

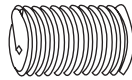

Name	Spaenaur No.	Thread Size	Qty.	Page
HeliCoil Industrial Screw Threaded Insert 18-8 Stainless Steel	627-851	#10-24	12	C209
	627-853	1/4"-20		
	627-854	5/16"-18		
	627-855	3/8"-16	10	C210
	627-856	7/16"-14		
	627-857	1/2"-13		
HeliCoil Threaded Insert Tap Finishing Plug For Aluminum or Steel	627-859	5/8"-11	1	C208
	627-860	3/4"-10		
	874-011	#10-24		
	874-013	1/4"-20		
	874-014	5/16"-18		
HeliCoil Installation Tool	874-015	3/8"-16	1	C209
	874-016	7/16"-14		
	874-017	1/2"-13		
	874-019	5/8"-11		
	874-020	3/4"-10		
	876-030	#10-24		
	876-683	1/4"-20		
	876-033	5/16"-18		
876-685	3/8"-16			
HeliCoil Installation Tool	876-035	7/16"-14	1	C208
	876-036	1/2"-13		
	876-038	5/8"-11		
	876-039	3/4"-10		

Regular Size Drawer: 13-3/8" x 9-1/4" x 2". Grey Enamelled Drawer fits the Slide Racks shown on page A2
Inside lid label shows Part Nos. for ordering refills, installation instructions, etc.

HeliCoil ASSORTIMENT ASSORTIMENT **805-464**

**Inch Fine (U.N.F.)
304 Stainless Steel
24 sizes - 88 only HeliCoil Inserts**

Shipping Weight **3.5 kg** (7.75 lbs.)

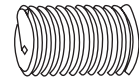

Name	Spaenaur No.	Thread Size	Qty.	Page	
HeliCoil Industrial Screw Threaded Insert 304 Stainless Steel	627-867	#10-32	12	C211	
	627-868	1/4"-28			
	627-869	5/16"-24			
	627-870	3/8"-24	10	C212	
	627-871	7/16"-20			
	627-872	1/2"-20			
	HeliCoil Threaded Insert Tap Finishing Plug For Aluminum or Steel	627-874	5/8"-18	1	C211
		627-875	3/4"-16		
874-070		#10-32			
874-071		1/4"-28			
874-072		5/16"-24			
874-073		3/8"-24			
874-074		7/16"-20			
HeliCoil Installation Tool	874-075	1/2"-20	1	C208	
	874-077	5/8"-18			
	874-078	3/4"-16			
	876-070	#10-32			
	876-071	1/4"-28			
	876-072	5/16"-24			
	876-073	3/8"-24			
	876-074	7/16"-20			
876-075	1/2"-20				
876-077	5/8"-18				
876-078	3/4"-16				

A70

P: 1-800-265-8772 F: 1-888-252-6380 service@spaenaur.com

Spaenaur reserves the right to substitute parts in any assortment without notice. For any questions or suggestions about our Assortments and Plastikits, please contact us 1-800-265-8772. © 2018 Spaenaur Inc. All rights reserved. Catalog may not be reproduced, in whole or in part, without the written permission of Spaenaur Inc. Subject to Catalog Terms and Conditions of Use available at Spaenaur.com and on page TC2 and TC3 at the back of this catalog. Spaenaur se réserve le droit de remplacer des pièces dans n'importe quel assortiment sans préavis. Pour toute question ou suggestion concernant nos Assortiments et Plastikits, veuillez nous contacter au 1-800-265-8772. © 2018 Spaenaur Inc. Tous droits réservés. Le catalogue ne peut être reproduit, en tout ou en partie, sans l'autorisation écrite de Spaenaur Inc. L'utilisation est soumise aux Conditions d'utilisation du Catalogue disponibles sur Spaenaur.com et à la page TC4 et TC5 à la fin de ce catalogue.

HeliCoil[®] METRIC ASSORTMENTS



ASSORTMENT 805-465
ASSORTIMENT

METRIC COARSE AND FINE

304 Stainless Steel

Contains: 108 Pieces - 22 Sizes (M5 to M12 sizes) Plus 7 Taps and 7 Installation Tools. Complete with installation instructions

Shipping Weight **2.6 kg** (5.75 lbs.)



Name	Spaenaur No.	Thread Size	Overall Length	Compatible Drill Size	Qty.	Page
304 Stainless Steel Industrial Screw Threaded	627-920	M5 x 0.80	7.5mm	5.20mm	12	C213
	627-B98-1Y	M6 x 1.00	9.0mm	6.25mm		
	627-931	M8 x 1.00	8.0mm	8.25mm		
	627-924	M8 x 1.25	12.0mm	8.30mm		C215
	627-327	M10 x 1.25	15.0mm	10.25mm		C215
	627-325	M10 x 1.25		10.50mm		C216
	627-925	M10 x 1.50	10.50mm	C215		
627-926	M12 x 1.75	18.0mm	12.50mm	10	C213	
Name	Spaenaur No.	Thread Size	Width A/F	Compatible Drill Size	Qty.	Page
Tap Finishing Plug For Aluminum / Steel	874-520	M5 x 0.80	4.95mm	5.30mm	1	C213
	874-521	M6 x 1.00	6.14mm	6.30mm		
	874-570	M8 x 1.00	7.36mm	8.30mm		
	874-524	M8 x 1.25		8.40mm		
	874-571	M10 x 1.25	7.08mm	10.25mm	1	C216
	874-525	M10 x 1.50		10.50mm		
	874-526	M12 x 1.75	8.33mm	12.50mm	1	C213
	Name	Spaenaur No.	Thread Size			Qty.
Installation Tool	877-000	M5 x 0.80			1	C208
	877-001	M6 x 1.00				
	877-011	M8 x 1.00				C208
	877-004	M8 x 1.25				C215
	877-012	M10 x 1.25				C208
	877-005	M10 x 1.50				C215
	877-006	M12 x 1.75				C208

ASSORTMENT 805-466
ASSORTIMENT

METRIC SPARK PLUG SERIES

304 Stainless Steel

Contains: 10 sizes - 60 Inserts Plus 5 Taps and 5 Installation Tools

Shipping Weight **5.67 kg** (12-1/2 lbs.)

Name	Spaenaur No.	Thread Size	Overall Length	Qty.	Page	
HeliCoil Industrial Screw Threaded Insert Plug Tap For Steel	627-883	7/8"-18	5/8"	6	C214	
	627-938	M10 x 1.00	1/2"			
	627-939	M12 x 1.25	3/4"			
	627-940		3/8"			
	627-941	7/16"				
	627-942	M14 x 1.25	0.472"			
	627-945		1/2"			
	627-943		3/4"			
	627-944	M18 x 1.50	1/2"			C214
	627-946		1/2"			C215
Name	Spaenaur No.	Thread Size		Qty.	Page	
Hand Tool Spark Plug Series Inch and Metric	876-086	7/8"-18		1	C214	
	874-086					
	874-531	M10 x 1.0				
	877-017					
	874-532	M12 x 1.25				
	877-018					
	874-533	M14 x 1.25				
	877-019					
	874-536	M18 x 1.50				C214
	877-020					C215

ASSORTMENT **B-558C**
ASSORTIMENT

STEEL FLAT WASHERS

Zinc Plated
17 SIZES
1190 PIECES



REGULAR SIZE welded Steel grey enamel
Drawer has hinged lid and "scooped" Bins.
Drawer fits the Slide Racks shown on Page A2

Shipping Weight - **8.16 kg** (18 lbs.)

Compatible Bolt Size	Spaenaur No.	Inner Diameter	Outer Diameter	Thickness	Qty.	Page
#8	656-B54-1T	11/64"	3/4"	0.031"	100	D3
	656-B37-2Y	3/16"	7/16"	0.036" - 0.065"	200	D2
	656-B32-1W		1/2"	0.055" - 0.065"	150	D4
#14	656-B35-1A	1/4"	5/8"	0.044" - 0.052"		100
3/16"	656-B46-1X		9/16"	0.036" - 0.065"		
1/4"	656-B01-1Y	5/16"	3/4"	0.051" - 0.080"	50	D3
5/16"	656-B34-1Y	11/32"	1-1/4"	0.065"	40	
	656-B19-1M		1-1/2"	0.083"	50	
	656-B72-1X	3/8"	7/8"	0.064" - 0.104"	40	D3
3/8"	656-B66-1T	25/64"	1-1/2"	0.083"	25	D2
	92-SN-ZP	7/16"	1"	0.064" - 0.104"		D3
	656-B28-1E		1-3/4"	0.078"		D2
7/16"	656-B68-1W	1/2"	1-1/4"	0.064" - 0.104"	10	D2
1/2"	656-B57-1M	9/16"	1-3/8"	0.086" - 0.132"		
9/16"	B-927-ZP	5/8"	1-1/2"	0.122" - 0.177"		
3/4"	105-SN-ZP	13/16"	2"			

ASSORTMENT **805-520**
ASSORTIMENT

FLAT WASHERS
18-8 Stainless Steel

16 SIZES
967 PIECES



REGULAR SIZE Steel, grey enamel Drawer
will fit Slide Racks shown on page A2.

Shipping Weight **4.31 kg** (9-1/2 lbs.)

Spaenaur No.	Compatible Bolt Size	Inner Diameter	Outer Diameter	Thickness	Qty.	Page
W-2009	#2	0.0937"	1/4"	0.012" - 0.022"	100	D6
658-B06-2T	#4	0.1250"	5/16"	0.022" - 0.041"		D6
658-B05-1N	#6	0.1470"	3/8"			E33
658-B04-1C	#8	0.1710"				D6
658-B02-2P	#10	0.2000"	7/16"			D6
W-2037	#12	0.2430"	1/2"	0.045" - 0.075"	50	D6
658-015	1/4"	0.2810"	5/8"	0.034" - 0.068"		
658-B26-1P	5/16"	0.3430"	3/4"			
W-2039	3/8"	0.3910"	1"	0.040" - 0.075"		
658-B22-1W	7/16"	0.5000"	1-1/8"	0.045" - 0.075"		
658-B21-1K	1/2"	0.5620"	1-1/4"	0.056" - 0.112"		
658-B16-1C	5/8"	0.6870"	1-1/2"			
658-B20-1T	3/4"	0.8120"	1-7/8"	0.075" - 0.155"		
658-B29-1N	7/8"	0.9370"	2-1/4"			
658-B25-1A	1"	1.0625"	2-1/2"	0.109" - 0.140"		
W-2072	1-1/4"	1.3120"	2-3/4"		2	

PLASTIKIT **804-081**
«PLASTIKIT»

14 SIZES
270 PIECES

FLAT AND HELICAL LOCKWASHERS
STEEL, Zinc Plated

Put up in a clear durable plastic container with hinged lid.
Size: 1" x 2-3/4" x 4-1/2"

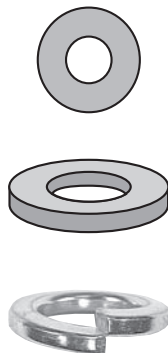

Name	Spaenaur No.	Compatible Bolt Size	Thickness	Qty.	Page
Steel Flat Washer Zinc Plated	656-B48-1P	#6	0.036" - 0.065"	20	D2
	656-B55-1X	#8	0.044" - 0.052"		D4
	656-B07-1M	#10	0.036" - 0.065"		E33
	656-B33-1M	1/4"	0.051" - 0.080"	10	D2
	656-B47-1A	5/16"			
	656-B02-1Z	3/8"			
Helical Lockwasher Zinc Plated	W-177	1/2"	0.098" - 0.112"	10	D5
	W-311	#6	0.031"	20	D22
	663-W03-1M	#8	0.040"		
	663-W05-1A	#10	0.047"		
	16-SN	1/4"	0.062"		
	17-SN	5/16"	0.078"		
	663-W06-1P	3/8"	0.094"		
20-SN	1/2"	0.125"			

ASSORTMENT
ASSORTIMENT **805-519**

BRASS FLAT WASHERS
16 SIZES - 1315 PIECES

REGULAR SIZE Steel, grey enamel Drawer will fit Slide Racks shown on page A2

Shipping Weight:
3.18 kg (7 lbs.)



Spaenaur No.	Compatible Screw Size	Compatible Bolt Size	Inner Diameter	Outer Diameter	Thickness	Qty.	Page	
649-B01-2C	#2		0.092"	3/16"	0.018"	200	D8	
W-501	#3		0.105"	1/4"	0.020"			
649-B20-1M	#4		0.119"	9/32"	0.025"			
W-528	#5	1/8"	0.133"	5/16"	0.028"	100		
649-B21-1X	#6	5/32"	0.147"					0.032"
649-B14-1N	#8		0.172"	3/8"	0.036"			
649-B13-1C	#10	3/16"	0.200"	7/16"	0.040"			25
649-B19-1X	#12	7/32"	0.227"	1/2"	0.051"			
649-B09-1P	#14	1/4"	0.260"	9/16"	0.064"			10
649-B15-1T	#18	5/16"	0.310"	11/16"	0.050"			
649-B18-1M	#20		0.337"	3/4"	0.081"			
W-540		3/8"	0.390"	0.682"	0.091"	10		
649-B17-1W	#30	7/16"	1/2"	1-1/8"	0.102"			
649-B12-1Y	#34	1/2"	9/16"	1-1/4"	0.114"			
W-519		5/8"	11/16"	1-1/2"				
649-B03-1M		3/4"	13/16"	1-7/8"				

ASSORTMENT
ASSORTIMENT **B-584A**

FIBRE WASHERS of Red, Vulcanized Fibre
24 SIZES — 1000 PIECES

REGULAR SIZE Steel, grey enamel Racks shown on page A2

Shipping Weight:
2.49 kg (5-1/2 lbs.)

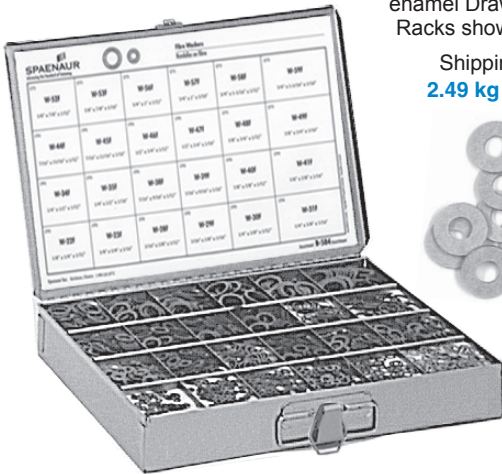

Name	Spaenaur No.	Inner Diameter	Outer Diameter	Qty.	Page
Flat Washer 1/32" Thickness	638-C01-1C	1/8"	1/4"	50	D11
	W-28F	3/16"	3/8"		
	W-30F	1/4"	1/2"		
	638-C03-1T		9/16"		
	W-38F	5/16"	9/16"	25	
	W-40F	3/8"	5/8"		
	W-44F	7/16"	11/16"		
	W-46F	1/2"	3/4"		
	W-48F	5/8"	7/8"	25	
	W-52F		1"		
W-56F	3/4"	1-1/16"	50		
W-58F		3/8"			
Flat Washer 1/16" Thickness	W-23F	1/8"	1/4"	50	
	W-29F	3/16"	3/8"		
	638-C05-1W	1/4"	1/2"		
	638-C09-1P		9/16"		
	W-39F	5/16"	5/8"	25	
	W-41F	7/16"	11/16"		
	W-45F	1/2"	3/4"		
	W-47F	5/8"	7/8"		
	W-49F		1"		
	W-53F	3/4"	1-1/16"		
W-57F					
W-59F					

PLASTIKIT
«PLASTIKIT» **804-082**

DIN 125

Metric FLAT and HELICAL LOCKWASHERS

Steel, Zinc Plated
14 SIZES – 280 PIECES

Put up in a clear durable plastic container with hinged lid. Size: 1" x 2-3/4" x 4-1/2".



Name	Spaenaur No.	Compatible Bolt Size	Inner Diameter	Outer Diameter	Thickness	Qty.	Page
Split Lockwashers	664-C07-1P	M4	4.1mm	7.6mm	0.9mm	20	D25
	664-007ZP	M5	5.1mm	9.2mm	1.2mm		
	664-008ZP	M6	6.1mm	11.8mm	1.6mm		
	664-009ZP	M7	7.1mm	12.8mm	2.0mm		
	664-C10-1Y	M8	8.1mm	14.8mm	2.2mm		
	664-011ZP	M10	10.2mm	18.1mm	2.5mm		
	664-012ZP	M12	12.2mm	21.1mm	2.5mm		
Flat Washers	657-W03-1M	M4	4.3mm	9.0mm	0.8mm	20	D12
	657-008ZP	M5	5.3mm	10.0mm	1.0mm		
	657-W04-1Y	M6	6.4mm	12.0mm	1.6mm		
	657-010ZP	M7	7.4mm	14.0mm	2.0mm		
	657-011ZP	M8	8.4mm	16.0mm	2.0mm		
	657-012ZP	M10	10.5mm	20.0mm	2.5mm		
	657-013ZP	M12	13.0mm	24.0mm	2.5mm		

A

ASSORTMENT
ASSORTIMENT **805-446**

~DIN 125A
~ ISO 7089

Metric FLAT WASHERS
A2 Stainless Steel



20 Sizes
893 Pieces

Shipping Weight:
3.2 kg (7 lb.)



Spaenaur No.	Compatible Bolt Size	Inner Diameter (min.)	Outer Diameter (max.)	Thickness (nom.)	Qty.	Page								
659-F12-1M	M1.6	1.7mm	4.0mm	0.3mm	100	D15								
659-F06-1N	M2	2.2mm	5.0mm											
659-003	M2.3	2.5mm	6.0mm	0.5mm	50		D15							
659-004	M2.6	2.8mm	7.0mm											
659-F03-1P	M3	3.2mm	8.0mm	0.8mm	80			D15						
659-006	M3.5	3.7mm							10.0mm					
659-F04-2Y	M4	4.3mm	9.0mm	1.0mm	70				D15					
659-008	M5	5.3mm	10.0mm	1.6mm	60					D15				
659-F01-1X	M6	6.4mm	12.0mm	2.0mm	40						D15			
659-F10-1K	M8	8.4mm	16.0mm	2.5mm	20							D15		
659-F02-1A	M10	10.5mm	20.0mm	3.0mm	15	D15								
659-013	M12	13.0mm	24.0mm	4.0mm	10								D15	
659-014	M14	15.0mm	28.0mm	3.0mm	6		D15							
659-015	M16	17.0mm	30.0mm	4.0mm	5									D15
659-016	M18	19.0mm	34.0mm	4.0mm	4			D15						
659-F11-1W	M20	21.0mm	37.0mm	4.0mm	3									
659-018	M22	23.0mm	39.0mm	4.0mm	2				D15					
659-019	M24	25.0mm	44.0mm							D15				
659-020	M27	28.0mm	50.0mm								D15			
659-021	M30	31.0mm	56.0mm									D15		

ASSORTMENT
ASSORTIMENT **805-447**

~DIN 125A
~ ISO 7090

Metric FLAT WASHERS
Brass



20 Sizes
940 Pieces

Shipping Weight:
3.2 kg (7 lb.)



Spaenaur No.	Compatible Bolt Size	Inner Diameter (min.)	Outer Diameter (max.)	Thickness (nom.)	Qty.	Page								
650-001	M1.7	1.8mm	4.5mm	0.3mm	100	D15								
650-002	M2	2.2mm	5.0mm											
650-003	M2.3	2.5mm	6.0mm	0.5mm	50		D15							
650-004	M2.6	2.8mm	7.0mm											
650-005	M3	3.2mm	8.0mm	0.8mm	80			D15						
650-006	M3.5	3.7mm							10.0mm					
650-007	M4	4.3mm	9.0mm	1.0mm	70				D15					
650-008	M5	5.3mm	10.0mm	1.6mm	60					D15				
650-009	M6	6.4mm	12.0mm	2.0mm	40						D15			
650-026	M7	7.4mm	14.0mm	2.5mm	20							D15		
650-K01-1C	M8	8.4mm	16.0mm	3.0mm	15	D15								
650-012	M10	10.5mm	20.0mm	4.0mm	10								D15	
650-013	M12	13.0mm	24.0mm	3.0mm	6		D15							
650-014	M14	15.0mm	28.0mm	4.0mm	5									D15
650-015	M16	17.0mm	30.0mm	4.0mm	4			D15						
650-K02-1N	M18	19.0mm	34.0mm	4.0mm	3									
650-017	M20	21.0mm	37.0mm	4.0mm	2				D15					
650-018	M22	23.0mm	39.0mm							D15				
650-019	M24	25.0mm	44.0mm								D15			
650-021	M30	31.0mm	56.0mm									D15		

ASSORTMENT
ASSORTIMENT **805-448**

~DIN 125A
~ ISO 7089

Inch & Metric FLAT WASHERS
6/6 Nylon

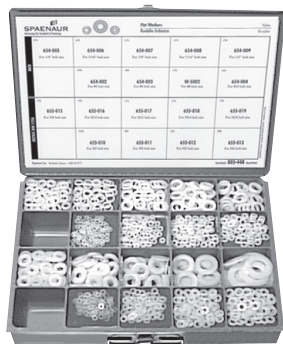

18 Sizes
1000 Pieces

Shipping Weight:
2.27 kg (5 lb.)



Spaenaur No.	Compatible Bolt Size	Inner Diameter	Outer Diameter	Thickness	Qty.	Page								
655-010	M3	3.2mm	7mm	0.5mm	100	D15								
655-011	M4	4.3mm	9mm	0.8mm	80		D15							
655-012	M5	5.3mm	11mm	1.0mm	70			D15						
655-013	M6	6.4mm	12mm	1.5mm	60				D15					
655-015	M8	8.4mm	16mm	1.6mm	50					D15				
655-016	M10	10.5mm	22mm	2.5mm	40						D15			
655-017	M12	13.0mm	24mm	3.0mm	35							D15		
655-018	M16	17.0mm	30mm	3.0mm	30								D15	
655-019	M20	21.0mm	37mm	0.032"	100									D10
654-G02-1A	#4	0.115"	0.250"	0.032"	80									
654-003	#6	0.140"	0.312"	0.062"	70	D10								
654-G06-1N	#8	0.170"	0.375"	0.062"	60		D10							
654-004	#10	0.194"	0.500"	0.093"	50			D10						
654-G07-1T	1/4"	0.257"	0.500"	0.093"	40				D10					
654-006	5/16"	0.317"	0.625"	0.093"	35					D10				
654-007	3/8"	0.380"	0.750"	0.093"	30						D10			
654-008	7/16"	0.443"	0.750"									D10		
654-009	1/2"	0.505"	0.750"										D10	

ASSORTMENT **805-411**

~DIN 125

This Standard has been replaced. Please see Catalog Page R21 for more information.

Metric

FLAT WASHERS

Steel, Plated & Plain

21 SIZES - 943 PIECES

All drawers shown above are REGULAR SIZE, welded steel, have hinged lids and finished in grey enamel. Drawers will fit Slide Racks shown on A2



Shipping Weight: **3.52 kg** (7-1/4 lbs.)



Spaenaur No.	Compatible Bolt Size	Inner Diameter	Outer Diameter	Thickness	Qty.	Page
657-001ZP	M1.7	1.8mm	4.5mm	0.3mm	100	D12
657-002ZP	M2	2.2mm	5.0mm			
657-003ZP	M2.3	2.5mm	6.0mm			
657-004ZP	M2.6	2.8mm	7.0mm			
657-W02-1W	M3	3.2mm	8.0mm	0.5mm	50	
657-006ZP	M3.5	3.7mm				
657-W03-1M	M4	4.3mm	9.0mm	0.8mm	80	
657-008ZP	M5	5.3mm	10.0mm	1.0mm	70	
657-W04-1Y	M6	6.4mm	12.0mm	1.6mm	60	
657-010ZP	M7	7.4mm	14.0mm			
657-011ZP	M8	8.4mm	16.0mm	2.0mm	40	
657-012ZP	M10	10.5mm	20.0mm			
657-013ZP	M12	13.0mm	24.0mm	2.5mm	20	
657-014ZP	M14	15.0mm	28.0mm			
657-015ZP	M16	17.0mm	30.0mm	3.0mm	10	
657-016ZP	M18	19.0mm	34.0mm			
657-017	M20	21.0mm	37.0mm			
657-018	M22	23.0mm	39.0mm	4.0mm	4	
657-W20-1P	M24	25.0mm	44.0mm			
657-020ZP	M27	28.0mm	50.0mm	4.0mm	3	
657-W07-1Y	M30	31.0mm	56.0mm			

ASSORTMENT **A-203**

Inch Sizes

SPLIT LOCKWASHERS

Steel, Plated



Helical, "Regular" and "Light" Styles

14 SIZES
582 PIECES

Regular Size Drawer Size: 13-3/8" x 9-1/4" x 2"
See page A2 for Storage Slide Rack

Shipping Weight: **2.95 kg** (6-1/2 lbs.)



Style	Spaenaur No.	Bolt Size	Width	Thickness	Qty.	Page
Light	B-488	#4	0.035"	0.020"	50	D24
	B-489	#6	0.040"	0.025"		
	B-490	#8	0.047"	0.031"		
	663-W01-1K	#10	0.055"	0.040"		
	B-492	#12	0.062"	0.047"		
Regular	663-W05-1A	#10	0.062"	0.047"	75	D22
	16-SN	1/4"	0.109"	0.062"		
	17-SN	5/16"	0.125"	0.078"		
	663-W06-1P	3/8"	0.141"	0.094"	35	
	19-SN	7/16"	0.156"	0.109"	30	
	20-SN	1/2"	0.171"	0.125"	20	
	21-SN	9/16"	0.188"	0.141"	15	
	22-SN	5/8"	0.203"	0.156"	20	
	23-SN	3/4"	0.234"	0.188"	12	

ASSORTMENT **805-528**

Inch Sizes

SPLIT LOCKWASHERS

(18-8) Stainless Steel
Helical, "Regular" Styles

16 SIZES - 1000 PIECES

Regular Drawer Size: 13-3/8" x 9-1/4" x 2" See page A2 for Storage Slide Racks.

Shipping Wt. **3.62 kg** (8 lbs.)



Spaenaur No.	Bolt Size	Width	Thickness	Qty.	Page
667-P08-2N	#2	0.035"	0.020"	100	D23
W-2022	#3	0.040"	0.025"		
667-P03-2X	#4		0.031"		
667-P04-2A	#6	0.047"			
667-P16-1A	#8	0.055"	0.040"	50	D23
667-P02-2M	#10	0.062"	0.047"		
667-P12-1K	#12	0.070"	0.056"		
667-P06-1W	1/4"	0.109"	0.062"	25	
667-P24-1K	5/16"	0.125"	0.078"		
667-P01-2W	3/8"	0.141"	0.094"	15	
W-2031	7/16"	0.156"	0.109"		
667-P11-1T	1/2"	0.171"	0.125"	10	
W-2033	5/8"	0.203"	0.156"		
W-2034	3/4"	0.234"	0.188"	10	
W-2035	7/8"	0.266"	0.219"		
667-P23-1T	1"	0.297"	0.250"		

CATALOG 14 SPAENAUR

ASSORTMENT **805-449** **DIN 127B**
ASSORTIMENT

Metric SPLIT LOCKWASHERS
A2 STAINLESS STEEL
Helical - Plain Ends
20 SIZES, 950 PIECES



Spaenaur No.	Bolt Size	Inner Diameter	Outer Diameter	Thickness	Qty.	Page
668-001	M2	2.1mm	4.4mm	0.5mm	100	D25
668-002	M2.3	2.4mm	4.9mm	0.6mm		
668-003	M2.6	2.7mm	5.2mm	0.8mm		
668-A01-1P	M3	3.1mm	6.2mm			
668-005	M3.5	3.6mm	6.7mm	0.9mm		
668-006	M4	4.1mm	7.6mm	1.2mm	80	
668-007	M5	5.1mm	9.2mm	1.6mm	60	
668-008	M6	6.1mm	11.8mm	1.6mm	50	
668-009	M7	7.1mm	12.8mm		40	
668-010	M8	8.1mm	14.8mm	2.0mm	30	
668-011	M10	10.2mm	18.1mm	2.2mm	15	
668-012	M12	12.2mm	21.1mm	2.5mm		
668-013	M14	14.2mm	24.1mm	3.0mm	10	
668-014	M16	16.2mm	27.4mm	3.5mm	8	
668-015	M18	18.2mm	29.4mm		6	
668-016	M20	20.2mm	33.6mm	4.0mm	5	
668-017	M22	22.5mm	35.9mm			
668-018	M24	24.5mm	40.0mm	5.0mm	4	
668-A06-1K	M27	27.5mm	43.0mm			
668-020	M30	30.5mm	48.2mm	6.0mm		

Regular Size grey enamel Steel Drawer will fit Slide Racks on page A2
Shipping Wt. **3.4 kg** (7-1/2 lbs.)

ASSORTMENT **805-413**
ASSORTIMENT

DIN 127B

DIN 7980

for use with Hex Head Cap Screws (DIN 931/933)

for use with Socket Head Cap Screws (DIN 912)

Metric SPLIT LOCKWASHERS
STEEL, ZINC PLATED
Helical - Plain Ends
24 SIZES - 1381 PIECES



Spaenaur No.	Bolt Size	Inner Diameter	Outer Diameter	Thickness	Qty.	Page	
DIN 127B							
664-001ZP	M2	2.1mm	4.4mm	0.5mm	100	D25	
664-002ZP	M2.3	2.4mm	4.9mm	0.6mm			
664-003ZP	M2.6	2.7mm	5.2mm	0.8mm			
664-C13-1T	M3	3.1mm	6.2mm				
664-C07-1P	M3.5	3.6mm	6.7mm	0.9mm			
664-007ZP	M4	4.1mm	7.6mm	1.2mm	80		
664-008ZP	M5	5.1mm	9.2mm	1.6mm	60		
664-009ZP	M6	6.1mm	11.8mm	1.6mm	50		
664-C10-1Y	M7	7.1mm	12.8mm		40		
664-011ZP	M8	8.1mm	14.8mm	2.0mm	30		
664-012ZP	M10	10.2mm	18.1mm	2.2mm			
664-013ZP	M12	12.2mm	21.1mm	2.5mm	15		
664-014ZP	M14	14.2mm	24.1mm	3.0mm	10		
664-015ZP	M16	16.2mm	27.4mm	3.5mm	8		
664-016ZP	M18	18.2mm	29.4mm		6		
664-017ZP	M20	20.2mm	33.6mm	4.0mm	40		
664-018ZP	M22	22.5mm	35.9mm				
664-019ZP	M24	24.5mm	40.0mm	5.0mm			
DIN 7980							
664-050ZP	M3	3.1mm	5.6mm	1.0mm	100		D27
664-C02-1K	M4	4.1mm	7.0mm	1.2mm			
664-052ZP	M5	5.1mm	8.8mm	1.6mm	80		
664-053ZP	M6	6.1mm	9.9mm		70		
664-054ZP	M8	8.1mm	12.7mm	2.0mm	50		
664-055ZP	M10	10.2mm	16.0mm	2.5mm	40		

Regular Size grey enamel Steel Drawer will fit Slide Racks on page A2
Shipping Wt. **3.4 kg** (7-1/2 lbs.)

ASSORTIMENT 4640-S
ASSORTIMENT

Tooth Lockwashers
Steel, Zinc Plated

30 VARIETIES - 877 PIECES

Furnished in a Regular Size grey enamelled steel drawer with hinged lid and scooped bins. Drawer will fit Slide Racks shown on page A2

Shipping Weight: **2.6 kg** (5.75 lbs.)



Name	Spaenaur No.	Screw / Bolt Size	Outer Diameter	Thickness	Qty.	Page
External Tooth Flat	42-SN	#4	0.260" - 0.245"	0.019" - 0.015"	25	D30
	43-SN	#6	0.320" - 0.305"	0.022" - 0.016"	35	
	44-SN	#8	0.381" - 0.365"	0.023" - 0.018"		
	671-W04-1W	#10	0.410" - 0.395"	0.025" - 0.020"		
	145	1/4"	0.510" - 0.494"	0.028" - 0.023"	25	
	47-SN	5/16"	0.588" - 0.610"	0.034" - 0.028"		
	49-SN	3/8"	0.694" - 0.670"	0.040" - 0.032"		
	1351	7/16"	0.760" - 0.740"	0.045" - 0.037"		
	1352	1/2"	0.900" - 0.880"			
	1349	9/16"	0.985" - 0.960"	0.045" - 0.037"	20	
	1481	5/8"	1.070" - 1.045"	0.050" - 0.042"	15	
51-SN	3/4"	1.260" - 1.220"	0.055" - 0.047"	12		
External Tooth - Countersunk	1063	#6	0.300" - 0.285"	0.018"	35	
	671-W02-1T	#8	0.353" - 0.337"			
	888	#10	0.370" - 0.353"	0.022"	30	
	671-W05-1M	#12	0.430" - 0.410"			
	1072	1/4"	0.513" - 0.487"	0.025"	25	
	1066	9/32"	0.543" - 0.523"			
	901	5/16"	0.625" - 0.603"	0.032"	20	
	58-SN	3/8"	0.801" - 0.776"	0.035"	10	
W-335	7/16"	0.890" - 0.863"	0.035"	10		
Internal Tooth Flat	671-W09-1Y	#4	0.270" - 0.255"	0.019" - 0.015"	25	
	671-W07-1X	#6	0.285" - 0.275"	0.021" - 0.017"	35	
	671-W11-1Y	#8	0.340" - 0.325"	0.023" - 0.018"		
	671-W03-1K	#10	0.381" - 0.365"	0.025" - 0.020"		
	1741	#12	0.410" - 0.394"	0.028" - 0.023"	25	
	788	1/4"	0.478" - 0.460"	0.034" - 0.028"		
	55-SN	5/16"	0.610" - 0.594"	0.040" - 0.032"	20	
	671-W12-1C	3/8"	0.692" - 0.670"	0.040" - 0.032"	20	
57-SN	7/16"	0.789" - 0.740"	0.040" - 0.032"	20		

A

ASSORTIMENT 805-529
ASSORTIMENT

Tooth Lockwashers

410 Stainless Steel
18 VARIETIES - 1050 PIECES



Spaenaur No.	Screw / Bolt Size	Outer Diameter	Thickness	Qty.	Page	
External Tooth Flat						
675-A01-2A	#4	0.260"-0.245"	0.019"-0.015"	100	D30	
W-2047	#6	0.320"-0.305"	0.022"-0.016"			
675-A03-2Y	#8	0.381"-0.365"	0.023"-0.018"			
675-A08-1W	#10	0.410"-0.395"	0.025"-0.020"	30		
675-A09-1M	#12	0.475"-0.460"	0.028"-0.023"			
675-A10-1W	1/4"	0.510"-0.494"	0.040"-0.032"	25		
W-2053	3/8"	0.694"-0.670"	0.045"-0.037"			
W-2055	1/2"	0.900"-0.880"	0.050"-0.042"	20		
W-2056	5/8"	1.071"-1.045"	0.050"-0.042"	20		
Internal Tooth Flat						
675-A02-2N	#4	0.270"-0.255"	0.019"-0.015"	100		
675-A05-1N	#6	0.285"-0.275"	0.021"-0.017"			
675-A06-1T	#8	0.340"-0.325"	0.023"-0.018"			
W-2062	#10	0.381"-0.365"	0.025"-0.020"	50		
W-2063	#12	0.410"-0.394"	0.028"-0.023"			
W-2064	1/4"	0.478"-0.460"	0.034"-0.028"	25		
675-A07-1K	3/8"	0.692"-0.670"	0.045"-0.037"			
W-2067	1/2"	0.900"-0.867"	0.045"-0.037"	15		
675-001	3/4"	1.245"-1.220"	0.055"-0.047"	10		

ASSORTMENT
ASSORTIMENT **805-533**

TOOTH LOCKWASHERS
PHOSPHOR BRONZE
16 VARIETIES - 1000 PIECES

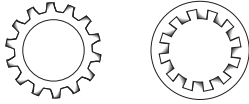

Furnished in a Regular Size grey enamelled steel drawer with hinged lid and scooped bins.
Drawer will fit Slide Racks shown on page A2

Shipping Weight **2.04 kg** (4-1/2 lbs.)

Spaenaur No.	Screw / Bolt Size	Outer Diameter	Thickness	Qty.	Page
External Tooth Flat					
W-545	#4	0.260" - 0.245"	0.019" - 0.015"	100	D30
673-A03-1N	#6	0.320" - 0.305"	0.022" - 0.016"		
W-547	#8	0.381" - 0.365"	0.023" - 0.018"		
W-548	#10	0.410" - 0.395"	0.025" - 0.020"		
673-A06-1W	1/4"	0.510" - 0.494"	0.028" - 0.023"	50	D30
Internal Tooth Flat					
W-550	#4	0.270" - 0.255"	0.019" - 0.015"	50	D30
W-571	#5	0.280" - 0.245"	0.021" - 0.017"		
W-541	#6	0.285" - 0.275"			
W-542	#8	0.340" - 0.325"	0.023" - 0.018"	100	
673-A01-1Y	#10	0.381" - 0.365"	0.025" - 0.020"		
W-572	#12	0.410" - 0.394"			
W-544	1/4"	0.478" - 0.460"	0.028" - 0.023"	50	
673-A05-1K	3/8"	0.692" - 0.670"	0.040" - 0.032"	20	
W-576	1/2"	0.900" - 0.867"	0.045" - 0.037"	10	
W-578	5/8"	1.071" - 1.045"	0.050" - 0.042"		
W-579	3/4"	1.245" - 1.220"	0.055" - 0.047"		

PLASTIKIT
«PLASTIKIT» **1706**

TOOTH LOCKWASHER
STEEL ZINC PLATED
19 VARIETIES - 188 PIECES

Put up in a clear durable plastic container with hinged lid.

Size: 1" x 2-3/4" x 4-1/2"

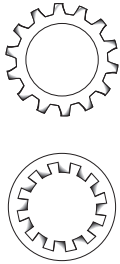

Spaenaur No.	Screw / Bolt Size	Outer Diameter	Thickness	Qty.	Page
External Tooth Flat					
671-W04-1W	#10	0.410" - 0.395"	0.025" - 0.020"	15	D30
145-A	#12	0.475" - 0.460"	0.028" - 0.023"	20	
145	1/4"	0.510" - 0.494"			
47-SN	5/16"	0.588" - 0.610"	0.034" - 0.028"	25	
49-SN	3/8"	0.694" - 0.670"	0.040" - 0.032"	10	
1351	7/16"	0.760" - 0.740"			
1352	1/2"	0.900" - 0.880"	0.045" - 0.037"	5	
1349	9/16"	0.985" - 0.960"	0.050" - 0.042"	4	
1481	5/8"	1.070" - 1.045"	0.055" - 0.047"	3	
51-SN	3/4"	1.260" - 1.220"	0.055" - 0.047"	2	
Internal Tooth Flat					
671-W03-1K	#10	0.381" - 0.365"	0.025" - 0.020"	15	D30
1741	#12	0.410" - 0.394"			
788	1/4"	0.478" - 0.460"	0.028" - 0.023"	10	
55-SN	5/16"	0.610" - 0.594"	0.034" - 0.028"	5	
671-W12-1C	3/8"	0.692" - 0.670"	0.040" - 0.032"		
57-SN	7/16"	0.789" - 0.740"			
671-W01-1N	1/2"	0.867" - 0.900"	0.045" - 0.037"	2	
B-404	5/8"	1.071" - 1.045"	0.050" - 0.042"		
B-405	3/4"	1.245" - 1.220"	0.055" - 0.047"		

ASSORTMENT
ASSORTIMENT **805-437A**

DIN 6797A
EXTERNAL TOOTH

DIN 6797J
INTERNAL TOOTH

Metric TOOTH
LOCKWASHERS - FLAT
STEEL, Zinc Plated

24 VARIETIES - 850 PIECES

Furnished in a Regular Size grey enamelled steel drawer, with hinged lid and scoop bins.
Drawer will fit Slide Racks shown on page A2

Shipping Wt: **2.72 kg** (6 lbs.)

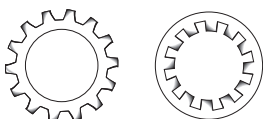

Name	Spaenaur No.	Screw / Bolt Size	Inner Diameter	Outer Diameter	Thickness	Qty.	Page
External Tooth Flat Lockwasher	672-020ZP	M3	3.2mm	6.0mm	0.4mm	40	D32
	672-030ZP	M3.5	3.7mm	7.0mm	0.5mm		
	672-021ZP	M4	4.3mm	8.0mm			
	672-022ZP	M5	5.3mm	10.0mm	0.6mm		
	672-023ZP	M6	6.4mm	11.0mm	0.7mm	35	
	672-039YZ	M7	7.4mm	12.5mm	0.8mm		
	672-024ZP	M8	8.4mm	15.0mm	1.0mm		
	672-025ZP	M10	10.5mm	18.0mm		0.9mm	
	672-026ZP	M12	12.5mm	20.5mm	1.2mm	30	
	672-027ZP	M14	14.5mm	24.0mm		1.4mm	
672-028ZP	M16	16.5mm	26.0mm	1.0mm	35		
672-032ZP	M18	19.0mm	30.0mm				
672-033ZP	M20	21.0mm	33.0mm	0.5mm	40		
672-K03-1T	M3	3.2mm	6.0mm				
672-012ZP	M3.5	3.7mm	7.0mm				
672-K02-1N	M4	4.3mm	8.0mm				
Internal Tooth Flat Lockwasher	672-003ZP	M5	5.3mm	10.0mm	0.6mm	35	D32
	672-004ZP	M6	6.4mm	11.0mm	0.7mm		
	672-005ZP	M8	8.4mm	15.0mm	0.8mm		
	672-006ZP	M10	10.5mm	18.0mm	0.9mm		
	672-007ZP	M12	13.0mm	20.5mm	1.0mm		
	672-008ZP	M14	14.5mm	24.0mm			
	672-009ZP	M16	16.5mm	26.0mm	1.2mm	30	
	672-014ZP	M18	19.0mm	30.0mm	1.4mm	25	

ASSORTMENT
ASSORTIMENT **805-451**

DIN 6797A
EXTERNAL
TOOTH

DIN 6797J
INTERNAL
TOOTH

METRIC TOOTH
LOCKWASHERS - FLAT
A2 STAINLESS STEEL

24 VARIETIES - 850 PIECES

Furnished in a Regular Size grey enameled steel drawer with hinged lid and scoop bins. Drawer will fit Slide Racks shown on page A2.

Shipping Wt. **2.95 kg** (6-1/2 lbs.)

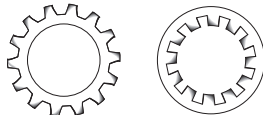

Name	Spaenaur No.	Compatible Bolt Size	Inner Diameter	Outer Diameter	Thickness	Qty.	Page
Flat Washer with External Tooth	676-003	M3	3.2mm	6.0mm	0.4mm	40	D32
	676-004	M3.5	3.7mm	7.0mm	0.5mm		
	676-005	M4	4.3mm	8.0mm	0.6mm		
	676-006	M5	5.3mm	10.0mm	0.7mm		
	676-007	M6	6.4mm	11.0mm	0.8mm	35	
	676-009	M8	8.4mm	15.0mm	0.9mm		
	676-010	M10	10.5mm	18.0mm	1.0mm		
	676-011	M12	12.5mm	20.5mm	1.2mm		
	676-012	M15	14.5mm	24.0mm	1.4mm	25	
	676-013	M16	16.5mm	26.0mm	1.4mm		
	676-014	M18	19.0mm	30.0mm	1.4mm		
	676-015	M20	21.0mm	33.0mm	1.4mm		
Flat Washer with Internal Tooth	676-F01-1N	M3	3.2mm	6.0mm	0.4mm	40	D32
	676-021	M3.5	3.7mm	7.0mm	0.5mm		
	676-022	M4	4.3mm	8.0mm	0.6mm		
	676-023	M5	5.3mm	10.0mm	0.7mm		
	676-024	M6	6.4mm	11.0mm	0.8mm	35	
	676-026	M8	8.4mm	15.0mm	0.9mm		
	676-027	M10	10.5mm	18.0mm	1.0mm		
	676-028	M12	13.0mm	20.5mm	1.2mm		
	676-029	M14	14.5mm	24.0mm	1.2mm	30	
	676-030	M16	16.5mm	26.0mm	1.2mm		
	676-031	M18	19.0mm	30.0mm	1.4mm		
	676-032	M20	21.0mm	33.0mm	1.4mm		

A

ASSORTMENT
ASSORTIMENT **805-438**

DIN 6798A
EXTERNAL
TOOTH

DIN 6798J
INTERNAL
TOOTH

METRIC
OVERLAP TOOTH LOCKWASHERS - FLAT
SPRING STEEL, Zinc Plated

24 VARIETIES - 730 PIECES

Furnished in a grey enameled steel drawer, REGULAR SIZE with hinged lid and scoop bins. Drawer will fit Slide Racks shown on page A2.

Shipping Weight: **2.72 kg** (6 lbs.)



Name	Spaenaur No.	Compatible Bolt Size	Inner Diameter	Outer Diameter	Thickness	Qty.	Page
Flat Lockwasher With External Tooth	672-052ZP	M3	3.2mm	6.0mm	0.4mm	40	D33
	672-053ZP	M3.5	3.7mm	7.0mm	0.5mm		
	672-054ZP	M4	4.3mm	8.0mm	0.6mm		
	672-K08-1A	M5	5.3mm	10.0mm	0.7mm		
	672-056ZP	M6	6.4mm	11.0mm	0.8mm	35	
	672-057ZP	M8	8.4mm	15.0mm	0.9mm		
	672-058ZP	M10	10.5mm	18.0mm	1.0mm		
	672-059ZP	M12	12.5mm	20.5mm	1.2mm		
	672-060ZP	M14	14.5mm	24.0mm	1.4mm	25	
	672-061ZP	M16	16.5mm	26.0mm	1.4mm		
	672-062ZP	M18	19.0mm	30.0mm	1.4mm		
	672-063ZP	M20	21.0mm	33.0mm	1.4mm		
Flat Lockwasher With Internal Tooth	672-068ZP	M3	3.2mm	6.0mm	0.4mm	40	D33
	672-069ZP	M3.5	3.7mm	7.0mm	0.5mm		
	672-070ZP	M4	4.3mm	8.0mm	0.6mm		
	672-071ZP	M5	5.3mm	10.0mm	0.7mm		
	672-072ZP	M6	6.4mm	11.0mm	0.8mm	30	
	672-073ZP	M8	8.4mm	15.0mm	0.9mm		
	672-074ZP	M10	10.5mm	18.0mm	1.0mm		
	672-075ZP	M12	12.5mm	20.5mm	1.0mm		
	672-076ZP	M14	14.5mm	24.0mm	1.2mm	20	
	672-077ZP	M16	16.5mm	26.0mm	1.2mm		
	672-078ZP	M18	19.0mm	30.0mm	1.4mm		
	672-079ZP	M20	21.0mm	33.0mm	1.4mm		

CATALOG 14

SPAENAUR

ASSORTMENT **805-470**
ASSORTIMENT

DIN 6798A
EXTERNAL
TOOTH

DIN 6798J
INTERNAL
TOOTH

Furnished in a Regular Size grey enamelled steel drawer with hinged lid and scoop bins. Drawer will fit Slide Racks shown on page A2.



METRIC
OVERLAP TOOTH LOCKWASHERS - FLAT
A2 STAINLESS STEEL
22 VARIETIES - 760 PIECES

Name	Spaenaur No.	Compatible Bolt Size	Inner Diameter	Outer Diameter	Thickness	Qty.	Page
Flat Lockwasher With External Tooth	676-035	M2	2.2mm	4.5mm	0.3mm	40	D33
	676-036	M2.5	2.7mm	5.5mm	0.4mm		
	676-037	M3	3.2mm	6.0mm			
	676-039	M4	4.3mm	8.0mm	0.5mm		
	676-040	M5	5.3mm	10.0mm	0.6mm		
	676-041	M6	6.4mm	11.0mm	0.7mm		
	676-043	M8	8.4mm	15.0mm	0.8mm	35	
	676-044	M10	10.5mm	18.0mm	0.9mm	30	
	676-045	M12	12.5mm	20.5mm	1.0mm	25	
	676-046	M14	14.5mm	24.0mm			
Flat Lockwasher With Internal Tooth	676-047	M16	16.5mm	26.0mm	1.2mm	40	
	676-052	M2	2.2mm	4.5mm	0.4mm		
	676-053	M2.5	2.7mm	5.5mm			
	676-F02-1T	M3	3.2mm	6.0mm			
	676-057	M5	5.3mm	10.0mm	0.6mm		
	676-058	M6	6.4mm	11.0mm	0.7mm		
	676-060	M8	8.4mm	15.0mm	0.8mm	35	
	676-061	M10	10.5mm	18.0mm	0.9mm	30	
	676-062	M12	12.5mm	20.5mm	1.0mm	25	
	676-063	M14	14.5mm	24.0mm			
676-064	M16	16.5mm	26.0mm	1.2mm			

ASSORTMENT **805-516C**
ASSORTIMENT

Regular Size welded steel drawer has hinged lid and is finished in grey enamel. Fits into Slide Racks shown on page A2.

Shipping Wt. **3.74 kg** (8-1/4 lbs.)



INCH AND METRIC NORD-LOCK®
VIBRATION PROOF FASTENERS
Zinc Plated Steel

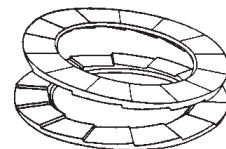

14 SIZES - 361 GLUED PAIRS

Name	Spaenaur No.	Compatible Bolt Size	Inner Diameter	Outer Diameter	Pair Thickness	Qty.	Page
Lockwasher (Inch)	677-A61-1G	#10	5.4mm	9.0mm	1.8mm	50	D36
	677-A68-1Z	3/8"	0.406"	0.654"	0.098"		
	677-A70-1Z	7/16"	0.449"	0.728"			
	677-A59-1G	1"	1.098"	1.535"	0.134"	15	
Lockwasher (Metric)	677-A66-1P	M6	6.5mm	10.8mm	1.8mm	50	
	677-A67-1Y	M8	8.7mm	13.5mm	2.5mm		
	677-A86-1W	M12	13.0mm	19.5mm			
	677-A73-1G	M14	15.2mm	30.7mm	3.4mm	25	
	677-A75-1M	M16	17.0mm	25.4mm			
	677-A83-1S	M20	21.4mm	30.7mm			
	677-A56-1Z	M22	23.4mm	34.5mm			
	677-A82-1Z	M30	31.4mm	47.0mm	6.6mm	2	
	677-A85-1G	M33	34.4mm	48.5mm			
	677-A51-1M	M39	40.4mm	58.5mm			

ASSORTMENT 805-527
ASSORTIMENT 805-527

Inch & Metric Sizes
SPRING TENSION WASHERS
 Steel - Plain Finish

Bowed and Wave
29 SIZES - 1175 WASHERS

Furnished in a Regular Size grey enamelled STEEL Drawer, with scooped bins. Drawer will fit into Slide Racks shown on page A2

Shipping Weight: **2.26 kg** (5 lbs.)

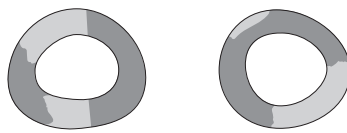

A

Name	Spaenaur No.	Compatible Bolt Size	Inner Diameter	Outer Diameter	Material Thickness	Qty.	Page
Washer Bowed Spring Tension Type	W-2075		0.095" - 0.099"	0.297" - 0.307"	0.009"	25	D65
	W-209		1/8"	1/2"	0.016"	50	
	W-261		11/64"	15/64"	0.010"	25	
	W-172		3/16"	9/16"	0.008"	50	
	W-208			3/4"	0.020"		
	680-003			0.370"	0.010"		
	W-262		13/64"	7/16"	0.014"	25	
	680-002			17/32"	0.014"		
	W-210		1/4"	1/2"	0.016"	50	
	W-162S		17/64"		0.010"		
	W-211		9/32"	5/8"	0.012"	25	
	W-213		0.320"		0.020"		
	W-214		21/64"	1/2"	0.012"		
	W-268		25/64"	3/4"	0.020"	50	
	W-269		7/16"		0.017"		
	680-B01-1K		0.505"		0.015"		
W-393		11/16"	29/32"	0.025"	25		
649-B04-1K		49/64"	1"	0.020"			
Washer Spring Type Single Wave - Inch	W-379	#10	0.204" - 0.195"	0.313" - 0.293"	0.016"	50	
	B-1373	1/4"	17/64"	1/2"	0.008"		
	B-1374	3/8"	13/32"	39/64"	0.010"		
	W-383	7/16"	29/64"	0.840"	0.015"		
	W-142	9/16"	37/64"	7/8"	0.032"		
W-385	5/8"		0.659" - 0.640"	0.885" - 0.865"	0.015"	50	
Washer Spring Type Single Wave - Metric	681-136	M3.5	3.7mm	8.0mm	0.5mm	50	D66
	681-112	M4	4.3mm	9.0mm			
	681-114	M6	6.4mm	12.0mm			
	681-138	M20	21.0mm	36.0mm	1.6mm	50	
Washer Spring Type Double Wave	681-129	M8	8.1mm	13.8mm	0.2mm	25	D67

CATALOG 14

SPAENAUR

ASSORTMENT **805-417A**
ASSORTIMENT

METRIC SPRING TENSION WASHERS
High Grade Tempered Steel
Plain Finish (Oil)

Contains 24 SIZES - 1800 PIECES

Bowed Spring **DIN 137A**

Single Wave Spring **DIN 137B**

Double Wave Spring Washers **DIN 137A**

Regular Size welded STEEL drawer is finished in grey enamel with 24 scooped bins. Will fit into the Slide Racks shown on page A2

Shipping weight **3.06 kg** (6.75 lbs.)

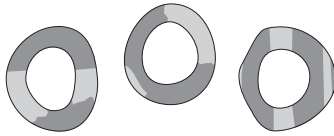

Spaenaur No.	Compatible Bolt Size	Inner Diameter	Outer Diameter	Overall Height	Material Thickness	Qty.	Page
681-100	M2	2.3mm	4.5mm	0.50mm	0.30mm	100	D66
681-101	M2.5	2.8mm	5.5mm	0.55mm			
681-102	M3	3.2mm	6.0mm	0.65mm			
681-111			8.0mm	0.80mm			
681-135	M3.5	3.7mm	7.0mm	0.70mm	0.40mm	50	D66
681-136			8.0mm	0.90mm			
681-103	M4	4.3mm	9.0mm	1.00mm	0.50mm	100	D66
681-112				0.80mm			
681-104	M5	5.3mm	10.0mm	0.90mm	0.50mm	100	D66
681-113			11.0mm	1.10mm			
681-124	M6	6.2mm	11.3mm	1.50mm	0.25mm	50	D66
681-D28-1M			11.0mm	1.10mm			
681-114	M7	7.4mm	12.0mm	1.30mm	0.50mm	100	D66
681-106			1.20mm				
681-115YZ	M8	8.1mm	14.0mm	1.50mm	0.80mm	80	D66
681-129			1.35mm				
681-D23-1C	M8	8.4mm	17.0mm	1.50mm	0.80mm	60	D66
681-107			1.70mm				
681-D22-1Y	M10	10.5mm	18.0mm	2.00mm	0.80mm	50	D66
681-117			21.0mm	2.10mm			
681-109	M12	13.0mm	22.0mm		0.80mm	40	D66
681-118			24.0mm	2.50mm			
681-119	M14	15.0mm	28.0mm	3.00mm	1.60mm	30	D66
681-120	M16	17.0mm	30.0mm	3.20mm	1.60mm	20	D66

ASSORTMENT **B-598**
ASSORTIMENT

INCH
Finishing Washers

Steel, Stainless Steel & Brass Plated

Contains 20 SIZES - 1700 PIECES



Name	Spaenaur No.	Compatible Bolt Size	Outer Diameter	Qty.	Page	
Washer For Finishing Screw Countersunk & Flush Type	7141	#4	25/64"	100	D68	
	7137	#6	11/32"			
	7143		7/16"			
	7138	3/8"				
	643-A02-1T	#8	17/32"			
	7145-B					
	7146	#9				
	7139	#10	15/32"			
	7147		19/32"			
	643-A04-1W	#12	9/16"			
	7148		11/16"			
	W-374NP	1/4"	25/32"			50
	7150	9/32"				25
	7151	5/16"	7/8"			
7153	3/8"	1-1/8"	50			
Washer Cup Type	122816N			9/16"		
	W-88		3/4"			
Washer Flange Type Countersunk	W-10	#8	0.615"	100	D68	
Washer Flush Countersunk	642-A01-1T	#10	0.719"			
	W-316	#8	1/2"			

Regular Size welded STEEL drawer is finished in grey enamel with 24 scooped bins. Will fit into the Slide Racks shown on page A2
Shipping weight **3.06 kg** (6.75 lbs.)

ASSORTMENT 805-629
ASSORTIMENT 805-629

SHIM RINGS
Steel Not Plated
Without Keyway

73 SIZES - 730 PIECES

Large size welded STEEL grey enamelled
 Drawer has "scooped" bins.
 Drawer fits Slide Racks on page A3

Shipping Wgt. **4.42 kg** (9.75 lbs)

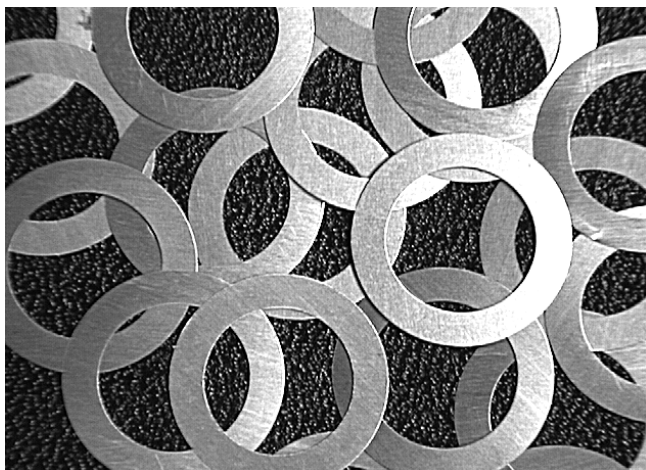

Inner Diameter	Outer Diameter	Spaenaur No.	Thickness	Qty.	Page
3/8"	5/8"	656-150	0.002"	10	D76
		656-151	0.003"		
		656-152	0.005"		
		656-153	0.010"		
		656-154	0.015"		
		656-155	0.020"		
		656-156	0.031"		
		656-157	0.047"		
		656-158	0.062"		
		656-159	0.002"		
1/2"	3/4"	656-160	0.003"		
		656-161	0.004"		
		656-162	0.005"		
		656-163	0.010"		
		656-164	0.015"		
		656-165	0.020"		
		656-166	0.031"		
		656-167	0.047"		
		656-B61-1A	0.062"		
		656-169	0.002"		
5/8"	1"	656-170	0.003"		
		656-171	0.004"		
		656-172	0.005"		
		656-173	0.010"		
		656-174	0.015"		
		656-175	0.020"		
		656-176	0.031"		
		656-177	0.047"		
		656-178	0.062"		
		656-179	0.002"		
3/4"	1-1/8"	656-180	0.003"		
		656-181	0.004"		
		656-182	0.005"		
		656-183	0.010"		
		656-184	0.015"		
		656-185	0.020"		
		656-186	0.031"		
		656-187	0.047"		
		656-188	0.062"		
		656-191	0.002"		
7/8"	1-3/8"	656-189	0.010"		
		656-190	0.015"		
		656-192	0.031"		
		656-193	0.002"		
		656-194	0.003"		
		656-195	0.004"		
		656-196	0.005"		
		656-197	0.010"		
		656-198	0.015"		
		656-199	0.020"		
1"	1-1/2"	656-200	0.031"		
		656-201	0.047"		
		656-202	0.062"		
		656-203	0.003"		
		656-204	0.005"		
		656-205	0.010"		
		656-206	0.004"		
		656-207	0.005"		
		656-208	0.010"		
		656-209	0.031"		
1-1/4"	1-3/4"	656-210	0.047"		
		656-211	0.003"		
		656-212	0.005"		
		656-213	0.010"		
		656-214	0.005"		
		656-215	0.010"		
		656-216	0.020"		
		656-217	0.005"		
		656-218	0.010"		
		656-219	0.020"		
1-3/8"	1-7/8"	656-220	0.005"		
		656-221	0.010"		
		656-222	0.020"		
		656-221	0.010"		
		656-222	0.020"		

A

ASSORTMENT 805-630
ASSORTIMENT 805-630

SHIM RINGS WITH KEYWAY

Steel, Not Plated

64 SIZES — 490 PIECES

Large Size welded STEEL, grey enamelled Drawer has "scooped" bins. Fits Slide Racks shown on page A3
 Shipping weight **4.31 kg** (9.5 lbs.)

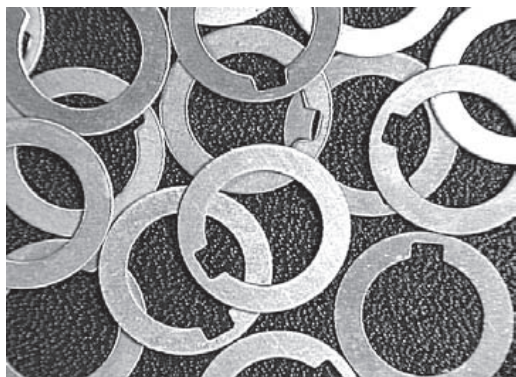

Keyway Width	Inner Diameter	Outer Diameter	Spaenaur No.	Thickness	Qty.	Page			
1/4"	1"	1-1/2"	656-331	0.001"	10	D77			
			656-332	0.002"					
			656-333	0.003"					
			656-334	0.004"					
			656-335	0.005"					
			656-336	0.007"					
			656-337	0.010"	7				
			656-338	0.012"					
			656-339	0.020"					
			656-340	0.025"					
			1/8"	1/2"	3/4"		656-341	0.031"	4
							656-342	0.047"	
							656-343	0.062"	
							656-344	0.093"	
							656-345	0.125"	10
							656-346	0.005"	
656-347	0.010"								
656-304	0.004"	10							
656-305	0.005"								
656-306	0.010"								
3/16"	3/8"	5/8"	656-307	0.031"	7				
			656-308	0.047"					
			656-309	0.062"	4				
			656-310	0.125"					
			656-300	0.004"		10			
			656-301	0.005"					
	656-302	0.010"							
	5/8"	5/8"	1"	656-303	0.031"	7			
				656-311	0.004"				
				656-312	0.005"				
				656-313	0.010"	10			
				656-314	0.015"				
656-315				0.031"					
656-316				0.047"	4				
656-317				0.002"					
656-318				0.003"					
7/8"		1-3/8"	1-1/8"	656-319	0.005"	10			
				656-320	0.010"				
				656-321	0.012"				
				656-322	0.015"	7			
				656-323	0.031"				
				656-324	0.047"				
				656-325	0.003"	10			
				656-326	0.004"				
				656-327	0.005"				
3/4"	7/8"	1-3/8"	656-328	0.010"	7				
			656-329	0.031"					
			656-330	0.047"					
			656-348	0.002"	10				
			656-349	0.003"					
			656-350	0.004"					
	5/16"	1-1/4"	1-3/4"	656-351	0.005"	10			
				656-352	0.006"				
				656-353	0.007"				
				656-354	0.008"				
				656-355	0.010"				
				656-356	0.012"				
656-357				0.015"	7				
656-358				0.020"					
656-359				0.025"					
656-360				0.031"	4				
656-361				0.062"					
656-362				0.093"					
656-363	0.125"								

Inch

Pouce

ASSORTMENT
ASSORTIMENT **805-637C**

**POP® RIVETS
& BACK-UP
WASHERS**

**21 VARIETIES
2700 PIECES**

Size 1" x 2-3/4" x 4-1/2"
Shipping Weight: **7.03 kg** (15.5 lbs.)

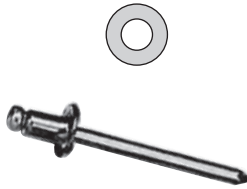

Name	Shank Diameter	Spaenaur No.	Rivet Body Length	Grip Range	Qty.	Page	
POP Rivets	3/32"	310-A16-1C	0.240"	0.031" - 0.125"	100	E18	
		PR-72	0.365"	0.126" - 0.250"		E19	
		PR-3	0.265"	0.063" - 0.125"		E24	
	310-A08-1W	E18					
	1/8"	PR-2	0.328"	0.126" - 0.187"		E25	
		PR-1	0.328"			E24	
		PR-11	0.390"	0.188" - 0.250"		E19	
		PR-66				E24	
		PR-14				E21	
		5/32"	PR-100	0.502"		0.251" - 0.312"	E21
			PR-13	0.640"			E24
	PR-69		0.353"	0.126" - 0.187"		E18	
	3/16"	310-392	0.435"	0.188" - 0.250"		E21	
		PR-64	0.540"	0.251" - 0.375"		E18	
		PR-106	0.470"	0.126" - 0.250"		E21	
		PR-58	0.565"	0.251" - 0.375"		E19	
		PR-77				E18	
	PR-55	0.690"	0.376" - 0.500"	E18			
Name	Compatible Hole Size	Spaenaur No.	Inner Diameter	Outer Diameter	Qty.	Page	
Washer Steel Flat Plain, Zinc, Nickel, Copper Finishes	#5	656-B38-1C	0.130"	7/16"	300	D4 E33	
Washer Flat Aluminum, Copper	#6	647-D01-1E	0.147"	3/8"		D9 E33	
Washer Flat 18-8 Stainless Steel	#10	658-B02-2P	0.200"	7/16"		D6 E33	

ASSORTMENT
ASSORTIMENT **805-671D**

**DOME-HEAD
POP® RIVETS
ALUMINUM RIVET
STEEL MANDREL**

**DOME HEAD
OPEN END**

**2701 PIECES
22 SIZES**

Large Size Grey enamelled
Steel Drawer will fit Slide
Racks, shown on page A3



Name	Spaenaur No.	Shank Diameter	Rivet Body Length	Qty.	Page		
POP Rivets	310-A16-1C	3/32"	0.240"	100	E18		
	PR-72		0.365"		E19		
	PR-3		0.265"		0.063" - 0.125"	E24	
	310-A08-1W	E18					
	PR-2	1/8"	0.328"		E25		
	PR-1				E24		
	PR-11				0.390"	0.188" - 0.250"	E19
	PR-66						E24
	PR-14						E21
	PR-100				5/32"	0.502"	E24
	PR-13					0.640"	E18
	PR-69	0.353"	E21				
	310-392	5/32"	0.435"		E18		
	PR-64		0.540"		E21		
	PR-106	3/16"	0.470"		E19		
	PR-58		0.565"		0.251" - 0.375"	E18	
	PR-77					E18	
	PR-55	0.690"	E18				
Name	Spaenaur No.	Compatible Bolt Size	Inner Diameter	Outer Diameter	Thickness	Qty.	Page
Flat Washer Steel Zinc Finish	656-B38-1C	#5	0.130"	7/16"	0.038" - 0.046"	300	D4 E33
Flat Washer Aluminum	647-D01-1E	#6	0.147"	3/8"	0.032"		D9 E33
Flat Washer 18-8 Stainless Steel	658-B02-2P	#10	0.200"	7/16"	0.022" - 0.041"		D6 E33
Name	Spaenaur No.	For Rivet Diameter		For Use With		Qty.	Page
Popset Hand Plier Rivet Tool	876-2100	3/32" - 1/8"		Aluminum/Steel/Stainless Rivets		1	

CATALOG 14.03
2019/04/18

SPAENAUR

A

ASSORTMENT **805-672A**
ASSORTIMENT

**Dome-Head
POP® Rivets**

**ALUMINUM, PLAIN FINISH
DOME HEAD - OPEN END**
Shank Diameter 3/32 in. - 3/16 in.

**1851 PIECES
21 SIZES**

Large Size Grey enamelled Steel
Drawer will fit Slide Racks,
shown on page A3



Name	Spaenaur No.	Shank Diameter	Rivet Body Length	Pkg Qty.	Page		
POP Rivet Dome Head Open End 5056 Aluminum Body	310-A16-1C	3/32"	0.240"	100	E18		
	PR-72		0.365"		E19		
	310-311				E18		
	310-353	1/8"	0.265"		E19		
	310-A08-1W				E18		
	310-A18-1T		0.328"				
	310-306		0.765"				
	POP Rivet Large Flange Open End 5052 Aluminum Body	PR-69	5/32"			0.353"	75
		310-356			0.540"	E18	
		PR-64				E19	
	POP Rivet 120 Degree Countersunk Head Open End 5056 Aluminum Body	310-A12-1Y	3/16"		0.440"	25	E18
		310-A17-1N					E18
		PR-58			0.565"		E19
		PR-77					E18
		310-310			0.940"		
310-327		1.190"					
POP Rivet Large Flange Open End 5052 Aluminum Body	PR-62	1/8"	0.265"	100	E19		
	PR-63		0.400"				
	310-352		0.265"				
POP Rivet Large Flange Open End 5052 Aluminum Body	310-A07-1K	3/16"	0.565"	50	E20		
Name	Spaenaur No.	For Rivet Diameter	For Use With	Pkg Qty.	Page		
Popset Hand Plier Rivet Tool	876-2100	3/32" - 1/8"	Aluminum/Steel/ Stainless Rivets	1			

ASSORTMENT **805-A03-1K**
ASSORTIMENT

**COTTER PINS
BRASS PLAIN FINISH**

Round, Extended
Prong Type

**16 Sizes
1075 Pieces**

Shipping Wt. **3.47 kg** (7.65 lbs.)

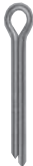

Spaenaur No.	Pin Diameter	Length Under Head	Qty.	Page				
CP-500	1/16"	1/2"	100	E43				
CP-501		3/4"						
CP-502		1"						
CP-506	3/32"	1/2"			25			
CP-507		3/4"						
CP-508		1"						
092-C01-1W		1-1/4"						
CP-511	1/8"	2"				100		
CP-515		1"						
CP-517		1-1/2"						
CP-519		2"						
CP-525	5/32"	1-1/2"					50	
CP-527		2"						
CP-531		3/4"						
CP-534	3/16"	1-1/2"						50
CP-536		2"						
			25					

ASSORTMENT **B-585**
ASSORTIMENT

**HAMMER-LOK
COTTER PINS**

PLAIN STEEL

**14 Sizes
1445 Pieces**

Shipping Weight:
4.23 kg (9-1/2 lbs.)



Spaenaur No.	Pin Diameter	Length Under Head	Qty.	Page
CP-55	1/16"	1/2"	150	E42
CP-56		1"	200	
CP-57	3/32"	1/2"	150	
CP-58		3/4"		
CP-59		1"		
CP-60		1-1/2"		
CP-61	1/8"	1"	80	
CP-62		1-1/4"	75	
CP-63		1-1/2"		
CP-64		2"		
CP-65	5/32"	1-1/2"		
091-A02-1X		2"		
CP-67	3/16"	1-1/2"	75	
CP-68		2"	50	

Regular Size welded steel drawer has hinged lid and is finished
in grey enamel. Fits into Slide Racks shown on page A2.

CATALOG 14.03
2019/04/18

SPAENAUR



ASSORTMENT
ASSORTIMENT **805-523**

COTTER PINS

18-8 STAINLESS STEEL
ROUND, EXTENDED
PRONG STYLE

20 Sizes
1400 Pieces

Spaenaur No.	Pin Diameter	Length Under Head	Qty.	Page		
CP-2003	1/32"	1/2"	100	E44		
093-F16-1N	3/64"					
093-F12-1A	1/16"				3/4"	
093-F11-1X					1"	
CP-2010	5/64"	1-1/4"		E44		
CP-2011		1/2"		L93		
CP-2012	3/32"	3/4"		50	E44	
CP-2015		1"				
093-F10-1M		1-1/4"				
CP-2017		1-1/2"				
CP-2018	2"	75				
CP-2019	1/8"	1"	50	E44		
093-F09-1X		1-1/4"				
CP-2022		1-1/2"				
093-F02-1Y	5/32"	2"	25	E44		
CP-2000		1-1/2"				
093-F21-1W	2"	1"			5	E43
CP-2030	1"					
CP-2031	3/16"	1"	5	E43		
CP-2036	1/4"	2"	15			

Shipping Wt. **3.78 kg** (8.35 lbs.)

Regular size welded STEEL drawers have hinged lid, SCOOPED bins, and are finished in grey enamel. Drawers fit Slide Racks on page A2.



ASSORTMENT
ASSORTIMENT **B-581**

COTTER PINS

PLAIN STEEL
ROUND, EXTENDED
PRONG STYLE

14 Sizes
1575 Pieces



Spaenaur No.	Pin Diameter	Length Under Head	Qty.	Page	
CP-2	1/16"	3/4"	75	E43	
091-A04-1P		1"	200		
CP-4		1-1/4"	150		
CP-9	3/32"	3/4"	125		
091-A13-1M		1"			
CP-11		1-1/4"			
091-A14-1X	1/8"	1-1/2"	80		E43
091-A17-2Y		2"			
091-A15-1A		1"			
091-A11-1K	5/32"	1-1/4"	75		E43
091-A30-1P		1-1/2"	100	L75	
091-A39-1A	5/32"	2"	45	E43	
091-A18-1C		1-1/2"	50		
091-A19-1N		2"	50		

Shipping Wt. **5.53 kg** (10 lbs.)

PLASTIKIT
«PLASTIKIT» **A-44**

COTTER PINS
Round Plain Steel

14 Sizes - 250 Pieces

Clear plastic box with hinged lid. Size 1" x 2-3/4" x 4-1/2"

Spaenaur No.	Pin Diameter	Length Under Head	Qty.	Page	
CP-2	1/16"	3/4"	5	E43	
091-A04-1P		1"	45		
CP-4		1-1/4"	15		
CP-9		3/4"	25		
091-A13-1M	3/32"	1"	20		
CP-11		1-1/4"			
091-A14-1X		1-1/2"			
CP-13		1-3/4"			10
091-A15-1A	1/8"	1"	20		E43
091-A11-1K		1-1/4"	15		
091-A30-1P		1-1/2"	5	E43	
091-A39-1A	2"				
091-A18-1C	5/32"	1-1/2"	5	E43	
091-A19-1N		2"	15		

ASSORTMENT
ASSORTIMENT
805-475

~ **DIN 94**

Metric
COTTER PINS

Plain Steel
24 SIZES
1473 PIECES

Regular size welded STEEL drawer has hinged lid "scooped" bins, and is finished in Grey enamel. Drawer fits Slide Racks shown on page A2

Shipping weight:
5.56 kg (12.25 lbs)



Spaenaur No.	Pin Diameter	Length Under Head	Qty.	Page	
091-313	2.0mm	16mm	100	E45	
091-315		20mm			
091-317		25mm			
091-323	2.5mm	20mm			80
091-325		25mm			
091-327		32mm			
091-329		40mm			
091-334	3.2mm	20mm			25
091-337		28mm			
091-340		40mm			
091-342	4.0mm	50mm	20		
091-347		25mm			
091-349		32mm			
091-351		40mm			
091-353	5.0mm	50mm	50		
091-358		25mm			
091-360		32mm			
091-363	6.3mm	45mm	15		
091-366		63mm			
091-372	8.0mm	40mm	5		
091-374		50mm			
091-376		63mm			
091-384	8.0mm	50mm	4		
091-386		63mm			

CATALOG 14

SPAENAUR

A

ASSORTMENT
ASSORTIMENT **A-212**

HITCH PIN CLIPS
Steel - Zinc Plated

Internal Type
(Hairpin Cotter)

20 SIZES - 444 PIECES

Large size grey enamel steel drawer
Size: 18" x 12" x 3"

Shipping Weight:
4.99 kg (11 lbs.)

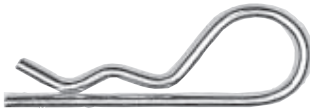

Name	Spaenaur No.	Pin Diameter	Length Under Head	Qty.	Page	
Hitch Pin Clinch Type - Steel	CP-101	3/8"	1-1/4"	5	E59	
	CP-99		1-1/2"			
Name	Spaenaur No.	Wire Gauge	Compatible Clevis Pin Diameter	Overall Length	Qty.	Page
Hitch Pin Clip Zinc Plated	CP-75H	0.028"	1/8" - 5/32"	0.600"	50	E49 E51
	090-G22-1K	0.042"	3/16" - 3/8"	29/32"		E51
	CP-69H	0.062"		1-5/32"	E49	
	CP-70H	0.073"	5/16" - 3/8"	1-7/16"		E51
	CP-83H	0.080"	3/8" - 1/2"	1-9/16"	40	
	CP-86H	3/32"	1/4" - 5/8"	2-5/16"	20	
	090-G18-1N		3/8" - 3/4"	2-1/2"	25	
	090-G06-1N	6.35mm - 12.70mm	1-5/8"	40	E51	
	CP-88H	1/8"	7/16" - 3/4"	2-9/16"	20	E49 E51
	CP-95H		3/4" - 1-1/8"	3-1/8"	10	E50 E51
	CP-72H	0.148"	5/8" - 1"	3-5/16"	20	
	CP-89H	5/32"		2-15/16"	10	
	CP-97H	0.162"	1/2" x 1" - 7/8" x 1" Rectangular	3-7/16"	8	E50 E51
	CP-90H	0.177"	5/8" - 1"	3-1/4"	10	
	CP-73H		3/4" - 1-1/16"	3-1/2"	8	
CP-92H	7/8" - 1-1/4"	3-3/4"	5			
CP-98H	0.243"	3/4" - 1"		4"		
Hitch Pin Clip Right Angle Grip	090-103	0.157"	3/8" - 1/2"	2"	10	E59

ASSORTMENT
ASSORTIMENT **805-508**

~ DIN 94

Metric COTTER PINS
A2 Stainless Steel
24 Sizes - 1473 Pieces

Regular size welded STEEL drawer has hinged lid "scooped" bins, and is finished in Grey enamel. Drawer fits Slide Racks shown on page A2

Shipping Weight: **5.44 kg** (12 lbs.)



Pin Diameter	Spaenaur No.	Length Under Head	Qty.	Page
2.0mm	093-815	18mm	100	E48
	093-817	22mm		
	093-819	25mm		
2.5mm	093-828	22mm	100	
	093-830	32mm		
	093-832	40mm		
3.2mm	093-834	16mm	80	
	093-839	32mm		
	093-842	45mm		
4.0mm	093-845	63mm	80	
	093-847	22mm	25	
	093-850	32mm	80	
093-854	50mm			
093-856	63mm			
5.0mm	093-858	80mm	20	
	093-F03-1C	45mm	50	
	093-867	63mm		
6.3mm	093-869	80mm		15
	093-875	36mm		
	093-886	50mm		
8.0mm	093-888	63mm	5	
	093-884	32mm	4	
	093-896	40mm	30	
10.0mm	093-898	50mm	2	

ASSORTMENT
ASSORTIMENT **805-509**

METRIC

HITCH PIN CLIPS
STEEL, Zinc Plated

INTERNAL TYPE
(HAIRPIN COTTERS)

Single Loop Style
and Double Loop Style.

14 SIZES - 150 PIECES

Regular Size Grey
Enamelled Drawer fits
the Slide Racks shown
on page A2

Shipping Weight **5.44 kg** (12 lbs.)

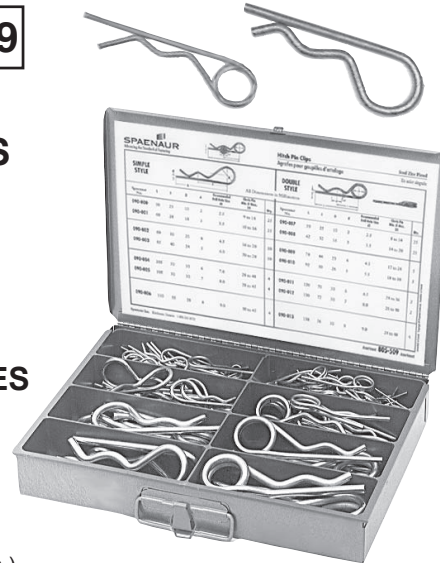

Name	Spaenaur No.	Wire Gauge	Compatible Drill Size	Compatible Clevis Pin Diameter	Overall Length	Qty.	Page
Hitch Pin Clip Single Loop	090-000	2mm	2.5mm	9mm - 14mm	50mm	25	E53 E54
	090-001	3mm	3.5mm	10mm - 16mm	60mm		
	090-002	4mm	4.5mm	16mm - 20mm			
	090-003	5mm	6.0mm	20mm - 28mm	85mm	10	
	090-004	6mm	7.0mm	28mm - 40mm	105mm		
	090-005	7mm	8.0mm	28mm - 45mm	110mm		
	090-006	8mm	9.0mm	30mm - 45mm			
Hitch Pin Clip Double Loop	090-007	2mm	2.5mm	8mm - 14mm	50mm	25	E53 E55
	090-008	3mm	3.5mm	14mm - 20mm	62mm		
	090-009	4mm	4.5mm	17mm - 24mm	78mm		
	090-010	5mm	5.5mm	18mm - 30mm	92mm	5	
	090-011	6mm	6.5mm	24mm - 36mm	120mm		
	090-G10-1K	7mm	8.0mm	26mm - 40mm	130mm	2	
	090-013	8mm	9.0mm	24mm - 40mm	130mm		

A88

P: 1-800-265-8772 F: 1-888-252-6380 service@spaenaur.com

Spaenaur reserves the right to substitute parts in any assortment without notice. For any questions or suggestions about our Assortments and Plastikits, please contact us 1-800-265-8772. © 2018 Spaenaur Inc. All rights reserved. Catalog may not be reproduced, in whole or in part, without the written permission of Spaenaur Inc. Subject to Catalog Terms and Conditions of Use available at Spaenaur.com and on page TC2 and TC3 at the back of this catalog. Spaenaur se réserve le droit de remplacer des pièces dans n'importe quel assortiment sans préavis. Pour toute question ou suggestion concernant nos Assortiments et Plastikits, veuillez nous contacter au 1-800-265-8772. © 2018 Spaenaur Inc. Tous droits réservés. Le catalogue ne peut être reproduit, en tout ou en partie, sans l'autorisation écrite de Spaenaur Inc. L'utilisation est soumise aux Conditions d'utilisation du Catalogue disponibles sur Spaenaur.com et à la page TC4 et TC5 à la fin de ce catalogue.

PLASTIKIT
«PLASTIKIT» **A-62**

HITCH PIN CLIPS
Steel, Zinc Plated

14 Sizes
40 Pieces



Internal Type

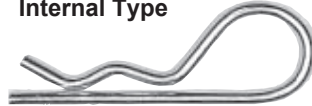

Clear Plastic Box - 1" x 2-3/4" x 4-1/2"

Spaenaur No.	Wire Gauge	Compatible Clevis Pin Diameter	Overall Length	Qty.	Page
CP-76H	0.042"	3/16" - 3/8"	29/32"	4	E49
CP-69H	0.062"		1-5/32"	5	E49 E51
CP-70H	0.073"	5/16" - 3/8"	1-7/16"		
CP-83H	0.080"	3/8" - 1/2"	1-9/16"		
090-G06-1N	3/32"	6.35mm - 12.70mm	1-5/8"	4	E51
CP-86H		1/4" - 5/8"	2-5/16"	3	E49 E51
CP-88H	1/8"	7/16" - 3/4"	2-9/16"		
CP-95H		3/4" - 1-1/8"	3-1/8"	1	
CP-89H		5/32"	5/8" - 1"	2-15/16"	3
CP-72H	0.148"	3/4" - 1-1/8"	3-5/16"	1	E50 E51
CP-90H	0.177"	5/8" - 1"	3-1/4"	3	
CP-73H		3/4" - 1-1/16"	3-1/2"	1	
CP-92H		7/8" - 1-1/4"	3-3/4"		
CP-98H	0.243"	3/4" - 1"	4"		

PLASTIKIT
«PLASTIKIT» **A-45**

HAIR PIN COTTERS
Steel, Plated

7 Sizes - 140 Pieces

Clear Plastic Box - 1" x 2-3/4" x 4-1/2"



Spaenaur No.	Center Eye Diameter	Overall Length	Qty.	Page
B-1474	1/16"	23/64"	20	E60
B-1490	3/32"	7/16"		
B-1475-SS	7/64"	1/2"		
B-1473	1/8"	31/64"		
B-1476	9/64"	15/32"		
090-G21-1T	3/16"	5/8"		
2198	5/16"	15/16"		E60 K20

ASSORTMENT
ASSORTMENT **805-503A** **LYNCH PIN**

Steel C1010 - C1018, Zinc Plated
- Designed For Safety -

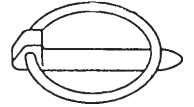

Style	Spaenaur No.	Pin Diameter	Inside Ring Diameter	Qty.	Page
Style 1	233-256	3/16"	1"	10	E69
	233-F35-1X		1-1/4"		
	233-F88-1Y	1/4"	1-3/8"		
	233-F40-1Y	5/16"	1-5/8"		
Style 2	233-F62-1A	1/4"	1-3/8"	10	
	233-262	11/32"	1-9/16"	4	
	233-255	5/16"	1-1/4"		
	233-G02-1W	7/16"	1-3/8"	5	
	B-1999		1-7/8"	4	
	B-2004			3	
		233-F74-1A			

Regular Drawer Size 13-3/8" x 9-1/4" x 2"

Grey Enamelled Drawer will fit slide racks shown on page A2
Shipping weight: **4.42 kg** (9.75 lbs.)

ASSORTMENT
ASSORTMENT **B-597**

HAIR PIN COTTERS
External Type Steel, Plated
11 SIZES - 1300 PIECES



Regular Drawer Pin Size 13-3/8" x 9-1/4" x 2"
Welded Steel drawer has "scooped" bins, and is finished in Grey Enamel. Drawer fits Slide Racks shown on page A2
Shipping Weight **2.27 kg** (5 lbs.)

Spaenaur No.	Wire Gauge	Centre Eye Inside Diameter	Overall Length	Qty.	Page
B-1474	0.026"	1/16"	23/64"	150	E60
B-1490	0.028"	3/32"	7/16"		
B-1476	0.032"	9/64"	15/32"		
B-1717		3/16"	21/32"	100	
B-1475-SS	0.036"	7/64"	1/2"	150	
B-1473	0.047"	1/8"	31/64"		
090-G21-1T		3/16"	5/8"	50	E60 K20
2198	0.048"	5/16"	15/16"		100
C-285	0.062"	5/32"	3/4"		
090-104		1/8"	11/16"		
CP-79H		3/8"	7/8"		

ASSORTMENT
ASSORTMENT **805-510A** **LYNCH PIN**

Metric Sizes
10 SIZES - 110 PIECES

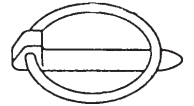

Style	Pin Length	Spaenaur No.	Pin Diameter	Qty.	Page
Style 1	32mm	233-F92-1N	5.2mm	20	E70
	40mm	233-110	4.5mm		
	45mm	233-F90-2Y	6.0mm		
Style 2	40mm	233-101	7.0mm	10	
		233-102	8.0mm		
		233-103	9.0mm	8	
		233-124	9.5mm		
		233-105	10.0mm		
		233-106	10.5mm		
		233-107	11.0mm		

Regular Size: 13-3/8" x 9-1/4" x 2"

Grey Enamelled Drawer will fit Slide Racks shown on page A2
Shipping weight **4.99 kg** (11 lbs.)

ASSORTMENT
ASSORTIMENT **B-555D**

CLEVIS PINS
Steel, Zinc Plated

Grade C-1008 / C-1018 Hardened

32 SIZES - 340 PIECES

Furnished in LARGE SIZE grey enamelled steel drawer with "scooped" bins. Drawer will fit into the Slide Racks shown on page A3

Shipping weight: **10.88 kg** (24 lbs.)



Hole Diameter	Pin Diameter	Spaenaur No.	Length Under Head	Qty.	Page		
0.080"		233-003	0.672" - 0.692"				
3/32"	1/4"	233-F37-1P	3/4"	15	E77		
		233-F24-1A	1"				
		233-F09-1X	13/16"				
1/8"	1/4"	1058	1-1/4"	15			
		233-F34-1M	1-7/16"	12			
		233-F68-1K	1-9/16"	10			
		233-F22-1M	7/8"	15			
233-F51-1P	15/16"						
233-F23-1X	1"						
9/64"	5/16"	233-F30-1N	1-1/8"	12			
		1056	1-5/8"	10			
		233-F38-1Y	1-3/4"				
5/32"	3/8"	233-F27-1C	5/8"	12	E78		
		B-371	3/4"				
		233-F11-1X	7/8"	10			
		233-F12-1A	1"				
		233-F69-1W	1-1/8"				
		233-F28-1N	1-1/4"				
		B-375	1-5/16"				
		B-376	1-3/8"				
		233-F77-1C	1-1/2"				
		233-G05-1A	1-5/8"				
		233-F02-1Y	1-7/8"			6	
		233-F03-1C	2-1/4"				
		233-F26-1Y	2-15/32"	8			
		7/16"	3/8"	B-381		1"	25
				1054		1-1/4"	
				233-F31-1T		1-1/2"	
1055	1-3/4"						
1/2"	3/8"	B-385	1-17/32"	6			
		233-F01-1P	1-5/8"				

ASSORTMENT
ASSORTIMENT **805-476**

INCH SIZES
DOWEL PINS
Alloy Steel
Not Plated

Precision Ground
Case-hardened

24 Sizes
410 Pieces

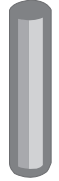

Shipping Weight:
5.1 kg (11.25 lbs.)

Spaenaur No.	Outside Diameter	Pin Length	Qty.	Page
238-019	1/8"	1/2"	25	E82
238-023		1"		
238-025		1-1/2"		
238-028	3/16"	1/2"	20	
238-030		3/4"		
238-032		1"		
238-034		1-1/2"		
238-036	1/4"	2"	15	
238-037		1/2"	25	
238-C24-1A		3/4"	20	
238-042	1/4"	1-1/4"	15	
238-043		1-1/2"		
238-D19-1Y		2"		
238-049	5/16"	1/2"	10	
238-051		3/4"		
238-053		1"		
238-055		1-1/2"		
238-057	3/8"	2"	15	
238-062		5/8"		
238-065		1"		
238-068	3/8"	1-3/4"	10	
238-069		2"		
238-073		1"		
238-077	7/16"	2"		

ASSORTMENT
ASSORTIMENT **805-473**

DIN 7
METRIC
DOWEL PINS
Steel
Not Plated

M6 Tolerance
Not Hardened

24 Sizes
410 Pieces

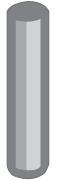

Outside Diameter	Spaenaur No.	Pin Length	Qty.	Page
3mm	238-205	16mm	25	E86
	238-206	20mm		
	238-208	30mm		
	238-209	36mm		
4mm	238-213	14mm	20	
	238-215	20mm		
	238-217	30mm		
	238-219	40mm		
5mm	238-223	20mm	10	
	238-225	30mm		
	238-227	40mm		
	238-229	50mm		
6mm	238-232	14mm	15	
	238-235	20mm		
	238-238	30mm		
	238-240	40mm		
8mm	238-246	20mm	10	
	238-248	30mm		
	238-250	40mm		
	238-252	50mm		
10mm	238-255	20mm	10	
	238-256	30mm		
	238-257	40mm		
	238-258	60mm		

Assortments come in a REGULAR SIZE welded steel drawer with hinged lid, and finished in Grey enamel. Drawers will fit into the slide Racks shown on page A2

ASSORTMENT
ASSORTIMENT **805-484**



DIN 6325 METRIC

DOWEL PINS
STEEL, Not Plated

Precision ground Tol.
M6 - HARDENED
HRC 60 ±2

24 SIZES
410 PIECES

Shipping Weight:
4.55 kg (10.04W lb.)



Assortment comes in a REGULAR SIZE welded steel drawer with hinged lid, and finished in Grey enamel. Drawer will fit Slide Racks shown on page A2

Spaenaur No.	Outside Diameter	Pin Length	Qty.	Page						
238-101	1.5mm	8mm	25	E84						
238-102		12mm								
238-D15-1M	2.0mm	10mm			20	E85				
238-108		16mm								
238-115		12mm								
238-117	3.0mm	16mm					15	E85		
238-119		20mm								
238-125	4.0mm	10mm							10	E85
238-127		14mm								
238-129		18mm								
238-137	5.0mm	12mm	10	E85						
238-139		16mm								
238-C16-1N	6.0mm	20mm			10	E85				
238-145		16mm								
238-149		28mm								
238-150	8.0mm	30mm					10	E85		
238-160		20mm								
238-163	10.0mm	30mm							10	E85
238-166		40mm								
238-177		30mm								
238-180	12.0mm	40mm	10	E85						
238-182		50mm								
238-195	12.0mm	60mm			10	E85				
238-196		60mm								

ASSORTMENT
ASSORTIMENT **A-218**

Made to ASME B18.8.2

INCH SIZES

TAPER PINS
STEEL, Not Plated



23 SIZES
186 PIECES

Regular Size welded STEEL drawer has hinged lid, SCOOPED bins, and is finished in Grey enamel. Drawer fits Slide Racks shown on page A2

Shipping Weight: **4.08 kg (9 lbs.)**

Spaenaur No.	Pin Size Number	Large End Diameter	Pin Length	Qty.	Page				
TP-601	#00	0.141"	1"	10	E88				
TP-602			1-1/2"						
TP-603			1"						
TP-604	#0	0.156"	1-1/2"			6	E88		
TP-605			1"						
TP-606			1-1/2"						
TP-607	#1	0.172"	2"					8	E88
TP-608			1-1/4"						
TP-609			1-1/2"						
TP-610	#2	0.193"	2"						
TP-611			1-1/4"						
TP-612			1-1/2"						
TP-613	#3	0.219"	2"	6	E88				
TP-614			1-1/2"						
TP-615			2"						
TP-616	#4	0.250"	2-1/2"			6	E88		
TP-617			1-1/2"						
TP-618			1-3/4"						
TP-619	#5	0.289"	2"					6	E88
TP-620			2-1/2"						
TP-621			2"						
TP-623	#6	0.341"	2"						
TP-625			#7	0.409"	3"				

ASSORTMENT
ASSORTIMENT **805-474**

DIN 1B ~ DIN EN 22339B
~ ISO 2339B

METRIC
TAPER PINS
STEEL, Not Plated



Turned Not Hardened

24 SIZES
200 PIECES



Regular size welded STEEL drawer has hinged lid, "scooped" bins, and is finished in Grey enamel. Drawer fits Slide Racks shown on page A2

Shipping weight:
3.74 kg (8.25 lbs.)

Small End Diameter	Spaenaur No.	Pin Length	Qty.	Page				
3mm	238-302	20mm	10	E91				
	238-304	26mm						
	238-306	30mm						
	238-309	40mm						
4mm	238-314	20mm			6	E92		
	238-316	26mm						
	238-318	30mm						
	238-321	40mm						
5mm	238-325	20mm					6	E92
	238-329	30mm						
	238-332	40mm						
	238-334	50mm						
6mm	238-337	20mm	6	E92				
	238-340	30mm						
	238-342	40mm						
	238-344	50mm						
8mm	238-351	30mm			6	E92		
	238-352	36mm						
	238-353	40mm						
	238-354	50mm						
10mm	238-362	32mm					6	E92
	238-363	40mm						
	238-364	50mm						
	238-365	60mm						

METRIC SLOTTED SPRING TENSION PINS

DIN 1481 This Standard has been replaced. Please see Catalog Page R21 for more information.

ASSORTMENT 805-479

STAINLESS STEEL
24 SIZES / 355 PIECES

Outside Diameter	Compatible Hole Diameter	Spaenaur No.	Pin Length	Qty.	Page				
2.0mm	2.10mm	240-500	12mm	20	E96				
		240-501	18mm						
2.5mm	2.60mm	240-502	14mm	20		E96			
		240-503	20mm						
3.0mm	3.10mm	240-504	14mm	15			E96		
		240-505	18mm						
3.5mm	3.65mm	240-524	20mm	15				E96	
		240-506	16mm						
4.0mm	4.15mm	240-510	20mm	15					E96
		240-511	24mm						
5.0mm	5.15mm	240-513	20mm	10	E96				
		240-514	24mm						
6.0mm	6.15mm	240-515	24mm	10		E96			
		240-516	30mm						
8.0mm	8.25mm	240-517	50mm	10			E96		
		240-518	20mm						
10.0mm	10.25mm	240-519	26mm	10				E96	
		240-K07-1P	36mm						
10.0mm	10.25mm	240-521	22mm	10					E96
		240-522	26mm						
10.0mm	10.25mm	240-523	30mm	10	E96				

ASSORTMENT 805-480

SPRING STEEL
Not Plated
24 SIZES / 350 PIECES

Outside Diameter	Compatible Hole Diameter	Spaenaur No.	Pin Length	Qty.	Page				
2.0mm	2.10mm	238-524	12mm	20	E101				
		238-527	18mm						
2.5mm	2.60mm	238-538	14mm	20		E101			
		238-541	20mm						
3.0mm	3.10mm	238-553	14mm	15			E101		
		238-555	18mm						
3.5mm	3.65mm	238-569	16mm	15				E101	
		238-571	20mm						
4.0mm	4.15mm	238-573	24mm	15					E101
		238-587	16mm						
4.5mm	4.65mm	238-589	20mm	10	E102				
		238-591	24mm						
5.0mm	5.15mm	238-606	18mm	10		E102			
		238-625	20mm						
6.0mm	6.15mm	238-627	24mm	10			E102		
		238-644	24mm						
8.0mm	8.25mm	238-646	30mm	10				E102	
		238-650	50mm						
10.0mm	10.25mm	238-659	20mm	10					E102
		238-662	26mm						
12.0mm	12.30mm	238-664	36mm	10	E102				
		238-676	22mm						
12.0mm	12.30mm	238-678	26mm	10		E102			
		238-694	24mm						

Regular size welded STEEL drawer is finished in Grey enamel. Drawer will fit into the Slide Racks shown on page A2.
Shipping Weight: **2.83 kg** (6.25 lbs.)

ASSORTMENT 805-518A

SLOTTED SPRING TENSION PINS
Chrome Stainless Steel – Inch Sizes

24 SIZES
335 PIECES

Regular Size grey enamelled steel drawer will fit slide racks shown on page A2

Shipping Weight: **2.8 kg** (6.2 lbs.)

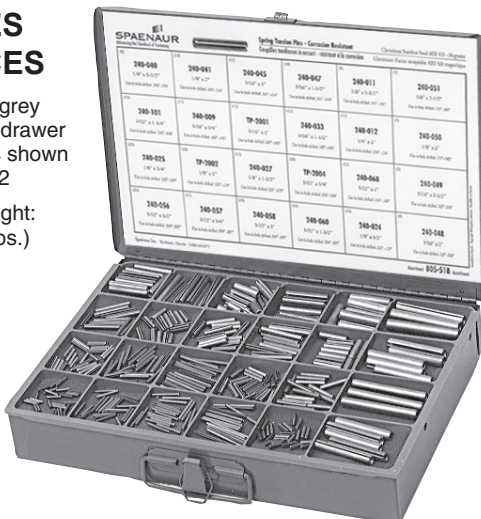

Outside Diameter	Compatible Hole Diameter	Spaenaur No.	Pin Length	Qty.	Page		
3/32"	0.094" - 0.097"	240-K03-1W	1/2"	25	E98		
		240-057	3/4"				
		240-058	1"				
		240-060	1-1/2"				
1/8"	0.125" - 0.129"	240-024	1/2"	25		E98	
		240-025	3/4"				
		TP-2002	1"				
		240-027	1-1/2"				
5/32"	0.156" - 0.160"	TP-2004	3/4"	20			E98
		240-K02-1K	1"				
		240-101	1-1/4"				
		240-101	1-1/4"				
3/16"	0.187" - 0.192"	240-009	3/4"	15	E98		
		TP-2001	1"				
		240-033	1-1/2"				
		240-012	1"				
1/4"	0.250" - 0.256"	240-040	1-1/2"	8		E98	
		240-K01-1T	2"				
		240-045	1"				
		240-047	1-1/2"				
5/16"	0.312" - 0.318"	240-048	2"	5			E98
		240-049	2-1/2"				
		240-011	1-1/2"				
		240-050	2"				
3/8"	0.375" - 0.382"	240-051	2-1/2"	3	E98		

ASSORTMENT
ASSORTIMENT **A-211**

TENSION PINS
(Slotted Spring Pins)

STEEL
Plain Finish

24 SIZES
335 PIECES



Regular
Size Drawer:
13-3/8" x 9-1/4" x 2"

Outside Diameter	Spaenaur No.	Pin Length	Qty.	Page
3/32"	TP-1	1/2"	25	E99
	TP-3	3/4"		
	TP-5	1"		
	TP-7	1-1/2"		
1/8"	TP-8	1/2"	25	E99
	TP-10	3/4"		
	TP-12	1"		
	TP-14	1-1/2"		
5/32"	TP-15	3/4"	20	E99
	TP-17	1"		
	TP-19	1-1/2"		
3/16"	TP-20	3/4"	15	E99
	TP-22	1"		
	TP-24	1-1/2"		
1/4"	TP-27	1"	8	E99
	TP-29	1-1/2"		
	TP-31	2"		
5/16"	TP-32	1"	12	E99
	TP-34	1-1/2"		
	TP-36	2"		
	TP-38	2-1/2"		
3/8"	TP-39	1-1/2"	8	E99
	TP-41	2"		
	TP-43	2-1/2"		

PLASTIKIT
«PLASTIKIT» **A-61**

TENSION PINS
(Slotted Spring Pins)

STEEL
Plain Finish

24 SIZES
123 PIECES



Clear plastic box
with hinged lid.

Outside Diameter	Spaenaur No.	Pin Length	Qty.	Page
3/32"	TP-1	1/2"	10	E99
	TP-3	3/4"		
	TP-5	1"		
	TP-7	1-1/2"		
1/8"	TP-8	1/2"	10	E99
	TP-10	3/4"		
	TP-12	1"		
	TP-14	1-1/2"		
5/32"	TP-15	3/4"	8	E99
	TP-17	1"		
	TP-19	1-1/2"		
3/16"	TP-20	3/4"	5	E99
	TP-22	1"		
	TP-24	1-1/2"		
1/4"	TP-27	1"	4	E99
	TP-29	1-1/2"		
	TP-31	2"		
5/16"	TP-32	1"	4	E99
	TP-34	1-1/2"		
	TP-36	2"		
	TP-38	2-1/2"		
3/8"	TP-39	1-1/2"	3	E99
	TP-41	2"		
	TP-43	2-1/2"		

PLASTIKIT
«PLASTIKIT» **804-002**

ISO 8752

METRIC
TENSION PINS
(Slotted Spring Pins)
Spring Steel - Plain Finish

24 SIZES - 180 PIECES

Clear plastic box with hinged lid.
Size: 1" x 2-3/4" x 4-1/2"



Outside Diameter	Compatible Hole Diameter	Spaenaur No.	Pin Length	Qty.	Page				
1.0mm	1.10mm	238-501	5mm	10	E101				
		238-504	10mm						
		238-507	16mm						
1.5mm	1.60mm	238-511	5mm			10	E101		
		238-514	10mm						
		238-519	20mm						
		238-523	10mm						
2.0mm	2.10mm	238-528	20mm					10	E101
		238-533	30mm						
		238-551	10mm						
3.0mm	3.10mm	238-556	20mm	10	E101				
		238-D02-1W	30mm						
		238-564	40mm						
		238-584	10mm						
4.0mm	4.15mm	238-589	20mm			5	E101		
		238-594	30mm						
		238-597	40mm						
		238-625	20mm						
5.0mm	5.15mm	238-630	30mm					5	E101
		238-633	40mm						
		238-642	20mm						
6.0mm	6.15mm	238-646	30mm	5	E101				
		238-648	40mm						
		238-650	50mm						



COILED SPRING PINS

Carbon Steel, Plain Finish

Inch Sizes



A

ASSORTMENT 805-491

Regular Size drawer has hinged lid and 24 "Scooped" bins. Drawer fits Slide Racks as shown on page A2
Shipping weight: **2.72 kg** (6 lbs.)

24 SIZES - 350 PIECES

Outside Diameter	Compatible Hole Diameter	Spaenaur No.	Pin Length	Qty.	Page
5/64"	0.077" - 0.081"	239-218	5/16"	20	E103
3/32"	0.093" - 0.097"	239-235	3/8"		
7/64"	0.108" - 0.112"	239-256	9/16"		
		239-326	3/4"		
1/8"	0.124" - 0.129"	239-272	5/16"		
		239-312	1/2"		
5/32"	0.155" - 0.160"	239-290	3/8"	15	
		239-293	9/16"		
		239-298	15/16"		
3/16"	0.185" - 0.192"	239-341	1/2"	10	
		239-343	5/8"		
		239-318	1"		
7/32"	0.217" - 0.224"	239-360	5/8"	10	
		239-362	3/4"		
		239-367	1-1/8"		
		239-377	9/16"		
1/4"	0.247" - 0.256"	239-388	3/4"	10	
		239-393	1-1/4"		
		239-395	1-3/4"		
		239-407	1"		
5/16"	0.308" - 0.319"	239-410	1-3/8"	15	
		239-415	2-1/4"		
3/8"	0.370" - 0.383"	239-423	1"	10	
		239-424	1-1/4"		

PLASTIKIT «PLASTIKIT» 804-004

Clear plastic box with hinged lid.
Size: 1" x 2-3/4" x 4-1/2"

25 SIZES - 210 PIECES

Outside Diameter	Compatible Hole Diameter	Spaenaur No.	Pin Length	Qty.	Page
1/16"	0.061" - 0.065"	239-203	1/4"	10	E103
		239-205	3/8"		
		239-207	1/2"		
		239-211	3/4"		
5/64"	0.077" - 0.081"	239-221	1/2"	10	
		239-225	3/4"		
		239-229	1"		
3/32"	0.093" - 0.097"	239-311	1/2"	5	
		239-240	3/4"		
		239-244	1"		
		239-248	1-1/2"		
1/8"	0.124" - 0.129"	239-312	1/2"	10	
		239-278	3/4"		
		239-325	1"		
5/32"	0.155" - 0.160"	239-D17-1X	1-1/2"	5	
		239-304	3/4"		
		239-299	1"		
3/16"	0.185" - 0.192"	239-332	1-1/2"	10	
		239-345	3/4"		
		239-318	1"		
1/4"	0.247" - 0.256"	239-303	1-1/2"	5	
		239-388	3/4"		
		239-319	1"		
		239-394	1-1/2"		
3/8"	0.370" - 0.383"	239-399	1"	10	
		239-316	2"		

ASSORTMENT 805-440A

METRIC & INCH Coiled Spring Pins

Carbon Steel - Plain Finish

24 ITEMS - 350 PIECES

Regular Size Welded STEEL drawer is finished in Grey enamel. Drawer will fit into the Slide Racks shown on page A2

Shipping Wt. **2.85 kg** (6-1/4 lbs.)



Name	Outside Diameter	Compatible Hole Diameter	Spaenaur No.	Pin Length	Qty.	Page
Coiled Spring Pin Carbon Steel Plain Finish Metric ISO 8750	2.0mm	1.97mm - 2.07mm	239-764	5mm	20	E106
			239-766	8mm		
	2.5mm	2.47mm - 2.58mm	239-781	6mm	15	
			239-783	10mm		
	3.0mm	2.97mm - 3.10mm	239-798	8mm	10	
			239-800	12mm		
	4.0mm	3.97mm - 4.10mm	239-814	8mm	10	
			239-817	14mm		
	5.0mm	4.95mm - 5.12mm	239-822	24mm	10	
			239-832	10mm		
	6.0mm	5.95mm - 6.13mm	239-835	16mm	10	
			239-840	26mm		
6.3mm	6.25mm - 6.45mm	239-849	12mm	10		
		239-853	20mm			
8.0mm	7.93mm - 8.17mm	239-857	28mm	10		
		239-858	30mm			
10.0mm	9.93mm - 10.20mm	239-880	45mm	15		
		239-890	24mm			
Spring Pin Coiled Carbon Steel Plain Finish	1/4"	0.247" - 0.256"	239-894	35mm	15	
			239-896	45mm		
			239-906	20mm	15	
			239-911	30mm		
			239-376	1/2"	15	
			239-379	11/16"		

PLASTIKIT 804-003A
«PLASTIKIT»

METRIC



COILED SPRING PINS
Carbon Steel - Plain Finish

25 SIZES - 205 PIECES

Clear plastic box with hinged lid. Size: 1" x 2-3/4" x 4-1/2"

Outside Diameter	Compatible Hole Diameter	Spaenaur No.	Pin Length	Qty.	Page
0.8mm	0.080mm - 0.83mm	240-754	10mm	10	E106
1.0mm	1.00mm - 1.03mm	240-760	6mm		
		240-762	10mm		
		240-765	16mm		
		239-752	6mm		
1.5mm	1.50mm - 1.57mm	239-754	10mm		
		239-756	14mm		
		239-760	22mm		
		239-767	10mm		
2.0mm	1.97mm - 2.07mm	239-772	20mm		
		239-776	28mm		
		239-799	10mm		
		239-804	20mm		
3.0mm	2.97mm - 3.10mm	239-809	30mm		
		239-811	40mm		
		239-820	20mm		
		239-825	30mm		
4.0mm	3.97mm - 4.10mm	239-827	40mm		
		239-837	20mm		
		239-842	30mm		
		239-844	40mm		
5.0mm	4.95mm - 5.12mm	239-853	20mm		
		239-858	30mm		
		239-860	40mm		
		239-862	50mm		
6.0mm	5.95mm - 6.13mm			5	

PLASTIKIT A-56
«PLASTIKIT»

12 SIZES
100 PIECES

WOODRUFF KEYS
Sae 1035 Carbon Steel

Inch Sizes
Not Plated



KEYS in 12 sizes, as used frequently in every garage.
Supplier provided container (Not Standard Size)

Compatible Shaft Diameter	Spaenaur No.	Machine Key Width	Qty.	Page
1/2"	WK-2	3/32"	10	E108
	WK-3	1/8"		
5/8"	WK-4	3/32"	15	
	131-A01-1T	1/8"		
	WK-6			
3/4"	WK-8	5/32"	10	
7/8"	WK-10	3/16"	5	
	WK-11			
1"	131-A03-1W	7/32"	3	
	WK-14			
1-1/4"	WK-19	3/16"	2	
	WK-20	7/32"		

ASSORTMENT A-207
ASSORTIMENT

16 SIZES
210 PIECES



WOODRUFF KEYS
SAE 1035 CARBON STEEL - Not Plated

Put up in a REGULAR SIZE grey enamelled STEEL drawer. All bins are SCOOPED for easy removal of contents. Drawer will fit into the Slide Racks shown on page A2

Machine Key Width	Spaenaur No.	Compatible Shaft Diameter	Qty.	Page
3/32"	WK-2	1/2"	15	E108
	WK-4	5/8"		
1/8"	WK-3	1/2"	20	
	131-A01-1T	5/8"		
5/32"	WK-6		15	
	WK-8	3/4"	12	
	WK-10	7/8"	15	
3/16"	131-A04-1M	3/4"	12	
	WK-11	7/8"		
	131-A03-1W	1"		
7/32"	WK-16	1-1/8"	8	
	WK-20	1-1/4"		
1/4"	WK-12A	7/8"	12	
	WK-15	1"		
	WK-18	1-1/8"		
5/16"	WK-15B	1"	12	

ASSORTMENT 805-469
ASSORTIMENT

METRIC DIN 6888

WOODRUFF KEYS
Carbon Steel - Not Plated

21 SIZES
280 PIECES

Furnished in a regular size grey enamelled steel drawer, with lid and scooped bins. Drawer will fit the Slide Racks shown on Page A2

Shipping Weight: **2.95 kg** (6.5 lbs.)



Machine Key Width	Spaenaur No.	Compatible Shaft Diameter	Qty.	Page
1.5mm	132-001	4mm - 6mm	20	E109
2.0mm	132-002	6mm - 8mm		
2.5mm	132-003	8mm - 10mm	15	
3.0mm	132-005			
	132-006			
4.0mm	132-007	10mm - 12mm	10	
	132-008			
5.0mm	132-009	12mm - 17mm	5	
	132-010			
6.0mm	132-011	17mm - 22mm	10	
	132-012			
	132-014			
	132-015			
8.0mm	132-016	22mm - 30mm	5	
	132-017			
	132-018			
10.0mm	132-019	29mm - 38mm		
	132-020			
	132-021			
	132-022			
	132-023			

A

PLASTIKIT
«PLASTIKIT» **804-070**

METRIC **DIN 6888**

WOODRUFF KEYS
Carbon Steel, Not Plated

11 SIZES
100 PIECES

Size: 1" x 2-3/4" x 4-1/2"



Spaenaur No.	Width	Compatible Shaft Diameter	Height	Length	Qty.	Pages
132-006	3mm	8mm - 10mm	3.7mm	9.66mm	10	E109
132-007			5.0mm	12.65mm		
132-008			6.5mm	15.72mm		
132-009	4mm	10mm - 12mm	5.0mm	12.65mm		
132-010			6.5mm	15.72mm		
132-011			7.5mm	18.57mm		
132-012	5mm	12mm - 17mm	6.5mm	15.72mm		
132-014			9.0mm	21.63mm		
132-015	6mm	17mm - 22mm	7.5mm	18.57mm		
132-016			9.0mm	21.63mm		
132-017			10.0mm	24.49mm	5	

ASSORTMENT
ASSORTIMENT **805-471**

DIN 6885-A
METRIC

SHAFT KEYS
STEEL - Not Plated

24 SIZES - 345 PIECES

Put up in a REGULAR SIZE grey enamelled STEEL drawer. Drawer fits Slide Racks shown on page A2 13-3/8" W. x 9-1/4" D. x 2" H

Shipping Weight:
5.67 kg (12.5 lbs.)

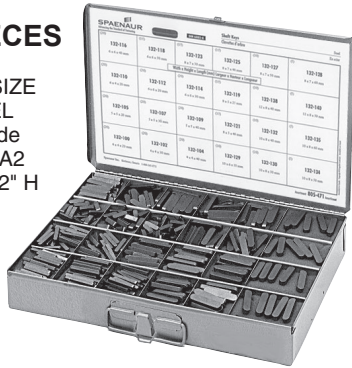

Compatible Shaft Diameter	Width	Height	Spaenaur No.	Length	Qty.	Page
10-12mm	4mm	4mm	132-A06-1X	20mm	20	E111
			132-102	30mm		
			132-104	40mm		
12-17mm	5mm	5mm	132-105	20mm		
			132-107	30mm		
			132-109	40mm		
17-22mm	6mm	4mm	132-110	20mm		
		6mm	132-112	20mm		
	6mm	6mm	132-114	30mm		
		6mm	132-116	40mm		
22-30mm	8mm	5mm	132-118	50mm		
			132-119	25mm		
	7mm	132-A08-1P	40mm			
		132-123	30mm			
		132-125	40mm			
30-38mm	6mm	8mm	132-127	50mm		
			132-128	60mm		
	8mm	132-129	50mm			
		132-024	30mm			
38-44mm	12mm	8mm	132-132	40mm		
			132-134	50mm		
			132-135	60mm		
38-44mm	12mm	8mm	132-138	40mm		
			132-140	50mm		

ASSORTMENT
ASSORTIMENT **805-404**



R1000 and R1200 Series

RETAINING RINGS
Carbon Spring Steel,
Phosphate Coated or Plain
20 SIZES - 795 PIECES

External Radial Assembly

Put up in "regular size" grey enamelled STEEL drawer. All bins have "scooped" bottoms. Drawer fits into Slide Racks shown on page A2 Shipping Weight **2.3 kg** (5.25 lbs.).

Finish	Ring Thickness	Spaenaur No.	Compatible Shaft Diameter	Qty.	Page
Phosphate	0.015"	R1000-X11	7/64"	40	E121
		R1000-12	1/8"	50	E124
	0.025"	R1000-X18	3/16"	40	E121
		R1000-18		50	E124
		R1200-18		60	E125
		R1000-X21	7/32"	30	E121
		R1000-25	0.250"	50	E124
		R1200-25		50	E125
	R1200-31	0.312"	50	E121	
	R1000-X31		50	E124	
	R1200-37	0.375"	40	E121	
	0.035"	R1000-37	3/8"	40	E121
		R1000-43	7/16"	25	E124
		R1200-43		30	E125
		0.042"	R1000-50	0.500"	25
R1200-56	0.562"		30	E121	
R1000-62	5/8"		20	E121	
0.050"	R1000-75	0.750"	15	E124	
	Plain	0.015"	R1200-12	0.125"	60
0.025"		R1000-15	5/32"	40	E125

Inch
Pouce



Internal / External Retaining Rings

Bagues de retenue internes / externes

ASSORTMENT
ASSORTIMENT **805-406**



R3000 Series
Internal - Axial Assembly
RETAINING RINGS
Carbon Spring Steel,
Phosphate Coated or Plain

16 VARIETIES - 336 PIECES

Put up in "regular size" grey enamelled STEEL drawer 13-3/8" x 9-1/4" x 2". All bins have "scooped" bottoms. Drawer fits into Slide Racks shown on page A2

Shipping Weight **2.25 kg** (4.95 lbs.).

Ring Thickness	Spaenaur No.	Compatible Housing/Bore Diameter	Groove Diameter	Qty.	Page
0.015"	R3000-X25	0.250"	0.268"	50	E121 E127
	R3000-X31	0.312"	0.330"		
0.025"	R3000-X37	0.375"	0.397"	30	
	R3000-X43	0.438"	0.461"		
0.035"	R3000-X50	0.500"	0.530"	40	
	R3000-X62	0.625"	0.665"		
0.042"	R3000-X75	0.750"	0.796"	20	
	R3000-X100	1.000"	1.066"		
0.042"	R3000-X102	1.023"	1.091"	15	
	R3000-X106	1.062"	1.130"		
0.050"	R3000-X125	1.250"	1.330"	8	
	R3000-X137	1.375"	1.461"		
	R3000-X150	1.500"	1.594"		
0.062"	R3000-X162	1.625"	1.725"	5	
	R3000-X175	1.750"	1.858"		
				4	

ASSORTMENT
ASSORTIMENT **805-430A**

R3100 Series External - Axial Assembly
RETAINING RINGS

Carbon Spring Steel,
Phosphate Coated or Plain, our option.

26 VARIETIES - 225 PIECES

Put up in "regular size" grey enamelled STEEL drawer 13-3/8" x 9-1/4" x 2". All bins have "scooped" bottoms. Drawer fits into Slide Racks shown on page A2

Shipping Wt. **2.50 kg** (5-1/2 lbs.)



PLASTIKIT
«PLASTIKIT» **A-58**



R1000 and R1200 Series
External - Radial Assembly
RETAINING RINGS

Carbon Spring Steel,
Phosphate Coated or Plain

19 SIZES - 169 PIECES

Name	Ring Thickness	Spaenaur No.	Compatible Shaft Diameter	Qty.	Page	
Retaining Ring R1200 Series External Bowed Carbon Spring Steel	0.015"	R1200-12	0.125"	10	E121 E125	
		R1200-18	0.188"			
	0.025"	R1200-25	0.250"			
		R1200-31	0.312"			
		R1200-37	0.375"			
0.035"	R1200-43	0.438"	5			
0.042"	R1200-56	0.562"				
Retaining Ring R1000 Series External	0.015"	R1000-X11	7/64"	10	E121 E124	
		R1000-12	1/8"			
	0.025"	R1000-15	5/32"			
		R1000-X18	3/16"			
		R1000-18	3/16"			
		R1000-X21	7/32"			
		R1000-25	0.250"			
	R1000-X31	0.312"				
	0.035"	R1000-37	3/8"			8
		R1000-43	7/16"			7
0.042"	R1000-50	0.500"	5			
	R1000-62	5/8"	4			

Spaenaur No.	Compatible Shaft Diameter	Groove Diameter	Qty.	Page
R3100-15ST	0.156"	0.146"	10	E129
R3100-18	0.188"	0.175"	25	E121 E129
R3100-25	0.250"	0.230"		
R3100-31	0.312"	0.290"	20	E129
255-D17-1T	0.375"	0.352"		
R3100-39	0.394"	0.369"	14	E129
R3100-43	0.438"	0.412"	20	
R3100-46	0.469"	0.443"	10	E121 E129
R3100-50	0.500"	0.468"		
R3100-55	0.551"	0.519"	8	E121 E129
R3100-59	0.594"	0.559"		
255-D03-1C	0.625"	0.588"	6	E129
R3100-68	0.688"	0.646"		
R3100-75	0.750"	0.704"	6	E129
R3100-78	0.781"	0.733"		
R3100-81	0.812"	0.762"	14	E129
R3100-84	0.844"	0.791"	4	E121 E129
R3100-87	0.875"	0.821"		
R3100-100	1.000"	0.940"	4	E121 E129
R3100-112	1.125"	1.059"		
R3100-118	1.188"	1.118"	3	E129
R3100-125	1.250"	1.176"		
R3100-137	1.375"	1.291"	3	E129
R3100-150	1.500"	1.406"		
R3100-156	1.562"	1.468"	2	E129
R3100-175	1.750"	1.650"		

CATALOG 14 SPAENAUR

P: 1-800-265-8772 F: 1-888-252-6380 service@spaenaur.com

A97

Spaenaur reserves the right to substitute parts in any assortment without notice. For any questions or suggestions about our Assortments and Plastikits, please contact us 1-800-265-8772. © 2018 Spaenaur Inc. All rights reserved. Catalog may not be reproduced, in whole or in part, without the written permission of Spaenaur Inc. Subject to Catalog Terms and Conditions of Use available at Spaenaur.com and on page TC2 and TC3 at the back of this catalog. Spaenaur se réserve le droit de remplacer des pièces dans n'importe quel assortiment sans préavis. Pour toute question ou suggestion concernant nos Assortiments et Plastikits, veuillez nous contacter au 1-800-265-8772. © 2018 Spaenaur Inc. Tous droits réservés. Le catalogue ne peut être reproduit, en tout ou en partie, sans l'autorisation écrite de Spaenaur Inc. L'utilisation est soumise aux Conditions d'utilisation du Catalogue disponibles sur Spaenaur.com et à la page TC4 et TC5 à la fin de ce catalogue.

ASSORTMENT
ASSORTIMENT **805-443**

DIN 6799

METRIC
RETAINING
RINGS
External

17 SIZES
450 PIECES

Regular size grey
enamelled STEEL drawer
13-5/16" x 9-1/4" x 2"
Shipping Weight:
2.35 kg (5-1/5 lbs.)



Spaenaur No.	Compatible Shaft Diameter	Groove Diameter	Qty.	Page
250-517	1.0mm - 1.4mm	0.8mm	40	E139
250-501	1.4mm - 2.0mm	1.2mm	35	
250-502	2.0mm - 2.5mm	1.5mm		
250-503	2.5mm - 3.0mm	1.9mm		
250-F07-1Y	3.0mm - 4.0mm	2.3mm	30	
250-F09-1W	4.0mm - 5.0mm	3.2mm	25	
250-F06-1P	5.0mm - 7.0mm	4.0mm		
250-F05-1A	6.0mm - 8.0mm	5.0mm		
250-508	7.0mm - 9.0mm	6.0mm		
250-509	8.0mm - 11.0mm	7.0mm		
250-510	9.0mm - 12.0mm	8.0mm	20	
250-511	10.0mm - 14.0mm	9.0mm		
250-512	11.0mm - 15.0mm	10.0mm		
250-F12-1T	13.0mm - 18.0mm	12.0mm		
250-514	16.0mm - 24.0mm	15.0mm		
250-515	20.0mm - 31.0mm	19.0mm		
250-516	25.0mm - 38.0mm	24.0mm		

A

ASSORTMENT
ASSORTIMENT **805-441A**

DIN 471

Metric EXTERNAL
RETAINING RINGS
Carbon Spring Steel Plain Finish
28 SIZES - 300 PIECES

Regular size grey enamelled STEEL drawer,
13-5/16" x 9-1/4" x 2". Shipping Weight: **2.35 kg** (5-1/5 lbs.)



Spaenaur No.	Compatible Shaft Diameter	Groove Diameter	Qty.	Page
255-500	4mm	3.8mm	25	E131
255-501	5mm	4.8mm	20	
255-D04-1N	6mm	5.7mm		
255-503	7mm	6.7mm		
255-504	8mm	7.6mm		
255-505	9mm	8.6mm		
255-506	10mm	9.6mm	10	
255-507	11mm	10.5mm		
255-D01-2P	12mm	11.5mm		
255-D20-1K	14mm	13.4mm		
255-510	15mm	14.3mm		
255-511	16mm	15.2mm		
255-512	17mm	16.2mm		
255-513	18mm	17.0mm		
255-514	19mm	18.0mm		
255-D19-1W	20mm	19.0mm		
255-516	22mm	21.0mm		
255-D09-1X	25mm	23.9mm		
255-518	28mm	26.6mm		
255-519	30mm	28.6mm		
255-520	32mm	30.3mm		
255-521	35mm	33.0mm		
255-522	38mm	36.0mm		
255-523	40mm	37.5mm		
255-524	42mm	39.5mm		
255-525	45mm	42.5mm		
255-526	48mm	45.5mm		
255-527	50mm	47.0mm		

ASSORTMENT
ASSORTIMENT **805-442**

DIN 472

Metric INTERNAL
RETAINING RINGS
Carbon Spring Steel Plain Finish
28 SIZES - 300 PIECES

Regular size grey enamelled STEEL drawer,
13-5/16" x 9-1/4" x 2". Shipping Weight: **2.35 kg** (5-1/5 lbs.)



Ring Thickness (Max.)	Spaenaur No.	Compatible Housing/Bore Diameter	Groove Diameter	Qty.	Page
1.00mm	254-500	10mm	10.4mm	25	E133
	254-501	11mm	11.4mm	20	
	254-502	12mm	12.5mm		
	254-503	13mm	13.6mm		
	254-504	14mm	14.6mm		
	254-505	15mm	15.7mm		
	254-A13-1W	16mm	16.8mm	10	
	254-507	17mm	17.8mm		
	254-508	18mm	19.0mm		
	254-509	19mm	20.0mm		
	254-510	20mm	21.0mm		
	254-511	21mm	22.0mm		
	254-512	22mm	23.0mm		
	254-513	24mm	25.2mm		
254-514	25mm	26.2mm			
254-515	26mm	27.2mm			
254-A14-1M	28mm	29.4mm	5		
254-517	30mm	31.4mm			
254-518	32mm	33.7mm			
1.50mm	254-519	35mm	37.0mm	5	
	254-520	37mm	39.0mm		
	254-521	38mm	40.0mm		
1.75mm	254-522	40mm	42.5mm		
	254-A11-1T	42mm	44.5mm		
	254-524	45mm	47.5mm		
	254-525	47mm	49.5mm		
2.00mm	254-A15-1X	48mm	50.5mm	5	
	254-527	50mm	53.0mm		

A

ASSORTMENT 805-505

Gripper Clips
TEMPERED STEEL

KEEP THINGS IN THEIR PLACE

- TOOL CRIBS
- TRUCKS
- CARTS
- SHOVELS
- LABS
- BRUSHES
- MOPS
- BROOMS
- JIGS
- MACHINE PARTS
- ASSEMBLY FIXTURES
- CLEANING EQUIPMENT
- TUBES
- HOSES
- FIXTURES
- PIPES
- FLASHLIGHTS

11 Clips, 125 Pieces, plus 131 Mounting Screws

REGULAR SIZE grey enamelled drawer fits the Slide Racks shown on page A2

Shipping Weight: **3.06 kg** (6-3/4 lbs.)

Name	Spaenaur No.	Overall Depth	Width	Height	Holding Capacity	Qty.	Page
Gripper Clips Material: Polypropylene	C-914	11/32"	1/2"	9/16"	7/32" - 1/2"	50	F16
Gripper Clips Material: Spring Steel	C-915	1/2"	1-3/8"	15/16"	3/8" - 5/8"	14	
	C-916	5/8"	1-5/8"	1-1/4"	3/4" - 1-1/8"	9	
Gripper Clips - Tempered Steel	086-F65-1N		1-3/4"		1" - 1-3/8"		
Gripper Clips - Fully Coated	086-F64-1C	1/2"	1-3/8"	15/16"	3/8" - 5/8"	13	
	086-F62-1P	5/8"	1-5/8"	1-1/4"	3/4" - 1-1/8"	8	
Gripper Clips - Half Coated	086-005				1" - 1-3/8"		
		086-006				1-1/2" - 1-7/8"	
Gripper Clips	086-007						
Name	Spaenaur No.	Head Type	Screw Length	Thread Diameter	Screw Finish	Qty.	
Tapping Screw Phillips Drive Type AB ASME/ANSI B18.6.4	530-B80-1K	Pan	1/2"	#6	Zinc	50	B81
	1943			#10	Zinc Chromate	81	

GEAR-TYPE HOSE CLAMPS

Stainless Steel

10 SIZES
58 CLAMPS

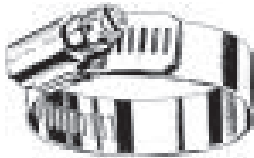

ASSORTMENT 805-623

HS SERIES

Band Width	Spaenaur No.	Clamping Diameter	Qty.	Page
5/16"	HS-4	5/16"	6	G2
	HS-6	3/8"		
1/2"	HS-8	1/2"		
	HS-10	5/8"		
	HS-16	1"		
	HS-24	1-1/2"		
	HS-32	2"		
	HS-44	2-3/4"		
	HS-52	3-1/4"	5	
	HS-64	4"		

ASSORTMENT 805-639

HAS SERIES "ALL STAINLESS"

Band Width	Spaenaur No.	Clamping Diameter	Qty.	Page
1/2"	HAS-8	1/2"	6	G2
	HAS-10	5/8"		
	079-A53-1A	1"		
	HAS-24	1-1/2"		
	HAS-32	2"		
	HAS-44	2-3/4"		
	5/16"	079-A02-1X	4"	5
		079-A11-1K	5/16"	6
	079-102	3/8"		

Put up in Grey enamelled STEEL Drawer, with hinged lid and "Adjusta-bins". Drawer will fit into our Slide Racks, as shown on page A3. Shipping Wt. **4.42 kg** (9-3/4 lbs.)

ASSORTMENT 805-645

INNER SHIELD HOSE CLAMPS

16 Sizes - 94 Clamps



Furnished in a LARGE SIZE grey enamelled STEEL Drawer, with scooped bins. Drawer will fit into the Slide Racks shown on page A3

Shipping Weight: **5.21 kg** (11-1/2 lbs.)



Name	Spaenaur No.	Clamping Diameter	Qty.	Page
Inner Shield Clamps - Micro Series	079-A05-1Y	7/16"	6	G4
	079-026	11/16"		
	079-A13-1M	1-1/8"		
Inner Shield Clamps - Full Series	079-013	1/2"		
	079-014	7/8"		
	079-015			
	079-016	1"		
	079-017	1-1/4"		
	079-018	1-1/2"		
	079-019	1-3/4"		
	079-020	2"		
	079-021	2-1/4"	4	
	079-022	2-1/2"		
079-023	2-3/4"			
079-024	3"			
Acid-Resistant Worm Drive Hose Clamps	079-878	15mm - 24mm	12	G6

ASSORTMENT **805-656** **AWAB**

METRIC
Acid-Resistant Worm
DRIVE HOSE CLAMPS
12 SIZES - 88 PIECES

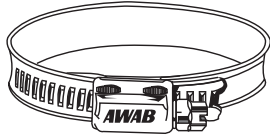

Furnished in grey enamelled LARGE SIZE Steel Drawer with hinged lid and 'Adjusta-bins'. Drawer will fit into Slide Racks shown on page A3
Shipping Weight: **5.90 kg** (13 lbs.)

Name	Spaenaur No.	Range D2-D1 mm	(Inch Equiv.) Min.-Max.	Qty.	Page
Acid-Resistant Worm Drive Hose Clamps	079-875	8mm - 14mm	5/16" - 9/16"	10	G6
	079-C15-1K	13mm - 20mm	1/2" - 13/16"		
	079-878	15mm - 24mm	5/8" - 15/6"		
	079-879	19mm - 28mm	3/4" - 1-1/8"		
	079-881	26mm - 38mm	1-1/16" - 1-1/2"		
	079-883	38mm - 50mm	1-1/2" - 2"		
	079-885	38mm - 64mm	1-1/2" - 2-1/2"	7	
	079-886	51mm - 76mm	2" - 3"	5	
	079-A06-1C	70mm - 95mm	2-3/4" - 3-3/4"		
	079-889	89mm - 114mm	3-1/2" - 4-1/2"		
079-890	102mm - 140mm	4" - 5-1/2"	4		
Name	Spaenaur No.	Tip Width Number		Qty.	Page
Flexible Hex. Socket Driver	876-837	7mm		1	G6

ASSORTMENT **805-646**

HOSE CLAMPS
All 316 Stainless Steel
15 Sizes - 133 Clamps

Furnished in a grey enamelled LARGE SIZE STEEL Drawer, with hinged lid and "Adjusta-bins". Drawer will fit into our Slide Racks as shown on page A3
Shipping Wt. **6.3 kg** (13.851 lbs.)



Name	Spaenaur No.	Clamping Diameter	Qty.	Page	
Hose Clamps Stainless Steel - Full Series	079-801	3/8"	15	G4	
	079-A52-1X	5/8"			
	079-803	3/4"			
	079-804	1"	10		
	079-805	1-1/4"			
	079-A10-1T	1-1/2"			
	079-A04-1P	1-3/4"	8		
	079-A09-1K	2"			
	079-809	2-1/4"			
	079-A12-1W	2-3/4"	6		G4
	079-811	3-1/4"	5		
	079-812	3-3/4"			
	079-813	4-1/2"			4
	079-814	5-1/2"			
	Hose Clamps Stainless Steel - Micro Series	079-A54-1P	1/4"		15

ASSORTMENT **805-514**

HOSE CLAMPS
Nylon 6/6
17 SIZES - 120 CLAMPS

Put up in a grey enamelled REGULAR SIZE Steel Drawer with hinged lid and 'Adjusta-bins'. Drawer will fit into Slide Racks shown on page A2
Shipping Weight: **3.34 kg** (5.15W lbs.)



Band Width	Spaenaur No.	Clamp Range Inch Min.-Max. ± .01"	Qty.	Page
7/32"	078-001	0.246" - 0.290"	15	G7
	078-A02-1A	0.360" - 0.406"		
	078-004	0.475" - 0.536"	10	
	078-007	0.670" - 0.780"		
	078-A01-1X	0.730" - 0.830"	5	
	078-009	0.870" - 0.975"		
1/4"	078-003	0.410" - 0.468"	10	
	078-005	0.538" - 0.608"		
	078-006	0.597" - 0.665"		
5/16"	078-010	0.953" - 1.094"	5	
	078-011	1.031" - 1.188"		
11/32"	078-012	1.250" - 1.425"	4	
	078-013	1.406" - 1.610"		
	078-014	1.594" - 1.813"		
13/32"	078-015	1.790" - 2.110"	4	
	078-016	1.875" - 2.125"		
	078-017	2.120" - 2.390"		

A

2-EAR CLAMP ASSORTMENTS

2-ear Clamps
Plus Installation Tool
In Each Assortment.

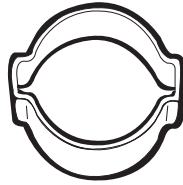

ASSORTMENT 805-655

2-EAR CLAMPS PLATED STEEL CLAMPS

23 Sizes - 241 Pieces

Shipping Weight: **5.76 kg.** (12.70 lbs.)



ASSORTMENT 805-654

300 Series STAINLESS STEEL CLAMPS

23 Sizes - 241 Pieces

Shipping Weight: **5.22 kg.** (11.50 lbs.)

Each Assortment is furnished in a Large Size grey enamel steel drawer with hinged lid and catch. Drawers have scooped bins for easy access and will fit into Slide Racks shown on page A3

Both Assortments are similar except for the clamp material.

Name	Band Thickness	Band Width	Spaenaur No.	Clamping Diameter	Qty.	Page	
Oetiker 2-Ear Clamps	0.0197"	0.138"	079-050	5/32"	10	G8	
	0.0236"		079-A20-1C	11/64"			
	0.0276"	0.236"	0.197"	079-A21-1N	3/16"		20
			0.236"	079-053	1/4"		
	0.0394"	0.276"	079-A22-1T	5/16"	10		
			079-055	3/8"			
			079-057	1/2"			
	0.0472"	0.315"	079-A23-1K	9/16"	10		
			079-A24-1W	19/32"			
	0.0473"	0.315"	079-A25-1M	3/4"	10		
			079-060	5/8"			
	0.0591"	0.394"	079-A26-1X	13/16"	10		
			079-A27-1A	7/8"			
			079-A28-1P	15/16"			
			079-A29-1Y	1"			
			079-066	1-1/16"			
			079-067	1-1/8"			
			079-A46-1T	1-5/16"			
079-A44-1C			1-7/16"				
079-A39-1A			1-1/2"				
079-A45-1N			1-5/8"				
079-A30-1P			1-3/4"				
Oetiker Installation Pincers			876-852		1		

Name	Band Thickness	Band Width	Spaenaur No.	Clamping Diameter	Qty.	Page	
Oetiker 2-Ear Clamps	0.0197"	0.138"	079-850	5/32"	10	G8	
			079-A55-1Y	11/64"			
	0.0276"	0.236"	0.197"	079-A42-1P	3/16"		20
			0.236"	079-A14-1X	1/4"		
	0.0315"	0.276"	079-A36-1W	5/16"	10		
			079-A38-1X	3/8"			
			079-A31-1Y	1/2"			
		0.295"	079-A32-1C	9/16"			
			0.315"	079-A33-1N			19/32"
	0.0394"	0.354"	079-A37-1M	5/8"	10		
			079-A40-1X	3/4"			
	0.0591"	0.394"	079-A34-1T	13/16"	10		
			079-A41-1A	7/8"			
			079-A49-1M	15/16"			
			079-A35-1K	1"			
			079-A43-1Y	1-1/16"			
			079-A48-1W	1-5/16"			
			079-A19-1N	1-7/16"			
079-A50-1W			1-1/2"				
079-A51-1M			1-5/8"				
079-867			1-1/8"				
079-873			1-3/4"				
Oetiker Installation Pincers			876-852		1		

PLASTIKIT
«PLASTIKIT» **A-49A**

**GENERAL PURPOSE
SOLDERING WIRING TERMINALS**

Non-Insulated

CONTAINS 13 SIZES, 100 PIECES

Packed in durable, clear plastic box with hinged lid.
Size: 1" x 2-3/4" x 4-1/2"

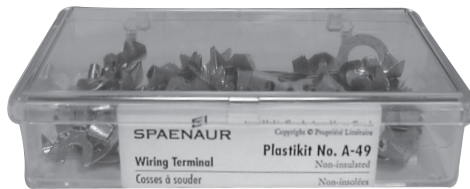

Screw Size	Spaenaur No.	Overall Length	Clamp Inside Width	Qty.	Pages
#4	WT-10	1/2"	3/32"	10	G37
#6	WT-11	9/16"		7/64"	
	WT-12	5/8"			
#8	WT-13	9/16"	5/32"	10	
	WT-4				
	WT-14	11/16"	7/64"	5	
	WT-5				
#10	WT-14A	3/4"		10	
	WT-16A				
	WT-7	15/16"	7/32"		
1/4"	WT-16	1-1/32"	3/16"	5	
3/8"	WT-8	1-1/8"		10	
	WT-9	1-1/4"	1/4"	10	

A

PLASTIKIT
«PLASTIKIT» **804-083**

**Insulated
SOLDERLESS
TERMINALS**

16 SIZES - 160 PIECES

Put up in a translucent polypropylene plastic container.
Size: 7" x 3-1-2" x 1-1/4"

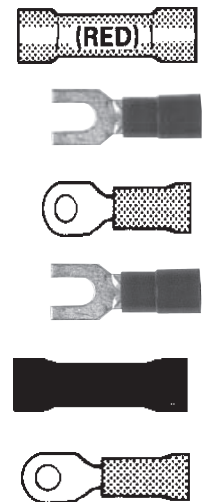

Name	Insulation Length	Insulation Colour	Compatible Wire Size	Barrel Inside Diameter	Spaenaur No.	Compatible Screw/Stud Size	Ring Outside Width	Overall Length	Qty.	Page
Ring Tongue Terminals Insulated	7/16"	Yellow	12 AWG to 10 AWG	13/64"	622-B08-1T	#10	3/8"	59/64"	10	G39
					WT-97	#12 - 1/4"	33/64"	1-11/64"		
					WT-98	3/8"	19/32"	1-9/32"		
		Blue	16 AWG to 14 AWG	5/32"	WT-91	#5 - #6	15/64"	3/4"		
					WT-93	#10	21/64"	29/32"		
					WT-94	#12 - 1/4"	15/32"	1-7/64"		
		Red	22 AWG to 16 AWG 22 AWG to 18 AWG	1/8"	WT-86	#5 - #6	7/32"	25/32"		
					WT-88	#10	21/64"	55/64"		
					WT-90	3/8"	17/32"	1-1/4"		
Fork Tongue Terminals	3/8" 19/64" 23/64" 5/16"	Yellow	12 AWG to 10 AWG	0.169"	WT-103	#10	1/2"	1"	10	G40
					Blue	16 AWG to 14 AWG		0.144"		
		Red	22 AWG to 18 AWG	0.144"						
					WT-100	#5 - #6		1"		
Insulated Solderless Butt Connector		Yellow	12 AWG to 10 AWG		WT-85				10	G41
		Blue	16 AWG to 14 AWG		WT-84					
		Red	22 AWG to 18 AWG		WT-83					

ASSORTMENT **805-628A**
ASSORTIMENT

67 Sizes  **Total: 1010 terminals**

Includes insulated Standard Ring, Spade, Hook, Three-way and Four-way Terminals, Quick-disconnect, Butt, Trailer, and T-type connectors. Most complete "Terminal" Kit available

Large Size Drawer: 18" x 12" x 3" With 32 SCOOPED compartments.

Drawer fits Slide Racks on page A3

Shipping Weight: **4.86 kg** (12.75 lbs.)

Large size
SOLDERLESS TERMINALS

Name	Spaenaur No.	Compatible Wire Size	Compatible Screw/Stud Size	Overall Length	Insulation Colour	Qty.	Page	
Ring Tongue Terminals Insulated	622-B08-1T	12 AWG - 10 AWG	#10	59/64"	Yellow	15	G39	
	WT-97		#12 - 1/4"	1-11/64"		10		
	WT-98		3/8"	1-9/32"		10		
	WT-91	16 AWG - 14 AWG	#5 - #6	3/4"	Blue	20		
	WT-92		#10	29/32"		10		
	WT-93		#12 - 1/4"	1-7/64"		10		
	WT-94		3/8"	1-1/4"		10		
	WT-95	22 AWG - 16 AWG	#5 - #6	25/32"	Red	20		
	WT-86		#12 - 1/4"	1-7/64"		10		
	WT-89		#5 - #6	27/32"		20		
	WT-87	22 AWG - 18 AWG	#10	55/64"	Red	10		
	WT-88		3/8"	1-1/4"		10		
WT-90	#10		1"	15				
Fork Tongue Terminals	622-B07-1N	12 AWG - 10 AWG	#4 to #6	29/32"	Blue	20	G40	
	622-109	16 AWG - 14 AWG	#6	31/32"		15		
	WT-102	22 AWG - 18 AWG	#6	29/32"	Red	20		
	622-108		#5 to #6	1"		20		
	WT-100		#6	1"		15		
Insulated Solderless Fork and Spade Terminals	622-129	12 AWG - 10 AWG	#6	Yellow	15	G41		
	622-161	16 AWG - 14 AWG	#10				Blue	
	622-128		#6					
	622-160	22 AWG - 18 AWG	#10	Red				
	622-131		#6					
	622-B22-1T	22 AWG - 18 AWG	#10	Red				
	622-130		#10					
622-159								
Name	Spaenaur No.	Compatible Wire Size	Compatible Tab Width	Connector Gender	Insulation Colour	Qty.	Page	
Insulated Shoulderless Disconnects	622-121	12 AWG - 10 AWG	1/4"	Male	Yellow	15	G41	
	622-118			Female				
	622-124			Male				
	622-123	16 AWG - 14 AWG	3/16"	Female	Blue			
	622-120			Male				
	622-117	22 AWG - 18 AWG	1/4"	Female	Red			
	622-122			Male				
	622-119			Female				
	622-116							
Name	Spaenaur No.	Compatible Wire Size	Connector Gender		Insulation Colour	Qty.	Page	
Fully Insulated Nylon Coupler	622-180	12 AWG - 10 AWG	Male	Female	Blue	15	G41	
	622-A01-1Z		Female					
	622-137	16 AWG - 14 AWG	Male	Female				
	622-B05-1Y		Female					
	622-B09-1K	22 AWG - 18 AWG	Male	Female				
622-132	Female							
Solderless Connectors & Bullets	622-B24-1W	16 AWG - 14 AWG	Female	Male	Blue	20	G37	
	622-143							Female
	622-162							Male
	622-145	18 AWG - 14 AWG	Female	Female	Natural	15		
	622-B26-1X							Female
622-125	0.156"							
Name	Spaenaur No.	Compatible Wire Size	Connector Gender		Insulation Colour	Qty.	Page	
Insulated Solderless Splice Connectors	622-B20-1C	12 AWG - 10 AWG			Yellow	5	G41	
	622-139					15		
	622-112					10		
	622-B13-1M	16 AWG - 14 AWG			Blue	10		
	622-B21-1N					15		
622-B19-1N	22 AWG - 18 AWG				15			
Insulated Solderless Butt Connector	622-110	22 AWG - 18 AWG			Red	20	G37	
	WT-85	12 AWG - 10 AWG			Yellow			
	WT-84	16 AWG - 14 AWG			Blue			
	WT-83	22 AWG - 18 AWG			Red			
Solderless Closed-End Connectors Clear Nylon with Tinned Copper	622-149	18 AWG - 10 AWG				15	G37	
Female T-Tap Connectors Fully Insulated	622-B06-1C	22 AWG - 18 AWG				10	G37	
Female Piggyback Disconnect Terminal	622-147	22 AWG - 14 AWG				15	G38	
Snap Terminal Connectors	WT-65	16 AWG - 14 AWG				15	G41	
Economy, Female Disconnect	622-144							
1/4" M.Q.D. Adapter	622-126							
Name	Spaenaur No.	Compatible Wire Size	Compatible Screw / Stud Size	Hole Size	Connector Gender	Qty.	Page	
Double (Male-Female) Adapter	622-148		1/4"		Male-Female	15	G38	
Flanged Fork Tongue Terminals	WT-99	22 AWG - 18 AWG	#6	0.144"		20	G40	

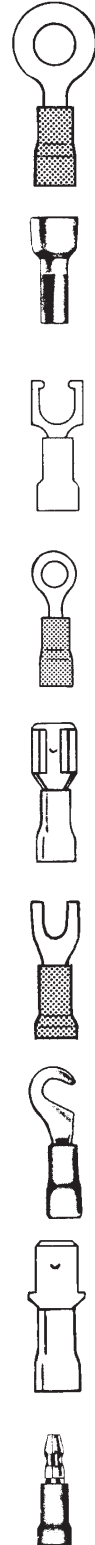

ASSORTMENT A-200-B

NON-INSULATED SOLDERLESS TERMINALS

24 SIZES - 478 PIECES
Plus one (T-138) Crimping Tool.

REGULAR SIZE welded STEEL Drawer has hinged lid, "scooped" bins, and is finished in Grey enamel. Drawer will fit into Slide Racks shown on page A2

Shipping Wt. **2.84 kg** (6-1/4 lbs.)

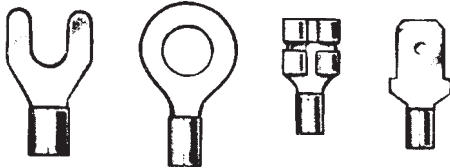

A

Name	Spaenaur No.	Compatible Wire Size	Compatible Screw/Stud Size	Hole Size	Qty.	Page
Spade Tongue Terminals	WT-47	16 AWG - 14 AWG	#4 - #6	9/64"	20	G38
	WT-48		#10	13/64"		
	WT-46	22 AWG - 18 AWG	#4 - #6	9/64"	30	
	WT-45					
Name	Spaenaur No.	Compatible Wire Size	Connector Gender	Contact Material	Qty.	Page
Solderless Connectors & Bullets	622-125	0.156"	Female	Copper	15	G37 G38
Name	Spaenaur No.	Compatible Wire Size	Compatible Screw/Stud Size	Barrel Inside Diameter	Qty.	Page
Hook Type Terminal	WT-75	22 AWG - 18 AWG	#4 to #8	11/64"	20	G38
Ring Tongue Terminal Uninsulated	622-B01-2P	12 AWG - 10 AWG	1/4"	17/64"	25	
	WT-38	16 AWG - 14 AWG	#5 to #6	9/64"		
	WT-39		#10	13/64"	20	
	WT-40	22 AWG - 18 AWG	#10	13/64"	25	
Name	Spaenaur No.	Compatible Wire Size			Qty.	Page
Flag Type Terminals	WT-52	12 AWG - 10 AWG			20	G38
	WT-51	16 AWG - 14 AWG				
	WT-50	22 AWG - 16 AWG				
Butt Connectors	WT-54	16 AWG - 14 AWG				
Name	Spaenaur No.	Inside Diameter	Outside Diameter	Overall Length	Qty.	
Distributor Cap Rubber Hood	RB-62	7/32"	7/8"	1"	7	
Name	Spaenaur No.	Clip Finish	Receptacle Type	P2P: Compatible Crimping Tool	Qty.	Page
Ignition Repair Parts	WT-106	Cadmium	Angled	T-138	15	G43
	622-B11-1K	Nickel	Straight		20	
Name	Spaenaur No.	For Wire Gauge	Special Features		Qty.	Page
Molex Crimper Tools	876-F18-1T	22 - 10	Cushion Handles		1	G44
Name	Spaenaur No.	Size		Qty.	Page	
Snap Terminal Connectors	622-B23-1K	Standard		25	G38	
Name	Spaenaur No.	Connector Gender		Qty.	Page	
Quick Connect Terminals	WT-59	Female		20	G38	
	WT-57					
	WT-56	Male				
Name	Spaenaur No.			Qty.	Page	
Spade Bolts	R-328			30	G43	

CATALOG 14.04
2019/08/08

SPAENAUR

ASSORTMENT
ASSORTIMENT **A-215**

21 SIZES - 541 PIECES

Plus one (876-1836) Crimping Tool.

REGULAR SIZE welded STEEL Drawer has hinged lid, "scooped" bins and is finished in Grey enamel. Drawer will fit into Slide Racks shown on page A2

Shipping Wt. **2.95 kg** (6-1/2 lbs.)

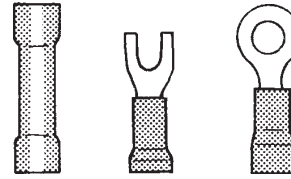

Plastic Insulated
SOLDERLESS
TERMINALS

Name	Insulation Length	Insulation Colour	Compatible Wire Size	Spaenaur No.	Compatible Screw/Stud Size	Outside Width	Overall Length	Qty.	Page			
Ring -Tongue Terminals Insulated	7/16"	Yellow	12 AWG - 10 AWG	622-B08-1T	#10	3/8"	59/64"	25	G39			
				WT-97	#12 - 1/4"	33/64"	1-11/64"					
				WT-98	3/8"	19/32"	1-9/32"					
		Blue	16 AWG - 14 AWG	WT-91	#5 - #6	15/64"	3/4"	30				
				WT-92	#10	21/64"	55/64"					
				WT-93	#10	29/32"	29/32"					
	Red	22 AWG - 16 AWG	WT-94	#12 - 1/4"	15/32"	1-7/64"	25					
			WT-95	3/8"	17/32"	1-1/4"						
			WT-86	#5 - #6	7/32"	25/32"		30				
	22 AWG - 18 AWG	WT-89	#12 - 1/4"	15/32"	1-7/64"	25						
		WT-90	3/8"	17/32"	1-1/4"							
		WT-87	#5 - #6	9/32"	27/32"		30					
Fork -Tongue Terminals	1/2"	Yellow	12 AWG - 10 AWG	WT-103	#10	3/8"	1"	25	G40			
				Blue	16 AWG - 14 AWG	622-B07-1N	#4 - #6			19/64"	29/32"	30
						WT-102	#10			23/64"	31/32"	25
Insulated Solderless Butt Connector		Yellow	12 AWG - 10 AWG	WT-85	#5 - #6	5/16"	1"	25	G41			
				Blue	16 AWG - 14 AWG	WT-84						
						Red	22 AWG - 18 AWG			WT-83		
All Purpose Electrician's Tool			18 ga. - 8 ga.	876-1836				1	G44			

ASSORTMENT
ASSORTIMENT **805-502**



235 CONNECTORS
350 TERMINALS

Drawer Size: 13-3/8" x 9-1/4" x 2"
Drawers will fit into the Slide Racks shown on page A2



Name	Product Type	Angle	Spaenaur No.	Number of Contacts	Qty.	Page
Molex KK International System	PCB Connector	Right Angle	700-101	10	10	G55
	Top Entry PCB Connector		700-103			
	Bottom Entry PCB Connector	Straight	700-102			
	Square Pin Straight Wafer		700-104			
	Crimp Terminal		700-105			
	Friction Lock Wafer		700-510	1	350	
			700-114	2	10	
			700-115	3	5	
			700-116	4		
			700-117	5		
		700-118	6			
		700-119	10			
		Right Angle	700-108	4	10	
700-109	5		5			
700-110	6					
700-111	7					
700-112	8					
Molex KK International System Connector & Terminal Housings	700-113	10		15		
	700-093	2				
	700-094	3				
	700-095	4				
	700-096	5				
	700-138	6				
	700-098	7	10			
700-099	8					
700-100	10					
Name	Tool Type	Spaenaur No.	For Use With	Qty.	Page	
Tools	Crimping Tool	876-482	Installing 0.093 terminals	1	G54	
	Extraction Tool	876-485	Removing Terminals		G55	

Inch

Plug Buttons / Self-Tapping Drain Plugs / Grease Fittings

Pouce

Cache-trous / Bouchons de vidange autotaraudeurs / Embouts de graissage

ASSORTIMENT
ASSORTIMENT **A-206A**

PLUG BUTTONS

Brass and Steel

Nickel Plated Finish.

14 SIZES - 312 PIECES

Furnished in Regular Size grey enamelled steel drawer with scooped bins for easy access. Drawer will fit into Slide Racks shown on page A2

Shipping Weight: **2.49 kg** (5-1/2 lbs.)



Name	Spaenaur No.	Panel Thickness Range	Compatible Hole Size	Outside Diameter	Qty.	Page
Plug Buttons Standard Type Brass - Coated	B-1689	0.020" - 0.062"	5/16"	7/16"	25	H2
	69-SN	0.032" - 0.046"	9/32"	13/32"		
	244-A02-1Y	0.035" - 0.062"	1/4"		30	
	84-SN	0.037" - 0.062"	1/2"	21/32"	35	
	80-SN	0.037" - 0.078"	3/8"	17/32"		
	86-SN	0.037" - 0.093"	3/4"	15/16"	20	
	B-1835N	0.062" - 0.078"	7/32"	11/32"	30	
	85-SN		5/8"	51/64"	20	
	87-SN	0.062" - 0.093"	7/8"	1-1/16"	15	
	244-A01-1P		1"	1-5/32"	12	
243-E01-1Y	1-1/4"		1-7/16"			
Plug Buttons - Standard Type - Steel - Coated	B-893	1/32" - 1/16"	1-1/2"	1-41/64"	8	
Plug Buttons - Standard Type - Plain	244-001	1/32" - 3/32"	11/16"	7/8"	20	H2
	81-SN	7/64" - 11/64"	15/32"	5/8"	25	

PLASTIKIT
«PLASTIKIT» **804-084**

PLUG BUTTONS

Steel - Nickel Plated
7 SIZES — 56 PLUGS

Furnished in a 1" x 2-3/4" x 4-1/2" handy clear plastic box with hinged lid.

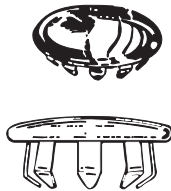

Spaenaur No.	Panel Thickness Range	Compatible Hole Size	Outside Diameter	Qty.	Page
243-E07-1M	0.031" - 0.093"	7/8"	1-1/16"	8	H3
243-004	0.032" - 0.062"	7/16"	21/32"		H2
243-E02-1C	0.037" - 0.062"	1/2"			
B-1786-N	0.037" - 0.078"	3/8"	1/2"		H3
B-1745N	0.037" - 0.093"	3/4"	15/16"		
B-1797-N	0.062" - 0.093"	1"	1-5/32"		H2
B-1794-N	0.062" - 0.109"	5/8"	51/64"		

ASSORTIMENT
ASSORTIMENT **A-202**

SELF TAPPING DRAIN & FILLER PLUGS

Steel, Zinc Plated

7 SIZES - 17 PIECES

In a translucent polypropylene box 7" x 3-1/2" x 1-1/4"

Shipping Wt. **.34 kg** (0.75 lbs.)



Compatible Thread Size	Spaenaur No.	Qty.	Page
1/2" - 20	B-1704	6	H7
	B-1705	4	
	246-007	2	
5/8" - 18	B-1706	1	
11/16" - 16	B-1707		
3/4" - 16	B-1708		
7/8" - 18	B-1709		

ASSORTIMENT
ASSORTIMENT **B-599**

INCH GREASE FITTINGS

Steel - Zinc Plated

12 SIZES - 145 FITTINGS

Furnished in Regular Size grey enamel Steel drawer with scooped bins for easy access. Drawer will fit into Slide Rack shown on page A2.

Shipping Weight **2.85 kg** (6-1/4 lbs.)

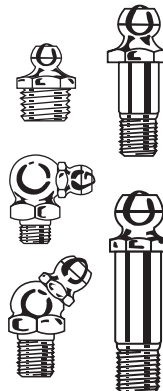

External Thread Size	Width Across Flats	Spaenaur No.	Overall Length	Qty.	Page
1/8"-28	7/16"	GF-644	9/16"	15	H12
		GF-610	11/16"	20	
		GF-612	27/32"	10	
		GF-613			
		GF-688	57/64"	25	
GF-611	29/32"				
1/4"-28	0.276"	GF-698	1-1/8"	5	
	5/16"	GF-641	35/64"		
	0.354"	GF-680	31/32"	10	
5/16"-24	3/8"	113-W07-2W	57/64"	15	
		GF-911	3/4"		
		GF-711	21/32"		

CATALOG 14

SPAENAUR

P: 1-800-265-8772 F: 1-888-252-6380 service@spaenaur.com

A107

Spaenaur reserves the right to substitute parts in any assortment without notice. For any questions or suggestions about our Assortments and Plastikits, please contact us 1-800-265-8772. © 2018 Spaenaur Inc. All rights reserved. Catalog may not be reproduced, in whole or in part, without the written permission of Spaenaur Inc. Subject to Catalog Terms and Conditions of Use available at Spaenaur.com and on page TC2 and TC3 at the back of this catalog. Spaenaur se réserve le droit de remplacer des pièces dans n'importe quel assortiment sans préavis. Pour toute question ou suggestion concernant nos Assortiments et Plastikits, veuillez nous contacter au 1-800-265-8772. © 2018 Spaenaur Inc. Tous droits réservés. Le catalogue ne peut être reproduit, en tout ou en partie, sans l'autorisation écrite de Spaenaur Inc. L'utilisation est soumise aux Conditions d'utilisation du Catalogue disponibles sur Spaenaur.com et à la page TC4 et TC5 à la fin de ce catalogue.

A

**INCH
GREASE FITTINGS**

Each Plastikit is put up in a clear durable plastic container with hinged lid.
Size: 1" x 2-3/4" x 4-1/2"

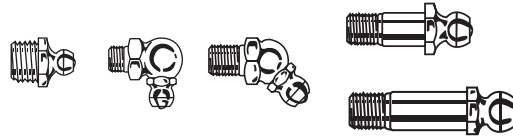

PLASTIKIT
«PLASTIKIT» **804-079**

**Stainless Steel
7 SIZES
19 GREASE FITTINGS**

PLASTIKIT
«PLASTIKIT» **A-55**

**Steel - Zinc Plated
9 SIZES
52 GREASE FITTINGS**

External Thread Size	External Thread Length	Spaenaur No.	Width Across Flats	Overall Length	Qty.	Page
1/4"-28	7/64"	113-800	5/16"	17/32"	3	H13
		113-W01-1P	3/8"	3/4"		
		113-801		13/16"		
1/8"-27	3/16"	113-W06-1K	7/16"	5/8"	2	H13
		113-805		7/8"		
	7/32"	113-806		61/64"		
		113-804		1-1/4"		

External Thread Size	Spaenaur No.	Width Across Flats	Overall Length	Qty.	Page
1/8"-28	GF-644	7/16"	9/16"	5	H12
	GF-610		11/16"	15	
	GF-612		27/32"	3	
	GF-613				
	GF-688		57/64"	5	
	GF-611		29/32"	3	
1/4"-28	GF-641	5/16"	35/64"	12	H12
	113-W07-2W	0.354"	57/64"	3	
	GF-911	3/8"	3/4"		

ASSORTMENT
ASSORTIMENT **805-444**

Metric

GREASE FITTINGS
Steel - Zinc Plated

Fine Thread

DIN 71412

**12 SIZES
120 PIECES**

Comes in a REGULAR SIZE grey enamelled STEEL drawer which will fit Slide Racks shown on page A2

Shipping Weight **2.54 kg** (5.6 lbs.)



Name	External Thread Length	Overall Length	Spaenaur No.	Width Across Flats	External Thread Size	Qty.	Page		
Hydraulic Grease Fittings Metric (Grease Fittings)	5.5mm	15mm	113-001	7mm	M6 x 1.00	10	H14		
			113-002	9mm	M8 x 1.00				
			113-003	11mm	M10 x 1.00				
		18mm	113-007	9mm	M6 x 1.00				
			113-008	M8 x 1.00					
			113-009	11mm	M10 x 1.00				
	20mm	113-004	9mm	M6 x 1.00					
		113-W03-1C	M8 x 1.00						
	Conversion Adapters Metric (Hex Head Pipe Plugs)			113-010				M6 x 1.00	H10
				113-011	M8 x 1.00				
113-012				M10 x 1.00					

PLASTIKIT
«PLASTIKIT» **804-078**

METRIC

GREASE FITTINGS
STEEL - Zinc Plated

DIN 71412

11 SIZES - 77 PIECES
Styles H1, H2 and H3



Name	External Thread Length	Category	Fitting Type	Overall Length	Spaenaur No.	Width Across Flats	External Thread Size	Qty.	Page
Hydraulic Grease Fittings - Grease Fittings	5.5 mm	H1	Straight	15mm	113-001	7mm	M6 x 1.00	7	H14
					113-002	9mm	M8 x 1.00		
					113-014	M8 x 1.25			
					113-003	11mm	M10 x 1.00		
					113-013	M10 x 1.50			
					113-004	9mm	M6 x 1.00		
		H2	45°	20mm	113-W03-1C	11mm	M8 x 1.00		
					113-006	11mm	M10 x 1.00		
					113-007	9mm	M6 x 1.00		
		H3	90°	18mm	113-008	9mm	M8 x 1.00		
					113-009	11mm	M10 x 1.00		

A108

P: 1-800-265-8772 F: 1-888-252-6380 service@spaenaur.com

Spaenaur reserves the right to substitute parts in any assortment without notice. For any questions or suggestions about our Assortments and Plastikits, please contact us 1-800-265-8772. © 2018 Spaenaur Inc. All rights reserved. Catalog may not be reproduced, in whole or in part, without the written permission of Spaenaur Inc. Subject to Catalog Terms and Conditions of Use available at Spaenaur.com and on page TC2 and TC3 at the back of this catalog. Spaenaur se réserve le droit de remplacer des pièces dans n'importe quel assortiment sans préavis. Pour toute question ou suggestion concernant nos Assortiments et Plastikits, veuillez nous contacter au 1-800-265-8772. © 2018 Spaenaur Inc. Tous droits réservés. Le catalogue ne peut être reproduit, en tout ou en partie, sans l'autorisation écrite de Spaenaur Inc. L'utilisation est soumise aux Conditions d'utilisation du Catalogue disponibles sur Spaenaur.com et à la page TC4 et TC5 à la fin de ce catalogue.

Inch

Pouce

ASSORTIMENT B-550-M-A
ASSORTIMENT B-550-M-A

EXTENSION & COMPRESSION SPRINGS
STEEL - Black & Zinc Finish
57 SIZES - 264 PIECES

LARGE SIZE Welded STEEL Drawer
 Furnished in strong metal case, with hinged lid,
 and finished in green enamel.

Shipping Weight **5.10 kg** (11-1/4 lbs.)



Extension Spring



Conical Spring



Compression Long



Compression spring



Universal spring

Name	Spaenaur No.	Overall Length	Spring Outside Diameter	Wire Gauge	Qty.	Page	
Compression Long	B-623	10"	5/8"	0.062"	1	H16	
	B-624		11/16"				
	610-A02-1A		3/4"				
	B-626	7/8"	0.080"				
	B-618	11-1/2"	7/32"	0.041"			
	610-A01-1X		5/16"	0.047"			
	B-620		3/8"	0.062"			
B-621	1/2"		0.062"				
Conical	B-662	1-1/4"		0.065"	3		
Extension	B-656	1"	3/16"	0.022"	6	H17	
	610-A09-1W		1/4"			H20	
	B-613	1-5/8"	3/8"	0.037"			
	B-611			0.054"			
	B-616	4-7/8"	1/2"	0.072"		2	
	B-606	5-1/4"	9/32"	0.042"		3	
	B-617		9/16"	0.080"			
	B-614	5-3/8"	7/16"	0.062"	2		
	B-610	5-1/2"	11/32"	0.047"	3	H17	
	B-605	5-3/4"	1/4"	0.025"			
	B-615	6-3/8"	7/16"	0.047"	2		
	B-607	6-5/8"	9/32"	0.340"			
	B-608	6-3/4"	5/16"	0.470"	3		
	B-603	7-1/4"	3/16"	0.250"			
	B-604	9"	7/32"	0.031"			
	B-627		7/16"	0.062"	4		
	B-600		9/16"	0.080"			
	B-601		5/8"	0.800"	1	H17	
	B-602		13/16"	0.080"			
	B-612	10"	3/8"	0.054"	2		
Compression	B-648	5/16"	1/8"	0.015"	10	H18	
	B-633	9/16"	19/32"	0.054"			
	B-640	5/8"	11/32"	0.028"	12		
	B-643	11/16"	7/32"	0.032"			
	B-646	3/4"	1/4"	0.018"	10		
	B-637		7/16"	0.047"			
	B-631	27/32"	11/16"	0.054"	6		
	B-634	7/8"	1/2"	0.047"			
	B-687	1-1/16"	9/32"	0.032"	10	H18	
	B-645		1/4"				
	B-638	1-1/2"	1-3/32"	0.047"			
	B-628			0.054"	3		
	B-642	1-5/8"	9/32"	0.034"	10		
	B-644			0.028"			
	B-639	1-7/8"	3/8"	0.034"	8		
	B-629	1-15/16"	1"	0.062"	3		
	B-632	2"	5/8"	0.105"	5		
	B-630		7/8"	0.054"	3		
	B-636	2-1/4"	7/16"	0.062"	8		
	B-647	2-3/8"	7/32"	0.016"	6		
B-622	3"	5/8"	0.800"	4			
B-635	3-1/8"	1/2"	0.041"	6			
B-650	5"	3/8"					
B-651	6"	7/16"	0.054"	3			
B-653	7-1/4"	9/16"	0.062"	2	H16		
B-654	9-1/4"	1/2"	0.047"				
B-655		9/16"	0.054"				
B-652	9-1/2"	7/16"	0.047"	3			

A

CATALOG 14.04
 2019/08/08

SPAENAUR

Spaenaur reserves the right to substitute parts in any assortment without notice. For any questions or suggestions about our Assortments and Plastikits, please contact us 1-800-265-8772. © 2018 Spaenaur Inc. All rights reserved. Catalog may not be reproduced, in whole or in part, without the written permission of Spaenaur Inc. Subject to Catalog Terms and Conditions of Use available at Spaenaur.com and on page TC2 and TC3 at the back of this catalog. Spaenaur se réserve le droit de remplacer des pièces dans n'importe quel assortiment sans préavis. Pour toute question ou suggestion concernant nos Assortiments et Plastikits, veuillez nous contacter au 1-800-265-8772. © 2018 Spaenaur Inc. Tous droits réservés. Le catalogue ne peut être reproduit, en tout ou en partie, sans l'autorisation écrite de Spaenaur Inc. L'utilisation est soumise aux Conditions d'utilisation du Catalogue disponibles sur Spaenaur.com et à la page TC4 et TC5 à la fin de ce catalogue.

ASSORTMENT
ASSORTIMENT **805-632A**

COMPRESSION SPRINGS

Steel - Zinc Plated

30 SIZES - 435 PIECES

Put up in a LARGE SIZE grey enamelled Steel Drawer, with hinged lid and "Adjusta-bins." Drawer will fit into our Slide Racks, as shown on page A3

Shipping Weight **6.24 kg** (13.75 lbs.)



Name	Spaenaur No.	Spring Outside Diameter	Overall Length	Wire Gauge	Qty.	Page
Utility Springs - Compression Type	B-648	1/8"	5/16"	0.015"	15	H18
	B-643	7/32"	11/16"	0.032"	25	
	B-647		2-3/8"	0.016"	20	
	B-646	1/4"	3/4"	0.018"	25	
	B-645		1-1/2"	0.032"		
	B-687	9/32"	1-1/16"	0.034"	20	
	B-642		1-5/8"			
	B-644		1-7/8"			
	B-640	11/32"	5/8"	0.028"	25	
	B-639	3/8"	1-7/8"	0.034"	20	
	B-638	13/32"	1-1/2"	0.047"		
	B-637	7/16"	3/4"	0.062"	15	
	B-636		2-1/4"			
	B-635	1/2"	7/8"	0.047"	20	
	B-634		3-1/8"	0.041"		
	B-632	5/8"	2"	0.105"	8	
	B-622		3"	0.800"		
	B-631	11/16"	27/32"	0.054"	15	
	B-630	7/8"	2"	0.062"	10	
	B-629	1"	1-15/16"	0.062"	8	
B-628	1-3/32"	1-1/2"	0.054"	6		
B-618	7/32"	11-1/2"	0.041"	5		
610-A01-1X	5/16"					
B-620	3/8"	0.062"	20			
B-621	1/2"	0.054"				
610-A10-1K	19/32"	9/16"	0.062"	5		
B-623	5/8"	10"	0.091"			
B-624	11/16"		0.080"			
610-A02-1A	3/4"	7/8"	0.047"	5		
B-626	7/8"					

ASSORTMENT
ASSORTIMENT **805-633**

EXTENSION SPRINGS

Steel - Black & Zinc Finish

29 Sizes - 268 Pieces

Put up in a LARGE SIZE grey enamelled Steel Drawer, with hinged lid and "Adjusta-bins." Drawer will fit into our Slide Racks, as shown on page A3

Shipping Weight **8.39 kg** (18-1/2 lbs.)

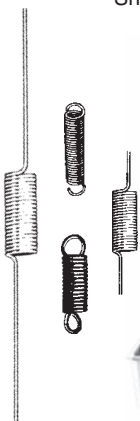

Name	Spaenaur No.	Overall Length	Spring Outside Diameter	Wire Gauge	Qty.	Page
Extension Springs Single Loop	B-659	1/2"	3/32"	0.014"	20	H17
	B-660	5/8"	1/8"	0.018"		
	B-656	1"	3/16"	0.022"		
	610-A09-1W		1/4"	0.054"		
	B-611	1-5/8"	3/8"	0.037"	15	
	B-613		5-1/2"	1/2"		
B-661	4-7/8"	1/2"	0.072"	8		
B-616	5-1/4"	9/32"	0.042"	5		
B-606		9/16"	0.080"			
B-617	5-3/8"	7/16"	0.062"	10		
B-614		5-1/2"	11/32"		0.047"	
B-610	5-3/4"	1/4"	0.025"	5		
B-605		6-3/8"	7/16"		0.047"	
B-615	6-5/8"	9/32"	0.340"	5		
B-607		5/16"	0.470"			
B-608	6-3/4"	3/16"	0.250"	12		
B-603		7/32"	0.031"			
610-A07-1T	9"	7/16"	0.062"	5		
B-627		9/16"	0.080"			
B-600	5/8"	0.800"	0.080"	3		
B-601		13/16"			0.054"	
B-602	10"	3/8"	0.041"	10		
B-612		5"	0.054"			
B-650	6"	7/16"	0.054"	5		
B-651		9/16"	0.062"			
B-652	9-1/4"	1/2"	0.047"	5		
B-654		9/16"	0.054"			
B-653	9-1/2"	7/16"	0.047"	5		
B-655		7/16"	0.047"			

EXTENSION AND COMPRESSION SPRINGS

Clear PLASTIC CONTAINERS - durable and practical.
Hinged lids - all plastic - no metal pins to rust or break.
Positive gripping clasp - no spilling of contents.

Size: 1" x 2-3/4" x 4-1/2"



A-26



A-27



A-28



PLASTIKIT
«PLASTIKIT» **A-28**

25 SIZES - 54 PIECES

Steel - Zinc Plated
EXTENSION & COMPRESSION SPRINGS

Name	Spaenaur No.	Spring Outside Diameter	Overall Length	Wire Gauge	Qty.	Page
Compression Springs	B-648	1/8"	5/16"	0.015"	2	H18
	B-647	7/32"	11/16"	0.032"		
	B-643		2-3/8"	0.016"	3	
	B-646	1/4"	3/4"	0.018"		
	B-645		1-1/2"	0.032"	2	
	B-644	9/32"	1-1/16"		3	
	B-687		1-5/8"	0.034"	2	
	B-642	1-7/8"				
	B-640	11/32"	5/8"	0.028"	3	
	B-638	13/32"	1-1/2"		0.047"	
	B-637	7/16"	3/4"	0.047"		
	B-635	1/2"	7/8"		0.041"	
	B-634		3-1/8"			
	B-633	19/32"	9/16"	0.054"	1	
B-631	11/16"	27/32"	0.054"	H18		
Extension Springs	B-659	3/32"	1/2"	0.014"	2	H17
	B-660	1/8"	5/8"	0.018"		
	B-665	5/32"	1-5/16"			
	B-656	3/16"	1"	0.022"	3	
	B-664	7/32"	1-1/4"	0.028"		
	B-667		2"	0.025"	2	
	610-A09-1W	1/4"	1"	0.022"		
	B-666	5/16"	1-9/32"	0.023"	2	
	B-613	3/8"	1-5/8"	0.037"		
	B-611			0.054"	H20	
						H17

PLASTIKIT
«PLASTIKIT» **A-27**

17 SIZES - 44 PIECES

Steel - Zinc Plated
COMPRESSION SPRINGS

Name	Spaenaur No.	Spring Outside Diameter	Overall Length	Wire Gauge	Qty.	Page
Compression Springs - Closed, Squared, or Squared & Ground Ends	B-648	1/8"	5/16"	0.015"	4	H18
	B-643	7/32"	11/16"	0.032"		
	B-647		2-3/8"	0.016"	2	
	B-646	1/4"	3/4"	0.018"		
	B-645		1-1/2"	0.032"	2	
	B-687	9/32"	1-1/16"			
	B-642		1-5/8"			
	B-644	1-7/8"	0.028"	5		
	B-640	11/32"			5/8"	
	B-639	3/8"	1-7/8"	0.034"	1	
	B-638	13/32"	1-1/2"	0.047"		
	B-637	7/16"	3/4"		0.062"	
	B-636		2-1/4"	0.047"		
	B-634	1/2"	7/8"		0.041"	
B-635	3-1/8"					
B-631	11/16"	27/32"	0.054"	2		
Compression Springs - Plain Ends	610-A10-1K	19/32"			9/16"	

PLASTIKIT
«PLASTIKIT» **A-26**

Steel - Zinc Plated
EXTENSION SPRINGS
10 SIZES - 45 PIECES

Spaenaur No.	Spring Outside Diameter	Wire Gauge	Overall Length	Qty.	Page
B-659	3/32"	0.014"	1/2"	4	H17
B-660	1/8"	0.018"	5/8"	6	
B-665	5/32"		1-5/16"	5	
B-656	3/16"	0.022"	1"		
B-667	7/32"	0.025"	2"	4	
B-664		0.028"	1-1/4"	5	
610-A09-1W	1/4"	0.022"	1"		
B-666	5/16"	0.023"	1-9/32"		
B-613	3/8"	0.037"	1-5/8"	3	
B-611		0.054"			
					H17

ASSORTMENT **805-642**
ASSORTIMENT

HOLE PLUGS
Smooth or Matte Finish
BLACK & NATURAL
Nylon 6/6

64 ITEMS - 860 PIECES

Furnished in Large Size, 18" x 12" x 3" Grey enameled STEEL Drawers, with scooped bins. Drawer will fit into Slide Racks shown on page A3

Shipping Weight: **4.26 kg** (9.4 lbs.)



Panel Thickness Range	Compatible Hole Size	Outside Diameter	Spaenaur No.	Colour	Qty.	Page	
0.031" - 0.062"	0.218"	3/8"	245-104	Natural	15	J2	
			245-105	Black			
	0.250"	27/64"	245-106	Natural			
			245-108	Black			
			245-109				
0.031" - 0.072"	0.625"	51/64"	245-107	Black			
			245-138		Natural		
			245-136	Black			
			245-W03-1Y		245-137		
0.031" - 0.094"	0.125"	13/64"	245-114	Natural	20		
			245-115	Black			
	0.150"	1/4"	245-116	Natural			
			245-117	Black			
0.031" - 0.109"	0.687"	57/64"	245-140	Natural	10		
			245-142	Black			
			245-143				
	0.750"	63/64"	245-141	Black			
			245-146			Natural	
			245-144	Black			
	0.812"	1-1/32"	245-145			Black	
			245-147				
			245-154	Natural			
	0.875"	1-5/64"	245-152	Black			
			245-155				
			245-153	Natural			
	1.000"	1-7/32"	245-156			Natural	
			245-158				
			245-157	Black			
	0.031" - 0.140"	0.187"	11/32"			245-159	Natural
				245-160			
				245-162		Black	
0.312"		29/64"	245-161	Black			
			245-163				
			245-102	Natural			
245-100		Black					
245-103			Black				
245-101		Natural					
0.375"			37/64"	245-110	Natural		
		245-W04-1C					
		245-W08-1W		Black			
245-111		Natural					
0.500"			43/64"	245-120	Natural		
		245-118					
	245-123	Black					
0.562"	47/64"		245-W01-1A	Black			
		245-121	Natural				
		245-119		Black			
0.437"	39/64"	245-130	Natural				
		245-128					
		245-131	Black				
0.031" - 0.171"	0.437"	39/64"		245-129	Black		
			245-132				
			245-133	Natural			
0.059" - 0.080"	0.787"	63/64"	245-134		Black	10	
			245-135				
			245-126	Natural			
245-124	Black						
245-H02-1K		Black					
245-125	Natural						
245-148		Black					
245-150	Black						
245-149		Black					
245-151	Black						

J2

J2

Inch

Pouce

Hole Plug & Bushing / Nylon Snap Bushings

Obturateur et douille / Douilles à pression en nylon

A

ASSORTMENT
ASSORTIMENT **805-627**

Nylon Hole & Vent Plugs
HOLE PLUG & BUSHING

22 SIZES
475 PIECES

Large Size Grey Enamelled Drawer fits the Slide Racks shown on Page A3

Shipping weight **3.85 kg** (8.5 lbs.)



Panel Thickness Range	Spaenaur No.	Mounting Hole Size	Head Diameter	Colour	Qty.	Page
0.062"	245-019	0.187"	1/4"	Black	50	J36
	245-W06-1T	0.250"	5/16"			
	245-021	0.312"	3/8"			
0.125"	245-022	0.375"	15/32"	White	40	J36
	245-023	0.437"	17/32"		35	
	245-024	0.500"	37/64"		30	
	245-025	0.562"	21/32"		25	
	245-H03-1W	0.625"	23/32"		20	
	245-027	0.687"	25/32"	Black	15	J36
	245-028	0.750"	59/64"	White		
	245-029	0.812"	57/64"	Black	10	J36
	245-030	0.875"	1-1/64"			
	245-032	1.000"	1-13/64"	White	6	J36
	245-033	1.093"	1-7/32"	Black		
	245-035	1.187"	1-5/16"	White	5	J36
	245-036	1.250"	1-3/8"			
	245-037	1.375"	1-1/2"	Black	4	J36
	245-038	1.500"	1-43/64"			
	245-039	1.750"	1-29/32"	White	3	J36
245-040	2.000"	2-9/64"				

ASSORTMENT
ASSORTIMENT **805-626**

Nylon Hole & Vent Plugs
BLACK NYLON
SNAP BUSHINGS

32 SIZES - 693 PIECES

Large Size Grey Enamelled Drawer fits the Slide Racks shown on Page A3

Shipping weight **4.5 kg** (10 lbs.)



Mounting Hole Diameter	Spaenaur No.	Inner Diameter	Flange Diameter	Overall Height	Qty.	Page			
0.250"	315-700	1/8"	5/16"	5/16"	50	J58			
0.312"	315-701	3/16"	3/8"						
0.375"	315-703	1/4"	15/32"						
0.437"	315-706	5/16"	17/32"	13/32"	40	J58			
	315-708		37/64"						
0.500"	315-709	3/8"	21/32"				25	30	J58
	315-711								
0.562"	315-713	7/16"	23/32"				20	15	J58
	315-714	1/4"							
	315-715	7/16"							
0.625"	315-G06-1A	1/2"	27/32"	10	5	J58			
	315-720	9/16"							
0.687"	315-722	1/2"	57/64"	5	3	J58			
0.750"	315-724	39/64"							
0.812"	315-726	9/16"	61/64"	20	10	J58			
	315-730	1/2"							
	315-731	9/16"							
0.875"	315-732	5/8"	1-1/8"	15	5	J58			
	315-734	3/4"							
1.000"	315-735	13/16"	1-7/32"	10	5	J58			
	315-736	7/8"							
	315-737	15/16"							
1.187"	315-739	1"	1-5/16"	5	3	J58			
1.250"	315-740		1-23/64"						
1.375"	315-742	1-1/16"	1-15/32"	10	5	J58			
	315-744		1-1/8"						
	315-746		1-5/16"						
1.500"	315-748	1-3/8"	1-7/8"	5	3	J58			
	315-749		1-5/8"						
1.750"	315-783	1-31/32"	2-1/8"	3	J58	J58			
	315-750		2-21/32"						

CATALOG 14.06 SPAENAUR

P: 1-800-265-8772 F: 1-888-252-6380 service@spaenaur.com

A113

Spaenaur reserves the right to substitute parts in any assortment without notice. For any questions or suggestions about our Assortments and Plastikits, please contact us 1-800-265-8772. © 2018 Spaenaur Inc. All rights reserved. Catalog may not be reproduced, in whole or in part, without the written permission of Spaenaur Inc. Subject to Catalog Terms and Conditions of Use available at Spaenaur.com and on page TC2 and TC3 at the back of this catalog. Spaenaur se réserve le droit de remplacer des pièces dans n'importe quel assortiment sans préavis. Pour toute question ou suggestion concernant nos Assortiments et Plastikits, veuillez nous contacter au 1-800-265-8772. © 2018 Spaenaur Inc. Tous droits réservés. Le catalogue ne peut être reproduit, en tout ou en partie, sans l'autorisation écrite de Spaenaur Inc. L'utilisation est soumise aux Conditions d'utilisation du Catalogue disponibles sur Spaenaur.com et à la page TC4 et TC5 à la fin de ce catalogue.

ASSORTMENT
ASSORTIMENT **805-621A**

General Purpose
RUBBER BUMPERS
"Most Popular Selected Sizes"
30 STYLES - 655 PIECES

Large Size Grey enamelled Steel Drawer will fit Slide Racks, shown on page A3
Shipping wt. **6.19 kg** (13-1/2 lbs.)

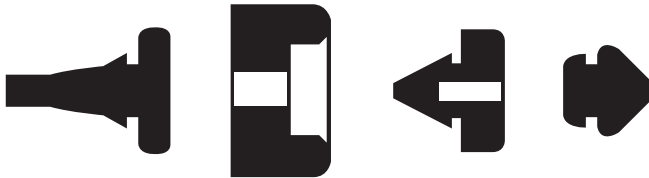

Bumper Type	Compatible Hole Size	Spaenaur No.	Groove Thickness	Outside Diameter	Exposed Bumper Height	Stem Height	Qty.	Page
Mushroom or Button Type	5/32"	315-G19-1P	3/64"	5/16"	3/32"	15/32"	25	J47
	11/64"	RB-71		11/32"	21/64"	1/2"		
	3/16"	315-054	1/32"	7/16"	5/16"	9/32"	30	J49
	7/32"	RB-143	1/16"		9/64"	9/64"	25	
	15/64"	315-077	3/32"	2-1/2"	1/2"		10	J47
		RB-116	3/64"	7/16"	7/32"	3/64"	50	J47
	1/4"	RB-73	1/32"	29/32"	1/4"	3/32"	20	J48
		315-004	3/64"	1/2"	7/64"	9/64"		
		315-G70-1A	1/16"	5/8"	1/4"	13/32"	30	J47
		RB-127		29/32"	5/16"	1/16"	15	
		315-031		15/16"	25/64"	15/64"	20	
	9/32"	315-H75-1A	3/32"	1/2"	5/16"	7/32"	20	J47
		RB-343	1/8"	13/32"	7/32"	1/16"	30	
		RB-25		17/64"	15/64"	20		
	5/8"	315-G62-1N	1/16"	1/2"	1/4"	1/4"	30	J49
		315-H38-1P			5/16"	11/64"	15	
		315-H89-1Y			11/32"		30	
	19/64"	4224	3/64"	5/8"	5/32"	55/64"	20	J48
	5/16"	RB-21	1/16"	7/8"	1/8"	3/16"	20	J49
		RB-302	5/64"	7/8"	1/8"	1/16"		
4214		3/32"	5/8"	1/4"	1/8"			
Plug Bumpers	7/16"	315-463		11/16"	5/32"	5/32"		J50
Door Silencers		RB-155		1/2"	9/16"	11/64"	15	J44
Bumper Type	Compatible Hole Size	Spaenaur No.	Overall Height	Outside Diameter	Recess Depth	Recess Diameter	Qty.	Page
Recess Type	1/8"	RB-42	1/4"	1/2"	1/8"	1/4"	20	J45
	3/16"	4243	17/32"	7/8"	9/32"	3/8"		
Recess Type With Steel Washer Insert	1/8"	315-H28-1C	17/64"	3/4"	1/4"	11/64"	15	J46
	3/16"	315-H58-1W	17/32"	1"	3/8"	1/4"		
Bolt Cap Bumper		315-G12-1N	7/16"	5/8"				J44
Bumper Type	Compatible Hole Size	Spaenaur No.	Head Thickness	Outside Diameter	Groove Width	Groove Diameter	Qty.	Page
Plastic Diaphragm Grommets	1/2"	RB-305	11/32"	1-1/16"	1/8"	13/16"	15	J63
Bumper Type	Spaenaur No.	Outside Diameter	Bumper Height	Thread Size	Stud/Nail Size	Qty.	Page	
Moulded In Screw, Stud Or Tacks	4253	5/8"	19/32"	#8-32	3/8"	15	J51	

ASSORTIMENT B-580
ASSORTIMENT B-580

RUBBER GROMMETS & BUSHINGS

32 SIZES - 687 PIECES

Furnished in Large Size, Grey Enamelled STEEL Drawer, with scooped bins. Drawer will fit into the Slide Racks shown on page A3

Shipping Wt. **6.01 kg.** (13-1/4 lbs.)

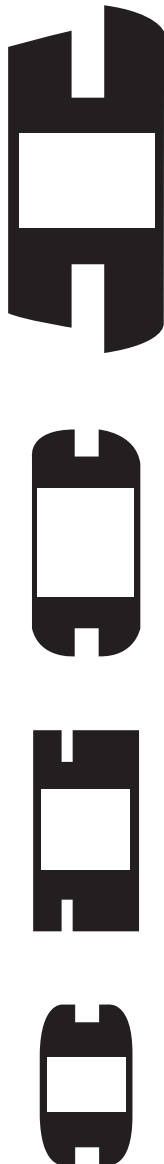
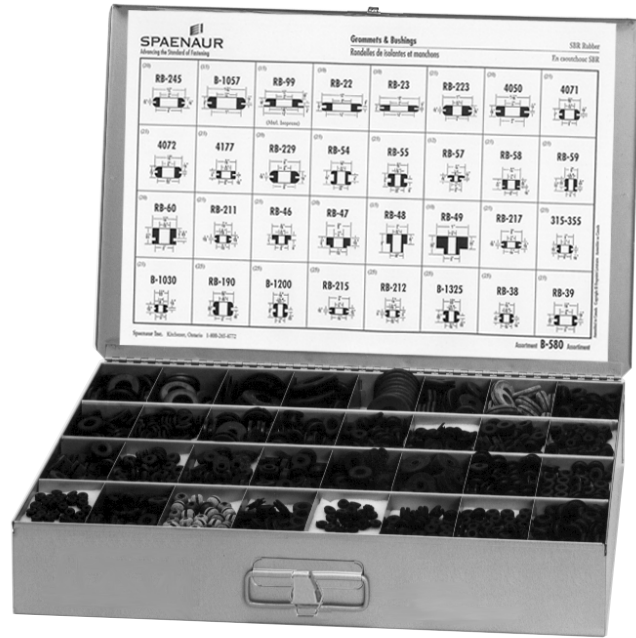

Style	Outer Diameter	Groove Diameter	Spaenaur No.	Groove Width	Bore Diameter	Overall Thickness	Qty.	Page
Rubber Grommet	11/32"	1/4"	B-1030	1/16"	1/8"	0.218"	25	J64
			B-1200		3/32"	5/32"		3/8"
	7/16"	5/16"	315-H46-1W	1/16"	3/16"	3/16"		
			RB-38			7/32"		
			315-H53-1Y			1/4"		
	15/32"	3/32"	B-1325	5/16"	9/64"	9/32"		
	1/2"	3/8"	315-G18-2A	1/16"	9/32"	1/4"		7/32"
	9/16"		4177			1/4"		
		13/32"	RB-55	1/8"	13/64"	3/8"		
	5/8"	7/16"	315-G56-2A	1/16"	1/4"	3/16"		
			315-H71-1K	3/16"		5/16"		
	21/32"	1/2"	4071	1/16"	5/16"	5/16"		
			RB-190	3/32"	9/32"	27/64"		
	11/16"	15/32"	RB-54	1/4"		7/16"		20
		1/2"	RB-39	1/16"	3/8"	9/32"		25
7/8"	5/8"	315-G71-1P	5/16"			7/16"	12	
		RB-229	3/16"	5/16"	25			
1"	3/8"	RB-223	1/16"	5/16"		5/16"		
1-1/16"	3/4"	315-G22-2W			1/2"	5/16"	20	
1-1/8"	7/8"	RB-245	3/16"	5/8"	7/16"			
1-5/16"	1"	315-H54-1C	1/16"	11/16"	3/8"	15		
		RB-23			1/4"			
1-5/8"	1-1/4"	RB-22	1/8"	3/4"	5/16"	10		
Rubber Grommets	3/8"	1/4"	315-G14-1K	1/16"	5/32"	11/32"	25	J67
			315-G26-1X	1/16"	1/8"	3/16"		
	9/16"	3/8"	RB-58		1/4"	9/32"		
	11/16"	1/2"	RB-60	5/64"	5/16"	27/64"		
	1-3/32"	RB-99	1/8"	5/8"	5/16"	15		
Rubber Bushings	3/16"	3/8"	315-G43-1X	9/16"	1/8"	1/4"	25	J56
	1/4"	7/16"	RB-47	5/8"	3/16"	20		
		1/2"	RB-49	1"	11/32"	17/32"	10	
	5/16"	15/32"	RB-48	3/4"	5/16"	5/8"	15	

CATALOG 14.10 SPAENAUR

PLASTIKIT
«PLASTIKIT» **A-32**



RUBBER GROMMETS

12 SIZES - 52 PIECES



Outer Diameter	Spaenaur No.	Groove Diameter	Groove Width	Bore Diameter	Overall Thickness	Qty.	Page
11/32"	B-1030	1/4"	1/16"	1/8"	0.218"	4	J64
7/16"	B-1200		3/32"	5/32"	3/8"	6	J64
	315-H53-1Y	5/16"	1/8"	3/16"	1/4"	6	
15/32"	B-1325	3/32"	5/16"	9/64"	9/32"	5	J64
1/2"	315-G18-2A	3/8"	1/16"	1/4"	7/32"	8	
5/8"	315-G56-2A	7/16"		5/16"	3/16"	4	
21/32"	4071	1/2"		3/8"	5/16"	3	
7/8"	315-G71-1P	5/8"		5/16"	5/16"	2	
1"	RB-223	3/4"	1/2"	1/2"	7/16"	4	J65
1-1/16"	315-H67-1N	13/16"				1/2"	1/2"
1-1/8"	RB-245	7/8"	3/16"	5/8"	7/16"	3	J66
1-1/4"	B-992	1"	1/16"	1/2"	1/4"	2	J65

O-RING SEALS

Temperature Range: **-40° to +121°C** (-40° to +250°F).

36 VARIETIES - 428 PIECES



ASSORTMENT A-216

Made of Nitrile (Buna N)

ASSORTMENT 805-606

Made of Viton

Width	Spaenaur No.	Inner Diameter	Outer Diameter	Qty.	Page			
0.070"	OR-006N	0.114"	1/4"	30	J85			
	OR-007N	0.145"	9/32"					
	OR-008N	0.176"	5/16"					
	OR-009N	0.208"	11/32"					
	0.103"	OR-010N	0.239"	3/8"	20	J85		
		OR-011N	0.301"	7/16"				
		OR-012N	0.364"	1/2"				
		OR-013N	0.426"	9/16"				
		OR-014N	0.489"	5/8"				
		OR-015N	0.551"	11/16"				
0.139"	OR-016N	0.614"	3/4"	10	J85			
	OR-110N	0.362"	9/16"					
	OR-111N	0.424"	5/8"					
	OR-112N	0.487"	11/16"					
	OR-113N	0.549"	3/4"					
	OR-114N	0.612"	13/16"					
	OR-115N	0.674"	7/8"					
	OR-116N	0.737"	15/16"					
	0.210"	OR-210N	0.734"			1"	6	J85
		OR-211N	0.796"			1-1/16"		
OR-212N		0.859"	1-1/8"					
OR-213N		0.921"	1-3/16"					
OR-214N		0.984"	1-1/4"					
OR-215N		1.046"	1-5/16"					
OR-216N		1.109"	1-3/8"					
OR-217N		1.171"	1-7/16"					
OR-218N		1.234"	1-1/2"					
OR-219N		1.296"	1-9/16"					
OR-220N		1.359"	1-5/8"					
OR-221N		1.421"	1-11/16"					
OR-222N		1.484"	1-3/4"					
OR-223N		1.609"	1-7/8"					
OR-224N		1.734"	2"					
0.210"		OR-325N	1.475"	1-7/8"	6	J86		
	OR-326N	1.600"	2"					
	OR-327N	1.725"	2-1/8"					

Width	Spaenaur No.	Inner Diameter	Outer Diameter	Qty.	Page	
0.070"	320-006	0.114"	1/4"	30	J87	
	320-007	0.145"	9/32"			
	320-008	0.176"	5/16"			
	0.103"	320-009	0.208"	11/32"		20
		320-010	0.239"	3/8"		
		320-011	0.301"	7/16"		
		320-012	0.364"	1/2"		
		320-013	0.426"	9/16"		
		320-014	0.489"	5/8"		
	0.139"	320-015	0.551"	11/16"		15
		320-016	0.614"	3/4"		
		320-110	0.362"	9/16"		
		320-111	0.424"	5/8"		
		320-112	0.487"	11/16"		
		320-113	0.549"	3/4"		
320-114		0.612"	13/16"			
320-115		0.674"	7/8"			
320-116		0.737"	15/16"			
0.210"		320-210	0.734"	1"	6	
	320-211	0.796"	1-1/16"			
	320-212	0.859"	1-1/8"			
	320-213	0.921"	1-3/16"			
	320-214	0.984"	1-1/4"			
	320-215	1.046"	1-5/16"			
	320-216	1.109"	1-3/8"			
	320-217	1.171"	1-7/16"			
	320-218	1.234"	1-1/2"			
	320-219	1.296"	1-9/16"			
	320-220	1.359"	1-5/8"			
	320-221	1.421"	1-11/16"			
	320-222	1.484"	1-3/4"			
	320-223	1.609"	1-7/8"			
	320-224	1.734"	2"			
	0.210"	320-325	1.475"	1-7/8"		6
320-326		1.600"	2"			
320-327		1.725"	2-1/8"			

Furnished in Large Size Grey enameled STEEL Drawer, with scooped bins. Size: 18" x 12" x 3"
Drawer will fit into the Slide Racks, shown on page A3. Shipping Wt. **3.96 kg** (8-3/4 lbs.)

A116

P: 1-800-265-8772 F: 1-888-252-6380 service@spaenaur.com

Spaenaur reserves the right to substitute parts in any assortment without notice. For any questions or suggestions about our Assortments and Plastikits, please contact us 1-800-265-8772. © 2018 Spaenaur Inc. All rights reserved. Catalog may not be reproduced, in whole or in part, without the written permission of Spaenaur Inc. Subject to Catalog Terms and Conditions of Use available at Spaenaur.com and on page TC2 and TC3 at the back of this catalog. Spaenaur se réserve le droit de remplacer des pièces dans n'importe quel assortiment sans préavis. Pour toute question ou suggestion concernant nos Assortiments et Plastikits, veuillez nous contacter au 1-800-265-8772. © 2018 Spaenaur Inc. Tous droits réservés. Le catalogue ne peut être reproduit, en tout ou en partie, sans l'autorisation écrite de Spaenaur Inc. L'utilisation est soumise aux Conditions d'utilisation du Catalogue disponibles sur Spaenaur.com et à la page TC4 et TC5 à la fin de ce catalogue.

PLASTIKIT
«PLASTIKIT» **804-001**

O-RING SEALS
Viton

19 SIZES - 78 PIECES



Spaenaur No.	Outer Diameter	Inner Diameter	Qty.	Page
320-006	1/4"	0.114"	5	J87
320-007	9/32"	0.145"		
320-008	5/16"	0.176"		
320-009	11/32"	0.208"		
320-010	3/8"	0.239"		
320-011	7/16"	0.301"		
320-012	1/2"	0.364"	3	
320-110	9/16"	0.362"	3	
320-013		0.426"	5	
320-111	5/8"	0.424"	3	
320-014		0.489"	5	
320-112		0.487"	3	
320-015	11/16"	0.551"	5	
320-113		0.549"	3	
320-016	3/4"	0.614"	5	
320-114	13/16"	0.612"	3	
320-115	7/8"	0.674"		
320-116	15/16"	0.737"		
320-210	1"	0.734"	2	

ASSORTMENT
ASSORTIMENT **805-A05-2M**

O-RING SPLICING KIT
8 PIECES - 8 SIZES

Kit comes in a Regular Size Grey Enamelled STEEL drawer, and will fit the Slide Racks as shown on page A2

Drawer: 13³/₈" x 9¹/₄" x 2"
Shipping Weight: **1.93 kg** (4-1/4 lbs.)

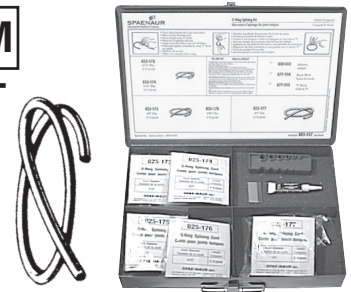

Name	Spaenaur No.	Outer Diameter	Qty.	Page	
O-Ring Splicing Cord	825-B01-1P	0.070"	5'	J84	
	825-174	0.103"			
	825-175	0.139"			
	825-176	0.210"			
	825-177	0.275"			
Name	Spaenaur No.	Blade Length	Blade Width	Qty.	Page
Cutting & Splicing Jig	877-505	4" (overall)	16" (overa	1	J84
Razor Blade	877-504	1-1/2"	3/4"		
Name	Spaenaur No.	Weight	Qty.	Page	
Turbo Fuse Super Glue	800-B78-1W	2 g	2		

PLASTIKIT
«PLASTIKIT» **804-069**

O-RING SEALS
Nitrile

19 SIZES - 78 PIECES



Spaenaur No.	Outer Diameter	Inner Diameter	Qty.	Page
OR-006N	1/4"	0.114"	5	J85
OR-007N	9/32"	0.145"		
OR-008N	5/16"	0.176"		
OR-009N	11/32"	0.208"		
OR-010N	3/8"	0.239"		
OR-011N	7/16"	0.301"		
OR-012N	1/2"	0.364"	3	
OR-110N	9/16"	0.362"	3	
OR-013N		0.426"	5	
OR-014N	5/8"	0.489"	3	
OR-112N	11/16"	0.487"		
OR-015N		0.551"		
OR-113N	3/4"	0.549"	3	
OR-016N		0.614"	5	
OR-114N	13/16"	0.612"	3	
OR-111N	7/8"	0.424"		
OR-115N		0.674"		
OR-116N	15/16"	0.737"	2	
OR-210N	1"	0.734"		

ASSORTMENT
ASSORTIMENT
805-625

METRIC
O-RING SEALS
Made of Nitrile

36 Sizes
439 Pieces

Furnished in Large Size, Grey enamelled STEEL Drawer, with scooped bins. Drawer will fit into the Slide Racks, shown on page A3.
Size: 18" x 12" x 3"

Shipping Weight:
3.97 kg (8.75 lbs.)

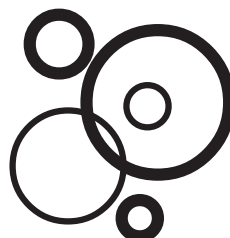

Spaenaur No.	Inner Diameter	Outer Diameter	Qty.	Page
204-003	3mm	7mm	30	J92
204-004	4mm	8mm		
204-A01-1W	5mm	9mm		
204-006	6mm	10mm	20	
204-007	7mm	11mm		
204-008	8mm	12mm	15	
204-009	9mm	13mm		
206-109	11mm	14mm		
206-111	11mm	16mm	10	
206-112	12mm	17mm		
206-113	13mm	18mm	6	
206-114	14mm	19mm		
206-115	15mm	20mm		
206-116	16mm	21mm	10	
206-117	17mm	22mm		
206-118	18mm	23mm	6	
206-119	19mm	24mm		
206-569	20mm	26mm	6	
206-321		27mm	10	
206-570	20mm	28 mm	6	
204-120		29mm	10	
206-572	22mm	29mm	6	
206-323	23mm	30mm		
206-573		31mm	10	
206-325	25mm	32mm	6	
206-575		33mm		
204-125	27mm	34mm	10	
206-327		36mm		6
206-577	30mm	37mm	10	
206-330		38mm		6
206-580	33mm	40mm	6	
206-583		45mm		
206-588	38mm	48mm	6	
204-A03-1X		51mm		
204-641	41mm	51mm	6	
204-644	44mm	54mm		

PLASTIKIT
«PLASTIKIT» **804-071**

GERMAN METRIC SIZES
O-RING SEALS
Nitrile

28 SIZES - 128 PIECES

Clear durable plastic container with hinged lid.
Size: 4-1/2" x 2-3/4" x 1"

Shipping Weight: .252 kg (1/4 lb.)



Spaenaur No.	Inner Diameter	Outer Diameter	Qty.	Page
204-003	3mm	7mm	6	J92
206-004	4mm	7mm		
206-006	6mm	9mm		
204-006		10mm		
204-010	10mm	14mm		
206-110	12mm	15mm		
206-012		17mm		
206-112	12mm	17mm		
204-014	14mm	18mm		
206-015	15mm	21mm		
206-116	16mm			
206-569	19mm	26mm	4	
206-120	20mm	25mm	6	
206-321		26mm		
204-120		28mm		
206-572		29mm		
204-125	25mm	33mm	4	
206-327	27mm			
206-332	32mm	38mm		
206-583	33mm	40mm		
204-A03-1X	38mm	48mm	2	
206-339	39mm	45mm	4	
204-650	50mm	60mm	2	

METRIC
O-RING SPLICING CORD

Solve that problem of **LARGE Metric O-Ring** availability. Now YOU can make any standard size in **German** or **Swedish** cross-section.

ASSORTMENT
ASSORTIMENT **805-455**

German
Metric O-Rings
Cord Stock Refill

6 SIZES, 9 PIECES

Shipping Weight: 1.8 kg (4 lbs.)

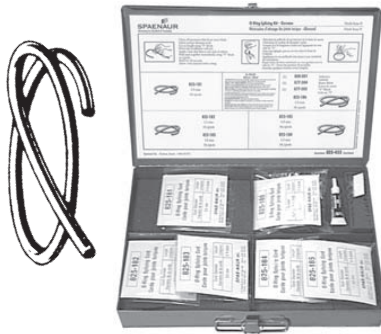

Name	Spaenaur No.	Outer Diameter	Hardness	Qty.	Page
O-Ring NITRILE (Buna-N) Metric Cord Stock	825-181	2.0mm	Duro 70	5'	J91
	825-182	2.5mm			
	825-184	3.5mm			
	825-185	4.0mm			
	825-186	5.0mm			
O-Ring-Swedish Metric Sizes	825-183	3.0mm			
Name	Spaenaur No.	Blade Length	Blade Width	Qty.	Page
Razor Blade	877-504	1-1/2"	3/4"	1	J84
Cutting & Splicing Jig	877-505	4"	3/16"		
Name	Spaenaur No.	Weight		Qty.	
Turbo Fuse Super Glue	800-B78-1W	2g		2	

ASSORTMENT
ASSORTIMENT **805-456**

Swedish
Metric O-Rings
Cord Stock Refill

5 SIZES, 8 PIECES

Shipping Weight: 1.9 kg (4-1/4 lbs.)

Name	Spaenaur No.	Outer Diameter		Qty.	Page
O-Ring-Swedish Metric Sizes	825-187	1.6mm		5'	J91
	825-188	2.4mm			
	825-183	3.0mm			
	825-190	5.7mm			
	825-191	8.4mm			
Name	Spaenaur No.	Blade Length	Blade Width	Qty.	Page
Razor Blade	877-504	1-1/2"	3/4"	1	J84
Cutting & Splicing Jig	877-505	4"	3/16"		
Name	Spaenaur No.	Weight		Qty.	
Turbo Fuse Super Glue	800-B78-1W	2g		2	

Kit comes in Grey enamelled STEEL Drawer. Drawer will fit into the Slide Racks, as shown on page A2.

Size: 13-3/8" x 9-1/4" x 2" Buy your refills by the foot.

ASSORTMENT 805-499A

**Anti-Corrosive
"MARINE" FASTENERS
19 VARIETIES — 636 PIECES**

Furnished in LARGE SIZE, grey enamelled Steel Drawer with scooped bins. Drawer will fit into the Slide Racks shown on page A3
Shipping weight: **3.52 kg** (7-3/4 lbs.)



A

Contains most popular fastener items for Canvas Covers, Camping Gear, etc.

Name	Spaenaur No.	Material	Finish	Compatible Bolt Size	Outer Diameter	Thickness	Qty.	Page
Washer Lockwasher Flat With Internal Tooth ASME/ANSI B18.21.1	675-A05-1N	410 Stainless Steel	Plain	#6	0.285" - 0.275"	0.021" - 0.017"	15	D30
Cap Snap Fastener 1/4" Barrel	106-W10-1X	Brass	Nickel Plated	#6			100	M24
Socket Snap Fastener	548-D							
Eyelet Attaching Type Stud Fastener	550-S		Nickel Finish				24	M27
Washer Common Sense Fastener 100 Pk	400A							
Name	Spaenaur No.	Thread Size	Thread Diameter	Screw Finish	Head Type	Screw Length	Qty.	Page
Machine Screw Phillips Drive 18-8 Stainless Steel ASME/ANSI B18.6.3	424-G21-1P	#6 - 32	#6	Nickel Plated	Flat	3/4"	15	B31
Tapping Screw Slot Drive 18-8 Stainless Steel Type AB ASME/ANSI B18.6.4	ST-2133						30	B80
Wood Screw Slot Drive Brass ASME B18.6.1	WS-503				Oval	1/2"	20	B64
Name	Spaenaur No.	Material	Barrel Length	Overall Diameter			Qty.	Page
Eyelet Snap Fastener	550-A	Brass	1/4"	0.600"			100	M24
	550-B							
Cap Snap Fastener 5/16" Barrel	106-W01-1Y		5/16"				25	
Name	Spaenaur No.	Nut Thickness	Nut Material				Qty.	
Nut Hex Machine Screw ASME/ANSI B18.6.3	HN-2003	7/64"	18-8 Stainless Steel				15	
Name	Spaenaur No.	Finish	Material Attachment Mechanism				Qty.	Page
Stud Common Sense Fastener with Two Screw Base 100 Pk	401-CS	Nickel Finish	Single, Two Screw Base				10	M27
Eyelet Common Sense Fastener with 1/4" Prongs 100 Pk	400	Nickel Plated	1/4" Prongs				24	
Flanged Stud Stainless Steel Screw Phillips Drive	106-036		#8 x 5/8" Stainless Steel Screw				15	M24
Name	Spaenaur No.	For Use With					Qty.	Page
2 In 1 Anvil Die for Rivets	670-T	Top: Snap Buttons; Bottom: Snap Eyelets						
Drive Tool Setting Punch for Regular Size Buttons and Eyelets	164-T	Durable Dots					1	M25
Hand Punch	450-T	400, 400B, 420, 420B Eyelets						M27
Name	Spaenaur No.	Grip Range					Qty.	Page
Quik-Snap Stud for use with Socket Snap Fastener	106-001	0.040" - 0.375"					15	M24

Used to assemble our REGULAR SIZE ASSORTMENTS.

Drawer Size: 13-3/8" W x 9-1/4" D x 2" H

Fits #814-751, #814-404, and #814-406
Slide Racks shown on page A75.



814-408
8 Compartments
(*814-408T)

814-412
12 Compartments
(*814-412T)



Assortment Box
Heavy Duty Steel
All Welded Construction
Finish: Grey Enamel



814-416
16 Compartments
(*814-416T)

814-420
20 Compartments
(*814-420T)



**Includes Interior Tray of
High-Impact Styrene**

(*Replacement Insert Trays are available.
Use number with "T" suffix to order
tray only.)



814-421
21 Compartments
(*814-421T)

814-424
24 Compartments
(*814-424T)



All drawers on this page,
Approx. Shipping Weight **1.8 kg** (4 lbs.)

All drawers on this page have "SCOOPED" bins

PKG QTY. 1



(*814-498T)

*Replacement Insert
Tray available.

ADJUSTA-BIN DRAWER Regular Size

814-498
With 9 Dividers
Weight: **1.8 kg** (4 lbs.)

814-401
Extra Plastic Bin Dividers
PKG QTY. 27

Heavy Duty Steel - All Welded Construction
Includes Interiors of *High-Impact Styrene*

PKG QTY. 1
Except extra bin dividers



814-020

LOCKING HINGES for slide racks with padlock attachment

814-020 for 814-406 Slide Racks

814-021 for 814-404 Slide Rack

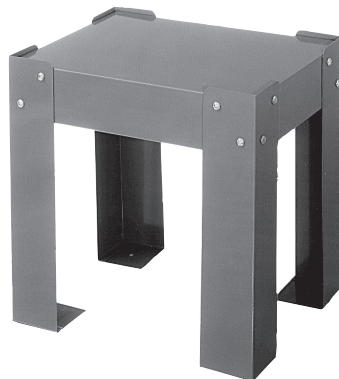

814-720

Slide Rack BASE

814-720 Base will raise Slide Racks,
shown at left, 15" from floor.

Weight **5.4 kg** (12 lbs.).

Used to assemble our **LARGE SIZE ASSORTMENTS.****Drawer Size: 18" W x 12" D x 3" H**Fits #814-754 and #814-604
Slide Racks shown on A76.**814-718**6 Vertical
Compartments
(*814-718T)**814-719**6 Horizontal
Compartments
(*814-719T)

Assortment Box
Heavy Duty Steel
All Welded Construction
Finish: Grey Enamel

814-71512 Compartments
(*814-715T)**814-716**16 Compartments
(*814-716T)

Includes Interior tray of
High-Impact Styrene

(*Replacement Insert Trays are available.
 Use number with "T" suffix to order
 tray only.)

814-71720 Compartments
(*814-717T)**814-621**21 Compartments
(*814-621T)**814-624**24
Compartments
(*814-624T)**814-632**32
Compartments
(*814-632T)

All drawers on this page,
 Approx. Shipping Weight **3.3 kg** (7-1/4 lbs.)

All drawers on this page have "SCOOPED" bins.

PKG QTY. 1

A122

P: 1-800-265-8772 F: 1-888-252-6380 service@spenaaur.com

Spaenaur reserves the right to substitute parts in any assortment without notice. For any questions or suggestions about our Assortments and Plastikits, please contact us 1-800-265-8772. © 2018 Spaenaur Inc. All rights reserved. Catalog may not be reproduced, in whole or in part, without the written permission of Spaenaur Inc. Subject to Catalog Terms and Conditions of Use available at Spaenaur.com and on page TC2 and TC3 at the back of this catalog. Spaenaur se réserve le droit de remplacer des pièces dans n'importe quel assortiment sans préavis. Pour toute question ou suggestion concernant nos Assortiments et Plastikits, veuillez nous contacter au 1-800-265-8772. © 2018 Spaenaur Inc. Tous droits réservés. Le catalogue ne peut être reproduit, en tout ou en partie, sans l'autorisation écrite de Spaenaur Inc. L'utilisation est soumise aux Conditions d'utilisation du Catalogue disponibles sur Spaenaur.com et à la page TC4 et TC5 à la fin de ce catalogue.

ADJUSTA-BIN DRAWER Large Size - Two styles



(*814-698T)
(*Replacement Insert
Tray available.)

814-698
Drawer with 9 Dividers
Weight: **3.4 kg** (7-1/2 lbs.)

814-601
Extra
Plastic Bin Dividers
PKG QTY. 27

814-778
Drawer with 12 Dividers
Weight: **3.2 kg** (7 lbs.)

814-779
Extra
Plastic Bin Dividers
PKG QTY. 24

**Heavy Duty Steel - All Welded Construction
Includes Interiors of High-Impact Styrene**



(*814-778T)



**LOCKING
HINGES**
for slide racks with
padlock attachment
814-020
use with 814-604



**814-753
LARGE SIZE
EXPANDO-BOX**
with movable dividers.

Shipping Weight
3.3 kg (7-1/4 lbs.)

PKG QTY. 1
Except extra bin dividers

Slide Rack BASE 814-721

SLIDE RACK and BASE MATERIAL

- Heavy Duty Steel
- All Welded Construction
- Grey Enamel Finish



Weight
7.2 kg
(16 lbs.)

Will raise Slide Racks
814-754 and 814-604
15" from floor.

Helpful organizers for your fasteners!

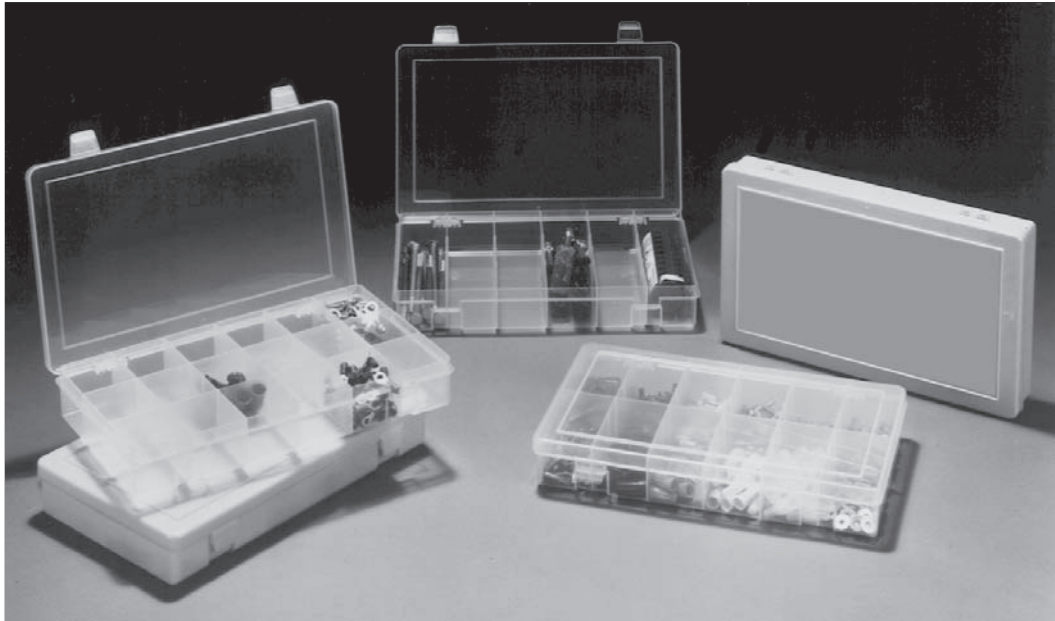

Small Plastic Compartment Boxes

(Contents not included)

Dimensions 11" Width x 1-3/4" Height x 6-3/4" Depth

These boxes are ideal for organizing, storing and protecting a wide variety of small parts and tools. Three different configurations allow a wide selection of compartment sizes and shapes to fit just about every need. Manufactured from high strength, oil resistant polypropylene, these boxes are furnished with two heavy-duty reinforced hinges with a special "stop" feature, allowing the cover to remain in the open position.

Spaenaur No.	Compartments	Compartments I.D. Size, W x H x D	Colour
814-057	6	1-3/4" x 1-9/16" x 6-1/4"	Clear
814-058	6	1-3/4" x 1-9/16" x 6-1/4"	Yellow
814-059	12	1-3/4" x 1-9/16" x 3-1/8"	Clear
814-060	12	1-3/4" x 1-9/16" x 3-1/8"	Yellow
814-061	18	1-3/4" x 1-9/16" x 2"	Clear
814-069	3 to 18	1-3/4" x 1-9/16" x 2" (adjustable)	Clear
814-070	3 to 18	1-3/4" x 1-9/16" x 2" (adjustable)	Yellow

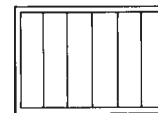

Six Compartment

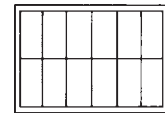

Twelve Compartment

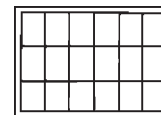

Eighteen Compartment

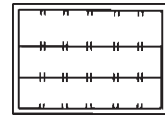

Adjustable Compartment

PKG QTY. 1

814-026

Dura-Hang™ Panel Hangers

Made of Steel and Nickel Plated these hangers are ideal to hang storage racks 814-043 and 814-044.



They are adjustable to fit up to 3-3/8" wide panels.

PKG QTY. 1 Set
(Includes 2 hangers and a wrench)

814-043

Storage Rack Holds 5 Regular Size Plastic Compartment Boxes

This versatile cold rolled steel rack with grey baked enamel finish has been designed for three way use. Keyhole slots are furnished for wall mounting. A handle is provided and bolt holes permit stacking.



(Plastic Boxes not included)

A must for any busy workshop!

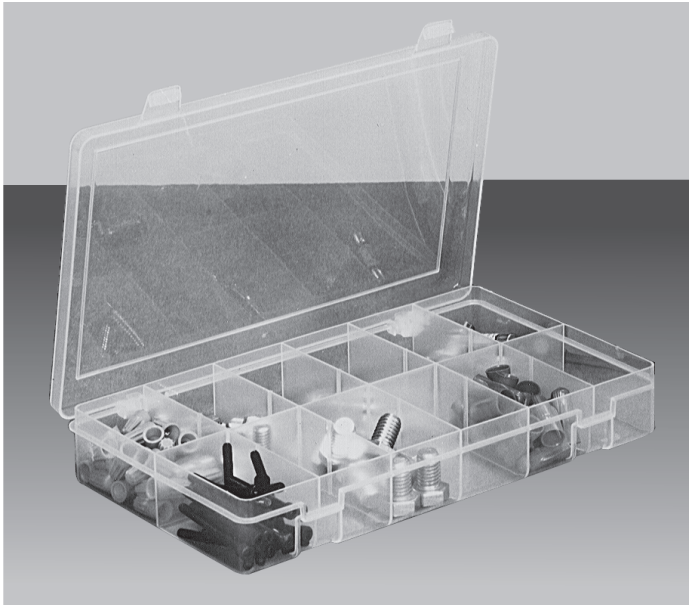

(Contents not included)

Large Plastic Compartment Boxes

Dimensions 13-1/8" Width x
2-5/16" Height x 9" Depth

These larger boxes are ideal for organizing, storing and protecting a wide variety of small parts and tools. Five different configurations allow a wide selection of compartment sizes and shapes to fit just about every need. Manufactured from high strength, oil resistant clear polypropylene, these boxes are furnished with two heavy-duty reinforced hinges with a special "stop" feature, allowing the cover to remain in the open position.

Spaenaur No.	Compartments	Compartments I.D. Size, W x H x D	Colour
814-063	6	2-1/16" x 2" x 8-1/2"	Clear
814-064	12	2-1/16" x 2" x 4-1/4"	Clear
814-065	16	3-1/8" x 2" x 2-1/16"	Clear
814-066	18	2-1/16" x 2" x 2-1/16", 4-1/4"	Clear
814-067	24	2-1/16" x 2" x 2-1/16"	Clear
814-068	4 to 24	2-1/16" x 2" x 2-1/16" (adjustable)	Clear

PKG QTY. 1



Six
Compartment

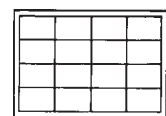

Sixteen
Compartment



Twelve
Compartment

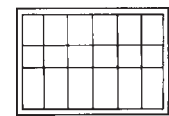

Eighteen
Compartment

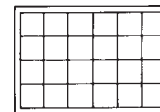

Twenty Four
Compartment

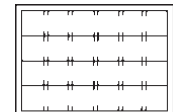

Adjustable
Compartment



(Plastic Boxes not included)

814-044

Storage Rack Holds 5 Large Size Plastic Compartment Boxes

This versatile cold rolled steel rack with grey baked enamel finish has been designed for three way use. Keyhole slots are furnished for wall mounting. A handle is provided and bolt holes permit stacking.



814-021

Locking Hinges
for Slide Racks 814-043
and 814-044 to hold
boxes in place when
being transported in a
moving vehicle. Padlock
not provided.

Also fits slide rack
814-404

PKG QTY. 1

A

DRAWER CABINETS

Cold rolled steel finished in rust and acid resistant baked enamel is the fabricating material. The use of vertical supports in construction results in great strength and allows Durham Drawer Cabinets to be stacked, regardless of the weight involved. The no-drag drawers have two embossed runners for smooth easy travel. The possibility of the drawers slipping out of the cabinet has been eliminated by a positive stop mechanism. Drawers for all Durham Drawer Cabinets offer double interlocked design resulting in unequalled rigidity. Handles are the full width of the drawers and are raised above the drawer so that the full front is available for identification. The sides of each drawer are designed to hold dividers on one inch centres. Two dividers are provided with each drawer. They have a special snap-in feature which keeps them snugly in place yet easily removable.

PKG QTY. 1

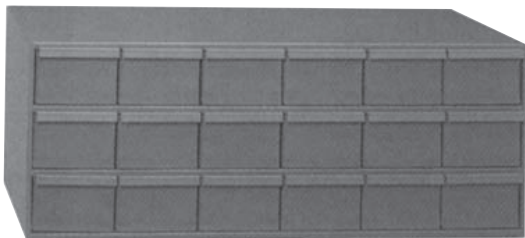

814-739

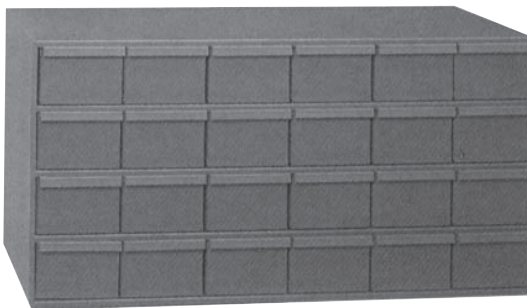

814-740

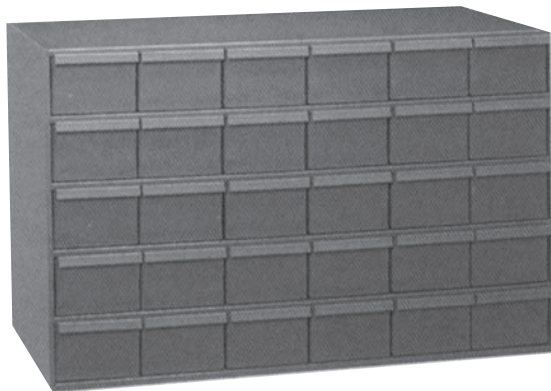

814-741



814-744

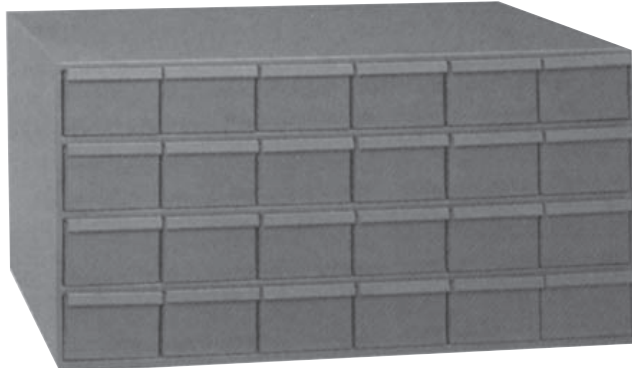

814-743

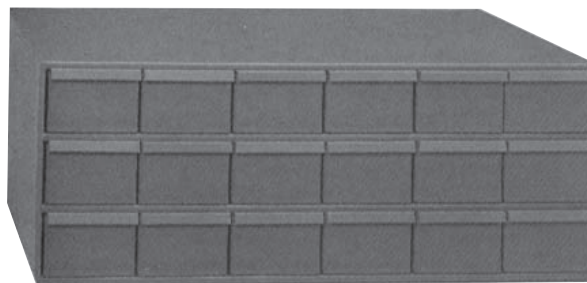

814-742

SPAENAUR CATALOG 14

... DRAWER CABINETS continued

PKG QTY. 1



More Drawer Cabinets on the following 2 pages.

DURHAM HEAVY DUTY WELDED STEEL DRAWER CABINETS

SPAENAUR No.	Width Inches	Height Inches	Depth Inches	No. of Drawers	Drawer Width Inches	Drawer Height Inches	Drawer Depth Inches	No. of Drawer Dividers	Weight kg (lbs.)
814-739	33-3/4	12-7/8	11-3/4	18	5-3/8	3-1/2	11-1/4	36	22.2 (49)
814-740	33-3/4	17	11-3/4	24	5-3/8	3-1/2	11-1/4	48	29 (64)
814-741	33-3/4	21-1/8	11-3/4	30	5-3/8	3-1/2	11-1/4	60	39.5 (87)
814-742	33-3/4	12-7/8	17-1/4	18	5-3/8	3-1/2	17	36	32.6 (72)
814-743	33-3/4	17	17-1/4	24	5-3/8	3-1/2	17	48	42.6 (94)
814-744	33-3/4	21-1/8	17-1/4	30	5-3/8	3-1/2	17	60	53.5 (118)
814-750	Base for Cabinets 34-1/8 W x 17-1/2 D x 5-3/4 H								7.7 (17)

All Cabinets and Drawers are finished in Grey Baked Enamel

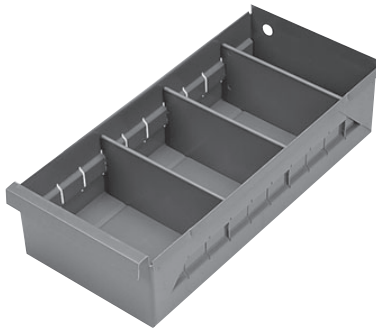

Drawers feature sides slotted on one inch centres to hold high impact plastic dividers firmly in place. They also have two easy glide runners and full width handles. Drawers come with two high impact plastic dividers.

PKG QTY. 1

Drawer Dividers are made of a high impact plastic, with special snap-in features to hold them in place.



814-037 Grey plastic dividers
PKG QTY. 12

814-750

Sturdy, all-steel base for cabinets 814-742, 814-743 and 814-744. Shipped unassembled, fasteners provided.



Cabinets and drawers are shipped with or without cardholders at our option.

PKG QTY. 1

... DRAWER CABINETS continued



814-003

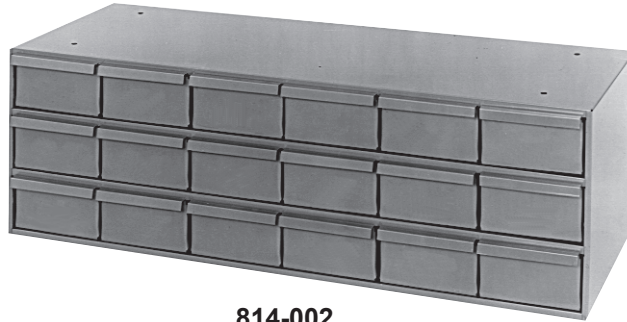

814-002

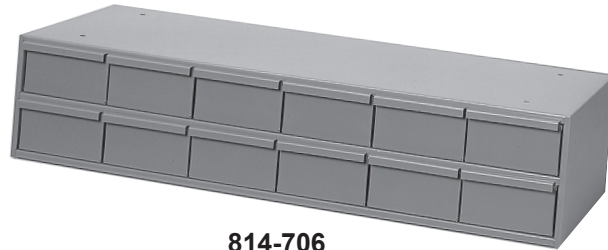

814-706

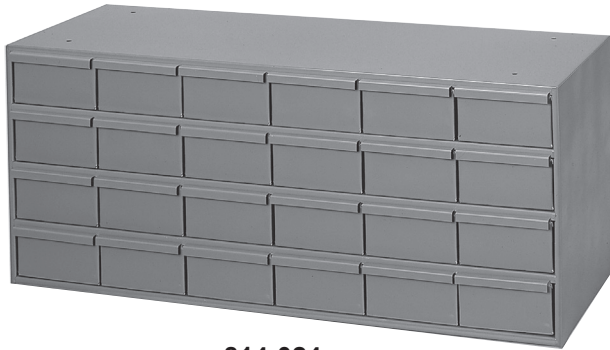

814-024



814-006



814-007



814-009



814-705

Cabinets and drawers are shipped with or without cardholders at our option.

DURHAM HEAVY DUTY WELDED STEEL DRAWER CABINETS

SPAENAUR No.	Width Inches	Height Inches	Depth Inches	No. of Drawers	Drawer Width Inches	Drawer Height Inches	Drawer Depth Inches	No. of Drawer Dividers	Weight kg (lbs.)
814-007	11-7/8	10-7/8	11-5/8	6	5-3/8	2-3/4	11-1/4	12	7.7 (17)
814-009	17-1/8	11	11-5/8	9	5-3/8	2-3/4	11-1/4	18	12.7 (28)
814-003	17-1/4	21-1/4	11-5/8	18	5-3/8	2-3/4	11-1/4	36	22.7 (50)
814-705	22-3/4	7-3/8	11-5/8	8	5-3/8	2-3/4	11-1/4	16	10.4 (23)
814-006	34	4	11-5/8	6	5-3/8	2-3/4	11-1/4	12	7.7 (17)
814-706	33-3/4	7-3/8	11-5/8	12	5-3/8	2-3/4	11-1/4	24	14 (31)
814-002	34	11	11-5/8	18	5-3/8	2-3/4	11-1/4	36	20.7 (45.6)
814-024	34	14-1/2	11-5/8	24	5-3/8	2-3/4	11-1/4	48	21.2 (60)

All Cabinets and Drawers are finished in Grey Baked Enamel

PKG QTY. 1

More Drawer Cabinets shown on page A126 and A127

**814-004
DRAWER**
(dividers not included)

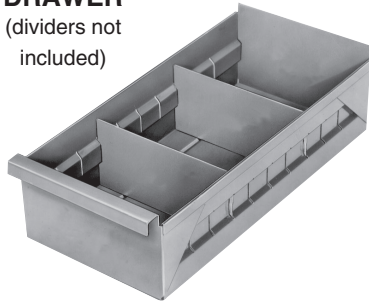

5-3/8" W x 2-3/4" H x 11-1/4" D
Shipping Weight: **0.9 kg** (2 lbs.)

Drawers feature sides slotted on one inch centres to hold high impact plastic dividers firmly in place. They also have two easy glide runners and full width handles.

Drawer will fit cabinets

Spaenaur No.
814-002
814-003
814-006
814-007
814-009
814-024
814-705
814-706
814-780
814-781
814-782

Shown on page A86 and A87.

PKG QTY. 1

**814-005
PLASTIC DRAWER
DIVIDERS**



Drawer Dividers are made of a high impact plastic, with special snap-in features to hold them in place.

Plastic dividers fit the 814-004 drawer.

PKG QTY. 24

These all steel Drawer cabinet Systems come complete with their own rugged bases. They are manufactured on automated tooling to provide uniformity. Only prime cold rolled steel is used, and they are finished in rust and acid resistant baked enamel. Drawers feature a special interlocking design resulting in superior strength. Each drawer comes with two high impact plastic dividers. They also include full width handles, embossed runners for smooth, easy opening and positive stops to prevent spilling.

**STORAGE
CABINETS**

**Not Stocked,
Pricing on Request.**

48 Drawer cabinet



72 Drawer cabinet



96 Drawer cabinet



PKG QTY. 1

SPAENAUR No.	Width Inches	Height Inches	Depth Inches	No. of Drawers	Drawer Width Inches	Drawer Height Inches	Drawer Depth Inches	No. of Drawer Dividers	Weight kg (lbs.)
814-780	34-1/8	33-3/4	12-1/4	48	5-3/8	2-3/4	11-1/4	96	73 (161)
814-781	34-1/8	48-1/8	12-1/4	72	5-3/8	2-3/4	11-1/4	144	98 (216)
814-782	34-1/8	62-1/2	12-1/4	96	5-3/8	2-3/4	11-1/4	192	136 (300)

A

STORAGE BINS 12" Deep

Designed as heavy duty units for storing a wide variety of parts, Durham Storage Bins are extremely sturdy as the result of being welded throughout on especially designed machines. Durham Storage Bins, produced of heavy gauge steel, finished in rust and acid resistant baked enamel, will not warp, twist or sag out of alignment. Fully hemmed lips on each bin keep parts securely in place and eliminate the possibility of spillage.

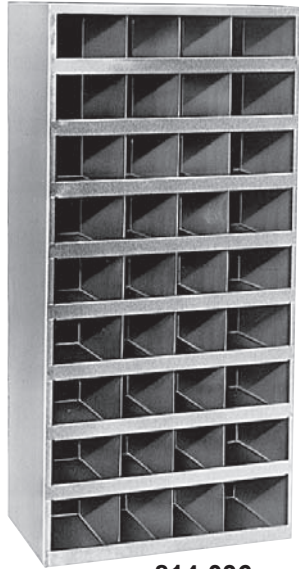

814-036



814-072

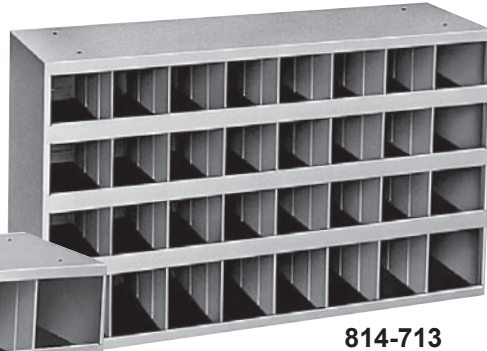

814-713

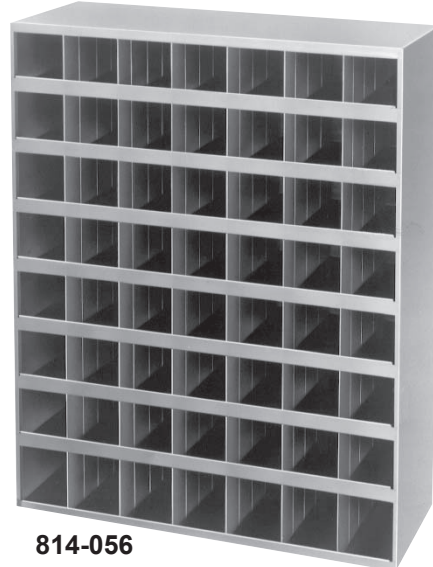

814-056

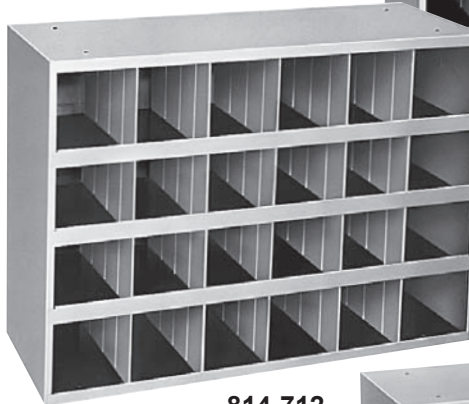

814-712

All Storage Bins come in
GREY BAKED ENAMEL.

PKG QTY. 1

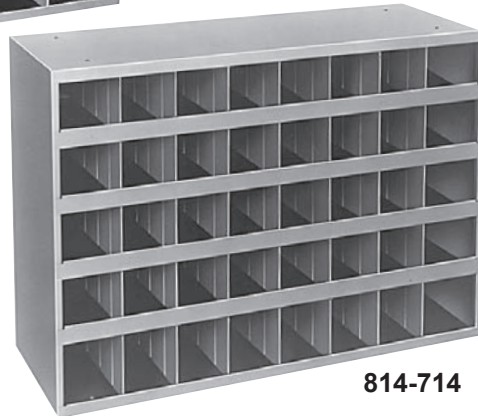

814-714



814-042

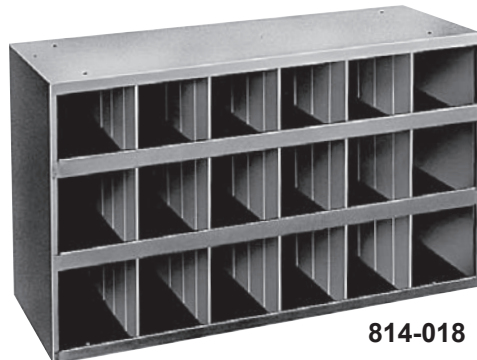

814-018

CATALOG 14

SPAENAUR

A

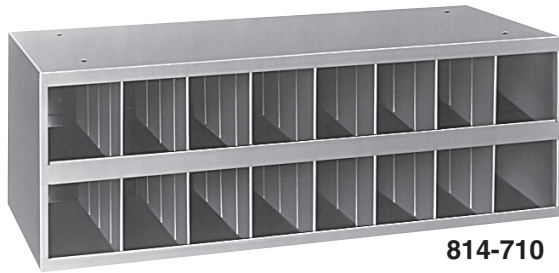

814-710

PKG QTY. 1

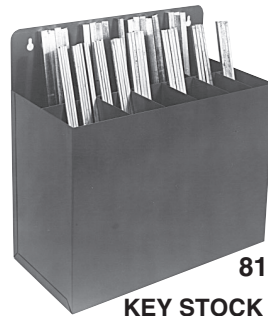

814-722

KEY STOCK RACK

Designed to hold material used in the manufacture of keyways which generally run from 1/8 inch square up to 3/4 inches square and approximately 12 inches long. Offers a total of 10 compartments for the convenient storage of stock of 10 different sizes. Keyhole slots permit wall mounting. Contents not included.



814-001

THREADED ROD CABINET

Separates and holds threaded rods, as tall as 36 inches (**914.4 mm**) and as short as 13 inches (**330.2 mm**), in 18 separate compartments, 2 inches (**50.8 mm**) in diameter.



No. 814-008

Special base for storage bins and cabinets

WELDING ROD CABINET

Holds standard welding rod up to 18 inches long. There are six openings, each 18-1/2 inches deep by 4 inches high by 5-1/4 inches wide.

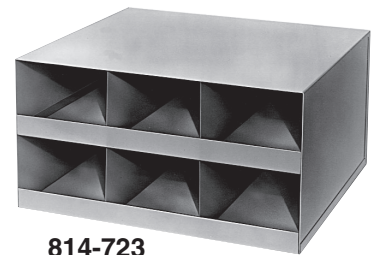

814-723

DURHAM STORAGE BIN INFORMATION

PKG QTY. 1

SPAENAUR No.	Width Inches	Height Inches	Depth Inches	No. of Bins/ Sections	Bin Width Inches	Bin Height Inches	Bin Depth Inches	Weight kg (lbs.)
814-722	12-1/4	12	6-1/4	10	VARIOUS	9	3	2.38 (5.24)
814-723	16-1/8	8-1/8	18-1/2	6	5-1/4	4	18	8.2 (18)
814-036	18	42	12	36	4	4-1/2	11-7/8	20 (44)
814-710	33-3/4	11-1/2	12	16	4	5-1/8	11-7/8	10.9 (24)
814-018	33-3/4	19-1/4	12	18	5-1/4	6-3/8	11-7/8	15.9 (35)
814-712	33-3/4	23-7/8	12	24	5-3/8	5-1/2	11-7/8	16.3 (36)
814-713	33-3/4	19-1/4	12	32	4	4-1/2	11-7/8	15.9 (35)
814-714	33-3/4	23-7/8	12	40	4	4-1/2	11-7/8	19 (42)
814-042	35-1/2	42	12	42	5-3/8	5-1/2	11-7/8	32.2 (71)
814-056	35-1/4	42	12	56	4-7/8	5-1/8	11-7/8	34.0 (75)
814-072	35-1/4	42	12	72	4	4-1/2	11-7/8	36.3 (80)
814-001	24-1/8	24	6-7/8	18	-	-	-	7.3 (16)
814-008	34-1/8	5-3/4	12-1/4	-	-	-	-	5.4 (12)

All Storage Bins come in GREY BAKED ENAMEL

CATALOG 14 SPAENAUR

A

STORAGE BINS

9" Deep

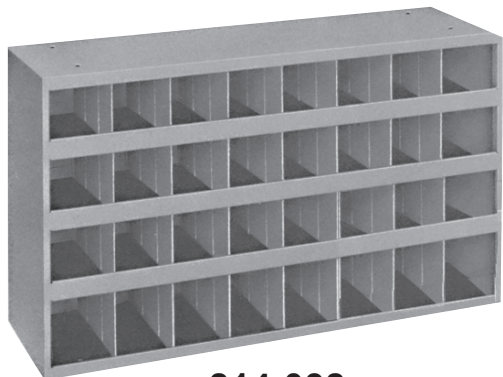

814-038

Durham's 9" deep Bins feature the same quality construction as the 12" deep models described on page A88. They are ideal for use when floor space is at a premium or the full 12" depth is not needed. All 9" deep Durham Bins are modular and easily combined to make larger units. Stock parts are accessible, and a 1-1/8" ledge on each shelf provides space to hold labels for content identification.



814-040

Sturdy, all steel Bin base.

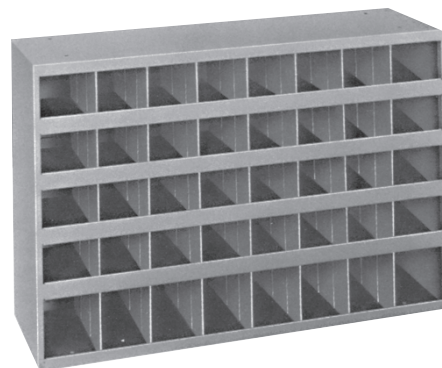

814-039

DURHAM STORAGE BIN INFORMATION

SPAENAUR No.	Width inches	Height Inches	Depth Inches	No. of Bins/ Sections	Bin Width Inches	Bin Height Inches	Bin Depth Inches	Weight kg (lbs.)
814-038	33-3/4	19-1/4	8-1/2	32	4	4-1/2	8-3/8	15.4 (34)
814-039	33-3/4	22-1/4	8-1/2	40	4	4	8-3/8	17.7 (39)
814-040	34	5-3/4	9	—	—	—	—	5.4 (12)

STORAGE BIN DOORS with padlock attachment.

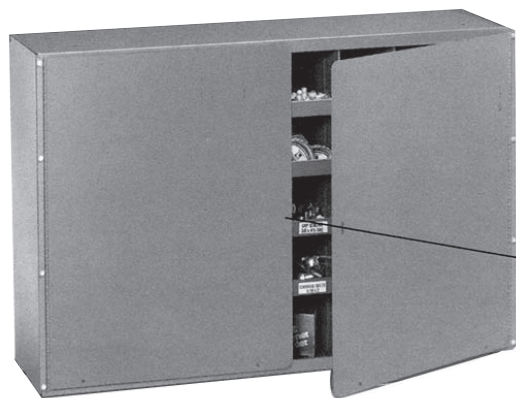

Priced per Set.

814-022

Doors are for Storage Bins 814-042, 814-056 and 814-072 shown on A91.

814-023

Doors are for Storage Bins 814-712 and 814-714 shown on A91

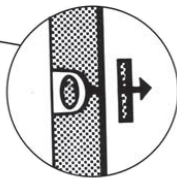

Doors are attached using sheet metal screws or pop rivets (Not supplied).

All Storage Bins and Door Sets are finished in GREY BAKED ENAMEL.

SPAENAUR CATALOG 14

Storage Units

In addition to a wide variety of bins, cabinets, racks and drawers designed for the storage of small parts, *SPAENAUR* also offers a number of units designed for specialized storage applications. Like all other *SPAENAUR* products, these special storage units are produced of prime cold rolled steel finished in rust and acid resistant baked enamel utilizing a specialized design technique which minimizes the possibility of warping, twisting or sagging out of alignment. Note possibility of combining storage cabinets and storage bins.

UTILITY CABINETS with PLASTIC DRAWERS

General purpose utility cabinets featuring break resistant, styrene, clear plastic drawers with lock-in dividers and scooped bottoms.



Prime cold rolled steel-interlocking and welded construction

Grey Baked Enamel

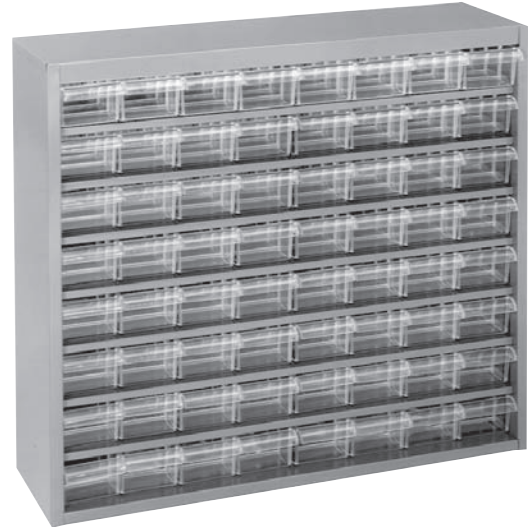

SPAENAUR No. 814-700

20 Drawers - 40 Dividers
Cabinet Dimensions:
16-3/4" W x 12" H x 6-3/8" D
Shipping Weight **5.9 kg** (13 lbs.)
PKG QTY. 1

SPAENAUR No. 814-747

64 Drawers – 128 Dividers
Cabinet Dimensions:
25-7/8" W x 21-3/8" H x 6-3/8" D
Shipping Weight
15 kg (33 lbs.)
PKG QTY. 1

EXTRA PLASTIC DIVIDERS

SPAENAUR No. 814-702
PKG QTY. 20

EXTRA PLASTIC DRAWERS

SPAENAUR No. 814-701
2-7/8" W x 1-7/8" H x 5-1/2" D
Shipping Weight **0.45 kg** (1 lb.)
PKG QTY. 1

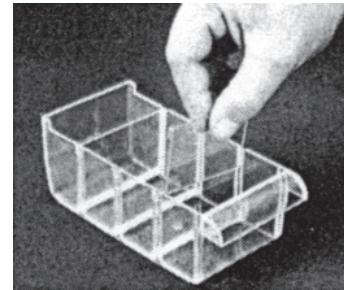

A

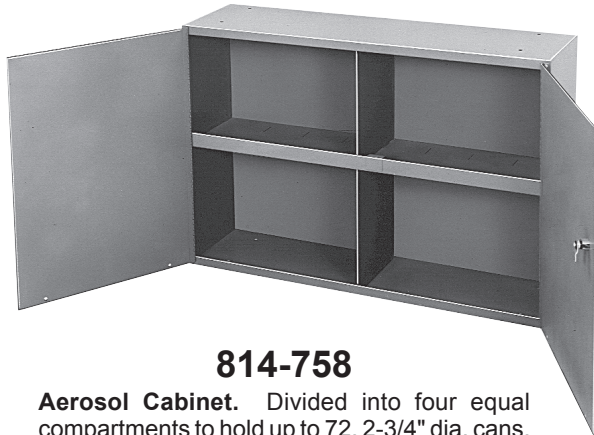

814-758

Aerosol Cabinet. Divided into four equal compartments to hold up to 72, 2-3/4" dia. cans. Double doors with key-lock protect contents.

814-756

Multi-Purpose Bin. Removable vertical dividers allow the creation of double-width openings, each with scoops. Key-hole slots are provided for wall mounting.

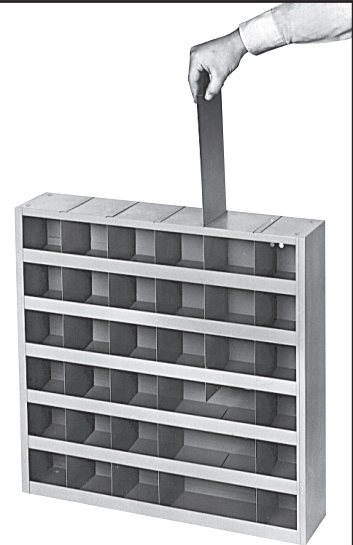

PKG QTY. 1

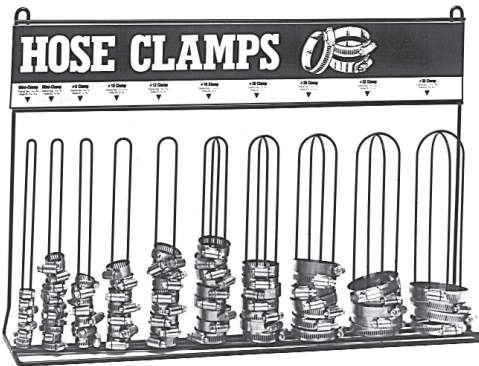

814-703

Hose Clamp Rack. Ten-post rack allows easy access to adjustable hose clamps from the smallest mini-clamp up to the 2-3/4" nom. I.D., #36 clamp. May be countertop or wall-mounted; two built-in hanger loops provided. Sign panel lists clamp diameters. Contents not included.

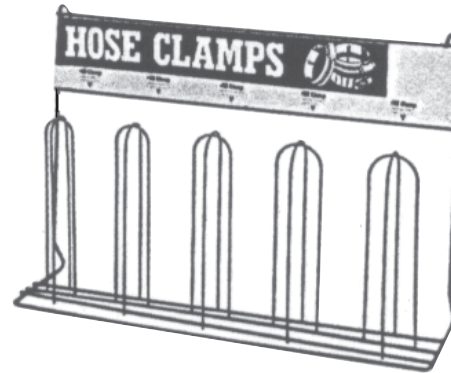

814-783

This 5 post model holds from the 2-1/16" diameter #40 to the 5" #72. For countertop use or may be wall-mounted using two built-in hanger loops provided. Sign panel lists clamp diameters.

Specifications	814-756	814-758	814-703	814-783
Width (inches)	23-3/4	33-3/4	23-1/4	23-1/4
Height (inches)	23-3/4	22-1/4	15-3/4	16-1/8
Depth (inches)	4-3/4	8-1/2	5-3/8	5-3/8
No. of Sections	36	4	10	5
Material	Prime rolled steel - interlocking construction		Heavy Duty Wire	
Colour	Grey baked enamel		Black baked enamel	
Weight kg (lbs.)	9.98 (22)	14 (31)	2.3 (5)	2.3 (5)

Heavy Duty Welded Steel Storage Bins



814-785

Contents not included.

- All welded steel construction
- Grey, powder coated, baked enamel finish
- No sharp edges
- Ribbed dividers add strength
- Fully hemmed shelves have 1/8" turn to hold labels
- Shipped assembled for immediate use



814-786

Contents not included.



No. 814-008
Special base for storage bins and cabinets. Base information can be found on page A131.

SPAENAUR No.	Width Inches	Height Inches	Depth Inches	No. of Bins/ Sections	Bin Width Inches	Bin Height Inches	Bin Depth Inches	Weight kg (lbs.)
814-785	33-7/8	23-7/8	11-29/32	12	8	6-5/8	12	16.3 (36)
814-786	33-3/4	42	12	20	8	8-1/2	11-7/8	22.2

PKG QTY. 1

Aerosol/Utility Products

These cabinets are ideal for storage of aerosol cans and utility items of all kinds. Our two vertical models each feature two adjustable shelves, a hinged door with two friction catches, a plated door handle to make opening easy, and key hole slots for wall mounting. Interlocking, welded design provides these aerosol/utility cabinets with maximum strength.

The rugged, all steel aerosol can caddy offers convenient storage for up to six aerosol cans. It can be easily wall mounted using key holes provided.

All aerosol/utility products are prime cold-rolled steel and finished in an acid/rust resistant grey baked enamel.



Small Cabinet

SPAENAUR No. 814-773

30" high x 13-3/4" wide x 12-3/4" depth

Large Cabinet

SPAENAUR No. 814-774

32-3/4" high x 19-7/8" wide x 14-1/4" depth



PKG QTY. 1

Can Caddy

SPAENAUR No. 814-775

21-1/2" wide x 5-1/4" high
x 3-1/8" depth

Contents not included with any item on this page.

A

High quality, all steel storage cabinets and door trays are designed specifically for use in outfitting trucks and vans. For applications including fastener storage, public utility, service vehicle, electrical, plumbing, TV repair, mobile food service, or sign painting, these units are ready to install. Both cabinets and door trays are reinforced for rigidity, and designed to handle extra weight. Regardless of the parts, tools, or supplies to be stored, these truck/van storage products from SPAENAUR are the perfect solution.

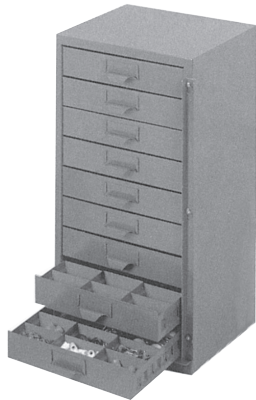

814-736

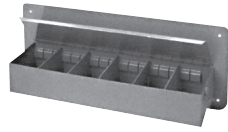

814-046
(with tray cover)

Easy-access **Durham Door Trays** are produced with horizontal sections; each rounded section has slots for adjustable dividers for the convenient creation of individual compartment sizes. Models **814-046** and **814-734** come with 9 dividers.



814-734
(with tray covers)

Durham Storage Cabinets with easy-glide drawers are equipped with unique locking bars to keep the drawers securely closed while the vehicle is in motion. The **814-736** has nine drawers with adjustable dividers for maximum flexibility, and all drawers offer convenient handles. The **814-737** has a single, fixed centre divider in each drawer.



Locking Bars (used on 814-736 and 814-737, keep storage cabinet drawers securely shut.



814-737

SPECIFICATIONS	SPAENAUR No			
	814-046	814-734	814-736	814-737
Width (inches)	21	21	12-5/8	12-5/8
Height (inches)	8	21	24-1/2	24-1/2
Depth (inches)	4-3/4	4-3/4	12-1/8	12-1/8
No. Drawers/Trays	1	3	9	4
Drawer/Trays				
Width (inches)	18-1/4	18-1/4	11	11
Height (inches)	3-1/4	3-1/4	2	4-7/8
Depth (inches)	4-1/2	4-1/2	10-3/4	10-7/8
No. Removable				
Drawer/Tray Dividers	9	9	81	0
Material	Heavy duty steel - interlocked and welded construction.			
Colour	Grey baked enamel.			
Weight kg (lbs.)	3.6 (8)	6.8 (15)	20.9 (46)	14.5 (32)

SPAENAUR
Fasteners Right Now®

Looking for our Assortment Storage Solutions?
See Pages A2-A4

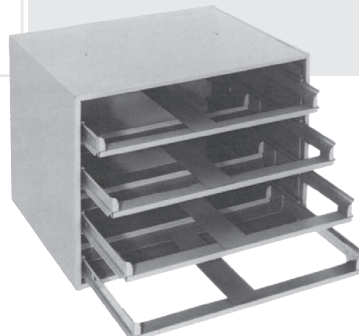

SPAENAUR CATALOG 14

A136

P: 1-800-265-8772 F: 1-888-252-6380 service@spenaaur.com

Spaenaur reserves the right to substitute parts in any assortment without notice. For any questions or suggestions about our Assortments and Plastikits, please contact us 1-800-265-8772. © 2018 Spaenaur Inc. All rights reserved. Catalog may not be reproduced, in whole or in part, without the written permission of Spaenaur Inc. Subject to Catalog Terms and Conditions of Use available at Spaenaur.com and on page TC2 and TC3 at the back of this catalog. Spaenaur se réserve le droit de remplacer des pièces dans n'importe quel assortiment sans préavis. Pour toute question ou suggestion concernant nos Assortiments et Plastikits, veuillez nous contacter au 1-800-265-8772. © 2018 Spaenaur Inc. Tous droits réservés. Le catalogue ne peut être reproduit, en tout ou en partie, sans l'autorisation écrite de Spaenaur Inc. L'utilisation est soumise aux Conditions d'utilisation du Catalogue disponibles sur Spaenaur.com et à la page TC4 et TC5 à la fin de ce catalogue.

Durham Literature Racks provide a convenient and compact way to store literature and still keep it readily accessible and visible, with the tops of literature exposed for easy identification. Keyhole slots are provided for wall mounting. Most models accommodate 150 standard 8-1/2" x 11" sheets, while others are wider, to hold magazines and special forms. Three 360° rotating literature racks (814-762, -763 and -764) are capable of holding a wide assortment of standard size literature in minimum space.

Literature and Rotating Literature Racks

Specifications	SPAENAUR No				
	814-724	814-725	814-762	814-763	814-764
Height (inches)	36	26-1/4	66	48-1/2	21-1/4
Width (inches)	9-3/4	13-1/8	14-1/8	14-1/8	14-1/8
Depth (inches)	4	13-15/16	14-1/8	14-1/8	14-1/8
Opening					
A. Width (inches)	8-13/16	12-1/2	8-11/16	8-11/16	8-11/16
B. Depth (inches)	3/4	5/16	1	1	1
C. Height (inches)	8-1/2	6	8-1/2	8-1/2	8-1/2
Paper Width (inches)	8-1/2	12	8-1/2	8-1/2	8-1/2
No. of Pockets	11	10	92	88	20
Weight kg (lbs.)	6.8 (16)	5.9 (11)	61.7 (139)	40 (88)	21.3 (48)

Construction is of sturdy heavy-gauge steel. Standard finish Desert Tan

PKG QTY. 1

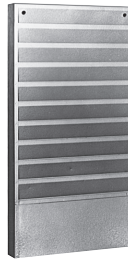

814-725
Not a Con-Tur® Rack.

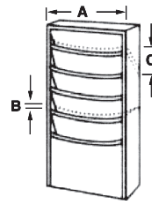

CON-TUR® Literature Racks



814-724



814-763



814-764

Contents not included.



814-762

Horizontal Racks

Durham sturdy all-steel horizontal racks, designed for floor or desk-top use, provide handy storage for computer printouts. They are rigid, will not warp or twist, and are shipped set up ready for use. These racks are modular, and may be arranged vertically or horizontally. Fasteners are provided to join individual units. Models with six or eight openings are available, and shelves have label holders to identify contents. All racks are finished in Desert Tan baked enamel. Horizontal printout racks may be combined with horizontal literature racks.

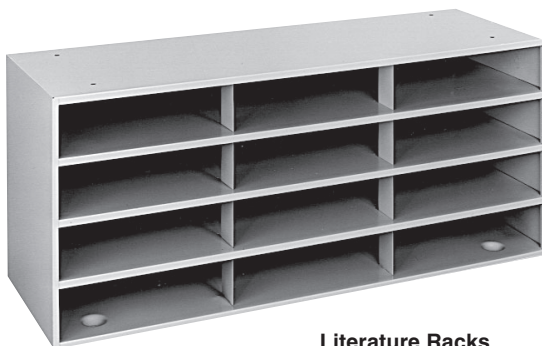

Literature Racks

Horizontal Data Organizer

Data organizers are designed specifically for storing and organizing computer printouts and reports. These all steel units are finished in desert tan baked enamel and may be arranged horizontally or stacked vertically. Label holders for content identification are provided. Rubber feet are included to protect surfaces on desks and files.

Specifications	Horizontal Literature Racks SPAENAUR No.	
	814-732	814-733
Height (inches)	10-7/8	14-1/4
Width (inches)	33-3/4	33-3/4
Depth (inches)	11-5/8	11-5/8
Opening Width (inches)	11	11
Opening Depth (inches)	11-1/2	11-1/2
Opening Height (inches)	3	3
Number of Openings	9	12
Paper Width (inches)	8-1/2	8-1/2
Weight kg (lbs.)	9.5 (21)	12.3 (27)

PKG QTY. 1

HOLD UP TO 10" DIAMETER SPOOLS.

All steel construction.

- Plated steel rods for heavy spools.
- Grey baked enamel finish, rust and acid-resistant.
- Counter or wall mount with lag holes and keyhole slots.
- Convenient carrying handle on single rod model 814-759.

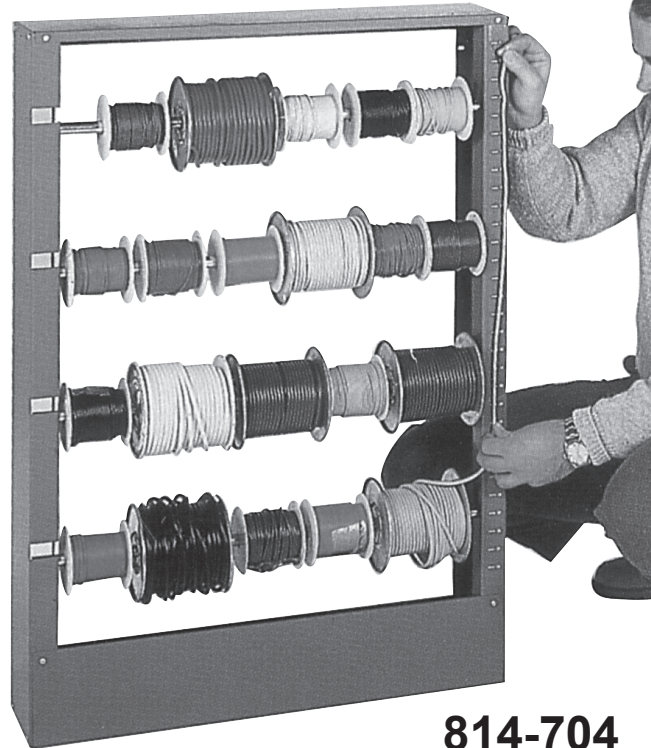

814-704

814-760

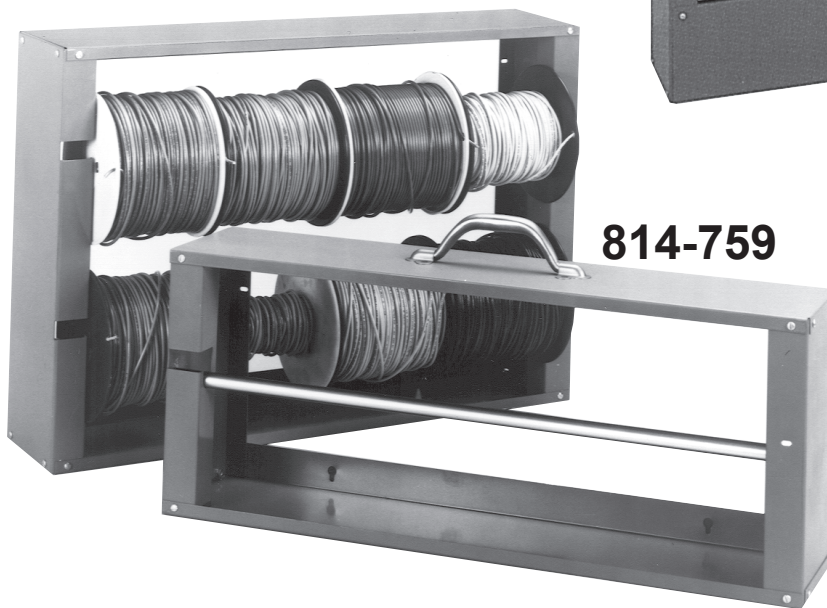

814-759

To meet your needs...
Durham industrial quality,
portable wire spool racks
are perfect for shop, job
site, or vehicular use.

Specifications	Spaenaur No. 814-759 (one rod)	Spaenaur No. 814-760 (two rods)	Spaenaur No. 814-704 (four rods)
Width (inches)	26-1/8	26-1/8	26-1/8
Height (inches)	10-3/8	17-7/8	37-1/8
Depth (inches)	6	6	6
No. of Sections	1	2	4
Material	Prime rolled steel - interlocking construction		
Colour	Grey baked enamel		
Weight kg (lbs.)	4.08 (9)	4.99 (11)	11.34 (25)

Contents not included with any item on this page.

PKG QTY. 1

SPAENAUR
 CATALOG 14.05
 2019/12/18

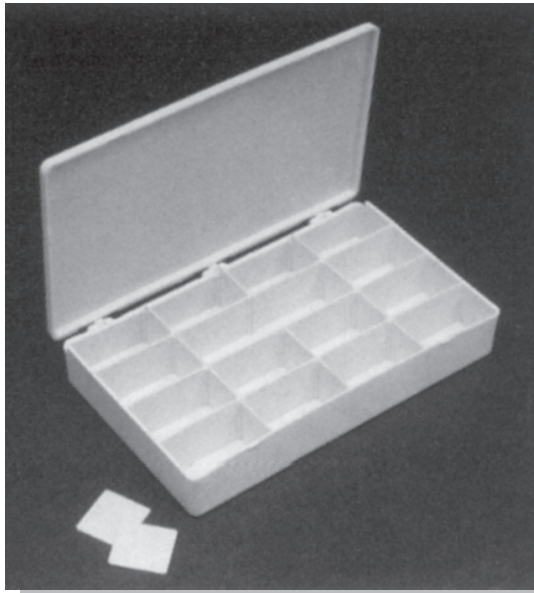

Polypropylene Boxes

These extremely durable polypropylene boxes are moulded with heavy duty, heat-sealed hinges and resist solvents such as gasoline, oil and most common chemicals. They are excellent for organizing and carrying small items for the mechanic, plumber, electrician, or handyman.

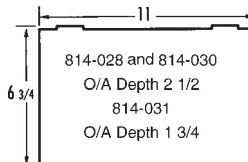

Overall Dimensions (814-028 to 814-031)

Natural Translucent Colour.

PKG QTY. 1

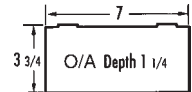

Overall Dimensions (814-032 only)

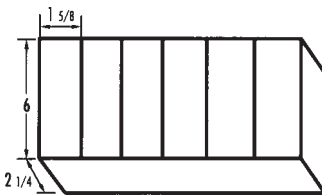

814-028

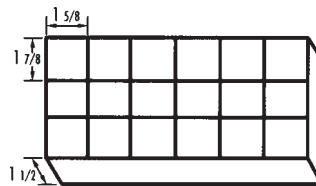

814-030

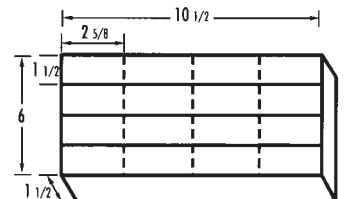

814-031

Tool Box with two Cantilever trays

These rugged plastic tool boxes make it easy to organize tools in a small space. The tool boxes are lightweight, rustproof, dentproof, scratch resistant and feature draw tight latches and tongue-and-groove construction for a secure seal. They are also ideal as repair kits, sample cases or sports supply boxes.

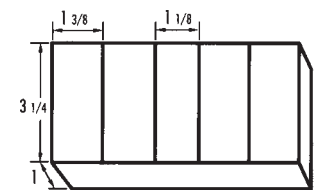

814-032

Overall Dimensions
16-3/8" x 8-5/8" x 7"

Two trays – 11 compartments

Grey colour

Tray Configurations:

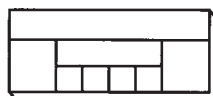

Top

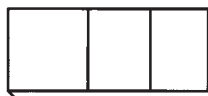

Bottom

PKG QTY. 1

SPAENAUR No. 814-033

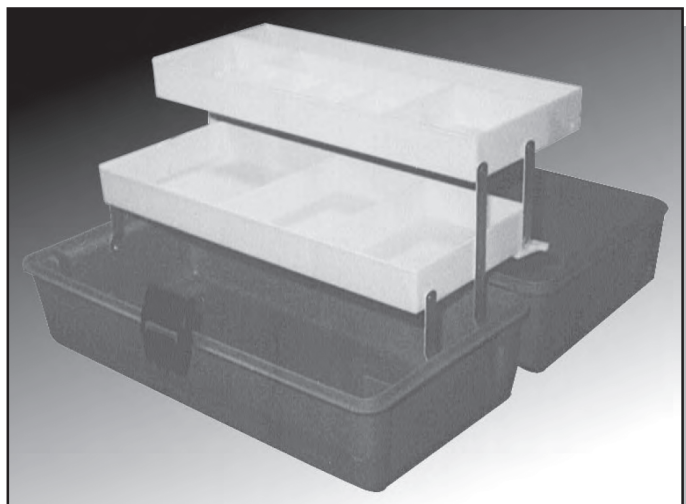

A

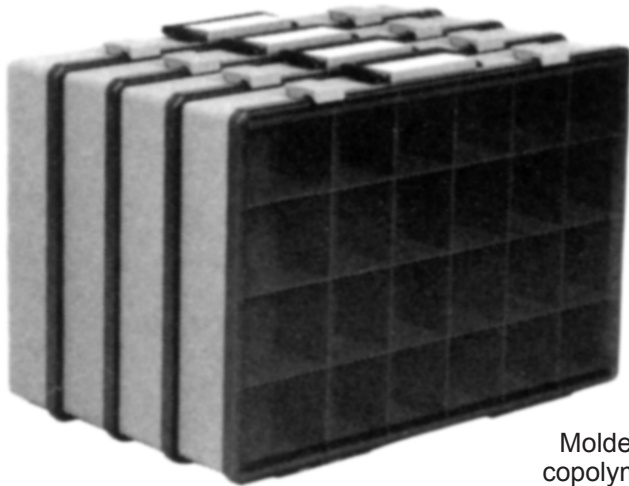

Super-Satchel Storage Cases

Molded in grey copolymer resins.



Storing and organizing materials in industrial environments takes on a new meaning with Super-Satchel Storage Cases. They offer lots of flexibility in storage and will out-perform Standard Industrial Slide Rack Boxes. Storing them flat or upright allows plenty of options for developing custom storage systems. With two draw-tight latches, a luggage style handle and lighter weight (3.5 lb. vs. 8 lb. in metal), Super-Satchel Cases are 100% portable.

814-776

Size: 18-1/2" x 13" x 3"

24 Compartments (fixed positions.)

A: 18-1/2" C: 3" E: 4"
B: 13" D: 3" F: 2-7/8"

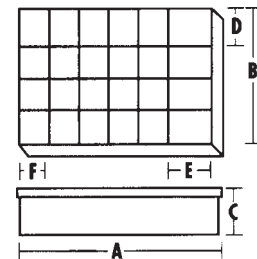

Features include . . .

- See-through lid allows quick identification of contents.
- Molded in copolymer resins that will not dent. Super-Satchel Storage Cases resist common solvents and odors.
- Copolymer resins will not rust which means no corrosion carryover onto box contents.
- Brass pinned hinges for optimum strength and durability.
- Molded integral feet allow these containers to stand upright making ideal presentation cases.
- Rounded corners, no sharp edges and lightweight covers that won't slam on fingers make these cases "user friendly."
- Identification card holder for quick case selection.

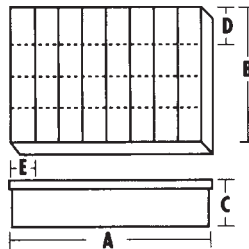

A: 18-1/2"
B: 13"
C: 3"
D: 2-15/16"
E: 2-1/8"

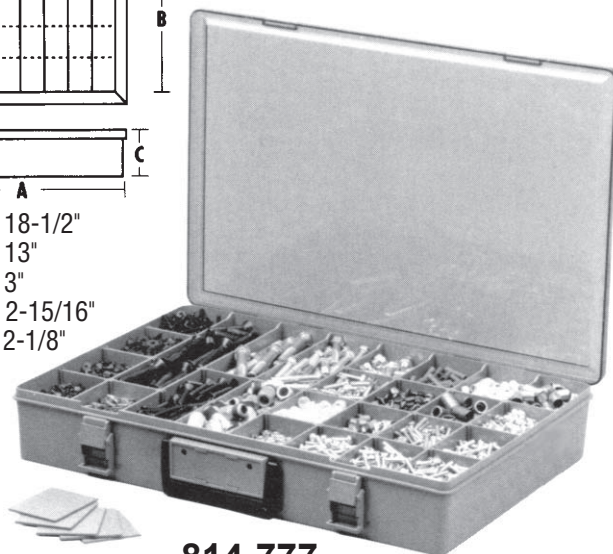

814-777

Adjusts from 8 to 32 compartments.
8 fixed dividers (Solid lines.)
24 moveable dividers (Dotted lines.)

Contents of cases not included

PKG QTY. 1

CATALOG 14

SPAENAUR

A140

P: 1-800-265-8772 F: 1-888-252-6380 service@spaenaur.com

Spaenaur reserves the right to substitute parts in any assortment without notice. For any questions or suggestions about our Assortments and Plastikits, please contact us 1-800-265-8772. © 2018 Spaenaur Inc. All rights reserved. Catalog may not be reproduced, in whole or in part, without the written permission of Spaenaur Inc. Subject to Catalog Terms and Conditions of Use available at Spaenaur.com and on page TC2 and TC3 at the back of this catalog. Spaenaur se réserve le droit de remplacer des pièces dans n'importe quel assortiment sans préavis. Pour toute question ou suggestion concernant nos Assortiments et Plastikits, veuillez nous contacter au 1-800-265-8772. © 2018 Spaenaur Inc. Tous droits réservés. Le catalogue ne peut être reproduit, en tout ou en partie, sans l'autorisation écrite de Spaenaur Inc. L'utilisation est soumise aux Conditions d'utilisation du Catalogue disponibles sur Spaenaur.com et à la page TC4 et TC5 à la fin de ce catalogue.

Product	Inch	Metric	Product	Inch	Metric
English Index					
#			M		
2-Ear Clamp	A102		Machine Screw	A25-29, A33	A30-34
A			Marine Fastener	A119	
Assortment Boxes, Empty	A120-125, A139-140		N		
Automotive Fasteners	A43		Nord-Lock® Washers	A80	A80
AVK®	A67-68		O		
AVK® Inserts & Tools, Assortments	A67-68		Organizer Cabinets	A135	
AWAB Hose Clamps		A101	O-Ring	A116-117	A117-118
B			P		
Barb-Sert®	A68	A68	Panel Nut	A65	A64
Bins, Steel, & Storage	A127, A129-137		Plastic, Boxes	A4, A124-125, A139-140	
Blind Rivet	A85		Plug Button	A107	
Boxes, Metal & Plastic	A2-4, A120-125, A129, A139-140		Pop® Rivet	A85-86	
Boxes, Security	A136		R		
Bumper, rubber	A114		Racks, Literature	A137	
Bushing	A113, A115		Retaining Ring	A96-98	A99
C			Rope Storage	A138	
Cabinets, Metal	A126-136		S		
Clevis Pin	A90		Security Boxes	A136	
Coiled Spring Pin	A94	A94-95	Self-Drilling Screw	A40	
Compartment Boxes Plastic	A124-125, A133, A139-140		Shaft Key		A96
Concrete Anchor	A66		Shear-Loc®	A59-60	A59-60
Cotter Pin	A86-87	A87-88	Shim Rings	A83-84	
Countr-Bor	A52		Slide Racks (Storage)	A2-3	
D			Soldering Terminal	A103	
Dowel Pin	A90	A90-91	Solderless Terminal	A104-106	
Drain Plug	A107		Split Washer	A72, A75	A73, A76
Drawers, Metal	A120-123, A129		Spool Racks	A138	
Durham Storage Hardware	A120-138		Spring Tension Pin	A92-93	A92-93
E			Spring Tension Washer	A81-82	A81-82
E-Z LOK®	A69	A69	Spring, Extension & Compression	A109-111	
F			Square Head Set Screw	A57	A58
Fibre Washer	A73		Storage Cabinets	A126-129	
Flat Washer	A72-73	A74-75	T		
G			Tampruf™ Screw	A41	
Grease Fitting	A107-108	A108	Taper Pin	A91	A91
Gripper Clip	A100		Tapping Screw	A25, A35-40	
Grommet, Rubber	A115-116		Thread-Cutting Screw	A41	
H			Thumbscrew	A59	
Hair Pin	A89		Tinnerman® Spring Nut	A63	
HeliCoil®	A70	A71	Tooth Lockwasher	A77-78	A78-80
Hex Head Cap Screw	A44-49	A49-51	Torx®	A42	
Hex Nut	A60	A60-61	W		
Hex Socket Cap Screw	A52, A56	A52-55, A57-58	Well Nut®	A65	A65
Hitch Pin	A88-89	A88	Wing Nut	A62	
Hole Plug	A112-113		Wire Spool Racks	A138	
Hose Clamp	A100-101		Wood Screw	A34	
Hose Clamp Racks	A134		Woodruff Key	A95	A95-96
L					
L•9® Fastening System	A47				
Locknut	A61	A62			
Lynch Pin	A89	A89			

Index de section

Product	Inch	Metric	Product	Inch	Metric
Index français					
A					
Ancrages à manchon	A66		Goupilles coniques	A91	A91
Assortiments, boîtes, vides	A120-125, A139-140		Goupilles d'attelage	A88-89	A88
Attaches de serrage	A100		Goupilles ressort spirales	A94	A94-95
AVK®	A67-68		Goupilles tendueuses à ressort	A92-93	A92-93
Axes de chape	A90		H		
B					
Bagues de retenue	A96-98	A99	HeliCoil ^{MD}	A70	A71
Barb-Sert®	A68	A68	J		
Boîtes, métal et plastique	A2-4, A120-125, A129, A139-140		Joint torique	A116-117	A117-118
Boîtes, sécurité	A136		M		
Bouchon	A112-113		Matériel d'entreposage Durham	A120-138	
Bouchon de drain	A107		N		
C					
Cabinet à glissières	A2-3		Nord-Lock ^{MD} , Rondelles	A80	A80
Cabinet de rangement	A126-129		P		
Cabinet de sécurité	A136		Pare-choc caoutchouc	A114	
Cabinet organisateur	A135		Pare-chocs de caoutchouc	A113, A115	
Cabinet, métal	A126-136		Plastique, Boîtes	A4, A124-125, A139-140	
Caché-trous	A107		Présentoirs, brochures	A137	
Caoutchouc Œillets	A115-116		R		
Chevilles d'essieu	A89	A89	Rangement de corde	A138	
Clavettes d'arbre		A96	Râtelier à bobines	A138	
Clavettes-disques	A95	A95-96	Rivet aveugles	A85	
Collier de serrage	A100-101		Rivet Pop®	A85-86	
Colliers de serrage a 2 oreilles	A102		Rondelle de blocage dent	A77-78	A78-80
Colliers de serrage AWAB		A101	Rondelle de calage	A83-84	
Compartiments, boîtes, plastique	A124-125, A133, A139-140		Rondelle fendue	A72, A75	A73, A76
Compartiments, rangement, & acier	A127, A129-137		Rondelles en fibres	A73	
Connecteurs à soudures	A103		Rondelles plates	A72-73	A74-75
Cosses sans soudures	A104-106		Rondelles tendueuses à ressort	A81-82	A81-82
Countr-Bor	A52		S		
D					
D'écrous freinés	A61	A62	Shear-Loc ^{MD}	A59-60	A59-60
Douilles et outils AVK®, Assortiments	A67-68		Supports pour bobines de fil	A138	
E					
Écrou a ressort Tinnerman ^{MD}	A63		Système de fixations L•9 ^{MD}	A47	
Écrou de panneau	A65	A64	T		
Écrous hexagonaux	A60	A60-61	Tiroirs, métal	A120-123, A129	
Écrous papillon	A62		Torx ^{MD}	A42	
Embout de graissage	A107-108	A108	V		
Épingle à cheveux	A89		Vis à bois	A34	
Extension et compression de ressort	A109-111		Vis à tête creuse hexagonale	A52, A56	A52-55, A57-58
E-Z LOK ^{MD}	A69	A69	Vis à tête hexagonale	A44-49	A49-51
F					
Fixations automobiles	A43		Vis autoperceuses	A40	
Fixations marines	A119		Vis autotaraudeuses	A25, A35-40	
G					
Goupille	A90	A90-91	Vis autotaraudeuses taillant le filet	A41	
Goupille fendue	A86-87	A87-88	Vis de pression à tête carrée	A57	A58
			Vis de serrage	A59	
			Vis mécaniques	A25-29, A33	A30-34
			Vis Tampruf ^{MC}	A41	
			W		
			Well Nut®	A65	A65