

# 2020 Product Catalog

MSRP Effective Oct. 2020

Newest Products to the  
SnapNrack Catalog

SpeedSeal™

Ultra Rail Clamps

Adjustable Tile Hook

Conduit Supports

Array Edge Screen



**SnapNrack™**  
**Solar Mounting Solutions**

877-732-2860



[www.SnapNrack.com](http://www.SnapNrack.com)



[contact@snapNrack.com](mailto:contact@snapNrack.com)

# Quality. Innovative. Superior.

---

SnapNrack Solar Mounting Solutions are engineered to optimize material use and labor resources and improve overall installation quality and safety.

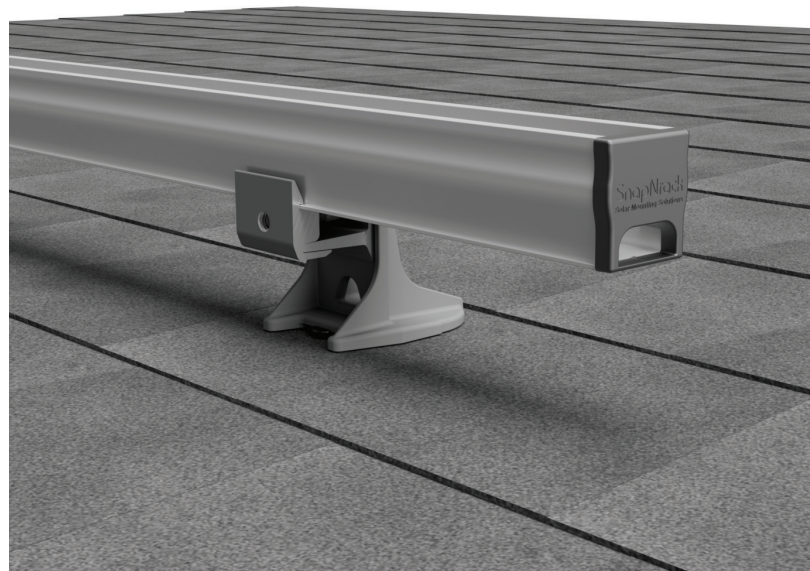
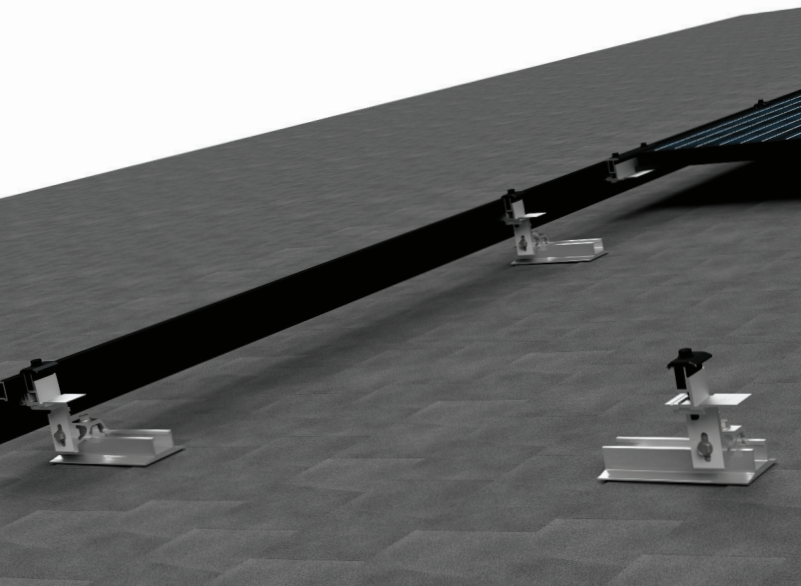

SnapNrack's **RL Universal System (RL-U)** for composition shingle roofs provides the greatest labor efficiency featuring Universal Mounts that attach to market leading frame thicknesses with an installer focused process allowing the system to be installed by a single person, saving time on the roof.

The SnapNrack **Ultra Rail Roof Mount** portfolio satisfies virtually all residential roof types featuring labor saving components like the snap-in mounts and splices along with the open rail channel and accessories to create the industry's leading Wire Management Solutions.

# Table of Contents

## Pitched Roof

### RL Universal | *Railless Mounting* **3**

RL-U Components 4

Wire Management & Grounding 4

### Ultra Rail | *Rail-based Mounting* **5**

UR-40/60 Rail & Accessories 6

Flashing & L Foot Attachments 7

Module Clamps 8

Tile Roof Solutions 9

Wire Management Solutions 10

### SpeedSeal™ Technology | *Lag Driven Sealant Solution* **11**

**NEW**

SpeedSeal™ Foot for Ultra Rail 12

SpeedSeal™ Track for RL Universal 12

## Flat & Metal Roofs

### Ultra Rail Tilt System **13**

Metal Roof Attachments 15

Standoff Components & Accessories 15

### Accessories **16**

## Ground Mount

### Series 200 | *Ground Mount* **17**

Series 200 Rail & Structural Fittings 18

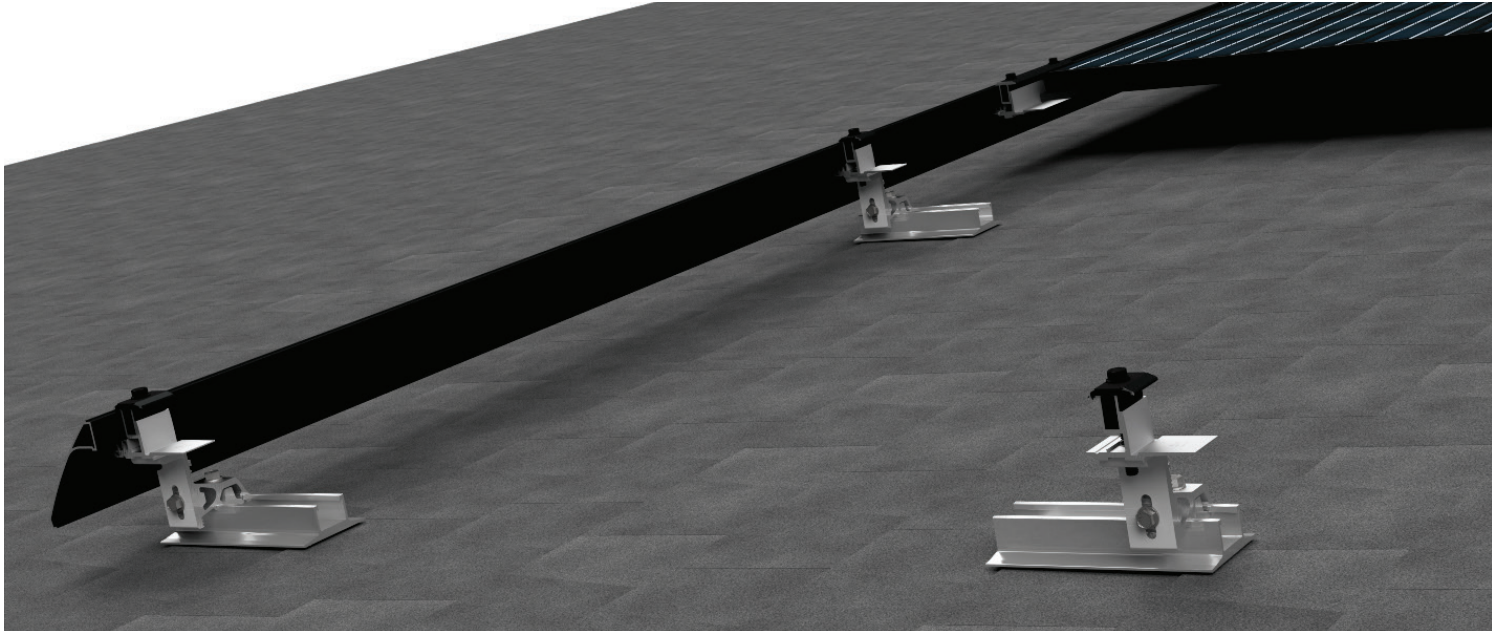

## SnapNrack RL Universal The Fastest Mounting System. Period

SnapNrack RL Universal Mounting System is designed to provide the fastest, most intuitive install experience on the roof. The direct mount system features four basic components for easy material management. Features incredible flexibility with a single Universal Mount that fits module heights from 32 - 40 mm and the highest spans of any current rail less system. The installer focused process allows the system to be installed by a single person.

- The RL Universal Skirt ensures a strong structure for leveling and alignment of first row of modules.
- A single Umbrella Lag screw secures flashing and Flash Track to roof in one complete action. The Flash Track is designed for maximum versatility with 6 inches of North-South adjustability for all Mounts.
- A single Mount is used at all locations on array and is an extreme time saver by eliminating link interference through the flexibility of the Mount to change orientation.
- The Links clamp onto the top of modules securing them in place while providing row-to-row bonding.

### More Info

[RL Universal Product Page](#)

### RL Universal Configuration Tool

Design a system & download a BOM to quote with the online Configuration Tool

### Visit Resource Library

Download Structural Engineering, Installation Manuals & System Drawings





RL-U Mount Kit with Flashing

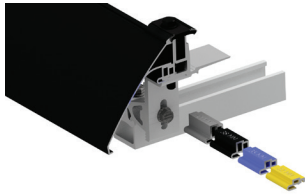

RL-U Skirt with Mount & Spacers Assembly (Sold Separately)

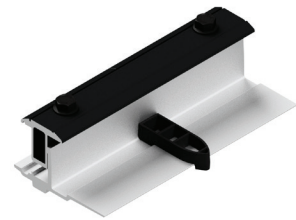

RL Universal Link

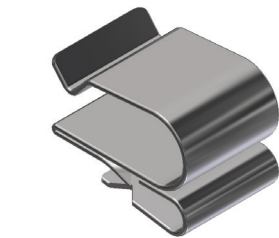

Smart Clip II



Smart Clip XL

## RL-U Skirt Components

Description	SKU	MSRP	QTY*
RL Universal Landscape Skirt, Black (Bundle of 72, priced as each)	232-02492	\$37.90	72 EA
RL Universal Landscape Skirt, Black (Box of 6)	015-11791	\$257.18	1 Box
RL Universal Double Portrait Skirt, Black (Bundle of 72, priced as each)	232-02493	\$45.60	72 EA
RL Universal Double Portrait Skirt, Black (Box of 6)	015-11792	\$308.00	1 Box
RL Universal Skirt Spacer, 32mm	232-02494	\$0.65	20 EA
RL Universal Skirt Spacer, 35mm	232-02495	\$0.65	20 EA
RL Universal Skirt Spacer, 38mm	232-02496	\$0.65	20 EA
RL Universal Skirt Spacer, 40mm	232-02497	\$0.65	20 EA

## RL-U Mount Components

Description	SKU	MSRP	QTY*
Comp Flashing, 9" x 12", Black Alum (requires Umbrella Lag)	232-01375	\$5.25	20 EA
Comp Flashing, 9" x 12", Silver Alum (requires Umbrella Lag)	232-01376	\$4.35	20 EA
Comp Flashing, 9" X 12", Black Galvalume (requires Umbrella Lag)	232-01377	\$4.50	20 EA
Umbrella Lag, 4"	242-92266	\$1.55	20 EA
RL Universal Mount Kit	242-92285	\$15.00	20 EA
RL Universal Link	242-02156	\$9.50	20 EA
RL Universal Ridge Mount	242-02157	\$19.00	10 EA

## RL-U Wire Management & Accessories

Description	SKU	MSRP	QTY*
Smart Clip II	232-01173	\$0.40	100 EA
Smart Clip XL	232-01176	\$0.55	100 EA
Wire Saver	242-92262	\$2.69	20 EA
Junction Box S with Comp Kit	242-01113	\$34.87	1 Kit
Junction Box XL with Comp Kit	242-92121	\$49.95	1 Kit
Universal Wire Clamp for J Box	242-09025	\$3.87	1 EA
MLPE Frame Attachment Kit	242-02151	\$4.25	20 EA
Flash Track Universal Wire Clamp	242-92641	\$6.13	20 EA
RL Flash Track Leveling Spacer	242-92254	\$8.98	20 EA

\* QTY (Quantity) listed is the standard package and minimum order quantity. SnapRack products are sold through distribution and may be available as individual units.

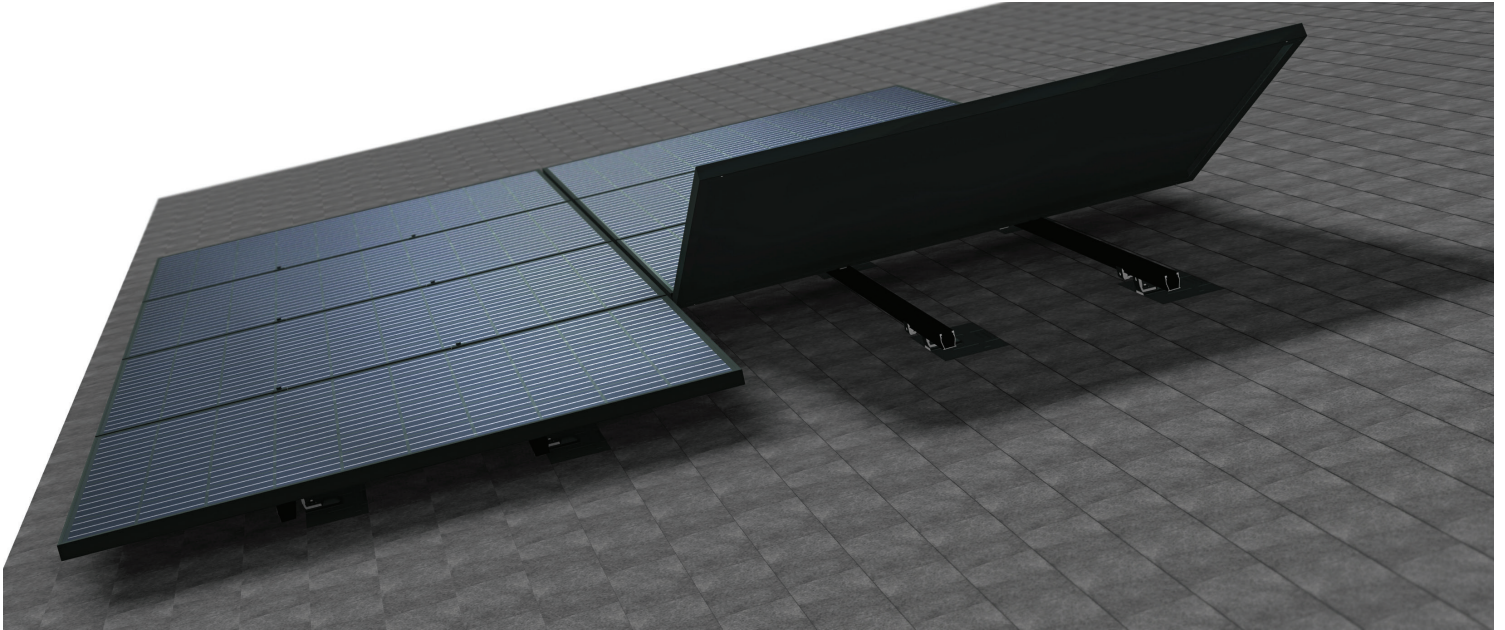

## **SnapNrack Ultra Rail** **The Ultimate Value in Rooftop Solar**

Ultra Rail is the ultimate rail solution for mounting solar modules on the roof. The entire system is a snap to install utilizing new pre-assembled Ultra Rail Mounts that include snap-in brackets for attaching rail. Snap-in module clamps provide an intuitive install experience installers know and love.

- Industry-leading aesthetics with Universal End Clamps and snap-in End Caps that make the mounting system invisible underneath the array
- Unparalleled wire management solutions with accessories such as Junction Boxes, Universal Wire Clamps, MLPE Attachment Kits, and Conduit Clamps
- Low profile rail maintains the open channel with room for running wires resulting in a top quality finished install
- UR-40 has the largest span capabilities of any light rail solution
- UR-60 is a heavy duty profile for higher loading conditions

### **More Info**

[Ultra Rail Product Page](#)

### **Ultra Rail Configuration Tool**

Design a system & download a BOM to quote with the online Configuration Tool

### **Visit Resource Library**

Download Structural Engineering, Installation Manuals & System Drawings

# UR-40/60 Rail & Accessories



UR-40 Rail, Black



UR-40 Splice



UR-40 End Cap



UR-60 Rail, Black



UR-60 Splice



UR-60 End Cap

## UR-40 Rail

Description	SKU	MSRP	QTY*
UR-40 Rail, 168", Black (Bundle of 144, priced as each)	232-02451	\$55.37	144 EA
UR-40 Rail, 168", Silver (Bundle of 144, priced as each)	232-02450	\$51.76	144 EA
UR-40 Rail, 168", Mill (Bundle of 144, priced as each)	232-02449	\$45.25	144 EA
UR-40 Rail Set, 168", Black (Box of 8)	015-10202	\$509.42	1 Box
UR-40 Rail Set, 168", Silver (Box of 8)	015-10201	\$476.19	1 Box
UR-40 Rail, 168", Black (Box of 4)	015-10199	\$285.28	1 Box
UR-40 Rail, 168", Silver (Box of 4)	015-10200	\$266.67	1 Box

## UR-60 Rail

Description	SKU	MSRP	QTY*
UR-60 Rail 168", Black (Bundle of 120, priced as each)	232-02483	\$72.55	120 EA
UR-60 Rail 168", Silver (Bundle of 120, priced as each)	232-02482	\$65.25	120 EA
UR-60 Rail 168", Mill (Bundle of 120, priced as each)	232-02481	\$55.86	120 EA
UR-60 Rail Set, 168", Black (Box of 8)	015-10206	\$667.46	1 Box
UR-60 Rail Set, 168", Silver (Box of 8)	015-10205	\$600.30	1 Box
UR-60 Rail Set, 168", Black (Box of 4)	015-10197	\$373.78	1 Box
UR-60 Rail Set, 168", Silver (Box of 4)	015-10198	\$336.17	1 Box

## UR-40 Rail Accessories

Description	SKU	MSRP	QTY*
UR-40 Splice, Silver	242-01213	\$7.25	20 EA
UR-40 Splice, Black	242-01214	\$7.50	20 EA
UR-40 End Cap	232-02452	\$0.70	20 EA

## UR-60 Rail Accessories

Description	SKU	MSRP	QTY*
UR-60 Splice, Silver	242-01213	\$8.25	20 EA
UR-60 Splice, Black	242-01214	\$8.50	20 EA
UR-60 End Cap	232-02452	\$0.70	20 EA

\* QTY (Quantity) listed is the standard package and minimum order quantity. SnapNrack products are sold through distribution and may be available as individual units.

# Flashing & L Foot Attachments



Comp Flashing



Ultra Rail Umbrella L Foot



Umbrella Lag

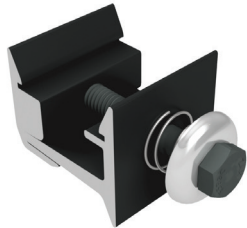

Ultra Rail Mounting Hardware, Black



L Foot Extension Kit

## Composition Shingle Flashing & L Foot

Description	SKU	MSRP	QTY*
Ultra Rail Umbrella L Foot, Silver	242-01219	\$6.00	20 EA
Ultra Rail Umbrella L Foot, Black	242-01220	\$6.70	20 EA
Ultra Rail Mounting Hardware, Silver	242-01229	\$2.56	20 EA
Ultra Rail Mounting Hardware, Black	242-01230	\$2.86	20 EA
Ultra Rail All Purpose L Foot (90°), Black	242-01239	\$7.38	20 EA
Ultra Rail All Purpose L Foot (90°), Silver	242-01223	\$6.68	20 EA
Comp Flashing, 9" x 12", Black Alum (requires Umbrella Lag)	232-01375	\$5.25	20 EA
Comp Flashing, 9" x 12", Silver Alum (requires Umbrella Lag)	232-01376	\$4.35	20 EA
Comp Flashing, 9" X 12", Black Galvalume (requires Umbrella Lag)	232-01377	\$4.50	20 EA
L Foot Extension Kit	242-01120	\$1.75	20 EA
Umbrella Lag, 4"	242-92266	\$1.55	20 EA



## SnapNrack Module Attachments - Ultra Rail - S200

**Module Clamps** are available for all PV module frame sizes. **Universal End Clamps** are a unique one-size-fits-all that slips inside the module frame – completely out of sight. The rails are cut flush with the modules and finished with SnapNrack End Caps to create a system with a flush, clean line. All Module Clamps work with Ultra Rail and Series 200 Ground Mount. Module Clamps ship pre-assembled, ready to install.



Ultra Rail Mid Clamp,  
Black

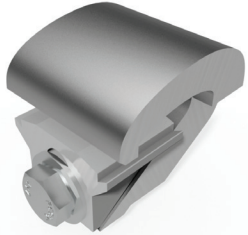

Universal End Clamp



Ultra Rail End Clamp,  
Black

Mid Clamps			
Description	SKU	MSRP	QTY*
Ultra Rail Mid Clamp, Silver	242-02070	\$3.56	20 EA
Ultra Rail Mid Clamp, Black	242-02071	\$3.56	20 EA
End Clamps			
Description	SKU	MSRP	QTY*
Universal End Clamp	242-02215	\$5.46	20 EA
Ultra Rail End Clamp, Silver	242-02072	\$6.41	20 EA
Ultra Rail End Clamp, Black	242-02073	\$6.41	20 EA

\* QTY (Quantity) listed is the standard package and minimum order quantity. SnapNrack products are sold through distribution and may be available as individual units.

# Tile Roof Solutions



Ultra Rail Tile Roof Hook F

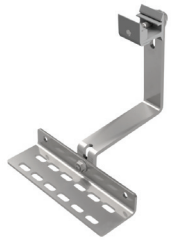

Ultra Rail Adjustable Tile Hook



Tile Hook Replacement Flashing, S

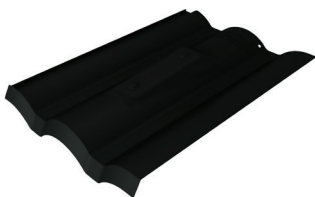

Tile Hook Replacement Flashing, W

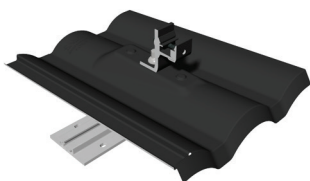

Ultra Rail W Tile Replacement with W Tile Hardware Kit

## Tile Roof Hooks

Description	SKU	MSRP	QTY*
Ultra Rail Tile Roof Hook F	242-01247	\$9.85	20 EA
Ultra Rail Tile Roof Hook WS	242-01248	\$12.88	20 EA
Ultra Rail Adjustable Tile Hook	242-02729	\$13.50	10 EA

 Ultra Rail Tile Roof Hook F is for application on flat tile roofs only. Ultra Rail Tile Roof Hook WS is for application on both W & S Shaped tile roofs.

Ultra Rail Flat Tile Hook includes Ultra Rail Mounting Hardware.

## Tile Hook Replacement Flashing

Description	SKU	MSRP	QTY*
Tile Hook Replacement Flashing, Flat	232-60055	\$10.41	20 EA
Tile Hook Replacement Flashing, S	232-60056	\$10.41	20 EA
Tile Hook Replacement Flashing, W	232-60057	\$10.41	20 EA

 Ultra Rail Tile Hook Replacement Flashings are for Tile Hook installations when necessary to replace broken tiles.

## Tile Replacement Kits

Description	SKU	MSRP	QTY*
Flat Tile Replacement	232-01190_BK	\$10.41	10 EA
W Tile Replacement	232-01191_BK	\$10.41	10 EA
S Tile Replacement	232-01192_BK	\$10.41	10 EA
Ultra Rail Flat Tile Hardware Kit	242-01250	\$12.88	10 Kits
Ultra Rail W Tile Hardware Kit	242-01251	\$12.88	10 Kits
Ultra Rail S Tile Hardware Kit	242-01252	\$12.88	10 Kits
L Foot Extension Kit	242-01120	\$1.75	10 EA

 Ultra Rail Umbrella L Foot includes Ultra Rail Mounting Hardware.

Ultra Rail Tile Replacements require matching Tile Replacement Hardware Kit. Ultra Rail Tile Replacements do not include mounting hardware kits. Ultra Rail Tile Hardware Kits include Base, Riser, Umbrella L Foot, and Umbrella Nut.

## Deck Level Flashing for Tile

Description	SKU	MSRP	QTY*
PS45 Deck Level Flashing Set, (1) 9x9 & (1) 4X13	242-02723	\$4.98	20 Sets
PS45 Deck Level Flashing Set, (1) 5X13 & (1) 4X17	242-02728	\$8.98	20 Sets
Protecto-Tak Spray Adhesive	131-01347	\$29.99	20 EA

# Wire Management Solutions

## SnapNrack Wire Management - Ultra Rail - S200

SnapNrack offers the largest set of mounting accessories to enhance the install process. SnapNrack **Wire Management Solutions** comprise a set of dedicated components to reliably and cost-effectively secure PV module and microinverter leads. All components are made of materials which have been selected for their ability to handle high UV exposure and extreme rooftop temperatures common under solar arrays.



Junction Box XL



Universal Wire Clamp



Wire Retention Clip



Ground Lug R,  
6-12 AWG

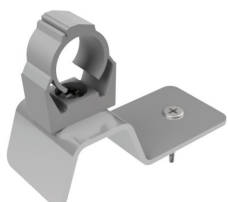

Conduit Support  
3/4" PVC



Conduit Support  
3/4" EMT

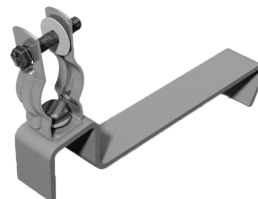

Conduit Support -  
Tile

### Wire & Electronics Management

Description	SKU	MSRP	QTY*
Junction Box R for Rail	242-01104	\$28.50	1 EA
Junction Box XL for Rail	242-92120	\$44.95	1 EA
Junction Box S with Comp Kit	242-01113	\$34.87	1 EA
Junction Box XL with Comp Kit	242-92121	\$49.95	1 Kit
Universal Wire Clamp for Rail	242-02150	\$3.56	20 EA
Universal Wire Clamp for J Box	242-09025	\$3.87	1 EA
Snap-in Wire Retention Clip	232-01106	\$0.47	20 EA
Smart Clip II	232-01173	\$0.40	100 EA
Smart Clip XL	232-01176	\$0.55	100 EA
MLPE Rail Attachment Kit	242-92093	\$2.26	20 Kits
MLPE Frame Attachment Kit	242-02151	\$4.25	20 EA



MLPE Rail Attachment Kit includes over-sized Fender Washer, Channel Nut and serrated Flange Bolt.

### Grounding Solutions

Description	SKU	MSRP	QTY*
Ground Lug R, 6-12 AWG	242-02101	\$4.75	20 EA

### Conduit Supports

Description	SKU	MSRP	QTY*
Conduit Support Assembly, 3/4" EMT	242-02730	\$5.70	20 EA
Conduit Support Assembly, 1" EMT	242-02731	\$6.21	20 EA
Conduit Support Assembly, 3/4" PVC	242-02732	\$5.70	20 EA
Conduit Support Assembly, 1" PVC	242-02733	\$6.21	20 EA
Conduit Support for Tile, 3/4" EMT	242-02104	\$5.70	20 EA
Conduit Support for Tile, 1" EMT	242-02108	\$6.21	20 EA

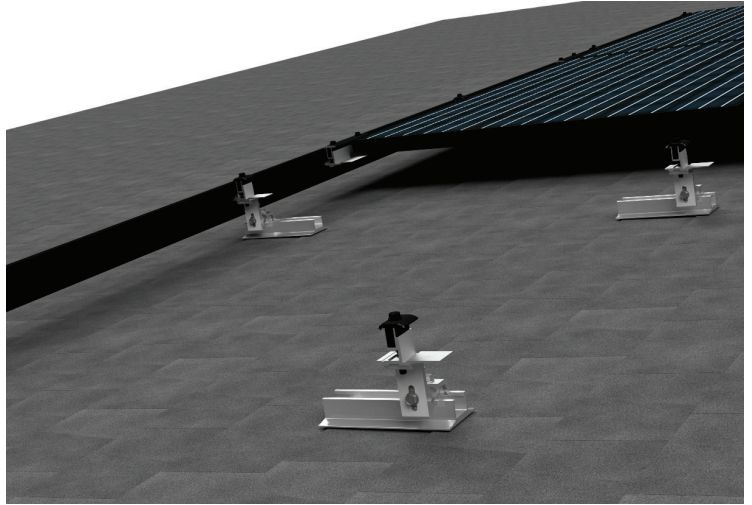
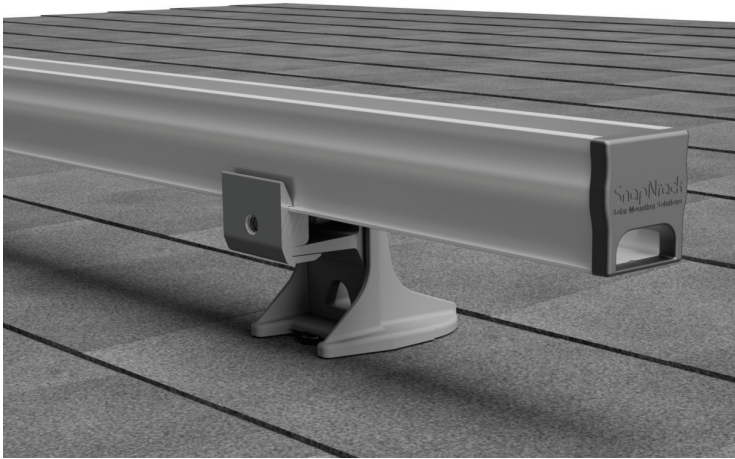

## SnapNrack SpeedSeal™ Technology Lag Driven Sealant Solution for Ultra Rail & RL Universal

SnapNrack is introducing a new generation of roof attachments with an innovative design that eliminates the need for flashing by using a patent pending Lag Driven Sealant Technology. The **new** SpeedSeal™ Foot & SpeedSeal™ Track dramatically speeds up the installation process by allowing installers to lag straight to a structural member with no in-between components like flashings or additional bases, and eliminates damage to shingles from the installation process. The SpeedSeal™ Technology takes over by compressing sealant into the cavity, shingle surfaces and lag hole, as the SpeedSeal™ Foot or SpeedSeal™ Track is secured to the rafter. The 100% waterproof solution provides a lasting seal and passes UL 2582 Wind Driven Rain Test and ASTM E2140 Water Column Testing standards.

- **Integrated Flashings** - Sealant fills around lag screw keeping roof and structure sealed and intact
- **Fastest Roof Attachment in Solar** - Simply locate rafter, fill sealant cavity & secure to roof. No in-between components such as flashings or bases.
- **Less Time. Less Parts. Less Tools** - No more need for a pry bar to rip up shingles & single tool installation with ½” socket.

# SpeedSeal™ Foot & SpeedSeal™ Track

## A New Generation of Roof Attachments



- Innovative design incorporates flashing reliability into a single roof attachment
- 100% waterproof solution
- Sealing cavity with compressible barrier secures sealant in place & fills voids

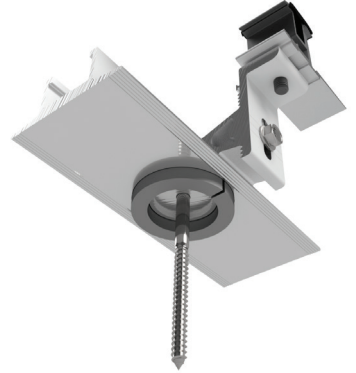

## Lag Driven Sealant Waterproofing

- Time Tested Roof Sealant provides lasting seal
- Sealant is compressed into cavity and lag hole as attachment is secured to rafter
- Active sealant solidifies bond if ever touched by liquid
- Technology passes UL 2582 Wind Driven Rain Test and ASTM E2140 Water Column Testing standards. Patent Pending.

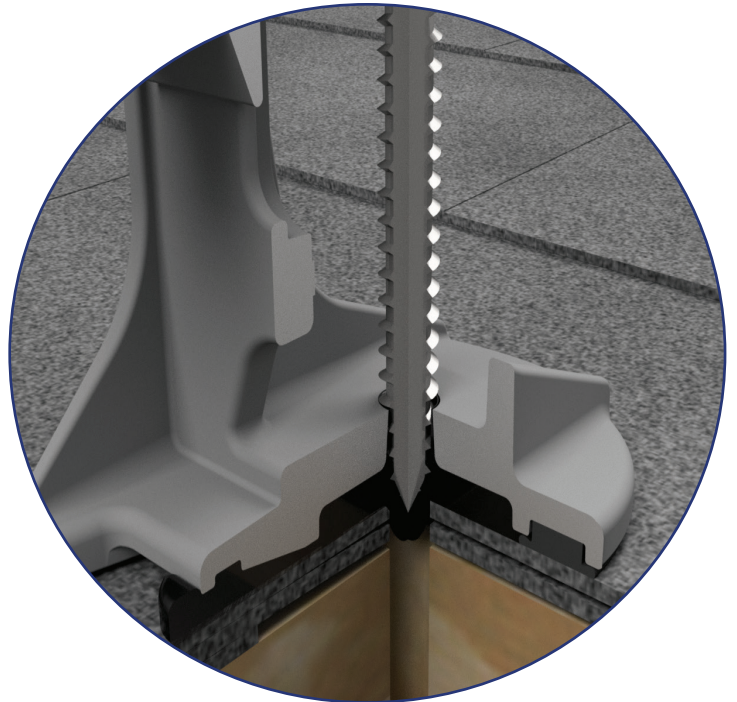

UR SpeedSeal™ Foot,  
Black

SpeedSeal™ Foot			
Description	SKU	MSRP	QTY*
UR SpeedSeal™ Foot, Silver	242-02163	\$9.50	20 EA
UR SpeedSeal™ Foot, Black	242-02167	\$10.50	20 EA
Sealing Washer Lag, 4 1/2", SS	242-02168	\$1.25	20 EA



RL-U SpeedSeal™  
Mount Kit

SpeedSeal™ Track			
Description	SKU	MSRP	QTY*
RL-U SpeedSeal™ Mount Kit	242-92642	\$18.75	20 EA
Sealing Washer Lag, 4 1/2", SS	242-02168	\$1.25	20 EA

## Tilt System Roof Attachments

Roof Type	Description	SKU	MSRP	QTY*	
Foam Roof	Ultra Rail Variable Tilt Standoff Kit	242-92117	\$44.95	20 EA	
Metal Roof	Select this SKU	Ultra Rail Variable Tilt Hardware Kit for Metal Roof Attachments	242-92116	\$30.16	20 EA
	Plus <b>ONE</b> of these SKUs	Metal Roof Base	242-02036	\$5.70	20 EA
		Standard Base Seam Clamp	242-05000	\$6.88	20 EA
		Wide Base Seam Clamp	242-05001	\$7.83	20 EA
	Corrugated Straddle Block	232-02421	\$3.56	20 EA	
Flat Roof	Select <b>ONE</b> of these SKUs	Standoff Base 1-Hole	242-00017	\$2.75	20 EA
		4-Hole Base w/(2) ¼"x3" Lag Screws (TJI Roofs)	242-02218	\$4.25	20 EA
	Plus this SKU	Ultra Rail Front Tilt Standoff, 5½"	242-92106	\$11.95	20 EA
	Plus <b>ONE</b> of these SKUs	Ultra Rail Rear Tilt Standoff, 10"	242-92107	\$13.80	20 EA
		Ultra Rail Rear Tilt Standoff, 14"	242-92108	\$16.45	20 EA
		Ultra Rail Rear Tilt Standoff, 23"	242-92109	\$19.95	20 EA
		Ultra Rail Simple Tilt Front Leg 10° (no base)	242-03217	\$8.00	20 EA
	Ultra Rail Simple Tilt Back Leg 10° Portrait (no base)	242-03215	\$12.00	20 EA	
	Ultra Rail Simple Tilt Back Leg 10° Landscape (no base)	242-03216	\$10.00	20 EA	

 Ultra Rail Tilt Standoffs include a Standoff Shaft and Ultra Rail Tilt Clamp (Standoff Clamp, L Foot, and Ultra Rail Mounting Hardware). Bases are to be ordered separately. Order 5½" Standoff for front leg and 10", 14", or 23" for rear leg to obtain desired tilt angle. **Please refer to Ultra Rail Tilt Angle Table (Nominal).**

Ultra Rail Variable Tilt Hardware Kit for Metal Roof Attachments includes L Feet, Ultra Rail Mounting Hardware, and miscellaneous hardware to complete kit for front and rear legs. Metal roof attachments (without L Foot) and section of Ultra Rail for rear leg are to be ordered separately.

Ultra Rail Variable Tilt Standoff Kit includes (2) 6-Hole Bases, (2) 7" HD standoffs, (2) Standoff Clamps and L Feet with Ultra Rail Mounting Hardware for both front and rear legs. Section of Ultra Rail for rear leg to be ordered separately.

**Please refer to Ultra Rail Tilt Angle Table (Nominal) to obtain desired tilt angles for 5° - 30° Fixed Tilt Kit Standoffs with Ultra Rail Tilt Clamps.**

**Variable Tilt hardware and Simple Tilt hardware *can be* installed with Standoffs and such, they are not approved in SnapNrack Structural Engineering Reports.**

Simple Tilt requires 4ft spacing for portrait modules and 2ft spacing for landscape modules between mounts front to rear, and is only available as a direct mount to roof structure.

Ideal for use with E-Curb (pourable penetration sealant), Simple Tilt Attachments are for application on flat roofs only.

Note that Simple Tilt SKUs are referred to in Structural Documentation as Tilt Leg Plus.

# Tilt & Standoff Systems

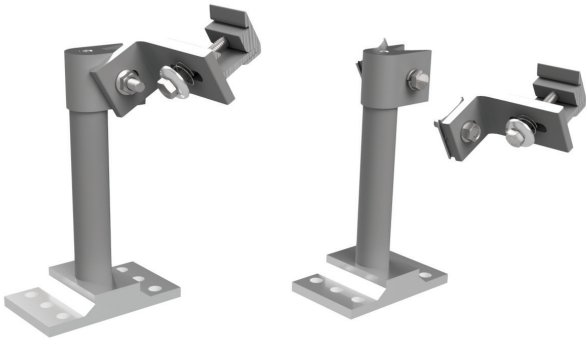

Ultra Rail Variable Tilt Standoff Kit



Ultra Rail Variable Tilt Hardware Kit for Metal Roof Attachments

## Ultra Rail Tilt Angle Table (Nominal)

5° - 30° Fixed Tilt Kits - Standoffs with Ultra Rail Tilt Clamps

Front to back attachment spacing	Landscape			Portrait		
	5 1/2" & 10" Standoffs	5 1/2" & 14" Standoffs	5 1/2" & 23" Standoffs	5 1/2" & 10" Standoffs	5 1/2" & 14" Standoffs	5 1/2" & 23" Standoffs
16"	16°	28°	N/A	N/A	N/A	N/A
24"	10°	20°	N/A	N/A	N/A	N/A
32"	8°	15°	28°	8°	15°	28°
48"	N/A	N/A	N/A	5°	10°	20°

### Notes:

1. Table is based on 60 cell modules
2. Table assumes mounting zone on portrait modules not exceeding 25% of module length
3. Maximum tilt angle allowed = 30° relative to horizontal
4. All tilt ups must have 5-1/2" Standoff in front

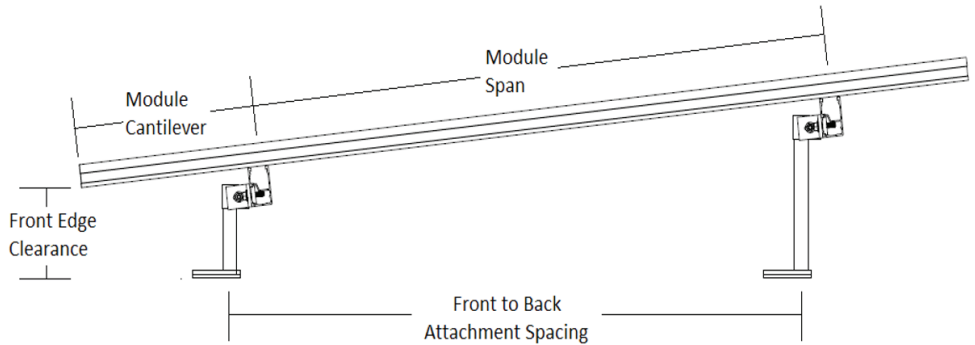

## Ultra Rail Simple Tilt System



Ultra Rail Simple Tilt Portrait

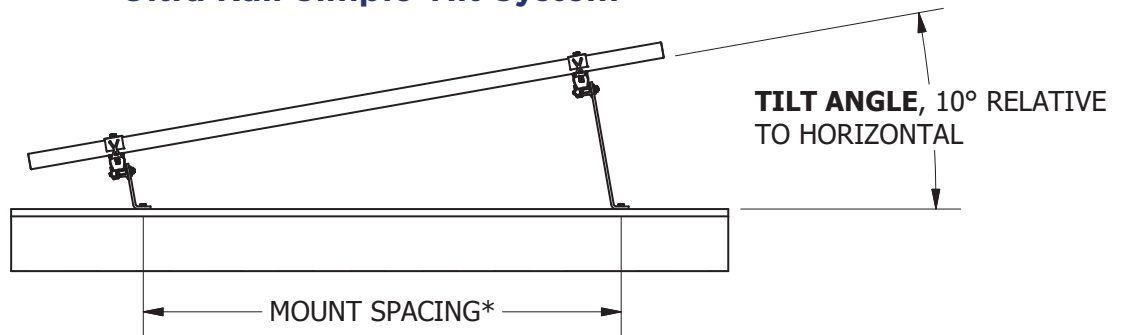

\*4'-0" PORTRAIT  
2'-0" LANDSCAPE

\* QTY (Quantity) listed is the standard package and minimum order quantity. SnapRack products are sold through distribution and may be available as individual units.



Ultra Rail Metal Roof Base w/ L Foot



Ultra Rail Standard Base Seam Clamp w/ L Foot & Lock



Ultra Rail Flush Standoff, 7" w/ 1-Hole Base & Rain Collar (All Sold Separately)



Rubber Rain Collar

Metal Roof Attachments			
Description	SKU	MSRP	QTY*
Ultra Rail Metal Roof Base w/ L Foot	242-02158	\$10.45	20 EA
Ultra Rail Standard Base Seam Clamp w/ L Foot & Lock	242-05158	\$12.50	20 EA
Ultra Rail Wide Base Seam Clamp w/ L Foot & Lock	242-05159	\$13.25	20 EA
Ultra Rail All Purpose L Foot (90°), Silver	242-01223	\$6.68	20 EA
Ultra Rail Hanger Bolt Clamp	242-01128	\$6.22	20 EA
Corrugated Straddle Block	232-02421	\$3.56	20 EA
Metal Roof Base	242-02036	\$5.70	20 EA
Standard Base Seam Clamp	242-05000	\$6.88	20 EA
Wide Base Seam Clamp	242-05001	\$7.83	20 EA

Standoff Mount Roof Attachments			
Description	SKU	MSRP	QTY*
Ultra Rail Flush Standoff, 5½"	242-01257	\$9.07	20 EA
Ultra Rail Flush Standoff, 7"	242-01258	\$9.75	20 EA
Ultra Rail Flush Standoff, 8½"	242-01259	\$10.32	20 EA
Standoff Base 1-Hole	242-00017	\$2.75	20 EA
4-Hole Base w/(2) ¼"x3" Lag Screws	242-02218	\$4.25	20 EA
Metal Roof Base	242-02036	\$5.70	20 EA
Ultra Rail HD Standoff Kit, 7" w/Base	242-01265	\$15.10	20 EA
Standoff Spacer, 1"	242-92081	\$1.66	20 EA

 Standoff Mount Roof Attachments are sold separately and not in kits.  
 HD Standoff Mount Roof Attachments with base are sold as a kit.

Standoff Mount Roof Accessories			
Description	SKU	MSRP	QTY*
Chem Link E-Curb, 4.5" x 3.5", Gray, Pourable (Pack of 4)	131-01357	\$147.00	1 Pack
Rubber Rain Collar	232-01000	\$1.18	20 EA
Standoff Flashing, Straight Cone for HD Base, 18" X 18" X 4", Galv	131-01213	\$18.04	12 EA
Standoff Flashing, Verde 1.0STF, Skinny Cone for Tile, 20" x 20" x 3", Dead Soft Alum	175-05001	\$16.25	25 EA
Standoff Flashing, Offset Cone for 1-Hole Base, 18 ¾" x 15" x 4", Galv	131-01216	\$13.00	20 EA
Standoff Flashing, Oatey 11830, No Caulk Rubber Cone, 9" x 12½", Galv	015-00162	\$11.00	12 EA
Standoff Flashing, Verde 1.0SSO, Deck Level for 1-Hole Base, 10" x 12" x 1", Galv	175-05005	\$5.75	25 EA





Skirt, 162"

Array Skirt			
Description	SKU	MSRP	QTY*
Skirt Set, 162" (Box of 6)	015-11787	\$506.35	1 Box
Skirt, 162" (Bundle of 60, priced as each)	232-01259	\$78.13	60 EA
Skirt Frame Mount	242-92211	\$4.75	20 EA
Skirt Splice	232-01251	\$2.37	20 EA
Skirt End Cap Pair	232-01250	\$2.13	20 EA

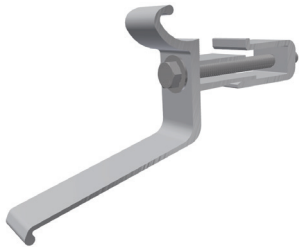

Skirt Frame Mount

Array Edge Screen			
Description	SKU	MSRP	QTY*
Array Edge Screen, 4" Black (100')	232-03996	\$66.80	1 EA
Array Edge Screen, 8" Black (100')	232-04001	\$137.85	1 EA
Array Edge Screen Clip, 4"	232-03993	\$2.13	20 EA
Array Edge Screen Clip, 8"	232-03994	\$2.61	20 EA

Misc.			
Description	SKU	MSRP	QTY*
Original Channel Nut	232-02005	\$0.71	20 EA
UEC Rail Cutting Tool	232-02284	\$14.25	20 EA
Rail Cover, 48"	232-01033	\$9.59	20 EA



## **SnapNrack Series 200** **The Adaptable High Quality Solution for Ground Mount Installations**

The Series 200 Ground Mount System is designed to attach easily to a standard 1 ½” galvanized pipe structure using structural pipe fittings. Using a standard three to four-module high assembly, the system is efficient and flexible while optimizing materials and minimizing system footprint. Industry leading installation times are achieved with unique snap-in fasteners.

- Assembles easily using snap-in bonding pipe clamps that connect the rails
- Fully compatible with all SnapNrack module clamps and accessories
- Ground rail channel keeps wires neatly organized providing a clean finished look to every install
- Industry’s largest offering of Wire Management accessories include snap-in Junction Boxes, Universal Wire Clamps, as well as ground rail channel to keep wires neatly organized
- Maximum versatility with the ability to configure easily to desired tilt between 0 and 45 degrees
- Using pipe structural fittings, labor hours to install the system are typically less than required for a more complicated racking system not using standardized components

### **More Info**

[Series 200 Ground Mount Product Page](#)

### **Configuration Tool**

Design a system & download a BOM to quote with the online Configuration Tool

### **Visit Resource Library**

Download Structural Engineering, Installation Manuals & System Drawings

# Series 200 Components

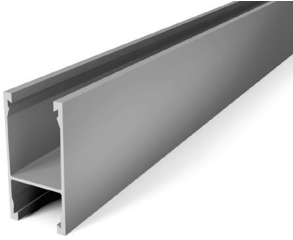

Ground Rail

Series 200 Rail			
Description	SKU	MSRP	QTY*
Ground Rail Set, 162", Silver (Box of 2)	015-09819	\$191.90	1 Box
Ground Rail Set, 162", Silver (Box of 4)	015-09855	\$342.00	1 Box
Ground Rail, 162", Silver (Bundle of 112)	232-01072	\$79.32	112 EA
Ground Rail End Cap	232-01043	\$2.61	20 EA

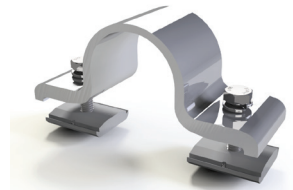

Bonding Pipe Clamp



Double Adjustable  
Socket Tee, Hollaender

Series 200 Structural Fittings			
Description	SKU	MSRP	QTY*
Bonding Pipe Clamp for 1 ½" Pipe	242-09004	\$6.65	20 EA
Single Socket Tee, Hollaender (5EXT-8), 1 ½", AL-MG	172-05818	\$21.00	1 EA
Single Adjustable Socket Tee, Hollaender (17-8), 1 ½", AL-MG	172-05803	\$21.50	1 EA
Double Adjustable Socket Tee, Hollaender (19E-8), 1 ½", AL-MG	172-05804	\$28.00	1 EA
Rectangular Base Flange, Hollaender (46-8), 1 ½", AL-MG	172-05807	\$20.00	1 EA
Plug End, Hollaender (62-8), 1 ½" Sched 40, AL	172-05808	\$5.50	1 EA

\* QTY (Quantity) listed is the standard package and minimum order quantity. SnapRack products are sold through distribution and may be available as individual units.

# Place Your Order

Contact your SnapNrack distributor, which can be found at [www.SnapNrack.com/where-to-buy](http://www.SnapNrack.com/where-to-buy), contact us directly at [contact@snapNrack.com](mailto:contact@snapNrack.com), or call us **Toll Free at (877) 732-2860** for technical support.

SnapNrack distributors have trained knowledgeable staff that can provide product design and ordering assistance.

## **MSRP**

Prices published in this document are Manufacturer Suggested Retail Prices (MSRP) and should be used for reference only. Prices are subject to change without notice. The quantity (QTY) shown is based on the standard package and is the recommended order quantity.

## **Warranty**

All SnapNrack products are covered by a **25-year limited warranty**. For complete details please visit [www.SnapNrack.com/resources](http://www.SnapNrack.com/resources).

