



Inspire

2016 Catalog

FURNITURE FOR INSPIRED LEARNING.™



SMITHSYSTEM®



A shift in classroom and furniture design philosophy.

Not only is the 21st Century Classroom designed around the curriculum, the curriculum is designed around the student. In today's successfully designed classroom, everything starts with the student.

See more:
smithsystem.com/21centuryclassroom

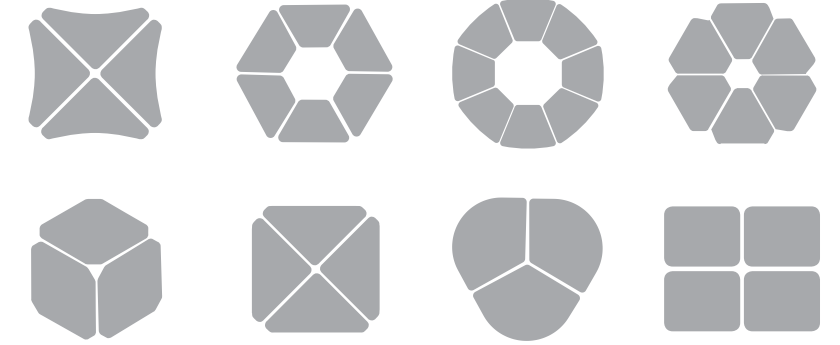

Adaptable to varying group sizes.

Students work alone, in pairs or in small groups throughout the day. So desks need to be capable of forming compact pods and other groups. Research shows groups of four to five students work best. Growing class sizes is necessitating groups of five or six.

Even advanced desks don't move themselves.

Mobility is a crucial feature for furniture in a Collaborative Learning classroom. So, always consider optional casters for desks and tables. Without them, moving desks is a struggle for small students, and reconfiguring classrooms disrupts progress on lessons and projects.

Consider management of project materials.

The educator needs more tools to facilitate group and project learning. One invaluable resource is a cabinet that allows project materials to be sorted and stored for each group, distributed to the group when needed, then put away when finished. This is also a valuable space for storing manipulatives.

Consider different learning modalities.

The 21st Century Classroom supports passive and active learning lesson plans. It eases the transition from lecture style to learner-led and teacher-guided lessons. The classroom makes use of analog and digital visual presentation technology.

Connectivity is key.

Whether they're working with tablets or laptops, students need the ability to connect with data and other resources. It is crucial for 21st Century Classrooms to provide students with both power, as well as WiFi, for their devices.

Designing the classroom around the curriculum.

A fundamental shift in orientation makes the 21st Century Classroom different from all that have come before it.

The shift comes from the widespread adoption of Collaborative Learning curriculum. Classrooms in the 21st Century must support it because it will be the dominant model of education for the foreseeable future.

Collaborative Learning is different than traditional methods in two fundamental ways. First, Collaborative Learning is student centered, empowering the student to be an active participant in the learning process.

Second, Collaborative Learning revolves around solving open-ended problems or creating some sort of a "product" which could be

anything from a report, a poster or a video. These projects give the students an opportunity to develop the widest range of learning skills.

The educational benefits of Collaborative Learning include:

- Producing higher group and individual achievement, higher-quality reasoning strategies, more and more new ideas and solutions to problems.
- Developing higher-level thinking (not just recalling facts), oral communication, self-management and leadership skills.
- Learning to confidently present and defend ideas, which increases the student's self-esteem and responsibility.
- Fostering growth in maturity and confidence on the parts of the learners, because it promotes student-educator interaction and exposes the student to diverse perspectives.



EXPLORE





Two-level workspaces in Social Learning Area.

Varying the height of the workspaces is a subtle way of making a large open space seem more intimate. This helps students relax, let down their guard and collaborate more openly in small group work. Here, the Smith System Café Table and Flavors™ Fixed Height Stools create the upper-level workspaces.

View pages 164-179 for more meeting tables.



Here, the term Commons means shared, not ordinary.

This informal, energizing space is for sharing. Here, independent study, research and collaboration share space.

The Commons is designed to invite students and encourage them to work individually or together in gathering information, exploring ideas and expressing what they've learned through any number of media, whether it's video, live presentation with visual aids, written report or poster.

The starting point for a successful design is to break the space into different zones that support different parts of the learning process or learning modalities.

- Social Learning Area
- Quiet Study Area

- Connected Area
- Collaborative Areas
- Book/Media Storage and Display

Each of these areas supports a different type of learning activity.

The Social Learning Area is dedicated to informal interaction. To do this, it offers a relaxing environment where students can open up and exchange ideas. For inspiration, consider a coffee house.

In the Quiet Study Area, the student may research information for a group project or study regular school subjects.

The Connected Area. This could apply to the entire space, but should be addressed in the planning phase to determine which areas might be dedicated to fixed desktop computers and which should provide power for laptops and tablets.

Collaborative Areas for group work. They work like mini collaborative learning classrooms.

Students look for information in the Commons. Effective and imaginative book and media storage and display areas can make the search faster and more enjoyable.

Relaxed seating contributes to collaboration.

Another strategy for encouraging students to think more openly and share more freely is to provide comfortable seating for small groups. It's possible to achieve a lounge-like effect with Chat™ Chairs connected by Chat Wedges surrounding a Chat Planner Activity Table.

Don't box in students or their thinking.

Providing visual relief from the tyranny of right angles can help students to think outside the box. In the photo below, designers deftly employed Acrobat™ Crescent Desks to create imaginative work spaces for groups of two to six students—all supported with connectivity thanks to I-0™ Posts.

The Learning Commons Overview.

Sharing is the key concept. An active learning environment shares the best ideas of a Collaborative Learning classroom and provides learning resources in the form of written and recorded media, all while providing an environment that invites students to explore, work together and enjoy learning.





STEM Environment



THE COMMONS *Challenging students to think big.*

The power of 3 in STEM environments.

Think in terms of three rooms. *One: the Classroom*, primarily for math and engineering subjects. *Two: the Lab*, for science and technology. *Three: the Commons*, where students freely collaborate and learn from each other.

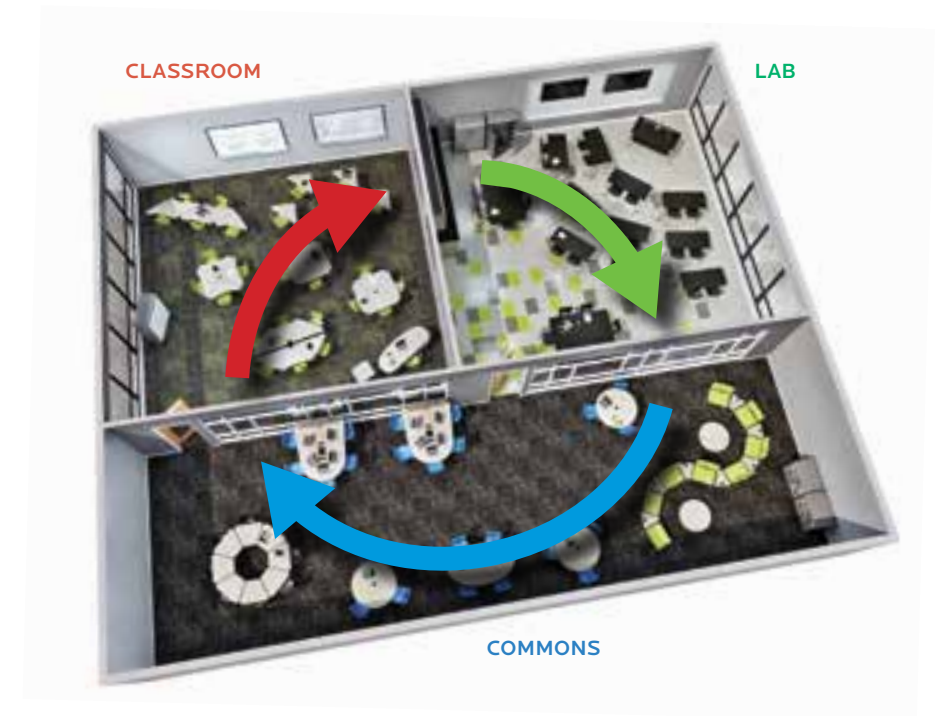

Two fundamental steps in optimizing a STEM environment.

First dedicate the appropriate space to the subject, then complement the Science, Technology, Engineering and Math curriculum with the right furniture.

Creating a successful STEM environment requires thinking beyond the subjects being taught, and thinking about *how* the subjects are being taught. The result of taking this step can be a dynamic space that's geared for teaching these interrelated subjects. (See the 3-D environment top right).

After composing the classroom, lab and commons areas, determining how to furnish them becomes a question of which furniture best complements the curriculum. Going forward, STEM will most likely be taught in a collaborative learning environment. What this

means to the designer is, you can't just fill the lab with tables, the classroom with desks and call it good. Rather, the classroom layout must accommodate both the students and teacher with:

- Clusters (or pods) of desks to accommodate small group work for two to six students.
- Unimpeded access to all parts of the room for the teacher.
- Learning zones. In Collaborative Learning classrooms, different groups may need access to different learning tools, like computers or whiteboards.
- Movement.

When choosing student desks or tables, flexibility and adaptability are key so look for models capable of being arranged into compact pods that accommodate six to eight students. Together with adaptability and flexibility comes mobility. It's crucial because it allows the furniture to be easily reconfigured. Choose chairs and desks with casters.

Finally, the furniture's ergonomics help students in STEM classrooms concentrate and encourage them to collaborate. Read more about *Flavors™ Seating* (shown in the photo to the right) on page 20.

It's a 21st Century Classroom. Connectivity is mandatory.

Because STEM classes make great use of technology, students need the ability to connect with data and other resources. Optimized STEM classrooms allow students to have power for their computers or tablet devices as well as WiFi.

There's still no shrink ray.

It's science, not science fiction, so STEM classrooms need a means for organizing project materials. That is the reason *Smith System Cascade™ Storage* exists. Educators can organize, store, manage and distribute project materials, or 3-D manipulatives from the *Cascade* unit to the student's desk or to the teacher's desk.

Teachers use the latest tools available.

Even in project-based STEM classrooms, teachers need to present information to the entire class. Increasingly, these presentations are augmented by visual and audio-visual materials.

Stimulating the imagination.

In addition to performing a function in the classroom, furnishings also contribute to the learning environment by adding color to the room. Whether you select a color to create a mood for a room, to carry a design theme or element into the classroom, or to spread the school colors, no manufacturer offers more options than *Smith System*.



THE CLASSROOM *Imparting instruction. Encouraging interaction.*



THE LAB *Inquiry, experimentation, observation and discovery.*

SEATING

Seating Intro	18–19
Flavors™ Intro	20–21
Stack Chair	22–23
Stools	24
Sled Base Seating	25
Adjustable Chair & Stool	26
Tablet Arm Chair	27
Noodle™ Seating	28–29
Plato™ Intro	30–31
Stack Chair	32–33
Adjustable Chair & Stools	33
Tablet Arm Chair	34
Stools	35
Intuit™ Intro	36–37
Stack Chair	38
Adjustable Chair & Stool	39
Chat™ Intro	40–41
Chat Chair & Scooter	42–43
Chat Tables	44–45
UXL™ Intro	46
Stack & Mobile Chairs	47
Arm Chairs	48–49
Chair Dolly	49
Nest & Fold Chair	50
Adjustable Chair & Stools	51
Beam Seating	52–53

DESKS & TABLES

Desks & Tables Intro	54–55
Interchange™ Intro	56–59
Wing™ Desk	60
Swoop Wing™ Desk	61
Open Front Wing™ Desk	62–63
Diamond Single-Student Desk	64
Diamond Two-Student Desk	65
Diamond Open Front Desk	66–67
Single-Student Desk	68
Single- & Two-Student Open Front Desk	68
3-2-1 Desk™	70–71
Rectangle Activity Tables	72–74
Science Tables	75
Activity Tables	76–77
Power	78
Accessories	79
UXL™ Intro	80–83
Diamond Desk	84–85
Wing Desk	86
Open Front Desk	87
Crescent Table	88–89
Power Bar	91
Rectangle Tables	92–94
Desk Fence	93
Science Table	95
I-O Post End Cap	95
Half Round End Cap, Round & Corner Tables	96
Square & Trapezoid Tables	97
UXL Accessories	98–99
Nest & Fold Tables	100–103
Adjustable Nest & Fold Tables	104–105
How to read a UXL Part Number	106–107
Silhouette™ Intro	108–111
Silhouette Desks	112–113
Silhouette Sequence™ Desk	114
Silhouette Curve Desk	114
Silhouette Accessories	115
Flexline™ Intro	116–117
Single-Student Desk	118
Hard Plastic Top Desk	119

Two-Student Desk	120–121
Desk Accessories	122–123
Arc-8 Desks	124–127
Flexline with Cascade Storage	128–129
Flex™ Computer Stations	130–131
Elemental™ Desk	132–133
Planner™ Intro	134–135
Huddle™ Desks	136–137
Single-Student Desk	138
Two-Student Desk	139
Three-Student Desk	141
Cascade™ Storage Accessories	142
Rectangle Activity Tables	144–145
Trapezoid, Square, Round, Half Moon & Contour Activity Tables	146–147
Planner Table Accessories	148–149
Science Tables	150–151
Access Stations	154
Accessories	155
Graphic Arts	156–157
Teacher Desks	158
Lecterns	159–160
Teacher Wardrobe, File Cabinet, Bookcase	161
Power Options	162
Mounts: Tables, Desks and Workstations	163
Meeting Tables Intro	164–167
Multi-Media Tables	168–170
Oval Café Tables	171
Café Tables	174–179
Acrobat™ Intro	180–183
Acrobat Single-Student Desk	184
Acrobat Two-Student Desk	185
Acrobat Three-Student Desk	186
Acrobat Accessories	187
Acrobat Instructor Desk	188
Acrobat Peninsula	189
Acrobat Workstations	190–193
Crescent Tables	194–195
Crescent Presentation Station	196
Crescent Accessories	197
Early Childhood Intro	198–199
Activity Tables	200–203
Husky Activity Tables	204–205

CASCADE

Cascade™ Storage System Intro	206–207
Cascade Storage Intro	208–211
Cascade Storage Cases	212–215
Cascade Storage Cabinets	216–219
Cascade Storage Towers	220–223
Cascade Storage Wardrobe	224–225
Cascade Storage Cubby	226–227
Cascade Presentation Carts	228–229
Cascade Totes	230
Cascade™ Teacher Desks Intro	232–235
Cascade Teacher Desk Single Cabinets	236–237
Cascade Teacher Desk Double Cabinets	238–239
Cascade Teacher Desk Single Bullet	240–241
Cascade Teacher Desk Double Bullet	242–243
Lift™ Desk	244–245
Acrobat Teacher Desk Rect. & Peninsula	246–247

LIBRARY

Library Intro	248–249
Library Carrel	250–251
Library Nomads	252–253
Library Booktrucks	254–257

POWER, COLORS & INDEX

Power Intro	258–259
Style Options	
Color Finishes	260
Tops/Edges	261
Index	262–270
Terms & Conditions	271

Seating

Seating is unique as a fingerprint. Students sit in thousands of different positions; upright, slouched, twisted and tilted. They stretch out their legs, sit on them, cross them and bounce them. They will balance on their chair or teeter on the back, tempting gravity—and common sense.

Which Ergonomics Matter Most?

Here are some ways administrators can get the most ergonomic bang for their buck.



1 Right Size

- Properly sized classroom seating supports healthy posture and decreases fidgeting.
- Students should be able to sit with their feet firmly planted on the floor and their backs against their chairs.

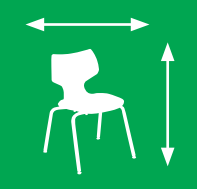

2 Right Fit/Adjustable

- Both seating and desks need to be properly scaled to fit the size of the individual student.
- We offer a wide range of heights in seating—typically four or five per product line. We also offer up to three sizes per line. (Our desking lines are adjustable.)

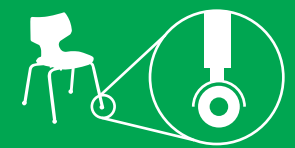

3 Function

- 21st Century learning often requires seating to be moved throughout the day, so chairs must be light enough, or fitted with casters, to allow students of all ages to move them quickly and easily.

4 Seating that doesn't fight the student

- A chair that allows some movement on the part of the student can promote learning. But how much movement?
- Consider our Graduated Movement Concept, a design idea educators can use to tailor the ergonomics of the classroom furniture to support the curriculum. Through subtle differences in design, our Intuit™ line gently limits movement, Plato™ allows moderate movement and Flavors™ permits utmost movement.



Intuit™ Seating

Conceived to contain movement and direct attention straight ahead. It works like a bucket seat, providing back and shoulder support, while orienting the student toward the front.

SEE PAGE 36



Plato™ Seating

Allows more movement, so students can face front and both sides. This Euro-spec chair provides a wide seat pan, flex and pronounced lumbar support to encourage good posture and breathing.

SEE PAGE 30



Flavors™ Seating

Offers maximum movement and four seating positions. Its seat back flexes front to back and torsionally, allowing students to shift and move without chair resistance.

SEE PAGE 20



Flavors™ Noodle

This four-position seating line provides the benefits of a stability ball, but with more overall stability and back support, and less student misuse.

SEE PAGE 28



Chat™ Seating

This hybrid is a welcome option for social learning situations, combining the comfortable dimensions of lounge seating with the durability of polypropylene. It rolls on integrated casters.

SEE PAGE 40



UXL™ Seating

Known for its generous proportions, this line is customizable to fit almost every situation in an educational environment. It's so broad, you can maintain a consistent design scheme throughout the building.

SEE PAGE 46



Flavors™ Seating



Stacking



Sled Base



Mobile Stacking



Fixed Height Stools



Adjustable Stools



Adjustable Chairs



P-Tablet Arm Chairs

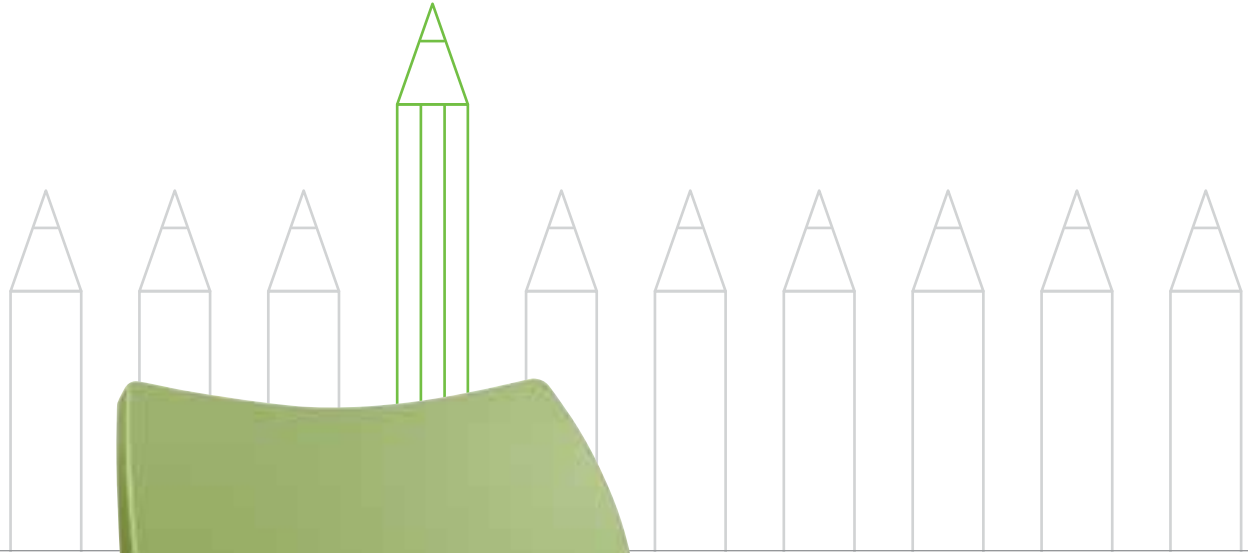

A four-position chair perfect for project learning situations.

Freedom of movement.

Flavors Seating removes as many restrictions to student movement as possible.

- A relatively flat seat pan with a waterfall front allows the student to comfortably face front, back and either side.

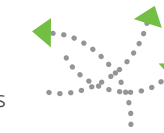

Less restricting to the shoulders and spine.

To further enable the student to work with students on either side, the seat back provides torsional flex – allowing the student to gently twist to face left or right.



Move, breathe and concentrate.

A subtle front to back flex allows the student to move and adjust their posture, which promotes better concentration.

For classrooms that move and students of all sizes.

- Flavors Seating is light enough for most students to move in the classroom without problem.
- Achieve additional mobility with optional casters on the Adjustable Chair, Stools and Stacking Chair.
- Stacking models come in six sizes and Sled Base models come in four sizes so you can pair the appropriately sized chair with the student in all grade levels.

Construction.

Built for the demands of a school environment.

- The durable, high-density polypropylene shell stands up to the challenges of a real-world classroom.
- Made of 18-gauge welded steel, the frame is protected with chrome plating or a rugged powder coat finish.
- For added comfort, the shell rests directly on the frame (not on the rivets).





Model 11847
14" seat height,
'B' Shell.
Shown in Apple.

Model 11848
16" seat height,
'B' Shell.
Shown in Blueberry.

Model 11849
18" seat height,
'A' Shell.
Shown in Black.

Model 11844
8" seat height,
'C' Shell.
Shown in Cerulean.

Model 11845
10" seat height,
'C' Shell.
Shown in Purple.

Model 11846
12" seat height,
'C' Shell.
Shown in Navy.

NEW FRAME COLOR! PLATINUM



Flavors Stack Chair

Four-position chair allows student to sit comfortably facing front, either side or rear. Flexing seat back provides support and allows student to turn with less restriction. Flat seat pan with waterfall front edge. Six sizes. Available in 19 colors.

- The shell rests on the frame, not rivets, to add comfort.
- High-density polypropylene with color throughout the shell.
- Durable swivel-base glides, with non-staining nylon bases and chrome-plated steel covers come standard.
- Choose optional steel or felt glides.
- The legs are strong, 18-gauge welded steel with a durable chrome finish.
- Chrome legs with durable chrome finish or Platinum powder coat finish.
- Stacks four chairs high.

MODEL	DESCRIPTION		D"	W"	H"	F.C.	CUBE	WT.	UPS	2016 LIST
11844	Flavors Stack Chair	C shell - 8"h	13.5	15.0	8	125	1.2	5	*	\$ 90.00
11845	Flavors Stack Chair	C shell - 10"h	13.5	15.0	10	125	1.2	7	*	\$ 90.00
11846	Flavors Stack Chair	C shell - 12"h	14.5	15.0	12	125	1.2	7	*	\$ 95.00
11847	Flavors Stack Chair	B shell - 14"h	17.0	17.5	14	125	2.0	9	*	\$ 101.00
11848	Flavors Stack Chair	B shell - 16"h	18.0	17.5	16	125	2.0	9	*	\$ 105.00
11849	Flavors Stack Chair	A shell - 18"h	20.5	19.5	18	125	2.7	10	*	\$ 109.00
S	Steel glide optional	Set of 4 installed								\$ upcharge
F	Felt glide optional	Set of 4 installed								\$ upcharge

Glide Options:
Nylon base glides are standard.
Steel and Felt base glides are optional and are quoted.

This is factory installed option not available for field installation. Glide option must be on original chair order.

Steel glide option: Add 'S' to follow Model No.
Felt glide option: Add 'F' to follow Model No.

Chrome frame option: CHR
Platinum frame option: PLT
Add Model No.



Flavors Mobile Stack Chair

Four-position chair allows student to sit comfortably facing front, either side or rear. Flexing seat back provides support and allows student to turn with less restriction. Flat seat pan with waterfall front edge. Available in 19 colors.

- The shell rests on the frame, not rivets, to add comfort.
- High-density polypropylene with color throughout the shell.
- The legs are strong, 18-gauge welded steel.
- Chrome legs with durable chrome finish or Platinum powder coat finish.

MODEL	DESCRIPTION		D"	W"	H"	F.C.	CUBE	WT.	UPS	2016 LIST
11860	Flavors Mobile Chair*	B shell - 14"h	18.5	18	14	125	2.0	11	*	\$ 139.00
11854	Flavors Mobile Chair	B shell - 16"h	19.5	18	16	125	2.0	11	*	\$ 139.00
11855	Flavors Mobile Chair	A shell - 18"h	22	20	18	125	2.4	12	*	\$ 149.00

* Available summer 2016

FLAVORS CHAIR SHELL COLOR CHOICE

- Apple
- Black
- Blueberry
- Burgundy
- Cerulean
- Charcoal
- Chocolate
- Clementine
- Forest Green
- Fuchsia
- Mint
- Mocha
- Navy
- Persian Blue
- Purple
- Red
- White
- Yellow

FRAME

- Chrome
- Platinum

ORANGE NEW 2016 COLOR View all finish options on page 260.

DIMENSION CHART

Model	A	B	C	D	E	F	G	Leg Diameter
11844	17.5"	12.0"	13.5"	12.0"	15"	8"	11.00"	1"
11845	20.0"	12.0"	13.5"	12.0"	15"	10"	11.00"	1"
11846	22.0"	12.0"	14.5"	12.0"	15"	12"	11.00"	1"
11847	26.0"	14.5"	17"	14.5"	17.5"	14"	13.75"	1"
11848	28.5"	14.5"	18"	14.5"	17.5"	16"	13.75"	1"
11849	31.5"	16.0"	20.5"	16.0"	19.5"	18"	15.00"	1"

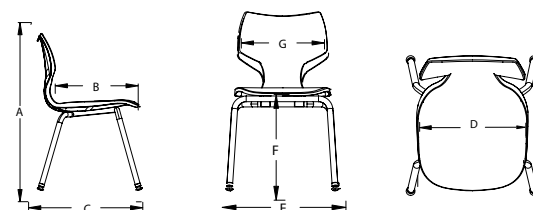



Flavors™ Seating with Silhouette™ Desks.



Model 11856
12" seat height, 'C' Shell.
Shown in Apple.

Model 11857
14" seat height, 'B' Shell.
Shown in Mocha.

Model 11858
16" seat height, 'B' Shell.
Shown in Chocolate.

Model 11859
18" seat height, 'A' Shell.
Shown in Cerulean.



Model 11890 28"h
Shown in Charcoal with
Platinum frame.

Model 11889 24"h
Shown in Apple with
Platinum frame.

NEW FRAME COLOR! PLATINUM

Flavors Stools

Fixed-height. Four-position chair allows student to sit comfortably facing front, either side or rear. Flexing seat back provides support and allows student to turn with less restriction. Flat seat pan with waterfall front edge. Available in 19 colors.

- The shell rests on the frame, not rivets, to add comfort.
- High-density polypropylene with color throughout the shell.
- Durable swivel-base glides with non-staining nylon bases and chrome-plated steel covers come standard.
- Choose optional steel or felt glides.
- The legs are strong, 18-gauge welded steel.
- Choose legs with durable chrome finish or Platinum powder coat finish.
- Front and rear Footrest Bars (in Platinum powder coat) protected against scuffing by a rugged plastic shell.

MODEL	DESCRIPTION	D"	W"	H"	F.C.	CUBE	WT.	UPS	2016 LIST
11889	Flavors Fixed-height Stool	A shell - 24"h	18.5	19	24	125	2.0	12	* \$ 154.00
11890	Flavors Fixed-height Stool	A shell - 28"h	18.5	19	28	125	2.0	13	* \$ 160.00
S	Steel glide optional							Set of 4 installed	\$ upcharge
F	Felt glide optional							Set of 4 installed	\$ upcharge

Glide Options:

Nylon base glides are standard. Steel and Felt base glides are optional and are quoted.

This is factory installed option not available for field installation. Glide option must be on original chair order.

Steel glide option: Add 'S' to follow Model No.
Felt glide option: Add 'F' to follow Model No.

FLAVORS CHAIR SHELL COLOR CHOICE

- Apple
- Burgundy
- Black
- Cerulean
- Blueberry
- Charcoal
- ORANGE NEW 2016 COLOR
- Chocolate
- Clementine
- Forest Green
- Mocha
- Fuchsia
- Mint
- Mocha
- Navy
- Persian Blue
- Purple
- Red
- White
- Yellow

FRAME

- Chrome
- Sled Base Chrome only.
- Platinum

View all finish options on page 260.



Flavors Sled Base Seating

Four-position chair allows student to sit comfortably facing front, either side or rear. Flexing seat back provides support and allows student to turn with less restriction. Flat seat pan with waterfall front edge. Four sizes. Available in 19 colors.

- The shell rests on the frame, not rivets, to add comfort.
- High-density polypropylene with color throughout the shell.
- The legs are strong, 18-gauge welded steel.
- Durable glides with non-staining nylon bases come standard, or choose optional felt glides.
- Legs available in durable chrome finish only.

MODEL	DESCRIPTION	D"	W"	H"	F.C.	CUBE	WT.	UPS	2016 LIST
11856	Flavors Sled Chair	C shell - 12"h	14.5	15	12	125	1.5	8	* \$ 149.00
11857	Flavors Sled Chair	B shell - 14"h	18.8	17.3	14	125	1.9	10	* \$ 159.00
11858	Flavors Sled Chair	B shell - 16"h	19	17.5	16	125	2.0	11	* \$ 169.00
11859	Flavors Sled Chair	A shell - 18"h	21	19	18	125	2.4	12	* \$ 179.00
F	Felt glide option							Set of 4 installed	no upcharge

Glide Options

Nylon base is standard. Optional is felt base. Use felt for vct floors and nylon for carpet floors.

This is factory installed option not available for field installation. Glide option must be on original chair order.

Felt glide option: Add 'F' to follow Model No.

DIMENSION CHART

Model	A	B	C	D	E
11856	12"	15"	14.5"	22"	12"
11857	14"	17.3"	18.8"	26"	14.5"
11858	16"	17.5"	19"	29"	14.5"
11859	18"	19"	21"	31"	16"

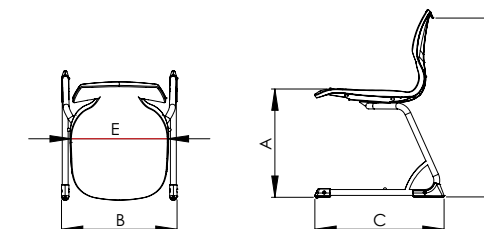



Flavors Adjustable Chair

Flexing seat back provides support and allows student to turn with less restriction. Flat seat pan with waterfall front edge. Available in 19 colors. 5-star base in Black. Specify 'A' shell for grade 5+. B Shell has a gas lift that is specifically designed for elementary use, grades 1-4, less weight is required to activate the mechanism.

- Flavors Seating adjustable chair height ranges from 16-21" for A shell; 14-18" for B shell.
- The shell rests on the frame, not rivets, to add comfort.
- High-density polypropylene with color throughout the shell.
- Available with 2" casters or glides.



MODEL	DESCRIPTION		D"	W"	H"	F.C.	CUBE	WT.	UPS	2016 LIST
11840	Flavors Adjustable Chair - w/casters	A shell	25	25	16-21	85	2.1	26	*	\$ 263.00
11841	Flavors Adjustable Chair - w/glides	A shell	25	25	16-21	85	2.1	26	*	\$ 263.00
11830	Flavors Adjustable Chair - w/casters	B shell	22	22	14-18	85	2.1	26	*	\$ 230.00
11831	Flavors Adjustable Chair - w/glides	B shell	22	22	14-18	85	2.1	26	*	\$ 230.00



Flavors Adjustable Stool

Flexing seat back provides support and allows student to turn with less restriction. Flat seat pan with waterfall front edge. Available in 19 colors. 5-star base in Black. Durable chrome footrest.

- Flavors Adjustable stool height ranges from 22-32".
- The shell rests on the frame, not rivets, to add comfort.
- High-density polypropylene with color throughout the shell.
- Available with 2" casters or glides.

MODEL	DESCRIPTION		D"	W"	H"	F.C.	CUBE	WT.	UPS	2016 LIST
11842	Flavors Adjustable Stool - w/casters	A shell	28	28	22-32	85	2.4	34	*	\$ 409.00
11843	Flavors Adjustable Stool - w/glides	A shell	28	28	22-32	85	2.4	34	*	\$ 409.00

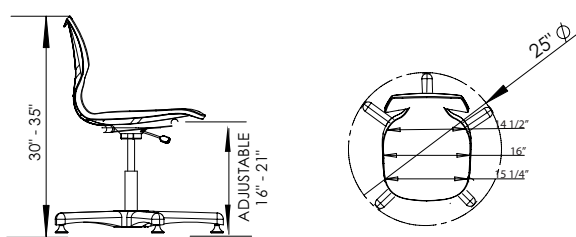

Flavors Adjustable Chair (A Shell)

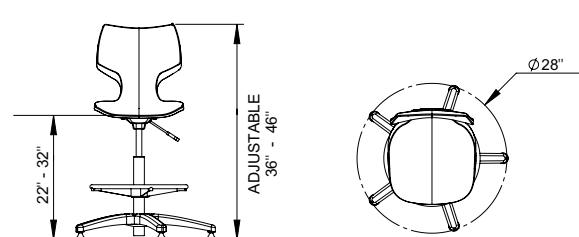

Flavors Adjustable Stool



Flavors P-Tablet Arm Chair
Model 11820V. Shown in Grey Mesh top with Apple edge and Apple Shell.

Flavors P-Tablet Arm Chairs

Right or left-hand model available. Chrome frame is standard. Top is available in 3/4 in. (4 mm) T-Mold edge or 3/4 in. Bullet T-Mold edge (standard) thickness. Choose from 11 standard laminate colors, 21 edge colors, and 19 shell colors.

- High-pressure laminate top.
- The shell rests on the frame, not rivets, to add comfort.
- High-density polypropylene with color throughout shell.
- Durable glides with non-staining nylon bases come standard, or choose optional steel or felt glides.
- The chrome-plated frame is strong, 18-gauge welded steel.
- Legs available in durable chrome finish only.

MODEL	DESCRIPTION		D"	W"	H"	F.C.	CUBE	WT.	UPS	2016 LIST
11820V	P-Tablet Arm Chair - Right Hand	A shell	20	17	18	125	6.3	21	*	\$ 215.00
11821V	P-Tablet Arm Chair - Left Hand	A shell	20	17	18	125	6.3	21	*	\$ 215.00
S	Steel glide optional	Set of 4 installed								\$ upcharge
F	Felt glide optional	Set of 4 installed								\$ upcharge

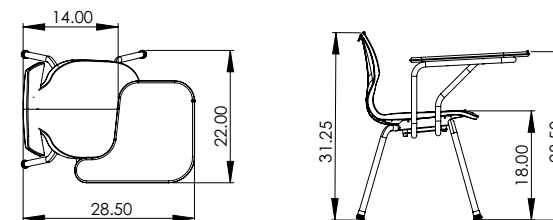

Flavors P-Tablet Arm Chair

Flavors Tablet Chairs Have Top and Edge Choices

- 3/4" Tops**
- C** 4mm T-Mold CHOICE 1: **CHOICE 1** - 3/4" top with 4mm T-Mold to follow Model No.
 - V** Bullet T-Mold CHOICE 2: **CHOICE 2** - 3/4" top with Bullet T-Mold to follow Model No.

Glide Options:

Nylon base glides are standard. Steel and Felt base glides are optional and are quoted.

This is factory installed option not available for field installation. Glide option must be on original chair order.

Steel glide option: Add 'S' to follow Model No.

Felt glide option: Add 'F' to follow Model No.

FLAVORS DESK LAMINATE COLOR CHOICE

- Amber Cherry, Blond Echo, Golden Oak, Grey Nebula, Pewter Mesh, Wild Cherry
- Asian Night, Fusion Maple, Grey Mesh, New Age Oak, Tan Echo

FRAME

- Chrome

FLAVORS CHAIR SHELL & DESK EDGE COLOR CHOICE

- Apple, Burgundy, Chocolate, Fuchsia, Navy, Red
- Black, Cerulean, Clementine, Mint, Persian Blue, White
- Blueberry, Charcoal, Forest Green, Mocha, Purple, Yellow
- ORANGE** NEW 2016 COLOR

View all finish options on page 260.

ADDITIONAL EDGE ONLY COLOR CHOICE

- Champagne
- Platinum



Student seating with patented movement.



Model 11852 -16"

Flavors™ Noodle Chair

The Noodle Chair is designed to help the student concentrate and be healthier. It has a patented suspension that allows it to move with – not resist – the student. It provides all the benefits of sitting on a large ball, but with the added advantages of more stability and back support. The Noodle Chair is perfectly suited to fidgety students. Available in 19 colors.

- The shell rests on a patented suspension, allowing the seat pan to tilt slightly in all directions.
- A four-position chair offering the utmost freedom of movement.
- High-density polypropylene shell with color throughout.
- Durable swivel-base glides with non-staining nylon bases and chrome-plated steel covers, come standard. Or choose optional felt or stainless steel glides.
- The legs are strong, 18-gauge welded steel with a durable chrome finish.

NEW FRAME COLOR! PLATINUM

MODEL	DESCRIPTION		D"	W"	H"	F.C.	CUBE	WT.	UPS	2016 LIST
11851	Noodle Chair	A shell - 18"h	20.5	19.5	18	125	2	15	*	\$ 199.00
11852	Noodle Chair	B shell - 16"h	18	18	16	125	1.2	14	*	\$ 189.00
11853	Noodle Chair	B shell - 14"h	17	17.5	14	125	1.2	14	*	\$ 189.00
S	Steel glide optional	Set of 4 installed								\$ upcharge
F	Felt glide optional	Set of 4 installed								\$ upcharge

Glide Options:
 Nylon base glides are standard.
 Steel and Felt base glides are optional and are quoted.

This is factory installed option not available for field installation. Glide option must be on original chair order.

Steel glide option: Add 'S' to follow Model No.
Felt glide option: Add 'F' to follow Model No.

Educators agree that allowing movement encourages better breathing and helps students concentrate. The Noodle Chair represents a practical solution for classrooms everywhere.

See the Noodle Chair in action at: smithsystem.com/noodle

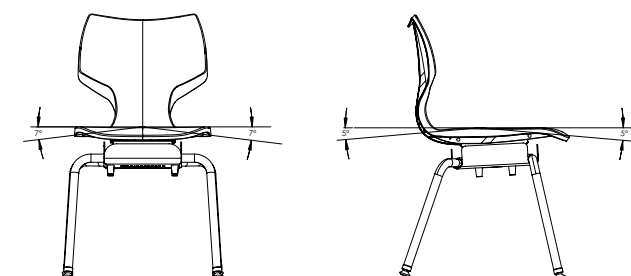

Model	A	B	C	D	E	F	G	Leg Diameter
11851	31"	16"	20.5"	16"	19.5"	18"	15"	1"
11852	29"	14.5"	18"	14.5"	18"	16"	13.75"	1"
11853	26"	14.5"	17"	14.5"	17.5"	14"	13.75"	1"

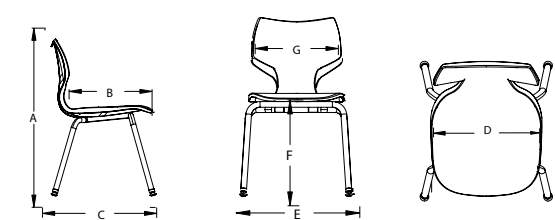

FLAVORS NOODLE CHAIR SHELL COLOR CHOICE

- | | | | | | | |
|-----------|----------|--------------|---------|--------------|--------|----------|
| Apple | Burgundy | Chocolate | Fuchsia | Navy | Red | Chrome |
| Black | Cerulean | Clementine | Mint | Persian Blue | White | Platinum |
| Blueberry | Charcoal | Forest Green | Mocha | Purple | Yellow | |
- ORANGE** NEW 2016 COLOR View all finish options on page 260.

See more: smithsystem.com/noodle





Plato™ Seating



Stacking



Mobile Stacking



Fixed Height Stools



Adjustable Stools



P-Tablet Arm Chairs



Adjustable Chairs

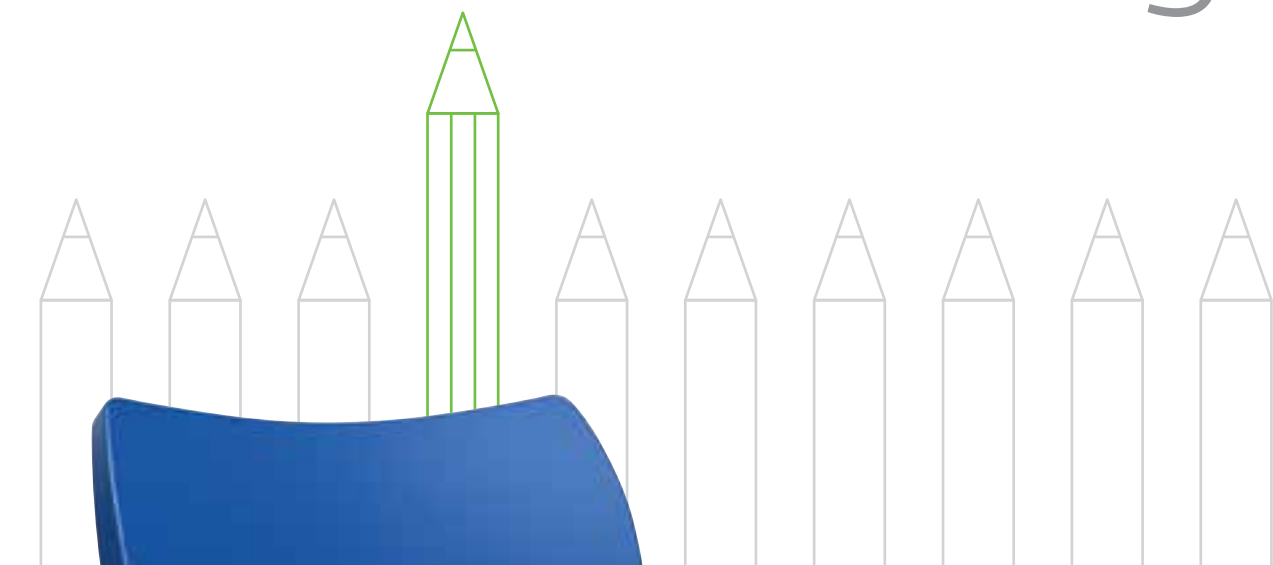

Its pronounced lumbar support promotes posture, breathing and attention.

Support, with freedom.

Plato Seating is a three-position chair, allowing the student to comfortably face the front and both sides. The "Euro-Spec" seatback draws on the design of European school seating where lumbar support is closely studied and mandated.

- The seatback flexes to provide relief from a fixed, rigid seating position.

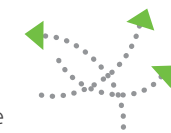

Better posture and better breathing.

Studies show a link between improved student posture and a number of health benefits, including better breathing, as well as academic benefits, including better concentration.

A solid choice for classrooms of all kinds.

Plato Seating is well-suited for collaborative classrooms as well as traditional classrooms. It allows students to work with others on either side, yet for individual study and lectures, it helps them stay alert and focused.



For classrooms of all kinds and students of all sizes.

- Plato Seating is light enough for most students to move in the classroom without difficulty.
- Achieve additional mobility with optional casters on the Adjustable Chair and Stools and to the Stacking Chair.
- Stacking models come in three sizes so you can pair the appropriately sized chair with the student in all grade levels.



Construction. Built for the demands of a school environment.

- The durable, high-density polypropylene shell stands up to the challenges of a real-world classroom.
- Made of 18-gauge welded steel, the frame is protected with chrome plating.
- For added comfort, the shell rests directly on the frame (not on the rivets).





Model 00950
18" seat height, 'A' Shell.
Shown in Persian Blue.

Model 00951
16" seat height, 'B+' Shell.
Shown in Cerulean.

Model 00952
14" seat height, 'B' Shell.
Shown in Apple.

Plato Stack Chair

The Plato Stack Chair provides roominess for today's growing students through its oversized seat pan. Built to what's called Euro-Spec (short for European Specifications), the seatback offers some flex front-to-back and provides pronounced lumbar support, encouraging good posture and breathing. Its fresh, yet familiar shape connotes comfort to the student. 14", 16" and 18" sizes.

- The shell rests on the frame, not rivets, to add comfort.
- High-density polypropylene shell with color throughout.
- The legs are strong, 18-gauge welded steel with a durable chrome finish.
- Stacks 5-6 chairs high.
- Durable swivel-base glides with non-staining nylon bases and chrome-plated steel covers come standard. Or choose optional steel or felt glides.
- 18 colors.

MODEL	DESCRIPTION		D"	W"	H"	F.C.	CUBE	WT.	UPS	2016 LIST
00950	Plato Stack Chair	A shell - 18"h	21	19	18	125	4.0	11	*	\$ 99.00
00951	Plato Stack Chair	B+ shell - 16"h	18.25	17	16	125	4.0	9	*	\$ 95.00
00952	Plato Stack Chair	B shell - 14"h	16	15	14	125	4.0	8	*	\$ 89.00
F	Felt glide optional	Set of 4 installed								\$ upcharge
S	Steel glide optional	Set of 4 installed								\$ upcharge

Glide Options:

Nylon base glides are standard.

Steel and Felt base glides are optional and are quoted.

This is factory installed option not available for field installation. Glide option must be on original chair order.

Steel glide option: Add 'S' to follow Model No.

Felt glide option: Add 'F' to follow Model No.

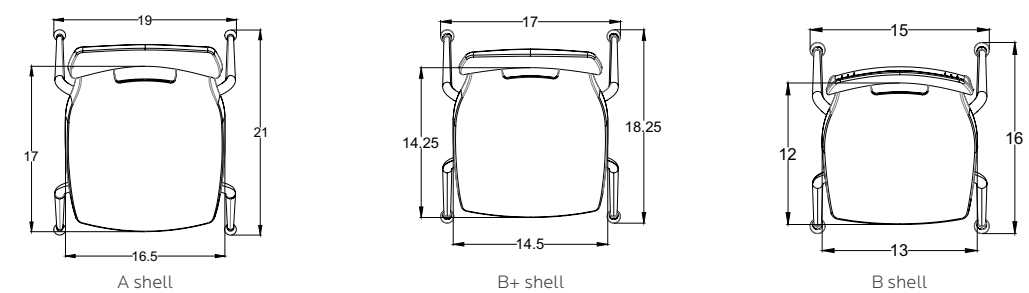

Plato seat pans are oversized for today's growing kids. Choose from A, B+ and B shells.



Shown in Fuchsia.

Plato Mobile Stack Chair

The Plato Mobile Stack Chair provides roominess for today's growing students through its oversized seat pan. Built to what's called Euro-Spec (short for European Specifications) the seatback offers some flex front-to-back and provides pronounced lumbar support, encouraging good posture and breathing. Its fresh, yet familiar shape connotes comfort to the student. Mobility makes ingress/egress easier and allows classroom configurations to change quickly throughout the day.

- The shell rests on the frame, not rivets, to add comfort.
- High-density polypropylene shell with color throughout.
- Durable casters add mobility.
- The legs are strong, 18-gauge welded steel with a durable chrome finish.
- Stacks 5-6 chairs high.
- 18 colors.

MODEL	DESCRIPTION	D"	W"	H"	F.C.	CUBE	WT.	UPS	2016 LIST
00953	Plato Mobile Stack Chair	22	20	18	125		12	*	\$ 129.00



Adjustable Chair Model 00960

Adjustable Stool Model 00966

Plato Adjustable Chair and Plato Adjustable Stool

The Plato Adjustable Chair provides roominess for today's growing students through its oversized seat pan. Built to what's called Euro-Spec (short for European Specifications), the seat back offers some flex front-to-back and provides pronounced lumbar support, encouraging good posture and breathing. Its fresh, yet familiar shape connotes comfort to the student.

- The shell rests on the frame, not rivets, to add comfort.
- High-density polypropylene shell with color throughout.
- 5-star base in Black.
- Choose glides or casters.
- Adjusts from 16-21" high (chair) and 22-32" high (stool).
- 18 colors.

MODEL	DESCRIPTION		D"	W"	H"	F.C.	CUBE	WT.	UPS	2016 LIST
00960	Plato Adjustable Chair	w/ glides	25	25	16-21	85	2.1	26	*	\$ 253.00
00961	Plato Adjustable Chair	w/ casters	25	25	16-21	85	2.1	26	*	\$ 253.00
00965	Plato Adjustable Stool	w/ glides	28	28	22-32	85	2.4	34	*	\$ 399.00
00966	Plato Adjustable Stool	w/ casters	28	28	22-32	85	2.4	34	*	\$ 399.00

PLATO CHAIR SHELL COLOR CHOICE

Apple	Burgundy	Chocolate	Fuchsia	Navy	Red	Chrome
Black	Cerulean	Clementine	Mint	Persian Blue	White	
Blueberry	Charcoal	Forest Green	Mocha	Purple	Yellow	

View all finish options on page 260.



Plato P-Tablet Arm Chair
Model 00975V. Shown in Grey Mesh top with Apple edge and Apple Shell.

Plato P-Tablet Chairs

Plato Seating allows the student to comfortably face front and the side. The seatback offers some flex front-to-back and offers pronounced lumbar support, encouraging good posture and breathing on the part of the student. Top is available in 3/4 in. Choose from 4mm T-Mold edge or Bullet T-Mold edge (standard). Chair shell available in 18 colors. Tablet in 11 standard laminate colors and 21 edge colors. Frame in Chrome.

- High-pressure laminate top.
- The shell rests on the frame, not rivets, to add comfort.
- High-density polypropylene shell with color throughout.
- Durable swivel-base glides with non-staining nylon bases and chrome-plated steel covers come standard. Or choose optional steel or felt glides.
- The legs are strong, 18-gauge welded steel with a durable chrome finish.

MODEL	DESCRIPTION	D"	W"	H"	F.C.	CUBE	WT.	UPS	2016 LIST
00975V	Plato P-Tablet Right-hand - A shell	21	19	18	125	15	15	*	\$ 205.00
00976V	Plato P-Tablet Left-hand - A shell	21	19	18	125	15	15	*	\$ 205.00
S	Steel glide optional								\$ upcharge
F	Felt glide optional								\$ upcharge

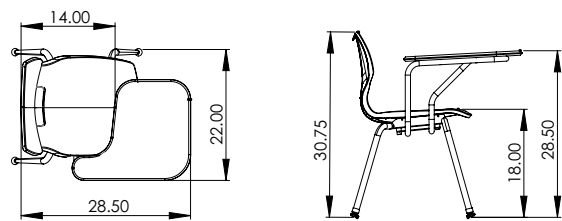

Plato P-Tablet Arm Chair

Plato Tablet Chairs Have Top and Edge Choices

- 3/4" Tops**
- CHOICE 1** - 3/4" top with 4mm T-Mold
C to follow Model No.
- CHOICE 2** - 3/4" top with Bullet T-Mold
V to follow Model No.

Glide Options

Nylon base glides are standard. Steel and Felt base glides are optional and are quoted.

This is factory installed option not available for field installation. Glide option must be on original chair order.

Steel glide option: Add 'S' to follow Model No.
Felt glide option: Add 'F' to follow Model No.



Plato 28''h Fixed-height Stool
Model 00980. Shown in Persian Blue.



Plato 24''h Fixed-height Stool
Model 00981. Shown in Apple.



Pair Plato Chairs & Stools with a Café Table, see page 174

Plato Stools

The Plato Fixed-height Stool provides roominess for today's growing students through its oversized seat pan. Built to what's called Euro-Spec (short for European Specifications) the seatback offers some flex front-to-back and provides pronounced lumbar support, encouraging good posture and breathing. Its fresh, yet familiar shape connotes comfort to the student.

- The shell rests on the frame, not rivets, to add comfort.
- High-density polypropylene shell with color throughout.
- Durable swivel-base glides with non-staining nylon bases and chrome-plated steel covers come standard. Or choose optional steel or felt glides.
- The legs are strong, 18-gauge welded steel with a durable chrome finish.
- 18 colors.

MODEL	DESCRIPTION	D"	W"	H"	F.C.	CUBE	WT.	UPS	2016 LIST
00980	Plato Fixed-height Stool A shell - 28''h	21	19	28	125	18	18	*	\$ 150.00
00981	Plato Fixed-height Stool A shell - 24''h	21	19	24	125	16	16	*	\$ 144.00
S	Steel glide optional								\$ upcharge
F	Felt glide optional								\$ upcharge

Glide Options:

Nylon base glides are standard.

Steel and Felt base glides are optional and are quoted.

This is factory installed option not available for field installation. Glide option must be on original chair order.

Steel glide option: Add 'S' to follow Model No.

Felt glide option: Add 'F' to follow Model No.

PLATO DESK TOP LAMINATE COLOR CHOICE

- Amber Cherry
- Blond Echo
- Golden Oak
- Grey Nebula
- Pewter Mesh
- Wild Cherry
- Asian Night
- Fusion Maple
- Grey Mesh
- New Age Oak
- Tan Echo

FRAME

- Chrome

PLATO CHAIR SHELL & DESK EDGE COLOR CHOICE

- Apple
- Burgundy
- Chocolate
- Fuchsia
- Navy
- Red
- Black
- Cerulean
- Clementine
- Mint
- Persian Blue
- White
- Blueberry
- Charcoal
- Forest Green
- Mocha
- Purple
- Yellow

ADDITIONAL EDGE ONLY COLOR CHOICE

- Champagne
- Orange
- Platinum

View all finish options on page 260.



Intuit™ Seating

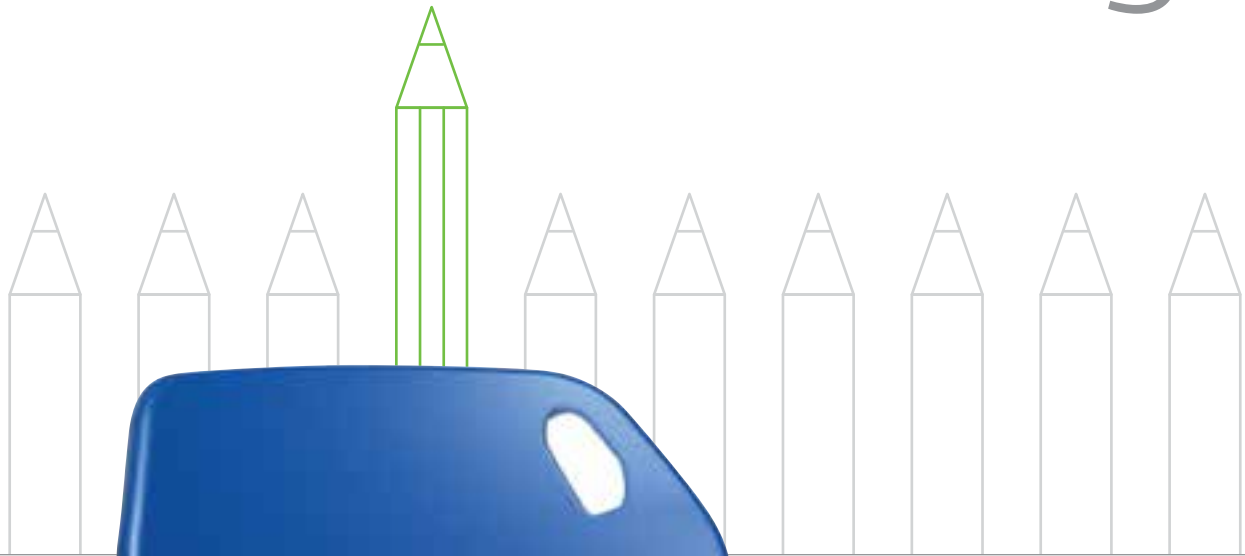

It comfortably directs attention straight ahead.



Stacking



Adjustable Chairs



Adjustable Stools

For contemporary classrooms and students.

The Intuit chair was designed to make the student feel comfortable before even sitting down through its use of familiar, graceful curves.

- The chair's inviting shape gives an honest indication of how comfortable it is.
- The bucket design provides great back and shoulder support while offering just the right amount of flex.

Holds attention without confining it.

Intuit Seating gently and subtly directs the student's attention to the front without being restrictive. Its design allows a movement and its dimensions don't constrict the student.

For use throughout the school.

A welcome addition to learning environments of all kinds, including classrooms, computer labs, art and music rooms. Plus administrative offices.

For classrooms of kinds and students of all sizes. 

- Stacking models come in four sizes so you can pair the appropriately sized chair with the student in all grade levels.
- Generously proportioned shell offers comfortable seating for a broad range of student sizes within the grade level.
- Achieve additional mobility with optional casters on the Adjustable Chair and Stools.

Construction. 

Built for the demands of a social environment.

- The durable, high-density polypropylene shell stands up to the challenges of a real-world classroom.
- Made of 18-gauge welded steel, the frame is protected with rugged powder coat finish.
- For added comfort, the shell rests directly on the frame (not on the rivets).



Model 00514
14" seat height, 'B' Shell.
Shown in Clementine.

Model 00562
16" seat height, 'B' Shell.
Shown in Fuchsia.

Model 00509
18" seat height, 'A' Shell.
Shown in Navy.

Model 00560
19" seat height, 'A+' Shell.
Shown in Purple.

Intuit Stack Chair

Its comfortable bucket seat design provides great support for the back and shoulders while comfortably orienting the student toward the front. Subtle flex in the Intuit Chair's back provides some movement for the student, but movement to the sides and back is limited. Available in four sizes, 18 colors. Durable frame in Black or Platinum.

- No sharp edges around handle.
- The light texture on the chair surface resists scratching.
- Mig-welded 16-gauge steel frame.
- Swivel chrome plated glides come with nylon base. Or choose optional steel or felt glides.
- Stacks 5-6 chairs high.
- The shell rests on the frame, not on rivets.
- 3 sizes of shells available: 'A+' on 19" seat height; 'A' on 18" seat height and 'B' on 16" and 14" seat height.

MODEL	DESCRIPTION		D"	W"	H"	F.C.	CUBE	WT.	UPS	2016 LIST
00560	Intuit Stack Chair	A+ shell - 19"h	22	20.8	19	125	4	15	*	\$ 160.00
00509	Intuit Stack Chair	A shell - 18"h	19.9	18.9	18	125	4	15	*	\$ 140.00
00562	Intuit Stack Chair	B shell - 16"h	17.6	16.9	16	125	3.4	9	*	\$ 120.00
00563	Intuit Stack Chair	B shell - 14"h	17.6	16.8	14	125	3.4	9	*	\$ 115.00
S	Steel glide optional	Set of 4 installed								\$ upcharge
F	Felt glide optional	Set of 4 installed								\$ upcharge

Glide Options:

Nylon base glides are standard. Steel and Felt base glides are optional and are quoted.

This is factory installed option not available for field installation. Glide option must be on original chair order.

Steel glide option: Add 'S' to follow Model No.
Felt glide option: Add 'F' to follow Model No.

DIMENSION CHART						
Model	A	B	C	D	E	F
00560	22.06"	16"	32.3"	19.61"	20.81"	19"
00509	19.85"	15.63"	30.41"	17.65"	18.89"	18"
00562	17.64"	12.8"	26.59"	15.69"	16.91"	16"
00563	17.64"	12.8"	25.1"	15.69"	16.84"	14"

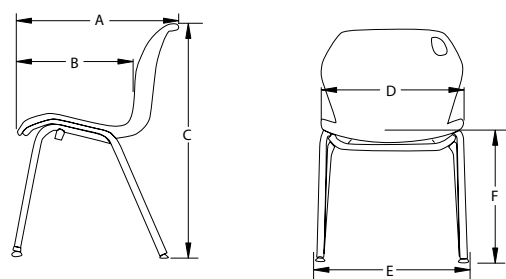

Intuit Adjustable Chair

Its comfortable bucket seat design provides great support for the back and shoulders while comfortably orienting the student toward the front. Subtle flex in the Intuit Chair's back provides some movement for the student. Swivel base allows student to face 360°. Seat height Adjustable. Available in two sizes, 18 colors. Durable five-star base and frame in Black. Choose casters or glides. Specify 'A' shell for grade 5+ or adult use. B Shell has a gas lift that is specifically designed for elementary use, grades 1-4, less weight is required to activate the mechanism. Black base only.

Shown in Persian Blue.

MODEL	DESCRIPTION		D"	W"	H"	F.C.	CUBE	WT.	UPS	2016 LIST
00530	Intuit Adj. Chair - w/glides	A+ shell	25	25	16-21	85		29	*	\$ 333.00
00531	Intuit Adj. Chair - w/2" casters	A+ shell	25	25	16-21	85		29	*	\$ 333.00
00532	Intuit Adj. Chair - w/glides	B shell	22	22	14-18	85		25	*	\$ 321.00
00533	Intuit Adj. Chair - w/2" casters	B shell	22	22	14-18	85		25	*	\$ 321.00



Intuit Adjustable Stool

Its comfortable bucket seat design provides great support for the back and shoulders while comfortably orienting the student toward the front. Subtle flex in the Intuit Chair's back provides some movement for the student. Swivel base allows student to face 360°. Seat height Adjustable. Available in 18 colors. Durable 28" five-star base and frame in Black. Choose casters or glides. Black base only.

Shown in Mint.

MODEL	DESCRIPTION		D"	W"	H"	F.C.	CUBE	WT.	UPS	2016 LIST
00540	Intuit Adj. Stool - w/glides	A+ shell	28	28	22-32	85		37	*	\$ 479.00
00541	Intuit Adj. Stool - w/2" casters	A+ shell	28	28	22-32	85		37	*	\$ 479.00

INTUIT CHAIR SHELL COLOR CHOICE

Apple	Burgundy	Chocolate	Fuchsia	Navy	Red
Black	Cerulean	Clementine	Mint	Persian Blue	White
Blueberry	Charcoal	Forest Green	Mocha	Purple	Yellow

FRAME

Black
Platinum

View all finish options on page 260.

Platinum frame only for QS. All shell colors QS.



Chat™ Seating



Six Chat Chairs and a Square Chat Planner™ Table combine to create an inviting area for casual collaboration.

Comfortable, reconfigurable seating for commons areas.



Their mobility and flexibility make it easy to create collaborative breakout areas.

A combination of Chat Chairs and Chat Wedge Tables allow imaginative configurations that encourage interaction.



Chat Chairs can be connected to create benches. These Chat Chairs have optional power outlets.



Chat Chairs are highly mobile, enabling students to easily remove chairs from groups and add them to others.



Two Chat Chairs, with optional outlets for powering devices, are teamed with a Chat Wedge to create a small meeting area.

A New Kind of Chair

This hybrid is a welcome option for social learning situations and commons area seating. It merges the comfortable dimensions of lounge seating with the kind of durability expected in a school setting.

A chair of choice.

- Students will choose to sit in a Chat Chair because its roomy dimensions connote relaxation and informality.
- Chat Chairs with fabric covered cushions offer an even more comfortable place for students to sit while they interact and exchange ideas.



Temporarily fixed in place or mobile.

- Chat Chairs can be linked together to form rows. They can also be joined to Chat Wedge tables to create curved configurations.
- Integrated casters make relocating Chat Chairs easy for any student.

Construction.

Built for the demands of a school environment.

- Underseat power outlets available for powering devices used in social learning.
- The durable, high-density polypropylene seat pan and seat back stands up to the challenges of a real-world schools.
- Made of 18-gauge welded steel, the frame is protected with a rugged powder coat finish.
- Available with fabric covered cushion on the seat pan.
- For added comfort, it rests directly on the frame (not on the rivets).





Chat Wedge with Power, Model CHWDGPD. Shown in Golden Oak top with Navy edge and Platinum frame. Shown with Chat Chair with Fabric Seat, Model CH11FIP100.



Cascade™ Mega-Towers, with Dry Erase Whiteboard. See page 223 to order.

Cascade™ Mini-Cabinet, see page 218 to order.

Café Round top, Model 01504 with 16" Circular Base, Model 01450.

Chat Chairs can be joined together to create a bench effect, shown with Fabric Seats in Persian Blue, Model CH11FJP300.

Chat Chair

The Chat Chair is a new concept in seating, providing an option between lounge seating and classroom seating. The Chat Chair offers large dimensions, encouraging the student to engage in relaxed collaborative learning or social learning settings. The Chat Chair offers excellent flexibility: integrated casters provide easy mobility. It can be ganged, or positioned individually. Available in 15 poly and 14 fabric colors with nylon or felt glides.

- Link them together or position them individually.
- Integrated casters provide easy mobility.
- Extra wide seat pan constructed of choice: polypropylene (P) or fabric (F).
- Seat back constructed of polypropylene (P), available in 15 colors.
- 16-gauge welded-steel frame in Platinum.

MODEL	DESCRIPTION	D"	W"	H"	F.C.	CUBE	WT.	UPS	2016 LIST
CH11P_P_00	Polypropylene 18" high w/ nylon glide	24	24.5	18	125	26	26	*	\$ 299.00
CH21P_P_00	Polypropylene 18" high w/ felt glide	24	24.5	18	125	26	26	*	\$ 299.00
CH11F_P_00	Fabric 18" high w/ nylon glide	24	24.5	18	125	26	26	*	\$ 375.00
CH21F_P_00	Fabric 18" high w/ felt glide	24	24.5	18	125	26	26	*	\$ 375.00
Chat Chair with Power									
CH11P_P_01	Poly, 2 Power 18" high w/ nylon glide	24	24.5	18	125	26	26	*	\$ 449.00
CH11P_P_02	Poly, 1 Power, 1 twin USB 18" high w/ nylon glide	24	24.5	18	125	26	26	*	\$ 569.00

Seat Color Choice for 1st __ Choose 1 letter Back Color Choice for 2nd __ Choose 1 letter

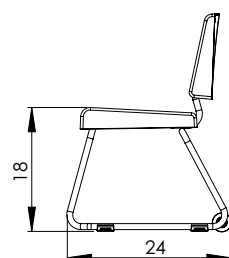

Chat™ Chair is 32" high, floor to top of back. 24.5" wide and 24" deep.



The Chat Chair is available with optional outlets, for powering devices students need for social learning.

- Option 1, 2 power
- Option 2, 1 power, 1 twin USB



Ingenious integrated casters provide easy wheelbarrow mobility for the Chat Chair and glides allow the chair to sit securely in one place.



Chat Scooter **NEW FOR 2016**

Integrated handle and casters make the Chat Scooter an easy, casual and fun seating option. Students sit on either side of the flat seat, even two per chair. Available in 15 colors with Nylon or felt glides. *Not intended to be ganged with Chat Chair or Chat Wedge Table.*

MODEL	DESCRIPTION	D"	W"	H"	F.C.	CUBE	WT.	UPS	2016 LIST
CH31P_P_00	Polypropylene 18" high w/ nylon glide	24	24.5	18	125	18	18	*	\$ 199.00
CH41P_P_00	Polypropylene 18" high w/ felt glide	24	24.5	18	125	18	18	*	\$ 199.00

How to read a Chat™ Chair 10-digit Part Number

Here's our simple system for ordering Chat Chairs exactly the way you want them. Just decide what features and options you want, find them in the columns below and write them down in sequence.

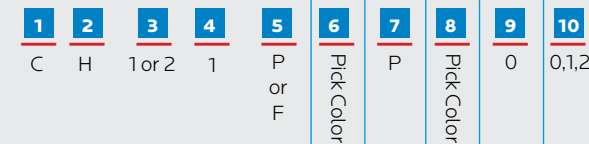

1 Chair Type CH = Chair	2 Chair Size/Type 1 = 18" high w/ nylon glide 2 = 18" high w/ felt glide	4 Frame Color 1 = Platinum	5 Seat Type P = Poly F = Fabric	6 Seat Color See Shell Color Chart Choose 1 Letter	7 Back Type P = Poly	8 Back Color See Shell Color Chart Choose 1 Letter	9 Screen 0 = No Screen	10 Power 0 = No Power 1 = Power 2 = Power w/USB
--------------------------------------	--	---	---	--	-----------------------------------	--	-------------------------------------	--

Polypropylene (P) Seat; Polypropylene (P) Back or Fabric (F) Seat.

CHAT CHAIR SHELL COLOR CHOICE

● Apple A	● Burgundy D	● Clementine E	● Mocha T	● Purple K
● Black B	● Cerulean S	● Forest Green F	● Navy I	● Red L
● Blueberry C	● Chocolate Q	● Mint H	● Persian Blue J	● White* M

FRAME: ● Platinum

*White available in poly only, not fabric. View all finish options on page 260.



In this social learning suite, Chat™ Chairs linked with Chat Wedge Tables surround a Chat Planner™ Round Activity Table.



Chat Wedge Table

Complement Chat Chairs with Chat Wedge Tables. These 60° tables allow you to create large, inviting seating spaces in commons areas, libraries, hallways and entry areas. The durable laminate top (available in 11 colors) and edge band (available in 21 colors) can complement or contrast the color of the Chat Chairs.

Chat Wedge Table with 4 plug Power Dome, Model CHWDGPD
Shown in Pewter Mesh top with Charcoal edge and Platinum frame.

- Rugged 16-gauge steel legs available in Platinum.
- Choose Wedge, Wedge with 4 plug Power Dome or new Soft Touch Dome.

MODEL	DESCRIPTION	D"	W"	H"	F.C.	CUBE	WT.	UPS	2016 LIST
CHWDG	Chat Wedge Table	19.5	20.5	16.82	70	16	*	\$	149.00
CHWDGPD	Chat Wedge Table w/4 Plug Power Dome	19.5	20.5	16.82	70	16	*	\$	369.00
CHWDGQD	Chat Wedge Table w/Soft Touch Dome, 3 Power	19.5	20.5	16.82	70	16	*	\$	309.00
CHWDGRD	Chat Wedge Table w/Soft Touch Dome, 1 Power, 1 twin USB	19.5	20.5	16.82	70	16	*	\$	394.00
Optional Accessories									
17060	15ft. cord Power Socket					70	4	\$	192.00

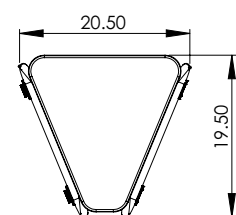

Chat Wedge Table Model CHWDG



Power Socket, Model 17060 is durable and attaches securely to the work surface.



MODEL	DESCRIPTION	D"	W"	H"	F.C.	CUBE	WT.	UPS	2016 LIST
Chat Planner Activity Tables*									
25031L	Square Table 1" leveling glides	24	24	15-24*	70			*	\$ 318.00
25032L	Rectangle Table 1" leveling glides	24	42	15-24*	70			*	\$ 398.00
25030L	Round Table 1" leveling glides	36" round		15-24*	70			*	\$ 396.00
* Chat Planner Activity Tables adjust in 1" increments from 15-24".									
Coffee height Café Table									
01504	Café Round top only	36" dia.			70	2.25	33	*	\$ 184.00
01450	Café 16"h Circular Base coffee table height	24" dia.		16	70	5.5	38	*	\$ 280.00
* See page 179 for all Café options.									

Wedge Tables Have Top and Edge Choices

1 1/4" Tops

CHOICE 1 - 1 1/4" top with Bumper T-Mold no letter to follow Model No.

CHOICE 3 - 1 1/4" top with 4mm T-Mold D to follow Model No.

Planner Tables Have Top and Edge Choices

1 1/4" Tops

CHOICE 1 - 1 1/4" top with Bumper T-Mold no letter to follow Model No.

CHOICE 3 - 1 1/4" top with 4mm T-Mold D to follow Model No.

3/4" Tops

CHOICE 5 - 3/4" top with 4mm T-Mold C to follow Model No.

CHOICE 6 - 3/4" top with Bullet T-Mold V to follow Model No.

CHAT TABLES TOP LAMINATE COLOR CHOICE							FRAME
Amber Cherry	Blond Echo	Golden Oak	Grey Nebula	Pewter Mesh	Wild Cherry	Platinum	
Asian Night	Fusion Maple	Grey Mesh	New Age Oak	Tan Echo			
CHAT TABLES EDGE COLOR CHOICE							
Apple	Burgundy	Champagne	Forest Green	Mocha	Persian Blue	Red	
Black	Cerulean	Chocolate	Fuchsia	Navy	Platinum	White	
Blueberry	Charcoal	Clementine	Mint	Orange	Purple	Yellow	

View all finish options on page 260.



UXL™ Seating



Stacking Mobile Stacking Stacking with Arms

So customizable, even the options offer options.



Tablet Arm Chair Nest & Fold Adjustable Chair Beam Seating

No seating line offers more versatility.

The UXL furniture line includes desking, tables and seating. The idea behind it is to be so versatile, that this single line could be used throughout a school.

When it comes to seating, The UXL Chair is dozens of chairs in one – all starting with the comfortable and spacious UXL Stacking Chair. From there, add utility and functionality with the many available options.

Options that add functionality.



- Choose from two styles of tablet arms: P-Tablet and FoldAway Tablet Arm.
- Underseat wire Book Basket available in durable powder coat.

What are my choices?

- Seat backs available in durable polypropylene in 18 colors.
- Seat pans available in durable polypropylene in 18 colors or comfortable fabric in 16 colors – mix or match them with the seat back colors.
- Choose Stack or Nest & Fold Chairs.
- Add mobility with casters.
- Add comfort with optional arms.



It enhances the design scheme.

By choosing UXL, you can choose the same seat colors as the edge band colors of the desks and tables – and those colors will match. This is one of the ways UXL allows you to maintain a consistent design scheme throughout the entire building.



UXL 18" Stacking Chair in Cerulean. UXL 16" Stacking Chair in Cerulean. UXL 14" Stacking Chair in Cerulean.

UXL Stack Chair

This comfortably proportioned line of seating complements other furnishings in the UXL line. This highly customizable seating lets you choose polypropylene or fabric seats in 18 colors you can mix or match with seat back colors. Other options include Book Baskets and Long Ganging Device. Stack 10 high.

Polypropylene (P) Seat or Fabric (F) Seat Choice. Polypropylene (P) Back is standard.

- Fabric seats in 16 colors.
- Polypropylene seat and backs in 18 colors to mix or match.
- High-density polypropylene seats and seat backs have color throughout.
- Casters or nylon glides.
- 14", 16", 18" models.
- Optional Book Baskets.
- Optional Long Ganging Device.
- Chairs without Book Baskets stack 10 high.

MODEL	DESCRIPTION	D"	W"	H"	F.C.	CUBE	WT.	UPS	2016 LIST
UXL Stack Chair with Polypropylene Seat & Back									
XL183P_P_	18"h Stack Chair glides	25	21	18	125		14	*	\$ 209.00
XL163P_P_	16"h Stack Chair B shell - w/ glides	21	17	16	125		13	*	\$ 198.00
XL143P_P_	14"h Stack Chair B shell - w/ glides	21	17	14	125		12	*	\$ 194.00
UXL Stack Chair with Fabric Seat & Polypropylene Back									
XL183F_P_	18"h Stack Chair* glides	25	21	18	125		14	*	\$ 264.00

* Fabric Seat available in 18" high Stack Chair only.

UXL Stack Mobile Chair



Adding casters makes this comfortably proportioned line of seating mobile and even more versatile. This highly customizable seating lets you choose polypropylene or fabric seats from 18 mix or match seat and seat back colors. Other options include Book Baskets and Long Ganging Devices. Stack 10 high. Platinum frame.

Polypropylene (P) Seat or Fabric (F) Seat Choice. Polypropylene (P) Back is standard.

MODEL	DESCRIPTION	D"	W"	H"	F.C.	CUBE	WT.	UPS	2016 LIST
UXL Stack Chair with Polypropylene Seat & Back									
XL187P_P_	18"h Stack Chair casters	25	21	18	125		14	*	\$ 270.00
XL167P_P_	16"h Stack Chair B shell - w/ casters	21	17	16	125		12	*	\$ 259.00
XL147P_P_	14"h Stack Chair B shell - w/ casters	21	17	14	125		11	*	\$ 254.00
UXL Stack Chair with Fabric Seat & Polypropylene Back									
XL187F_P_	18"h Stack Chair* casters	25	21	18	125		15	*	\$ 325.00

* Fabric Seat available in 18" high Stack Chair only.

UXL SEAT & BACK COLOR CHOICE		Seat Color Choice for 1st	Choose 1 letter	Back Color Choice for 2nd	Choose 1 letter	FRAME
● Apple A	● Burgundy D	● Chocolate Q	● Fuchsia G	● Navy I	● Red L	● Platinum
● Black B	● Cerulean S	● Clementine E	● Mint H	● Persian Blue J	● White* M	
● Blueberry C	● Charcoal* R	● Forest Green F	● Mocha T	● Purple K	● Yellow N	

* White and Charcoal available in poly only. Charcoal in 18" only. View all finish options on page 260.



UXL Stack Chair with Arms

Adding arms makes this comfortably proportioned line of seating even more comfortable. This highly customizable seating lets you choose: polypropylene or fabric seats, from 18 mix or match seat and seat back colors and between casters and glides. Other options include Book Baskets and Long Ganging Devices. Stack 10 high. 18" model. Platinum frame.

Polypropylene (P) Seat or Fabric (F) Seat Choice.
Polypropylene (P) Back is standard.

MODEL	DESCRIPTION	D"	W"	H"	F.C.	CUBE	WT.	UPS	2016 LIST
UXL Stack Chair with Polypropylene Seat									
XL183P_P_LR	18"h Stack Chair w/ arms	glides	25	21	18	125	17	*	\$ 323.00
XL187P_P_LR	18"h Stack Chair w/ arms	casters	25	21	18	125	19	*	\$ 384.00
UXL Stack Chair with Fabric Seat									
XL183F_P_LR	18"h Stack Chair w/ arms	glides	25	21	18	125	18	*	\$ 378.00
XL187F_P_LR	18"h Stack Chair w/ arms	casters	25	21	18	125	20	*	\$ 439.00

Seat Color Choice for 1st Choose 1 letter
Back Color Choice for 2nd Choose 1 letter



UXL FoldAway Tablet Arm Chair

This comfortably proportioned line of seating offers a FoldAway Tablet Arm. Other choices include: left or right Tablet Arm, polypropylene or fabric seats, 18 mix or match seat and seat back colors and casters and glides. Book Baskets and Long Ganging Devices also available. 18" model. Platinum frame.

Polypropylene (P) Seat and Polypropylene (P) Back.
FoldAway Tablet Black only.

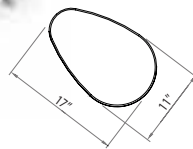

MODEL	DESCRIPTION	D"	W"	H"	F.C.	CUBE	WT.	UPS	2016 LIST
XL183P_P_NF	18"h Stack Chair w/right Fold-away Tablet	29	22.5	18	125		19		\$ 387.00
XL183P_P_FN	18"h Stack Chair w/left Fold-away Tablet	29	22.5	18	125		19		\$ 387.00

Seat Color Choice for 1st Choose 1 letter
Back Color Choice for 2nd Choose 1 letter

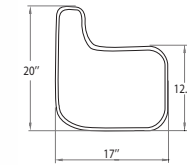

UXL P-Tablet Arm Chair

This comfortably proportioned line of seating offers a fixed P-Tablet Arm, available in 11 laminate finishes and 21 Edge Colors. Other choices include: left or right Tablet Arm, 18 mix or match seat and seat back colors and casters and glides. Book Baskets and Long Ganging Devices also available. 18" model. Platinum frame.

Polypropylene (P) Seat and Polypropylene (P) Back.

With Book Basket: chair bottom to bed of Book Basket is 6";
front opening is 4.75" and rear opening is 5.5".

MODEL	DESCRIPTION	D"	W"	H"	F.C.	CUBE	WT.	UPS	2016 LIST
UXL P-Tablet Arm Chair with Polypropylene Seat & Back (Glides)									
XL183P_P_NT_---	18"h Stack Chair w/ right arm P-Tablet	30	25	18	125		24	*	\$ 310.00
XL183P_P_TN_---	18"h Stack Chair w/ left arm P-Tablet	30	25	18	125		24	*	\$ 310.00
UXL P-Tablet Arm Chair with Polypropylene Seat & Back (Casters)									
XL187P_P_NT_---	18"h Stack Chair w/ right arm P-Tablet	30	25	18	125		24	*	\$ 370.00
XL187P_P_TN_---	18"h Stack Chair w/ left arm P-Tablet	30	25	18	125		24	*	\$ 370.00

Seat Color Choice for 1st Choose 1 letter
Back Color Choice for 2nd Choose 1 letter
Tablet Laminate Color Choice for 3rd, 4th & 5th Choose 3 letters
Tablet Edge Color Choice for 6th Choose 1 letter



Premium Stack Chair Dolly

Premium Trolley provides stable, maneuverable transport of 10 UXL Stacking Chairs (18" only). Features: locking casters, a padded handle that folds away for compact storage and four anchoring cups – one for each chair leg. Black.

MODEL	DESCRIPTION	D"	W"	H"	F.C.	CUBE	WT.	UPS	2016 LIST
55016 BLA	Stack Chair Dolly	29	27	10	125		30	*	\$ 394.00



STACK CHAIR LONG GANGING DEVICE
Model 70861
\$ 13.00



UXL CHAIR BOOK BASKET (for 18" only)
Model 77930 PLT
\$ 43.00
FELT GLIDE SET FOR STACK CHAIR
Model 17580
\$ 8.00

UXL SEAT, BACK & EDGE MOLDING COLOR CHOICE

Apple A	Burgundy D	Chocolate Q	Fuchsia G	Navy I	Red L	Champagne O
Black B	Cerulean S	Clementine E	Mint H	Persian Blue J	White* M	Orange U
Blueberry C	Charcoal* R	Forest Green F	Mocha T	Purple K	Yellow N	Platinum P

UXL LAMINATE DESK TOP COLOR CHOICE

Amber Cherry AME	Fusion Maple MAP	Grey Nebula GNB	Tan Echo TAC	Platinum
Asian Night ANG	Golden Oak GOK	New Age Oak NEW	Wild Cherry CHE	
Blond Echo BEE	Grey Mesh GRE	Pewter Mesh PEW		

*White and Charcoal available in poly and edge only, not fabric. View all finish options on page 260.



Mint

Blueberry

Persian Blue

Apple

Nest & Fold



UXL Nest & Fold Chairs can be moved together. Because they don't require stacking or extra equipment for transport, they save time, effort and expense. Shown in Persian Blue, Apple and Blueberry with optional arms.

Complement UXL Nest & Fold Chairs with UXL Nest & Fold Tables, offering portability and efficient storage. See pages 102-105.



UXL Nest & Fold Chair

This comfortably proportioned line of seating complements other furnishings in the UXL line. Very mobile thanks to casters, and very compact to store, the UXL Nest & Fold Chair is highly customizable. 18 mix or match poly seat and seat back colors and 16 fabric seat colors. Platinum frame only. Not available in Charcoal or White seat (due to fabric).

Fabric (F) Seat and Polypropylene (P) Back.

MODEL	DESCRIPTION	D"	W"	H"	F.C.	CUBE	WT.	UPS	2016 LIST
NF187F_P_	UXL Nest & Fold Chair	22.5	21.25	18	125		16	*	\$ 345.00
NF187F_P_LR	UXL Nest & Fold Chair with arms	22.5	21.25	18	125		21	*	\$ 448.00



UXL Adjustable Chair

This comfortably proportioned seating adjusts 16" – 21"h and swivels; it complements other furnishings in the UXL line. Highly customizable, it lets you choose polypropylene or fabric seats from 18 mix or match seat and seat back colors and between casters and glides. 18" model.

Polypropylene (P) Seat or Fabric (F) Seat Choice.

MODEL	DESCRIPTION		D"	W"	H"	F.C.	CUBE	WT.	UPS	2016 LIST
UXL Adjustable Chair with Polypropylene Seat										
XL031P_P_	UXL Adjustable Chair	glides	25	25	16-21	85		25	*	\$ 353.00
XL035P_P_	UXL Adjustable Chair	casters	25	25	16-21	85		22	*	\$ 363.00
XL031P_P_LR	UXL Adjustable Chair w/ Arms	glides	25	25	16-21	85		31	*	\$ 492.00
XL035P_P_LR	UXL Adjustable Chair w/ Arms	casters	25	25	16-21	85		29	*	\$ 502.00
UXL Adjustable Chair with Fabric Seat										
XL031F_P_	UXL Adjustable Chair	glides	25	25	16-21	85		23	*	\$ 405.00
XL035F_P_	UXL Adjustable Chair	casters	25	25	16-21	85		20	*	\$ 415.00
XL031F_P_LR	UXL Adjustable Chair w/ Arms	glides	25	25	16-21	85		29	*	\$ 543.00
XL035F_P_LR	UXL Adjustable Chair w/ Arms	casters	25	25	16-21	85		27	*	\$ 553.00



UXL Adjustable Stool

This comfortably proportioned seating adjusts 23 1/2" – 30"h and swivels; it complements other furnishings in the UXL line. Highly customizable, it lets you choose polypropylene or fabric seats from 18 mix or match seat and seat back colors and between casters and glides. 18" model.

Polypropylene (P) Seat or Fabric (F) Seat Choice.

MODEL	DESCRIPTION		D"	W"	H"	F.C.	CUBE	WT.	UPS	2016 LIST
UXL Adjustable Stool with Polypropylene Seat										
XL041P_P_	UXL Adjustable Stool	glides	28	28	23.5-30	85		29	*	\$ 424.00
XL045P_P_	UXL Adjustable Stool	casters	28	28	23.5-30	85		26	*	\$ 433.00
XL041P_P_LR	UXL Adjustable Stool w/ Arms	glides	28	28	23.5-30	85		32	*	\$ 562.00
XL045P_P_LR	UXL Adjustable Stool w/ Arms	casters	28	28	23.5-30	85		29	*	\$ 572.00
UXL Adjustable Stool with Fabric Seat										
XL041F_P_	UXL Adjustable Stool	glides	28	28	23.5-30	85		27	*	\$ 475.00
XL045F_P_	UXL Adjustable Stool	casters	28	28	23.5-30	85		24	*	\$ 486.00
XL041F_P_LR	UXL Adjustable Stool w/ Arms	glides	28	28	23.5-30	85		30	*	\$ 614.00
XL045F_P_LR	UXL Adjustable Stool w/ Arms	casters	28	28	23.5-30	85		27	*	\$ 625.00

UXL SEAT & BACK COLOR CHOICE Seat Color Choice for 1st Choose 1 letter Back Color Choice for 2nd Choose 1 letter **FRAME**

Apple A	Burgundy D	Chocolate Q	Fuchsia G	Navy I	Red L	Platinum
Black B	Cerulean S	Clementine E	Mint H	Persian Blue J	White* M	
Blueberry C	Charcoal* R	Forest Green F	Mocha T	Purple K	Yellow N	

*White and Charcoal available in poly and edge only, not fabric. View all finish options on page 260.



UXL Beam Seating

For lecture rooms, common and reception areas, this highly customizable free-standing seating can be configured to meet a wide variety of needs. Choose: polypropylene seats from 18 mix or match seat and seat back colors. Optional Arms, FoldAway Tablet Arms and Tables available. Glide legset (BG) standard. Polypropylene (P) Seat and Back. Glides standard.



1	MODEL	DESCRIPTION	D"	W"	H"	F.C.	CUBE	WT.	UPS	2016 LIST
0	BG0P_P_	UXL Beam Seating (2 Seat)	22.5	48	31.49	70		51		\$ 792.00
1	BG1P_P_	UXL Beam Seating (3 Seat)	22.5	71.5	31.49	70		70		\$ 1,100.00
2	BG2P_P_	UXL Beam Seating (4 Seat)	22.5	95	31.49	70		90		\$ 1,396.00
3	BG3P_P_	UXL Beam Seating (5 Seat)	22.5	118.5	31.49	70		109		\$ 1,705.00
4	BG4P_P_	UXL Beam Seating (1 Seat / 1 Table)	22.5	48	31.49	70		49		\$ 605.00
5	BG5P_P_	UXL Beam Seating (2 Seats / 1 Table)	22.5	71.5	31.49	70		68		\$ 913.00
6	BG6P_P_	UXL Beam Seating (3 Seats / 1 Table)	22.5	95	31.49	70		88		\$ 1,209.00
7	BG7P_P_	UXL Beam Seating (4 Seats / 1 Table)	22.5	118.5	31.49	70		107		\$ 1,518.00
8	BG8P_P_	UXL Beam Seating (2 Seats / 2 Tables)	22.5	95	31.49	70		86		\$ 1,022.00
9	BG9P_P_	UXL Beam Seating (3 Seats / 2 Tables)	22.5	118.5	31.49	70		105		\$ 1,331.00

UXL Beam Seating Optional Accessories

Optional Arms for UXL Beam Seating

Add to end of Beam Part Number. List Left Arm choice 0-5 and Right Arm choice 0-5.

Additional \$ +69.00 per

Optional Fold Away Tablet Arm for UXL Beam Seating

Add to end of Beam Part Number. List Left Arm choice 0-5 and Right Arm choice 0-5.

Additional \$+178.00 per

Optional Table for UXL Beam Seating

18" x 18" table in place of one seat.

Subtract cost from Beam Seating cost \$ -187.00 per

2, 3, 9

UXL SEAT, BACK & EDGE MOLDING COLOR CHOICE

- Apple **A**
- Burgundy **D**
- Chocolate **Q**
- Fuchsia **G**
- Navy **I**
- Red **L**
- Black **B**
- Cerulean **S**
- Clementine **E**
- Mint **H**
- Persian Blue **J**
- White **M**
- Blueberry **C**
- Charcoal **R**
- Forest Green **F**
- Mocha **T**
- Purple **K**
- Yellow **N**

FRAME

- Platinum

View all finish options on page 260.

UXL Beam Seating building a part number

4 CHOOSE LEFT ARM:

No Arm (0), One Arm (1),
Two Arms (2), Three Arms (3),
Four Arms (4), Five Arms (5)

5 CHOOSE RIGHT ARM:

No Arm (0), One Arm (1),
Two Arms (2), Three Arms (3),
Four Arms (4), Five Arms (5)

6 CHOOSE LEFT TABLET ARM:

No Arm (0), One Arm (1),
Two Arms (2), Three Arms (3),
Four Arms (4), Five Arms (5)

7 CHOOSE RIGHT TABLET ARM:

No Arm (0), One Arm (1),
Two Arms (2), Three Arms (3),
Four Arms (4), Five Arms (5)

8 UXL LAMINATE DESK TOP COLOR CHOICE

- Amber Cherry **AME**
- Golden Oak **GOK**
- Pewter Mesh **PEW**
- Asian Night **ANG**
- Grey Mesh **GRE**
- Tan Echo **TAC**
- Blond Echo **BEE**
- Grey Nebula **GNB**
- Wild Cherry **CHE**
- Fusion Maple **MAP**
- New Age Oak **NEW**

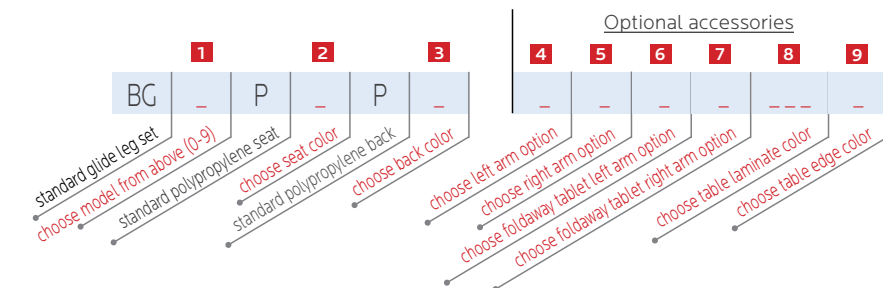

Reception areas.
Waiting rooms.
Lecture halls.



Shown 3 Sets of 4 Seat UXL Beam Seating in an auditorium setting. Model BG2PIPI - Navy Poly Shells.



BG1PJP31



BG5PJPJ0000GNBJ



BG1PLPL0012

Desks & Tables

Today's learning environments present an unprecedented challenge to desks and tables, demanding greater versatility and durability. Our desks and tables are designed for multiple reconfigurations—pods, pairs, rows and more—and are reinforced to withstand the constant movement.

Mobile

In collaborative learning classrooms, students have to be able to move desks and tables without help.

Reconfigurable

Today, the shape of desk and table work surfaces must allow the furniture to fit into a compact pod for small group work and work in pairs, or make them suitable for individual work.

Future Proof

Desks and tables are moved constantly. They must be built strong to withstand this use well into the future. Their shapes must add functionality with future use in mind, rather than contributing gimmicky, non-functional arrangements in the classroom. Learn more at smithsystem.com/collaborative-desks.

Functionality

- "Pie-shaped" desktops allow students to make compact pods for working in groups.
- Casters provide needed mobility for the desk—don't make students drag them across the floor.
- The suggested minimum workspace is 27 in.

Durability

- Structural Framing – steel reinforcing beams attach to each leg, adding rigidity and preventing wobbly legs. Don't settle for Easy On Brackets on tables and desks in collaborative learning classrooms.
- The T-Mold edge band, used on Smith System Desks and Tables, is stapled every six inches to provide superior fastening power.

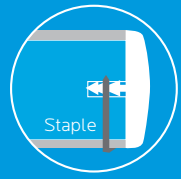
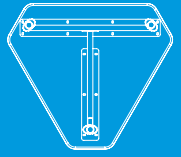
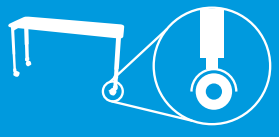
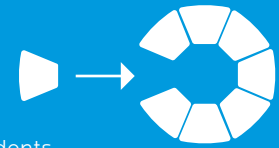

Beyond design, consider how it's engineered and built

As active parts of the education process, desks and tables absorb more hard use.

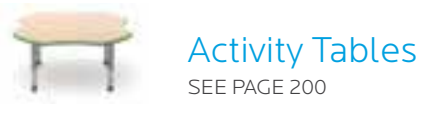
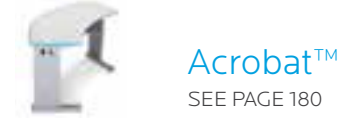
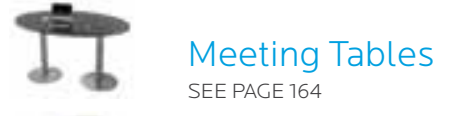
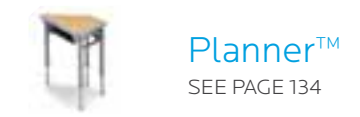
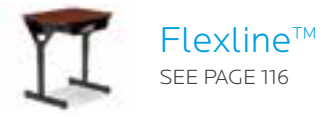

Right Size

Fitting the chair and desk or table to the student is important, as a proper fit helps academic performance while a poor fit hinders it.



SUGGESTED DESK AND CHAIR HEIGHTS:

TABLE HEIGHT	~19"	~22"	~24"	~27"	~29"
CHAIR HEIGHT	10"	12"	14"	16"	18"
3-4 year olds	50%	50%			
Kindergarten		50%	50%		
Grade 1			100%		
Grade 2			25%	75%	
Grade 3 - 4				100%	
Grade 5				50%	50%
Grade 6 - 12					100%



Healthy Construction

Smith System desks and tables are made for healthy learning environments, and are UL Greenguard Gold Certified.

Dependability

Smith System backs its tables and desks with a lifetime warranty on the frame and legs and a 12-year warranty on tabletops and desktops.



Availability

Smith System employs lean manufacturing techniques allowing us to make tables and desks to order and Quick Ship them.





Interchange™

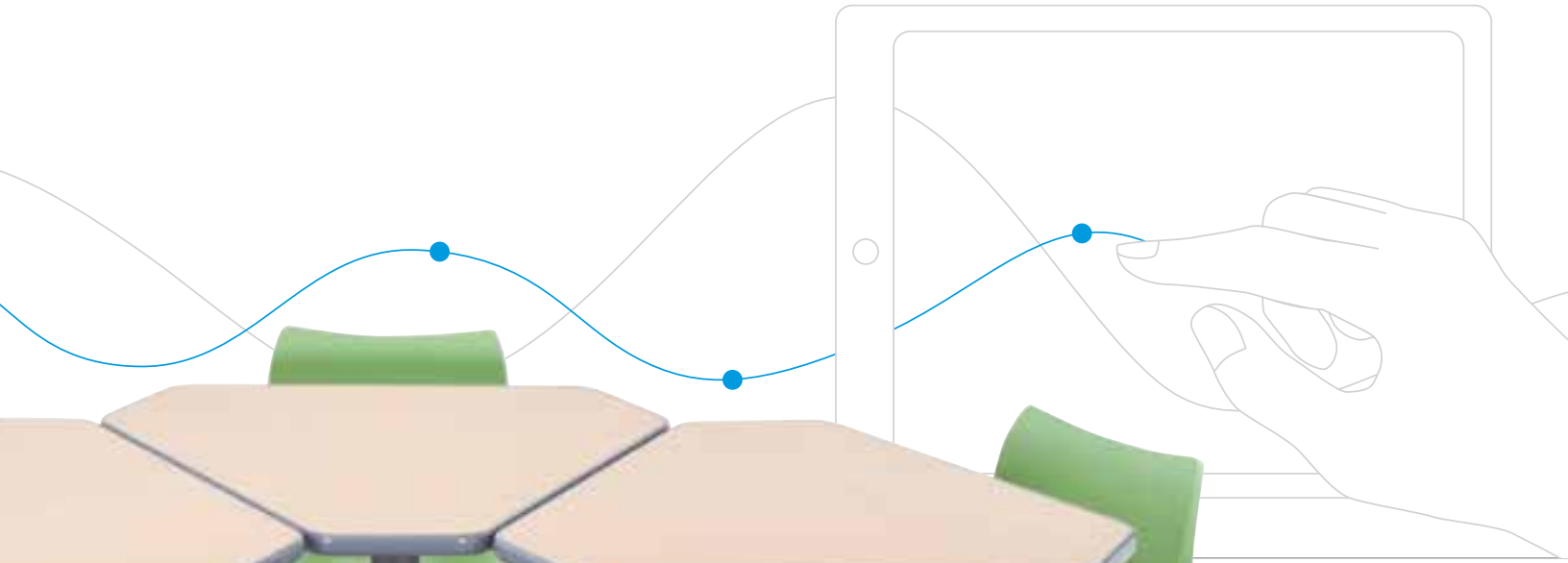

Open Front Wing Desk



Diamond Desk



Wing Desk



Diamond Open Front Desk



Swoop Wing Desk



Student Desk



3-2-1 Desk



Activity Tables

Contemporary styling, solid functionality and innovative desktop designs.

For 21st Century Classrooms.

Its unique combination of functionality, style and practicality gives the Interchange line its innate unity and beauty.

- Interchange Wing™, Diamond™ and 3-2-1™ Desks for collaborative learning (and traditional) classrooms.
- Interchange Student Desks for traditional classrooms.



Dependability.

- Lifetime warranty on the frame and legs, 12-year warranty on table and desktops.



Healthy construction.

- UL Greenguard Gold Certified.

Unbeatable construction.

- The T-Mold edge band, used on Interchange Desks and Tables, is stapled every six inches to provide superior fastening power.
- The work surfaces are high-pressure laminate that stand up to heavy use.
- Structural Framing – steel reinforcing beams attached to each leg – adding rigidity and preventing wobbly legs. Don't settle for Easy On Brackets for tables and desks in collaborative learning classrooms.

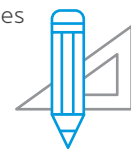



Interchange

Interchange Wing™ Desk



Wing Desks shown at 34" h with 24" h Flavors Fixed-height Stools, Model 11889. Shown in Asian Night top with Apple edge and Platinum frame.



All Interchange Desks can be set at 34" h for use with a 24" stool or standing.



The unique shape of Interchange Wing Desks allows you to oppose desks in a compact area, or in rows for lectures, testing or individual work.



Shown in Grey Mesh top with Persian Blue edge and Platinum frame. Shown with optional Flavors Stack Chair, Model 11849.



Interchange Wing™ Desk

This compact, contemporary desk designed for collaborative learning provides sleek looks, solid functionality and great flexibility. It can be arranged in countless ways for groups of all sizes. Its work surface provides ample space for work of all kinds. Order it in any of 11 standard laminate colors, 21 edge colors and Black or Platinum frame.

- Durable desktop available in 1 1/4" or 3/4" thickness, with a high-pressure laminate surface.
- Rugged powder coat surface on legs resists wear.
- Chrome-plated lower legs of 16-gauge steel resist scuffing.
- Sock-style glide caps add protection.
- 1" adjustable leveling glides provide stability on uneven floors.
- Now available with Cascade™ standard width (SW) Tote Tray Kit.

Shown in Grey Mesh top with Persian Blue edge and Platinum frame.

MODEL	DESCRIPTION	D"	W"	H"	F.C.	CUBE	WT.	UPS	2016 LIST
03095	Interchange Wing Desk	23.5	41	22-34	70	2.4	45	*	\$ 242.00
66013	Interchange SW (standard width) Tote Tray w/housing								\$ 88.00
66014	Interchange SW (standard width) housing only								\$ 68.00

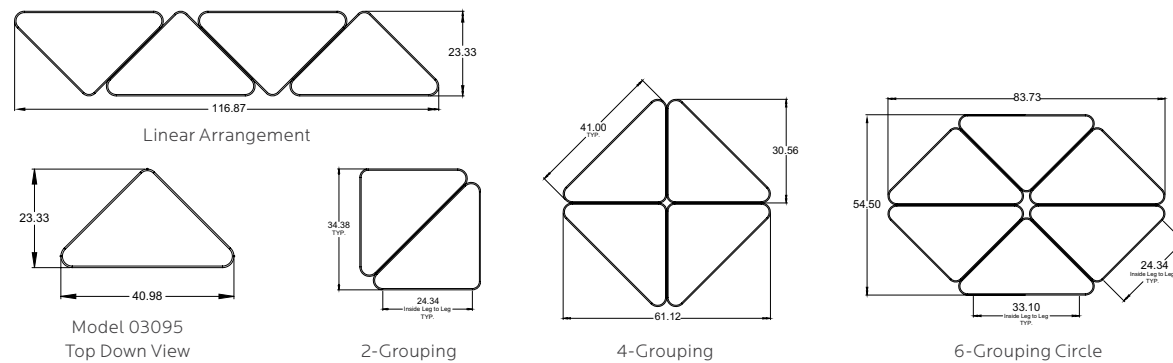

NEW FOR 2016

Interchange Wing now available with standard width tote.

Make it mobile with casters
Order Model 17576
\$ 76.00 List

Mix Wing & Swoop Wing Desks
Swoop Wing page 61



Interchange Swoop Wing™ Desk

This compact, contemporary desk designed for collaborative learning provides sleek looks, solid functionality and great flexibility. It can be arranged in countless ways for groups of all sizes. The swoop in the work surface provides a sense of place for the student. Order it in any of 11 standard laminate colors, 21 edge colors and Black or Platinum frame.

Shown in Fusion Maple top with Clementine edge and Platinum frame. Shown with optional Flavors Stack Chair, Model 11849.

MODEL	DESCRIPTION	D"	W"	H"	F.C.	CUBE	WT.	UPS	2016 LIST
03097	Interchange Swoop Wing Desk	23.5	41	22-34	70	2.4	43	*	\$ 245.00

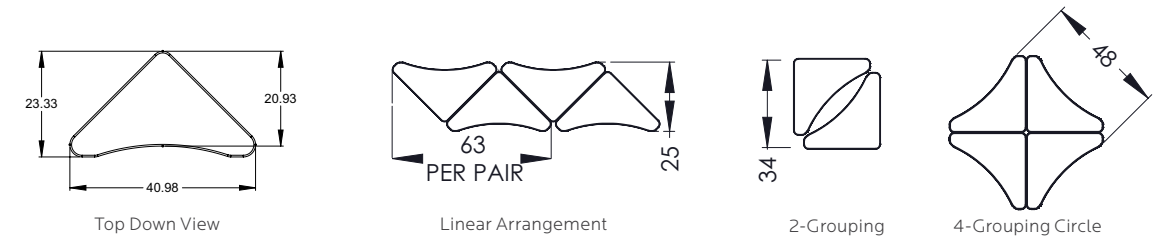

Interchange Swoop Wing and Student Desks Have Top and Edge Choices

1 1/4" Tops

- CHOICE 1** - 1 1/4" top with Bumper T-Mold no letter to follow Model No.
- CHOICE 2** - 1 1/4" top with 4mm T-Mold to follow Model No.

3/4" Tops

- CHOICE 3** - 3/4" top with 4mm T-Mold to follow Model No.
- CHOICE 4** - 3/4" top with Bullet T-Mold to follow Model No.



THE DETAILS THAT SET US APART.
All Smith System Collaborative Desks have structural framing which prevents wobbly legs and contributes to a longer service life.

INTERCHANGE LAMINATE COLOR CHOICE						LEG COLOR CHOICE	
Amber Cherry	Blond Echo	Golden Oak	Grey Nebula	Pewter Mesh	Wild Cherry	Black	Platinum
Asian Night	Fusion Maple	Grey Mesh	New Age Oak	Tan Echo			
INTERCHANGE EDGE COLOR CHOICE							
Apple	Burgundy	Charcoal	Forest Green	Mocha	Persian Blue	Red	
Black	Cerulean	Chocolate	Fuchsia	Navy	Platinum	White	
Blueberry	Champagne	Clementine	Mint	Orange	Purple	Yellow	

View all finish options on page 260.



Shown in Grey Mesh top with Cerulean edge and Platinum frame.

Interchange Wing™ Open Front Desk

This flexible contemporary desk provides both sleek looks and solid functionality. Its space-saving desktop provides ample work space and allows it to create compact groups of four. It offers the convenience of a built-in Bookbox, and can be ordered in any of 11 standard laminate colors, 21 edge colors and Black or Platinum frame.

- Interchange Open Front Desks are made with your choice of bumper edge tops.
- Edge moldings resist wear, choices available (see chart, below).
- Rugged powder coat surface on legs resists wear.
- Chrome-plated lower legs of 16-gauge steel resist scuffing.
- Sock-style glide caps add protection.
- 1" adjustable leveling glides provide stability on uneven floors.

MODEL	DESCRIPTION	D"	W"	H"	F.C.	CUBE	WT.	UPS	2016 LIST
04503	Wing Open Front	23.5	41	22-32	70	2.4	50	*	\$ 310.00
67638	Optional Backpack Hook							*	\$ 8.00

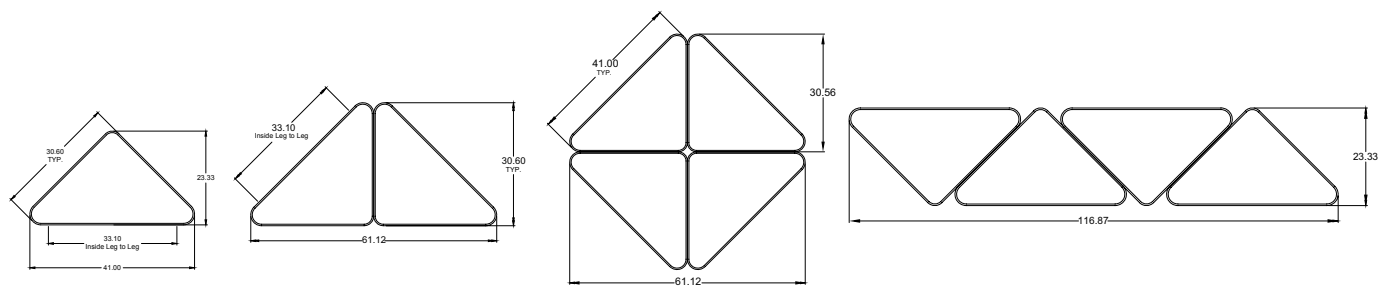

Shown in Grey Mesh top with Persian Blue edge and Platinum frame. Shown with optional Flavors Stack Chair, Model 11849. See page 22.

Interchange Open Front Desks Have Top and Edge Choices

1 1/4" Tops

CHOICE 1 - 1 1/4" top with Bumper T-Mold no letter to follow Model No.

CHOICE 2 - 1 1/4" top with 4mm T-Mold **D** to follow Model No.

3/4" Tops

CHOICE 3 - 3/4" top with 4mm T-Mold **C** to follow Model No.

CHOICE 4 - 3/4" top with Bullet T-Mold **V** to follow Model No.

Make it mobile with casters

Order Model 17576
\$ 76.00 List

INTERCHANGE LAMINATE COLOR CHOICE

Amber Cherry	Blond Echo	Golden Oak	Grey Nebula	Pewter Mesh	Wild Cherry
Asian Night	Fusion Maple	Grey Mesh	New Age Oak	Tan Echo	

LEG COLOR CHOICE

Black
Platinum

INTERCHANGE EDGE COLOR CHOICE

Apple	Burgundy	Charcoal	Forest Green	Mocha	Persian Blue	Red
Black	Cerulean	Chocolate	Fuchsia	Navy	Platinum	White
Blueberry	Champagne	Clementine	Mint	Orange	Purple	Yellow

View all finish options on page 260.

Optimize classroom space with Interchange Wing™ Desks.

Interchange Wing Desks allow great flexibility when it comes to creating compact pods of two, three and four students. The flexibility comes from the shape of the desktop. Its pie shape allows four students to work in a very compact area. Three students, even smaller. Two students can work almost side-by-side, facing or at an angle – whichever suits their activity.



Optional Backpack Hook Model 67638 \$ 8.00
Keeps floors tidy and backpacks handy.



Put two Interchange Diamond Desks together and students can work in a pair.



Three Interchange Diamond Desks approximate a semi-circle for three students.

Interchange Diamond™ Desk

This contemporary desk designed for collaborative learning classrooms provides sleek looks and solid functionality. It can be arranged in compact groups of up to six. Its large work surface provides ample space for projects and work of all kinds. And it can be ordered in any of 11 standard laminate colors, 21 edge colors and Black or Platinum frame.

- Durable desktop available in 1 1/4" or 3/4" thickness, with a high-pressure laminate surface.
- Edge moldings resist wear, choices available (see chart).
- Rugged powder coat surface on legs resists wear.
- Chrome-plated lower legs of 16-gauge steel resist scuffing.
- Sock-style glide caps add protection.
- 1" adjustable leveling glides provide stability on uneven floors.
- Adjustable desk height, from 22-34" in 1" increments.
- Only three (not four) legs to adjust on Single-Student Diamond Desk.
- Now available with Cascade™ standard width (SW) Tote Tray Kit



Six Interchange Diamond Desks form a compact group with ample space to work.

MODEL	DESCRIPTION	D"	W"	H"	F.C.	CUBE	WT.	UPS	2016 LIST
03082	Interchange Diamond Student Desk	30	34	22-34	70	2.7	49	*	\$ 243.00
03083	Interchange Mini Diamond Student Desk*	27	30.5	22-34	70	2.7	42	*	\$ 238.00
66013	Interchange SW (standard width) Tote Tray w/housing								\$ 88.00
66014	Interchange SW (standard width) housing only								\$ 68.00

*Accommodates up to 18" stack chair.



Crucial for desks in collaborative learning classrooms, Structural Framing provides a stronger work surface and prevents legs from wobbling.

Make it mobile with casters
Order Model 17576
\$ 76.00 List



NEW 2016

Interchange Diamond Desk and Two-Student Diamond Desk now available with standard width (SW) tote.

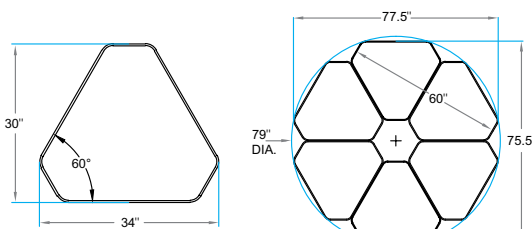

Model 03082. Interchange Diamond Student Desk

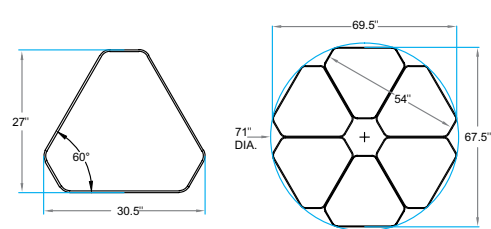

Model 03083. Interchange Mini Diamond Student Desk



Shown in Asian Night top with Charcoal edge and Platinum frame with Plato Mobile Chairs in Fuchsia.

Interchange Two-Student Diamond Desk

This contemporary desk designed for collaborative learning classrooms provides sleek looks and solid functionality. It can be arranged in compact groups of up to six. Its large work surface provides ample space for two students and work of all kinds. And it can be ordered in any of 11 standard laminate colors, 21 edge colors and Black or Platinum frame. Now available with Cascade standard width (SW) Tote Tray Kit.



Shown in Pewter Mesh top with Persian Blue edge and Platinum frame.

MODEL	DESCRIPTION	D"	W"	H"	F.C.	CUBE	WT.	UPS	2016 LIST
03081	Interchange Two-Student Diamond Desk	36	60	22-34	70	7.8	78		\$ 372.00
66013	Interchange SW (standard width) Tote Tray w/housing								\$ 88.00
66014	Interchange SW (standard width) housing only								\$ 68.00

Interchange Diamond Desks Have Top and Edge Choices

- 1 1/4" Tops**
- CHOICE 1** - 1 1/4" top with Bumper T-Mold no letter to follow Model No.
 - CHOICE 2** - 1 1/4" top with 4mm T-Mold **D** to follow Model No.
- 3/4" Tops**
- CHOICE 3** - 3/4" top with 4mm T-Mold **C** to follow Model No.
 - CHOICE 4** - 3/4" top with Bullet T-Mold **V** to follow Model No.

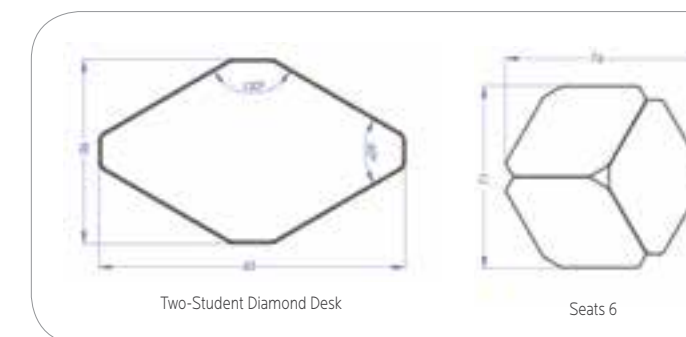

INTERCHANGE LAMINATE COLOR CHOICE

- Amber Cherry
- Blond Echo
- Golden Oak
- Grey Nebula
- Pewter Mesh
- Wild Cherry
- Asian Night
- Fusion Maple
- Grey Mesh
- New Age Oak
- Tan Echo
- Black
- Platinum

LEG COLOR CHOICE

- Black
- Platinum

INTERCHANGE EDGE COLOR CHOICE

- Apple
- Burgundy
- Charcoal
- Forest Green
- Mocha
- Persian Blue
- Red
- Black
- Cerulean
- Chocolate
- Fuchsia
- Navy
- Platinum
- White
- Blueberry
- Champagne
- Clementine
- Mint
- Orange
- Purple
- Yellow

View all finish options on page 260.



Shown in Grey Mesh top with Apple edge and Platinum frame.

Interchange Diamond™ Open Front Desk

This flexible contemporary desk provides both sleek looks and solid functionality. Its space-saving desktop provides ample work space and allows it to create compact groups of up to six. It offers the convenience of a built-in Bookbox, and can be ordered in any of 11 laminate colors, 21 edge colors and Black or Platinum frame.

- Interchange Open Front Desks are made with your choice of bumper edge tops.
- Edge moldings resist wear, choices available (see chart, below).
- Rugged powder coat surface on legs resists wear.
- Chrome-plated lower legs of 16-gauge steel resist scuffing.
- Sock-style glide caps add protection.
- 1" adjustable leveling glides provide stability on uneven floors.

MODEL	DESCRIPTION	D"	W"	H"	F.C.	CUBE	WT.	UPS	2016 LIST
04504	Diamond Open Front	30	34	22-32	70	2.7	58	*	\$ 340.00
04505	Mini Diamond Open Front*	27	30.5	22-32	70	2.7	50	*	\$ 330.00

*Accommodates up to 18" stack chair.

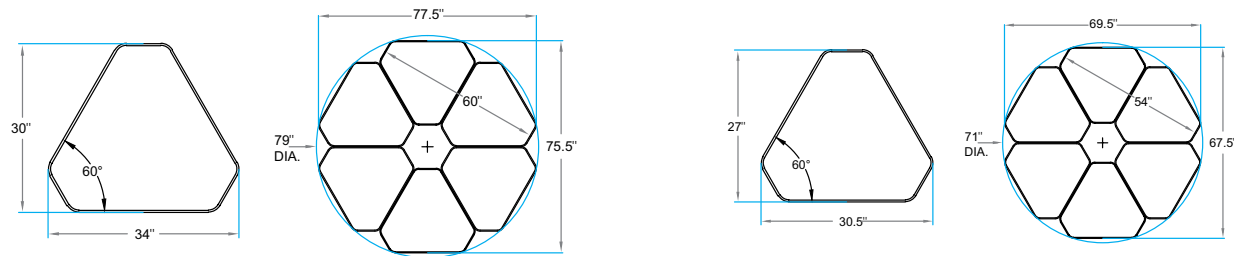

Model 04504
Interchange Diamond Student Desk

Model 04505
Interchange Mini Diamond Student Desk

Interchange Open Front Desks Have Top and Edge Choices

1 1/4" Tops

3/8" Bumper T-Mold CHOICE 1 → **CHOICE 1** - 1 1/4" top with Bumper T-Mold no letter to follow Model No.

4mm T-Mold CHOICE 2 → **CHOICE 2** - 1 1/4" top with 4mm T-Mold D to follow Model No.

3/4" Tops

4mm T-Mold CHOICE 3 → **CHOICE 3** - 3/4" top with 4mm T-Mold C to follow Model No.

Bullet T-Mold CHOICE 4 → **CHOICE 4** - 3/4" top with Bullet T-Mold V to follow Model No.

Make it mobile with casters
Order Model 17576
\$ 76.00 List

INTERCHANGE LAMINATE COLOR CHOICE

- Amber Cherry
- Blond Echo
- Golden Oak
- Grey Nebula
- Pewter Mesh
- Wild Cherry
- Asian Night
- Fusion Maple
- Grey Mesh
- New Age Oak
- Tan Echo

LEG COLOR CHOICE

- Black
- Platinum

INTERCHANGE EDGE COLOR CHOICE

- Apple
- Burgundy
- Charcoal
- Forest Green
- Mocha
- Persian Blue
- Red
- Black
- Cerulean
- Chocolate
- Fuchsia
- Navy
- Platinum
- White
- Blueberry
- Champagne
- Clementine
- Mint
- Orange
- Purple
- Yellow

View all finish options on page 260.



Model 04505

Shown in Pewter Mesh top with Orange edge, Platinum frame with optional casters. Shown with optional Flavors Mobile Stack Chair. Optional casters, 17576.



When arranged in a half or whole circle, create an opening for I-O™ Post to provide connectivity for students. See page 259.



Optional Backpack Hook
Model 67638 \$ 8.00

Available on Mini Diamond Open Front (Model 04505) and Diamond Open Front (Model 04504) Desks.



Interchange Student Desks

This sleek, contemporary desk provides solid functionality and matches the look of Interchange student desks. Order it in any of 11 standard laminate colors, 21 edge colors and Black or Platinum frame.

Shown in Blond Echo top with Cerulean edge and Platinum frame. Shown with optional Flavors Stack Chair, Model 11849 in Cerulean.

MODEL	DESCRIPTION	D"	W"	H"	F.C.	CUBE	WT.	UPS	2016 LIST
04080	Interchange Single-Student Desk	20	27	22-34	70	1.1	44	*	\$ 278.00
04083	Interchange Two-Student Desk*	20	48	22-34	70	2.4	74	*	\$ 333.00
04090	Interchange Curve	21	29	22-34	70	2.4	48	*	\$ 288.00
66013	Interchange SW (standard width) Tote Tray w/housing								\$ 88.00
66014	Interchange SW (standard width) housing only								\$ 68.00

*66013 and 66014 totes are not available for 04083 Two-Student model

Interchange Single- and Two-Student Open Front Desks

These contemporary desks provide both sleek looks and solid functionality. Their large work surfaces provide ample space for projects and work of all kinds. They offer the convenience of a built-in Bookbox, and can be ordered in any of 11 standard laminate colors, 21 edge colors and Black or Platinum frame.

- Interchange Open Front Desks are made with your choice of bumper edge tops.
- Edge moldings resist wear, choices available (see chart, below).
- Rugged powder coat surface on legs resists wear.
- Chrome-plated lower legs of 16-gauge steel resist scuffing.
- Sock-style glide caps add protection.
- 1" adjustable leveling glides provide stability on uneven floors.



Single-Student Open Front Desk. Shown in Wild Cherry Top with Black edge and Black frame.



Two-Student Open Front Desk. Shown in New Age Oak Top with Black edge and Black frame.

MODEL	DESCRIPTION	D"	W"	H"	F.C.	CUBE	WT.	UPS	2016 LIST
04500	Single-Student Open Front	20	27	22-32	70	1.3	37	*	\$ 310.00
04502	Two-Student Open Front	24	48	22-32	70	3.0	52	*	\$ 430.00



Make it mobile with casters
Order Model 17576
\$ 76.00 List

Compact and contemporary.

Cascade™ totes now available on select Interchange desk models.

NEW FOR 2016



Interchange Single-Student desk, Model 04080 shown with optional Interchange SW Tote Tray with Housing Model 66013.

These desks are designed for collaborative learning and provide sleek looks, solid functionality and great flexibility. They can be arranged in countless ways for groups of all sizes.

New Cascade standard width (SW) tote is available on Interchange 20x27, Curve, 321 LS, Mini Diamond, Diamond, Two-Student Diamond and Wing desks for 2016.





Interchange 3-2-1 Desk in Blond Echo top and Apple edge with Flavors Seating in Apple.



Shown in Tan Echo top with Apple, Persian Blue and Fuchsia edge and Platinum frame. Shown with optional Intuit Chair, Model 00562.

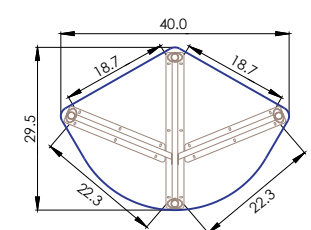

Model 03002 Bottom View

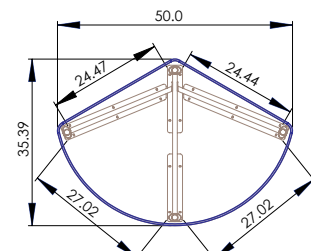

Model 03011 Bottom View



Interchange™ 3-2-1 Desk™

This versatile, contemporary table designed for collaborative learning provides sleek looks and solid functionality. The two-student desks can be arranged in many ways for both individual and group learning. Its work surface provides ample space for work of all kinds. Order it in any of 11 standard laminate colors, 21 edge colors and Black or Platinum frame.

- Durable desk top available in 1 1/4" or 3/4" thickness, with a high-pressure laminate surface.
- Edge moldings resist wear, choices available (see chart).
- Rugged powder coat surface on legs resists wear.
- Chrome-plated lower legs of 16-gauge steel resist scuffing.
- Sock-style glide caps add protection.
- 1" adjustable leveling glides provide stability on uneven floors.
- Adjustable table height in 1" increments.

Shown in Grey Nebula top with Mint edge and Platinum frame.

MODEL	DESCRIPTION	D"	W"	H"	F.C.	CUBE	WT.	UPS	2016 LIST
03002*	3-2-1 Desk	29.5	40	22-34	70	1.9	55	*	\$ 317.00
03011	3-2-1 - LS Desk	35	50	22-34	70	2.4	67		\$ 363.00
66013**	Interchange SW (standard width) Tote Tray w/housing								\$ 88.00
66014**	Interchange SW (standard width) housing only								\$ 68.00

* For Pre-K through grade 2 cooperative learning classrooms with 14"h chairs and smaller.
** Available for 03011 LS only.



Two students can work at a single 3-2-1 Desk.



Combine two 3-2-1 Desks for four students to work together.



Combine three 3-2-1 Desks and create a six-student group.



3" Interchange Casters

Add easy mobility to Interchange Tables with casters. Cap available in Platinum or Black. Wheels, Black only. 4 Locking Wheels.

MODEL	DESCRIPTION	D"	W"	H"	F.C.	CUBE	WT.	UPS	2016 LIST
17576	3" Dual-Wheel Caster Set of 4, 4 locking				70	0.1	5	*	\$ 76.00

Castors available in Black or Platinum Cap. Wheels are Black.

1 1/4" Tops

Interchange 3-2-1 Desks Have Top and Edge Choices

CHOICE 1 - 1 1/4" top with Bumper T-Mold no letter to follow Model No.

CHOICE 2 - 1 1/4" top with 4mm T-Mold **D** to follow Model No.

3/4" Tops

CHOICE 3 - 3/4" top with 4mm T-Mold **C** to follow Model No.

CHOICE 4 - 3/4" top with Bullet T-Mold **V** to follow Model No.

Structural Framing

Crucial for desks in collaborative learning classrooms. Structural Framing provides a stronger work surface and prevents legs from wobbling.

INTERCHANGE LAMINATE COLOR CHOICE

Amber Cherry	Blond Echo	Golden Oak	Grey Nebula	Pewter Mesh	Wild Cherry
Asian Night	Fusion Maple	Grey Mesh	New Age Oak	Tan Echo	

LEG COLOR CHOICE

Black	Platinum
-------	----------

INTERCHANGE EDGE COLOR CHOICE

Apple	Burgundy	Charcoal	Forest Green	Mocha	Persian Blue	Red
Black	Cerulean	Chocolate	Fuchsia	Navy	Platinum	White
Blueberry	Champagne	Clementine	Mint	Orange	Purple	Yellow

View all finish options on page 260.



Shown in Tan Echo top with Persian Blue edge and Platinum frame. Shown with optional Flavors Stack Chair, Model 11849.

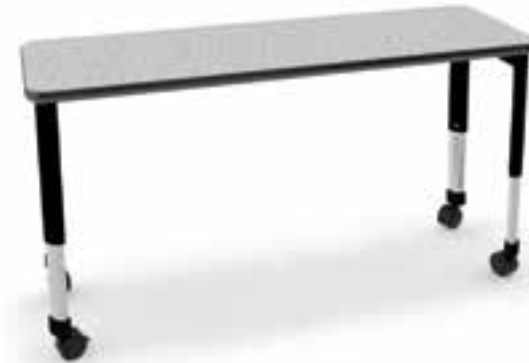

20" d Interchange Activity Table, Model 04085
Shown in Grey Nebula top with Charcoal edge and Black frame. Shown with optional casters, Model 17576.



24" d Interchange Activity Table, Model 04102
Shown in Blond Echo top with Persian Blue edge and Platinum frame.



30" d Interchange Activity Table, Model 04107
Shown in Amber Cherry top with Chocolate edge and Black frame.



36" d Interchange Activity Table, Model 04112
Shown in Grey Nebula top with Red edge and Platinum frame.



42" d Interchange Activity Table, Model 04116
Shown in New Age Oak top with Cerulean Blue edge and Platinum frame.



48" d Interchange Activity Table, Model 04121.
Shown in Amber Cherry top with Clementine edge and Black frame.

Interchange Rectangle Activity Tables

This sleek, contemporary desk provides solid functionality and matches the look of Interchange student desks. Order it in any of 11 standard laminate colors, 21 edge colors and Black or Platinum frame.

- Rugged frame of 1" x 2" 14-gauge steel tube cross supports welded to 16-gauge elliptical tubes.
- Unique telescoping elliptical tube leg of 16-gauge steel adjusts height in 1" increments.
- 14-gauge cross brace along the length of the table reinforces the strength of the table legs.

Add Casters for mobility

- Add easy mobility to Interchange tables with casters. Cap available in Platinum or Black. Wheels, Black only. Model 17576, \$76 List Price, 3" Caster Pack (4 Locking, Threaded Caster)



**Please note: When ordering a power unit (p.78), it cannot be placed in the center of 24" deep, 30" deep and 36" deep models.*

AddPower
SEE PAGE 258 FOR ORDER INFO



Interchange Rectangle Activity Tables

MODEL	DESCRIPTION		D"	W"	H"	F.C.	CUBE	WT.	UPS	2016 LIST
20" deep models										
04080	Interchange Activity Table	Rectangle	20	27	22-34	70	1.1	44	*	\$ 278.00
04081	Interchange Activity Table	Rectangle	20	30	22-34	70	1.3	49	*	\$ 288.00
04082	Interchange Activity Table	Rectangle	20	36	22-34	70	1.5	58	*	\$ 298.00
04083	Interchange Activity Table	Rectangle	20	48	22-34	70	2.0	74	*	\$ 333.00
04084	Interchange Activity Table	Rectangle	20	54	22-34	70	2.2	79		\$ 356.00
04085	Interchange Activity Table	Rectangle	20	60	22-34	70	2.5	84		\$ 395.00
04086	Interchange Activity Table	Rectangle	20	72	22-34	70	3.0	98		\$ 420.00
04087	Interchange Activity Table	Rectangle	20	90	22-34	70	3.7	114		\$ 530.00
24" deep models										
04100	Interchange Activity Table	Rectangle	24	36	22-34	70	1.75	68	*	\$ 386.00
04101	Interchange Activity Table	Rectangle	24	48	22-34	70	2.3	82	*	\$ 432.00
04131	Interchange Activity Table	Rectangle	24	54	22-34	70	2.6	88		\$ 466.00
04102	Interchange Activity Table	Rectangle	24	60	22-34	70	2.9	92		\$ 486.00
04103	Interchange Activity Table	Rectangle	24	72	22-34	70	3.5	107		\$ 540.00
04104	Interchange Activity Table	Rectangle	24	90	22-34	70	4.4	122		\$ 596.00
30" deep models										
04105	Interchange Activity Table	Rectangle	30	36	22-34	70	2.2	78	*	\$ 469.00
04106	Interchange Activity Table	Rectangle	30	48	22-34	70	2.9	92		\$ 490.00
04107	Interchange Activity Table	Rectangle	30	60	22-34	70	3.7	106		\$ 543.00
04108	Interchange Activity Table	Rectangle	30	72	22-34	70	4.4	122		\$ 601.00
04109	Interchange Activity Table	Rectangle	30	90	22-34	70	5.5	139		\$ 700.00
36" deep models										
04111	Interchange Activity Table	Rectangle	36	48	22-34	70	3.5	104		\$ 572.00
04112	Interchange Activity Table	Rectangle	36	60	22-34	70	4.4	120		\$ 594.00
04113	Interchange Activity Table	Rectangle	36	72	22-34	70	5.3	137		\$ 642.00
04114	Interchange Activity Table	Rectangle	36	90	22-34	70	6.6	160		\$ 754.00
42" deep models										
04116	Interchange Activity Table	Rectangle	42	60	22-34	70	5.1	145		\$ 728.00
04117	Interchange Activity Table	Rectangle	42	72	22-34	70	6.1	165		\$ 802.00
04118	Interchange Activity Table	Rectangle	42	90	22-34	70	7.7	197		\$ 937.00
48" deep models										
04121	Interchange Activity Table	Rectangle	48	60	22-34	70	5.8	161		\$ 791.00
04122	Interchange Activity Table	Rectangle	48	72	22-34	70	7.0	183		\$ 877.00
04123	Interchange Activity Table	Rectangle	48	90	22-34	70	8.8	217		\$ 1,021.00

Quality is in the details.

All interchange tables come standard with structurally supported legs. Build quality that you can trust to stand up to today's classroom.

20", 24", 30", and 36" deep models have one center support channel that is 2" x 3" wide 14-gauge steel, with 11-gauge steel endplates for maximum stability.



42" and 48" deep models have two center supports.

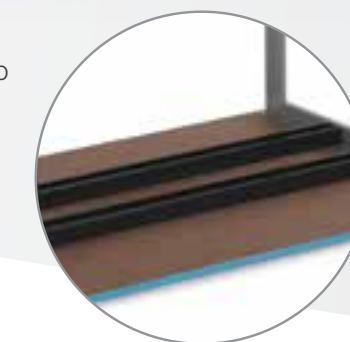

Model 04103T. Shown in Black Trespa Top Lab Plus top and Platinum frame.

Interchange Science Table Trespa™ TopLab™ Plus

This sturdy, contemporary science table provides sleek looks and solid functionality. Its TrespaTopLab Plus work surface is designed for maximum durability. It is resistant to a large number of aggressive chemicals (as identified by SEFA and PSI) if cleaned within 24 hours. It is engineered for moisture and scratch resistance. The table provides ample space for projects of all kinds.

Color Choices: **Black or Grey** Trespa Top Lab Plus top; Platinum or Black frame.

MODEL	DESCRIPTION		D"	W"	H"	F.C.	CUBE	WT.	UPS	2016 LIST
24" deep models										
04101T	Science Table	Rectangle	24	48	22-34	70	2.7	112		\$ 1,153.00
04102T	Science Table	Rectangle	24	60	22-34	70	3.3	122		\$ 1,382.00
04103T	Science Table	Rectangle	24	72	22-34	70	4.0	137		\$ 1,610.00
04131T	Science Table	Rectangle	24	54	22-34	70	3.0	118		\$ 1,275.00
30" deep models										
04106T	Science Table	Rectangle	30	48	22-34	70	3.3	122		\$ 1,386.00
04107T	Science Table	Rectangle	30	60	22-34	70	4.2	136		\$ 1,656.00
04108T	Science Table	Rectangle	30	72	22-34	70	4.9	152		\$ 1,932.00

Interchange Tables Have Top and Edge Choices

1 1/4" Tops

CHOICE 1 - 1 1/4" top with Bumper T-Mold no letter to follow Model No.

CHOICE 2 - 1 1/4" top with 4mm T-Mold **D** to follow Model No.

3/4" Tops

CHOICE 3 - 3/4" top with 4mm T-Mold **C** to follow Model No.

CHOICE 4 - 3/4" top with Bullet T-Mold **V** to follow Model No.

INTERCHANGE EDGE COLOR CHOICE

- Apple
- Black
- Blueberry
- Burgundy
- Cerulean
- Champagne
- Charcoal
- Chocolate
- Clementine
- Forest Green
- Fuchsia
- Mint
- Mocha
- Navy
- Orange
- Persian Blue
- Platinum
- Purple
- Red
- White
- Yellow

View all finish options on page 260.

INTERCHANGE LAMINATE COLOR CHOICE

- Amber Cherry
- Blond Echo
- Golden Oak
- Grey Nebula
- Pewter Mesh
- Wild Cherry
- Asian Night
- Fusion Maple
- Grey Mesh
- New Age Oak
- Tan Echo
- Black
- Platinum



Interchange Square
Shown in Golden Oak top with Clementine edge and Platinum frame.



Interchange Kidney
Shown in Grey Nebula top with Cerulean edge and Platinum frame.

Interchange Round
Shown in Grey Nebula top with Platinum edge and Platinum frame.



Interchange Contour
Shown in Golden Oak top with Mint edge and Platinum frame.

Interchange Trapezoid
Shown in Grey Nebula top, Red edge and Platinum frame.



Interchange Flower
Shown in Golden Oak top with Apple edge and Platinum frame.



Interchange Half Moon
Shown in Fusion Maple top with Chocolate edge and Platinum frame. Optional casters, Model 17576. Plato 14" Stack Chair in Chocolate. Flavors 18" Stack Chair in Chocolate.

Interchange Activity Tables

These contemporary tables provide both sleek looks and solid functionality. Their large work surfaces provide ample space for projects and work of all kinds. Their look matches that of Interchange student desks. Choose from 11 standard laminate colors, 21 edge colors and Black or Platinum frame.

- Rugged frame of 1" x 2" 14-gauge steel tube cross supports welded to 16-gauge elliptical tubes.
- Unique telescoping elliptical tube leg of 16-gauge steel adjusts height in 1" increments.
- 14-gauge cross brace along the length of the table reinforces the strength of the table legs.

**Please note: When ordering a power unit (p.78), it cannot be placed in the center of this table.*

MODEL	DESCRIPTION	D"	W"	H"	F.C.	CUBE	WT.	UPS	2016 LIST
04110	Interchange Activity Table	Square	36	36	22-34	70	3.0	85	\$ 496.00
04115	Interchange Activity Table	Square	42	42	22-34	70	4.0	106	\$ 623.00
04119	Interchange Activity Table	Square	48	48	22-34	70	5.0	133	\$ 672.00
04124	Interchange Activity Table	Round	42" dia.		22-34	70	2.3	88	\$ 563.00
04125	Interchange Activity Table	Round	48" dia.		22-34	70	2.6	100	\$ 611.00
04126	Interchange Activity Table	Round	60" dia.		22-34	70	3.0	150	\$ 816.00
04127	Interchange Activity Table	Trapezoid	30	60	22-34	70		92	\$ 532.00
04128	Interchange Activity Table	Half Moon	36	72	22-34	70	4.5	104	\$ 639.00
04129	Interchange Activity Table	Contour	36	72	22-34	70	4.5	124	\$ 652.00
04130	Interchange Activity Table	Kidney	48	72	22-34	70	6.0	151	\$ 869.00
04132	Interchange Activity Table	Flower	60" dia.		22-34	70	6.0	151	\$ 816.00

Interchange Tables Have Top and Edge Choices

- 1 1/4" Tops**
- CHOICE 1** - 1 1/4" top with Bumper T-Mold no letter to follow Model No.
 - CHOICE 2** - 1 1/4" top with 4mm T-Mold to follow Model No.
- 3/4" Tops**
- CHOICE 3** - 3/4" top with 4mm T-Mold to follow Model No.
 - CHOICE 4** - 3/4" top with Bullet T-Mold to follow Model No.

Optional Dome Power Module
Order Model 017088 BLA
4 power \$ 220.00

AddPower*
SEE PAGE 258 FOR ORDER INFO

**Power cannot be placed in the center of the table.*

INTERCHANGE LAMINATE COLOR CHOICE

- Amber Cherry
- Blond Echo
- Golden Oak
- Grey Nebula
- Pewter Mesh
- Wild Cherry
- Asian Night
- Fusion Maple
- Grey Mesh
- New Age Oak
- Tan Echo
- Black
- Platinum

INTERCHANGE EDGE COLOR CHOICE

- Apple
- Burgundy
- Charcoal
- Forest Green
- Mocha
- Persian Blue
- Red
- Black
- Cerulean
- Chocolate
- Fuchsia
- Navy
- Platinum
- White
- Blueberry
- Champagne
- Clementine
- Mint
- Orange
- Purple
- Yellow

View all finish options on page 260.



AddPower

This symbol indicates you can add power to select tables.



You will find the "ADD POWER" logo throughout this catalog. It signifies which Smith System tables are compatible with our 2016 power units.

When ordering, please submit a drawing with your order to indicate the desired positioning of the power unit on the work surface. All power accessories are special order, a custom feature per table and are non-returnable. For more information call 800.328.1061.



Flat Power Module

Shown, Model 017098 SLV
1 power, 1 Twin USB port

MODEL	DESCRIPTION	D"	W"	H"	UPS	2016 LIST
017098 SLV	1 power, 1 Twin USB port				*	\$ 260.00
017097 SLV	2 power				*	\$ 175.00



NEW 2016 Soft Touch Dome Power Module

Shown, Model 017079 BLA
2 power, 1 Twin USB port,
1 power cord

MODEL	DESCRIPTION	D"	W"	H"	UPS	2016 LIST
017079 BLA	2 power, 1 Twin USB port				*	\$ 245.00
017078 BLA	3 power				*	\$ 160.00



Dome Power Module

4 power
2 power cords

MODEL	DESCRIPTION	D"	W"	H"	UPS	2016 LIST
017088 BLA	4 power	3.5	3.56	3.86	*	\$ 220.00



Surface Power Module

Shown, Model 017093 SLV
4 power

MODEL	DESCRIPTION	D"	W"	H"	UPS	2016 LIST
017093 SLV	4 power	3	8	.11	*	\$ 350.00
017086 SLV	2 power, 4 USB	3	8	.11	*	\$ 350.00



Retractable Power Module

Shown, Model 017085 SLV
2 power, 2 Twin USB ports

MODEL	DESCRIPTION	D"	W"	H"	UPS	2016 LIST
017085 SLV	2 power, 4 USB	4.43	8.25	1.34	*	\$ 495.00
017092 SLV	4 power	4.43	8.25	1.34	*	\$ 495.00



Retractable Mini Power Module

2 power

MODEL	DESCRIPTION	D"	W"	H"	UPS	2016 LIST
017091 SLV	2 power	3.7	3.7	1.17	*	\$ 250.00

Structural Framing



Structural framing makes this desk more solid now and in the future.

Mobile furniture needs the reinforcement of structural framing.

Reinforced to support heavy projects without bowing.

The larger the work surface, the greater the need for structural framing.



Interchange and Planner™ Rectangle Modesty Panel

Designed to complement tables in the Interchange and Planner lines. Order it in any of the 11 standard laminate colors, 21 edge colors.

MODEL	DESCRIPTION	D"	W"	H"	F.C.	CUBE	WT.	UPS	2016 LIST
17201	Modesty Panel for 36" wide table				70		18	*	\$ 102.00
17202	Modesty Panel for 48" wide table				70		24	*	\$ 119.00
17203	Modesty Panel for 60" wide table				70		30	*	\$ 135.00
17204	Modesty Panel for 72" wide table				70		36		\$ 154.00
17205	Modesty Panel for 90" wide table				70		44		\$ 187.00

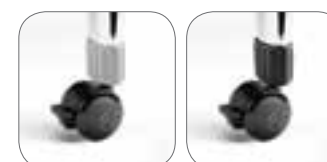

3" Interchange Casters

Add easy mobility to Interchange Tables with casters. Cap available in Platinum or Black. Wheels, Black only. 4 Locking Wheels.

MODEL	DESCRIPTION	D"	W"	H"	F.C.	CUBE	WT.	UPS	2016 LIST
17576	3" Mobile Interchange Caster / Threaded (4 locking)	3			70	0.1	5	*	\$ 76.00

Casters available in Black or Platinum Cap. Wheels are Black.



Desk Fence

Create carrel-like applications for peer work or individual study in libraries or labs with our Desk Fence. It filters light and defines workstations, yet keeps the area open and visible. Combine Desk Fences with an I-O™ Post to create powered workstations. Screw or clamp down onto most tops. Choose from 19 standard colors. Pole is Platinum.

- Apple
- Cerulean
- Clementine
- Navy
- Red
- Black
- Champagne
- Forest Green
- Persian Blue
- White
- Blueberry
- Charcoal
- Mint
- Platinum
- Yellow
- Burgundy
- Chocolate
- Mocha
- Purple

MODEL	DESCRIPTION	D"	W"	H"	F.C.	CUBE	WT.	UPS	2016 LIST
DF24	24" wide Desk Fence	2	24	14	70	0.75	4	*	\$ 159.00
DF30	30" wide Desk Fence	2	30	14	70	1.0	6	*	\$ 171.00
DF36	36" wide Desk Fence	2	36	14	70	1.25	8	*	\$ 183.00
DF48	48" wide Desk Fence	2	48	14	70	1.5	10		\$ 207.00
DF60	60" wide Desk Fence	2	60	14	70	2.0	12		\$ 231.00



UXL™ Desks & Tables

A line with a contemporary aesthetic, offering great breadth and versatility.

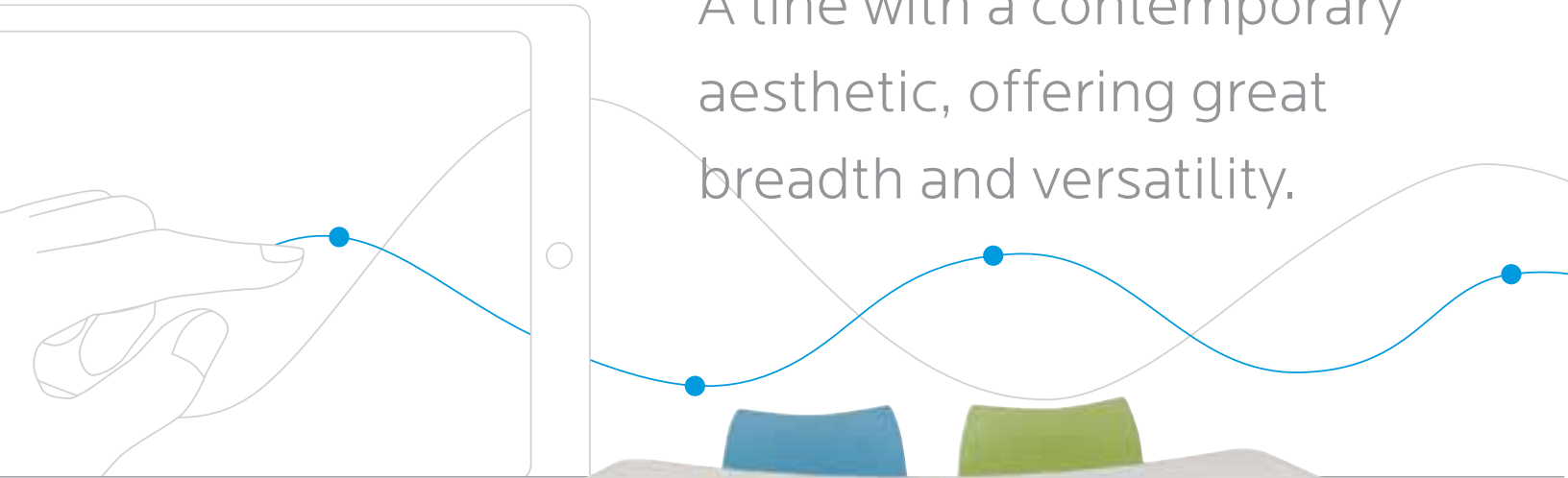

Open Front Desk



Wing Desk



Diamond Desk



Crescent Table



Two-Student Table



Trapezoid Table



Nest & Fold Table

For a consistent design scheme.

This broad, highly customizable line can be used throughout the school. This allows you to maintain consistent colors, finishes and leg shapes, bringing unity to the school's décor.

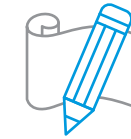

For collaborative learning or traditional classrooms.

- UXL Diamond, Wing, Trapezoid and Crescent Desks provide functionality and classic styling to collaborative learning classrooms.
- UXL Open Front Desks offer functionality and classic styling in traditional classrooms.

Choose from six leg options.

- Fixed-height leg with glide
- Fixed-height leg with caster
- Push-button leg with glide
- Push button leg with caster
- Tapered fixed-height leg with caster
- Tapered fixed-height leg with glide



Table options.

UXL Tables can be configured in countless ways, allowing them to perform admirably as activity tables, student desks, media stations or teacher/administration desks.

Nest & Fold Tables.

Mobile tables with tilting work surfaces that allow them to be stored compactly.

Dependability.

- Lifetime warranty on the frame and legs, 12-year warranty on table and desktops.



UXL Power Bar.

Café height table that provides easy, convenient access to power through two Power Domes.

Healthy construction.

- UL Greenguard Gold Certified.







6, Single-Student Diamond Desks, Model XLSSDM.
Shown with optional adjustable-height leg with caster (SC).
Shown with optional Flavors Stack Chairs.



2, Two-Student Diamond Desks, Model XLTSDM
Shown with optional adjustable-height leg with caster (SC).
Shown with optional UXL Stack Chairs.



2, Two-Student Diamond Desks, Model XLTSDM configured with 2, Single-Student Diamond Desks, Model XLSSDM
Shown with optional fixed-height leg with caster (FC). Shown with optional UXL Stack Chairs.



Shown in Grey Mesh top with Apple edge and Platinum frame. Shown with optional fixed-height leg with caster (FC).

UXL Diamond Desk

The UXL Diamond Desk is contemporary, customizable in appearance and, thanks to its diamond-shaped work surface, highly suitable for both individual and group work. It allows you to maintain a consistent design scheme with the UXL furniture throughout the building or facility. Choose from 11 standard laminate colors, and 21 standard edge colors. Platinum frame only. Available in Single-Student, Mini Diamond and Two-Student models.

- UXL Desks are standard with a 3/4" Bullet T-Mold and fixed-height legs (FL).
- Optional 1 1/4" thick work surface available.

MODEL	DESCRIPTION	D"	W"	H"	F.C.	CUBE	WT.	UPS	2016 LIST
Single-Student Diamond									
XLSSDM___ PLTFL	Single-Student Fixed-height leg	30	34	29.5	85		40	*	\$ 431.00
Single-Student Mini Diamond*									
XLSDM___ PLTFL	Single-Student Mini Fixed-height leg	27	30.5	29.5	85		37	*	\$ 426.00
Two-Student Diamond									
XLTSDM___ PLTFL	Two-Student Fixed-height leg	36	60	29.5	85		70		\$ 570.00

*Accommodates up to 18" stack chair.

Choose **MODEL** 7 8 9 10 **PLT** **FL**

Pick Laminate Color

Pick Edge Color

Fixed-height (FL) leg set is standard. See page 107 to order optional leg sets.

UXL LAMINATE DESK TOP COLOR CHOICE

Amber Cherry AME	Fusion Maple MAP	Grey Nebula GNB	Tan Echo TAC
Asian Night ANG	Golden Oak GOK	New Age Oak NEW	Wild Cherry CHE
Blond Echo BEE	Grey Mesh GRE	Pewter Mesh PEW	

FRAME CHOICE

Platinum **PLT**

UXL EDGE COLOR CHOICE

Apple A	Burgundy D	Charcoal R	Forest Green F	Mocha T	Persian Blue J	Red L
Black B	Cerulean S	Chocolate Q	Fuchsia G	Navy I	Platinum P	White M
Blueberry C	Champagne O	Clementine E	Mint H	Orange U	Purple K	Yellow N

View all finish options on page 260.

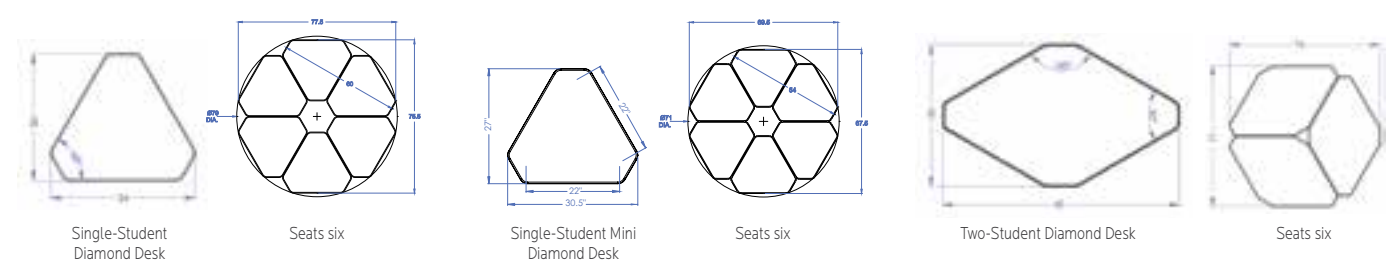



UXL Wing Desk, Model XLSSWGTACPLTFC
Shown in Tan Echo top with Platinum edge and Platinum frame. Shown with optional fixed-height leg with casters (FC).

Shown with optional Flavors Stack Chairs. Many colors to choose from. See page 22.



UXL Wing Desk

The UXL Wing Desk is contemporary, customizable in appearance and, thanks to its wing shape work surface, highly versatile. It allows you to maintain a consistent design scheme with the UXL furniture throughout the building or facility. Choose from 11 standard laminate colors, and 21 standard edge colors. Platinum frame only.

Shown in Maple top with Cerulean edge and Platinum frame. Shown with standard fixed-height legs (FL).

- UXL Desks are standard with a 3/4" Bullet T-Mold and fixed-height legs (FL).
- Optional 1 1/4" thick work surface available.

MODEL	DESCRIPTION	D"	W"	H"	F.C.	CUBE	WT.	UPS	2016 LIST
XLSSWG___ _PLTFL	UXL Wing Fixed-height leg	23.5	41	29.5	85	40	40	*	\$ 431.00

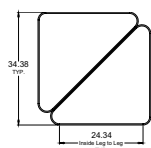

2-Grouping

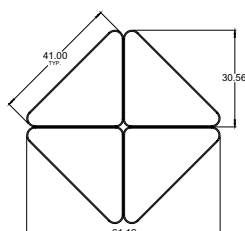

4-Grouping

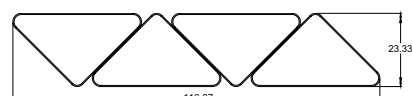

Linear Arrangement

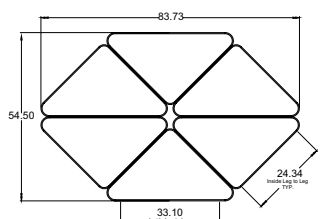

6-Grouping Circle



UXL Two-Student Open Front Desk
Shown in Blond Echo top with Mint edge and Platinum frame. Shown with optional Flavors Stack Chairs, Model 11849.

UXL Single-Student Open Front Desk
Shown in Fusion Maple top with Fuchsia edge and Platinum frame. Shown with optional Intuit Stack Chair, Model 00560.



UXL Open Front Desk

The UXL Open Front Desk is contemporary, customizable in appearance and, thanks to its large work surface and Bookbox, highly functional. It allows you to maintain a consistent design scheme with the UXL furniture throughout the building or facility. Choose from 11 standard laminate colors, and 21 standard edge colors. Platinum frame only.

- UXL Desks are standard with a 3/4" Bullet T-Mold and fixed-height legs (FL).
- Optional 1 1/4" thick work surface available.

MODEL	DESCRIPTION	D"	W"	H"	F.C.	CUBE	WT.	UPS	2016 LIST
Single-Student Open Front									
OF2027___ _PLTFL	Single-Student Fixed-height leg	20	27	29.5	85	45	45	*	\$ 330.00
Two-Student Open Front									
OF2448___ _PLTFL	Two-Student Fixed-height leg	24	48	29.5	85	80	80	*	\$ 455.00
Single-Student, no book box									
XL2027___ _PLTFL	Single-Student Fixed-height leg	20	27	29.5	70	2.6	46	*	\$ 384.00
XLCURV___ _PLTFL	Single-Student Fixed-height leg	21	29	29.5	70	1.4	56	*	\$ 386.00

Choose MODEL

7 8 9 10

Pick Laminate Color

Pick Edge Color

PLT FL

Fixed-height (FL) leg set is standard. See page 107 to order optional leg sets.

View all UXL leg options on page 107.

- Fixed-height leg with glide or caster
- Adjustable-height leg with glide or caster
- Tapered fixed-height leg with glide or caster

UXL LAMINATE DESK TOP COLOR CHOICE

- Amber Cherry **AME**
- Asian Night **ANG**
- Blond Echo **BEE**
- Fusion Maple **MAP**
- Golden Oak **GOK**
- Grey Mesh **GRE**
- Grey Nebula **GNB**
- New Age Oak **NEW**
- Pewter Mesh **PEW**
- Tan Echo **TAC**
- Wild Cherry **CHE**

FRAME CHOICE

- Platinum **PLT**

UXL EDGE COLOR CHOICE

- Apple **A**
- Black **B**
- Blueberry **C**
- Burgundy **D**
- Cerulean **S**
- Champagne **O**
- Charcoal **R**
- Chocolate **Q**
- Clementine **E**
- Forest Green **F**
- Fuchsia **G**
- Mint **H**
- Mocha **T**
- Navy **I**
- Orange **U**
- Persian Blue **J**
- Platinum **P**
- Purple **K**
- Red **L**
- White **M**
- Yellow **N**

View all finish options on page 260.



Three UXL Crescent Tables, Model UL72CRGRERPLTFC
 Shown in Grey Mesh top with Platinum edge and Platinum frame. Optional fixed-height leg with caster (FC). Shown with optional Retractable Mini Power Module, Model 017091, \$ 250.00.

UXL Crescent Table

Create a dynamic workspace for groups of up to six students with UXL Crescent Tables. They allow you to maintain a consistent design scheme with the UXL furniture throughout the building or facility. Choose from 11 standard laminate colors, and 21 standard edge colors. Platinum frame only.

- UXL Crescent Tables are standard with a 1 1/4" thick work surface.
- Each UXL Crescent Table has 5 fixed-height legs (FL).

MODEL	DESCRIPTION	D"	W"	H"	F.C.	CUBE	WT.	UPS	2016 LIST
UL72CR____PLTFL	UXL 72" Crescent	35.6	72	29.5	70	6.0	120		\$ 750.00
UL48NC____PLTFL	UXL 48" Half Round End Cap	30	48	29.5	70	2.8	80		\$ 515.00

* Half Round can be used with UXL Crescent or (2) 24" deep UXL Tables

Choose **UL72CR** **UL48NC**

7 8 9 10 Pick Laminate Color

PLT FL Pick Edge Color

Fixed-height (FL) leg set is standard. See page 107 to order optional leg sets.

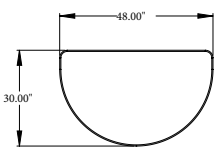
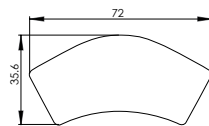

Model UL48NC. Shown in Grey Mesh top with Navy edge and Platinum frame (FL).



Create a UXL Crescent Work Area: three UXL Crescent Tables and three 48" Half Round End Caps.



Sit up to 4 students at once with UXL Crescent Desk.

Create a UXL Crescent Work Area with three UXL Crescent Tables. Students can sit on both sides.



Shown with optional Retractable Mini Power Module, Model 017091 SLV (2 power, 10' cord) \$ 250.00

AddPower
 SEE PAGE 258 FOR ORDER INFO

UXL CRESCENT LAMINATE COLOR CHOICE

Amber Cherry AME	Fusion Maple MAP	Grey Nebula GNB	Tan Echo TAC
Asian Night ANG	Golden Oak GOK	New Age Oak NEW	Wild Cherry CHE
Blond Echo BEE	Grey Mesh GRE	Pewter Mesh PEW	

FRAME CHOICE

Platinum **PLT**

UXL CRESCENT EDGE COLOR CHOICE

Apple A	Burgundy D	Charcoal R	Forest Green F	Mocha T	Persian Blue J	Red L
Black B	Cerulean S	Chocolate Q	Fuchsia G	Navy I	Platinum P	White M
Blueberry C	Champagne O	Clementine E	Mint H	Orange U	Purple K	Yellow N

View all finish options on page 260.



UXL Power Bar™

The UXL Power Bar provides easy and convenient access to power. The work surface of the Power Bar is 42"H, accommodating students who're standing or seated on stools. For extra stability, it can be mounted to a wall with the included mounting bracket. (Hardware used to mount the bracket to the wall must be supplied by the installer based on the type of wall. Two sets of stabilizers are also included. One set is suited for use against a wall, the other is for island applications.)

- Choose from 5 Power Module options. Power Module price reflects two Power Modules, Left and Right.
- Durable tabletop in 1 1/4" thickness.
- Laminate top available in 11 colors and 21 edge colors.
- Frame is available in Platinum only.
- Hole in one leg for power cord.

Model ULPB60GREBPLTFT
Shown in Grey Mesh top with Black edge.
Shown in wall stabilizer configuration.

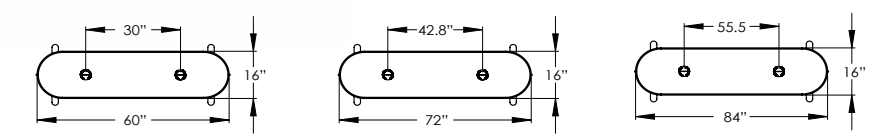

MODEL	DESCRIPTION	D"	W"	H"	F.C.	WT.	2016 LIST
(x2) Dome Power Modules [#017088 BLA]							
ULPB60 --- PLTFT	16"x60" Power Bar	16	60	42	85	58	\$ 1,150.00
ULPB72 --- PLTFT	16"x72" Power Bar	16	72	42	85	67	\$ 1,195.00
ULPB84 --- PLTFT	16"x84" Power Bar	16	84	42	85	74	\$ 1,250.00
(x2) Flat Power Modules - 1 Power / Twin USB [#017098 SLV]							
ULPB60 --- 22TFT	16"x60" Power Bar	16	60	42	85	58	\$ 1,230.00
ULPB72 --- 22TFT	16"x72" Power Bar	16	72	42	85	67	\$ 1,275.00
ULPB84 --- 22TFT	16"x84" Power Bar	16	84	42	85	74	\$ 1,330.00
(x2) Flat Power Modules - 2 Power [#017097 SLV]							
ULPB60 --- 33TFT	16"x60" Power Bar	16	60	42	85	58	\$ 1,060.00
ULPB72 --- 33TFT	16"x72" Power Bar	16	72	42	85	67	\$ 1,105.00
ULPB84 --- 33TFT	16"x84" Power Bar	16	84	42	85	74	\$ 1,160.00
(x2) Soft Touch Dome Power Modules - 2 Power / Twin USB [#017079 BLA]							
ULPB60 --- 44TFT	16"x60" Power Bar	16	60	42	85	58	\$ 1,200.00
ULPB72 --- 44TFT	16"x72" Power Bar	16	72	42	85	67	\$ 1,245.00
ULPB84 --- 44TFT	16"x84" Power Bar	16	84	42	85	74	\$ 1,300.00
(x2) Soft Touch Dome Power Modules - 3 Power [#017078 BLA]							
ULPB60 --- 55TFT	16"x60" Power Bar	16	60	42	85	58	\$ 1,030.00
ULPB72 --- 55TFT	16"x72" Power Bar	16	72	42	85	67	\$ 1,075.00
ULPB84 --- 55TFT	16"x84" Power Bar	16	84	42	85	74	\$ 1,130.00

To specify *no power* or two *different* power units on one Power Bar, please contact customer service for pricing.

BUILD YOUR PART NUMBER:

Choose ULPB60 ULPB72 ULPB84	7 8 9 10 Pick Laminate Color	10 Pick Edge Color	11 12 T Pick Power Units	FT Fixed-height 42"H (FT) leg set.
---	---	------------------------------	--	--

View all finish options on page 260.



20" Deep UXL Rectangle Table

Model XL2060BEEPPLTFC. Shown in Blond Echo top with Platinum edge and Platinum frame. Optional leg set FC. Shown with optional UXL Mobile Chairs.

24" Deep UXL Rectangle Tables

Model XL2490CHEBPLTFL. Shown in Cherry top with Black edge and Platinum frame. Shown with optional UXL Mobile Chairs.



UXL Rectangle Tables

UXL furniture is highly customizable, so you can precisely tailor the functionality and appearance of a desk or table to the needs of the student and classroom environment. This means you can maintain a consistent design scheme throughout the building or facility. Choose from 11 standard laminate colors, and 21 standard edge colors.

- UXL Tables are standard with a 3/4" Bullet T-Mold top and fixed-height legs (FL).
- UXL Tables can be customized with other Smith System top and edge choices.



Choose MODEL **7** **8** **9** **10** **PLT** **FL**

Pick Laminate Color

Pick Edge Color

Fixed-height (FL) leg set is standard. See page 107 to order optional leg sets.



30" Deep UXL Rectangle Tables

Model XL3060TACAPLTFL. Shown in Tan Echo top with Apple edge and Platinum frame.



36" Deep UXL Rectangle Tables

Model XL3660GNBLPLTFC. Shown in Grey Nebula top with Red edge and Platinum frame. Optional fixed-height leg with casters. See page 107.



42" Deep UXL Rectangle Tables

Model XL4260NEWHPLTFL. Shown in New Age Oak top with Mint edge and Platinum frame. Shown with optional UXL Mobile Chairs.



Desk Fences

Create carrel-like applications for peer work or individual study with our Desk Fence. It filters light and defines workstations, yet keeps the area open and visible. Choose from 19 standard colors. Pole is Platinum. View page 79 for colors and model numbers.



UXL Rectangle Tables

MODEL	DESCRIPTION	D"	W"	H"	F.C.	CUBE	WT.	UPS	2016 LIST
20" deep models									
XL2027___PLTFL	Rectangle - Single-student	20	27	29.5	70	1.4	56	*	\$ 384.00
XL2030___PLTFL	Rectangle - Single-student	20	30	29.5	70	1.4	56	*	\$ 386.00
XL2036___PLTFL	Rectangle - Single-student	20	36	29.5	70	1.7	61	*	\$ 414.00
XL2048___PLTFL	Rectangle - Two-student	20	48	29.5	70	2.2	70	*	\$ 453.00
XL2060___PLTFL	Rectangle - Two-student	20	60	29.5	70	2.8	75		\$ 504.00
XL2072___PLTFL	Rectangle - Two-student	20	72	29.5	70	3.3	90		\$ 580.00
XL2090___PLTFL	Rectangle - Three-student	20	90	29.5	70	4.2	100		\$ 652.00
24" deep models									
XL2430___PLTFL	Rectangle - Single-student	24	30	29.5	70	1.7	60	*	\$ 407.00
XL2436___PLTFL	Rectangle - Single-student	24	36	29.5	70	2.0	75	*	\$ 440.00
XL2448___PLTFL	Rectangle - Two-student	24	48	29.5	70	2.7	80	*	\$ 487.00
XL2460___PLTFL	Rectangle - Two-student	24	60	29.5	70	3.3	90		\$ 547.00
XL2472___PLTFL	Rectangle - Two-student	24	72	29.5	70	4.0	105		\$ 620.00
XL2490___PLTFL	Rectangle - Three-student	24	90	29.5	70	5.0	122		\$ 693.00
48" wide Half Round End Cap									
XL48NC___PLTFL	48" Half Round End Cap	30	48	29.5	70	2.8	80		\$ 515.00
30" deep models									
XL3036___PLTFL	Rectangle - Single-student	30	36	29.5	70	2.5	78	*	\$ 466.00
XL3048___PLTFL	Rectangle - Two-student	30	48	29.5	70	3.3	90	*	\$ 519.00
XL3060___PLTFL	Rectangle - Two-student	30	60	29.5	70	4.2	104		\$ 586.00
XL3072___PLTFL	Rectangle - Two-student	30	72	29.5	70	5.0	120		\$ 664.00
XL3090___PLTFL	Rectangle - Three-student	30	90	29.5	70	6.25	137		\$ 746.00
60" wide Half Round End Cap									
XL60HR___PLTFL	60" Half Round End Cap	30	60	29.5	70	2.1	65	*	\$ 559.00
36" deep models									
XL3648___PLTFL	Rectangle - Single-student	36	48	29.5	70	4.0	100	*	\$ 581.00
XL3660___PLTFL	Rectangle - Two-student	36	60	29.5	70	5.0	118	*	\$ 656.00
XL3672___PLTFL	Rectangle - Two-student	36	72	29.5	70	6.0	137		\$ 732.00
XL3690___PLTFL	Rectangle - Three-student	36	90	29.5	70	7.5	152		\$ 835.00
42" deep models									
XL4248___PLTFL	Rectangle - Single-student	42	48	29.5	70	4.67	110	*	\$ 696.00
XL4260___PLTFL	Rectangle - Two-student	42	60	29.5	70	5.8	132	*	\$ 785.00
XL4272___PLTFL	Rectangle - Two-student	42	72	29.5	70	7.0	148		\$ 878.00
XL4290___PLTFL	Rectangle - Three-student	42	90	29.5	70	8.8	167		\$ 1,001.00

UXL LAMINATE DESK TOP COLOR CHOICE

- Amber Cherry **AME**
- Asian Night **ANG**
- Blond Echo **BEE**
- Fusion Maple **MAP**
- Golden Oak **GOK**
- Grey Mesh **GRE**
- Grey Nebula **GNB**
- New Age Oak **NEW**
- Pewter Mesh **PEW**
- Tan Echo **TAC**
- Wild Cherry **CHE**

FRAME CHOICE

- Platinum **PLT**

UXL EDGE COLOR CHOICE

- Apple **A**
- Black **B**
- Blueberry **C**
- Burgundy **D**
- Cerulean **S**
- Champagne **O**
- Charcoal **R**
- Chocolate **Q**
- Clementine **E**
- Forest Green **F**
- Fuchsia **G**
- Mint **H**
- Mocha **T**
- Navy **I**
- Orange **U**
- Persian Blue **J**
- Platinum **P**
- Purple **K**
- Red **L**
- White **M**
- Yellow **N**

View all finish options on page 260.



UXL Science Table

The sturdy UXL Science Table allows you to match the design scheme created by UXL Tables throughout the building in the science lab. It features the added durability of a Trespa™ TopLab™ Plus work surface. Choose the work surface in Grey or Black. Standard with fixed-height legs (FL).

Model **XT2454GRYPLTFL**. Shown with Trespa™ TopLab™ Plus top.



Color Choice: ___
Grey Trespa TopLab Plus (**GRY**) or Black Trespa TopLab Plus (**BLA**).

MODEL	DESCRIPTION	D"	W"	H"	F.C.	CUBE	WT.	UPS	2016 LIST
24" deep models									
XT2448___PLTFL	24"d x 48"w Trespa TopLab Plus	24	48	29.5	70	2.3	81		\$ 1,232.00
XT2454___PLTFL	24"d x 54"w Trespa TopLab Plus	24	54	29.5	70	2.6	87		\$ 1,358.00
XT2460___PLTFL	24"d x 60"w Trespa TopLab Plus	24	60	29.5	70	2.9	91		\$ 1,478.00
XT2472___PLTFL	24"d x 72"w Trespa TopLab Plus	24	72	29.5	70	3.5	106		\$ 1,738.00



UXL Table I~O™ Post End Cap

Surround an I~O™ Post with two UXL™ Table I~O™ Post End Caps to create an island of connectivity. Fixed-height leg set standard. See page 107 for leg set options. Choose from ten standard laminate colors and 21 standard edge colors. Platinum (**PLT**) frame.

Shown in New Age Oak top with Cerulean edge and Platinum frame.

MODEL	DESCRIPTION	D"	W"	H"	F.C.	CUBE	WT.	UPS	2016 LIST
XL48EC___PLTFL	UXL Table I~O™ Post End Cap	30	48				80		\$ 515.00

Choose MODEL **7** **8** **9** **10** **PLT** **FL**

Pick Laminate Color

Pick Edge Color

Fixed-height (FL) leg set is standard. See page 107 to order optional leg sets.

AddPower
SEE PAGE 258 FOR ORDER INFO



Create a UXL Conference Table: two UXL Half Round Tables XL60HR and two XL3060 Rectangle Tables
 Shown in Tan Echo top with Apple edge and Platinum frame and optional adjustable leg set AL.
 Shown with optional UXL Stack Chairs.



UXL Half Round End Cap Table

UXL furniture is highly customizable, so you can precisely tailor the functionality and appearance of a desk or table to the needs of the student and classroom environment. This means you can maintain a consistent design scheme throughout the building or facility. Choose from 11 standard laminate colors, and 21 standard edge colors.

- UXL Tables are standard with a 3/4" Bullet T-Mold and fixed-height legs (FL).
- UXL Tables can be customized with other Smith System top and edge choices.



XL60HRTACAPLTAL
 60" Half Round End Cap. Shown in Tan Echo top with Apple edge and Platinum frame. Optional leg set (AL).

UXL Round Table

XL42RDAMEQPLTTL Shown in Amber Cherry top with Chocolate edge and Platinum frame. Optional tapered leg set with casters (TL).



UXL Corner Table

XL55STRBEE SPLTFL Shown in Blond Echo top with Cerulean edge and Platinum frame.



UXL Square Table

UL6060GREHPLTAL Shown in Grey Mesh top with Mint edge and Platinum frame. Optional push-button adjustable leg set (AL). 1 1/4" top recommended (UL).



UXL Trapezoid Table

XL72TRGNBLPLTAC Shown in Grey Nebula top with Red edge and Platinum frame. Optional push-button adjustable leg set with casters (AC).

MODEL	DESCRIPTION	D"	W"	H"	F.C.	CUBE	WT.	UPS	2016 LIST
UXL Half Round Top Table									
XL60HR___PLTFL	60" Half Round End Cap	30	60	29.5	70	2.1	65	*	\$ 559.00
XL48NC___PLTFL	48" Half Round End Cap	30	48	29.5	70	2.1	90		\$ 515.00
UXL Corner Table									
XL5STR___PLTFL	Corner Table	30	48	29.5	70	2.1	90		\$ 635.00
UXL Round Table									
XL42RD___PLTFL	42" round	42 dia.		29.5	70	2.1	86		\$ 480.00
XL48RD___PLTFL	48" round	48 dia.		29.5	70	2.1	98		\$ 508.00
XL60RD___PLTFL	60" round	60 dia.		29.5	70	2.1	136		\$ 710.00
UXL Square Table									
XL3030___PLTFL	30" Square	30	30	29.5	70	2.0	65	*	\$ 427.00
XL3636___PLTFL	36" Square	36	36	29.5	70	3.0	81	*	\$ 523.00
XL4242___PLTFL	42" Square	42	42	29.5	70	4.08	100	*	\$ 649.00
UL6060___PLTFL	60" Square	60	60	29.5	70	2.1	86		\$ 1,015.00
UXL Trapezoid Table									
XL60TR___PLTFL	Trapezoid	30	60	29.5	70	3.6	90		\$ 575.00
XL72TR___PLTFL	Trapezoid	30	72	29.5	70	4.4	106		\$ 650.00

AddPower

SEE PAGE 258 FOR ORDER INFO

Choose MODEL **7** **8** **9** **10** **PLT** **FL**

Pick Laminate Color

Pick Edge Color

Fixed-height (FL) leg set is standard. See page 107 to order optional leg sets.

UXL LAMINATE DESK TOP COLOR CHOICE

- Amber Cherry **AME**
- Asian Night **ANG**
- Blond Echo **BEE**
- Fusion Maple **MAP**
- Golden Oak **GOK**
- Grey Mesh **GRE**
- Grey Nebula **GNB**
- New Age Oak **NEW**
- Pewter Mesh **PEW**
- Tan Echo **TAC**
- Wild Cherry **CHE**

FRAME CHOICE

- Platinum **PLT**

UXL EDGE COLOR CHOICE

- Apple **A**
- Black **B**
- Blueberry **C**
- Burgundy **D**
- Cerulean **S**
- Champagne **O**
- Charcoal **R**
- Chocolate **Q**
- Clementine **E**
- Forest Green **F**
- Fuchsia **G**
- Mint **H**
- Mocha **T**
- Navy **I**
- Orange **U**
- Persian Blue **J**
- Platinum **P**
- Purple **K**
- Red **L**
- White **M**
- Yellow **N**

View all finish options on page 260.

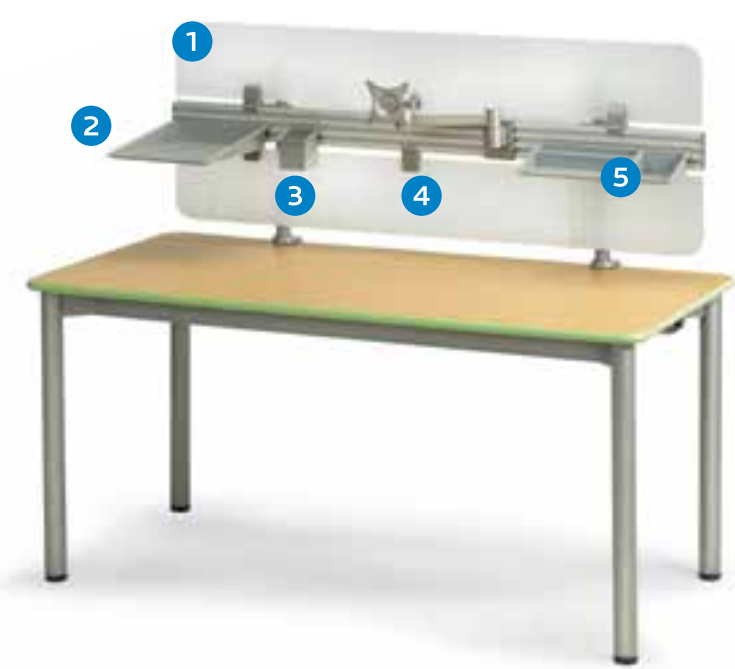

- 1 Two Screens, Model 17321
- 2 Document Tray Portrait, Model 38545 PLT
- 3 Plastic Stationery Holder, Model 38548 PLT
- 4 Monitor Mount with arm, Models 17653 and 17654
- 5 Plastic Stationery Trap, Model 38547 PLT



Spring-Loaded Table-Mounted Flat-Panel Monitor Mount, Model 17655 PLT

UXL Modesty Panel

Designed to complement UXL Rectangle Top Tables, these Modesty Panels are available in 11 standard laminate colors and 21 edge colors that match the UXL color scheme.



MODEL	DESCRIPTION	D"	W"	H"	F.C.	CUBE	WT.	UPS	2016 LIST
17100	30"w Desk Modesty Panel	3/4	22	13.5			13	*	\$ 94.00
17101	36"w Desk Modesty Panel	3/4	28	13.5			15	*	\$ 102.00
17102	48"w Desk Modesty Panel	3/4	40	13.5			19	*	\$ 119.00
17103	60"w Desk Modesty Panel	3/4	52	13.5			23		\$ 135.00
17104	72"w Desk Modesty Panel	3/4	64	13.5			27		\$ 154.00
17105	90"w Desk Modesty Panel	3/4	82	13.5			35		\$ 187.00

UXL Table Accessories

MODEL	DESCRIPTION	D"	W"	H"	F.C.	CUBE	WT.	UPS	2016 LIST
Partition Walls with No Screen									
17300	35" wide Accessory Wall	18" tall	35	18	70		23	*	\$ 318.00
17301	43" wide Accessory Wall	18" tall	43	18	70		26	*	\$ 349.00
17302	54.75" wide Accessory Wall	18" tall	54.75	18	70		34		\$ 366.00
17303	66.5" wide Accessory Wall	18" tall	66.5	18	70		36		\$ 385.00
Partition Walls with 1 Screen									
17310	35" wide Accessory Wall	18" tall	35	18	70		43	*	\$ 484.00
17311	43" wide Accessory Wall	18" tall	43	18	70		48	*	\$ 527.00
17312	54.75" wide Accessory Wall	18" tall	54.75	18	70		58		\$ 578.00
17313	66.5" wide Accessory Wall	18" tall	66.5	18	70		62		\$ 618.00
Partition Walls with 2 Screens									
17320	35" wide Accessory Wall	18" tall	35	18	70		63	*	\$ 675.00
17321	43" wide Accessory Wall	18" tall	43	18	70		70	*	\$ 729.00
17322	54.75" wide Accessory Wall	18" tall	54.75	18	70		82		\$ 812.00
17323	66.5" wide Accessory Wall	18" tall	66.5	18	70		82		\$ 877.00
Partition Wall Accessories									
38545 PLT	Document Tray (Portrait)	14	10.5	2.5			1	*	\$ 22.00
38546 PLT	Document Tray (Landscape)	11	14	2.5			1	*	\$ 22.00
38547 PLT	Plastic Stationery Tray	5.5	15	2.5			1	*	\$ 20.00
38548 PLT	Plastic Stationery Holder	3	3	3.5			1	*	\$ 14.00
17653 PLT	Monitor Mount for Universal Rail						3	*	\$ 120.00
17654 PLT	Monitor Mount Arm						2	*	\$ 52.00
17655 PLT	Spring Loaded Monitor Mount	5	5	21	70		9	*	\$ 199.00



UXL Table Ganging Device

Connect UXL tables with the easy to use UXL Ganging Device.

Great with Collaborative shaped desks, too.



UXL Wire Manager

UXL Power Socket and UXL Wire Manager, shown in open position.



Power Socket is durable and attaches securely to the work surface. Model 17060 with 15 ft. long cord.

MODEL	DESCRIPTION	D"	W"	H"	F.C.	CUBE	WT.	UPS	2016 LIST
17040	Wire Manager for 30"w Table	5	24	5	70		8		\$ 261.00
17041	Wire Manager for 36"w Table	5	30	5	70		10		\$ 291.00
17042	Wire Manager for 48"w Table	5	42	5	70		14		\$ 310.00
17043	Wire Manager for 60"w Table	5	54	5	70		18		\$ 351.00
17044	Wire Manager for 72"w Table	5	66	5	70		26		\$ 382.00
17045	Wire Manager for 90"w Table	5	84	5	70		32		\$ 443.00
17060	Power Socket (4 Power Plugs, 2 Data Plugs) 15' Cord				70		4		\$ 192.00
67628 PLT	Table Ganging Device						1		\$ 30.00
67636 PLT	Backpack Hook (bolts on to UXL rails)								\$ 40.00





Create a UXL Nest & Fold Conference Table: two UXL Nest & Fold Half Round Tables and two UXL Nest & Fold Rectangle Tables. Shown in Amber Cherry top with Black edge and Platinum frame. Shown with optional UXL Nest & Fold Chairs.

UXL Nest & Fold Table

UXL Nest & Fold Tables provide a stable, spacious work surface and contemporary appearance. They offer added utility when not in use through their easy mobility and compact storage. Because they're part of an integrated line of seating and desking, they let you maintain a consistent design scheme throughout the building or facility. Choose from 11 standard laminate colors, and 21 standard edge colors. Platinum frame only.

- UXL Nest & Fold Tables are standard with a 1 1/4" top with 3/8" Bumper T-Mold edge (**FL**).
- Optional top choice: 1 1/4" top with 4mm T-Mold edge. Replace **FL** in model number with **FM**.

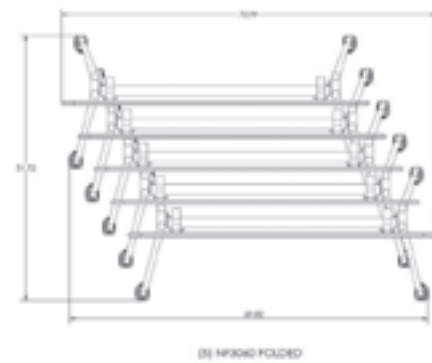

UXL Nest & Fold Tables offer improved performance even when not in use. Their tabletops fold and legs nest, allowing them to store more compactly. Standard casters make them easy to move.



UXL Nest & Fold Rectangle Top Table

FL3060AMEBPLT Shown in Amber Cherry top with Black edge and Platinum frame. Optional UXL Nest & Fold Chairs.

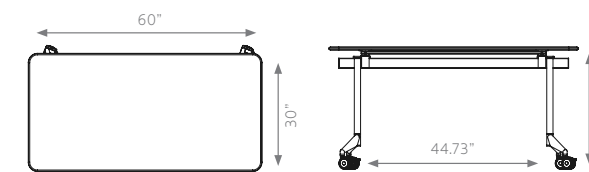

MODEL	DESCRIPTION	D"	W"	H"	F.C.	CUBE	WT.	UPS	2016 LIST
FL2448 _ _ _ PLT	24x48 Rectangle	24	48	30	70	102	102	*	\$ 899.00
FL2460 _ _ _ PLT	24x60 Rectangle	24	60	30	70	110	110		\$ 949.00
FL2472 _ _ _ PLT	24x72 Rectangle	24	72	30	70	118	118		\$ 975.00
FL3048 _ _ _ PLT	30x48 Rectangle	30	48	30	70	112	112		\$ 949.00
FL3060 _ _ _ PLT	30x60 Rectangle	30	60	30	70	120	120		\$ 999.00
FL3072 _ _ _ PLT	30x72 Rectangle	30	72	30	70	128	128		\$ 1,049.00



UXL Nest & Fold Half Round Top Table

FL60HRAMEBPLT Shown in Amber Cherry top with Black edge and Platinum frame.

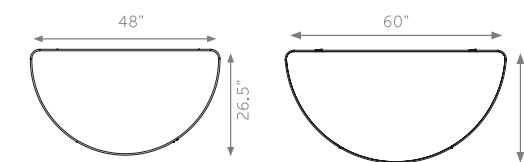

MODEL	DESCRIPTION	D"	W"	H"	F.C.	CUBE	WT.	UPS	2016 LIST
FL48HR _ _ _ PLT	48" Half Round	26.5	48	30	70	82	82		\$ 949.00
FL60HR _ _ _ PLT	60" Half Round	30.25	60	30	70	90	90		\$ 999.00

1 1/4" TOP

3/8" Bumper T-Mold **FL**

4mm T-Mold **FM**

FL or FM Choose Size

7 8 9 10 Pick Laminate Color

PLT Pick Edge Color

Fixed-height leg set is standard.

UXL LAMINATE DESK TOP COLOR CHOICE

- Amber Cherry **AME**
- Asian Night **ANG**
- Blond Echo **BEE**
- Fusion Maple **MAP**
- Golden Oak **GOK**
- Grey Mesh **GRE**
- Grey Nebula **GNB**
- New Age Oak **NEW**
- Pewter Mesh **PEW**
- Tan Echo **TAC**
- Wild Cherry **CHE**

FRAME CHOICE

- Platinum **PLT**

UXL EDGE COLOR CHOICE

- Apple **A**
- Black **B**
- Blueberry **C**
- Burgundy **D**
- Cerulean **S**
- Champagne **O**
- Charcoal **R**
- Chocolate **Q**
- Clementine **E**
- Forest Green **F**
- Fuchsia **G**
- Mint **H**
- Mocha **T**
- Navy **I**
- Orange **U**
- Persian Blue **J**
- Platinum **P**
- Purple **K**
- Red **L**
- White **M**
- Yellow **N**

View all finish options on page 260.



Adjustable Height Nest & Fold

UXL Nest & Fold Tables provide a stable, spacious work surface and contemporary appearance. They offer added utility when not in use through their easy mobility and compact storage. Because they're part of an integrated line of seating and desking, they let you maintain a consistent design scheme throughout the building or facility.

NEW for 2016



Model AL3072ANGBPLT.
Shown in Asian Night top with Black edge.
Paired with UXL Adjustable Stool.

UXL LAMINATE DESK TOP COLOR CHOICE

- Amber Cherry **AME**
- Asian Night **ANG**
- Blond Echo **BEE**
- Fusion Maple **MAP**
- Golden Oak **GOK**
- Grey Mesh **GRE**
- Grey Nebula **GNB**
- New Age Oak **NEW**
- Pewter Mesh **PEW**
- Tan Echo **TAC**
- Wild Cherry **CHE**

FRAME CHOICE

- Platinum **PLT**

UXL EDGE COLOR CHOICE

- Apple **A**
- Black **B**
- Blueberry **C**
- Burgundy **D**
- Cerulean **S**
- Champagne **O**
- Charcoal **R**
- Chocolate **Q**
- Clementine **E**
- Forest Green **F**
- Fuchsia **G**
- Mint **H**
- Mocha **T**
- Navy **I**
- Orange **U**
- Persian Blue **J**
- Platinum **P**
- Purple **K**
- Red **L**
- White **M**
- Yellow **N**

View all finish options on page 260.



(6) Model AL3072ANGBPLT. Shown 36" and 24" heights with 24" Fixed Height Plato Stools and 18" high Plato Stack Chairs.

UXL Nest & Fold Table

ADJUSTABLE HEIGHT

UXL Nest & Fold Adjustable Height Tables can be raised in one inch increments from 26" to 36". Choose from 11 standard laminate colors, and 21 standard edge colors. Platinum frame only.

- UXL Nest & Fold Tables are standard with a 1 1/4" top with 3/8" Bumper T-Mold edge (**AL**).
- Optional top choice: 1 1/4" top with 4mm T-Mold edge. Replace **AL** in model number with **AM**.
- Easy to use release mechanism spans the top length.
- Adjustable in one-inch increments with an Allen wrench.

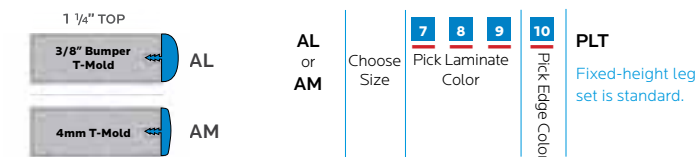

MODEL	DESCRIPTION	D"	W"	H"	F.C.	CUBE	WT.	UPS	2016 LIST
Adjustable Rectangle									
AL2448____PLT	24x48 Rectangle	Adjustable Height	24	48	26-36	70	104	*	\$ 974.00
AL2460____PLT	24x60 Rectangle	Adjustable Height	24	60	26-36	70	112		\$ 1,024.00
AL2472____PLT	24x72 Rectangle	Adjustable Height	24	72	26-36	70	120		\$ 1,050.00
AL3048____PLT	30x48 Rectangle	Adjustable Height	30	48	26-36	70	114		\$ 1,024.00
AL3060____PLT	30x60 Rectangle	Adjustable Height	30	60	26-36	70	122		\$ 1,074.00
AL3072____PLT	30x72 Rectangle	Adjustable Height	30	72	26-36	70	130		\$ 1,124.00
Adjustable Half Round									
AL48HR____PLT	48" Half Round	Adjustable Height	26.5	48	26-36	70	84		\$ 1,027.00
AL60HR____PLT	60" Half Round	Adjustable Height	30.25	60	26-36	70	92		\$ 1,074.00



How to Read a UXL™ Part Number

Here's our simple system for ordering UXL tables exactly the way you want them.

1. Decide what features and options you want.
2. Find them in the columns below.
3. Write them down in sequence.

Or just pick a pre-configured model and all you have to do is specify your color choice.

1	2	3	4	5	6	7	8	9	10	P	L	T	14	15
		Pick Colors				Frame			Leg					
1 2 Type 3/4" Tops XL = UXL Table 3/4" bullet X8 = UXL Table 4mm t-mold OF = Open Front Desk <hr/> 1-1/4" Tops UL = UXL Table 3/8" bumper U8 = UXL Table 4mm t-mold OL = Open Front Desk <hr/> FL = Nest & Fold 3/8" bumper FM = Nest & Fold 4mm t-mold <hr/> AL = Adjustable Nest & Fold 3/8" bumper AM = Adjustable Nest & Fold 4mm t-mold		3 4 5 6 Desk Top Size 2027 = 20"d x 27"w *3048 = 30"d x 48"w 55TR = corner table 2030 = 20"d x 30"w *3060 = 30"d x 60"w *48HR = 48" dia. half round 2036 = 20"d x 36"w *3072 = 30"d x 72"w 48NC = 48" dia. crescent end 2048 = 20"d x 48"w 3090 = 30"d x 90"w 42RD = 42" round 2060 = 20"d x 60"w 3636 = 36"d x 36"w 48RD = 48" round 2072 = 20"d x 72"w 3648 = 36"d x 48"w 60RD = 60" round 2090 = 20"d x 90"w 3660 = 36"d x 60"w 6060 = 60" square 2430 = 24"d x 30"w 3672 = 36"d x 72"w 60TR = 60"w trapezoid 2436 = 24"d x 36"w 3690 = 36"d x 90"w 72TR = 72"w trapezoid *2448 = 24"d x 48"w 4242 = 42"d x 42"w *2460 = 24"d x 60"w 4248 = 42"d x 48"w *2472 = 24"d x 72"w 4260 = 42"d x 60"w 2490 = 24"d x 90"w 4272 = 42"d x 72"w 3030 = 30"d x 30"w 4290 = 42"d x 90"w 3036 = 30"d x 36"w *60HR = 60" dia. half round				Open Front Desk Top Size 2027 = 20"d x 27"w 2448 = 24"d x 48"w <hr/> Collaborative Desk Top Size SSDM = Single-Student SMDM = Mini Single-Student TSDM = Two-Student SSWG = Wing Desk 72CR = 72" Crescent CURV = Curve Desk			*Nest & Fold Desk Top Size Available sizes designated with "*"					
7 8 9 Laminate Color See Laminate Color Chart Choose 3 Letters		10 Edge Color See Edge Color Chart Choose 1 Letter		11 12 13 Frame Color PLT = Platinum		14 15 Leg Type FL = Straight Fixed-height leg w/glide, 29.5"h (standard) \$0 FC = Straight Fixed-height leg w/caster, 29.5"h +\$15 AL = Push-button Adjustable-height leg w/glide, 27.5-33.5"h +\$140 AC = Push-button Adjustable-height leg w/caster, 26.5-33.5"h +\$146 SL = Push-button Adjustable-height leg w/glide, 23.5-29.5"h +\$140 SC = Push-button Adjustable-height leg w/caster, 23.5-29.5"h +\$146 TG = Tapered Fixed-height leg w/glide, 29.5"h +\$39 TL = Tapered Fixed-height leg w/caster, 29.5"h +\$39 *pricing for set of 4 legs								

UXL LAMINATE DESK TOP COLOR CHOICE

Amber Cherry AME	Blond Echo BEE	Golden Oak GOK	Grey Nebula GNB	Pewter Mesh PEW	Wild Cherry CHE
Asian Night ANG	Fusion Maple MAP	Grey Mesh GRE	New Age Oak NEW	Tan Echo TAC	

UXL EDGE COLOR CHOICE

Apple A	Burgundy D	Charcoal R	Forest Green F	Mocha T	Persian Blue J	Red L
Black B	Cerulean S	Chocolate Q	Fuchsia G	Navy I	Platinum P	White M
Blueberry C	Champagne O	Clementine E	Mint H	Orange U	Purple K	Yellow N

View all finish options on page 260.

UXL Leg Options

Fixed-height leg with glide (FL) is standard in the list price.

For the other legs available please add:

1. The following prices to the list price.
2. The 2 digit letter code to the end of the part #.

- Model FL** - Fixed-height leg with glide 29.5" h
- Model AL** - Push-button adjustable-height leg with glide 27.5"- 33.5" h
Add \$140 Add AL
- Model SL** - 23.5"-29.5" h
Add \$140 Add SL
- Model FC** - Fixed-height leg with caster 29.5" h
Add \$15 Add FC
- Model AC** - Push-button adjustable-height leg with caster 26.5"-33.5" h
Add \$146 Add AC
- Model SC** - 23.5"-29.5" h
Add \$146 Add SC
- Model TL** - Tapered fixed-height leg with caster
Add \$39 Add TL
- Model TG** - Tapered fixed-height leg with glide (not shown)
Add \$39 Add TG

All legs come in Platinum (PLT) and are 2" in diameter.

- Pricing for set of 4 legs.
- Crescent Table with FL leg set includes 5 legs. If ordering optional leg set, additional charge will apply for the cost of the extra leg.

UXL Nest & Fold Tables Top and Edge 1 1/4" Tops Fixed: FL (3/8" Bumper T-Mold) 1 1/4" Tops Adjustable: AL (3/8" Bumper T-Mold) FM (4mm T-Mold) AM (3/8" Bumper T-Mold)	UXL Open Front Desks Top and Edge 3/4" Tops: OF (Bullet T-Mold) 1 1/4" Tops: OL (3/8" Bumper T-Mold)	UXL Tables & UXL Desks Top and Edge 3/4" Tops: X8 (4mm T-Mold) 1 1/4" Tops: U8 (4mm T-Mold) XL (Bullet T-Mold) UL (3/8" Bumper T-Mold)
---	---	---



Silhouette™

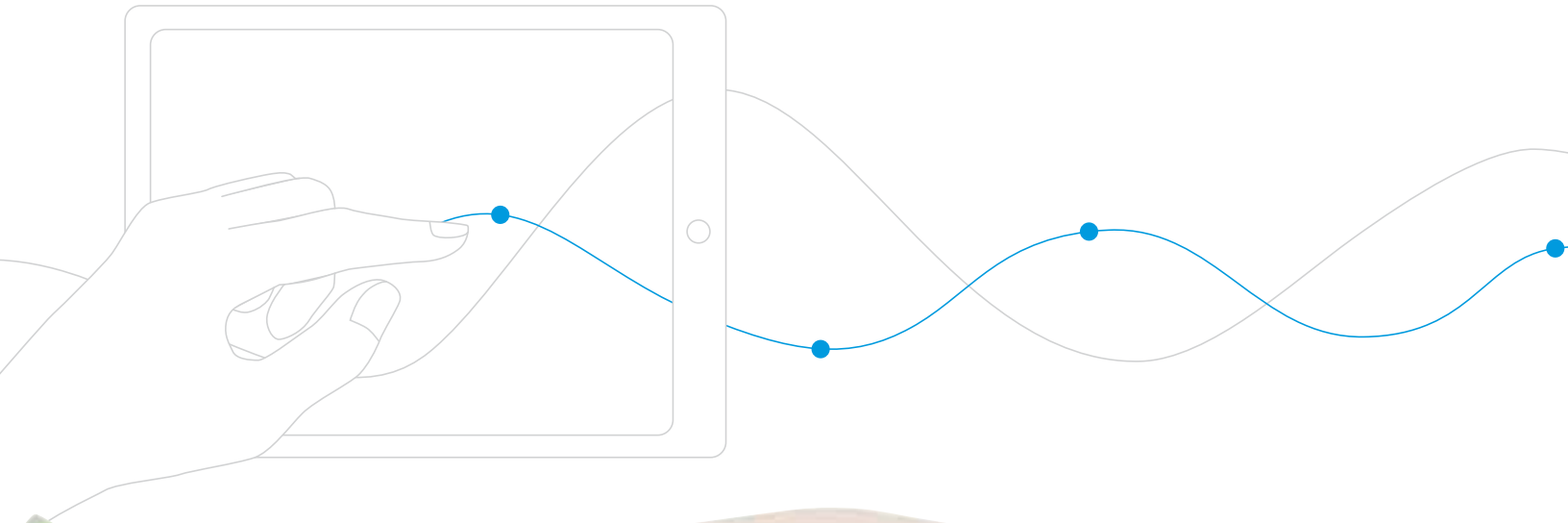

Silhouette Desk



Two-Student Silhouette



Sequence Desk



Curve Desk



The standard desk that sets a new standard.

Stable.

The Silhouette desk is a contemporary, economic solution for all classrooms. Its durable cantilevered design, adjustable legs and optional storage accessories make it a timeless favorite. Single and two-student options are available.

Strong.

It provides a notably strong surface that can withstand heavy loads and daily wear. A practical backpack peg is standard. Optional accessories include steel book box, wire book basket and Cascade™ Storage tote trays.

Stunning.

Sometimes, elegant simplicity is all you need in a student desk. That's where Silhouette shines.





Silhouette Desk

The Silhouette Desk is a contemporary desk that combines elegant design, durability and functionality. It's stable and strong, and its leg design allows easy ingress and egress. A backpack peg is standard. Choose from three Bookbox options.

- Choose from three durable desktops, 1 1/4" thick or 3/4" thick with high-pressure laminate surface, or hard plastic.
- Cantilevered design allows easy ingress and egress.
- Adjustable leg height from 24"-33" in 1" increments. Only two (not four) legs to adjust.
- Choose from several edge band treatments.
- Rugged powder coat surface on legs resists wear.
- Lockable endcap/glide combination that resists tampering.
- Choose from fixed-height or adjustable frame.



Model (2) 01650 and (1) 01661
Shown in New Age Oak top with Navy edge and Platinum frame with Optional 17576 3" Casters. Also, Flavors Mobile Chairs in Charcoal.

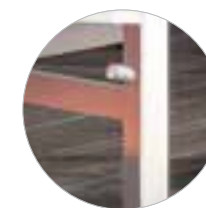

A practical backpack peg is standard.
Model 01661. Shown in Asian Night top with Fuchsia edge and Platinum frame.



Model 01650. Shown in Blond Echo top with Platinum edge and Platinum frame. Optional SW tote tray, Model 30925 and optional 18" Flavors™ Stack Chair, Model 11849.

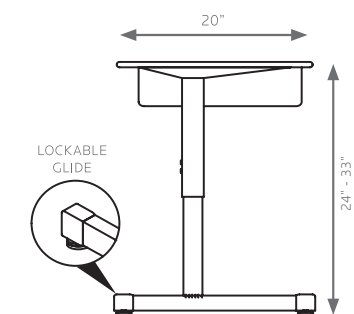

MODEL	DESCRIPTION	D"	W"	H"	F.C.	CUBE	WT.	UPS	2016 LIST
01600	Silhouette Desk Single-Student	18	24	24-33	70	1.2	36	*	\$ 169.00
01602	Silhouette Desk Single-Student, fixed-height, w/glides	18	24	29.5	70	1.2	36	*	\$ 169.00
01603	Silhouette Desk Single-Student, fixed-height, w/casters	18	24	29.5	70	1.2	36	*	\$ 245.00
01650	Silhouette Desk Single-Student	20	27	24-33	70	1.3	40	*	\$ 179.00
01649	Silhouette Desk Single-Student, fixed-height, w/glides	20	27	29.5	70	1.3	40	*	\$ 179.00
01648	Silhouette Desk Single-Student, fixed-height, w/casters	20	27	29.5	70	1.3	40	*	\$ 255.00
01660	Silhouette Desk Two-Student (Available in 1 1/4" top only)	20	48	24-33	70	1.3	75	*	\$ 249.00
01662	Silhouette Desk Two-Student, fixed-height, w/glides	20	48	29.5	70	1.3	75	*	\$ 249.00
01664	Silhouette Desk Two-Student, fixed-height, w/casters	20	48	29.5	70	1.3	75	*	\$ 325.00
01661	Silhouette Desk Two-Student (Available in 1 1/4" top only)	20	54	24-33	70	1.4	79	*	\$ 269.00
01663	Silhouette Desk Two-Student, fixed-height, w/glides	20	54	29.5	70	1.4	79	*	\$ 269.00
01665	Silhouette Desk Two-Student, fixed-height, w/casters	20	54	29.5	70	1.4	79	*	\$ 345.00
Hard Plastic Top Option (18x24, 20x27 Single-Student Silhouette Only)									
01601	Silhouette Desk Hard Plastic top	18	24	24-33	70	1.3	36	*	\$ 197.00
01604	Silhouette Desk Hard Plastic top, fixed-height, w/glides	18	24	29.5	70	1.3	36	*	\$ 197.00
01605	Silhouette Desk Hard Plastic top, fixed-height, w/casters	18	24	29.5	70	1.3	36	*	\$ 273.00
01651	Silhouette Desk Hard Plastic top	20	27	24-33	70	1.3	40	*	\$ 207.00
01647	Silhouette Desk Hard Plastic top, fixed-height, w/glides	20	27	29.5	70	1.3	40	*	\$ 207.00
01646	Silhouette Desk Hard Plastic top, fixed-height, w/casters	20	27	29.5	70	1.3	40	*	\$ 238.00



Make them mobile.

Order Model 17576 \$ 76.00 List

HARD PLASTIC DESK TOP COLOR CHOICE

- CHERRY
- OAK
- SAND
- MAPLE
- GREY

Hard plastic is not available through the Quick Ship program.

NEW FOR 2016

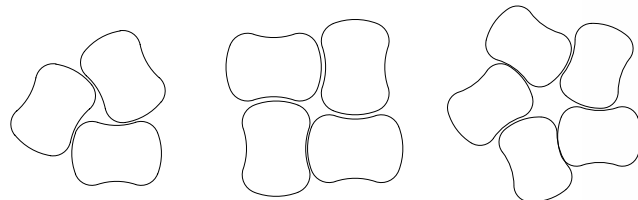

Model 01659. Shown with fixed-height caster leg.

Silhouette Sequence™ Desk

The Silhouette Sequence Desk is a contemporary desk for collaborative classrooms, combining elegant design, durability and functionality. It's stable and strong, and its leg design allows easy ingress and egress. A backpack peg is standard. Choose from three Bookbox options.

Make them mobile.
Order Model 17576
\$ 76.00 List

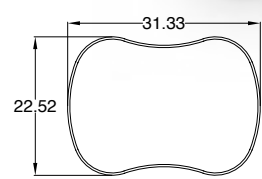

Silhouette Sequence desk's unique shape adapts to both traditional and collaborative environments.

MODEL	DESCRIPTION	D"	W"	H"	F.C.	CUBE	WT.	UPS	2016 LIST
01655	Silhouette Sequence Single-Student	23	31	24-33	70	1.2	36	*	\$ 225.00
01658	Silhouette Sequence Single-Student, fixed-height, w/glides	23	31	29.5	70	1.2	36	*	\$ 225.00
01659	Silhouette Sequence Single-Student, fixed-height, w/casters	23	31	29.5	70	1.2	36	*	\$ 301.00



Model 01654. Shown in New Age Oak top with Cerulean edge and Platinum fixed-height frame.

Silhouette Curve Desk

The Silhouette Curve Desk is a contemporary desk for transitional classrooms, combining elegant design, durability and functionality. It's stable and strong, and its leg design allows easy ingress and egress. A backpack peg is standard. Choose from three Bookbox options.

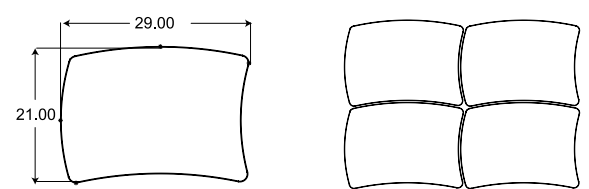

MODEL	DESCRIPTION	D"	W"	H"	F.C.	CUBE	WT.	UPS	2016 LIST
01653	Silhouette Curve Single-Student	21	29	24-33	70	1.2	36	*	\$ 225.00
01654	Silhouette Curve Single-Student, fixed-height, w/glides	21	29	29.5	70	1.2	36	*	\$ 225.00
01657	Silhouette Curve Single-Student, fixed-height, w/casters	21	29	29.5	70	1.2	36	*	\$ 301.00

Silhouette Accessories



Steel Bookbox
Durable Steel Bookbox in rugged Black or Platinum powder coat finish. Special order Champagne.



Wire Bookbox
Wire Bookbox in rugged Black powder coat finish.



Extra Wide Tote Tray
Translucent EW tote tray interfaces with Cascade™ Storage Units that hold EW Trays.

MODEL	DESCRIPTION	D"	W"	H"	F.C.	CUBE	WT.	UPS	2016 LIST
Silhouette Desk Accessories									
17190	Steel Bookbox – for 18 x 24 & 20 x 27 desk	15	20	4	70	3.0	8	*	\$ 61.00
17200	Wire book basket	15	18	3.5	70	3.0	5	*	\$ 51.00
30925	SW (Standard Width) tote tray with housing	16.8	13.5	3	70	1.13	8	*	\$ 93.00
30926	EW (Extra Wide) tote tray with housing	16.8	19.6	3	70	1.13	10	*	\$ 103.00
17576	3" Dual-Wheel Caster, Set of 4, 4 locking				70	0.1	5	*	\$ 76.00



Model 01600C. Shown in Grey Mesh top with Apple edge and Platinum frame. Shown with optional EW tote tray, Model 30926. Shown with optional 18" Plato Stack Chair, Model 00950.



Model 01650. Shown in Fusion Maple top with Mint Bumper T-Mold and Platinum frame. Shown with optional Steel Bookbox, Model 17190. Shown with optional 19" Intuit Chair, Model 00560.

Silhouette Desks Have Top and Edge Choices

- 1 1/4" Tops**
 - CHOICE 1** - 1 1/4" top with Bumper T-Mold (no letter to follow Model No.)
 - CHOICE 2** - 1 1/4" top with 4mm T-Mold (D to follow Model No.)
- 3/4" Tops**
 - CHOICE 3** - 3/4" top with 4mm T-Mold (C to follow Model No.)
 - CHOICE 4** - 3/4" top with Bullet T-Mold (V to follow Model No.)



Model 01661. Shown in Wild Cherry top with Black Bumper T-Mold and Black frame. Shown with 2 optional Steel Bookboxes, Model 17190.

*Two-Student desks use 1 1/4" tops.

SILHOUETTE DESK LAMINATE COLOR CHOICE						FRAME COLOR CHOICE	
Amber Cherry	Blond Echo	Golden Oak	Grey Nebula	Pewter Mesh	Wild Cherry	Black	Platinum
Asian Night	Fusion Maple	Grey Mesh	New Age Oak	Tan Echo			

SILHOUETTE DESK EDGE COLOR CHOICE						
Apple	Burgundy	Charcoal	Forest Green	Mocha	Persian Blue	Red
Black	Cerulean	Chocolate	Fuchsia	Navy	Platinum	White
Blueberry	Champagne	Clementine	Mint	Orange	Purple	Yellow

View all finish options on page 260.



Flexline™



Single-Student Desk



Two-Student Desk



Elemental Desk



Arc Desk



Computer Station

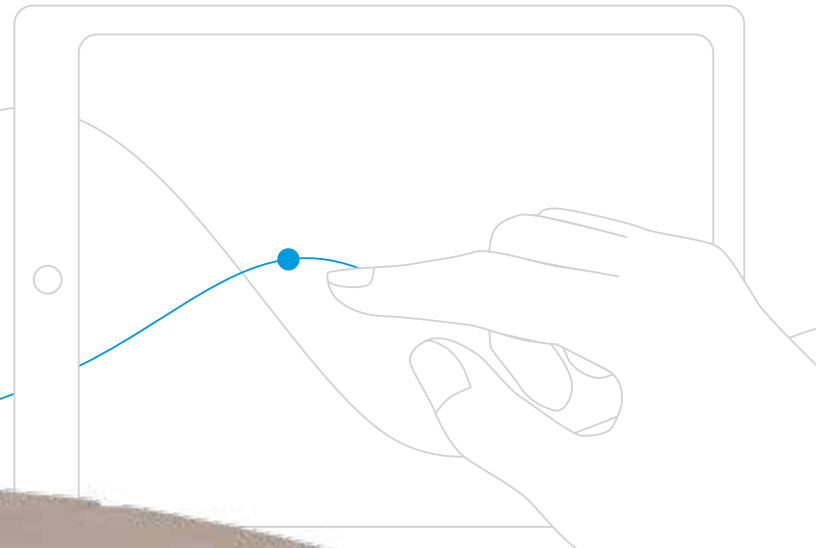

Setting the standard for collaborative learning desks with unbeatable flexibility and ergonomics.

Designed for active classrooms.

- Cantilever leg sets allow the student to stand or sit easily without knocking knees.
- Easy ingress and egress speeds up transitions in an active classroom.

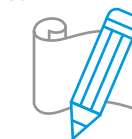

Designed for active use.

- The T-Mold edge band, used on Flex Desks and Tables, is stapled every six inches to provide superior fastening power.
- The work surfaces are high-pressure laminate that stand up to heavy use.

Dependability.

- Lifetime warranty on the frame and legs, 12-year warranty on table and desktops.



Models for collaborative learning or traditional classrooms.

- Arc™ Desks can be reconfigured in all the arrangements needed in a collaborative learning classroom.
- Flexline Desks, available in one- and two-student models offer excellent performance in traditional classrooms.
- Arc and Flexline Desks have a built-in backpack peg to keep classrooms tidy.

Healthy construction.

- UL Greenguard Gold Certified.





20" deep Flex Desk Model 01360
Shown in Grey Mesh top with Apple edge and Platinum frame. Shown with optional Flavors Chair, Model 11849 and optional EW Tote Tray, Model 30926.



Shown with optional casters, Model 17576 for wheelbarrow-style mobility.

Single-Student Flex Desk

It takes less flexing to get in and out of a spacious, stable Flex Student Desk. Its design moves the support away from the corners so the student has more knee room for easier ingress/egress, saving time whenever she/he stands up or sits down. Choose from 11 standard laminate colors, 21 standard edge colors and two frame colors.

- Patented backpack peg keeps student items organized. Can be positioned inside or outside of either leg. "Y" Leg shape allows easy ingress and egress for students.
- Adjustable desk height, from 24"-32" in 1" increments. Only two (not four) legs to adjust.
- Durable desktop available in 1 1/4" or 3/4" thickness, all with a high-pressure laminate surface.
- Edge moldings resist wear, choices available (see chart).
- Rugged powder coat surface on legs resists wear.
- Lockable endcap/glide combination that resists tampering.

MODEL	DESCRIPTION		D"	W"	H"	F.C.	CUBE	WT.	UPS	2016 LIST
20" deep										
01356	Flex Desk	Single-Student	20	32	24-32	70	3.2	47	*	\$ 251.00
01360	Flex Desk	Single-Student	20	27	24-32	70	2.6	41	*	\$ 231.00
01368	Flex Desk	Single-Student	20	36	24-32	70	3.6	50	*	\$ 267.00
24" deep										
01370	Flex Desk	Single-Student	24	27	24-32	70	3.1	46	*	\$ 249.00
01371	Flex Desk	Single-Student	24	36	24-32	70	4.5	55	*	\$ 284.00
Tie Plate										
17220	Tie Plate for Flex Desk					70		2	*	\$ 23.00

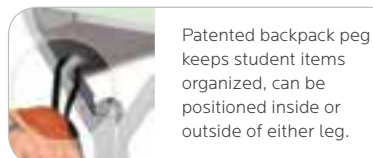

Patented backpack peg keeps student items organized, can be positioned inside or outside of either leg.

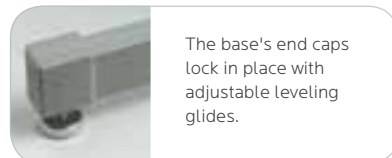

The base's end caps lock in place with adjustable leveling glides.

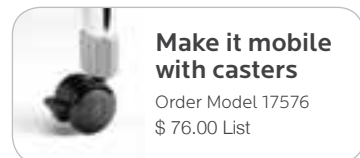

Make it mobile with casters
Order Model 17576 \$ 76.00 List



Hard Plastic Top Single-Student Flex Desk

It takes less flexing to get in and out of a spacious, stable Flex Student Desk. Its design moves the support away from the corners so the student has more knee room for easier ingress/egress, saving time whenever she/he stands up or sits down. Choose from five hard plastic finishes/colors, and three standard frame colors. Hard plastic is not on our Quick Ship program.

Shown with optional Steel Bookbox, Model 17190 \$ 61.00

MODEL	DESCRIPTION		D"	W"	H"	F.C.	CUBE	WT.	UPS	2016 LIST
20" deep										
01362	Flex Desk, Hard Plastic Top	Single-Student	20	27	24-32	70	2.6	41	*	\$ 259.00
01369	Flex Desk, Hard Plastic Top	Single-Student	20	36	24-32	70	3.6	50	*	\$ 287.00

DIMENSION CHART

Model	A	B	C
01356	20"	32"	24.25"
01360	20"	27"	21.25"
01368	20"	36"	30.25"
01370	24"	27"	21.25"
01371	24"	36"	30.25"
01362	20"	27"	21.25"
01369	20"	36"	30.25"

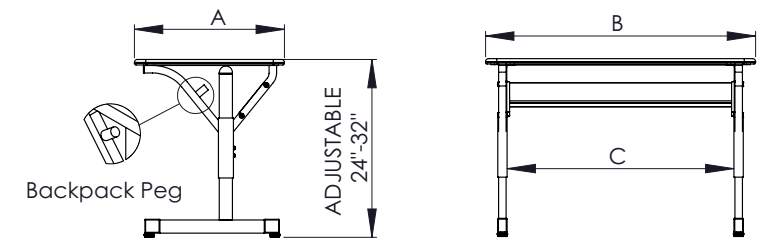

HARD PLASTIC DESK TOP COLOR CHOICE

- CHERRY
 - OAK
 - SAND
 - MAPLE
 - GREY
- Hard plastic is not available through the Quick Ship program.

FLEX DESK LAMINATE COLOR CHOICE

- Amber Cherry
- Blond Echo
- Golden Oak
- Grey Nebula
- Pewter Mesh
- Wild Cherry
- Asian Night
- Fusion Maple
- Grey Mesh
- New Age Oak
- Tan Echo
- Black
- Platinum

FLEX DESK EDGE COLOR CHOICE

- Apple
- Burgundy
- Charcoal
- Forest Green
- Mocha
- Persian Blue
- Red
- Black
- Cerulean
- Chocolate
- Fuchsia
- Navy
- Platinum
- White
- Blueberry
- Champagne
- Clementine
- Mint
- Orange
- Purple
- Yellow

Flex Desks Have Top and Edge Choices

- 1 1/4" Tops**
 - CHOICE 1 - 1 1/4" top with Bumper T-Mold no letter to follow Model No.
 - CHOICE 2 - 1 1/4" top with 4mm T-Mold D to follow Model No.
- 3/4" Tops**
 - CHOICE 3 - 3/4" top with 4mm T-Mold C to follow Model No.
 - CHOICE 4 - 3/4" top with Bullet T-Mold V to follow Model No.

View all finish options on page 260.



Flex Desks offer great access for students and can be equipped with casters and Cascade™ totes. Shown with Flavors™ Seating.

20" deep Flex Desk, Model 01361
Shown in Blond Echo top with Persian Blue edge and Platinum frame. Shown with optional Flavors Chairs, Model 11849 and optional EW tote tray, Model 30926.



Shown with two optional Steel Bookboxes, Model 17190, see page 123.

Two-Student Flex Desk

It takes less flexing to get in and out of this spacious, stable two-student desk. Its design moves the support away from the corners so the students have more knee room for easier ingress/egress, saving time whenever they stand up or sit down. Choose from 11 standard laminate colors, 21 standard edge colors and two frame colors.

Flex Desks Have Top and Edge Choices

- 1 1/4" Tops**
- CHOICE 1** - 1 1/4" top with Bumper T-Mold no letter to follow Model No.
 - CHOICE 2** - 1 1/4" top with 4mm T-Mold to follow Model No.
- 3/4" Tops**
- CHOICE 3** - 3/4" top with 4mm T-Mold to follow Model No.
 - CHOICE 4** - 3/4" top with Bullet T-Mold to follow Model No.

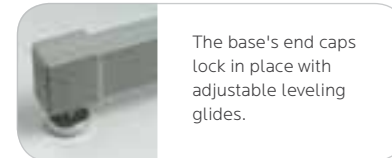

The base's end caps lock in place with adjustable leveling glides.

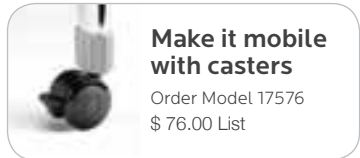

Make it mobile with casters
Order Model 17576
\$ 76.00 List

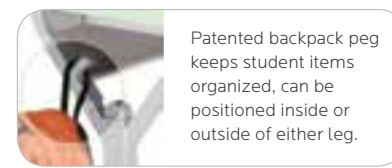

Patented backpack peg keeps student items organized, can be positioned inside or outside of either leg.

DIMENSION CHART

Model	A	B	C
01354	20"	48"	42.25"
01355	20"	54"	48.25"
01361	20"	60"	54.25"
01363	20"	72"	66.25"
01359	24"	72"	66.25"
01380	24"	54"	48.25"
01381	24"	60"	54.25"
01382	24"	48"	42.25"

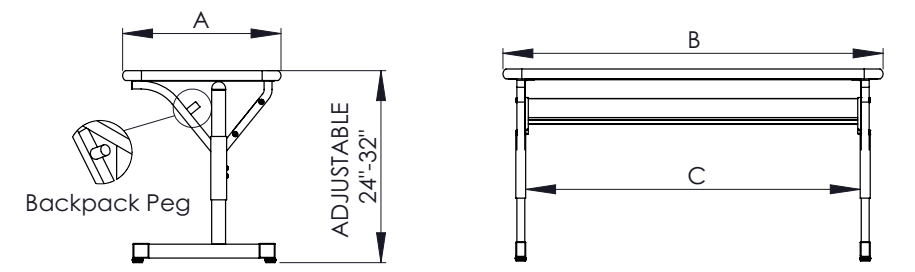

MODEL	DESCRIPTION	D"	W"	H"	F.C.	CUBE	WT.	UPS	2016 LIST
20" deep									
01354	Flex Desk	20	48	24-32	70	4.1	61	*	\$ 301.00
01355	Flex Desk	20	54	24-32	70	4.5	65		\$ 321.00
01361	Flex Desk	20	60	24-32	70	5.5	73		\$ 333.00
01363	Flex Desk	20	72	24-32	70	6.0	89		\$ 418.00
24" deep									
01359	Flex Desk	24	72	24-32	70	7.25	98		\$ 444.00
01380	Flex Desk	24	54	24-32	70	5.9	72		\$ 333.00
01381	Flex Desk	24	60	24-32	70	6.5	88		\$ 388.00
01382	Flex Desk	24	48	24-32	70	4.9	67		\$ 318.00

FLEX DESK LAMINATE COLOR CHOICE

- Amber Cherry, Blond Echo, Golden Oak, Grey Nebula, Pewter Mesh, Wild Cherry
- Asian Night, Fusion Maple, Grey Mesh, New Age Oak, Tan Echo

FRAME COLOR CHOICE

- Black, Platinum

FLEX DESK EDGE COLOR CHOICE

- Apple, Burgundy, Charcoal, Forest Green, Mocha, Persian Blue, Red
- Black, Cerulean, Chocolate, Fuchsia, Navy, Platinum, White
- Blueberry, Champagne, Clementine, Mint, Orange, Purple, Yellow

View all finish options on page 260.



Flex Desks with optional Intuit™ Chairs in Black.

Fully Integrated System

EW Totes containing project packets or individual student work fit both the Cascade Storage unit and underneath select Smith System desks. They can be moved between the two places easily.



Flexline Desks accommodate either SW or EW tote trays.

Accessories for Single- and Two-Student Flex Desks



Desk Fence

Create carrel-like applications for peer work or individual study in libraries or labs with our Desk Fence. It filters light and defines workstations, yet keeps the area open and visible. Combine Desk Fences with an I-O™ Post to create powered workstations. Screw or clamp down onto most tops. Choose from 19 standard colors (see page 79). Pole is Platinum.

MODEL	DESCRIPTION	D"	W"	H"	F.C.	CUBE	WT.	UPS	2016 LIST
DF24	24" wide Desk Fence	2	24	14	70	0.75	4	*	\$ 159.00
DF30	30" wide Desk Fence	2	30	14	70	1.0	6	*	\$ 171.00
DF36	36" wide Desk Fence	2	36	14	70	1.25	8	*	\$ 183.00
DF48	48" wide Desk Fence	2	48	14	70	1.5	10		\$ 207.00
DF60	60" wide Desk Fence	2	60	14	70	2.0	12		\$ 231.00



Steel Bookbox

Durable Steel Bookbox in rugged Black or Platinum powder coat finish.



Wire Bookbox

Wire Bookbox in rugged Black powder coat finish.

MODEL	DESCRIPTION	D"	W"	H"	F.C.	CUBE	WT.	UPS	2016 LIST
17190	Steel Bookbox	15	20	4	70	3.0	8	*	\$ 61.00
17200	Wire book basket	15	18	3.5	70	3.0	5	*	\$ 51.00

Tote Trays

Translucent EW Tote Tray interfaces with Cascade™ Storage Units that hold EW Trays. For 20 x 27 desk and larger sizes.



CASCADE TOTE COMPATIBILITY

DESKS	SW	EW
Silhouette	✓	✓
Flex Student	✓	✓
Flex Two-Student	✓	✓
Arc	✓	✓

MODEL	DESCRIPTION	D"	W"	H"	F.C.	CUBE	WT.	UPS	2016 LIST
30925	SW (Standard Width) Tote Tray with Housing	16.8	13.5	3	70	1.13	10	*	\$ 93.00
30926	EW (Extra Wide) Tote Tray with Housing	16.8	19.6	3	70	1.13	10	*	\$ 103.00



I-O™ Post

Distribute power and connectivity throughout large areas to computer users with the I-O Post. Network/phone ready, it has eight knockouts that allow the school to create a connection with one cable to the source. It also has eight grounded plugs to provide power. Available in Platinum powder coat, the I-O Post also has room to house a Wi-Fi repeater.

MODEL	DESCRIPTION	D"	W"	H"	F.C.	CUBE	WT.	UPS	2016 LIST
17090	I-O Post	19	19	44.7	70	10.0	45		\$ 1,645.00
17091	I-O Post Hard Wire	19	19	44.7	70	10.0	45		\$ 1,865.00
Optional Accessory									
17589	I-O Post Caster Pack	2 locking, 2 non-locking							\$ 50.00



Casters

Smooth dual-wheel casters roll easily, providing excellent mobility for desks. 4-Locking wheels.

MODEL	DESCRIPTION	D"	W"	H"	F.C.	CUBE	WT.	UPS	2016 LIST
17576	3" Dual-Wheel Caster Set of 4, 4 locking				70	0.1	5	*	\$ 76.00





ARC™ Desks

The many faces of
classroom collaboration.



Arc-8 Flex Desks side-by-side for partner work. | Arc-8 Flex Desks can be ordered with optional casters for mobility.



Arc-8 Flex Desk, Model 01351. Shown in Blond Echo top with Apple edge and Platinum frame. Shown with optional EW Tote Tray, Model 30926 and Flavors Stack Chair, Model 11849.



Arc-8 LS Flex Desk, Model 01350. Shown in Grey Nebula top with Black edge and Black frame.

Arc-8 Flex Desk

Chosen for collaborative learning classrooms, the stable Arc-8 Desk offers ample workspace and exceptional ingress and egress to the student – crucial in an active classroom. This design saves time whenever she/he stands up or sits down. Choose from 11 standard laminate colors, 21 standard edge colors and Black or Platinum frame colors.

- “Y” Leg shape allows easy ingress and egress for students.
- Desk height adjusts from 24"-32" in 1" increments. Only two legs to adjust.
- Durable desktop available in 1 1/4" or 3/4" thickness, all with a high-pressure laminate surface.
- Edge moldings resist wear, choices available (see chart).
- Rugged powder coat surface on legs resists wear.

MODEL	DESCRIPTION		D"	W"	H"	F.C.	CUBE	WT.	UPS	2016 LIST
01351	Arc-8 Flex Desk	Single-Student	22	35	24-32	70	4.0	45	*	\$ 256.00
01350	Arc-8LS Flex Desk	Single-Student	27	35	24-32	70	4.5	50	*	\$ 301.00
01353	ADA* Arc Desk (*Americans with Disabilities)		28	47	24-32	70	5.5	75		\$ 393.00
Optional Accessories										
17576	3" Dual-Wheel Caster Pack	Set of 4, 4 Locking	4	4	3	70	0.5	5	*	\$ 76.00
30925	SW (Standard Width) Tote Tray	with Housing	16.8	13.5	3	70	1.13	10	*	\$ 93.00
30926	EW (Extra Wide) Tote Tray	with Housing	16.8	19.6	3	70	1.13	8	*	\$ 103.00
17016	Steel Bookbox for Arc Desk		15	21	3.5	70	3.0	6	*	\$ 65.00



Steel Bookbox Model 17016



Tote Tray Model 30925 or 30926

ARC DESK LAMINATE COLOR CHOICE

- Amber Cherry
- Blond Echo
- Golden Oak
- Grey Nebula
- Pewter Mesh
- Wild Cherry
- Black
- Asian Night
- Fusion Maple
- Grey Mesh
- New Age Oak
- Tan Echo
- Platinum

FRAME COLOR CHOICE

- Black
- Platinum

ARC DESK EDGE COLOR CHOICE

- Apple
- Burgundy
- Charcoal
- Forest Green
- Mocha
- Persian Blue
- Red
- Black
- Cerulean
- Chocolate
- Fuchsia
- Navy
- Platinum
- White
- Blueberry
- Champagne
- Clementine
- Mint
- Orange
- Purple
- Yellow

View all finish options on page 260.

Comparison of top sizes of the three models of Arc Desks (Top view)

Desks in the Arc line offer great flexibility in the classroom thanks to their distinctively shaped desktops. Arrange them in compact circles for group work, in smaller groups, pairs or even individually.

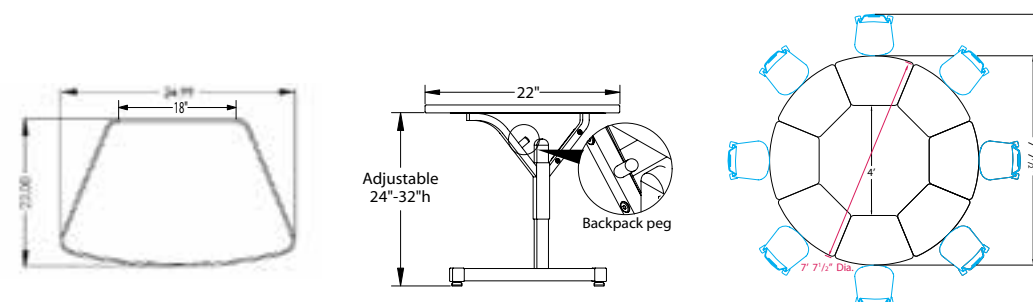

Arc-8 Flex Desk
Eight desks form 7 ft. 7 1/2 in. diameter circle.

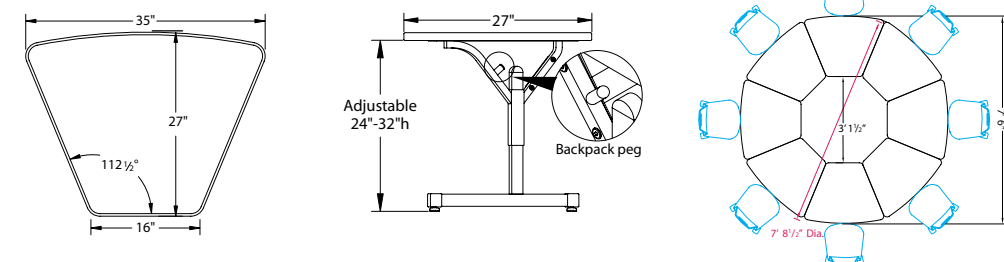

Arc-8 LS Flex Desk
Eight desks form 7 ft. 8 1/2 in. diameter circle.

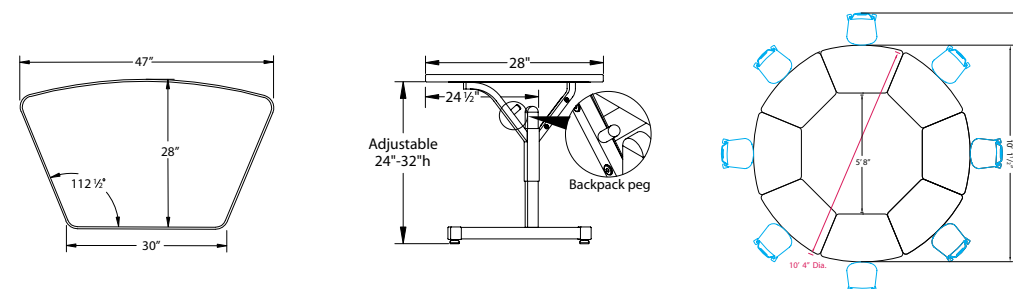

ADA Arc Desk
Eight desks form 10 ft. 4 in. diameter circle.

Arc Tables Have Top and Edge Choices

- 1 1/4" Tops**
 - CHOICE 1** - 1 1/4" top with Bumper T-Mold no letter to follow Model No.
 - CHOICE 2** - 1 1/4" top with 4mm T-Mold to follow Model No.
- 3/4" Tops**
 - CHOICE 3** - 3/4" top with 4mm T-Mold to follow Model No.
 - CHOICE 4** - 3/4" top with Bullet T-Mold to follow Model No.

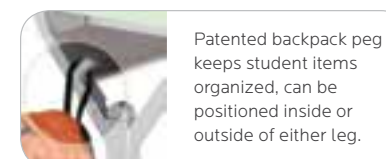

Patented backpack peg keeps student items organized, can be positioned inside or outside of either leg.

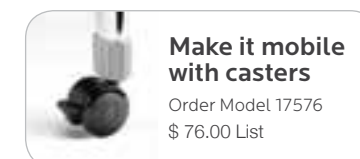

Make it mobile with casters

Order Model 17576 \$ 76.00 List



Flexline Desks Optimize the Utility of Cascade™ Storage.

FlexLine Desks help you make the most of the versatile Cascade system of organizing, storing and distributing learning materials. Both FlexLine and Arc™ desks can accommodate totes held in Cascade Storage units, providing easy, seamless transfer of learning materials between desk and cabinet.



Student Tote Storage and Transfer

Cascade totes containing student work can transfer directly from the storage unit to under-desktop and back.



Arc Student Desk Model 01351V.
Shown with optional tote tray with Housing Model 30926.
See page 142.

CASCADE TOTE COMPATIBILITY

DESKS	SW	EW
Silhouette	✓	✓
Flex Student	✓	✓
Flex Two-Student	✓	✓
Arc	✓	✓



Watch the Cascade Storage Video:
SMITHSYSTEM.COM/CASCADE-STORAGE

The Cascade Storage System

Tailored to every schoolroom and curriculum.

- Nine sizes
- Casters or glides
- Optional doors
- Totes, shelves or cubbies
- 18 powder coat and 21 edge molding colors

Cascade Cases

Equip your Cascade Case with tote trays to hold a wide variety of learning materials. Add utility with an optional riser shelf and lectern.



Mini-Case



Mid-Case



Mega-Case



Cascade Cabinets

Available with shelves, it holds a wide variety of learning materials. Optional riser shelf and lectern make this perfect for presentations.



Mini-Cabinet



Mid-Cabinet



Mega-Cabinet



Cascade Towers

Available with tote trays, it holds a wide variety of learning materials. Provides maximum capacity and can be configured many ways.



View all Cascade Storage System products on page 206-231.



Flex Station

Choose the Flex Station for easy ingress/egress for students, a strong, stable work surface and for its ingenious Wire Manager that keeps cabling stowed neatly out of sight. Features two handy backpack pegs. Choose from 11 standard laminate colors, 21 standard edge colors and two frame colors.

- Durable desktop is 1 1/4" thick with a high-pressure laminate surface.
- Edge moldings resist wear, choose Bumper T-Mold (standard) or 4mm T-Mold.
- For maximum stability, a 14-gauge steel mounting plate is welded to a Y-Leg made of 16-gauge steel tubing.
- Our patented backpack peg is on both the right and left leg, allowing backpacks to be hung under or outside the desk.
- Legs adjust from 24" to 32" high in 1" increments.

Model 01386. Shown in Wild Cherry top with Black edge and Black frame. Shown with optional 3" casters, Model 17576. Shown with optional Flavors Adjustable Chairs.

MODEL	DESCRIPTION	D"	W"	H"	F.C.	CUBE	WT.	UPS	2016 LIST
24" deep models									
01373	Flex Station w/ Tilt Down Wire Manager	24	30	24-32	70	3.3	65	*	\$ 327.00
01374	Flex Station w/ Tilt Down Wire Manager	24	36	24-32	70	4.0	68	*	\$ 354.00
01376	Flex Station w/ Tilt Down Wire Manager	24	48	24-32	70	5.5	88	*	\$ 420.00
01377	Flex Station w/ Tilt Down Wire Manager	24	60	24-32	70	7.0	96		\$ 501.00
01378	Flex Station w/ Tilt Down Wire Manager	24	72	24-32	70	8.5	106		\$ 563.00
30" deep models									
01383	Flex Station w/ Tilt Down Wire Manager	30	36	24-32	70	4.5	76	*	\$ 395.00
01384	Flex Station w/ Tilt Down Wire Manager	30	48	24-32	70	6.0	98		\$ 473.00
01385	Flex Station w/ Tilt Down Wire Manager	30	30	24-32	70	4.2	70		\$ 362.00
01386	Flex Station w/ Tilt Down Wire Manager	30	60	24-32	70	7.5	106		\$ 553.00
01387	Flex Station w/ Tilt Down Wire Manager	30	72	24-32	70	9.0	120		\$ 626.00
17221	Tie Plate for Flex Station				70		2	*	\$ 28.00



Model 01383. Shown in Grey Nebula top with Red edge and Platinum frame. Shown with optional CPU Holder, Model 17213.



CPU Holder, Model 17213
Adjusts 8.5 - 11.6" wide and 16.75 - 21.25" high. Black steel. Locks. \$ 159.00.



Corner Flex Station

Optimize space utilization and user ingress/egress with the Corner Flex Station. It offers a strong, stable work surface and an ingenious Wire Manager that keeps cabling stowed neatly out of sight. Choose from 11 standard laminate colors, 21 standard edge colors and two frame colors. 25" front and back, 24" on 4 sides.

Shown in Fusion Maple top with Platinum edge and Platinum frame. Shown with optional Intuit Adjustable Chair, Model 00531.

MODEL	DESCRIPTION	D"	W"	H"	F.C.	CUBE	WT.	UPS	2016 LIST
01379	Corner Flex Station	34	58	24-32	70	7.5	85		\$ 538.00

AddPower

SEE PAGE 258 FOR ORDER INFO



Model 17081



Model 17084



Power Socket is durable and attaches securely to the work surface. Model 17060 with 15 ft. long cord.

MODEL	DESCRIPTION	D"	W"	H"	F.C.	CUBE	WT.	UPS	2016 LIST
17081	6 Outlet Electric Strip w/ Surge, 4' Cord	3	3	12	70	0.1	4	*	\$ 65.00
17084	10 Outlet Electric Strip w/ Surge, 15' Cord	3	8	12	70	0.1	5	*	\$ 152.00
17060	Power Socket (4 Power Plugs 2 Data Plugs), 15' Cord	3	10	7	70	0.01	4	*	\$ 192.00

Caster options

17576	3" Dual-Wheel Caster	Set of 4, 4 locking	3" dia.	3	70	0.1	5	*	\$ 76.00
17554	4" Dual-Wheel Caster Pack	Set of 4, 2 locking	4" dia.	4	70	0.2	5	*	\$ 107.00

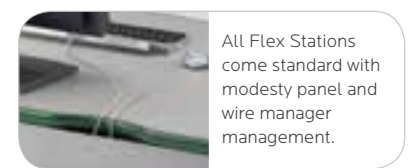

All Flex Stations come standard with modesty panel and wire manager management.



Lockable end-cap/glide combination resists tampering.

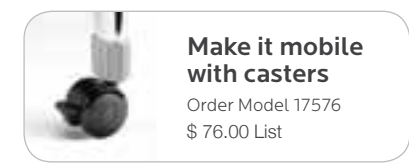

Make it mobile with casters
Order Model 17576 \$ 76.00 List

Flex Stations Have Top and Edge Choices

1 1/4" Tops

CHOICE 1 - 3/8" Bumper T-Mold no letter to follow Model No.

CHOICE 2 - 4mm T-Mold to follow Model No.

FLEX STATION LAMINATE COLOR CHOICE

Amber Cherry	Blond Echo	Golden Oak	Grey Nebula	Pewter Mesh	Wild Cherry
Asian Night	Fusion Maple	Grey Mesh	New Age Oak	Tan Echo	

FRAME COLOR CHOICE

Black	Platinum
-------	----------

FLEX STATION EDGE COLOR CHOICE

Apple	Burgundy	Charcoal	Forest Green	Mocha	Persian Blue	Red
Black	Cerulean	Chocolate	Fuchsia	Navy	Platinum	White
Blueberry	Champagne	Clementine	Mint	Orange	Purple	Yellow

View all finish options on page 260.



Shown in Grey Mesh top with White edge, Black Bookbox and leg. Shown with optional Intuit Stack chair, Model 00509.

Elemental Rectangle Top Desk

The Elemental Rectangle Top Desk allows the designer to choose the top finish, T-Mold, Bookbox and leg colors and to combine them in countless combinations. It offers an innovative system for attaching legs that makes installation quick and easy.

- 3/4" high-pressure laminate top is standard.
- Bullet-shaped T-Mold contributes to a lighter profile.
- Contoured sides add strength while creating a contemporary look.
- Fully integrated pencil tray and plastic Bookbox.
- Strong, 18-gauge steel upper legs have durable powder coat surfaces.
- Durable 16-gauge steel lower legs are chrome plated to resist wear.
- 1" adjustable leveling glides provide stability on uneven floors.



Shown in Grey Mesh top with Blueberry edge, Bookbox and leg.

MODEL	DESCRIPTION	D"	W"	H"	F.C.	CUBE	WT.	UPS	2016 LIST
Rectangle top									
01475V	Open Front Desk	20	27	23-32	85	1.3	26	*	\$ 183.00



Shown in Pewter Mesh top with Persian Blue edge and Platinum Bookbox and leg.

Elemental Wave Top Desk

The Elemental Wave Top Desk adds design flair while allowing the designer to choose the top finish, T-Mold, Bookbox and leg colors and to combine them in countless combinations. It offers an innovative system for attaching legs that makes installation quick and easy.

- 3/4" high-pressure laminate top is standard.
- Bullet-shaped T-Mold contributes to a lighter profile.
- Contoured sides add strength while creating a contemporary look.
- Fully integrated pencil tray and plastic Bookbox.
- Strong, 18-gauge steel upper legs have durable powder coat surfaces.
- Durable 16-gauge steel lower legs are chrome plated to resist wear.
- 1" adjustable leveling glides provide stability on uneven floors.

MODEL	DESCRIPTION	D"	W"	H"	F.C.	CUBE	WT.	UPS	2016 LIST
Wave top									
01476V	Open Front Desk	20	27	23-32	85	1.3	26	*	\$ 185.00



Shown in Maple top with Burgundy Bookbox and leg.

Elemental Hard Plastic Top Desk

The Elemental Hard Plastic Top Desk comes in five top finishes and allows the designer to choose the Bookbox and leg colors and to combine them in countless combinations. It offers an innovative system for attaching legs that makes installation quick and easy. Hard Plastic is not available through our Quick Ship Program.

- Hard Plastic top.
- Contoured sides add strength while creating a contemporary look.
- Fully integrated pencil tray and plastic Bookbox.
- Strong, 18-gauge steel upper legs have durable powder coat surfaces.
- Durable 16-gauge steel lower legs are chrome plated to resist wear.
- 1" adjustable leveling glides provide stability on uneven floors.

MODEL	DESCRIPTION	D"	W"	H"	F.C.	CUBE	WT.	UPS	2016 LIST
Hard plastic top									
01477	Open Front Desk	20	27	23-32	85	1.3	24	*	\$ 210.00

HARD PLASTIC DESK TOP COLOR CHOICE

- CHERRY
 - OAK
 - SAND
 - MAPLE
 - GREY
- Hard plastic is not available through the Quick Ship program.

Elemental Desks Have Top and Edge Choices

1 1/4" Tops

- CHOICE 1** - 1 1/4" top with Bumper T-Mold no letter to follow Model No.
- CHOICE 2** - 1 1/4" top with 4mm T-Mold **D** to follow Model No.

3/4" Tops

- CHOICE 3** - 3/4" top with 4mm T-Mold **C** to follow Model No.
- CHOICE 4** - 3/4" top with Bullet T-Mold **V** to follow Model No.

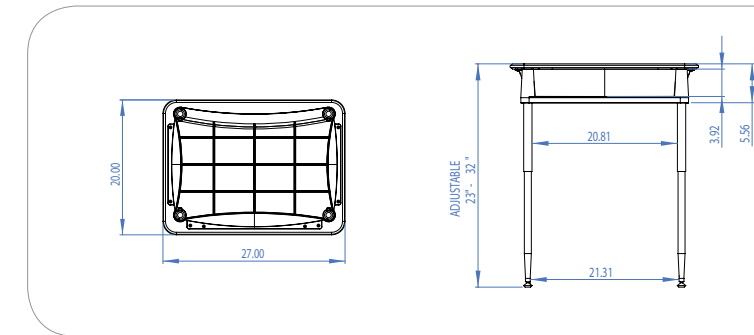

ELEMENTAL DESK LAMINATE COLOR CHOICE

- Amber Cherry
- Blond Echo
- Golden Oak
- Grey Nebula
- Pewter Mesh
- Wild Cherry
- Asian Night
- Fusion Maple
- Grey Mesh
- New Age Oak
- Tan Echo

ELEMENTAL DESK BOOKBOX AND LEG COLOR CHOICE

- Apple
 - Burgundy
 - Forest Green
 - Navy
 - Red
 - Black*
 - Chocolate
 - Fuchsia
 - Platinum*
 - Yellow
 - Blueberry
 - Clementine
 - Mint
 - Purple
- * Black and Platinum Bookboxes and Legs are stocked. Other colors require minimum order and extended lead times.

ELEMENTAL DESK EDGE COLOR CHOICE

- Apple
- Burgundy
- Chocolate
- Fuchsia
- Navy
- Platinum
- White
- Black
- Cerulean
- Clementine
- Mint
- Orange
- Purple
- Yellow
- Blueberry
- Charcoal
- Forest Green
- Mocha
- Persian Blue
- Red

View all finish options on page 260.



Planner™

Maximum strength and stability for a wide variety of applications.



Huddle™ Desk



Student Desk



Activity Table



Science Table



Teacher Desk



Lab Station



Graphic Arts



Lecterns

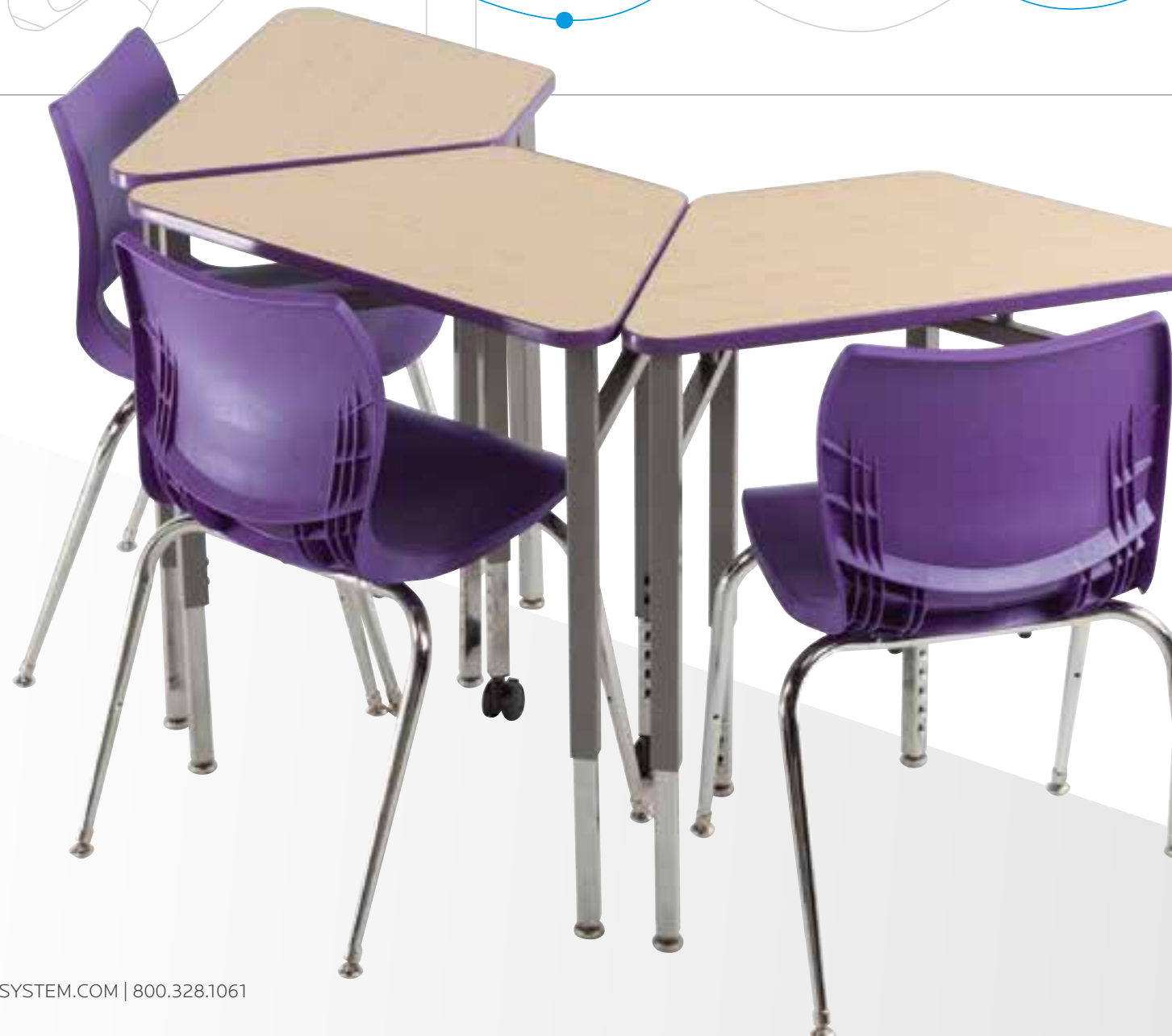

Unshakable foundation.

What sets Planner desks and tables apart is their rock-solid bases.

- Steel legs, one at each corner, welded to two steel cross members at each corner.
- Heavy gauge steel modesty panel bolted to each leg across the front.

Unbeatable construction.

- T-Mold edge bands on Planner desks and tables are stapled every six inches to provide superior fastening power.
- The work surfaces are high-pressure laminate that stand up to heavy use.

For collaborative learning or traditional classrooms.

- Huddle desks provide tremendous durability in collaborative learning classrooms.
- Planner student desks offer the same strengths in traditional classrooms.

Healthy construction.

- UL Greenguard Gold certified.



Offering flexibility, functionality and mobility.

- Planner student desks are available in a variety of sizes including two- and three-student models.
- Huddle desks are available in three sizes.
- Built-in backpack pegs keep classrooms tidy.
- Steel Bookboxes and caster sets available.



Planner activity tables' versatility is a strength.

- Work surfaces available in Trapezoid, Square, Round, Half-Moon and Contour shapes.
- Trespa™ TopLab™ Plus surfaces available for labs and art rooms.
- Modesty panels available.

Teacher desks offer durability, flexibility.

- Available in a wide range of sizes with options of drawer pedestals.

Dependability.

- Lifetime warranty on the frame and legs, 12-year warranty on table and desktops.





Huddle-6 Student Desk, Model 01265. Shown with optional Steel Bookbox, Model 17015

Huddle™ Student Desk

This compact collaborative learning desk offers maximum strength and stability. Its size allows more students to fit in a classroom and its trapezoid desktop enables compact circles to be created for group work. Features handy backpack peg. Choose from 11 standard laminate colors, 21 standard edge band and two leg colors. See size choices, below.

- Patented backpack peg that keeps student items organized, can be positioned inside or outside of either leg.
- Adjustable desk height, from 22"-32" in 1" increments.
- Durable desktop available in 1 1/4" or 3/4" thickness, all with a high-pressure laminate surface.
- Steel front panel adds stability.
- "H" Frame construction adds strength.
- Rugged powder coat surface on legs resists wear.
- Leg sets don't shimmy or rock.

MODEL	DESCRIPTION	D"	W"	H"	F.C.	CUBE	WT.	UPS	2016 LIST
01265	Huddle-6 Student Desk - 6' circle	18	30	22-32	70	1.1	35	*	\$ 233.00
01266	Huddle-8 Student Desk - 7' circle	18	30	22-32	70	1.1	36	*	\$ 237.00
01267	Huddle-8LS	24	30	22-32	70	1.4	42	*	\$ 251.00

Smith System recommends the Huddle-6 and Huddle-8 for grades K-5; Huddle-8LS for upper grades.

Huddle Bookbox

17015	Bookbox for Huddle-6 Desk #01265 - 6" w/back	15	21	3.5	70	0.5	6	*	\$ 65.00
17016	Bookbox for Huddle-8 Desk #01266 & 01267 - 10" w/back	15	21	3.5	70	0.5	6	*	\$ 65.00

Bookboxes available in Black and Platinum.

30925	SW (Standard Width) tote tray with housing	16.8	13.5	3	70	1.13	8	*	\$ 93.00
-------	--	------	------	---	----	------	---	---	----------

Cascade SW tote works on Model 01267 only.



HUDDLE-8™ LS STUDENT DESK

Model 01267. Shown in Grey Mesh top with Forest Green edge and Platinum frame. Optional SW Cascade Tote Tray w/housing, Model 30925.



Side-by-Side



Half-Circle



Full-Circle

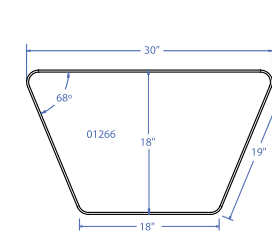

Huddle-8 (top down view)

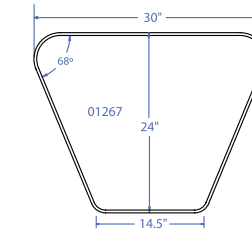

Huddle-8LS (top down view)

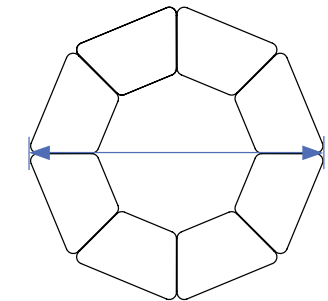

This configuration of Huddle-8 Desks is 7 ft. in diameter.



HUDDLE-6™ STUDENT DESK

Model 01265. Shown in New Age Oak top with Purple edge and Platinum frame. Shown with optional Plato Stack Chairs, see page 32.

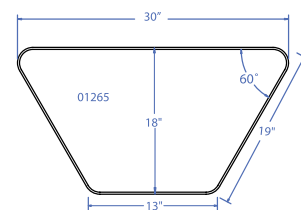

Huddle-6 (top down view)

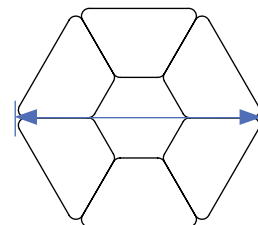

Configuration of Huddle-6 Desks is 6 ft. in diameter.

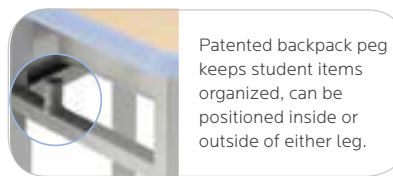

Patented backpack peg keeps student items organized, can be positioned inside or outside of either leg.

Planner Huddle Have Top and Edge Choices

1 1/4" Tops

CHOICE 1 - 1 1/4" top with Bumper T-Mold no letter to follow Model No.

CHOICE 2 - 1 1/4" top with 4mm T-Mold **D** to follow Model No.

3/4" Tops

CHOICE 3 - 3/4" top with 4mm T-Mold **C** to follow Model No.

CHOICE 4 - 3/4" top with Bullet T-Mold **V** to follow Model No.

Make it mobile with casters

Order Model 17576
\$ 76.00 List

PLANNER DESK LAMINATE COLOR CHOICE

- Amber Cherry
- Blond Echo
- Golden Oak
- Grey Nebula
- Pewter Mesh
- Wild Cherry
- Asian Night
- Fusion Maple
- Grey Mesh
- New Age Oak
- Tan Echo

FRAME COLOR CHOICE

- Black
- Platinum

PLANNER DESK EDGE COLOR CHOICE

- Apple
- Burgundy
- Charcoal
- Forest Green
- Mocha
- Persian Blue
- Red
- Black
- Cerulean
- Chocolate
- Fuchsia
- Navy
- Platinum
- White
- Blueberry
- Champagne
- Clementine
- Mint
- Orange
- Purple
- Yellow

View all finish options on page 260.



Planner Single-Student Desk

This spacious desk offers maximum strength and stability and is best suited for traditional classrooms. Features handy backpack peg. Choose from 11 standard laminate colors, and 21 standard edge colors.

- Patented backpack peg that keeps student items organized can be positioned inside or outside of either leg.
- Adjustable desk height, from 22"-32" in 1" increments.
- Durable desktop available in 1 1/4" or 3/4" thickness, all with a high pressure laminate surface.
- Edge moldings resist wear, choices available (see chart).
- Steel front panel adds stability.
- Rugged powder coat surface on legs resists wear.

Model 01272V. Shown in Grey Mesh top with Persian Blue edge and Platinum frame. Shown with optional Plato Stack Chair, Model 00950.

MODEL	DESCRIPTION	D"	W"	H"	F.C.	CUBE	WT.	UPS	2016 LIST
20" deep models									
01272	Planner Student Desk	20	27	22-32	70	1.0	36	*	\$ 226.00
01274	Planner Student Desk	20	36	22-32	70	1.4	42	*	\$ 260.00
01279	Planner Student Desk	20	32	22-32	70	1.8	40	*	\$ 242.00
24" deep models									
01285	Planner Student Desk	24	27	22-32	70	1.3	42	*	\$ 252.00
01286	Planner Student Desk	24	36	22-32	70	1.8	50	*	\$ 278.00



Planner Single-Student Desk with Hard Plastic Top

This desk offers maximum strength and stability and is best suited for traditional classrooms. Its spacious, durable hard plastic work surface provides ample working room for projects of all kinds. Features handy backpack peg. Choose from five hard plastic finishes, and two leg colors. Hard Plastic is not available through the Quick Ship program.

Shown with optional Steel Bookbox, Model 17190 \$ 61.00

MODEL	DESCRIPTION	D"	W"	H"	F.C.	CUBE	WT.	UPS	2016 LIST
01273	Planner Student Desk Hard Plastic Top	20	27	22-32	70	1.0	36	*	\$ 253.00
01291	Planner Student Desk Hard Plastic Top	20	36	22-32	70	1.4	42	*	\$ 293.00

HARD PLASTIC DESK TOP COLOR CHOICE

- CHERRY
- OAK
- SAND
- MAPLE
- GREY

Hard plastic is not available through the Quick Ship program.



Planner Two-Student Desk

This desk offers maximum strength and stability while providing ample workspace for two students. Features handy backpack peg. Choose from 11 standard laminate colors, and 21 standard edge colors.

Model 01290. Shown in Grey Nebula top with Navy edge and Black frame. Shown with two optional Steel Bookboxes, Model 17190.

MODEL	DESCRIPTION	D"	W"	H"	F.C.	CUBE	WT.	UPS	2016 LIST
20" deep models									
01276	Planner Student Desk Two-student	20	48	22-32	70	1.8	50	*	\$ 292.00
01278	Planner Student Desk Two-student	20	54	22-32	70	2.0	54		\$ 307.00
01280	Planner Student Desk Two-student	20	60	22-32	70	2.2	75		\$ 323.00
01284	Planner Student Desk Two-student	20	72	22-32	70	2.5	89		\$ 362.00
24" deep models									
01287	Planner Student Desk Two-student	24	48	22-32	70	2.2	61		\$ 312.00
01288	Planner Student Desk Two-student	24	54	22-32	70	2.4	67		\$ 342.00
01289	Planner Student Desk Two-student	24	60	22-32	70	2.7	84		\$ 383.00
01290	Planner Student Desk Two-student	24	72	22-32	70	3.1	98		\$ 426.00

DIMENSION CHART

Model	A	B	C	D
01276	20"	15.25"	48"	42"
01278	20"	15.25"	54"	48"
01280	20"	15.25"	60"	54"
01284	20"	15.25"	72"	66"
01287	24"	19.25"	48"	42"
01288	24"	19.25"	54"	48"
01289	24"	19.25"	60"	54"
01290	24"	19.25"	72"	66"

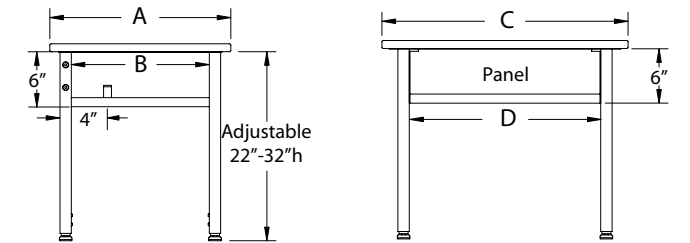

Planner Desks Have Top and Edge Choices

- 1 1/4" Tops**
 - CHOICE 1** - 1 1/4" top with Bumper T-Mold no letter to follow Model No.
 - CHOICE 2** - 1 1/4" top with 4mm T-Mold **D** to follow Model No.
- 3/4" Tops**
 - CHOICE 3** - 3/4" top with 4mm T-Mold **C** to follow Model No.
 - CHOICE 4** - 3/4" top with Bullet T-Mold **V** to follow Model No.



Two-Student Planner Desk, Model 01289. Shown in Golden Oak top with Black edge and Black frame.

PLANNER DESK LAMINATE COLOR CHOICE

- Amber Cherry
- Blond Echo
- Golden Oak
- Grey Nebula
- Pewter Mesh
- Wild Cherry
- Asian Night
- Fusion Maple
- Grey Mesh
- New Age Oak
- Tan Echo
- Black
- Platinum

PLANNER DESK EDGE COLOR CHOICE

- Apple
- Burgundy
- Charcoal
- Forest Green
- Mocha
- Persian Blue
- Red
- Black
- Cerulean
- Chocolate
- Fuchsia
- Navy
- Platinum
- White
- Blueberry
- Champagne
- Clementine
- Mint
- Orange
- Purple
- Yellow

View all finish options on page 260.

DIMENSION CHART

Model	A	B	C	D
01272	20"	15.25"	27"	21"
01274	20"	15.25"	36"	30"
01279	20"	15.25"	32"	26"
01285	24"	19.25"	27"	21"
01286	24"	19.25"	36"	30"
01273	20"	15.25"	27"	21"
01291	20"	15.25"	36"	30"

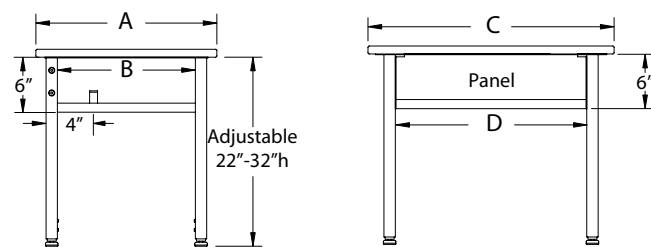



Planner Single-Student Desks with Intuit Stack Chairs in the classroom.



20" deep Planner Three-Student Desk Model 01295
Shown in Fusion Maple top with Persian Blue edge and Platinum frame. Shown with optional Flavors Chairs in Persian Blue.

Planner™ Three-Student Desk

This spacious desk offers maximum strength and stability for three students and is best suited for traditional classrooms. Features handy backpack pegs. Choose from 11 standard laminate colors and 21 standard edge colors.

- Patented backpack peg that keeps student items organized can be positioned inside or outside either leg.
- Adjustable desk height, from 22"-32" in 1" increments.
- Durable desktop available in 1-1/4" only, with high-pressure laminate surface.
- Edge moldings resist wear, choices available (see chart).
- Steel front panel adds stability.
- Rugged powder coat surface on legs resists wear.

MODEL	DESCRIPTION	D"	W"	H"	F.C.	CUBE	WT.	UPS	2016 LIST
20" deep models									
01295	Planner Student Desk Three-Student	20	84	22-32	70	2.9	86		\$ 417.00
24" deep models									
01296	Planner Student Desk Three-Student	24	84	22-32	70	2.9	98		\$ 482.00

Planner Three Student Desk has Top and Edge Choices

1 1/4" Tops

3/8" Bumper T-Mold CHOICE 1 ← CHOICE 1 - 1 1/4" top with Bumper T-Mold no letter to follow Model No.

4mm T-Mold CHOICE 2 ← CHOICE 2 - 1 1/4" top with 4mm T-Mold D to follow Model No.

Make it mobile with casters
Order Model 17576
\$ 76.00 List

AddPower
SEE PAGE 258 FOR ORDER INFO

PLANNER DESK LAMINATE COLOR CHOICE

- Amber Cherry
- Blond Echo
- Golden Oak
- Grey Nebula
- Pewter Mesh
- Wild Cherry
- Asian Night
- Fusion Maple
- Grey Mesh
- New Age Oak
- Tan Echo

FRAME COLOR CHOICE

- Black
- Platinum

PLANNER DESK EDGE COLOR CHOICE

- Apple
- Burgundy
- Charcoal
- Forest Green
- Mocha
- Persian Blue
- Red
- Black
- Cerulean
- Chocolate
- Fuchsia
- Navy
- Platinum
- White
- Blueberry
- Champagne
- Clementine
- Mint
- Orange
- Purple
- Yellow

View all finish options on page 260.





Cascade™ Storage

The 3" EW totes can be used under selected desks; Silhouette, Planner Rectangles, Flexline™ and Arc™.

Planner Student Desk Model 01272V
shown with optional Tote Tray with Housing
Model 30926

CASCADE TOTE COMPATIBILITY

DESKS	SW	EW
Planner Student	✓	✓
Planner Two-Student	✓	✓
Planner Three-Student	✓	✓
Huddle - 8 LS	✓	✗
Huddle - 6	✗	✗
Huddle - 8	✗	✗



Tote Trays

Translucent tote trays interface with Cascade™ Storage Units that hold totes.

- EW and SW totes work on 20 x 27 rectangles and larger.
- SW tote works with Huddle-8 LS Desk, Model 01267.



MODEL	DESCRIPTION	D"	W"	H"	F.C.	CUBE	WT.	UPS	2016 LIST
30926	EW (Extra Wide) tote tray with Housing	16.8	19.6	3	70	1.13	10	*	\$ 103.00
30925	SW (Standard Width) tote tray* with Housing	16.8	13.5	3	70	1.13	8	*	\$ 93.00

*Use with 01267 Huddle Desk.



Steel Bookbox

Durable Steel Bookbox in rugged Black or Platinum powder coat finish.



Wire Bookbox

Wire Bookbox in rugged Black powder coat finish.

MODEL	DESCRIPTION	D"	W"	H"	F.C.	CUBE	WT.	UPS	2016 LIST
17190	Steel Bookbox	15	20	4	70	3.0	8	*	\$ 61.00
17200	Wire book basket	15	18	3.5	70	3.0	5	*	\$ 51.00



Castors

Add easy mobility to Planner Student Desks with these castors. Choose a set of two for wheelbarrow mobility, or a set of four for level mobility.

MODEL	DESCRIPTION	D"	W"	H"	F.C.	CUBE	WT.	UPS	2016 LIST
17576	3" Dual-Wheel Caster	(4 locking, Threaded)			70	0.1	5	*	\$ 76.00

*Limits leg height: 4 castors change desk height to 24.5" low to 34.5" high; wheelbarrow castors change desk height to 24.5" low to 32.5" high.



Planner Single-Student Desks with Intuit Stack Chairs in the classroom.



36" deep Rectangle Planner Activity Table, Model 25570L
Shown in New Age Oak with Mocha edge and Platinum frame, low range legs. Shown with optional Flavors Stack Chairs, Model 11845 in Mocha, Chocolate and Cerulean.

Planner Rectangle Activity Table

This table offers maximum strength and stability for a wide variety of classroom uses. Three height ranges available allow you to fit the table to the grade range of the student. Choose from 11 standard laminate colors, 21 standard edge colors and two leg colors (Black and Platinum).

- High-pressure laminate surface resists wear.
- Choose from several edge treatments.
- Table height adjusts 24" to 34" in 1" increments, meets ADA requirements.
- 1" adjustable leveling glides provide stability on uneven floors.

AddPower

SEE PAGE 258 FOR ORDER INFO

*Please note: When ordering a power unit (p. 162), it cannot be placed in the center of 20" deep, 24" deep, 30" deep and 36" deep models.



Model 25980V. 20"d x 72"w. Shown in New Age Oak top with Apple edge and Platinum frame.



Model 25830. 24"d x 72"w. Shown in Grey Mesh top with Blueberry edge and Platinum frame.



Model 25530V. 30"d x 72"w. Shown in Amber Cherry top with Chocolate edge and Black frame.



Model 25700. 42"d x 60"w. Shown in Fusion Maple top with Charcoal edge and Platinum frame.

MODEL	DESCRIPTION		D"	W"	H"	F.C.	CUBE	WT.	UPS	2016 LIST
20" deep models										
25950	Planner Activity Table	Rectangle	20	36	24-34	70	1.7	58	*	\$ 333.00
25960	Planner Activity Table	Rectangle	20	48	24-34	70	2.2	64	*	\$ 380.00
25970	Planner Activity Table	Rectangle	20	60	24-34	70	2.8	73		\$ 430.00
25980	Planner Activity Table	Rectangle	20	72	24-34	70	3.3	86		\$ 481.00
25990	Planner Activity Table	Rectangle	20	90	24-34	70	4.2	108		\$ 516.00
24" deep models										
25800	Planner Activity Table	Rectangle	24	36	24-34	70	2.0	60	*	\$ 367.00
25810	Planner Activity Table	Rectangle	24	48	24-34	70	2.6	69	*	\$ 411.00
25820	Planner Activity Table	Rectangle	24	60	24-34	70	3.3	76		\$ 463.00
25830	Planner Activity Table	Rectangle	24	72	24-34	70	4.0	105		\$ 515.00
25840	Planner Activity Table	Rectangle	24	90	24-34	70	5.0	122		\$ 568.00
30" deep models										
25500	Planner Activity Table	Rectangle	30	36	24-34	70	2.5	76	*	\$ 447.00
25510	Planner Activity Table	Rectangle	30	48	24-34	70	3.0	90	*	\$ 466.00
25520	Planner Activity Table	Rectangle	30	60	24-34	70	3.8	104		\$ 518.00
25530	Planner Activity Table	Rectangle	30	72	24-34	70	4.5	120		\$ 572.00
25540	Planner Activity Table	Rectangle	30	90	24-34	70	6.3	137		\$ 667.00
36" deep models										
25550	Planner Activity Table	Rectangle	36	48	24-34	70	3.6	102		\$ 545.00
25560	Planner Activity Table	Rectangle	36	60	24-34	70	4.5	118		\$ 565.00
25570	Planner Activity Table	Rectangle	36	72	24-34	70	5.4	135		\$ 612.00
25580	Planner Activity Table	Rectangle	36	90	24-34	70	6.8	158		\$ 718.00
42" deep models										
25590	Planner Activity Table	Rectangle	42	90	24-34	70	8.75	195		\$ 892.00
25700	Planner Activity Table	Rectangle	42	60	24-34	70	5.8	143		\$ 694.00
25710	Planner Activity Table	Rectangle	42	72	24-34	70	7.0	163		\$ 763.00
48" deep models										
25720	Planner Activity Table	Rectangle	48	60	24-34	70	6.7	159		\$ 754.00
25730	Planner Activity Table	Rectangle	48	72	24-34	70	8.0	181		\$ 835.00
25740	Planner Activity Table	Rectangle	48	90	24-34	70	10.0	215		\$ 972.00

Optional legs for 30" and 36" deep models:

- Low range available in 15-24"h. Add **L** following model number. Available in Black and Platinum frame only. *Longer lead time applies.*
- Fixed-height leg available in 29.5"h. Add **X** following model number. Available in Black only. *Longer lead time applies.*

Planner Desks Have Top and Edge Choices

- 1 1/4" Tops**
- CHOICE 1** - 1 1/4" top with Bumper T-Mold no letter to follow Model No.
 - CHOICE 2** - 1 1/4" top with 4mm T-Mold **D** to follow Model No.
- 3/4" Tops**
- CHOICE 3** - 3/4" top with 4mm T-Mold **C** to follow Model No.
 - CHOICE 4** - 3/4" top with Bullet T-Mold **V** to follow Model No.

Structural Framing



20", 24", 30" & 36" deep Models
Center support channel is 2" by 3" wide of 14-gauge steel, with 11-gauge steel endplates for maximum stability.

42" & 48" deep Models
Two 2" x 3" 14-gauge steel support channels with 11-gauge steel endplates provide maximum stability.



Planner Trapezoid Activity Table

Model 25600. Shown in Golden Oak top with Black edge and Black frame.



Planner Half Moon Activity Table

Model 25650. Shown in Grey Mesh top with Persian Blue edge and Platinum frame.



Planner Square Activity Table

Model 25610. Shown in Wild Cherry top with Black edge and Black frame.



Planner Contour Activity Table

Model 25660. Shown in Tan Echo top with Mint edge and Platinum frame.



Planner Round Activity Table

Model 25620. Shown in Grey Nebula top with Platinum edge and Platinum frame.

Planner Activity Tables

This table offers maximum strength and stability for a wide variety of classroom uses. Three height ranges available allow you to fit the table to the grade range of the student. Choose from 11 standard laminate colors, 21 standard edge colors and two leg colors.

- High-pressure laminate surface resists wear.
- Choose from several edge treatments.
- Table height adjusts 24" to 34" in 1" increments, meets ADA requirements.
- 1" adjustable leveling glides provide stability on uneven floors.
- Low range available in 15-24"h. Add **L** following model number. Longer lead time may apply.
- Fixed-height leg available in 29.5"h. Add **X** following model number. Available in Black only.

*Please note: When ordering a power unit (p. 162), it cannot be placed in the center of these tables.

MODEL	DESCRIPTION		D"	W"	H"	F.C.	CUBE	WT.	UPS	2016 LIST
25600	Planner Activity Table	Trapezoid	30	60	24-34	70	3.8	90		\$ 506.00
25610	Planner Activity Table	Square	48	48	24-34	70	4.8	133		\$ 640.00
25620	Planner Activity Table	Round	42" dia.		24-34	70	3.7	86		\$ 537.00
25630	Planner Activity Table	Round	48" dia.		24-34	70	4.8	98		\$ 582.00
25640	Planner Activity Table	Round	60" dia.		24-34	70	7.5	148		\$ 778.00
25650	Planner Activity Table	Half Moon	36	72	24-34	70	5.25	102		\$ 609.00
25660	Planner Activity Table	Contour	36	72	24-34	70	5.25	128		\$ 620.00
Not Shown										
25665	Planner Activity Table	Kidney	48	72	24-34	70	7.0	149		\$ 831.00
25645	Planner Activity Table	Flower	60" dia.		24-34	70	7.5	148		\$ 778.00

Planner Tables Have Top and Edge Choices

1 1/4" Tops

CHOICE 1 - 1 1/4" top with Bumper T-Mold no letter to follow Model No.

CHOICE 2 - 1 1/4" top with 4mm T-Mold **D** to follow Model No.

3/4" Tops

CHOICE 3 - 3/4" top with 4mm T-Mold **C** to follow Model No.

CHOICE 4 - 3/4" top with Bullet T-Mold **V** to follow Model No.

Make it mobile with casters
Order Model 17576
\$ 76.00 List

AddPower
SEE PAGE 258 FOR ORDER INFO

PLANNER TABLE LAMINATE COLOR CHOICE

Amber Cherry	Blond Echo	Golden Oak	Grey Nebula	Pewter Mesh	Wild Cherry
Asian Night	Fusion Maple	Grey Mesh	New Age Oak	Tan Echo	

FRAME COLOR CHOICE

Black	Platinum
-------	----------

PLANNER TABLE EDGE COLOR CHOICE

Apple	Burgundy	Charcoal	Forest Green	Mocha	Persian Blue	Red
Black	Cerulean	Chocolate	Fuchsia	Navy	Platinum	White
Blueberry	Champagne	Clementine	Mint	Orange	Purple	Yellow

View all finish options on page 260.



Planner Legsets

Standard Leg

- Adjustable from 24"-34", features 1" leveling glides to assure a steady table on uneven floors.
- Black and Platinum frame only.
- Accepts caster, Model 17576.



High Leg Inserts

- For 20", 24" and 30" deep tables only.
- Order special lower leg insert set for adjustment from 30¹/₄" to 40¹/₄" high.
- 4 pack.
- Does not accept casters, Model 17500.
- + \$59.00



Short Adjustable Leg

- Designed for Early Childhood use, this option allows height adjustability from 15"-24" in 1" increments.
- Features 1" leveling glides.
- Available on select Planner 30" & 36" depth tables.
- Add **L** following model number.
- Black and Platinum frame only.
- Longer lead time may apply.



Fixed-Height Leg

- Set at 29¹/₂", features 1" leveling glides to assure a steady table on uneven floors.
- Available on select Planner models.
- Black only.
- Add **X** following model number.
- Does not accept casters.
- Longer lead time may apply.



Planner Rectangle Modesty Panel

Designed to complement tables in the Interchange and Planner lines. Order it in any of 11 standard laminate colors, 21 edge colors.

MODEL	DESCRIPTION	D"	W"	H"	F.C.	CUBE	WT.	UPS	2016 LIST
<i>Accessories</i>									
17201	Modesty Panel for 36" wide table				70		18	*	\$ 102.00
17202	Modesty Panel for 48" wide table				70		24	*	\$ 119.00
17203	Modesty Panel for 60" wide table				70		30	*	\$ 135.00
17204	Modesty Panel for 72" wide table				70		36		\$ 154.00
17205	Modesty Panel for 90" wide table				70		44		\$ 187.00

Make It Mobile – Add Casters



Casters

Add easy mobility to Planner Activity, Science and Art Tables with these casters. Choose a set of two for wheelbarrow mobility, or a set of four for level mobility.

MODEL	DESCRIPTION	D"	W"	H"	F.C.	CUBE	WT.	UPS	2016 LIST
17576	3" Dual-Wheel Caster Set of 4, 4 locking				70	0.1	5	*	\$ 76.00
<i>Limits leg height: 4 casters change table height to 26.5" low - 36.5" high; wheelbarrow casters change table height to 26.5" low to 34.5" high.</i>									
17554	4" Dual-Wheel Caster Pack Set of 4, 2 locking	4" dia.		4	70	0.2	5	*	\$ 107.00
<i>Model 17554, not for wheelbarrowing</i>									





Choose a durable high-pressure laminate top or Trespa TopLab Plus top that offers excellent chemical resistance.



Planner Science Table with Laminate Top

1 1/4" thick with vinyl edge band. Graphite Nebula laminate top with Black edge. Choose Black or Platinum frame.

- Supports up to 400 lbs.
- Table height adjusts 24" to 34" in 1" increments, meets ADA requirements.
- 1" adjustable leveling glides provide stability on uneven floors.

MODEL	DESCRIPTION	D"	W"	H"	F.C.	CUBE	WT.	UPS	2016 LIST
11260	Planner Science Table	24	48	24-34	70	2.3	85		\$ 447.00
11263	Planner Science Table	24	54	24-34	70	2.6	90		\$ 471.00
11266	Planner Science Table	24	60	24-34	70	2.9	95		\$ 496.00
11269	Planner Science Table	24	72	24-34	70	3.5	110		\$ 548.00



Model 11268. Shown in Grey Trespa TopLab Plus and Platinum frame. Shown with optional UXL™ Stack Chairs.

Trespa™ TopLab™ Plus Planner Table

This sturdy, contemporary science table provides sleek looks and solid functionality. Its Trespa TopLab Plus work surface is designed for maximum durability. It is resistant to a large number of aggressive chemicals (as identified by SEFA and PSI) if cleaned within 24 hours. The table provides ample space for projects of all kinds.

- Supports up to 400 lbs.
- Table height adjusts 24" to 34" in 1" increments, meets ADA requirements.
- 1" adjustable leveling glides provide stability on uneven floors.
- Color Choices: Black or Grey top; Platinum or Black frame.

Model 25715. Shown in Grey Trespa TopLab Plus and Platinum frame. Shown with optional UXL™ Stack Chairs.



MODEL	DESCRIPTION	D"	W"	H"	F.C.	CUBE	WT.	UPS	2016 LIST
24" deep									
11262	Trespa™ TopLab™ Plus Planner Science Table	24	48	24-34	70	2.3	112		\$ 1,163.00
11265	Trespa™ TopLab™ Plus Planner Science Table	24	54	24-34	70	2.6	122		\$ 1,296.00
11268	Trespa™ TopLab™ Plus Planner Science Table	24	60	24-34	70	2.9	130		\$ 1,395.00
11271	Trespa™ TopLab™ Plus Planner Science Table	24	72	24-34	70	3.5	152		\$ 1,628.00
30" deep									
11288	Trespa™ TopLab™ Plus Planner Science Table	30	60	24-34	70	3.5	152		\$ 1,628.00
42" deep									
25705	Trespa™ TopLab™ Plus Planner Science Table	42	60	24-34	70	5.0	180		\$ 2,246.00
25715	Trespa™ TopLab™ Plus Planner Science Table	42	72	24-34	70	6.0	202		\$ 2,618.00
48" deep									
25725	Trespa™ TopLab™ Plus Planner Science Table	48	60	24-34	70	5.8	240		\$ 2,523.00
25735	Trespa™ TopLab™ Plus Planner Science Table	48	72	24-34	70	7.0	284		\$ 2,951.00

Make it mobile with casters
Model 17576 \$76.00 List
See page 148 to order.

TRESPA COLOR CHOICE

- Black
- Grey

FRAME COLOR CHOICE

- Black
- Platinum



Planner Lab Station Model 24510. Shown in Grey Nebula top with Black edge and Black frame. Shown with optional Flat Panel Monitor Mount, Model 17350.

Planner Lab, One-, Two- and Three-Student

Provides maximum strength and stability. Keeps cables and wires tucked neatly away with an integral Wire Manager and wires tucked neatly away with an integral Wire Manager. Comes with handy backpack pegs. Choose from 11 standard laminate colors, 21 standard edge colors and two frame colors.

- Available in multiple lengths and widths, allowing you to create workstations for one, two and three students.
- 1 1/4" thick top with high pressure laminate surface and 3/8" thick bumper edge molding stapled every 8".
- Cord cutout at rear of work surface. 8" high x 3" deep Wire Manager of 16-gauge steel with cable ports.

MODEL	DESCRIPTION	D"	W"	H"	F.C.	CUBE	WT.	UPS	2016 LIST
24" deep models									
24610	Planner Lab Station One-student	24	36	22-32	70	1.8	56	*	\$ 413.00
24500	Planner Lab Station Two-student	24	48	22-32	70	2.4	68	*	\$ 459.00
24510	Planner Lab Station Two-student	24	60	22-32	70	3.0	80		\$ 523.00
24520	Planner Lab Station Two-student	24	72	22-32	70	3.6	92		\$ 575.00
24620	Planner Lab Station Three-student	24	84	22-32	70	4.2	104		\$ 634.00
30" deep models									
24530	Planner Lab Station One-student	30	30	22-32	70	2.0	59	*	\$ 421.00
24630	Planner Lab Station One-student	30	36	22-32	70	2.5	65	*	\$ 460.00
24540	Planner Lab Station Two-student	30	48	22-32	70	3.0	80	*	\$ 495.00
24550	Planner Lab Station Two-student	30	60	22-32	70	3.8	95		\$ 573.00
24560	Planner Lab Station Two-student	30	72	22-32	70	4.5	110		\$ 635.00
24570	Planner Lab Station Three-student	30	84	22-32	70	5.5	125		\$ 696.00

PLANNER LAB STATION LAMINATE COLOR CHOICE

- Amber Cherry
- Blond Echo
- Golden Oak
- Grey Nebula
- Pewter Mesh
- Wild Cherry
- Asian Night
- Fusion Maple
- Grey Mesh
- New Age Oak
- Tan Echo

FRAME COLOR CHOICE

- Black
- Platinum

PLANNER LAB STATION EDGE COLOR CHOICE

- Apple
- Burgundy
- Charcoal
- Forest Green
- Mocha
- Persian Blue
- Red
- Black
- Cerulean
- Chocolate
- Fuchsia
- Navy
- Platinum
- White
- Blueberry
- Champagne
- Clementine
- Mint
- Orange
- Purple
- Yellow

View all finish options on page 260.



Planner Cluster Work Centers

Provides maximum strength and stability. Its semi-hexagonal shape allows three students to work in a compact space against a wall. Or put two together for a compact six-student work group. Includes a cutout in the desktop and a Wire Manager. Choose from 11 standard laminate colors, 21 standard edge colors and two frame colors.

- 1 1/4" thick top with high-pressure laminate surface and 3/8" thick bumper edge.
- Adjustable table height from 22" up to 32" in 1" increments.
- Chrome-plated lower legs resist scuffing.
- Legs of 1 1/4" square, 12-gauge steel tubes with powder coat finish.
- 1" adjustable leveling glides provide stability on uneven floors.

MODEL	DESCRIPTION	D"	W"	H"	F.C.	CUBE	WT.	UPS	2016 LIST
24580	Cluster Work Center - Trap 40"x40"x40"x80"	35	80	22-32	70	5.4	125		\$ 769.00

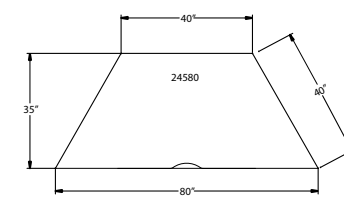

35" Deep Planner Work Center Top View



Shown with optional Flat Panel Mounts with Tilt, Model 17350 \$ 109.00

Planner Lab, Corner Station



This maximizes space utilization by allowing students to work in a corner. It provides the strength and stability that Planner Labs are known for. Cutout in desktop helps manage cables while allowing a snug fit against both walls. Choose from 11 standard laminate colors, 21 standard edge colors and two frame colors.

Shown in Fusion Maple top with Black edge and Platinum frame.

MODEL	DESCRIPTION	D"	W"	H"	F.C.	CUBE	WT.	UPS	2016 LIST
24600	Corner Planner Lab Station - 6 Sided Corner	30	48	22-32	70	5.8	114		\$ 689.00

Access Station, Single-, Two- and Three-Student



Provides maximum strength and stability for computer work, plus great security for cables and wires thanks to a locking Wire Manager. Comes with handy backpack peg. Choose from 11 standard laminate colors, 21 standard edge colors and two frame colors.

- Chrome-plated lower legs resist scuffing.
- 1" adjustable leveling glides provide stability on uneven floors.
- Full-length locking 6" deep door has cord cutouts, providing easy access to wires.
- Adjustable table height from 22" up to 32" in 1" increments.



Lift-up door with key lock standard. Wire Manager keeps wires tucked away neatly.

Shown in Grey Nebula top with Clementine edge and Platinum frame. Shown with optional Intuit™ Stack Chairs, Model 00560.

MODEL	DESCRIPTION		D"	W"	H"	F.C.	CUBE	WT.	UPS	2016 LIST
24" deep models*										
11140	Access Station	Single-student	24	30	22-32	70	3.5	56	*	\$ 502.00
11141	Access Station	Single-student	24	36	22-32	70	4.25	63	*	\$ 540.00
11142	Access Station	Single-student	24	42	22-32	70	5.0	70		\$ 578.00
11143	Access Station	Two-student	24	48	22-32	70	5.7	76		\$ 604.00
11144	Access Station	Two-student	24	60	22-32	70	7.0	93		\$ 690.00
11145	Access Station	Two-student	24	72	22-32	70	8.5	110		\$ 771.00
11146	Access Station	Three-Student	24	84	22-32	70	9.7	126		\$ 856.00
<i>*24" deep models will not accommodate Keyboard Trays.</i>										
30" deep models										
11160	Access Station	Single-student	30	30	22-32	70	4.4	72	*	\$ 532.00
11161	Access Station	Single-student	30	36	22-32	70	5.4	79	*	\$ 574.00
11162	Access Station	Single-student	30	42	22-32	70	6.2	86		\$ 617.00
11163	Access Station	Two-student	30	48	22-32	70	7.0	92		\$ 651.00
11164	Access Station	Two-student	30	60	22-32	70	9.3	109		\$ 746.00
11165	Access Station	Two-student	30	72	22-32	70	8.8	126		\$ 843.00
11166	Access Station	Three-Student	30	84	22-32	70	12.0	142		\$ 942.00

Access Station, 5-Sided Corner



This maximizes space utilization while providing maximum strength and stability, plus great security for cables and wires thanks to a locking Wire Manager. Choose from 11 standard laminate colors, 21 standard edge colors and two frame colors.

Shown in Blond Echo top with Cerulean edge and Platinum frame.

MODEL	DESCRIPTION		D"	W"	H"	F.C.	CUBE	WT.	UPS	2016 LIST
24" deep models*										
11147	Access Station	5-Sided Corner	24	48	22-32	70	8.0	112		\$ 891.00
30" deep models*										
11167	Access Station	5-Sided Corner	30	48	22-32	70	11.0	128		\$ 925.00



Casters

Add easy mobility to Planner Student Desks and Planner Computer Stations with these casters. Choose a set of two for wheelbarrow mobility, or a set of four for level mobility.

MODEL	DESCRIPTION	D"	W"	H"	F.C.	CUBE	WT.	UPS	2016 LIST	
17576	3" Dual-Wheel Caster Set of 4, 4 Locking				70	0.1	5	*	\$ 76.00	
<i>Limits leg height: 4 casters change desk height to 24.5" low to 34.5" high; wheelbarrow casters change desk height to 24.5" low to 32.5" high.</i>										
17554	4" Dual-Wheel Caster Pack Set of 4, 2 locking 4" dia.			4	70	0.2	5	*	\$ 107.00	
<i>Model 17554, not for wheelbarrowing</i>										



CPU Holder

Heavy steel plate mounts under work surface. Black steel tube frame with locks to hold tower in place.

MODEL	DESCRIPTION	D"	W"	H"	F.C.	CUBE	WT.	UPS	2016 LIST	
Optional Accessories										
17213	CPU Holder	14 - 18.5	8.5 - 11.6	16.75 - 21.25	70	0.5	12	*	\$ 159.00	
	• PC Dimensions	9.75 - 17.5	5.4 - 6	15.25 - 7.5						
17217	CPU Holder	14 - 18.75	8.5 - 9.2	13 - 17.25	70	0.5	10	*	\$ 149.00	
	• PC Dimensions	9.5 - 17.4	3 - 7.25	9.4 - 13.5						



Adjustable Keyboard Shelf

Features 6" height adjustment with 10° tilt and 180° swivel with easy single control. 11"d x 28"w steel tray has padded palm rest.

MODEL	DESCRIPTION	D"	W"	H"	F.C.	CUBE	WT.	UPS	2016 LIST	
17620	Pull-out Keyboard	adjustable height	17	28	6	70	1.3	20	*	\$ 270.00
17622	Pull-out Keyboard	adjustable height	17	20	6	70		20	*	\$ 265.00
<i>*24" deep Planner Access models will not accommodate Keyboard Trays.</i>										



Flat Panel Mount Tilt Model

Tilts and is height adjustable to optimize user ergonomics.

For additional Flat Panel Mounts, see page 163

MODEL	DESCRIPTION	D"	W"	H"	F.C.	CUBE	WT.	UPS	2016 LIST
17350	Flat Panel Mount w/ Tilt	8	5	18	70	0.9	6	*	\$ 109.00

Access Station Power Strips



Model 17081



Model 17084



Power Socket is durable and attaches securely to the work surface. Model 17060 with 15 ft. long cord.

MODEL	DESCRIPTION	D"	W"	H"	F.C.	CUBE	WT.	UPS	2016 LIST
17081	6 Outlet Electric Strip w/ Surge, 4' Cord	3	3	12	70	0.1	4	*	\$ 65.00
17084	10 Outlet Electric Strip w/ Surge, 15' Cord	3	8	12	70	0.1	5	*	\$ 152.00
17060	Power Socket (4 Power Plugs 2 Data Plugs) 15' Cord	3	10	7	70	0.01	4	*	\$ 192.00



CAD Desk

Split-Top work surface enables paper-and-pencil drafting and computer rendering. It features Planner construction for maximum strength and stability. Available in three color/finish combinations. Optional accessories for CAD Desk only.

- 3/4" thick top with high-pressure laminate surface and flat 3mm edge with pencil stop.
- Adjustable top slope has a range of 0 to 45 degrees.
- Adjustable table height (29"-39") accommodates stools.
- Fully box-welded leg sets of 1 3/16" x 2 1/2" 16-gauge steel tube with 1 1/4" square 14-gauge steel tube legs.

Shown with optional CPU Holder, **Model 17213** \$ 159.00.
Optional Flat-Panel Monitor Mount, **Model 17352** \$ 199.00.
Optional Intuit Adjustable Stool, **Model 00541** \$ 479.00.

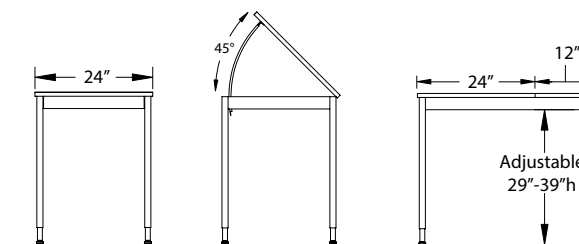

Split Top Graphic Arts Table, Model 27346. Shown in Grey top, Black edge and Black frame. Shown with optional Flavors Stool, Model 11890.

Graphic Arts Table

The Split-Top Graphic Arts Table provides both a standard adjustable incline area and a flat work surface. It features Planner construction for maximum strength and stability. Available in three color/finish combinations.

- 3/4" thick top with high-pressure laminate surface and flat 3mm edge with pencil stop.
- Adjustable top slope has a range of 0 to 45 degrees.
- Adjustable table height (29"-39") accommodates stools.
- Fully box-welded leg sets of 1 3/16" x 2 1/2" 16-gauge steel tube with 1 1/4" square 14-gauge steel tube legs.

MODEL	DESCRIPTION	D"	W"	H"	F.C.	CUBE	WT.	UPS	2016 LIST
27346	Graphic Arts Table Split Top	24	36	29-39	70	3.4	62	*	\$ 523.00



A rugged steel brace holds the tilting desktop securely in place.

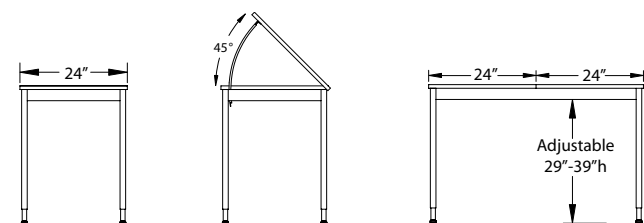

MODEL	DESCRIPTION	D"	W"	H"	F.C.	CUBE	WT.	UPS	2016 LIST
27344	CAD Station - two 24 x 24 Surfaces, 1 Slope Adjustable	24	48	29-39	70	5.2	72	*	\$ 769.00



One-Piece Slope-Top Graphic Arts Table, Model 27347. Shown in Cherry top, Black edge and Black frame.

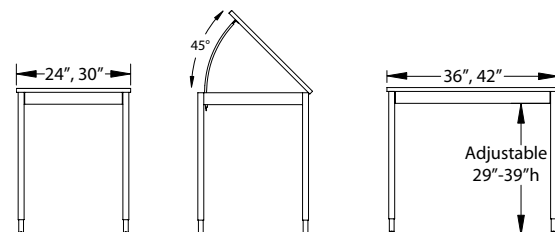

Graphic Arts Table

The One-Piece Slope-Top Graphic Arts Table provides a standard adjustable incline area. It features Planner construction for maximum strength and stability. Available in three color/finish combinations.

- 3/4" thick top with high-pressure laminate surface and flat 3mm edge with pencil stop.
- Adjustable top slope has a range of 0 to 45 degrees.
- Fully box-welded leg sets of 1 3/16" x 2 1/2" 16-gauge steel tube with 1 1/4" square 14-gauge steel tube legs.
- Adjustable table height (29"-39") accommodates stools.

MODEL	DESCRIPTION	D"	W"	H"	F.C.	CUBE	WT.	UPS	2016 LIST
27345	Graphic Arts Table One-Piece Top	24	36	29-39	70	3.4	62	*	\$ 516.00
27347	Graphic Arts Table One-Piece Top	30	42	29-39	70	5.7	80	*	\$ 679.00

Order one of our Stools to complete your Graphic Arts Desk.



Flavors Stool See page 24



Flavors Adj. Stool See page 26



Plato Adj. Stool See page 33



Plato Stool See page 35



Intuit Adj. Stool See page 39

ORDER COLOR CHOICE

TOP:
EDGE:
FRAME:

CHOICE 1
● Maple

CHOICE 2
● Cherry
● Black

CHOICE 3
● Grey
● Black



Planner Teacher Desk Model 24000. Shown in Fusion Maple top with Platinum edge and Platinum frame.



Planner Teacher Desk Model 24010D. Shown in Amber Cherry top with Champagne edge and Black frame. Shown with optional Dual Surface Desktop Lectern, Model 00471.

Planner Teacher Desk

Single and Double Pedestal

Built to withstand years of use, comes with a suspended double drawer, lockable for security, located on the right or left side. Drawers run full depth for maximum storage; their full extension ball bearing slides provide complete access and quiet operation.

Frame color choice: Black or Platinum.

- Steel front panel adds stability.
- "H" Frame construction adds strength.
- Rugged powder coat surface on legs resists wear.
- Welded-end leg sets don't shimmy or rock.
- Full-width pulls on drawers for easy use.
- Full-height sides on file drawers for hanging files.
- Durable desktop available in 1 1/4" thickness, all with a high-pressure laminate surface.
- Edge moldings resist wear, choices available (see chart).

MODEL	DESCRIPTION	D"	W"	H"	F.C.	CUBE	WT.	UPS	2016 LIST
24000	Planner Teacher Desk* Single Pedestal LH	30	48	29	70		130		\$ 935.00
24001	Planner Teacher Desk* Single Pedestal RH	30	48	29	70		130		\$ 935.00
24010	Planner Teacher Desk* Double Pedestal	30	60	29	70		168		\$ 1,188.00

* Planner Teacher Desks are for project jobs and have an eight week lead time. Please call Smith System for more information.

Planner Teacher Desks Have Top and Edge Choices

1 1/4" Tops

CHOICE 1 - 1 1/4" top with Bumper T-Mold no letter to follow Model No.

CHOICE 3 - 1 1/4" top with 4mm T-Mold to follow Model No.

We Quick Ship Cascade Teacher Desks, see pages 232-243.

AddPower SEE PAGE 258 FOR ORDER INFO

PLANNER DESK LAMINATE COLOR CHOICE

- Amber Cherry
- Blond Echo
- Golden Oak
- Grey Nebula
- Pewter Mesh
- Wild Cherry
- Asian Night
- Fusion Maple
- Grey Mesh
- New Age Oak
- Tan Echo

FRAME COLOR CHOICE

- Black
- Platinum

PLANNER DESK EDGE COLOR CHOICE

- Apple
- Burgundy
- Charcoal
- Forest Green
- Mocha
- Persian Blue
- Red
- Black
- Cerulean
- Chocolate
- Fuchsia
- Navy
- Platinum
- White
- Blueberry
- Champagne
- Clementine
- Mint
- Orange
- Purple
- Yellow

View all finish options on page 260.



Dual Surface Desktop Lectern, Model 00470.



Shown in Burgundy.

Dual Surface Desktop Lectern

Its distinctive shape allows the instructor to reference two sources simultaneously and, thanks to its rugged steel construction, it can support a laptop. Mount to tabletop with either our Clamp-On or Bolt-On Mount.

Color Choices: Choose from 20 powder coat color options.



Shown in Clementine.

Curl Top Desktop Lectern

This strong lectern can hold large, heavy reference materials and thanks to its curl top design, it can hold large books open. Mount to tabletop with either our Clamp-On or Bolt-On Mount.

Color Choices: Choose from 20 powder coat color options.

MODEL	DESCRIPTION	D"	W"	H"	F.C.	CUBE	WT.	UPS	2016 LIST
Dual Surface Desktop Lectern									
00470	w/Swing Arm	19	19	6	70	1.3	22	*	\$ 225.00
00471	w/Swing Arm	19	19	6	70	1.3	25	*	\$ 225.00
00472	w/Spring Loaded Swing Arm	19	19	6	70	1.3	23	*	\$ 250.00
Curl top Desktop Lectern									
00480	w/Swing Arm	14.5	19	4	70	0.6	19	*	\$ 225.00
00481	w/Swing Arm	14.5	19	4	70	0.6	22	*	\$ 225.00
00482	w/Spring Loaded Swing Arm	14.5	19	4	70	0.6	20	*	\$ 250.00



Mobile Lectern

Combining a Deluxe Tabletop Lectern with a Box/Box/File pedestal with 2" casters. Model 04622.

Top: Choose from our 11 laminate colors.

Edge: Choose from our 21 edge colors.

Base: Choose Black or Platinum.



Deluxe Tabletop Lectern

High-pressure laminate top with retainer and large storage area for reference materials. Model 04619.

Top: Choose from our 11 laminate colors.

Edge: Choose from our 21 edge colors.

Base: Choose Black or Platinum.



Teacher Wardrobe Cabinet and 2-Drawer and 4-Drawer File

Steel construction. Compartments and drawers lock. Drawers have an interlock system that prevents accidental tipping caused by more than one drawer opening at a time. Full extension ball bearing slides allow full access to drawer contents. Black or Platinum.

- Drawers have tall sides to accommodate hanging folders.
- Cabinets are fully welded 20-gauge steel with heavy-gauge bracing for long-term use.
- Full width integral pulls increase safety and enhance aesthetics.
- Full extension ball bearing slides allow full drawer access.

MODEL	DESCRIPTION	D"	W"	H"	F.C.	CUBE	WT.	UPS	2016 LIST
19175	Teacher Wardrobe Cabinet*	24	24	54	175	13.5	161		\$ 1,472.00
19160	2 Drawer File*	15	26.5	28	125	7.3	75		\$ 398.00
19161	4 Drawer File*	15	26.5	52	125	13	135		\$ 712.00

* Items are for project jobs and have an eight week lead time. Please call Smith System for more information. Not a drop ship item.

MODEL	DESCRIPTION	D"	W"	H"	F.C.	CUBE	WT.	UPS	2016 LIST
04622	Mobile Lectern Drawer Pedestal	20	18	38	85	8.7	76		\$ 552.00
04619	Deluxe Tabletop Lectern	20	18	13	125	3.0	21		\$ 197.00



Mobile Lectern

Fully welded heavy-gauge steel with laminate top, three storage shelves, retaining lip on surface, grommet holes for wires. 3" dual wheel casters for mobility (two locking). Model 00502.

Top: Choose from our 11 laminate colors.

Edge: Choose from our 21 edge colors.

Base: Black.



Projector Lectern

Cart accommodates digital and over-head projectors alongside its 18" x 20" lectern that can be positioned on the right or left. Base unit features storage shelf. 16" x 18" projector area includes rubber mat to steady equipment. Lectern and base have grommet holes for routing wires. 3" dual wheel casters add mobility (two locking). Model 04620.

Top: Choose from our 11 laminate colors.

Edge: Choose from our 21 edge colors.

Base: Black.

MODEL	DESCRIPTION	D"	W"	H"	F.C.	CUBE	WT.	UPS	2016 LIST
00502	Mobile Lectern	17	25	44	175	12.0	64		\$ 560.00
04620	Projector Lectern Cart	18	30	42	85	11.1			\$ 644.00

Lecterns Have Top and Edge Choices

3/4" Tops

CHOICE 1 - 3/4" top with 4mm T-Mold
C to follow Model No.

CHOICE 2 - 3/4" top with Bullet T-Mold
V to follow Model No.



Bookcases

34 1/2" wide Bookcases are available in three heights: 29" with one adjustable shelf, 47" with three adjustable shelves and 59" with four adjustable shelves to be adjusted in 1" increments with easy-to-use clips. Fully welded 20-gauge steel. Black or Platinum.

- 34 1/2" wide Bookcases are available in three heights: 29" with one adjustable shelf, 47" with three adjustable shelves and 59" with four adjustable shelves.
- The bookcase's bends and joints are designed for extended usefulness.
- Bookcase is fully welded 20-gauge steel.
- The shelves are constructed of 20-gauge steel with 'C' brackets for added strength.

MODEL	DESCRIPTION	D"	W"	H"	F.C.	CUBE	WT.	UPS	2016 LIST
19164	2-Shelf Bookcase*	12.5	34.5	29	125		52		\$ 385.00
19165	4-Shelf Bookcase*	12.5	34.5	47	125		72		\$ 587.00
19166	5-Shelf Bookcase*	12.5	34.5	59	125		92		\$ 688.00

* Items are for project jobs and have an eight week lead time. Please call Smith System for more information. Not a drop ship item.

PLANNER LECTERN LAMINATE COLOR CHOICE

- Amber Cherry
- Fusion Maple
- Grey Nebula
- Tan Echo
- Asian Night
- Golden Oak
- New Age Oak
- Wild Cherry
- Blond Echo
- Grey Mesh
- Pewter Mesh

FRAME COLOR CHOICE

- Black
- Platinum Platinum for Model 04619 & 04622 only.

PLANNER LECTERN EDGE COLOR CHOICE & POWDER COAT COLOR CHOICE FOR DUAL SURFACE / CURL TOP

- Apple
- Burgundy
- Charcoal
- Forest Green
- Mocha
- Persian Blue
- Red
- Black
- Cerulean
- Chocolate
- Fuchsia
- Navy
- Platinum
- Blueberry
- Champagne
- Clementine
- Mint
- Orange
- Purple
- Yellow

View all finish options on page 260.



AddPower

This symbol indicates you can add power to select tables.



You will find the "ADD POWER" logo throughout this catalog. It signifies which Smith System tables are compatible with our 2016 power units.

When ordering, please submit a drawing with your order to indicate the desired positioning of the power unit on the work surface. All power accessories are special order, a custom feature per table and are non-returnable. For more information call 800.328.1061.



Flat Power Module

Shown, Model 017098 SLV
1 power, 1 Twin USB port

MODEL	DESCRIPTION	D"	W"	H"	UPS	2016 LIST
017098 SLV	1 power, 1 Twin USB port				*	\$ 260.00
017097 SLV	2 power				*	\$ 175.00



NEW 2016 Soft Touch Dome Power Module

Shown, Model 017079 BLA
2 power, 1 Twin USB port,
1 power cord

MODEL	DESCRIPTION	D"	W"	H"	UPS	2016 LIST
017079 BLA	2 power, 1 Twin USB port				*	\$ 245.00
017078 BLA	3 power				*	\$ 160.00



Dome Power Module

4 power
2 power cords

MODEL	DESCRIPTION	D"	W"	H"	UPS	2016 LIST
017088 BLA	4 power	3.5	3.56	3.86	*	\$ 220.00



Surface Power Module

Shown, Model 017093 SLV
4 power

MODEL	DESCRIPTION	D"	W"	H"	UPS	2016 LIST
017093 SLV	4 power	3	8	.11	*	\$ 350.00
017086 SLV	2 power, 4 USB	3	8	.11	*	\$ 350.00



Retractable Power Module

Shown, Model 017085 SLV
2 power, 2 Twin USB ports

MODEL	DESCRIPTION	D"	W"	H"	UPS	2016 LIST
017085 SLV	2 power, 4 USB	4.43	8.25	1.34	*	\$ 495.00
017092 SLV	4 power	4.43	8.25	1.34	*	\$ 495.00



Retractable Mini Power Module

2 power

MODEL	DESCRIPTION	D"	W"	H"	UPS	2016 LIST
017091 SLV	2 power	3.7	3.7	1.17	*	\$ 250.00

Mounts for tables, desks and workstations.



Flat Panel Mount

Tilt Model 17350
Tilts and is height adjustable to optimize user ergonomics.



Flat Panel Mount

Tilt & Swivel Model 17351
Tilts, swivels and is height adjustable to optimize user ergonomics.



Flat Panel Mount

Swing-Out Arm with Tilt & Swivel Model 17352
It can be tilted, swiveled, raised, lowered and moved closer to the user. Bolt-On model shown.



Flat Panel Mount

Swing-Out Arm with Tilt & Swivel Model 17353
It can be tilted, swiveled, raised, lowered and moved closer to the user. Clamp-On model shown.



Spring-Loaded Flat Mount

Spring-Loaded Mount Model 17655
It can be tilted, swiveled, raised, lowered and moved closer to the user. Spring loaded arm enables one-handed adjustments.

MODEL	DESCRIPTION	D"	W"	H"	F.C.	CUBE	WT.	UPS	2016 LIST
17350	Flat Panel Mount	8	5	18	70	0.9	6	*	\$ 109.00
17351	Flat Panel Mount	7	5	18	70	0.9	6	*	\$ 149.00
17352	Flat Panel Mount Swing-out Arm	7	5	18	70	0.9	8	*	\$ 199.00
17353	Flat Panel Mount Swing-out Arm	7	6	20	70	1.1	11	*	\$ 199.00
17655	Flat Panel Mount	5	5	21	70	0.35	11	*	\$ 199.00



Pole Leg Riser Shelf

Clamp-On Pole (Platinum only). 1 1/4" Top available in 11 standard laminate colors and 21 standard edge colors to match Planner Lab.

MODEL	DESCRIPTION	D"	W"	H"	F.C.	CUBE	WT.	UPS	2016 LIST
17665	Riser Shelf	12	24	12	70	0.5	26	*	\$ 212.00
17666	Riser Shelf	12	30	12	70	0.6	29	*	\$ 239.00
17667	Riser Shelf	12	36	12	70	0.75	34	*	\$ 263.00
17668	Riser Shelf	12	48	12	70	1.0	45	*	\$ 311.00
17669	Riser Shelf	12	60	12	70	1.25	51		\$ 356.00
17677	Riser Shelf	12	72	12	70	1.5	73		\$ 499.00
17679	Riser Shelf	12	84	12	70	1.75	94		\$ 634.00
17680	Riser Shelf	12	90	12	70	1.9	106		\$ 651.00



Meeting Tables

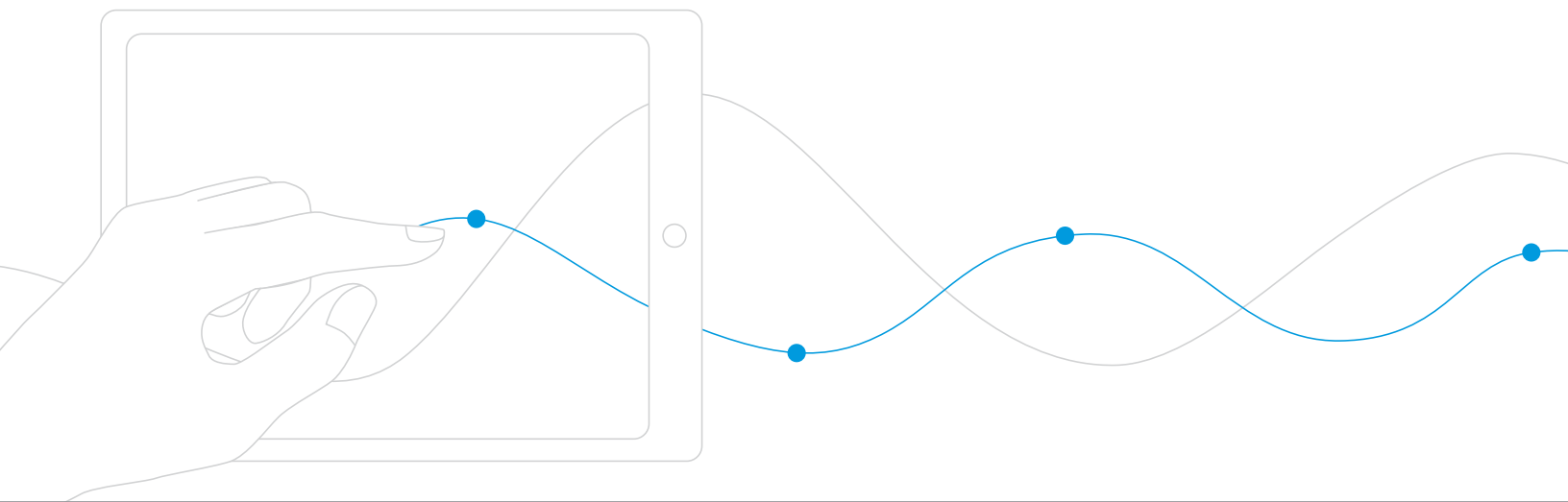

More options for collaborative, social and distance learning.

- [Large Round End Multi-Media Table](#)
SEE PAGE 168
- [Half Boat Multi-Media Table](#)
SEE PAGE 169
- [Rectangle Multi-Media Table](#)
SEE PAGE 169
- [Medium Multi-Media Table](#)
SEE PAGE 170
- [Oval Double Café Table](#)
SEE PAGE 171
- [Square Café Tables](#)
SEE PAGE 175
- [Round Café Tables](#)
SEE PAGE 178

From now on, students will be working together on all of their academic subjects. In some cases, they may work on two or more subjects at the same time. Additionally, more and more students are participating in "distance learning," receiving lectures or instruction via video from teachers located away from the classroom.

These new methods for learning require new resources, created expressly to facilitate their instruction. The wide variety of Smith System meeting tables addresses both traditional and emerging needs (with special attention paid to connectivity) identified for classrooms, labs and commons areas.

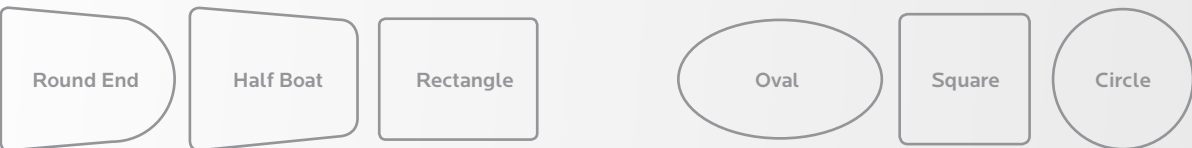

Multi-Media Tables

Café Table Tops

AddPower

-  **Surface Power Module**
Shown, Model 017093 SLV
4 power
SEE PAGE 258
-  **Retractable Power Module**
Shown, Model 017085 SLV
2 power, 4 USB
SEE PAGE 258



Medium Round End Multi-Media Table

Three to four students can gather for group work or distance learning. While not shown here, power is available.



Large Round End Multi-Media Table

Eye contact for those at the table plus great sightlines to an end-mounted flatscreen. Note the optional integrated power supply in the work surface.



Oval Café Table

This inviting table encourages student interaction. Both 29" and 42" high bases available.



Shown: Two Round End Multi-Media Tables, Model 04138.
 Shown in Asian Night top with Charcoal edge and Platinum frame.
 Shown with optional Intuit Adjustable Height Stools in Cerulean
 and two optional TV Mounts, Model 17354.



Round End Multi-Media Table, Model 04138
Shown in Pewter Mesh top with Charcoal edge and Platinum frame. Shown with optional Flavors Chairs in Charcoal and optional TV Mount, Model 17354.

Make it mobile with casters
Order Model 17576
\$ 76.00 List



Shown, 2, Flat Surface Power Module
Model 017086 SLV
2 Power, 4 USB Ports

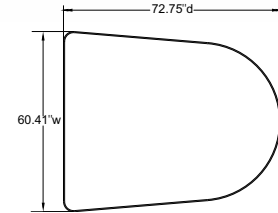

Large Round End Multi-Media Table

Features lines that flare, providing clear sightlines for individuals viewing the monitor, participating in distance learning or engaged in group discussions or presentations. It comfortably accommodates two along each side and two at the head of the table.

MODEL	DESCRIPTION	D"	W"	H"	F.C.	CUBE	WT.	UPS	2016 LIST
04137	Round End Multi-Media Table	No Power	72.75	60.5	22-34		170		\$ 995.00
04138	Round End Multi-Media Table	4 Power & 8 USB	72.75	60.5	22-34		170		\$ 1,695.00
04139	Round End Multi-Media Table	8 Power	72.75	60.5	22-34		170		\$ 1,695.00
04140	Round End Multi-Media Table	6 Power & 4 USB	72.75	60.5	22-34		170		\$ 1,695.00
Optional Accessory									
17354	TV Mount	32-50" Monitors/TVs	13	32	25	70		38	\$ 495.00

*Add "M" to table model number when ordering mount 17354. Mount will be centered.

Note: The tables on these pages are oversized and leave factory with extra packaging. Call for shipping weights.

MEETING TABLE LAMINATE COLOR CHOICE

- Amber Cherry
- Blond Echo
- Golden Oak
- Grey Nebula
- Pewter Mesh
- Wild Cherry
- Asian Night
- Fusion Maple
- Grey Mesh
- New Age Oak
- Tan Echo

FRAME COLOR CHOICE

- Black
- Platinum

MEETING TABLES EDGE COLOR CHOICE

- Apple
- Burgundy
- Charcoal
- Forest Green
- Mocha
- Persian Blue
- Red
- Black
- Cerulean
- Chocolate
- Fuchsia
- Navy
- Platinum
- White
- Blueberry
- Champagne
- Clementine
- Mint
- Orange
- Purple
- Yellow

View all finish options on page 260.

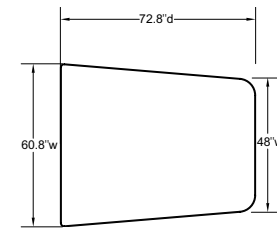

Half Boat Multi-Media Table

When used alone, this sleek contemporary desk promotes interaction by allowing eye contact with all at the table. It's also great for distance learning labs when a monitor is placed at one end. Combine two for large group work. Order it in any of 11 standard laminate colors, 21 edge colors, and Black or Platinum frame.

Shown in Fusion Maple top with Platinum edge and Platinum frame. Shown with optional Flavors Chairs in Charcoal and optional TV Mount, Model 17354.

MODEL	DESCRIPTION	D"	W"	H"	F.C.	CUBE	WT.	UPS	2016 LIST
Half Boat Multi-Media Table									
04235	Half Boat Multi-Media Table	No Power	72.8	48-60	22-34	70	9	193	\$ 1,025.00
04236	Half Boat Multi-Media Table	4 Power & 8 USB	72.8	48-60	22-34	70	9	193	\$ 1,725.00
04237	Half Boat Multi-Media Table	8 Power	72.8	48-60	22-34	70	9	193	\$ 1,725.00
04238	Half Boat Multi-Media Table	6 Power & 4 USB	72.8	48-60	22-34	70	9	193	\$ 1,725.00
Optional Accessory									
17354	TV Mount	32-50" Monitors/TVs	13	32	25	70		38	\$ 495.00

*Add "M" to table model number when ordering mount 17354. Mount will be centered.

Note: The tables on these pages are oversized and leave factory with extra packaging. Call for shipping weights.

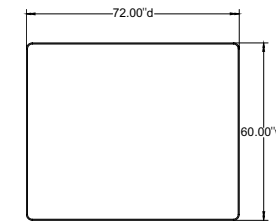

Rectangle Multi-Media Table

This spacious rectangular table with sleek contemporary looks provides generous workspaces with the option of integrated power and USB, conveniently located on the work surface. Order it in any of 11 standard laminate colors, 21 edge colors and Black or Platinum frame.

Shown in Grey Mesh top with White edge and Platinum frame. Shown with optional UXL Adjustable Stools and optional TV Mount, Model 17354.

MODEL	DESCRIPTION	D"	W"	H"	F.C.	CUBE	WT.	UPS	2016 LIST
Rectangle Multi-Media Table									
04146	Large Multi-Media Table	No Power	72	60	22-34	70	10	217	\$ 1,025.00
04147	Large Multi-Media Table	4 Power & 8 USB	72	60	22-34	70	10	217	\$ 1,725.00
04148	Large Multi-Media Table	8 Power	72	60	22-34	70	10	217	\$ 1,725.00
04149	Large Multi-Media Table	6 Power & 4 USB	72	60	22-34	70	10	217	\$ 1,725.00
Optional Accessory									
17354	TV Mount	32-50" Monitors/TVs	13	32	25	70		38	\$ 495.00

*Add "M" to table model number when ordering mount 17354. Mount will be centered.

Note: The tables on these pages are oversized and leave factory with extra packaging. Call for shipping weights.



Oval Double Café Table, Model 01544
Shown in Asian Night laminate with Charcoal edge and Platinum frame. Shown with two, 2 power Flat Power Modules and standing height 24" dia. Circular Café Bases.

Oval Double Café Table

Its oval shape was borrowed from the tables in coffee shops with the intention of promoting casual, unforced interaction among students in social learning situations. Its height allows students to walk up and immediately join a conversation with students seated on stools. It also offers the option of integrated power and USB connectivity, conveniently located on the work surface. Order it in any of 11 standard laminate colors, 21 edge colors, and Black or Platinum base.

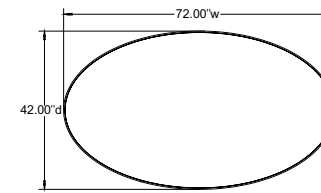

Shown in New Age Oak top with Platinum edge and Platinum frame. Shown with optional Flavors™ Chairs and optional TV Mount, Model 17354.

Make it mobile with casters
Order Model 17576
\$ 76.00 List

Medium Multi-Media Table

Designed to accommodate three to four students in a compact area, this table with sleek contemporary looks can be used for small group work or distance learning. It also offers the option of integrated power and USB connectivity, conveniently located on the work surface. Order it in any of 11 standard laminate colors, 21 edge colors, and Black or Platinum frame.

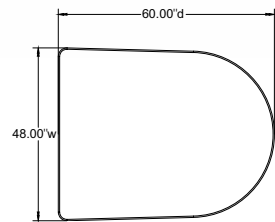

MODEL	DESCRIPTION	D"	W"	H"	F.C.	CUBE	WT.	UPS	2016 LIST
Medium Multi-Media Table									
04160	Medium Group Table	No Power	60	44-48	22-34	70	5.8	153	\$ 749.00
04161	Medium Group Table	2 Power & 4 USB	60	44-48	22-34	70	5.8	153	\$ 1,099.00
04162	Medium Group Table	4 Power	60	44-48	22-34	70	5.8	153	\$ 1,099.00
Optional Accessory									
17354	TV Mount	32-50" Monitors/TVs	13	32	25	70		38	\$ 495.00

*Add "M" to table model number when ordering mount 17354. Mount will be centered.

Large Monitor Mount

The large monitor table mount allows 32 – 50" monitors or TVs to be easily mounted to a table for use in conferences, displays or presentations. Great for a multimedia table such as our Round End Group Table, 04137, 04138, 04139, 04140. This mount bolts to the table top for a sturdy long lasting presentation aide. Mount is adjustable in height to allow a variety of monitor sizes. **Accommodates VESA mounting, 100mm x 100mm to 400mm x 200mm**, and 100 lb. max weight. Also comes with a keyed lock for security. Available in Platinum only.



MODEL	DESCRIPTION	D"	W"	H"	F.C.	CUBE	WT.	UPS	2016 LIST
17354	TV Mount	32-50" Monitors/TVs	7	18	19-23	70		38	\$ 495.00

*Add "M" to table model number when ordering mount 17354. Mount will be centered.

MODEL	DESCRIPTION	D"	W"	H"	F.C.	CUBE	WT.	2016 LIST
Standing Height								
01543	Oval Double Café two, 4 Power Dome	42	72	42	100	14	140	\$ 1,189.00
01544	Oval Double Café two, 2 Power Flat	42	72	42	100	14	140	\$ 1,099.00
01545	Oval Double Café one, 2 Power Flat, one 1 Power 2 USB	42	72	42	100	14	140	\$ 1,184.00
01546	Oval Double Café two, 1 Power 2 USB	42	72	42	100	14	140	\$ 1,269.00
01552	Oval Double Café No Power	42	72	42	100	14	140	\$ 749.00
01554	Oval Double Café two, 3 Power Soft Touch Dome	42	72	42	100	14	140	\$ 1,069.00
01555	Oval Double Café two, 2 Power Soft Touch Dome, 1 Twin USB	42	72	42	100	14	140	\$ 1,239.00
01556	Oval Double Café one, 3 Power Soft Touch Dome, one 2 Power, 1 Twin USB	42	72	42	100	14	140	\$ 1,154.00
Seating Height								
01547	Oval Double Café two, 4 Power Dome	42	72	29	100	14	140	\$ 1,149.00
01548	Oval Double Café two, 2 Power Flat	42	72	29	100	14	140	\$ 1,059.00
01549	Oval Double Café one, 2 Power Flat, one 1 Power 2 USB	42	72	29	100	14	140	\$ 1,144.00
01551	Oval Double Café two, 1 Power 2 USB	42	72	29	100	14	140	\$ 1,229.00
01553	Oval Double Café No Power	42	72	29	100	14	140	\$ 709.00
01557	Oval Double Café two, 3 Power Soft Touch Dome	42	72	42	100	14	140	\$ 1,029.00
01558	Oval Double Café two, 2 Power Soft Touch Dome, 1 Twin USB	42	72	42	100	14	140	\$ 1,199.00
01559	Oval Double Café one, 3 Power Soft Touch Dome, one 2 Power, 1 Twin USB	42	72	42	100	14	140	\$ 1,114.00

MEETING TABLE LAMINATE COLOR CHOICE

Amber Cherry	Blond Echo	Golden Oak	Grey Nebula	Pewter Mesh	Wild Cherry
Asian Night	Fusion Maple	Grey Mesh	New Age Oak	Tan Echo	

BASE COLOR CHOICE

Black	Platinum
-------	----------

MEETING TABLE EDGE COLOR CHOICE

Apple	Burgundy	Charcoal	Forest Green	Mocha	Persian Blue	Red
Black	Cerulean	Chocolate	Fuchsia	Navy	Platinum	White
Blueberry	Champagne	Clementine	Mint	Orange	Purple	Yellow

View all finish options on page 260.

Note: The tables on these pages are oversized and leave factory with extra packaging.





Plug-In, recharge and collaborate

Our Café tables are a popular choice for creating casual meeting areas in commons areas. Students can gather and collaborate in a more laid back atmosphere.

Available in four heights

16"	29"	36"	42"
COFFEE	SITTING	K-8 STANDING	STANDING



42" Round Café Table
Shown with 42"h, 30" Circular Base
Grey Mesh top with Platinum Edge
(01506 top + 01457 base + 017097 power)



36" Square Café Table
Shown with 42"h, 24" Circular Base
Grey Nebula top with Persian Blue Edge
(01503 top + 01453 base + 017097 power)



30" Square Café Table
Shown with 36"h, 24" crisscross base.
Wild Cherry top with Black edge.
(01501 top + 01460 base + 017097 power)



36" Round Café Table
Shown with 36"h, 24" circular base.
Pewter Mesh top with Clementine edge.
(01504 top + 01452 base + 017097 power)



48" Round Café Table
Shown with 29"h, 30" circular base,
New Age Oak top with Navy Edge.
(01507 top + 01455 base + 017097 power)



36" Square Café Table
Shown with Grey Nebula top with Persian Blue edge. 42"h, 30" circular base.
(01503 top + 01457 base + 017097 power)



30" Round Café Table
Shown with 42"h, 24" crisscross base.
Asian Night top with Apple edge.
(01502 top + 01461 base + 017097 power)



42" Round Café Table
Shown with 29"h, 30" crisscross base,
Grey Mesh top with Platinum Edge.
(01506 top + 01463 base + 017097 power)



Meeting Café Tables



30" Round Top with 42" h Circular Base (Top 01502 + Base 01453 + 017098 Flat Power)

42" Round Top with 29" h Circular Base (Top 01506 + Base 01455, No Power)

36" Round Top with 36" h Circular Base (Top 01504 + Base 01452, No Power)

36" Round Top with 16" h Circular Base (Top 01504 + Base 01450, No Power)



Circular Base



Crisscross Base

Base Color Options

Crisscross and Circular bases are available in Platinum and Black. Both base options come with an extra durable coating that protects the integrity of the powdercoat finish over time.

● Platinum ● Black

CAFE BASE COMPATIBILITY CHART / RECOMMENDED PAIRING

	24" Circular	30" Circular	24" Crisscross	30" Crisscross
Round 30" dia.	X		X	
Round 36" dia.	X		X	
Round 42" dia.		X		X
Round 48" dia.		X		X
Square 30x30	X		X	
Square 36x36	X	X		X
Square 42x42		X		X



Café Tables are a popular choice for creating casual meeting areas in commons, libraries and classrooms. Start by choosing (1) a top, (2) then choose from four heights: 42" Standing Height, 36" K-8 Standing Height, 29" Sitting Height or 16" Coffee Height. Next, choose from Circular or Crisscross styles. Both 42" and 36" Standing Height models offer Backpack hooks, standard. (3) Choose optional power for the top, power cord runs out bottom of base. 1 1/4" thick top available in all standard finishes. Bases available in Platinum or Black.

1) Café Top - Choose Table Top

MODEL	DESCRIPTION	D"	W"	H"	F.C.	CUBE	WT.	UPS	2016 LIST
Square Café Table Tops									
01501	Square top only	30	30		70	1.5	29	*	\$ 161.00
01503	Square top only	36	36		70	2.25	42	*	\$ 190.00
01505	Square top only	42	42		70	3.0	57	*	\$ 241.00
Round Café Table Tops									
01502	Round top only	30" dia.			70	1.5	25	*	\$ 155.00
01504	Round top only	36" dia.			70	2.25	33	*	\$ 184.00
01506	Round top only	42" dia.			70	3.0	45	*	\$ 235.00
01507	Round top only	48" dia.			70	4.0	58		\$ 273.00

VIEW CHART ON PAGE 178

2) Café Base - Choose Base

MODEL	DESCRIPTION	D"	W"	H"	F.C.	CUBE	WT.	UPS	2016 LIST
Circular Bases									
01450	24" Circular Base coffee table height	24" dia.		16	70	5.5	38	*	\$ 280.00
01451	24" Circular Base sitting height	24" dia.		29	70	6.75	39	*	\$ 290.00
01452	24" Circular Base k-8 standing height	24" dia.		36	70	8.5	42	*	\$ 300.00
01453	24" Circular Base standing height	24" dia.		42	70	10.0	45	*	\$ 310.00
01454	30" Circular Base coffee table height	30" dia.		16	70	8.5	55	*	\$ 345.00
01455	30" Circular Base sitting height	30" dia.		29	70	8.5	56	*	\$ 355.00
01456	30" Circular Base k-8 standing height	30" dia.		36	70	10.75	59	*	\$ 365.00
01457	30" Circular Base standing height	30" dia.		42	70	12.25	62	*	\$ 375.00
Crisscross Bases									
01458	24" Crisscross Base coffee table height	24" dia.		16	70	5.5	16	*	\$ 240.00
01459	24" Crisscross Base sitting height	24" dia.		29	70	6.75	17	*	\$ 250.00
01460	24" Crisscross Base k-8 standing height	24" dia.		36	70	8.5	20	*	\$ 260.00
01461	24" Crisscross Base standing height	24" dia.		42	70	10.0	23	*	\$ 270.00
01462	30" Crisscross Base coffee table height	30" dia.		16	70	8.5	20	*	\$ 260.00
01463	30" Crisscross Base sitting height	30" dia.		29	70	8.5	21	*	\$ 270.00
01464	30" Crisscross Base k-8 standing height	30" dia.		36	70	10.75	24	*	\$ 280.00
01465	30" Crisscross Base standing height	30" dia.		42	70	12.25	27	*	\$ 290.00

3) Café Power - Choose Surface Power



MODEL	DESCRIPTION	F.C.	CUBE	WT.	UPS	2016 LIST
017088	Power Dome 4 Power	70	.25		*	\$ 220.00
017097	Flat Surface Power Module 2 Power	70	.25		*	\$ 175.00
017098	Flat Surface Power Module 1 Power / 1 Twin USB	70	.25		*	\$ 260.00
017079	Soft Touch Dome 2 Power / 1 Twin USB					\$ 245.00
017078	Soft Touch Dome 3 Power					\$ 160.00



Acrobat™

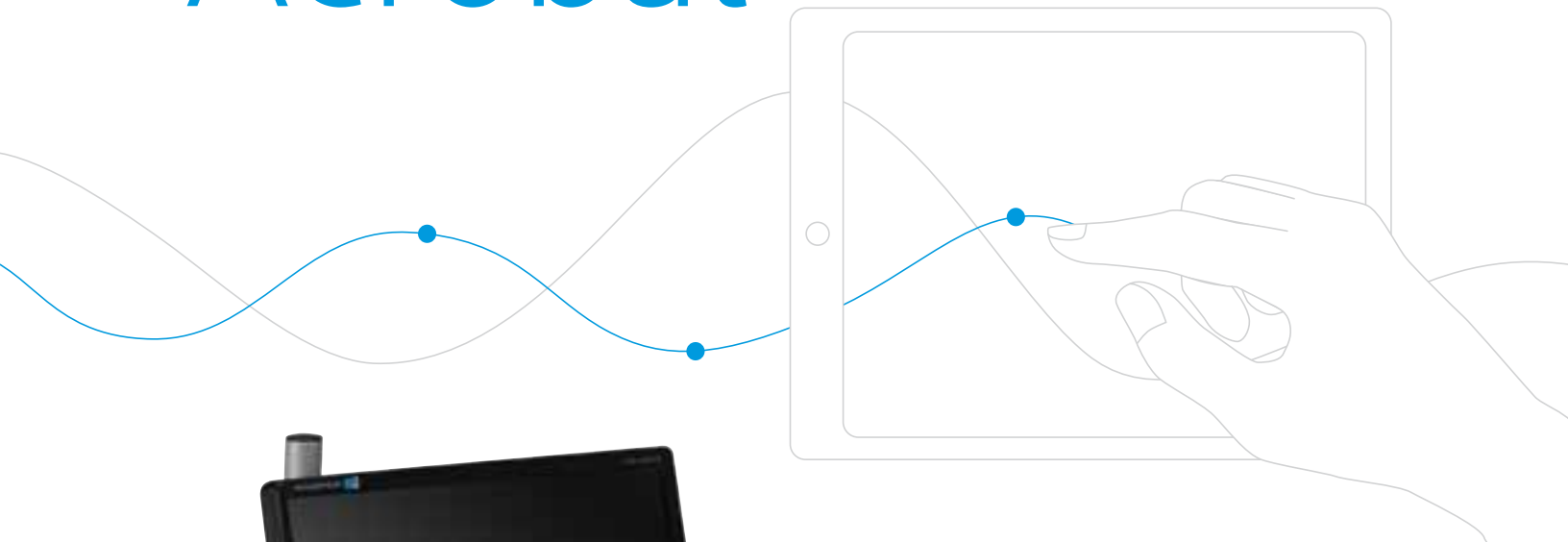

Single-Student Desk



Two-Student Desk



Three-Student Desk



Instructor Desk



Corner Workstation



Bullet Workstation



Contour Workstation

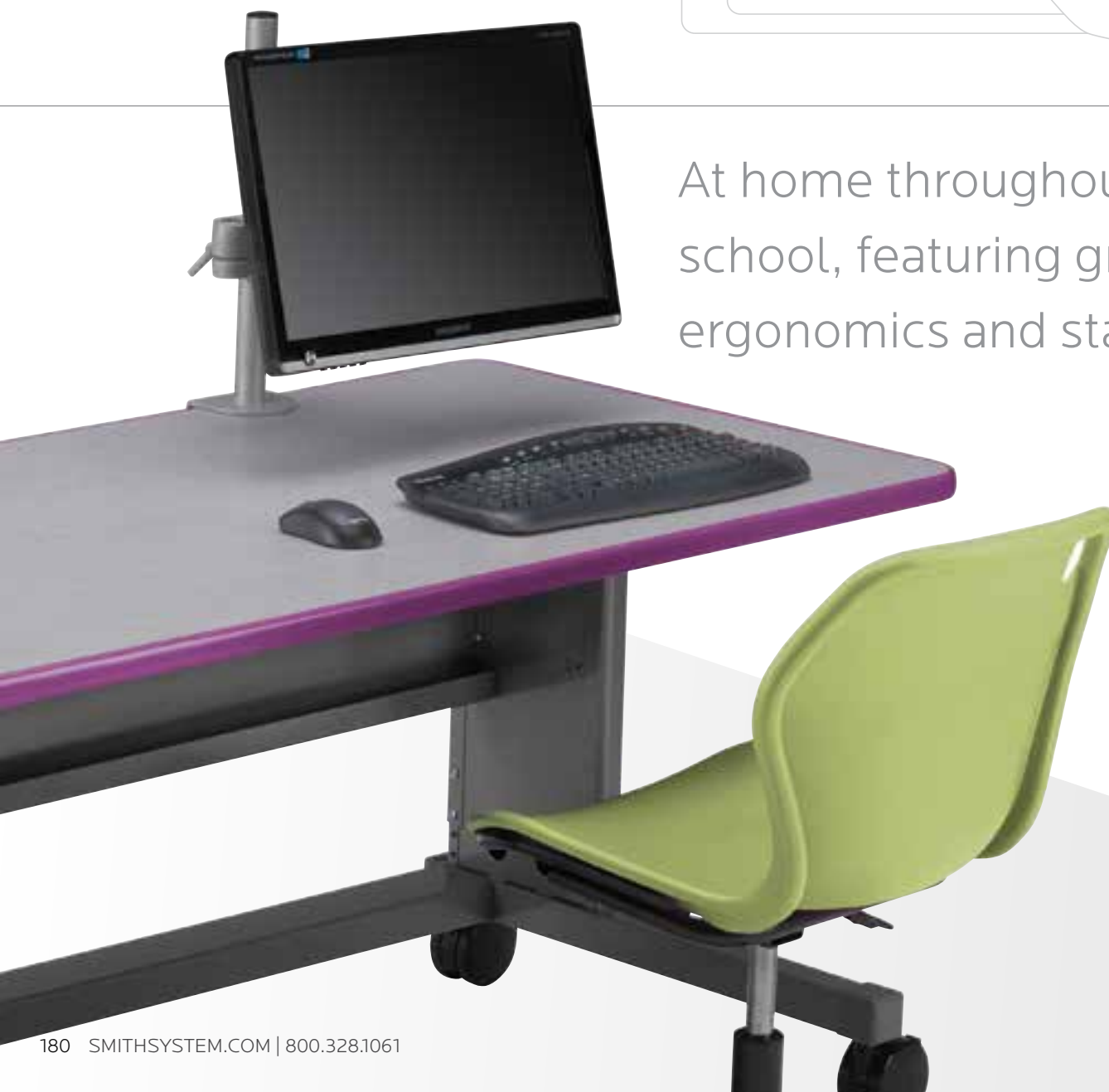

At home throughout the school, featuring great ergonomics and stability.

Unique design integrates functionalities.

- Cantilever design moves legs out of the way and allows great ingress and egress.
- Integrated modesty panel with integral cable management system.
- Can be used in the classroom, computer lab, commons or administrative area.

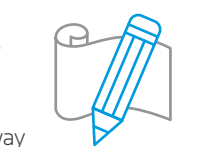

Add more functionality with options.

- Casters add mobility.
- Drawer Pedestal and pull-out Knee Drawer add storage.
- Detachable Planner™ Conference Table converts the desk into a peninsula for small conferences.



Unbeatable construction.

- The T-Mold edge band is stapled every six inches to provide superior fastening power.
- The work surfaces are high-pressure laminate that stand up to heavy use.

Dependability.

- Lifetime warranty on the frame and legs, 12-year warranty on table and desktops.



Healthy construction.

- UL Greenguard Gold certified.

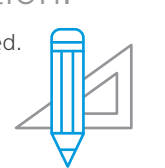





Shown in Blond Echo top with White edge and Platinum frame. Shown with optional Intuit™ Stack Chair, Model 00561.



Shown in Fusion Maple top with Mint edge and Platinum frame. Shown with optional casters, Model 17554; optional Intuit™ Adjustable Chair, Model 00531; and optional Flat Panel Mount, Model 17351.

Acrobat Single-Student Rectangle Desk

Combining maximum stability, a generous workspace and great ingress/egress, the Acrobat Single-Student Rectangle Desk also offers an integrated modesty panel and wire manager. Choose from 11 standard laminate colors, 21 standard edge colors and two frame colors.

- Cable tray and port holes in the modesty panel keep wires neatly organized.
- Strong 10" deep double-wall legs are 18-gauge steel with radius corners.
- The base is 16-gauge steel, color matched to the legs, featuring lock-in-place end caps and adjustable leveling glides.

MODEL	DESCRIPTION	D"	W"	H"	F.C.	CUBE	WT.	UPS	2016 LIST
20" deep models									
26280	Single-Student Desk	20	30	24-36	70	2.6	77	*	\$ 541.00
26281	Single-Student Desk	20	36	24-36	70	3.1	83	*	\$ 575.00
26282	Single-Student Desk	20	48	24-36	70	4.1	95	*	\$ 627.00
24" deep models									
26383	Single-Student Desk	24	30	24-36	70	3.1	82	*	\$ 595.00
26393	Single-Student Desk	24	36	24-36	70	3.4	88	*	\$ 633.00
26403	Single-Student Desk	24	48	24-36	70	4.3	100	*	\$ 690.00
30" deep models									
26423	Single-Student Desk	30	30	24-36	70	3.6	88	*	\$ 644.00
26433	Single-Student Desk	30	36	24-36	70	4.2	95	*	\$ 680.00

DIMENSION CHART

Model	A	B	C	D	E	F
26280	20"	9"	24-36"	30"	14"	25"
26281	20"	9"	24-36"	36"	14"	31"
26282	20"	9"	24-36"	48"	14"	43"
26283	24"	11.75"	24-36"	30"	14"	25"
26393	24"	11.75"	24-36"	36"	14"	31"
26403	24"	11.75"	24-36"	48"	14"	43"
26423	30"	16.5"	24-36"	30"	14"	25"
26433	30"	16.5"	24-36"	36"	14"	31"

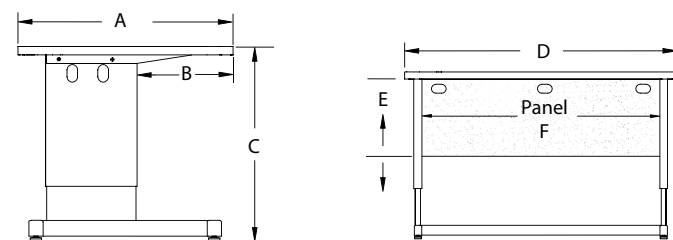

Shown with optional UXL™ Nest & Fold Chairs, see page 50 to order.



Shown with optional CPU Holder, Model 17213, optional casters, Model 17554.

Order an optional Flat Panel Monitor Mount, Model 17350.

Acrobat Two-Student Rectangle Desk

Combining maximum stability, generous workspaces and great ingress/egress for two students, the Acrobat Two-Student Rectangle Desk also offers an integrated modesty panel and wire manager. Choose from 11 standard laminate colors, 21 standard edge colors and two frame colors.

MODEL	DESCRIPTION	D"	W"	H"	F.C.	CUBE	WT.	UPS	2016 LIST
20" deep models									
26283	Two-Student Desk	20	60	24-36	70	4.2	108	*	\$ 692.00
26284	Two-Student Desk	20	72	24-36	70	5.1	116	*	\$ 757.00
24" deep models									
26413	Two-Student Desk	24	60	24-36	70	5.1	113		\$ 762.00
26380	Two-Student Desk	24	72	24-36	70	6.1	121		\$ 833.00

DIMENSION CHART

Model	A	B	C	D	E	F
26283	20"	9"	24-36"	60"	14"	55"
26284	20"	9"	24-36"	72"	14"	65"
26413	24"	11.75"	24-36"	60"	14"	55"
26380	24"	11.75"	24-36"	72"	14"	67"

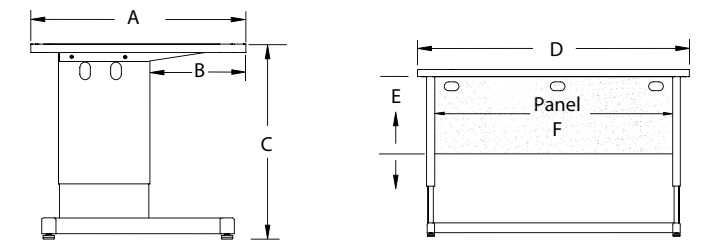

1 1/4" Tops

Acrobat Desks Have Top and Edge Choices

CHOICE 1 - 1 1/4" top with Bumper T-Mold no letter to follow Model No.

CHOICE 2 - 1 1/4" top with 4mm T-Mold to follow Model No.

Make it mobile with casters

Two available in Acrobat

Model 17576 (3") \$ 76 List

Model 17554 (4") \$ 107 List

AddPower
SEE PAGE 258 FOR ORDER INFO

ACROBAT DESK LAMINATE COLOR CHOICE

- | | | | | | |
|--------------|--------------|------------|-------------|-------------|-------------|
| Amber Cherry | Blond Echo | Golden Oak | Grey Nebula | Pewter Mesh | Wild Cherry |
| Asian Night | Fusion Maple | Grey Mesh | New Age Oak | Tan Echo | |

ACROBAT DESK EDGE COLOR CHOICE

- | | | | | | | |
|-----------|-----------|------------|--------------|--------|--------------|--------|
| Apple | Burgundy | Charcoal | Forest Green | Mocha | Persian Blue | Red |
| Black | Cerulean | Chocolate | Fuchsia | Navy | Platinum | White |
| Blueberry | Champagne | Clementine | Mint | Orange | Purple | Yellow |

View all finish options on page 260.



Model 26285. Shown in Pewter Mesh top with White edge and Platinum frame. Shown with optional Flavors™ Seating in Persian Blue.

Acrobat Three-Student Rectangle Desk

Combining maximum stability, generous workspaces and great ingress/egress for three students, the Acrobat Three-Student Rectangle Desk also offers an integrated modesty panel and Wire Manager. Choose from 11 standard laminate colors, 21 standard edge colors and two frame colors.

- Cable tray and port holes in the modesty panel keep wires neatly organized.
- Strong 10" deep double-wall legs are 18-gauge steel with radius corners.
- The base is 16-gauge steel, color matched to the legs, featuring lock-in-place end caps and adjustable leveling glides.

MODEL	DESCRIPTION	D"	W"	H"	F.C.	CUBE	WT.	UPS	2016 LIST
20" deep models									
26285	Three-Student Desk	20	90	24-36	70	6.4	130	*	\$ 827.00
24" deep models									
26390	Three-Student Desk	24	90	24-36	70	7.7	143		\$ 906.00



Make it mobile with casters
 Model 17576 (3") \$ 76.00 List See page 197
 Model 17554 (4") \$ 107.00 List to order

DIMENSION CHART

Model	A	B	C	D	E	F
26285	20"	9"	24-36"	90"	14"	85"
26290	24"	11.75"	24-36"	90"	14"	85"

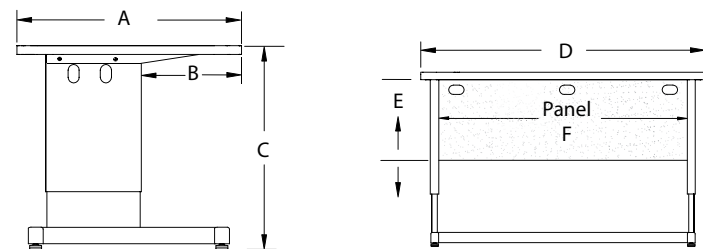

Pull-Out Knee Drawer

Store your essentials out of sight with this pull-out drawer for Acrobat Desks. Black molded drawer mounts under work surface. Molded pencil area 18"d. Drawer height 1.875"h. Inside width 20.5".

MODEL	DESCRIPTION	D"	W"	H"	F.C.	CUBE	WT.	UPS	2016 LIST
17342	Center Drawer for Acrobat	18	23	1.875	70	0.5	5	*	\$ 69.00



Desk Fence

Create carrel-like applications for peer work or individual study in libraries or labs with our Desk Fence. It filters light and defines workstations, yet keeps the area open and visible. Combine Desk Fences with an I-O™ Post to create powered workstations. Screw or clamp down onto most tops. Choose from 20 standard colors, see page 79. Pole is Platinum.

MODEL	DESCRIPTION	D"	W"	H"	F.C.	CUBE	WT.	UPS	2016 LIST
DF24	24" wide Desk Fence	2	24	14	70	0.75	4	*	\$ 159.00
DF30	30" wide Desk Fence	2	30	14	70	1.0	6	*	\$ 171.00
DF36	36" wide Desk Fence	2	36	14	70	1.25	8	*	\$ 183.00
DF48	48" wide Desk Fence	2	48	14	70	1.5	10		\$ 207.00
DF60	60" wide Desk Fence	2	60	14	70	2.0	12		\$ 231.00



CPU Holder

Heavy steel plate mounts under work surface. Black steel tube frame with locks to hold tower in place.

MODEL	DESCRIPTION	D"	W"	H"	F.C.	CUBE	WT.	UPS	2016 LIST
Optional Accessories									
17213	CPU Holder	14 - 18.5	8.5 - 11.6	16.75 - 21.25	70	0.5	12	*	\$ 159.00
	• PC Dimensions	9.75 - 17.5	5.4 - .6	15.25 - .75					
17217	CPU Holder	14 - 18.75	8.5 - 9.2	13 - 17.25	70	0.5	10	*	\$ 149.00
	• PC Dimensions	9.5 - 17.4	3 - 7.25	9.4 - 13.5					

Acrobat Desks Top and Edge Choices



CHOICE 1 - 1 1/4" top with Bumper T-Mold
no letter to follow Model No.



CHOICE 2 - 1 1/4" top with 4mm T-Mold
D to follow Model No.

AddPower
SEE PAGE 258 FOR ORDER INFO

ACROBAT DESK LAMINATE COLOR CHOICE

Amber Cherry	Blond Echo	Golden Oak	Grey Nebula	Pewter Mesh	Wild Cherry
Asian Night	Fusion Maple	Grey Mesh	New Age Oak	Tan Echo	

FRAME COLOR CHOICE

Black	Platinum
-------	----------

ACROBAT DESK EDGE COLOR CHOICE

Apple	Burgundy	Charcoal	Forest Green	Mocha	Persian Blue	Red
Black	Cerulean	Chocolate	Fuchsia	Navy	Platinum	White
Blueberry	Champagne	Clementine	Mint	Orange	Purple	Yellow

View all finish options on page 260.



Shown in Asian Night top with Purple edge and Platinum frame.
Shown with optional Casters, Model 17554 \$ 107.00;
optional Intuit™ Adjustable Chair, Model 00531 \$ 333.00
and optional Flat Panel Mount, Model 17353 \$ 199.00



See more Teacher Desk options
on pages 232–247.

Acrobat Rectangle Instructor Desk

Combining maximum stability, generous workspaces and great ingress/egress, the Acrobat Rectangle Instructor Desk also offers an integrated modesty panel and Wire Manager. Choose from 11 standard laminate colors, 21 standard edge colors and two frame colors.

- Cable tray and port holes in the modesty panel keep wires neatly organized.
- Strong 10" deep double-wall legs are 18-gauge steel with radius corners.
- The base is 16-gauge steel, color matched to the legs, featuring lock-in-place end caps and adjustable leveling glides.

MODEL	DESCRIPTION	D"	W"	H"	F.C.	CUBE	WT.	UPS	2016 LIST
30" deep models									
26443	Rectangle Instructor Desk	30	48	24-36	70	5.2	110		\$ 747.00
26453	Rectangle Instructor Desk	30	60	24-36	70	6.3	125		\$ 822.00
26526	Rectangle Instructor Desk	30	72	24-36	70	7.3	140		\$ 917.00
26528	Rectangle Instructor Desk w/ Box/Box/File Ped	30	60	24-36	85	10.7	191		\$ 1,177.00



Model 26000

Planner™ Conference Table

This mobile, versatile table nests with an Acrobat Rectangle Desk (30"d) to create a peninsula desk for small conferences. When detached, the teacher can be situated in the notch to present lessons to groups of up to three students. Choose from 11 standard laminate colors, 21 standard edge colors and two frame colors. Casters standard (Model 17553).

MODEL	DESCRIPTION	D"	W"	H"	F.C.	CUBE	WT.	UPS	2016 LIST
26000	Planner Conference Table with casters	48" dia.		27-31	70		94		\$ 733.00

Model 26000 comes standard with casters, Model 17553.

Create a Peninsula Instructor Desk

Start with the Acrobat Rectangle Desk* and add the Planner™ Conference Table, Model 26000.

*Be sure to order casters (Model 17576) for your Acrobat Instructor rectangle desk to create Peninsula Instructor Desk.



Shown in Golden Oak top with Platinum edge and Platinum frame. Shown with optional Mobile Drawer Pedestal Model 19173.

Acrobat Peninsula Instructor Desk

Featuring a generous workspace enhanced by a Peninsula (suited for one-to-one or one-to-two conferences), maximum stability and great ingress/egress, the Acrobat Peninsula Instructor Desk also offers an integrated modesty panel and Wire Manager. Choose from 11 standard laminate colors, 21 standard edge colors and two frame colors.

MODEL	DESCRIPTION	D"	W"	H"	F.C.	CUBE	WT.	UPS	2016 LIST
26213	Peninsula Instructor Desk	36	72	24-36	70	7.8	151		\$ 978.00
26233	Peninsula Instructor Desk	36	60	24-36	70	6.5	135		\$ 878.00



Platinum

Mobile Drawer Pedestal

Steel construction, drawers lock and have an interlock system that prevents accidental tipping caused by more than one drawer opening at a time. Full extension ball bearing slides allow full access to drawer contents. Black or Platinum. With 2" dual-wheel casters.

MODEL	DESCRIPTION	D"	W"	H"	F.C.	CUBE	WT.	UPS	2016 LIST
19172	Mobile Drawer Pedestal File/File	22	15.5	27.5	100	5.7	50		\$ 359.00
19173	Mobile Drawer Pedestal Box/Box/File	22	15.5	25.5	100	5.7	50		\$ 355.00

Acrobat Desks Have Top and Edge Choices

1 1/4" Tops

CHOICE 1 - 1 1/4" top with Bumper T-Mold no letter to follow Model No.

CHOICE 2 - 1 1/4" top with 4mm T-Mold D to follow Model No.

Make it mobile with casters

Model 17576 (3") \$ 76 List
Model 17554 (4") \$ 107 List

AddPower
SEE PAGE 258 FOR ORDER INFO

ACROBAT DESK LAMINATE COLOR CHOICE

- Amber Cherry
- Blond Echo
- Golden Oak
- Grey Nebula
- Pewter Mesh
- Wild Cherry
- Asian Night
- Fusion Maple
- Grey Mesh
- New Age Oak
- Tan Echo

FRAME COLOR CHOICE

- Black
- Platinum

ACROBAT DESK EDGE COLOR CHOICE

- Apple
- Burgundy
- Charcoal
- Forest Green
- Mocha
- Persian Blue
- Red
- Black
- Cerulean
- Chocolate
- Fuchsia
- Navy
- Platinum
- White
- Blueberry
- Champagne
- Clementine
- Mint
- Orange
- Purple
- Yellow

View all finish options on page 260.



Acrobat Tech Lab. Shown in Tan Echo with Chocolate edge and Platinum frame. Shown with optional Partition Walls, Model 17322 and optional Flavors™ Seating in Chocolate.

Acrobat Tech Lab

Optimizes floor space while combining maximum stability, generous workspace and great ingress/egress. The Acrobat Tech Lab also offers integrated modesty panels and a Wire Manager. Choose from 11 standard laminate colors, 21 standard edge colors and two frame colors.

- Cable tray and port holes in the modesty panel keep wires neatly organized.
- Strong 10" deep double-wall legs are 18-gauge steel with radius corners.
- The base is 16-gauge steel, color matched to the legs, featuring lock-in-place end caps and adjustable leveling glides.

MODEL	DESCRIPTION	D"	W"	H"	F.C.	CUBE	WT.	UPS	2016 LIST
Acrobat Tech Lab									
26498	Tech Lab Center	24	60	24-36	70	9.8	173		\$ 1,131.00
Acrobat Tech Lab Corner Riser Shelf									
17605	Tech Lab Corner Riser Shelf	12	60	12	70	3.5	86		\$ 667.00



See page 98 for Partition Wall Accessories.

MODEL	DESCRIPTION	D"	W"	H"	F.C.	CUBE	WT.	UPS	2016 LIST
Partition Wall with 2 Screens									
17320	35"w Accessory Wall		35	18"	70	63	*		\$ 675.00
17321	43"w Accessory Wall		43	18"	70	70	*		\$ 729.00
17322	54.75"w Accessory Wall		54.75	18"	70	82			\$ 812.00
17323	66.5"w Accessory Wall		66.5	18"	70	82			\$ 877.00



Shown in Wild Cherry top with Black edge and Black frame.

Acrobat Corner Workstation

Optimizes floor space while combining maximum stability, generous workspace and great ingress/egress. The Acrobat Corner Workstation also offers integrated modesty panels and a Wire Manager. Choose from 11 standard laminate colors, 21 standard edge colors and two frame colors.

- Cable tray and port holes in the modesty panel keep wires neatly organized.
- Strong 10" deep double-wall legs are 18-gauge steel with radius corners.
- The base is 16-gauge steel, color matched to the legs, featuring lock-in-place end caps and adjustable leveling glides.

MODEL	DESCRIPTION	D"	W"	H"	F.C.	CUBE	WT.	UPS	2016 LIST
Acrobat Corner Workstation									
26492	Corner Workstation - 5 sided	30	48	24-36	70	7.0	148		\$ 936.00
26493	Corner Workstation - 5 sided	24	42	24-36	70	5.5	127		\$ 875.00
26494	Corner Workstation - 5 sided	24	36	24-36	70	4.5	106		\$ 789.00
Acrobat Corner Riser Shelf									
17469	For 48"w Corner Workstation	12	48	12	70	2.8	67		\$ 558.00
17603	For 42"w Corner Workstation	12	42	12	70	2.5	59		\$ 516.00
17601	For 36"w Corner Workstation	12	36	12	70	2.1	49	*	\$ 475.00

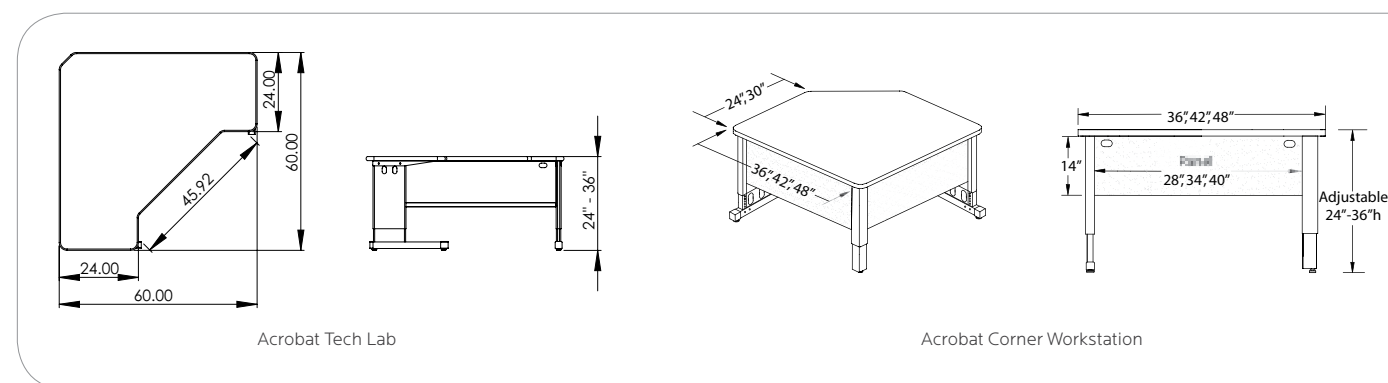

Acrobat Workstations Tables Have Top and Edge Choices

1 1/4" Tops

CHOICE 1 - 3/8" Bumper T-Mold no letter to follow Model No.

CHOICE 3 - 4mm T-Mold D to follow Model No.

AddPower
SEE PAGE 258 FOR ORDER INFO

ACROBAT WORKSTATION LAMINATE COLOR CHOICE

- Amber Cherry, Blond Echo, Golden Oak, Grey Nebula, Pewter Mesh, Wild Cherry
- Asian Night, Fusion Maple, Grey Mesh, New Age Oak, Tan Echo

FRAME COLOR CHOICE

- Black, Platinum

ACROBAT WORKSTATION EDGE COLOR CHOICE

- Apple, Burgundy, Charcoal, Forest Green, Mocha, Persian Blue, Red
- Black, Cerulean, Chocolate, Fuchsia, Navy, Platinum, White
- Blueberry, Champagne, Clementine, Mint, Orange, Purple, Yellow

View all finish options on page 260.



Acrobat Rectangle Model 26413

Acrobat Corner Model 26492

2-Drawer Pedestal Model 19172

Intuit™ Adjustable Chair Model 00531

Acrobat Bullet Model 26515

Shown Asian Night Laminate, Apple edge, Platinum frame.



Shown with optional casters, Model 17554 \$ 107.00 and optional Intuit Adjustable Chair, Model 00531 \$ 333.00

Shown Grey Nebula laminate, Purple Edge, Platinum Frame.

Acrobat Bullet Workstation

Combining maximum stability and great ingress/egress, the Acrobat Bullet Workstation also offers a versatile workspace; its round end lends itself to one-on-one interaction. With integrated modesty panel and Wire Manager. Choose from 11 standard laminate colors, 21 standard edge colors and two frame colors.

- Cable tray and port holes in the modesty panel keep wires neatly organized.
- Strong 10" deep double-wall legs are 18-gauge steel with radius corners.
- The base is 16-gauge steel, color matched to the legs, featuring lock-in-place end caps and adjustable leveling glides.

MODEL	DESCRIPTION	D"	W"	H"	F.C.	CUBE	WT.	UPS	2016 LIST
26515	Bullet Workstation	24	45	24-36	70	4.8	92	*	\$ 712.00
26512	Bullet Workstation	30	45	24-36	70	5.0	99	*	\$ 762.00
26516	Bullet Workstation	30	60	24-36	70	6.3	115		\$ 840.00
26522	Bullet Workstation	30	72	24-36	70	7.3	129		\$ 932.00
26536	Bullet Instructor Desk	w/Box/Box/File Ped & Lectern	30	60	24-36	85	14.0	202	\$ 1,392.00
26538	Bullet Instructor Desk	w/Box/Box/File Ped & Lectern	30	72	24-36	85	15.0	215	\$ 1,484.00



Acrobat Contour Instructor Desk

Featuring a generous workspace enhanced by a gentle curve that encourages interaction, maximum stability and great ingress/egress, the Acrobat Contour Instructor Desk also offers an integrated modesty panel and Wire Manager. Choose from 11 standard laminate colors, 21 standard edge colors and two frame colors.

Shown with optional Deluxe Tabletop Lectern Model 04619. Shown with optional Mobile Drawer Pedestal Model 19173.

MODEL	DESCRIPTION	D"	W"	H"	F.C.	CUBE	WT.	UPS	2016 LIST
26203	Contour Instructor Desk	36	72	24-36	70	7.8	155		\$ 982.00
26223	Contour Instructor Desk	36	60	24-36	70	6.5	139		\$ 882.00



Riser Shelves

For Planner™, Flexline™, ADA and Acrobat™ Desks.

1 1/4" thick top with bumper edge. Adjusts from 7.5" to 12".

MODEL	DESCRIPTION	D"	W"	H"	F.C.	CUBE	WT.	UPS	2016 LIST
17645	24" wide Riser Shelf	12	24	7.5-12	70	1.0	31	*	\$ 207.00
17646	30" wide Riser Shelf	12	30	7.5-12	70	1.2	34	*	\$ 233.00
17647	36" wide Riser Shelf	12	36	7.5-12	70	1.5	39	*	\$ 257.00
17648	48" wide Riser Shelf	12	48	7.5-12	70	2.0	50	*	\$ 306.00
17649	60" wide Riser Shelf	12	60	7.5-12	70	2.4	56	*	\$ 351.00
17657	72" wide Riser Shelf	12	72	7.5-12	70	2.8	78		\$ 494.00
17659	84" wide Riser Shelf	12	84	7.5-12	70	3.2	99		\$ 628.00



Deluxe Tabletop Lectern

High-pressure laminate top with retainer and large storage area for reference materials.

Top: Choose from our 11 laminate colors.
Edge: Choose from our 21 edge colors.
Base: Choose Black or Platinum.

Lecterns Have Top and Edge Choices

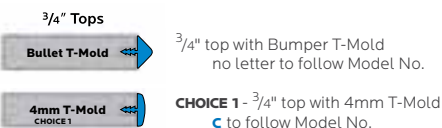

MODEL	DESCRIPTION	D"	W"	H"	F.C.	CUBE	WT.	UPS	2016 LIST
04619	Deluxe Tabletop Lectern	20	18	13	125	3.0	21		\$ 197.00

See Lectern page 160 for more information.

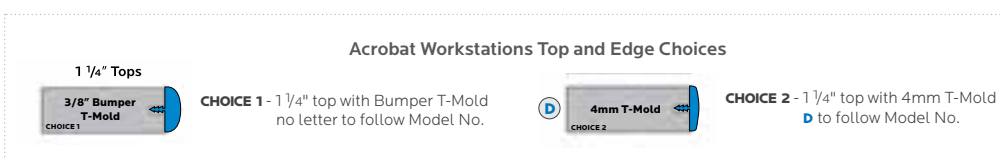

AddPower
SEE PAGE 258 FOR ORDER INFO

ACROBAT WORKSTATION LAMINATE COLOR CHOICE

- Amber Cherry
- Blond Echo
- Golden Oak
- Grey Nebula
- Pewter Mesh
- Wild Cherry
- Asian Night
- Fusion Maple
- Grey Mesh
- New Age Oak
- Tan Echo
- Black
- Platinum

ACROBAT WORKSTATION EDGE COLOR CHOICE

- Apple
- Burgundy
- Charcoal
- Forest Green
- Mocha
- Persian Blue
- Red
- Black
- Cerulean
- Chocolate
- Fuchsia
- Navy
- Platinum
- White
- Blueberry
- Champagne
- Clementine
- Mint
- Orange
- Purple
- Yellow

View all finish options on page 260.



In this commons, Acrobat Crescent tables provide versatile work spaces while defining the boundary between social and collaborative learning zones.



Team Crescent Pod: Three Acrobat Crescent Desks, Model 26550 with three UXL Table 3/4 Round End Cap, Model UL48RC_PLTFL. Shown in Golden Oak top with Cerulean edge and Platinum frame. Shown with optional Flavors Stack Chairs, Model 11849 in Cerulean Blue and optional Mini Power Module, Model 017091 SLV.



Acrobat Crescent Table

This versatile table is great for working individually or for in groups of two or more. A group of three can cluster around an I-O Post™ for shared connectivity and individual or group computer work. It features a generous workspace, maximum stability, great ingress/egress, and an integrated modesty panel and wire manager. Choose from 11 standard laminate colors, 21 standard edge colors and two frame colors.

Acrobat Crescent Table, Model 26550
Shown in Grey Mesh top with Cerulean edge and Platinum frame.

MODEL	DESCRIPTION	D"	W"	H"	F.C.	CUBE	WT.	UPS	2016 LIST	
26550	Acrobat Crescent Table	30	60	24-36	70	6.5	125		\$ 925.00	
26551	Acrobat Crescent Table	30	72	24-36	70	7.5	140		\$ 1,040.00	
Optional Casters										
17574	4" Dual-Wheel Caster Pack			Set of 5, 2 locking	4" dia.	4	70	0.2	5	\$ 134.00



UXL Table 3/4 Round End Cap (for use with Acrobat Crescent)

Combine a UXL Table 3/4 Round End Cap with two Acrobat Crescent Tables to create a large half-circle workspace. Or position it on the end of a rectangular desk to create a peninsula for small-group meetings. See pg. 107 for leg set options. Choose from 11 standard laminate colors, 21 standard edge colors and Platinum (PLT) frame.

UXL Table 3/4 Round End Cap, Model UL48RCGOKSPLTFC. Shown in Blond Echo top with Cerulean edge and Platinum frame. Optional fixed-height leg with Caster (FC).

- Desktop is 1 1/4" thick high-pressure laminate surface with Bumper T-Mold to match edge detail of Acrobat Crescent Desks, Model 26550 and Model 26551.

MODEL	DESCRIPTION	D"	W"	H"	F.C.	CUBE	WT.	UPS	2016 LIST
UL48RC_PLTFL	UXL 3/4 Round End Cap*	48" diameter							\$ 496.00

*For use with Acrobat Crescent Tables only.

UXL Optional Leg Sets Available (see page 107 for more information)

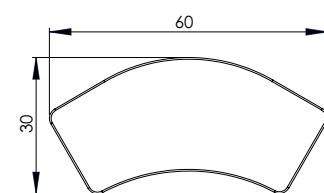

Top Down View

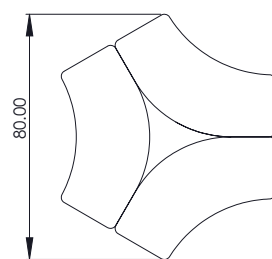

Cluster of three Acrobat Crescent Tables

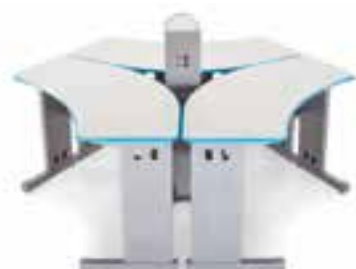

Shown in Grey Mesh top with Cerulean Blue edge and Platinum frame. Shown with optional I-O Post, Model 17090.

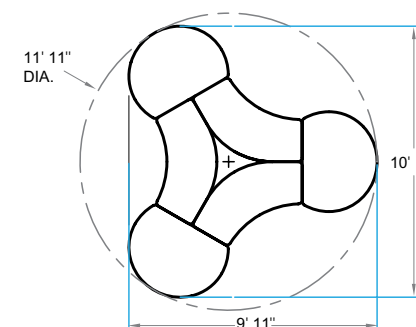

Three Acrobat Crescent Desks, with three 3/4 Round End Cap Desks and one I-O Post make a "Team Crescent Pod" for collaborative learning.



Shown with optional Retractable Mini Power Module, Model 017091 SLV (2 power, 10' cord) \$ 250.00



Acrobat Crescent Teacher Presentation Station

This versatile table is great for front of classroom presentations. It features a generous workspace, maximum stability, great ingress/egress, and an integrated modesty panel and wire manager. Add an optional Dual Surface Desktop Lectern to conveniently hold your laptop and presentation materials. Choose from 11 standard laminate colors, 21 standard edge colors and two frame colors.

Shown with optional power, 017091SLV

AddPower
SEE PAGE 258 FOR ORDER INFO



Dual Surface Lectern



MODEL	DESCRIPTION	D"	W"	H"	F.C.	CUBE	WT.	UPS	2016 LIST
26550	Acrobat Crescent Table	30	60	24-36	70	6.5	125		\$ 925.00
26551	Acrobat Crescent Table	30	72	24-36	70	7.5	140		\$ 1,040.00
Optional Casters									
17574	4" Dual-Wheel Caster Pack	Set of 5, 2 locking		4" dia.	4	70	0.2	5	* \$ 134.00
Dual Surface Desktop Lectern									
00470	w/Swing Arm	Clamp-On		19	19	6	70	1.3	22 * \$ 225.00
00471	w/Swing Arm	Bolt-On		19	19	6	70	1.3	25 * \$ 225.00
00472	w/Spring Loaded Swing Arm	Clamp-On		19	19	6	70	1.3	23 * \$ 250.00

ACROBAT CRESCENT LAMINATE COLOR CHOICE

- Amber Cherry
- Blond Echo
- Golden Oak
- Grey Nebula
- Pewter Mesh
- Wild Cherry
- Asian Night
- Fusion Maple
- Grey Mesh
- New Age Oak
- Tan Echo

FRAME COLOR CHOICE

- Black
- Platinum

ACROBAT CRESCENT EDGE COLOR CHOICE

- Apple
- Burgundy
- Charcoal
- Forest Green
- Mocha
- Persian Blue
- Red
- Black
- Cerulean
- Chocolate
- Fuchsia
- Navy
- Platinum
- White
- Blueberry
- Champagne
- Clementine
- Mint
- Orange
- Purple
- Yellow

View all finish options on page 260.



Adjustable Keyboard Shelf

Features 6" height adjustment with 10° tilt and 180° swivel with easy single control. 11"d x 28"w steel tray has padded palm rest.

MODEL	DESCRIPTION	D"	W"	H"	F.C.	CUBE	WT.	UPS	2016 LIST
17620	Pull-out Keyboard	adjustable height	17	28	6	70	1.3	20	* \$ 270.00
17622	Pull-out Keyboard	adjustable height	17	20	6	70		20	* \$ 265.00



CPU Holder

Heavy steel plate mounts under work surface. Black steel tube frame with locks to hold tower in place.

MODEL	DESCRIPTION	D"	W"	H"	F.C.	CUBE	WT.	UPS	2016 LIST
Optional Accessories									
17213	CPU Holder	14 - 18.5	8.5 - 11.6	16.75 - 21.25	70	0.5	12	*	\$ 159.00
	• PC Dimensions	9.75 - 17.5	5.4 - .6	15.25 - .75					
17217	CPU Holder	14 - 18.75	8.5 - 9.2	13 - 17.25	70	0.5	10	*	\$ 149.00
	• PC Dimensions	9.5 - 17.4	3 - 7.25	9.4 - 13.5					



Casters

Dual-wheel casters roll easily, providing excellent mobility for desks. Use 2 for wheelbarrow style mobility (Model 17576 only).

MODEL	DESCRIPTION	D"	W"	H"	F.C.	CUBE	WT.	UPS	2016 LIST
17576	3" Dual-Wheel Caster Pack	Set of 4, 4 locking		3" dia		70	0.1	5	* \$ 76.00
17554	4" Dual-Wheel Caster Pack	Set of 4, 2 locking		4" dia.	4	70	0.2	5	* \$ 107.00

Note: Planner Conference Table, Model 26000, comes standard with casters, Model 17553 and matches up with Model 17576 casters only.



Pull-Out Knee Drawer

Store your essentials out of sight with this pull-out drawer for Acrobat Desks. Black molded drawer mounts under work surface. Molded pencil area 18"d. Drawer height 1.875"h. Inside width 20.5".

MODEL	DESCRIPTION	D"	W"	H"	F.C.	CUBE	WT.	UPS	2016 LIST
17342	Center Drawer for Acrobat	18	23	1.875	70	0.5	5	*	\$ 69.00



Model 17081



Model 17084



Power Socket is durable and attaches securely to the work surface. Model 17060 with 15 ft. long cord.

AddPower
SEE PAGE 258 FOR ORDER INFO

MODEL	DESCRIPTION	D"	W"	H"	F.C.	CUBE	WT.	UPS	2016 LIST
17081	6 Outlet Electric Strip w/ Surge, 4' Cord	3	3	12	70	0.1	4	*	\$ 65.00
17084	10 Outlet Electric Strip w/ Surge, 15' Cord	3	8	12	70	0.1	5	*	\$ 152.00
17060	Power Socket (4 Power Plugs 2 Data Plugs) 15' Cord	3	10	7	70	0.01	4	*	\$ 192.00

Early Childhood



The love of learning is born here.

For every student, the first days are the most important. Creating the kind of environment that welcomes the student, stimulates learning and facilitates the teacher's lessons is made easy with choices from the Smith System portfolio. Moreover, our early childhood and kindergarten furniture is made to fit kids in the Pre-K age group.



Cascade™ Cubby Storage

Mobile storage that combines accessibility and organization.

SEE PAGE 226



Interchange™ 3-2-1 Desks™

They allow students to work individually, in pairs and in groups up to six.

SEE PAGE 70



Flavors™ Stack Chair

Proportioned to fit students in an active pre-k classroom.

SEE PAGE 22



Arc™ Desks

Flexibility and great ergonomics make them an asset in any classroom.

SEE PAGE 126



Calming colors, like the ones in this classroom, help engage young learners and keep them on task.



Standard Activity Tables

This classroom standby is sturdy, stable and has graceful, yet strong legs. Models available to serve all levels of students from Pre-K through Adult. Choose from 11 standard laminate colors, 21 standard edge colors and eight leg colors.

- Strong, 18-gauge steel upper leg is 1 1/8" in diameter, protected with a durable powder coat surface.
- Sturdy 1 1/4" desktop with a high-pressure laminate surface above and durable backing sheet below.
- 3/8" thick bumper edge stapled in place every six inches.
- Rugged, 16-gauge steel lower leg is 1" in diameter, chrome plated for protection.



36"d x 72" w Rectangle Activity Table, Model 01064
Shown in New Age Oak top with Persian Blue edge and Platinum legs.



36"d x 36" w Square Activity Table, Model 01073
Shown in Fusion Maple top with Mocha edge and Platinum legs.



30"d x 60" w Trapezoid Activity Table, Model 01134
Shown in Tan Echo top with Cerulean edge and Platinum legs.



48" diameter Round Activity Table, Model 01104
Shown in Golden Oak top with Black edge and Platinum legs.

ACTIVITY TABLE LAMINATE COLOR CHOICE

- Amber Cherry
- Blond Echo
- Golden Oak
- Grey Nebula
- Pewter Mesh
- Wild Cherry
- Asian Night
- Fusion Maple
- Grey Mesh
- New Age Oak
- Tan Echo

ACTIVITY TABLE LEG COLOR CHOICE

- Black
- Navy
- Platinum
- Red
- Forest Green
- Persian Blue
- Purple
- Yellow

ACTIVITY TABLE EDGE COLOR CHOICE

- Apple
- Burgundy
- Charcoal
- Forest Green
- Mocha
- Persian Blue
- Red
- Black
- Cerulean
- Chocolate
- Fuchsia
- Navy
- Platinum
- White
- Blueberry
- Champagne
- Clementine
- Mint
- Orange
- Purple
- Yellow

View all finish options on page 260.

Standard Activity Tables

RECTANGLE

MODEL	DESCRIPTION	D"	W"	H"	F.C.	CUBE	WT.	UPS	2016 LIST
24" deep models									
01003	Rectangle Activity Table	21" - 30" adj. height	24	36	21-30	70	1.4	42	* \$ 237.00
01004	Rectangle Activity Table	15" - 24" adj. height	24	36	15-24	70	1.3	42	* \$ 237.00
01005	Rectangle Activity Table	11" - 16" adj. height	24	36	11-16	70	1.3	41	* \$ 237.00
01013	Rectangle Activity Table	21" - 30" adj. height	24	48	21-30	70	1.6	52	* \$ 256.00
01014	Rectangle Activity Table	15" - 24" adj. height	24	48	15-24	70	1.5	52	* \$ 256.00
01015	Rectangle Activity Table	11" - 16" adj. height	24	48	11-16	70	1.5	51	* \$ 256.00
01913	Rectangle Activity Table	21" - 30" adj. height	24	60	21-30	70	1.9	62	* \$ 268.00
01914	Rectangle Activity Table	15" - 24" adj. height	24	60	15-24	70	1.8	62	\$ 268.00
01915	Rectangle Activity Table	11" - 16" adj. height	24	60	11-16	70	1.8	61	\$ 268.00
30" deep models									
01023	Rectangle Activity Table	21" - 30" adj. height	30	48	21-30	70	1.9	62	* \$ 268.00
01024	Rectangle Activity Table	15" - 24" adj. height	30	48	15-24	70	1.8	62	* \$ 268.00
01025	Rectangle Activity Table	11" - 16" adj. height	30	48	11-16	70	1.8	61	* \$ 268.00
01033	Rectangle Activity Table	21" - 30" adj. height	30	60	21-30	70	2.3	75	\$ 291.00
01034	Rectangle Activity Table	15" - 24" adj. height	30	60	15-24	70	2.2	75	\$ 291.00
01035	Rectangle Activity Table	11" - 16" adj. height	30	60	11-16	70	2.2	74	\$ 291.00
01043	Rectangle Activity Table	21" - 30" adj. height	30	72	21-30	70	2.6	94	\$ 340.00
01044	Rectangle Activity Table	15" - 24" adj. height	30	72	15-24	70	2.5	94	\$ 340.00
01045	Rectangle Activity Table	11" - 16" adj. height	30	72	11-16	70	2.5	93	\$ 340.00
36" deep models									
01923	Rectangle Activity Table	21" - 30" adj. height	36	48	21-30	70	2.2	73	\$ 297.00
01924	Rectangle Activity Table	15" - 24" adj. height	36	48	15-24	70	2.1	73	\$ 297.00
01925	Rectangle Activity Table	11" - 16" adj. height	36	48	11-16	70	2.1	72	\$ 297.00
01053	Rectangle Activity Table	21" - 30" adj. height	36	60	21-30	70	2.5	87	\$ 349.00
01054	Rectangle Activity Table	15" - 24" adj. height	36	60	15-24	70	2.4	87	\$ 349.00
01055	Rectangle Activity Table	11" - 16" adj. height	36	60	11-16	70	2.4	86	\$ 349.00
01063	Rectangle Activity Table	21" - 30" adj. height	36	72	21-30	70	3.0	102	\$ 378.00
01064	Rectangle Activity Table	15" - 24" adj. height	36	72	15-24	70	2.9	102	\$ 378.00
01065	Rectangle Activity Table	11" - 16" adj. height	36	72	11-16	70	2.9	101	\$ 378.00

SQUARE

MODEL	DESCRIPTION	D"	W"	H"	F.C.	CUBE	WT.	UPS	2016 LIST
36" deep models									
01073	Square Activity Table	21" - 30" adj. height	36	36	21-30	70	1.9	57	* \$ 268.00
01074	Square Activity Table	15" - 24" adj. height	36	36	15-24	70	1.8	57	* \$ 268.00
01075	Square Activity Table	11" - 16" adj. height	36	36	11-16	70	1.8	56	* \$ 268.00
48" deep models									
01083	Square Activity Table	21" - 30" adj. height	48	48	21-30	70	2.6	92	* \$ 345.00
01084	Square Activity Table	15" - 24" adj. height	48	48	15-24	70	2.5	92	* \$ 345.00
01085	Square Activity Table	11" - 16" adj. height	48	48	11-16	70	2.5	91	* \$ 345.00

TRAPEZOID

MODEL	DESCRIPTION	D"	W"	H"	F.C.	CUBE	WT.	UPS	2016 LIST
01133	30x60 Trapezoid Activity Table	21" - 30" adj. height	30	60	21-30	70	2.3	57	* \$ 300.00
01134	30x60 Trapezoid Activity Table	15" - 24" adj. height	30	60	15-24	70	2.2	57	* \$ 300.00
01135	30x60 Trapezoid Activity Table	11" - 16" adj. height	30	60	11-16	70	2.2	56	* \$ 300.00

Standard Activity Tables

ROUND

MODEL	DESCRIPTION	D"	W"	H"	F.C.	CUBE	WT.	UPS	2016 LIST
42" diameter models									
01093	Round Activity Table	21" - 30" adj. height	42" diameter	21-30	70	2.3	60		\$ 314.00
01094	Round Activity Table	15" - 24" adj. height	42" diameter	15-24	70	2.2	60		\$ 314.00
01095	Round Activity Table	11" - 16" adj. height	42" diameter	11-16	70	2.2	59		\$ 314.00
48" diameter models									
01103	Round Activity Table	21" - 30" adj. height	48" diameter	21-30	70	2.6	75		\$ 345.00
01104	Round Activity Table	15" - 24" adj. height	48" diameter	15-24	70	2.5	75		\$ 345.00
01105	Round Activity Table	11" - 16" adj. height	48" diameter	11-16	70	2.5	74		\$ 345.00
60" diameter models									
01883	Round Activity Table	21" - 30" adj. height	60" diameter	21-30	70	3.9	112		\$ 556.00
01884	Round Activity Table	15" - 24" adj. height	60" diameter	15-24	70	3.8	112		\$ 556.00
01885	Round Activity Table	11" - 16" adj. height	60" diameter	11-16	70	3.8	112		\$ 556.00

KIDNEY

01143	Kidney Activity Table	21" - 30" adj. height	48	72	21-30	70	3.8	116	\$ 493.00
01144	Kidney Activity Table	15" - 24" adj. height	48	72	15-24	70	3.7	116	\$ 493.00
01145	Kidney Activity Table	11" - 16" adj. height	48	72	11-16	70	3.7	115	\$ 493.00

HALF MOON

01153	Half Moon Activity Table	21" - 30" adj. height	36	72	21-30	70	3.7	90	\$ 412.00
01154	Half Moon Activity Table	15" - 24" adj. height	36	72	15-24	70	3.6	90	\$ 412.00
01155	Half Moon Activity Table	11" - 16" adj. height	36	72	11-16	70	3.6	89	\$ 412.00

HORSESHOE

01933	Horseshoe Activity Table	21" - 30" adj. height	60	66	21-30	70	4.2	130	\$ 710.00
01934	Horseshoe Activity Table	15" - 24" adj. height	60	66	15-24	70	4.1	130	\$ 710.00
01935	Horseshoe Activity Table	11" - 16" adj. height	60	66	11-16	70	4.1	129	\$ 710.00

CLOVER

01203	Clover Activity Table	21" - 30" adj. height	48" diameter	21-30	70	2.6	70		\$ 338.00
01204	Clover Activity Table	15" - 24" adj. height	48" diameter	15-24	70	2.5	70		\$ 338.00
01205	Clover Activity Table	11" - 16" adj. height	48" diameter	11-16	70	2.5	70		\$ 338.00

FLOWER

01213	Flower Activity Table	21" - 30" adj. height	60" diameter	21-30	70	3.9	104		\$ 545.00
01214	Flower Activity Table	15" - 24" adj. height	60" diameter	15-24	70	3.8	104		\$ 545.00
01215	Flower Activity Table	11" - 16" adj. height	60" diameter	11-16	70	3.8	104		\$ 545.00

LEG SETS FOR ACTIVITY TABLE

01180	Leg set for 21" - 30"h	70	0.6	10	*	\$ 102.00
01181	Leg set for 15" - 24"h	70	0.5	10	*	\$ 102.00
01184	Leg set for 11" - 16"h	70	0.5	9	*	\$ 102.00

Activity Tables Have Top and Edge Choices



CHOICE 1 - 1 1/4" top with Bumper T-Mold no letter to follow Model No.



CHOICE 2 - 1 1/4" top with 4mm T-Mold **D** to follow Model No.

Standard Activity Tables

This classroom standby is sturdy, stable and has graceful, yet strong legs. Models available to serve all levels of students from Pre-K through Adult. Choose from 11 standard laminate colors, 21 standard edge colors and eight leg colors.

- Strong, 18-gauge steel upper leg is 1 1/8" in diameter, protected with a durable powder coat surface.
- Sturdy 1 1/4" desktop with a high-pressure laminate surface above and durable backing sheet below.
- 3/8" thick bumper edge stapled in place every six inches.
- Rugged, 16-gauge steel lower leg is 1" in diameter, chrome plated for protection.



48" diameter Clover Activity Table, Model 01204
Shown in Blond Echo top with Apple edge and Platinum legs. Shown with optional Flavors™ Stack Chairs.



48"d x 72"w Kidney Activity Table, Model 01144
Shown in Tan Echo top with Persian Blue edge and Persian Blue legs.



36"d x 72"w Half Moon Activity Table, Model 01153
Shown in Fusion Maple top with Purple edge and Purple legs.



60"d x 66"w Horseshoe Activity Table, Model 01933
Shown in Grey Nebula top with Red edge and Red legs.



60" diameter Flower Activity Table, Model 01214
Shown in Grey Nebula top with Purple edge and Purple legs.



Husky Activity Tables

Created to make a welcoming statement, the friendly, colorful tubular legs and colorful nylon glides distinguish the Husky line. Choose from 11 standard laminate colors, 21 standard edge colors and 9 leg colors.

- 1 1/4" thick table top with high-pressure laminate surface and backer sheet.
- 3/8" thick bumper edge stapled in place every six inches.
- Sturdy table legs feature upper section of 1 3/4" diameter.
- 17-gauge steel tube with the lower section chrome plated.
- 1 1/2" diameter, 13-gauge steel tube.



Husky Rectangle Activity Table, Model 04301
Shown in Grey Nebula top with Platinum edge and Platinum Husky legs.



Husky Round Activity Table, Model 04335
Shown in Fusion Maple top with Black edge and Black Husky Legs.



Husky Kidney Activity Table, Model 04341
Shown in Tan Echo top with Persian Blue edge and Platinum Husky legs.



Husky Clover Activity Table, Model 04380
Shown in Fusion Maple top with Apple edge and Platinum Husky legs.

HUSKY ACTIVITY TABLE LAMINATE COLOR CHOICE

- Amber Cherry
- Blond Echo
- Golden Oak
- Grey Nebula
- Pewter Mesh
- Wild Cherry
- Asian Night
- Fusion Maple
- Grey Mesh
- New Age Oak
- Tan Echo

HUSKY ACTIVITY TABLE LEG COLOR CHOICE

- Black
- Clementine
- Mint
- Platinum
- Red
- Blueberry
- Forest Green
- Navy
- Purple

HUSKY ACTIVITY TABLE EDGE COLOR CHOICE

- Apple
- Burgundy
- Charcoal
- Forest Green
- Mocha
- Persian Blue
- Red
- Black
- Cerulean
- Chocolate
- Fuchsia
- Navy
- Platinum
- White
- Blueberry
- Champagne
- Clementine
- Mint
- Orange
- Purple
- Yellow

View all finish options on page 260.

Husky Activity Tables

RECTANGLE

MODEL	DESCRIPTION	D"	W"	H"	F.C.	CUBE	WT.	UPS	2016 LIST
24" deep rectangle models									
04300	Husky Rectangle Activity Table	21" - 30" adj. height	24	60	21-30	70	1.9	66	\$ 290.00
04301	Husky Rectangle Activity Table	15" - 24" adj. height	24	60	15-24	70	1.9	66	\$ 290.00
30" deep rectangle models									
04305	Husky Rectangle Activity Table	21" - 30" adj. height	30	48	21-30	70	1.9	66	* \$ 288.00
04306	Husky Rectangle Activity Table	15" - 24" adj. height	30	48	15-24	70	1.9	66	* \$ 288.00
04310	Husky Rectangle Activity Table	21" - 30" adj. height	30	60	21-30	70	2.3	79	\$ 316.00
04311	Husky Rectangle Activity Table	15" - 24" adj. height	30	60	15-24	70	2.3	79	\$ 316.00
04320	Husky Rectangle Activity Table	21" - 30" adj. height	30	72	21-30	70	2.6	91	\$ 360.00
04321	Husky Rectangle Activity Table	15" - 24" adj. height	30	72	15-24	70	2.6	91	\$ 360.00
36" deep rectangle models									
04360	Husky Rectangle Activity Table	21" - 30" adj. height	36	72	21-30	70	3.0	106	\$ 396.00
04361	Husky Rectangle Activity Table	15" - 24" adj. height	36	72	15-24	70	3.0	106	\$ 396.00

ROUND

04325	Husky Round Activity Table	21" - 30" adj. height	42" diameter	21-30	70	2.3	66	*	\$ 358.00
04326	Husky Round Activity Table	15" - 24" adj. height	42" diameter	15-24	70	2.3	66	*	\$ 358.00
04330	Husky Round Activity Table	21" - 30" adj. height	48" diameter	21-30	70	2.6	79		\$ 365.00
04331	Husky Round Activity Table	15" - 24" adj. height	48" diameter	15-24	70	2.6	79		\$ 365.00
04335	Husky Round Activity Table	21" - 30" adj. height	60" diameter	21-30	70	3.9	116		\$ 588.00
04336	Husky Round Activity Table	15" - 24" adj. height	60" diameter	15-24	70	3.9	116		\$ 588.00

KIDNEY

04340	Husky Kidney Activity Table	21" - 30" adj. height	48	72	21-30	70	3.6	120	\$ 513.00
04341	Husky Kidney Activity Table	15" - 24" adj. height	48	72	15-24	70	3.6	120	\$ 513.00

TRAPEZOID

04350	Husky Trapezoid Activity Table	21" - 30" adj. height	30	60	21-30	70	2.3	61	\$ 320.00
04351	Husky Trapezoid Activity Table	15" - 24" adj. height	30	60	15-24	70	2.3	61	\$ 320.00

SQUARE

04370	Husky Square Activity Table	21" - 30" adj. height	48	48	21-30	70	2.6	96	\$ 365.00
04371	Husky Square Activity Table	15" - 24" adj. height	48	48	15-24	70	2.6	96	\$ 365.00

CLOVER

04380	Husky Clover Activity Table	21" - 30" adj. height	48" diameter	21-30	70	2.6	73		\$ 363.00
04381	Husky Clover Activity Table	15" - 24" adj. height	48" diameter	15-24	70	2.6	73		\$ 363.00

FLOWER

04390	Husky Flower Activity Table	21" - 30" adj. height	60" diameter	21-30	70	3.9	109		\$ 581.00
04391	Husky Flower Activity Table	15" - 24" adj. height	60" diameter	15-24	70	3.9	109		\$ 581.00

LEG SETS FOR HUSKY ACTIVITY TABLE

MODEL	DESCRIPTION	D"	W"	H"	F.C.	CUBE	WT.	UPS	2016 LIST
17770	Leg set for 15" - 24"h				70	0.6	14	*	\$ 119.00
17771	Leg set for 21" - 30"h				70	0.5	16	*	\$ 119.00

Husky Activity Tables Have Top and Edge Choices

1 1/4" Tops

CHOICE 1 - 1 1/4" top with Bumper T-Mold no letter to follow Model No.

CHOICE 2 - 1 1/4" top with 4mm T-Mold D to follow Model No.

Cascade Storage

Imagine a classroom where four or five groups of six students are working on projects. The teacher circulates about, providing information, direction and encouragement. With so much going on, the need for classroom management becomes clear. To allow for all this activity, materials and resources must be organized and readily available to students. Independent access to resources for students frees the teacher to direct and instruct as needed. That's the idea behind Cascade.



9 Sizes.
Totes or Shelves.



Overview
SEE PAGES 208-211

Cases
SEE PAGES 212-215

Cabinets
SEE PAGES 216-219

Towers
SEE PAGES 220-223

Cubby
SEE PAGES 226-227

Presentation Carts
SEE PAGES 228-229

Teacher Desks
SEE PAGES 232-247

Teacher tote storage and transfer
Cascade totes can transfer between Teacher Storage and desk.



Student tote storage and transfer
Cascade totes containing student work can transfer directly from the storage unit to under-desktop and back.





Cascade™ Storage System

Tailored to every school room and curriculum

- Nine sizes
- Casters or glides
- Totes, shelves or cubbies
- 18 powder coat colors
- White board back on Mega-Tower size

Cascade Cases

SEE PGS 212-215

Equip your Cascade Case with tote trays to hold a wide variety of learning materials. Add utility with an optional riser shelf and lectern.



Mini-Case



Mid-Case



Mega-Case



Cascade Cabinets

SEE PGS 216-219

Available with tote trays, it holds a wide variety of learning materials. Optional riser shelf and lectern make this perfect for presentations.



Mini-Cabinet



Mid-Cabinet



Mega-Cabinet



Cascade Towers

SEE PGS 220-223

Available with tote trays, it holds a wide variety of learning materials. Provides maximum capacity and can be configured many ways.



Mini-Tower



Mid-Tower



Mega-Tower



Cascade™ Case
Available in 3 widths with option of tote trays or shelves. Add utility with an optional riser shelf.



Cascade™ Cabinet
Available in 3 widths with option of tote trays or shelves. Optional riser shelf and lectern make this perfect for presentations.



Cascade™ Tower
Available in 3 widths. Available with 3 sizes of tote trays or shelves, it holds a wide variety of learning materials.



Cascade Cases

SEE PGS 212-215

Equip your Cascade Case with shelves to hold a wide variety of learning materials. Add utility with an optional riser shelf and lectern.



Mini-Case



Mid-Case



Mega-Case



Cascade Cabinets

SEE PGS 216-219

Available with shelves, it holds a wide variety of learning materials. Optional riser shelf and lectern make this perfect for presentations.



Mini-Cabinet



Mid-Cabinet



Mega-Cabinet



Cascade Towers

SEE PGS 220-223

Available with shelves, it holds a wide variety of learning materials. Provides maximum capacity and can be configured many ways.



Mini-Tower



Mid-Tower



Mega-Tower



A customizable system for organizing, storing, distributing and presenting materials.

Arc, Huddle, Silhouette, Planner and Interchange Desks



Interchange Wing Desk, Model 03095.
Shown with a SW Tote Tray, Model 66013.
SEE PAGE 60.



Interchange 20x27, Model 04080.
Shown with a SW Tote Tray, Model 66013.
SEE PAGE 68.



Interchange Diamond Desk, Model 03082.
Shown with a SW Tote Tray, Model 66013.
SEE PAGE 64.



Flexline Arc Student Desk, Model 01351.
Shown with an EW Tote Tray, Model 30926.
SEE PAGE 126.



Huddle-8 LS Student Desk, Model 01267.
Shown with a SW tote 30925.
SEE PAGE 137.



Silhouette Student Desk, Model 01600.
Shown with an EW Tote Tray, Model 30926.
SEE PAGE 115.



20" deep Flex Two-Student Desk, Model 01361.
Shown with two EW Tote Trays, Model 30926.
SEE PAGE 123.



20" deep Flex Desk, Model 01360.
Shown with an EW Tote Tray, Model 30926.
SEE PAGE 123.



Planner Student Desk, Model 01272.
Shown with an EW Tote Tray, Model 30926.
SEE PAGE 142.

Organizing Project Learning

The teacher organizes project materials in a tote tray to be assigned to a group. This makes it easy for the group to share the materials without separating (and possibly losing) any.



CASCADE TOTE COMPATIBILITY

DESKS	SW*	EW*
Silhouette	✓	✓
Flex Student	✓	✓
Flex Two-Student	✓	✓
Planner Student	✓	✓
Planner Two-Student	✓	✓
Planner Three-Student	✓	✓
Arc	✓	✓
Huddle - 8 LS	✓	✗
Huddle - 6	✗	✗
Huddle - 8	✗	✗
INTERCHANGE DESKS		
Diamond	✓	✗
Diamond Two-Student	✓	✗
Mini Diamond	✓	✗
Wing	✓	✗
20x27	✓	✗
Curve	✓	✗
3-2-1 LS	✓	✗

*SW = Standard Width EW = Extra Wide Width



Riser Shelf

Lectern
Case only.



Laptop Shelf

Optional Laptop Shelf **Model 17670 PLT**
\$ 130.00 (Available when ordering a riser shelf).



To learn more, watch the Cascade Storage Video:
smithsystem.com/cascade-storage



Cascade

Storage



Cascade Mini-Case

These compact, versatile, mobile storage units are available with either tote trays or shelves and can be fitted with numerous options including locking doors, and a riser shelf. Our Cascade Storage System allows educators to organize, store and distribute learning materials. These mobile storage units are highly customizable to hold items in a wide range of sizes and shapes – from sheets of paper to art supplies.



Model 111000000PA
Mini-Case with Casters
Open with shelves

Model 121000000PA
Mini-Case with casters
Door with shelves

Model 110V05000PA GOK A
Mini-Case with casters
Open with EW totes & riser

Model 121V00000PA GOK A
Mini-Case with casters
Door with shelves & riser

Cascade Mid-Case



Model 211000000PS
Mid-Case with casters
Open with shelves

Model 221000000PS
Mid-Case with casters
Door with shelves

Model 210V10000PS GOK S
Mid-Case with casters
Open with SW totes & riser

Model 221V00000PS GOK S
Mid-Case with casters
Door with shelves & riser

Cascade Mega-Case



Model 310015000PE
Mega-Case with casters
Open with SW totes

Model 321000000PE
Mega-Case with casters
Door with shelves



Model 311100000PE GOK E
Mega-Case with casters
Open with shelves and riser

Model 321100000PE GOK E
Mega-Case with casters
Door with shelves and riser



Laptop Shelf

Optional Laptop Shelf **Model 17670 PLT**
\$ 130.00 (Available when ordering a riser shelf).

CASCADE LAMINATE COLOR CHOICE

- Amber Cherry **AME**
- Blond Echo **BEE**
- Golden Oak **GOK**
- Grey Nebula **GNB**
- Pewter Mesh **PEW**
- Wild Cherry **CHE**
- Asian Night **ANG**
- Fusion Maple **MAP**
- Grey Mesh **GRE**
- New Age Oak **NEW**
- Tan Echo **TAC**

CASCADE END PANEL AND EDGE COLOR CHOICE

- Apple **A**
- Burgundy **D**
- Charcoal **R**
- Forest Green **F**
- Mocha **T**
- Persian Blue **J**
- Red **L**
- Black **B**
- Cerulean **S**
- Chocolate **Q**
- Fuchsia **G**
- Navy **I**
- Platinum **P**
- White* **M**
- Blueberry **C**
- Champagne **O***
- Clementine **E**
- Mint **H**
- Orange* **U**
- Purple **K**
- Yellow **N**

* Edge color only. View all finish options on page 260.

Cascade Mini-Cases

MODEL	DESCRIPTION	D"	W"	H"	F.C.	WT.	2016 LIST
Shelves							
11100000P_	Open w/ shelves	19	21	30.4	100	49	\$ 458.00
12100000P_	Door w/ shelves	19	21	30.4	100	56	\$ 524.00
111V0000P_	Open w/ shelves & riser	19	21	37	100	65	\$ 670.00
121V0000P_	Door w/ shelves & riser	19	21	37	100	72	\$ 737.00
111L0000P_	Open w/ shelves & lectern	19	21	41.5	100	67	\$ 678.00
121L0000P_	Door w/ shelves & lectern	19	21	41.5	100	74	\$ 744.00
Extra Wide (EW) Totes							
110005000P_	Open w/ five 3" EW totes	19	21	30.4	100	52	\$ 677.00
120005000P_	Door w/ five 3" EW totes	19	21	30.4	100	59	\$ 750.00
110V05000P_	Open w/ five 3" EW totes & riser	19	21	37	100	69	\$ 910.00
120V05000P_	Door w/ five 3" EW totes & riser	19	21	37	100	76	\$ 985.00
110L05000P_	Open w/ five 3" EW totes & lectern	19	21	41.5	100	71	\$ 920.00
120L05000P_	Door w/ five 3" EW totes & lectern	19	21	41.5	100	78	\$ 993.00
110003010P_	Open w/ three 3" & one 6" EW tote	19	21	30.4	100	53	\$ 652.00
120003010P_	Door w/ three 3" & one 6" EW tote	19	21	30.4	100	60	\$ 725.00
110V03010P_	Open w/ three 3" & one 6" EW tote & riser	19	21	37	100	69	\$ 886.00
120V03010P_	Door w/ three 3" & one 6" EW tote & riser	19	21	37	100	76	\$ 960.00
110L03010P_	Open w/ three 3" & one 6" EW tote & lectern	19	21	41.5	100	73	\$ 895.00
120L03010P_	Door w/ three 3" & one 6" EW tote & lectern	19	21	41.5	100	80	\$ 968.00

Cascade Mid-Cases

MODEL	DESCRIPTION	D"	W"	H"	F.C.	WT.	2016 LIST
Shelves							
211000000P_	Open w/ shelves	19	29	30.4	100	63	\$ 571.00
221000000P_	Doors w/ shelves	19	29	30.4	100	74	\$ 688.00
211V00000P_	Open w/ shelves & riser	19	29	37	100	87	\$ 804.00
221V00000P_	Doors w/ shelves & riser	19	29	37	100	98	\$ 921.00
211L00000P_	Open w/ shelves & lectern	19	29	41.5	100	89	\$ 813.00
221L00000P_	Doors w/ shelves & lectern	19	29	41.5	100	100	\$ 929.00
Standard Width (SW) Totes							
210010000P_	Open w/ ten 3" SW totes	19	29	30.4	100	69	\$ 823.00
220010000P_	Doors w/ ten 3" SW totes	19	29	30.4	100	80	\$ 951.00
210V10000P_	Open w/ ten 3" SW totes & riser	19	29	37	100	93	\$ 1,080.00
220V10000P_	Doors w/ ten 3" SW totes & riser	19	29	37	100	104	\$ 1,207.00
210L10000P_	Open w/ ten 3" SW totes & lectern	19	29	41.5	100	95	\$ 1,088.00
220L10000P_	Doors w/ ten 3" SW totes & lectern	19	29	41.5	100	106	\$ 1,217.00
210006020P_	Open w/ six 3" & two 6" SW totes	19	29	30.4	100	70	\$ 803.00
220006020P_	Doors w/ six 3" & two 6" SW totes	19	29	30.4	100	81	\$ 931.00
210V06020P_	Open w/ six 3" & two 6" SW totes & riser	19	29	37	100	95	\$ 1,060.00
220V06020P_	Doors w/ six 3" & two 6" SW totes & riser	19	29	37	100	106	\$ 1,187.00
210L06020P_	Open w/ six 3" & two 6" SW totes & lectern	19	29	41.5	100	97	\$ 1,069.00
220L06020P_	Doors w/ six 3" & two 6" SW totes & lectern	19	29	41.5	100	108	\$ 1,197.00

Cascade Mega-Cases

MODEL	DESCRIPTION	D"	W"	H"	F.C.	WT.	2016 LIST
Shelves							
311000000P_	Open w/ shelves	19	43	30.4	100	82	\$ 730.00
321000000P_	Doors w/ shelves	19	43	30.4	100	96	\$ 869.00
311100000P_	Open w/ shelves & riser	19	43	37	100	117	\$ 979.00
321100000P_	Doors w/ shelves & riser	19	43	37	100	131	\$ 1,119.00
311J00000P_	Open w/ shelves & lectern	19	43	41.5	100	119	\$ 987.00
321J00000P_	Doors w/ shelves & lectern	19	43	41.5	100	133	\$ 1,127.00
311N00000P_	Open w/ shelves & presentation top	19	43	59.25	100	137	\$ 1,141.00
321N00000P_	Doors w/ shelves & presentation top	19	43	59.25	100	151	\$ 1,281.00
Standard Width (SW) Totes							
310015000P_	Open w/ fifteen 3" SW totes	19	43	30.4	100	90	\$ 1,094.00
320015000P_	Doors w/ fifteen 3" SW totes	19	43	30.4	100	104	\$ 1,248.00
310115000P_	Open w/ fifteen 3" SW totes & riser	19	43	37	100	115	\$ 1,368.00
320115000P_	Doors w/ fifteen 3" SW totes & riser	19	43	37	100	129	\$ 1,523.00
310J15000P_	Open w/ fifteen 3" SW totes & lectern	19	43	41.5	100	117	\$ 1,378.00
320J15000P_	Doors w/ fifteen 3" SW totes & lectern	19	43	41.5	100	131	\$ 1,531.00
310N15000P_	Open w/ fifteen 3" SW totes & presentation top	19	43	59.25	100	145	\$ 1,547.00
320N15000P_	Doors w/ fifteen 3" SW totes & presentation top	19	43	59.25	100	159	\$ 1,701.00
310009030P_	Open w/ nine 3" & three 6" SW totes	19	43	30.4	100	92	\$ 1,065.00
320009030P_	Doors w/ nine 3" & three 6" SW totes	19	43	30.4	100	106	\$ 1,219.00
310J09030P_	Open w/ nine 3" & three 6" SW totes & riser	19	43	37	100	117	\$ 1,339.00
320J09030P_	Doors w/ nine 3" & three 6" SW totes & riser	19	43	37	100	131	\$ 1,493.00
310J09030P_	Open w/ nine 3" & three 6" SW totes & lectern	19	43	44.5	100	119	\$ 1,348.00
320J09030P_	Doors w/ nine 3" & three 6" SW totes & lectern	19	43	44.5	100	133	\$ 1,502.00
310N09030P_	Open w/ nine 3" & three 6" SW totes & presentation top	19	43	59.25	100	147	\$ 1,518.00
320N09030P_	Doors w/ nine 3" & three 6" SW totes & presentation top	19	43	59.25	100	161	\$ 1,671.00
Extra Wide (EW) Totes							
A10010000P_	Open w/ ten 3" EW totes	19	43	30.4	100	92	\$ 1,150.00
A20010000P_	Doors w/ ten 3" EW totes	19	43	30.4	100	106	\$ 1,303.00
A10110000P_	Open w/ ten 3" EW totes & riser	19	43	37	100	117	\$ 1,424.00
A20110000P_	Doors w/ ten 3" EW totes & riser	19	43	37	100	131	\$ 1,578.00
A10J10000P_	Open w/ ten 3" EW totes & lectern	19	43	41.5	100	119	\$ 1,433.00
A20J10000P_	Doors w/ ten 3" EW totes & lectern	19	43	41.5	100	133	\$ 1,587.00
A10N10000P_	Open w/ ten 3" EW totes & presentation top	19	43	68	100	147	\$ 1,602.00
A20N10000P_	Doors w/ ten 3" EW totes & presentation top	19	43	68	100	161	\$ 1,756.00
A10006020P_	Open w/ six 3" & two 6" EW totes	19	43	30.4	100	92	\$ 1,100.00
A20006020P_	Doors w/ six 3" & two 6" EW totes	19	43	30.4	100	106	\$ 1,253.00
A10106020P_	Open w/ six 3" & two 6" EW totes & riser	19	43	37	100	117	\$ 1,373.00
A20106020P_	Doors w/ six 3" & two 6" EW totes & riser	19	43	37	100	131	\$ 1,527.00
A10J06020P_	Open w/ six 3" & two 6" EW totes & lectern	19	43	41.5	100	119	\$ 1,383.00
A20J06020P_	Doors w/ six 3" & two 6" EW totes & lectern	19	43	41.5	100	133	\$ 1,537.00
A10N06020P_	Open w/ six 3" & two 6" EW totes & presentation top	19	43	68	100	147	\$ 1,553.00
A20N06020P_	Doors w/ six 3" & two 6" EW totes & presentation top	19	43	68	100	161	\$ 1,707.00

CASCADE LAMINATE COLOR CHOICE

Amber Cherry AME	Blond Echo BEE	Golden Oak GOK	Grey Nebula GNB	Pewter Mesh PEW	Wild Cherry CHE
Asian Night ANG	Fusion Maple MAP	Grey Mesh GRE	New Age Oak NEW	Tan Echo TAC	

CASCADE END PANEL AND EDGE COLOR CHOICE

Apple A	Burgundy D	Charcoal R	Forest Green F	Mocha T	Persian Blue J	Red L
Black B	Cerulean S	Chocolate Q	Fuchsia G	Navy I	Platinum P	White* M
Blueberry C	Champagne O*	Clementine E	Mint H	Orange* U	Purple K	Yellow N

* Edge color only. View all finish options on page 260.



Cascade

Storage



Cascade Mini-Cabinet

These versatile, mobile storage units with a large capacity and a small footprint are available with either tote trays or shelves and can be fitted with numerous options including locking doors, and a riser shelf. Our Cascade Storage System allows educators to organize, store and distribute learning materials. These mobile storage units are highly customizable to hold items in a wide range of sizes and shapes – from sheets of paper to art supplies.



Cascade Mid-Cabinet



Cascade Mega-Cabinet

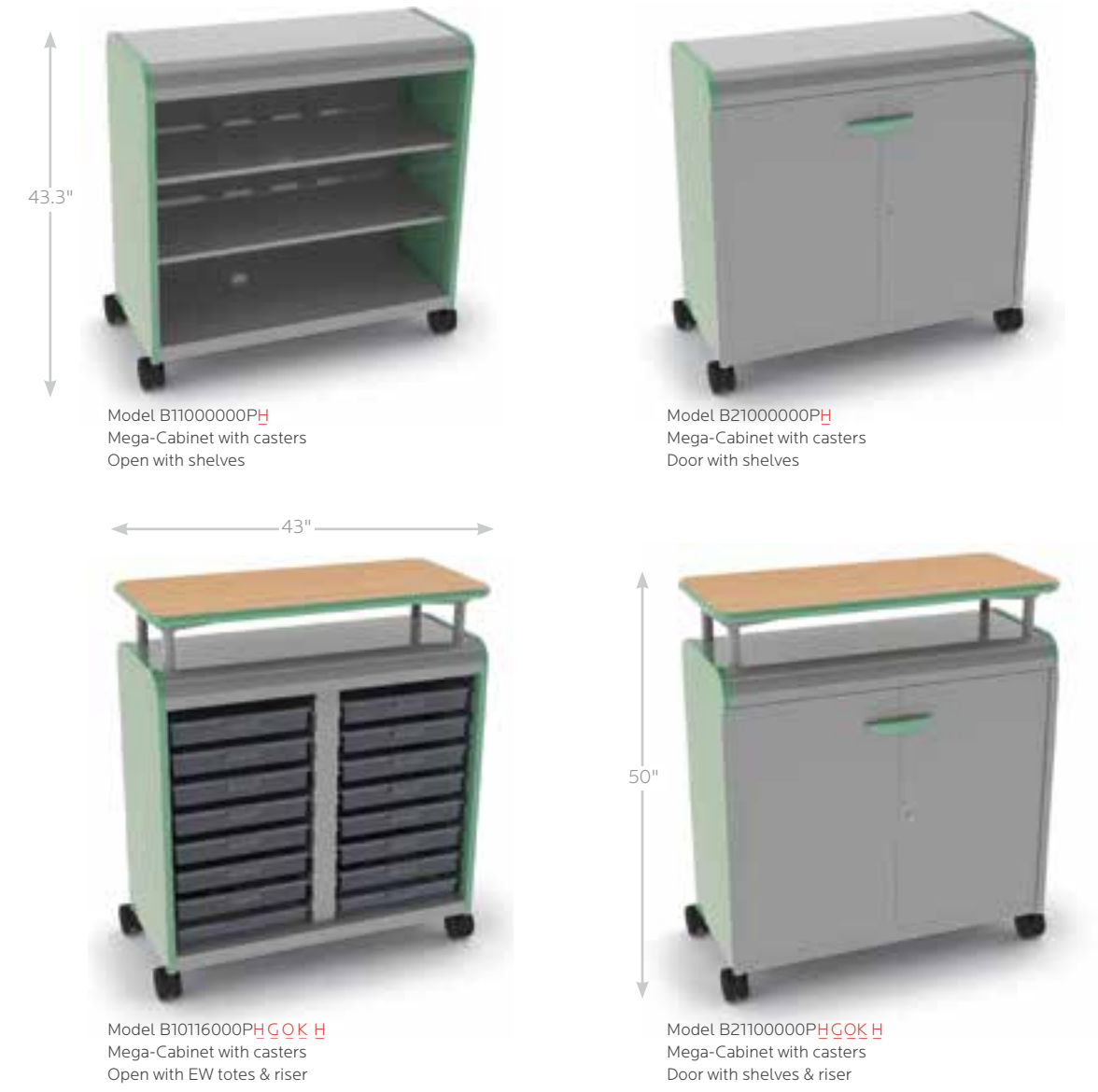

CASCADE LAMINATE COLOR CHOICE

- Amber Cherry AME, Blond Echo BEE, Golden Oak GOK, Grey Nebula GNB, Pewter Mesh PEW, Wild Cherry CHE
- Asian Night ANG, Fusion Maple MAP, Grey Mesh GRE, New Age Oak NEW, Tan Echo TAC

CASCADE END PANEL AND EDGE COLOR CHOICE

- Apple A, Burgundy D, Charcoal R, Forest Green F, Mocha T, Persian Blue J, Red L
- Black B, Cerulean S, Chocolate Q, Fuchsia G, Navy I, Platinum P, White* M
- Blueberry C, Champagne O*, Clementine E, Mint H, Orange* U, Purple K, Yellow N

* Edge color only. View all finish options on page 260.

Cascade Mini-Cabinet

MODEL	DESCRIPTION	D"	W"	H"	F.C.	WT.	2016 LIST
Shelves							
41100000P_	Open w/ shelves	19	21	43.3	100	63	\$ 582.00
42100000P_	Door w/ shelves	19	21	43.3	100	73	\$ 674.00
411V0000P_-----	Open w/ shelves & riser	19	21	50	100	78	\$ 795.00
421V0000P_-----	Door w/ shelves & riser	19	21	50	100	88	\$ 887.00
Extra Wide (EW) Totes							
41008000P_	Open w/ eight 3" EW totes	19	21	43.3	100	74	\$ 918.00
42008000P_	Door w/ eight 3" EW totes	19	21	43.3	100	84	\$ 1,019.00
410V8000P_-----	Open w/ eight 3" EW totes & riser	19	21	50	100	89	\$ 1,152.00
420V8000P_-----	Door w/ eight 3" EW totes & riser	19	21	50	100	99	\$ 1,253.00
41004020P_	Open w/ four 3" and two 6" EW totes	19	21	43.3	100	72	\$ 868.00
42004020P_	Door w/ four 3" and two 6" EW totes	19	21	43.3	100	82	\$ 970.00
410V4020P_-----	Open w/ four 3" and two 6" EW totes & riser	19	21	50	100	87	\$ 1,103.00
420V4020P_-----	Door w/ four 3" and two 6" EW totes & riser	19	21	50	100	97	\$ 1,204.00
41000040P_	Open w/ four 6" EW totes	19	21	43.3	100	72	\$ 818.00
42000040P_	Door w/ four 6" EW totes	19	21	43.3	100	82	\$ 920.00
410V0040P_-----	Open w/ four 6" EW totes & riser	19	21	50	100	87	\$ 1,053.00
420V0040P_-----	Door w/ four 6" EW totes & riser	19	21	50	100	97	\$ 1,153.00

Cascade Mid-Cabinet

MODEL	DESCRIPTION	D"	W"	H"	F.C.	WT.	2016 LIST
Shelves							
51100000P_	Open w/ shelves	19	29	43.3	100	81	\$ 717.00
52100000P_	Doors w/ shelves	19	29	43.3	100	97	\$ 877.00
511V0000P_-----	Open w/ shelves & riser	19	29	50	100	101	\$ 950.00
521V0000P_-----	Doors w/ shelves & riser	19	29	50	100	117	\$ 1,110.00
Standard Width (SW) Totes							
510016000P_	Open w/ sixteen 3" SW totes	19	29	43.3	100	97	\$ 1,100.00
520016000P_	Doors w/ sixteen 3" SW totes	19	29	43.3	100	113	\$ 1,275.00
510V16000P_-----	Open w/ sixteen 3" SW totes & riser	19	29	50	100	117	\$ 1,357.00
520V16000P_-----	Doors w/ sixteen 3" SW totes & riser	19	29	50	100	123	\$ 1,532.00
510008040P_	Open w/ eight 3" and four 6" SW totes	19	29	43.3	100	95	\$ 1,061.00
520008040P_	Doors w/ eight 3" and four 6" SW totes	19	29	43.3	100	111	\$ 1,237.00
510V08040P_-----	Open w/ eight 3" and four 6" SW totes & riser	19	29	50	100	115	\$ 1,317.00
520V08040P_-----	Doors w/ eight 3" and four 6" SW totes & riser	19	29	50	100	121	\$ 1,493.00
51000080P_	Open w/ eight 6" SW totes	19	29	43.3	100	95	\$ 1,021.00
52000080P_	Doors w/ eight 6" SW totes	19	29	43.3	100	111	\$ 1,198.00
510V0080P_-----	Open w/ eight 6" SW totes & riser	19	29	50	100	115	\$ 1,278.00
520V0080P_-----	Doors w/ eight 6" SW totes & riser	19	29	50	100	121	\$ 1,455.00

CASCADE LAMINATE COLOR CHOICE

Amber Cherry AME	Blond Echo BEE	Golden Oak GOK	Grey Nebula GNB	Pewter Mesh PEW	Wild Cherry CHE
Asian Night ANG	Fusion Maple MAP	Grey Mesh GRE	New Age Oak NEW	Tan Echo TAC	

CASCADE END PANEL AND EDGE COLOR CHOICE

Apple A	Burgundy D	Charcoal R	Forest Green F	Mocha T	Persian Blue J	Red L
Black B	Cerulean S	Chocolate Q	Fuchsia G	Navy I	Platinum P	White* M
Blueberry C	Champagne O*	Clementine E	Mint H	Orange* U	Purple K	Yellow N

* Edge color only. View all finish options on page 260.

Cascade Mega-Cabinet

MODEL	DESCRIPTION	D"	W"	H"	F.C.	WT.	2016 LIST
Shelves							
B3100000P_	Open w/ shelves	19	43	38.4	100	100	\$ 884.00
B4100000P_	Doors w/ shelves	19	43	38.4	100	119	\$ 1,077.00
B3110000P_-----	Open w/ shelves & riser	19	43	45	100	126	\$ 1,134.00
B4110000P_-----	Doors w/ shelves & riser	19	43	45	100	144	\$ 1,327.00
B1100000P_	Open w/ shelves	19	43	43.3	100	105	\$ 909.00
B2100000P_	Doors w/ shelves	19	43	43.3	100	124	\$ 1,103.00
B1110000P_-----	Open w/ shelves & riser	19	43	50	100	131	\$ 1,159.00
B2110000P_-----	Doors w/ shelves & riser	19	43	50	100	149	\$ 1,352.00
Standard Width (SW) Totes							
610024000P_	Open w/ twenty-four 3" SW totes	19	43	43.3	100	132	\$ 1,468.00
620024000P_	Doors w/ twenty-four 3" SW totes	19	43	43.3	100	150	\$ 1,679.00
610124000P_-----	Open w/ twenty-four 3" SW totes & riser	19	43	50	100	158	\$ 1,727.00
620124000P_-----	Doors w/ twenty-four 3" SW totes & riser	19	43	50	100	176	\$ 1,954.00
610012060P_	Open w/ twelve 3" and six 6" SW totes	19	43	43.3	100	132	\$ 1,408.00
620012060P_	Doors w/ twelve 3" and six 6" SW totes	19	43	43.3	100	150	\$ 1,621.00
610112060P_-----	Open w/ twelve 3" and six 6" SW totes & riser	19	43	50	100	158	\$ 1,683.00
620112060P_-----	Doors w/ twelve 3" and six 6" SW totes & riser	19	43	50	100	176	\$ 1,895.00
Extra Wide (EW) Totes							
B10016000P_	Open w/ sixteen 3" EW totes	19	43	43.3	100	132	\$ 1,555.00
B20016000P_	Doors w/ sixteen 3" EW totes	19	43	43.3	100	150	\$ 1,768.00
B10116000P_-----	Open w/ sixteen 3" EW totes & riser	19	43	50	100	158	\$ 1,830.00
B20116000P_-----	Doors w/ sixteen 3" EW totes & riser	19	43	50	100	176	\$ 2,029.00
B1000080P_	Open w/ eight 6" EW totes	19	43	43.3	100	132	\$ 1,357.00
B2000080P_	Doors w/ eight 6" EW totes	19	43	43.3	100	150	\$ 1,568.00
B1010080P_-----	Open w/ eight 6" EW totes & riser	19	43	50	100	158	\$ 1,631.00
B2010080P_-----	Doors w/ eight 6" EW totes & riser	19	43	50	100	176	\$ 1,843.00
B10008040P_	Open w/ eight 3" and four 6" EW totes	19	43	43.3	100	132	\$ 1,459.00
B20008040P_	Doors w/ eight 3" and four 6" EW totes	19	43	43.3	100	150	\$ 1,671.00
B10108040P_-----	Open w/ eight 3" and four 6" EW totes & riser	19	43	50	100	158	\$ 1,734.00
B20108040P_-----	Doors w/ eight 3" and four 6" EW totes & riser	19	43	50	100	176	\$ 1,945.00

Note: When ordering a Riser Shelf for a Mega-Cabinet, 1 1/4" thick top is only option available.

Cascade Cabinet Lecterns

MODEL	DESCRIPTION	D"	W"	H"	F.C.	CUBE	WT.	UPS	2016 LIST
Cascade Mini-Cabinet*									
411L0000P_-----	Open w/ shelves & lectern	19	21	48	100	11.1	80		\$ 863.00
Cascade Mid-Cabinet*									
511L0000P_-----	Open w/ shelves & lectern	19	29	48	100	15.3	103		\$ 959.00
Cascade Mega-Cabinet*									
611J0000P_-----	Open w/ shelves & lectern	19	43	48	100	22.7	128		\$ 1,166.00

* with casters



Cascade

Storage

Cascade Mini-Tower

These versatile, mobile storage units with a large capacity and a small footprint are available with either tote trays or shelves and can be fitted with locking doors. Our Cascade Storage System allows educators to organize, store and distribute learning materials. These mobile storage units are highly customizable to hold items in a wide range of sizes and shapes – from sheets of paper to art supplies.



Model 711000000PG
Mini-Tower with casters
Open with shelves

Model 721000000PG
Mini-Tower with casters
Door with shelves

Model 710012000PG
Mini-Tower with casters
Open with EW totes

Model 720012000PG
Mini-Tower with casters
Door with EW totes

Cascade Mid-Tower



Model 811000000PE
Mid-Tower with casters
Open with shelves

Model 821000000PE
Mid-Tower with casters
Door with shelves

Model 810024000PE
Mid-Tower with casters
Open with SW totes

Model 820024000PE
Mid-Tower with casters
Door with SW totes

Cascade Mega-Tower



Model 911000000PL
Mega-Tower with casters
Open with shelves

Model 921000000PL
Mega-Tower with casters
Door with shelves

Model 910009093PL
Mega-Tower with casters
Open with SW totes

Model C10024000PA
Mega-Tower with casters
Open with EW totes

Add Whiteboard Back to Mega-Tower size + \$ 195 to list price



CASCADE END PANEL AND EDGE COLOR CHOICE

- | | | | | | | |
|-------------|--------------|--------------|----------------|-----------|----------------|----------|
| Apple A | Burgundy D | Charcoal R | Forest Green F | Mocha T | Persian Blue J | Red L |
| Black B | Cerulean S | Chocolate Q | Fuchsia G | Navy I | Platinum P | White* M |
| Blueberry C | Champagne O* | Clementine E | Mint H | Orange* U | Purple K | Yellow N |

* Edge color only. View all finish options on page 260.



Cascade Mini-Tower

MODEL	DESCRIPTION		D"	W"	H"	F.C.	WT.	2016 LIST
Shelves								
71100000P_	Open w/ shelves	with casters	19	21	61.4	100	81	\$ 730.00
72100000P_	Door w/ shelves	with casters	19	21	61.4	100	97	\$ 858.00
Extra Wide (EW) Totes								
71001200P_	Open w/ twelve 3" EW totes	with casters	19	21	61.4	100	96	\$ 1,219.00
72001200P_	Door w/ twelve 3" EW totes	with casters	19	21	61.4	100	112	\$ 1,360.00
710003050P_	Open w/ three 3" and five 6" EW totes	with casters	19	21	61.4	100	94	\$ 1,129.00
720003050P_	Door w/ three 3" and five 6" EW totes	with casters	19	21	61.4	100	110	\$ 1,270.00
710000060P_	Open w/ six 6" EW totes	with casters	19	21	61.4	100	96	\$ 1,069.00
720000060P_	Door w/ six 6" EW totes	with casters	19	21	61.4	100	112	\$ 1,210.00



Cascade Mid-Tower

MODEL	DESCRIPTION		D"	W"	H"	F.C.	WT.	2016 LIST
Shelves								
81100000P_	Open w/ shelves	with casters	19	29	61.4	100	102	\$ 897.00
82100000P_	Doors w/ shelves	with casters	19	29	61.4	100	128	\$ 1,126.00
Standard Width (SW) Totes								
81002400P_	Open w/ twenty-four 3" SW totes	with casters	19	29	61.4	100	125	\$ 1,454.00
82002400P_	Doors w/ twenty-four 3" SW totes	with casters	19	29	61.4	100	151	\$ 1,704.00
810006062P_	Open w/ six 3" and six 6" and two 12" SW totes	with casters	19	29	61.4	100	121	\$ 1,370.00
820006062P_	Doors w/ six 3" and six 6" and two 12" SW totes	with casters	19	29	61.4	100	147	\$ 1,621.00
810000120P_	Open w/ twelve 6" SW totes	with casters	19	29	61.4	100	125	\$ 1,337.00
820000120P_	Doors w/ twelve 6" SW totes	with casters	19	29	61.4	100	151	\$ 1,588.00



Cascade Mega-Tower with thirty-six SW totes. Shown in Red.



Cascade Mega-Towers

MODEL	DESCRIPTION		D"	W"	H"	F.C.	WT.	2016 LIST
Shelves								
91100000P_	Open w/ shelves	with casters	19	43	61.4	100	134	\$ 1,128.00
92100000P_	Doors w/ shelves	with casters	19	43	61.4	100	167	\$ 1,405.00
911W0000P_	Open w/ shelves and whiteboard back	with casters	19	43	61.4	100	134	\$ 1,323.00
921W0000P_	Doors w/ shelves and whiteboard back	with casters	19	43	61.4	100	167	\$ 1,600.00
Standard Width (SW) Totes								
91003600P_	Open w/ thirty-six 3" SW totes	with casters	19	43	61.4	100	209	\$ 1,940.00
92003600P_	Doors w/ thirty-six 3" SW totes	with casters	19	43	61.4	100	242	\$ 2,244.00
910009093P_	Open w/ nine 3" and nine 6" and three 12" SW totes	with casters	19	43	61.4	100	209	\$ 1,815.00
920009093P_	Doors w/ nine 3" and nine 6" and three 12" SW totes	with casters	19	43	61.4	100	242	\$ 2,120.00
910009150P_	Open w/ nine 3" and fifteen 6" SW totes	with casters	19	43	61.4	100	209	\$ 1,852.00
920009150P_	Doors w/ nine 3" and fifteen 6" SW totes	with casters	19	43	61.4	100	242	\$ 2,156.00
Extra Wide (EW) Totes								
C1002400P_	Open w/ twenty-four 3" EW totes	with casters	19	43	61.4	100	209	\$ 2,073.00
C2002400P_	Doors w/ twenty-four 3" EW totes	with casters	19	43	61.4	100	242	\$ 2,378.00
C10014060P_	Open w/ fourteen 3" and six 6" EW totes	with casters	19	43	61.4	100	209	\$ 1,991.00
C20014060P_	Doors w/ fourteen 3" and six 6" EW totes	with casters	19	43	61.4	100	242	\$ 2,296.00

Whiteboard Back available for Mega-Tower size, +\$195 to list price. Add W to 4th character to order. Example on page 231.

CASCADE END PANEL AND EDGE COLOR CHOICE

- Apple A
- Burgundy D
- Charcoal R
- Forest Green F
- Mocha T
- Persian Blue J
- Red L
- Black B
- Cerulean S
- Chocolate Q
- Fuchsia G
- Navy I
- Platinum P
- White* M
- Blueberry C
- Champagne O*
- Clementine E
- Mint H
- Orange* U
- Purple K
- Yellow N

* Edge color only. View all finish options on page 260.

See Cascade in action at: smithsystem.com/cascade-storage





Cascade Teacher Wardrobe with totes

This high-capacity, versatile, mobile storage unit is available with tote trays and a shelf and can be fitted with optional locking doors. Our Cascade Storage System allows educators to organize, store and distribute learning materials. This mobile storage unit is highly customizable to hold items in a wide range of sizes and shapes – from daily assignments to art supplies.

Lessen the footprint of your teacher's area.

Conveniently store the essentials.



Model R10006062P
Cascade Teacher Wardrobe with casters.
Open with SW totes.



Model L10024000PE
Cascade Teacher Wardrobe with casters.
Open with SW totes.

Available with locking doors.

Cascade Teacher Wardrobe with totes

MODEL	DESCRIPTION	D"	W"	H"	F.C.	WT.	2016 LIST
Right-hand Standard Width (SW) Totes							
R10024000P_	Open w/ twenty-four 3" SW totes with casters	19	43	61.4	100	147	\$ 1,707.00
R20024000P_	Doors w/ twenty-four 3" SW totes with casters	19	43	61.4	100	179	\$ 2,011.00
R10000120P_	Open w/ twelve 6" SW totes with casters	19	43	61.4	100	147	\$ 1,590.00
R10006062P_	Open w/ six 3" and six 6" and two 12" SW totes with casters	19	43	61.4	100	147	\$ 1,623.00
R20000120P_	Doors w/ twelve 6" SW totes with casters	19	43	61.4	100	179	\$ 1,895.00
R20006062P_	Doors w/ six 3" and six 6" and two 12" SW totes with casters	19	43	61.4	100	179	\$ 1,928.00

Note: *Specify whether you would like shelf/wardrobe on Left or Right. Model numbers for Left-hand Shelf begin with L.

Whiteboard Back available for Mega-Tower size, +\$ 195 to list price
Add W to 4th character to order. Example: R10W24000P_



S10000000PD
Mini-Tower Wardrobe



Model T10000000PE
Mid-Tower Wardrobe



Model U10000000PL
Mega-Tower Wardrobe

Get those jackets off the backs of your beautiful new Flavors chairs and into a Cascade Wardrobe Closet.

Cascade Wardrobe Closet with full length coat rod

MODEL	DESCRIPTION	D"	W"	H"	F.C.	CUBE	WT.	2016 LIST
Cascade Mini-Tower Wardrobe								
S10000000P_	Open w/ shelf and rod with casters	19	21	61.4	100	11.1	88	\$ 700.00
S20000000P_	Doors w/ shelf and rod with casters	19	21	61.4	100	11.1	88	\$ 828.00
Cascade Mid-Tower Wardrobe								
T10000000P_	Open w/ shelf and rod with casters	19	29	61.4	100	15.3	132	\$ 865.00
T20000000P_	Doors w/ shelf and rod with casters	19	29	61.4	100	15.3	132	\$ 1,094.00
Cascade Mega-Tower Wardrobe								
U10000000P_	Open w/ shelf and rod with casters	19	43	61.4	100	22.7	137	\$ 1,092.00
U20000000P_	Open w/ shelf and rod with casters	19	43	61.4	100	22.7	137	\$ 1,369.00

CASCADE END PANEL AND EDGE COLOR CHOICE

- Apple A
- Burgundy D
- Charcoal R
- Forest Green F
- Mocha T
- Persian Blue J
- Red L
- Black B
- Cerulean S
- Chocolate Q
- Fuchsia G
- Navy I
- Platinum P
- White* M
- Blueberry C
- Champagne O*
- Clementine E
- Mint H
- Orange* U
- Purple K
- Yellow N

* Edge color only. View all finish options on page 260.



Cubby Mega-Tower

Cubby Mega-Cabinet

Cubby Mega-Case

Cascade Cubby

These versatile storage units feature large cubbies for organizing backpacks of all sizes, with room left over. They offer the additional benefit of mobility thanks to their 4" or 5" dual-wheel casters. Lockable doors are available as an option, as is a Whiteboard on the Cubby Mega Tower.

The Cascade Cubby combines the quality of ready access you get with shelf storage with the organizational advantages you get with tote storage. Whether used for holding student backpacks or for learning materials, they perform well. Cascade Cubbies are the newest addition to our flexible, scalable, comprehensive solutions for organization, storage and distribution of materials within the school.

- All-steel cabinet rolls on dual-wheel casters: 4" casters for Mega-Case; 5" casters for Mega-Tower and Mega-Cabinet
- Whiteboard back available on Mega-Tower for +\$195.00 list.

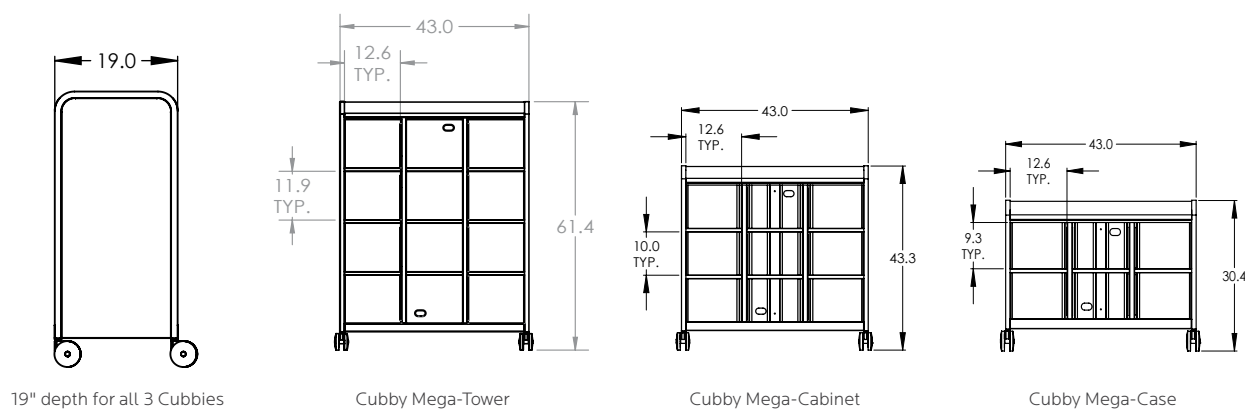

Cascade Cubby Mega-Tower
Model F11000000P_A
Shown in Apple.

Cascade Cubby Mega-Cabinet
Model E11000000P_C
Shown in Blueberry.

Cascade Cubby Mega-Case
Model D11000000P_E
Shown in Clementine.

Cascade Cubby

MODEL	DESCRIPTION		D"	W"	H"	F.C.	CUBE	WT.	UPS	2016 LIST
Cascade Cubby Mega-Tower										
F11000000P_	Open w/ 12 Cubbies	with casters	19	43	61.4	100		135		\$ 1,595.00
F21000000P_	Doors w/ 12 Cubbies	with casters	19	43	61.4	100		154		\$ 1,872.00
F31000000P_	Open w/ 12 Cubbies	with glides	19	43	56.4	100		132		\$ 1,570.00
F41000000P_	Doors w/ 12 Cubbies	with glides	19	43	56.4	100		151		\$ 1,847.00
Cascade Cubby Mega-Cabinet										
E11000000P_	Open w/ 9 Cubbies	with casters	19	43	43.4	100		128		\$ 1,295.00
E21000000P_	Doors w/ 9 Cubbies	with casters	19	43	43.4	100		147		\$ 1,488.00
E31000000P_	Open w/ 9 Cubbies	with glides	19	43	38.4	100		125		\$ 1,270.00
E41000000P_	Doors w/ 9 Cubbies	with glides	19	43	38.4	100		144		\$ 1,463.00
Cascade Cubby Mega-Case										
D11000000P_	Open w/ 6 Cubbies	with casters	19	43	30.4	100		97		\$ 995.00
D21000000P_	Doors w/ 6 Cubbies	with casters	19	43	30.4	100		111		\$ 1,134.00
D31000000P_	Open w/ 6 Cubbies	with glides	19	43	25.4	100		94		\$ 970.00
D41000000P_	Doors w/ 6 Cubbies	with glides	19	43	25.4	100		108		\$ 1,109.00

Whiteboard Back available for Mega-Tower size, +\$195 to list price
Add W to 4th character to order. Example: F11W00000P_



CASCADE END PANEL AND EDGE COLOR CHOICE

- Apple **A**
- Burgundy **D**
- Charcoal **R**
- Forest Green **F**
- Mocha **T**
- Persian Blue **J**
- Red **L**
- Black **B**
- Cerulean **S**
- Chocolate **Q**
- Fuchsia **G**
- Navy **I**
- Platinum **P**
- White* **M**
- Blueberry **C**
- Champagne **O***
- Clementine **E**
- Mint **H**
- Orange* **U**
- Purple **K**
- Yellow **N**

* Edge color only. View all finish options on page 260.



The Presentation Cart is a compact dual purpose storage unit—accommodates lecture and storage needs.



Model 311N00000PGMAPG
Cascade Mega-Case Presentation Cart. Shown in Fuchsia End Panels. Riser Shelf and Lectern shown in Fusion Maple Laminate top color with Fuchsia edge color.

Cascade Presentation Carts (Mega-Case with Riser & Lectern)

This mobile presentation station demonstrates the versatility and utility of the Cascade concept. It is based on a Cascade Mega-Case fitted with a riser shelf and lectern. It also provides ample space for storing and organizing presentation materials.

- All-steel cabinet rolls on 4" dual-wheel casters.
- 1 1/4" top available in 11 standard laminate colors.
- Choice of Bumper T-Mold (standard **N**) or 4mm T-Mold (replace **N** with **Q** in part number) in 21 standard colors.

MODEL	DESCRIPTION	D"	W"	H"	F.C.	CUBE	WT.	2016 LIST
Shelves								
311N00000P_	Open w/ shelves & presentation top	with casters	19	43	59.5	100	18	137 \$ 1,141.00
321N00000P_	Doors w/ shelves & presentation top	with casters	19	43	59.5	100	18	151 \$ 1,281.00
Standard Width (SW) Totes								
310N15000P_	Open w/ fifteen 3" totes & presentation top	with casters	19	43	59.5	100	18	145 \$ 1,547.00
320N15000P_	Doors w/ fifteen 3" totes & presentation top	with casters	19	43	59.5	100	18	159 \$ 1,701.00
310N09030P_	Open w/ nine 3" & three 6" SW totes & presentation top	with casters	19	43	59.5	100	18	147 \$ 1,518.00
320N09030P_	Doors w/ nine 3" & three 6" SW totes & presentation top	with casters	19	43	59.5	100	18	151 \$ 1,671.00

1 1/4" Tops
3/8" Bumper T-Mold (N) N = Mega Case (1 1/4" Bumper T-Mold)
4mm T-Mold (Q) Q = Mega Case (1 1/4" 4mm T-mold)

Mega-Case with riser and lectern available with 1 1/4" top only.
 Choice **N** is standard edge. For optional edge option **Q**, replace **N** with **Q** in model number.



With five inside outlets and four exterior outlets the AV Presentation cart is a media specialist's dream.

Model V21100000PGIACG
Cascade Mega-Case AV Presentation Cart. Shown in Fuchsia End Panel & Door Handle. Riser Shelf shown in Tan Echo Laminate top color with Fuchsia edge color.



Model V21100000PGIACG
Cascade Mega-Case

Cascade AV Presentation Carts

This presentation cart provides movable, lockable storage for AV equipment, and a durable work surface. Available in 18 colors. Locking doors open 270° to provide obstruction-free access to AV gear and materials.

- Ventilation ports to help cool electronic devices and projectors.
- Cord and access ports located on back.
- Total of four electrical outlets outside and five inside connected with one 12 foot cord.
- Rolls smoothly on 4" double-wheel casters.
- 16.5" x 40.5" inside shelf included



Model W21100000PSIACS
Cascade Mid-Case

MODEL	DESCRIPTION	D"	W"	H"	F.C.	CUBE	WT.	2016 LIST
V21100000P_	Cascade Mega-Case AV Presentation Cart	19	43	37	100	22.7	125	\$ 1,950.00
W21100000P_	Cascade Mid-Case AV Presentation Cart	19	29	37	100		98	\$ 1,750.00



Shown: ventilation ports to help cool electronic devices, cord access ports and one of two power modules with two external outlets. There are also five electrical outlets on the inside, not shown.

CASCADE LAMINATE COLOR CHOICE

- Amber Cherry **AME** Blond Echo **BEE** Golden Oak **GOK** Grey Nebula **GNB** Pewter Mesh **PEW** Wild Cherry **CHE**
- Asian Night **ANG** Fusion Maple **MAP** Grey Mesh **GRE** New Age Oak **NEW** Tan Echo **TAC**

CASCADE END PANEL AND EDGE COLOR CHOICE

- Apple **A** Burgundy **D** Charcoal **R** Forest Green **F** Mocha **T** Persian Blue **J** Red **L**
- Black **B** Cerulean **S** Chocolate **Q** Fuchsia **G** Navy **I** Platinum **P** White* **M**
- Blueberry **C** Champagne **O*** Clementine **E** Mint **H** Orange* **U** Purple **K** Yellow **N**

* Edge color only. View all finish options on page 260.



Standard Width (SW) Tote



Extra Wide (EW) Tote



MODEL	DESCRIPTION	D"	W"	H"	F.C.	CUBE	WT.	UPS	2016 LIST
Totes with housing									
30925	SW (Standard Width) housing with tote	16.8	13.5	3	70	8	8		\$ 93.00
30926	EW (Extra Wide) housing with tote	16.8	19.6	3	70	10	10		\$ 103.00
30927	SW (Standard Width) housing only				70	2	2		\$ 55.00
30928	EW (Extra Width) housing only				70	3	3		\$ 69.00
Interchange Totes with standard width housing									
66013	Interchange SW (standard width) tote tray w/housing								\$ 88.00
66014	Interchange SW (standard width) housing only								\$ 68.00
Standard Width Totes									
66000	SW Single Depth tote Clear 3"	16.8	12.3	3	70	4	4		\$ 20.00
66001	SW Double Depth tote Clear 6"	16.8	12.3	6	70	6	6		\$ 29.00
66002	SW Quad Depth tote Clear 12"	16.8	12.3	12	70	8	8		\$ 47.00
Extra Wide Totes									
66010	EW Single Depth tote Clear	16.6	18.4	3	70	5	5		\$ 36.00
66011	EW Double Depth tote Clear	16.6	18.4	6	70	7	7		\$ 47.00
Tote Lids									
66020	SW tote lid	16.8	13.5	1	70	2	2		\$ 17.00
66021	EW tote lid	16.6	18.4	1	70	3	3		\$ 20.00
66030	Plastic Label Cover (Avery® Label sold separately. #5162)								\$ 2.00

Standard Width (SW) Tote with Lid (66020) & Label Cover (66030)



Extra Wide (EW) Tote with Lid (66021) & Label Cover (66030) For desk compatibility, see page 211.



Mega-Tower Whiteboard Back Option.

ADD \$195 LIST
AVAILABLE ON ANY
MEGA-TOWER UNIT.



Cascade Mega-Tower with Whiteboard Back Option

To specify a whiteboard back to any Cascade Mega-Tower simply add \$195 to the list price and add a "W" to the 4th position in its model number. See below examples.

MODEL	DESCRIPTION	D"	W"	H"	F.C.	WT.	2016 LIST
Add "W" to fourth position and add \$195 to list price to specify whiteboard back.							
911W00000P_	Open w/ shelves w/whiteboard back	19	43	61.4	100	134	\$ 1,323.00
921W00000P_	Doors w/ shelves w/whiteboard back	19	43	61.4	100	167	\$ 1,600.00

CASCADE LAMINATE COLOR CHOICE

- Amber Cherry **AME**
- Blond Echo **BEE**
- Golden Oak **GOK**
- Grey Nebula **GNB**
- Pewter Mesh **PEW**
- Wild Cherry **CHE**
- Asian Night **ANG**
- Fusion Maple **MAP**
- Grey Mesh **GRE**
- New Age Oak **NEW**
- Tan Echo **TAC**

CASCADE END PANEL AND EDGE COLOR CHOICE

- Apple **A**
- Burgundy **D**
- Chocolate **Q**
- Fuchsia **G**
- Navy **I**
- Platinum **P**
- White* **M**
- Black **B**
- Cerulean **S**
- Clementine **E**
- Mint **H**
- Orange* **U**
- Purple **K**
- Yellow **N**
- Blueberry **C**
- Charcoal **R**
- Forest Green **F**
- Mocha **T**
- Persian Blue **J**
- Red **L**

* Edge color only. View all finish options on page 260.



Cascade™ Teacher's Desk



The Teacher's Desk for the 21st Century.

Single Cabinet
SEE PAGES 236-237

Double Cabinet
SEE PAGES 238-239

Single Bullet Cabinet
SEE PAGES 240-241

Double Bullet Cabinet
SEE PAGES 242-243

Lift Desk
SEE PAGES 244-245

Acrobat Teacher Desk
SEE PAGES 246-247

The teacher's role has evolved from transmitting knowledge and maintaining order to facilitating learning and managing learning materials. That's why the teacher's equipment has evolved, also.

Developed in anticipation of these 21st Century needs, the Cascade Teacher's Desk makes use of Cascade Totes that can be transferred directly to Cascade Storage Units and properly equipped student desks. This allows the Teacher's desk to be the central hub in managing projects and learning materials.



Transfer from cabinet
Totes from the Cascade Wardrobe can be removed and distributed as needed.



Transfer to teacher's desk
Totes holding materials needed for the day's lesson can be moved to the pedestal.

Transfer to student

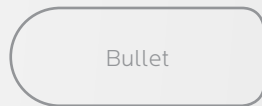
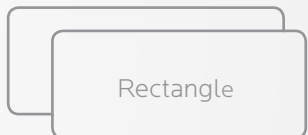
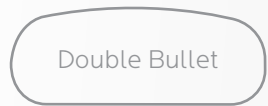



CASCADE
MINI-CASE,
LECTERN
PAGE 214



21096 BOOK CART
PAGE 254



CASCADE
MEGA-TOWER
PAGE 223



UXL TEACHER
MOBILE CHAIR
PAGE 48

CASCADE TEACHER DESK
PAGE 238

The essentials
for teacher success.

SMITHSYSTEM.COM/FURNITURE-TYPES/TEACHER



Model 26151. Shown in Grey Mesh top with Fuchsia edge and Platinum frame.

Cascade Teacher Desk Single Cabinet

The Cascade Teacher Desk offers a stable, mobile and versatile workspace, integrated wire manager and modesty panel and great ingress/egress plus the unique capabilities of Cascade Storage, a scalable solution for organization, storage and distribution of learning materials. Locate the pedestal on the left or right side; its drawers are Cascade Totes. 1 1/4" top with Bumper T-Mold. Choose from 11 standard laminate colors and 21 standard edge colors. Platinum or Black frame.

- Work surface is rugged high-pressure laminate.
- Fully welded 20-gauge steel frame for durability.
- Rolls smoothly on 3" dual-wheel casters.
- Standard width (SW) totes.

MODEL	DESCRIPTION	D"	W"	H"	F.C.	CUBE	WT.	UPS	2016 LIST
Standard Width (SW) Totes									
26150	Open w/six 3" SW totes	Left-hand	24	54	30.25	70	122		\$ 869.00
26151	Open w/six 3" SW totes	Right-hand	24	54	30.25	70	122		\$ 869.00
26152	Door w/six 3" SW totes	Left-hand	24	54	30.25	70	129		\$ 976.00
26153	Door w/six 3" SW totes	Right-hand	24	54	30.25	70	129		\$ 976.00

*Add "G" to model number to specify glides. Casters are standard. Add \$25 list to single ped and \$50 list to double ped.



Model 26155. Shown in Fusion Maple top with Clementine edge and Platinum frame.

Cascade Teacher Desk Single Cabinet

The Cascade Teacher Desk offers a stable, mobile and versatile workspace, integrated wire manager and modesty panel and great ingress/egress plus the unique capabilities of Cascade Storage, a scalable solution for organization, storage and distribution of learning materials. Locate the pedestal on the left or right side; its drawers are Cascade Totes. 1 1/4" top with Bumper T-Mold. Choose from 11 standard laminate colors and 21 standard edge colors. Platinum or Black frame.

- Work surface is rugged high-pressure laminate.
- Fully welded 20-gauge steel frame for durability.
- Rolls smoothly on 3" dual-wheel casters.

MODEL	DESCRIPTION	D"	W"	H"	F.C.	CUBE	WT.	UPS	2016 LIST
Standard Width (SW) Totes									
26154	Open w/two 3" and one 12" SW totes	Left-hand	24	54	30.25	70	122		\$ 839.00
26155	Open w/two 3" and one 12" SW totes	Right-hand	24	54	30.25	70	122		\$ 839.00
26156	Door w/two 3" and one 12" SW totes	Left-hand	24	54	30.25	70	129		\$ 946.00
26157	Door w/two 3" and one 12" SW totes	Right-hand	24	54	30.25	70	129		\$ 946.00

*Add "G" to model number to specify glides. Casters are standard. Add \$25 list to single ped and \$50 list to double ped.



Model 26159. Shown in Grey Nebula top with Blueberry edge and Platinum frame.

Cascade Teacher Desk Single Cabinet

The Cascade Teacher Desk offers a stable, mobile and versatile workspace, integrated wire manager and modesty panel and great ingress/egress. Locate the pedestal with locking drawers on the left or right side. 1 1/4" top with Bumper T-Mold. Choose from 11 standard laminate colors and 21 standard edge colors. Platinum or Black frame.

- Work surface is rugged high-pressure laminate.
- Fully welded 20-gauge steel frame for durability.
- Rolls smoothly on 3" dual-wheel casters

MODEL	DESCRIPTION	D"	W"	H"	F.C.	CUBE	WT.	UPS	2016 LIST
26158	Left-hand Teacher Desk - Box/Box/File	24	54	30.25	70		142		\$ 905.00
26159	Right-hand Teacher Desk - Box/Box/File	24	54	30.25	70		142		\$ 905.00

*Add "G" to model number to specify glides. Casters are standard. Add \$25 list to single ped and \$50 list to double ped.



Model 19198



Model 19199

MODEL	DESCRIPTION	D"	W"	H"	F.C.	CUBE	WT.	UPS	2016 LIST
Cascade Free Standing Drawer Pedestals									
19195	Drawer Ped Open w/top and six 3" SW totes	21	16	30.25	100	5	50		\$ 470.00
19196	Drawer Ped Open w/top and two 3" and one 12" SW totes	21	16	30.25	100	5	50		\$ 440.00
19197	Drawer Ped w/door and top and six 3" SW totes	21	16	30.25	100	5	50		\$ 584.00
19198	Drawer Ped w/door and top and two 3" and one 12" SW totes	21	16	30.25	100	5	50		\$ 553.00
19199	Box/Box/File Pedestal	21	16	29	100	5	50		\$ 506.00

1 1/4" Tops

Cascade Teacher Desks Have Top and Edge Choices

CHOICE 1 - 1 1/4" top with Bumper T-Mold no letter to follow Model No.

CHOICE 2 - 1 1/4" top with 4mm T-Mold D to follow Model No.

AddPower
SEE PAGE 258 FOR ORDER INFO

CASCADE TEACHER DESK LAMINATE COLOR CHOICE

Amber Cherry, Blond Echo, Golden Oak, Grey Nebula, Pewter Mesh, Wild Cherry, Black, Asian Night, Fusion Maple, Grey Mesh, New Age Oak, Tan Echo, Platinum

CASCADE TEACHER DESK EDGE COLOR CHOICE

Apple, Burgundy, Charcoal, Forest Green, Mocha, Persian Blue, Red, Black, Cerulean, Chocolate, Fuchsia, Navy, Platinum, White, Blueberry, Champagne, Clementine, Mint, Orange, Purple, Yellow

View all finish options on page 260.



Model 26171. Shown in Blond Echo top with Persian Blue edge and Platinum frame.

Cascade Teacher Desk Double Cabinet

The Cascade Teacher Desk offers a stable, mobile and versatile workspace, integrated wire manager and modesty panel and great ingress/egress plus the unique capabilities of Cascade Storage, a scalable solution for organization, storage and distribution of learning materials. The two pedestals' drawers are Cascade totes. 1 1/4" top with Bumper T-Mold. Choose from 11 standard laminate colors and 21 standard edge colors. Platinum or Black frame.

- Work surface is rugged high-pressure laminate.
- Fully welded 20-gauge steel frame for durability.
- Rolls smoothly on 3" dual-wheel casters.

MODEL	DESCRIPTION	D"	W"	H"	F.C.	CUBE	WT.	UPS	2016 LIST
-------	-------------	----	----	----	------	------	-----	-----	-----------

Standard Width (SW) Totes

26170	Open w/twelve 3" SW totes	24	67	30.25	70		153		\$ 1,097.00
26171	Open w/four 3" and two 12" SW totes	24	67	30.25	70		153		\$ 1,145.00

*Add "G" to model number to specify glides. Casters are standard. Add \$25 list to single ped and \$50 list to double ped.



Cascade Teacher Desk Double Cabinet

One of the pedestals has locking drawers, the other has Cascade Totes for drawers. 1 1/4" top with Bumper T-Mold. Choose from 11 standard laminate colors and 21 standard edge colors. Platinum or Black frame.

Model 26173. Shown in Blond Echo top with Persian Blue edge and Platinum frame.

MODEL	DESCRIPTION	D"	W"	H"	F.C.	CUBE	WT.	UPS	2016 LIST
-------	-------------	----	----	----	------	------	-----	-----	-----------

Standard Width (SW) Totes & Pedestal

26172	Open w/six 3" totes & Box/Box/File pedestal	24	67	30.25	70		173		\$ 1,262.00
26173	Open w/two 3", one 12" tote and Box/Box/File pedestal	24	67	30.25	70		173		\$ 1,212.00

*Add "G" to model number to specify glides. Casters are standard. Add \$25 list to single ped and \$50 list to double ped.



Cascade Teacher Desk Double Cabinet

The two pedestals' drawers are Cascade Totes that can be secured with locking doors. 1 1/4" top with Bumper T-Mold. Choose from 11 standard laminate colors and 21 standard edge colors. Platinum or Black frame.

Model 26175. Shown in Amber Cherry top with Black edge and Platinum frame.

MODEL	DESCRIPTION	D"	W"	H"	F.C.	CUBE	WT.	UPS	2016 LIST
-------	-------------	----	----	----	------	------	-----	-----	-----------

Standard Width (SW) Totes

26174	Door w/twelve 3" totes	24	67	30.25	70		167		\$ 1,433.00
26175	Door w/four 3" and two 12" totes	24	67	30.25	70		167		\$ 1,371.00

*Add "G" to model number to specify glides. Casters are standard. Add \$25 list to single ped and \$50 list to double ped.



Double Cabinet with Two Pedestals, Model 26178
Shown with Amber Cherry top, Black edge and Platinum frame.
Shown with optional UXL Mobile Chair.



Model 26177. Shown in Blond Echo top with Persian Blue edge and Platinum frame.

Cascade Teacher Desk Double Cabinet

The Cascade Teacher Desk offers a stable, mobile and versatile workspace, integrated wireway and modesty panel and great ingress/egress plus the unique capabilities of Cascade Storage, a scalable solution for organization, storage and distribution of learning materials. One of the pedestals has locking drawers, the other has Cascade Totes for drawers, secured with a locking door. 1 1/4" top with Bumper T-Mold. Choose from 11 standard laminate colors and 21 standard edge colors. Platinum or Black frame.

MODEL	DESCRIPTION	D"	W"	H"	F.C.	CUBE	WT.	UPS	2016 LIST
-------	-------------	----	----	----	------	------	-----	-----	-----------

Standard Width (SW) Totes & Pedestal

26176	Door w/six 3" totes & Box/Box/File pedestal	24	67	30.25	70		180		\$ 1,374.00
26177	Door w/two 3", one 12" tote & Box/Box/File pedestal	24	67	30.25	70		180		\$ 1,326.00

Pedestals

26178	Two Box/Box/File pedestals	24	67	30.25	70		193		\$ 1,278.00
26188	One File/File & One Box/Box/File pedestal	24	67	30.25	70		193		\$ 1,278.00

*Add "G" to model number to specify glides. Casters are standard. Add \$25 list to single ped and \$50 list to double ped.

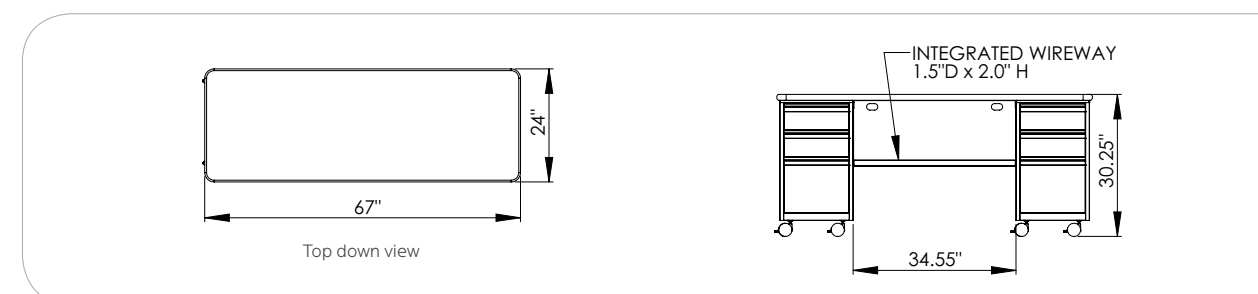

Cascade Teacher Desks Have Top and Edge Choices

1 1/4" Tops

CHOICE 1 3/8" Bumper T-Mold
CHOICE 1 - 1 1/4" top with Bumper T-Mold no letter to follow Model No.

CHOICE 2 4mm T-Mold
CHOICE 2 - 1 1/4" top with 4mm T-Mold to follow Model No.

AddPower
SEE PAGE 258 FOR ORDER INFO

CASCADE TEACHER DESK LAMINATE COLOR CHOICE

Amber Cherry, Blond Echo, Golden Oak, Grey Nebula, Pewter Mesh, Wild Cherry, Asian Night, Fusion Maple, Grey Mesh, New Age Oak, Tan Echo, Black, Platinum

CASCADE TEACHER DESK EDGE COLOR CHOICE

Apple, Burgundy, Charcoal, Forest Green, Mocha, Persian Blue, Red, Black, Cerulean, Chocolate, Fuchsia, Navy, Platinum, White, Blueberry, Champagne, Clementine, Mint, Orange, Purple, Yellow

View all finish options on page 260.



Model 26161. Shown in Fusion Maple top with Red edge and Platinum frame.



Model 26163. Shown in Fusion Maple top with Red edge and Platinum frame.



Model 26165. Shown in Fusion Maple top with Red edge and Platinum frame.

MODEL	DESCRIPTION		D"	W"	H"	F.C.	CUBE	WT.	UPS	2016 LIST
Standard Width (SW) Totes										
26162	Open w/ two 3" and one 12" totes	Left Hand	24	60	30.25			129		\$ 866.00
26163	Open w/ two 3" and one 12" totes	Right Hand	24	60	30.25			129		\$ 866.00
26166	Open w/ six 3" totes	Left Hand	24	60	30.25			129		\$ 972.00
26167	Open w/ six 3" totes	Right Hand	24	60	30.25			129		\$ 972.00
26164	Door w/ two 3" and one 12" totes	Left Hand	24	60	30.25			136		\$ 895.00
26165	Door w/ two 3" and one 12" totes	Right Hand	24	60	30.25			136		\$ 895.00
26168	Door w/ six 3" totes	Left Hand	24	60	30.25			136		\$ 1,002.00
26169	Door w/ six 3" totes	Right Hand	24	60	30.25			136		\$ 1,002.00

*Add "G" to model number to specify glides. Casters are standard. Add \$25 list to single ped and \$50 list to double ped.

Cascade Teacher Desk Single Bullet Cabinet

The Cascade Teacher Desk offers a stable, mobile and versatile workspace, integrated wire manager and modesty panel and great ingress/egress plus the unique capabilities of Cascade Storage, a scalable solution for organization, storage and distribution of learning materials. Three drawers: Box/Box/File. 1 1/4" top with Bumper T-Mold. Choose from 11 standard laminate colors and 21 standard edge colors. Platinum or Black frame.

- Work surface is rugged high-pressure laminate.
- Fully welded 20-gauge steel frame for durability.
- Rolls smoothly on 3" dual-wheel casters.

MODEL	DESCRIPTION		D"	W"	H"	F.C.	CUBE	WT.	UPS	2016 LIST
Pedestal										
26160	Teacher Desk w/ Box/Box/File ped	Left hand	24	60	30.25			149		\$ 932.00
26161	Teacher Desk w/ Box/Box/File ped	Right hand	24	60	30.25			149		\$ 932.00

*Add "G" to model number to specify glides. Casters are standard. Add \$25 list to single ped and \$50 list to double ped.

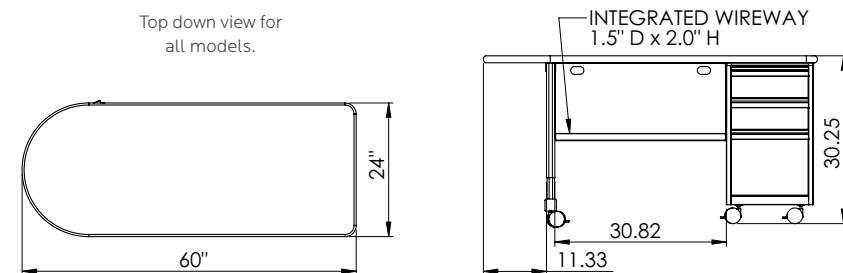
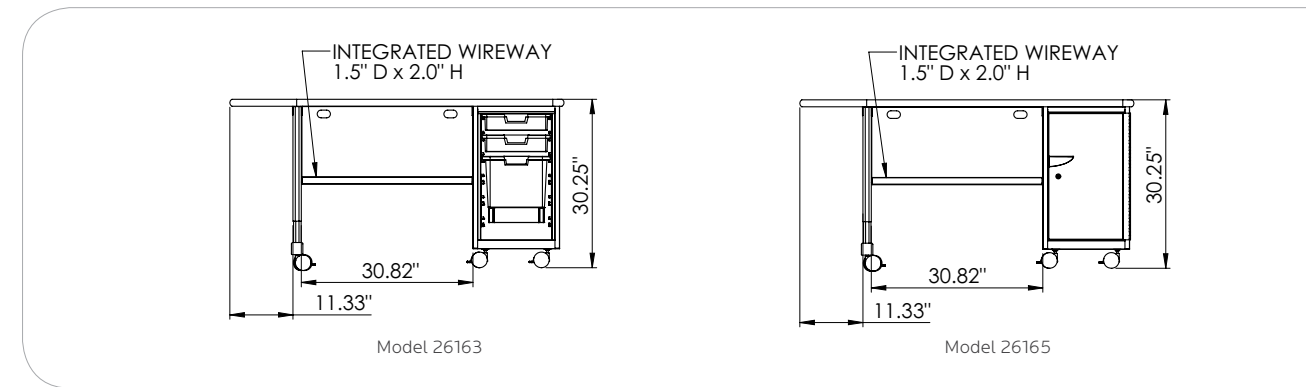

Cascade Teacher Desks Have Top and Edge Choices

1 1/4" Tops

CHOICE 1 - 3/8" Bumper T-Mold no letter to follow Model No.

CHOICE 2 - 4mm T-Mold to follow Model No.

CHOICE 1 - 1 1/4" top with Bumper T-Mold no letter to follow Model No.

CHOICE 2 - 1 1/4" top with 4mm T-Mold to follow Model No.

AddPower SEE PAGE 258 FOR ORDER INFO

CASCADE TEACHER DESK LAMINATE COLOR CHOICE

Amber Cherry, Blond Echo, Golden Oak, Grey Nebula, Pewter Mesh, Wild Cherry, Black, Asian Night, Fusion Maple, Grey Mesh, New Age Oak, Tan Echo, Platinum

CASCADE TEACHER DESK EDGE COLOR CHOICE

Apple, Burgundy, Charcoal, Forest Green, Mocha, Persian Blue, Red, Black, Cerulean, Chocolate, Fuchsia, Navy, Platinum, White, Blueberry, Champagne, Clementine, Mint, Orange, Purple, Yellow

View all finish options on page 260.



Model 26182. Shown in Blond Echo top with Cerulean edge and Platinum frame.

Model 26184. Shown in Blond Echo top with Cerulean edge and Platinum frame.

Cascade Teacher Desk Double Bullet Cabinet

The Cascade Teacher Desk offers a stable, mobile and versatile workspace, integrated wire manager and modesty panel and great ingress/egress plus the unique capabilities of Cascade Storage, a scalable solution for organization, storage and distribution of learning materials. The two pedestals' drawers are Cascade totes. 1 1/4" top with Bumper T-Mold. Choose from 11 standard laminate colors and 21 standard edge colors. Platinum or Black frame.

- Work surface is rugged high-pressure laminate.
- Fully welded 20-gauge steel frame for durability.
- Rolls smoothly on 3" dual-wheel casters.

MODEL	DESCRIPTION	D"	W"	H"	F.C.	CUBE	WT.	UPS	2016 LIST
Standard Width (SW) Totes									
26182	Open w/ twelve 3" totes	28	72	30.25	70	167			\$ 1,246.00
26184	Open Desk w/ four 3" & two 12" totes	28	72	30.25	70	167			\$ 1,185.00
26183	Door w/ twelve 3" totes	28	72	30.25	70	181			\$ 1,473.00
26185	Door w/ four 3" and two 12" totes	28	72	30.25	70	181			\$ 1,411.00

*Add "G" to model number to specify glides. Casters are standard. Add \$25 list to single ped and \$50 list to double ped.

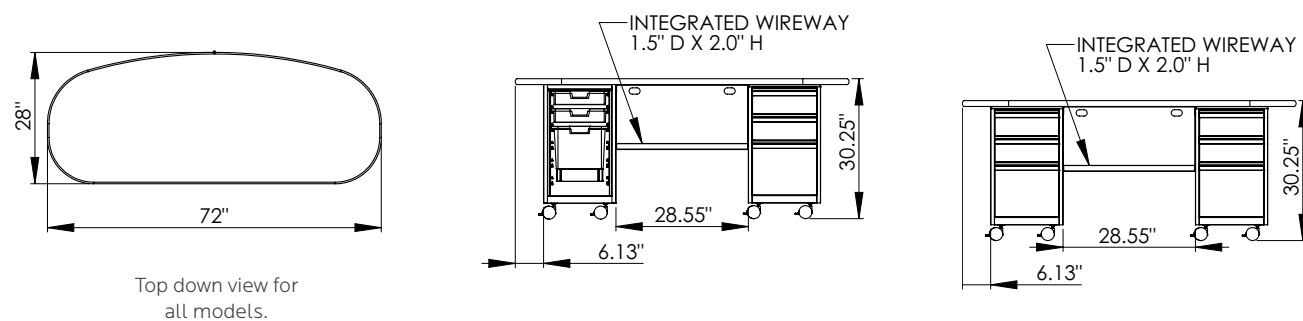

Model 26179. Shown in Blond Echo top with Cerulean edge and Platinum frame.



Model 26180. Shown in Blond Echo top with Cerulean edge and Platinum frame.

MODEL	DESCRIPTION	D"	W"	H"	F.C.	CUBE	WT.	UPS	2016 LIST
Standard Width (SW) Totes & Pedestal									
26179	Open w/ two 3" & one 12" totes & Box/Box/File Pedestals	28	72	30.25			187		\$ 1,252.00
26186	Open w/ six 3" & Box/Box/File Pedestals	28	72	30.25			187		\$ 1,301.00
26181	Door w/ two 3" totes & one 12" tote & Box/Box/File Pedestals	28	72	30.25			194		\$ 1,365.00
26187	Door w/ six 3" & Box/Box/File Pedestals	28	72	30.25			194		\$ 1,414.00
Pedestal									
26180	Two Box/Box/File Pedestals	28	72	30.25			207		\$ 1,318.00
26194	One File/File & One Box/Box/File	28	72	30.25			207		\$ 1,318.00

*Add "G" to model number to specify glides. Casters are standard. Add \$25 list to single ped and \$50 list to double ped.



Model 19198



Model 19199

MODEL	DESCRIPTION	D"	W"	H"	F.C.	CUBE	WT.	UPS	2016 LIST
Cascade Free Standing Drawer Pedestals									
19195	Drawer Ped Open w/top and six 3" SW totes	21	16	30.25	100	5	50		\$ 470.00
19196	Drawer Ped Open w/top and two 3" and one 12" SW totes	21	16	30.25	100	5	50		\$ 440.00
19197	Drawer Ped w/door and top and six 3" SW totes	21	16	30.25	100	5	50		\$ 584.00
19198	Drawer Ped w/door and top and two 3" and one 12" SW totes	21	16	30.25	100	5	50		\$ 553.00
19199	Box/Box/File Pedestal	21	16	29	100	5	50		\$ 506.00

Cascade Teacher Desks Have Top and Edge Choices

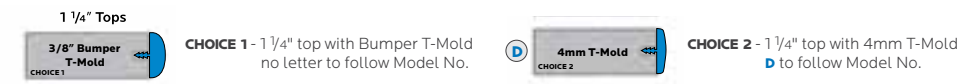

AddPower
SEE PAGE 258 FOR ORDER INFO

CASCADE TEACHER DESK LAMINATE COLOR CHOICE

- Amber Cherry
- Blond Echo
- Golden Oak
- Grey Nebula
- Pewter Mesh
- Wild Cherry
- Asian Night
- Fusion Maple
- Grey Mesh
- New Age Oak
- Tan Echo

FRAME COLOR CHOICE

- Black
- Platinum

CASCADE TEACHER DESK EDGE COLOR CHOICE

- Apple
- Burgundy
- Charcoal
- Forest Green
- Mocha
- Persian Blue
- Red
- Black
- Cerulean
- Chocolate
- Fuchsia
- Navy
- Platinum
- White
- Blueberry
- Champagne
- Clementine
- Mint
- Orange
- Purple
- Yellow

View all finish options on page 260.

Rectangle and Oval Lift Desk

Crank its stable work surface up and the Lift Desk easily accommodates work by a student or teacher in the standing position. Crank it down, and it accommodates work in a sitting position. The crank is easily accessible and its gearing makes lifting and lowering the desktop easy – even if loaded with something as heavy as a computer monitor. Choose from 11 standard laminate colors, 21 standard edge colors and two frame colors. Casters standard.

- Designed to meet ADA specifications for those with special needs or disabilities.
- Crank handle folds out of the way when not in use.

MODEL	DESCRIPTION	D"	W"	H"	F.C.	CUBE	WT.	UPS	2016 LIST
26540	Lift Desk - Rectangle top	30	36	29-45	70	5	118		\$ 849.00
26542	Lift Desk - Rectangle top	30	60	29-45	70	8	170		\$ 949.00
26541	Lift Desk - Oval top	30	50	29-45	70	7	100		\$ 899.00
26543	Lift Desk - Oval top	30	80	29-45	70	11	130		\$ 999.00



Shown in middle height position. Blond Echo top with Cerulean edge and Black frame.

Lift Desk - Oval top, Model 26541.
Shown in Pewter Mesh top with Apple edge and Platinum frame. Shown with optional Intuit Adjustable Stool, Model 00541.



Raising and lowering the height of the Lift Desk's work surface is made easy by the highly accessible, smooth-operating crank. The range is from 29" to 45" high.

The Lift Teacher Desk allows the teacher to work while standing, sitting in a standard height chair or on a stool. This allows the desk to work as a platform for presentations or as a standard desk.



Shown in lowest height position. New Age Oak top with Cerulean edge and Platinum frame.



Built in modesty panel increases in height as table is cranked.

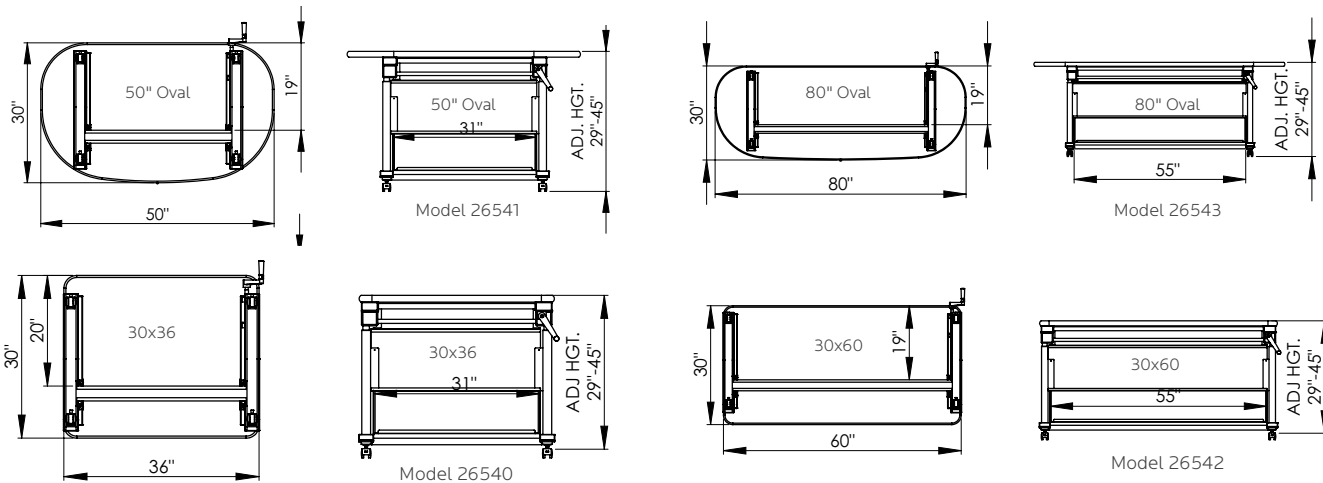

LIFT DESK LAMINATE COLOR CHOICE

- Amber Cherry
- Blond Echo
- Golden Oak
- Grey Nebula
- Pewter Mesh
- Wild Cherry
- Asian Night
- Fusion Maple
- Grey Mesh
- New Age Oak
- Tan Echo

FRAME COLOR CHOICE

- Black
- Platinum

LIFT DESK EDGE COLOR CHOICE

- Apple
- Burgundy
- Charcoal
- Forest Green
- Mocha
- Persian Blue
- Red
- Black
- Cerulean
- Chocolate
- Fuchsia
- Navy
- Platinum
- White
- Blueberry
- Champagne
- Clementine
- Mint
- Orange
- Purple
- Yellow

View all finish options on page 260.

Lift Desks Have Top and Edge Choices

1 1/4" Tops

CHOICE 1 - 1 1/4" top with Bumper T-Mold no letter to follow Model No.

CHOICE 2 - 1 1/4" top with 4mm T-Mold D to follow Model No.



Shown with optional Casters, Model 17554 \$107.00; optional Intuit Adjustable Chair, Model 00531 \$333.00 and optional Flat Panel Mount, Model 17353 \$199.00

Acrobat Rectangle Instructor Desk

Combining maximum stability, a generous workspaces and great ingress/egress, the Acrobat Rectangle Instructor Desk also offers an integrated modesty panel and wire manager. Choose from 11 standard laminate colors, 21 standard edge colors and two frame colors.

- Cable tray and port holes in the modesty panel keep wires neatly organized.
- Strong 10" deep double-wall legs are 18-gauge steel with radius corners.
- The base is 16-gauge steel, color matched to the legs, featuring lock-in-place end caps and adjustable leveling glides.

MODEL	DESCRIPTION	D"	W"	H"	F.C.	CUBE	WT.	UPS	2016 LIST
30" deep models									
26443	Rectangle Instructor Desk	30	48	24-36	70	5.2	110		\$ 747.00
26453	Rectangle Instructor Desk	30	60	24-36	70	6.3	125		\$ 822.00
26526	Rectangle Instructor Desk	30	72	24-36	70	7.3	140		\$ 917.00
26528	Rectangle Instructor Desk w/ Box/Box/File Ped	30	60	24-36	85	10.7	191		\$ 1,177.00



Acrobat Peninsula Instructor Desk

Featuring a generous workspace enhanced by a Peninsula (suited for one-to-one or one-to-two conferences), maximum stability and great ingress/egress, the Acrobat Peninsula Instructor Desk also offers an integrated modesty panel and wire manager. Choose from 11 standard laminate colors, 21 standard edge colors and two frame colors.

Shown in Golden Oak top with Platinum edge and Platinum frame. Shown with optional Mobile Drawer Pedestal Model 19173.

MODEL	DESCRIPTION	D"	W"	H"	F.C.	CUBE	WT.	UPS	2016 LIST
26213	Peninsula Instructor Desk	36	72	24-36	70	7.8	151		\$ 978.00
26233	Peninsula Instructor Desk	36	60	24-36	70	6.5	135		\$ 878.00



Mobile Drawer Pedestal

Steel construction, drawers lock and have an interlock system that prevents accidental tipping caused by more than one drawer opening at a time. Full extension ball bearing slides allow full access to drawer contents. Black or Platinum. With 2" dual-wheel casters.

MODEL	DESCRIPTION	D"	W"	H"	F.C.	CUBE	WT.	UPS	2016 LIST
19172	Mobile Drawer Pedestal File/File	22	15.5	27.5	100	5.7	50		\$ 359.00
19173	Mobile Drawer Pedestal Box/Box/File	22	15.5	25.5	100	5.7	50		\$ 355.00



Casters

Dual-wheel casters roll easily, providing excellent mobility for desks. Use 2 for wheelbarrow style mobility (Model 17576 only).

MODEL	DESCRIPTION	D"	W"	H"	F.C.	CUBE	WT.	UPS	2016 LIST
17576	3" Dual-Wheel Caster Pack Set of 4, 4 locking	3" dia.		3	70	0.1	5	*	\$ 76.00
17554	4" Dual-Wheel Caster Pack Set of 4, 2 locking	4" dia.		4	70	0.2	5	*	\$ 107.00

Acrobat Teacher Desks Have Top and Edge Choices

1 1/4" Tops

3/8" Bumper T-Mold CHOICE 1

CHOICE 1 - 1 1/4" top with Bumper T-Mold no letter to follow Model No.

4mm T-Mold CHOICE 2

CHOICE 2 - 1 1/4" top with 4mm T-Mold to follow Model No.

AddPower
SEE PAGE 258 FOR ORDER INFO

ACROBAT WORKSTATION LAMINATE COLOR CHOICE

- Amber Cherry
- Blond Echo
- Golden Oak
- Grey Nebula
- Pewter Mesh
- Wild Cherry
- Asian Night
- Fusion Maple
- Grey Mesh
- New Age Oak
- Tan Echo
- Black
- Platinum

ACROBAT WORKSTATION EDGE COLOR CHOICE

- Apple
- Burgundy
- Charcoal
- Forest Green
- Mocha
- Persian Blue
- Red
- Black
- Cerulean
- Chocolate
- Fuchsia
- Navy
- Platinum
- White
- Blueberry
- Champagne
- Clementine
- Mint
- Orange
- Purple
- Yellow

View all finish options on page 260.



Library Commons

What does the library commons have in common with the library? While still a space dedicated to fueling the student's mind and imagination, it's become an active environment where students learn by researching, interacting and creating.



Library Carrel System
Helps students focus in independent study, research or testing.
SEE PAGE 250



Nomads
Mobile Nomads are meant to move with ease.
SEE PAGE 252



Booktrucks
Single or double sided, practically a library on wheels.
SEE PAGES 254-257



36" H

Carrel Adder

Carrel Starter

Model 26682 + 26683. Shown in Wild Cherry with Black edge and Black frame. Shown with optional Intuit Adjustable Stools in Black, Model 00541.



28" H

Model 26682. Shown in Wild Cherry with Black edge and Black frame. Shown with optional Intuit Stack Chair in Black, Model 00560.



Model 26684. Shown in Pewter Mesh top with Persian Blue edge and Platinum frame. Shown with optional UXL Nest & Fold Chair with Arms in Persian Blue, Model NF187PJPJLR.



Model 26680. Shown in Wild Cherry with Black edge and Platinum frame. Shown with optional UXL Adjustable Chair in Black, Model XL035FBPB.

Acrobat™ Carrel System

The work surface can be sat at 28 in. high to serve as a desk or workstation, or at 36 in. high to serve as a kiosk for patron usage. Panels are pre-drilled for both heights. Choose from 11 standard laminate colors, 21 standard edge colors and two frame colors.

- Top and end panels surrounded by 3/8" thick bumper edge stapled in place every eight inches.
- 1 1/4" thick end panels and work surface with high-pressure laminate.
- Overall height 48".
- 18-gauge steel back panel.

MODEL	DESCRIPTION	D"	W"	H"	F.C.	CUBE	WT.	UPS	2016 LIST
Carrel Starter									
26680	Acrobat Carrel Starter	27	24	48	70	4.0	128		\$ 605.00
26682	Acrobat Carrel Starter	27	36	48	70	4.5	145		\$ 639.00
26684	Acrobat Carrel Starter	27	48	48	70	5.0	163		\$ 671.00
Carrel Adder									
26681	Acrobat Carrel Adder	27	24	48	70	4.0	87		\$ 498.00
26683	Acrobat Carrel Adder	27	36	48	70	4.5	104		\$ 531.00
26685	Acrobat Carrel Adder	27	48	48	70	5.0	119		\$ 563.00



AddPower

Add a flat surface power unit to the carrel system. Allow students to plug-in and recharge. See page 258 for more details.

Library Carrels Have Top and Edge Choices

1 1/4" Tops

3/8" Bumper T-Mold
CHOICE 1

4mm T-Mold
CHOICE 2

CHOICE 1 - 1 1/4" top with Bumper T-Mold no letter to follow Model No.

CHOICE 2 - 1 1/4" top with 4mm T-Mold **D** to follow Model No.

LIBRARY CARRELS LAMINATE COLOR CHOICE

- Amber Cherry
- Fusion Maple
- Grey Nebula
- Tan Echo
- Asian Night
- Golden Oak
- New Age Oak
- Wild Cherry
- Blond Echo
- Grey Mesh
- Pewter Mesh

LIBRARY CARRELS EDGE COLOR CHOICE

- Apple
- Burgundy
- Charcoal
- Forest Green
- Mocha
- Persian Blue
- Red
- Black
- Cerulean
- Chocolate
- Fuchsia
- Navy
- Platinum
- White
- Blueberry
- Champagne
- Clementine
- Mint
- Orange
- Purple
- Yellow

FRAME COLOR CHOICE

- Black
- Platinum

View all finish options on page 260.



Model 21677. Shown in Platinum frame with Fusion Maple top and radius end panels with Black edge.



Model 21675. Shown in Platinum frame with Pewter Mesh top and radius end panels with Platinum edge.

Nomad – Radius End Panels

3' Nomad are practically a library on wheels. 4" dual-wheel casters for great mobility. Top and Radius End Panels included. Mobile Nomads are meant to move with ease. Weight limit 300 lbs. Available without casters for a traditional shelving application.

MODEL	DESCRIPTION	D"	W"	H"	F.C.	CUBE	WT.	UPS	2016 LIST
21675	3' Nomad 4 flat shelves w/ 2"backstops	25	39.5	34			154		\$ 1,258.00
21677	3' Nomad 6 flat shelves w/ 2"backstops	25	39.5	50	70		216		\$ 1,495.00

NOMAD ROUND END PANEL COLOR CHOICES

	CHOICE 1	CHOICE 2	CHOICE 3
TOP AND END PANEL	Fusion Maple	Wild Cherry	Pewter Mesh
FRAME	Platinum	Platinum	Platinum

RADIUS EDGE COLOR CHOICE

Apple	Burgundy	Charcoal	Forest Green	Mocha	Persian Blue	Red
Black	Cerulean	Chocolate	Fuchsia	Navy	Platinum	White
Blueberry	Champagne	Clementine	Mint	Orange	Purple	Yellow

View all finish options on page 260.



Model 21682. Shown in Platinum frame with Pewter Mesh top and end panels.



Nomad – Square End Panels

3' Nomad are practically a library on wheels. 4" dual-wheel casters for great mobility. Mobile Nomads are meant to move with ease. Square End Panels. Weight limit 300 lbs. Available without casters for a traditional shelving application.

Model 21676. Shown in Platinum frame with Fusion Maple top.

MODEL	DESCRIPTION	D"	W"	H"	F.C.	CUBE	WT.	UPS	2016 LIST
21682	3' Nomad 4 flat shelves w/ 2"backstops	25	39.5	30	70		154		\$ 1,258.00
21676	3' Nomad 6 flat shelves w/ 2"backstops	25	39.5	47	70	8.0	192		\$ 1,495.00

NOMAD SQUARE END PANEL COLOR CHOICES

	CHOICE 1	CHOICE 2	CHOICE 3
TOP AND END PANEL	Fusion Maple	Wild Cherry	Pewter Mesh
FRAME	Platinum	Platinum	Platinum



Six Sloping Shelf Booktruck

4" soft-tread, dual-wheel casters standard. Optional are 5" dual-wheel or 5" single-wheel. Available in 19 colors.

- Choose from single- or double-sided configurations.
- Baked-on powder coat finish provides lasting color.
- Choose from 19 colors.
- Double-sided models have sloping shelves that are 34" long x 7 1/2" deep on each side and a 6" high back.
- 18-gauge steel, welded construction.

Shown in Blueberry. Shown with optional Shelf Dividers, Model 21104 \$ 26.00

MODEL	DESCRIPTION	D"	W"	H"	F.C.	CUBE	WT.	UPS	2016 LIST
21001	Six Sloping Shelf Truck	18	36	43	150	17.0	73		\$ 517.00
21004	Six Sloping Shelf Truck w/6 book supports	18	36	43	150	17.0	76		\$ 569.00



Four Sloping, Bottom Flat Shelf Booktruck

4" soft-tread, dual-wheel casters standard. Optional are 5" dual-wheel or 5" single-wheel.

Shown in Clementine.

MODEL	DESCRIPTION	D"	W"	H"	F.C.	CUBE	WT.	UPS	2016 LIST
21021	Four Sloping, Bottom Flat Shelf Truck	18	36	43	150	17.0	71		\$ 484.00



Three Sloping Shelf Booktruck

4" soft-tread, dual-wheel casters standard. Optional are 5" dual-wheel or 5" single-wheel. Available in 19 colors.

Model 21092 (left). Shown in Champagne.
Shown with optional Shelf Dividers, Model 21105, \$ 29.00
Model 21096 (right). Shown in Mint.

MODEL	DESCRIPTION	D"	W"	H"	F.C.	CUBE	WT.	UPS	2016 LIST
21092	Three Sloping Shelf Truck	14	36	43	150	15.2	60		\$ 377.00
21094	Three Sloping Shelf Truck 3 book supports	14	36	43	150	15.2	62		\$ 403.00
21096	Three Sloping Shelf Truck	14	24	43	150	12.2	46	*	\$ 376.00



Three Flat Shelf Booktruck

4" soft-tread, dual-wheel casters standard. Optional are 5" dual-wheel or 5" single-wheel. Available in 19 colors.

Shown in Burgundy.

MODEL	DESCRIPTION	D"	W"	H"	F.C.	CUBE	WT.	UPS	2016 LIST
21051	Three Flat Shelf Truck	18	36	43	150	17.0	62		\$ 444.00



Model 21103. Three flat shelves. Shown in Navy.



Model 21102. Four sloping shelves and one flat base shelf. Shown in Forest Green.



Model 21101. Six sloping shelves. Shown in Red.

Gorilla Truck™

Choose from 3 models: six sloping shelves; four sloping shelves and one flat base shelf or three flat shelves. Six 5" casters. Available in 19 colors.

- 600-lb. capacity.
- Fixed middle casters make it easy for the truck to pivot on an axis — great for getting over thresholds.
- 5" dual wheel casters with soft tread for quiet, smooth rolling operation.

MODEL	DESCRIPTION	D"	W"	H"	F.C.	CUBE	WT.	UPS	2016 LIST
21101	Gorilla Truck 6 Sloping Shelf w/six 4" casters	18	36	44	150	17.0	89		\$ 628.00
21102	Gorilla Truck 4 sloping shelf/bottom flat six 4" casters	18	36	44	150	17.0	84		\$ 598.00
21103	Gorilla Truck 3 flat shelf, six 4" casters	18	36	44	150	17.0	78		\$ 556.00

Unique teeter-totter motion

Slightly lower center wheels create a teeter-totter motion that guides the Gorilla Cart smoothly over thresholds and uneven thresholds.



Spinning action

Because the Gorilla Cart spins on the center wheels, accessing both sides in narrow aisles is a breeze.



BOOKTRUCK COLOR CHOICE

- Apple
- Burgundy
- Chocolate
- Fuchsia
- Navy
- Purple
- Black
- Cerulean
- Clementine
- Mint
- Persian Blue
- Red
- Blueberry
- Champagne
- Forest Green
- Mocha
- Platinum
- Sand
- Yellow

*Black, Sand, Platinum Quick Ship colors up to 5. View all finish options on page 260.



A cart so versatile, it couldn't be kept in the library.

The 12 large compartments in an Everything Cart enable it to organize and transport much more than books or even media. Whether it's holding maracas and tambourines, or art supplies, it helps distribute educational materials more quickly and easily.

Everything Cart™

Two shelves with six bins. 4" soft-tread, dual-wheel casters standard. Optional are 5" dual-wheel or 5" single-wheel. Available in 19 colors.

Shown in Apple.

- Baked-on powder coat finish provides lasting color.
- Helps save time collecting materials.
- 18-gauge welded steel construction.
- 4" dual wheel casters with soft tread for quiet, smooth rolling operation.

MODEL	DESCRIPTION	D"	W"	H"	F.C.	CUBE	WT.	UPS	2016 LIST
21088	Everything Cart	18	36	36	150	15.0	70		\$ 528.00

Booktruck Accessories



Booktruck Sliding Shelf Divider

Helps keep books in place and limit shifting. Available in 3 pack. Choose Black or Smoke.

Shown in Black.

MODEL	DESCRIPTION	D"	W"	H"	F.C.	CUBE	WT.	UPS	2016 LIST
21104	Dividers for models 21001-21031	7		6	70	0.1	2	*	\$ 26.00
21105	Dividers for models 21092-21096	10		6	70		2	*	\$ 29.00



Booktruck Top

This shelf adds utility. For Smith System 36" booktrucks, it includes pole supports in Platinum. Choose from 11 laminate colors and 21 edge colors. To assure maximum strength, only the 1 1/4" thick top is available.

Shown in Golden Oak top with Red edge.

MODEL	DESCRIPTION	D"	W"	H"	F.C.	CUBE	WT.	UPS	2016 LIST
21109	Booktruck Top	18	38	1.25			35		\$ 249.00



4" Dual-wheel Casters
4 pack. Soft thread.

No-locking wheels
17560 \$65.00

2-locking wheels
17565 \$75.00



5" Dual-wheel Casters
4 pack. Soft thread.

No-locking wheels
17566 \$90.00

2-locking wheels
17567 \$103.00

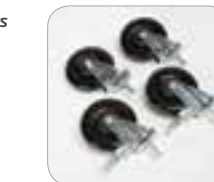

5" Single-wheel Casters
4 pack. Rubber wheel.

No-locking wheels
17568 \$101.00

2-locking wheels
17569 \$118.00

BOOKTRUCK TOP LAMINATE COLOR CHOICE

- Amber Cherry
- Blond Echo
- Golden Oak
- Grey Nebula
- Pewter Mesh
- Wild Cherry
- Asian Night
- Fusion Maple
- Grey Mesh
- New Age Oak
- Tan Echo

BOOKTRUCK & TOP EDGE COLOR CHOICE

- Apple
 - Cerulean
 - Forest Green
 - Navy
 - Red
 - Charcoal*
 - Black
 - Champagne
 - Fuchsia
 - Persian Blue
 - Orange*
 - Blueberry
 - Chocolate
 - Mint
 - Platinum
 - Sand
 - Yellow
 - Burgundy
 - Clementine
 - Mocha
 - Purple
- *Additional edge only color choice

View all finish options on page 260.

AddPower

This symbol indicates you can add power to select tables.



You will find the "ADD POWER" logo throughout this catalog. It signifies which Smith System tables are compatible with our 2016 power units.

When ordering, please submit a drawing with your order to indicate the desired positioning of the power unit on the work surface. All power accessories are special order, a custom feature per table and are non-returnable. For more information call 800.328.1061.



Flat Power Module

Shown, Model 017098 SLV
1 power, 1 Twin USB port

MODEL	DESCRIPTION	D"	W"	H"	UPS	2016 LIST
017098 SLV	1 power, 1 Twin USB port				*	\$ 260.00
017097 SLV	2 power				*	\$ 175.00



NEW 2016 Soft Touch Dome Power Module

Shown, Model 017079 BLA
2 power, 1 Twin USB port,
1 power cord

MODEL	DESCRIPTION	D"	W"	H"	UPS	2016 LIST
017079 BLA	2 power, 1 Twin USB port				*	\$ 245.00
017078 BLA	3 power				*	\$ 160.00



Dome Power Module

4 power
2 power cords

MODEL	DESCRIPTION	D"	W"	H"	UPS	2016 LIST
017088 BLA	4 power	3.5	3.56	3.86	*	\$ 220.00



Surface Power Module

Shown, Model 017093 SLV
4 power

MODEL	DESCRIPTION	D"	W"	H"	UPS	2016 LIST
017093 SLV	4 power	3	8	.11	*	\$ 350.00
017086 SLV	2 power, 4 USB	3	8	.11	*	\$ 350.00



Retractable Power Module

Shown, Model 017085 SLV
2 power, 2 Twin USB ports

MODEL	DESCRIPTION	D"	W"	H"	UPS	2016 LIST
017085 SLV	2 power, 4 USB	4.43	8.25	1.34	*	\$ 495.00
017092 SLV	4 power	4.43	8.25	1.34	*	\$ 495.00



Retractable Mini Power Module

2 power

MODEL	DESCRIPTION	D"	W"	H"	UPS	2016 LIST
017091 SLV	2 power	3.7	3.7	1.17	*	\$ 250.00

Supplying the school's ever increasing need for power.

When schools discovered tablet devices, the floodgates opened and the paperless and bookless era had arrived. Smith System is ready with a wide array of products to supply needed power.



Chat™ Chair and Wedge table with Dome Power Module.



Power Bar with two Dome Power Modules.



Café Table with Power Module.

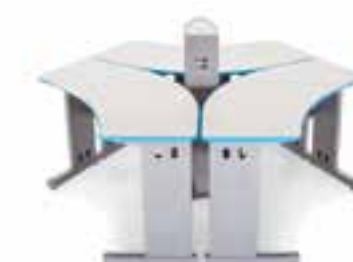

Acrobat™ Crescent Desks with I-O Post™.



Interchange Media Table with two Surface Power Modules.

Add power to any room with the I-O Post™ and I-O Tower.™

I-O™ Post

Distribute power and connectivity throughout large areas to computer users with the I-O Post. Network/phone ready, it has eight knockouts that allow the school to create a connection with one cable to the source. It also has eight grounded plugs to provide power. Available in Platinum powder coat, the I-O Post also has room to house a Wi-Fi repeater.



MODEL	DESCRIPTION	D"	W"	H"	F.C.	CUBE	WT.	UPS	2016 LIST
17090	I-O Post	19	19	44.7	70	10.0	45		\$ 1,645.00
17091	I-O Post Hard Wire	19	19	44.7	70	10.0	45		\$ 1,865.00
17095	I-O Tower (160)	19	19	54.75	70				\$ 2,728.00
<i>(16 total outlets, both the top and bottom holes will be filled from the factory with power outlets)</i>									
17096	I-O Tower (80-Upper)	19	19	54.75	70				\$ 1,843.00
<i>(8 total outlets mounted in the upper holes. The bottom holes will be blocked off with plates)</i>									
17097	I-O Tower (80-Lower)	19	19	54.75	70				\$ 1,843.00
<i>(represents 8 total outlets mounted in the lower holes. The upper holes will be blocked off with plates)</i>									
Optional Accessories (I-O Post Sold Separately. Items to be installed in I-O Post)									
17589	I-O Post Caster Pack							2 locking, 2 non-locking	\$ 50.00

Standard Laminate Options

Want to specify a different laminate?

No problem. If you have 20 or more tops of the same color -60 or -38 there is no upcharge. Have 20 or less? We can quote for you with the Wilsonart code and - finish style. We can specify other laminates - call to inquire and get a quote.



For 2016, all 11 of the above laminates are -60, if you need to match a laminate from a previous year, please let us know on your order (example Pewter Mesh 4878-38, our new standard is -60).

Standard Color Options

See product page for application and availability.



Standard Top and Edge Options

Available in 3/4" and 1 1/4" thicknesses, Smith System tables and desktops give you the option of lending the tops of the room a light or substantial feel. Similarly, our edge band treatments give the choice of curved, gentle profile of bullet or bumper edges.

When choosing (D, C, V) of top and edge molding, put the designator at the end of the model number. Example: 04500V = Model 04500 with a 3/4" top and a Bullet T-Mold edge.

Each product is different, consult the specific product page for available options.

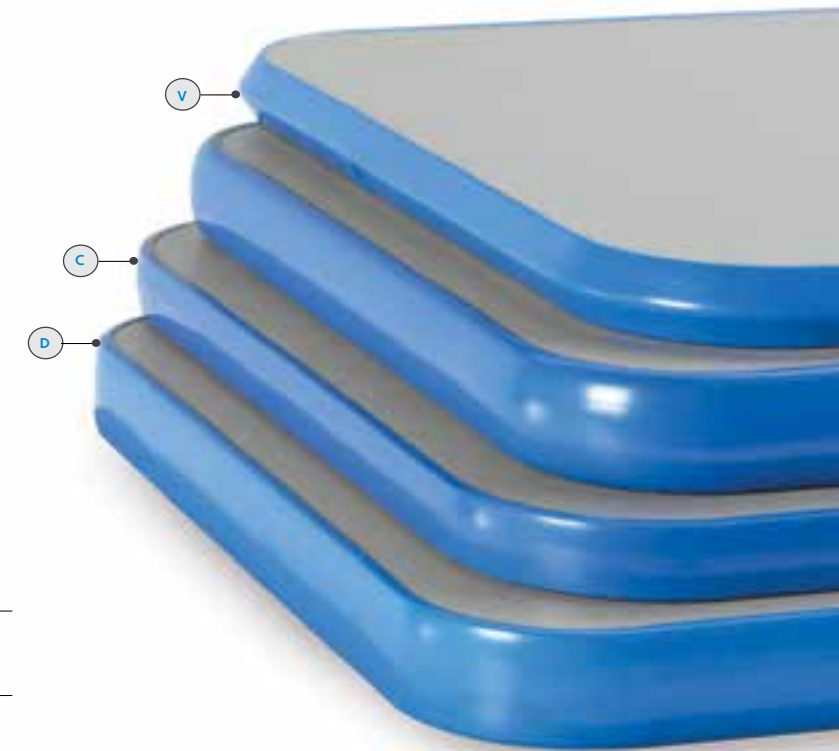

Choose from many different edge and top profiles.

1 1/4" TOPS

3/4" TOPS

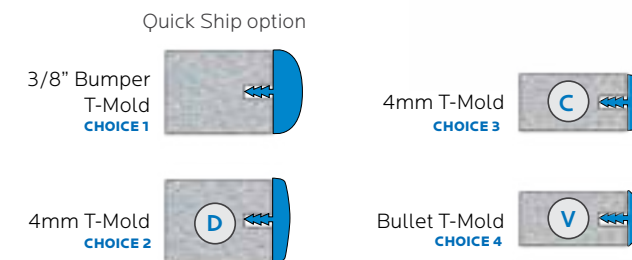

Consult the specific product page for available options.

Our tables carry a **12-year warranty on tops** and a **lifetime frame warranty**.

Smith System Only uses **High Pressure Laminate** and our edging is stapled into place every **6 - 8 inches**.



There are 11 Quick Ship laminate colors and 21 bumper edge colors. Frame color availability is specified on the catalog page. Quick Ship lead time for 21 bumper edge tables and 40 chairs is 5 business days, though this may extend during the busy summer season. Please call for specific availability. If the product components are in stock, they will ship as soon as possible. All tops are made to order and not returnable.

INDEX

Model	Description	Page
Lecterns		
04619	Deluxe Table Top Lectern	160, 193
04620	Projector Lectern Cart	160
04622	Mobile Lectern - drawer pedestal	160
00502	Mobile Lectern	160
Dual Surface Desktop Lecterns		
00470	Lectern w/Swing Arm, Clamp-On	159, 196
00471	Lectern w/Swing Arm, Bolt-On	159, 196
00472	Lectern w/Spring Loaded Swing Arm, Clamp-On	159, 196
Curl Top Desktop Lecterns		
00480	Lectern w/Swing Arm, Clamp-On	159
00481	Lectern w/Swing Arm, Bolt-On	159
00482	Lectern w/Spring Loaded Swing Arm, Clamp-On	159
Intuit™ Seating		
00560	19" Intuit Stack Chair - A+ shell, powder coat frame	38
00509	18" Intuit Stack Chair - A shell, powder coat frame	38
00562	16" Intuit Stack Chair - B shell, powder coat frame	38
00563	14" Intuit Stack Chair - B shell, powder coat frame	38
72134F	Optional Felt Glide for Intuit Stack Chair-set of 4	38
00530	Intuit Adj. Chair - A+, glides	39
00531	Intuit Adj. Chair - A+, casters	39
00532	Intuit Adj. - B shell w/glides	39
00533	Intuit Adj. - B shell, w/casters	39
00540	Intuit Adj. Stool - A+ shell, glides	39
00541	Intuit Adj. Stool - A+ shell, casters	39
Plato™ Seating		
00950	18" Plato - A shell, chrome frame	32
00951	16" Plato - B+ shell, chrome frame	32
00952	14" Plato - B shell, chrome frame	32
00953	18" Plato Mobile Stack Chair - A Shell, chrome frame	33
00960	Plato Adjustable Chair w/glides - A Shell	33
00961	Plato Adjustable Chair w/casters - A Shell	33
00965	Plato Adjustable Stool w/glides - A Shell	33
00966	Plato Adjustable Stool w/casters - A Shell	33
00975V	18" Plato A shell, P-Tablet Right Hand (RH)	34
00976V	18" Plato A shell, P-Tablet Left Hand (LH)	34
00980	28" Plato Fixed Height Stool	35
00981	24" Plato Fixed Height Stool	35
Rectangle Activity Tables		
01003	24"dx36" w Rectangle, height adjusts 21"-30"	201
01004	24"dx36" w Rectangle, height adjusts 15"-24"	201
01005	24"dx36" w Rectangle, height adjusts 11"-16"	201
01013	24"dx48" w Rectangle, height adjusts 21"-30"	201
01014	24"dx48" w Rectangle, height adjusts 15"-24"	201
01015	24"dx48" w Rectangle, height adjusts 11"-16"	201
01913	24"dx60" w Rectangular, height adjusts 21"-30"	201
01914	24"dx60" w Rectangular, height adjusts 15"-24"	201
01915	24"dx60" w Rectangular, height adjusts 11"-16"	201
01023	30"dx48" w Rectangle, height adjusts 21"-30"	201
01024	30"dx48" w Rectangle, height adjusts 15"-24"	201
01025	30"dx48" w Rectangle, height adjusts 11"-16"	201
01033	30"dx60" w Rectangle, height adjusts 21"-30"	201
01034	30"dx60" w Rectangle, height adjusts 15"-24"	201
01035	30"dx60" w Rectangle, height adjusts 11"-16"	201
01043	30"dx72" w Rectangle, height adjusts 21"-30"	201
01044	30"dx72" w Rectangle, height adjusts 15"-24"	201
01045	30"dx72" w Rectangle, height adjusts 11"-16"	201
01923	36"dx48" w Rectangular, height adjusts 21"-30"	201
01924	36"dx48" w Rectangular, height adjusts 15"-24"	201
01925	36"dx48" w Rectangular, height adjusts 11"-16"	201
01053	36"dx60" w Rectangle, height adjusts 21"-30"	201
01054	36"dx60" w Rectangle, height adjusts 15"-24"	201
01055	36"dx60" w Rectangle, height adjusts 11"-16"	201
01063	36"dx72" w Rectangle, height adjusts 21"-30"	201

Model	Description	Page
01064	36"dx72" w Rectangle, height adjusts 15"-24"	201
01065	36"dx72" w Rectangle, height adjusts 11"-16"	201
Square Activity Table		
01073	36"dx36" w Square Activity Table, height adjusts 21"-30"	201
01074	36"dx36" w Square Activity Table, height adjusts 15"-24"	201
01075	36"dx36" w Square Activity Table, height adjusts 11"-16"	201
01083	48"dx48" w Square Activity Table, height adjusts 21"-30"	201
01084	48"dx48" w Square Activity Table, height adjusts 15"-24"	201
01085	48"dx48" w Square Activity Table, height adjusts 11"-16"	201
Round Activity Tables		
01093	42" dia. Round Activity Table, height adjusts 21"-30"	202
01094	42" dia. Round Activity Table, height adjusts 15"-24"	202
01095	42" dia. Round Activity Table, height adjusts 11"-16"	202
01103	48" dia. Round Activity Table, height adjusts 21"-30"	202
01104	48" dia. Round Activity Table, height adjusts 15"-24"	202
01105	48" dia. Round Activity Table, height adjusts 11"-16"	202
01883	60" dia. Round Activity Table, height adjusts 21"-30"	202
01884	60" dia. Round Activity Table, height adjusts 15"-24"	202
01885	60" dia. Round Activity Table, height adjusts 11"-16"	202
Trapezoid Activity Tables		
01133	30"x60" Trapezoid Table, height adjusts 21"-30"	201
01134	30"x60" Trapezoid Table, height adjusts 15"-24"	201
01135	30"x60" Trapezoid Table, height adjusts 11"-16"	201
Kidney Activity Tables		
01143	Kidney Activity Table, height adjusts 21"-30"	202
01144	Kidney Activity Table, height adjusts 15"-24"	202
01145	Kidney Activity Table, height adjusts 11"-16"	202
Half Moon Activity Tables		
01153	Half Moon Activity Table, height adjusts 21"-30"	202
01154	Half Moon Activity Table, height adjusts 15"-24"	202
01155	Half Moon Activity Table, height adjusts 11"-16"	202
Horseshoe Activity Tables		
01933	60"dx66" w Horseshoe Table, height adjusts 21"-30"	202
01934	60"dx66" w Horseshoe Table, height adjusts 15"-24"	202
01935	60"dx66" w Horseshoe Table, height adjusts 11"-16"	202
Clover Activity Tables		
01203	Clover Activity Table, 48" dia., height adjusts 21"-30"	202
01204	Clover Activity Table, 48" dia., height adjusts 15"-24"	202
01205	Clover Activity Table, 48" dia., height adjusts 11"-16"	202
Flower Activity Tables		
01213	Flower Activity Table, 60" dia., height adjusts 21"-30"	202
01214	Flower Activity Table, 60" dia., height adjusts 15"-24"	202
01215	Flower Activity Table, 60" dia., height adjusts 11"-16"	202
Leg Sets for Activity Tables		
01180	Leg Set for Activity Tables, height adjusts 21"-30"	202
01181	Leg Set for Activity Tables, height adjusts 15"-24"	202
01184	Leg Set for Activity Tables, height adjusts 11"-16" h	202
Huddle™ Student Desks		
01265	Huddle-6 Student Desk for 6 student - 6' circle	136
01266	Huddle-8 Student Desk for 8 student - 7' circle	136
01267	Huddle-8LS	136
Planner™ Student Desk		
01272	20"dx27" w Student Desk, Single-Student	138
01273	20"dx27" w Student Desk, Single w/HP Top	138
01279	20"dx32" w Student Desk, Single-Student	138
01274	20"dx36" w Student Desk, Single-Student	138
01291	20"dx36" w Student Desk, Single-Student w/HP Top	138
01285	24"dx27" w Student Desk, Single-Student	138
01286	24"dx36" w Student Desk, Single-Student	138
01276	20"dx48" w Student Desk, Two-Student	139
01278	20"dx54" w Student Desk, Two-Student	139
01280	20"dx60" w Student Desk, Two-Student	139
01284	20"dx72" w Student Desk, Two-Student	139
01287	24"dx48" w Student Desk, Two-Student	139

Model	Description	Page
01288	24"dx54" w Student Desk, Two-Student	139
01289	24"dx60" w Student Desk, Two-Student	139
01290	24"dx72" w Student Desk, Two-Student	139
01295	20"dx84" w Student Desk, Three-Student	141
01296	24"dx84" w Student Desk, Three-Student	141
Arc™ Student Desks		
01350	27"dx35" w Arc-8 LS Flex Desk	126
01351	22"dx35" w Arc-8 Flex Desk, Single-Student	126
01353	28"dx47" w ADA Arc Desk	126
Flex™ Student Desks		
01360	20"dx27" w Flex Desk, Single-Student	118
01362	20"dx27" w Flex Desk, Single-Student w/HP Top	119
01356	20"dx32" w Flex Desk, Single-Student	118
01368	20"dx36" w Flex Desk, Single-Student	118
01369	20"dx36" w Flex Desk, Single-Student w/HP Top	119
01370	24"dx27" w Flex Desk, Single-Student	118
01371	24"dx36" w Flex Desk, Single-Student	118
01354	20"dx48" w Flex Desk, Two-Student	121
01355	20"dx54" w Flex Desk, Two-Student	121
01361	20"dx60" w Flex Desk, Two-Student	121
01363	20"dx72" w Flex Desk, Two-Student	121
01359	24"dx72" w Flex Desk, Two-Student	121
01380	24"dx54" w Flex Desk, Two-Student	121
01381	24"dx60" w Flex Desk, Two-Student	121
01382	24"dx48" w Flex Desk, Two-Student	121
Flex Desk Accessories		
17190	Steel bookbox	115, 123, 142
17200	Wire book basket	115, 123, 142
Flex Stations		
01373	24"dx30" w Flex Station w/Tilt Down Wire Manager	130
01374	24"dx36" w Flex Station w/Tilt Down Wire Manager	130
01376	24"dx48" w Flex Station w/Tilt Down Wire Manager	130
01377	24"dx60" w Flex Station w/Tilt Down Wire Manager	130
01378	24"dx72" w Flex Station w/Tilt Down Wire Manager	130
01379	34"dx58" w Corner Flex Station 25" F&B, 24" on 4 sides	131
01383	30"dx36" w Flex Station w/Tilt Down Wire Manager	130
01384	30"dx48" w Flex Station w/Tilt Down Wire Manager	130
01385	30"dx30" w Flex Station w/Tilt Down Wire Manager	130
01386	30"dx60" w Flex Station w/Tilt Down Wire Manager	130
01387	30"dx72" w Flex Station w/Tilt Down Wire Manager	130
Elemental™ Open Front Desks		
01475V	Open Front Desk - rectangle top	132
01476V	Open Front Desk - wave top	132
01477	Open Front Desk - HP rectangle top	133
Café Table Bases and Tops: order separately		
01501	30"dx30" w Café Top	179
01502	30" Round Café Top	179
01503	36"dx36" w Café Top	179
01504	36" Round Café Top	45, 179
01505	42"dx42" w Café Top	179
01506	42" Round Café Top	179
01507	48" Round Café Top	179
Circular Café Bases		
01450	Circular Base, 24" dia. coffee table height 16"h	45, 179
01451	Circular Base, 24" dia. sitting height table 29"h	179
01452	Circular Base, 24" dia. k-8 standing height table 36"h	179
01453	Circular Base, 24" dia. standing height 42"h	179
01454	Circular Base, 30" dia. coffee table height 16"h	179
01455	Circular Base, 30" dia. sitting table height 29"h	179
01456	Circular Base, 30" dia. k-8 standing height table 36"h	179
01457	Circular Base, 30" dia. standing height 42"h	179
Crisscross Bases		
01458	Crisscross Base, 24" dia. coffee table height 16"h	179
01459	Crisscross Base, 24" dia. sitting height table 29"h	179

Model	Description	Page
01460	Crisscross Base, 24" dia. k-8 standing height table 36"h	179
01461	Crisscross Base, 24" dia. standing height 42"h	179
01462	Crisscross Base, 30" dia. coffee table height 16"h	179
01463	Crisscross Base, 30" dia. sitting height table 29"h	179
01464	Crisscross Base, 30" dia. k-8 standing height table 36"h	179
01465	Crisscross Base, 30" dia. standing height 42"h	179
Optimal Power for Café Tops		
017088	Power Dome, 4 power	179
017097	Flat Surface Power Module, 2 Power	179
017098	Flat Surface Power Module, 1 Power 2 USB	179
017078 BLA	Soft Touch Power Dome, 3 Power	179
017079 BLA	Soft Touch Power Dome, 2 Power, 2 Port USB	179
Oval Double Café Tables (w/two 24" Circular Bases)		
01543	w/two, 4 Power Dome, standing height	171
01544	w/two, 2 Power Flat, standing height	171
01545	w/one, 2 Power Flat, one 1 Power 2 USB, standing height	171
01546	w/two, 1 Power 2 USB, standing height	171
01547	w/two, 4 Power Dome, sitting height	171
01548	w/two, 2 Power Flat, sitting height	171
01549	w/one, 2 Power Flat, one 1 Power 2 USB, sitting height	171
01551	w/two, 1 Power 2 USB, sitting height	171
01552	no Power, standing height	171
01553	no Power, sitting height	171
01554	w/ two, 3 Power, standing height	171
01555	w/ two, 2 power, 1 Twin USB port, standing height	171
01556	w/ one, 3 Power, one 2 Power, 1 Twin USB, standing height	171
01557	w/ two, 3 Power, sitting height	171
01558	w/ two, 2 power, 1 Twin USB port, sitting height	171
01559	w/one, 3 Power, one 2 Power, 1 Twin USB, sitting height	171
Silhouette™ Desks		
01600	18x24" Silhouette, Single-Student	113
01601	18x24" Silhouette, w/HP top	113
01602	18x24" Silhouette, Single-Student, fixed-height, w/glides	113
01603	18x24" Silhouette, Single-Student, fixed-height, w/casters	113
01604	18x24" Silhouette, w/HP top, fixed-height, w/glides	113
01605	18x24" Silhouette, w/HP top, fixed-height, w/casters	113
01646	20x27" Silhouette, w/HP top, fixed-height, w/casters	113
01647	20x27" Silhouette, w/HP top, fixed-height, w/glides	113
01648	20x27" Silhouette, Single-Student, fixed-height, w/casters	113
01649	20x27" Silhouette, Single-Student, fixed-height, w/glides	113
01650	20x27" Silhouette, Single-Student	113
01651	20x27" Silhouette, w/HP top	113
01660	20x48" Silhouette, Two-Student	113
01662	20x48" Silhouette, Two-Student, fixed-height, w/glides	113
01664	20x48" Silhouette, Two-Student, fixed-height, w/casters	113
01661	20x54" Silhouette, Two-Student	113
01663	20x54" Silhouette, Two-Student, fixed-height, w/glides	113
01665	20x54" Silhouette, Two-Student, fixed-height, w/casters	113
01655	Silhouette Sequence Desk	114
01658	Silhouette Sequence, Single-Student, fixed-height, w/glides	114
01659	Silhouette Sequence, Single-Student, fixed-height, w/casters	114
01653	Silhouette Curve Desk	114
01654	Silhouette Curve, Single-Student, fixed-height, w/glides	114
01657	Silhouette Curve, Single-Student, fixed-height, w/casters	114
Interchange Open Front Student Desks		
04500	Single-Student Open Front Rectangle	68
04502	Two-Student Open Front Rectangle	68
04503	Wing Open Front	62
04504	Diamond Open Front	66
04505	Mini Diamond Open Front	66
67638	Open Front Backpack Hook	62, 66
Interchange Student Desks		
03002	3-2-1 Desk	70
03011	3-2-1-LS Desk	70

Model	Description	Page
03081	Interchange Two Student Diamond Desk	65
03082	Interchange Diamond Student Desk	64
03083	Interchange Mini Diamond Desk	64
03095	Interchange Wing Desk	60
03097	Interchange Swoop Wing Desk	61
04080	20"dx27"w Interchange Student Desk	68, 74
04081	20"dx30"w Interchange Student Desk	74
04082	20"dx36"w Interchange Student Desk	74
04083	20"dx48"w Interchange Student Desk	68, 74
04084	20"dx54"w Interchange Student Desk	74
04085	20"dx60"w Interchange Student Desk	74
04086	20"dx72"w Interchange Student Desk	74
04087	20"dx90"w Interchange Student Desk	74
04090	Interchange Curve Desk	68
Interchange Rectangle Activity Tables		
04100	Rectangle Interchange Activity Table, 24"dx36"w	74
04101	Rectangle Interchange Activity Table, 24"dx48"w	74
04131	Rectangle Interchange Activity Table, 24"dx54"w	74
04102	Rectangle Interchange Activity Table, 24"dx60"w	74
04103	Rectangle Interchange Activity Table, 24"dx72"w	74
04104	Rectangle Interchange Activity Table, 24"dx90"w	74
04105	Rectangle Interchange Activity Table, 30"dx36"w	74
04106	Rectangle Interchange Activity Table, 30"dx48"w	74
04107	Rectangle Interchange Activity Table, 30"dx60"w	74
04108	Rectangle Interchange Activity Table, 30"dx72"w	74
04109	Rectangle Interchange Activity Table, 30"dx90"w	74
04111	Rectangle Interchange Activity Table, 36"dx48"e	74
04112	Rectangle Interchange Activity Table, 36"dx60"w	74
04113	Rectangle Interchange Activity Table, 36"dx72"w	74
04114	Rectangle Interchange Activity Table, 36"dx90"w	74
04116	Rectangle Interchange Activity Table, 42"dx60"w	74
04117	Rectangle Interchange Activity Table, 42"dx72"w	74
04118	Rectangle Interchange Activity Table, 42"dx90"w	74
04121	Rectangle Interchange Activity Table, 48"dx60"w	74
04122	Rectangle Interchange Activity Table, 48"dx72"w	74
04123	Rectangle Interchange Activity Table, 48"dx90"w	74
Interchange Square Activity Tables		
04110	Square Interchange Activity Table, 36"dx36"w	76
04115	Square Interchange Activity Table, 42"dx42"w	76
04119	Square Interchange Activity Table, 48"dx48"w	76
Interchange Round Activity Tables		
04125	Round Interchange Activity Table, 48" dia	76
04126	Round Interchange Activity Table, 60" dia	76
04124	Round Interchange Activity Table, 42" dia	76
Interchange Activity Tables		
04127	Trapezoid Interchange Activity Table, 30"dx60"w	76
04128	Half Moon Interchange Activity Table, 36"dx72"w	76
04129	Contour Interchange Activity Table, 36"dx72"w	76
04130	Kidney Interchange Activity Table, 48"dx72"w	76
04132	Flower Interchange Activity Table, 60" dia.	76
Interchange Science Tables		
04101T	Trespa TopLab Plus Interchange Science Table, 24"dx48"w	75
04102T	Trespa TopLab Plus Interchange Science Table, 24"dx60"w	75
04103T	Trespa TopLab Plus Interchange Science Table, 24"dx72"w	75
04106T	Trespa TopLab Plus Interchange Science Table, 30"dx48"w	75
04107T	Trespa TopLab Plus Interchange Science Table, 30"dx60"w	75
04108T	Trespa TopLab Plus Interchange Science Table, 30"dx72"w	75
04131T	Trespa TopLab Plus Interchange Science Table, 24"dx54"w	75
04101_CHM	Interchange Activity Table w/Chemsurf Top, 24"dx48"w	NIC
04102_CHM	Interchange Activity Table w/Chemsurf Top, 24"dx60"w	NIC
04103_CHM	Interchange Activity Table w/Chemsurf Top, 24"dx72"w	NIC
04106_CHM	Interchange Activity Table w/Chemsurf Top, 30"dx48"w	NIC
04107_CHM	Interchange Activity Table w/Chemsurf Top, 30"dx60"w	NIC
04108_CHM	Interchange Activity Table w/Chemsurf Top, 30"dx72"w	NIC

Model	Description	Page
04131_CHM	Interchange Activity Table w/Chemsurf Top, 24"dx54"w	NIC
Meeting Tables		
04137	Large Round End Multi-Media Table	168
04138	Large Round End Multi-Media Table w/ 4 Power, 8 USB	168
04139	Large Round End Multi-Media Table w/ 8 Power	168
04140	Large Round End Multi-Media Table w/ 6 Power, 4 USB	168
04146	Rectangle Multi-Media Table	169
04147	Rectangle Multi-Media Table, 4 Power & 8 USB	169
04148	Rectangle Multi-Media Table, 8 Power	169
04149	Rectangle Multi-Media Table, 6 Power & 4 USB	169
04160	Medium Round End Multi-Media Table	170
04161	Medium Round End Multi-Media Table, 2 Power, 4 USB	170
04162	Medium Round End Multi-Media Table, 4 Power	170
04235	Half Boat Multi-Media Table	169
04236	Half Boat Multi-Media Table, 4 Power & 8 USB	169
04237	Half Boat Multi-Media Table, 8 Power	169
04238	Half Boat Multi-Media Table, 6 Power & 4 USB	169
Husky™ Rectangle Activity Tables		
04300	24"dx60"w Rectangle Activity Table, height adjusts 21"-30"	205
04301	24"dx60"w Rectangle Activity Table, height adjusts 15"-24"	205
04305	30"dx48"w Rectangle Activity Table, height adjusts 21"-30"	205
04306	30"dx48"w Rectangle Activity Table, height adjusts 15"-24"	205
04310	30"dx60"w Rectangle Activity Table, height adjusts 21"-30"	205
04311	30"dx60"w Rectangle Activity Table, height adjusts 15"-24"	205
04320	30"dx72"w Rectangle Activity Table, height adjusts 21"-30"	205
04321	30"dx72"w Rectangle Activity Table, height adjusts 15"-24"	205
04360	36"dx72"w Rectangle Activity Table, height adjusts 21"-30"	205
04361	36"dx72"w A Rectangle Activity Table, height adjusts 15"-24"	205
Husky Round Activity Tables		
04325	42" dia. Round Activity Table, height adjusts 21"-30"	205
04326	42" dia. Round Activity Table, height adjusts 15"-24"	205
04330	48" dia. Round Activity Table, height adjusts 21"-30"	205
04331	48" dia. Round Activity Table, height adjusts 15"-24"	205
04335	60" dia. Round Activity Table, height adjusts 21"-30"	205
04336	60" dia. Round Activity Table, height adjusts 15"-24"	205
Husky Kidney Activity Tables		
04340	48"dx72"w Kidney Activity Table, height adjusts 21"-30"	205
04341	48"dx72"w Kidney Activity Table, height adjusts 15"-24"	205
Husky Trapezoid Activity Tables		
04350	30"dx60"w Trapezoid Activity Table, height adjusts 21"-30"	205
04351	30"dx60"w Trapezoid Activity Table, height adjusts 15"-24"	205
Husky Square Activity Tables		
04370	48"dx48"w Square Activity Table, height adjusts 21"-30"	205
04371	48"dx48"w Square Activity Table, height adjusts 15"-24"	205
Husky Clover Activity Tables		
04380	48" dia. Clover Activity Table, height adjusts 21"-30"	205
04381	48" dia. Clover Activity Table, height adjusts 15"-24"	205
Husky Flower Activity Tables		
04390	60" dia. Flower Husky Activity Table, height adjusts 21"-30"	205
04391	60" dia. Flower Husky Activity Table, height adjusts 15"-24"	205
Husky Leg Sets		
17770	Husky Leg Set for Activity Tables, height adjusts 15"-24"	205
17771	Husky Leg Set for Activity Tables, height adjusts 21"-30"	205
17772	Husky Leg Set for Activity Tables, height adjusts 11"-16"	205
Access Station 24" deep		
11140	24"dx30"w Access Station, Single-Student	154
11141	24"dx36"w Access Station, Single-Student	154
11142	24"dx42"w Access Station, Single-Student	154
11143	24"dx48"w Access Station, Two-Student	154
11144	24"dx60"w Access Station, Two-Student	154
11145	24"dx72"w Access Station, Two-Student	154
11146	24"dx84"w Access Station, Three-Student	154
11147	24"dx48"w Access Station, 5-sided Corner	154

Model	Description	Page
Access Stations 30" deep		
11160	30"dx30"w Access Station, Single-Student	154
11161	30"dx36"w Access Station, Single-Student	154
11162	30"dx42"w Access Station, Single-Student	154
11163	30"dx48"w Access Station, Two-Student	154
11164	30"dx60"w Access Station, Two-Student	154
11165	30"dx72"w Access Station, Two-Student	154
11166	30"dx84"w Access Station, Three-Student	154
11167	30"dx48"w Access Station, 5-sided Corner	154
Planner Science Tables		
11260	Science Table w/laminate top w/ T-edge, 24"dx 48"w	150
11261	Science Table w/Chemsurf top, 24"dx48"w	NIC
11262	Science Table w/Trespa TopLab, 24"dx48"w	151
11263	Science Table w/laminate top w/ T-edge, 24"dx54"w	150
11264	Science Table w/Chemsurf top, 24"dx54"w	NIC
11265	Science Table w/Trespa TopLab, 24"dx54"w	151
11266	Science Table w laminate top w/ T-edge, 24"dx60"w	150
11267	Science Table w/Chemsurf top, 24"dx60"w	NIC
11268	Science Table w/Trespa TopLab, 24"dx60"w	151
11269	Science Table w/laminate top w/ T-edge, 24"dx72"w	150
11270	Science Table w/Chemsurf top, 24"dx72"w	NIC
11271	Science Table w/Trespa TopLab, 24"dx72"w	151
11278	Science Table w/Chemsurf top, 30"dx48"w	NIC
11275	Science Table w/Chemsurf top, 30"dx54"w	NIC
11273	Science Table w/Chemsurf top, 30"dx60"w	NIC
11274	Science Table w/Chemsurf top, 30"dx72"w	NIC
11286	Science Table w/Trespa TopLab, 30"dx48"w	NIC
11287	Science Table w/Trespa TopLab, 30"dx54"w	NIC
11288	Science Table w/Trespa TopLab, 30"dx60"w	151
11289	Science Table w/Trespa TopLab, 30"dx72"w	NIC
Flavors™ Chairs 20-29		
11820V	Flavors P-Tablet, Right Hand (RH) - A shell	27
11821V	Flavors P-Tablet, Left Hand (LH) - A shell	27
11830	Flavors Adjustable Chair - B shell, w/casters	26
11831	Flavors Adjustable Chair w/glides	26
11840	Flavors Adjustable Chair - A shell, w/casters	26
11841	Flavors Adjustable Chair - A shell, w/glides	26
11842	Flavors Adjustable Stool - A shell, w/casters	26
11843	Flavors Adjustable Stool - A shell, w/glides	26
11844	8"h Flavors Stack Chair - C shell	23
11845	10"h Flavors Stack Chair - C shell	23
11846	12"h Flavors Stack Chair - C shell	23
11847	14"h Flavors Stack Chair - B shell	23
11848	16"h Flavors Stack Chair - B shell	23
11849	18"h Flavors Stack Chair - A shell	23
11851	18"h Flavors Noodle Chair - A shell	29
11852	16"h Flavors Noodle Chair - B shell	29
11853	14"h Flavors Noodle Chair - B shell	29
11854	16"h Flavors Stack Chair - B shell, on Casters	23
11855	18"h Flavors Stack Chair - A shell, on Casters	23
11856	12"h Flavors Sled Base Chair - C shell	25
11857	14"h Flavors Sled Base Chair - B shell	25
11858	16"h Flavors Sled Base Chair - B shell	25
11859	18"h Flavors Sled Base Chair - A shell	25
11860	14"h Flavors Stack Chair - B shell, on Casters	23
11889	24"h Flavors Fixed Height Stool - A shell	24
11890	28"h Flavors Fixed Height Stool - A shell	24
17531	Felt glide option for Flavors stacking chairs	23
17558	Steel glide option for stacking chairs, Set of 4 installed	23
17559	Felt glide option for stacking chairs, Set of 4 installed	23
Chat™ Chairs 40-45		
CH11P_P_00	18"h Chat Chair w/Nylon Glides	42
CH21P_P_00	18"h Chat Chair w/Felt Glides	42
CH11F_P_00	18"h Chat Chair, Fabric Seat w/Nylon Glides	42

Model	Description	Page
CH21F_P_00	18"h Chat Chair, Fabric Seat w/Felt Glides	42
Chat Chairs w/Power (under seat, mount)		
CH11P_P_01	18"h Chat Chair w/2 Power	42
CH11F_P_02	18"h Chat Chair, w/ 1 Power/1 Twin USB	42
CH31F_P_00	18" Chat Scooter w/ Nylon Glides	43
CH41F_P_00	18" Chat Scooter w/Felt Glides	43
Chat Wedge Tables		
CHWDG	Chat Wedge Table	44
CHWDGPD	Chat Wedge w/4 Power Dome	44
CHWDGQD	Chat Wedge w/ Soft Touch 3Pwr Dome	44
CHWDGRD	Chat Wedge w/ Soft Touch 1Pwr/1USB Dome	44
Accessories for Workstations		
17015	Bookbox for Huddle-6 Desk #01265	136
17016	Bookbox for Huddle-8 Desk	126, 136
17060	Power Socket 4 plugs 2 data 15' Cord	155, 197
17081	6 Outlet Electric Strip w/Surge, 4' Cord	155
17084	10 Outlet Electric Strip w/Surge, 15' Cord	155
17090	I-O™ Post	122, 259
17091	I-O Post Hard Wire	122, 259
17095	I-O Tower	259
17096	I-O Tower (80-Upper)	259
17097	I-O Tower (80-Lower)	259
17589	IO Post Caster Pack, 2 Locking, 2 non-locking	122, 259
17190	Steel Bookbox	115, 123, 142
17200	Wire Book Basket	115, 123, 142
Accessories – Interchange™, Planner Activity Tables		
17201	Modesty Panel for 36" wide table	79, 149
17202	Modesty Panel for 48" wide table	79, 149
17203	Modesty Panel for 60" wide table	79, 149
17204	Modesty Panel for 72" wide table	79, 149
17205	Modesty Panel for 90" wide table	79, 149
17213	CPU Holder w/locks	155, 187, 197
17217	CPU Holder w/locks	155, 187, 197
17220	Tie plates for FlexDesk	118
17221	Tie plate for FlexStation	130
17241*4	Mobile Interchange Caster/Stem Pack 4"	NIC
17241*5	Mobile Interchange Caster/Stem Pack 5"	NIC
17342	Center Drawer for Acrobat 19"w ID	187, 197
17350	Flat Panel Mount w/Tilt	155, 163
17351	Flat Panel Mount w/Tilt & Swivel	163
17352	Flat Panel Mount w/Swing-Out Arm w/Tilt & Swivel	163
17353	Clamp-on Flat Panel Mount w/Swing-Out Arm w/Tilt & Swivel	163
17354	Large Monitor Table Mount (32" to 50")	168-170
17655	Spring Loaded Flat Panel Mount with tilt,swivel	163
Casters for Flex, Planner & Acrobat		
17554	4" Dual wheel Pack, Set of 4, 2 locking	131, 148, 155, 197, 247
17576	3" Dual wheel Pack, Set of 4, 4 locking	78, 126, 131, 142, 148, 155, 197, 247
Acrobat™ Corner Riser Shelves		
17469	Corner Riser Shelf for 48" corner work station	191
17601	Corner Riser Shelf for 36" corner work station	191
17603	Corner Riser Shelf for 42" corner work station	191
17605	Corner Riser Shelf for 60" Tech Lab	190
17620	Pull-out Keyboard, adjustable height	155, 197
17622	Pull-out Keyboard, adjustable height	155, 197
17645	Riser Shelf, 1-1/4" top, 12"dx24"w	193
17646	Riser Shelf, 1-1/4" top, 12"dx30"w	193
17647	Riser Shelf, 1-1/4" top, 12"dx36"w	193
17648	Riser Shelf, 1-1/4" top, 12"dx48"w	193
17649	Riser Shelf, 1-1/4" top, 12"dx60"w	193
17657	Riser Shelf, 1-1/4" top 12"dx72"w	193
17659	Riser Shelf, 1-1/4" top 12"dx84"w	193
Riser Shelves with Clamp-On Pole (Platinum only)		
17665	Riser Shelf, 1-1/4" top, 12"dx24"w	163
17666	Riser Shelf, 1-1/4" top, 12"dx30"w	163

Model	Description	Page
17667	Riser Shelf, 1-1/4" top, 12"dx36"w	163
17668	Riser Shelf, 1-1/4" top, 12"dx48"w	163
17669	Riser Shelf, 1-1/4" top, 12"dx60"w	163
17677	Riser Shelf, 1-1/4" top, 12"dx72"w	163
17679	Riser Shelf, 1-1/4" top, 12"dx84"w	163
17680	Riser Shelf, 1-1/4" top, 12"dx90"w	163
Desk Fence		
DF24	Desk Fence 24"w	78, 123, 187
DF30	Desk Fence 30"w	78, 123, 187
DF36	Desk Fence 36"w	78, 123, 187
DF48	Desk Fence 48"w	78, 123, 187
DF60	Desk Fence 60"w	78, 123, 187
Storage: Files, Bookcases, Drawer Pedestals		
19160	2 Drawer (Vertical) File full extension ball bearing slides	161
19161	4 Drawer (Vertical) File full extension ball bearing slides	161
19164	Bookcase, 2 shelves	161
19165	Bookcase, 4 shelves	161
19166	Bookcase, 5 shelves	161
19172	Mobile Drawer Pedestal, File/File	189, 247
19173	Mobile Drawer Pedestal, Box/Box/File	189, 247
19175	Teacher Wardrobe Cabinet	161
Booktrucks		
21001	6 Sloping Shelf w/4" casters	254
21004	6 Sloping Shelf w/6 book supports w/4" casters	254
21021	4 sloping & bottom flat w/4" casters	254
21051	3 Flat shelf w/4" casters	254
21088	Everything Cart™, 2 Shelf w/ 6 bins	256
21092	3 Sloping Shelf Truck w/4" Casters	254
21094	3 Sloping Shelf Truck w/3 book supports & 4" Casters	254
21096	3 Sloping Shelf Truck w/4" Casters	254
21101	Gorilla Truck™ 6 Sloping Shelf w/six 4" casters	255
21102	Gorilla Truck 4 sloping shelf/bottom flat w/six 4" casters	255
21103	Gorilla Truck 3 flat shelf, w/six 4" casters	255
21104	3 pack of sliding dividers for 21001-21031	257
21105	3 pack of sliding dividers for 21092-21096	257
21109	Book Truck Top, fits 36" wide trucks, platinum bracket	257
17560	Booktruck 4" Caster pack set of 4	257
17565	Booktruck 4" Caster pack 2 locking, set of 4	257
17566	Booktruck 5" Caster pack set of 4	257
17567	Booktruck 5" Caster pack 2 locking, set of 4	257
17568	Booktruck 5" Caster pack single wheel set of 4	257
17569	Booktruck 5" Caster pack single wheel 2 locking set of 4	257
Nomads™ and Mobile Shelving		
21682	Nomad 4 flat shelves, square end panels	253
21675	Nomad 4 flat shelves, radius end panels	252
21676	Nomad 6 flat shelves, square end panels	253
21677	Nomad 6 flat shelves, radius end panels, 6 shelves	252
Planner™ Teacher Desk		
24000	Planner Teacher Desk, Single Pedestal (LH) 30"dx48"w	158
24001	Planner Teacher Desk, Single Pedestal (RH) 30"dx48"w	158
24010	Planner Teacher Desk, Double Pedestal 30"dx60"w	158
Planner Lab Station		
24610	Planner Lab Station 24"dx36"w	152
24500	Planner Lab Station 24"dx48"w	152
24510	Planner Lab Station 24"dx60"w	152
24520	Planner Lab Station 24"dx72"w	152
24620	Planner Lab Station 24"dx84"w	152
24530	Planner Lab Station 30"dx30"w	152
24630	Planner Lab Station 30"dx36"w	152
24540	Planner Lab Station 30"dx48"w	152
24550	Planner Lab Station 30"dx60"w	152
24560	Planner Lab Station 30"dx72"w	152
24570	Three Student Planner Lab Station 30"dx84"w	152

Model	Description	Page
Planner Corner Lab Station		
24600	Corner Planner Lab Station, 6 sided corner 30"dx48"w	153
Planner Cluster Work Centers		
24580	Cluster Work Center, Trap 35"dx80"w	153
Planner Activity Tables - Rectangle		
25950	20"dx36"w Rectangle Planner Activity Table	145
25960	20"dx48"w Rectangle Planner Activity Table	145
25970	20"dx60"w Rectangle Planner Activity Table	145
25980	20"dx72"w Rectangle Planner Activity Table	145
25990	20"dx90"w Rectangle Planner Activity Table	145
25031L	24"dx24"w Rectangle Planner Activity Table	45
25032L	24"dx42"w Rectangle Planner Activity Table	45
25800	24"dx36"w Rectangle Planner Activity Table	145
25810	24"dx48"w Rectangle Planner Activity Table	145
25820	24"dx60"w Rectangle Planner Activity Table	145
25830	24"dx72"w Rectangle Planner Activity Table	145
25840	24"dx90"w Rectangle Planner Activity Table	145
25500	30"dx36"w Rectangle Planner Activity Table	145
25510	30"dx48"w Rectangle Planner Activity Table	145
25520	30"dx60"w Rectangle Planner Activity Table	145
25530	30"dx72"w Rectangle Planner Activity Table	145
25540	30"dx90"w Rectangle Planner Activity Table	145
25550	36"dx48"w Rectangle Planner Activity Table	145
25560	36"dx60"w Rectangle Planner Activity Table	145
25570	36"dx72"w Rectangle Planner Activity Table	145
25580	36"dx90"w Rectangle Planner Activity Table	145
25700	42"dx60"w Rectangle Planner Activity Table	145
25710	42"dx72"w Rectangle Planner Activity Tables	145
25590	42"dx90"w Rectangle Planner Activity Table	145
25720	48"dx60"w Rectangle Planner Activity Table	145
25730	48"dx72"w Rectangle Planner Activity Table	145
25740	48"dx90"w Rectangle Planner Activity Table	145
17500	Planner Activity Table High Leg Inserts (4 pack)	148
Planner Activity Tables		
25600	Trapezoid Planner Activity Table, 30"dx60"w	147
25610	Square Planner Activity Table, 48"dx48"w	147
25030L	36" dia. Round Planner Activity Table	45
25620	42" dia. Round Planner Activity Table	147
25630	48" dia. Round Planner Activity Table	147
25640	60" dia. Round Planner Activity Table	147
25645	Flower Planner Activity Table, 60" dia.	147
25650	Half Moon Planner Activity Table, 36"dx72"w	147
25660	Contour Planner Activity Table, 36"dx72"w	147
25665	Kidney Planner Activity Table, 48"dx72"w	147
Planner™ Science Tables		
25705	Planner Trespa TopLab Plus Science Table, 42"dx60"w	151
25715	Planner Trespa TopLab Plus Science Table, 42"dx72"w	151
25725	Planner Trespa TopLab Plus Science Table, 48"dx60"w	151
25735	Planner Trespa TopLab Plus Science Table, 48"dx72"w	151
26000	Planner Breakaway Peninsula Table, 48" dia.	188
Single Pedestal Cascade Teacher Desk		
26150	SP Cascade Teacher Desk w/6x3" totes (LH)	236
26151	SP Cascade Teacher Desk w/6x3" totes (RH)	236
26152	SP Cascade Teacher Desk w/6x3" totes (LH) w/door	236
26153	SP Cascade Teacher Desk w/6x3" totes (RH) w/door	236
26154	SP Cascade Teacher Desk w/ 2x3" & 1x12" tote (LH)	236
26155	SP Cascade Teacher Desk w/ 2x3" & 1x12" tote (RH)	236
26156	SP Cascade Teacher Desk w/2x3" & 1x12" tote w/door	236
26157	SP Cascade Teacher Desk w/2x3" & 1x12" tote w/door	236
26158	SP Cascade Teacher Desk BBF Ped (LH)	237
26159	SP Cascade Teacher Desk BBF Ped (RH)	237
Single Bullet Cascade Teacher Desk		
26160	SB Teacher Desk BBF (LH)	240
26161	SB Teacher Desk BBF (RH)	240

Model	Description	Page
26162	SB Teacher Desk w/two 3" totes & one 12" tote (LH)	241
26163	SB Teacher Desk w/two 3" totes & one 12" tote (RH)	241
26164	SB Teacher Desk w/two 3" totes & one 12" tote (LH) w/Door	241
26165	SB Teacher Desk w/two 3" totes & one 12" tote (RH) w/Door	241
26166	SB Cascade Teacher Desk w/six 3" totes (LH)	241
26167	SB Cascade Teacher Desk w/six totes (RH)	241
26168	SB Cascade Teacher Desk w/six totes (LH) w/Door	241
26169	SB Cascade Teacher Desk w/six totes (RH) w/Door	241
Double Pedestal Cascade Teacher Desk		
26170	DP Teacher Desk w/twelve 3" totes	238
26171	DP Teacher Desk w/four 3" & two 12" tote	238
26172	DP Teacher Desk w/six 3" totes & BBF Ped	238
26173	DP Teacher Desk w/two 3" & one 12" tote & BBF Ped	238
26174	DP Teacher Desk w/twelve 3" totes w/door	238
26175	DP Teacher Desk w/four 3" & two 12" totes w/door	238
26176	DP Teacher Desk w/six 3" totes & BBF Ped w/door	239
26177	DP Teacher Desk w/two 3" & one 12" tote & BBF Ped w/door	239
26178	DP Cascade Teacher Desk w/two BBF Peds	239
26179	DP Cascade Teacher Desk w/two 3" & one 12" & BBF	243
26180	DP Cascade Teacher Desk w/two BBF	243
26181	DP Teacher Desk w/two 3" totes, one 12" tote w/door & BBF	243
26182	DP Cascade Teacher Desk w/twelve 3"	242
26183	DP Cascade Teacher Desk w/twelve 3" w/door	242
26184	DP Cascade Teacher Desk w/four 3" & two 12"	242
26185	DP Cascade Teacher Desk w/four 3" and two 12" w/door	242
26186	DP Cascade Teacher Desk w/six 3" & BBF	243
26187	DP Cascade Teacher Desk w/six 3" & BBF w/door	243
26188	DP Cascade Teacher Desk w/FF & BBF	239
26194	DP Cascade Teacher Desk w/one FF & one BBF	243
Cascade™ Teacher Desk Accessories		
19195	Cascade Drawer Ped w/top & six 3" totes	237, 243
19196	Cascade Drawer Ped w/top & two 3" & one 12" tote	237, 243
19197	Cascade Drawer Ped w/door & top six 3" totes	237, 243
19198	Cascade Drawer Ped w/door & top & two 3", one 12" tote	237, 243
19199	Box/Box/File Pedestal	237, 243
Acrobat™ Desks		
26280	Acrobat Desk, 20"dx30"w	184
26281	Acrobat Desk, 20"dx36"w	184
26282	Acrobat Desk, 20"dx48"w	184
26283	Acrobat Desk, 20"dx60"w	185
26284	Acrobat Desk, 20"dx72"w	185
26285	Acrobat Desk, 20"dx90"w	186
26380	Acrobat Desk, 24"dx72"w	185
26390	Acrobat Desk, 24"dx90"w	186
26383	Acrobat Desk, 24"dx30"w	184
26393	Acrobat Desk, 24"dx36"w	184
26403	Acrobat Desk, 24"dx48"w	184
26413	Acrobat Desk, 24"dx60"w	185
26423	Acrobat Desk, 30"dx30"w	184
26433	Acrobat Desk, 30"dx36"w	184
26443	Acrobat Desk, 30"dx48"w	188, 246
26453	Acrobat Desk, 30"dx60"w	188, 246
26213	Peninsula Instructor Desk, 36"dx72"w	189, 247
26233	Peninsula Instructor Desk, 36"dx60"w	189, 247
26526	Acrobat workstation, 30"dx72"w	188, 246
26528	Acrobat Instructor Desk w/BBF Pedestal, 30"dx60"w	188, 246
Acrobat Workstations		
26203	Contour Instructor Desk, 36"dx72"w	193
26223	Contour Instructor Desk, 36"dx60"w	193
26492	Acrobat Corner work station, 5 sided 30"dx48"w	191
26493	Acrobat Corner work station, 5 sided 24"dx42"w	191
26494	Acrobat Corner work station, 5 sided 24"dx36"w	191
26498	Tech Lab Center, 7 sided corner, 24"dx60"w	190
26512	Acrobat Bullet workstation, 30"dx45"w	192

Model	Description	Page
26515	Acrobat Bullet workstation, 24"dx45"w	192
26516	Acrobat Bullet workstation, 30"dx60"w	192
26522	Acrobat Bullet workstation, 30"dx72"w	192
26536	Bullet Instructor Desk w/BBF Ped & Lectern, 30"dx60"w	192
26538	Bullet Instructor Desk w/BBF Ped & Lectern, 30"dx72"w	192
Lift Desk		
26540	Rectangle Lift Desk, 30"dx36"w	244
26541	Oval Lift Desk, 30"dx50"w	244
26542	Rectangle Lift Desk, 30"dx60"w	244
26543	Oval Lift Desk, 30"dx80"w	244
Acrobat Desks		
26550	Acrobat Crescent Table 60"dx60"w	194, 196
26551	Acrobat Crescent Table 72"dx72"w	194, 196
26680	Acrobat Carrel Starter surface, 28"h or 36"h, 27"dx24"w	250
26681	Acrobat Carrel Adder surface, 28"h or 36"h, 27"dx24"w	250
26682	Acrobat Carrel Starter surface, 28"h or 36"h, 27"dx36"w	250
26683	Acrobat Carrel Adder surface, 28"h or 36"h, 27"dx36"w	250
26684	Acrobat Carrel Starter surface, 28"h or 36"h, 27"dx48"w	250
26685	Acrobat Carrel Adder surface, 28"h or 36"h, 27"dx48"w	250
Graphic Arts Tables		
27344	CAD Station 2 - 24 x 24 surfaces, 1 slope adj.	156
27345	Graphic Arts Table, One-Piece Top, 24"dx36"w	156
27346	Graphic Arts Table, Split-Top, 24"dx36"w	157
27347	Graphic Arts Table, One-Piece Top, 30"dx42"w	156
UXL™ Stack Chairs		
XL183P_P_	18" UXL Stack Chair w/glides	47
XL163P_P_	16" UXL Stack Chair - B shell, w/glides	47
XL143P_P_	14" UXL Stack Chair - B shell, w/glides	47
XL187P_P_	18" UXL Stack Chair w/casters	47
XL167P_P_	16" UXL Stack Chair - B shell, w/casters	47
XL147P_P_	14" UXL Stack Chair - B shell, w/casters	47
XL183P_P_LR	18" UXL Stack Chair w/glides, w/arms	48
XL187P_P_LR	18" UXL Stack Chair w/casters, w/arms	48
XL183P_P_NF	18" UXL Stack Chair w/FoldAway Tablet (Right)	48
XL183P_P_FN	18" UXL Stack Chair w/FoldAway Tablet (Left)	48
XL183P_P_NT	18" UXL Stack Chair w/P-Tablet Option (Right)	49
XL183P_P_TN	18" UXL Stack Chair w/P-Tablet Option (Left)	49
XL187P_P_TN	18" UXL Stack Chair w/P-Tablet Option (Left)	49
XL183F_P_	18" UXL Stack Chair w/Fabric Seat Option	47
XL187F_P_	18" UXL Stack Chair w/casters and Fabric Seat	47
XL183F_P_LR	18" UXL Stack Chair w/Fabric Seat and Arms	48
XL187F_P_LR	18" UXL Stack Chair w/Fabric Seat Option, Arms	48
UXL™ Adjustable Chairs		
XL031P_P_	UXL Adjustable Chair w/glides	51
XL035P_P_	UXL Adjustable Chair w/casters	51
XL041P_P_	UXL Adjustable Stool w/glides	51
XL045P_P_	UXL Adjustable Stool w/casters	51
XL031P_P_LR	UXL Adjustable Chair w/glides, w/arms	51
XL035P_P_LR	UXL Adjustable Chair w/casters, w/arms	51
XL041P_P_LR	UXL Adjustable Stool w/glides, w/arms	51
XL045P_P_LR	UXL Adjustable Stool w/casters, w/arms	51
XL031F_P_	UXL Adjustable Chair w/glides, w/Fabric Seat	51
XL035F_P_	UXL Adjustable Chair w/casters, w/Fabric Seat	51
XL041F_P_	UXL Adjustable Stool w/glides, w/Fabric Seat	51
XL045F_P_	UXL Adjustable Stool w/casters, w/Fabric Seat	51
XL031F_P_LR	UXL Adjustable Chair w/glides, w/Fabric Seat, w/arms	51
XL035F_P_LR	UXL Adjustable Chair w/casters, w/Fabric Seat, w/arms	51
XL041F_P_LR	UXL Adjustable Stool w/glides, w/Fabric Seat, w/arms	51
XL045F_P_LR	UXL Adjustable Stool w/casters, w/Fabric Seat, w/arms	51
UXL Nest & Fold Chairs		
NF187F_P_	UXL Nest & Fold Chair	50
NF187F_P_LR	UXL Nest & Fold Chair w/arms	50

Model	Description	Page
UXL Chair Accessories		
77930 PLT	Book Basket	49
70861	Stack Chair Long Ganging Device	49
17580	Felt Glide Set for Stack Chair	49
55016 BLA	Premium Stack Chair Dolly	49
UXL Beam Seating		
B_0P_P_	UXL Beam Seating (2 Seat)	52
B_1P_P_	UXL Beam Seating (3 Seat)	52
B_2P_P_	UXL Beam Seating (4 Seat)	52
B_3P_P_	UXL Beam Seating (5 Seat)	52
BM1818	18" X 18" Table option instead of seat (subtract cost)	52
	Part of above P/N FoldAway Tablet Arm option	52
	Part of above P/N Optional Arm	52
UXL Rectangle Tables		
XL2030	UXL 20"dx30"w Table	94
XL2036	UXL 20"dx36"w Table	94
XL2048	UXL 20"dx48"w Table	94
XL2060	UXL 20"dx60"w Table	94
XL2072	UXL 20"dx72"w Table	94
XL2090	UXL 20"dx90"w Table	94
XL2430	UXL 24"dx30"w Table	94
XL2436	UXL 24"dx36"w Table	94
XL2448	UXL 24"dx48"w Table	94
XL2460	UXL 24"dx60"w Table	94
XL2472	UXL 24"dx72"w Table	94
XL2490	UXL 24"dx90"w Table	94
XL3030	UXL 30"dx30"w Table	97
XL3036	UXL 30"dx36"w Table	94
XL3048	UXL 30"dx48"w Table	94
XL3060	UXL 30"dx60"w Table	94
XL3072	UXL 30"dx72"w Table	94
XL3090	UXL 30"dx90"w Table	94
XL3636	UXL 36"dx36"w Table	97
XL3648	UXL 36"dx48"w Table	94
XL3660	UXL 36"dx60"w Table	94
XL3672	UXL 36"dx72"w Table	94
XL3690	UXL 36"dx90"w Table	94
XL4242	UXL 42"dx42"w Table	97
XL4248	UXL 42"dx48"w Table	94
XL4260	UXL 42"dx60"w Table	94
XL4272	UXL 42"dx72"w Table	94
XL4290	UXL 42"dx90"w Table	94
UXL Tables		
XL48EC	UXL Table I-O Post 48" Half Round/End Cap	95
XL48NC	UXL 48" Half Round Table	94, 97
UL48RC	UXL 3/4 Round End Cap Table	195
XL42RD	UXL 42" Round Table	97
XL48RD	UXL 48" Round Table	97
XL60RD	UXL 60" Round Table	97
XL60HR	UXL 60" Half-Round Table	94, 97
XL5STR	UXL Corner Table	97
UL6060	UXL 60" Square (1 1/4" top UL) Table	97
XL60TR	UXL 30"dx60"w Trapezoid Table	97
XL72TR	UXL 30"dx72"w Trapezoid Table	97
UL60FL	UXL 60" Flower Table	NIC
UXL Student Desks		
OF2027	UXL 20x27 Open Front Desk	87
OF2448	UXL 24x48 Two-Student Open Front Desk	87
XLSSDM	UXL Diamond Desk	84
XL2027	UXL Single-Student	87
XLCURV	UXL Single-Student	87
XLSMDM	UXL Mini Diamond Desk	84
XLTSDM	UXL Two-Student Diamond Desk	84
XLSSWG	UXL Wing Desk	86

Model	Description	Page
UL72CR	UXL 72" Crescent Table	88
UXL Science Tables w/Fixed Height Legs		
XT2448	UXL 24"dx48"w Trespa TopLab Plus Science Table	95
XT2454	UXL 24"dx54"w Trespa TopLab Plus Science Table	95
XT2460	UXL 24"dx60"w Trespa TopLab Plus Science Table	95
XT2472	UXL 24"dx72"w Trespa TopLab Plus Science Table	95
UXL Table Leg Set Options		
(AL)	Upcharge for AL Leg Push Button Adj. Leg Set w/glides	87, 107
(SL)	Upcharge for SL Leg Push Button Adj. Leg Set w/glides	87, 107
(AC)	Upcharge for AC Leg Push Button Adj. Leg Set w/casters	87, 107
(SC)	Upcharge for SC Leg Push Button Adj. Leg Set w/casters	87, 107
(FL)	Standard Leg Set UXL Fixed Leg Set w/glides	87, 107
(FC)	Upcharge for FC Leg Fixed Leg Set w/casters	87, 107
(TL)	Upcharge for TL Leg Tapered Leg Set w/casters	87, 107
(TG)	Upcharge for TG Leg Tapered Leg Set w/glide	87, 107
UXL Nest & Fold Tables		
FL2448	UXL Nest & Fold Table, 24"dx48"w	103
FL2460	UXL Nest & Fold Table, 24"dx60"w	103
FL2472	UXL Nest & Fold Table, 24"dx72"w	103
FL3048	UXL Nest & Fold Table, 30"dx48"w	103
FL3060	UXL Nest & Fold Table, 30"dx60"w	103
FL3072	UXL Nest & Fold Table, 30"dx72"w	103
FL48HR	UXL Nest & Fold Table, 48" Half Round Table	103
FL60HR	UXL Nest & Fold Table, 60" Half Round Table	103
AL2448	UXL Adj. Nest & Fold Table, 24"dx48"w	105
AL2460	UXL Adj. Nest & Fold Table, 24"dx60"w	105
AL2472	UXL Adj. Nest & Fold Table, 24"dx72"w	105
AL3048	UXL Adj. Nest & Fold Table, 30"dx48"w	105
AL3060	UXL Adj. Nest & Fold Table, 30"dx60"w	105
AL3072	UXL Adj. Nest & Fold Table, 30"dx72"w	105
AL48HR	UXL Adj. Nest & Fold Table, 48" Half Round Table	105
AL60HR	UXL Adj. Nest & Fold Table, 60" Half Round Table	105
UXL Power Bar		
ULPB60	16x60 Power Bar	91
ULPB72	16x72 Power Bar	91
ULPB84	16x84 Power Bar	91
UXL Accessories		
17060	Power Socket (4 Power Plugs, 2 Data Plugs) 15' cord	99
67628 PLT	Table Ganging Device	99
17040	Wire Manager for 30"w Table	99
17041	Wire Manager for 36"w Table	99
17042	Wire Manager for 48"w Table	99
17043	Wire Manager for 60"w Table	99
17044	Wire Manager for 72"w Table	99
17045	Wire Manager for 90"w Table	99
17100	30"W Desk Modesty Panel	99
17101	36"W Desk Modesty Panel	99
17102	48"W Desk Modesty Panel	99
17103	60"W Desk Modesty Panel	99
17104	72"W Desk Modesty Panel	99
17105	90"W Desk Modesty Panel	99
Partition Walls		
17300	35" Accessory Wall with no screen (18" Tall)	98
17301	43" Accessory Wall with no screen (18" Tall)	98
17302	54.75" Accessory Wall with no screen (18" Tall)	98
17303	66.5" Accessory Wall with no screen (18" Tall)	98
17310	35" Accessory Wall with 1 screen (18" Tall)	98
17311	43" Accessory Wall with 1 screen (18" Tall)	98
17312	54.75" Accessory Wall with 1 screen (18" Tall)	98
17313	66.5" Accessory Wall with 1 screen (18" Tall)	98
17320	35" Accessory Wall with 2 screen (18" Tall)	98, 190
17321	43" Accessory Wall with 2 screen (18" Tall)	98, 190
17322	54.75" Accessory Wall with 2 screen (18" Tall)	98, 190
17323	66.5" Accessory Wall with 2 screen (18" Tall)	98, 190

Model	Description	Page
UXL Partition Wall Accessories		
38545 PLT	Document Tray (Portrait)	98
38546 PLT	Document Tray (Landscape)	98
38547 PLT	Plastic Stationary Tray	98
38548 PLT	Plastic Stationary Holder	98
17653 PLT	Monitor Mount for Universal Rail	98
17654 PLT	Monitor Mount Arm	98
17655 PLT	Spring Loaded Monitor Mount	98
CASCADE™ STORAGE		
Cascade Mini-Case w/Casters		
111000000P	Open w/shelves	214
121000000P	Door w/shelves	214
111V00000P	Open w/shelves & riser	214
121V00000P	Door w/shelves & riser	214
111L00000P	Open w/shelves & Lectern	214
121L00000P	Door w/shelves & Lectern	214
110005000P	Open w/five 3" EW totes	214
120005000P	Door w/five 3" EW totes	214
110V05000P	Open w/five 3" EW totes & riser	214
120V05000P	Door w/five 3" EW totes & riser	214
110L05000P	Open w/five 3" EW totes & Lectern	214
120L05000P	Door w/five 3" EW totes & Lectern	214
110003010P	Open w/three 3" & one 6" EW tote	214
120003010P	Door w/three 3" & one 6" EW tote	214
110V03010P	Open w/three 3" & one 6" EW tote & riser	214
120V03010P	Door w/three 3" & one 6" EW tote & riser	214
110L03010P	Open w/three 3" & one 6" EW tote & Lectern	214
120L03010P	Door w/three 3" & one 6" EW tote & Lectern	214
Cascade Mid-Case w/Casters		
211000000P	Open w/shelves	214
221000000P	Doors w/shelves	214
211V00000P	Open w/shelves & riser	214
221V00000P	Doors w/shelves & riser	214
211L00000P	Open w/shelves & Lectern	214
221L00000P	Doors w/shelves & Lectern	214
210010000P	Open w/ten 3" totes	214
220010000P	Doors w/ten 3" totes	214
210V10000P	Open w/ten 3" totes & riser	214
220V10000P	Doors w/ten 3" totes & riser	214
210L10000P	Open w/ten 3" totes & Lectern	214
220L10000P	Doors w/ten 3" totes & Lectern	214
210006020P	Open w/six 3" & two 6" totes	214
220006020P	Doors w/six 3" & two 6" totes	214
210V06020P	Open w/six 3" & two 6" totes & riser	214
220V06020P	Doors w/six 3" & two 6" totes & riser	214
210L06020P	Open w/six 3" & two 6" totes & Lectern	214
220L06020P	Doors w/six 3" & two 6" totes & Lectern	214
Cascade Mega-Case w/Casters		
311000000P	Open w/shelves	215
321000000P	Doors w/shelves	215
311V00000P	Open w/shelves & riser	215
321V00000P	Doors w/shelves & riser	215
311L00000P	Open w/shelves & Lectern	215
321L00000P	Doors w/shelves & Lectern	215
311N00000P	Open w/shelves & presentation top	228
321N00000P	Doors w/shelves & presentation top	228
310015000P	Open w/fifteen 3" totes	215
320015000P	Doors w/fifteen 3" totes	215
310115000P	Open w/fifteen 3" totes & riser	215
320115000P	Doors w/fifteen 3" totes & riser	215
310J15000P	Open w/fifteen " totes & Lectern	215
320J15000P	Doors w/fifteen 3" totes & Lectern	215
310N15000P	Open w/fifteen 3" totes & presentation top	228
320N15000P	Doors w/fifteen 3" totes & presentation top	228

Model	Description	Page
310009030P	Open w/nine 3" & three 6" totes	215
320009030P	Doors w/nine 3" & three 6" totes	215
310109030P	Open w/nine 3" & three 6" totes & riser	215
320109030P	Doors w/nine 3" & three 6" totes & riser	215
310J09030P	Open w/nine 3" & three 6" totes & Lectern	215
320J09030P	Doors w/nine 3" & three 6" totes & Lectern	215
310N09030P	Open w/nine 3" & three 6" totes & presentation top	228
320N09030P	Doors w/nine 3" & three 6" totes & presentation top	228
A10006020P	Open w/six 3" & two 6" EW totes	215
A20006020P	Doors w/six 3" & two 6" EW totes	215
A10106020P	Open w/six 3" & two 6" EW totes & riser	215
A20106020P	Doors w/six 3" & two 6" EW totes & riser	215
A10J06020P	Open w/six 3" & two 6" EW totes & Lectern	215
A20J06020P	Doors w/six 3" & two 6" EW totes & Lectern	215
A10N06020P	Open w/six 3" & two 6" EW totes & presentation top	228
A20N06020P	Doors w/six 3" & two 6" EW totes & presentation top	228
A10010000P	Open w/ten 3" EW totes	215
A20010000P	Doors w/ten 3" EW totes	215
A10110000P	Open w/ten 3" EW totes & riser	215
A20110000P	Doors w/ten 3" EW totes & riser	215
A10J10000P	Open w/ten 3" EW totes & Lectern	215
A20J10000P	Doors w/ten 3" EW totes & Lectern	215
A10N10000P	Open w/ten 3" EW totes & presentation top	228
A20N10000P	Doors w/ten 3" EW totes & presentation top	228
Cascade Mini-Cabinet w/Casters		
411000000P	Open w/shelves	218
421000000P	Door w/shelves	218
411V00000P	Open w/shelves & riser	218
421V00000P	Door w/shelves & riser	218
411L00000P	Open w/shelves & lectern	218
410008000P	Open w/eight 3" EW totes	218
420008000P	Door w/eight 3" EW totes	218
410V08000P	Open w/eight 3" EW totes & riser	218
420V08000P	Door w/eight 3" EW totes & riser	218
410004020P	Open w/four 3" 2x6" EW tote	218
420004020P	Door w/four 3" 2x6" EW tote	218
410V04020P	Open w/four 3" 2x6" EW tote & riser	218
420V04020P	Door w/four 3" 2x6" EW tote & riser	218
410000040P	Open w/four 6" EW tote	218
420000040P	Door w/four 6" EW tote	218
410V00040P	Open w/four 6" EW tote & riser	218
420V00040P	Door w/four 6" EW tote & riser	218
Cascade Mid-Cabinet w/Casters		
511000000P	Open w/shelves	218
521000000P	Doors w/shelves	218
511V00000P	Open w/shelves & riser	218
521V00000P	Doors w/shelves & riser	218
511L00000P	Open w/shelves & Lectern	218
510016000P	Open w/sixteen 3" totes	218
520016000P	Doors w/sixteen 3" totes	218
510V16000P	Open w/sixteen 3" totes & riser	218
520V16000P	Doors w/sixteen 3" totes & riser	218
510008040P	Open w/eight 3" 4x6" tote	218
520008040P	Doors w/eight 3" 4x6" tote	218
510V08040P	Open w/eight 3" 4x6" tote & riser	218
520V08040P	Doors w/eight 3" 4x6" tote & riser	218
510000080P	Open w/eight 6" totes	218
520000080P	Doors w/eight 6" totes	218
510V00080P	Open w/eight 6" totes & riser	218
520V00080P	Doors w/eight 6" totes & riser	218
Cascade Mega-Cabinet w/Glides		
B31000000P	Open w/shelves & glides	219
B41000000P	Doors w/shelves & glides	219
B31100000P	Open w/shelves, riser & glides	219

Model	Description	Page
B41100000P	Doors w/shelves, riser & glides	219
Cascade Mega-Cabinet w/Casters		
B11000000P	Open w/shelves	219
B21000000P	Doors w/shelves	219
B11100000P	Open w/shelves & riser	219
B21100000P	Doors w/shelves & riser	219
611100000P	Open w/shelves & Lectern	219
610024000P	Open w/twenty-four 3" totes	219
620024000P	Doors w/twenty-four 3" totes	219
610124000P	Open w/twenty-four 3" totes & riser	219
620124000P	Doors w/twenty-four 3" totes & riser	219
610012060P	Doors w/twelve 3" & six 6" tote	219
610112060P	Open w/twelve 3" & six 6" tote & riser	219
620112060P	Doors w/twelve 3" & six 6" tote & riser	219
B10016000P	Open w/sixteen 3" EW totes	219
B20016000P	Doors w/sixteen 3" EW totes	219
B10116000P	Open w/sixteen 3" EW totes & riser	219
B20116000P	Doors w/sixteen 3" EW totes & riser	219
B1000080P	Open w/eight 6" EW totes	219
B2000080P	Doors w/eight 6" EW totes	219
B1010080P	Open w/eight 6" EW totes & riser	219
B2010080P	Doors w/eight 6" EW totes & riser	219
B10008040P	Open w/eight 3" & four 6" EW totes	219
B20008040P	Doors w/eight 3" & four 6" EW totes	219
B10108040P	Open w/eight 3" & four 6" EW totes & riser	219
B20108040P	Doors w/eight 3" & four 6" EW totes & riser	219
Cascade Mini-Tower w/Casters		
711000000P	Open w/shelves	222
721000000P	Door w/shelves	222
S10000000P	Open w/shelf and wardrobe rod	225
S20000000P	Doors w/shelf and wardrobe rod	225
710012000P	Open w/twelve 3" EW totes	222
720012000P	Door w/twelve 3" EW totes	222
710003050P	Open w/three 3" 5x6" EW totes	222
720003050P	Door w/three 3" 5x6" EW totes	222
71000060P	Open w/six 6" EW totes	222
72000060P	Door w/six 6" EW totes	222
Cascade Mid-Tower w/Casters		
811000000P	Open w/shelves	222
821000000P	Doors w/shelves	222
T10000000P	Open w/shelf & wardrobe rod	225
T20000000P	Doors w/shelf & wardrobe rod	225
810024000P	Open w/twenty-four 3" totes	222
820024000P	Doors w/twenty-four 3" totes	222
810006062P	Open w/six 3" & six 6" & two 12" totes	222
820006062P	Doors w/six 3" & six 6" & two 12" totes	222
810000120P	Open w/twelve 6" totes	222
820000120P	Doors w/twelve 6" totes	222
Cascade Mega-Tower w/Casters		
911000000P	Open w/shelves	223
921000000P	Doors w/shelves	223
U10000000P	Open w/shelf & wardrobe rod	225
U20000000P	Doors w/shelf & wardrobe rod	225
910036000P	Open w/thirty-six 3" totes	223
920036000P	Doors w/thirty-six 3" totes	223
910009150P	Open w/nine 3" & fifteen 6" totes	223
920009150P	Doors w/nine 3" & fifteen 6" totes	223
910009093P	Open w/nine 3" & nine 6" & three 12" totes	223
920009093P	Doors w/nine 3" & nine 6" & three 12" totes	223
C10024000P	Open w/twenty-four 3" EW totes	223
C20024000P	Doors w/twenty-four 3" EW totes	223
C10014060P	Open w/fourteen 3" & six 6" EW totes	223

Model	Description	Page
C20014060P	Doors w/fourteen 3" & six 6" EW totes	223
Cascade Wardrobe w/Casters		
R10024000P	Open w/twenty-four 3" SW totes	224
R20024000P	Doors w/twenty-four 3" SW totes	224
R10000120P	Open w/twelve 6" SW totes	224
R20000120P	Doors w/twelve 6" SW totes	224
R10006062P	Open w/six 3" & six 6" & two 12" SW totes	224
R20006062P	Doors w/six 3" & six 6" & two 12" SW totes	224
Cascade AV Carts		
W21100000P	Cascade Mid-Case AV Presentation Cart	229
V21100000P	Cascade Mega-Case AV Presentation Cart	229
Cascade Cubbies w/Casters		
D11000000P	Mega Case Open w/6 Cubbies	227
D21000000P	Mega Case Doors w/6 Cubbies	227
E11000000P	Mega Cabinet Open w/9 Cubbies	227
E21000000P	Mega Cabinet Doors w/9 Cubbies	227
F11000000P	Mega Tower Open w/12 Cubbies	227
F21000000P	Mega Tower Doors w/12 Cubbies	227
Cascade Cubbies w/Glides		
D31000000P	Mega Case Open w/ 6 Cubbies	227
D41000000P	Mega Case Door w/6 Cubbies	227
E31000000P	Mega Cabinet Open w/9 Cubbies	227
E41000000P	Mega Cabinet Door w/9 Cubbies	227
F31000000P	Mega Tower Open w/12 Cubbies	227
F41000000P	Mega Tower Door w/12 Cubbies	227
Cascade Accessories		
17670 PLT	Optional Laptop Shelf for Cascade	213, 214
Add "W"	Whiteboard Back for Mega-Tower	231
30925	SW housing w/tote	123, 126, 136, 142, 230
30926	EW housing w/tote	123, 126, 142, 230
66013	Interchange SW Tote Tray w/housing	60, 64, 68, 70, 211, 230
66014	Interchange SW housing only	60, 64, 68, 70, 211, 230
30927	SW (Standard Width) housing only	230
30928	EW (Extra Wide) housing only	230
66000	SW Single Depth tote Clear	230
66001	SW Double Depth tote Clear	230
66002	SW Quad Depth tote Clear	230
66010	EW Single Depth tote Clear	230
66011	EW Double Depth tote Clear	230
66020	SW tote Lid	230
66021	EW tote Lid	230
66030	Plastic Label Cover	230
Power Options		
017086 SLV	Flat Surface, 2 Power, 4 USB, silver	78, 162, 258
017093 SLV	Flat Surface, 4 Power, silver	78, 162, 258
017088 BLA	Dome, 4 Power, black	78, 162, 258
017091 SLV	Retractable Surface, 2 Power, silver	78, 162, 258
017085 SLV	Retractable Surface, 2 Power, 4 USB, silver	78, 162, 258
017092 SLV	Retractable Surface, 4 Power, silver	78, 162, 258
017097 SLV	Flat Round, 2 Power	78, 162, 258
017098 SLV	Flat Round, 1 Power, one 2 Port USB	78, 162, 258
017078 BLA	Soft Touch Power Dome, 3 Power	78, 162, 258
017079 BLA	Soft Touch Power Dome, 2 Power, 2 Port USB	78, 162, 258
17060	Power Socket	45, 99, 131, 155, 197
17081	6 Outlet Electric Strip w/Surge	131, 155, 197
17084	10 Outlet Electric Strip w/Surge	131, 155, 197
17090	I-O Post	259
17091	I-O Post Hard Wire	259
17095	I-O Tower	259
17096	I-O Tower (80-Upper)	259
17097	I-O Tower (80-Lower)	259
17589	I-O Post Caster Pack, 2 Locking, 2 non-casters	259