

## z/OS® V2.2 DFSMS™: Latest and Greatest

*Barbara McDonald*  
IBM - [bawhite@us.ibm.com](mailto:bawhite@us.ibm.com)

*August 10, 2015*  
*Session 17814*



#SHAREorg



SHARE is an independent volunteer-run information technology association that provides **education, professional networking and industry influence.**



© Copyright IBM Corp. 2015

# Disclaimer

*The information on the new product is intended to outline our general product direction and it should not be relied on in making a purchasing decision. The information on the new product is for informational purposes only and may not be incorporated into any contract. The information on the new product is not a commitment, promise, or legal obligation to deliver any material, code or functionality. The development, release, and timing of any features or functionality described for our products remains at our sole discretion.*

# Connect with IBM z Systems on social media!



Subscribe to the new [IBM Mainframe Weekly](#) digital newsletter to get the latest updates on the IBM Mainframe!



[System z Advocates](#) \*\*  
[IBM Mainframe- Unofficial Group](#)  
[IBM System z Events](#)  
[Mainframe Experts Network](#)  
[SHARE](#)



[IBM System z](#) \*\*  
[IBM Master the Mainframe Contest](#)  
[IBM Destination z](#)  
[SHARE Inc.](#)



[IBM System z](#) \*\*  
[IBM System z Events](#)  
[Destination z](#)  
[SHARE](#)

## Blogs

[IBM Mainframe Insights](#) \*\*  
[Millennial Mainframer](#)  
[#MainframeDebate blog](#)  
[SHARE blog](#)  
[IBM Destination z](#)  
[Dancing Dinosaur](#)  
[Bob's Mainframe Blog](#)



[Google+](#)



## Key Websites

- [Mainframe Insights](#)
- [Engines of Progress](#)
- [z Systems Software](#)
- [IBM z Systems Redbooks](#)
- [DFSMS](#)
- [z/OS Storage Management Tools](#)



[IBM System z](#) \*\*  
[Destination z](#)



[IBM Mainframe50](#)

Include the hashtag [#Mainframe](#), and also see [#z13](#) and [#IBMz](#)

# IBM Redbooks



- New look for [IBM z Systems Redbooks](#)
  - Connect with them on Facebook, Twitter, LinkedIn
  - [5 Things to Know About IBM Redbook for IBM z13](#)
- Check out their BLOGS
  - [zEDC Compression](#)
  - [DS8870 and z13 Synergy](#)
- Stay tuned for a new DFSMS V2.2 Redbook
  - z/OS V2R2: Storage Management and Utilities
- Visit their Booth at the SHARE Expo
  - IBM Redbooks Booth #101

Complete your session evaluations online at [www.SHARE.org/Orlando-Eval](http://www.SHARE.org/Orlando-Eval)



# DFSMS™: Providing System Managed Storage on z/OS®

Storing, managing, protecting, and serving data on z Systems



**DFSMS is the standard methodology worldwide for managing enterprise data and storage on the z/OS platform**

**DFSMS strategy addresses explosive growth and management of customer data**

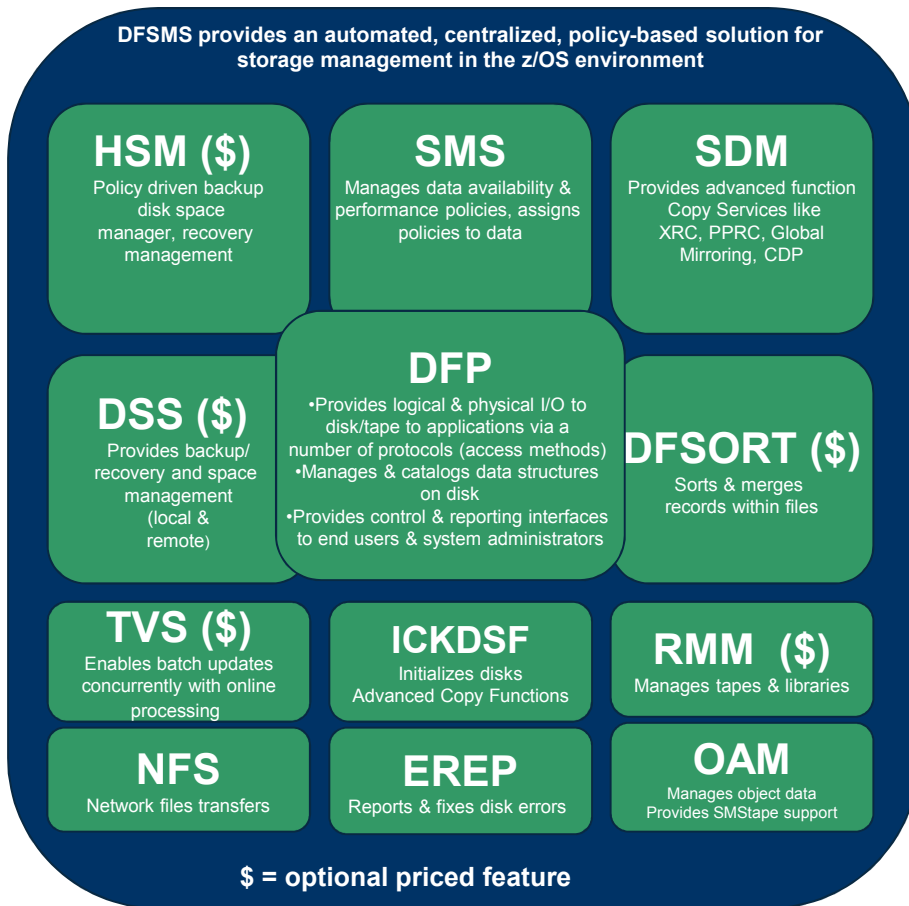

**DFSMS drives value as the data hub for System z:**

- **Creates integrated solutions by exploiting new hardware features**
  - Enable better utilization and management of Storage HW
- **Maintains leadership in policy based storage management**
  - Improved storage administrator productivity and simplified management of the z/OS environment
- **Strengthens business resiliency by exploiting new opportunities and advancements in data protection solutions**
  - Point-in-time copy, fast replication, and continuous data mirroring functions while preserving consistency
- **Supports growing businesses and mission critical workloads by providing continuous availability, scalability/performance and flexibility of storage and data**
  - Increased data storage capacity and scalability to cope with explosive growth of data volumes and database sizes
  - High Availability with simpler, faster, and more reliable recovery operations
  - Ability to cope with increased security and compliance requirements
- **Enables cross platform data and storage**
  - Data availability at all levels of the storage hierarchy

Complete your session evaluations online at [www.SHARE.org/Orlando-Eval](http://www.SHARE.org/Orlando-Eval)

# z/OS® DFSMS™ V2.2 GA Highlights

## (September 2015)

- **DFSMSHsm**
  - DFSMS Storage Tiers Enhancements
  - Fast Replication Enhancements
  - DFSMSHsm / DFSMSdss zEDC Exploitation
- **Catalog / IDCAMS**
  - Support for > 255 GDGs
  - MODIFY CATALOG Security Enhancement
  - Catalog RAS Enhancements
  - IDCAMS VERIFY RECOVER
  - IDCAMS RAS Enhancements
- **SMS**
  - Space Constraint Relief
  - RAS Enhancements
  - Storage Group Space Alert Messages
- **Access Methods**
  - QSAM/BSAM zEDC Exploitation
  - RLS Index Level Locking
  - Secondary Space Reduction
  - LISTSTAT Command
  - VSAM LSR Dynamic Buffer Addition
- **Open/Close/EOV**
  - Dynamic Exits
  - RAS Enhancements
- **DADSM/CVAF**
  - RAS Enhancements
- **DFSORT**
  - zHPF Exploitation
  - Functional Enhancements
- **DFSMSrmm**
  - WHILECATALOG Support
  - SEARCHDATASET / SEARCHVOLUME Enhancements
- **DFSMS / Storage Synergy**
  - Multi-Target PPRC
  - IBM zHyperWrite™
  - Easy Tier® Application Hints
  - XRC Workload Write Pacing
  - Multiple Incremental FlashCopy

Complete your session evaluations online at [www.SHARE.org/Orlando-Eval](http://www.SHARE.org/Orlando-Eval)

# Additional Sessions to Note

## OAM:

- **Session 17809:** DFSMS Object Support Overview: Data Archiving with OAM, **Thursday 10AM**
- **Session 17591 :** The Ups and Downs of Directing OAM Data to Tape, **Tuesday 1:45PM**

## IBM Tape HW:

- **Session 17964:** TS7700 Technical Update - What's That I Hear About R3.2?, **Thursday 10AM**
- **Session 17963:** Using the TS7700 to your Data's Advantage, **Thursday 4:30PM**

## PDSE:

- **Session 17831:** PDSE Member Generations: Implementation and ISPF Exploitation, **Tuesday 3:15PM**
- **Session 17830:** The PDS to PDSE conversion: A Totally Expected Journey, **Wednesday 11:15AM**
- **Session 17452:** PDSE Trials, Tribulations and Rewards, **Wednesday 1:45PM**
- **Session 17230/1:** ISPF Hidden Treasures and New Features Part 1 &2, **Thursday 8:30AM**

**Session 17135: DFSMS Free for All, Wednesday 5:45PM**

# DFSMS V2.2 Statements of Direction

- **DFSMSrmm**

- z/OS V2.2 is planned to be the last release to provide support in the Common Information Model (CIM) component for the Java<sup>™</sup> Managed Provider Interface (JPMI).
- z/OS V2.2 is planned to be the last release to support the DFSMSrmm CIM Provider.

- **System Data Mover (SDM)**

- z/OS V2.2 is planned to be the last release to include a number of TSO/E-based SDM related commands.
  - Does **NOT** effect query commands (CQUERY, FCQUERY, RQUERY, XQUERY, XSTATUS) or the XSET command.
- IBM recommends you use the REXX version of these commands (introduced with z/OS R12).



# z/OS DFSMS Highlights

- **DFSMSHsm**

- **V2.2 GA**

- DFSMS Storage Tiers Enhancements
    - DFSMSHsm Fast Replication Enhancements
    - DFSMSHsm / DFSMSdss zEDC Exploitation

- **Session 17804:** Transition to Transitions, **Wednesday 3:15PM**
- **Session 17805:** DFSMSHsm DB2 Backup Enhancements, **Tuesday 11:15AM**
- **Session 17793:** zEDC: Huge Response Time Improvements in Compression, **Friday 11:15AM**
- **Session 17613:** Rethinking HSM Policies with Automated Storage Tiering, **Monday 3:15**
- **Session 17832:** Preparing SMSVSAM for HSM and Catalog - VSAM RLS Performance and Tuning, **Friday 10AM**

# DFSMSHsm

- DFSMS Storage Tiers
  - Today...

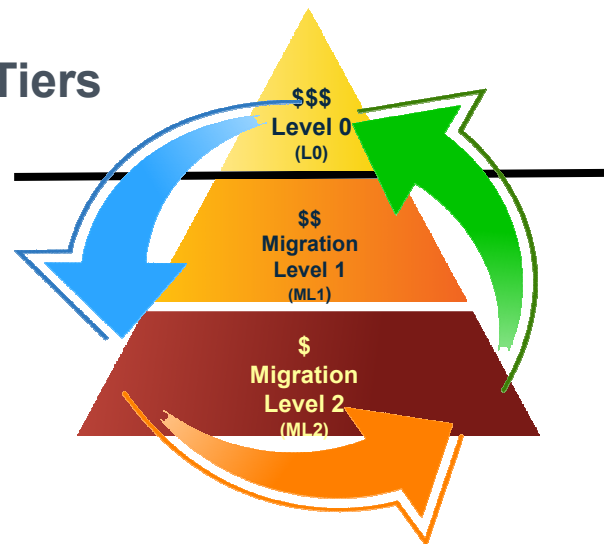

- **With V2.1**, DFSMS Storage Tiers introduced automated, policy-based space management that moves SMS-managed data from tier to tier **within** the Primary (Level 0) Hierarchy, allowing for policy-based management of “**active**” data.
  - Automated movement provided via the existing DFSMSHsm Space Management function; movement is referred to as a '**Class Transition**'
  - Space management functions will determine if a data set is eligible to be transitioned, based on management class criteria. SMS Management Class provides the Class Transition policies.
  - Data remains in its original format and can be immediately accessed after the movement is complete.
  - Enhanced support for DB2, CICS and zFS data

Complete your session evaluations online at [www.SHARE.org/Orlando-Eval](http://www.SHARE.org/Orlando-Eval)

# DFSMSHsm

- **DFSMS Storage Tiers Enhancements**

- Today, the Class Transition function is limited to automatic space management processing.
- **New enhancement:** Enable Class Transitions to be initiated with the various Migration commands.
  - The various Migrate commands are enhanced to support class transitions at the data set, volume and storage group level.
    - New keywords: **BOTH, MIGRATIONONLY, TRANSITIONONLY**
    - The default behavior is to perform **both** migration and transition processing for VOLUME and STORAGEGROUP operations.
    - The default for MIGRATE DATASET is to perform a migration. The TRANSITION keyword indicates that a transition should be performed.

**? Why it Matters:** Storage Tiers in general allows users to better align storage costs with changing business value and minimize the TCO of System z data. The new enhancements extend the use of tiering and improve the usability of the function.

# DFSMSHsm

- **DFSMS Additional Storage Tiers Enhancements**
  - Today, for “classic” migration, command initiated volume migration is single threaded. This severely limits the throughput.
  - **New enhancement:** New **STORAGEGROUP** keyword to initiate migration for all volumes within a storage group *in parallel*.
    - Primary Space Management processing will be performed for the storage groups, as opposed to the standard volume-by-volume processing performed by MIGRATE VOLUME.
      - **Use Case:** Clients create DB2 image copies (using FlashCopy) to a specific storage group and then invoke DFSMSHsm MIGRATE to move the copies to tape.
      - This enhancement enables a single command to process all of the volumes in the storage group in *parallel*.
- **? Why it Matters:** Significantly improve the throughput for command initiated space management and improve usability.

# DFSMSHsm

- **DFSMS Additional Storage Tiers Enhancements**
  - Today, moving data to newly defined disk volumes within a storage environment can be manually intensive and cumbersome.
  - **New enhancement:** Enable the DFSMS Class Transition function to move data laterally to the same tier of storage, in addition to the ability of moving data to different tiers storage.
    - **MOVE** keyword added to the MIGRATE DSNAME, VOLUME and STORAGEGROUP commands.
      - Every data set will be processed, regardless of management class policy or threshold, and ACS routines will be invoked to determine the new storage class and/or storage group.
      - **Use Case:** Move DB2 data from existing smaller volumes to the new larger, newly defined EAVs.

**? Why it Matters:** Simplify the task of migrating data to newly defined disk volumes.

# DFSMSHsm

- **DFSMSHsm Fast Replication Enhancements**
  - Dump commands (Command, Auto, Fast Replication) today must be processed on the same DFSMSHsm host that initiated the request.
    - The resources of a single DFSMSHsm host do not scale to the large copy pool sizes that need to be processed.
  - **New enhancement:** Distribute dump work across all hosts in a sysplex-wide Common Dump Queue (CDQ).
    - Introduces an architecture to distribute workload across host members in an HSMPLex, and the new architecture allows for flexible configurations.
    - Invoked and controlled via SETSYS commands.
- **? Why it Matters:** Improves overall throughput by distributing the workload across the sysplex instead of concentrating it on a single LPAR.

DFSMSHsm DB2  
Backup  
Enhancements,  
Tuesday 11:15AM

Complete your session evaluations online at [www.SHARE.org/Orlando-Eval](http://www.SHARE.org/Orlando-Eval)

# DFSMSHsm

- **DFSMSHsm Fast Replication Dump Enhancements**

- For Dump Stacking today, the stacking value takes precedence over the number of available tasks.
- Volumes from different copy pools are not stacked onto the same tape.
- **New enhancements:**
  - Provide a minimum stack option to indicate that fully utilizing the available dump tasks is more desirable than optimizing stacking.
    - Added a new **MINSTACK**, minimum stack, parameter and an **MAXSTACK** alias for the STACK parameter.
    - Depending on the value of MINSTACK, it may be possible that the **use of multi-tasking will use more tapes.**
  - Allow multiple Copy pools to be stacked onto the same tape.
    - This will occur when the copy pools are dumped at the same time and use the same dump classes. Today this only occurs with Automatic Dump.

**? Why it Matters:** Optimize Dump throughput and improve usability.

# DFSMSHsm

- **DFSMSHsm Fast Replication Dump Enhancements**

- Today, updating the expiration date is manually intensive, as it can take thousands of FIXCDS commands to update the expiration date of a single copy pool dump version.
- **New enhancements:**
  - Provide a new command to update the expiration date for a copy pool dump copy.
    - New **UPDTCDS** command updates **ALL** of the CDS records that need to be updated to reflect the new expiration date.
    - Avoid using hundreds of FIXCDS commands.

**? Why it Matters:** Optimize Dump throughput and improve usability.



# DFSMSHsm

- **DFSMSHsm Fast Replication Messaging Enhancements**

- Today, finding messages related to a Fast Replication command is very difficult because they are written to shared logs.
  - First, find the correct log and then search through all of the messages for all HSM activity.
- **New enhancement:** Provide an option to dynamically allocate a unique message data set and write all DFSMSHsm and DFSMSdss messages for a specific FRBACKUP or copy pool Automatic Dump to that data set.
  - Invoked via SETSYS command
    - **SETSYS FASTREPLICATION(MESSAGE DATASET(YES|NO HLQ(hlq)))**
    - Indicates that all Fast Replication messages should go to a unique data set with a unique **HLQ**.
    - Each message is prefixed with the date and timestamp, along with the ID of the host the wrote the message.
    - Message Data Sets must be SMS managed.
- **SHARE Requirement Addressed:** SSMVSS14005

**? Why it Matters:** Greatly simplify problem determination.

# DFSMSHsm

- **DFSMSHsm/DFSMSdss Exploitation of zEDC**

- **New enhancements:** DSS and HSM now exploit zEDC for dumping and restoring data and when HSM uses DSS to move data.

- DSS

- Supports DUMP, RESTORE, COPY, DEFRAG, CONSOLIDATE, RELEASE, and PRINT of zEDC compressed format data sets
      - Supports new compression keyword for DUMP
        - » Accepted for all FULL, TRACKS, physical and logical DATASET backups to **DASD and tape**

- HSM

- Supports MIGRATION, RECALL, BACKUP, RECOVER, FULL-VOLUME DUMP, RECOVER FROMDUMP, FRBACKUP, FRRECOV, ABACKUP, ARECOVER of zEDC compressed format data sets
      - Uses the DFSMSdss zEDC support for certain functions.
        - » Migrate/Recall
        - » Backup/Recover
        - » Full Volume DUMP
        - » Recover and FRRECOV from DUMP

**? Why it Matters:** Provides efficient compression and lower CPU overhead than the processor-based and software-based compression methods already available.\*

zEDC: Huge  
Response Time  
Improvements in  
Compression,  
Friday 11:15AM

\* Disclaimer: *Based on projections and/or measurements completed in a controlled environment. Results may vary by customer based on individual workload, configuration and software levels.*

ns online at [www.SHARE.org/Orlando-Eval](http://www.SHARE.org/Orlando-Eval)

# ML1 zEDC Compression – Value!

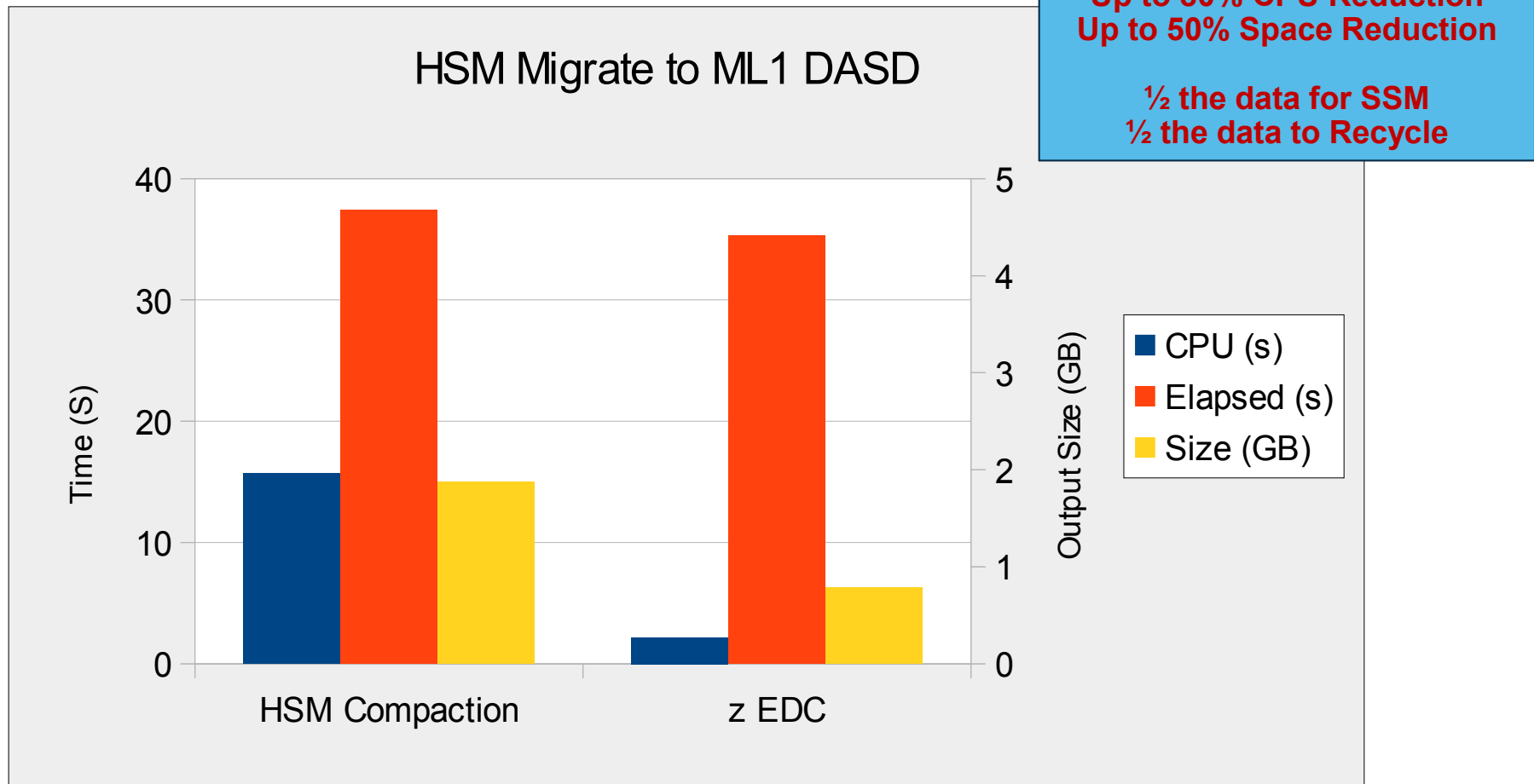

*\* Disclaimer: Based on projections and/or measurements completed in a controlled environment. Results may vary by customer based on individual workload, configuration and software levels.*

Complete your session evaluations online at [www.SHARE.org/Orlando-Eval](http://www.SHARE.org/Orlando-Eval)

# ML1 zEDC Compression – Value!

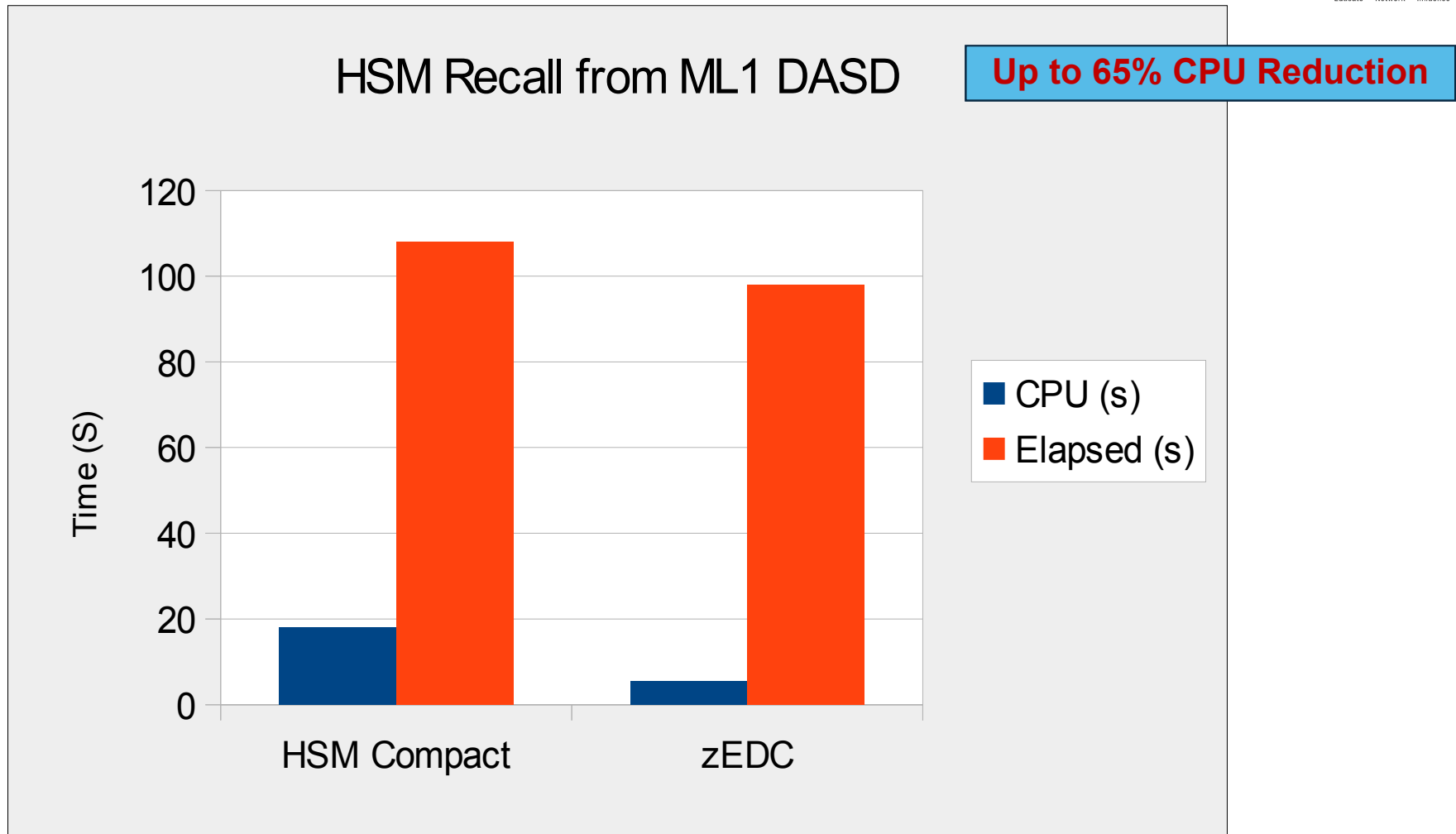

*\* Disclaimer: Based on projections and/or measurements completed in a controlled environment. Results may vary by customer based on individual workload, configuration and software levels.*

Complete your session evaluations online at [www.SHARE.org/Orlando-Eval](http://www.SHARE.org/Orlando-Eval)

# APAR OA48394 ML2 zEDC Compression



## HSM Migrate to ML2 (TS7720 - HYDRA)

**Up to 15% CPU Reduction**  
**Up to 24% Elapsed Time Reduction**  
**½ the data to Recycle**

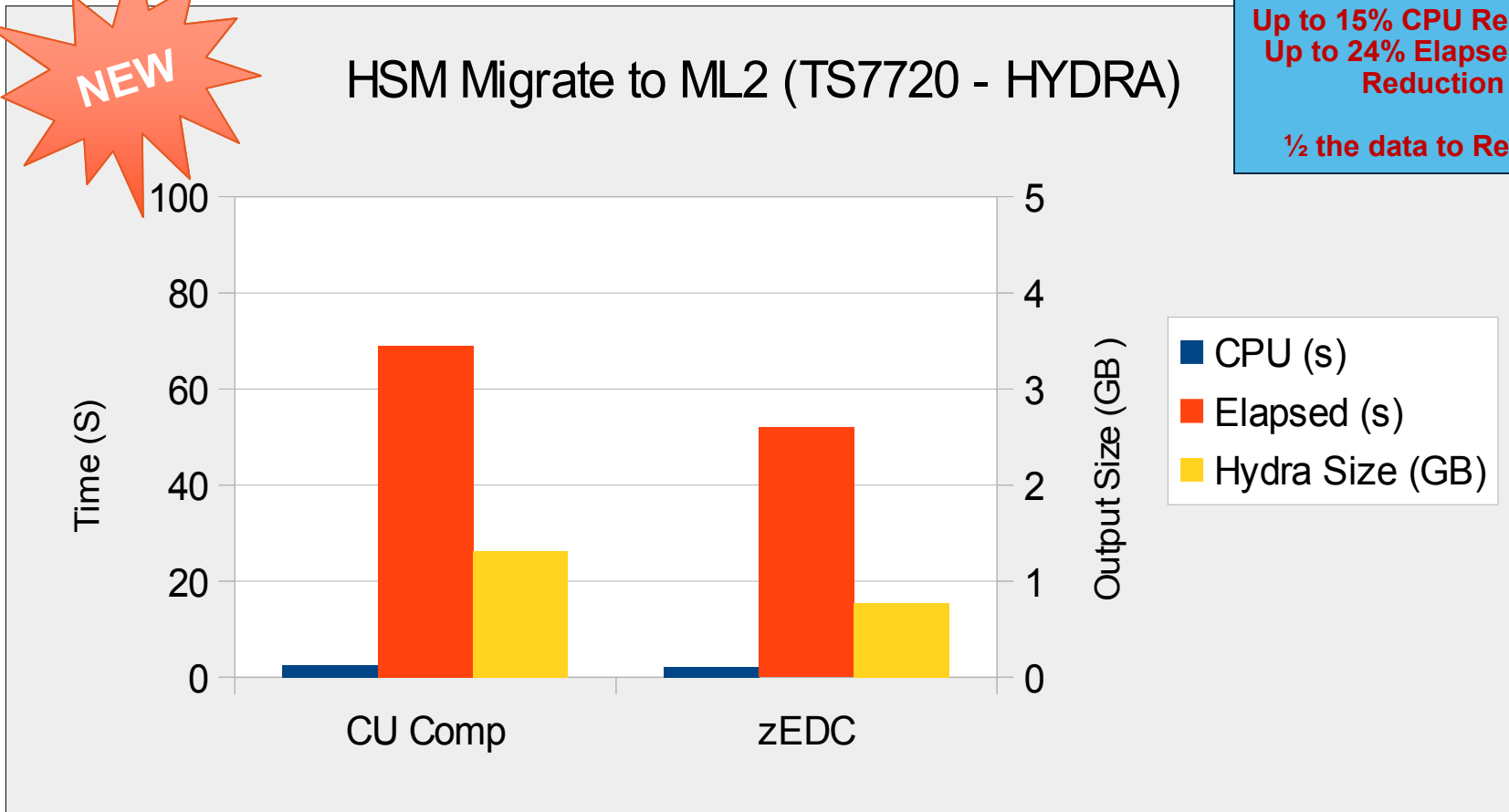

*\* Disclaimer: Based on projections and/or measurements completed in a controlled environment. Results may vary by customer based on individual workload, configuration and software levels.*

Complete your session evaluations online at [www.SHARE.org/Orlando-Eval](http://www.SHARE.org/Orlando-Eval)

# z/OS DFSMS Highlights

- **Catalog / IDCAMS**

- **V2.2 GA**

- Support for > 255 GDGs
- MODIFY CATALOG Security Enhancement
- Catalog RAS Enhancements
- IDCAMS VERIFY RECOVER
- IDCAMS RAS Enhancements

**Session 17875:** ICF Catalog Management Fundamentals, **Wednesday 10AM**

**Session 17832:** Preparing SMSVSAM for HSM and Catalog - VSAM RLS Performance and Tuning, **Friday 10AM**

***From Seattle:***

**Session 17104:** What's New with DFSMS ICF Catalog and IDCAMS, **Wednesday 4:30PM**

# Catalog

- **GDG Extended (GDGE)**

- Today, only up to 255 GDSs are controlled by a GDG.
- **New enhancement:** New DEFINE **EXTENDED** keyword allows up to 999 GDS to be active within 1 GDG.
  - DEFINE SMS.GDG GDG EXTENDED LIMIT(999)
    - Default is NOEXTENDED LIMIT (255)
    - **ALTER LIMIT(limit)** is provided to modify the max number (between 1 and now 999)
  - Enabled via SYS1.PARMLIB member IGGCATxx
    - New **GDGEXTENDED** variable set to “YES” (default is “NO”).
  - **Coexistence considerations**
    - **ALL** systems in an installation should be at z/OS V2.2 or higher before enabling GDGEs, and it’s expected that there will be no attempt to fall back a prior release.
    - Coexistence APAR OA46009 (Catalog) and OA46116 (DSS) prevents access to GDGEs on lower level systems.
- **SHARE Requirement Addressed:** GO6SMG91037

**? Why it Matters:** Support a larger number of GDSs to make it easier to manage data sets that are created frequently. For example, it will be possible to specify a full year of GDSs be kept.

# Catalog

- **Additional GDG Enhancements**

- When users take the default NOSCRATCH option on DEFINE, it can leave unwanted data sets when GDSes roll off.
- In addition, users sometimes inadvertently put retention periods on their GDSs. System administrators would like for these data sets to be deleted regardless of retention periods.
- **New enhancements:**
  - New **GDGSCRATCH (YES|NO)** parmlib variable overrides IDCAMS keyword on GDG DEFINE.
    - If not set or parmlib variable is GDGSCRATCH(NO), the keyword specified on the DEFINE GDG takes precedence.
  - New **PURGE** keyword added to IDCAMS DEFINE and ALTER GDG which allows user to specify what happens to unexpired GDSs during roll-off.
    - Specifies that when the SCRATCH is set, unexpired generation data sets (GDSs) are to be deleted during roll off processing. Default is NOPURGE.
    - New variable, **GDGPURGE (YES|NO)**, for SYS1.PARMLIB member IGGCATxx. Default is “NO”. Overrides DEFINE GDG setting when PURGE is set.

**? Why it Matters:** Allows system administrators more control over and flexibility with GDG processing.

Complete your session evaluations online at [www.SHARE.org/Orlando-Eval](http://www.SHARE.org/Orlando-Eval)



# Catalog



- **MODIFY CATALOG Security Enhancement**

- Existing requirements to provide access to the Catalog Address Space reporting commands without also allowing ability to issue commands which might alter the catalog configuration.
  - A user via SDSF might be able to issue an "F CATALOG,ALLOCATED" command, but not be able to issue an "F CATALOG,CLOSE(usercat)" command.
- **New enhancement:** New RACF resource profile checked by catalog command processing to insure that the issuer of a command is authorized to execute that command.
  - Allows users utilizing SDSF to issue operator reporting commands, the results of which they can view at their terminal, but not permit them to issue commands that change the catalog configuration.
  - New optional **OPERCMD5** profile,  
MVS.MODIFY.STC.CATALOG.CATALOG.SECURE

**? Why it Matters:** Provide more granular security and better operational flexibility.

# Catalog

- **RAS Enhancements**

- **Catalog Attributes Healthcheck**

- A shared catalog must be defined with SHAREOPTIONS(3 4) and must reside on a shared volume.
    - Catalogs that reside on shared volumes will become damaged if referred to by another system and the shareoptions are inconsistently set.
    - **New enhancement:** A new healthcheck will be designed to identify catalogs residing on volumes whose devices are defined as shared in the active IODF that might have their SHAREOPTIONS set incorrectly.

**? Why it Matters:** Damage to incorrectly shared catalogs can now be avoided. Further, for catalogs on non-shared devices, the shareoptions can be set to (3,3), which will provide for more efficient access and better overall performance.

# Catalog



- **RAS Enhancements**
  - **DFSMSdss Restore of a User Catalog to Any Volume**
    - Today, DFSMSdss only allows a user catalog to be restored to the same volume from which it was dumped (ie source dump volume must match restore target volume).
    - **New enhancement:** Allows a user catalog to be restored to any volume.
      - Device geometry must match and applies only to logical restore.
      - Restriction for physical data set restore remains.

**? Why it Matters:** Improves the users ability to recover a user catalog.

# IDCAMS

- **VERIFY RECOVER Enhancement**

- Currently, customers run IDCAMS EXAMINE on their datasets to look for errors. Some of the errors can be corrected by running the existing IDCAMS VERIFY or VERIFY RECOVER function.
  - However, both forms of IDCAMS VERIFY do not correct most of the errors returned from EXAMINE, and customers would need to either reorganize their datasets or obtain backup copies.
- **New enhancement:** EXAMINE and IDCAMS VERIFY RECOVER are enhanced to correct the following errors returned by EXAMINE:
  - IDC11718I DATA COMPONENT HIGH-USED RBA IS NOT EQUAL TO CA SIZE
  - IDC11728I DATA FOUND IN EMPTY CI
  - IDC11724I DATA COMPONENT CA NOT KNOWN TO SEQUENCE SET.
- Now, there are 3 ways to run IDCAMS VERIFY:
  - IDCAMS VERIFY (without RECOVER)
  - IDCAMS VERIFY RECOVER
  - **New enhancement:** EXAMINE followed by IDCAMS VERIFY RECOVER:
    - Functional only when EXAMINE and IDCAMS VERIFY RECOVER are run in the same job step.

**? Why it Matters:** Improved error recovery.

Complete your session evaluations online at [www.SHARE.org/Orlando-Eval](http://www.SHARE.org/Orlando-Eval)

# IDCAMS

- RAS Enhancements

- REPRO MERGECAT output is too long

- REPRO MERGECAT currently produces up to 6 lines for each entry that is processed; one blank line, one or two for the IDC0639I message (Sphere conversion started), a blank line, and one or two for the IDC01402I (Sphere conversion ended). The one or two lines depend on the length of the dataset name.
    - **New enhancement:** Add MESSAGELEVEL keyword to REPRO.
      - New keyword **MESSAGELEVEL(ALL|SHORT)**
      - **ALL** is the default and is the same as the current output
      - **SHORT** reduces the number of lines for each entry

**? Why it Matters:** Satisfy customers requirements to make REPRO more usable and flexible.

# IDCAMS

- RAS Enhancements

- PRINT and REPRO functions cannot process damaged VSAM CIs or records.
  - **New enhancement:** Add CIMODE keyword to PRINT and REPRO.
    - New keyword **CIMODE**, which PRINTs or REPROs by CI rather than by record.
    - Opens VSAM data set in CIMODE and is primarily for use with ESDS, but could be used to access a KSDS data component directly.

**? Why it Matters:** Improved error diagnosis / recovery by allowing processing if CI or VSAM record is damaged.

# z/OS DFSMS Highlights



- **SMS**
  - **V2.2 GA**
    - Space Constraint Relief
    - RAS Enhancements
    - Storage Group Space Alert Messages

**Session 17836:**  
Reading Someone  
Else's ACS Routines,  
**Thursday 3:15AM**

Complete your session evaluations online at [www.SHARE.org/Orlando-Eval](http://www.SHARE.org/Orlando-Eval)

# SMS

- **Space Constraint Relief**

- Currently for **non-Guaranteed Space** allocation, SMS Space Constraint Relief (SCR) processing reduces the requested space by the data class specified percentage, 'Reduce Space Up To (%)', if the originally requested space cannot be satisfied.
- **New enhancement:** SMS will extend the existing space reduction function to **Guaranteed Space** allocations to reduce allocation failures.
  - A new sub-parameter, **Guaranteed Space Reduction (Y | N)**, is added to the data class panel for the user to specify whether space reduction on guaranteed space allocation is permitted or not.
  - Instead of allocating the smallest space quantity, SCR space reduction function is enhanced to allocate the largest possible space that satisfies the specified reduction percentage for both guaranteed space and non-guaranteed space requests.
  - **Note:** Space reduction will remain unsupported for striping allocation.

**? Why it Matters:** Helps reduce allocation failures when the requested space is not available.



# SMS

- RAS Enhancements

- Read-only Variable

- Currently the user cannot provide installation specific values to the ACS routines via existing ACS read-only variables.
    - **New enhancement:** SMS provides a new user defined ACS Read-only variable in SMS IGDSMSxx parmlib member:
      - **USER\_ACSVAR(value1,value2,value3)**
      - The new parameter has 3 positional values.
      - Each value is a user-defined 8 character string.
      - The positional values of the new parameter can be altered by the following SETSMS command:

**SETSMS USER\_ACSVAR(value1,value2, value3)**

**? Why it Matters:** Each installation can specify unique values, similar to how the system symbols are defined, to assign proper constructs without a need to modify the ACS routines constantly, making it easier to reuse ACS routines on different systems.

# SMS

- Read-only Variable Example

## *Production System*

## *Test System*

```
SYS1.PARMLIB(IGDSMSxx) :  
USER_ACSVAR(PROD,,)
```

```
SYS1.PARMLIB(IGDSMSxx) :  
USER_ACSVAR(TEST,,)
```

```
PROC DATACLAS          /* DATA CLASS ACS ROUTINE */  
  IF &USER_ACSVAR(1) = 'PROD' THEN  
    SET &DATACLAS = 'PROD_DC'  
  ELSE  
    IF &USER_ACSVAR(1) = 'TEST' THEN  
      SET &DATACLAS = 'TEST_DC'  
    ELSE  
      WRITE '***** UNEXPECTED VALUE FOR USER_ACSVAR'  
    EXIT CODE(0)  
  END                    /* END DATACLAS ROUTINE */
```

# SMS

- **Storage Group Space Alert Messages**

- Currently, SMS VTOC Data Set Services (VDSS) issues IGD17380I to notify a user that the cumulative space allocated on the selected storage group has exceeded the high allocation threshold.
  - *IGD17380I STORAGE GROUP (sgname) IS ESTIMATED AT xx% OF CAPACITY, WHICH EXCEEDS ITS HIGH ALLOCATION THRESHOLD OF zz%*
- **New enhancement:** SMS will be designed to allow you to specify new storage group space warning thresholds separately from the high allocation thresholds.
  - Create new alert threshold attributes in the storage group panel:
    - TOTAL SPACE ALERT THRESHOLD %..... (0-99)**
    - TRACK-MANAGED SPACE ALERT THRESHOLD %.....(0-99)**
  - If the alert threshold value is not specified, it defaults to zero and no alert messages will be issued.
  - New alert messages, IGD400I and IGD401I, will be issued to the console when the alert thresholds have been reached.

# SMS

- **Storage Group Space Alert Messages**
  - **IGD400I TOTAL SPACE ALERT ON STORAGE GROUP (sgname) CURRENT USAGE (xx%), ALERT THRESHOLD (yy%)**
  - **IGD401I TRACK-MANAGED SPACE ALERT ON STORAGE GROUP (sgname)CURRENT USAGE (xx%), ALERT THRESHOLD (yy%)**
    - The alert messages will be issued at an incremental interval to prevent them from being issued too frequently.
    - IGD401I is issued only for the pool storage group containing one or more EAV volumes.
- **? Why it Matters:** Allows users to set a lower threshold for warning messages, which can provide more time to react to storage group space shortage conditions.

# SMS

- **Storage Group Space Alert Messages**

- **New enhancement:** A new optional keyword, **ALERT**, is introduced for the DISPLAY SMS command.
  - **D SMS**[,{STORGRP|SG}{(sgname|**ALERT**|ALL)}[,LISTVOL]
  - The new optional keyword, **ALERT**, is used to display any pool storage groups which have already reached either the total space alert threshold or the track-managed alert threshold.
  - The existing message, IGD002I, will be enhanced to include the space information: total space, total track-managed space, usage percentages and alert thresholds on the system at which the command is issued if the information is available.
  - The space information is shown for pool storage groups only.

**? Why it Matters:** Makes it easier to see when it might be necessary to change a storage group's space management settings or add volumes to a storage group.

# SMS

## ▪ Sample Output for **D SMS,SG(ALERT)**

```
IGD002I 11:50:04 DISPLAY SMS 021
```

```
STORGRP  TYPE      SYSTEM= 1 2 3 4 5 6 7 8
SXP02    POOL          + + + + + + + +
  SPACE INFORMATION:
  TOTAL SPACE = 306458MB USAGE% = 99 ALERT% = 65
  TRACK-MANAGED SPACE = 106220MB USAGE% = 100 ALERT% = 50
***** LEGEND *****
. THE STORAGE GROUP OR VOLUME IS NOT DEFINED TO THE SYSTEM
+ THE STORAGE GROUP OR VOLUME IS ENABLED
- THE STORAGE GROUP OR VOLUME IS DISABLED
* THE STORAGE GROUP OR VOLUME IS QUIESCED
D THE STORAGE GROUP OR VOLUME IS DISABLED FOR NEW ALLOCATIONS ONLY
Q THE STORAGE GROUP OR VOLUME IS QUIESCED FOR NEW ALLOCATIONS ONLY
> THE VOLSER IN UCB IS DIFFERENT FROM THE VOLSER IN CONFIGURATION
SYSTEM  1 = SYSTEM1      SYSTEM  2 = SYSTEM2      SYSTEM  3 = SYSTEM3
SYSTEM  4 = SYSTEM4      SYSTEM  5 = SYSTEM5      SYSTEM  6 = SYSTEM6
SYSTEM  7 = SYSTEM7      SYSTEM  8 = SYSTEM8
```

- Note: Only one storage group SXP02 has its usages which have reached the alert thresholds.

# z/OS DFSMS Highlights



- **Access Methods**
  - **V2.2 GA**
    - QSAM/BSAM zEDC Exploitation
    - RLS Index Level Locking
    - Secondary Space Reduction
    - LISTSTAT Command
    - VSAM LSR Dynamic Buffer Addition

**Session 17551:** System z Batch Network Analyzer (zBNA) Tool Hands-on Lab\*\*, **Thursday 3:15PM**

\*\*The latest technology option support including zEDC BSAM/QSAM compression will be included in the lab.

**Session 17793:** zEDC: Huge Response Time Improvements in Compression, **Friday 11:15AM**

**Session 17257:** Getting the Most out of your VSAM Data Sets in CICS by Using RLS , **Thursday 8:30AM**

**Session 17835:** SHARE Live!: VSAM and RLS New Functions in z/OS 2.1 and 2.2, **Thursday 11:15AM**

Complete your session evaluations online at [www.SHARE.org/Orlando-Eval](http://www.SHARE.org/Orlando-Eval)

# QSAM/BSAM Data Set Compression with zEDC

*Improved compression ratios and performance\**

- **Reduce the cost of keeping your sequential data online**
  - zEDC compresses data up to 4X, saving up to 75% of your sequential disk space.
    - That's as much as 2X better than generic or tailored compression
  - Capture new business opportunities due to lower cost of keeping data online.
- **Better I/O elapsed time for sequential access**
  - Potentially run batch workloads faster than either uncompressed or QSAM/BSAM current compression.
- **Sharply lower CPU cost over existing compression**
  - Enables more pervasive use of compression.
  - Up to 80% reduced CPU cost compared to tailored and generic compression options.
    - CPU cost for zEDC is ~0.1sec/GB in testing on a zEC12
- **Simple Enablement**
  - Use policy to enable zEDC.

*\* Disclaimer: Based on projections and/or measurements completed in a controlled environment. Results may vary by customer based on individual workload, configuration and software levels.*

Complete your session evaluations online at [www.SHARE.org/Orlando-Eval](http://www.SHARE.org/Orlando-Eval)



# BSAM/QSAM zEDC Compression – Value!

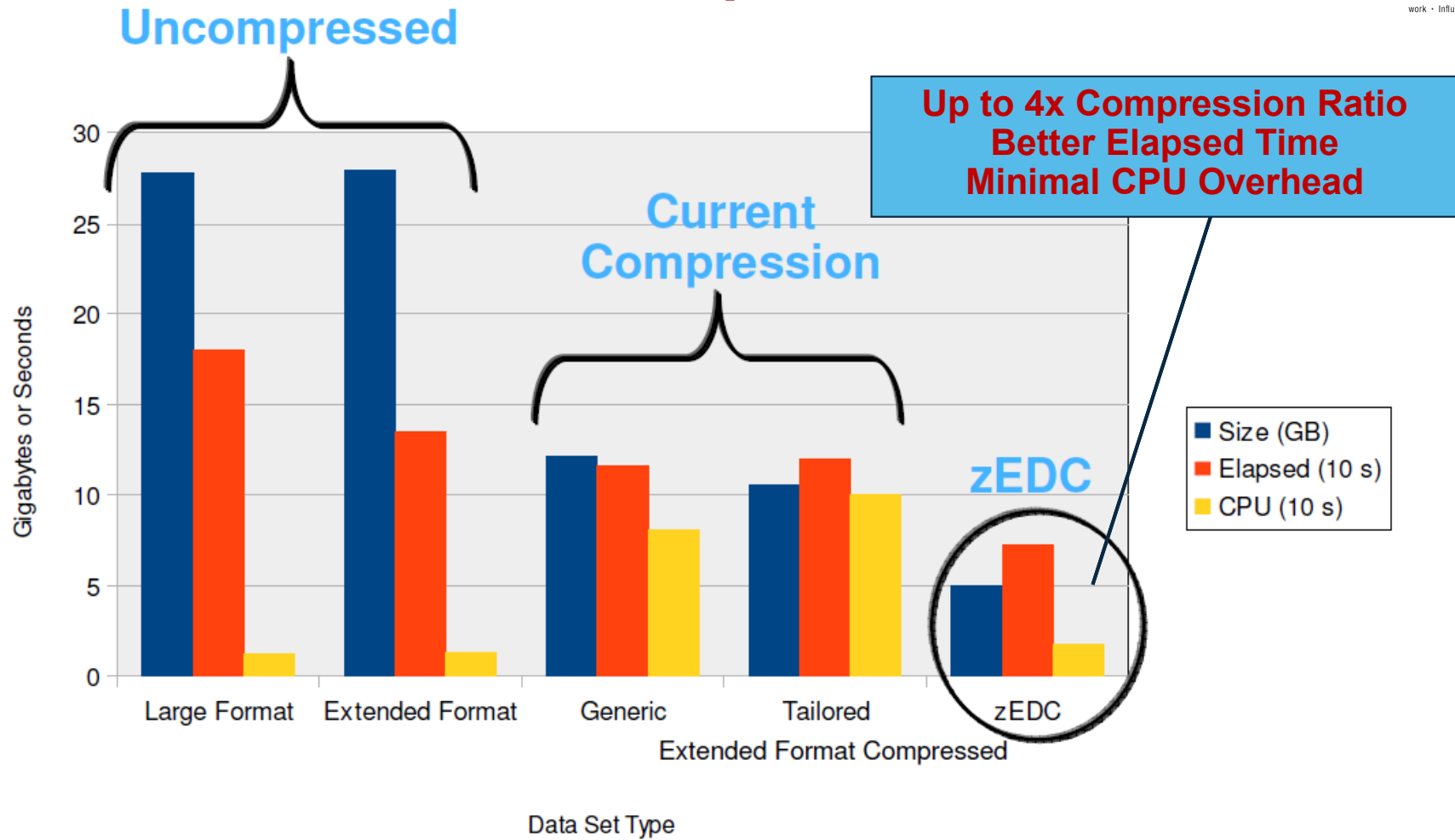

\* Disclaimer: Based on projections and/or measurements completed in a controlled environment. Results may vary by customer based on individual workload, configuration and software levels.

Complete your session evaluations online at [www.SHARE.org/Orlando-Eval](http://www.SHARE.org/Orlando-Eval)

# QSAM/BSAM zEDC – Setup



- zEDC setup is similar to that used for existing types of compression (generic and tailored)
  - It can be selected at either or both the data class level or system level.
    - **Data class level**
      - In addition to existing Tailored (T) and Generic (G) values, new **zEDC Required (ZR)** and **zEDC Preferred (ZP)** values will be available on the COMPACTION option in data class.
      - When COMPACTION=Y in data class, the system level is used.
    - **System level**
      - In addition to existing TAILORED and GENERIC values, new **zEDC Required (ZEDC\_R)** and **zEDC Preferred (ZEDC\_P)** values will be available on the COMPRESS parameter found in IGDSMSxx member of SYS1.PARMLIB.
    - **Activated using SET SMS=xx or at IPL**
      - Data class continues to take precedence over system level. The default continues to be GENERIC.
- QSAM/BSAM Conversion
  - Existing QSAM/BSAM data sets (whether compressed or not) must be copied to a new target data set allocated with zEDC compression.
    - Normal tools can be used to perform the copy, for example IEBGENER or REPRO
  - DSS supports COPY, DUMP, RESTORE, DEFRAg, CONSOLIDATE, RELEASE, PRINT
  - Supported in all DFSMSHsm functions
    - MIGRATION, RECALL, BACKUP, RECOVER, FULL-VOLUME DUMP, RECOVER FROMDUMP, FRBACKUP, FRRECOV, ABACKUP, ARECOVER

Complete your session evaluations online at [www.SHARE.org/Orlando-Eval](http://www.SHARE.org/Orlando-Eval)

# Access Methods

- **RLS Index Level Locking**

- Today when processing VSAM data sets, there is a single point of contention (DIWA) preventing concurrent VSAM RLS data CI splits in different CAs, CI reclaims, and spanned-record insertions and updates.
- **New enhancement:** Introduce a new level of serialization at the sequence set index CI level.
  - New locks used during CI SPLIT, CI RECLAIM, spanned record activity.
  - CA split / reclaim activity will still use data-set level lock.
  - Enabled by default on all systems on V1R13 and above.
  - New SMF fields were added to MVS System Management Facilities (SMF) for the new index record locks.
- **Toleration Considerations:**
  - Toleration APAR OA42676 is required to be installed on all V1R13 and V2R1 systems across the sysplex prior to bringing a V2R2 system into the sysplex.

**? Why it Matters:** Reduces contention and **improves performance** for many frequently updated VSAM key-sequenced and variable-length relative record (KSDS and VRRDS) data sets.

# Access Methods

- **RLS Index Level Locking**

- **Additional feature** will chain the I/O for the multiple segments of a spanned record so that only one I/O is needed to write out the spanned record.

- This will be available for NSR buffering only (not LSR or GSR).

**? Why it Matters:** Reduces I/O overhead when using spanned records and the window for inconsistent spanned-record segments.

# Access Methods

- **Secondary Space Reduction**

- Currently to allocate a secondary extent on the current volume, VSAM, RLS, PDSE, BAM and SAM will try to satisfy the user's specified amount on the DEFINE by calling DADSM extend services.
  - When there is not enough free space available on the current volume, EOVS will call SMS to switch volumes and try to extend onto a new volume.
  - This algorithm can be inefficient in leaving large amounts of free space behind on the current volume which is less than what the user specified for secondary amount.
- **New enhancement:** Allow the system to extend data sets by less than their originally specified secondary space allocation amounts when doing so would avoid allocation of space on additional volumes.

# Access Methods

- **Secondary Space Reduction**

- DADSM will provide a new minimum allocation amount on the DADSM Extend interface.
  - This new parameter along with the current secondary allocation amount on the IDCAM DEFINE, will allow DADSM the ability to determinate the largest free space to allocate.
- The allocated space must be equal to or greater than the minimum quantity derived from the attribute **Reduce Space Up To (%)** on the ISMF data class definition under “Space Constraint Relief”, and be less than or equal to the original specified secondary allocation amount.
  - Reduce Space Up To means Remove up to that amount
- This support will be for SMS managed non-striped VSAM data sets and Non-VSAM data sets.
- New SMF fields:
  - **SMF64SSR** –if secondary space reduction was used
  - **SMF64NTA** –size of extent returned in Tracks

**? Why it Matters:** Help to improve disk space utilization.

# Access Methods

- **LISTSTAT Command**

- Currently, to see the SMF64 data set statistics for a VSAM cluster, the data set needs to be closed and then the LISTCAT command shows the latest SMF64 statistics.
- **New enhancement:** New function command to provide point-in-time SYSPLEX-wide statistics for open VSAM data sets that are using RLS.
  - **IDCAMS SHCDS LISTSTAT('cluster')**
  - Does not require the data set to be closed to get the most current data set statistics.
  - Shipped on z/OS V1.13 and above with OA42435.

**? Why it Matters:** Improved reporting of VSAM RLS statistics on demand and without the requirement to close the data set and then issue a LISTCAT command or retrieve SMF64 records. .

# Access Methods

- **VSAM LSR Dynamic Buffer Addition**

- Currently with LSR buffering, if there are no available buffers to process a request (ie they're in use by other requests), the request will fail with a logic error indicating "no buffers".
- **New enhancement:** Dynamically add buffers to LSR pool as needed.
  - The current buffer pool is expanded with the same settings.
    - If successful, an informational RC = x'44' is returned in the RPL feedback word; otherwise, the "no buffers" logic error will still be returned.
  - Not supported for GSR buffer processing, Cross memory mode, SRB mode or TCB's running in Key 9.
  - New message:

**IDA9990I VSAM DBA ADDED xxxxx DATA|INDEX BUFFERS of yyyyy BYTES EACH TO SHRPOOL zzz BECAUSE THERE WERE INSUFFICIENT BUFFERS TO PROCESS THE REQUEST.**

**RECOMMENDATION: FOR PERFORMANCE, REBUILD THE SHARED POOL WITH AN INCREASE IN SIZE.**

**? Why it Matters:** Prevents errors from minor space miscalculations and avoids outages to rebuild the AIX.



# z/OS DFSMS Highlights

- **Open/Close/EOV**
  - **V2.2 GA**
    - Dynamic Tape Exits
    - RAS Enhancements

**Session 17811:**  
DFSMS SMStape:  
Overview, **Tuesday**  
**1:45PM**

# OCE

- **Dynamic Exits**
  - Current design of DFSMS Open/Close/EOV Installation Tape exits requires IPL for changes to be put into effect.
    - In addition, there is no way to add multiple exit routines for the exit.
  - **New enhancement:** Several DFSMS Open/Close/EOV Installation Tape exits will be converted to be dynamic.
    - Impacted tape exits include: **Label Anomaly, Volume Mount, File Validation, File Start, and File End.**
    - All exits are AMODE 31, reentrant and persistent until the next IPL.
    - New rules for parameter list and execution, as well as return code decisions when multiple exits are called. See z/OS DFSMS Installation Exits, SC23-6850, for specific details and considerations.
- **? Why it Matters:** Provides added flexibility, and no need to IPL to manage changes with Tape Installation exits. Allows multiple exit routines to be associated with each exit.

# OCE



- **OCE RAS Enhancements**

- **Abend code Elimination**

- **New enhancement:** Eliminate abend code A13, reason code 18 by automatically selecting the correct volume during Open processing for multivolume tape data sets.

**? Why it Matters:** Provide improved usability.

- **Add JOBID & SYSPLEXID to SMF 14/15**

- **New enhancement:** JOBID and SYSPLEXID are now added to SMF 14/15 (non-VSAM data set activity) records.
      - Rollback to V2.1 with OA43798.
    - **SHARE Requirement Addressed:** SSMVSE11033 (SHARE Top 75)

**? Why it Matters:** Make chargeback and capacity planning easier.

# OCE

- **OCE RAS Enhancements**

- **Improved DEVSUPxx Processing**

- There is a subset of DEVSUPxx PARMLIB member keywords that are initially reset to their default values before processing the member. However, other keywords and their values are left intact.
      - This creates an inconsistency in how all keywords are processed.
    - **New enhancement:** All keywords will be treated in a consistent manner so that none will be initially reset to their default values both during IPL and with processing SET DEVSUP command.
      - The **SET DEVSUP=xx** target can specify only the keyword(s) that need to be changed.
    - Continued processing of the DEVSUP member stops at the point where a keyword error is detected. There is no indication which DEVSUP member is processed.
    - **New enhancement:** If syntax error is detected, the system continues processing and IEA252E message is issued:
      - IEA252E DEVSUPxx: INVALID SYNTAX ON LINE yyyy. MEMBER PROCESSING CONTINUES

**? Why it Matters:** Provide improved usability.

Complete your session evaluations online at [www.SHARE.org/Orlando-Eval](http://www.SHARE.org/Orlando-Eval)

# OCE

- **OCE RAS Enhancements**

- **Improved DEVSUPxx Processing**

- SET DEVSUP MVS command can only support single value
      - In addition, IEASYSxx PARMLIB member supports only single value for the DEVSUP keyword.
    - **New enhancement:** Allow you to specify more than one DEVSUPxx member in a single SET command.
      - SET DEVSUP=(xx,yy,zz...)
      - IEASYSxx PARMLIB member now supports multiple values for DEVSUP keyword: DEVSUP=(xx,yy,zz...)
    - **New enhancement:** Display additional information about tape-related DEVSUPxx parameters with new support in the DEVSERV command.
      - A new **DEVSERV QLIB** operand will display settings for TAPEAUTHDSN, TAPEAUTHF1, TAPEAUTHRC4, and TAPEAUTHRC8.

**? Why it Matters:** Provide improved usability.

# z/OS DFSMS Highlights



- **DADSM / CVAF**
  - **V2.2 GA**
    - RAS Enhancements

Complete your session evaluations online at [www.SHARE.org/Orlando-Eval](http://www.SHARE.org/Orlando-Eval)

# DADSM / CVAF

- **DADSM RAS Enhancements**

- As documented the DADSM pre-processing exit, IGGPRE00, does not support space changes of SMS managed datasets.
- ***New enhancement:*** Allow the IGGPRE00 exit to be able to alter SMS managed allocations (ie primary-space and secondary-space quantities).
  - IGGPRE00 parm list will include a pointer to the IGGDACRE control block.

**? Why it Matters:** Improved usability and flexibility with the DADSM user exit.

# z/OS DFSMS Highlights



- **DFSORT**
  - **V2.2 GA**
    - zHPF Exploitation
    - Functional Enhancements

**Session 17837: New Features in  
z/OS 2.1 and z/OS 2.2 DFSORT,  
Wednesday 3:15PM**

Complete your session evaluations online at [www.SHARE.org/Orlando-Eval](http://www.SHARE.org/Orlando-Eval)



# DFSORT

- **zHPF Exploitation**

- Currently DFSORT does not exploit zHPF.
  - DFSORT normally uses EXCP for processing of basic and large format sequential input and output data sets (SORTIN, SORTOUT, OUTFIL).
  - DFSORT already uses BSAM for extended format sequential input and output data sets (SORTIN, SORTOUT and OUTFIL). BSAM already supports zHPF.
- **New enhancement:** Update DFSORT to prefer BSAM for SORTIN/SORTOUT/OUTFIL when zHPF is available.
  - DFSORT will automatically take advantage of zHPF if it is available on your system; no user actions are necessary.

**? Why it Matters:** Taking advantage of the higher start rates and bandwidth available with zHPF is expected to provide significant performance benefits on systems where zHPF is available.

# DFSORT

- **Functional Enhancements**

- **Date conversion AGE function**

- Customers often want to calculate the date duration that specifies the number of years, months, and days between an input date and current date.
    - **New enhancement:** A date conversion function **AGE** for the BUILD and OVERLAY operands of DFSORT's INREC, OUTREC and OUTFIL statements can now be used to calculate the date duration (ie time between a given date and the current date):
      - **AGE=YMD** produces a 8 byte result which has duration in years (0-9999), months (00-12), and days (00-31).
      - **AGE=YM** produces a 6 byte result which has duration in years (0-9999), months (00-12).
      - **AGE=YD** produces a 7 byte result which has duration in years (0-9999), days (00-366).

- **Date conversion WEEKNUM function**

- Customers often want to calculate the week of the year for an input date.
    - **New enhancement:** A date conversion function WEEKNUM for the BUILD and OVERLAY operands of DFSORT's INREC, OUTREC and OUTFIL statements can now be used to calculate the week number that represents the week of the year.
      - **WEEKNUM=USA** returns an integer in the range of 1 to 54 that represents the week of the year. The week starts with Sunday, and January 1 is always in the first week.
      - **WEEKNUM=ISO** function returns an integer in the range of 1 to 53 that represents the week of the year. The week starts with Monday and includes 7 days.

**? Why it Matters:** Provide additional flexibility in creating reports and to help improve the usability of reports generated with these new functions.

Complete your session evaluations online at [www.SHARE.org/Orlando-Eval](http://www.SHARE.org/Orlando-Eval)

# z/OS DFSMS Highlights



- **DFSMSrmm**
  - **V2.2 GA**
    - WHILECATALOG Support
    - SEARCHDATASET / SEARCHVOLUME Enhancements

**Session 17592:** RMM and HSM Report Generator, **Monday 1:45PM**

**Session 17717:** RMM and HSM Report Generator Hands-on Lab , **Tuesday 12:30PM**

**Session 17813:** The Best of What's New in DFSMSrmm, **Wednesday 8:30AM**

**Session 17548:** OMEGAMON XE for Storage and RMM Reporting, **Thursday 8:30AM**

Complete your session evaluations online at [www.SHARE.org/Orlando-Eval](http://www.SHARE.org/Orlando-Eval)

# DFSMSrmm

- **WHILECATALOG Support**

- In V1R3 RMM introduced a new method for tape expiration processing.
  - **EXPDT** (expiration date) allowed tape expiration to be on a specified date. This method is fast and simple, but does not allow expiration to be managed by catalog status (ie is the dataset cataloged).
- **New enhancement: WHILECATALOG\*** attribute for datasets allows users to specify whether datasets should be retained or expired by date when catalog entries for them exist.
  - Especially useful for GDG datasets – use WHILECATALOG to keep cataloged GDGs available until they're uncataloged as new generations are created.
  - Can be set as a default, or can be changed using CHANGEDATASET.
  - Can be defined PARMLIB with separate defaults specified for GDG and non-GDG datasets.

**? Why it Matters:** Provides improved usability and flexibility for tape retention / expiration processing.

**\*NOTE: Toleration PTFs are available**

Complete your session evaluations online at [www.SHARE.org/Orlando-Eval](http://www.SHARE.org/Orlando-Eval)

# DFSMSrmm

- **SEARCHDATASET / SEARCHVOLUME Enhancements**

- **New enhancement:** Search volumes and data sets by date/time ranges.
  - **SEARCHDATASET** and **SEARCHVOLUME** TSO commands are enhanced to allow users to select records by creation time.
  - RMM SEARCHDATASET OWNER(\*) LIMIT(\*)  
CRDATE(START(2013/110,**220000**) END(2013/111,**040000**)) CLIST('RMM  
CHANGEDATASET ',')EXPDT(2013/120)'
    - Date\_Time\_Range contains START(start\_date,**start\_time**)END(end\_date,**end\_time**)

**? Why it Matters:** Provides improved usability by narrowing searches and creating smaller command lists.

# z/OS DFSMS Highlights



- **DFSMS / Storage Synergy**

- **V2.2 GA**

- Multi-Target PPRC
- IBM zHyperWrite™
- Easy Tier Application Hints
- XRC Workload Write Pacing
- Multiple Incremental FlashCopy

- **Session 17017:** Significant Advancements in System z Resiliency Provided by GDPS, **Wednesday 1:45PM**
- **Session 17092:** IBM DS8870 Enterprise Storage News and Review, **Thursday 3:15PM**
- **Session 17839:** Multi-Target Replication with IBM DS8870, **Thursday 8:30AM**
- **Session 17022:** Extending z/OS Mainframe Workload Availability with GDPS/Active-Active, **Thursday 4:30PM**
- **Session 17454:** Effective Backups: Selecting the Right Backup Mechanism to Match the Business Requirement, **Tuesday 4:30PM**
- **Session 17576:** SHARE Live!: More Data, Less Chatter: Improving Performance on z/OS via IBM zHPF, **Friday 10AM**

Complete your session evaluations online at [www.SHARE.org/Orlando-Eval](http://www.SHARE.org/Orlando-Eval)

# Storage Synergy

- **Multi-Target PPRC (MT-PPRC)**
  - Allow a single volume to be the source for more than one PPRC relationship.
    - The capability of having multiple relationships allows for many different possible configurations.
    - This function will also support an incremental resynchronization capability between the two target volumes in both planned and unplanned HyperSwap® situations.
    - TPC-R and GDPS will provide support for MT-PPRC.

**? Why it Matters:** Having a second PPRC target and allowing for a quick incremental resync between the two targets prevents losing all Disaster Recover capability from a single outage.

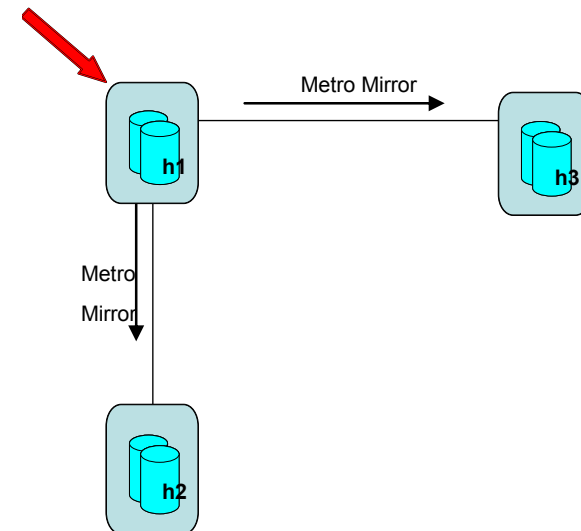

# Storage Synergy

- **IBM zHyperWrite™ - DS8870 Log Write Accelerator for DB2**

- New technology that combines DS8000 and z/OS enhancements that deliver performance benefits for writing operations to DB2 logs in the Metro Mirror (PPRC) environment.
  - Reduces latency overhead compared to normal storage based synchronous mirroring.
  - Can help reduce up to 43% of the DB2 log write time.\*

**? Why it Matters:** Provide improved DB2 transactional response time and log throughput improvements.

- **Easy Tier Application Hints**

- System Storage Easy Tier is now designed to allow software-defined policy information to be communicated to Easy Tier control units, to help them efficiently deploy storage.
  - Easy Tier currently optimizes data placement and tiering based on workload history and this does not always reflect the future performance requirements of the data.
  - New planned exploitation by DB2 to provide hints to Easy Tier on the DS8000 when a database reorganize is done so that the target data set for the database will be reorganized and optimized based on the activity of the application.

**? Why it Matters:** Intended to help steer data placement within Easy Tier volumes to meet application performance objectives.

\*Disclaimer: Based on projections and/or measurements completed in a controlled environment. Results may vary by customer based on individual workload, configuration and software levels. <sup>1</sup>Measurements for comparisons were completed as part of a formal performance evaluation on a dedicated, isolated test system.

Complete your session evaluations online at [www.SHARE.org/Orlando-Eval](http://www.SHARE.org/Orlando-Eval)



# Storage Synergy

- **XRC Workload Write Pacing**

- XRC is designed to work with z/OS Workload Manager to control XRC Write Pacing.
  - Reduces administrative overhead on hand managing XRC write pacing.
  - Avoids the need to define XRC write pacing on a per volume level allowing greater flexibility in configurations.
  - Prevents low priority work from interfering with the Recovery Point Objective of critical applications.

**? Why it Matters:** Simplifies XRC usage by eliminating the need to constantly adjust the write pacing settings and/or allocation of data to volumes..

- **Multiple Incremental FlashCopy**

- New FlashCopy function that supports up to 12 targets for incremental FlashCopy.
  - Previously only a single incremental FlashCopy was allowed for any individual volume.
  - Incremental FlashCopy allows a full physical copy to be created much more quickly than a non-incremental FlashCopy.

**? Why it Matters:** Provide more flexibility and resilience for FlashCopy helps to better protect application availability and provide improved data protection across physical volume failure events.

# z/OS® DFSMS™ Highlights



- Where to find additional information:
  - V2.1
    - **DFSMS Using the New Functions (SC23-6857-00)** - <http://www-05.ibm.com/e-business/linkweb/publications/servlet/pbi.wss?CTY=US&FNC=SRX&PBL=sc23-6857>
  - R13
    - **DFSMS Using the New Functions (SC26-7473-08)** – (<http://publibz.boulder.ibm.com/cgi-bin/bookmgr/Shelves/ez2zo111?filter=DFSMS+Using+the+New+Functions+&SUBMIT=Search+titles>)
    - **z/OS V1.13 DFSMS Technical Update** - (<http://www.redbooks.ibm.com/abstracts/sq247961.html?Open>)

Complete your session evaluations online at [www.SHARE.org/Orlando-Eval](http://www.SHARE.org/Orlando-Eval)

## Sources for more information

- Information about [DFSMS](#) and components
  - [http://publib.boulder.ibm.com/infocenter/zos/basics/index.jsp?topic=/com.ibm.zos.s.zdatamgmt/zsysprog\\_c\\_dfsmselements.htm](http://publib.boulder.ibm.com/infocenter/zos/basics/index.jsp?topic=/com.ibm.zos.s.zdatamgmt/zsysprog_c_dfsmselements.htm)
- Information about [DFSORT](#)
  - <http://www-01.ibm.com/support/docview.wss?rs=0&uid=isg3T7000077>
- Information about [z/OS Storage Management Tools](#)
  - <http://www-03.ibm.com/systems/storage/software/zos/index.html>
- Information about [IBM Tivoli Storage Productivity Center](#)
  - <http://www-03.ibm.com/systems/storage/software/center/index.html>
- Information about [IBM System Storage Disk](#) systems
  - <http://www-03.ibm.com/systems/storage/disk/ds8000/index.html>
- Information about [IBM System Storage Tape](#) systems
  - <http://www-03.ibm.com/systems/storage/tape/?lnk=mprST-tsys>

# Thank You!



Complete your session evaluations online at [www.SHARE.org/Orlando-Eval](http://www.SHARE.org/Orlando-Eval)

# Trademarks and Disclaimers

The following are trademarks of the International Business Machines Corporation in the United States and/or other countries. For a complete list of IBM Trademarks, see [www.ibm.com/legal/copytrade.shtml](http://www.ibm.com/legal/copytrade.shtml):

CICS*	FICON*	Lotus*	System Storage
DB2*	FlashCopy*	MQSeries*	Tivoli*
DFSMS	GDDM*	Multiprise*	TotalStorage*
DFSMSdfp	GDPS*	OMEGAMON*	Virtualization Engine
DFSMSdss	geoManager*	OS/390*	VisualAge*
DFSMSShsm	HiperSockets	Parallel Sysplex*	VM/ESA*
DFSMSrmm	HyperSwap	PR/SM	VSE/ESA
DFSORT	IBM*	QMF	VTAM*
DFSMS	IBM logo*	RACF*	WebSphere*
DS4000	ImagePlus*	Rational*	z/Architecture*
DS6000	IMS	RMF	z/OS*
DS8000	Intelligent Miner	System i	z/VM*
Enterprise Storage Server*	Language Environment*	System z	z/VSE
ESCON*		System z9	zSeries*
			zSeries Entry License Charge

The following are trademarks or registered trademarks of other companies:

Java and all Java based trademarks and logos are trademarks of Sun Microsystems, Inc., in the United States and other countries or both

Microsoft, Windows, Windows NT and the Windows logo are registered trademarks of Microsoft Corporation in the United States, other countries, or both.

Intel, Intel logo, Intel Inside, Intel Inside logo, Intel Centrino, Intel Centrino logo, Celeron, Intel Xeon, Intel SpeedStep, Itanium, and Pentium are trademarks or registered trademarks of Intel Corporation or its subsidiaries in the United States and other countries.

UNIX is a registered trademark of The Open Group in the United States and other countries or both.

Linux is a trademark of Linus Torvalds in the United States, other countries, or both.

Other company, product, or service names may be trademarks or service marks of others.

## NOTES:

Any performance data contained in this document was determined in a controlled environment. Actual results may vary significantly and are dependent on many factors including system hardware configuration and software design and configuration. Some measurements quoted in this document may have been made on development-level systems. There is no guarantee these measurements will be the same on generally-available systems. Users of this document should verify the applicable data for their specific environment.

IBM hardware products are manufactured from new parts, or new and serviceable used parts. Regardless, our warranty terms apply.

Information is provided "AS IS" without warranty of any kind.

Complete your session evaluations online at [www.SHARE.org/Orlando-Eval](http://www.SHARE.org/Orlando-Eval)

## Trademarks and Disclaimers (continued)

### NOTES:

All customer examples cited or described in this presentation are presented as illustrations of the manner in which some customers have used IBM products and the results they may have achieved. Actual environmental costs and performance characteristics will vary depending on individual customer configurations and conditions.

This publication was produced in the United States. IBM may not offer the products, services or features discussed in this document in other countries, and the information may be subject to change without notice. Consult your local IBM business contact for information on the product or services available in your area.

All statements regarding IBM's future direction and intent are subject to change or withdrawal without notice, and represent goals and objectives only.

Information about non-IBM products is obtained from the manufacturers of those products or their published announcements. IBM has not tested those products and cannot confirm the performance, compatibility, or any other claims related to non-IBM products. Questions on the capabilities of non-IBM products should be addressed to the suppliers of those products.

Prices are suggested US list prices and are subject to change without notice. Starting price may not include a hard drive, operating system or other features. Contact your IBM representative or Business Partner for the most current pricing in your geography.

Any proposed use of claims in this presentation outside of the United States must be reviewed by local IBM country counsel prior to such use.

The information could include technical inaccuracies or typographical errors. Changes are periodically made to the information herein; these changes will be incorporated in new editions of the publication. IBM may make improvements and/or changes in the product(s) and/or the program(s) described in this publication at any time without notice.

Any references in this information to non-IBM Web sites are provided for convenience only and do not in any manner serve as an endorsement of those Web sites. The materials at those Web sites are not part of the materials for this IBM product and use of those Web sites is at your own risk.

IBM makes no representation or warranty regarding third-party products or services including those designated as ServerProven, ClusterProven or BladeCenter Interoperability Program products. Support for these third-party (non-IBM) products is provided by non-IBM Manufacturers.

IBM may have patents or pending patent applications covering subject matter in this document. The furnishing of this document does not give you any license to these patents. Send license inquires, in writing, to IBM Director of Licensing, IBM Corporation, New Castle Drive, Armonk, NY 10504-1785 USA.