

---

# **Apache ShardingSphere document**

**v5.1.2**

**Apache ShardingSphere**

**Jun 17, 2022**

<b>1</b>	<b>Overview</b>	<b>1</b>
1.1	Introduction	1
1.1.1	ShardingSphere-JDBC	2
1.1.2	ShardingSphere-Proxy	2
1.1.3	ShardingSphere-Sidecar(TODO)	3
1.1.4	Hybrid Architecture	4
1.2	Solution	5
1.3	Roadmap	6
<b>2</b>	<b>Quick Start</b>	<b>7</b>
2.1	ShardingSphere-JDBC	7
2.1.1	Scenarios	7
2.1.2	Limitations	7
2.1.3	Requirements	7
2.1.4	Procedure	7
2.2	ShardingSphere-Proxy	8
2.2.1	Get ShardingSphere-Proxy	8
2.2.2	Rule Configuration	8
2.2.3	Import Dependencies	9
2.2.4	Start Server	9
2.2.5	Use ShardingSphere-Proxy	9
<b>3</b>	<b>Concepts</b>	<b>10</b>
3.1	Adaptor	10
3.1.1	ShardingSphere-JDBC	10
3.1.2	ShardingSphere-Proxy	11
3.1.3	Hybrid Adaptors	13
3.2	Mode	13
3.2.1	Background	13
3.2.2	Memory mode	14
3.2.3	Standalone mode	14

3.2.4	Cluster mode . . . . .	14
3.3	DistSQL . . . . .	14
3.3.1	Background . . . . .	14
3.3.2	Challenges . . . . .	14
3.3.3	Goal . . . . .	15
3.3.4	Notice . . . . .	15
3.4	Pluggable Architecture . . . . .	15
3.4.1	Background . . . . .	15
3.4.2	Challenges . . . . .	15
3.4.3	Goal . . . . .	15
3.4.4	Implementation . . . . .	16
L1 Kernel Layer . . . . .		16
L2 Feature Layer . . . . .		16
L3 Ecosystem Layer . . . . .		17
<b>4</b>	<b>Features</b>	<b>18</b>
4.1	DB Compatibility . . . . .	18
4.1.1	Background . . . . .	18
4.1.2	Challenges . . . . .	18
4.1.3	Goal . . . . .	19
4.1.4	SQL Parser . . . . .	19
MySQL . . . . .		19
openGauss . . . . .		20
PostgreSQL . . . . .		20
SQLServer . . . . .		21
Oracle . . . . .		21
SQL92 . . . . .		21
4.1.5	DB Protocol . . . . .	21
4.1.6	Feature Support . . . . .	21
MySQL . . . . .		22
PostgreSQL . . . . .		22
SQLServer . . . . .		23
Oracle . . . . .		23
SQL92 . . . . .		23
4.2	Cluster Management . . . . .	23
4.2.1	Background . . . . .	23
4.2.2	Challenges . . . . .	23
4.2.3	Goal . . . . .	24
4.2.4	Core Concept . . . . .	24
Circuit Breaker . . . . .		24
Request Limit . . . . .		24
4.3	Sharding . . . . .	24
4.3.1	Background . . . . .	24
Vertical Sharding . . . . .		25
Horizontal Sharding . . . . .		26

4.3.2	Challenges . . . . .	27
4.3.3	Goal . . . . .	27
4.3.4	Core Concept . . . . .	27
	Overview . . . . .	27
	Table . . . . .	27
	Data Node . . . . .	29
	Sharding . . . . .	30
	Inline Expression . . . . .	31
	Distributed Primary Key . . . . .	35
	Hint Sharding Route . . . . .	37
4.3.5	Use Norms . . . . .	37
	Background . . . . .	37
	SQL . . . . .	38
	Pagination . . . . .	42
4.4	Distributed Transaction . . . . .	44
4.4.1	Background . . . . .	44
	Local Transaction . . . . .	45
	2PC Transaction . . . . .	45
	BASE Transaction . . . . .	46
4.4.2	Challenge . . . . .	46
4.4.3	Goal . . . . .	47
4.4.4	Core Concept . . . . .	47
	Navigation . . . . .	47
	XA . . . . .	47
	BASE . . . . .	48
4.4.5	Use Norms . . . . .	49
	Background . . . . .	49
	Local Transaction . . . . .	49
	XA . . . . .	49
	BASE . . . . .	53
4.5	Readwrite-splitting . . . . .	53
4.5.1	Background . . . . .	53
4.5.2	Challenges . . . . .	54
4.5.3	Goal . . . . .	55
4.5.4	Core Concept . . . . .	55
	Primary Database . . . . .	55
	Replica Database . . . . .	56
	Primary Replica Replication . . . . .	56
	Load Balance Strategy . . . . .	56
4.5.5	Use Norms . . . . .	56
	Supported . . . . .	56
	Unsupported . . . . .	56
4.6	HA . . . . .	56
4.6.1	Background . . . . .	56
4.6.2	Challenges . . . . .	57

4.6.3	Goal	57
4.6.4	Core Concept	58
	high Availability Type	58
	Dynamic Readwrite-Splitting	58
4.6.5	Use Norms	58
	Supported	58
	Unsupported	58
4.7	Scaling	58
4.7.1	Background	58
4.7.2	Challenges	58
4.7.3	Goal	59
4.7.4	Status	59
4.7.5	Core Concept	59
	Scaling Job	59
	Inventory Data	59
	Incremental Data	59
4.7.6	User Norms	59
	Supported	59
	Unsupported	60
4.8	Encryption	60
4.8.1	Background	60
4.8.2	Challenges	60
4.8.3	Goal	61
4.8.4	Core Concept	61
	Logic Column	61
	Cipher Column	61
	Query Assistant Column	61
	Plain Column	61
4.8.5	Use Norms	61
	Supported	61
	Unsupported	62
4.9	Shadow DB	62
4.9.1	Background	62
4.9.2	Challenges	62
4.9.3	Goal	63
4.9.4	Core Concept	63
	Production Database	63
	Shadow Database	63
	Shadow Algorithm	63
4.9.5	Use Norms	63
	Supported	63
	Unsupported	64
4.10	Observability	65
4.10.1	Background	65
4.10.2	Challenges	66

4.10.3	Goal	66
4.10.4	Core Concept	66
	Agent	66
	APM	67
	Tracing	67
	Metrics	67
4.10.5	Use Norms	67
	Compile source code	67
	Agent configuration	67
	Used in ShardingSphere-Proxy	70
<b>5</b>	<b>User Manual</b>	<b>71</b>
5.1	ShardingSphere-JDBC	71
5.1.1	Java API	72
	Overview	72
	Usage	72
	Mode Configuration	73
	Data Source	75
	Rules	75
5.1.2	YAML Configuration	89
	Overview	89
	Usage	89
	YAML Syntax Explanation	90
	Mode Configuration	90
	Data Source	91
	Rules	92
5.1.3	JDBC Driver	98
	Overview	98
	Usage	98
5.1.4	Spring Boot Starter	100
	Overview	100
	Usage	100
	Use ShardingSphere Data Source in Spring	100
	Mode Configuration	101
	Data Source	102
	Rules	103
5.1.5	Spring Namespace	111
	Overview	111
	Usage	111
	Configure Spring Bean	111
	Use ShardingSphere Data Source in Spring	113
	Mode Configuration	113
	Data Source	116
	Rules	117
5.1.6	Properties Configuration	128

	Configuration Item Explanation . . . . .	129
5.1.7	Builtin Algorithm . . . . .	130
	Introduction . . . . .	130
	Usage . . . . .	130
	Metadata Repository . . . . .	130
	Sharding Algorithm . . . . .	131
	Key Generate Algorithm . . . . .	136
	Load Balance Algorithm . . . . .	137
	Encryption Algorithm . . . . .	137
	Shadow Algorithm . . . . .	139
5.1.8	Special API . . . . .	140
	Sharding . . . . .	140
	Transaction . . . . .	144
	Observability . . . . .	152
5.1.9	Unsupported Items . . . . .	155
	DataSource Interface . . . . .	155
	Connection Interface . . . . .	156
	Statement and PreparedStatement Interface . . . . .	156
	ResultSet Interface . . . . .	156
	JDBC 4.1 . . . . .	156
5.2	ShardingSphere-Proxy . . . . .	156
5.2.1	Startup . . . . .	157
	Use Binary Tar . . . . .	157
	Use Docker . . . . .	159
	Use Helm . . . . .	160
5.2.2	Yaml Configuration . . . . .	163
	Authority . . . . .	164
	Properties . . . . .	165
	Rules . . . . .	167
5.2.3	DistSQL . . . . .	167
	Syntax . . . . .	167
	Usage . . . . .	208
5.2.4	Logging . . . . .	215
	To distinguish databases in the same log . . . . .	215
	To distinguish databases and users in the same log . . . . .	216
	To split into different log files . . . . .	216
5.2.5	Scaling . . . . .	217
	Introduction . . . . .	217
	Build . . . . .	217
	Manual . . . . .	221
5.3	ShardingSphere-Sidecar . . . . .	233
5.3.1	Introduction . . . . .	233
5.3.2	Comparison . . . . .	234

6.1	Mode	235
6.1.1	StandalonePersistRepository	235
6.1.2	ClusterPersistRepository	235
6.1.3	GovernanceWatcher	236
6.2	Configuration	236
6.2.1	RuleBuilder	236
6.2.2	YamlRuleConfigurationSwapper	237
6.2.3	ShardingSphereYamlConstruct	238
6.3	Kernel	239
6.3.1	SQLRouter	239
6.3.2	SQLRewriteContextDecorator	239
6.3.3	SQLExecutionHook	239
6.3.4	ResultProcessEngine	240
6.3.5	StoragePrivilegeHandler	240
6.3.6	DynamicDataSourceStrategy	240
6.4	DataSource	240
6.4.1	DatabaseType	240
6.4.2	DialectTableMetaDataLoader	241
6.4.3	DataSourcePoolMetaData	241
6.4.4	DataSourcePoolActiveDetector	242
6.5	SQL Parser	242
6.5.1	DatabaseTypedSQLParserFacade	242
6.5.2	SQLVisitorFacade	242
6.6	Proxy	243
6.6.1	DatabaseProtocolFrontendEngine	243
6.6.2	AuthorityProvideAlgorithm	243
6.7	Data Sharding	243
6.7.1	ShardingAlgorithm	243
6.7.2	KeyGenerateAlgorithm	244
6.7.3	DatetimeService	244
6.7.4	DatabaseSQLEntry	245
6.8	Readwrite-splitting	245
6.8.1	ReadwriteSplittingType	245
6.8.2	ReplicaLoadBalanceAlgorithm	245
6.9	HA	246
6.9.1	DatabaseDiscoveryProviderAlgorithm	246
6.10	Distributed Transaction	246
6.10.1	ShardingSphereTransactionManager	246
6.10.2	XATransactionManagerProvider	246
6.10.3	XADDataSourceDefinition	247
6.10.4	DataSourcePropertyProvider	247
6.11	Scaling	247
6.11.1	ScalingEntry	247
6.11.2	JobCompletionDetectAlgorithm	248
6.11.3	DataConsistencyCalculateAlgorithm	248



6.12	SQL Checker . . . . .	248
6.12.1	SQLChecker . . . . .	248
6.13	Encryption . . . . .	248
6.13.1	EncryptAlgorithm . . . . .	248
6.13.2	QueryAssistedEncryptAlgorithm . . . . .	249
6.14	Shadow DB . . . . .	249
6.14.1	ShadowAlgorithm . . . . .	249
6.15	Observability . . . . .	249
6.15.1	PluginDefinitionService . . . . .	249
6.15.2	PluginBootService . . . . .	250
<b>7</b>	<b>Reference</b>	<b>251</b>
7.1	Management . . . . .	251
7.1.1	Data Structure in Registry Center . . . . .	251
	/rules . . . . .	252
	/props . . . . .	252
	/metadata/\${schemaName}/dataSources . . . . .	253
	/metadata/\${schemaName}/rules . . . . .	253
	/metadata/\${schemaName}/tables . . . . .	254
	/nodes/compute_nodes . . . . .	254
	/nodes/storage_nodes . . . . .	254
7.2	Sharding . . . . .	254
7.2.1	SQL Parsing . . . . .	255
7.2.2	SQL Route . . . . .	255
7.2.3	SQL Rewrite . . . . .	255
7.2.4	SQL Execution . . . . .	256
7.2.5	Result Merger . . . . .	256
7.2.6	Query Optimization . . . . .	256
7.2.7	Parse Engine . . . . .	256
	Abstract Syntax Tree . . . . .	256
	SQL Parser . . . . .	257
7.2.8	Route Engine . . . . .	261
	Sharding Route . . . . .	261
	Broadcast Route . . . . .	263
7.2.9	Rewrite Engine . . . . .	265
	Correctness Rewrite . . . . .	265
	Identifier Rewrite . . . . .	265
	Column Derivation . . . . .	267
	Pagination Revision . . . . .	269
	Batch Split . . . . .	270
	Optimization Rewrite . . . . .	271
7.2.10	Execute Engine . . . . .	272
	Connection Mode . . . . .	272
	Automatic Execution Engine . . . . .	274
7.2.11	Merger Engine . . . . .	277

	Iteration Merger . . . . .	278
	Order-by Merger . . . . .	278
	Group-by Merger . . . . .	280
	Aggregation Merger . . . . .	283
	Pagination Merger . . . . .	283
7.3	Transaction . . . . .	284
7.3.1	Navigation . . . . .	284
7.3.2	XA Transaction . . . . .	285
	Transaction Begin . . . . .	285
	Execute actual sharding SQL . . . . .	285
	Commit or Rollback . . . . .	286
7.3.3	Seata BASE transaction . . . . .	286
	Init Seata Engine . . . . .	287
	Transaction Begin . . . . .	287
	Execute actual sharding SQL . . . . .	287
	Commit or Rollback . . . . .	288
7.4	Scaling . . . . .	288
7.4.1	Principle Description . . . . .	288
7.4.2	Phase Description . . . . .	288
	Preparing Phase . . . . .	288
	Inventory Phase . . . . .	289
	Incremental Phase . . . . .	289
	Switching Phase . . . . .	289
7.5	Encryption . . . . .	289
7.5.1	Process Details . . . . .	289
	Overall Architecture . . . . .	290
	Encryption Rule . . . . .	290
	Encryption Process . . . . .	292
7.5.2	Detailed Solution . . . . .	293
	New Business . . . . .	293
	Online Business Transformation . . . . .	295
7.5.3	The advantages of Middleware encryption service . . . . .	299
7.5.4	Solution . . . . .	300
	EncryptAlgorithm . . . . .	300
	QueryAssistedEncryptAlgorithm . . . . .	300
7.6	Shadow . . . . .	301
7.6.1	Overall Architecture . . . . .	301
7.6.2	Shadow Rule . . . . .	302
7.6.3	Routing Process . . . . .	303
7.6.4	Shadow Judgment Process . . . . .	303
	DML Statement . . . . .	303
	DDL Statement . . . . .	303
7.6.5	Shadow Algorithm . . . . .	304
7.6.6	Use Example . . . . .	304
	Scenario . . . . .	304

	Shadow DB configuration . . . . .	304
	Shadow DB environment . . . . .	305
	Shadow algorithm example . . . . .	306
7.7	Test . . . . .	309
7.7.1	Integration Test . . . . .	309
7.7.2	Module Test . . . . .	309
7.7.3	Performance Test . . . . .	309
7.7.4	Sysbench Test . . . . .	309
7.7.5	Integration Test . . . . .	309
	Process . . . . .	310
	Notice . . . . .	313
7.7.6	Performance Test . . . . .	313
	Performance Test . . . . .	313
	Sysbench Test . . . . .	323
7.7.7	Module Test . . . . .	354
	SQL Parser Test . . . . .	354
	SQL Rewrite Test . . . . .	356
7.8	FAQ . . . . .	357
7.8.1	[JDBC] Why there may be an error when configure both sharding-sphere-jdbc-spring-boot-starter and a spring-boot-starter of certain datasource pool(such as druid)? . . . . .	357
7.8.2	[JDBC] Why is xsd unable to be found when Spring Namespace is used? . . . . .	358
7.8.3	[JDBC] Found a JtaTransactionManager in spring boot project when integrating with transaction of XA . . . . .	358
7.8.4	[Proxy] In Windows environment, could not find or load main class org.apache.shardingsphere.proxy.Bootstrap, how to solve it? . . . . .	358
7.8.5	[Proxy] How to add a new logic schema dynamically when use ShardingSphere-Proxy? . . . . .	358
7.8.6	[Proxy] How to use a suitable database tools connecting ShardingSphere-Proxy? . . . . .	359
7.8.7	[Proxy] When using a client such as Navicat to connect to ShardingSphere-Proxy, if ShardingSphere-Proxy does not create a Schema or does not add a Resource, the client connection will fail? . . . . .	359
7.8.8	[Sharding] How to solve Cloud not resolve placeholder ...in string value ... error? . . . . .	360
7.8.9	[Sharding] Why does float number appear in the return result of inline expression? . . . . .	360
7.8.10	[Sharding] If sharding database is partial, should tables without sharding database & table configured in sharding rules? . . . . .	360
7.8.11	[Sharding] When generic Long type SingleKeyTableShardingAlgorithm is used, why doesClassCastException: Integer can not cast to Long exception appear? . . . . .	360
7.8.12	[Sharding;raw-latex:PROXY] When implementing the StandardShardingAlgorithm custom algorithm, the specific type of Comparable is specified as Long, and the field type in the database table is bigint, a ClassCastException: Integer can not cast to Long exception occurs. . . . .	360

7.8.13	[Sharding] Why are the default distributed auto-increment key strategy provided by ShardingSphere not continuous and most of them end with even numbers? .	361
7.8.14	[Sharding] How to allow range query with using inline sharding strategy(BETWEEN AND, >, <, >=, <=)? . . . . .	361
7.8.15	[Sharding] Why does my custom distributed primary key do not work after implementing KeyGenerateAlgorithm interface and configuring type property?	361
7.8.16	[Sharding] In addition to internal distributed primary key, does ShardingSphere support other native auto-increment keys? . . . . .	362
7.8.17	[Encryption] How to solve that data encryption can't work with JPA? . . .	362
7.8.18	[DistSQL] How to set custom JDBC connection properties or connection pool properties when adding a data source using DistSQL? . . . . .	362
7.8.19	[DistSQL] How to solve Resource [xxx] is still used by [SingleTableRule] . exception when dropping a data source using DistSQL? . . .	363
7.8.20	[DistSQL] How to solve Failed to get driver instance for jdbcURL=xxx . exception when adding a data source using DistSQL? . . . . .	363
7.8.21	[Other] How to debug when SQL can not be executed rightly in ShardingSphere?	363
7.8.22	[Other] Why do some compiling errors appear? Why did not the IDEA index the generated codes? . . . . .	363
7.8.23	[Other] In SQLSever and PostgreSQL, why does the aggregation column without alias throw exception? . . . . .	364
7.8.24	[Other] Why does Oracle database throw "Order by value must implements Comparable" exception when using Timestamp Order By? . . . . .	364
7.8.25	[Other] In Windows environment,when cloning ShardingSphere source code through Git, why prompt filename too long and how to solve it? . . . . .	365
7.8.26	[Other] How to solve Type is required error? . . . . .	366
7.8.27	[Other] How to speed up the metadata loading when service starts up? . . . . .	366
7.8.28	[Other] The ANTLR plugin generates codes in the same level directory as src, which is easy to commit by mistake. How to avoid it? . . . . .	366
7.8.29	[Other] Why is the database sharding result not correct when using Proxool? .	367
7.8.30	[Other] The property settings in the configuration file do not take effect when integrating ShardingSphere with Spring Boot 2.x ? . . . . .	368
7.8.31	[ShardingSphere-JDBC] The tableName and columnName configured in yaml or properties leading incorrect result when loading Oracle metadata? . . . . .	369
7.9	API Change Histories . . . . .	370
7.9.1	ShardingSphere-JDBC . . . . .	370
	YAML configuration . . . . .	370
	Java API . . . . .	385
	Spring namespace configuration change history . . . . .	412
	Spring Boot Starter Configuration . . . . .	433
7.9.2	ShardingSphere-Proxy . . . . .	449
	5.0.0-beta . . . . .	449
	5.0.0-alpha . . . . .	451
	ShardingSphere-4.x . . . . .	453
	ShardingSphere-3.x . . . . .	455
7.10	DistSQL . . . . .	456

7.10.1	Syntax . . . . .	456
	RDL Syntax . . . . .	456
	RQL Syntax . . . . .	473
	RAL Syntax . . . . .	487
	Reserved word . . . . .	487
<b>8</b>	<b>Downloads</b>	<b>489</b>
8.1	Latest Releases . . . . .	489
	8.1.1 Apache ShardingSphere - Version: 5.1.2 ( Release Date: June 13th, 2022 ) . . . . .	489
8.2	All Releases . . . . .	489
8.3	Verify the Releases . . . . .	489

## Stargazers Over Time

## Contributors Over Time

Apache ShardingSphere is positioned as a Database Plus, and aims at building a standard layer and ecosystem above heterogeneous databases. It focuses on how to reuse existing databases and their respective upper layer, rather than creating a new database. The goal is to minimize or eliminate the challenges caused by underlying databases fragmentation.

The concepts at the core of the project are Connect, Enhance and Pluggable.

- **Connect:** Flexible adaptation of database protocol, SQL dialect and database storage. It can quickly connect applications and heterogeneous databases quickly.
- **Enhance:** Capture database access entry to provide additional features transparently, such as: redirect (sharding, readwrite-splitting and shadow), transform (data encrypt and mask), authentication (security, audit and authority), governance (circuit breaker and access limitation and analyze, QoS and observability).
- **Pluggable:** Leveraging the micro kernel and 3 layers pluggable mode, features and database ecosystem can be embedded flexibly. Developers can customize their ShardingSphere just like building with LEGO blocks.

ShardingSphere became an [Apache](#) Top-Level Project on April 16, 2020.

Welcome to interact with community via the official [mail list](#) and the [ShardingSphere Slack](#).

## 1.1 Introduction

Apache ShardingSphere including 3 independent products: JDBC, Proxy & Sidecar (Planning). They all provide functions of data scale-out, distributed transaction and distributed governance, applicable in a variety of situations such as Java isomorphism, heterogeneous language and Cloud-Native.

As the cornerstone of enterprises, the relational database has a huge market share. Therefore, we prefer to focus on its incrementation instead of a total overturn.

### 1.1.1 ShardingSphere-JDBC

ShardingSphere-JDBC defines itself as a lightweight Java framework that provides extra services at the Java JDBC layer. With the client end connecting directly to the database, it provides services in the form of a jar and requires no extra deployment and dependence. It can be considered as an enhanced JDBC driver, which is fully compatible with JDBC and all kinds of ORM frameworks.

- Applicable in any ORM framework based on JDBC, such as JPA, Hibernate, Mybatis, Spring JDBC Template or direct use of JDBC;
- Supports any third-party database connection pool, such as DBCP, C3P0, BoneCP, HikariCP;
- Support any kind of JDBC standard database: MySQL, PostgreSQL, Oracle, SQLServer and any JDBC adapted databases.

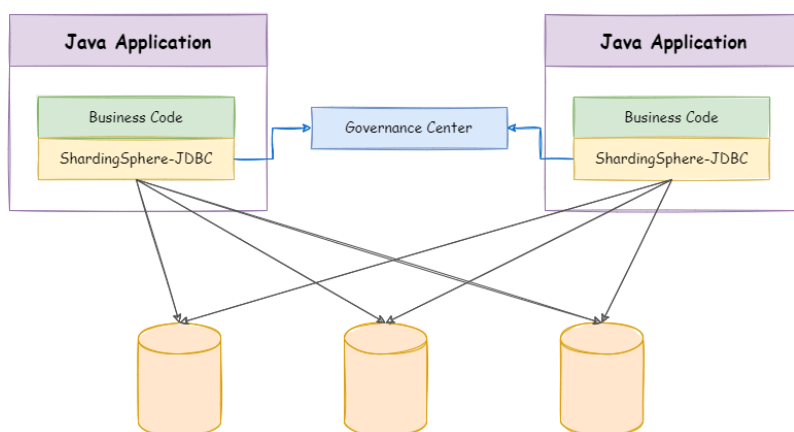

### 1.1.2 ShardingSphere-Proxy

ShardingSphere-Proxy defines itself as a transparent database proxy, providing a database server that encapsulates database binary protocol to support heterogeneous languages. Currently, MySQL and PostgreSQL (compatible with PostgreSQL-based databases, such as openGauss) versions are provided. It can use any kind of terminal (such as MySQL Command Client, MySQL Workbench, etc.) that is compatible of MySQL or PostgreSQL protocol to operate data, which is friendlier to DBAs.

- Transparent towards applications, it can be used directly as MySQL and PostgreSQL servers;
- Applicable to any kind of terminal that is compatible with MySQL and PostgreSQL protocol.

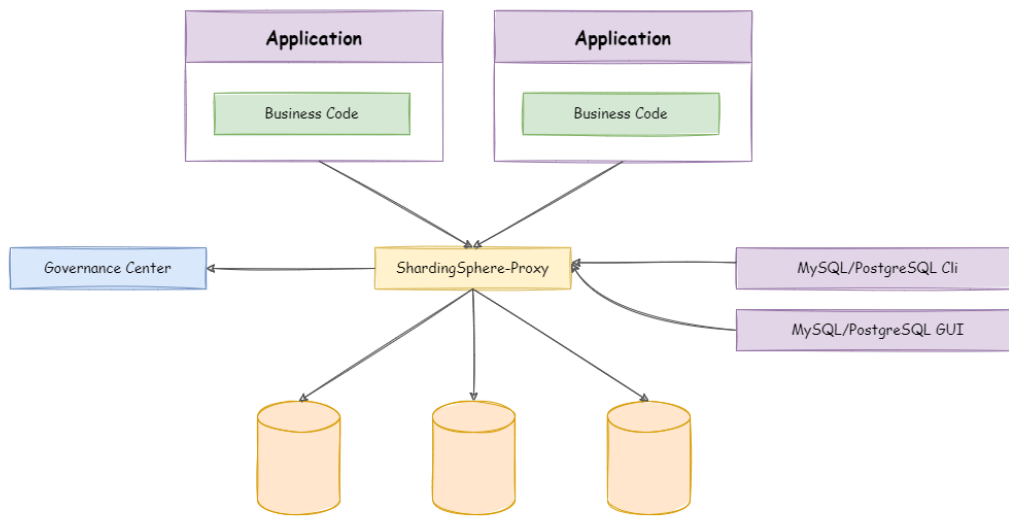

### 1.1.3 ShardingSphere-Sidecar(TODO)

ShardingSphere-Sidecar (TODO) defines itself as a cloud-native database agent of the Kubernetes environment, in charge of all database access in the form of a sidecar. It provides a mesh layer interacting with the database, we call this Database Mesh.

Database Mesh emphasizes how to connect distributed data-access applications with the databases. Focusing on interaction, it effectively organizes the interaction between messy applications and databases. The applications and databases that use Database Mesh to visit databases will form a large grid system, where they just need to be put into the right positions accordingly. They are all governed by the mesh layer.



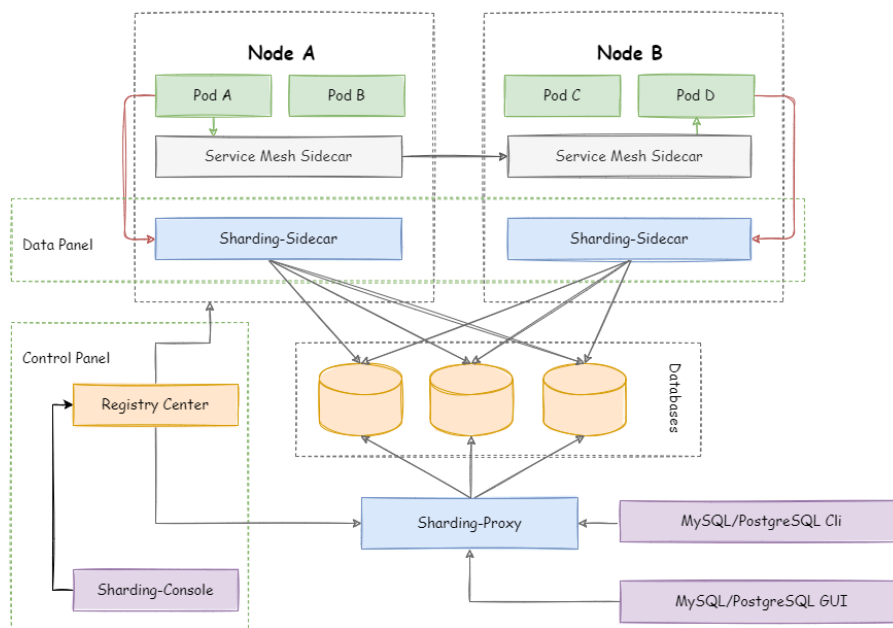

	<i>ShardingSphere-JDBC</i>	<i>ShardingSphere-Proxy</i>	<i>ShardingSphere-Sidecar</i>
Database	Any	MySQL/PostgreSQL	MySQL/PostgreSQL
Connections Count Cost	High	Low	High
Supported Languages	Java Only	Any	Any
Performance	Low loss	Relatively High loss	Low loss
Decentralization	Yes	No	No
Static Entry	No	Yes	No

### 1.1.4 Hybrid Architecture

ShardingSphere-JDBC adopts a decentralized architecture, applicable to high-performance light-weight OLTP application developed with Java. ShardingSphere-Proxy provides static entry and all languages support, applicable for OLAP application and the sharding databases management and operation situation.

ShardingSphere is an ecosystem consisting of multiple endpoints together. Through a mixed use of ShardingSphere-JDBC and ShardingSphere-Proxy and a unified sharding strategy by the same registry center, ShardingSphere can build an application system that is applicable to all kinds of scenarios. Architects can adjust the system architecture to the most applicable one to their needs to conduct business more freely.

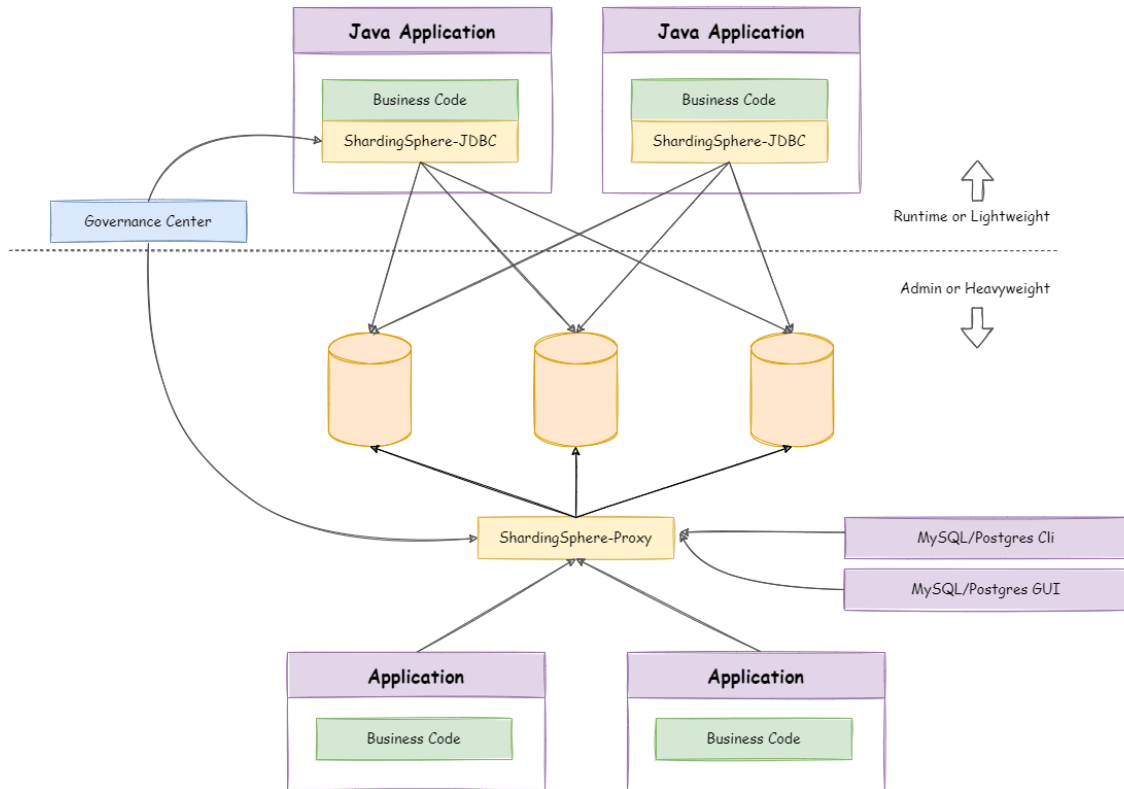

## 1.2 Solution

Solutions/ Features		Data Security	Database Gateway	Stress Testing
	Distributed Database*			
	Data Sharding	Data Encrypt	Heterogeneous Databases Supported	Shadow Database
	Readwrite splitting	Row Authority (TODO)	SQL Dialect Translate (TODO)	Observability
	Distributed Transaction	SQL Audit (TODO)		
	Elastic Scale-out	SQL Firewall (TODO)		
	Highly Available			

## 1.3 Roadmap

In shortest time, this chapter provides users with a simplest quick start with Apache ShardingSphere.

**Example Codes:** <https://github.com/apache/shardingsphere/tree/master/examples>

## 2.1 ShardingSphere-JDBC

### 2.1.1 Scenarios

There are four ways you can configure Apache ShardingSphere: Java, YAML, Spring namespace and Spring boot starter. Developers can choose the preferred method according to their requirements.

### 2.1.2 Limitations

Currently only Java language is supported.

### 2.1.3 Requirements

The development environment requires Java JRE 8 or later.

### 2.1.4 Procedure

1. Rules configuration.

Please refer to [User Manual](#) for more details.

2. Import Maven dependency

```
<dependency>
  <groupId>org.apache.shardingsphere</groupId>
  <artifactId>shardingsphere-jdbc-core-spring-boot-starter</artifactId>
```

```
<version>${latest.release.version}</version>
</dependency>
```

Notice: Please change `${latest.release.version}` to the actual version.

### 3. Edit application.yml.

```
spring:
  shardingsphere:
    datasource:
      names: ds_0, ds_1
      ds_0:
        type: com.zaxxer.hikari.HikariDataSource
        driverClassName: com.mysql.cj.jdbc.Driver
        jdbcUrl: jdbc:mysql://localhost:3306/demo_ds_0?serverTimezone=UTC&
useSSL=false&useUnicode=true&characterEncoding=UTF-8
        username: root
        password:
      ds_1:
        type: com.zaxxer.hikari.HikariDataSource
        driverClassName: com.mysql.cj.jdbc.Driver
        jdbcUrl: jdbc:mysql://localhost:3306/demo_ds_1?serverTimezone=UTC&
useSSL=false&useUnicode=true&characterEncoding=UTF-8
        username: root
        password:
    rules:
      sharding:
        tables:
          ...
```

## 2.2 ShardingSphere-Proxy

### 2.2.1 Get ShardingSphere-Proxy

ShardingSphere-Proxy is available at: - [Binary Distribution](#) - [Docker](#) - [Helm](#)

### 2.2.2 Rule Configuration

Edit `%SHARDINGSPHERE_PROXY_HOME%/conf/config-xxx.yaml`.

Edit `%SHARDINGSPHERE_PROXY_HOME%/conf/server.yaml`.

`%SHARDINGSPHERE_PROXY_HOME%` is the shardingsphere proxy extract path. for example: `/opt/shardingsphere-proxy-bin/`

Please refer to [Configuration Manual](#) for more details.

### 2.2.3 Import Dependencies

If the backend database is PostgreSQL, there' s no need for additional dependencies.

If the backend database is MySQL, please download [mysql-connector-java-5.1.47.jar](#) or [mysql-connector-java-8.0.11.jar](#) and put it into %SHARDINGSPHERE\_PROXY\_HOME%/ext-lib directory.

### 2.2.4 Start Server

- Use default configuration to start

```
sh %SHARDINGSPHERE_PROXY_HOME%/bin/start.sh
```

Default port is 3307, default profile directory is %SHARDINGSPHERE\_PROXY\_HOME%/conf/ .

- Customize port and profile directory

```
sh %SHARDINGSPHERE_PROXY_HOME%/bin/start.sh ${port} ${proxy_conf_directory}
```

### 2.2.5 Use ShardingSphere-Proxy

Use MySQL or PostgreSQL client to connect ShardingSphere-Proxy. For example with MySQL:

```
mysql -u${proxy_username} -p${proxy_password} -h${proxy_host} -P${proxy_port}
```

The functions of Apache ShardingSphere are pretty complex with hundreds of modules, but the concepts are very simple and clear. Most modules are horizontal extensions faced to these concepts.

The concepts include: adaptor faced to independent products, runtime mode faced to startup, DistSQL faced to users and pluggable architecture faced to developers.

This chapter describes concepts about Apache ShardingSphere.

## 3.1 Adaptor

Apache ShardingSphere including 2 independent products: ShardingSphere-JDBC & ShardingSphere-Proxy. They all provide functions of data scale-out, distributed transaction and distributed governance, applicable in a variety of situations such as Java isomorphism, heterogeneous language and Cloud-Native.

### 3.1.1 ShardingSphere-JDBC

As the first product and the predecessor of Apache ShardingSphere, ShardingSphere-JDBC defines itself as a lightweight Java framework that provides extra service at Java JDBC layer. With the client end connecting directly to the database, it provides service in the form of jar and requires no extra deployment and dependence. It can be considered as an enhanced JDBC driver, which is fully compatible with JDBC and all kinds of ORM frameworks.

- Applicable in any ORM framework based on JDBC, such as JPA, Hibernate, Mybatis, Spring JDBC Template or direct use of JDBC;
- Support any third-party database connection pool, such as DBCP, C3P0, BoneCP, HikariCP;
- Support any kind of JDBC standard database: MySQL, PostgreSQL, Oracle, SQLServer and any JDBC adapted databases.

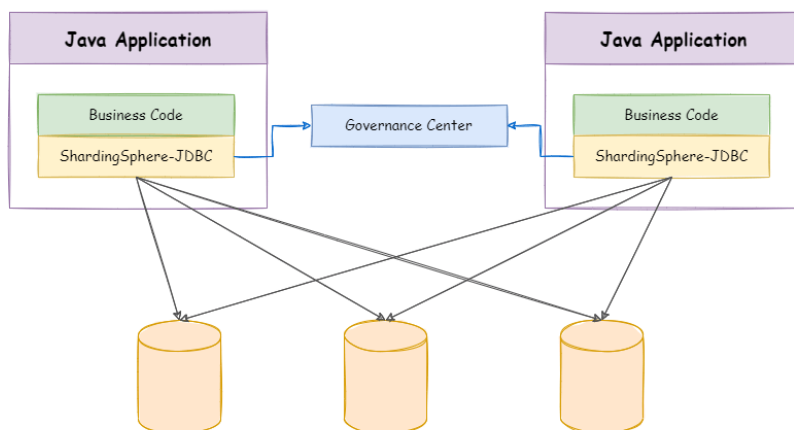

	<i>ShardingSphere-JDBC</i>	<i>ShardingSphere-Proxy</i>
Database	Any	MySQL/PostgreSQL
Connections Count Cost	More	Less
Supported Languages	Java Only	Any
Performance	Low loss	Relatively High loss
Decentralization	Yes	No
Static Entry	No	Yes

ShardingSphere-JDBC is suitable for java application.

**Source Codes:** <https://github.com/apache/shardingsphere/tree/master/shardingsphere-jdbc>

### 3.1.2 ShardingSphere-Proxy

ShardingSphere-Proxy is the second product of Apache ShardingSphere. It defines itself as a transparent database proxy, providing a database server that encapsulates database binary protocol to support heterogeneous languages. Currently, MySQL and PostgreSQL (compatible with PostgreSQL-based databases, such as openGauss) versions are provided. It can use any kind of terminal (such as MySQL Command Client, MySQL Workbench, etc.) that is compatible with MySQL or PostgreSQL protocol to operate data, which is friendlier to DBAs

- Totally transparent to applications, it can be used directly as MySQL/PostgreSQL;



- Applicable to any kind of client end that is compatible with MySQL/PostgreSQL protocol.

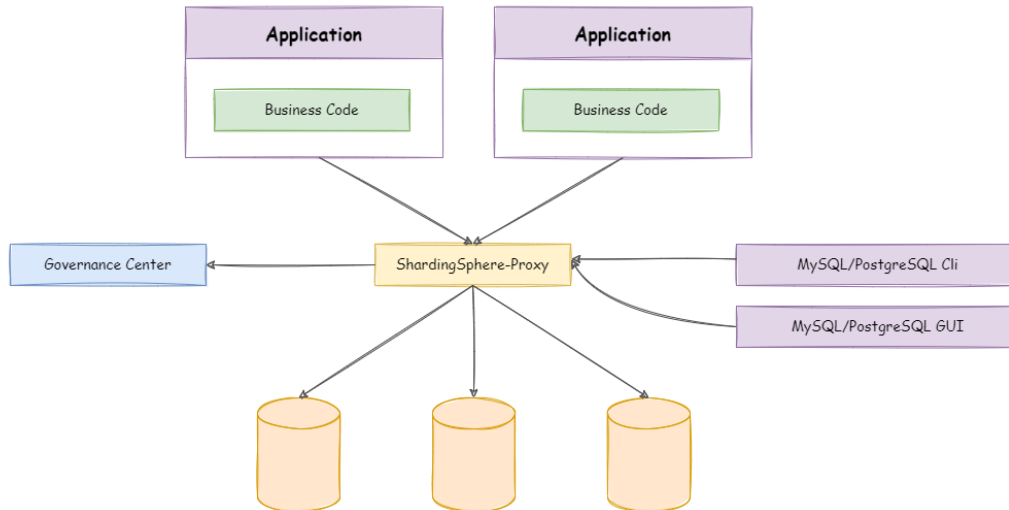

	<i>ShardingSphere-JDBC</i>	<i>ShardingSphere-Proxy</i>
Database	Any	MySQL/PostgreSQL
Connections Count Cost	High	Low
Supported Languages	Java Only	Any
Performance	Low loss	Relatively high loss
Decentralization	Yes	No
Static Entry	No	Yes

The advantages of ShardingSphere-Proxy lie in supporting heterogeneous languages and providing operational entries for DBA.

**Source Codes:** <https://github.com/apache/shardingsphere/tree/master/shardingsphere-proxy>

### 3.1.3 Hybrid Adaptors

ShardingSphere-JDBC adopts a decentralized architecture, applicable to high-performance light-weight OLTP application developed with Java. ShardingSphere-Proxy provides static entry and all languages support, applicable for OLAP application and the sharding databases management and operation situation.

ShardingSphere is an ecosystem consisting of multiple endpoints together. Through a mixed use of ShardingSphere-JDBC and ShardingSphere-Proxy and a unified sharding strategy by the same registry center, ShardingSphere can build an application system that is applicable to all kinds of scenarios. Architects can adjust the system architecture to the most applicable one to their needs to conduct business more freely.

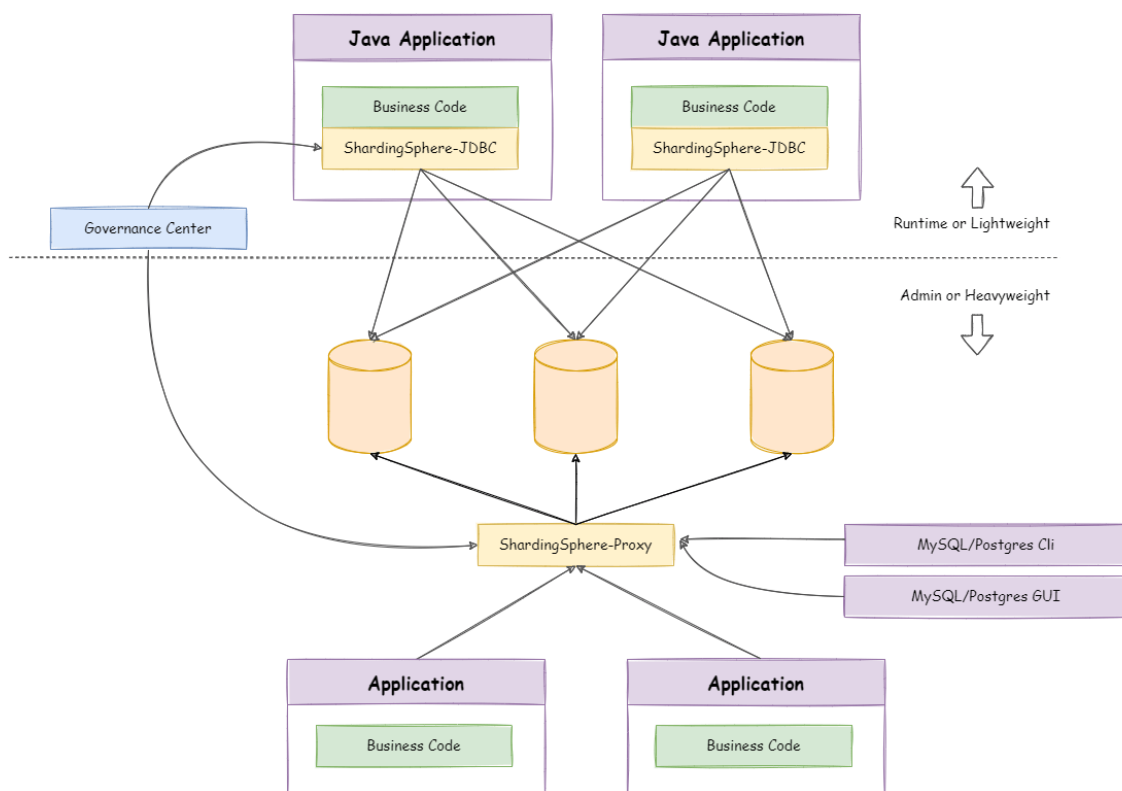

## 3.2 Mode

### 3.2.1 Background

In order to meet the different needs of users for quick test startup, stand-alone running and cluster running, Apache shardingsphere provides various mode such as memory, stand-alone and cluster.

### 3.2.2 Memory mode

Suitable for fast integration testing, which is convenient for testing, such as for developers looking to perform fast integration function testing. This is the default mode of Apache ShardingSphere.

### 3.2.3 Standalone mode

Suitable in a standalone environment, through which data sources, rules, and metadata can be persisted. Will create a `.shardingsphere` file in the root directory to store configuration data by default.

### 3.2.4 Cluster mode

Suitable for use in distributed scenarios which provides metadata sharing and state coordination among multiple computing nodes. It is necessary to provide registry center for distributed coordination, such as ZooKeeper or Etcd.

**Source Codes:** <https://github.com/apache/shardingsphere/tree/master/shardingsphere-mode>

## 3.3 DistSQL

### 3.3.1 Background

DistSQL (Distributed SQL) is Apache ShardingSphere specific SQL, which provide added-on operation capability beside standard SQL.

### 3.3.2 Challenges

When using ShardingSphere-Proxy, developers can operate data just like using database, but they need to configure resources and rules through YAML file (or registry center). However, the format of YAML and habits changed by using registry center are not friendly to DBA.

DistSQL enables users to operate Apache ShardingSphere like a database, transforming it from a framework and middleware for developers to a database product for DBAs.

DistSQL is divided into RDL, RQL and RAL.

- RDL (Resource & Rule Definition Language) responsible for the definition of resources and rules;
- RQL (Resource & Rule Query Language) responsible for the query of resources and rules;
- RAL (Resource & Rule Administration Language) responsible for the added-on administrator feature of hint, transaction type switch, sharding execute planning and so on.

### 3.3.3 Goal

**It is the design goal of DistSQL to break the boundary between middleware and database and let developers use Apache ShardingSphere just like database.**

### 3.3.4 Notice

DistSQL can use for ShardingSphere-Proxy only, not for ShardingSphere-JDBC now.

**Source Codes:** <https://github.com/apache/shardingsphere/tree/master/shardingsphere-distsql>

## 3.4 Pluggable Architecture

### 3.4.1 Background

In Apache ShardingSphere, many functionality implementations are uploaded through *SPI (Service Provider Interface)*, which is a kind of API for the third party to implement or expand, and can be applied in framework expansion or component replacement.

### 3.4.2 Challenges

Pluggable architecture is very difficult to design for the project architecture. It needs to make each module decouple to independent and imperceptible to each other totally, and enables appendable functions in a way of superposition through a pluggable kernel. Design an architecture to completely isolate each function, not only can stimulate the enthusiasm of the open source community, but also can guarantee the quality of the project.

Apache ShardingSphere begin to focus on pluggable architecture from version 5.x, features can be embedded into project flexibility. Currently, the features such as data sharding, readwrite-splitting, data encrypt, shadow database, and SQL dialects / database protocols such as MySQL, PostgreSQL, SQLServer, Oracle supported are all weaved by plugins. Developers can customize their own ShardingSphere just like building lego blocks. There are lots of SPI extensions for Apache ShardingSphere now and increase continuously.

### 3.4.3 Goal

**It is the design goal of Apache shardingsphere pluggable architecture to enable developers to customize their own unique systems just like building blocks.**

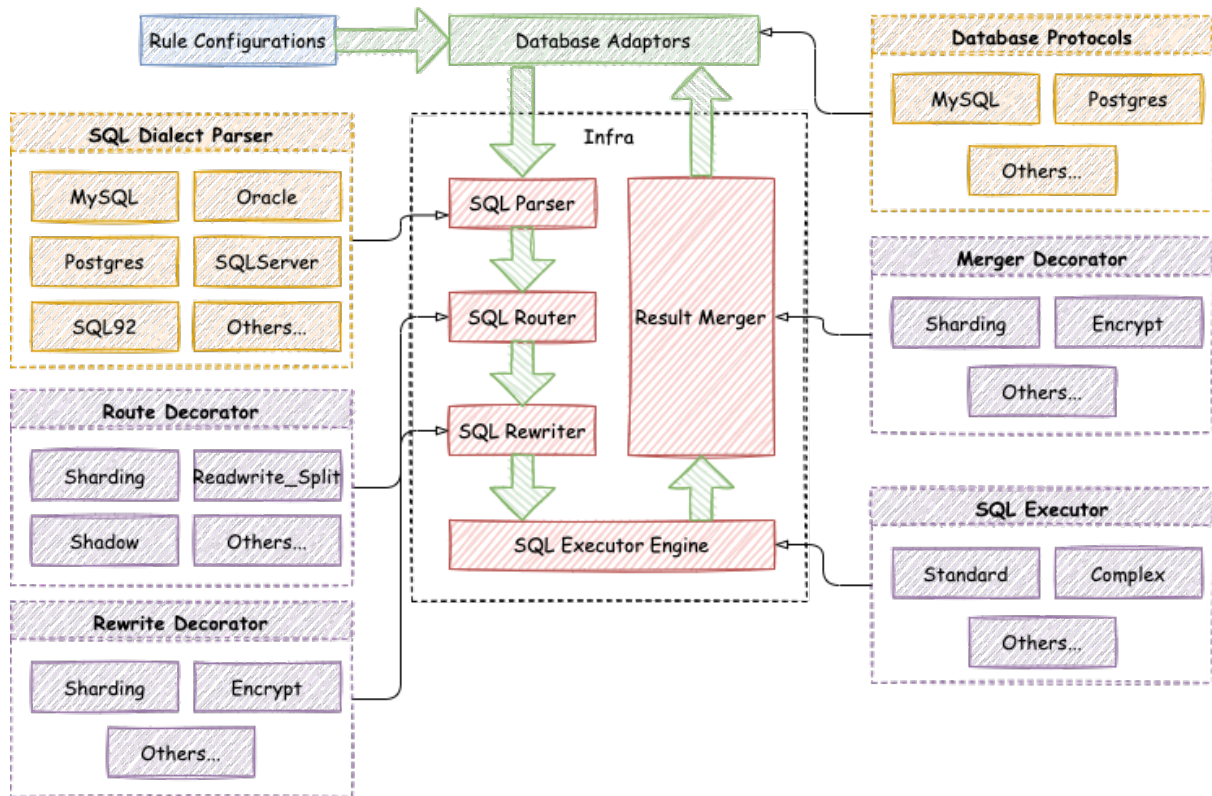

### 3.4.4 Implementation

The pluggable architecture of Apache ShardingSphere are composed by L1 Kernel Layer, L2 Feature Layer and L3 Ecosystem Layer.

#### L1 Kernel Layer

An abstraction of basic capabilities of database. All components are required and the specific implementation can be replaced by pluggable way. It includes query optimizer, distributed transaction engine, distributed execution engine, authority engine and scheduling engine.

#### L2 Feature Layer

Used to provide enhanced capability. All components are optional and can contain zero or multiple components. Components isolate each other and multiple components can be used together super-imposed. It includes data sharding, readwrite-splitting, database highly availability, data encryption, shadow database and so on. The user-defined feature can be fully customized and extended for the top-level interface defined by Apache ShardingSphere without changing kernel codes.

### **L3 Ecosystem Layer**

Used to integrate into the current database ecosystem. It includes database protocol, SQL parser and storage adapter.

Apache ShardingSphere provides a variety of features, from database kernel and database distributed solution to applications closed features.

There is no boundary for these features, warmly welcome more open source engineers to join the community and provide exciting ideas and features.

## 4.1 DB Compatibility

### 4.1.1 Background

With information technology innovating, more and more applications established in the new fields, prompt and push evolution of human society's cooperation mode. Data is increasing explosively, the data storage and computing method are facing innovation all the time.

Transaction, big data, association analysis, Internet of things and other scenarios subdivided quickly, a single database can not apply to all application scenarios anymore. At the same time, the internal of scenario is becoming more and more detailed, and it has become normal for similar scenarios to use different databases.

The trend of database fragmentation is coming.

### 4.1.2 Challenges

There is no unified database access protocol and SQL dialect, as well as the maintenance and monitoring methods differences by various databases, learning and maintenance cost of developers and DBAs are increasing rapidly. Improving the compatibility with the original database is the premise of providing incremental services on it.

The compatibility between SQL dialect and database protocol is the key point to improve database compatibility.

### 4.1.3 Goal

The goal of database compatibility for Apache ShardingSphere is make user feel nothing changed among various original databases.

### 4.1.4 SQL Parser

SQL is the standard operation language between users and databases. SQL Parse engine used to parse SQL into an abstract syntax tree to provide Apache ShardingSphere understand and implement the add-on features.

It supports SQL dialect for MySQL, PostgreSQL, SQLServer, Oracle, openGauss and SQL that conform to the SQL92 specification. However, due to the complexity of SQL syntax, there are still a little of SQL do not support yet.

This chapter has listed unsupported SQLs reference for users.

There are some unsupported SQLs maybe missing, welcome to finish them. We will try best to support the unavailable SQLs in future versions.

**Source Codes:** <https://github.com/apache/shardingsphere/tree/master/shardingsphere-sql-parser>

#### MySQL

The unsupported SQL list for MySQL are as follows:

SQL
CLONE LOCAL DATA DIRECTORY = 'clone_dir'
INSTALL COMPONENT 'file://component1' , 'file://component2'
UNINSTALL COMPONENT 'file://component1' , 'file://component2'
REPAIR TABLE t_order
OPTIMIZE TABLE t_order
CHECKSUM TABLE t_order
CHECK TABLE t_order
SET RESOURCE GROUP group_name
DROP RESOURCE GROUP group_name
CREATE RESOURCE GROUP group_name TYPE = SYSTEM
ALTER RESOURCE GROUP rg1 VCPU = 0-63

**Source Codes:** <https://github.com/apache/shardingsphere/tree/master/shardingsphere-sql-parser/shardingsphere-sql-parser-dialect/shardingsphere-sql-parser-mysql>



**openGauss**

The unsupported SQL list for openGauss are as follows:

SQL
CREATE type avg_state AS (total bigint, count bigint);
CREATE AGGREGATE my_avg(int4) (stype = avg_state, sfunc = avg_transfn, finalfunc = avg_finalfn)
CREATE TABLE agg_data_2k AS SELECT g FROM generate_series(0, 1999) g;
CREATE SCHEMA alt_nsp1;
ALTER AGGREGATE alt_agg3(int) OWNER TO regress_alter_generic_user2;
CREATE CONVERSION alt_conv1 FOR 'LATIN1' TO 'UTF8' FROM iso8859_1_to_utf8;
CREATE FOREIGN DATA WRAPPER alt_fdw1
CREATE SERVER alt_fserv1 FOREIGN DATA WRAPPER alt_fdw1
CREATE LANGUAGE alt_lang1 HANDLER plpgsql_call_handler
CREATE STATISTICS alt_stat1 ON a, b FROM alt_regress_1
CREATE TEXT SEARCH DICTIONARY alt_ts_dict1 (template=simple)
CREATE RULE def_view_test_ins AS ON INSERT TO def_view_test DO INSTEAD INSERT INTO def_test SELECT new.*
ALTER TABLE alterlock SET (toast.autovacuum_enabled = off)
CREATE PUBLICATION pub1 FOR TABLE alter1.t1, ALL TABLES IN SCHEMA alter2

**Source Codes:** <https://github.com/apache/shardingsphere/tree/master/shardingsphere-sql-parser/shardingsphere-sql-parser-dialect/shardingsphere-sql-parser-opengauss>

**PostgreSQL**

The unsupported SQL list for PostgreSQL are as follows:

SQL
CREATE type avg_state AS (total bigint, count bigint);
CREATE AGGREGATE my_avg(int4) (stype = avg_state, sfunc = avg_transfn, finalfunc = avg_finalfn)
CREATE TABLE agg_data_2k AS SELECT g FROM generate_series(0, 1999) g;
CREATE SCHEMA alt_nsp1;
ALTER AGGREGATE alt_agg3(int) OWNER TO regress_alter_generic_user2;
CREATE CONVERSION alt_conv1 FOR 'LATIN1' TO 'UTF8' FROM iso8859_1_to_utf8;
CREATE FOREIGN DATA WRAPPER alt_fdw1
CREATE SERVER alt_fserv1 FOREIGN DATA WRAPPER alt_fdw1
CREATE LANGUAGE alt_lang1 HANDLER plpgsql_call_handler
CREATE STATISTICS alt_stat1 ON a, b FROM alt_regress_1
CREATE TEXT SEARCH DICTIONARY alt_ts_dict1 (template=simple)
CREATE RULE def_view_test_ins AS ON INSERT TO def_view_test DO INSTEAD INSERT INTO def_test SELECT new.*
ALTER TABLE alterlock SET (toast.autovacuum_enabled = off)
CREATE PUBLICATION pub1 FOR TABLE alter1.t1, ALL TABLES IN SCHEMA alter2

**Source Codes:** <https://github.com/apache/shardingsphere/tree/master/shardingsphere-sql-parser/shardingsphere-sql-parser-dialect/shardingsphere-sql-parser-postgresql>

### SQLServer

The unsupported SQL list for SQLServer are as follows:

TODO

**Source Codes:** <https://github.com/apache/shardingsphere/tree/master/shardingsphere-sql-parser/shardingsphere-sql-parser-dialect/shardingsphere-sql-parser-sqlserver>

### Oracle

The unsupported SQL list for Oracle are as follows:

TODO

**Source Codes:** <https://github.com/apache/shardingsphere/tree/master/shardingsphere-sql-parser/shardingsphere-sql-parser-dialect/shardingsphere-sql-parser-oracle>

### SQL92

The unsupported SQL list for SQL92 are as follows:

TODO

**Source Codes:** <https://github.com/apache/shardingsphere/tree/master/shardingsphere-sql-parser/shardingsphere-sql-parser-dialect/shardingsphere-sql-parser-sql92>

## 4.1.5 DB Protocol

Apache ShardingSphere implements MySQL and PostgreSQL Protocol.

**Source Codes:** <https://github.com/apache/shardingsphere/tree/master/shardingsphere-db-protocol>

## 4.1.6 Feature Support

Apache ShardingSphere provides the ability of distributed collaboration for the database, and abstracts part of the database features to the upper layer for unified management to reduce the difficulty of users.

Therefore, for the unified provided features, the native SQL will no longer be transferred to the database, and it will be prompted that the operation is not supported. User can use the feature provided by ShardingSphere to replace it.

This chapter has listed unsupported database features and related SQLs reference for users.

There are some unsupported SQLs maybe missing, welcome to finish them.

## MySQL

The unsupported SQL list for MySQL are as follows:

### User & Role

SQL
CREATE USER 'finley' @ 'localhost' IDENTIFIED BY 'password'
ALTER USER 'finley' @ 'localhost' IDENTIFIED BY 'new_password'
DROP USER 'finley' @ 'localhost' ;
CREATE ROLE 'app_read'
DROP ROLE 'app_read'
SHOW CREATE USER finley
SET PASSWORD = 'auth_string'
SET ROLE DEFAULT;

### Authorization

SQL
GRANT ALL ON db1.* TO 'jeffrey' @ 'localhost'
GRANT SELECT ON world.* TO 'role3' ;
GRANT 'role1' , 'role2' TO 'user1' @ 'localhost'
REVOKE INSERT ON . FROM 'jeffrey' @ 'localhost'
REVOKE 'role1' , 'role2' FROM 'user1' @ 'localhost'
REVOKE ALL PRIVILEGES, GRANT OPTION FROM user_or_role
SHOW GRANTS FOR 'jeffrey' @ 'localhost'
SHOW GRANTS FOR CURRENT_USER
FLUSH PRIVILEGES

## PostgreSQL

The unsupported SQL list for PostgreSQL are as follows:

TODO

## SQLServer

The unsupported SQL list for SQLServer are as follows:

TODO

## Oracle

The unsupported SQL list for Oracle are as follows:

TODO

## SQL92

The unsupported SQL list for SQL92 are as follows:

TODO

## 4.2 Cluster Management

### 4.2.1 Background

As the scale of data continues to expand, a distributed database has become a trend gradually. The unified management ability of cluster perspective, and control ability of individual components are necessary ability in modern database system.

### 4.2.2 Challenges

The challenge is ability which are unified management of centralized management, and operation in case of single node in failure.

Centralized management is to uniformly manage the state of database storage nodes and middleware computing nodes, and can detect the latest updates in the distributed environment in real time, further provide information with control and scheduling.

In the overload traffic scenario, circuit breaker and request limiting for a node to ensure whole database cluster can run continuously is a challenge to control ability of a single node.

### 4.2.3 Goal

**The goal of Apache ShardingSphere management module is to realize the integrated management ability from database to computing node, and provide control ability for components in case of failure.**

### 4.2.4 Core Concept

#### Circuit Breaker

Fuse connection between Apache ShardingSphere and the database. When an Apache ShardingSphere node exceeds the max load, stop the node's access to the database, so that the database can ensure sufficient resources to provide services for other Apache ShardingSphere nodes.

#### Request Limit

In the face of overload requests, open request limiting to protect some requests can still respond quickly.

## 4.3 Sharding

### 4.3.1 Background

The traditional solution that stores all the data in one concentrated node has hardly satisfied the requirement of massive data scenario in three aspects, performance, availability and operation cost.

In performance, the relational database mostly uses B+ tree index. When the data amount exceeds the threshold, deeper index will increase the disk IO access number, and thereby, weaken the performance of query. In the same time, high concurrency requests also make the centralized database to be the greatest limitation of the system.

In availability, capacity can be expanded at a relatively low cost and any extent with stateless service, which can make all the pressure, at last, fall on the database. But the single data node or simple primary-replica structure has been harder and harder to take these pressures. Therefore, database availability has become the key to the whole system.

From the aspect of operation costs, when the data in a database instance has reached above the threshold, DBA's operation pressure will also increase. The time cost of data backup and data recovery will be more uncontrollable with increasing amount of data. Generally, it is a relatively reasonable range for the data in single database case to be within 1TB.

Under the circumstance that traditional relational databases cannot satisfy the requirement of the Internet, there are more and more attempts to store the data in native distributed NoSQL. But its incompatibility with SQL and imperfection in ecosystem block it from defeating the relational database in the competition, so the relational database still holds an unshakable position.

Sharding refers to splitting the data in one database and storing them in multiple tables and databases according to some certain standard, so that the performance and availability can be improved. Both methods can effectively avoid the query limitation caused by data exceeding affordable threshold. What's more, database sharding can also effectively disperse TPS. Table sharding, though cannot ease the database pressure, can provide possibilities to transfer distributed transactions to local transactions, since cross-database upgrades are once involved, distributed transactions can turn pretty tricky sometimes. The use of multiple primary-replica sharding method can effectively avoid the data concentrating on one node and increase the architecture availability.

Splitting data through database sharding and table sharding is an effective method to deal with high TPS and mass amount data system, because it can keep the data amount lower than the threshold and evacuate the traffic. Sharding method can be divided into vertical sharding and horizontal sharding.

### Vertical Sharding

According to business sharding method, it is called vertical sharding, or longitudinal sharding, the core concept of which is to specialize databases for different uses. Before sharding, a database consists of many tables corresponding to different businesses. But after sharding, tables are categorized into different databases according to business, and the pressure is also separated into different databases. The diagram below has presented the solution to assign user tables and order tables to different databases by vertical sharding according to business need.

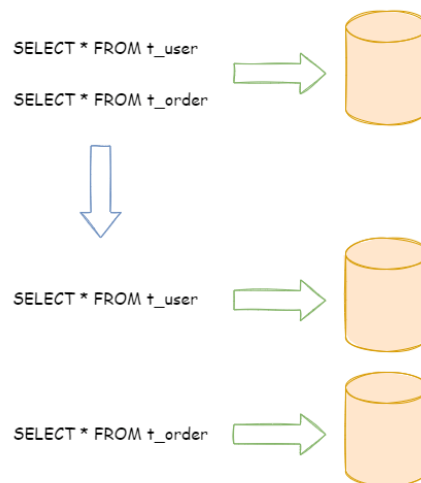

Vertical sharding requires to adjust the architecture and design from time to time. Generally speaking, it is not soon enough to deal with fast changing needs from Internet business and not able to really solve the single-node problem. it can ease problems brought by the high data amount and concurrency

amount, but cannot solve them completely. After vertical sharding, if the data amount in the table still exceeds the single node threshold, it should be further processed by horizontal sharding.

### Horizontal Sharding

Horizontal sharding is also called transverse sharding. Compared with the categorization method according to business logic of vertical sharding, horizontal sharding categorizes data to multiple databases or tables according to some certain rules through certain fields, with each sharding containing only part of the data. For example, according to primary key sharding, even primary keys are put into the 0 database (or table) and odd primary keys are put into the 1 database (or table), which is illustrated as the following diagram.

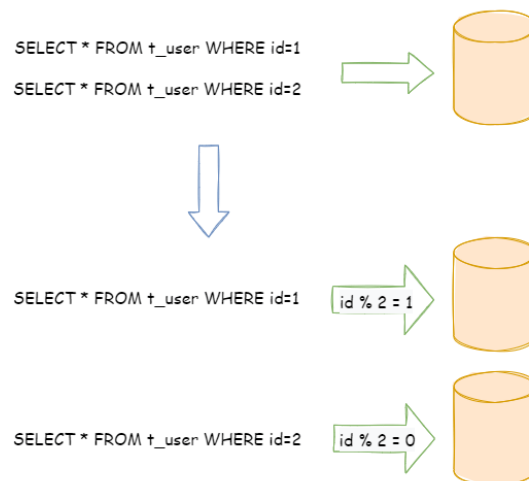

Theoretically, horizontal sharding has overcome the limitation of data processing volume in single machine and can be extended relatively freely, so it can be taken as a standard solution to database sharding and table sharding.

### 4.3.2 Challenges

Though sharding has solved problems such as performance, availability and single-node backup and recovery, its distributed architecture has also introduced some new problems as acquiring profits.

One problem is that application development engineers and database administrators' operations become exceptionally laborious, when facing such scattered databases and tables. They should know exactly which database table is the one to acquire data from.

Another challenge is that, the SQL that runs rightly in single-node databases may not be right in the sharding database. The change of table name after sharding, or misconducts caused by operations such as pagination, order by or aggregated group by are just the case in point.

Cross-database transaction is also a tricky thing that distributed databases need to deal. Fair use of sharding tables can also lead to the full use of local transactions when single-table data amount decreases. Troubles brought by distributed transactions can be avoided by the wise use of different tables in the same database. When cross-database transactions cannot be avoided, some businesses still need to keep transactions consistent. Internet giants have not massively adopted XA based distributed transactions since they are not able to ensure its performance in high-concurrency situations. They usually replace strongly consistent transactions with eventually consistent soft state.

### 4.3.3 Goal

**The main design goal of the data sharding modular of Apache ShardingSphere is to try to reduce the influence of sharding, in order to let users use horizontal sharding database group like one database.**

**Source Codes:** <https://github.com/apache/shardingsphere/tree/master/shardingsphere-features/shardingsphere-sharding>

### 4.3.4 Core Concept

#### Overview

This chapter is to introduce core concepts of data sharding.

#### Table

Table is the core concept of data sharding transparently. There are diversified tables provided for different data sharding requirements by Apache ShardingSphere.



### Logic Table

The logical name of the horizontal sharding databases (tables) with the same schema, it is the logical table identification in SQL. For instance, the data of order is divided into 10 tables according to the last number of the primary key, and they are from `t_order_0` to `t_order_9`, whose logic name is `t_order`.

### Actual Table

The physical table that really exists in the horizontal sharding database, i.e., `t_order_0` to `t_order_9` in the instance above.

### Binding Table

It refers to a group of sharding tables with the same sharding rules. When using binding tables in multi-table correlating query, you must use the sharding key for correlation, otherwise Cartesian product correlation or cross-database correlation will appear, which will affect query efficiency. For example, `t_order` and `t_order_item` are both sharded by `order_id`, and use `order_id` to correlate, so they are binding tables with each other. Cartesian product correlation will not appear in the multi-tables correlating query, so the query efficiency will increase greatly. Take this one for example, if SQL is:

```
SELECT i.* FROM t_order o JOIN t_order_item i ON o.order_id=i.order_id WHERE o.order_id in (10, 11);
```

When binding table relations are not configured, suppose the sharding key `order_id` routes value 10 to sharding 0 and value 11 to sharding 1, there will be 4 SQLs in Cartesian product after routing:

```
SELECT i.* FROM t_order_0 o JOIN t_order_item_0 i ON o.order_id=i.order_id WHERE o.order_id in (10, 11);

SELECT i.* FROM t_order_0 o JOIN t_order_item_1 i ON o.order_id=i.order_id WHERE o.order_id in (10, 11);

SELECT i.* FROM t_order_1 o JOIN t_order_item_0 i ON o.order_id=i.order_id WHERE o.order_id in (10, 11);

SELECT i.* FROM t_order_1 o JOIN t_order_item_1 i ON o.order_id=i.order_id WHERE o.order_id in (10, 11);
```

With binding table configuration and use `order_id` to correlate, there should be 2 SQLs after routing:

```
SELECT i.* FROM t_order_0 o JOIN t_order_item_0 i ON o.order_id=i.order_id WHERE o.order_id in (10, 11);

SELECT i.* FROM t_order_1 o JOIN t_order_item_1 i ON o.order_id=i.order_id WHERE o.order_id in (10, 11);
```

In them, since table `t_order` specifies sharding conditions, it will be taken by ShardingSphere as the primary table of query. All the route computations will only use the sharding strategy of the primary table, so sharding computation of `t_order_item` table will use the conditions of `t_order`.

### Broadcast Table

It refers to tables that exist in all sharding database sources. The schema and data must consist in each database. It can be applied to the small data volume that needs to correlate with big data tables to query, dictionary table for example.

### Single Table

It refers to only one table that exists in all sharding database sources. It is suitable for little data in table without sharding.

### Data Node

As the atomic unit of sharding, it consists of data source name and actual table name, e.g. `ds_0.t_order_0`.

Mapping relationship between logic tables and actual tables and can be divided into two kinds: uniform topology and user-defined topology.

### Uniform topology

It means that tables are evenly distributed in each data source, for example:

```
db0
├─ t_order0
└─ t_order1
db1
├─ t_order0
└─ t_order1
```

The data node configurations will be as follows:

```
db0.t_order0, db0.t_order1, db1.t_order0, db1.t_order1
```

## User-defined topology

It means that tables are distributed with certain rules, for example:

```
db0
├── t_order0
└── t_order1
db1
├── t_order2
├── t_order3
└── t_order4
```

The data node configurations will be as follows:

```
db0.t_order0, db0.t_order1, db1.t_order2, db1.t_order3, db1.t_order4
```

## Sharding

### Sharding Key

Column used to determine database (table) sharding. For example, in last number modulo of order ID sharding, order ID is taken as the sharding key. The full route executed when there is no sharding column in SQL has a poor performance. Besides single sharding column, Apache ShardingSphere also supports multiple sharding columns.

### Sharding Algorithm

Data sharding can be achieved by sharding algorithms through =, >=, <=, >, <, BETWEEN and IN. It can be implemented by developers themselves, or using built-in syntactic sugar of Apache ShardingSphere, with high flexibility.

### Auto Sharding Algorithm

It provides syntactic sugar for sharding algorithm. It used to manage all data nodes automatically, user do not care about the topology of physical data nodes. It includes lots of implementation for Mod, Hash, Range and Time Interval etc.

### User-Defined Sharding Algorithm

It provides interfaces for developers to implement the sharding algorithm related to business implementation, and allows users to manage the physical topology physical data nodes by themselves. It includes:

- Standard Sharding Algorithm

It is to process the sharding case in which single sharding keys =, IN, BETWEEN AND, >, <, >=, <= are used.

- Complex Keys Sharding Algorithm

It is to process the sharding case in which multiple sharding keys are used. It has a relatively complex logic that requires developers to deal by themselves.

- Hint Sharding Algorithm

It is to process the sharding case in which Hint is used.

### Sharding Strategy

It includes the sharding key and the sharding algorithm, and the latter one is extracted out for its independence. Only sharding key + sharding algorithm can be used in sharding operation.

### SQL Hint

In the case that the sharding column is not decide by SQL but other external conditions, SQL hint can be used to inject sharding value. For example, databases are shard according to the staff' s ID, but column does not exist in the database. SQL Hint can be used by two ways, Java API and SQL comment (TODO). Please refer to [Hint](#) for more details.

### Inline Expression

#### Motivation

Configuration simplicity and unity are two main problems that inline expression intends to solve.

In complex sharding rules, with more data nodes, a large number of configuration repetitions make configurations difficult to maintain. Inline expressions can simplify data node configuration work.

Java codes are not helpful in the unified management of common configurations. Writing sharding algorithms with inline expressions, users can store rules together, making them easier to be browsed and stored.

## Syntax Explanation

The use of inline expressions is really direct. Users only need to configure `${ expression }` or `$->{ expression }` to identify them. ShardingSphere currently supports the configurations of data nodes and sharding algorithms. Inline expressions use Groovy syntax, which can support all kinds of operations, including inline expressions. For example:

`${begin..end}` means range

`${[unit1, unit2, unit_x]}` means enumeration

If there are many continuous `${ expression }` or `$->{ expression }` expressions, according to each sub-expression result, the ultimate result of the whole expression will be in cartesian combination.

For example, the following inline expression:

```
${['online', 'offline']}_table${1..3}
```

Will be parsed as:

```
online_table1, online_table2, online_table3, offline_table1, offline_table2,
offline_table3
```

## Configuration

### Data Node

For evenly distributed data nodes, if the data structure is as follow:

```
db0
├── t_order0
└── t_order1
db1
├── t_order0
└── t_order1
```

It can be simplified by inline expression as:

```
db${0..1}.t_order${0..1}
```

Or

```
db$->{0..1}.t_order$->{0..1}
```

For self-defined data nodes, if the data structure is:

```
db0
├── t_order0
└── t_order1
```

```
db1
├─ t_order2
├─ t_order3
└─ t_order4
```

It can be simplified by inline expression as:

```
db0.t_order${0..1},db1.t_order${2..4}
```

Or

```
db0.t_order$->{0..1},db1.t_order$->{2..4}
```

For data nodes with prefixes, inline expression can also be used to configure them flexibly, if the data structure is:

```
db0
├─ t_order_00
├─ t_order_01
├─ t_order_02
├─ t_order_03
├─ t_order_04
├─ t_order_05
├─ t_order_06
├─ t_order_07
├─ t_order_08
├─ t_order_09
├─ t_order_10
├─ t_order_11
├─ t_order_12
├─ t_order_13
├─ t_order_14
├─ t_order_15
├─ t_order_16
├─ t_order_17
├─ t_order_18
├─ t_order_19
└─ t_order_20
db1
├─ t_order_00
├─ t_order_01
├─ t_order_02
├─ t_order_03
├─ t_order_04
├─ t_order_05
├─ t_order_06
├─ t_order_07
├─ t_order_08
└─ t_order_09
```

```

├─ t_order_10
├─ t_order_11
├─ t_order_12
├─ t_order_13
├─ t_order_14
├─ t_order_15
├─ t_order_16
├─ t_order_17
├─ t_order_18
├─ t_order_19
└─ t_order_20

```

Users can configure separately, data nodes with prefixes first, those without prefixes later, and automatically combine them with the cartesian product feature of inline expressions. The example above can be simplified by inline expression as:

```
db${0..1}.t_order_0${0..9}, db${0..1}.t_order_${10..20}
```

Or

```
db$->{0..1}.t_order_0$->{0..9}, db$->{0..1}.t_order_${10..20}
```

### Sharding Algorithm

For single sharding SQL that uses = and IN, inline expression can replace codes in configuration.

Inline expression is a piece of Groovy code in essence, which can return the corresponding real data source or table name according to the computation method of sharding keys.

For example, sharding keys with the last number 0 are routed to the data source with the suffix of 0, those with the last number 1 are routed to the data source with the suffix of 1, the rest goes on in the same way. The inline expression used to indicate sharding algorithm is:

```
ds${id % 10}
```

Or

```
ds$->{id % 10}
```

## Distributed Primary Key

### Motivation

In the development of traditional database software, the automatic sequence generation technology is a basic requirement. All kinds of databases have provided corresponding support for this requirement, such as MySQL auto-increment key, Oracle auto-increment sequence and so on. It is a tricky problem that there is only one sequence generated by different data nodes after sharding. Auto-increment keys in different physical tables in the same logic table can not perceive each other and thereby generate repeated sequences. It is possible to avoid clashes by restricting the initiative value and increasing the step of auto-increment key. But introducing extra operation rules can make the solution lack integrity and scalability.

Currently, there are many third-party solutions that can solve this problem perfectly, (such as UUID and others) relying on some particular algorithms to generate unrepeated keys or introducing sequence generation services. We have provided several built-in key generators, such as UUID, SNOWFLAKE. Besides, we have also extracted a key generator interface to make users implement self-defined key generator.

### Built-In Key Generator

#### UUID

Use `UUID.randomUUID()` to generate the distributed key.

#### NanoID

Generate a string of length 21 distributed key.

#### SNOWFLAKE

Users can configure the strategy of each table in sharding rule configuration module, with default snowflake algorithm generating 64bit long integral data.

As the distributed sequence generation algorithm published by Twitter, snowflake algorithm can ensure sequences of different processes do not repeat and those of the same process are ordered.



## Principle

In the same process, it makes sure that IDs do not repeat through time, or through order if the time is identical. In the same time, with monotonously increasing time, if servers are generally synchronized, generated sequences are generally assumed to be ordered in a distributed environment. This can guarantee the effectiveness in index field insertion, like the sequence of MySQL InnoDB storage engine.

In the sequence generated with snowflake algorithm, binary form has 4 parts, 1 bit sign, 41bit timestamp, 10bit work ID and 12bit sequence number from high to low.

- sign bit (1bit)

Reserved sign bit, constantly to be zero.

- timestamp bit (41bit)

41bit timestamp can contain 2 to the power of 41 milliseconds. One year can use  $365 * 24 * 60 * 60 * 1000$  milliseconds. We can see from the calculation:

```
Math.pow(2, 41) / (365 * 24 * 60 * 60 * 1000L);
```

The result is approximately equal to 69.73 years. Apache ShardingSphere snowflake algorithm starts from November 1st, 2016, and can be used until 2086, which we believe can satisfy the requirement of most systems.

- work ID bit (10bit)

The sign is the only one in Java process. If applied in distributed deployment, each work ID should be different. The default value is 0 and can be set through properties.

- sequence number bit (12bit)

The sequence number is used to generate different IDs in a millisecond. If the number generated in that millisecond exceeds 4,096 (2 to the power of 12), the generator will wait till the next millisecond to continue.

Please refer to the following picture for the detailed structure of snowflake algorithm sequence.

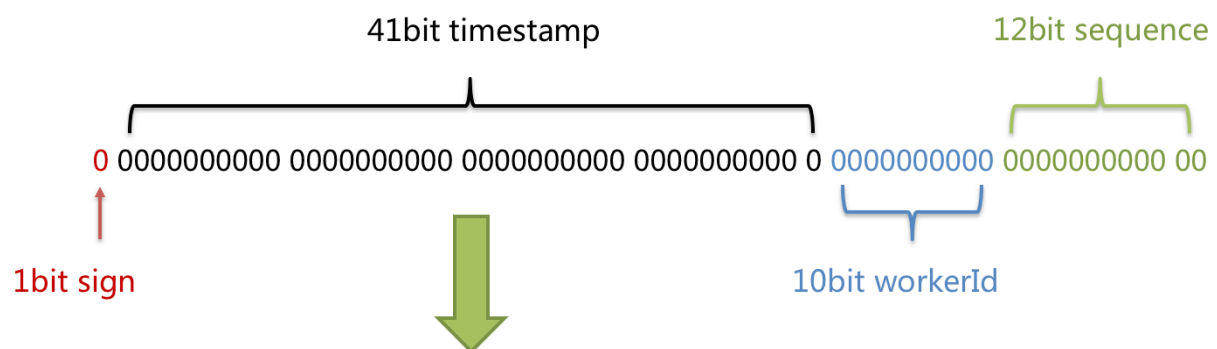

Time duration:  $2^{41} / (365 * 24 * 60 * 60 * 1000L) = 69.73$  years  
 Working applications count:  $2^{10} = 1024$   
 TPS of sequence generated:  $2^{12} * 1000 = 4,096k$

### Clock-Back

The clock-back of server can generate repeated sequence, so the default distributed sequence generator has provided a maximum clock-back millisecond. If the clock-back time has exceeded it, the program will report error. If it is within the tolerance range, the generator will wait till after the last generation time and then continue to work. The default maximum clock-back millisecond is 0 and can be set through properties.

### Hint Sharding Route

#### Motivation

Apache ShardingSphere can be compatible with SQL in way of parsing SQL statements and extracting columns and values to shard. If SQL does not have sharding conditions, it is impossible to shard without full data node route.

In some applications, sharding conditions are not in SQL but in external business logic. So it requires to designate sharding result externally, which is referred to as `Hint` in ShardingSphere.

#### Mechanism

Apache ShardingSphere uses `ThreadLocal` to manage sharding key values. Users can program to add sharding conditions to `HintManager`, but the condition is only effective within the current thread.

In addition to the programming method, Apache ShardingSphere is able to cite `Hint` through special notation in SQL, so that users can use that function in a more transparent way.

The SQL designated with sharding hint will ignore the former sharding logic but directly route to the designated node.

### 4.3.5 Use Norms

#### Background

Though Apache ShardingSphere intends to be compatible with all the SQLs and stand-alone databases, the distributed scenario has brought more complex situations to the database. Apache ShardingSphere wants to solve massive data OLTP problem first and complete relevant OLAP support problem little by little.

## SQL

### SQL Supporting Status

Compatible with all regular SQL when **routing to single data node**; **The SQL routing to multiple data nodes** is pretty complex, it divides the scenarios as totally supported, experimental supported and unsupported.

#### Totally Supported

Fully support DML, DDL, DCL, TCL and most regular DAL. Support complex query with pagination, DISTINCT, ORDER BY, GROUP BY, aggregation and table JOIN. Support PostgreSQL and openGauss database SCHEMA DDL and DML statements.

#### Regular Query

- SELECT Clause

```
SELECT select_expr [, select_expr ...] FROM table_reference [, table_reference ...]
[WHERE predicates]
[GROUP BY {col_name | position} [ASC | DESC], ...]
[ORDER BY {col_name | position} [ASC | DESC], ...]
[LIMIT {[offset,] row_count | row_count OFFSET offset}]
```

- select\_expr

```
*
| [DISTINCT] COLUMN_NAME [AS] [alias]
| (MAX | MIN | SUM | AVG)(COLUMN_NAME | alias) [AS] [alias]
| COUNT(* | COLUMN_NAME | alias) [AS] [alias]
```

- table\_reference

```
tbl_name [AS] alias [index_hint_list]
| table_reference ([INNER] | {LEFT|RIGHT} [OUTER]) JOIN table_factor [JOIN ON
conditional_expr | USING (column_list)]
```

#### Subquery

Stable supported when sharding keys are using in both subquery and outer query, and values of sharding keys are the same.

For example:

```
SELECT * FROM (SELECT * FROM t_order WHERE order_id = 1) o WHERE o.order_id = 1;
```

Stable supported for subquery with [pagination](#).

For example:

```
SELECT * FROM (SELECT row_.*, rownum rownum_ FROM (SELECT * FROM t_order) row_
WHERE rownum <= ?) WHERE rownum > ?;
```

### Sharding value in expression

Sharding value in calculated expressions will lead to full routing.

For example, if create\_time is sharding value:

```
SELECT * FROM t_order WHERE to_date(create_time, 'yyyy-mm-dd') = '2019-01-01';
```

### Experimental Supported

Experimental support specifically refers to use of Federation execution engine. The engine still in rapid development, basically available to users, but it still needs lots of optimization. It is an experimental product.

### Subquery

Experimental supported when sharding keys are not using for both subquery and outer query, or values of sharding keys are not the same.

For example:

```
SELECT * FROM (SELECT * FROM t_order) o;

SELECT * FROM (SELECT * FROM t_order) o WHERE o.order_id = 1;

SELECT * FROM (SELECT * FROM t_order WHERE order_id = 1) o;

SELECT * FROM (SELECT * FROM t_order WHERE order_id = 1) o WHERE o.order_id = 2;
```

### Join with cross databases

When tables in a join query are distributed on different database instances, sql statement will be supported by Federation execution engine. Assuming that t\_order and t\_order\_item are sharding tables with multiple data nodes, and no binding table rules are configured, t\_user and t\_user\_role are single tables that distributed on different database instances. Federation execution engine can support the following commonly used join query:

```
SELECT * FROM t_order o INNER JOIN t_order_item i ON o.order_id = i.order_id WHERE o.order_id = 1;
```

```
SELECT * FROM t_order o INNER JOIN t_user u ON o.user_id = u.user_id WHERE o.user_id = 1;
```

```
SELECT * FROM t_order o LEFT JOIN t_user_role r ON o.user_id = r.user_id WHERE o.user_id = 1;
```

```
SELECT * FROM t_order_item i LEFT JOIN t_user u ON i.user_id = u.user_id WHERE i.user_id = 1;
```

```
SELECT * FROM t_order_item i RIGHT JOIN t_user_role r ON i.user_id = r.user_id WHERE i.user_id = 1;
```

```
SELECT * FROM t_user u RIGHT JOIN t_user_role r ON u.user_id = r.user_id WHERE u.user_id = 1;
```

### Unsupported

CASE WHEN can not support as following:

- CASE WHEN containing sub-query
- CASE WHEN containing logical-table (instead of table alias)

### SQL Example

Stable supported SQL	Necessary conditions
SELECT * FROM tbl_name	
SELECT * FROM tbl_name WHERE (col1 = ? or col2 = ?) and col3 = ?	
SELECT * FROM tbl_name WHERE col1 = ? ORDER BY col2 DESC LIMIT ?	
SELECT COUNT(*), SUM(col1), MIN(col1), MAX(col1), AVG(col1) FROM tbl_name WHERE col1 = ?	
SELECT COUNT(col1) FROM tbl_name WHERE col2 = ? GROUP BY col1 ORDER BY col3 DESC LIMIT ?, ?	
SELECT DISTINCT * FROM tbl_name WHERE col1 = ?	
SELECT COUNT(DISTINCT col1), SUM(DISTINCT col1) FROM tbl_name	
(SELECT * FROM tbl_name)	
SELECT * FROM (SELECT * FROM tbl_name WHERE col1 = ?) o WHERE o.col1 = ?	Subquery and outer query in same sharded data node after route
INSERT INTO tbl_name (col1, col2, ...) VALUES (?, ?, ...)	
INSERT INTO tbl_name VALUES (?, ?, ...)	
INSERT INTO tbl_name (col1, col2, ...) VALUES(1 + 2, ?, ...)	
INSERT INTO tbl_name (col1, col2, ...) VALUES (?, ?, ...), (?, ?, ...)	
INSERT INTO tbl_name (col1, col2, ...) SELECT col1, col2, ...FROM tbl_name WHERE col3 = ?	Inserted and selected table must be the same or binding tables
REPLACE INTO tbl_name (col1, col2, ...) SELECT col1, col2, ...FROM tbl_name WHERE col3 = ?	Replaced and selected table must be the same or binding tables
UPDATE tbl_name SET col1 = ? WHERE col2 = ?	
DELETE FROM tbl_name WHERE col1 = ?	
CREATE TABLE tbl_name (col1 int, ...)	
ALTER TABLE tbl_name ADD col1 varchar(10)	
DROP TABLE tbl_name	
TRUNCATE TABLE tbl_name	
CREATE INDEX idx_name ON tbl_name	
DROP INDEX idx_name ON tbl_name	
DROP INDEX idx_name	

Experimental supported SQL	Necessary conditions
SELECT * FROM (SELECT * FROM tbl_name) o	
SELECT * FROM (SELECT * FROM tbl_name) o WHERE o.col1 = ?	
SELECT * FROM (SELECT * FROM tbl_name WHERE col1 = ?) o	
SELECT * FROM (SELECT * FROM tbl_name WHERE col1 = ?) o WHERE o.col1 = ?	Subquery and outer query in different sharded data node after route
SELECT (SELECT MAX(col1) FROM tbl_name) a, col2 from tbl_name	
SELECT SUM(DISTINCT col1), SUM(col1) FROM tbl_name	
SELECT col1, SUM(col2) FROM tbl_name GROUP BY col1 HAVING SUM(col2) > ?	
SELECT col1, col2 FROM tbl_name UNION SELECT col1, col2 FROM tbl_name	
SELECT col1, col2 FROM tbl_name UNION ALL SE- LECT col1, col2 FROM tbl_name	

Slow SQL	Reason
SELECT * FROM tbl_name WHERE to_date(create_time, 'yyyy-mm-dd') = ?	Full route because of sharding value in cal- culate expression

Unsupported SQL	Reason	So lution
INSERT INTO tbl_name (col1, col2, ...) SELECT * FROM tbl_name WHERE col3 = ?	SELECT clause does not sup- port *-shorthand and built-in key generator	.
REPLACE INTO tbl_name (col1, col2, ...) SELECT * FROM tbl_name WHERE col3 = ?	SELECT clause does not sup- port *-shorthand and built-in key generator	.
SELECT MAX(tbl_name.col1) FROM tbl_name	Use table name as column owner in function	I nstead of table alias

### Pagination

Totally support pagination queries of MySQL, PostgreSQL and Oracle; partly support SQLServer pagi-  
nation query due to its complexity.

## Pagination Performance

### Performance Bottleneck

Pagination with query offset too high can lead to a low data accessibility, take MySQL as an example:

```
SELECT * FROM t_order ORDER BY id LIMIT 1000000, 10
```

This SQL will make MySQL acquire another 10 records after skipping 1,000,000 records when it is not able to use indexes. Its performance can thus be deduced. In sharding databases and sharding tables (suppose there are two databases), to ensure the data correctness, the SQL will be rewritten as this:

```
SELECT * FROM t_order ORDER BY id LIMIT 0, 1000010
```

It also means taking out all the records prior to the offset and only acquire the last 10 records after ordering. It will further aggravate the performance bottleneck effect when the database is already slow in execution. The reason for that is the former SQL only needs to transmit 10 records to the user end, but now it will transmit  $1,000,010 * 2$  records after the rewrite.

### Optimization of ShardingSphere

ShardingSphere has optimized in two ways.

Firstly, it adopts stream process + merger ordering to avoid excessive memory occupation. SQL rewrite unavoidably occupies extra bandwidth, but it will not lead to sharp increase of memory occupation. Most people may assume that ShardingSphere would upload all the  $1,000,010 * 2$  records to the memory and occupy a large amount of it, which can lead to memory overflow. But each ShardingSphere comparison only acquires current result set record of each shard, since result set records have their own order. The record stored in the memory is only the current position pointed by the cursor in the result set of the shard routed to. For the item to be sorted which has its own order, merger ordering only has the time complexity of  $O(mn(\log m))$ , and the number of shard  $m$  is generally small enough to be considered as  $O(n)$ , with a very low performance consumption.

Secondly, ShardingSphere further optimizes the query that only falls into single shards. Requests of this kind can guarantee the correctness of records without rewriting SQLs. Under this kind of situation, ShardingSphere will not do that in order to save the bandwidth.

### Pagination Solution Optimization

For LIMIT cannot search for data through indexes, if the ID continuity can be guaranteed, pagination by ID is a better solution:

```
SELECT * FROM t_order WHERE id > 100000 AND id <= 100010 ORDER BY id
```

Or use the ID of last record of the former query result to query the next page:



```
SELECT * FROM t_order WHERE id > 100000 LIMIT 10
```

### Pagination Sub-query

Both Oracle and SQLServer pagination need to be processed by sub-query, ShardingSphere supports pagination related sub-query.

- Oracle

Support rownum pagination:

```
SELECT * FROM (SELECT row_.*, rownum rownum_ FROM (SELECT o.order_id as order_id
FROM t_order o JOIN t_order_item i ON o.order_id = i.order_id) row_ WHERE rownum <=
?) WHERE rownum > ?
```

Do not support rownum + BETWEEN pagination for now.

- SQLServer

Support TOP + ROW\_NUMBER() OVER pagination:

```
SELECT * FROM (SELECT TOP (?) ROW_NUMBER() OVER (ORDER BY o.order_id DESC) AS
rownum, * FROM t_order o) AS temp WHERE temp.rownum > ? ORDER BY temp.order_id
```

Support OFFSET FETCH pagination after SQLServer 2012:

```
SELECT * FROM t_order o ORDER BY id OFFSET ? ROW FETCH NEXT ? ROWS ONLY
```

Do not support WITH xxx AS (SELECT ...) pagination. Because SQLServer automatically generated by Hibernate uses WITH statements, Hibernate SQLServer pagination or two TOP + sub-query pagination is not available now.

- MySQL, PostgreSQL

Both MySQL and PostgreSQL support LIMIT pagination, no need for sub-query:

```
SELECT * FROM t_order o ORDER BY id LIMIT ? OFFSET ?
```

## 4.4 Distributed Transaction

### 4.4.1 Background

Database transactions should satisfy the features of ACID (atomicity, consistency, isolation and durability).

- Atomicity guarantees that each transaction is treated as a single unit, which either succeeds completely, or fails completely;

- Consistency ensures that a transaction can only bring the database from one valid state to another, maintaining database invariants;
- Isolation ensures that concurrent execution of transactions leaves the database in the same state that would have been obtained if the transactions were executed sequentially;
- Durability guarantees that once a transaction has been committed, it will remain committed even in the case of a system failure (e.g., power outage or crash).

In single data node, transactions are only restricted to the access and control of single database resources, called local transactions. Almost all the mature relational databases have provided native support for local transactions. But in distributed application situations based on micro-services, more and more of them require to include multiple accesses to services and the corresponding database resources in the same transaction. As a result, distributed transactions appear.

Though the relational database has provided perfect native ACID support, it can become an obstacle to the system performance under distributed situations. How to make databases satisfy ACID features under distributed situations or find a corresponding substitute solution, is the priority work of distributed transactions.

### **Local Transaction**

It means let each data node to manage their own transactions on the premise that any distributed transaction manager is not on. They do not have any coordination and communication ability, or know other data nodes have succeeded or not. Though without any consumption in performance, local transactions are not capable enough in high consistency and eventual consistency.

### **2PC Transaction**

The earliest distributed transaction model of XA standard is X/Open Distributed Transaction Processing (DTP) model brought up by X/Open, XA for short.

Distributed transaction based on XA standard has little intrusion to businesses. Its biggest advantage is the transparency to users, who can use distributed transactions based on XA standard just as local transactions. XA standard can strictly guarantee ACID features of transactions.

That guarantee can be a double-edged sword. It is more proper in the implementation of short transactions with fixed time, because it will lock all the resources needed during the implementation process. For long transactions, data monopolization during its implementation will lead to an obvious concurrency performance recession for business systems depend on hot spot data. Therefore, in high concurrency situations that take performance as the highest, distributed transaction based on XA standard is not the best choice.

## BASE Transaction

If we call transactions that satisfy ACID features as hard transactions, then transactions based on BASE features are called soft transactions. BASE is the abbreviation of basically available, soft state and eventually consistent those three factors.

- Basically available feature means not all the participants of distributed transactions have to be online at the same time.
- Soft state feature permits some time delay in system renewal, which may not be noticed by users.
- Eventually consistent feature of systems is usually guaranteed by message availability.

There is a high requirement for isolation in ACID transactions: all the resources must be locked during the transaction implementation process. The concept of BASE transactions is uplifting mutex operation from resource level to business level through business logic. Broaden the requirement for high consistency to exchange the rise in system throughput.

Highly consistent transactions based on ACID and eventually consistent transactions based on BASE are not silver bullets, and they can only take the most effect in the most appropriate situations. The detailed distinctions between them are illustrated in the following table to help developers to choose technically:

	<i>Local transaction</i>	<i>2PC (3PC) transaction</i>	<i>BASE transaction</i>
Business transformation	None	None	Relevant interface
Consistency	Not support	Support	Eventual consistency
Isolation	Not support	Support	Business-side guarantee
Concurrency performance	No influence	Serious recession	Minor recession
Situation	Inconsistent operation at business side	Short transaction & low concurrency	Long transaction & high concurrency

### 4.4.2 Challenge

For different application situations, developers need to reasonably weight the performance and the function between all kinds of distributed transactions.

Highly consistent transactions do not have totally the same API and functions as soft transactions, and they cannot switch between each other freely and invisibly. The choice between highly consistent transactions and soft transactions as early as development decision-making phase has sharply increased the design and development cost.

Highly consistent transactions based on XA is relatively easy to use, but is not good at dealing with long transaction and high concurrency situation of the Internet. With a high access cost, soft transactions require developers to transform the application and realize resources lock and backward compensation.

### 4.4.3 Goal

The main design goal of the distributed transaction modular of Apache ShardingSphere is to integrate existing mature transaction cases to provide an unified distributed transaction interface for local transactions, 2PC transactions and soft transactions; compensate for the deficiencies of current solutions to provide a one-stop distributed transaction solution.

Source Codes: <https://github.com/apache/shardingsphere/tree/master/shardingsphere-kernel/shardingsphere-transaction>

### 4.4.4 Core Concept

#### Navigation

This chapter mainly introduces the core concepts of distributed transactions, including:

- XA transaction
- BASE transaction

#### XA

2PC transaction submit uses the [DTP Model](#) defined by X/OPEN, in which created AP (Application Program), TM (Transaction Manager) and RM (Resource Manager) can guarantee a high transaction consistency. TM and RM use XA protocol for bidirectional streaming. Compared with traditional local transactions, XA transactions have a prepared phase, where the database cannot only passively receive commands, but also notify the submitter whether the transaction can be accepted. TM can collect all the prepared results of branch transactions before submitting all of them together, which has guaranteed the distributed consistency.

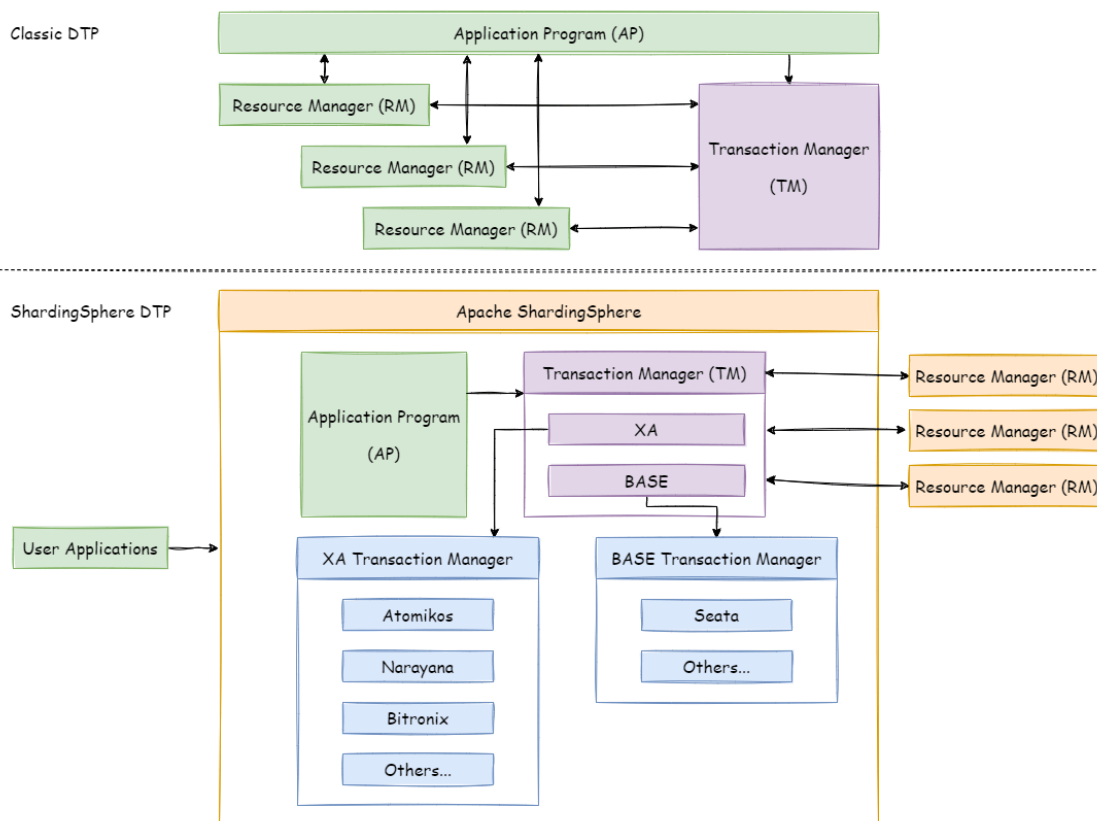

Java implements the XA model through defining a JTA interface, in which Resource Manager requires an XA driver provided by database manufacturers and TransactionManager is provided by transaction manager manufacturers. Traditional transaction managers need to be bound with application server, which poises a high use cost. Built-in transaction managers have already been able to provide services through jar packages. Integrated with Apache ShardingSphere, it can guarantee the high consistency in cross-database transactions after sharding.

Usually, to use XA transaction, users must use its connection pool provided by transaction manager manufacturers. However, when Apache ShardingSphere integrates XA transactions, it has separated the management of XA transaction and its connection pool, so XA will not invade the applications.

### BASE

A paper published in 2008 first mentioned on BASE transaction, it advocates the use of eventual consistency to instead of consistency when improve concurrency of transaction processing.

TCC and Saga are two regular implementations. They use reverse operation implemented by developers themselves to ensure the eventual consistency when data rollback. SEATA implements SQL reverse operation automatically, so that BASE transaction can be used without the intervention of developers.

Apache ShardingSphere integrates SEATA as solution of BASE transaction.

## 4.4.5 Use Norms

### Background

Though Apache ShardingSphere intends to be compatible with all distributed scenario and best performance, under CAP theorem guidance, there is no sliver bullet with distributed transaction solution.

Apache ShardingSphere wants to give the user choice of distributed transaction type and use the most suitable solution in different scenarios.

### Local Transaction

#### Supported

- Support none-cross-database transactions. For example, sharding table or sharding database with its route result in same database;
- Support cross-database transactions caused by logic exceptions. For example, update two databases in transaction with exception thrown, data can rollback in both databases.

#### Unsupported

- Do not support the cross-database transactions caused by network or hardware crash. For example, when update two databases in transaction, if one database crashes before commit, then only the data of the other database can commit.

### XA

#### Supported

- Support Savepoint;
- PostgreSQL/OpenGauss, in the transaction block, the SQL execution is abnormal, then run `Commit`, transactions are automatically rollback;
- Support cross-database transactions after sharding;
- Operation atomicity and high data consistency in 2PC transactions;
- When service is down and restarted, commit and rollback transactions can be recovered automatically;
- Support use XA and non-XA connection pool together.

## Unsupported

- Recover committing and rolling back in other machines after the service is down;
- MySQL, in the transaction block, the SQL execution is abnormal, and run Commit, and data remains consistent.

## XA Transaction managed by XA Statement

- When using XA START to open a XA Transaction, ShardingSphere will pass it to backend database directly, you have to manage this transaction by yourself;
- When recover from a crush, you have to call XA RECOVER to check unfinished transaction, and choose to commit or rollback using xid. Or you can use ONE PHASE commit without PREPARE.

```

MySQL [(none)]> use test1
      |MySQL [(none)]> use test2
Reading table information for completion of table and column names
      |Reading table information for completion of table and column
names
You can turn off this feature to get a quicker startup with -A
      |You can turn off this feature to get a quicker startup with -A
      |
Database changed
      |Database changed
MySQL [test1]> XA START '61c052438d3eb';
      |MySQL [test2]> XA START '61c0524390927';
Query OK, 0 rows affected (0.030 sec)
      |Query OK, 0 rows affected (0.009 sec)
      |
MySQL [test1]> update test set val = 'xatest1' where id = 1;
      |MySQL [test2]> update test set val = 'xatest2' where id = 1;
Query OK, 1 row affected (0.077 sec)
      |Query OK, 1 row affected (0.010 sec)
      |
MySQL [test1]> XA END '61c052438d3eb';
      |MySQL [test2]> XA END '61c0524390927';
Query OK, 0 rows affected (0.006 sec)
      |Query OK, 0 rows affected (0.008 sec)
      |
MySQL [test1]> XA PREPARE '61c052438d3eb';
      |MySQL [test2]> XA PREPARE '61c0524390927';
Query OK, 0 rows affected (0.018 sec)
      |Query OK, 0 rows affected (0.011 sec)

```

```

|
MySQL [test1]> XA COMMIT '61c052438d3eb';
|MySQL [test2]> XA COMMIT '61c0524390927';
Query OK, 0 rows affected (0.011 sec)
|Query OK, 0 rows affected (0.018 sec)

|
MySQL [test1]> select * from test where id = 1;
|MySQL [test2]> select * from test where id = 1;
+----+-----+
| id | val      |
+----+-----+
|  1 | xatest1  |
+----+-----+
1 row in set (0.016 sec)
|
+----+-----+
| id | val      |
+----+-----+
|  1 | xatest2  |
+----+-----+
1 row in set (0.129 sec)

MySQL [test1]> XA START '61c05243994c3';
|MySQL [test2]> XA START '61c052439bd7b';
Query OK, 0 rows affected (0.047 sec)
|Query OK, 0 rows affected (0.006 sec)

|
MySQL [test1]> update test set val = 'xarollback' where id = 1;
|MySQL [test2]> update test set val = 'xarollback' where id =
1;
Query OK, 1 row affected (0.175 sec)
|Query OK, 1 row affected (0.008 sec)

|
MySQL [test1]> XA END '61c05243994c3';
|MySQL [test2]> XA END '61c052439bd7b';
Query OK, 0 rows affected (0.007 sec)
|Query OK, 0 rows affected (0.014 sec)

|
MySQL [test1]> XA PREPARE '61c05243994c3';
|MySQL [test2]> XA PREPARE '61c052439bd7b';
Query OK, 0 rows affected (0.013 sec)
|Query OK, 0 rows affected (0.019 sec)

|

```



```

MySQL [test1]> XA ROLLBACK '61c05243994c3';
      |MySQL [test2]> XA ROLLBACK '61c052439bd7b';
Query OK, 0 rows affected (0.010 sec)
      |Query OK, 0 rows affected (0.010 sec)
      |
MySQL [test1]> select * from test where id = 1;
      |MySQL [test2]> select * from test where id = 1;
+----+-----+
| id | val      |
+----+-----+
|  1 | xatest1  |
+----+-----+
1 row in set (0.009 sec)
      |
+----+-----+
| id | val      |
+----+-----+
|  1 | xatest2  |
+----+-----+
1 row in set (0.083 sec)

MySQL [test1]> XA START '61c052438d3eb';
Query OK, 0 rows affected (0.030 sec)

MySQL [test1]> update test set val = 'recover' where id = 1;
Query OK, 1 row affected (0.072 sec)

MySQL [test1]> select * from test where id = 1;
+----+-----+
| id | val      |
+----+-----+
|  1 | recover  |
+----+-----+
1 row in set (0.039 sec)

MySQL [test1]> XA END '61c052438d3eb';
Query OK, 0 rows affected (0.005 sec)

MySQL [test1]> XA PREPARE '61c052438d3eb';
Query OK, 0 rows affected (0.020 sec)

MySQL [test1]> XA RECOVER;
+-----+-----+-----+-----+
| formatID | gtrid_length | bqual_length | data          |
+-----+-----+-----+-----+
|          1 |          13 |           0 | 61c052438d3eb |
+-----+-----+-----+-----+
1 row in set (0.010 sec)

```

```

MySQL [test1]> XA RECOVER CONVERT XID;
+-----+-----+-----+-----+
| formatID | gtrid_length | bqual_length | data |
+-----+-----+-----+-----+
|          1 |           13 |             0 | 0x36316330353234333864336562 |
+-----+-----+-----+-----+
1 row in set (0.011 sec)

MySQL [test1]> XA COMMIT 0x36316330353234333864336562;
Query OK, 0 rows affected (0.029 sec)

MySQL [test1]> XA RECOVER;
Empty set (0.011 sec)

```

## BASE

### Supported

- Support cross-database transactions after sharding;
- Support RC isolation level;
- Rollback transaction according to undo log;
- Support recovery committing transaction automatically after the service is down.

### Unsupported

- Do not support other isolation level except RC.

### To Be Optimized

- SQL parsed twice by Apache ShardingSphere and SEATA.

## 4.5 Readwrite-splitting

### 4.5.1 Background

Database throughput has faced the bottleneck with increasing TPS. For the application with massive concurrence read but less write in the same time, we can divide the database into a primary database and a replica database. The primary database is responsible for the insert, delete and update of transactions, while the replica database is responsible for queries. It can significantly improve the query performance of the whole system by effectively avoiding row locks.

One primary database with multiple replica databases can further enhance processing capacity by distributing queries evenly into multiple data replicas. Multiple primary databases with multiple replica databases can enhance not only throughput but also availability. Therefore, the system can still run normally, even though any database is down or physical disk destroyed.

Different from the sharding that separates data to all nodes according to sharding keys, readwrite-splitting routes read and write separately to primary database and replica databases according to SQL analysis.

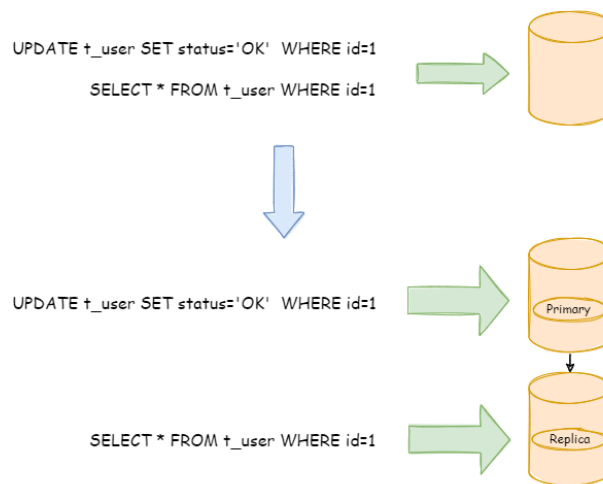

Data in readwrite-splitting nodes are consistent, whereas that in shards is not. The combined use of sharding and readwrite-splitting will effectively enhance the system performance.

### 4.5.2 Challenges

Though readwrite-splitting can enhance system throughput and availability, it also brings inconsistent data, including that among multiple primary databases and among primary databases and replica databases. What's more, it also brings the same problem as data sharding, complicating developer and operator's maintenance and operation. The following diagram has shown the complex topological relations between applications and database groups when sharding used together with readwrite-splitting.

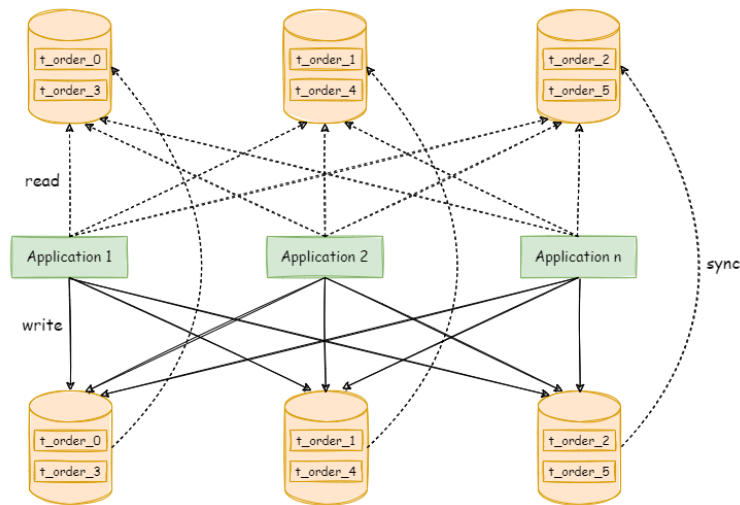

### 4.5.3 Goal

The main design goal of readwrite-splitting of Apache ShardingSphere is to try to reduce the influence of readwrite-splitting, in order to let users use primary-replica database group like one database.

Source Codes: <https://github.com/apache/shardingsphere/tree/master/shardingsphere-features/shardingsphere-readwrite-splitting>

### 4.5.4 Core Concept

#### Primary Database

It refers to the database used in data insertion, update and deletion. It only supports single primary database for now.

## Replica Database

It refers to the database used in data query. It supports multiple replica databases.

## Primary Replica Replication

It refers to the operation to asynchronously replicate data from the primary database to the replica database. Because of the asynchrony of primary-replica synchronization, there may be short-time data inconsistency between them.

## Load Balance Strategy

Through this strategy, queries separated to different replica databases.

### 4.5.5 Use Norms

#### Supported

- Provide the readwrite-splitting configuration of one primary database with multiple replica databases, which can be used alone or with sharding table and database;
- Primary nodes need to be used for both reading and writing in the transaction;
- Forcible primary database route based on SQL Hint;

#### Unsupported

- Data replication between the primary and the replica databases;
- Data inconsistency caused by replication delay between databases;
- Double or multiple primary databases to provide write operation;
- The data for transaction across primary and replica nodes are inconsistent; In the readwrite-splitting model, primary nodes need to be used for both reading and writing in the transaction.

## 4.6 HA

### 4.6.1 Background

High availability is the most basic requirement of modern systems. As the cornerstone of the system, the database is also essential for high availability.

In the distributed database system with storage-compute splitting, the high availability solution of storage node and compute node are different. The stateful storage nodes need to pay attention to data consistency, health detection, primary node election and so on; The stateless compute nodes need to

detect the changes of storage nodes, they also need to set up an independent load balancer and have the ability of service discovery and request distribution.

Apache ShardingSphere provides compute nodes and reuse database as storage nodes. Therefore, the high availability solution it adopts is to use the high availability solution of the database itself as the high availability of the storage node, and detect the changes automatically.

### 4.6.2 Challenges

Apache ShardingSphere needs to detect high availability solution of diversified storage nodes automatically, and can also integrate the readwrite splitting dynamically, which is the main challenge of implementation.

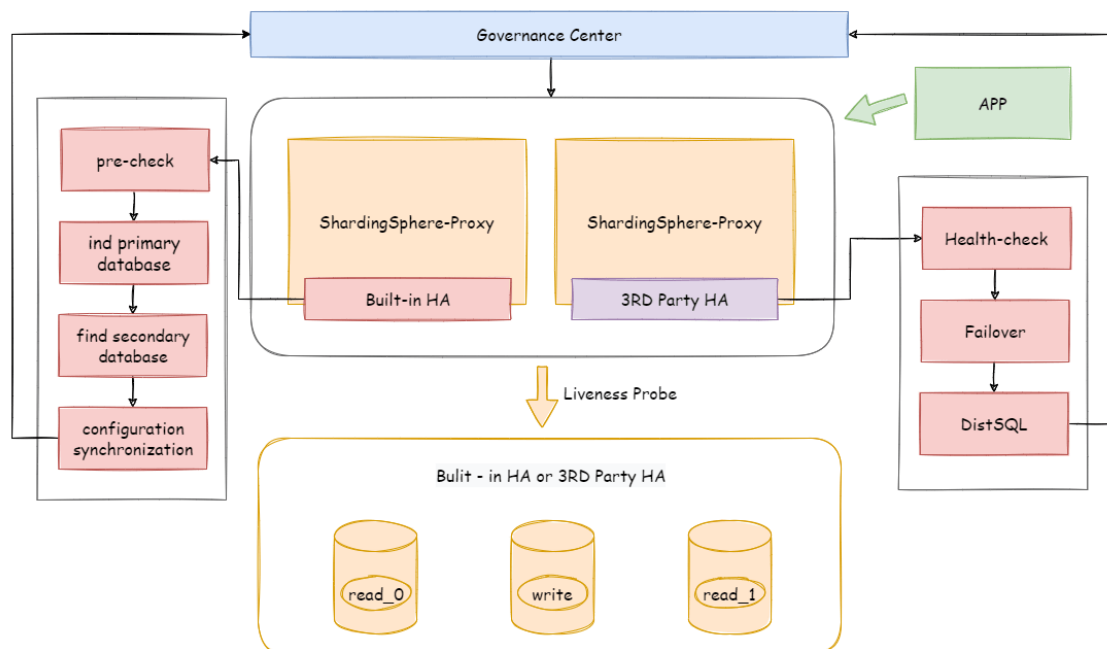

### 4.6.3 Goal

**The main goal of Apache ShardingSphere high availability module which is ensuring 7 \* 24-hour uninterrupted database service as much as possible.**

**Source Codes:** <https://github.com/apache/shardingsphere/tree/master/shardingsphere-features/shardingsphere-db-discovery>

## 4.6.4 Core Concept

### high Availability Type

Apache ShardingSphere does not provide high availability solution of database, it reuses 3rd party high availability solution and auto-detect switch of primary and replica databases. Specifically, the ability of Apache ShardingSphere provided is database discovery, detect the primary and replica databases automatically, and updates the connection of compute nodes to the databases.

### Dynamic Readwrite-Splitting

When high availability and readwrite-splitting are used together, there is unnecessary to configure specific primary and replica databases for readwrite-splitting. Highly available data sources will update the primary and replica databases of readwrite-splitting dynamically, and route the query and update SQL correctly.

## 4.6.5 Use Norms

### Supported

- MySQL MGR single-primary mode.

### Unsupported

- MySQL MGR multi-primary mode.

## 4.7 Scaling

### 4.7.1 Background

There is a problem which how to migrate data from stand-alone database to sharding data nodes safely and simply; For applications which have used Apache ShardingSphere, scale out elastically is a mandatory requirement.

### 4.7.2 Challenges

Apache ShardingSphere provides great flexibility in sharding algorithms, but it gives a great challenge to scaling out. So it's the first challenge that how to find a way can support kinds of sharding algorithms and scale data nodes efficiently.

What's more, During the scaling process, it should not affect the running applications. So It is another big challenge for scaling to reduce the time window of data unavailability during the scaling as much as possible, or even completely unaware.

Finally, scaling should not affect the existing data. How to ensure the availability and correctness of data is the third challenge of scaling.

ShardingSphere-Scaling is a common solution for migrating or scaling data.

### 4.7.3 Goal

**The main design goal of ShardingSphere-Scaling is providing common solution which can support kinds of sharding algorithm and reduce the impact as much as possible during scaling.**

### 4.7.4 Status

ShardingSphere-Scaling since version **4.1.0**. Current status is in **alpha** development.

**Source Codes:** <https://github.com/apache/shardingsphere/tree/master/shardingsphere-kernel/shardingsphere-data-pipeline>

### 4.7.5 Core Concept

#### Scaling Job

It refers one complete process of scaling data from old rule to new rule.

#### Inventory Data

It refers all existing data stored in data nodes before the scaling job started.

#### Incremental Data

It refers the new data generated by application during scaling job.

### 4.7.6 User Norms

#### Supported

- Migrate data outside into databases which managed by Apache ShardingSphere;
- Scale out data between data nodes of Apache ShardingSphere.



## Unsupported

- Scale table without primary key, primary key can not be composite;
- Scale table with composite primary key;
- Do not support scale on in used databases, need to prepare a new database cluster for target.

## 4.8 Encryption

### 4.8.1 Background

Security control has always been a crucial link of data governance, data encryption falls into this category. For both Internet enterprises and traditional sectors, data security has always been a highly valued and sensitive topic. Data encryption refers to transforming some sensitive information through encrypt rules to safely protect the private data. Data involves client's security or business sensibility, such as ID number, phone number, card number, client number and other personal information, requires data encryption according to relevant regulations.

The demand for data encryption is generally divided into two situations in real business scenarios:

1. When the new business start to launch, and the security department stipulates that the sensitive information related to users, such as banks and mobile phone numbers, should be encrypted and stored in the database, and then decrypted when used. Because it is a brand new system, there is no inventory data cleaning problem, so the implementation is relatively simple.
2. For the service has been launched, and plaintext has been stored in the database before. The relevant department suddenly needs to encrypt the data from the on-line business. This scenario generally needs to deal with three issues as followings:
  - How to encrypt the historical data, a.k.a.s data clean.
  - How to encrypt the newly added data and store it in the database without changing the business SQL and logic; then decrypt the taken out data when use it.
  - How to securely, seamlessly and transparently migrate plaintext and ciphertext data between business systems.

### 4.8.2 Challenges

In the real business scenario, the relevant business development team often needs to implement and maintain a set of encryption and decryption system according to the needs of the company's security department. When the encryption scenario changes, the encryption system often faces the risk of reconstruction or modification. In addition, for the online business system, it is relatively complex to realize seamless encryption transformation with transparency, security and low risk without modifying the business logic and SQL.

### 4.8.3 Goal

**Provides a security and transparent data encryption solution, which is the main design goal of Apache ShardingSphere data encryption module.**

**Source Codes:** <https://github.com/apache/shardingsphere/tree/master/shardingsphere-features/shardingsphere-encrypt>

### 4.8.4 Core Concept

#### Logic Column

Column name used to encryption, it is the logical column identification in SQL. It includes cipher column(required), query assistant column(optional) and plain column(optional).

#### Cipher Column

Encrypted data column.

#### Query Assistant Column

Column used to assistant for query. For non-idempotent encryption algorithms with higher security level, irreversible idempotent columns provided for query.

#### Plain Column

Column used to persist plain column, for service provided during data encrypting. Should remove them after data clean.

### 4.8.5 Use Norms

#### Supported

- Encrypt/decrypt one or more columns in the database table;
- Compatible with all regular SQL.

## Unsupported

- Need to process original inventory data before encryption;
- Encrypted fields cannot support case insensitive queries;
- The value of encryption columns cannot support comparison, such as: >, <, ORDER BY, BETWEEN, LIKE, etc;
- The value of encryption columns cannot support calculation, such as AVG, SUM, and calculation expressions.

## 4.9 Shadow DB

### 4.9.1 Background

Under the distributed application architecture based on microservices, business requires multiple services to be completed through a series of services and middleware calls. The pressure testing of a single service can no longer reflect the real scenario.

In the test environment, the cost of rebuild complete set of pressure test environment similar to the production environment is too high. It is usually impossible to simulate the complexity and data of the production environment.

So, it is the better way to use the production environment for pressure test. The test results obtained real capacity and performance of the system accurately.

### 4.9.2 Challenges

pressure testing on production environment is a complex and huge task. Coordination and adjustments between microservices and middlewares required to cope with the transparent transmission of different flow rates and pressure test tags. Usually we will build a complete set of pressure testing platform for different test plans.

Data isolation have to be done at the database-level, in order to ensure the reliability and integrity of the production data, data generated by pressure testing routed to test database. Prevent test data from polluting the real data in the production database.

This requires business applications to perform data classification based on the transparently transmitted pressure test identification before executing SQL, and route the corresponding SQL to the corresponding data source.

### 4.9.3 Goal

\*\*Apache ShardingSphere focuses on data solutions in pressure testing on production environment.

The main goal of the Apache ShardingSphere shadow Database module is routing pressure testing data to user defined database automatically.\*\*

**Source Codes:** <https://github.com/apache/shardingsphere/tree/master/shardingsphere-features/shardingsphere-shadow>

### 4.9.4 Core Concept

#### Production Database

The database used for production data.

#### Shadow Database

The database for pressure testing data isolation.

#### Shadow Algorithm

The shadow algorithms are closely related to business, there are 2 types of shadow algorithms provided.

- Column based shadow algorithm

Recognize data from SQL and route to shadow databases. Suitable for test data driven scenario.

- Hint based shadow algorithm

Recognize comment from SQL and route to shadow databases. Suitable for identify passed by upstream system scenario.

### 4.9.5 Use Norms

#### Supported

- Hint based shadow algorithm support all SQL;
- Column based shadow algorithm support part of SQL.

**Unsupported**

**Hint based shadow algorithm**

- None

**Column based shadow algorithm**

- Does not support DDL;
- Does not support range, group and subquery, for example: BETWEEN, GROUP BY ...HAVING...;

SQL support list:

- INSERT

SQL	Supported
INSERT INTO table (column,...) VALUES (value,...)	Y
INSERT INTO table (column,...) VALUES (value,...),(value,...),...	Y
INSERT INTO table (column,...) SELECT column1 from table1 where column1 = value1	N

- SELECT/UPDATE/DELETE

Condition*	SQL	Supported
=	SELECT/UPDATE/DELETE ... WHERE column = value	Y
LIKE/NOT LIKE	SELECT/UPDATE/DELETE ... WHERE column LIKE/NOT LIKE value	Y
IN/NOT IN	SELECT/UPDATE/DELETE ... WHERE column IN/NOT IN (value1,value2,...)	Y
BETWEEN	SELECT/UPDATE/DELETE ... WHERE column BETWEEN value1 AND value2	N
GROUP BY ...HAVING...	SELECT/UPDATE/DELETE ... WHERE ...GROUP BY column HAVING column > value	N
Subquery	SELECT/UPDATE/DELETE ... WHERE column = (SELECT column FROM table WHERE column = value)	N

## 4.10 Observability

### 4.10.1 Background

In order to grasp the distributed system status, observe running state of the cluster is a new challenge. The point-to-point operation mode of logging in to a specific server cannot suite to large number of distributed servers. Telemetry through observable data is the recommended operation and maintenance mode for them. Tracking, metrics and logging are important ways to obtain observable data of system status.

APM (application performance monitoring) is to monitor and diagnose the performance of the system by collecting, storing and analyzing the observable data of the system. Its main functions include performance index monitoring, call stack analysis, service topology, etc.

Apache ShardingSphere is not responsible for gathering, storing and demonstrating APM data, but provides the necessary information for the APM. In other words, Apache ShardingSphere is only responsible for generating valuable data and submitting it to relevant systems through standard protocols or plug-ins. Tracing is to obtain the tracking information of SQL parsing and SQL execution. Apache ShardingSphere provides support for SkyWalking, Zipkin, Jaeger and OpenTelemetry by default. It also supports users to develop customized components through plug-in.

- Use Zipkin or Jaeger

Just provides correct Zipkin or Jaeger server information in the agent configuration file.

- Use OpenTelemetry

OpenTelemetry was merged by OpenTracing and OpenCensus in 2019. In this way, you only need to fill in the appropriate configuration in the agent configuration file according to [OpenTelemetry SDK Autoconfigure Guide](#).

- Use SkyWalking

Enable the SkyWalking plug-in in configuration file and need to configure the SkyWalking apm-toolkit.

- Use SkyWalking's automatic monitor probe

Cooperating with [Apache SkyWalking](#) team, Apache ShardingSphere team has realized ShardingSphere automatic monitor probe to automatically send performance data to SkyWalking. Note that automatic probe in this way cannot be used together with Apache ShardingSphere plug-in probe.

Metrics used to collect and display statistical indicator of cluster. Apache ShardingSphere supports Prometheus by default.

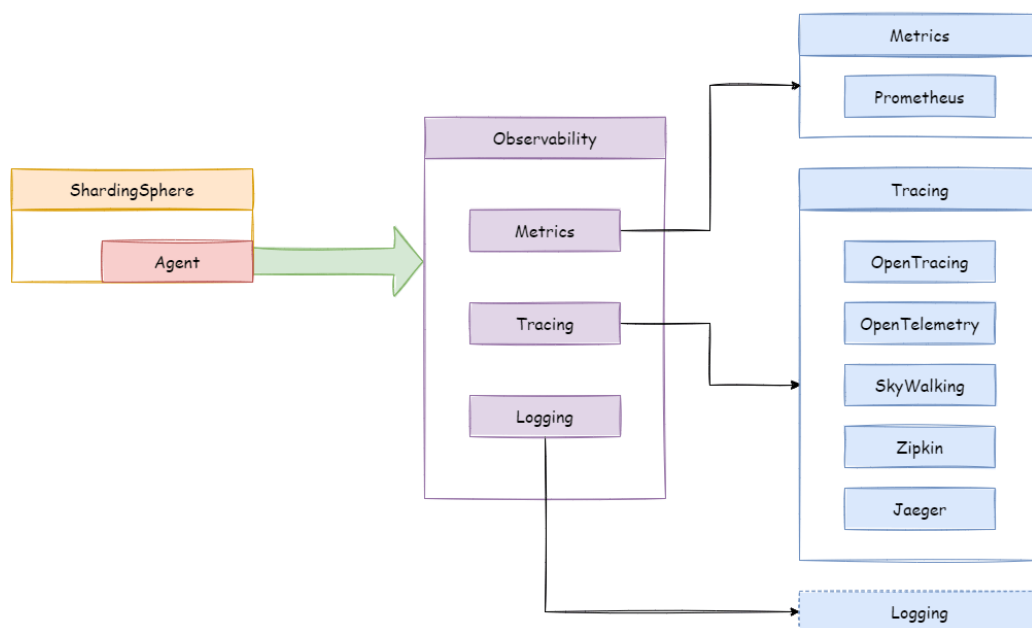

### 4.10.2 Challenges

Tracing and metrics need to collect system information through event tracking. Lots of events tracking make kernel code mess, difficult to maintain, and difficult to customize extend.

### 4.10.3 Goal

**The goal of Apache ShardingSphere observability module is providing as many performance and statistical indicators as possible and isolating kernel code and embedded code.**

**Source Codes:** <https://github.com/apache/shardingsphere/tree/master/shardingsphere-agent>

### 4.10.4 Core Concept

#### Agent

Based on bytecode enhance and plug-in design to provide tracing, metrics and logging features. Enable the plugin in agent to collect data and send data to the integrated 3rd APM system.

## APM

APM is the abbreviation for application performance monitoring. It works for performance diagnosis of distributed systems, including chain demonstration, service topology analysis and so on.

### Tracing

Tracing data between distributed services or internal processes will be collected by agent. It then will be sent to APM system.

### Metrics

System statistical indicator which collected from agent. Write to time series databases periodically. 3rd party UI can display the metrics data simply.

## 4.10.5 Use Norms

### Compile source code

Download Apache ShardingSphere from GitHub,Then compile.

```
git clone --depth 1 https://github.com/apache/shardingsphere.git
cd shardingsphere
mvn clean install -Dmaven.javadoc.skip=true -Dcheckstyle.skip=true -Drat.skip=true
-Djacoco.skip=true -DskipITs -DskipTests -Prelease
```

Output directory: shardingsphere-agent/shardingsphere-agent-distribution/target/apache-shardingsphere-`{latest.release.version}`-shardingsphere-agent-bin.tar.gz

### Agent configuration

- Directory structure

```
Create agent directory, and unzip agent distribution package to the directory. ``shell mkdir agent
tar -zxvf apache-shardingsphere-latest.release.version - shardingsphere - agent - bin.tar.gz -
Cagentcdagenttree. conf agent.yaml logback.xml plugins shardingsphere-
agent - logging - base-{latest.release.version}.jar shardingsphere-agent-
metrics-prometheus-latest.release.version.jar shardingsphere - agent -
tracing - jaeger-{latest.release.version}.jar shardingsphere-agent-tracing-
opentelemetry-latest.release.version.jar shardingsphere - agent - tracing -
opentracing-{latest.release.version}.jar shardingsphere-agent-tracing-zipkin-
{latest.release.version}.jar shardingsphere-agent.jar
```

\* Configuration file

agent.yaml is a configuration file. The plug-ins include Jaeger, opentracing,



Zipkin, opentelemetry, logging and Prometheus.

Remove the corresponding plug-in in `ignoredPluginNames` to start the plug-in.

```

```yaml
applicationName: shardingsphere-agent
ignoredPluginNames:
  - Jaeger
  - OpenTracing
  - Zipkin
  - OpenTelemetry
  - Logging
  - Prometheus

plugins:
  Prometheus:
    host: "localhost"
    port: 9090
    props:
      JVM_INFORMATION_COLLECTOR_ENABLED : "true"
  Jaeger:
    host: "localhost"
    port: 5775
    props:
      SERVICE_NAME: "shardingsphere-agent"
      JAEGER_SAMPLER_TYPE: "const"
      JAEGER_SAMPLER_PARAM: "1"
  Zipkin:
    host: "localhost"
    port: 9411
    props:
      SERVICE_NAME: "shardingsphere-agent"
      URL_VERSION: "/api/v2/spans"
      SAMPLER_TYPE: "const"
      SAMPLER_PARAM: "1"
  OpenTracing:
    props:
      OPENTRACING_TRACER_CLASS_NAME: "org.apache.skywalking.apm.toolkit.
opentracing.SkywalkingTracer"
  OpenTelemetry:
    props:
      otel.resource.attributes: "service.name=shardingsphere-agent"
      otel.traces.exporter: "zipkin"
  Logging:
    props:
      LEVEL: "INFO"

```

- Parameter description:

Name	Description	Value range	Default value
JVM _IN-FORMATION_COLLECTION_ENABLED	Start JVM collector	true, false	true
SERVICE_NAME	Tracking service name	Custom	shardingsphere-agent
JAEGERSAMPLER_TYPE	Jaeger sampler rate type	const, probabilistic, ratelimiting, remote	const
JAEGERSAMPLER_PARAMETER	Jaeger sampler rate parameter	const:0, 1, probabilistic:0.0 - 1.0, ratelimiting: > 0, Customize the number of acquisitions per second, remote: need to customize the remote service address, JAEGER_SAMPLER_MANAGER_HOST_PORT	1 (const type)
SAMPLER_TYPE	Zipkin sample rate type	const, counting, ratelimiting, boundary	const
SAMPLER_PARAMETER	Zipkin sampling rate parameter	const:0, 1, counting:0.01 - 1.0, ratelimiting: > 0, boundary:0.0001 - 1.0	1 (const type)
otel.resource.attributes	opentelemetry properties	String key value pair (, split)	service.name=shardingsphere-agent
otel.traces.exporter	Tracing exporter	zipkin, jaeger	zipkin
otel.traces.sampler	Open-telemetry sample rate type	always_on, always_off, traceidratio	always_on
otel.traces.sampler.argument	Open-telemetry sample rate parameter	traceidratio: 0.0 - 1.0	1.0

### Used in ShardingSphere-Proxy

- Startup script

Configure the absolute path of shardingsphere-agent.jar to the start.sh startup script of shardingsphere proxy.

```
nohup java ${JAVA_OPTS} ${JAVA_MEM_OPTS} \  
-javaagent:/xxxxx/agent/shardingsphere-agent.jar \  
-classpath ${CLASS_PATH} ${MAIN_CLASS} >> ${STDOUT_FILE} 2>&1 &
```

- Launch plugin

```
bin/start.sh
```

After normal startup, you can view the startup log of the plugin in the shardingsphere proxy log, and you can view the data at the configured address.

This chapter describes how to use projects of Apache ShardingSphere.

## 5.1 ShardingSphere-JDBC

Configuration is the only module in ShardingSphere-JDBC that interacts with application developers, through which developers can quickly and clearly understand the functions provided by ShardingSphere-JDBC.

This chapter is a configuration manual for ShardingSphere-JDBC, which can also be referred to as a dictionary if necessary.

ShardingSphere-JDBC has provided 4 kinds of configuration methods for different situations. By configuration, application developers can flexibly use data sharding, readwrite-splitting, data encryption, shadow database or the combination of them.

Mixed rule configurations are very similar to single rule configuration, except for the differences from single rule to multiple rules.

It should be noted that the superposition between rules are data source and table name related. If the previous rule is data source oriented aggregation, the next rule needs to use the aggregated logical data source name configured by the previous rule when configuring the data source; Similarly, if the previous rule is table oriented aggregation, the next rule needs to use the aggregated logical table name configured by the previous rule when configuring the table.

Please refer to [Example](#) for more details.

### 5.1.1 Java API

#### Overview

Java API is the basic configuration methods in ShardingSphere-JDBC, and other configurations will eventually be transformed into Java API configuration methods.

The Java API is the most complex and flexible configuration method, which is suitable for the scenarios requiring dynamic configuration through programming.

#### Usage

##### Import Maven Dependency

```
<dependency>
  <groupId>org.apache.shardingsphere</groupId>
  <artifactId>shardingsphere-jdbc-core</artifactId>
  <version>${shardingsphere.version}</version>
</dependency>
```

##### Create Data Source

ShardingSphere-JDBC Java API consists of schema name, mode configuration, data source map, rule configurations and properties.

The `ShardingSphereDataSource` created by `ShardingSphereDataSourceFactory` implements the standard JDBC `DataSource` interface.

```
String schemaName = "foo_schema"; // Indicate logic schema name
ModeConfiguration modeConfig = ... // Build mode configuration
Map<String, DataSource> dataSourceMap = ... // Build actual data sources
Collection<RuleConfiguration> ruleConfigs = ... // Build concentrate rule
configurations
Properties props = ... // Build properties
DataSource dataSource = ShardingSphereDataSourceFactory.
createDataSource(schemaName, modeConfig, dataSourceMap, ruleConfigs, props);
```

Please refer to [Mode Configuration](#) for more mode details.

Please refer to [Data Source Configuration](#) for more data source details.

Please refer to [Rules Configuration](#) for more rule details.

## Use Data Source

Developer can choose to use native JDBC or ORM frameworks such as JPA, Hibernate or MyBatis through the DataSource.

Take native JDBC usage as an example:

```
// Create ShardingSphereDataSource
DataSource dataSource = ShardingSphereDataSourceFactory.
createDataSource(schemaName, modeConfig, dataSourceMap, ruleConfigs, props);

String sql = "SELECT i.* FROM t_order o JOIN t_order_item i ON o.order_id=i.order_
id WHERE o.user_id=? AND o.order_id=?";
try (
    Connection conn = dataSource.getConnection();
    PreparedStatement ps = conn.prepareStatement(sql)) {
    ps.setInt(1, 10);
    ps.setInt(2, 1000);
    try (ResultSet rs = preparedStatement.executeQuery()) {
        while(rs.next()) {
            // ...
        }
    }
}
}
```

## Mode Configuration

### Root Configuration

Class name: org.apache.shardingsphere.infra.config.mode.ModeConfiguration

Attributes:

<i>Name*</i>	<i>Data Type</i>	<i>Description</i>	<i>DefaultValue*</i>
type	String	Type of mode configurationValues could be: Memory, Standalone, Cluster	Memory
repository	PersistRepositoryConfiguration	Persist repository configurationMemory type does not need persist, could be nullStandalone type uses StandalonePersistRepositoryConfigurationCluster type uses ClusterPersistRepositoryConfiguration	
overwrite	boolean	Whether overwrite persistent configuration with local configuration	false

### Standalone Persist Configuration

Class name: org.apache.shardingsphere.mode.repository.standalone.StandalonePersistRepositoryConfiguration

Attributes:

<i>Name</i>	<i>DataType</i>	<i>Description</i>
type	String	Type of persist repository
props	Properties	Properties of persist repository

### Cluster Persist Configuration

Class name: org.apache.shardingsphere.mode.repository.cluster.ClusterPersistRepositoryConfiguration

Attributes:

<i>Name</i>	<i>DataType</i>	<i>Description</i>
type	String	Type of persist repository
namespace	String	Namespace of registry center
serverLists	String	Server lists of registry center
props	Properties	Properties of persist repository

Please refer to [Builtin Persist Repository List](#) for more details about type of repository.

## Data Source

ShardingSphere-JDBC Supports all JDBC drivers and database connection pools.

## Example

In this example, the database driver is MySQL, and connection pool is HikariCP, which can be replaced with other database drivers and connection pools. When using ShardingSphere JDBC, the property name of the JDBC pool depends on the definition of the respective JDBC pool, and is not defined by ShardingSphere. For related processing, please refer to the class `org.apache.shardingsphere.infra.datasource.pool.creator.DataSourcePoolCreator`.

```
Map<String, DataSource> dataSourceMap = new HashMap<>();

// Configure the 1st data source
HikariDataSource dataSource1 = new HikariDataSource();
dataSource1.setDriverClassName("com.mysql.jdbc.Driver");
dataSource1.setJdbcUrl("jdbc:mysql://localhost:3306/ds_1");
dataSource1.setUsername("root");
dataSource1.setPassword("");
dataSourceMap.put("ds_1", dataSource1);

// Configure the 2nd data source
HikariDataSource dataSource2 = new HikariDataSource();
dataSource2.setDriverClassName("com.mysql.jdbc.Driver");
dataSource2.setJdbcUrl("jdbc:mysql://localhost:3306/ds_2");
dataSource2.setUsername("root");
dataSource2.setPassword("");
dataSourceMap.put("ds_2", dataSource2);

// Configure other data sources
...
```

## Rules

Rules are pluggable part of Apache ShardingSphere. This chapter is a java rule configuration manual for ShardingSphere-JDBC.



## Sharding

### Root Configuration

Class name: org.apache.shardingsphere.sharding.api.config.ShardingRuleConfiguration

Attributes:

Name	Data Type	Description	Default Value
tables (+)	Collection<ShardingTableRuleConfiguration>	Sharding table rules	.
autoTables (+)	Collection<ShardingAutoTableRuleConfiguration>	Sharding automatic table rules	.
bindingTableGroups (*)	Collection<String>	Binding table rules	Empty
broadcastTables (*)	Collection<String>	Broadcast table rules	Empty
defaultDatabaseShardingStrategy (?)	ShardingStrategyConfiguration	Default database sharding strategy	Not sharding
defaultTableShardingStrategy (?)	ShardingStrategyConfiguration	Default table sharding strategy	Not sharding
defaultKeyGenerateStrategy (?)	KeyGeneratorConfiguration	Default key generator	Snowflake
defaultShardingColumn (?)	String	Default sharding column name	None
shardingAlgorithms (+)	Map<String, ShardingSphereAlgorithmConfiguration>	Sharding algorithm name and configurations	None
keyGenerators (?)	Map<String, ShardingSphereAlgorithmConfiguration>	Key generate algorithm name and configurations	None

### Sharding Table Configuration

Class name: org.apache.shardingsphere.sharding.api.config.ShardingTableRuleConfiguration

Attributes:

Name*	Data Type	Description	Default Value
logicTable	String	Name of sharding logic table	.
actualDataNodes (?)	String	Describe data source names and actual tables, delimiter as point. Multiple data nodes split by comma, support inline expression	Broadcast table or databases sharding only
databaseShardingStrategy (?)	ShardingStrategyConfiguration	Databases sharding strategy	Use default databases sharding strategy
tableShardingStrategy (?)	ShardingStrategyConfiguration	Tables sharding strategy	Use default tables sharding strategy
keyGeneratorStrategy (?)	KeyGeneratorConfiguration	Key generator configuration	Use default key generator

### Sharding Automatic Table Configuration

Class name: org.apache.shardingsphere.sharding.api.config.ShardingAutoTableRuleConfiguration

Attributes:

Name	Data Type	Description	Default Value
logicTable	String	Name of sharding logic table	.
actualDataSources (?)	String	Data source names. Multiple data nodes split by comma	Use all configured data sources
shardingStrategy (?)	ShardingStrategyConfiguration	Sharding strategy	Use default sharding strategy
keyGenerateStrategy (?)	KeyGeneratorConfiguration	Key generator configuration	Use default key generator

## Sharding Strategy Configuration

### Standard Sharding Strategy Configuration

Class name: org.apache.shardingsphere.sharding.api.config.strategy.sharding.StandardShardingStrategyConfiguration

Attributes:

<i>Name</i>	<i>DataType</i>	<i>Description</i>
shardingColumn	String	Sharding column name
shardingAlgorithmName	String	Sharding algorithm name

### Complex Sharding Strategy Configuration

Class name: org.apache.shardingsphere.sharding.api.config.strategy.sharding.ComplexShardingStrategyConfiguration

Attributes:

<i>Name</i>	<i>DataType</i>	<i>Description</i>
shardingColumns	String	Sharding column name, separated by commas
shardingAlgorithmName	String	Sharding algorithm name

### Hint Sharding Strategy Configuration

Class name: org.apache.shardingsphere.sharding.api.config.strategy.sharding.HintShardingStrategyConfiguration

Attributes:

<i>Name</i>	<i>DataType</i>	<i>Description</i>
shardingAlgorithmName	String	Sharding algorithm name

### None Sharding Strategy Configuration

Class name: org.apache.shardingsphere.sharding.api.config.strategy.sharding.NoneShardingStrategyConfiguration

Attributes: None

Please refer to [Built-in Sharding Algorithm List](#) for more details about type of algorithm.

### Key Generate Strategy Configuration

Class name: org.apache.shardingsphere.sharding.api.config.strategy.keygen.KeyGenerateStrategyConfiguration

Attributes:

<i>Name</i>	<i>DataType</i>	<i>Description</i>
column	String	Column name of key generate
keyGeneratorName	String	key generate algorithm name

Please refer to [Built-in Key Generate Algorithm List](#) for more details about type of algorithm.

### Readwrite-splitting

#### Root Configuration

Class name: org.apache.shardingsphere.readwritesplitting.api.ReadwriteSplittingRuleConfiguration

Attributes:

<i>Name*</i>	<i>DataType</i>	<i>Description</i>
dataSources (+)	Collection<ReadwriteSplittingDataSourceRuleConfiguration>	Data sources of write and reads
loadBalancers (*)	Map<String, ShardingSphereAlgorithmConfiguration>	Load balance algorithm name and configurations of replica data sources

### Readwrite-splitting Data Source Configuration

Class name: org.apache.shardingsphere.readwritesplitting.api.rule.ReadwriteSplittingDataSourceRuleConfiguration

Attributes:

Name	DataType	Description	Default Value
name	String	Readwrite-splitting data source name	.
type	String	Readwrite-splitting type, such as: Static, Dynamic	.
props	Properties	Readwrite-splitting required properties. Static: write-data-source-name, read-data-source-names, Dynamic: auto-aware-data-source-name	.
loadBalancerName (?)	String	Load balance algorithm name of replica sources	Round robin load balance algorithm

Please refer to [Built-in Load Balance Algorithm List](#) for more details about type of algorithm. Please refer to [Use Norms](#) for more details about query consistent routing.

### HA

#### Root Configuration

Class name: org.apache.shardingsphere.dbdiscovery.api.config.DatabaseDiscoveryRuleConfiguration

Attributes:

Name	DataType	Description
dataSources (+)	Collection<DatabaseDiscoveryDataSourceRuleConfiguration>	Data source configuration
discoveryHeartbeats (+)	Map<String, DatabaseDiscoveryHeartBeatConfiguration>	Detect heartbeat configuration
discoveryTypes (+)	Map<String, ShardingSphereAlgorithmConfiguration>	Database discovery type configuration

### Data Source Configuration

Class name: org.apache.shardingsphere.dbdiscovery.api.config.rule.DatabaseDiscoveryDataSourceRuleConfiguration

Attributes:

Name	Data Type	Description	Default Value
groupName (+)	String	Database discovery group name	.
dataSourceNames (+)	Collection<String>	Data source names, multiple data source names separated with comma. Such as: ds_0, ds_1	.
discoverHeartbeatName (+)	String	Detect heartbeat name	.
discoveryTypeName (+)	String	Database discovery type name	.

### Detect Heartbeat Configuration

Class name: org.apache.shardingsphere.dbdiscovery.api.config.rule.DatabaseDiscoveryHeartBeatConfiguration

Attributes:

Name	Data Type	Description	Default Value
props (+)	Properties	Detect heartbeat attribute configuration, keep-alive-cron configuration, cron expression. Such as: '0/5 * * * * ?'	.

### Database Discovery Type Configuration

Class name: org.apache.shardingsphere.infra.config.algorithm.ShardingSphereAlgorithmConfiguration

Attributes:

<i>Name</i>	<i>DataType</i>	<i>Description</i>	<i>Default Value</i>
type (+)	String	Database discovery type, such as: MySQL.MGR	.
props (?)	Properties	Required parameters for high-availability types, such as MGR's group-name	.

## Encryption

### Root Configuration

Class name: org.apache.shardingsphere.encrypt.api.config.EncryptRuleConfiguration

Attributes:

<i>Name</i>	<i>DataType</i>	<i>Description</i>	<i>Default Value</i>
tables (+)	Collection<EncryptTableRuleConfiguration>	Encrypt table rule configurations	
encryptors (+)	Map<String, ShardingSphereAlgorithmConfiguration>	Encrypt algorithm name and configurations	
queryWithCipherColumn (?)	boolean	Whether query with cipher column for data encrypt. User you can use plaintext to query if have	true

### Encrypt Table Rule Configuration

Class name: org.apache.shardingsphere.encrypt.api.config.rule.EncryptTableRuleConfiguration

Attributes:

<i>Name*</i>	<i>DataType</i>	<i>Description</i>
name	String	Table name
columns (+)	Collection <EncryptColumnRuleConfiguration>	Encrypt column rule configurations
queryWithCipherColumn (?)	boolean	The current table whether query with cipher column for data encrypt.

### Encrypt Column Rule Configuration

Class name: org.apache.shardingsphere.encrypt.api.config.rule.EncryptColumnRuleConfiguration

Attributes:

<i>Name</i>	<i>DataType</i>	<i>Description</i>
logicColumn	String	Logic column name
cipherColumn	String	Cipher column name
assistedQueryColumn (?)	String	Assisted query column name
plainColumn (?)	String	Plain column name
encryptorName	String	Encrypt algorithm name

### Encrypt Algorithm Configuration

Class name: org.apache.shardingsphere.infra.config.algorithm.ShardingSphereAlgorithmConfiguration

Attributes:

<i>Name</i>	<i>DataType</i>	<i>Description</i>
name	String	Encrypt algorithm name
type	String	Encrypt algorithm type
properties	Properties	Encrypt algorithm properties

Please refer to [Built-in Encrypt Algorithm List](#) for more details about type of algorithm.



## Shadow DB

### Root Configuration

Class name: org.apache.shardingsphere.shadow.api.config.ShadowRuleConfiguration

Attributes:

Name	DataType	Description	Default Value
dataSources	Map<String, ShadowDataSourceConfiguration>	Shadow data source mapping name and configuration	
tables	Map<String, ShadowTableConfiguration>	Shadow table name and configuration	
defaultShadowAlgorithmName	String	Default shadow algorithm name	
shadowAlgorithms	Map<String, ShardingSphereAlgorithmConfiguration>	Shadow algorithm name and configuration	

### Shadow Data Source Configuration

Class name: org.apache.shardingsphere.shadow.api.config.datasource.ShadowDataSourceConfiguration

Attributes:

Name	DataType	Description
sourceDataSourceName	String	Production data source name
shadowDataSourceName	String	Shadow data source name

### Shadow Table Configuration

Class name: org.apache.shardingsphere.shadow.api.config.table.ShadowTableConfiguration

Attributes:

Name	DataType	Description
dataSourceNames	Collection<String>	Shadow table location shadow data source mapping names
shadowAlgorithmNames	Collection<String>	Shadow table location shadow algorithm names

## Shadow Algorithm Configuration

Please refer to [Built-in Shadow Algorithm List](#).

## SQL Parser

### Root Configuration

Class: org.apache.shardingsphere.parser.config.SQLParserRuleConfiguration

Attributes:

<i>name</i>	<i>DataType</i>	<i>Description</i>
sqlCommentParseEnabled (?)	boolean	Whether to parse SQL comments
parseTreeCache (?)	CacheOption	Parse syntax tree local cache configuration
sqlStatementCache (?)	CacheOption	sql statement local cache configuration

### Cache option Configuration

Class: org.apache.shardingsphere.sql.parser.api.CacheOption

Attributes:

<i>name</i>	<i>DataType</i> *	<i>Description</i>	<i>Default Value</i>
initialCapacity	int	Initial capacity of local cache	parser syntax tree local cache default value 128, SQL statement cache default value 2000
maximumSize (?)	long	Maximum capacity of local cache	The default value of local cache for parsing syntax tree is 1024, and the default value of sql statement cache is 65535

## Mixed Rules

### Configuration Item Explanation

```

/* Data source configuration */
HikariDataSource writeDataSource0 = new HikariDataSource();
writeDataSource0.setDriverClassName("com.mysql.jdbc.Driver");
writeDataSource0.setJdbcUrl("jdbc:mysql://localhost:3306/db0?serverTimezone=UTC&
useSSL=false&useUnicode=true&characterEncoding=UTF-8");
writeDataSource0.setUsername("root");
writeDataSource0.setPassword("");

HikariDataSource writeDataSource1 = new HikariDataSource();
// ...Omit specific configuration.

HikariDataSource read0fwriteDataSource0 = new HikariDataSource();
// ...Omit specific configuration.

HikariDataSource read1fwriteDataSource0 = new HikariDataSource();
// ...Omit specific configuration.

HikariDataSource read0fwriteDataSource1 = new HikariDataSource();
// ...Omit specific configuration.

HikariDataSource read1fwriteDataSource1 = new HikariDataSource();
// ...Omit specific configuration.

Map<String, DataSource> datasourceMaps = new HashMap<>(6);

datasourceMaps.put("write_ds0", writeDataSource0);
datasourceMaps.put("write_ds0_read0", read0fwriteDataSource0);
datasourceMaps.put("write_ds0_read1", read1fwriteDataSource0);

datasourceMaps.put("write_ds1", writeDataSource1);
datasourceMaps.put("write_ds1_read0", read0fwriteDataSource1);
datasourceMaps.put("write_ds1_read1", read1fwriteDataSource1);

/* Sharding rule configuration */
// The enumeration value of `ds_${0..1}` is the name of the logical data source
configured with read-query
ShardingTableRuleConfiguration tOrderRuleConfiguration = new
ShardingTableRuleConfiguration("t_order", "ds_${0..1}.t_order_${[0, 1]}");
tOrderRuleConfiguration.setKeyGenerateStrategy(new
KeyGenerateStrategyConfiguration("order_id", "snowflake"));
tOrderRuleConfiguration.setTableShardingStrategy(new
StandardShardingStrategyConfiguration("order_id", "tOrderInlineShardingAlgorithm
"));
Properties tOrderShardingInlineProps = new Properties();

```

```

tOrderShardingInlineProps.setProperty("algorithm-expression", "t_order_${order_id %
2}");
tOrderRuleConfiguration.getShardingAlgorithms().putIfAbsent(
"tOrderInlineShardingAlgorithm", new ShardingSphereAlgorithmConfiguration("INLINE",
tOrderShardingInlineProps));

ShardingTableRuleConfiguration tOrderItemRuleConfiguration = new
ShardingTableRuleConfiguration("t_order_item", "ds_${0..1}.t_order_item_${[0, 1]}
");
tOrderItemRuleConfiguration.setKeyGenerateStrategy(new
KeyGenerateStrategyConfiguration("order_item_id", "snowflake"));
tOrderRuleConfiguration.setTableShardingStrategy(new
StandardShardingStrategyConfiguration("order_item_id",
"tOrderItemInlineShardingAlgorithm"));
Properties tOrderItemShardingInlineProps = new Properties();
tOrderItemShardingInlineProps.setProperty("algorithm-expression", "t_order_item_${
order_item_id % 2}");
tOrderRuleConfiguration.getShardingAlgorithms().putIfAbsent(
"tOrderItemInlineShardingAlgorithm", new ShardingSphereAlgorithmConfiguration(
"INLINE", tOrderItemShardingInlineProps));

ShardingRuleConfiguration shardingRuleConfiguration = new
ShardingRuleConfiguration();
shardingRuleConfiguration.getTables().add(tOrderRuleConfiguration);
shardingRuleConfiguration.getTables().add(tOrderItemRuleConfiguration);
shardingRuleConfiguration.getBindingTableGroups().add("t_order, t_order_item");
shardingRuleConfiguration.getBroadcastTables().add("t_bank");
// Default database strategy configuration
shardingRuleConfiguration.setDefaultDatabaseShardingStrategy(new
StandardShardingStrategyConfiguration("user_id", "default_db_strategy_inline"));
Properties defaultDatabaseStrategyInlineProps = new Properties();
defaultDatabaseStrategyInlineProps.setProperty("algorithm-expression", "ds_${user_
id % 2}");
shardingRuleConfiguration.getShardingAlgorithms().put("default_db_strategy_inline",
new ShardingSphereAlgorithmConfiguration("INLINE",
defaultDatabaseStrategyInlineProps));

// Key generate algorithm configuration
Properties snowflakeProperties = new Properties();
shardingRuleConfiguration.getKeyGenerators().put("snowflake", new
ShardingSphereAlgorithmConfiguration("SNOWFLAKE", snowflakeProperties));

/* Data encrypt rule configuration */
Properties encryptProperties = new Properties();
encryptProperties.setProperty("aes-key-value", "123456");
EncryptColumnRuleConfiguration columnConfigAes = new
EncryptColumnRuleConfiguration("username", "username", "", "username_plain", "name_
encryptor");

```

```

EncryptColumnRuleConfiguration columnConfigTest = new
EncryptColumnRuleConfiguration("pwd", "pwd", "assisted_query_pwd", "", "pwd_
encryptor");
EncryptTableRuleConfiguration encryptTableRuleConfig = new
EncryptTableRuleConfiguration("t_user", Arrays.asList(columnConfigAes,
columnConfigTest));
// Data encrypt algorithm configuration
Map<String, ShardingSphereAlgorithmConfiguration> encryptAlgorithmConfigs = new
LinkedHashMap<>(2, 1);
encryptAlgorithmConfigs.put("name_encryptor", new
ShardingSphereAlgorithmConfiguration("AES", encryptProperties));
encryptAlgorithmConfigs.put("pwd_encryptor", new
ShardingSphereAlgorithmConfiguration("assistedTest", encryptProperties));
EncryptRuleConfiguration encryptRuleConfiguration = new
EncryptRuleConfiguration(Collections.singleton(encryptTableRuleConfig),
encryptAlgorithmConfigs);

/* Readwrite-splitting rule configuration */
Properties readwriteProps1 = new Properties();
readwriteProps1.setProperty("write-data-source-name", "write_ds0");
readwriteProps1.setProperty("read-data-source-names", "write_ds0_read0, write_ds0_
read1");
ReadwriteSplittingDataSourceRuleConfiguration dataSourceConfiguration1 = new
ReadwriteSplittingDataSourceRuleConfiguration("ds_0", "Static", readwriteProps1,
"roundRobin");
Properties readwriteProps2 = new Properties();
readwriteProps2.setProperty("write-data-source-name", "write_ds0");
readwriteProps2.setProperty("read-data-source-names", "write_ds1_read0, write_ds1_
read1");
ReadwriteSplittingDataSourceRuleConfiguration dataSourceConfiguration2 = new
ReadwriteSplittingDataSourceRuleConfiguration("ds_1", "Static", readwriteProps2,
"roundRobin");

// Load balance algorithm configuration
Map<String, ShardingSphereAlgorithmConfiguration> loadBalanceMaps = new HashMap<>
(1);
loadBalanceMaps.put("roundRobin", new ShardingSphereAlgorithmConfiguration("ROUND_
ROBIN", new Properties()));

ReadwriteSplittingRuleConfiguration readWriteSplittingRuleConfiguration = new
ReadwriteSplittingRuleConfiguration(Arrays.asList(dataSourceConfiguration1,
dataSourceConfiguration2), loadBalanceMaps);

/* Other Properties configuration */
Properties otherProperties = new Properties();
otherProperties.setProperty("sql-show", "true");

/* The variable `shardingDataSource` is the logic data source referenced by other

```

```
frameworks(such as ORM, JPA, etc.) */
DataSource shardingDataSource = ShardingSphereDataSourceFactory.
createDataSource(datasourceMaps, Arrays.asList(shardingRuleConfiguration,
readWriteSplittingRuleConfiguration, encryptRuleConfiguration), otherProperties);
```

## 5.1.2 YAML Configuration

### Overview

YAML configuration provides interaction with ShardingSphere JDBC through configuration files. When used with the governance module together, the configuration of persistence in the configuration center is YAML format.

YAML configuration is the most common configuration mode, which can omit the complexity of programming and simplify user configuration.

### Usage

#### Import Maven Dependency

```
<dependency>
  <groupId>org.apache.shardingsphere</groupId>
  <artifactId>shardingsphere-jdbc-core</artifactId>
  <version>${shardingsphere.version}</version>
</dependency>
```

### YAML Format

ShardingSphere-JDBC YAML file consists of schema name, mode configuration, data source map, rule configurations and properties.

Note: The example connection pool is HikariCP, which can be replaced with other connection pools according to business scenarios.

```
# Alias of the datasource in JDBC.
# Through this parameter to connect, ShardingSphere-JDBC and ShardingSphere-Proxy.
# Default value: logic_db
schemaName (?):

mode:

dataSources:

rules:
- !FOO_XXX
```

```

    ...
- !BAR_XXX
    ...

props:
  key_1: value_1
  key_2: value_2

```

Please refer to [Mode Configuration](#) for more mode details.

Please refer to [Data Source Configuration](#) for more data source details.

Please refer to [Rules Configuration](#) for more rule details.

### Create Data Source

The ShardingSphereDataSource created by YamlShardingSphereDataSourceFactory implements the standard JDBC DataSource interface.

```

File yamlFile = // Indicate YAML file
DataSource dataSource = YamlShardingSphereDataSourceFactory.
createDataSource(yamlFile);

```

### Use Data Source

Same with Java API.

### YAML Syntax Explanation

!! means instantiation of that class

! means self-defined alias

- means one or multiple can be included

[] means array, can substitutable with - each other

### Mode Configuration

#### Configuration Item Explanation

```

mode (?): # Default value is Memory
  type: # Type of mode configuration. Values could be: Memory, Standalone, Cluster
  repository (?): # Persist repository configuration. Memory type does not need
persist
  overwrite: # Whether overwrite persistent configuration with local configuration

```

## Memory Mode

```
mode:
  type: Memory
```

## Standalone Mode

```
mode:
  type: Standalone
  repository:
    type: # Type of persist repository
    props: # Properties of persist repository
      foo_key: foo_value
      bar_key: bar_value
  overwrite: # Whether overwrite persistent configuration with local configuration
```

## Cluster Mode

```
mode:
  type: Cluster
  repository:
    type: # Type of persist repository
    props: # Properties of persist repository
      namespace: # Namespace of registry center
      server-lists: # Server lists of registry center
      foo_key: foo_value
      bar_key: bar_value
  overwrite: # Whether overwrite persistent configuration with local configuration
```

Please refer to [Builtin Persist Repository List](#) for more details about type of repository.

## Data Source

It is divided into single data source configuration and multi data source configuration. ShardingSphere-JDBC Supports all JDBC drivers and database connection pools.

In this example, the database driver is MySQL, and connection pool is HikariCP, which can be replaced with other database drivers and connection pools. When using ShardingSphere JDBC, the property name of the JDBC pool depends on the definition of the respective JDBC pool, and is not defined by ShardingSphere. For related processing, please refer to the class `org.apache.shardingsphere.infra.datasource.pool.creator.DataSourcePoolCreator`. For example, with Alibaba Druid 1.2.9, using `url` instead of `jdbcUrl` in the example below is the expected behavior.



## Configuration Item Explanation

```

dataSources: # Data sources configuration, multiple <data-source-name> available
  <data-source-name>: # Data source name
    dataSourceClassName: # Data source class name
    driverClassName: # Class name of database driver, ref property of connection
pool
  jdbcUrl: # Database URL, ref property of connection pool
  username: # Database username, ref property of connection pool
  password: # Database password, ref property of connection pool
  # ... Other properties for data source pool

```

## Example

```

dataSources:
  ds_1:
    dataSourceClassName: com.zaxxer.hikari.HikariDataSource
    driverClassName: com.mysql.jdbc.Driver
    jdbcUrl: jdbc:mysql://localhost:3306/ds_1
    username: root
    password:
  ds_2:
    dataSourceClassName: com.zaxxer.hikari.HikariDataSource
    driverClassName: com.mysql.jdbc.Driver
    jdbcUrl: jdbc:mysql://localhost:3306/ds_2
    username: root
    password:

# Configure other data sources

```

## Rules

Rules are pluggable part of Apache ShardingSphere. This chapter is a YAML rule configuration manual for ShardingSphere-JDBC.

## Sharding

### Configuration Item Explanation

```

rules:
- !SHARDING
  tables: # Sharding table configuration
    <logic-table-name> (+): # Logic table name
      actualDataNodes (?): # Describe data source names and actual tables (refer to

```

```

Inline syntax rules)
  databaseStrategy (?): # Databases sharding strategy, use default databases
sharding strategy if absent. sharding strategy below can choose only one.
  standard: # For single sharding column scenario
    shardingColumn: # Sharding column name
    shardingAlgorithmName: # Sharding algorithm name
  complex: # For multiple sharding columns scenario
    shardingColumns: # Sharding column names, multiple columns separated with
comma
    shardingAlgorithmName: # Sharding algorithm name
  hint: # Sharding by hint
    shardingAlgorithmName: # Sharding algorithm name
  none: # Do not sharding
  tableStrategy: # Tables sharding strategy, same as database sharding strategy
  keyGenerateStrategy: # Key generator strategy
    column: # Column name of key generator
    keyGeneratorName: # Key generator name
autoTables: # Auto Sharding table configuration
  t_order_auto: # Logic table name
  actualDataSources (?): # Data source names
  shardingStrategy: # Sharding strategy
    standard: # For single sharding column scenario
      shardingColumn: # Sharding column name
      shardingAlgorithmName: # Auto sharding algorithm name
bindingTables (+): # Binding tables
  - <logic_table_name_1, logic_table_name_2, ...>
  - <logic_table_name_1, logic_table_name_2, ...>
broadcastTables (+): # Broadcast tables
  - <table-name>
  - <table-name>
defaultDatabaseStrategy: # Default strategy for database sharding
defaultTableStrategy: # Default strategy for table sharding
defaultKeyGenerateStrategy: # Default Key generator strategy
defaultShardingColumn: # Default sharding column name

# Sharding algorithm configuration
shardingAlgorithms:
  <sharding-algorithm-name> (+): # Sharding algorithm name
    type: # Sharding algorithm type
    props: # Sharding algorithm properties
    # ...

# Key generate algorithm configuration
keyGenerators:
  <key-generate-algorithm-name> (+): # Key generate algorithm name
    type: # Key generate algorithm type
    props: # Key generate algorithm properties
    # ...

```

## Readwrite-splitting

### Configuration Item Explanation

```
rules:
- !READWRITE_SPLITTING
  dataSources:
    <data-source-name> (+): # Logic data source name of readwrite-splitting
      type: # Readwrite-splitting type, such as: Static, Dynamic
      props:
        auto-aware-data-source-name: # Auto aware data source name(Use with
database discovery)
        write-data-source-name: # Write data source name
        read-data-source-names: # Read data source names, multiple data source
names separated with comma
        loadBalancerName: # Load balance algorithm name

# Load balance algorithm configuration
loadBalancers:
  <load-balancer-name> (+): # Load balance algorithm name
    type: # Load balance algorithm type
    props: # Load balance algorithm properties
      # ...
```

Please refer to [Built-in Load Balance Algorithm List](#) for more details about type of algorithm. Please refer to [Use Norms](#) for more details about query consistent routing.

## HA

```
rules:
- !DB_DISCOVERY
  dataSources:
    <data-source-name> (+): # Logic data source name
    dataSourceNames: # Data source names
      - <data-source>
      - <data-source>
    discoveryHeartbeatName: # Detect heartbeat name
    discoveryTypeName: # Database discovery type name

# Heartbeat Configuration
discoveryHeartbeats:
  <discovery-heartbeat-name> (+): # heartbeat name
  props:
    keep-alive-cron: # This is cron expression, such as: '0/5 * * * * ?'

# Database Discovery Configuration
discoveryTypes:
```

```

<discovery-type-name> (+): # Database discovery type name
  type: # Database discovery type, such as: MySQL.MGR
  props (?):
    group-name: 92504d5b-6dec-11e8-91ea-246e9612aaf1 # Required parameters for
database discovery types, such as MGR's group-name

```

## Distributed Transaction

### Configuration Item Explanation

#### LOCAL Model

```

rules:
- !TRANSACTION
  defaultType: LOCAL

```

#### XA Model

```

rules:
- !TRANSACTION
  defaultType: XA
  providerType: Narayana

```

## Encryption

### Configuration Item Explanation

```

rules:
- !ENCRYPT
  tables:
    <table-name> (+): # Encrypt table name
      columns:
        <column-name> (+): # Encrypt logic column name
          cipherColumn: # Cipher column name
          assistedQueryColumn (?): # Assisted query column name
          plainColumn (?): # Plain column name
          encryptorName: # Encrypt algorithm name
          queryWithCipherColumn(?): # The current table whether query with cipher
column for data encrypt.

# Encrypt algorithm configuration
  encryptors:
    <encrypt-algorithm-name> (+): # Encrypt algorithm name
      type: # Encrypt algorithm type
      props: # Encrypt algorithm properties

```

```

# ...

queryWithCipherColumn: # Whether query with cipher column for data encrypt. User
you can use plaintext to query if have

```

Please refer to [Built-in Encrypt Algorithm List](#) for more details about type of algorithm.

## Shadow DB

### Configuration Item Explanation

```

rules:
- !SHADOW
  dataSources:
    shadowDataSource:
      sourceDataSourceName: # Production data source name
      shadowDataSourceName: # Shadow data source name
  tables:
    <table-name>:
      dataSourceNames: # Shadow table location shadow data source names
        - <shadow-data-source>
      shadowAlgorithmNames: # Shadow table location shadow algorithm names
        - <shadow-algorithm-name>
  defaultShadowAlgorithmName: # Default shadow algorithm name
  shadowAlgorithms:
    <shadow-algorithm-name> (+): # Shadow algorithm name
      type: # Shadow algorithm type
      props: # Shadow algorithm property configuration
      # ...

```

## Mixed Rules

The overlay between rule items in a mixed configuration is associated by the data source name and the table name.

If the previous rule is aggregation-oriented, the next rule needs to use the aggregated logical data source name configured by the previous rule when configuring the data source. Similarly, if the previous rule is table aggregation-oriented, the next rule needs to use the aggregated logical table name configured by the previous rule when configuring the table.

## Configuration Item Explanation

```

dataSources: # Configure the real data source name.
  write_ds:
    # ...Omit specific configuration.
  read_ds_0:
    # ...Omit specific configuration.
  read_ds_1:
    # ...Omit specific configuration.

rules:
- !SHARDING # Configure data sharding rules.
  tables:
    t_user:
      actualDataNodes: ds.t_user_${0..1} # Data source name 'ds' uses the logical
data source name of the readwrite-splitting configuration.
      tableStrategy:
        standard:
          shardingColumn: user_id
          shardingAlgorithmName: t_user_inline
      shardingAlgorithms:
        t_user_inline:
          type: INLINE
          props:
            algorithm-expression: t_user_${user_id % 2}

- !ENCRYPT # Configure data encryption rules.
  tables:
    t_user: # Table `t_user` is the name of the logical table that uses the data
sharding configuration.
      columns:
        pwd:
          plainColumn: plain_pwd
          cipherColumn: cipher_pwd
          encryptorName: encryptor_aes
      encryptors:
        encryptor_aes:
          type: aes
          props:
            aes-key-value: 123456abc

- !READWRITE_SPLITTING # Configure readwrite-splitting rules.
  dataSources:
    ds: # The logical data source name 'ds' for readwrite-splitting is used in
data sharding.
      type: Static
      props:
        write-data-source-name: write_ds # Use the real data source name 'write_

```

```
ds'.
    read-data-source-names: read_ds_0, read_ds_1 # Use the real data source
name 'read_ds_0', 'read_ds_1'.
    loadBalancerName: roundRobin
    loadBalancers:
        roundRobin:
            type: ROUND_ROBIN

props:
    sql-show: true
```

## SQL-parser

### Configuration Item Explanation

```
rules:
- !SQL_PARSER
  sqlCommentParseEnabled: # Whether to parse SQL comments
  sqlStatementCache: # SQL statement local cache
    initialCapacity: # Initial capacity of local cache
    maximumSize: # Maximum capacity of local cache
  parseTreeCache: # Parse tree local cache
    initialCapacity: # Initial capacity of local cache
    maximumSize: # Maximum capacity of local cache
```

### 5.1.3 JDBC Driver

#### Overview

ShardingSphere-JDBC provides JDBC driver, it permits user using ShardingSphere by configuration updating only, without any code changes.

#### Usage

#### Import Maven Dependency

```
<dependency>
  <groupId>org.apache.shardingsphere</groupId>
  <artifactId>shardingsphere-jdbc-core</artifactId>
  <version>${shardingsphere.version}</version>
</dependency>
```

## Driver Usage

### Native Driver Usage

```

Class.forName("org.apache.shardingsphere.driver.ShardingSphereDriver"); // Or use
SPI to register database driver
String jdbcUrl = "jdbc:shardingsphere:classpath:config.yaml";

String sql = "SELECT i.* FROM t_order o JOIN t_order_item i ON o.order_id=i.order_
id WHERE o.user_id=? AND o.order_id=?";
try (
    Connection conn = DriverManager.getConnection(jdbcUrl);
    PreparedStatement ps = conn.prepareStatement(sql)) {
    ps.setInt(1, 10);
    ps.setInt(2, 1000);
    try (ResultSet rs = preparedStatement.executeQuery()) {
        while(rs.next()) {
            // ...
        }
    }
}
}

```

### Database Connection Pool Usage

```

String driverClassName = "org.apache.shardingsphere.driver.ShardingSphereDriver";
String jdbcUrl = "jdbc:shardingsphere:classpath:config.yaml";

// Use HikariCP as sample
HikariDataSource dataSource = new HikariDataSource();
dataSource.setDriverClassName(driverClassName);
dataSource.setJdbcUrl(jdbcUrl);

String sql = "SELECT i.* FROM t_order o JOIN t_order_item i ON o.order_id=i.order_
id WHERE o.user_id=? AND o.order_id=?";
try (
    Connection conn = dataSource.getConnection();
    PreparedStatement ps = conn.prepareStatement(sql)) {
    ps.setInt(1, 10);
    ps.setInt(2, 1000);
    try (ResultSet rs = preparedStatement.executeQuery()) {
        while(rs.next()) {
            // ...
        }
    }
}
}

```



## Configuration Explanation

### Driver Class Name

`org.apache.shardingsphere.driver.ShardingSphereDriver`

### URL Configuration Explanation

- Use `jdbc:shardingsphere:` as prefix
- Configuration file: `xxx.yaml`, keep consist format with [YAML Configuration](#)
- Configuration file loading rule:
  - No prefix for loading from absolute path
  - Prefix with `classpath:` for loading from java class path

## 5.1.4 Spring Boot Starter

### Overview

ShardingSphere-JDBC provides official Spring Boot Starter to make convenient for developers to integrate ShardingSphere-JDBC and Spring Boot.

### Usage

#### Import Maven Dependency

```
<dependency>
  <groupId>org.apache.shardingsphere</groupId>
  <artifactId>shardingsphere-jdbc-core-spring-boot-starter</artifactId>
  <version>${shardingsphere.version}</version>
</dependency>
```

### Use ShardingSphere Data Source in Spring

Developer can inject to use native JDBC or ORM frameworks such as JPA, Hibernate or MyBatis through the `DataSource`.

Take native JDBC usage as an example:

```
@Resource
private DataSource dataSource;
```

## Mode Configuration

Default is Memory mode.

### Configuration Item Explanation

```
spring.shardingsphere.mode.type= # Type of mode configuration. Values could be:
Memory, Standalone, Cluster
spring.shardingsphere.mode.repository= # Persist repository configuration. Memory
type does not need persist
spring.shardingsphere.mode.override= # Whether overwrite persistent configuration
with local configuration
```

### Memory Mode

```
spring.shardingsphere.mode.type=Memory
```

### Standalone Mode

```
spring.shardingsphere.mode.type=Standalone
spring.shardingsphere.mode.repository.type= # Type of persist repository
spring.shardingsphere.mode.repository.props.<key>= # Properties of persist
repository
spring.shardingsphere.mode.override= # Whether overwrite persistent configuration
with local configuration
```

### Cluster Mode

```
spring.shardingsphere.mode.type=Cluster
spring.shardingsphere.mode.repository.type= # Type of persist repository
spring.shardingsphere.mode.repository.props.namespace= # Namespace of registry
center
spring.shardingsphere.mode.repository.props.server-lists= # Server lists of
registry center
spring.shardingsphere.mode.repository.props.<key>= # Properties of persist
repository
spring.shardingsphere.mode.override= # Whether overwrite persistent configuration
with local configuration
```

Please refer to [Builtin Persist Repository List](#) for more details about type of repository.

## Data Source

### Use Native Data Source

#### Configuration Item Explanation

```

spring.shardingsphere.datasource.names= # Actual data source name, multiple split
by `,`

# <actual-data-source-name> indicate name of data source name
spring.shardingsphere.datasource.<actual-data-source-name>.type= # Full class name
of database connection pool
spring.shardingsphere.datasource.<actual-data-source-name>.driver-class-name= #
Class name of database driver, ref property of connection pool
spring.shardingsphere.datasource.<actual-data-source-name>.jdbc-url= # Database
URL, ref property of connection pool
spring.shardingsphere.datasource.<actual-data-source-name>.username= # Database
username, ref property of connection pool
spring.shardingsphere.datasource.<actual-data-source-name>.password= # Database
password, ref property of connection pool
spring.shardingsphere.datasource.<actual-data-source-name>.<xxx>= # ... Other
properties for data source pool

```

#### Example

In this example, the database driver is MySQL, and connection pool is HikariCP, which can be replaced with other database drivers and connection pools. When using ShardingSphere JDBC, the property name of the JDBC pool depends on the definition of the respective JDBC pool, and is not defined by ShardingSphere. For related processing, please refer to the class `org.apache.shardingsphere.infra.datasource.pool.creator.DataSourcePoolCreator`. For example, with Alibaba Druid 1.2.9, using `url` instead of `jdbc-url` in the example below is the expected behavior.

```

# Configure actual data sources
spring.shardingsphere.datasource.names=ds1,ds2

# Configure the 1st data source
spring.shardingsphere.datasource.ds1.type=com.zaxxer.hikari.HikariDataSource
spring.shardingsphere.datasource.ds1.driver-class-name=com.mysql.jdbc.Driver
spring.shardingsphere.datasource.ds1.jdbc-url=jdbc:mysql://localhost:3306/ds1
spring.shardingsphere.datasource.ds1.username=root
spring.shardingsphere.datasource.ds1.password=

# Configure the 2nd data source
spring.shardingsphere.datasource.ds2.type=com.zaxxer.hikari.HikariDataSource
spring.shardingsphere.datasource.ds2.driver-class-name=com.mysql.jdbc.Driver

```

```
spring.shardingsphere.datasource.ds2.jdbc-url=jdbc:mysql://localhost:3306/ds2
spring.shardingsphere.datasource.ds2.username=root
spring.shardingsphere.datasource.ds2.password=
```

### Use JNDI Data Source

If developer plan to use ShardingSphere-JDBC in Web Server (such as Tomcat) with JNDI data source, `spring.shardingsphere.datasource.${datasourceName}.jndiName` can be used as an alternative to series of configuration of data source.

### Configuration Item Explanation

```
spring.shardingsphere.datasource.names= # Actual data source name, multiple split
by `,`

# <actual-data-source-name> indicate name of data source name
spring.shardingsphere.datasource.<actual-data-source-name>.jndi-name= # JNDI of
data source
```

### Example

```
# Configure actual data sources
spring.shardingsphere.datasource.names=ds1,ds2

# Configure the 1st data source
spring.shardingsphere.datasource.ds1.jndi-name=java:comp/env/jdbc/ds1
# Configure the 2nd data source
spring.shardingsphere.datasource.ds2.jndi-name=java:comp/env/jdbc/ds2
```

### Rules

Rules are pluggable part of Apache ShardingSphere. This chapter is a Spring Boot Starter rule configuration manual for ShardingSphere-JDBC.

## Sharding

### Configuration Item Explanation

```
spring.shardingsphere.datasource.names= # Omit the data source configuration,
please refer to the usage

# Standard sharding table configuration
spring.shardingsphere.rules.sharding.tables.<table-name>.actual-data-nodes= #
Describe data source names and actual tables, delimiter as point, multiple data
nodes separated with comma, support inline expression. Absent means sharding
databases only.

# Databases sharding strategy, use default databases sharding strategy if absent.
sharding strategy below can choose only one.

# For single sharding column scenario
spring.shardingsphere.rules.sharding.tables.<table-name>.database-strategy.
standard.sharding-column= # Sharding column name
spring.shardingsphere.rules.sharding.tables.<table-name>.database-strategy.
standard.sharding-algorithm-name= # Sharding algorithm name

# For multiple sharding columns scenario
spring.shardingsphere.rules.sharding.tables.<table-name>.database-strategy.complex.
sharding-columns= # Sharding column names, multiple columns separated with comma
spring.shardingsphere.rules.sharding.tables.<table-name>.database-strategy.complex.
sharding-algorithm-name= # Sharding algorithm name

# Sharding by hint
spring.shardingsphere.rules.sharding.tables.<table-name>.database-strategy.hint.
sharding-algorithm-name= # Sharding algorithm name

# Tables sharding strategy, same as database sharding strategy
spring.shardingsphere.rules.sharding.tables.<table-name>.table-strategy.xxx= #
Omitted

# Auto sharding table configuraiton
spring.shardingsphere.rules.sharding.auto-tables.<auto-table-name>.actual-data-
sources= # data source names

spring.shardingsphere.rules.sharding.auto-tables.<auto-table-name>.sharding-
strategy.standard.sharding-column= # Sharding column name
spring.shardingsphere.rules.sharding.auto-tables.<auto-table-name>.sharding-
strategy.standard.sharding-algorithm-name= # Auto sharding algorithm name

# Key generator strategy configuration
spring.shardingsphere.rules.sharding.tables.<table-name>.key-generate-strategy.
column= # Column name of key generator
```

```

spring.shardingsphere.rules.sharding.tables.<table-name>.key-generate-strategy.key-generator-name= # Key generator name

spring.shardingsphere.rules.sharding.binding-tables[0]= # Binding table name
spring.shardingsphere.rules.sharding.binding-tables[1]= # Binding table name
spring.shardingsphere.rules.sharding.binding-tables[x]= # Binding table name

spring.shardingsphere.rules.sharding.broadcast-tables[0]= # Broadcast tables
spring.shardingsphere.rules.sharding.broadcast-tables[1]= # Broadcast tables
spring.shardingsphere.rules.sharding.broadcast-tables[x]= # Broadcast tables

spring.shardingsphere.sharding.default-database-strategy.xxx= # Default strategy for database sharding
spring.shardingsphere.sharding.default-table-strategy.xxx= # Default strategy for table sharding
spring.shardingsphere.sharding.default-key-generate-strategy.xxx= # Default Key generator strategy
spring.shardingsphere.sharding.default-sharding-column= # Default sharding column name

# Sharding algorithm configuration
spring.shardingsphere.rules.sharding.sharding-algorithms.<sharding-algorithm-name>.type= # Sharding algorithm type
spring.shardingsphere.rules.sharding.sharding-algorithms.<sharding-algorithm-name>.props.xxx=# Sharding algorithm properties

# Key generate algorithm configuration
spring.shardingsphere.rules.sharding.key-generators.<key-generate-algorithm-name>.type= # Key generate algorithm type
spring.shardingsphere.rules.sharding.key-generators.<key-generate-algorithm-name>.props.xxx= # Key generate algorithm properties

```

Please refer to [Built-in Sharding Algorithm List](#) and [Built-in Key Generate Algorithm List](#) for more details about type of algorithm.

### Attention

Inline expression identifier can use `${...}` or `$->{...}`, but `${...}` is conflict with spring placeholder of properties, so use `$->{...}` on spring environment is better.

## Readwrite splitting

### Configuration Item Explanation

```

spring.shardingsphere.datasource.names= # Omit the data source configuration,
please refer to the usage

spring.shardingsphere.rules.readwrite-splitting.data-sources.<readwrite-splitting-
data-source-name>.type= # Readwrite-splitting type, such as: Static, Dynamic
spring.shardingsphere.rules.readwrite-splitting.data-sources.<readwrite-splitting-
data-source-name>.props.auto-aware-data-source-name= # Auto aware data source
name(Use with database discovery)
spring.shardingsphere.rules.readwrite-splitting.data-sources.<readwrite-splitting-
data-source-name>.props.write-data-source-name= # Write data source name
spring.shardingsphere.rules.readwrite-splitting.data-sources.<readwrite-splitting-
data-source-name>.props.read-data-source-names= # Read data source names, multiple
data source names separated with comma
spring.shardingsphere.rules.readwrite-splitting.data-sources.<readwrite-splitting-
data-source-name>.load-balancer-name= # Load balance algorithm name

# Load balance algorithm configuration
spring.shardingsphere.rules.readwrite-splitting.load-balancers.<load-balance-
algorithm-name>.type= # Load balance algorithm type
spring.shardingsphere.rules.readwrite-splitting.load-balancers.<load-balance-
algorithm-name>.props.xxx= # Load balance algorithm properties

```

Please refer to [Built-in Load Balance Algorithm List](#) for more details about type of algorithm. Please refer to [Use Norms](#) for more details about query consistent routing.

## HA

### Configuration Item Explanation

```

spring.shardingsphere.datasource.names= # Omit the data source configuration,
please refer to the usage

spring.shardingsphere.rules.database-discovery.data-sources.<database-discovery-
data-source-name>.data-source-names= # Data source names, multiple data source
names separated with comma. Such as: ds_0, ds_1
spring.shardingsphere.rules.database-discovery.data-sources.<database-discovery-
data-source-name>.discovery-heartbeat-name= # Detect heartbeat name
spring.shardingsphere.rules.database-discovery.data-sources.<database-discovery-
data-source-name>.discovery-type-name= # Database discovery type name

spring.shardingsphere.rules.database-discovery.discovery-heartbeats.<discovery-
heartbeat-name>.props.keep-alive-cron= # This is cron expression, such as: '0/5 * *

```

```
* * ?'
```

```
spring.shardingsphere.rules.database-discovery.discovery-types.<discovery-type-name>.type= # Database discovery type, such as: MySQL.MGR
spring.shardingsphere.rules.database-discovery.discovery-types.<discovery-type-name>.props.group-name= # Required parameters for database discovery types, such as MGR's group-name
```

## Encryption

### Configuration Item Explanation

```
spring.shardingsphere.datasource.names= # Omit the data source configuration, please refer to the usage

spring.shardingsphere.rules.encrypt.tables.<table-name>.query-with-cipher-column= # Whether the table uses cipher columns for query
spring.shardingsphere.rules.encrypt.tables.<table-name>.columns.<column-name>.cipher-column= # Cipher column name
spring.shardingsphere.rules.encrypt.tables.<table-name>.columns.<column-name>.assisted-query-column= # Assisted query column name
spring.shardingsphere.rules.encrypt.tables.<table-name>.columns.<column-name>.plain-column= # Plain column name
spring.shardingsphere.rules.encrypt.tables.<table-name>.columns.<column-name>.encryptor-name= # Encrypt algorithm name

# Encrypt algorithm configuration
spring.shardingsphere.rules.encrypt.encryptors.<encrypt-algorithm-name>.type= # Encrypt algorithm type
spring.shardingsphere.rules.encrypt.encryptors.<encrypt-algorithm-name>.props.xxx= # Encrypt algorithm properties

spring.shardingsphere.rules.encrypt.queryWithCipherColumn= # Whether query with cipher column for data encrypt. User you can use plaintext to query if have
```

Please refer to [Built-in Encrypt Algorithm List](#) for more details about type of algorithm.

## Shadow DB

### Configuration Item Explanation

```
spring.shardingsphere.datasource.names= # Omit the data source configuration, please refer to the usage

spring.shardingsphere.rules.shadow.data-sources.shadow-data-source.source-data-
```



```

source-name= # Production data source name
spring.shardingsphere.rules.shadow.data-sources.shadow-data-source.shadow-data-
source-name= # Shadow data source name

spring.shardingsphere.rules.shadow.tables.<table-name>.data-source-names= # Shadow
table location shadow data source names (multiple values are separated by ",")
spring.shardingsphere.rules.shadow.tables.<table-name>.shadow-algorithm-names= #
Shadow table location shadow algorithm names (multiple values are separated by ",")

spring.shardingsphere.rules.shadow.defaultShadowAlgorithmName= # Default shadow
algorithm name, optional item.

spring.shardingsphere.rules.shadow.shadow-algorithms.<shadow-algorithm-name>.type=
# Shadow algorithm type
spring.shardingsphere.rules.shadow.shadow-algorithms.<shadow-algorithm-name>.props.
xxx= # Shadow algorithm property configuration

```

## Mixed Rules

### Configuration Item Explanation

```

# data source configuration
spring.shardingsphere.datasource.names= write-ds0,write-ds1,write-ds0-read0,write-
ds1-read0

spring.shardingsphere.datasource.write-ds0.jdbc-url= # Database URL connection
spring.shardingsphere.datasource.write-ds0.type= # Database connection pool type
name
spring.shardingsphere.datasource.write-ds0.driver-class-name= # Database driver
class name
spring.shardingsphere.datasource.write-ds0.username= # Database username
spring.shardingsphere.datasource.write-ds0.password= # Database password
spring.shardingsphere.datasource.write-ds0.xxx= # Other properties of database
connection pool

spring.shardingsphere.datasource.write-ds1.url= # Database URL connection
# ...Omit specific configuration.

spring.shardingsphere.datasource.write-ds0-read0.url= # Database URL connection
# ...Omit specific configuration.

spring.shardingsphere.datasource.write-ds1-read0.url= # Database URL connection
# ...Omit specific configuration.

# Sharding rules configuration
# Databases sharding strategy

```

```
spring.shardingsphere.rules.sharding.default-database-strategy.standard.sharding-
column=user_id
spring.shardingsphere.rules.sharding.default-database-strategy.standard.sharding-
algorithm-name=default-database-strategy-inline
# Binding table rules configuration ,and multiple groups of binding-tables
configured with arrays
spring.shardingsphere.rules.sharding.binding-tables[0]=t_user,t_user_detail
spring.shardingsphere.rules.sharding.binding-tables[1]= # Binding table names,
multiple table name are separated by commas
spring.shardingsphere.rules.sharding.binding-tables[x]= # Binding table names,
multiple table name are separated by commas
# Broadcast table rules configuration
spring.shardingsphere.rules.sharding.broadcast-tables= # Broadcast table names,
multiple table name are separated by commas

# Table sharding strategy
# The enumeration value of `ds_${0..1}` is the name of the logical data source
configured with readwrite-splitting
spring.shardingsphere.rules.sharding.tables.t_user.actual-data-nodes=ds_${0..1}.
t_user_${0..1}
spring.shardingsphere.rules.sharding.tables.t_user.table-strategy.standard.
sharding-column=user_id
spring.shardingsphere.rules.sharding.tables.t_user.table-strategy.standard.
sharding-algorithm-name=user-table-strategy-inline

# Data encrypt configuration
# Table `t_user` is the name of the logical table that uses for data sharding
configuration.
spring.shardingsphere.rules.encrypt.tables.t_user.columns.username.cipher-
column=username
spring.shardingsphere.rules.encrypt.tables.t_user.columns.username.encryptor-
name=name-encryptor
spring.shardingsphere.rules.encrypt.tables.t_user.columns.pwd.cipher-column=pwd
spring.shardingsphere.rules.encrypt.tables.t_user.columns.pwd.encryptor-name=pwd-
encryptor

# Data encrypt algorithm configuration
spring.shardingsphere.rules.encrypt.encryptors.name-encryptor.type=AES
spring.shardingsphere.rules.encrypt.encryptors.name-encryptor.props.aes-key-
value=123456abc
spring.shardingsphere.rules.encrypt.encryptors.pwd-encryptor.type=AES
spring.shardingsphere.rules.encrypt.encryptors.pwd-encryptor.props.aes-key-
value=123456abc

# Key generate strategy configuration
spring.shardingsphere.rules.sharding.tables.t_user.key-generate-strategy.
column=user_id
spring.shardingsphere.rules.sharding.tables.t_user.key-generate-strategy.key-
```

```

generator-name=snowflake

# Sharding algorithm configuration
spring.shardingsphere.rules.sharding.sharding-algorithms.default-database-strategy-
inline.type=INLINE
# The enumeration value of `ds_${user_id % 2}` is the name of the logical data
source configured with readwrite-splitting
spring.shardingsphere.rules.sharding.sharding-algorithms.default-database-strategy-
inline.algorithm-expression=ds${user_id % 2}
spring.shardingsphere.rules.sharding.sharding-algorithms.user-table-strategy-
inline.type=INLINE
spring.shardingsphere.rules.sharding.sharding-algorithms.user-table-strategy-
inline.algorithm-expression=t_user_${user_id % 2}

# Key generate algorithm configuration
spring.shardingsphere.rules.sharding.key-generators.snowflake.type=SNOWFLAKE

# read query configuration
# ds_0,ds_1 is the logical data source name of the readwrite-splitting
spring.shardingsphere.rules.readwrite-splitting.data-sources.ds_0.type=Static
spring.shardingsphere.rules.readwrite-splitting.data-sources.ds_0.props.write-data-
source-name=write-ds0
spring.shardingsphere.rules.readwrite-splitting.data-sources.ds_0.props.read-data-
source-names=write-ds0-read0
spring.shardingsphere.rules.readwrite-splitting.data-sources.ds_0.load-balancer-
name=read-random
spring.shardingsphere.rules.readwrite-splitting.data-sources.ds_1.type=Static
spring.shardingsphere.rules.readwrite-splitting.data-sources.ds_1.props.write-data-
source-name=write-ds1
spring.shardingsphere.rules.readwrite-splitting.data-sources.ds_1.props.read-data-
source-names=write-ds1-read0
spring.shardingsphere.rules.readwrite-splitting.data-sources.ds_1.load-balancer-
name=read-random

# Load balance algorithm configuration
spring.shardingsphere.rules.readwrite-splitting.load-balancers.read-random.
type=RANDOM

```

## SQL Parser

### Configuration Item Explanation

```

spring.shardingsphere.rules.sql-parser.sql-comment-parse-enabled= # Whether to
parse SQL comments

spring.shardingsphere.rules.sql-parser.sql-statement-cache.initial-capacity= #

```

```
Initial capacity of SQL statement local cache
spring.shardingsphere.rules.sql-parser.sql-statement-cache.maximum-size= # Maximum
capacity of SQL statement local cache

spring.shardingsphere.rules.sql-parser.parse-tree-cache.initial-capacity= # Initial
capacity of parse tree local cache
spring.shardingsphere.rules.sql-parser.parse-tree-cache.maximum-size= # Maximum
local cache capacity of parse tree
```

### 5.1.5 Spring Namespace

#### Overview

ShardingSphere-JDBC provides official Spring Namespace to make convenient for developers to integrate ShardingSphere-JDBC and Spring.

#### Usage

#### Import Maven Dependency

```
<dependency>
  <groupId>org.apache.shardingsphere</groupId>
  <artifactId>shardingsphere-jdbc-core-spring-namespace</artifactId>
  <version>${shardingsphere.version}</version>
</dependency>
```

#### Configure Spring Bean

#### Configuration Item Explanation

Namespace: <http://shardingsphere.apache.org/schema/shardingsphere/datasource/datasource-5.1.2.xsd>

```
<shardingsphere:data-source />
```

Name	Type*	Description
id	Attribute	Spring Bean Id
database-name (?)	Attribute	JDBC data source alias
data-source-names	Attribute	Data source name, multiple data source names are separated by commas
rule-refs	Attribute	Rule name, multiple rule names are separated by commas
mode (?)	Tag	Mode configuration
props (?)	Tag	Properties configuration, Please refer to <a href="#">Properties Configuration</a> for more details

### Example

```
<beans xmlns="http://www.springframework.org/schema/beans"
  xmlns:xsi="http://www.w3.org/2001/XMLSchema-instance"
  xmlns:shardingsphere="http://shardingsphere.apache.org/schema/shardingsphere/datasource"
  xsi:schemaLocation="http://www.springframework.org/schema/beans
    http://www.springframework.org/schema/beans/spring-beans.xsd
    http://shardingsphere.apache.org/schema/shardingsphere/datasource
    http://shardingsphere.apache.org/schema/shardingsphere/datasource/datasource.xsd"
  >
  <shardingsphere:data-source id="ds" database-name="foo_schema" data-source-names="..." rule-refs="...">
    <shardingsphere:mode type="..." />
    <props>
      <prop key="xxx.xxx">${xxx.xxx}</prop>
    </props>
  </shardingsphere:data-source>
</beans>
```

## Use ShardingSphere Data Source in Spring

Same with Spring Boot Starter.

### Mode Configuration

#### Configuration Item Explanation

Namespace: <http://shardingsphere.apache.org/schema/shardingsphere/datasource/datasource-5.1.2.xsd>

```
<shardingsphere:mode />
```

Name	Type	Description	Default Value
type	Attribute	Type of mode configuration. Values could be: Memory, Standalone, Cluster	
repository-ref (?)	Attribute	Persist repository configuration. Memory type does not need persist	
overwrite (?)	Attribute	Whether overwrite persistent configuration with local configuration	false

### Memory Mode

It is the default value.

### Example

```
<?xml version="1.0" encoding="UTF-8"?>
<beans xmlns="http://www.springframework.org/schema/beans"
  xmlns:xsi="http://www.w3.org/2001/XMLSchema-instance"
  xmlns:shardingsphere="http://shardingsphere.apache.org/schema/
shardingsphere/datasource"
  xsi:schemaLocation="http://www.springframework.org/schema/beans
  http://www.springframework.org/schema/beans/spring-
beans.xsd
  http://shardingsphere.apache.org/schema/shardingsphere/
datasource
  http://shardingsphere.apache.org/schema/shardingsphere/
datasource/datasource.xsd">
  <shardingsphere:data-source id="ds" database-name="foo_schema" data-source-
names="..." rule-refs="..." />
</beans>
```

## Standalone Mode

### Configuration Item Explanation

Namespace: <http://shardingsphere.apache.org/schema/shardingsphere/mode-repository/standalone/repository-5.1.2.xsd>

Name	Type	Description
id	Attribute	Name of persist repository bean
type	Attribute	Type of persist repository
props (?)	Tag	Properties of persist repository

### Example

```
<?xml version="1.0" encoding="UTF-8"?>
<beans xmlns="http://www.springframework.org/schema/beans"
  xmlns:xsi="http://www.w3.org/2001/XMLSchema-instance"
  xmlns:shardingsphere="http://shardingsphere.apache.org/schema/
shardingsphere/datasource"
  xmlns:standalone="http://shardingsphere.apache.org/schema/shardingsphere/
mode-repository/standalone"
  xsi:schemaLocation="http://www.springframework.org/schema/beans
  http://www.springframework.org/schema/beans/spring-
beans.xsd
  http://shardingsphere.apache.org/schema/shardingsphere/
datasource
  http://shardingsphere.apache.org/schema/shardingsphere/
datasource/datasource.xsd
  http://shardingsphere.apache.org/schema/shardingsphere/
mode-repository/standalone
  http://shardingsphere.apache.org/schema/shardingsphere/
mode-repository/standalone/repository.xsd">
  <standalone:repository id="standaloneRepository" type="File">
    <props>
      <prop key="path">target</prop>
    </props>
  </standalone:repository>

  <shardingsphere:data-source id="ds" database-name="foo_schema" data-source-
names="..." rule-refs="..." >
    <shardingsphere:mode type="Standalone" repository-ref="standaloneRepository
" overwrite="true" />
  </shardingsphere:data-source>
</beans>
```

## Cluster Mode

### Configuration Item Explanation

Namespace: <http://shardingsphere.apache.org/schema/shardingsphere/mode-repository/cluster/repository-5.1.2.xsd>

Name	Type	Description
id	Attribute	Name of persist repository bean
type	Attribute	Type of persist repository
namespace	Attribute	Namespace of registry center
server-lists	Attribute	Server lists of registry center
props (?)	Tag	Properties of persist repository

### Example

```
<?xml version="1.0" encoding="UTF-8"?>
<beans xmlns="http://www.springframework.org/schema/beans"
  xmlns:xsi="http://www.w3.org/2001/XMLSchema-instance"
  xmlns:shardingsphere="http://shardingsphere.apache.org/schema/
shardingsphere/datasource"
  xmlns:cluster="http://shardingsphere.apache.org/schema/shardingsphere/mode-
repository/cluster"
  xsi:schemaLocation="http://www.springframework.org/schema/beans
  http://www.springframework.org/schema/beans/spring-
beans.xsd
  http://shardingsphere.apache.org/schema/shardingsphere/
datasource
  http://shardingsphere.apache.org/schema/shardingsphere/
datasource/datasource.xsd
  http://shardingsphere.apache.org/schema/shardingsphere/
mode-repository/cluster
  http://shardingsphere.apache.org/schema/shardingsphere/
mode-repository/cluster/repository.xsd">
  <cluster:repository id="clusterRepository" type="Zookeeper" namespace=
"regCenter" server-lists="localhost:3182">
    <props>
      <prop key="max-retries">3</prop>
      <prop key="operation-timeout-milliseconds">1000</prop>
    </props>
  </cluster:repository>

  <shardingsphere:data-source id="ds" database-name="foo_schema" data-source-
names="..." rule-refs="...">
    <shardingsphere:mode type="Cluster" repository-ref="clusterRepository"
overwrite="true" />

```



```
</shardingsphere:data-source>
</beans>
```

Please refer to [Builtin Persist Repository List](#) for more details about type of repository.

## Data Source

Any data source configured as spring bean can be cooperated with spring namespace.

## Example

In this example, the database driver is MySQL, and connection pool is HikariCP, which can be replaced with other database drivers and connection pools. When using ShardingSphere JDBC, the property name of the JDBC pool depends on the definition of the respective JDBC pool, and is not defined by ShardingSphere. For related processing, please refer to the class `org.apache.shardingsphere.infra.datasource.pool.creator.DataSourcePoolCreator`. For example, with Alibaba Druid 1.2.9, using `url` instead of `jdbcUrl` in the example below is the expected behavior.

```
<beans xmlns="http://www.springframework.org/schema/beans"
  xmlns:xsi="http://www.w3.org/2001/XMLSchema-instance"
  xmlns:shardingsphere="http://shardingsphere.apache.org/schema/
shardingsphere/datasource"
  xsi:schemaLocation="http://www.springframework.org/schema/beans
  http://www.springframework.org/schema/beans/spring-
beans.xsd
  http://shardingsphere.apache.org/schema/shardingsphere/
datasource
  http://shardingsphere.apache.org/schema/shardingsphere/
datasource/datasource.xsd
  ">
  <bean id="ds1" class="com.zaxxer.hikari.HikariDataSource" destroy-method="close
">
    <property name="driverClassName" value="com.mysql.jdbc.Driver" />
    <property name="jdbcUrl" value="jdbc:mysql://localhost:3306/ds1" />
    <property name="username" value="root" />
    <property name="password" value="" />
  </bean>

  <bean id="ds2" class="com.zaxxer.hikari.HikariDataSource" destroy-method="close
">
    <property name="driverClassName" value="com.mysql.jdbc.Driver" />
    <property name="jdbcUrl" value="jdbc:mysql://localhost:3306/ds2" />
    <property name="username" value="root" />
    <property name="password" value="" />
  </bean>
```

```
<shardingsphere:data-source id="ds" database-name="foo_schema" data-source-
names="ds1,ds2" rule-refs="..." />
</beans>
```

## Rules

Rules are pluggable part of Apache ShardingSphere. This chapter is a Spring namespace rule configuration manual for ShardingSphere-JDBC.

## Sharding

### Configuration Item Explanation

Namespace: <http://shardingsphere.apache.org/schema/shardingsphere/sharding/sharding-5.1.2.xsd>

```
<sharding:rule />
```

<i>Name</i>	<i>Type</i>	<i>Description</i>
id	A ttribute	Spring Bean Id
table-rules (?)	Tag	Sharding table rule configuration
auto-table-rules (?)	Tag	Automatic sharding table rule configuration
binding-table-rules (?)	Tag	Binding table rule configuration
broadcast-table-rules (?)	Tag	Broadcast table rule configuration
default-database-strategy-ref (?)	A ttribute	Default database strategy name
default-table-strategy-ref (?)	A ttribute	Default table strategy name
default-key-generate-strategy-ref (?)	A ttribute	Default key generate strategy name
default-sharding-column (?)	A ttribute	Default sharding column name

```
<sharding:table-rule />
```

<i>Name</i>	<i>Type</i>	<i>Description</i>
logic-table	Attribute	Logic table name
actual-data-nodes	Attribute	Describe data source names and actual tables, delimiter as point, multiple data nodes separated with comma, support inline expression. Absent means sharding databases only.
actual-data-sources	Attribute	Data source names for auto sharding table
database-strategy-ref	Attribute	Database strategy name for standard sharding table
table-strategy-ref	Attribute	Table strategy name for standard sharding table
sharding-strategy-ref	Attribute	sharding strategy name for auto sharding table
key-generate-strategy-ref	Attribute	Key generate strategy name

<sharding:binding-table-rules />

<i>Name</i>	<i>Type</i>	<i>Description</i>
binding-table-rule (+)	Tag	Binding table rule configuration

<sharding:binding-table-rule />

<i>Name</i>	<i>Type</i>	<i>Description</i>
	• Type*	
logic-tables	Attribute	Binding table name, multiple tables separated with comma

<sharding:broadcast-table-rules />

<i>Name</i>	<i>Type</i>	<i>Description</i>
broadcast-table-rule (+)	Tag	Broadcast table rule configuration

<sharding:broadcast-table-rule />

<i>Name</i>	<i>Type</i>	<i>Description</i>
table	Attribute	Broadcast table name

<sharding:standard-strategy />

<i>Name</i>	<i>Type</i>	<i>Description</i>
id	Attribute	Standard sharding strategy name
sharding-column	Attribute	Sharding column name
algorithm-ref	Attribute	Sharding algorithm name

<sharding:complex-strategy />

<i>Name</i>	<i>Type</i>	<i>Description</i>
id	Attribute	Complex sharding strategy name
sharding-columns	Attribute	Sharding column names, multiple columns separated with comma
algorithm-ref	Attribute	Sharding algorithm name

<sharding:hint-strategy />

<i>Name</i>	<i>Type</i>	<i>Description</i>
id	Attribute	Hint sharding strategy name
algorithm-ref	Attribute	Sharding algorithm name

<sharding:none-strategy />

<i>Name</i>	<i>Type</i>	<i>Description</i>
id	Attribute	Sharding strategy name

<sharding:key-generate-strategy />

<i>Name</i>	<i>Type</i>	<i>Description</i>
id	Attribute	Key generate strategy name
column	Attribute	Key generate column name
algorithm-ref	Attribute	Key generate algorithm name

<sharding:sharding-algorithm />

<i>Name</i>	<i>Type</i>	<i>Description</i>
id	Attribute	Sharding algorithm name
type	Attribute	Sharding algorithm type
props (?)	Tag	Sharding algorithm properties

<sharding:key-generate-algorithm />

Name	Type	Description
id	Attribute	Key generate algorithm name
type	Attribute	Key generate algorithm type
props (?)	Tag	Key generate algorithm properties

Please refer to [Built-in Sharding Algorithm List](#) and [Built-in Key Generate Algorithm List](#) for more details about type of algorithm.

### Attention

Inline expression identifier can use `${...}` or `$->{...}`, but `${...}` is conflict with spring placeholder of properties, so use `$->{...}` on spring environment is better.

### Readwrite-splitting

#### Configuration Item Explanation

Namespace: <http://shardingsphere.apache.org/schema/shardingsphere/readwrite-splitting/readwrite-splitting-5.1.2.xsd>

<readwrite-splitting:rule />

Name	Type	Description
	.	
	Type*	
id	Attribute	Spring Bean Id
data-source-rule (+)	Tag	Readwrite-splitting data source rule configuration

<readwrite-splitting:data-source-rule />

Name	Type	Description
id	Attribute	Readwrite-splitting data source rule name
type	Attribute	Readwrite-splitting type, such as: Static, Dynamic
props	Tag	Readwrite-splitting required properties. Static: write-data-source-name, read-data-source-names, Dynamic: auto-aware-data-source-name
load-balance - algorithm-ref	Attribute	Load balance algorithm name

<readwrite-splitting:load-balance-algorithm />

Name	Type	Description
id	Attribute	Load balance algorithm name
type	Attribute	Load balance algorithm type
props (?)	Tag	Load balance algorithm properties

Please refer to [Built-in Load Balance Algorithm List](#) for more details about type of algorithm. Please refer to [Use Norms](#) for more details about query consistent routing.

## HA

### Configuration Item Explanation

Namespace: <http://shardingsphere.apache.org/schema/shardingsphere/database-discovery/database-discovery-5.1.2.xsd>

<database-discovery:rule />

Name	Type	Description
id	Attribute	Spring Bean Id
data-source-rule (+)	tag	Data source rule configuration
discovery-heartbeat (+)	tag	Detect heartbeat rule configuration

<database-discovery:data-source-rule />

Name	Type	Description
id	Attribute	Data source rule Id
data-source-names	Attribute	Data source names, multiple data source names separated with comma. Such as: ds_0, ds_1
discovery-heartbeat-name	Attribute	Detect heartbeat name
discovery-type-name	Attribute	Database discovery type name

<database-discovery:discovery-heartbeat />

Name	Type*	Description
id	Attribute	Detect heartbeat Id
props	tag	Detect heartbeat attribute configuration, keep-alive-cron configuration, cron expression. Such as: '0/5 * * * * ?'

<database-discovery:discovery-type />

Name	Type*	Description
id	Attribute	Database discovery type Id
type	Attribute	Database discovery type, such as: MySQL.MGR
props (?)	tag	Required parameters for database discovery types, such as MGR's group-name

## Encryption

### Configuration Item Explanation

Namespace: <http://shardingsphere.apache.org/schema/shardingsphere/encrypt/encrypt-5.1.2.xsd>

<encrypt:rule />

Name	Type*	Description	Default Value
id	Attribute	Spring Bean Id	
queryWithCipherColumn (?)	Attribute	Whether query with cipher column for data encrypt. User you can use plaintext to query if have	true
table (+)	Tag	Encrypt table configuration	

<encrypt:table />

Name	Type	Description
name	Attribute	Encrypt table name
column (+)	Tag	Encrypt column configuration
query-with-cipher-column(?)	Attribute	Whether the table query with cipher column for data encrypt. User you can use plain-text to query if have

<encrypt:column />

Name	Type	Description
logic-column	Attribute	Column logic name
cipher-column	Attribute	Cipher column name
assisted-query-column (?)	Attribute	Assisted query column name
plain-column (?)	Attribute	Plain column name
encrypt-algorithm-ref	Attribute	Encrypt algorithm name

<encrypt:encrypt-algorithm />

Name	Type	Description
id	Attribute	Encrypt algorithm name
type	Attribute	Encrypt algorithm type
props (?)	Tag	Encrypt algorithm properties

Please refer to [Built-in Encrypt Algorithm List](#) for more details about type of algorithm.

## Shadow DB

### Configuration Item Explanation

Namespace: <http://shardingsphere.apache.org/schema/shardingsphere/shadow/shadow-5.1.2.xsd>

<shadow:rule />

Name	Type	Description
id	Attribute	Spring Bean Id
data-source(?)	Tag	Shadow data source configuration
default-shadow-algorithm-name(?)	Tag	Default shadow algorithm configuration
shadow-table(?)	Tag	Shadow table configuration

<shadow:data-source />



<i>Name</i>	<i>Type</i>	<i>Description</i>
id	Attribute	Spring Bean Id
source-data-source-name	Attribute	Production data source name
shadow-data-source-name	Attribute	Shadow data source name

<shadow:default-shadow-algorithm-name />

<i>Name</i>	<i>Type</i>	<i>Description</i>
name	Attribute	Default shadow algorithm name

<shadow:shadow-table />

<i>Name</i>	<i>Type</i>	<i>Description</i>
name	Attribute	Shadow table name
data-sources	Attribute	Shadow table location shadow data source names (multiple values are separated by “,” )
algorithm (?)	Tag	Shadow table location shadow algorithm configuration

<shadow:algorithm />

<i>Name</i>	<i>Type</i>	<i>Description</i>
shadow-algorithm-ref	Attribute	Shadow table location shadow algorithm name

<shadow:shadow-algorithm />

<i>Name</i>	<i>Type</i>	<i>Description</i>
id	Attribute	Shadow algorithm name
type	Attribute	Shadow algorithm type
props (?)	Attribute	Shadow algorithm property configuration

## SQL Parser

### Configuration Item Explanation

Namespace: <http://shardingsphere.apache.org/schema/shardingsphere/sql-parser/sql-parser-5.1.2.xsd>

<sql-parser:rule />

Name	Type	Description
id	Attribute	Spring Bean Id
sql-comment-parse-enable	Attribute	Whether to parse SQL comments
parse-tree-cache-ref	Attribute	Parse tree local cache name
sql-statement-cache-ref	Attribute	SQL statement local cache name

<sql-parser:cache-option />

Name	Type	Description
id	Attribute	Local cache configuration item name
initial-capacity	Attribute	Initial capacity of local cache
maximum-size	Attribute	Maximum capacity of local cache

## Mixed Rules

### Configuration Item Explanation

```
<beans xmlns="http://www.springframework.org/schema/beans"
  xmlns:xsi="http://www.w3.org/2001/XMLSchema-instance"
  xmlns:shardingsphere="http://shardingsphere.apache.org/schema/
shardingsphere/datasource"
  xmlns:readwrite-splitting="http://shardingsphere.apache.org/schema/
shardingsphere/readwrite-splitting"
  xmlns:encrypt="http://shardingsphere.apache.org/schema/shardingsphere/
encrypt"
  xsi:schemaLocation="http://www.springframework.org/schema/beans
  http://www.springframework.org/schema/beans/spring-
beans.xsd
  http://shardingsphere.apache.org/schema/shardingsphere/
datasource
  http://shardingsphere.apache.org/schema/shardingsphere/
datasource/datasource.xsd
  http://shardingsphere.apache.org/schema/shardingsphere/
readwrite-splitting
  http://shardingsphere.apache.org/schema/shardingsphere/
readwrite-splitting/readwrite-splitting.xsd
  http://shardingsphere.apache.org/schema/shardingsphere/
encrypt
  http://shardingsphere.apache.org/schema/shardingsphere/
encrypt/encrypt.xsd
  ">
  <bean id="write_ds0" class=" com.zaxxer.hikari.HikariDataSource" init-method=
"init" destroy-method="close">
    <property name="driverClassName" value="com.mysql.jdbc.Driver" />
    <property name="jdbcUrl" value="jdbc:mysql://localhost:3306/write_ds?
```

```

useSSL=false&useUnicode=true&characterEncoding=UTF-8" />
    <property name="username" value="root" />
    <property name="password" value="" />
</bean>

<bean id="read_ds0_0" class=" com.zaxxer.hikari.HikariDataSource" init-method=
"init" destroy-method="close">
    <!-- ...Omit specific configuration. -->
</bean>

<bean id="read_ds0_1" class=" com.zaxxer.hikari.HikariDataSource" init-method=
"init" destroy-method="close">
    <!-- ...Omit specific configuration. -->
</bean>

<bean id="write_ds1" class=" com.zaxxer.hikari.HikariDataSource" init-method=
"init" destroy-method="close">
    <!-- ...Omit specific configuration. -->
</bean>

<bean id="read_ds1_0" class=" com.zaxxer.hikari.HikariDataSource" init-method=
"init" destroy-method="close">
    <!-- ...Omit specific configuration. -->
</bean>

<bean id="read_ds1_1" class=" com.zaxxer.hikari.HikariDataSource" init-method=
"init" destroy-method="close">
    <!-- ...Omit specific configuration. -->
</bean>

<!-- load balance algorithm configuration for readwrite-splitting -->
<readwrite-splitting:load-balance-algorithm id="randomStrategy" type="RANDOM" /
>

<!-- readwrite-splitting rule configuration -->
<readwrite-splitting:rule id="readWriteSplittingRule">
    <readwrite-splitting:data-source-rule id="ds_0" type="Static" load-balance-
algorithm-ref="randomStrategy">
        <props>
            <prop key="write-data-source-name">write_ds0</prop>
            <prop key="read-data-source-names">read_ds0_0, read_ds0_1</prop>
        </props>
    </readwrite-splitting:data-source-rule>
    <readwrite-splitting:data-source-rule id="ds_1" type="Static" load-balance-
algorithm-ref="randomStrategy">
        <props>
            <prop key="write-data-source-name">write_ds1</prop>
            <prop key="read-data-source-names">read_ds1_0, read_ds1_1</prop>

```

```

        </props>
    </readwrite-splitting:data-source-rule>
</readwrite-splitting:rule>

    <!-- sharding strategy configuration -->
    <sharding:standard-strategy id="databaseStrategy" sharding-column="user_id"
algorithm-ref="inlineDatabaseStrategyAlgorithm" />
    <sharding:standard-strategy id="orderTableStrategy" sharding-column="order_id"
algorithm-ref="inlineOrderTableStrategyAlgorithm" />
    <sharding:standard-strategy id="orderItemTableStrategy" sharding-column="order_
item_id" algorithm-ref="inlineOrderItemTableStrategyAlgorithm" />

    <sharding:sharding-algorithm id="inlineDatabaseStrategyAlgorithm" type="INLINE
">
        <props>
            <!-- the expression enumeration is the logical data source name of the
readwrite-splitting configuration -->
            <prop key="algorithm-expression">ds_${user_id % 2}</prop>
        </props>
    </sharding:sharding-algorithm>
    <sharding:sharding-algorithm id="inlineOrderTableStrategyAlgorithm" type=
"INLINE">
        <props>
            <prop key="algorithm-expression">t_order_${order_id % 2}</prop>
        </props>
    </sharding:sharding-algorithm>
    <sharding:sharding-algorithm id="inlineOrderItemTableStrategyAlgorithm" type=
"INLINE">
        <props>
            <prop key="algorithm-expression">t_order_item_${order_item_id % 2}</
prop>
        </props>
    </sharding:sharding-algorithm>

    <!-- sharding rule configuration -->
    <sharding:rule id="shardingRule">
        <sharding:table-rules>
            <!-- the expression 'ds_{0..1}' enumeration is the logical data source
name of the readwrite-splitting configuration -->
            <sharding:table-rule logic-table="t_order" actual-data-nodes="ds_{0..
1}.t_order_${0..1}" database-strategy-ref="databaseStrategy" table-strategy-ref=
"orderTableStrategy" key-generate-strategy-ref="orderKeyGenerator"/>
            <sharding:table-rule logic-table="t_order_item" actual-data-nodes="ds_
{0..1}.t_order_item_${0..1}" database-strategy-ref="databaseStrategy" table-
strategy-ref="orderItemTableStrategy" key-generate-strategy-ref="itemKeyGenerator"/
>
        </sharding:table-rules>
        <sharding:binding-table-rules>

```

```

        <sharding:binding-table-rule logic-tables="t_order, t_order_item"/>
    </sharding:binding-table-rules>
    <sharding:broadcast-table-rules>
        <sharding:broadcast-table-rule table="t_address"/>
    </sharding:broadcast-table-rules>
</sharding:rule>

<!-- data encrypt configuration -->
<encrypt:encrypt-algorithm id="name_encryptor" type="AES">
    <props>
        <prop key="aes-key-value">123456</prop>
    </props>
</encrypt:encrypt-algorithm>
<encrypt:encrypt-algorithm id="pwd_encryptor" type="assistedTest" />

<encrypt:rule id="encryptRule">
    <encrypt:table name="t_user">
        <encrypt:column logic-column="username" cipher-column="username" plain-
column="username_plain" encrypt-algorithm-ref="name_encryptor" />
        <encrypt:column logic-column="pwd" cipher-column="pwd" assisted-query-
column="assisted_query_pwd" encrypt-algorithm-ref="pwd_encryptor" />
    </encrypt:table>
</encrypt:rule>

<!-- datasource configuration -->
<!-- the element data-source-names's value is all of the datasource name -->
<shardingsphere:data-source id="readQueryDataSource" data-source-names="write_
ds0, read_ds0_0, read_ds0_1, write_ds1, read_ds1_0, read_ds1_1"
    rule-refs="readWriteSplittingRule, shardingRule, encryptRule" >
    <props>
        <prop key="sql-show">true</prop>
    </props>
</shardingsphere:data-source>
</beans>

```

### 5.1.6 Properties Configuration

Apache ShardingSphere provides the way of property configuration to configure system level configuration.

**Configuration Item Explanation**

<i>Name</i>	<i>DataType*</i>	<i>Description</i>	<i>DefaultValue*</i>
sql-show (?)	boolean	Whether show SQL or not in log. Print SQL details can help developers debug easier. The log details include: logic SQL, actual SQL and SQL parse result. Enable this property will log into log topic ShardingSphere-SQL, log level is INFO	false
sql-simple (?)	boolean	Whether show SQL details in simple style	false
kernel-executor-size (?)	int	The max thread size of worker group to execute SQL. One ShardingSphereDataSource will use a independent thread pool, it does not share thread pool even different data source in same JVM	infinite
max-connections-per-query (?)	int	Max opened connection size for each query	1
check-table-meta-data-enabled (?)	boolean	Whether validate table meta data consistency when application startup or updated	false
check-duplicate-table-enabled (?)	boolean	Whether validate duplicate table when application startup or updated	false
sql-federation-enabled (?)	boolean	Whether enable SQL federation	false

## 5.1.7 Builtin Algorithm

### Introduction

Apache ShardingSphere allows developers to implement algorithms via SPI; At the same time, Apache ShardingSphere also provides a couple of builtin algorithms for simplify developers.

### Usage

The builtin algorithms are configured by type and props. Type is defined by the algorithm in SPI, and props is used to deliver the customized parameters of the algorithm.

No matter which configuration type is used, the configured algorithm is named and passed to the corresponding rule configuration. This chapter distinguishes and lists all the builtin algorithms of Apache ShardingSphere according to its functions for developers' reference.

### Metadata Repository

#### File Repository

Type: File

Mode: Standalone

Attributes:

<i>Name</i>	<i>Type</i>	<i>Description</i>	<i>Default Value</i>
path	String	Path for metadata persist	.shardingsphere

#### ZooKeeper Repository

Type: ZooKeeper

Mode: Cluster

Attributes:

<i>Name</i>	<i>Type</i>	<i>Description</i>	<i>Default Value</i>
retryIntervalMilliseconds	int	Milliseconds of retry interval	500
maxRetries	int	Max retries of client connection	3
timeToLiveSeconds	int	Seconds of ephemeral data live	60
operationTimeoutMilliseconds	int	Milliseconds of operation timeout	500
digest	String	Password of login	

### Etcd Repository

Type: Etcd

Mode: Cluster

Attributes:

<i>Name</i>	<i>Type</i>	<i>Description</i>	<i>Default Value</i>
timeToLiveSeconds	long	Seconds of ephemeral data live	30
connectionTimeout	long	Seconds of connection timeout	30

### Sharding Algorithm

#### Auto Sharding Algorithm

#### Modulo Sharding Algorithm

Type: MOD

Attributes:

<i>Name</i>	<i>DataType</i>	<i>Description</i>
sharding-count	int	Sharding count

#### Hash Modulo Sharding Algorithm

Type: HASH\_MOD

Attributes:

<i>Name</i>	<i>DataType</i>	<i>Description</i>
sharding-count	int	Sharding count

#### Volume Based Range Sharding Algorithm

Type: VOLUME\_RANGE

Attributes:

<i>Name</i>	<i>DataType</i>	<i>Description</i>
range-lower	long	Range lower bound, throw exception if lower than bound
range-upper	long	Range upper bound, throw exception if upper than bound
sharding-volume	long	Sharding volume



### Boundary Based Range Sharding Algorithm

Type: BOUNDARY\_RANGE

Attributes:

Name	Data Type	Description
sharding-ranges	String	Range of sharding border, multiple boundaries separated by commas

### Auto Interval Sharding Algorithm

Type: AUTO\_INTERVAL

Attributes:

Name	Data Type*	Description
datetime-lower	String	Shard datetime begin boundary, pattern: yyyy-MM-dd HH:mm:ss
datetime-upper	String	Shard datetime end boundary, pattern: yyyy-MM-dd HH:mm:ss
sharding-seconds	long	Max seconds for the data in one shard, allows sharding key timestamp format seconds with time precision, but time precision after seconds is automatically erased

## Standard Sharding Algorithm

Apache ShardingSphere built-in standard sharding algorithm are:

### Inline Sharding Algorithm

With Groovy expressions, `InlineShardingStrategy` provides single-key support for the sharding operation of = and IN in SQL. Simple sharding algorithms can be used through a simple configuration to avoid laborious Java code developments. For example, `t_user_${u_id % 8}` means table `t_user` is divided into 8 tables according to `u_id`, with table names from `t_user_0` to `t_user_7`. Please refer to [Inline Expression](#) for more details.

Type: INLINE

Attributes:

Name	Data Type *	Description	Default Value
algorithm-expression	String	Inline expression sharding algorithm	.
allow-range-query-with-inline-sharding (?)	boolean	Whether range query is allowed. Note: range query will ignore sharding strategy and conduct full routing	false

### Interval Sharding Algorithm

Type: INTERVAL

Attributes:

<i>Name</i>	<i>• DataType*</i>	<i>Description</i>	<i>• DefaultValue*</i>
date time -pat tern	String	Timestamp pattern of sharding value, must can be transformed to Java LocalDateTime. For example: yyyy-MM-dd HH:mm:ss, yyyy-MM-dd or HH:mm:ss etc. But Gy-MM etc. related to java.time.chrono. JapaneseDate are not supported	•
da teti me-l ower	String	Datetime sharding lower boundary, pattern is defined datetime-pattern	•
da teti me-u pper (?)	String	Datetime sharding upper boundary, pattern is defined datetime-pattern	Now
sha rdin g-su ffix -pat tern	String	Suffix pattern of sharding data sources or tables, must can be transformed to Java LocalDateTime, must be consistent with date-time-interval-unit. For example: yyyyMM	•
date time -int erval -am ount (?)	int	Interval of sharding value	1
da teti me-i nter val-unit (?)	String	Unit of sharding value interval, must can be transformed to Java ChronoUnit's Enum value. For example: MONTHS	DAYS

## Complex Sharding Algorithm

### Complex Inline Sharding Algorithm

Please refer to [Inline Expression](#) for more details.

Type: COMPLEX\_INLINE

<i>Name</i>	<i>DataType*</i>	<i>Description</i>	<i>Default Value</i>
sharding-columns (?)	String	sharding column names	.
algorithm-expression	String	Inline expression sharding algorithm	.
allow-range-query-with-inline-sharding (?)	boolean	Whether range query is allowed. Note: range query will ignore sharding strategy and conduct full routing	false

## Hint Sharding Algorithm

### Hint Inline Sharding Algorithm

Please refer to [Inline Expression](#) for more details.

Type: COMPLEX\_INLINE

<i>Name</i>	<i>DataType</i>	<i>Description</i>	<i>Default Value</i>
algorithm-expression	String	Inline expression sharding algorithm	\${value}

## Class Based Sharding Algorithm

Realize custom extension by configuring the sharding strategy type and algorithm class name.

Type: CLASS\_BASED

Attributes:

Name	Data Type	Description
strategy	String	Sharding strategy type, support STANDARD, COMPLEX or HINT (case insensitive)
algorithmClassName	String	Fully qualified name of sharding algorithm

### Key Generate Algorithm

#### Snowflake

Type: SNOWFLAKE

Attributes:

Name	Data Type *	Description	Default Value
max-tolerate-time-difference-milliseconds (?)	long	The max tolerate time for different server's time difference in milliseconds	10 milliseconds
max-vibration-offset (?)	int	The max upper limit value of vibrate number, range [0, 4096). Notice: To use the generated value of this algorithm as sharding value, it is recommended to configure this property. The algorithm generates $key \bmod 2^n$ ( $2^n$ is usually the sharding amount of tables or databases) in different milliseconds and the result is always 0 or 1. To prevent the above sharding problem, it is recommended to configure this property, its value is $(2^n) - 1$	1

## UUID

Type: UUID

Attributes: None

## Load Balance Algorithm

### Round Robin Algorithm

Type: ROUND\_ROBIN

Attributes: None

### Random Algorithm

Type: RANDOM

Attributes: None

### Weight Algorithm

Type: WEIGHT

Attributes:

All read data in use must be configured with weights

<i>Name</i>	<i>Data Type</i>	<i>Description</i>
• (+)	double	The attribute name uses the read database name, and the parameter fills in the weight value corresponding to the read database. The minimum value of the weight parameter range > 0, the total <= Double.MAX_VALUE.

## Encryption Algorithm

### MD5 Encrypt Algorithm

Type: MD5

Attributes: None

### AES Encrypt Algorithm

Type: AES

Attributes:

<i>Name</i>	<i>DataType</i>	<i>Description</i>
aes-key-value	String	AES KEY

### RC4 Encrypt Algorithm

Type: RC4

Attributes:

<i>Name</i>	<i>DataType</i>	<i>Description</i>
rc4-key-value	String	RC4 KEY

### SM3 Encrypt Algorithm

Type: SM3

Attributes:

<i>Name</i>	<i>DataType</i>	<i>Description</i>
sm3-salt	String	SM3 SALT (should be blank or 8 bytes long)

### SM4 Encrypt Algorithm

Type: SM4

Attributes:

<i>Name</i>	<i>DataType</i>	<i>Description</i>
sm4-key	String	SM4 KEY (should be 16 bytes)
sm4-mode	String	SM4 MODE (should be CBC or ECB)
sm4-iv	String	SM4 IV (should be specified on CBC, 16 bytes long)
sm4-padding	String	SM4 PADDING (should be PKCS5Padding or PKCS7Padding, NoPadding excepted)

## Shadow Algorithm

### Column Shadow Algorithm

#### Column Value Match Shadow Algorithm

Type: VALUE\_MATCH

Attributes:

<i>Name</i>	<i>DataType</i>	<i>Description</i>
column	String	Shadow column
operation	String	SQL operation type (INSERT, UPDATE, DELETE, SELECT)
value	String	Shadow column matching value

#### Column Regex Match Shadow Algorithm

Type: REGEX\_MATCH

Attributes:

<i>Name</i>	<i>DataType</i>	<i>Description</i>
column	String	Shadow column
operation	String	SQL operation type (insert, update, delete, select)
regex	String	Shadow column matching regular expression

## Hint Shadow Algorithm

### Simple Hint Shadow Algorithm

Type: SIMPLE\_HINT

Attributes:

Configure at least a set of arbitrary key-value pairs. For example: foo:bar

<i>Name</i>	<i>DataType</i>	<i>Description</i>
foo	String	bar



## 5.1.8 Special API

This chapter will introduce the special API of ShardingSphere-JDBC.

### Sharding

This chapter will introduce the Sharding API of ShardingSphere-JDBC.

### Hint

#### Introduction

Apache ShardingSphere uses ThreadLocal to manage sharding key value or hint route. Users can add sharding values to HintManager, and those values only take effect within the current thread.

Apache ShardingSphere is able to add special comments in SQL to hint route too.

Usage of hint:

- Sharding columns are not in SQL and table definition, but in external business logic.
- Some operations forced to do in the primary database.
- Some operations forced to do in the database chosen by yourself.

### Usage

#### Sharding with Hint

#### Hint Configuration

Hint algorithms require users to implement the interface of `org.apache.shardingsphere.api.sharding.hint.HintShardingAlgorithm`. Apache ShardingSphere will acquire sharding values from HintManager to route.

Take the following configurations for reference:

```
rules:
- !SHARDING
  tables:
    t_order:
      actualDataNodes: demo_ds_${0..1}.t_order_${0..1}
      databaseStrategy:
        hint:
          algorithmClassName: xxx.xxx.xxx.HintXXXAlgorithm
      tableStrategy:
        hint:
```

```

        algorithmClassName: xxx.xxx.xxx.HintXXXAlgorithm
defaultTableStrategy:
  none:
defaultKeyGenerateStrategy:
  type: SNOWFLAKE
  column: order_id

props:
  sql-show: true

```

### Get HintManager

```
HintManager hintManager = HintManager.getInstance();
```

### Add Sharding Value

- Use `hintManager.addDatabaseShardingValue` to add sharding key value of data source.
- Use `hintManager.addTableShardingValue` to add sharding key value of table.

Users can use `hintManager.setDatabaseShardingValue` to add sharding in hint route to some certain sharding database without sharding tables.

### Clean Hint Values

Sharding values are saved in `ThreadLocal`, so it is necessary to use `hintManager.close()` to clean `ThreadLocal`.

**``HintManager`` has implemented ``AutoCloseable``. We recommend to close it automatically with ``try with resource``.**

### Codes:

```

// Sharding database and table with HintManager
String sql = "SELECT * FROM t_order";
try (HintManager hintManager = HintManager.getInstance();
     Connection conn = dataSource.getConnection();
     PreparedStatement preparedStatement = conn.prepareStatement(sql)) {
    hintManager.addDatabaseShardingValue("t_order", 1);
    hintManager.addTableShardingValue("t_order", 2);
    try (ResultSet rs = preparedStatement.executeQuery()) {
        while (rs.next()) {
            // ...
        }
    }
}

```

```

    }
}

// Sharding database and one database route with HintManager
String sql = "SELECT * FROM t_order";
try (HintManager hintManager = HintManager.getInstance();
     Connection conn = dataSource.getConnection();
     PreparedStatement preparedStatement = conn.prepareStatement(sql)) {
    hintManager.setDatabaseShardingValue(3);
    try (ResultSet rs = preparedStatement.executeQuery()) {
        while (rs.next()) {
            // ...
        }
    }
}
}

```

### Primary Route with Hint

#### Use manual programming

##### Get HintManager

Be the same as sharding based on hint.

##### Configure Primary Database Route

- Use `hintManager.setWriteRouteOnly` to configure primary database route.

##### Clean Hint Value

Be the same as data sharding based on hint.

##### Codes:

```

String sql = "SELECT * FROM t_order";
try (HintManager hintManager = HintManager.getInstance();
     Connection conn = dataSource.getConnection();
     PreparedStatement preparedStatement = conn.prepareStatement(sql)) {
    hintManager.setWriteRouteOnly();
    try (ResultSet rs = preparedStatement.executeQuery()) {
        while (rs.next()) {
            // ...
        }
    }
}

```

```
}
}
```

### Use special SQL comments

#### Terms of Use

To use SQL Hint function, users need to set `sqlCommentParseEnabled` to `true`. The comment format only supports `/* */` for now. The content needs to start with `ShardingSphere hint:`, and the attribute name needs to be `writeRouteOnly`.

#### Codes:

```
/* ShardingSphere hint: writeRouteOnly=true */
SELECT * FROM t_order;
```

### Route to the specified database with Hint

#### Use manual programming

#### Get HintManager

Be the same as sharding based on hint.

#### Configure Database Route

- Use `hintManager.setDataSourceName` to configure database route.

#### Codes:

```
String sql = "SELECT * FROM t_order";
try (HintManager hintManager = HintManager.getInstance();
    Connection conn = dataSource.getConnection();
    PreparedStatement preparedStatement = conn.prepareStatement(sql)) {
    hintManager.setDataSourceName("ds_0");
    try (ResultSet rs = preparedStatement.executeQuery()) {
        while (rs.next()) {
            // ...
        }
    }
}
}
```

## Use special SQL comments

### Terms of Use

To use SQL Hint function, users need to set `sqlCommentParseEnabled` to `true`. Currently, only support routing to one data source. The comment format only supports `/* */` for now. The content needs to start with `ShardingSphere hint:`, and the attribute name needs to be `dataSourceName`.

### Codes:

```
/* ShardingSphere hint: dataSourceName=ds_0 */  
SELECT * FROM t_order;
```

### Transaction

Using distributed transaction through Apache ShardingSphere is no different from local transaction. In addition to transparent use of distributed transaction, Apache ShardingSphere can switch distributed transaction types every time the database accesses.

Supported transaction types include local, XA and BASE. It can be set before creating a database connection, and default value can be set when Apache ShardingSphere startup.

### Use Java API

#### Import Maven Dependency

```
<dependency>  
  <groupId>org.apache.shardingsphere</groupId>  
  <artifactId>shardingsphere-jdbc-core</artifactId>  
  <version>${shardingsphere.version}</version>  
</dependency>  
  
<!-- import if using XA transaction -->  
<dependency>  
  <groupId>org.apache.shardingsphere</groupId>  
  <artifactId>shardingsphere-transaction-xa-core</artifactId>  
  <version>${shardingsphere.version}</version>  
</dependency>  
  
<!-- import if using BASE transaction -->  
<dependency>  
  <groupId>org.apache.shardingsphere</groupId>  
  <artifactId>shardingsphere-transaction-base-seata-at</artifactId>  
  <version>${shardingsphere.version}</version>  
</dependency>
```

## Use Distributed Transaction

```

TransactionTypeHolder.set(TransactionType.XA); // Support TransactionType.LOCAL,
TransactionType.XA, TransactionType.BASE
try (Connection conn = dataSource.getConnection()) { // Use
ShardingSphereDataSource
    conn.setAutoCommit(false);
    PreparedStatement ps = conn.prepareStatement("INSERT INTO t_order (user_id,
status) VALUES (?, ?)");
    ps.setObject(1, 1000);
    ps.setObject(2, "init");
    ps.executeUpdate();
    conn.commit();
}

```

## Use Spring Boot Starter

### Import Maven Dependency

```

<dependency>
    <groupId>org.apache.shardingsphere</groupId>
    <artifactId>shardingsphere-jdbc-core-spring-boot-starter</artifactId>
    <version>${shardingsphere.version}</version>
</dependency>

<!-- import if using XA transaction -->
<dependency>
    <groupId>org.apache.shardingsphere</groupId>
    <artifactId>shardingsphere-transaction-xa-core</artifactId>
    <version>${shardingsphere.version}</version>
</dependency>

<!-- import if using BASE transaction -->
<dependency>
    <groupId>org.apache.shardingsphere</groupId>
    <artifactId>shardingsphere-transaction-base-seata-at</artifactId>
    <version>${shardingsphere.version}</version>
</dependency>

```

## Configure Transaction Manager

```

@Configuration
@EnableTransactionManagement
public class TransactionConfiguration {

    @Bean
    public PlatformTransactionManager txManager(final DataSource dataSource) {
        return new DataSourceTransactionManager(dataSource);
    }

    @Bean
    public JdbcTemplate jdbcTemplate(final DataSource dataSource) {
        return new JdbcTemplate(dataSource);
    }
}

```

## Use Distributed Transaction

```

@Transactional
@ShardingSphereTransactionType(TransactionType.XA) // Support TransactionType.
LOCAL, TransactionType.XA, TransactionType.BASE
public void insert() {
    jdbcTemplate.execute("INSERT INTO t_order (user_id, status) VALUES (?, ?)",
(PreparedStatementCallback<Object>) ps -> {
        ps.setObject(1, i);
        ps.setObject(2, "init");
        ps.executeUpdate();
    });
}

```

## Use Spring Namespace

### Import Maven Dependency

```

<dependency>
    <groupId>org.apache.shardingsphere</groupId>
    <artifactId>shardingsphere-jdbc-core-spring-namespace</artifactId>
    <version>${shardingsphere.version}</version>
</dependency>

<!-- import if using XA transaction -->
<dependency>
    <groupId>org.apache.shardingsphere</groupId>
    <artifactId>shardingsphere-transaction-xa-core</artifactId>

```

```

    <version>${shardingsphere.version}</version>
</dependency>

<!-- import if using BASE transaction -->
<dependency>
    <groupId>org.apache.shardingsphere</groupId>
    <artifactId>shardingsphere-transaction-base-seata-at</artifactId>
    <version>${shardingsphere.version}</version>
</dependency>

```

### Configure Transaction Manager

```

<!-- ShardingDataSource configuration -->
<!-- ... -->

<bean id="transactionManager" class="org.springframework.jdbc.datasource.
DataSourceTransactionManager">
    <property name="dataSource" ref="shardingDataSource" />
</bean>
<bean id="jdbcTemplate" class="org.springframework.jdbc.core.JdbcTemplate">
    <property name="dataSource" ref="shardingDataSource" />
</bean>
<tx:annotation-driven />

<!-- Enable auto scan @ShardingSphereTransactionType annotation to inject the
transaction type before connection created -->
<sharding:tx-type-annotation-driven />

```

### Use Distributed Transaction

```

@Transactional
@ShardingSphereTransactionType(TransactionType.XA) // Support TransactionType.
LOCAL, TransactionType.XA, TransactionType.BASE
public void insert() {
    jdbcTemplate.execute("INSERT INTO t_order (user_id, status) VALUES (?, ?)",
(PreparedStatementCallback<Object>) ps -> {
        ps.setObject(1, i);
        ps.setObject(2, "init");
        ps.executeUpdate();
    });
}

```



## Atomikos Transaction

The default XA transaction manager of Apache ShardingSphere is Atomikos.

## Data Recovery

`xa_tx.log` generated in the project `logs` folder is necessary for the recovery when XA crashes. Please keep it.

## Update Configuration

Developer can add `jdbc.properties` in classpath of the application to customize Atomikos configuration. For detailed configuration rules.

Please refer to [Atomikos official documentation](#) for more details.

## Bitronix Transaction

## Import Maven Dependency

```
<properties>
  <btm.version>2.1.3</btm.version>
</properties>

<dependency>
  <groupId>org.apache.shardingsphere</groupId>
  <artifactId>shardingsphere-jdbc-core</artifactId>
  <version>${shardingsphere.version}</version>
</dependency>

<dependency>
  <groupId>org.apache.shardingsphere</groupId>
  <artifactId>shardingsphere-transaction-xa-core</artifactId>
  <version>${shardingsphere.version}</version>
</dependency>

<dependency>
  <groupId>org.apache.shardingsphere</groupId>
  <artifactId>shardingsphere-transaction-xa-bitronix</artifactId>
  <version>${shardingsphere.version}</version>
</dependency>

<dependency>
  <groupId>org.codehaus.btm</groupId>
  <artifactId>btm</artifactId>
```

```
<version>${btm.version}</version>
</dependency>
```

### Customize Configuration Items

Please refer to [Bitronix official documentation](#) for more details.

### Configure XA Transaction Manager Type

Yaml:

```
- !TRANSACTION
  defaultType: XA
  providerType: Bitronix
```

SpringBoot:

```
spring:
  shardingsphere:
    props:
      xa-transaction-manager-type: Bitronix
```

Spring Namespace:

```
<shardingsphere:data-source id="xxx" data-source-names="xxx" rule-refs="xxx">
  <props>
    <prop key="xa-transaction-manager-type">Bitronix</prop>
  </props>
</shardingsphere:data-source>
```

### Narayana Transaction

#### Import Maven Dependency

```
<properties>
  <narayana.version>5.9.1.Final</narayana.version>
  <jboss-transaction-spi.version>7.6.0.Final</jboss-transaction-spi.version>
  <jboss-logging.version>3.2.1.Final</jboss-logging.version>
</properties>

<dependency>
  <groupId>org.apache.shardingsphere</groupId>
  <artifactId>shardingsphere-jdbc-core</artifactId>
  <version>${shardingsphere.version}</version>
</dependency>
```

```
<!-- Import if using XA transaction -->
<dependency>
  <groupId>org.apache.shardingsphere</groupId>
  <artifactId>shardingsphere-transaction-xa-core</artifactId>
  <version>${shardingsphere.version}</version>
</dependency>

<dependency>
  <groupId>org.apache.shardingsphere</groupId>
  <artifactId>shardingsphere-transaction-xa-narayana</artifactId>
  <version>${shardingsphere.version}</version>
</dependency>
<dependency>
  <groupId>org.jboss.narayana.jta</groupId>
  <artifactId>jta</artifactId>
  <version>${narayana.version}</version>
</dependency>
<dependency>
  <groupId>org.jboss.narayana.jts</groupId>
  <artifactId>narayana-jts-integration</artifactId>
  <version>${narayana.version}</version>
</dependency>
<dependency>
  <groupId>org.jboss</groupId>
  <artifactId>jboss-transaction-spi</artifactId>
  <version>${jboss-transaction-spi.version}</version>
</dependency>
<dependency>
  <groupId>org.jboss.logging</groupId>
  <artifactId>jboss-logging</artifactId>
  <version>${jboss-logging.version}</version>
</dependency>
```

### Customize Configuration Items

Add `jbossts-properties.xml` in classpath of the application to customize Narayana configuration.

Please refer to [Narayana official documentation](#) for more details.

## Configure XA Transaction Manager Type

Yaml:

```
- !TRANSACTION
  defaultType: XA
  providerType: Narayana
```

SpringBoot:

```
spring:
  shardingsphere:
    props:
      xa-transaction-manager-type: Narayana
```

Spring Namespace:

```
<shardingsphere:data-source id="xxx" data-source-names="xxx" rule-refs="xxx">
  <props>
    <prop key="xa-transaction-manager-type">Narayana</prop>
  </props>
</shardingsphere:data-source>
```

## Seata Transaction

### Startup Seata Server

Download seata server according to [seata-work-shop](#).

### Create Undo Log Table

Create undo\_log table in each physical database (sample for MySQL).

```
CREATE TABLE IF NOT EXISTS `undo_log`
(
  `id`          BIGINT(20)  NOT NULL AUTO_INCREMENT COMMENT 'increment id',
  `branch_id`  BIGINT(20)  NOT NULL COMMENT 'branch transaction id',
  `xid`        VARCHAR(100) NOT NULL COMMENT 'global transaction id',
  `context`    VARCHAR(128) NOT NULL COMMENT 'undo_log context,such as
serialization',
  `rollback_info` LONGBLOB  NOT NULL COMMENT 'rollback info',
  `log_status` INT(11)     NOT NULL COMMENT '0:normal status,1:defense status',
  `log_created` DATETIME   NOT NULL COMMENT 'create datetime',
  `log_modified` DATETIME  NOT NULL COMMENT 'modify datetime',
  PRIMARY KEY (`id`),
  UNIQUE KEY `ux_undo_log` (`xid`, `branch_id`)
) ENGINE = InnoDB
```

```
AUTO_INCREMENT = 1
DEFAULT CHARSET = utf8 COMMENT ='AT transaction mode undo table';
```

## Update Configuration

Configure seata.conf file in classpath.

```
client {
  application.id = example    ## application unique ID
  transaction.service.group = my_test_tx_group    ## transaction group
}
```

Modify file.conf and registry.conf if needed.

## Observability

Introduce how to use agent and integrate 3rd party with observability.

## Use Agent

### Build

#### Local Build

```
> cd shardingsphere/shardingsphere-agent
> mvn clean install
```

## Download (Not Released Yet)

```
> wget http://xxxxx/shardingsphere-agent.tar.gz
> tar -zxvcf shardingsphere-agent.tar.gz
```

## Configuration

Found agent.yaml file:

```
applicationName: shardingsphere-agent
ignoredPluginNames: # A collection of ignored plugins
  - Opentracing
  - Jaeger
  - Zipkin
  - Prometheus
```

```
- OpenTelemetry
- Logging

plugins:
  Prometheus:
    host: "localhost"
    port: 9090
    props:
      JVM_INFORMATION_COLLECTOR_ENABLED : "true"
  Jaeger:
    host: "localhost"
    port: 5775
    props:
      SERVICE_NAME: "shardingsphere-agent"
      JAEGER_SAMPLER_TYPE: "const"
      JAEGER_SAMPLER_PARAM: "1"
      JAEGER_REPORTER_LOG_SPANS: "true"
      JAEGER_REPORTER_FLUSH_INTERVAL: "1"
  Zipkin:
    host: "localhost"
    port: 9411
    props:
      SERVICE_NAME: "shardingsphere-agent"
      URL_VERSION: "/api/v2/spans"
  Opentracing:
    props:
      OPENTRACING_TRACER_CLASS_NAME: "org.apache.skywalking.apm.toolkit.
opentracing.SkywalkingTracer"
  OpenTelemetry:
    props:
      otel.resource.attributes: "service.name=shardingsphere-agent" # Multiple
configurations can be split by ','
      otel.traces.exporter: "zipkin"
  Logging:
    props:
      LEVEL: "INFO"
```

## Startup

Add arguments in startup script.

```
-javaagent:\absolute path\shardingsphere-agent.jar
```

## APM Integration

### Usage

#### Use OpenTracing

- Method 1: inject Tracer provided by APM system through reading system parameters

Add startup arguments

```
-Dorg.apache.shardingsphere.tracing.opentracing.tracer.class=org.apache.skywalking.apm.toolkit.opentracing.SkywalkingTracer
```

Call initialization method.

```
ShardingTracer.init();
```

- Method 2: inject Tracer provided by APM through parameter.

```
ShardingTracer.init(new SkywalkingTracer());
```

*Notice: when using SkyWalking OpenTracing agent, the OpenTracing plug-in of Apache ShardingSphere Agent cannot be used at the same time to prevent the two plug-ins from conflicting with each other.*

#### Use SkyWalking's Automatic Agent

Please refer to [SkyWalking Manual](#).

#### Use OpenTelemetry

Just fill in the configuration in `agent.yaml`. For example, export Traces data to Zipkin.

```
OpenTelemetry:
  props:
    otel.resource.attributes: "service.name=shardingsphere-agent"
    otel.traces.exporter: "zipkin"
    otel.exporter.zipkin.endpoint: "http://127.0.0.1:9411/api/v2/spans"
```

## Result Demonstration

No matter in which way, it is convenient to demonstrate APM information in the connected system. Take SkyWalking for example:

## Application Architecture

Use ShardingSphere-Proxy to visit two databases, 192.168.0.1:3306 and 192.168.0.2:3306, and there are two tables in each one of them.

## Topology

It can be seen from the picture that the user has accessed ShardingSphere-Proxy 18 times, with each database twice each time. It is because two tables in each database are accessed each time, so there are totally four tables accessed each time.

## Tracking Data

SQL parsing and implementation can be seen from the tracing diagram.

/Sharding-Sphere/parseSQL/ indicates the SQL parsing performance this time.

/Sharding-Sphere/executeSQL/ indicates the SQL parsing performance in actual execution.

## Exception

Exception nodes can be seen from the tracing diagram.

/Sharding-Sphere/executeSQL/ indicates the exception results of SQL.

/Sharding-Sphere/executeSQL/ indicates the exception log of SQL execution.

## 5.1.9 Unsupported Items

### DataSource Interface

- Do not support timeout related operations



### Connection Interface

- Do not support operations of stored procedure, function and cursor
- Do not support native SQL
- Do not support savepoint related operations
- Do not support Schema/Catalog operation
- Do not support self-defined type mapping

### Statement and PreparedStatement Interface

- Do not support statements that return multiple result sets (stored procedures, multiple pieces of non-SELECT data)
- Do not support the operation of international characters

### ResultSet Interface

- Do not support getting result set pointer position
- Do not support changing result pointer position through none-next method
- Do not support revising the content of result set
- Do not support acquiring international characters
- Do not support getting Array

### JDBC 4.1

- Do not support new functions of JDBC 4.1 interface

For all the unsupported methods, please read `org.apache.shardingsphere.driver.jdbc.unsupported` package.

## 5.2 ShardingSphere-Proxy

Configuration is the only module in ShardingSphere-Proxy that interacts with application developers, through which developer can quickly and clearly understand the functions provided by ShardingSphere-Proxy.

This chapter is a configuration manual for ShardingSphere-Proxy, which can also be referred to as a dictionary if necessary.

ShardingSphere-Proxy provided YAML configuration, and used DistSQL to communicate. By configuration, application developers can flexibly use data sharding, readwrite-splitting, data encryption, shadow database or the combination of them.

Rule configuration keeps consist with YAML configuration of ShardingSphere-JDBC. DistSQL and YAML can be replaced each other.

Please refer to [Example](#) for more details.

### 5.2.1 Startup

This chapter will introduce the deployment and startup of ShardingSphere-Proxy.

#### Use Binary Tar

##### Startup Steps

1. Get ShardingSphere-Proxy binary package from [download page](#).
2. After the decompression, revise `conf/server.yaml` and documents begin with `config-` prefix, `conf/config-xxx.yaml` for example, to configure sharding rules and readwrite-splitting rules. Please refer to [Configuration Manual](#) for the configuration method.
3. Please run `bin/start.sh` for Linux operating system; run `bin/start.bat` for Windows operating system to start ShardingSphere-Proxy. To configure start port and document location, please refer to [Quick Start](#).

#### Using database protocol

##### Using PostgreSQL

1. Use any PostgreSQL terminal to connect, such as `psql -U root -h 127.0.0.1 -p 3307`.

##### Using MySQL

1. Copy MySQL's JDBC driver to folder `ext-lib/`.
2. Use any MySQL terminal to connect, such as `mysql -u root -h 127.0.0.1 -P 3307`.

##### Using openGauss

1. Copy openGauss's JDBC driver whose package prefixed with `org.opengauss` to folder `ext-lib/`.
2. Use any openGauss terminal to connect, such as `gsqldb -U root -h 127.0.0.1 -p 3307`.

### Using metadata persist repository

### Using ZooKeeper

Integrated ZooKeeper Curator client by default.

### Using Etcd

1. Copy Etcd's client driver to folder `ext-lib/`.

### Using Distributed Transaction

Same with ShardingSphere-JDBC. please refer to [Distributed Transaction](#) for more details.

### Using user-defined algorithm

When developer need to use user-defined algorithm, should use the way below to configure algorithm, use sharding algorithm as example.

1. Implement `ShardingAlgorithm` interface.
2. Create `META-INF/services` directory in the resources directory.
3. Create a new file `org.apache.shardingsphere.sharding.spi.ShardingAlgorithm` in the `META-INF/services` directory.
4. Absolute path of the implementation class are write to the file `org.apache.shardingsphere.sharding.spi.ShardingAlgorithm`
5. Package Java file to jar.
6. Copy jar to ShardingSphere-Proxy's `ext-lib/` folder.
7. Configure user-defined Java class into YAML file. Please refer to [Configuration Manual](#) for more details.

### Notices

1. ShardingSphere-Proxy uses 3307 port in default. Users can start the script parameter as the start port number, like `bin/start.sh 3308`.
2. ShardingSphere-Proxy uses `conf/server.yaml` to configure the registry center, authentication information and public properties.
3. ShardingSphere-Proxy supports multi-logic data sources, with each yaml configuration document named by `config-` prefix as a logic data source.

## Use Docker

### Pull Official Docker Image

```
docker pull apache/shardingsphere-proxy
```

### Build Docker Image Manually (Optional)

```
git clone https://github.com/apache/shardingsphere
mvn clean install
cd shardingsphere-distribution/shardingsphere-proxy-distribution
mvn clean package -Prelease,docker
```

### Configure ShardingSphere-Proxy

Create `server.yaml` and `config-xxx.yaml` to configure sharding rules and server rule in `/${your_work_dir}/conf/`. Please refer to [Configuration Manual](#). Please refer to [Example](#).

### Run Docker

```
docker run -d -v /${your_work_dir}/conf:/opt/shardingsphere-proxy/conf -e PORT=3308 -p13308:3308 apache/shardingsphere-proxy:latest
```

#### Notice

- You can define port 3308 and 13308 by yourself. 3308 refers to docker port; 13308 refers to the host port.
- You have to volume conf dir to `/opt/shardingsphere-proxy/conf`.

```
docker run -d -v /${your_work_dir}/conf:/opt/shardingsphere-proxy/conf -e JVM_OPTS="-Djava.awt.headless=true" -e PORT=3308 -p13308:3308 apache/shardingsphere-proxy:latest
```

#### Notice

- You can define JVM related parameters to environment variable `JVM_OPTS`.

```
docker run -d -v /${your_work_dir}/conf:/opt/shardingsphere-proxy/conf -v /${your_work_dir}/ext-lib:/opt/shardingsphere-proxy/ext-lib -p13308:3308 apache/shardingsphere-proxy:latest
```

#### Notice

- If you need to import external jar packages (such as MySQL/openGauss JDBC driver, custom algorithm, etc.), you may bind mount a volume to `/opt/shardingsphere-proxy/ext-lib`.

## Access ShardingSphere-Proxy

It is in the same way as connecting to PostgreSQL.

```
psql -U ${your_username} -h ${your_host} -p 13308
```

## FAQ

Question 1: there is I/O exception (`java.io.IOException`) when process request to `{}->unix://localhost:80`: Connection is refused.

Answer: before building image, please make sure docker daemon thread is running.

Question 2: there is error report of being unable to connect to the database.

Answer: please make sure the designated PostgreSQL's IP in `/${your_work_dir}/conf/config-xxx.yaml` configuration is accessible to Docker container.

Question 3: How to start ShardingSphere-Proxy whose backend databases are MySQL or openGauss.

Answer: Mount the directory where `mysql-connector.jar` or `opengauss-jdbc.jar` stores to `/opt/shardingsphere-proxy/ext-lib`.

Question 4: How to import user-defined sharding strategy?

Answer: Volume the directory where `shardingsphere-strategy.jar` stores to `/opt/shardingsphere-proxy/ext-lib`.

## Use Helm

Use [Helm](#) to provide guidance for the installation of ShardingSphere-Proxy instance in Kubernetes cluster.

## Quick Start

```
helm repo add shardingsphere https://shardingsphere.apache.org/charts
helm install shardingsphere-proxy shardingsphere/apache-shardingsphere-proxy
```

## Step By Step

### Requirements

1. Kubernetes 1.18+
2. kubectl
3. Helm 3.2.0+

Use StorageClass to allow dynamic provisioning of Persistent Volumes (PV) for data persistent.

## Install

### Online installation

1. Add ShardingSphere-Proxy to the local helm repo:

```
helm repo add shardingsphere https://shardingsphere.apache.org/charts
```

2. Install ShardingSphere-Proxy charts:

```
helm install shardingsphere-proxy shardingsphere/apache-shardingsphere-proxy
```

### Source installation

```
cd apache-shardingsphere-proxy/charts/governance
helm dependency build
cd ../../
helm dependency build
cd ..
helm install shardingsphere-proxy apache-shardingsphere-proxy
```

Charts will be installed with default configuration if above commands executed. Please refer configuration items description below to get more details. Execute `helm list` to acquire all installed releases.

## Uninstall

```
helm uninstall shardingsphere-proxy
```

Delete all release records by default, add `--keep-history` to keep them.

## Parameters

### Governance-Node parameters

Name	Description	Value
<code>governance.enabled</code>	Switch to enable or disable the governance helm chart	<code>`` true ``</code>

**Governance-Node ZooKeeper parameters**

Name	Description	Value
governance.zookeeper.enabled	Switch to enable or disable the ZooKeeper helm chart	true
governance.zookeeper.replicaCount	Number of ZooKeeper nodes	1
governance.zookeeper.persistence.enabled	Enable persistence on ZooKeeper using PVC(s)	<code>false</code>
governance.zookeeper.persistence.storageClass	Persistent Volume storage class	""
governance.zookeeper.persistence.accessModes	Persistent Volume access modes	["ReadWriteOnce"]
governance.zookeeper.persistence.size	Persistent Volume size	8Gi
governance.zookeeper.resources.limits	The resources limits for the ZooKeeper containers	{}
governance.zookeeper.resources.requests.memory	The requested memory for the ZooKeeper containers	<code>256Mi</code>
governance.zookeeper.resources.requests.cpu	The requested cpu for the ZooKeeper containers	250m

**Compute-Node ShardingSphere-Proxy parameters**

Name	Description	Value
compute.image.repository	Image name of ShardingSphere-Proxy.	apache/shardingsphere-proxy
compute.image.pullPolicy	The policy for pulling ShardingSphere-Proxy image	`` IfNotPresent``
compute.image.tag	ShardingSphere-Proxy image tag	5.1.2
compute.imagePullSecrets	Specify docker-registry secret names as an array	[]
compute.resources.limits	The resources limits for the ShardingSphere-Proxy containers	{}
compute.resources.requests.memory	The requested memory for the ShardingSphere-Proxy containers	2Gi
compute.resources.requests.cpu	The requested cpu for the ShardingSphere-Proxy containers	200m
compute.replicas	Number of cluster replicas	3
compute.service.type	ShardingSphere-Proxy network mode	ClusterIP
compute.service.port	ShardingSphere-Proxy expose port	3307
compute.mysqlConnector.version	MySQL connector version	5.1.49
compute.startPort	ShardingSphere-Proxy start port	3307
compute.serverConfig	ServerConfiguration file for ShardingSphere-Proxy	""

**5.2.2 Yaml Configuration**

The YAML configuration of ShardingSphere-JDBC is the subset of ShardingSphere-Proxy. In server.yaml file, ShardingSphere-Proxy can configure authority feature and more properties for Proxy only.

This chapter will introduce the extra YAML configuration of ShardingSphere-Proxy.



## Authority

It is used to set up initial user to login compute node, and authority data of storage node.

## Configuration Item Explanation

```
rules:
  - !AUTHORITY
    users:
      - # Username, authorized host and password for compute node. Format:
        <username>@<hostname>:<password>, hostname is % or empty string means do not care
        about authorized host
        provider:
          type: # authority provider for storage node, the default value is ALL_
            PERMITTED
```

## Example

### ALL\_PERMITTED

```
rules:
  - !AUTHORITY
    users:
      - root@localhost:root
      - my_user@:pwd
    provider:
      type: ALL_PERMITTED
```

### DATABASE\_PERMITTED

```
rules:
  - !AUTHORITY
    users:
      - root@:root
      - my_user@:pwd
    provider:
      type: DATABASE_PERMITTED
    props:
      user-database-mappings: root@=sharding_db, root@=test_db, my_user@127.0.0.
1=sharding_db
```

The above configuration means: - The user root can access sharding\_db when connecting from any host - The user root can access test\_db when connecting from any host - The user my\_user can access sharding\_db only when connected from 127.0.0.1

Refer to [Authority Provider](#) for more implementations.

## Properties

### Introduction

Apache ShardingSphere provides the way of property configuration to configure system level configuration.

Configuration Item Explanation

<i>Name</i>	<i>DataType*</i>	<i>Description</i>	<i>DefaultValue*</i>	<i>DynamicUpdate*</i>
sql-show (?)	boolean	Whether show SQL or not in log. Print SQL details can help developers debug easier. The log details include: logic SQL, actual SQL and SQL parse result. Enable this property will log into log topic ShardingSphere-SQL, log level is INFO.	false	true
sql-simple (?)	boolean	Whether show SQL details in simple style.	false	true
kernel-executorsize (?)	int	The max thread size of worker group to execute SQL. One ShardingSphere-DataSource will use a independent thread pool, it does not share thread pool even different data source in same JVM.	infinite	false
max-connections-per-query (?)	int	Max opened connection size for each query.	1	true
check-table-metadata-enabled (?)	boolean	Whether validate table metadata consistency when application startup or updated.	false	true
5.2. ShardingSphere-Proxy flush-threshold (?)		Flush threshold for every records from	128	true

Properties can be updated by [DistSQL#RAL](#). Dynamic update can take effect immediately, static update can take effect after restarted.

## Rules

The rules of ShardingSphere-Proxy are the same as rules of ShardingSphere-JDBC. Please refer to [rules of ShardingSphere-JDBC](#).

### 5.2.3 DistSQL

This chapter will introduce the detailed syntax of [DistSQL](#).

#### Syntax

This chapter describes the syntax of DistSQL in detail, and introduces use of DistSQL with practical examples.

#### RDL Syntax

RDL (Resource & Rule Definition Language) responsible for definition of resources/rules.

#### Resource Definition

##### Syntax

```
ADD RESOURCE dataSource [, dataSource] ...

ALTER RESOURCE dataSource [, dataSource] ...

DROP RESOURCE dataSourceName [, dataSourceName] ... [ignore single tables]

dataSource:
    simpleSource | urlSource

simpleSource:
    dataSourceName(HOST=hostname,PORT=port,DB=dbName,USER=user [,PASSWORD=password]
[,PROPERTIES(poolProperty [,poolProperty] ...)])

urlSource:
    dataSourceName(URL=url,USER=user [,PASSWORD=password] [,PROPERTIES(poolProperty
[,poolProperty]) ...])

poolProperty:
    "key"= ("value" | value)
```

- Before adding resources, please confirm that a distributed database has been created, and execute the use command to successfully select a database
- Confirm that the added resource can be connected normally, otherwise it will not be added successfully
- Duplicate dataSourceName is not allowed to be added
- In the definition of a dataSource, the syntax of simpleSource and urlSource cannot be mixed
- poolProperty is used to customize connection pool properties, key must be the same as the connection pool property name, value supports int and String types
- ALTER RESOURCE is not allowed to change the real data source associated with this resource
- ALTER RESOURCE will switch the connection pool. This operation may affect the ongoing business, please use it with caution
- DROP RESOURCE will only delete logical resources, not real data sources
- Resources referenced by rules cannot be deleted
- If the resource is only referenced by single table rule, and the user confirms that the restriction can be ignored, the optional parameter ignore single tables can be added to perform forced deletion

### Example

```
ADD RESOURCE resource_0 (  
  HOST=127.0.0.1,  
  PORT=3306,  
  DB=db0,  
  USER=root,  
  PASSWORD=root  
) , resource_1 (  
  HOST=127.0.0.1,  
  PORT=3306,  
  DB=db1,  
  USER=root  
) , resource_2 (  
  HOST=127.0.0.1,  
  PORT=3306,  
  DB=db2,  
  USER=root,  
  PROPERTIES("maximumPoolSize"=10)  
) , resource_3 (  
  URL="jdbc:mysql://127.0.0.1:3306/db3?serverTimezone=UTC&useSSL=false",  
  USER=root,  
  PASSWORD=root,  
  PROPERTIES("maximumPoolSize"=10,"idleTimeout"="30000")
```

```
);

ALTER RESOURCE resource_0 (
    HOST=127.0.0.1,
    PORT=3309,
    DB=db0,
    USER=root,
    PASSWORD=root
), resource_1 (
    URL="jdbc:mysql://127.0.0.1:3309/db1?serverTimezone=UTC&useSSL=false",
    USER=root,
    PASSWORD=root,
    PROPERTIES("maximumPoolSize"=10,"idleTimeout"="30000")
);

DROP RESOURCE resource_0, resource_1;
DROP RESOURCE resource_2, resource_3 ignore single tables;
```

## Rule Definition

This chapter describes the syntax of rule definition.

## Sharding

### Syntax

#### Sharding Table Rule

```
CREATE SHARDING TABLE RULE shardingTableRuleDefinition [,
shardingTableRuleDefinition] ...

ALTER SHARDING TABLE RULE shardingTableRuleDefinition [,
shardingTableRuleDefinition] ...

DROP SHARDING TABLE RULE tableName [, tableName] ...

CREATE DEFAULT SHARDING shardingScope STRATEGY (shardingStrategy)

ALTER DEFAULT SHARDING shardingScope STRATEGY (shardingStrategy)

DROP DEFAULT SHARDING shardingScope STRATEGY;

CREATE SHARDING ALGORITHM shardingAlgorithmDefinition [,
shardingAlgorithmDefinition] ...
```

```

ALTER SHARDING ALGORITHM shardingAlgorithmDefinition [,
shardingAlgorithmDefinition] ...

DROP SHARDING ALGORITHM algorithmName [, algorithmName] ...

CREATE SHARDING KEY GENERATOR keyGeneratorDefinition [, keyGeneratorDefinition] ...

ALTER SHARDING KEY GENERATOR keyGeneratorDefinition [, keyGeneratorDefinition] ...

DROP SHARDING KEY GENERATOR keyGeneratorName [, keyGeneratorName] ...

shardingTableRuleDefinition:
    shardingAutoTableRule | shardingTableRule

shardingAutoTableRule:
    tableName(resources, shardingColumn, algorithmDefinition [,
keyGenerateDeclaration])

shardingTableRule:
    tableName(dataNodes [, databaseStrategy] [, tableStrategy] [,
keyGenerateDeclaration])

resources:
    RESOURCES(resource [, resource] ...)

dataNodes:
    DATANODES(dataNode [, dataNode] ...)

resource:
    resourceName | inlineExpression

dataNode:
    resourceName | inlineExpression

shardingColumn:
    SHARDING_COLUMN=columnName

algorithmDefinition:
    TYPE(NAME=shardingAlgorithmType [, PROPERTIES([algorithmProperties]))

keyGenerateDeclaration:
    keyGenerateDefinition | keyGenerateConstruction

keyGenerateDefinition:
    KEY_GENERATE_STRATEGY(COLUMN=columnName, strategyDefinition)

shardingScope:
    DATABASE | TABLE

```

```

databaseStrategy:
    DATABASE_STRATEGY(shardingStrategy)

tableStrategy:
    TABLE_STRATEGY(shardingStrategy)

keyGenerateConstruction
    KEY_GENERATE_STRATEGY(COLUMN=columnName, KEY_
GENERATOR=keyGenerateAlgorithmName)

shardingStrategy:
    TYPE=strategyType, shardingColumn, shardingAlgorithm

shardingAlgorithm:
    existingAlgorithm | autoCreativeAlgorithm

existingAlgorithm:
    SHARDING_ALGORITHM=shardingAlgorithmName

autoCreativeAlgorithm:
    SHARDING_ALGORITHM(algorithmDefinition)

strategyDefinition:
    TYPE(NAME=keyGenerateStrategyType [, PROPERTIES([algorithmProperties]))

shardingAlgorithmDefinition:
    shardingAlgorithmName(algorithmDefinition)

algorithmProperties:
    algorithmProperty [, algorithmProperty] ...

algorithmProperty:
    key=value

keyGeneratorDefinition:
    keyGeneratorName (algorithmDefinition)

```

- RESOURCES needs to use data source resources managed by RDL
- shardingAlgorithmType specifies the type of automatic sharding algorithm, please refer to [Auto Sharding Algorithm](#)
- keyGenerateStrategyType specifies the distributed primary key generation strategy, please refer to [Key Generate Algorithm](#)
- Duplicate tableName will not be created
- shardingAlgorithm can be reused by different Sharding Table Rule, so when executing DROP SHARDING TABLE RULE, the corresponding shardingAlgorithm will not be removed



- To remove shardingAlgorithm, please execute DROP SHARDING ALGORITHM
- strategyType specifies the sharding strategy, please refer to [Sharding Strategy](#)
- Sharding Table Rule supports both Auto Table and Table at the same time. The two types are different in syntax. For the corresponding configuration file, please refer to [Sharding](#)
- When using the autoCreativeAlgorithm way to specify shardingStrategy, a new sharding algorithm will be created automatically. The algorithm naming rule is table-Name\_strategyType\_shardingAlgorithmType, such as t\_order\_database\_inline

### Sharding Binding Table Rule

```
CREATE SHARDING BINDING TABLE RULES bindTableRulesDefinition [,
bindTableRulesDefinition] ...

ALTER SHARDING BINDING TABLE RULES bindTableRulesDefinition [,
bindTableRulesDefinition] ...

DROP SHARDING BINDING TABLE RULES bindTableRulesDefinition [,
bindTableRulesDefinition] ...

bindTableRulesDefinition:
    (tableName [, tableName] ... )
```

- ALTER will overwrite the binding table configuration in the database with the new configuration

### Sharding Broadcast Table Rule

```
CREATE SHARDING BROADCAST TABLE RULES (tableName [, tableName] ... )

ALTER SHARDING BROADCAST TABLE RULES (tableName [, tableName] ... )

DROP SHARDING BROADCAST TABLE RULES
```

- ALTER will overwrite the broadcast table configuration in the database with the new configuration

### Sharding Scaling Rule

```
CREATE SHARDING SCALING RULE scalingName [scalingRuleDefinition]

DROP SHARDING SCALING RULE scalingName

ENABLE SHARDING SCALING RULE scalingName

DISABLE SHARDING SCALING RULE scalingName
```

```

scalingRuleDefinition:
  [inputDefinition] [, outputDefinition] [, streamChannel] [, completionDetector]
  [, dataConsistencyChecker]

inputDefinition:
  INPUT ([workerThread] [, batchSize] [, rateLimiter])

outputDefinition:
  OUTPUT ([workerThread] [, batchSize] [, rateLimiter])

completionDetector:
  COMPLETION_DETECTOR (algorithmDefinition)

dataConsistencyChecker:
  DATA_CONSISTENCY_CHECKER (algorithmDefinition)

rateLimiter:
  RATE_LIMITER (algorithmDefinition)

streamChannel:
  STREAM_CHANNEL (algorithmDefinition)

workerThread:
  WORKER_THREAD=intValue

batchSize:
  BATCH_SIZE=intValue

intValue:
  INT

```

- ENABLE is used to set which sharding scaling rule is enabled;
- DISABLE will disable the sharding scaling rule currently in use;
- Enabled by default when creating the first sharding scaling rule in a logical database.

### Example

#### Sharding Table Rule

##### *Key Generator*

```

CREATE SHARDING KEY GENERATOR snowflake_key_generator (
TYPE(NAME=SNOWFLAKE)
);

```

```
ALTER SHARDING KEY GENERATOR snowflake_key_generator (
TYPE(NAME=SNOWFLAKE))
);

DROP SHARDING KEY GENERATOR snowflake_key_generator;
```

*Auto Table*

```
CREATE SHARDING TABLE RULE t_order (
RESOURCES(resource_0,resource_1),
SHARDING_COLUMN=order_id,TYPE(NAME=hash_mod,PROPERTIES("sharding-count"=4)),
KEY_GENERATE_STRATEGY(COLUMN=another_id,TYPE(NAME=snowflake))
);

ALTER SHARDING TABLE RULE t_order (
RESOURCES(resource_0,resource_1,resource_2,resource_3),
SHARDING_COLUMN=order_id,TYPE(NAME=hash_mod,PROPERTIES("sharding-count"=16)),
KEY_GENERATE_STRATEGY(COLUMN=another_id,TYPE(NAME=snowflake))
);

DROP SHARDING TABLE RULE t_order;

DROP SHARDING ALGORITHM t_order_hash_mod;
```

*Table*

```
CREATE SHARDING ALGORITHM table_inline (
TYPE(NAME=inline,PROPERTIES("algorithm-expression"="t_order_item_${order_id % 2}"))
);

CREATE SHARDING TABLE RULE t_order_item (
DATANODES("resource_${0..1}.t_order_item_${0..1}"),
DATABASE_STRATEGY(TYPE=standard,SHARDING_COLUMN=user_id,SHARDING_
ALGORITHM(TYPE(NAME=inline,PROPERTIES("algorithm-expression"="resource_${user_id %
2}")))),
TABLE_STRATEGY(TYPE=standard,SHARDING_COLUMN=order_id,SHARDING_ALGORITHM=table_
inline),
KEY_GENERATE_STRATEGY(COLUMN=another_id,KEY_GENERATOR=snowflake_key_generator)
);

ALTER SHARDING ALGORITHM database_inline (
TYPE(NAME=inline,PROPERTIES("algorithm-expression"="resource_${user_id % 4}"))
),table_inline (
TYPE(NAME=inline,PROPERTIES("algorithm-expression"="t_order_item_${order_id % 4}"))
);

ALTER SHARDING TABLE RULE t_order_item (
DATANODES("resource_${0..3}.t_order_item${0..3}"),
```

```

DATABASE_STRATEGY(TYPE=standard,SHARDING_COLUMN=user_id,SHARDING_
ALGORITHM=database_inline),
TABLE_STRATEGY(TYPE=standard,SHARDING_COLUMN=order_id,SHARDING_ALGORITHM=table_
inline),
KEY_GENERATE_STRATEGY(COLUMN=another_id,KEY_GENERATOR=snowflake_key_generator)
);

DROP SHARDING TABLE RULE t_order_item;

DROP SHARDING ALGORITHM database_inline;

CREATE DEFAULT SHARDING DATABASE STRATEGY (
TYPE = standard,SHARDING_COLUMN=order_id,SHARDING_ALGORITHM=database_inline
);

ALTER DEFAULT SHARDING DATABASE STRATEGY (
TYPE = standard,SHARDING_COLUMN=another_id,SHARDING_ALGORITHM=database_inline
);

DROP DEFAULT SHARDING DATABASE STRATEGY;

```

### Sharding Binding Table Rule

```

CREATE SHARDING BINDING TABLE RULES (t_order,t_order_item),(t_1,t_2);

ALTER SHARDING BINDING TABLE RULES (t_order,t_order_item);

DROP SHARDING BINDING TABLE RULES;

DROP SHARDING BINDING TABLE RULES (t_order,t_order_item);

```

### Sharding Broadcast Table Rule

```

CREATE SHARDING BROADCAST TABLE RULES (t_b,t_a);

ALTER SHARDING BROADCAST TABLE RULES (t_b,t_a,t_3);

DROP SHARDING BROADCAST TABLE RULES;

```

## Sharding Scaling Rule

```
CREATE SHARDING SCALING RULE sharding_scaling(
INPUT(
  WORKER_THREAD=40,
  BATCH_SIZE=1000
),
OUTPUT(
  WORKER_THREAD=40,
  BATCH_SIZE=1000
),
STREAM_CHANNEL(TYPE(NAME=MEMORY, PROPERTIES("block-queue-size"=10000))),
COMPLETION_DETECTOR(TYPE(NAME=IDLE, PROPERTIES("incremental-task-idle-seconds-
threshold"=1800))),
DATA_CONSISTENCY_CHECKER(TYPE(NAME=DATA_MATCH, PROPERTIES("chunk-size"=1000))
);

ENABLE SHARDING SCALING RULE sharding_scaling;

DISABLE SHARDING SCALING RULE sharding_scaling;

DROP SHARDING SCALING RULE sharding_scaling;
```

## Single Table

### Definition

```
CREATE DEFAULT SINGLE TABLE RULE singleTableRuleDefinition

ALTER DEFAULT SINGLE TABLE RULE singleTableRuleDefinition

DROP DEFAULT SINGLE TABLE RULE

singleTableRuleDefinition:
  RESOURCE = resourceName
```

- RESOURCE needs to use data source resource managed by RDL

## Example

### Single Table Rule

```
CREATE DEFAULT SINGLE TABLE RULE RESOURCE = ds_0

ALTER DEFAULT SINGLE TABLE RULE RESOURCE = ds_1

DROP DEFAULT SINGLE TABLE RULE
```

## Readwrite-Splitting

### Syntax

```
CREATE READWRITE_SPLITTING RULE readwriteSplittingRuleDefinition [,
readwriteSplittingRuleDefinition] ...

ALTER READWRITE_SPLITTING RULE readwriteSplittingRuleDefinition [,
readwriteSplittingRuleDefinition] ...

DROP READWRITE_SPLITTING RULE ruleName [, ruleName] ...

readwriteSplittingRuleDefinition:
    ruleName ([staticReadwriteSplittingRuleDefinition |
dynamicReadwriteSplittingRuleDefinition]
            [, loadBalancerDefinition])

staticReadwriteSplittingRuleDefinition:
    WRITE_RESOURCE=writeResourceName, READ_RESOURCES(resourceName [, resourceName]
... )

dynamicReadwriteSplittingRuleDefinition:
    AUTO_AWARE_RESOURCE=resourceName

loadBalancerDefinition:
    TYPE(NAME=loadBalancerType [, PROPERTIES([algorithmProperties] )) )

algorithmProperties:
    algorithmProperty [, algorithmProperty] ...

algorithmProperty:
    key=value
```

- Support the creation of static readwrite-splitting rules and dynamic readwrite-splitting rules
- Dynamic readwrite-splitting rules rely on database discovery rules

- loadBalancerType specifies the load balancing algorithm type, please refer to [Load Balance Algorithm](#)
- Duplicate ruleName will not be created

### Example

```
// Static
CREATE READWRITE_SPLITTING RULE ms_group_0 (
WRITE_RESOURCE=write_ds,
READ_RESOURCES(read_ds_0,read_ds_1),
TYPE(NAME=random)
);

// Dynamic
CREATE READWRITE_SPLITTING RULE ms_group_1 (
AUTO_AWARE_RESOURCE=group_0,
TYPE(NAME=random,PROPERTIES(read_weight='2:1'))
);

ALTER READWRITE_SPLITTING RULE ms_group_1 (
WRITE_RESOURCE=write_ds,
READ_RESOURCES(read_ds_0,read_ds_1,read_ds_2),
TYPE(NAME=random,PROPERTIES(read_weight='2:0'))
);

DROP READWRITE_SPLITTING RULE ms_group_1;
```

### DB Discovery

#### Syntax

```
CREATE DB_DISCOVERY RULE ruleDefinition [, ruleDefinition] ...

ALTER DB_DISCOVERY RULE ruleDefinition [, ruleDefinition] ...

DROP DB_DISCOVERY RULE ruleName [, ruleName] ...

CREATE DB_DISCOVERY TYPE databaseDiscoveryTypeDefinition [,
databaseDiscoveryTypeDefinition] ...

ALTER DB_DISCOVERY TYPE databaseDiscoveryTypeDefinition [,
databaseDiscoveryTypeDefinition] ...

DROP DB_DISCOVERY TYPE discoveryTypeName [, discoveryTypeName] ...
```

```

CREATE DB_DISCOVERY HEARTBEAT databaseDiscoveryHeartbaetDefinition [,
databaseDiscoveryHeartbaetDefinition] ...

ALTER DB_DISCOVERY HEARTBEAT databaseDiscoveryHeartbaetDefinition [,
databaseDiscoveryHeartbaetDefinition] ...

DROP DB_DISCOVERY HEARTBEAT discoveryHeartbeatName [, discoveryHeartbeatName] ...

ruleDefinition:
    (databaseDiscoveryRuleDefinition | databaseDiscoveryRuleConstruction)

databaseDiscoveryRuleDefinition
    ruleName (resources, typeDefinition, heartbeatDefinition)

databaseDiscoveryRuleConstruction
    ruleName (resources, TYPE = discoveryTypeName, HEARTBEAT =
discoveryHeartbeatName)

databaseDiscoveryTypeDefinition
    discoveryTypeName (typeDefinition)

databaseDiscoveryHeartbaetDefinition
    discoveryHeartbeatName (PROPERTIES (properties))

resources:
    RESOURCES(resourceName [, resourceName] ...)

typeDefinition:
    TYPE(NAME=typeName [, PROPERTIES([properties] )])

heartbeatDefinition
    HEARTBEAT (PROPERTIES (properties))

properties:
    property [, property] ...

property:
    key=value

```

- discoveryType specifies the database discovery service type, ShardingSphere has built-in support for MySQL.MGR
- Duplicate ruleName will not be created
- The discoveryType and discoveryHeartbeat being used cannot be deleted
- Names with - need to use " " when changing
- When removing the discoveryRule, the discoveryType and discoveryHeartbeat used by the discoveryRule will not be removed



## Example

### When creating a `discoveryRule`, create both `discoveryType` and `discoveryHeartbeat`

```

CREATE DB_DISCOVERY RULE db_discovery_group_0 (
  RESOURCES(ds_0, ds_1, ds_2),
  TYPE(NAME='MySQL.MGR',PROPERTIES('group-name'='92504d5b-6dec')),
  HEARTBEAT(PROPERTIES('keep-alive-cron'='0/5 * * * * ?'))
);

ALTER DB_DISCOVERY RULE db_discovery_group_0 (
  RESOURCES(ds_0, ds_1, ds_2),
  TYPE(NAME='MySQL.MGR',PROPERTIES('group-name'='246e9612-aaf1')),
  HEARTBEAT(PROPERTIES('keep-alive-cron'='0/5 * * * * ?'))
);

DROP DB_DISCOVERY RULE db_discovery_group_0;

DROP DB_DISCOVERY TYPE db_discovery_group_0_mgr;

DROP DB_DISCOVERY HEARTBEAT db_discovery_group_0_heartbeat;

```

### Use the existing `discoveryType` and `discoveryHeartbeat` to create a `discoveryRule`

```

CREATE DB_DISCOVERY TYPE db_discovery_group_1_mgr(
  TYPE(NAME='MySQL.MGR',PROPERTIES('group-name'='92504d5b-6dec'))
);

CREATE DB_DISCOVERY HEARTBEAT db_discovery_group_1_heartbeat(
  PROPERTIES('keep-alive-cron'='0/5 * * * * ?')
);

CREATE DB_DISCOVERY RULE db_discovery_group_1 (
  RESOURCES(ds_0, ds_1, ds_2),
  TYPE=db_discovery_group_1_mgr,
  HEARTBEAT=db_discovery_group_1_heartbeat
);

ALTER DB_DISCOVERY TYPE db_discovery_group_1_mgr(
  TYPE(NAME='MySQL.MGR',PROPERTIES('group-name'='246e9612-aaf1'))
);

ALTER DB_DISCOVERY HEARTBEAT db_discovery_group_1_heartbeat(
  PROPERTIES('keep-alive-cron'='0/10 * * * * ?')
);

```

```
ALTER DB_DISCOVERY RULE db_discovery_group_1 (
RESOURCES(ds_0, ds_1),
TYPE=db_discovery_group_1_mgr,
HEARTBEAT=db_discovery_group_1_heartbeat
);

DROP DB_DISCOVERY RULE db_discovery_group_1;

DROP DB_DISCOVERY TYPE db_discovery_group_1_mgr;

DROP DB_DISCOVERY HEARTBEAT db_discovery_group_1_heartbeat;
```

## Encrypt

### Syntax

```
CREATE ENCRYPT RULE encryptRuleDefinition [, encryptRuleDefinition] ...

ALTER ENCRYPT RULE encryptRuleDefinition [, encryptRuleDefinition] ...

DROP ENCRYPT RULE tableName [, tableName] ...

encryptRuleDefinition:
    tableName(COLUMNS(columnDefinition [, columnDefinition] ...), QUERY_WITH_
CIPHER_COLUMN=queryWithCipherColumn)

columnDefinition:
    (NAME=columnName [, PLAIN=plainColumnName] , CIPHER=cipherColumnName,
encryptAlgorithm)

encryptAlgorithm:
    TYPE(NAME=encryptAlgorithmType [, PROPERTIES([algorithmProperties] )) )

algorithmProperties:
    algorithmProperty [, algorithmProperty] ...

algorithmProperty:
    key=value
```

- PLAIN specifies the plain column, CIPHER specifies the cipher column
- encryptAlgorithmType specifies the encryption algorithm type, please refer to [Encryption Algorithm](#)
- Duplicate tableName will not be created
- queryWithCipherColumn support uppercase or lowercase true or false

## Example

```

CREATE ENCRYPT RULE t_encrypt (
  COLUMNS(
    (NAME=user_id,PLAIN=user_plain,CIPHER=user_cipher,TYPE(NAME=AES,PROPERTIES('aes-
key-value'='123456abc'))),
    (NAME=order_id, CIPHER =order_cipher,TYPE(NAME=MD5))
  ), QUERY_WITH_CIPHER_COLUMN=true),
t_encrypt_2 (
  COLUMNS(
    (NAME=user_id,PLAIN=user_plain,CIPHER=user_cipher,TYPE(NAME=AES,PROPERTIES('aes-
key-value'='123456abc'))),
    (NAME=order_id, CIPHER=order_cipher,TYPE(NAME=MD5))
  ), QUERY_WITH_CIPHER_COLUMN=FALSE);

ALTER ENCRYPT RULE t_encrypt (
  COLUMNS(
    (NAME=user_id,PLAIN=user_plain,CIPHER=user_cipher,TYPE(NAME=AES,PROPERTIES('aes-
key-value'='123456abc'))),
    (NAME=order_id,CIPHER=order_cipher,TYPE(NAME=MD5))
  ), QUERY_WITH_CIPHER_COLUMN=TRUE);

DROP ENCRYPT RULE t_encrypt,t_encrypt_2;

```

## Shadow

### Syntax

```

CREATE SHADOW RULE shadowRuleDefinition [, shadowRuleDefinition] ...

ALTER SHADOW RULE shadowRuleDefinition [, shadowRuleDefinition] ...

CREATE SHADOW ALGORITHM shadowAlgorithm [, shadowAlgorithm] ...

ALTER SHADOW ALGORITHM shadowAlgorithm [, shadowAlgorithm] ...

DROP SHADOW RULE ruleName [, ruleName] ...

DROP SHADOW ALGORITHM algorithmName [, algorithmName] ...

CREATE DEFAULT SHADOW ALGORITHM NAME = algorithmName

shadowRuleDefinition: ruleName(resourceMapping, shadowTableRule [, shadowTableRule]
...)

resourceMapping: SOURCE=resourceName, SHADOW=resourceName

```

```

shadowTableRule: tableName(shadowAlgorithm [, shadowAlgorithm] ...)

shadowAlgorithm: ([algorithmName, ] TYPE(NAME=shadowAlgorithmType,
PROPERTIES([algorithmProperties] ...))

algorithmProperties: algorithmProperty [, algorithmProperty] ...

algorithmProperty: key=value

```

- Duplicate ruleName cannot be created
- resourceMapping specifies the mapping relationship between the source database and the shadow library. You need to use the resource managed by RDL, please refer to [resource](#)
- shadowAlgorithm can act on multiple shadowTableRule at the same time
- If algorithmName is not specified, it will be automatically generated according to ruleName, tableName and shadowAlgorithmType
- shadowAlgorithmType currently supports VALUE\_MATCH, REGEX\_MATCH and SIMPLE\_HINT
- shadowTableRule can be reused by different shadowRuleDefinition, so when executing DROP SHADOW RULE, the corresponding shadowTableRule will not be removed
- shadowAlgorithm can be reused by different shadowTableRule, so when executing ALTER SHADOW RULE, the corresponding shadowAlgorithm will not be removed

### Example

```

CREATE SHADOW RULE shadow_rule(
SOURCE=demo_ds,
SHADOW=demo_ds_shadow,
t_order((simple_hint_algorithm, TYPE(NAME=SIMPLE_HINT, PROPERTIES("shadow"="true",
foo="bar"))), (TYPE(NAME=REGEX_MATCH, PROPERTIES("operation"="insert", "column"=
"user_id", "regex"='[1]')))),
t_order_item((TYPE(NAME=VALUE_MATCH, PROPERTIES("operation"="insert", "column"=
"user_id", "value"='1')))));

ALTER SHADOW RULE shadow_rule(
SOURCE=demo_ds,
SHADOW=demo_ds_shadow,
t_order((simple_hint_algorithm, TYPE(NAME=SIMPLE_HINT, PROPERTIES("shadow"="true",
foo="bar"))), (TYPE(NAME=REGEX_MATCH, PROPERTIES("operation"="insert", "column"=
"user_id", "regex"='[1]')))),
t_order_item((TYPE(NAME=VALUE_MATCH, PROPERTIES("operation"="insert", "column"=
"user_id", "value"='1')))));

CREATE SHADOW ALGORITHM
(simple_hint_algorithm, TYPE(NAME=SIMPLE_HINT, PROPERTIES("shadow"="true", "foo"=

```

```

"bar"))),
(user_id_match_algorithm, TYPE(NAME=REGEX_MATCH,PROPERTIES("operation"="insert",
"column"="user_id", "regex"='[1]')));

ALTER SHADOW ALGORITHM
(simple_hint_algorithm, TYPE(NAME=SIMPLE_HINT, PROPERTIES("shadow"="false", "foo"=
"bar"))),
(user_id_match_algorithm, TYPE(NAME=VALUE_MATCH,PROPERTIES("operation"="insert",
"column"="user_id", "value"='1')));

DROP SHADOW RULE shadow_rule;

DROP SHADOW ALGORITHM simple_hint_algorithm;

CREATE DEFAULT SHADOW ALGORITHM NAME = simple_hint_algorithm;

```

## RQL Syntax

RQL (Resource & Rule Query Language) responsible for resources/rules query.

## Resource Query

### Syntax

```
SHOW DATABASE RESOURCES [FROM databaseName]
```

## Return Value Description

Column	Description
name	Data source name
type	Data source type
host	Data source host
port	Data source port
db	Database name
attribute	Data source attribute

## Example

```
mysql> show database resources;
+-----+-----+-----+-----+-----+-----+
| name | type | host      | port | db | attribute
|
+-----+-----+-----+-----+-----+-----+
| ds_0 | MySQL | 127.0.0.1 | 3306 | ds_0 | {"minPoolSize":1,
"connectionTimeoutMilliseconds":30000,"maxLifetimeMilliseconds":1800000,"readOnly
":false,"idleTimeoutMilliseconds":60000,"maxPoolSize":50} |
| ds_1 | MySQL | 127.0.0.1 | 3306 | ds_1 | {"minPoolSize":1,
"connectionTimeoutMilliseconds":30000,"maxLifetimeMilliseconds":1800000,"readOnly
":false,"idleTimeoutMilliseconds":60000,"maxPoolSize":50} |
+-----+-----+-----+-----+-----+-----+
2 rows in set (0.84 sec)
```

## Rule Query

This chapter describes the syntax of rule query.

## Sharding

### Syntax

#### Sharding Table Rule

```
SHOW SHARDING TABLE tableRule | RULES [FROM databaseName]

SHOW SHARDING ALGORITHMS [FROM databaseName]

SHOW UNUSED SHARDING ALGORITHMS [FROM databaseName]

SHOW SHARDING TABLE RULES USED ALGORITHM algorithmName [FROM databaseName]

SHOW SHARDING KEY GENERATORS [FROM databaseName]

SHOW UNUSED SHARDING KEY GENERATORS [FROM databaseName]
```

```
SHOW SHARDING TABLE RULES USED KEY GENERATOR keyGeneratorName [FROM databaseName]
```

```
SHOW DEFAULT SHARDING STRATEGY
```

```
SHOW SHARDING TABLE NODES;
```

```
tableRule:
```

```
  RULE tableName
```

- Support query all data fragmentation rules and specified table query
- Support query all sharding algorithms

### Sharding Binding Table Rule

```
SHOW SHARDING BINDING TABLE RULES [FROM databaseName]
```

### Sharding Broadcast Table Rule

```
SHOW SHARDING BROADCAST TABLE RULES [FROM databaseName]
```

### Sharding Scaling Rule

```
SHOW SHARDING SCALING RULES [FROM databaseName]
```

## Return Value Description

### Sharding Table Rule

Column	Description
table	Logical table name
actual_data_nodes	Actual data node
actual_data_sources	Actual data source (Displayed when creating rules by RDL)
database_strategy_type	Database sharding strategy type
database_sharding_column	Database sharding column
database_sharding_algorithm_type	Database sharding algorithm type
database_sharding_algorithm_props	Database sharding algorithm properties
table_strategy_type	Table sharding strategy type
table_sharding_column	Table sharding column
table_sharding_algorithm_type	Table sharding algorithm type
table_sharding_algorithm_props	Table sharding algorithm properties
key_generate_column	Sharding key generator column
key_generator_type	Sharding key generator type
key_generator_props	Sharding key generator properties

### Sharding Algorithms

Column	Description
name	Sharding algorithm name
type	Sharding algorithm type
props	Sharding algorithm properties

### Unused Sharding Algorithms

Column	Description
name	Sharding algorithm name
type	Sharding algorithm type
props	Sharding algorithm properties



### Sharding key generators

Column	Description
name	Sharding key generator name
type	Sharding key generator type
props	Sharding key generator properties

### Unused Sharding Key Generators

Column	Description
name	Sharding key generator name
type	Sharding key generator type
props	Sharding key generator properties

### Default Sharding Strategy

Column	Description
name	Strategy name
type	Sharding strategy type
sharding_column	Sharding column
sharding_algorithm_name	Sharding algorithm name
sharding_algorithm_type	Sharding algorithm type
sharding_algorithm_props	Sharding algorithm properties

### Sharding Table Nodes

Column	Description
name	Sharding rule name
nodes	Sharding nodes

### Sharding Binding Table Rule

Column	Description
sharding_binding_tables	sharding Binding Table list

### Sharding Broadcast Table Rule

Column	Description
sharding_broadcast_tables	sharding Broadcast Table list

### Sharding Scaling Rule

Column	Description
name	name of sharding scaling rule
input	data read configuration
output	data write configuration
stream_channel	algorithm of stream channel
completion_detector	algorithm of completion detecting
data_consistency_checker	algorithm of data consistency checking

### Example

#### Sharding Table Rule

*SHOW SHARDING TABLE RULES*

```
mysql> SHOW SHARDING TABLE RULES;
+-----+-----+-----+-----+
| table      | actual_data_nodes          | actual_data_sources | database_
strategy_type | database_sharding_column | database_sharding_algorithm_type |
database_sharding_algorithm_props          | table_strategy_type | table_sharding_
column | table_sharding_algorithm_type | table_sharding_algorithm_props
          | key_generate_column | key_generator_type | key_generator_props |
+-----+-----+-----+-----+
| t_order    | ds_${0..1}.t_order_${0..1} |                       | INLINE
          | user_id              | INLINE                | algorithm-
expression:ds_${user_id % 2} | INLINE                | order_id              | INLINE
          | algorithm-expression:t_order_${order_id % 2} | order_id
          | SNOWFLAKE            |                       |
| t_order_item | ds_${0..1}.t_order_item_${0..1} |                       | INLINE
          | user_id              | INLINE                | algorithm-
```

```

expression:ds_{$user_id % 2} | INLINE | order_id | INLINE
| algorithm-expression:t_order_item_{$order_id % 2} | order_item_id
| SNOWFLAKE |
| t2 | | ds_0,ds_1 |
| | | mod | id | mod
| sharding-count:10 |
+-----+-----+-----+-----+
-----+-----+-----+-----+
-----+-----+-----+-----+
-----+-----+-----+-----+
+-----+-----+-----+-----+
3 rows in set (0.02 sec)

```

SHOW SHARDING TABLE RULE *tableName*

```

mysql> SHOW SHARDING TABLE RULE t_order;
+-----+-----+-----+-----+-----+-----+-----+-----+
+-----+-----+-----+-----+-----+-----+-----+-----+
+-----+-----+-----+-----+-----+-----+-----+-----+
+-----+-----+-----+-----+-----+-----+-----+-----+
+-----+-----+-----+-----+-----+-----+-----+-----+
| table | actual_data_nodes | actual_data_sources | database_strategy_
type | database_sharding_column | database_sharding_algorithm_type | database_
sharding_algorithm_props | table_strategy_type | table_sharding_column |
table_sharding_algorithm_type | table_sharding_algorithm_props |
key_generate_column | key_generator_type | key_generator_props |
+-----+-----+-----+-----+-----+-----+-----+-----+
+-----+-----+-----+-----+-----+-----+-----+-----+
+-----+-----+-----+-----+-----+-----+-----+-----+
+-----+-----+-----+-----+-----+-----+-----+-----+
+-----+-----+-----+-----+-----+-----+-----+-----+
| t_order | ds_{$0..1}.t_order_{$0..1} | | INLINE |
user_id | INLINE | algorithm-expression:ds_{$
{user_id % 2} | INLINE | order_id | INLINE
| algorithm-expression:t_order_{$order_id % 2} | order_id | SNOWFLAKE
| |
+-----+-----+-----+-----+-----+-----+-----+-----+
+-----+-----+-----+-----+-----+-----+-----+-----+
+-----+-----+-----+-----+-----+-----+-----+-----+
+-----+-----+-----+-----+-----+-----+-----+-----+
+-----+-----+-----+-----+-----+-----+-----+-----+
1 row in set (0.01 sec)

```

SHOW SHARDING ALGORITHMS

```
mysql> SHOW SHARDING ALGORITHMS;
+-----+-----+-----+
| name          | type  | props                                |
+-----+-----+-----+
| t_order_inline | INLINE | algorithm-expression=t_order_${order_id % 2} |
| t_order_item_inline | INLINE | algorithm-expression=t_order_item_${order_id % 2} |
+-----+-----+-----+
2 row in set (0.01 sec)
```

*SHOW UNUSED SHARDING ALGORITHMS*

```
mysql> SHOW UNUSED SHARDING ALGORITHMS;
+-----+-----+-----+
| name          | type  | props                                |
+-----+-----+-----+
| t1_inline     | INLINE | algorithm-expression=t_order_${order_id % 2} |
+-----+-----+-----+
1 row in set (0.01 sec)
```

*SHOW SHARDING TABLE RULES USED ALGORITHM `algorithmName`*

```
mysql> SHOW SHARDING TABLE RULES USED ALGORITHM t_order_inline;
+-----+-----+
| type | name |
+-----+-----+
| table | t_order |
+-----+-----+
1 row in set (0.01 sec)
```

*SHOW SHARDING KEY GENERATORS*

```
mysql> SHOW SHARDING KEY GENERATORS;
+-----+-----+-----+
| name          | type  | props |
+-----+-----+-----+
| t_order_snowflake | snowflake | |
| t_order_item_snowflake | snowflake | |
| uuid_key_generator | uuid     | |
+-----+-----+-----+
3 row in set (0.01 sec)
```

*SHOW UNUSED SHARDING KEY GENERATORS*

```
mysql> SHOW UNUSED SHARDING KEY GENERATORS;
+-----+-----+-----+
| name          | type  | props          |
+-----+-----+-----+
| uuid_key_generator | uuid  |                |
+-----+-----+-----+
1 row in set (0.01 sec)
```

*SHOW SHARDING TABLE RULES USED KEY GENERATOR keyGeneratorName*

```
mysql> SHOW SHARDING TABLE RULES USED KEY GENERATOR keyGeneratorName;
+-----+-----+
| type | name |
+-----+-----+
| table | t_order |
+-----+-----+
1 row in set (0.01 sec)
```

*SHOW DEFAULT SHARDING STRATEGY*

```
mysql> SHOW DEFAULT SHARDING STRATEGY ;
+-----+-----+-----+-----+-----+
| name      | type  | sharding_column | sharding_algorithm_name | sharding_
algorithm_type | sharding_algorithm_props          |
+-----+-----+-----+-----+-----+
| TABLE   | NONE  |                |                |
|          |       |                |                |
| DATABASE | STANDARD | order_id      | database_inline | INLINE
|          | {algorithm-expression=ds_${user_id % 2}} |
+-----+-----+-----+-----+-----+
2 rows in set (0.07 sec)
```

*SHOW SHARDING TABLE NODES*

```
mysql> SHOW SHARDING TABLE NODES;
+-----+-----+
| name | nodes
+-----+-----+
| t_order | ds_0.t_order_0, ds_1.t_order_1, ds_0.t_order_2, ds_1.t_order_3 |
+-----+-----+
1 row in set (0.02 sec)
```

### Sharding Binding Table Rule

```
mysql> SHOW SHARDING BINDING TABLE RULES;
+-----+
| sharding_binding_tables |
+-----+
| t_order,t_order_item |
| t1,t2                  |
+-----+
2 rows in set (0.00 sec)
```

### Sharding Broadcast Table Rule

```
mysql> SHOW SHARDING BROADCAST TABLE RULES;
+-----+
| sharding_broadcast_tables |
+-----+
| t_1                       |
| t_2                       |
+-----+
2 rows in set (0.00 sec)
```

### Sharding Scaling Rule

```
mysql> SHOW SHARDING SCALING RULES;
+-----+-----+-----+-----+-----+-----+
| name          | input          | output          | stream_channel | completion_detector |
+-----+-----+-----+-----+-----+-----+
| data_consistency_checker |                |                |                |                    |
+-----+-----+-----+-----+-----+-----+
| sharding_scaling | {"workerThread":40,"batchSize":1000} | {"workerThread":40,
"batchSize":1000} | {"type":"MEMORY","props":{"block-queue-size":"10000"}} | {"type":
"IDLE","props":{"incremental-task-idle-seconds-threshold":"1800"}} | {"type":
"DATA_MATCH","props":{"chunk-size":"1000"}} |
+-----+-----+-----+-----+-----+-----+

```

```

-----+-----
-----+-----
-----+-----+
-----+
1 row in set (0.00 sec)

```

## Single Table

### Syntax

```

SHOW SINGLE TABLE (tableRule | RULES) [FROM databaseName]

SHOW SINGLE TABLES

tableRule:
    RULE tableName

```

### Return Value Description

#### Single Table Rule

Column	Description
name	Rule name
resource_name	Data source name

#### Single Table

Column	Description
table_name	Single table name
resource_name	The resource name where the single table is located

### Example

*single table rules*

```

sql> show single table rules;
+-----+-----+
| name   | resource_name |
+-----+-----+
| default | ds_1          |

```

```
+-----+-----+
1 row in set (0.01 sec)
```

*single tables*

```
mysql> show single tables;
+-----+-----+
| table_name | resource_name |
+-----+-----+
| t_single_0 | ds_0          |
| t_single_1 | ds_1          |
+-----+-----+
2 rows in set (0.02 sec)
```

**Readwrite-Splitting**

**Syntax**

```
SHOW READWRITE_SPLITTING RULES [FROM databaseName]
```

**Return Value Description**

Column	Description
name	Rule name
auto_aware_data_source_name	Auto-Aware discovery data source name (Display configuration dynamic readwrite splitting rules)
write_data_source_name	Write data source name
read_data_source_names	Read data source name list
load_balancer_type	Load balance algorithm type
load_balancer_props	Load balance algorithm parameter

**Example**

*Static Readwrite Splitting Rules*

```
mysql> show readwrite_splitting rules;
+-----+-----+-----+-----+
| name          | auto_aware_data_source_name | write_data_source_name | read_data_source_names | load_balancer_type | load_balancer_props |
+-----+-----+-----+-----+
| ms_group_0   |                               | ds_primary             | ds_slave_0,           |                    |
```



```
ds_slave_1 | random          |          |
+-----+-----+-----+-----+
-----+-----+-----+
1 row in set (0.00 sec)
```

*Dynamic Readwrite Splitting Rules*

```
mysql> show readwrite_splitting rules from readwrite_splitting_db;
+-----+-----+-----+-----+
-----+-----+-----+
| name          | auto_aware_data_source_name | write_data_source_name | read_data_
source_names | load_balancer_type | load_balancer_props |
+-----+-----+-----+-----+
-----+-----+-----+
| readwrite_ds | ms_group_0                |                          |
          | random          | read_weight=2:1      |
+-----+-----+-----+-----+
-----+-----+-----+
1 row in set (0.01 sec)
```

*Static Readwrite Splitting Rules And Dynamic Readwrite Splitting Rules*

```
mysql> show readwrite_splitting rules from readwrite_splitting_db;
+-----+-----+-----+-----+
-----+-----+-----+
| name          | auto_aware_data_source_name | write_data_source_name | read_data_
source_names | load_balancer_type | load_balancer_props |
+-----+-----+-----+-----+
-----+-----+-----+
| readwrite_ds | ms_group_0                | write_ds                | read_ds_0,
read_ds_1 | random          | read_weight=2:1      |
+-----+-----+-----+-----+
-----+-----+-----+
1 row in set (0.00 sec)
```

**DB Discovery**

**Syntax**

```
SHOW DB_DISCOVERY RULES [FROM databaseName]

SHOW DB_DISCOVERY TYPES [FROM databaseName]

SHOW DB_DISCOVERY HEARTBEATS [FROM databaseName]
```

## Return Value Description

### DB Discovery Rule

Column	Description
group_name	Rule name
data_source_names	Data source name list
primary_data_source_name	Primary data source name
discovery_type	Database discovery service type
discovery_heartbeat	Database discovery service heartbeat

### DB Discovery Type

Column	Description
name	Type name
type	Type category
props	Type properties

### DB Discovery Heartbeat

Column	Description
name	Heartbeat name
props	Heartbeat properties

## Example

### DB Discovery Rule

```
mysql> show db_discovery rules;
+-----+-----+-----+-----+
| group_name          | data_source_names | primary_data_source_name | discovery_
type                |
discovery_heartbeat |
+-----+-----+-----+-----+
| db_discovery_group_0 | ds_0,ds_1,ds_2   | ds_0                    | {name=db_
discovery_group_0_mgr, type=MySQL.MGR, props={group-name=92504d5b-6dec}} |
{name=db_discovery_group_0_heartbeat, props={keep-alive-cron=0/5 * * * * ?}} |
```

```

+-----+-----+-----+-----+
+-----+-----+-----+-----+
+-----+
1 row in set (0.20 sec)

```

*DB Discovery Type*

```

mysql> show db_discovery types;
+-----+-----+-----+
| name          | type      | props          |
+-----+-----+-----+
| db_discovery_group_0_mgr | MySQL.MGR | {group-name=92504d5b-6dec} |
+-----+-----+-----+
1 row in set (0.01 sec)

```

*DB Discovery Heartbeat*

```

mysql> show db_discovery heartbeats;
+-----+-----+
| name          | props          |
+-----+-----+
| db_discovery_group_0_heartbeat | {keep-alive-cron=0/5 * * * * ?} |
+-----+-----+
1 row in set (0.01 sec)

```

**Encrypt**

**Syntax**

```

SHOW ENCRYPT RULES [FROM databaseName]

SHOW ENCRYPT TABLE RULE tableName [from databaseName]

```

- Support to query all data encryption rules and specify logical table name query

### Return Value Description

Column	Description
table	Logical table name
logic_column	Logical column name
logic_data_type	Logical column data type
cipher_column	Ciphertext column name
cipher_data_type	Ciphertext column data type
plain_column	Plaintext column name
plain_data_type	Plaintext column data type
assisted_query_column	Assisted query column name
assisted_query_data_type	Assisted query column data type
encryptor_type	Encryption algorithm type
encryptor_props	Encryption algorithm parameter
query_with_cipher_column	Whether to use encrypted column for query

### Example

Show Encrypt Rules

```
mysql> show encrypt rules from encrypt_db;
+-----+-----+-----+-----+-----+
+-----+-----+-----+-----+-----+
+-----+-----+-----+-----+-----+
| table      | logic_column | logic_data_type | cipher_column | cipher_data_type |
plain_column | plain_data_type | assisted_query_column | assisted_query_data_type |
encryptor_type | encryptor_props          | query_with_cipher_column |
+-----+-----+-----+-----+-----+
+-----+-----+-----+-----+-----+
+-----+-----+-----+-----+-----+
| t_encrypt  | user_id      |                | user_cipher   |                  |
user_plain  |              |                |              |                  |
AES         | aes-key-value=123456abc | true          |              |                  |
| t_encrypt  | order_id     |                | order_cipher  |                  |
|           |              |                |              |                  |
MD5        |              |                |              |                  |
| t_encrypt_2 | user_id      |                | user_cipher   |                  |
user_plain  |              |                |              |                  |
AES         | aes-key-value=123456abc | false        |              |                  |
| t_encrypt_2 | order_id     |                | order_cipher  |                  |
|           |              |                |              |                  |
MD5        |              |                |              |                  |
+-----+-----+-----+-----+-----+
+-----+-----+-----+-----+-----+
+-----+-----+-----+-----+-----+
```

```
4 rows in set (0.78 sec)
```

Show Encrypt Table Rule Table Name

```
mysql> show encrypt table rule t_encrypt;
+-----+-----+-----+-----+-----+-----+-----+-----+
+-----+-----+-----+-----+-----+-----+-----+-----+
+-----+-----+-----+-----+-----+-----+-----+-----+
| table      | logic_column | logic_data_type | cipher_column | cipher_data_type |
plain_column | plain_data_type | assisted_query_column | assisted_query_data_type |
encryptor_type | encryptor_props          | query_with_cipher_column |
+-----+-----+-----+-----+-----+-----+-----+-----+
+-----+-----+-----+-----+-----+-----+-----+-----+
| t_encrypt | user_id      |                  | user_cipher   |                  |
user_plain  |              |                  |              |                  |
AES         | aes-key-value=123456abc | true            |              |                  |
| t_encrypt | order_id    |                  | order_cipher  |                  |
|          |            |                  |              |                  |
MD5         |              |                  |              |                  |
+-----+-----+-----+-----+-----+-----+-----+-----+
+-----+-----+-----+-----+-----+-----+-----+-----+
2 rows in set (0.01 sec)

mysql> show encrypt table rule t_encrypt from encrypt_db;
+-----+-----+-----+-----+-----+-----+-----+-----+
+-----+-----+-----+-----+-----+-----+-----+-----+
+-----+-----+-----+-----+-----+-----+-----+-----+
| table      | logic_column | logic_data_type | cipher_column | cipher_data_type |
plain_column | plain_data_type | assisted_query_column | assisted_query_data_type |
encryptor_type | encryptor_props          | query_with_cipher_column |
+-----+-----+-----+-----+-----+-----+-----+-----+
+-----+-----+-----+-----+-----+-----+-----+-----+
| t_encrypt | user_id      |                  | user_cipher   |                  |
user_plain  |              |                  |              |                  |
AES         | aes-key-value=123456abc | true            |              |                  |
| t_encrypt | order_id    |                  | order_cipher  |                  |
|          |            |                  |              |                  |
MD5         |              |                  |              |                  |
+-----+-----+-----+-----+-----+-----+-----+-----+
+-----+-----+-----+-----+-----+-----+-----+-----+
2 rows in set (0.01 sec)
```

## Shadow

### Syntax

```
SHOW SHADOW shadowRule | RULES [FROM databaseName]
```

```
SHOW SHADOW TABLE RULES [FROM databaseName]
```

```
SHOW SHADOW ALGORITHMS [FROM databaseName]
```

```
shadowRule:
  RULE ruleName
```

- Support querying all shadow rules and specified table query
- Support querying all shadow table rules
- Support querying all shadow algorithms

### Return Value Description

#### Shadow Rule

Column	Description
rule_name	Rule name
source_name	Source database
shadow_name	Shadow database
shadow_table	Shadow table

#### Shadow Table Rule

Column	Description
shadow_table	Shadow table
shadow_algorithm_name	Shadow algorithm name

#### Shadow Algorithms

Column	Description
shadow_algorithm_name	Shadow algorithm name
type	Shadow algorithm type
props	Shadow algorithm properties
is_default	Default

## Shadow Rule status

Column	Description
status	Enable

## Example

*SHOW SHADOW RULES*

```
mysql> show shadow rules;
+-----+-----+-----+-----+
| rule_name      | source_name | shadow_name | shadow_table |
+-----+-----+-----+-----+
| shadow_rule_1  | ds_1       | ds_shadow_1 | t_order      |
| shadow_rule_2  | ds_2       | ds_shadow_2 | t_order_item |
+-----+-----+-----+-----+
2 rows in set (0.02 sec)
```

*SHOW SHADOW RULE ruleName*

```
mysql> show shadow rule shadow_rule_1;
+-----+-----+-----+-----+
| rule_name      | source_name | shadow_name | shadow_table |
+-----+-----+-----+-----+
| shadow_rule_1  | ds_1       | ds_shadow_1 | t_order      |
+-----+-----+-----+-----+
1 rows in set (0.01 sec)
```

*SHOW SHADOW TABLE RULES*

```
mysql> show shadow table rules;
+-----+-----+-----+-----+
| shadow_table | shadow_algorithm_name |
+-----+-----+-----+-----+
| t_order_1   | user_id_match_algorithm,simple_hint_algorithm_1 |
+-----+-----+-----+-----+
1 rows in set (0.01 sec)
```

*SHOW SHADOW ALGORITHMS*

```
mysql> show shadow algorithms;
```

```

-----+-----+
| shadow_algorithm_name | type          | props
| is_default          |
+-----+-----+
-----+-----+
| user_id_match_algorithm | REGEX_MATCH   | operation=insert,column=user_id,
regex=[1] | false        |
| simple_hint_algorithm_1 | SIMPLE_HINT   | shadow=true,foo=bar
| false              |
+-----+-----+
-----+-----+
2 rows in set (0.01 sec)

```

### RAL Syntax

RAL (Resource & Rule Administration Language) responsible for the added-on feature of hint, transaction type switch, scaling, sharding execute planning and so on.



Hint

Statement	Function	Example
SET READWRITE_SPLITTING HINT SOURCE = [auto / write]	For current connection, set readwrite splitting routing strategy (automatic or forced to write data source)	SET <b>READWRITE_SPLITTING</b> HINT SOURCE = write
SET SHARDING HINT DATABASE_VALUE = yy	For current connection, set sharding value for database sharding only, yy: sharding value	SET SHARDING HINT DATABASE_VALUE = 100
ADD SHARDING HINT DATABASE_VALUE xx = yy	For current connection, add sharding value for table, xx: logic table, yy: database sharding value	ADD SHARDING HINT DATABASE_VALUE t_order = 100
ADD SHARDING HINT TABLE_VALUE xx = yy	For current connection, add sharding value for table, xx: logic table, yy: table sharding value	ADD SHARDING HINT TABLE_VALUE t_order = 100
CLEAR HINT SETTINGS	For current connection, clear all hint settings	CLEAR HINT
CLEAR [SHARDING HINT / READWRITE_SPLITTING HINT]	For current connection, clear hint settings of sharding or readwrite splitting	CLEAR READWRITE_SPLITTING HINT
SHOW [SHARDING / READWRITE_SPLITTING] HINT STATUS	For current connection, query hint settings of sharding or readwrite splitting	SHOW READWRITE_SPLITTING HINT STATUS

## Scaling

Statement	Function	Example
SHOW SCALING LIST	Query running list	SHOW SCALING LIST
SHOW SCALING STATUS jobId	Query scaling status, xx: jobId	SHOW SCALING STATUS 1234
START SCALING jobId	Start scaling, xx: jobId	START SCALING 1234
STOP SCALING jobId	Stop scaling, xx: jobId	STOP SCALING 1234
DROP SCALING jobId	Drop scaling, xx: jobId	DROP SCALING 1234
RESET SCALING jobId	reset progress, xx: jobId	RESET SCALING 1234
CHECK SCALING jobId	Data consistency check with algorithm in server.yaml, xx: jobId	CHECK SCALING 1234
SHOW SCALING CHECK ALGORITHMS	Show available consistency check algorithms	SHOW SCALING CHECK ALGORITHMS
CHECK SCALING {jobId} by type(name={algorithmType})	Data consistency check with defined algorithm	CHECK SCALING 1234 by type(name=DEFAULT)
STOP SCALING SOURCE WRITING jobId	The source ShardingSphere data source is discontinued, xx: jobId	STOP SCALING SOURCE WRITING 1234
RESTORE SCALING SOURCE WRITING jobId	Restore source data source writing, xx: jobId	RESTORE SCALING SOURCE WRITING 1234
APPLY SCALING jobId	Switch to target ShardingSphere metadata, xx: jobId	APPLY SCALING 1234

## Circuit Breaker

Statement	Function	Example
[ENABLE / DISABLE] READWRITE_SPLITTING (READ)? resourceName [FROM databaseName]	Enable or disable read data source	ENABLE READWRITE_SPLITTING READ resource_0
[ENABLE / DISABLE] INSTANCE instanceId	Enable or disable proxy instance	DISABLE INSTANCE instance_1
SHOW INSTANCE LIST	Query proxy instance information	SHOW INSTANCE LIST
SHOW READWRITE_SPLITTING (READ)? resourceName [FROM databaseName]	Query all read resources status	SHOW READWRITE_SPLITTING READ RESOURCES

Global Rule

Statement	Function	Example
SHOW AUTHORITY RULE	Query authority rule configuration	SHOW AUTHORITY RULE
SHOW TRANSACTION RULE	Query transaction rule configuration	SHOW TRANSACTION RULE
SHOW SQL_PARSER RULE	Query SQL parser rule configuration	SHOW SQL_PARSER RULE
ALTER TRANSACTION RULE(DEFAULT=XA, TYPE(NAME=Narayana, PROPERTIES("key1" = "value1", "key2" = "value2" ...)))	Alter transaction rule configuration, DEFAULT: default transaction type, support LOCAL, XA, BASE; NAME: name of transaction manager, support Atomikos, Narayana and Bitronix	ALTER TRANSACTION RULE(DEFAULT=XA, TYPE(NAME=Narayana, PROPERTIES("databaseName" = "jbosssts", "host" = "127.0.0.1")))
ALTER SQL_PARSER RULE SQL_COMMENT_PARSE_ENABLE=false, PARSE_TREE_CACHE(INITIAL_CAPACITY=xx, MAXIMUM_SIZE=xx, CONCURRENCY_LEVEL=xx), SQL_STATEMENT_CACHE(INITIAL_CAPACITY=xxx, MAXIMUM_SIZE=xxx, CONCURRENCY_LEVEL=xxx)	Alter SQL parser rule configuration, SQL_COMMENT_PARSE_ENABLE: whether to parse the SQL comment, PARSE_TREE_CACHE: local cache configuration of syntax tree, SQL_STATEMENT_CACHE: local cache of SQL statement	ALTER SQL_PARSER RULE SQL_COMMENT_PARSE_ENABLE=false, PARSE_TREE_CACHE(INITIAL_CAPACITY=10, MAXIMUM_SIZE=11, CONCURRENCY_LEVEL=1), SQL_STATEMENT_CACHE(INITIAL_CAPACITY=11, MAXIMUM_SIZE=11, CONCURRENCY_LEVEL=100)

## Other

Statement	Function	Example
SHOW INSTANCE MODE	Query the mode configuration of the proxy	SHOW INSTANCE MODE
COUNT DATABASE RULES [FROM database]	Query the number of rules in a database	COUNT DATABASE RULES
SET VARIABLE proxy_property_name = xx	proxy_property_name is one of <a href="#">properties configuration</a> of proxy, name is split by underscore	SET VARIABLE sql_show = true
SET VARIABLE transaction_type = xx	Modify transaction_type of the current connection, supports LOCAL, XA, BASE	SET VARIABLE transaction_type = XA
SET VARIABLE agent_plugins_enabled = [TRUE / FALSE]	Set whether the agent plugins are enabled, the default value is false	SET VARIABLE agent_plugins_enabled = TRUE
SHOW ALL VARIABLES	Query proxy all properties configuration	SHOW ALL VARIABLES
SHOW VARIABLE variable_name	Query proxy variable, name is split by underscore	SHOW VARIABLE sql_show
PREVIEW SQL	Preview the actual SQLs	PREVIEW SELECT * FROM t_order
PARSE SQL	Parse SQL and output abstract syntax tree	PARSE SELECT * FROM t_order
REFRESH TABLE METADATA	Refresh the metadata of all tables	REFRESH TABLE METADATA
REFRESH TABLE METADATA [tableName / tableName FROM RESOURCE resourceName]	Refresh the metadata of a table	REFRESH TABLE METADATA t_order FROM resource ds_1
SHOW TABLE METADATA tableName [, tableName] ...	Query table metadata	SHOW TABLE METADATA t_order
EXPORT DATABASE CONFIG [FROM database_name] [, file="file_path" ]	Query / export resources and rule configuration in database	EXPORT DATABASE CONFIG FROM <b>read-write_</b> splitting_db
SHOW RULES USED RESOURCE resourceName [from database]	Query the rules for using the specified resource in database	SHOW RULES USED RESOURCE ds_0 FROM databaseName

## Notice

ShardingSphere-Proxy does not support hint by default, to support it, set `proxy-hint-enabled` to `true` in `conf/server.yaml`.

## Usage

This chapter will introduce how to use DistSQL to manage resources and rules in a distributed database.

## Pre-work

Use MySQL as example, can replace to other databases.

1. Start the MySQL service;
2. Create to be registered MySQL databases;
3. Create role and user in MySQL with creation permission for ShardingSphere-Proxy;
4. Start Zookeeper service;
5. Add mode and authentication configurations to `server.yaml`;
6. Start ShardingSphere-Proxy;
7. Use SDK or terminal connect to ShardingSphere-Proxy.

## Create Logic Database

1. Create logic database

```
CREATE DATABASE foo_db;
```

2. Use newly created logic database

```
USE foo_db;
```

## Resource Operation

More details please see concentrate rule examples.

## Rule Operation

More details please see concentrate rule examples.

## Notice

1. Currently, DROP DATABASE will only remove the logical distributed database, not the user's actual database;
2. DROP TABLE will delete all logical fragmented tables and actual tables in the database;
3. CREATE DATABASE will only create a logical distributed database, so users need to create actual databases in advance.

## Sharding

### Resource Operation

- Configure data source information

```
ADD RESOURCE ds_0 (  
HOST=127.0.0.1,  
PORT=3306,  
DB=ds_1,  
USER=root,  
PASSWORD=root  
);  
  
ADD RESOURCE ds_1 (  
HOST=127.0.0.1,  
PORT=3306,  
DB=ds_2,  
USER=root,  
PASSWORD=root  
);
```

## Rule Operation

- Create sharding rule

```
CREATE SHARDING TABLE RULE t_order(  
RESOURCES(ds_0,ds_1),  
SHARDING_COLUMN=order_id,  
TYPE(NAME=hash_mod,PROPERTIES("sharding-count"=4)),  
KEY_GENERATE_STRATEGY(COLUMN=order_id,TYPE(NAME=snowflake))  
);
```

- Create sharding table

```
CREATE TABLE `t_order` (  
  `order_id` int NOT NULL,  
  `user_id` int NOT NULL,  
  `status` varchar(45) DEFAULT NULL,  
  PRIMARY KEY (`order_id`)  
) ENGINE=InnoDB DEFAULT CHARSET=utf8mb4
```

- Drop sharding table

```
DROP TABLE t_order;
```

- Drop sharding rule

```
DROP SHARDING TABLE RULE t_order;
```

- Drop resource

```
DROP RESOURCE ds_0, ds_1;
```

- Drop distributed database

```
DROP DATABASE foo_db;
```

## Readwrite\_splitting

### Resource Operation

```
ADD RESOURCE write_ds (  
  HOST=127.0.0.1,  
  PORT=3306,  
  DB=ds_0,  
  USER=root,  
  PASSWORD=root  
) , read_ds (  
  HOST=127.0.0.1,  
  PORT=3307,  
  DB=ds_0,  
  USER=root,  
  PASSWORD=root  
);
```

## Rule Operation

- Create readwrite\_splitting rule

```
CREATE READWRITE_SPLITTING RULE group_0 (  
WRITE_RESOURCE=write_ds,  
READ_RESOURCES(read_ds),  
TYPE(NAME=random)  
);
```

- Alter readwrite\_splitting rule

```
ALTER READWRITE_SPLITTING RULE group_0 (  
WRITE_RESOURCE=write_ds,  
READ_RESOURCES(read_ds),  
TYPE(NAME=random,PROPERTIES(read_weight='2:0'))  
);
```

- Drop readwrite\_splitting rule

```
DROP READWRITE_SPLITTING RULE group_0;
```

- Drop resource

```
DROP RESOURCE write_ds,read_ds;
```

- Drop distributed database

```
DROP DATABASE readwrite_splitting_db;
```

## Encrypt

### Resource Operation

```
ADD RESOURCE ds_0 (  
  HOST=127.0.0.1,  
  PORT=3306,  
  DB=ds_0,  
  USER=root,  
  PASSWORD=root  
);
```



## Rule Operation

- Create encrypt rule

```
CREATE ENCRYPT RULE t_encrypt (
  COLUMNS(
    (NAME=user_id,PLAIN=user_plain,CIPHER=user_cipher,TYPE(NAME=AES,PROPERTIES(
      'aes-key-value'='123456abc'))),
    (NAME=order_id,PLAIN=order_plain,CIPHER =order_cipher,TYPE(NAME=RC4,
      PROPERTIES('rc4-key-value'='123456abc'))))
  ));
```

- Create encrypt table

```
CREATE TABLE `t_encrypt` (
  `id` int(11) NOT NULL,
  `user_id` varchar(45) DEFAULT NULL,
  `order_id` varchar(45) DEFAULT NULL,
  PRIMARY KEY (`id`)
) ENGINE=InnoDB DEFAULT CHARSET=utf8mb4;
```

- Alter encrypt rule

```
ALTER ENCRYPT RULE t_encrypt (
  COLUMNS(
    (NAME=user_id,PLAIN=user_plain,CIPHER=user_cipher,TYPE(NAME=AES,PROPERTIES(
      'aes-key-value'='123456abc'))))
  ));
```

- Drop encrypt rule

```
DROP ENCRYPT RULE t_encrypt;
```

- Drop resource

```
DROP RESOURCE ds_0;
```

- Drop distributed database

```
DROP DATABASE encrypt_db;
```

## DB Discovery

### Resource Operation

```

ADD RESOURCE ds_0 (
HOST=127.0.0.1,
PORT=3306,
DB=ds_0,
USER=root,
PASSWORD=root
),RESOURCE ds_1 (
HOST=127.0.0.1,
PORT=3306,
DB=ds_1,
USER=root,
PASSWORD=root
),RESOURCE ds_2 (
HOST=127.0.0.1,
PORT=3306,
DB=ds_2,
USER=root,
PASSWORD=root
);

```

### Rule Operation

- Create DB discovery rule

```

CREATE DB_DISCOVERY RULE db_discovery_group_0 (
RESOURCES(ds_0, ds_1),
TYPE(NAME=MySQL.MGR,PROPERTIES('group-name'='92504d5b-6dec')),
HEARTBEAT(PROPERTIES('keep-alive-cron'='0/5 * * * * ?'))
);

```

- Alter DB discovery rule

```

ALTER DB_DISCOVERY RULE db_discovery_group_0 (
RESOURCES(ds_0, ds_1, ds_2),
TYPE(NAME=MySQL.MGR,PROPERTIES('group-name'='92504d5b-6dec')),
HEARTBEAT(PROPERTIES('keep-alive-cron'='0/5 * * * * ?'))
);

```

- Drop db\_discovery rule

```

DROP DB_DISCOVERY RULE db_discovery_group_0;

```

- Drop db\_discovery type

```
DROP DB_DISCOVERY TYPE db_discovery_group_0_mgr;
```

- Drop db\_discovery heartbeat

```
DROP DB_DISCOVERY HEARTBEAT db_discovery_group_0_heartbeat;
```

- Drop resource

```
DROP RESOURCE ds_0,ds_1,ds_2;
```

- Drop distributed database

```
DROP DATABASE discovery_db;
```

## Shadow

### Resource Operation

```
ADD RESOURCE ds_0 (  
HOST=127.0.0.1,  
PORT=3306,  
DB=ds_0,  
USER=root,  
PASSWORD=root  
) ,ds_1 (  
HOST=127.0.0.1,  
PORT=3306,  
DB=ds_1,  
USER=root,  
PASSWORD=root  
) ,ds_2 (  
HOST=127.0.0.1,  
PORT=3306,  
DB=ds_2,  
USER=root,  
PASSWORD=root  
);
```

## Rule Operation

- Create shadow rule

```
CREATE SHADOW RULE group_0(
SOURCE=ds_0,
SHADOW=ds_1,
t_order((simple_hint_algorithm, TYPE(NAME=SIMPLE_HINT, PROPERTIES("foo"="bar"))),
(TYPE(NAME=REGEX_MATCH, PROPERTIES("operation"="insert", "column"="user_id", "regex"="'[1]')"))),
t_order_item((TYPE(NAME=SIMPLE_HINT, PROPERTIES("foo"="bar"))));
```

- Alter shadow rule

```
ALTER SHADOW RULE group_0(
SOURCE=ds_0,
SHADOW=ds_2,
t_order_item((TYPE(NAME=SIMPLE_HINT, PROPERTIES("foo"="bar"))));
```

- Drop shadow rule

```
DROP SHADOW RULE group_0;
```

- Drop resource

```
DROP RESOURCE ds_0,ds_1,ds_2;
```

- Drop distributed database

```
DROP DATABASE foo_db;
```

## 5.2.4 Logging

This chapter will introduce the detailed syntax of Logging which is used when users need to distinguish databases or users in the log. To achieve a specific goal, following configurations can be added to logback.xml:

### To distinguish databases in the same log

```
<appender name="databaseConsole" class="ch.qos.logback.core.ConsoleAppender">
  <encoder>
    <pattern>[%-5level] %d{yyyy-MM-dd HH:mm:ss.SSS} [%thread] [%X{database}]
%logger{36} - %msg%n</pattern>
  </encoder>
</appender>

<logger name="ShardingSphere-SQL" level="info" additivity="false">
```

```
<appender-ref ref="databaseConsole" />
</logger>
```

### To distinguish databases and users in the same log

```
<appender name="databaseConsole" class="ch.qos.logback.core.ConsoleAppender">
  <encoder>
    <pattern>[%-5level] %d{yyyy-MM-dd HH:mm:ss.SSS} [%thread] [%X{database}] [
%X{user}] %logger{36} - %msg%n</pattern>
  </encoder>
</appender>

<logger name="ShardingSphere-SQL" level="info" additivity="false">
  <appender-ref ref="databaseConsole" />
</logger>
```

### To split into different log files

```
<appender name="SiftingFile" class="ch.qos.logback.classic.sift.SiftingAppender">
  <discriminator>
    <key>database</key>
    <defaultValue>none</defaultValue>
  </discriminator>
  <sift>
    <appender name="File-${database}" class="ch.qos.logback.core.FileAppender">
      <file>logs/${database}.log</file>
      <append>true</append>
      <encoder charset="UTF-8">
        <pattern>[%-5level] %d{yyyy-MM-dd HH:mm:ss.SSS} [%thread] [%X{user}
] %logger{36} - %msg%n</pattern>
      </encoder>
    </appender>
  </sift>
</appender>

<logger name="ShardingSphere-SQL" level="info" additivity="false">
  <appender-ref ref="SiftingFile" />
</logger>
```

## 5.2.5 Scaling

### Introduction

ShardingSphere-Scaling is a common solution for migrating data to ShardingSphere or scaling data in Apache ShardingSphere since **4.1.0**, current state is **Experimental** version.

### Build

#### Build&Deployment

1. Execute the following command to compile and generate the ShardingSphere-Proxy binary package:

```
git clone --depth 1 https://github.com/apache/shardingsphere.git
cd shardingsphere
mvn clean install -Dmaven.javadoc.skip=true -Dcheckstyle.skip=true -Drat.skip=true
-Djacoco.skip=true -DskipITs -DskipTests -Prelease
```

The binary packages: - /shardingsphere-distribution/shardingsphere-proxy-distribution/target/apache-shardingsphere-`{latest.release.version}`-shardingsphere-proxy-bin.tar.gz

Or get binary package from [download page](#).

Scaling is an experimental feature, if scaling job fail, you could try nightly version, click here to [download nightly build](#).

2. Unzip the proxy distribution package, modify the configuration file `conf/config-sharding.yaml`. Please refer to [proxy startup manual](#) for more details.
3. Modify the configuration file `conf/server.yaml`. Please refer to [Mode Configuration](#) for more details. Type of mode must be `Cluster` for now, please start the registry center before running proxy.

Configuration Example:

```
mode:
  type: Cluster
  repository:
    type: ZooKeeper
    props:
      namespace: governance_ds
      server-lists: localhost:2181
      retryIntervalMilliseconds: 500
      timeToLiveSeconds: 60
      maxRetries: 3
      operationTimeoutMilliseconds: 500
  overwrite: false
```

4. Enable scaling

Way 1. Modify `scalingName` and scaling configuration in `conf/config-sharding.yaml`.

Configuration Items Explanation:

```
rules:
- !SHARDING
  # ignored configuration

  scalingName: # Enabled scaling action config name
  scaling:
    <scaling-action-config-name> (+):
      input: # Data read configuration. If it's not configured, then part of its
configuration will take effect.
        workerThread: # Worker thread pool size for inventory data ingestion from
source. If it's not configured, then use system default value.
        batchSize: # Maximum records count of a DML select operation. If it's not
configured, then use system default value.
        rateLimiter: # Rate limit algorithm. If it's not configured, then system
will skip rate limit.
          type: # Algorithm type. Options:
          props: # Algorithm properties
        output: # Data write configuration. If it's not configured, then part of its
configuration will take effect.
          workerThread: # Worker thread pool size for data importing to target. If it
's not configured, then use system default value.
          batchSize: # Maximum records count of a DML insert/delete/update operation.
If it's not configured, then use system default value.
          rateLimiter: # Rate limit algorithm. If it's not configured, then system
will skip rate limit.
            type: # Algorithm type. Options:
            props: # Algorithm properties
          streamChannel: # Algorithm of channel that connect producer and consumer,
used for input and output. If it's not configured, then system will use MEMORY type
            type: # Algorithm type. Options: MEMORY
            props: # Algorithm properties
            block-queue-size: # Property: data channel block queue size. Available
for types: MEMORY
          completionDetector: # Completion detect algorithm. If it's not configured,
then system won't continue to do next steps automatically.
            type: # Algorithm type. Options: IDLE
            props: # Algorithm properties
            incremental-task-idle-seconds-threshold: # If incremental tasks is idle
more than so much seconds, then it could be considered as almost completed.
Available for types: IDLE
          dataConsistencyChecker: # Data consistency check algorithm. If it's not
configured, then system will skip this step.
            type: # Algorithm type. Options: DATA_MATCH, CRC32_MATCH
            props: # Algorithm properties
            chunk-size: # Maximum records count of a query operation for check
```

type of dataConsistencyChecker could be got by executing DistSQL SHOW SCALING CHECK ALGORITHMS. Simple comparison: - DATA\_MATCH : Support all types of databases, but it's not the best performant one. - CRC32\_MATCH : Support MySQL, performance is better than DATA\_MATCH.

Auto Mode Configuration Example:

```
rules:
- !SHARDING
  # ignored configuration

  scalingName: scaling_auto
  scaling:
    scaling_auto:
      input:
        workerThread: 40
        batchSize: 1000
      output:
        workerThread: 40
        batchSize: 1000
      streamChannel:
        type: MEMORY
        props:
          block-queue-size: 10000
      completionDetector:
        type: IDLE
        props:
          incremental-task-idle-seconds-threshold: 1800
      dataConsistencyChecker:
        type: DATA_MATCH
        props:
          chunk-size: 1000
```

Manual Mode Configuration Example:

```
rules:
- !SHARDING
  # ignored configuration

  scalingName: scaling_manual
  scaling:
    scaling_manual:
      input:
        workerThread: 40
        batchSize: 1000
      output:
        workerThread: 40
        batchSize: 1000
      streamChannel:
        type: MEMORY
```



```

    props:
      block-queue-size: 10000
  dataConsistencyChecker:
    type: DATA_MATCH
    props:
      chunk-size: 1000

```

Way 2: Configure scaling by DistSQL

Auto Mode Configuration Example:

```

CREATE SHARDING SCALING RULE scaling_auto (
INPUT(
  WORKER_THREAD=40,
  BATCH_SIZE=1000
),
OUTPUT(
  WORKER_THREAD=40,
  BATCH_SIZE=1000
),
STREAM_CHANNEL(TYPE(NAME=MEMORY, PROPERTIES("block-queue-size"=10000))),
COMPLETION_DETECTOR(TYPE(NAME=IDLE, PROPERTIES("incremental-task-idle-seconds-
threshold"=1800))),
DATA_CONSISTENCY_CHECKER(TYPE(NAME=DATA_MATCH, PROPERTIES("chunk-size"=1000)))
);

```

Manual Mode Configuration Example:

```

CREATE SHARDING SCALING RULE scaling_manual (
INPUT(
  WORKER_THREAD=40,
  BATCH_SIZE=1000
),
OUTPUT(
  WORKER_THREAD=40,
  BATCH_SIZE=1000
),
STREAM_CHANNEL(TYPE(NAME=MEMORY, PROPERTIES("block-queue-size"=10000))),
DATA_CONSISTENCY_CHECKER(TYPE(NAME=DATA_MATCH, PROPERTIES("chunk-size"=1000)))
);

```

Please refer to [RDL#Sharding](#) for more details.

#### 5. Import JDBC driver dependency

If the backend database is in following table, please download JDBC driver jar and put it into `shardingsphere-proxy/lib` directory.

RDBMS	JDBC driver	Reference
MySQL	<code>mysql-connector-java-5.1.47.jar</code> < <a href="https://repo1.maven.org/maven2/mysql/mysql-connector-java/5.1.47/mysql-connector-java-5.1.47.jar">https://repo1.maven.org/maven2/mysql/mysql-connector-java/5.1.47/mysql-connector-java-5.1.47.jar</a> >`_`	Connector/J Versions
openGauss	<code>opengauss-jdbc-2.0.1-compatibility.jar</code>	

6. Start up ShardingSphere-Proxy:

```
sh bin/start.sh
```

7. Check proxy log logs/stdout.log:

```
[INFO ] [main] o.a.s.p.frontend.ShardingSphereProxy - ShardingSphere-Proxy start success
```

It means proxy start up successfully.

**Shutdown**

```
sh bin/stop.sh
```

**Manual**

**Manual**

**Environment**

JAVA, JDK 1.8+.

The migration scene we support:

Source	Target
MySQL(5.1.15 ~ 5.7.x)	MySQL(5.1.15 ~ 5.7.x)
PostgreSQL(9.4 ~ )	PostgreSQL(9.4 ~ )
openGauss(2.1.0)	openGauss(2.1.0)

Supported features:

Feature	MySQL	PostgreSQL	openGauss
Inventory migration	Supported	Supported	Supported
Incremental migration	Supported	Supported	Supported
Create table automatically	Supported	Supported	Supported
DATA_MATCH data consistency check	Supported	Supported	Supported
CRC32_MATCH data consistency check	Supported	Unsupported	Unsupported

**Attention:**

For RDBMS which Create table automatically feature is not supported, we need to create sharding tables manually.

**Privileges**

**MySQL**

1. Enable binlog

Configuration Example of MySQL 5.7 my.cnf:

```
[mysqld]
server-id=1
log-bin=mysql-bin
binlog-format=row
binlog-row-image=full
max_connections=600
```

Execute the following SQL to confirm whether binlog is turned on or not:

```
show variables like '%log_bin%';
show variables like '%binlog%';
```

As shown below, it means binlog has been turned on:

Variable_name	Value
log_bin	ON
binlog_format	ROW
binlog_row_image	FULL

2. Privileges of account that scaling use should include Replication privileges.

Execute the following SQL to confirm whether the user has migration permission or not:

```
SHOW GRANTS FOR 'user';
```

Result Example:

Grants for \${username}@\${host}
GRANT REPLICATION SLAVE, REPLICATION CLIENT ON *.* TO \${username}@\${host}
.....

## PostgreSQL

1. Enable `test_decoding` feature.
2. Adjust WAL configuration

Configuration Example of `postgresql.conf`:

```
wal_level = logical
max_replication_slots = 10
max_connections = 600
```

Please refer to [Write Ahead Log](#) and [Replication](#) for more details.

## DistSQL API for auto mode

### Preview current sharding rule

Example:

```
preview SELECT COUNT(1) FROM t_order;
```

Response:

```
mysql> preview SELECT COUNT(1) FROM t_order;
+-----+-----+
-----+
| data_source_name | actual_sql
|
+-----+-----+
-----+
| ds_0             | SELECT COUNT(1) FROM t_order_0 UNION ALL SELECT COUNT(1) FROM
t_order_1 |
| ds_1             | SELECT COUNT(1) FROM t_order_0 UNION ALL SELECT COUNT(1) FROM
t_order_1 |
+-----+-----+
-----+
2 rows in set (0.65 sec)
```

### Start scaling job

1. Add new data source resources

Please refer to [RDL#Data Source](#) for more details.

Create database on underlying RDBMS first, it will be used in following DistSQL.

Example:

```
ADD RESOURCE ds_2 (
  URL="jdbc:mysql://127.0.0.1:3306/scaling_ds_2?serverTimezone=UTC&useSSL=false",
  USER=root,
  PASSWORD=root,
  PROPERTIES("maximumPoolSize"=10,"idleTimeout"="30000")
), ds_3 (
  URL="jdbc:mysql://127.0.0.1:3306/scaling_ds_3?serverTimezone=UTC&useSSL=false",
  USER=root,
  PASSWORD=root,
  PROPERTIES("maximumPoolSize"=10,"idleTimeout"="30000")
), ds_4 (
  URL="jdbc:mysql://127.0.0.1:3306/scaling_ds_4?serverTimezone=UTC&useSSL=false",
  USER=root,
  PASSWORD=root,
  PROPERTIES("maximumPoolSize"=10,"idleTimeout"="30000")
);
```

2. Alter sharding table rule for tables to be scaled

We could scale all tables or partial tables. Binding tables must be scaled together.

Currently, scaling job could only be emitted by executing ALTER SHARDING TABLE RULE DistSQL.

Please refer to [RDL#Sharding](#) for more details.

SHARDING TABLE RULE support two types: TableRule and AutoTableRule. Following is a comparison of the two sharding rule types:

Type	AutoTableRule	TableRule
Definition	Auto Sharding Algorithm	<code>`User-Defined Sharding Algorithm &lt; <a href="https://shardingsphere.apache.org/document/current/en/features/sharding/concept/sharding/#user-defined-sharding-algorithm">https://shardingsphere.apache.org/document/current/en/features/sharding/concept/sharding/#user-defined-sharding-algorithm</a>&gt;`</code>

Meaning of fields in DistSQL is the same as YAML configuration, please refer to [YAML Configuration#Sharding](#) for more details.

Example of alter AutoTableRule:

```
ALTER SHARDING TABLE RULE t_order (
  RESOURCES(ds_2, ds_3, ds_4),
  SHARDING_COLUMN=order_id,
  TYPE(NAME=hash_mod,PROPERTIES("sharding-count"=6)),
  KEY_GENERATE_STRATEGY(COLUMN=order_id,TYPE(NAME=snowflake))
);
```

RESOURCES is altered from (ds\_0, ds\_1) to (ds\_2, ds\_3, ds\_4), and sharding-count is altered from 4 to 6, it will emit scaling job.

Uncompleted example of alter TableRule:

```

ALTER SHARDING ALGORITHM database_inline (
TYPE(NAME=INLINE,PROPERTIES("algorithm-expression"="ds_${user_id % 3 + 2}"))
);

ALTER SHARDING TABLE RULE t_order (
DATANODES("ds_${2..4}.t_order_${0..1}"),
DATABASE_STRATEGY(TYPE=standard,SHARDING_COLUMN=user_id,SHARDING_
ALGORITHM=database_inline),
TABLE_STRATEGY(TYPE=standard,SHARDING_COLUMN=order_id,SHARDING_ALGORITHM=t_order_
inline),
KEY_GENERATE_STRATEGY(COLUMN=order_id,TYPE(NAME=snowflake))
), t_order_item (
DATANODES("ds_${2..4}.t_order_item_${0..1}"),
DATABASE_STRATEGY(TYPE=standard,SHARDING_COLUMN=user_id,SHARDING_
ALGORITHM=database_inline),
TABLE_STRATEGY(TYPE=standard,SHARDING_COLUMN=order_id,SHARDING_ALGORITHM=t_order_
item_inline),
KEY_GENERATE_STRATEGY(COLUMN=order_item_id,TYPE(NAME=snowflake))
);

```

algorithm-expression of database\_inline is alerted from ds\_\${user\_id % 2} to ds\_\${user\_id % 3 + 2}, and DATANODES of t\_order is alerted from ds\_\${0..1}.t\_order\_\${0..1} to ds\_\${2..4}.t\_order\_\${0..1}, it will emit scaling job.

Currently, ALTER SHARDING ALGORITHM will take effect immediately, but table rule will not, it might cause inserting data into source side failure, so alter sharding table rule to AutoTableRule is recommended for now.

### List scaling jobs

Please refer to [RAL#Scaling](#) for more details.

Example:

```
show scaling list;
```

Response:

```

mysql> show scaling list;
+-----+-----+-----+-----+-----+
| id          | tables                | sharding_total_count | active |
create_time  | stop_time             |                       |       |
+-----+-----+-----+-----+-----+
| 659853312085983232 | t_order_item, t_order | 2                       | false |
2021-10-26 20:21:31 | 2021-10-26 20:24:01 |                       |       |
| 660152090995195904 | t_order_item, t_order | 2                       | false |

```

```
2021-10-27 16:08:43 | 2021-10-27 16:11:00 |
+-----+-----+-----+-----+-----+
-----+
2 rows in set (0.04 sec)
```

**Get scaling progress**

Example:

```
show scaling status {jobId};
```

Response:

```
mysql> show scaling status 660152090995195904;
+-----+-----+-----+-----+-----+
-----+
| item | data_source | status | inventory_finished_percentage | incremental_idle_
seconds |
+-----+-----+-----+-----+-----+
-----+
| 0    | ds_1        | FINISHED | 100 | 2834
|
| 1    | ds_0        | FINISHED | 100 | 2834
|
+-----+-----+-----+-----+-----+
-----+
2 rows in set (0.00 sec)
```

Current scaling job is finished, new sharding rule should take effect, and not if scaling job is failed.

status values:

Value	Description
PREPARING	preparing
RUNNING	running
EXECUTE_INVENTORY_TASK	inventory task running
EXE- CUTE_INCREMENTAL_TASK	incremental task running
FINISHED	finished (The whole process is completed, and the new rules have been taken effect)
PREPARING_FAILURE	preparation failed
E CUTE_INVENTORY_TASK_FAILURE	inventory task failed
EXE CUTE_INCREMENTAL_TASK_FAILURE	incremental task failed

If status fails, you can check the log of proxy to view the error stack and analyze the problem.

### Preview new sharding rule

Example:

```
preview SELECT COUNT(1) FROM t_order;
```

Response:

```
mysql> PREVIEW SELECT COUNT(1) FROM t_order;
+-----+-----+
-----+
| data_source_name | actual_sql
|
+-----+-----+
-----+
| ds_2            | SELECT COUNT(1) FROM t_order_0 UNION ALL SELECT COUNT(1) FROM
t_order_1 |
| ds_3            | SELECT COUNT(1) FROM t_order_0 UNION ALL SELECT COUNT(1) FROM
t_order_1 |
| ds_4            | SELECT COUNT(1) FROM t_order_0 UNION ALL SELECT COUNT(1) FROM
t_order_1 |
+-----+-----+
-----+
3 rows in set (0.21 sec)
```

### Other DistSQL

Please refer to [RAL#Scaling](#) for more details.

### DistSQL manual mode whole process example

On manual mode, data consistency check and switch configuration could be emitted manually. Please refer to [RAL#Scaling](#) for more details.

This example show how to migrate data from MySQL to proxy.

Most SQLs should be executed in proxy, except few ones mentioned for MySQL.



## Create source databases

It's not needed in practice. It just simulates databases for testing.

Execute SQLs in MySQL:

```
DROP DATABASE IF EXISTS scaling_ds_0;
CREATE DATABASE scaling_ds_0 DEFAULT CHARSET utf8;

DROP DATABASE IF EXISTS scaling_ds_1;
CREATE DATABASE scaling_ds_1 DEFAULT CHARSET utf8;
```

## Login proxy

```
mysql -h127.0.0.1 -P3307 -uroot -proot
```

## Create and configure logical database

Create logical database:

```
CREATE DATABASE scaling_db;

USE scaling_db
```

Add source database resource:

```
ADD RESOURCE ds_0 (
  URL="jdbc:mysql://127.0.0.1:3306/scaling_ds_0?serverTimezone=UTC&useSSL=false",
  USER=root,
  PASSWORD=root,
  PROPERTIES("maximumPoolSize"=50,"idleTimeout"="60000")
), ds_1 (
  URL="jdbc:mysql://127.0.0.1:3306/scaling_ds_1?serverTimezone=UTC&useSSL=false",
  USER=root,
  PASSWORD=root,
  PROPERTIES("maximumPoolSize"=50,"idleTimeout"="60000")
);
```

Configure rules: Configure tables of existing system in sharding rule, sharding table rules and INLINE algorithm will be used to fit existing tables name.

```
CREATE SHARDING ALGORITHM database_inline (
  TYPE(NAME=INLINE,PROPERTIES("algorithm-expression"="ds_${user_id % 2}"))
);
CREATE SHARDING ALGORITHM t_order_inline (
  TYPE(NAME=INLINE,PROPERTIES("algorithm-expression"="t_order_${order_id % 2}"))
```

```

);
CREATE SHARDING ALGORITHM t_order_item_inline (
TYPE(NAME=INLINE,PROPERTIES("algorithm-expression"="t_order_item_${order_id % 2}"))
);

CREATE SHARDING TABLE RULE t_order (
DATANODES("ds_${0..1}.t_order_${0..1}"),
DATABASE_STRATEGY(TYPE=standard,SHARDING_COLUMN=user_id,SHARDING_
ALGORITHM=database_inline),
TABLE_STRATEGY(TYPE=standard,SHARDING_COLUMN=order_id,SHARDING_ALGORITHM=t_order_
inline),
KEY_GENERATE_STRATEGY(COLUMN=order_id,TYPE(NAME=snowflake))
), t_order_item (
DATANODES("ds_${0..1}.t_order_item_${0..1}"),
DATABASE_STRATEGY(TYPE=standard,SHARDING_COLUMN=user_id,SHARDING_
ALGORITHM=database_inline),
TABLE_STRATEGY(TYPE=standard,SHARDING_COLUMN=order_id,SHARDING_ALGORITHM=t_order_
item_inline),
KEY_GENERATE_STRATEGY(COLUMN=order_item_id,TYPE(NAME=snowflake))
);

CREATE SHARDING SCALING RULE scaling_manual2 (
DATA_CONSISTENCY_CHECKER(TYPE(NAME=CRC32_MATCH))
);

```

### Create test tables and initialize records

It's not needed in practice.

```

CREATE TABLE t_order (order_id INT NOT NULL, user_id INT NOT NULL, status
VARCHAR(45) CHARSET utf8mb4, PRIMARY KEY (order_id));
CREATE TABLE t_order_item (item_id INT NOT NULL, order_id INT NOT NULL, user_id INT
NOT NULL, status VARCHAR(45) CHARSET utf8mb4, creation_date DATE, PRIMARY KEY
(item_id));

INSERT INTO T_ORDER (order_id, user_id, status) VALUES (1,2,'ok'),(2,4,'ok'),(3,6,
'ok'),(4,1,'ok'),(5,3,'ok'),(6,5,'ok');
INSERT INTO T_ORDER_ITEM (item_id, order_id, user_id, status) VALUES (1,1,2,'ok'),
(2,2,4,'ok'),(3,3,6,'ok'),(4,4,1,'ok'),(5,5,3,'ok'),(6,6,5,'ok');

```

## Run migration

Preview sharding:

```
mysql> PREVIEW SELECT COUNT(1) FROM t_order;
+-----+-----+
| data_source_name | actual_sql
|
+-----+-----+
| ds_0             | SELECT COUNT(1) FROM t_order_0 UNION ALL SELECT COUNT(1) FROM
t_order_1 |
| ds_1             | SELECT COUNT(1) FROM t_order_0 UNION ALL SELECT COUNT(1) FROM
t_order_1 |
+-----+-----+
2 rows in set (0.65 sec)
```

Create target databases in MySQL:

```
DROP DATABASE IF EXISTS scaling_ds_10;
CREATE DATABASE scaling_ds_10 DEFAULT CHARSET utf8;

DROP DATABASE IF EXISTS scaling_ds_11;
CREATE DATABASE scaling_ds_11 DEFAULT CHARSET utf8;

DROP DATABASE IF EXISTS scaling_ds_12;
CREATE DATABASE scaling_ds_12 DEFAULT CHARSET utf8;
```

Add target database resource:

```
ADD RESOURCE ds_2 (
  URL="jdbc:mysql://127.0.0.1:3306/scaling_ds_10?serverTimezone=UTC&useSSL=false
",
  USER=root,
  PASSWORD=root,
  PROPERTIES("maximumPoolSize"=50,"idleTimeout"="60000")
), ds_3 (
  URL="jdbc:mysql://127.0.0.1:3306/scaling_ds_11?serverTimezone=UTC&useSSL=false
",
  USER=root,
  PASSWORD=root,
  PROPERTIES("maximumPoolSize"=50,"idleTimeout"="60000")
), ds_4 (
  URL="jdbc:mysql://127.0.0.1:3306/scaling_ds_12?serverTimezone=UTC&useSSL=false
",
  USER=root,
  PASSWORD=root,
```

```
PROPERTIES("maximumPoolSize"=50,"idleTimeout"="60000")
);
```

Alter sharding rule to emit scaling job:

```
ALTER SHARDING ALGORITHM database_inline (
TYPE(NAME=INLINE,PROPERTIES("algorithm-expression"="ds_${user_id % 3 + 2}"))
);

ALTER SHARDING TABLE RULE t_order (
DATANODES("ds_${2..4}.t_order_${0..1}"),
DATABASE_STRATEGY(TYPE=standard,SHARDING_COLUMN=user_id,SHARDING_
ALGORITHM=database_inline),
TABLE_STRATEGY(TYPE=standard,SHARDING_COLUMN=order_id,SHARDING_ALGORITHM=t_order_
inline),
KEY_GENERATE_STRATEGY(COLUMN=order_id,TYPE(NAME=snowflake))
), t_order_item (
DATANODES("ds_${2..4}.t_order_item_${0..1}"),
DATABASE_STRATEGY(TYPE=standard,SHARDING_COLUMN=user_id,SHARDING_
ALGORITHM=database_inline),
TABLE_STRATEGY(TYPE=standard,SHARDING_COLUMN=order_id,SHARDING_ALGORITHM=t_order_
item_inline),
KEY_GENERATE_STRATEGY(COLUMN=order_item_id,TYPE(NAME=snowflake))
);
```

Query job progress:

```
mysql> SHOW SCALING LIST;
+-----+-----+-----+-----+-----+-----+-----+-----+
| id          | tables          | sharding_ |
total_count | active | create_time      | stop_time |
+-----+-----+-----+-----+-----+-----+
| 0130317c30317c3054317c7363616c696e675f6462 | t_order,t_order_item | 2
| true | 2022-04-16 17:22:19 | NULL |
+-----+-----+-----+-----+-----+-----+
1 row in set (0.34 sec)

mysql> SHOW SCALING STATUS 0130317c30317c3054317c7363616c696e675f6462;
+-----+-----+-----+-----+-----+-----+-----+-----+
| item | data_source | status          | active | inventory_finished_ |
percentage | incremental_idle_seconds |
+-----+-----+-----+-----+-----+-----+-----+
| 0    | ds_0       | EXECUTE_INCREMENTAL_TASK | true  | 100
```

```

      | 8 |
| 1 | ds_1 | EXECUTE_INCREMENTAL_TASK | true | 100
      | 7 |
+-----+-----+-----+-----+-----+
-----+
2 rows in set (0.02 sec)

```

When status is EXECUTE\_INCREMENTAL\_TASK, it means inventory migration stage is successful, it's running on incremental migration stage.

Choose an idle time of business system, stop source database writing or stop upper database operation.

Stop source writing in proxy:

```

mysql> STOP SCALING SOURCE WRITING 0130317c30317c3054317c7363616c696e675f6462;
Query OK, 0 rows affected (0.07 sec)

```

Data consistency check:

```

mysql> CHECK SCALING 0130317c30317c3054317c7363616c696e675f6462 BY TYPE
(NAME=CRC32_MATCH);
+-----+-----+-----+-----+-----+
-----+
| table_name | source_records_count | target_records_count | records_count_
matched | records_content_matched |
+-----+-----+-----+-----+-----+
-----+
| t_order    | 6                    | 6                    | true
| true      |                      |                      |
| t_order_item | 6                    | 6                    | true
| true      |                      |                      |
+-----+-----+-----+-----+-----+
-----+
2 rows in set (2.16 sec)

```

Apply metadata:

```

mysql> APPLY SCALING 0130317c30317c3054317c7363616c696e675f6462;
Query OK, 0 rows affected (0.22 sec)

```

Preview sharding again:

```

mysql> PREVIEW SELECT COUNT(1) FROM t_order;
+-----+-----+-----+-----+-----+
-----+
| data_source_name | actual_sql
|
+-----+-----+-----+-----+-----+
-----+
| ds_2              | SELECT COUNT(1) FROM t_order_0 UNION ALL SELECT COUNT(1) FROM

```

```

t_order_1 |
| ds_3      | SELECT COUNT(1) FROM t_order_0 UNION ALL SELECT COUNT(1) FROM
t_order_1 |
| ds_4      | SELECT COUNT(1) FROM t_order_0 UNION ALL SELECT COUNT(1) FROM
t_order_1 |
+-----+
-----+
3 rows in set (0.21 sec)
    
```

Sharding already take effect.

Optionally, unused ds\_0 and ds\_1 could be removed.

### 5.3 ShardingSphere-Sidecar

#### 5.3.1 Introduction

ShardingSphere-Sidecar (TODO) defines itself as a cloud native database agent of the Kubernetes environment, in charge of all the access to the database in the form of sidecar.

It provides a mesh layer interacting with the database, we call this as Database Mesh.

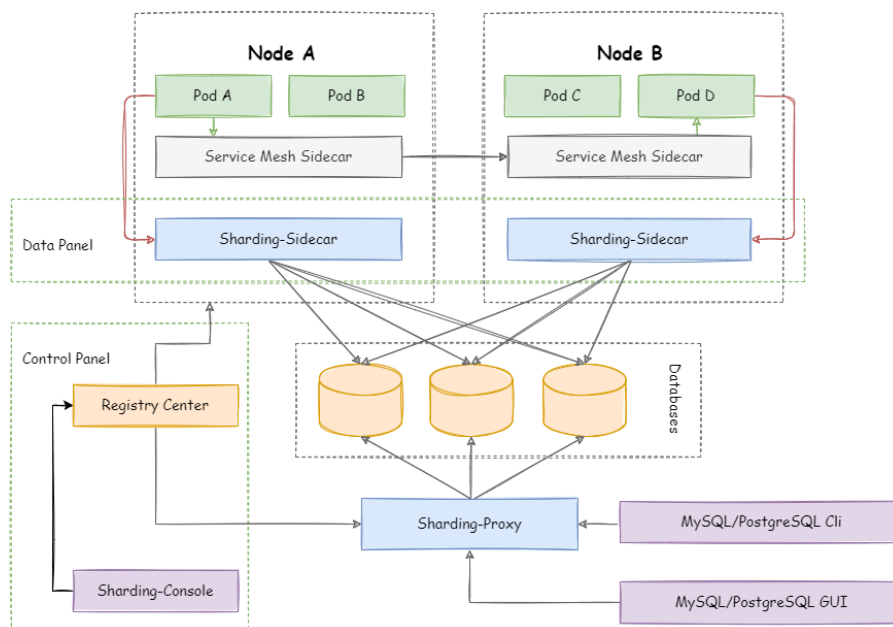

### 5.3.2 Comparison

	<i>ShardingSphere-JDBC</i>	<i>ShardingSphere-Proxy</i>	<i>ShardingSphere-Sidecar</i>
Database	Any	MySQL/PostgreSQL	MySQL
Connections Count Cost	High	Low	High
Supported Languages	Java Only	Any	Any
Performance	Low loss	Relatively High loss	Low loss
Decentralization	Yes	No	Yes
Static Entry	No	Yes	No

The advantage of ShardingSphere-Sidecar lies in its cloud native support for Kubernetes and Mesos.

Apache ShardingSphere provides dozens of SPI based extensions. it is very convenient to customize the functions for developers.

This chapter lists all SPI extensions of Apache ShardingSphere. If there is no special requirement, users can use the built-in implementation provided by Apache ShardingSphere; advanced users can refer to the interfaces for customized implementation.

Apache ShardingSphere community welcomes developers to feed back their implementations to the [open-source community](#), so that more users can benefit from it.

## 6.1 Mode

### 6.1.1 StandalonePersistRepository

<i>SPI Name</i>	<i>Description</i>
StandalonePersistRepository	Standalone mode Configuration persistence

<i>Implementation Class</i>	<i>Description</i>
FileRepository	File persistence
H2Repository	H2 persistence

### 6.1.2 ClusterPersistRepository

<i>SPI Name</i>	<i>Description</i>
ClusterPersistRepository	Registry center repository



<i>Implementation Class</i>	<i>Description</i>
CuratorZookeeperRepository	ZooKeeper registry center repository
EtcdRepository	Etcd registry center repository

### 6.1.3 GovernanceWatcher

<i>SPI Name</i>	<i>Description</i>
GovernanceWatcher	Governance watcher

<i>Implementation Class</i>	<i>Description</i>
ComputeNodeStateChangedWatcher	Compute node changed watcher
GlobalAckChangedWatcher	Global ack changed watcher
GlobalLocksChangedWatcher	Global locks changed watcher
GlobalRuleChangedWatcher	Global rule changed watcher
MetaDataChangedWatcher	Meta data changed watcher
PropertiesChangedWatcher	Properties changed watcher
StorageNodeStateChangedWatcher	Storage node changed watcher

## 6.2 Configuration

### 6.2.1 RuleBuilder

<i>SPI Name</i>	<i>Description</i>
RuleBuilder	Used to convert user configurations to rule objects

<i>Implementation Class</i>	<i>Description</i>
AlgorithmProvidedReadwriteSplittingRuleBuilder	Used to convert algorithm-based read-write separation user configuration into read-write separation rule objects
AlgorithmProvidedDatabaseDiscoveryRuleBuilder	Used to convert algorithm-based database discovery user configuration into database discovery rule objects
AlgorithmProvidedShardingRuleBuilder	Used to convert algorithm-based sharding user configuration into sharding rule objects
AlgorithmProvidedEncryptionRuleBuilder	Used to convert algorithm-based encryption user configuration into encryption rule objects
AlgorithmProvidedShadowRuleBuilder	Used to convert algorithm-based shadow database user configuration into shadow database rule objects
ReadwriteSplittingRuleBuilder	Used to convert read-write separation user configuration into read-write separation rule objects
DatabaseDiscoveryRuleBuilder	Used to convert database discovery user configuration into database discovery rule objects
SingleTableRuleBuilder	Used to convert single-table user configuration into a single-table rule objects
AuthorityRuleBuilder	Used to convert permission user configuration into permission rule objects
ShardingRuleBuilder	Used to convert sharding user configuration into sharding rule objects
EncryptRuleBuilder	Used to convert encrypted user configuration into encryption rule objects
ShadowRuleBuilder	Used to convert shadow database user configuration into shadow database rule objects
TransactionRuleBuilder	Used to convert transaction user configuration into transaction rule objects
SQLParserRuleBuilder	Used to convert SQL parser user configuration into SQL parser rule objects

### 6.2.2 YamlRuleConfigurationSwapper

<i>SPI Name</i>	<i>Description</i>
YamlRuleConfigurationSwapper	Used to convert YAML configuration to standard user configuration

<i>Implementation Class</i>	<i>Description</i>
ReadwriteSplittingRuleAlgorithmProviderConfigurationYamlSwapper	Used to convert algorithm-based read-write separation configuration into read-write separation standard configuration
DatabaseDiscoveryRuleAlgorithmProviderConfigurationYamlSwapper	Used to convert algorithm-based database discovery configuration into database discovery standard configuration
ShardingRuleAlgorithmProviderConfigurationYamlSwapper	Used to convert algorithm-based sharding configuration into sharding standard configuration
EncryptRuleAlgorithmProviderConfigurationYamlSwapper	Used to convert algorithm-based encryption configuration into encryption standard configuration
ShadowRuleAlgorithmProviderConfigurationYamlSwapper	Used to convert algorithm-based shadow database configuration into shadow database standard configuration
ReadwriteSplittingRuleConfigurationYamlSwapper	Used to convert the YAML configuration of read-write separation into the standard configuration of read-write separation
DatabaseDiscoveryRuleConfigurationYamlSwapper	Used to convert the YAML configuration of database discovery into the standard configuration of database discovery
AuthorityRuleConfigurationYamlSwapper	Used to convert the YAML configuration of permission rules into standard configuration of permission rules
ShardingRuleConfigurationYamlSwapper	Used to convert the YAML configuration of the shard into the standard configuration of the shard
EncryptRuleConfigurationYamlSwapper	Used to convert encrypted YAML configuration into encrypted standard configuration
ShadowRuleConfigurationYamlSwapper	Used to convert the YAML configuration of the shadow database into the standard configuration of the shadow database
TransactionRuleConfigurationYamlSwapper	Used to convert the YAML configuration of the transaction into the standard configuration of the transaction
SingleTableRuleConfigurationYamlSwapper	Used to convert the YAML configuration of the single table into the standard configuration of the single table
SQLParserRuleConfigurationYamlSwapper	Used to convert the YAML configuration of the SQL parser into the standard configuration of the SQL parser

### 6.2.3 ShardingSphereYamlConstruct

<i>SPI Name</i>	<i>Description</i>
ShardingSphereYamlConstruct	Used to convert customized objects and YAML to each other

<i>Implementation Class</i>	<i>Description</i>
NoneShardingStrategyConfigurationYamlConstruct	Used to convert non sharding strategy and YAML to each other

## 6.3 Kernel

### 6.3.1 SQLRouter

<i>SPI Name</i>	<i>Description</i>
SQLRouter	Used to process routing results

<i>Implementation Class</i>	<i>Description</i>
ReadwriteSplittingSQLRouter	Used to process read-write separation routing results
DatabaseDiscoverySQLRouter	Used to process database discovery routing results
SingleTableSQLRouter	Used to process single-table routing results
ShardingSQLRouter	Used to process sharding routing results
ShadowSQLRouter	Used to process shadow database routing results

### 6.3.2 SQLRewriteContextDecorator

<i>SPI Name</i>	<i>Description</i>
SQLRewriteContextDecorator	Used to process SQL rewrite results

<i>SPI Name</i>	<i>Description</i>
ShardingSQLRewriteContextDecorator	Used to process sharding SQL rewrite results
EncryptionSQLRewriteContextDecorator	Used to process encryption SQL rewrite results

### 6.3.3 SQLExecutionHook

<i>SPI Name</i>	<i>Description</i>
SQLExecutionHook	Hook of SQL execution

<i>Implementation Class</i>	<i>Description</i>
TransactionalSQLExecutionHook	Transaction hook of SQL execution

### 6.3.4 ResultProcessEngine

<i>SPI Name</i>	<i>Description</i>
ResultProcessEngine	Used by merge engine to process result set

<i>Implementation Class</i>	<i>Description</i>
ShardingResultMergerEngine	Used by merge engine to process sharding result set
EncryptResultDecoratorEngine	Used by merge engine to process encryption result set

### 6.3.5 StoragePrivilegeHandler

<i>SPI Name</i>	<i>Description</i>
StoragePrivilegeHandler	Use SQL dialect to process privilege metadata

<i>Implementation Class</i>	<i>Description</i>
PostgreSQLPrivilegeHandler	Use PostgreSQL dialect to process privilege metadata
SQLServerPrivilegeHandler	Use SQLServer dialect to process privilege metadata
OraclePrivilegeHandler	Use Oracle dialect to process privilege metadata
MySQLPrivilegeHandler	Use MySQL dialect to process privilege metadata

### 6.3.6 DynamicDataSourceStrategy

<i>SPI Name</i>	<i>Description</i>
DynamicDataSourceStrategy	Dynamic data source fetch strategy

<i>Implementation Class</i>	<i>Description</i>
DatabaseDiscoveryDynamicDataSourceStrategy	Use database discovery to dynamic fetch data source

## 6.4 DataSource

### 6.4.1 DatabaseType

<i>SPI Name</i>	<i>Description</i>
DatabaseType	Supported database type

<i>Implementation Class</i>	<i>Description</i>
SQL92DatabaseType	SQL92 database type
MySQLDatabaseType	MySQL database
MariaDBDatabaseType	MariaDB database
PostgreSQLDatabaseType	PostgreSQL database
OracleDatabaseType	Oracle database
SQLServerDatabaseType	SQLServer database
H2DatabaseType	H2 database
OpenGaussDatabaseType	OpenGauss database

#### 6.4.2 DialectTableMetaDataReader

<i>SPI Name</i>	<i>Description</i>
DialectTableMetaDataReader	Use SQL dialect to load meta data rapidly

<i>Implementation Class</i>	<i>Description</i>
MySQLTableMetaDataReader	Use MySQL dialect to load meta data
OracleTableMetaDataReader	Use Oracle dialect to load meta data
PostgreSQLTableMetaDataReader	Use PostgreSQL dialect to load meta data
SQLServerTableMetaDataReader	Use SQLServer dialect to load meta data
H2TableMetaDataReader	Use H2 dialect to load meta data
OpenGaussTableMetaDataReader	Use OpenGauss dialect to load meta data

#### 6.4.3 DataSourcePoolMetaDataReader

<i>SPI Name</i>	<i>Description</i>
DataSourcePoolMetaDataReader	Data source pool meta data

<i>Implementation Class</i>	<i>Description</i>
DBCPDataSourcePoolMetaDataReader	DBCP data source pool meta data
HikariDataSourcePoolMetaDataReader	Hikari data source pool meta data

### 6.4.4 DataSourcePoolActiveDetector

<i>SPI Name</i>	<i>Description</i>
DataSourcePoolActiveDetector	Data source pool active detector

<i>Implementation Class</i>	<i>Description</i>
DefaultDataSourcePoolActiveDetector	Default data source pool active detector
HikariDataSourcePoolActiveDetector	Hikari data source pool active detector

## 6.5 SQL Parser

### 6.5.1 DatabaseTypedSQLParserFacade

<i>SPI Name</i>	<i>Description</i>
DatabaseTypedSQLParserFacade	SQL parser facade for lexer and parser

<i>Implementation Class</i>	<i>Description</i>
MySQLParserFacade	SQL parser facade for MySQL
PostgreSQLParserFacade	SQL parser facade for PostgreSQL
SQLServerParserFacade	SQL parser facade for SQLServer
OracleParserFacade	SQL parser facade for Oracle
SQL92ParserFacade	SQL parser facade for SQL92
OpenGaussParserFacade	SQL parser facade for openGauss

### 6.5.2 SQLVisitorFacade

<i>SPI Name</i>	<i>Description</i>
SQLVisitorFacade	SQL AST visitor facade

<i>Implementation Class</i>	<i>Description</i>
MySQLStatementSQLVisitorFacade	SQL visitor of statement extracted facade for MySQL
PostgreSQLStatementSQLVisitorFacade	SQL visitor of statement extracted facade for PostgreSQL
SQLServerStatementSQLVisitorFacade	SQL visitor of statement extracted facade for SQLServer
OracleStatementSQLVisitorFacade	SQL visitor of statement extracted facade for Oracle
SQL92StatementSQLVisitorFacade	SQL visitor of statement extracted facade for SQL92

## 6.6 Proxy

### 6.6.1 DatabaseProtocolFrontendEngine

<i>SPI Name</i>	<i>Description</i>
DatabaseProtocolFrontendEngine	Regulate parse and adapter protocol of database access for ShardingSphere-Proxy

<i>Implementation Class</i>	<i>Description</i>
MySQLFrontendEngine	Base on MySQL database protocol
PostgreSQLFrontendEngine	Base on PostgreSQL database protocol
OpenGaussFrontendEngine	Base on openGauss database protocol

### 6.6.2 AuthorityProviderAlgorithm

<i>SPI Name</i>	<i>Description</i>
AuthorityProviderAlgorithm	User authority loading logic

<i>Implementation Class</i>	<i>Type</i>	<i>Description</i>
NativeAuthorityProviderAlgorithm (Deprecated)	NATIVE	Persist user authority defined in server.yaml into the backend database. An admin user will be created if not existed
AllPermittedPrivilegesProviderAlgorithm	ALL_PERMITTED	All privileges granted to user by default (No authentication). Will not interact with the actual database
SchemaPermittedPrivilegesProviderAlgorithm	DATABASE_PERMISSIONED	Permissions configured through the attribute user-database-mappings

## 6.7 Data Sharding

### 6.7.1 ShardingAlgorithm

<i>SPI Name</i>	<i>Description</i>
ShardingAlgorithm	Sharding algorithm



<i>Implementation Class</i>	<i>Description</i>
BoundaryBased RangeShardingAlgorithm	Boundary based range sharding algorithm
VolumeBased RangeShardingAlgorithm	Volume based range sharding algorithm
ComplexInlineShardingAlgorithm	Complex inline sharding algorithm
MutableIntervalShardingAlgorithm	Mutable interval sharding algorithm
ClassBasedShardingAlgorithm	Class based sharding algorithm
HintInlineShardingAlgorithm	Hint inline sharding algorithm
FixedIntervalShardingAlgorithm	Fixed interval sharding algorithm
HashModShardingAlgorithm	Hash modulo sharding algorithm
InlineShardingAlgorithm	Inline sharding algorithm
ModShardingAlgorithm	Modulo sharding algorithm
ModuloShardingAlgorithmProvidedByCosId	Modulo sharding algorithm provided by CosId
FixedIntervalShardingAlgorithmProvidedByCosId	Fixed interval sharding algorithm provided by CosId
SnowflakeKeyBasedFixedIntervalShardingAlgorithmProvidedByCosId	Snowflake key-based fixed interval sharding algorithm provided by CosId

### 6.7.2 KeyGenerateAlgorithm

<i>SPI Name</i>	<i>Description</i>
KeyGenerateAlgorithm	Key generate algorithm

<i>Implementation Class</i>	<i>Description</i>
SnowflakeKeyGenerateAlgorithm	Snowflake key generate algorithm
UUIDKeyGenerateAlgorithm	UUID key generate algorithm
CosIdKeyGenerateAlgorithm	CosId key generate algorithm
SnowflakeKeyGenerateAlgorithmProvidedByCosId	Snowflake key generate algorithm provided by CosId
NanoIdKeyGenerateAlgorithm	NanoId key generate algorithm

### 6.7.3 DatetimeService

<i>SPI Name</i>	<i>Description</i>
DatetimeService	Use current time for routing

<i>Implementation Class</i>	<i>Description</i>
DatabaseDatetimeServiceDelegate	Get the current time from the database for routing
SystemDatetimeService	Get the current time from the application system for routing

## 6.7.4 DatabaseSQLEntry

<i>SPI Name</i>	<i>Description</i>
DatabaseSQLEntry	Database dialect for get current time

<i>Implementation Class</i>	<i>Description</i>
MySQLDatabaseSQLEntry	MySQL dialect for get current time
PostgreSQLDatabaseSQLEntry	PostgreSQL dialect for get current time
OracleDatabaseSQLEntry	Oracle dialect for get current time
SQLServerDatabaseSQLEntry	SQLServer dialect for get current time

## 6.8 Readwrite-splitting

### 6.8.1 ReadwriteSplittingType

<i>SPI 名称</i>	<i>详细说明</i>
ReadwriteSplittingType	Readwrite-splitting type

<i>已知实现类</i>	<i>详细说明</i>
StaticReadwriteSplittingType	Static readwrite-splitting type
DynamicReadwriteSplittingType	Dynamic readwrite-splitting type

### 6.8.2 ReplicaLoadBalanceAlgorithm

<i>SPI Name</i>	<i>Description</i>
ReplicaLoadBalanceAlgorithm	Load balance algorithm of replica databases

<i>Implementation Class</i>	<i>Description</i>
RoundRobinReplicaLoadBalanceAlgorithm	Round robin load balance algorithm of replica databases
RandomReplicaLoadBalanceAlgorithm	Random load balance algorithm of replica databases
WeightReplicaLoadBalanceAlgorithm	Weight load balance algorithm of replica databases

## 6.9 HA

### 6.9.1 DatabaseDiscoveryProviderAlgorithm

<i>SPI Name</i>	<i>Description</i>
DatabaseDiscoveryProviderAlgorithm	Database discovery provider algorithm

<i>Implementation Class</i>	<i>Description</i>
MGRDatabaseDiscoveryProviderAlgorithm	Database discovery provider algorithm of MySQL's MGR
MySQLNormalReplicationDatabaseDiscoveryProviderAlgorithm	Database discovery provider algorithm of MySQL's replication
OpenGaussNormalReplicationDatabaseDiscoveryProviderAlgorithm	Database discovery provider algorithm of open-Gauss's replication

## 6.10 Distributed Transaction

### 6.10.1 ShardingSphereTransactionManager

<i>SPI Name</i>	<i>Description</i>
ShardingSphereTransactionManager	Distributed transaction manager

<i>Implementation Class</i>	<i>Description</i>
XAShardingSphereTransactionManager	XA distributed transaction manager
SeataATShardingSphereTransactionManager	Seata distributed transaction manager

### 6.10.2 XATransactionManagerProvider

<i>SPI Name</i>	<i>Description</i>
XATransactionManagerProvider	XA distributed transaction manager

<i>Implementation Class</i>	<i>Description</i>
AtomikosTransactionManagerProvider	XA distributed transaction manager based on Atomikos
NarayanaXATransactionManagerProvider	XA distributed transaction manager based on Narayana
BitronixXATransactionManagerProvider	XA distributed transaction manager based on Bitronix

### 6.10.3 XADataSourceDefinition

<i>SPI Name</i>	<i>Description</i>
XADataSourceDefinition	Auto convert Non XA data source to XA data source

<i>Implementation Class</i>	<i>Description</i>
MySQLXAD ataSourceDefinition	Auto convert Non XA MySQL data source to XA MySQL data source
MariaDBXAD ataSourceDefinition	Auto convert Non XA MariaDB data source to XA MariaDB data source
PostgreSQLXAD ataSourceDefinition	Auto convert Non XA PostgreSQL data source to XA PostgreSQL data source
OracleXAD ataSourceDefinition	Auto convert Non XA Oracle data source to XA Oracle data source
SQLServerXAD ataSourceDefinition	Auto convert Non XA SQLServer data source to XA SQLServer data source
H2XAD ataSourceDefinition	Auto convert Non XA H2 data source to XA H2 data source

### 6.10.4 DataSourcePropertyProvider

<i>SPI Name</i>	<i>Description</i>
DataSourcePropertyProvider	Used to get standard properties of data source pool

<i>Implementation Class</i>	<i>Description</i>
HikariCPPropertyProvider	Used to get standard properties of HikariCP

## 6.11 Scaling

### 6.11.1 ScalingEntry

<i>SPI Name</i>	<i>Description</i>
ScalingEntry	Entry of scaling

<i>Implementation Class</i>	<i>Description</i>
MySQLScalingEntry	MySQL entry of scaling
PostgreSQLScalingEntry	PostgreSQL entry of scaling
OpenGaussScalingEntry	openGauss entry of scaling

### 6.11.2 JobCompletionDetectAlgorithm

<i>SPI Name</i>	<i>Description</i>
JobCompletionDetectAlgorithm	Job completion check algorithm

<i>Implementation Class</i>	<i>Description</i>
IdleRuleAtedJobCompletionDetectAlgorithm	Incremental task idle time based algorithm

### 6.11.3 DataConsistencyCalculateAlgorithm

<i>SPI Name</i>	<i>Description</i>
DataConsistencyCalculateAlgorithm	Check data consistency algorithm

<i>Implementation Class</i>	<i>Description</i>
DataMatchData ConsistencyCalculateAlgorithm	Check data consistency with every recodes one by one
CRC32MatchData ConsistencyCalculateAlgorithm	Use CRC32 to check data consistency

## 6.12 SQL Checker

### 6.12.1 SQLChecker

<i>SPI Name</i>	<i>Description</i>
SQLChecker	SQL checker

<i>Implementation Class</i>	<i>Description</i>
AuthorityChecker	Authority checker

## 6.13 Encryption

### 6.13.1 EncryptAlgorithm

<i>SPI Name</i>	<i>Description</i>
EncryptAlgorithm	Data encrypt algorithm

<i>Implementation Class</i>	<i>Description</i>
MD5EncryptAlgorithm	MD5 data encrypt algorithm
AESEncryptAlgorithm	AES data encrypt algorithm
RC4EncryptAlgorithm	RC4 data encrypt algorithm
SM3EncryptAlgorithm	SM3 data encrypt algorithm
SM4EncryptAlgorithm	SM4 data encrypt algorithm

### 6.13.2 QueryAssistedEncryptAlgorithm

<i>SPI Name</i>	<i>Description</i>
QueryAssistedEncryptAlgorithm	Data encrypt algorithm which include query assisted column

<i>Implementation Class</i>	<i>Description</i>
None	

## 6.14 Shadow DB

### 6.14.1 ShadowAlgorithm

<i>SPI Name</i>	<i>Description</i>
ShadowAlgorithm	shadow routing algorithm

<i>Implementation Class</i>	<i>Description</i>
ColumnValueMatchShadowAlgorithm	Column value match shadow algorithm
ColumnRegexMatchShadowAlgorithm	Column regex match shadow algorithm
SimpleHintShadowAlgorithm	Simple hint shadow algorithm

## 6.15 Observability

### 6.15.1 PluginDefinitionService

<i>SPI Name</i>	<i>Description</i>
PluginDefinitionService	Agent plugin definition

<i>Implementation Class</i>	<i>Description</i>
PrometheusPluginDefinitionService	Prometheus plugin
BaseLoggingPluginDefinitionService	Logging plugin
JaegerPluginDefinitionService	Jaeger plugin
OpenTelemetryTracingPluginDefinitionService	OpenTelemetryTracing plugin
OpenTracingPluginDefinitionService	OpenTracing plugin
ZipkinPluginDefinitionService	Zipkin plugin

### 6.15.2 PluginBootService

<i>SPI Name</i>	<i>Description</i>
PluginBootService	Plugin startup service definition

<i>Implementation Class</i>	<i>Description</i>
PrometheusPluginBootService	Prometheus plugin startup class
BaseLoggingPluginBootService	Logging plugin startup class
JaegerTracingPluginBootService	Jaeger plugin startup class
OpenTelemetryTracingPluginBootService	OpenTelemetryTracing plugin startup class
OpenTracingPluginBootService	OpenTracing plugin startup class
ZipkinTracingPluginBootService	Zipkin plugin startup class

This chapter contains a section of technical implementation and test process with Apache ShardingSphere, which provide the reference with users and developers.

## 7.1 Management

### 7.1.1 Data Structure in Registry Center

Under defined namespace, rules, props and metadata nodes persist in YAML, modifying nodes can dynamically refresh configurations. nodes node persist the runtime node of database access object, to distinguish different database access instances.

```

namespace
├── rules                                     # Global rule configuration
├── props                                    # Properties configuration
├── metadata                                 # Metadata configuration
│   ├── ${schema_1}                         # Schema name 1
│   │   ├── dataSources                     # Datasource configuration
│   │   ├── rules                           # Rule configuration
│   │   └── tables                           # Table configuration
│   │       ├── t_1
│   │       └── t_2
│   ├── ${schema_2}                         # Schema name 2
│   │   ├── dataSources                     # Datasource configuration
│   │   ├── rules                           # Rule configuration
│   │   └── tables                           # Table configuration
├── nodes
│   ├── compute_nodes
│   │   ├── online
│   │   │   ├── proxy
│   │   │   │   ├── UUID                   # Proxy instance identifier
│   │   │   │   └── ....
│   │   └── jdbc

```





### /metadata/\${schemaName}/dataSources

A collection of multiple database connection pools, whose properties (e.g. DBCP, C3P0, Druid and HikariCP) are configured by users themselves.

```

ds_0:
  initializationFailTimeout: 1
  validationTimeout: 5000
  maxLifetime: 1800000
  leakDetectionThreshold: 0
  minimumIdle: 1
  password: root
  idleTimeout: 60000
  jdbcUrl: jdbc:mysql://127.0.0.1:3306/ds_0?serverTimezone=UTC&useSSL=false
  dataSourceClassName: com.zaxxer.hikari.HikariDataSource
  maximumPoolSize: 50
  connectionTimeout: 30000
  username: root
  poolName: HikariPool-1
ds_1:
  initializationFailTimeout: 1
  validationTimeout: 5000
  maxLifetime: 1800000
  leakDetectionThreshold: 0
  minimumIdle: 1
  password: root
  idleTimeout: 60000
  jdbcUrl: jdbc:mysql://127.0.0.1:3306/ds_1?serverTimezone=UTC&useSSL=false
  dataSourceClassName: com.zaxxer.hikari.HikariDataSource
  maximumPoolSize: 50
  connectionTimeout: 30000
  username: root
  poolName: HikariPool-2

```

### /metadata/\${schemaName}/rules

Rule configurations, including sharding, readwrite-splitting, data encryption, shadow DB configurations.

```

- !SHARDING
  xxx

- !READWRITE_SPLITTING
  xxx

- !ENCRYPT
  xxx

```

### /metadata/\${schemaName}/tables

Use separate node storage for each table, dynamic modification of metadata content is not supported currently.

```

name: t_order                                # Table name
columns:                                     # Columns
  id:                                         # Column name
    caseSensitive: false
    dataType: 0
    generated: false
    name: id
    primaryKey: true
  order_id:
    caseSensitive: false
    dataType: 0
    generated: false
    name: order_id
    primaryKey: false
indexs:                                       # Index
  t_user_order_id_index:                     # Index name
    name: t_user_order_id_index

```

### /nodes/compute\_nodes

It includes running instance information of database access object, with sub-nodes as the identifiers of currently running instance, which is automatically generated at each startup using UUID. Those identifiers are temporary nodes, which are registered when instances are on-line and cleared when instances are off-line. The registry center monitors the change of those nodes to govern the database access of running instances and other things.

### /nodes/storage\_nodes

It is able to orchestrate replica database, delete or disable data dynamically.

## 7.2 Sharding

The major sharding processes of all the three ShardingSphere products are identical. According to whether query optimization is performed, they can be divided into standard kernel process and federation executor engine process. The standard kernel process consists of SQL Parse => SQL Route => SQL Rewrite => SQL Execute => Result Merge, which is used to process SQL execution in standard sharding scenarios. The federation executor engine process consists of SQL Parse => Logical Plan Optimize => Physical Plan Optimize => Plan Execute => Standard Kernel Process. The federation executor engine perform logical plan optimization and physical

plan optimization. In the optimization execution phase, it relies on the standard kernel process to route, rewrite, execute, and merge the optimized logical SQL.

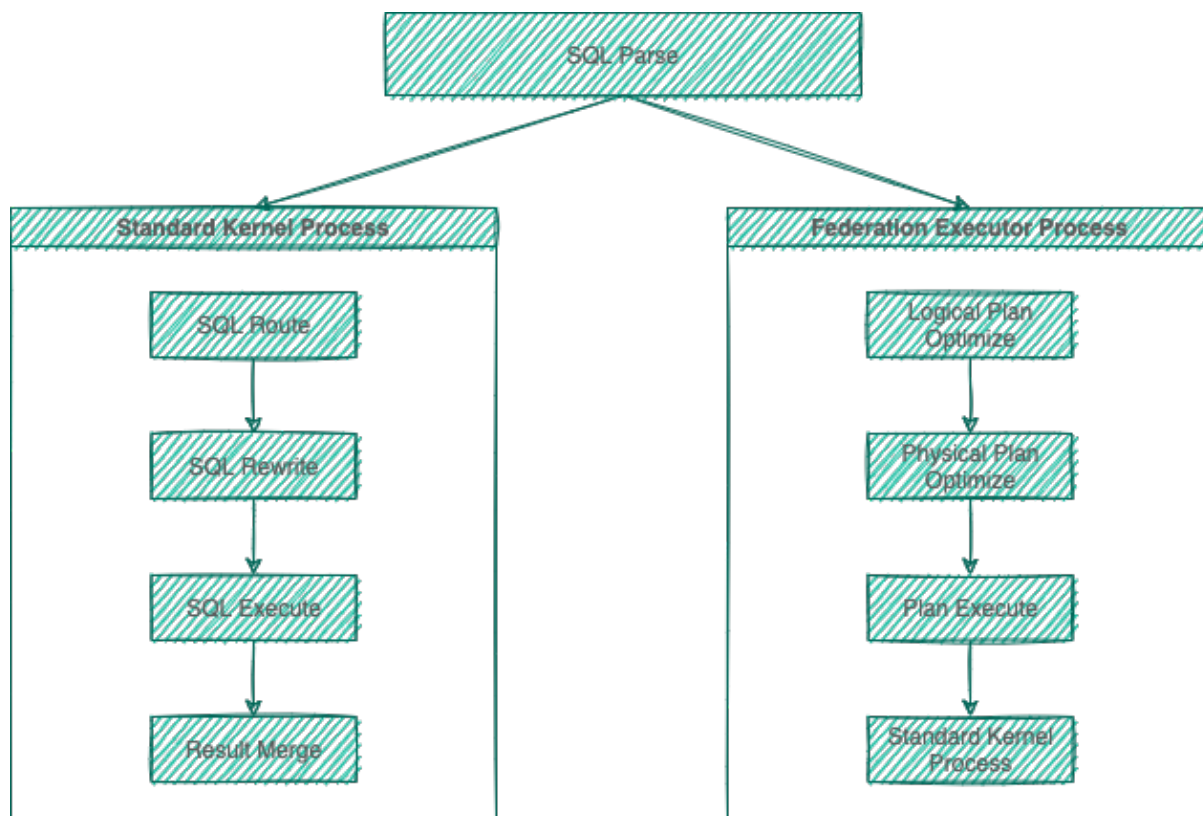

### 7.2.1 SQL Parsing

It is divided into lexical parsing and syntactic parsing. The lexical parser will split SQL into inseparable words, and then the syntactic parser will analyze SQL and extract the parsing context, which can include tables, options, ordering items, grouping items, aggregation functions, pagination information, query conditions and placeholders that may be revised.

### 7.2.2 SQL Route

It is the sharding strategy that matches users' configurations according to the parsing context and the route path can be generated. It supports sharding route and broadcast route currently.

### 7.2.3 SQL Rewrite

It rewrites SQL as statement that can be rightly executed in the real database, and can be divided into correctness rewrite and optimization rewrite.

### 7.2.4 SQL Execution

Through multi-thread executor, it executes asynchronously.

### 7.2.5 Result Merger

It merges multiple execution result sets to output through unified JDBC interface. Result merger includes methods as stream merger, memory merger and addition merger using decorator merger.

### 7.2.6 Query Optimization

Supported by federation executor engine(under development), optimization is performed on complex query such as join query and subquery. It also supports distributed query across multiple database instances. It uses relational algebra internally to optimize query plan, and then get query result through the best query plan.

### 7.2.7 Parse Engine

Compared to other programming languages, SQL is relatively simple, but it is still a complete set of programming language, so there is no essential difference between parsing SQL grammar and parsing other languages (Java, C and Go, etc.).

#### Abstract Syntax Tree

The parsing process can be divided into lexical parsing and syntactic parsing. Lexical parser is used to divide SQL into indivisible atomic signs, i.e., Token. According to the dictionary provided by different database dialect, it is categorized into keyword, expression, literal value and operator. SQL is then converted into abstract syntax tree by syntactic parser.

For example, the following SQL:

```
SELECT id, name FROM t_user WHERE status = 'ACTIVE' AND age > 18
```

Its parsing AST (Abstract Syntax Tree) is this:

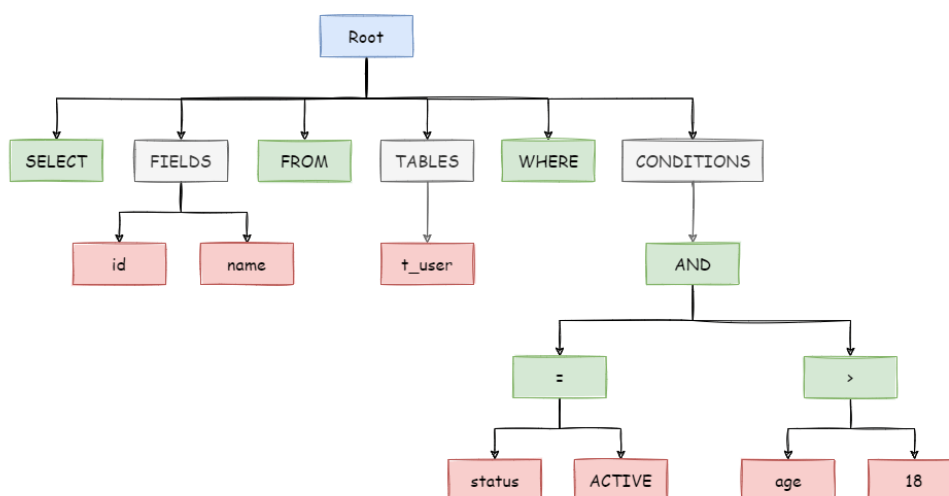

To better understand, the Token of keywords in abstract syntax tree is shown in green; that of variables is shown in red; what's to be further divided is shown in grey.

At last, through traversing the abstract syntax tree, the context needed by sharding is extracted and the place that may need to be rewritten is also marked out. Parsing context for the use of sharding includes select items, table information, sharding conditions, auto-increment primary key information, Order By information, Group By information, and pagination information (Limit, Rownum and Top). One-time SQL parsing process is irreversible, each Token is parsed according to the original order of SQL in a high performance. Considering similarities and differences between SQL of all kinds of database dialect, SQL dialect dictionaries of different types of databases are provided in the parsing module.

## SQL Parser

### History

As the core of database sharding and table sharding, SQL parser takes the performance and compatibility as its most important index. ShardingSphere SQL parser has undergone the upgrade and iteration of 3 generations of products.

To pursue good performance and quick achievement, the first generation of SQL parser uses Druid before 1.4.x version. As tested in practice, its performance exceeds other parsers a lot.

The second generation of SQL parsing engine begins from 1.5.x version, ShardingSphere has adopted fully self-developed parsing engine ever since. Due to different purposes, ShardingSphere does not need to transform SQL into a totally abstract syntax tree or traverse twice through visitor. Using half

parsing method, it only extracts the context required by data sharding, so the performance and compatibility of SQL parsing is further improved.

The third generation of SQL parsing engine begins from 3.0.x version. ShardingSphere tries to adopt ANTLR as a generator for the SQL parsing engine, and uses Visit to obtain SQL Statement from AST. Starting from version 5.0.x, the architecture of the parsing engine has been refactored. At the same time, it is convenient to directly obtain the parsing results of the same SQL to improve parsing efficiency by putting the AST obtained from the first parsing into the cache. Therefore, we recommend that users adopt PreparedStatement this SQL pre-compilation method to improve performance. Currently, users can also use ShardingSphere's SQL parsing engine independently to obtain AST and SQL Statements for a variety of mainstream relational databases. In the future, the SQL parsing engine will continue to provide powerful functions such as SQL formatting and SQL templating.

## Features

- Independent SQL parsing engine
- The syntax rules can be easily expanded and modified (using ANTLR)
- Support multiple dialects

Database	Status
MySQL	perfect supported
PostgreSQL	perfect supported
SQLServer	supported
Oracle	supported
SQL92	supported
openGauss	supported

- SQL format (developing)
- SQL parameterize (developing)

## API Usage

- Maven

```
<dependency>
  <groupId>org.apache.shardingsphere</groupId>
  <artifactId>shardingsphere-sql-parser-engine</artifactId>
  <version>${project.version}</version>
</dependency>
<!-- According to the needs, introduce the parsing module of the specified dialect
(take MySQL as an example), you can add all the supported dialects, or just what
you need -->
<dependency>
  <groupId>org.apache.shardingsphere</groupId>
  <artifactId>shardingsphere-sql-parser-mysql</artifactId>
```

```
<version>${project.version}</version>
</dependency>
```

- Get AST

```
CacheOption cacheOption = new CacheOption(128, 1024L);
SQLParserEngine parserEngine = new SQLParserEngine(sql, cacheOption);
ParseASTNode parseASTNode = parserEngine.parse(sql, useCache);
```

- GET SQLStatement

```
CacheOption cacheOption = new CacheOption(128, 1024L);
SQLParserEngine parserEngine = new SQLParserEngine(sql, cacheOption);
ParseASTNode parseASTNode = parserEngine.parse(sql, useCache);
SQLVisitorEngine sqlVisitorEngine = new SQLVisitorEngine(sql, "STATEMENT",
useCache, new Properties());
SQLStatement sqlStatement = sqlVisitorEngine.visit(parseASTNode);
```

- SQL Format

```
ParseASTNode parseASTNode = parserEngine.parse(sql, useCache);
SQLVisitorEngine sqlVisitorEngine = new SQLVisitorEngine(sql, "STATEMENT",
useCache, new Properties());
SQLStatement sqlStatement = sqlVisitorEngine.visit(parseASTNode);
```

example:



Original SQL	Formatted SQL
select a+1 as b, name n from table1 join table2 where id=1 and name= 'lu' ;	SELECT a + 1 AS b, name n FROM table1 JOIN table2 WHERE id = 1 and name = 'lu' ;
select id, name, age, sex, ss, yy from table1 where id=1;	SELECT id , name , age , sex , ss , yy FROM table1 WHERE id = 1;
select id, name, age, count(*) as n, (select id, name, age, sex from table2 where id=2) as sid, yyyy from table1 where id=1;	SELECT id , name , age , COUNT(*) AS n, ( SELECT id , name , age , sex FROM table2 WHERE id = 2 ) AS sid, yyyy FROM table1 WHERE id = 1;
select id, name, age, sex, ss, yy from table1 where id=1 and name=1 and a=1 and b=2 and c=4 and d=3;	SELECT id , name , age , sex , ss , yy FROM table1 WHERE id = 1 and name = 1 and a = 1 and b = 2 and c = 4 and d = 3;
ALTER TABLE t_order ADD column4 DATE, ADD column5 DATETIME, engine ss max_rows 10,min_rows 2, ADD column6 TIMESTAMP, ADD column7 TIME;	ALTER TABLE t_order ADD column4 DATE, ADD column5 DATETIME, ENGINE ss MAX_ROWS 10, MIN_ROWS 2, ADD column6 TIMESTAMP, ADD column7 TIME
CREATE TABLE IF NOT EXISTS runoob_tbl(runoob_id INT UNSIGNED AUTO_INCREMENT,runoob_title VARCHAR(100) NOT NULL,runoob_author VARCHAR(40) NOT NULL,runoob_test NATIONAL CHAR(40),submission_date DATE,PRIMARY KEY (runoob_id))ENGINE=InnoDB DEFAULT CHARSET=utf8;	CREATE TABLE IF NOT EXISTS runoob_tbl ( runoob_id INT UNSIGNED AUTO_INCREMENT, runoob_title VARCHAR(100) NOT NULL, runoob_author VARCHAR(40) NOT NULL , runoob_test NATIONAL CHAR(40), submission_date DATE, PRIMARY KEY (runoob_id)) ENGINE = InnoDB DEFAULT CHARSET = utf8;
INSERT INTO t_order_item(order_id, user_id, status, creation_date) values (1, 1, 'insert', '2017-08-08' ),(2, 2, 'insert', '2017-08-08' ) ON DUPLICATE KEY UPDATE status = 'init' ;	INSERT INTO t_order_item (order_id , user_id , status , creation_date) VALUES (1, 1, 'insert', '2017-08-08' ), (2, 2, 'insert', '2017-08-08' ) ON DUPLICATE KEY UPDATE status = 'init' ;
INSERT INTO t_order SET order_id = 1, user_id = 1, status = convert(to_base64(aes_encrypt(1, 'key' )) USING utf8) ON DUPLICATE KEY UPDATE status = VALUES(status);	INSERT INTO t_order SET order_id = 1, user_id = 1, status = CONVERT(to_base64(aes_encrypt(1 , 'key' )) USING utf8) ON DUPLICATE KEY UPDATE status = VALUES(status);
INSERT INTO t_order (order_id, user_id, status) SELECT order_id, user_id, status FROM t_order WHERE order_id = 1;	INSERT INTO t_order (order_id , user_id , status) SELECT order_id , user_id , status FROM t_order WHERE order_id = 1;

## 7.2.8 Route Engine

It refers to the sharding strategy that matches databases and tables according to the parsing context and generates route path. SQL with sharding keys can be divided into single-sharding route (equal mark as the operator of sharding key), multiple-sharding route (IN as the operator of sharding key) and range sharding route (BETWEEN as the operator of sharding key). SQL without sharding key adopts broadcast route.

Sharding strategies can usually be set in the database or by users. Strategies built in the database are relatively simple and can generally be divided into last number modulo, hash, range, tag, time and so on. More flexible, sharding strategies set by users can be customized according to their needs. Together with automatic data migration, database middle layer can automatically shard and balance the data without users paying attention to sharding strategies, and thereby the distributed database can have the elastic scaling-out ability. In ShardingSphere's roadmap, elastic scaling-out ability will start from 4.x version.

### Sharding Route

It is used in the situation to route according to the sharding key, and can be sub-divided into 3 types, direct route, standard route and Cartesian product route.

#### Direct Route

The conditions for direct route are relatively strict. It requires to shard through Hint (use HintAPI to appoint the route to databases and tables directly). On the premise of having database sharding but not table sharding, SQL parsing and the following result merging can be avoided. Therefore, with the highest compatibility, it can execute any SQL in complex situations, including sub-queries, self-defined functions. Direct route can also be used in the situation where sharding keys are not in SQL. For example, set sharding key as 3.

```
hintManager.setDatabaseShardingValue(3);
```

If the routing algorithm is value % 2, when a logical database t\_order corresponds to two physical databases t\_order\_0 and t\_order\_1, the SQL will be executed on t\_order\_1 after routing. The following is a sample code using the API.

```
String sql = "SELECT * FROM t_order";
try (
    HintManager hintManager = HintManager.getInstance();
    Connection conn = dataSource.getConnection();
    PreparedStatement pstmt = conn.prepareStatement(sql)) {
    hintManager.setDatabaseShardingValue(3);
    try (ResultSet rs = pstmt.executeQuery()) {
        while (rs.next()) {
            //...
        }
    }
}
```

```
}
}
```

### Standard Route

Standard route is ShardingSphere's most recommended sharding method. Its application range is the SQL that does not include joint query or only includes joint query between binding tables. When the sharding operator is equal mark, the route result will fall into a single database (table); when sharding operators are BETWEEN or IN, the route result will not necessarily fall into the only database (table). So one logic SQL can finally be split into multiple real SQL to execute. For example, if sharding is according to the odd number or even number of order\_id, a single table query SQL is as the following:

```
SELECT * FROM t_order WHERE order_id IN (1, 2);
```

The route result will be:

```
SELECT * FROM t_order_0 WHERE order_id IN (1, 2);
SELECT * FROM t_order_1 WHERE order_id IN (1, 2);
```

The complexity and performance of the joint query are comparable with those of single-table query. For instance, if a joint query SQL that contains binding tables is as this:

```
SELECT * FROM t_order o JOIN t_order_item i ON o.order_id=i.order_id WHERE order_id IN (1, 2);
```

Then, the route result will be:

```
SELECT * FROM t_order_0 o JOIN t_order_item_0 i ON o.order_id=i.order_id WHERE order_id IN (1, 2);
SELECT * FROM t_order_1 o JOIN t_order_item_1 i ON o.order_id=i.order_id WHERE order_id IN (1, 2);
```

It can be seen that, the number of divided SQL is the same as the number of single tables.

### Cartesian Route

Cartesian route has the most complex situation, it cannot locate sharding rules according to the binding table relationship, so the joint query between non-binding tables needs to be split into Cartesian product combination to execute. If SQL in the last case is not configured with binding table relationship, the route result will be:

```
SELECT * FROM t_order_0 o JOIN t_order_item_0 i ON o.order_id=i.order_id WHERE order_id IN (1, 2);
SELECT * FROM t_order_0 o JOIN t_order_item_1 i ON o.order_id=i.order_id WHERE order_id IN (1, 2);
SELECT * FROM t_order_1 o JOIN t_order_item_0 i ON o.order_id=i.order_id WHERE
```

```
order_id IN (1, 2);
SELECT * FROM t_order_1 o JOIN t_order_item_1 i ON o.order_id=i.order_id WHERE
order_id IN (1, 2);
```

Cartesian product route has a relatively low performance, so it should be careful to use.

### Broadcast Route

For SQL without sharding key, broadcast route is used. According to SQL types, it can be divided into five types, schema & table route, database schema route, database instance route, unicast route and ignore route.

### Schema & Table Route

Schema & table route is used to deal with all the operations of physical tables related to its logic table, including DQL and DML without sharding key and DDL, etc. For example.

```
SELECT * FROM t_order WHERE good_prority IN (1, 10);
```

It will traverse all the tables in all the databases, match the logical table and the physical table name one by one and execute them if succeeded. After routing, they are:

```
SELECT * FROM t_order_0 WHERE good_prority IN (1, 10);
SELECT * FROM t_order_1 WHERE good_prority IN (1, 10);
SELECT * FROM t_order_2 WHERE good_prority IN (1, 10);
SELECT * FROM t_order_3 WHERE good_prority IN (1, 10);
```

### Database Schema Route

Database schema route is used to deal with database operations, including the SET database management order used to set the database and transaction control statement as TCL. In this case, all physical databases matched with the name are traversed according to logical database name, and the command is executed in the physical database. For example:

```
SET autocommit=0;
```

If this command is executed in `t_order`, `t_order` will have 2 physical databases. And it will actually be executed in both `t_order_0` and `t_order_1`.

### Database Instance Route

Database instance route is used in DCL operation, whose authorization statement aims at database instances. No matter how many schemas are included in one instance, each one of them can only be executed once. For example:

```
CREATE USER customer@127.0.0.1 identified BY '123';
```

This command will be executed in all the physical database instances to ensure customer users have access to each instance.

### Unicast Route

Unicast route is used in the scenario of acquiring the information from some certain physical table. It only requires to acquire data from any physical table in any database. For example:

```
DESCRIBE t_order;
```

The descriptions of the two physical tables, t\_order\_0 and t\_order\_1 of t\_order have the same structure, so this command is executed once on any physical table.

### Ignore Route

Ignore route is used to block the operation of SQL to the database. For example:

```
USE order_db;
```

This command will not be executed in physical database. Because ShardingSphere uses logic Schema, there is no need to send the Schema shift order to the database.

The overall structure of route engine is as the following:

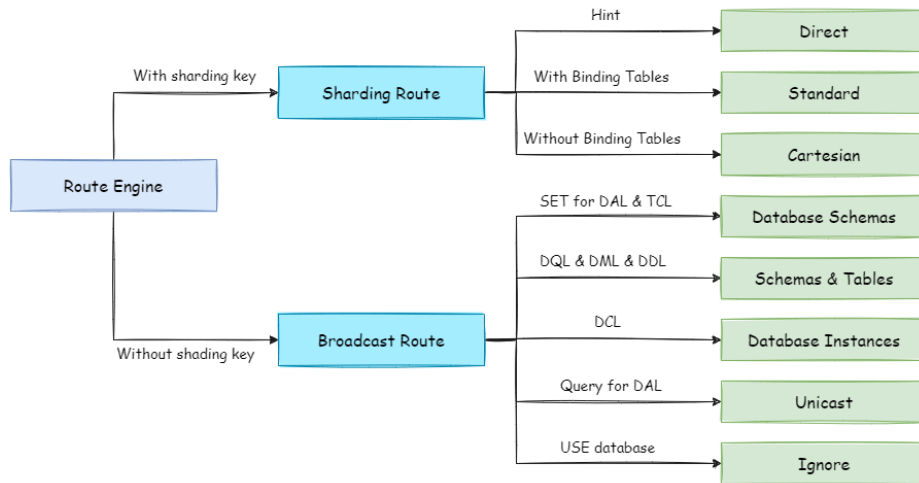

### 7.2.9 Rewrite Engine

The SQL written by engineers facing logic databases and tables cannot be executed directly in actual databases. SQL rewrite is used to rewrite logic SQL into rightly executable ones in actual databases, including two parts, correctness rewrite and optimization rewrite.

#### Correctness Rewrite

In situation with sharding tables, it requires to rewrite logic table names in sharding settings into actual table names acquired after routing. Database sharding does not require to rewrite table names. In addition to that, there are also column derivation, pagination information revision and other content.

#### Identifier Rewrite

Identifiers that need to be rewritten include table name, index name and schema name. Table name rewrite refers to the process to locate the position of logic tables in the original SQL and rewrite it as the physical table. Table name rewrite is one typical situation that requires to parse SQL. From a most plain case, if the logic SQL is as follow:

```
SELECT order_id FROM t_order WHERE order_id=1;
```

If the SQL is configured with sharding key order\_id=1, it will be routed to Sharding Table 1. Then, the SQL after rewrite should be:

```
SELECT order_id FROM t_order_1 WHERE order_id=1;
```

In this most simple kind of SQL, whether parsing SQL to abstract syntax tree seems unimportant, SQL can be rewritten only by searching for and substituting characters. But in the following situation, it is unable to rewrite SQL rightly merely by searching for and substituting characters:

```
SELECT order_id FROM t_order WHERE order_id=1 AND remarks=' t_order xxx';
```

The SQL rightly rewritten is supposed to be:

```
SELECT order_id FROM t_order_1 WHERE order_id=1 AND remarks=' t_order xxx';
```

Rather than:

```
SELECT order_id FROM t_order_1 WHERE order_id=1 AND remarks=' t_order_1 xxx';
```

Because there may be similar characters besides the table name, the simple character substitute method cannot be used to rewrite SQL. Here is another more complex SQL rewrite situation:

```
SELECT t_order.order_id FROM t_order WHERE t_order.order_id=1 AND remarks=' t_order xxx';
```

The SQL above takes table name as the identifier of the field, so it should also be revised when SQL is rewritten:

```
SELECT t_order_1.order_id FROM t_order_1 WHERE t_order_1.order_id=1 AND remarks=' t_order xxx';
```

But if there is another table name defined in SQL, it is not necessary to revise that, even though that name is the same as the table name. For example:

```
SELECT t_order.order_id FROM t_order AS t_order WHERE t_order.order_id=1 AND remarks=' t_order xxx';
```

SQL rewrite only requires to revise its table name:

```
SELECT t_order.order_id FROM t_order_1 AS t_order WHERE t_order.order_id=1 AND remarks=' t_order xxx';
```

Index name is another identifier that can be rewritten. In some databases (such as MySQL/SQLServer), the index is created according to the table dimension, and its names in different tables can repeat. In some other databases (such as PostgreSQL/Oracle), however, the index is created according to the database dimension, index names in different tables are required to be one and the only.

In ShardingSphere, schema management method is similar to that of the table. It uses logic schema to manage a set of data sources, so it requires to replace the logic schema written by users in SQL with physical database schema.

ShardingSphere only supports to use schema in database management statements but not in DQL and DML statements, for example:

```
SHOW COLUMNS FROM t_order FROM order_ds;
```

Schema rewrite refers to rewriting logic schema as a right and real schema found arbitrarily with unicast route.

### Column Derivation

Column derivation in query statements usually results from two situations. First, ShardingSphere needs to acquire the corresponding data when merging results, but it is not returned through the query SQL. This kind of situation aims mainly at GROUP BY and ORDER BY. Result merger requires sorting and ranking according to items of GROUP BY and ORDER BY field. But if sorting and ranking items are not included in the original SQL, it should be rewritten. Look at the situation where the original SQL has the information required by result merger:

```
SELECT order_id, user_id FROM t_order ORDER BY user_id;
```

Since `user_id` is used in ranking, the result merger needs the data able to acquire `user_id`. The SQL above is able to acquire `user_id` data, so there is no need to add columns.

If the selected item does not contain the column required by result merger, it will need to add column, as the following SQL:

```
SELECT order_id FROM t_order ORDER BY user_id;
```

Since the original SQL does not contain `user_id` needed by result merger, the SQL needs to be rewritten by adding columns, and after that, it will be:

```
SELECT order_id, user_id AS ORDER_BY_DERIVED_0 FROM t_order ORDER BY user_id;
```

What's to be mentioned, column derivation will only add the missing column rather than all of them; the SQL that includes `*` in SELECT will also selectively add columns according to the meta-data information of tables. Here is a relatively complex SQL column derivation case:

```
SELECT o.* FROM t_order o, t_order_item i WHERE o.order_id=i.order_id ORDER BY user_id, order_item_id;
```

Suppose only `t_order_item` table contains `order_item_id` column, according to the meta-data information of tables, the `user_id` in sorting item exists in table `t_order` as merging result, but `order_item_id` does not exist in `t_order`, so it needs to add columns. The SQL after that will be:

```
SELECT o.*, order_item_id AS ORDER_BY_DERIVED_0 FROM t_order o, t_order_item i WHERE o.order_id=i.order_id ORDER BY user_id, order_item_id;
```

Another situation of column derivation is using AVG aggregation function. In distributed situations, it is not right to calculate the average value with  $avg1 + avg2 + avg3 / 3$ , and it should be rewritten as  $(sum1 + sum2 + sum3) / (count1 + count2 + count3)$ . This requires to rewrite the SQL that contains AVG as SUM and COUNT and recalculate the average value in result merger. Such as the following SQL:



```
SELECT AVG(price) FROM t_order WHERE user_id=1;
```

Should be rewritten as:

```
SELECT COUNT(price) AS AVG_DERIVED_COUNT_0, SUM(price) AS AVG_DERIVED_SUM_0 FROM t_order WHERE user_id=1;
```

Then it can calculate the right average value through result merger.

The last kind of column derivation is in SQL with INSERT. With database auto-increment key, there is no need to fill in primary key field. But database auto-increment key cannot satisfy the requirement of only one primary key being in the distributed situation. So ShardingSphere provides a distributed auto-increment key generation strategy, enabling users to replace the current auto-increment key invisibly with a distributed one without changing existing codes through column derivation. Distributed auto-increment key generation strategy will be expounded in the following part, here we only explain the content related to SQL rewrite. For example, if the primary key of t\_order is order\_id, and the original SQL is:

```
INSERT INTO t_order (`field1`, `field2`) VALUES (10, 1);
```

It can be seen that the SQL above does not include an auto-increment key, which will be filled by the database itself. After ShardingSphere set an auto-increment key, the SQL will be rewritten as:

```
INSERT INTO t_order (`field1`, `field2`, order_id) VALUES (10, 1, xxxxx);
```

Rewritten SQL will add auto-increment key name and its value generated automatically in the last part of INSERT FIELD and INSERT VALUE. xxxxx in the SQL above stands for the latter one.

If INSERT SQL does not contain the column name of the table, ShardingSphere can also automatically generate auto-increment key by comparing the number of parameter and column in the table meta-information. For example, the original SQL is:

```
INSERT INTO t_order VALUES (10, 1);
```

The rewritten SQL only needs to add an auto-increment key in the column where the primary key is:

```
INSERT INTO t_order VALUES (xxxxx, 10, 1);
```

When auto-increment key derives column, if the user writes SQL with placeholder, he only needs to rewrite parameter list but not SQL itself.

## Pagination Revision

The scenarios of acquiring pagination data from multiple databases is different from that of one single database. If every 10 pieces of data are taken as one page, the user wants to take the second page of data. It is not right to take, acquire `LIMIT 10, 10` under sharding situations, and take out the first 10 pieces of data according to sorting conditions after merging. For example, if the SQL is:

```
SELECT score FROM t_score ORDER BY score DESC LIMIT 1, 2;
```

The following picture shows the pagination execution results without SQL rewrite.

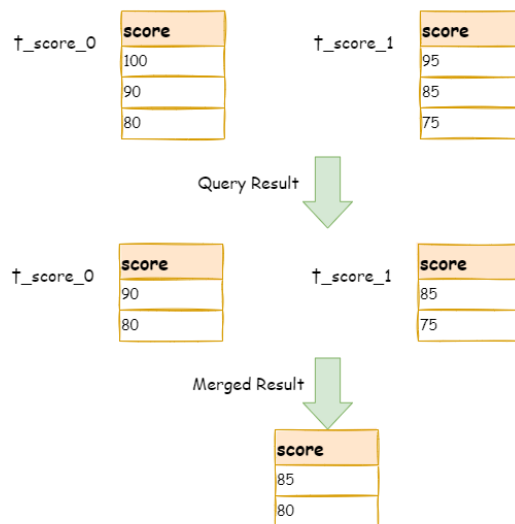

As shown in the picture, if you want to acquire the second and the third piece of data ordered by score common in both tables, and they are supposed to be 95 and 90. Since the executed SQL can only acquire the second and the third piece of data from each table, i.e., 90 and 80 from `t_score_0`, 85 and 75 from `t_score_1`. When merging results, it can only merge from 90, 80, 85 and 75 already acquired, so the right result cannot be acquired anyway.

The right way is to rewrite pagination conditions as `LIMIT 0, 3`, take out all the data from the first two pages and combine sorting conditions to calculate the right data. The following picture shows the execution of pagination results after SQL rewrite.

**SELECT score FROM t\_score ORDER BY score DESC LIMIT 0, 3**

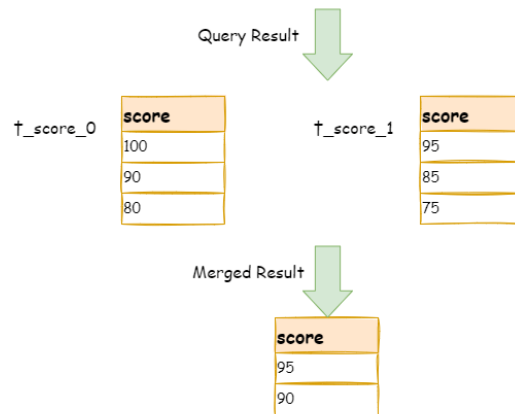

The latter the offset position is, the lower the efficiency of using LIMIT pagination will be. There are many ways to avoid using LIMIT as pagination method, such as constructing a secondary index to record line record number and line offset amount, or using the tail ID of last pagination data as the pagination method of conditions of the next query.

When revising pagination information, if the user uses placeholder method to write SQL, he only needs to rewrite parameter list rather than SQL itself.

### Batch Split

When using batch inserted SQL, if the inserted data crosses sharding, the user needs to rewrite SQL to avoid writing excessive data into the database. The differences between insert operation and query operation are: though the query sentence has used sharding keys that do not exist in current sharding, they will not have any influence on data, but insert operation has to delete extra sharding keys. Take the following SQL for example:

```
INSERT INTO t_order (order_id, xxx) VALUES (1, 'xxx'), (2, 'xxx'), (3, 'xxx');
```

If the database is still divided into two parts according to odd and even number of order\_id, this SQL will be executed after its table name is revised. Then, both shards will be written with the same record. Though only the data that satisfies sharding conditions can be taken out from query statement, it is not reasonable for the schema to have excessive data. So the SQL should be rewritten as:

```
INSERT INTO t_order_0 (order_id, xxx) VALUES (2, 'xxx');
INSERT INTO t_order_1 (order_id, xxx) VALUES (1, 'xxx'), (3, 'xxx');
```

IN query is similar to batch insertion, but IN operation will not lead to wrong data query result. Through rewriting IN query, the query performance can be further improved. Like the following SQL:

```
SELECT * FROM t_order WHERE order_id IN (1, 2, 3);
```

Is rewritten as:

```
SELECT * FROM t_order_0 WHERE order_id IN (2);  
SELECT * FROM t_order_1 WHERE order_id IN (1, 3);
```

The query performance will be further improved. For now, ShardingSphere has not realized this rewrite strategy, so the current rewrite result is:

```
SELECT * FROM t_order_0 WHERE order_id IN (1, 2, 3);  
SELECT * FROM t_order_1 WHERE order_id IN (1, 2, 3);
```

Though the execution result of SQL is right, but it has not achieved the most optimized query efficiency.

### Optimization Rewrite

Its purpose is to effectively improve the performance without influencing the correctness of the query. It can be divided into single node optimization and stream merger optimization.

#### Single Node Optimization

It refers to the optimization that stops the SQL rewrite from the route to the single node. After acquiring one route result, if it is routed to a single data node, result merging is unnecessary to be involved, so there is no need for rewrites as derived column, pagination information and others. In particular, there is no need to read from the first piece of information, which reduces the pressure for the database to a large extent and saves meaningless consumption of the network bandwidth.

#### Stream Merger Optimization

It only adds sorting items and sorting orders identical with grouping items and ORDER BY to GROUP BY SQL, and they are used to transfer memory merger to stream merger. In the result merger part, stream merger and memory merger will be explained in detail.

The overall structure of rewrite engine is shown in the following picture.

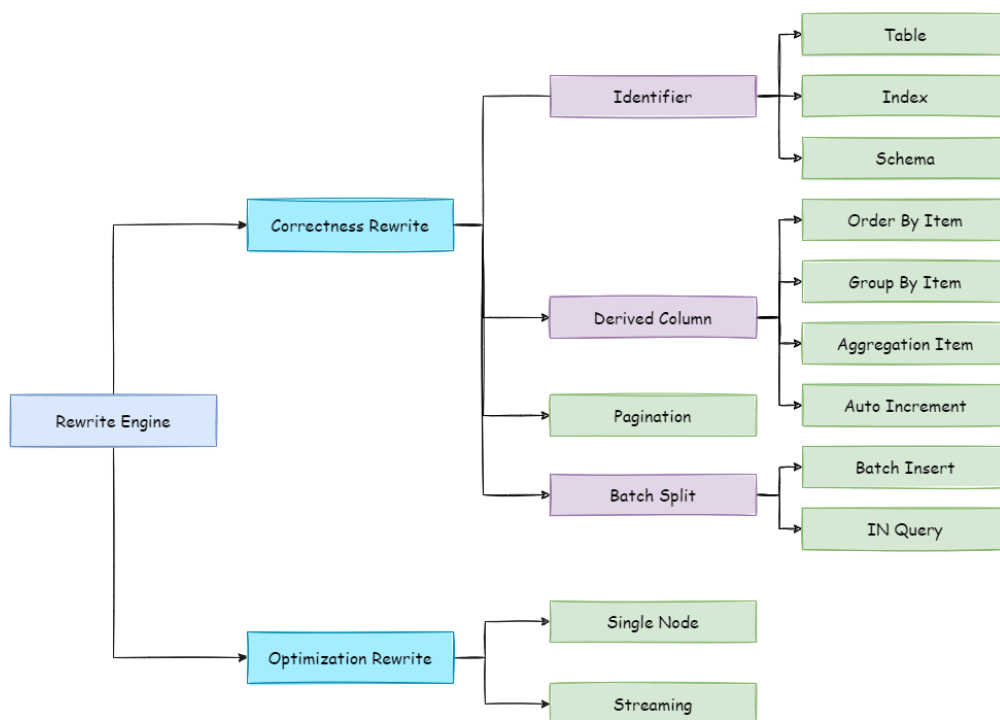

### 7.2.10 Execute Engine

ShardingSphere adopts a set of automatic execution engine, responsible for sending the true SQL, which has been routed and rewritten, to execute in the underlying data source safely and effectively. It does not simply send the SQL through JDBC to directly execute in the underlying data source, or put execution requests directly to the thread pool to concurrently execute, but focuses more on the creation of a balanced data source connection, the consumption generated by the memory usage, the maximum utilization of the concurrency and other problems. The objective of the execution engine is to automatically balance between the resource control and the execution efficiency.

#### Connection Mode

From the perspective of resource control, the connection number of the business side's visit of the database should be limited. It can effectively prevent some certain business from occupying excessive resource, exhausting database connection resources and influencing the normal use of other businesses. Especially when one database contains many tables, a logic SQL that does not contain any sharding key will produce a large amount of physical SQLs that fall into different tables in one database. If each physical SQL takes an independent connection, a query will undoubtedly take up excessive resources.

From the perspective of execution efficiency, holding an independent database connection for each sharding query can make effective use of multi-thread to improve execution efficiency. Opening an independent thread for each database connection can parallelize IO produced consumption. Holding

an independent database connection for each sharding query can also avoid loading the query result to the memory too early. It is enough for independent database connections to maintain result set quotation and cursor position, and move the cursor when acquiring corresponding data.

Merging result set by moving down its cursor is called stream merger. It does not require to load all the query results to the memory. Thus, it is able to save memory resource effectively and reduce trash recycle frequency. When it is not able to make sure each sharding query holds an independent database connection, it requires to load all the current query results to the memory before reusing that database connection to acquire the query result from the next sharding table. Therefore, though the stream merger can be used, under this kind of circumstances, it will also degenerate to the memory merger.

The control and protection of database connection resources is one thing, adopting better merging model to save the memory resources of middleware is another thing. How to deal with the relationship between them is a problem that ShardingSphere execution engine should solve. To be accurate, if a sharding SQL needs to operate 200 tables under some database case, should we choose to create 200 parallel connection executions or a serial connection execution? Or to say, how to choose between efficiency and resource control?

Aiming at the above situation, ShardingSphere has provided a solution. It has put forward a Connection Mode concept divided into two types, MEMORY\_STRICTLY mode and CONNECTION\_STRICTLY mode.

#### **MEMORY\_STRICTLY Mode**

The prerequisite to use this mode is that ShardingSphere does not restrict the connection number of one operation. If the actual executed SQL needs to operate 200 tables in some database instance, it will create a new database connection for each table and deal with them concurrently through multi-thread to maximize the execution efficiency. When the SQL is up to standard, it will choose stream merger in priority to avoid memory overflow or frequent garbage recycle.

#### **CONNECTION\_STRICTLY Mode**

The prerequisite to use this mode is that ShardingSphere strictly restricts the connection consumption number of one operation. If the SQL to be executed needs to operate 200 tables in database instance, it will create one database connection and operate them serially. If shards exist in different databases, it will still be multi-thread operations for different databases, but with only one database connection being created for each operation in each database. It can prevent the problem brought by excessive occupation of database connection from one request. The mode chooses memory merger all the time.

The MEMORY\_STRICTLY mode is applicable to OLAP operation and can increase the system capacity by removing database connection restrictions. It is also applicable to OLTP operation, which usually has sharding keys and can be routed to a single shard. So it is a wise choice to control database connection strictly to make sure resources of online system databases can be used by more applications.

## Automatic Execution Engine

ShardingSphere uses which mode at first is up to users' setting and they can choose to use MEMORY\_STRICTLY mode or CONNECTION\_STRICTLY mode according to their actual business scenarios.

The solution gives users the right to choose, requiring them to know the advantages and disadvantages of both modes and make decision according to the actual business situations. No doubt, it is not the best solution due to increasing users' study cost and use cost.

This kind of dichotomy solution lacks flexible coping ability to switch between two modes with static initialization. In practical situations, route results of each time may differ with different SQL and placeholder indexes. It means some operations may need to use memory merger, while others are better to use stream merger. Connection modes should not be set by users before initializing ShardingSphere, but should be decided dynamically by the situation of SQL and placeholder indexes.

To reduce users' use cost and solve the dynamic connection mode problem, ShardingSphere has extracted the thought of automatic execution engine in order to eliminate the connection mode concept inside. Users do not need to know what are so called MEMORY\_STRICTLY mode and CONNECTION\_STRICTLY mode, but let the execution engine to choose the best solution according to current situations.

Automatic execution engine has narrowed the selection scale of connection mode to each SQL operation. Aiming at each SQL request, automatic execution engine will do real-time calculations and evaluations according to its route result and execute the appropriate connection mode automatically to strike the most optimized balance between resource control and efficiency. For automatic execution engine, users only need to configure `maxConnectionSizePerQuery`, which represents the maximum connection number allowed by each database for one query.

The execution engine can be divided into two phases: `preparation` and `execution`.

### Preparation Phrase

As indicated by its name, this phrase is used to prepare the data to be executed. It can be divided into two steps: result set grouping and unit creation.

Result set grouping is the key to realize the internal connection model concept. According to the configuration option of `maxConnectionSizePerQuery`, execution engine will choose an appropriate connection mode combined with current route result.

Detailed steps are as follow:

1. Group SQL route results according to data source names.
2. Through the equation in the following picture, users can acquire the SQL route result group to be executed by each database case within the `maxConnectionSizePerQuery` permission range and calculate the most optimized connection mode of this request.

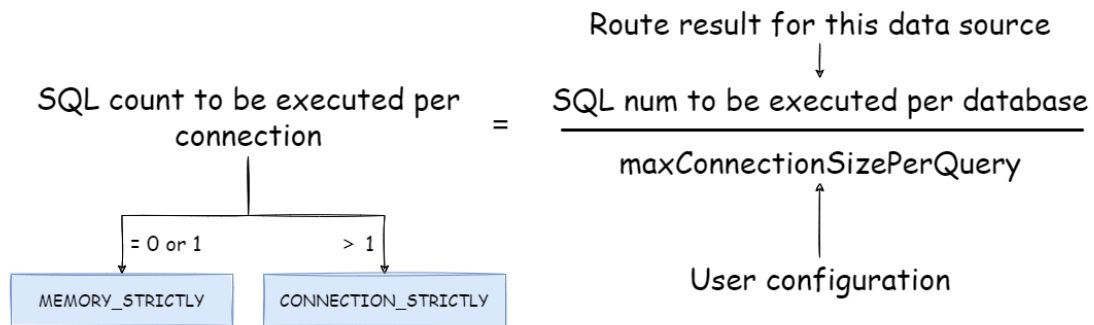

Within the range that `maxConnectionSizePerQuery` permits, when the request number that one connection needs to execute is more than 1, meaning current database connection cannot hold the corresponding data result set, it must use memory merger. On the contrary, when it equals to 1, meaning current database connection can hold the according data result set, it can use stream merger.

Each choice of connection mode aims at each physical database; that is to say, if it is routed to more than one databases, the connection mode of each database may mix with each other and not be the same in one query.

Users can use the route group result acquired from the last step to create the execution unit. When the data source uses technologies, such as database connection pool, to control database connection number, there is some chance for deadlock, if it has not dealt with concurrency properly. As multiple requests waiting for each other to release database connection resources, it will generate hunger wait and cause the crossing deadlock problem.

For example, suppose one query needs to acquire two database connections from a data source and apply them in two table sharding queries routed to one database. It is possible that Query A has already acquired a database connection from that data source and waits to acquire another connection; but in the same time, Query B has also finished it and waits. If the maximum connection number that the connection pool permits is 2, those two query requests will wait forever. The following picture has illustrated the deadlock situation:



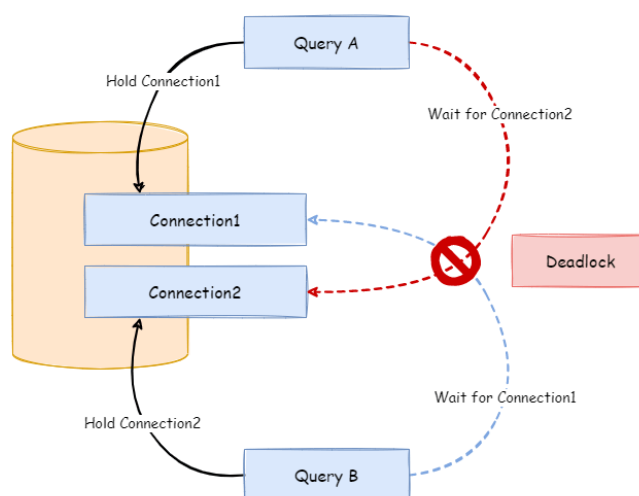

To avoid the deadlock, ShardingSphere will go through synchronous processing when acquiring database connection. When creating execution units, it acquires all the database connections that this SQL requires for once with atomic method and reduces the possibility of acquiring only part of the resources. Due to the high operation frequency, locking the connection each time when acquiring it can decrease ShardingSphere's concurrency. Therefore, it has improved two aspects here:

1. Avoid the setting that locking only takes one database connection each time. Because under this kind of circumstance, two requests waiting for each other will not happen, so there is no need for locking. Most OLTP operations use sharding keys to route to the only data node, which will make the system in a totally unlocked state, thereby improve the concurrency efficiency further. In addition to routing to a single shard, readwrite-splitting also belongs to this category.
2. Only aim at MEMORY\_STRICTLY mode to lock resources. When using CONNECTION\_STRICTLY mode, all the query result sets will release database connection resources after loading them to the memory, so deadlock wait will not appear.

### Execution Phrase

Applied in actually SQL execution, this phrase can be divided into two steps: group execution and merger result generation.

Group execution can distribute execution unit groups generated in preparation phrase to the underlying concurrency engine and send events according to each key steps during the execution process, such as starting, successful and failed execution events. Execution engine only focuses on message sending rather than subscribers of the event. Other ShardingSphere modules, such as distributed transac-

tions, invoked chain tracing and so on, will subscribe focusing events and do corresponding operations. Through the connection mode acquired in preparation phrase, ShardingSphere will generate memory merger result set or stream merger result set, and transfer it to the result merger engine for the next step.

The overall structure of execution engine is shown as the following picture:

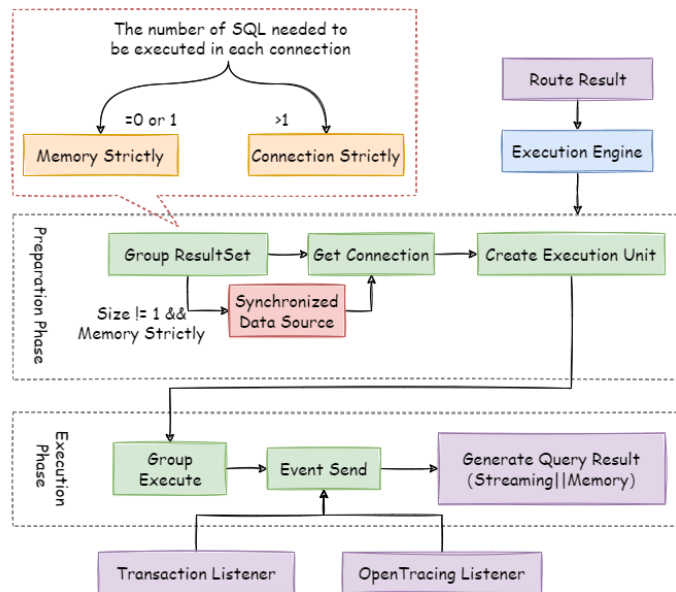

### 7.2.11 Merger Engine

Result merger refers to merging multi-data result set acquired from all the data nodes as one result set and returning it to the request end rightly.

In function, the result merger supported by ShardingSphere can be divided into five kinds, iteration, order-by, group-by, pagination and aggregation, which are in composition relation rather than clash relation. In structure, it can be divided into stream merger, memory merger and decorator merger, among which, stream merger and memory merger clash with each other; decorator merger can be further processed based on stream merger and memory merger.

Since the result set is returned from database line by line instead of being loaded to the memory all at once, the most prior choice of merger method is to follow the database returned result set, for it is able to reduce the memory consumption to a large extend.

Stream merger means, each time, the data acquired from the result set is able to return the single piece of right data line by line.

It is the most suitable one for the method that the database returns original result set. Iteration, order-

by, and stream group-by belong to stream merger.

Memory merger needs to iterate all the data in the result set and store it in the memory first. after unified grouping, ordering, aggregation and other computations, it will pack it into data result set, which is visited line by line, and return that result set.

Decorator merger merges and reinforces all the result sets function uniformly. Currently, decorator merger has pagination merger and aggregation merger these two kinds.

### Iteration Merger

As the simplest merger method, iteration merger only requires the combination of multiple data result sets into a single-direction chain table. After iterating current data result sets in the chain table, it only needs to move the element of chain table to the next position and iterate the next data result set.

### Order-by Merger

Because there is ORDER BY statement in SQL, each data result has its own order. So it is enough only to order data value that the result set cursor currently points to, which is equal to sequencing multiple already ordered arrays, and therefore, order-by merger is the most suitable ordering algorithm in this situation.

When merging order inquiries, ShardingSphere will compare current data values in each result set (which is realized by Java Comparable interface) and put them into the priority queue. Each time when acquiring the next piece of data, it only needs to move down the result set in the top end of the line, reenter the priority order according to the new cursor and relocate its own position.

Here is an instance to explain ShardingSphere's order-by merger. The following picture is an illustration of ordering by the score. Data result sets returned by 3 tables are shown in the example and each one of them has already been ordered according to the score, but there is no order between 3 data result sets. Order the data value that the result set cursor currently points to in these 3 result sets. Then put them into the priority queue. the data value of t\_score\_0 is the biggest, followed by that of t\_score\_2 and t\_score\_1 in sequence. Thus, the priority queue is ordered by the sequence of t\_score\_0, t\_score\_2 and t\_score\_1.

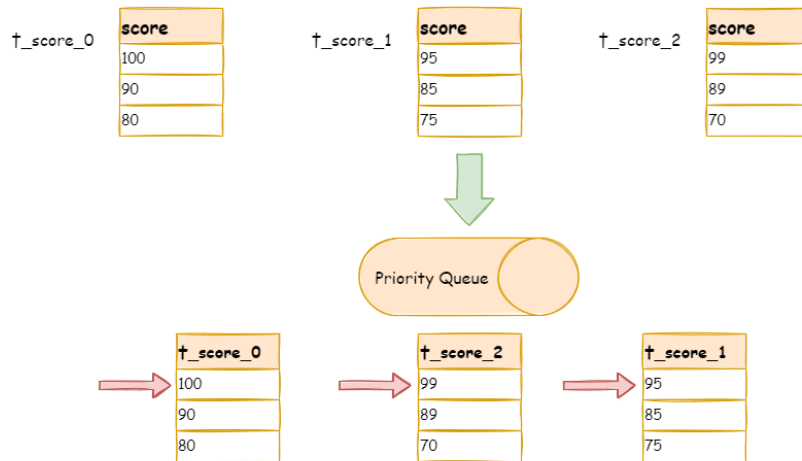

This diagram illustrates how the order-by merger works when using next invocation. We can see from the diagram that when using next invocation, t\_score\_0 at the first of the queue will be popped out. After returning the data value currently pointed by the cursor (i.e., 100) to the client end, the cursor will be moved down and t\_score\_0 will be put back to the queue.

While the priority queue will also be ordered according to the t\_score\_0 data value (90 here) pointed by the cursor of current data result set. According to the current value, t\_score\_0 is at the last of the queue, and in the second place of the queue formerly, the data result set of t\_score\_2, automatically moves to the first place of the queue.

In the second next operation, t\_score\_2 in the first position is popped out of the queue. Its value pointed by the cursor of the data result set is returned to the client end, with its cursor moved down to rejoin the queue, and the following will be in the same way. If there is no data in the result set, it will not rejoin the queue.

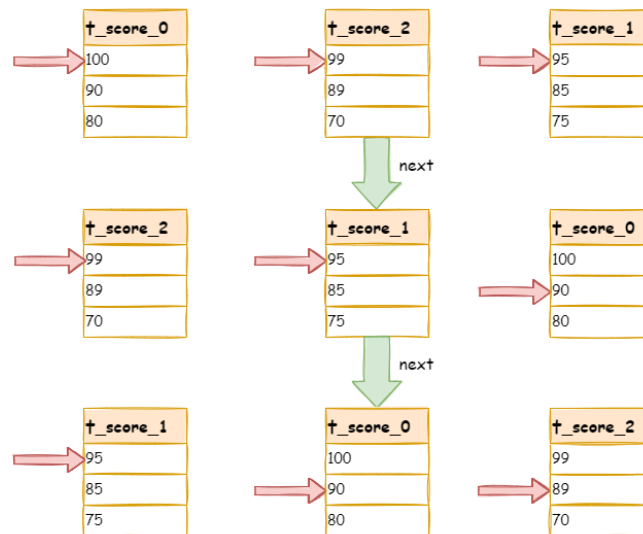

It can be seen that, under the circumstance that data in each result set is ordered while result sets are disordered, ShardingSphere does not need to upload all the data to the memory to order. In the order-by merger method, each next operation only acquires the right piece of data each time, which saves the memory consumption to a large extent.

On the other hand, the order-by merger has maintained the orderliness on horizontal axis and vertical axis of the data result set. Naturally ordered, vertical axis refers to each data result set itself, which is acquired by SQL with ORDER BY. Horizontal axis refers to the current value pointed by each data result set, and its order needs to be maintained by the priority queue. Each time when the current cursor moves down, it requires to put the result set in the priority order again, which means only the cursor of the first data result set can be moved down.

### Group-by Merger

With the most complicated situation, group-by merger can be divided into stream group-by merger and memory group-by merger. Stream group-by merger requires SQL field and order item type (ASC or DESC) to be the same with group-by item. Otherwise, its data accuracy can only be maintained by memory merger.

For instance, if it is sharded by subject, table structure contains examinees' name (to simplify, name repetition is not taken into consideration) and score. The SQL used to acquire each examinee' s total score is as follow:

```
SELECT name, SUM(score) FROM t_score GROUP BY name ORDER BY name;
```

When order-by item and group-by item are totally consistent, the data obtained is continuous. The data to group are all stored in the data value that data result set cursor currently points to, stream group-by merger can be used, as illustrated by the diagram:

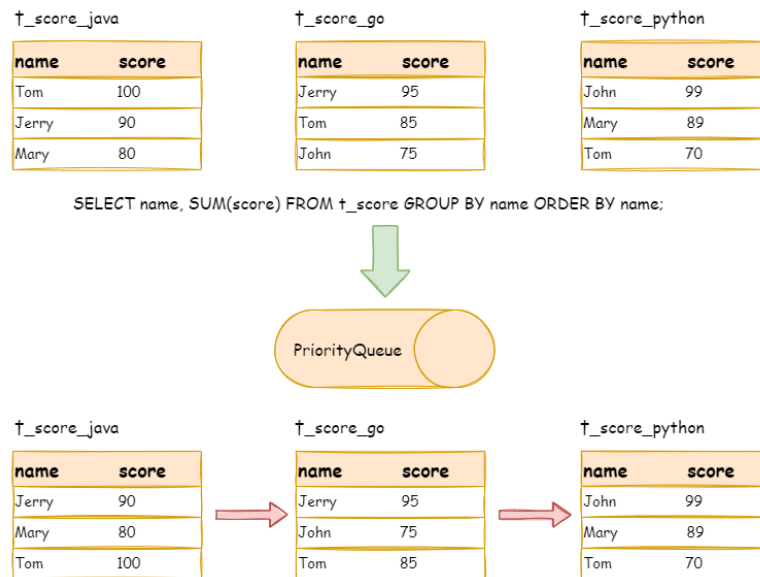

The merging logic is similar to that of order-by merger. The following picture shows how stream group-by merger works in next invocation.

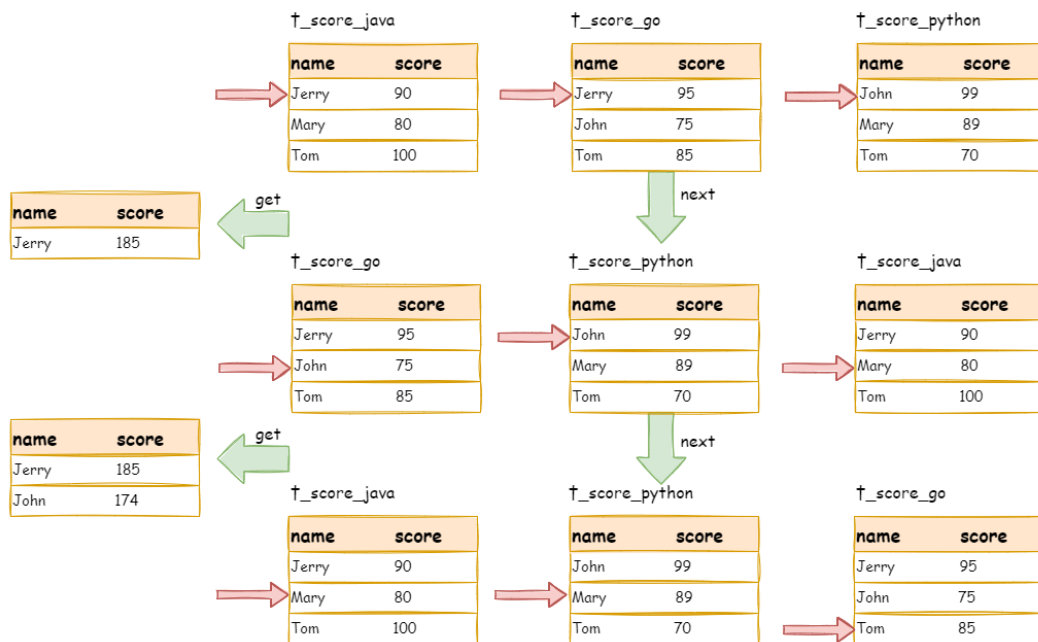

We can see from the picture, in the first next invocation, `t_score_java` in the first position, along with other result set data also having the grouping value of “Jerry”, will be popped out of the queue. After acquiring all the students’ scores with the name of “Jerry”, the accumulation operation will be proceeded. Hence, after the first next invocation is finished, the result set acquired is the sum of Jerry’ s scores. In the same time, all the cursors in data result sets will be moved down to a different data value next to “Jerry” and rearranged according to current result set value. Thus, the data that contains the second name “John” will be put at the beginning of the queue.

Stream group-by merger is different from order-by merger only in two points:

1. It will take out all the data with the same group item from multiple data result sets for once.
2. It does the aggregation calculation according to aggregation function type.

For the inconsistency between the group item and the order item, it requires to upload all the data to the memory to group and aggregate, since the relevant data value needed to acquire group information is not continuous, and stream merger is not able to use. For example, acquire each examinee’ s total score through the following SQL and order them from the highest to the lowest:

```
SELECT name, SUM(score) FROM t_score GROUP BY name ORDER BY score DESC;
```

Then, stream merger is not able to use, for the data taken out from each result set is the same as the original data of the diagram ordered by score in the upper half part structure.

When SQL only contains group-by statement, according to different database implementation, its sequencing order may not be the same as the group order. The lack of ordering statement indicates the order is not important in this SQL. Therefore, through SQL optimization re-write, ShardingSphere can

automatically add the ordering item same as grouping item, converting it from the memory merger that consumes memory to stream merger.

### Aggregation Merger

Whether stream group-by merger or memory group-by merger processes the aggregation function in the same way. Therefore, aggregation merger is an additional merging ability based on what have been introduced above, i.e., the decorator mode. The aggregation function can be categorized into three types, comparison, sum and average.

Comparison aggregation function refers to MAX and MIN. They need to compare all the result set data and return its maximum or minimum value directly.

Sum aggregation function refers to SUM and COUNT. They need to sum up all the result set data.

Average aggregation function refers only to AVG. It must be calculated through SUM and COUNT of SQL re-write, which has been mentioned in SQL re-write, so we will state no more here.

### Pagination Merger

All the merger types above can be paginated. Pagination is the decorator added on other kinds of mergers. ShardingSphere augments its ability to paginate the data result set through the decorator mode. Pagination merger is responsible for filtering the data unnecessary to acquire.

ShardingSphere's pagination function can be misleading to users in that they may think it will take a large amount of memory. In distributed scenarios, it can only guarantee the data accuracy by rewriting `LIMIT 10000000, 10` to `LIMIT 0, 10000010`. Users can easily have the misconception that ShardingSphere uploads a large amount of meaningless data to the memory and has the risk of memory overflow. Actually, it can be known from the principle of stream merger, only memory group-by merger will upload all the data to the memory. Generally speaking, however, SQL used for OLAP grouping, is applied more frequently to massive calculation or small result generation rather than vast result data generation. Except for memory group-by merger, other cases use stream merger to acquire data result set. So ShardingSphere would skip unnecessary data through next method in result set, rather than storing them in the memory.

What's to be noticed, pagination with LIMIT is not the best practice actually, because a large amount of data still needs to be transmitted to ShardingSphere's memory space for ordering. LIMIT cannot search for data by index, so paginating with ID is a better solution on the premise that the ID continuity can be guaranteed. For example:

```
SELECT * FROM t_order WHERE id > 100000 AND id <= 100010 ORDER BY id;
```

Or search the next page through the ID of the last query result, for example:

```
SELECT * FROM t_order WHERE id > 10000000 LIMIT 10;
```

The overall structure of merger engine is shown in the following diagram:



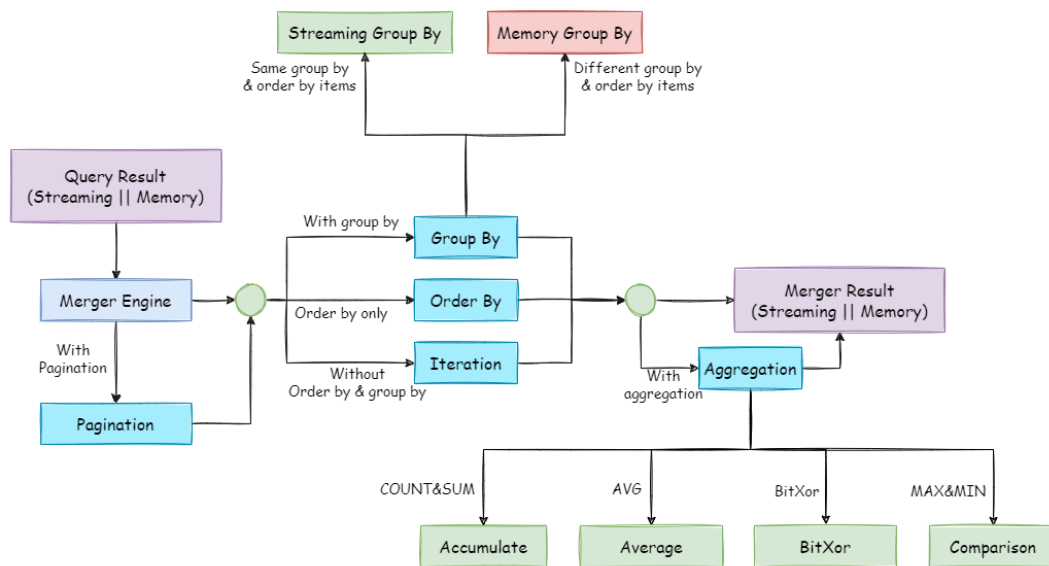

## 7.3 Transaction

### 7.3.1 Navigation

This chapter mainly introduces the principles of the distributed transactions:

- 2PC transaction with XA
- BASE transaction with Seata

### 7.3.2 XA Transaction

XAShardingSphereTransactionManager is XA transaction manager of Apache ShardingSphere. Its main responsibility is manage and adapt multiple data sources, and sent corresponding transactions to concrete XA transaction manager.

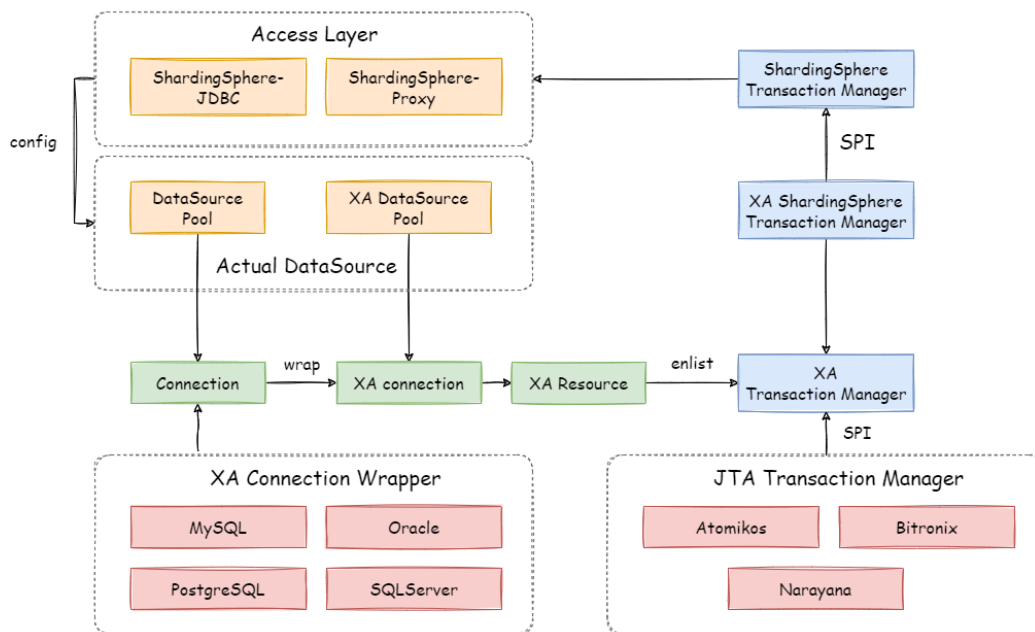

#### Transaction Begin

When receiving set autoCommit=0 from client, XAShardingSphereTransactionManager will use XA transaction managers to start overall XA transactions, which is marked by XID.

#### Execute actual sharding SQL

After XAShardingSphereTransactionManager register the corresponding XAResource to the current XA transaction, transaction manager will send XAResource.start command to databases. After databases received XAResource.end command, all SQL operator will mark as XA transaction.

For example:

```
XAResource1.start          ## execute in the enlist phase
statement.execute("sql1");
statement.execute("sql2");
XAResource1.end           ## execute in the commit phase
```

sql1 and sql2 in example will be marked as XA transaction.

## Commit or Rollback

After `XAShardingSphereTransactionManager` receives the commit command in the access, it will delegate it to the actual XA manager. It will collect all the registered `XAResource` in the thread, before sending `XAResource.end` to mark the boundary for the XA transaction. Then it will send prepare command one by one to collect votes from `XAResource`. If all the `XAResource` feedback is OK, it will send commit command to finally finish it; If there is any No `XAResource` feedback, it will send rollback command to roll back. After sending the commit command, all `XAResource` exceptions will be submitted again according to the recovery log to ensure the atomicity and high consistency.

For example:

```
XAResource1.prepare      ## ack: yes
XAResource2.prepare      ## ack: yes
XAResource1.commit
XAResource2.commit

XAResource1.prepare      ## ack: yes
XAResource2.prepare      ## ack: no
XAResource1.rollback
XAResource2.rollback
```

### 7.3.3 Seata BASE transaction

When integrating Seata AT transaction, we need to integrate TM, RM and TC component into ShardingSphere transaction manager. Seata have proxied `DataSource` interface in order to RPC with TC. Similarly, Apache ShardingSphere faced to `DataSource` interface to aggregate data sources too. After Seata `DataSource` encapsulation, it is easy to put Seata AT transaction into Apache ShardingSphere sharding ecosystem.

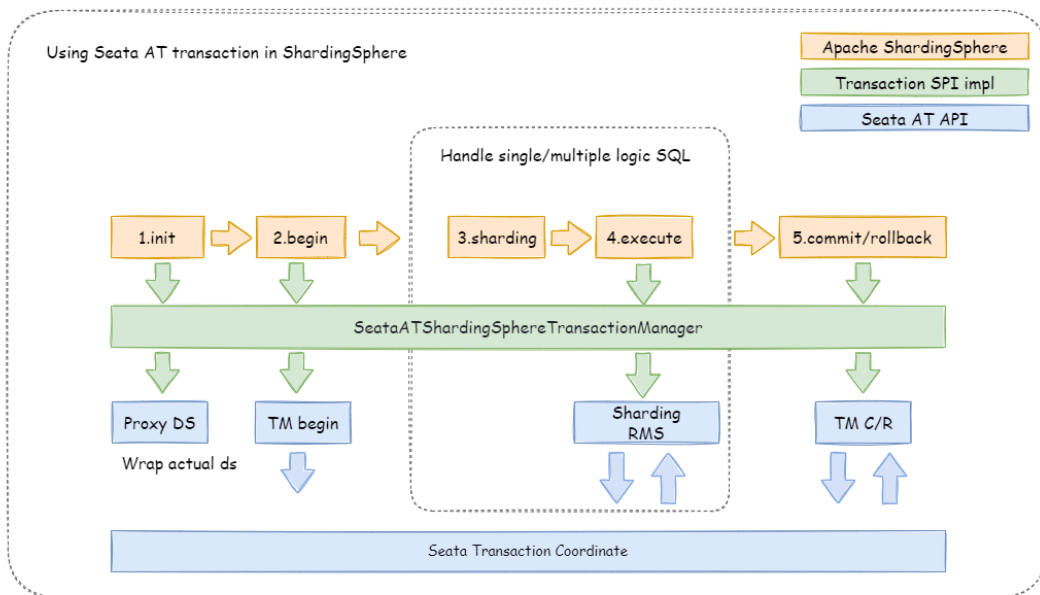

### Init Seata Engine

When an application containing `ShardingSphereTransactionBaseSeataAT` startup, the user-configured `DataSource` will be wrapped into `seata DataSourceProxy` through `seata.conf`, then registered into RM.

### Transaction Begin

TM controls the boundaries of global transactions. TM obtains the global transaction ID by sending `Begin` instructions to TC. All branch transactions participate in the global transaction through this global transaction ID. The context of the global transaction ID will be stored in the thread local variable.

### Execute actual sharding SQL

Actual SQL in Seata global transaction will be intercepted to generate undo snapshots by RM and sends participate instructions to TC to join global transaction. Since actual sharding SQLs executed in multi-threads, global transaction context should transfer from main thread to child thread, which is exactly the same as context transfer between services.

## Commit or Rollback

When submitting a seata transaction, TM sends TC the commit and rollback instructions of the global transaction. TC coordinates all branch transactions for commit and rollback according to the global transaction ID.

## 7.4 Scaling

### 7.4.1 Principle Description

Consider about these challenges of ShardingSphere-Scaling, the solution is: Use two database clusters temporarily, and switch after the scaling is completed.

Advantages:

1. No effect for origin data during scaling.
2. No risk for scaling failure.
3. No limited by sharding strategies.

Disadvantages:

1. Redundant servers during scaling.
2. All data needs to be moved.

ShardingSphere-Scaling will analyze the sharding rules and extract information like datasource and data nodes. According the sharding rules, ShardingSphere-Scaling create a scaling job with 4 main phases.

1. Preparing Phase.
2. Inventory Phase.
3. Incremental Phase.
4. Switching Phase.

### 7.4.2 Phase Description

#### Preparing Phase

ShardingSphere-Scaling will check the datasource connectivity and permissions, statistic the amount of inventory data, record position of log, shard tasks based on amount of inventory data and the parallelism set by the user.

### Inventory Phase

Executing the Inventory data migration tasks sharded in preparing phase. ShardingSphere-Scaling uses JDBC to query inventory data directly from data nodes and write to the new cluster using new rules.

### Incremental Phase

The data in data nodes is still changing during the inventory phase, so ShardingSphere-Scaling need to synchronize these incremental data to new data nodes. Different databases have different implementations, but generally implemented by change data capture function based on replication protocols or WAL logs.

- MySQL: subscribe and parse binlog.
- PostgreSQL: official logic replication `test_decoding`.

These captured incremental data, Apache ShardingSphere also write to the new cluster using new rules.

### Switching Phase

In this phase, there may be a temporary read only time, make the data in old data nodes static so that the incremental phase complete fully. The read only time is range seconds to minutes, it depends on the amount of data and the checking data. After finished, Apache ShardingSphere can switch the configuration by register-center and config-center, make application use new sharding rule and new data nodes.

## 7.5 Encryption

### 7.5.1 Process Details

Apache ShardingSphere can encrypt the plaintext by parsing and rewriting SQL according to the encryption rule, and store the plaintext (optional) and ciphertext data to the database at the same time. Queries data only extracts the ciphertext data from database and decrypts it, and finally returns the plaintext to user. Apache ShardingSphere transparently process of data encryption, so that users do not need to know to the implementation details of it, use encrypted data just like as regular data. In addition, Apache ShardingSphere can provide a relatively complete set of solutions whether the online business system has been encrypted or the new online business system uses the encryption function.

## Overall Architecture

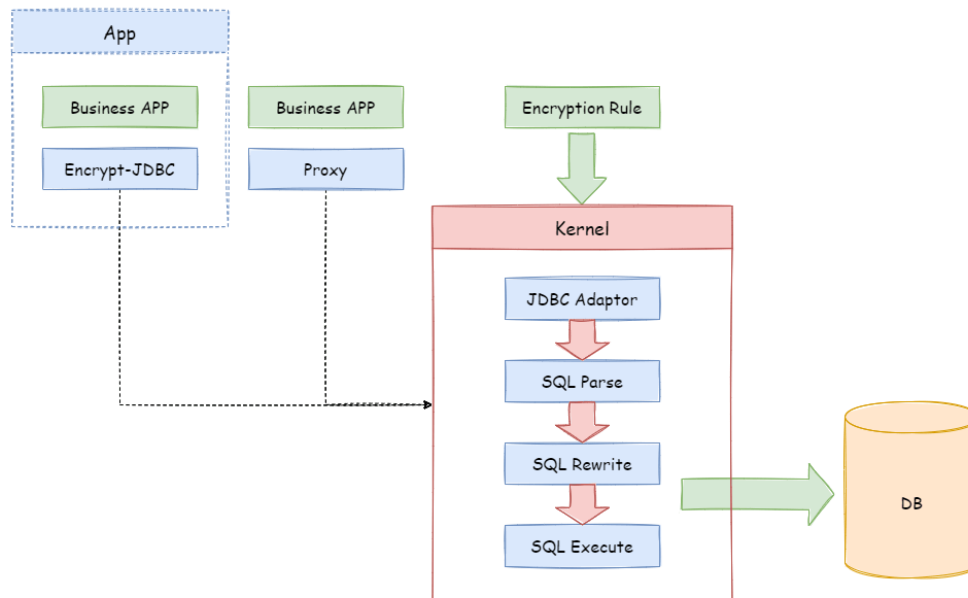

Encrypt module intercepts SQL initiated by user, analyzes and understands SQL behavior through the SQL syntax parser. According to the encryption rules passed by the user, find out the fields that need to be encrypted/decrypted and the encryptor/decryptor used to encrypt/decrypt the target fields, and then interact with the underlying database. ShardingSphere will encrypt the plaintext requested by the user and store it in the underlying database; and when the user queries, the ciphertext will be taken out of the database for decryption and returned to the end user. ShardingSphere shields the encryption of data, so that users do not need to perceive the process of parsing SQL, data encryption, and data decryption, just like using ordinary data.

### Encryption Rule

Before explaining the whole process in detail, we need to understand the encryption rules and configuration, which is the basis of understanding the whole process. The encryption configuration is mainly divided into four parts: data source configuration, encrypt algorithm configuration, encryption table rule configuration, and query attribute configuration. The details are shown in the following figure:

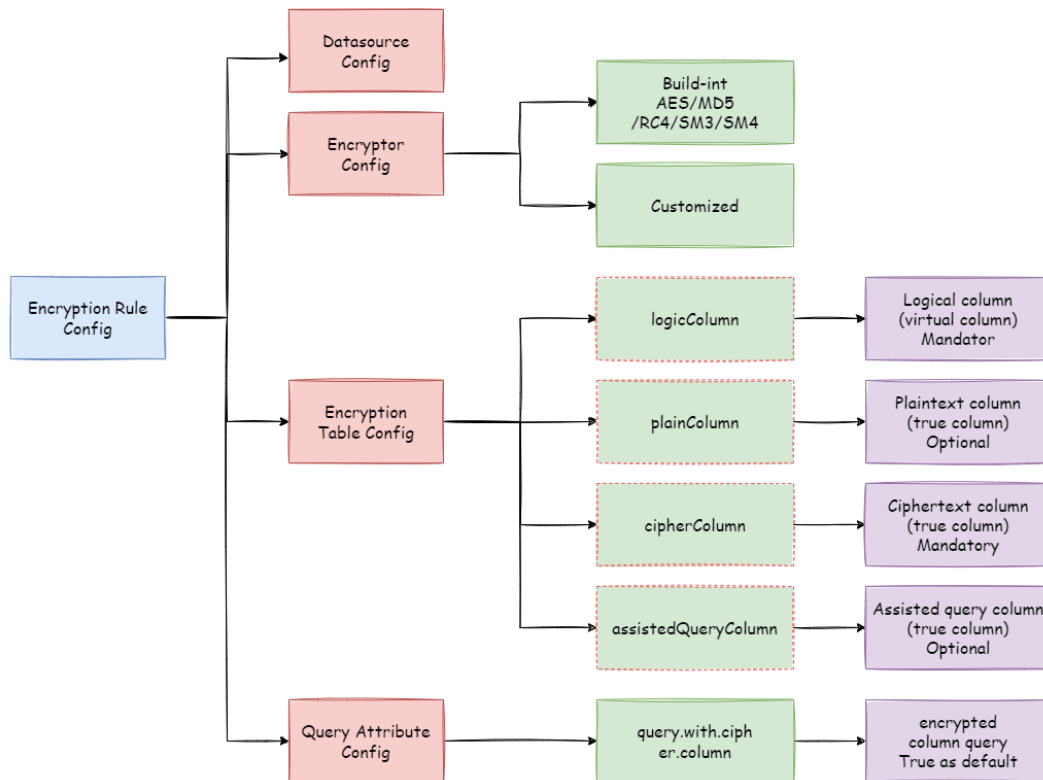

**Datasource Configuration:** The configuration of DataSource.

**Encrypt Algorithm Configuration:** What kind of encryption strategy to use for encryption and decryption. Currently ShardingSphere has five built-in encryption/decryption strategies: AES, MD5, RC4, SM3, and SM4. Users can also implement a set of encryption/decryption algorithms by implementing the interface provided by Apache ShardingSphere.

**Encryption Table Configuration:** Show the ShardingSphere data table which column is used to store cipher column data (cipherColumn), which column is used to store plain text data (plainColumn), and which column users want to use for SQL writing (logicColumn)

How to understand Which column do users want to use to write SQL (logicColumn)?

We can understand according to the meaning of Apache ShardingSphere. The ultimate goal of Apache ShardingSphere is to shield the encryption of the underlying data, that is, we do not want users to know how the data is encrypted/decrypted, how to store plaintext data in plainColumn, and ciphertext data in cipherColumn. In other words, we do not even want users to know the existence and use of plainColumn and cipherColumn. Therefore, we need to provide users with a column in conceptual. This column can be separated from the real column of the underlying database. It can be a real column in the database table or not, so that the user can freely change the plainColumn and The column name of cipherColumn. Or delete plainColumn and choose to never store plain text and only store cipher text. As long as the user's SQL is written according to this logical column, and the correct mapping relationship between logicColumn and plainColumn, cipherColumn is given in the encryption rule.



Why do you do this? The answer is at the end of the article, that is, to enable the online services to seamlessly, transparently, and safely carry out data encryption migration.

**Query Attribute configuration:** When the plaintext data and ciphertext data are stored in the underlying database table at the same time, this attribute switch is used to decide whether to directly query the plaintext data in the database table to return, or to query the ciphertext data and decrypt it through Apache ShardingSphere to return. This switch supports table level and whole rule level configuration, and table level has the highest priority.

### Encryption Process

For example, if there is a table in the database called t\_user, there are actually two fields pwd\_plain in this table, used to store plain text data, pwd\_cipher, used to store cipher text data, and define logicColumn as pwd. Then, when writing SQL, users should write to logicColumn, that is, `INSERT INTO t_user SET pwd = '123'`. Apache ShardingSphere receives the SQL, and through the encryption configuration provided by the user, finds that pwd is a logicColumn, so it decrypt the logical column and its corresponding plaintext data. As can be seen that \*\* Apache ShardingSphere has carried out the column-sensitive and data-sensitive mapping conversion of the logical column facing the user and the plaintext and ciphertext columns facing the underlying database. As shown below:

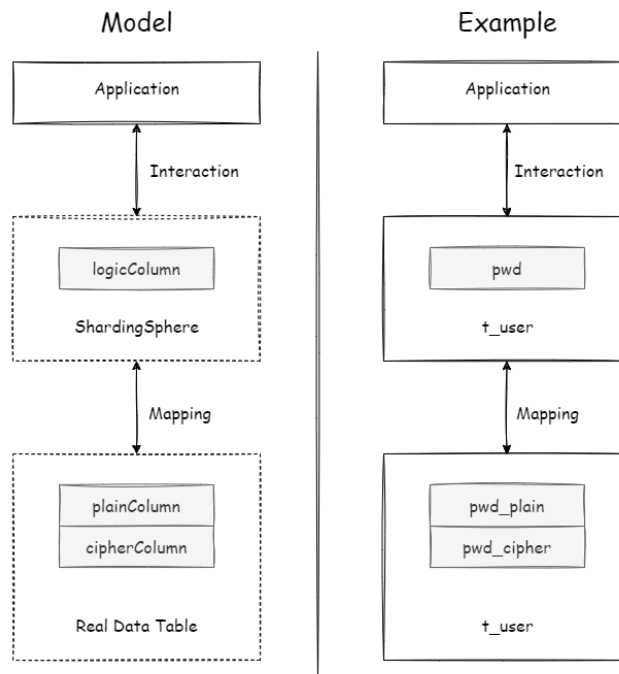

This is also the core meaning of Apache ShardingSphere, which is to separate user SQL from the underlying data table structure according to the encryption rules provided by the user, so that the SQL writer by user no longer depends on the actual database table structure. The connection, mapping, and conversion between the user and the underlying database are handled by Apache ShardingSphere.

Why should we do this? It is still the same : in order to enable the online business to seamlessly, transparently and safely perform data encryption migration.

In order to make the reader more clearly understand the core processing flow of Apache ShardingSphere, the following picture shows the processing flow and conversion logic when using Apache ShardingSphere to add, delete, modify and check, as shown in the following figure.

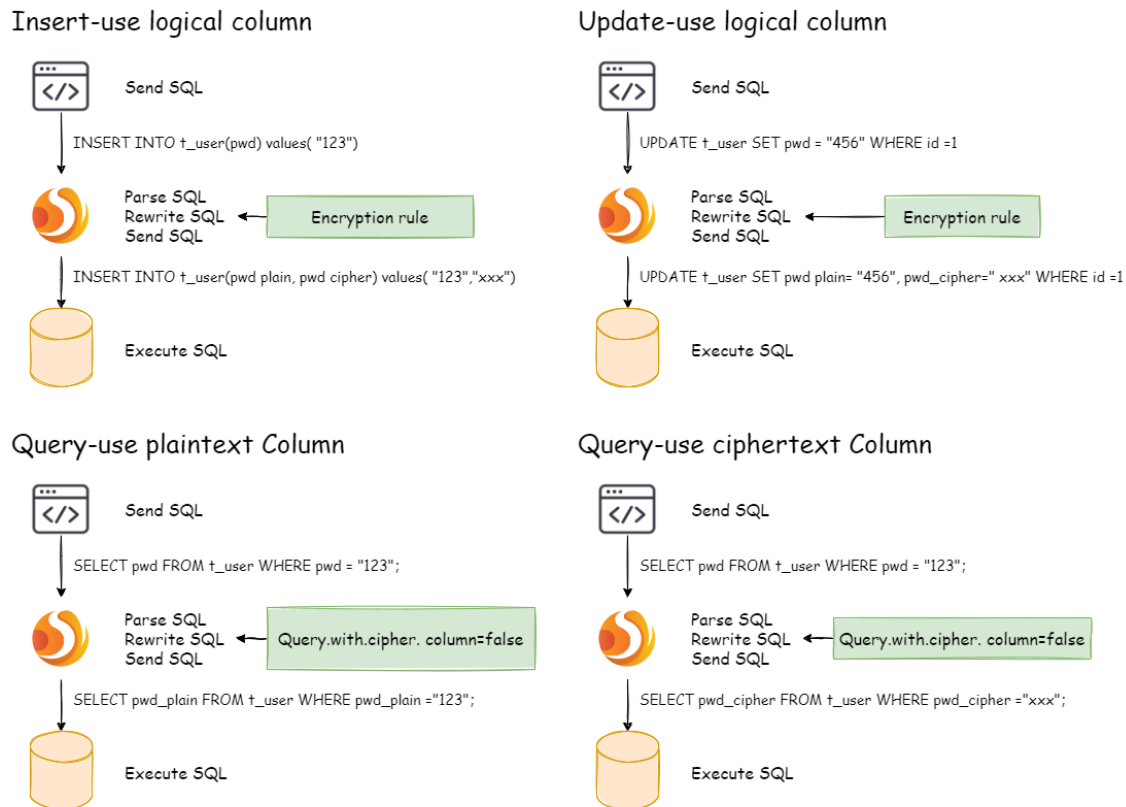

### 7.5.2 Detailed Solution

After understanding the Apache ShardingSphere encryption process, you can combine the encryption configuration and encryption process with the actual scenario. All design and development are to solve the problems encountered in business scenarios. So for the business scenario requirements mentioned earlier, how should ShardingSphere be used to achieve business requirements?

#### New Business

**Business scenario analysis:** The newly launched business is relatively simple because everything starts from scratch and there is no historical data cleaning problem.

**Solution description:** After selecting the appropriate encrypt algorithm, such as AES, you only need to configure the logical column (write SQL for users) and the ciphertext column (the data table stores the ciphertext data). It can also be different \*\*. The recommended configuration is as follows (shown in Yaml format):

```

-!ENCRYPT
encryptors:
  aes_encryptor:
    type: AES
    props:
      aes-key-value: 123456abc
tables:
  t_user:
    columns:
      pwd:
        cipherColumn: pwd
        encryptorName: aes_encryptor
  
```

With this configuration, Apache ShardingSphere only needs to convert logicColumn and cipherColumn. The underlying data table does not store plain text, only cipher text. This is also a requirement of the security audit part. If users want to store plain text and cipher text together in the database, they just need to add plainColumn configuration. The overall processing flow is shown below:

New online service

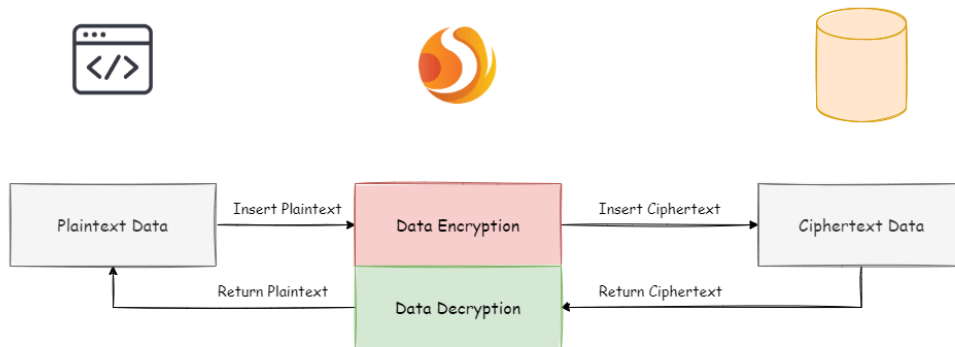

## Online Business Transformation

Business scenario analysis: As the business is already running online, there must be a large amount of plain text historical data stored in the database. The current challenges are how to enable historical data to be encrypted and cleaned, how to enable incremental data to be encrypted, and how to allow businesses to seamlessly and transparently migrate between the old and new data systems.

Solution description: Before providing a solution, let's brainstorm: First, if the old business needs to be desensitized, it must have stored very important and sensitive information. This information has a high gold content and the business is relatively important. If it is broken, the whole team KPI is over. Therefore, it is impossible to suspend business immediately, prohibit writing of new data, encrypt and clean all historical data with an encrypt algorithm, and then deploy the previously reconstructed code online, so that it can encrypt and decrypt online and incremental data. Such a simple and rough way, based on historical experience, will definitely not work.

Then another relatively safe approach is to rebuild a pre-release environment exactly like the production environment, and then encrypt the **Inventory plaintext data** of the production environment through the relevant migration and washing tools and store it in the pre-release environment. The **Increment data** is encrypted by tools such as MySQL replica query and the business party's own development, encrypted and stored in the database of the pre-release environment, and then the refactored code can be deployed to the pre-release environment. In this way, the production environment is a set of environment for **modified/queries with plain text as the core**; the pre-release environment is a set of **encrypt/decrypt queries modified with ciphertext as the core**. After comparing for a period of time, the production flow can be cut into the pre-release environment at night. This solution is relatively safe and reliable, but it takes more time, manpower, capital, and costs. It mainly includes: pre-release environment construction, production code rectification, and related auxiliary tool development. Unless there is no way to go, business developers generally go from getting started to giving up.

Business developers must hope: reduce the burden of capital costs, do not modify the business code, and be able to safely and smoothly migrate the system. So, the encryption function module of ShardingSphere was born. It can be divided into three steps:

### 1. Before system migration

Assuming that the system needs to encrypt the pwd field of t\_user, the business side uses Apache ShardingSphere to replace the standardized JDBC interface, which basically requires no additional modification (we also provide Spring Boot Starter, Spring Namespace, YAML and other access methods to achieve different services demand). In addition, demonstrate a set of encryption configuration rules, as follows:

```
-!ENCRYPT
encryptors:
  aes_encryptor:
    type: AES
    props:
      aes-key-value: 123456abc
tables:
  t_user:
```

```

columns:
  pwd:
    plainColumn: pwd
    cipherColumn: pwd_cipher
    encryptorName: aes_encryptor
queryWithCipherColumn: false
    
```

According to the above encryption rules, we need to add a column called `pwd_cipher` in the `t_user` table, that is, `cipherColumn`, which is used to store ciphertext data. At the same time, we set `plainColumn` to `pwd`, which is used to store plaintext data, and `logicColumn` is also set to `pwd`. Because the previous SQL was written using `pwd`, that is, the SQL was written for logical columns, so the business code did not need to be changed. Through Apache ShardingSphere, for the incremental data, the plain text will be written to the `pwd` column, and the plain text will be encrypted and stored in the `pwd_cipher` column. At this time, because `queryWithCipherColumn` is set to `false`, for business applications, the plain text column of `pwd` is still used for query storage, but the cipher text data of the new data is additionally stored on the underlying database table `pwd_cipher`. The processing flow is shown below:

Online Service Refactor - before migration

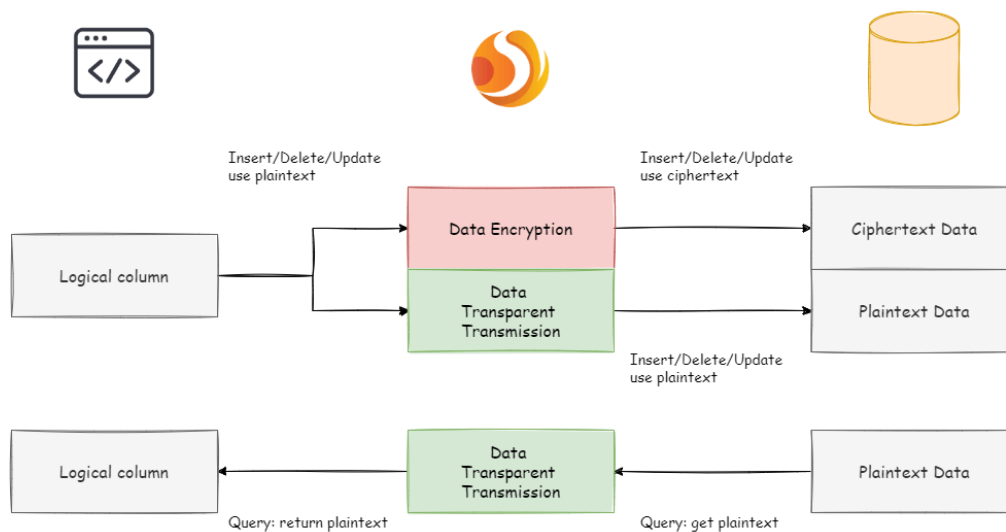

When the newly added data is inserted, it is encrypted as ciphertext data through Apache ShardingSphere and stored in the `cipherColumn`. Now it is necessary to process historical plaintext inventory data. **As Apache ShardingSphere currently does not provide the corresponding migration and washing tools, the business party needs to encrypt and store the plain text data in `pwd` to `pwd_cipher`.**

2. During system migration

The incremental data has been stored by Apache ShardingSphere in the ciphertext column and the plaintext is stored in the plaintext column; after the historical data is encrypted and cleaned by the

business party itself, the ciphertext is also stored in the ciphertext column. That is to say, the plaintext and the ciphertext are stored in the current database. Since the `queryWithCipherColumn = false` in the configuration item, the ciphertext has never been used. Now we need to set the `queryWithCipherColumn` in the encryption configuration to true in order for the system to cut the ciphertext data for query. After restarting the system, we found that the system business is normal, but Apache ShardingSphere has started to extract the ciphertext data from the database, decrypt it and return it to the user; and for the user's insert, delete and update requirements, the original data will still be stored in the plaintext column, the encrypted ciphertext data is stored in the ciphertext column.

Although the business system extracts the data in the ciphertext column and returns it after decryption; however, it will still save a copy of the original data to the plaintext column during storage. Why? The answer is: in order to be able to roll back the system. **Because as long as the ciphertext and plaintext always exist at the same time, we can freely switch the business query to cipherColumn or plainColumn through the configuration of the switch item.** In other words, if the system is switched to the ciphertext column for query, the system reports an error and needs to be rolled back. Then just set `queryWithCipherColumn = false`, Apache ShardingSphere will restore, that is, start using plainColumn to query again. The processing flow is shown in the following figure:

Online Service Refactor - during migration

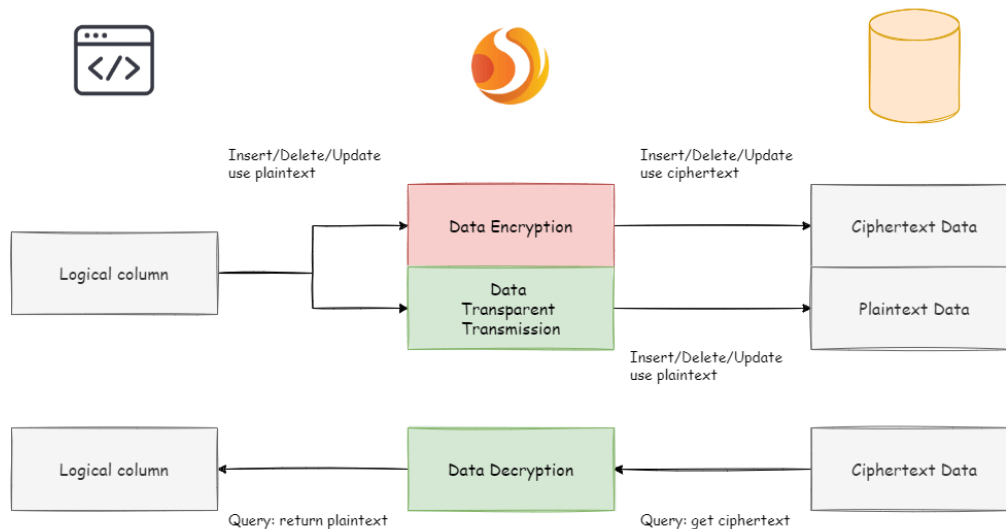

### 3. After system migration

Due to the requirements of the security audit department, it is generally impossible for the business system to keep the plaintext and ciphertext columns of the database permanently synchronized. We need to delete the plaintext data after the system is stable. That is, we need to delete plainColumn (ie pwd) after system migration. The problem is that now the business code is written for `pwd SQL`, delete the `pwd` in the underlying data table stored in plain text, and use `pwd_cipher` to decrypt to get

the original data, does that mean that the business side needs to rectify all SQL, thus Do not use the pwd column that is about to be deleted? Remember the core meaning of our encrypt module?

This is also the core meaning of encrypt module. According to the encryption rules provided by the user, the user SQL is separated from the underlying database table structure, so that the user's SQL writing no longer depends on the actual database table structure. The connection, mapping, and conversion between the user and the underlying database are handled by ShardingSphere.

Yes, because of the existence of logicColumn, users write SQL for this virtual column. Apache ShardingSphere can map this logical column and the ciphertext column in the underlying data table. So the encryption configuration after migration is:

```
-!ENCRYPT
encryptors:
  aes_encryptor:
    type: AES
    props:
      aes-key-value: 123456abc
tables:
  t_user:
    columns:
      pwd: # pwd and pwd_cipher transformation mapping
      cipherColumn: pwd_cipher
      encryptorName: aes_encryptor
```

The processing flow is as follows:

## Online Service Refactor - after migration

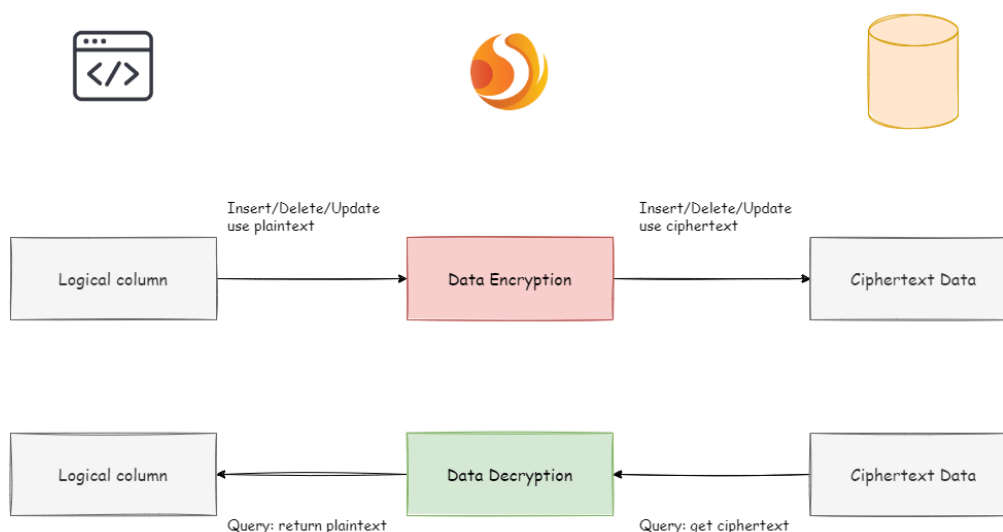

So far, the online service encryption and rectification solutions have all been demonstrated. We provide Java, YAML, Spring Boot Starter, Spring Namespace multiple ways for users to choose to use, and strive to fulfill business requirements. The solution has been continuously launched on JD Digits, providing internal basic service support.

### 7.5.3 The advantages of Middleware encryption service

1. Transparent data encryption process, users do not need to pay attention to the implementation details of encryption.
2. Provide a variety of built-in, third-party (AKS) encryption strategies, users only need to modify the configuration to use.
3. Provides a encryption strategy API interface, users can implement the interface to use a custom encryption strategy for data encryption.
4. Support switching different encryption strategies.
5. For online services, it is possible to store plaintext data and ciphertext data synchronously, and decide whether to use plaintext or ciphertext columns for query through configuration. Without changing the business query SQL, the on-line system can safely and transparently migrate data before and after encryption.



### 7.5.4 Solution

Apache ShardingSphere has provided two data encryption solutions, corresponding to two ShardingSphere encryption and decryption interfaces, i.e., `EncryptAlgorithm` and `QueryAssistedEncryptAlgorithm`.

On the one hand, Apache ShardingSphere has provided internal encryption and decryption implementations for users, which can be used by them only after configuration. On the other hand, to satisfy users' requirements for different scenarios, we have also opened relevant encryption and decryption interfaces, according to which, users can provide specific implementation types. Then, after simple configurations, Apache ShardingSphere can use encryption and decryption solutions defined by users themselves to desensitize data.

#### EncryptAlgorithm

The solution has provided two methods `encrypt()` and `decrypt()` to encrypt/decrypt data for encryption.

When users INSERT, DELETE and UPDATE, ShardingSphere will parse, rewrite and route SQL according to the configuration. It will also use `encrypt()` to encrypt data and store them in the database. When using SELECT, they will decrypt sensitive data from the database with `decrypt()` reversely and return them to users at last.

Currently, Apache ShardingSphere has provided five types of implementations for this kind of encrypt solution, MD5 (irreversible), AES (reversible), RC4 (reversible), SM3 (irreversible) and SM4 (reversible), which can be used after configuration.

#### QueryAssistedEncryptAlgorithm

Compared with the first encrypt scheme, this one is more secure and complex. Its concept is: even the same data, two same user passwords for example, should not be stored as the same desensitized form in the database. It can help to protect user information and avoid credential stuffing.

This scheme provides three functions to implement, `encrypt()`, `decrypt()` and `queryAssistedEncrypt()`. In `encrypt()` phase, users can set some variable, timestamp for example, and encrypt a combination of original data + variable. This method can make sure the encrypted data of the same original data are different, due to the existence of variables. In `decrypt()` phase, users can use variable data to decrypt according to the encryption algorithms set formerly.

Though this method can indeed increase data security, another problem can appear with it: as the same data is stored in the database in different content, users may not be able to find out all the same original data with equivalent query (`SELECT FROM table WHERE encryptedColumn = ?`) according to this encryption column. Because of it, we have brought out assistant query column, which is generated by `queryAssistedEncrypt()`. Different from `decrypt()`, this method uses another way to encrypt the original data; but for the same original data, it can generate consistent encryption data. Users can store data processed by `queryAssistedEncrypt()` to assist the query of original data. So there may be one more assistant query column in the table.

`queryAssistedEncrypt()` and `encrypt()` can generate and store different encryption data; `decrypt()` is reversible and `queryAssistedEncrypt()` is irreversible. So when querying the original data, we will parse, rewrite and route SQL automatically. We will also use assistant query column to do WHERE queries and use `decrypt()` to decrypt `encrypt()` data and return them to users. All these can not be felt by users.

For now, ShardingSphere has abstracted the concept to be an interface for users to develop rather than providing accurate implementation for this kind of encrypt solution. ShardingSphere will use the accurate implementation of this solution provided by users to desensitize data.

## 7.6 Shadow

### 7.6.1 Overall Architecture

Apache ShardingSphere makes shadow judgments on incoming SQL by parsing SQL, according to the shadow rules set by the user in the configuration file, route to production DB or shadow DB.

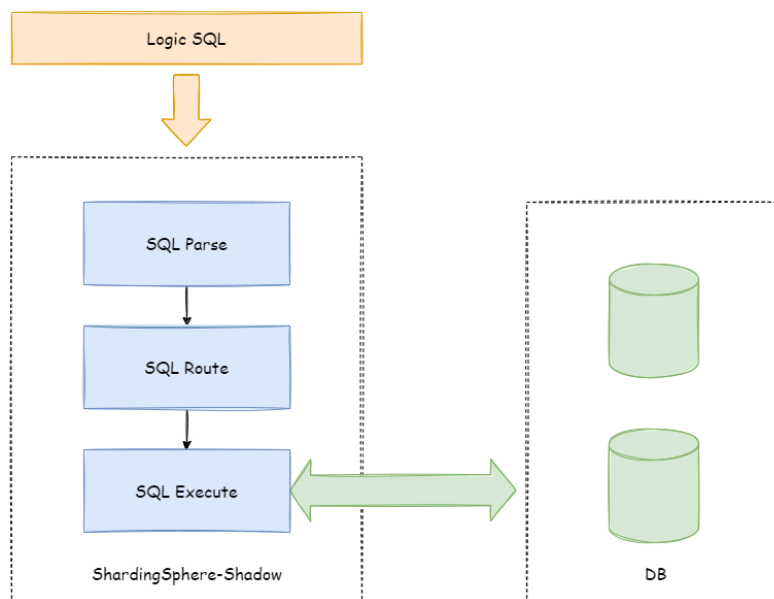

### 7.6.2 Shadow Rule

Shadow rules include shadow data source mapping, shadow tables, and shadow algorithms.

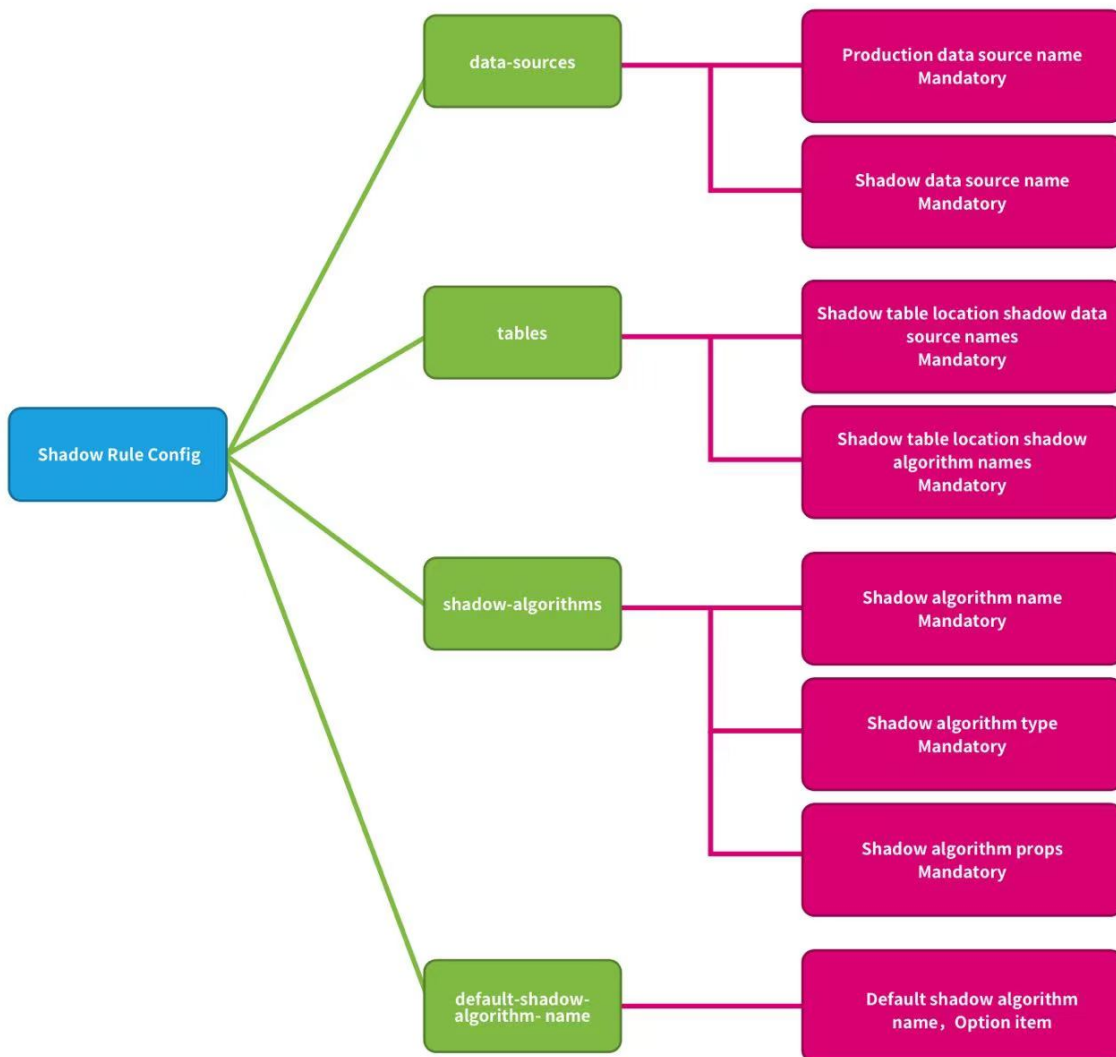

**data-sources:** Production data source name and shadow data source name mappings.

**tables:** Shadow tables related to stress testing. Shadow tables must exist in the specified shadow DB, and the shadow algorithm needs to be specified.

**shadow-algorithms:** SQL routing shadow algorithm.

**default-shadow-algorithm-name:** Default shadow algorithm. Optional item, the default matching algorithm for tables that not configured with the shadow algorithm.

### 7.6.3 Routing Process

Take the INSERT statement as an example. When writing data Apache ShardingSphere will parse the SQL, and then construct a routing chain according to the rules in the configuration file.

In the current version of the function, the shadow function is the last execution unit in the routing chain, that is, if there are other rules that require routing, such as sharding, Apache ShardingSphere will first route to a certain database according to the sharding rules, and then perform the shadow routing decision process.

If determined that the execution of SQL satisfies the configuration of the shadow rule, the data routed to the corresponding shadow database, and the production data remains unchanged.

### 7.6.4 Shadow Judgment Process

The Shadow DB performs shadow judgment on the executed SQL statements.

Shadow judgment supports two types of algorithms, users can choose one or combine them according to actual business needs.

#### DML Statement

Support two type shadow algorithms.

The shadow judgment first judges whether there is an intersection between SQL related tables and configured shadow tables.

If there is an intersection, determine the shadow algorithm associated with the shadow table of the intersection in turn, and any one of them was successful. SQL statement executed shadow DB.

If shadow tables have no intersection, or shadow algorithms are unsuccessful, SQL statement executed production DB.

#### DDL Statement

Only support note shadow algorithm.

In the pressure testing scenarios, DDL statements are not need tested generally. It is mainly used when initializing or modifying the shadow table in the shadow DB.

The shadow judgment first judges whether the executed SQL contains notes.

If contains notes, determine the note shadow algorithms in the shadow rule in turn, and any one of them was successful. SQL statement executed shadow DB.

The executed SQL does not contain notes, or shadow algorithms are unsuccessful, SQL statement executed production DB.

## 7.6.5 Shadow Algorithm

Shadow algorithm details, please refer to [List of built-in shadow algorithms](#)

## 7.6.6 Use Example

### Scenario

Assume that the e-commerce website wants to perform pressure testing on the order business, the pressure testing related table `t_order` is a shadow table, the production data executed to the `ds` production DB, and the pressure testing data executed to the database `ds_shadow` shadow DB.

### Shadow DB configuration

The configuration example of `config-shadow.yaml`(YAML):

```
databaseName: shadow_db

dataSources:
  ds:
    url: jdbc:mysql://127.0.0.1:3306/ds?serverTimezone=UTC&useSSL=false
    username: root
    password:
    connectionTimeoutMilliseconds: 30000
    idleTimeoutMilliseconds: 60000
    maxLifetimeMilliseconds: 1800000
    maxPoolSize: 50
    minPoolSize: 1
  shadow_ds:
    url: jdbc:mysql://127.0.0.1:3306/shadow_ds?serverTimezone=UTC&useSSL=false
    username: root
    password:
    connectionTimeoutMilliseconds: 30000
    idleTimeoutMilliseconds: 60000
    maxLifetimeMilliseconds: 1800000
    maxPoolSize: 50
    minPoolSize: 1

rules:
- !SHADOW
  dataSources:
    shadowDataSource:
      sourceDataSourceName: ds
      shadowDataSourceName: shadow_ds
  tables:
    t_order:
```

```

dataSourceNames:
  - shadowDataSource
shadowAlgorithmNames:
  - simple-hint-algorithm
  - user-id-value-match-algorithm
shadowAlgorithms:
  simple-hint-algorithm:
    type: SIMPLE_HINT
    props:
      foo: bar
  user-id-insert-match-algorithm:
    type: VALUE_MATCH
    props:
      operation: insert
      column: user_id
      regex: 0
- !SQL_PARSER
sqlCommentParseEnabled: true

```

**Note:** If you use the Hint shadow algorithm, the parse SQL comment configuration item `sql-comment-parse-enabled: true` need to be turned on. turned off by default. please refer to [SQL-PARSER Configuration](#)

### Shadow DB environment

- Create the shadow DB `ds_shadow`.
- Create shadow tables, tables structure must be consistent with the production environment. Assume that the `t_order` table created in the shadow DB. Create table statement need to add SQL comment `/*foo:bar,... */`.

```

CREATE TABLE t_order (order_id INT(11) primary key, user_id int(11) not null, ...)
/*foo:bar,...*/

```

Execute to the shadow DB.

**Note:** If use the MySQL client for testing, the link needs to use the parameter `-c`, for example:

```
mysql> mysql -u root -h127.0.0.1 -P3306 -proot -c
```

Parameter description: keep the comment, send the comment to the server

Execute SQL containing annotations, for example:

```
SELECT * FROM table_name /*shadow:true,foo:bar*/;
```

Comment statement will be intercepted by the MySQL client if parameter `-c` not be used, for example:

```
SELECT * FROM table_name;
```

Affect test results.

### Shadow algorithm example

#### 1. Column shadow algorithm example

Assume that the `t_order` table contains a list of `user_id` to store the order user ID. The data of the order created by the user whose user ID is 0 executed to shadow DB, other data executed to production DB.

```
INSERT INTO t_order (order_id, user_id, ...) VALUES (xxx..., 0, ...)
```

No need to modify any SQL or code, only need to control the data of the testing to realize the pressure testing.

Column Shadow algorithm configuration (YAML):

```
shadowAlgorithms:
  user-id-insert-match-algorithm:
    type: VALUE_MATCH
    props:
      operation: insert
      column: user_id
      regex: 0
```

**Note:** When the shadow table uses the column shadow algorithm, the same type of shadow operation (INSERT, UPDATE, DELETE, SELECT) currently only supports a single column.

#### 2. Hint shadow algorithm example

Assume that the `t_order` table does not contain columns that can matching. Executed SQL statement need to add SQL note `/*foo:bar,.. */`

```
SELECT * FROM t_order WHERE order_id = xxx /*foo:bar,.. */
```

SQL executed to shadow DB, other data executed to production DB.

Note Shadow algorithm configuration (YAML):

```
shadowAlgorithms:
  simple-hint-algorithm:
    type: SIMPLE_HINT
    props:
      foo: bar
```

#### 3. Hybrid two shadow algorithm example

Assume that the pressure testing of the `t_order` gauge needs to cover the above two scenarios.

```
INSERT INTO t_order (order_id, user_id, ...) VALUES (xxx..., 0, ...);

SELECT * FROM t_order WHERE order_id = xxx /*foo:bar,...*/;
```

Both will be executed to shadow DB, other data executed to production DB.

2 type of shadow algorithm example (YAML):

```
shadowAlgorithms:
  user-id-value-match-algorithm:
    type: VALUE_MATCH
    props:
      operation: insert
      column: user_id
      value: 0
  simple-hint-algorithm:
    type: SIMPLE_HINT
    props:
      foo: bar
```

#### 4. Default shadow algorithm example

Assume that the column shadow algorithm used for the t\_order, all other shadow tables need to use the note shadow algorithm.

```
INSERT INTO t_order (order_id, user_id, ...) VALUES (xxx..., 0, ...);

INSERT INTO t_xxx_1 (order_item_id, order_id, ...) VALUES (xxx..., xxx..., ...) /
/*foo:bar,...*/;

SELECT * FROM t_xxx_2 WHERE order_id = xxx /*foo:bar,...*/;

SELECT * FROM t_xxx_3 WHERE order_id = xxx /*foo:bar,...*/;
```

Both will be executed to shadow DB, other data executed to production DB.

Default shadow algorithm configuration (YAML):

```
rules:
- !SHADOW
dataSources:
  shadowDataSource:
    sourceDataSourceName: ds
    shadowDataSourceName: shadow_ds
tables:
  t_order:
    dataSourceNames:
    - shadowDataSource
    shadowAlgorithmNames:
    - simple-hint-algorithm
```



```

    - user-id-value-match-algorithm
shadowAlgorithms:
  simple-hint-algorithm:
    type: SIMPLE_HINT
    props:
      foo: bar
  user-id-insert-match-algorithm:
    type: VALUE_MATCH
    props:
      operation: insert
      column: user_id
      regex: 0
- !SQL_PARSER
sqlCommentParseEnabled: true

```

**Note:** The default shadow algorithm only supports Hint shadow algorithm. When using ensure that the configuration items of props in the configuration file are less than or equal to those in the SQL comment, And the specific configuration of the configuration file should same as the configuration written in the SQL comment. The fewer configuration items in the configuration file, the looser the matching conditions

```

shadowAlgorithms:
  simple-note-algorithm:
    type: SIMPLE_HINT
    props:
      foo: bar
      foo1: bar1

```

For example, the ‘props’ item have 2 configure, the following syntax can be used in SQL:

```
SELECT * FROM t_xxx_2 WHERE order_id = xxx /*foo:bar, foo1:bar1*/
```

```
SELECT * FROM t_xxx_2 WHERE order_id = xxx /*foo:bar, foo1:bar1, foo2:bar2, ...*/
```

```

shadowAlgorithms:
  simple-note-algorithm:
    type: SIMPLE_HINT
    props:
      foo: bar

```

For example, the ‘props’ item have 1 configure, the following syntax can be used in SQL:

```
SELECT * FROM t_xxx_2 WHERE order_id = xxx /*foo:foo*/
```

```
SELECT * FROM t_xxx_2 WHERE order_id = xxx /*foo:foo, foo1:bar1, ...*/
```

## 7.7 Test

Apache ShardingSphere provides test engines for integration, module and performance.

### 7.7.1 Integration Test

Provide point to point test which connect real ShardingSphere and database instances.

They define SQLs in XML files, engine run for each database independently. All test engines designed to modify the configuration files to execute all assertions without any **Java code** modification. It does not depend on any third-party environment, ShardingSphere-Proxy and database used for testing are provided by docker image.

### 7.7.2 Module Test

Provide module test engine for complex modules.

They define SQLs in XML files, engine run for each database independently too It includes SQL parser and SQL rewriter modules.

### 7.7.3 Performance Test

Provide multiple performance test methods, includes Sysbench, JMH or TPCC and so on.

### 7.7.4 Sysbench Test

### 7.7.5 Integration Test

The SQL parsing unit test covers both SQL placeholder and literal dimension. Integration test can be further divided into two dimensions of strategy and JDBC; the former one includes strategies as Sharding, table Sharding, database Sharding, and readwrite-splitting while the latter one includes Statement and PreparedStatement.

Therefore, one SQL can drive 5 kinds of database parsing \* 2 kinds of parameter transmission modes + 5 kinds of databases \* 5 kinds of Sharding strategies \* 2 kinds of JDBC operation modes = 60 test cases, to enable ShardingSphere to achieve the pursuit of high quality.

## Process

The Parameterized in JUnit will collect all test data, and pass to test method to assert one by one. The process of handling test data is just like a leaking hourglass:

## Configuration

- environment type
  - /shardingsphere-integration-test-suite/src/test/resources/env-native.properties
  - /shardingsphere-integration-test-suite/src/test/resources/env/SQL-TYPE/dataset.xml
  - /shardingsphere-integration-test-suite/src/test/resources/env/SQL-TYPE/schema.xml
- test case type
  - /shardingsphere-integration-test-suite/src/test/resources/cases/SQL-TYPE/SQL-TYPE-integration-test-cases.xml
  - /shardingsphere-integration-test-suite/src/test/resources/cases/SQL-TYPE/dataset/FEATURE-TYPE/\*.xml
- sql-case
  - /sharding-sql-test/src/main/resources/sql/sharding/SQL-TYPE/\*.xml

## Environment Configuration

Integration test depends on existed database environment, developer need to setup the configuration file for corresponding database to test:

Firstly, setup configuration file /shardingsphere-integration-test-suite/src/test/resources/env-native.properties, for example:

```
# the switch for PK, concurrent, column index testing and so on
it.run.additional.cases=false

# test scenarios, could define multiple rules
it.scenarios=db,tbl,dbtbl_with_replica_query,replica_query

# database type, could define multiple databases(H2,MySQL,Oracle,SQLServer,
PostgreSQL)
it.cluster.databases=MySQL,PostgreSQL

# MySQL configuration
it.mysql.host=127.0.0.1
it.mysql.port=13306
it.mysql.username=root
it.mysql.password=root

## PostgreSQL configuration
```

```

it.postgresql.host=db.psql
it.postgresql.port=5432
it.postgresql.username=postgres
it.postgresql.password=postgres

## SQLServer configuration
it.sqlserver.host=db.mssql
it.sqlserver.port=1433
it.sqlserver.username=sa
it.sqlserver.password=Jdbc1234

## Oracle configuration
it.oracle.host=db.oracle
it.oracle.port=1521
it.oracle.username=jdbc
it.oracle.password=jdbc

```

Secondly, setup configuration file `/shardingsphere-integration-test-suite/src/test/resources/env/SQL-TYPE/dataset.xml`. Developer can set up metadata and expected data to start the data initialization in `dataset.xml`. For example:

```

<dataset>
  <metadata data-nodes="tbl.t_order_${0..9}">
    <column name="order_id" type="numeric" />
    <column name="user_id" type="numeric" />
    <column name="status" type="varchar" />
  </metadata>
  <row data-node="tbl.t_order_0" values="1000, 10, init" />
  <row data-node="tbl.t_order_1" values="1001, 10, init" />
  <row data-node="tbl.t_order_2" values="1002, 10, init" />
  <row data-node="tbl.t_order_3" values="1003, 10, init" />
  <row data-node="tbl.t_order_4" values="1004, 10, init" />
  <row data-node="tbl.t_order_5" values="1005, 10, init" />
  <row data-node="tbl.t_order_6" values="1006, 10, init" />
  <row data-node="tbl.t_order_7" values="1007, 10, init" />
  <row data-node="tbl.t_order_8" values="1008, 10, init" />
  <row data-node="tbl.t_order_9" values="1009, 10, init" />
</dataset>

```

Developer can customize DDL to create databases and tables in `schema.xml`.

## Assertion Configuration

So far have confirmed what kind of sql execute in which environment in upon configuration, here define the data for assert. There are two kinds of config for assert, one is at /shardingsphere-integration-test-suite/src/test/resources/cases/SQL-TYPE/SQL-TYPE-integration-test-cases.xml. This file just like an index, defined the sql, parameters and expected index position for execution. the SQL is the value for sql-case-id. For example:

```
<integration-test-cases>
  <dml-test-case sql-case-id="insert_with_all_placeholders">
    <assertion parameters="1:int, 1:int, insert:String" expected-data-file="insert_for_order_1.xml" />
    <assertion parameters="2:int, 2:int, insert:String" expected-data-file="insert_for_order_2.xml" />
  </dml-test-case>
</integration-test-cases>
```

Another kind of config for assert is the data, as known as the corresponding expected-data-file in SQL-TYPE-integration-test-cases.xml, which is at /shardingsphere-integration-test-suite/src/test/resources/cases/SQL-TYPE/dataset/FEATURE-TYPE/\*.xml.

This file is very like the dataset.xml mentioned before, and the difference is that expected-data-file contains some other assert data, such as the return value after a sql execution. For examples:

```
<dataset update-count="1">
  <metadata data-nodes="db_${0..9}.t_order">
    <column name="order_id" type="numeric" />
    <column name="user_id" type="numeric" />
    <column name="status" type="varchar" />
  </metadata>
  <row data-node="db_0.t_order" values="1000, 10, update" />
  <row data-node="db_0.t_order" values="1001, 10, init" />
  <row data-node="db_0.t_order" values="2000, 20, init" />
  <row data-node="db_0.t_order" values="2001, 20, init" />
</dataset>
```

Util now, all config files are ready, just launch the corresponding test case is fine. With no need to modify any Java code, only set up some config files. This will reduce the difficulty for ShardingSphere testing.

## Running Integration Tests

### Run with Docker

```
./mvnw -B clean install -f shardingsphere-test/shardingsphere-integration-test/pom.xml -Pit.env.docker -Dit.cluster.adapters=proxy,jdbc -Dit.scenarios=${scenario_name_1,scenario_name_1,scenario_name_n} -Dit.cluster.databases=MySQL
```

Running the above command will build a Docker image `apache/shardingsphere-proxy-test:latest` for integration testing. The existing test Docker image can be reused without rebuilding if only the test code is modified. Use the following command to skip the image building and run the integration tests directly:

```
./mvnw -B clean install -f shardingsphere-test/shardingsphere-integration-test/shardingsphere-integration-test-suite/pom.xml -Pit.env.docker -Dit.cluster.adapters=proxy,jdbc -Dit.scenarios=${scenario_name_1,scenario_name_1,scenario_name_n} -Dit.cluster.databases=MySQL
```

### Notice

1. If Oracle needs to be tested, please add Oracle driver dependencies to the pom.xml.
2. 10 splitting-databases and 10 splitting-tables are used in the integrated test to ensure the test data is full, so it will take a relatively long time to run the test cases.

## 7.7.6 Performance Test

Provides result for each performance test tools.

### Performance Test

#### Target

The performance of ShardingSphere-JDBC, ShardingSphere-Proxy and MySQL would be compared here. INSERT & UPDATE & DELETE which regarded as a set of associated operation and SELECT which focus on sharding optimization are used to evaluate performance for the basic scenarios (single route, readwrite-splitting & encrypt & sharding, full route). While another set of associated operation, INSERT & SELECT & DELETE, is used to evaluate performance for readwrite-splitting. To achieve the result better, these tests are performed with jmeter which based on a certain amount of data with 20 concurrent threads for 30 minutes, and one MySQL has been deployed on one machine, while the scenario of MySQL used for comparison is deployed on one machine with one instance.

## Test Scenarios

### Single Route

On the basis of one thousand data volume, four databases that are deployed on the same machine and each contains 1024 tables with `id` used for database sharding and `k` used for table sharding are designed for this scenario, single route select sql statement is chosen here. While as a comparison, MySQL runs with INSERT & UPDATE & DELETE statement and single route select sql statement on the basis of one thousand data volume.

### Readwrite-splitting

One primary database and one replica database, which are deployed on different machines, are designed for this scenario based on ten thousand data volume. While as a comparison, MySQL runs with INSERT & SELECT & DELETE sql statement on the basis of ten thousand data volume.

### Readwrite-splitting & Encrypt & Sharding

On the basis of one thousand data volume, four databases that are deployed on different machines and each contains 1024 tables with `id` used for database sharding, `k` used for table sharding, `c` encrypted with aes and `pad` encrypted with md5 are designed for this scenario, single route select sql statement is chosen here. While as a comparison, MySQL runs with INSERT & UPDATE & DELETE statement and single route select sql statement on the basis of one thousand data volume.

### Full Route

On the basis of one thousand data volume, four databases that are deployed on different machines and each contains one table are designed for this scenario, field `id` is used for database sharding and `k` is used for table sharding, full route select sql statement is chosen here. While as a comparison, MySQL runs with INSERT & UPDATE & DELETE statement and full route select sql statement on the basis of one thousand data volume.

## Testing Environment

### Table Structure of Database

The structure of table here refer to `sbtest` in `sysbench`.

```
CREATE TABLE `tbl` (
  `id` bigint(20) NOT NULL AUTO_INCREMENT,
  `k` int(11) NOT NULL DEFAULT 0,
  `c` char(120) NOT NULL DEFAULT '',
  `pad` char(60) NOT NULL DEFAULT ''
```

```
PRIMARY KEY (`id`)  
);
```

### Test Scenarios Configuration

The same configurations are used for ShardingSphere-JDBC and ShardingSphere-Proxy, while MySQL with one database connected is designed for comparison. The details for these scenarios are shown as follows.

### Single Route Configuration

```
schemaName: sharding_db  
  
dataSources:  
  ds_0:  
    url: jdbc:mysql://***.***.***.***:****/ds?serverTimezone=UTC&useSSL=false  
    username: test  
    password:  
    connectionTimeoutMilliseconds: 30000  
    idleTimeoutMilliseconds: 60000  
    maxLifetimeMilliseconds: 1800000  
    maxPoolSize: 200  
  ds_1:  
    url: jdbc:mysql://***.***.***.***:****/ds?serverTimezone=UTC&useSSL=false  
    username: test  
    password:  
    connectionTimeoutMilliseconds: 30000  
    idleTimeoutMilliseconds: 60000  
    maxLifetimeMilliseconds: 1800000  
    maxPoolSize: 200  
  ds_2:  
    url: jdbc:mysql://***.***.***.***:****/ds?serverTimezone=UTC&useSSL=false  
    username: test  
    password:  
    connectionTimeoutMilliseconds: 30000  
    idleTimeoutMilliseconds: 60000  
    maxLifetimeMilliseconds: 1800000  
    maxPoolSize: 200  
  ds_3:  
    url: jdbc:mysql://***.***.***.***:****/ds?serverTimezone=UTC&useSSL=false  
    username: test  
    password:  
    connectionTimeoutMilliseconds: 30000  
    idleTimeoutMilliseconds: 60000  
    maxLifetimeMilliseconds: 1800000  
    maxPoolSize: 200
```



```

rules:
- !SHARDING
  tables:
    tbl:
      actualDataNodes: ds_${0..3}.tbl${0..1023}
      tableStrategy:
        standard:
          shardingColumn: k
          shardingAlgorithmName: tbl_table_inline
      keyGenerateStrategy:
        column: id
        keyGeneratorName: snowflake
  defaultDatabaseStrategy:
    inline:
      shardingColumn: id
      shardingAlgorithmName: default_db_inline
  defaultTableStrategy:
    none:
  shardingAlgorithms:
    tbl_table_inline:
      type: INLINE
      props:
        algorithm-expression: tbl${k % 1024}
    default_db_inline:
      type: INLINE
      props:
        algorithm-expression: ds_${id % 4}
  keyGenerators:
    snowflake:
      type: SNOWFLAKE

```

### Readwrite-splitting Configuration

```

schemaName: sharding_db

dataSources:
  primary_ds:
    url: jdbc:mysql://***.***.***.***:****/ds?serverTimezone=UTC&useSSL=false
    username: test
    password:
    connectionTimeoutMilliseconds: 30000
    idleTimeoutMilliseconds: 60000
    maxLifetimeMilliseconds: 1800000
    maxPoolSize: 200
  replica_ds_0:
    url: jdbc:mysql://***.***.***.***:****/ds?serverTimezone=UTC&useSSL=false

```

```

username: test
password:
connectionTimeoutMilliseconds: 30000
idleTimeoutMilliseconds: 60000
maxLifetimeMilliseconds: 1800000
maxPoolSize: 200
rules:
- !READWRITE_SPLITTING
  dataSources:
    readwrite_ds:
      type: Static
      props:
        write-data-source-name: primary_ds
        read-data-source-names: replica_ds_0

```

### Readwrite-splitting & Encrypt & Sharding Configuration

```

schemaName: sharding_db

dataSources:
  primary_ds_0:
    url: jdbc:mysql://***.***.***.***:****/ds?serverTimezone=UTC&useSSL=false
    username: test
    password:
    connectionTimeoutMilliseconds: 30000
    idleTimeoutMilliseconds: 60000
    maxLifetimeMilliseconds: 1800000
    maxPoolSize: 200
  replica_ds_0:
    url: jdbc:mysql://***.***.***.***:****/ds?serverTimezone=UTC&useSSL=false
    username: test
    password:
    connectionTimeoutMilliseconds: 30000
    idleTimeoutMilliseconds: 60000
    maxLifetimeMilliseconds: 1800000
    maxPoolSize: 200
  primary_ds_1:
    url: jdbc:mysql://***.***.***.***:****/ds?serverTimezone=UTC&useSSL=false
    username: test
    password:
    connectionTimeoutMilliseconds: 30000
    idleTimeoutMilliseconds: 60000
    maxLifetimeMilliseconds: 1800000
    maxPoolSize: 200
  replica_ds_1:
    url: jdbc:mysql://***.***.***.***:****/ds?serverTimezone=UTC&useSSL=false

```

```

username: test
password:
connectionTimeoutMilliseconds: 30000
idleTimeoutMilliseconds: 60000
maxLifetimeMilliseconds: 1800000
maxPoolSize: 200
primary_ds_2:
  url: jdbc:mysql://***.***.***.***:****/ds?serverTimezone=UTC&useSSL=false
  username: test
  password:
  connectionTimeoutMilliseconds: 30000
  idleTimeoutMilliseconds: 60000
  maxLifetimeMilliseconds: 1800000
  maxPoolSize: 200
replica_ds_2:
  url: jdbc:mysql://***.***.***.***:****/ds?serverTimezone=UTC&useSSL=false
  username: test
  password:
  connectionTimeoutMilliseconds: 30000
  idleTimeoutMilliseconds: 60000
  maxLifetimeMilliseconds: 1800000
  maxPoolSize: 200
primary_ds_3:
  url: jdbc:mysql://***.***.***.***:****/ds?serverTimezone=UTC&useSSL=false
  username: test
  password:
  connectionTimeoutMilliseconds: 30000
  idleTimeoutMilliseconds: 60000
  maxLifetimeMilliseconds: 1800000
  maxPoolSize: 200
replica_ds_3:
  url: jdbc:mysql://***.***.***.***:****/ds?serverTimezone=UTC&useSSL=false
  username: test
  password:
  connectionTimeoutMilliseconds: 30000
  idleTimeoutMilliseconds: 60000
  maxLifetimeMilliseconds: 1800000
  maxPoolSize: 200
rules:
- !SHARDING
  tables:
    tbl:
      actualDataNodes: readwrite_ds_${0..3}.tbl${0..1023}
      databaseStrategy:
        standard:
          shardingColumn: id
          shardingAlgorithmName: tbl_database_inline
      tableStrategy:

```

```

    standard:
      shardingColumn: k
      shardingAlgorithmName: tbl_table_inline
    keyGenerateStrategy:
      column: id
      keyGeneratorName: snowflake
  bindingTables:
  - tbl
  defaultDataSourceName: primary_ds_1
  defaultTableStrategy:
    none:
  shardingAlgorithms:
    tbl_database_inline:
      type: INLINE
      props:
        algorithm-expression: readwrite_ds_${id % 4}
    tbl_table_inline:
      type: INLINE
      props:
        algorithm-expression: tbl${k % 1024}
  keyGenerators:
    snowflake:
      type: SNOWFLAKE
- !READWRITE_SPLITTING
  dataSources:
    readwrite_ds_0:
      type: Static
      props:
        write-data-source-name: primary_ds_0
        read-data-source-names: replica_ds_0
        loadBalancerName: round_robin
    readwrite_ds_1:
      type: Static
      props:
        write-data-source-name: primary_ds_1
        read-data-source-names: replica_ds_1
        loadBalancerName: round_robin
    readwrite_ds_2:
      type: Static
      props:
        write-data-source-name: primary_ds_2
        read-data-source-names: replica_ds_2
        loadBalancerName: round_robin
    readwrite_ds_3:
      type: Static
      props:
        write-data-source-name: primary_ds_3
        read-data-source-names: replica_ds_3

```

```

    loadBalancerName: round_robin
loadBalancers:
  round_robin:
    type: ROUND_ROBIN
- !ENCRYPT:
  encryptors:
    aes_encryptor:
      type: AES
      props:
        aes-key-value: 123456abc
    md5_encryptor:
      type: MD5
  tables:
    sbtest:
      columns:
        c:
          plainColumn: c_plain
          cipherColumn: c_cipher
          encryptorName: aes_encryptor
      pad:
        cipherColumn: pad_cipher
        encryptorName: md5_encryptor

```

## Full Route Configuration

```

schemaName: sharding_db

dataSources:
  ds_0:
    url: jdbc:mysql://***.***.***.***:****/ds?serverTimezone=UTC&useSSL=false
    username: test
    password:
    connectionTimeoutMilliseconds: 30000
    idleTimeoutMilliseconds: 60000
    maxLifetimeMilliseconds: 1800000
    maxPoolSize: 200
  ds_1:
    url: jdbc:mysql://***.***.***.***:****/ds?serverTimezone=UTC&useSSL=false
    username: test
    password:
    connectionTimeoutMilliseconds: 30000
    idleTimeoutMilliseconds: 60000
    maxLifetimeMilliseconds: 1800000
    maxPoolSize: 200
  ds_2:
    url: jdbc:mysql://***.***.***.***:****/ds?serverTimezone=UTC&useSSL=false

```

```

username: test
password:
connectionTimeoutMilliseconds: 30000
idleTimeoutMilliseconds: 60000
maxLifetimeMilliseconds: 1800000
maxPoolSize: 200
ds_3:
url: jdbc:mysql://***.***.***.***:****/ds?serverTimezone=UTC&useSSL=false
username: test
password:
connectionTimeoutMilliseconds: 30000
idleTimeoutMilliseconds: 60000
maxLifetimeMilliseconds: 1800000
maxPoolSize: 200
rules:
- !SHARDING
tables:
tbl:
actualDataNodes: ds_${0..3}.tbl1
tableStrategy:
standard:
shardingColumn: k
shardingAlgorithmName: tbl_table_inline
keyGenerateStrategy:
column: id
keyGeneratorName: snowflake
defaultDatabaseStrategy:
standard:
shardingColumn: id
shardingAlgorithmName: default_database_inline
defaultTableStrategy:
none:
shardingAlgorithms:
default_database_inline:
type: INLINE
props:
algorithm-expression: ds_${id % 4}
tbl_table_inline:
type: INLINE
props:
algorithm-expression: tbl1
keyGenerators:
snowflake:
type: SNOWFLAKE

```

## Test Result Verification

### SQL Statement

```

INSERT+UPDATE+DELETE sql statements:
INSERT INTO tbl(k, c, pad) VALUES(1, '###-###-###', '###-###');
UPDATE tbl SET c='###-###-###', pad='###-###' WHERE id=?;
DELETE FROM tbl WHERE id=?

SELECT sql statement for full route:
SELECT max(id) FROM tbl WHERE id%4=1

SELECT sql statement for single route:
SELECT id, k FROM tbl ignore index(`PRIMARY`) WHERE id=1 AND k=1

INSERT+SELECT+DELETE sql statements:
INSERT INTO tbl1(k, c, pad) VALUES(1, '###-###-###', '###-###');
SELECT count(id) FROM tbl1;
SELECT max(id) FROM tbl1 ignore index(`PRIMARY`);
DELETE FROM tbl1 WHERE id=?

```

### Jmeter Class

Consider the implementation of [shardingsphere-benchmark](#) Notes: the notes in [shardingsphere-benchmark/README.md](#) should be taken attention to

### Compile & Build

```

git clone https://github.com/apache/shardingsphere-benchmark.git
cd shardingsphere-benchmark/shardingsphere-benchmark
mvn clean install

```

### Perform Test

```

cp target/shardingsphere-benchmark-1.0-SNAPSHOT-jar-with-dependencies.jar apache-
jmeter-4.0/lib/ext
jmeter -n -t test_plan/test.jmx
test.jmx example:https://github.com/apache/shardingsphere-benchmark/tree/master/
report/script/test_plan/test.jmx

```

## Process Result Data

Make sure the location of result.jtl file is correct.

```
sh shardingsphere-benchmark/report/script/gen_report.sh
```

## Display of Historical Performance Test Data

In progress, please wait.

## Sysbench Test

At least 5 machines are required:

```
Jenkins * 1: ${host-jenkins}
Sysbench * 1: ${host-sysbench}
ShardingSphere-Proxy * 1: ${host-proxy}
MySQL Server * 2: ${host-mysql-1}, ${host-mysql-2}
```

The hardware standards of Jenkins and Sysbench machines can appropriately lower.

## Software Environment

```
Jenkins: The latest version
Sysbench: 1.0.20
ShardingSphere-Proxy: package from master branch
MySQL Server: 5.7.28
```

## Test Program

According to the above hardware environment, the configuration parameters are as follows, and the parameters should be adjusted according to the changes in the hardware environment.

## ShardingSphere-Proxy Configuration

```
Proxy runs on ${host-proxy}
Version includes: Master branch, 4.1.1, 3.0.0
Scenarios: config-sharding, config-replica-query, config-sharding-replica-query,
config-encrypt
Configurations: Refer to Appendix 1
```



## MySQL Server Configuration

Two MySQL instances runs on `host-mysql-1` and `host-mysql-2` machines respectively.

Need to create the 'sbtest' database on both instances in advance.  
 Set parameter: `max_prepared_stmt_count = 500000`  
 Set parameter: `max_connections = 2000`

## Jenkins Configuration

Create 6 Jenkins tasks, and each task calls the next task in turn: (runs on the `host-jenkins` machine).

1. `sysbench_install`: Pull the latest code, package the Proxy compression package

The following tasks are run on a separate Sysbench pressure generating machine via Jenkins slave: (runs on the `host-sysbench` machine)

2. `sysbench_sharding`:

- a. Sharding scenarios for remote deployment of various versions of Proxy
- b. Execute Sysbench command to pressure test Proxy
- c. Execute Sysbench command to pressure test MySQL Server
- d. Save Sysbench stress test results
- e. Use drawing scripts to generate performance curves and tables (see Appendix 2 for drawing scripts)

3. `sysbench_master_slave`:

- a. Read and write separation scenarios for remote deployment of various versions of Proxy
- b. Execute Sysbench command to pressure test Proxy
- c. Execute Sysbench command to pressure test MySQL Server
- d. Save Sysbench stress test results
- e. Use drawing scripts to generate performance curves and tables

4. `sysbench_sharding_master_slave`:

- a. Remote deployment of sharding + read-write splitting scenarios of various versions of Proxy
- b. Execute Sysbench command to pressure test Proxy
- c. Execute Sysbench command to pressure test MySQL Server
- d. Save Sysbench stress test results
- e. Use drawing scripts to generate performance curves and tables

5. `sysbench_encrypt`:

- a. Encryption scenarios for remote deployment of various versions of Proxy
- b. Execute Sysbench command to pressure test Proxy
- c. Execute Sysbench command to pressure test MySQL Server
- d. Save Sysbench stress test results
- e. Use drawing scripts to generate performance curves and tables

6. `sysbench_result_aggregation`:

- a. Re-execute the drawing script for the pressure test results of all tasks

```
python3 plot_graph.py sharding
python3 plot_graph.py ms
python3 plot_graph.py sharding_ms
python3 plot_graph.py encrypt
```

b. Use Jenkins **"Publish HTML reports"** plugin to integrate all images into one HTML page

### Testing Process

Take sysbench sharding as an example (other scenarios are similar)

#### Enter the Sysbench pressure test result directory

```
cd /home/jenkins/sysbench_res/sharding
```

#### Create the folder for this build

```
mkdir $BUILD_NUMBER
```

#### Take the last 14 builds and save them in a hidden file

```
ls -v | tail -n14 > .build_number.txt
```

### Deployment and stress testing

Step 1: Execute remote deployment script to deploy Proxy to {host-proxy}

```
./deploy_sharding.sh
```

```
#!/bin/sh
rm -fr apache-shardingsphere-*shardingsphere-proxy-bin
tar zxvf apache-shardingsphere-*shardingsphere-proxy-bin.tar.gz
sh stop_proxy.sh
cp -f prepared_conf/mysql-connector-java-5.1.47.jar apache-shardingsphere-*shardingsphere-proxy-bin/lib
cp -f prepared_conf/start.sh apache-shardingsphere-*shardingsphere-proxy-bin/bin
cp -f prepared_conf/config-sharding.yaml prepared_conf/server.yaml apache-shardingsphere-*shardingsphere-proxy-bin/conf
./apache-shardingsphere-*shardingsphere-proxy-bin/bin/start.sh
sleep 30
```

Step 2: Execute the sysbench script

```

# master
cd /home/jenkins/sysbench_res/sharding
cd $BUILD_NUMBER
sysbench oltp_read_only --mysql-host=${host-proxy} --mysql-port=3307 --mysql-
user=root --mysql-password='root' --mysql-db=sbtest --tables=10 --table-
size=1000000 --report-interval=10 --time=3600 --threads=10 --max-requests=0 --
percentile=99 --mysql-ignore-errors="all" --rand-type=uniform --range_selects=off -
-auto_inc=off cleanup
sysbench oltp_read_only --mysql-host=${host-proxy} --mysql-port=3307 --mysql-
user=root --mysql-password='root' --mysql-db=sbtest --tables=10 --table-
size=1000000 --report-interval=10 --time=3600 --threads=10 --max-requests=0 --
percentile=99 --mysql-ignore-errors="all" --rand-type=uniform --range_selects=off -
-auto_inc=off prepare
sysbench oltp_read_only      --mysql-host=${host-proxy} --mysql-port=3307 --
mysql-user=root --mysql-password='root' --mysql-db=sbtest --tables=10 --table-
size=1000000 --report-interval=30 --time=180 --threads=256 --max-requests=0 --
percentile=99 --mysql-ignore-errors="all" --range_selects=off --rand-type=uniform
--auto_inc=off run
sysbench oltp_read_only      --mysql-host=${host-proxy} --mysql-port=3307 --
mysql-user=root --mysql-password='root' --mysql-db=sbtest --tables=10 --table-
size=1000000 --report-interval=30 --time=180 --threads=256 --max-requests=0 --
percentile=99 --mysql-ignore-errors="all" --range_selects=off --rand-type=uniform
--auto_inc=off run | tee oltp_read_only.master.txt
sysbench oltp_point_select    --mysql-host=${host-proxy} --mysql-port=3307 --
mysql-user=root --mysql-password='root' --mysql-db=sbtest --tables=10 --table-
size=1000000 --report-interval=30 --time=180 --threads=256 --max-requests=0 --
percentile=99 --mysql-ignore-errors="all" --range_selects=off --rand-type=uniform
--auto_inc=off run | tee oltp_point_select.master.txt
sysbench oltp_read_write      --mysql-host=${host-proxy} --mysql-port=3307 --
mysql-user=root --mysql-password='root' --mysql-db=sbtest --tables=10 --table-
size=1000000 --report-interval=30 --time=180 --threads=256 --max-requests=0 --
percentile=99 --mysql-ignore-errors="all" --range_selects=off --rand-type=uniform
--auto_inc=off run | tee oltp_read_write.master.txt
sysbench oltp_write_only      --mysql-host=${host-proxy} --mysql-port=3307 --
mysql-user=root --mysql-password='root' --mysql-db=sbtest --tables=10 --table-
size=1000000 --report-interval=30 --time=180 --threads=256 --max-requests=0 --
percentile=99 --mysql-ignore-errors="all" --range_selects=off --rand-type=uniform
--auto_inc=off run | tee oltp_write_only.master.txt
sysbench oltp_update_index    --mysql-host=${host-proxy} --mysql-port=3307 --
mysql-user=root --mysql-password='root' --mysql-db=sbtest --tables=10 --table-
size=1000000 --report-interval=30 --time=180 --threads=256 --max-requests=0 --
percentile=99 --mysql-ignore-errors="all" --range_selects=off --rand-type=uniform
--auto_inc=off run | tee oltp_update_index.master.txt
sysbench oltp_update_non_index --mysql-host=${host-proxy} --mysql-port=3307 --
mysql-user=root --mysql-password='root' --mysql-db=sbtest --tables=10 --table-
size=1000000 --report-interval=30 --time=180 --threads=256 --max-requests=0 --
percentile=99 --mysql-ignore-errors="all" --range_selects=off --rand-type=uniform
--auto_inc=off run | tee oltp_update_non_index.master.txt

```

```

sysbench oltp_delete          --mysql-host=${host-proxy} --mysql-port=3307 --
mysql-user=root --mysql-password='root' --mysql-db=sbtest --tables=10 --table-
size=1000000 --report-interval=30 --time=180 --threads=256 --max-requests=0 --
percentile=99 --mysql-ignore-errors="all" --range_selects=off --rand-type=uniform
--auto_inc=off run | tee oltp_delete.master.txt
sysbench oltp_read_only --mysql-host=${host-proxy} --mysql-port=3307 --mysql-
user=root --mysql-password='root' --mysql-db=sbtest --tables=10 --table-
size=1000000 --report-interval=10 --time=3600 --threads=10 --max-requests=0 --
percentile=99 --mysql-ignore-errors="all" --rand-type=uniform --range_selects=off -
-auto_inc=off cleanup

```

4.1.1, 3.0.0, three scenarios of direct connection to MySQL, repeat steps 1 and 2 above.

### Execute stop proxy script

```
./stop_proxy.sh
```

```

#!/bin/sh
./3.0.0_sharding-proxy/bin/stop.sh
./4.1.1_apache-shardingsphere-4.1.1-sharding-proxy-bin/bin/stop.sh
./apache-shardingsphere-*shardingsphere-proxy-bin/bin/stop.sh

```

### Generate pressure test curve picture

```

# Generate graph
cd /home/jenkins/sysbench_res/
python3 plot_graph.py sharding

```

### Use Jenkins Publish HTML reports plugin to publish pictures to the page

```

HTML directory to archive: /home/jenkins/sysbench_res/graph/
Index page[s]: 01_sharding.html
Report title: HTML Report

```

### sysbench test case describe

#### oltp\_point\_select

```

Prepare Statement (ID = 1): SELECT c FROM sbtest1 WHERE id=?
Execute Statement: ID = 1

```

**oltp\_read\_only**

```

Prepare Statement (ID = 1): 'COMMIT'
Prepare Statement (ID = 2): SELECT c FROM sbtest1 WHERE id=?
Statement: 'BEGIN'
Execute Statement: ID = 2
Execute Statement: ID = 2
Execute Statement: ID = 2
Execute Statement: ID = 2
Execute Statement: ID = 2
Execute Statement: ID = 2
Execute Statement: ID = 2
Execute Statement: ID = 2
Execute Statement: ID = 2
Execute Statement: ID = 2
Execute Statement: ID = 2
Execute Statement: ID = 1

```

**oltp\_write\_only**

```

Prepare Statement (ID = 1): 'COMMIT'
Prepare Statement (ID = 2): UPDATE sbtest1 SET k=k+1 WHERE id=?
Prepare Statement (ID = 3): UPDATE sbtest6 SET c=? WHERE id=?
Prepare Statement (ID = 4): DELETE FROM sbtest1 WHERE id=?
Prepare Statement (ID = 5): INSERT INTO sbtest1 (id, k, c, pad) VALUES (?, ?, ?, ?)
Statement: 'BEGIN'
Execute Statement: ID = 2
Execute Statement: ID = 3
Execute Statement: ID = 4
Execute Statement: ID = 5
Execute Statement: ID = 1

```

**oltp\_read\_write**

```

Prepare Statement (ID = 1): 'COMMIT'
Prepare Statement (ID = 2): SELECT c FROM sbtest1 WHERE id=?
Prepare Statement (ID = 3): UPDATE sbtest3 SET k=k+1 WHERE id=?
Prepare Statement (ID = 4): UPDATE sbtest10 SET c=? WHERE id=?
Prepare Statement (ID = 5): DELETE FROM sbtest8 WHERE id=?
Prepare Statement (ID = 6): INSERT INTO sbtest8 (id, k, c, pad) VALUES (?, ?, ?, ?)
Statement: 'BEGIN'
Execute Statement: ID = 2
Execute Statement: ID = 2
Execute Statement: ID = 2
Execute Statement: ID = 2
Execute Statement: ID = 2

```

```
Execute Statement: ID = 2
Execute Statement: ID = 2
Execute Statement: ID = 2
Execute Statement: ID = 2
Execute Statement: ID = 2
Execute Statement: ID = 3
Execute Statement: ID = 4
Execute Statement: ID = 5
Execute Statement: ID = 6
Execute Statement: ID = 1
```

### oltp\_update\_index

```
Prepare Statement (ID = 1): UPDATE sbtest1 SET k=k+1 WHERE id=?
Execute Statement: ID = 1
```

### oltp\_update\_non\_index

```
Prepare Statement (ID = 1): UPDATE sbtest1 SET c=? WHERE id=?
Execute Statement: ID = 1
```

### oltp\_delete

```
Prepare Statement (ID = 1): DELETE FROM sbtest1 WHERE id=?
Execute Statement: ID = 1
```

## Appendix 1

### Master branch version

server.yaml

```
rules:
  -!AUTHORITY
    users:
      - root@%:root
      - sharding@:sharding
    provider:
      type: ALL_PERMITTED
props:
  max-connections-size-per-query: 1
  kernel-executor-size: 16 # Infinite by default.
```

```

proxy-frontend-flush-threshold: 128 # The default value is 128.
proxy-hint-enabled: false
sql-show: false
check-table-metadata-enabled: false
show-process-list-enabled: false
proxy-backend-query-fetch-size: -1
check-duplicate-table-enabled: false
proxy-frontend-executor-size: 0
proxy-backend-executor-suitable: OLAP
proxy-frontend-max-connections: 0
sql-federation-enabled: false

```

### config-sharding.yaml

```

schemaName: sbtest
dataSources:
  ds_0:
    url: jdbc:mysql://${host-mysql-1}:3306/sbtest?serverTimezone=UTC&useSSL=false
    username: root
    password:
    connectionTimeoutMilliseconds: 30000
    idleTimeoutMilliseconds: 60000
    maxLifetimeMilliseconds: 1800000
    maxPoolSize: 256
    minPoolSize: 256
  ds_1:
    url: jdbc:mysql://${host-mysql-2}:3306/sbtest?serverTimezone=UTC&useSSL=false
    username: root
    password:
    connectionTimeoutMilliseconds: 30000
    idleTimeoutMilliseconds: 60000
    maxLifetimeMilliseconds: 1800000
    maxPoolSize: 256
    minPoolSize: 256
rules:
- !SHARDING
  tables:
    sbtest1:
      actualDataNodes: ds_${0..1}.sbtest1_${0..99}
      tableStrategy:
        standard:
          shardingColumn: id
          shardingAlgorithmName: table_inline_1
      keyGenerateStrategy:
        column: id
        keyGeneratorName: snowflake
    sbtest2:
      actualDataNodes: ds_${0..1}.sbtest2_${0..99}

```

```
tableStrategy:
  standard:
    shardingColumn: id
    shardingAlgorithmName: table_inline_2
keyGenerateStrategy:
  column: id
  keyGeneratorName: snowflake
sbtest3:
  actualDataNodes: ds_${0..1}.sbtest3_${0..99}
  tableStrategy:
    standard:
      shardingColumn: id
      shardingAlgorithmName: table_inline_3
  keyGenerateStrategy:
    column: id
    keyGeneratorName: snowflake
sbtest4:
  actualDataNodes: ds_${0..1}.sbtest4_${0..99}
  tableStrategy:
    standard:
      shardingColumn: id
      shardingAlgorithmName: table_inline_4
  keyGenerateStrategy:
    column: id
    keyGeneratorName: snowflake
sbtest5:
  actualDataNodes: ds_${0..1}.sbtest5_${0..99}
  tableStrategy:
    standard:
      shardingColumn: id
      shardingAlgorithmName: table_inline_5
  keyGenerateStrategy:
    column: id
    keyGeneratorName: snowflake
sbtest6:
  actualDataNodes: ds_${0..1}.sbtest6_${0..99}
  tableStrategy:
    standard:
      shardingColumn: id
      shardingAlgorithmName: table_inline_6
  keyGenerateStrategy:
    column: id
    keyGeneratorName: snowflake
sbtest7:
  actualDataNodes: ds_${0..1}.sbtest7_${0..99}
  tableStrategy:
    standard:
      shardingColumn: id
```



```

    shardingAlgorithmName: table_inline_7
  keyGenerateStrategy:
    column: id
    keyGeneratorName: snowflake
  sbtest8:
    actualDataNodes: ds_${0..1}.sbtest8_${0..99}
    tableStrategy:
      standard:
        shardingColumn: id
        shardingAlgorithmName: table_inline_8
    keyGenerateStrategy:
      column: id
      keyGeneratorName: snowflake
  sbtest9:
    actualDataNodes: ds_${0..1}.sbtest9_${0..99}
    tableStrategy:
      standard:
        shardingColumn: id
        shardingAlgorithmName: table_inline_9
    keyGenerateStrategy:
      column: id
      keyGeneratorName: snowflake
  sbtest10:
    actualDataNodes: ds_${0..1}.sbtest10_${0..99}
    tableStrategy:
      standard:
        shardingColumn: id
        shardingAlgorithmName: table_inline_10
    keyGenerateStrategy:
      column: id
      keyGeneratorName: snowflake
  defaultDatabaseStrategy:
    standard:
      shardingColumn: id
      shardingAlgorithmName: database_inline
  shardingAlgorithms:
    database_inline:
      type: INLINE
      props:
        algorithm-expression: ds_${id % 2}
    table_inline_1:
      type: INLINE
      props:
        algorithm-expression: sbtest1_${id % 100}
    table_inline_2:
      type: INLINE
      props:
        algorithm-expression: sbtest2_${id % 100}

```

```
table_inline_3:
  type: INLINE
  props:
    algorithm-expression: sbtest3_${id % 100}
table_inline_4:
  type: INLINE
  props:
    algorithm-expression: sbtest4_${id % 100}
table_inline_5:
  type: INLINE
  props:
    algorithm-expression: sbtest5_${id % 100}
table_inline_6:
  type: INLINE
  props:
    algorithm-expression: sbtest6_${id % 100}
table_inline_7:
  type: INLINE
  props:
    algorithm-expression: sbtest7_${id % 100}
table_inline_8:
  type: INLINE
  props:
    algorithm-expression: sbtest8_${id % 100}
table_inline_9:
  type: INLINE
  props:
    algorithm-expression: sbtest9_${id % 100}
table_inline_10:
  type: INLINE
  props:
    algorithm-expression: sbtest10_${id % 100}
keyGenerators:
  snowflake:
    type: SNOWFLAKE
```

#### config-readwrite-splitting.yaml

```
schemaName: sbtest
dataSources:
  ds_0:
    url: jdbc:mysql://${host-mysql-1}:3306/sbtest?serverTimezone=UTC&useSSL=false
    username: root
    password:
    connectionTimeoutMilliseconds: 30000
    idleTimeoutMilliseconds: 60000
    maxLifetimeMilliseconds: 1800000
    maxPoolSize: 128
```

```

    minPoolSize: 128
rules:
- !READWRITE_SPLITTING
  dataSources:
    readwrite_ds:
      primaryDataSourceName: ds_0
      replicaDataSourceNames:
        - ds_0
        - ds_0

```

#### config-shadow.yaml

```

schemaName: sbtest
dataSources:
  primary_ds_0:
    url: jdbc:mysql://${host-mysql-1}:3306/sbtest?serverTimezone=UTC&useSSL=false
    username: root
    password:
    connectionTimeoutMilliseconds: 30000
    idleTimeoutMilliseconds: 60000
    maxLifetimeMilliseconds: 1800000
    maxPoolSize: 256
    minPoolSize: 256
  primary_ds_1:
    url: jdbc:mysql://${host-mysql-2}:3306/sbtest?serverTimezone=UTC&useSSL=false
    username: root
    password:
    connectionTimeoutMilliseconds: 30000
    idleTimeoutMilliseconds: 60000
    maxLifetimeMilliseconds: 1800000
    maxPoolSize: 256
    minPoolSize: 256
rules:
- !SHARDING
  tables:
    sbtest1:
      actualDataNodes: ds_${0..1}.sbtest1_${0..99}
      tableStrategy:
        standard:
          shardingColumn: id
          shardingAlgorithmName: table_inline_1
      keyGenerateStrategy:
        column: id
        keyGeneratorName: snowflake
    sbtest2:
      actualDataNodes: ds_${0..1}.sbtest2_${0..99}
      tableStrategy:
        standard:

```

```
    shardingColumn: id
    shardingAlgorithmName: table_inline_2
  keyGenerateStrategy:
    column: id
    keyGeneratorName: snowflake
  sbtest3:
    actualDataNodes: ds_${0..1}.sbtest3_${0..99}
    tableStrategy:
      standard:
        shardingColumn: id
        shardingAlgorithmName: table_inline_3
    keyGenerateStrategy:
      column: id
      keyGeneratorName: snowflake
  sbtest4:
    actualDataNodes: ds_${0..1}.sbtest4_${0..99}
    tableStrategy:
      standard:
        shardingColumn: id
        shardingAlgorithmName: table_inline_4
    keyGenerateStrategy:
      column: id
      keyGeneratorName: snowflake
  sbtest5:
    actualDataNodes: ds_${0..1}.sbtest5_${0..99}
    tableStrategy:
      standard:
        shardingColumn: id
        shardingAlgorithmName: table_inline_5
    keyGenerateStrategy:
      column: id
      keyGeneratorName: snowflake
  sbtest6:
    actualDataNodes: ds_${0..1}.sbtest6_${0..99}
    tableStrategy:
      standard:
        shardingColumn: id
        shardingAlgorithmName: table_inline_6
    keyGenerateStrategy:
      column: id
      keyGeneratorName: snowflake
  sbtest7:
    actualDataNodes: ds_${0..1}.sbtest7_${0..99}
    tableStrategy:
      standard:
        shardingColumn: id
        shardingAlgorithmName: table_inline_7
    keyGenerateStrategy:
```

```
    column: id
    keyGeneratorName: snowflake
  sbtest8:
    actualDataNodes: ds_${0..1}.sbtest8_${0..99}
    tableStrategy:
      standard:
        shardingColumn: id
        shardingAlgorithmName: table_inline_8
    keyGenerateStrategy:
      column: id
      keyGeneratorName: snowflake
  sbtest9:
    actualDataNodes: ds_${0..1}.sbtest9_${0..99}
    tableStrategy:
      standard:
        shardingColumn: id
        shardingAlgorithmName: table_inline_9
    keyGenerateStrategy:
      column: id
      keyGeneratorName: snowflake
  sbtest10:
    actualDataNodes: ds_${0..1}.sbtest10_${0..99}
    tableStrategy:
      standard:
        shardingColumn: id
        shardingAlgorithmName: table_inline_10
    keyGenerateStrategy:
      column: id
      keyGeneratorName: snowflake

  defaultDatabaseStrategy:
    standard:
      shardingColumn: id
      shardingAlgorithmName: database_inline
  shardingAlgorithms:
    database_inline:
      type: INLINE
      props:
        algorithm-expression: ds_${id % 2}
    table_inline_1:
      type: INLINE
      props:
        algorithm-expression: sbtest1_${id % 100}
    table_inline_2:
      type: INLINE
      props:
        algorithm-expression: sbtest2_${id % 100}
    table_inline_3:
```

```

    type: INLINE
    props:
      algorithm-expression: sbtest3_${id % 100}
table_inline_4:
  type: INLINE
  props:
    algorithm-expression: sbtest4_${id % 100}
table_inline_5:
  type: INLINE
  props:
    algorithm-expression: sbtest5_${id % 100}
table_inline_6:
  type: INLINE
  props:
    algorithm-expression: sbtest6_${id % 100}
table_inline_7:
  type: INLINE
  props:
    algorithm-expression: sbtest7_${id % 100}
table_inline_8:
  type: INLINE
  props:
    algorithm-expression: sbtest8_${id % 100}
table_inline_9:
  type: INLINE
  props:
    algorithm-expression: sbtest9_${id % 100}
table_inline_10:
  type: INLINE
  props:
    algorithm-expression: sbtest10_${id % 100}
keyGenerators:
  snowflake:
    type: SNOWFLAKE
- !READWRITE_SPLITTING
dataSources:
  ds_0:
    primaryDataSourceName: primary_ds_0
    replicaDataSourceNames:
      - primary_ds_0
      - primary_ds_0
  ds_1:
    name: ds_1
    primaryDataSourceName: primary_ds_1
    replicaDataSourceNames:
      - primary_ds_1
      - primary_ds_1

```

## config-encrypt.yaml

```
schemaName: sbtest
dataSources:
  ds_0:
    url: jdbc:mysql://${host-mysql-1}:3306/sbtest?serverTimezone=UTC&useSSL=false
    username: root
    password:
    connectionTimeoutMilliseconds: 30000
    idleTimeoutMilliseconds: 60000
    maxLifetimeMilliseconds: 1800000
    maxPoolSize: 256
    minPoolSize: 256
rules:
- !ENCRYPT
  encryptors:
    md5_encryptor:
      type: MD5
  tables:
    sbtest1:
      columns:
        pad:
          cipherColumn: pad
          encryptorName: md5_encryptor
    sbtest2:
      columns:
        pad:
          cipherColumn: pad
          encryptorName: md5_encryptor
    sbtest3:
      columns:
        pad:
          cipherColumn: pad
          encryptorName: md5_encryptor
    sbtest4:
      columns:
        pad:
          cipherColumn: pad
          encryptorName: md5_encryptor
    sbtest5:
      columns:
        pad:
          cipherColumn: pad
          encryptorName: md5_encryptor
    sbtest6:
      columns:
        pad:
          cipherColumn: pad
          encryptorName: md5_encryptor
```

```
sbtest7:
  columns:
    pad:
      cipherColumn: pad
      encryptorName: md5_encryptor
sbtest8:
  columns:
    pad:
      cipherColumn: pad
      encryptorName: md5_encryptor
sbtest9:
  columns:
    pad:
      cipherColumn: pad
      encryptorName: md5_encryptor
sbtest10:
  columns:
    pad:
      cipherColumn: pad
      encryptorName: md5_encryptor
```

#### config-database-discovery.yaml

```
schemaName: sbtest
dataSources:
  ds_0:
    url: jdbc:postgresql://127.0.0.1:5432/demo_primary_ds
    username: postgres
    password: postgres
    connectionTimeoutMilliseconds: 3000
    idleTimeoutMilliseconds: 60000
    maxLifetimeMilliseconds: 1800000
    maxPoolSize: 50
    minPoolSize: 1
  ds_1:
    url: jdbc:postgresql://127.0.0.1:5432/demo_replica_ds_0
    username: postgres
    password: postgres
    connectionTimeoutMilliseconds: 3000
    idleTimeoutMilliseconds: 60000
    maxLifetimeMilliseconds: 1800000
    maxPoolSize: 50
    minPoolSize: 1
  ds_2:
    url: jdbc:postgresql://127.0.0.1:5432/demo_replica_ds_1
    username: postgres
    password: postgres
    connectionTimeoutMilliseconds: 3000
```



```

idleTimeoutMilliseconds: 60000
maxLifetimeMilliseconds: 1800000
maxPoolSize: 50
minPoolSize: 1
rules:
- !DB_DISCOVERY
  dataSources:
    readwrite_ds:
      dataSourceNames:
        - ds_0
        - ds_1
        - ds_2
      discoveryHeartbeatName: mgr-heartbeat
      discoveryTypeName: mgr
  discoveryHeartbeats:
    mgr-heartbeat:
      props:
        keep-alive-cron: '0/5 * * * * ?'
  discoveryTypes:
    mgr:
      type: MySQL.MGR
      props:
        group-name: 92504d5b-6dec-11e8-91ea-246e9612aaf1

```

#### 4.1.1 version

server.yaml

```

authentication:
  users:
    root:
      password: root
  sharding:
    password: sharding
    authorizedSchemas: sharding_db
props:
  max.connections.size.per.query: 10
  acceptor.size: 256 # The default value is available processors count * 2.
  executor.size: 128 # Infinite by default.
  proxy.frontend.flush.threshold: 128 # The default value is 128.
  # LOCAL: Proxy will run with LOCAL transaction.
  # XA: Proxy will run with XA transaction.
  # BASE: Proxy will run with B.A.S.E transaction.
  proxy.transaction.type: LOCAL
  proxy.opentracing.enabled: false
  proxy.hint.enabled: false
  query.with.cipher.column: true

```

```
sql.show: false
allow.range.query.with.inline.sharding: false
```

## config-sharding.yaml

```
schemaName: sbtest
dataSources:
  ds_0:
    url: jdbc:mysql://${host-mysql-1}:3306/sbtest?serverTimezone=UTC&useSSL=false
    username: root
    password:
    connectionTimeoutMilliseconds: 30000
    idleTimeoutMilliseconds: 60000
    maxLifetimeMilliseconds: 1800000
    maxPoolSize: 256
  ds_1:
    url: jdbc:mysql://${host-mysql-2}:3306/sbtest?serverTimezone=UTC&useSSL=false
    username: root
    password:
    connectionTimeoutMilliseconds: 30000
    idleTimeoutMilliseconds: 60000
    maxLifetimeMilliseconds: 1800000
    maxPoolSize: 256
shardingRule:
  tables:
    sbtest1:
      actualDataNodes: ds_${0..1}.sbtest1_${0..99}
      tableStrategy:
        inline:
          shardingColumn: id
          algorithmExpression: sbtest1_${id % 100}
      keyGenerator:
        type: SNOWFLAKE
        column: id
    sbtest2:
      actualDataNodes: ds_${0..1}.sbtest2_${0..99}
      tableStrategy:
        inline:
          shardingColumn: id
          algorithmExpression: sbtest2_${id % 100}
      keyGenerator:
        type: SNOWFLAKE
        column: id
    sbtest3:
      actualDataNodes: ds_${0..1}.sbtest3_${0..99}
      tableStrategy:
        inline:
          shardingColumn: id
```

```
    algorithmExpression: sbtest3_${id % 100}
  keyGenerator:
    type: SNOWFLAKE
    column: id
sbtest4:
  actualDataNodes: ds_${0..1}.sbtest4_${0..99}
  tableStrategy:
    inline:
      shardingColumn: id
      algorithmExpression: sbtest4_${id % 100}
  keyGenerator:
    type: SNOWFLAKE
    column: id
sbtest5:
  actualDataNodes: ds_${0..1}.sbtest5_${0..99}
  tableStrategy:
    inline:
      shardingColumn: id
      algorithmExpression: sbtest5_${id % 100}
  keyGenerator:
    type: SNOWFLAKE
    column: id
sbtest6:
  actualDataNodes: ds_${0..1}.sbtest6_${0..99}
  tableStrategy:
    inline:
      shardingColumn: id
      algorithmExpression: sbtest6_${id % 100}
  keyGenerator:
    type: SNOWFLAKE
    column: id
sbtest7:
  actualDataNodes: ds_${0..1}.sbtest7_${0..99}
  tableStrategy:
    inline:
      shardingColumn: id
      algorithmExpression: sbtest7_${id % 100}
  keyGenerator:
    type: SNOWFLAKE
    column: id
sbtest8:
  actualDataNodes: ds_${0..1}.sbtest8_${0..99}
  tableStrategy:
    inline:
      shardingColumn: id
      algorithmExpression: sbtest8_${id % 100}
  keyGenerator:
    type: SNOWFLAKE
```

```

    column: id
  sbtest9:
    actualDataNodes: ds_${0..1}.sbtest9_${0..99}
    tableStrategy:
      inline:
        shardingColumn: id
        algorithmExpression: sbtest9_${id % 100}
    keyGenerator:
      type: SNOWFLAKE
      column: id
  sbtest10:
    actualDataNodes: ds_${0..1}.sbtest10_${0..99}
    tableStrategy:
      inline:
        shardingColumn: id
        algorithmExpression: sbtest10_${id % 100}
    keyGenerator:
      type: SNOWFLAKE
      column: id
  defaultDatabaseStrategy:
    inline:
      shardingColumn: id
      algorithmExpression: ds_${id % 2}

```

#### config-master\_slave.yaml

```

schemaName: sbtest
dataSources:
  ds_0:
    url: jdbc:mysql://${host-mysql-1}:3306/sbtest?serverTimezone=UTC&useSSL=false
    username: root
    password:
    connectionTimeoutMilliseconds: 30000
    idleTimeoutMilliseconds: 60000
    maxLifetimeMilliseconds: 1800000
    maxPoolSize: 256
masterSlaveRule:
  name: ms_ds
  masterDataSourceName: ds_0
  slaveDataSourceNames:
    - ds_0
    - ds_0

```

#### config-sharding-master\_slave.yaml

```

schemaName: sbtest
dataSources:
  primary_ds_0:

```

```

url: jdbc:mysql://${host-mysql-1}:3306/sbtest?serverTimezone=UTC&useSSL=false
username: root
password:
connectionTimeoutMilliseconds: 30000
idleTimeoutMilliseconds: 60000
maxLifetimeMilliseconds: 1800000
maxPoolSize: 256
primary_ds_1:
url: jdbc:mysql://${host-mysql-2}:3306/sbtest?serverTimezone=UTC&useSSL=false
username: root
password:
connectionTimeoutMilliseconds: 30000
idleTimeoutMilliseconds: 60000
maxLifetimeMilliseconds: 1800000
maxPoolSize: 256
shardingRule:
tables:
sbtest1:
actualDataNodes: ds_${0..1}.sbtest1_${0..99}
tableStrategy:
inline:
shardingColumn: id
algorithmExpression: sbtest1_${id % 100}
keyGenerator:
type: SNOWFLAKE
column: id
sbtest2:
actualDataNodes: ds_${0..1}.sbtest2_${0..99}
tableStrategy:
inline:
shardingColumn: id
algorithmExpression: sbtest2_${id % 100}
keyGenerator:
type: SNOWFLAKE
column: id
sbtest3:
actualDataNodes: ds_${0..1}.sbtest3_${0..99}
tableStrategy:
inline:
shardingColumn: id
algorithmExpression: sbtest3_${id % 100}
keyGenerator:
type: SNOWFLAKE
column: id
sbtest4:
actualDataNodes: ds_${0..1}.sbtest4_${0..99}
tableStrategy:
inline:

```

```
    shardingColumn: id
    algorithmExpression: sbtest4_${id % 100}
  keyGenerator:
    type: SNOWFLAKE
    column: id
sbtest5:
  actualDataNodes: ds_${0..1}.sbtest5_${0..99}
  tableStrategy:
    inline:
      shardingColumn: id
      algorithmExpression: sbtest5_${id % 100}
  keyGenerator:
    type: SNOWFLAKE
    column: id
sbtest6:
  actualDataNodes: ds_${0..1}.sbtest6_${0..99}
  tableStrategy:
    inline:
      shardingColumn: id
      algorithmExpression: sbtest6_${id % 100}
  keyGenerator:
    type: SNOWFLAKE
    column: id
sbtest7:
  actualDataNodes: ds_${0..1}.sbtest7_${0..99}
  tableStrategy:
    inline:
      shardingColumn: id
      algorithmExpression: sbtest7_${id % 100}
  keyGenerator:
    type: SNOWFLAKE
    column: id
sbtest8:
  actualDataNodes: ds_${0..1}.sbtest8_${0..99}
  tableStrategy:
    inline:
      shardingColumn: id
      algorithmExpression: sbtest8_${id % 100}
  keyGenerator:
    type: SNOWFLAKE
    column: id
sbtest9:
  actualDataNodes: ds_${0..1}.sbtest9_${0..99}
  tableStrategy:
    inline:
      shardingColumn: id
      algorithmExpression: sbtest9_${id % 100}
  keyGenerator:
```

```

    type: SNOWFLAKE
    column: id
  sbtest10:
    actualDataNodes: ds_${0..1}.sbtest10_${0..99}
    tableStrategy:
      inline:
        shardingColumn: id
        algorithmExpression: sbtest10_${id % 100}
    keyGenerator:
      type: SNOWFLAKE
      column: id
  defaultDatabaseStrategy:
    inline:
      shardingColumn: id
      algorithmExpression: ds_${id % 2}
  masterSlaveRules:
    ds_0:
      masterDataSourceName: primary_ds_0
      slaveDataSourceNames: [primary_ds_0, primary_ds_0]
      loadBalanceAlgorithmType: ROUND_ROBIN
    ds_1:
      masterDataSourceName: primary_ds_1
      slaveDataSourceNames: [primary_ds_1, primary_ds_1]
      loadBalanceAlgorithmType: ROUND_ROBIN

```

### config-encrypt.yaml

```

schemaName: sbtest
dataSources:
  ds_0:
    url: jdbc:mysql://${host-mysql-1}:3306/sbtest?serverTimezone=UTC&useSSL=false
    username: root
    password:
    connectionTimeoutMilliseconds: 30000
    idleTimeoutMilliseconds: 60000
    maxLifetimeMilliseconds: 1800000
    maxPoolSize: 256
encryptRule:
  encryptors:
    encryptor_md5:
      type: md5
  tables:
    sbtest1:
      columns:
        pad:
          cipherColumn: pad
          encryptor: encryptor_md5
    sbtest2:

```

```
columns:
  pad:
    cipherColumn: pad
    encryptor: encryptor_md5
sbtest3:
  columns:
    pad:
      cipherColumn: pad
      encryptor: encryptor_md5
sbtest4:
  columns:
    pad:
      cipherColumn: pad
      encryptor: encryptor_md5
sbtest5:
  columns:
    pad:
      cipherColumn: pad
      encryptor: encryptor_md5
sbtest6:
  columns:
    pad:
      cipherColumn: pad
      encryptor: encryptor_md5
sbtest7:
  columns:
    pad:
      cipherColumn: pad
      encryptor: encryptor_md5
sbtest8:
  columns:
    pad:
      cipherColumn: pad
      encryptor: encryptor_md5
sbtest9:
  columns:
    pad:
      cipherColumn: pad
      encryptor: encryptor_md5
sbtest10:
  columns:
    pad:
      cipherColumn: pad
      encryptor: encryptor_md5
```



### 3.0.0 version

#### server.yaml

```

authentication:
  username: root
  password: root
props:
  max.connections.size.per.query: 10
  acceptor.size: 256 # The default value is available processors count * 2.
  executor.size: 128 # Infinite by default.
  proxy.frontend.flush.threshold: 128 # The default value is 128.
  # LOCAL: Proxy will run with LOCAL transaction.
  # XA: Proxy will run with XA transaction.
  # BASE: Proxy will run with B.A.S.E transaction.
  proxy.transaction.type: LOCAL
  proxy.opentracing.enabled: false
  sql.show: false

```

#### config-sharding.yaml

```

schemaName: sbtest
dataSources:
  ds_0:
    url: jdbc:mysql://${host-mysql-1}:3306/sbtest?serverTimezone=UTC&useSSL=false
    username: root
    password:
    autoCommit: true
    connectionTimeout: 30000
    idleTimeout: 60000
    maxLifetime: 1800000
    maximumPoolSize: 256
  ds_1:
    url: jdbc:mysql://${host-mysql-2}:3306/sbtest?serverTimezone=UTC&useSSL=false
    username: root
    password:
    autoCommit: true
    connectionTimeout: 30000
    idleTimeout: 60000
    maxLifetime: 1800000
    maximumPoolSize: 256
shardingRule:
  tables:
    sbtest1:
      actualDataNodes: ds_${0..1}.sbtest1_${0..99}
      tableStrategy:
        inline:
          shardingColumn: id
          algorithmExpression: sbtest1_${id % 100}

```

```
sbtest2:
  actualDataNodes: ds_${0..1}.sbtest2_${0..99}
  tableStrategy:
    inline:
      shardingColumn: id
      algorithmExpression: sbtest2_${id % 100}
sbtest3:
  actualDataNodes: ds_${0..1}.sbtest3_${0..99}
  tableStrategy:
    inline:
      shardingColumn: id
      algorithmExpression: sbtest3_${id % 100}
sbtest4:
  actualDataNodes: ds_${0..1}.sbtest4_${0..99}
  tableStrategy:
    inline:
      shardingColumn: id
      algorithmExpression: sbtest4_${id % 100}
sbtest5:
  actualDataNodes: ds_${0..1}.sbtest5_${0..99}
  tableStrategy:
    inline:
      shardingColumn: id
      algorithmExpression: sbtest5_${id % 100}
sbtest6:
  actualDataNodes: ds_${0..1}.sbtest6_${0..99}
  tableStrategy:
    inline:
      shardingColumn: id
      algorithmExpression: sbtest6_${id % 100}
sbtest7:
  actualDataNodes: ds_${0..1}.sbtest7_${0..99}
  tableStrategy:
    inline:
      shardingColumn: id
      algorithmExpression: sbtest7_${id % 100}
sbtest8:
  actualDataNodes: ds_${0..1}.sbtest8_${0..99}
  tableStrategy:
    inline:
      shardingColumn: id
      algorithmExpression: sbtest8_${id % 100}
sbtest9:
  actualDataNodes: ds_${0..1}.sbtest9_${0..99}
  tableStrategy:
    inline:
      shardingColumn: id
      algorithmExpression: sbtest9_${id % 100}
```

```

sbtest10:
  actualDataNodes: ds_${0..1}.sbtest10_${0..99}
  tableStrategy:
    inline:
      shardingColumn: id
      algorithmExpression: sbtest10_${id % 100}
  defaultDatabaseStrategy:
    inline:
      shardingColumn: id
      algorithmExpression: ds_${id % 2}

```

#### config-master\_slave.yaml

```

schemaName: sbtest
dataSources:
  ds_0:
    url: jdbc:mysql://${host-mysql-1}:3306/sbtest?serverTimezone=UTC&useSSL=false
    username: root
    password:
    autoCommit: true
    connectionTimeout: 30000
    idleTimeout: 60000
    maxLifetime: 1800000
    maximumPoolSize: 256
masterSlaveRule:
  name: ms_ds
  masterDataSourceName: ds_0
  slaveDataSourceNames:
    - ds_0
    - ds_0

```

#### config-sharding-master\_slave.yaml

```

schemaName: sbtest
dataSources:
  primary_ds_0:
    url: jdbc:mysql://${host-mysql-1}:3306/sbtest?serverTimezone=UTC&useSSL=false
    username: root
    password:
    autoCommit: true
    connectionTimeout: 30000
    idleTimeout: 60000
    maxLifetime: 1800000
    maximumPoolSize: 256
  primary_ds_1:
    url: jdbc:mysql://${host-mysql-2}:3306/sbtest?serverTimezone=UTC&useSSL=false
    username: root
    password:

```

```
autoCommit: true
connectionTimeout: 30000
idleTimeout: 60000
maxLifetime: 1800000
maximumPoolSize: 256
shardingRule:
  tables:
    sbtest1:
      actualDataNodes: ds_${0..1}.sbtest1_${0..99}
      tableStrategy:
        inline:
          shardingColumn: id
          algorithmExpression: sbtest1_${id % 100}
    sbtest2:
      actualDataNodes: ds_${0..1}.sbtest2_${0..99}
      tableStrategy:
        inline:
          shardingColumn: id
          algorithmExpression: sbtest2_${id % 100}
    sbtest3:
      actualDataNodes: ds_${0..1}.sbtest3_${0..99}
      tableStrategy:
        inline:
          shardingColumn: id
          algorithmExpression: sbtest3_${id % 100}
    sbtest4:
      actualDataNodes: ds_${0..1}.sbtest4_${0..99}
      tableStrategy:
        inline:
          shardingColumn: id
          algorithmExpression: sbtest4_${id % 100}
    sbtest5:
      actualDataNodes: ds_${0..1}.sbtest5_${0..99}
      tableStrategy:
        inline:
          shardingColumn: id
          algorithmExpression: sbtest5_${id % 100}
    sbtest6:
      actualDataNodes: ds_${0..1}.sbtest6_${0..99}
      tableStrategy:
        inline:
          shardingColumn: id
          algorithmExpression: sbtest6_${id % 100}
    sbtest7:
      actualDataNodes: ds_${0..1}.sbtest7_${0..99}
      tableStrategy:
        inline:
          shardingColumn: id
```

```

    algorithmExpression: sbtest7_${id % 100}
sbtest8:
  actualDataNodes: ds_${0..1}.sbtest8_${0..99}
  tableStrategy:
    inline:
      shardingColumn: id
      algorithmExpression: sbtest8_${id % 100}
sbtest9:
  actualDataNodes: ds_${0..1}.sbtest9_${0..99}
  tableStrategy:
    inline:
      shardingColumn: id
      algorithmExpression: sbtest9_${id % 100}
sbtest10:
  actualDataNodes: ds_${0..1}.sbtest10_${0..99}
  tableStrategy:
    inline:
      shardingColumn: id
      algorithmExpression: sbtest10_${id % 100}
defaultDatabaseStrategy:
  inline:
    shardingColumn: id
    algorithmExpression: ds_${id % 2}
masterSlaveRules:
  ds_0:
    masterDataSourceName: primary_ds_0
    slaveDataSourceNames: [primary_ds_0, primary_ds_0]
    loadBalanceAlgorithmType: ROUND_ROBIN
  ds_1:
    masterDataSourceName: primary_ds_1
    slaveDataSourceNames: [primary_ds_1, primary_ds_1]
    loadBalanceAlgorithmType: ROUND_ROBIN

```

config-encrypt.yaml

Unsupported

## Appendix 2

plot\_graph.py

```

import sys
import matplotlib.pyplot as plt
import numpy as np
def generate_graph(path, case_name):
    dataset = {
        'build_num': [],

```

```

        'master_version': [],
        'master_xa': [],
        '4.1.1_version': [],
        '3.0.0_version': [],
        'mysql_server': []
    }
    with open(path + './.build_number.txt') as builds:
        for line in builds:
            dataset['build_num'].append(int(line))
    generate_data(path, case_name, dataset)
    print(dataset)
    fig, ax = plt.subplots()
    ax.grid(True)
    plt.title(case_name)
    data = [dataset['master_version'][-7:], dataset['master_xa'][-7:], dataset['4.
1.1_version'][-7:], dataset['3.0.0_version'][-7:], dataset['mysql_server'][-7:]]
    columns = dataset['build_num'][-7:]
    rows = ['master', 'xa', '4.1.1', '3.0.0', 'mysql']
    rcolors = plt.cm.BuPu(np.full(len(rows), 0.1))
    ccolors = plt.cm.BuPu(np.full(len(columns), 0.1))
    the_table = plt.table(cellText=data, rowLabels=rows, colLabels=columns,
rowColours=rcolors, colColours=ccolors,
                        loc='bottom', bbox=[0.0, -0.50, 1, .28])
    plt.subplots_adjust(left=0.15, bottom=0.3, right=0.98)
    plt.xticks(range(14))
    ax.set_xticklabels(dataset['build_num'])
    plt.plot(dataset['master_version'], 'o-', color='magenta', label='master_
version')
    plt.plot(dataset['master_xa'], 'o-', color='darkviolet', label='master_xa')
    plt.plot(dataset['4.1.1_version'], 'r--', color='blue', label='4.1.1_version')
    plt.plot(dataset['3.0.0_version'], 'r--', color='orange', label='3.0.0_version
')
    plt.plot(dataset['mysql_server'], 'r--', color='lime', label='mysql_server')
    plt.xlim()
    plt.legend()
    plt.xlabel('build_num')
    plt.ylabel('transactions per second')
    plt.savefig('graph/' + path + '/' + case_name)
    plt.show()
def generate_data(path, case_name, dataset):
    for build in dataset['build_num']:
        fill_dataset(build, case_name, dataset, path, 'master_version', '.master.
txt')
        fill_dataset(build, case_name, dataset, path, 'master_xa', '.xa.txt')
        fill_dataset(build, case_name, dataset, path, '4.1.1_version', '.4_1_1.txt
')
        fill_dataset(build, case_name, dataset, path, '3.0.0_version', '.3_0_0.txt
')
```

```

        fill_dataset(build, case_name, dataset, path, 'mysql_server', '.mysql.txt')
def fill_dataset(build, case_name, dataset, path, version, suffix):
    try:
        with open(path + '/' + str(build) + '/' + case_name + suffix) as version_
master:
            value = 0
            for line in version_master:
                if 'transactions:' in line:
                    items = line.split('(')
                    value = float(items[1][:-10])
                dataset[version].append(value)
    except FileNotFoundError:
        dataset[version].append(0)
if __name__ == '__main__':
    path = sys.argv[1]
    generate_graph(path, 'oltp_point_select')
    generate_graph(path, 'oltp_read_only')
    generate_graph(path, 'oltp_write_only')
    generate_graph(path, 'oltp_read_write')
    generate_graph(path, 'oltp_update_index')
    generate_graph(path, 'oltp_update_non_index')
    generate_graph(path, 'oltp_delete')

```

### 7.7.7 Module Test

Provides test engine with each complex modules.

#### SQL Parser Test

##### Prepare Data

Not like Integration test, SQL parse test does not need a specific database environment, just define the sql to parse, and the assert data:

##### SQL Data

As mentioned sql-case-id in Integration test, test-case-id could be shared in different module to test, and the file is at shardingsphere-sql-parser/shardingsphere-sql-parser-test/src/main/resources/sql/supported/\${SQL-TYPE}/\*.xml

## Assert Data

The assert data is at `shardingsphere-sql-parser/shardingsphere-sql-parser-test/src/main/resources/case/${SQL-TYPE}/*.xml` in that xml file, it could assert against the table name, token or sql condition and so on. For example:

```
<parser-result-sets>
  <parser-result sql-case-id="insert_with_multiple_values">
    <tables>
      <table name="t_order" />
    </tables>
    <tokens>
      <table-token start-index="12" table-name="t_order" length="7" />
    </tokens>
    <sharding-conditions>
      <and-condition>
        <condition column-name="order_id" table-name="t_order" operator=
"EQUAL">
          <value literal="1" type="int" />
        </condition>
        <condition column-name="user_id" table-name="t_order" operator=
"EQUAL">
          <value literal="1" type="int" />
        </condition>
      </and-condition>
      <and-condition>
        <condition column-name="order_id" table-name="t_order" operator=
"EQUAL">
          <value literal="2" type="int" />
        </condition>
        <condition column-name="user_id" table-name="t_order" operator=
"EQUAL">
          <value literal="2" type="int" />
        </condition>
      </and-condition>
    </sharding-conditions>
  </parser-result>
</parser-result-sets>
```

When these configs are ready, launch the test engine in `shardingsphere-sql-parser/shardingsphere-sql-parser-test` to test SQL parse.



## SQL Rewrite Test

### Target

Facing logic databases and tables cannot be executed directly in actual databases. SQL rewrite is used to rewrite logic SQL into rightly executable ones in actual databases, including two parts, correctness rewrite and optimization rewrite. rewrite tests are for these targets.

### Test

The rewrite tests are in the test folder under sharding-core/sharding-core-rewrite . Followings are the main part for rewrite tests:

- test engine
- environment configuration
- assert data

Test engine is the entrance of rewrite tests, just like other test engines, through Junit [Parameterized](#), read every and each data in the xml file under the target test type in test\resources, and then assert by the engine one by one

Environment configuration is the yaml file under test type under test\resources\yaml. The configuration file contains dataSources, shardingRule, encryptRule and other info. for example:

```
dataSources:
  db: !!com.zaxxer.hikari.HikariDataSource
    driverClassName: org.h2.Driver
    jdbcUrl: jdbc:h2:mem:db;DB_CLOSE_DELAY=-1;DATABASE_TO_UPPER=false;MODE=MYSQL
    username: sa
    password:

## sharding Rules
rules:
- !SHARDING
  tables:
    t_account:
      actualDataNodes: db.t_account_${0..1}
      tableStrategy:
        standard:
          shardingColumn: account_id
          shardingAlgorithmName: account_table_inline
      keyGenerateStrategy:
        column: account_id
        keyGeneratorName: snowflake
    t_account_detail:
      actualDataNodes: db.t_account_detail_${0..1}
      tableStrategy:
        standard:
```

```

    shardingColumn: order_id
    shardingAlgorithmName: account_detail_table_inline
bindingTables:
  - t_account, t_account_detail
shardingAlgorithms:
  account_table_inline:
    type: INLINE
    props:
      algorithm-expression: t_account_${account_id % 2}
  account_detail_table_inline:
    type: INLINE
    props:
      algorithm-expression: t_account_detail_${account_id % 2}
keyGenerators:
  snowflake:
    type: SNOWFLAKE

```

Assert data are in the xml under test type in test\resources. In the xml file, yml-rule means the environment configuration file path, input contains the target SQL and parameters, output contains the expected SQL and parameters. The db-type described the type for SQL parse, default is SQL92. For example:

```

<rewrite-assertions yml-rule="yml/sharding/sharding-rule.yml">
  <!-- to change SQL parse type, change db-type -->
  <rewrite-assertion id="create_index_for_mysql" db-type="MySQL">
    <input sql="CREATE INDEX index_name ON t_account ('status')" />
    <output sql="CREATE INDEX index_name ON t_account_0 ('status')" />
    <output sql="CREATE INDEX index_name ON t_account_1 ('status')" />
  </rewrite-assertion>
</rewrite-assertions>

```

After set up the assert data and environment configuration, rewrite test engine will assert the corresponding SQL without any Java code modification.

## 7.8 FAQ

### 7.8.1 [JDBC] Why there may be an error when configure both shardingsphere-jdbc-spring-boot-starter and a spring-boot-starter of certain datasource pool(such as druid)?

Answer:

1. Because the spring-boot-starter of certain datasource pool (such as druid) will be configured before shardingsphere-jdbc-spring-boot-starter and create a default datasource, then conflict occur when ShardingSphere-JDBC create datasources.

2. A simple way to solve this issue is removing the spring-boot-starter of certain datasource pool, shardingSphere-jdbc create datasources with suitable pools.

### 7.8.2 [JDBC] Why is xsd unable to be found when Spring Namespace is used?

Answer:

The use norm of Spring Namespace does not require to deploy xsd files to the official website. But considering some users' needs, we will deploy them to ShardingSphere's official website.

Actually, META-INF:raw-latex:spring.schemas in the jar package of shardingSphere-jdbc-spring-namespace has been configured with the position of xsd files: META-INF:raw-latex:namespace:raw-latex:\sharding`.xsd and META-INF:raw-latex:namespace:raw-latex:\replica`-query.xsd, so you only need to make sure that the file is in the jar package.

### 7.8.3 [JDBC] Found a JtaTransactionManager in spring boot project when integrating with transaction of XA

Answer:

1. shardingSphere-transaction-xa-core include atomikos, it will trigger auto-configuration mechanism in spring-boot, add @SpringBootApplication(exclude = JtaAutoConfiguration.class) will solve it.

### 7.8.4 [Proxy] In Windows environment, could not find or load main class org.apache.shardingsphere.proxy.Bootstrap, how to solve it?

Answer:

Some decompression tools may truncate the file name when decompressing the ShardingSphere-Proxy binary package, resulting in some classes not being found.

The solutions:

Open cmd.exe and execute the following command:

```
tar zxvf apache-shardingsphere-${RELEASE.VERSION}-shardingsphere-proxy-bin.tar.gz
```

### 7.8.5 [Proxy] How to add a new logic schema dynamically when use ShardingSphere-Proxy?

Answer:

When using ShardingSphere-Proxy, users can dynamically create or drop logic schema through Dist-SQL, the syntax is as follows:

```
CREATE (DATABASE | SCHEMA) [IF NOT EXISTS] schemaName;  
  
DROP (DATABASE | SCHEMA) [IF EXISTS] schemaName;
```

Example:

```
CREATE DATABASE sharding_db;  
  
DROP SCHEMA sharding_db;
```

### 7.8.6 [Proxy] How to use a suitable database tools connecting ShardingSphere-Proxy?

Answer:

1. ShardingSphere-Proxy could be considered as a mysql sever, so we recommend using mysql command line tool to connect to and operate it.
2. If users would like use a third-party database tool, there may be some errors cause of the certain implementation/options.
3. The currently tested third-party database tools are as follows:
  - Navicat: 11.1.13, 15.0.20.
  - DataGrip: 2020.1, 2021.1 (turn on “introspect using jdbc metadata” in idea or datagrip).
  - WorkBench: 8.0.25.

### 7.8.7 [Proxy] When using a client such as Navicat to connect to ShardingSphere-Proxy, if ShardingSphere-Proxy does not create a Schema or does not add a Resource, the client connection will fail?

Answer:

1. Third-party database tools will send some SQL query metadata when connecting to ShardingSphere-Proxy. When ShardingSphere-Proxy does not create a schema or does not add a resource, ShardingSphere-Proxy cannot execute SQL.
2. It is recommended to create schema and resource first, and then use third-party database tools to connect.
3. Please refer to [Related introduction](#) the details about resource.

### 7.8.8 [Sharding] How to solve Cloud not resolve placeholder ...in string value ... error?

Answer:

`${...}` or `$->{...}` can be used in inline expression identifiers, but the former one clashes with place holders in Spring property files, so `$->{...}` is recommended to be used in Spring as inline expression identifiers.

### 7.8.9 [Sharding] Why does float number appear in the return result of inline expression?

Answer:

The division result of Java integers is also integer, but in Groovy syntax of inline expression, the division result of integers is float number. To obtain integer division result, `A/B` needs to be modified as `A.intdiv(B)`.

### 7.8.10 [Sharding] If sharding database is partial, should tables without sharding database & table configured in sharding rules?

Answer:

No, ShardingSphere will recognize it automatically.

### 7.8.11 [Sharding] When generic Long type SingleKeyTableShardingAlgorithm is used, why does ClassCastException: Integer can not cast to Long exception appear?

Answer:

You must make sure the field in database table consistent with that in sharding algorithms. For example, the field type in database is `int(11)` and the sharding type corresponds to genetic type is `Integer`, if you want to configure `Long` type, please make sure the field type in the database is `bigint`.

### 7.8.12 [Sharding:raw-latex:PROXY] When implementing the Standard-ShardingAlgorithm custom algorithm, the specific type of Comparable is specified as Long, and the field type in the database table is bigint, a ClassCastException: Integer can not cast to Long exception occurs.

Answer:

When implementing the `doSharding` method, it is not recommended to specify the specific type of `Comparable` in the method declaration, but to convert the type in the implementation of the `doSharding` method. You can refer to the `ModShardingAlgorithm#doSharding` method.

### 7.8.13 [Sharding] Why are the default distributed auto-augment key strategy provided by ShardingSphere not continuous and most of them end with even numbers?

Answer:

ShardingSphere uses snowflake algorithms as the default distributed auto-augment key strategy to make sure unrepeated and decentralized auto-augment sequence is generated under the distributed situations. Therefore, auto-augment keys can be incremental but not continuous.

But the last four numbers of snowflake algorithm are incremental value within one millisecond. Thus, if concurrency degree in one millisecond is not high, the last four numbers are likely to be zero, which explains why the rate of even end number is higher.

In 3.1.0 version, the problem of ending with even numbers has been totally solved, please refer to: <https://github.com/apache/shardingsphere/issues/1617>

### 7.8.14 [Sharding] How to allow range query with using inline sharding strategy(BETWEEN AND, >, <, >=, <=)?

Answer:

1. Update to 4.1.0 above.
2. Configure(A tip here: then each range query will be broadcast to every sharding table):
  - Version 4.x: `allow.range.query.with.inline.sharding` to `true` (Default value is `false`).
  - Version 5.x: `allow-range-query-with-inline-sharding` to `true` in `InlineShardingStrategy` (Default value is `false`).

### 7.8.15 [Sharding] Why does my custom distributed primary key do not work after implementing KeyGenerateAlgorithm interface and configuring type property?

Answer:

`Service Provider Interface (SPI)` is a kind of API for the third party to implement or expand. Except implementing interface, you also need to create a corresponding file in `META-INF/services` to make the JVM load these SPI implementations.

More detail for SPI usage, please search by yourself.

Other ShardingSphere `functionality implementation` will take effect in the same way.

### 7.8.16 [Sharding] In addition to internal distributed primary key, does ShardingSphere support other native auto-increment keys?

Answer:

Yes. But there is restriction to the use of native auto-increment keys, which means they cannot be used as sharding keys at the same time.

Since ShardingSphere does not have the database table structure and native auto-increment key is not included in original SQL, it cannot parse that field to the sharding field. If the auto-increment key is not sharding key, it can be returned normally and is needless to be cared. But if the auto-increment key is also used as sharding key, ShardingSphere cannot parse its sharding value, which will make SQL routed to multiple tables and influence the rightness of the application.

The premise for returning native auto-increment key is that INSERT SQL is eventually routed to one table. Therefore, auto-increment key will return zero when INSERT SQL returns multiple tables.

### 7.8.17 [Encryption] How to solve that data encryption can't work with JPA?

Answer:

Because DDL for data encryption has not yet finished, JPA Entity cannot meet the DDL and DML at the same time, when JPA that automatically generates DDL is used with data encryption.

The solutions are as follows:

1. Create JPA Entity with `logicColumn` which needs to encrypt.
2. Disable JPA auto-ddl, For example setting `auto-ddl=none`.
3. Create table manually. Table structure should use `cipherColumn`, `plainColumn` and `assist-edQueryColumn` to replace the `logicColumn`.

### 7.8.18 [DistSQL] How to set custom JDBC connection properties or connection pool properties when adding a data source using DistSQL?

Answer:

1. If you need to customize JDBC connection properties, please take the `urlSource` way to define `dataSource`.
2. ShardingSphere presets necessary connection pool properties, such as `maxPoolSize`, `idle-Timeout`, etc. If you need to add or overwrite the properties, please specify it with `PROPERTIES` in the `dataSource`.
3. Please refer to [Related introduction](#) for above rules.

### 7.8.19 [DistSQL] How to solve Resource [xxx] is still used by [SingleTableRule] . exception when dropping a data source using DistSQL?

Answer:

1. Resources referenced by rules cannot be deleted
2. If the resource is only referenced by single table rule, and the user confirms that the restriction can be ignored, the optional parameter ignore single tables can be added to perform forced deletion

```
DROP RESOURCE dataSourceName [, dataSourceName] ... [ignore single tables]
```

### 7.8.20 [DistSQL] How to solve Failed to get driver instance for jdbcURL=xxx . exception when adding a data source using DistSQL?

Answer:

ShardingSphere Proxy do not have jdbc driver during deployment. Some example of this include mysql-connector. To use it otherwise following syntax can be used:

```
ADD RESOURCE dataSourceName [..., dataSourceName]
```

### 7.8.21 [Other] How to debug when SQL can not be executed rightly in ShardingSphere?

Answer:

sql.show configuration is provided in ShardingSphere-Proxy and post-1.5.0 version of ShardingSphere-JDBC, enabling the context parsing, rewritten SQL and the routed data source printed to info log. sql.show configuration is off in default, and users can turn it on in configurations.

A Tip: Property sql.show has changed to sql-show in version 5.x.

### 7.8.22 [Other] Why do some compiling errors appear? Why did not the IDEA index the generated codes?

Answer:

ShardingSphere uses lombok to enable minimal coding. For more details about using and installment, please refer to the official website of [lombok](#).

The codes under the package org.apache.shardingsphere.sql.parser.autogen are generated by ANTLR. You may execute the following command to generate codes:

```
./mvnw -Dcheckstyle.skip=true -Drat.skip=true -Dmaven.javadoc.skip=true -Djacoco.skip=true -DskipITs -DskipTests install -T1C
```



The generated codes such as `org.apache.shardingsphere.sql.parser.autogen.PostgreSQLStatementParser` may be too large to be indexed by the IDEA. You may configure the IDEA's property `idea.max.intellisense.filesize=10000`.

### 7.8.23 [Other] In SQLServer and PostgreSQL, why does the aggregation column without alias throw exception?

Answer:

SQLServer and PostgreSQL will rename aggregation columns acquired without alias, such as the following SQL:

```
SELECT SUM(num), SUM(num2) FROM tablexxx;
```

Columns acquired by SQLServer are empty string and (2); columns acquired by PostgreSQL are empty sum and sum(2). It will cause error because ShardingSphere is unable to find the corresponding column.

The right SQL should be written as:

```
SELECT SUM(num) AS sum_num, SUM(num2) AS sum_num2 FROM tablexxx;
```

### 7.8.24 [Other] Why does Oracle database throw “Order by value must implements Comparable” exception when using Timestamp Order By?

Answer:

There are two solutions for the above problem: 1. Configure JVM parameter “-oracle.jdbc.J2EE13Compliant=true” 2. Set `System.getProperties().setProperty(“oracle.jdbc.J2EE13Compliant”, “true”)` codes in the initialization of the project.

Reasons:

`org.apache.shardingsphere.sharding.merge.dql.orderby.OrderByValue#getOrderValues()`:

```
private List<Comparable<?>> getOrderValues() throws SQLException {
    List<Comparable<?>> result = new ArrayList<>(orderByItems.size());
    for (OrderByItem each : orderByItems) {
        Object value = queryResult.getValue(each.getIndex(), Object.class);
        Preconditions.checkState(null == value || value instanceof Comparable,
            "Order by value must implements Comparable");
        result.add((Comparable<?>) value);
    }
    return result;
}
```

After using `resultSet.getObject(int index)`, for TimeStamp oracle, the system will decide whether to return `java.sql.TimeStamp` or define `oracle.sql.TIMESTAMP` according to the property of ora-

cle.jdbc.J2EE13Compliant. See oracle.jdbc.driver.TimestampAccessor#getObject(int var1) method in ojdbc codes for more detail:

```
Object getObject(int var1) throws SQLException {
    Object var2 = null;
    if(this.rowSpaceIndicator == null) {
        DatabaseError.throwSQLException(21);
    }

    if(this.rowSpaceIndicator[this.indicatorIndex + var1] != -1) {
        if(this.externalType != 0) {
            switch(this.externalType) {
                case 93:
                    return this.getTimestamp(var1);
                default:
                    DatabaseError.throwSQLException(4);
                    return null;
            }
        }
    }

    if(this.statement.connection.j2ee13Compliant) {
        var2 = this.getTimestamp(var1);
    } else {
        var2 = this.getTIMESTAMP(var1);
    }
}

return var2;
}
```

### 7.8.25 [Other] In Windows environment,when cloning ShardingSphere source code through Git, why prompt filename too long and how to solve it?

Answer:

To ensure the readability of source code,the ShardingSphere Coding Specification requires that the naming of classes,methods and variables be literal and avoid abbreviations,which may result in Some source files have long names.

Since the Git version of Windows is compiled using msys,it uses the old version of Windows Api,limiting the file name to no more than 260 characters.

The solutions are as follows:

Open cmd.exe (you need to add git to environment variables) and execute the following command to allow git supporting log paths:

```
git config --global core.longpaths true
```

If we use windows 10, also need enable win32 log paths in registry editor or group strategy(need reboot):  
> Create the registry key HKLM\SYSTEM\CurrentControlSet\Control\FileSystem LongPathsEnabled (Type: REG\_DWORD) in registry editor, and be set to 1. > Or click “setting” button in system menu, print “Group Policy” to open a new window “Edit Group Policy”, and then click ‘Computer Configuration’ > ‘Administrative Templates’ > ‘System’ > ‘Filesystem’, and then turn on ‘Enable Win32 long paths’ option.

Reference material:

<https://docs.microsoft.com/zh-cn/windows/desktop/FileIO/naming-a-file> <https://ourcodeworld.com/articles/read/109/how-to-solve-filename-too-long-error-in-git-powershell-and-github-application-for-windows>

### 7.8.26 [Other] How to solve Type is required error?

Answer:

In Apache ShardingSphere, many functionality implementation are uploaded through SPI, such as Distributed Primary Key. These functions load SPI implementation by configuring the type, so the type must be specified in the configuration file.

### 7.8.27 [Other] How to speed up the metadata loading when service starts up?

Answer:

1. Update to 4.0.1 above, which helps speed up the process of loading table metadata.
2. Configure:
  - `max.connections.size.per.query`(Default value is 1) higher referring to connection pool you adopt(Version  $\geq$  3.0.0.M3 & Version  $<$  5.0.0).
  - `max-connections-size-per-query`(Default value is 1) higher referring to connection pool you adopt(Version  $\geq$  5.0.0).

### 7.8.28 [Other] The ANTLR plugin generates codes in the same level directory as src, which is easy to commit by mistake. How to avoid it?

Answer:

Goto `Settings -> Languages & Frameworks -> ANTLR v4 default project settings` and configure the output directory of the generated code as `target/gen` as shown:

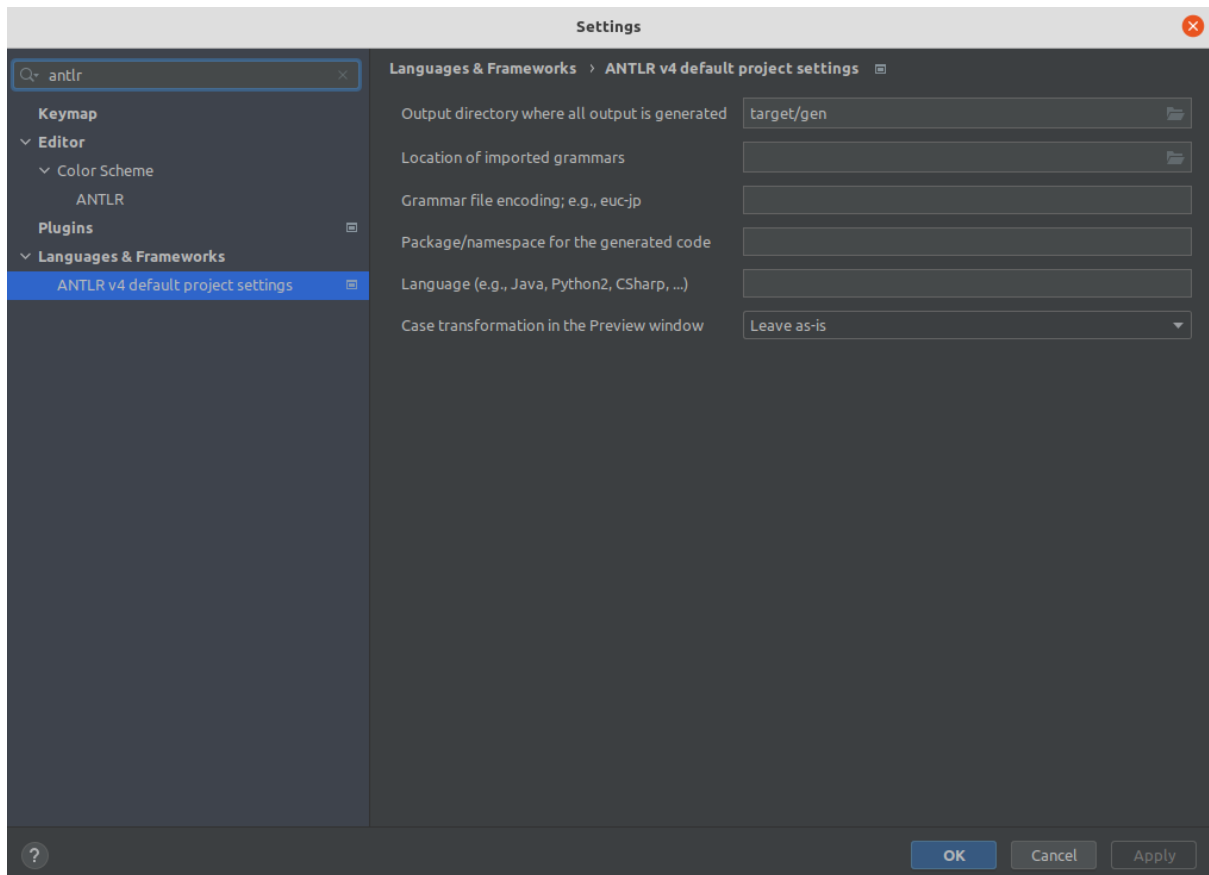

### 7.8.29 [Other] Why is the database sharding result not correct when using Proxool?

Answer:

When using Proxool to configure multiple data sources, each one of them should be configured with alias. It is because Proxool would check whether existing alias is included in the connection pool or not when acquiring connections, so without alias, each connection will be acquired from the same data source.

The followings are core codes from ProxoolDataSource getConnection method in Proxool:

```
if(!ConnectionPoolManager.getInstance().isPoolExists(this.alias)) {
    this.registerPool();
}
```

For more alias usages, please refer to [Proxool official website](#).

### 7.8.30 [Other] The property settings in the configuration file do not take effect when integrating ShardingSphere with Spring Boot 2.x ?

Answer:

Note that the property name in the Spring Boot 2.x environment is constrained to allow only lowercase letters, numbers and short transverse lines, [a-z] [0-9] and -.

Reasons:

In the Spring Boot 2.x environment, ShardingSphere binds the properties through Binder, and the unsatisfied property name (such as camel case or underscore.) can throw a NullPointerException exception when the property setting does not work to check the property value. Refer to the following error examples:

Underscore case: database\_inline

```
spring.shardingsphere.rules.sharding.sharding-algorithms.database_inline.  
type=INLINE  
spring.shardingsphere.rules.sharding.sharding-algorithms.database_inline.props.  
algorithm-expression=ds-${user_id % 2}
```

```
Caused by: org.springframework.beans.factory.BeanCreationException: Error creating  
bean with name 'database_inline': Initialization of bean failed; nested exception  
is java.lang.NullPointerException: Inline sharding algorithm expression cannot be  
null.
```

...

```
Caused by: java.lang.NullPointerException: Inline sharding algorithm expression  
cannot be null.
```

```
at com.google.common.base.Preconditions.checkNotNull(Preconditions.java:897)
```

```
at org.apache.shardingsphere.sharding.algorithm.sharding.inline.  
InlineShardingAlgorithm.getAlgorithmExpression(InlineShardingAlgorithm.java:58)
```

```
at org.apache.shardingsphere.sharding.algorithm.sharding.inline.  
InlineShardingAlgorithm.init(InlineShardingAlgorithm.java:52)
```

```
at org.apache.shardingsphere.spring.boot.registry.  
AbstractAlgorithmProvidedBeanRegistry.  
postProcessAfterInitialization(AbstractAlgorithmProvidedBeanRegistry.java:98)
```

```
at org.springframework.beans.factory.support.  
AbstractAutowireCapableBeanFactory.  
applyBeanPostProcessorsAfterInitialization(AbstractAutowireCapableBeanFactory.  
java:431)
```

...

Camel case: databaseInline

```
spring.shardingsphere.rules.sharding.sharding-algorithms.databaseInline.type=INLINE  
spring.shardingsphere.rules.sharding.sharding-algorithms.databaseInline.props.  
algorithm-expression=ds-${user_id % 2}
```

```

Caused by: org.springframework.beans.factory.BeanCreationException: Error creating
bean with name 'databaseInline': Initialization of bean failed; nested exception is
java.lang.NullPointerException: Inline sharding algorithm expression cannot be
null.
    ...
Caused by: java.lang.NullPointerException: Inline sharding algorithm expression
cannot be null.
    at com.google.common.base.Preconditions.checkNotNull(Preconditions.java:897)
    at org.apache.shardingsphere.sharding.algorithm.sharding.inline.
InlineShardingAlgorithm.getAlgorithmExpression(InlineShardingAlgorithm.java:58)
    at org.apache.shardingsphere.sharding.algorithm.sharding.inline.
InlineShardingAlgorithm.init(InlineShardingAlgorithm.java:52)
    at org.apache.shardingsphere.spring.boot.registry.
AbstractAlgorithmProvidedBeanRegistry.
postProcessAfterInitialization(AbstractAlgorithmProvidedBeanRegistry.java:98)
    at org.springframework.beans.factory.support.
AbstractAutowireCapableBeanFactory.
applyBeanPostProcessorsAfterInitialization(AbstractAutowireCapableBeanFactory.
java:431)
    ...

```

From the exception stack, the `AbstractAlgorithmProvidedBeanRegistry.registerBean` method calls `PropertyUtil.containsPropertyPrefix (environment, prefix)`, and `PropertyUtil.containsPropertyPrefix (environment, prefix)` determines that the configuration of the specified prefix does not exist, while the method uses `Binder` in an unsatisfied property name (such as camelcase or underscore) causing property settings does not to take effect.

### 7.8.31 [ShardingSphere-JDBC] The tableName and columnName configured in yaml or properties leading incorrect result when loading Oracle metadata?

Answer:

Note that, in Oracle's metadata, the `tableName` and `columnName` is default UPPERCASE, while double-quoted such as `CREATE TABLE "TableName" ("Id" number)` the `tableName` and `columnName` is the actual content double-quoted, refer to the following SQL for the reality in metadata:

```

SELECT OWNER, TABLE_NAME, COLUMN_NAME, DATA_TYPE FROM ALL_TAB_COLUMNS WHERE TABLE_
NAME IN ('TableName')

```

The ShardingSphere uses the `OracleTableMetadataLoader` to load the metadata, keep the `tableName` and `columnName` in the `yaml` or `properties` consistent with the metadata.

The ShardingSphere assembled the SQL using the following code:

```

private String getTableMetadataSQL(final Collection<String> tables, final
DatabaseMetadata metaData) throws SQLException {
    StringBuilder stringBuilder = new StringBuilder(28);
    if (versionContainsIdentityColumn(metaData)) {

```

```

        stringBuilder.append(", IDENTITY_COLUMN");
    }
    if (versionContainsCollation(metaData)) {
        stringBuilder.append(", COLLATION");
    }
    String collation = stringBuilder.toString();
    return tables.isEmpty() ? String.format(TABLE_META_DATA_SQL, collation)
        : String.format(TABLE_META_DATA_SQL_IN_TABLES, collation, tables.
stream().map(each -> String.format("%s", each)).collect(Collectors.joining(",
")));
}

```

## 7.9 API Change Histories

This chapter contains a section of API change histories of different projects of Apache ShardingSphere: ShardingSphere-JDBC, ShardingSphere-Proxy and ShardingSphere-Sidecar.

### 7.9.1 ShardingSphere-JDBC

This chapter contains a section of API change histories of Apache ShardingSphere-JDBC.

#### YAML configuration

##### 5.0.0-alpha

#### Data Sharding

#### Configuration Item Explanation

```

dataSources: # Omit the data source configuration, please refer to the usage

rules:
- !SHARDING
  tables: # Sharding table configuration
    <logic-table-name> (+): # Logic table name
      actualDataNodes (?): # Describe data source names and actual tables (refer to
Inline syntax rules)
      databaseStrategy (?): # Databases sharding strategy, use default databases
sharding strategy if absent. sharding strategy below can choose only one.
        standard: # For single sharding column scenario
          shardingColumn: # Sharding column name
          shardingAlgorithmName: # Sharding algorithm name
        complex: # For multiple sharding columns scenario
          shardingColumns: # Sharding column names, multiple columns separated with

```

```

comma
    shardingAlgorithmName: # Sharding algorithm name
    hint: # Sharding by hint
        shardingAlgorithmName: # Sharding algorithm name
    none: # Do not sharding
    tableStrategy: # Tables sharding strategy, same as database sharding strategy
    keyGenerateStrategy: # Key generator strategy
        column: # Column name of key generator
        keyGeneratorName: # Key generator name
    autoTables: # Auto Sharding table configuration
        t_order_auto: # Logic table name
        actualDataSources (?): # Data source names
        shardingStrategy: # Sharding strategy
            standard: # For single sharding column scenario
                shardingColumn: # Sharding column name
                shardingAlgorithmName: # Auto sharding algorithm name
    bindingTables (+): # Binding tables
        - <logic_table_name_1, logic_table_name_2, ...>
        - <logic_table_name_1, logic_table_name_2, ...>
    broadcastTables (+): # Broadcast tables
        - <table-name>
        - <table-name>
    defaultDatabaseStrategy: # Default strategy for database sharding
    defaultTableStrategy: # Default strategy for table sharding
    defaultKeyGenerateStrategy: # Default Key generator strategy

# Sharding algorithm configuration
shardingAlgorithms:
    <sharding-algorithm-name> (+): # Sharding algorithm name
        type: # Sharding algorithm type
        props: # Sharding algorithm properties
        # ...

# Key generate algorithm configuration
keyGenerators:
    <key-generate-algorithm-name> (+): # Key generate algorithm name
        type: # Key generate algorithm type
        props: # Key generate algorithm properties
        # ...

props:
    # ...

```



## Replica Query

### Configuration Item Explanation

```

dataSources: # Omit the data source configuration, please refer to the usage

rules:
- !REPLICA_QUERY
  dataSources:
    <data-source-name> (+): # Logic data source name of replica query
      primaryDataSourceName: # Primary data source name
      replicaDataSourceNames:
        - <replica-data_source-name> (+) # Replica data source name
      loadBalancerName: # Load balance algorithm name

    # Load balance algorithm configuration
    loadBalancers:
      <load-balancer-name> (+): # Load balance algorithm name
        type: # Load balance algorithm type
        props: # Load balance algorithm properties
          # ...

  props:
    # ...

```

Please refer to [Built-in Load Balance Algorithm List](#) for more details about type of algorithm.

## Encryption

### Configuration Item Explanation

```

dataSource: # Omit the data source configuration, please refer to the usage

rules:
- !ENCRYPT
  tables:
    <table-name> (+): # Encrypt table name
      columns:
        <column-name> (+): # Encrypt logic column name
          cipherColumn: # Cipher column name
          assistedQueryColumn (?): # Assisted query column name
          plainColumn (?): # Plain column name
          encryptorName: # Encrypt algorithm name

    # Encrypt algorithm configuration
    encryptors:
      <encrypt-algorithm-name> (+): # Encrypt algorithm name

```

```

    type: # Encrypt algorithm type
    props: # Encrypt algorithm properties
        # ...

    queryWithCipherColumn: # Whether query with cipher column for data encrypt. User
you can use plaintext to query if have

```

Please refer to [Built-in Encrypt Algorithm List](#) for more details about type of algorithm.

## Shadow DB

### Configuration Item Explanation

```

dataSources: # Omit the data source configuration, please refer to the usage

rules:
- !SHADOW
  column: # Shadow column name
  sourceDataSourceNames: # Source Data Source names
    # ...
  shadowDataSourceNames: # Shadow Data Source names
    # ...

props:
  # ...

```

## Governance

### Configuration Item Explanation

```

governance:
  name: # Governance name
  registryCenter: # Registry center
    type: # Governance instance type. Example:Zookeeper, etcd
    serverLists: # The list of servers that connect to governance instance,
including IP and port number; use commas to separate
    overwrite: # Whether to overwrite local configurations with config center
configurations; if it can, each initialization should refer to local configurations

```

## ShardingSphere-4.x

### Data Sharding

#### Configuration Item Explanation

```

dataSources: # Data sources configuration, multiple `data_source_name` available
  <data_source_name>: # <!!Data source pool implementation class> `!!` means class
  instantiation
    driverClassName: # Class name of database driver
    url: # Database URL
    username: # Database username
    password: # Database password
    # ... Other properties for data source pool

shardingRule:
  tables: # Sharding rule configuration, multiple `logic_table_name` available
    <logic_table_name>: # Name of logic table
      actualDataNodes: # Describe data source names and actual tables, delimiter as
      point, multiple data nodes separated with comma, support inline expression. Absent
      means sharding databases only. Example: ds${0..7}.tbl${0..7}

      databaseStrategy: # Databases sharding strategy, use default databases
      sharding strategy if absent. sharding strategy below can choose only one
      standard: # Standard sharding scenario for single sharding column
      shardingColumn: # Name of sharding column
        preciseAlgorithmClassName: # Precise algorithm class name used for `=`
        and `IN`. This class need to implements PreciseShardingAlgorithm, and require a no
        argument constructor
        rangeAlgorithmClassName: # Range algorithm class name used for
        `BETWEEN`. This class need to implements RangeShardingAlgorithm, and require a no
        argument constructor
        complex: # Complex sharding scenario for multiple sharding columns
        shardingColumns: # Names of sharding columns. Multiple columns
        separated with comma
        algorithmClassName: # Complex sharding algorithm class name. This class
        need to implements ComplexKeysShardingAlgorithm, and require a no argument
        constructor
        inline: # Inline expression sharding scenario for single sharding column
        shardingColumn: # Name of sharding column
        algorithmInlineExpression: # Inline expression for sharding algorithm
        hint: # Hint sharding strategy
        algorithmClassName: # Hint sharding algorithm class name. This class
        need to implements HintShardingAlgorithm, and require a no argument constructor
        none: # Do not sharding
      tableStrategy: # Tables sharding strategy, Same as databases sharding
      strategy
      keyGenerator:

```

```

    column: # Column name of key generator
    type: # Type of key generator, use default key generator if absent, and
there are three types to choose, that is, SNOWFLAKE/UUID
    props: # Properties, Notice: when use SNOWFLAKE, `max.tolerate.time.
difference.milliseconds` for `SNOWFLAKE` need to be set. To use the generated value
of this algorithm as sharding value, it is recommended to configure `max.vibration.
offset`

bindingTables: # Binding table rule configurations
  - <logic_table_name1, logic_table_name2, ...>
  - <logic_table_name3, logic_table_name4, ...>
  - <logic_table_name_x, logic_table_name_y, ...>
broadcastTables: # Broadcast table rule configurations
  - table_name1
  - table_name2
  - table_name_x

defaultDataSourceName: # If table not configure at table rule, will route to
defaultDataSourceName
defaultDatabaseStrategy: # Default strategy for sharding databases, same as
databases sharding strategy
defaultTableStrategy: # Default strategy for sharding tables, same as tables
sharding strategy
defaultKeyGenerator:
  type: # Type of default key generator, use user-defined ones or built-in ones,
e.g. SNOWFLAKE, UUID. Default key generator is `org.apache.shardingsphere.core.
keygen.generator.impl.SnowflakeKeyGenerator`
  column: # Column name of default key generator
  props: # Properties of default key generator, e.g. `max.tolerate.time.
difference.milliseconds` for `SNOWFLAKE`

masterSlaveRules: # Read-write splitting rule configuration, more details can
reference Read-write splitting part
  <data_source_name>: # Data sources configuration, need consist with data source
map, multiple `data_source_name` available
  masterDataSourceName: # more details can reference Read-write splitting part
  slaveDataSourceNames: # more details can reference Read-write splitting part
  loadBalanceAlgorithmType: # more details can reference Read-write splitting
part
  props: # Properties configuration of load balance algorithm
    <property-name>: # property key value pair

props: # Properties
  sql.show: # To show SQLS or not, default value: false
  executor.size: # The number of working threads, default value: CPU count
  check.table.metadata.enabled: # To check the metadata consistency of all the
tables or not, default value : false
  max.connections.size.per.query: # The maximum connection number allocated by each

```

```
query of each physical database. default value: 1
```

## Read-Write Split

### Configuration Item Explanation

```
dataSources: # Omit data source configurations; keep it consistent with data
sharding

masterSlaveRule:
  name: # Read-write split data source name
  masterDataSourceName: # Master data source name
  slaveDataSourceNames: # Slave data source name
    - <data_source_name1>
    - <data_source_name2>
    - <data_source_name_x>
  loadBalanceAlgorithmType: # Slave database load balance algorithm type; optional
value, ROUND_ROBIN and RANDOM, can be omitted if `loadBalanceAlgorithmClassName`
exists
  props: # Properties configuration of load balance algorithm
    <property-name>: # property key value pair

props: # Property configuration
  sql.show: # Show SQL or not; default value: false
  executor.size: # Executing thread number; default value: CPU core number
  check.table.metadata.enabled: # Whether to check table metadata consistency when
it initializes; default value: false
  max.connections.size.per.query: # The maximum connection number allocated by each
query of each physical database. default value: 1
```

Create a DataSource through the YamlMasterSlaveDataSourceFactory factory class:

```
DataSource dataSource = YamlMasterSlaveDataSourceFactory.
createDataSource(yamlFile);
```

## Data Masking

### Configuration Item Explanation

```
dataSource: # Ignore data sources configuration

encryptRule:
  encryptors:
    <encryptor-name>:
      type: # Encryptor type
```

```

    props: # Properties, e.g. `aes.key.value` for AES encryptor
        aes.key.value:
tables:
    <table-name>:
        columns:
            <logic-column-name>:
                plainColumn: # Plaintext column name
                cipherColumn: # Ciphertext column name
                assistedQueryColumn: # AssistedColumns for query, when use
ShardingQueryAssistedEncryptor, it can help query encrypted data
                encryptor: # Encrypt name

```

## Orchestration

### Configuration Item Explanation

```

dataSources: # Omit data source configurations
shardingRule: # Omit sharding rule configurations
masterSlaveRule: # Omit read-write split rule configurations
encryptRule: # Omit encrypt rule configurations

orchestration:
    name: # Orchestration instance name
    overwrite: # Whether to overwrite local configurations with registry center
configurations; if it can, each initialization should refer to local configurations
    registry: # Registry center configuration
        type: # Registry center type. Example:zookeeper
        serverLists: # The list of servers that connect to registry center, including
IP and port number; use commas to seperate addresses, such as: host1:2181,
host2:2181
        namespace: # Registry center namespace
        digest: # The token that connects to the registry center; default means there
is no need for authentication
        operationTimeoutMilliseconds: # Default value: 500 milliseconds
        maxRetries: # Maximum retry time after failing; default value: 3 times
        retryIntervalMilliseconds: # Interval time to retry; default value: 500
milliseconds
        timeToLiveSeconds: # Living time of temporary nodes; default value: 60 seconds

```

## ShardingSphere-3.x

### Data Sharding

#### Configuration Item Explanation

```

dataSources: # Data sources configuration, multiple `data_source_name` available
  <data_source_name>: # <!!Data source pool implementation class> `!!` means class
  instantiation
    driverClassName: # Class name of database driver
    url: # Database URL
    username: # Database username
    password: # Database password
    # ... Other properties for data source pool

shardingRule:
  tables: # Sharding rule configuration, multiple `logic_table_name` available
    <logic_table_name>: # Name of logic table
      actualDataNodes: # Describe data source names and actual tables, delimiter as
      point, multiple data nodes separated with comma, support inline expression. Absent
      means sharding databases only. Example: ds${0..7}.tbl${0..7}

      databaseStrategy: # Databases sharding strategy, use default databases
      sharding strategy if absent. sharding strategy below can choose only one
      standard: # Standard sharding scenario for single sharding column
        shardingColumn: # Name of sharding column
          preciseAlgorithmClassName: # Precise algorithm class name used for `=`
          and `IN`. This class need to implements PreciseShardingAlgorithm, and require a no
          argument constructor
          rangeAlgorithmClassName: # Range algorithm class name used for
          `BETWEEN`. This class need to implements RangeShardingAlgorithm, and require a no
          argument constructor
          complex: # Complex sharding scenario for multiple sharding columns
            shardingColumns: # Names of sharding columns. Multiple columns
            separated with comma
            algorithmClassName: # Complex sharding algorithm class name. This class
            need to implements ComplexKeysShardingAlgorithm, and require a no argument
            constructor
          inline: # Inline expression sharding scenario for single sharding column
            shardingColumn: # Name of sharding column
            algorithmInlineExpression: # Inline expression for sharding algorithm
          hint: # Hint sharding strategy
            algorithmClassName: # Hint sharding algorithm class name. This class
            need to implements HintShardingAlgorithm, and require a no argument constructor
          none: # Do not sharding
      tableStrategy: # Tables sharding strategy, Same as databases sharding
      strategy

```

```

    keyGeneratorColumnName: # Column name of key generator, do not use Key
generator if absent
    keyGeneratorClassName: # Key generator, use default key generator if absent.
This class need to implements KeyGenerator, and require a no argument constructor

    logicIndex: # Name if logic index. If use `DROP INDEX XXX` SQL in Oracle/
PostgreSQL, This property needs to be set for finding the actual tables
    bindingTables: # Binding table rule configurations
    - <logic_table_name1, logic_table_name2, ...>
    - <logic_table_name3, logic_table_name4, ...>
    - <logic_table_name_x, logic_table_name_y, ...>
    bindingTables: # Broadcast table rule configurations
    - table_name1
    - table_name2
    - table_name_x

    defaultDataSourceName: # If table not configure at table rule, will route to
defaultDataSourceName
    defaultDatabaseStrategy: # Default strategy for sharding databases, same as
databases sharding strategy
    defaultTableStrategy: # Default strategy for sharding tables, same as tables
sharding strategy
    defaultKeyGeneratorClassName: # Default key generator class name, default value
is `io.shardingsphere.core.keygen.DefaultKeyGenerator`. This class need to
implements KeyGenerator, and require a no argument constructor

    masterSlaveRules: # Read-write splitting rule configuration, more details can
reference Read-write splitting part
    <data_source_name>: # Data sources configuration, need consist with data source
map, multiple `data_source_name` available
    masterDataSourceName: # more details can reference Read-write splitting part
    slaveDataSourceNames: # more details can reference Read-write splitting part
    loadBalanceAlgorithmType: # more details can reference Read-write splitting
part
    loadBalanceAlgorithmClassName: # more details can reference Read-write
splitting part
    configMap: # User-defined arguments
    key1: value1
    key2: value2
    keyx: valuex

props: # Properties
    sql.show: # To show SQLS or not, default value: false
    executor.size: # The number of working threads, default value: CPU count
    check.table.metadata.enabled: #T o check the metadata consistency of all the
tables or not, default value : false

configMap: # User-defined arguments

```



```
key1: value1
key2: value2
keyx: valuex
```

## Read-Write Split

### Configuration Item Explanation

```
dataSources: # Ignore data sources configuration, same as sharding

masterSlaveRule:
  name: # Name of master slave data source
  masterDataSourceName: # Name of master data source
  slaveDataSourceNames: # Names of Slave data sources
    - <data_source_name1>
    - <data_source_name2>
    - <data_source_name_x>
  loadBalanceAlgorithmClassName: # Load balance algorithm class name. This class
  need to implements MasterSlaveLoadBalanceAlgorithm, and require a no argument
  constructor
  loadBalanceAlgorithmType: # Load balance algorithm type, values should be:
  `ROUND_ROBIN` or `RANDOM`. Ignore if `loadBalanceAlgorithmClassName` is present

props: # Properties
  sql.show: # To show SQLS or not, default value: false
  executor.size: # The number of working threads, default value: CPU count
  check.table.metadata.enabled: # To check the metadata consistency of all the
  tables or not, default value : false

configMap: # User-defined arguments
  key1: value1
  key2: value2
  keyx: valuex
```

Create a DataSource through the YamlMasterSlaveDataSourceFactory factory class:

```
DataSource dataSource = MasterSlaveDataSourceFactory.createDataSource(yamlFile);
```

## Orchestration

### Configuration Item Explanation

```

dataSources: # Ignore data sources configuration
shardingRule: # Ignore sharding rule configuration
masterSlaveRule: # Ignore master slave rule configuration

orchestration:
  name: # Name of orchestration instance
  overwrite: # Use local configuration to overwrite registry center or not
  registry: # Registry configuration
    serverLists: # Registry servers list, multiple split as comma. Example:
host1:2181,host2:2181
    namespace: # Namespace of registry
    digest: # Digest for registry. Default is not need digest.
    operationTimeoutMilliseconds: # Operation timeout time in milliseconds, default
value is 500 milliseconds
    maxRetries: # Max number of times to retry, default value is 3
    retryIntervalMilliseconds: # Time interval in milliseconds on each retry,
default value is 500 milliseconds
    timeToLiveSeconds: # Time to live in seconds of ephemeral keys, default value
is 60 seconds

```

## ShardingSphere-2.x

### Data Sharding

#### Configuration Item Explanation

```

dataSources:
  db0: !!org.apache.commons.dbcp.BasicDataSource
    driverClassName: org.h2.Driver
    url: jdbc:h2:mem:db0;DB_CLOSE_DELAY=-1;DATABASE_TO_UPPER=false;MODE=MYSQL
    username: sa
    password:
    maxActive: 100
  db1: !!org.apache.commons.dbcp.BasicDataSource
    driverClassName: org.h2.Driver
    url: jdbc:h2:mem:db1;DB_CLOSE_DELAY=-1;DATABASE_TO_UPPER=false;MODE=MYSQL
    username: sa
    password:
    maxActive: 100

shardingRule:
  tables:

```

```

config:
  actualDataNodes: db${0..1}.t_config
t_order:
  actualDataNodes: db${0..1}.t_order_${0..1}
  databaseStrategy:
    standard:
      shardingColumn: user_id
      preciseAlgorithmClassName: io.shardingjdbc.core.yaml.fixture.
SingleAlgorithm
  tableStrategy:
    inline:
      shardingColumn: order_id
      algorithmInlineExpression: t_order_${order_id % 2}
    keyGeneratorColumnName: order_id
    keyGeneratorClass: io.shardingjdbc.core.yaml.fixture.IncrementKeyGenerator
t_order_item:
  actualDataNodes: db${0..1}.t_order_item_${0..1}
  # The strategy of binding the rest of the tables in the table is the same as
the strategy of the first table
  databaseStrategy:
    standard:
      shardingColumn: user_id
      preciseAlgorithmClassName: io.shardingjdbc.core.yaml.fixture.
SingleAlgorithm
  tableStrategy:
    inline:
      shardingColumn: order_id
      algorithmInlineExpression: t_order_item_${order_id % 2}
bindingTables:
  - t_order,t_order_item
# Default database sharding strategy
defaultDatabaseStrategy:
  none:
defaultTableStrategy:
  complex:
    shardingColumns: id, order_id
    algorithmClassName: io.shardingjdbc.core.yaml.fixture.MultiAlgorithm
props:
  sql.show: true

```

## Read-Write Split

### concept

In order to relieve the pressure on the database, the write and read operations are separated into different data sources. The write library is called the master library, and the read library is called the slave library. One master library can be configured with multiple slave libraries.

### Supported

1. Provides a read-write separation configuration with one master and multiple slaves, which can be used independently or with sub-databases and sub-meters.
2. Independent use of read-write separation to support SQL transparent transmission.
3. In the same thread and the same database connection, if there is a write operation, subsequent read operations will be read from the main library to ensure data consistency.
4. Spring namespace.
5. Hint-based mandatory main library routing.

### Unsupported

1. Data synchronization between the master library and the slave library.
2. Data inconsistency caused by the data synchronization delay of the master library and the slave library.
3. Double writing or multiple writing in the main library.

### rule configuration

```
dataSources:
  db_master: !!org.apache.commons.dbcp.BasicDataSource
    driverClassName: org.h2.Driver
    url: jdbc:h2:mem:db_master;DB_CLOSE_DELAY=-1;DATABASE_TO_UPPER=false;MODE=MYSQL
    username: sa
    password:
    maxActive: 100
  db_slave_0: !!org.apache.commons.dbcp.BasicDataSource
    driverClassName: org.h2.Driver
    url: jdbc:h2:mem:db_slave_0;DB_CLOSE_DELAY=-1;DATABASE_TO_UPPER=false;
MODE=MYSQL
    username: sa
    password:
    maxActive: 100
  db_slave_1: !!org.apache.commons.dbcp.BasicDataSource
```

```

    driverClassName: org.h2.Driver
    url: jdbc:h2:mem:db_slave_1;DB_CLOSE_DELAY=-1;DATABASE_TO_UPPER=false;
MODE=MYSQL
    username: sa
    password:
    maxActive: 100

masterSlaveRule:
  name: db_ms
  masterDataSourceName: db_master
  slaveDataSourceNames: [db_slave_0, db_slave_1]
  configMap:
    key1: value1

```

Create a DataSource through the MasterSlaveDataSourceFactory factory class:

```
DataSource dataSource = MasterSlaveDataSourceFactory.createDataSource(yamlFile);
```

## Orchestration

### Configuration Item Explanation

Zookeeper sharding table and database Orchestration Configuration Item Explanation

```

dataSources: Data sources configuration

shardingRule: Sharding rule configuration

orchestration: Zookeeper Orchestration Configuration
  name: Orchestration name
  overwrite: Whether to overwrite local configurations with config center
configurations; if it can, each initialization should refer to local configurations
  zookeeper: Registry center Configuration
    namespace: Registry center namespace
    serverLists: The list of servers that connect to governance instance, including
IP and port number, use commas to separate, such as: host1:2181,host2:2181
    baseSleepTimeMilliseconds: The initial millisecond value of the interval to
wait for retry
    maxSleepTimeMilliseconds: The maximum millisecond value of the interval to wait
for retry
    maxRetries: The maximum retry count
    sessionTimeoutMilliseconds: The session timeout milliseconds
    connectionTimeoutMilliseconds: The connecton timeout milliseconds
    digest: Permission token to connect to Zookeeper. default no authorization is
required

```

Etdcd sharding table and database Orchestration Configuration Item Explanation

```

dataSources: Data sources configuration

shardingRule: Sharding rule configuration

orchestration: Etcd Orchestration Configuration
  name: Orchestration name
  overwrite: Whether to overwrite local configurations with config center
  configurations; if it can, each initialization should refer to local configurations
  etcd: Registry center Configuration
    serverLists: The list of servers that connect to governance instance, including
  IP and port number, use commas to separate, such as: http://host1:2379,http://
  host2:2379
    timeToLiveSeconds: Time to live seconds for ephemeral nodes
    timeoutMilliseconds: The request timeout milliseconds
    maxRetries: The maximum retry count
    retryIntervalMilliseconds: The retry interval milliseconds

```

#### Sharding table and database Data source construction method

```

DataSource dataSource = OrchestrationShardingDataSourceFactory.
createDataSource(yamlFile);

```

#### Read-Write split Data source construction method

```

DataSource dataSource = OrchestrationMasterSlaveDataSourceFactory.
createDataSource(yamlFile);

```

## Java API

### 5.0.0-beta

## Sharding

### Root Configuration

Class name: org.apache.shardingsphere.sharding.api.config.ShardingRuleConfiguration

Attributes:

<i>Name</i>	<i>DataType</i>	<i>Description</i>	<i>Default Value</i>
tables (+)	Collection<ShardingTableRuleConfiguration>	Sharding table rules	.
autoTables (+)	Collection<ShardingAutoTableRuleConfiguration>	Sharding automatic table rules	.
bindingTableGroups (*)	Collection<String>	Binding table rules	Empty
broadcastTables (*)	Collection<String>	Broadcast table rules	Empty
defaultDatabaseShardingStrategy (?)	ShardingStrategyConfiguration	Default database sharding strategy	Not sharding
defaultTableShardingStrategy (?)	ShardingStrategyConfiguration	Default table sharding strategy	Not sharding
defaultKeyGenerateStrategy (?)	KeyGeneratorConfiguration	Default key generator	Snowflake
shardingAlgorithms (+)	Map<String, ShardingSphereAlgorithmConfiguration>	Sharding algorithm name and configurations	None
keyGenerators (?)	Map<String, ShardingSphereAlgorithmConfiguration>	Key generate algorithm name and configurations	None

### Sharding Table Configuration

Class name: org.apache.shardingsphere.sharding.api.config.ShardingTableRuleConfiguration

Attributes:

Name*	Data Type	Description	Default Value
logic Table	String	Name of sharding logic table	.
actualData Nodes (?)	String	Describe data source names and actual tables, delimiter as point. Multiple data nodes split by comma, support inline expression	Broadcast table or databases sharding only
databaseShardingStrategy (?)	ShardingStrategyConfiguration	Databases sharding strategy	Use default databases sharding strategy
tableShardingStrategy (?)	ShardingStrategyConfiguration	Tables sharding strategy	Use default tables sharding strategy
keyGenerateStrategy (?)	KeyGeneratorConfiguration	Key generator configuration	Use default key generator

### Sharding Automatic Table Configuration

Class name: org.apache.shardingsphere.sharding.api.config.ShardingAutoTableRuleConfiguration

Attributes:

Name	Data Type	Description	Default Value
logicTable	String	Name of sharding logic table	.
actualDataSources (?)	String	Data source names. Multiple data nodes split by comma	Use all configured data sources
shardingStrategy (?)	ShardingStrategyConfiguration	Sharding strategy	Use default sharding strategy
keyGenerateStrategy (?)	KeyGeneratorConfiguration	Key generator configuration	Use default key generator



## Sharding Strategy Configuration

### Standard Sharding Strategy Configuration

Class name: org.apache.shardingsphere.sharding.api.config.strategy.sharding.StandardShardingStrategyConfiguration

Attributes:

<i>Name</i>	<i>DataType</i>	<i>Description</i>
shardingColumn	String	Sharding column name
shardingAlgorithmName	String	Sharding algorithm name

### Complex Sharding Strategy Configuration

Class name: org.apache.shardingsphere.sharding.api.config.strategy.sharding.ComplexShardingStrategyConfiguration

Attributes:

<i>Name</i>	<i>DataType</i>	<i>Description</i>
shardingColumns	String	Sharding column name, separated by commas
shardingAlgorithmName	String	Sharding algorithm name

### Hint Sharding Strategy Configuration

Class name: org.apache.shardingsphere.sharding.api.config.strategy.sharding.HintShardingStrategyConfiguration

Attributes:

<i>Name</i>	<i>DataType</i>	<i>Description</i>
shardingAlgorithmName	String	Sharding algorithm name

### None Sharding Strategy Configuration

Class name: org.apache.shardingsphere.sharding.api.config.strategy.sharding.NoneShardingStrategyConfiguration

Attributes: None

Please refer to [Built-in Sharding Algorithm List](#) for more details about type of algorithm.

### Key Generate Strategy Configuration

Class name: org.apache.shardingsphere.sharding.api.config.strategy.keygen.KeyGenerateStrategyConfiguration

Attributes:

<i>Name</i>	<i>DataType</i>	<i>Description</i>
column	String	Column name of key generate
keyGeneratorName	String	key generate algorithm name

Please refer to [Built-in Key Generate Algorithm List](#) for more details about type of algorithm.

### Readwrite-splitting

#### Root Configuration

Class name: ReadwriteSplittingRuleConfiguration

Attributes:

<i>Name*</i>	<i>DataType</i>	<i>Description</i>
dataSources (+)	Collection<ReadwriteSplittingDataSourceRuleConfiguration>	Data sources of write and reads
loadBalancers (*)	Map<String, ShardingSphereAlgorithmConfiguration>	Load balance algorithm name and configurations of replica data sources

### Readwrite-splitting Data Source Configuration

Class name: ReadwriteSplittingDataSourceRuleConfiguration

Attributes:

Name	DataType	Description	Default Value
name	String	Readwrite-splitting data source name	.
writeDataSourceName	String	Write sources source name	.
readDataSourceNames (+)	Collection <String>	Read sources source name list	.
loadBalancerName (?)	String	Load balance algorithm name of replica sources	Round robin load balance algorithm

Please refer to [Built-in Load Balance Algorithm List](#) for more details about type of algorithm.

### Encryption

#### Root Configuration

Class name: org.apache.shardingsphere.encrypt.api.config.EncryptRuleConfiguration

Attributes:

Name	DataType	Description	Default Value
tables (+)	Collection<EncryptTableRuleConfiguration>	Encrypt table rule configurations	
encryptors (+)	Map<String, ShardingSphereAlgorithmConfiguration>	Encrypt algorithm name and configurations	
queryWithCipherColumn (?)	boolean	Whether query with cipher column for data encrypt. User you can use plaintext to query if have	true

### Encrypt Table Rule Configuration

Class name: org.apache.shardingsphere.encrypt.api.config.rule.EncryptTableRuleConfiguration

Attributes:

<i>Name*</i>	<i>DataType</i>	<i>Description</i>
name	String	Table name
columns (+)	Collection <EncryptColumnRuleConfiguration>	Encrypt column rule configurations

### Encrypt Column Rule Configuration

Class name: org.apache.shardingsphere.encrypt.api.config.rule.EncryptColumnRuleConfiguration

Attributes:

<i>Name</i>	<i>DataType</i>	<i>Description</i>
logicColumn	String	Logic column name
cipherColumn	String	Cipher column name
assistedQueryColumn (?)	String	Assisted query column name
plainColumn (?)	String	Plain column name
encryptorName	String	Encrypt algorithm name

### Encrypt Algorithm Configuration

Class name: org.apache.shardingsphere.infra.config.algorithm.ShardingSphereAlgorithmConfiguration

Attributes:

<i>Name</i>	<i>DataType</i>	<i>Description</i>
name	String	Encrypt algorithm name
type	String	Encrypt algorithm type
properties	Properties	Encrypt algorithm properties

Please refer to [Built-in Encrypt Algorithm List](#) for more details about type of algorithm.

## Shadow DB

### Root Configuration

Class name: org.apache.shardingsphere.shadow.api.config.ShadowRuleConfiguration

Attributes:

<i>Name</i>	<i>Data Type</i>	<i>Description</i>
column	String	Shadow field name in SQL, SQL with a value of true will be routed to the shadow database for execution
sourceDataSourcesNames	List <String>	Source data source names
shadowDataSourcesNames	List <String>	Shadow data source names

## Governance

### Configuration Item Explanation

#### Management

##### *Configuration Entrance*

Class name: org.apache.shardingsphere.governance.repository.api.config.GovernanceConfiguration

Attributes:

<i>Name</i>	<i>Data Type</i>	<i>Description</i>
name	String	Governance instance name
registryCenterConfiguration	RegistryCenterConfiguration	Config of registry-center

The type of registryCenter could be Zookeeper or Etcd.

##### *Governance Instance Configuration*

Class name: org.apache.shardingsphere.governance.repository.api.config.ClusterPersistRepositoryConfiguration

Attributes:

Name*	Data Type*	Description
type	String	Governance instance type, such as: Zookeeper, etcd
serverLists	String	The list of servers that connect to governance instance, including IP and port number, use commas to separate, such as: host1:2181,host2:2181
props	Properties	Properties for center instance config, such as options of zookeeper
overwrite	boolean	Local configurations overwrite config center configurations or not; if they overwrite, each start takes reference of local configurations

#### ZooKeeper Properties Configuration

Name	Data Type*	Description	Default Value
digest (?)	String	Connect to authority tokens in registry center	No need for authority
operationTimeoutMilliseconds (?)	int	The operation timeout milliseconds	500 milliseconds
maxRetries (?)	int	The maximum retry count	3
retryIntervalMilliseconds (?)	int	The retry interval milliseconds	500 milliseconds
timeToLiveSeconds (?)	int	Time to live seconds for ephemeral nodes	60 seconds

#### Etcd Properties Configuration

Name	Data Type	Description	Default Value
timeToLiveSeconds (?)	long	Time to live seconds for data persist	30 seconds

## ShardingSphere-4.x

### Sharding

#### ShardingDataSourceFactory

<i>Name</i>	<i>DataType</i>	<i>Explanation</i>
dataSourceMap	Map<String, DataSource>	Data sources configuration
shardingRuleConfig	ShardingRuleConfiguration	Data sharding configuration rule
props (?)	Properties	Property configurations

#### ShardingRuleConfiguration

<i>Name</i>	<i>DataType</i>	<i>Explanation</i>
tableRuleConfigs	Collection	Sharding rule list
bindingTableGroups (?)	Collection	Binding table rule list
broadcastTables (?)	Collection	Broadcast table rule list
defaultDataSourceName (?)	String	Tables not configured with sharding rules will locate according to default data sources
defaultDatabaseShardingStrategyConfig (?)	ShardingStrategyConfiguration	Default database sharding strategy
defaultTableShardingStrategyConfig (?)	ShardingStrategyConfiguration	Default table sharding strategy
defaultKeyGeneratorConfig (?)	KeyGeneratorConfiguration	Default key generator configuration, use user-defined ones or built-in ones, e.g. SNOWFLAKE/UUID. Default key generator is <code>org.apache.shardingsphere.core.keygen.generator.impl.SnowflakeKeyGenerator</code>
masterSlaveRuleConfigs (?)	Collection	Read-write split rules, default indicates not using read-write split

### TableRuleConfiguration

<i>Name</i>	<i>DataType</i>	<i>Explanation</i>
logicTable	String	Name of logic table
actual-DataNodes (?)	String	Describe data source names and actual tables, delimiter as point, multiple data nodes split by comma, support inline expression. Absent means sharding databases only. Example: ds: math:{0..7}.tbl{0..7}
database-ShardingStrategyConfig (?)	Sharding Strategy-Configuration	Databases sharding strategy, use default databases sharding strategy if absent
table-ShardingStrategyConfig (?)	Sharding Strategy-Configuration	Tables sharding strategy, use default databases sharding strategy if absent
key GeneratorConfig (?)	KeyGeneratorConfiguration	Key generator configuration, use default key generator if absent
encryptorConfiguration (?)	EncryptorConfiguration	Encrypt generator configuration

### StandardShardingStrategyConfiguration

Subclass of ShardingStrategyConfiguration.

<i>Name</i>	<i>DataType</i>	<i>Explanation</i>
shardingColumn	String	Sharding column name
preciseShardingAlgorithm	PreciseShardingAlgorithm	Precise sharding algorithm used in = and IN
rangeShardingAlgorithm (?)	RangeShardingAlgorithm	Range sharding algorithm used in BETWEEN



### ComplexShardingStrategyConfiguration

The implementation class of `ShardingStrategyConfiguration`, used in complex sharding situations with multiple sharding keys.

<i>Name</i>	<i>DataType</i>	<i>Explanation</i>
shardingColumns	String	Sharding column name, separated by commas
shardingAlgorithm	Complex KeysShardingAlgorithm	Complex sharding algorithm

### InlineShardingStrategyConfiguration

The implementation class of `ShardingStrategyConfiguration`, used in sharding strategy of inline expression.

<i>Name</i>	<i>DataType</i>	<i>Explanation</i>
shardingColumns	String	Sharding column name, separated by commas
algorithmExpression	String	Inline expression of sharding strategies, should conform to groovy syntax; refer to Inline expression for more details

### HintShardingStrategyConfiguration

The implementation class of `ShardingStrategyConfiguration`, used to configure hint sharding strategies.

<i>Name</i>	<i>DataType</i>	<i>Description</i>
shardingAlgorithm	HintShardingAlgorithm	Hint sharding algorithm

### NoneShardingStrategyConfiguration

The implementation class of `ShardingStrategyConfiguration`, used to configure none-sharding strategies.

### KeyGeneratorConfiguration

Name	Data Type	Description
column	String	Column name of key generator
type	String	Type of key generator, use user-defined ones or built-in ones, e.g. SNOWFLAKE, UUID
props	Properties	The Property configuration of key generators

### Properties

Property configuration that can include these properties of these key generators.

#### SNOWFLAKE

Name	Data Type*	Explanation
max.tolerate.time.difference.milliseconds (?)	long	The max tolerate time for different server's time difference in milliseconds, the default value is 10
max.vibration.offset (?)	int	The max upper limit value of vibrate number, range [0, 4096), the default value is 1. Notice: To use the generated value of this algorithm as sharding value, it is recommended to configure this property. The algorithm generates $key \bmod 2^n$ ( $2^n$ is usually the sharding amount of tables or databases) in different milliseconds and the result is always 0 or 1. To prevent the above sharding problem, it is recommended to configure this property, its value is $(2^n) - 1$

## Readwrite-splitting

### MasterSlaveDataSourceFactory

Name	DataType	Explanation
dataSourceMap	Map<String, DataSource>	Mapping of data source and its name
master SlaveRuleConfig	MasterSlaveRuleConfiguration	Master slave rule configuration
props (?)	Properties	Property configurations

### MasterSlaveRuleConfiguration

Name	DataType	Explanation
name	String	Readwrite-splitting data source name
masterDataSourceName	String	Master database source name
slaveDataSourceNames	Collection	Slave database source name list
loadBalanceAlgorithm (?)	MasterSlaveLoadBalanceAlgorithm	Slave database load balance

## Properties

Property configuration items, can be of the following properties.

Name	DataType*	Explanation
sql.show (?)	boolean	Print SQL parse and rewrite log or not, default value: false
executor.size (?)	int	Be used in work thread number implemented by SQL; no limits if it is 0. default value: 0
max.connections.size.per.query (?)	int	The maximum connection number allocated by each query of each physical database, default value: 1
check.table.metadata.enabled (?)	boolean	Check meta-data consistency or not in initialization, default value: false

## Data Masking

### EncryptDataSourceFactory

<i>Name</i>	<i>DataType</i>	<i>Explanation</i>
dataSource	DataSource	Data source
encryptRuleConfig	EncryptRuleConfiguration	encrypt rule configuration
props (?)	Properties	Property configurations

### EncryptRuleConfiguration

<i>Name</i>	<i>DataType</i>	<i>Explanation</i>
encryptors	Map<String, EncryptorRuleConfiguration>	Encryptor names and encryptors
tables	Map<String, EncryptTableRuleConfiguration>	Encrypt table names and encrypt tables

## Properties

Property configuration items, can be of the following properties.

<i>Name</i>	<i>DataType</i>	<i>Explanation</i>
	• Data Type*	
sql.show (?)	boolean	Print SQL parse and rewrite log or not, default value: false
query.with.cipher.column (?)	boolean	When there is a plainColumn, use cipherColumn or not to query, default value: true

## Orchestration

### OrchestrationShardingDataSourceFactory

<i>Name</i>	<i>DataType</i>	<i>Explanation</i>
dataSourceMap	Map<String, DataSource>	Same as `` ShardingDataSourceFactory``
shardingRuleConfig	ShardingRuleConfiguration	Same as `` ShardingDataSourceFactory``
props (?)	Properties	Same as `` ShardingDataSourceFactory``
orchestrationConfig	OrchestrationConfiguration	Orchestration rule configurations

### OrchestrationMasterSlaveDataSourceFactory

Name	DataType	Explanation
dataSourceMap	Map<String, DataSource>	Same as MasterSlaveDataSourceFactory
master SlaveRule-Config	MasterSlaveRuleConfiguration	Same as MasterSlaveDataSourceFactory
configMap (?)	Map<String, Object>	Same as MasterSlaveDataSourceFactory
props (?)	Properties	Same as `` ShardingDataSourceFactory``
orch estrationConfig	Orche strationConfiguration	Orchestration rule configurations

### OrchestrationEncryptDataSourceFactory

Name	DataType	Explanation
dataSource	DataSource	Same as ` EncryptDataSourceFactory`
en cryptRuleConfig	Enc rypptRuleConfiguration	Same as ` EncryptDataSourceFactory`
props (?)	Properties	Same as ` EncryptDataSourceFactory`
orch estrationConfig	Orche strationConfiguration	Orchestration rule configurations

### OrchestrationConfiguration

Name	DataType	Explanation
instanceC onfiguration-Map	Map<String, Cen terConfiguration>	config map of con fig-center&registry-center, the key is center' s name, the value is the co nfig-center/registry-center

## CenterConfiguration

Name	Data Type	Explanation
type	String	The type of center instance(zookeeper/etcd/apollo/nacos)
properties	String	Properties for center instance config, such as options of zookeeper
orchestrationType	String	The type of orchestration center: config-center or registry-center, if both, use "setOrchestrationType( "registry_center,config_center" );"
serverLists	String	Connect to server lists in center, including IP address and port number; addresses are separated by commas, such as host1:2181,host2:2181
namespace (?)	String	Namespace of center instance

## Properties

Property configuration items, can be of the following properties.

Name	Data Type*	Explanation
overwrite	boolean	Local configurations overwrite center configurations or not; if they overwrite, each start takes reference of local configurations

If type of center is zookeeper with config-center&registry-center, properties could be set with the follow options:

Name	Data Type*	Explanation
digest (?)	String	Connect to authority tokens in registry center; default indicates no need for authority
operationTimeoutMilliseconds (?)	int	The operation timeout millisecond number, default to be 500 milliseconds
maxRetries (?)	int	The maximum retry count, default to be 3 times
retryIntervalMilliseconds (?)	int	The retry interval millisecond number, default to be 500 milliseconds
timeToLiveSeconds (?)	int	The living time for temporary nodes, default to be 60 seconds

If type of center is etcd with config-center&registry-center, properties could be set with the following options:

Name	Data Type*	Explanation
timeToLiveSeconds (?)	long	The etcd TTL in seconds, default to be 30 seconds

If type of center is apollo with config-center&registry-center, properties could be set with the following options:

Name	Data Type*	Explanation
appId (?)	String	Apollo appId, default to be "APOLLO_SHARDINGSPHERE"
env (?)	String	Apollo env, default to be "DEV"
clusterName (?)	String	Apollo clusterName, default to be "default"
administrator (?)	String	Apollo administrator, default to be ""
token (?)	String	Apollo token, default to be ""
portalUrl (?)	String	Apollo portalUrl, default to be ""
connectTimeout (?)	int	Apollo connectTimeout, default to be 1000 milliseconds
readTimeout (?)	int	Apollo readTimeout, default to be 5000 milliseconds

If type of center is nacos with config-center&registry-center, properties could be set with the follow options:

<i>Name</i>	<i>Data Type</i>	<i>Explanation</i>
group (?)	String	Nacos group, "SHARDING_SPHERE_DEFAULT_GROUP" in default
timeout (?)	long	Nacos timeout, default to be 3000 milliseconds

### ShardingSphere-3.x

#### Sharding

#### ShardingDataSourceFactory

<i>Name</i>	<i>DataType</i>	<i>Explanation</i>
dataSourceMap	Map<String, DataSource>	Data sources configuration
shardingRuleConfig	ShardingRuleConfiguration	Data sharding configuration rule
configMap (?)	Map<String, Object>	Config map
props (?)	Properties	Property configurations

#### ShardingRuleConfiguration

<i>Name</i>	<i>DataType</i>	<i>Explanation</i>
tableRuleConfigs	Collection	Table rule configuration
bindingTableGroups (?)	Collection	Binding table groups
broadcastTables (?)	Collection	Broadcast table groups
defaultDataSourceName (?)	String	Tables not configured with sharding rules will locate according to default data sources
defaultDatabaseShardingStrategyConfig (?)	ShardingStrategyConfiguration	Default database sharding strategy
defaultTableShardingStrategyConfig (?)	ShardingStrategyConfiguration	Default table sharding strategy
defaultKeyGeneratorConfig (?)	KeyGenerator	Default key generator, default value is io.shardingsphere.core.keygen.DefaultKeyGenerator
masterSlaveRuleConfigs (?)	Collection	Read-write splitting rule configuration



### TableRuleConfiguration

<i>Name</i>	<i>DataType</i>	<i>Explanation</i>
logicTable	String	Name of logic table
actual-DataNodes (?)	String	Describe data source names and actual tables, delimiter as point, multiple data nodes split by comma, support inline expression. Absent means sharding databases only. Example: ds: math:{0..7}.tbl{0..7}
database-ShardingStrategyConfig (?)	Sharding Strategy-Configuration	Databases sharding strategy, use default databases sharding strategy if absent
table-ShardingStrategyConfig (?)	Sharding Strategy-Configuration	Tables sharding strategy, use default databases sharding strategy if absent
logicIndex (?)	String	Name if logic index. If use DROP INDEX XXX SQL in Oracle/PostgreSQL, This property needs to be set for finding the actual tables
key GeneratorConfig (?)	String	Key generator column name, do not use Key generator if absent
keyGenerator (?)	KeyGenerator	Key generator, use default key generator if absent

### StandardShardingStrategyConfiguration

Subclass of ShardingStrategyConfiguration.

<i>Name</i>	<i>DataType</i>	<i>Explanation</i>
shardingColumn	String	Sharding column name
preciseShardingAlgorithm	PreciseShardingAlgorithm	Precise sharding algorithm used in = and IN
rangeShardingAlgorithm (?)	RangeShardingAlgorithm	Range sharding algorithm used in BETWEEN

### ComplexShardingStrategyConfiguration

Subclass of ShardingStrategyConfiguration.

<i>Name</i>	<i>DataType</i>	<i>Explanation</i>
shardingColumns	String	Sharding column name, separated by commas
shardingAlgorithm	Complex KeysShardingAlgorithm	Complex sharding algorithm

### InlineShardingStrategyConfiguration

Subclass of ShardingStrategyConfiguration.

<i>Name</i>	<i>DataType</i>	<i>Explanation</i>
shardingColumns	String	Sharding column name, separated by commas
algorithmExpression	String	Inline expression of sharding strategies, should conform to groovy syntax; refer to Inline expression for more details

### HintShardingStrategyConfiguration

Subclass of ShardingStrategyConfiguration.

<i>Name</i>	<i>DataType</i>	<i>Description</i>
shardingAlgorithm	HintShardingAlgorithm	Hint sharding algorithm

### NoneShardingStrategyConfiguration

Subclass of ShardingStrategyConfiguration.

### Properties

Enumeration of properties.

<i>Name</i>	<i>Data Type*</i>	<i>Explanation</i>
sql.show (?)	boolean	Print SQL parse and rewrite log, default value: false
executor.size (?)	int	The number of SQL execution threads, zero means no limit. default value: 0
max.connections.size.per.query (?)	int	Max connection size for every query to every actual database. default value: 1
check.table.metadata.enabled (?)	boolean	Check the metadata consistency of all the tables, default value : false

### configMap

User-defined arguments.

### Readwrite-splitting

#### MasterSlaveDataSourceFactory

<i>Name</i>	<i>DataType</i>	<i>Description</i>
dataSourceMap	Map<String, DataSource>	Map of data sources and their names
masterSlaveRuleConfig	MasterSlaveRuleConfiguration	Master slave rule configuration
configMap (?)	Map<String, Object>	Config map
props (?)	Properties	Properties

#### MasterSlaveRuleConfiguration

<i>Name</i>	<i>DataType</i>	<i>Description</i>
name	String	Name of master slave data source
masterDataSourceName	String	Name of master data source
slaveDataSourceNames	Collection	Names of Slave data sources
loadBalanceAlgorithm (?)	MasterSlaveLoadBalanceAlgorithm	Load balance algorithm

### configMap

User-defined arguments.

### PropertiesConstant

Enumeration of properties.

Name	• Dat aTy pe*	Description
sql.show (?)	b ool ean	To show SQLS or not, default value: false
executor.size (?)	int	The number of working threads, default value: CPU count
max.conne ctions.size.per.query (?)	int	Max connection size for every query to every actual database. default value: 1
check.ta ble.metadata.enabled (?)	b ool ean	Check the metadata consistency of all the tables, default value : false

### Orchestration

#### OrchestrationShardingDataSourceFactory

Name	Data Type	Explanation
dataSourceMap	Map<String, DataSource>	Same as `` ShardingDataSourceFactory``
sha rdingRuleConfig	Shar dingRuleConfiguration	Same as `` ShardingDataSourceFactory``
configMap (?)	Map<String, Object>	Same with `` ShardingDataSourceFactory``
props (?)	Properties	Same as `` ShardingDataSourceFactory``
orch estrationConfig	Orche strationConfiguration	Orchestration rule configurations

### OrchestrationMasterSlaveDataSourceFactory

Name	DataType	Explanation
dataSourceMap	Map<String, DataSource>	Same as MasterSlaveDataSourceFactory
master SlaveRule-Config	MasterSlaveRuleConfiguration	Same as MasterSlaveDataSourceFactory
configMap (?)	Map<String, Object>	Same as MasterSlaveDataSourceFactory
props (?)	Properties	Same as ``ShardingDataSourceFactory``
orchestrationConfig	OrchestrationConfiguration	Orchestration configurations

### OrchestrationConfiguration

Name	DataType	Explanation
name	String	Name of orchestration instance
overwrite	boolean	Use local configuration to overwrite registry center or not
regCenterConfig	RegistryCenterConfiguration	Registry center configuration

### RegistryCenterConfiguration

Name	DataType	Explanation
serverLists	String	Registry servers list, multiple split as comma. Example: host1:2181,host2:2181
namespace (?)	String	Namespace of registry
digest (?)	String	Digest for registry. Default is not need digest.
operationTime outMilliseconds (?)	int	Operation timeout time in milliseconds. Default value is 500 milliseconds.
maxRetries (?)	int	Max number of times to retry. Default value is 3
retryIntervalMilliseconds (?)	int	Time interval in milliseconds on each retry. Default value is 500 milliseconds.
timeToLiveSeconds (?)	int	Time to live in seconds of ephemeral keys. Default value is 60 seconds.

## ShardingSphere-2.x

### Readwrite-splitting

#### concept

In order to relieve the pressure on the database, the write and read operations are separated into different data sources. The write library is called the master library, and the read library is called the slave library. One master library can be configured with multiple slave libraries.

#### Supported

1. Provides a readwrite-splitting configuration with one master and multiple slaves, which can be used independently or with sub-databases and sub-meters.
2. Independent use of readwrite-splitting to support SQL transparent transmission.
3. In the same thread and the same database connection, if there is a write operation, subsequent read operations will be read from the main library to ensure data consistency.
4. Spring namespace.
5. Hint-based mandatory main library routing.

#### Unsupported

1. Data synchronization between the master library and the slave library.
2. Data inconsistency caused by the data synchronization delay of the master library and the slave library.
3. Double writing or multiple writing in the main library.

#### Code development example

##### only readwrite-splitting

```
// Constructing a readwrite-splitting data source, the readwrite-splitting data
source implements the DataSource interface, which can be directly processed as a
data source. masterDataSource, slaveDataSource0, slaveDataSource1, etc. are real
data sources configured using connection pools such as DBCP
Map<String, DataSource> dataSourceMap = new HashMap<>();
dataSourceMap.put("masterDataSource", masterDataSource);
dataSourceMap.put("slaveDataSource0", slaveDataSource0);
dataSourceMap.put("slaveDataSource1", slaveDataSource1);

// Constructing readwrite-splitting configuration
```

```

MasterSlaveRuleConfiguration masterSlaveRuleConfig = new
MasterSlaveRuleConfiguration();
masterSlaveRuleConfig.setName("ms_ds");
masterSlaveRuleConfig.setMasterDataSourceName("masterDataSource");
masterSlaveRuleConfig.getSlaveDataSourceNames().add("slaveDataSource0");
masterSlaveRuleConfig.getSlaveDataSourceNames().add("slaveDataSource1");

DataSource dataSource = MasterSlaveDataSourceFactory.
createDataSource(dataSourceMap, masterSlaveRuleConfig);

```

### sharding table and database + readwrite-splitting

```

// Constructing a readwrite-splitting data source, the readwrite-splitting data
source implements the DataSource interface, which can be directly processed as a
data source. masterDataSource, slaveDataSource0, slaveDataSource1, etc. are real
data sources configured using connection pools such as DBCP
Map<String, DataSource> dataSourceMap = new HashMap<>();
dataSourceMap.put("masterDataSource0", masterDataSource0);
dataSourceMap.put("slaveDataSource00", slaveDataSource00);
dataSourceMap.put("slaveDataSource01", slaveDataSource01);

dataSourceMap.put("masterDataSource1", masterDataSource1);
dataSourceMap.put("slaveDataSource10", slaveDataSource10);
dataSourceMap.put("slaveDataSource11", slaveDataSource11);

// Constructing readwrite-splitting configuration
MasterSlaveRuleConfiguration masterSlaveRuleConfig0 = new
MasterSlaveRuleConfiguration();
masterSlaveRuleConfig0.setName("ds_0");
masterSlaveRuleConfig0.setMasterDataSourceName("masterDataSource0");
masterSlaveRuleConfig0.getSlaveDataSourceNames().add("slaveDataSource00");
masterSlaveRuleConfig0.getSlaveDataSourceNames().add("slaveDataSource01");

MasterSlaveRuleConfiguration masterSlaveRuleConfig1 = new
MasterSlaveRuleConfiguration();
masterSlaveRuleConfig1.setName("ds_1");
masterSlaveRuleConfig1.setMasterDataSourceName("masterDataSource1");
masterSlaveRuleConfig1.getSlaveDataSourceNames().add("slaveDataSource10");
masterSlaveRuleConfig1.getSlaveDataSourceNames().add("slaveDataSource11");

// Continue to create ShardingDataSource through ShardingSlaveDataSourceFactory
ShardingRuleConfiguration shardingRuleConfig = new ShardingRuleConfiguration();
shardingRuleConfig.getMasterSlaveRuleConfigs().add(masterSlaveRuleConfig0);
shardingRuleConfig.getMasterSlaveRuleConfigs().add(masterSlaveRuleConfig1);

DataSource dataSource = ShardingDataSourceFactory.createDataSource(dataSourceMap,

```

```
shardingRuleConfig);
```

## ShardingSphere-1.x

### Readwrite-splitting

#### concept

In order to relieve the pressure on the database, the write and read operations are separated into different data sources. The write library is called the master library, and the read library is called the slave library. One master library can be configured with multiple slave libraries.

#### Supported

1. Provides a readwrite-splitting configuration with one master and multiple slaves, which can be used independently or with sub-databases and sub-meters.
2. In the same thread and the same database connection, if there is a write operation, subsequent read operations will be read from the main library to ensure data consistency.
3. Spring namespace.
4. Hint-based mandatory main library routing.

#### Unsupported

1. Data synchronization between the master library and the slave library.
2. Data inconsistency caused by the data synchronization delay of the master library and the slave library.
3. Double writing or multiple writing in the main library.

#### Code development example

```
// Constructing a readwrite-splitting data source, the readwrite-splitting data
// source implements the DataSource interface, which can be directly processed as a
// data source. masterDataSource, slaveDataSource0, slaveDataSource1, etc. are real
// data sources configured using connection pools such as DBCP
Map<String, DataSource> slaveDataSourceMap0 = new HashMap<>();
slaveDataSourceMap0.put("slaveDataSource00", slaveDataSource00);
slaveDataSourceMap0.put("slaveDataSource01", slaveDataSource01);
// You can choose the master-slave library load balancing strategy, the default is
// ROUND_ROBIN, and there is RANDOM to choose from, or customize the load strategy
DataSource masterSlaveDs0 = MasterSlaveDataSourceFactory.createDataSource("ms_0",
"masterDataSource0", masterDataSource0, slaveDataSourceMap0,
```



```

MasterSlaveLoadBalanceStrategyType.ROUND_ROBIN);

Map<String, DataSource> slaveDataSourceMap1 = new HashMap<>();
slaveDataSourceMap1.put("slaveDataSource10", slaveDataSource10);
slaveDataSourceMap1.put("slaveDataSource11", slaveDataSource11);
DataSource masterSlaveDs1 = MasterSlaveDataSourceFactory.createDataSource("ms_1",
"masterDataSource1", masterDataSource1, slaveDataSourceMap1,
MasterSlaveLoadBalanceStrategyType.ROUND_ROBIN);

// Constructing readwrite-splitting configuration
Map<String, DataSource> dataSourceMap = new HashMap<>();
dataSourceMap.put("ms_0", masterSlaveDs0);
dataSourceMap.put("ms_1", masterSlaveDs1);

```

### Spring namespace configuration change history

#### ShardingSphere-5.0.0-beta

#### Sharding

#### Configuration Item Explanation

Namespace: <http://shardingsphere.apache.org/schema/shardingsphere/sharding/sharding-5.0.0.xsd>

<sharding:rule />

Name	Type	Description
id	A ttribute	Spring Bean Id
table-rules (?)	Tag	Sharding table rule configuration
auto-table-rules (?)	Tag	Automatic sharding table rule configuration
binding-table-rules (?)	Tag	Binding table rule configuration
broadcast-table-rules (?)	Tag	Broadcast table rule configuration
default-database-strategy-ref (?)	A ttribute	Default database strategy name
default-table-strategy-ref (?)	A ttribute	Default table strategy name
default-key-generate-strategy-ref (?)	A ttribute	Default key generate strategy name
default-sharding-column (?)	A ttribute	Default sharding column name

<sharding:table-rule />

<i>Name</i>	<i>Type</i>	<i>Description</i>
logic-table	Attribute	Logic table name
actual-data-nodes	Attribute	Describe data source names and actual tables, delimiter as point, multiple data nodes separated with comma, support inline expression. Absent means sharding databases only.
actual-data-sources	Attribute	Data source names for auto sharding table
database-strategy-ref	Attribute	Database strategy name for standard sharding table
table-strategy-ref	Attribute	Table strategy name for standard sharding table
sharding-strategy-ref	Attribute	sharding strategy name for auto sharding table
key-generate-strategy-ref	Attribute	Key generate strategy name

<sharding:binding-table-rules />

<i>Name</i>	<i>Type</i>	<i>Description</i>
binding-table-rule (+)	Tag	Binding table rule configuration

<sharding:binding-table-rule />

<i>Name</i>	<i>Type</i>	<i>Description</i>
	• Type*	
logic-tables	Attribute	Binding table name, multiple tables separated with comma

<sharding:broadcast-table-rules />

<i>Name</i>	<i>Type</i>	<i>Description</i>
broadcast-table-rule (+)	Tag	Broadcast table rule configuration

<sharding:broadcast-table-rule />

<i>Name</i>	<i>Type</i>	<i>Description</i>
table	Attribute	Broadcast table name

<sharding:standard-strategy />

<i>Name</i>	<i>Type</i>	<i>Description</i>
id	Attribute	Standard sharding strategy name
sharding-column	Attribute	Sharding column name
algorithm-ref	Attribute	Sharding algorithm name

<sharding:complex-strategy />

<i>Name</i>	<i>Type</i>	<i>Description</i>
id	Attribute	Complex sharding strategy name
sharding-columns	Attribute	Sharding column names, multiple columns separated with comma
algorithm-ref	Attribute	Sharding algorithm name

<sharding:hint-strategy />

<i>Name</i>	<i>Type</i>	<i>Description</i>
id	Attribute	Hint sharding strategy name
algorithm-ref	Attribute	Sharding algorithm name

<sharding:none-strategy />

<i>Name</i>	<i>Type</i>	<i>Description</i>
id	Attribute	Sharding strategy name

<sharding:key-generate-strategy />

<i>Name</i>	<i>Type</i>	<i>Description</i>
id	Attribute	Key generate strategy name
column	Attribute	Key generate column name
algorithm-ref	Attribute	Key generate algorithm name

<sharding:sharding-algorithm />

<i>Name</i>	<i>Type</i>	<i>Description</i>
id	Attribute	Sharding algorithm name
type	Attribute	Sharding algorithm type
props (?)	Tag	Sharding algorithm properties

<sharding:key-generate-algorithm />

Name	Type	Description
id	Attribute	Key generate algorithm name
type	Attribute	Key generate algorithm type
props (?)	Tag	Key generate algorithm properties

Please refer to [Built-in Sharding Algorithm List](#) and [Built-in Key Generate Algorithm List](#) for more details about type of algorithm.

### Attention

Inline expression identifier can use  $\${...}$  or  $\$->\{...}$ , but  $\${...}$  is conflict with spring placeholder of properties, so use  $\$->\{...}$  on spring environment is better.

### Readwrite-Splitting

#### Configuration Item Explanation

Namespace: <http://shardingsphere.apache.org/schema/shardingsphere/readwrite-splitting/readwrite-splitting-5.0.0.xsd>

<readwrite-splitting:rule />

Name	Type	Description
	.	
	Type*	
id	Attribute	Spring Bean Id
data-source-rule (+)	Tag	Readwrite-splitting data source rule configuration

<readwrite-splitting:data-source-rule />

Name	Type	Description
id	Attribute	Readwrite-splitting data source rule name
write-data-source-name	Attribute	Write data source name
read-data-source-names	Attribute	Read data source names, multiple data source names separated with comma
load-balance-algorithm-ref	Attribute	Load balance algorithm name

<readwrite-splitting:load-balance-algorithm />

Name	Type	Description
id	Attribute	Load balance algorithm name
type	Attribute	Load balance algorithm type
props (?)	Tag	Load balance algorithm properties

Please refer to [Built-in Load Balance Algorithm List](#) for more details about type of algorithm. Please refer to [Use Norms](#) for more details about query consistent routing.

## Encryption

### Configuration Item Explanation

Namespace: <http://shardingsphere.apache.org/schema/shardingsphere/encrypt/encrypt-5.0.0.xsd>

<encrypt:rule />

Name	Type *	Description	Default Value
id	Attribute	Spring Bean Id	
queryWithCipherColumn (?)	Attribute	Whether query with cipher column for data encrypt. User you can use plaintext to query if have	true
table (+)	Tag	Encrypt table configuration	

<encrypt:table />

Name	Type	Description
name	Attribute	Encrypt table name
column (+)	Tag	Encrypt column configuration

<encrypt:column />

Name	Type	Description
logic-column	Attribute	Column logic name
cipher-column	Attribute	Cipher column name
assisted-query-column (?)	Attribute	Assisted query column name
plain-column (?)	Attribute	Plain column name
encrypt-algorithm-ref	Attribute	Encrypt algorithm name

<encrypt:encrypt-algorithm />

<i>Name</i>	<i>Type</i>	<i>Description</i>
id	Attribute	Encrypt algorithm name
type	Attribute	Encrypt algorithm type
props (?)	Tag	Encrypt algorithm properties

Please refer to [Built-in Encrypt Algorithm List](#) for more details about type of algorithm.

## Shadow-DB

### Configuration Item Explanation

Namespace: <http://shardingsphere.apache.org/schema/shardingsphere/shadow/shadow-5.0.0.xsd>

<shadow:rule />

<i>Name</i>	<i>Type</i>	<i>Description</i>
id	At-tribute	Spring Bean Id
column	At-tribute	Shadow column name
map-pings(?)	Tag	Mapping relationship between production database and shadow database

<shadow:mapping />

<i>Name</i>	<i>Type</i>	<i>Description</i>
product-data-source-name	Attribute	Production database name
shadow-data-source-name	Attribute	Shadow database name

## 4.x

### Sharding

#### Configuration Item Explanation

Namespace: <http://shardingsphere.apache.org/schema/shardingsphere/sharding/sharding.xsd>

<sharding:data-source />

<i>Name</i>	<i>Type</i>	<i>Description</i>
id	Attribute	Spring Bean Id
sharding-rule	Tag	Sharding rule configuration
props (?)	Tag	Properties

<sharding:sharding-rule />

<i>Name</i>	<i>T ype</i>	<i>Description</i>
data-source-names	Attribute	Data source Bean list with comma separating multiple Beans
table-rules	Tag	Configuration objects of table sharding rules
binding-table-rules (?)	Tag	Binding table rule list
broadcast-table-rules (?)	Tag	Broadcast table rule list
default-data-source-name (?)	Attribute	Tables without sharding rules will be located through default data source
default-database-strategy-ref (?)	Attribute	Default database sharding strategy, which corresponds to id of ; default means the database is not split
default-table-strategy-ref (?)	Attribute	Default table sharding strategy, which corresponds to id of ; default means the database is not split
default-key-generator (?)	Attribute	Default key generator configuration, use user-defined ones or built-in ones, e.g. SNOWFLAKE/UUID. Default key generator is org.apache.shardingsphere.core.keygen.generator.impl.SnowflakeKeyGenerator
encrypt-rule (?)	Tag	Encrypt rule

<sharding:table-rules />

<i>Name</i>	<i>Type</i>	<i>Description</i>
table-rule (+)	Tag	Configuration objects of table sharding rules

<sharding:table-rule />

<i>Name</i>	<i>Type</i>	<i>Description</i>
logic-table	Attribute	Logic table name
actual-data-nodes (?)	Attribute	Describe data source names and actual tables, delimiter as point, multiple data nodes separated with comma, support inline expression. Absent means sharding databases only.
database-strategy-ref	Attribute	Database strategy name for standard sharding table
table-strategy-ref	Attribute	Table strategy name for standard sharding table
key-generate-strategy-ref	Attribute	Key generate strategy name

<sharding:binding-table-rules />

<i>Name</i>	<i>Type</i>	<i>Description</i>
binding-table-rule (+)	Tag	Binding table rule configuration

<sharding:binding-table-rule />

<i>Name</i>	<i>Type</i>	<i>Description</i>
	• Type*	
logic-tables	Attribute	Binding table name, multiple tables separated with comma

<sharding:broadcast-table-rules />

<i>Name</i>	<i>Type</i>	<i>Description</i>
broadcast-table-rule (+)	Tag	Broadcast table rule configuration

<sharding:broadcast-table-rule />

<i>Name</i>	<i>Type</i>	<i>Description</i>
table	Attribute	Broadcast table name

<sharding:standard-strategy />



Name	Type	Description
id	Attribute	Standard sharding strategy name
sharding-column	Attribute	Sharding column name
precise-algorithm-ref (?)	Attribute	Precise algorithm reference, applied in = and IN; the class needs to implement PreciseShardingAlgorithm interface
range-algorithm-ref (?)	Attribute	Range algorithm reference, applied in BETWEEN; the class needs to implement RangeShardingAlgorithm interface

<sharding:complex-strategy />

Name	Type	Description
id	Attribute	Complex sharding strategy name
sharding-columns	Attribute	Sharding column names, multiple columns separated with comma
algorithm-ref	Attribute	Complex sharding algorithm reference; the class needs to implement ComplexKeysShardingAlgorithm interface

<sharding:inline-strategy />

Name	Type	Description
id	Attribute	Spring Bean Id
sharding-columns	Attribute	Sharding column names, multiple columns separated with comma
algorithm-ref	Attribute	Sharding algorithm inline expression, which needs to conform to groovy statements

<sharding:hint-database-strategy />

Name	Type	Description
id	Attribute	Hint sharding strategy name
algorithm-ref	Attribute	Hint sharding algorithm; the class needs to implement HintShardingAlgorithm interface

<sharding:none-strategy />

Name	Type	Description
id	Attribute	Spring Bean Id

<sharding:key-generator />

Name	Type	Description
column	Attribute	Auto-increment column name
type	Attribute	Auto-increment key generator Type; self-defined generator or internal Type generator (SNOWFLAKE/UUID) can both be selected
props-ref	Attribute	The Property configuration reference of key generators

Properties Property configuration that can include these properties of these key generators.

SNOWFLAKE | Name | Data Type | Explanation | | ——— | ——— | ————— | | max.tolerate.time.difference.milliseconds (?) | long | The max tolerate time for different server's time difference in milliseconds, the default value is 10 | | max.vibration.offset (?) | int | The max upper limit value of vibrate number, range [0, 4096), the default value is 1. Notice: To use the generated value of this algorithm as sharding value, it is recommended to configure this property. The algorithm generates key mod  $2^n$  ( $2^n$  is usually the sharding amount of tables or databases) in different milliseconds and the result is always 0 or 1. To prevent the above sharding problem, it is recommended to configure this property, its value is  $(2^n) - 1$  |

<sharding:encrypt-rules />

Name	Type	Description
encryptor-rule (+)	Tag	Encryptor rule

<sharding:encrypt-rule />

Name	Type	Description
encrypt:encrypt-rule(?)	Tag	Encrypt rule

<sharding:props />

Name	Type	Description
sql.show (?)	Attribute	Show SQL or not; default value: false
executor.size (?)	Attribute	Executing thread number; default value: CPU core number
max.connections.size.per.query (?)	Attribute	The maximum connection number that each physical database allocates to each query; default value: 1
checktable.metadata.enabled (?)	Attribute	Whether to check meta-data consistency of sharding table when it initializes; default value: false
query.with.cipher.column (?)	Attribute	When there is a plainColumn, use cipherColumn or not to query, default value: true

## Readwrite-Splitting

### Configuration Item Explanation

Namespace: <http://shardingsphere.apache.org/schema/shardingsphere/master-slave/master-slave.xsd>

<master-slave:data-source />

Name	Type	Explanation
id	Attribute	Spring Bean id
master-data-source-name	Attribute	Bean id of data source in master database
slave-data-source-names	Attribute	Bean id list of data source in slave database; multiple Beans are separated by commas
strategy-ref (?)	Attribute	Slave database load balance algorithm reference; the class needs to implement MasterSlaveLoadBalanceAlgorithm interface
strategy-type (?)	Attribute	Load balance algorithm type of slave database; optional value: ROUND_ROBIN and RANDOM; if there is load-balance-algorithm-class-name, the configuration can be omitted
config-map (?)	Tag	Users' self-defined configurations
props (?)	Tag	Attribute configurations

<master-slave:props />

Name	Type	Explanation
sql.show (?)	Attribute	Show SQL or not; default value: false
executor.size (?)	Attribute	Executing thread number; default value: CPU core number
max.connections.size.per.query (?)	Attribute	The maximum connection number that each physical database allocates to each query; default value: 1
check-table-metadata.enabled (?)	Attribute	Whether to check meta-data consistency of sharding table when it initializes; default value: false

<master-slave:load-balance-algorithm />

4.0.0-RC2 version added

Name	Type	Explanation
id	Attribute	Spring Bean Id
type	Attribute	Type of load balance algorithm, 'RANDOM' 或 'ROUND_ROBIN' , support custom extension
props-ref (?)	Attribute	Properties of load balance algorithm

## Data Masking

### Configuration Item Explanation

Namespace: <http://shardingsphere.apache.org/schema/shardingsphere/encrypt/encrypt.xsd>

<encrypt:data-source />

Name	Type	Type
id	Attribute	Spring Bean Id
data-source-name	Attribute	Encrypt data source Bean Id
props (?)	Tag	Attribute configurations

<encrypt:encryptors />

Name	Type	Type
encryptor(+)	Tag	Encryptor configuration

<encrypt:encryptor />

Name	Type	Type
id	Attribute	Names of Encryptor
type	Attribute	Types of Encryptor, including MD5/AES or customize type
props-re	Attribute	Attribute configurations

<encrypt:tables />

Name	Type	Type
table(+)	Tag	Encrypt table configuration

<encrypt:table />

Name	Type	Type
column(+)	Tag	Encrypt column configuration

<encrypt:column />

<i>Name</i>	<i>Type</i>	<i>Description</i>
logic-column	Attribute	Column logic name
cipher-column	Attribute	Cipher column name
assisted-query-column (?)	Attribute	Assisted query column name
plain-column (?)	Attribute	Plain column name

<encrypt:props />

<i>Name</i>	<i>Type</i>	<i>Description</i>
sql.show (?)	Attribute	Show SQL or not; default value: false
query.with.cipher.column (?)	Attribute	When there is a plainColumn, use cipherColumn or not to query, default value: true

## Orchestration

### Data Sharding + Orchestration

Namespace: <http://shardingsphere.apache.org/schema/shardingsphere/orchestration/orchestration.xsd>

<orchestration:master-slave-data-source />

<i>Name</i>	<i>Type</i>	<i>Description</i>
id	Attribute	Id
data-source-ref (?)	Attribute	Orchestrated database Id
registry-center-ref	Attribute	Registry center Id
overwrite	Attribute	Whether to overwrite local configurations with registry center configurations; if it can, each initialization should refer to local configurations; default means not to overwrite

### Read-Write Split + Orchestration

Namespace: <http://shardingsphere.apache.org/schema/shardingsphere/orchestration/orchestration.xsd>

<orchestration:sharding-data-source />

Name	Type	Description
id	Attribute	Id
data-source-ref (?)	Attribute	Orchestrated database Id
registry-center-ref	Attribute	Registry center Id
overwrite	Attribute	Use local configuration to overwrite registry center or not

### Data Masking + Orchestration

Namespace: <http://shardingsphere.apache.org/schema/shardingsphere/orchestration/orchestration.xsd>

<orchestration:encrypt-data-source />

Name	Type	Description
id	Attribute	Id
data-source-ref (?)	Attribute	Orchestrated database Id
registry-center-ref	Attribute	Registry center Id
overwrite	Attribute	Use local configuration to overwrite registry center or not

### Orchestration registry center

Namespace: <http://shardingsphere.apache.org/schema/shardingsphere/orchestration/orchestration.xsd>

<orchestration:registry-center />

Name	Type	Description
id	At-tribute	Spring Bean Id of registry center
type	At-tribute	Registry center type. Example:zookeeper
server-lists	At-tribute	Registry servers list, multiple split as comma. Example: host1:2181,host2:2181
namespace (?)	At-tribute	Namespace of registry
digest (?)	At-tribute	Digest for registry. Default is not need digest
operation-timeout- milliseconds (?)	At-tribute	Operation timeout time in milliseconds, default value is 500 seconds
max-retries (?)	At-tribute	Max number of times to retry, default value is 3
retry-interval- milliseconds (?)	At-tribute	Time interval in milliseconds on each retry, default value is 500 milliseconds
time-to-live-seconds (?)	At-tribute	Living time of temporary nodes; default value: 60 seconds
props-ref (?)	At-tribute	Other customize properties of registry center

### 3.x

Attention Inline expression identifier can use  $\${...}$  or  $\$->\{...}$ , but  $\${...}$  is conflict with spring placeholder of properties, so use  $\$->\{...}$  on spring environment is better.

## Sharding

### Configuration Item Explanation

```
<?xml version="1.0" encoding="UTF-8"?>
<beans xmlns="http://www.springframework.org/schema/beans"
  xmlns:xsi="http://www.w3.org/2001/XMLSchema-instance"
  xmlns:p="http://www.springframework.org/schema/p"
  xmlns:context="http://www.springframework.org/schema/context"
  xmlns:tx="http://www.springframework.org/schema/tx"
  xmlns:sharding="http://shardingsphere.io/schema/shardingsphere/sharding"
  xsi:schemaLocation="http://www.springframework.org/schema/beans
    http://www.springframework.org/schema/beans/spring-beans.
xsd
    http://shardingsphere.io/schema/shardingsphere/sharding
    http://shardingsphere.io/schema/shardingsphere/sharding/
```

```

sharding.xsd
    http://www.springframework.org/schema/context
    http://www.springframework.org/schema/context/spring-
context.xsd
    http://www.springframework.org/schema/tx
    http://www.springframework.org/schema/tx/spring-tx.xsd">
<context:annotation-config />
<context:component-scan base-package="io.shardingsphere.example.spring.
namespace.jpa" />

<bean id="entityManagerFactory" class="org.springframework.orm.jpa.
LocalContainerEntityManagerFactoryBean">
    <property name="dataSource" ref="shardingDataSource" />
    <property name="jpaVendorAdapter">
        <bean class="org.springframework.orm.jpa.vendor.
HibernateJpaVendorAdapter" p:database="MYSQL" />
    </property>
    <property name="packagesToScan" value="io.shardingsphere.example.spring.
namespace.jpa.entity" />
    <property name="jpaProperties">
        <props>
            <prop key="hibernate.dialect">org.hibernate.dialect.MySQLDialect</
prop>
            <prop key="hibernate.hbm2ddl.auto">create</prop>
            <prop key="hibernate.show_sql">>true</prop>
        </props>
    </property>
</bean>
<bean id="transactionManager" class="org.springframework.orm.jpa.
JpaTransactionManager" p:entityManagerFactory-ref="entityManagerFactory" />
<tx:annotation-driven />

<bean id="ds0" class="org.apache.commons.dbcp.BasicDataSource" destroy-method=
"close">
    <property name="driverClassName" value="com.mysql.jdbc.Driver" />
    <property name="url" value="jdbc:mysql://localhost:3306/ds0" />
    <property name="username" value="root" />
    <property name="password" value="" />
</bean>

<bean id="ds1" class="org.apache.commons.dbcp.BasicDataSource" destroy-method=
"close">
    <property name="driverClassName" value="com.mysql.jdbc.Driver" />
    <property name="url" value="jdbc:mysql://localhost:3306/ds1" />
    <property name="username" value="root" />
    <property name="password" value="" />
</bean>

```



```

    <bean id="preciseModuloDatabaseShardingAlgorithm" class="io.shardingsphere.
example.spring.namespace.jpa.algorithm.PreciseModuloDatabaseShardingAlgorithm" />
    <bean id="preciseModuloTableShardingAlgorithm" class="io.shardingsphere.
example.spring.namespace.jpa.algorithm.PreciseModuloTableShardingAlgorithm" />

    <sharding:standard-strategy id="databaseShardingStrategy" sharding-column=
"user_id" precise-algorithm-ref="preciseModuloDatabaseShardingAlgorithm" />
    <sharding:standard-strategy id="tableShardingStrategy" sharding-column="order_
id" precise-algorithm-ref="preciseModuloTableShardingAlgorithm" />

    <sharding:data-source id="shardingDataSource">
        <sharding:sharding-rule data-source-names="ds0,ds1">
            <sharding:table-rules>
                <sharding:table-rule logic-table="t_order" actual-data-nodes="ds$-
{0..1}.t_order$->{0..1}" database-strategy-ref="databaseShardingStrategy" table-
strategy-ref="tableShardingStrategy" generate-key-column-name="order_id" />
                <sharding:table-rule logic-table="t_order_item" actual-data-nodes=
"ds$->{0..1}.t_order_item$->{0..1}" database-strategy-ref="databaseShardingStrategy
" table-strategy-ref="tableShardingStrategy" generate-key-column-name="order_item_
id" />
            </sharding:table-rules>
            <sharding:binding-table-rules>
                <sharding:binding-table-rule logic-tables="t_order, t_order_item" /
>
            </sharding:binding-table-rules>
            <sharding:broadcast-table-rules>
                <sharding:broadcast-table-rule table="t_config" />
            </sharding:broadcast-table-rules>
        </sharding:sharding-rule>
    </sharding:data-source>
</beans>

```

## Readwrite-splitting

### Configuration Item Explanation

```

<?xml version="1.0" encoding="UTF-8"?>
<beans xmlns="http://www.springframework.org/schema/beans"
xmlns:xsi="http://www.w3.org/2001/XMLSchema-instance"
xmlns:context="http://www.springframework.org/schema/context"
xmlns:p="http://www.springframework.org/schema/p"
xmlns:tx="http://www.springframework.org/schema/tx"
xmlns:master-slave="http://shardingsphere.io/schema/shardingsphere/
masterslave"
xsi:schemaLocation="http://www.springframework.org/schema/beans
http://www.springframework.org/schema/beans/spring-beans.

```

```

xsd
    http://www.springframework.org/schema/context
    http://www.springframework.org/schema/context/spring-
context.xsd
    http://www.springframework.org/schema/tx
    http://www.springframework.org/schema/tx/spring-tx.xsd
    http://shardingsphere.io/schema/shardingsphere/masterlave
    http://shardingsphere.io/schema/shardingsphere/masterlave/
master-slave.xsd">
    <context:annotation-config />
    <context:component-scan base-package="io.shardingsphere.example.spring.
namespace.jpa" />

    <bean id="entityManagerFactory" class="org.springframework.orm.jpa.
LocalContainerEntityManagerFactoryBean">
        <property name="dataSource" ref="masterSlaveDataSource" />
        <property name="jpaVendorAdapter">
            <bean class="org.springframework.orm.jpa.vendor.
HibernateJpaVendorAdapter" p:database="MYSQL" />
        </property>
        <property name="packagesToScan" value="io.shardingsphere.example.spring.
namespace.jpa.entity" />
        <property name="jpaProperties">
            <props>
                <prop key="hibernate.dialect">org.hibernate.dialect.MySQLDialect</
prop>
                <prop key="hibernate.hbm2ddl.auto">create</prop>
                <prop key="hibernate.show_sql">>true</prop>
            </props>
        </property>
    </bean>
    <bean id="transactionManager" class="org.springframework.orm.jpa.
JpaTransactionManager" p:entityManagerFactory-ref="entityManagerFactory" />
    <tx:annotation-driven />

    <bean id="ds_master" class="org.apache.commons.dbcp.BasicDataSource" destroy-
method="close">
        <property name="driverClassName" value="com.mysql.jdbc.Driver" />
        <property name="url" value="jdbc:mysql://localhost:3306/ds_master" />
        <property name="username" value="root" />
        <property name="password" value="" />
    </bean>

    <bean id="ds_slave0" class="org.apache.commons.dbcp.BasicDataSource" destroy-
method="close">
        <property name="driverClassName" value="com.mysql.jdbc.Driver" />
        <property name="url" value="jdbc:mysql://localhost:3306/ds_slave0" />
        <property name="username" value="root" />

```

```

    <property name="password" value="" />
  </bean>

  <bean id="ds_slave1" class="org.apache.commons.dbcp.BasicDataSource" destroy-
method="close">
    <property name="driverClassName" value="com.mysql.jdbc.Driver" />
    <property name="url" value="jdbc:mysql://localhost:3306/ds_slave1" />
    <property name="username" value="root" />
    <property name="password" value="" />
  </bean>

  <bean id="randomStrategy" class="io.shardingsphere.api.algorithm.masterslave.
RandomMasterSlaveLoadBalanceAlgorithm" />
  <master-slave:data-source id="masterSlaveDataSource" master-data-source-name=
"ds_master" slave-data-source-names="ds_slave0, ds_slave1" strategy-ref=
"randomStrategy">
    <master-slave:props>
      <prop key="sql.show">${sql_show}</prop>
      <prop key="executor.size">10</prop>
      <prop key="foo">bar</prop>
    </master-slave:props>
  </master-slave:data-source>
</beans>

```

## Orchestration

### Configuration Item Explanation

```

<?xml version="1.0" encoding="UTF-8"?>
<beans xmlns="http://www.springframework.org/schema/beans"
  xmlns:xsi="http://www.w3.org/2001/XMLSchema-instance"
  xmlns:sharding="http://shardingsphere.io/schema/shardingsphere/
orchestration/sharding"
  xmlns:master-slave="http://shardingsphere.io/schema/shardingsphere/
orchestration/masterslave"
  xmlns:reg="http://shardingsphere.io/schema/shardingsphere/orchestration/reg"
  xsi:schemaLocation="http://www.springframework.org/schema/beans
    http://www.springframework.org/schema/beans/spring-
beans.xsd
    http://shardingsphere.io/schema/shardingsphere/
orchestration/reg
    http://shardingsphere.io/schema/shardingsphere/
orchestration/reg/reg.xsd
    http://shardingsphere.io/schema/shardingsphere/
orchestration/sharding
    http://shardingsphere.io/schema/shardingsphere/

```

```

orchestration/sharding/sharding.xsd
        http://shardingsphere.io/schema/shardingsphere/
orchestration/masterslave
        http://shardingsphere.io/schema/shardingsphere/
orchestration/masterslave/master-slave.xsd">

    <reg:registry-center id="regCenter" server-lists="localhost:2181" namespace=
"orchestration-spring-namespace-demo" overwrite="false" />
    <sharding:data-source id="shardingMasterSlaveDataSource" registry-center-ref=
"regCenter" />
    <master-slave:data-source id="masterSlaveDataSource" registry-center-ref=
"regCenter" />
</beans>

```

## 2.x

### Readwrite-splitting

#### The configuration example for Spring namespace

```

<?xml version="1.0" encoding="UTF-8"?>
<beans xmlns="http://www.springframework.org/schema/beans"
    xmlns:xsi="http://www.w3.org/2001/XMLSchema-instance"
    xmlns:context="http://www.springframework.org/schema/context"
    xmlns:sharding="http://shardingsphere.io/schema/shardingjdbc/sharding"
    xmlns:masterslave="http://shardingsphere.io/schema/shardingjdbc/masterslave"
    xsi:schemaLocation="http://www.springframework.org/schema/beans
        http://www.springframework.org/schema/beans/spring-beans.
xsd
        http://www.springframework.org/schema/context
        http://www.springframework.org/schema/context/spring-
context.xsd
        http://shardingsphere.io/schema/shardingjdbc/sharding
sharding.xsd
        http://shardingsphere.io/schema/shardingjdbc/masterslave
masterslave.xsd
        ">
    <!-- Actual source data Configuration -->
    <bean id="dbtbl_0_master" class="org.apache.commons.dbcp.BasicDataSource"
destroy-method="close">
        <property name="driverClassName" value="com.mysql.jdbc.Driver"/>
        <property name="url" value="jdbc:mysql://localhost:3306/dbtbl_0_master"/>
        <property name="username" value="root"/>
        <property name="password" value=""/>

```

```

</bean>

<bean id="dbtbl_0_slave_0" class="org.apache.commons.dbcp.BasicDataSource"
destroy-method="close">
  <property name="driverClassName" value="com.mysql.jdbc.Driver"/>
  <property name="url" value="jdbc:mysql://localhost:3306/dbtbl_0_slave_0"/>
  <property name="username" value="root"/>
  <property name="password" value=""/>
</bean>

<bean id="dbtbl_0_slave_1" class="org.apache.commons.dbcp.BasicDataSource"
destroy-method="close">
  <property name="driverClassName" value="com.mysql.jdbc.Driver"/>
  <property name="url" value="jdbc:mysql://localhost:3306/dbtbl_0_slave_1"/>
  <property name="username" value="root"/>
  <property name="password" value=""/>
</bean>

<bean id="dbtbl_1_master" class="org.apache.commons.dbcp.BasicDataSource"
destroy-method="close">
  <property name="driverClassName" value="com.mysql.jdbc.Driver"/>
  <property name="url" value="jdbc:mysql://localhost:3306/dbtbl_1_master"/>
  <property name="username" value="root"/>
  <property name="password" value=""/>
</bean>

<bean id="dbtbl_1_slave_0" class="org.apache.commons.dbcp.BasicDataSource"
destroy-method="close">
  <property name="driverClassName" value="com.mysql.jdbc.Driver"/>
  <property name="url" value="jdbc:mysql://localhost:3306/dbtbl_1_slave_0"/>
  <property name="username" value="root"/>
  <property name="password" value=""/>
</bean>

<bean id="dbtbl_1_slave_1" class="org.apache.commons.dbcp.BasicDataSource"
destroy-method="close">
  <property name="driverClassName" value="com.mysql.jdbc.Driver"/>
  <property name="url" value="jdbc:mysql://localhost:3306/dbtbl_1_slave_1"/>
  <property name="username" value="root"/>
  <property name="password" value=""/>
</bean>

<!-- Readwrite-splitting DataSource Configuration -->
<master-slave:data-source id="dbtbl_0" master-data-source-name="dbtbl_0_master"
slave-data-source-names="dbtbl_0_slave_0, dbtbl_0_slave_1" strategy-type="ROUND_
ROBIN" />
<master-slave:data-source id="dbtbl_1" master-data-source-name="dbtbl_1_master"
slave-data-source-names="dbtbl_1_slave_0, dbtbl_1_slave_1" strategy-type="ROUND_

```

```

ROBIN" />

    <sharding:inline-strategy id="databaseStrategy" sharding-column="user_id"
algorithm-expression="dbtbl_${user_id % 2}" />
    <sharding:inline-strategy id="orderTableStrategy" sharding-column="order_id"
algorithm-expression="t_order_${order_id % 4}" />

    <sharding:data-source id="shardingDataSource">
        <sharding:sharding-rule data-source-names="dbtbl_0, dbtbl_1">
            <sharding:table-rules>
                <sharding:table-rule logic-table="t_order" actual-data-nodes=
"dbtbl_${0..1}.t_order_${0..3}" database-strategy-ref="databaseStrategy" table-
strategy-ref="orderTableStrategy"/>
            </sharding:table-rules>
        </sharding:sharding-rule>
    </sharding:data-source>
</beans>

```

## Spring Boot Starter Configuration

### 5.0.0-beta

### Sharding

### Configuration Item Explanation

```

spring.shardingsphere.datasource.names= # Omit the data source configuration,
please refer to the usage

# Standard sharding table configuration
spring.shardingsphere.rules.sharding.tables.<table-name>.actual-data-nodes= #
Describe data source names and actual tables, delimiter as point, multiple data
nodes separated with comma, support inline expression. Absent means sharding
databases only.

# Databases sharding strategy, use default databases sharding strategy if absent.
sharding strategy below can choose only one.

# For single sharding column scenario
spring.shardingsphere.rules.sharding.tables.<table-name>.database-strategy.
standard.<sharding-algorithm-name>.sharding-column= # Sharding column name
spring.shardingsphere.rules.sharding.tables.<table-name>.database-strategy.
standard.<sharding-algorithm-name>.sharding-algorithm-name= # Sharding algorithm
name

# For multiple sharding columns scenario

```

```

spring.shardingsphere.rules.sharding.tables.<table-name>.database-strategy.complex.
<sharding-algorithm-name>.sharding-columns= # Sharding column names, multiple
columns separated with comma
spring.shardingsphere.rules.sharding.tables.<table-name>.database-strategy.complex.
<sharding-algorithm-name>.sharding-algorithm-name= # Sharding algorithm name

# Sharding by hint
spring.shardingsphere.rules.sharding.tables.<table-name>.database-strategy.hint.
<sharding-algorithm-name>.sharding-algorithm-name= # Sharding algorithm name

# Tables sharding strategy, same as database sharding strategy
spring.shardingsphere.rules.sharding.tables.<table-name>.table-strategy.xxx= #
Omitted

# Auto sharding table configuraiton
spring.shardingsphere.rules.sharding.auto-tables.<auto-table-name>.actual-data-
sources= # data source names

spring.shardingsphere.rules.sharding.auto-tables.<auto-table-name>.sharding-
strategy.standard.sharding-column= # Sharding column name
spring.shardingsphere.rules.sharding.auto-tables.<auto-table-name>.sharding-
strategy.standard.sharding-algorithm= # Auto sharding algorithm name

# Key generator strategy configuration
spring.shardingsphere.rules.sharding.tables.<table-name>.key-generate-strategy.
column= # Column name of key generator
spring.shardingsphere.rules.sharding.tables.<table-name>.key-generate-strategy.key-
generator-name= # Key generator name

spring.shardingsphere.rules.sharding.binding-tables[0]= # Binding table name
spring.shardingsphere.rules.sharding.binding-tables[1]= # Binding table name
spring.shardingsphere.rules.sharding.binding-tables[x]= # Binding table name

spring.shardingsphere.rules.sharding.broadcast-tables[0]= # Broadcast tables
spring.shardingsphere.rules.sharding.broadcast-tables[1]= # Broadcast tables
spring.shardingsphere.rules.sharding.broadcast-tables[x]= # Broadcast tables

spring.shardingsphere.sharding.default-database-strategy.xxx= # Default strategy
for database sharding
spring.shardingsphere.sharding.default-table-strategy.xxx= # Default strategy for
table sharding
spring.shardingsphere.sharding.default-key-generate-strategy.xxx= # Default Key
generator strategy

# Sharding algorithm configuration
spring.shardingsphere.rules.sharding.sharding-algorithms.<sharding-algorithm-name>.
type= # Sharding algorithm type
spring.shardingsphere.rules.sharding.sharding-algorithms.<sharding-algorithm-name>.

```

```

props.xxx=# Sharding algorithm properties

# Key generate algorithm configuration
spring.shardingsphere.rules.sharding.key-generators.<key-generate-algorithm-name>.
type= # Key generate algorithm type
spring.shardingsphere.rules.sharding.key-generators.<key-generate-algorithm-name>.
props.xxx= # Key generate algorithm properties

```

Please refer to [Built-in sharding Algorithm List](#) and [Built-in keygen Algorithm List](#).

## Readwrite-splitting

### Configuration Item Explanation

```

spring.shardingsphere.datasource.names= # Omit the data source configuration,
please refer to the usage

spring.shardingsphere.rules.readwrite-splitting.data-sources.<readwrite-splitting-
data-source-name>.primary-data-source-name= # Write data source name
spring.shardingsphere.rules.readwrite-splitting.data-sources.<readwrite-splitting-
data-source-name>.replica-data-source-names= # Read data source names, multiple
data source names separated with comma
spring.shardingsphere.rules.readwrite-splitting.data-sources.<readwrite-splitting-
data-source-name>.load-balancer-name= # Load balance algorithm name

# Load balance algorithm configuration
spring.shardingsphere.rules.readwrite-splitting.load-balancers.<load-balance-
algorithm-name>.type= # Load balance algorithm type
spring.shardingsphere.rules.readwrite-splitting.load-balancers.<load-balance-
algorithm-name>.props.xxx= # Load balance algorithm properties

```

Please refer to [Built-in Load Balance Algorithm List](#) for more details about type of algorithm.

## Encryption

### Configuration Item Explanation

```

spring.shardingsphere.datasource.names= # Omit the data source configuration,
please refer to the usage

spring.shardingsphere.rules.encrypt.tables.<table-name>.columns.<column-name>.
cipher-column= # Cipher column name
spring.shardingsphere.rules.encrypt.tables.<table-name>.columns.<column-name>.
assisted-query-column= # Assisted query column name
spring.shardingsphere.rules.encrypt.tables.<table-name>.columns.<column-name>.

```



```
plain-column= # Plain column name
spring.shardingsphere.rules.encrypt.tables.<table-name>.columns.<column-name>.
encryptor-name= # Encrypt algorithm name

# Encrypt algorithm configuration
spring.shardingsphere.rules.encrypt.encryptors.<encrypt-algorithm-name>.type= #
Encrypt algorithm type
spring.shardingsphere.rules.encrypt.encryptors.<encrypt-algorithm-name>.props.xxx=
# Encrypt algorithm properties
```

## Shadow DB

### Configuration Item Explanation

```
spring.shardingsphere.datasource.names= # Omit the data source configuration,
please refer to the usage

spring.shardingsphere.rules.shadow.column= # Shadow column name
spring.shardingsphere.rules.shadow.shadow-mappings.<product-data-source-name>= #
Shadow data source name
```

## Governance

### Configuration Item Explanation

### Management

```
spring.shardingsphere.governance.name= # Governance name
spring.shardingsphere.governance.registry-center.type= # Governance instance type.
Example:Zookeeper, etcd, Apollo, Nacos
spring.shardingsphere.governance.registry-center.server-lists= # The list of
servers that connect to governance instance, including IP and port number; use
commas to separate
spring.shardingsphere.governance.registry-center.props= # Other properties
spring.shardingsphere.governance.override= # Whether to overwrite local
configurations with config center configurations; if it can, each initialization
should refer to local configurations
```

## Mixed Rules

### Configuration Item Explanation

```

# data source configuration
spring.shardingsphere.datasource.names= write-ds0,write-ds1,write-ds0-read0,write-
ds1-read0

spring.shardingsphere.datasource.write-ds0.url= # Database URL connection
spring.shardingsphere.datasource.write-ds0.type= # Database connection pool type
name
spring.shardingsphere.datasource.write-ds0.driver-class-name= # Database driver
class name
spring.shardingsphere.datasource.write-ds0.username= # Database username
spring.shardingsphere.datasource.write-ds0.password= # Database password
spring.shardingsphere.datasource.write-ds0.xxx= # Other properties of database
connection pool

spring.shardingsphere.datasource.write-ds1.url= # Database URL connection
# ...Omit specific configuration.

spring.shardingsphere.datasource.write-ds0-read0.url= # Database URL connection
# ...Omit specific configuration.

spring.shardingsphere.datasource.write-ds1-read0.url= # Database URL connection
# ...Omit specific configuration.

# Sharding rules configuration
# Databases sharding strategy
spring.shardingsphere.rules.sharding.default-database-strategy.standard.sharding-
column=user_id
spring.shardingsphere.rules.sharding.default-database-strategy.standard.sharding-
algorithm-name=default-database-strategy-inline
# Binding table rules configuration ,and multiple groups of binding-tables
configured with arrays
spring.shardingsphere.rules.sharding.binding-tables[0]=t_user,t_user_detail
spring.shardingsphere.rules.sharding.binding-tables[1]= # Binding table names,
multiple table name are separated by commas
spring.shardingsphere.rules.sharding.binding-tables[x]= # Binding table names,
multiple table name are separated by commas
# Broadcast table rules configuration
spring.shardingsphere.rules.sharding.broadcast-tables= # Broadcast table names,
multiple table name are separated by commas

# Table sharding strategy
# The enumeration value of `ds_${0..1}` is the name of the logical data source
configured with readwrite-splitting
spring.shardingsphere.rules.sharding.tables.t_user.actual-data-nodes=ds_${0..1}.

```

```

t_user_${0..1}
spring.shardingsphere.rules.sharding.tables.t_user.table-strategy.standard.
sharding-column=user_id
spring.shardingsphere.rules.sharding.tables.t_user.table-strategy.standard.
sharding-algorithm-name=user-table-strategy-inline

# Data encrypt configuration
# Table `t_user` is the name of the logical table that uses for data sharding
configuration.
spring.shardingsphere.rules.encrypt.tables.t_user.columns.username.cipher-
column=username
spring.shardingsphere.rules.encrypt.tables.t_user.columns.username.encryptor-
name=name-encryptor
spring.shardingsphere.rules.encrypt.tables.t_user.columns.pwd.cipher-column=pwd
spring.shardingsphere.rules.encrypt.tables.t_user.columns.pwd.encryptor-name=pwd-
encryptor

# Data encrypt algorithm configuration
spring.shardingsphere.rules.encrypt.encryptors.name-encryptor.type=AES
spring.shardingsphere.rules.encrypt.encryptors.name-encryptor.props.aes-key-
value=123456abc
spring.shardingsphere.rules.encrypt.encryptors.pwd-encryptor.type=AES
spring.shardingsphere.rules.encrypt.encryptors.pwd-encryptor.props.aes-key-
value=123456abc

# Key generate strategy configuration
spring.shardingsphere.rules.sharding.tables.t_user.key-generate-strategy.
column=user_id
spring.shardingsphere.rules.sharding.tables.t_user.key-generate-strategy.key-
generator-name=snowflake

# Sharding algorithm configuration
spring.shardingsphere.rules.sharding.sharding-algorithms.default-database-strategy-
inline.type=INLINE
# The enumeration value of `ds_${user_id % 2}` is the name of the logical data
source configured with readwrite-splitting
spring.shardingsphere.rules.sharding.sharding-algorithms.default-database-strategy-
inline.algorithm-expression=ds_${user_id % 2}
spring.shardingsphere.rules.sharding.sharding-algorithms.user-table-strategy-
inline.type=INLINE
spring.shardingsphere.rules.sharding.sharding-algorithms.user-table-strategy-
inline.props.algorithm-expression=t_user_${user_id % 2}

# Key generate algorithm configuration
spring.shardingsphere.rules.sharding.key-generators.snowflake.type=SNOWFLAKE

# read query configuration
# ds_0,ds_1 is the logical data source name of the readwrite-splitting

```

```

spring.shardingsphere.rules.readwrite-splitting.data-sources.ds_0.write-data-
source-name=write-ds0
spring.shardingsphere.rules.readwrite-splitting.data-sources.ds_0.read-data-source-
names=write-ds0-read0
spring.shardingsphere.rules.readwrite-splitting.data-sources.ds_0.load-balancer-
name=read-random
spring.shardingsphere.rules.readwrite-splitting.data-sources.ds_1.write-data-
source-name=write-ds1
spring.shardingsphere.rules.readwrite-splitting.data-sources.ds_1.read-data-source-
names=write-ds1-read0
spring.shardingsphere.rules.readwrite-splitting.data-sources.ds_1.load-balancer-
name=read-random

# Load balance algorithm configuration
spring.shardingsphere.rules.readwrite-splitting.load-balancers.read-random.
type=RANDOM

```

## Shardingsphere-4.x

### Data Sharding

#### Configuration Item Explanation

```

spring.shardingsphere.datasource.names= #Data source name; multiple data sources
are separated by commas

spring.shardingsphere.datasource.<data-source-name>.type= #Database connection pool
type name
spring.shardingsphere.datasource.<data-source-name>.driver-class-name= #Database
driver class name
spring.shardingsphere.datasource.<data-source-name>.url= #Database url connection
spring.shardingsphere.datasource.<data-source-name>.username= #Database username
spring.shardingsphere.datasource.<data-source-name>.password= #Database password
spring.shardingsphere.datasource.<data-source-name>.xxx= #Other properties of
database connection pool

spring.shardingsphere.sharding.tables.<logic-table-name>.actual-data-nodes= #It is
consisted of data source name + table name, separated by decimal points; multiple
tables are separated by commas and support inline expressions; default means using
existing data sources and logic table names to generate data nodes; it can be
applied in broadcast tables (each database needs a same table for relevance query,
dictionary table mostly) or the situation with sharding database but without
sharding table (table structures of all the databases are consistent)

#Database sharding strategy; default means using default database sharding
strategy; it can only choose one of the following sharding strategies

```

```

#It is applied in standard sharding situation of single-sharding key
spring.shardingsphere.sharding.tables.<logic-table-name>.database-strategy.
standard.sharding-column= #Sharding column name
spring.shardingsphere.sharding.tables.<logic-table-name>.database-strategy.
standard.precise-algorithm-class-name= #Precise algorithm class name, applied in =
and IN; the class needs to implement PreciseShardingAlgorithm interface and provide
parameter-free constructor
spring.shardingsphere.sharding.tables.<logic-table-name>.database-strategy.
standard.range-algorithm-class-name= #Range sharding algorithm class name, applied
in BETWEEN, optional; the class should implement RangeShardingAlgorithm interface
and provide parameter-free constructor

#It is applied in complex sharding situations with multiple sharding keys
spring.shardingsphere.sharding.tables.<logic-table-name>.database-strategy.complex.
sharding-columns= #Sharding column name, with multiple columns separated by commas
spring.shardingsphere.sharding.tables.<logic-table-name>.database-strategy.complex.
algorithm-class-name= #Complex sharding algorithm class name; the class needs to
implement ComplexKeysShardingAlgorithm interface and provide parameter-free
constructor

#Inline expression sharding strategy
spring.shardingsphere.sharding.tables.<logic-table-name>.database-strategy.inline.
sharding-column= #Sharding column name
spring.shardingsphere.sharding.tables.<logic-table-name>.database-strategy.inline.
algorithm-expression= #Inline expression of sharding algorithm, which needs to
conform to groovy statements

#Hint Sharding Strategy
spring.shardingsphere.sharding.tables.<logic-table-name>.database-strategy.hint.
algorithm-class-name= #Hint algorithm class name; the class needs to implement
HintShardingAlgorithm interface and provide parameter-free constructor

#Table sharding strategy, same as database sharding strategy
spring.shardingsphere.sharding.tables.<logic-table-name>.table-strategy.xxx=
#Omitted

spring.shardingsphere.sharding.tables.<logic-table-name>.key-generator.column=
#Auto-increment column name; default means not using auto-increment key generator
spring.shardingsphere.sharding.tables.<logic-table-name>.key-generator.type= #Auto-
increment key generator type; default means using default auto-increment key
generator; user defined generator or internal generator (SNOWFLAKE, UUID) can both
be selected
spring.shardingsphere.sharding.tables.<logic-table-name>.key-generator.props.
<property-name>= #Properties, Notice: when use SNOWFLAKE, `max.tolerate.time.
difference.milliseconds` for `SNOWFLAKE` need to be set. To use the generated value
of this algorithm as sharding value, it is recommended to configure `max.vibration.
offset`

```

```
spring.shardingsphere.sharding.binding-tables[0]= #Binding table rule list
spring.shardingsphere.sharding.binding-tables[1]= #Binding table rule list
spring.shardingsphere.sharding.binding-tables[x]= #Binding table rule list

spring.shardingsphere.sharding.broadcast-tables[0]= #Broadcast table rule list
spring.shardingsphere.sharding.broadcast-tables[1]= #Broadcast table rule list
spring.shardingsphere.sharding.broadcast-tables[x]= #Broadcast table rule list

spring.shardingsphere.sharding.default-data-source-name= #Tables without sharding
rules will be located through default data source
spring.shardingsphere.sharding.default-database-strategy.xxx= #Default database
sharding strategy
spring.shardingsphere.sharding.default-table-strategy.xxx= #Default table sharding
strategy
spring.shardingsphere.sharding.default-key-generator.type= #Default auto-increment
key generator of type; it will use org.apache.shardingsphere.core.keygen.generator.
impl.SnowflakeKeyGenerator in default; user defined generator or internal generator
(SNOWFLAKE or UUID) can both be used
spring.shardingsphere.sharding.default-key-generator.props.<property-name>= #Auto-
increment key generator property configuration, such as max.tolerate.time.
difference.milliseconds of SNOWFLAKE algorithm

spring.shardingsphere.sharding.master-slave-rules.<master-slave-data-source-name>.
master-data-source-name= #Refer to readwrite-splitting part for more details
spring.shardingsphere.sharding.master-slave-rules.<master-slave-data-source-name>.
slave-data-source-names[0]= #Refer to readwrite-splitting part for more details
spring.shardingsphere.sharding.master-slave-rules.<master-slave-data-source-name>.
slave-data-source-names[1]= #Refer to readwrite-splitting part for more details
spring.shardingsphere.sharding.master-slave-rules.<master-slave-data-source-name>.
slave-data-source-names[x]= #Refer to readwrite-splitting part for more details
spring.shardingsphere.sharding.master-slave-rules.<master-slave-data-source-name>.
load-balance-algorithm-class-name= #Refer to readwrite-splitting part for more
details
spring.shardingsphere.sharding.master-slave-rules.<master-slave-data-source-name>.
load-balance-algorithm-type= #Refer to readwrite-splitting part for more details

spring.shardingsphere.props.sql.show= #Show SQL or not; default value: false
spring.shardingsphere.props.executor.size= #Executing thread number; default value:
CPU core number
```

## Readwrite Split

### Configuration Item Explanation

```
#Omit data source configurations; keep it consistent with data sharding

spring.shardingsphere.sharding.master-slave-rules.<master-slave-data-source-name>.
master-data-source-name= #Data source name of master database
spring.shardingsphere.sharding.master-slave-rules.<master-slave-data-source-name>.
slave-data-source-names[0]= #Data source name list of slave database
spring.shardingsphere.sharding.master-slave-rules.<master-slave-data-source-name>.
slave-data-source-names[1]= #Data source name list of slave database
spring.shardingsphere.sharding.master-slave-rules.<master-slave-data-source-name>.
slave-data-source-names[x]= #Data source name list of slave database
spring.shardingsphere.sharding.master-slave-rules.<master-slave-data-source-name>.
load-balance-algorithm-class-name= #Load balance algorithm class name; the class
needs to implement MasterSlaveLoadBalanceAlgorithm interface and provide parameter-
free constructor
spring.shardingsphere.sharding.master-slave-rules.<master-slave-data-source-name>.
load-balance-algorithm-type= #Load balance algorithm class of slave database;
optional value: ROUND_ROBIN and RANDOM; if there is load-balance-algorithm-class-
name, the configuration can be omitted

spring.shardingsphere.props.sql.show= #Show SQL or not; default value: false
spring.shardingsphere.props.executor.size= #Executing thread number; default value:
CPU core number
spring.shardingsphere.props.check.table.metadata.enabled= #Whether to check meta-
data consistency of sharding table when it initializes; default value: false
```

## Data Masking

### Configuration Item Explanation

```
#Omit data source configurations; keep it consistent with data sharding

spring.shardingsphere.encrypt.encryptors.<encryptor-name>.type= #Type of encryptor,
use user-defined ones or built-in ones, e.g. MD5/AES
spring.shardingsphere.encrypt.encryptors.<encryptor-name>.props.<property-name>=
#Properties, Notice: when use AES encryptor, `aes.key.value` for AES encryptor need
to be set
spring.shardingsphere.encrypt.tables.<table-name>.columns.<logic-column-name>.
plainColumn= #Plain column name
spring.shardingsphere.encrypt.tables.<table-name>.columns.<logic-column-name>.
cipherColumn= #Cipher column name
spring.shardingsphere.encrypt.tables.<table-name>.columns.<logic-column-name>.
assistedQueryColumn= #AssistedColumns for query, when use
```

```
ShardingQueryAssistedEncryptor, it can help query encrypted data
spring.shardingsphere.encrypt.tables.<table-name>.columns.<logic-column-name>.
encryptor= #Encryptor name
```

## Orchestration

### Configuration Item Explanation

```
#Omit data source, data sharding, readwrite split and data masking configurations

spring.shardingsphere.orchestration.name= #Orchestration instance name
spring.shardingsphere.orchestration.override= #Whether to overwrite local
configurations with registry center configurations; if it can, each initialization
should refer to local configurations
spring.shardingsphere.orchestration.registry.type= #Registry center type.
Example:zookeeper
spring.shardingsphere.orchestration.registry.server-lists= #The list of servers
that connect to registry center, including IP and port number; use commas to
separate
spring.shardingsphere.orchestration.registry.namespace= #Registry center namespace
spring.shardingsphere.orchestration.registry.digest= #The token that connects to
the registry center; default means there is no need for authentication
spring.shardingsphere.orchestration.registry.operation-timeout-milliseconds= #The
millisecond number for operation timeout; default value: 500 milliseconds
spring.shardingsphere.orchestration.registry.max-retries= #Maximum retry time after
failing; default value: 3 times
spring.shardingsphere.orchestration.registry.retry-interval-milliseconds= #Interval
time to retry; default value: 500 milliseconds
spring.shardingsphere.orchestration.registry.time-to-live-seconds= #Living time of
temporary nodes; default value: 60 seconds
spring.shardingsphere.orchestration.registry.props= #Customize registry center
props.
```

## shardingsphere-3.x

### Sharding

#### Configuration Item Explanation

```
sharding.jdbc.datasource.names= #Names of data sources. Multiple data sources
separated with comma

sharding.jdbc.datasource.<data-source-name>.type= #Class name of data source pool
sharding.jdbc.datasource.<data-source-name>.driver-class-name= #Class name of
```



```

database driver
sharding.jdbc.datasource.<data-source-name>.url= #Database URL
sharding.jdbc.datasource.<data-source-name>.username= #Database username
sharding.jdbc.datasource.<data-source-name>.password= #Database password
sharding.jdbc.datasource.<data-source-name>.xxx= #Other properties for data source
pool

sharding.jdbc.config.sharding.tables.<logic-table-name>.actual-data-nodes=
#Describe data source names and actual tables, delimiter as point, multiple data
nodes separated with comma, support inline expression. Absent means sharding
databases only. Example: ds${0..7}.tbl${0..7}

#Databases sharding strategy, use default databases sharding strategy if absent.
sharding strategy below can choose only one.

#Standard sharding scenario for single sharding column
sharding.jdbc.config.sharding.tables.<logic-table-name>.database-strategy.standard.
sharding-column= #Name of sharding column
sharding.jdbc.config.sharding.tables.<logic-table-name>.database-strategy.standard.
precise-algorithm-class-name= #Precise algorithm class name used for `=` and `IN`.
This class need to implements PreciseShardingAlgorithm, and require a no argument
constructor
sharding.jdbc.config.sharding.tables.<logic-table-name>.database-strategy.standard.
range-algorithm-class-name= #Range algorithm class name used for `BETWEEN`. This
class need to implements RangeShardingAlgorithm, and require a no argument
constructor

#Complex sharding scenario for multiple sharding columns
sharding.jdbc.config.sharding.tables.<logic-table-name>.database-strategy.complex.
sharding-columns= #Names of sharding columns. Multiple columns separated with comma
sharding.jdbc.config.sharding.tables.<logic-table-name>.database-strategy.complex.
algorithm-class-name= #Complex sharding algorithm class name. This class need to
implements ComplexKeysShardingAlgorithm, and require a no argument constructor

#Inline expression sharding scenario for si-gle s-arding column
sharding.jdbc.config.sharding.tables.<logic-table-name>.database-strategy.inline.
sharding-column= #Name of sharding column
sharding.jdbc.config.sharding.tables.<logic-table-name>.database-strategy.inline.
algorithm-expression= #Inline expression for sharding algorithm

#Hint sharding strategy
sharding.jdbc.config.sharding.tables.<logic-table-name>.database-strategy.hint.
algorithm-class-name= #Hint sharding algorithm class name. This class need to
implements HintShardingAlgorithm, and require a no argument constructor

#Tables sharding strategy, Same as database- shar-ing strategy
sharding.jdbc.config.sharding.tables.<logic-table-name>.table-strategy.xxx= #Ignore

```

```

sharding.jdbc.config.sharding.tables.<logic-table-name>.key-generator-column-name=
#Column name of key generator, do not use Key generator if absent
sharding.jdbc.config.sharding.tables.<logic-table-name>.key-generator-class-name=
#Key generator, use default key generator if absent. This class need to implements
KeyGenerator, and require a no argument constructor

sharding.jdbc.config.sharding.tables.<logic-table-name>.logic-index= #Name if logic
index. If use `DROP INDEX XXX` SQL in Oracle/PostgreSQL, This property needs to be
set for finding the actual tables

sharding.jdbc.config.sharding.binding-tables[0]= #Binding table rule configurations
sharding.jdbc.config.sharding.binding-tables[1]= #Binding table rule configurations
sharding.jdbc.config.sharding.binding-tables[x]= #Binding table rule configurations

sharding.jdbc.config.sharding.broadcast-tables[0]= #Broadcast table rule
configurations
sharding.jdbc.config.sharding.broadcast-tables[1]= #Broadcast table rule
configurations
sharding.jdbc.config.sharding.broadcast-tables[x]= #Broadcast table rule
configurations

sharding.jdbc.config.sharding.default-data-source-name= #If table not configure at
table rule, will route to defaultDataSourceName
sharding.jdbc.config.sharding.default-database-strategy.xxx= #Default strategy for
sharding databases, same as databases sharding strategy
sharding.jdbc.config.sharding.default-table-strategy.xxx= #Default strategy for
sharding tables, same as tables sharding strategy
sharding.jdbc.config.sharding.default-key-generator-class-name= #Default key
generator class name, default value is `io.shardingsphere.core.keygen.
DefaultKeyGenerator`. This class need to implements KeyGenerator, and require a no
argument constructor

sharding.jdbc.config.sharding.master-slave-rules.<master-slave-data-source-name>.
master-data-source-name= #more details can reference readwrite-splitting part
sharding.jdbc.config.sharding.master-slave-rules.<master-slave-data-source-name>.
slave-data-source-names[0]= #more details can reference readwrite-splitting part
sharding.jdbc.config.sharding.master-slave-rules.<master-slave-data-source-name>.
slave-data-source-names[1]= #more details can reference readwrite-splitting part
sharding.jdbc.config.sharding.master-slave-rules.<master-slave-data-source-name>.
slave-data-source-names[x]= #more details can reference readwrite-splitting part
sharding.jdbc.config.sharding.master-slave-rules.<master-slave-data-source-name>.
load-balance-algorithm-class-name= #more details can reference readwrite-splitting
part
sharding.jdbc.config.sharding.master-slave-rules.<master-slave-data-source-name>.
load-balance-algorithm-type= #more details can reference readwrite-splitting part
sharding.jdbc.config.config.map.key1= #more details can reference Readwrite-
splitting part
sharding.jdbc.config.config.map.key2= #more details can reference Readwrite-

```

```

splitting part
sharding.jdbc.config.config.map.keyx= #more details can reference Readwrite-
splitting part

sharding.jdbc.config.props.sql.show= #To show SQLS or not, default value: false
sharding.jdbc.config.props.executor.size= #The number of working threads, default
value: CPU count

sharding.jdbc.config.config.map.key1= #User-defined arguments
sharding.jdbc.config.config.map.key2= #User-defined arguments
sharding.jdbc.config.config.map.keyx= #User-defined arguments

```

## Readwrite-splitting

### Configuration Item Explanation

```

#Ignore data sources configuration, same as sharding

sharding.jdbc.config.sharding.master-slave-rules.<master-slave-data-source-name>.
master-data-source-name= #Name of master data source
sharding.jdbc.config.sharding.master-slave-rules.<master-slave-data-source-name>.
slave-data-source-names[0]= #Name of master data source
sharding.jdbc.config.sharding.master-slave-rules.<master-slave-data-source-name>.
slave-data-source-names[1]= #Names of Slave data sources
sharding.jdbc.config.sharding.master-slave-rules.<master-slave-data-source-name>.
slave-data-source-names[x]= #Names of Slave data sources
sharding.jdbc.config.sharding.master-slave-rules.<master-slave-data-source-name>.
load-balance-algorithm-class-name= #Load balance algorithm class name. This class
need to implements MasterSlaveLoadBalanceAlgorithm, and require a no argument
constructor
sharding.jdbc.config.sharding.master-slave-rules.<master-slave-data-source-name>.
load-balance-algorithm-type= #Load balance algorithm type, values should be:
`ROUND_ROBIN` or `RANDOM`. Ignore if `load-balance-algorithm-class-name` is present

sharding.jdbc.config.config.map.key1= #User-defined arguments
sharding.jdbc.config.config.map.key2= #User-defined arguments
sharding.jdbc.config.config.map.keyx= #User-defined arguments

sharding.jdbc.config.props.sql.show= #To show SQLS or not, default value: false
sharding.jdbc.config.props.executor.size= #The number of working threads, default
value: CPU count
sharding.jdbc.config.props.check.table.metadata.enabled= #Check the metadata
consistency of all the tables, default value: false

```

## Orchestration

### Configuration Item Explanation

```
#Ignore data sources, sharding and readwrite splitting configuration

sharding.jdbc.config.sharding.orchestration.name= #Name of orchestration instance
sharding.jdbc.config.sharding.orchestration.override= #Use local configuration to
overwrite registry center or not
sharding.jdbc.config.sharding.orchestration.registry.server-lists= #Registry servers
list, multiple split as comma. Example: host1:2181,host2:2181
sharding.jdbc.config.sharding.orchestration.registry.namespace= #Namespace of
registry
sharding.jdbc.config.sharding.orchestration.registry.digest= #Digest for registry.
Default is not need digest.
sharding.jdbc.config.sharding.orchestration.registry.operation-timeout-
milliseconds= #Operation timeout time in milliseconds, default value is 500
milliseconds
sharding.jdbc.config.sharding.orchestration.registry.max-retries= #Max number of
times to retry, default value is 3
sharding.jdbc.config.sharding.orchestration.registry.retry-interval-milliseconds=
#Time interval in milliseconds on each retry, default value is 500 milliseconds
sharding.jdbc.config.sharding.orchestration.registry.time-to-live-seconds= #Time to
live in seconds of ephemeral keys, default value is 60 seconds
```

## Shardingsphere-2.x

### Sharding

### Configuration Item Explanation

```
# Ignore data sources configuration

sharding.jdbc.config.sharding.default-data-source-name= #Tables without sharding
rules will be located through default data source
sharding.jdbc.config.sharding.default-database-strategy.inline.sharding-column=
#Name of database sharding column
sharding.jdbc.config.sharding.default-database-strategy.inline.algorithm-
expression= #Inline expression for database sharding algorithm
sharding.jdbc.config.sharding.tables.t_order.actualDataNodes= #Describe data source
names and actual tables, delimiter as point, multiple data nodes separated with
comma, support inline expression. Absent means sharding databases only. Example: ds
${0..7}.tbl${0..7}
sharding.jdbc.config.sharding.tables.t_order.tableStrategy.inline.shardingColumn=
#Name of table sharding column
sharding.jdbc.config.sharding.tables.t_order.tableStrategy.inline.
algorithmInlineExpression= #Inline expression for table sharding algorithm
```

```
sharding.jdbc.config.sharding.tables.t_order.keyGeneratorColumnName= #Column name
of key generator, do not use Key generator if absent

sharding.jdbc.config.sharding.tables.<logic-table-name>.key-generator-column-name=
#Column name of key generator, do not use Key generator if absent
sharding.jdbc.config.sharding.tables.<logic-table-name>.key-generator-class-name=
#Key generator, use default key generator if absent. This class need to implements
KeyGenerator, and require a no argument constructor
```

## Readwrite-splitting

### Configuration Item Explanation

```
# Ignore data sources configuration

sharding.jdbc.config.masterslave.load-balance-algorithm-type= #Load balance
algorithm class of slave database; optional value: ROUND_ROBIN and RANDOM; if there
is load-balance-algorithm-class-name, the configuration can be omitted
sharding.jdbc.config.masterslave.name= # master name
sharding.jdbc.config.masterslave.master-data-source-name= #Name of master data
source
sharding.jdbc.config.masterslave.slave-data-source-names= #Name of master data
source
```

## Orchestration

### Configuration Item Explanation

```
# Ignore data sources configuration

sharding.jdbc.config.orchestration.name= #Name of orchestration instance
sharding.jdbc.config.orchestration.override= #Use local configuration to overwrite
registry center or not

sharding.jdbc.config.sharding.orchestration.name= #Name of orchestration instance
sharding.jdbc.config.sharding.orchestration.override= #Use local configuration to
overwrite registry center or not
sharding.jdbc.config.sharding.orchestration.registry.server-lists= #Registry servers
list, multiple split as comma. Example: host1:2181,host2:2181
sharding.jdbc.config.sharding.orchestration.registry.namespace= #Namespace of
registry
sharding.jdbc.config.sharding.orchestration.registry.digest= #Digest for registry.
Default is not need digest.
```

```

sharding.jdbc.config.sharding.orchestration.registry.operation-timeout-
milliseconds= #Operation timeout time in milliseconds, default value is 500
milliseconds
sharding.jdbc.config.sharding.orchestration.registry.max-retries= #Max number of
times to retry, default value is 3
sharding.jdbc.config.sharding.orchestration.registry.retry-interval-milliseconds=
#Time interval in milliseconds on each retry, default value is 500 milliseconds
sharding.jdbc.config.sharding.orchestration.registry.time-to-live-seconds= #Time to
live in seconds of ephemeral keys, default value is 60 seconds

# The configuration in Zookeeper
sharding.jdbc.config.orchestration.zookeeper.namespace= #Namespace of zookeeper
registry
sharding.jdbc.config.orchestration.zookeeper.server-lists= #Zookeeper Registry
servers list, multiple split as comma. Example: host1:2181,host2:2181

# The configuration in Etcd
sharding.jdbc.config.orchestration.etcd.server-lists= #Etcd Registry servers list,
multiple split as comma. Example: host1:2181,host2:2181

```

## 7.9.2 ShardingSphere-Proxy

### 5.0.0-beta

#### Data Source Configuration Item Explanation

```

schemaName: # Logic schema name.

dataSources: # Data sources configuration, multiple <data-source-name> available.
  <data-source-name>: # Different from ShardingSphere-JDBC configuration, it does
not need to be configured with database connection pool.
  url: # Database URL.
  username: # Database username.
  password: # Database password.
  connectionTimeoutMilliseconds: # Connection timeout milliseconds.
  idleTimeoutMilliseconds: # Idle timeout milliseconds.
  maxLifetimeMilliseconds: # Maximum life milliseconds.
  maxPoolSize: 50 # Maximum connection count in the pool.
  minPoolSize: 1 # Minimum connection count in the pool.

rules: # Keep consist with ShardingSphere-JDBC configuration.
# ...

```

## Authentication

It is used to verify the authentication to log in ShardingSphere-Proxy, which must use correct user name and password after the configuration of them.

```
rules:
- !AUTHORITY
  users:
    - root@localhost:root # <username>@<hostname>:<password>
    - sharding@:sharding
  provider:
    type: NATIVE # Must be explicitly specified.
```

If the hostname is % or empty, it means no restrict to the user's host.

The type of the provider must be explicitly specified. Refer to [5.11 Proxy](#) for more implementations.

## Proxy Properties

```
props:
  sql-show: # Whether show SQL or not in log. Print SQL details can help developers
  debug easier. The log details include: logic SQL, actual SQL and SQL parse result.
  Enable this property will log into log topic ShardingSphere-SQL, log level is INFO.
  sql-simple: # Whether show SQL details in simple style.
  executor-size: # The max thread size of worker group to execute SQL. One
  ShardingSphereDataSource will use a independent thread pool, it does not share
  thread pool even different data source in same JVM.
  max-connections-size-per-query: # Max opened connection size for each query.
  check-table-metadata-enabled: # Whether validate table meta data consistency when
  application startup or updated.
  proxy-frontend-flush-threshold: # Flush threshold for every records from
  databases for ShardingSphere-Proxy.
  proxy-transaction-type: # Default transaction type of ShardingSphere-Proxy.
  Include: LOCAL, XA and BASE.
  proxy-opentracing-enabled: # Whether enable opentracing for ShardingSphere-Proxy.
  proxy-hint-enabled: # Whether enable hint for ShardingSphere-Proxy. Using Hint
  will switch proxy thread mode from IO multiplexing to per connection per thread,
  which will reduce system throughput.
  xa-transaction-manager-type: # XA Transaction manager type. Include: Atomikos,
  Narayana and Bitronix.
```

## 5.0.0-alpha

### Data Source Configuration Item Explanation

```

schemaName: # Logic schema name.

dataSourceCommon:
  username: # Database username.
  password: # Database password.
  connectionTimeoutMilliseconds: # Connection timeout milliseconds.
  idleTimeoutMilliseconds: # Idle timeout milliseconds.
  maxLifetimeMilliseconds: # Maximum life milliseconds.
  maxPoolSize: 50 # Maximum connection count in the pool.
  minPoolSize: 1 # Minimum connection count in the pool.

dataSources: # Data sources configuration, multiple <data-source-name> available.
  <data-source-name>: # Different from ShardingSphere-JDBC configuration, it does
not need to be configured with database connection pool.
  url: # Database URL.
rules: # Keep consist with ShardingSphere-JDBC configuration.
# ...

```

### Override dataSourceCommon Configuration

If you want to override the 'dataSourceCommon' property, configure it separately for each data source.

```

dataSources: # Data sources configuration, multiple <data-source-name> available.
  <data-source-name>: # Different from ShardingSphere-JDBC configuration, it does
not need to be configured with database connection pool.
  url: # Database URL.
  username: # Database username, Override dataSourceCommon username property.
  password: # Database password, Override dataSourceCommon password property.
  connectionTimeoutMilliseconds: # Connection timeout milliseconds, Override
dataSourceCommon connectionTimeoutMilliseconds property.
  idleTimeoutMilliseconds: # Idle timeout milliseconds, Override dataSourceCommon
idleTimeoutMilliseconds property.
  maxLifetimeMilliseconds: # Maximum life milliseconds, Override dataSourceCommon
maxLifetimeMilliseconds property.
  maxPoolSize: 50 # Maximum connection count in the pool, Override
dataSourceCommon maxPoolSize property.
  minPoolSize: 1 # Minimum connection count in the pool, Override
dataSourceCommon minPoolSize property.

```



## Authentication

It is used to verify the authentication to log in ShardingSphere-Proxy, which must use correct user name and password after the configuration of them.

```
authentication:
  users:
    root: # Self-defined username.
      password: root # Self-defined password.
    sharding: # Self-defined username.
      password: sharding # Self-defined password.
      authorizedSchemas: sharding_db, replica_query_db # Schemas authorized to this
user, please use commas to connect multiple schemas. Default authorized schemas is
all of the schemas.
```

## Proxy Properties

```
props:
  sql-show: # Whether show SQL or not in log. Print SQL details can help developers
debug easier. The log details include: logic SQL, actual SQL and SQL parse result.
Enable this property will log into log topic ShardingSphere-SQL, log level is INFO.
  sql-simple: # Whether show SQL details in simple style.
  acceptor-size: # The max thread size of accepter group to accept TCP connections.
  executor-size: # The max thread size of worker group to execute SQL. One
ShardingSphereDataSource will use a independent thread pool, it does not share
thread pool even different data source in same JVM.
  max-connections-size-per-query: # Max opened connection size for each query.
  check-table-metadata-enabled: # Whether validate table meta data consistency when
application startup or updated.
  query-with-cipher-column: # Whether query with cipher column for data encrypt.
User you can use plaintext to query if have.
  proxy-frontend-flush-threshold: # Flush threshold for every records from
databases for ShardingSphere-Proxy.
  proxy-transaction-type: # Default transaction type of ShardingSphere-Proxy.
Include: LOCAL, XA and BASE.
  proxy-opentracing-enabled: # Whether enable opentracing for ShardingSphere-Proxy.
  proxy-hint-enabled: # Whether enable hint for ShardingSphere-Proxy. Using Hint
will switch proxy thread mode from IO multiplexing to per connection per thread,
which will reduce system throughput.
```

## ShardingSphere-4.x

### Data Source and Sharding Configuration Item Explanation

#### Data Sharding

```

schemaName: # Logic data schema name.

dataSources: # Data source configuration, which can be multiple data_source_name.
  <data_source_name>: # Different from Sharding-JDBC configuration, it does not
  need to be configured with database connection pool.
    url: # Database url connection.
    username: # Database username.
    password: # Database password.
    connectionTimeoutMilliseconds: 30000 # Connection timeout.
    idleTimeoutMilliseconds: 60000 # Idle timeout setting.
    maxLifetimeMilliseconds: 1800000 # Maximum lifetime.
    maxPoolSize: 65 # Maximum connection number in the pool.

shardingRule: #Omit data sharding configuration and be consistent with Sharding-
JDBC configuration.

```

#### Read-write splitting

```

schemaName: # Logic data schema name.

dataSources: # Omit data source configurations; keep it consistent with data
sharding.

masterSlaveRule: # Omit data source configurations; keep it consistent with
Sharding-JDBC.

```

#### Data Masking

```

dataSource: # Ignore data sources configuration.

encryptRule:
  encryptors:
    <encryptor-name>:
      type: # encryptor type.
      props: # Properties, e.g. `aes.key.value` for AES encryptor.
        aes.key.value:
  tables:
    <table-name>:
      columns:

```

```

<logic-column-name>:
  plainColumn: # plaintext column name.
  cipherColumn: # ciphertext column name.
  assistedQueryColumn: # AssistedColumns for query, when use
ShardingQueryAssistedEncryptor, it can help query encrypted data.
  encryptor: # encrypt name.
props:
  query.with.cipher.column: true #Whether use cipherColumn to query or not

```

## Overall Configuration Explanation

### Orchestration

It is the same with Sharding-JDBC configuration.

### Proxy Properties

```

# Omit configurations that are the same with Sharding-JDBC.

props:
  acceptor.size: # The thread number of accept connection; default to be 2 times of
cpu core.
  proxy.transaction.type: # Support LOCAL, XA, BASE; Default is LOCAL transaction,
for BASE type you should copy ShardingTransactionManager associated jar to lib
directory.
  proxy.opentracing.enabled: # Whether to enable opentracing, default not to
enable; refer to [APM](https://shardingsphere.apache.org/document/current/en/
features/orchestration/apm/) for more details.
  check.table.metadata.enabled: # Whether to check metadata consistency of sharding
table when it initializes; default value: false.

```

### Authentication

It is used to verify the authentication to log in Sharding-Proxy, which must use correct user name and password after the configuration of them.

```

authentication:
  users:
    root: # self-defined username.
      password: root # self-defined password.
    sharding: # self-defined username.
      password: sharding # self-defined password.
  authorizedSchemas: sharding_db, masterslave_db # schemas authorized to this

```

user, please use commas to connect multiple schemas. Default authorizedSchemas is all of the schemas.

## ShardingSphere-3.x

### Data sources and sharding rule configuration reference

#### Data Sharding

```
schemaName: # Logic database schema name.

dataSources: # Data sources configuration, multiple `data_source_name` available.
  <data_source_name>: # Different with Sharding-JDBC, do not need configure data
  source pool here.
    url: # Database URL.
    username: # Database username.
    password: # Database password.
    autoCommit: true # The default config of hikari connection pool.
    connectionTimeout: 30000 # The default config of hikari connection pool.
    idleTimeout: 60000 # The default config of hikari connection pool.
    maxLifetime: 1800000 # The default config of hikari connection pool.
    maximumPoolSize: 65 # The default config of hikari connection pool.

shardingRule: # Ignore sharding rule configuration, same as Sharding-JDBC.
```

#### Read-write splitting

```
schemaName: # Logic database schema name.

dataSources: # Ignore data source configuration, same as sharding.

masterSlaveRule: # Ignore read-write splitting rule configuration, same as
Sharding-JDBC.
```

### Global configuration reference

#### Orchestration

Same as configuration of Sharding-JDBC.

## Proxy Properties

```
# Ignore configuration which same as Sharding-JDBC.

props:
  acceptor.size: # Max thread count to handle client's requests, default value is
CPU*2.
  proxy.transaction.enabled: # Enable transaction, only support XA now, default
value is false.
  proxy.opentracing.enabled: # Enable open tracing, default value is false. More
details please reference[APM](https://shardingsphere.apache.org/document/current/
en/features/orchestration/apm/).
  check.table.metadata.enabled: # To check the metadata consistency of all the
tables or not, default value : false.
```

## Authorization

To perform Authorization for Sharding Proxy when login in. After configuring the username and password, you must use the correct username and password to login into the Proxy.

```
authentication:
  username: root
  password:
```

## 7.10 DistSQL

This chapter will introduce the detailed syntax of DistSQL.

### 7.10.1 Syntax

This chapter describes the syntax of DistSQL in detail, and introduces use of DistSQL with practical examples.

#### RDL Syntax

RDL (Resource & Rule Definition Language) responsible for definition of resources/rules.

## Resource Definition

This chapter describes the syntax of resource definition.

### ADD RESOURCE

#### Description

The ADD RESOURCE syntax is used to add resources for the currently selected schema.

#### Syntax

```
AddResource ::=
  'ADD' 'RESOURCE' dataSource (',' dataSource)*

dataSource ::=
  dataSourceName '(' ( 'HOST' '=' hostName ',' 'PORT' '=' port ',' 'DB' '=' dbName
| 'URL' '=' url ) ',' 'USER' '=' user (',' 'PASSWORD' '=' password )? (','
'PROPERTIES' '(' ( key '=' value ) ( ',' key '=' value )* ')' )? ')'

dataSourceName ::=
  identifier

hostname ::=
  identifier | ip

dbName ::=
  identifier

port ::=
  int

password ::=
  identifier | int | string

user ::=
  identifier

url ::=
  identifier | string
```

### Supplement - Before adding resources, please confirm that a schema has been created in Proxy, and execute the use command to successfully select a schema - Confirm that the added resource can be connected normally, otherwise it will not be added successfully - dataSourceName is case-sensitive - dataSourceName needs to be unique within the current schema - dataSourceName name only allows letters, numbers and \_, and must start with a letter - poolProperty is used to customize connection

pool parameters, key must be the same as the connection pool parameter name, value supports int and String types - When password contains special characters, it is recommended to use the string form; for example, the string form of password@123 is "password@123"

### Example - Add resource using standard mode

```
ADD RESOURCE ds_0 (
  HOST=127.0.0.1,
  PORT=3306,
  DB=db_0,
  USER=root,
  PASSWORD=root
);
```

- Add resource and set connection pool parameters using standard mode

```
ADD RESOURCE ds_1 (
  HOST=127.0.0.1,
  PORT=3306,
  DB=db_1,
  USER=root,
  PASSWORD=root
  PROPERTIES("maximumPoolSize"=10)
);
```

- Add resource and set connection pool parameters using URL patterns

```
ADD RESOURCE ds_2 (
  URL="jdbc:mysql://127.0.0.1:3306/db_2?serverTimezone=UTC&useSSL=false",
  USER=root,
  PASSWORD=root,
  PROPERTIES("maximumPoolSize"=10,"idleTimeout"="30000")
);
```

### Reserved word

```
ADD, RESOURCE, HOST, PORT, DB, USER, PASSWORD, PROPERTIES, URL
```

### Related links - [Reserved word](#)

## ALTER RESOURCE

### Description

The ALTER RESOURCE syntax is used to alter resources for the currently selected schema.

### Syntax

```
AlterResource ::=
  'ALTER' 'RESOURCE' dataSource (',' dataSource)*

dataSource ::=
  dataSourceName '(' ( 'HOST' '=' hostname ',' 'PORT' '=' port ',' 'DB' '=' dbName
  | 'URL' '=' url ) ',' 'USER' '=' user (',' 'PASSWORD' '=' password )? (','
  'PROPERTIES' '(' ( key '=' value ) ( ',' key '=' value )* ')' )? ')'

dataSourceName ::=
  identifier

hostname ::=
  identifier | ip

dbName ::=
  identifier

port ::=
  int

password ::=
  identifier | int | string

user ::=
  identifier

url ::=
  identifier | string
```

### Supplement - Before altering the resources, please confirm that a schema exists in Proxy, and execute the use command to successfully select a schema - dataSourceName is case-sensitive - dataSourceName needs to be unique within the current schema - dataSourceName name only allows letters, numbers and \_, and must start with a letter - poolProperty is used to customize connection pool parameters, key must be the same as the connection pool parameter name, value supports int and String types - When password contains special characters, it is recommended to use the string form; for example, the string form of password@123 is "password@123"

### Example - Alter resource using standard mode



```
ALTER RESOURCE ds_0 (
  HOST=127.0.0.1,
  PORT=3306,
  DB=db_0,
  USER=root,
  PASSWORD=root
);
```

- Alter resource and set connection pool parameters using standard mode

```
ALTER RESOURCE ds_1 (
  HOST=127.0.0.1,
  PORT=3306,
  DB=db_1,
  USER=root,
  PASSWORD=root
  PROPERTIES("maximumPoolSize"=10)
);
```

- Alter resource and set connection pool parameters using URL patterns

```
ALTER RESOURCE ds_2 (
  URL="jdbc:mysql://127.0.0.1:3306/db_2?serverTimezone=UTC&useSSL=false",
  USER=root,
  PASSWORD=root,
  PROPERTIES("maximumPoolSize"=10,"idleTimeout"="30000")
);
```

### Reserved word

```
ALTER, RESOURCE, HOST, PORT, DB, USER, PASSWORD, PROPERTIES, URL
```

### Related links - [Reserved word](#)

### DROP RESOURCE

#### Description

The DROP RESOURCE syntax is used to drop resources from the current schema

## Syntax

```
DropResource ::=
  'DROP' 'RESOURCE' ( 'IF' 'EXISTS' )? dataSourceName ( ',' dataSourceName )* (
  'IGNORE' 'SINGLE' 'TABLES' )?
```

## Supplement

- DROP RESOURCE will only drop resources in Proxy, the real data source corresponding to the resource will not be dropped
- Unable to drop resources already used by rules. Resources are still in used. will be prompted when removing resources used by rules
- The resource need to be removed only contains SINGLE TABLE RULE, and when the user confirms that this restriction can be ignored, the IGNORE SINGLE TABLES keyword can be added to remove the resource ### Example
- Drop a resource

```
DROP RESOURCE ds_0;
```

- Drop multiple resources

```
DROP RESOURCE ds_1, ds_2;
```

- Ignore single table rule remove resource

```
DROP RESOURCE ds_1 IGNORE SINGLE TABLES;
```

- Drop the resource if it exists

```
DROP RESOURCE IF EXISTS ds_2;
```

## Reserved word

```
DROP, RESOURCE, IF, EXISTS, IGNORE, SINGLE, TABLES
```

## Related links

- [Reserved word](#)

## Rule Definition

This chapter describes the syntax of rule definition.

## Sharding

This chapter describes the syntax of sharding.

## CREATE SHARDING ALGORITHM

### Description

The CREATE SHARDING ALGORITHM syntax is used to create a sharding algorithm for the currently selected schema.

### Syntax

```
CreateShardingAlgorithm ::=
  'CREATE' 'SHARDING' 'ALGORITHM' shardingAlgorithmName '(' algorithmDefinition ')'
```

```
algorithmDefinition ::=
  'TYPE' '(' 'NAME' '=' algorithmType ( ',' 'PROPERTIES' '(' propertyDefinition
  ')' )? ')'
```

```
propertyDefinition ::=
  ( key '=' value ) ( ',' key '=' value )*
```

```
shardingAlgorithmName ::=
  identifier
```

```
algorithmType ::=
  identifier
```

## Supplement

- `algorithmType` is the sharding algorithm type. For detailed sharding algorithm type information, please refer to [Sharding Algorithm](#)

## Example

### 1.Create sharding algorithms

```
-- create a sharding algorithm of type INLINE
CREATE SHARDING ALGORITHM inline_algorithm (
    TYPE(NAME=inline, PROPERTIES("algorithm-expression"="t_order_${user_id % 2}"))
);

-- create a sharding algorithm of type AUTO_INTERVAL
CREATE SHARDING ALGORITHM interval_algorithm (
    TYPE(NAME=auto_interval, PROPERTIES("datetime-lower"="2022-01-01 00:00:00",
"datetime-upper"="2022-01-03 00:00:00", "sharding-seconds"="86400"))
);
```

## Reserved word

```
CREATE, SHARDING, ALGORITHM, TYPE, NAME, PROPERTIES
```

## Related links

- [Reserved word](#)

## CREATE SHARDING TABLE RULE

### Description

The `CREATE SHARDING TABLE RULE` syntax is used to add sharding table rule for the currently selected schema

## Syntax

```

CreateShardingTableRule ::=
  'CREATE' 'SHARDING' 'TABLE' 'RULE' ( tableDefinition | autoTableDefinition ) ( ','
  ( tableDefinition | autoTableDefinition ) )*

tableDefinition ::=
  tableName '(' 'DATANODES' '(' dataNode ( ',' dataNode )* ')' ( ',' 'DATABASE_
  STRATEGY' '(' strategyDefinition ')' )? ( ',' 'TABLE_STRATEGY' '('
  strategyDefinition ')' )? ( ',' 'KEY_GENERATE_STRATEGY' '('
  keyGenerateStrategyDefinition ')' )? ')'

autoTableDefinition ::=
  tableName '(' 'RESOURCES' '(' resourceName ( ',' resourceName )* ')' ','
  'SHARDING_COLUMN' '=' columnName ',' algorithmDefinition ( ',' 'KEY_GENERATE_
  STRATEGY' '(' keyGenerateStrategyDefinition ')' )? ')'

strategyDefinition ::=
  'TYPE' '=' strategyType ',' ( 'SHARDING_COLUMN' | 'SHARDING_COLUMNS' ) '='
  columnName ',' algorithmDefinition

keyGenerateStrategyDefinition ::=
  'KEY_GENERATE_STRATEGY' '(' 'COLUMN' '=' columnName ',' ( 'KEY_GENERATOR' '='
  algorithmName | algorithmDefinition ) ')'

algorithmDefinition ::=
  ( 'SHARDING_ALGORITHM' '=' algorithmName | 'TYPE' '(' 'NAME' '=' algorithmType (
  ',' 'PROPERTIES' '(' propertyDefinition ')' )? ) ')'

propertyDefinition ::=
  ( key '=' value ) ( ',' key '=' value )*

tableName ::=
  identifier

resourceName ::=
  identifier

columnName ::=
  identifier

algorithmName ::=
  identifier

```

## Supplement

- `tableDefinition` is defined for standard sharding table rule; `autoTableDefinition` is defined for auto sharding table rule. For standard sharding rules and auto sharding rule, refer to [Data Sharding](#).
- use standard sharding table rule
  - DATANODES can only use resources that have been added to the current schema, and can only use `INLINE` expressions to specify required resources
  - `DATABASE_STRATEGY`, `TABLE_STRATEGY` are the database sharding strategy and the table sharding strategy, which are optional, and the default strategy is used when not configured
  - The attribute `TYPE` in `strategyDefinition` is used to specify the type of [Sharding Algorithm](#), currently only supports `STANDARD`, `COMPLEX`. Using `COMPLEX` requires specifying multiple sharding columns with `SHARDING_COLUMNS`.
- use auto sharding table rule
  - `RESOURCES` can only use resources that have been added to the current schema, and the required resources can be specified by enumeration or `INLINE` expression
  - Only auto sharding algorithm can be used, please refer to [Auto Sharding Algorithm](#)
- `algorithmType` is the sharding algorithm type, please refer to [Sharding Algorithm](#)
- The auto-generated algorithm naming rule is `tableName _ strategyType _ shardingAlgorithmType`
- The auto-generated primary key strategy naming rule is `tableName _ strategyType`
- `KEY_GENERATE_STRATEGY` is used to specify the primary key generation strategy, which is optional. For the primary key generation strategy, please refer to [Distributed Primary Key](#)

## Example

### 1. Standard sharding table rule

- **Create standard sharding table rule by specifying sharding algorithms**

```

-- create sharding algorithms
CREATE SHARDING ALGORITHM database_inline (
  TYPE(NAME=inline, PROPERTIES("algorithm-expression"="t_order_${user_id % 2}"))
), table_inline (
  TYPE(NAME=inline, PROPERTIES("algorithm-expression"="t_order_${order_id % 2}"))
);

-- create a sharding rule by specifying sharding algorithms
CREATE SHARDING TABLE RULE t_order (
  DATANODES("ds_${0..1}.t_order_${0..1}"),
  DATABASE_STRATEGY(TYPE=standard, SHARDING_COLUMN=user_id, SHARDING_

```

```

ALGORITHM=database_inline),
    TABLE_STRATEGY(TYPE=standard, SHARDING_COLUMN=order_id, SHARDING_
ALGORITHM=table_inline)
);

```

- Use the default sharding database strategy, create standard sharding table rule by specifying a sharding algorithm

```

-- create sharding algorithms
CREATE SHARDING ALGORITHM database_inline (
    TYPE(NAME=inline, PROPERTIES("algorithm-expression"="t_order_${user_id % 2}"))
), table_inline (
    TYPE(NAME=inline, PROPERTIES("algorithm-expression"="t_order_${order_id % 2}"))
);

-- create a default sharding database strategy
CREATE DEFAULT SHARDING DATABASE STRATEGY (
    TYPE = standard, SHARDING_COLUMN=order_id, SHARDING_ALGORITHM=database_inline
);

-- create a sharding table rule by specifying a sharding algorithm
CREATE SHARDING TABLE RULE t_order (
    DATANODES("ds_${0..1}.t_order_${0..1}"),
    TABLE_STRATEGY(TYPE=standard, SHARDING_COLUMN=order_id, SHARDING_
ALGORITHM=table_inline)
);

```

- Use both the default sharding and the default sharding strategy, create standard sharding table rule

```

-- create sharding algorithms
CREATE SHARDING ALGORITHM database_inline (
    TYPE(NAME=inline, PROPERTIES("algorithm-expression"="t_order_${user_id % 2}"))
), table_inline (
    TYPE(NAME=inline, PROPERTIES("algorithm-expression"="t_order_${order_id % 2}"))
);

-- create a default sharding database strategy
CREATE DEFAULT SHARDING DATABASE STRATEGY (
    TYPE = standard, SHARDING_COLUMN=order_id, SHARDING_ALGORITHM=database_inline
);

-- create a default sharding table strategy
CREATE DEFAULT SHARDING TABLE STRATEGY (
    TYPE = standard, SHARDING_COLUMN=order_id, SHARDING_ALGORITHM=table_inline
);

```

```
);

-- create a sharding table rule
CREATE SHARDING TABLE RULE t_order (
    DATANODES("ds_${0..1}.t_order_${0..1}")
);
```

- **Create standard sharding table rule and sharding algorithms at the same time**

```
CREATE SHARDING TABLE RULE t_order (
    DATANODES("ds_${0..1}.t_order_${0..1}"),
    DATABASE_STRATEGY(TYPE=standard, SHARDING_COLUMN=user_id, SHARDING_
ALGORITHM(TYPE(NAME=inline, PROPERTIES("algorithm-expression"="ds_${user_id % 2}
")))),
    TABLE_STRATEGY(TYPE=standard, SHARDING_COLUMN=user_id, SHARDING_
ALGORITHM(TYPE(NAME=inline, PROPERTIES("algorithm-expression"="ds_${order_id % 2}
"))))
);
```

## 2.Auto sharding table rule

- **create auto sharding table rule**

```
CREATE SHARDING TABLE RULE t_order (
    RESOURCES(ds_0, ds_1),
    SHARDING_COLUMN=order_id, TYPE(NAME=MOD, PROPERTIES("sharding-count"=4))
);
```

### Reserved word

```
CREATE, SHARDING, TABLE, RULE, DATANODES, DATABASE_STRATEGY, TABLE_STRATEGY, KEY_
GENERATE_STRATEGY, RESOURCES, SHARDING_COLUMN, TYPE, SHARDING_COLUMN, KEY_
GENERATOR, SHARDING_ALGORITHM, COLUMN, NAME, PROPERTIES
```

### Related links

- [Reserved word](#)
- [CREATE SHARDING ALGORITHM](#)
- [CREATE DEFAULT\\_SHARDING STRATEGY](#)



## CREATE DEFAULT SHARDING STRATEGY

### Description

The CREATE DEFAULT SHARDING STRATEGY syntax is used to create a default sharding strategy

### Syntax

```

CreateDefaultShardingStrategy ::=
  'CREATE' 'DEFAULT' 'SHARDING' ('DATABASE' | 'TABLE') 'STRATEGY' '('
shardingStrategy ')'

shardingStrategy ::=
  'TYPE' '=' strategyType ',' ( 'SHARDING_COLUMN' '=' columnName | 'SHARDING_
COLUMN' '=' columnNames ) ',' ( 'SHARDING_ALGORITHM' '=' algorithmName |
algorithmDefinition )

algorithmDefinition ::=
  'TYPE' '(' 'NAME' '=' algorithmType ( ',' 'PROPERTIES' '(' propertyDefinition
')' )? ')'

columnName ::=
  columnName (',' columnName)+

columnName ::=
  identifier

algorithmName ::=
  identifier

algorithmType ::=
  identifier

```

### Supplement

- When using the complex sharding algorithm, multiple sharding columns need to be specified using SHARDING\_COLUMNS
- `algorithmType` is the sharding algorithm type. For detailed sharding algorithm type information, please refer to [Sharding Algorithm](#)

## Example

### 1. Create a default sharding strategy by using an existing sharding algorithm

```
-- create a sharding algorithm
CREATE SHARDING ALGORITHM database_inline (
    TYPE(NAME=inline, PROPERTIES("algorithm-expression"="t_order_${order_id % 2}"))
);

-- create a default sharding database strategy
CREATE DEFAULT SHARDING DATABASE STRATEGY (
    TYPE=standard, SHARDING_COLUMN=user_id, SHARDING_ALGORITHM=database_inline
);
```

### 2. Create sharding algorithm and default sharding table strategy at the same time

```
-- create a default sharding table strategy
CREATE DEFAULT SHARDING TABLE STRATEGY (
    TYPE=standard, SHARDING_COLUMN=user_id, SHARDING_ALGORITHM(TYPE(NAME=inline,
PROPERTIES("algorithm-expression"="t_order_${user_id % 2}")))
);
```

## Related links

- [CREATE SHARDING ALGORITHM](#)

## CREATE SHARDING BINDING TABLE RULE

### Description

The CREATE SHARDING BINDING TABLE RULE syntax is used to add binding relationships and create binding table rules for tables with sharding table rules

### Syntax

```
CreateBindingTableRule ::=
    'CREATE' 'SHARDING' 'BINDING' 'TABLE' 'RULES' bindingTableDefinition (','
bindingTableDefinition)*

bindingTableDefinition ::=
    '(' tableName (',' tableName)* ')'
```

```
tableName ::=
  identifier
```

## Supplement

- Creating binding relationships rules can only use sharding tables
- A sharding table can only have one binding relationships
- The sharding table for creating binding relationships needs to use the same resources and the same actual tables. For example `ds_${0..1}.t_order_${0..1}` and `ds_${0..1}.t_order_item_${0..1}`
- The sharding table for creating binding relationships needs to use the same sharding algorithm for the sharding column. For example `t_order_{order_id % 2}` and `t_order_item_{order_item_id % 2}`
- Only one binding rule can exist, but can contain multiple binding relationships, so can not execute `CREATE SHARDING BINDING TABLE RULE` more than one time. When a binding table rule already exists but a binding relationship needs to be added, you need to use `ALTER SHARDING BINDING TABLE RULE` to modify the binding table rule

## Example

### 1.Create a binding table rule

```
-- Before creating a binding table rule, you need to create sharding table rules t_
order, t_order_item
CREATE SHARDING BINDING TABLE RULES (t_order,t_order_item);
```

### 2.Create multiple binding table rules

```
-- Before creating binding table rules, you need to create sharding table rules t_
order, t_order_item, t_product, t_product_item
CREATE SHARDING BINDING TABLE RULES (t_order,t_order_item),(t_product,t_product_
item);
```

## Related links

- [CREATE SHARDING TABLE RULE](#)

## CREATE SHARDING BROADCAST TABLE RULE

### Description

The CREATE SHARDING BROADCAST TABLE RULE syntax is used to create broadcast table rules for tables that need to be broadcast (broadcast tables)

### Syntax

```
CreateBroadcastTableRule ::=
  'CREATE' 'SHARDING' 'BROADCAST' 'TABLE' 'RULES' '(' tableName (',' tableName)* ')'
  '
tableName ::=
  identifier
```

### Supplement

- tableName can use an existing table or a table that will be created
- Only one broadcast rule can exist, but can contain multiple broadcast tables, so can not execute CREATE SHARDING BROADCAST TABLE RULE more than one time. When the broadcast table rule already exists but the broadcast table needs to be added, you need to use ALTER BROADCAST TABLE RULE to modify the broadcast table rule

### Example

#### Create sharding broadcast table rule

```
-- Add t_province, t_city to broadcast table rules
CREATE SHARDING BROADCAST TABLE RULES (t_province, t_city);
```

## CREATE SHARDING KEY GENERATOR

### Description

The CREATE SHARDING KEY GENERATOR syntax is used to add a distributed primary key generator for the currently selected logic database

### Syntax

```

CreateShardingAlgorithm ::=
  'CREATE' 'SHARDING' 'KEY' 'GENERATOR' keyGeneratorName '(' algorithmDefinition ')'
  ;

algorithmDefinition ::=
  'TYPE' '(' 'NAME' '=' algorithmType ( ',' 'PROPERTIES' '(' propertyDefinition
  ')' )? ')'

propertyDefinition ::=
  ( key '=' value ) ( ',' key '=' value )*

keyGeneratorName ::=
  identifier

algorithmType ::=
  identifier

```

### Supplement

- algorithmType is the key generate algorithm type. For detailed key generate algorithm type information, please refer to [KEY GENERATE ALGORITHM](#)

### Example

#### Create a distributed primary key generator

```

CREATE SHARDING KEY GENERATOR snowflake_key_generator (
  TYPE(NAME=SNOWFLAKE, PROPERTIES("max-vibration-offset"=3))
);

```

## Reserved word

```
CREATE, SHARDING, KEY, GENERATOR, TYPE, NAME, PROPERTIES
```

## Related links

- [Reserved word](#)

## RQL Syntax

RQL (Resource & Rule Query Language) responsible for resources/rules query.

## Resource Query

This chapter describes the syntax of resource query.

## SHOW RESOURCE

### Description

The SHOW RESOURCE syntax is used to query the resources that have been added to the specified schema.

### Syntax

```
ShowResource ::=  
  'SHOW' 'SCHEMA' 'RESOURCES' ('FROM' schemaName)?  
  
schemaName ::=  
  identifier
```

### Supplement

- When schemaName is not specified, the default is the currently used SCHEMA; if SCHEMA is not used, it will prompt No database selected.

### Return Value Description

Column	Description
name	Data source name
type	Data source type
host	Data source host
port	Data source port
db	Database name
attribute	Data source attribute

### Example

- Query resources for the specified schema

```
SHOW SCHEMA RESOURCES FROM sharding_db;
```

```
+-----+-----+-----+-----+-----+-----+-----+
| name | type | host      | port | db  | connection_timeout_milliseconds | idle_
timeout_milliseconds | max_lifetime_milliseconds | max_pool_size | min_pool_size |
read_only | other_attributes
|
+-----+-----+-----+-----+-----+-----+-----+
| ds_0 | MySQL | 127.0.0.1 | 3306 | db_0 | 30000 | 60000
| 1800000 | 50 | 1 |
false | {"dataSourceProperties":{"cacheServerConfiguration":"true",
```





```

|
+-----+-----+-----+-----+-----+-----+-----+-----+-----+
-----+-----+-----+-----+-----+-----+-----+-----+-----+
-----+-----+-----+-----+-----+-----+-----+-----+-----+
-----+-----+-----+-----+-----+-----+-----+-----+-----+
-----+-----+-----+-----+-----+-----+-----+-----+-----+
-----+-----+-----+-----+-----+-----+-----+-----+-----+
-----+-----+-----+-----+-----+-----+-----+-----+-----+
-----+-----+-----+-----+-----+-----+-----+-----+-----+
| ds_0 | MySQL | 127.0.0.1 | 3306 | db_0 | 30000 | 60000
| 1800000 | 50 | 1 |
false | {"dataSourceProperties":{"cacheServerConfiguration":"true",
"elideSetAutoCommits":"true","useServerPrepStmts":"true","cachePrepStmts":"true",
"rewriteBatchedStatements":"true","cacheResultSetMetadata":"false",
"useLocalSessionState":"true","maintainTimeStats":"false","prepStmtCacheSize":
"200000","tinyInt1isBit":"false","prepStmtCacheSqlLimit":"2048",
"zeroDateTimeBehavior":"round","netTimeoutForStreamingResults":"0"},
"healthCheckProperties":{},"initializationFailTimeout":1,"validationTimeout":5000,
"leakDetectionThreshold":0,"registerMbeans":false,"allowPoolSuspension":false,
"autoCommit":true,"isolateInternalQueries":false} |
| ds_1 | MySQL | 127.0.0.1 | 3306 | db_1 | 30000 | 60000
| 1800000 | 50 | 1 |
false | {"dataSourceProperties":{"cacheServerConfiguration":"true",
"elideSetAutoCommits":"true","useServerPrepStmts":"true","cachePrepStmts":"true",
"rewriteBatchedStatements":"true","cacheResultSetMetadata":"false",
"useLocalSessionState":"true","maintainTimeStats":"false","prepStmtCacheSize":
"200000","tinyInt1isBit":"false","prepStmtCacheSqlLimit":"2048",
"zeroDateTimeBehavior":"round","netTimeoutForStreamingResults":"0"},
"healthCheckProperties":{},"initializationFailTimeout":1,"validationTimeout":5000,
"leakDetectionThreshold":0,"registerMbeans":false,"allowPoolSuspension":false,
"autoCommit":true,"isolateInternalQueries":false} |
+-----+-----+-----+-----+-----+-----+-----+-----+-----+
-----+-----+-----+-----+-----+-----+-----+-----+-----+
-----+-----+-----+-----+-----+-----+-----+-----+-----+
-----+-----+-----+-----+-----+-----+-----+-----+-----+
-----+-----+-----+-----+-----+-----+-----+-----+-----+
-----+-----+-----+-----+-----+-----+-----+-----+-----+
-----+-----+-----+-----+-----+-----+-----+-----+-----+
-----+-----+-----+-----+-----+-----+-----+-----+-----+

```

```
-----+
2 rows in set (0.26 sec)
```

## SHOW UNUSED RESOURCE

### Description

The SHOW UNUSED RESOURCE syntax is used to query resources in the specified schema that have not been referenced by rules.

### Syntax

```
ShowUnusedResource ::=
  'SHOW' 'UNUSED' 'SCHEMA'? 'RESOURCES' ('FROM' schemaName)?

schemaName ::=
  identifier
```

### Supplement

- When schemaName is not specified, the default is the currently used SCHEMA; if SCHEMA is not used, it will prompt No database selected.

#### ### Return Value Description

Column	Description
name	Data source name
type	Data source type
host	Data source host
port	Data source port
db	Database name
attribute	Data source attribute

#### ### Example

- Query resources for the specified schema

```
SHOW UNUSED SCHEMA RESOURCES FROM sharding_db;
```

```
+-----+-----+-----+-----+-----+-----+-----+-----+
-----+-----+-----+-----+-----+-----+-----+-----+
-----+-----+-----+-----+-----+-----+-----+-----+
-----+-----+-----+-----+-----+-----+-----+-----+
-----+-----+-----+-----+-----+-----+-----+-----+
```



- Query resources for the current schema

```
SHOW UNUSED SCHEMA RESOURCES;
```

```
+-----+-----+-----+-----+-----+-----+-----+-----+-----+
| name | type | host      | port | db   | connection_timeout_milliseconds | idle_timeout_milliseconds | max_lifetime_milliseconds | max_pool_size | min_pool_size | read_only | other_attributes |
+-----+-----+-----+-----+-----+-----+-----+-----+-----+
| ds_0 | MySQL | 127.0.0.1 | 3306 | db_0 | 30000 | 60000 | 1800000 | 50 | 1 | false | {"dataSourceProperties":{"cacheServerConfiguration":"true",
"elideSetAutoCommits":"true","useServerPrepStmts":"true","cachePrepStmts":"true",
"rewriteBatchedStatements":"true","cacheResultSetMetadata":"false",
"useLocalSessionState":"true","maintainTimeStats":"false","prepStmtCacheSize":
"200000","tinyInt1isBit":"false","prepStmtCacheSqlLimit":"2048",
"zeroDateTimeBehavior":"round","netTimeoutForStreamingResults":"0"},
"healthCheckProperties":{},"initializationFailTimeout":1,"validationTimeout":5000,
"leakDetectionThreshold":0,"registerMbeans":false,"allowPoolSuspension":false,
"autoCommit":true,"isolateInternalQueries":false} |
+-----+-----+-----+-----+-----+-----+-----+-----+-----+
+-----+-----+-----+-----+-----+-----+-----+-----+-----+
```

```

-----+
1 rows in set (0.26 sec)

```

## SHOW USED RESOURCE

### Description

The SHOW USED RESOURCE syntax is used to query the resources that have been added to the specified schema.

### Syntax

```

ShowUsedResource ::=
  'SHOW' 'USED' 'SCHEMA' 'RESOURCES' ('FROM' schemaName)?

schemaName ::=
  identifier

```

### Supplement

- When schemaName is not specified, the default is the currently used SCHEMA; if SCHEMA is not used, it will prompt No database selected.

#### ### Return Value Description

Column	Description
name	Data source name
type	Data source type
host	Data source host
port	Data source port
db	Database name
attribute	Data source attribute

#### ### Example

- Query resources for the specified schema

```
SHOW USED SCHEMA RESOURCES FROM sharding_db;
```

```

+-----+-----+-----+-----+-----+-----+-----+-----+-----+-----+
| name | type | host      | port | db   | connection_timeout_milliseconds | idle_timeout_milliseconds | max_lifetime_milliseconds | max_pool_size | min_pool_size | read_only | other_attributes |
+-----+-----+-----+-----+-----+-----+-----+-----+-----+-----+
| ds_0 | MySQL | 127.0.0.1 | 3306 | db_0 | 30000 | 60000 | 1800000 | 50 | 1 | false | {"dataSourceProperties":{"cacheServerConfiguration":"true",
"elideSetAutoCommits":"true","useServerPrepStmts":"true","cachePrepStmts":"true",
"rewriteBatchedStatements":"true","cacheResultSetMetadata":"false",
"useLocalSessionState":"true","maintainTimeStats":"false","prepStmtCacheSize":
"200000","tinyInt1isBit":"false","prepStmtCacheSqlLimit":"2048",
"zeroDateBehavior":"round","netTimeoutForStreamingResults":"0"},
"healthCheckProperties":{},"initializationFailTimeout":1,"validationTimeout":5000,
"leakDetectionThreshold":0,"registerMbeans":false,"allowPoolSuspension":false,
"autoCommit":true,"isolateInternalQueries":false} |
| ds_1 | MySQL | 127.0.0.1 | 3306 | db_1 | 30000 | 60000 | 1800000 | 50 | 1 | false | {"dataSourceProperties":{"cacheServerConfiguration":"true",
"elideSetAutoCommits":"true","useServerPrepStmts":"true","cachePrepStmts":"true",
"rewriteBatchedStatements":"true","cacheResultSetMetadata":"false",

```







## Rule Query

This chapter describes the syntax of rule query.

## Sharding

This chapter describes the syntax of sharding.

## SHOW SHARDING TABLE RULE

### Description

The SHOW SHARDING TABLE RULE syntax is used to query the sharding table rule in the specified schema.

### Syntax

```
ShowShardingTableRule ::=
  'SHOW' 'SHARDING' 'TABLE' ('RULE' tableName | 'RULES') ('FROM' schemaName)?

tableName ::=
  identifier

schemaName ::=
  identifier
```

## Supplement

- When schemaName is not specified, the default is the currently used SCHEMA. If SCHEMA is not used, No database selected will be prompted.

### Return value description

Column	Description
table	Logical table name
actual_data_nodes	Actual data node
actual_data_sources	Actual data source (Displayed when creating rules by RDL)
database_strategy_type	Database sharding strategy type
database_sharding_column	Database sharding column
<b>database_</b> sharding_algorithm_type	Database sharding algorithm type
database_s harding_algorithm_props	Database sharding algorithm properties
table_strategy_type	Table sharding strategy type
table_sharding_column	Table sharding column
<b>table_</b> sharding_algorithm_type	Table sharding algorithm type
table_s harding_algorithm_props	Table sharding algorithm properties
key_generate_column	Sharding key generator column
key_generator_type	Sharding key generator type
key_generator_props	Sharding key generator properties

### Example - Query the sharding table rules of the specified logical schema

```
SHOW SHARDING TABLE RULES FROM sharding_db;
```

```
+-----+-----+-----+-----+
+-----+-----+-----+-----+
+-----+-----+-----+-----+
+-----+-----+-----+-----+
+-----+-----+-----+-----+
| table          | actual_data_nodes | actual_data_sources | database_strategy_type |
database_sharding_column | database_sharding_algorithm_type | database_sharding_
algorithm_props | table_strategy_type | table_sharding_column | table_sharding_
algorithm_type | table_sharding_algorithm_props | key_generate_column | key_
generator_type | key_generator_props |
+-----+-----+-----+-----+
+-----+-----+-----+-----+
+-----+-----+-----+-----+
+-----+-----+-----+-----+
| t_order       |                   | ds_0,ds_1           |
|               |                   |                       |
|               | mod               | order_id             | mod
| sharding-count=4 |                   |                       |
```

```

| t_order_item |          | ds_0,ds_1 |          |
|              | mod     | order_id  | mod     |
| sharding-count=4 |          |          |          |
+-----+-----+-----+-----+
+-----+-----+-----+-----+
+-----+-----+-----+-----+
+-----+-----+-----+-----+
+-----+-----+-----+-----+
2 rows in set (0.12 sec)

```

- Query the sharding table rules of the current logic schema

```
SHOW SHARDING TABLE RULES;
```

```

+-----+-----+-----+-----+
+-----+-----+-----+-----+
+-----+-----+-----+-----+
+-----+-----+-----+-----+
+-----+-----+-----+-----+
| table      | actual_data_nodes | actual_data_sources | database_strategy_type |
database_sharding_column | database_sharding_algorithm_type | database_sharding_
algorithm_props | table_strategy_type | table_sharding_column | table_sharding_
algorithm_type | table_sharding_algorithm_props | key_generate_column | key_
generator_type | key_generator_props |
+-----+-----+-----+-----+
+-----+-----+-----+-----+
+-----+-----+-----+-----+
+-----+-----+-----+-----+
+-----+-----+-----+-----+
| t_order    |          | ds_0,ds_1 |          |
|            | mod     | order_id  | mod     |
| sharding-count=4 |          |          |          |
| t_order_item |          | ds_0,ds_1 |          |
|              | mod     | order_id  | mod     |
| sharding-count=4 |          |          |          |
+-----+-----+-----+-----+
+-----+-----+-----+-----+
+-----+-----+-----+-----+
+-----+-----+-----+-----+
+-----+-----+-----+-----+
2 rows in set (0.12 sec)

```

- Query the specified sharding table rule

```
SHOW SHARDING TABLE RULE t_order;
```

```
+-----+-----+-----+-----+
+-----+-----+-----+-----+
-----+-----+-----+-----+
--++-----+
| table          | actual_data_nodes | actual_data_sources | database_strategy_type |
database_sharding_column | database_sharding_algorithm_type | database_sharding_
algorithm_props | table_strategy_type | table_sharding_column | table_sharding_
algorithm_type | table_sharding_algorithm_props | key_generate_column | key_
generator_type | key_generator_props |
+-----+-----+-----+-----+
+-----+-----+-----+-----+
-----+-----+-----+-----+
--++-----+
| t_order       |                   | ds_0,ds_1           |                   |
          | mod              | order_id            | mod              |
          | sharding-count=4 |                   |                   |
+-----+-----+-----+-----+
+-----+-----+-----+-----+
-----+-----+-----+-----+
--++-----+
1 rows in set (0.12 sec)
```

### RAL Syntax

RAL (Resource & Rule Administration Language) responsible for the added-on feature of hint, transaction type switch, scaling, sharding execute planning and so on.

### Reserved word

### Resource definition

```
ADD, RESOURCE, HOST, PORT, DB, USER, PASSWORD, PROPERTIES, URL
```

## Supplement

- The above reserved words are not case-sensitive

## 8.1 Latest Releases

Apache ShardingSphere is released as source code tarballs with corresponding binary tarballs for convenience. The downloads are distributed via mirror sites and should be checked for tampering using GPG or SHA-512.

### 8.1.1 Apache ShardingSphere - Version: 5.1.2 ( Release Date: June 13th, 2022 )

- Source Codes: [SRC](#) ( [ASC](#), [SHA512](#) )
- ShardingSphere-JDBC Binary Distribution: [TAR](#) ( [ASC](#), [SHA512](#) )
- ShardingSphere-Proxy Binary Distribution: [TAR](#) ( [ASC](#), [SHA512](#) )
- ShardingSphere-Agent Binary Distribution: [TAR](#) ( [ASC](#), [SHA512](#) )

## 8.2 All Releases

Find all releases in the [Archive repository](#). Find all incubator releases in the [Archive incubator repository](#).

## 8.3 Verify the Releases

PGP signatures [KEYS](#)

It is essential that you verify the integrity of the downloaded files using the PGP or SHA signatures. The PGP signatures can be verified using GPG or PGP. Please download the [KEYS](#) as well as the [asc](#) signature files for relevant distribution. It is recommended to get these files from the main distribution directory and not from the mirrors.

```
gpg -i KEYS
```

or

```
pgpk -a KEYS
```

or

```
gpg -ka KEYS
```

To verify the binaries/sources you can download the relevant asc files for it from main distribution directory and follow the below guide.

```
gpg --verify apache-shardingsphere-*****.asc apache-shardingsphere-*****
```

or

```
pgpv apache-shardingsphere-*****.asc
```

or

```
gpg apache-shardingsphere-*****.asc
```