



2021 Dealer Rigging Guide





Genuine Yamaha parts and accessories. Why choose anything else?

Yamaha is a name synonymous with performance, quality and reliability - and behind it is a reputation earned from years of creating outboard engines and marine products which incorporate the most advanced and innovative technology. In fact, millions of water sports enthusiasts and professionals the world over choose Yamaha, simply because it's the name they know and trust - and because they know we apply the very same high standards and attention to detail to everything we make. So it's no surprise that they also choose Yamaha when it comes to their parts and accessories. What's more, all our products are designed to work seamlessly with each other, which means not just co-ordinated design, looks and styling, but more dependable performance and a comforting feeling of peace of mind.

There's an impressively wide range too, extending from exciting watersport accessories, smart steering wheels and high-performance props - to hi-tech marine lubricants, ingenious security locks and protective covers for engines and watercraft. Not to mention remote controls and steering systems, switches, filters, fuel tanks and other practical things! Check out too, our line-up of Digital Network Gauges and electronic control systems - with its integral, centrally-managed system of command and control, comes a revolution in boating comfort and enjoyment.

So whatever you may need to enhance your fun and enjoyment on the water, we've got it covered - with products that are designed to perform and built to last. Just as you'd expect from Yamaha.



Propellers

Propeller Information	2
Series description	3
Selection guide by model	6

Outboard Rigging & Accessories

Helm Master EX	14
Instruments	20
Remote controls	22
Steering & Steering Systems	28
Outboard Maintenance & Accessories	32

Rigging Order Guide

Mechanical Remote Control	36
Y-COP	49
DBW Remote Control	52

Fuel and Energy systems

Filters and Fuel Accessories	142
Fuel Tanks and Accessories	144
Other Rigging & Accessories	145

Outboard Essentials and Spare parts

Marine Service Kits	147
Outboard Essentials	152
Anodes, Impellers, Thermostats	154
Spark plugs	156
Oil Filters	157
Outboard accessories	158

WaveRunner Accessories	160
------------------------	-----

Yamalube	162
----------	-----

Propellers and Propeller Accessories



Propeller Information

THE PROPELLER MAKES ALL THE DIFFERENCE.

If you haven't tried one of Yamaha's comprehensive range of propeller solutions, you're not getting the most out of your outboard. In fact, the right Yamaha propeller can maximize your outboard's acceleration, top speed, fuel economy and lifespan, all while providing a quieter ride and better handling. No matter what your application, there's a genuine Yamaha propeller that can help you achieve peak performance.

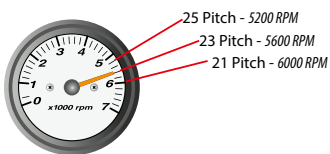

PITCH

Pitch is the 'theoretical' distance (in inches) a propeller would travel in one full revolution, if it were travelling through solid matter. A prop with low pitch will deliver better acceleration/hole shot and pushing power but a lower top speed, while a higher pitch prop will provide less thrust, but with a higher top speed. The correct propeller will allow your engine to reach the upper portion of the W-O-T range specified by the manufacturer with a normal-to-heavy load, but without exceeding it. Each inch of pitch is equal to approximately 150 +/- 50 RPM.

DIAMETER

Diameter means the total width of the "circle" at the blade tips as the propeller spins. Larger diameter props push more water and reach deeper down into the water, so they're typically used on large, heavy boats or ones with higher-placed engine mountings. A smaller diameter prop is usually used on lighter boats, where the prop operates closer to the surface of the water - or when you need a higher engine RPM.

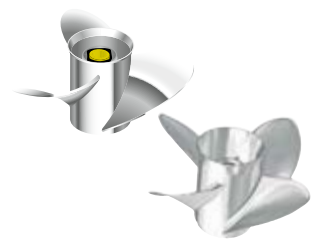
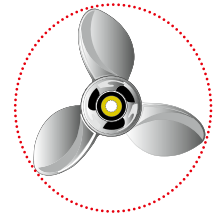

NUMBER OF BLADES

Three-bladed propellers are the most common, offering good overall performance, top speed, and efficiency for most applications. While a four-bladed prop will provide increased bow and stern-lift and reduce prop ventilation, this normally means more drag on the engine, resulting in lower top speeds and different handling characteristics.

BLADE GEOMETRY

Blade geometry refers to the actual shape of the blade (or ear). By manipulating the blade's shape, diameter and pitch progression, different performance characteristics can be created for each different type and style of propeller.

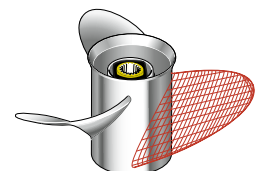

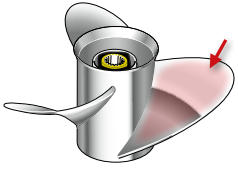

BLADE SURFACE AREA

Blade surface area refers to the total surface of the blades. The greater the blade surface area, the more water the prop pushes, for better hole shot and increased planing efficiency. However, too much blade area can create significantly more drag, potentially restricting engine RPM and causing negative boat-handling issues.

CUP

Cup is the small curved lip on the blade tip and/or trailing edge. Used in proper amounts, cup helps reduce ventilation and propeller slippage, allowing for higher engine mounting and greater bow lift. However, too much cup may cause excessive steering torque and bow lift - and limit the engine's ability to develop and maintain proper RPM at a certain pitch.

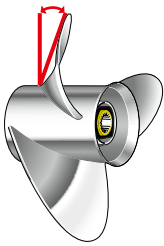
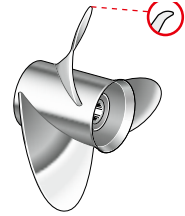

RAKE

Rake is the angle of the blade in relation to the propeller's barrel, or centre, and is expressed in degrees. A high rake propeller is best suited to applications where the engine is mounted high, to help reduce ventilation and increase bow lift. However, too much rake can strain the engine, decrease hole shot and produce negative performance and handling results. A propeller with a low rake angle will cause less strain on the engine, resulting in potentially better hole shot and higher operating rpm at W-O-T.

SDS - SHIFT DAMPENER SYSTEM

Reducing the annoying shift shock and noise normally associated with moving between gears, Yamaha's unique Shift Dampening System (SDS) uses a splined aft washer and a splined rubber hub to absorb noise and vibration. This carefully engineered solution brings smoother, quieter gear shifts.

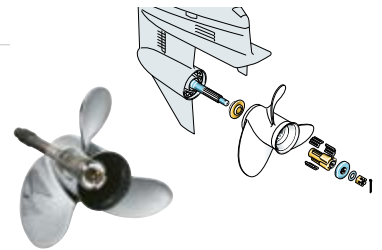

Propeller Series

ALUMINUM/PLASTIC SERIES

Offering Yamaha design, quality and performance in a low-cost, lightweight propeller. This is a good all-around choice for your Yamaha outboard. Available in a wide variety of sizes and pitches for Yamaha outboards between 2 and 225 horse power, in right-hand and select left-hand rotation.



DUAL THRUST SERIES

Specially designed for sailboats and other large-displacement craft, Yamaha's patented Dual Thrust propellers are built to handle the job of pushing heavy loads through water. The hub is carefully designed to redirect exhaust flow away from the blades, so Dual Thrust models cut through "clean water" for higher efficiency and better acceleration. It is recommended that you contact an authorised Yamaha Dealer for advice on installation.



TALON GP SERIES (WITH SDS)

Designed for outboards from F70 to F130. Our Talon – SDS propeller with our exclusive Shift Dampener System (SDS™) brings a better top speed while offering a comfortable ride. The smooth shifting and quiet, in-gear operation, even at trolling speeds, will be particularly beneficial on smaller, in-line outboards.





TALON SERIES (WITH SDS)

Specially engineered to reduce ventilation and enhance bow lift, Yamaha's TALON aluminum 3-bladed propellers offer excellent holding power in turns, with enhanced "grip" for improved control. In addition, they feature better overall performance and greater cruising efficiency in a planed trim position than conventional 3-bladed aluminum propellers. TALON props are especially effective on mid-sized deep- and mod-V aluminum boats, particularly in applications with the potential for aerated water beneath the boat. The Yamaha SDS mechanism is integrated to reduce shifting vibration and noise. Can be used with standard spacer.



K SERIES TALON STAINLESS STEEL (WITH SDS)

K-Series Talon Stainless Steel SDS propellers combine quiet, clunk-free shifting and smooth in-gear operation (even at low speeds) with a high-performance, good looking stainless steel propeller – a first for mid-range horsepower outboards. Now, medium-sized Aluminium, FRP and RIB boats using Yamaha's F70 up through to the all-new F130A can enjoy the unbeatable combination of smooth and quiet operation with great all-around performance. Just as the Talon Aluminium series, this SDS hub system requires no special hardware to operate.



BLACK STAINLESS STEEL SERIES

An excellent general-purpose choice, these props are made from stainless steel, with a cost-effective black paint coating, allowing for a blade that is thinner, more efficient and more durable than an aluminum propeller. Available in a wide variety of sizes and pitches for Yamaha outboards between 25 and 300 horse power, in right-hand and select left-hand rotation.



RELIANCE SERIES (WITH SDS)

Reliance is CAD-designed to increase performance. Designed primarily for use with Yamaha's F150 and F200 in-line 4 outboards, it also provides excellent all-around performance. Faster at all RPM ranges and having better anti-ventilation characteristics (grip) in most applications than Yamaha's proven Black Stainless Steel props, Reliance Series props are highly-polished stainless steel, featuring impressive cast-in naming on the barrel and excellent corrosion resistance. Now available with Yamaha's exclusive Shift Dampener System (SDS).



SALTWATER SERIES II (WITH SDS)

A powerful choice for today's larger offshore boats, Saltwater Series II propellers are a highly-polished, larger diameter design. Aggressive rake and extra cupping on the blades provide superior midrange fuel efficiency, along with excellent anti-ventilation characteristics. For offshore fishermen, that translates to longer cruising range and better handling in rough seas. Also available with the Yamaha Shift Dampener System (SDS).



SALTWATER SERIES HS4 (WITH SDS)

A polished stainless steel propeller with 4 blades, for certain V6 4-stroke engines. Compared with the conventional 3-bladed propeller, the 4-blade configuration has a larger blade surface area, which can catch much more water and obtain higher thrust performance. As a result, this propeller will obtain better acceleration and be more stable in operation under rough water. However, top speed performance is generally slightly less than a 3-blade design. L/H rotation propellers are available.

SALTWATER SERIES XL

A premium prop designed exclusively for the V8 5.3L 4-stroke Yamaha outboards. Designed to harness the awesome power of these engines and convert it into massive amounts of thrust, Saltwater XL propellers have more diameter and 21% more blade area than even our largest Saltwater Series II propellers. This helps the F350 generate up to 45% more thrust than other 250hp-class outboards, and provides large offshore boats with plenty of power to plane quickly, as well as great acceleration and top-end speed. Available with the SDS Shift Dampening System. (Note: deduct two inches of pitch for same or similar performance when converting non-SDS XL propellers to SDS-equipped Saltwater Series XL propellers.)



SALTWATER SERIES XL4 AND XL4-HP (WITH SDS)

Designed exclusively for Yamaha's V8 5.3L F350 outboard, this 4 bladed prop offers incredible thrust and quick-on-the-plane capability, yet with quiet and smooth operation thanks to Yamaha's unique SDS Shift Dampener System. Two XL4 prop types are available: XL4 (15" and 17") designed for very large, heavy offshore boats - and the XL4-HP (22" and 24") designed for lighter, high-performance multi-engined offshore boats.



XTO (SDS) PROPELLERS

With diameters from 16 to 17 1/8 inches and increased blade surface, XTO OS™ propellers are engineered to complement the torque potential of our V8 XTO Offshore™ outboard on 50-foot-plus boats. Features our patented, Shift Dampener System (SDS) for a smoother ride.



Propellers

ALUMINUM SERIES

Outboard Model	Part Number	Diameter	Pitch	Blade	Hub	Rotation	Remark
2A/2B/2C	6A1-45943-00-00	7 1/4	4	3	A	RH	
	646-45944-01-00	7 1/4	4 1/2	3	A	RH	
	6F8-45942-01-00	7 1/4	5	3	A	RH	
	646-45942-01-00	7 1/4	5 1/2	3	A	RH	
F2,5A 3A	6L5-45949-00-00	7 1/4	5	3	BS	RH	
	6L5-45952-00-00	7 1/2	5 1/2	3	BS	RH	
	6L5-45943-00-00	7 1/4	6	3	BS	RH	
	6L5-45945-00-00	7 1/4	7 1/4	3	BS	RH	
	6L5-45947-00-00	7 1/4	8 1/4	3	BS	RH	
4A / 5C (--1991)	644-45941-01-00	7 1/4	5	3	B	RH	
	654-45941-01-00	7 1/4	6 1/2	3	B	RH	
	6E0-45943-09-00	7 1/2	7	3	B	RH	
	654-45943-01-00	7 1/4	7 1/4	3	B	RH	
	6E0-45941-09-00	7 1/2	8	3	B	RH	
	6E0-45947-00-00	7 1/4	8 1/4	3	B	RH	
F4A / F4B / F5A / F6C 4A / 5C (1992--)	6E0-45949-00-00	7 1/4	6 1/2	3	BA	RH	
	6E0-45943-01-00	7 1/2	7	3	BA	RH	
	6E0-45941-01-00	7 1/2	8	3	BA	RH	Spline engagement
	6E0-45952-00-00	7 1/4	8 1/4	3	BA	RH	
	6E0-45954-00-00	7 1/2	9	3	BA	RH	
6A / 6B / 8A / 8B / E8D	655-45949-00-00	7 1/4	5	3	C	RH	
	655-45947-01-00	9	5 3/4	3	C	RH	
	655-45945-00-00	9	6 1/2	3	C	RH	
	647-45943-00-00	9	7	3	C	RH	
	655-45943-00-00	9	7 1/2	3	C	RH	
	647-45947-00-00	9	9	3	C	RH	
	647-45941-00-00	9 1/4	9 1/4	3	C	RH	
F6A / F8C / F9,9F / F9,9J 6C / 8C	6G1-45947-00-00	8 1/2	6 1/2	3	N	RH	
	6G1-45943-00-00	8 1/2	7 1/2	3	N	RH	
	6G1-45952-00-00	8 1/2	8	3	N	RH	
	6G1-45941-00-00	8 1/2	8 1/2	3	N	RH	
	6G1-45954-00-00	8 1/2	9 1/4	3	N	RH	
F8B / F9,9B / F9,9C / F15A / F15C 9,9D / 15D / 9,9F / 15F	683-45949-00-00	9 1/2	6 1/2	3	J	RH	
	63V-45947-00-00	9 1/4	8	3	J	RH	
	683-45952-00-00	9 1/4	9 3/4	3	J	RH	
	683-45943-00-00	9 1/4	10 1/2	3	J	RH	
	683-45941-00-00	9 1/4	12	3	J	RH	
F8B / F9,9B / F9,9C / F15A / F15C / F20B / 9,9D / 15D / 9,9F / 15F	63V-45945-10-00	9 1/4	9	3	J1	RH	
	63V-45952-10-00	9 1/4	10	3	J1	RH	
	63V-45943-10-00	9 1/4	11	3	J1	RH	
	63V-45941-10-00	9 1/4	12	3	J1	RH	
F25A / F25D / F25G 20C / 20D / 25B / 25D / 25N / 25V / 30A / 30D / 30G	664-45943-01-00	9 7/8	8	3	F	RH	
	664-45941-01-00	9 7/8	9	3	F	RH	
	62C-45941-00-00	9 7/8	10	3	F	RH	
	664-45945-00-00	9 7/8	10 1/2	3	F	RH	
	664-45947-01-00	9 7/8	11 1/4	3	F	RH	
	664-45954-01-00	9 7/8	12	3	F	RH	
	664-45949-02-00	9 7/8	13	3	F	RH	
	664-45952-00-00	9 7/8	14	3	F	RH	
F30A / F30B / F40A / F40B / F40F / F50A / F50F / F50H / F60A / F60C / F60F 40H / 40V / 40Q / 40X / 50D / 50G / 50H / PRO 50 / 55B	63D-45941-00-00	12 1/4	8	3	G	RH	
	663-45956-01-00	12 1/4	9	3	G	RH	
	663-45954-01-00	11 3/4	10	3	G	RH	G-series all-rounder
	663-45958-01-00	11 1/4	14	3	G	RH	
	663-45949-01-00	10 3/4	16	3	G	RH	
	69W-45947-00-00	11 5/8	11	3	G	RH	
	69W-45952-00-00	11 3/8	12	3	G	RH	
	69W-45945-00-00	11 1/8	13	3	G	RH	G-series commercial & durable propeller
	69W-45958-00-00	11 1/4	14	3	G	RH	
	69W-45943-00-00	11	15	3	G	RH	
	6H5-45952-00-00	10 5/8	12	3	G	RH	
	6H5-45945-00-00	10 3/8	13	3	G	RH	G-series for light boat
	6H5-45958-00-00	10 1/4	14	3	G	RH	
6H5-45943-00-00	10	15	3	G	RH		

ALUMINUM SERIES

	6E5-45954-00-00	14	11	3	K	RH	
	6E5-45949-00-00	13 5/8	13	3	K	RH	
F70A / F80A / F80B / F100A / F100D / F100F / F115A / F115B	6E5-45958-00-00	13 5/8	14	3	K	RH	
60F / 70B / 75A / 75C / PRO75 / 80A / 85A / 90A / 100A / PRO V 100 / 115A / 115B / 115C / 130A / 130B / 140A / 140B / 140C	6E5-45947-00-00	13 1/2	15	3	K	RH	
	6E5-45945-01-00	13 1/4	17	3	K	RH	
	6E5-45941-00-00	13	19	3	K	RH	
	6E5-45943-00-00	12 5/8	21	3	K	RH	
	6E5-45952-00-00	13	23	3	K	RH	
	6E5-45956-00-00	13	25	3	K	RH	
F150A / F150D / F175A / F200A / F200C / F200F / F200G	6G5-45941-00-00	15 1/4	15	3	M	RH	
150A / 150C / 150F / Z150P / 175A / 175B / 175D / Z175G / 200A / 200B / 200F / Z200N	6G5-45952-00-00	14 5/8	16	3	M	RH	
	6G5-45947-01-00	14 1/2	17	3	M	RH	
	6G5-45945-01-00	14	19	3	M	RH	
	6G5-45943-01-00	13 3/4	21	3	M	RH	
	6G5-45949-00-00	13 1/2	23	3	M	RH	
FL150A / FL150D / FL200C / FL200F / FL200G / L150A / L150C / L150F / LZ150P / L200A / L200B / L200F / LZ200N	6K1-45947-00-00	14 1/2	17	3	ML	LH	
	6K1-45945-00-00	14	19	3	ML	LH	

DUAL THRUST SERIES (ALUMINUM)

Outboard Model	Part Number	Diameter	Pitch	Blade	Hub	Rotation	Remark
6C / 8C	6G1-W4592-00-00	9	5	3	N	RH	
F6A / F8C / F9,9F / F9.9J	6G1-W4591-01-00	9	7	3	N	RH	
F8B / F9,9B / F9,9C / F15A / F15C / F20B	683-W4592-02-00	9 3/4	6 1/2	3	J	RH	
9,9D / 15D / 9,9F / 15F	683-W4591-02-00	9 3/4	8	3	J	RH	
FT8D / FT9,9A / FT9,9D / FT9,9G / FT9,9L	69G-45941-00-00	11 3/4	5 3/4	3	R	RH	
	69G-45943-00-00	11 3/4	7	3	R	RH	
	6G8-45947-00-00	11 3/4	9 1/4	3	R	RH	
F25A/G	6J8-W4591-00-00	10 5/8	8 1/4	3	F	RH	
FT25B / FT25F	68U-45941-00-00	12 1/4	9	3	G	RH	
FT50B / FT50C / FT50G / FT50J / FT60B / FT60D / FT60G	68S-45941-00-00	14	11	3	K	RH	

TALON GP SERIES - SDS (ALUMINUM)

Outboard Model	Part Number	Diameter	Pitch	Blade	Hub	Rotation	Remark
	6FP-45941-00-00	13 5/8	14	3	K	RH	
	6FP-45943-00-00	13 1/2	15	3	K	RH	
F70A / F80A / F80B / F100A / F100D / F100F / F115A / F115B / F130A	6FP-45945-00-00	13 1/4	16	3	K	RH	
	6FP-45947-00-00	13 1/8	17	3	K	RH	
	6FP-45949-00-00	13	18	3	K	RH	

TALON SERIES (ALUMINUM)

Outboard Model	Part Number	Diameter	Pitch	Blade	Hub	Rotation	Remark
60F / 70B / 75A / 75C / PRO75 / 80A / 85A / 90A / 100A / PRO V 100 / 115A / 115B / 115C / 130A / 130B / 140A / 140B / 140C	6EK-45941-00-00	13 1/2	9	3	K	RH	
	6EK-45943-00-00	13 1/2	10 1/2	3	K	RH	
	6EK-45945-00-00	13 1/2	12	3	K	RH	
F70A / F80A / F80B / F100A / F100D / F100F / F115A / F115B	6EK-45947-00-00	13 1/2	14	3	K	RH	
	6EK-45949-00-00	13 1/2	16	3	K	RH	

STAINLESS STEEL SERIES

Outboard Model	Part Number	Diameter	Pitch	Blade	Hub	Rotation	Remark
F25A / F25D / F25G	6FP-45941-00-00	13 5/8	14	3	K	RH	
20C / 20D / 25B / 25D / 25N / 25V / 30A / 30D / 30G	6FP-45943-00-00	13 1/2	15	3	K	RH	

Propellers

BLACK STAINLESS STEEL SERIES

Outboard Model	Part Number	Diameter	Pitch	Blade	Hub	Rotation	Remark
	663-45972-60-00	12	11	3	G	RH	
F30A / F30B / F40A / F40B / F40F / F50A / F50F / F50H / F60A / F60C / F60F	663-45970-60-00	11 3/4	12	3	G	RH	
	663-45974-02-00	10 5/8	13	3	G	RH	
	663-45974-60-00	11 1/2	13	3	G	RH	
40H / 40V / 40Q / 40X / 50D / 50H / 50G / PRO50 / 55B	663-45930-00-98	10 1/4	14	3	G	RH	
	663-45976-00-00	10 1/4	15	3	G	RH	
	663-45978-00-98	10 1/4	16	3	G	RH	
F70A / F80A / F80B / F100A / F100D / F100F / F115A / F115B	688-45932-60-00	13 1/2	14	3	K	RH	
	688-45978-60-00	13 1/2	16	3	K	RH	
60F / 70B / 75A / 75C / PRO75 / 80A / 85A / 90A / 100A / PROV100 / 115A / 115B / 115C / 130A / 130B / 140A / 140B / 140C	688-45930-02-00	13	17	3	K	RH	
	688-45970-03-00	13	19	3	K	RH	
	688-45972-02-00	13	21	3	K	RH	
	688-45974-02-00	13	23	3	K	RH	
	688-45976-01-98	13	25	3	K	RH	
FL115A / FL115B	6L6-45930-01-00	13	17	3	KL	LH	
L130A / L130B / L140B / L140C	6L6-45970-00-00	13	19	3	KL	LH	
	6L6-45972-00-00	13	21	3	KL	LH	
F150A / F150D / F200A / F200C / F225A / F225B / F250A / F250B	6G5-45932-00-00	15 3/4	13	3	M	RH	
	6G5-45970-02-00	15 1/4	15	3	M	RH	
150A / 150C / 150F / Z150P / 175A / 175B / 175D / Z175G / 200A / 200B / 200F / Z200N / 220A / 225A / 225B / 225D / 250A / 250B / 250G / Z250D	6G5-45978-03-00	13 3/4	17	3	M	RH	
	6G5-45974-03-00	13 3/4	19	3	M	RH	
	6G5-45972-02-00	13 3/4	21	3	M	RH	
	6G5-45976-01-00	13 3/8	23	3	M	RH	
	6G5-45930-00-00	13 3/8	25	3	M	RH	
FL150A / FL150D / FL200A / FL200C / FL225A / FL225B / FL250A / FL250B	6K1-45970-01-00	15 1/4	15	3	ML	LH	
L150A / L150C / L150F / LZ150P / L200A / L200B / L200F / LZ200N / L250A / L250B / L250G / LZ250D	6K1-45978-02-00	13 3/4	17	3	ML	LH	
	6K1-45974-02-00	13 3/4	19	3	ML	LH	
	6K1-45972-01-00	13 3/4	21	3	ML	LH	
	6K1-45976-00-00	13 3/8	23	3	ML	LH	

K SERIES TALON STAINLESS STEEL (WITH SDS)

Outboard Model	Part Number	Diameter	Pitch	Blade	Hub	Rotation	Remark
	6N7-45970-00-00	13 1/8	14	3	K	RH	
	6N7-45972-00-00	13 1/8	16	3	K	RH	
F70A / F80B / F100D / F100F / F115A / F115B / F130A	6N7-45974-00-00	13 1/8	18	3	K	RH	
	6N7-45976-00-00	13 1/8	19	3	K	RH	
	6N7-45978-00-00	13 1/8	20	3	K	RH	
	6N7-45930-00-00	13 1/8	22	3	K	RH	
	6N7-45932-00-00	13 1/8	24	3	K	RH	
FL115A/B	6N4-45970-00-00	13 1/8	14	3	K	LH	
	6N4-45972-00-00	13 1/8	16	3	K	LH	
	6N4-45974-00-00	13 1/8	18	3	K	LH	
	6N4-45978-00-00	13 1/8	20	3	K	LH	

RELIANCE SERIES - SDS - GENERATION 2

Outboard Model	Part Number	Diameter	Pitch	Blade	Hub	Rotation	Remark
	68F-45932-20-00	14 1/2	13	3	M	RH	
F150A / F150D / F175A / F200A / F200C / F200F / F200G / F225A / F225B / F225C / F225F / F250A / F250B / F250D / F300B	68F-45930-20-00	14 1/2	14	3	M	RH	
	68F-45970-20-00	14 1/2	15	3	M	RH	
	68F-45972-20-00	14 1/4	17	3	M	RH	
	68F-45978-20-00	14 1/4	18	3	M	RH	
	68F-45974-20-00	13 3/4	19	3	M	RH	SDS spacer (688-45997-01-00) required for 68F/68G SDS propellers.
	68F-45976-20-00	13 3/4	21	3	M	RH	
	68G-45930-20-00	14 1/2	14	3	ML	LH	
FL150A / FL150D / FL200A / FL200C / FL200F / FL200G / FL225A / FL225B / FL225F / FL250A / FL250B / FL250D / FL300B	68G-45970-20-00	14 1/2	15	3	ML	LH	
	68G-45972-20-00	14 1/4	17	3	ML	LH	
	68G-45978-20-00	14 1/4	18	3	ML	LH	
	68G-45974-20-00	13 3/4	19	3	ML	LH	
	68G-45976-20-00	13 3/4	21	3	ML	LH	

SALTWATER SERIES II SDS - GENERATION 2

Outboard Model	Part Number	Diameter	Pitch	Blade	Hub	Rotation	Remark
F200A / F200C / F225A / F225B / F225C / F225F / F250A / F250B / F250D / F300B	6CE-45930-20-00	15 3/4	13	3	T	RH	
	6CE-45976-20-00	15 3/4	15	3	T	RH	
	6CE-45938-20-00	15 1/2	16	3	T	RH	
	6CE-45978-20-00	15 1/2	17	3	T	RH	
	6CE-45934-20-00	15 1/4	18	3	T	RH	
	6CE-45970-20-00	15 1/4	19	3	T	RH	
	6CE-45932-20-00	15	20	3	T	RH	
	6CE-45972-20-00	15	21	3	T	RH	
	6CE-45936-20-00	14 3/4	22	3	T	RH	SDS spacer (688-45997-01-00) required for 6CE/6CF SDS GEN 2 propellers.
	6CE-45974-20-00	14 3/4	23	3	T	RH	
FL200A / FL200C / FL225A / FL225B / FL225F / FL250A / FL250B / FL250D / FL300B	6CF-45930-20-00	15 3/4	13	3	TL	LH	
	6CF-45976-20-00	15 3/4	15	3	TL	LH	
	6CF-45978-20-00	15 1/2	17	3	TL	LH	
	6CF-45934-20-00	15 1/4	18	3	TL	LH	
	6CF-45970-20-00	15 1/4	19	3	TL	LH	
	6CF-45932-20-00	15	20	3	TL	LH	
	6CF-45972-20-00	15	21	3	TL	LH	
	6CF-45936-20-00	14 3/4	22	3	TL	LH	
6CF-45974-20-00	14 3/4	23	3	TL	LH		

SALT WATER SERIES HS4 SDS - GENERATION 2

Outboard Model	Part Number	Diameter	Pitch	Blade	Hub	Rotation	Remark
F200A / F200C / F225A / F225B / F225C / F225F / F250A / F250B / F250D / F300B	6CE-45B70-20-00	15	21	4	T	RH	
	6CE-45B72-20-00	15	22	4	T	RH	
	6CE-45B74-20-00	15	23	4	T	RH	SDS spacer (688-45997-01-00) required for 6CE/6CF SDS GEN 2 propellers.
FL200A / FL200C / FL225A / FL225B / FL225F / FL250A / FL250B / FL250D / FL300B	6CF-45B70-20-00	15	21	4	TL	LH	
	6CF-45B72-20-00	15	22	4	TL	LH	
	6CF-45B74-20-00	15	23	4	TL	LH	

SALTWATER SERIES XL - SDS GENERATION 2

Outboard Model	Part Number	Diameter	Pitch	Blade	Hub	Rotation	Remark
F350A (2011--), F300D	6AW-45970-20-00	16 1/4	15	3	X	RH	
	6AW-45972-20-00	16 1/4	17	3	X	RH	
	6AW-45974-20-00	15 1/2	19	3	X	RH	
	6AW-45976-20-00	15 1/4	21	3	X	RH	
	6AW-45978-20-00	15 1/4	23	3	X	RH	F350A (until to 2015 MY) need Spacer 6AW-45997-00-00
	6AX-45970-20-00	16 1/4	15	3	XL	LH	
FL350A (2011--), FL300D	6AX-45972-20-00	16 1/4	17	3	XL	LH	
	6AX-45974-20-00	15 1/2	19	3	XL	LH	
	6AX-45976-20-00	15 1/4	21	3	XL	LH	
	6AX-45978-20-00	15 1/4	23	3	XL	LH	

SALTWATER SERIES XL4 & XL4-HP - SDS GENERATION 2

Outboard Model	Part Number	Diameter	Pitch	Blade	Hub	Rotation	Remark
F350A, F300D	6AW-45B70-20-00	16 1/8	15	4	X	RH	
	6AW-45B72-20-00	16 1/8	17	4	X	RH	
	6AW-45B76-20-00	15 3/8	22	4	X	RH	
	6AW-45B74-20-00	15 3/8	24	4	X	RH	F350A (until to 2015 MY) Need Spacer 6AW-45997-00-00
FL350A, FL300D	6AX-45B70-20-00	16 1/8	15	4	XL	LH	
	6AX-45B72-20-00	16 1/8	17	4	XL	LH	
	6AX-45B76-20-00	15 3/8	22	4	XL	LH	
6AX-45B74-20-00	15 3/8	24	4	XL	LH		

Propellers

XTO PROPELLERS

Outboard Model	Part Number	Diameter	Pitch	Blade	Hub	Rotation	Remark
XF375/XF425	6GR-45970-10-00	17 1/8	15	3	Y	RH	
	6GR-45D70-10-00	16 7/8	16	3	Y	RH	available from summer 2020
	6GR-45972-10-00	16 7/8	17	3	Y	RH	
	6GR-45938-10-00	16 5/8	18	3	Y	RH	
	6GR-45974-10-00	16 5/8	19	3	Y	RH	
	6GR-45936-10-00	16 3/8	20	3	Y	RH	
	6GR-45976-10-00	16 3/8	21	3	Y	RH	
	6GR-45934-10-00	16 1/8	22	3	Y	RH	
	6GR-45978-10-00	16 1/8	23	3	Y	RH	
	6GR-45932-10-00	16	24	3	Y	RH	
	6GR-45930-10-00	16	25	3	Y	RH	
XF375/XF425	6GS-45970-10-00	17 1/8	15	3	YL	LH	
	6GS-45D70-10-00	16 7/8	16	3	YL	LH	available from summer 2020
	6GS-45972-10-00	16 7/8	17	3	YL	LH	
	6GS-45938-10-00	16 5/8	18	3	YL	LH	
	6GS-45974-10-00	16 5/8	19	3	YL	LH	
	6GS-45936-10-00	16 3/8	20	3	YL	LH	
	6GS-45976-10-00	16 3/8	21	3	YL	LH	
	6GS-45934-10-00	16 1/8	22	3	YL	LH	
	6GS-45978-10-00	16 1/8	23	3	YL	LH	
	6GS-45932-10-00	16	24	3	YL	LH	
	6GS-45930-10-00	16	25	3	YL	LH	
6GS-45D72-10-00	16	26	3	YL	LH		

E-DRIVE PROPELLER

E-Drive Model	Part Number	Diameter	Pitch	Blade	Hub	Rotation	Remark
M15	XEA-45941-00-00	---	---	plastic	---	RH	
M12 / M18 ---2009	MKY-00137-81-21	---	---	plastic	---	RH	
M12 / M18 2010---	MKY-00206-11-22	---	---	plastic	---	RH	
M20 / M26 ---2009	MKY-00137-81-22	---	---	plastic	---	RH	
M20 2010---	MKY-00209-11-60	---	---	plastic	---	RH	
M26 2010---	MKY-00137-81-70	---	---	plastic	---	RH	
M32	MKY-00137-81-29	---	---	plastic	---	RH	

«HYDRA-DRIVE» DIESEL STERN DRIVE BLACK STAINLESS STEEL PROPELLER

Drive Model	Part Number	Diameter	Pitch	Blade	Hub	Rotation	Remark
Single propeller, right-hand rotation	6U3-45971-00-00	18	13	3	WR	RH	
	6U3-45973-00-00	17 1/2	15	3	WR	RH	
	6U3-45975-00-00	17	17	3	WR	RH	
	6U3-45977-00-00	16 3/4	19	3	WR	RH	
	6U3-45979-00-00	16 3/8	21	3	WR	RH	
Single propeller, counter rotation	6U3-45971-10-00	18	13	3	WL	LH	
	6U3-45973-10-00	17 1/2	15	3	WL	LH	
	6U3-45975-10-00	17	17	3	WL	LH	
	6U3-45977-10-00	16 3/4	19	3	WL	LH	
	6U3-45979-10-00	16 3/8	21	3	WL	LH	
TRP (Twin Rotation Propellers) Front	6U4-45942-00-00	15	22	3	(front)	TRP	
	6U4-45946-00-00	15	23	3	(front)	TRP	
	6U4-45951-00-00	15	24	3	(front)	TRP	
	6U4-45955-00-98	15	26	3	(front)	TRP	
	6U4-45959-00-98	15	28	3	(front)	TRP	
TRP (Twin Rotation Propellers) Rear	6U4-45944-00-00	15	22	3	(rear)	TRP	
	6U4-45948-00-00	15	23	3	(rear)	TRP	
	6U4-45953-00-00	15	24	3	(rear)	TRP	
	6U4-45957-00-98	15	26	3	(rear)	TRP	
	6U4-45961-00-98	15	28	3	(rear)	TRP	

PROPELLER SPARE PARTS

Type	Outboard Model	Propeller Mark	Front Spacer	Rear Spacer	Washer	Nut	Cotter pin
Regular Model	F2.5A	BS	6EE-G5987-00-00				
	F4B/F5A/F6C	BA	6EE-G5978-00-00				
	F8C/F8F	N	6N0-G5978-10-00	N/A (Not Required)			
	F9.9J	N	6G1-45987-02-00		902-0110M-01-00	901-7110M-01-00	914-90300-20-00
	F15C/F20B	J	6E7-45987-01-00				
	F25D	F	6L2-45987-01-00	689-45997-00-00	929-90142-00-00	901-71140-13-00	914-90300-30-00
	F30B/F40F	G			903-8922M-01-00		
	F50H/F60F	G	663-45987-02	66T-45997-00-00	90389-22M01	901-71160-11-00	914-90300-30-00
	F70A	K			903-8925M-00-00		
	F80B/F100D	K	688-45987-01-00	67F-45997-00-00	90389-25M00		
	F(L)115A/F(L)115B/F130A	K, KL					
	F(L)150A/F(L)150D	M, ML	63P-45987-00-00				
	F175A/F(L)200F	M/T, ML/TL		688-45997-01-00	929-90182-00-00	901-7118M-04-00	914-90400-30-00
	F(L)225F/F(L)250D/F(L)300B (4,2L V6)	T, TL	69J-45987-00-00				
	F(L)350A (V8), F(L)300D	X, XL	6AW-45987-00-00	6AW-45997-00	902-0119M-01-00		
Dual Thrust Model	FT8D/FT8G	R					
	FT9.9L	R	6G8-45987-02-00	6G8-45997-00 00	902-0110M-02-00	901-7110M-07-00	
	FT25F	G	663-45987-02	68U-45997-00-00	929-90162-00-00	901-71160-11-00	914-90300-30-00
	FT50J, FT60G	K	688-45987-01-00	67F-45997-00-00	903-8925M-00-00		

Propeller Accessories



PROP WRENCH

Specially made to fit the prop nut on a Yamaha V4 (2 strokes) or V6 (2-4 strokes) outboard, it also has a helpful 9/16" square opening on the reverse side, designed for opening garboard drain plugs.

MAR-PRPWR-NC-H1

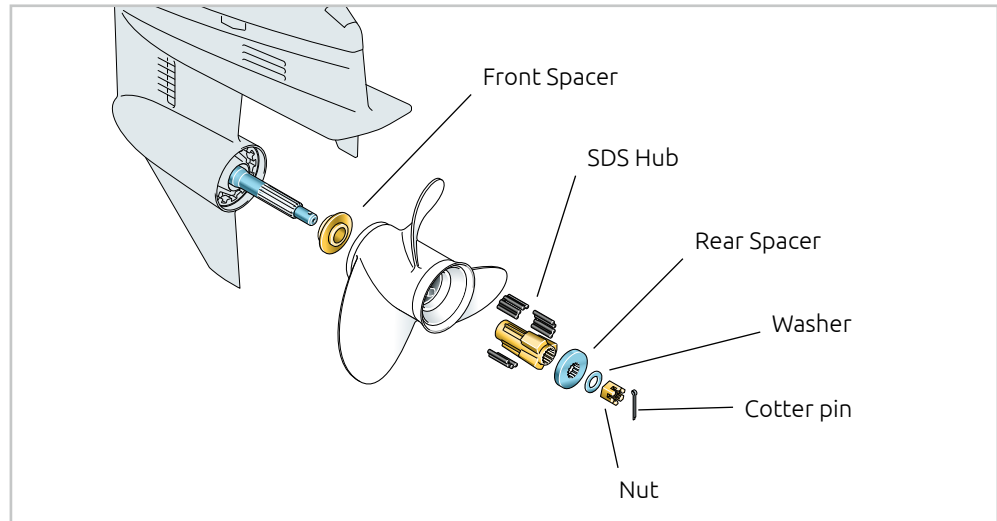

SDS SPACERS

Required for installing an SDS propeller on engines with non-SDS propellers installed - or when the engine in the crate is equipped with a non-SDS spacer.

Part Number	Description	QTY
6AW-45997-10-00	For Saltwater XL/XL4 (SDS GEN 1)	1
6AW-45997-00-00	For Saltwater XL/XL4 (SDS GEN 2 and non-SDS)	1
6CE-45997-00-00	For F150D/F175A/ F225F/F250D/F300B V6 4.2L, F200F/G SDS GEN 1 SPACER	1
688-45997-01-00	For F150D/F175A/F200F-G/F225F/F250D/F300B V6 4.2L, (SDS GEN 2 SPACER and NON-SDS)	1
688-45997-00-00	For XTO (425/375)	1



SDS HUBS

If the damper hub eventually wears on a SDS prop, a replacement hub is available to restore its original shift-dampening efficiency and performance.

Part Number	Description	QTY
6AW-45C81-00-00	For F350A V8 SDS propeller (Gen1 from --2014)	1
6AW-45C81-10-00	For F350A V8 SDS propeller (Gen2 from 2015 --)	1
6CE-45C81-00-00	For F150D/F175A/F225F/F250D/F300B V6 4.2L, F200F/G, SDS propeller	1
6EK-45C82-09-00	For TALON aluminium and Stainless Steel propeller	1
6GR-45C81-10-00	For XTO (375/425)	1



OB - PROPELLER STORAGE BAG

Made of Hi-Vis orange Ripstop nylon, this bag is designed for trailering and long term storage. As more and more countries are mandating the coverage of the propeller, during the transportation of a boat, this high quality bag is a necessity for any boating enthusiast. The padding, the adjustability and the ease of installation, also make it an obvious choice.





Innovation in control and comfort

Designed for professionals, enthusiasts and casual users alike, Yamaha's all-new Helm Master EX control rigging system makes boat operations both easy and enjoyable with a sophisticated array of features. It is designed for both single and multiple outboard engine set-ups.

FUNCTION TABLE

Function	Digital Electronic Control	Digital Electronic Steering	Autopilot	Joystick
	Level 1	Level 2	Level 3	Level 4
Variable Troll RPM Switch (VTS)	x	x	x	
Single Lever	x	x	x	
Speed Control	x	x	x	
Pattern Shift	x	x	x	
Trim Assist	x	x	x	
Neutral Hold	x	x	x	
Adjustable Lock to Lock		x	x	
Adjustable Steering Friction		x	x	
Heading Hold			x	
Course Hold			x	
Pattern Steer			x	
Track Point			x	
Joystick Maneuverability (incl. Single Engine)				x
SetPoint® Suite Features (incl. Single Engine)				x
Track Point with SetPoint® Final Stop				x
Electronic Key Switch (EKS) with Y-COP®	x	x	x	
CL5 Display	x	x	x	
MFD Interfaces	x	x	x	

Digital Electronic Control (DEC)

Completely redesigned with greater ergonomic comfort and new capabilities, the all-new Helm Master EX control is available in single handle, or twin handle for twin- through quad-engine installations. In both instances, the base of the control is the same, allowing for easier, more consistent installation between models.

Additionally, there is one simple wire leading to a bank of one or more separate ECUs (one per engine), mounted remotely. There are no additional ECUs needed for second station installations, making under-console and second station rigging streamlined and less complex.

SEPARATE ECU



The easily accessible port helps Yamaha dealers connect YDIS for system compatibility scan and diagnosis.



Highlighted features

SINGLE LEVER OPERATION

Press this button to control multiple outboards with the port-side lever only.



SPEED CONTROL

Once you reach your desired RPM or Boat Speed *2 by the control lever(s), press speed DN button to hold or throttle up or down with the touch of a button. Buttons are conveniently located on the port-side lever for easy use with Single Lever mode.



PATTERN SHIFT

Activated when you are in-gear (trolling) and press speed DN, system takes care of automatic shifting to further lower trolling speed. Applicable also to reverse shift. You can go as far as 10% in gear and 90% out of gear.

AUTO TRIM

Automates engine trim as you accelerate or decelerate to maximize performance and fuel economy. Trim Assist can be activated by compatible Yamaha gauges. Five points preset is available by specific RPM or Boat Speed *.

* Control by Boat Speed is available only when upgraded to Autopilot or Joystick.

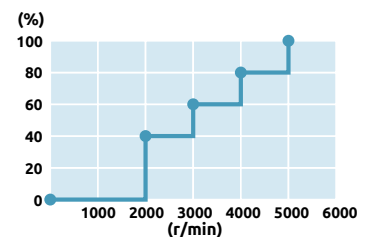

LOCK TO LOCK AND STEERING FRICTION

With new variable lock-to-lock settings (four to nine rotations) and adjustable steering friction (100 – 200 percent) become available automatically based on outboard rpm. Customer can also choose to select heavier steering load manually (like when in heavy seas, for example) or can set the DES system to not use auto-increase/decrease features.



Autopilot

AUTOPILOT FUNCTIONS

Heading Hold automatically maintains set compass heading but allows for drift. Course Hold keeps course, even under current and/or wind. Track Point pilots automatically along an operator set of waypoints (route)*



Standard Autopilot functions

Course Hold

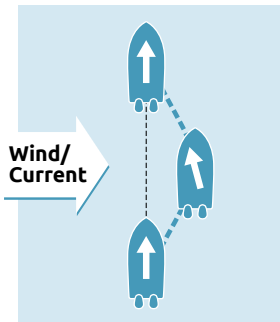

Holds the vessels course automatically adjusting for wind or current drift.

Track Point *1

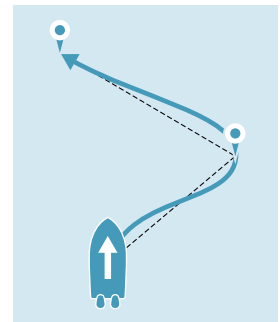

Navigates through operator selected MFD waypoints.



Heading Hold

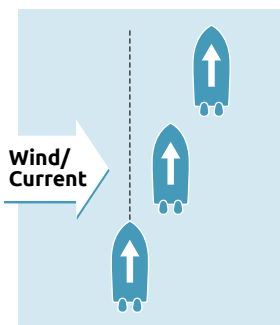

Holds the vessels compass setting. Applicable also to reverse shift for enhanced back trolling.

Arrow Buttons

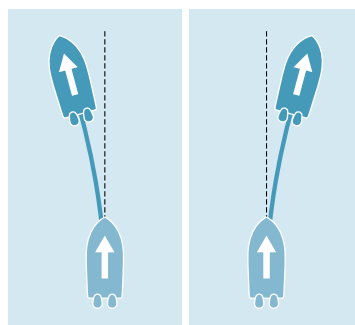

Press this button to change the set heading of your boat at Heading/ Course Hold modes. Short press : 1 degree increment. Long press : 5 degrees increment. Hold the button down for further steering.

Pattern Steer

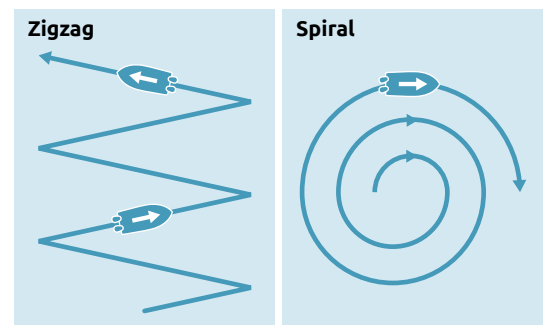

Pre-selected patterns that are adjustable - Sprial and Zig-zag - useful to find signs of fish at a target spot.

TRACK POINT with SETPOINT

Approaching the final destination of Track Point, the boat will automatically slow down and finally stop *4.

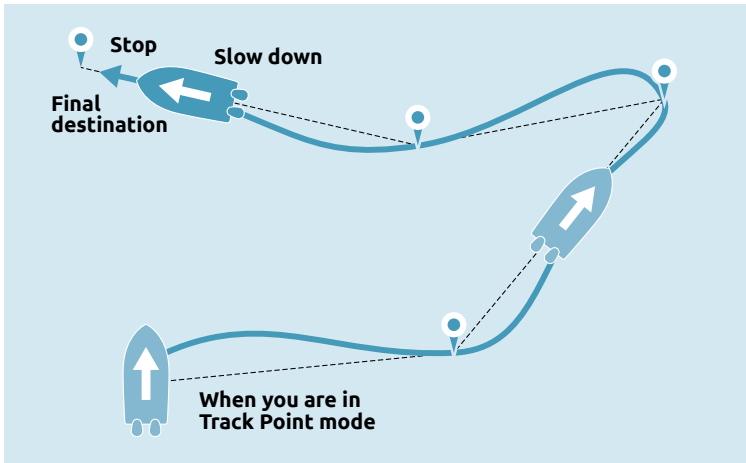

Upon arrival at final destination, shifting neutral activates either of following;

- Boat stop automatically, then SetPoint *2
- Boat stop automatically (no SetPoint)
- No automatic stop



Autopilot with Joystick Adjustability *2

More intuitive Autopilot control by Joystick knob - adjustment of speed, course and heading without touching steering wheel or throttle levers.

Speed Adjust

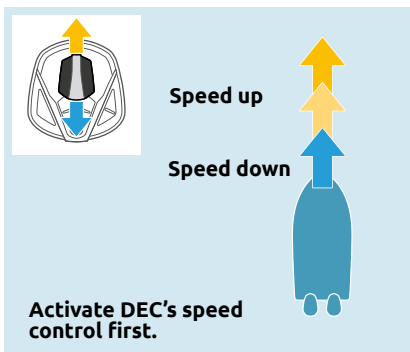

Course Adjust

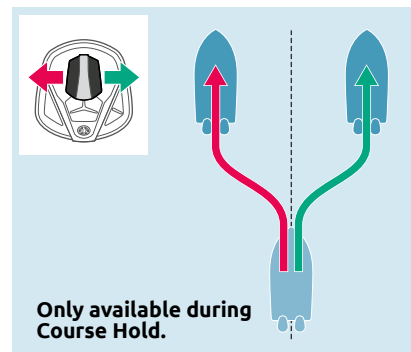

Heading Adjust

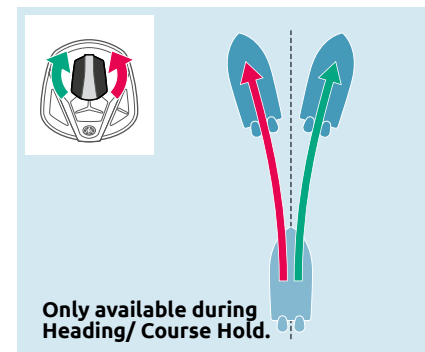

- *1: The latest version of NMEA2000 Gateway (6YG) or compatible Multifunction display is required for Track Point and DriftPoint Track to obtain MFD navigation route information via NMEA 2000 network.
- *2: Available when upgraded to Joystick (full upgrade).
- *3: Except first generation F350A (6AW), model year up to 2010.
- *4: Boat may pass by the final destination depending on MFD.
- * Autopilot/ SetPoint do not monitor or avoid people, other boats, obstacles, etc. Skipper needs to stay at helm with lanyard switch and keep proper lookout to avoid collisions.

Joystick

JOYSTICK MANEUVERABILITY AND SETPOINT FEATURES

Previously available only for multiple engines, Helm Master EX is now also available for single engine applications.

Staypoint (not available on single engine installation) Seeks to automatically maintain both boat heading and position.

Fish Point Seeks to automatically maintain boat position (not heading).

Drift Point Seeks to maintain heading only while allowing natural drift.



SETPOINT suite features

SetPoint® has three primary modes - StayPoint®, FishPoint® and DriftPoint® - offers captains even greater control for situations such as fishing, controlled drifting and maintaining position.

DRIFTPOINT

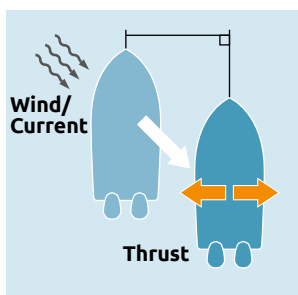

Keeps heading.
Great for drift-fishing a wreck or kite fishing.

DRIFTPOINT TRACK *4

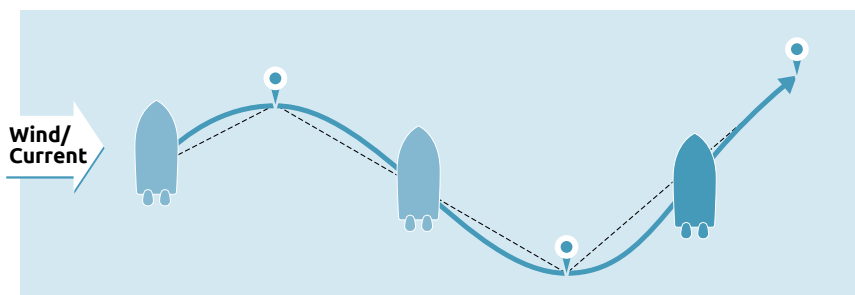

Keep the heading and drift to trace the waypoint (s) which you set from MFD - like following same depth contour or keeping distance from shore. You can enter this mode to push DRIFTPOINT button when MFD navigation route is set.

FISHPOINT

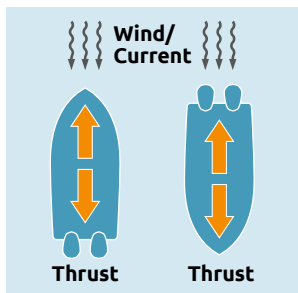

Keeps position.
This mode uses minimal RPM to hold your position. Perfect for stationary fishing.

STAYPOINT

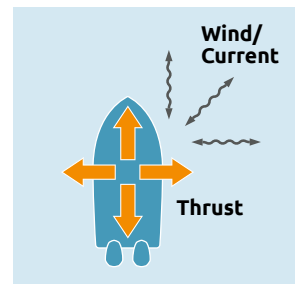

Keeps position and heading.
Handy when waiting for a bridge or for your turn to approach a fuel dock.

JOYSTICK

Press this button to activate Joystick maneuvering mode shown in the adjacent page.



Thrust Adjustment

5 steps Joystick thrust adjustment. It can also adjust Autopilot steering sensitivity.

Joystick maneuvering

Low speed Joystick maneuvering is extremely intuitive and useful for various occasions like docking, turning in the confined space or navigating through no-wake zone. Single-hand, fingertip joystick operation integrates control of the throttle, shift and steering – instead of multiple boat operating devices like conventional steering wheel and control levers.

Standard maneuver

Moving forward, backward, and turn right or left

Lateral maneuver

Moving left, right or diagonal

Pivot-turn maneuver

Rotating left or right on the spot

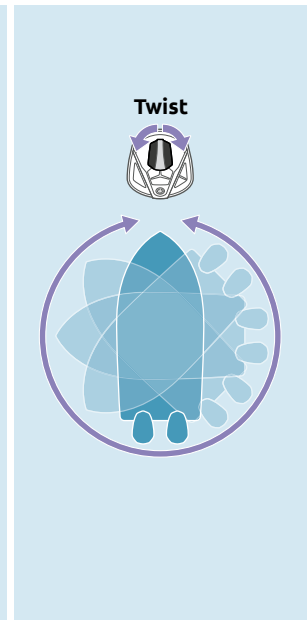
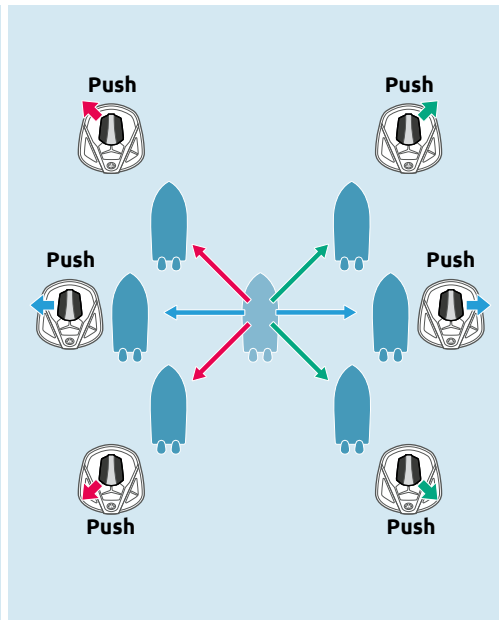
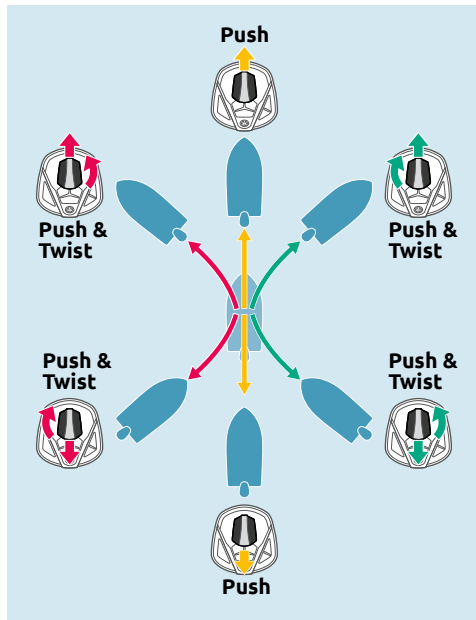

Multiple engines



Single engine



- *1: Joystick maneuvering performance, especially sideways move is dependent on boat/ engine application
- *2: Joystick sideways operation and StayPoint are not applicable to single engine application.
- *3: Except first generation F350A (6AW), model year up to 2010.
- *4: The latest version of NMEA2000 Gateway (6YG) is required for Track Point and DriftPoint Track to obtain MFD navigation route information via NMEA 2000 network.
- * Autopilot/ SetPoint do not monitor or avoid people, other boats, obstacles, shoal, etc. Skipper needs to stay at helm with lanyard switch and keep proper lookout to avoid collisions.

Key switch and key fob

ELECTRONIC KEY SWITCHES (EKS)

All new back-lit switch panels offer a slim, space-saving, push-button design and modern look. These new panels save critical dash space.



SMART KEY FOB

Yamaha is introducing a full new Yamaha Y-COP theft deterrent system. Although it is part of Yamaha's new Drive-by-wire Helm Master EX line-up, it works on boats powered by any EFI Yamaha outboard, even in combination with Yamaha's previous rigging system. It unlocks automatically when you approach the console. Locking the boat once leaving you can do by the push of a button.





Instruments

Today's boat owners want more information than ever before - and Yamaha Digital Network Gauges deliver it.

Yamaha is proud to offer a comprehensive line-up of Digital Network Gauges, to bring you more convenience, flexibility, and clear information than you ever thought possible. This really is the leading edge of rigging technology, matched up with the supreme level of innovation and reliability you've come to expect from Yamaha. Experience it.

CL5 GAUGE

An all-new, thin Yamaha CL5 touchscreen is small in size but big on information and ability. Its sophisticated, modern design features intuitive operation and matches the latest boat console trends. *1

Description	Part Number
Replacement Cover	6YM-87278-00-00
Replacement Bezel	6YM-83512-00-00 (x2)



CL5 FUNCTIONS

Regular indications*2:	Alert indication*2:	Setting *2
• Shift position	• Overheat	• Trim Assist (On/Off) and Preset
• Engine speed	• Low oil pressure	• PTT Switch Preset (Quad engine)
• Trim position	• Low voltage	• Tank Preset
• Engine temperature	• Water in fuel	• Calibration
• Cooling water pressure	• Check engine	• Steer Friction (Regular/Heavy)
• Oil pressure	• Check system	• Lock to Lock (Constant/Variable)
• Main battery voltage	• Steering malfunction	• Speed Control (RPM/GPS)
• Sub-battery voltage	• Low fuel pressure	• Autopilot Setting
• Boat speed		• Joystick and SetPoint Setting
• Fuel economy	Condition indication*2:	• Reset
• Fuel consumption	• Yamaha security system on duty	• Trip Information
• Fuel flow	• Engine under warming up icon	• Diagnosis (Trouble codes)
• Engine operating hours	• Engine synchronization icon	• Technician setting
• Trip meter	• Autopilot icon and status/ bar	• Maintenance Reminder
• Available fuel volume	• Speed Control icon	
• Connections for up to 4 tanks	• Single Lever icon	
• Seawater temperature	• Trim Assist icon	
• Depth	• Status message	
• Maintenance interval notice	• Maintenance Reminder	
• Trolling speed adjustment (depending on model)		

*1 These displays are also compatible with mechanical controlled outboards, both come in convenient kits for mechanical and Drive By Wire, please see the display option section

*2 Contents of indication may vary by outboard models and/or external accessories applied.

DIGITAL NETWORK GAUGES (6Y8 ROUND)

6Y8 Digital Network Gauges are simple, streamlined and sophisticated. The large LCD displays provide easy-to-read information at a glance, allowing you to monitor everything from engine function and fuel management to trim levels, battery voltage, and more. Available as a convenient Rigging Kit. (please see the display option section)

General Features:

- Each LCD display can show multiple types of information.
- Information is shown in 2 different formats for main (large - on top) and sub-information (small - below).
- Pre-selectable sub-information selection.
- Each LCD display performs a self-function check on start-up.
- Backlighting can be dimmed individually or together (when multiple gauges are installed).

6Y8 TACHOMETER (ROUND)

6Y8-8350T-20-00

- Engine speed • Trim position • Oil pressure • Cooling water pressure (*2)
- Total operating hours • Trip hours • Battery voltage • Engine temperature • Maintenance interval notice • Overheat alert • Low oil pressure alert • Low battery voltage alert • Water in fuel alert • Check Engine alert • Trolling speed adjustment (depends on outboard model) • Diagnosis code



6Y8 SPEED/FUEL COMBINATION METER (ROUND)

6Y8-83500-20-00

- Boat speed (*1) • Trip meter • Clock • Battery voltage • Fuel tank level (up to 2 tanks) • Fuel flow • Fuel consumption • Fuel economy • Seawater temperature (*2) • Seawater depth (*2)



OPTIONAL ROUND DASHBOARD

Description	Part Number
DASHBOARD ROUND (2 HOLES)	YMM09D010000
GAUGE PLATE RINGS (2 PCS)	YMM09PR10000

(*1) GPS connection required (NMEA 0813)

(*2) Optional sensor required (see page 81)



Remote Controls



Yamaha Remote Controls set the standard for operator comfort, convenience and flexibility. Their intuitive ergonomic designs allow for virtually effortless, one-hand control of throttle and shift functions, and allow for surprisingly easy command of horsepower and multiple engine installations.

REMOTE CONTROL TYPE	MODEL	MOUNTING POSITION	NUMBER OF ENGINES			Side Mount
			Single	Twin	Triple	
DIGITAL (DRIVE-BY-WIRE) (F150G - XTO)	6X9	Top Mount				
	6X9	Flush Mount				
MECHANICAL (F30 - F200F)	703	Side Mount				
	704	Top Mount				
	6X3	Flush Mount				

MECHANICAL REMOTE CONTROLS

Operated by mechanical cable to control throttle and shift mechanism.

1 - 703 SINGLE ENGINE SIDE MOUNT

Designed with broad compatibility in mind, this remote control can be fitted to almost every boat type and is compatible with almost every engine in the Yamaha Outboard range. The 703 delivers all of the basic control functions and open throttle can also be configured in either the push or pull direction. It can be used both at right side or left side configuration.



GAUGE	6Y8 (Round) / CL5*
ENGINE	
SWITCH	

2 - 6X3 SINGLE ENGINE FLUSH MOUNT

A right-side flush mounted mechanical remote control with integrated lanyard switch. Push action to open throttle. Single key switch panel (without lanyard switch) and 10-pin wire harness supplied separately. It can be used both at right side or left side configuration.



	6Y8 (Round) / CL5*	
GAUGE		
ENGINE		
SWITCH		

3 - SINGLE 704 TOP MOUNT

The 705 Top Mount is designed for use with electric start models and ideally fitted to center console boats. Available in single and twin lever configurations for single and twin engine installations. A switch panel and extension wire harness are required to connect to the engine 10-pin harness.



	6Y8 (Round) / CL5*	
GAUGE		
ENGINE		
SWITCH		

4 - TWIN 704 TOP MOUNT



*) EFI outboard models

MECHANICAL CONTROL BOXES

#	Part Number	Engine	Throttle		PTT	Mount	Remarks
			Push	Pull			
1a	703-48207-22-00	Single	1		1	Side mount	For Electric start models.
1	703-48260-20-00			1			For Manual start models.
	703-48206-20-00			1			(replacement of 701 control)
2	6X3-48206-10-00		1		1	Starboard mount	REMOTE CTRL 6X3 FM (run about)
2b	6X3-48206-21-00		1		1	Port mount	REMOTE CTRL 6X3 FM (center console)
3	704-48205-R0-00	Twin	1		1	Top Mount	
4	704-48207-R0-00		1		1		

Outboard Rigging & Accessories

703 THROTTLE CONVERSION

Description	Part Number
703 Conversion Kit (Pull to Push)	703-48261-01-00
703 Conversion Kit (Push to Pull)	703-48261-11-00

704 CONTROL SPACER KITS

Description	Part Number
For 704 Premium Single	704-48293-20-00
For 704 Premium Twin	704-48293-30-00

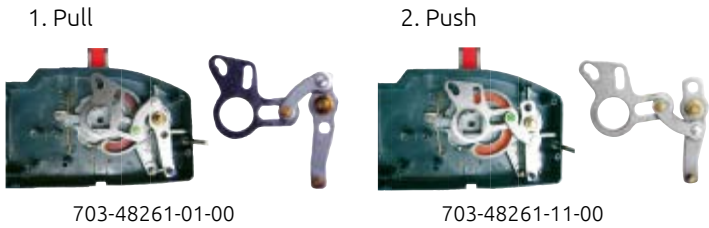

REMOTE CONTROL - REMOTE CONTROL ATTACHMENT KITS

The best way to convert your Yamaha outboard throttle and shift cable from manual to remote operation with the least amount of fuss.

- Solid & durable corrosion-resistant construction
- For use with remote controls and control cables
- Steering hook not included

We strongly recommend that all cable specification and installation work be carried out by an Authorised Yamaha Dealer, where further product details and helpful advice are always available.

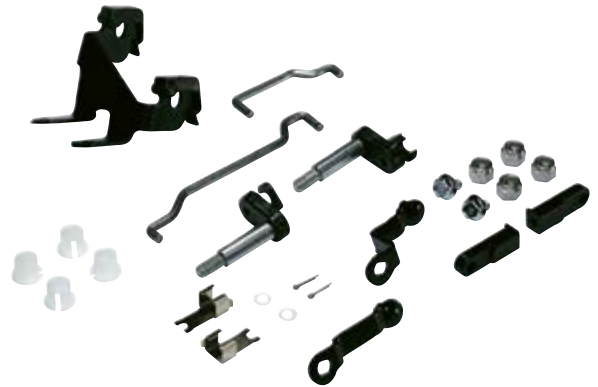

Engine	Part Number
F6A/F6B/F8C/FT8D	6DR-48501-00-00
F15C/F20B	6AH-48501-00-00
F8A/B/F9.9A/B/FT9.9A	6G8-48501-03-00
F9.9C/FT9.9D/F15A	66M-48501-00-00
F9.9F/F9.9J	6DR-48501-00-00
FT9.9G/FT9.9L	6DR-48501-00-00

Engine	Part Number
F25A/F20A/ FT25B	65W-48501-00-00
F25D	6BL-48501-00-00
F20G/F25G	6FM-48501-00-00
40Q	6R6-48501-00-00
40X	66T-48501-01-00



DIGITAL DRIVE-BY-WIRE (DBW) REMOTE CONTROLS

The operation of throttle and shift is controlled electronically by the Digital Network System, providing you with smoother remote control - and with no cable friction! Multiple engine remote controls feature automatic engine RPM synchronization. Thanks to the convenience of our "plug and play" systems, rigging work is now simplicity itself - even 2nd station installation is a breeze. For more detailed information please also see the Helm Master EX section



6X9 DIGITAL DBW REMOTE CONTROL

An exclusive suite of binnacle style drive-by-wire remote control boxes. Available in single, twin, triple or Quad engine versions and fully compatible with Yamaha's Helm Master EX

1 - 6X9 SINGLE ENGINE TOP MOUNT



2 - 6X9 TWIN/TRIPLE/QUAD ENGINE TOP MOUNT



6X9 DBW SINGLE ENGINE FLUSH MOUNT

A compact, flush side-mounted digital drive-by-wire remote control box with an integrated lanyard switch. Key switch panel and main wire harness supplied separately.

3 - 6X9 SINGLE ENGINE FLUSH MOUNT



Outboard Rigging & Accessories

REMOTE CONTROL CABLES

Only the very best cable performs smoothly and reliably enough to be a match for the renowned quality of a Yamaha Remote Control.

Premium PowerMatched control cable (YPM)



Stainless Steel Rod Wiper seal 16" max swivel Nickel-plated brass sleeve Swivel seat Rotary swaged stainless steel hub Ultraviolet-stabilised high-density polyethylene outer jacket Long-lay oil-tempered wires High-density polyethylene liner Nylon-covered stranded core wire



Splines reduce contact area with liner for ultra low friction

STANDARD CABLE (Y32)

Yamaha offers you a choice of remote control cables that are a perfect match for our controls. These well proven original cables have set the standard with advanced technology that reduces friction and delivers excellent performance. The standard-core wires increase strength and reduce binding, allowing for a 4-inch bend radius.

MID-RANGE CABLE (C8)

This mid-range cable offers great efficiency, thanks to high level of flexibility for a reduced cable bend radius. Featuring stainless steel cables and fittings as well as a very high resistance blue outer jacket for protection against abrasion, UV and chemicals.

PREMIUM POWERMATCHED CONTROL CABLE (YPM)

These are top-of-the-line cables, with features and performance that have made them the first choice of professional riggers. The ultra-low-friction inner core wire has splines and a special cover to reduce contact with the liner, allowing rigging to even tighter tolerances; another benefit is reduced 'play' at the cable ends. We strongly recommend the use of Premium PowerMatched cables for boats with severe applications and long cable lengths, on twin-engine installations - and in fact, on any boat where unrivalled smoothness is required. These cables are designed to run smoothly even if installation demands that curves or a radius be applied within the cable run.

FEET	CM	Standard (Y32)	Mid-range (C8)	Premium (YPM)
5'	152	YMM-21005-00-00	-	-
6'	183	YMM-21006-00-00	YMM-21006-C8-00	YMM-21006-PM-30
7'	213	YMM-21007-00-00	YMM-21007-C8-00	YMM-21007-PM-30
8'	244	YMM-21008-00-00	YMM-21008-C8-00	YMM-21008-PM-30
9'	274	YMM-21009-00-00	YMM-21009-C8-00	YMM-21009-PM-30
10'	305	YMM-21010-00-00	YMM-21010-C8-00	YMM-21010-PM-30
11'	335	YMM-21011-00-00	YMM-21011-C8-00	YMM-21011-PM-30
12'	366	YMM-21012-00-00	YMM-21012-C8-00	YMM-21012-PM-30
13'	396	YMM-21013-00-00	YMM-21013-C8-00	YMM-21013-PM-30
14'	427	YMM-21014-00-00	YMM-21014-C8-00	YMM-21014-PM-30
15'	457	YMM-21015-00-00	YMM-21015-C8-00	YMM-21015-PM-30
16'	488	YMM-21016-00-00	YMM-21016-C8-00	YMM-21016-PM-30
17'	518	YMM-21017-00-00	YMM-21017-C8-00	YMM-21017-PM-30
18'	549	YMM-21018-00-00	YMM-21018-C8-00	YMM-21018-PM-30
19'	579	YMM-21019-00-00	YMM-21019-C8-00	YMM-21019-PM-30
20'	610	YMM-21020-00-00	YMM-21020-C8-00	YMM-21020-PM-30
21'	640	YMM-21021-00-00	YMM-21021-C8-00	YMM-21021-PM-30
22'	671	YMM-21022-00-00	YMM-21022-C8-00	YMM-21022-PM-30
23'	701	YMM-21023-00-00	YMM-21023-C8-00	YMM-21023-PM-30
24'	732	YMM-21024-00-00	YMM-21024-C8-00	YMM-21024-PM-30
25'	762	YMM-21025-00-00	YMM-21025-C8-00	YMM-21025-PM-30
26'	792	YMM-21026-00-00	YMM-21026-C8-00	YMM-21026-PM-30
27'	823	YMM-21027-00-00	YMM-21027-C8-00	YMM-21027-PM-30
28'	853	-	YMM-21028-C8-00	YMM-21028-PM-30
29'	884	-	YMM-21029-C8-00	YMM-21029-PM-30
30'	914	YMM-21030-00-00	YMM-21030-C8-00	YMM-21030-PM-30

Yamaha recommends YPM cables. If not applicable for rigging certain types of boats, C8 or Y32 cables may be used.

SWITCH PANELS - FOR MECHANICAL REMOTE CONTROL



1 - SINGLE ENGINE KEY SWITCH WITH LANYARD



2 - SINGLE ENGINE MAIN STATION SWITCH WITH PANEL



3 - TWIN ENGINE KEY SWITCH WITH LANYARD

4 - REPLACEMENT LANYARD CORD



#	Part Number	Description	Remote control	Remark
1	704-82570-12-00	Single key switch with lanyard	For 704 single	With choke switch
2	64D-82570-22-00	Single engine Main Station switch with panel	For 6X3/6X7	with 2P coupler for Emergency Stop switch
3	6Y8-82570-04-00	Twin key switch with lanyard	For 704 twin	For Digital network system (6Y8)
4	682-82556-00-00	Engine shut-off lanyard cord	---	Replacement lanyard cord



Steering & Steering Systems



STEERING WHEELS



1



2



3



4



5



6



7*



8



9

#	Part Number	Diameter (mm)	
1	YMM-24001-00-WH	335	STEERING WHEEL WHITE LONG SPOKE
2	YMM-24001-00-BK	335	STEERING WHEEL BLACK LONG SPOKE
3	YMM-24002-00-BK	342	STEERING WHEEL BLACK 4-SPOKE
4	YMM-24005-00-BK	350	STEERING WHEEL BLACK 5-SPOKE
5	YMM-24005-00-GY	342	STEERING WHEEL GREY 5-SPOKE
6	YMM-24003-00-BK	350	STEERING WHEEL BLACK
7*	YMM-24007-00-BS	350	STEERING WHL BLACK/SILVER METAL
8	YMM-24004-00-BK	280	STEERING WHEEL BLACK SMALL
9	YMM-24006-00-CH	345	STEERING WHEEL CHROME 5-SPOKE
10*	YMM-24007-00-BK	350	STEERING WHEEL BLACK
11*	YMM-24008-00-BS	350	STEERING WHEEL LUXE BLACK/SILVER
12*	YMM-24009-00-BK	350	STEERING WHEEL BLACK/BLACK GRIP
-	YMM-24000-01-00	-	HUB FOR STEERING WHEELS (X63)

HYDRAULICS STEERING BY L&S

Part Number	Kit name	Technical capacity	Contents
YMEKT2203349	KIT LS125PRO	Up to 125 HP	Complete kits. Standard systems including cylinder, helm pup with lock valve. Standard fittings, 10m hose and a filling funnel
YMEKT2203350	KIT LS175PRO	Up to 175 HP	
YMEKT2203351	KIT LS225PRO	Up to 225 HP	
YMEKT2204020	KITLS3500PRO	Up to 350 HP	
YMEKT2204021	LS 232C/29HB	Up to 300HP (different model)	

Miscellaneous items for Hydraulic steering systems

Part Number	Suited for	Description
YMESP2200810	LS125PRO	hose - inner diameter 6mm
YMESP2200024	All other kits	hose - inner diameter 8mm

Kit accessories and hydraulic L&S oil

Part Number	Part name
YMESP2201058	Pump Bezel
YMESP2201753	Bulkhead strain relief

HYDRAULIC LS OIL

YMEH02200017	Hydraulic oil
--------------	---------------



SPARE PARTS

Helm pump spare parts

Part Number	Description	Helm pump
YMESP1200668	Seal kit	20 HB CAR
YMESP2200807	Set of straight fittings	
YMESP2201989	Set of elbow fittings	
YMESP2200453	Mounting kit	
YMESP1206025	Shaft end key	
YMESP2201276	Equipped gauge cap	
YMESP1200668	Seal kit	26 HB CAR
YMESP2200021	Set of elbow fittings	
YMESP2200453	Mounting kit	
YMESP1206025	Shaft end key	
YMESP2201276	Equipped gauge cap	
YMESP1200668	Seal kit	
YMESP2200021	Set of elbow fittings	30 HB CAR
YMESP2200453	Mounting kit	
YMESP1206025	Shaft end key	
YMESP2201276	Equipped gauge cap	
YMESP1202263	Seal kit	
YMESP2200021	Set of elbow fittings	
YMESP2200453	Mounting kit	29 CT HB CAR
YMESP1206025	Shaft end key	
YMESP2201276	Equipped gauge cap	

Cylinder spare parts

Part Number	Spare part description	Cylinder
YMESP1206496	Seal kit	VHM EX 125HP
YMESP1206348	Bolt for fixing on Motor arm	
YMESP2200808	Set of fittings for 6mm	
YMESP1206243	Equipped rod	
YMESP1206497	Seal kit	
YMESP1206348	Bolt for fixing on Motor arm	
YMESP1206348	Bolt for fixing on Motor arm	VHM EX 175HP
YMESP2203356	Set of fittings 8 MM	
YMESP1206248	Equipped rod	
YMESP1206498	Seal kit	
YMESP1206348	Bolt for fixing on Motor arm	
YMESP2203356	Set of fittings 8 MM	
YMESP1206348	Bolt for fixing on Motor arm	VHM EX 225HP
YMESP2203356	Set of fittings 8 MM	
YMESP1205512	Equipped rod	
YMESP1205803	Seal kit	
YMESP1206090	Bolt for fixing on Motor arm	
YMESP1206127	Equipped rod	
YMESP1206127	Equipped rod	VHM EX 350HP
YMESP2200023	set of stainless steel fittings 8mm	
YMESP2202103	tie bar 1 cylinder / 2 motors	
YMESP1200638	Seal kit	
YMESP1206090	Bolt for fixing on Motor arm	
YMESP1202184	Equipped rod	
YMESP1203224	Equipped lever	YMESP1200766
YMESP2200023	set of stainless steel fittings 8mm	
YMESP1200766	Cylinder tube	

MECHANICAL STEERING SYSTEMS



Y12 Helm/Bezel



Y25 Bezel



Y24 Helm/Bezel



Y22 Helm (fast-connect system)



Y23 Helm (non self-centring fast-connect system)

All these systems are highly responsive and are designed and built to our exacting standards of safety, durability and comfort. The Y22 and Y23 helms (or Y20 kit) can be used for all types of applications. Our Y23 helm has a special non self-centring mechanism, which means the wheel won't return automatically to the straight ahead position after a turn. Both these helms have to be installed with a Y25 Bezel, which is available in 20° and 90° versions.

Number of turns lock-to-lock: Y12 - approx 2.5 Y22/Y23 - approx 3.8 Y24 - approx 3

The Y12 (or Y10 kit) is for smaller boats with engines below 40kW (or below 55hp). Y24 can be applied if a simpler, more conventional system is required.

Y10 COMPLETE KIT FOR ENGINES BELOW 40KW (OR BELOW 55HP) INCLUDING Y11, Y12 AND STEERING WHEEL YMM-24003-00-BK

FEET	CM	Part Number	Part Name
8'	244	YMM-22208-00-00	CABLE Y10 STEERING 8
9'	274	YMM-22209-00-00	CABLE Y10 STEERING 9
10'	305	YMM-22210-00-00	CABLE Y10 STEERING 10
11'	335	YMM-22211-00-00	CABLE Y10 STEERING 11
12'	366	YMM-22212-00-00	CABLE Y10 STEERING 12
13'	396	YMM-22213-00-00	CABLE Y10 STEERING 13
14'	427	YMM-22214-00-00	CABLE Y10 STEERING 14
15'	457	YMM-22215-00-00	CABLE Y10 STEERING 15

Y11 STEERING CABLE (TO BE USED WITH Y12)

FEET	CM	Part Number	Part Name
7'	213	YMM-22007-00-00	CABLE Y11 STEERING 7
8'	244	YMM-22008-00-00	CABLE Y11 STEERING 8
9'	274	YMM-22009-00-00	CABLE Y11 STEERING 9
10'	305	YMM-22010-00-00	CABLE Y11 STEERING 10
11'	335	YMM-22011-00-00	CABLE Y11 STEERING 11
12'	366	YMM-22012-00-00	CABLE Y11 STEERING 12
13'	396	YMM-22013-00-00	CABLE Y11 STEERING 13
14'	427	YMM-22014-00-00	CABLE Y11 STEERING 14
15'	457	YMM-22015-00-00	CABLE Y11 STEERING 15
16'	488	YMM-22016-00-00	CABLE Y11 STEERING 16
17'	518	YMM-22017-00-00	CABLE Y11 STEERING 17
18'	549	YMM-22018-00-00	CABLE Y11 STEERING 18
20'	610	YMM-22020-00-00	CABLE Y11 STEERING 20

Y12 STEERING

Part Name	Part Number
Y12 Helm/Bezel	YMM-22400-00-00
Y22 Helm (fast-connect system)	YMM-22500-00-00
Y23 Helm (non self-centring fast-connect)	YMM-22500-10-00
Y24 Helm/Bezel	YMM-22510-00-00
Y25 Bezel (90° version)	YMM-22550-00-00
Y25 Bezel (20° version)	YMM-22551-00-00

Y20 COMPLETE KIT FOR ALL ENGINES (INCLUDING Y21, Y22, Y25 AND STEERING WHEEL) YMM-24007-00-BK

FEET	CM	Part Number	Part Name
10'	305	YMM-22310-00-00	CABLE Y20 STEERING 10
11'	335	YMM-22311-00-00	CABLE Y20 STEERING 11
12'	366	YMM-22312-00-00	CABLE Y20 STEERING 12
13'	396	YMM-22313-00-00	CABLE Y20 STEERING 13
14'	427	YMM-22314-00-00	CABLE Y20 STEERING 14
15'	457	YMM-22315-00-00	CABLE Y20 STEERING 15
16'	488	YMM-22316-00-00	CABLE Y20 STEERING 16
17'	518	YMM-22317-00-00	CABLE Y20 STEERING 17

Y21 STEERING CABLE (TO BE USED WITH Y22/Y23/Y24)

FEET	CM	Part Number	Part Name
7'	213	YMM-22107-00-00	CABLE Y21 STEERING 7
8'	244	YMM-22108-00-00	CABLE Y21 STEERING 8
9'	274	YMM-22109-00-00	CABLE Y21 STEERING 9
10'	305	YMM-22110-00-00	CABLE Y21 STEERING 10
11'	335	YMM-22111-00-00	CABLE Y21 STEERING 11
12'	366	YMM-22112-00-00	CABLE Y21 STEERING 12
13'	396	YMM-22113-00-00	CABLE Y21 STEERING 13
14'	427	YMM-22114-00-00	CABLE Y21 STEERING 14
15'	457	YMM-22115-00-00	CABLE Y21 STEERING 15
16'	488	YMM-22116-00-00	CABLE Y21 STEERING 16
17'	518	YMM-22117-00-00	CABLE Y21 STEERING 17
18'	549	YMM-22118-00-00	CABLE Y21 STEERING 18
19'	579	YMM-22119-00-00	CABLE Y21 STEERING 19
20'	610	YMM-22120-00-00	CABLE Y21 STEERING 20
21'	640	YMM-22121-00-00	CABLE Y21 STEERING 21
22'	671	YMM-22122-00-00	CABLE Y21 STEERING 22
23'	701	YMM-22123-00-00	CABLE Y21 STEERING 23
24'	732	YMM-22124-00-00	CABLE Y21 STEERING 24
25'	762	YMM-22125-00-00	CABLE Y21 STEERING 25

ACCESSORIES FOR MECHANICAL SYSTEMS

Some outboard models require additional accessories for the connection between the steering cable and the engine.

Description	Part Number
Clamp block to support steering cables (aluminium and stainless steel)	YMM-22601-00-00
Splash well mounting support for steering cables (corrosion resistant)	YMM-22602-00-00
Clamp block to support steering cables (corrosion resistant painted steel)	YMM-22603-00-00
Clevis for YMM-22601-00-00, YMM-22602-00-00 or YMM-22603-00-00	YMM-22610-00-00
Clevis for YMM-22601-00-00, YMM-22602-00-00 or YMM-22603-00-00	YMM-22611-00-00



Y11 Steering Cable with Transom Support (YMM-22601-00-00) using Clamp block.

Clevis YMM-22610-00-00

Clevis YMM-22611-00-00

STEERING GUIDE ATTACHMENT KITS

These kits are required for connection between the steering cable end and the outboard's steering hook.

Model	Part Number
F8C(-03/2007)/FT8D(-03/2007)	68T-61350-00-00
F8C(04/2007-)/FT8D(04/2007-)/F9.9J/FT9.9L	68T-61350-10-00
9.9F/15F/F9.9C/FT9.9D/F15A	63V-61350-00-00
FT9.9A/F9.9B	6G8-61350-00-00
F15C/F20B	6AH-61350-00-00
20C/20D/25B/25N/25V/30D/30G/40Q	689-61350-02-00
F25D/FT25F/F30B/F40F	6BG-61350-00-00
40V/50H/F50A/FT50C	63D-61350-00-00
F20A/F25A/FT25B/F30A/F40B/C/D/F50F/H/ F60A/C/F/FT50G/J/FT60B/D/G/F70A/40X	65W-61350-00-00
F25G	6FM-61350-00-00
50G/60F/70B/75C/90A/75A/85A	688-61350-10-00
F80A/B/F100A/D/F	67F-61350-00-00
F100F/F115B/F130A	6EK-61350-00-00
F100B/F115A/F150A/F175A/V4/V6 (2 & 4 stroke)	6E5-61350-02-00
Tie-Bar Kit	
F115 to F300 (V6) Adjustable distance: 600-800mm	6E5-61301-01-00



Outboard Rigging & Accessories

STEERING HOOKS

Model	Type	Part Number
Universal Steering Hook (A50) for engines between 5 and 25hp		YMM-21220-00-00
6C/D/8C/9.9D/15D/40Q	Ball post type, not for F8B/F9.9A/B/25J	676-48511-02-00
F6A/F8C/FT8D/F9.9C/FT9.9D/F9.9F/FT9.9G/F9.9J/FT9.9LF15A/9.9F/15F	Steering guide type	63V-48511-01-00
F8A/B/F9.9A/B/25J/30D ('87-'96)	Ball post type	6G8-48511-10-00
F8A/B/F9.9A/B/25J/30D ('87-'96)	Steering guide type	6G8-48511-20-00
F15C/F20B		6AH-48511-01-00
20C('85-'96) 20D/25B/25D/N/30A/G ('85-'89)	Ball post type/Steering guide type	689-48511-02-00
20D/25N ('90-'00)	Ball post type/Steering guide type	6L2-48511-00-00
20D/25N ('01-) 25J/30D ('94--)		6J8-48511-01-4D
25J/30DETO ('99-'01)	Steering guide type	6J8-48511-52-00
F20A/F25A/F25D/F25G/FT25B/FT25F/F30A/F30B/F40B/F40F/F50F/F50H/ FT50B/FT50G/FT50J/F60A/F60C/F60F/FT60B/FT60D/FT60G/F70A/40X	Steering guide type	65W-48511-01-00
25B/50G/60F/70B	Steering guide type	6H3-48511-52-00
25B/Q/40H/50D/50G/60F/70B/75A/80A/85A/90A/55B ('95--)	Ball post type	688-48511-01-4D
55B ('92-'94)	Steering guide type	688-48511-51-1D
55B ('95-'98)	Steering guide type	688-48511-52-00
55B ('90-'94) 75A/85A ('90-'93)	Ball post type	688-48511-01-4D
75C/90A	Steering guide type	688-48511-12-00
25Q/40H/50D	Steering guide type	6H4-48511-51-4D
40V/Y/F40A/F45A/50H/F50A/B/FT50B/C		63D-48511-01-00
F80A/F80B/F100A/F100D	Steering guide type	67F-48511-01-00
F115A	Steering guide type	68V-48511-01-00

Outboard Maintenance & Accessories



RIGGING HOSE

Keep your cables protected and uncluttered with a Rigging Hose. Yamaha Hoses are tough yet flexible and are constructed from crush-resistant, UV-protected material to ensure a longer life span. Hoses are mounted using a chromium-plated copper or plastic bracket and come in black, gray or metallic blue colours.

2"		
Black	25ft/7,62m	MAR-RIGHS-BK-25
Gray/Black	25ft/7,62m	ABB-RIGHS-GY-25
White/Black	25ft/7,62m	MAR-RHS20-WT-25
Metallic blue	25ft/7,62m	ABB-RIGHS-BE-25
2,5" XTO		
Black	25ft/7,62m	MAR-RHS25-BK-25
White/Black	25ft/7,62m	MAR-RHS25-WT-25

RIGGING GROMMETS

These handy devices replace rubber engine grommets on bigger engines and provide positive attachment without the need for clamps. They can be threaded directly onto one end of a rigging hose with Transom Brackets at the other end.

115-250 (2-stroke)	MAR-GROMM-ET-01
F150	MAR-GRMMT-F1-50
F200B/C-F250A/B	MAR-GRMMT-LG-4S



TRANSOM PLATES

Yamaha recommend these transom plates for boats with engines from 60hp and up.

F30 - V6 (non SBW) engines aluminium 10mm	YMM-09TP0-00-01
V6 SBW and V8 engines aluminium 10mm	YMM-09TP0-00-02

TRANSOM FLANGES

The tough plastic bracket is easy to install by just threading the Rigging Hose onto it. It requires no clamp, yet provides positive engagement. Use with the rigging Grommet on the other end for quick, easy rigging. When the chromium plated copper "through transom bracket" is used, the rigging hose is fitted with the clamp.

2"	
Chrome transom bracket with 2 anodised stainless steel clamps	ABA-THRUT-RA-SM
Transom flange Black	MAR-THRUT-RS-M2
Transom flange White	MAR-FLNG2-0W-T0
2,5" XTO	
Black	MAR-TFLNG-25-BK
White	MAR-TFLNG-25-WT



TRANSOM BOLTS

Outboard	Part Number	Thread	Total length	Boat transom thickness (*)
	90101-12M51-00	M12	95mm	
	90101-12M65-00	M12	105mm	
F25D - F300B	90101-12M03-00	M12	115mm	55-65mm
	90101-12M05-00	M12	130mm	65-75mm
	901-01120-47-00	M12	150mm	75-95mm
F300 - XTO **	901-01120-51-00	M12	85mm	75-95mm
	901-01120-53-00	M12	110mm	95-115mm
	901-01120-31-00	M12	150mm	75-95mm
	901-01120-68-00	M12	170mm	75-95mm
	901-01120-54-00	M12	180mm	115mm-
	901-01120-56-00	M12	210mm	115mm-
	901-01120-57-00	M12	230mm	115mm-

* Reference data

** High tension bolts



Outboard Rigging & Accessories

TILT LIMITER

The tilt limiter will help improve customer satisfaction in applications where the top cowling would come in contact with the boat at full tilt. (Adjacent list shows applicable engine serial numbers) Check with your dealer for installation validation following owner manual instruction.

Model	Starting Serial Number	Tilt Limiter Kit
F50H	6C1-1047118-	6C5-825EY-00-00
F60F	6C5-1053953-	6C5-825EY-00-00
FT50J	6C2-1014367-	6C5-825EY-00-00
FT60G	6C6-1020951-	6C5-825EY-00-00
F70A	6CJ-1019836-	6C5-825EY-00-00
F80B	6D7-1014351-	6D8-825EY-00-00
F100F	All engine	63P-825EY-01-00
F100D	6D9-1020147-	6D8-825EY-00-00
F115A	68V-1124466-	63P-825EY-01-00
FL115A	68W-1005001-	63P-825EY-01-00
F115B	All engine	63P-825EY-01-00
FL115B	All engine	63P-825EY-01-00
F130A	All engine	63P-825EY-01-00
F150A	63P-1106291-	63P-825EY-01-00
FL150A	64P-1013389-	63P-825EY-01-00
F150D	All engine	63P-825EY-01-00
FL150D	All engine	63P-825EY-01-00
F175A	All engine	63P-825EY-01-00
F200F	All engine	63P-825EY-01-00
FL200F	All engine	63P-825EY-01-00
F200G	All engine	6CE-825EY-00-00
FL200G	All engine	6CE-825EY-00-00
F225F	6CL-1001428-	6CE-825EY-00-00
FL225F	6CM-1000253-	6CE-825EY-00-00
F250D	6CG-1003350-	6CE-825EY-00-00
FL250D	6CH-1000945-	6CE-825EY-00-00
F300B	6CE-1005964-	6CE-825EY-00-00
FL300B	6CF-1002506-	6CE-825EY-00-00



Rigging Order Guide - Index diagrams



Mechanical Remote Control

Tiller handle	36
Side Mount	38
Flush Mount	40
Top Mount Single	42
Top Mount Twin	44
Mechanical Display option	45



Y-COP

Y-cop information	49
Single and Twin engine	50
Tiller handle	51



DBW Remote Control

How to read the diagram and parts list	52
Single Flush Side-Mount level 1	54
Single Flush Side-Mount level 2	56
Single Flush Side-Mount level 3-4	60
Single Flush Side-Mount 2nd station level 1	64
Single Flush Side-Mount 2nd station level 2	66
Single Flush Side-Mount 2nd station level 3-4	68
Single level 1	70
Single level 2	74
Single level 3-4	78
Single 2nd station level 1	82
Single 2nd station level 2	84
Single 2nd station level 3-4	86
Twin level 1	88
Twin level 2	92
Twin level 3-4	96
Twin 2nd station level 1	100
Twin 2nd station level 2	102
Twin 2nd station level 3-4	104
Triple level 1	106
Triple level 2	108
Triple level 3-4	112
Triple 2nd station level 1	116
Triple 2nd station level 2	118
Triple 2nd station level 3-4	120
Quad level 1	122
Quad level 2	124
Quad level 3-4	128
Quad 2nd station level 1	132
Quad 2nd station level 2	134
Quad 2nd station level 3-4	136
Display option	138



Rigging Order Guide

MULTI-FUNCTION TILLER HANDLE

Our convenient 6X4 Multi-function Tiller Handle is available as an option for mid-range outboard models.

- Ergonomic design and longer, larger-diameter throttle grip
- Contoured, composite-coated lever for smooth, comfortable shifting
- Easy access Power Trim and Tilt switch for on-the-go operation
- Neat and conveniently positioned LED engine warning lamp
- Key switch and STOP switch easily accessible from the handle
- Built-in NEUTRAL switch and buzzer for simple rigging

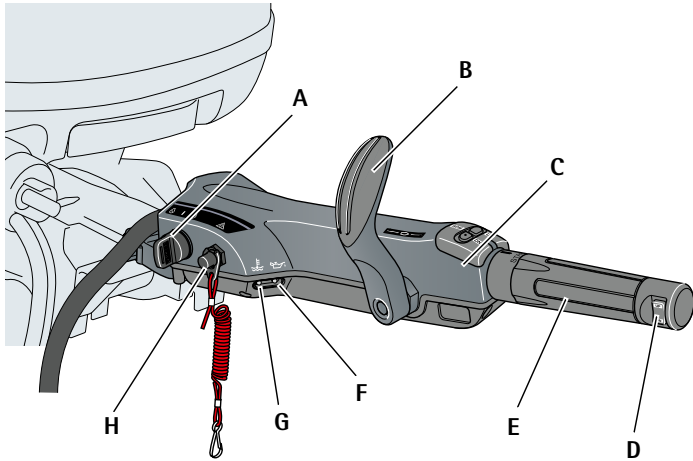

1 - TILLER HANDLE - MAIN BODY

Applicable to F20 – F130*

- A - Engine start/stop
- B - Shift control
- C - Variable trolling switch
- D - PTT Control
- E - Throttle Control
- F - Low oil pressure alert
- G - Overheat alert
- H - Emergency stop lanyard

* F25A/F25D/FT25F are without C/F/G - depending on models - Consult your dealer

2 - FITTING KIT

Fitting kits may differ by outboard model, as shown in the table below

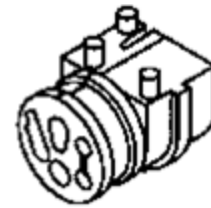

3 - ENGINE GROMMET

Some outboard models require an engine grommet to fit additional wire leads.

4 - YCOP ATTACHMENT KIT

Required to activate YCOP immobilizer installed with Multifunction Tiller Handle. See page 20 for installation details

6Y8-762A0-01-00 Y-COP Attachment Kit 6X4



OUTBOARD MODEL	1*	2	3	4
	TILLER HANDLE - MAIN BODY	FITTING KIT	ENGINE GROMMET FOR YCOP	Y-COP ATTACHMENT KIT
F20G		6X4-42102-L0-00		
F25G		6X4-42102-F0-00		
F30B/F40F/FT25F		6X4-42102-82-00	(Not Required)	
F50F/F50H/FT50G/FT50J/ F60C/ F60F/FT60D/FT60G	6X4-42103-6A-00	6X4-42102-92-00	6C5-42725-50-00	6Y8-W0035-C0-00
F70A			(Not Required)	
F80D/F100F**		6X4-42102-G1-00		
F80B/F100D		6X4-42102-A2-00	68V-42725-20-00	
F115B/F130A		6X4-42102-C0-00	(Not Required)	

* F25A/F25D/FT25F are without C/F/G - depending on models - Consult your dealer

** F100F needs installation plate 6EK-42121-00-00

MULTI-FUNCTION TILLER HANDLE

SINGLE ENGINE (6Y8 GAUGE + 6X4 MULTI-FUNCTION TILLER HANDLE)



Part Number	Description	Qty	Note
RIGGING KIT			
6YR-762G0-81-00	6Y8 Round Tachometer Kit	1	
MULTI-FUNCTION TILLER HANDLE			
6X4-42103-A0-00	6X4 Multi-function Tiller Handle	1	
TILLER HANDLE FITTING KIT			
6X4-42102-82-00	F30B/F40F	1	
6X4-42102-92-00	F50H/FT50J/F60F/FT60G/F70A		
6X4-42102-A2-00	F80B/F100D		
6X4-42102-C1-00	F115B		

Rigging Order Guide

MECHANICAL REMOTE CONTROL

SINGLE ENGINE (6Y8 GAUGES + 703 SIDE MOUNT)

SINGLE ENGINE	703 REMOTE CONTROL	6Y8 GAUGE
-------------------------	------------------------------	---------------------

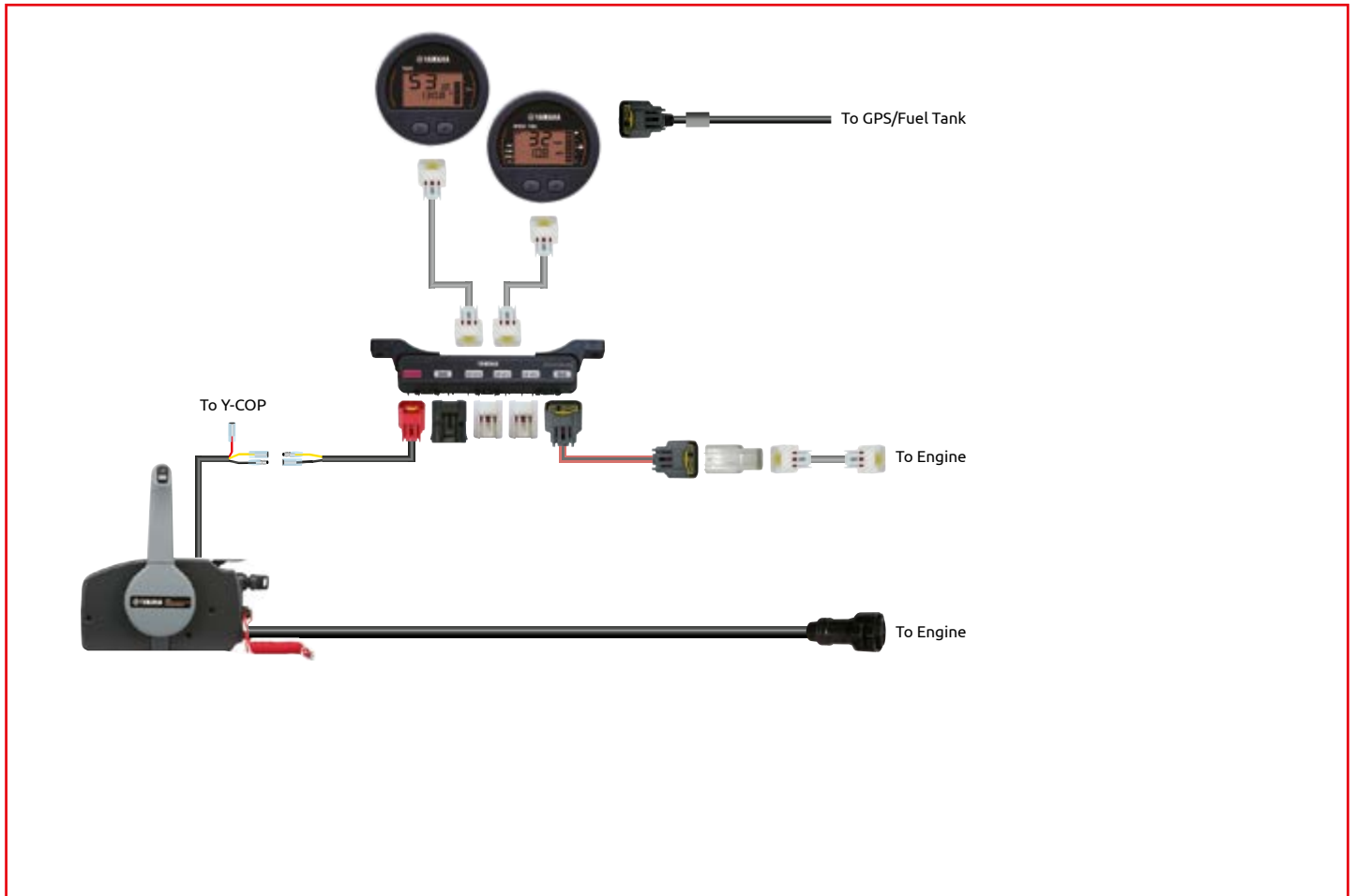

Part Number	Description	Qty	Note
RIGGING KIT			
6YR-762G0-81-00	6Y8 Round Tachometer Kit	1	
6YR-762G0-91-00	6Y8 Round Tacho + Speedo/FMM Kit (Shown above)	1	
REMOTE CONTROL BOX			
703-48207-23-00	703 Side mount remote control	1	

MECHANICAL REMOTE CONTROL

SINGLE ENGINE (CL5 COLOUR DISPLAY + 703 SIDE MOUNT)

SINGLE ENGINE	703 REMOTE CONTROL	CL5 GAUGE
-------------------------	------------------------------	---------------------

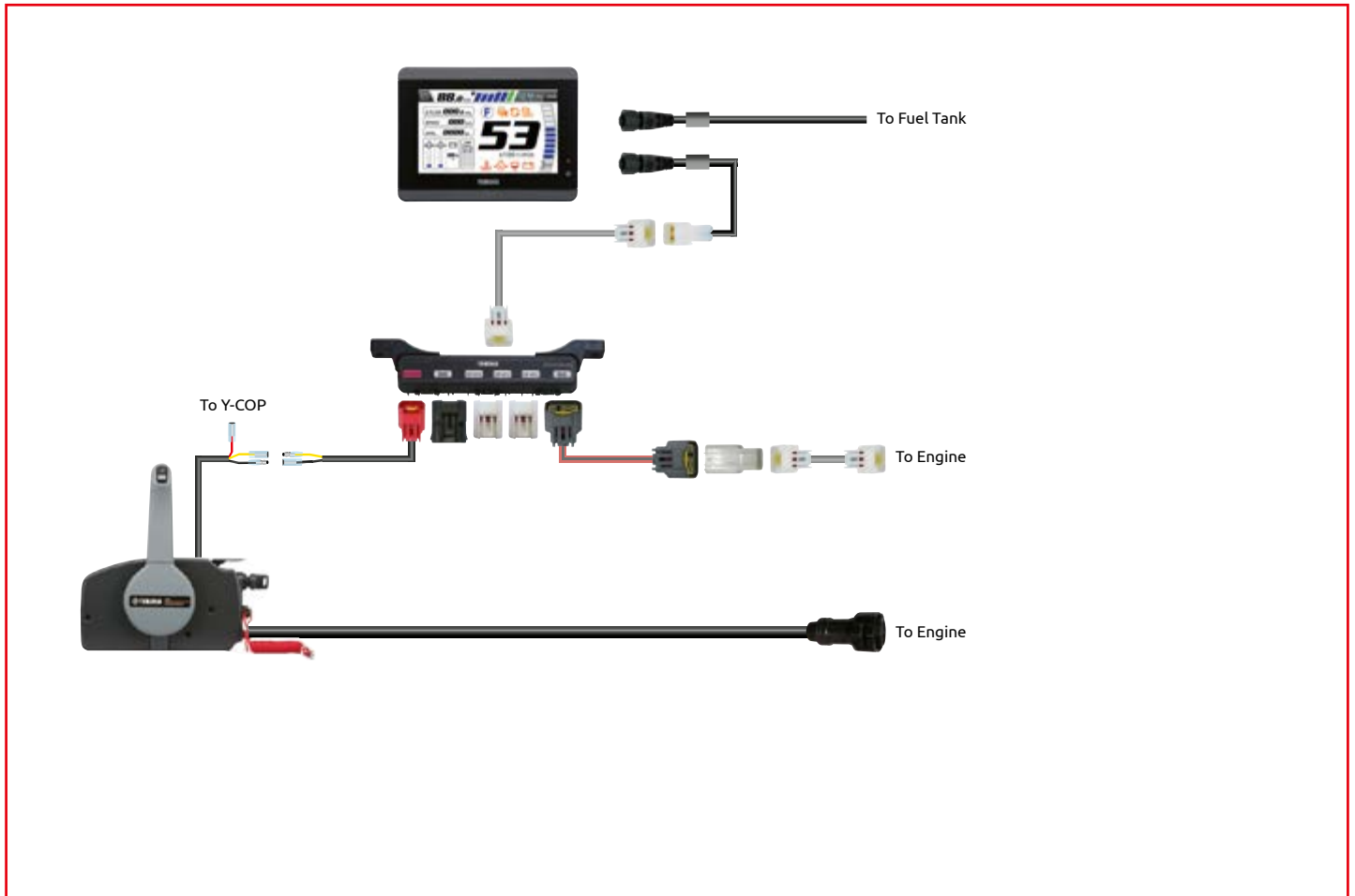

Part Number	Description	Qty	Note
RIGGING KIT			
6YM-762G0-20-00	CL5 Single mechanical rigging kit	1	For contents see: Mechanical Display options
REMOTE CONTROL BOX			
703-48207-23-00	703 Side mount remote control	1	

Rigging Order Guide

MECHANICAL REMOTE CONTROL

SINGLE ENGINE (6Y8 GAUGES + 6X3 FLUSH MOUNT)

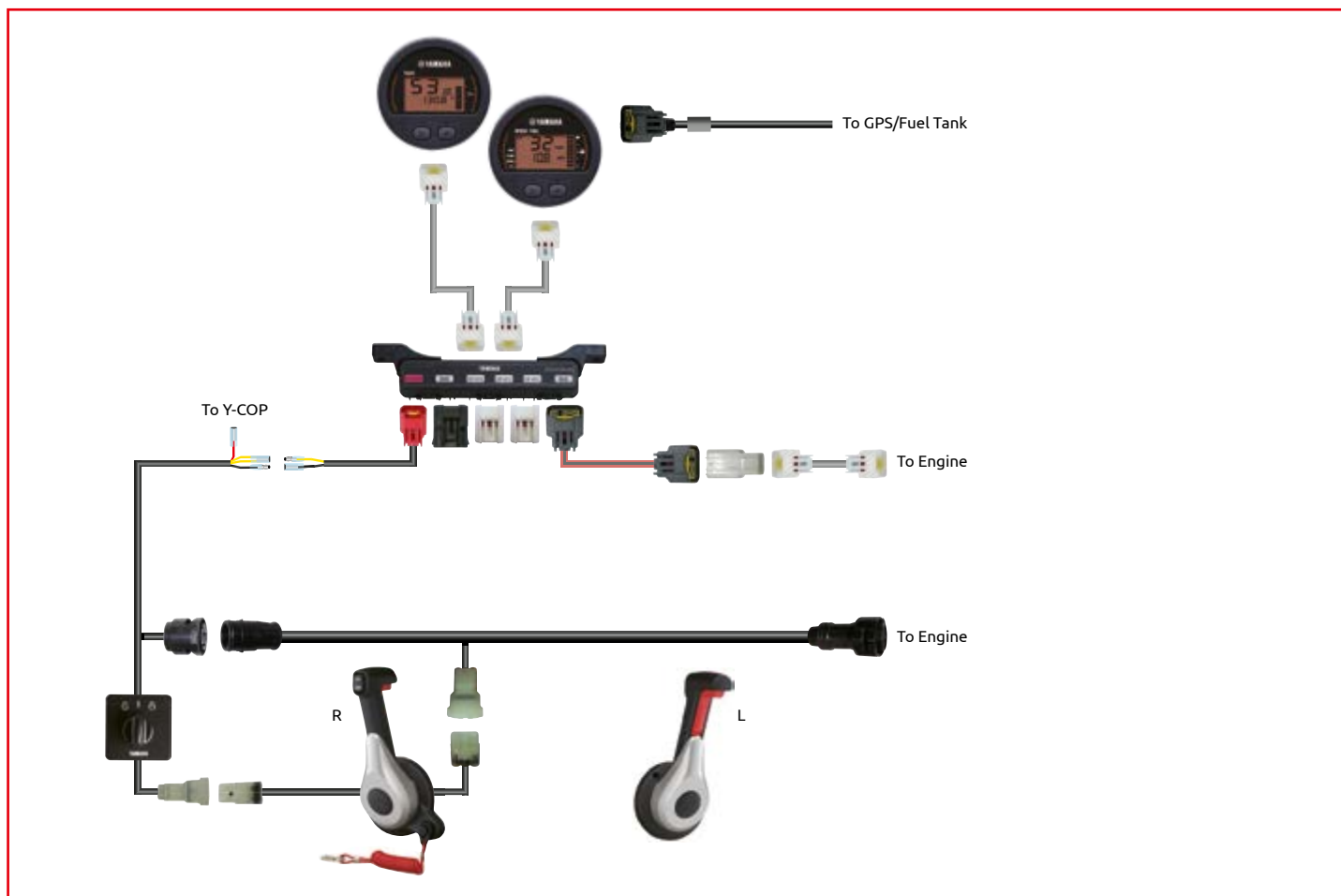

Part Number	Description	Qty	Note
-------------	-------------	-----	------

RIGGING KIT

6YR-762G0-81-00	6Y8 Round Tachometer Kit	1	
6YR-762G0-91-00	6Y8 Round Tacho + Speedo/FMM Kit (Shown above)	1	

RIGGING KIT

YMM-KITYD-10-01	Premium Remote Control Flush Mount (right side)	1	
YMM-KITYD-10-02	Premium Remote Control Flush Mount (left side)	1	

KIT CONTENTS

YMM-KITYD-10-01	Premium Remote Control Flush Mount (right side)	Qty	Note
6X3-48206-11-00	Flush Mount 6X3 Remote Control	1	
64D-82570-22-00	Panel Switch Assy Single	1	
688-8258A-60-00	Main Harness 10P 6m (19,7ft)	1	Other lengths available
YMM-KITYD-10-02	Premium Remote Control Flush Mount (left side)	Qty	Note
6X3-48206-22-00	Flush Mount 6X3 Remote Control	1	
704-82570-12-00	Panel Switch Assy Single	1	With lanyard
688-8258A-60-00	Main Harness 10P 6m (19,7ft)	1	Other lengths available

HARNESS OPTIONS

Main harness 10P	Length
688-8258A-50-00	5 m (16 ft)
688-8258A-60-00	6 m (19 ft)
688-8258A-70-00	7 m (23 ft)
6K1-8258A-40-00	8 m (26 ft)
61B-8258A-01-00	9.5 m (32 ft)

MECHANICAL REMOTE CONTROL

SINGLE ENGINE (CL5 COLOUR DISPLAY + 6X3 FLUSH MOUNT)

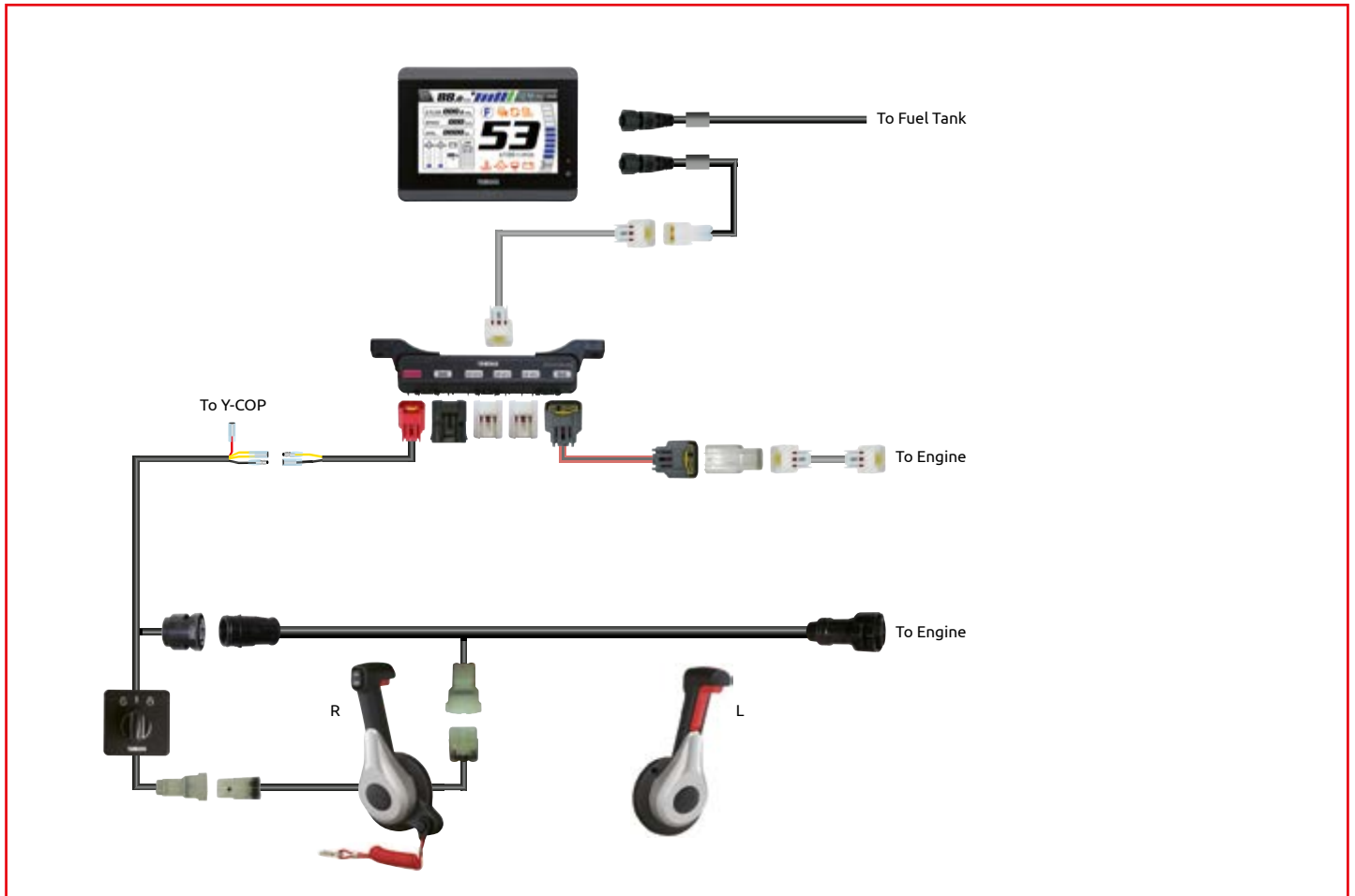

Part Number	Description	Qty	Note
RIGGING KIT			
6YM-762G0-20-00	CL5 Single mechanical rigging kit	1	For contents see: Mechanical Display options

RIGGING KIT			
YMM-KITYD-10-01	Premium Remote Control Flush Mount (right side)	1	
YMM-KITYD-10-02	Premium Remote Control Flush Mount (left side)		

KIT CONTENTS

YMM-KITYD-10-01	Premium Remote Control Flush Mount (right side)	Qty	Note
6X3-48206-11-00	Flush Mount 6X3 Remote Control	1	
64D-82570-22-00	Panel Switch Assy Single	1	
688-8258A-60-00	Main Harness 10P 6m (19,7ft)	1	Other lengths available
YMM-KITYD-10-02	Premium Remote Control Flush Mount (left side)	Qty	Note
6X3-48206-22-00	Flush Mount 6X3 Remote Control	1	
704-82570-12-00	Panel Switch Assy Single	1	With lanyard
688-8258A-60-00	Main Harness 10P 6m (19,7ft)	1	Other lengths available

HARNESS OPTIONS

Main harness 10P	Length
688-8258A-50-00	5 m (16 ft)
688-8258A-60-00	6 m (19 ft)
688-8258A-70-00	7 m (23 ft)
6K1-8258A-40-00	8 m (26 ft)
61B-8258A-01-00	9.5 m (32 ft)

Rigging Order Guide

MECHANICAL REMOTE CONTROL

SINGLE ENGINE (6Y8 GAUGES + 704 TOP MOUNT)

SINGLE ENGINE	704 REMOTE CONTROL	6Y8 GAUGE
-------------------------	------------------------------	---------------------



Part Number	Description	Qty	Note
RIGGING KIT			
6YR-762G0-81-00	6Y8 Round Tachometer Kit	1	
6YR-762G0-91-00	6Y8 Round Tacho + Speedo/FMM Kit (Shown above)	1	

RIGGING KIT			
YMM-KITYD-10-03	Premium Remote Control Top Mount	1	

KIT CONTENTS			
Part Number	Description	Qty	Note
YMM-KITYD-10-03	Premium Remote Control Top Mount	1	
704-48205-R1-00	704 Top Mount Single	1	
704-82570-12-00	Panel Switch Assy Single	1	
6K1-8258A-40-00	Main Harness 10P 8m (26,7ft)	1	Other lengths available

HARNESS OPTIONS	
Main harness 10P	Length
688-8258A-50-00	5 m (16 ft)
688-8258A-60-00	6 m (19 ft)
688-8258A-70-00	7 m (23 ft)
6K1-8258A-40-00	8 m (26 ft)
61B-8258A-01-00	9.5 m (32 ft)

MECHANICAL REMOTE CONTROL

SINGLE ENGINE (CL5 COLOUR DISPLAY + 704 TOP MOUNT)

SINGLE ENGINE	704 REMOTE CONTROL	CL5 GAUGE
-------------------------	------------------------------	---------------------



Part Number	Description	Qty	Note
RIGGING KIT			
6YM-762G0-20-00	CL5 Single mechanical rigging kit	1	For contents see: Mechanical Display options

RIGGING KIT			
YMM-KITYD-10-03	Premium Remote Control Top Mount	1	

KIT CONTENTS

Part Number	Description	Qty	Note
YMM-KITYD-10-03	Premium Remote Control Top Mount		
704-48205-R1-00	704 Top Mount Single	1	
704-82570-12-00	Panel Switch Assy Single	1	
6K1-8258A-40-00	Main Harness 10P 8m (26,7ft)	1	Other lengths available

HARNESS OPTIONS

Main harness 10P	Length
688-8258A-50-00	5 m (16 ft)
688-8258A-60-00	6 m (19 ft)
688-8258A-70-00	7 m (23 ft)
6K1-8258A-40-00	8 m (26 ft)
61B-8258A-01-00	9.5 m (32 ft)

Rigging Order Guide

MECHANICAL REMOTE CONTROL

TWIN ENGINE (CL5 COLOUR DISPLAY)

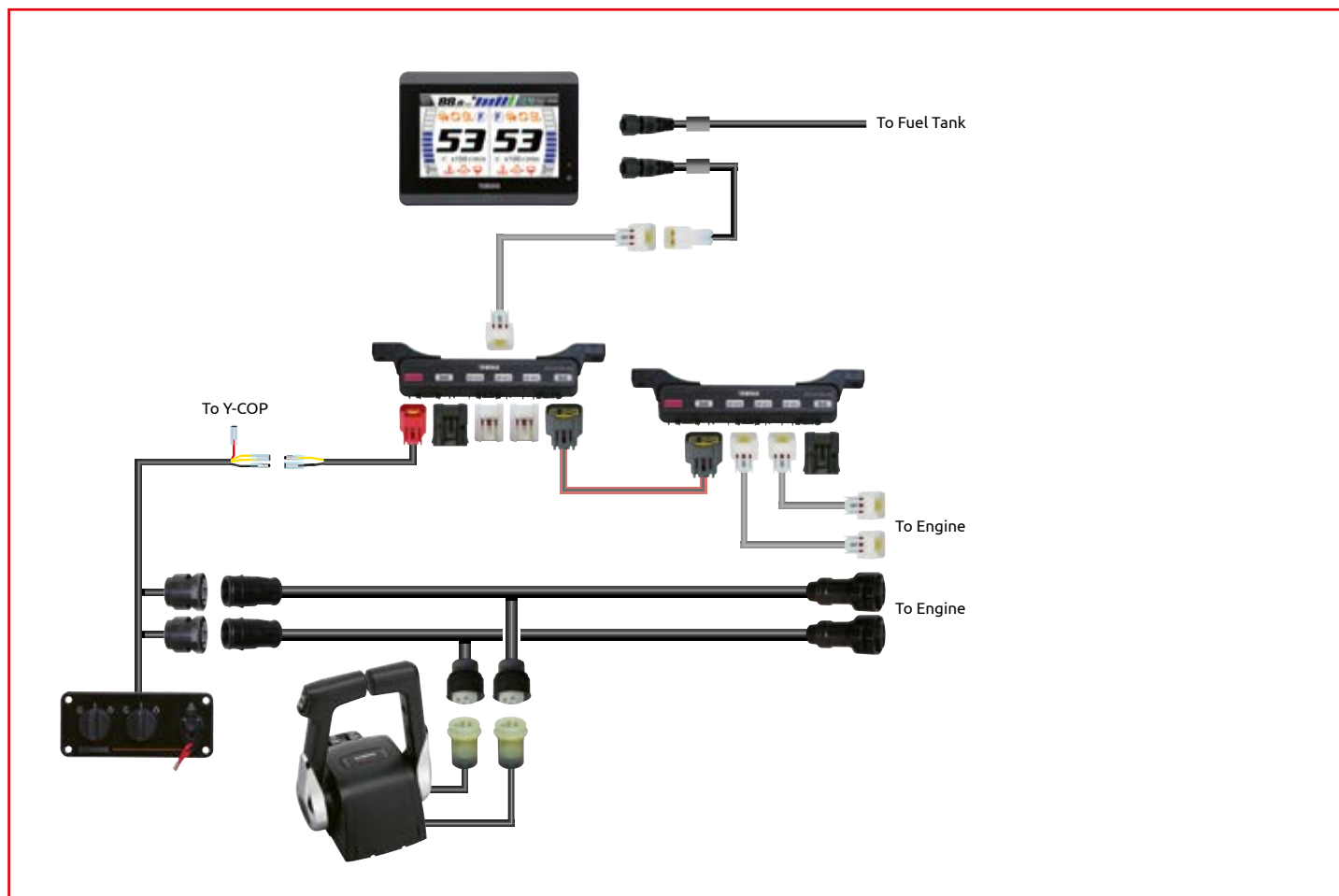

Part Number	Description	Qty	Note
-------------	-------------	-----	------

RIGGING KIT

6YM-762R0-00-00	CL5 Counter Rotation Rigging Kit	1	
-----------------	----------------------------------	---	--

KIT CONTENTS

Part Number	Description	Qty	Note
6YM-762R0-00-00	Premium Remote Control Top Mount Kit	1	
704-48207-R1-00	704 Top Mount Twin	1	
6Y8-82570-04-00	Panel Switch Assy Twin	1	
6YM-83710-10-00	CL5 Gauge	1	
6YM-83553-00-00	Conversion harness	1	
6YD-8356N-00-00	Fuel tank wire	1	
6Y8-81920-01-00	Multi-hub	1	
6Y8-82553-31-00	Main bus wire 7.6m (25ft)	1	Other lengths available
6Y8-82521-11-00	Pigtail bus wire 0.6m (2ft)	1	Other lengths available
6Y8-82521-31-00	Pigtail bus wire 1.8m (6ft)	1	Other lengths available
6Y8-82521-41-00	Pigtail bus wire 2.7m (9ft)	1	Other lengths available
6Y8-83553-01-00	System power Supply	1	
6K1-8258A-40-00	Main Harness 10P 8m (26,7ft)	1	Other lengths available
61B-8258A-01-00	Main Harness 10P 9.5m (31ft)	1	Other lengths available
6Y8-82582-11-00	4 pin cap	3	
6Y8-82582-01-00	2 pin cap	1	

HARNESS OPTIONS

Pigtail bus wire	Length	Pigtail bus wire	Length	Main harness 10P	Length
6Y8-82521-01-00	0.3m (1 ft)	6Y8-82521-31-00	1.8m (6 ft)	688-8258A-50-00	5 m (16 ft)
6Y8-82521-11-00	0.6m (2 ft)	6Y8-82521-41-00	2.7m (9 ft)	688-8258A-60-00	6 m (19 ft)
6Y8-82521-21-00	0.9m (3 ft)	6Y8-82521-51-00	3.6m (12 ft)	688-8258A-70-00	7 m (23 ft)
				6K1-8258A-40-00	8 m (26 ft)
				61B-8258A-01-00	9.5 m (32 ft)

MECHANICAL REMOTE CONTROL (DISPLAY)

6Y8 ROUND TACHO RIGGING KIT (6YR-762G0-81-00)

SINGLE	6Y8
ENGINE	GAUGE



	6YR-762G0-81-00	6Y8 round tacho rigging kit	Qty	Note
1	6Y8-8350T-20-00	Tachometer Assy (Round)	1	
2	6Y8-81920-01-00	Multi-Hub Assy	1	
3	6Y8-81920-11-00	Inline hub Assy	1	
4	6Y8-82553-21-00	Main bus Harness 6 pin 6.1 m (20 ft)	1	
5	6Y8-82521-41-00	Pigtail bus Harness 4 pin 2.7 m (9 ft)	1	
6	6Y8-82521-11-00	Pigtail bus Harness 4 pin 0.6 m (2 ft)	1	
7	6Y8-82582-11-00	Terminal cap (4 pin/device)	2	
8	6Y8-83553-01-00	System power supply wire 2.4 m (8 ft)	1	

Rigging Order Guide

MECHANICAL REMOTE CONTROL (DISPLAY)

6Y8 ROUND TACHO + SPEEDO/RIGGING KIT (6YR-762G0-91-00)

SINGLE
ENGINE

6Y8
GAUGE

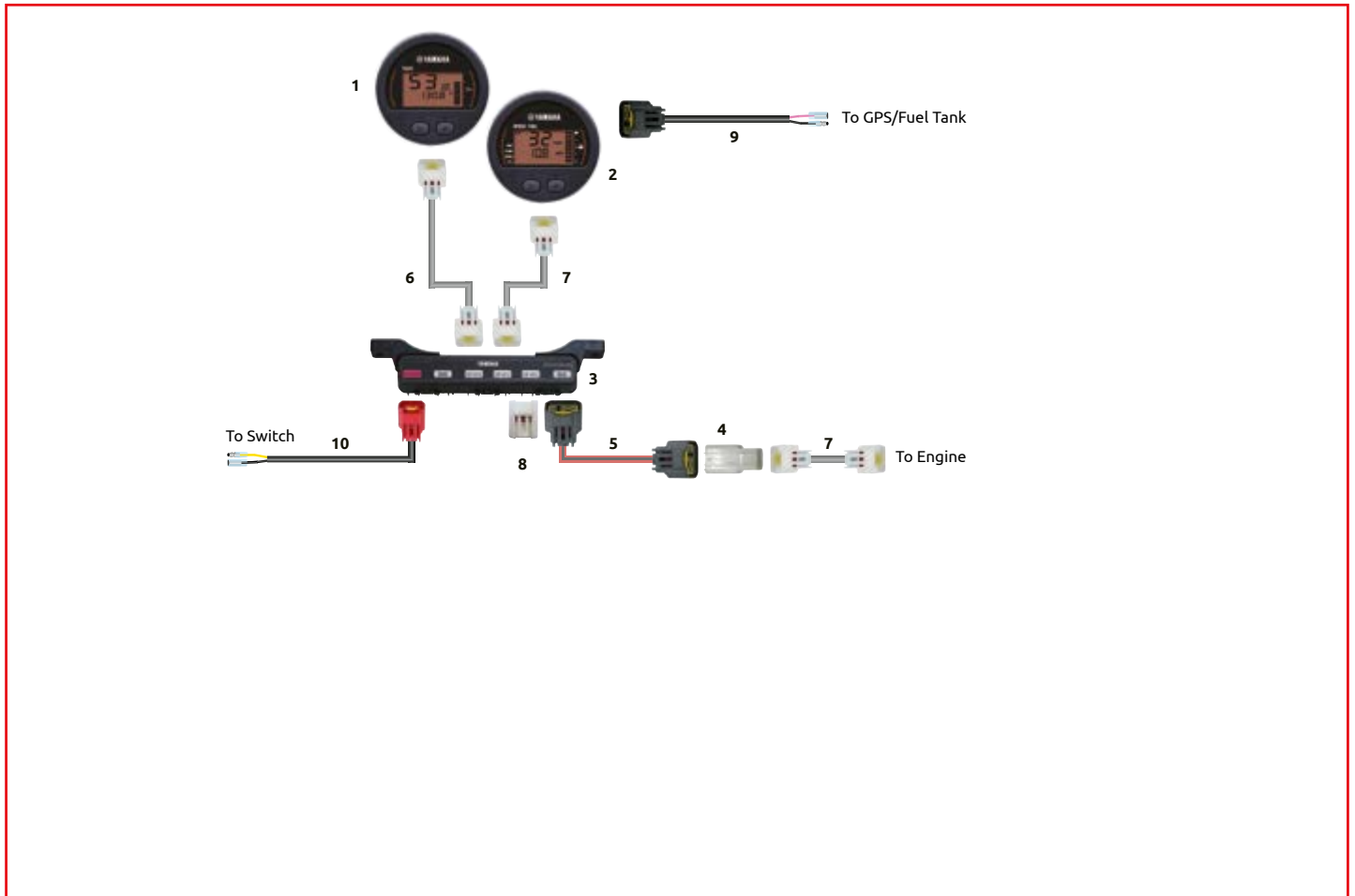

	6YR-762G0-91-00	Round Tacho + Speedo Rigging kit	Qty	Note
1	6Y8-8350T-20-00	Tachometer Assy (Round)	1	
2	6Y8-83500-11-00	Speedo & FMM meter Assy (Round)	1	
3	6Y8-81920-01-00	Multi-hub Assy	1	
4	6Y8-81920-11-00	Inline hub Assy	1	
5	6Y8-82553-21-00	Main bus Harness 6 pin 6.1 m (20 ft)	1	
6	6Y8-82521-31-00	Pigtail bus Harness 4 pin 1.8 m (6 ft)	1	
7	6Y8-82521-11-00	Pigtail bus Harness 4 pin 0.6 m (2 ft)	2	
8	6Y8-82582-11-00	Terminal cap (4 pin/device)	1	
9	6Y8-8356N-01-00	6Y8 PGS/FUEL wire (NMEA 0183)	1	
10	6Y8-83553-01-00	System power supply wire 2.4 m (8 ft)	1	

MECHANICAL REMOTE CONTROL (DISPLAY)

DISPLAY OPTION CL5 COLOUR TOUCH GAUGE RIGGING KIT (6YM-762G0-20-00)

CL5
 MECHANICAL

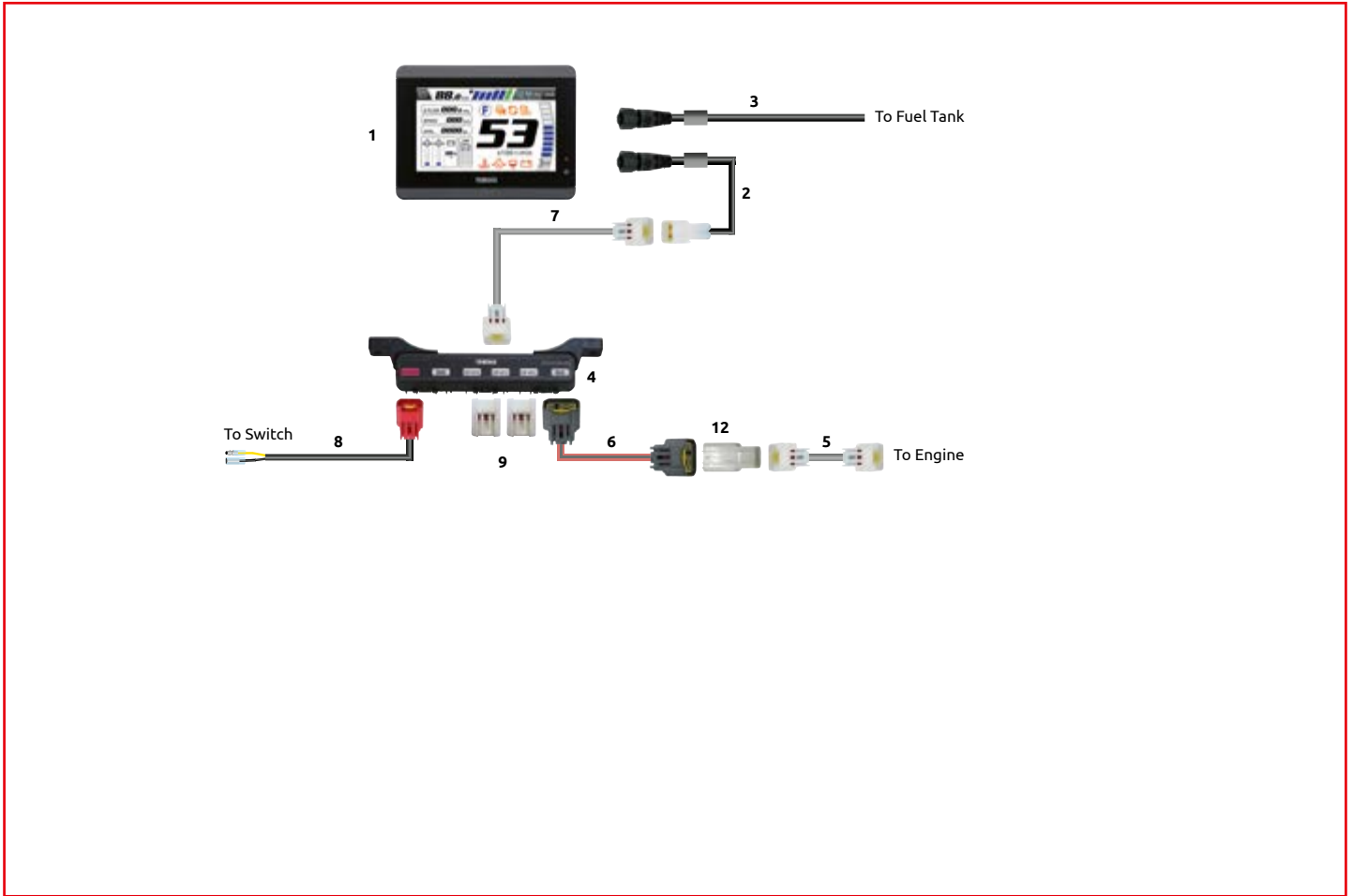

	6YM-762G0-20-00	CL5 Color Touch Gauge Kit - MECH	Qty	Note
1	6YM-8A371-01-00	CL5 Display	1	
2	6YM-83553-00-00	Conversion Harness 0.9m / 3 ft	1	Optional elbow connector 0.9m 6YM-83553-10-00
3	6YD-8356N-00-00	Fuel Tank Wire	1	Optional elbow connector 6YM-8356N-00-00
4	6Y8-81920-01-00	Multihub	1	
6	6Y8-82553-21-00	Main bus wire 6.1m / 20 ft	1	Other lengths available
7	6Y8-82521-11-00	Pigtail bus wire 0.6m / 2 ft	1	Other lengths available
5	6Y8-82521-31-00	Pigtail bus wire 1.8m / 2 ft	1	Other lengths available
8	6Y8-83553-02-00	System power supply	1	
9	6Y8-82582-11-00	Cap	2	
12	6Y8-81920-11-00	Single hub	1	

Rigging Order Guide

MECHANICAL REMOTE CONTROL (DISPLAY)

DISPLAY OPTION CL5 COLOUR TOUCH GAUGE RIGGING KIT (6YM-762G0-20-00)



	6YM-762G0-20-00	CL5 Color Touch Gauge Kit - MECH	Qty	Note
1	6YM-8A371-01-00	CL5 Display	1	
2	6YM-83553-00-00	Conversion Harness 0.9m / 3 ft	1	Optional elbow connector 0.9m 6YM-83553-10-00
3	6YD-8356N-00-00	Fuel Tank Wire	1	Optional elbow connector 6YM-8356N-00-00
4	6Y8-81920-01-00	Multihub	1	
5	6Y8-82521-31-00	Pigtail bus wire 1.8m / 2 ft	1	Other lengths available
6	6Y8-82553-21-00	Main bus wire 6.1m / 20 ft	1	Other lengths available
7	6Y8-82521-11-00	Pigtail bus wire 0.6m / 2 ft	1	Other lengths available
8	6Y8-83553-02-00	System power supply	1	
9	6Y8-82582-11-00	Cap	2	
12	6Y8-81920-11-00	Single hub	1	

	Additional	Part Name	Qty	Note
10	6Y8-82521-11-00	Pigtail bus wire 1.8m / 1 ft	1	Other lengths available
11	6YG-8A2D0-11-00	6YG Gate way	1	
13	6YG-82521-00-00	NMEA Harness	1	

Yamaha Y-COP

Yamaha is introducing a full new Yamaha Y-COP theft-deterrent system. Although it is part of Yamaha's new Drive-by-wire Helm Master EX line-up, it works on boats powered by any EFI Yamaha outboard, even in combination with Yamaha's previous rigging system.



THE IMPORTANCE OF THEFT-DETERRENT SYSTEMS

Unfortunately, theft of outboard motors is a recurring story. Yamaha's Y-COP, an effective, easy to install and simple to use theft deterrent system, is available as an option for all Yamaha EFI outboards.

As a unit with enabled Y-COP can only be unlocked by the owner, this will significantly reduce the interest in stealing Yamaha outboards. This is not only a 'peace of mind' for the customer, but will, in many countries, also reduce his insurance costs. (the customer should check with his insurance company whether and what benefits he will get after installing Y-COP).

With Yamaha's new Helm Master EX suite of Rigging components, there is a new, more advanced, version of Y-COP available

YAMAHA'S NEW Y-COP VERSION

The new version of Y-COP consists of an all new key-fob and a separate receiver, to be mounted behind the dashboard. As the unit is directly linked to the outboard's ECU, it prevents the engine from starting when activated.



The buoyant key-fob is water resistant enough to survive short immersion in un-deep water. Two fobs are provided with each Electronic Key Switch (EKS) panel, and up to four more can be programmed into the system.

If necessary, such as in the case of loss, the operator can unlock the system using a four-digit code assigned at the factory or one chosen by the operator. Additionally, the battery-operated fob self-monitors its battery level and audibly alerts the operator when the battery is low.

Together with the kit comes a 'Y-COP' sticker which can be put on the engine cowling or the console next to the electronics panel, to clearly indicate the engines are equipped with a Y-COP immobilizer.



EASY OPERATION OF YAMAHA'S NEW Y-COP

To lock the boat, simply turn-off the outboards and push the lock-button on the floating key-fob. Via the receiving unit, the outboard's ECU will be locked. A single 'beep' will sound on the boat, to assure the outboard (-s) are not possible to start anymore.

Upon arriving back at the boat, just getting close to the receiving unit in the console, will automatically release the outboards again, indicated by a double 'beep' sound. There is no need to take the key-fob out of your pocket!

WHICH OUTBOARDS IS Y-COP COMPATIBLE WITH

Y-COP works on all EFI (Electronic Fuel Injection) Yamaha engines, which are all models from F20G and up (including tiller-handle models). Y-COP can be combined with tiller handles, 6Y8 digital network switches and the new 'Helm-master EX' switches. 2nd station is only available with the new Helm Master EX system. Y-COP is integrated in Yamaha's new 'Helm Master EX' range of rigging materials. When combining with 6X6 rigging materials, Y-COP can be purchased separately.

Rigging Order Guide

Y-COP

Y-COP SINGLE ENGINE

Y-COP TWIN ENGINES (MECH)

Y-COP TWIN ENGINES (DBW)

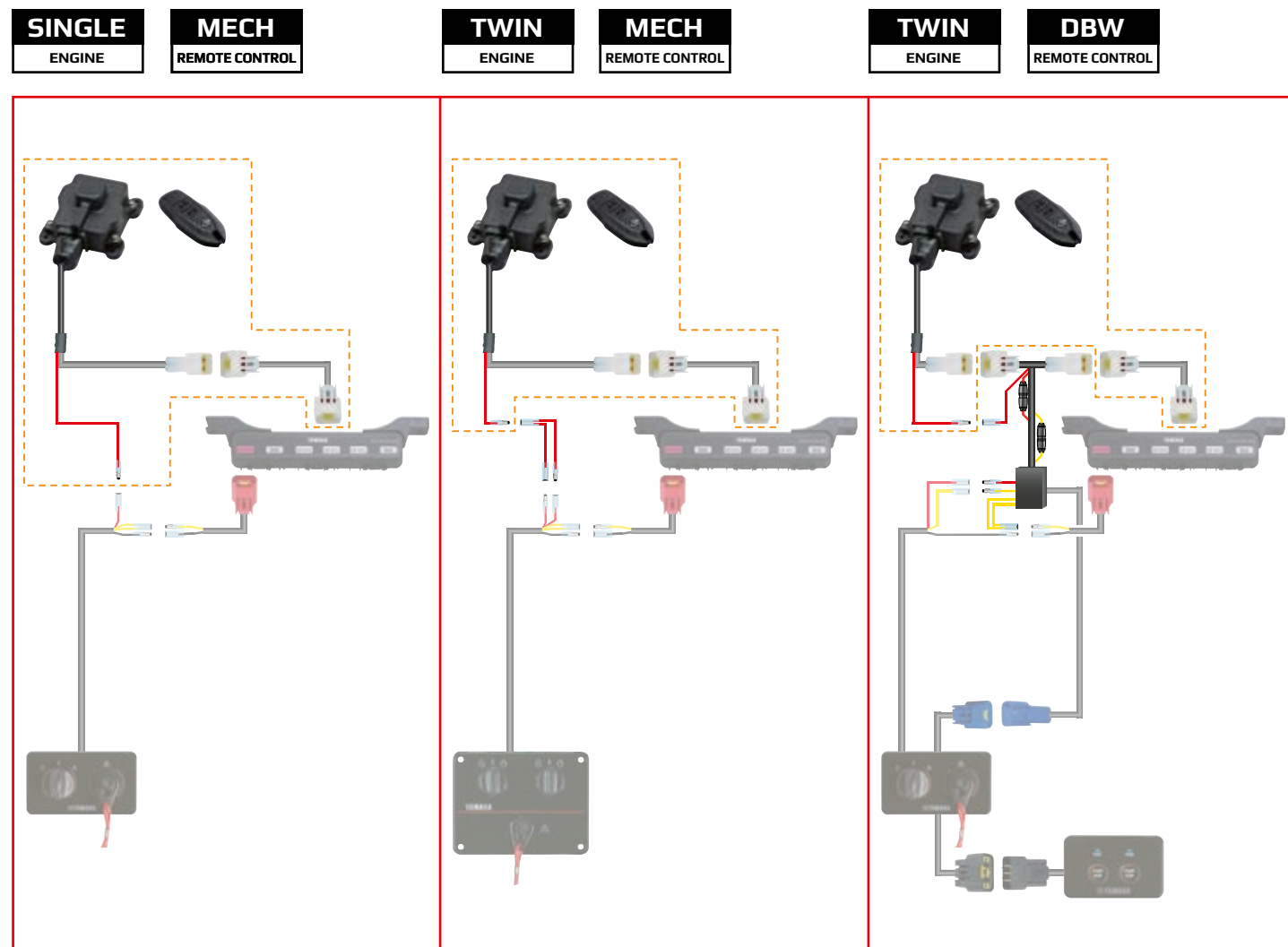

Y-COP WITH SINGLE ENGINE

Part Number	Description	Qty	Note
Y-COP KIT			
6X9-762D0-00-00	Y-COP Kit	1	

KIT CONTENTS

6X9-86260-00-00	Receiver assy and 2 key fobs	1	6X9-86261-00-00 Key fob
6X9-86261-00-00	Pigtail Bus Wire	1	0.6m (2 ft)

Y-COP WITH MULTIPLE ENGINES (MECHANICAL REMOTE CONTROL)

Part Number	Description	Qty	Note
Y-COP			
6X9-762D0-00-00	Y-COP Kit	1	
6H5-81315-00-00	Y-COP Power Distribution Wire (for multiple engines / Mechanical control)	1	

Y-COP WITH MULTIPLE ENGINES (DBW REMOTE CONTROL)

Part Number	Description	Qty	Note
Y-COP			
6X9-762D0-00-00	Y-COP Kit	1	
6Y8-81315-01-00	Y-COP Power Distribution Wire (for multiple engines / DBW control)	1	

Y-COP

Y-COP WITH 6X4 MULTI-FUNCTION TILLER HANDLE

SINGLE
ENGINE

6X4
TILLER HANDLE

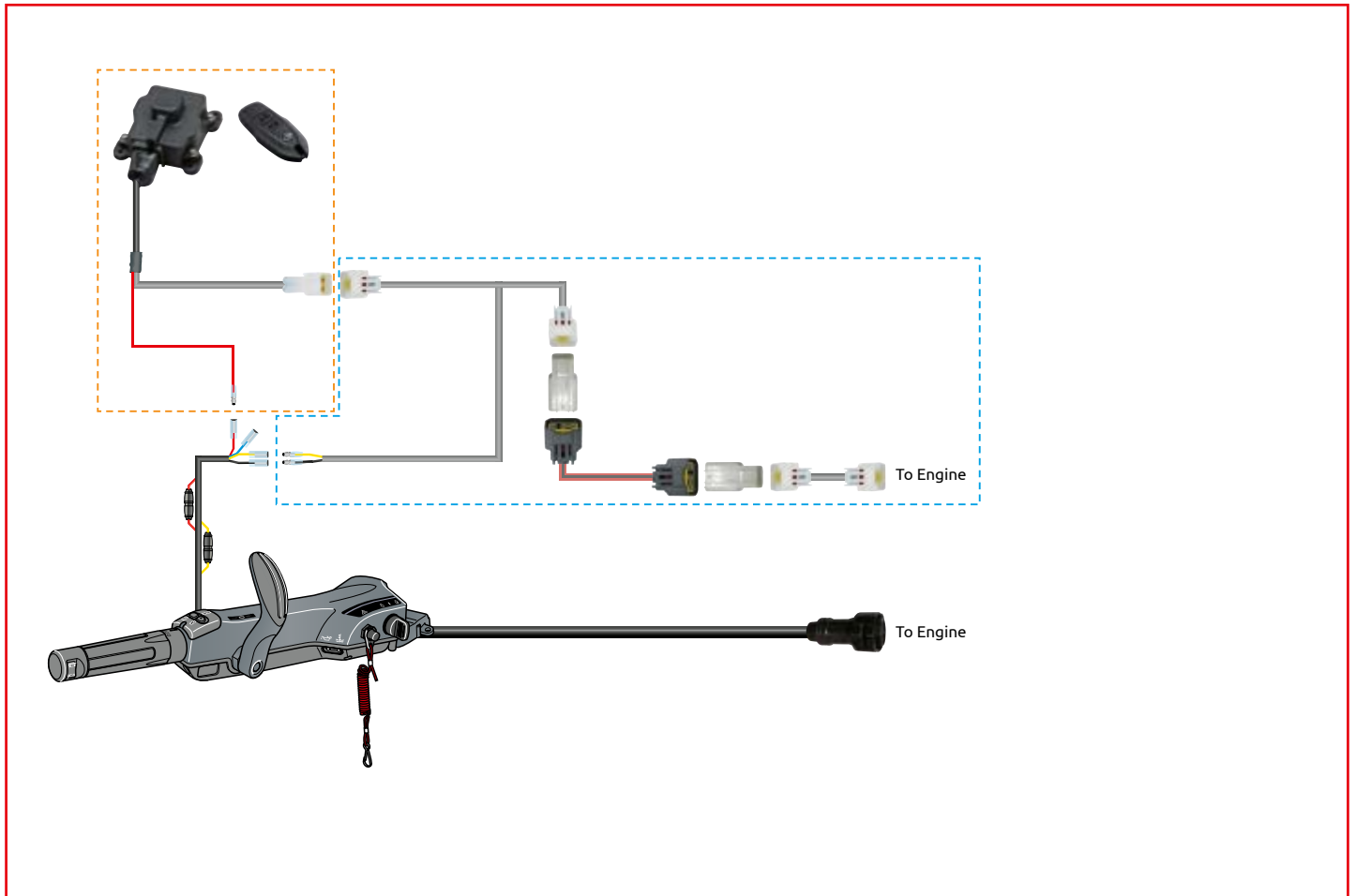

Part Number	Description	Qty	Note
Y-COP			
6X9-762D0-00-00	Y-COP Kit	1	
6Y8-762A0-01-00	Y-COP Attachment Kit (required for Y-COP + 6X4 handle installation)	1	

Y-COP ATTACHMENT KIT 6X4 CONTENTS

6X9-86261-00-00	Pigtail Bus Wire	1	3.6m (12 ft)
6Y8-81920-11-00	Single hub	1	
6Y8-82553-01-00	Main Bus Wire	1	0.3m (1 ft)
6Y5-83553-M1-00	Wire lead	1	2.5m (8 ft)
6Y8-82117-00-00	Pigtail Bus Wire with power lead	1	

ENGINE GROMMET FOR Y-COP HARNESS*

6C5-42725-50-00	F50H/FT50J/F50F/FT60G	1	
68V-42725-20-00	F80B/F100D/F115A	1	

*Required for Y-COP + 6X4 Tiller Handle installations on the specific engine models listed above.

How to read the diagram

On this page you will see a visualization of all the components and connections separated by what is mounted at the Console side and the Stern side. Or encase it is a 2nd station what is mounted at the main helm or at the 2nd station.

QUAD LEVEL 3-4 INTEGRATED

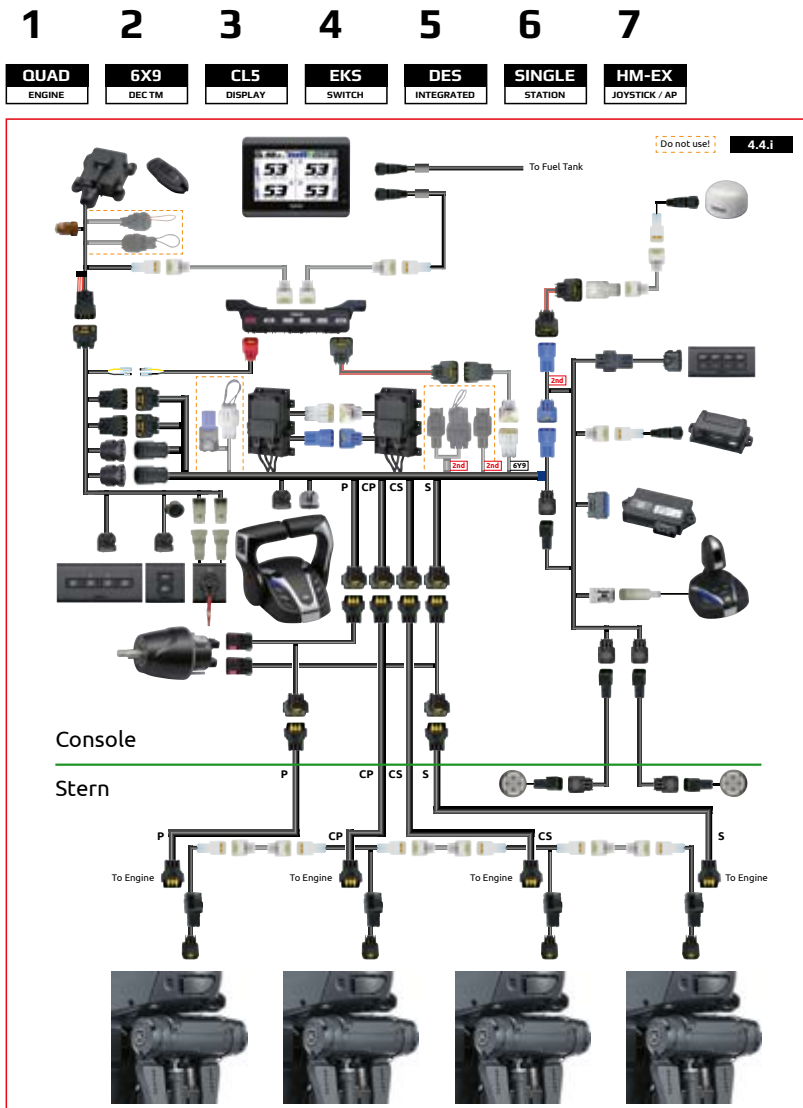

IN THIS EXAMPLE INDICATED BY BLOCKS:

1. Quad installation -> 4 engine installation
2. 6X9 new rigging -> in this example a top mount (TM) remote control.
3. CL5 gauge/display -> in this example a CL5 display is used. For other options please see display section. In level 3-4 for map options such as trackpoint a Multifunction display with chart options is required.
4. EKS -> Electronic Key switches. The new 6X9 push button switches are used.
5. Digital electronic steering Integrated -> in this example an engine with build in electronic steering. This can also be Bolt-on electronic steering.
6. Single station -> in this example the main station is displayed
7. HM-EX Joystick / Autopilot -> when expanding from level 1, 2 to 3-4 in the drawing's components are added corresponding to the level.

How to read the parts list

ORDER SUGGESTION:

In the blue box a suggestion is made on what to order in this example for a quad installation level 3-4. It corresponds to all components in the scheme on the left page.

Encase of a 2nd station the components listed are the components to be added at the 2nd station.

The joystick kits needs to be ordered at the local distributor sales department. Other display options may be found in the display options section.

QUAD LEVEL 3-4 INTEGRATED PARTS				
	Description	Qty	Note	
LEVEL 1	6X9-48209-00-00	6X9 DEC Top mount - Quad	1	
	6YM-762G0-00-00	CL5 Color Touch Gauge Kit - DEC*	1	
	6X9-762B0-31-00	EKS Kit - Quad	1	
	6X6-8258A-40-00	Main harness 16P 12m / 39 ft	2	Other lengths available
	6X6-8258A-70-00	Main harness 16P 15m / 49 ft	2	Other lengths available
LEVEL 2	6X9-76250-00-00	Compact Helm unit	1	Tilt type available (Kit: 6GR-762H0-00-00)
	6GR-81115-00-00	SCU link harness (Port/ Stbd) 1.5m (5 ft)	2	Other lengths available
	6GR-81115-20-00	SCU link harness (Center) 1.5m (5 ft)	2	Other lengths available
	6Y8-82521-11-00	Pigtail bus wire 0.6m / 2 ft	3	Other lengths available
	6GR-8258A-10-00	Helm harness Main St Twin/Triple/Quad 0.9m / 3 ft	2	Other lengths available
LEVEL 3-4	** Joystick/AP Kit - Quad	1		
	6Y8-82553-50-00	Main bus wire 3m / 10 ft	1	Other lengths available
	6Y8-82521-01-00	Pigtail bus wire 0.3m / 1 ft	1	Other lengths available

Level 3 and 4 requires a compatible multi-function display for map functions
 *) For other display options, check the 'display' section in this guide | **) Order at the local distributor sales department

KIT CONTENTS			
	Description	Qty	Note
6YM-762G0-00-00	CL5 Color Touch Gauge Kit - DEC		
6YM-83710-10-00	CL5 Display	1	
6YM-83553-00-00	Conversion Harness	1	0.9 m (3 ft)
6YD-8356N-00-00	Fuel Tank Wire	1	
6Y8-81920-01-00	Multihub	1	
6Y9-83553-00-00	Conversion harness	1	
6Y8-82553-01-00	Main bus wire	1	0.3m (1 ft), other lengths available
6Y8-82521-31-00	Pigtail bus wire	1	1.8m (6 ft), other lengths available
6Y8-83553-02-00	System power supply	1	
6Y8-82582-11-00	Terminal Cap White	2	

KIT CONTENTS:

In the green box: If in the blue box a kit is mentioned for example a "EKS kit Quad" the contents of this kit is explained here.

HARNESS OPTIONS					
Main harness 16P	Length (m)	Main bus wire	Length	Pigtail bus wire	Length
6X6-8258A-90-00	1.5m (5 ft)	6Y8-82553-01-00	0.3m (1 ft)	6Y8-82521-01-00	0.3m (1 ft)
6X6-8258A-50-00	3.7m (12 ft)	6Y8-82553-50-00	3m (10 ft)	6Y8-82521-11-00	0.6m (2 ft)
6X6-8258A-60-00	5.2m (17 ft)	6Y8-82553-11-00	4.6m (15 ft)	6Y8-82521-21-00	0.9m (3 ft)
6X6-8258A-00-00	6m (19 ft)	6Y8-82553-21-00	6.1m (20 ft)	6Y8-82521-31-00	1.8m (6 ft)
6X6-8258A-10-00	7m (23 ft)	6Y8-82553-31-00	7.6m (25 ft)	6Y8-82521-41-00	2.7m (9 ft)
6X6-8258A-20-00	8m (26 ft)	6Y8-82553-41-00	9.1m (30 ft)	6Y8-82521-51-00	3.6m (12 ft)
6X6-8258A-30-00	10m (32 ft)				
6X6-8258A-40-00	12m (39 ft)	Helm Harness	Length	SCU Link harness P/S	Length
6X6-8258A-70-00	15m (49 ft)	6GR-8258A-00-00	0.9m (3 ft)	6X9-81115-00-00	0.3m (1 ft)
6X6-8258A-80-00	24m (79 ft)	6GR-8258A-40-00	1.8m (6 ft)	6GR-81115-00-00	1.5m (5 ft)
		6GR-8258A-60-00	2.7m (9 ft)	6GR-81115-10-00	3.0m (10 ft)
SCU Link harness Center	Length	Extension for Prop lights	Length		
6X9-81115-10-00	0.3m (1 ft)	6GR-82586-20-00	6m (19 ft)		
6GR-81115-20-00	1.5m (5 ft)	6X9-82586-30-00	9.1m (30 ft)		
6GR-81115-30-00	3.0m (10 ft)	6X9-82586-40-00	12.2m (40 ft)		

HARNESS OPTIONS:

In the purple box: If in the blue or green box is mentioned "other lengths" available alternative lengths are displayed here. If the boat requires alternative lengths of cables then indicated in the blue box then these part numbers may replace them.

In the kits the lengths cannot be adjusted for longer cables if required they need to be ordered additional.

2ND STATION:

Encase of an 2nd station setup with integrated steering here the location of 2 additional harnesses is shown (gray rectangle) which need to be installed between the Port and Starboard 16 pin harness. These harnesses are then indicated in the blue box (6GR-8258A-V0-00).

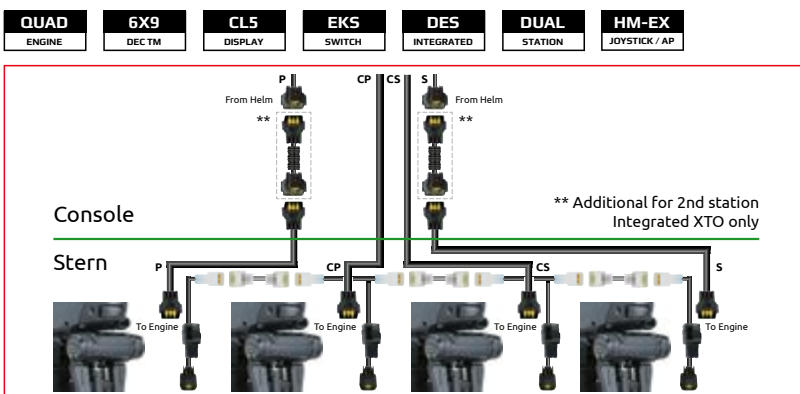

Rigging Order Guide

DBW REMOTE CONTROL (MAIN STATION)

SINGLE FLUSH SIDE-MOUNT LEVEL 1

SINGLE ENGINE	6X9 DEC SM	CL5 DISPLAY	EKS SWITCH	DES STEERING	SINGLE STATION
-------------------------	----------------------	-----------------------	----------------------	------------------------	--------------------------

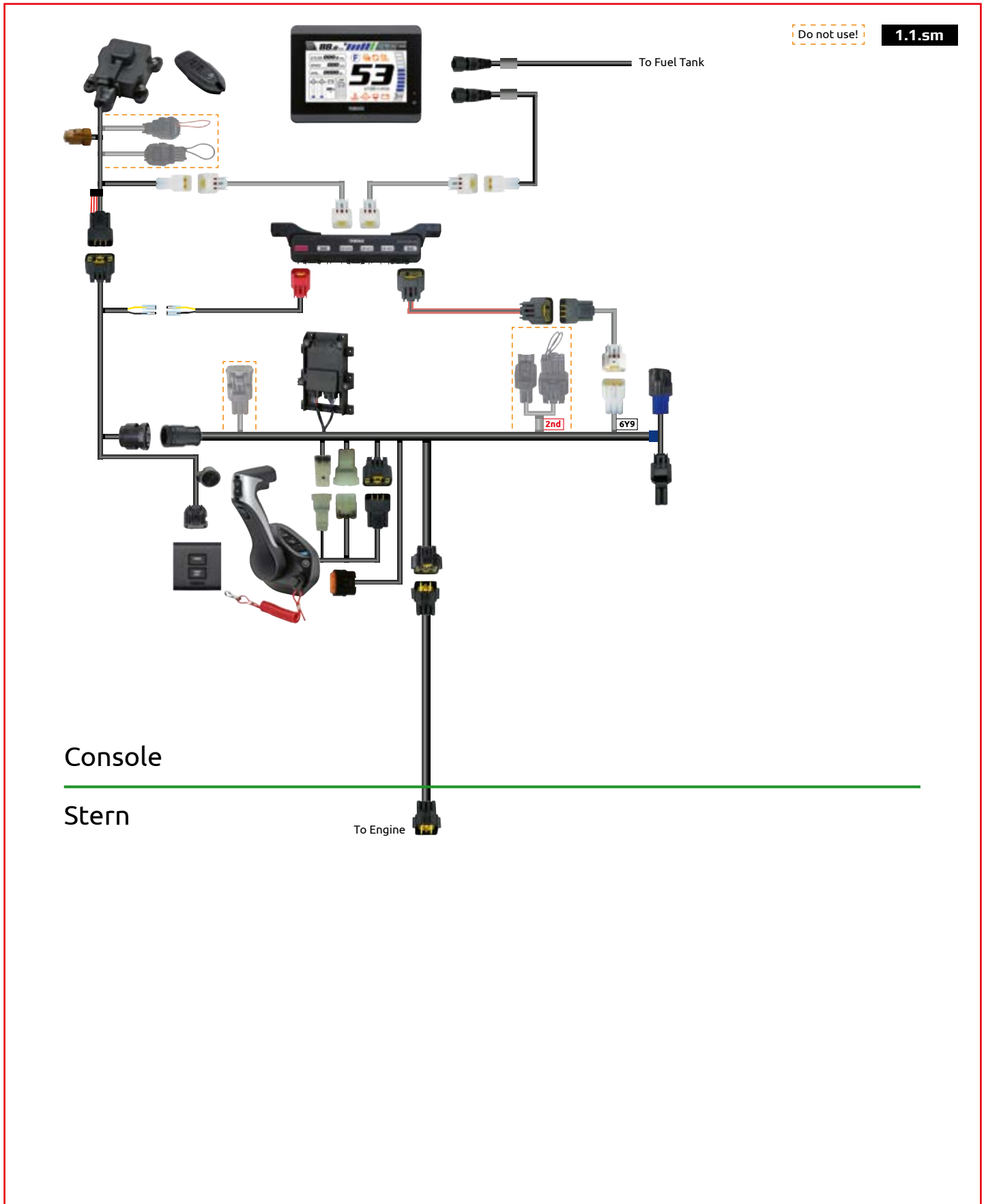

SINGLE FLUSH SIDE-MOUNT LEVEL 1 PARTS

	Part Number	Description	Qty	Note
LEVEL 1	6X9-48206-00-00	6X9 DEC Side mount - single	1	
	6YM-762G0-00-00	CL5 Color Touch Gauge Kit - DEC*	1	
	6X9-762B0-C0-00	EKS Kit - Single	1	
	6X6-8258A-20-00	Main harness 16P 8m / 26 ft	1	Other lengths available

*) For other display options, check the 'display' section in this guide

KIT CONTENTS

Part Number	Description	Qty	Note
6YM-762G0-00-00	CL5 Color Touch Gauge Kit - DEC	1	
6YM-83710-10-00	CL5 Display	1	
6YM-83553-00-00	Conversion Harness	1	0.9m (3 ft)
6YD-8356N-00-00	Fuel Tank Wire	1	
6Y8-81920-01-00	Multihub	1	
6Y9-83553-00-00	Conversion harness	1	
6Y8-82553-01-00	Main bus wire	1	0.3m (1 ft), other lengths available
6Y8-82521-31-00	Pigtail bus wire	1	1.8m (6 ft), other lengths available
6Y8-83553-02-00	System power supply	1	
6Y8-82582-11-00	Terminal Cap White	2	

Part Number	Description	Qty	Note
6X9-762B0-C0-00	EKS Kit - Single Side Mount	1	
6X9-82570-00-00	Power Switch	1	
6X9-82716-21-00	EKS harness	1	
6X9-86254-00-00	Immobilizer + key fob (2pcs)	1	433 Mhz
6Y8-82521-11-00	Pigtail bus wire	1	0.6m (2 ft)
6Y8-48277-00-00	Sticker	1	

HARNESS OPTIONS

Main harness 16P	Length	Main bus wire	Length	Pigtail bus wire	Length
6X6-8258A-90-00	1.5m (5 ft)	6Y8-82553-01-00	0.3m (1 ft)	6Y8-82521-01-00	0.3m (1 ft)
6X6-8258A-50-00	3.7m (12 ft)	6Y8-82553-50-00	3m (10 ft)	6Y8-82521-11-00	0.6m (2 ft)
6X6-8258A-60-00	5.2m (17 ft)	6Y8-82553-11-00	4.6m (15 ft)	6Y8-82521-21-00	0.9m (3 ft)
6X6-8258A-00-00	6m (19 ft)	6Y8-82553-21-00	6.1m (20 ft)	6Y8-82521-31-00	1.8m (6 ft)
6X6-8258A-10-00	7m (23 ft)	6Y8-82553-31-00	7.6m (25 ft)	6Y8-82521-41-00	2.7m (9 ft)
6X6-8258A-20-00	8m (26 ft)	6Y8-82553-41-00	9.1m (30 ft)	6Y8-82521-51-00	3.6m (12 ft)
6X6-8258A-30-00	10m (32 ft)				
6X6-8258A-40-00	12m (39 ft)				
6X6-8258A-70-00	15m (49 ft)				
6X6-8258A-80-00	24m (79 ft)				

Rigging Order Guide

DBW REMOTE CONTROL (MAIN STATION)

SINGLE FLUSH SIDE-MOUNT LEVEL 2 BOLT-ON

SINGLE ENGINE	6X9 DEC 5M	CL5 DISPLAY	EKS SWITCH	DES BOLT-ON	SINGLE STATION
-------------------------	----------------------	-----------------------	----------------------	-----------------------	--------------------------

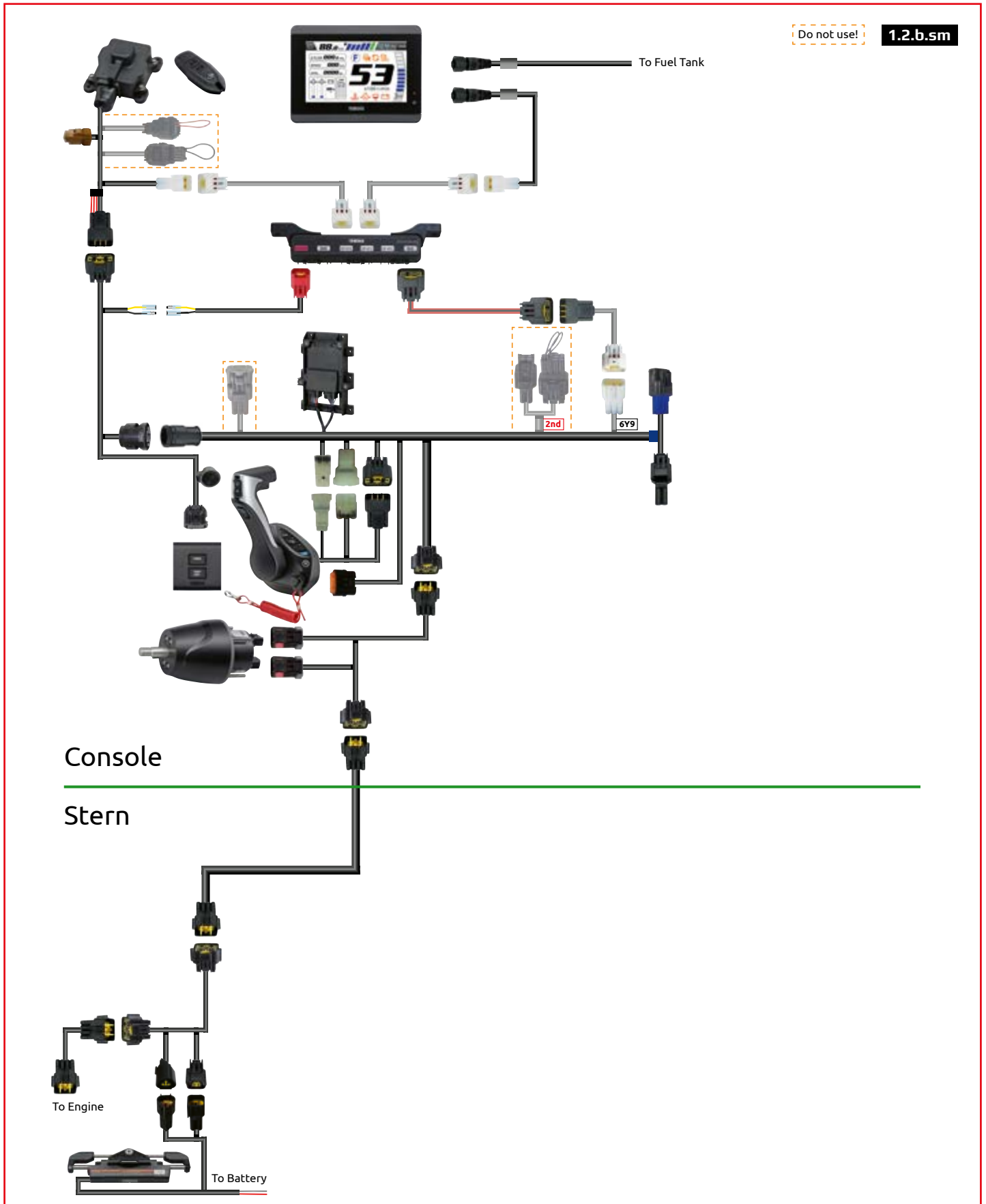

SINGLE FLUSH SIDE-MOUNT LEVEL 2 BOLT-ON PARTS

	Description	Qty	Note	
LEVEL 1	6X9-48206-00-00	6X9 DEC Side mount - single	1	
	6YM-762G0-00-00	CL5 Color Touch Gauge Kit - DEC*	1	
	6X9-762B0-C0-00	EKS Kit - Single	1	
	6X6-8258A-20-00	Main harness 16P 8m / 26 ft	1	Other lengths available
	6X9-762S0-00-00	Bolt-on DES KIT	1	
LEVEL 2	6X9-438A0-00-00	Steering actuator harness 2.4m / 8 ft	1	Other lengths available
	6X6-8258A-50-00	Main harness 16P 3.7m / 12 ft	1	Other lengths available
	6X9-615A0-00-00	Compact Helm unit	1	Tilt type available (Kit: 6GR-762H0-00-00)
	6GR-8258A-00-00	Helm harness Main St Single 0.9m / 3 ft	1	Other lengths available

*) For other display options, check the 'display' section in this guide

KIT CONTENTS

Part Number	Description	Qty	Note
6YM-762G0-00-00	CL5 Color Touch Gauge Kit - DEC	1	
6YM-83710-10-00	CL5 Display	1	
6YM-83553-00-00	Conversion Harness	1	0.9 m (3 ft)
6YD-8356N-00-00	Fuel Tank Wire	1	
6Y8-81920-01-00	Multihub	1	
6Y9-83553-00-00	Conversion harness	1	
6Y8-82553-01-00	Main bus wire	1	0.3m (1 ft), other lengths available
6Y8-82521-31-00	Pigtail bus wire	1	1.8m (6 ft), other lengths available
6Y8-83553-02-00	System power supply	1	
6Y8-82582-11-00	Terminal Cap White	2	

Part Number	Description	Qty	Note
6X9-762B0-C0-00	EKS Kit - Single Side Mount	1	
6X9-82570-00-00	Power Switch	1	
6X9-82716-21-00	EKS harness	1	
6X9-86254-00-00	Immobilizer + key fob (2pcs)	1	433 Mhz
6Y8-82521-11-00	Pigtail bus wire	1	0.6m (2 ft)
6Y8-48277-00-00	Sticker	1	

Part Number	Description	Qty	Note
6X9-762S0-00-00	Bolt-on DES KIT	1	
6X9-42401-00-00	Actuator	1	
6X9-8258A-90-00	Split Harness	1	

HARNESS OPTIONS

Main harness 16P	Length	Main bus wire	Length	Pigtail bus wire	Length
6X6-8258A-90-00	1.5m (5 ft)	6Y8-82553-01-00	0.3m (1 ft)	6Y8-82521-01-00	0.3m (1 ft)
6X6-8258A-50-00	3.7m (12 ft)	6Y8-82553-50-00	3m (10 ft)	6Y8-82521-11-00	0.6m (2 ft)
6X6-8258A-60-00	5.2m (17 ft)	6Y8-82553-11-00	4.6m (15 ft)	6Y8-82521-21-00	0.9m (3 ft)
6X6-8258A-00-00	6m (19 ft)	6Y8-82553-21-00	6.1m (20 ft)	6Y8-82521-31-00	1.8m (6 ft)
6X6-8258A-10-00	7m (23 ft)	6Y8-82553-31-00	7.6m (25 ft)	6Y8-82521-41-00	2.7m (9 ft)
6X6-8258A-20-00	8m (26 ft)	6Y8-82553-41-00	9.1m (30 ft)	6Y8-82521-51-00	3.6m (12 ft)
6X6-8258A-30-00	10m (32 ft)				
6X6-8258A-40-00	12m (39 ft)	Steering Actuator Harness	Length	Helm Harness	Length
6X6-8258A-70-00	15m (49 ft)	6X9-438A0-00-00	2.4m (8 ft)	6GR-8258A-00-00	0.9m (3 ft)
6X6-8258A-80-00	24m (79 ft)	6X9-438A0-10-00	4.5m (15 ft)	6GR-8258A-40-00	1.8m (6 ft)

Rigging Order Guide

DBW REMOTE CONTROL (MAIN STATION)

SINGLE FLUSH SIDE-MOUNT LEVEL 2 INTEGRATED

SINGLE ENGINE	6X9 DEC SM	CL5 DISPLAY	EKS SWITCH	DES INTEGRATED	SINGLE STATION
-------------------------	----------------------	-----------------------	----------------------	--------------------------	--------------------------

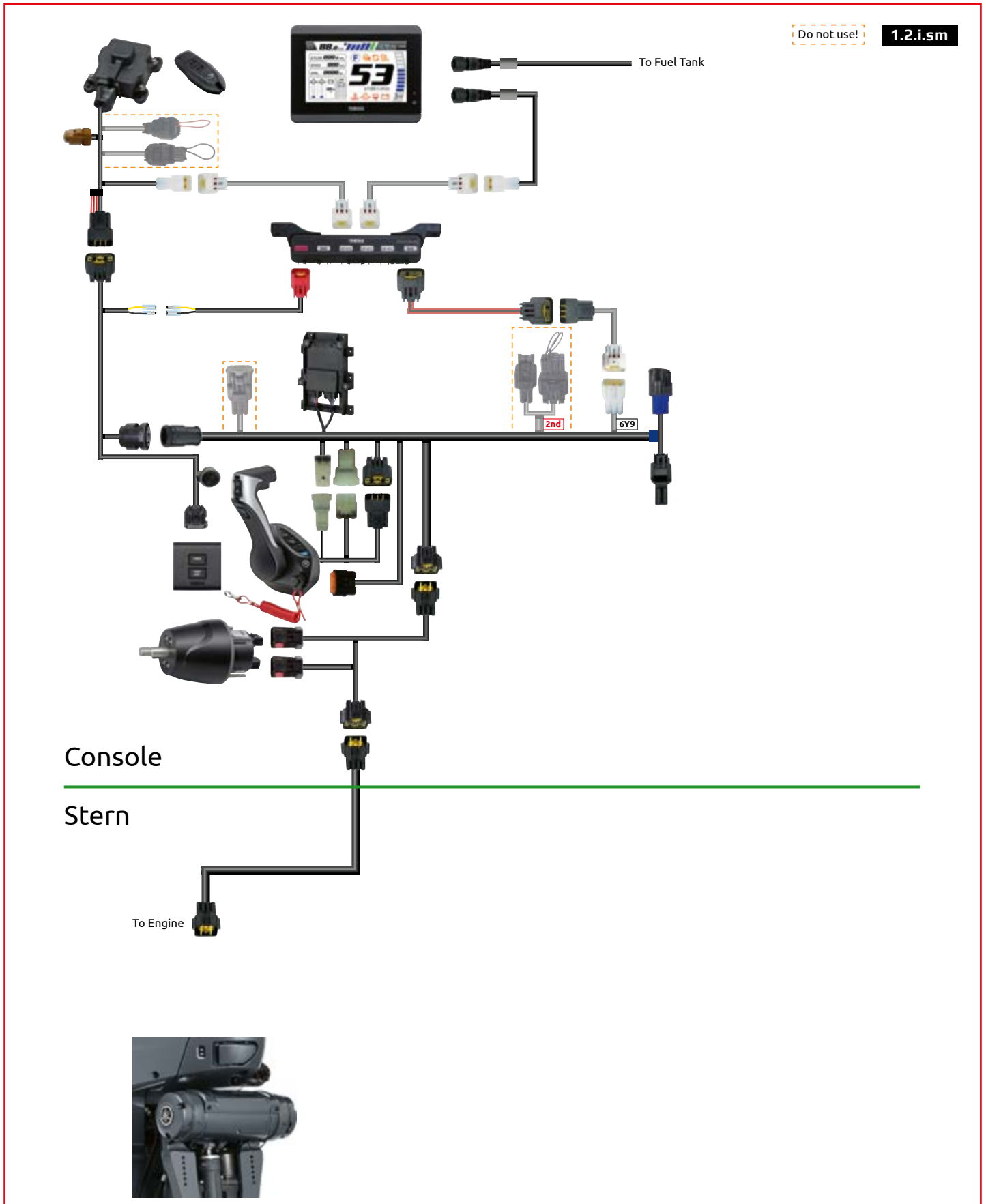

SINGLE LEVEL 2 FLUSH SIDE-MOUNT INTEGRATED PARTS

	Description	Qty	Note
LEVEL 1	6X9-48206-00-00	6X9 DEC Side mount - single	1
	6YM-762G0-00-00	CL5 Color Touch Gauge Kit - DEC*	1
	6X9-762B0-C0-00	EKS Kit - Single	1
	6X6-8258A-20-00	Main harness 16P 8m / 26 ft	1 Other lengths available
LEVEL 2	6X9-615A0-00-00	Compact Helm unit	1 Tilt type available (Kit: 6GR-762H0-00-00)
	6GR-8258A-00-00	Helm harness Main St Single 0.9m / 3 ft	1 Other lengths available

*) For other display options, check the 'display' section in this guide

KIT CONTENTS

6YM-762G0-00-00	CL5 Color Touch Gauge Kit - DEC	Qty	Note
6YM-83710-10-00	CL5 Display	1	
6YM-83553-00-00	Conversion Harness	1	0.9 m (3 ft)
6YD-8356N-00-00	Fuel Tank Wire	1	
6Y8-81920-01-00	Multihub	1	
6Y9-83553-00-00	Conversion harness	1	
6Y8-82553-01-00	Main bus wire	1	0.3m (1 ft), other lengths available
6Y8-82521-31-00	Pigtail bus wire	1	1.8m (6 ft), other lengths available
6Y8-83553-02-00	System power supply	1	
6Y8-82582-11-00	Terminal Cap White	2	
6X9-762B0-C0-00	EKS Kit - Single Side Mount	Qty	Note
6X9-82570-00-00	Power Switch	1	
6X9-82716-21-00	EKS harness	1	
6X9-86254-00-00	Immobilizer + key fob (2pcs)	1	433 Mhz
6Y8-82521-11-00	Pigtail bus wire	1	0.6m (2 ft)
6Y8-48277-00-00	Sticker	1	

HARNESS OPTIONS

Main harness 16P	Length	Main bus wire	Length	Pigtail bus wire	Length
6X6-8258A-90-00	1.5m (5 ft)	6Y8-82553-01-00	0.3m (1 ft)	6Y8-82521-01-00	0.3m (1 ft)
6X6-8258A-50-00	3.7m (12 ft)	6Y8-82553-50-00	3m (10 ft)	6Y8-82521-11-00	0.6m (2 ft)
6X6-8258A-60-00	5.2m (17 ft)	6Y8-82553-11-00	4.6m (15 ft)	6Y8-82521-21-00	0.9m (3 ft)
6X6-8258A-00-00	6m (19 ft)	6Y8-82553-21-00	6.1m (20 ft)	6Y8-82521-31-00	1.8m (6 ft)
6X6-8258A-10-00	7m (23 ft)	6Y8-82553-31-00	7.6m (25 ft)	6Y8-82521-41-00	2.7m (9 ft)
6X6-8258A-20-00	8m (26 ft)	6Y8-82553-41-00	9.1m (30 ft)	6Y8-82521-51-00	3.6m (12 ft)
6X6-8258A-30-00	10m (32 ft)				
6X6-8258A-40-00	12m (39 ft)	Helm Harness	Length		
6X6-8258A-70-00	15m (49 ft)	6GR-8258A-00-00	0.9m (3 ft)		
6X6-8258A-80-00	24m (79 ft)	6GR-8258A-40-00	1.8m (6 ft)		

Rigging Order Guide

DBW REMOTE CONTROL (MAIN STATION)

SINGLE FLUSH SIDE-MOUNT LEVEL 3-4 BOLT-ON

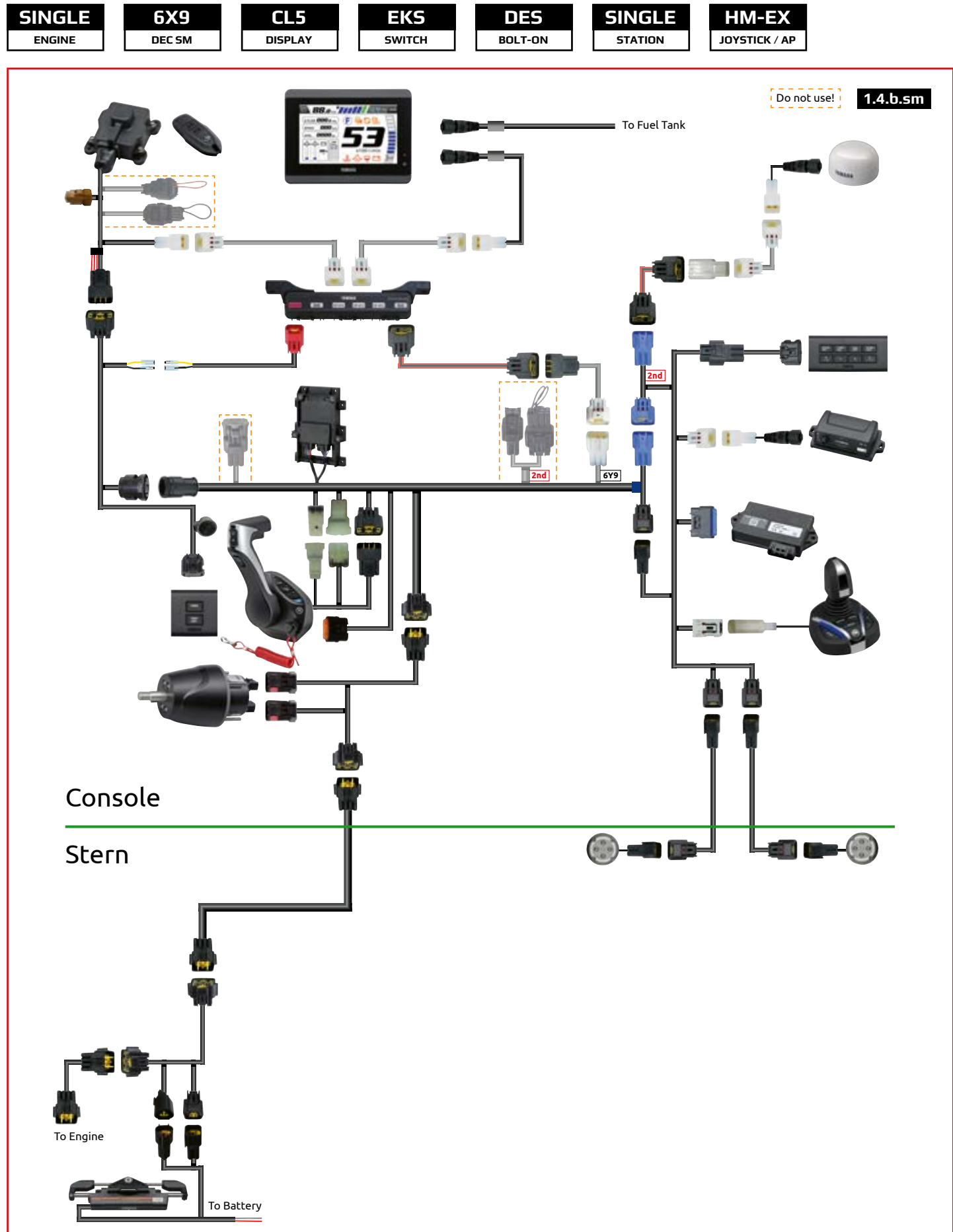

SINGLE FLUSH SIDE-MOUNT LEVEL 3-4 BOLT-ON PARTS

	Description	Qty	Note
LEVEL 1	6X9-48206-00-00	6X9 DEC Side mount - single	1
	6YM-762G0-00-00	CL5 Color Touch Gauge Kit - DEC*	1
	6X9-762B0-C0-00	EKS Kit - Single	1
	6X6-8258A-20-00	Main harness 16P 8m / 26 ft	1 Other lengths available
	6X9-762S0-00-00	Bolt-on DES KIT	1
LEVEL 2	6X9-438A0-00-00	Steering actuator harness 2.4m / 8 ft	1 Other lengths available
	6X6-8258A-50-00	Main harness 16P 3.7m / 12 ft	1 Other length available
	6X9-615A0-00-00	Compact Helm unit	1 Tilt type available (Kit: 6GR-762H0-00-00)
	6GR-8258A-00-00	Helm harness Main St Single 0.9m / 3 ft	1 Other lengths available
	**	Auto Pilot Kit Single	1
LEVEL 3	6Y8-82553-50-00	Main bus wire 3m / 10 ft	1 Other lengths available
	6Y8-82521-01-00	Pigtail bus wire 0.3m / 1 ft	1 Other lengths available
	Level 3 requires an compatible multi-function display for map functions		
	**	Joystick/AP Kit - Single	1
LEVEL 4	6Y8-82553-50-00	Main bus wire 3m / 10 ft	1 Other lengths available
	6Y8-82521-01-00	Pigtail bus wire 0.3m / 1 ft	1 Other lengths available
	Level 4 requires an compatible multi-function display for map functions		

*) For other display options, check the 'display' section in this guide | **) Order at the local distributor sales department

KIT CONTENTS

Part Number	Description	Qty	Note
6YM-762G0-00-00	CL5 Color Touch Gauge Kit - DEC	1	
6YM-83710-10-00	CL5 Display	1	
6YM-83553-00-00	Conversion Harness	1	0.9 m (3 ft)
6YD-8356N-00-00	Fuel Tank Wire	1	
6Y8-81920-01-00	Multihub	1	
6Y9-83553-00-00	Conversion harness	1	
6Y8-82553-01-00	Main bus wire	1	0.3m (1 ft), other lengths available
6Y8-82521-31-00	Pigtail bus wire	1	1.8m (6 ft), other lengths available
6Y8-83553-02-00	System power supply	1	
6Y8-82582-11-00	Terminal Cap White	2	

Part Number	Description	Qty	Note	Part Number	Description	Qty	Note
6X9-762B0-C0-00	EKS Kit - Single Side Mount			**	Joystick/AP Kit - Single		
6X9-82570-00-00	Power Switch	1		6X9-8253V-00-00	Autopilot panel	1	
6X9-82716-21-00	EKS harness	1		6X9-88107-00-00	GPS antenna	1	
6X9-86254-00-00	Immobilizer + key fob (2pcs)	1	433 Mhz	6X9-8A410-00-00	Heading sensor	1	
6Y8-82521-11-00	Pigtail bus wire	1	0.6m (2 ft)	6X9-8591T-10-00	Boat Control Unit	1	
6Y8-48277-00-00	Sticker	1		6Y8-81920-11-00	Single hub	1	
				6X9-82386-01-00	BCU Harness	1	
6X9-762S0-00-00	Bolt-on DES KIT			6YM-83553-00-00	Conversion harness	2	
6X9-42401-00-00	Actuator	1		6X9-482A0-00-00	Joystick Assy	1	level 4 only
6X9-8258A-90-00	Split Harness	1		6ES-83720-01-00	Prop lights	2	level 4 only

**) Order at the local distributor sales department

HARNESS OPTIONS

Main harness 16P	Length	Main bus wire	Length	Pigtail bus wire	Length
6X6-8258A-90-00	1.5m (5 ft)	6Y8-82553-01-00	0.3m (1 ft)	6Y8-82521-01-00	0.3m (1 ft)
6X6-8258A-50-00	3.7m (12 ft)	6Y8-82553-50-00	3m (10 ft)	6Y8-82521-11-00	0.6m (2 ft)
6X6-8258A-60-00	5.2m (17 ft)	6Y8-82553-11-00	4.6m (15 ft)	6Y8-82521-21-00	0.9m (3 ft)
6X6-8258A-00-00	6m (19 ft)	6Y8-82553-21-00	6.1m (20 ft)	6Y8-82521-31-00	1.8m (6 ft)
6X6-8258A-10-00	7m (23 ft)	6Y8-82553-31-00	7.6m (25 ft)	6Y8-82521-41-00	2.7m (9 ft)
6X6-8258A-20-00	8m (26 ft)	6Y8-82553-41-00	9.1m (30 ft)	6Y8-82521-51-00	3.6m (12 ft)
6X6-8258A-30-00	10m (32 ft)				
6X6-8258A-40-00	12m (39 ft)	Steering Actuator Harness	Length	Helm Harness	Length
6X6-8258A-70-00	15m (49 ft)	6X9-438A0-00-00	2.4m (8 ft)	6GR-8258A-00-00	0.9m (3 ft)
6X6-8258A-80-00	24m (79 ft)	6X9-438A0-10-00	4.5m (15 ft)	6GR-8258A-40-00	1.8m (6 ft)
Extension for Prop lights	Length				
6X9-82586-20-00	6m (19 ft)				
6X9-82586-30-00	9.1m (30 ft)				
6X9-82586-40-00	12.2m (40 ft)				

Rigging Order Guide

DBW REMOTE CONTROL (MAIN STATION)

SINGLE FLUSH SIDE-MOUNT LEVEL 3-4 INTEGRATED

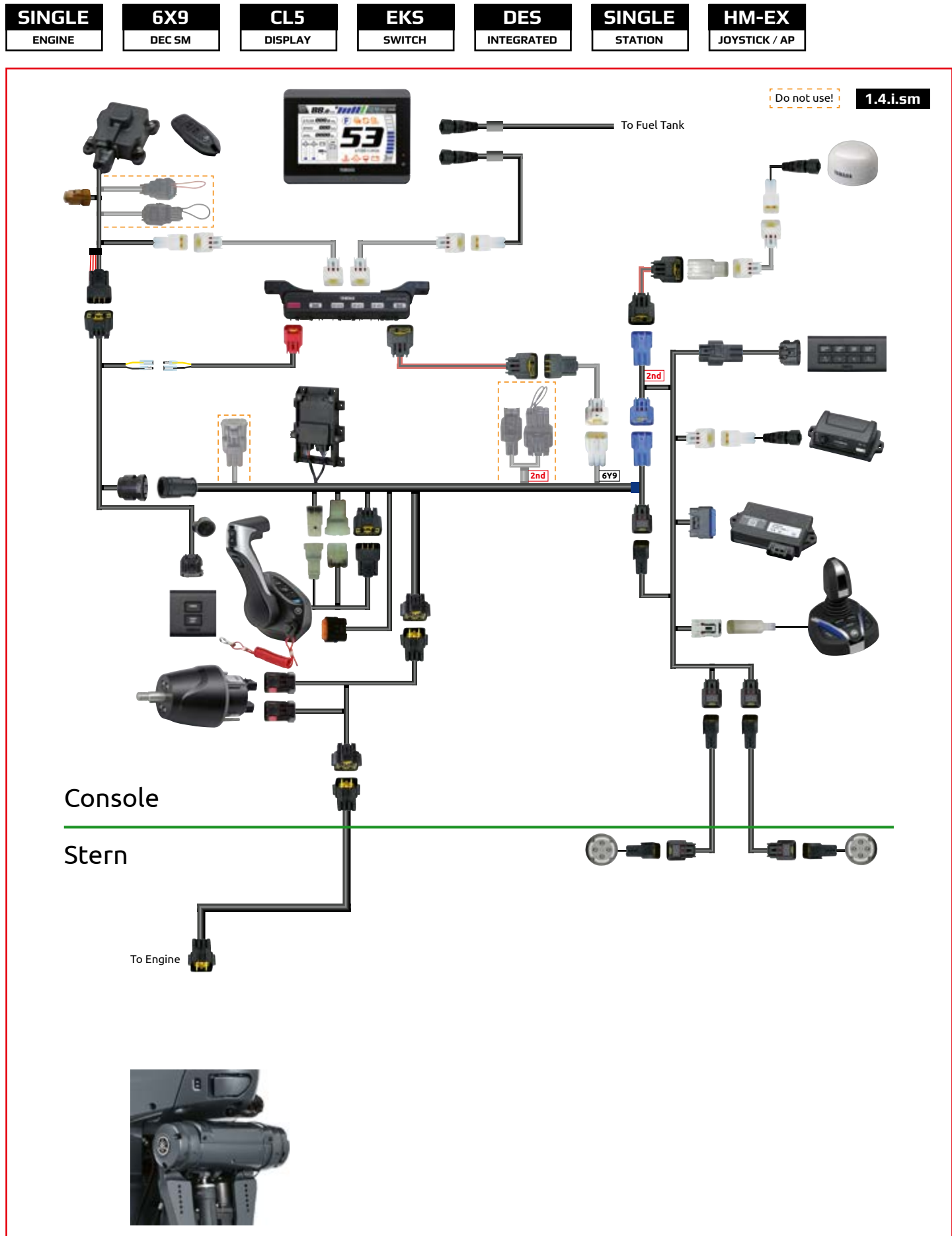

SINGLE FLUSH SIDE-MOUNT LEVEL 3-4 INTEGRATED PARTS

	Description	Qty	Note
LEVEL 1	6X9-48206-00-00	6X9 DEC Side mount - single	1
	6YM-762G0-00-00	CL5 Color Touch Gauge Kit - DEC*	1
	6X9-762B0-C0-00	EKS Kit - Single	1
LEVEL 2	6X6-8258A-20-00	Main harness 16P 8m / 26 ft	1 Other length available
	6X9-615A0-00-00	Compact Helm unit	1 Tilt type available (Kit: 6GR-762H0-00-00)
	6GR-8258A-00-00	Helm harness Main St Single 0.9m / 3 ft	1 Other length available
LEVEL 3	**	Auto Pilot Kit Single	1
	6Y8-82553-50-00	Main bus wire 3m / 10 ft	1 Other length available
	6Y8-82521-01-00	Pigtail bus wire 0.3m / 1 ft	1 Other length available
Level 3 requires an compatible multi-function display for map functions			
LEVEL 4	**	Joystick/AP Kit - Single	1
	6Y8-82553-50-00	Main bus wire 3m / 10 ft	1 Other length available
	6Y8-82521-01-00	Pigtail bus wire 0.3m / 1 ft	1 Other length available
Level 4 requires an compatible multi-function display for map functions			
*) For other display options, check the 'display' section in this guide **) Order at the local distributor sales department			

KIT CONTENTS

Part Number	Description	Qty	Note
6YM-762G0-00-00	CL5 Color Touch Gauge Kit - DEC	1	
6YM-83710-10-00	CL5 Display	1	
6YM-83553-00-00	Conversion Harness	1	0.9 m (3 ft)
6YD-8356N-00-00	Fuel Tank Wire	1	
6Y8-81920-01-00	Multihub	1	
6Y9-83553-00-00	Conversion harness	1	
6Y8-82553-01-00	Main bus wire	1	0.3m (1 ft), other lengths available
6Y8-82521-31-00	Pigtail bus wire	1	1.8m (6 ft), other lengths available
6Y8-83553-02-00	System power supply	1	
6Y8-82582-11-00	Terminal Cap White	2	

Part Number	Description	Qty	Note	Part Number	Description	Qty	Note
6X9-762B0-C0-00	EKS Kit - Single Side Mount	1		**	Joystick/AP Kit - Single	1	
6X9-82570-00-00	Power Switch	1		6X9-8253V-00-00	Autopilot panel	1	
6X9-82716-21-00	EKS harness	1		6X9-88107-00-00	GPS antenna	1	
6X9-86254-00-00	Immobilizer + key fob (2pcs)	1	433 Mhz	6X9-8A410-00-00	Heading sensor	1	
6Y8-82521-11-00	Pigtail bus wire	1	0.6m (2 ft)	6X9-8591T-10-00	Boat Control Unit	1	
6Y8-48277-00-00	Sticker	1		6Y8-81920-11-00	Single hub	1	
				6X9-82386-01-00	BCU Harness	1	
				6YM-83553-00-00	Conversion harness	2	
				6X9-482A0-00-00	Joystick Assy	1	level 4 only
				6ES-83720-01-00	Prop lights	2	level 4 only
**) Order at the local distributor sales department							

HARNESS OPTIONS

Main harness 16P	Length	Main bus wire	Length	Pigtail bus wire	Length
6X6-8258A-90-00	1.5m (5 ft)	6Y8-82553-01-00	0.3m (1 ft)	6Y8-82521-01-00	0.3m (1 ft)
6X6-8258A-50-00	3.7m (12 ft)	6Y8-82553-50-00	3m (10 ft)	6Y8-82521-11-00	0.6m (2 ft)
6X6-8258A-60-00	5.2m (17 ft)	6Y8-82553-11-00	4.6m (15 ft)	6Y8-82521-21-00	0.9m (3 ft)
6X6-8258A-00-00	6m (19 ft)	6Y8-82553-21-00	6.1m (20 ft)	6Y8-82521-31-00	1.8m (6 ft)
6X6-8258A-10-00	7m (23 ft)	6Y8-82553-31-00	7.6m (25 ft)	6Y8-82521-41-00	2.7m (9 ft)
6X6-8258A-20-00	8m (26 ft)	6Y8-82553-41-00	9.1m (30 ft)	6Y8-82521-51-00	3.6m (12 ft)
6X6-8258A-30-00	10m (32 ft)				
6X6-8258A-40-00	12m (39 ft)	Helm Harness	Length	Extension for Prop lights	Length
6X6-8258A-70-00	15m (49 ft)	6GR-8258A-00-00	0.9m (3 ft)	6X9-82586-20-00	6m (19 ft)
6X6-8258A-80-00	24m (79 ft)	6GR-8258A-40-00	1.8m (6 ft)	6X9-82586-30-00	9.1m (30 ft)
				6X9-82586-40-00	12.2m (40 ft)

Rigging Order Guide

DBW REMOTE CONTROL (2ND STATION)

SINGLE 2ND STATION FLUSH SIDE-MOUNT LEVEL 1

SINGLE ENGINE	6X9 DEC SM	CL5 DISPLAY	EKS SWITCH	DES STEERING	DUAL STATION
-------------------------	----------------------	-----------------------	----------------------	------------------------	------------------------

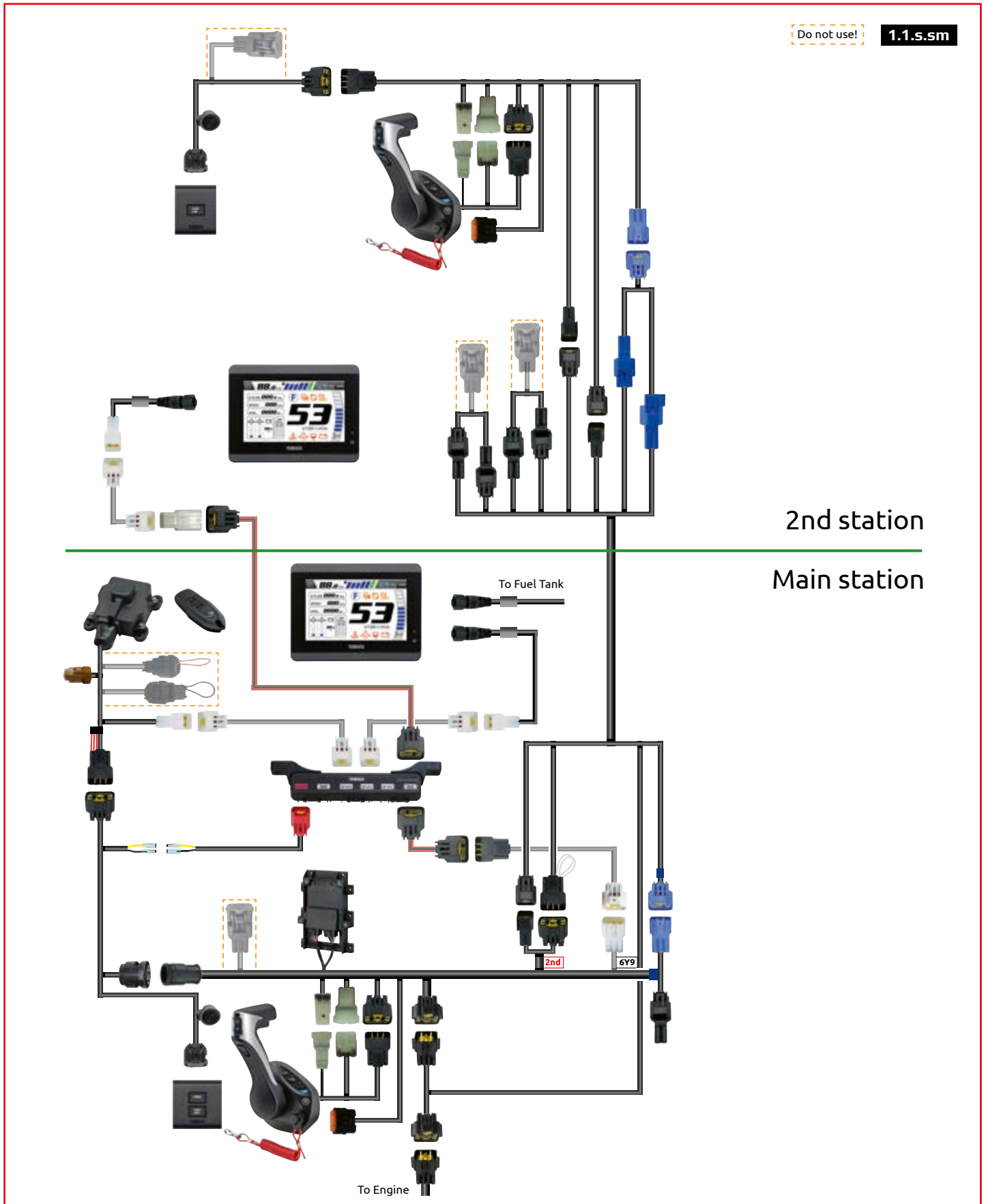

SINGLE 2ND STATION FLUSH SIDE-MOUNT LEVEL 1 PARTS

	Description	Qty	Note
LEVEL 1	6X9-48206-10-00	6X9 DEC Side mount - single	1 2nd station
	6YM-83710-10-00	CL5 Color Touch Gauge*	1 Display only
	6YM-83553-00-00	Conversion Harness for CL5	1
	6Y8-81920-11-00	Single hub	1
	6Y8-82521-11-00	Pigtail bus wire 0.6m / 2 ft	1 Other lengths available
	6Y8-82553-11-00	Main bus wire 4.6m / 15 ft	1 Other lengths available
	6X9-762B0-G0-00	EKS Kit - Single 2nd St	1
	6X9-8258A-00-00	2nd station harness Port 5m / 16 ft	1 Other lengths available
	*) For other display options, check the 'display' section in this guide		

KIT CONTENTS

Part Number	Description	Qty	Note
6X9-762B0-G0-00	EKS Kit - Single 2nd St	1	
6X9-82570-B0-00	Start/Stop Switch	1	
6X9-82716-60-00	EKS harness	1	

HARNESS OPTIONS

Main bus wire	Length	Pigtail bus wire	Length	2nd helm harness Port	Length
6Y8-82553-01-00	0.3m (1 ft)	6Y8-82521-01-00	0.3m (1 ft)	6X9-8258A-00-00	5m (16 ft)
6Y8-82553-50-00	3m (10 ft)	6Y8-82521-11-00	0.6m (2 ft)	6X9-8258A-10-00	8m (26 ft)
6Y8-82553-11-00	4.6m (15 ft)	6Y8-82521-21-00	0.9m (3 ft)	6X9-8258A-20-00	12m (38 ft)
6Y8-82553-21-00	6.1m (20 ft)	6Y8-82521-31-00	1.8m (6 ft)		
6Y8-82553-31-00	7.6m (25 ft)	6Y8-82521-41-00	2.7m (9 ft)		
6Y8-82553-41-00	9.1m (30 ft)	6Y8-82521-51-00	3.6m (12 ft)		

Rigging Order Guide

DBW REMOTE CONTROL (2ND STATION)

SINGLE 2ND STATION FLUSH SIDE-MOUNT LEVEL 2

SINGLE ENGINE	6X9 DEC 5M	CL5 DISPLAY	EKS SWITCH	DES STEERING	DUAL STATION
-------------------------	----------------------	-----------------------	----------------------	------------------------	------------------------

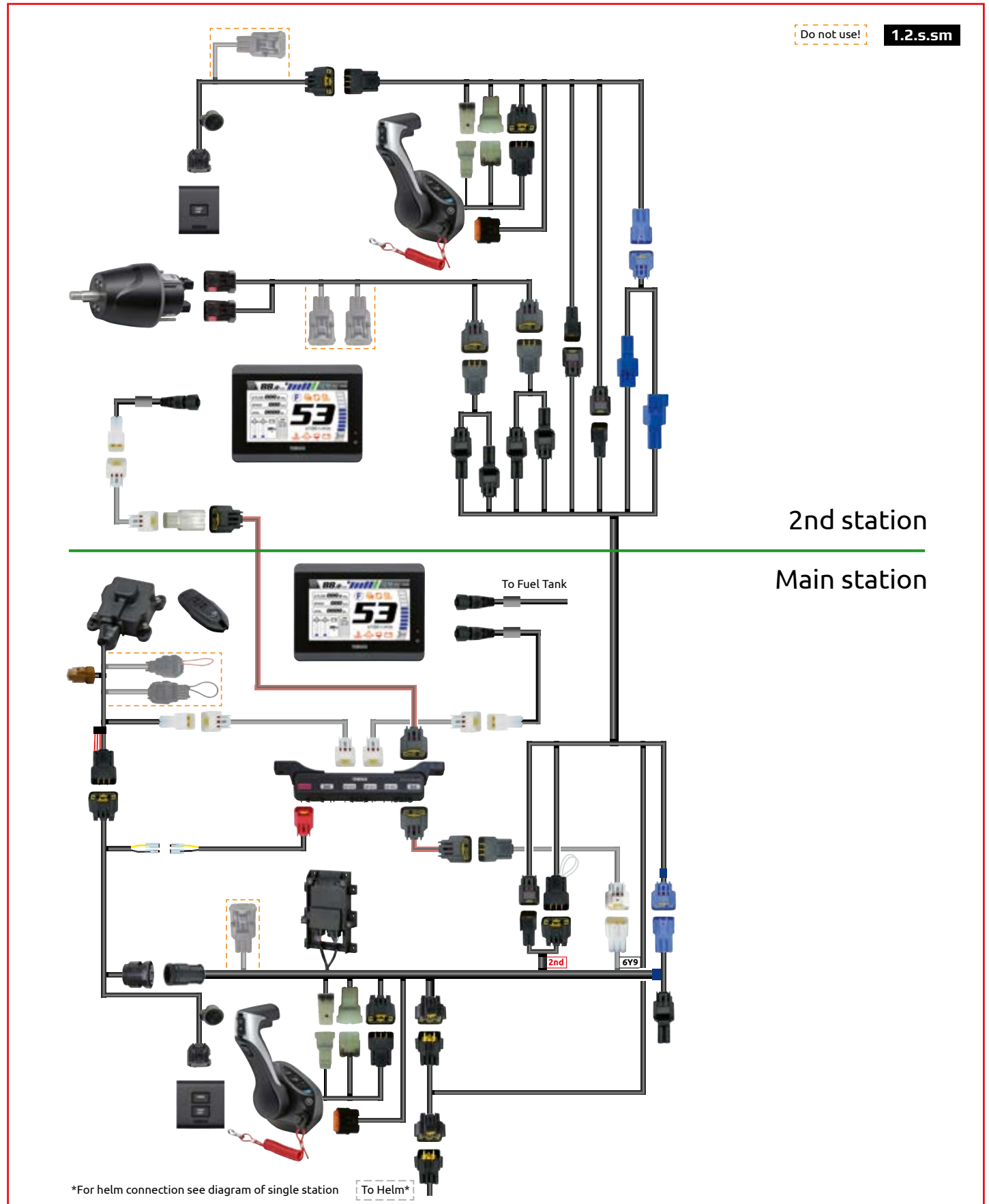

SINGLE 2ND STATION FLUSH SIDE-MOUNT LEVEL 2 PARTS

	Description	Qty	Note
	6X9-48206-10-00 6X9 DEC Side mount - single	1	2nd station
	6YM-83710-10-00 CL5 Color Touch Gauge*	1	Display only
	6YM-83553-00-00 Conversion Harness for CL5	1	
	6Y8-81920-11-00 Single hub	1	
LEVEL 1	6Y8-82521-11-00 Pigtail bus wire 0.6m / 2 ft	1	Other lengths available
	6Y8-82553-11-00 Main bus wire 4.6m / 15 ft	1	Other lengths available
	6X9-762B0-G0-00 EKS Kit - Single 2nd St	1	
	6X9-8258A-00-00 2nd station harness Port 5m / 16 ft	1	Other lengths available
	6GR-8258A-V0-00 Extension Harness**	1	Only For Integrated Steering
LEVEL 2	6X9-615A0-00-00 Compact Helm unit	1	Tilt type available (Kit: 6GR-762H0-00-00)
	6X9-8258A-A0-00 Helm harness 2nd St Single 0.9m / 3 ft	1	

*) For other display options, check the 'display' section in this guide

KIT CONTENTS

		Qty	Note
6X9-762B0-G0-00	EKS Kit - Single 2nd St		
6X9-82570-B0-00	Start/Stop Switch	1	
6X9-82716-60-00	EKS harness	1	

HARNESS OPTIONS

Main bus wire	Length	Pigtail bus wire	Length	2nd helm harness Port	Length
6Y8-82553-01-00	0.3m (1 ft)	6Y8-82521-01-00	0.3m (1 ft)	6X9-8258A-00-00	5m (16 ft)
6Y8-82553-50-00	3m (10 ft)	6Y8-82521-11-00	0.6m (2 ft)	6X9-8258A-10-00	8m (26 ft)
6Y8-82553-11-00	4.6m (15 ft)	6Y8-82521-21-00	0.9m (3 ft)	6X9-8258A-20-00	12m (38 ft)
6Y8-82553-21-00	6.1m (20 ft)	6Y8-82521-31-00	1.8m (6 ft)		
6Y8-82553-31-00	7.6m (25 ft)	6Y8-82521-41-00	2.7m (9 ft)		
6Y8-82553-41-00	9.1m (30 ft)	6Y8-82521-51-00	3.6m (12 ft)		

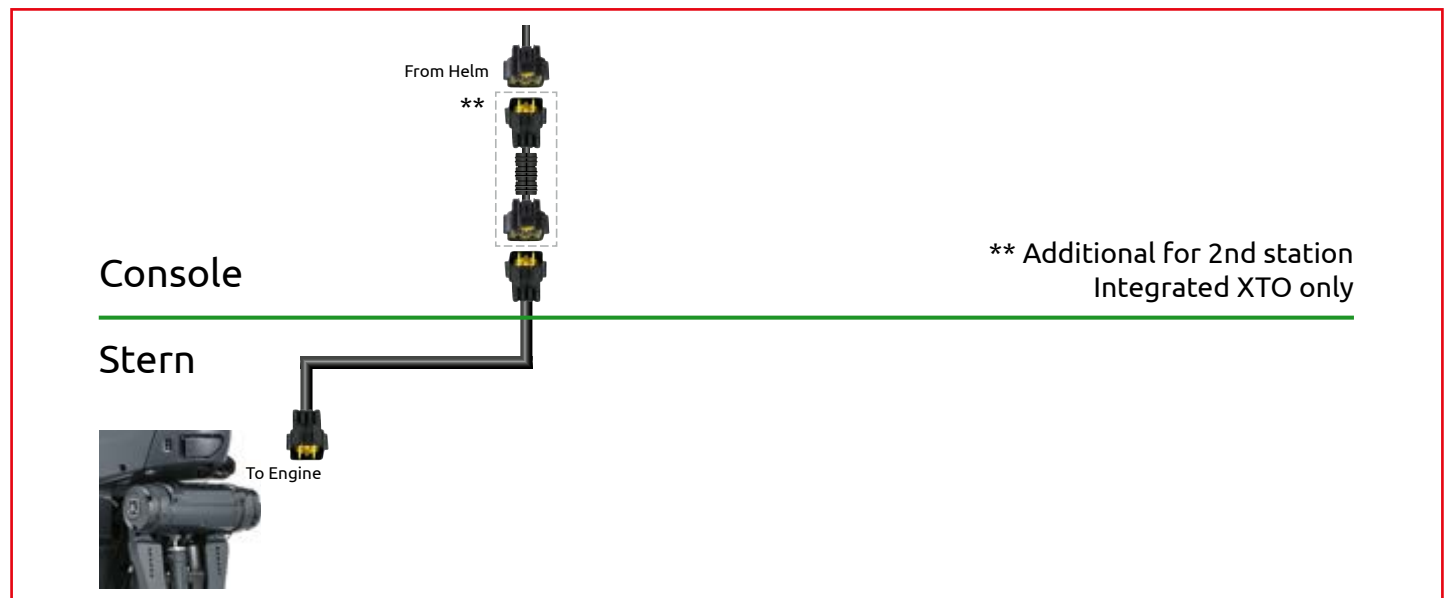

Rigging Order Guide

DBW REMOTE CONTROL (2ND STATION)

SINGLE 2ND STATION FLUSH SIDE-MOUNT LEVEL 3-4

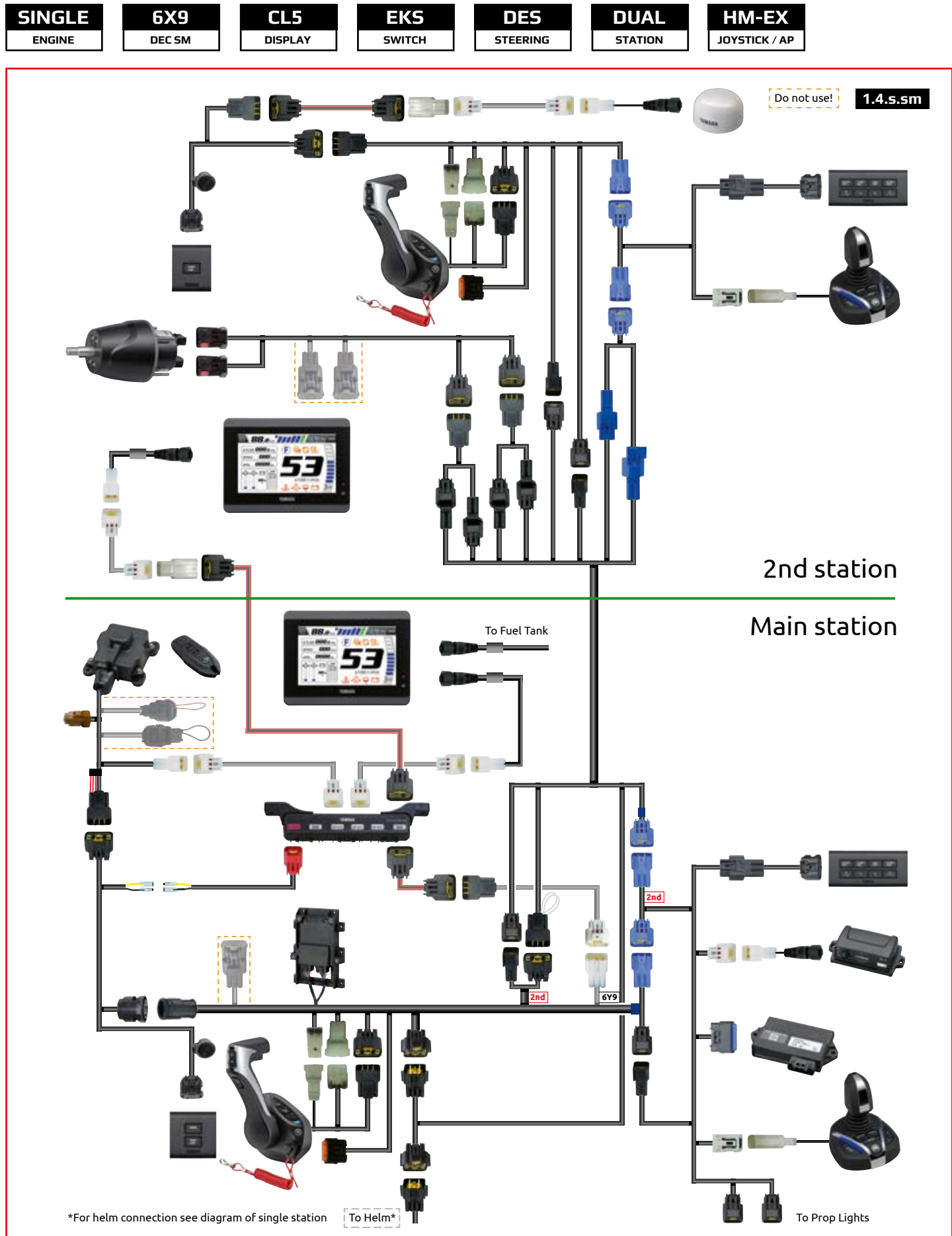

SINGLE 2ND STATION FLUSH SIDE-MOUNT LEVEL 3-4 PARTS

	Description	Qty	Note
	6X9-48206-10-00 6X9 DEC Side mount - single	1	2nd station
	6YM-83710-10-00 CL5 Color Touch Gauge*	1	Display only
	6YM-83553-00-00 Conversion Harness for CL5	1	
	6Y8-81920-11-00 Single hub	1	
LEVEL 1	6Y8-82521-11-00 Pigtail bus wire 0.6m / 2 ft	1	Other lengths available
	6Y8-82553-11-00 Main bus wire 4.6m / 15 ft	1	Other lengths available
	6X9-762B0-G0-00 EKS Kit - Single 2nd St	1	
	6X9-8258A-00-00 2nd station harness Port 5m / 16 ft	1	Other lengths available
	6GR-8258A-V0-00 Extension Harness**	1	Only For Integrated Steering
LEVEL 2	6X9-615A0-00-00 Compact Helm unit	1	Tilt type available (Kit: 6GR-762H0-00-00)
	6X9-8258A-A0-00 Helm harness 2nd St Single 0.9m / 3 ft	1	
LEVEL 3	6X9-762P0-10-00 Auto Pilot Panel kit 2nd station	1	
	Level 3 requires an compatible multi-function display for map functions		
LEVEL 4	6X9-482A0-00-00 Joystick Assy for 2nd station	1	
	Level 4 requires an compatible multi-function display for map functions		
	*) For other display options, check the 'display' section in this guide		

KIT CONTENTS

Part Number	Description	Qty	Note
6X9-762B0-G0-00	EKS Kit - Single 2nd St	1	
6X9-82570-B0-00	Start/Stop Switch	1	
6X9-82716-60-00	EKS harness	1	

HARNESS OPTIONS

Main bus wire	Length	Pigtail bus wire	Length	2nd helm harness Port	Length
6Y8-82553-01-00	0.3m (1 ft)	6Y8-82521-01-00	0.3m (1 ft)	6X9-8258A-00-00	5m (16 ft)
6Y8-82553-50-00	3m (10 ft)	6Y8-82521-11-00	0.6m (2 ft)	6X9-8258A-10-00	8m (26 ft)
6Y8-82553-11-00	4.6m (15 ft)	6Y8-82521-21-00	0.9m (3 ft)	6X9-8258A-20-00	12m (38 ft)
6Y8-82553-21-00	6.1m (20 ft)	6Y8-82521-31-00	1.8m (6 ft)		
6Y8-82553-31-00	7.6m (25 ft)	6Y8-82521-41-00	2.7m (9 ft)		
6Y8-82553-41-00	9.1m (30 ft)	6Y8-82521-51-00	3.6m (12 ft)		

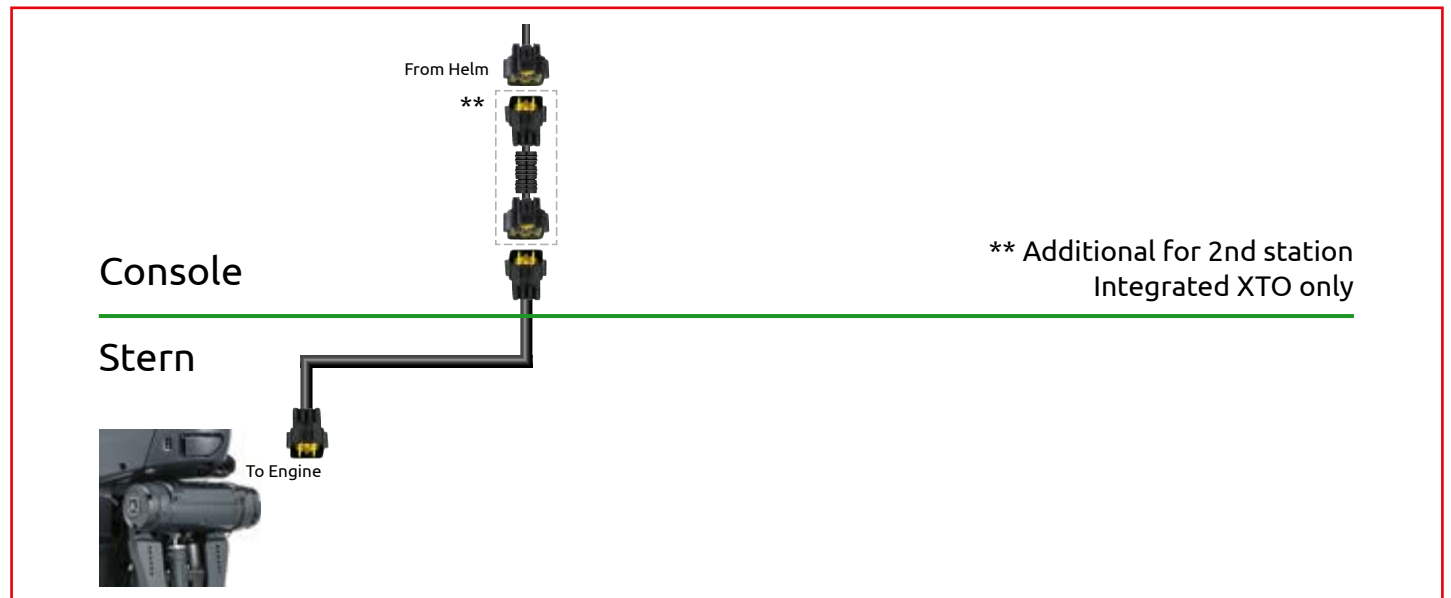

Rigging Order Guide

DBW REMOTE CONTROL (MAIN STATION)

SINGLE LEVEL 1

SINGLE ENGINE	6X9 DEC TM	CL5 DISPLAY	EKS SWITCH	DES STEERING	SINGLE STATION
-------------------------	----------------------	-----------------------	----------------------	------------------------	--------------------------

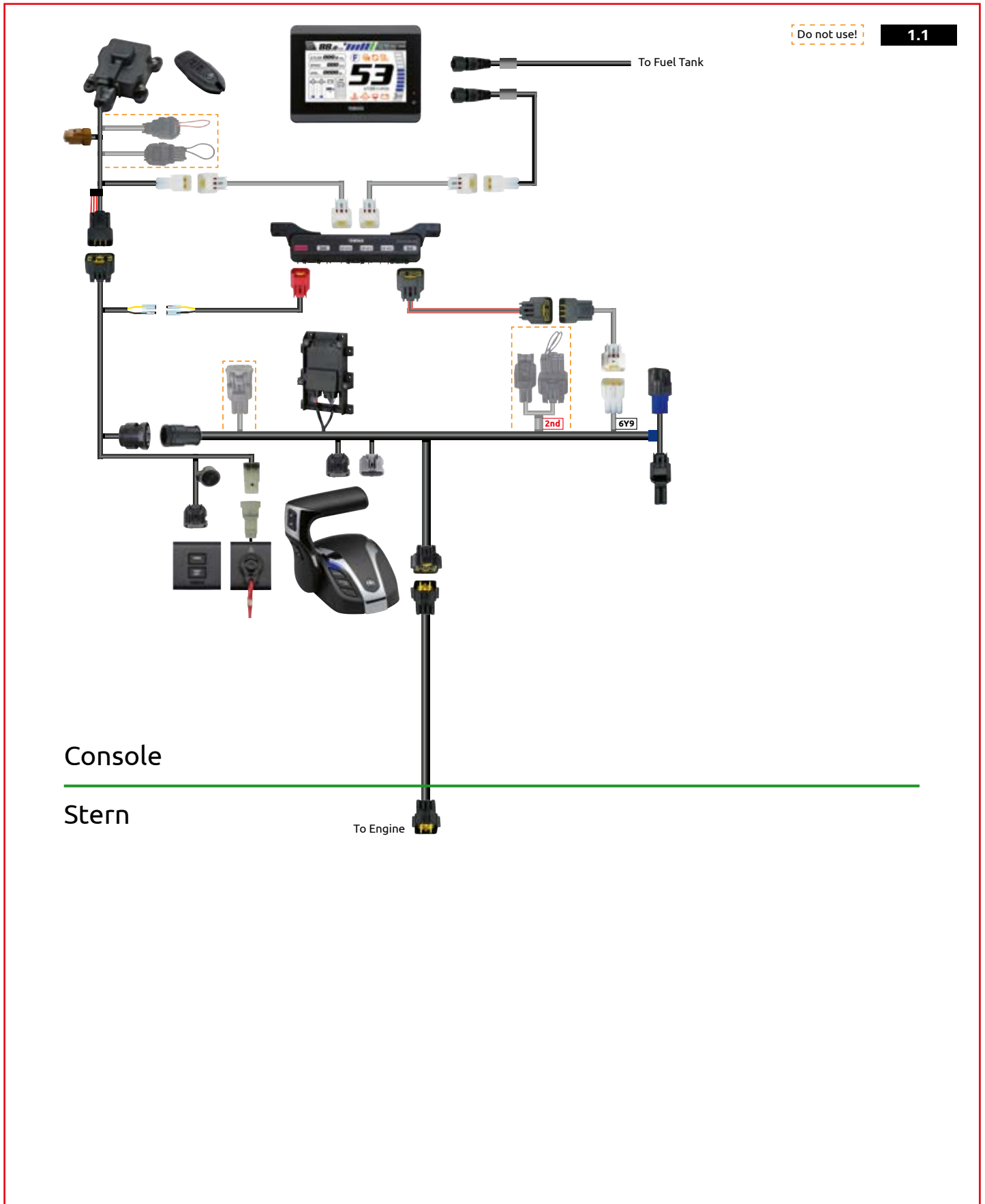

SINGLE LEVEL 1 PARTS

	Part Number	Description	Qty	Note
LEVEL 1	6X9-48205-00-00	6X9 DEC Top mount - single	1	
	6YM-762G0-00-00	CL5 Color Touch Gauge Kit - DEC*	1	
	6X9-762B0-01-00	EKS Kit - Single	1	
	6X6-8258A-20-00	Main harness 16P 8m / 26 ft	1	Other lengths available

*) For other display options, check the 'display' section in this guide

KIT CONTENTS

Part Number	Description	Qty	Note
6YM-762G0-00-00	CL5 Color Touch Gauge Kit - DEC	1	
6YM-83710-10-00	CL5 Display	1	
6YM-83553-00-00	Conversion Harness	1	0.9m (3 ft)
6YD-8356N-00-00	Fuel Tank Wire	1	
6Y8-81920-01-00	Multihub	1	
6Y9-83553-00-00	Conversion harness	1	
6Y8-82553-01-00	Main bus wire	1	0.3m (1 ft), other lengths available
6Y8-82521-31-00	Pigtail bus wire	1	1.8m (6 ft), other lengths available
6Y8-83553-02-00	System power supply	1	
6Y8-82582-11-00	Terminal Cap White	2	

Part Number	Description	Qty	Note
6X9-762B0-01-00	EKS Kit - Single	1	
6X9-82570-00-00	Power Switch	1	
6X9-82716-21-00	EKS harness	1	
6X9-82570-70-00	Lanyard switch	1	
6X9-86254-00-00	Immobilizer + key fob (2pcs)	1	433 Mhz
6Y8-82521-11-00	Pigtail bus wire	1	0.6m (2 ft)
6Y8-48277-00-00	Sticker	1	

HARNESS OPTIONS

Main harness 16P	Length	Main bus wire	Length	Pigtail bus wire	Length
6X6-8258A-90-00	1.5m (5 ft)	6Y8-82553-01-00	0.3m (1 ft)	6Y8-82521-01-00	0.3m (1 ft)
6X6-8258A-50-00	3.7m (12 ft)	6Y8-82553-50-00	3m (10 ft)	6Y8-82521-11-00	0.6m (2 ft)
6X6-8258A-60-00	5.2m (17 ft)	6Y8-82553-11-00	4.6m (15 ft)	6Y8-82521-21-00	0.9m (3 ft)
6X6-8258A-00-00	6m (19 ft)	6Y8-82553-21-00	6.1m (20 ft)	6Y8-82521-31-00	1.8m (6 ft)
6X6-8258A-10-00	7m (23 ft)	6Y8-82553-31-00	7.6m (25 ft)	6Y8-82521-41-00	2.7m (9 ft)
6X6-8258A-20-00	8m (26 ft)	6Y8-82553-41-00	9.1m (30 ft)	6Y8-82521-51-00	3.6m (12 ft)
6X6-8258A-30-00	10m (32 ft)				
6X6-8258A-40-00	12m (39 ft)				
6X6-8258A-70-00	15m (49 ft)				
6X6-8258A-80-00	24m (79 ft)				

Rigging Order Guide

DBW REMOTE CONTROL (MAIN STATION)

SINGLE LEVEL 1 STANDARD

SINGLE ENGINE	6X9 DEC TM	CL5 DISPLAY	STD SWITCH	DES STEERING	SINGLE STATION
-------------------------	----------------------	-----------------------	----------------------	------------------------	--------------------------

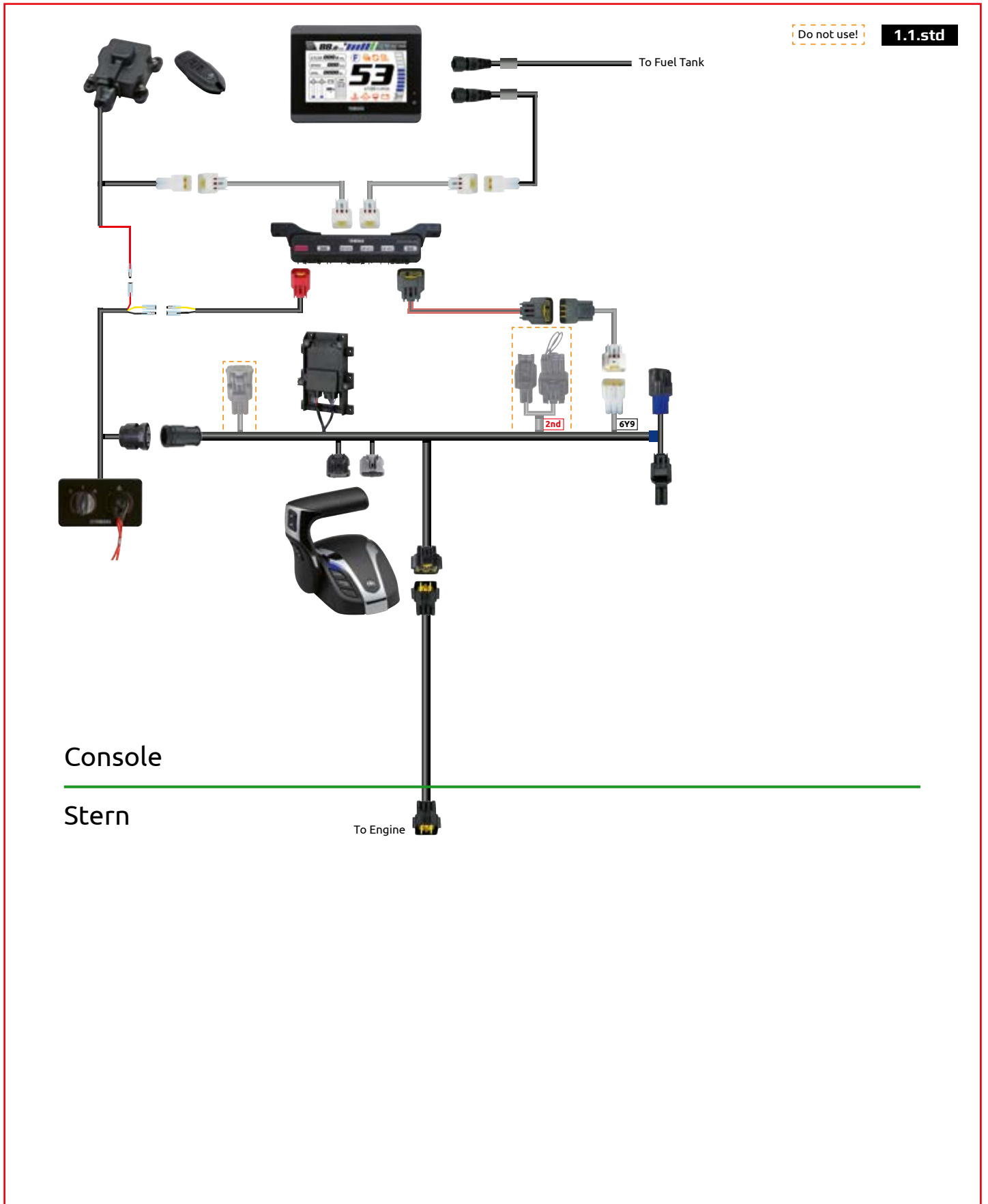

SINGLE LEVEL 1 STANDARD PARTS

	Description	Qty	Note
	6X9-48205-00-00	6X9 DEC Top mount - single	1
	6YM-762G0-00-00	CL5 Color Touch Gauge Kit - DEC*	1
LEVEL 1	6X6-82570-33-00	Main Switch	1
	6X9-762D0-00-00	Immobilizer Kit	1
	6X6-8258A-20-00	Main harness 16P 8m / 26 ft	1 Other lengths available

*) For other display options, check the 'display' section in this guide

KIT CONTENTS

	Description	Qty	Note
6YM-762G0-00-00	CL5 Color Touch Gauge Kit - DEC	1	
6YM-83710-10-00	CL5 Display	1	
6YM-83553-00-00	Conversion Harness	1	0.9m (3 ft)
6YD-8356N-00-00	Fuel Tank Wire	1	
6Y8-81920-01-00	Multihub	1	
6Y9-83553-00-00	Conversion harness	1	
6Y8-82553-01-00	Main bus wire	1	0.3m (1 ft), other lengths available
6Y8-82521-31-00	Pigtail bus wire	1	1.8m (6 ft), other lengths available
6Y8-83553-02-00	System power supply	1	
6Y8-82582-11-00	Terminal Cap White	2	
6X9-762D0-00-00	Immobilizer Kit	Qty	Note
6X9-86254-00-00	Immobilizer + key fob (2pcs)	1	433Mhz
6Y8-82521-11-00	Pigtail bus wire	1	0.6m (2 ft)
6Y8-48277-00-00	Sticker	1	

HARNESS OPTIONS

Main harness 16P	Length	Mainbus	Length	Pigtail	Length
6X6-8258A-90-00	1.5m (5 ft)	6Y8-82553-01-00	0.3m (1 ft)	6Y8-82521-01-00	0.3m (1 ft)
6X6-8258A-50-00	3.7m (12 ft)	6Y8-82553-50-00	3m (10 ft)	6Y8-82521-11-00	0.6m (2 ft)
6X6-8258A-60-00	5.2m (17 ft)	6Y8-82553-11-00	4.6m (15 ft)	6Y8-82521-21-00	0.9m (3 ft)
6X6-8258A-00-00	6m (19 ft)	6Y8-82553-21-00	6.1m (20 ft)	6Y8-82521-31-00	1.8m (6 ft)
6X6-8258A-10-00	7m (23 ft)	6Y8-82553-31-00	7.6m (25 ft)	6Y8-82521-41-00	2.7m (9 ft)
6X6-8258A-20-00	8m (26 ft)	6Y8-82553-41-00	9.1m (30 ft)	6Y8-82521-51-00	3.6m (12 ft)
6X6-8258A-30-00	10m (32 ft)				
6X6-8258A-40-00	12m (39 ft)				
6X6-8258A-70-00	15m (49 ft)				
6X6-8258A-80-00	24m (79 ft)				

Rigging Order Guide

DBW REMOTE CONTROL (MAIN STATION)

SINGLE LEVEL 2 BOLT-ON

SINGLE ENGINE	6X9 DEC TM	CL5 DISPLAY	EKS SWITCH	DES BOLT-ON	SINGLE STATION
-------------------------	----------------------	-----------------------	----------------------	-----------------------	--------------------------

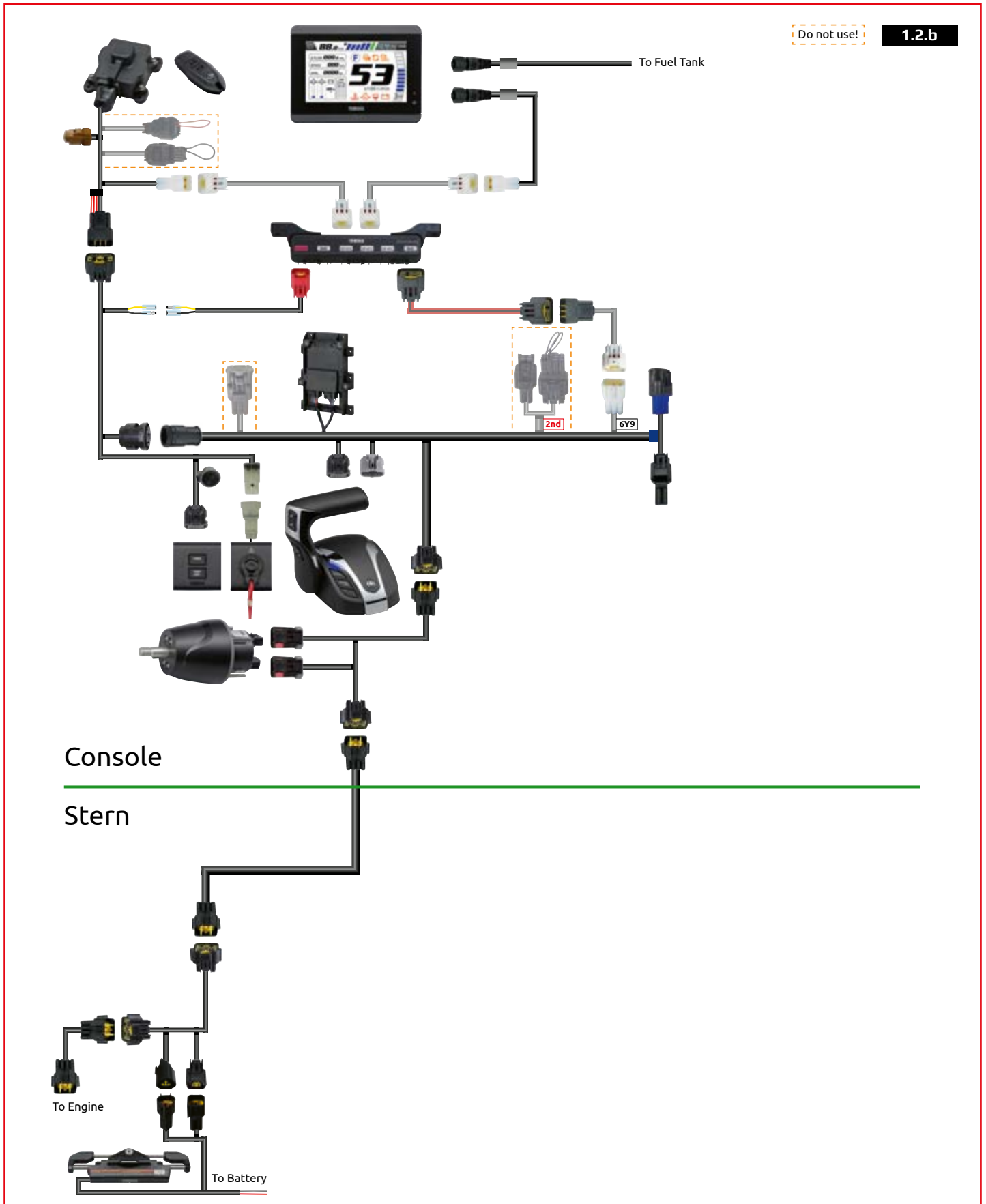

SINGLE LEVEL 2 BOLT-ON PARTS

	Description	Qty	Note	
LEVEL 1	6X9-48205-00-00	6X9 DEC Top mount - single	1	
	6YM-762G0-00-00	CL5 Color Touch Gauge Kit - DEC*	1	
	6X9-762B0-01-00	EKS Kit - Single	1	
	6X6-8258A-20-00	Main harness 16P 8m / 26 ft	1	Other lengths available
	6X9-762S0-00-00	Bolt-on DES KIT	1	
LEVEL 2	6X9-438A0-00-00	Steering actuator harness 2.4m / 8 ft	1	Other lengths available
	6X6-8258A-50-00	Main harness 16P 3.7m / 12 ft	1	Other lengths available
	6X9-615A0-00-00	Compact Helm unit	1	Tilt type available (Kit: 6GR-762H0-00-00)
	6GR-8258A-00-00	Helm harness Main St Single 0.9m / 3 ft	1	Other lengths available

*) For other display options, check the 'display' section in this guide

KIT CONTENTS

Part Number	Description	Qty	Note
6YM-762G0-00-00	CL5 Color Touch Gauge Kit - DEC	1	
6YM-83710-10-00	CL5 Display	1	
6YM-83553-00-00	Conversion Harness	1	0.9 m (3 ft)
6YD-8356N-00-00	Fuel Tank Wire	1	
6Y8-81920-01-00	Multihub	1	
6Y9-83553-00-00	Conversion harness	1	
6Y8-82553-01-00	Main bus wire	1	0.3m (1 ft), other lengths available
6Y8-82521-31-00	Pigtail bus wire	1	1.8m (6 ft), other lengths available
6Y8-83553-02-00	System power supply	1	
6Y8-82582-11-00	Terminal Cap White	2	

Part Number	Description	Qty	Note
6X9-762B0-01-00	EKS Kit - Single	1	
6X9-82570-00-00	Power Switch	1	
6X9-82716-21-00	EKS harness	1	
6X9-82570-70-00	Lanyard switch	1	
6X9-86254-00-00	Immobilizer + key fob (2pcs)	1	433 Mhz
6Y8-82521-11-00	Pigtail bus wire	1	0.6m (2 ft)
6Y8-48277-00-00	Sticker	1	

Part Number	Description	Qty	Note
6X9-762S0-00-00	Bolt-on DES KIT	1	
6X9-42401-00-00	Actuator	1	
6X9-8258A-90-00	Split Harness	1	

HARNESS OPTIONS

Main harness 16P	Length	Main bus wire	Length	Pigtail bus wire	Length
6X6-8258A-90-00	1.5m (5 ft)	6Y8-82553-01-00	0.3m (1 ft)	6Y8-82521-01-00	0.3m (1 ft)
6X6-8258A-50-00	3.7m (12 ft)	6Y8-82553-50-00	3m (10 ft)	6Y8-82521-11-00	0.6m (2 ft)
6X6-8258A-60-00	5.2m (17 ft)	6Y8-82553-11-00	4.6m (15 ft)	6Y8-82521-21-00	0.9m (3 ft)
6X6-8258A-00-00	6m (19 ft)	6Y8-82553-21-00	6.1m (20 ft)	6Y8-82521-31-00	1.8m (6 ft)
6X6-8258A-10-00	7m (23 ft)	6Y8-82553-31-00	7.6m (25 ft)	6Y8-82521-41-00	2.7m (9 ft)
6X6-8258A-20-00	8m (26 ft)	6Y8-82553-41-00	9.1m (30 ft)	6Y8-82521-51-00	3.6m (12 ft)
6X6-8258A-30-00	10m (32 ft)				
6X6-8258A-40-00	12m (39 ft)	Steering Actuator Harness	Length	Helm Harness	Length
6X6-8258A-70-00	15m (49 ft)	6X9-438A0-00-00	2.4m (8 ft)	6GR-8258A-00-00	0.9m (3 ft)
6X6-8258A-80-00	24m (79 ft)	6X9-438A0-10-00	4.5m (15 ft)	6GR-8258A-40-00	1.8m (6 ft)

Rigging Order Guide

DBW REMOTE CONTROL (MAIN STATION)

SINGLE LEVEL 2 INTEGRATED

SINGLE ENGINE	6X9 DEC TM	CL5 DISPLAY	EKS SWITCH	DES INTEGRATED	SINGLE STATION
-------------------------	----------------------	-----------------------	----------------------	--------------------------	--------------------------

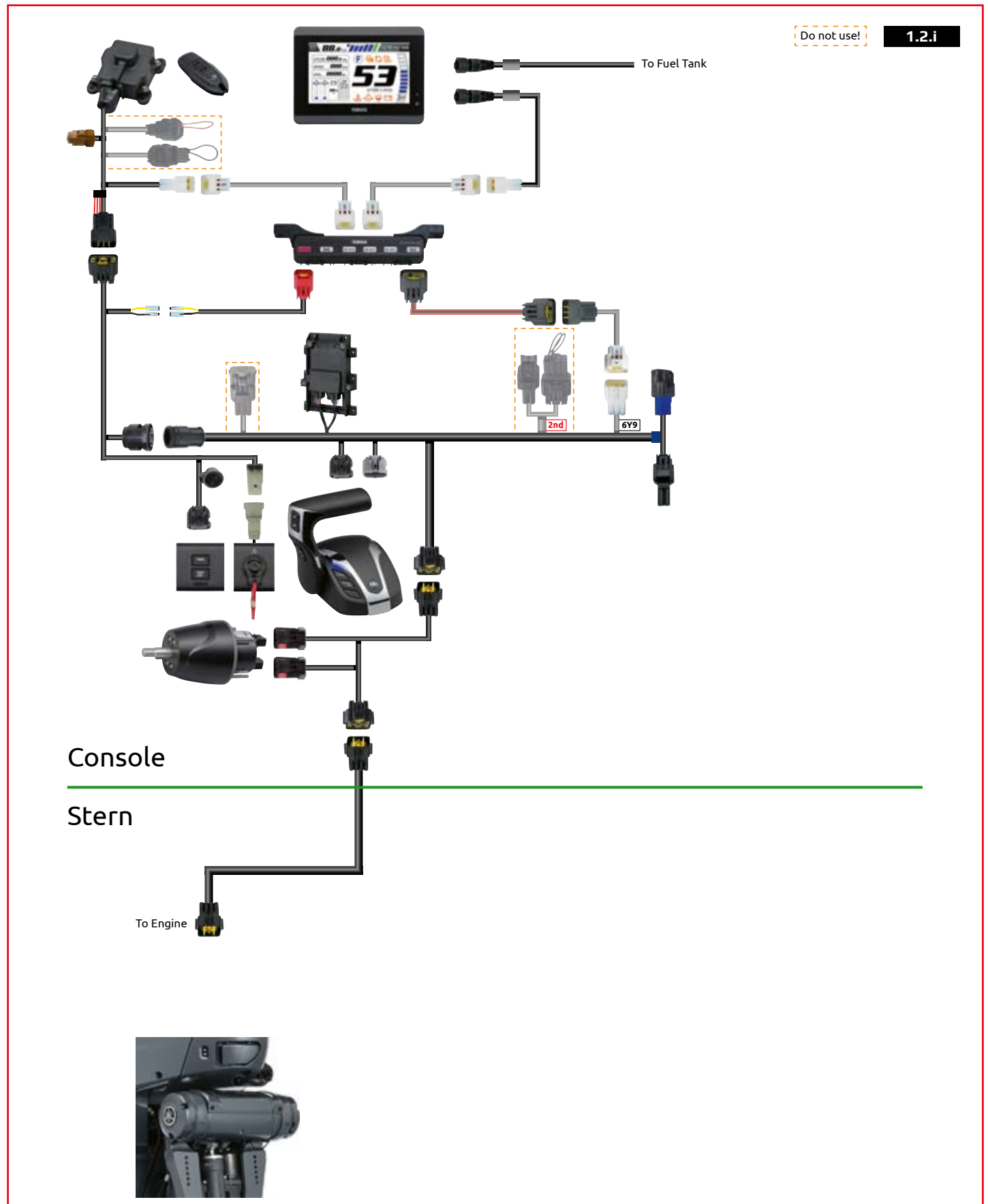

SINGLE LEVEL 2 INTEGRATED PARTS

	Description	Qty	Note
LEVEL 1	6X9-48205-00-00	6X9 DEC Top mount - single	1
	6YM-762G0-00-00	CL5 Color Touch Gauge Kit - DEC*	1
	6X9-762B0-01-00	EKS Kit - Single	1
	6X6-8258A-20-00	Main harness 16P 8m / 26 ft	1 Other lengths available
LEVEL 2	6X9-615A0-00-00	Compact Helm unit	1 Tilt type available (Kit: 6GR-762H0-00-00)
	6GR-8258A-00-00	Helm harness Main St Single 0.9m / 3 ft	1 Other lengths available

*) For other display options, check the 'display' section in this guide

KIT CONTENTS

Part Number	Description	Qty	Note
6YM-762G0-00-00	CL5 Color Touch Gauge Kit - DEC	1	
6YM-83710-10-00	CL5 Display	1	
6YM-83553-00-00	Conversion Harness	1	0.9 m (3 ft)
6YD-8356N-00-00	Fuel Tank Wire	1	
6Y8-81920-01-00	Multihub	1	
6Y9-83553-00-00	Conversion harness	1	
6Y8-82553-01-00	Main bus wire	1	0.3m (1 ft), other lengths available
6Y8-82521-31-00	Pigtail bus wire	1	1.8m (6 ft), other lengths available
6Y8-83553-02-00	System power supply	1	
6Y8-82582-11-00	Terminal Cap White	2	
6X9-762B0-01-00	EKS Kit - Single	1	
6X9-82570-00-00	Power Switch	1	
6X9-82716-21-00	EKS harness	1	
6X9-82570-70-00	Lanyard switch	1	
6X9-86254-00-00	Immobilizer + key fob (2pcs)	1	433 Mhz
6Y8-82521-11-00	Pigtail bus wire	1	0.6m (2 ft)
6Y8-48277-00-00	Sticker	1	

HARNESS OPTIONS

Main harness 16P		Main bus wire		Pigtail bus wire	
	Length		Length		Length
6X6-8258A-90-00	1.5m (5 ft)	6Y8-82553-01-00	0.3m (1 ft)	6Y8-82521-01-00	0.3m (1 ft)
6X6-8258A-50-00	3.7m (12 ft)	6Y8-82553-50-00	3m (10 ft)	6Y8-82521-11-00	0.6m (2 ft)
6X6-8258A-60-00	5.2m (17 ft)	6Y8-82553-11-00	4.6m (15 ft)	6Y8-82521-21-00	0.9m (3 ft)
6X6-8258A-00-00	6m (19 ft)	6Y8-82553-21-00	6.1m (20 ft)	6Y8-82521-31-00	1.8m (6 ft)
6X6-8258A-10-00	7m (23 ft)	6Y8-82553-31-00	7.6m (25 ft)	6Y8-82521-41-00	2.7m (9 ft)
6X6-8258A-20-00	8m (26 ft)	6Y8-82553-41-00	9.1m (30 ft)	6Y8-82521-51-00	3.6m (12 ft)
6X6-8258A-30-00	10m (32 ft)				
6X6-8258A-40-00	12m (39 ft)	Helm Harness		Length	
6X6-8258A-70-00	15m (49 ft)	6GR-8258A-00-00	0.9m (3 ft)		
6X6-8258A-80-00	24m (79 ft)	6GR-8258A-40-00	1.8m (6 ft)		

Rigging Order Guide

DBW REMOTE CONTROL (MAIN STATION)

SINGLE LEVEL 3-4 BOLT-ON

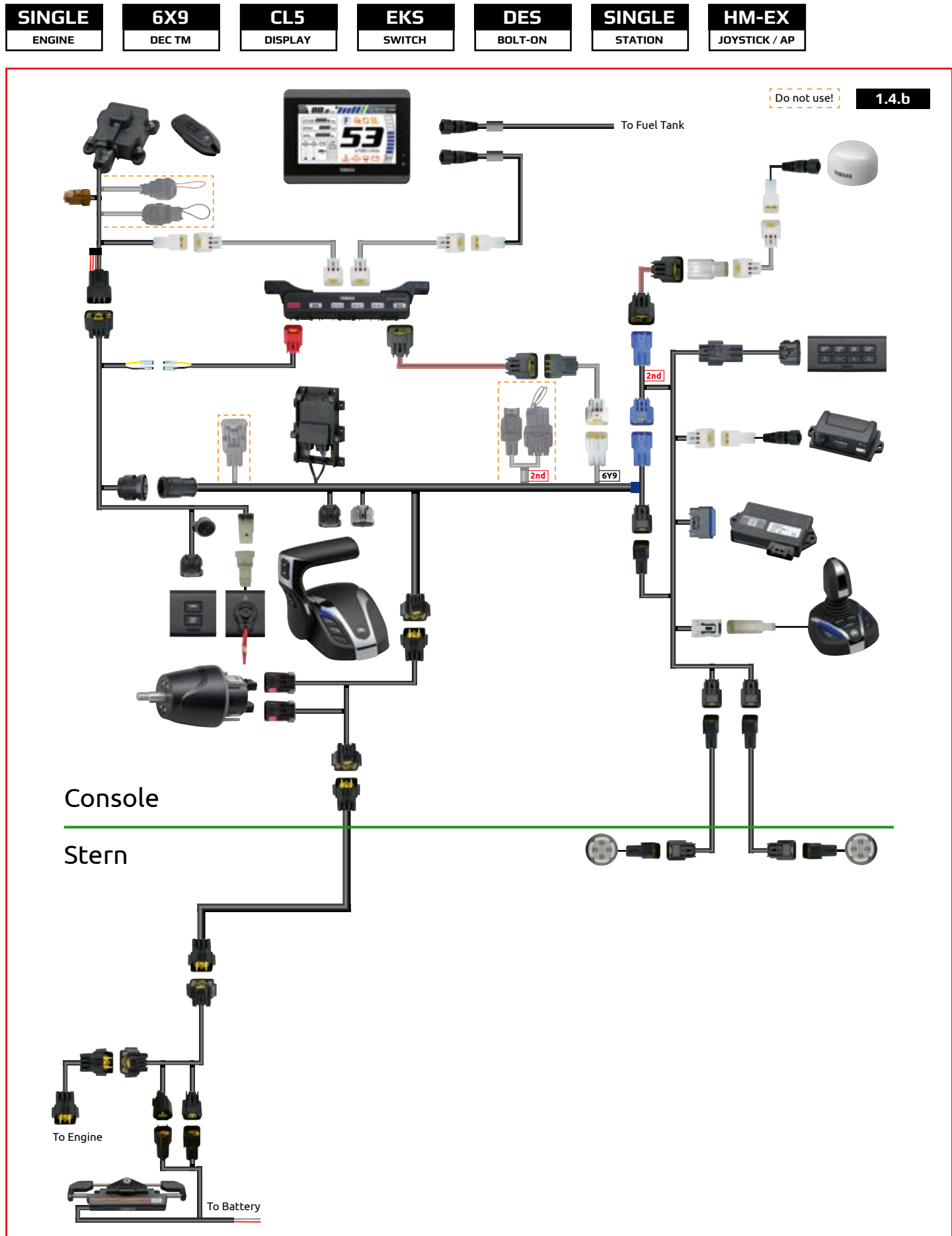

SINGLE LEVEL 3-4 BOLT-ON PARTS

	Description	Qty	Note
LEVEL 1	6X9-48205-00-00	6X9 DEC Top mount - single	1
	6YM-762G0-00-00	CL5 Color Touch Gauge Kit - DEC*	1
	6X9-762B0-01-00	EKS Kit - Single	1
	6X6-8258A-20-00	Main harness 16P 8m / 26 ft	1 Other lengths available
	6X9-762S0-00-00	Bolt-on DES KIT	1
LEVEL 2	6X9-438A0-00-00	Steering actuator harness 2.4m / 8 ft	1 Other lengths available
	6X6-8258A-50-00	Main harness 16P 3.7m / 12 ft	1 Other length available
	6X9-615A0-00-00	Compact Helm unit	1 Tilt type available (Kit: 6GR-762H0-00-00)
	6GR-8258A-00-00	Helm harness Main St Single 0.9m / 3 ft	1 Other lengths available
	**	Auto Pilot Kit Single	1
LEVEL 3	6Y8-82553-50-00	Main bus wire 3m / 10 ft	1 Other lengths available
	6Y8-82521-01-00	Pigtail bus wire 0.3m / 1 ft	1 Other lengths available
	Level 3 requires an compatible multi-function display for map functions		
	**	Joystick/AP Kit - Single	1 Upgrade from level 3 p/n: 6X9-762J0-40-00
LEVEL 4	6Y8-82553-50-00	Main bus wire 3m / 10 ft	1 Other lengths available
	6Y8-82521-01-00	Pigtail bus wire 0.3m / 1 ft	1 Other lengths available
Level 4 requires an compatible multi-function display for map functions			
*) For other display options, check the 'display' section in this guide **) Order at the local distributor sales department			

KIT CONTENTS

Part Number	Description	Qty	Note
6YM-762G0-00-00	CL5 Color Touch Gauge Kit - DEC	1	
6YM-83710-10-00	CL5 Display	1	
6YM-83553-00-00	Conversion Harness	1	0.9 m (3 ft)
6YD-8356N-00-00	Fuel Tank Wire	1	
6Y8-81920-01-00	Multihub	1	
6Y9-83553-00-00	Conversion harness	1	
6Y8-82553-01-00	Main bus wire	1	0.3m (1 ft), other lengths available
6Y8-82521-31-00	Pigtail bus wire	1	1.8m (6 ft), other lengths available
6Y8-83553-02-00	System power supply	1	
6Y8-82582-11-00	Terminal Cap White	2	

Part Number	Description	Qty	Note	Part Number	Description	Qty	Note
6X9-762B0-01-00	EKS Kit - Single	1		**	Joystick/AP Kit - Single	1	
6X9-82570-00-00	Power Switch	1		6X9-8253V-00-00	Autopilot panel	1	
6X9-82716-21-00	EKS harness	1		6X9-88107-00-00	GPS antenna	1	
6X9-82570-70-00	Lanyard switch	1		6X9-8A410-00-00	Heading sensor	1	
6X9-86254-00-00	Immobilizer + key Fob (2pcs)	1	433 Mhz	6X9-8591T-10-00	Boat Control Unit	1	
6Y8-82521-11-00	Pigtail bus wire	1	0.6m (2 ft)	6Y8-81920-11-00	Single hub	1	
6Y8-48277-00-00	Sticker	1		6X9-82386-01-00	BCU Harness	1	
				6YM-83553-00-00	Conversion harness	2	
6X9-762S0-00-00	Bolt-on DES KIT	1		6X9-482A0-00-00	Joystick Assy	1	level 4 only
6X9-42401-00-00	Actuator	1		6ES-83720-01-00	Prop lights	2	level 4 only
6X9-8258A-90-00	Split Harness	1		**) Order at the local distributor sales department			

HARNESS OPTIONS

Main harness 16P	Length	Main bus wire	Length	Pigtail bus wire	Length
6X6-8258A-90-00	1.5m (5 ft)	6Y8-82553-01-00	0.3m (1 ft)	6Y8-82521-01-00	0.3m (1 ft)
6X6-8258A-50-00	3.7m (12 ft)	6Y8-82553-50-00	3m (10 ft)	6Y8-82521-11-00	0.6m (2 ft)
6X6-8258A-60-00	5.2m (17 ft)	6Y8-82553-11-00	4.6m (15 ft)	6Y8-82521-21-00	0.9m (3 ft)
6X6-8258A-00-00	6m (19 ft)	6Y8-82553-21-00	6.1m (20 ft)	6Y8-82521-31-00	1.8m (6 ft)
6X6-8258A-10-00	7m (23 ft)	6Y8-82553-31-00	7.6m (25 ft)	6Y8-82521-41-00	2.7m (9 ft)
6X6-8258A-20-00	8m (26 ft)	6Y8-82553-41-00	9.1m (30 ft)	6Y8-82521-51-00	3.6m (12 ft)
6X6-8258A-30-00	10m (32 ft)				
6X6-8258A-40-00	12m (39 ft)	Steering Actuator Harness	Length	Helm Harness	Length
6X6-8258A-70-00	15m (49 ft)	6X9-438A0-00-00	2.4m (8 ft)	6GR-8258A-00-00	0.9m (3 ft)
6X6-8258A-80-00	24m (79 ft)	6X9-438A0-10-00	4.5m (15 ft)	6GR-8258A-40-00	1.8m (6 ft)
Extension for Prop lights	Length				
6X9-82586-20-00	6m (19 ft)				
6X9-82586-30-00	9.1m (30 ft)				
6X9-82586-40-00	12.2m (40 ft)				

Rigging Order Guide

DBW REMOTE CONTROL (MAIN STATION)

SINGLE LEVEL 3-4 INTEGRATED

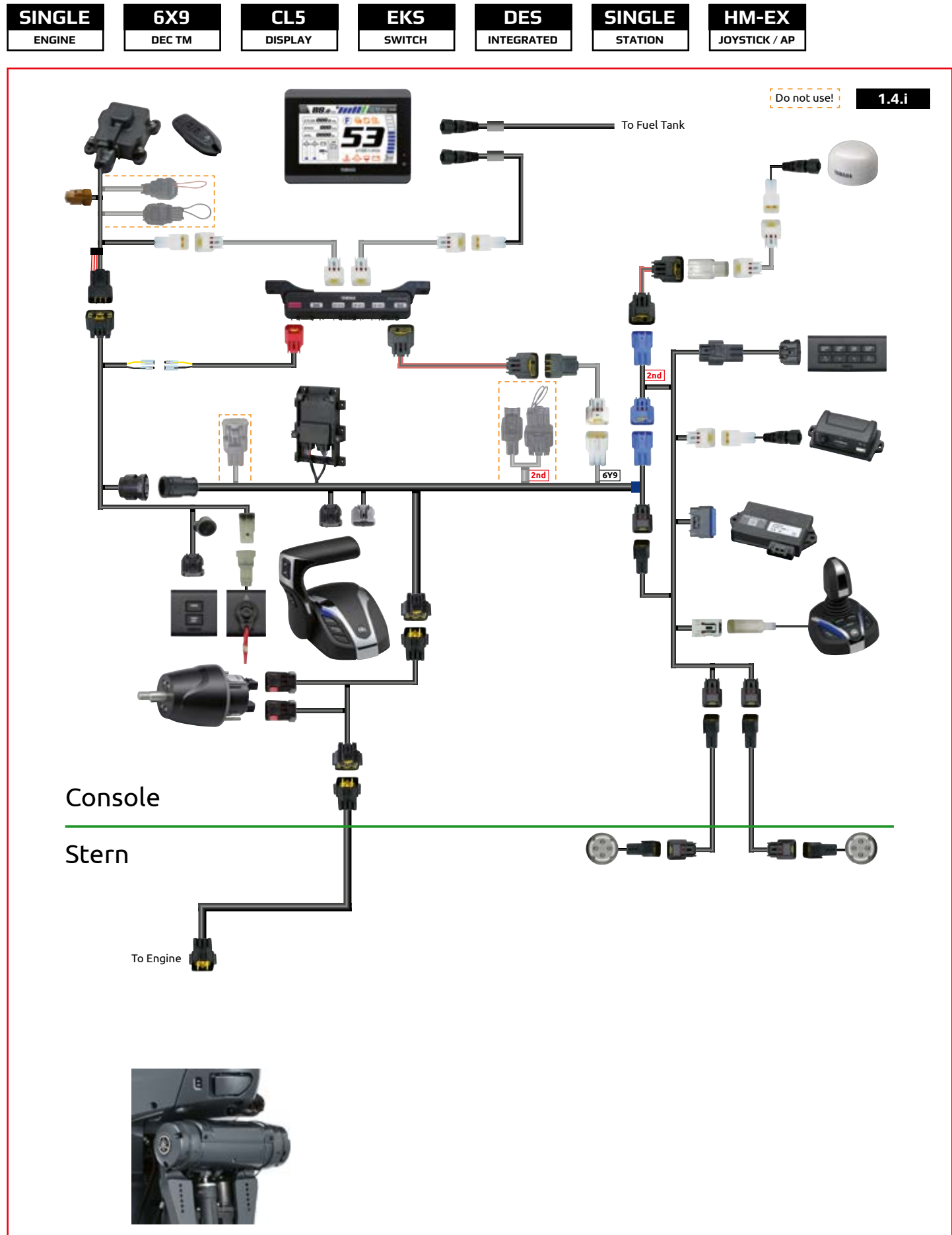

SINGLE LEVEL 3-4 INTEGRATED PARTS

	Description	Qty	Note
LEVEL 1	6X9-48205-00-00	6X9 DEC Top mount - single	1
	6YM-762G0-00-00	CL5 Color Touch Gauge Kit - DEC*	1
	6X9-762B0-01-00	EKS Kit - Single	1
LEVEL 2	6X6-8258A-20-00	Main harness 16P 8m / 26 ft	1 Other length available
	6X9-615A0-00-00	Compact Helm unit	1 Tilt type available (Kit: 6GR-762H0-00-00)
	6GR-8258A-00-00	Helm harness Main St Single 0.9m / 3 ft	1 Other length available
LEVEL 3	**	Auto Pilot Kit Single	1
	6Y8-82553-50-00	Main bus wire 3m / 10 ft	1 Other length available
	6Y8-82521-01-00	Pigtail bus wire 0.3m / 1 ft	1 Other length available
LEVEL 4	Level 3 requires an compatible multi-function display for map functions		
	**	Joystick/AP Kit - Single	1 Upgrade from level 3 p/n: 6X9-762J0-40-00
	6Y8-82553-50-00	Main bus wire 3m / 10 ft	1 Other length available
	6Y8-82521-01-00	Pigtail bus wire 0.3m / 1 ft	1 Other length available
Level 4 requires an compatible multi-function display for map functions			
*) For other display options, check the 'display' section in this guide **) Order at the local distributor sales department			

KIT CONTENTS

Part Number	Description	Qty	Note
6YM-762G0-00-00	CL5 Color Touch Gauge Kit - DEC	1	
6YM-83710-10-00	CL5 Display	1	
6YM-83553-00-00	Conversion Harness	1	0.9 m (3 ft)
6YD-8356N-00-00	Fuel Tank Wire	1	
6Y8-81920-01-00	Multihub	1	
6Y9-83553-00-00	Conversion harness	1	
6Y8-82553-01-00	Main bus wire	1	0.3m (1 ft), other lengths available
6Y8-82521-31-00	Pigtail bus wire	1	1.8m (6 ft), other lengths available
6Y8-83553-02-00	System power supply	1	
6Y8-82582-11-00	Terminal Cap White	2	

Part Number	Description	Qty	Note	Part Number	Description	Qty	Note
6X9-762B0-01-00	EKS Kit - Single	1		**	Joystick/AP Kit - Single	1	
6X9-82570-00-00	Power Switch	1		6X9-8253V-00-00	Autopilot panel	1	
6X9-82716-21-00	EKS harness	1		6X9-88107-00-00	GPS antenna	1	
6X9-82570-70-00	Lanyard switch	1		6X9-8A410-00-00	Heading sensor	1	
6X9-86254-00-00	Immobilizer + key fob (2pcs)	1	433 Mhz	6X9-8591T-10-00	Boat Control Unit	1	
6Y8-82521-11-00	Pigtail bus wire	1	0.6m (2 ft)	6Y8-81920-11-00	Single hub	1	
6Y8-48277-00-00	Sticker	1		6X9-82386-01-00	BCU Harness	1	
				6YM-83553-00-00	Conversion harness	2	
				6X9-482A0-00-00	Joystick Assy	1	level 4 only
				6ES-83720-01-00	Prop lights	2	level 4 only
**) Order at the local distributor sales department							

HARNESS OPTIONS

Main harness 16P	Length	Main bus wire	Length	Pigtail bus wire	Length
6X6-8258A-90-00	1.5m (5 ft)	6Y8-82553-01-00	0.3m (1 ft)	6Y8-82521-01-00	0.3m (1 ft)
6X6-8258A-50-00	3.7m (12 ft)	6Y8-82553-50-00	3m (10 ft)	6Y8-82521-11-00	0.6m (2 ft)
6X6-8258A-60-00	5.2m (17 ft)	6Y8-82553-11-00	4.6m (15 ft)	6Y8-82521-21-00	0.9m (3 ft)
6X6-8258A-00-00	6m (19 ft)	6Y8-82553-21-00	6.1m (20 ft)	6Y8-82521-31-00	1.8m (6 ft)
6X6-8258A-10-00	7m (23 ft)	6Y8-82553-31-00	7.6m (25 ft)	6Y8-82521-41-00	2.7m (9 ft)
6X6-8258A-20-00	8m (26 ft)	6Y8-82553-41-00	9.1m (30 ft)	6Y8-82521-51-00	3.6m (12 ft)
6X6-8258A-30-00	10m (32 ft)				
6X6-8258A-40-00	12m (39 ft)	Helm Harness	Length	Extension for Prop lights	Length
6X6-8258A-70-00	15m (49 ft)	6GR-8258A-00-00	0.9m (3 ft)	6X9-82586-20-00	6m (19 ft)
6X6-8258A-80-00	24m (79 ft)	6GR-8258A-40-00	1.8m (6 ft)	6X9-82586-30-00	9.1m (30 ft)
				6X9-82586-40-00	12.2m (40 ft)

Rigging Order Guide

DBW REMOTE CONTROL (2ND STATION)

SINGLE 2ND STATION LEVEL 1

SINGLE ENGINE	6X9 DEC TM	CL5 DISPLAY	EKS SWITCH	DES STEERING	DUAL STATION
-------------------------	----------------------	-----------------------	----------------------	------------------------	------------------------

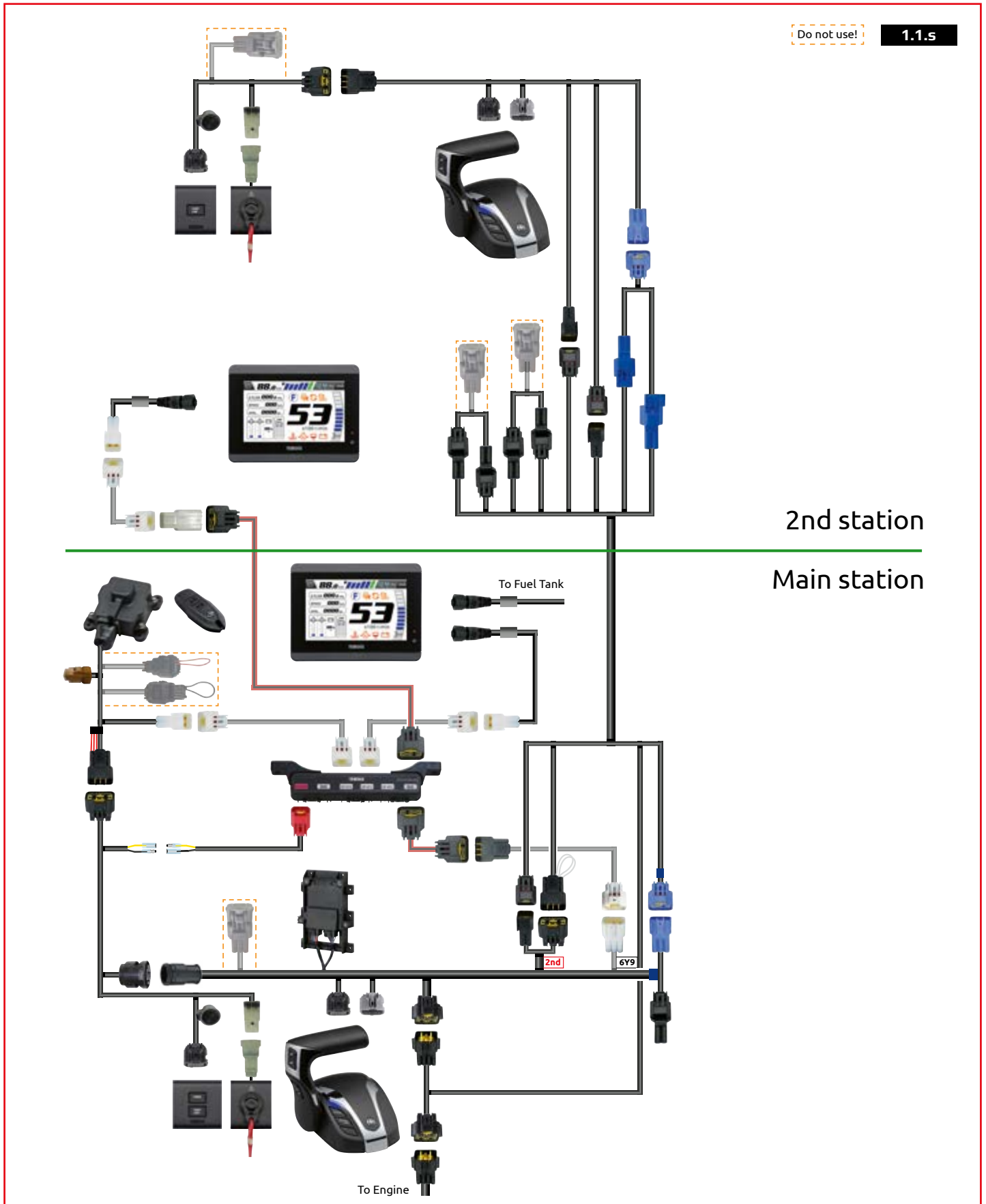

SINGLE 2ND STATION LEVEL 1 PARTS

	Description	Qty	Note
LEVEL 1	6X9-48205-10-00	6X9 DEC Top mount - single	1 2nd station
	6YM-83710-10-00	CL5 Color Touch Gauge*	1 Display only
	6YM-83553-00-00	Conversion Harness for CL5	1
	6Y8-81920-11-00	Single hub	1
	6Y8-82521-11-00	Pigtail bus wire 0.6m / 2 ft	1 Other lengths available
	6Y8-82553-11-00	Main bus wire 4.6m / 15 ft	1 Other lengths available
	6X9-762B0-80-00	EKS Kit - Single 2nd St	1
	6X9-8258A-00-00	2nd station harness Port 5m / 16 ft	1 Other lengths available
	*) For other display options, check the 'display' section in this guide		

KIT CONTENTS

Part Number	Description	Qty	Note
6X9-762B0-01-00	EKS Kit - Single 2nd St		
6X9-82570-B0-00	Start/Stop Switch	1	
6X9-82716-60-00	EKS harness	1	
6X9-82570-70-00	Lanyard switch	1	

HARNESS OPTIONS

Main bus wire	Length	Pigtail bus wire	Length	2nd helm harness Port	Length
6Y8-82553-01-00	0.3m (1 ft)	6Y8-82521-01-00	0.3m (1 ft)	6X9-8258A-00-00	5m (16 ft)
6Y8-82553-50-00	3m (10 ft)	6Y8-82521-11-00	0.6m (2 ft)	6X9-8258A-10-00	8m (26 ft)
6Y8-82553-11-00	4.6m (15 ft)	6Y8-82521-21-00	0.9m (3 ft)	6X9-8258A-20-00	12m (38 ft)
6Y8-82553-21-00	6.1m (20 ft)	6Y8-82521-31-00	1.8m (6 ft)		
6Y8-82553-31-00	7.6m (25 ft)	6Y8-82521-41-00	2.7m (9 ft)		
6Y8-82553-41-00	9.1m (30 ft)	6Y8-82521-51-00	3.6m (12 ft)		

Rigging Order Guide

DBW REMOTE CONTROL (2ND STATION)

SINGLE 2ND STATION LEVEL 2

SINGLE ENGINE	6X9 DEC TM	CL5 DISPLAY	EKS SWITCH	DES STEERING	DUAL STATION
-------------------------	----------------------	-----------------------	----------------------	------------------------	------------------------

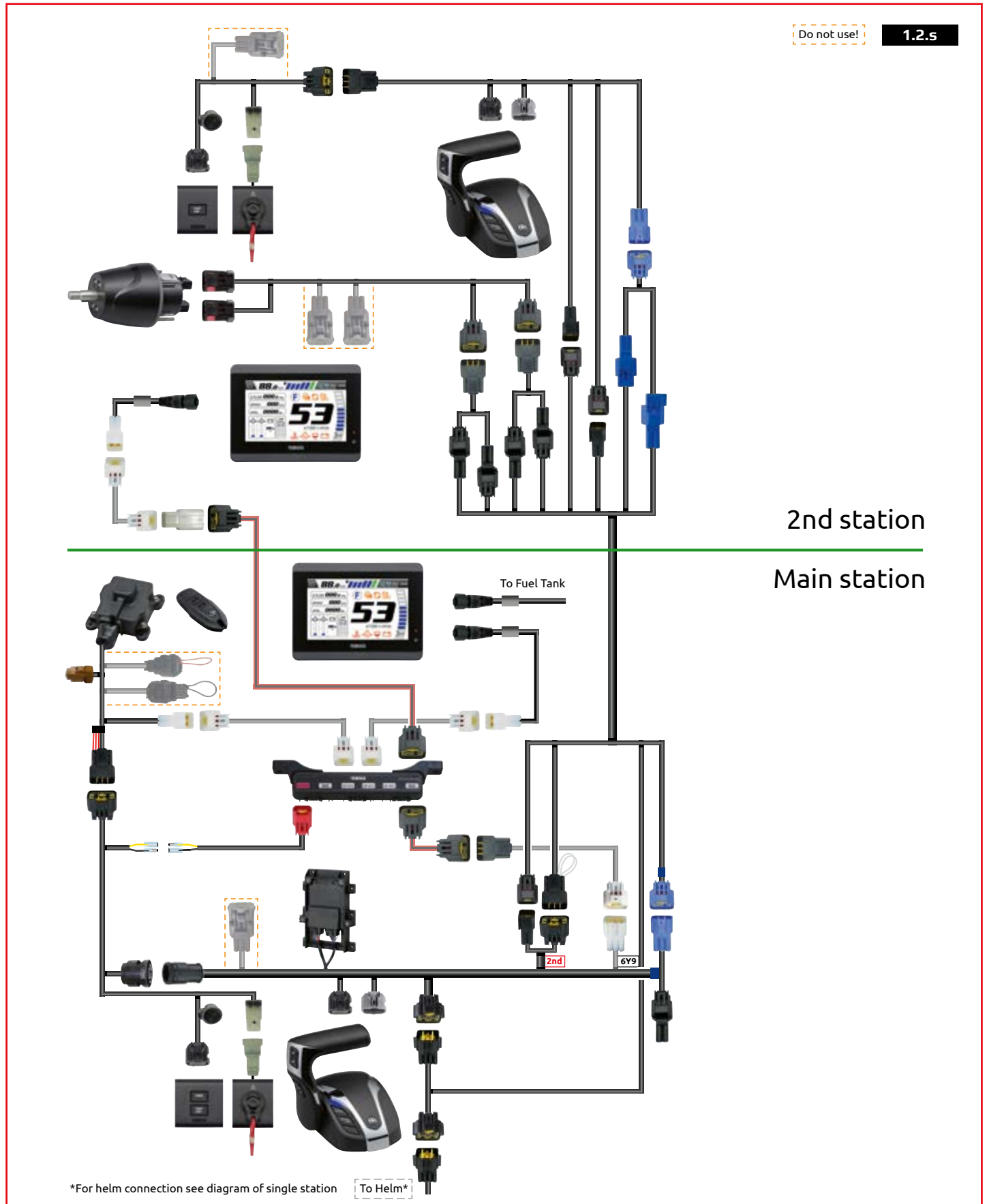

For helm connection see diagram of single station To Helm

SINGLE 2ND STATION LEVEL 2 PARTS

	Description	Qty	Note
	6X9-48205-10-00	1	6X9 DEC Top mount - single
	6YM-83710-10-00	1	CL5 Color Touch Gauge*
	6YM-83553-00-00	1	Conversion Harness for CL5
	6Y8-81920-11-00	1	Single hub
LEVEL 1	6Y8-82521-11-00	1	Pigtail bus wire 0.6m / 2 ft
	6Y8-82553-11-00	1	Main bus wire 4.6m / 15 ft
	6X9-762B0-80-00	1	EKS Kit - Single 2nd St
	6X9-8258A-00-00	1	2nd station harness Port 5m / 16 ft
	6GR-8258A-V0-00	1	Extension Harness**
LEVEL 2	6X9-615A0-00-00	1	Compact Helm unit
	6X9-8258A-A0-00	1	Helm harness 2nd St Single 0.9m / 3 ft

*) For other display options, check the 'display' section in this guide

KIT CONTENTS

		Qty	Note
6X9-762B0-01-00	EKS Kit - Single 2nd St		
6X9-82570-B0-00	Start/Stop Switch	1	
6X9-82716-60-00	EKS harness	1	
6X9-82570-70-00	Lanyard switch	1	

HARNESS OPTIONS

Main bus wire	Length	Pigtail bus wire	Length	2nd helm harness Port	Length
6Y8-82553-01-00	0.3m (1 ft)	6Y8-82521-01-00	0.3m (1 ft)	6X9-8258A-00-00	5m (16 ft)
6Y8-82553-50-00	3m (10 ft)	6Y8-82521-11-00	0.6m (2 ft)	6X9-8258A-10-00	8m (26 ft)
6Y8-82553-11-00	4.6m (15 ft)	6Y8-82521-21-00	0.9m (3 ft)	6X9-8258A-20-00	12m (38 ft)
6Y8-82553-21-00	6.1m (20 ft)	6Y8-82521-31-00	1.8m (6 ft)		
6Y8-82553-31-00	7.6m (25 ft)	6Y8-82521-41-00	2.7m (9 ft)		
6Y8-82553-41-00	9.1m (30 ft)	6Y8-82521-51-00	3.6m (12 ft)		

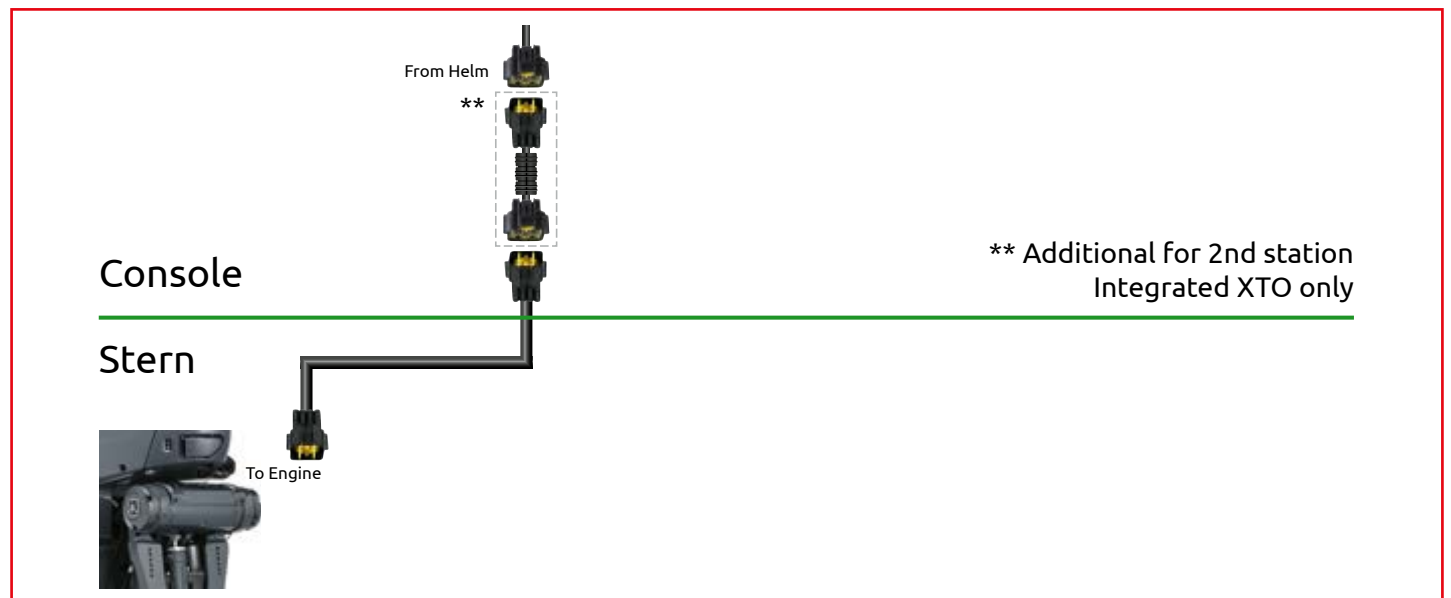

Rigging Order Guide

DBW REMOTE CONTROL (2ND STATION)

SINGLE 2ND STATION LEVEL 3-4

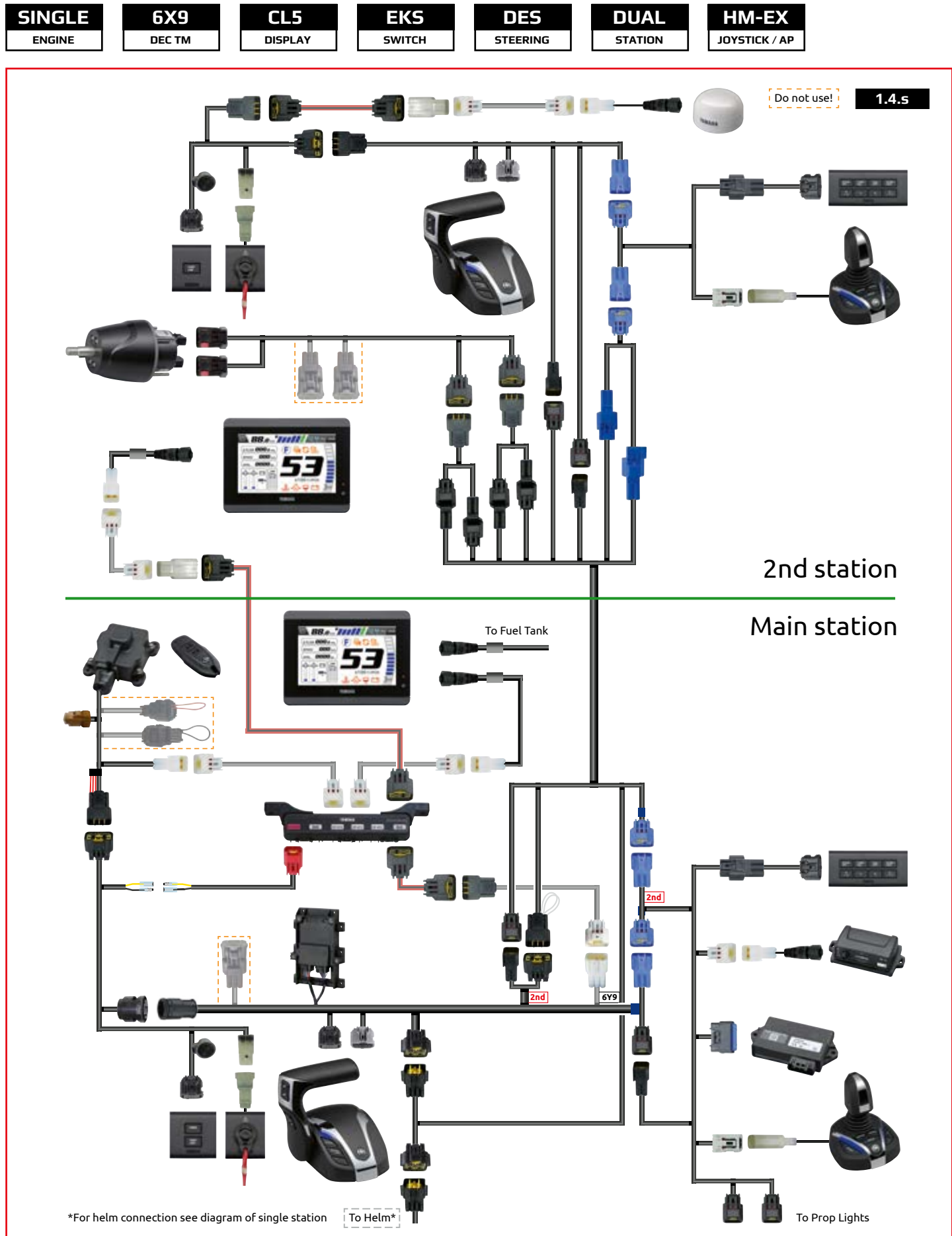

SINGLE 2ND STATION LEVEL 3-4 PARTS

	Description	Qty	Note
	6X9-48205-10-00 6X9 DEC Top mount - single	1	2nd station
	6YM-83710-10-00 CL5 Color Touch Gauge*	1	Display only
	6YM-83553-00-00 Conversion Harness for CL5	1	
	6Y8-81920-11-00 Single hub	1	
LEVEL 1	6Y8-82521-11-00 Pigtail bus wire 0.6m / 2 ft	1	Other lengths available
	6Y8-82553-11-00 Main bus wire 4.6m / 15 ft	1	Other lengths available
	6X9-762B0-80-00 EKS Kit - Single 2nd St	1	
	6X9-8258A-00-00 2nd station harness Port 5m / 16 ft	1	Other lengths available
	6GR-8258A-V0-00 Extension Harness**	1	Only For Integrated Steering
LEVEL 2	6X9-615A0-00-00 Compact Helm unit	1	Tilt type available (Kit: 6GR-762H0-00-00)
	6X9-8258A-A0-00 Helm harness 2nd St Single 0.9m / 3 ft	1	
LEVEL 3	6X9-762P0-10-00 Auto Pilot Panel kit 2nd station	1	
	Level 3 requires an compatible multi-function display for map functions		
LEVEL 4	6X9-482A0-00-00 Joystick Assy for 2nd station	1	
	Level 4 requires an compatible multi-function display for map functions		
	*) For other display options, check the 'display' section in this guide		

KIT CONTENTS

Part Number	Description	Qty	Note
6X9-762B0-01-00	EKS Kit - Single 2nd St	1	
6X9-82570-B0-00	Start/Stop Switch	1	
6X9-82716-60-00	EKS harness	1	
6X9-82570-70-00	Lanyard switch	1	

HARNESS OPTIONS

Main bus wire	Length	Pigtail bus wire	Length	2nd helm harness Port	Length
6Y8-82553-01-00	0.3m (1 ft)	6Y8-82521-01-00	0.3m (1 ft)	6X9-8258A-00-00	5m (16 ft)
6Y8-82553-50-00	3m (10 ft)	6Y8-82521-11-00	0.6m (2 ft)	6X9-8258A-10-00	8m (26 ft)
6Y8-82553-11-00	4.6m (15 ft)	6Y8-82521-21-00	0.9m (3 ft)	6X9-8258A-20-00	12m (38 ft)
6Y8-82553-21-00	6.1m (20 ft)	6Y8-82521-31-00	1.8m (6 ft)		
6Y8-82553-31-00	7.6m (25 ft)	6Y8-82521-41-00	2.7m (9 ft)		
6Y8-82553-41-00	9.1m (30 ft)	6Y8-82521-51-00	3.6m (12 ft)		

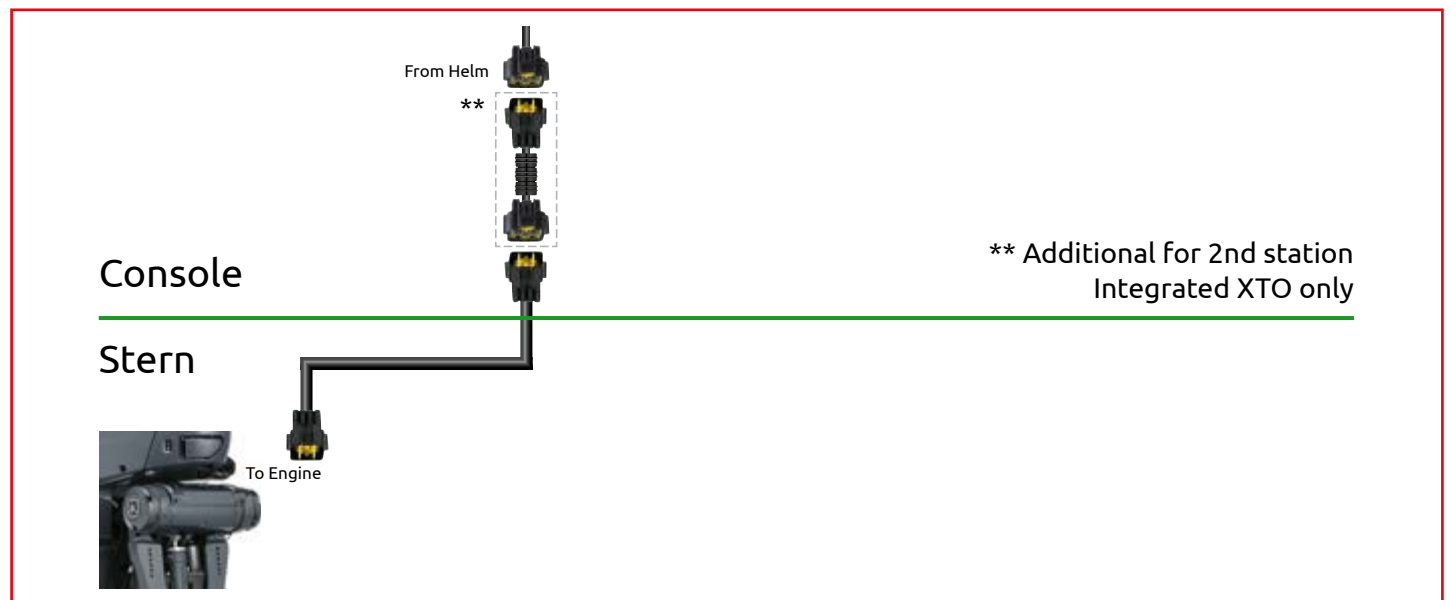

Rigging Order Guide

DBW REMOTE CONTROL (MAIN STATION)

TWIN LEVEL 1

TWIN ENGINE	6X9 DEC TM	CL5 DISPLAY	EKS SWITCH	DES STEERING	SINGLE STATION
-----------------------	----------------------	-----------------------	----------------------	------------------------	--------------------------

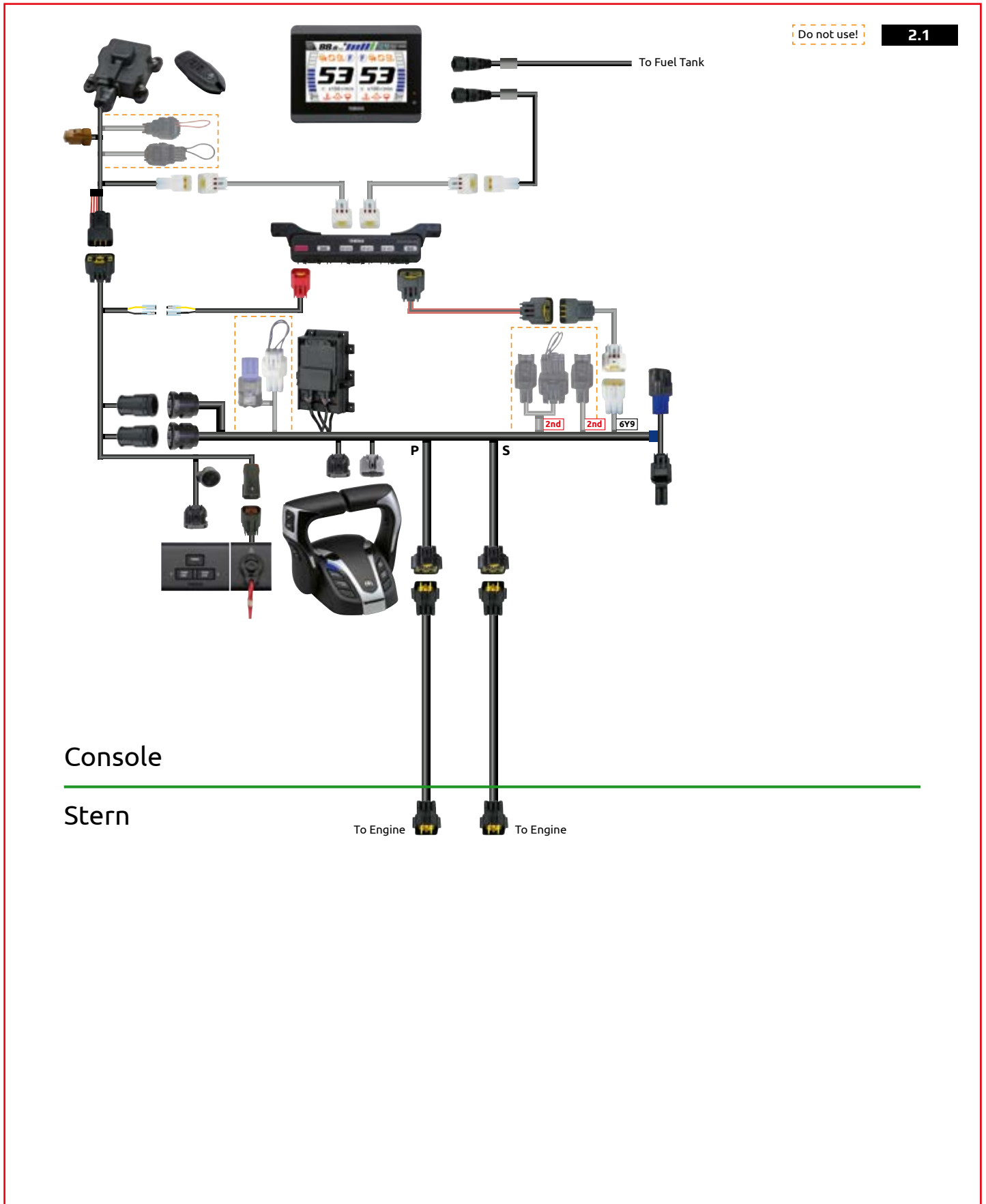

TWIN LEVEL 1 PARTS

	Description	Qty	Note
	6X9-48207-00-00	6X9 DEC Top mount - Twin	1
	6YM-762G0-00-00	CL5 Color Touch Gauge Kit - DEC*	1
LEVEL 1	6X9-762B0-11-00	EKS Kit - Twin	1
	6X6-8258A-20-00	Main harness 16P 8m / 26 ft	1 Other lengths available
	6X6-8258A-30-00	Main harness 16P 10m / 32 ft	1 Other lengths available

*) For other display options, check the 'display' section in this guide

KIT CONTENTS

6YM-762G0-00-00	CL5 Color Touch Gauge Kit - DEC	Qty	Note
6YM-83710-10-00	CL5 Display	1	
6YM-83553-00-00	Conversion Harness	1	0.9 m (3 ft)
6YD-8356N-00-00	Fuel Tank Wire	1	
6Y8-81920-01-00	Multihub	1	
6Y9-83553-00-00	Conversion harness	1	
6Y8-82553-01-00	Main bus wire	1	0.3m (1 ft), other lengths available
6Y8-82521-31-00	Pigtail bus wire	1	1.8m (6 ft), other lengths available
6Y8-83553-02-00	System power supply	1	
6Y8-82582-11-00	Terminal Cap White	2	

6X9-762B0-11-00	EKS Kit - Twin	Qty	Note
6X9-82570-10-00	Power Switch	1	
6X9-82716-31-00	EKS harness	1	
6X9-82570-80-00	Lanyard switch	1	
6X9-86254-00-00	Immobilizer + key fob (2pcs)	1	433Mhz
6Y8-82521-11-00	Pigtail bus wire	1	0.6m (2 ft)
6Y8-48277-00-00	Sticker	1	

HARNESS OPTIONS

Main harness 16P	Length	Main bus wire	Length	Pigtail bus wire	Length
6X6-8258A-90-00	1.5m (5 ft)	6Y8-82553-01-00	0.3m (1 ft)	6Y8-82521-01-00	0.3m (1 ft)
6X6-8258A-50-00	3.7m (12 ft)	6Y8-82553-50-00	3m (10 ft)	6Y8-82521-11-00	0.6m (2 ft)
6X6-8258A-60-00	5.2m (17 ft)	6Y8-82553-11-00	4.6m (15 ft)	6Y8-82521-21-00	0.9m (3 ft)
6X6-8258A-00-00	6m (19 ft)	6Y8-82553-21-00	6.1m (20 ft)	6Y8-82521-31-00	1.8m (6 ft)
6X6-8258A-10-00	7m (23 ft)	6Y8-82553-31-00	7.6m (25 ft)	6Y8-82521-41-00	2.7m (9 ft)
6X6-8258A-20-00	8m (26 ft)	6Y8-82553-41-00	9.1m (30 ft)	6Y8-82521-51-00	3.6m (12 ft)
6X6-8258A-30-00	10m (32 ft)				
6X6-8258A-40-00	12m (39 ft)				
6X6-8258A-70-00	15m (49 ft)				
6X6-8258A-80-00	24m (79 ft)				

Rigging Order Guide

DBW REMOTE CONTROL (MAIN STATION)

TWIN LEVEL 1 STANDARD

TWIN ENGINE	6X9 DEC TM	CL5 DISPLAY	STD SWITCH	DES STEERING	SINGLE STATION
-----------------------	----------------------	-----------------------	----------------------	------------------------	--------------------------

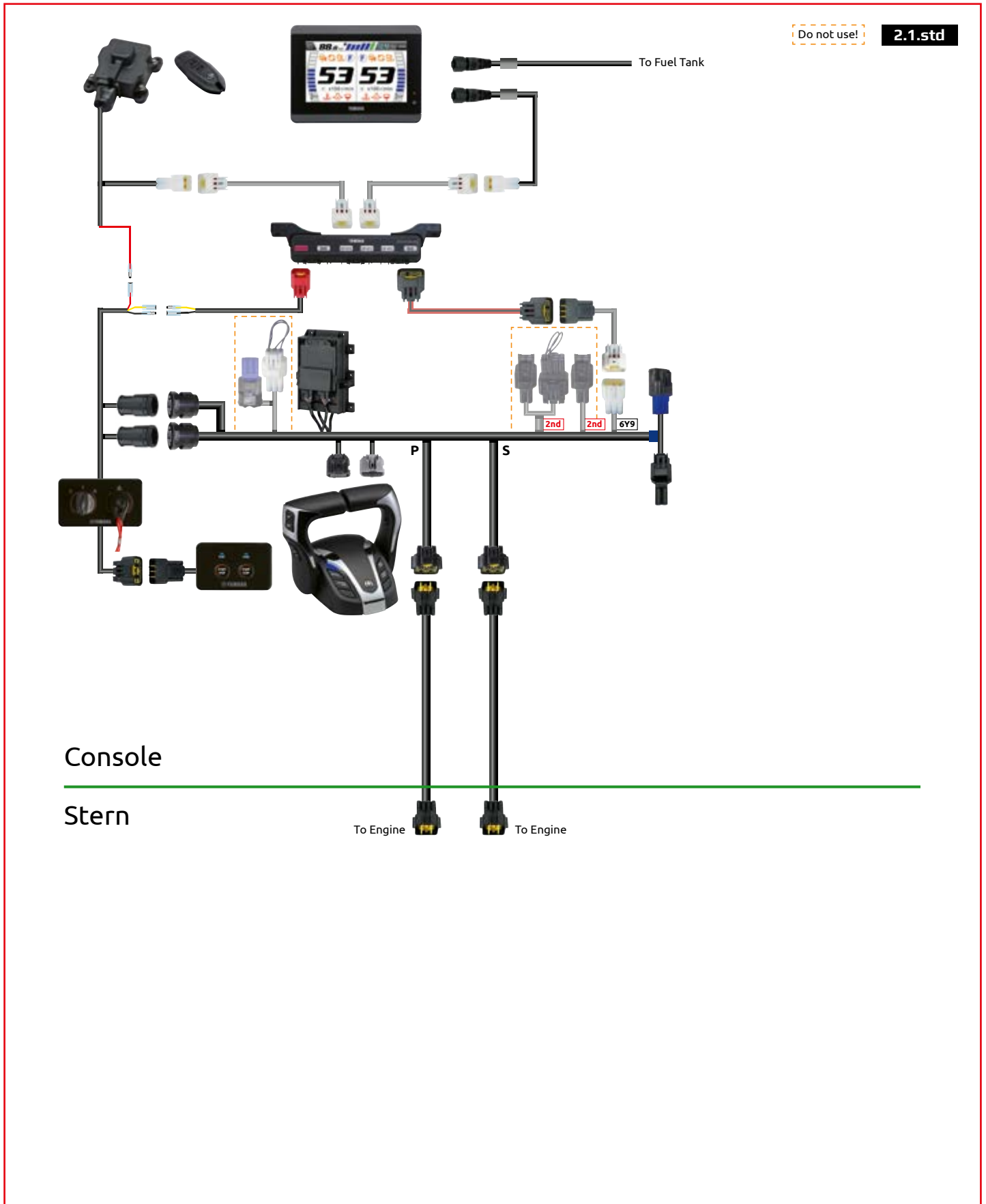

TWIN LEVEL 1 STANDARD PARTS

	Description	Qty	Note	
LEVEL 1	6X9-48207-00-00	6X9 DEC Top mount - Twin	1	
	6YM-762G0-00-00	CL5 Color Touch Gauge Kit - DEC*	1	
	6X9-762D0-00-00	Immobilizer Kit	1	
	6X6-762B0-00-00	Main Switch Kit	1	All start option 6X6-82570-D0-00
	6X6-8258A-20-00	Main harness 16P 8m / 26 ft	1	Other lengths available
	6X6-8258A-30-00	Main harness 16P 10m / 32 ft	1	Other lengths available

*) For other display options, check the 'display' section in this guide

KIT CONTENTS

6YM-762G0-00-00	CL5 Color Touch Gauge Kit - DEC	Qty	Note
6YM-83710-10-00	CL5 Display	1	
6YM-83553-00-00	Conversion Harness	1	0.9 m (3 ft)
6YD-8356N-00-00	Fuel Tank Wire	1	
6Y8-81920-01-00	Multihub	1	
6Y9-83553-00-00	Conversion harness	1	
6Y8-82553-01-00	Main bus wire	1	0.3m (1 ft), other lengths available
6Y8-82521-31-00	Pigtail bus wire	1	1.8m (6 ft), other lengths available
6Y8-83553-02-00	System power supply	1	
6Y8-82582-11-00	Terminal Cap White	2	
6X9-762D0-00-00	Immobilizer Kit	Qty	Note
6X9-86254-00-00	Immobilizer + key Fob (2pcs)	1	433Mhz
6Y8-82521-11-00	Pigtail bus wire	1	0.6m (2 ft)
6Y8-48277-00-00	Sticker	1	

HARNESS OPTIONS

Main harness 16P	Length	Mainbus	Length	Pigtail	Length
6X6-8258A-90-00	1.5m (5 ft)	6Y8-82553-01-00	0.3m (1 ft)	6Y8-82521-01-00	0.3m (1 ft)
6X6-8258A-50-00	3.7m (12 ft)	6Y8-82553-50-00	3m (10 ft)	6Y8-82521-11-00	0.6m (2 ft)
6X6-8258A-60-00	5.2m (17 ft)	6Y8-82553-11-00	4.6m (15 ft)	6Y8-82521-21-00	0.9m (3 ft)
6X6-8258A-00-00	6m (19 ft)	6Y8-82553-21-00	6.1m (20 ft)	6Y8-82521-31-00	1.8m (6 ft)
6X6-8258A-10-00	7m (23 ft)	6Y8-82553-31-00	7.6m (25 ft)	6Y8-82521-41-00	2.7m (9 ft)
6X6-8258A-20-00	8m (26 ft)	6Y8-82553-41-00	9.1m (30 ft)	6Y8-82521-51-00	3.6m (12 ft)
6X6-8258A-30-00	10m (32 ft)				
6X6-8258A-40-00	12m (39 ft)				
6X6-8258A-70-00	15m (49 ft)				
6X6-8258A-80-00	24m (79 ft)				

Rigging Order Guide

DBW REMOTE CONTROL (MAIN STATION)

TWIN LEVEL 2 BOLT-ON

TWIN ENGINE	6X9 DEC TM	CL5 DISPLAY	EKS SWITCH	DES BOLT-ON	SINGLE STATION
-----------------------	----------------------	-----------------------	----------------------	-----------------------	--------------------------

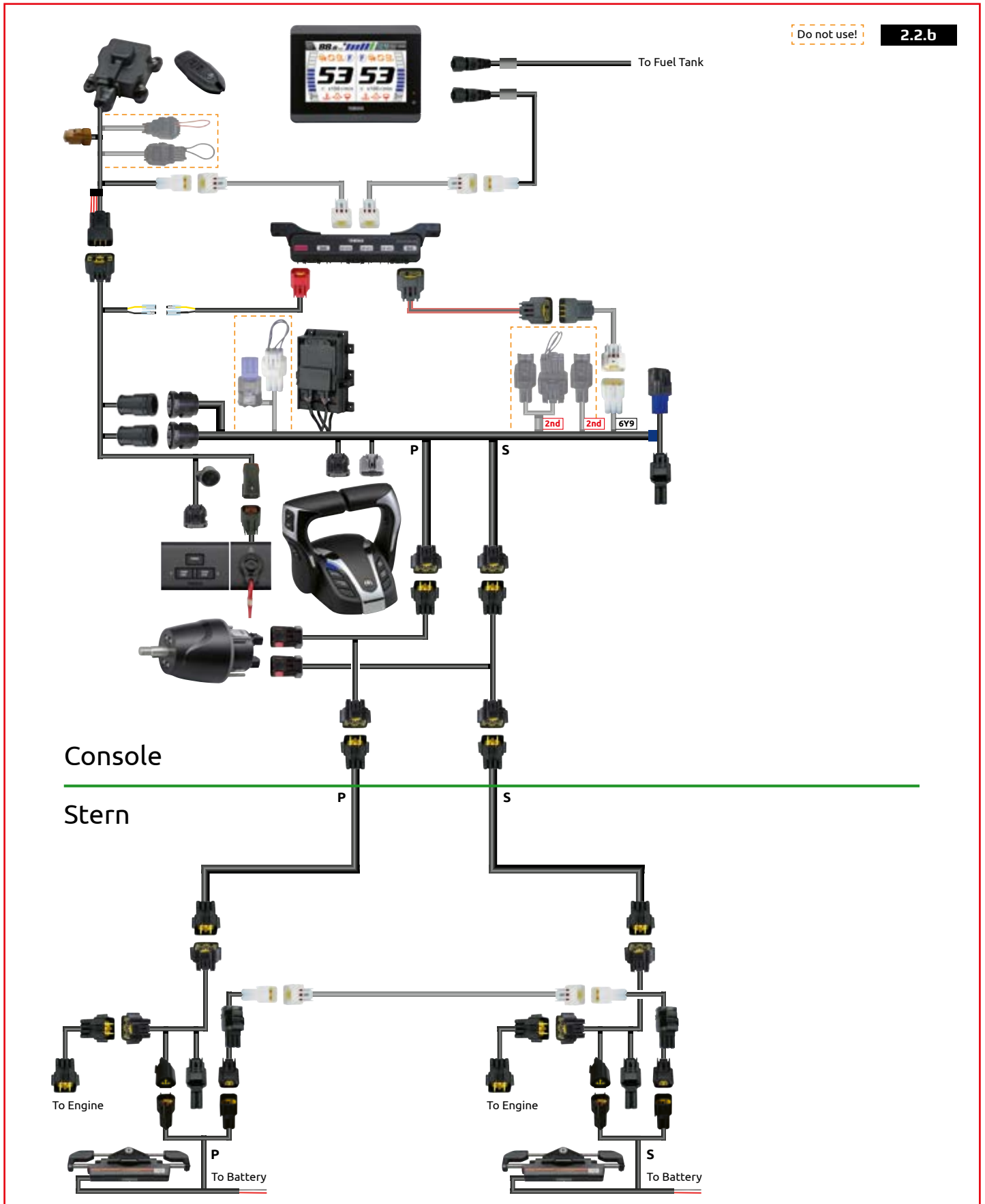

TWIN LEVEL 2 BOLT-ON PARTS

	Description	Qty	Note	
LEVEL 1	6X9-48207-00-00	6X9 DEC Top mount - Twin	1	
	6YM-762G0-00-00	CL5 Color Touch Gauge Kit - DEC*	1	
	6X9-762B0-11-00	EKS Kit - Twin	1	
	6X6-8258A-20-00	Main harness 16P 8m / 26 ft	1	Other lengths available
	6X6-8258A-30-00	Main harness 16P 10m / 32 ft	1	Other lengths available
LEVEL 2	6X9-762S0-00-00	Bolt-on DES KIT	2	
	6X9-438A0-00-00	Steering actuator harness 2.4m / 8 ft	2	Other lengths available
	6X6-8258A-50-00	Main harness 16P 3.7m / 12 ft	2	Other lengths available
	6X9-615A0-00-00	Compact Helm unit	1	Tilt type available (Kit: 6GR-762H0-00-00)
	6Y8-82521-11-00	Pigtail bus wire 0.6m / 2 ft	1	Other lengths available
	6GR-81115-00-00	SCU link harness (Port/Stbd) 1.5m (5 ft)	2	Other lengths available
	6GR-8258A-10-00	Helm harness Main St Twin/Triple/Quad 0.9m / 3 ft	2	Other lengths available

*) For other display options, check the 'display' section in this guide

KIT CONTENTS

6YM-762G0-00-00	CL5 Color Touch Gauge Kit - DEC	Qty	Note
6YM-83710-10-00	CL5 Display	1	
6YM-83553-00-00	Conversion Harness	1	0.9 m (3 ft)
6YD-8356N-00-00	Fuel Tank Wire	1	
6Y8-81920-01-00	Multihub	1	
6Y9-83553-00-00	Conversion harness	1	
6Y8-82553-01-00	Main bus wire	1	0.3m (1 ft), other lengths available
6Y8-82521-31-00	Pigtail bus wire	1	1.8m (6 ft), other lengths available
6Y8-83553-02-00	System power supply	1	
6Y8-82582-11-00	Terminal Cap White	2	
6X9-762B0-11-00	EKS Kit - Twin	Qty	Note
6X9-82570-10-00	Power Switch	1	
6X9-82716-31-00	EKS harness	1	
6X9-82570-80-00	Lanyard switch	1	
6X9-86254-00-00	Immobilizer + key fob (2pcs)	1	433Mhz
6Y8-82521-11-00	Pigtail bus wire	1	0.6m (2 ft)
6Y8-48277-00-00	Sticker	1	
6X9-762S0-00-00	Bolt-on DES KIT	Qty	Note
6X9-42401-00-00	Actuator	1	
6X9-8258A-90-00	Split Harness	1	

HARNESS OPTIONS

Main harness 16P	Length	Main bus wire	Length	Pigtail bus wire	Length
6X6-8258A-90-00	1.5m (5 ft)	6Y8-82553-01-00	0.3m (1 ft)	6Y8-82521-01-00	0.3m (1 ft)
6X6-8258A-50-00	3.7m (12 ft)	6Y8-82553-50-00	3m (10 ft)	6Y8-82521-11-00	0.6m (2 ft)
6X6-8258A-60-00	5.2m (17 ft)	6Y8-82553-11-00	4.6m (15 ft)	6Y8-82521-21-00	0.9m (3 ft)
6X6-8258A-00-00	6m (19 ft)	6Y8-82553-21-00	6.1m (20 ft)	6Y8-82521-31-00	1.8m (6 ft)
6X6-8258A-10-00	7m (23 ft)	6Y8-82553-31-00	7.6m (25 ft)	6Y8-82521-41-00	2.7m (9 ft)
6X6-8258A-20-00	8m (26 ft)	6Y8-82553-41-00	9.1m (30 ft)	6Y8-82521-51-00	3.6m (12 ft)
6X6-8258A-30-00	10m (32 ft)				
6X6-8258A-40-00	12m (39 ft)	Steering Actuator Harness	Length	Helm Harness	Length
6X6-8258A-70-00	15m (49 ft)	6X9-438A0-00-00	2.4m (8 ft)	6GR-8258A-10-00	0.9m (3 ft)
6X6-8258A-80-00	24m (79 ft)	6X9-438A0-10-00	4.5m (15 ft)	6GR-8258A-50-00	1.8m (6 ft)
				6GR-8258A-60-00	2.7m (9 ft)
SCU Link harness P/S	Length				
6X9-81115-00-00	0.3m (1 ft)				
6GR-81115-00-00	1.5m (5 ft)				
6GR-81115-10-00	3.0m (10 ft)				

Rigging Order Guide

DBW REMOTE CONTROL (MAIN STATION)

TWIN LEVEL 2 INTEGRATED

TWIN ENGINE	6X9 DEC TM	CL5 DISPLAY	EKS SWITCH	DES INTEGRATED	SINGLE STATION
-----------------------	----------------------	-----------------------	----------------------	--------------------------	--------------------------

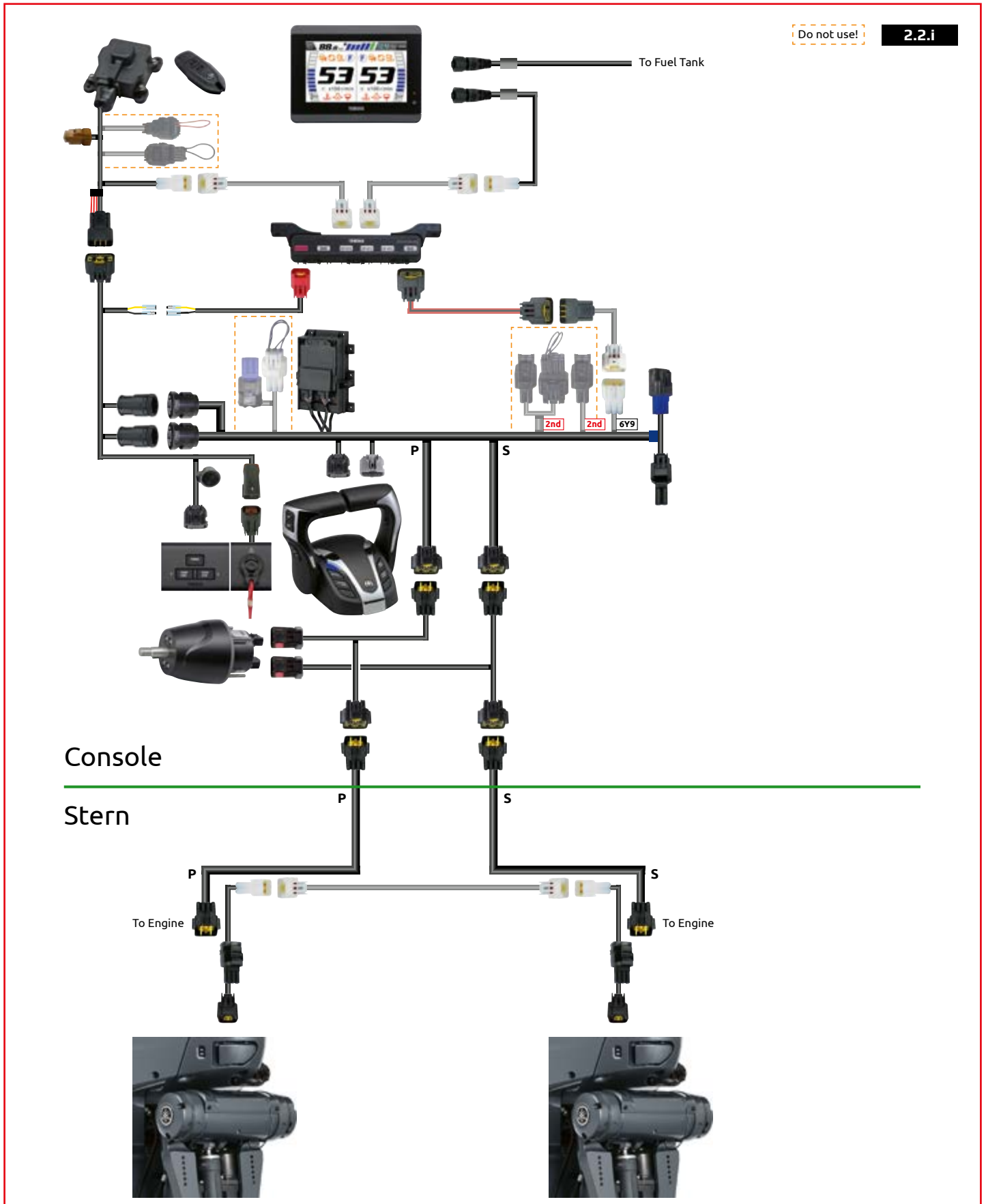

TWIN LEVEL 2 INTEGRATED PARTS

	Description	Qty	Note	
LEVEL 1	6X9-48207-00-00	6X9 DEC Top mount - Twin	1	
	6YM-762G0-00-00	CL5 Color Touch Gauge Kit - DEC*	1	
	6X9-762B0-11-00	EKS Kit - Twin	1	
	6X6-8258A-20-00	Main harness 16P 8m / 26 ft	1	Other lengths available
	6X6-8258A-30-00	Main harness 16P 10m / 32 ft	1	Other lengths available
LEVEL 2	6X9-615A0-00-00	Compact Helm unit	1	Tilt type available (Kit: 6GR-762H0-00-00)
	6GR-81115-00-00	SCU link harness (Port/ Stbd) 1.5m (5 ft)	2	Other lengths available
	6Y8-82521-11-00	Pigtail bus wire 0.6m / 2 ft	1	Other lengths available
	6GR-8258A-10-00	Helm harness Main St Twin/Triple/Quad 0.9m / 3 ft	2	Other lengths available

*) For other display options, check the 'display' section in this guide

KIT CONTENTS

Part Number	Description	Qty	Note
6YM-762G0-00-00	CL5 Color Touch Gauge Kit - DEC	1	
6YM-83710-10-00	CL5 Display	1	
6YM-83553-00-00	Conversion Harness	1	0.9 m (3 ft)
6YD-8356N-00-00	Fuel Tank Wire	1	
6Y8-81920-01-00	Multihub	1	
6Y9-83553-00-00	Conversion harness	1	
6Y8-82553-01-00	Main bus wire	1	0.3m (1 ft), other lengths available
6Y8-82521-31-00	Pigtail bus wire	1	1.8m (6 ft), other lengths available
6Y8-83553-02-00	System power supply	1	
6Y8-82582-11-00	Terminal Cap White	2	
6X9-762B0-11-00	EKS Kit - Twin	1	
6X9-82570-10-00	Power Switch	1	
6X9-82716-31-00	EKS harness	1	
6X9-82570-80-00	Lanyard switch	1	
6X9-86254-00-00	Immobilizer + key fob (2pcs)	1	433Mhz
6Y8-82521-11-00	Pigtail bus wire	1	0.6m (2 ft)
6Y8-48277-00-00	Sticker	1	

HARNESS OPTIONS

Main harness 16P	Length	Main bus wire	Length	Pigtail bus wire	Length
6X6-8258A-90-00	1.5m (5 ft)	6Y8-82553-01-00	0.3m (1 ft)	6Y8-82521-01-00	0.3m (1 ft)
6X6-8258A-50-00	3.7m (12 ft)	6Y8-82553-50-00	3m (10 ft)	6Y8-82521-11-00	0.6m (2 ft)
6X6-8258A-60-00	5.2m (17 ft)	6Y8-82553-11-00	4.6m (15 ft)	6Y8-82521-21-00	0.9m (3 ft)
6X6-8258A-00-00	6m (19 ft)	6Y8-82553-21-00	6.1m (20 ft)	6Y8-82521-31-00	1.8m (6 ft)
6X6-8258A-10-00	7m (23 ft)	6Y8-82553-31-00	7.6m (25 ft)	6Y8-82521-41-00	2.7m (9 ft)
6X6-8258A-20-00	8m (26 ft)	6Y8-82553-41-00	9.1m (30 ft)	6Y8-82521-51-00	3.6m (12 ft)
6X6-8258A-30-00	10m (32 ft)				
6X6-8258A-40-00	12m (39 ft)	Helm Harness	Length	SCU Link harness P/S	Length
6X6-8258A-70-00	15m (49 ft)	6GR-8258A-10-00	0.9m (3 ft)	6X9-81115-00-00	0.3m (1 ft)
6X6-8258A-80-00	24m (79 ft)	6GR-8258A-50-00	1.8m (6 ft)	6GR-81115-00-00	1.5m (5 ft)
		6GR-8258A-60-00	2.7m (9 ft)	6GR-81115-10-00	3.0m (10 ft)

Rigging Order Guide

DBW REMOTE CONTROL (MAIN STATION)

TWIN LEVEL 3-4 BOLT-ON

TWIN ENGINE	6X9 DEC TM	CL5 DISPLAY	EKS SWITCH	DES BOLT-ON	SINGLE STATION	HM-EX JOYSTICK / AP
-----------------------	----------------------	-----------------------	----------------------	-----------------------	--------------------------	-------------------------------

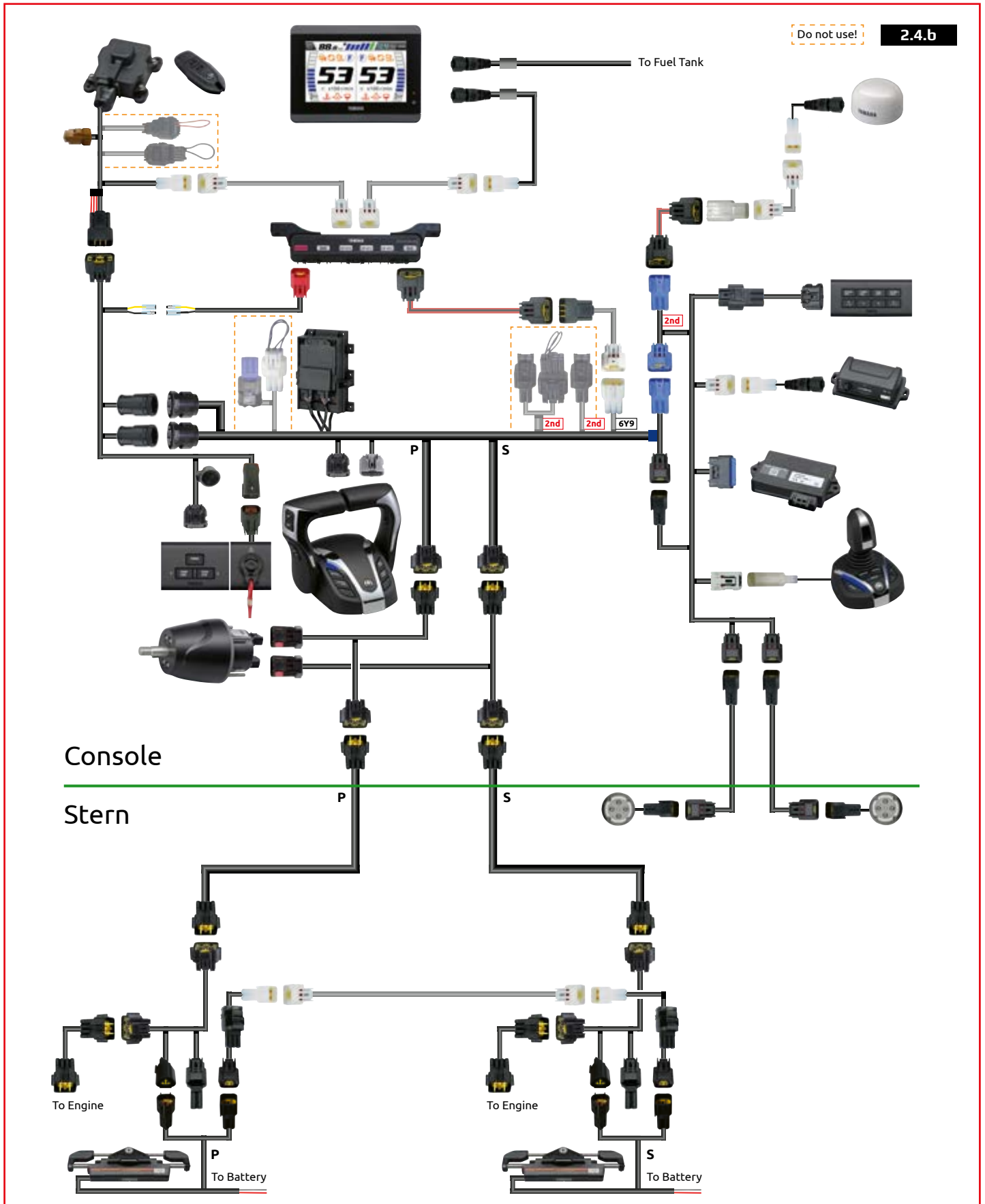

TWIN LEVEL 3-4 BOLT-ON PARTS

	Description	Qty	Note	
LEVEL 1	6X9-48207-00-00	6X9 DEC Top mount - Twin	1	
	6YM-762G0-00-00	CL5 Color Touch Gauge Kit - DEC*	1	
	6X9-762B0-11-00	EKS Kit - Twin	1	
	6X6-8258A-20-00	Main harness 16P 26ft / 8m	1	Other lengths available
	6X6-8258A-30-00	Main harness 16P 32ft / 10m	1	Other lengths available
LEVEL 2	6X9-76250-00-00	Bolt-on DES KIT	2	
	6X9-438A0-00-00	Steering actuator harness 2.4m / 8 ft	2	Other lengths available
	6X6-8258A-50-00	Main harness 16P 3.7m / 12 ft	2	Other lengths available
	6X9-615A0-00-00	Compact Helm unit	1	Tilt type available (Kit: 6GR-762H0-00-00)
	6Y8-82521-11-00	Pigtail bus wire 0.6m / 2 ft	1	Other lengths available
	6GR-81115-00-00	SCU link harness (Port/Stbd) 1.5m (5 ft)	2	Other lengths available
LEVEL 3	6GR-8258A-10-00	Helm harness Main St Twin/Triple/Quad 0.9m / 3 ft	2	Other lengths available
	**	Auto Pilot Kit Twin	1	
	6Y8-82553-50-00	Main bus wire 3m / 10 ft	1	Other lengths available
	6Y8-82521-01-00	Pigtail bus wire 0.3m / 1 ft	1	Other lengths available
Level 3 requires an compatible multi-function display for map functions				
LEVEL 4	**	Joystick/AP Kit - Twin	1	Upgrade from level 3 **
	6Y8-82553-50-00	Main bus wire 3m / 10 ft	1	Other lengths available
	6Y8-82521-01-00	Pigtail bus wire 0.3m / 1 ft	1	Other lengths available
	Level 4 requires an compatible multi-function display for map functions			

*) For other display options, check the 'display' section in this guide | **) Order at the local distributor sales department

KIT CONTENTS

6YM-762G0-00-00	CL5 Color Touch Gauge Kit - DEC	Qty	Note
6YM-83710-10-00	CL5 Display	1	
6YM-83553-00-00	Conversion Harness	1	0.9 m (3 ft)
6YD-8356N-00-00	Fuel Tank Wire	1	
6Y8-81920-01-00	Multihub	1	
6Y9-83553-00-00	Conversion harness	1	
6Y8-82553-01-00	Main bus wire	1	0.3m (1 ft), other lengths available
6Y8-82521-31-00	Pigtail bus wire	1	1.8m (6 ft), other lengths available
6Y8-83553-02-00	System power supply	1	
6Y8-82582-11-00	Terminal Cap White	2	

6X9-762B0-11-00	EKS Kit - Twin	Qty	Note	**	Joystick/AP Kit - Twin	Qty	Note
6X9-82570-10-00	Power Switch	1		6X9-8253V-00-00	Autopilot panel	1	
6X9-82716-31-00	EKS harness	1		6X9-88107-00-00	GPS antenna	1	
6X9-82570-80-00	Lanyard switch	1		6X9-8A410-00-00	Heading sensor	1	
6X9-86254-00-00	Immobilizer + key fob (2pcs)	1	433Mhz	6X9-8591T-xx-00	Boat Control Unit***	1	
6Y8-82521-11-00	Pigtail bus wire	1	0.6m (2 ft)	6Y8-81920-11-00	Single hub	1	
6Y8-48277-00-00	Sticker	1		6X9-82386-01-00	BCU Harness	1	
6X9-76250-00-00	Bolt-on DES KIT	Qty	Note	6YM-83553-00-00	Conversion harness	2	
6X9-42401-00-00	Actuator	1		6X9-482A0-00-00	Joystick Assy	1	level 4 only
6X9-8258A-90-00	Split Harness	1		6ES-83720-01-00	Prop lights	2	level 4 only

***) Order at the local distributor sales department

**) Depends on Level 3 (6X9-8591T-11-00) or 4 (6X9-85917-21-00)

HARNESS OPTIONS

Main harness 16P	Length	Main bus wire	Length	Pigtail bus wire	Length
6X6-8258A-90-00	1.5m (5 ft)	6Y8-82553-01-00	0.3m (1 ft)	6Y8-82521-01-00	0.3m (1 ft)
6X6-8258A-50-00	3.7m (12 ft)	6Y8-82553-50-00	3m (10 ft)	6Y8-82521-11-00	0.6m (2 ft)
6X6-8258A-60-00	5.2m (17 ft)	6Y8-82553-11-00	4.6m (15 ft)	6Y8-82521-21-00	0.9m (3 ft)
6X6-8258A-00-00	6m (19 ft)	6Y8-82553-21-00	6.1m (20 ft)	6Y8-82521-31-00	1.8m (6 ft)
6X6-8258A-10-00	7m (23 ft)	6Y8-82553-31-00	7.6m (25 ft)	6Y8-82521-41-00	2.7m (9 ft)
6X6-8258A-20-00	8m (26 ft)	6Y8-82553-41-00	9.1m (30 ft)	6Y8-82521-51-00	3.6m (12 ft)
6X6-8258A-30-00	10m (32 ft)				
6X6-8258A-40-00	12m (39 ft)	Steering Actuator Harness	Length	Helm Harness	Length
6X6-8258A-70-00	15m (49 ft)	6X9-438A0-00-00	2.4m (8 ft)	6GR-8258A-10-00	0.9m (3 ft)
6X6-8258A-80-00	24m (79 ft)	6X9-438A0-10-00	4.5m (15 ft)	6GR-8258A-50-00	1.8m (6 ft)
				6GR-8258A-60-00	2.7m (9 ft)
SCU Link harness P/S	Length	Extension for Prop lights	Length		
6X9-81115-00-00	0.3m (1 ft)	6X9-82586-20-00	6m (19 ft)		
6GR-81115-00-00	1.5m (5 ft)	6X9-82586-30-00	9.1m (30 ft)		
6GR-81115-10-00	3.0m (10 ft)	6X9-82586-40-00	12.2m (40 ft)		

Rigging Order Guide

DBW REMOTE CONTROL (MAIN STATION)

TWIN LEVEL 3-4 INTEGRATED

TWIN ENGINE	6X9 DEC TM	CL5 DISPLAY	EKS SWITCH	DES INTEGRATED	SINGLE STATION	HM-EX JOYSTICK / AP
-----------------------	----------------------	-----------------------	----------------------	--------------------------	--------------------------	-------------------------------

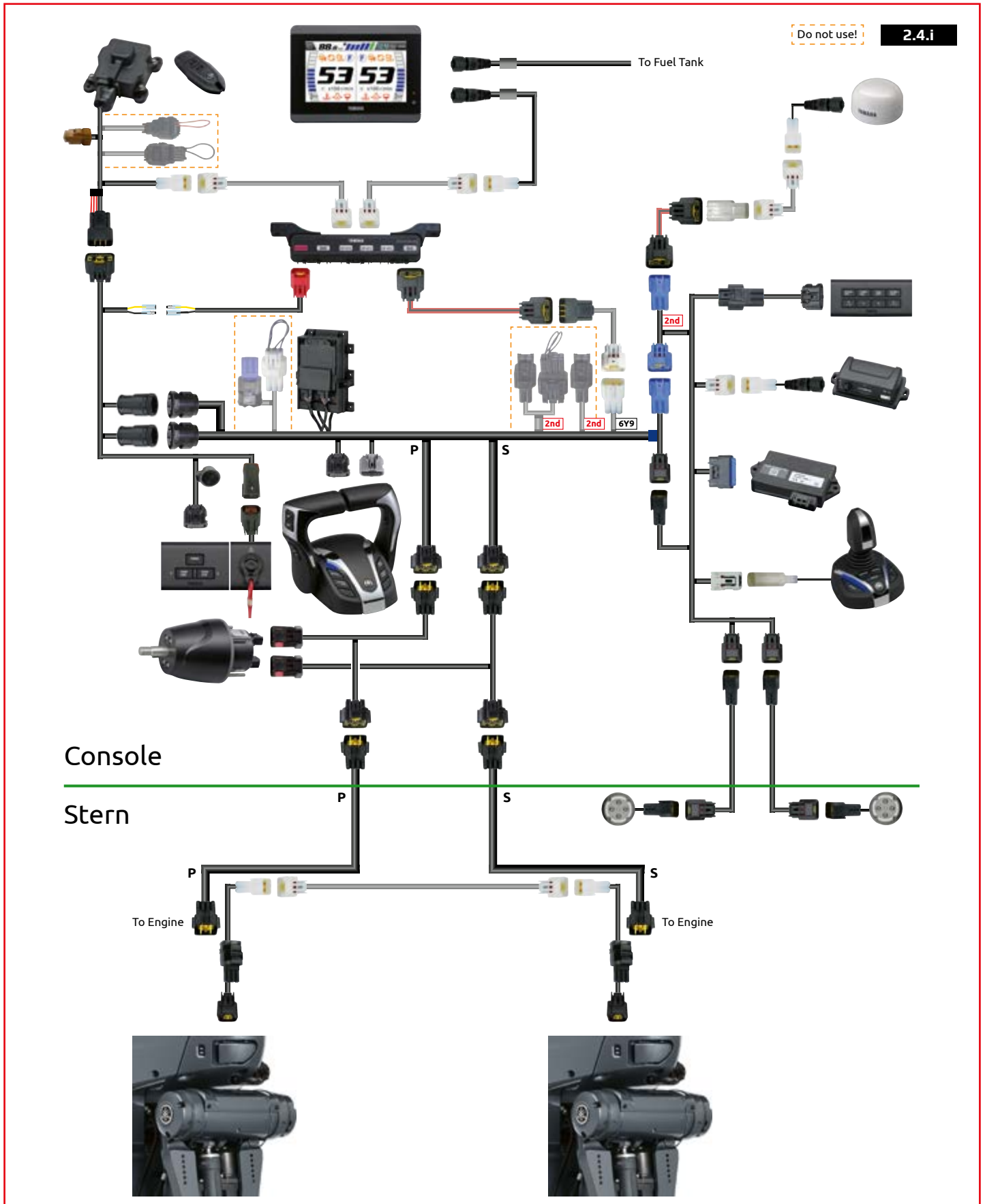

TWIN LEVEL 3-4 INTEGRATED PARTS

	Description	Qty	Note	
LEVEL 1	6X9-48207-00-00	6X9 DEC Top mount - Twin	1	
	6YM-762G0-00-00	CL5 Color Touch Gauge Kit - DEC*	1	
	6X9-762B0-11-00	EKS Kit - Twin	1	
	6X6-8258A-20-00	Main harness 16P 26ft / 8m	1	Other lengths available
	6X6-8258A-30-00	Main harness 16P 32ft / 10m	1	Other lengths available
LEVEL 2	6X9-615A0-00-00	Compact Helm unit	1	Tilt type available (Kit: 6GR-762H0-00-00)
	6GR-81115-00-00	SCU link harness (Port/ Stbd) 1.5m (5 ft)	2	Other lengths available
	6Y8-82521-11-00	Pigtail bus wire 0.6m / 2 ft	1	Other lengths available
	6GR-8258A-10-00	Helm harness Main St Twin/Triple/Quad 0.9m / 3 ft	2	Other lengths available
LEVEL 3	**	Auto Pilot Kit Twin	1	
	6Y8-82553-50-00	Main bus wire 3m / 10 ft	1	Other lengths available
	6Y8-82521-01-00	Pigtail bus wire 0.3m / 1 ft	1	Other lengths available
	Level 3 requires an compatible multi-function display for map functions			
LEVEL 4	**	Joystick/AP Kit - Twin	1	Upgrade from level 3 **
	6Y8-82553-50-00	Main bus wire 3m / 10 ft	1	Other lengths available
	6Y8-82521-01-00	Pigtail bus wire 0.3m / 1 ft	1	Other lengths available
	Level 4 requires an compatible multi-function display for map functions			

*) For other display options, check the 'display' section in this guide | **) Order at the local distributor sales department

KIT CONTENTS

Part Number	Description	Qty	Note
6YM-762G0-00-00	CL5 Color Touch Gauge Kit - DEC		
6YM-83710-10-00	CL5 Display	1	
6YM-83553-00-00	Conversion Harness	1	0.9 m (3 ft)
6YD-8356N-00-00	Fuel Tank Wire	1	
6Y8-81920-01-00	Multihub	1	
6Y9-83553-00-00	Conversion harness	1	
6Y8-82553-01-00	Main bus wire	1	0.3m (1 ft), other lengths available
6Y8-82521-31-00	Pigtail bus wire	1	1.8m (6 ft), other lengths available
6Y8-83553-02-00	System power supply	1	
6Y8-82582-11-00	Terminal Cap White	2	

Part Number	Description	Qty	Note	Order at Sales**	Description	Qty	Note
6X9-762B0-11-00	EKS Kit - Twin				Joystick/AP Kit - Twin		
6X9-82570-10-00	Power Switch	1		6X9-8253V-00-00	Autopilot panel	1	
6X9-82716-31-00	EKS harness	1		6X9-88107-00-00	GPS antenna	1	
6X9-82570-80-00	Lanyard switch	1		6X9-8A410-00-00	Heading sensor	1	
6X9-86254-00-00	Immobilizer + key Fob (2pcs)	1	433Mhz	6X9-8591T-xx-00	Boat Control Unit***	1	
6Y8-82521-11-00	Pigtail bus wire	1	0.6m (2 ft)	6Y8-81920-11-00	Single hub	1	
6Y8-48277-00-00	Sticker	1		6X9-82386-01-00	BCU Harness	1	
				6YM-83553-00-00	Conversion harness	2	
				6X9-482A0-00-00	Joystick Assy	1	level 4 only
				6E5-83720-01-00	Prop lights	2	level 4 only

***) Order at the local distributor sales department

**) Depends on Level 3 (6X9-8591T-11-00) or 4 (6X9-85917-21-00)

HARNESS OPTIONS

Main harness 16P	Length	Main bus wire	Length	Pigtail bus wire	Length
6X6-8258A-90-00	1.5m (5 ft)	6Y8-82553-01-00	0.3m (1 ft)	6Y8-82521-01-00	0.3m (1 ft)
6X6-8258A-50-00	3.7m (12 ft)	6Y8-82553-50-00	3m (10 ft)	6Y8-82521-11-00	0.6m (2 ft)
6X6-8258A-60-00	5.2m (17 ft)	6Y8-82553-11-00	4.6m (15 ft)	6Y8-82521-21-00	0.9m (3 ft)
6X6-8258A-00-00	6m (19 ft)	6Y8-82553-21-00	6.1m (20 ft)	6Y8-82521-31-00	1.8m (6 ft)
6X6-8258A-10-00	7m (23 ft)	6Y8-82553-31-00	7.6m (25 ft)	6Y8-82521-41-00	2.7m (9 ft)
6X6-8258A-20-00	8m (26 ft)	6Y8-82553-41-00	9.1m (30 ft)	6Y8-82521-51-00	3.6m (12 ft)
6X6-8258A-30-00	10m (32 ft)				
6X6-8258A-40-00	12m (39 ft)	Helm Harness	Length	SCU Link harness P/S	Length
6X6-8258A-70-00	15m (49 ft)	6GR-8258A-10-00	0.9m (3 ft)	6X9-81115-00-00	0.3m (1 ft)
6X6-8258A-80-00	24m (79 ft)	6GR-8258A-50-00	1.8m (6 ft)	6GR-81115-00-00	1.5m (5 ft)
		6GR-8258A-60-00	2.7m (9 ft)	6GR-81115-10-00	3.0m (10 ft)
Extension for Prop lights	Length				
6X9-82586-20-00	6m (19 ft)				
6X9-82586-30-00	9.1m (30 ft)				
6X9-82586-40-00	12.2m (40 ft)				

Rigging Order Guide

DBW REMOTE CONTROL (2ND STATION)

TWIN 2ND STATION LEVEL 1

TWIN ENGINE	6X9 DEC TM	CL5 DISPLAY	EKS SWITCH	DES STEERING	DUAL STATION
-----------------------	----------------------	-----------------------	----------------------	------------------------	------------------------

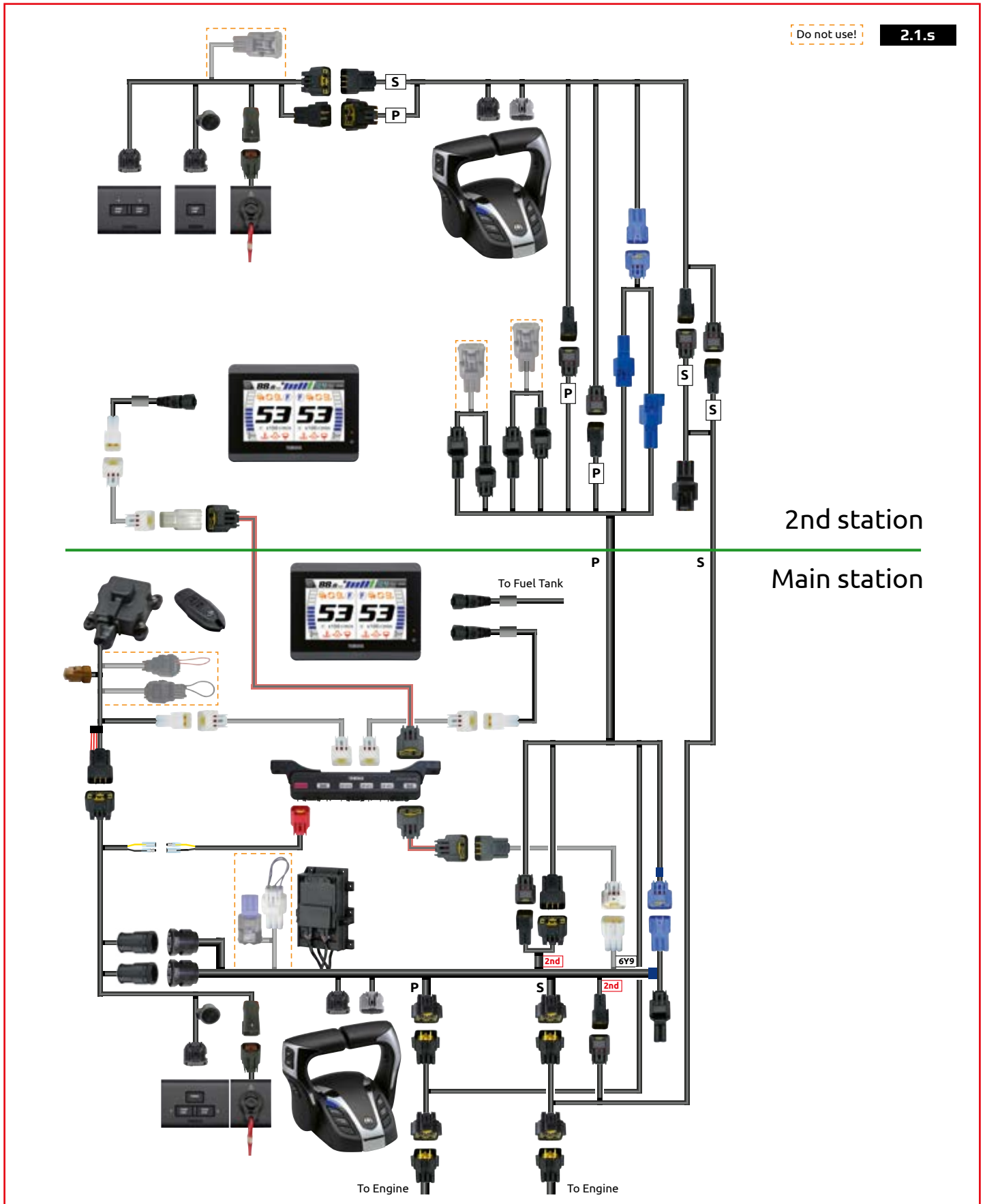

TWIN 2ND STATION LEVEL 1 PARTS

	Description	Qty	Note
	6X9-48207-10-00 6X9 DEC Top mount - twin/tr/Quad	1	2nd station
	6YM-83710-10-00 CL5 Color Touch Gauge*	1	Display only
	6YM-83553-00-00 Conversion Harness for CL5	1	
	6Y8-81920-11-00 Single hub	1	
LEVEL 1	6Y8-82521-11-00 Pigtail bus wire 0.6m / 2 ft	1	Other lengths available
	6Y8-82553-11-00 Main bus wire 4.6m / 15 ft	1	Other lengths available
	6X9-762B0-90-00 EKS Kit - Twin 2nd St	1	
	6X9-8258A-00-00 2nd station harness Port 5m / 16 ft	1	Other lengths available
	6X9-8258A-30-00 2nd station harness Stbd 5m / 16 ft	1	Other lengths available

*) For other display options, check the 'display' section in this guide

KIT CONTENTS

Part Number	Description	Qty	Note
6X9-762B0-90-00	EKS Kit - Twin 2nd St		
6X9-82570-B0-00	All Start/Stop Switch	1	
6X9-82570-30-00	Start/Stop Switch	1	
6X9-82716-70-00	EKS harness	1	
6X9-82570-80-00	Lanyard switch	1	

HARNESS OPTIONS

Main bus wire	Length	Pigtail bus wire	Length	2nd helm harness Port	Length
6Y8-82553-01-00	0.3m (1 ft)	6Y8-82521-01-00	0.3m (1 ft)	6X9-8258A-00-00	5m (16 ft)
6Y8-82553-50-00	3m (10 ft)	6Y8-82521-11-00	0.6m (2 ft)	6X9-8258A-10-00	8m (26 ft)
6Y8-82553-11-00	4.6m (15 ft)	6Y8-82521-21-00	0.9m (3 ft)	6X9-8258A-20-00	12m (38 ft)
6Y8-82553-21-00	6.1m (20 ft)	6Y8-82521-31-00	1.8m (6 ft)		
6Y8-82553-31-00	7.6m (25 ft)	6Y8-82521-41-00	2.7m (9 ft)	2nd helm harness Stbd	Length
6Y8-82553-41-00	9.1m (30 ft)	6Y8-82521-51-00	3.6m (12 ft)	6X9-8258A-30-00	5m (16 ft)
				6X9-8258A-40-00	8m (26 ft)
				6X9-8258A-50-00	12m (38 ft)

Rigging Order Guide

DBW REMOTE CONTROL (2ND STATION)

TWIN 2ND STATION LEVEL 2

TWIN ENGINE	6X9 DEC TM	CL5 DISPLAY	EKS SWITCH	DES STEERING	DUAL STATION
-----------------------	----------------------	-----------------------	----------------------	------------------------	------------------------

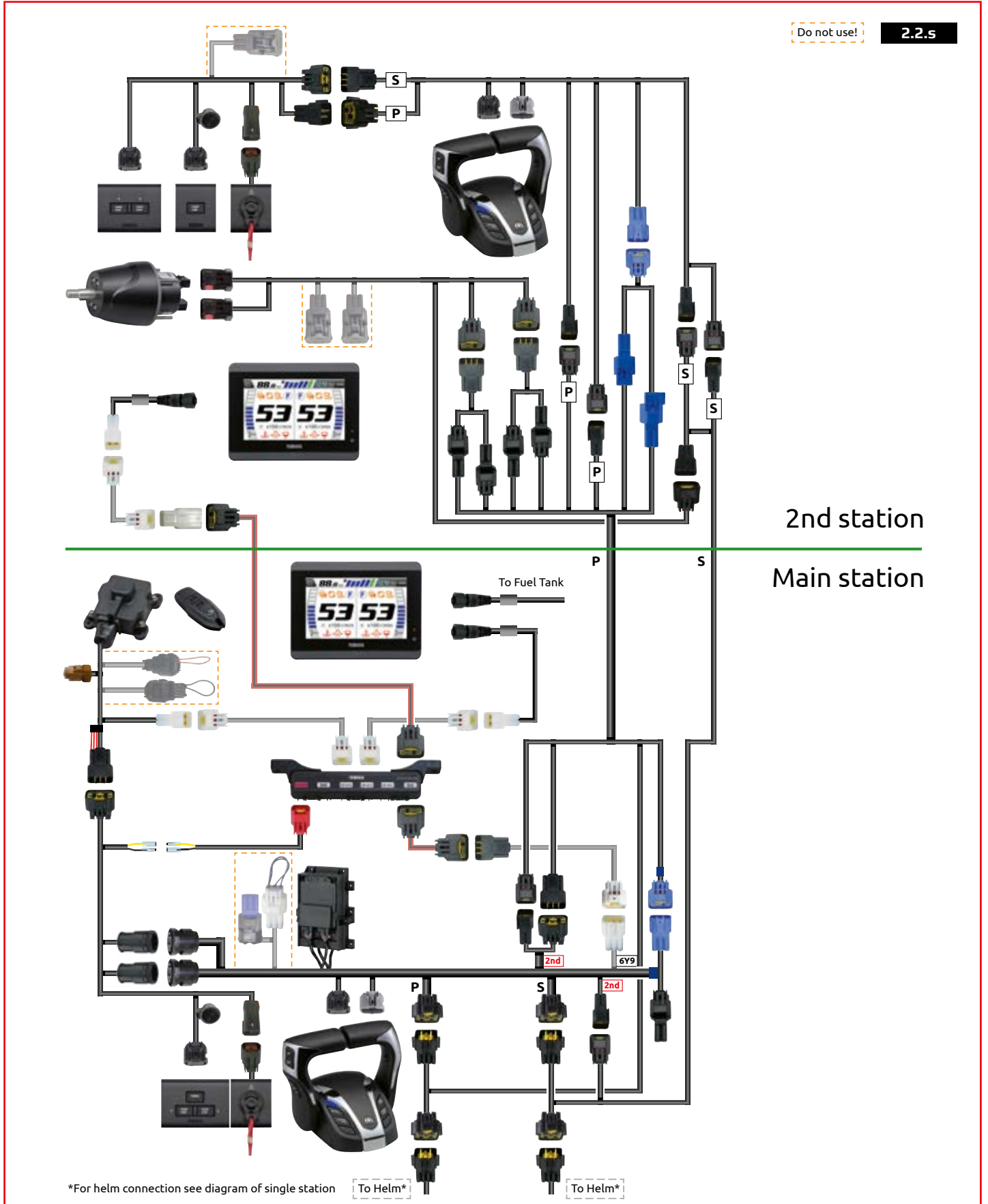

TWIN 2ND STATION LEVEL 2 PARTS

	Description	Qty	Note
	6X9-48207-10-00 6X9 DEC Top mount - twin/tr/Quad	1	2nd station
	6YM-83710-10-00 CL5 Color Touch Gauge*	1	Display only
	6YM-83553-00-00 Conversion Harness for CL5	1	
	6Y8-81920-11-00 Single hub	1	
LEVEL 1	6Y8-82521-11-00 Pigtail bus wire 0.6m / 2 ft	1	Other lengths available
	6Y8-82553-11-00 Main bus wire 4.6m / 15 ft	1	Other lengths available
	6X9-762B0-90-00 EKS Kit - Twin 2nd St	1	
	6X9-8258A-00-00 2nd station harness Port 5m / 16 ft	1	Other lengths available
	6X9-8258A-30-00 2nd station harness Stbd 5m / 16 ft	1	Other lengths available
	6GR-8258A-V0-00 Extension Harness**	2	Only For Integrated Steering
LEVEL 2	6X9-615A0-00-00 Compact Helm unit	1	Tilt type available (Kit: 6GR-762H0-00-00)
	6X9-8258A-B0-00 Helm harness 2nd St Twin 0.9m / 3 ft	1	

*) For other display options, check the 'display' section in this guide

KIT CONTENTS

Part Number	Description	Qty	Note
6X9-762B0-90-00	EKS Kit - Twin 2nd St		
6X9-82570-B0-00	All Start/Stop Switch	1	
6X9-82570-30-00	Start/Stop Switch	1	
6X9-82716-70-00	EKS harness	1	
6X9-82570-80-00	Lanyard switch	1	

HARNESS OPTIONS

Main bus wire	Length	Pigtail bus wire	Length	2nd helm harness Port	Length
6Y8-82553-01-00	0.3m (1 ft)	6Y8-82521-01-00	0.3m (1 ft)	6X9-8258A-00-00	5m (16 ft)
6Y8-82553-50-00	3m (10 ft)	6Y8-82521-11-00	0.6m (2 ft)	6X9-8258A-10-00	8m (26 ft)
6Y8-82553-11-00	4.6m (15 ft)	6Y8-82521-21-00	0.9m (3 ft)	6X9-8258A-20-00	12m (38 ft)
6Y8-82553-21-00	6.1m (20 ft)	6Y8-82521-31-00	1.8m (6 ft)		
6Y8-82553-31-00	7.6m (25 ft)	6Y8-82521-41-00	2.7m (9 ft)	2nd helm harness Stbd	Length
6Y8-82553-41-00	9.1m (30 ft)	6Y8-82521-51-00	3.6m (12 ft)	6X9-8258A-30-00	5m (16 ft)
				6X9-8258A-40-00	8m (26 ft)
				6X9-8258A-50-00	12m (38 ft)

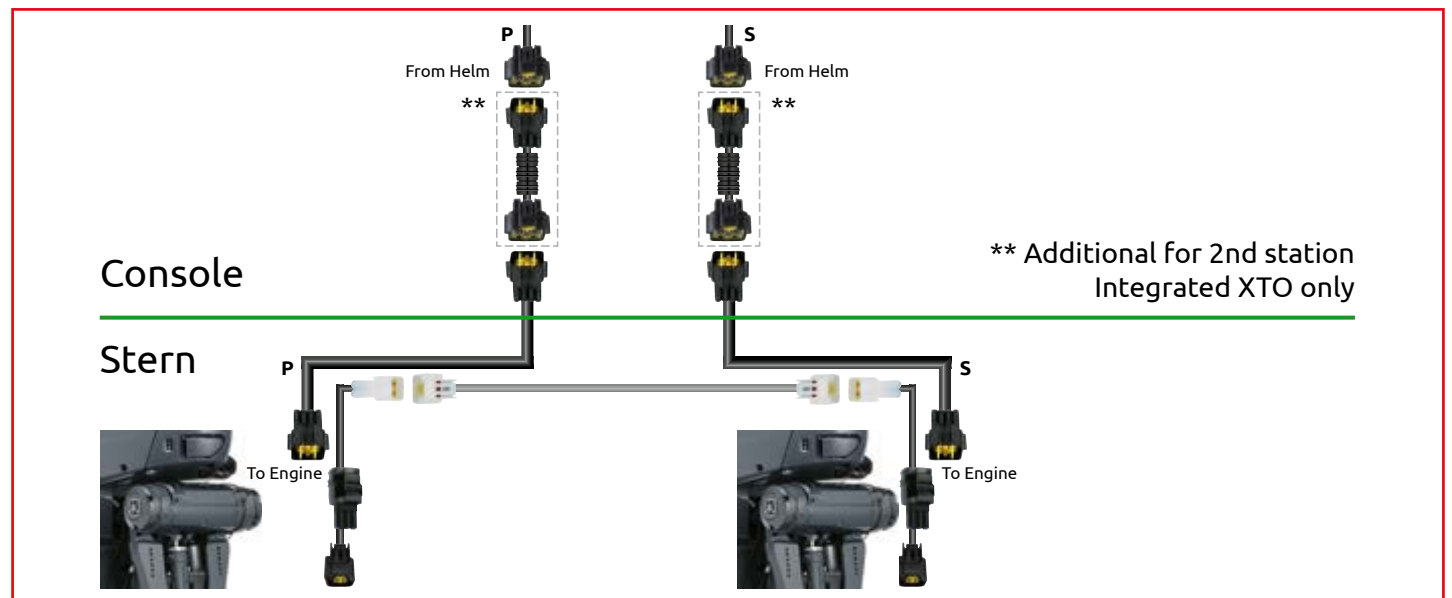

Rigging Order Guide

DBW REMOTE CONTROL (2ND STATION)

TWIN 2ND STATION LEVEL 3-4

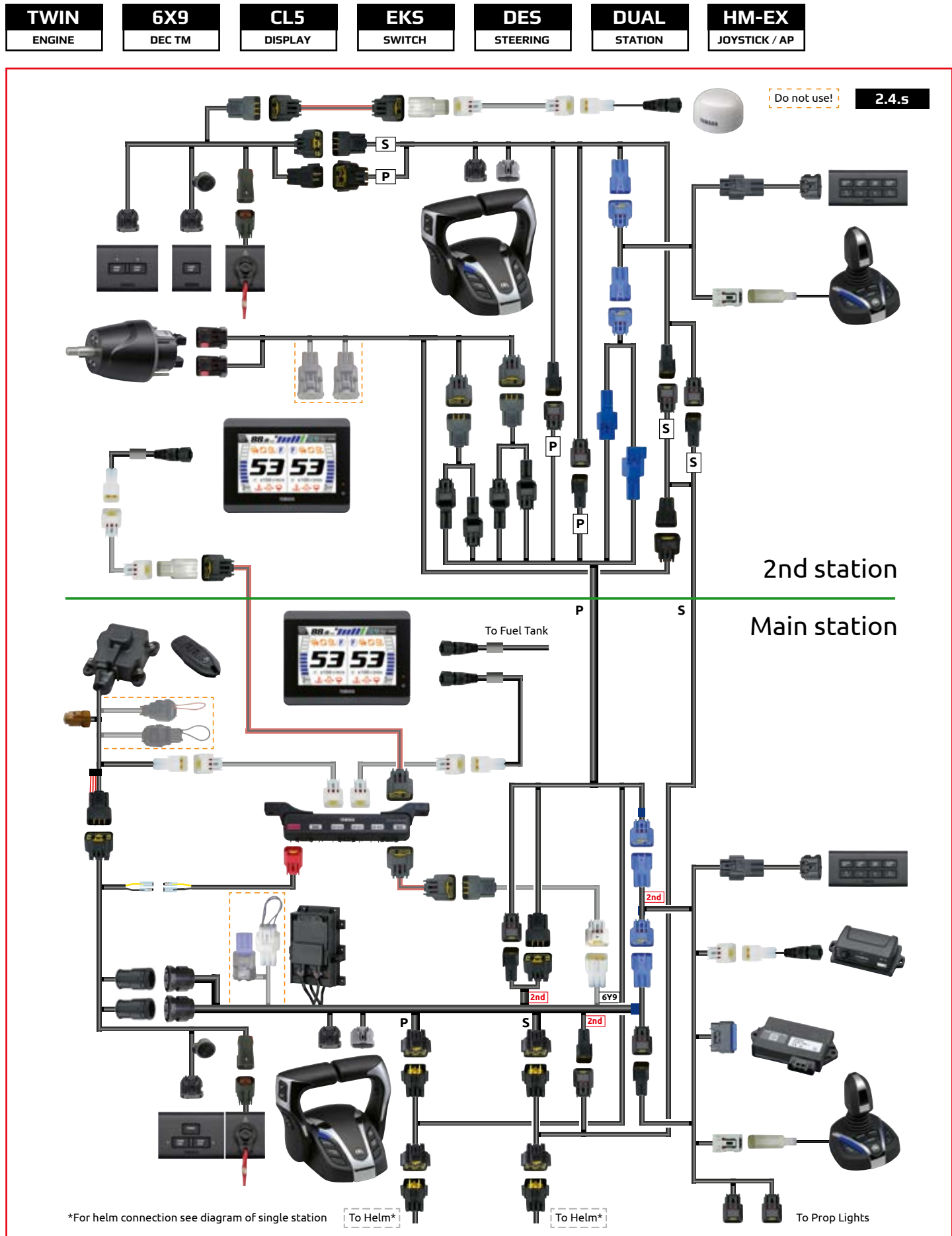

TWIN 2ND STATION LEVEL 3-4 PARTS

	Description	Qty	Note
LEVEL 1	6X9-48207-10-00	6X9 DEC Top mount - twin/tr/Quad	1 2nd station
	6YM-83710-10-00	CL5 Color Touch Gauge*	1 Display only
	6YM-83553-00-00	Conversion Harness for CL5	1
	6Y8-81920-11-00	Pigtail bus wire 0.6m / 2 ft	1
	6Y8-82521-11-00	Main bus wire 4.6m / 15 ft	1 Other lengths available
	6Y8-82553-11-00	Main Bus Wire 4.6m (15 ft)	1 Other lengths available
	6X9-762B0-90-00	EKS Kit - Twin 2nd St	1
	6X9-8258A-00-00	2nd station harness Port 5m / 16 ft	1 Other lengths available
	6X9-8258A-30-00	2nd station harness Stbd 5m / 16 ft	1 Other lengths available
	6GR-8258A-V0-00	Extension Harness**	2 Only For Integrated Steering
LEVEL 2	6X9-615A0-00-00	Compact Helm unit	1 Tilt type available (Kit: 6GR-762H0-00-00)
	6X9-8258A-B0-00	Helm harness 2nd St Twin 0.9m / 3 ft	1
LEVEL 3	6X9-762P0-10-00	Auto Pilot Panel kit 2nd station	1
	Level 3 requires an compatible multi-function display for map functions		
LEVEL 4	6X9-482A0-00-00	Joystick Kit 2nd station	1
	Level 4 requires an compatible multi-function display for map functions		

*) For other display options, check the 'display' section in this guide

KIT CONTENTS

Part Number	Description	Qty	Note
6X9-762B0-90-00	EKS Kit - Twin 2nd St	1	
6X9-82570-B0-00	All Start/Stop Switch	1	
6X9-82570-30-00	Start/Stop Switch	1	
6X9-82716-70-00	EKS harness	1	
6X9-82570-80-00	Lanyard switch	1	

HARNESS OPTIONS

Main bus wire	Length	Pigtail bus wire	Length	2nd helm harness Port	Length
6Y8-82553-01-00	0.3m (1 ft)	6Y8-82521-01-00	0.3m (1 ft)	6X9-8258A-00-00	5m (16 ft)
6Y8-82553-50-00	3m (10 ft)	6Y8-82521-11-00	0.6m (2 ft)	6X9-8258A-10-00	8m (26 ft)
6Y8-82553-11-00	4.6m (15 ft)	6Y8-82521-21-00	0.9m (3 ft)	6X9-8258A-20-00	12m (38 ft)
6Y8-82553-21-00	6.1m (20 ft)	6Y8-82521-31-00	1.8m (6 ft)		
6Y8-82553-31-00	7.6m (25 ft)	6Y8-82521-41-00	2.7m (9 ft)	2nd helm harness Stbd	Length
6Y8-82553-41-00	9.1m (30 ft)	6Y8-82521-51-00	3.6m (12 ft)	6X9-8258A-30-00	5m (16 ft)
				6X9-8258A-40-00	8m (26 ft)
				6X9-8258A-50-00	12m (38 ft)

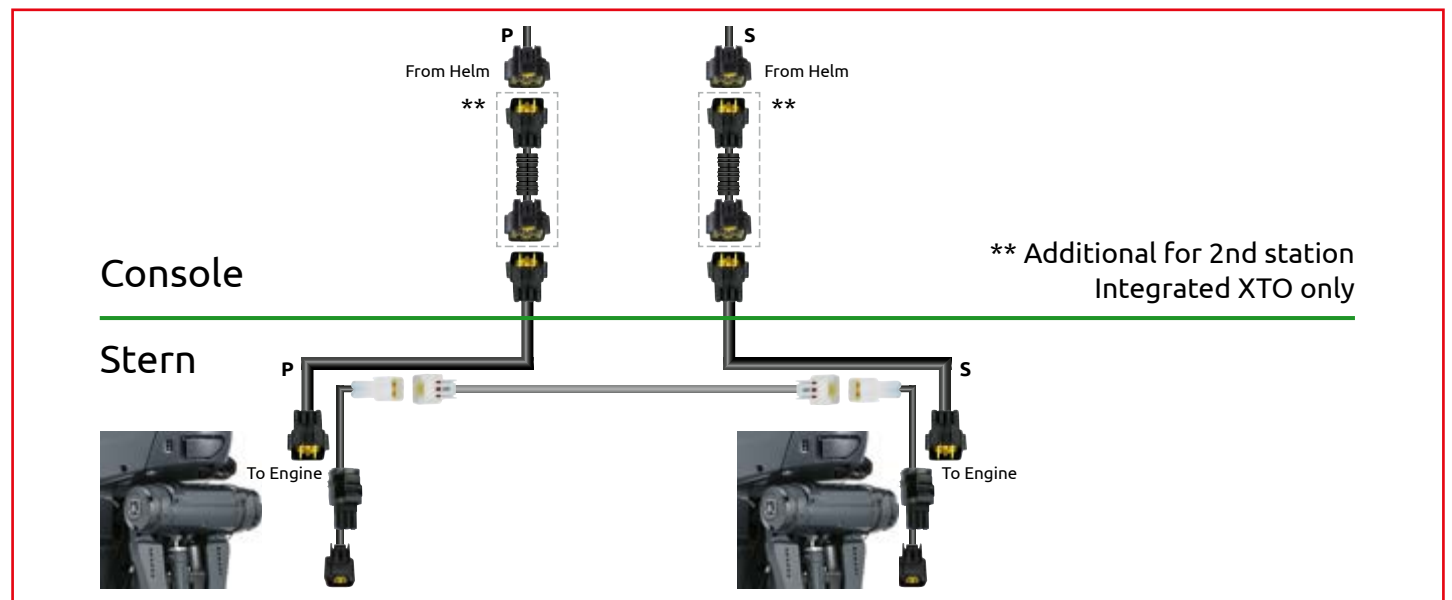

Rigging Order Guide

DBW REMOTE CONTROL (MAIN STATION)

TRIPLE LEVEL 1

TRIPLE ENGINE	6X9 DEC TM	CL5 DISPLAY	EKS SWITCH	DES STEERING	SINGLE STATION
-------------------------	----------------------	-----------------------	----------------------	------------------------	--------------------------

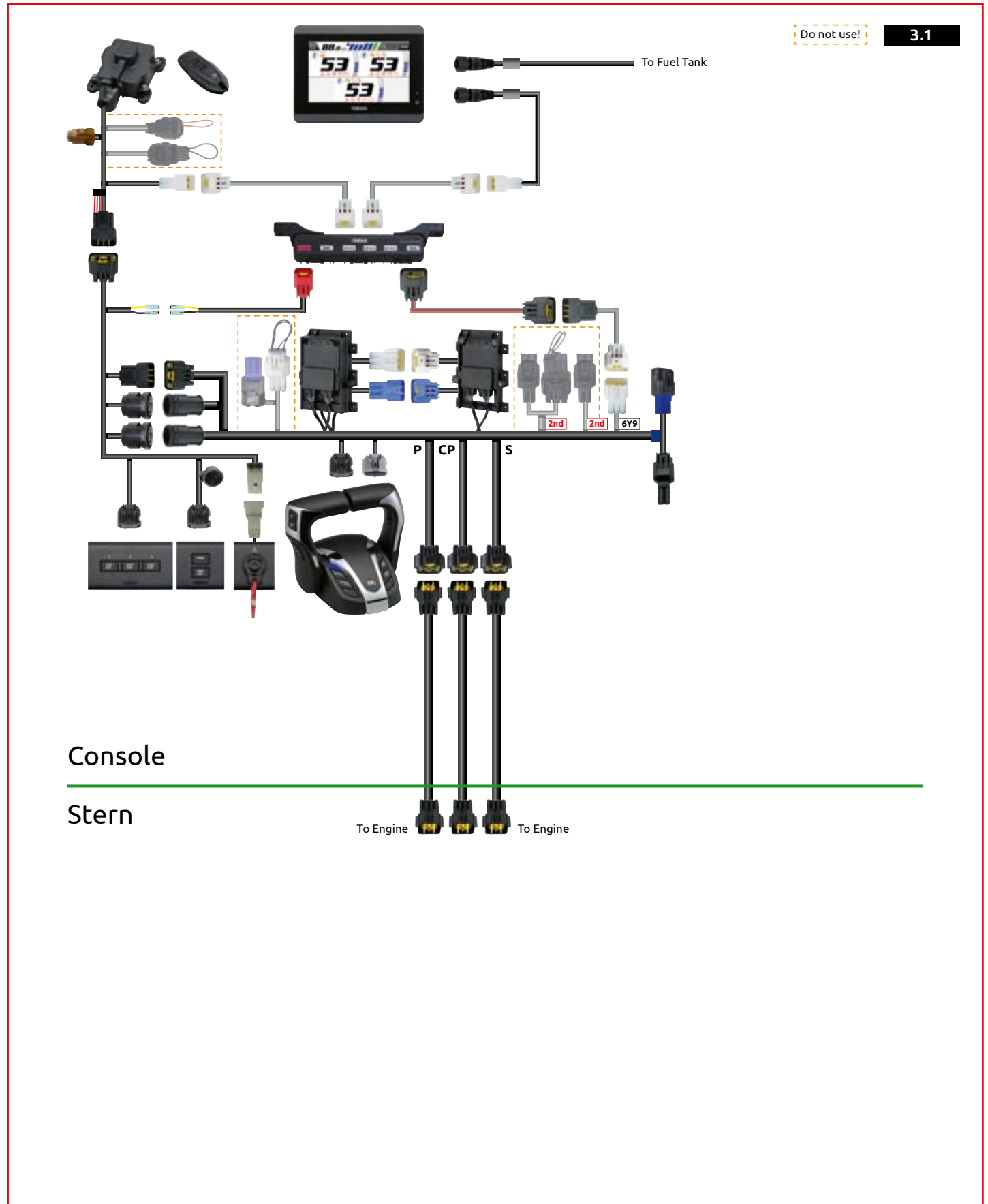

Console

Stern

TRIPLE LEVEL 1 PARTS

	Description	Qty	Note
	6X9-48208-00-00	6X9 DEC Top mount - Triple	1
	6YM-762G0-00-00	CL5 Color Touch Gauge Kit - DEC*	1
LEVEL 1	6X9-762B0-21-00	EKS Kit - Triple	1
	6X6-8258A-30-00	Main harness 16P 10m / 32 ft	1 Other lengths available
	6X6-8258A-40-00	Main harness 16P 12m / 39 ft	2 Other lengths available

*) For other display options, check the 'display' section in this guide

KIT CONTENTS

6YM-762G0-00-00	CL5 Color Touch Gauge Kit - DEC	Qty	Note
6YM-83710-10-00	CL5 Display	1	
6YM-83553-00-00	Conversion Harness	1	0.9 m (3 ft)
6YD-8356N-00-00	Fuel Tank Wire	1	
6Y8-81920-01-00	Multihub	1	
6Y9-83553-00-00	Conversion harness	1	
6Y8-82553-01-00	Main bus wire	1	0.3m (1 ft), other lengths available
6Y8-82521-31-00	Pigtail bus wire	1	1.8m (6 ft), other lengths available
6Y8-83553-02-00	System power supply	1	
6Y8-82582-11-00	Terminal Cap White	2	

6X9-762B0-21-00	EKS Kit - Triple	Qty	Note
6X9-82570-00-00	Power Switch	1	
6X9-82570-40-00	Individual start stop	1	
6X9-82716-41-00	EKS harness	1	
6X9-82570-C0-00	Lanyard switch	1	
6X9-86254-00-00	Immobilizer + key fob (2pcs)	1	433Mhz
6Y8-82521-11-00	Pigtail bus wire	1	0.6m (2 ft)
6Y8-48277-00-00	Sticker	1	

HARNESS OPTIONS

Main harness 16P	Length	Main bus wire	Length	Pigtail bus wire	Length
6X6-8258A-90-00	1.5m (5 ft)	6Y8-82553-01-00	0.3m (1 ft)	6Y8-82521-01-00	0.3m (1 ft)
6X6-8258A-50-00	3.7m (12 ft)	6Y8-82553-50-00	3m (10 ft)	6Y8-82521-11-00	0.6m (2 ft)
6X6-8258A-60-00	5.2m (17 ft)	6Y8-82553-11-00	4.6m (15 ft)	6Y8-82521-21-00	0.9m (3 ft)
6X6-8258A-00-00	6m (19 ft)	6Y8-82553-21-00	6.1m (20 ft)	6Y8-82521-31-00	1.8m (6 ft)
6X6-8258A-10-00	7m (23 ft)	6Y8-82553-31-00	7.6m (25 ft)	6Y8-82521-41-00	2.7m (9 ft)
6X6-8258A-20-00	8m (26 ft)	6Y8-82553-41-00	9.1m (30 ft)	6Y8-82521-51-00	3.6m (12 ft)
6X6-8258A-30-00	10m (32 ft)				
6X6-8258A-40-00	12m (39 ft)				
6X6-8258A-70-00	15m (49 ft)				
6X6-8258A-80-00	24m (79 ft)				

Rigging Order Guide

DBW REMOTE CONTROL (MAIN STATION)

TRIPLE LEVEL 2 BOLT-ON

TRIPLE ENGINE	6X9 DEC TM	CL5 DISPLAY	EKS SWITCH	DES BOLT-ON	SINGLE STATION
-------------------------	----------------------	-----------------------	----------------------	-----------------------	--------------------------

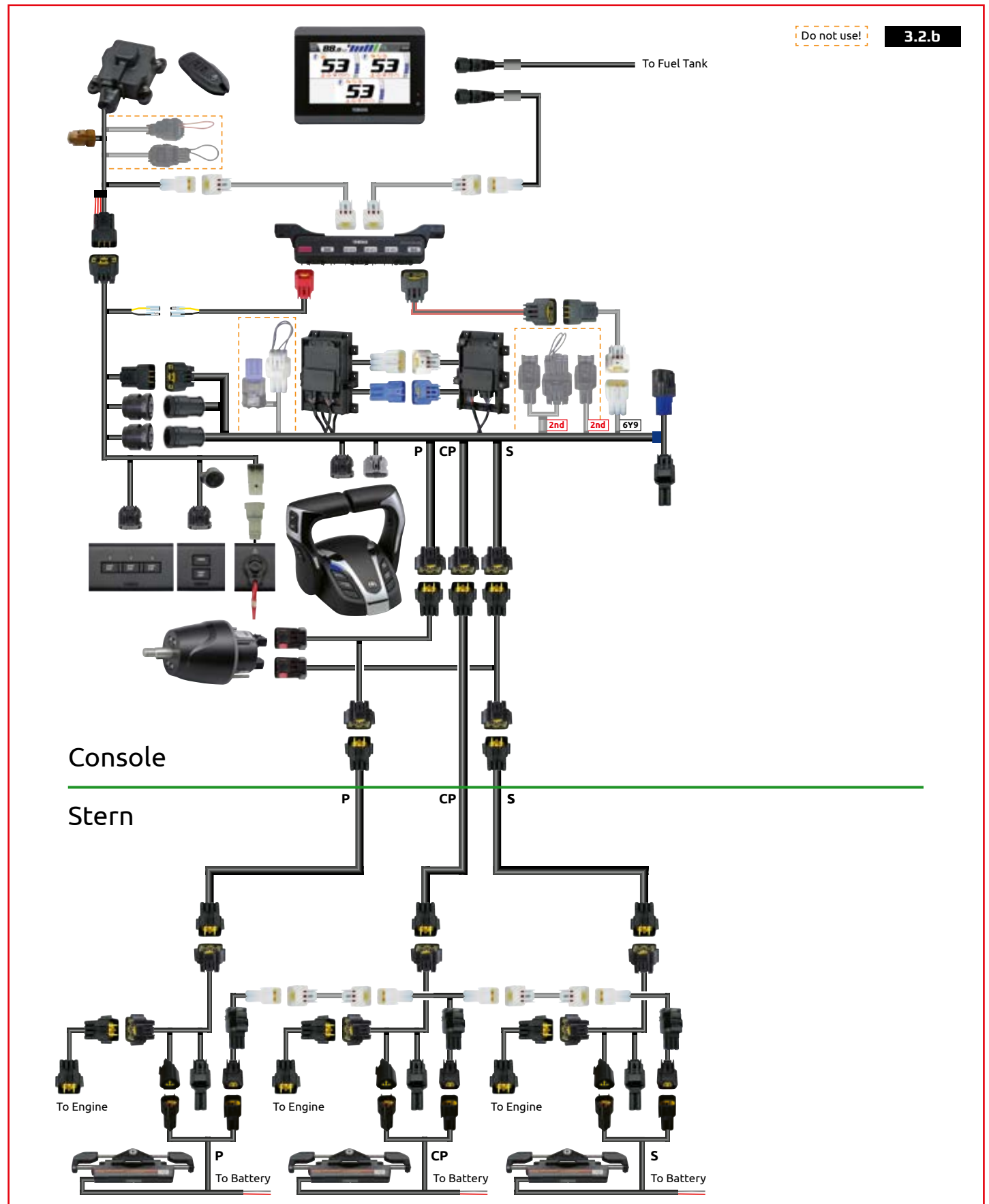

TRIPLE LEVEL 2 BOLT-ON PARTS

	Description	Qty	Note	
LEVEL 1	6X9-48208-00-00	6X9 DEC Top mount - Triple	1	
	6YM-762G0-00-00	CL5 Color Touch Gauge Kit - DEC*	1	
	6X9-762B0-21-00	EKS Kit - Triple	1	
	6X6-8258A-30-00	Main harness 16P 10m / 32 ft	1	Other lengths available
	6X6-8258A-40-00	Main harness 16P 12m / 39 ft	2	Other lengths available
LEVEL 2	6X9-762S0-00-00	Bolt-on DES KIT	3	
	6X9-438A0-00-00	Steering actuator harness 2.4m / 8 ft	3	Other lengths available
	6X6-8258A-50-00	Main harness 16P 3.7m / 12 ft	3	Other lengths available
	6X9-615A0-00-00	Compact Helm unit	1	Tilt type available (Kit: 6GR-762H0-00-00)
	6Y8-82521-11-00	Pigtail bus wire 0.6m / 2 ft	2	Other lengths available
	6GR-81115-00-00	SCU link harness (Port/ Stbd) 1.5m (5 ft)	2	Other lengths available
	6GR-81115-20-00	SCU link harness (Center) 1.5m (5 ft)	1	Other lengths available
	6GR-8258A-10-00	Helm harness Main St Twin/Triple/Quad 0.9m / 3 ft	2	Other lengths available

*) For other display options, check the 'display' section in this guide

KIT CONTENTS

6YM-762G0-00-00	CL5 Color Touch Gauge Kit - DEC	Qty	Note
6YM-83710-10-00	CL5 Display	1	
6YM-83553-00-00	Conversion Harness	1	0.9 m (3 ft)
6YD-8356N-00-00	Fuel Tank Wire	1	
6Y8-81920-01-00	Multihub	1	
6Y9-83553-00-00	Conversion harness	1	
6Y8-82553-01-00	Main bus wire	1	0.3m (1 ft), other lengths available
6Y8-82521-31-00	Pigtail bus wire	1	1.8m (6 ft), other lengths available
6Y8-83553-02-00	System power supply	1	
6Y8-82582-11-00	Terminal Cap White	2	
6X9-762B0-21-00	EKS Kit - Triple	Qty	Note
6X9-82570-00-00	Power Switch	1	
6X9-82570-40-00	Individual start stop	1	
6X9-82716-41-00	EKS harness	1	
6X9-82570-C0-00	Lanyard switch	1	
6X9-86254-00-00	Immobilizer + key fob (2pcs)	1	433Mhz
6Y8-82521-11-00	Pigtail bus wire	1	0.6m (2 ft)
6Y8-48277-00-00	Sticker	1	
6X9-762S0-00-00	Bolt-on DES KIT	Qty	Note
6X9-42401-00-00	Actuator	1	
6X9-8258A-90-00	Split Harness	1	

HARNESS OPTIONS

Main harness 16P	Length	Main bus wire	Length	Pigtail bus wire	Length
6X6-8258A-90-00	1.5m (5 ft)	6Y8-82553-01-00	0.3m (1 ft)	6Y8-82521-01-00	0.3m (1 ft)
6X6-8258A-50-00	3.7m (12 ft)	6Y8-82553-50-00	3m (10 ft)	6Y8-82521-11-00	0.6m (2 ft)
6X6-8258A-60-00	5.2m (17 ft)	6Y8-82553-11-00	4.6m (15 ft)	6Y8-82521-21-00	0.9m (3 ft)
6X6-8258A-00-00	6m (19 ft)	6Y8-82553-21-00	6.1m (20 ft)	6Y8-82521-31-00	1.8m (6 ft)
6X6-8258A-10-00	7m (23 ft)	6Y8-82553-31-00	7.6m (25 ft)	6Y8-82521-41-00	2.7m (9 ft)
6X6-8258A-20-00	8m (26 ft)	6Y8-82553-41-00	9.1m (30 ft)	6Y8-82521-51-00	3.6m (12 ft)
6X6-8258A-30-00	10m (32 ft)				
6X6-8258A-40-00	12m (39 ft)	Steering Actuator Harness	Length	Helm Harness	Length
6X6-8258A-70-00	15m (49 ft)	6X9-438A0-00-00	2.4m (8 ft)	6GR-8258A-10-00	0.9m (3 ft)
6X6-8258A-80-00	24m (79 ft)	6X9-438A0-10-00	4.5m (15 ft)	6GR-8258A-50-00	1.8m (6 ft)
				6GR-8258A-60-00	2.7m (9 ft)
SCU Link harness P/S	Length	SCU Link harness Center	Length		
6X9-81115-00-00	0.3m (1 ft)	6X9-81115-10-00	0.3m (1 ft)		
6GR-81115-00-00	1.5m (5 ft)	6GR-81115-20-00	1.5m (5 ft)		
6GR-81115-10-00	3.0m (10 ft)	6GR-81115-30-00	3.0m (10 ft)		

Rigging Order Guide

DBW REMOTE CONTROL (MAIN STATION)

TRIPLE LEVEL 2 INTEGRATED

TRIPLE ENGINE	6X9 DEC TM	CL5 DISPLAY	EKS SWITCH	DES INTEGRATED	SINGLE STATION
-------------------------	----------------------	-----------------------	----------------------	--------------------------	--------------------------

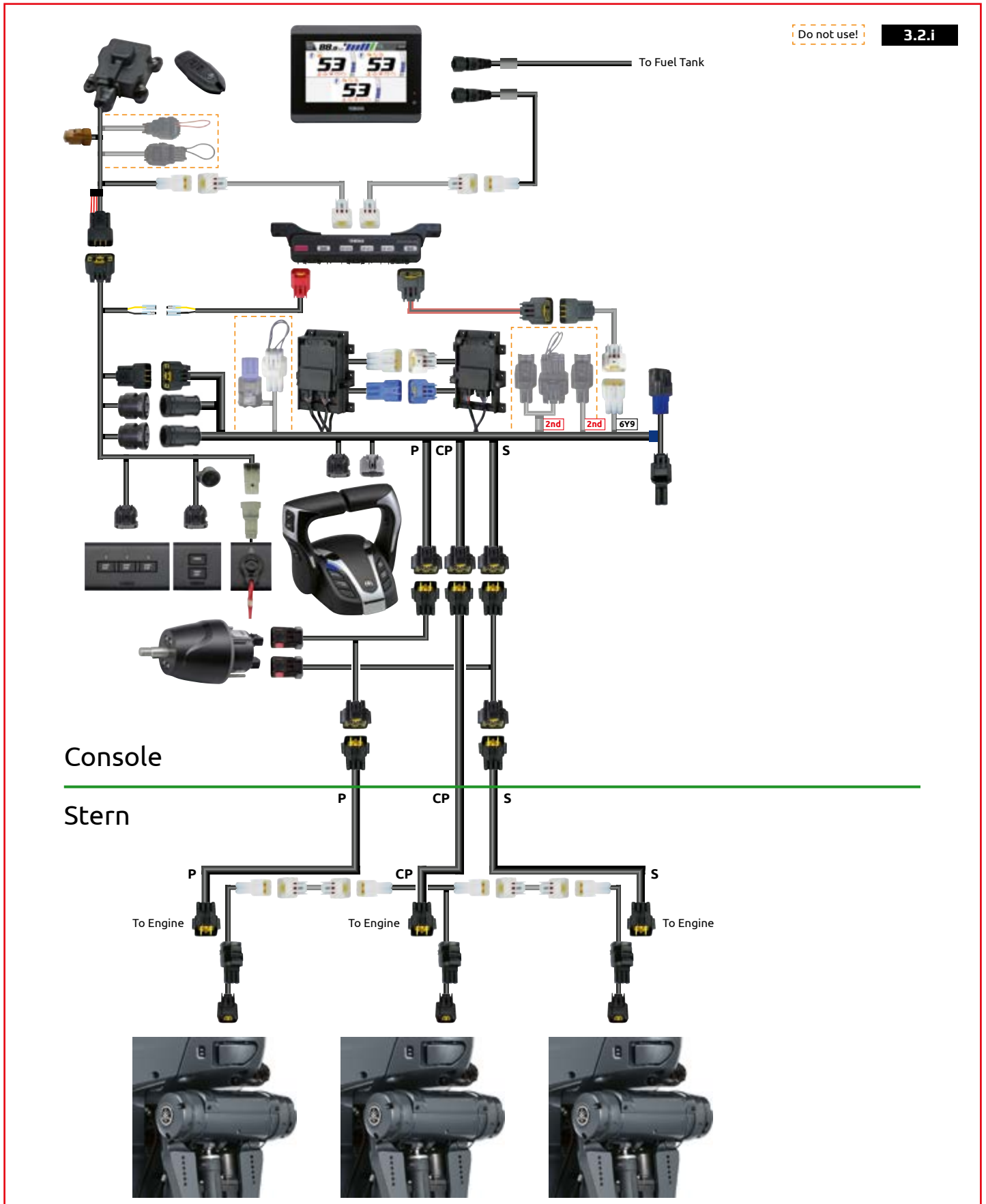

TRIPLE LEVEL 2 INTEGRATED PARTS

	Description	Qty	Note
	6X9-48208-00-00	6X9 DEC Top mount - Triple	1
	6YM-762G0-00-00	CL5 Color Touch Gauge Kit - DEC*	1
LEVEL 1	6X9-762B0-21-00	EKS Kit - Triple	1
	6X6-8258A-30-00	Main harness 16P 10m / 32 ft	1 Other lengths available
	6X6-8258A-40-00	Main harness 16P 12m / 39 ft	2 Other lengths available
	6X9-615A0-00-00	Compact Helm unit	1 Tilt type available (Kit: 6GR-762H0-00-00)
	6GR-81115-00-00	SCU link harness (Port/ Stbd) 1.5m (5 ft)	2 Other lengths available
LEVEL 2	6GR-81115-20-00	SCU link harness (Center) 1.5m (5 ft)	1 Other lengths available
	6Y8-82521-11-00	Pigtail bus wire 0.6m / 2 ft	2 Other lengths available
	6GR-8258A-10-00	Helm harness Main St Twin/Triple/Quad 0.9m / 3 ft	2 Other lengths available

*) For other display options, check the 'display' section in this guide

KIT CONTENTS

Part Number	Description	Qty	Note
6YM-762G0-00-00	CL5 Color Touch Gauge Kit - DEC	1	
6YM-83710-10-00	CL5 Display	1	
6YM-83553-00-00	Conversion Harness	1	0.9 m (3 ft)
6YD-8356N-00-00	Fuel Tank Wire	1	
6Y8-81920-01-00	Multihub	1	
6Y9-83553-00-00	Conversion harness	1	
6Y8-82553-01-00	Main bus wire	1	0.3m (1 ft), other lengths available
6Y8-82521-31-00	Pigtail bus wire	1	1.8m (6 ft), other lengths available
6Y8-83553-02-00	System power supply	1	
6Y8-82582-11-00	Terminal Cap White	2	
6X9-762B0-21-00	EKS Kit - Triple	Qty	Note
6X9-82570-00-00	Power Switch	1	
6X9-82570-40-00	Individual start stop	1	
6X9-82716-41-00	EKS harness	1	
6X9-82570-C0-00	Lanyard switch	1	
6X9-86254-00-00	Immobilizer + key fob (2pcs)	1	433Mhz
6Y8-82521-11-00	Pigtail bus wire	1	0.6m (2 ft)
6Y8-48277-00-00	Sticker	1	

HARNESS OPTIONS

Main harness 16P		Main bus wire		Pigtail bus wire	
	Length		Length		Length
6X6-8258A-90-00	1.5m (5 ft)	6Y8-82553-01-00	0.3m (1 ft)	6Y8-82521-01-00	0.3m (1 ft)
6X6-8258A-50-00	3.7m (12 ft)	6Y8-82553-50-00	3m (10 ft)	6Y8-82521-11-00	0.6m (2 ft)
6X6-8258A-60-00	5.2m (17 ft)	6Y8-82553-11-00	4.6m (15 ft)	6Y8-82521-21-00	0.9m (3 ft)
6X6-8258A-00-00	6m (19 ft)	6Y8-82553-21-00	6.1m (20 ft)	6Y8-82521-31-00	1.8m (6 ft)
6X6-8258A-10-00	7m (23 ft)	6Y8-82553-31-00	7.6m (25 ft)	6Y8-82521-41-00	2.7m (9 ft)
6X6-8258A-20-00	8m (26 ft)	6Y8-82553-41-00	9.1m (30 ft)	6Y8-82521-51-00	3.6m (12 ft)
6X6-8258A-30-00	10m (32 ft)				
6X6-8258A-40-00	12m (39 ft)				
6X6-8258A-70-00	15m (49 ft)				
6X6-8258A-80-00	24m (79 ft)				
Helm Harness		SCU Link harness P/S		SCU Link harness Center	
	Length		Length		Length
6GR-8258A-10-00	0.9m (3 ft)	6X9-81115-00-00	0.3m (1 ft)	6X9-81115-10-00	0.3m (1 ft)
6GR-8258A-50-00	1.8m (6 ft)	6GR-81115-00-00	1.5m (5 ft)	6GR-81115-20-00	1.5m (5 ft)
6GR-8258A-60-00	2.7m (9 ft)	6GR-81115-10-00	3.0m (10 ft)	6GR-81115-30-00	3.0m (10 ft)

Rigging Order Guide

DBW REMOTE CONTROL (MAIN STATION)

TRIPLE LEVEL 3-4 BOLT-ON

TRIPLE ENGINE	6X9 DEC TM	CL5 DISPLAY	EKS SWITCH	DES BOLT-ON	SINGLE STATION	HM-EX JOYSTICK / AP
-------------------------	----------------------	-----------------------	----------------------	-----------------------	--------------------------	-------------------------------

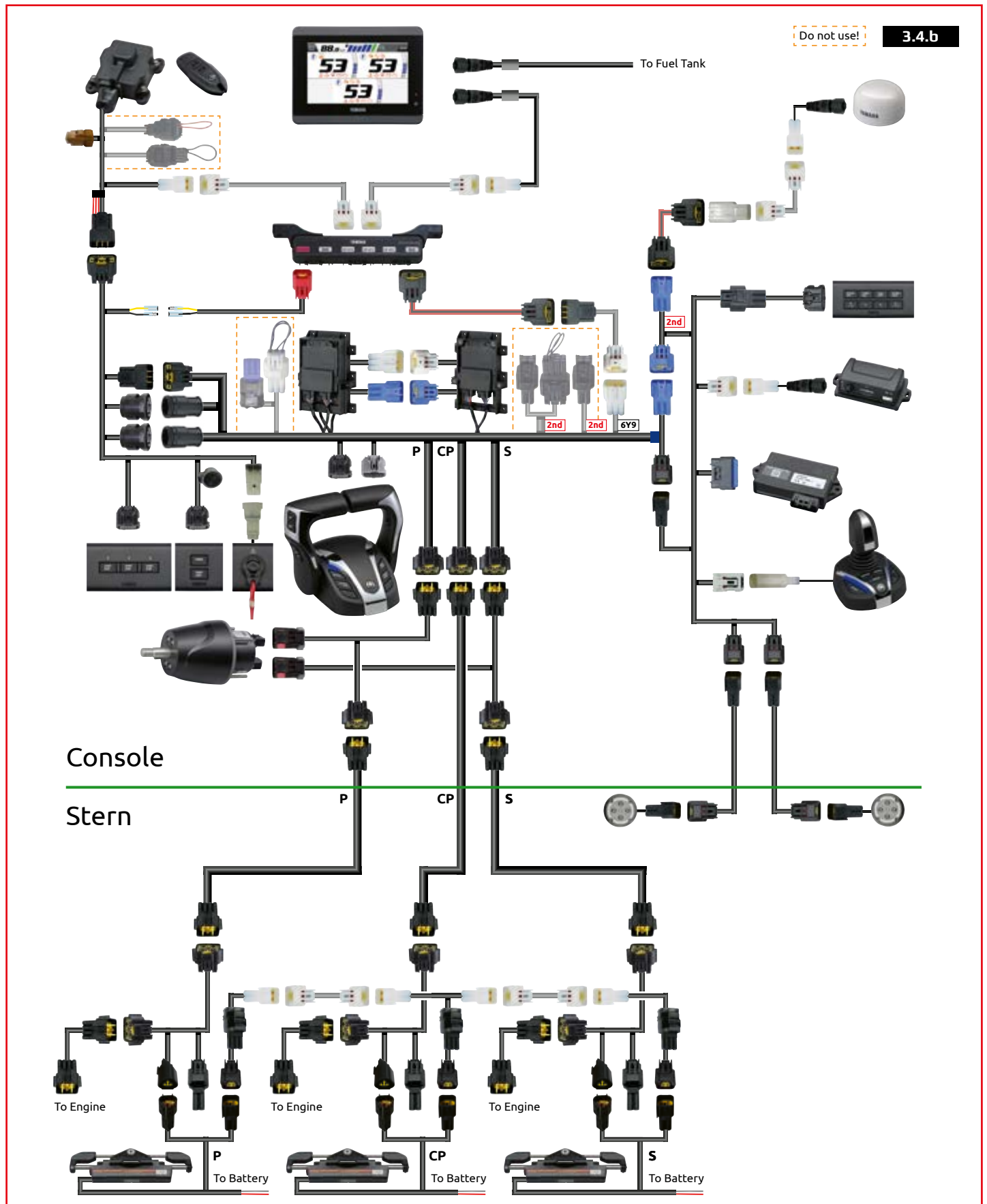

TRIPLE LEVEL 3-4 BOLT-ON PARTS

	Description	Qty	Note	
LEVEL 1	6X9-48208-00-00	6X9 DEC Top mount - Triple	1	
	6YM-762G0-00-00	CL5 Color Touch Gauge Kit - DEC*	1	
	6X9-762B0-21-00	EKS Kit - Triple	1	
	6X6-8258A-30-00	Main harness 16P 10m / 32 ft	1	Other lengths available
	6X6-8258A-40-00	Main harness 16P 12m / 39 ft	2	Other lengths available
LEVEL 2	6X9-762S0-00-00	Bolt-on DES KIT	3	
	6X9-438A0-00-00	Steering actuator harness 2.4m / 8 ft	3	Other lengths available
	6X6-8258A-50-00	Main harness 16P 3.7m / 12 ft	3	Other lengths available
	6X9-615A0-00-00	Compact Helm unit	1	Tilt type available (Kit: 6GR-762H0-00-00)
	6Y8-82521-11-00	Pigtail bus wire 0.6m / 2 ft	2	Other lengths available
	6GR-81115-00-00	SCU link harness (Port/ Stbd) 1.5m (5 ft)	2	Other lengths available
	6GR-81115-20-00	SCU link harness (Center) 1.5m (5 ft)	1	Other lengths available
LEVEL 3-4	6GR-8258A-10-00	Helm harness Main St Twin/Triple/Quad 0.9m / 3 ft	2	Other lengths available
	**	Joystick/AP Kit - Triple	1	
	6Y8-82553-50-00	Main bus wire 3m / 10 ft	1	Other lengths available
	6Y8-82521-01-00	Pigtail bus wire 0.3m / 1 ft	1	Other lengths available

Level 3 and 4 requires an compatible multi-function display for map functions
 *) For other display options, check the 'display' section in this guide | **) Order at the local distributor sales department

KIT CONTENTS

Part Number	Description	Qty	Note
6YM-762G0-00-00	CL5 Color Touch Gauge Kit - DEC	1	
6YM-83710-10-00	CL5 Display	1	
6YM-83553-00-00	Conversion Harness	1	0.9 m (3 ft)
6YD-8356N-00-00	Fuel Tank Wire	1	
6Y8-81920-01-00	Multihub	1	
6Y9-83553-00-00	Conversion harness	1	
6Y8-82553-01-00	Main bus wire	1	0.3m (1 ft), other lengths available
6Y8-82521-31-00	Pigtail bus wire	1	1.8m (6 ft), other lengths available
6Y8-83553-02-00	System power supply	1	
6Y8-82582-11-00	Terminal Cap White	2	

Part Number	Description	Qty	Note	Part Number	Description	Qty	Note
6X9-762B0-21-00	EKS Kit - Triple			**	Joystick/AP Kit - Triple		
6X9-82570-00-00	Power Switch	1		6X9-8253V-00-00	Autopilot panel	1	
6X9-82570-40-00	Individual start stop	1		6X9-88107-00-00	GPS antenna	1	
6X9-82716-41-00	EKS harness	1		6X9-8A410-00-00	Heading sensor	1	
6X9-82570-C0-00	Lanyard switch	1		6X9-8591T-30-00	Boat Control Unit	1	
6X9-86254-00-00	Lanyard switch	1	433Mhz	6Y8-81920-11-00	Single hub	1	
6Y8-82521-11-00	Pigtail bus wire	1	0.6m (2 ft)	6X9-82386-01-00	BCU Harness	1	
6Y8-48277-00-00	Sticker	1		6YM-83553-00-00	Conversion harness	2	
6X9-762S0-00-00	Bolt-on DES KIT			6X9-482A0-00-00	Joystick Assy	1	
6X9-42401-00-00	Actuator	1		6ES-83720-01-00	Prop lights	2	
6X9-8258A-90-00	Split Harness	1		**) Order at the local distributor sales department			

HARNESS OPTIONS

Main harness 16P	Length	Main bus wire	Length	Pigtail bus wire	Length
6X6-8258A-90-00	1.5m (5 ft)	6Y8-82553-01-00	0.3m (1 ft)	6Y8-82521-01-00	0.3m (1 ft)
6X6-8258A-50-00	3.7m (12 ft)	6Y8-82553-50-00	3m (10 ft)	6Y8-82521-11-00	0.6m (2 ft)
6X6-8258A-60-00	5.2m (17 ft)	6Y8-82553-11-00	4.6m (15 ft)	6Y8-82521-21-00	0.9m (3 ft)
6X6-8258A-00-00	6m (19 ft)	6Y8-82553-21-00	6.1m (20 ft)	6Y8-82521-31-00	1.8m (6 ft)
6X6-8258A-10-00	7m (23 ft)	6Y8-82553-31-00	7.6m (25 ft)	6Y8-82521-41-00	2.7m (9 ft)
6X6-8258A-20-00	8m (26 ft)	6Y8-82553-41-00	9.1m (30 ft)	6Y8-82521-51-00	3.6m (12 ft)
6X6-8258A-30-00	10m (32 ft)				
6X6-8258A-40-00	12m (39 ft)	Steering Actuator Harness	Length	Helm Harness	Length
6X6-8258A-70-00	15m (49 ft)	6X9-438A0-00-00	2.4m (8 ft)	6GR-8258A-10-00	0.9m (3 ft)
6X6-8258A-80-00	24m (79 ft)	6X9-438A0-10-00	4.5m (15 ft)	6GR-8258A-50-00	1.8m (6 ft)
				6GR-8258A-60-00	2.7m (9 ft)
SCU Link harness P/S	Length	SCU Link harness Center	Length	Extension for Prop lights	Length
6X9-81115-00-00	0.3m (1 ft)	6X9-81115-10-00	0.3m (1 ft)	6X9-82586-20-00	6m (19 ft)
6GR-81115-00-00	1.5m (5 ft)	6GR-81115-20-00	1.5m (5 ft)	6X9-82586-30-00	9.1m (30 ft)
6GR-81115-10-00	3.0m (10 ft)	6GR-81115-30-00	3.0m (10 ft)	6X9-82586-40-00	12.2m (40 ft)

Rigging Order Guide

DBW REMOTE CONTROL (MAIN STATION)

TRIPLE LEVEL 3-4 INTEGRATED

TRIPLE ENGINE	6X9 DEC TM	CL5 DISPLAY	EKS SWITCH	DES INTEGRATED	SINGLE STATION	HM-EX JOYSTICK / AP
-------------------------	----------------------	-----------------------	----------------------	--------------------------	--------------------------	-------------------------------

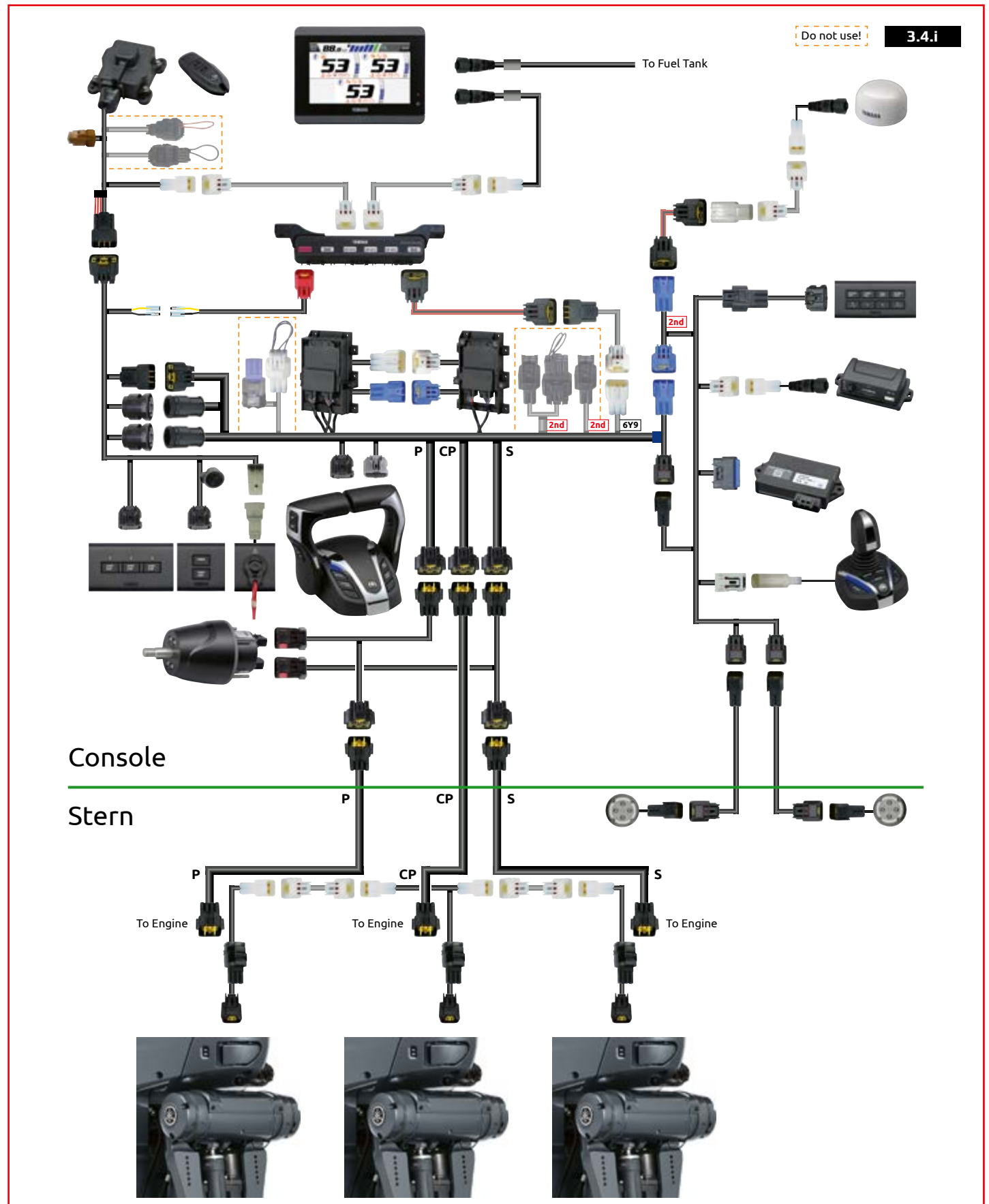

TRIPLE LEVEL 3-4 INTEGRATED PARTS

	Description	Qty	Note	
LEVEL 1	6X9-48208-00-00	6X9 DEC Top mount - Triple	1	
	6YM-762G0-00-00	CL5 Color Touch Gauge Kit - DEC*	1	
	6X9-762B0-21-00	EKS Kit - Triple	1	
	6X6-8258A-30-00	Main harness 16P 10m / 32 ft	1	Other lengths available
	6X6-8258A-40-00	Main harness 16P 12m / 39 ft	2	Other lengths available
LEVEL 2	6X9-615A0-00-00	Compact Helm unit	1	Tilt type available (Kit: 6GR-762H0-00-00)
	6GR-81115-00-00	SCU link harness (Port/ Stbd) 1.5m (5 ft)	2	Other lengths available
	6GR-81115-20-00	SCU link harness (Center) 1.5m (5 ft)	1	Other lengths available
	6Y8-82521-11-00	Pigtail bus wire 0.6m / 2 ft	2	Other lengths available
	6GR-8258A-10-00	Helm harness Main St Twin/Triple/Quad 0.9m / 3 ft	2	Other lengths available
LEVEL 3-4	**	Joystick/AP Kit - Triple	1	
	6Y8-82553-50-00	Main bus wire 3m / 10 ft	1	Other lengths available
	6Y8-82521-01-00	Pigtail bus wire 0.3m / 1 ft	1	Other lengths available

Level 3 and 4 requires an compatible multi-function display for map functions
 *) For other display options, check the 'display' section in this guide | **) Order at the local distributor sales department

KIT CONTENTS

Part Number	Description	Qty	Note
6YM-762G0-00-00	CL5 Color Touch Gauge Kit - DEC	1	
6YM-83710-10-00	CL5 Display	1	
6YM-83553-00-00	Conversion Harness	1	0.9 m (3 ft)
6YD-8356N-00-00	Fuel Tank Wire	1	
6Y8-81920-01-00	Multihub	1	
6Y9-83553-00-00	Conversion harness	1	
6Y8-82553-01-00	Main bus wire	1	0.3m (1 ft), other lengths available
6Y8-82521-31-00	Pigtail bus wire	1	1.8m (6 ft), other lengths available
6Y8-83553-02-00	System power supply	1	
6Y8-82582-11-00	Terminal Cap White	2	

Part Number	Description	Qty	Note	Part Number	Description	Qty	Note
6X9-762B0-21-00	EKS Kit - Triple	1		**	Joystick/AP Kit - Triple	1	
6X9-82570-00-00	Power Switch	1		6X9-8253V-00-00	Autopilot panel	1	
6X9-82570-40-00	Individual start stop	1		6X9-88107-00-00	GPS antenna	1	
6X9-82716-41-00	EKS harness	1		6X9-8A410-00-00	Heading sensor	1	
6X9-82570-C0-00	Lanyard switch	1		6X9-8591T-30-00	Boat Control Unit	1	
6X9-86254-00-00	Immobilizer + key fob (2pcs)	1	433Mhz	6Y8-81920-11-00	Single hub	1	
6Y8-82521-11-00	Pigtail bus wire	1	0.6m (2 ft)	6X9-82386-01-00	BCU Harness	1	
6Y8-48277-00-00	Sticker	1		6YM-83553-00-00	Conversion harness	2	
				6X9-482A0-00-00	Joystick Assy	1	
				6ES-83720-01-00	Prop lights	2	

***) Order at the local distributor sales department

HARNES OPTIONS

Main harness 16P	Length (m)	Main bus wire	Length	Pigtail bus wire	Length
6X6-8258A-90-00	1.5m (5 ft)	6Y8-82553-01-00	0.3m (1 ft)	6Y8-82521-01-00	0.3m (1 ft)
6X6-8258A-50-00	3.7m (12 ft)	6Y8-82553-50-00	3m (10 ft)	6Y8-82521-11-00	0.6m (2 ft)
6X6-8258A-60-00	5.2m (17 ft)	6Y8-82553-11-00	4.6m (15 ft)	6Y8-82521-21-00	0.9m (3 ft)
6X6-8258A-00-00	6m (19 ft)	6Y8-82553-21-00	6.1m (20 ft)	6Y8-82521-31-00	1.8m (6 ft)
6X6-8258A-10-00	7m (23 ft)	6Y8-82553-31-00	7.6m (25 ft)	6Y8-82521-41-00	2.7m (9 ft)
6X6-8258A-20-00	8m (26 ft)	6Y8-82553-41-00	9.1m (30 ft)	6Y8-82521-51-00	3.6m (12 ft)
6X6-8258A-30-00	10m (32 ft)				
6X6-8258A-40-00	12m (39 ft)	Helm Harness	Length	SCU Link harness P/S	Length
6X6-8258A-70-00	15m (49 ft)	6GR-8258A-10-00	0.9m (3 ft)	6X9-81115-00-00	0.3m (1 ft)
6X6-8258A-80-00	24m (79 ft)	6GR-8258A-50-00	1.8m (6 ft)	6GR-81115-00-00	1.5m (5 ft)
		6GR-8258A-60-00	2.7m (9 ft)	6GR-81115-10-00	3.0m (10 ft)
SCU Link harness Center	Length	Extension for Prop lights	Length		
6X9-81115-10-00	0.3m (1 ft)	6X9-82586-20-00	6m (19 ft)		
6GR-81115-20-00	1.5m (5 ft)	6X9-82586-30-00	9.1m (30 ft)		
6GR-81115-30-00	3.0m (10 ft)	6X9-82586-40-00	12.2m (40 ft)		

Rigging Order Guide

DBW REMOTE CONTROL (2ND STATION)

TRIPLE 2ND STATION LEVEL 1

TRIPLE ENGINE	6X9 DEC TM	CL5 DISPLAY	EKS SWITCH	DES STEERING	DUAL STATION
-------------------------	----------------------	-----------------------	----------------------	------------------------	------------------------

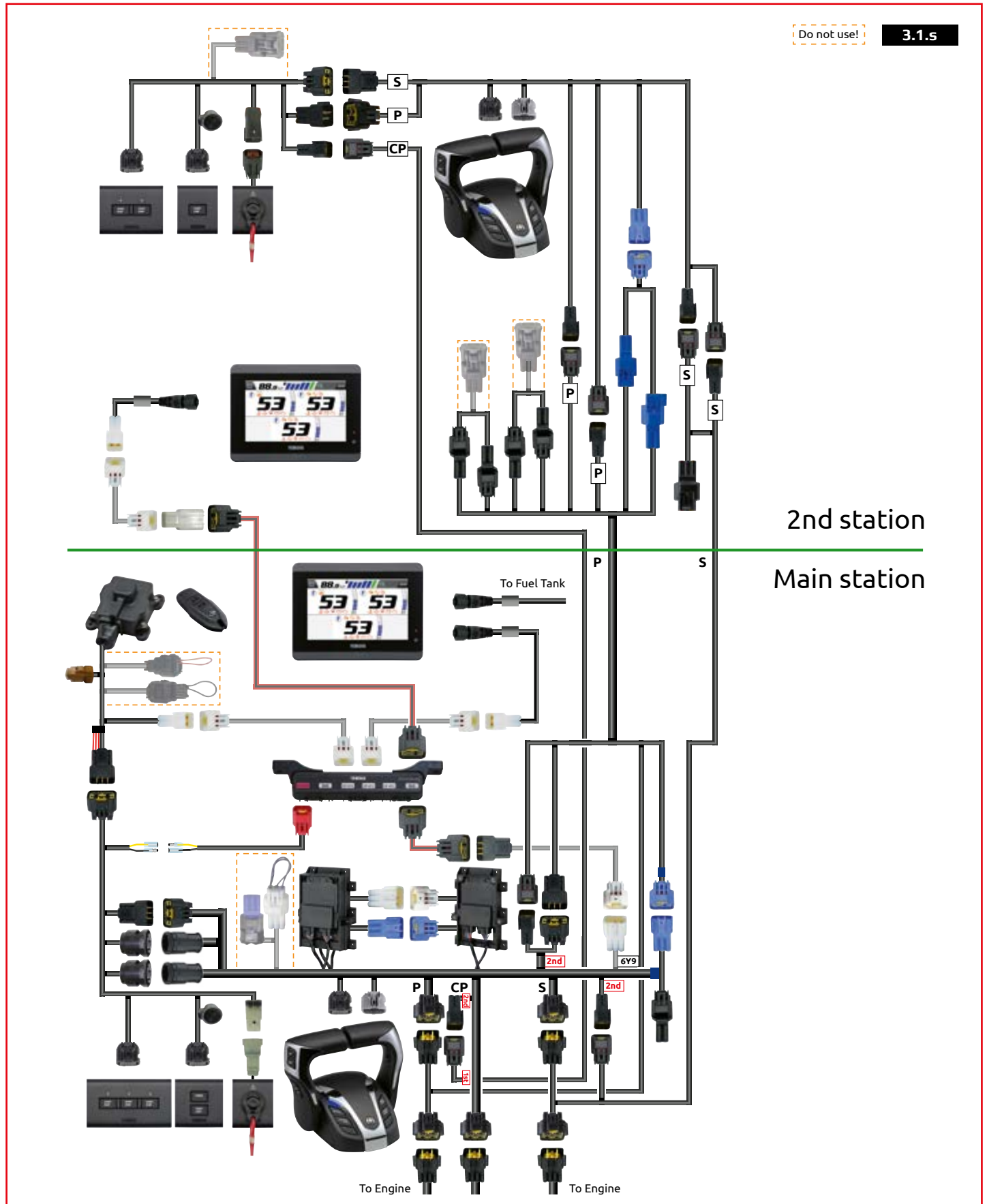

TRIPLE 2ND STATION LEVEL 1 PARTS

	Description	Qty	Note
	6X9-48207-10-00 6X9 DEC Top mount - twin/tr/Quad	1	2nd station
	6YM-83710-10-00 CL5 Color Touch Gauge*	1	Display only
	6YM-83553-00-00 Conversion Harness for CL5	1	
	6Y8-81920-11-00 Single hub	1	
LEVEL 1	6Y8-82521-11-00 Pigtail bus wire 0.6m / 2 ft	1	Other lengths available
	6Y8-82553-11-00 Main bus wire 4.6m / 15 ft	1	Other lengths available
	6X9-762B0-A0-00 EKS Kit - Triple 2nd St	1	
	6X9-8258A-00-00 2nd station harness Port 5m / 16 ft	1	Other lengths available
	6X9-8258A-30-00 2nd station harness Stbd 5m / 16 ft	1	Other lengths available
	6X9-8258A-60-00 2nd station harness Center 5m / 16 ft	1	Other lengths available

*) For other display options, check the 'display' section in this guide

KIT CONTENTS

Part Number	Description	Qty	Note
6X9-762B0-A0-00	EKS Kit - Triple 2nd St		
6X9-82570-B0-00	All Start/Stop Switch	1	
6X9-82570-40-00	Start/Stop Switch	1	
6X9-82716-80-00	EKS harness	1	
6X9-82570-C0-00	Lanyard switch	1	

HARNESS OPTIONS

Main bus wire		Pigtail bus wire		2nd helm harness Port		2nd helm harness Stbd		2nd helm harness Center	
	Length		Length		Length		Length		Length
6Y8-82553-01-00	0.3m (1 ft)	6Y8-82521-01-00	0.3m (1 ft)	6X9-8258A-00-00	5m (16 ft)	6X9-8258A-30-00	5m (16 ft)	6X9-8258A-60-00	5m (16 ft)
6Y8-82553-50-00	3m (10 ft)	6Y8-82521-11-00	0.6m (2 ft)	6X9-8258A-10-00	8m (26 ft)	6X9-8258A-40-00	8m (26 ft)	6X9-8258A-70-00	8m (26 ft)
6Y8-82553-11-00	4.6m (15 ft)	6Y8-82521-21-00	0.9m (3 ft)	6X9-8258A-20-00	12m (38 ft)	6X9-8258A-50-00	12m (38 ft)	6X9-8258A-80-00	12m (38 ft)
6Y8-82553-21-00	6.1m (20 ft)	6Y8-82521-31-00	1.8m (6 ft)						
6Y8-82553-31-00	7.6m (25 ft)	6Y8-82521-41-00	2.7m (9 ft)						
6Y8-82553-41-00	9.1m (30 ft)	6Y8-82521-51-00	3.6m (12 ft)						

Rigging Order Guide

DBW REMOTE CONTROL (2ND STATION)

TRIPLE 2ND STATION LEVEL 2

TRIPLE ENGINE	6X9 DEC TM	CL5 DISPLAY	EKS SWITCH	DES STEERING	DUAL STATION
-------------------------	----------------------	-----------------------	----------------------	------------------------	------------------------

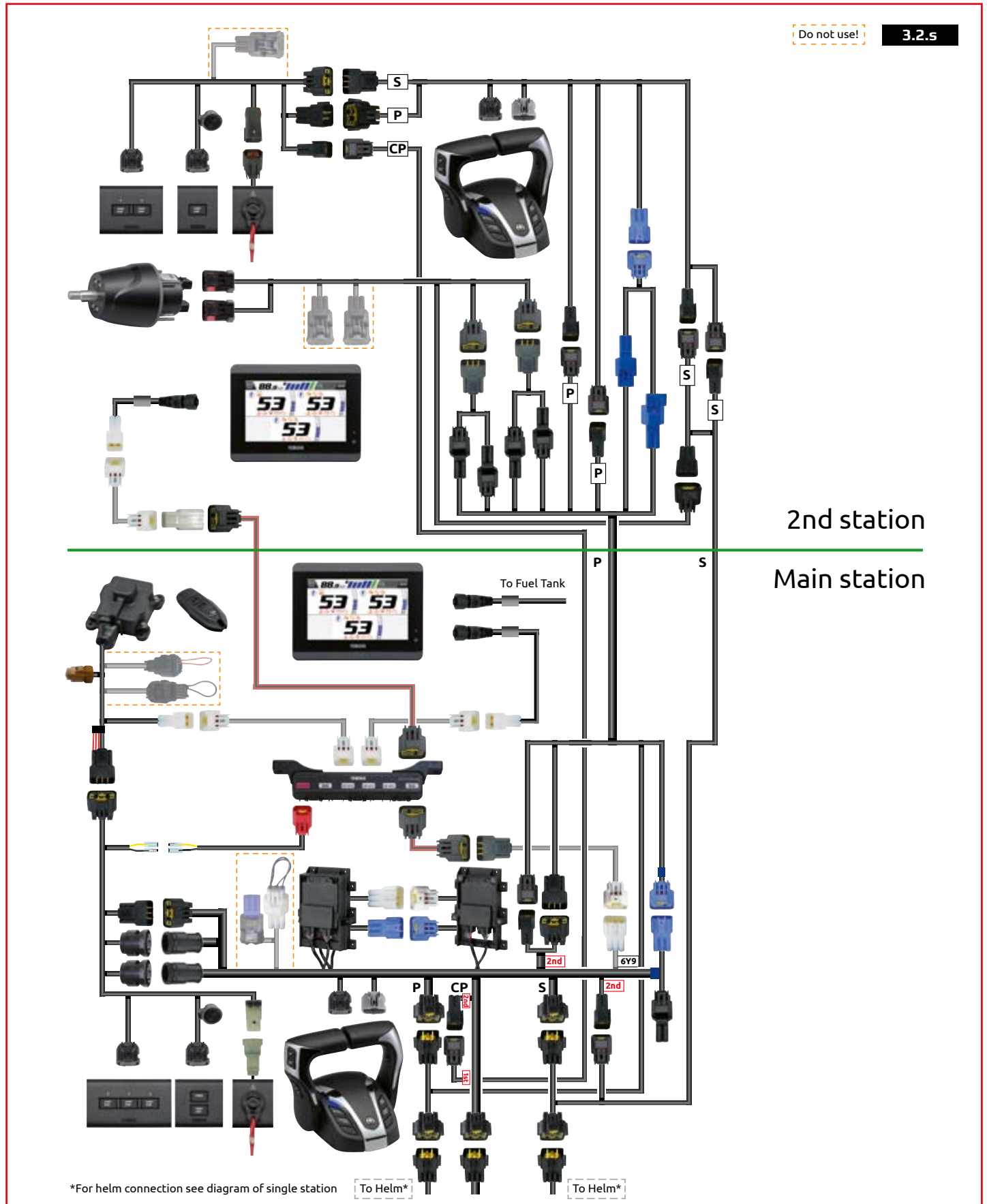

TRIPLE 2ND STATION LEVEL 2 PARTS

	Description	Qty	Note
	6X9-48207-10-00	1	2nd station
	6YM-83710-10-00	1	Display only
	6YM-83553-00-00	1	
	6Y8-81920-11-00	1	
	6Y8-82521-11-00	1	Other lengths available
LEVEL 1	6Y8-82553-11-00	1	Other lengths available
	6X9-762B0-A0-00	1	
	6X9-8258A-00-00	1	Other lengths available
	6X9-8258A-30-00	1	Other lengths available
	6X9-8258A-60-00	1	Other lengths available
	6GR-8258A-V0-00	2	Only For Integrated Steering
LEVEL 2	6X9-615A0-00-00	1	Tilt type available (Kit: 6GR-762H0-00-00)
	6GR-8258A-B0-00	1	

*) For other display options, check the 'display' section in this guide

KIT CONTENTS

Part Number	Description	Qty	Note
6X9-762B0-A0-00	EKS Kit - Triple 2nd St		
6X9-82570-B0-00	All Start/Stop Switch	1	
6X9-82570-40-00	Start/Stop Switch	1	
6X9-82716-80-00	EKS harness	1	
6X9-82570-C0-00	Lanyard switch	1	

HARNESS OPTIONS

Main bus wire	Length	Pigtail bus wire	Length
6Y8-82553-01-00	0.3m (1 ft)	6Y8-82521-01-00	0.3m (1 ft)
6Y8-82553-50-00	3m (10 ft)	6Y8-82521-11-00	0.6m (2 ft)
6Y8-82553-11-00	4.6m (15 ft)	6Y8-82521-21-00	0.9m (3 ft)
6Y8-82553-21-00	6.1m (20 ft)	6Y8-82521-31-00	1.8m (6 ft)
6Y8-82553-31-00	7.6m (25 ft)	6Y8-82521-41-00	2.7m (9 ft)
6Y8-82553-41-00	9.1m (30 ft)	6Y8-82521-51-00	3.6m (12 ft)

2nd helm harness Port	Length	2nd helm harness Stbd	Length	2nd helm harness Center	Length
6X9-8258A-00-00	5m (16 ft)	6X9-8258A-30-00	5m (16 ft)	6X9-8258A-60-00	5m (16 ft)
6X9-8258A-10-00	8m (26 ft)	6X9-8258A-40-00	8m (26 ft)	6X9-8258A-70-00	8m (26 ft)
6X9-8258A-20-00	12m (38 ft)	6X9-8258A-50-00	12m (38 ft)	6X9-8258A-80-00	12m (38 ft)

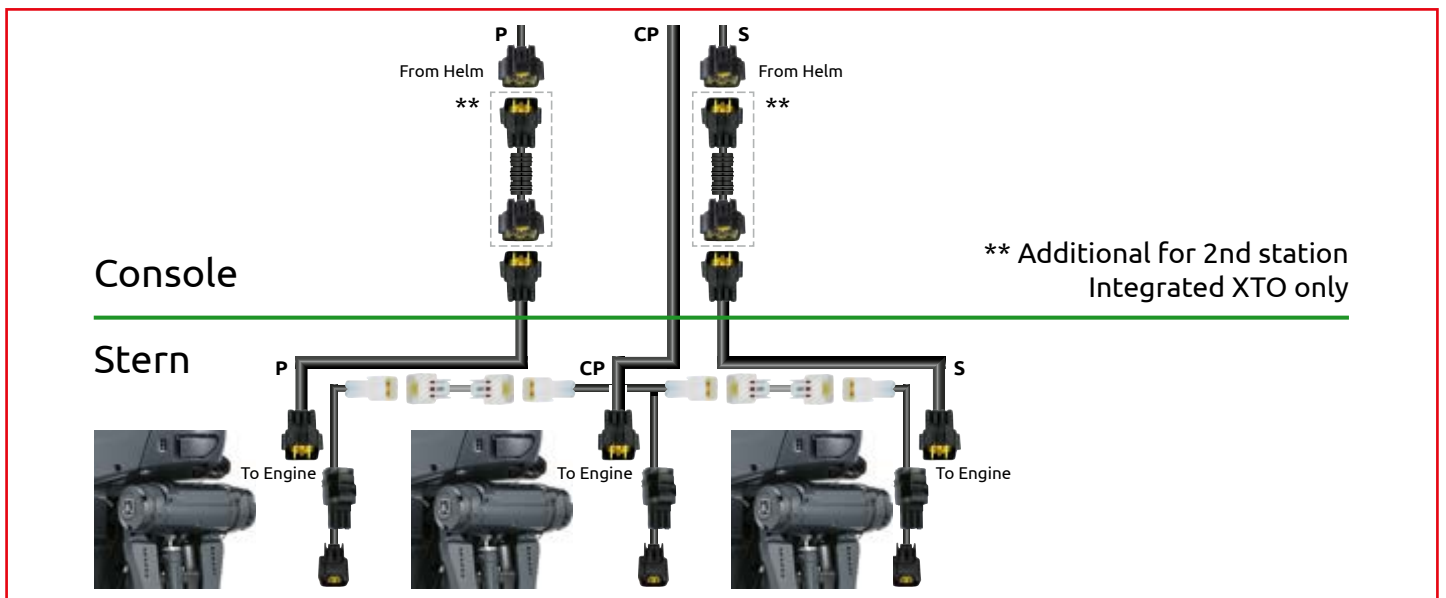

Rigging Order Guide

DBW REMOTE CONTROL (2ND STATION)

TRIPLE 2ND STATION LEVEL 3-4

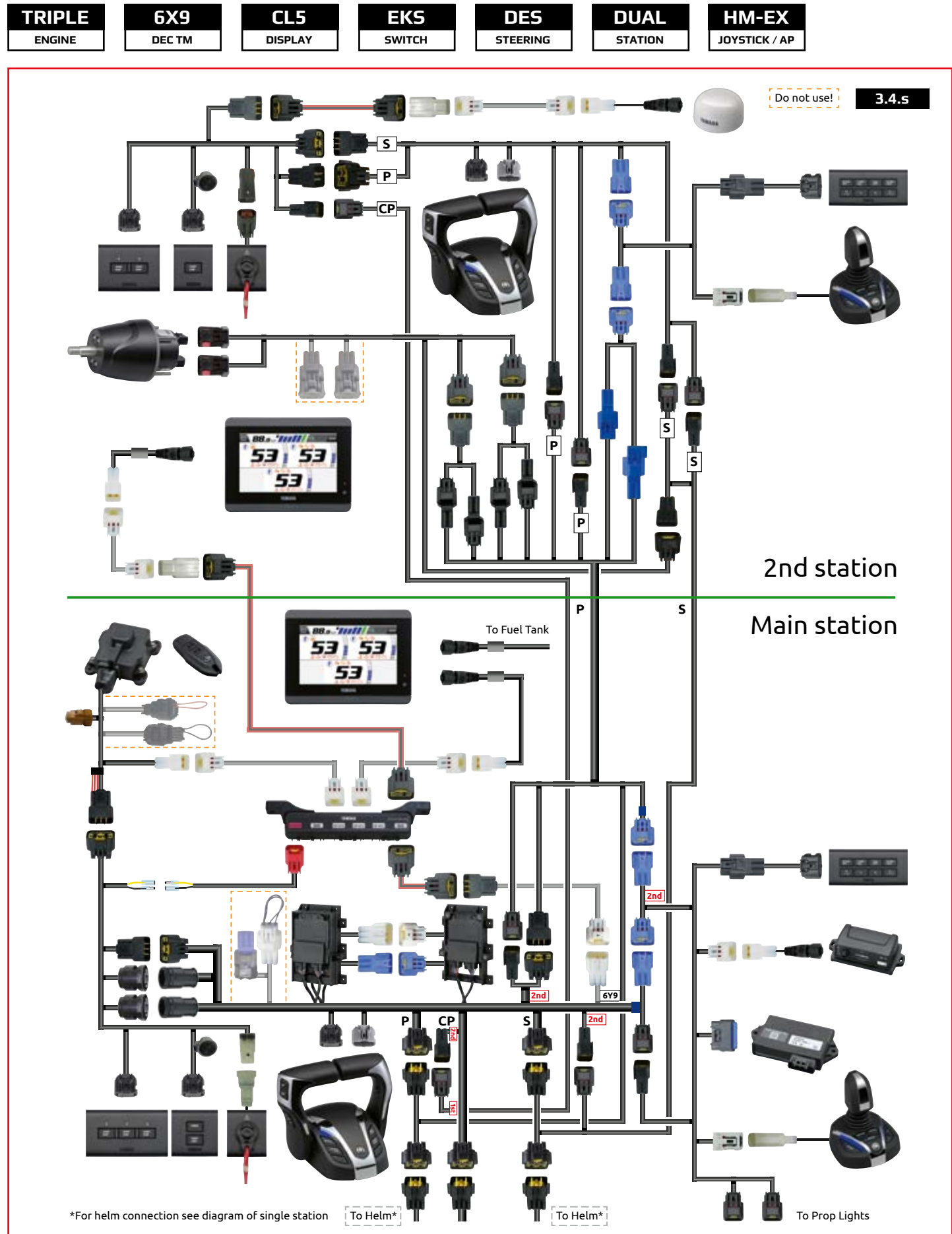

TRIPLE 2ND STATION LEVEL 3-4 PARTS

	Description	Qty	Note
	6X9-48207-10-00 6X9 DEC Top mount - twin/tr/Quad	1	2nd station
	6YM-83710-10-00 CL5 Color Touch Gauge*	1	Display only
	6YM-83553-00-00 Conversion Harness for CL5	1	
	6Y8-81920-11-00 Single hub	1	
	6Y8-82521-11-00 Pigtail bus wire 0.6m / 2 ft	1	Other lengths available
LEVEL 1	6Y8-82553-11-00 Main bus wire 4.6m / 15 ft	1	Other lengths available
	6X9-762B0-A0-00 EKS Kit - Triple 2nd St	1	
	6X9-8258A-00-00 2nd station harness Port 5m / 16 ft	1	Other lengths available
	6X9-8258A-30-00 2nd station harness Stbd 5m / 16 ft	1	Other lengths available
	6X9-8258A-60-00 2nd station harness Center 5m / 16 ft	1	Other lengths available
	6GR-8258A-V0-00 Extension Harness**	2	Only For Integrated Steering
LEVEL 2	6X9-615A0-00-00 Compact Helm unit	1	Tilt type available (Kit: 6GR-762H0-00-00)
	6GR-8258A-B0-00 Helm harness 2nd St 0.9m / 3 ft	1	
	6X9-482A0-00-00 Joystick Assy for 2nd station	1	
LEVEL 3-4	6X9-762P0-10-00 Auto Pilot Panel kit 2nd station	1	
Level 3 and 4 requires an compatible multi-function display for map functions			
*) For other display options, check the 'display' section in this guide			

KIT CONTENTS

Part Number	Description	Qty	Note
6X9-762B0-A0-00	EKS Kit - Triple 2nd St	1	
6X9-82570-B0-00	All Start/Stop Switch	1	
6X9-82570-40-00	Start/Stop Switch	1	
6X9-82716-80-00	EKS harness	1	
6X9-82570-C0-00	Lanyard switch	1	

HARNESS OPTIONS

Main bus wire	Length	Pigtail bus wire	Length
6Y8-82553-01-00	0.3m (1 ft)	6Y8-82521-01-00	0.3m (1 ft)
6Y8-82553-50-00	3m (10 ft)	6Y8-82521-11-00	0.6m (2 ft)
6Y8-82553-11-00	4.6m (15 ft)	6Y8-82521-21-00	0.9m (3 ft)
6Y8-82553-21-00	6.1m (20 ft)	6Y8-82521-31-00	1.8m (6 ft)
6Y8-82553-31-00	7.6m (25 ft)	6Y8-82521-41-00	2.7m (9 ft)
6Y8-82553-41-00	9.1m (30 ft)	6Y8-82521-51-00	3.6m (12 ft)

2nd helm harness Port	Length	2nd helm harness Stbd	Length	2nd helm harness Center	Length
6X9-8258A-00-00	5m (16 ft)	6X9-8258A-30-00	5m (16 ft)	6X9-8258A-60-00	5m (16 ft)
6X9-8258A-10-00	8m (26 ft)	6X9-8258A-40-00	8m (26 ft)	6X9-8258A-70-00	8m (26 ft)
6X9-8258A-20-00	12m (38 ft)	6X9-8258A-50-00	12m (38 ft)	6X9-8258A-80-00	12m (38 ft)

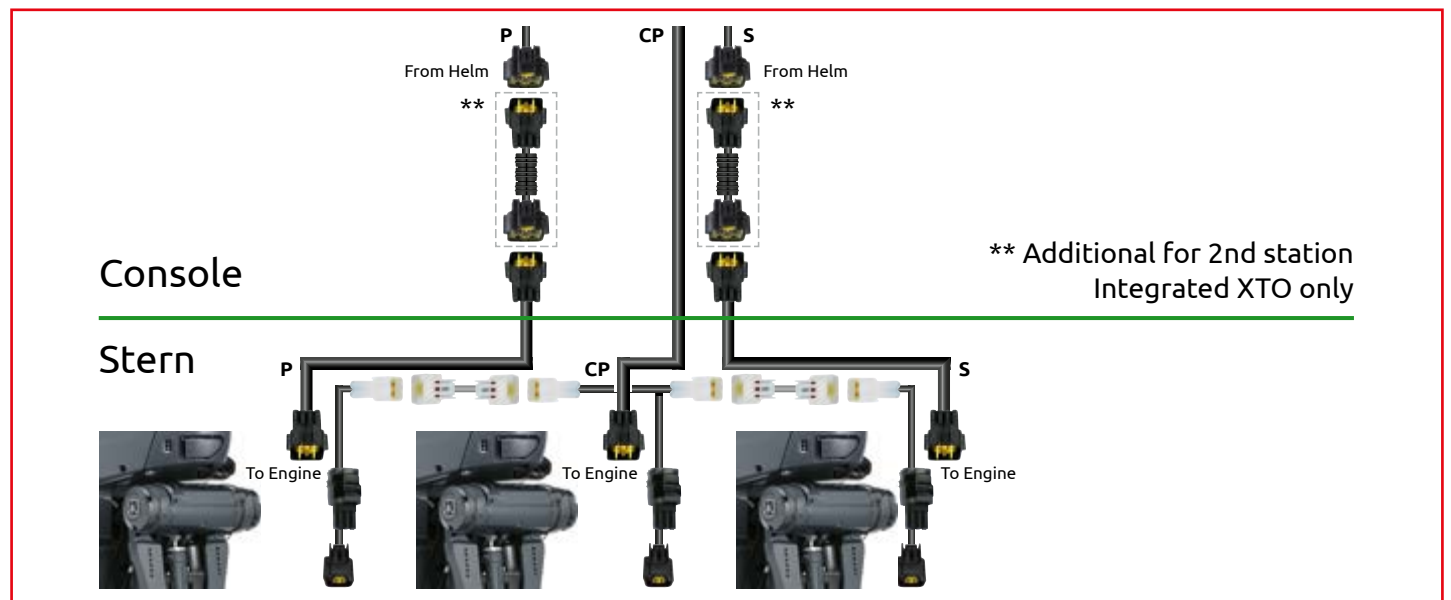

Rigging Order Guide

DBW REMOTE CONTROL (MAIN STATION)

QUAD LEVEL 1

QUAD ENGINE	6X9 DEC TM	CL5 DISPLAY	EKS SWITCH	DES STEERING	SINGLE STATION
-----------------------	----------------------	-----------------------	----------------------	------------------------	--------------------------

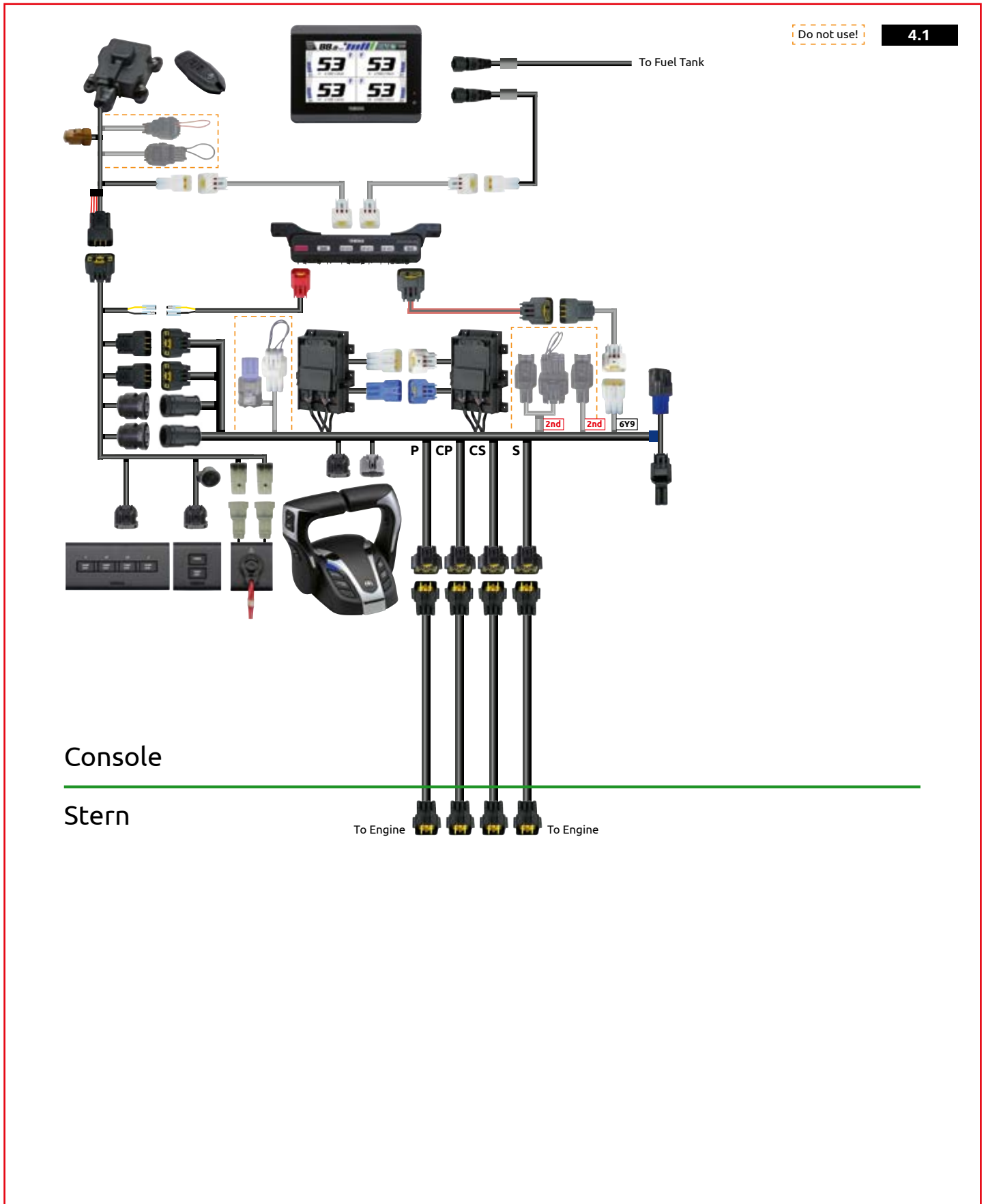

Do not use!

4.1

Console

Stern

To Engine To Engine

QUAD LEVEL 1 PARTS

	Description	Qty	Note
	6X9-48209-00-00	6X9 DEC Top mount - Quad	1
	6YM-762G0-00-00	CL5 Color Touch Gauge Kit - DEC*	1
LEVEL 1	6X9-762B0-31-00	EKS Kit - Quad	1
	6X6-8258A-40-00	Main harness 16P 12m / 39 ft	2 Other lengths available
	6X6-8258A-70-00	Main harness 16P 15m / 49 ft	2 Other lengths available

*) For other display options, check the 'display' section in this guide

KIT CONTENTS

6YM-762G0-00-00	CL5 Color Touch Gauge Kit - DEC	Qty	Note
6YM-83710-10-00	CL5 Display	1	
6YM-83553-00-00	Conversion Harness	1	0.9 m (3 ft)
6YD-8356N-00-00	Fuel Tank Wire	1	
6Y8-81920-01-00	Multihub	1	
6Y9-83553-00-00	Conversion harness	1	
6Y8-82553-01-00	Main bus wire	1	0.3m (1 ft), other lengths available
6Y8-82521-31-00	Pigtail bus wire	1	1.8m (6 ft), other lengths available
6Y8-83553-02-00	System power supply	1	
6Y8-82582-11-00	Terminal Cap White	2	

6X9-762B0-31-00	EKS Kit - Quad	Qty	Note
6X9-82570-00-00	Power Switch	1	
6X9-82570-50-00	Individual start stop	1	
6X9-82716-91-00	EKS harness	1	
6X9-82570-D0-00	Lanyard switch	1	
6X9-86254-00-00	Immobilizer + key fob (2pcs)	1	433Mhz
6Y8-82521-11-00	Pigtail bus wire	1	0.6m (2 ft)
6Y8-48277-00-00	Sticker	1	

HARNESS OPTIONS

Main harness 16P	Length	Main bus wire	Length	Pigtail bus wire	Length
6X6-8258A-90-00	1.5m (5 ft)	6Y8-82553-01-00	0.3m (1 ft)	6Y8-82521-01-00	0.3m (1 ft)
6X6-8258A-50-00	3.7m (12 ft)	6Y8-82553-50-00	3m (10 ft)	6Y8-82521-11-00	0.6m (2 ft)
6X6-8258A-60-00	5.2m (17 ft)	6Y8-82553-11-00	4.6m (15 ft)	6Y8-82521-21-00	0.9m (3 ft)
6X6-8258A-00-00	6m (19 ft)	6Y8-82553-21-00	6.1m (20 ft)	6Y8-82521-31-00	1.8m (6 ft)
6X6-8258A-10-00	7m (23 ft)	6Y8-82553-31-00	7.6m (25 ft)	6Y8-82521-41-00	2.7m (9 ft)
6X6-8258A-20-00	8m (26 ft)	6Y8-82553-41-00	9.1m (30 ft)	6Y8-82521-51-00	3.6m (12 ft)
6X6-8258A-30-00	10m (32 ft)				
6X6-8258A-40-00	12m (39 ft)				
6X6-8258A-70-00	15m (49 ft)				
6X6-8258A-80-00	24m (79 ft)				

Rigging Order Guide

DBW REMOTE CONTROL (MAIN STATION)

QUAD LEVEL 2 BOLT-ON

QUAD ENGINE	6X9 DEC TM	CL5 DISPLAY	EKS SWITCH	DES BOLT-ON	SINGLE STATION
-----------------------	----------------------	-----------------------	----------------------	-----------------------	--------------------------

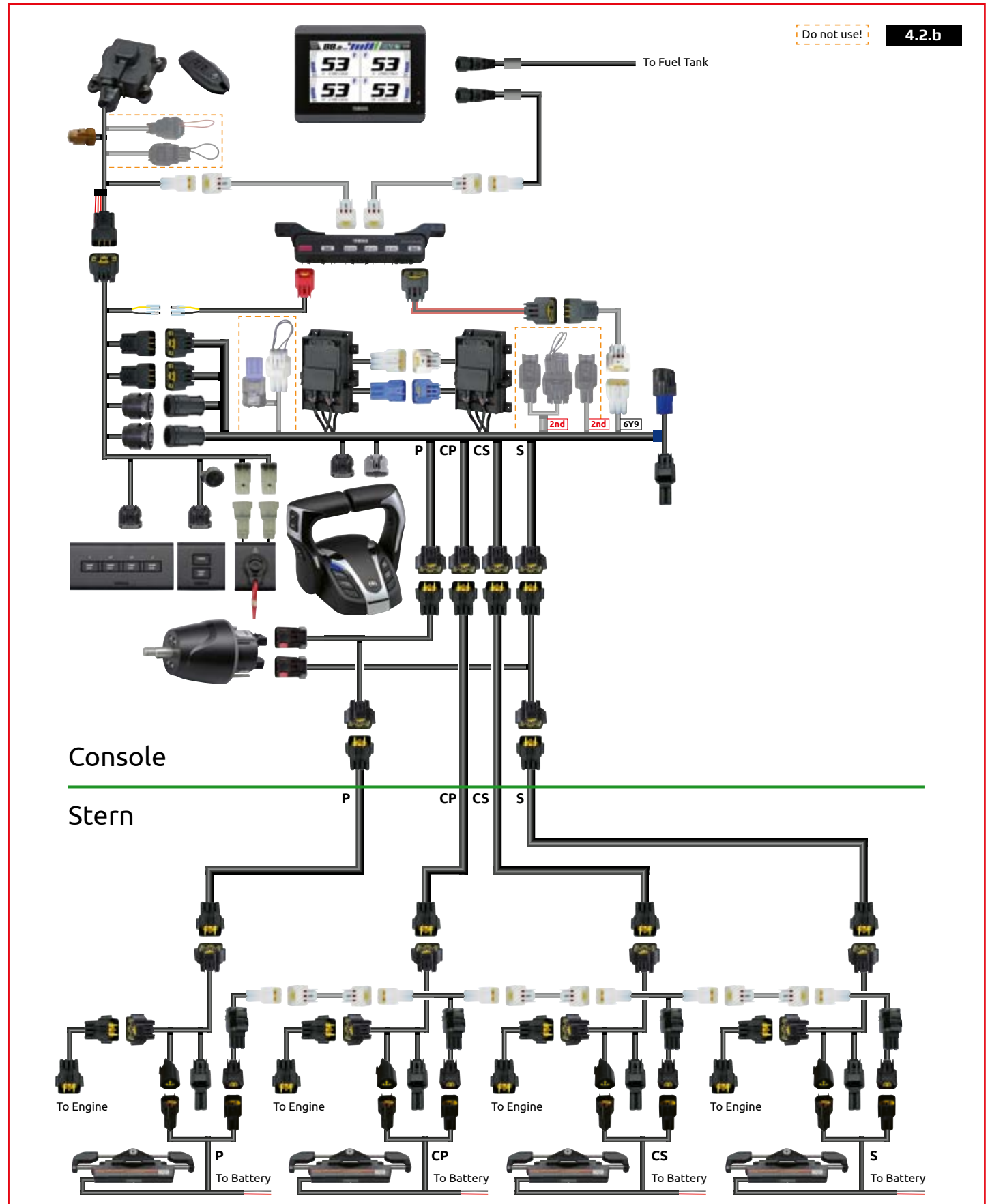

QUAD LEVEL 2 BOLT-ON PARTS

	Description	Qty	Note	
LEVEL 1	6X9-48209-00-00	6X9 DEC Top mount - Quad	1	
	6YM-762G0-00-00	CL5 Color Touch Gauge Kit - DEC*	1	
	6X9-762B0-31-00	EKS Kit - Quad	1	
	6X6-8258A-40-00	Main harness 16P 12m / 39 ft	2	Other lengths available
	6X6-8258A-70-00	Main harness 16P 15m / 49 ft	2	Other lengths available
LEVEL 2	6X9-762S0-00-00	Bolt-on DES KIT	4	
	6X9-438A0-00-00	Steering actuator harness 2.4m / 8 ft	4	Other lengths available
	6X6-8258A-50-00	Main harness 16P 3.7m / 12 ft	4	Other lengths available
	6X9-615A0-00-00	Compact Helm unit	1	Tilt type available (Kit: 6GR-762H0-00-00)
	6Y8-82521-11-00	Pigtail Bus Wire 0.6m / 2 ft	3	Other lengths available
	6GR-81115-00-00	SCU link harness (Port/ Stbd) 1.5m (5 ft)	2	Other lengths available
	6GR-81115-20-00	SCU link harness (Center) 1.5m (5 ft)	2	Other lengths available
	6GR-8258A-10-00	Helm harness Main St Twin/Triple/Quad 0.9m / 3 ft	2	Other lengths available

*) For other display options, check the 'display' section in this guide

KIT CONTENTS

Part Number	Description	Qty	Note
6YM-762G0-00-00	CL5 Color Touch Gauge Kit - DEC	1	
6YM-83710-10-00	CL5 Display	1	
6YM-83553-00-00	Conversion Harness	1	0.9 m (3 ft)
6YD-8356N-00-00	Fuel Tank Wire	1	
6Y8-81920-01-00	Multihub	1	
6Y9-83553-00-00	Conversion harness	1	
6Y8-82553-01-00	Main bus wire	1	0.3m (1 ft), other lengths available
6Y8-82521-31-00	Pigtail bus wire	1	1.8m (6 ft), other lengths available
6Y8-83553-02-00	System power supply	1	
6Y8-82582-11-00	Terminal Cap White	2	

Part Number	Description	Qty	Note
6X9-762B0-31-00	EKS Kit - Quad	1	
6X9-82570-00-00	Power Switch	1	
6X9-82570-50-00	Individual start stop	1	
6X9-82716-91-00	EKS harness	1	
6X9-82570-D0-00	Lanyard switch	1	
6X9-86254-00-00	Immobilizer + key fob (2pcs)	1	433Mhz
6Y8-82521-11-00	Pigtail bus wire	1	0.6m (2 ft)
6Y8-48277-00-00	Sticker	1	

Part Number	Description	Qty	Note
6X9-762S0-00-00	Bolt-on DES KIT	1	
6X9-42401-00-00	Actuator	1	
6X9-8258A-90-00	Split Harness	1	

HARNESS OPTIONS

Main harness 16P	Length	Main bus wire	Length	Pigtail bus wire	Length
6X6-8258A-90-00	1.5m (5 ft)	6Y8-82553-01-00	0.3m (1 ft)	6Y8-82521-01-00	0.3m (1 ft)
6X6-8258A-50-00	3.7m (12 ft)	6Y8-82553-50-00	3m (10 ft)	6Y8-82521-11-00	0.6m (2 ft)
6X6-8258A-60-00	5.2m (17 ft)	6Y8-82553-11-00	4.6m (15 ft)	6Y8-82521-21-00	0.9m (3 ft)
6X6-8258A-00-00	6m (19 ft)	6Y8-82553-21-00	6.1m (20 ft)	6Y8-82521-31-00	1.8m (6 ft)
6X6-8258A-10-00	7m (23 ft)	6Y8-82553-31-00	7.6m (25 ft)	6Y8-82521-41-00	2.7m (9 ft)
6X6-8258A-20-00	8m (26 ft)	6Y8-82553-41-00	9.1m (30 ft)	6Y8-82521-51-00	3.6m (12 ft)
6X6-8258A-30-00	10m (32 ft)				
6X6-8258A-40-00	12m (39 ft)	Steering Actuator Harness	Length	Helm Harness	Length
6X6-8258A-70-00	15m (49 ft)	6X9-438A0-00-00	2.4m (8 ft)	6GR-8258A-10-00	0.9m (3 ft)
6X6-8258A-80-00	24m (79 ft)	6X9-438A0-10-00	4.5m (15 ft)	6GR-8258A-50-00	1.8m (6 ft)
				6GR-8258A-60-00	2.7m (9 ft)
SCU Link harness P/S	Length	SCU Link harness Center	Length		
6X9-81115-00-00	0.3m (1 ft)	6X9-81115-10	0.3m (1 ft)		
6GR-81115-00-00	1.5m (5 ft)	6GR-81115-20	1.5m (5 ft)		
6GR-81115-10-00	3.0m (10 ft)	6GR-81115-30	3.0m (10 ft)		

Rigging Order Guide

DBW REMOTE CONTROL (MAIN STATION)

QUAD LEVEL 2 INTEGRATED

QUAD ENGINE	6X9 DEC TM	CL5 DISPLAY	EKS SWITCH	DES INTEGRATED	SINGLE STATION
-----------------------	----------------------	-----------------------	----------------------	--------------------------	--------------------------

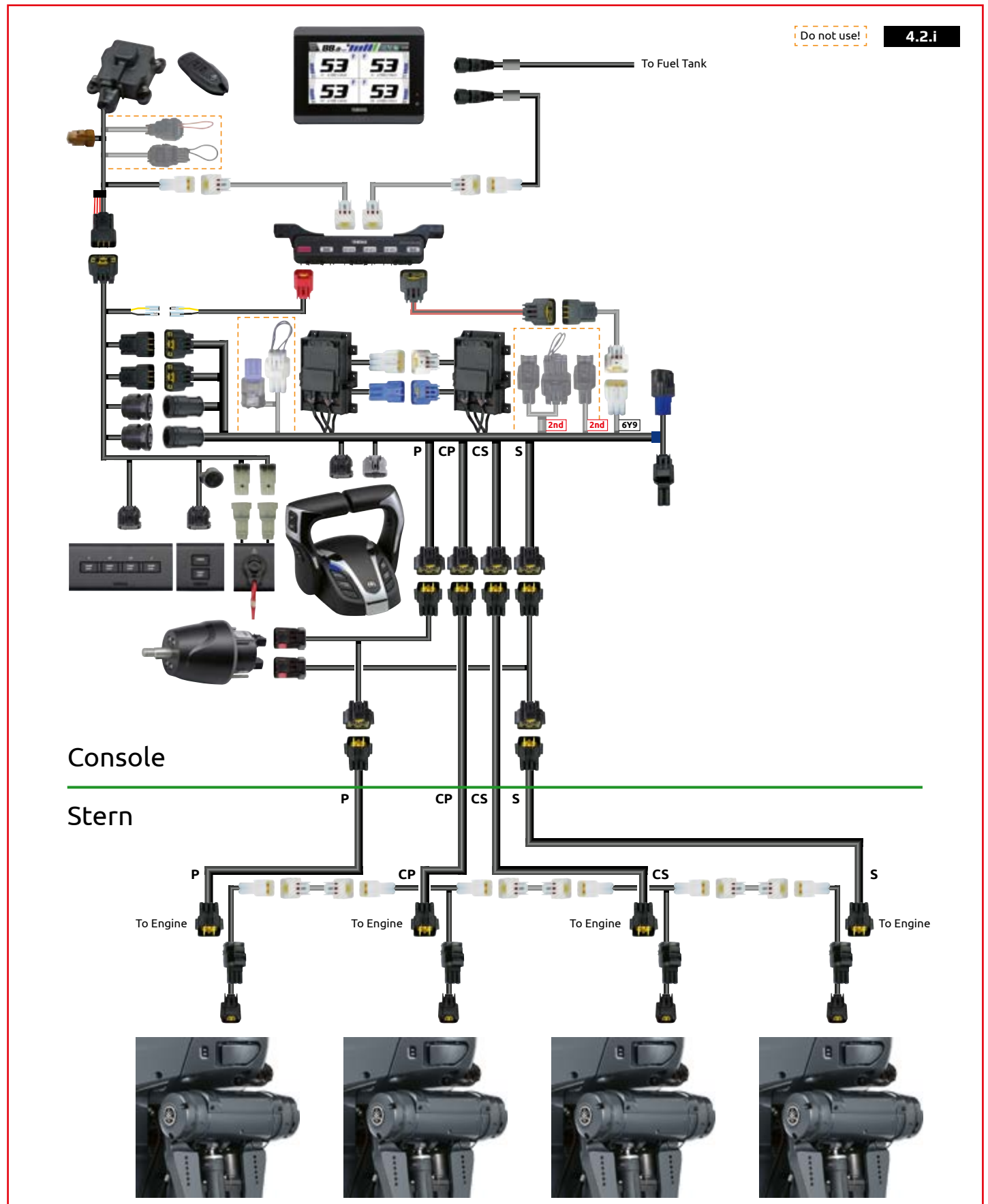

QUAD LEVEL 2 INTEGRATED PARTS

	Description	Qty	Note
	6X9-48209-00-00	6X9 DEC Top mount - Quad	1
	6YM-762G0-00-00	CL5 Color Touch Gauge Kit - DEC*	1
LEVEL 1	6X9-762B0-31-00	EKS Kit - Quad	1
	6X6-8258A-40-00	Main harness 16P 12m / 39 ft	2 Other lengths available
	6X6-8258A-70-00	Main harness 16P 15m / 49 ft	2 Other lengths available
	6X9-615A0-00-00	Compact Helm unit	1 Tilt type available (Kit: 6GR-762H0-00-00)
	6GR-81115-00-00	SCU link harness (Port/ Stbd) 1.5m (5 ft)	2 Other lengths available
LEVEL 2	6GR-81115-20-00	SCU link harness (Center) 1.5m (5 ft)	2 Other lengths available
	6Y8-82521-11-00	Pigtail bus wire 0.6m / 2 ft	3 Other lengths available
	6GR-8258A-10-00	Helm harness Main St Twin/Triple/Quad 0,9m / 3 ft	2 Other lengths available

*) For other display options, check the 'display' section in this guide

KIT CONTENTS

Part Number	Description	Qty	Note
6YM-762G0-00-00	CL5 Color Touch Gauge Kit - DEC	1	
6YM-83710-10-00	CL5 Display	1	
6YM-83553-00-00	Conversion Harness	1	0.9 m (3 ft)
6YD-8356N-00-00	Fuel Tank Wire	1	
6Y8-81920-01-00	Multihub	1	
6Y9-83553-00-00	Conversion harness	1	
6Y8-82553-01-00	Main bus wire	1	0.3m (1 ft), other lengths available
6Y8-82521-31-00	Pigtail bus wire	1	1.8m (6 ft), other lengths available
6Y8-83553-02-00	System power supply	1	
6Y8-82582-11-00	Terminal Cap White	2	

Part Number	Description	Qty	Note
6X9-762B0-31-00	EKS Kit - Quad	1	
6X9-82570-00-00	Power Switch	1	
6X9-82570-50-00	Individual start stop	1	
6X9-82716-91-00	EKS harness	1	
6X9-82570-D0-00	Lanyard switch	1	
6X9-86254-00-00	Immobilizer + key fob (2pcs)	1	433Mhz
6Y8-82521-11-00	Pigtail bus wire	1	0.6m (2 ft)
6Y8-48277-00-00	Sticker	1	

HARNESS OPTIONS

Main harness 16P	Length	Main bus wire	Length	Pigtail bus wire	Length
6X6-8258A-90-00	1.5m (5 ft)	6Y8-82553-01-00	0.3m (1 ft)	6Y8-82521-01-00	0.3m (1 ft)
6X6-8258A-50-00	3.7m (12 ft)	6Y8-82553-50-00	3m (10 ft)	6Y8-82521-11-00	0.6m (2 ft)
6X6-8258A-60-00	5.2m (17 ft)	6Y8-82553-11-00	4.6m (15 ft)	6Y8-82521-21-00	0.9m (3 ft)
6X6-8258A-00-00	6m (19 ft)	6Y8-82553-21-00	6.1m (20 ft)	6Y8-82521-31-00	1.8m (6 ft)
6X6-8258A-10-00	7m (23 ft)	6Y8-82553-31-00	7.6m (25 ft)	6Y8-82521-41-00	2.7m (9 ft)
6X6-8258A-20-00	8m (26 ft)	6Y8-82553-41-00	9.1m (30 ft)	6Y8-82521-51-00	3.6m (12 ft)
6X6-8258A-30-00	10m (32 ft)				
6X6-8258A-40-00	12m (39 ft)				
6X6-8258A-70-00	15m (49 ft)				
6X6-8258A-80-00	24m (79 ft)				

Helm Harness	Length	SCU Link harness P/S	Length	SCU Link harness Center	Length
6GR-8258A-10-00	0.9m (3 ft)	6X9-81115-00-00	0.3m (1 ft)	6X9-81115-10	0.3m (1 ft)
6GR-8258A-50-00	1.8m (6 ft)	6GR-81115-00-00	1.5m (5 ft)	6GR-81115-20	1.5m (5 ft)
6GR-8258A-60-00	2.7m (9 ft)	6GR-81115-10-00	3.0m (10 ft)	6GR-81115-30	3.0m (10 ft)

Rigging Order Guide

DBW REMOTE CONTROL (MAIN STATION)

QUAD LEVEL 3-4 BOLT-ON

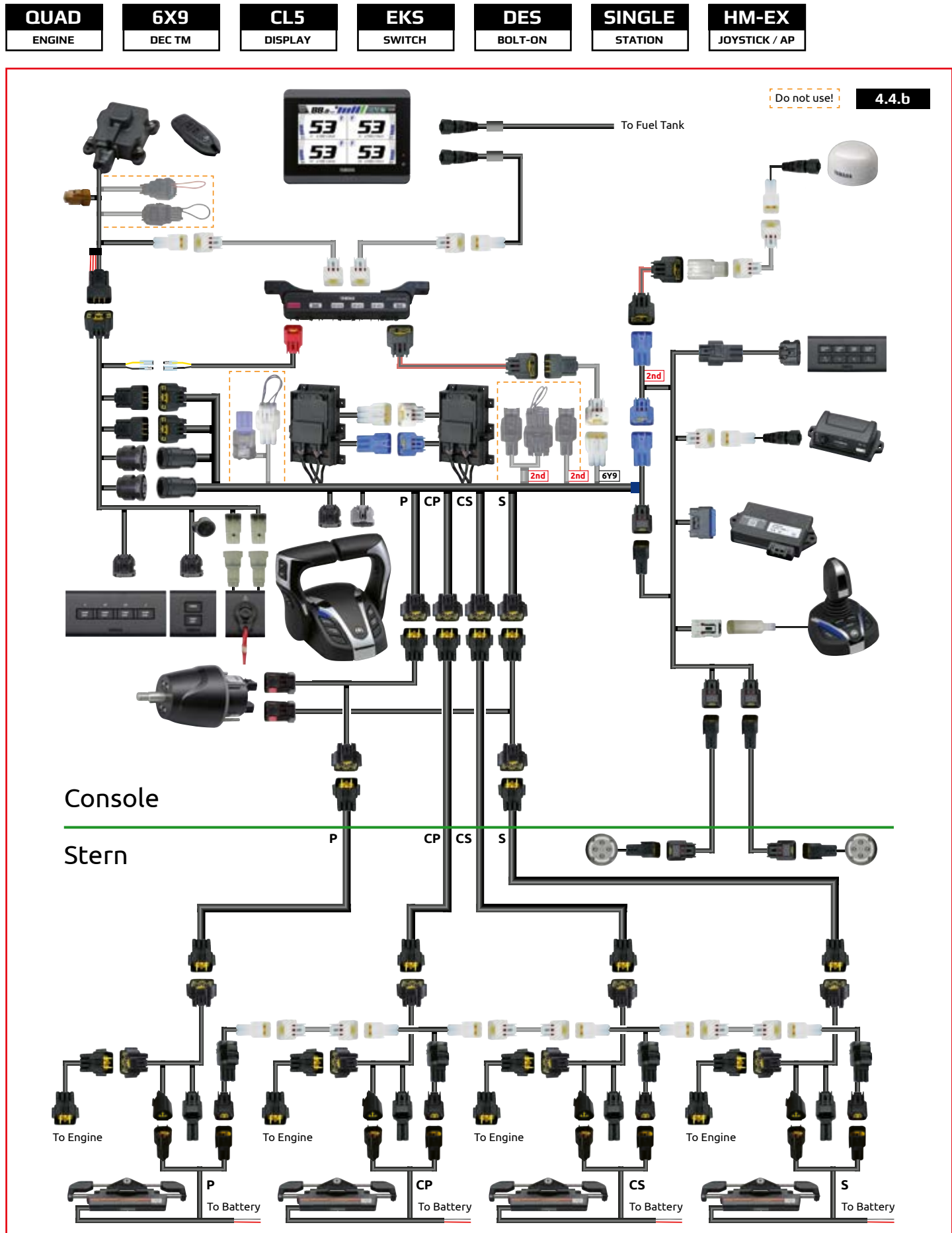

QUAD LEVEL 3-4 BOLT-ON PARTS

	Description	Qty	Note	
LEVEL 1	6X9-48209-00-00	6X9 DEC Top mount - Quad	1	
	6YM-762G0-00-00	CL5 Color Touch Gauge Kit - DEC*	1	
	6X9-762B0-31-00	EKS Kit - Quad	1	
	6X6-8258A-40-00	Main harness 16P 12m / 39 ft	2	Other lengths available
	6X6-8258A-70-00	Main harness 16P 15m / 49 ft	2	Other lengths available
LEVEL 2	6X9-762S0-00-00	Bolt-on DES KIT	4	
	6X9-438A0-00-00	Steering actuator harness 2.4m / 8 ft	4	Other lengths available
	6X6-8258A-50-00	Main harness 16P 3.7m / 12 ft	4	Other lengths available
	6X9-615A0-00-00	Compact Helm unit	1	Tilt type available (Kit: 6GR-762H0-00-00)
	6Y8-82521-11-00	Pigtail bus wire 0.6m / 2 ft	3	Other lengths available
	6GR-81115-00-00	SCU link harness (Port/Stbd) 1.5m (5 ft)	2	Other lengths available
	6GR-81115-20-00	SCU link harness (Center) 1.5m (5 ft)	2	Other lengths available
LEVEL 3-4	6GR-8258A-10-00	Helm harness Main St Twin/Triple/Quad 0.9m / 3 ft	2	Other lengths available
	**	Joystick/AP Kit - Quad	1	
	6Y8-82553-50-00	Main bus wire 3m / 10 ft	1	Other lengths available
	6Y8-82521-01-00	Pigtail bus wire 0.3m / 1 ft	1	Other lengths available

Level 3 and 4 requires an compatible multi-function display for map functions
 *) For other display options, check the 'display' section in this guide | **) Order at the local distributor sales department

KIT CONTENTS

Part Number	Description	Qty	Note
6YM-762G0-00-00	CL5 Color Touch Gauge Kit - DEC	1	
6YM-83710-10-00	CL5 Display	1	
6YM-83553-00-00	Conversion Harness	1	0.9 m (3 ft)
6YD-8356N-00-00	Fuel Tank Wire	1	
6Y8-81920-01-00	Multihub	1	
6Y9-83553-00-00	Conversion harness	1	
6Y8-82553-01-00	Main bus wire	1	0.3m (1 ft), other lengths available
6Y8-82521-31-00	Pigtail bus wire	1	1.8m (6 ft), other lengths available
6Y8-83553-02-00	System power supply	1	
6Y8-82582-11-00	Terminal Cap White	2	

Part Number	Description	Qty	Note	Part Number	Description	Qty	Note
6X9-762B0-31-00	EKS Kit - Quad	1		**	Joystick/AP Kit - Quad	1	
6X9-82570-00-00	Power Switch	1		6X9-8253V-00-00	Autopilot panel	1	
6X9-82570-50-00	Individual start stop	1		6X9-88107-00-00	GPS antenna	1	
6X9-82716-91-00	EKS harness	1		6X9-8A410-00-00	Heading sensor	1	
6X9-82570-D0-00	Lanyard switch	1		6X9-8591T-40-00	Boat Control Unit (BCU)	1	
6X9-86254-00-00	Immobilizer + key fob (2pcs)	1	433Mhz	6Y8-81920-11-00	Single hub	1	
6Y8-82521-11-00	Pigtail bus wire	1	0.6m (2 ft)	6X9-82386-01-00	BCU Harness	1	
6Y8-48277-00-00	Sticker	1		6YM-83553-00-00	Conversion harness	2	
6X9-762S0-00-00	Bolt-on DES KIT	1		6X9-482A0-00-00	Joystick Assy	1	
6X9-42401-00-00	Actuator	1		6ES-83720-01-00	Prop lights	2	
6X9-8258A-90-00	Split Harness	1		**) Order at the local distributor sales department			

HARNESS OPTIONS

Main harness 16P	Length	Main bus wire	Length	Pigtail bus wire	Length
6X6-8258A-90-00	1.5m (5 ft)	6Y8-82553-01-00	0.3m (1 ft)	6Y8-82521-01-00	0.3m (1 ft)
6X6-8258A-50-00	3.7m (12 ft)	6Y8-82553-50-00	3m (10 ft)	6Y8-82521-11-00	0.6m (2 ft)
6X6-8258A-60-00	5.2m (17 ft)	6Y8-82553-11-00	4.6m (15 ft)	6Y8-82521-21-00	0.9m (3 ft)
6X6-8258A-00-00	6m (19 ft)	6Y8-82553-21-00	6.1m (20 ft)	6Y8-82521-31-00	1.8m (6 ft)
6X6-8258A-10-00	7m (23 ft)	6Y8-82553-31-00	7.6m (25 ft)	6Y8-82521-41-00	2.7m (9 ft)
6X6-8258A-20-00	8m (26 ft)	6Y8-82553-41-00	9.1m (30 ft)	6Y8-82521-51-00	3.6m (12 ft)
6X6-8258A-30-00	10m (32 ft)				
6X6-8258A-40-00	12m (39 ft)	Steering Actuator Harness	Length	Helm Harness	Length
6X6-8258A-70-00	15m (49 ft)	6X9-438A0-00-00	2.4m (8 ft)	6GR-8258A-10-00	0.9m (3 ft)
6X6-8258A-80-00	24m (79 ft)	6X9-438A0-10-00	4.5m (15 ft)	6GR-8258A-50-00	1.8m (6 ft)
				6GR-8258A-60-00	2.7m (9 ft)
SCU Link harness P/S	Length	SCU Link harness Center	Length	Extension for Prop lights	Length
6X9-81115-00-00	0.3m (1 ft)	6X9-81115-10-00	0.3m (1 ft)	6X9-82586-20-00	6m (19 ft)
6GR-81115-00-00	1.5m (5 ft)	6GR-81115-20-00	1.5m (5 ft)	6X9-82586-30-00	9.1m (30 ft)
6GR-81115-10-00	3.0m (10 ft)	6GR-81115-30-00	3.0m (10 ft)	6X9-82586-40-00	12.2m (40 ft)

Rigging Order Guide

DBW REMOTE CONTROL (MAIN STATION)

QUAD LEVEL 3-4 INTEGRATED

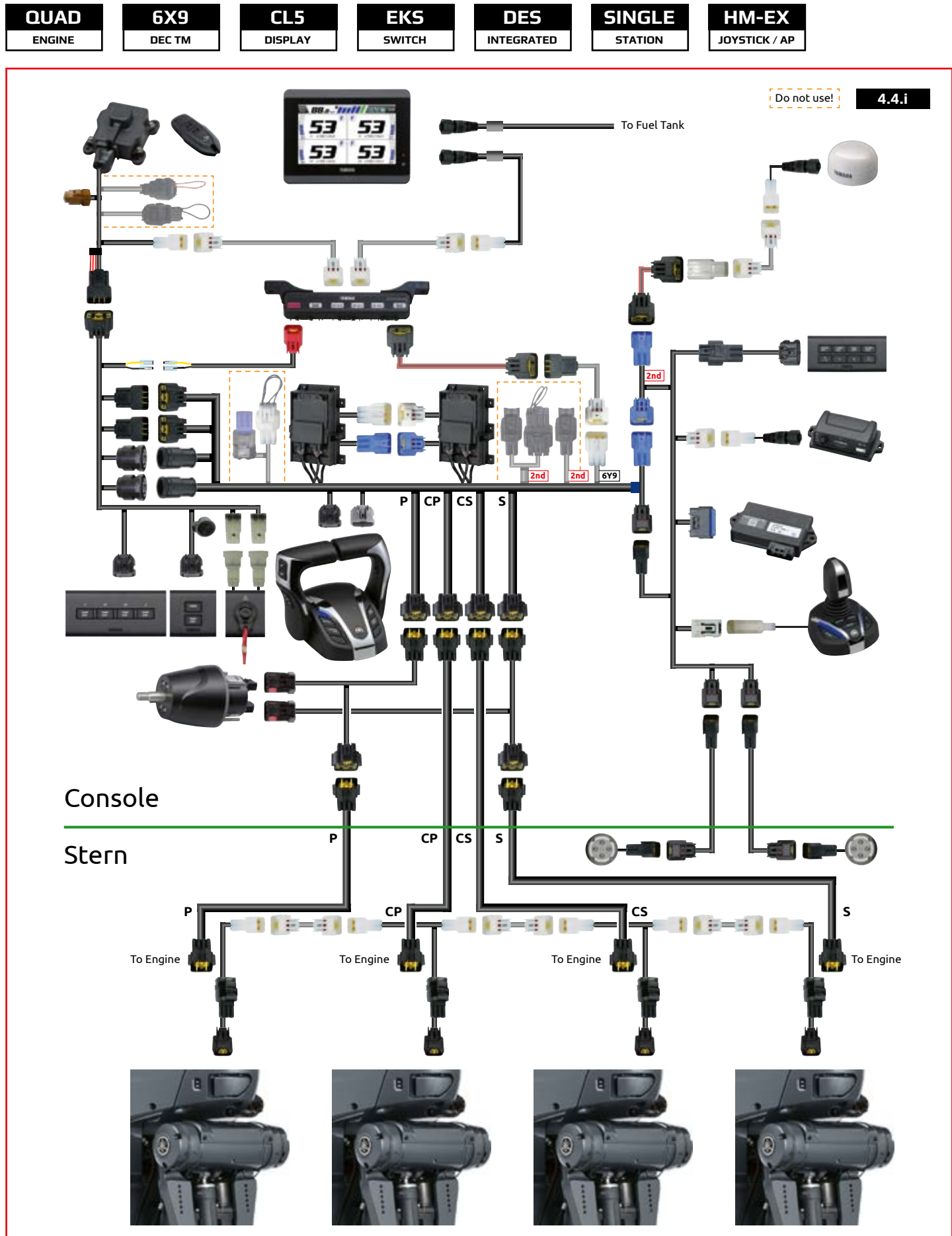

QUAD LEVEL 3-4 INTEGRATED PARTS

	Description	Qty	Note	
LEVEL 1	6X9-48209-00-00	6X9 DEC Top mount - Quad	1	
	6YM-762G0-00-00	CL5 Color Touch Gauge Kit - DEC*	1	
	6X9-762B0-31-00	EKS Kit - Quad	1	
	6X6-8258A-40-00	Main harness 16P 12m / 39 ft	2	Other lengths available
	6X6-8258A-70-00	Main harness 16P 15m / 49 ft	2	Other lengths available
LEVEL 2	6X9-762S0-00-00	Compact Helm unit	1	Tilt type available (Kit: 6GR-762H0-00-00)
	6GR-81115-00-00	SCU link harness (Port/ Stbd) 1.5m (5 ft)	2	Other lengths available
	6GR-81115-20-00	SCU link harness (Center) 1.5m (5 ft)	2	Other lengths available
	6Y8-82521-11-00	Pigtail bus wire 0.6m / 2 ft	3	Other lengths available
	6GR-8258A-10-00	Helm harness Main St Twin/Triple/Quad 0,9m / 3 ft	2	Other lengths available
LEVEL 3-4	**	Joystick/AP Kit - Quad	1	
	6Y8-82553-50-00	Main bus wire 3m / 10 ft	1	Other lengths available
	6Y8-82521-01-00	Pigtail bus wire 0.3m / 1 ft	1	Other lengths available

Level 3 and 4 requires an compatible multi-function display for map functions
 *) For other display options, check the 'display' section in this guide | **) Order at the local distributor sales department

KIT CONTENTS

Part Number	Description	Qty	Note
6YM-762G0-00-00	CL5 Color Touch Gauge Kit - DEC	1	
6YM-83710-10-00	CL5 Display	1	
6YM-83553-00-00	Conversion Harness	1	0.9 m (3 ft)
6YD-8356N-00-00	Fuel Tank Wire	1	
6Y8-81920-01-00	Multihub	1	
6Y9-83553-00-00	Conversion harness	1	
6Y8-82553-01-00	Main bus wire	1	0.3m (1 ft), other lengths available
6Y8-82521-31-00	Pigtail bus wire	1	1.8m (6 ft), other lengths available
6Y8-83553-02-00	System power supply	1	
6Y8-82582-11-00	Terminal Cap White	2	

Part Number	Description	Qty	Note	Part Number	Description	Qty	Note
6X9-762B0-31-00	EKS Kit - Quad			**	Joystick/AP Kit - Quad		
6X9-82570-00-00	Power Switch	1		6X9-8253V-00-00	Autopilot panel	1	
6X9-82570-50-00	Individual start stop	1		6X9-88107-00-00	GPS antenna	1	
6X9-82716-91-00	EKS harness	1		6X9-8A410-00-00	Heading sensor	1	
6X9-82570-D0-00	Lanyard switch	1		6X9-8591T-40-00	Boat Control Unit (BCU)	1	
6X9-86254-00-00	Immobilizer + key fob (2pcs)	1	433Mhz	6Y8-81920-11-00	Single hub	1	
6Y8-82521-11-00	Pigtail bus wire	1	0.6m (2 ft)	6X9-82386-01-00	BCU Harness	1	
6Y8-48277-00-00	Sticker	1		6YM-83553-00-00	Conversion harness	2	
				6X9-482A0-00-00	Joystick Assy	1	
				6ES-83720-01-00	Prop lights	2	

***) Order at the local distributor sales department

HARNESS OPTIONS

Main harness 16P	Length (m)	Main bus wire	Length	Pigtail bus wire	Length
6X6-8258A-90-00	1.5m (5 ft)	6Y8-82553-01-00	0.3m (1 ft)	6Y8-82521-01-00	0.3m (1 ft)
6X6-8258A-50-00	3.7m (12 ft)	6Y8-82553-50-00	3m (10 ft)	6Y8-82521-11-00	0.6m (2 ft)
6X6-8258A-60-00	5.2m (17 ft)	6Y8-82553-11-00	4.6m (15 ft)	6Y8-82521-21-00	0.9m (3 ft)
6X6-8258A-00-00	6m (19 ft)	6Y8-82553-21-00	6.1m (20 ft)	6Y8-82521-31-00	1.8m (6 ft)
6X6-8258A-10-00	7m (23 ft)	6Y8-82553-31-00	7.6m (25 ft)	6Y8-82521-41-00	2.7m (9 ft)
6X6-8258A-20-00	8m (26 ft)	6Y8-82553-41-00	9.1m (30 ft)	6Y8-82521-51-00	3.6m (12 ft)
6X6-8258A-30-00	10m (32 ft)				
6X6-8258A-40-00	12m (39 ft)	Helm Harness	Length	SCU Link harness P/S	Length
6X6-8258A-70-00	15m (49 ft)	6GR-8258A-10-00	0.9m (3 ft)	6X9-81115-00-00	0.3m (1 ft)
6X6-8258A-80-00	24m (79 ft)	6GR-8258A-50-00	1.8m (6 ft)	6GR-81115-00-00	1.5m (5 ft)
		6GR-8258A-60-00	2.7m (9 ft)	6GR-81115-10-00	3.0m (10 ft)
SCU Link harness Center	Length	Extension for Prop lights	Length		
6X9-81115-10-00	0.3m (1 ft)	6X9-82586-20-00	6m (19 ft)		
6GR-81115-20-00	1.5m (5 ft)	6X9-82586-30-00	9.1m (30 ft)		
6GR-81115-30-00	3.0m (10 ft)	6X9-82586-40-00	12.2m (40 ft)		

Rigging Order Guide

DBW REMOTE CONTROL (2ND STATION)

QUAD 2ND STATION LEVEL 1

QUAD ENGINE	6X9 DEC TM	CL5 DISPLAY	EKS SWITCH	DES STEERING	DUAL STATION
-----------------------	----------------------	-----------------------	----------------------	------------------------	------------------------

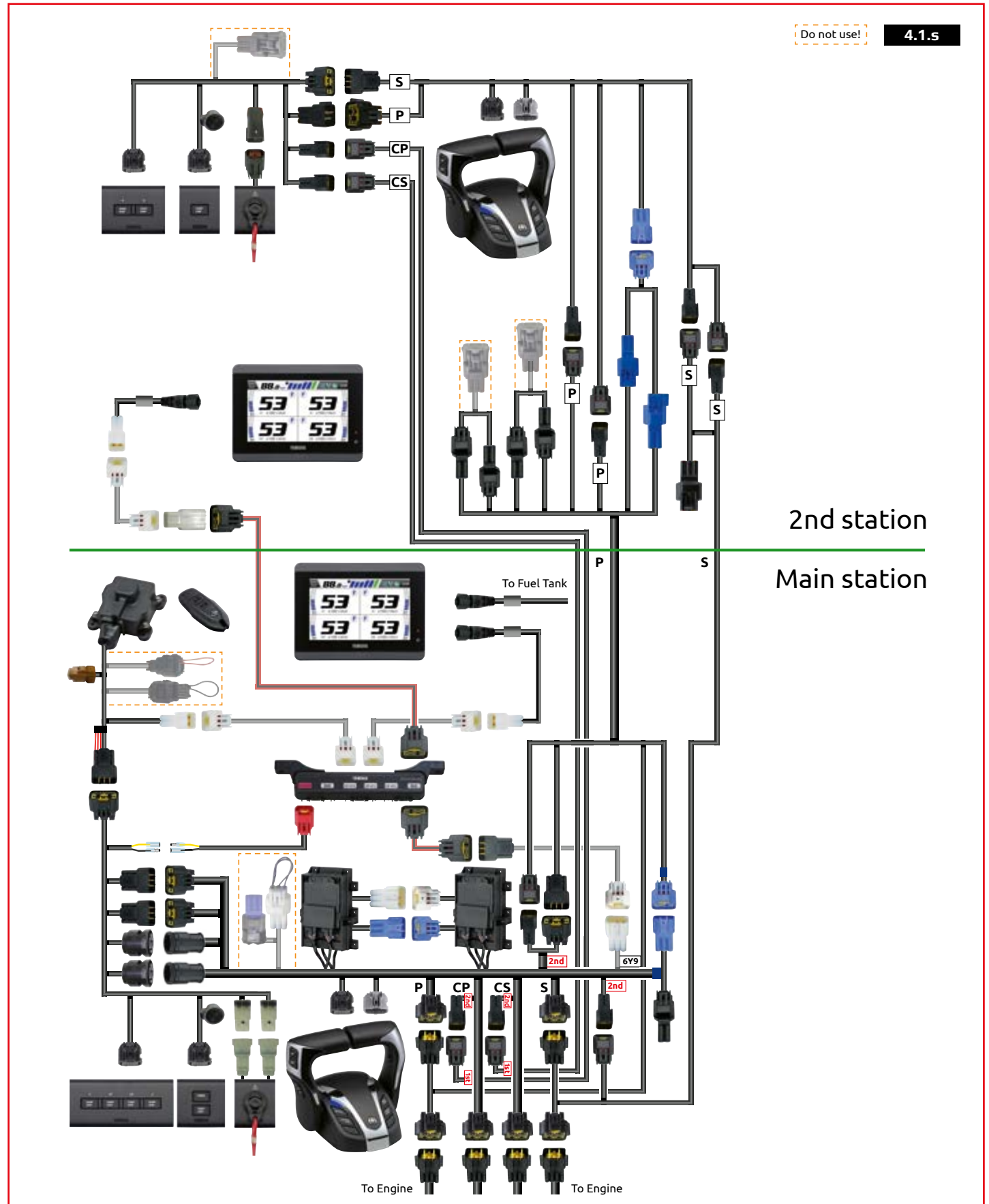

QUAD 2ND STATION LEVEL 1 PARTS

	Description	Qty	Note
	6X9-48207-10-00 6X9 DEC Top mount - twin/tr/Quad	1	2nd station
	6YM-83710-10-00 CL5 Color Touch Gauge*	1	Display only
	6YM-83553-00-00 Conversion Harness for CL5	1	
	6Y8-81920-11-00 Single hub	1	
LEVEL 1	6Y8-82521-11-00 Pigtail bus wire 0.6m / 2 ft	1	Other lengths available
	6Y8-82553-11-00 Main bus wire 4.6m / 15 ft	1	Other lengths available
	6X9-762B0-B0-00 EKS Kit - Quad 2nd St	1	
	6X9-8258A-00-00 2nd station harness Port 5m / 16 ft	1	Other lengths available
	6X9-8258A-30-00 2nd station harness Stbd 5m / 16 ft	1	Other lengths available
	6X9-8258A-60-00 2nd station harness Center 5m / 16 ft	2	Other lengths available

*) For other display options, check the 'display' section in this guide

KIT CONTENTS

		Qty	Note
6X9-762B0-B0-00	EKS Kit - Quad 2nd St		
6X9-82570-B0-00	All Start/Stop Switch	1	
6X9-82570-50-00	Start/Stop Switch	1	
6X9-82716-A0-00	EKS harness	1	
6X9-82570-D0-00	Lanyard switch	1	

HARNESS OPTIONS

Main bus wire	Length	Pigtail bus wire	Length		
6Y8-82553-01-00	0.3m (1 ft)	6Y8-82521-01-00	0.3m (1 ft)		
6Y8-82553-50-00	3m (10 ft)	6Y8-82521-11-00	0.6m (2 ft)		
6Y8-82553-11-00	4.6m (15 ft)	6Y8-82521-21-00	0.9m (3 ft)		
6Y8-82553-21-00	6.1m (20 ft)	6Y8-82521-31-00	1.8m (6 ft)		
6Y8-82553-31-00	7.6m (25 ft)	6Y8-82521-41-00	2.7m (9 ft)		
6Y8-82553-41-00	9.1m (30 ft)	6Y8-82521-51-00	3.6m (12 ft)		
2nd helm harness Port	Length	2nd helm harness Stbd	Length	2nd helm harness Center	Length
6X9-8258A-00-00	5m (16 ft)	6X9-8258A-30-00	5m (16 ft)	6X9-8258A-60-00	5m (16 ft)
6X9-8258A-10-00	8m (26 ft)	6X9-8258A-40-00	8m (26 ft)	6X9-8258A-70-00	8m (26 ft)
6X9-8258A-20-00	12m (38 ft)	6X9-8258A-50-00	12m (38 ft)	6X9-8258A-80-00	12m (38 ft)

Rigging Order Guide

DBW REMOTE CONTROL (2ND STATION)

QUAD 2ND STATION LEVEL 2

QUAD ENGINE	6X9 DEC TM	CL5 DISPLAY	EKS SWITCH	DES STEERING	DUAL STATION
-----------------------	----------------------	-----------------------	----------------------	------------------------	------------------------

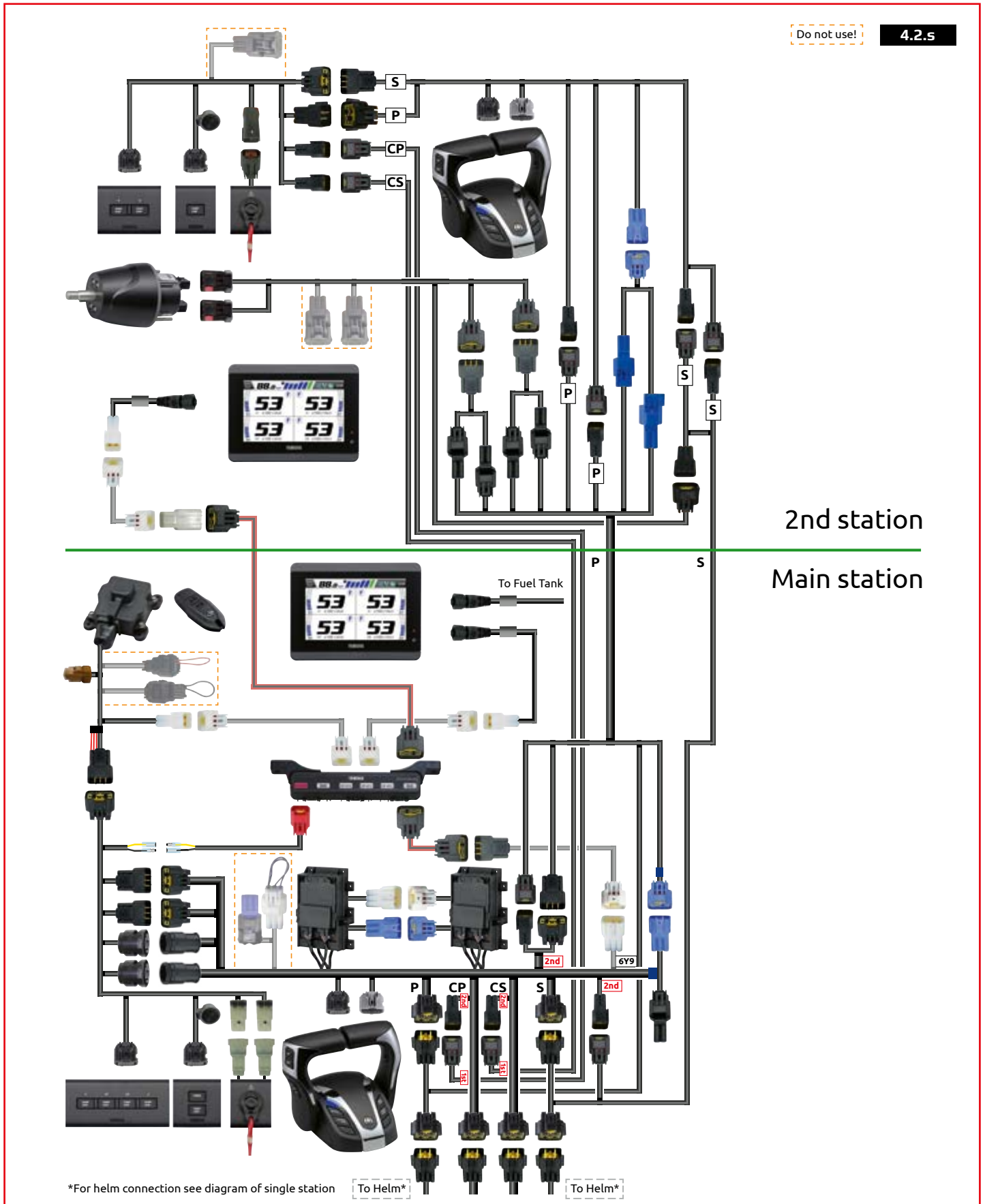

QUAD 2ND STATION LEVEL 2 PARTS

	Description	Qty	Note
	6X9-48207-10-00	1	6X9 DEC Top mount - twin/tr/Quad
	6YM-83710-10-00	1	CL5 Color Touch Gauge*
	6YM-83553-00-00	1	Conversion Harness for CL5
	6Y8-81920-11-00	1	Single hub
	6Y8-82521-11-00	1	Pigtail bus wire 0.6m / 2 ft
LEVEL 1	6Y8-82553-11-00	1	Main bus wire 4.6m / 15 ft
	6X9-762B0-B0-00	1	EKS Kit - Quad 2nd St
	6X9-8258A-00-00	1	2nd station harness Port 5m / 16 ft
	6X9-8258A-30-00	1	2nd station harness Stbd 5m / 16 ft
	6X9-8258A-60-00	2	2nd station harness Center 5m / 16 ft
	6GR-8258A-V0-00	2	Extension Harness**
LEVEL 2	6X9-615A0-00-00	1	Compact Helm unit
	6GR-8258A-B0-00	1	Helm harness 2nd St 0.9m / 3 ft

*) For other display options, check the 'display' section in this guide

KIT CONTENTS

Part Number	Description	Qty	Note
6X9-762B0-B0-00	EKS Kit - Quad 2nd St		
6X9-82570-B0-00	All Start/Stop Switch	1	
6X9-82570-50-00	Start/Stop Switch	1	
6X9-82716-A0-00	EKS harness	1	
6X9-82570-D0-00	Lanyard switch	1	

HARNESS OPTIONS

Main bus wire	Length	Pigtail bus wire	Length
6Y8-82553-01-00	0.3m (1 ft)	6Y8-82521-01-00	0.3m (1 ft)
6Y8-82553-50-00	3m (10 ft)	6Y8-82521-11-00	0.6m (2 ft)
6Y8-82553-11-00	4.6m (15 ft)	6Y8-82521-21-00	0.9m (3 ft)
6Y8-82553-21-00	6.1m (20 ft)	6Y8-82521-31-00	1.8m (6 ft)
6Y8-82553-31-00	7.6m (25 ft)	6Y8-82521-41-00	2.7m (9 ft)
6Y8-82553-41-00	9.1m (30 ft)	6Y8-82521-51-00	3.6m (12 ft)

2nd helm harness Port	Length	2nd helm harness Stbd	Length	2nd helm harness Center	Length
6X9-8258A-00-00	5m (16 ft)	6X9-8258A-30-00	5m (16 ft)	6X9-8258A-60-00	5m (16 ft)
6X9-8258A-10-00	8m (26 ft)	6X9-8258A-40-00	8m (26 ft)	6X9-8258A-70-00	8m (26 ft)
6X9-8258A-20-00	12m (38 ft)	6X9-8258A-50-00	12m (38 ft)	6X9-8258A-80-00	12m (38 ft)

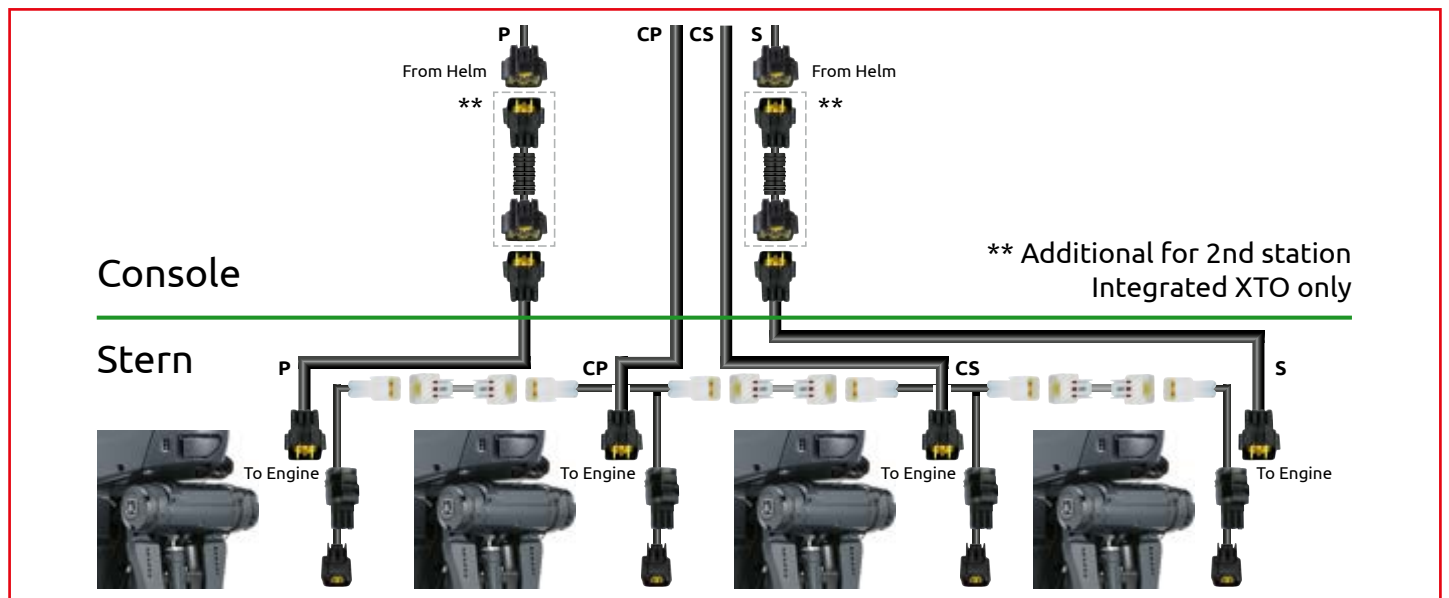

Rigging Order Guide

DBW REMOTE CONTROL (2ND STATION)

QUAD 2ND STATION LEVEL 3-4

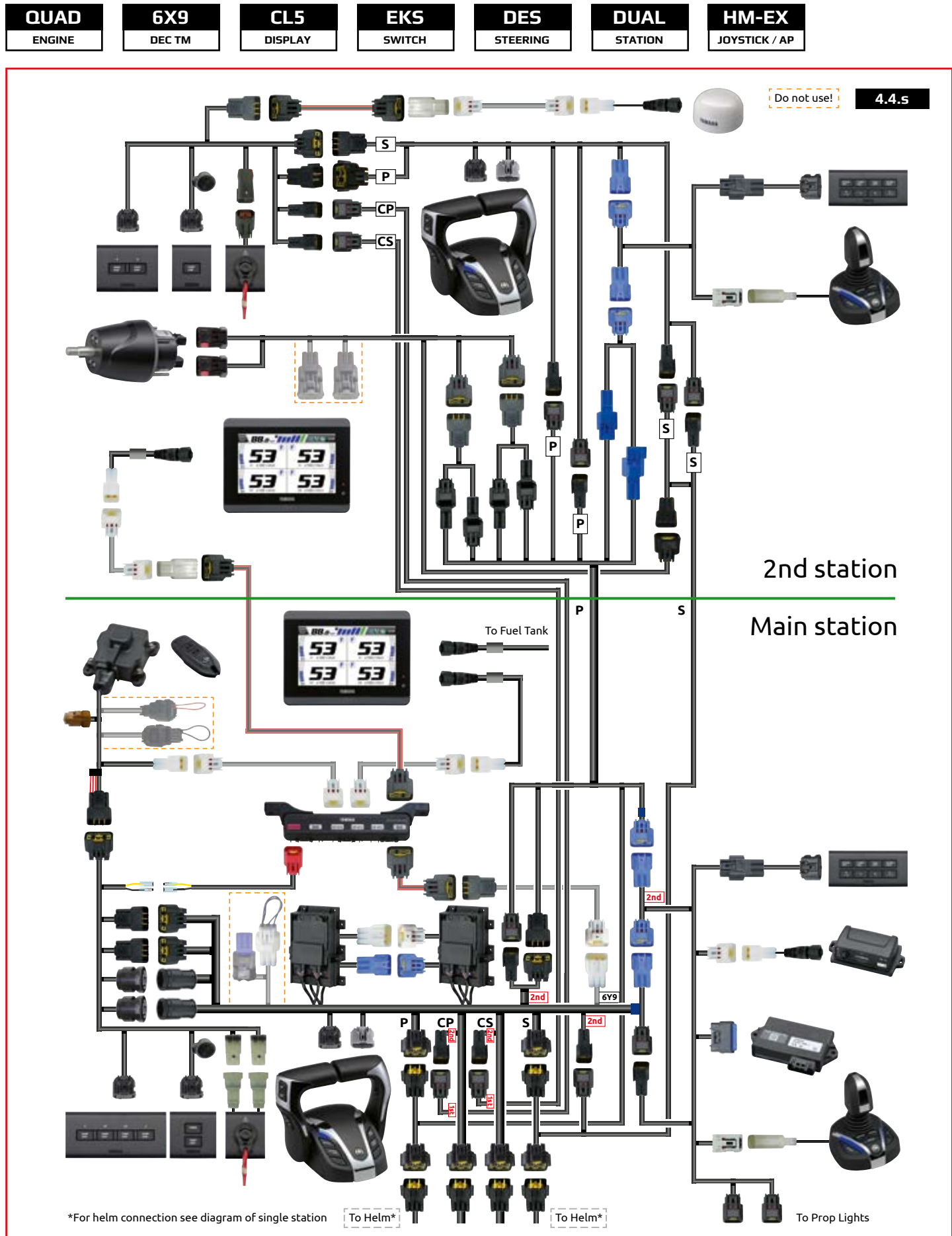

QUAD 2ND STATION LEVEL 3-4 PARTS

	Description	Qty	Note
	6X9-48207-10-00 6X9 DEC Top mount - twin/tr/Quad	1	2nd station
	6YM-83710-10-00 CL5 Color Touch Gauge*	1	Display only
	6YM-83553-00-00 Conversion Harness for CL5	1	
	6Y8-81920-11-00 Single hub	1	
	6Y8-82521-11-00 Pigtail bus wire 0.6m / 2 ft	1	Other lengths available
LEVEL 1	6Y8-82553-11-00 Main bus wire 4.6m / 15 ft	1	Other lengths available
	6X9-762B0-B0-00 EKS Kit - Quad 2nd St	1	
	6X9-8258A-00-00 2nd station harness Port 5m / 16 ft	1	Other lengths available
	6X9-8258A-30-00 2nd station harness Stbd 5m / 16 ft	1	Other lengths available
	6X9-8258A-60-00 2nd station harness Center 5m / 16 ft	2	Other lengths available
	6GR-8258A-V0-00 Extension Harness**	2	Only For Integrated Steering
LEVEL 2	6X9-615A0-00-00 Compact Helm unit	1	Tilt type available (Kit: 6GR-762H0-00-00)
	6GR-8258A-B0-00 Helm harness 2nd St 0.9m / 3 ft	1	
	6X9-482A0-00-00 Joystick Assy for 2nd station	1	
LEVEL 3-4	6X9-762P0-10-00 Auto Pilot Panel kit 2nd station	1	
Level 3 and 4 requires an compatible multi-function display for map functions			
*) For other display options, check the 'display' section in this guide			

KIT CONTENTS

Part Number	Description	Qty	Note
6X9-762B0-B0-00	EKS Kit - Quad 2nd St	1	
6X9-82570-B0-00	All Start/Stop Switch	1	
6X9-82570-50-00	Start/Stop Switch	1	
6X9-82716-A0-00	EKS harness	1	
6X9-82570-D0-00	Lanyard switch	1	

HARNESS OPTIONS

Main bus wire	Length	Pigtail bus wire	Length
6Y8-82553-01-00	0.3m (1 ft)	6Y8-82521-01-00	0.3m (1 ft)
6Y8-82553-50-00	3m (10 ft)	6Y8-82521-11-00	0.6m (2 ft)
6Y8-82553-11-00	4.6m (15 ft)	6Y8-82521-21-00	0.9m (3 ft)
6Y8-82553-21-00	6.1m (20 ft)	6Y8-82521-31-00	1.8m (6 ft)
6Y8-82553-31-00	7.6m (25 ft)	6Y8-82521-41-00	2.7m (9 ft)
6Y8-82553-41-00	9.1m (30 ft)	6Y8-82521-51-00	3.6m (12 ft)

2nd helm harness Port	Length	2nd helm harness Stbd	Length	2nd helm harness Center	Length
6X9-8258A-00-00	5m (16 ft)	6X9-8258A-30-00	5m (16 ft)	6X9-8258A-60-00	5m (16 ft)
6X9-8258A-10-00	8m (26 ft)	6X9-8258A-40-00	8m (26 ft)	6X9-8258A-70-00	8m (26 ft)
6X9-8258A-20-00	12m (38 ft)	6X9-8258A-50-00	12m (38 ft)	6X9-8258A-80-00	12m (38 ft)

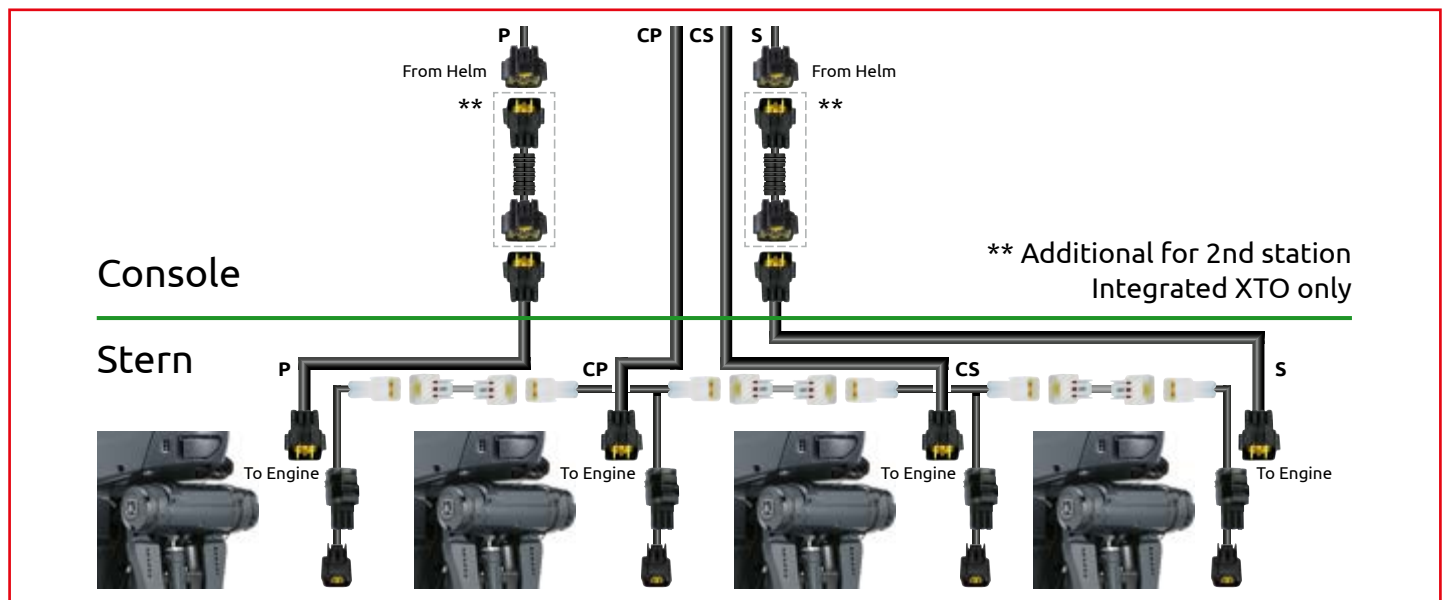

Rigging Order Guide

DBW REMOTE CONTROL (DISPLAY)

DISPLAY OPTION CL5 COLOR TOUCH GAUGE RIGGING KIT (6YM-762G0-00-00)

CL5
DEC

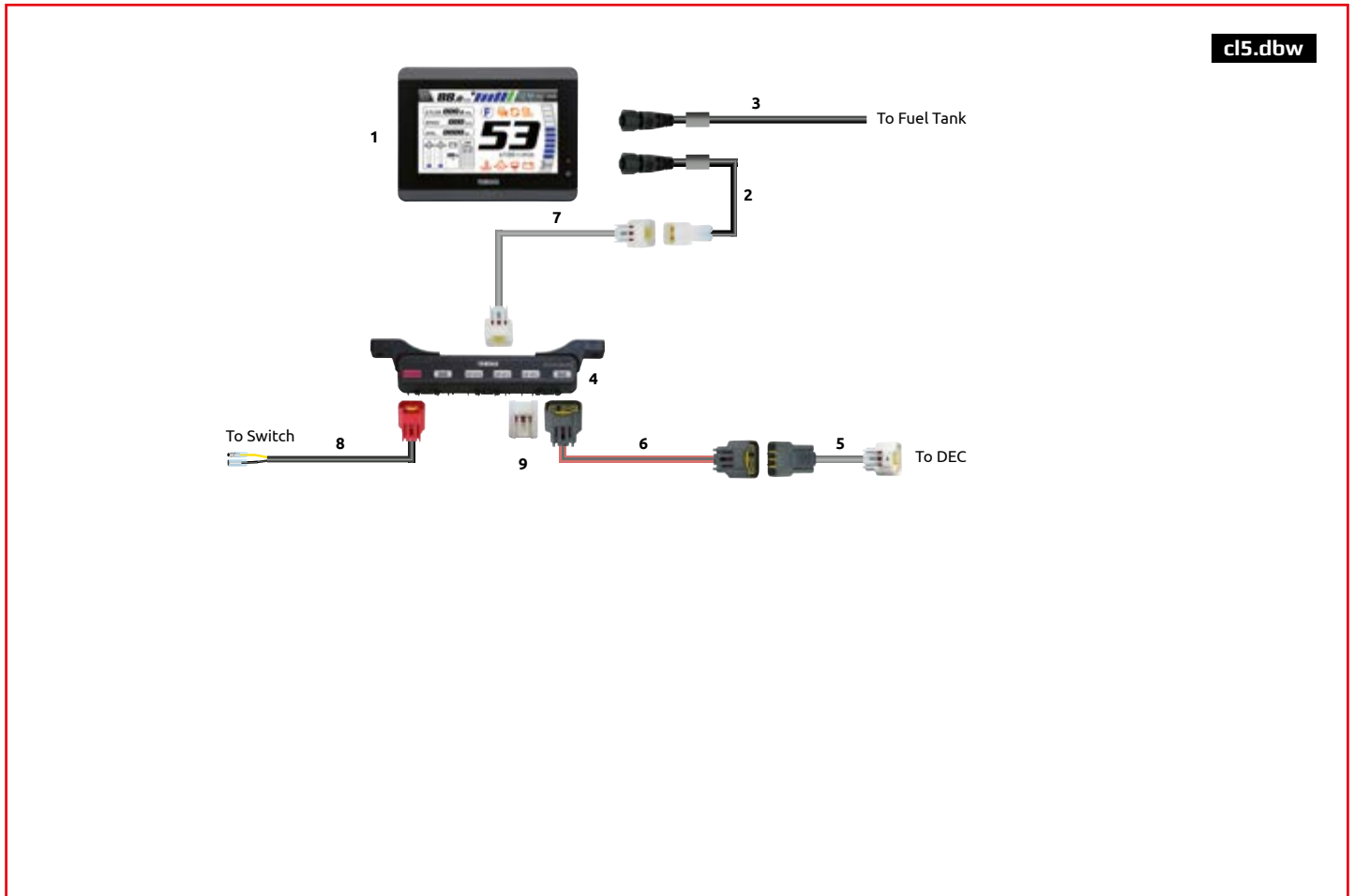

	6YM-762G0-00-00	CL5 Color Touch Gauge Kit - DEC	Qty	Note
1	6YM-83371-01-00	CL5 Display	1	
2	6YM-83553-00-00	Conversion Harness 0.9m / 3 ft	1	Optional elbow connector 6YM-83553-10-00
3	6YD-8356N-00-00	Fuel Tank Wire	1	Optional elbow connector 6YM-8356N-00-00
4	6Y8-81920-01-00	Multihub	1	
5	6Y9-83553-00-00	Conversion harness	1	
6	6Y8-82553-21-00	Main bus wire 0.3m / 1 ft	1	Other lengths available
7	6Y8-82521-11-00	Pigtail bus wire 1.8m / 1 ft	1	Other lengths available
8	6Y8-83553-02-00	System power supply	1	
9	6Y8-82582-11-00	Cap	2	

DBW REMOTE CONTROL (DISPLAY)

DISPLAY OPTION CL5 COLOR TOUCH GAUGE RIGGING KIT (6YM-762G0-00-00)

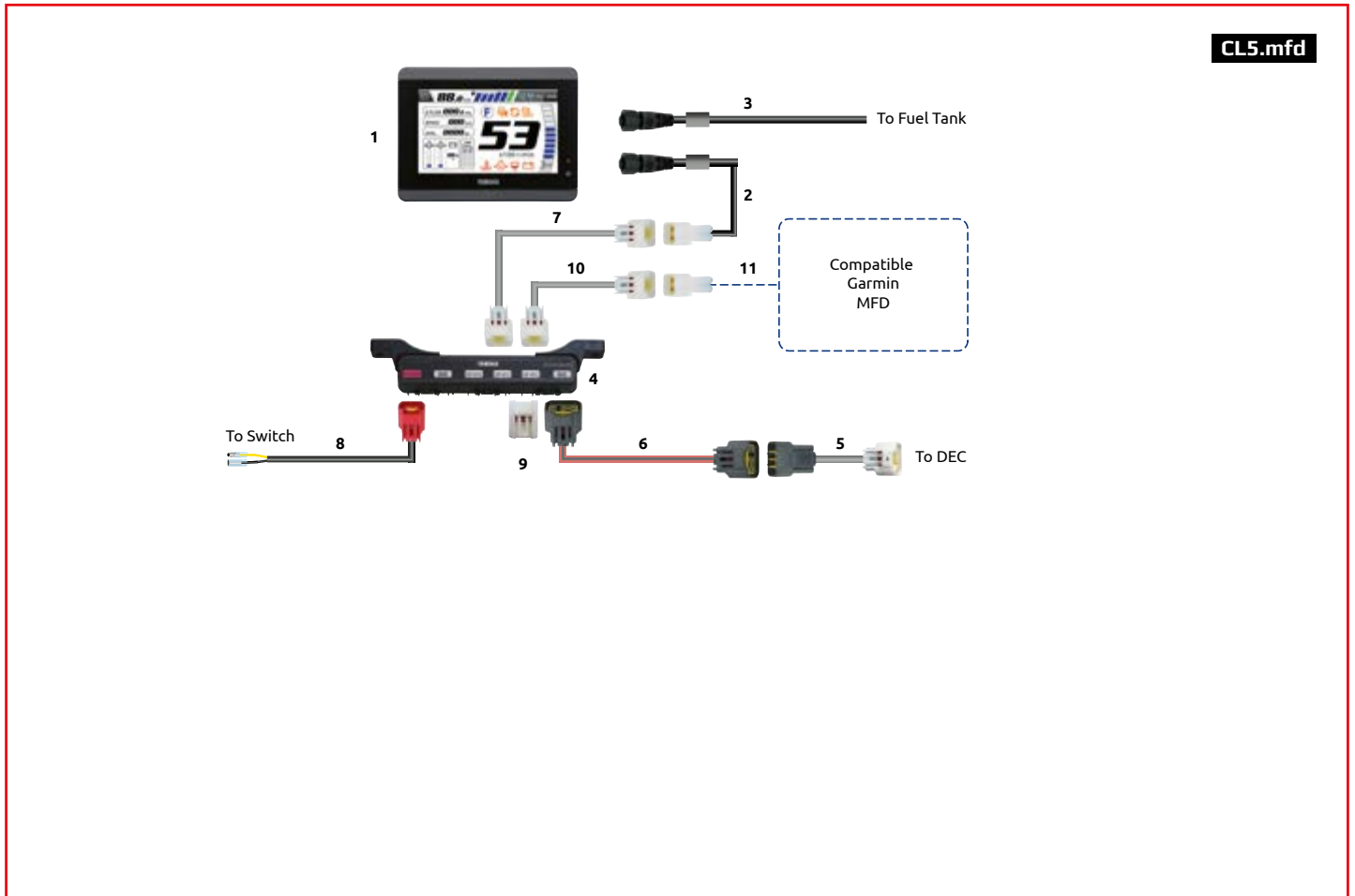

	6YM-762G0-00-00	CL5 Color Touch Gauge Kit - DEC	Qty	Note
1	6YM-83371-01-00	CL5 Display	1	
2	6YM-83553-00-00	Conversion Harness 0.9m / 3 ft	1	Optional elbow connector 6YM-83553-10-00
3	6YD-8356N-00-00	Fuel Tank Wire	1	Optional elbow connector 6YM-8356N-00-00
4	6Y8-81920-01-00	Multihub	1	
5	6Y9-83553-00-00	Conversion harness	1	
6	6Y8-82553-21-00	Main bus wire 0.3m / 1 ft	1	Other lengths available
7	6Y8-82521-11-00	Pigtail bus wire 1.8m / 1 ft	1	Other lengths available
8	6Y8-83553-02-00	System power supply	1	
9	6Y8-82582-11-00	Cap	2	

	Additional	Part Name	Qty	Note
10	6Y8-82521-11-00	Pigtail bus wire 1.8m / 1 ft	1	Other lengths available
11	6YM-83553-00-00	Conversion Harness 0.9m / 3 ft	1	Or Garmin J1939 connector

Rigging Order Guide

DBW REMOTE CONTROL (DISPLAY)

DISPLAY OPTION MFD INTERFACE TYPE 1 RIGGING KIT FOR GARMIN (6YM-762G0-40-00)

MFD
TYPE 1

6X9
DEC

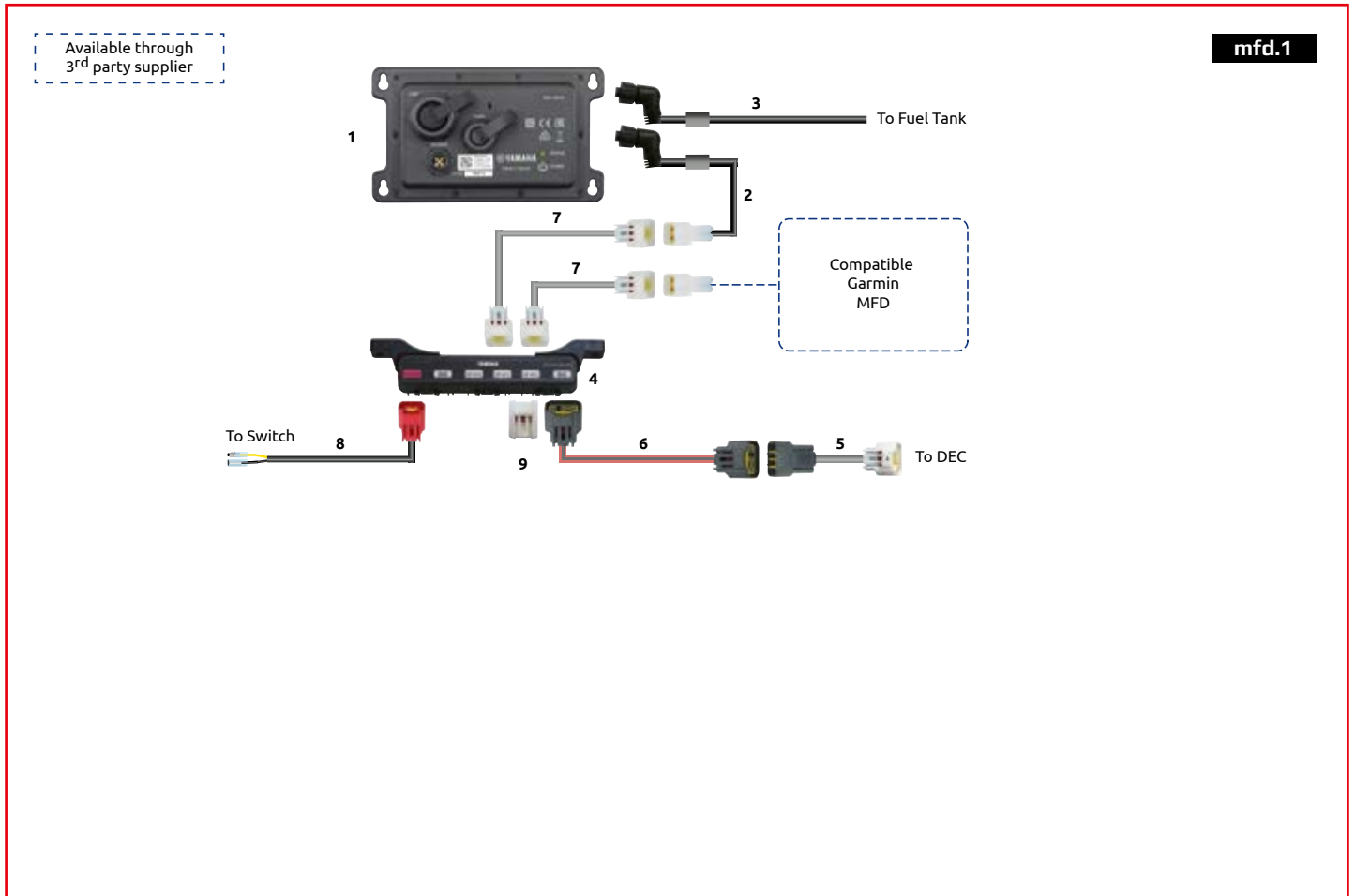

	6YM-762G0-40-00	MFD interface Type 1 Kit (for Garmin)	Qty	Note
1	6YM-8A2D0-10-00	Interface unit	1	
2	6YM-83553-10-00	Conversion Harness 0.9m / 3 ft	1	Elbow connector
3	6YM-8356N-00-00	Fuel Tank Wire	1	Elbow connector
4	6Y8-81920-01-00	Multihub	1	
5	6Y9-83553-00-00	Conversion harness 0.3m / 1 ft	1	
6	6Y8-82553-01-00	Main bus wire 0.3m / 1 ft	1	Other lengths available
7	6Y8-82521-31-00	Pigtail bus wire 1.8m / 6 ft	2	Other lengths available
8	6Y8-83553-01-00	System power supply 2.4m / 8 ft	1	
9	6Y8-82582-11-00	Cap	1	

DBW REMOTE CONTROL (DISPLAY)

DISPLAY OPTION MFD INTERFACE TYPE 2 RIGGING KIT (6YM-762G0-50-00)

MFD
TYPE 2

6X9
DEC

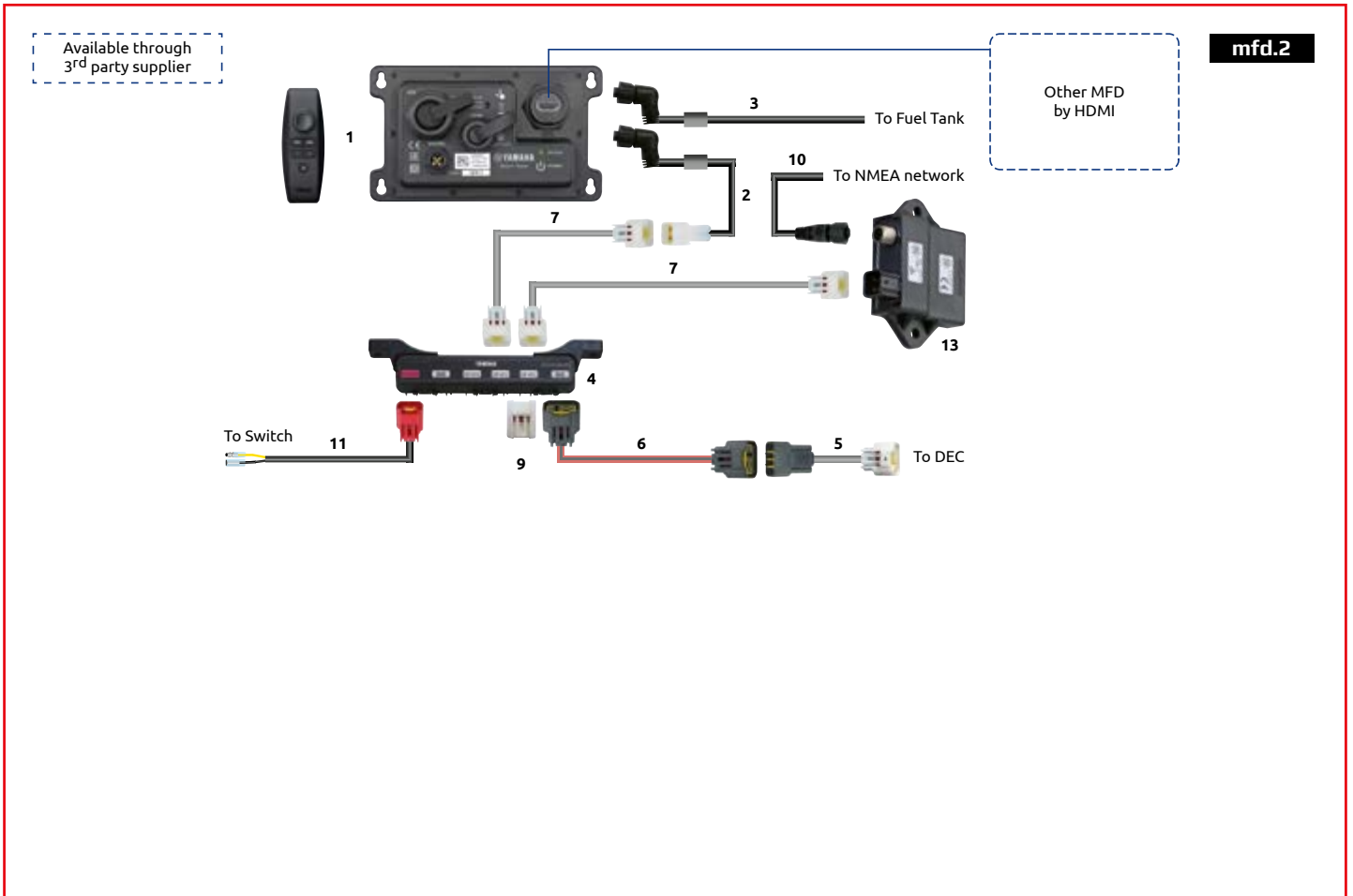

	6YM-762G0-50-00	MFD interface Type 2 Kit	Qty	Note
1	6YM-8A201-00-00	Interface unit	1	
2	6YM-83553-10-00	Conversion Harness 0.9m / 1 ft	1	Elbow connector
3	6YM-8356N-00-00	Fuel Tank Wire	1	Elbow connector
4	6Y8-81920-01-00	Multihub	1	
5	6Y9-83553-00-00	Conversion harness 0.3m / 1 ft	1	
6	6Y8-82553-01-00	Main bus wire 0.3m / 1 ft	1	Other lengths available
7	6Y8-82521-31-00	Pigtail bus wire 1.8m / 1 ft	2	Other lengths available
9	6Y8-82582-11-00	Cap	1	
10	6YG-82521-00-00	NMEA Harness	1	
11	6Y8-83553-01-00	System power supply 2.4m / 8 ft	1	
12	6YM-8533A-00-00	HDMI cable	1	
13	6YG-8A2D0-11-00	6YG Gate way	1	

Filters and Fuel Accessories



FUEL FILTERS

Keeping your fuel clean really is an important issue where boating is concerned. Contaminated fuel affects performance and can increase the wear and tear on your engine. The trouble is that countless small dirt particles are already in the fuel before it gets anywhere near your boat - and that's where Yamaha Water Separating Fuel Filters come in. They are designed to be the most efficient systems available for removing dirt before it can enter the pumps and injection system. Without one of these, dirty, unfiltered fuel could block the internal fuel passages, causing the engine to run poorly - or even to fail.

Instead of the standard 35/27-micron filter, the Yamaha 10-micron filter will protect your engine by removing dirt, water and small foreign particles. These superior 10-micron filters are strongly recommended for all engines, especially HPDI and EFI models.

However, it's important to choose a fuel filter with the right capacity for your engine and to regularly maintain it, to avoid reduced performance and engine damage. A simple rule of thumb is to ensure that the litres-per-hour (LPH) of the filter is greater than that of the engine. This figure can be found in your owner's manual.

Remember, a filter that is too big or too good cannot cause problems, but one that is too small or dirty can restrict fuel flow, possibly resulting in engine failure.

WHAT MAKES THIS FILTER UNIQUE:

This is the only filter on the market that is fully homologated. This is due to the metal bowl structure on the bottom of the filter. Making it fully fire proof gaining a Ce, ISO 10088 and ABYC standard. This means it can be used anywhere in the world. In addition the thread on top of the filter towards the mount is unique. This means that it can be only replaced with a YAMAHA genuine replacement filter.

These are 10 micron filters that will protect the engine from foreign particles. 10micron filters are far superior then standard offered marine filters

The flowrate is indicated on the filter itself and in the part number: So YMEEFWS00180A is 180Liters/H YmeEFWS00360 is 360L/H and 620L/H flowrate wise. It is also printed on the filter itself.

Following this logic: Up to 115HP engines the 180 filter can be used. From 115 to XTO the 360 can be used. We recommend the 620 for heavy usage of the 300HP+ range

Part number	Part description
YMEFWS00180A	OB - FUEL WATER SEP S ASSY
YMEFWS00180E	OB - FUEL WATER SEP S ELEMENT
YMEFWS00360A	OB - FUEL WATER SEP M ASSY
YMEFWS00360E	OB - FUEL WATER SEP M ELEMENT
YMEFWS00620A	OB - FUEL WATER SEP L ASSY
YMEFWS00620E	OB - FUEL WATER SEP L ELEMENT
YMEFWS00SSPT	OB - FUEL WATER SEP SS PLATE
YMEFWS06D	OB - ELBOW FITTING 06 MM
YMEFWS08D	OB - ELBOW FITTING 08 MM
YMEFWS10D	OB - ELBOW FITTING 10 MM
YMEFWS06D	OB - STRAIGHT FITTING 06 MM
YMEFWS08D	OB - STRAIGHT FITTING 08 MM
YMEFWS10D	OB - STRAIGHT FITTING 10 MM



GENUINE YAMAHA WATER SEPARATOR/FUEL FILTER:

Corrosion-resistant and specifically designed to fit into smaller areas.
Recommended for outboards up to 70HP.

Filter features:

- Manufactured from lightweight resin material.
- Comes with In & Out connectors (can be swapped)
- Clear bowl to allow easy checking of flow and filtering
- 10-micron filter element
- Fluid capacity of 60cc
- Water separation capacity of 99% or more



Water Separator Filter
907-94469-05-00

Water Separator Filter
907-94469-09-00

Water Separator Filter
907-94469-07-00

WATER SEPARATOR FILTERS

Description	Horsepower	Part Number
Water Separator Filter	Up to 70HP	907-94469-09-00
Water Separator Filter by 40 pieces bulk	Up to 70HP	907-94469-08-00
Water/Fuel Separator Filter 10-micron including connectors in 8/O8mm	Up to 175HP	907-94469-05-00
Water/Fuel Separator Filter 10-micron including connectors in 10/O8mm	Up to 350HP	907-94469-07-00

Replacement filters:

Replacement Filter 10-Micron (including new O-ring) - Up to 70HP	907-94469-14-00
Replacement Filter-10 Micron - For 175HP up to 350HP	907-94469-13-00

FILTERS

Description	Part Number
Replacement element for filter kit between 50hp and 115hp	YMM-2E114-00-00
Replacement element for filter kit over 115hp	YMM-2E227-01-00
Replacement element for filter kit for twin engine installation or professional use (Note: A filter is never "too big". A larger filter will last longer than one which is "just large enough")	YMM-2E341-01-00



Connectors



Replacement filters

CONNECTORS

Description	Part Number
Connectors for YMM-2W095-00-00 and YMM-2W227-00-00 (1/4" NPT ports):	
Straight fitting for 6.5mm hose	YMM-2FS06-00-00
Straight fitting for 8mm hose	YMM-2FS08-00-00
Straight fitting for 10mm hose	YMM-2FS10-00-00
Elbow fitting for 8mm hose	YMM-2FE08-00-00
Elbow fitting for 10mm hose	YMM-2FE10-00-00
Connectors for YMM-2W341-00-00 (3/8" NPT ports):	
Straight fitting for 8mm hose	YMM-2SF08-00-00
Straight fitting for 10mm hose	YMM-2SF10-00-00

Fuel Tanks and Accessories

FUEL TANK:

Description	Part Number
Yamaha 12 litre plastic tank (length 363mm x width 265mm x height 230mm)	6YL-24201-07-0Q
Yamaha 25 litre plastic tank (length 536mm x width 362mm x height 233mm)	6YK-24201-03-0Q



FUEL PICKUP:

Description	Part Number
12 litres	979-51242-61-0Q
25 litres	979-51242-62-0Q



FUEL CAP:

Description	Part Number
12 litre tank	MAR-COMBI-CP-12
25 litre tank with fuel gauge	MAR-COMBI-CP-25
25 litre tank without fuel gauge	6YK-24610-10-00



JERRY CAN:

Description	Part Number
5 litre Jerry can	YMM-5LTRE-00-11
No-spill spout for 5 litre Jerry can	YMM-NSPSP-T0-00
1 litre Jerry can	YMM-10LTR-E0-10



FUEL PIPE JOINT (FEMALE):

Description	Part Number
For 6mm OM side	6G1-24305-05-00
For 6mm Tank side	6Y1-24305-06-00
For 8mm OM side	6E5-24305-06-00
For 8mm Tank side	6Y2-24305-06-00



FUEL PIPE JOINT (MALE):

Description	Part Number
For 6mm	6G1-24304-10-00
For 8mm	6E5-24304-20-00



PRIMARY PUMP:

Description	Part Number
For 6mm	6Y1-24360-52-00
For 8mm	6Y2-24360-52-00
6mm F4B/F5A/F6C under the cowl	6BX-24360-00-00



FUEL HOSE:

Description	Part Number
6mm 30m of A1 marine fuel hose. Iso and CE certified.	YMEFH06X13MM
8mm 30m of A1 marine fuel hose. Iso and CE certified.	YMEFH08X13MM
10mm 30m of A1 marine fuel hose. Iso and CE certified.	YMEFH10X13MM



FUEL PIPE COMPLETE:

Description	Part Number
6mm, 3m, both ends with joint	6Y1-24306-55-00
6mm, 3m, with one joint	6Y4-24306-84-00
8mm, 3m, both ends with joint	6Y2-24306-56-00
8mm, 3m, with one joint	6Y2-24306-45-00
6mm, 3m, Permanent Sealed, both ends with joint	6YL-24306-54-00
8mm, 3m, Permanent Sealed, with one joint	6YK-24306-44-00



Note : Fuel pipes and related parts presented in this section are intended for portable use only.

Other Rigging & Accessories

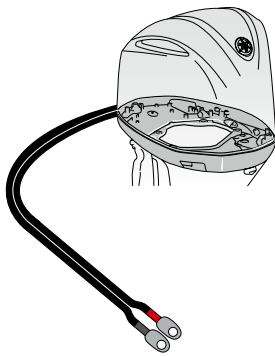

ENGINE BATTERY CABLE

Used to connect Yamaha Outboard Motors to 12V batteries.

Description	Part Number
F(T)50 - F(T)60	6C5-82105-01-00
F70	6C5-82105-U1-00
F80/F100/F115/F130A	68V-82105-J1-00
F150	63P-82105-01-00
F175/F200F/F200G	6DA-82105-01-00
V6 3.3L	6P2-82105-02-00
V6 4.2L 6CE	6CB-82105-01-00
V6 4.2L 6KA	6KA-82105-00-00
F350A	6AW-82105-01-00
XTO	6GR-82105-00-00

FUSE CARTRIDGES

Amps	Part Number
50	63P-82151-00-00
60	6P2-82151-00-00
80	61A-82151-00-00
100	6CE-82151-00-00

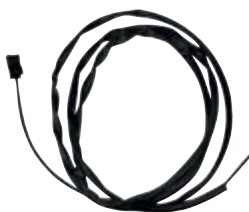

BATTERY ISOLATOR LEADS

Allows the starter battery to be charged first, when other battery is being used for onboard accessories.

Description	Part Number
F150A	68F-81949-02-00
F175 to F350 (except V6 4.2L)	69J-81949-02-00
F225F/F250D/F300B V6 4.2L	6CE-81949-00-00
V4 4,2L / 6H	6H2-81949-02-00
V4 4,2L / 6K	6K2-81949-02-00
XTO	6GR-81949-01-00



WAVERUNNER BATTERY

Dry charge WaveRunner battery.

Description	Part Number
Battery YUASA YB16CLB (19AH)	EU0821100900
Battery BS BTX20HL	907983BTX20L
Battery BSBB16CL-B	907983BB16CL

BS BATTERY

New sealed and factory activated battery line by BS.

- No acid handling
- Ready & easy to use
- Multi-positional fitment

Description	Part Number	Max Size (mm)
12V-19Ah-260A	907983BB16CL	175x100x175
12V-18A -260A	907983BTX20L	1475x87x155



YAMAHA BATTERY BOXES

Size	Max Battery Size	Part Number
Small	Length 277mm x Width 186mm	YMM-BTBX0-00-24
Large	Length 327mm x Width 186mm	YMM-BTBX0-00-27

BATTERY CHARGERS

Unique battery charging technology: Fully automatic switch mode charger that analyses the state of the battery, charges and automatically switches to maintenance charging when ready. Includes battery testing, fault detection and float maintenance. Always ensuring a full charge to prolong battery life time.

Designed for safety: Spark-free, protected from reverse polarity connections and short-circuit proof. Light and compact: Easy to store and handle.

Yamaha Approved: Tested and approved by Yamaha service engineers to fit and work perfectly with the Yamaha Outboards range.

Quick connection: Combine it with YEC quick connectors - the Built-in Panel Plug, Charger Indicator and Indicator Panel 150 - for reading the charge condition of your battery and/or for easier access between your Yamaha's battery and the YEC-9 or YEC-50 charger.

Battery Charger	Part Number
1 - YEC-9: 6-step charger that can charge the battery of your Yamaha outboard.	YME-YEC09-EU-00
2 - YEC-50: 8-step charger that can charge the battery of your Yamaha outboard.	YME-YEC50-EU-00
Flushmount charge indicator	YME-YECIP-15-00
Charge indicator cable	YME-YECPL-05-00



Marine Service Kits

Introducing marine service kits! These new kits are tailored for easy servicing of your out board Engine. Below the kits are shown per engine family, and separately the content of each kits.

BASIC SERVICE KIT

Part Number	Description
KIT60000BAS0	SERV KIT F30B-F40F
KIT60100BAS0	SERV KIT F40H-F50H-F60F
KIT60200BAS0	SERV KIT F40G-F70A
KIT60300BAS0	SERV KIT F80D-F100F
KIT60400BAS0	SERV KIT F115B-F130A
KIT60500BAS0	SERV KIT F150D-F150F
KIT60600BAS0	SERV KIT F150G-F175A&C-F200F&G
KIT60700BAS0	SERV KIT F200C-F225B
KIT60800BAS0	SERV KIT F225F-F250D-F300B
KIT60900BAS0	SERV KIT F425A-XF425N

KIT60000BAS0

Part Number	Description	Qty
5GH134406100	ELEMENT ASSY, OIL CLEANER	1
62Y-12414-00	Thermostat gasket	1
66M124110100	THERMOSTAT	1
94702-00418	PLUG, SPARK (NGK DPR6EB-9)	3
90430-14M09	engine oil gasket	1
90430-08003	Drain / fill gasket gearbox oil	2
6D8WS24A0000	Fuel filter	1
6D8-24564-00	O-ring fuel filter	1
6C5-24251-00	STRAINER 1	1
6BG-13915-01	FILTER	1
6BG-14984-00	GASKET, FLOAT CHAMBER	1

KIT60100BAS0

Part Number	Description	Qty
5GH134406100	ELEMENT ASSY, OIL CLEANER	1
62Y-12414-00	Thermostat gasket	1
66M-12411-01	thermostat	1
94702-00418	SPARK PLUG DPR6EB-9	4
90430-14M09	engine oil gasket	1
90430-08003	Drain / fill gasket gearbox oil	2
6D8WS24A0000	Fuel filter	1
6D8-24564-00	O-ring fuel filter	1
6C5-24251-00	Strainer 1	1
6C5-13915-00	filter fuel	1
6C5-14984-10	GASKET, FLOAT CHAMBER	1

KIT60200BAS0

Part Number	Description	Qty
5GH134406100	ELEMENT ASSY, OIL CLEANER	1
62Y-12414-00	Thermostat gasket	1
66M124110100	THERMOSTAT	1
94702-00429	PLUG, SPARK (NGK LKR7E)	4
90430-14M09	engine oil gasket	1
90430-08003	Drain / fill gasket gearbox oil	2
6D8WS24A0000	Fuel filter	1
6D8-24564-00	O-ring fuel filter	1
6C5-24251-00	STRAINER 1	1
6C5-13915-00	filter fuel	1
6C5-14984-10	GASKET, FLOAT CHAMBER	1

KIT60300BAS0

Part Number	Description	Qty
5GH134407100	ELEMENT ASSY, OIL CLEANER	1
6FP-12411-00	THERMOSTAT	1
94702-00440	PLUG, SPARK (NGK LKR6E 9N)	4
90430-14M09	GASKET	1
90430-08003	Drain / fill gasket gearbox oil	2
6D8WS24A0000	ELEMENT, FILTER	1
6D8-24564-00	GASKET	1
6FP-13915-00	FILTER	1
6FP-14984-00	GASKET, FLOAT CHAMBER	1
6C5-24251-00	STRAINER 1	1

KIT60400BAS0

Part Number	Description	Qty
5GH134407100	ELEMENT ASSY, OIL CLEANER	1
6EK-12411-00	THERMOSTAT	1
94702-00437	PLUG, SPARK (NGK LKR6E)	4
90430-14M09	GASKET	1
90430-08003	Drain / fill gasket gearbox oil	2
6D8WS24A0000	ELEMENT, FILTER	1
6D8-24564-00	GASKET	1
63P-13915-00	FILTER	1
6CB-14984-00	GASKET, FLOAT CHAMBER	1
6CB-13016-00	O-RING	1

KIT60500BAS0

Part Number	Description	Qty
69J134400400	ELEMENT ASSY, OIL CLEANER	1
63P-12414-00	GASKET, COVER	1
67F-12411-01	THERMOSTAT	1
94702-00391	PLUG, SPARK (NGK LFR5A-11)	4
90430-14M09	GASKET	1
90430-08003	Drain / fill gasket gearbox oil	2
6P3WS24A0100	ELEMENT, FILTER	1
6P3-24564-00	GASKET	1
69J-24501-10	FILTER, FUEL	1
63P-13915-00	FILTER	1
63P-14984-00	GASKET, FLOAT CHAMBER	1

Outboard Essentials and Spare parts

KIT60600BAS0

Part Number	Description	Qty
69J134400400	ELEMENT ASSY, OIL CLEANER	1
6DA-12411-01	THERMOSTAT	1
94702-00400	PLUG, SPARK (NGK LFR6A-11)	4
90430-14M09	GASKET	1
90430-08003	Drain / fill gasket gearbox oil	2
6P3WS24A0100	ELEMENT, FILTER	1
6P3-24564-00	GASKET	1
6CB-24501-01	FILTER, FUEL	1
63P-13915-00	FILTER	1
6CB-14984-00	GASKET, FLOAT CHAMBER	1
6CB-13016-00	O-RING	1

KIT60700BAS0

Part Number	Description	Qty
69J134400400	ELEMENT ASSY, OIL CLEANER	1
67F-12411-01	THERMOSTAT	2
94702-00400	PLUG, SPARK (NGK LFR6A-11)	6
90430-14M09	GASKET	1
90430-08003	Drain / fill gasket gearbox oil	2
6P3WS24A0100	ELEMENT, FILTER	1
6P3-24564-00	GASKET	1
6CB-24501-01	FILTER, FUEL	1
63P-13915-00	FILTER	1
6CB-14984-00	GASKET, FLOAT CHAMBER	1
6CB-13016-00	O-RING	1

KIT60800BAS0

Part Number	Description	Qty
N26134400300	ELEMENT ASSY, OIL CLEANER	1
6CE-12411-00	THERMOSTAT	2
94702-00400	PLUG, SPARK (NGK LFR6A-11)	6
90430-14M09	GASKET	1
90430-08003	Drain / fill gasket gearbox oil	2
6P3WS24A0100	ELEMENT, FILTER	1
6P3-24564-00	GASKET	1
6CB-24501-01	FILTER, FUEL	1
63P-13915-00	FILTER	1
6CB-14984-00	GASKET, FLOAT CHAMBER	1
6CB-13016-00	O-RING	1

KIT60900BAS0

Part Number	Description	Qty
N26134400300	ELEMENT ASSY, OIL CLEANER	1
6H3-12411-20	THERMOSTAT	1
66M-12411-01	THERMOSTAT	1
6GR-12411-00	THERMOSTAT	2
94702-00442	PLUG, SPARK (NGK ILMAR7E9)	8
93210-34633	O-RING	1
6GR-13411-00	STRAINER, OIL	1
932100981100	O-RING	2
6P3WS24A0100	ELEMENT, FILTER	1
6P3-24564-00	GASKET	1

ANODE KIT A

Part Number	Description
KIT60000ANA0	ANA KIT F30B-F40F-F40H-F50H-F60F
67F-45371-00	Tab Trim for F40G-F70A
KIT60300ANA0	ANA KIT F80D-F100F-F115B-F130A
KIT60500ANA0	ANA KIT F150D-F150F
KIT60600ANA0	ANA KIT F150G-F175A&C-F200F&G
KIT60700ANA0	ANA KIT F200C-F225B-F225F-F250D-F300B
KIT60900ANA0	ANA KIT F425A-XF425N

KIT60000ANA0

Part Number	Description	Qty
67C-45371-00	TAB-TRIM	1
67C-45251-00	ANODE	1

67F-45371-00

Part Number	Description	Qty
67F-45371-00	Tab Trim for F40G-F70A	1

KIT60300ANA0

Part Number	Description	Qty
6E5-45371-01	TAB-TRIM	1
6H1-45251-03	ANODE	1

KIT60500ANA0

Part Number	Description	Qty
6J9-45371-01	TAB-TRIM	1
6G5-45251-02	Anodes	1

KIT60600ANA0

Part Number	Description	Qty
6J9-45371-01	TAB-TRIM	1
6AW-45251-00	ANODE	1

KIT60700ANA0

Part Number	Description	Qty
6CE-45373-00	ANODE	1
6G5-45251-02	ANODE	1

KIT60900ANA0

Part Number	Description	Qty
6AW-45373-00	ANODE	1
6AW-45251-00	ANODE	1

ANODE KIT B

Part Number	Description
KIT60000ANB0	ANB KIT F30B-F40F
KIT60100ANB0	ANB KIT F40H-F50H-F60F
KIT60200ANB0	ANB KIT F40G-F70A
KIT60300ANB0	ANB KIT F80D-F100F
KIT60400ANB0	ANB KIT F115B-F130A
KIT60500ANB0	ANB KIT F150D-F150F
KIT60600ANB0	ANB KIT F150G-F175A&C-F200F&G
KIT60700ANB0	ANB KIT F200C-F225B
KIT60800ANB0	ANB KIT F225F-F250D-F300B
KIT60900ANB0	ANB KIT F425A-XF425N

KIT60000ANB0

Part Number	Description	Qty
65W-45251-00	Anode	1
6G8-11325-00	Anode	4
62Y-11325-00	Anode	1

KIT60100ANB0

Part Number	Description	Qty
65W-45251-00	Anode	2
663-45251-00	Anode	1
6G8-11325-00	Anode	4
62Y-11325-00	Anode	1

KIT60200ANB0

Part Number	Description	Qty
65W-45251-00	Anode	2
65W-45251-00	Anode	1
6G8-11325-00	Anode	3
62Y-11325-00	Anode	1

KIT60300ANB0

Part Number	Description	Qty
6G8-11325-00	ANODE	1
63P-11325-01	ANODE	1
6G8-11325-00	ANODE	2
63P-11325-21	ANODE	1
6G8-11325-00	ANODE	1

KIT60400ANB0

Part Number	Description	Qty
6G8-11325-00	Anode	1
63P-11325-01	Anode	1
6G8-11325-00	Anode	1
67F-11325-01	Anode	1
6EK-11325-00	Anode	1
6G8-11325-00	Anode	1

KIT60500ANB0

Part Number	Description	Qty
63P-11325-21	Anode	1
63P-11325-11	Anode	4
63P-11325-01	Anode	1
67F-11325-01	Anode	2
68T-11325-00	Anode	8
67F-11325-01	Anode	1

KIT60600ANB0

Part Number	Description	Qty
67F-11325-01	ANODE	2
6E5-11325-00	ANODE	1
68T-11325-00	ANODE	2
67F-11325-01	ANODE	1
6E5-11325-00	ANODE	1

KIT60700ANB0

Part Number	Description	Qty
6P3-11325-00	ANODE	2
6P2-11325-00	ANODE	2
6E5-11325-00	ANODE	2
67F-11325-01	ANODE	4
6E5-11325-00	ANODE	4
6E5-11325-00	ANODE	1

KIT60800ANB0

Part Number	Description	Qty
63P-11325-01	ANODE	4
6AW-1132P-00	ANODE 5	4
68T-11325-00	ANODE	2
6AW-1132N-01	ANODE 4	2
67F-11325-01	ANODE	8
63P-11325-11	ANODE	2

KIT60900ANB0

Part Number	Description	Qty
6AW-1132L-00	ANODE 2	6
6AW-1132P-00	ANODE 5	3
6G8-11325-00	ANODE	2
63P-11325-21	ANODE	1
6G8-11325-00	ANODE	2
6G8-11325-00	ANODE	4

Outboard Essentials and Spare parts

IMPELLER REPAIR KIT

Part Number	Description
KIT60000XMP0	IMP SERV F30B-F40F
KIT60100XMP0	IMP SERV F40H-F50H-F60F
KIT60200XMP0	IMP SERV F40G-F70A
KIT60300XMP0	IMP SERV F80D-F100F-F115B-F130A
KIT60500XMP0	IMP SERV F150D-F150F
KIT60600XMP0	IMP SERV F150G-F175A&C-F200C&F&G-F225B
KIT60800XMP0	IMP SERV F225F-F250D-F300B
KIT60900XMP0	IMP SERV F425A-XF425N

KIT60000XMP0

Part Number	Description	Qty
63D-44322-00	INSERT, CARTRIDGE	1
6H4-44352-02	IMPELLER	1
93210-59MG7	O-RING	1
90280-03M03	KEY, WOODRUFF	1
63D-44323-00	OUTER PLATE, CARTRIDGE	1
63D-44316-00	GASKET, WATER PUMP	1
93210-48001	O-RING	1

KIT60100XMP0

Part Number	Description	Qty
63D-44322-00	INSERT, CARTRIDGE	1
6H3-44352-00	IMPELLER	1
93210-59MG7	O-RING	1
90280-03024	KEY, WOODRUFF	1
63D-44323-00	OUTER PLATE, CARTRIDGE	1
63D-44316-00	GASKET, WATER PUMP	1

KIT60200XMP0

Part Number	Description	Qty
63D-44322-00	INSERT, CARTRIDGE	1
6H3-44352-00	IMPELLER	1
90280-03M03	KEY, WOODRUFF	1
6CJ-44315-00	GASKET, WATER PUMP	1
6CJ-44323-00	OUTER PLATE, CARTRIDGE	1
6CJ-44324-00	GASKET, CARTRIDGE	1
6CJ-44316-00	GASKET, WATER PUMP	1
93210-46044	O-RING	1

KIT60300XMP0

Part Number	Description	Qty
9321037M6700	O-RING	1
61A-44322-02	INSERT, CARTRIDGE	1
93210-86M38	O-RING	1
6E5-44352-01	IMPELLER	1
6EK-44323-00	OUTER PLATE, CARTRIDGE	1
6E5-44315-A0	GASKET, WATER PUMP	1
90280-04M05	KEY, WOODRUFF	1

KIT60500XMP0

Part Number	Description	Qty
93210-86M38	O-r	1
61A-44322-02	Insert	1
9321037M6700	O-r	1
6E5-44352-01	Impeller	1
6G5-44323-01	Outer plate	1
6E5-44315-A0	Gasket	1

KIT60600XMP0

Part Number	Description	Qty
9321037M6700	O-RING	1
61A-44322-02	INSERT, CARTRIDGE	1
93210-86M38	O-RING	1
6E5-44352-01	IMPELLER	1
6G5-44323-01	OUTER PLATE, CARTRIDGE	1
6E5-44315-A0	GASKET, WATER PUMP	1
90280-04M05	KEY, WOODRUFF	1

KIT60800XMP0

Part Number	Description	Qty
9321037M6700	O-RING	1
6AW-44322-00	INSERT, CARTRIDGE	1
93210-94003	O-RING	1
6CE-44352-00	IMPELLER	1
6CE-44323-01	OUTER PLATE, CARTRIDGE	1
6CE-44315-00	GASKET, WATER PUMP	1
90280-04002	KEY, WOODRUFF	1

KIT60900XMP0

Part Number	Description	Qty
9321037M6700	O-RING	1
6GR-44322-00	INSERT, CARTRIDGE	1
93211-08001	O-RING	1
6GR-44352-00	IMPELLER	1
6GR-44323-00	OUTER PLATE, CARTRIDGE	1
93210-97690	O-RING	1

SERVICE KITS OVERVIEW

Engine type	Engine type	Model type	Service Kit	Service Kit
F30BEHDL	F30BETS/BET	6BTD	KIT60000BASO	KIT60000ANB0
	F30BETL	6BTD	SERV KIT F30B-F40F	ANB KIT F30B-F40F
F40FEDL		6BGD	KIT60000ANA0	KIT60000XMP0
F40FEHDS	F40FETS/FET	6BGD	ANA KIT F30B-F40F-F40H-F50H-F60F	IMP SERV F30B-F40F
F40FEHDL	F40FETL	6BGD		
F40HET	F40HETL	6AKF	KIT60100BASO	KIT60100ANB0
F50HED	F50HEDL	6C1G	SERV KIT F40H-F50H-F60F	ANB KIT F40H-F50H-F60F
F50HETL		6C1G		
F60FET	F60FETL	6C5G	KIT60000ANA0	KIT60100XMP0
			ANA KIT F30B-F40F-F40H-F50H-F60F	IMP SERV F40H-F50H-F60F
F40GET	F40GETL	6CYA	KIT60200BASO	KIT60200ANB0
F70AET	F70AETL	6CJA	SERV KIT F40G-F70A	ANB KIT F40G-F70A
F70AETX		6CJA		
			67F-45371-00	KIT60200XMP0
			Tab Trim for F40G-F70A	IMP SERV F40G-F70A
F80DET	F80DETL	6HV3	KIT60300BASO	KIT60300ANB0
F100FET	F100FETL	6HJ3	SERV KIT F80D-F100F	ANB KIT F80D-F100F
			KIT60300ANA0	KIT60300XMP0
			ANA KIT F80D-F100F-F115B-F130A	IMP SERV F80D-F100F-F115B-F130A
F115BET	F115BETL	6EK6	KIT60400BASO	KIT60400ANB0
F130AET	F130AETL	6EM5	SERV KIT F115B-F130A	ANB KIT F115B-F130A
			KIT60300ANA0	KIT60300XMP0
			ANA KIT F80D-F100F-F115B-F130A	IMP SERV F80D-F100F-F115B-F130A
F150DET	F150DETL	63PH	KIT60500BASO	KIT60500ANB0
F150FET	F150FETX	6BMC	SERV KIT F150D-F150F	ANB KIT F150D-F150F
			KIT60500ANA0	KIT60500XMP0
			ANA KIT F150D-F150F	IMP SERV F150D-F150F
F150GET	F150GETL	6HP3	KIT60600BASO	KIT60600ANB0
F175AET	F175AETL	6FA6	SERV KIT F150G-F175A&C-F200F&G	ANB KIT F150G-F175A&C-F200F&G
F175CET	F175CETL	6HS3		
F200FET	F200FETL	6DA7	KIT60600ANA0	KIT60600XMP0
F200GET	F200GETL	6DV7	ANA KIT F150G-F175A&C-F200F&G	IMP SERV
F200GETX		6DV7		F150G-F175A&C-F200C&F&G-F225B
F200CET	F200CETX	6ALF	KIT60700BASO	KIT60700ANB0
F225BET	F225BETX	6ASE	SERV KIT F200C-F225B	ANB KIT F200C-F225B
			KIT60700ANA0	KIT60600XMP0
			ANA KIT F200C-F225B-F225F-F250D-F300B	IMP SERV F150G-F175A&C-F200C&F&G-F225B
F225FET	F225FETX	6CLA	KIT60800BASO	KIT60800ANB0
F250DET	F250DET	6CGA	SERV KIT F225F-F250D-F300B	ANB KIT F225F-F250D-F300B
F300BET	F300BETX	6CEA		
F300BET1X	F300BET2X	6CEA	KIT60700ANA0	KIT60800XMP0
			ANA KIT F200C-F225B-F225F-F250D-F300B	IMP SERV F225F-F250D-F300B
XF425NSA		6GR1	KIT60900BASO	KIT60900ANB0
XF425NSA2		6GR1	SERV KIT F425A-XF425N	ANB KIT F425A-XF425N
XF425NSA7		6GR1		
F425ASTX		6GR2	KIT60900ANA0	KIT60900XMP0
			ANA KIT F425A-XF425N	IMP SERV F425A-XF425N

Outboard Essentials



OUTBOARD ESSENTIALS

Outboard Motor Covers

There is no better way of protecting your Outboard than a genuine Outboard motor cover. These breathable covers are designed to fit like a second skin for every engine in the range from the 2.5hp upwards. Smart and stylish, they are manufactured from a highly durable waterproof fabric resistant to rot, mildew and UV exposure.

Outboard Model	Part Number
F2.5A	YMM-09100-00-00
F2.5B	YMM-09100-01-00
F4A	YMM-09101-00-00
F4B/F5A/F6C	YMM-09101-01-00
F6A/F8C/F9.9F/F9.9J	YMM-09102-00-00
F15C/F20B/F20C	YMM-09103-00-00
F20D/F25D	YMM-09104-00-00
F30B/F40F	YMM-09105-00-00
F40D/F50F/F60C	YMM-09106-00-00
F40G/F50H/F60F	MAR-MTRCV-FS-70
F70A	YMM-09113-00-00
F80/F100	YMM-09107-00-00
F115A	YMM-09108-00-00
F115B/F130A	MAR-MTRCV-11-50
F150D/F174AF200F-G	MAR-MTRCV-F2-01
F225F/F250D/F300B	MAR-MTRCV-F4-2L

OUTBOARD VENTED SPLASH COVER

Designed to be fitted while using your engine, this cover provides the ultimate protection against scratches and UV rays.

The tight fit allows on and off water usage. Perfect on the waves, perfect on the trailer...

- UV stable, breathable, felt lined and water resistant.
- High quality material and finish.
- Features a breathable mesh around the intake ports.

Type	Part Number
F100F, F80D	YME-MCVR1-00-GY
F115B/BET, F130A	YME-MCVR1-15-GY
F150G, F175A, F200B/F/G	YME-MCVR2-00-GY
F30B/F40F	YME-MCVRF-34-GY
F300B, F250D, F225F	YME-MCVR3-00-GY
F70A, FT70, F60F, FT60G, F50H	YME-MCVR5-67-GY

FLUSHING BAGS

Made out of heavy duty plastic, these bags are designed to hold shape and stand up on their own. After a day of boating, cleanse your engine with fresh water. Just fill the bag until the water passes the intake inlets and idle your engine in neutral for 5 to 10 minutes. Finally, unscrew the drain plug and let the water flow out.

Type	Part Number
Small Flushing Bag	YME-MSVBG-0S-BK
Large Flushing Bag	YME-MSVBG-0L-BK



ENGINE FLUSH KIT

This extremely useful piece of equipment connects in seconds to your garden hose and allows you to flush out harmful salt and sand. It can also be used for out-of-water operation for tune-ups.

For F4/F5/F6 engines

ABB-FLUSH-JD-00



TRAILER SUPPORT

The Yamaha Trailer Support stops your outboard motor moving excessively whilst your boat is being towed on a trailer. Quickly and easily installed over the port trim rod, this support prevents long term damage to both the boat and the engine. One Yamaha Trailer Support will provide adequate support for the F115A up to V6 series. V8 models will require two supports. Please note this product does not work with the F115B or F130A.

Description	Part Number
TRAILER SUPPORT	MAR-MTSPT-YM-10
Single trim ram support	MAR-MTSPT-SR-00

YAMAHA TIE DOWNS

Both include two 25mm x 1.80m straps rated for 540 kg.

Type	Part Number
Blue, cam-lock buckle	ACC-0SS58-40-28
Blue, ratcheting	ACC-0SS58-40-30



FENDER SOCKS

These high specification fender socks have been produced in a UV and saltwater resistant material. The socks come in black with a white Yamaha logo.

Description	Part Number
0 - 6 metres (fits 13 x 50cm fender)	YMM-09FS0-00-01
6 - 10 metres (fits 15 x 60cm fender)	YMM-09FS0-00-02

SPRAY PAINT

Scratches can cause rust or other types of damage. Fix them quickly and effectively with our high-quality, durable Yamaha aerosols and primers. They've been developed specifically for marine use and offer the best colour match for Yamaha outboards. Box 6 x 400ml Cans.

Description	Part Number
Ocean Blue (for OM until 1983)	YMM304000B10
Marine Blue (for OM from 1983 until 1993)	YMM30400MB10
Bluish Grey Metal (for OM from 1994)	YMM30400GM10
Bluish Grey Metal 1 (for F30 to F350 OM from 2008)*	YMM30400GM10
Bluish Grey Metal 2 (F2.5 to F25)	YMM30400GM20
Dark Blue (for origin OM)	YMM30400DB10
Top Coat	YMM30400TC10
Filling Primer	YMM30400FP10
Zincprimer (anti-corrosive for aluminium parts)	YMM30400ZP10
Propeller White (All aluminium prop)	YMM30400PW10

* For previous model colour codes consult your Yamaha Dealer



NEW MARINE TOUCH UP PAINT, STICKS AND SPRAY FOR WAVERUNNERS AND OUTBOARD ENGINES

YMEVXCSTKWHT	WR - PAINT STICK WHT
YMEVXCSTK0BK	WR - PAINT STICK BK
YMEVXCSPYWHT	WR - PAINT SPRAY WHT
YMEVXCSPY0BK	WR - PAINT SPRAY BK
YMEXTSPYCLCT	OB - PAINT SPRAY XTO CLEAR WHT
YMEXTSPYBWHT	OB - PAINT SPRAY XTO BASE WHT

Outboard Essentials and Spare parts

ANODES

The materials and build quality of a Yamaha engine means it's already highly resistant to corrosion. The addition of a self-sacrificing anode will improve this even further. As a first line of defence, an anode is meant to corrode instead of your engine. It can easily be replaced by another, thereby protecting the engine. However, high-quality Yamaha anodes are more durable than most of their competitors and will need to be changed less often, thereby maximising the protection of your engine.

CYLINDER ANODES

Outboard Model	Part Number
F2.5A / 2B / 3A / F4A / 4A/5C ('90-) / F4B / F5A / F6C	6L5-45251-03-00
4A/5C ('89) / F8A/B/F9.9A/B ('88)	677-45251-00-00
4A/5C/F8A/B/F9.9A/B ('89) / 9.9D/15D ('88/'89)	6E0-45251-12-00
4A/5C ('-88)	6E0-45251-00-00
6C/D/8C ('90-)	6N0-G5251-00-00
6C/D/8C ('-89)	6N0-WG525-00-00
6C/D/8C ('-89)	6E0-45251-12-00
F6A/B/F8C / F9,9F / F9,9J	68T-45251-00-00
F8A/B/9.9D/F9.9B/15D / F9.9A ('-94)	6E8-45251-02-00
F9.9A/FT9.9A ('94-)	6G8-45251-01-00
FT8D/9.9F/F9.9C/FT9.9D/ FT9,9G / FT9,9L /15F/ F15A/F20A / F25A/25B/V/ F25D /30G/H/40V/X/ F30A/F40A/B/C/ F50A/F/50H/FT25B/C ('00-)	61N-45251-01-00
F15C / F20B	6AH-45251-00-00
FT25F / F30B / F40F / F60A/C/FT60B / 40V/X/50H/ F40A/F50A/B ('-99) / F50H / F60F	67C-45251-00-00
F25G	6G8-11325-00-00
F50H / F60F / FT50J / FT60G	65W-45251-00-00
F(L)300A / F(L)350A	6AW-45373-00-00

TAB TRIM ANODES

F9.9C/F15A	66M-45371-00-00
40Q/50G/55B/PRO50	679-45371-00-00
20C/D/25D/N/30A/D/40H/V/X/50D/H / F40A/ F45A/F50A ('-00)	664-45371-01-00
FT25B/C/F30A/ FT25F / F25G / F30B / F40F / F40A/B/C/F50A/F/ F50H /F60A/C / F60F	67C-45371-00-00
60F/70B/75A/C/PRO75/80A/85A/90A / FT50B ('-00) FT50C/G/ FT50J /FT60B/D/ FT60G / F70A / F80A/B/F100A/D	67F-45371-00-00
100A/115A/B/C/130B/140A/B/F100B/F100F/ F115A/F115B /150A/175A/200A ('-97) 220A/ PROV100	6E5-45371-01-00
150A/175A/200A ('98-) / 150C/F/175B/D/200B/ F/G/225A/F/225B/D / PROV200/F150A/Z150P/Q/ Z175G/H/Z200N / F200F / F(L)200G	6J9-45371-01-00
150A/175A/200A	6K1-45371-00-00
LF150A/L150C/F/L200B/F/LZ150P/LZ200N	6K1-45371-02-00
FL115A/ FL115B /L130B/L140B	6L6-45371-00-00
(L)225C/G/(L)250A/B/ F(L)200A/ F(L)200C / F(L)225A / / F(L)225B / F(L)250A / F(L)250B / F(L)225F / F(L)250D / F(L)300B	61A-45371-00-00
Z200P/(L)Z250D/F/(L)Z300A	69L-45371-00-00

BRACKET ANODES

FT8D/FT9.9D/F15A/F20A / F15C / F20B / F25A / F25G (PT model) /FT25B/F30A/30D/F40B/C / 40X/V/FT50C/50H/F60A/FT60B / F70A	65W-45251-00-00
25B/Q/40H/50D/G/55B/60F/70B/75A/C/80A /85A/90A/F80A/B/F100A/D/ F100F/ F(L)115B / PRO50/75 ('90-)	6H1-45251-03-00
40H/50D/60F/70B/80A/90A ('89)	99999-03935-00
40H/50D/60F/70B/80A/90A ('-88)	688-45251-01-00
25B/FT25B/F30A/40V/F40A/B/F45A / FT50A/B/50G/H/PRO50/55B/60F/70B	663-45251-00-00
40V/F40A/F45A/50H/F50A/FT50B	63D-45251-01-00
115A/140A/150A/175A/200A/220A	6E5-45251-00-00
100A/115B/C/ F(L)115A/ (L)130B/(L)140B	6G5-45251-02-00

PROV100/150/200/Vmax	6AW-45251-00-00
(L)F150A/(L)150A/C/F/175A/B/D/F	6AW-45251-00-00
(L)200A/B/F/G/(L)225A/B/C/D/G/(L)250A/B	6AW-45251-00-00
(L)Z150P/Q/Z175G/H/(L)Z200N/P/	6AW-45251-00-00
Z250D/F/ F(L)200A / F200B / F(L)200C	6AW-45251-00-00
F(L)225A / F(L)225B / F225C / F(L)250A	6AW-45251-00-00
F(L)250B / (L)Z300A / F(L)300A / F(L)350A	6AW-45251-00-00
F(L)225F / F(L)250D / F(L)300B	6AW-45251-00-00
F(L)200F / F(L)200G	6AW-45251-00-00

STERN-DRIVE DIESEL ANODES

Type / Engine Model	Part Number
Anode for intercooler - ME370 / ME422	N51-45251-00-00
Anode for heat exchanger - ME370 / ME422	N51-11325-01-00
intermediate Anode - ME422	6U0-45251-00-00
Anode for TRP Drive (rear) - ME422	6U4-45251-00-00
Anode for TRP Drive (front) - ME422	6U4-45373-00-00
Anode for SP drive - ME422	6U3-45251-00-00

F300A/F350A (V8) ANODES

Type	Part Number
Anode for thermostat cover	6AW-1132R-00-00
Anode for rectifier/regulator	6E5-11325-00-00
Bolt Anode	6AW-11325-00-00
Cylinder head anode	67F-11328-00-00
Anode for engine block	6AW-1132P-00-00
Anode for Exhaust cover	6AW-1132M-00-00
Anode for Exhaust	99999-03946-00
Anode for Exhaust	6AW-1132L-00-00
Anode for engine block	63P-11325-01-00
Anode intermediate plate/Exhaust Guide	6AW-1132T-00-00
Anode intermediate plate/Exhaust Guide	6AW-1132S-00-00
Anode intermediate plate/Exhaust Guide	63P-11325-11-00

IMPELLERS

This vital component of the water pump ensures a continuous supply of the correct amount of coolant to the engine. Like all our parts, a Yamaha Impeller is intended for use with a Yamaha engine, so it's advisable to specify one every time it needs replacing.

Outboard/Engine Model	Part Number
2A/2B/2C	646-44352-01-00
F2.5A/3A/Malta	6L5-44352-00-00
4A/5C/F4A/F4B/F5A/F6C	6E0-44352-00-00
F6A/F8C/F9,9F/F9,9J	68T-44352-00-00
6C/8C	6G1-44352-00-00
F8B/F9.9A/B/D/FT9.9A/9,9D/15D	682-44352-03-00
FT8D/F9.9C/FT9.9D/FT9,9G/FT9,9L/9,9F/15F/F15A/ F15C/F20B	63V-44352-01-00
20C/25D/30A	689-44352-02-00
20D/25N	6L2-44352-00-00
F20A/F25A/FT25B/F25G/25B/V/F25D/FT25F/F30A/ F30B/F40F/30D/G/F40B/40H/X/50D	6H4-44352-02-00
F40A/C/40V/F45A/50G/H/55B/PRO50/F50A/B/F/ F50H FT50B/C/G/FT50J/F60A/C/F60F/FT60B/D/ FT60G/60F/70B ('-03)/F70A	6H3-44352-00-00
40Q	6F5-44352-00-00

IMPELLERS

60F ('04 --)/70B ('04 --)/75A/C/PRO75/80A/85A/90A	688-44352-03-00
F80A/B/F100A/D	67F-44352-00-00
V4/V6 2T/F100F/F(L)115A/F(L)115B/F(L)150A/ F175A/F(L)200F/F(L)200G	6E5-44352-01-00
F(L)225F/F(L)250D/F(L)300B	6CE-44352-00-00
F(L)300A/F(L)350A	6AW-44352-00-00
Stern-drive diesel ME370/ME372/ME422/ME432	6TA-12457-00-00

THERMOSTATS

A thermostat regulates the perfect engine operating temperature. A correctly performing thermostat prevents engine over-cooling which can cause dilution of the oil and reduction of filtration, resulting in greater engine wear.

Outboard Model:	Part Number
3A/4A/5C/6C/8C/25N (--'93)/25NWO ('01/'02)	6E5-12411-02-00
9,9F/15F/25N ('94--)/40V/100A/115C/(L)130B/ (L)150F/175D/(L)200F/200G/225D/(L)250A/(L)Z150P/ Z150Q/Z175G/(L)Z200N/Z200P/225G/(L)250B	6E5-12411-30-00
F15C/F20B	6AH-12411-00-00
9,9D/15D/20C/25D/40Q/55B	6F5-12411-03-00
30D/75C/90A	688-12411-11-00
50G/60F/70B	6H3-12411-11-00
F100B/F(L)115A/(L)Z250D/Z250F/(L)Z300A	60V-12411-00-00
F2,5A	69M-12411-01-00
F4A/F4B/F5A/F6C/F6A/F8B/F8C/FT8D/F9,9C/F9,9F/ F9,9J/FT9,9A/FT9,9D/FT9,9G/FT9,9L/F15A/F9,9B/ F25A/FT25B/F25D/FT25F/F30B/F40F/F30A/F40B/ F40A/F50A/FT50B/C/F50F/F50H/FT50G/FT50J/F60A/ FT60B/F60C/F60F/FT60D/FT60G/F70A	66M-12411-01-00
F25G	6FM-12411-00-00
F80A/F100A (99/'00')	66M-12411-01-00
F80A/F100A (01/'--)	67F-12411-01-00
F100D	6D9-12411-00-00
F(L)115B	6EK-12411-00-00
F80B/F100B/F(L)150A/F(L)200A F(L)200C/F(L)225A/F(L)225B/ F225C/F(L)250A/F(L)250B	67F-12411-01-00
F100F	6FP-12411-00-00
F(L)225F/F(L)250D/F(L)300B	6CE-12411-00-00
F(L)200F/F(L)200G/F175A	6DA-12411-00-00
F(L)300A/F(L)350A	6AW-12411-00-00
WaveRunner Model:	
FX.../FZS/FZS	60E-12411-01-00
VX...	6D3-12411-00-00

PRIMARY FUEL FILTERS

Fuel filters and replacement cartridges with high power filtering to block any small particles in the fuel. Remember to change this filter regularly using genuine Yamaha parts.

Outboard Model	Part Number
3A / F2,5A / F4A	6L5-24251-00-00
4A / 5C / 6C / 8C	646-24251-02-00
F4B / F5A / F6A / F6C / F8C / FT8D / F9,9J / FT9,9L	68T-24251-01-00
F9,9C / FT9,9D / F15A / F25A / FT25B (--'04)	65W-24251-10-00
F9,9C (1001584 --) / FT9,9D (1001139 --) / F15A (1009198 --) / F25A & FT25B (1013331 --) ('04 --)	61N-24563-10-00
F25G	6D8-24563-00-00
F30A / F40B	65W-24251-10-00
FT50B (--'00)	61N-24563-10-00
FT50B ('01--)	68V-24563-00-00

PRIMARY FUEL FILTERS

F60A / FT60B (--'03)	68V-24563-00-00
F60A / FT60B ('04--)	61N-24563-10-00
F50F / FT50G / F60C / FT60D (--'06)	68V-24563-00-00
F50F / FT50G / F60C / FT60D ('07--)	6D8-WS24A-00-00
F30B / F40F / F50H / F60F / FT50J / FT60G / F70A	6D8-WS24A-00-00
F80A / F100A (--'01)	67F-24251-02-00
F80A / F100A ('02--)	61N-24563-10-00
F80B / F100D / F(L)115A (--'06)	68V-24563-00-00
F80B / F100D / F(L)115A ('07--) / F(L)115B	6D8-WS24A-00-00
F100F	6D8-24563-00-00
F(L)150A / F(L)200A / F200B / F(L)225A (--'06)	65L-24563-00-00
F(L)150A / F(L)200A / F200B / F(L)225A ('07--)	6P3-WS24A-01-00
F(L)200C / F(L)250A (--'06)	6P2-WS245-00-00
F(L)200C / F(L)250A ('07--)	6P3-WS24A-01-00
F(L)225B / F225C / F(L)225F (V6 4,2L) / F(L)250D (V6 4,2L) / F(L)300A / F(L)300B (V6 4,2L) / F(L)350A / F(L)200F / F(L)200G / F175A	6P3-WS24A-01-00
9,9F / 15F / F15C / F20B / 25N / F25D / FT25F / 30D / 40V / 50G / F50A / 60F / 75C / 90A / 100A / F100B / 115C / (L)130B / (L)150F / 175D / (L)200F / 200G / 225D	61N-24563-10-00
115B	6F5-24563-00-00
(L)250A	61A-24563-00-00
225G / 250B	65L-24563-00-00
(L)Z150P / (L)Z150Q / Z175G / (L)Z200N / Z200P (--'04)	68F-24563-00-00
(L)Z150P / (L)Z150Q / Z175G / (L)Z200N / Z200P ('05/'06)	68F-24563-10-00
(L)Z150P / (L)Z150Q / Z175G / (L)Z200N / Z200P ('07--)	6P3-WS24A-01-00
(L)Z250D / Z250F (--'03)	68F-24563-00-00
(L)Z250D / Z250F ('04/'06)	68F-24563-10-00
(L)Z250D / Z250F ('07--)	6P3-WS24A-01-00
(L)Z300A (--'06)	68F-24563-10-00
(L)Z300A ('07--)	6P3-WS24A-01-00

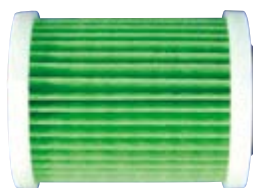

Outboard Essentials and Spare parts

NGK SPARK PLUGS

These provide the ultimate performance for your engine. They're high-quality, reliable and their advanced materials and design provide superior anti-fouling characteristics, which reduce carbon build-up over a wide heat range. "V Type" plugs include a thin centre electrode tip, which is made of precious metal for added corrosion and oxidation resistance. The result: fast, sure starts and less misfiring, even in the coldest weather.

- Ribbed to eliminate flash-over and improve performance
- Highest quality ceramic insulators improve heat dissipation and electrical insulation to provide long term durability
- More Gaskets for peak performance
- Deep-seated copper core provides maximum engine efficiency at high and low speeds
- Projected insulator precision-engineered to prevent fouling and misfiring
- Nickel alloy tip prevents fouling, maximises performance and extends plug life

OUTBOARD MODEL	PART NUMBER	NGK REF.
(L)Z150P/Z150Q (VMAX)	94702-00405-00	BKR6EKU
Z175G/(L)Z200N/Z200P (VMAX)/(L)Z250D/Z250F (VMAX)/(L)Z300A	94702-00404-00	BKR7EKU
2B	94702-00249-00	BR5HS
F2,5A/F4A	94701-00248-00	BR6HS
3A/F6A/F8C/FT8D/F9,9F/F9,9J/FT9,9G/FT9,9L	94702-00274-00	BR6HS10
4A/5C/20C/25D/40X	94701-00110-00	BR7HS
6C/8C/9,9D/9,9F/15D/15F/20D/25N/25V/25B/30D/40H/40V	94702-00271-00	BR7HS10
40Q	94701-00195-00	BR8HS
30G/50D/50G/50H/55B/60F/70B/75A/75C/80A/85A/90A/100A/115A/115B/115C/140A/150A/150C/150F/175A/175B/175D/200A/200B/200F/200G/225D/(L)250A/(L)250G	94702-00247-00	BR8HS10
130B/140B/200C/225B/250B/225G (VMAX)	94701-00309-00	BR9HS10
F8B	94701-00300-00	CR5HS
F9,9A/F9,9B	94701-00282-00	CR6HS
F60A/FT60B	94701-00406-00	DPR5EA9
F9,9C/FT9,9D/F15A/F25A/FT25B/F30A/F40A/F40B/F50A/FT50B/FT50C	94701-00375-00	DPR6EA9
F15C/F20B/F25D/F25G/FT25F/F30B/F40F/F50F/F50H/FT50G/FT50J/F60C/F60F/FT60D/FT60G	94702-00418-00	DPR6EB9
F80A/F80B/F100A/F100B/F100D/F(L)150A/F(L)200A/F(L)225A	94702-00391-00	LFR5A11
F(L)115A/F175A/F(L)200C/F(L)200F/F(L)200G/F(L)225B/F225C/F(L)250A/F(L)250B/F(L)300A/F(L)350A/F(L)225F/F(L)250D/F(L)300B	94702-00400-00	LFR6A11
F100F	NC	LKR6E-9N
F4B/F5A/F6C	94702-00372-00	CR6HSB
F70A	94702-00429-00	LKR7E
F(L)115B	94702-00437-00	LKR6E
STERN-DRIVE ESSENCE	94701-00365-00	BR6FS

WAVERUNNER MODEL	PART NUMBER	NGK REF.
XL800/XLT800/GP800/WB800/GP800R	94701-00204-00	BR8ES
XLT1200/XL1200LTD/GP1200R/GP1300R	94702-00396-00	BR8ES11
SJ650/650T/650TL/650TX/FX1/PRO TX700/WB700/XL700/WVT700/W.RAIDER 760/WVT760/XL760/WB760/GP760/W.RAIDER 1100/WVT1100/SUV1200/GP1200/XL1200	94701-00195-00	BR8HS
SJ700/W.RAIDER 700	94701-00110-00	BR7HS
FX140/FX140 CRUISER/FX160/FX160 CRUISER/FX1100 HO/HO CRUISER/VX 1100 SPORT & DELUXE	94702-00409-00	CR9EB
FX SHO/FX SHO CRUISER 2008--2014/FX HO/FX HO CRUISER 2009--2014/FZR/FZS 2009--2013/VX1800 2011--2014	94702-00427-00	LFR6A
FX SVHO/FX SVHO CRUISER/FZS/FZR 2014	94702-0043-500	LFR7A

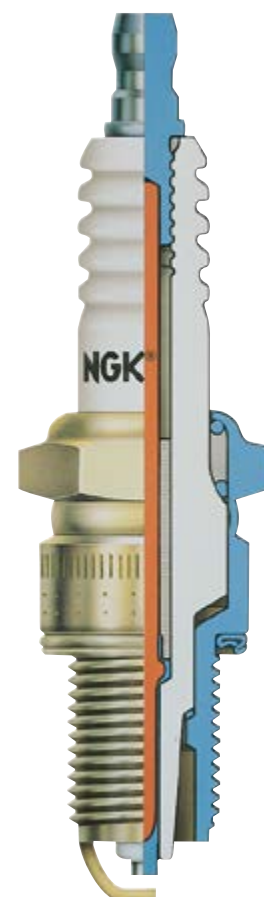

OIL FILTERS

The oil filter is an essential component that contributes to the lifetime of the engine. Compromising on the quality or replacement timing of this part may result in serious technical issues and we always recommend the use of a genuine YAMAHA oil filter. Build quality and high filtering power ensure your engine receives the very highest levels of safety.

OUTBOARD MODEL	PART NUMBER
F8A/B/F9,9A/B/FT9,9A (--1989)	6G8-13411-01-00
F8A/F9,9A/B/FT9,9A (1990--)	6G8-13440-00-00
F25G	5GH-13440-60-00
F9,9C 2000--/FT9,9D 2000--/F15A 2000--/F20A 2000--/F25A 2000--/FT25B/ F30A/F40A 2000--/F40B '01--/F50A '99--'05/F50F --05/FT50B 2000--/FT50C --05/FT50G --05/F60A --05/F60C --05/FT60B --05/FT60D --05/F80A 2000--/ F80B/F100A 2000--/F100B/F100D/F(L)115A/F115B	5GH-13440-30-00
F15C 07--/F20B 07--/F25D/FT25F/F30B/F40F/F50A 06--/FT50C 06--/FT60B 06--/F50F 06--/FT50G 06--/F60A 06--/F60C 06--/FT60D 06--/F50H/F60F/ FT50J/FT60G/F70A/VX CRUISER/DELUXE 08--11/VX SPORT 08/FX/FX HO/FX HO CRUISER 08	5GH-13440-50-00
F9,9C '98/FT9,9D '99/F15A '98/F20A '98/F25A '98/'99/F40A '99/F40B 2000/ F50A '95--'98/FT50B '96--'99/F80A/F100A '99	3FV-13440-20-00
F(L)150A/F175A/F(L)200A/F(L)200C/F(L)200F/F(L)200G/F(L)225A/F(L)225B/ F225C/F(L)250A/F(L)250B/FX SHO/FX SHO CRUISER/FX HO CRUISER/FZR/ FZS	69J-13440-03-00
F100F	5GH-13440-70-00
F(L)300A/F(L)350A/F(L)225F/F(L)250D/F(L)300B	N26-13440-02-00
WaveRunner Model	Part Number
FX140/FX140 CRUISER/FX160/FX160 CRUISER/FX-H.O CRUISER/FX-HIGH OUTPUT/VX 1100 SPORT & DELUXE	5GH-13440-30-00
Stern Drive Model	Part Number
ME 370 STI/ME 372 STI/ME 420 STI/ME 422 STI/ME 432 STI	YD9-09153-00-02

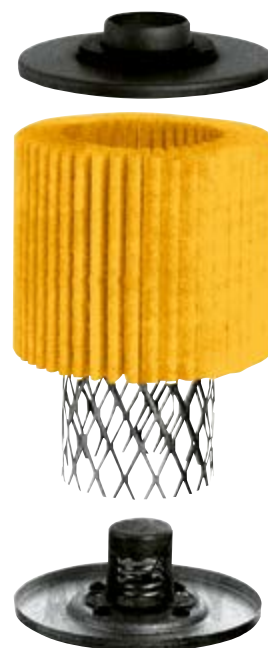

AIR FILTERS

WAVERUNNER MODEL	PART NUMBER
Air filter for: "SJ 700"	62T-14451-00-00
Air filter for: "VX"	6D3-14451-00-00
Air filter for: "FX 140/FX 1100"	6B6-14451-01-00
Air filter for: "FX 1800/FZR/FZS"	6S5-E4451-00-00
Stern Drive Model	Part Number
Air filter for "ME 372/ME 422/ME 432"	N51-14451-00-00



Outboard Essentials and Spare parts

ENGINE TIMING BELTS

The timing belt is a vital element of your 4-stroke engine, used to synchronize the movement of valves with the pistons. For 2-stroke HPDI engines the timing belt is used to drive the high pressure fuel pump. The timing belt should be replaced every five years or every 1000 hours of operation (1st maturity reached).

OUTBOARD/STERN DRIVE MODEL	PART NUMBER	REMARKS
F6A --04 / F8C --04 / FT8D --04 / F9,9F / F9,9J / FT9,9G / FT9,9L	68T-46241-00-00	
F6A 05-- / F8C 05-- / FT8D 05--	68T-46241-00-00	
F8B/FT9,9A/F9,9B	6G8-46241-00-00	
F9,9C/FT9,9D/F15A	66M-46241-00-00	
F15C / F20B	6AH-46241-00-00	
F25A/FT25B/F30A/F40B	65W-46241-00-00	
F40A/F50A/FT50B/C/F60A/FT60B	62Y-46241-00-00	
F25D / FT25F / F30B / F40F / F50F/FT50G/ FT50J / F50H / F60C/ F60F /FT60D / FT60G / F70A	6C5-46241-00-00	
F25G	6FM-46241-00-00	
F80A/B/F100A/B/D/F(L)115A/	67F-46241-00-00	
F100F	6FP-W4624-00-00	
F(L)115B	6EK-W4624-00-00	With rotor bolts
F(L)150A	63P-46241-00-00	
F(L)200A/F(L)225A/	69J-46241-00-00	
F(L)200C / F(L)225B / F225C / F(L)250A / F(L)250B	6P2-46241-01-00	
(L)Z150P / Z150Q / Z175G / (L)Z200N / Z200P (--2003)	68F-46241-00-00	
(L)Z150P / Z150Q / Z175G / (L)Z200N / Z200P (2004---)	68F-46241-10-00	
(L)Z250D/Z250F/(L)Z300A	60V-46241-00-00	
F175A /F(L)200F / F(L)200G	6DA-W4624-00-00	
F(L)300A / F(L)350A	6AW-W4624-00-00	With rotor bolts
F(L)225F / F(L)250D / F(L)300B	6CB-W4624-00-00	With rotor bolts
ME422	YU1-35681-91-95	
ME422 / ME432	6TA-12444-00-00	
ME370 / ME372	6TC-12444-00-00	
ME370 / ME372	6TC-12445-01-00	

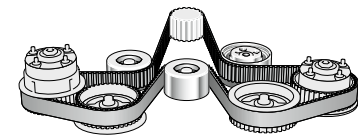

OUTBOARD MOTOR KEYS



300 and 700 series - Key cover replacement
703-82577-00-00



300 and 700 series - 18mm Switch cap replacement
6K1-82532-00-00



OM KEY NUMBER:	PART NUMBER	MATCHING CAP KEY	PART NUMBER
111	90890-55957-00	Cap Key	676-82577-00-00
112	90890-55958-00	Cap Key	676-82577-00-00
113	90890-55959-00	Cap Key	676-82577-00-00
121	90890-55960-00	Cap Key	676-82577-00-00
122	90890-55961-00	Cap Key	676-82577-00-00
123	90890-55962-00	Cap Key	676-82577-00-00
371	90890-55868-00	Cap Key	703-82577-00-00
372	90890-55869-00	Cap Key	703-82577-00-00
373	90890-55870-00	Cap Key	703-82577-00-00
374	90890-55871-00	Cap Key	703-82577-00-00
375	90890-55872-00	Cap Key	703-82577-00-00
376	90890-55873-00	Cap Key	703-82577-00-00
377	90890-55874-00	Cap Key	703-82577-00-00
378	90890-55875-00	Cap Key	703-82577-00-00
379	90890-55876-00	Cap Key	703-82577-00-00
380	90890-55877-00	Cap Key	703-82577-00-00
381	90890-55878-00	Cap Key	703-82577-00-00
382	90890-55879-00	Cap Key	703-82577-00-00
383	90890-55880-00	Cap Key	703-82577-00-00
384	90890-55881-00	Cap Key	703-82577-00-00
385	90890-55882-00	Cap Key	703-82577-00-00
386	90890-55883-00	Cap Key	703-82577-00-00
387	90890-55884-00	Cap Key	703-82577-00-00
388	90890-55885-00	Cap Key	703-82577-00-00
389	90890-55886-00	Cap Key	703-82577-00-00
390	90890-55887-00	Cap Key	703-82577-00-00
451	90890-55820-00	Cap Key	676-82577-00-00
452	90890-55821-00	Cap Key	676-82577-00-00
453	90890-55822-00	Cap Key	676-82577-00-00
454	90890-55823-00	Cap Key	676-82577-00-00
455	90890-55824-00	Cap Key	676-82577-00-00
456	90890-55825-00	Cap Key	676-82577-00-00
457	90890-55826-00	Cap Key	676-82577-00-00
458	90890-55827-00	Cap Key	676-82577-00-00
459	90890-55828-00	Cap Key	676-82577-00-00
460	90890-55829-00	Cap Key	676-82577-00-00
461	90890-55830-00	Cap Key	676-82577-00-00
462	90890-55831-00	Cap Key	676-82577-00-00
463	90890-55832-00	Cap Key	676-82577-00-00
464	90890-55833-00	Cap Key	676-82577-00-00
465	90890-55834-00	Cap Key	676-82577-00-00
466	90890-55835-00	Cap Key	676-82577-00-00
467	90890-55836-00	Cap Key	676-82577-00-00
468	90890-55837-00	Cap Key	676-82577-00-00
469	90890-55838-00	Cap Key	676-82577-00-00
470	90890-55839-00	Cap Key	676-82577-00-00
721	90890-56004-00	Cap Key	703-82577-00-00

OM KEY NUMBER:	PART NUMBER	MATCHING CAP KEY	PART NUMBER
727	90890-56005-00	Cap Key	703-82577-00-00
730	90890-56006-00	Cap Key	703-82577-00-00
731	90890-56007-00	Cap Key	703-82577-00-00
732	90890-56008-00	Cap Key	703-82577-00-00
733	90890-56009-00	Cap Key	703-82577-00-00
741	90890-56010-00	Cap Key	703-82577-00-00
747	90890-56011-00	Cap Key	703-82577-00-00
750	90890-56012-00	Cap Key	703-82577-00-00
751	90890-56013-00	Cap Key	703-82577-00-00
752	90890-56014-00	Cap Key	703-82577-00-00
753	90890-56015-00	Cap Key	703-82577-00-00
821	90890-56016-00	Cap Key	676-82577-00-00
827	90890-56017-00	Cap Key	676-82577-00-00
830	90890-56018-00	Cap Key	676-82577-00-00
831	90890-56019-00	Cap Key	676-82577-00-00
832	90890-56020-00	Cap Key	676-82577-00-00
833	90890-56021-00	Cap Key	676-82577-00-00
841	90890-56022-00	Cap Key	676-82577-00-00
847	90890-56023-00	Cap Key	676-82577-00-00
850	90890-56024-00	Cap Key	676-82577-00-00
851	90890-56025-00	Cap Key	676-82577-00-00
852	90890-56026-00	Cap Key	676-82577-00-00
853	90890-56027-00	Cap Key	676-82577-00-00

NEW FOR 2015 - 2 KEY SET INCLUDING PLASTIC CAP KEY.

OM Key number:	Part number
457	6X6-82511-09-A1
462	6X6-82511-09-A2
463	6X6-82511-09-A3
827	6X6-82511-09-A4
832	6X6-82511-09-A5
833	6X6-82511-09-A6
847	6X6-82511-09-A7
852	6X6-82511-09-A8
853	6X6-82511-09-A9





FOLDING RE-BOARDING STEP

Provides a wide-step surface for ease of boarding, especially in deep water.

Part Number

MWV-FSTEP-VX-11

MWV-FSTEP-FX-06

MWV-FSTEP-FZ-09



FENDER

Engineered specifically for WaveRunners. Easy to hang wherever your craft needs protection.

Part Number

MWV-WVRNR-HH-BL (BLUE)

MWV-WVRNR-HH-BK (BLACK)



STORAGE PACK

Need to bring along items that you do not want to move around in the storage compartment or get wet, such as keys, wallets, pagers or cell phones? This pack is your answer.

Part Number

MWV-BOWPA-CK-00



PULL-UP CLEAT

This pop-up cleat can be easily retrofitted and stows flush to maintain the sleek lines of your WaveRunner. A simple and stylish way to tether your ride.

Part Number

MWV-PUCLE-AT-07



WAVERUNNER DOCK LINE

To easily dock your WaveRunner get the Yamaha dockline, made of floating multi-filament polypropylene, oil, gas, UV, mildew & salt water resistant. Black, 1cm diameter line.

Part Number

MWV-DLDE3-12-BK 3.65m (12ft)

MWV-DLDE3-15-BK 4.55m (15ft)



COVER STORAGE BAG

Yamaha's handy storage bag gives you a place to store your WaveRunner cover neatly while not in use. Made of the same durable material as the Yamaha WaveRunner cover.

Part Number

MWV-WVRNR-BG-01



WAVERUNNER LIFTING HARNESS

Very useful in moving even the heaviest PWC. Brackets grip tight and are vinyl coated to help protect the finish. Two large stainless steel D-rings can be easily connected to a davit or other suitable lifting mechanism. Double-layer, high-strength webbing has superior UV and saltwater resistance. Rated up to 500kg.

Part Number

MWV-LFTHR-ES-10

WAVERUNNER COVERS

These tough, durable covers are specifically designed to fit the sleek curves and powerful shape of your machine – so it looks good even when it's not on the water.



Fuel filler access



Ventilation system



Eyelet access

The highest quality water-resistant materials are used, so they shrug off the damaging elements and protect your cover against fading and rot.

Important note: During transport, the cover must always be secured with straps running under the watercraft, using the special reinforced eyelets on the cover sides.



Fuel filler access - The precisely placed zip opening allows easy access to the fuel filler cap without the need to remove the cover.

Eyelet access - The cover allows easy access to the eyelets at the front and stern of the craft for securing with dock lines – or when using tie-down straps for transportation.

Ventilation system - To reduce the risk of humidity formation, these covers have a special ventilation system to allow air to circulate freely around the machine when in storage. The design also helps create a partial vacuum under the cover when moving on a trailer during transport, drawing it more tightly against the hull and topside surfaces.

Model	Part number	Color	Year
EX DELUXE SERIES	MWV-CVREX-DL-19	Charcoal/Black	2017- 2021
EX SPORT SERIES	MWV-CVREX-DL-19	Charcoal/Black	2017- 2021
EXR	MWV-CVREX-DL-19	Charcoal/Black	2019- 2021
EX	MWV-CVREX-BS-19	Charcoal/Black	2017- 2021
GP1800 SERIES	MWV-CVRGP-00-19	Charcoal/Black	2017 - 2020
FZR SERIES	MWV-CVRFZ-GY-18	Charcoal/Grey	2009 - 2016
FZS SERIES	MWV-CVRFZ-GY-18	Charcoal/Grey	2009 - 2016
FX SERIES	MWV-CVRFX-CH-19	Charcoal/Grey	2019 - 2021
FX SERIES	MWV-CVRFX-CH-18	Charcoal/Grey	2012 - 2018
FX CRUISER - LIMITED SERIES	MWV-CVRRCR-CH-19	Charcoal/Black	2019-2021
FX CRUISER - LIMITED SERIES	MWV-CVRRCR-CH-18	Charcoal/Black	2012 - 2018
VXR SERIES	MWV-CVRVR-BC-19	Charcoal/Black	2015 - 2019
VXS SERIES	MWV-CVRVS-BC-15	Charcoal/Black	2015 - 2016
VX CRUISER - LIMITED SERIES	MWV-CVRVX-CR-19	Charcoal/Black	2015 - 2020
VX DELUXE - VX -VXC SERIES	MWV-CVRVX-BC-19	Charcoal/Black	2015 - 2020
V1 SERIES	MWV-CVRV1-CH-15	Charcoal/Black	2015
SUPERJET	MWV-CVRSJ-GY-12	Black	2012 - 2019



Yamalube lubricants and Careline marine products

FOR THE SMOOTH, LONG TERM RELIABILITY OF YOUR YAMAHA, THERE'S SIMPLY NOTHING BETTER!

Yamalube marine lubricants are specifically formulated for Yamaha outboard engines and personal watercraft - and tested to levels they would never normally experience in the hands of an owner. The result is a smoother, more confident ride every time you hit the water.

QUALITY PROTECTION FOR EXTREME CONDITIONS

Yamalube is designed to work at its best under pressure - the sort it will face every day in Yamaha's mighty 5.3 litre, 32-valve V8 outboard, the F350.

HELPING ENGINES TO LIVE LONGER

By minimizing engineering enemies like spark-plug fouling, ring-sticking and pre-ignition, Yamalube oil protects engines better - for longer.

KEEPING YOUR ENGINE CLEANER

The powerful, efficient action of the anti-oxidants in Yamalube marine lubricants keep engine components clean and prevent the formation of sludge.

ANTI-CORROSION AND ANTI-RUST

Special features fight corrosion and rust, ensuring maximum protection of the engine's internal components against the hazards of the marine environment.

FORMULATED TO NMMA STANDARDS

To be certified by the NMMA (National Marine Manufacturers Association) engine oils must meet their stringent standards for viscosity, corrosion, filter-plugging, foaming and aeration.





YAMALUBE 4-S FULLY SYNTHETIC MARINE OIL

A unique, top-performance marine formula oil, specially developed for high horsepower outboard engines - with the focus on providing improved fuel economy.

FEATURES & BENEFITS

Unique marine formula, compatible with engines with catalytic converters or exhaust gas treatment devices

Provides excellent fuel economy - better than the majority of engine oils in the market

Advanced anti-wear protection for the engine components

Powerful anti-oxidant action to protect engine parts and keep them clean

Unique corrosion inhibitor protects the vital engine parts against the marine environment - both when running and at idle

Keeps the engine ultra-clean and preserves its power

To give your customer the best possible advice, please see the Yamalube application charts on pages 103-105.



SPECIFICATIONS

STANDARDS: Approved as FC-W Catalyst Compatible™, a New FC-W Specification, Issued in 2009 by NMMA (National Marine Manufacturers Association) – the only approved 5W30 oil available in the market.

Oil GRADE	SAE
Colour	Visual
Density at 15°C (59°F)	ASTM D1298
Kinematic viscosity at 100°C (212°F)	ASTM D445
Viscosity index	ASTM D2270
Flash point	ASTM D92
Pour point	ASTM D97
Total Base Number	ASTM D2896





YAMALUBE 4-S SUPER SYNTHETIC MARINE OIL

Very high performance motor oil specially developed for 4-stroke outboard motors.

FEATURES & BENEFITS

Approved in rust test and corrosion standard, as specified by the NMMA

Improved fuel economy

Advanced anti-wear protection

Powerful anti-oxidant action to protect engine parts and keep them clean

Unique corrosion inhibitor protects the vital engine parts against the marine environment - both when running and at idle

Good detergency & dispersancy to clean the engine and preserve its power

Excellent shear stability to ensure good lubrication under all conditions

To give your customer the best possible advice, please see the Yamalube application charts on pages 103-105.



SPECIFICATIONS

STANDARDS: Officially approved as FC-WTM by NMMA (National Marine Manufacturers Association)

Oil GRADE	SAE	10W-30
Colour	Visual	Brown
Density at 15°C (59°F)	ASTM D1298	0.879 g/cm3
Kinematic viscosity at 100°C (212°F)	ASTM D445	10.8 mm2/s
Viscosity index	ASTM D2270	145
Flash point	ASTM D92	225°C
Pour point	ASTM D97	-37.5°C
Total Base Number	ASTM D2896	6.88 mg KOH/g
Sulphated ash	ASTM D874	0.76 mass %





YAMALUBE 4-S SYNTHETIC MARINE OIL

This high-performance motor oil, has been developed for 4-stroke outboard motors and 4-stroke Yamaha personal watercraft.

FEATURES & BENEFITS

Good anti-wear protection

Powerful anti-oxidant action to protect engine parts and keep them clean

Long lasting protection against engine stress, resulting in smooth operation of the engine

Improved detergency and dispersancy to keep the engine clean and preserve its power & fuel efficiency

Good anti-corrosion and anti-foaming properties

To give your customer the best possible advice, please see the Yamalube application charts on pages 103-105.



SPECIFICATIONS

STANDARDS: Exceeds API SJ standards

OIL GRADE	SAE	10W-30	10W-40
Colour	Visual	Brown	Brown
Density at 15°C (59°F)	ASTM D1298	0.880 g/cm ³	0.879 g/cm ³
Kinematic viscosity at 100°C (212°F)	ASTM D445	10.8 mm ² /s	13.4 mm ² /s
Viscosity index	ASTM D2270	147	155
Flash point	ASTM D92	224°C	220°C
Pour point	ASTM D97	-40°C	-40°C
Total Base Number	ASTM D2896	7.64 mg KOH/g	7.61 mg KOH/g
Foam sequence II	ASTM D892	20/0 ml max.	20/0 ml max.
Sulphated ash	ASTM D874	1.0 mass %	1.02 mass %





YAMALUBE 2-W ENGINE OIL

A premium semi-synthetic oil, specially developed, tested and approved by Yamaha for 2-stroke Yamaha personal watercraft engines

FEATURES & BENEFITS

Low ash minimizes plug fouling and pre-ignition

Detergent/dispersant formulation to minimise deposits on pistons and cylinder rings

Good lubricity and anti-scuffing protection for smooth engine operation

Good anti-corrosion and anti-rust capability

Reduces production of exhaust smoke

To give your customer the best possible advice, please see the Yamalube application charts on pages 103-105.



SPECIFICATIONS

	Visual	Purple
Colour	Visual	Purple
Density at 15°C (59°F)	ASTM D1298	0.8628 g/cm ³
Kinematic viscosity at 100°C (212°F)	ASTM D445	6.74 mm ² /s
Viscosity index	ASTM D2270	136
Flash point	ASTM D92	96°C
Pour point	ASTM D97	-42°C
Total Base Number	ASTM D2896	1.6 mg KOH/g

YAMALUBE 2-M SUPER ENGINE OIL

High quality special formulation for 2-stroke marine engines. Developed, tested and approved by Yamaha.

FEATURES & BENEFITS

High quality anti-wear formula to protect against piston binding

Enhances the cleanliness of engine components - particularly the piston and exhaust port - and prevents sludge formation

Outstanding anti-corrosion and anti-rust capability to provide protection for the engine components

Lowers exhaust smoke by burning without leaving sticky deposits

Reduces ring-sticking, spark plug fouling and pre-ignition

Withstands the high temperatures and pressures found in modern engines - low aquatic toxicity

To give your customer the best possible advice, please see the Yamalube application charts on pages 103-105.



SPECIFICATIONS

Colour	Visual	Dark Green
Density at 15°C (59°F)	ASTM D1298	0.8714 g/cm ³
Kinematic viscosity at 100°C (212°F)	ASTM D445	6.807 mm ² /s
Viscosity index	ASTM D2270	145
Flash point	ASTM D92	88°C
Pour point	ASTM D97	-45°C
Total Base Number	ASTM D2896	10.7 mg KOH/g

YAMALUBE STERNDRIVE DIESEL OIL

Special high-performance engine oil developed for gasoline and diesel-powered inboard engines. Developed, tested and approved by Yamaha.

FEATURES & BENEFITS

Better cold flow characteristics make for easier engine starting

Excellent viscosity stability and reduced friction in all conditions

Exceptional anti-wear and anti-corrosion protection that prolongs engine life

Good anti-oxidant action and detergency to protect the engine parts and keep them clean

Strong dispersancy to keep particles in suspension and prevent the build-up of damaging sludge

To give your customer the best possible advice, please see the Yamalube application charts on pages 103-105.



SPECIFICATIONS

STANDARDS: Equivalent to API CF specifications

Viscosity Grade	SAE	15W-40
Colour	Visual	Brown
Density at 15°C (59°F)	ASTM D1298	0.887 g/cm ³
Kinematic viscosity at 100°C (212°F)	ASTM D445	14.7 mm ² /s
Viscosity index	ASTM D2270	135
Flash point	ASTM D92	240°C
Pour point	ASTM D97	-32.5°C
Total Base Number	ASTM D2896	11.0 mg KOH/g
Foam sequence II	ASTM D892	20/0 ml max.
Sulphated ash	ASTM D874	1.6 mass %

YAMALUBE SAE90 GL5 GEAR OIL

This top-performance gear oil was mainly developed to meet the demands of our V8 F350 outboard engine, and is therefore the natural choice for all sterndrive gear cases. Developed, tested and approved by Yamaha.

FEATURES & BENEFITS

Extreme pressure and anti-wear properties give good gear performance under heavy loads and repeated shocks.

Provides very good rust protection against the harsh conditions of the marine environment

High oxidation stability and thermal resistance helps prevent the formation of deposits around seals

Smooth, easy gear shifting is ensured, both at high and low temperatures

Designed to control foaming in the gear case

Retains viscosity and leaves a protective oil film on all surfaces

To give your customer the best possible advice, please see the Yamalube application charts on pages 103-105.



SPECIFICATIONS

STANDARDS: Equivalent to API GL5 specifications

OIL Grade	SAE90	GL5
Colour	Visual	Brown
Density at 15°C (59°F)	ASTM D1298	0.899 g/cm3
Kinematic viscosity at 100°C (212°F)	ASTM D445	16.55 mm2/s
Viscosity index	ASTM D2270	98
Flash point	ASTM D92	232°C
Pour point	ASTM D97	-18°C
Total Acid Number	ASTM D664	2.23 mg KOH/g
Foam sequence II	ASTM D892	10/0 ml max.

YAMALUBE SAE90 GL4 GEAR OIL

A premium quality gear oil developed for all outboard gear cases. Developed, tested and approved by Yamaha.

FEATURES & BENEFITS

Better cold flow characteristics ensure easier engine starting

Excellent viscosity stability in use, with reduced friction

Exceptional anti-wear and anti-corrosion protection to prolong engine life

Good anti-oxidant action and detergency to protect engine parts and keep them clean

Strong dispersancy to keep carbon particles in suspension and prevent the build-up of damaging sludge

To give your customer the best possible advice, please see the Yamalube application charts on pages 103-105.



SPECIFICATIONS

STANDARDS: Equivalent to API CF specifications

OIL Grade	SAE90	GL4
Colour	Visual	Brown
Density at 15°C (59°F)	ASTM D1298	0.895 g/cm3
Kinematic viscosity at 100°C (212°F)	ASTM D445	15.22 mm2/s
Viscosity index	ASTM D2270	97
Flash point	ASTM D92	224°C
Pour point	ASTM D97	-18°C
Total Acid Number	ASTM D664	1.06 mg KOH/g
Foam sequence II	ASTM D892	10/0 ml max.

YAMALUBE GEAR OIL PUMP

This handy pump makes light work of gearbox oil changes on outboards. Designed to fit the Yamalube 1 Litre gear oil containers, it comes complete with adapters to fit the gearbox fillers on all Yamaha models, as well as most other leading brands.

FEATURES & BENEFITS

- Simple and compact
- Easy operation



PACKAGING SIZE	CONTAINER TYPE	PACK LOT	PART NUMBER
1 Pcs		1x	YMD-GL4PM-P1-00

YAMALUBE LICAL GREASE

Premium multi-purpose grease - combining the advantages of both lithium and calcium - dispersed in highly refined base oils. It contains anti-wear and extreme pressure additives, anti-oxidants and corrosion inhibitors. Developed, tested and approved by Yamaha.

FEATURES & BENEFITS

- Mixability with almost all other conventional soap greases
- Excellent mechanical stability prevents ejection - or losses of consistency - even under severe operating conditions
- Very good pumpability
- Does not contain lead or other heavy metals considered harmful to health or the environment
- Outstanding water-resistance. In fact, no significant change in performance has been observed, even when this grease has been deliberately contaminated with water
- Can help to lower maintenance costs
- Equivalent to ISO 6743-9: L-XBDHB 2 and DIN 51 502: KP2K – 25 standards



PACKAGING SIZE	CONTAINER TYPE	PACK LOT	PART NUMBER
250 ML	Tube	12x	YMD-69010-0T-A3
400 GR	Cartridge	1x	YMD-69010-0C-02

YAMALUBE CONTACT CLEANER

A non-chlorinated degreasing agent which removes persistent dirt, grease and grime from contacts, electrical systems and spark plugs.

FEATURES & BENEFITS

The exclusive formula replaces standard chlorinate-based cleaners and is therefore less aggressive to some plastics.

APPLICATION

Spray from a short distance directly onto dirty areas

Allow approximately 10 seconds to dry

Finish drying off with a rag or compressed air



PACKAGING SIZE	CONTAINER TYPE	PACK LOT	PART NUMBER
400 ML	Aerosol can	12x	YMD-65049-A0-91

YAMALUBE PAINT & PLASTIC POLISH

The powered vehicle industry uses more and more high-quality metal, plastic and Perspex parts, treated with different paints, varnish, dyes and finishes. Yamalube Paint & Plastic Polish restores and maintains a deep gloss on almost any smooth surface.

FEATURES & BENEFITS

Removes fine scratches, treats matt areas and revitalizes colours

Economical - easy to handle and use

Solvent-free

Water-repellent

APPLICATION

Shake well before use. Apply sparingly with a cloth or polishing swab.

Polish off with a soft polishing cloth

For surfaces on motorcycles and scooters, such as:

- Lacquered metal parts (uni-colour, multi-colour, metallic paints)
- Dyed or varnished smooth plastic parts
- Perspex panels
- Helmet visors
- Airbrushed, weathered or refurbished paint
- Painted rims
- Decorative stickers and decals - it will not remove them



PACKAGING SIZE	CONTAINER TYPE	PACK LOT	PART NUMBER
220 ML	Aerosol can	12x	YMD-65049-00-61

YAMALUBE CARBURETTOR & INJECTOR CLEANER

A powerful formula, specially developed to eliminate deposits and varnish on butterfly valves, throttle-chambers, nozzles, tanks, floats, and venturi tubes.

FEATURES & BENEFITS

Reduces fuel consumption while increasing engine performance. It also helps the engine idle more evenly and improves acceleration - clean engines last longer too!

APPLICATION

With the engine turned off, disassemble the air filter and spray the Yamalube Carburettor & Injector Cleaner into the air intake pipe

Leave for 10 minutes

Repeat with the engine on, spraying the product directly onto nozzles, throttle-chambers etc.



PACKAGING SIZE	CONTAINER TYPE	PACK LOT	PART NUMBER
400 ML	Aerosol can	12x	YMD-65049-A1-01

YAMALUBE CLEANING GEL

This cleaning gel is designed for use on all components to remove dirt, grime and grease quickly and efficiently. Its gentle acid and alkaline-free formula ensures that there's no risk of damage or staining.

FEATURES & BENEFITS

Removes the toughest contaminants actively and without residue

Incorporates anti-corrosion additives

Adheres strongly, even to vertical surfaces

Dries without residue and leaves a lasting shine

APPLICATION

Spray the entire vehicle with Yamalube Cleaning Gel, let it work in for 5 minutes, then rinse down thoroughly with a strong water jet

For extreme contamination (e.g. chain grease or encrusted oil) leave it to work for up to 30 minutes after application before thoroughly rinsing down, until there is no more noticeable foaming - if necessary, a sponge can be used to remove the toughest blemishes or dirt.

Do not use under hot sun or apply to heated surfaces!



TYPE	PACKAGING SIZE	CONTAINER TYPE	PACK LOT	PART NUMBER
Pro-Active Cleaning Gel	1 L	Bottle	6x	YMD-65049-00-21
Pro-Active Cleaning Gel	25 L	Barrel	1x	YMD-65049-00-41
Tap for 25 L barrel	1 Pcs		3x	YMD-65049-P0-20

YAMALUBE PARTS CLEANER

Yamalube Parts Cleaner is a potent multipurpose degreaser designed to clean and degrease metal parts.

FEATURES & BENEFITS

Brings engine back to its original appearance

Effectively dissolves and removes tar stains, dirty grease, oil, fuel and grime without the need for water

Safe on most rubber, plastic and painted metal surfaces

APPLICATION

Spray 20 cm from the surface

Allow approximately 10 seconds to dry

Respray on very dirty areas



PACKAGING SIZE	CONTAINER TYPE	PACK LOT	PART NUMBER
400 ML	Aerosol can	12x	YMD-65049-A0-71

YAMALUBE WEATHER PROTECTION SPRAY

Suitable for: Rust and corrosion, caused by wetness and humidity, eat away at metal parts thus reducing its value and appeal. Not many know there is a reliable and effective protection against it. Yamalube Weather Protection Spray protects and prevents metal parts from corrosion.

FEATURES & BENEFITS

With regular use, reliably protects all metal parts of the vehicle against corrosion and stops existing corrosion in its tracks

Forms a "self-healing", transparent protective film that closes immediately again after being touched, making it better than wax

Perfect for winter lay-up to protect against salt

Lubricates and displaces moisture

APPLICATION

Shake the can before use. Only apply the product to clean, dry surfaces

Spray on the product evenly and sparingly, or apply with a soaked cloth, and wipe down with a soft cloth afterwards. For winter lay-up, spray on generously (without wiping off)

Tip: The product can be easily removed with Yamalube Cleaning Gel

Note: Do not spray on hot surfaces! Do not spray on brake disks or tyre tread!



PACKAGING SIZE	CONTAINER TYPE	PACK LOT	PART NUMBER
300 ML	Aerosol can	6x	YMD-65049-A0-51

YAMALUBE SILICON SPRAY

Black engine parts often suffer from dulling as a result of the harsh environment to which they are exposed and especially from the effect of sun-bleaching. Yamalube Silicon Spray restores and refreshes sun-bleached parts while protecting plastics.

FEATURES & BENEFITS

Yamalube Silicon Spray serves to optically refurbish:

- Greyed and bleached metal motorcycle parts painted or unpainted (e.g. engine block, frame, fork, engine side covers, rims, etc.)

- Rough and varnished plastic and rubber parts (e.g. side panels, inside panels, mudguards, fixtures, carbon parts, top case, plastic case, blinkers, mirrors, etc.)

APPLICATION

Wash the vehicle thoroughly with Yamalube Cleaning Gel and then chamois it down

Shake the can well and spray on a thin, even coat from about 20 cm away. Then allow to dry thoroughly

Wipe down any smooth plastic parts, such as linings, with an absorbent cloth after application

Note: To protect surfaces that may not be treated (e.g. tyres, seat, speedometer cover), only apply the product to rims, linings, fittings etc. with a soaked cloth. Do not spray directly onto these parts!



PACKAGING SIZE	CONTAINER TYPE	PACK LOT	PART NUMBER
300 ML	Aerosol can	6x	YMD-65049-A0-41

Application charts for Yamalube marine products

YAMALUBE LUBRICANTS FOR: OUTBOARD ENGINES, WAVERUNNERS AND HYDRADRIVE (STERNDRIVE) ENGINES

APPLICATION	SAE	AVAILABLE PACKAGING SIZE	CONTAINER TYPE	PACK LOT	PART NUMBER
4-S Fully Synthetic Marine Oil					
4-stroke engines	5W-30	1 L	Bottle	12x	YMD-63080-01-00
		4 L	Bottle	4x	YMD-63080-04-00
4-S Super Synthetic Marine Oil					
4-stroke engines	10W-30	1 L	Bottle	12x	YMD-63070-01-00
		4 L	Bottle	4x	YMD-63070-04-00
		60 L	Barrel	1x	YMD-63070-60-00
4-S Synthetic Marine Oil					
4-stroke engines	10W-30	1 L	Bottle	12x	YMD-63050-01-00
		4 L	Bottle	4x	YMD-63050-04-00
		60 L	Barrel	1x	YMD-63050-60-00
		200 L	Drum	1x	YMD-63052-20-80
	10W-40	1 L	Bottle	12x	YMD-63060-01-00
		4 L	Bottle	4x	YMD-63060-04-00
		60 L	Barrel	1x	YMD-63060-60-00
		200 L	Drum	1x	YMD-63062-08-00
2-W engine oil					
2-stroke engines	NA	1 L	Bottle	12x	YMD-63023-01-00
		4 L	Bottle	4x	YMD-63023-04-00
2-M Super engine oil					
2-stroke engines	NA	1 L	Bottle	12x	YMD-63021-01-A3
		4 L	Bottle	4x	YMD-63021-04-00
		60 L	Barrel	1x	YMD-63021-60-03
Sterndrive diesel oil					
Sterndrive diesel engines	15W-40	1 L	Bottle	12x	YMD-63042-01-A3
		4 L	Bottle	4x	YMD-63042-04-00
		60 L	Barrel	1x	YMD-63042-60-00
SAE90 GL5 gear oil					
V8 F350 outboard engine & all sterndrive gear cases	NA	1 L	Bottle	12x	YMD-73011-10-03
		20 L	Barrel	1x	YMD-73011-20-03
		60 L	Barrel	1x	YMD-73011-60-02
		200 L	Drum	1x	YMD-73011-20-52
SAE90 GL4 gear oil					
All outboard gear cases	NA	250 ML	Tube	12x	YMD-73010-0T-A3
		1 L	Bottle	12x	YMD-73010-10-A3
		20 L	Barrel	1x	YMD-73010-20-03
		60 L	Barrel	1x	YMD-73010-60-02
		200 L	Drum	1x	YMD-73010-20-52

YAMALUBE CARELINE

APPLICATION	AVAILABLE PACKAGING SIZE	CONTAINER TYPE	PACK LOT	PART NUMBER
Lical Grease				
Outboard, personal watercraft and inboard gear cases	250 ML	Tube	12x	YMD-69010-0T-A3
	400 GR	Cartridge	12x	YMD-69010-0C-02
Gear Oil Pump				
Gear oil pump 1L	1 Pcs		1x	YMD-GL4PM-P1-00

YAMALUBE LUBRICANTS FOR: OUTBOARD ENGINES (BY MODEL)

HP	MODEL	ENGINE OIL				GEAR OIL		
		SAE		Yamalube TYPE	ENGINE OIL CHANGE QUANTITY (LITRE)	SAE	GRADE	LITRE
4-Stroke								
2.5	F2.5A	10W-30	10W-40	•	0.4	90	GL-4	0.75
4	F4A	10W-30	10W-40	•	0.5	90	GL-4	0.1
4 ~ 6	F4B / F5A / F6C	10W-30	10W-40	•	0.6	90	GL-4	0.1
6 ~ 8	F6B / F8C / F8F / FT8D / FT8G	10W-30	10W-40	•	0.8	90	GL-4	F: 0.15 / FT: 0.37
9.9	F9.9F / FT9.9G	10W-30	10W-40	•	0.8	90	GL-4	F: 0.15 / FT: 0.37
9.9 ~ 15	F9.9C / FT9.9D / F15A / F15B	10W-30	10W-40	•	1.2	90	GL-4	F: 0.25 / FT: 0.37
9.9 ~ 20	F9.9H / F13.5B / F15C / F20B / F20C	10W-30	10W-40	•	1.8	90	GL-4	0.3
20 ~ 25	F20D / F25D / FT25F	10W-30	10W-40	•	1.6	90	GL-4	F: 0.32 / FT: 0.43
25	F25G	10W-30	10W-40	•	1.1	90	GL-4	0.37
30 ~ 40	F30A / F30B / F40B / F40F	10W-30	10W-40	•	1.7	90	GL-4	0.43
30 ~ 40	F30B / F40F	10W-30	10W-40	•	1.7	90	GL-4	0.43
40 ~ 60	F40D / F50F / F50D / FT50C / F60C / FT50G / FT60T	10W-30	10W-40	•	2.1	90	GL-4	F: 0.43 / FT: 0.67
70	F70A	10W-30	10W-40	•	2.1	90	GL-4	0.67
80 ~ 100	F80B / F100D	10W-30	10W-40	•	3.7	90	GL-4	0.67
80 ~ 100	F80C / F100B	10W-30	10W-40	•	3.7	90	GL-4	0.76
115	F115A / FL115A	10W-30	10W-40	•	3.7	90	GL-4	F: 0.76 / FL: 0.72
115	F100F / F115B / FL115B / F130A	10W-30	10W-40	•	3.2	90	GL-4	F: 0.76 / FL: 0.72
150	F150A / FL150A / F150D / FL150D	10W-30	10W-40	•	4.7	90	GL-4	F: 0.98 / FL: 0.87
175	F175A	10W-30	10W-40	•	4.5	90	GL-4	0.98
200	F200F / FL200F / F200G / FL200G	10W-30	10W-40	•	4.5	90	GL-4	0.98
200	F200A / FL200A / F200B / FL200B / F200C / FL200C	10W-30	10W-40	•	4.7	90	GL-4	F: 1.15 / FL: 1.0
225	F225A / FL225A / F225B / FL225B	10W-30	10W-40	•	4.7	90	GL-4	F: 1.15 / FL: 1.0
225	F225C	10W-30	10W-40	•	4.7	90	GL-4	0.92
250	F250A / FL250A / F250B / FL250B	10W-30	10W-40	•	4.7	90	GL-4	F: 1.15 / FL: 1.0
225 ~ 300	F225F / FL225F / F250D / FL250D / F300B / FL300B	10W-30	10W-40	•	6.3	90	GL-5	F: 1.04 / FL: 1.0
300 ~ 350	F300A / FL300A / F350A / FL350A	10W-30	10W-40	•	6.5	90	GL-5	F: 1.52 / FL: 1.31
2-Stroke								
4 ~ 5	4A/B/C ~ 5C	TCW3-RL	NA	+	NA	90	GL-4	0.1
6 ~ 8	6C ~ 8C	TCW3-RL	NA	+	NA	90	GL-4	0.16
9.9 ~ 15	9.9D / 9.9F ~ 15D / 15F	TCW3-RL	NA	+	NA	90	GL-4	0.19
20	20C	TCW3-RL	NA	+	NA	90	GL-4	0.18
20 ~ 25	20D ~ 25D	TCW3-RL	NA	+	NA	90	GL-4	0.37
25 ~ 30	25B/X ~ 30H	TCW3-RL	NA	+	NA	90	GL-4	0.32
25 ~ 30	25J ~ 30D	TCW3-RL	NA	+	NA	90	GL-4	0.2
40 ~ 50	40V/X/Y ~ 50H	TCW3-RL	NA	+	NA	90	GL-4	0.43
50 ~ 55	50G ~ 55B	TCW3-RL	NA	+	NA	90	GL-4	0.5
60 ~ 90	60F / 70B / 75A / 80A / 85A / 90A	TCW3-RL	NA	+	NA	90	GL-4	0.61
115 ~ 130	115A ~ 130C	TCW3-RL	NA	+	NA	90	GL-4	0.61
150	150A/F/G/J	TCW3-RL	NA	+	NA	90	GL-4	0.98 / L: 0.87
150 ~ 200	Z150P ~ Z200P	TCW3-RL	NA	+	NA	90	GL-4	Z: 0.98 / LZ: 0.87
175 ~ 200	175A/B/D/F/G/H ~ 200G	TCW3-RL	NA	+	NA	90	GL-4	0.98
200	200A/C/F/H/J	TCW3-RL	NA	+	NA	90	GL-4	0.98 / L: 0.87
200	Z200N / LZ200N	TCW3-RL	NA	+	NA	90	GL-4	Z: 0.98 / LZ: 0.87
200	Z200P/Q	TCW3-RL	NA	+	NA	90	GL-4	0.98
225 ~ 250	225B/C/D/F/G/H ~ 250A/C/D/G	TCW3-RL	NA	+	NA	90	GL-4	1.15 / L: 1.0
250 ~ 300	Z250C/D/F - LZ250C/D/F ~ Z300A / LZ300A	TCW3-RL	NA	+	NA	90	GL-4	Z: 1.15 / LZ: 1.0
300	Z300B	TCW3-RL	NA	+	NA	90	GL-4	1.0

YAMALUBE LUBRICANTS FOR: WAVERUNNERS

ENGINE OIL

MODEL	SAE	Yamalube OIL TYPE	ENGINE OIL CHANGE QUANTITY (LITRE)
4-Stroke			
VX Sport/VX Deluxe/VX Cruiser/V1	10W-30	Synthetic or semi-synthetic engine oil	2.2
FX SHO/FX Cruiser SHO	10W-30	Synthetic or semi-synthetic engine oil	3.1
FX HO/FX Cruiser HO	10W-30	Synthetic or semi-synthetic engine oil	3.1
FZR / FZS	10W-30	Synthetic or semi-synthetic engine oil	3.1
VXS/VXR	10W-30	Synthetic or semi-synthetic engine oil	3.1
FX SVHO/FX Cruiser SVHO	10W-30	Synthetic or semi-synthetic engine oil	3.6
FZR SVHO / FZS SVHO	10W-30	Synthetic or semi-synthetic engine oil	3.6
2-Stroke			
GP1300	NA	2-W engine oil	NA

NEW YAMALUBE LINE-UP CONVERSION TABLE

	Old Line Up		New Line Up				
Usage		4- Stroke	Especially good for low/ medium/high HP	OR	Especially good for medium/high HP	OR	Especially good for high HP
IF USED	Fuel ECO 10W30	UPGRADE TO	Synthetic 10W30	OR	Super Synthetic FC-W 10W30	OR	Fully Synthetic FC-W 5W30
IF USED	Fuel ECO 10W40	UPGRADE TO	Synthetic 10W40				
IF USED	FC-W 10W30	UPGRADE TO		OR	Super Synthetic FC-W 10W30		Fully Synthetic FC-W 5W30
IF USED	FC-W 10W40	UPGRADE TO		OR	Super Synthetic FC-W 10W30		Fully Synthetic FC-W 5W30

FULLY SYNTHETIC FC-W 5W30

This premium marine engine oil offers excellent fuel economy and extended oil drain intervals, along with ultimate engine cleanliness & protection. Important note: Use this oil only after the running-in period - and for engines with low mileage. As a guide, we recommend you do not use this oil for an engine which is more than 7 years old.





www.yamaha-motor.eu

YOU YAMAHA MOTOR EXPERIENCE

YOU YAMAHA MOTOR SERVICES

Follow us on:



Yamaha Motor Europe N.V.

Koolhovenlaan 101
 1119 NC Schiphol-Rijk
 P.O.Box 75033
 1117 ZN Schiphol
 The Netherlands
 + 31 20 654 6000

Dealer

Always wear a helmet, eye protection and protective clothing. Yamaha encourage you to ride safely and respect fellow riders and the environment. Images shown depict professional riders performing under controlled conditions. Specifications and appearance of Yamaha products as shown here are subject to change without notice and may vary according to requirements and conditions. For further details, please consult your Yamaha dealer.



21_DL1_MAR_EU_EN

