



# Schumacher

IRRIGATION  
2020



## Agricultural Irrigation Products Catalog

Air Relief Valve.....	14	Pipe, Aluminum.....	46-48, 51
Ball & Socket.....	100-107	Pipe, Nu-Flex Poly.....	53
Band & Hook/Latch.....	133-135	Pipe, PVC Underground.....	49-50
Band-It Tool & Accessories.....	37	Pipe, Towline.....	31
Cam Loc.....	108-109	Pipe, Vacuum.....	57
Chain.....	65, 137	Pitot Tube.....	180
Clamp, Horseshoe.....	132	Pivot Parts.....	154-162
Clamp, Ringlock.....	132	Pressure Guage.....	164
Clamps, Hose.....	37, 41-43	Pressure Relief Valve.....	14-15
Cone, Concentric.....	125-126	Primer Valve.....	209
Cone, Eccentric.....	127	Primer, Hand.....	210-211
Coupler, Dresser.....	17, 19, 22, 203	Primer, Intake Manifold.....	213
Coupler, Ringlock.....	92-94	Primer, Power.....	211
Coupler, Sprinkler.....	95-96	Pump Accessories.....	202-215
Coupler, Twistlock.....	94	Pumps.....	188-201
Coupler, Underground.....	16-17	PVC Cement, Primer & Lube.....	27
Coupling, Riser Valve.....	98	Reducer.....	22, 25, 114
Coupling, Saddle.....	98	Repair Coupler.....	18-19
Coupling, Threaded Alum & Steel....	169, 176	Rings, Weld-on/Bolt-on.....	132-133
Disc, Alum/Steel.....	131	Riser Valve J.....	13
Drains.....	30, 154, 169	Riser Valve L.....	13
Draw Band.....	16	Riser Valve Tee.....	10-11
Elbow, Suction.....	204	Riser, Sprinkler.....	31
Elbow, Surface.....	110-113	Rodent Door.....	27
Elbow, Underground.....	21, 23, 26	Saddle.....	12
Elbow, Weld-on.....	122-123	Screen, Suction.....	204-208
End Cap.....	22, 24, 109, 121	Siphon Tubes.....	53
End Plug.....	109, 120-121	Sprinkler.....	61-62, 66
Fiberglass Tape (Powr-Wrap).....	18	Sprinkler Leveler & Elbow.....	38
Filter, Inline Screen.....	163	Storage Basket.....	99
Fittings, Hose.....	32-36, 101, 106, 109	T Pipe.....	9
Fittings, Malleable.....	174-180	Tee, Surface.....	115-117
Fittings, PVC.....	23-27, 112, 115-116, 119	Tee, Underground.....	20, 24, 26
Fittings, Surface.....	54, 110-121	Tee, Weld-on.....	124
Fittings, Underground.....	8-27	Telescope.....	137
Flanges.....	25, 128-130	Towline.....	30-31
Gasket.....	16, 19, 129, 182-186	Trailers.....	63
Gate Sock & Clip.....	56	Tubing, Steel & Aluminum.....	45
Gates.....	55-56	Valve Opener.....	167
Generator.....	216	Valve Stub & Accessories.....	165-166
Hose & Accessories.....	39-40, 63	Valve Tee, Independent.....	167
Hose Pull Coupler.....	65	Valve, Alfalfa.....	143
Hose Splice.....	32-33, 36, 64	Valve, Ball.....	139
Increaser.....	35, 114, 119	Valve, Check.....	147-148
Industrial Groove.....	97	Valve, Chemigation.....	146
J Pipe.....	8	Valve, Combo.....	149
L Pipe.....	8	Valve, Gate.....	138, 144
Motor, Electric.....	216	Valve, Inline Butterfly.....	150
Murphy Switch.....	214-215	Valve, Low Pressure.....	145
Nipples, TOE & TBE.....	170-173	Valve, Surge Gate.....	143
		Valve, Wafer Butterfly.....	139-142
		Volume Gun.....	72-89
		Volume Gun Stand.....	60-61
		Water Meter.....	152-153
		Wheeline.....	38
		Z Pipe.....	9

## CLAIMS

Claims for shortages, defective or damaged goods must be made within five (5) days from receipt of shipment.

Damages occurring "in transit" are the responsibility of the freight company and should be noted on the bill of lading when the shipment is received. Submit a claim directly to the carrier as soon as possible.

## RETURNS AND CANCELLATIONS

Merchandise may be returned only at the option of SCHUMACHER IRRIGATION, INC. Merchandise authorized for return

- 1) must be returned freight prepaid,
- 2) must be in new re-saleable condition, and
- 3) is subject to a 15% restocking charge
- 4) custom-built fittings cannot be returned, unless approved by a Schumacher representative

Credit will be issued to your account when the items are received back at our office.

Orders may be canceled at the option of SCHUMACHER IRRIGATION, INC. If the request is received prior to shipment. **Nonstandard/Custom-built** items may not be canceled without substantial penalty after material is "in process of manufacture."

## GUARANTEE

All products are guaranteed against defect due to faulty workmanship or material. This guarantee is void when merchandise is used for purposes other than that for which it was designed or if improper pressures are maintained.

## LIABILITY

SCHUMACHER IRRIGATION, INC. is not responsible for delays and losses beyond our control or for losses or damages due to application of equipment for uses other than that for which it is designed or for operation under pressures not recommended. Suitability of the merchandise for the job for which it is sold is the sole responsibility of the buyer regardless of advise or recommendations by the seller. SCHUMACHER IRRIGATION, INC. assumes no responsibility for system design or for any damages or losses due to lack of minimum water requirements for crops being irrigated with SCHUMACHER IRRIGATION, INC. equipment.

## CONTACT



Schumacher Irrigation, Inc.  
205 4th Street  
PO Box 289  
Platte Center, NE 68653  
USA

Phone: 402-246-3685  
Toll Free: 800-246-3685  
Fax: 402-246-2072  
Email: [irrigate@schumacherirrigation.com](mailto:irrigate@schumacherirrigation.com)  
Website: [www.schumacherirrigation.com](http://www.schumacherirrigation.com)

## BILLING AND LATE CHARGES

All payments are due on the 10th of the following month from the date of the invoice. Account statements are sent at the end of each month. After 30 days the principal is subject to an annual finance charge of 18%.

## FREIGHT

- All prices are F.O.B. Platte Center, Nebraska.
- Standard items are usually shipped the same day the order is received.
- Shipments via UPS, Speedee, ASAP Express and FedEx are shipped prepaid and the freight charge is added to your order.
- Shipments via common carrier are shipped freight collect.
- Freight charges on pipe delivered by our driver: \$3.00 per loaded mile.
- Deliveries by car / pickup without trailer are \$1.00 per loaded mile.

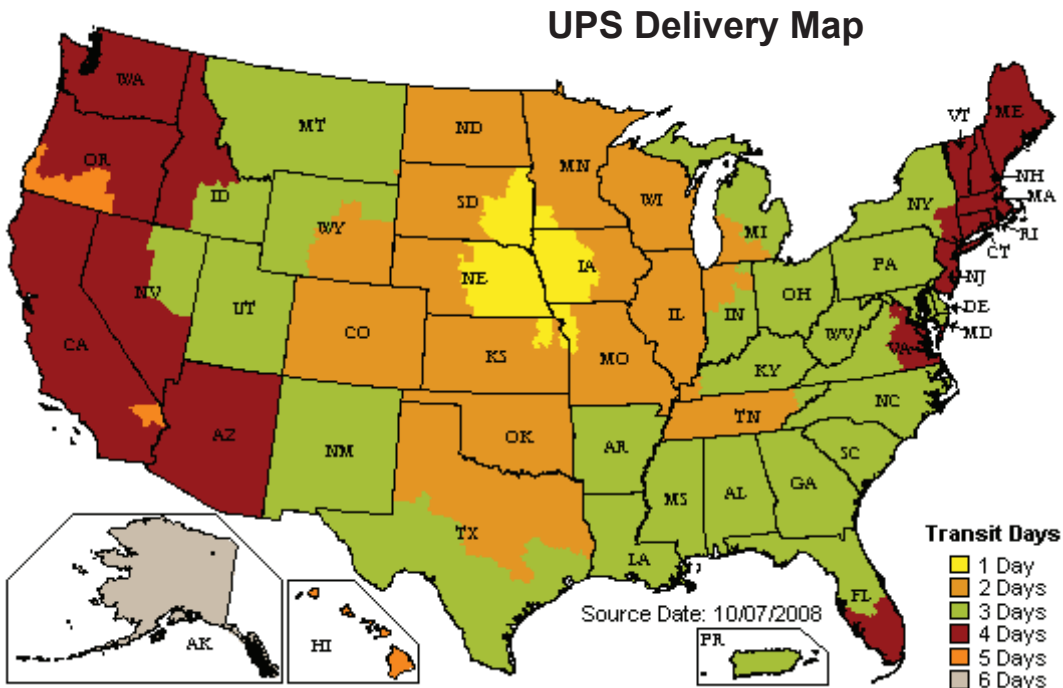

© Copyright 2020 Schumacher Irrigation, Inc. All Rights Reserved.

Prices subject to change without notice.

Material contained in this catalog may not be reproduced in whole or part without written permission from Schumacher Irrigation, Inc.

Always Open...  
**SchumacherIrrigation.com**  
*Your Irrigation Superstore*

# Nursery/Greenhouse Irrigation Catalog

Also ask for your new Nursery/Greenhouse/Grower Catalog featuring drip/micro, sprinkler, and other irrigation products pertaining to the nursery & greenhouse industry.

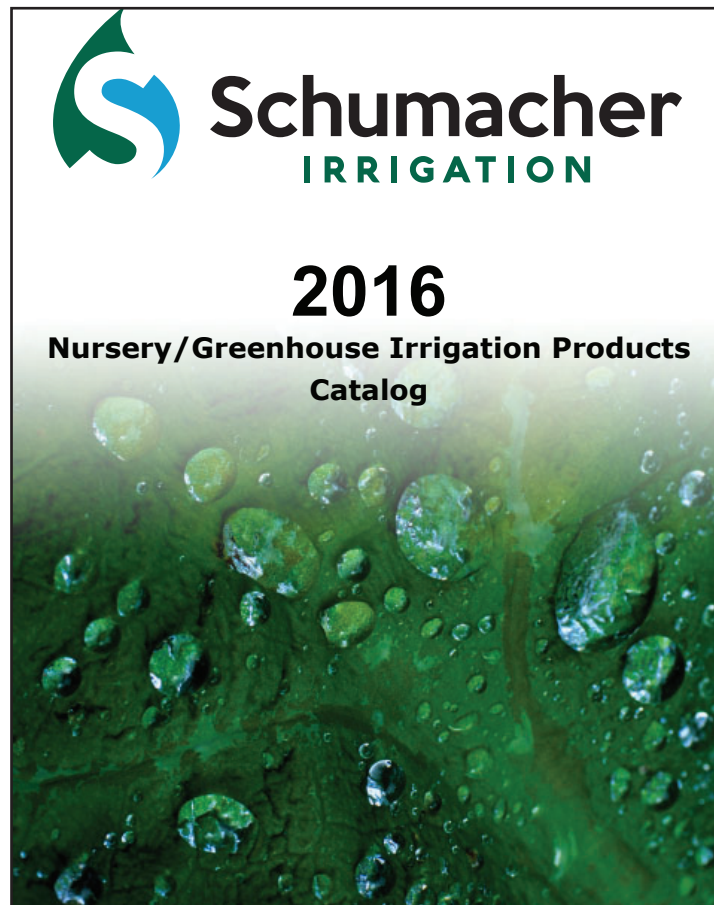

Always Open...

**SchumacherIrrigation.com**

*Your Irrigation Superstore*

To receive the Nursery/Greenhouse Irrigation Catalog:

**Call: 1-800-246-3685**









or Download the catalog at [www.schumacherirrigation.com](http://www.schumacherirrigation.com)

or Fax your request to 402-246-2072

or E-mail your request to [irrigate@schumacherirrigation.com](mailto:irrigate@schumacherirrigation.com)

## Section One



 Underground Risers	8-13
 Air Relief Valves	14
 Pressure Relief Valves	15
 Underground Couplers	16-17
 Repair Couplers	18-19
 Steel Underground Fittings	20-22
 PVC Underground Fittings	23-26
 Drain Risers	27
 PVC Glue, Primer & Lube	27

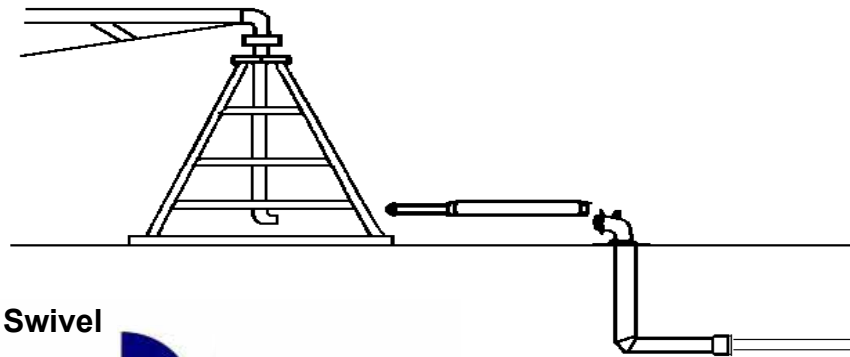

360° Swivel

60"



**ELBOW**

Elbow on top swivels in a complete 360° circle to face any direction needed.

The above elbow is used along side the pivot pad. The elbow can be removed so that when the pivot is moved from one pad to another the "L" will be flush with the ground.

# UNDERGROUND RISERS

## J PIPE (GALV., STAINLESS OR PVC)

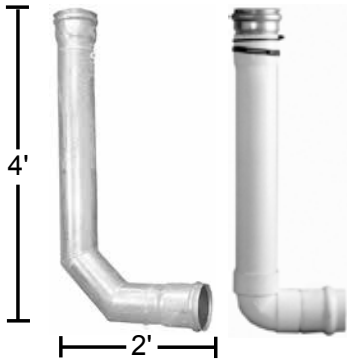

Size	Galvanized Steel			Stainless Steel			PVC #125		
	Part #	Weight	List	Part #	Weight	List	Part #	Weight	List
6" PIP	6-2000	36.0	316.00	9-8011		695.00	6-2724	12.1	255.00
8" PIP	6-2001	48.5	365.00	9-8012		965.00	6-2725	35.8	340.00
10" PIP	6-2002	61.7	435.00	9-8013		1,100.00	6-2726	31.5	485.00
12" PIP	6-2003	76.4	535.00				6-2727	39.5	595.00
4" IPS	8-1419	22.5	279.00						
6" IPS	6-2004	35.4	316.00	9-8014		695.00	6-2728	12.1	255.00
8" IPS	6-2005	48.5	365.00	9-8015		965.00	6-2729	36.0	340.00
10" IPS	6-2006	61.7	435.00	9-8016		1,100.00	6-2730	31.5	485.00
12" IPS	6-2007	76.4	535.00				6-2731	39.5	595.00

J Pipe: 48" x 24"  
Female Bottom PIP/IPS  
Female RL OD Top  
UPS Shippable.

- Metric sizes available, please call.
- 12 ga. tubing (optional 11,10, or 7)

## L PIPE (SHORT BASE) (GALV., STAINLESS OR PVC)

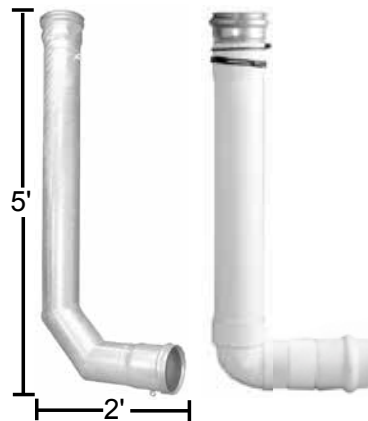

Size	Galvanized Steel			Stainless Steel			PVC #125		
	Part #	Weight	List	Part #	Weight	List	Part #	Weight	List
6" PIP	6-1981	41.1	332.00	9-8017		759.00	6-2716	20.9	260.00
8" PIP	6-1982	55.3	383.00	9-8018		1,040.00	6-2717	36.4	345.00
10" PIP	6-1983	70.2	457.00	9-8019		1,259.00	6-2718	52.7	495.00
12" PIP	6-1984	86.6	562.00				6-2719	72.8	610.00
4" IPS	8-1418	25.9	293.00						
6" IPS	6-1991	41.1	332.00	9-8020		759.00	6-2720	23.9	260.00
8" IPS	6-1992	55.3	383.00	9-8021		1,040.00	6-2721	41.6	345.00
10" IPS	6-1993	70.2	457.00	9-8022		1,259.00	6-2722	60.5	495.00
12" IPS	6-1994	86.6	562.00				6-2723	81.5	610.00

L Pipe: 60" x 24"  
Female Bottom PIP/IPS  
Female RL OD Top.

- Metric sizes available, please call.
- 12 ga. tubing (optional 11,10, or 7)

## L PIPE (LONG BASE) (GALVANIZED STEEL)

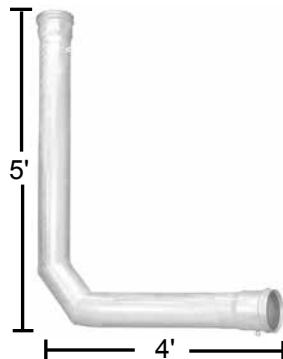

Size	Part #	Weight	List
6" PIP	6-1981-L	54.7	365.00
8" PIP	6-1982-L	73.3	421.00
10" PIP	6-1983-L	92.8	503.00
12" PIP	6-1984-L	113.8	618.00
4" IPS	8-1418-L	34.9	322.00
6" IPS	6-1991-L	54.7	365.00
8" IPS	6-1992-L	73.3	421.00
10" IPS	6-1993-L	92.8	503.00
12" IPS	6-1994-L	113.8	618.00

L Pipe: 60" x 40"  
Female Bottom PIP/IPS  
Female RL OD Top.

- Metric sizes available, please call.
- 12 ga. tubing (optional 11,10, or 7)



# UNDERGROUND RISERS

Underground Fittings

## Z PIPE (SHORT BASE) (GALV., STAINLESS OR PVC)



FRL Size	Galvanized Steel				Stainless Steel			PVC #125		
	Part #	Weight	List	Part #	Weight	List	Part #	Weight	List	
6" PIP	6-1961	59.8	<b>355.00</b>	9-8029		<b>965.00</b>	6-2700	29.2	<b>379.00</b>	
8" PIP	6-1962	80.0	<b>415.00</b>	9-8030		<b>1,312.00</b>	6-2701	53.3	<b>479.00</b>	
10" PIP	6-1963	101.3	<b>530.00</b>	9-8031		<b>1,595.00</b>	6-2702	78.5	<b>599.00</b>	
12" PIP	6-1968	124.0	<b>695.00</b>				6-2703	100.5	<b>799.00</b>	
4" IPS	8-1416	38.3	<b>295.00</b>							
6" IPS	6-1971	59.8	<b>355.00</b>	9-8032		<b>965.00</b>	6-2704	33.8	<b>449.00</b>	
8" IPS	6-1972	80.0	<b>415.00</b>	9-8033		<b>1,312.00</b>	6-2705	61.0	<b>579.00</b>	
10" IPS	6-1973	101.3	<b>530.00</b>	9-8034		<b>1,595.00</b>	6-2706	91.3	<b>739.00</b>	
12" IPS	6-1969	124.0	<b>695.00</b>				6-2707	107.3	<b>969.00</b>	

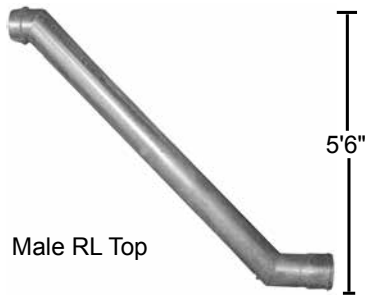

MRL Size	Galvanized Steel				Stainless Steel			PVC #125		
	Part #	Weight	List	Part #	Weight	List	Part #	Weight	List	
6" PIP	6-1964	61.4	<b>355.00</b>	9-8035		<b>965.00</b>	6-2708	29.2	<b>379.00</b>	
8" PIP	6-1965	81.1	<b>415.00</b>	9-8036		<b>1,312.00</b>	6-2709	52.3	<b>479.00</b>	
10" PIP	6-1966	102.8	<b>530.00</b>	9-8037		<b>1,595.00</b>	6-2710	79.0	<b>599.00</b>	
12" PIP	6-1967	130.8	<b>695.00</b>				6-2711	97.5	<b>799.00</b>	
4" IPS	8-1417	38.3	<b>295.00</b>							
6" IPS	6-1974	61.4	<b>355.00</b>	9-8038		<b>965.00</b>	6-2712	33.8	<b>449.00</b>	
8" IPS	6-1975	81.1	<b>415.00</b>	9-8039		<b>1,312.00</b>	6-2713	60.0	<b>579.00</b>	
10" IPS	6-1976	106.9	<b>530.00</b>	9-8040		<b>1,595.00</b>	6-2714	91.8	<b>739.00</b>	
12" IPS	6-1977	130.8	<b>695.00</b>				6-2715	106.3	<b>969.00</b>	

Z Pipe: 15"x84"x15"  
Female Bottom PIP/IPS.  
Nipples & other acc. optional.

- Metric sizes available, please call.
- 12 ga. tubing (optional 11, 10, or 7)

## T PIPE (GALVANIZED OR STAINLESS STEEL)

T Pipe: 60" x 24"  
Double Female Bottom PIP/IPS  
Female RL OD Top

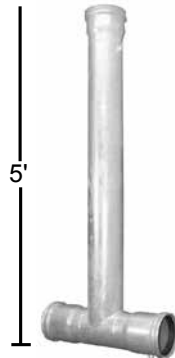

- Metric sizes available, please call.
- 12 ga. tubing (optional 11,10, or 7)

Size	Galvanized Steel			Stainless Steel		
	Part #	Weight	List	Part #	Weight	List
6" PIP	6-1986	42.0	<b>319.00</b>	9-8023		<b>735.00</b>
8" PIP	6-1987	56.5	<b>365.00</b>	9-8024		<b>1,100.00</b>
10" PIP	6-1988	72.7	<b>449.00</b>	9-8025		<b>1,295.00</b>
12" PIP	6-1989	76.4	<b>550.00</b>			
4" IPS	8-1420	25.5	<b>229.00</b>			
6" IPS	6-1996	42.0	<b>319.00</b>	9-8026		<b>735.00</b>
8" IPS	6-1997	56.5	<b>365.00</b>	9-8027		<b>1,100.00</b>
10" IPS	6-1998	72.7	<b>449.00</b>	9-8028		<b>1,295.00</b>
12" IPS	6-1990	89.4	<b>550.00</b>			

## RISER TEE (MPT TOP) (GALVANIZED STEEL)



Size	Part #	Weight	List
6"x6"x2"mpt x54", PIP	9-8132		<b>210.00</b>
8"x8"x2"mpt x54", PIP	9-5319		<b>250.00</b>
10"x10"x2"mpt x54", PIP	9-8133		<b>280.00</b>

-For use as air relief valve in the line.

## PIP RISER VALVE TEE (GALVANIZED OR STAINLESS STEEL)

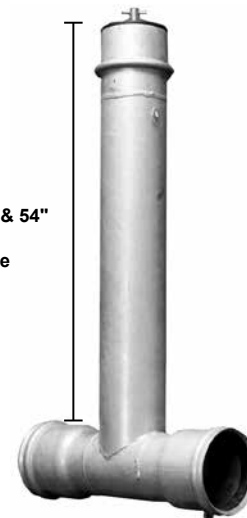

30", 36", 42", & 54"

The riser length is measured from the top of the mainline to the top of the valve.

Option: Male ends may be substituted for female.

\*Custom-Built Fittings will be made to order.

Other sizes available on request.  
Special discounts on quantity orders.  
Metric Sizes available.  
Please call for special requests.

4" Valve Top		PIP Galvanized Steel			PIP Stainless Steel		
Size	Part #	Weight	List	Part #	Weight	List	
6"x6"x4"x30"	6-3921	27.2	210.00	9-8224		729.00	
6"x6"x4"x36"	6-3922	29.5	226.00	9-8225		768.00	
6"x6"x4"x42"	6-3923	31.7	240.00	9-8226		787.00	
6"x6"x4"x54"	6-3924		255.00	9-8227		824.00	
8"x8"x4"x30"	6-3931	32.3	259.00	9-8228		780.00	
8"x8"x4"x36"	6-3932	34.6	275.00	9-8229		988.00	
8"x8"x4"x42"	6-3933	36.8	290.00	9-8230		1,007.00	
8"x8"x4"x54"	6-3934	41.3	305.00	9-8231		1,044.00	
10"x10"x4"x30"	6-3941	39.5	295.00	9-8232		1,027.00	
10"x10"x4"x36"	6-3942	41.7	305.00	9-8233		1,045.00	
10"x10"x4"x42"	6-3943	44.0	320.00	9-8234		1,064.00	
10"x10"x4"x54"	6-3944	48.5	335.00	9-8235		1,101.00	
12"x12"x4"x30"	6-3951	44.6	330.00	9-8236		1,838.00	
12"x12"x4"x36"	6-3952	46.9	345.00	9-8237		1,857.00	
12"x12"x4"x42"	6-3953	49.1	360.00	9-8238		1,876.00	
12"x12"x4"x54"	6-3954	53.6	375.00	9-8239		1,913.00	

6" Valve Top		PIP Galvanized Steel			PIP Stainless Steel		
Size	Part #	Weight	List	Part #	Weight	List	
6"x6"x6"x30"	6-3961	36.0	259.00	9-8041		806.00	
6"x6"x6"x36"	6-3962	39.4	279.00	9-8042		838.00	
6"x6"x6"x42"	6-3963	42.8	299.00	9-8043		870.00	
6"x6"x6"x54"	6-3964	49.6	319.00	9-8044		933.00	
8"x8"x6"x30"	6-3971	41.4	305.00	9-8049		940.00	
8"x8"x6"x36"	6-3972	44.8	325.00	9-8050		972.00	
8"x8"x6"x42"	6-3973	48.2	345.00	9-8051		1,004.00	
8"x8"x6"x54"	6-3974	55.0	365.00	9-8052		1,067.00	
10"x10"x6"x30"	6-3981	49.0	340.00	9-8057		1,091.00	
10"x10"x6"x36"	6-3982	52.4	360.00	9-8058		1,123.00	
10"x10"x6"x42"	6-3983	55.8	380.00	9-8059		1,155.00	
10"x10"x6"x54"	6-3984	62.6	400.00	9-8060		1,218.00	
12"x12"x6"x30"	6-3991	54.5	419.00	9-8240		1,860.00	
12"x12"x6"x36"	6-3992	57.9	439.00	9-8241		1,886.00	
12"x12"x6"x42"	6-3993	61.3	459.00	9-8242		1,911.00	
12"x12"x6"x54"	6-3994	68.1	479.00	9-8243		1,963.00	

8" Valve Top		PIP Galvanized Steel			PIP Stainless Steel		
Size	Part #	Weight	List	Part #	Weight	List	
8"x8"x8"x30"	8-1300	58.0	495.00	9-8065		1,382.00	
8"x8"x8"x36"	8-1301	62.5	505.00	9-8066		1,420.00	
8"x8"x8"x42"	8-1302	67.0	515.00	9-8067		1,459.00	
8"x8"x8"x54"	8-1303	76.0	525.00	9-8068		1,536.00	
10"x10"x8"x30"	8-1308	66.3	525.00	9-8073		1,551.00	
10"x10"x8"x36"	8-1309	70.8	535.00	9-8074		1,589.00	
10"x10"x8"x42"	8-1310	75.3	545.00	9-8075		1,628.00	
10"x10"x8"x54"	8-1311	84.3	555.00	9-8076		1,705.00	
12"x12"x8"x30"	8-1316	72.6	575.00	9-8244		2,234.00	
12"x12"x8"x36"	8-1317	77.1	585.00	9-8245		2,395.00	
12"x12"x8"x42"	8-1318	81.6	595.00	9-8246		2,445.00	
12"x12"x8"x54"	8-1319	90.6	605.00	9-8247		2,545.00	

10" Valve Top		PIP Galvanized Steel			PIP Stainless Steel		
Size	Part #	Weight	List	Part #	Weight	List	
10"x10"x10"x30"	9-7857	74.9	605.00	9-8081		1,970.00	
10"x10"x10"x36"	9-7859	80.6	615.00	9-8082		2,027.00	
10"x10"x10"x42"	9-7861	86.2	625.00	9-8083		2,083.00	
10"x10"x10"x54"	9-7863	97.5	645.00	9-8084		2,196.00	
12"x12"x10"x30"	9-7865	81.2	660.00	9-8248		2,678.00	
12"x12"x10"x36"	9-7867	86.9	670.00	9-8249		2,729.00	
12"x12"x10"x42"	9-7869	92.5	680.00	9-8250		2,780.00	
12"x12"x10"x54"	9-7871	103.8	699.00	9-8251		2,882.00	

# IPS RISER VALVE TEES

## IPS RISER VALVE TEE (GALVANIZED OR STAINLESS STEEL)

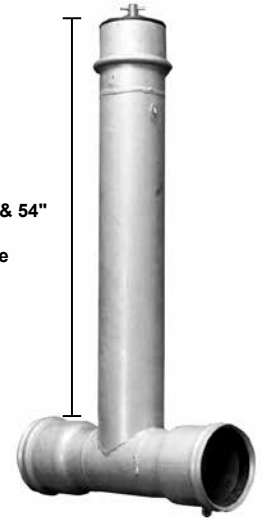

30", 36", 42", &amp; 54"

The riser length is measured from the top of the mainline to the top of the valve.

Option: Male ends may be substituted for female.

\*Custom-Built Fittings will be made to order.

Other sizes available on request.  
 Special discounts on quantity orders.  
 Metric Sizes available.  
 Please call for special requests.

Underground Fittings

4" Valve Top		IPS Galvanized Steel		Stainless Steel		
Size	Part #	Weight	List	Part #	Weight	List
4"x4"x4"x30	6-3915	17.8	189.00	9-8252		654.00
4"x4"x4"x36	6-3916	20.1	205.00	9-8253		673.00
4"x4"x4"x42	6-3917	22.3	219.00	9-8254		691.00
4"x4"x4"x54	6-3918	26.8	229.00	9-8255		729.00
6"x6"x4"x30"	6-3925	27.2	210.00	9-8256		771.00
6"x6"x4"x36"	6-3926	29.5	226.00	9-8257		789.00
6"x6"x4"x42"	6-3927	31.7	240.00	9-8258		808.00
6"x6"x4"x54"	6-3928	36.2	255.00	9-8259		845.00
8"x8"x4"x30"	6-3935	32.3	259.00	9-8260		916.00
8"x8"x4"x36"	6-3936	34.6	275.00	9-8261		934.00
8"x8"x4"x42"	6-3937	36.8	290.00	9-8262		953.00
8"x8"x4"x54"	6-3938	41.3	305.00	9-8263		990.00
10"x10"x4"x30"	6-3945	39.5	295.00	9-8264		1,088.00
10"x10"x4"x36"	6-3946	41.7	305.00	9-8265		1,107.00
10"x10"x4"x42"	6-3947	44.0	320.00	9-8266		1,125.00
10"x10"x4"x54"	6-3948	48.5	335.00	9-8267		1,162.00
12"x12"x4"x30"	6-3955	44.6	330.00	9-8268		1,083.00
12"x12"x4"x36"	6-3956	46.9	345.00	9-8269		1,102.00
12"x12"x4"x42"	6-3957	49.1	360.00	9-8270		1,121.00
12"x12"x4"x54"	6-3958	53.6	375.00	9-8271		1,158.00

6" Valve Top		IPS Galvanized Steel		Stainless Steel		
Size	Part #	Weight	List	Part #	Weight	List
6"x6"x6"x30"	6-3965	36.0	259.00	9-8045		848.00
6"x6"x6"x36"	6-3966	39.4	279.00	9-8046		879.00
6"x6"x6"x42"	6-3967	42.8	299.00	9-8047		911.00
6"x6"x6"x54"	6-3968	49.6	319.00	9-8048		974.00
8"x8"x6"x30"	6-3975	41.4	305.00	9-8053		930.00
8"x8"x6"x36"	6-3976	44.8	325.00	9-8054		961.00
8"x8"x6"x42"	6-3977	48.2	345.00	9-8055		993.00
8"x8"x6"x54"	6-3978	55.0	365.00	9-8056		1,057.00
10"x10"x6"x30"	6-3985	49.0	340.00	9-8061		1,147.00
10"x10"x6"x36"	6-3986	52.4	360.00	9-8062		1,178.00
10"x10"x6"x42"	6-3987	55.8	380.00	9-8063		1,210.00
10"x10"x6"x54"	6-3988	62.6	400.00	9-8064		1,273.00
12"x12"x6"x30"	6-3995	54.5	419.00	9-8272		1,105.00
12"x12"x6"x36"	6-3996	57.9	439.00	9-8273		1,131.00
12"x12"x6"x42"	6-3997	61.3	459.00	9-8274		1,156.00
12"x12"x6"x54"	6-3998	68.1	479.00	9-8275		1,208.00

8" Valve Top		IPS Galvanized Steel		Stainless Steel		
Size	Part #	Weight	List	Part #	Weight	List
8"x8"x8"x30"	8-1304	58.0	495.00	9-8069		1,371.00
8"x8"x8"x36"	8-1305	62.5	505.00	9-8070		1,410.00
8"x8"x8"x42"	8-1306	67.0	515.00	9-8071		1,448.00
8"x8"x8"x54"	8-1307	76.0	525.00	9-8072		1,526.00
10"x10"x8"x30"	8-1312	66.3	525.00	9-8077		1,606.00
10"x10"x8"x36"	8-1313	70.8	535.00	9-8078		1,645.00
10"x10"x8"x42"	8-1314	75.3	545.00	9-8079		1,683.00
10"x10"x8"x54"	8-1315	84.3	555.00	9-8080		1,761.00
12"x12"x8"x30"	8-1320	72.6	575.00	9-8276		1,590.00
12"x12"x8"x36"	8-1321	77.1	585.00	9-8277		1,640.00
12"x12"x8"x42"	8-1322	81.6	595.00	9-8278		1,690.00
12"x12"x8"x54"	8-1323	90.6	605.00	9-8279		1,790.00

10" Valve Top		IPS Galvanized Steel		Stainless Steel		
Size	Part #	Weight	List	Part #	Weight	List
10"x10"x10"x30"	9-7856	74.9	605.00	9-8085		2,025.00
10"x10"x10"x36"	9-7858	80.6	615.00	9-8086		2,082.00
10"x10"x10"x42"	9-7860	86.2	625.00	9-8087		2,138.00
10"x10"x10"x54"	9-7862	97.5	645.00	9-8088		2,251.00
12"x12"x10"x30"	9-7864	81.2	660.00	9-8280		1,923.00
12"x12"x10"x36"	9-7866	86.9	670.00	9-8281		1,974.00
12"x12"x10"x42"	9-7868	92.5	680.00	9-8282		2,025.00
12"x12"x10"x54"	9-7870	103.8	699.00	9-8283		2,127.00

# BOLT-ON SADDLES & RISERS

## SADDLE RISER (POWDER COATED OR GALVANIZED)



For PIP or IPS use.  
Steel powder coated or galvanized.

Size	36" Riser			42" Riser		
	Part #	Weight	List	Part #	Weight	List
6"x4"	6-3820	22.0	<b>180.00</b>	6-3825	22.0	<b>225.00</b>
8"x4"	6-3821	24.0	<b>190.00</b>	6-3826	24.0	<b>225.00</b>
10"x4"	6-3822	26.0	<b>200.00</b>	6-3827	26.0	<b>200.00</b>
12"x4"	6-3823	28.0	<b>225.00</b>	6-3828	28.0	<b>210.00</b>

## SADDLE RISER (WITH PVC RISER)



- Lightweight
- Easy to install
- Durable
- Sunlight (UV) Inhibited
- UPS Shippable
- For PIP or IPS use
- Using 3"x36" & 48" PVC Riser Pipe
- Using 3" outlet on galvanized saddle
- Using 3" x4" galvanized valve stubs.

Size	42" Riser			54" Riser		
	Part #	Weight	List	Part #	Weight	List
6"x4"	6-3804	20.0	<b>237.00</b>	6-3807	21.3	<b>239.00</b>
8"x4"	6-3805	21.0	<b>247.00</b>	6-3808	22.3	<b>249.00</b>
10"x4"	6-3806	24.0	<b>272.00</b>	6-3809	20.0	<b>274.00</b>
12"x4"	6-3830	26.0	<b>292.00</b>	6-3831	27.3	<b>294.00</b>

## SADDLE (GALVANIZED STEEL)



For OD, PIP or IPS use.

Size	3" FPT Outlet			4" FPT Outlet			6" FPT Outlet		
	Part #	Weight	List	Part #	Weight	List	Part #	Weight	List
6"	6-3810	11.0	<b>130.00</b>	6-3814	12.0	<b>140.00</b>			
8"	6-3811	12.0	<b>140.00</b>	6-3815	13.0	<b>150.00</b>	9-7632	20.0	<b>202.00</b>
10"	6-3812	15.0	<b>165.00</b>	6-3816	16.0	<b>170.00</b>	9-7633	22.0	<b>216.00</b>
12"	6-3813	17.0	<b>185.00</b>	6-3817	18.0	<b>190.00</b>	9-7634	24.0	<b>238.00</b>
15"	9-7628	23.0	<b>217.00</b>				9-7635	26.0	<b>281.00</b>
18"	9-7629	28.0	<b>639.00</b>				9-7636	31.0	<b>700.00</b>

## PVC RISER PIPE



- 3" & 4" double male threaded
- High density polyethylene riser pipe with UV inhibitor (SCH80)

Size	36" Long (for 42" Riser)			48" Long (for 54" Riser)		
	Part #	Weight	List	Part #	Weight	List
3"	6-3802	4.0	<b>18.00</b>	6-3803	5.3	<b>20.00</b>
4"	6-3790	6.6	<b>29.00</b>	6-3791	8.8	<b>39.00</b>

## RISER VALVE J (GALVANIZED STEEL)

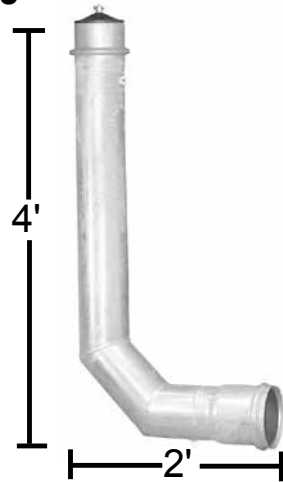

Size	Part #	Weight	List
6"x4" PIP	9-7850	43.9	<b>385.00</b>
6"x6" PIP	6-4001	39.0	<b>369.00</b>
8"x4" PIP	9-7851	53.8	<b>455.00</b>
8"x6" PIP	9-7852	63.7	<b>480.00</b>
8"x8" PIP	6-4002	59.0	<b>575.00</b>
<b>6"x4" IPS</b>	<b>9-7853</b>	<b>43.9</b>	<b>385.00</b>
<b>6"x6" IPS</b>	<b>6-4005</b>	<b>39.0</b>	<b>369.00</b>
<b>8"x4" IPS</b>	<b>9-7854</b>	<b>53.8</b>	<b>455.00</b>
<b>8"x6" IPS</b>	<b>9-7855</b>	<b>63.7</b>	<b>480.00</b>
<b>8"x8" IPS</b>	<b>6-4006</b>	<b>59.0</b>	<b>575.00</b>

## RISER VALVE L (GALVANIZED STEEL)

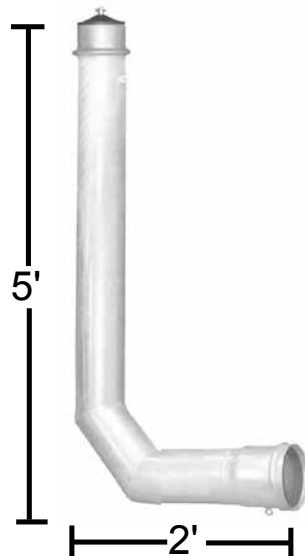

Size	Part #	Weight	List
6"x4" PIP	8-1410	48.4	<b>404.00</b>
6"x6" PIP	8-1324	44.1	<b>387.00</b>
8"x4" PIP	8-1412	58.3	<b>478.00</b>
8"x6" PIP	8-1414	70.5	<b>504.00</b>
8"x8" PIP	8-1326	65.8	<b>604.00</b>
<b>6"x4" IPS</b>	<b>8-1411</b>	<b>48.4</b>	<b>404.00</b>
<b>6"x6" IPS</b>	<b>8-1325</b>	<b>44.1</b>	<b>387.00</b>
<b>8"x4" IPS</b>	<b>8-1413</b>	<b>58.3</b>	<b>478.00</b>
<b>8"x6" IPS</b>	<b>8-1415</b>	<b>70.5</b>	<b>504.00</b>
<b>8"x8" IPS</b>	<b>8-1327</b>	<b>65.8</b>	<b>604.00</b>

## STEEL NIPPLE (WELDED ON)



Size	Part #	Weight	List
2"	6-2960	0.5	<b>30.00</b>
3"	6-2961	1.5	<b>35.00</b>
4"	6-2962	2.7	<b>45.00</b>

Nipples welded on for air relief, surge plug, etc.

## STEEL ARM (WELDED ON)



Size	Male Thread			Female Thread		
	Part #	Weight	List	Part #	Weight	List
2"	6-2963		<b>60.00</b>	6-2936		<b>58.00</b>
3"	6-2934	5.5	<b>132.00</b>	6-2937	5.4	<b>128.00</b>
4"	6-2935	8.5	<b>165.00</b>	6-2938	7.7	<b>165.00</b>

Elbow is welded on vertical risers for air relief, surge plug, etc.

## AIR RELIEF VALVE (CAST ALUM)



Standard



Continuous

Size	Standard			Continuous		
	Part #	Weight	List	Part #	Weight	List
1.5"	6-1909	1.2	<b>25.00</b>			
2"	6-1910	1.6	<b>29.00</b>	9-7829	6.0	<b>221.00</b>
3"	6-1912	3.1	<b>65.00</b>	9-7830	9.7	<b>235.00</b>
4"	6-1913	6.0	<b>129.00</b>	9-7831		<b>395.00</b>

Venting air in any pressurized pipe is of major importance. Air relief valves help protect the irrigation system from serious head surges and water hammer.

Continuous Action Air Vents:

- Exhaust Large Volumes of Trapped Air from the Pipeline.
- Provide Continuous Air Release during system operation.

## AIR RELIEF VALVE (NYLON / POLYPROPYLENE)



Guardian



Continuous

Size	Guardian (Nylon)			Continuous (Poly)		
	Part #	Weight	List	Part #	Weight	List
1"	9-6952	0.2	<b>48.00</b>			
2"	9-6953	0.3	<b>65.00</b>	9-6951	1.1	<b>219.00</b>
3"	9-6954	0.7	<b>183.00</b>			

Advantages

- Made of corrosion-resistant reinforced UV protected composite materials. No metal to rust or corrode.
- 5-year warranty

## TRI-ACTION VALVE (CAST ALUMINUM)

1. Pressure Relief
2. Air Relief
3. Vacuum Relief



Size	0-50 psi			50-160 psi		
	Part #	Weight	List	Part #	Weight	List
3"	6-1915	17.0	<b>470.00</b>	6-1914	24.0	<b>470.00</b>

## TRI-ACTION VALVE PARTS

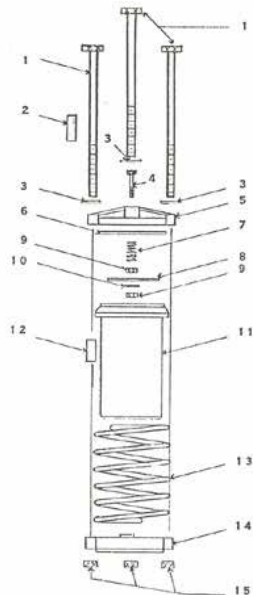

Description	Position	Part #	Weight	List
Hanger Bolt (3 req.)	1	9-7453	-	<b>18.00</b>
Decal	2	9-7454	-	<b>7.00</b>
Hanger Washer (3 req.)	3	9-7455	-	<b>2.00</b>
Valve Disc Stem	4	9-7456	-	<b>2.00</b>
Head Cap	5	9-7457	-	<b>52.00</b>
Cap Gasket	6	9-7458	-	<b>7.00</b>
Retainer Spring	7	9-7459	-	<b>3.00</b>
Valve Disc	8	9-7460	-	<b>8.00</b>
Stem Nut (2 req.)	9	9-7461	-	<b>2.00</b>
Washer	10	9-7462	-	<b>2.00</b>
Valve Body	11	9-7463	-	<b>180.00</b>
Gauge Indicator	12	9-7464	-	<b>8.00</b>
Compression Spring	13	9-7465	-	<b>178.00</b>
Hanger	14	9-7466	-	<b>74.00</b>
Hanger Bolt Nut (3 req.)	15	9-7467	-	<b>2.00</b>

## PRESSURE RELIEF VALVE 4" FPT



### 4" FPT Cast Aluminum

PSI	Part #	Weight	List
50#	6-1919	5.5	<b>186.00</b>
80#	6-1920	5.5	<b>186.00</b>
100#	6-1921	5.5	<b>186.00</b>
125#	6-1922	6.0	<b>195.00</b>
160#	6-1923	6.0	<b>195.00</b>

## PRESSURE RELIEF VALVE 3" FPT

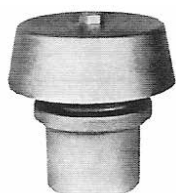

Cast Alum.



Steel Galv.

3" FPT Cast Aluminum				3" FPT Steel Galvanized			
PSI	Part #	Weight	List	PSI	Part #	Weight	List
80#	9-6822	6.0	<b>189.00</b>	80#	9-6823		<b>155.00</b>

## PRESSURE RELIEF VALVE FIELD SET (CAST IRON)



PSI Range	Spring Color	2" FPT		2-1/2" FPT		3" FPT		4" FPT	
		Part #	List	Part #	List	Part #	List	Part #	List
0-25#	Gray	9-7832	<b>156.00</b>	9-7836	<b>165.00</b>	9-7840	<b>156.00</b>	9-7844	<b>208.00</b>
30-40#	Yellow	9-7833	<b>158.00</b>	9-7837	<b>179.00</b>	9-7841	<b>189.00</b>	9-7845	<b>219.00</b>
45-85#	Black	9-7834	<b>138.00</b>	9-7838	<b>159.00</b>	9-7842	<b>145.00</b>	9-7846	<b>201.00</b>
85-150#	Yellow/Blue	9-7835	<b>189.00</b>	9-7839	<b>219.00</b>	9-7843	<b>215.00</b>	9-7847	<b>245.00</b>

## Pressure Guard™

**Features:**

- Cast Iron Body
- Brass Guide Bushing
- Stainless Guide Rod

# UNDERGROUND COUPLERS

## COUPLER (WELD-ON)



Size	PVC OD	Black Steel			Powder Coated Steel			Stainless Steel		
		Part #	Weight	List	Part #	Weight	List	Part #	Weight	List
6" PIP	6.14"	9-5043	6.0	36.00	6-2231	6.0	59.00	9-5159	3.5	110.00
8" PIP	8.16"	9-5044	8.0	45.00	6-2232	8.0	68.00	9-5160	6.5	189.00
10" PIP	10.20"	9-5045	11.0	65.00	6-2233	11.0	96.00	9-8099		211.00
12" PIP	12.24"	9-5046	13.0	80.00	6-2234	13.0	115.00	9-8285		250.00
15" PIP	15.30"	9-7441	14.8	166.00	6-2235	14.0	240.00			
18" PIP	18.70"				6-2600	19.0	412.00			
2" IPS	2.375"				6-2217		47.00			
2.5" IPS	2.875"				6-2218		48.00			
3" IPS	3.50"				6-2219	2.0	40.00			
4" IPS	4.50"	9-5037	3.0	30.00	6-2220	3.0	47.00	9-5156	2.5	55.00
6" IPS	6.625"	9-5038	6.0	36.00	6-2221	6.0	59.00	9-5157	3.5	115.00
8" IPS	8.625"	9-5039	8.0	45.00	6-2222	8.0	68.00	9-5158	6.5	165.00
10" IPS	10.75"	9-5040	11.0	65.00	6-2223	11.0	96.00	9-8100		242.00
12" IPS	12.75"	9-5041	13.0	80.00	6-2224	13.0	115.00	9-8150		229.00
6" Metric	6.625"				6-2226		44.30			
8" Metric	7.87"				6-2227		72.00			
10" Metric	9.84"				6-2228		81.50			
12" Metric	12.41"				6-2229		110.00			

## GASKET (UNDERGROUND)



Round Back



Square Back

Size	Round Back			Square Back		
	Part #	Weight	List	Part #	Weight	List
6" PIP	6-4241	0.3	11.00	9-7645	1.8	11.00
8" PIP	6-4242	0.6	14.00	9-7647	2.0	13.00
10" PIP	6-4243	0.8	20.00	9-7638	2.3	25.00
12" PIP	6-4244	1.0	26.00	9-7640	2.5	32.00
15" PIP	6-4245		29.00	9-7641		37.00
18" PIP	9-5291		53.00	9-7642		77.00
4" IPS	6-4233		11.00	9-7643	1.3	8.00
6" IPS	6-4234	0.3	11.00	9-7644	1.8	11.00
8" IPS	6-4235	0.6	14.00	9-7646	2.0	13.00
10" IPS	6-4236	0.8	20.00	9-7637	2.3	25.00
12" IPS	6-4237	1.0	26.00	9-7639		32.00

## DRAW BAND (PAINTED STEEL)



Size	Part #	Weight	List
6"	6-1704	0.6	10.10
8"	6-1705	0.7	10.30
10"	6-1706	0.9	10.70
* 12"	6-1707	1.0	11.00
14"	6-1708	1.1	12.00
15"	6-1709	1.2	13.50

\*Silver: Extra large for all sizes of PVC Pipe, #50 - #200

\* 12" for use on 10" Newby boot



# UNDERGROUND COUPLERS & MALE ENDS

Underground Fittings

## WELD-ON MALE END (POWDER COATED STEEL)



Size	Part #	Weight	List
6" PIP	6-2281	3.5	<b>56.00</b>
8" PIP	6-2282	6.5	<b>61.00</b>
10" PIP	6-2283	10.5	<b>74.00</b>
12" PIP	6-2284	12.5	<b>90.00</b>
15" PIP	6-2285	14.0	<b>158.00</b>
<b>4" IPS</b>	6-2289	2.5	<b>52.00</b>
<b>6" IPS</b>	6-2290	3.5	<b>56.00</b>
<b>8" IPS</b>	6-2291	6.5	<b>61.00</b>
<b>10" IPS</b>	6-2292	10.5	<b>74.00</b>
<b>12" IPS</b>	6-2293	12.5	<b>90.00</b>

## BOLT-ON COUPLER (BLACK OR POWDER COATED STEEL)



Black Steel



Powder Coated

 9" long.  
 Male weld-on x bolt-on coupler

Size	Black Steel			Powder Coated Steel		
	Part #	Weight	List	Part #	Weight	List
4" OD	9-5019	8.0	<b>57.00</b>			
6" PIP/OD	9-5023	11.0	<b>73.00</b>	6-4015	11.0	<b>107.00</b>
8" PIP/OD	9-5026	14.5	<b>86.00</b>	6-4016	14.0	<b>128.00</b>
10" PIP/OD	9-5029	18.5	<b>110.00</b>	6-4017	18.0	<b>167.00</b>
12" PIP/OD	9-5032	22.0	<b>210.00</b>	6-4018	22.0	<b>216.00</b>
15" PIP				6-4019	25.0	<b>265.00</b>
18.7" PIP				6-9787	30.0	<b>350.00</b>
20.4" PIP				9-5843	35.0	<b>385.00</b>
<b>4" IPS</b>	9-5021	8.0	<b>57.00</b>	6-4010	8.0	<b>72.00</b>
<b>6" IPS</b>	9-5024	11.0	<b>73.00</b>	6-4011	11.0	<b>107.00</b>
<b>8" IPS</b>	9-5027	14.5	<b>86.00</b>	6-4012	14.0	<b>128.00</b>
<b>10" IPS</b>	9-5030	18.5	<b>110.00</b>	6-4013	18.0	<b>167.00</b>
<b>12" IPS</b>	9-5033	22.0	<b>210.00</b>	6-4014	22.0	<b>216.00</b>



Half Coupler Only



PIP Flange Pack (Single)

IPS Flange Pack (Single)

Size	Half Coupler Only			PIP Flange Pack (Single)			IPS Flange Pack (Single)		
	Part #	Weight	List	Part #	Weight	List	Part #	Weight	List
4"	6-2045	6.0	<b>44.00</b>	6-2027	3.0	<b>28.00</b>	6-2016	2.0	<b>28.00</b>
6"	6-2047	7.0	<b>71.00</b>	6-2011	4.0	<b>36.00</b>	6-2017	4.0	<b>36.00</b>
8"	6-2048	9.0	<b>84.00</b>	6-2012	4.5	<b>44.00</b>	6-2018	4.5	<b>44.00</b>
10"	6-2049	13.0	<b>109.00</b>	6-2013	6.0	<b>58.00</b>	6-2019	6.0	<b>58.00</b>
12"	6-2062	16.0	<b>135.00</b>	6-2014	7.5	<b>81.00</b>	6-2020	7.5	<b>81.00</b>
15"	9-5848	19.0	<b>171.00</b>	9-5851	8.0	<b>101.00</b>			
18.7"	9-5849	22.0	<b>229.00</b>	9-5852	18.0	<b>135.00</b>			
20.4"	9-5850	25.0	<b>250.00</b>	9-5853	22.0	<b>148.00</b>			

# REPAIR COUPLERS

## REPAIR COUPLER (PVC)



- 100 psi maximum pressure.
- 19" long

PIP				IPS		
Size	Part #	Weight	List	Part #	Weight	List
4"				9-8116	4.2	40.00
6"	6-2261	4.0	65.00	6-2264	4.0	55.00
8"	6-2262	6.0	90.00	6-2265	6.0	65.00
10"	6-2263	10.0	140.00	6-2266	10.0	100.00
12"	6-2267	15.0	193.00	6-2269	15.0	122.00
15"	6-2268	20.0	287.00			

## PVC PIPE (PLAIN X GASKET, 31" LONG)



PIP (#100 psi)				IPS (#125 psi)		
Size	Part #	Weight	List	Part #	Weight	List
6"	6-2294	4.8	60.00	6-2299	5.5	75.00
8"	6-2295	4.8	90.00	6-2300	9.4	110.00
10"	6-2296	13.2	120.00	6-2301	14.6	155.00
12"	6-2297	13.2	150.00	6-2302	20.5	230.00
15"	6-2298	30.1	210.00			

## TELESCOPING REPAIR COUPLER (PVC)



- Gasket included
- 100 psi maximum pressure

PIP				IPS		
Size	Part #	Weight	List	Part #	Weight	List
6"	6-2610	8.8	125.00	6-2615	9.5	175.00
8"	6-2611	14.4	180.00	6-2616	15.4	166.00
10"	6-2612	23.2	260.00	6-2617	24.6	216.00
12"	6-2613	34.3	343.00	6-2618	35.5	352.00
15"	6-2614	50.1	497.00			

## FULL REPAIR WRAP



- 125 max psi
- Ideal to stop leaks without cutting pipeline.

Size	Part #	Weight	List
OD 4" dia x 8" long	6-9829	11.0	205.00
IPS 4" dia x 8" long	6-9830	11.0	210.00
OD/PIP 6" dia x 8" long	6-9831	12.0	250.00
IPS 6" dia x 8" long	6-9832	12.0	250.00
OD/PIP 8" dia x 8" long	6-9833	13.0	295.00
IPS 8" dia x 8" long	6-9834	13.0	295.00
OD 10" dia x 8" long	6-9835	19.0	295.00
IPS 10" dia x 8" long	6-9836	19.0	385.00
OD/PIP 12" dia x 8" long	6-9837	20.0	385.00
IPS 12" dia x 8" long	6-9838	20.0	439.00

## FIBERGLASS TAPE



- < 60 psi = 8 Layers/Wraps Min.
- > 60 psi = 10 Layers/Wraps Min.

Size	Dimensions	Part #	Weight	List
1/4" Pipe	1" Wide x 30" Long	6-9562	0.2	10.00
1/2" Pipe	1" Wide x 32" Long	6-9563		17.00
3/4" Pipe	2" Wide x 30" Long	6-9564	0.2	12.00
1" Pipe	2" Wide x 60" Long	6-9565	0.2	15.00
2" - 4" Pipe	3" Wide x 108" Long	6-9566	0.7	25.00
3" Pipe	8" Wide x 72" Long	6-9567	0.7	40.00
6" Pipe	4" Wide x 180" Long	6-9568	0.7	40.00
8" Pipe	4" Wide x 360" Long	6-9569	1.3	70.00
10" Pipe	6" Wide x 300" Long	6-9932		150.00

## BOLT-ON REPAIR COUPLER (POWDER COATED STEEL)



- 180 psi maximum pressure.
- 16" long

Size	PIP Complete			IPS Complete		
	Part #	Weight	List	Part #	Weight	List
4"				6-2207	12.0	141.00
6"	6-2206	21.0	186.00	6-2213	21.0	186.00
8"	6-2208	26.0	230.00	6-2214	26.0	230.00
10"	6-2210	36.0	289.00	6-2215	36.0	289.00
12"	6-2212	44.0	429.00	6-2216	44.0	429.00
15"	6-2200	52.0	540.00			
18.7"	6-9888	58.0	867.00			



Size	Body Only			PIP Flange Pack (Single)			IPS Flange Pack (Single)		
	Part #	Weight	List	Part #	Weight	List	Part #	Weight	List
4"	6-2033	8.0	85.00				6-2016	2.0	28.00
6"	6-2034	13.0	114.00	6-2011	4.0	36.00	6-2017	4.0	36.00
8"	6-2035	17.0	142.00	6-2012	4.5	44.00	6-2018	4.5	44.00
10"	6-2036	24.0	173.00	6-2013	6.0	58.00	6-2019	6.0	58.00
12"	6-2037	29.0	267.00	6-2014	7.5	81.00	6-2020	7.5	81.00
15"	6-2038	36.0	351.00	9-5851	8.0	101.00			
18.7"				9-5852	18.0	135.00			
20.4"				9-5853	22.0	148.00			

-Fits OD, PIP, & IPS Flange Packs

2 Flange Packs Required per repair coupler.



Size	PIP/OD Gasket (Bolt-on)			IPS Gasket (Bolt-on)		
	Part #	Weight	List	Part #	Weight	List
4"				9-5833		5.30
6"	9-5837		11.00	9-5836		11.00
8"	9-5839		14.00	9-5838		14.00
10"	9-5829		22.00	9-5828		22.00
12"	9-5831		26.00	9-5830		26.00
15"	9-5832		28.00			
18.7"	9-5841		40.00			
20.4"	9-5842		41.00			

## REPAIR COUPLER (GALVANIZED STEEL)



- Metric sizes available, please call.
- 200 psi maximum pressure on 2" to 10".
- 150 psi maximum pressure on 12" and 15".
- 16" long

Size	PIP			IPS		
	Part #	Weight	List	Part #	Weight	List
4"				6-2239	7.0	99.00
6"	6-2250	13.0	115.00	6-2240	13.0	115.00
8"	6-2251	17.0	148.00	6-2241	17.0	148.00
10"	6-2252	21.0	198.00	6-2242	21.0	198.00
12"	6-2253	24.0	265.00	6-2243	24.0	265.00
15"	6-2255	50.0	485.00			

## FLANGE ADAPTER

(GALVANIZED STEEL)



PIP				IPS		
Size	Part #	Weight	List	Part #	Weight	List
4"				6-4043	10.1	75.00
6"	6-4051	15.3	115.00	6-4045	15.3	115.00
8"	6-4052	20.9	135.00	6-4046	20.9	135.00
10"	6-4053	27.6	165.00	6-4047	27.6	165.00
12"	6-4054	36.0	199.00	6-4048	36.0	199.00

- Metric sizes available, please call.

## SERVICE TEE

(GALVANIZED STEEL)



PIP				IPS			
Size	Part #	Weight	List	Size	Part #	Weight	List
6"x6"x4"	6-4064	17.4	153.00	4"x4"x2"	6-4060	8.7	149.00
8"x8"x3"	9-5311	19.0	144.00	6"x6"x4"	6-4061	17.4	153.00
8"x8"x4"	6-4065	27.5	192.00	8"x8"x4"	6-4062	22.5	192.00

- Other sizes available, please call.
- Metric sizes available, please call.
- Male threaded also available.

## TEE

(GALVANIZED STEEL)



PIP				IPS		
Size	Part #	Weight	List	Part #	Weight	List
4"				6-4073	13.5	140.00
6"	6-4079	13.5	169.00	6-4074	24.8	169.00
8"	6-4080	33.0	245.00	6-4075	33.0	245.00
10"	6-4081	44.3	355.00	6-4076	44.3	355.00
12"	6-4082	66.2	492.00	6-4077	66.2	492.00
15"	6-4083	77.6	935.00			

## TEE, BOLT-ON

(GALVANIZED STEEL)



PIP/OD				IPS		
Size	Part #	Weight	List	Part #	Weight	List
4"	9-7988		339.00	9-7979		339.00
6"	9-7984		445.00	9-7980		445.00
8"	9-7985		495.00	9-7981		495.00
10"	9-7986		645.00	9-7982		645.00
12"	9-7987		840.00	9-7983		840.00

## CROSS

(GALVANIZED STEEL)



PIP				IPS		
Size	Part #	Weight	List	Part #	Weight	List
4"				6-4093	21.0	225.00
6"	6-4099	37.6	305.00	6-4094	37.6	305.00
8"	6-4100	50.0	345.00	6-4095	50.0	345.00
10"	6-4101	66.6	465.00	6-4096	66.6	465.00
12"	6-4102	79.2	685.00	6-4097	79.2	685.00
15"	6-4103	92.4	1,137.00			

- Metric sizes available, please call.
- Reducing sizes also available. Please call.

## 45° ELBOW (GALVANIZED STEEL)



11° and 22° are available at the same price.

Size	PIP			IPS		
	Part #	Weight	List	Part #	Weight	List
4"				6-4137	12.8	135.00
6"	6-4130	22.2	160.00	6-4138	22.2	160.00
8"	6-4131	29.5	195.00	6-4139	29.5	195.00
10"	6-4132	39.0	249.00	6-4140	39.0	249.00
12"	6-4133	46.4	295.00	6-4141	46.4	295.00

## 45° ELBOW, BOLT-ON (GALVANIZED STEEL)



11° and 22° are available at the same price.

Size	PIP/OD			IPS		
	Part #	Weight	List	Part #	Weight	List
4"	9-7960		255.00	9-7951		255.00
6"	9-7956		329.00	9-7952		329.00
8"	9-7957		361.00	9-7953		361.00
10"	9-7958		468.00	9-7954		468.00
12"	9-7959		595.00	9-7955		595.00

## 90° ELBOW (GALVANIZED STEEL)



Size	PIP			IPS		
	Part #	Weight	List	Part #	Weight	List
4"				6-4157	10.5	145.00
6"	6-4150	22.2	175.00	6-4158	22.2	175.00
8"	6-4151	29.5	225.00	6-4159	29.5	225.00
10"	6-4152	39.0	295.00	6-4160	39.0	295.00
12"	6-4153	46.4	350.00	6-4161	46.4	350.00

## 90° ELBOW, BOLT-ON (GALVANIZED STEEL)



Size	PIP/OD			IPS		
	Part #	Weight	List	Part #	Weight	List
4"	9-7974		317.00	9-7965		317.00
6"	9-7970		400.00	9-7966		400.00
8"	9-7971		439.00	9-7967		439.00
10"	9-7972		558.00	9-7968		558.00
12"	9-7973		705.00	9-7969		705.00

# STEEL UNDERGROUND FITTINGS

## REDUCER/ADAPTER (GALVANIZED STEEL)

S



Size	Part #	Weight	List
6" PIP x 4" IPS	6-4110	10.2	<b>125.00</b>
<b>6" IPS</b> x 6" PIP	6-4121	12.0	<b>120.00</b>
8" PIP x 6" PIP	6-4111	16.5	<b>145.00</b>
<b>8" IPS</b> x 8" PIP	6-4122	16.0	<b>125.00</b>
10" PIP x 8" PIP	6-4112	22.2	<b>175.00</b>
<b>10" IPS</b> x 10" PIP	6-4123	22.0	<b>169.00</b>
12" PIP x 10" PIP	6-4113	37.0	<b>275.00</b>
<b>12" IPS</b> x 12" PIP	6-4124	26.0	<b>210.00</b>

## REDUCER/ADAPTER, BOLT-ON (POWDER COATED OR GALVANIZED STEEL)

T



Size	Finish	Part #	Weight	List
4" IPS x 4" OD	Powder Coated	6-4020	13.0	<b>141.00</b>
6" OD/PIP x 8" OD/PIP	Galvanized	9-8127		<b>245.00</b>
6" IPS x 6" OD/PIP	Powder Coated	6-4022	21.0	<b>186.00</b>
8" IPS x 6" OD/PIP	Galvanized	6-4024	27.5	<b>245.00</b>
<b>8" IPS x 6" IPS</b>	Galvanized	6-4026	27.5	<b>245.00</b>
8" IPS x 8" OD/PIP	Powder Coated	6-4027	26.0	<b>230.00</b>
10" OD/PIP x 8" OD/PIP	Galvanized	6-4029	35.2	<b>299.00</b>
<b>10" IPS x 8" IPS</b>	Galvanized	6-4031	35.2	<b>299.00</b>
<b>10" IPS</b> x 10" OD/PIP	Powder Coated	6-4032		<b>289.00</b>
12" OD/PIP x 10" OD/PIP	Galvanized	6-4034	44.0	<b>450.00</b>
<b>12" IPS</b> x 12" OD/PIP	Powder Coated	6-4036	44.0	<b>429.00</b>

## DOUBLE COUPLER (GALVANIZED STEEL)

L



Size	PIP			IPS		
	Part #	Weight	List	Part #	Weight	List
4"				6-4179	6.0	<b>95.00</b>
6"	6-4171	12.0	<b>100.00</b>	6-4180	12.0	<b>100.00</b>
8"	6-4172	16.0	<b>120.00</b>	6-4181	16.0	<b>120.00</b>
10"	6-4173	22.0	<b>150.00</b>	6-4182	22.0	<b>150.00</b>
12"	6-4174	26.0	<b>189.00</b>	6-4183	26.0	<b>189.00</b>
15"	6-4175	28.0	<b>469.00</b>			

• Metric sizes available, please call.

## END PLUG (GALVANIZED STEEL)

L



Size	PIP			IPS		
	Part #	Weight	List	Part #	Weight	List
4"				6-4197	2.9	<b>75.00</b>
6"	6-4191	4.5	<b>80.00</b>	6-4198	4.5	<b>80.00</b>
8"	6-4192	9.8	<b>90.00</b>	6-4199	9.8	<b>90.00</b>
10"	6-4193	14.5	<b>105.00</b>	6-4200	14.5	<b>105.00</b>
12"	6-4188	18.3	<b>130.00</b>	6-4201	18.3	<b>130.00</b>
15"	6-4189	14.0	<b>260.00</b>			

## END CAP (GALVANIZED STEEL)

L



Size	PIP			IPS		
	Part #	Weight	List	Part #	Weight	List
4"				6-4211	3.4	<b>65.00</b>
6"	6-4203	7.0	<b>75.00</b>	6-4212	7.0	<b>75.00</b>
8"	6-4204	11.3	<b>85.00</b>	6-4213	11.3	<b>85.00</b>
10"	6-4205	15.0	<b>115.00</b>	6-4214	15.0	<b>115.00</b>
12"	6-4206	18.8	<b>139.00</b>	6-4215	18.8	<b>139.00</b>
15"	6-4207	14.0	<b>345.00</b>			

• Metric sizes available, please call.

## 90° ELBOW (PVC-SOLVENT)



Size	PIP			IPS			PIP A&H		
	Part #	Weight	List	Part #	Weight	List	Part #	Weight	List
4"							6-2315	2.0	25.00
6"	6-2311	4.0	68.00	6-2560	4.0	55.00	6-2316	1.5	40.00
8"	6-2312	8.0	125.00	6-2561	6.0	90.00	6-2317	2.5	50.00
10"	6-2313	8.0	175.00	6-2562	8.0	135.00	6-2318	3.0	75.00
12"	6-2314	14.0	245.00	6-2563	14.0	190.00	6-2319	3.5	114.00
15"	6-2320	20.0	380.00						

• 4" A&H is IPS Size.

#100 psi test, except A&H which is #22/#50 psi test.

• Metric sizes available, please call.

## 45° ELBOW (PVC-SOLVENT)



Size	PIP			IPS			PIP A&H		
	Part #	Weight	List	Part #	Weight	List	Part #	Weight	List
4"							6-2325	1.3	35.00
6"	6-2321	1.0	30.00	6-2550	1.0	30.00	6-2326	1.5	25.00
8"	6-2322	2.0	50.00	6-2551	2.0	50.00	6-2327	1.8	35.00
10"	6-2323	2.5	75.00	6-2552	2.5	75.00	6-2328	2.0	40.00
12"	6-2324	3.0	115.00	6-2553	3.0	110.00	6-2329	3.0	65.00
15"	6-2330	4.0	175.00						

• 4" A&H is IPS Size.

#100 psi test, except A&H which is #22/#50 psi test.

• Metric sizes available, please call.

## 22-1/2° ELBOW (PVC-SOLVENT)



Size	PIP		
	Part #	Weight	List
6"	6-2270	1.0	25.00
8"	6-2271	2.0	35.00
10"	6-2272	2.5	60.00
12"	6-2273	3.0	85.00
15"	6-2274	4.0	145.00

#100 psi test.

• Metric sizes available, please call.

**11°, 15°, 30° AND 60° ELBOWS AVAILABLE UPON REQUEST.  
PLEASE CALL.**

# SOLVENT PVC PIPE FITTINGS

## TEE (PVC-SOLVENT)

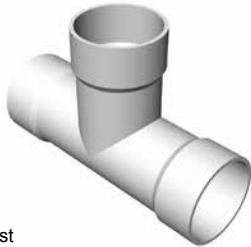

#100 psi test

- Metric sizes available, please call.

Size	PIP			IPS		
	Part #	Weight	List	Part #	Weight	List
4"				6-2335	2.3	40.00
6"	6-2331	5.0	60.00	6-2570	5.0	80.00
8"	6-2332	9.0	90.00	6-2571	9.0	100.00
10"	6-2333	14.0	140.00	6-2572	14.0	145.00
12"	6-2334	18.0	225.00	6-2573	18.0	225.00
15"	6-2336	25.0	385.00			

## REDUCING TEE (PVC-SOLVENT)



#100 psi test

- Metric sizes available, please call.

Size	Part #	Weight	List
6" PIP x 4" IPS	6-2340	3.5	45.00
8" PIP x 4" IPS	6-2341	4.5	60.00
8" x 6" PIP	6-2342	8.5	75.00
6" x 4" IPS	6-2574	4.0	52.00
8" x 4" IPS	6-2575	5.0	70.00
8" x 6" IPS	6-2576	9.0	90.00

## WYE (PVC-SOLVENT)



Drain Only

Size	Part #	Weight	List
6" PIP A&H	6-2601		44.00
8" PIP A&H	6-2602		99.00
10" PIP A&H	6-2603		144.00

## END CAP (PVC-SOLVENT)



#100 psi test, except A&H which is #22/#50 psi test.

- Metric sizes available, please call.

Size	PIP			IPS			PIP A&H		
	Part #	Weight	List	Part #	Weight	List	Part #	Weight	List
6"	6-2410	1.5	27.00	6-2580	1.5	23.00	6-2420	0.2	7.00
8"	6-2411	2.0	35.00	6-2581	2.0	30.00	6-2421	0.6	12.00
10"	6-2412	2.5	55.00	6-2582	2.5	47.00	6-2422	2.5	19.00
12"	6-2413	3.0	75.00	6-2583	3.0	90.00	6-2423	3.0	28.00
15"	6-2414	4.0	120.00				6-2424	4.0	49.00

## COUPLING (PVC-SOLVENT)



#100 psi test, except A&H which is #22/#50 psi test.

- Metric sizes available, please call.

Size	PIP			IPS			PIP A&H		
	Part #	Weight	List	Part #	Weight	List	Part #	Weight	List
4"				6-2430	0.5	12.00	*6-2434	0.4	9.00
6"	6-2431	1.0	19.00	6-2585	1.0	15.00	6-2435	0.8	12.00
8"	6-2432	2.0	25.00	6-2586	2.0	25.00	6-2436	1.5	12.00
10"	6-2433	5.0	40.00	6-2587	5.0	45.00	6-2437	3.0	17.00
12"	6-2428	7.0	61.00	6-2588	7.0	65.00			
15"	6-2429	10.0	105.00						

- 4" A&H is IPS Size.



## REDUCER (PVC-SOLVENT)

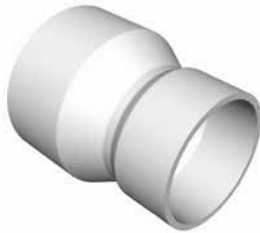

Size	PIP				IPS			PIP A&H		
	Part #	Weight	List		Part #	Weight	List	Part #	Weight	List
*6" x 4"	6-2440	1.5	<b>25.00</b>		6-2590	1.5	<b>20.00</b>	6-2443	0.6	<b>15.00</b>
8" x 6"	6-2441	2.0	<b>35.00</b>		6-2591	2.0	<b>30.00</b>	6-2444	1.5	<b>19.00</b>
10" x 8"	6-2442	3.0	<b>50.00</b>		6-2592	3.0	<b>60.00</b>	6-2445	2.0	<b>30.00</b>
12" x 10"	6-2438	4.0	<b>70.00</b>		6-2593	4.0	<b>80.00</b>	6-2446	2.5	<b>45.00</b>
15" x 12"	6-2439	5.0	<b>110.00</b>							

#100 psi test, except A&H which is #22/#50 psi test.  
 • Metric sizes available, please call.

• 4" IPS Size.

## ADAPTER (PVC-SOLVENT)



Size	Part #	Weight	List
6" IPS x PIP	6-2451	1.5	<b>25.00</b>
8" IPS x PIP	6-2452	2.5	<b>35.00</b>
10" IPS x PIP	6-2453	5.0	<b>55.00</b>

#100 psi test

## FLANGE (PVC-SOLVENT)



Size	PIP			IPS		
	Part #	Weight	List	Part #	Weight	List
3"				9-7659		<b>36.00</b>
4"				6-2484	2.8	<b>43.00</b>
6"	6-2480	5.6	<b>78.50</b>	6-2485	4.7	<b>69.00</b>
8"	6-2481	8.3	<b>115.00</b>	6-2486	6.8	<b>123.00</b>
10"	6-2482	14.3	<b>165.00</b>	6-2487	11.6	<b>210.00</b>
12"	6-2483	21.9	<b>235.00</b>	6-2488		<b>229.00</b>

## FEMALE THREADED ADAPTER (PVC-SOLVENT)



Size	PIP			IPS		
	Part #	Weight	List	Part #	Weight	List
4"				6-2470		<b>15.00</b>
6"	6-2461		<b>70.00</b>	6-2471		<b>60.00</b>
8"	6-2462		<b>100.00</b>	6-2472		<b>90.00</b>
10"	6-2463		<b>140.00</b>	6-2473		<b>122.00</b>
12"	6-2464		<b>160.00</b>	6-2474		<b>182.00</b>

#100 psi test, except A&H which is #22/#50 psi test.

## MALE THREADED ADAPTER (PVC-SOLVENT)



Size	PIP			IPS		
	Part #	Weight	List	Part #	Weight	List
4"				6-2475		<b>14.00</b>
6"	6-2466		<b>60.00</b>	6-2476		<b>54.00</b>
8"	6-2467		<b>85.00</b>	6-2477		<b>76.00</b>
10"	6-2468		<b>125.00</b>	6-2478		<b>137.00</b>
12"	6-2469		<b>145.00</b>	6-2479		<b>204.00</b>

#100 psi test, except A&H which is #22/#50 psi test.

## BUSHING (PVC-SOLVENT)



Size	Part #	Weight	List
6" PIP x IPS	6-2595		<b>24.00</b>
8" PIP x IPS	6-2596		<b>35.00</b>
10" PIP x IPS	6-2597		<b>53.00</b>
12" PIP x IPS	6-2598		<b>81.00</b>

IPS outside x PIP inside

# GASKETED PVC PIPE FITTINGS

## 90° ELBOW (PVC-GASKETED)

#100 PSI Test



Size	PIP			IPS		
	Part #	Weight	List	Part #	Weight	List
6"	6-2350		<b>90.00</b>	6-2520		<b>115.00</b>
8"	6-2351		<b>140.00</b>	6-2521		<b>175.00</b>
10"	6-2352		<b>220.00</b>	6-2522		<b>250.00</b>
12"	6-2353		<b>310.00</b>	6-2523		<b>340.00</b>
15"	6-2354		<b>630.00</b>			

## 45° ELBOW (PVC-GASKETED)

#100 PSI Test



Size	PIP			IPS		
	Part #	Weight	List	Part #	Weight	List
6"	6-2360		<b>80.00</b>	6-2510		<b>80.00</b>
8"	6-2361		<b>110.00</b>	6-2511		<b>110.00</b>
10"	6-2362		<b>160.00</b>	6-2512		<b>160.00</b>
12"	6-2363		<b>225.00</b>	6-2513		<b>240.00</b>
15"	6-2364		<b>455.00</b>			

## 22-1/2° ELBOW (PVC-GASKETED)

#100 PSI Test



Size	PIP			IPS		
	Part #	Weight	List	Part #	Weight	List
6"	6-2355		<b>65.00</b>	6-2500		<b>75.00</b>
8"	6-2356		<b>100.00</b>	6-2501		<b>90.00</b>
10"	6-2357		<b>145.00</b>	6-2502		<b>160.00</b>
12"	6-2358		<b>210.00</b>	6-2503		<b>210.00</b>
15"	6-2359		<b>350.00</b>			

## TEE (PVC-GASKETED)

#100 PSI Test



Size	PIP			IPS		
	Part #	Weight	List	Part #	Weight	List
6"	6-2365		<b>105.00</b>	6-2540		<b>90.00</b>
8"	6-2366		<b>140.00</b>	6-2541		<b>160.00</b>
10"	6-2367		<b>215.00</b>	6-2542		<b>235.00</b>
12"	6-2368		<b>290.00</b>	6-2543		<b>325.00</b>
15"	6-2369		<b>525.00</b>			

**11°, 15°, 30° AND 60° ELBOWS AVAILABLE UPON REQUEST.  
#100 PSI TEST, EXCEPT A&H WHICH IS #22/#50 PSI TEST.**

## DRAINAGE RISER (PVC-SOLVENT)



6", 8", 10" = 7'4" Long  
 12" = 6'4" Long

### Complete Drainage Riser

Size	Part #	Weight	List
4" x 6"	6-2110	20.3	<b>280.00</b>
6" x 8"	6-2120	35.8	<b>380.00</b>
8" x 10"	6-2130	61.4	<b>580.00</b>

### Perforated Body Only

6" x 7'4" #100	6-2110-C	16.0	<b>137.00</b>
8" x 7'4" #80	6-2120-C	28.9	<b>179.00</b>
10" x 7'4" #80	6-2130-C	48.8	<b>300.00</b>
12" x 6'4" #80	9-6958	48.2	<b>349.00</b>

The Drainage Riser comes fully assembled and includes the appropriately sized:

- 90° elbow (A&H)
- Increaser (A&H)
- Cap (A&H)

The Drainage Riser is made to fit PIP (Plastic Irrigation Pipe).

The Drainage Riser is made to local Soil Conservation Office Specifications.

Other sizes are available on request.

## RODENT DOOR (PAINTED STEEL)



Size	Part #	Weight	List
4"	6-2181	0.2	<b>11.00</b>
6"	6-2182	0.6	<b>12.00</b>
8"	6-2183	0.8	<b>15.00</b>
10"	6-2184	1.5	<b>22.00</b>
12"	6-2185	2.3	<b>30.00</b>

## PRIMER (Step 1 of 2)



Size	Part #	Weight	List
1 quart	6-9170	2.0	<b>22.00</b>

It is highly recommended to apply primer on both pipe & socket before gluing to pre-soften & pre-prepare plastic pipe & fittings for bonding.

## PVC GLUE (Step 2 of 2)



Size	Part #	Weight	List
1 quart	6-9130	2.0	<b>24.00</b>
1 gallon	6-9140	8.5	<b>73.00</b>

Gray, C-200, PVC 12, Heavy Body for larger diameters.

When primer is still wet, apply heavy amt of glue on pipe & lighter amt. in socket. Wipe off excess.

## PIPE LUBE



Size	Part #	Weight	List
1 quart	6-9160	2.0	<b>13.00</b>
1 gallon	6-9150	8.5	<b>27.00</b>

One gallon of pipe lube will cover 50 8" pipe joints.

# WHY WAIT ON Custom Built Fittings

Fast, Low Cost Custom Built Irrigation & Industrial Fittings

Available in:

- Steel Powder Coat
- Steel Galvanized
- Aluminum
- Cast Aluminum
- PVC
- Stainless Steel #304









Call, fax, or e-mail your drawing, and we will  
send you a price.



## Section Two



Towline/Wheelmove

 Tow Line Parts	30-31
 3-Segment Adapters	32-33
 Hose Adapters	34-36
 Hose Accessories	37
 Wheel Move	38
 Discharge Hose	39
 Suction Hose	40
 Hose Clamps	41-43

## TOW COUPLER

All steel construction, zinc plated.  
Includes 2 Gaskets, 1 Quick Drain  
and 4 Half-Moon Pins.



Size	Part #	Weight	List
4"	3-0310	6.3	80.00

## STABILIZER CONVERSION KIT

Includes gaskets and pins.



Size	Part #	Weight	List
4"	3-0530	25.0	210.00

## TOW COUPLER EAR

Made of formed steel.  
Welds to coupler and holds half  
moon pin.



Size	Part #	Weight	List
3/8"	3-0320	0.3	1.00

## TOW COUPLER SKID PAN

Formed steel wear pan.  
Welds to bottom of coupler body.



Size	Part #	Weight	List
----	3-0330	0.6	3.00

## QUICK DRAIN

Fits into bottom of coupler body to  
drain line when shut down.  
Cotter pin is included.



Size	Part #	Weight	List
----	3-0340		1.50

## GASKET (LINDSAY)

Specify Drain or Non-Drain style.  
Fits coupler and stabilizer.  
**Stabilizer must have Non-Drain Gasket.**



Size	Part #	Weight	List
4" Drain	3-0350	0.3	2.00
4" Non-Drain	6-1614	0.3	3.20

## TOW PLUG

Fits into end coupler of tow line as  
hitch for towing.



Size	Part #	Weight	List
4"	3-0540	5.5	35.00

## TOW LINE PIPE



Size	Part #	Weight	List
4" x 40'	3-0380	35.6	212.00

Aluminum.  
Comes with Half-Moon Pins, Straps & Bolts installed.

## HALF MOON CLAMP



Galvanized steel.  
Attaches pipe to coupler with tow pins.

Size	Part #	Weight	List
4"	3-0410	0.9	4.00

## HALF MOON BOLT & NUT



Washer included with bolt.

Size	Part #	Weight	List
Bolt: 5/16" x 5/8"	3-0420	0.1	0.06
Nut: 5/16"	3-0430	0.1	0.03

## HALF MOON STRAP



Galvanized.  
Bolts to back side of half moon clamp to prevent clamp from pulling off of pipe.

Size	Part #	Weight	List
1"	3-0440	0.2	1.00

## HALF MOON PIN



Hardened steel, plated.  
Connects tow line pipe to coupler and stabilizer.

Size	Part #	Weight	List
3/8"	3-0450	0.1	1.50

## RISERS



Steel tubing.

3/4" FPT x 1" MPT				1" MPT x 1" MPT			
Size	Part #	Weight	List	Size	Part #	Weight	List
6" FxM	3-0465	0.6	6.50				
12" FxM	3-0460	0.9	7.50	12" MxM	3-0470	0.9	7.50
18" FxM	3-0466	1.1	8.50				
24" FxM	3-0461	1.4	10.00	24" MxM	3-0471	1.4	10.00
30" FxM	3-0467	1.6	11.00				
36" FxM	3-0468	1.9	12.50				
40" FxM	3-0462	2.1	13.00	40" MxM	3-0472	2.1	13.00
48" FxM	3-0469	2.5	15.00				
60" FxM	3-0463	2.9	17.00	60" MxM	3-0473	2.9	17.00
72" FxM	3-0464	3.4	20.00	72" MxM	3-0474	3.4	20.00

Towline/Wheelmove

# SHUG GRIP COUPLING

## COUPLING (SHUG GRIP)



- Complete sets include everything shown above
- Can be pulled with water inside hose.



### Complete:

Size	Part #	List
4"	9-5844	585.00
4-1/2"	9-5845	610.00
5"	9-5846	540.00
6"	6-9659	510.00
8"	9-5207	879.00

### Coupler Body: (Aluminum)

Size	Part #	List
4"	9-7468	237.00
4-1/2"	9-7469	305.00
5"	9-7470	387.00
5-1/2"	9-7471	447.00
6"	9-7472	222.00
8"	9-7473	460.00



### 3-Segment Clamp:

Size	Part #	List
4"	6-9608	85.00
4-1/2"	6-9609	89.00
5"	6-9610	100.00
6"	6-9611	115.00
8"	9-5184	135.00
10"	9-8291	429.00
12"	9-8292	489.00



### Sleeve:

Size	Part #	List
5-1/2" (4" thru 6")	9-7445	25.00
8"	9-7446	56.00



### Gasket:

Size	Part #	List
5-1/2" (4" thru 6")	9-7447	12.00
8"	9-7448	15.00



### Ring Band Lock:

Size	Part #	List
6" (4" thru 6")	9-7449	75.00
6" w/Steel Pin (4" thru 6")	9-7450	67.00
8" w/Steel Pin	9-7451	79.00

### Lynch Pin:

Size	Part #	List
5/16"	9-7452	3.00



# SHUG GRIP HOSE ADAPTERS

## COUPLER (SHUG GRIP)



Size	Part #	Steel		Aluminum		
		Weight	List	Part #	Weight	List
6" (5.5")	9-7921		89.00	9-7922		435.00
8"	9-7923		165.00			

## MALE END (SHUG GRIP)



Size	Part #	Steel		Aluminum		
		Weight	List	Part #	Weight	List
6" (5.5")	9-7924		70.00	9-7925		129.00
8"	9-7926		132.00			

## RING (SHUG GRIP)



Size	Part #	Steel	
		Weight	List
6"	9-7927		20.00
8"	9-7928		25.00

## HOSE FITTINGS



Size	Part #	Steel 10ga Galv.		Aluminum		
		Weight	List	Part #	Weight	List
4" FRL				6-9506	1.5	125.00
4" MRL				6-9507	1.2	125.00
5" FRL				6-9504	1.8	240.00
5" MRL				6-9505	1.4	240.00
6" FRL	6-9500		225.00	6-9502	2.4	470.00
6" MRL	6-9501		225.00	6-9503	1.8	470.00

Includes 3 segment clamp

## FULL ADAPTER



Includes 3 segment clamp

Size	Part #	Weight	List
4"	6-9889		185.00
4-1/2"	6-9656		189.00
5"	6-9657		210.00
6"	6-9658		260.00
8"	9-5246		490.00
10"	9-8293		715.00
12"	9-8294		780.00

## HALF ADAPTER



Weld-on  
Includes 3 segment clamp

Size	Part #	Steel		Aluminum		
		Weight	List	Part #	Weight	List
4"	6-9648		129.00	6-9652		90.00
4-1/2"	6-9649		135.00	6-9653		155.00
5"	6-9650		150.00	6-9654		188.00
6"	6-9651		175.00	6-9655		415.00
8"	9-5877		260.00	9-5247		470.00
10"	9-8295		605.00	9-7929		525.00
12"	9-8296		725.00	9-7930		630.00

Towline/Wheelmove

# HOSE ADAPTERS

## HOSE BARB - WELD-ON (BLACK & STAINLESS STEEL)



Size	No. of Ribs	Black Steel			Stainless Steel		
		Part #	Weight	List	Part #	Weight	List
2"	2	3-0601	0.4	13.00	9-8166		63.00
2-1/2"	2	9-5014	0.6	15.00			
3"	2	3-0602	0.8	14.00	9-8167		85.00
4"	3	3-0603	1.8	15.00	9-8168		105.00
4-1/2"	2	3-0604	1.9	20.00			
5"	2	3-0605	2.0	20.00	9-8169		105.00
6"	3	3-0606	3.3	21.00	9-8170		137.00
8"	3	3-0607	5.4	37.00	9-8171		150.00
10"	3	3-0608	10.0	54.00	9-8172		210.00
12"	2	3-0609	12.1	66.00	9-8173		250.00
14"					9-8174		300.00
16"	3	9-7553	18.8	137.00			

## HOSE BARB - WELD-ON (ALUMINUM)



Size	Thickness	Aluminum			Cast Aluminum			Sharp Barb		
		Part #	Weight	List	Part #	Weight	List	Part #	Weight	List
3"	.050	3-0641	0.5	35.00						
4"	.072	3-0652	1.1	38.00	9-8341		40.00	3-0636	1.5	96.00
4-1/2"								3-0637	1.7	97.00
5"	.078	3-0642	1.4	41.00				3-0638	1.9	95.00
6"	.058	3-0643	1.3	40.00	9-7794	2.6	52.00	3-0639	2.2	107.00
8"	.064	3-0644	1.6	44.00	9-7795	4.1	71.00	9-7803		130.00
10"					9-7796	6.0	96.00	9-8195		140.00

## HOSE ADAPTER - RINGLOCK (GALVANIZED STEEL)



Size	Female RL			Male RL		
	Part #	Weight	List	Part #	Weight	List
3"	6-8050	3.4	28.00	6-8053	3.0	26.00
4"	6-8051	4.5	36.00	6-8054	4.0	35.00
5"	6-8052	5.6	46.00	6-8055	5.0	46.00
6"	3-0681	6.1	59.00	3-0680	6.1	59.00
8"	3-0683	9.9	85.00	3-0682	9.9	85.00
10"	3-0679	14.5	115.00	3-0678	15.0	105.00

Also Available in Cast Aluminum, call for prices.

## HOSE ADAPTER - INCREASERS (GALVANIZED STEEL)



Size Barb x RL	Female RL			Male RL		
	Part #	Weight	List	Part #	Weight	List
4" x 6"	9-8117		<b>87.00</b>	9-8120		<b>89.00</b>
4-1/2" x 6"	9-8118		<b>106.00</b>	9-8121		<b>108.00</b>
6" x 8"	9-8119		<b>108.00</b>	9-8122		<b>114.00</b>

Also Available in Cast Aluminum, call for prices.

## HOSE ADAPTER - B&H (GALVANIZED STEEL)



Size	Female B&H			Male B&H		
	Part #	Weight	List	Part #	Weight	List
2"	6-8056	2.6	<b>29.00</b>	6-8060	1.9	<b>33.00</b>
3"	6-8057	4.5	<b>34.00</b>	6-8061	3.3	<b>38.00</b>
4"	6-8058	6.0	<b>38.00</b>	6-8062	4.3	<b>43.00</b>
5"	6-8059	7.5	<b>55.00</b>	6-8063	5.4	<b>66.00</b>
6"	9-5321	9.0	<b>70.00</b>	9-5322	6.5	<b>89.00</b>

## HOSE ADAPTER - FLANGED (GALVANIZED STEEL)



Size	Part #	Weight	List
4"	9-8301		<b>55.00</b>
6"	9-8302		<b>67.00</b>
8"	9-8303		<b>99.00</b>
10"	9-8304		<b>135.00</b>
12"	9-8305		<b>170.00</b>

Also Available in Cast Aluminum, call for prices.

**HOSE MENDER**

Size	Galvanized Steel			Plated Steel			Aluminum		
	Part #	Weight	List	Part #	Weight	List	Part #	Weight	List
1/2"				9-6835	0.1	<b>4.00</b>			
3/4"				9-6836	0.2	<b>4.50</b>			
1"				9-6837	0.3	<b>5.00</b>			
1-1/4"				9-6838	0.5	<b>7.00</b>			
1-1/2"				9-6839	0.5	<b>7.00</b>			
2"	6-8064	2.2	<b>28.00</b>	9-6840	0.8	<b>9.00</b>			
2-1/2"				9-6841	1.7	<b>18.00</b>			
3"	6-8065	3.8	<b>31.00</b>	9-6842	2.4	<b>18.00</b>	3-0645	0.5	<b>52.00</b>
4"	6-8066	5.0	<b>34.00</b>	9-6843	2.9	<b>22.00</b>	3-0653	1.1	<b>55.00</b>
5"	6-8067	6.3	<b>50.00</b>	9-6844	6.9	<b>70.00</b>	3-0646	1.4	<b>57.00</b>
6"	6-8068	7.5	<b>55.00</b>	9-6845	13.2	<b>58.00</b>	3-0647	1.3	<b>56.00</b>
8"	6-8069	14.0	<b>82.00</b>	9-6846	20.9	<b>149.00</b>	3-0648	1.6	<b>60.00</b>
10"	9-7892	16.0	<b>135.00</b>	9-6847		<b>215.00</b>			
12"	9-7893	20.0	<b>185.00</b>	9-6848		<b>320.00</b>			

**KING NIPPLE**  
(PLATED STEEL)

MPT x Barb

Size	Part #	Weight	List
1/2"	6-7000	0.2	<b>2.50</b>
3/4"	6-7001	0.3	<b>2.60</b>
1"	6-7002	0.6	<b>2.90</b>
1-1/4"	6-7003	0.7	<b>4.50</b>
1-1/2"	6-7004	1.1	<b>6.10</b>
2"	6-7005	1.7	<b>6.50</b>
2-1/2"	6-7006	2.1	<b>15.50</b>
3"	6-7007	3.1	<b>15.00</b>
4"	6-7008	3.1	<b>18.00</b>
5"	6-7009	4.1	<b>40.00</b>
6"	6-7010	12.2	<b>72.50</b>
8"	6-7011	16.4	<b>97.50</b>
10"	6-7012	21.8	<b>172.00</b>
12"	6-7013	33.2	<b>250.00</b>

## TOW HOSE



- Maximum: #125 psi
- Connects tow line to mainline.
- Both ends Male with hook & band.
- Other configurations and lengths available.

Size	Part #	Weight	List
4" x 12'	3-0655	14.0	<b>325.00</b>
4" x 17'	3-0650	18.0	<b>379.00</b>

## BAND-IT TOOL



Size	Part #	Weight	List
----	6-9093	4.5	<b>172.00</b>

## PREFORMED JUNIOR ADAPTER



Size	Part #	Weight	List
----	6-9094		<b>215.00</b>

\*For use with above tool on preformed clamps

## BANDING (STAINLESS STEEL)



- Other sizes are available, please call.
- Standard-Duty Type 201 Stainless.

Size	Part #	Weight	List
5/8" x 100'	6-9095	6.7	<b>167.00</b>
3/4" x 100'	9-7752		<b>191.00</b>

## BAND-IT BUCKLE



- For use with above Stainless Steel boxed banding.
- 100 Buckles/Box
- Standard-Duty Buckle

Size	Part #	Weight	List
5/8"	6-9096	2.6	<b>98.00</b>
3/4"	9-7753		<b>107.00</b>

## PREFORMED CLAMP



- For use with above tool and Jr. adapter
- Stainless Steel
- 25 per Box is available.

Type	Size	Part #	Weight	List
J215	3/4" wide x 5" ID	6-9097	0.3	<b>9.00</b>
J216	3/4" wide x 6" ID	6-9098	0.3	<b>10.00</b>

## GLUE - PLIOBOND #20 (FOR HOSE FITTINGS)



Size	Part #	Weight	List
1 Quart	9-6778	2.1	<b>52.00</b>

Towline/Wheelmove

# WHEEL MOVE (WHEELINE, SIDEROLL)

## WHEEL MOVE (COMPLETE)



Size	Part #	Weight	List
4"x 1280'	5-0160	Call	Call
5"x 1280'	5-0161	Call	Call

## WHEEL MOVE COUPLER SET (CAST ALUMINUM)



Size	Part #	Weight	List
4" Press-on	5-0167	8.0	89.00
5" Weld-on	5-0168	6.3	100.00

## SPRINKLER LEVELER



Size	Part #	Weight	List
3/4"	5-0165	2.4	15.00

## LEVELER ELBOW



Size	Part #	Weight	List
1" x 3/4"	5-0166		10.00

## WHEELS



Distance	# of Turns	Size	Dimension	Part #	4" Hub		5" Hub		
					Weight	List	Part #	Weight	List
		4'	48" 18 ga.	5-0170	34.0	130.00	5-0171	35.0	130.00
60'	4	5'	58" 18 ga.	5-0172	42.0	110.00	5-0173	42.0	110.00
50'	3	6'	64" 18 ga.	5-0174	44.0	115.00	5-0175	44.0	115.00
60'	3	7'	76" 18 ga.	5-0176	56.0	150.00	5-0177	56.0	150.00
50'	2	8'	96" 16 ga.	5-0178	78.0	300.00	5-0179	78.0	300.00
60'	2	10'	120" 16 ga.	5-0180	113.0	480.00	5-0181	113.0	480.00

## WIND BRACE



Size	Part #	5'		6' - 7'		
		Weight	List	Part #	Weight	List
4"	5-0182	8.3	65.00	5-0183	9.8	70.00
5"	5-0184	8.9	65.00	5-0185	9.8	70.00

## DISCHARGE HOSE (BLACK RUBBER-HIGH PRESSURE)

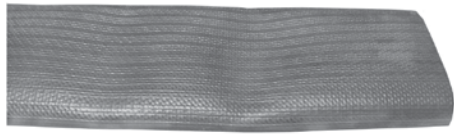
**Features:**

1. Ideal for Wheeline systems
2. Black rubber covering
3. Sized for use with irrigation fittings
4. Lightweight and flexible
5. Abrasion, UV, and kink resistant
6. Heavy duty discharge for use as a mainline for water and liquid manure, or agricultural and industrial sludge

Size	Max PSI	Flat Measurement	Part #	Wt/ft	List/ft
1-1/2"	150	2-1/2"	3-0590	0.8	<b>6.20</b>
2"	150	3-3/16"	3-0591	1.1	<b>6.80</b>
2-1/2"	150	4"	3-0592	1.5	<b>9.10</b>
3"	150	4-7/8"	3-0593	1.8	<b>9.20</b>
4"	200	6-1/4"	3-0651	0.8	<b>12.00</b>
4-1/2"	200	7-1/8"	3-0584	1.2	<b>17.00</b>
5"	200	7-7/8"	3-0597	1.0	<b>16.00</b>
6"	200	10"	3-0670	1.6	<b>19.00</b>
8"	200	13"	3-0671	2.6	<b>24.00</b>
10"	200		3-0585	5.1	<b>40.00</b>
12"	150		3-0586	5.8	<b>75.00</b>
16"	55		9-6850	3.5	<b>139.00</b>

\*\*\*We build custom hose assemblies\*\*\*

Towline/Wheelmove

## DISCHARGE HOSE (ORANGE PVC-MEDIUM PRESSURE)



Size	Max PSI	Part #	Wt/ft	List/ft
1-1/2"	150	3-0570	0.2	<b>1.60</b>
2"	150	3-0571	0.3	<b>1.90</b>
2-1/2"	150	3-0572	0.4	<b>2.50</b>
3"	150	3-0573	0.5	<b>3.70</b>
4"	125	3-0574	0.8	<b>6.20</b>
6"	115	3-0575	1.2	<b>8.60</b>
8"	70	3-0576	1.6	<b>16.10</b>
10"	65	9-8134	2.0	<b>29.00</b>

\*\*\*We build custom hose assemblies\*\*\*

## DISCHARGE HOSE (BLUE PVC-LOW PRESSURE)

**Features:**

1. Ideal for drip irrigation
2. No pig tailing
3. No snaking
4. Twisted yarn assures stability throughout the length of hose
5. Allows many times of use with the convenience of easy coiling for storage

Size	Max PSI	Part #	Wt/ft	List/ft
1-1/2"	70	3-0598	0.2	<b>0.70</b>
2"	65	3-0594	0.2	<b>1.00</b>
2-1/2"	60	3-0599	0.3	<b>1.30</b>
3"	60	3-0595	0.4	<b>1.50</b>
4"	60	3-0596	0.5	<b>2.00</b>
5"	40	9-6817	0.7	<b>7.00</b>
6"	45	3-0580	0.9	<b>5.00</b>
8"	45	3-0581	1.3	<b>6.60</b>
10"	35	3-0582	1.8	<b>21.00</b>
12"	30	3-0583	2.0	<b>29.00</b>
14"	30	6-9930	2.6	<b>50.00</b>
16"	30	6-9931	3.1	<b>55.00</b>

\*\*\*We build custom hose assemblies\*\*\*

# SUCTION HOSE

## PVC SUCTION HOSE (CORRUGATED-RIGHT SPIRAL)



Size ID	OD	Part #	Wt/ft	List/ft
1-1/2"	1.87"	6-0807	0.4	<b>3.00</b>
2"	2.41"	6-0808	0.6	<b>4.00</b>
2-1/2"	2.87"	3-0900	0.8	<b>6.00</b>
3"	3.54"	6-0809	1.0	<b>8.00</b>
4"	4.65"	3-0672	1.7	<b>13.00</b>
5"	5.73"	3-0675	2.3	<b>25.00</b>
6"	6.98"	3-0673	4.1	<b>26.00</b>
8"	9.14"	3-0674	6.3	<b>45.00</b>
10"	11.30"	3-0901	9.1	<b>88.00</b>
12"	13.31"	3-0902	10.1	<b>100.00</b>

• Left Hand Spiral also available. Please call.

\*\*\*We build custom hose assemblies\*\*\*

## PVC SUCTION HOSE (SMOOTH)



Size ID	OD	Part #	Wt/ft	List/ft
1-1/2"	1.82"	6-0010	0.5	<b>2.20</b>
2"	2.34"	6-0011	0.7	<b>3.20</b>
2-1/2"	2.88"	6-9929	1.0	<b>4.70</b>
3"	3.40"	6-0012	1.3	<b>5.50</b>
4"	4.44"	6-0013	1.9	<b>9.00</b>
5"	5.65"	6-0014	3.1	<b>16.50</b>
6"	6.56"	6-0015	4.6	<b>23.00</b>
8"	8.95"	6-0016	7.1	<b>44.00</b>
10"	11.34"	3-0903	12.4	<b>109.00</b>
12"	13.39"	3-0904	15.7	<b>135.00</b>

\*\*\*We build custom hose assemblies\*\*\*

## SUCTION HOSE (BLACK RUBBER)



Size ID	OD	DB Clamp #	Max PSI	Part #	Wt/ft	List/ft
1-1/2"	1.89"	-	150	6-0800	0.8	<b>5.00</b>
2"	2.40"	-	150	6-0801	1.0	<b>6.00</b>
2-1/2"	3.00"	-	100	9-7723	1.8	<b>7.00</b>
3"	3.46"	400	150	6-0802	1.5	<b>10.00</b>
4"	4.49"	525	150	6-0803	2.1	<b>13.00</b>
5"	5.55"	639	150	6-0804	3.3	<b>23.00</b>
6"	6.54"	769	75	6-0805	3.8	<b>26.00</b>
8"	8.70"	875	75	6-0806	6.5	<b>44.00</b>
10"	10.71"	1125	45	3-0905	9.7	<b>65.00</b>
12"	12.80"	1360	90	3-0906	14.1	<b>110.00</b>

\*\*\*We build custom hose assemblies\*\*\*



## T-BOLT HOSE CLAMP (ZINC PLATED)



**Zinc Plated Band, Bolt & Nut**

W1

**MIKALOR**

Features:

- 1" Wide Band
- Double Galvanization
- Allen screws allow for tightening in the points where there are space problems
- Thorough spot welding with high resistance to corrosion
- Use in agriculture, industry, construction, and wastewater
- Can be used many times over
- High resistance to corrosion

MM	Inches	Type	Box Qty	Part #	Weight	List
26-28	1.02-1.10	0.75" Suction	50	3-0703	0.2	2.00
29-31	1.14-1.22	1.0" Discharge	50	3-0704	0.2	2.50
32-35	1.26-1.38	1.0" Suction	50	3-0705	0.2	2.50
36-39	1.42-1.54		50	3-0706	0.2	2.70
40-43	1.57-1.69	1.5" Discharge	50	3-0708	0.2	4.20
44-47	1.73-1.85		50	9-5433	0.2	5.00
48-51	1.89-2.01	1.5" Suction	50	3-0709	0.2	4.50
52-55	2.05-2.17	2.0" Discharge	25	3-0710	0.2	4.60
56-59	2.20-2.32		25	9-5434	0.2	5.50
60-63	2.36-2.48	2.0" Suction	25	3-0712	0.2	6.20
64-67	2.52-2.64		25	3-0713	0.2	6.20
68-73	2.68-2.87	2.5" Discharge	25	3-0714	0.4	6.40
74-79	2.91-3.11	2.5" Suction	25	3-0715	0.4	6.40
80-85	3.15-3.35	3.0" Discharge	25	3-0716	0.4	6.50
86-91	3.39-3.58	3.0" Suction	25	3-0717	0.4	6.50
92-97	3.62-3.82		25	9-5435	0.4	6.50
98-103	3.86-4.06		25	3-0719	0.4	6.60
104-112	4.09-4.41	4.0" Discharge	25	3-0660	0.5	7.00
113-121	4.45-4.76	4.5" Suction	25	3-0720	0.5	7.00
122-130	4.80-5.12		25	3-0721	0.5	9.50
131-139	5.16-5.47	5.0" Discharge	10	3-0722	0.7	9.50
140-148	5.51-5.83	5.0" Suction	10	3-0723	0.7	10.00
149-161	5.87-6.34	6.0" Discharge	10	3-0661	0.7	10.00
162-174	6.38-6.85	6.0" Suction	10	3-0724	0.8	11.00
175-187	6.89-7.36	(For 6" SuctionBoot)	10	3-0725	0.9	11.00
188-200	7.40-7.87		10	3-0726	0.9	11.50
201-213	7.91-8.39	8.0" Discharge	10	3-0662	0.9	12.00
214-226	8.43-8.90	8.0" Suction	10	3-0727	1.0	13.50
227-239	8.94-9.41	(For 8" SuctionBoot)	10	3-0728	1.0	13.50
240-252	9.45-9.92		10	3-0729	1.0	15.00

## T-BOLT HOSE CLAMP (STAINLESS STEEL BAND W/ZINC PLATED HARDWARE)



**Stainless Steel Band,  
Zinc Plated Bolt & Nut  
(Hybrid)**

W2

**MIKALOR**

1" Wide Band

MM	Inches	Type	Box Qty	Part #	Weight	List
47-51	1.85-2.01	1.5" Suction	50	9-6891	0.1	8.50
51-55	2.01-2.17	2.0" Discharge	25	9-6892	0.1	8.50
55-59	2.17-2.32		25	9-6893	0.1	8.50
59-63	2.32-2.48	2.0" Suction	25	9-6894	0.1	8.80
63-68	2.48-2.68		25	9-6895	0.1	8.80
68-73	2.68-2.88	2.5" Discharge	25	9-6896	0.2	12.50
73-79	2.88-3.11	2.5" Suction	25	9-6897	0.2	12.50
79-85	3.11-3.35	3.0" Discharge	25	9-6898	0.2	12.50
85-91	3.35-3.59	3.0" Suction	25	9-6899	0.2	12.50
91-97	3.59-3.82		25	9-6900	0.2	12.50
97-104	3.82-4.10		25	9-6901	0.2	12.50
104-112	4.10-4.41	4.0" Discharge	25	9-6902	0.2	12.90
112-121	4.41-4.77	4.0" Suction	25	9-6903	0.2	12.90
121-130	4.77-5.12		25	9-6904	0.2	12.90
130-140	5.12-5.52	5.0" Discharge	10	9-6905	0.3	17.00
140-150	5.52-5.91	5.0" Suction	10	9-6906	0.3	17.00
150-162	5.91-6.38	6.0" Discharge	10	9-6907	0.3	17.50
162-174	6.38-6.86	6.0" Suction	10	9-6908	0.3	17.50
174-187	6.86-7.37	(For 6" Suction Boot)	10	9-6909	0.3	18.00
187-200	7.37-7.88		10	9-6910	0.4	18.00
201-213	7.88-8.39	8.0" Discharge	10	9-6911	0.4	19.00
213-226	8.39-8.90	8.0" Suction	10	9-6912	0.4	19.00
226-239	8.90-9.42	(For 8" Suction Boot)	10	9-6913	0.4	19.00
239-252	9.42-9.93		10	9-6914		19.00
252-265	9.93-10.44	10" Discharge	10	9-7539		24.00
265-278	10.44-10.95		10	9-8189		38.00
278-291	10.95-11.45	(For 10" Suction Boot)	10	9-8190		39.00
291-304	11.45-11.98		10	9-8191		40.00
304-317	11.98-12.49	12" Discharge**	10	9-7540		22.00
317-330	12.49-13.00		10	9-8192		41.00
330-343	13.00-13.51		10	9-8193		42.00
358-370	14.10-14.58	14" Discharge***	10	9-7541		23.00
408-420	16.08-16.55	16" Discharge***	10	9-7542		24.00

\*\*The 12" is a two band/two bolt clamp.

\*\*\*The 14" & 16" are not a Mikalor Clamp.

Towline/Wheelmove

## T-BOLT HOSE CLAMP (ALL STAINLESS STEEL)



All Stainless Steel  
Band, Bolt & Nut

W4

**MIKALOR**

Ideal for use on waste water and liquid handling hose fittings:

- All stainless steel.
- 1" wide x .025 thick
- 300 Series Stainless Steel band with Stainless steel bolt.
- A strong, positive method of assembling hose, duct connections, tubing, and component parts. They are used for high torque applications where ordinary hose clamps fail. They provide a 360 degree sealing surface by using a shoe or formed bridge. Nuts are self-locking, vibration resistant with nylon inserts.

MM	Inches	Type	Box Qty	Part #	Weight	List
29-31	1.14-1.22	1.0" Discharge	50	6-9518	0.1	6.00
31-34	1.22-1.34	1.0" Suction	50	6-9519	0.1	6.00
34-37	1.34-1.46		50	9-8194		6.50
37-40	1.46-1.58		50	6-9520	0.1	6.50
40-43	1.58-1.69	1.5" Discharge	50	6-9521	0.1	6.50
43-47	1.69-1.85		50	6-9522	0.1	7.00
47-51	1.85-2.01	1.5" Suction	50	6-9523	0.1	7.00
51-55	2.01-2.17	2.0" Discharge	25	6-9524	0.1	7.00
55-59	2.17-2.32		25	6-9525	0.1	7.00
59-63	2.32-2.48	2.0" Suction	25	6-9526	0.1	7.50
63-68	2.48-2.68		25	6-9527	0.1	7.50
68-73	2.68-2.88	2.5" Discharge	25	6-9528	0.2	11.00
73-79	2.88-3.11	2.5" Suction	25	6-9529	0.2	11.00
79-85	3.11-3.35	3.0" Discharge	25	6-9530	0.2	11.00
85-91	3.35-3.59	3.0" Suction	25	6-9531	0.2	11.00
91-97	3.59-3.82		25	6-9532	0.2	11.00
97-104	3.82-4.10		25	6-9533	0.2	11.00
104-112	4.10-4.41	4.0" Discharge	25	6-9534	0.2	12.00
112-121	4.41-4.77	4.0" Suction	25	6-9535	0.2	12.00
121-130	4.77-5.12		25	6-9536	0.2	12.00
130-140	5.12-5.52	5.0" Discharge	10	6-9537	0.3	16.00
140-150	5.52-5.91	5.0" Suction	10	6-9538	0.3	16.00
150-162	5.91-6.38	6.0" Discharge	10	6-9539	0.3	16.00
162-174	6.38-6.86	6.0" Suction	10	6-9540	0.3	16.00
174-187	6.86-7.37	(For 6" Suction Boot)	10	6-9541	0.3	17.00
187-200	7.37-7.88		10	6-9542	0.4	17.00
200-213	7.88-8.39	8.0" Discharge	10	6-9543	0.4	17.00
213-226	8.39-8.90	8.0" Suction	10	6-9544	0.4	18.00
226-239	8.90-9.42	(For 8" Suction Boot)	10	6-9545	0.4	18.00
239-252	9.42-9.93		10	6-9546	0.4	18.00

## DOUBLE BOLT CLAMP



Size	Type	Range	Part #	Weight	List
3"	# 400	3.50" - 3.81"	9-5801	1.5	12.00
4"	# 463	4.06" - 4.44"	3-0730	1.8	12.00
4-1/2"	# 525	4.25" - 4.94"	9-5802	2.3	17.00
5"	# 550	5.00" - 5.50"	9-5864	2.1	17.00
5-1/2"	# 600	5.50" - 6.06"	9-5865	3.0	17.00
6"	# 675	6.13" - 6.88"	3-0731	2.7	18.00
6-1/2"	# 769	6.50" - 7.56"	9-5803	3.8	22.00
7-7/8"	# 818	7.69" - 8.19"	9-5866	5.1	29.00
8"	# 875	8.25" - 8.88"	3-0732	5.6	33.00
9"	# 988	8.94" - 9.88"	9-5804	6.2	38.00
10"	# 1125	9.94" - 11.38"	3-0733	9.6	57.00
12"	# 1275	11.19" - 13.00"	3-0734	9.5	67.00
13"	# 1360	12.19" - 14.00"	9-5805	15.4	85.00
14-1/2"	# 1450	13.19" - 15.00"	9-5867	16.7	175.00
17"	# 1700	15.06" - 17.50"	9-5868	20.9	210.00

## DOUBLE BOLT SPIRAL CLAMP



Size	Right Hand Spiral (cw)			Left Hand Spiral (ccw)		
	Part #	Weight	List	Part #	Weight	List
1.5"	9-5001	0.2	9.00	9-7667		9.00
2"	6-9745	0.4	5.00	9-7668		5.00
2.5"	9-5003	0.5	12.00	9-7669		12.00
3"	6-9746	0.7	13.00	9-7670		13.00
4"	3-0800	1.0	17.50	9-7671		17.50
5"	3-0801	1.8	22.50	9-7672		22.50
6"	3-0802	2.0	20.00	9-7673		20.00
8"	3-0803	2.8	27.00	9-7674		27.00
10"	9-5000	3.5	30.00	9-7675		30.00
12"	9-5002	4.1	39.00	9-7676		39.00

# NU-FLEX TUBING & SIPHON TUBES

## OETIKER® CLAMP (SINGLE EAR)



- Oetiker ear type clamps "Breathe" and adapt to the expansion and contraction of hose affected by thermodynamics or aging, no need to re-tighten
- Clamps are lightweight and compact, important when bulky screw-type clamps interfere with limited space applications
- Provides a tamper-proof seal without damage to the hose
- Made of zinc plated 1008/1010 carbon steel
- Features a mechanical lock at the joint instead of a spot weld, preventing failure due to corrosion
- Low pressure applications



Size	Range (Inches)	Part #	Weight	List
3/8"	.350-.414	9-6779		0.40
7/16"	.381-.444	9-6780		0.40
15/32"	.394-.486	9-6781		0.40
1/2"	.453-.524	9-6782		0.40
35/64"	.472-.551	9-6783		0.40
9/16"	.496-.571	9-6784		0.40
5/8"	.543-.618	9-6785		0.40
21/32"	.547-.650	9-6786		0.40
11/16"	.594-.669	9-6787		0.40
23/32"	.618-.728	9-6788		0.40
3/4"	.669-.779	9-6789		0.40
13/16"	.716-.827	9-6790		0.50
7/8"	.779-.890	9-6791		0.50
15/16"	.839-.949	9-6792		0.50
1"	.898-1.008	9-6793		0.50
1-1/16"	.945-1.067	9-6794		0.50
1-1/8"	1.004-1.126	9-6795		0.50
1-3/16"	1.063-1.185	9-6796		0.50
1-5/16"	1.181-1.303	9-6797		0.50
1-3/8"	1.240-1.362	9-6798		0.60
1-15/32"	1.358-1.480	9-6799		0.60
1-9/16"	1.437-1.559	9-6800		0.60
1-5/8"	1.492-1.614	9-6801		0.60
1-11/16"	1.551-1.673	9-6802		0.60
1-23/32"	1.610-1.732	9-6803		0.60
1-3/4"	1.669-1.791	9-6804		0.70
1-13/16"	1.728-1.850	9-6805		0.70
1-7/8"	1.787-1.909	9-6806		0.70
1-15/16"	1.846-1.968	9-6807		0.70
2"	1.905-2.028	9-6808		0.70

Size	Part #	Weight	List
Pinch Clamp Tool	9-6809		45.00

## WORM-DRIVE CLAMP (STAINLESS STEEL BAND W/ZINC PLATED HARDWARE)



- 1/2" Wide Stainless Steel Band with Zinc plated Screw.
- Cold-formed stamped band thread, smoothed on the underside, combined with beveled band-edges protects hose from damage.
- The AISI-430 Stainless steel finish of the band and housing make this a very attractive clip.
- The maximum application pressure can vary depending on the type of hose used and the geometry of the coupling.

**Materials:**

- 1) Screw:
  - Qst 36-3 Mild Steel (DIN 1.0213)
  - Silver-white Cr3 Zinc-Plated

- 2) Band & Housing:

- X6Cr17 Stainless Steel (DIN 1.4016) (AISI-430)











MM	Inches	Part #	Box Qty	List
16-27	0.63-1.06	9-7595	50	1.00
20-32	0.78-1.25	9-7596	50	1.00
25-40	0.99-1.38	9-7597	50	1.00
30-45	1.19-1.78	9-7598	50	1.00
32-50	1.25-1.97	9-7599	50	1.00
40-60	1.56-2.34	9-7600	50	1.50
50-70	1.97-2.75	9-7601	50	1.50
60-80	2.34-3.16	9-7602	50	1.50
70-90	2.75-3.53	9-7603	50	1.50
80-100	3.16-3.94	9-7604	50	1.50
90-110	3.54-4.33	9-7605	25	2.00
100-120	3.94-4.72	9-7606	25	2.00
110-130	4.33-5.12	9-7607	25	2.00
120-140	4.72-5.51	9-7608	25	2.00
130-150	5.12-5.91	9-7609	25	2.00
140-160	5.51-6.30	9-7610	25	2.50
150-170	5.91-6.69	9-7611	25	2.50
160-180	6.30-7.09	9-7612	25	2.50
170-190	6.69-7.48	9-7613	10	2.50
180-200	7.09-7.87	9-7614	10	3.00
190-210	7.48-8.27	9-7615	10	3.00
200-220	7.87-8.66	9-7616	10	3.00
210-230	8.27-9.06	9-7617	10	3.00
220-240	8.66-9.45	9-7618	10	3.00

Towline/Wheelmove

# PIPE

## SECTION THREE



 Tubing	45
 Sprinkler Pipe	46
 Mainline Pipe	47-48
 PVC Underground Pipe	49-50
 Gated Pipe	51-52
 NU-Flex Tubing	53
 Siphon Tubes	54
 Pipe Accessories	55
 Gates & Accessories	55-56
 Vacuum & Drainage Pipe	57

## BLACK STEEL TUBING



12 Ga. (.105" Wall)				11 Ga. (.125" Wall)			10 Ga. (.135" Wall)			7 Ga. (.188" Wall)		
Dia. (O.D.)	Part #	Wt/ft	List/ft	Part #	Wt/ft	List/ft	Part #	Wt/ft	List/ft	Part #	Wt/ft	List/ft
2"				4-0507	2.4	<b>4.50</b>						
2-1/2"				4-0508	3.1	<b>5.50</b>						
3"				4-0509	2.6	<b>6.50</b>						
4"	4-0510	4.5	<b>10.50</b>	9-5145	4.9	<b>10.00</b>	9-5137	5.7	<b>13.00</b>			
5"	4-0511	5.6	<b>12.50</b>	9-5142	6.3	<b>11.00</b>	9-5141	7.2	<b>13.50</b>			
6"	4-0512	6.8	<b>14.00</b>				9-5138	8.6	<b>17.00</b>	9-5151	11.6	<b>25.00</b>
6-5/8"	4-0513	7.9	<b>15.00</b>				9-5139	9.6	<b>17.00</b>	9-5152	12.9	<b>25.00</b>
8"	4-0514	9.0	<b>17.50</b>	9-5144	10.3	<b>16.00</b>	9-5140	11.6	<b>27.00</b>	9-5153	15.6	<b>33.00</b>
8-5/8"	4-0515	12.2	<b>21.50</b>									
10"	4-0516	11.3	<b>22.00</b>				9-5136	14.5	<b>28.00</b>	9-5150	19.7	<b>40.00</b>
10-3/4"							9-5287	15.6	<b>31.00</b>			
12"	4-0517	13.6	<b>30.00</b>				9-5307	17.5	<b>38.00</b>	9-8123		<b>42.00</b>
12-3/4"							9-5288	18.6	<b>39.00</b>			

## STAINLESS STEEL 304 TUBING



Dia. (O.D.)	Gauge	Wall	Part #	W/ft	List/ft
4"	12 ga.	.105	9-8284		<b>38.00</b>
6"	12 ga.	.105	9-8095		<b>75.00</b>
8"	12 ga.	.105	9-8096		<b>99.00</b>
10"	12 ga.	.105	9-8097		<b>125.00</b>
12"	12 ga.	.105	9-8143		<b>147.00</b>

## ALUMINUM TUBING



Dia. (O.D.)	Wall	Part #	Weight	List
2"	.050	4-0540	0.36/ft	<b>Call</b>
3"	.050	4-0541	0.54/ft	<b>Call</b>
4"	.050	4-0520	0.73/ft	<b>Call</b>
4"	.072	4-0542	1.05/ft	<b>Call</b>
5"	.052	4-0543	0.94/ft	<b>Call</b>
5"	.078	4-0544	1.42/ft	<b>Call</b>
6"	.051	4-0521	1.10/ft	<b>Call</b>
6"	.058	4-0522	1.26/ft	<b>Call</b>
6"	.083	4-0545	1.81/ft	<b>Call</b>
7"	.064	4-0546	1.64/ft	<b>Call</b>
8"	.051	4-0523	1.50/ft	<b>Call</b>
8"	.064	4-0524	1.88/ft	<b>Call</b>
8"	.072	4-0547	2.11/ft	<b>Call</b>
8"	.090	4-0548	2.78/ft	<b>Call</b>
9"	.051	4-0621	1.75/ft	<b>Call</b>
9"	.064	4-0529	2.24/ft	<b>Call</b>
10"	.051	4-0525	1.90/ft	<b>Call</b>
10"	.064	4-0526	2.38/ft	<b>Call</b>
10"	.094	4-0549	3.44/ft	<b>Call</b>
12"	.064	4-0550	2.86/ft	<b>Call</b>
12"	.094	4-0551	4.19/ft	<b>Call</b>



## ALUMINUM



Size	20' Length			30' Length			40' Length		
	Part #	Weight	List	Part #	Weight	List	Part #	Weight	List
2"	4-0530	.45/ft	Call	4-0531	.42/ft	Call	4-0532	.41/ft	Call
3"	4-0536	.65/ft	Call	4-0537	.61/ft	Call	4-0538	.60/ft	Call
4"	4-0533	.86/ft	Call	4-0534	.82/ft	Call	4-0535	.80/ft	Call

Aluminum press-on coupler with 1" riser outlet. Gasket and band & hook included. Price excludes riser and sprinkler.

## PVC W/SPIKE COUPLER



Size	30' Length			40' Length		
	Part #	Weight	List	Part #	Weight	List
2"	4-3510	-	Call	4-3511	-	Call
2-1/2"	4-3512	-	Call	4-3513	-	Call

- Has 3/4" riser outlet.
- See page 90 for spike couplers

## PIECES/TRUCKLOAD:

Type	6"	8"	10"	12"
Hook & Band	255	143	90	63
Ringlock	195	120	87	63

# STANDARD ALUMINUM MAINLINE PIPE

## PLAIN

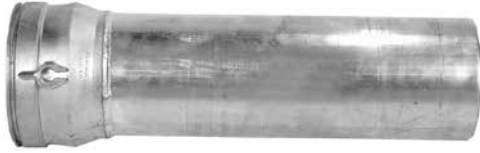

Size	Wall	Max PSI	Part #	Weight	List
4" x 20'	.050	---	4-0110	.79/ft	Call
4" x 30'	.050	---	4-0111	.77/ft	Call
4" x 40'	.050	---	4-0112	.76/ft	Call
6" x 10'	.051	---	4-0130	1.25/ft	Call
6" x 15'	.051	---	4-0131	1.20/ft	Call
6" x 20'	.051	---	4-0132	1.18/ft	Call
6" x 30'	.051	---	4-0133	1.15/ft	Call
6" x 40'	.051	---	4-0134	1.14/ft	Call
8" x 10'	.051	---	4-0160	1.73/ft	Call
8" x 15'	.051	---	4-0161	1.65/ft	Call
8" x 20'	.051	---	4-0162	1.62/ft	Call
8" x 30'	.051	---	4-0163	1.58/ft	Call
8" x 40'	.051	---	4-0164	1.56/ft	Call
10" x 10'	.051	---	4-0190	2.35/ft	Call
10" x 15'	.051	---	4-0191	2.20/ft	Call
10" x 20'	.051	---	4-0192	2.13/ft	Call
10" x 30'	.051	---	4-0193	2.05/ft	Call
10" x 40'	.051	---	4-0194	2.01/ft	Call

## BAND & HOOK



Pieces/Truckload:  
 4" - 575  
 6" - 255  
 8" - 143  
 10" - 90

Size	Wall	Max PSI	Part #	Weight	List
4" x 20'	.050	---	4-0120	.82/ft	Call
4" x 30'	.050	---	4-0121	.79/ft	Call
4" x 40'	.050	---	4-0122	.77/ft	Call
6" x 10'	.051	100#	4-0140	1.53/ft	Call
6" x 15'	.051	100#	4-0141	1.38/ft	Call
6" x 20'	.051	100#	4-0142	1.31/ft	Call
6" x 30'	.051	100#	4-0143	1.24/ft	Call
6" x 40'	.051	100#	4-0144	1.21/ft	Call
8" x 10'	.051	70#	4-0170	2.11/ft	Call
8" x 15'	.051	70#	4-0171	1.90/ft	Call
8" x 20'	.051	70#	4-0172	1.80/ft	Call
8" x 30'	.051	70#	4-0173	1.70/ft	Call
8" x 40'	.051	70#	4-0174	1.65/ft	Call
10" x 10'	.051	60#	4-0195	2.80/ft	Call
10" x 15'	.051	60#	4-0196	2.50/ft	Call
10" x 20'	.051	60#	4-0197	2.35/ft	Call
10" x 30'	.051	60#	4-0198	2.20/ft	Call
10" x 40'	.051	60#	4-0199	2.13/ft	Call

## RINGLOCK (STANDARD WALL)



Pieces/Truckload:  
 6" - 195  
 8" - 120  
 10" - 87

Size	Wall	Max PSI	Part #	Weight	List
6" x 10'	.051	125#	4-0150	1.81/ft	Call
6" x 15'	.051	125#	4-0151	1.58/ft	Call
6" x 20'	.051	125#	4-0152	1.46/ft	Call
6" x 30'	.051	125#	4-0153	1.34/ft	Call
6" x 40'	.051	125#	4-0154	1.28/ft	Call
8" x 10'	.051	90#	4-0180	2.48/ft	Call
8" x 15'	.051	90#	4-0181	2.15/ft	Call
8" x 20'	.051	90#	4-0182	1.99/ft	Call
8" x 30'	.051	90#	4-0183	1.83/ft	Call
8" x 40'	.051	90#	4-0184	1.75/ft	Call
10" x 10'	.051	70#	4-0185	3.29/ft	Call
10" x 15'	.051	70#	4-0186	2.83/ft	Call
10" x 20'	.051	70#	4-0187	2.59/ft	Call
10" x 30'	.051	70#	4-0188	2.36/ft	Call
10" x 40'	.051	70#	4-0189	2.25/ft	Call

Pipe

**RINGLOCK**  
(HEAVY WALL)

Big Gun Female Coupler x Full Male Aluminum Ring. Ringlock Clamp included.

Size	Wall	Max PSI	Part #	Weight	List
6" x 20'	.058	150#	4-0220	1.53/ft	Call
6" x 30'	.058	150#	4-0221	1.44/ft	Call
6" x 40'	.058	150#	4-0222	1.39/ft	Call
8" x 20'	.064	150#	4-0260	2.23/ft	Call
8" x 30'	.064	150#	4-0261	2.11/ft	Call
8" x 40'	.064	150#	4-0262	2.06/ft	Call
10" x 20'	.064	125#	4-0290	2.79/ft	Call
10" x 30'	.064	125#	4-0291	2.65/ft	Call
10" x 40'	.064	125#	4-0292	2.58/ft	Call

**TWIST LOCK PIPE**



Size	Wall	Max PSI	Part #	Weight	List
4" x 20'	.050	150#	4-0715	--	Call
4" x 30'	.050	150#	4-0716	--	Call
4" x 40'	.050	150#	4-0717	--	Call
5" x 20'	.051	150#	4-0718	--	Call
5" x 30'	.051	150#	4-0719	--	Call
5" x 40'	.051	150#	4-0720	--	Call
6" x 20'	.051	150#	4-0721	--	Call
6" x 30'	.058	150#	4-0722	--	Call
6" x 40'	.058	150#	4-0723	--	Call
8" x 20'	.064	125#	4-0724	--	Call
8" x 30'	.064	125#	4-0725	--	Call
8" x 40'	.064	125#	4-0726	--	Call

**Schumacher Irrigation stocks  
a selection of USED  
Aluminum pipe.**

**Call for prices and availability.**

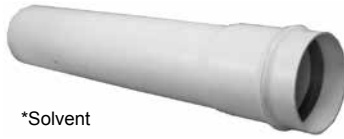

## 50# PVC GASKETED PIPE



\*Solvent

Diameter	O.D.	I.D.	Tickness	SDR	Part #	Weight	List
*6" PIP	6.14	5.989	.760	81	4-0610	1.1/ft	Call
8" PIP	8.16	7.958	.101	81	4-0650	1.7/ft	Call
10" PIP	10.20	9.948	.126	81	4-0681	2.6/ft	Call
12" PIP	12.24	11.938	.151	81	4-0691	3.8/ft	Call
15" PIP	15.30	14.922	.189	81	4-0695	5.8/ft	Call
*16" PIP	16.00	15.608	.196	81	4-0696	6.5/ft	Call

## 80# PVC GASKETED PIPE

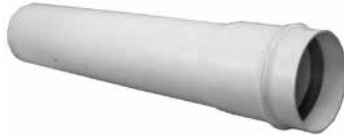

Diameter	O.D.	I.D.	Tickness	SDR	Part #	Weight	List
6" PIP	6.14	5.90	.12	51	4-0620	1.5/ft	Call
8" PIP	8.16	7.84	.16	51	4-0660	2.6/ft	Call
10" PIP	10.20	9.80	.20	51	4-0682	4.1/ft	Call
12" PIP	12.24	11.76	.24	51	4-0692	6.1/ft	Call
15" PIP	15.30	14.70	.30	51	4-0697	9.4/ft	Call
18" PIP	18.70	17.96	.37	51	4-0800	14.3/ft	Call
21" PIP	22.05	21.19	.43	51	4-0802	19.8/ft	Call
24" PIP	24.80	23.83	.49	51	4-0804	26.1/ft	Call
27" PIP	27.95	26.86	.55	51	4-0806	33.6/ft	Call

## 100# PVC GASKETED PIPE

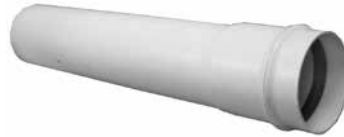

Diameter	O.D.	I.D.	Tickness	SDR	Part #	Weight	List
4" IPS	4.50	---	---	41	4-0644	1.0/ft	Call
6" IPS	6.63	6.30	.162	41	4-0850	2.2/ft	Call
8" IPS	8.63	8.21	.210	41	4-0851	3.6/ft	Call
10" IPS	10.75	10.23	.262	41	4-0852	5.7/ft	Call
12" IPS	12.75	12.13	.311	41	4-0853	8.0/ft	Call
6" PIP	6.14	5.84	.150	41	4-0630	1.9/ft	Call
8" PIP	8.16	7.76	.199	41	4-0670	3.3/ft	Call
10" PIP	10.20	9.70	.249	41	4-0683	5.1/ft	Call
12" PIP	12.24	11.64	.299	41	4-0693	7.5/ft	Call
15" PIP	15.30	14.46	.373	41	4-0698	11.7/ft	Call
18" PIP	18.7	17.78	.456	41	4-0801	17.6/ft	Call
21" PIP	22.05	20.97	.538	41	4-0803	24.6/ft	Call
24" PIP	24.8	23.59	.605	41	4-0805	32.4/ft	Call
27" PIP	27.95	26.59	.683	41	4-0807	41.8/ft	Call

## 125# PVC GASKETED PIPE

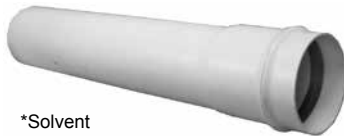

\*Solvent

Diameter	O.D.	I.D.	Tickness	SDR	Part #	Weight	List
1-1/4" IPS*	1.77	1.380	.197	32.5	4-3501	0.4/ft	Call
2" IPS	2.38	2.229	.073	32.5	4-3504	0.3/ft	Call
2-1/2" IPS	2.88	2.195	.088	32.5	4-0814	0.5/ft	Call
3" IPS	3.50	2.830	.108	32.5	4-0815	0.7/ft	Call
4" IPS	4.50	4.224	.138	32.5	4-0639	1.3/ft	Call
6" IPS	6.63	6.217	.204	32.5	4-0855	2.7/ft	Call
8" IPS	8.63	8.095	.265	32.5	4-0856	4.6/ft	Call
10" IPS	10.75	10.088	.331	32.5	4-0857	7.1/ft	Call
12" IPS	12.75	11.966	.392	32.5	4-0858	9.9/ft	Call
6" PIP	6.14	5.762	.189	32.5	4-0640	2.3/ft	Call
8" PIP	8.16	7.658	.251	32.5	4-0680	4.2/ft	Call
10" PIP	10.20	9.572	.314	32.5	4-0684	6.4/ft	Call
12" PIP	12.24	11.49	.377	32.5	4-0694	9.4/ft	Call
15" PIP	15.30	14.36	.471	32.5	4-0699	14.8/ft	Call

Pieces/Truckload:	6"	8"	10"	12"
50# PIP	285	158	103	70
80/100/125# PIP	261	143	90	63
125/160# IPS	210	110	72	--

All PVC is in 20' or 40' lengths. Gaskets are included. Call for installed prices.

## 160# PVC GASKETED PIPE

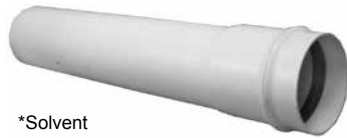

\*Solvent

Diameter	O.D.	I.D.	Tickness	SDR	Part #	Weight	List
1" IPS*	--	--	--	26	4-0816	--	Call
1-1/4" IPS*	1.66	1.532	0.064	26	4-3502	0.2/ft	Call
1-1/2" IPS	1.90	1.754	0.073	26	4-3503	0.3/ft	Call
2" IPS	2.38	2.193	0.091	26	4-3505	0.4/ft	Call
2-1/2" IPS	2.88	2.655	0.110	26	4-3506	0.6/ft	Call
3" IPS	3.50	3.230	0.135	26	4-3508	0.9/ft	Call
4" IPS	4.50	4.154	0.173	26	4-0671	1.6/ft	Call
6" IPS	6.63	6.115	0.255	26	4-0672	3.4/ft	Call
8" IPS	8.63	7.961	0.332	26	4-0673	5.7/ft	Call
10" IPS	10.75	9.924	0.413	26	4-0674	8.9/ft	Call
12" IPS	12.75	11.77	0.490	26	4-0808	12.67/ft	Call

## 200# PVC GASKETED PIPE

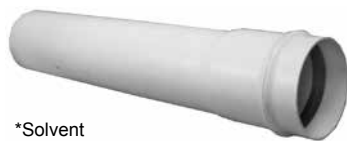

\*Solvent

Diameter	O.D.	I.D.	Tickness	SDR	Part #	Weight	List
1/2" IPS*	.84	.716	0.022	13.5	4-0817	0.098/ft	Call
3/4" IPS*	1.05	.930	0.060	21	4-0818	0.122/ft	Call
1" IPS*	1.315	1.189	0.063	21	4-3500	0.164/ft	Call
1-1/4" IPS*	1.660	1.502	0.079	21	4-0819	0.259/ft	Call
1-1/2" IPS	1.900	1.720	0.090	21	4-0820	0.338/ft	Call
2" IPS	2.375	2.149	0.113	21	4-3507	0.530/ft	Call
2-1/2" IPS	2.875	2.601	0.137	21	4-0821	0.776/ft	Call
3" IPS	3.500	3.166	0.167	21	4-0822	1.154/ft	Call
4" IPS	4.500	4.072	0.214	21	4-0809	1.900/ft	Call
6" IPS	6.625	5.993	0.316	21	4-0810	4.150/ft	Call
8" IPS	8.625	7.805	0.410	21	4-0811	7.055/ft	Call
10" IPS	10.75	9.728	0.500	21	4-0812	10.99/ft	Call
12" IPS	12.75	11.54	0.606	21	4-0813	15.53/ft	Call

## SCHEDULE 40 PVC PIPE (SOLVENT)



Diameter	O.D.	I.D.	Tickness	SDR	Part #	Weight	List
1/2"	0.840	0.612	0.109	--	4-0823	0.164/ft	Call
3/4"	1.050	0.824	0.113	--	4-0824	0.219/ft	Call
1"	1.315	1.049	0.133	--	4-0825	0.325/ft	Call
1-1/4"	1.660	1.380	0.140	--	4-0826	0.440/ft	Call
1-1/2"	1.900	1.610	0.145	--	4-0827	0.526/ft	Call
2"	2.375	2.067	0.154	--	4-0828	0.708/ft	Call
2-1/2"	2.875	2.469	0.203	--	4-0829	1.123/ft	Call
3"	3.500	3.068	0.216	--	4-0830	1.469/ft	Call
4"	4.500	4.026	0.237	--	4-0831	2.090/ft	Call
6"	6.625	6.065	0.280	--	4-0832	3.680/ft	Call
8"	8.625	7.962	0.332	--	4-0833	5.590/ft	Call

## SCHEDULE 80 PVC PIPE (SOLVENT)



Diameter	O.D.	I.D.	Tickness	SDR	Part #	Weight	List
1/2"	0.840	0.546	0.147	--	4-0834	0.205/ft	Call
3/4"	1.050	0.742	0.154	--	4-0835	0.278/ft	Call
1"	1.315	0.957	0.179	--	4-0836	0.409/ft	Call
1-1/4"	1.660	1.278	0.191	--	4-0837	0.567/ft	Call
1-1/2"	1.900	1.500	0.200	--	4-0838	0.686/ft	Call
2"	2.375	1.939	0.218	--	4-0839	0.949/ft	Call
2-1/2"	2.875	2.323	0.276	--	4-0840	1.449/ft	Call
3"	3.500	2.900	0.300	--	4-0841	1.938/ft	Call
4"	4.500	3.826	0.337	--	4-0842	2.833/ft	Call
6"	6.625	5.761	0.432	--	4-0843	5.446/ft	Call
8"	8.625	7.625	0.500	--	4-0844	8.270/ft	Call

All PVC is in 20' or 40' lengths. Gaskets are included. Call for installed prices.

Pieces/Truckload:	6"	8"	10"	12"
50# PIP	285	158	103	70
80/100/125# PIP	261	143	90	63
125/160# IPS	210	110	72	--

## ALUMINUM GATED PIPE - .051\*

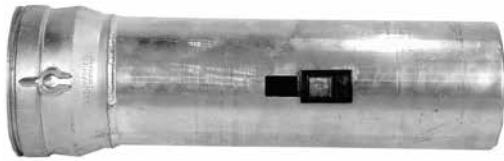

\* Gates included, but not installed.

Size x Length	Gate Spacing	Gates/ Pipe	Part #	Weight	List
6" x 20'	20"	12	4-0310	1.18/ft	Call
6" x 20'	30"	8	4-0320	1.18/ft	Call
6" x 20'	40"	6	4-0330	1.18/ft	Call
6" x 30'	20"	18	4-0311	1.15/ft	Call
6" x 30'	30"	12	4-0321	1.15/ft	Call
6" x 30'	36"	10	4-0323	1.15/ft	Call
6" x 30'	40"	9	4-0331	1.15/ft	Call
6" x 40'	20"	24	4-0312	1.14/ft	Call
6" x 40'	30"	16	4-0322	1.14/ft	Call
6" x 40'	40"	12	4-0332	1.14/ft	Call

Size x Length	Gate Spacing	Gates/ Pipe	Part #	Weight	List
8" x 20'	20"	12	4-0340	1.62/ft	Call
8" x 20'	30"	8	4-0350	1.62/ft	Call
8" x 20'	40"	6	4-0360	1.62/ft	Call
8" x 30'	20"	18	4-0341	1.58/ft	Call
8" x 30'	30"	12	4-0351	1.58/ft	Call
8" x 30'	36"	10	4-0353	1.58/ft	Call
8" x 30'	40"	9	4-0361	1.58/ft	Call
8" x 40'	20"	24	4-0342	1.56/ft	Call
8" x 40'	30"	16	4-0352	1.56/ft	Call
8" x 40'	40"	12	4-0362	1.56/ft	Call

Size x Length	Gate Spacing	Gates/ Pipe	Part #	Weight	List
10" x 20'	20"	12	4-0370	2.13/ft	Call
10" x 20'	30"	8	4-0380	2.13/ft	Call
10" x 20'	40"	6	4-0390	2.13/ft	Call
10" x 30'	20"	18	4-0371	2.05/ft	Call
10" x 30'	30"	12	4-0381	2.05/ft	Call
10" x 30'	36"	10	4-0383	2.05/ft	Call
10" x 30'	40"	9	4-0391	2.05/ft	Call
10" x 40'	20"	24	4-0372	2.01/ft	Call
10" x 40'	30"	16	4-0382	2.01/ft	Call
10" x 40'	40"	12	4-0392	2.01/ft	Call

Pipe

## PVC SURFACE GATED (STANDARD WALL)



- Above w/b&h will take 20-25 psi
- Compatible w/Aluminum pipe and fittings
- Adjustable Telescopic Coupler
- Gates included, but not installed.

Size x Length	Gate Spacing	Gates/ Pipe	Part #	Weight	List
6" x 30'	Plain	-	4-3305	1.5/ft	Call
6" x 30'	20"	18	4-3311	1.5/ft	Call
6" x 30'	30"	12	4-3321	1.5/ft	Call
6" x 30'	36"	10	4-3300	1.5/ft	Call
6" x 30'	40"	9	4-3331	1.5/ft	Call

Size x Length	Gate Spacing	Gates/ Pipe	Part #	Weight	List
8" x 30'	Plain	-	4-3306	2.0/ft	Call
8" x 30'	20"	18	4-3341	2.0/ft	Call
8" x 30'	30"	12	4-3351	2.0/ft	Call
8" x 30'	36"	10	4-3301	2.0/ft	Call
8" x 30'	40"	9	4-3361	2.0/ft	Call

Size x Length	Gate Spacing	Gates/ Pipe	Part #	Weight	List
10" x 30'	Plain	-	4-3307	2.5/ft	Call
10" x 30'	20"	18	4-3371	2.5/ft	Call
10" x 30'	30"	12	4-3381	2.5/ft	Call
10" x 30'	36"	10	4-3302	2.5/ft	Call
10" x 30'	40"	9	4-3391	2.5/ft	Call

Size x Length	Gate Spacing	Gates/ Pipe	Part #	Weight	List
12" x 30'	Plain	-	4-3308	3.0/ft	Call
12" x 30'	20"	18	4-3320	3.0/ft	Call
12" x 30'	30"	12	4-3324	3.0/ft	Call
12" x 30'	36"	10	4-3322	3.0/ft	Call
12" x 30'	40"	9	4-3323	3.0/ft	Call

# NU-FLEX TUBING & SIPHON TUBES

## NU-FLEX LAYFLAT SURFACE TUBING (FOR FLOOD/FURROW IRRIGATION)



Call for other sizes, mil thicknesses and tools.  
Advantages:

1. Low Cost
2. Reduced Labor Cost
3. New Product Every Season
4. Less friction loss than aluminum pipe
5. Can be used as mainline or gated pipe

Size	Length	Mil	Part #	Weight	List
5"	500'	6	6-9798	19.0	105.00
5"	1000'	6	6-9799	38.0	202.00
9"	1320'	5	6-9801	73.0	235.00
9"	1320'	7	6-9802	101.0	345.00
10"	1000'	10	6-9804	95.0	410.00
12"	1320'	5	6-9805	98.0	329.00
12"	950'	7	6-9807	98.0	315.00
12"	1320'	7	6-9808	136.0	434.00
12"	1320'	8	9-7693		496.00
12"	1000'	10	6-9809	153.0	410.00
15"	1320'	5	6-9810	126.0	402.00
15"	1320'	7	6-9812	174.0	555.00
18"	850'	7	6-9816	135.0	425.00
18"	600'	10	6-9818	135.0	428.00
21"	700'	8	6-9819	145.0	465.00
24"	700'	8	6-9821	166.0	535.00

Description	Part #	Weight	List
Slide Gate for Surface Tubing	9-5242		3.50

## SIPHON TUBES (ALUMINUM)

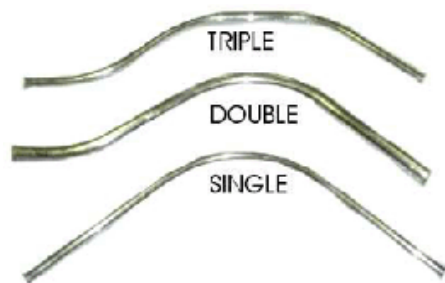

PVC Siphon tubes are also available, Call for Prices.

Size	Length	Single Bend		Double Bend		Triple Bend	
		Part #	List	Part #	List	Part #	List
1/2"	60"	9-5362	7.00	9-5379	6.00		
3/4"	54"			9-5380	10.00		
3/4"	60"	9-5363	10.00	9-5381	10.00	9-5405	10.00
3/4"	72"			9-5382	11.00	9-5406	11.00
1"	48"	9-5364	12.00				
1"	54"	9-5365	12.00	9-5383	12.00		
1"	60"	9-5366	12.00	9-5384	12.00	9-5407	12.00
1"	72"	9-5367	14.00	9-5385	14.00	9-5408	14.00
1"	90"					9-5409	19.00
1-1/4"	48"	9-5368	15.00				
1-1/4"	54"	9-5369	15.00	9-5386	15.00		
1-1/4"	60"	9-5370	15.00	9-5387	15.00	9-5410	15.00
1-1/4"	64"			9-5388	17.00		
1-1/4"	72"	9-5371	16.00	9-5389	17.00	9-5411	17.00
1-1/4"	90"					9-5412	19.00
1-1/2"	48"	9-5372	19.00				
1-1/2"	54"			9-5390	19.00		
1-1/2"	60"	9-5373	19.00	9-5391	19.00	9-5413	19.00
1-1/2"	64"			9-5392	24.00		
1-1/2"	72"	9-5374	22.00	9-5393	22.00	9-5414	22.00
1-1/2"	90"					9-5415	28.00
2"	48"	9-5375	26.00				
2"	54"			9-5394	26.00		
2"	60"	9-5376	26.00	9-5395	26.00	9-5416	26.00
2"	64"			9-5396	30.00		
2"	72"	9-5377	30.00	9-5397	30.00	9-5417	30.00
2"	90"					9-5418	38.00
3"	60"	9-5378	70.00	9-5398	70.00		
3"	72"			9-5399	92.00		
3"	90"			9-5400	108.00	9-5419	108.00
4"	72"			9-5401	136.00		
4"	96"			9-5402	160.00		
4"	120"					9-5420	229.00
5"	96"			9-5403	285.00	9-5421	285.00
5"	120"					9-5422	357.00
6"	96"			9-5404	360.00	9-5423	358.00
6"	120"					9-5424	453.00

Pipe

## PIPE TURNER



Size	Part #	Weight	List
6"	4-0475	10.3	<b>210.00</b>
8"	4-0476	11.3	<b>210.00</b>
9"	4-0477	12.3	<b>210.00</b>
10"	4-0478	12.3	<b>240.00</b>
12"	4-0479	12.8	<b>239.00</b>

## GATE TOOL



Size	Part #	Weight	List
--	6-1814		<b>6.00</b>

## REPLACEMENT COUPLER

(PVC SURFACE)



Size	Part #	Weight	List
6"	4-3392	1.5	<b>36.00</b>
8"	4-3393	3.0	<b>49.00</b>
10"	4-3394	3.5	<b>54.00</b>
12"	4-4400	4.0	<b>69.00</b>

## REPAIR SPLICER

(PVC SURFACE)



Size	Part #	Weight	List
6"	4-3395	0.5	<b>13.00</b>
8"	4-3396	1.0	<b>17.00</b>
10"	4-3397	1.0	<b>24.00</b>
12"	4-4401	1.5	<b>26.00</b>

## STEEL COLLAR

(PVC SURFACE)



Size	Part #	Weight	List
6"	4-3398	1.3	<b>12.00</b>
8"	4-3399	1.6	<b>14.00</b>
10"	4-3400	2.0	<b>16.00</b>
12"	4-3401	2.5	<b>18.00</b>

## CAPLOCK

(PVC SURFACE)

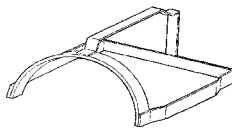

Features:

1. Easy to use
2. Saves time and money
3. Insert the plug and snap on the caplock

Size	Part #	Weight	List
6"	4-4402		<b>33.00</b>
8"	4-4403		<b>36.00</b>
10"	4-4404		<b>40.00</b>
12"	4-4405		<b>45.00</b>

## DAM GATE

Fits standard 1-1/4" x 2-5/8" Rectangle Hole



Size	Part #	Weight	List
6"	4-0460	0.1	<b>1.50</b>
8"-10"-12"	4-0461	0.1	<b>1.50</b>

Features:

1. Quick easy installation
2. Designed for use in either PVC or aluminum pipe
3. Fits standard 1 1/4" x 2 5/8" rectangular openings
4. Fits Tex-Flo openings
5. New design allows easier slide adjustments
6. Spring tension is at the center for equal sealing at front and rear of the gate
7. Manufactured from special materials to minimize environmental effects
8. UV inhibitor is added to help protect against the sun's ultra violet radiation
9. Water flow 90 GPM at 6 feet of head

## A GATE



Size	Part #	Weight	List
6"	9-8129		<b>1.20</b>
8"-10"-12"	9-8130		<b>1.20</b>

Features:

1. Fits standard 1 1/4" x 2 5/8" rectangular openings
2. Improved design to correctly fit Tex Flo New Style gate holes with rounded end, DO NOT have to install backwards.
3. Increased length in front of clip pocket to seal better and last much longer.
4. Used in both Aluminum & PVC Pipe.
5. Natural UV inhibitors to help protect from sunlight exposer damage.

## KEYHOLE GATE



Size	Part #	Weight	List
6"	4-0436	0.1	<b>1.50</b>
8"-10"-12"	4-0441	0.1	<b>1.50</b>

Features:

1. The triad keyhole gate is a fresh approach to irrigation gate problems. The spring mechanism is so unique a patent has been applied for.
2. Easiest keyhole gate on the market to install.
3. Manufactured from specially selected materials to minimize environmental effects
4. Fits standard keyhole openings
5. Excellent water flow, 60 GPM at 6 feet of head

**HASTINGS GATE**

Type	Size	Part #	Weight	List
Universal	8"-9"-10"	4-0462	0.1	<b>1.90</b>
Round Front	6"	4-0463	0.1	<b>2.40</b>
Round Front	8"-9"-10"	4-0464	0.1	<b>2.40</b>
Conversion	1-5/8"x4-1/4" Hole	4-0465	0.2	<b>4.20</b>



**Universal** (will fit round front gate hole)



**Round Front**

## Features:

1. Up to 85 GPM with a 42" head
2. Open, adjust and closes easily from a standing position with just the tap of a stick
3. Yellow Top: made of high strength, long-lasting natural polypropylene
4. Bottom: spring tension holds the gate firmly in any position in which the gate is set. Gasket is firmly molded to the bottom, holding it tightly against the pipe.
5. Gasket: new, improved design of molded synthetic rubber. This new material is more flexible, conforms more readily to the contour of the pipe

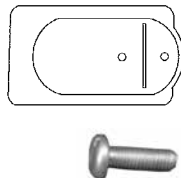
**NU-SLIDE GATE**

Description	Part #	Weight	List
Rubber Bottom only	4-0495		<b>4.50</b>
Screw (need 2/gate)	4-0496		<b>0.45</b>

**OVAL GATE**

Size	Part #	Weight	List
One size	4-0470	0.2	<b>2.20</b>

## Features:

1. Easily installed in a standard recessed oval hole (ames type)
2. Improved frame design
3. Flow rate 60 gallons per minute at 1 foot of head, full open
4. Easily adjustable slide regulates water flow
5. Manufactured from specially selected materials to improve weatherability

**GATE SOCK CLIP**

Size	Part #	Weight	List
Round 6"	4-0480	0.2	<b>3.50</b>
Round 8"	4-0481	0.2	<b>3.50</b>
Round 10"	4-0482	0.2	<b>3.50</b>
Round 12"	4-0483	0.2	<b>3.90</b>

**GATE SOCK**

Description	Part #	Weight	List
Vinyl Coated Polyester	4-0490	0.1	<b>4.95</b>

\*36" long with closed end



## ALUMINUM VACUUM PIPE



Bauer Style						Ringlock					
Size	Length	Wall	Type	Part #	List	Size	Length	Wall	Type	Part #	List
4"	5'	0.072	Cast Alum Ball/Socket w/lever	9-5062	169.00	4"	5'	0.072	Cast Alum Ring Lock w/rlc	9-5098	134.00
4"	10'	0.072	Cast Alum Ball/Socket w/lever	9-5063	202.00	4"	10'	0.072	Cast Alum Ring Lock w/rlc	9-5099	167.00
4"	15'	0.072	Cast Alum Ball/Socket w/lever	9-5064	235.00	4"	15'	0.072	Cast Alum Ring Lock w/rlc	9-5100	200.00
4"	20'	0.072	Cast Alum Ball/Socket w/lever	9-5065	269.00	4"	20'	0.072	Cast Alum Ring Lock w/rlc	9-5101	233.00
4"	25'	0.072	Cast Alum Ball/Socket w/lever	9-5066	301.00	4"	25'	0.072	Cast Alum Ring Lock w/rlc	9-5102	266.00
4"	30'	0.072	Cast Alum Ball/Socket w/lever	9-5067	335.00	4"	30'	0.072	Cast Alum Ring Lock w/rlc	9-5103	299.00
6"	5'	0.083	Cast Alum Ball/Socket w/lever	9-5068	281.00	6"	5'	0.083	Cast Alum Ring Lock w/rlc	9-5104	192.00
6"	10'	0.083	Cast Alum Ball/Socket w/lever	9-5069	347.00	6"	10'	0.083	Cast Alum Ring Lock w/rlc	9-5105	258.00
6"	15'	0.083	Cast Alum Ball/Socket w/lever	9-5070	414.00	6"	15'	0.083	Cast Alum Ring Lock w/rlc	9-5106	325.00
6"	20'	0.083	Cast Alum Ball/Socket w/lever	9-5071	480.00	6"	20'	0.083	Cast Alum Ring Lock w/rlc	9-5107	391.00
6"	25'	0.083	Cast Alum Ball/Socket w/lever	9-5072	547.00	6"	25'	0.083	Cast Alum Ring Lock w/rlc	9-5108	458.00
6"	30'	0.083	Cast Alum Ball/Socket w/lever	9-5073	613.00	6"	30'	0.083	Cast Alum Ring Lock w/rlc	9-5109	525.00
8"	5'	0.094	Cast Alum Ball/Socket w/lever	9-5074	535.00	8"	5'	0.094	Cast Alum Ring Lock w/rlc	9-5110	249.00
8"	10'	0.094	Cast Alum Ball/Socket w/lever	9-5075	636.00	8"	10'	0.094	Cast Alum Ring Lock w/rlc	9-5111	351.00
8"	15'	0.094	Cast Alum Ball/Socket w/lever	9-5076	739.00	8"	15'	0.094	Cast Alum Ring Lock w/rlc	9-5112	454.00
8"	20'	0.094	Cast Alum Ball/Socket w/lever	9-5077	840.00	8"	20'	0.094	Cast Alum Ring Lock w/rlc	9-5113	556.00
8"	25'	0.094	Cast Alum Ball/Socket w/lever	9-5078	942.00	8"	25'	0.094	Cast Alum Ring Lock w/rlc	9-5114	658.00
8"	30'	0.094	Cast Alum Ball/Socket w/lever	9-5079	1,045.00	8"	30'	0.094	Cast Alum Ring Lock w/rlc	9-5115	760.00

-Tough, durable aluminum vacuum pipe is available in a number of types of connections.  
 -We also manufacture vacuum fittings such as elbow, tees, end plugs, etc.

## PLASTIC DRAINAGE PIPE

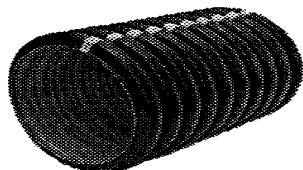









Available perforated or non-perforated.  
 Please call for fittings.

Size	Coorigated			Smooth Interior		
	Part #	Weight	List	Part #	Weight	List
3"	4-0700	--	Call			
4"	4-0701	--	Call			
5"	4-0702	--	Call			
6"	4-0703	--	Call			
8"	4-0704	--	Call			
10"	4-0705	--	Call			
12"	4-0706	--	Call	12"	--	Call
15"	4-0707	--	Call	15"	--	Call
18"	4-0708	--	Call	18"	--	Call
24"	4-0709	--	Call	24"	--	Call

\* Quantity and Truckload Discounts available. Please Call.

## SECTION FOUR



 Gun Stands & Carts	60-62
 Trailers, Travelers & Accs	63
 Traveler & Drag Hose	63
 Traveler Hose Menders	64
 Hose Pull Couplers	65
 Sprinklers	66-70
 Nozzles	71
 Volume Guns	72-89

# Traveler Parts

## Soft and Hard Hose Travelers

- Replacement Parts
- Cables
- Turbines
- Etc.

## GUN STAND (FOLD DOWN - MODEL A) (ALUMINUM)

Hook style. Aluminum.  
With 3" male threaded top.

Recommended Guns:

- Nelson 100
- Komet 101
- River
- Skipper

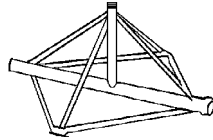

Size	Part #	Weight	List
4"	5-0110	40.0	<b>435.00</b>

## GUN STAND (STANDARD - MODEL B) (ALUMINUM)

Ideal stand for:

1. Hard to reach corners areas
2. Liquid manure applications
3. Pivot corners

Ringlock. Aluminum.

With 4" male threaded top.  
Water filled base for superior stability

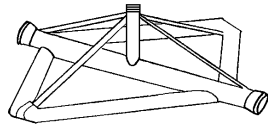

Recommended Guns:

- Small
- Medium
- Large

Size	Part #	Weight	List
6"	5-0120	48.0	<b>995.00</b>

## GIANT SPRINKLER STAND (GALVANIZED STEEL)

Recommended Guns:

- Nelson 100
- Komet 101
- River
- Skipper

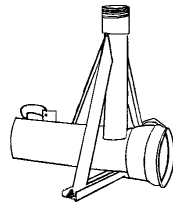

With male or female threaded top. Specify size.

Size	Part #	Weight	List
3"	5-0130	23.0	<b>225.00</b>
4"	5-0131	25.0	<b>245.00</b>
5"	5-0132	26.0	<b>310.00</b>
6"	5-0133	27.0	<b>370.00</b>

## GUN CART (GALVANIZED STEEL)

- With 2" FPT & 2-1/2" MPT top.
- Gun is not included. See pages 66-73.
- Standard Profile
- 57" Wheels
- 4" Male B&H and B&L

Recommended Guns:

- Nelson 100
- Komet 101
- River
- Skipper

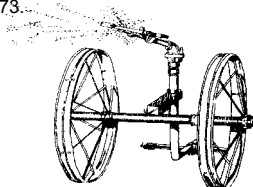

Size	Part #	Weight	List
4"	5-0140	116.0	<b>910.00</b>

## GUN STAND (MODEL LE) (ALUMINUM)

Recommended Guns:

- Nelson 100
- Komet 101
- River
- Skipper

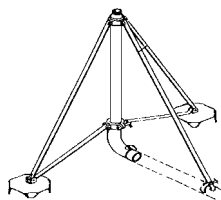

- With 2" FPT/2-1/2" MPT Top.
- State mainline size when ordering.
- 30" Riser Length.

Size	Part #	Weight	List
3"	5-0150	20.0	<b>590.00</b>
4"	9-7694		<b>590.00</b>
5"	9-7695		<b>610.00</b>

## SPRINKLER CART

Description	Part #	Weight	List
1000F w/Funny Sprinkler	9-7720	25.0	<b>270.00</b>
1250K w/K-1 Sprinkler	9-7721	38.0	<b>430.00</b>
1500H w/Hidra Sprinkler	9-7722	46.0	<b>595.00</b>

\* To order just the sprinkler see page 68.

### Model 1000F

1" Cart Body

Flow Range: 6 to 26 GPM

Pressure: 20 to 80 PSI

Coverage: Up to 120 Feet Diameter

25 lbs - Total Weight

All nozzles shown are included



3/4" Female Hose Swivel connection

### Model 1250K

1 1/4" Cart Body

Flow Range: 10 to 47 GPM

Pressure: 20 to 80 PSI

Coverage: Up to 150 Feet Diameter

38 lbs - Total Weight

All nozzles shown are included



1-1/4" MPT connection

### Model 1500H

1 1/4" Cart Body

Flow Range: 30 to 140 GPM

Pressure: 20 to 80 PSI

Coverage: Up to 200 Feet Diameter

46 lbs - Total Weight

All nozzles shown are included



1-1/2" MPT connection

PSI = Pressure at Sprinkler Nozzle  
 GPM = Gallons Per Minute at Nozzle

#### 1000F Sprinkler Cart Performance

Nozzle size	PSI	GPM	Jet Length/Feet (One Direction)	Wetted Circle Diameter/Feet
5mm (.20")	22	5.3	42	84
	29	6	46	92
	44	7	50	100
	58	9	54	108
6mm (.24")	22	7	43	86
	29	8.5	48	96
	44	10	54	108
7mm (.28")	58	12	58	116
	22	10	46	92
	29	11	50	100
9mm (.35")	44	14	56	112
	58	16	61	122
	22	16.4	50	100
	29	19	54	108
	44	23	61	122
	58	26	64	128

#### 1250K Sprinkler Cart Performance

Nozzle size	PSI	GPM	Jet Length/Feet (One Direction)	Wetted Circle Diameter/Feet
7mm (.28")	22	10	46	92
	29	11	50	100
	44	14	56	112
	58	16	61	122
8mm (.315")	22	13	51	102
	29	15	56	112
	44	18	62	124
	58	21	67	134
9mm (.354")	22	16	54	108
	29	19	57	114
	44	23	64	128
	58	26	69	138
10mm (.394")	22	20	56	112
	28	23	59	118
	44	28	67	134
	58	33	72	144
12mm (.472")	22	29	56	112
	29	34	62	124
	44	41	68	136
	58	47	77	154

#### 1250H Sprinkler Cart Performance

Nozzle size	PSI	GPM	Jet Length/Feet (One Direction)	Wetted Circle Diameter/Feet
12mm (.47") w/ 5mm (.19") diffuser nozzle	29	40	65	130
	44	48	78	156
	58	56	88	176
	73	62	98	196
14mm (.55") w/ 5mm (.19") diffuser nozzle	29	52	69	138
	44	63	82	164
	58	73	95	190
	73	81	101	202
16mm (.63") w/ 5mm (.19") diffuser nozzle	29	65	72	144
	44	80	85	170
	58	93	98	196
	73	103	108	216
18mm (.70") w/ 5mm (.19") diffuser nozzle	44	100	92	184
	58	115	101	202
	73	128	112	224

## TRAVELING SPRINKLER (RAINCOACH™)

- 1" FHT Inlet
- Economical Alternative for large turf areas
- Brass, aluminum, and stainless steel construction provides unmatched durability
- Combines 3/4" impact brass head with rotating sweep arms for full, even coverage
- Includes six nozzle set
- Allows for adjustable speed of travel for varied precipitation rates
- Minimizes turf scarring with front roller
- Equipped with 3/32" x 450' galvanized steel cable tow line
- Provides stable operation on rough terrain with wide/long wheel base
- Built-in valve shuts off water automatically at the end of run
- FIVE YEAR WARRANTY
- Throw: 110-145'
- Flow: 11.5-22.4 GPM
- PSI at Sprinkler: 55-75psi



Size	Part #	Weight	List
-	9-6812	56.0	<b>3,365.00</b>

## GUN OUTLET (CAST ALUMINUM)



- 2-1/2" Female Threaded Outlet
- Small "Guns" may be used on this sturdy outlet.
- The base is drilled for attaching a board for support of the sprinkler gun.

Size	Part #	Weight	List
4"	9-5243	3.5	<b>113.00</b>
5"	9-5244	4.5	<b>122.00</b>
6"	9-5245	5.5	<b>179.00</b>

## ADAPTER (GIANT SPRINKLER)

\* Use std 4" RLC



Description	Part #	Weight	List
3" Weld On x 3" Male	6-9790	3.5	<b>69.00</b>
3" Weld On x 3" Female	6-9791	4.0	<b>114.00</b>
4" Weld On x 4" Male	8-1427	5.0	<b>73.00</b>
4" Weld On x 4" Female	8-1426	5.5	<b>121.00</b>
3" Ringlock Clamp	6-1047	1.4	<b>19.00</b>
4" Ringlock Clamp	6-1038	1.6	<b>20.00</b>

## PIPE TRAILER

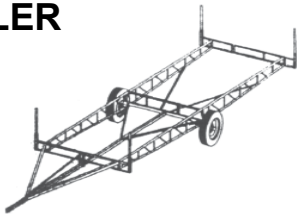

Maximum capacity of 4,000 lbs.  
For pipe up to 40' in length  
Dimensions:  
-35' overall length  
-102" wide  
-21' from stake pocket to stake pocket  
-14' from tongue to front stake pocket

Tongue	Part #	Weight	List
Single	5-0540	700.0	<b>2,365.00</b>
Double	5-0550	735.0	<b>2,435.00</b>

## TRAVELER CABLE (7 X 19)



Size	Length	Part #	Weight	List
5/16"	1,350'	9-5183		<b>1,360.00</b>
3/8"	1,350'	9-5182		<b>1,729.00</b>
7/16"	2,700'	6-9585	-	

## BULLET STOP



Size	Part #	Weight	List
5/16"	9-5181		<b>49.00</b>
3/8"	9-5180		<b>28.00</b>

## FOAM PIG



Size	For Hose Size	Part #	Weight	List
6"	4-5-6"	9-5309		<b>34.00</b>
7-1/4"	6"	9-6967		<b>27.00</b>
8"	6-8"	9-5310		<b>38.00</b>
10"	8-10"	9-6966		<b>58.00</b>

## SOFT HOSE, TRAVELER (REPLACEMENT)

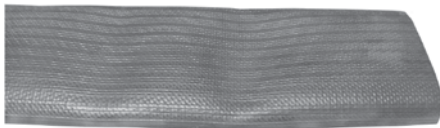

- 10 year limited warranty
- Cover allows maximum flexibility and good bend radius
- Ease of repair and restoration of damaged hoses to full working performance
- Long term storage stability and extended working life
- Superior resistance to ozone and ultraviolet light

Size	Length	Part #	Weight	List
2-1/2"	660'	6-9616	330.0	<b>Call</b>
3"	660'	6-9617	396.0	<b>Call</b>
3-1/2"	660'	6-9618	528.0	<b>Call</b>
4"	660'	5-0583	660.0	<b>Call</b>
4-1/2"	660'	5-0584	792.0	<b>Call</b>
5"	660'	6-9619	924.0	<b>Call</b>
6"	660'	6-9620	-	<b>Call</b>

## SLUDGE INJECTION HOSE (DRAG HOSE)



L.W.T.



Size	Length	Part #	Weight	List
4"	660'	5-0596	627.0	<b>Call</b>
4-1/2"	660'	5-0597	666.6	<b>Call</b>
5"	660'	9-7343	-	<b>Call</b>
5-1/2"	660'	9-7582	-	<b>Call</b>
6"	660'	9-7583	-	<b>Call</b>
8"	660'	9-7827	-	<b>Call</b>
10"	660'	9-7828	-	<b>Call</b>

Gun Stands/Sprinklers

# HOSE MENDERS

## HOSE MENDER (FOR HARD HOSE, BAND-IT)

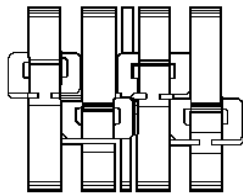

Hose ID	Part #	Weight	List
2.1"	6-1827		<b>350.00</b>
2.5"	6-1828		<b>381.00</b>
3.0"	6-1829		<b>606.00</b>
3.75"	6-1830		<b>679.00</b>
4.1"	6-1831		<b>676.00</b>
4.5"	6-1832		<b>640.00</b>
5.0"	6-1833		<b>695.00</b>

## HOSE MENDER (FOR HARD HOSE, SCREW)



- Instructions Included

Hose ID	Part #	Weight	List
0.90"	9-7682		<b>225.00</b>
1.10"	9-7677		<b>105.00</b>
1.18"	9-7573		<b>125.00</b>
1.30"	9-7678		<b>115.00</b>
1.40"	9-7679		<b>120.00</b>
1.43"	9-7574		<b>200.00</b>
1.60"	9-7680		<b>150.00</b>
1.67"	9-7575		<b>235.00</b>
1.80"	9-7681		<b>200.00</b>
1.90"	9-7576		<b>235.00</b>
2.00"	9-7683		<b>240.00</b>
2.10"	6-1820		<b>269.00</b>
2.30"	9-7686		<b>370.00</b>
2.50"	6-1821		<b>465.00</b>
2.70"	9-7684		<b>485.00</b>
3.00"	6-1822		<b>490.00</b>
3.30"	9-7577		<b>485.00</b>
3.70"	6-9792		<b>490.00</b>
4.00"	9-7685		<b>580.00</b>
4.10"	6-1824		<b>675.00</b>
4.20"	9-7579		<b>420.00</b>
4.50"	6-1825		<b>575.00</b>
4.60"	9-7580		<b>450.00</b>

## HOSE MENDER W/CLAMPS (FOR SOFT HOSE)



- 1/4" Wall x 10" Long
- Instructions Included

Size	Complete w/Clamps			Mender Only		
	Part #	Weight	List	Part #	Weight	List
2-1/2"	5-0588		<b>260.00</b>	9-7570		<b>32.00</b>
3"	5-0589		<b>320.00</b>	9-7571		<b>35.00</b>
3-1/2"	5-0590		<b>410.00</b>	9-7572		<b>145.00</b>
4"	5-0585	9.5	<b>135.00</b>	9-6763	7.1	<b>64.00</b>
4-1/2"	5-0586	10.6	<b>140.00</b>	9-6764	8.3	<b>69.00</b>
5"	5-0591		<b>215.00</b>	9-6765		<b>100.00</b>
6"	5-0592		<b>210.00</b>	9-6766		<b>100.00</b>



# HOSE PULL COUPLER

## HOSE PULL COUPLER



- Instructions Included
- Cast Aluminum
- Clamps for 4/5"x4" HPC (1/2" Wide) #25229340

### Cast Aluminum

Hose Size	Discharge	Part #	Weight	List
2-1/2"	3"	6-1800		<b>289.00</b>
3"	3"	6-1801		<b>815.00</b>
3"	4"	6-1802		<b>527.00</b>
4"	4"	6-1804	11.0	<b>555.00</b>
4-1/2"	4"	6-1805	11.0.0	<b>655.00</b>
4-1/2"	5"	6-1806		<b>710.00</b>
5"	5"	6-1807	12.1	<b>527.00</b>
6"	6"	8-1446		<b>795.00</b>

### Steel

4-1/2"	4"	6-8041	118.0	<b>901.00</b>
--------	----	--------	-------	---------------

## PLASTIC WEDGE (FOR HOSE PULL COUPLER)



Size	Part #	Weight	List
4"	9-6833		<b>62.00</b>
4-1/2"	9-6834		<b>72.00</b>

## BACK TO BACK COUPLER W/CHAINS



- Painted Steel

Size	Part #	Weight	List
3"	9-7568	5.0	<b>205.00</b>
4"	9-7344	6.0	<b>211.00</b>
5"	9-7345	7.0	<b>218.00</b>
6"	9-7346	8.5	<b>217.00</b>

## WELD-ON COUPLER W/CHAINS



- Black Steel

Size	Part #	Weight	List
3"	9-7569	2.5	<b>77.00</b>
4"	9-7347	3.0	<b>80.00</b>
5"	9-7348	3.5	<b>82.00</b>
6"	9-7349	4.3	<b>82.00</b>

## 3 LINK CHAIN



- Weld to coupler for hose pull coupler connection.
- Black Steel

Size	Part #	Weight	List
-	9-7342	0.8	<b>24.00</b>

## 1/2" BASE (BRASS)



20 JH

Description	Type	Part #	Weight	List
20 JH w/nozzle-Rainbird	full / brass	7-0109	0.5	30.15

### 20 JH

Straight Bore Nozzle  
Stream Height 6'

PSI @ Nozzle	7/64"		1/8"		9/64"		5/32"	
	Rad.	GPM	Rad.	GPM	Rad.	GPM	Rad.	GPM
35	38	2.05	38	2.68	39	3.39	39	4.19
40	38	2.19	39	2.86	40	3.62	39	4.47
45	39	2.32	39	3.03	40	3.84	40	4.73
50	39	2.45	39	3.20	40	4.05	40	5.00
55	39	2.57	40	3.35	40	4.24	40	5.23
60	39	2.68	40	3.50	41	4.43	41	5.47

## 1/2" BASE-PART TURN (PLASTIC)



429 PT

Description	Type	Part #	Weight	List
429 PT, w/nozzle-Naan	part / plastic	7-0296	0.2	14.50

### 429 NOZZLES

PSI @ Nozzle	Orange Nozzle 7/64"		Green Nozzle 1/8"		Blue Nozzle 9/64"		Black Nozzle 5/32"	
	GPM	Dia.	GPM	Dia.	GPM	Dia.	GPM	Dia.
15			1.80	66	2.30	67	2.70	69
20	1.60	66	2.10	68	2.50	69	3.10	70
30	2.00	70	2.60	75	3.00	77	3.80	80
40	2.30	74	3.00	78	3.40	82	4.40	83
50	2.60	77	3.30	82	3.80	84	4.90	85
60	2.90	79	3.70	84	4.20	86	5.40	90

## RAINBIRD 3/4" BASE (BRASS)



30 H



35A TNT

Description	Type	Part #	Weight	List
30 H w/nozzles	Full Circle	7-0110	0.9	<b>53.98</b>
35A TNT w/nozzle	Part Circle	7-0150	1.5	<b>108.59</b>

Straight Bore Nozzle  
Stream Height 9'

PSI @ Nozzle	9/64"		5/32"		11/64"		3/16"	
	Rad.	GPM	Rad.	GPM	Rad.	GPM	Rad.	GPM
25	40	2.90	41	3.50	41	4.30	42	5.10
30	40	3.10	42	3.90	44	4.70	45	5.60
35	41	3.40	43	4.20	45	5.10	47	6.00
40	41	3.60	44	4.50	46	5.40	48	6.40
45	42	3.80	44	4.70	46	5.70	49	6.80
50	42	4.10	45	5.00	47	6.10	50	7.20
55	43	4.20	45	5.20	48	6.30	50	7.60
60	43	4.40	46	5.50	48	6.60	51	7.90
65	44	4.60	46	5.80	49	6.90	51	8.20
70	44	4.80	47	5.90	49	7.20	52	8.50
75	45	5.00	47	6.10	50	7.40	52	8.80
80	45	5.10	48	6.30	50	7.70	53	9.10

Straight Bore Nozzle w/Spreader  
Stream Height 9'

PSI @ Nozzle	9/64" x 3/32"		5/32" x 3/32"		11/64" x 3/32"		3/16" x 3/32"		3/16" x 1/8"	
	Rad.	GPM	Rad.	GPM	Rad.	GPM	Rad.	GPM	Rad.	GPM
25	40	4.20	41	4.80	41	5.60	42	6.40	42	7.40
30	40	4.60	42	5.30	44	6.10	45	7.10	45	8.10
35	41	4.90	43	5.70	45	6.60	47	7.50	47	8.70
40	41	5.20	44	6.10	46	7.00	48	8.10	48	9.30
45	42	5.60	44	6.50	46	7.40	49	8.50	49	9.90
50	42	5.90	45	6.80	47	7.90	50	9.00	50	10.40
55	43	6.10	45	7.10	48	8.20	50	9.40	50	10.90
60	43	6.40	46	7.40	48	8.60	51	9.90	51	11.40
65	44	6.70	46	7.80	49	8.90	51	10.20	51	11.80
70	44	6.90	47	8.10	49	9.30	52	10.70	52	12.30
75	45	7.20	47	8.30	50	9.60	52	11.00	52	12.70
80	45	7.50	48	8.70	50	10.00	53	11.50	53	13.10

## WADE RAIN 3/4" BASE (BRASS)



WR-33



WR-35

Description	Type	Part #	Weight	List
WR-33 w/nozzles	Full Circle	9-7526	1.0	<b>22.00</b>
WR-35 w/nozzles	Part Circle	9-8125		<b>45.00</b>

Single Nozzle w/Plug  
27 Deg. Trajectory (No Vane)

PSI @ Nozzle	1/8"		9/94"		5/32"		11/64"		3/16"		13/64"		7/32"	
	Rad.	GPM	Rad.	GPM	Rad.	GPM	Rad.	GPM	Rad.	GPM	Rad.	GPM	Rad.	GPM
25	-	-	40	2.88	41	3.52	42	4.24	43	5.00	43	5.90	44	6.85
30	-	-	41	3.15	43	3.85	44	4.64	46	5.50	47	6.50	48	7.55
35	-	-	41	3.40	44	4.16	45	5.02	47	6.00	49	7.05	50	8.20
40	-	-	42	3.64	44	4.45	46	5.37	48	6.40	50	7.55	51	8.80
45	41	3.05	42	3.86	45	4.72	47	5.70	49	6.80	51	8.00	52	9.35
50	42	3.22	43	4.07	45	4.98	48	6.01	50	7.20	52	8.45	53	9.90
55	42	3.38	43	4.27	46	5.22	48	6.30	51	7.50	52	8.85	54	10.40
60	43	3.53	44	4.46	46	5.45	49	6.57	51	7.90	53	9.25	54	10.75
65	43	3.68	44	4.65	47	5.68	49	6.83	52	8.20	53	9.60	55	11.10
70	43	3.82	45	4.83	47	5.90	50	7.09	52	8.50	54	9.95	55	11.40
75	44	3.96	45	5.00	48	6.11	50	7.34	53	8.80	54	10.25	56	11.70
80	44	4.09	46	5.17	48	6.30	51	7.58	53	9.10	55	10.50	56	12.00

Double Nozzle  
27 Deg. Trajectory (No Vane)

PSI @ Nozzle	9/64" x 3/32" x		5/32" x 3/32" x		11/64" x 3/32" x		3/16" x 3/32" x		3/16" x 1/8"		13/64" x 1/8"		7/32" x 1/8"	
	Rad.	GPM	Rad.	GPM	Rad.	GPM	Rad.	GPM	Rad.	GPM	Rad.	GPM	Rad.	GPM
25	40	4.18	41	4.83	42	5.55	43	6.31	43	7.40	43	8.30	44	9.25
30	41	4.58	43	5.28	44	6.07	46	6.93	46	8.15	47	9.15	48	10.20
35	41	4.95	44	5.71	45	6.57	47	7.51	47	8.83	49	9.93	50	11.10
40	42	5.29	44	6.11	46	7.03	48	8.03	48	9.46	50	10.65	51	11.90
45	42	5.61	45	6.48	47	7.46	49	8.53	49	10.05	51	11.30	52	12.65
50	43	5.91	45	6.82	48	7.87	50	9.00	50	10.60	52	11.90	53	13.35
55	43	6.20	46	7.15	48	8.25	51	9.45	51	11.10	52	12.50	54	14.00
60	44	6.48	46	7.47	49	8.60	51	9.86	51	11.60	53	13.00	54	14.50
65	44	6.75	47	7.78	49	8.93	52	10.27	52	12.10	53	13.50	55	15.00
70	45	7.00	47	8.08	50	9.25	52	10.66	52	12.50	54	14.00	55	15.45
75	45	7.25	48	8.37	50	9.56	53	11.02	53	12.90	54	14.40	56	15.90
80	46	7.49	48	8.65	51	9.87	53	11.36	53	13.25	55	14.80	56	16.30

Gun Stands/Sprinklers

# SPRINKLERS



## 3/4" BASE (PLASTIC)



48 H

Description	Type	Part #	Weight	List
48 H w/nozzles-Rainbird	full / plastic	7-0120	0.3	16.69



Description	Size	Color	Part #	Weight	List
<b>Nozzle:</b>	5/32"	Black	9-7902		0.87
	11/64"	Brown	9-7903		0.87
	3/16"	Yellow	9-7904		0.87
	13/64"	Purple	9-7905		0.87
	7/32"	Orange	9-7906		0.87
<b>Spreader:</b>	3/32"	Green	9-7907		0.87
	1/8"	Blue	9-7908		0.87
<b>Back Plug:</b>	-	Orange	9-7909		0.87

Plastic Nozzle with Plug Performance										Plastic Nozzle with 3/32" Spreader Nozzle Performance										Plastic Nozzle with 1/8" Spreader Nozzle Performance									
psi @ Nozzle	NOZZLE SIZE					psi @ Nozzle	NOZZLE SIZE					psi @ Nozzle	NOZZLE SIZE																
	5/32" Rad. gpm	11/64" Rad. gpm	3/16" Rad. gpm	13/64" Rad. gpm	7/32" Rad. gpm		5/32" Rad. gpm	11/64" Rad. gpm	3/16" Rad. gpm	13/64" Rad. gpm	7/32" Rad. gpm		5/32" Rad. gpm	11/64" Rad. gpm	3/16" Rad. gpm	13/64" Rad. gpm	7/32" Rad. gpm												
30	-	-	-	-	-	30	-	-	-	-	-	30	-	-	-	-	-												
35	44	4.22	46	5.02	46	5.43	49	6.18	48	7.1	35	42	5.91	44	6.73	44	7.43	47	8.34	48	9.27								
40	46	4.5	48	5.48	50	6.26	52	7.22	50	8.27	40	45	6.32	45	7.24	46	8.02	49	8.91	50	10.03								
45	46	4.82	50	5.78	51	6.68	52	7.67	54	8.81	45	46	6.72	46	7.66	48	8.54	50	9.46	52	10.63								
50	48	5.03	51	6.17	52	7.1	53	8.12	54	9.29	50	46	7.1	48	8.1	50	9.01	52	10.04	54	11.19								
55	50	5.37	51	6.44	52	7.47	54	8.54	57	9.78	55	46	7.46	49	8.4	52	9.37	54	10.54	56	11.84								
60	50	5.54	51	6.67	52	7.7	55	8.93	58	10.25	60	47	7.76	50	8.88	52	9.89	54	11.04	56	12.3								
65	50	5.81	52	7.09	53	8.15	56	9.27	58	10.73	65	48	8.11	50	9.32	52	10.31	56	11.5	57	12.87								
70	51	6.04	54	7.33	54	8.45	56	9.66	58	11	70	48	8.39	51	9.59	54	10.66	56	11.95	58	13.29								
75	51	6.22	54	7.58	55	8.72	57	10	58	11.46	75	48	8.75	51	9.92	55	11.08	57	12.33	58	13.85								
80	51	6.46	55	7.84	55	8.97	57	10.31	59	11.8	80	49	8.99	52	10.25	55	11.46	58	12.75	60	14.24								

## 3/4" BASE (BRASS)



14070H

Description	Type	Part #	Weight	List
14070H w/nozzles-Rainbird	full / brass	7-0155	1.3	73.24

### Straight Bore Nozzle

Stream Height 10'

Psi @ Nozzle	5/32"		11/64"		3/16"		13/64"		7/32"		15/64"		1/4"		17/64"		9/32"	
	Rad.	GPM	Rad.	GPM	Rad.	GPM	Rad.	GPM	Rad.	GPM	Rad.	GPM	Rad.	GPM	Rad.	GPM	Rad.	GPM
25	-	-	-	-	44	5.10	45	6.00	46	7.00	46	8.00	47	9.10	48	10.30	48	11.50
30	-	-	-	-	47	5.60	48	6.60	49	7.60	50	8.80	51	10.00	51	11.20	52	12.60
35	46	4.20	47	5.10	49	6.10	50	7.10	51	8.20	52	9.50	52	10.80	53	12.00	54	13.60
40	46	4.50	48	5.40	50	6.50	51	7.60	52	8.80	53	10.10	54	11.50	55	13.00	56	14.60
45	47	4.80	49	5.80	51	6.90	52	8.10	54	9.30	55	10.70	56	12.20	57	13.80	58	15.40
50	48	5.00	50	6.10	52	7.20	53	8.50	55	9.80	56	11.30	57	12.90	58	14.50	59	16.30
55	48	5.30	50	6.40	53	7.60	54	8.90	56	10.30	54	11.80	59	13.50	59	15.20	61	17.10
60	49	5.50	51	6.70	53	7.90	55	9.30	57	10.80	58	12.40	60	14.10	61	15.90	62	17.80
65	49	5.70	52	6.90	54	8.30	56	9.70	58	11.20	59	12.90	61	14.70	62	16.50	63	18.50
70	50	5.90	52	7.20	55	8.60	57	10.00	59	11.60	60	13.40	62	15.20	63	17.20	65	19.20
75	50	6.20	53	7.40	55	8.90	58	10.40	60	12.10	61	13.80	63	15.70	-	-	-	-
80	50	6.40	53	7.70	56	9.10	58	10.70	61	12.40	62	14.30	64	16.30	-	-	-	-

### Straight Bore Nozzle w/Spreader

Stream Height 10'

Psi @ Nozzle	3/16" x 1/8"		13/64" x 1/8"		7/32" x 1/8"		15/64" x 1/8"		1/4" x 1/8"		17/64" x 1/8"		9/32" x 1/8"	
	Rad.	GPM	Rad.	GPM	Rad.	GPM	Rad.	GPM	Rad.	GPM	Rad.	GPM	Rad.	GPM
25	44	7.40	45	8.30	46	9.20	46	10.30	47	11.40	47	12.50	48	13.80
30	47	8.10	48	9.10	49	10.10	50	11.20	54	12.40	51	13.70	52	15.10
35	49	8.70	50	9.80	51	10.90	52	12.10	52	13.40	53	14.80	54	16.30
40	50	9.30	51	10.50	52	11.70	53	13.00	54	14.40	55	15.80	56	17.40
45	51	9.90	52	11.10	54	12.40	55	13.80	56	15.20	57	16.80	58	18.50
50	52	10.40	53	11.70	55	13.10	56	14.50	57	13.10	58	17.70	59	19.50
55	53	10.90	54	12.30	56	13.70	57	15.20	59	16.90	59	18.60	61	20.40
60	53	11.40	55	12.80	57	14.30	58	15.90	60	17.60	61	19.40	62	21.30
65	54	11.90	56	13.30	58	14.90	59	16.50	61	18.30	62	20.20	63	22.20
70	55	12.40	57	13.80	59	15.40	60	17.20	62	19.00	63	21.00	65	23.00
75	55	12.80	58	14.30	60	16.00	61	17.80	63	19.70	-	-	-	-
80	56	13.20	58	14.80	61	16.50	62	18.40	64	20.30	-	-	-	-

## 1-1/4" BASE (BRASS)

Description	Type	Part #	Weight	List
80 E w/nozzles-Rainbird	Full Circle	9-7761	5.0	332.34
85 EHD w/nozzles-Rainbird	Full Circle	9-7762	5.3	379.40
85 EHD-LA w/noz.-Rainbird	Part Turn	9-7763	5.3	379.40



**80 E**  
27°



**85 EHD**  
27°



**85 EHD-LA**  
17°

Straight Bore Nozzle w/Spreader  
Stream Height 14'

PSI @ Nozzle	11/32" x 7/32"		3/8" x 7/32"		13/32" x 7/32"		7/16" x 7/32"		15/32" x 7/32"	
	Rad.	GPM	Rad.	GPM	Rad.	GPM	Rad.	GPM	Rad.	GPM
25	61	23.30	62	26.50	64	29.60	66	32.90	66	36.40
30	64	25.60	65	29.10	68	32.40	69	36.10	72	40.00
35	67	27.70	68	31.40	72	35.10	74	39.00	77	43.30
40	69	29.60	71	33.60	75	37.60	77	41.80	80	46.30
45	71	31.50	73	35.70	77	39.90	79	44.40	82	49.20
50	73	33.20	75	37.70	79	42.10	81	46.80	84	51.90
55	75	34.90	77	39.70	81	44.30	83	49.10	86	54.70
60	77	36.50	79	41.40	83	46.60	86	51.50	88	57.20
65	79	38.00	81	43.20	84	48.60	87	53.80	90	59.80
70	81	40.10	83	44.90	86	50.40	89	55.90	91	62.10
75	82	41.00	84	46.70	87	52.40	90	57.90	93	64.30
80	83	42.60	86	48.30	89	54.30	92	60.00	94	66.70
85	85	43.80	87	49.80	90	56.00	93	62.00	96	68.80
90	86	45.70	89	51.40	92	57.90	95	63.90	97	70.70
95	87	46.60	90	53.00	93	59.60	96	65.80	98	72.80
100	88	47.90	91	54.50	94	61.20	97	67.50	99	74.80

## 1" BASE-PART TURN (BRASS)

Description	Type	Part #	Weight	List
65JADJ-TNT-Rainbird	Part Turn	7-0160	3.6	313.51

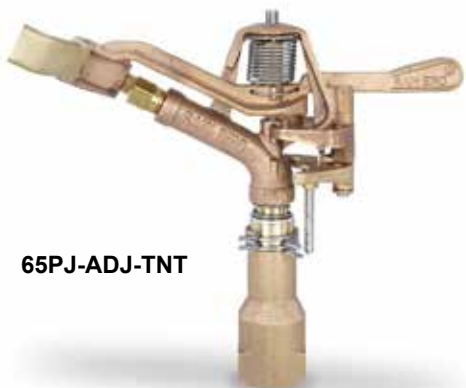

**65PJ-ADJ-TNT**

Straight Bore Nozzle  
Stream Height 10'

PSI @ Nozzle	1/4"	
	Rad.	GPM
50	57	12.90
55	57	13.60
60	58	14.20
65	62	14.90
70	63	15.40
75	64	16.00
80	65	16.50

# SPRINKLERS

## 1" BASE (BRASS)



70CWH

Description	Type	Part #	Weight	List
70CWH w/nozzles-Rainbird	Full Circle	7-0130	3.0	218.68

Straight Bore Nozzle w/Plug  
Stream Height 8'

PSI @ Nozzle	7/32"		1/4"		9/32"		5/16"		11/32"		3/8"		13/32"	
	Rad.	GPM	Rad.	GPM	Rad.	GPM	Rad.	GPM	Rad.	GPM	Rad.	GPM	Rad.	GPM
40	57	8.80	60	11.50	62	14.60	65	17.70	66	21.10	68	24.40	70	28.50
45	58	9.40	61	12.20	64	15.50	66	18.90	68	22.50	70	26.00	72	30.40
50	59	9.90	62	12.90	65	16.30	68	20.00	70	23.80	71	27.50	73	32.30
55	60	10.40	63	13.60	66	17.20	71	21.00	71	25.00	73	29.10	75	34.00
60	61	10.90	64	14.20	67	18.00	71	22.00	73	26.20	74	30.60	77	35.70
65	62	11.40	65	14.80	68	18.80	72	23.00	74	27.40	76	32.00	78	37.30
70	63	11.80	66	15.40	70	19.50	73	23.90	76	28.50	77	33.20	79	38.90
75	64	12.20	67	16.00	71	20.30	74	24.80	77	29.60	78	34.50	81	40.40
80	65	12.60	68	16.50	72	20.90	75	25.70	78	30.60	80	35.70	82	41.80

Straight Bore Nozzle w/Spreader  
Stream Height 8'

PSI @ Nozzle	7/32" x 1/8"		1/4" x 1/8"		9/32" x 1/8"		5/16" x 1/8"		11/32" x 1/8"		3/8" x 1/8"		13/32" x 1/8"	
	Rad.	GPM	Rad.	GPM	Rad.	GPM	Rad.	GPM	Rad.	GPM	Rad.	GPM	Rad.	GPM
40	57	11.60	60	14.30	62	17.40	65	20.50	61	23.90	68	27.20	70	31.40
45	58	12.40	61	15.20	64	18.50	66	21.90	68	25.50	70	29.00	72	33.40
50	59	13.00	62	16.00	65	19.40	68	23.10	70	26.90	71	30.60	73	35.50
55	60	13.70	63	16.90	66	20.40	70	24.30	71	28.30	73	32.40	75	37.40
60	61	14.30	64	17.60	67	21.40	71	25.40	73	29.60	74	34.00	77	39.20
65	62	15.00	65	18.40	69	22.40	72	26.60	74	31.00	76	35.60	78	40.90
70	63	15.50	66	19.10	70	23.20	73	27.60	75	32.20	77	36.90	79	42.70
75	64	16.00	67	19.80	71	24.10	74	28.60	77	33.40	78	38.30	81	44.30
80	65	16.50	68	20.40	72	24.80	75	29.60	78	34.50	80	39.60	82	45.80

## 1" BASE (PLASTIC)



7025



7025 Arm

Description	Type	Part #	Weight	List
7025 w/nozzles-Senninger	Full Circle	7-0140	1.1	69.50
#7025 Arm Only-Senninger	-	7-0141	0.3	23.00

Sprinkler Base Pressure (psi)	35	40	45	50	55	60	65	70
<b>#14 Nozzle (7/32")</b>								
Flow (gpm)	8.11	8.66	9.2	9.69	10.2	10.6	11	11.5
Diam. At 1.5' ht. (ft.)	106	111	113	115	117	119	121	123
Diam. At 6.0' ht. (ft.)	114	118	121	124	126	128	129	130
<b>#16 Nozzle (1/4")</b>								
Flow (gpm)	10.7	11.4	12.1	12.8	13.4	14	14.6	15.1
Diam. At 1.5' ht. (ft.)	111	117	120	123	126	129	131	133
Diam. At 6.0' ht. (ft.)	122	126	129	131	134	136	137	138
<b>#18 Nozzle (9/32")</b>								
Flow (gpm)	13.3	14.2	15	15.9	16.6	17.4	18.1	18.8
Diam. At 1.5' ht. (ft.)	118	124	127	129	134	139	142	144
Diam. At 6.0' ht. (ft.)	128	132	135	137	141	144	146	147
<b>#20 Nozzle (5/16")</b>								
Flow (gpm)	16	17.1	18.2	19.2	20.1	21	21.8	22.7
Diam. At 1.5' ht. (ft.)	124	130	134	137	142	146	150	153
Diam. At 6.0' ht. (ft.)	133	137	140	143	147	151	154	155
<b>#22 Nozzle (11/32")</b>								
Flow (gpm)	19.3	20.5	21.8	22.9	24.1	25.1	26.1	27.1
Diam. At 1.5' ht. (ft.)	126	133	141	148	153	157	160	162
Diam. At 6.0' ht. (ft.)	136	141	146	150	155	159	162	164
<b>#24 Nozzle (3/8")</b>								
Flow (gpm)	22.4	23.9	25.3	26.7	28	29.3	30.4	31.6
Diam. At 1.5' ht. (ft.)	130	138	145	151	156	160	166	169
Diam. At 6.0' ht. (ft.)	138	145	150	155	160	164	167	170

## NOZZLE (FOR 3/4" SPRINKLER)



Order vane separately.

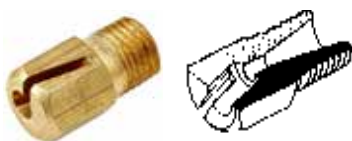

Description	Size	Part #	Weight	List
Range	1/8"	.125	7-0360	2.13
Range	9/64"	.140625	7-0330	2.13
Range	5/32"	.15625	7-0331	2.13
Range	11/64"	.171875	7-0332	2.13
Range	3/16"	.1875	7-0333	2.13
Range	13/64"	.203125	7-0334	2.13
Range	7/32"	.21875	7-0335	2.13
Range	15/64"	.234375	7-0336	2.13
Range	1/4"	.25	7-0337	2.13
Range	17/64"	.265625	7-0338	2.13
Range	9/32"	.28125	7-0339	2.13
Spreader 7°	3/32"	.09375	9-7804	1.50
Spreader 7°	7/64"	.109375	9-7805	1.50
Spreader 7°	1/8"	.125	9-7806	1.50
Spreader 7°	9/64"	.140625	9-7807	1.50
Spreader 7°	5/32"	.15625	9-7808	1.50
Spreader 7°	11/64"	.171875	9-7809	1.50
Spreader 7°	3/16"	.1875	9-7810	1.50
Spreader 7°	13/64"	.20313	9-7812	1.50
Spreader 7°	7/32"	.21875	9-7811	1.50
Spreader 20°	3/32"	.09375	7-0340	2.13
Spreader 20°	7/64"	.109375	7-0366	1.76
Spreader 20°	1/8"	.125	7-0341	2.13
Spreader 20°	9/64"	.140625	7-0362	1.76
Spreader 20°	5/32"	.15625	7-0361	1.76
Spreader 20°	11/64"	.171875	7-0364	1.76
Spreader 20°	3/16"	.1875	7-0365	1.76
Spreader 20°	13/64"	.20313	9-7813	1.50
Spreader 20°	7/32"	.21875	7-0363	1.76
Vanes for #30			6-9692	0.60
Back Plug			7-0342	1.23

## NOZZLE (FOR 1" SPRINKLER)

Brass:

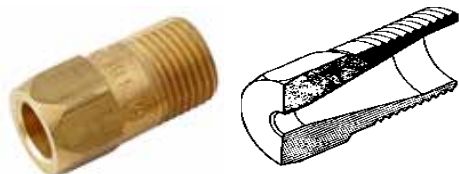

Plastic:

Description	Size	Part #	Weight	List
Range	7/32"	.21875	7-0343	8.51
Range	1/4"	.25	7-0344	9.36
Range	9/32"	.28125	7-0345	9.36
Range	5/16"	.3125	7-0346	8.51
Range	11/32"	.34375	7-0347	8.51
Range	3/8"	.375	7-0348	8.51
Range	13/32"	.40625	7-0349	8.51

Description	Size	Part #	Weight	List
Range #14	7/32"	.21875	7-0350	2.50
Range #16	1/4"	.25	7-0351	2.50
Range #18	9/32"	.28125	7-0352	2.50
Range #20	5/16"	.3125	7-0353	2.50
Range #22	11/32"	.34375	7-0354	2.50
Range #24	3/8"	.375	7-0355	2.50

## BEARING ASSEMBLY (FOR #30 RAINBIRD)



Size	Part #	Weight	List
3/4"	7-0356		11.30

Gun Stands/Sprinklers

## SMALL SPRINKLERS SIME

Description	Size	Part #	Weight	List
Funny	1" FPT	9-7717		76.00
K-1	1-1/4" FPT	9-7718		127.00
Hidra	1-1/2" FPT	9-7719		229.00



Funny Sprinkler

<b>FUNNY (28° Trajectory) 1" FNPT</b>									
PSI	Nozzle 5mm (.20")		Nozzle 6mm (.24")		Nozzle 7mm (.28")		Nozzle 9mm (.35")		Diameter
	GPM	Diameter	GPM	Diameter	GPM	Diameter	GPM	Diameter	
22	5.3	84	7	86	10	92	16.4	100	
29	6	92	8.5	96	11	100	19	108	
44	7	100	10	108	14	112	23	122	
58	9	108	12	116	16	122	26	128	



K-1 Sprinkler

<b>K1 (30° Trajectory) 1.25" FNPT Connection</b>									
PSI	Nozzle 8mm (.315")		Nozzle 9mm (.354")		Nozzle 10mm (.394")		Nozzle 12mm (.472")		Diameter
	GPM	Diameter	GPM	Diameter	GPM	Diameter	GPM	Diameter	
22	13	102	16	108	20	112	29	112	
29	15	112	19	114	23	118	34	124	
44	18	124	23	128	28	134	41	136	
58	21	134	26	138	33	144	47	154	



Hidra Sprinkler

<b>HIDRA (25° Trajectory) 1.5" FNPT Connection</b>									
PSI	Nozzle 12mm (.47")		Nozzle 14mm (.55")		Nozzle 16mm (.63")		Nozzle 18mm (.71")		Diameter
	GPM	Diameter	GPM	Diameter	GPM	Diameter	GPM	Diameter	
29	40	130	52	138	65	144	-	-	
44	48	156	63	164	80	170	100	184	
58	56	176	73	190	93	196	115	202	
73	62	196	81	202	103	216	128	224	
88	-	-	-	-	-	-	140	236	

## SMALL SPRINKLERS KOMET

Description	Size	Part #	Weight	List
#163	1-1/2" FPT	9-7826		325.00



### Taper Bore Nozzle

Noz Psi	Nozzle .31" 8 MM		Nozzle .39" 10 MM		Nozzle .47" 14 MM		Nozzle .55" 14 MM		Nozzle .63" 16 MM	
	GPM	DIA	GPM	DIA	GPM	DIA	GPM	DIA	GPM	DIA
40	26	141	35	154	47	167	61	175	77	182
50	29	151	39	165	53	179	68	188	86	197
60	32	159	43	177	58	190	75	200	94	210
70	34	165	46	185	62	198	81	208	101	218
80	36	173	50	193	67	208	87	216	109	224





Description	Type	Part #	Weight	List
F100 w/nozzle	Full Circle	7-0230	20.5	<b>954.91</b>
F150R w/nozzle	Full Circle	7-0240	43.0	<b>2,026.56</b>
F200 w/nozzle	Full Circle	7-0280	56.0	<b>3,236.00</b>
SR100 w/nozzle	Part Turn	7-0295	26.5	<b>1,436.91</b>
SR150 w/nozzle	Part Turn	7-0250	49.0	<b>2,454.56</b>
SR200 w/nozzle	Part Turn	7-0290	78.0.0	<b>4,533.00</b>



Nelson SR100



Nelson SR150



Nelson SR200

- Includes one nozzle on all guns.
- Includes flg x fpt adapter on 150 & 200 guns.

### 100 TAPER BORE NOZZLE — 24° TRAJECTORY

PSI	0.5"		0.55"		0.6"		0.65"		0.7"		0.75"		0.8"		0.85"		0.9"		1.0"	
	GPM	DIAM. FT.	GPM	DIAM. FT.	GPM	DIAM. FT.	GPM	DIAM. FT.	GPM	DIAM. FT.	GPM	DIAM. FT.	GPM	DIAM. FT.	GPM	DIAM. FT.	GPM	DIAM. FT.	GPM	DIAM. FT.
40	47	191	57	202	66	213	78	222	91	230	103	240	118	250	134	256	152	262	—	—
50	50	205	64	215	74	225	87	235	100	245	115	256	130	265	150	273	165	280	204	300
60	55	215	69	227	81	240	96	250	110	260	126	270	143	280	164	288	182	295	224	316
70	60	225	75	238	88	250	103	263	120	275	136	283	155	295	177	302	197	310	243	338
80	64	235	79	248	94	260	110	273	128	285	146	295	165	305	189	314	210	325	258	354
90	68	245	83	258	100	270	117	283	135	295	155	306	175	315	201	326	223	335	274	362
100	72	255	87	268	106	280	123	293	143	305	163	316	185	325	212	336	235	345	289	372
110	76	265	92	278	111	290	129	303	150	315	171	324	195	335	222	344	247	355	304	380

### 150 TAPER BORE NOZZLE — 24° TRAJECTORY

PSI	0.7"		0.8"		0.9"		1.0"		1.1"		1.2"		1.3"		1.4"	
	GPM	DIAM. FT.	GPM	DIAM. FT.	GPM	DIAM. FT.	GPM	DIAM. FT.	GPM	DIAM. FT.	GPM	DIAM. FT.	GPM	DIAM. FT.	GPM	DIAM. FT.
50	100	250	130	270	165	290	205	310	255	330	300	345	350	360	408	373
60	110	265	143	285	182	305	225	325	275	345	330	365	385	380	446	396
70	120	280	155	300	197	320	245	340	295	360	355	380	415	395	483	412
80	128	290	165	310	210	335	260	355	315	375	380	395	445	410	516	427
90	135	300	175	320	223	345	275	365	335	390	405	410	475	425	547	442
100	143	310	185	330	235	355	290	375	355	400	425	420	500	440	577	458
110	150	320	195	340	247	365	305	385	370	410	445	430	525	450	605	471
120	157	330	204	350	258	375	320	395	385	420	465	440	545	460	632	481

### 200 TAPER BORE NOZZLE — 27° TRAJECTORY

PSI	1.05"		1.1"		1.2"		1.3"		1.4"		1.5"		1.6"		1.75"		1.9"	
	GPM	DIAM. FT.	GPM	DIAM. FT.	GPM	DIAM. FT.	GPM	DIAM. FT.	GPM	DIAM. FT.	GPM	DIAM. FT.	GPM	DIAM. FT.	GPM	DIAM. FT.	GPM	DIAM. FT.
60	250	345	285	355	330	375	385	390	445	410	515	430	585	445	695	470	825	495
70	270	360	310	380	355	395	415	410	480	430	555	450	630	465	755	495	890	515
80	290	375	330	395	380	410	445	430	515	450	590	470	675	485	805	515	950	535
90	310	390	350	410	405	425	475	445	545	465	625	485	715	505	855	535	1005	555
100	325	400	370	420	425	440	500	460	575	480	660	500	755	520	900	550	1060	575
110	340	410	390	430	445	450	525	470	605	495	695	515	790	535	945	565	1110	590
120	355	420	405	440	465	460	545	480	630	505	725	530	825	550	985	580	1160	605
130	370	425	425	445	485	465	565	485	655	515	755	540	860	560	1025	590	1210	620

Gun Stands/Sprinklers

# KOMET (TWIN) VOLUME GUNS



Description	Pattern	Angle	Connection	Part #	Weight	List
Twin 101 Ultra	Part & Full	18° Pivot	2" Thread	7-0231	20.9	<b>1,287.30</b>
Twin 101 Ultra	Part & Full	24°	Flange/FPT	6-9769	20.9	<b>1,287.30</b>
Twin 101 Ultra	Part & Full	Vari Angle	Flange/FPT	6-9770	23.2	<b>1,539.30</b>
Twin 101 Ultra	Full Circle	24°	Flange/FPT	6-9771	18.7	<b>910.30</b>
Twin 101 Ultra Dust Control	Part & Full	44°	Flange/FPT	6-9775	20.9	<b>1,287.30</b>
Twin 101 Ultra Dust Control	Part & Full	Vari Angle	Flange/FPT	6-9776	23.2	<b>1,539.30</b>
Twin 140 Ultra	Part & Full	24°	Flanged	7-0251	22.1	<b>1,678.40</b>
Twin 140 Ultra	Part & Full	Vari Angle	Flanged	6-9777	22.1	<b>1,996.40</b>
Twin 140 Ultra Dust Control	Part & Full	44°	Flanged	6-9778	22.1	<b>1,678.40</b>
Twin 140 Ultra Dust Control	Part & Full	Vari Angle	Flanged	6-9779	25.4	<b>1,996.40</b>
Twin 160 Ultra	Part & Full	24°	Flanged	6-9780	29.8	<b>1,961.60</b>
Twin 160 Ultra	Part & Full	Vari Angle	Flanged	6-9781	34.2	<b>2,335.60</b>
Twin 160 Ultra	Full Circle	24°	Flanged	6-9782	25.4	<b>1,400.60</b>
Twin 202 Ultra	Part & Full	24°	Flanged	7-0300	30.9	<b>2,271.60</b>
Twin 202 Ultra	Part & Full	Vari Angle	Flanged	6-9786	35.3	<b>2,707.60</b>

- Includes one nozzle on all guns.
- Includes flg x 3" fpt adapter and gasket on 140, 160 & 202 guns.
- Vari Angle Guns adjust from 15° to 45°.



Twin 101 Ultra Performance Chart

Pressure PSI	Nozzle Ø12mm 0.47"		Nozzle Ø13mm 0.51"		Nozzle Ø14mm 0.55"		Nozzle Ø15mm 0.59"		Nozzle Ø16mm 0.63"		Nozzle Ø17mm 0.67"		Nozzle Ø18mm 0.71"		Nozzle Ø19mm 0.75"		Nozzle Ø20mm 0.79"		Nozzle Ø21mm 0.83"	
	Flow	Throw DIA.	Flow	Throw DIA.	Flow	Throw DIA.	Flow	Throw DIA.	Flow	Throw DIA.	Flow	Throw DIA.	Flow	Throw DIA.	Flow	Throw DIA.	Flow	Throw DIA.	Flow	Throw DIA.
	GPM	ft	GPM	ft	GPM	ft	GPM	ft	GPM	ft	GPM	ft	GPM	ft	GPM	ft	GPM	ft	GPM	ft
30	35	193	41	194	48	195	55	196	62	197	70	198	78	199	87	200	97	201	107	202
40	40	206	47	209	55	213	63	216	71	220	81	224	90	228	101	232	112	236	123	240
50	45	213	53	219	62	224	71	230	80	235	90	241	101	247	113	253	125	259	138	264
60	50	219	58	226	67	233	77	240	87	247	99	254	111	262	124	269	137	276	151	283
70	54	229	63	234	73	242	84	250	94	258	107	266	119	275	134	283	148	291	163	298
80	57	235	67	243	78	252	89	261	101	270	114	279	128	287	143	296	158	305	174	312
90	61	243	71	252	83	262	95	271	107	281	121	290	135	299	151	307	168	316	185	324
100	64	250	75	260	87	269	100	279	113	289	128	298	143	307	160	316	177	325	195	333
110	67	256	79	266	91	276	105	285	118	295	134	304	150	313	167	323	186	332	204	341

# KOMET (TWIN) VOLUME GUNS



Twin 140 Ultra Performance Chart

Pressure PSI	Nozzle Ø16mm 0.63"		Nozzle Ø17mm 0.67"		Nozzle Ø18mm 0.71"		Nozzle Ø19mm 0.75"		Nozzle Ø20mm 0.79"		Nozzle Ø21mm 0.83"		Nozzle Ø22mm 0.87"		Nozzle Ø23mm 0.91"		Nozzle Ø24mm 0.94"		Nozzle Ø25mm 0.98"		
	Flow	Throw DIA.	Flow	Throw DIA.	Flow	Throw DIA.	Flow	Throw DIA.	Flow	Throw DIA.	Flow	Throw DIA.	Flow	Throw DIA.	Flow	Throw DIA.	Flow	Throw DIA.	Flow	Throw DIA.	
	GPM	ft	GPM	ft	GPM	ft	GPM	ft	GPM	ft	GPM	ft	GPM	ft	GPM	ft	GPM	ft	GPM	ft	GPM
30	62	198	70	199	78	200	87	201	97	202	107	203	117	204	127	206	139	207	151	208	
40	71	221	81	225	90	229	101	233	112	237	123	241	135	245	147	248	161	252	175	256	
50	80	236	90	242	101	248	113	254	125	260	138	266	151	271	164	277	180	282	195	288	
60	87	248	99	256	111	263	124	270	137	278	151	284	165	291	180	297	197	304	214	311	
70	94	259	107	268	119	276	134	284	148	293	163	300	178	307	194	314	212	321	231	329	
80	101	271	114	280	128	289	143	298	158	306	174	314	191	321	208	329	227	336	247	345	
90	107	282	121	291	135	300	151	309	168	318	185	326	202	334	220	342	241	350	262	359	
100	113	290	128	299	143	308	160	318	177	327	195	335	213	343	232	352	254	360	276	370	
110	118	296	134	306	150	315	167	324	186	334	204	343	224	352	244	360	266	369	290	379	



Twin 160 Ultra Performance Chart

Pressure PSI	Nozzle Ø18mm 0.71"		Nozzle Ø19mm 0.75"		Nozzle Ø20mm 0.79"		Nozzle Ø21mm 0.83"		Nozzle Ø22mm 0.87"		Nozzle Ø23mm 0.91"		Nozzle Ø24mm 0.94"		Nozzle Ø25mm 0.98"		Nozzle Ø26mm 1.02"		Nozzle Ø27mm 1.06"		Nozzle Ø28mm 1.10"		Nozzle Ø29mm 1.14"		
	Flow	Throw DIA.	Flow	Throw DIA.	Flow	Throw DIA.	Flow	Throw DIA.	Flow	Throw DIA.	Flow	Throw DIA.	Flow	Throw DIA.	Flow	Throw DIA.	Flow	Throw DIA.	Flow	Throw DIA.	Flow	Throw DIA.	Flow	Throw DIA.	
	GPM	ft	GPM	ft	GPM	ft	GPM	ft	GPM	ft	GPM	ft	GPM	ft	GPM	ft	GPM	ft	GPM	ft	GPM	ft	GPM	ft	GPM
40	92	228	101	232	113	236	124	239	137	243	150	247	163	251	176	254	192	258	206	261	222	265	238	270	
50	102	254	113	260	127	266	138	272	153	277	168	283	182	289	197	295	215	301	230	307	248	313	266	317	
60	112	272	124	280	139	287	152	294	167	301	184	308	199	314	216	322	235	336	252	336	272	344	292	349	
70	121	284	134	292	150	301	164	308	181	315	199	323	215	330	233	338	254	347	273	355	294	363	315	371	
80	130	293	143	306	160	311	175	319	193	326	212	334	230	341	249	351	272	360	291	369	314	378	337	386	
90	137	303	152	312	170	321	186	329	205	337	225	345	244	353	264	362	288	372	309	381	333	391	357	399	
100	145	311	160	319	179	330	196	338	216	347	237	355	257	364	278	374	304	383	326	392	351	402	377	410	
110	152	319	168	329	188	338	205	347	226	356	249	365	270	374	292	384	319	393	342	402	368	412	395	420	
120	159	326	175	336	196	346	215	355	237	365	260	374	281	384	305	393	333	402	357	411	384	420	413	429	
130	165	334	182	344	204	354	223	364	246	373	271	383	293	392	317	401	347	410	371	439	400	428	429	436	



Twin 202 Ultra Performance Chart

Pressure PSI	Nozzle Ø22mm 0.87"		Nozzle Ø23mm 0.91"		Nozzle Ø24mm 0.94"		Nozzle Ø25mm 0.98"		Nozzle Ø26mm 1.02"		Nozzle Ø27mm 1.06"		Nozzle Ø28mm 1.10"		Nozzle Ø29mm 1.14"		Nozzle Ø30mm 1.18"		Nozzle Ø31mm 1.22"		Nozzle Ø32mm 1.26"		Nozzle Ø33mm 1.30"		
	Flow	Throw DIA.	Flow	Throw DIA.	Flow	Throw DIA.	Flow	Throw DIA.	Flow	Throw DIA.	Flow	Throw DIA.	Flow	Throw DIA.	Flow	Throw DIA.	Flow	Throw DIA.	Flow	Throw DIA.	Flow	Throw DIA.	Flow	Throw DIA.	
	GPM	ft	GPM	ft	GPM	ft	GPM	ft	GPM	ft	GPM	ft	GPM	ft	GPM	ft	GPM	ft	GPM	ft	GPM	ft	GPM	ft	GPM
40	137	243	150	247	163	251	176	255	192	258	206	262	222	265	238	270	255	275	273	279	292	284	307	284	
50	153	280	168	286	182	291	197	298	215	304	230	310	248	316	266	319	285	323	305	327	326	331	343	336	
60	167	303	184	310	199	317	216	325	235	332	252	339	272	347	292	352	312	357	334	363	357	368	376	375	
70	181	317	199	324	215	332	233	340	254	348	273	357	294	365	315	373	337	380	361	388	386	395	406	402	
80	193	328	212	336	230	343	249	352	272	361	291	370	314	380	337	381	360	396	386	404	412	412	434	419	
90	205	340	225	347	244	355	264	364	288	374	309	383	333	393	357	401	382	408	410	416	437	424	461	433	
100	216	348	237	357	257	366	278	375	304	385	326	394	351	404	377	412	403	420	432	428	461	436	486	446	
110	226	359	249	368	270	377	292	386	319	396	342	405	368	415	395	423	423	431	453	440	484	448	509	459	
120	237	369	260	379	281	388	305	397	333	407	357	416	384	425	413	434	441	442	473	450	505	458	532	470	
130	246	377	271	387	293	397	317	406	347	415	371	424	400	433	429	441	460	449	492	457	526	466	554	477	

Gun Stands/Sprinklers

# RIVER GEAR DRIVE SPRINKLERS



## RIVER (P-190)

Description	Pattern	Part #	Weight	List
River w/Nozzles	Part & Full	7-0325	10.4	395.00



1 1/2" FPT base  
Includes 3 nozzles  
120' - 228' Diameter

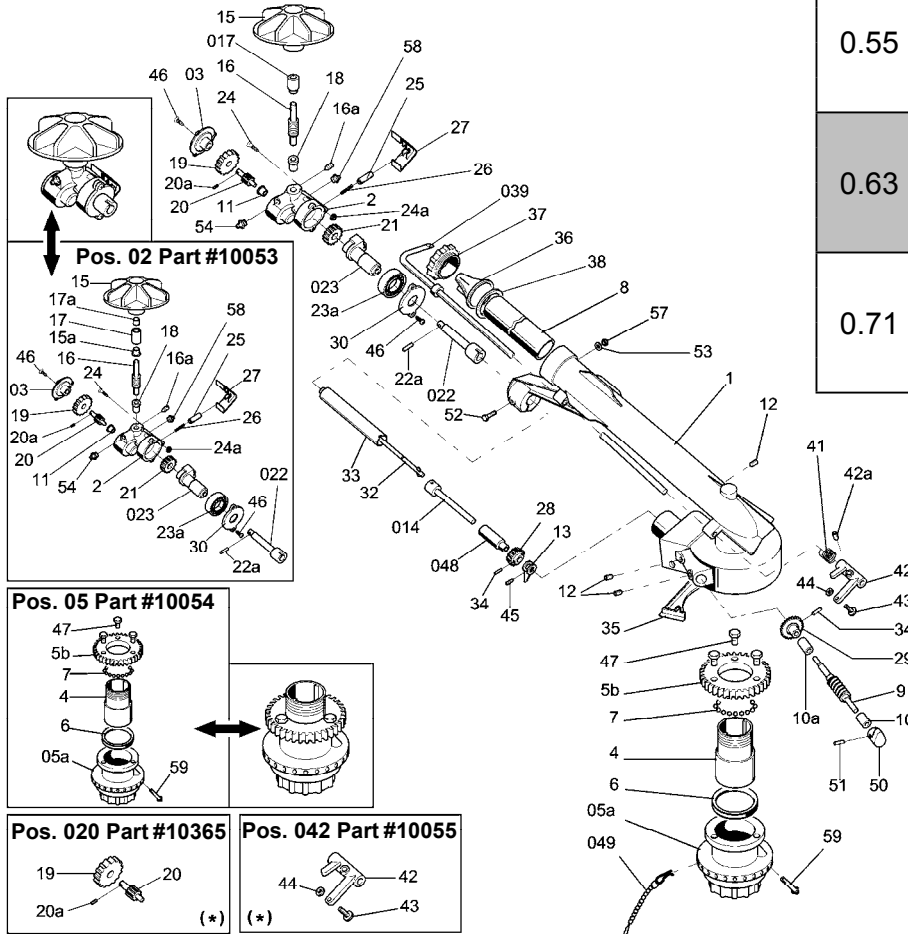

River 190 28 Degree				
Nozzle Diameter		Pressure	Diameter	Discharge
Inch	MM	PSI	Feet	GPM
0.4	10	29	120	23
		37	132	26
		44	136	28
		56	150	33
0.47	12	37	136	38
		44	144	41
		51	156	44
		56	170	47
0.55	14	37	136	51
		44	150	56
		51	164	61
		66	176	68
0.63	16	44	164	73
		51	176	79
		56	188	84
		70	204	94
0.71	18	44	164	92
		56	204	107
		70	216	119
		85	228	131

Gear-driven sprinklers are ideal for use on delicate seeds and plants or on heavy soils where light, gentle applications are required. Smooth running, continuous rotation makes these ideal for use on tripods, travelers or as an end sprinkler on pivots. All nozzles come complete with 22° and 28° trajectory nozzles. Companion flanges included.

- Advantages of "Sime" green Italian gear-driven volume sprinklers
- Smooth, continuous rotation with superior stream break-up and less vibration compared to impact driven guns.
  - Gentle sweeps are ideal for tender crops such as carrots, spinach, green beans, etc.
  - Give better coverage due to their rapid rotation (average 90 seconds).
  - Will run in lower temperatures without freezing.
  - Includes flip nozzles allowing one gun to have 22 & 28 degree capabilities.
  - Full & part-circle arc adjustments require no tools.
  - Priced lower than impact-driven volume guns.
  - Optional 25° nozzle available.

# RIVER GEAR DRIVE SPRINKLERS

**River**

Pos #	Part #	Description	List Price
1	30168	Sprinkler Body	153.10
2	30169	Gearbox	40.30
02	10053	Whole Head	310.60
02am	10169	Complete American Gearbox	446.20
03	10378	Cover w/ Bearing	11.40
4	30172	Internal Body	46.60
05	10054	Complete Crown	240.00
05a	10380	Crown	78.80
5b	30175	Toothed Ring	36.30
6	30176	U-Packing	8.30
7	30177	Sphere (Requires 36)	0.40
8	30178	Rectifier	12.90
9	30620	Worm Carter	29.93
10	30180	External Body Bearing	7.50
10a	30181	Internal Body Bearing	5.60
11	30182	Pinion Bearing	4.80
12	30183	Grub Screw	1.60
13	30184	Inversion Lever	9.50
014	10084-S	Complete Shaft	17.00
15	30186	Propeller	26.30
15a	30677	Du-Bearing For Gearbox	8.00
16	30628	Endless Screw	35.00
16a	30187	Grub Screw	1.60
017	10293	Bearing House	26.30
17a	30189	Du Bearing	10.50
18	30190	Blind Bearing	12.60
19	30191	Toothed Wheel	28.00
20	30192	Gearbox Pinion	11.20
020	10365-S	Complete Pinion	35.00
20a	30193	Pin For Pinion	1.00
21	30109	Gearbox Gear	16.00
22	30195	Gearbox Shaft	13.20
022	10459-S	Pin Head	Call
22a	30196	Elastic Pin	1.00
023	10411	Gearbox Support	30.60
23a	30198	Ball Bearing	20.20
24	30199	Screw	0.80
24a	30200	Nut	0.40

Pos #	Part #	Description	List Price
25	30201	Spring House	5.10
26	30203	Inversion Spring	1.80
27	30204	Cover	2.80
28	30205	Gear Z11	15.75
29	30206	Gear Z14	9.50
30	30207	Cover	6.90
32	20031	Shafting Bar	10.10
33	20032	Shafting Bar Cover	8.10
34	30208	Elastic Pin	1.00
35	30209	Inversion Lever Cover	4.80
36	30210-10	Nozzle 10Mm (.0040"), River	10.50
36	30210-12	Nozzle 12Mm (.0047"), River	10.50
36	30210-14	Nozzle 14Mm (.0055"), River	10.50
36	30210-16	Nozzle 16Mm (.0063"), River	10.50
36	30210-18	Nozzle 18Mm (.0071"), River	10.50
36a	3010451	Rubber Nozzle	Call
37	30211	Nozzle Lock Ring	7.10
38	30567	Packing For Nozzle	1.60
039	10091-S	Complete Jet-Breaker	14.00
41	30214	Spring For Lever	4.00
42	30215	Stream Breaker Lever	9.30
042	10055	Complete Stream Breaker Lever	19.70
42a	30216	Grub Screw	1.00
43	30217	Screw For Lever	8.00
44	30218	Nut	3.20
45	30219	Grub Screw	1.60
46	30220	Screw	1.00
47	30221	Crown Screws 6x12	0.80
048	10398-S	Shaft Bearing	11.00
48a	30223	Washer	1.60
049	10087-S	Inversion Cotter Pin	10.90
50	30227	Cam	3.20
51	30228	Elastic Pin	0.40
52	30229	Screw	2.40
53	30230	Washer	0.40
54	30231	Grease Nipple	1.80
57	30232	Nut	0.40
58	30233	Grease Nipple	0.90
59	30234	Grease Nipple	4.00

# SKIPPER GEAR DRIVE SPRINKLERS



## SKIPPER (P-191)

Description	Pattern	Part #	Weight	List
Skipper w/nozzle high speed	Part & Full	7-0303	9.4	<b>410.00</b>
Skipper Tool (to open gear box)		6-9582		<b>32.00</b>



- 1 1/2" FPT Base
- Includes 3 nozzles.
- 144' - 268' Diameter

Skipper 191 28 Degree				
Nozzle Diameter		Pressure	Diameter	Discharge
Inch	MM	PSI	Feet	GPM
0.4	10	29	120	23
		37	132	26
		44	136	28
		56	150	33
0.47	12	29	144	42
		44	164	51
		56	184	59
0.55	14	29	156	51
		44	176	66
		56	196	76
0.63	16	29	170	68
		44	190	83
		56	208	96
0.71	18	29	182	54
		44	202	106
		56	222	124
		70	242	137
0.78	20	29	196	93
		44	216	106
		56	242	124
0.86	22	44	236	161
		51	254	186
		56	274	209
0.94	24	44	248	167
		51	262	193
		56	282	215

Deduct 2% for 25 deg and 5% for 22 deg nozzles.

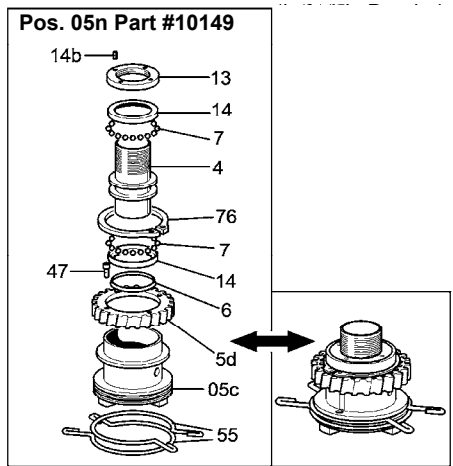
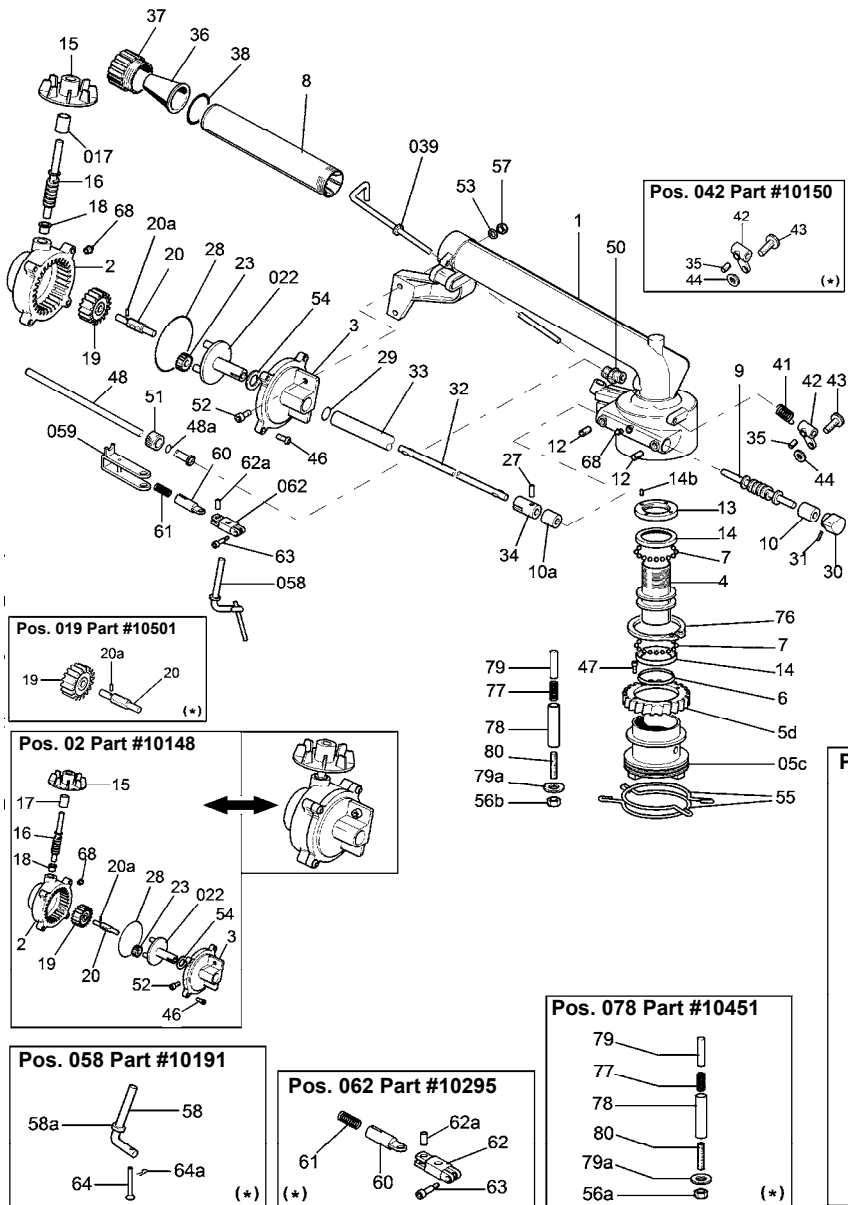

# SKIPPER GEAR DRIVE SPRINKLERS

**Skipper**

Pos #	Part #	Description	List Price
01	10402-S	Sprinkler Body	179.40
2	30737	Gearbox	40.30
02	10148-S	Complete Gearbox	279.90
02am	10170	Complete Head (Fast Rotation)	285.08
3	30738	Gearbox Cover	17.50
4	30739	Internal Body	43.30
05c	10473	Crown (New)	Call
5d	3010377	Ring Crown	43.00
5e-aus	3010489	Crown	Call
05e-aus	10461	Full Crown	Call
05n	10149-S	Complete Mounted Crown	Call
6	30743	U-Packing	10.00
7	30077	Sphere (Requires 22)	1.00
8	30178	Rectifier	12.90
9	30745	Body Endless Screw	38.00
10	30746	External Bearing	6.30
10a	30747	Internal Bearing	12.00
10b	30832	Bushing	6.30
11	30748	Pinion Bearing	4.80
12	30183	Grub Screw	1.60
13	20108	Threaded Ring For Crown	20.00
14	20109	Ball Bearing Ring	16.00
14b	30752	Grub Screw	1.00
15	30753	Propeller	23.60
15a	30831	Endless Screw	35.00
16	30628	Endless Screw	35.00
16a	30187	Grub Screw	1.60
017	10293	Bearing House	26.30
18	30190	Blind Bearing	12.60
19	3010533	Crown	Call
019	10501	Complete Pinion	Call
19a	30833	Crown	20.60
20	30755	Gearbox Pinion	11.50
20a	30193	Pin For Pinion	1.00
022	10255	Planetary Slow	30.30
022a	10256	Pad	22.05
23	30758	Slow Speed Gear	4.00
23a	30835	High Speed Gear	8.00
24	30836	High Speed Pinion	19.70
28	30613	O-Ring 2237	2.50
29	30678	O-Ring 121	1.00
30	30227	Cam	3.20
31	30228	Elastic Pin	0.40
32	20107	Shafting Bar	12.00
33	20162	Shafting Bar Cover	9.30
34	30185	Cap	7.88
35	30216	Grub Screw	1.00
36	30566-10	Nozzle, Standard 25°, 10mm (.0040")	11.50
36	30566-12	Nozzle, Standard 25°, 12mm (.0047")	11.50
36	30566-14	Nozzle, Standard 25°, 14mm (.0055")	11.50
36	30566-16	Nozzle, Standard 25°, 16mm (.0063")	11.50
36	30566-18	Nozzle, Standard 25°, 18mm (.0071")	11.50
36	30566-20	Nozzle, Standard 25°, 20mm (.0078")	11.50
36	30566-22	Nozzle, Standard 25°, 22mm (.0086")	11.50

Pos #	Part #	Description	List Price
36	30566-24	Nozzle, Standard 25°, 24mm (.0094")	11.50
36i	3010354-10	Nozzle, Flip 22°/28°, 10mm (.0040")	12.70
36i	3010354-12	Nozzle, Flip 22°/28°, 12mm (.0047")	12.70
36i	3010354-14	Nozzle, Flip 22°/28°, 14mm (.0055")	12.70
36i	3010354-16	Nozzle, Flip 22°/28°, 16mm (.0063")	12.70
36i	3010354-18	Nozzle, Flip 22°/28°, 18mm (.0071")	12.70
36i	3010354-20	Nozzle, Flip 22°/28°, 20mm (.0078")	12.70
36i	3010354-22	Nozzle, Flip 22°/28°, 22mm (.0086")	12.70
36i	3010354-24	Nozzle, Flip 22°/28°, 24mm (.0094")	12.70
36b	3010449	Nozzle	Call
37	30211	Nozzle Lock Ring	7.10
37a	3010443	Ring AU	Call
38	30567	Packing For Nozzle	1.60
039	10183-S	Jet-Breaker	25.00
41	30764	Jet-Breaker Ring	4.80
42	30765	Jet-Breaker Lever	8.80
042	10150	Complete Jet-Breaker Lever	27.00
43	30217	Screw For Lever	8.00
44	30218	Nut	3.20
46	30767	Screw	0.50
47	30768	Screw	0.50
48	20112	Secondary Pipe	26.00
48a	30734	O-Ring D.00 17,6 X 10 X 3,8	1.00
50	30770	Secondary Nozzle	19.80
51	30771	Ferrule	14.50
52	30578	Screw	1.60
53	30772	Washer	1.00
54	30773	Washer	2.50
55	30774	Inversion Ring	22.10
56	30837	Lever Protection	17.33
56a	30838	Sime Part	1.58
56b	30839	Nut M4	1.00
57	30511	Nut	1.60
058	10191-S	Central Shaft	27.80
059	10366	Inversion Fork	38.10
59a	30778	Pin For Fork	1.60
60	30779	Spring House	8.70
61	301093	Inversion Spring	4.00
062	10295	Complete Inversion Lever Clamp	69.00
62a	30782	Pin For Vice	4.00
63	30783	Screw	1.00
64a	30785	Spring For Bolt	1.60
65	30786	Bearing	3.10
66	30677	Du-Bearing For Gearbox	8.00
67	30189	Du Bearing	10.50
68	30233	Grease Nipple	0.90
75	30959	Washer D.00 5	1.60
76	3010378	Seeger	8.30
77	3010379	Spring	2.50
78	3010380	Spacer	2.80
078	10451	Complete Release	Call
79	3010381	Shafting Bar	4.10
79a	3010382	Washer	2.50
80	3010383	Prisoner	6.50

# MERCURY GEAR DRIVE SPRINKLERS



## MERCURY (P-202)

Description	Pattern	Part #	Weight	List
Mercury w/Nozzles	Part & Full	7-0304	15.1	670.00



- 2" FPT base
- Included 3 nozzles.
- 146' - 280' Diameter

Mercury 202 28 Degree				
Nozzle Diameter		Pressure	Diameter	Discharge
Inch	MM	PSI	Feet	GPM
0.4	10	29	120	23
		37	132	26
		44	136	28
		56	150	33
0.47	12	29	144	42
		44	164	51
		56	184	59
		70	202	66
0.55	14	29	156	51
		44	176	66
		56	196	76
		70	216	86
0.63	16	29	170	68
		44	190	83
		56	208	96
		70	228	107
0.71	18	44	184	105
		56	200	119
		70	216	130
		85	250	170
0.78	20	44	208	142
		56	228	165
		70	250	180
		85	276	203
0.86	22	44	220	161
		56	238	186
		70	262	209
		85	280	228
0.94	24	44	248	167
		56	262	193
		70	282	215

Deduct 2% for 25 deg and 5% for 22 deg nozzles.

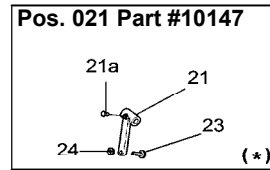
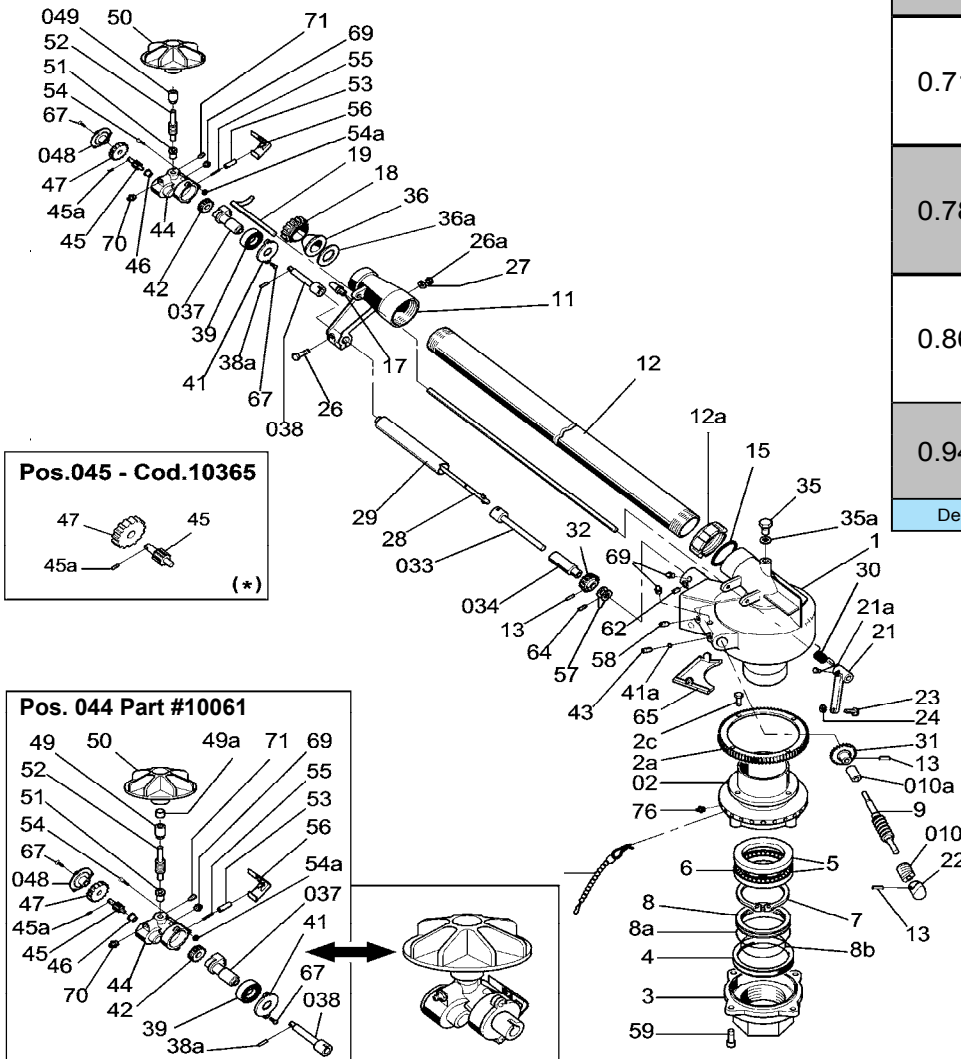



# MERCURY GEAR DRIVE SPRINKLERS

**Mercury**

Pos #	Part #	Description	List Price
1	30681	Sprinkler Body	262.50
02	10474-S	Crown Body	Call
2a	30683	Toothed Ring	85.00
2c	30221	Crown Screws 6x12	0.80
3	30684	Body Support	78.80
4	30685	U-Packing	9.00
5	30686	Ball Bearing Ring	26.00
6	30077	Sphere (Requires 30)	1.00
7	30687	Fastener Ring	7.10
8	30688	U-Packing Ring	22.30
8a	30689	External O-Ring	3.10
8b	30690	Internal O-Ring	2.60
9	30691	Endless Screw Body	61.30
9a	30080	Washer	2.00
010	10397	Threaded Bearing	17.00
010a	10395	Internal Bearing	11.00
11	30693	Pipe Head	76.50
12	20098	Principal Pipe	83.10
012	10377-S	Complete Principal Pipe	196.90
12a	30527	Ferrule For Pipe	29.70
13	30208	Elastic Pin	1.00
15	30588	O-Ring	3.20
17	30087	Secondary Nozzle	6.50
18	30211	Nozzle Lock Ring	7.10
19	20096	Jet Breaker Bar	43.70
021	10147	Stream Breaker Lever	56.90
21a	30091	Screw	1.00
22	30871	Camme	11.10
23	30093	Screw For Lever	9.50
24	30094	Nut For Lever	4.80
26	30229	Screw	2.40
26a	30232	Nut	0.40
27	30230	Washer	0.40
28	20097	Shafting Bar	8.90
29	20144	Shafting Bar Cover	8.90
30	30697	Spring For Lever	6.50
31	30098	Lateral Bevel Pinion	33.50
32	30099	Central Bevel Pinion	26.30
033	10083-S	Shaft	24.10
034	10401-S	Shaft Bearing	18.40
34a	30223	Washer	1.60
35	30102	Plug	6.20
35a	30103	Washer	0.40
36	30566-10	Nozzle, Standard 25°, 10mm (.40")	11.50
36	30566-12	Nozzle, Standard 25°, 12mm (.47")	11.50
36	30566-14	Nozzle, Standard 25°, 14mm (.55")	11.50
36	30566-16	Nozzle, Standard 25°, 16mm (.63")	11.50
36	30566-18	Nozzle, Standard 25°, 18mm (.71")	11.50
36	30566-20	Nozzle, Standard 25°, 20mm (.78")	11.50
36	30566-22	Nozzle, Standard 25°, 22mm (.86")	11.50
36	30566-24	Nozzle, Standard 25°, 24mm (.94")	11.50

Pos #	Part #	Description	List Price
36i	3010354-10	Nozzle, Flip 22°/28°, 10mm (.40")	12.70
36i	3010354-12	Nozzle, Flip 22°/28°, 12mm (.47")	12.70
36i	3010354-14	Nozzle, Flip 22°/28°, 14mm (.55")	12.70
36i	3010354-16	Nozzle, Flip 22°/28°, 16mm (.63")	12.70
36i	3010354-18	Nozzle, Flip 22°/28°, 18mm (.71")	12.70
36i	3010354-20	Nozzle, Flip 22°/28°, 20mm (.78")	12.70
36i	3010354-22	Nozzle, Flip 22°/28°, 22mm (.86")	12.70
36i	3010354-24	Nozzle, Flip 22°/28°, 24mm (.94")	12.70
36a	30567	Packing For Nozzle	1.60
36b	3010449	Nozzle	Call
037	10411	Gearbox Support	30.60
38	30106	Gearbox Shaft	17.50
038	10458	Pin Head	Call
38a	30196	Elastic Pin	1.00
39	30198	Ball Bearing	20.20
40	30677	Du-Bearing For Gearbox	8.00
41	30207	Cover	6.90
41a	30108	Plug	4.00
42	30109	Gearbox Gear	16.00
43	30160	Grub Screw	1.60
44	30169	Gearbox	40.30
044	10061	Complete Gearbox	319.30
044am	10168	America Head	322.88
45	30192	Gearbox Pinion	11.20
045	10365-S	Complete Pinion	35.00
45a	30193	Pin For Pinion	1.00
46	30182	Pinion Bearing	4.80
47	30191	Toothed Wheel	28.00
048	10378	Cover w/ Bearing	11.40
049	10293	Bearing House	26.30
49a	30189	Du Bearing	10.50
50	30112	Propeller	26.30
51	30190	Blind Bearing	12.60
52	30628	Endless Screw	35.00
53	30201	Spring House	5.10
54	30199	Screw	0.80
54a	30200	Nut	0.40
55	30113	Inversion Spring	2.00
56	30204	Cover	2.80
57	30184	Inversion Lever	9.50
58, 62	30118	Grub Screw	1.60
59	30559	Screw	1.80
60	30699	Ring	5.20
061	10087-S	Inversion Cotter Pin	10.90
64	30219	Grub Screw	1.60
65	30120	Inversion Lever Cover	6.50
67	30220	Screw	1.00
69	30233	Grease Nipple	0.90
70	30231	Grease Nipple	1.80
71	30187	Grub Screw	1.60
76	30234	Grease Nipple	4.00

# BIG RIVER GEAR DRIVE SPRINKLERS



## BIG RIVER (P-250)

Big River w/nozzle-Green

DISCONTINUED



72 & 116mm flange base (companion flange included.)  
238' - 354' Diameter

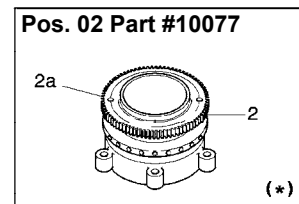
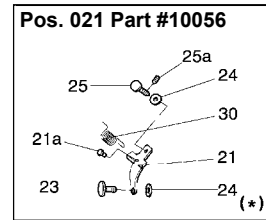
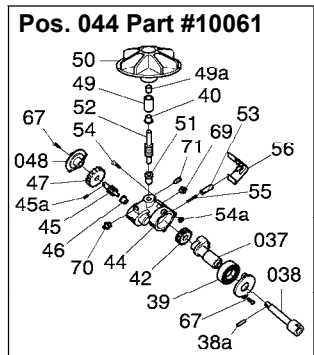
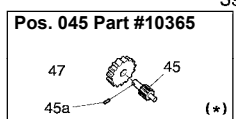
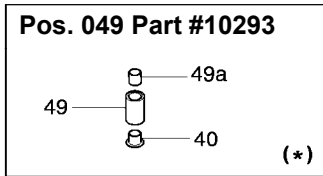
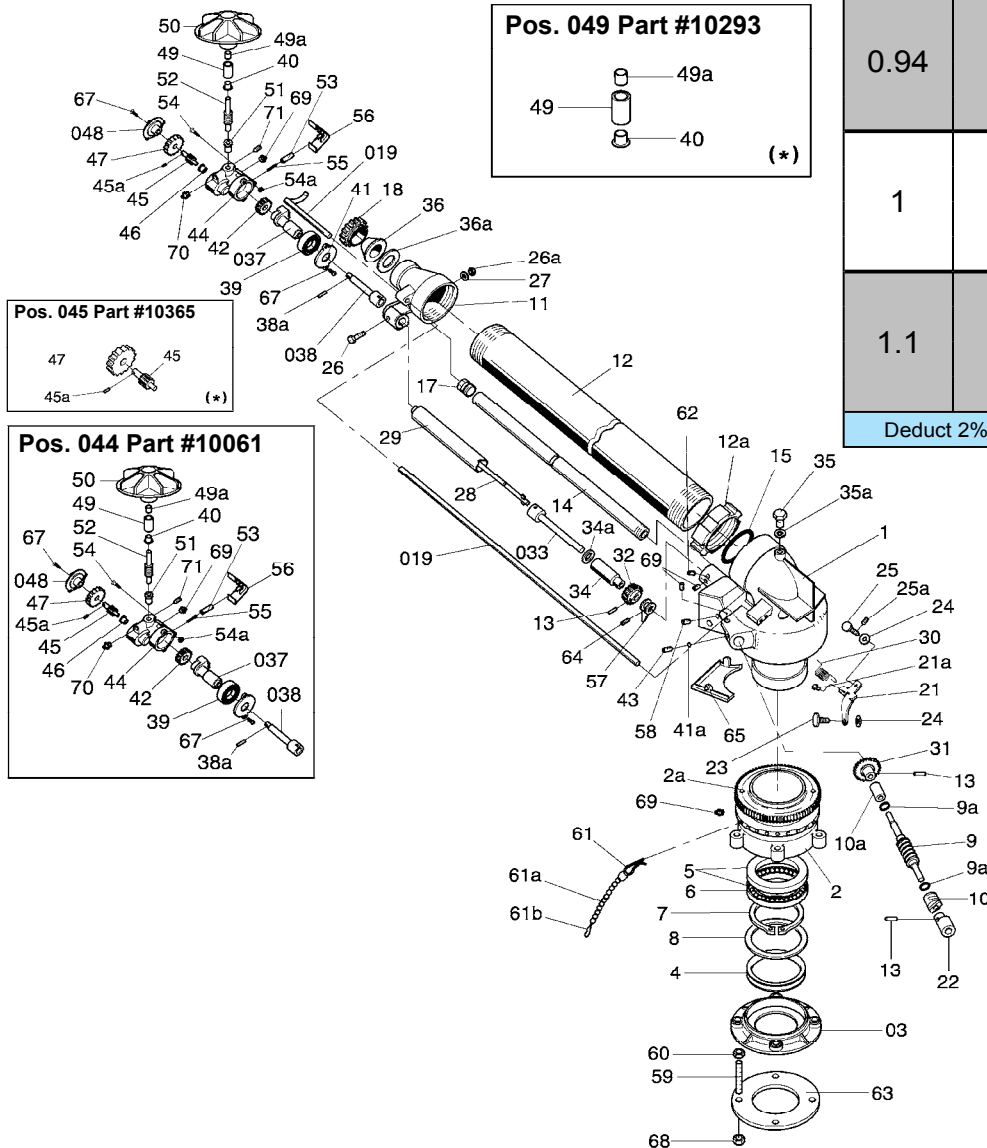

Big River 250 28 Degree				
Nozzle Diameter		Pressure	Diameter	Discharge
Inch	MM	PSI	Feet	GPM
0.71	18	44	196	119
		56	214	139
		70	230	124
		85	250	170
0.78	20	44	238	137
		56	264	159
		70	282	178
		85	300	194
0.86	22	56	268	186
		66	282	197
		70	294	208
		85	314	228
0.94	24	56	282	217
		66	294	230
		70	308	243
		85	328	266
1	26	56	294	250
		70	314	380
		85	338	307
		100	346	330
1.1	28	56	302	286
		70	320	319
		85	340	350
		100	354	378

Deduct 2% for 25 deg and 5% for 22 deg nozzles.

# BIG RIVER GEAR DRIVE SPRINKLERS

**Big River**

Pos #	Part #	Description	List Price
1	30070	Sprinkler Body	382.70
02	10077-S	Crown	192.50
03	10080-S	Body Support	113.70
4	30075	U-Packing 90X76X8	13.60
5	30076	Ball Bearing Ring	34.00
6	30077	Sphere (Requires 43)	1.00
7	30078	Fastener Ring D. 78	10.00
8	30079	U-Packing Ring	10.00
9	30597	Worm Carter	61.43
9a	30080	Washer	2.00
010	10395	Internal Bearing	11.00
010	10394	Threaded Bearing	17.00
11	30083	Pipe Head	119.90
12	20022	Principal Pipe	105.00
012	10376	Complete Principal Pipe	258.10
12a	30084	Ferrule For Pipe	44.90
13	30208	Elastic Pin	1.00
14	20094	Secondary Pipe	28.40
15	30085	O-Ring For Pipe	3.50
16	30086	Elastic Pin	1.10
17	30125	Secondary Nozzle	7.10
18	30056	Nozzle Lock Ring	31.50
019	10090-S	Jet Breaker Bar	65.00
20	30181	Internal Body Bearing	5.60
021	10056	Stream Breaker Lever	67.80
21a	30091	Screw	1.00
22	30092	Camme	13.50
23	30093	Screw For Lever	9.50
24	30094	Nut For Lever	4.80
25	30095	Lever Upper Screw	9.50
25a	30096	Elastic Pin	0.50
26	30229	Screw	2.40
26a	30232	Nut	0.40
27	30230	Washer	0.40
28	20024	Shafting Bar	14.50
29	20025-S	Shafting Bar Cover	13.20
30	30059	Spring For Lever	6.50
31	30098	Lateral Bevel Pinion	33.50
32	30099	Central Bevel Pinion	26.30
033	10083-S	Shaft	24.10
034	10401-S	Shaft Bearing	18.00
34a	30223	Washer	1.60
35	30102	Plug	6.20
35a	30103	Washer	0.40
36	30063-18	Nozzle, Standard 25°, 18mm (.71")	11.50
36	30063-20	Nozzle, Standard 25°, 20mm (.78")	11.50
36	30063-22	Nozzle, Standard 25°, 22mm (.86")	11.50
36	30063-24	Nozzle, Standard 25°, 24mm (.94")	11.50
36	30063-26	Nozzle, Standard 25°, 26mm (1")	11.50
36	30063-28	Nozzle, Standard 25°, 28mm (1.10")	11.50
36	30063-30	Nozzle, Standard 25°, 30mm (1.2")	11.50

Pos #	Part #	Description	List Price
36i	3010448-18	Nozzle, Flip 22°/28°, 18mm (.71")	12.70
36i	3010448-20	Nozzle, Flip 22°/28°, 20mm (.78")	12.70
36i	3010448-22	Nozzle, Flip 22°/28°, 22mm (.86")	12.70
36i	3010448-24	Nozzle, Flip 22°/28°, 24mm (.94")	12.70
36i	3010448-26	Nozzle, Flip 22°/28° 26mm (1")	12.70
36i	3010448-28	Nozzle, Flip 22°/28°, 28mm (1.10")	12.70
36i	3010448-30	Nozzle, Flip 22°/28° 30mm (1.2")	12.70
36a	30064	Packing For Nozzle	2.50
36b	3010450	Rubber Nozzle	Call
037	10411	Gearbox Support	30.60
38	30106	Gearbox Shaft	17.50
038	10458	Pin Head	Call
38a	30196	Elastic Pin	1.00
39	30198	Ball Bearing	20.20
40	30677	Du-Bearing For Gearbox	8.00
41	30207	Cover	6.90
41a	30108	Plug	4.00
42	30109	Gearbox Gear	16.00
43	30110	Grub Screw	1.60
44	30169	Gearbox	40.30
044	10061	Complete Gearbox	319.30
044am	10168	America Head	322.88
45	30192	Gearbox Pinion	11.20
045	10365-S	Complete Pinion	35.00
45a	30193	Pin For Pinion	1.00
46	30182	Pinion Bearing	4.80
47	30191	Toothed Wheel	28.00
048	10378	Cover w/ Bearing	11.40
049	10293	Bearing House	26.30
49a	30189	Du Bearing	10.50
50	30112	Propeller	26.30
51	30190	Blind Bearing	12.60
52	30628	Endless Screw	35.00
53	30201	Spring House	5.10
54	30199	Screw	0.80
54a	30200	Nut	0.40
55	30113	Inversion Spring	2.00
56	30204	Cover	2.80
57	30184	Inversion Lever	9.50
58	30114	Grub Screw	1.60
59	30115	Stud Bolt	3.20
60	30116	Nut M 10X6	1.00
061	10087-S	Inversion Cotter Pin	10.90
62	30118	Grub Screw	1.60
63	30119	Body Support Packing	7.90
64	30219	Grub Screw	1.60
65	30120	Inversion Lever Cover	6.50
67	30220	Screw	1.00
68	30121	Nut M10X10	1.00
69, 76	30233	Grease Nipple	0.90
70	30231	Grease Nipple	1.80
71	30187	Grub Screw	1.60

# MARINER GEAR DRIVE SPRINKLERS

## MARINER (P-401)

Description	Pattern	Part #	Weight	List
Mariner w/nozzle-Green high speed	Part & Full	7-0306	25.3	1,075.00



- 2 1/2" FPT base
- Includes 3 nozzles.
- 274' - 440' Diameter
- One Speed (Two speed also available.)

Mariner 401 28 Degree				
Nozzle Diameter		Pressure	Diameter	Discharge
Inch	MM	PSI	Feet	GPM
1	26	44	274	173
		56	308	211
		70	336	244
		85	354	273
1.1	28	44	294	242
		56	320	280
		70	340	313
		85	362	343
1.2	30	56	382	319
		70	354	356
		85	374	390
		100	398	421
1.25	32	56	340	359
		70	368	402
		85	384	440
		100	404	475
1.35	34	70	374	451
		85	398	494
		100	420	533
		115	440	571

Deduct 2% for 25 deg and 5% for 22 deg nozzles.

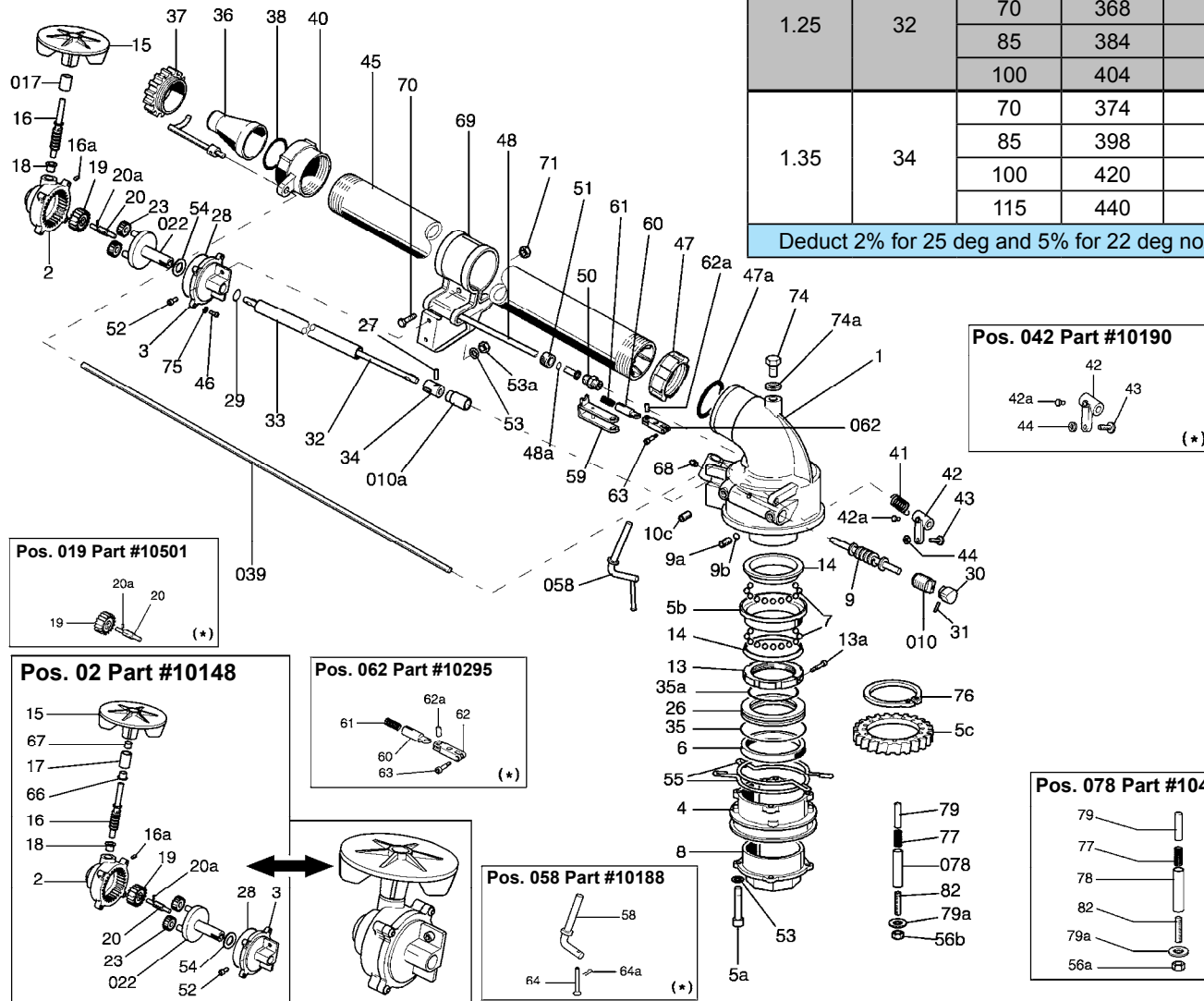

# MARINER GEAR DRIVE SPRINKLERS

## Mariner

Pos #	Part #	Description	List Price
01	10403-S	Sprinkler Body	437.40
2	30737	Gearbox	40.30
02	10148-S	Complete Gearbox	279.90
02am	10170	Complete Head	285.08
3	30738	Gearbox Cover	17.50
4	30862	Body Support	102.80
5	30863	Crown	118.50
5a	30945	Screw	4.00
5b	3010385	Ring Body Support	52.00
5c	3010363	Ring	80.10
6	30864	U-Packing Crown	13.20
7	30048	Sphere (Requires 52)	1.00
8	30865	Threaded Body Support	95.80
9	30866	Endless Screw	70.70
9a	30160	Grub Screw	1.60
9b	30108	Plug	4.00
010	10394	Threaded Bearing	17.00
010a	10404-S	Internal Bearing	10.00
10b	30080	Washer	2.00
10c	30114	Grub Screw	1.60
11	30748	Pinion Bearing	4.80
13	30868	Threaded Ring For Crown	40.30
13a	301014	Screw	1.60
14	30869	Ball Bearing Ring	43.70
15	30753	Propeller	23.60
16	30628	Endless Screw	35.00
16a	30187	Grub Screw	1.60
017	10293	Bearing House	26.30
18	30190	Blind Bearing	12.60
19	3010533	Crown	Call
019	10501	Complete Pinion	Call
20	30755	Gearbox Pinion	11.50
20a	30193	Pin For Pinion	1.00
022	10255	Planetary Slow	30.30
23	30758	Slow Speed Gear	4.00
26	30870	O-Ring	21.90
28	30613	O-Ring 2237	2.50
29	30678	O-Ring 121	1.00
30	30695	Cam	11.50
31	30208	Elastic Pin	1.00
32	20142	Shafting Bar	12.00
33	20145	Principal Pipe	12.00
34	30185	Cap	7.88
35	30946	O-Ring 3300	5.60
35a	30947	O-Ring 3262	4.80
36	30063-26	Nozzle, Standard 25°, 26mm (1")	11.50
36	30063-28	Nozzle, Standard 25°, 28mm (1.10")	11.50
36	30063-30	Nozzle, Standard 25°, 30mm (1.2")	11.50
36	30063-32	Nozzle, Standard 25°, 32mm (1.25")	11.50
36	30063-34	Nozzle, Standard 25°, 34mm (1.35")	11.50
37	30056	Nozzle Lock Ring	31.50
38	30064	Packing For Nozzle	2.50
039	10189-S	Jet-Breaker	61.30
40	30874	Pipe-Head	63.00
41	3010444	Jet Breaker Spring Lever	9.50
042	10190	Jet-Breaker Lever	54.70
42a, 94	30091	Screw	1.00

Pos #	Part #	Description	List Price
43	30093	Screw For Lever	9.50
44	30094	Nut For Lever	4.80
45	20127	Principal Pipe	98.40
46	30767	Screw	0.50
47	30877	Locking Ring For Pipe	38.60
47a	30949	O-Ring 3225	2.50
48	20136	Tube	18.90
48a	30734	O-Ring D. 17,6 X 10 X 3,8	1.00
50	30878	Secondary Nozzle	21.60
51	30771	Ferrule	14.50
52	30578	Screw	1.60
53	30557	Washer Grower D. 6	1.00
53a	30511	Nut	1.60
54	30773	Washer	2.50
55	30879	Inversion Ring	23.30
56	30968	Cover For Lever	19.00
56a	30973	Screw 4X30	1.00
56b	30839	Nut M4	1.00
058	10188	Central Shaft	40.00
059	10366	Inversion Fork	38.10
59a	30778	Pin For Fork	1.60
60	30779	Spring House	8.70
61	301093	Inversion Spring	4.00
062	10295	Complete Inversion Lever Clamp	69.00
62a	30782	Pin For Vice	4.00
63	30783	Screw	1.00
64a	30785	Spring For Bolt	1.60
65	30880	Inversion Lever Bearing	3.50
66	30677	Du-Bearing For Gearbox	8.00
67	30189	Du Bearing	10.50
68	30233	Grease Nipple	0.90
69	30881	Support	78.75
70	30426	Screw 8X25	10.50
71	30475	Nut 8X6	1.00
72	30724	Grub Screw	1.20
73a	30086	Elastic Pin	1.10
74	30102	Plug	6.20
74a	30103	Washer	0.40
75	30959	Washer D. 5	1.60
76	30049	Fastener Ring	13.10
77	3010358	Spring	2.40
78	3010359	Spacer	3.20
078	10452-S	Full Release	Call
79	3010360	Shafting Bar	4.10
79a	3010361	Washer	1.60
80	3010233	Area	Call
81	3010335	Bracket	Call
82	3010362	Prisoner	6.90
083	10110	Nut	Call
86	30447	Ring	Call
87	3010232	Lever	Call
88	20185	Pin	Call
90	20259-S	Roll	Call
93	30902	Lever	Call
95	30513	Screw	Call
96	30904	Nut	Call
100	3010767	Bearing For Jet Breaker	Call
101	3010768	Bearing With Head for Jet Breaker	Call

Gun Stands/Sprinklers

# POLARIS GEAR DRIVE SPRINKLERS



## POLARIS (P-400)

Polaris

DISCONTINUED



90 & 150mm flange connection  
302' - 418' Diameter

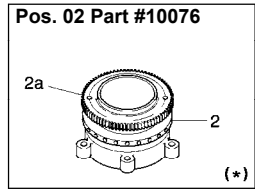
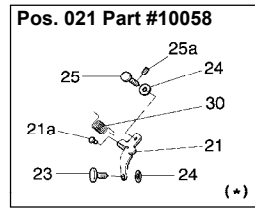
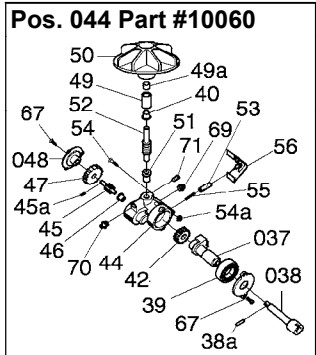
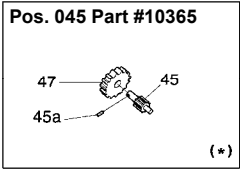
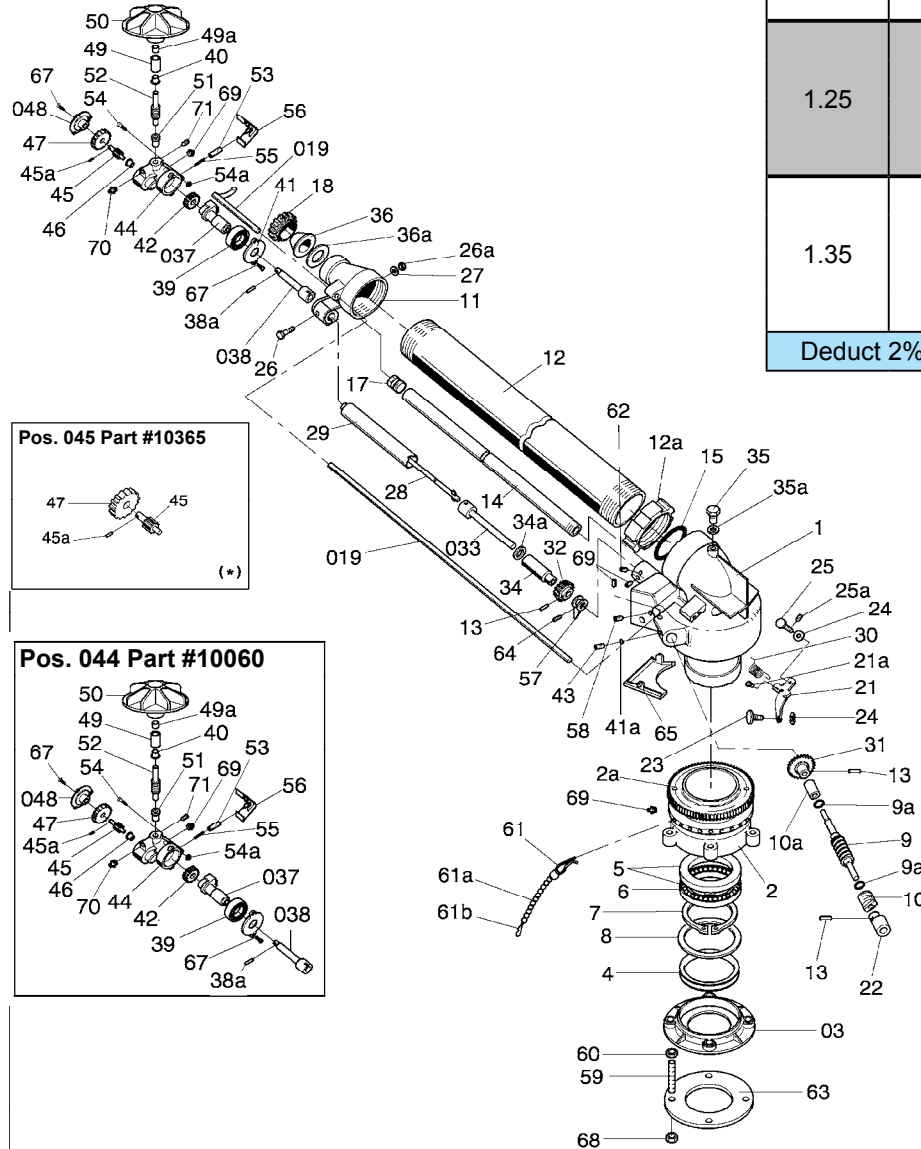

Polaris 200 28 Degree				
Nozzle Diameter		Pressure	Diameter	Discharge
Inch	MM	PSI	Feet	GPM
1	26	56	302	263
		70	230	295
		85	340	323
		100	362	348
1.1	28	56	314	300
		70	328	324
		85	354	366
		100	380	395
1.2	30	56	320	338
		70	340	378
		85	368	414
1.25	32	70	362	423
		85	380	464
		100	394	500
		115	404	536
1.35	34	70	374	472
		85	394	517
		100	404	558
		115	418	598

Deduct 2% for 25 deg and 5% for 22 deg nozzles.

# POLARIS GEAR DRIVE SPRINKLERS

**Polaris**

Pos #	Part #	Description	List Price
1	30041-S	Carter	280.00
02	10076	Crown	223.00
03	10079	Body Support	135.60
4	30046	U-Packing 117X98X11	16.20
5	30047	Ball Bearing Ring	48.00
6	30048	Sphere (Requires 36)	1.00
7	30049	Fastener Ring	13.10
8	30050	U-Packing Ring	10.00
9	30596	Endless Screw Body	80.00
9a	30080	Washer	2.00
010	10394	Threaded Bearing	17.00
010a	10396	Internal Bearing	15.00
11	30052	Pipe Head	140.00
12	20013	Principal Pipe	131.20
012	10375-S	Complete Principal Pipe	288.70
12a	30053	Threaded Ring For Pipe	59.10
13, 16	30208	Elastic Pin	1.00
14	20014	Secondary Pipe	35.00
15	30054	O-Ring	7.10
17	30125	Secondary Nozzle	7.10
18	30056	Nozzle Lock Ring	31.50
019	10089-S	Jet Breaker Bar	85.30
20	30057	Stream Breaker Bearing	4.40
021	10058	Stream Breaker Lever	67.80
21a	30091	Screw	1.00
22	30092	Camme	13.50
23	30093	Screw For Lever	9.50
24	30094	Nut For Lever	4.80
25	30095	Lever Upper Screw	9.50
25a	30096	Elastic Pin	0.50
26	30229	Screw	2.40
26a	30232	Nut	0.40
27	30230	Washer	0.40
28	20016	Shafting Bar	15.70
29	20017	Shafting Bar Cover	16.20
30	30059	Spring For Lever	6.50
31	30060	Lateral Bevel Pinion	39.80
32	30061	Central Bevel Pinion	29.10
033	10082	Shaft	28.00
034	10399	Shaft Bearing	21.90
34a	30223	Washer	1.60
35	30102	Plug	6.20
35a	30103	Washer	0.40
36	30063-26	Nozzle, Standard 25°, 26mm (1")	11.50
36	30063-28	Nozzle, Standard 25°, 28mm (1.10")	11.50
36	30063-30	Nozzle, Standard 25°, 30mm (1.2")	11.50

Pos #	Part #	Description	List Price
36	30063-32	Nozzle, Standard 25°, 32mm (1.25")	11.50
36	30063-34	Nozzle, Standard 25°, 34mm (1.35")	11.50
36a	30064	Packing For Nozzle	2.50
037	10411	Gearbox Support	30.60
38	30106	Gearbox Shaft	17.50
038	10458	Pin Head	Call
38a	30196	Elastic Pin	1.00
39	30198	Ball Bearing	20.20
40	30677	Du-Bearing For Gearbox	8.00
41	30207	Cover	6.90
41a	30108	Plug	4.00
42	30109	Gearbox Gear	16.00
43	30160	Grub Screw	1.60
44	30169	Gearbox	40.30
044	10060	Complete Gearbox	319.30
044am	10167	Gear	Call
45	30192	Gearbox Pinion	11.20
045	10365-S	Complete Pinion	35.00
45a	30193	Pin For Pinion	1.00
46	30182	Pinion Bearing	4.80
47	30191	Toothed Wheel	28.00
048	10378	Cover w/ Bearing	11.40
049	10293	Bearing House	26.30
49a	30189	Du Bearing	10.50
50	30112	Propeller	26.30
51	30190	Blind Bearing	12.60
52	30628	Endless Screw	35.00
53	30201	Spring House	5.10
54	30199	Screw	0.80
54a	30200	Nut	0.40
55	30066	Inversion Spring	2.10
56	30204	Cover	2.80
57	30184	Inversion Lever	9.50
58, 62	30118	Grub Screw	1.60
59	30115	Stud Bolt	3.20
60	30116	Nut M 10X6	1.00
061	10087-S	Inversion Cotter Pin	10.90
63	30068	Body Support Packing	13.00
64	30219	Grub Screw	1.60
65	30069	Inversion Lever Cover	7.60
67	30220	Screw	1.00
68	30121	Nut M10X10	1.00
69	30233	Grease Nipple	0.90
70	30231	Grease Nipple	1.80
71	30187	Grub Screw	1.60

# GEMINI GEAR DRIVE SPRINKLERS



## GEMINI (P-600 / P-1200)

Description	Pattern	Part #	Weight	List
Gemini (2 speed high or low switch)	Part & Full	7-0307	34.7	1,365.00



- 100 x 142mm flange connection (companion flange included)
- Includes 3 nozzles.
- 368' - 510' Diameter

Gemini 1200 28 Degree				
Nozzle Diameter	Pressure	Diameter	Discharge	
Inch	MM	PSI	Feet	GPM
1.2	30	56	328	319
		70	354	356
		85	374	390
		100	398	421
1.25	32	70	368	424
		85	84	464
		100	404	500
		115	426	536
1.35	34	70	380	472
		85	398	518
		100	420	558
		115	440	598
1.42	36	70	398	525
		85	420	574
		100	440	620
		115	458	664
1.5	38	85	434	635
		100	458	685
		115	472	733
		128	492	777
1.57	40	85	446	698
		100	472	753
		115	488	806
		128	510	855
1.65	42	88	460	717
		95	480	761
		100	500	783
		110	524	809
1.72	44	88	470	700
		95	480	730
		100	490	750
		110	500	810
1.8	46	88	474	825
		95	484	855
		100	494	875
		110	504	905
1.87	48	88	480	910
		95	490	940
		100	500	960
		110	510	995
1.95	50	88	500	925
		95	520	955
		100	540	1075
		110	570	1110

Deduct 2% for 25 deg and 5% for 22 deg nozzles.

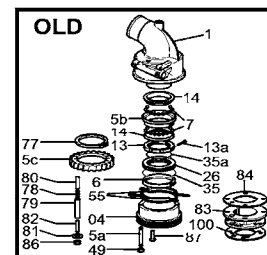
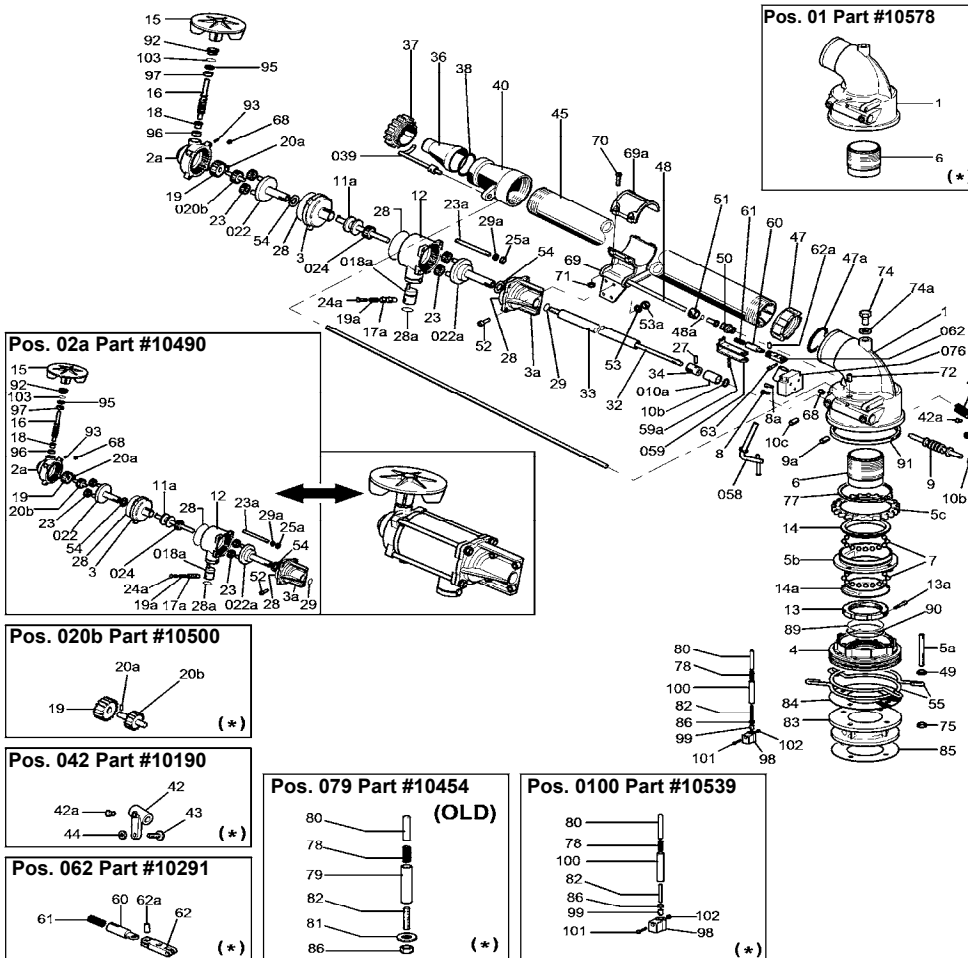





# GEMINI GEAR DRIVE SPRINKLERS

**Gemini**

Pos #	Part #	Description	List Price
1	3010760	Carter	Call
01	10578	Body	Call
2a	3010633	Head	Call
02a	10490	Complete Head	Call
3	301041	Gearbox Cover	23.00
3a	301042	Cover	26.30
4	3010761	Ring	Call
04	10390	Body Support	215.60
5	301045	Crown	301.80
5a	301046	Stud Bolt	9.50
5b	3010365	Ring	65.60
5c	3010366	Ring	63.00
6	20267	Body	Call
6-old	301047	U-Packing Crown	18.50
7	30048	Sphere (Requires 74)	1.00
8	301083	Screw 6X15 T.E.	1.60
8a	301084	Screw 6X15 T.C.E.I.	1.60
9	301048	Endless Screw	98.00
9a	30160	Grub Screw	1.60
9b	30108	Plug	4.00
010	10394	Threaded Bearing	17.00
010a	10404-S	Internal Bearing	10.00
10b	30080	Washer	2.00
10c	30118	Grub Screw	1.60
11	30748	Pinion Bearing	4.80
12	301050	Gearbox Central Body	76.60
13	3010762	Ring	Call
13a	301014	Screw	1.60
13-old	301052	Threaded Ring For Crown	72.80
14	301035	Spacer	Call
14a	3010763	Cover	Call
14-old	301053	Ball Bearing Ring	93.40
15	301054	Propeller	28.40
015br	10457	Propeller	Call
16	3010636	Screw	Call
16a	30187	Grub Screw	1.60
017	10293	Bearing House	26.30
17a	301055	Lever	15.00
17br	3010534	Bushing	Call
18	30031-S	Compass	7.50
018a	10294	Bush	47.50
19	30833	Crown	20.60
19a	30817	Spring	3.20
20	30836	High Speed Pinion	19.70
020b	10500	Pin	Call
20b	3010634	Pinion Pivot	Call
21a	301058	Pin	1.50
022	10285	Planetary	30.20
022a	10286	Second Planetary	106.10
23	30835	High Speed Gear	8.00
23a	301060	Stud Bolt	4.90
024	10287-S	Pinion	56.00
24a, 70	30965	Screw 6X30	3.20
25a, 86	30270	Nut	1.00
26	301063	O-Ring	53.00
28	30613	O-Ring 2237	2.50
28a	301064	O-Ring 123	1.00
29	30678	O-Ring 121	1.00
29a	30532	Washer Inox	1.00
30	30695	Cam	11.50
31, 73a	30208	Elastic Pin	1.00
32	20161	Shafting Bar	9.60
33	20156	Shafting Bar Cover	9.60
34	30185	Cap	7.88
35	301066	O-Ring	8.00
35a	301067	O-Ring	7.10
36	30063-30	Nozzle, Standard 25°, 30mm (1.2")	11.50
36	30063-32	Nozzle, Standard 25°, 32mm (1.25")	11.50
36	30063-34	Nozzle, Standard 25°, 34mm (1.35")	11.50
36	30063-36	Nozzle, Standard 25°, 36mm (1.42")	11.50
36	30063-38	Nozzle, Standard 25°, 38mm (1.50")	11.50
36	30063-40	Nozzle, Standard 25°, 40mm (1.57")	11.50
36	30063-42	Nozzle, Standard 25°, 42mm (1.65")	11.50
36	30063-44	Nozzle, Standard 25°, 44mm (1.72")	11.50
36	30063-46	Nozzle, Standard 25°, 46mm (1.80")	11.50
36	30063-48	Nozzle, Standard 25°, 48mm (1.87")	11.50
36	30063-50	Nozzle, Standard 25°, 50mm (1.95")	11.50

Pos #	Part #	Description	List Price
37	30056	Nozzle Lock Ring	31.50
38	30064	Packing For Nozzle	2.50
039	10288-S	Jet-Breaker	139.50
40	301068	Pipe-Head	83.10
41	3010444	Jet Breaker Spring Lever	9.50
042	10190	Jet-Breaker Lever	54.70
42a	30091	Screw	1.00
43	30093	Screw For Lever	9.50
44	30094	Nut For Lever	4.80
45	20158	Tube	70.88
47	30053	Threaded Ring For Pipe	59.10
47a	30054	O-Ring	7.10
48	20159	Secondary Pipe	32.30
48a	301069	O-Ring	1.60
49	30116	Nut M 10X6	1.00
50	301070	Secondary Nozzle	27.00
51	301071	Ferrule	16.00
52	30500	Screw 6X25	0.90
53	30557	Washer Grower D. 6	1.00
53a	30511	Nut	1.60
54	30773	Washer	2.50
55	301072	Inversion Ring	38.00
56	301073	Lever Protection	17.33
56a	301074	Sime Part	0.80
56b	30839	Nut M4	1.00
058	10188	Central Shaft	40.00
059	10290	Inversion Fork	41.60
59a	301077	Pin For Fork	1.60
60	301078	Spring House	16.00
61	301079	Inversion Spring	4.20
062	10291	Vice For Inversion Lever	48.10
62a	30782	Pin For Vice	4.00
63	30783	Screw	1.00
64	3010181	Gearbox Support	5.60
64a	30785	Spring For Bolt	1.60
66	30677	Du-Bearing For Gearbox	8.00
67	30189	Du Bearing	10.50
68	30233	Grease Nipple	0.90
69	3010646	Support	Call
69a	3010647	Clamp	Call
70-old	30521	Screw	1.80
71	3010648	Square Nuts	Call
71-old	30475	Nut 8X6	1.00
72	30724	Grub Screw	1.20
73	30057	Stream Breaker Bearing	4.40
74	30102	Plug	6.20
74a	30103	Washer	0.40
75	30121	Nut M10X10	1.00
076	10292	Levers Support	76.60
77	3010367	Seeger	15.10
78-old	301016	Spring	3.20
79-old	3010368	Spacer	3.20
079-old	10454	Disengagement	Call
80	3010369	Shafting Bar	4.40
81	3010370	Washer	1.60
82	3010855	Prisoner	Call
82-old	3010371	Prisoner	57.50
83	3010374	Flange	306.20
84	3010372	Gasket	9.50
85	3010772	Gasket	Call
85-old	3010373	Gasket	9.50
87	3010375	Screw 10X35	1.70
89	3010764	O-Ring	Call
89br	3010492	Bearing Cap	Call
90	3010765	O-Ring	Call
92	3010640	Ring	Call
93	30040-S	Grub Screwing	3.15
95	30030-S	Ring	12.00
96	3010613	Bearing	Call
97	30028-S	Bearing	24.50
98	3010653	Knob	Call
98-old, 103	3010570	O-Ring	Call
99	3010654	Nut	Call
0100	10539	Release	Call
101	3010428	Screw	Call
102	3010429	Nut	Call





















Gun Stands/Sprinklers

# Schumacher Irrigation is your source for hard to find irrigation parts and custom built irrigation fittings.



## Section Five



 Couplers and Male Ends	92-96
 Industrial Groove	97
 Storage Baskets	99
 Ball & Sockets	101-107
 Cam-Locs	108-109
 Fittings (Elbows, Tees, Adapters, Ect)	110-121
 Weld-on Elbows & Tees	122-124
 Weld-on Cones, Flg's & Discs	125-131
 Rings, Bands & Accessories	132-136
 Telescopes	137
 Valves	138-151
 Water Meters & Accessories	152-153
 Pivot Parts	154-159
 Pivot Sprinklers & Accessories	160-162
 Screens	163
 Pressure Gauges	164
 Valve Stubs & Accessories	165-167
 Drain Valves	168
 Threaded Parts (Nipples, Couplings & Fittings)	169-180
 Gaskets	182-186

# STEEL COUPLERS

## COUPLER (BLACK STEEL)



Size	Standard Punch				Deep Punch			Extra Deep Punch			Extra-Extra Deep		
	Part #	Depth	Weight	List	Part #	Depth	List	Part #	Depth	List	Part #	Depth	List
2"	6-0120		1.0	11.00									
3"	6-0121		1.0	12.50	9-5198	3"	15.00	9-5007	4"	18.00			
4"	6-0122	2-3/4"	1.5	16.50	9-5199	4"	20.00	9-5008	4-1/2"	20.00	9-5200	7"	35.00
5"	6-0123		2.0	17.00	9-5201	4"	25.00	9-5009	5"	25.00			
6"	6-0124	4-1/4"	2.8	17.00	9-5010	5-7/8"	34.00	9-5202	8-1/2"	49.00			
6-5/8"	6-0128		3.8	29.00									
7"	6-0118		3.5	31.00									
8"	6-0125	4"	4.5	22.00	9-5011	5-1/2"	46.00	9-5203	11"	65.00			
8-5/8"	6-0129		6.0	48.00									
10"	6-0126	3"	5.5	45.00	9-5012	6"	51.00						
12"	6-0127		9.0	70.00	9-5013	6"	43.00						

## COUPLER-10GA. (BLACK OR GALV. STEEL)



Size	10ga Black Steel			10ga Galvanized		
	Part #	Weight	List	Part #	Weight	List
4" Rd Back	9-7548		17.50			
4" Squ Back	6-8030	3.0	30.00			
6"	6-9662	4.5	25.00	6-9664	4.5	32.00
8"	6-9663	5.9	31.00	6-9665	5.9	35.00
10"	9-5305	7.2	41.00	9-8110		48.00
12"	9-7549		62.00	9-8111		72.00

# STEEL COUPLERS/MALE ENDS

## MALE RL END (BLACK OR GALV. STEEL)



Size	12ga Black Steel			10ga Black Steel			10ga Galv Steel		
	Part #	Weight	List	Part #	Weight	List	Part #	Weight	List
3"	6-0169	1.2	13.00						
4" Flat Ring	6-0170	1.5	15.00						
4" Wide Ring				6-8112	3.0	23.00			
5"	6-0171	2.0	17.00						
6"	6-0172	2.8	20.00	6-9764	4.2	27.00	6-9766	4.2	30.00
7"	6-0176	3.5	30.00						
8"	6-0173	4.5	31.00	6-9765	5.9	29.00	6-9767	5.9	34.00
10"	6-0174	5.5	45.00	9-5306	6.7	42.00	9-8145		50.00
12"	6-0175	9.0	65.00	9-7662		60.00	9-8146		69.00

## STAINLESS STEEL RL ENDS

(GALVANIZED STEEL)



Size	Stainless Steel Female			Stainless Steel Male End		
	Part #	Weight	List	Part #	Weight	List
4"	9-7518		84.00	9-7522		170.00
5"	9-7519		85.00	9-7523		179.00
6"	9-7520		85.00	9-7524		120.00
8"	9-7521		123.00	9-7525		125.00
10"	9-7891		155.00	9-8098		185.00
12"	9-8149		221.00	9-8218		340.00

## PRESS-ON RL COUPLER/MALE END

(GALVANIZED STEEL)



Size	Female RL			Male RL		
	Part #	Weight	List	Part #	Weight	List
3"	6-0223	2.0.0	20.00	6-0201	2.0.0	18.00
4"	6-0224	2.5	21.00	6-0202	2.5	20.00
5"	6-0225	3.5	27.00	6-0203	3.5	24.00
6"	6-0220	4.0.0	30.00	6-0210	4.0	26.00
7"	6-0226	5.5	39.00	6-0204	5.0.0	34.00
8"	6-0221	8.0.0	39.00	6-0211	7.0.0	37.00
10"	6-0222	10.5	58.00	6-0212	11.0.0	48.00
12"	6-0227	15.0.0	78.00	6-0205	14.0.0	61.00

Fittings

# CAST ALUMINUM COUPLERS

## COUPLER (CAST ALUMINUM)



Size	Part #	Weight	List
3"	6-0114	1.3	<b>23.00</b>
4"	6-0110	1.5	<b>26.00</b>
5"	6-0115	1.8	<b>32.00</b>
6"	6-0111	2.0	<b>41.00</b>
7"	6-0109	2.5	<b>40.00</b>
8"	6-0112	2.8	<b>50.00</b>
10"	6-0113	3.3	<b>62.00</b>

## RL COUPLER SET - SCHUMACHER (CAST ALUMINUM)



Size	Complete Set				Female RL			Male RL		
	Part #	Weight	List	Part #	Weight	List	Part #	Weight	List	
4"	6-0145	4.4	<b>63.00</b>	6-0147	1.5	<b>25.00</b>	6-0149	1.2	<b>18.00</b>	
5"	6-0146	5.0	<b>77.00</b>	6-0148	1.8	<b>33.00</b>	6-0154	1.4	<b>23.00</b>	
6"	6-0130	5.3	<b>84.00</b>	6-0150	2.4	<b>36.00</b>	6-0160	1.8	<b>25.00</b>	
7"	6-0134	6.3	<b>101.00</b>	6-0153	2.5	<b>44.00</b>	6-0163	1.9	<b>30.00</b>	
8"	6-0131	7.0	<b>101.00</b>	6-0151	2.8	<b>45.00</b>	6-0161	2.0	<b>32.00</b>	
10"	6-0132	8.1	<b>126.00</b>	6-0152	3.5	<b>57.00</b>	6-0162	2.3	<b>39.00</b>	
12"	6-0133	10.0	<b>186.00</b>	4-0015	5.5	<b>87.00</b>	4-0016	3.5	<b>63.00</b>	

Set Includes Standard Ringlock Clamp

## RL COUPLER SET - A&M (CAST ALUMINUM)



Size	Complete Set				Female RL			Male RL		
	Part #	Weight	List	Part #	Weight	List	Part #	Weight	List	
6"	6-0080	5.3	<b>87.00</b>	6-0089	2.4	<b>37.00</b>	6-0086	1.8	<b>26.00</b>	
8"	6-0081	7.0	<b>111.00</b>	6-0090	2.8	<b>50.00</b>	6-0087	2.0	<b>35.00</b>	
10"	6-0082	8.1	<b>114.00</b>	6-0091	3.5	<b>59.00</b>	6-0088	2.3	<b>28.00</b>	

Set Includes A&amp;M Ringlock Clamp

## TWIST LOCK ENDS (CAST ALUMINUM)



Size	Female				Male Ring			Full Male End		
	Part #	Weight	List	Part #	Weight	List	Part #	Weight	List	
4"	6-0141	2.3	<b>43.00</b>	6-0136	0.5	<b>16.50</b>				
5"	6-0142	3.3	<b>45.00</b>	6-0137	0.9	<b>20.00</b>				
6"	6-0143	2.8	<b>54.00</b>	6-0138	1.0	<b>26.00</b>	6-0135	2.8	<b>54.00</b>	
8"	6-0144	7.0	<b>90.00</b>	6-0139	2.3	<b>32.00</b>				

\*200-lbs. max. pressure on all sizes except 8".

# LATERAL COUPLERS

## LATERAL COUPLER (CAST ALUMINUM)



Size	Press-on			Weld-on		
	Part #	Weight	List	Part #	Weight	List
2"	6-0241	1.3	<b>33.00</b>	6-0260	1.2	<b>21.00</b>
3"	6-0242	1.6	<b>35.00</b>	6-0261	1.6	<b>22.00</b>
4"	6-0240	2.0	<b>46.00</b>	6-0262	2.0	<b>42.00</b>

All couplers have 1" outlet.

## KNOB STYLE COUPLER (CAST ALUMINUM)



Size	Part #	Weight	List	Lateral			Mainline		
				Part #	Weight	List	Part #	Weight	List
2" Press-on*	6-0263	1.0	<b>35.00</b>						
3" Weld-on*	6-0264	1.2	<b>33.00</b>						
4" Weld-on*	6-0265	1.8	<b>41.00</b>						
5" Weld-on							6-0266	3.2	<b>47.00</b>
6" Weld-on							6-0267	3.9	<b>59.00</b>

\*Lateral couplers have 1" outlet.

## COUPLER/MALE ENDS - ABC (GALVANIZED STEEL)



Size	Female Lateral*				Female Mainline			Male		
	Part #	Weight	List	Part #	Weight	List	Part #	Weight	List	
2"	6-0180	1.5	<b>40.00</b>	6-0183	0.3	<b>29.00</b>	6-0189	0.5	<b>25.00</b>	
3"	6-0181	3.3	<b>64.00</b>	6-0184	2.0	<b>50.00</b>	6-0190	1.3	<b>34.00</b>	
4"	6-0182	5.5	<b>91.00</b>	6-0185	4.0	<b>70.00</b>	6-0191	2.0	<b>41.00</b>	
5"				6-0186	7.3	<b>90.00</b>	6-0192	4.8	<b>71.00</b>	
6"				6-0187	9.5	<b>124.00</b>	6-0193	6.3	<b>88.00</b>	
8"				6-0188	15.5	<b>199.00</b>	6-0194	13.0	<b>165.00</b>	

- \*Lateral couplers have 1" outlet.
- Includes Spring and Gasket
- Call for prices on ABC Fittings.

## LATERAL COUPLER SET - BOLT-ON (CAST ALUMINUM)



- Has 1" Female threaded outlet.
- Includes band and hook.

Size	Part #	Weight	List
2"	6-0300	1.9	<b>44.00</b>
3"	6-0301	2.8	<b>56.00</b>
4"	6-0302	3.7	<b>68.00</b>
5"	6-0303	4.8	<b>93.00</b>
6"	6-0304	6.3	<b>110.00</b>

# LATERAL COUPLERS

## DETACHABLE COUPLER SET - HOOK (CAST ALUMINUM)



Includes "2" band and hook assemblies

Size	Part #	Weight	List
2"	6-0095	3.0.0	<b>51.00</b>
3"	6-0096	4.3	<b>66.00</b>
4"	6-0097	5.2	<b>70.00</b>
5"	6-0098	7.6	<b>98.00</b>
6"	6-0099	8.8	<b>117.00</b>

## DETACHABLE COUPLER - KNOB (CAST ALUMINUM)



Size	Part #	Weight	List
2"	6-9512	1.5	<b>47.00</b>
3"	6-9513	1.9	<b>64.00</b>
4"	6-9514	2.3	<b>77.00</b>
5"	6-9515	3.5	<b>98.00</b>
6"	6-9516	4.1	<b>132.00</b>
7"	6-9517	5.8	<b>143.00</b>

## SPIKE COUPLER (PVC-SOLVENT)



- 3/4" riser outlet
- Ideal for row crops, nurseries, or orchards
- Spike riser locks male & female coupler halves and stabilizes the riser in a vertical position
- Substantial savings over aluminum or buried solid set systems
- Improved weatherability PVC compounds
- Highest UV inhibitors.
- Highest impact resistance.
- Easy off season storage, simply remove spike riser.
- Non-corrosive aluminum tubing spike riser
- Quad seal prevents water leakage around spike.
- Slotted male end allows for up to 1-1/4" expansion and contraction of PVC pipe.
- Chevron seal gasket.

Size	Part #	Weight	List
2"	6-0305	1.5	<b>23.00</b>
2-1/2"	6-0306	2.0	<b>29.00</b>

## HOLD BAND (STEEL)



Size	Part #	Weight	List
3"	6-0235	0.3	<b>3.00</b>
4"	6-0236	0.3	<b>3.50</b>
5"	6-0237	0.4	<b>5.00</b>
6"	6-0230	0.5	<b>7.00</b>
8"	6-0231	0.8	<b>10.00</b>
10"	6-0232	0.9	<b>14.00</b>



## INDUSTRIAL GROOVE END



Size	Part #	Steel		Aluminum		
		Weight	List	Part #	Weight	List
2"	6-9721	0.8	<b>13.00</b>			
2-1/2"	6-9722	1.5	<b>25.00</b>			
3"	6-9723	1.0	<b>14.00</b>	6-9730	0.7	<b>19.00</b>
4"	6-9724	1.8	<b>19.00</b>	6-9731	1.1	<b>21.00</b>
5"	6-9725	2.3	<b>27.00</b>			
6"	6-9726	2.8	<b>28.00</b>	6-9732	1.9	<b>39.00</b>
8"	6-9727	4.3	<b>43.00</b>	6-9733	2.1	<b>50.00</b>
10"	6-9728	6.5	<b>61.00</b>	6-9734	2.4	<b>56.00</b>
12"	6-9729	8.5	<b>85.00</b>	6-9735		<b>79.00</b>

Galvanized Steel and Aluminum Groove Fittings Available. Please Inquire.

## INDUSTRIAL GROOVE CLAMP



\*Includes Gasket

Size	Part #	Weight	List
1-1/2"	9-6776	2.1	<b>8.00</b>
2"	6-9736	2.7	<b>17.00</b>
2-1/2"	6-9737		<b>20.00</b>
3"	6-9738	2.5	<b>12.00</b>
4"	6-9739	3.5	<b>15.00</b>
5"	6-9740	10.6	<b>57.00</b>
6"	6-9741	6.7	<b>22.00</b>
8"	6-9742	12.5	<b>40.00</b>
10"	6-9743	31.0	<b>122.00</b>
12"	6-9744	35.0	<b>125.00</b>

## INDUSTRIAL GROOVE GASKET



\*Cut-Away View

Size	Part #	Weight	List
1-1/2"	9-6777		<b>10.80</b>
2"	9-6767		<b>3.70</b>
2-1/2"	9-6768		<b>14.20</b>
3"	9-6769		<b>4.40</b>
4"	9-6770		<b>5.00</b>
5"	9-6771		<b>8.00</b>
6"	9-6772		<b>6.30</b>
8"	9-6773		<b>15.00</b>
10"	9-6774		<b>23.00</b>
12"	9-6775		<b>26.00</b>

**SADDLE COUPLING**

(CAST ALUMINUM)



Size	Part #	Weight	List
3/4"	6-0100	0.2	<b>6.00</b>
1"	4-0011	0.2	<b>7.00</b>

\*Weld-on

**BOLT-ON CENTER RISER**

(STEEL GALVANIZED)



Has 1" Female threaded outlet.

Size	Part #	Weight	List
3"	6-0255	3.0.0	<b>16.00</b>
4"	6-0256	4.0.0	<b>17.00</b>

**QUICK COUPLING RISER VALVE**

(CAST ALUMINUM)



Size	Part #	Weight	List
3/4" fpt x 3/4"	6-1579	0.7	<b>17.50</b>
1"mpt x 3/4"	6-1590	0.7	<b>17.50</b>
1"mpt x 1"	6-1591	0.8	<b>18.50</b>

- 3/4" Top outlet require 1.05"ODx.113" wall SCH40 pipe
- 1" Top outlet require 1.315"ODx.133" wall SCH40 pipe

**SPRINKLER DEFLECTOR**

(STEEL)



Type	Part #	Weight	List
Bolts to riser	6-1524	1.4	<b>19.00</b>

## STORAGE BASKET (GALVANIZED STEEL)

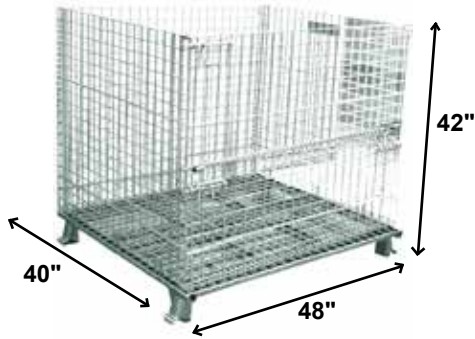

Size	Part #	Weight	List
X-Large	9-7754	158.0	359.00

High-visibility parts storage for manufacturing and warehousing. Features reinforced under carriage and support legs, fully galvanized finish and collapsible, stackable design for efficient storage. Folds flat for space-saving storage, with front drop-gate for easy access.

### Features and Benefits:

- 48" Wide x 40" Deep x 42" Overall Height, Outside measurements.
- Rugged 2-gauge 2"x2" wire mesh with reinforced under-structure.
- Front Drop Gate with side latches for parts accessibility and identification.
- Stackable up to 4 baskets high.
- 4000lbs capacity.



# BALL & SOCKET COUPLERS (BAUER STYLE)

## BALL - BAUER STYLE



- 8" (194) steel will fit to 8" (203) cast aluminum.
- 4" (108) steel will not fit to 4" (102) cast aluminum.

Size	*Black Steel			Cast Aluminum			Stainless Steel		
	Part #	Weight	List	Part #	Weight	List	Part #	Weight	List
2"	6-5000	0.3	<b>4.00</b>	6-5032	0.3	<b>16.00</b>	9-5326	0.3	<b>33.00</b>
3"	6-5001	0.5	<b>5.00</b>	6-5033	0.5	<b>21.00</b>	9-5327	0.7	<b>52.00</b>
3-1/2"	6-5002	0.8	<b>13.50</b>				9-5328	0.8	<b>55.00</b>
4"	6-5003	1.4	<b>11.00</b>	6-5034	1.2	<b>29.00</b>	9-5329	1.5	<b>102.00</b>
5"	6-5005	1.9	<b>13.50</b>	6-5035	1.7	<b>37.00</b>	9-5330	1.8	<b>105.00</b>
6"	6-5006	2.3	<b>17.50</b>	6-5036	2.2	<b>40.00</b>	9-5331	2.3	<b>155.00</b>
8"	6-5007	4.4	<b>32.00</b>	6-8042	3.2	<b>135.00</b>	9-5332	4.3	<b>267.00</b>
10"	9-6955	10.2	<b>35.00</b>	9-6956	6.2	<b>189.00</b>			
12"	9-5816	8.7	<b>103.00</b>						
16"	9-7879		<b>116.00</b>						

\*Galvanized also available.

## SOCKET - BAUER STYLE



Size	Black Steel			Cast Aluminum			Stainless Steel		
	Part #	Weight	List	Part #	Weight	List	Part #	Weight	List
2"	6-5008	0.2	<b>5.00</b>	6-5038	0.3	<b>25.00</b>	9-5333	0.3	<b>38.00</b>
3"	6-5009	0.5	<b>10.00</b>	6-5039	0.7	<b>35.00</b>	9-5334	0.7	<b>69.00</b>
3-1/2"	6-5010	0.8	<b>15.00</b>				9-5335	0.9	<b>75.00</b>
4"	6-5011	1.5	<b>15.00</b>	6-5040	1.4	<b>40.00</b>	9-5336	1.5	<b>117.00</b>
5"	6-5013	2.2	<b>23.50</b>	6-5041	2.1	<b>45.00</b>	9-5337	2.0	<b>149.00</b>
6"	6-5014	2.5	<b>31.00</b>	6-5042	2.6	<b>50.00</b>	9-5338	2.3	<b>225.00</b>
8"	6-5015	5.2	<b>59.00</b>	6-8043	4.0	<b>155.00</b>	9-5339	4.3	<b>290.00</b>
10"	9-7304	8.3	<b>130.00</b>	9-7305	5.5	<b>200.00</b>			
12"	9-5817	13.6	<b>227.00</b>						
16"	9-7880		<b>191.00</b>						

## LEVER - BAUER STYLE

(GALVANIZED STEEL)



\*Locking Bar (part # 9-7318) for 10", 12 and 16" Sold Separately

Size	MM	Part #	Weight	List
2"	50	6-5024	1.0	<b>17.00</b>
3"	76	6-5025	2.3	<b>28.00</b>
3-1/2"	89	6-5026	3.8	<b>39.00</b>
4"	108	6-5027	4.3	<b>40.00</b>
5"	127/133	6-5029	6.2	<b>57.00</b>
6"	152/159	6-5030	9.0	<b>90.00</b>
8"	194/203	6-5031	13.3	<b>115.00</b>
*10"	250	9-6979	24.1	<b>230.00</b>
*12"	300	9-5818	35.6	<b>430.00</b>
*16"	400	9-7881		<b>395.00</b>

## LOCKING BAR

(GALVANIZED STEEL)



Size	Part #	Weight	List
10", 12", 16"	9-7318	1.9	<b>35.00</b>

# BALL & SOCKET FITTINGS (BAUER STYLE)

## GASKET - BAUER STYLE (BAUER STYLE)



Size	MM	I.D.	Part #	Weight	List
2"	50	2.44"	6-5016	0.1	<b>1.10</b>
3"	76	3.48"	6-5017	0.1	<b>1.90</b>
3-1/2"	89	4.26"	6-5018	0.2	<b>6.50</b>
4"	108	5.20"	6-5019	0.2	<b>3.50</b>
5"	127/133	5.98"	6-5021	0.2	<b>6.70</b>
6"	152/159	6.69"	6-5022	0.5	<b>7.00</b>
8"	194	8.66"	6-5023	0.6	<b>11.50</b>
10"	250	--	9-6969	1.1	<b>15.00</b>
12"	300	--	9-5819	1.6	<b>22.00</b>
16"	400		9-7882		<b>17.00</b>

## HOSE ADAPTER - BALL BAUER STYLE



Size	Galvanized Steel			Cast Aluminum			Stainless Steel		
	Part #	Weight	List	Part #	Weight	List	Part #	Weight	List
2"	3-0684	0.7	<b>33.00</b>				9-5340	0.7	<b>73.00</b>
3"	3-0685	1.3	<b>35.00</b>				9-5341	1.5	<b>105.00</b>
4"	3-0686	3.2	<b>45.00</b>				9-5342	3.1	<b>200.00</b>
5"	3-0688	4.2	<b>65.00</b>						
6"	3-0689	5.6	<b>69.00</b>	9-7885		<b>106.00</b>	9-5343	5.9	<b>238.00</b>
8"	3-0690	9.8	<b>95.00</b>	9-7886		<b>212.00</b>	9-5344	10.7	<b>448.00</b>
10"	9-6975	20.2	<b>125.00</b>	9-7887		<b>305.00</b>			
12"	9-7385	20.8	<b>200.00</b>						
16"	9-7883		<b>150.00</b>						

## HOSE ADAPTER - SOCKET BAUER STYLE



Size	Galvanized Steel			Cast Aluminum			Stainless Steel		
	Part #	Weight	List	Part #	Weight	List	Part #	Weight	List
2"	3-0691	0.6	<b>33.00</b>				9-5345	0.8	<b>80.00</b>
3"	3-0692	1.3	<b>35.00</b>				9-5346	1.5	<b>124.00</b>
4"	3-0693	3.3	<b>45.00</b>				9-5347	2.9	<b>244.00</b>
5"	3-0695	4.2	<b>65.00</b>						
6"	3-0696	5.8	<b>72.00</b>	9-7888		<b>108.00</b>	9-5348	6.6	<b>327.00</b>
8"	3-0697	10.6	<b>117.00</b>	9-7889		<b>244.00</b>	9-5349	12.0	<b>525.00</b>
10"	9-6977	20.2	<b>155.00</b>	9-7890		<b>316.00</b>			
12"	9-7386	25.7	<b>342.00</b>						
16"	9-7884		<b>185.00</b>						

**BALL & SOCKET FITTINGS (BAUER STYLE)****90° ELBOW - BAUER STYLE**  
(GALVANIZED STEEL)

Size	MM	Part #	Weight	List
2"	50	6-9038	3.5	<b>70.00</b>
3"	76	6-9039	7.2	<b>112.00</b>
3-1/2"	89	6-9040	11.0	<b>150.00</b>
4"	108	6-9041	12.8	<b>165.00</b>
5"	133	6-9042	23.5	<b>225.00</b>
6"	159	6-9043	27.1	<b>279.00</b>
8"	194	6-9044	47.4	<b>340.00</b>
*10"	250	9-6963	62.3	<b>659.00</b>
*12"	300	9-7387	84.0	<b>1,075.00</b>

\* Locking Bar (part # 9-7318) for 10" &amp; 12" Lever is Sold Separately

**45° ELBOW - BAUER STYLE**  
(GALVANIZED STEEL)

Size	MM	Part #	Weight	List
2"	50	6-9045	3.5	<b>61.00</b>
3"	76	6-9046	7.2	<b>112.00</b>
3-1/2"	89	6-9047	10.8	<b>150.00</b>
4"	108	6-9048	12.6	<b>166.00</b>
5"	133	6-9049	20.2	<b>212.00</b>
6"	159	6-9050	23.8	<b>272.00</b>
8"	194	6-9051	47.4	<b>330.00</b>
*10"	250	9-6961	54.9	<b>577.00</b>
*12"	300	9-7388	73.8	<b>975.00</b>

\* Locking Bar (part # 9-7318) for 10" &amp; 12" Lever is Sold Separately

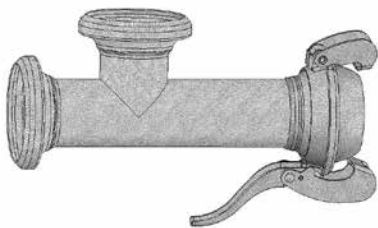
**LINE TEE - BAUER STYLE**  
(GALVANIZED STEEL)

Size	MM	Part #	Weight	List
2"	50	6-9052	13.2	<b>171.00</b>
3"	76	6-9053	15.2	<b>185.00</b>
3-1/2"	89	6-9054	17.7	<b>207.00</b>
4"	108	6-9055	20.1	<b>227.00</b>
5"	133	6-9056	27.8	<b>275.00</b>
6"	159	6-9057	30.5	<b>339.00</b>
8"	194	6-9058	49.3	<b>465.00</b>
*10"	250	9-6980	105.9	<b>920.00</b>
*12"	300	9-7389	140.1	<b>1,625.00</b>

\* Locking Bar (part # 9-7318) for 10" &amp; 12" Lever is Sold Separately

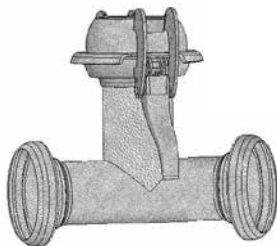
**END TEE - BAUER STYLE**  
(GALVANIZED STEEL)

Size	MM	Part #	Weight	List
2"	50	6-9059	13.2	<b>171.00</b>
3"	76	6-9060	15.2	<b>185.00</b>
3-1/2"	89	6-9061	17.7	<b>207.00</b>
4"	108	6-9062	20.1	<b>227.00</b>
5"	133	6-9063	27.8	<b>275.00</b>
6"	159	6-9064	30.5	<b>339.00</b>
8"	194	6-9065	49.3	<b>465.00</b>
*10"	250	9-6965	105.9	<b>920.00</b>
*12"	300	9-7390	140.1	<b>1,625.00</b>

\* Locking Bar (part # 9-7318) for 10" &amp; 12" Lever is Sold Separately

# BALL & SOCKET FITTINGS (BAUER STYLE)

## END PLUG - BAUER STYLE (GALVANIZED STEEL)



See page 94 for lever.

Size	MM	Part #	Weight	List
2"	50	6-9024	0.7	<b>40.00</b>
3"	76	6-9025	1.1	<b>40.00</b>
3-1/2"	89	6-9026	1.5	<b>50.00</b>
4"	108	6-9027	2.1	<b>50.00</b>
5"	133	6-9028	3.3	<b>59.00</b>
6"	159	6-9029	3.6	<b>62.00</b>
8"	194	6-9030	8.0	<b>87.00</b>
*10"	250	9-6964	14.6	<b>116.00</b>
*12"	300	9-7392	14.8	<b>186.00</b>

## ADAPTER - MPT X BALL BAUER STYLE (GALVANIZED STEEL)



Lever is included.

Size	MM	Part #	Weight	List
2"	50	6-9010	3.1	<b>82.00</b>
3"	76	6-9011	5.5	<b>102.00</b>
4"	108	6-9013	10.9	<b>137.00</b>
5"	133	6-9014	14.7	<b>180.00</b>
6"	159	6-9015	15.9	<b>215.00</b>
8"	194	6-9016	25.2	<b>325.00</b>
*10"	250	9-6949	40.0	<b>475.00</b>
*12"	300	9-7393		<b>865.00</b>

\* Locking Bar (part # 9-7318) for 10" & 12" Lever is Sold Separately

## ADAPTER - MPT X SOCKET BAUER STYLE (GALVANIZED STEEL)



Size	MM	Part #	Weight	List
2"	50	6-9017	1.1	<b>30.00</b>
3"	76	6-9018	1.8	<b>39.00</b>
4"	108	6-9020	3.5	<b>57.00</b>
5"	133	6-9021	6.0	<b>85.00</b>
6"	159	6-9022	7.8	<b>86.00</b>
8"	194	6-9023	14.1	<b>175.00</b>
*10"	250	9-6950	8.3	<b>360.00</b>
*12"	300	9-7394	13.6	<b>475.00</b>

# BALL & SOCKET FITTINGS (BAUER STYLE)

## ADAPTER - FLG X BALL BAUER STYLE (GALVANIZED STEEL)

Photo

Size	MM	Part #	Weight	List
2"	50	9-8315		<b>89.00</b>
3"	76	9-8316		<b>100.00</b>
4"	108	9-8317		<b>135.00</b>
5"	133	9-8318		<b>169.00</b>
6"	159	9-8319		<b>210.00</b>
8"	194	9-8320		<b>275.00</b>
*10"	250	9-8321		<b>439.00</b>
*12"	300	9-8322		<b>730.00</b>
*16"	400	9-8323		<b>850.00</b>

\* Locking Bar (part # 9-7318) for 10" & 12" Lever is Sold Separately

## ADAPTER - FLG X SOCKET BAUER STYLE (GALVANIZED STEEL)

Photo

Size	MM	Part #	Weight	List
2"	50	9-8306	0.7	<b>40.00</b>
3"	76	9-8307	1.1	<b>40.00</b>
4"	108	9-8308	2.1	<b>50.00</b>
5"	133	9-8309	3.3	<b>59.00</b>
6"	159	9-8310	3.6	<b>62.00</b>
8"	194	9-8311	8.0	<b>87.00</b>
10"	250	9-8312	14.6	<b>115.00</b>
12"	300	9-8313	14.8	<b>186.00</b>
16"	400	9-8314		<b>0.00</b>

## BAUER STYLE DIMENSIONS (STEEL)

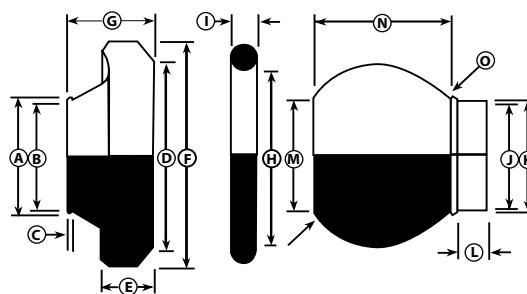

Size	MM	A	B	C	D	E	F	G	H	I	J	K	L	M	N	O
2"	50	2.01	1.91	0.24	2.83	0.67	3.27	1.22	2.44	0.37	1.91	2.01	0.28	1.97	2.17	2.76
3"	76	3.07	2.99	0.28	3.86	0.87	4.57	1.46	3.48	0.51	2.99	3.07	0.55	3.19	2.87	3.86
3-1/2"	89	3.62	3.50	-	4.76	0.98	5.40	1.85	4.26	0.51	3.50	3.62	0.55	3.66	2.99	4.72
4"	108	4.37	4.25	0.47	5.79	1.10	6.50	2.32	5.20	0.59	4.25	4.37	0.59	4.41	4.21	5.71
5"	133	5.39	5.20	0.47	6.42	1.34	7.52	2.13	5.98	0.71	5.20	5.39	0.67	5.39	3.78	6.26
6"	159	6.42	6.22	0.59	7.17	1.34	8.31	2.05	6.69	0.75	6.22	6.42	0.75	6.10	4.06	7.09
8"	194	7.95	7.64	0.71	9.09	1.34	10.51	2.99	8.66	0.75	7.64	7.87	0.67	7.87	5.00	9.06
10"	250	9.84	9.53	0.39	11.93	-	13.62	4.13	-	-	9.25	9.53	-	9.92	6.73	11.81
12"	300	11.81	11.42	0.47	13.70	-	15.78	4.21	-	1.10	11.54	11.81	-	11.81	6.89	13.46
16"	400	15.80	15.37	.39	17.77		20.09	4.79			15.29	15.76		15.29	8.27	17.61



# BALL & SOCKET COUPLERS (100/200 STYLE)

## BALL/SOCKET 100/200 STYLE (BLACK STEEL)



Gasket is included with socket.

### Ball w/Loose Ring

Size	MM	Part #	Weight	List
4"	100	6-5044	1.8	<b>12.50</b>
6"	150	6-5045	4.6	<b>29.00</b>
8"	200	6-5050	10.8	<b>100.00</b>
10"	250	6-5051	17.8	<b>103.00</b>
12"	300	6-5052	30.1	<b>224.00</b>
16"	400	9-7555	64.1	<b>230.00</b>

### Socket w/Lever Attached

Size	MM	Part #	Weight	List
4"	100	6-5046	2.4	<b>25.00</b>
6"	150	6-5047	3.8	<b>37.00</b>
6" (3-Hook)	150	9-6947	5.0	<b>48.00</b>
8"	200	6-5053	9.8	<b>125.00</b>
8" (3-Hook)	200	9-7648	12.5	<b>125.00</b>
10"	250	6-5054	13.4	<b>115.00</b>
*12"	300	6-5055	30.3	<b>227.00</b>
**16"	400	9-7556	57.7	<b>230.00</b>

\* Galvanized Steel Locking Bar (part # 9-7877) for 12" Lever is Sold Separately.  
 \*\* Galvanized Steel Locking Bar (part # 9-7878) for 16" Lever is Sold Separately.

## LOCKING BAR 100/200 STYLE



### Locking Bar (Galvanized)

Size	MM	Dimension	Part #	Weight	List
12"	300	3/4"x13"	9-7877		<b>12.00</b>
16"	400	1"x14"	9-7878		<b>4.00</b>

## GASKET 100/200 STYLE



Size	MM	I.D.	Part #	Weight	List
4"	100	4.75"	6-5048	0.2	<b>2.00</b>
6"	150	6.97"	6-5049	0.5	<b>5.50</b>
8"	200	9.22"	6-5056	0.6	<b>10.00</b>
10"	250	11.07"	6-5057	1.1	<b>21.00</b>
12"	300	13.99"	6-5058	1.3	<b>22.00</b>
16"	400	--	9-7557	3.3	<b>30.00</b>

**HOSE ADAPTER - BALL****100/200 STYLE**

(GALVANIZED STEEL)



Size	MM	Part #	Weight	List
4"	100	6-9073	3.6	<b>49.00</b>
6"	150	6-9074	7.9	<b>75.00</b>
8"	200	6-9075	16.2	<b>170.00</b>
10"	250	6-9076	27.8	<b>199.00</b>
12"	300	6-9077	42.2	<b>295.00</b>
16"	400	9-7558	82.9	<b>450.00</b>

**HOSE ADAPTER - SOCKET****100/200 STYLE**

(GALVANIZED STEEL)



Size	MM	Part #	Weight	List
4"	100	6-9078	4.2	<b>55.00</b>
6"	150	6-9079	7.1	<b>75.00</b>
8"	200	6-9080	15.2	<b>195.00</b>
10"	250	6-9081	23.4	<b>199.00</b>
*12"	300	6-9082	42.4	<b>349.00</b>
**16"	400	9-7559	76.5	<b>475.00</b>

\* Locking Bar (part # 9-7318) for 12" Lever is Sold Separately  
 \*\* Straight Bar for 16" Lever is included

**90° ELBOW****100/200 STYLE**

(GALVANIZED STEEL)



Size	MM	Part #	Weight	List
4"	100	6-9083	9.9	<b>135.00</b>
6"	150	6-9084	21.7	<b>185.00</b>
8"	200	6-9085	34.8	<b>421.00</b>
10"	250	6-9086	50.8	<b>465.00</b>
12"	300	6-9087	86.5	<b>750.00</b>

**45° ELBOW****100/200 STYLE**

(GALVANIZED STEEL)



Size	MM	Part #	Weight	List
4"	100	6-9088	9.7	<b>135.00</b>
6"	150	6-9089	18.4	<b>178.00</b>
8"	200	6-9090	31.4	<b>355.00</b>
10"	250	6-9091	43.4	<b>387.00</b>
12"	300	6-9092	76.3	<b>665.00</b>

# BALL & SOCKET FITTINGS (100/200 STYLE)

## ADAPTER - FLG X BALL

**100/200 STYLE**  
 (GALVANIZED STEEL)



Size	MM	Part #	Weight	List
4"	100	9-8330		<b>95.00</b>
6"	150	9-8331		<b>120.00</b>
8"	200	9-8332		<b>190.00</b>
10"	250	9-8333		<b>250.00</b>
12"	300	9-8334		<b>350.00</b>
16"	400	9-8335		<b>500.00</b>

## ADAPTER - FLG X SOCKET

**100/200 STYLE**  
 (GALVANIZED STEEL)



Size	MM	Part #	Weight	List
4"	100	9-8324		<b>110.00</b>
6"	150	9-8325		<b>140.00</b>
8"	200	9-8326		<b>260.00</b>
10"	250	9-8327		<b>270.00</b>
12"	300	9-8328		<b>425.00</b>
16"	400	9-8329		<b>545.00</b>

## 100/200 STYLE DIMENSIONS

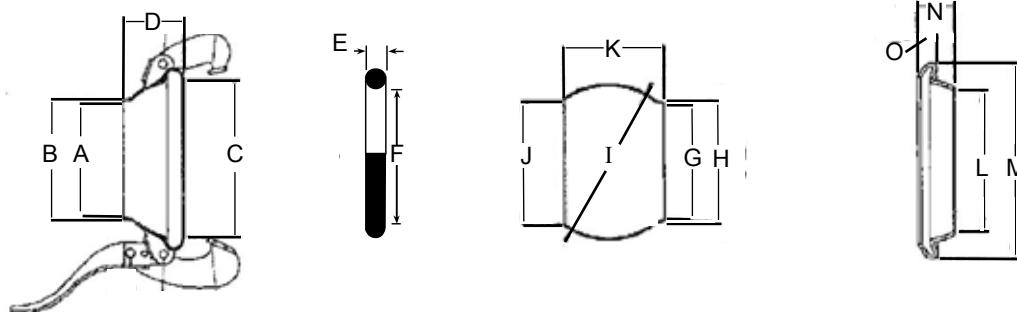

Size	MM	Socket				O Ring		Ball					Ring			
		A	B	C	D	E	F	G	H	I	J	K	L	M	N	O
4"	100	3.62	3.78	5.16	2.36			3.66	3.78	5.08	3.98	3.51	4.65	6.30	1.18	0.51
6"	150	5.44	5.63	7.17	2.76	0.57	6.97	5.44	5.63	6.90	5.59	4.14	6.66	8.78	1.50	0.59
8"	200	7.25	7.56	9.69	3.62	0.73	9.22	7.33	7.60	9.53	7.45	5.75	8.67	11.43	1.85	1.06
10"	250	9.38	9.73	11.86	4.33	0.87	11.07	9.22	9.57	11.82	9.93	6.74	11.15	14.11	2.40	1.30
12"	300	11.36	12.21	14.66	4.93	0.93	13.99	11.66	12.02	14.58	11.98	8.35	13.36	17.57	2.76	1.69
16"	400	15.91						15.91								

# CAM-LOC FITTINGS

## FEMALE THREAD X MALE CAM-LOC

(Cast Aluminum)

**"A"** Series



Size	Width	Part #	Weight	List
1/2"		9-5889	0.1	3.50
3/4"		9-5890	0.1	4.00
1"		9-5891	0.1	5.00
1-1/4"		9-5892	0.2	7.00
1-1/2"		9-5893	0.3	6.00
2"	2-1/2"	6-6918	0.4	7.00
2-1/2"	3"	6-6919	0.6	12.00
3"	3-5/8"	6-6920	0.7	13.00
4"	4-3/4"	6-6921	1.3	21.00
5"	5-3/4"	6-6922	1.6	42.00
6"	6-15/16"	6-6923	2.0.0	44.00
8"		6-6897	10.9	145.00
10"		9-7584	9.9	342.00

## FEMALE THREAD X FEMALE CAM-LOC

(Cast Aluminum)

**"D"** Series



Size	Width	Part #	Weight	List
1/2"		9-5904	0.2	7.80
3/4"		9-5905	0.2	10.00
1"		9-5906	0.4	12.00
1-1/4"		9-5907	0.7	15.00
1-1/2"		9-5908	0.8	14.00
2"	2-1/2"	6-6924	0.9	17.00
2-1/2"	3"	6-6925	1.2	25.00
3"	3-5/8"	6-6926	1.8	27.00
4"	4-3/4"	6-6927	2.8	40.00
5"	5-3/4"	6-6928	3.4	68.00
6"	6-15/16"	6-6929	5.1	76.00
8"		6-9788	9.5	239.00
10"		9-7585	12.5	544.00

## MALE THREAD X MALE CAM-LOC

(Cast Aluminum)

**"F"** Series



Size	Width	Part #	Weight	List
1/2"		9-5914	0.1	4.90
3/4"		9-5915	0.2	6.00
1"		9-5916	0.2	7.00
1-1/4"		9-5917	0.3	9.00
1-1/2"		9-5918	0.5	7.00
2"	2-1/2"	6-6930	0.7	9.00
2-1/2"	3"	6-6931	1.0.0	16.00
3"	3-5/8"	6-6932	1.3	18.00
4"	4-3/4"	6-6933	2.3	26.00
5"	5-3/4"	6-6934	2.9	50.00
6"	6-15/16"	6-6935	3.9	68.00
8"		9-6959	7.9	160.00
10"		9-7586	10.6	373.00

## MALE THREAD X FEMALE CAM-LOC

(Cast Aluminum)

**"B"** Series



Size	Width	Part #	Weight	List
1/2"		9-5894	0.2	6.50
3/4"		9-5895	0.2	10.00
1"		9-5896	0.4	12.00
1-1/4"		9-5897	0.6	14.00
1-1/2"		9-5898	0.7	14.00
2"	2-1/2"	6-6936	0.9	17.00
2-1/2"	3"	6-6937	1.0.0	23.00
3"	3-5/8"	6-6938	1.6	27.00
4"	4-3/4"	6-6939	2.4	36.00
5"	5-3/4"	6-6940	3.3	68.00
6"	6-15/16"	6-6941	5.0.0	79.00
8"		9-7587	8.0.0	228.00
10"		9-7588	12.1	548.00

## CAM-LOC FITTINGS

### Working Pressure:

Size	Max PSI
1/2" through 2"	250
2-1/2" through 4"	150
5" through 6"	75
8" through 12"	50

\*Note: Plastic, Stainless Steel, and Brass Cam-Loc Fittings available, please call.

\*Note: Cam-Loc fittings can also be used for fast & easy suction fittings.

\* Please note: 5" & 8" mfg. by different companies may not interchange.

## HOSE BARB X MALE

### CAM-LOC

(Cast Aluminum)

**"E"**

Series



Size	Width	Part #	Weight	List
1/2"		9-5909	0.1	3.50
3/4"		9-5910	0.1	5.00
1"		9-5911	0.2	6.00
1-1/4"		9-5912	0.3	8.00
1-1/2"		9-5913	0.4	6.00
2"	2-1/2"	6-6900	0.6	8.00
2-1/2"	3"	6-6901	0.9	15.00
3"	3-5/8"	6-6902	1.3	17.00
4"	4-3/4"	6-6903	2.1	25.00
5"	5-3/4"	6-6914	3.6	57.00
6"	6-15/16"	6-6915	6.2	72.00
8"		6-6899	10.0.0	235.00
10"		9-7589	12.9	438.00

## HOSE BARB X FEMALE

### CAM-LOC

(Cast Aluminum)

**"C"**

Series



Size	Width	Part #	Weight	List
1/2"		9-5899	0.2	12.00
3/4"		9-5900	0.3	8.00
1"		9-5901	0.4	10.00
1-1/4"		9-5902	0.7	14.00
1-1/2"		9-5903	0.7	13.00
2"	2-1/2"	6-6904	1.0.0	16.00
2-1/2"	3"	6-6905	1.3	23.00
3"	3-5/8"	6-6906	2.2	26.00
4"	4-3/4"	6-6907	3.2	39.00
5"	5-3/4"	6-6916	3.9	73.00
6"	6-15/16"	6-6917	7.7	96.00
8"		6-6898	15.5	285.00
10"		9-7590	16.7	689.00

## END CAP (DUST CAP)

### CAM-LOC

(Cast Aluminum)

**"DC"**



Size	Width	Part #	Weight	List
1/2"		9-5919	0.2	5.70
3/4"		9-5920	0.2	8.00
1"		9-5921	0.3	10.00
1-1/4"		9-5922	0.6	14.00
1-1/2"		9-5923	0.6	12.00
2"	2-1/2"	9-5924	0.8	14.00
2-1/2"	3"	9-5925	1.0.0	13.00
3"	3-5/8"	9-5926	1.3	25.00
4"	4-3/4"	9-5927	2.3	29.00
5"	5-3/4"	9-5928	3.1	51.00
6"	6-15/16"	9-5929	4.7	73.00
8"		9-6832	9.0.0	205.00
10"		9-7592	12.5	456.00

## END PLUG (DUST PLUG)

### CAM-LOC

(Cast Aluminum)

**"DP"**



Size	Width	Part #	Weight	List
1/2"		9-5930	0.1	3.00
3/4"		9-5931	0.1	4.00
1"		9-5932	0.1	5.00
1-1/4"		9-5933	0.2	6.00
1-1/2"		9-5934	0.3	5.00
2"	2-1/2"	9-5935	0.3	6.00
2-1/2"	3"	9-5936	0.5	12.00
3"	3-5/8"	9-5937	0.7	11.00
4"	4-3/4"	9-5938	1.2	18.00
5"	5-3/4"	9-5939	1.5	32.00
6"	6-15/16"	9-5940	2.5	40.00
8"		9-7593	4.0.0	99.00
10"		9-7594	5.4	233.00

## GASKET, CAM-LOC



Size	OD	ID	Part #	Weight	List
1/2"	1.024	0.669	9-6748		0.60
3/4"	1.375	0.875	9-6749		0.60
1"	1.563	1.063	9-6750		0.60
1-1/4"	1.938	1.359	9-6751		0.60
1-1/2"	2.188	1.625	9-6752		0.60
2"	2.625	2.000	6-6908		0.60
2-1/2"	3.125	2.375	6-6909		0.70
3"	3.719	3.000	6-6910		0.70
4"	4.875	4.000	6-6911	0.1	1.00
5"	5.906	4.875	6-6912	0.1	2.30
6"	7.063	6.000	6-6913	0.1	2.50
8"	9.125	8.000	9-5876	0.2	5.00
10"	11.875	9.875	9-7591	0.4	16.00

Fittings

## RINGLOCK ELBOW (GALVANIZED STEEL)



Size	45° Ringlock			90° Ringlock		
	Part #	Weight	List	Part #	Weight	List
3"	9-7395	4.8	<b>89.00</b>	9-7399	7.4	<b>125.00</b>
4"	9-7396	7.5	<b>102.00</b>	9-7400	12.0	<b>145.00</b>
5"	9-7397	9.6	<b>120.00</b>	9-7401	15.2	<b>150.00</b>
6"	6-0310	11.3	<b>120.00</b>	6-0320	24.4	<b>140.00</b>
8"	6-0311	15.9	<b>140.00</b>	6-0321	24.9	<b>180.00</b>
10"	6-0312	19.3	<b>175.00</b>	6-0322	30.6	<b>250.00</b>
12"	9-7398	31.6	<b>250.00</b>	9-7402	45.2	<b>310.00</b>

Ringlock clamp is not included.

## RINGLOCK ELBOW WITH 2" MALE THREAD (GALVANIZED STEEL)



Size	Part #	Weight	List
6"	9-8008		<b>170.00</b>
8"	9-8009		<b>210.00</b>
10"	9-8010		<b>280.00</b>

Ringlock clamp is not included.

## RINGLOCK 90° ELBOW MALE X MALE (GALVANIZED STEEL)



Size	Part #	Weight	List
3"	9-7403	7.6	<b>125.00</b>
4"	9-7404	12.0	<b>145.00</b>
5"	9-7405	15.2	<b>150.00</b>
6"	9-5350	14.8	<b>140.00</b>
8"	9-5351	23.1	<b>180.00</b>
10"	9-5352	30.7	<b>250.00</b>
12"	9-7406	45.2	<b>310.00</b>

Ringlock clamp is not included.

**RINGLOCK ELBOW**  
(CAST ALUMINUM)



Size	45° Ringlock			90° Ringlock		
	Part #	Weight	List	Part #	Weight	List
4"	9-7407	3.7	<b>108.00</b>	9-7410	4.4	<b>131.00</b>
5"	9-7408	4.7	<b>136.00</b>	9-7411	5.5	<b>163.00</b>
6"	6-0370	6.2	<b>145.00</b>	6-0380	8.2	<b>169.00</b>
8"	6-0371	8.3	<b>175.00</b>	6-0381	10.8	<b>199.00</b>
10"	6-0372	10.3	<b>215.00</b>	6-0382	15.3	<b>269.00</b>
12"	9-7409	14.5	<b>409.00</b>	9-7412	20.0	<b>550.00</b>

Ringlock clamp is not included.

**TWIST LOCK ELBOW**  
(CAST ALUMINUM)



Size	45° Twist Lock			90° Twist Lock		
	Part #	Weight	List	Part #	Weight	List
6"	6-0313	5.6	<b>205.00</b>	6-0314	6.1	<b>241.00</b>

Call for other twist-lock sizes

**HOOK STYLE ELBOW**  
(CAST ALUMINUM)



Size	45° Hook Style			90° Hook Style		
	Part #	Weight	List	Part #	Weight	List
2"	6-0390	3.0	<b>73.00</b>	6-0395	3.0.0	<b>60.00</b>
3"	6-0391	4.0	<b>89.00</b>	6-0396	4.0.0	<b>78.00</b>
4"	6-0392	5.0.0	<b>109.00</b>	6-0397	5.0.0	<b>100.00</b>

**KNOB STYLE ELBOW**  
(CAST ALUMINUM)



Size	45° Knob Style			90° Knob Style		
	Part #	Weight	List	Part #	Weight	List
2"	6-0403	2.1	<b>91.00</b>	6-0398	2.1	<b>98.00</b>
3"	6-0404	2.8	<b>109.00</b>	6-0399	2.8	<b>90.00</b>
4"	6-0405	4.1	<b>140.00</b>	6-0400	4.1	<b>150.00</b>
5"	6-0406	6.9	<b>186.00</b>	6-0401	6.9	<b>200.00</b>
6"	6-0407	9.1	<b>222.00</b>	6-0402	9.1	<b>239.00</b>

Fittings

**PLAIN ELBOW**  
(ALUMINUM)

Size	45° Alum. Plain			90° Alum. Plain		
	Part #	Weight	List	Part #	Weight	List
2"	6-0354	1.7	<b>69.00</b>	6-0364	2.0	<b>79.00</b>
3"	6-0355	1.8	<b>75.00</b>	6-0365	2.3	<b>89.00</b>
4"	6-0350	2.6	<b>85.00</b>	6-0360	2.8	<b>89.00</b>
5"	6-0356	3.2	<b>89.00</b>	6-0366	4.6	<b>105.00</b>
6"	6-0351	3.3	<b>105.00</b>	6-0361	4.5	<b>125.00</b>
8"	6-0352	4.6	<b>110.00</b>	6-0362	6.5	<b>135.00</b>
10"	6-0353	5.6	<b>130.00</b>	6-0363	8.0	<b>165.00</b>
12"	6-9001		<b>315.00</b>	6-8021		<b>375.00</b>

**SURFACE ELBOW**  
(PVC)

Size	45° Surface PVC			90° Surface PVC		
	Part #	Weight	List	Part #	Weight	List
6"	6-0340		<b>78.00</b>	6-0344		<b>87.00</b>
8"	6-0341		<b>95.00</b>	6-0345		<b>111.00</b>
10"	6-0342		<b>119.00</b>	6-0346		<b>150.00</b>
12"	6-0343		<b>152.00</b>	6-0347		<b>193.00</b>



# FLANGED FITTINGS

## FLANGED ELBOW (GALVANIZED STEEL)



Flanged 45°				Flanged 90°		
Size	Part #	Weight	List	Part #	Weight	List
4"	9-7941		<b>175.00</b>	9-7415	27.7	<b>165.00</b>
6"	9-7942		<b>195.00</b>	9-5825	39.0	<b>275.00</b>
8"	9-7943		<b>228.00</b>	9-5826	52.8	<b>325.00</b>
10"	9-7944		<b>275.00</b>	9-5827	67.1	<b>385.00</b>
12"	9-7945		<b>355.00</b>	9-7416	86.8	<b>485.00</b>

• Also Available in Cast Aluminum or Stainless Steel, call for prices.

## FLANGE X RINGLOCK ELBOW (GALVANIZED STEEL)



Flange x MRL				Flange x FRL		
Size	Part #	Weight	List	Part #	Weight	List
6"	9-7993		<b>266.00</b>	9-7996		<b>266.00</b>
8"	9-7994		<b>300.00</b>	9-7997		<b>300.00</b>
10"	9-7995		<b>360.00</b>	9-7998		<b>360.00</b>

• Also Available in Cast Aluminum or Stainless Steel, call for prices.

## FLANGED TEE (GALVANIZED STEEL)

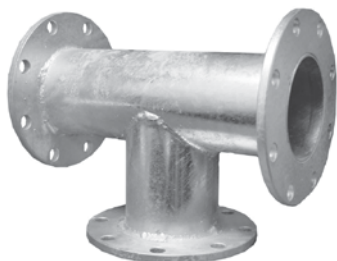

Size	Part #	Weight	List
4"	9-7423	32.6	<b>215.00</b>
6"	9-5822	44.9	<b>259.00</b>
8"	9-5823	61.2	<b>320.00</b>
10"	9-5824	78.1	<b>432.00</b>
12"	9-7424	103.0	<b>500.00</b>

• Also Available in Cast Aluminum or Stainless Steel, call for prices.

## FLANGED SPOOL (GALVANIZED STEEL)



Size	Length	Part #	Weight	List
4" x 4"	12" Long	9-7946		<b>115.00</b>
6" x 4"	3.5" Long	9-7999		<b>100.00</b>
6" x 6"	12" Long	9-7947		<b>130.00</b>
8" x 6"	3.5" Long	9-8000		<b>125.00</b>
8" x 8"	16" Long	9-7948		<b>158.00</b>
10" x 8"	3.5" Long	9-8001		<b>156.00</b>
10" x 10"	20" Long	9-7949		<b>195.00</b>
12" x 10"	3.5" Long	9-8299		<b>230.00</b>
12" x 12"	12" Long	9-7950		<b>278.00</b>

- Also Available in Cast Aluminum or Stainless Steel, call for prices.

## FLANGE ADAPTERS (GALVANIZED STEEL)



Size	Flg x Female RL				Flg x Male RL		
	Part #	Weight	List	Part #	Weight	List	
4"	9-6830	8.6	<b>59.00</b>	9-6831	8.6	<b>57.00</b>	
6"	6-6450	12.1	<b>80.00</b>	6-6459	12.1	<b>80.00</b>	
8"	6-6451	17.4	<b>100.00</b>	6-6549	17.4	<b>100.00</b>	
10"	6-6449	22.1	<b>130.00</b>	6-6458	22.1	<b>130.00</b>	
12"	6-6448	32.0	<b>190.00</b>	6-6457	32.0	<b>190.00</b>	

- Also Available in Cast Aluminum or Stainless Steel, call for prices.

## FLANGE X FRL INCREASERS - REDUCERS (GALVANIZED STEEL)



	Size	Part #	Weight	List
<b>Increaser:</b>	6" Flange x 8" FRL	9-8002		<b>111.00</b>
	8" Flange x 10" FRL	9-8003		<b>150.00</b>
<b>Reducer:</b>	8" Flange x 6" FRL	9-8004		<b>115.00</b>
	10" Flange x 8" FRL	9-8005		<b>140.00</b>

- Flange x Male Ringlock adapters are also available.
- Also Available in Cast Aluminum or Stainless Steel, call for prices.

## RINGLOCK END TEE (GALVANIZED STEEL)



Ringlock clamp is not included.

Size	Part #	Weight	List
3"	9-7417	9.0	150.00
4"	9-7418	13.6	165.00
5"	9-7419	17.0	192.00
6"	6-0410	19.6	165.00
8"	6-0411	27.1	215.00
10"	6-0412	33.3	325.00
12"	9-7420	52.0	359.00

## RINGLOCK END TEE (CAST ALUMINUM)



Ringlock clamp is not included.

Size	Part #	Weight	List
4"	9-7421	6.2	195.00
5"	9-7422	7.5	229.00
6"	6-0430	9.6	225.00
8"	6-0431	13.4	285.00
10"	6-0432	17.3	345.00

## PLAIN END TEE (ALUMINUM)



Size	Part #	Weight	List
2"	6-0444	3.3	90.00
3"	6-0445	3.6	90.00
4"	6-0440	3.9	99.00
5"	6-0446	6.6	120.00
6"	6-0441	6.6	160.00
8"	6-0442	8.9	185.00
10"	6-0443	11.5	225.00
12"	6-8026	16.1	725.00

## PLAIN END TEE (SURFACE PVC)



Size	Part #	Weight	List
6"	6-0447		112.00
8"	6-0448		141.00
10"	6-0449		175.00
12"	6-0453		235.00

## HOOK STYLE END TEE (CAST ALUMINUM)



Size	Part #	Weight	List
2"	6-0450	2.6	90.00
3"	6-0451	3.8	103.00
4"	6-0452	4.8	184.00

## TWIST LOCK END TEE (CAST ALUMINUM)



Size	Part #	Weight	List
6"	6-0316	9.1	272.00

## KNOB STYLE END TEE (ALUMINUM)



Size	Part #	Weight	List
2"	6-0460	2.6	114.00
3"	6-0461	3.5	125.00
4"	6-0462	6.4	141.00
*5"	6-0463	7.3	218.00
*6"	6-0464	8.8	240.00

\* Fabricated Aluminum.

Fittings

# LINE TEES & Y TEES

## RINGLOCK LINE TEE (GALVANIZED STEEL)



Size	Part #	Weight	List
3"	9-7426	9.0	<b>150.00</b>
4"	9-7427	13.6	<b>165.00</b>
5"	9-7428	17.0	<b>192.00</b>
6"	6-0610	19.6	<b>165.00</b>
8"	6-0611	27.1	<b>215.00</b>
10"	6-0612	33.3	<b>325.00</b>
12"	9-7429	52.0	<b>359.00</b>

## RINGLOCK LINE TEE (CAST ALUMINUM)



Size	Part #	Weight	List
4"	9-7430	6.2	<b>195.00</b>
5"	9-7431	7.5	<b>229.00</b>
6"	6-0630	9.6	<b>225.00</b>
8"	6-0631	13.4	<b>285.00</b>
10"	6-0632	17.3	<b>345.00</b>

## PLAIN LINE TEE (ALUMINUM)



Size	Part #	Weight	List
2"	6-0644	3.3	<b>90.00</b>
3"	6-0645	3.6	<b>90.00</b>
4"	6-0640	3.9	<b>99.00</b>
5"	6-0646	6.6	<b>120.00</b>
6"	6-0641	6.6	<b>160.00</b>
8"	6-0642	8.9	<b>185.00</b>
10"	6-0643	11.5	<b>225.00</b>
12"	6-8025	16.1	<b>725.00</b>

## PLAIN LINE TEE (SURFACE PVC)



Size	Part #	Weight	List
6"	6-0647		<b>112.00</b>
8"	6-0648		<b>141.00</b>
10"	6-0649		<b>175.00</b>
12"	6-0653		<b>235.00</b>

## TWIST LOCK LINE TEE (CAST ALUMINUM)

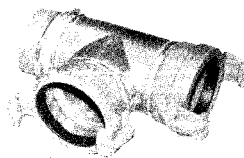

Size	Part #	Weight	List
6"	6-0317	9.1	<b>272.00</b>

## HOOK STYLE LINE TEE (CAST ALUMINUM)



Size	Part #	Weight	List
2"	6-0650	4.0.0	<b>100.00</b>
3"	6-0651	5.0.0	<b>122.00</b>
4"	6-0652	7.0.0	<b>161.00</b>

## KNOB STYLE LINE TEE

(CAST ALUMINUM)



Size	Part #	Weight	List
2"	6-0660	2.8	<b>105.00</b>
3"	6-0661	3.8	<b>125.00</b>
4"	6-0662	5.0.0	<b>140.00</b>
5"	6-0663	11.9	<b>215.00</b>
6"	6-0664	14.0	<b>269.00</b>

## PLAIN LINE Y TEE

(ALUMINUM)

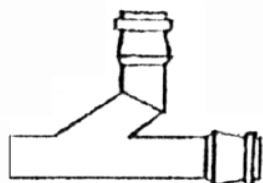

Size	Part #	Weight	List
6"	6-0550		<b>153.00</b>
8"	6-0551		<b>175.00</b>
10"	6-0552		<b>196.00</b>

## PLAIN Y TEE

(ALUMINUM)

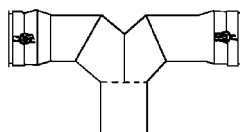

Size	Part #	Weight	List
6"	6-0540	7.2	<b>220.00</b>
8"	6-0541	9.6	<b>260.00</b>
10"	6-0542	12.5	<b>329.00</b>
12"	6-8027		<b>675.00</b>

## RINGLOCK Y TEE

(GALVANIZED STEEL)

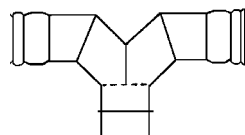

Size	Part #	Weight	List
6"	6-0510	24.7	<b>300.00</b>
8"	6-0511	33.8	<b>320.00</b>
10"	6-0512	41.8	<b>355.00</b>

## RINGLOCK Y TEE

(ALUMINUM)



Size	Part #	Weight	List
6"	6-0530	7.7	<b>269.00</b>
8"	6-0531	10.5	<b>279.00</b>
10"	6-0532	13.5	<b>359.00</b>

# REDUCERS

## PLAIN REDUCER (ALUMINUM)



Size	Part #	Weight	List
3" x 2"	6-0614	1.8	<b>65.00</b>
4" x 3"	6-0615	2.0	<b>65.00</b>
5" x 4"	8-1428	3.7	<b>95.00</b>
6" x 4"	6-0710	2.8	<b>74.00</b>
8" x 4"	6-0713	7.2	<b>140.00</b>
8" x 6"	6-0711	3.9	<b>80.00</b>
10" x 8"	6-0712	4.0	<b>94.00</b>
12" x 10"	6-9002		<b>325.00</b>

## RINGLOCK REDUCER (GALVANIZED STEEL)



Size	Part #	Weight	List
6" x 4"	6-0730	6.4	<b>90.00</b>
8" x 4"	6-0733	9.6	<b>180.00</b>
8" x 6"	6-0731	9.3	<b>105.00</b>
10" x 8"	6-0732	12.7	<b>135.00</b>

## HOOK STYLE REDUCER (CAST ALUMINUM)



Size	Part #	Weight	List
3" x 2"	6-0720	2.0	<b>63.00</b>
4" x 3"	6-0721	3.0	<b>66.00</b>

## KNOB STYLE REDUCER (CAST ALUMINUM)



Size	Part #	Weight	List
3" x 2"	6-0717	1.6	<b>95.00</b>
4" x 3"	6-0718	2.3	<b>115.00</b>
5" x 4"	6-0719	2.8	<b>152.00</b>
6" x 4"	6-0709	4.8	<b>155.00</b>

# REDUCER & INCREASERS

## SURFACE REDUCER (PVC)

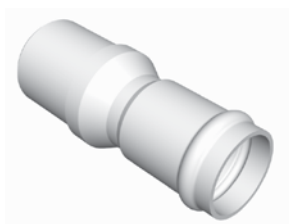

Size	Part #	Weight	List
8" x 6"	6-0714		<b>62.00</b>
10" x 8"	6-0715		<b>75.00</b>
12" x 10"	6-0716		<b>91.00</b>

## PLAIN INCREASER (ALUMINUM)



Size	Part #	Weight	List
4" x 6"	6-0740	4.8	<b>90.00</b>
6" x 8"	6-0741	6.3	<b>110.00</b>
8" x 10"	6-0742	9.1	<b>140.00</b>
10" x 12"	6-9003		<b>355.00</b>

## RINGLOCK INCREASER (GALVANIZED STEEL)



Size	Part #	Weight	List
6" x 8"	6-0760	11.3	<b>105.00</b>
8" x 10"	6-0761	14.3	<b>135.00</b>

## SURFACE INCREASER (PVC)

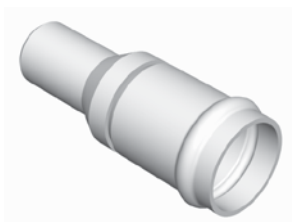

Size	Part #	Weight	List
6" x 8"	6-0743		<b>62.00</b>
8" x 10"	6-0744		<b>75.00</b>
10" x 12"	6-0745		<b>91.00</b>

# END PLUGS

## PLAIN END PLUG (ALUMINUM)



Size	Part #	Weight	List
4"	6-0810	1.4	49.00
5"	6-0814	2.4	59.00
6"	6-0811	2.5	59.00
8"	6-0812	3.8	65.00
10"	6-0813	4.6	74.00
12"	6-8020		125.00

## RINGLOCK END PLUG (GALVANIZED STEEL)



Size	Part #	Weight	List
3"	9-7432	1.8	45.00
4"	9-7433	2.3	50.00
5"	9-7434	3.5	55.00
6"	6-0830	4.9	55.00
8"	6-0831	6.9	65.00
10"	6-0832	9.9	100.00
12"	9-7435	15.1	110.00

## RINGLOCK END PLUG W/2" MPT (GALVANIZED STEEL)



Size	Part #	Weight	List
4"	9-8006		59.00
5"	9-8007		69.00
6"	9-8113		80.00
8"	9-8114		99.00
10"	9-8115		125.00

## HOOK STYLE END PLUG (CAST ALUMINUM)



Size	Part #	Weight	List
2"	6-0821	1.0.0	27.00
3"	6-0822	1.5	30.00
4"	6-0820	2.0.0	44.00
5"	6-0823	3.0.0	58.00
6"	6-0824	4.0.0	63.00

## TWIST LOCK END PLUG (CAST ALUMINUM)



Size	Part #	Weight	List
6"	6-0315	3.5	126.00



## KNOB STYLE END PLUG

(CAST ALUMINUM)



Size	Part #	Weight	List
2"	6-0833	0.8	<b>31.00</b>
3"	6-0834	1.3	<b>32.00</b>
4"	6-0835	1.8	<b>41.00</b>
5"	6-0836	2.3	<b>54.00</b>
6"	6-0837	3.0	<b>60.00</b>

## SURFACE END PLUG

(PVC)



Size	Part #	Weight	List
6"	6-0815		<b>29.00</b>
8"	6-0816		<b>35.00</b>
10"	6-0817		<b>44.00</b>
12"	6-0818		<b>56.00</b>

## RINGLOCK END CAP

(GALVANIZED STEEL)



Size	Part #	Weight	List
3"	9-7436	1.6	<b>45.00</b>
4"	9-7437	2.3	<b>50.00</b>
5"	9-7438	3.5	<b>55.00</b>
6"	6-0870	4.1	<b>78.00</b>
8"	6-0871	8.2	<b>87.00</b>
10"	9-7439	9.9	<b>100.00</b>
12"	9-7440	15.1	<b>110.00</b>

## END PLUG COVER, W/HANDLE,

### WELD-ON

 (CAST ALUMINUM)

Size	Part #	Weight	List
6"	9-7620	1.5	<b>51.00</b>
8"	9-7621	2.5	<b>68.00</b>
10"	9-7622	3.3	<b>78.00</b>

Aluminum end plug cover fits a coupler's weld socket for fabricating end plugs and end caps.

# WELD-ON ELBOWS

## SWEEPING ELBOW - WELD-ON (CAST ALUMINUM)



Size	Cast Alum 45° Sweep			Cast Alum 90° Sweep		
	Part #	Weight	List	Part #	Weight	List
3"	6-0270	1.0	<b>31.00</b>	6-0275	1.5	<b>53.00</b>
4"	6-0271	1.0	<b>33.00</b>	6-0276	1.7	<b>57.00</b>
5"	6-9943	1.5	<b>45.00</b>	6-9942	2.3	<b>75.00</b>
6"	6-0272	2.0	<b>55.00</b>	6-0277	4.0	<b>90.00</b>
8"	6-0273	3.5	<b>67.00</b>	6-0278	6.0	<b>108.00</b>
10"	6-0274	4.8	<b>98.00</b>	6-0279	9.5	<b>165.00</b>
12"	9-7413	5.5	<b>227.00</b>	9-7414	11.0	<b>379.00</b>

## SWEEPING ELBOW - WELD-ON (BLACK STEEL)

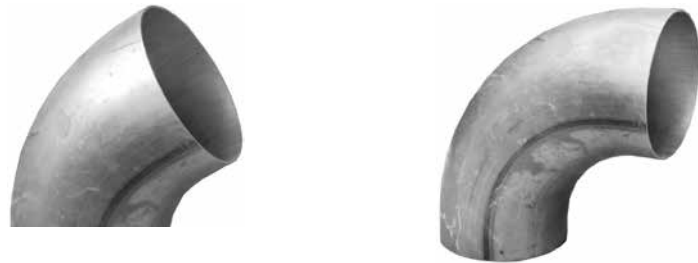

Size	Black Steel 45° Sweep				Black Steel 90° Sweep				
	Part #	Thickness	Weight	List	Part #	Thickness	"A"	Weight	List
2"	6-0075		2.0	<b>20.00</b>	6-0001			2.0	<b>26.00</b>
3"	6-0076		4.0	<b>37.00</b>	6-0002			4.0	<b>37.00</b>
4"	6-0077	.200"	5.5	<b>58.00</b>	6-0003	.200"	5.25"	5.7	<b>58.00</b>
4-1/2"	9-7755	.134"	3.0	<b>18.00</b>	9-7758	.134"		6.0	<b>24.00</b>
5"	9-8112			<b>50.00</b>	9-5017				<b>70.00</b>
5-5/8"	9-7894	.188"		<b>30.00</b>	9-7897	.188"			<b>41.00</b>
6"					9-7658	.072"	16.25"		<b>79.00</b>
6"	6-0078	.190"	10.0	<b>64.00</b>	6-0004	.190"	8.50"	13.4	<b>83.00</b>
6-5/8"	9-7756	.190"	6.0	<b>38.00</b>	9-7759	.190"		12.0	<b>63.00</b>
8"	9-6813	.190"	15.0	<b>70.00</b>	6-9939	.190"	11.50"	24.5	<b>110.00</b>
8-5/8"	9-7757	.190"	11.1	<b>75.00</b>	9-7760	.190"		22.1	<b>119.00</b>
10"	9-7776	.190"		<b>75.00</b>	9-7777	.190"			<b>130.00</b>
10-3/4"	9-7895	.250"		<b>119.00</b>	9-7898	.250"			<b>187.00</b>
12-3/4"	9-7896	.250"		<b>161.00</b>	9-7899	.250"			<b>256.00</b>

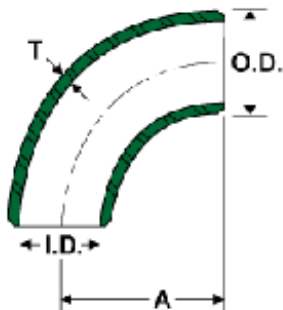

## MITERED ELBOW - WELD-ON (BLACK STEEL)



45°

Size	10 Gauge (.135")			7 Gauge (.188")		
	Part #	Weight	List	Part #	Weight	List
3"	6-0280	1.5	45.00			
4"	6-0281	3.6	50.00			
6"	6-0282	6.1	63.00	9-8196		86.00
8"	6-0283	10.8	75.00	9-8197		102.00
10"	6-0268	12.3	95.00	9-8198		106.00
12"	6-0269	15.9	110.00	9-8199		119.00

Measurements (Inside):

- 45 deg 3"x3" extensions
- 90 deg 3"x2"x3"



90°

Size	10 Gauge (.135")			7 Gauge (.188")		
	Part #	Weight	List	Part #	Weight	List
3"	6-0284	2.1	65.00			
4"	6-0285	5.4	65.00			
6"	6-0286	9.3	99.00	9-8200		149.00
8"	6-0287	14.1	115.00	9-8201		169.00
10"	6-0288	19.7	140.00	9-8202		185.00
12"	6-0289	26.1	195.00	9-8203		210.00

\*\*\*Stainless Steel also available\*\*\*

## 90° ELBOW - SCH 40 (BLACK STEEL)

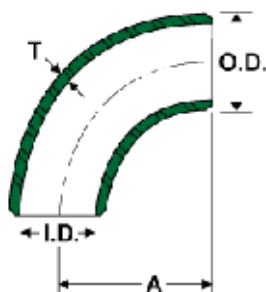

Size	Wall	OD	ID	"A"	Part #	Weight	List
3"	.216"	3.50"	3.07"	4.5"	9-5231	4.8	16.00
4"	.237"	4.50"	4.03"	6.0"	9-5233	8.9	26.00
6"	.280"	6.62"	6.06"	9.0"	9-5235	24.0	58.00
8"	.322"	8.62"	7.97"	12.0"	9-5237	47.8	110.00
10"	.365"	10.75"	10.02"	15.0"	9-5227	83.4	220.00
12"	.375"	12.75"	12.00"	18.0"	9-5229	123.0	322.00

-Long Radius

\* Other sizes available. Please Call.

## 45° ELBOW - SCH 40 (BLACK STEEL)

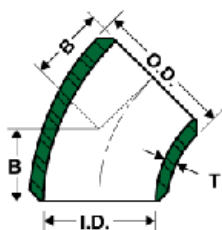

Size	Wall	OD	ID	"B"	Part #	Weight	List
3"	.216"	3.50"	3.07"	2.0"	9-5230	2.5	11.50
4"	.237"	4.50"	4.03"	2.5"	9-5232	4.5	21.00
6"	.280"	6.62"	6.06"	3.75"	9-5234	11.7	40.00
8"	.322"	8.62"	7.97"	5.0"	9-5236	23.3	67.00
10"	.365"	10.75"	10.02"	6.25"	9-5226	40.9	132.00
12"	.375"	12.75"	12.00"	7.5"	9-5228	61.4	190.00

\* Other sizes available. Please Call.

# WELD-ON TEES

## WELD-ON TEE (CAST ALUMINUM)



Size	Part #	Weight	List
3"	9-7425	1.5	<b>70.00</b>
4"	6-9940	2.0	<b>82.00</b>
5"	6-9941	2.5	<b>89.00</b>
6"	6-0290	3.0	<b>101.00</b>
8"	6-0291	5.8	<b>138.00</b>
10"	6-0292	8.0	<b>166.00</b>

## WELD-ON TEE (BLACK STEEL)



Measurements:  
4"x4" extensions

Size	10 Gauge (.135")			7 Gauge (.188")		
	Part #	Weight	List	Part #	Weight	List
4"	6-0293	11.5	<b>75.00</b>			
5"	6-0294	15.4	<b>80.00</b>			
6"	6-0295	14.3	<b>105.00</b>	9-8204		<b>105.00</b>
8"	6-0296	21.2	<b>115.00</b>	9-8205		<b>129.00</b>
10"	6-0297	29.0	<b>135.00</b>	9-8206		<b>139.00</b>
12"	6-0298	38.0	<b>175.00</b>	9-8207		<b>165.00</b>

\*\*\*Stainless Steel also available\*\*\*

## WELD-ON WYE TEE (BLACK STEEL)



\*\*\*Stainless Steel also available\*\*\*

Size	10 Gauge (.135")			7 Gauge (.188")		
	Part #	Weight	List	Part #	Weight	List
4"	9-8212		<b>98.00</b>			
5"	9-8213		<b>100.00</b>			
6"	9-8214		<b>108.00</b>	9-8208		<b>129.00</b>
8"	9-8215		<b>140.00</b>	9-8209		<b>150.00</b>
10"	9-8216		<b>150.00</b>	9-8210		<b>162.00</b>
12"	9-8217		<b>175.00</b>	9-8211		<b>188.00</b>

## TEE - SCH 40 (BLACK STEEL)

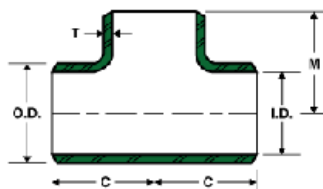

Size	Wall	OD	ID	"C"	Part #	Weight	List
3"	.216"	3.50"	3.07"	3.38"	9-5282	7.2	<b>35.00</b>
4"	.237"	4.50"	4.03"	4.12"	9-5283	12.7	<b>48.00</b>
6"	.280"	6.62"	6.06"	5.62"	9-5284	33.1	<b>79.00</b>
8"	.322"	8.62"	7.97"	7.0"	9-5285	56.5	<b>150.00</b>
10"	.365"	10.75"	10.02"	8.5"	9-5280	90.9	<b>280.00</b>
12"	.375"	12.75"	12.00"	10.0"	9-5281	136.0	<b>396.00</b>

\* Other sizes available. Please Call.

# CONCENTRIC CONES

## CONE (BLACK STEEL)



Size	14/12 Gauge			10 Gauge			7 Gauge		
	Part #	Weight	List	Part #	Weight	List	Part #	Weight	List
3" x 2"	6-1185	0.5	8.00						
4" x 2"	6-1186	1.0	10.00						
4" x 3"	6-1187	0.5	7.00						
5" x 3"	6-1188	1.5	13.00						
5" x 4"	6-1189	0.7	12.00						
6" x 3"	6-1190	2.0	20.00						
6" x 4"	6-1130	1.2	14.00	6-9747	2.3	18.00	9-7873		26.00
6" x 5"	6-1191	0.9	13.00	9-8297		18.00	9-8298		25.00
7" x 5"	6-1192	1.0	19.00						
7" x 6"	6-1193	1.0	19.00						
8" x 7"	6-1194	1.4	19.00						
8" x 4"	6-1131	2.5	45.00						
8" x 5"	6-1195	3.0	37.00						
8" x 6"	6-1132	2.5	26.00	6-9748	3.2	21.00	9-7874		37.00
9" x 8"	6-1196	1.7	23.00						
10" x 9"	6-1197	2.2	33.00						
10" x 8"	6-1133	3.2	27.00	6-9749	4.1	31.50	9-7875		49.00
12" x 10"	6-1138	4.0	45.00	6-9750	5.0	43.00	9-7876		60.00
12" x 8"	6-1198	7.5	71.00						
14" x 10"				6-8100	9.0	98.00			
14" x 12"				6-8101	5.0	55.00			
15" x 10"				9-7690		135.00			
16" x 10"				9-7689		209.00			
16" x 12"				6-8102	11.0	127.00			
16" x 14"				6-8103	6.0	67.00			
18" x 14"				6-8104	15.0	139.00			
18" x 16"				6-8105	7.0	95.00			
20" x 16"				6-8106	16.0	240.00			
20" x 18"				6-8107	7.5	114.00			
22" x 18"				6-8108		275.00			
22" x 20"				6-8109		161.00			
24" x 20"				6-8110		310.00			
24" x 22"				6-8111		195.00			

# CONCENTRIC CONES

## CONE

(CAST ALUMINUM)



Size	Material	Part #	Weight	List
3" x 2"	Cast Aluminum	6-1125	0.3	<b>11.00</b>
4" x 2"	Cast Aluminum	6-1126	0.3	<b>12.00</b>
4" x 3"	Cast Aluminum	6-1127	1.5	<b>17.50</b>
5" x 4"	Cast Aluminum	6-1128	0.8	<b>23.00</b>
6" x 4"	Cast Aluminum	6-1134	1.8	<b>33.00</b>
6" x 5"	Cast Aluminum	6-1129	1.0.0	<b>30.00</b>
8" x 4"	Cast Aluminum	6-1135	4.1	<b>99.00</b>
8" x 6"	Cast Aluminum	6-1136	2.3	<b>45.00</b>
8" x 7"	<b>Aluminum</b>	6-1164	0.2	<b>24.00</b>
9" x 8"	<b>Aluminum</b>	6-1165		<b>38.00</b>
10" x 8"	Cast Aluminum	6-1137	4.0.0	<b>59.00</b>
12" x 10"	Cast Aluminum	6-0865	5.0.0	<b>88.00</b>

## CONE

(STAINLESS STEEL)



Size	Material	Part #	Weight	List
6" x 4"	304 Stainless Steel	9-8147		<b>85.00</b>
8" x 6"	304 Stainless Steel	9-8107		<b>91.00</b>
10" x 8"	304 Stainless Steel	9-8108		<b>115.00</b>
12" x 8"	304 Stainless Steel	9-8148		<b>145.00</b>

## CONCENTRIC CONE - SCH 40

(BLACK STEEL)

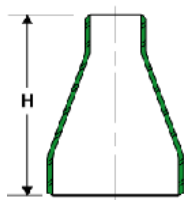

Size	"H"	Part #	Weight	List
3" x 2"	3.5"	9-5190	2.0	<b>16.00</b>
3" x 2-1/2"	3.5"	9-5191	2.2	<b>16.00</b>
4" x 2-1/2"	4.0"	9-5192	3.2	<b>41.00</b>
4" x 3"	4.0"	9-5193	3.3	<b>19.00</b>
6" x 4"	5.5"	9-5194	7.4	<b>39.00</b>
6" x 5"	5.5"	9-5195	7.6	<b>35.00</b>
8" x 4"	6.0"	9-5196	10.8	<b>68.00</b>
8" x 6"	6.0"	9-5197	12.3	<b>52.00</b>
10" x 6"	7.0"	9-5186	20.7	<b>94.00</b>
10" x 8"	8.0"	9-5187	22.1	<b>100.00</b>
12" x 10"	8.0"	9-5188	32.4	<b>124.00</b>
12" x 8"	8.0"	9-5189	30.5	<b>142.00</b>

\* Other sizes available. Please Call.

# ECCENTRIC CONES

## ECCENTRIC CONE (BLACK STEEL)

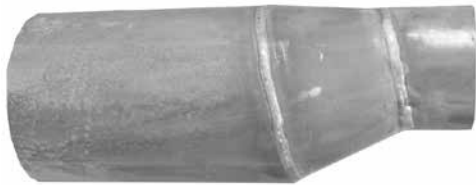

Size	Part #	Weight	List
3" x 2"	6-1124	2.3	<b>37.00</b>
4" x 2"	6-1139	3.0	<b>43.00</b>
4" x 3"	6-1145	2.5	<b>43.00</b>
5" x 3"	6-1146	3.8	<b>55.00</b>
5" x 4"	6-1147	3.3	<b>52.00</b>
6" x 3"	6-1148	5.0.0	<b>69.00</b>
6" x 4"	6-1140	4.3	<b>67.00</b>
6" x 5"	6-1149	3.8	<b>62.00</b>
8" x 4"	6-1141	10.5	<b>86.00</b>
8" x 5"	6-1154	10.0.0	<b>83.00</b>
8" x 6"	6-1142	8.8	<b>78.00</b>
10" x 6"	6-1180	14.0.0	<b>120.00</b>
10" x 8"	6-1143	12.5	<b>115.00</b>
12" x 6"	6-1181	15.0.0	<b>138.00</b>
12" x 8"	6-1182	13.5	<b>130.00</b>
12" x 10"	6-1144	13.0	<b>125.00</b>
14" x 12"	9-8109		<b>245.00</b>

## ECCENTRIC CONE (CAST ALUMINUM)



Can be cut to fit fabricated size.

Size	Part #	Weight	List
2-1/2" x 6"	6-1177	3.3	<b>84.00</b>
3" x 8"	6-1178	5.3	<b>118.00</b>

## ECCENTRIC CONE - SCH 40 (BLACK STEEL)

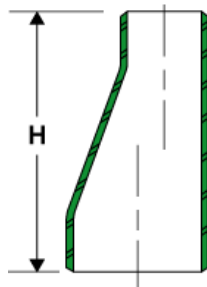

\* Other sizes available. Please Call.

Size	"H"	Part #	Weight	List
3" x 2"	3.5	9-5218	2.0	<b>25.00</b>
3" x 2-1/2"	3.5	9-5219	2.2	<b>23.00</b>
4" x 2-1/2"	4.0	9-5220	3.2	<b>32.00</b>
4" x 3"	4.0	9-5221	3.3	<b>30.00</b>
6" x 4"	5.5	9-5222	7.4	<b>62.00</b>
6" x 5"	5.5	9-5223	7.6	<b>51.00</b>
8" x 4"	6.0	9-5224	10.8	<b>144.00</b>
8" x 6"	6.0	9-5225	12.3	<b>79.00</b>
10" x 6"	7.0	9-5214	20.7	<b>181.00</b>
10" x 8"	8.0	9-5215	22.1	<b>103.00</b>
12" x 10"	8.0	9-5216	32.4	<b>161.00</b>
12" x 8"	8.0	9-5217	30.5	<b>252.00</b>

# FLANGES

## FLANGE (BLACK STEEL)



Includes Gasket

## Specifications:

- Carbon Steel (either A36 plate OR A283-C plate)
- Polyurethane coating (to avoid rust in transit)
- Mil finished plate x machined (125-250-rms) facing
- 1/2" thick; #150 psi test
- Full Face flanges; Standard Bolt Holes
- 1/16" red rubber flange gasket included
- DIN Flanges also available (please call)

Larger sizes available, please call for pricing and availability.

Size	Part #	Weight	List
<b>OD Size:</b>			
2"	6-1104	3.5	<b>13.00</b>
2-1/2"	6-1105	4.5	<b>18.00</b>
3"	6-1106	5.3	<b>12.50</b>
4"	6-1107	7.1	<b>17.00</b>
5"	6-1108	8.2	<b>19.00</b>
6"	6-1110	9.3	<b>21.00</b>
8"	6-1111	12.9	<b>29.00</b>
10"	6-1112	16.6	<b>40.00</b>
12"	6-1109	23.0	<b>59.00</b>
14"	8-1440	26.5	<b>125.00</b>
16"	8-1441	31.0	<b>149.00</b>
18"	8-1442	32.0	<b>179.00</b>
20"	8-1443	37.5	<b>215.00</b>
22"	8-1444	38.5	<b>289.00</b>
24"	8-1445	51.0	<b>375.00</b>
<b>IPS Size:</b>			
4-1/2"	9-6915	6.6	<b>17.00</b>
6-5/8"	6-9674	8.7	<b>21.00</b>
8-5/8"	6-9675	11.7	<b>29.00</b>
10-3/4"	6-9676	14.9	<b>40.00</b>
12-3/4"	6-9677	22.1	<b>59.00</b>
<b>For Valve Outlet:</b>			
6"	6-9678	6.1	<b>21.00</b>
8"	6-9679	8.9	<b>29.00</b>
10"	6-9680		<b>95.00</b>
12"	6-9681		<b>165.00</b>

Size	Part #	Thickness	ID	OD	Bolt Circle	# of Holes	Hole Size	Bolt Size
2"	6-1104	1/2"	2-1/16"	6"	4-3/4"	4	3/4"	5/8"
2-1/2"	6-1105	1/2"	2-9/16"	7"	5-1/2"	4	3/4"	5/8"
3"	6-1106	1/2"	3-1/16"	7.5"	6"	4	3/4"	5/8"
4"	6-1107	1/2"	4-1/16"	9"	7-1/2"	8	3/4"	5/8"
4-1/2" IPS Size	9-6915	1/2"	4.57"	9"	7-1/2"	8	3/4"	5/8"
5"	6-1108	1/2"	5-1/16"	10"	8-1/2"	8	7/8"	3/4"
6"	6-1110	1/2"	6-1/16"	11"	9-1/2"	8	7/8"	3/4"
6-5/8" IPS Size	6-9674	1/2"	6.72"	11"	9-1/2"	8	7/8"	3/4"
6" For Valve Outlet	6-9678	1/2"	8-1/16"	11"	9-1/2"	8	7/8"	3/4"
8"	6-1111	1/2"	8-1/16"	13.5"	11-3/4"	8	7/8"	3/4"
8-5/8" IPS Size	6-9675	1/2"	8.72"	13.5"	11-3/4"	8	7/8"	3/4"
8" For Valve Outlet	6-9679	1/2"	10-1/16"	13.5"	11-3/4"	8	7/8"	3/4"
10"	6-1112	1/2"	10-1/16"	16"	14-1/4"	12	1"	7/8"
10-3/4" IPS Size	6-9676	1/2"	10.88"	16"	14-1/4"	12	1"	7/8"
10" For Valve Outlet	6-9680	1/2"	12-1/16"	16"	14-1/4"	12	1"	7/8"
12"	6-1109	1/2"	12-1/16"	19"	17"	12	1"	7/8"
12-3/4"	6-9677	1/2"	12.88"	19"	17"	12	1"	7/8"
12" For Valve Outlet	6-9681	1/2"	14.13"	19"	17"	12	1"	7/8"
14"	8-1440	1/2"	14.13"	21"	18-3/4"	12	1-1/8"	1"
16"	8-1441	1/2"	16.13"	23.5"	21-1/4"	16	1-1/8"	1"
18"	8-1442	1/2"	18.13"	25"	22-3/4"	16	1-1/4"	1-1/8"
20"	8-1443	1/2"	20.13"	27.5"	25"	20	1-1/4"	1-1/8"
22"	8-1444	1/2"	22.13"	29.5"	27-1/4"	20	1-3/8"	1-1/4"
24"	8-1445	1/2"	24.13"	32"	29-1/2"	20	1-3/8"	1-1/4"



## FLANGE (CAST ALUMINUM)



Includes Gasket

Size	Part #	Weight	List
3"	6-1055	3.0.0	<b>70.00</b>
4"	6-1116	4.2	<b>72.00</b>
5"	6-1117	5.2	<b>80.00</b>
6"	6-1113	6.3	<b>85.00</b>
8"	6-1114	8.1	<b>109.00</b>
10"	6-1115	12.3	<b>167.00</b>
12"	6-1103	17.5	<b>257.00</b>

## FLANGE (STAINLESS STEEL)



Includes Gasket

Size	Part #	Weight	List
6"	9-8101		<b>145.00</b>
8"	9-8102		<b>235.00</b>
10"	9-8103		<b>287.00</b>

## FLANGE GASKET (RED RUBBER)



(Full Face)

Size	1/16" Thick			1/8" Thick		
	Part #	Weight	List	Part #	Weight	List
2"	6-1101		<b>1.75</b>	6-9666		<b>2.00</b>
2-1/2"	9-6814		<b>2.50</b>	9-7802		<b>2.00</b>
3"	6-1102		<b>2.50</b>	6-9667		<b>2.50</b>
4"	6-1118	0.2	<b>3.50</b>	6-9668		<b>3.50</b>
5"	6-1119	0.2	<b>4.50</b>	6-9669		<b>4.00</b>
6"	6-1120	0.3	<b>3.50</b>	6-9670		<b>5.00</b>
8"	6-1121	0.3	<b>4.00</b>	6-9671		<b>7.00</b>
10"	6-1122	0.3	<b>5.50</b>	6-9672		<b>10.00</b>
12"	6-1123	0.5	<b>8.00</b>	6-9673		<b>13.00</b>
14"	9-7797		<b>13.00</b>	8-1340		<b>18.00</b>
16"	9-7798		<b>15.00</b>	8-1341		<b>22.00</b>
18"	9-7799		<b>17.00</b>	8-1342		<b>25.00</b>
20"	9-7800		<b>19.00</b>	8-1343		<b>30.00</b>
22"	9-8300		<b>22.00</b>	8-1344		<b>30.00</b>
24"	9-7801		<b>22.00</b>	8-1345		<b>45.00</b>

## FLANGE - SQUARE (BLACK STEEL)



Size	Part #	Weight	List
4"	9-5466	3.0	<b>15.00</b>
6"	9-5467	1.9	<b>19.00</b>
8"	9-5468	3.1	<b>23.00</b>

## FLANGE GASKET - SQUARE

Size	Part #	Weight	List
4"/6"	9-8164		<b>10.00</b>
8"	9-8165		<b>17.00</b>

## FLANGE - BLIND (BLACK STEEL)



Includes Gasket

Size	OD	Thickness	Part #	Weight	List
2"	6"	1/2"	6-9707	4.0	<b>22.00</b>
2-1/2"	7"	1/2"	6-9708	5.5	<b>29.00</b>
3"	7-1/2"	1/2"	6-9709	6.5	<b>25.00</b>
4"	9"	1/2"	6-9710	9.2	<b>33.00</b>
5"	10"	1/2"	9-8163		<b>47.00</b>
6"	11"	1/2"	6-9711	13.8	<b>47.00</b>
8"	13-1/2"	1/2"	6-9712	21.3	<b>69.00</b>
10"	16"	1/2"	6-9713	28.1	<b>110.00</b>
12"	19"	1/2"	6-9714	42.3	<b>140.00</b>
14"	21"	1/2"	9-7724	51.5	<b>176.00</b>
16"	23-1/2"	1/2"	9-7725	60.0	<b>345.00</b>
18"	25"	1/2"	9-7726	70.0	<b>229.00</b>
20"	27-1/2"	1/2"	9-7727	90.0	<b>303.00</b>
24"	32"	1/2"	9-7728	125.0	<b>406.00</b>

## FLANGE - FEMALE THREADED (CAST IRON)



Includes Gasket

Thread Size	OD	Thickness	Part #	Weight	List
2"	6"	5/8"	6-9639	5.1	<b>27.00</b>
2-1/2"	7"	5/8"	6-9640	7.1	<b>30.00</b>
3"	7-1/2"	5/8"	6-9641	7.9	<b>35.00</b>
4"	9"	5/8"	6-9642	13.2	<b>39.00</b>
5"	10"	3/4"	6-9643	15.2	<b>60.00</b>
6"	11"	3/4"	6-9644	19.0	<b>65.00</b>
8"	13-1/2"	1"	6-9645	30.3	<b>110.00</b>
10"	16"	1"	6-9646	43.3	<b>223.00</b>
12"	19"	1"	6-9647	64.4	<b>249.00</b>

Female pipe thread ID

## FLANGE INSULATION KIT



## Includes:

- Nitrile-Face Phenolic Full Face Flange Gasket
- Mylar Sleeves
- Phenolic Washers (single washer kit)
- Steel Washers (single washer kit)
- Bolts & Nuts NOT included

This cathodically insulated kit prevents stray currents which cause undue corrosion and eventual breakdown of the metal. Also prevents leakage.

Size	Part #	Weight	List
2"	9-6928	0.4	<b>18.00</b>
2-1/2"	9-6929	0.6	<b>22.00</b>
3"	9-6930	0.6	<b>24.00</b>
4"	9-6931	0.8	<b>38.00</b>
5"	9-6932	1.0	<b>39.00</b>
6"	9-6933	1.2	<b>46.00</b>
8"	9-6934	1.6	<b>60.00</b>
10"	9-6935	3.0	<b>87.00</b>
12"	9-6936	3.2	<b>110.00</b>
14"	9-6937	4.2	<b>135.00</b>
16"	9-6938	5.6	<b>175.00</b>
18"	9-6939	6.4	<b>195.00</b>
20"	9-6940	7.2	<b>230.00</b>
22"	9-6941	8.5	<b>260.00</b>
24"	9-6942	9.8	<b>290.00</b>

## DISC - WELD-ON (ALUMINUM)



Size	Thickness	Part #	Weight	List
2"	.090"	6-1156	0.1	<b>3.00</b>
3"	.090"	6-1157	0.3	<b>4.00</b>
4"	.090"	6-1159	0.5	<b>5.00</b>
5"	.090"	6-1158	0.8	<b>6.00</b>
6"	.090"	6-1160	1.0.0	<b>8.50</b>
7"	.090"	9-5808		<b>10.00</b>
8"	.090"	6-1161	1.7	<b>11.00</b>
9"	.090"	9-5809	0.5	<b>12.50</b>
10"	.090"	6-1162	2.0.0	<b>14.00</b>
12"	.090"	6-1163	2.5	<b>18.00</b>

## DISC - WELD-ON (BLACK STEEL)



Size	Thickness	Part #	Weight	List
2"	3/16"	6-1170	0.1	<b>2.00</b>
3"	3/16"	6-1171	0.2	<b>3.00</b>
4"	3/16"	6-1150	0.4	<b>4.00</b>
5"	3/16"	6-1172	1.1	<b>5.00</b>
6"	3/16"	6-1151	1.0.0	<b>6.00</b>
7"	1/4"	6-1173	2.8	<b>9.00</b>
8"	3/16"	6-1152	3.3	<b>10.00</b>
9"	1/4"	6-1175	4.6	<b>12.00</b>
10"	3/16"	6-1153	4.0.0	<b>13.00</b>
11"	1/4"	6-1176	6.8	<b>18.00</b>
12"	3/16"	6-1174	5.8	<b>20.00</b>

# RINGS

## RINGLOCK CLAMP (PLATED STEEL)



Size	Schumacher Standard			Oversized (TL)			A&M (small)			Pierce (small)		
	Part #	Weight	List	Part #	Weight	List	Part #	Weight	List	Part #	Weight	List
3"	6-1047	1.4	19.00									
4"	6-1038	1.6	20.00							9-8220	1.6	19.00
5"	6-1039	1.8	21.00									
6"	6-1040	2.0	23.00	6-1043	2.0	25.00	6-0083	2.0	24.00	6-1060	2.0	22.00
7"	6-1036	2.3	27.00									
8"	6-1041	2.7	24.00	6-1044	2.5	27.00	6-0084	2.5	26.00	9-8221	2.7	25.00
10"	6-1042	3.5	30.00				6-0085	3.5	27.00	9-8222	3.5	30.00
12"	6-1037	5.3	36.00							9-8223	5.3	37.00

## BAIL SPRING (FOR RINGLOCK CLAMPS)



Size	Part #	Weight	List
-	6-1046	0.5	5.00

## HORSESHOE CLAMP (PAINTED STEEL)



Up to 50 psi

Size	Part #	Weight	List
6"	6-1050	1.5	23.00
7"	6-1054	1.6	19.00
8"	6-1051	1.7	26.00
10"	6-1052	2.1	29.00

## RING - WELD-ON (CAST ALUMINUM)



Size	Part #	Weight	List
6"	6-1010	0.6	14.00
8"	6-1011	0.9	17.00
10"	6-1012	1.1	21.00

## RING - WELD-ON (BLACK STEEL)



Size	Part #	Weight	List
4"	9-8131		7.00
6"	6-1020	1.0	9.00
8"	6-1021	1.1	12.00
10"	6-1022	1.4	14.00
12"	9-8142		25.50

## RING - BOLT-ON

(PAINTED STEEL)



Size	Part #	Weight	List
4"	9-5806	1.2	13.00
6"	6-1032	1.7	15.00
8"	6-1033	2.1	17.00
10"	6-1035	2.6	19.00
12"	9-5807		21.00

Max. 50 psi

## SINGLE BAND & HOOK

(GALVANIZED STEEL)



Single, Complete Assembly includes 1 band, 1 hook, 2 bolts, 2 nuts and 1 ferrule.

Single Band Only Assembly includes 1 band and 1 nut &amp; bolt.

Size	Complete			Band Only		
	Part #	Weight	List	Part #	Weight	List
2"	6-0913	0.5	12.00	6-0915	0.4	8.00
3"	6-0914	0.6	14.00	6-0916	1.3	9.00
4"	6-0910	0.6	15.00	6-0911		10.00
5"	6-0922	0.8	16.00	6-0924	1.9	12.00
6"	6-0920	2.8	17.00	6-0921	2.2	13.00
7"	6-0923	3.0	19.00	6-0925		14.00
8"	6-0930	3.8	20.00	6-0931	2.8	16.00
9"	6-0932	4.0	22.00	6-0933	2.1	18.00
10"	6-0940	4.5	23.00	6-0941	3.4	19.00
12"	6-0945	5.0	25.00	6-0942		21.00

## DOUBLE BAND & HOOK

(GALVANIZED STEEL)



Double, Complete Assembly includes 1 band, 2 hooks, 3 bolts, 3 nuts and 2 ferrules.

Size	Complete			Band Only		
	Part #	Weight	List	Part #	Weight	List
4"	6-0950	1.4	32.00	6-0951	0.3	22.00
6"	6-0960	3.6	34.00	6-0961	2.5	24.00
8"	6-0970	4.6	37.00	6-0971	3.1	27.00
10"	6-0980	5.3	40.00	6-0981	3.7	30.00
12"	6-0990	5.8	42.00	6-0991	0.3	32.00

## HOOK

(GALVANIZED STEEL)



Universal			Anderson			A&M Long			A&M Short		
Part #	Weight	List	Part #	Weight	List	Part #	Weight	List	Part #	Weight	List
6-0904	0.5	4.50	4-0012	0.5	4.20	4-0013		5.00	4-0014	0.4	5.00

# BAND & LATCH ACCESSORIES

## BAND & LATCH (KNOB STYLE)



2", 3"



4", 5", 6"

Size	Complete			Band Only		
	Part #	Weight	List	Part #	Weight	List
2"	6-0992	0.4	<b>9.00</b>	6-0953	0.6	<b>5.00</b>
3"	6-0993	0.5	<b>10.00</b>	6-0954	0.7	<b>6.00</b>
4"	6-0994	0.9	<b>13.50</b>	6-0955	0.8	<b>10.00</b>
5"	6-0995	1.6	<b>17.00</b>	6-0956	1.4	<b>13.00</b>
6"	6-0996	1.8	<b>21.00</b>	6-0957	1.7	<b>18.00</b>

## LATCH ONLY (KNOB STYLE)



CX



DX

Size	Type	Part #	Weight	List
2"-3"-4"	CX	6-0946	0.3	<b>5.00</b>
5"-6"	DX	6-0952	0.3	<b>5.00</b>

## KNOB - WELD-ON (CAST ALUMINUM)



Type	Part #	Weight	List
Cast Alum.	6-0844	0.1	<b>4.50</b>

## U - HOLDER



Type	Part #	Weight	List
Aluminum	6-0861	0.1	<b>9.00</b>
Steel	6-0860	0.3	<b>4.00</b>

## U - HOLDER FOR TELESCOPE (CAST ALUMINUM)



Size	Part #	Weight	List
-	6-0862	0.5	<b>23.00</b>

# BAND & LATCH ACCESSORIES

## LOCKING BLOCK



Steel



Aluminum

Type	Part #	Weight	List
Aluminum	6-0840	0.3	7.00
Steel	6-0850	0.3	4.00

## LOCK RING - WELD-ON (STEEL)



Type	Part #	Weight	List
Steel	6-0841		11.00

## LOCK RING - BOLT-ON (CAST ALUMINUM)



Type	Part #	Weight	List
Cast Alum.	6-0842	0.4	5.70

## LOCK PLATE STUB (CAST ALUMINUM)



\*Older lock plates are steel

Type	Part #	Weight	List
Cast Alum.	6-0843		5.50

## BAIL RING



Type	Part #	Weight	List
6" w/Steel Bracket	6-0846		37.00
6" w/Aluminum Bracket	6-0847		37.00
3",4",5" w/Aluminum Bracket	6-0848		20.00

## LUG - WELD-ON (ALUMINUM)



Type	Part #	Weight	List
6" Aluminum	6-0849	0.2	7.00
4" Aluminum	6-0851	0.1	4.50

\* To match above Bail Rings

# NUTS & BOLTS

## BOLT KITS

(FOR STEEL FLG X FLG)



Flg Size	Kit Size	Dimension	Part #	Weight	List
2", 3"	Set of 4	5/8"x 2" long	9-5882		<b>8.00</b>
4"	Set of 8	5/8"x 2" long	9-5883		<b>14.00</b>
5", 6", 8"	Set of 8	3/4"x 2" long	9-5884	4.9	<b>29.00</b>
10", 12"	Set of 12	7/8"x 2" long	9-5881	10.7	<b>45.00</b>

## BOLT KITS

(FOR WAFER VALVES)



Wafer Valve Kit for Steel Flanges						Wafer Valve Kit for PVC Flanges			
Flg Size	Kit Size	Dimension	Part #	Weight	List	Dimension	Part #	Weight	List
2", 3"	Set of 4	5/8"x 4"	9-5886		<b>10.00</b>	5/8"x 5"	9-6864		<b>12.00</b>
4"	Set of 8	5/8"x 4-1/2"	9-5887	5.0	<b>29.00</b>	5/8"x 6"	9-6865		<b>28.00</b>
5", 6", 8"	Set of 8	3/4"x 5"	9-5888	7.8	<b>30.00</b>	3/4"x 7"	9-6866		<b>60.00</b>
5", 6", 8"	<u>Bolt Only</u>	3/4" x 5-1/2"	9-5880		<b>3.80</b>				
10", 12"	Set of 12	7/8"x 5-1/2"	9-5885	17.7	<b>100.00</b>	7/8"x 8"	9-6863		<b>120.00</b>
16"	Set of 16	1" x 5-1/2"	9-7663		<b>116.00</b>				
18"	Set of 16	1-1/8" x 5-1/2"	9-7664		<b>158.00</b>				

## NUTS & BOLTS

(FOR BAND &amp; HOOK)



Type	Size	Grade	Part #	Weight	List
Bolt	3/8" x 1-1/2"	5	6-0901	0.1	<b>0.30</b>
Nut	3/8"	2	6-0902		<b>0.08</b>
Ferrule	5/16" Wide		6-0903		<b>0.60</b>
Ferrule	1/2" Wide		6-0899		<b>0.80</b>
Bolt	3/4" x 2"	5	6-0905	0.4	<b>1.70</b>
Nut	3/4"	2	6-0906	0.1	<b>0.50</b>

## CARRIAGE BOLT & NUT

(KNOB STYLE BAND &amp; LATCH)



Type	Size	Description	Part #	Weight	List
Bolt	5/16" x 1"	For 4" Back	6-0947	0.1	<b>0.20</b>
Bolt	5/16" x 1-1/2"	For 2", 3", 4" Front	6-0962	0.1	<b>0.30</b>
Bolt	3/8" x 1-1/4"	For 5", 6" Back (2 req)	6-0963	0.1	<b>0.30</b>
Bolt	3/8" x 1-3/4"	For 5", 6" Front	6-0964	0.1	<b>0.50</b>
Nut	5/16"		6-0965	0.1	<b>0.10</b>
Nut	3/8"		6-0966	0.1	<b>0.15</b>



# TELESCOPES & DROP PIPE

## TELESCOPE (ALUMINUM)

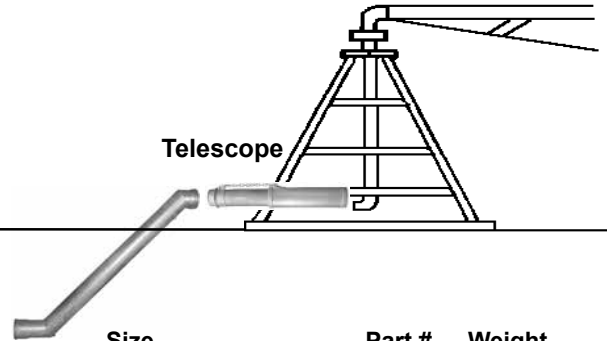
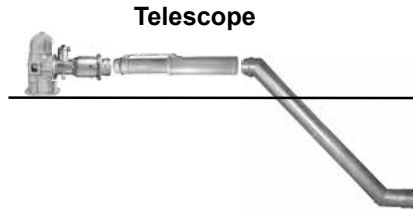

Size	Part #	Weight	List
6" x 2-4'	6-1220	15.5	<b>325.00</b>
6" x 5-10'	6-1221	26.5	<b>389.00</b>
6" x 10-20'	6-1222	44.7	<b>510.00</b>
8" x 2-4'	6-1223	20.5	<b>385.00</b>
8" x 5-10'	6-1224	33.7	<b>455.00</b>
8" x 10-20'	6-1225	55.6	<b>595.00</b>
10" x 2-4'	6-1226	21.7	<b>475.00</b>
10" x 5-10'	6-1227	37.1	<b>550.00</b>
10" x 10-20'	6-1228	62.7	<b>750.00</b>

### RINGLOCK:



Heavy wall aluminum construction.  
Male x Female Ends.  
Includes gaskets and chain.  
Ringlock clamp **not** included.

**Double Chain Telescopes for High Pressure or long extensions also available.**

Size	Part #	Weight	List
-	DOUBLECHAIN		<b>63.00</b>

## DROP PIPE (ALUMINUM)

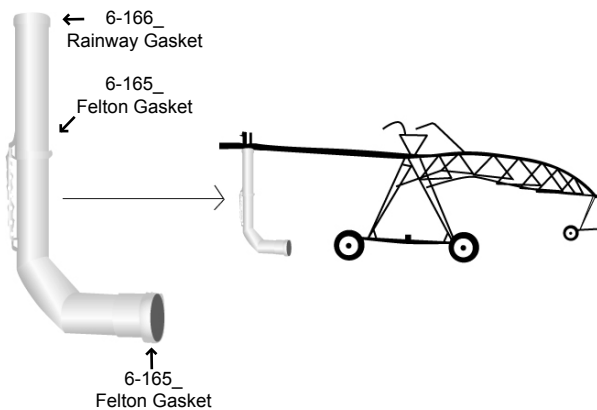

Size	Part #	Weight	List
6" x 7-15'	6-1310	32.2	<b>565.00</b>
6" to 8" x 7-15**	6-1320	39.3	<b>660.00</b>

- Heavy wall aluminum construction.
- Female x Female ends.
- Complete with gaskets & chain.
- Larger fitting is on elbow end.
- Specify make & model of pivot when ordering.

**Drop Hose also available. Please call for price.**

## CHAIN



Type	Part #	W/ft	List/ft
5/0 Size, Plated	3-0640	0.5	<b>6.50</b>

Horizontal Working Load Limit = 880 lbs.

Fittings

# GATE VALVES

## FLANGED GATE VALVE

(CAST IRON)



Size	Part #	Weight	List
3"	6-1347	57.0	<b>310.00</b>
4"	6-1348	66.1	<b>445.00</b>
5"	6-1349	153.0	<b>590.00</b>
6"	6-2070	130.1	<b>645.00</b>
8"	6-2080	213.0	<b>985.00</b>
10"	6-1350	282.2	<b>1,585.00</b>
12"	6-1351	392.0	<b>2,695.00</b>
16"	9-7778	1224.0	<b>7,757.00</b>

## IPS GASKETED GATE VALVE

(CAST IRON)



Size	Part #	Weight	List
4" IPS	6-9717	70.0	<b>450.00</b>
6" IPS	6-9718	132.0	<b>640.00</b>
8" IPS	6-9719	214.0	<b>1,103.00</b>

With 2" operation nut

## GATE VALVE

(PVC)

- IPS Slip x Slip (Solvent weld)
- Unrestricted Flow
- Quick Opening
- Trouble Free Simplicity
- Low Pressure
- Low Vacuum
- Low Cost



Size	Handle	Max PSI	Part #	Weight	List
4"	Metal	20 psi	9-5323	4.5	<b>145.00</b>
6"	Stainless Steel	10 psi	9-5324	16.0	<b>591.00</b>
8"	Stainless Steel	10 psi	9-5325	18.0	<b>827.00</b>
10"	Stainless Steel	10 psi	9-7691	53.0	<b>1,464.00</b>
12"	Stainless Steel	10 psi	9-7692	55.0	<b>1,550.00</b>

Applications include:

- Liquids
- Gases
- Dry Bulk/Solids
- Slurry

## FEMALE THREAD GATE VALVE

(BRASS)



Size	Part #	Weight	List
1/2"	6-1336	0.6	<b>9.00</b>
3/4"	6-1338	0.8	<b>13.00</b>
1"	6-1339	1.2	<b>19.00</b>
2"	6-1340	3.2	<b>49.00</b>
3"	6-1341	9.9	<b>147.00</b>
4"	6-1342	17.5	<b>265.00</b>

## FEMALE THREAD GATE VALVE

(PVC)



Size	Part #	Weight	List
1/2"	6-1352	0.5	<b>31.00</b>
3/4"	6-1353	0.5	<b>37.00</b>
1"	6-1354	0.7	<b>44.00</b>
2"	6-1355	2.0	<b>100.00</b>

# BALL & WAFER BUTTERFLY VALVES

## FEMALE THREAD BALL VALVE

(BRASS)



Size	Part #	Weight	List
1/2"	6-1331	0.5	<b>10.00</b>
3/4"	6-1332	0.4	<b>15.00</b>
1"	3-0560	0.8	<b>23.00</b>
2"	6-1333	1.6	<b>74.00</b>
3"	6-1334	13.5	<b>157.00</b>
4"	6-1335	11.6	<b>245.00</b>

## FEMALE THREAD BALL VALVE

(PVC)



Size	Part #	Weight	List
1/2"	6-1343	0.2	<b>2.00</b>
3/4"	6-1344	0.4	<b>3.00</b>
1"	6-1345	0.5	<b>4.00</b>
2"	6-1346	1.6	<b>12.00</b>
3"	6-9697	4.7	<b>54.00</b>
4"	6-9698	9.3	<b>101.00</b>

## WAFER VALVE - LEVER

(PVC)

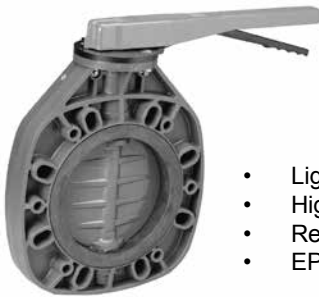

- Lightweight
- Highly Resistant to Corrosion
- Repairable
- EPDM Seal

Size	Max PSI	Part #	Weight	List
2"	150	9-5854	9.0	<b>188.00</b>
3"	150	9-5855	12.0	<b>215.00</b>
4"	150	9-5856	16.0	<b>244.00</b>
6"	115	9-5857	26.0	<b>389.00</b>
8"	115	9-5858	43.0	<b>507.00</b>
10"	115	9-5859	30.0	<b>699.00</b>

## WAFER VALVE - GEAR

(PVC)



- Lightweight
- Highly Resistant to Corrosion
- Repairable
- EPDM Seal

Size	Max PSI	Part #	Weight	List
4"	150	9-5860	11.0	<b>436.00</b>
6"	115	9-5861	15.0	<b>535.00</b>
8"	115	9-5862	31.0	<b>831.00</b>
10"	115	9-5863	38.0	<b>1,155.00</b>

# WAFER BUTTERFLY VALVES

## WAFER VALVE - LEVER



Max 200psi (2"-12")

Size	Ductile Iron Disc			Stainless Steel Disc		
	Part #	Weight	List	Part #	Weight	List
2"	9-7495	6.6	<b>74.00</b>	8-1351	6.6	<b>99.00</b>
2-1/2"	9-7496	8.2	<b>88.00</b>	8-1352	8.2	<b>112.00</b>
3"	9-7497	9.0	<b>96.00</b>	8-1353	9.0	<b>131.00</b>
4"	9-7501	11.9	<b>124.00</b>	6-2050	11.9	<b>150.00</b>
5"	9-7502	17.2	<b>169.00</b>	6-2055	17.2	<b>230.00</b>
6"	9-7503	19.0	<b>145.00</b>	6-2051	19.0	<b>260.00</b>
* 8"	9-7504	32.0	<b>210.00</b>	6-2052	32.0	<b>380.00</b>
* 10"	9-7505	48.5	<b>286.00</b>	6-2053	48.5	<b>525.00</b>
* 12"	9-7506	80.5	<b>574.00</b>	6-2054	80.5	<b>750.00</b>

\* Due to torque on the internal shaft 8", 10" and 12" Lever operated valves may not close 100%. For perfect water shut off, on these sizes, order the Gear operated valves listed below.

## WAFER VALVE - GEAR



Max 200psi (2"-12")

Size	Ductile Iron Disc			Stainless Steel Disc		
	Part #	Weight	List	Part #	Weight	List
2"	9-7498	18.7	<b>131.00</b>	8-1354	18.7	<b>160.00</b>
2-1/2"	9-7499	20.3	<b>137.00</b>	8-1355	20.3	<b>169.00</b>
3"	9-7500	21.2	<b>156.00</b>	8-1356	21.2	<b>198.00</b>
4"	9-7507	24.0	<b>139.00</b>	6-2056	24.0	<b>255.00</b>
5"	9-7508	28.7	<b>160.00</b>	6-2057	28.7	<b>315.00</b>
6"	9-7509	30.4	<b>194.00</b>	6-2058	30.4	<b>345.00</b>
8"	9-7510	47.8	<b>302.00</b>	6-2059	47.8	<b>430.00</b>
10"	9-7511	60.6	<b>390.00</b>	6-2060	60.6	<b>630.00</b>
12"	9-7512	112.0	<b>555.00</b>	6-2061	112.0	<b>875.00</b>
14"	9-7513	134.0	<b>1,117.00</b>	8-1205	122.0	<b>1,268.00</b>
16"	9-7514	181.0	<b>1,793.00</b>	8-1206	190.0	<b>1,700.00</b>
18"	9-7515	240.0	<b>1,685.00</b>	8-1207	240.0	<b>2,789.00</b>
20"	9-7516	395.0	<b>2,095.00</b>	8-1208	395.0	<b>3,750.00</b>
24"	9-7517	525.0	<b>3,555.00</b>	8-1209	525.0	<b>6,495.00</b>
30"	9-7649		<b>9,780.00</b>			
36"	9-7650		<b>14,035.00</b>			

### Features:

- Perfect Shut Off liquid and gas in both directions
- Economic Alternatives to gate, ball and plug valves
- Corrosion Free - Stems and body are not in contact with the line media. Bodies are protected with epoxy coating.
- No Flange Gaskets for installation
- Self centering disc by axial movement due to the floating coupling
- Compact light weight wafer design (Flangeless Lug and U-Section)
- Anti Blow Out Stem - The upper stem is fully retained by the retainer plate under pressure in unlikely event of primary seal fail.
- Easy replaceable seat without any special tools
- Easy installation for each type of actuators; manual, pneumatic, hydraulic and electric
- Wide range of material for various conditions
- Maintenance Free
- Minimal flow loss and turbulence
- Reliable for flow control
- Self Cleaning

# WAFER BUTTERFLY VALVES

## WAFER VALVE W/EXT GEAR

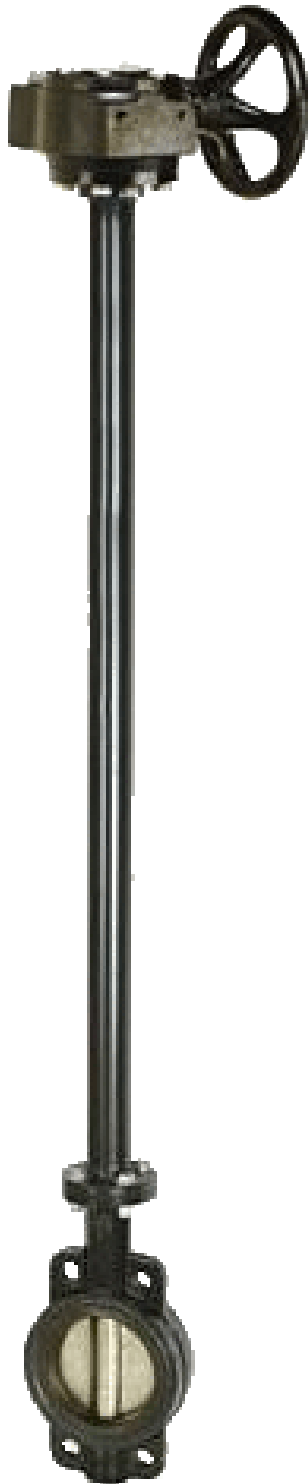

Valve Size	Extension Length	Ductile Iron Disc			Stainless Steel Disc		
		Part #	Weight	List	Part #	Weight	List
4"	24"	6-9882	29.0	<b>359.00</b>	9-7360	31.6	<b>400.00</b>
4"	36"	6-9883	32.0	<b>366.00</b>	9-7361	35.1	<b>408.00</b>
4"	48"	6-9884	35.0	<b>402.00</b>	9-7362	38.4	<b>443.00</b>
4"	60"	6-9885	38.0	<b>416.00</b>	9-7363	41.8	<b>457.00</b>
4"	72"	6-9886	41.0	<b>465.00</b>	9-7364	45.1	<b>506.00</b>
6"	24"	8-1380	45.0	<b>432.00</b>	9-7365	39.4	<b>579.00</b>
6"	36"	8-1381	48.0	<b>440.00</b>	9-7366	43.1	<b>587.00</b>
6"	48"	8-1382	51.0	<b>475.00</b>	9-7367	46.7	<b>622.00</b>
6"	60"	8-1383	55.0	<b>515.00</b>	9-7368	50.4	<b>662.00</b>
6"	72"	8-1384	59.0	<b>552.00</b>	9-7369	53.9	<b>699.00</b>
8"	24"	8-1385	55.0	<b>662.00</b>	9-7370	61.7	<b>881.00</b>
8"	36"	8-1386	58.0	<b>696.00</b>	9-7371	65.7	<b>915.00</b>
8"	48"	8-1387	61.0	<b>719.00</b>	9-7372	69.6	<b>938.00</b>
8"	60"	8-1388	65.0	<b>748.00</b>	9-7373	73.8	<b>967.00</b>
8"	72"	8-1389	69.0	<b>777.00</b>	9-7374	77.8	<b>996.00</b>
10"	24"	8-1390	75.0	<b>779.00</b>	9-7350	76.0	<b>1,223.00</b>
10"	36"	8-1391	78.0	<b>814.00</b>	9-7351	80.7	<b>1,257.00</b>
10"	48"	8-1392	81.0	<b>828.00</b>	9-7352	85.1	<b>1,271.00</b>
10"	60"	8-1393	85.0	<b>866.00</b>	9-7353	89.7	<b>1,309.00</b>
10"	72"	8-1394	89.0	<b>895.00</b>	9-7354	94.3	<b>1,338.00</b>
12"	24"	8-1395	87.0	<b>1,085.00</b>	9-7355	131.4	<b>1,725.00</b>
12"	36"	8-1396	90.0	<b>1,121.00</b>	9-7356	136.9	<b>1,762.00</b>
12"	48"	8-1397	93.0	<b>1,156.00</b>	9-7357	142.4	<b>1,797.00</b>
12"	60"	8-1398	97.0	<b>1,186.00</b>	9-7358	147.9	<b>1,827.00</b>
12"	72"	8-1399	101.0	<b>1,229.00</b>	9-7359	153.2	<b>1,870.00</b>
14"	24"	9-7375	153.4	<b>1,463.00</b>			
14"	36"	9-7376	158.9	<b>1,499.00</b>			
14"	48"	9-7377	164.4	<b>1,535.00</b>			
14"	60"	9-7378	169.9	<b>1,565.00</b>			
14"	72"	9-7379	175.2	<b>1,607.00</b>			
16"	24"	9-7380	212.5	<b>2,632.00</b>			
16"	36"	9-7381	219.6	<b>2,659.00</b>			
16"	48"	9-7382	226.4	<b>2,760.00</b>			
16"	60"	9-7383	233.5	<b>2,862.00</b>			
16"	72"	9-7384	240.3	<b>2,898.00</b>			

- 2", 2-1/2", 3", and 5", 18", 20" and 24" Valves w/Extensions are also available.
- Measurements are from center of valve to top.
- Call for taller extensions, such as 96".

Fittings

# WAFER BUTTERFLY VALVES

## WAFER VALVE - 2" SQ NUT (STAINLESS STEEL DISC)



Size	Part #	Weight	List
2"	6-9630	17.0	345.00
2-1/2"	6-9631	18.0	355.00
3"	6-9632	18.0	379.00
4"	6-9633	22.0	407.00
5"	6-9634	26.0	455.00
6"	6-9635	37.0	540.00
8"	6-9636	44.0	655.00
10"	6-9637	62.0	879.00
12"	6-9638	77.0	1,105.00

## WAFER VALVE - ELECTRIC



- 110/120 volt (call for 24 volt DC & 50 hz)
- EPDM seat
- Epoxy coated cast iron body

Size	Ductile Iron Disc			Stainless Steel Disc		
	Part #	Weight	List	Part #	Weight	List
2"	9-7474	32.0	1,220.00	6-8082	32.0	1,250.00
2-1/2"	9-7475	33.0	1,229.00	6-8083	33.0	1,275.00
3"	9-7476	33.0	1,260.00	6-8084	33.0	1,289.00
4"	9-7477	39.0	1,755.00	6-8085	39.0	1,815.00
5"	9-7478	42.0	1,785.00	6-8086	42.0	1,850.00
6"	9-7479	59.0	2,100.00	6-8087	59.0	3,055.00
8"	9-7480	68.0	2,650.00	6-8088	68.0	3,175.00
10"	9-7481	90.0	2,750.00	6-8089	90.0	3,315.00
12"	9-7482	105.0	3,885.00	6-8090	105.0	3,540.00

## LEVER HANDLE - WAFER VALVE



- Specify make of valve when ordering

Size	Part #	Weight	List
2"/3"	9-7779		22.50
4"	9-7780		25.00
5"/6"	9-7781		28.00
8"	9-7782		35.00
10"	9-7783		38.00
12"	9-7784		38.00

## INDEX PLATE - WAFER VALVE



- Specify make of valve when ordering

Size	Part #	Weight	List
2"/3"	9-7785		5.00
4"/5"/6"	9-7786		10.00
8"/10"/12"	9-7787		12.00

## HAND WHEEL - WAFER VALVE



- Specify make of valve when ordering

Size	Part #	Weight	List
2"/3"	9-7788		15.00
4"	9-7789		20.00
5"/6"	9-7790		25.00
8"	9-7791		32.00
10"	9-7792		35.00
12"/14"	9-7793		40.00

## GEARBOX WITH WHEEL - WAFER VALVE



- Specify make of valve when ordering

Size	Part #	Weight	List
2"/3"	9-7820		92.00
4"	9-7821		92.00
5"/6"	9-7822		110.00
8"	9-7823		160.00
10"	9-7824		160.00
12"/14"	9-7825		179.00

# SURGE VALVE & HYDRANTS

## ALFALFA VALVE STUB (FOR PIP PVC PIPE)



- \* Solid Arch
- \* Spigot for PIP PVC Pipe

Size	Part #	Weight	List
*6"	6-2102	19.0	<b>189.00</b>
8"	6-2103	29.0	<b>202.00</b>
10"	6-2104	40.0	<b>275.00</b>
12"	6-2105	55.0	<b>309.00</b>

## UNIVERSAL HYDRANT



Call for other sizes.

Size	Part #	Weight	List
6" x 6"	6-2106	16.0	<b>549.00</b>
8" x 8"	6-2107	23.0	<b>645.00</b>
10" x 10"	6-2108	32.0	<b>753.00</b>
12" x 12"	6-2109	34.0	<b>867.00</b>

## SURGE GATE VALVE



Size	Part #	Weight	List
6"	6-1505	39.0	<b>Call</b>
8"	6-1506	46.0	<b>Call</b>
10"	6-1507	58.0	<b>Call</b>
12"	9-8141	-	<b>Call</b>

Fittings

# STEM GATE VALVE

## THREADED STEM GATE VALVE (BRASS)



Size	Type	Max PSI	Part #	Weight	List
4"	Threaded*	45	6-9890	20.9	<b>320.00</b>
6"	Threaded*	37	6-9891	26.9	<b>479.00</b>

- Includes Handle
- Option: Stainless Steel disc valves can take up to 60psi on 4", 6", & 8" Valves

- Comes in easy to assembly 4 piece construction with high tensile hexagonal bolts and nylock nuts.
- Works as an operating device in the slurry industry, ideal for usage in confined spaces.

## FLANGED STEM GATE VALVE (BRASS)



Size	Type	Max PSI	Part #	Weight	List
4"	4-Bolt Flange*	45	9-5472	19.4	<b>395.00</b>
6"	4-Bolt Flange*	37	9-5473	23.4	<b>475.00</b>
8"	4-Bolt Flange*	22	9-5474	46.4	<b>885.00</b>

- Includes two O-Ring Gaskets
- Includes Handle
- Option: Stainless Steel disc valves can take up to 60psi on 4", 6", & 8" Valves

- Comes in easy to assembly 4 piece construction with high tensile hexagonal bolts and nylock nuts.
- Works as an operating device in the slurry industry, ideal for usage in confined spaces.

## ACCESSORIES - STEM GATE VALVE



<u>Handle:</u>	Size	Part #	Weight	List
	4"	9-6972		<b>75.00</b>
	6"	9-6973	6.4	<b>85.00</b>
	8"	9-6974		<b>99.00</b>

<u>O-Ring Gasket:</u>	Size	Part #	Weight	List
	4", 6"	9-6970		<b>4.00</b>
	8"	9-6971		<b>6.00</b>

## THREADED LEVER GATE VALVE (BRASS)



Size	Type	Max PSI	Part #	Weight	List
2"	Threaded	45	9-7702	4.0	<b>95.00</b>
3"	Threaded	45	9-7703	9.0	<b>179.00</b>
4"	Threaded	45	9-7704	15.0	<b>269.00</b>
6"	Threaded	22	9-7705	27.0	<b>470.00</b>



# LOW PRESSURE VALVES

## LOW PRESSURE VALVE (ALUMINUM)

45 psi max pressure



Size	Part #	Weight	List
6"	6-1460	10.0	<b>165.00</b>
8"	6-1461	15.0	<b>200.00</b>
10"	6-1462	20.0	<b>265.00</b>
12"	6-8028		<b>365.00</b>

## LOW PRESSURE END TEE VALVE (ALUMINUM)

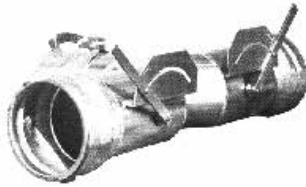

Size	Part #	Weight	List
6"	6-1301	21.0	<b>485.00</b>
8"	6-1302	27.0	<b>590.00</b>
10"	6-1303	34.0	<b>675.00</b>
12"	9-8144		<b>755.00</b>

## LOW PRESSURE VALVE (PVC)



Size	Part #	Weight	List
6"	6-1356		<b>230.00</b>
8"	6-1357		<b>255.00</b>
10"	6-1358		<b>290.00</b>
12"	6-1359		<b>345.00</b>

## LOW PRESSURE VALVE KIT

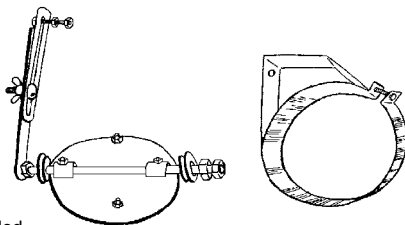

Instructions included

Size	Part #	Weight	List
6"	6-1473		<b>135.00</b>
8"	6-1474	9.9	<b>155.00</b>
10"	6-1475		<b>169.00</b>

## RUBBER MOLDED DISC (FOR LOW PRESSURE VALVE)



Size	Part #	Weight	List
6"	6-1013	4.0	<b>55.00</b>
8"	6-1014		<b>68.00</b>
10"	6-1367	6.2	<b>89.00</b>

## RUBBER WASHER (FOR LOW PRESSURE VALVE)



Size	Part #	Weight	List
5/8"	6-1015		<b>1.00</b>

## RINGLOCK CHEMIGATION VALVE

(GALVANIZED STEEL)



Includes: 2" ARV, 3/4" nuts & bolts, flange gaskets

Size	Part #	Weight	List
4"	9-6826	47.2	<b>515.00</b>
6"	6-1401	75.0	<b>647.00</b>
8"	6-1402	100.7	<b>808.00</b>
10"	6-1403	140.9	<b>945.00</b>
12"	9-6829	184.8	<b>2,465.00</b>

## FLANGE X COUPLER CHEMIGATION VALVE

(GALVANIZED STEEL)



Includes: 2" ARV, 3/4" nuts & bolts, flange gaskets

Size	Part #	Weight	List
4"	9-6824	38.8	<b>444.00</b>
6"	6-1360	63.0	<b>538.00</b>
8"	6-1361	83.3	<b>679.00</b>
10"	6-1362	118.8	<b>770.00</b>
12"	9-6827	142.7	<b>2,275.00</b>

## FLANGED CHEMIGATION VALVE

(GALVANIZED STEEL)



Includes: 2" ARV, & flange gaskets

Size	Part #	Weight	List
4"	9-6825	30.4	<b>371.00</b>
6"	6-1370	46.0	<b>429.00</b>
8"	6-1371	61.0	<b>550.00</b>
10"	6-1372	86.0	<b>595.00</b>
12"	9-6828	100.5	<b>1,995.00</b>

## INJECTION VALVE

(PVC-MISTER MIST'R)



- 3/4" Male Pipe Thread
- 15 psi release is standard (optional 9, 25, 65 or 80 psi available.)

Size	Part #	Weight	List
3/4" MPT	6-1523	0.1	<b>55.00</b>

## SWING CHECK VALVE - FPT (BRASS)



Size	Part #	Weight	List
3"	8-1330	7.3	141.00

## WAFER CHECK VALVE (CAST IRON)



Size	Ductile Iron Disc			Stainless Steel Disc		
	Part #	Weight	List	Part #	Weight	List
2"	9-7483	3.0	120.00	8-1400	3.0	130.00
2 1/2"	9-7484	4.0	135.00	8-1401	4.0	165.00
3"	9-7489	8.0	95.00	6-1770	8.0	100.00
4"	9-7490	13.0	120.00	6-1771	13.0	145.00
6"	9-7491	20.0	192.00	6-1772	20.0	249.00
8"	9-7492	38.0	315.00	6-1773	38.0	419.00
10"	9-7493	58.0	450.00	6-1774	58.0	610.00
12"	9-7494	93.0	592.00	6-1775	93.0	1,135.00
16"	9-7485	140.0	1,410.00	8-1402	140.0	2,705.00
18"	9-7486	400.0	1,180.00	8-1403	300.0	3,799.00
20"	9-7487	500.0	1,320.00	8-1404	400.0	4,645.00
24"	9-7488		1,965.00	8-1405	500.0	6,941.00

## CHECK VALVE - WELD ON (BLACK STEEL)

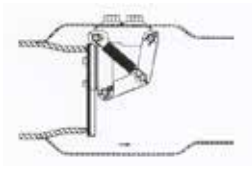

Galvanized or Epoxy-coated available at a nominal charge.

Size	Part #	Weight	List
4"	6-1463	12.0	160.00
5"	6-1464	15.0	220.00
6"	6-1465	16.2	250.00
8"	6-1466	28.2	245.00
10"	6-1467	41.6	305.00
12"	6-1468		510.00

## CHECK VALVE - WELD ON (CAST ALUMINUM)

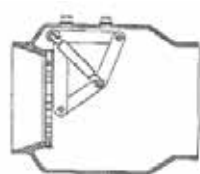

Size	Part #	Weight	List
4"	6-9682	5.1	175.00
5"	6-9683	6.9	185.00
6"	6-9684	9.3	220.00
8"	6-9685	14.5	285.00
10"	6-9686	19.7	295.00

# CHECK VALVES

## FLANGED CHECK VALVE (GALVANIZED STEEL)

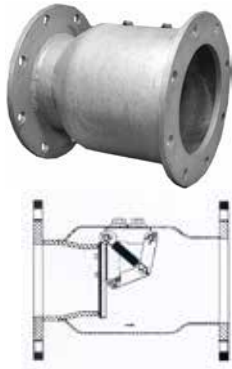

Size	Part #	Weight	List
4"	6-1710	27.0	330.00
5"	6-1711	29.0	320.00
6"	6-1712	34.1	410.00
8"	6-1713	56.6	485.00
10"	6-1714	73.0	585.00
12"	6-9751	106.0	1,141.00
14"	8-1346	220.0	3,515.00
16"	8-1347	325.0	4,539.00
20"	8-1348	400.0	6,510.00
22"	8-1349		Call
24"	8-1350	638.0	7,785.00

## FLANGED CHECK VALVE (CAST ALUMINUM)



Size	Part #	Weight	List
4"	6-9687	13.5	335.00
5"	6-9688	17.3	370.00
6"	6-9689	21.9	395.00
8"	6-9690	30.6	530.00
10"	6-9691	44.3	650.00

## RINGLOCK CHECK VALVE



Size	Part #	Weight	List
6"	6-1470	35.9	645.00
8"	6-1471	55.0	765.00
10"	6-1472	79.9	980.00

Includes:

- One Flg x Flg Check Valve
- One Flg x FRL Adapter
- One Flg x MRL Adapter
- Two Flange Bolt Kits and gaskets

## PLATE & SPRING ASSEMBLY

Complete:

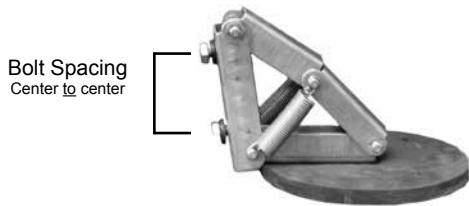

Size	Bolt Spacing	Part #	Weight	List
4"	1-1/8"	6-1736		295.00
	2"	6-1738		275.00
	2-1/2"	9-6916		110.00
5"	2-1/4"	6-1737		359.00
	2-1/2"	9-6917		122.00
6"	2-5/16"	6-1733	3.4	337.00
	2-1/2"	6-1500	5.0	275.00
	3-1/2"	9-5425	5.0	215.00
8"	3"	6-1501	10.0	175.00
	3-1/2"	6-1731	4.1	155.00
10"	3-1/2"	9-5427	14.0	315.00
	4-1/4"	6-1735	6.8	202.00
	4-1/2"	6-1502	14.0	225.00
12"	4-1/4"	9-7660		575.00
	4-1/2"	9-7661		315.00

Springs Only:

4"	9-7550	-	8.00
6"	9-7551	-	12.00
8"	9-7619	-	12.00
10"	9-7552	-	12.00

# COMBO VALVES

## WELD -ON COMBO VALVE (GALVANIZED STEEL)



130 maximum psi

Size	Part #	Weight	List
4"	6-1480	18.0	<b>430.00</b>
6"	6-1481	25.0	<b>545.00</b>
8"	6-1482	55.0	<b>705.00</b>
10"	6-1483	77.0	<b>955.00</b>
12"	6-1700	108.0	<b>940.00</b>

## HOOK STYLE COMBO VALVE (GALVANIZED STEEL)



130 maximum psi

Size	Part #	Weight	List
3"	6-1477	16.0	<b>511.00</b>
4"	6-1478	18.0	<b>545.00</b>
6"	6-1479	26.0	<b>605.00</b>
8"	6-1493	65.0	<b>775.00</b>

## RINGLOCK COMBO VALVE (GALVANIZED STEEL)



130 maximum psi

Size	Part #	Weight	List
4"	6-1476	17.0	<b>465.00</b>
6"	6-1484	27.0	<b>570.00</b>
8"	6-1485	58.0	<b>765.00</b>
10"	6-1486	88.0	<b>1,065.00</b>
12"	6-1701	120.0	<b>1,290.00</b>

## FLANGE COMBO VALVE (GALVANIZED STEEL)



130 maximum psi

Size	Part #	Weight	List
4"	9-8126		<b>559.00</b>
6"	6-1487	47.0	<b>750.00</b>
8"	6-1488	85.0	<b>1,019.00</b>
10"	6-1489	113.0	<b>1,175.00</b>
12"	6-1702	166.0	<b>1,785.00</b>

## COMBO VALVE PARTS



Description	Size	Part #	Weight	List
<b>Disc:</b>	4"	9-7770		<b>60.00</b>
	6"	6-1490	5.3	<b>79.00</b>
	8"	6-1491	7.8	<b>145.00</b>
	10"	6-1492	9.8	<b>192.00</b>
	12"	9-7771		<b>209.00</b>
<b>Packing Ring Set: (2-pieces/set)</b>	4"-6"	9-6815		<b>10.50</b>
	8"-12"	9-6816		<b>15.00</b>
<b>Packing Nut:</b>	4"-6"	9-7768		<b>11.00</b>
	8"-12"	9-7769		<b>21.00</b>
<b>Handle:</b>	4"	9-7764		<b>73.00</b>
	6"	9-7765		<b>80.00</b>
	8"-10"	9-7766		<b>105.00</b>
	12"	9-7767		<b>112.00</b>
<b>Hinge Pin:</b>	4"	9-7772		<b>10.00</b>
	6"	9-7773		<b>11.00</b>
	8"-10"	9-7774		<b>21.00</b>
	12"	9-7775		<b>21.00</b>

Fittings

# INLINE VALVE

## RINGLOCK INLINE VALVE (GALVANIZED STEEL)



150 max. psi on 4", 6", & 8" valves  
80 max psi on 10" valves

Size	Part #	Weight	List
6"	6-1440	19.0	<b>350.00</b>
8"	6-1441	29.0	<b>510.00</b>
10"	6-1442	43.0	<b>690.00</b>

## HOOK STYLE INLINE VALVE (GALVANIZED STEEL)



150 max. psi on 4", 6", & 8" valves  
80 max psi on 10" valves

Size	Part #	Weight	List
4"	6-1450	14.0	<b>305.00</b>
5"	6-1458	15.8	<b>310.00</b>
6"	6-1451	24.0	<b>380.00</b>
8"	6-1452	35.0	<b>515.00</b>
10"	6-1459	41.0	<b>775.00</b>

## WELD-ON INLINE VALVE (GALVANIZED STEEL)



150 max. psi on 4", 6", & 8" valves  
80 max psi on 10" valves

Size	Part #	Weight	List
4"	6-1453	12.0	<b>260.00</b>
5"	6-1454	13.5	<b>255.00</b>
6"	6-1455	20.0	<b>315.00</b>
8"	6-1456	31.0	<b>400.00</b>
10"	6-1457	36.0	<b>565.00</b>

## HOOK STYLE INLINE VALVE TEE (GALVANIZED STEEL)

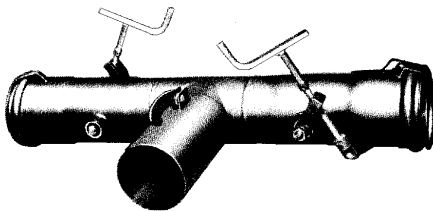

150 max. psi on 4", 6", & 8" valves  
80 max psi on 10" valves

Size	Part #	Weight	List
4"	6-1443	26.0	<b>720.00</b>
5"	6-1444	33.0	<b>805.00</b>
6"	6-1445	47.0	<b>659.00</b>
8"	6-1446	56.0	<b>1,320.00</b>

\*Also available in Ringlock  
\*Also available in Line Valve Tees.

# INLINE VALVE PARTS

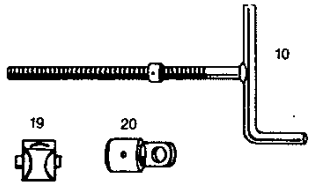
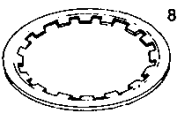
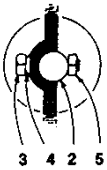
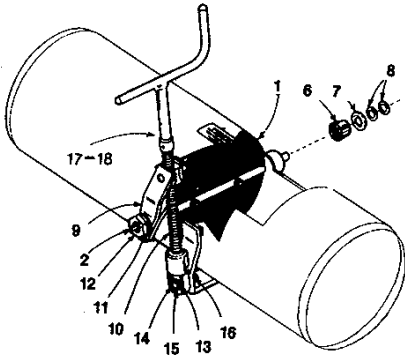

Description	Item #	Size	Part #	Weight	List
	1	4"	6-1495		27.00
	1	5"	6-1496		38.00
<b>Disc:</b>	1	6"	6-1497	2.3	44.00
	1	8"	6-1498	4.1	70.00
	1	10"	6-1499	5.0	138.00
<b>Shaft:</b>	2	4" (8" Long)	6-4250		27.00
	2	5" (9" Long)	6-4251		29.00
	2	6" (10" Long)	6-4252		44.00
	2	8" (12" Long)	6-4253		45.00
	2	10" (14" Long)	6-4254		55.00
<b>Hex Bolt: (Req 2, 3 for 10")</b>	3	4"-5"	6-4255		1.45
	3	6"-8"	6-4256		2.50
	3	10"	6-4257		2.50
<b>Washer: (Req 2)</b>	4	4"-5"	6-4258		0.80
	4	6"-8"	6-4259		0.45
<b>Hex Nut: (Req 2)</b>	5	4"-5"	6-4260		0.80
	5	6"-8"	6-4261		1.00
<b>Chevron Gasket: (Req 2)</b>	6	4"-5"	6-4262		2.40
	6	6"-8"-10"	6-4263		3.00
<b>Washer Reducer: (Req 2)</b>	7	4"-5"	6-4264		1.10
	7	6"-8"-10"	6-4265		1.10
<b>Retainer Ring: (Req 4)</b>	8	4"-5"	6-4266		2.00
	8	6"-8"-10"	6-4267		2.25
Arm Linkage (Req 2)	9		6-4268	0.2	2.90
Crank Assembly (includes 10, 17, 18, 19, 20)			6-4269		66.30
Washer, Star	11		6-4270		0.80
Jam Nut	12		6-4271	0.1	0.80
Ferrule SS	13		6-4272		0.80
Hex Bolt, Eg.	14		6-4273		0.50
Washer SAE	15		6-4274		0.40
Hex Nut, 3/8"	16		6-4275		0.30
Collar (req 2)	17		6-4276		7.50
Roll Pin (req 2)	18		6-4277		1.30
Stem & Handle	10		6-4278		35.00
Thrust Nut	19		6-4279		13.00
Yoke	20		6-4280	0.4	9.50

Fittings

**BOLT-ON WATER METER**

Size	Hole Size	GPM	Part #	Standard		* Reverse Impeller		
				Weight	NET	Part #	Weight	NET
4"	4"	50-900	6-1930	18.0	<b>1,375.00</b>	8-1431	14.0	<b>1,528.00</b>
6"	5"	90-1800	6-1931	22.0	<b>1,431.00</b>	8-1432	19.0	<b>1,583.00</b>
8"	5-1/8"	100-2250	6-1932	26.0	<b>1,510.00</b>	8-1433	23.0	<b>1,661.00</b>
10"	6"	0-2700	6-1933	30.0	<b>1,611.00</b>	8-1434	26.0	<b>1,765.00</b>
12"	7"	0-4000	6-1934	34.0	<b>1,735.00</b>	8-1435	30.0	<b>1,895.00</b>

\* Reverse Impeller Meters are for Liquid waste manure or other surface water applications.

- Above includes an overrun bearing, anti-reverse & canopy boot for 3-year warranty.
- State wall thickness & O.D. when ordering.
- + or - 2% Accuracy
- (12ga = .072, .064)

**MAG METER  
(SEAMETRIC)**

Size	Model	Part #	Stand Alone		For Pivot Panel		
			Weight	NET	Part #	Weight	NET
6"	AG3000	9-8137		<b>1,929.00</b>	9-8138		<b>2,229.00</b>
8"	AG3000	9-8139		<b>2,224.00</b>	9-8140		<b>2,524.00</b>
10"	AG3000	9-8135		<b>2,623.00</b>	9-8136		<b>2,832.00</b>

- No moving parts or bearings to replace.
- Backed by our industry leading 5-year warranty.
- 4-year battery life with a Free battery replacement.
- Saddle mount option easily replaces dated propeller meters (Call for prices).

**FLO-WISE AG ROTOR**

Size	Part #	Weight	NET
6", 8", 10" & 12"	9-7931		<b>1,250.00</b>

- Vertical or horizontal installation.
- No Vanes or Flow Conditioners Required.
- Battery operated, 3.6 Volt Lithium batteries (2 included).
- Sensor delivers an accuracy of +/- 2% of reading in a full pipe.
- 2 year manufacturer's warranty. 1 year warranty on replacement rotor.

**COMPONENTS FOR  
FLO-WISE AG ROTOR**

Size	Alum. Weldolet			Steel Weldolet		
	Part #	Weight	NET	Part #	Weight	NET
6"	9-7932	-	<b>70.00</b>	9-7935	-	<b>95.00</b>
8"	9-7933	-	<b>70.00</b>	9-7936	-	<b>95.00</b>
10"	9-7934	-	<b>70.00</b>	9-7937	-	<b>95.00</b>
12"				9-7938	-	<b>95.00</b>

Bolt-on Saddles are also available.



Description	Part #	Weight	List
Battery (2 required)	9-7939	-	<b>15.00</b>
Replacement Rotor	9-7940	-	<b>177.51</b>



## WATER METER FLOW TUBE (ALUMINUM)



Size	Length	M x F Ringlock			Flange x Flange		
		Part #	Weight	List	Part #	Weight	List
4"	5'	9-5295		<b>229.00</b>	9-5299		<b>330.00</b>
6"	7'	9-5296		<b>265.00</b>	9-5300		<b>376.00</b>
8"	9'	9-5297		<b>314.00</b>	9-5301		<b>456.00</b>
10"	10.5'	9-5298		<b>368.00</b>	9-5302		<b>606.00</b>

- Includes straightening vanes
- Also available in Black or Galvanized Steel.
- Call for Custom configurations and lengths.

## BUMP PIPE (FOR WATER METERS)

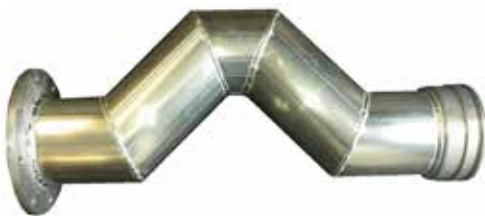

Bump pipe are used after water meters in flood irrigation applications to ensure a full pipe flow for accurate readings.

- Fabricated to the customer's specifications.
- Available in Aluminum, Galvanized Steel, or Black Steel.
- Please call for pricing.

## STRAIGHTENING VANES (FOR WATER METERS)



OD Pipe Size	Aluminum Weld-in			Steel Weld-in			Steel Bolt-in Tri-Vane		
	Part #	Weight	List	Part #	Weight	List	Part #	Weight	List
4"	9-6868		<b>29.00</b>	9-6877		<b>45.00</b>	9-6873		<b>104.00</b>
6"	9-6869	0.6	<b>34.00</b>	9-6878		<b>40.00</b>	9-6874		<b>112.00</b>
8"	9-6870		<b>35.00</b>	9-6879		<b>45.00</b>	9-6875		<b>191.00</b>
10"	9-6867		<b>39.00</b>	9-6876		<b>50.00</b>	9-6871		<b>209.00</b>
12"							9-6872		<b>215.00</b>

## STRAIGHTENING VANE (FLOW STRAIGHTENER) (STAINLESS STEEL)



Size	OD Pipe Size			IPS Pipe Size		
	Part #	Weight	<b>NET</b>	Part #	Weight	<b>NET</b>
6"	9-6880		<b>352.00</b>	9-6883		<b>352.00</b>
8"	9-6881		<b>382.00</b>	9-6884		<b>382.00</b>
10"	9-6882		<b>413.00</b>	9-6885		<b>413.00</b>

\* Bolt-on

Outside body is NOT included in price.

Flow straightener is a cone-shaped device that sits upstream from the meter and conditions the fluid to remove flow irregularities prior to measurement. The conditioned flow supports high accuracy flow measurement and virtually eliminates the need for space-consuming, costly upstream/downstream straight-pipe runs.

Fittings

# CENTER PIVOT PARTS

## DRIVE COUPLER ASSEMBLY



Size	Style	Part #	Weight	List
1" Round x 1" Square	Old Valley, Gifford Hill	6-1531	2.5	<b>27.00</b>
1" Round x 7/8" Square	New Valley	6-1532	2.5	<b>27.00</b>
1" Round x 3/4" Square	Gifford Hill, Olson, Lindsay, Electrogator	6-1533	2.5	<b>27.00</b>
1" Round w/KW x 3/4" Square	Old Lockwood	6-1534	2.5	<b>27.00</b>
1" Round w/KW x 1" Square	New Lockwood	8-1422	2.5	<b>27.00</b>
1-1/8" Round x 3/4" Square		8-1423	2.5	<b>27.00</b>
1-1/8" Round x 1" Square	Gifford Hill	8-1424	2.5	<b>27.00</b>

Description	Part #	Weight	List
Puck Only	2-0046		<b>5.00</b>

### Features:

1. Clover leaf style with live rubber insert absorbs shock and reduces wear on drive-line components.
2. Casting design holds bolt in place and requires only one wrench to install.
3. Aluminum alloy and five piece design makes this "U-Joint" easy to install or remove. No more rust.

## UNIVERSAL DRIVE COUPLING (PAINTED STEEL)

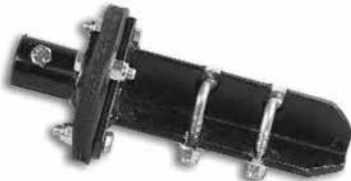

Description	Part #	Weight	List
Small Disc, Mini, 3/4" to 1-1/8"	9-7848		<b>32.00</b>
Large Disk, Regular, 3/4" to 1"	9-7849		<b>32.00</b>

### Features:

1. The rubber disc absorbs shock from gear motors to wheel drive.
2. The ends can be ordered to fit most any center pivot drive line.
3. The round end is split for easy installation and a tight fit.
4. The disc design allows for some misalignment on the drive line.
5. The units are Made in the USA using top materials.

## PIVOT DRAINS



Plastic Drain  
Valve

Style	Description	Part #	Weight	List
<b>Quick Drain: (Mushroom)</b>	Lindsay Type, 20-75 psi	2-1183		<b>3.00</b>
	Lindsay Type, 5-30 psi	2-1184		<b>4.00</b>
<b>Drain Valve:</b>	Star, Plastic	2-1182		<b>12.00</b>

# CENTER PIVOT PARTS

## PIVOT RUBBER BOOT



Description	Size	OD	Part #	Weight	List/ft
4-PLY:	6-5/8" x 16" long	7.01"	6-1535	3.5	39.00/ea
	6 5/8"/foot	7.01"	6-9580		38.70
	7"/foot		2-1270		96.00
	8"/foot		2-1271		48.00
	8-5/8"/foot		2-1272		65.00
2-PLY:	6"/foot	6.38"	6-9576	2.0	18.00
	6-5/8"/foot	7.01"	6-9577	2.2	22.00
	8"/foot	8.46"	6-9578	2.9	25.00
	10"/foot	10.63"	6-9579	5.1	40.00

## PIVOT BOOT CLAMP (STAINLESS STEEL)



Size	Part #	Weight	List
4-1/2"	2-1275		Call
5"	2-1276		Call
6"	2-1278		12.00
* 7/8" Wide, Hybrid	*6 5/8"	0.5	12.00
	7"		16.00
	8"	0.2	19.00
	8-5/8"		16.00
	10"		18.00

## PIVOT FLANGE GASKET



Description	Part #	Weight	List
5-9/16"	2-1317		4.00
6" (5" id x 8" od)	9-5436		9.00
6-5/8" (6-5/8" id x 8" od)	9-5437		7.70
8", Lindsay Style	2-1319		5.00

## END GUN BOOSTER PUMP (MOTOR & PUMP)



- All Parts are interchangeable with Berkeley Model #C2MPS  
 - With Leeson 2-HP (TEFC) 3-phase Motor, 460 volt

Description	Part #	Weight	List
2-HP, 130 GPM (2-1/2" Suction x 2" Discharge)	2-1106		863.00

## END GUN BOOSTER PUMP (COMPONENTS)



Description	Part #	Weight	List
Volute Case	2-1115		120.90
Motor Bracket	2-1111		112.20
Impeller, Cast Iron	2-1113		129.19
Impeller, Brass	2-1559		Call
Impeller, Stainless Steel	2-1560		129.20
Motor Bracket Gasket	2-1110		3.10
Volute Gasket	2-1114		3.10
Impeller Spacer	2-1561		3.10
Mechanical Seal	2-1112		20.00
Motor Only, 2-HP, 3-Phase, 460V	2-1118		636.50

## PIVOT END GUN VALVE



Description	Part #	Weight	List
3/4"	9-7651		104.00
1"	9-7652		104.00
2"	9-7653		160.00
2" 90°	9-7654		160.00

\* Includes automatic drain and plug.

# CENTER PIVOT PARTS

## PIVOT WEIGHT



- Ends of pipe are rounded for attractive appearance and functionality
- Strong UV inhibitors added to weight for longevity

Description	Length	Part #	Weight	List
<b>Polyethylene:</b>	15"	6-9548	1.0	<b>4.50</b>
	20"	6-9549	1.4	<b>4.50</b>
	24"	6-9550	1.5	<b>5.50</b>
	30"	6-9551	2.0	<b>6.90</b>
<b>PVC (FPT x FPT):</b>	10"	6-9552	2.0	<b>8.10</b>
	11"	6-9553	2.0	<b>8.50</b>
	13-3/4"	6-9554	2.5	<b>6.00</b>
	16-1/2"	6-9555	3.1	<b>8.00</b>

## PIVOT DROP ELBOW



Steel Galvanized



PVC, Single



PVC, Double

- U Pipes have 6" radius
- PVC Drop Elbow has strong UV inhibitors for year round use.

Type	Description	Part #	Weight	List
<b>Single, Steel Galv:</b>	3/4", MxF	6-6701		<b>7.10</b>
	3/4" MxM	2-1412		<b>Call</b>
<b>Single, PVC:</b>	125 Degree, 3/4" FPT x Barb	2-1086		<b>Call</b>
	125 Degree, 3/4" FxM	2-1088		<b>Call</b>
	180 Degree, 3/4" FPT x Barb	--	-	<b>Call</b>
	180 Degree, 3/4" MxF	2-1418		<b>3.00</b>
	180 Degree, 3/4" MxM	2-1417		<b>3.00</b>
<b>Double, PVC:</b>	180 Degree, 3/4" MPT x Barb	2-1419		<b>4.00</b>
	125 Degree, 3/4" FPT x Barb	--	-	<b>Call</b>
	125 Degree, 3/4" FxM	2-1408		<b>6.50</b>

## DROP RISER (GALVANIZED OR POLY)



- 3/4" MPT x 3/4" FPT



- 3/4" MPT x 3/4" FPT

- Polyethylene Drop Riser Features:**
- Strongest clamp on the market, 100% guaranteed.
  - Strong UV inhibitors for year round use.
  - These heavy duty drops are made from top quality polyethylene materials and the heaviest duty clamp on the market. These drops are engineered to withstand tough use conditions and are perfect for use in areas with corrosive water.

Size	Galvanized			Polyethylene		
	Part #	Weight	List	Part #	Weight	List
24"	--	--	<b>Call</b>	--	--	<b>Call</b>
30"	--	--	<b>Call</b>	2-1436	--	<b>Call</b>
36"	--	--	<b>Call</b>	2-1437	--	<b>Call</b>
42"	--	--	<b>Call</b>	2-1438	--	<b>Call</b>
48"	--	--	<b>Call</b>	2-1439	--	<b>Call</b>
54"	--	--	<b>Call</b>	2-1440	--	<b>Call</b>
60"	--	--	<b>Call</b>	2-1441	--	<b>Call</b>
66"	--	--	<b>Call</b>	2-1442	--	<b>Call</b>
72"	--	--	<b>Call</b>	2-1443	--	<b>Call</b>
78"	--	--	<b>Call</b>	2-1444	--	<b>Call</b>
84"	--	--	<b>Call</b>	2-1445	--	<b>Call</b>
90"	--	--	<b>Call</b>	2-1446	--	<b>Call</b>
96"	--	--	<b>Call</b>	2-1447	--	<b>Call</b>
102"	--	--	<b>Call</b>	2-1448	--	<b>Call</b>
108"	--	--	<b>Call</b>	--	--	<b>Call</b>
114"	--	--	<b>Call</b>	--	--	<b>Call</b>
120"	--	--	<b>Call</b>	--	--	<b>Call</b>

## UNIVERSAL DRIVE GEAR BOX

**Features**

1. Heavy-Duty gearbox with universal mounting.
2. Totally enclosed internal air expansion chamber.
3. High tensile strength worm shaft.
4. Most durable worm gear available.
5. One-piece high strength output shaft.
6. Heavy-duty taper roller bearings.
7. Extreme-duty ductile iron end caps.
8. New self-contained cartridge style input and output shaft seals eliminating oil leaks.
9. Plates seal cover for protection of unused input shaft

Description	Shaft Size	Gear Ratio	Type	Style
<b>Universal Gearbox</b>				
725-U Series	2-1/4" Short	<b>50:1</b>	Non-Tow	Universal
740-U Series	2-1/4" Short	<b>50:1</b>	Non-Tow	Universal
745-U Series	2-1/2" Short	<b>50:1</b>	Non-Tow	Universal
760-U Series	2-1/2" Short	<b>50:1</b>	Non-Tow	Universal
Durst	-	<b>50:1</b>	Non-Tow	Universal
TNT-2-U Series	2-1/4" Short	<b>50:1</b>	Towable	Universal
<b>Valley Style Gearbox</b>				
740-UV Series	2-1/4" Extended	<b>52:1</b>	Non-Tow	Valley
760-UV Series	2-1/2" Long	<b>52:1</b>	Non-Tow	Valley
Durst		<b>52:1</b>	Non-Tow	Valley
TNT-2-U Series	2-1/4" Extended	<b>52:1</b>	Towable	Valley
<b>*** Call For Pricing ***</b>				

## HELICAL GEAR MOTORS & STATOR ASSEMBLIES

**Features**

1. 460/380 Volt, 3 phase motor, 60/50 hz
2. Motor is thermally protected with automatic reset.
3. Class F2 Insulation, UL & CSA Certified.
4. Corrosion resistant finned aluminum motor frame.
5. Aluminum motor frame is sealed at junction points.
6. Integral heat-treated pinion gear on motor shaft.

<b>Complete Helical Gear Motor</b>			
Description	Gear Ratio	Motor HP	RPM
UMC	60:1	<b>3/4 HP</b>	29
UMC	50:1	<b>3/4 HP</b>	35
Durst	50:1	<b>3/4 HP</b>	34
UMC	40:1	<b>3/4 HP</b>	44
Durst	40:1	<b>3/4 HP</b>	43
UMC	30:1	<b>1.5 HP</b>	58
Durst	30:1	<b>1.5 HP</b>	57
UMC	25:1	<b>1.5 HP</b>	68
Durst	25:1	<b>1.5 HP</b>	68
UMC	20:1	<b>1.5 HP</b>	86
Durst	20:1	<b>1.5 HP</b>	86
<b>*** Call For Pricing ***</b>			

**Features**

1. 460/380 Volt, 3 phase motor, 60/50 hz
2. Available in 3/4 and 1-1/2 HP models
3. Class F insulation.
4. Totally interchangeable with Valmont Stators.
5. Includes the 4 mounting bolts, strain relief and wire nuts.
6. Aluminum motor frame resists corrosion.

<b>Replacement Stator</b>		
Description	Style	Motor HP
UMC	Power Saver	<b>3/4 HP</b>
Durst	Lindsay/Emerson	<b>3/4 HP</b>
Durst	Valley	<b>3/4 HP</b>
UMC	Power Saver	<b>1.5 HP</b>
Durst	Lindsay/Emerson	<b>1.5 HP</b>
Durst	Valley	<b>1.5 HP</b>
<b>*** Call For Pricing ***</b>		

# CENTER PIVOT PARTS

## SPLINED GEARMOTOR, GEAR, & MOTOR MODULES (U.S. MOTORS)



Complete Splined Center Drive			
U.S. Motors #	Gear Ratio	Motor HP	RPM
7843	58:1	1 HP	30
A856	47:1	1 HP	37
A799	31:1	1.5 HP	56
*** Call For Pricing ***			

**Features**

1. 460/380 Volt, 3 Phase, 60/50 hz
2. Special CorroGuard insulation for longer motor life.
3. Stainless steel motor frame for corrosion resistance.
4. Motor is thermally protected.
5. Splined motor/gearbox design.



Splined Motor Module		
U.S. Motors #	Motor HP	RPM
A726	1 HP	1750
A728	1.5 HP	1750
*** Call For Pricing ***		

**Features**

1. Top quality gear motor from the most experienced American mfg of center pivot gear motors.
2. Designed to operate in extreme environments. The gear motor has a corrosion resistant housing and incorporates an inherit overload protection for the motor.
3. Simplicity, flexibility and reliability.
4. 100% of all motors are factory tested before packaging.



Splined Gear Module		
U.S. Motors #	Gear Ratio	RPM
A732	58:1	30
A730	47:1	37
A800	31:1	56
*** Call For Pricing ***		

## NEMA 56 C-FACE GEAR BOX & MOTOR

**Features**

1. Universal mounting pattern.
2. Multiple available ratios available.
3. Aluminum gearbox housing.
4. Includes key-way coupling for the motor to gearbox connection.
5. Includes 2 seal savers for the output shafts.
6. High strength aluminum bronze bull gear.



UMC 56 C-Face Gear Box		
UMC #	Gear Ratio	RPM
09333-154A	60:1	29
09333-151A	50:1	35
09333-153A	40:1	43
09333-152A	30:1	58
*** Call For Pricing ***		

**Features**

1. Fits on any NEMA 56 C flanged center drive gearbox
2. Stainless steel motor frame for corrosion resistance.
3. CorroGuard insulation for longer motor life.
4. Motor is thermally protected



UMC 56 C-Face Motor		
Description	Motor HP	RPM
U.S. #5622	1	1800
Bluffton #UF17565	1	1725
UMC	1.5	1725
U.S. #5624	1.5	1800
Bluffton #UF12317	1.5	1725
*** Call For Pricing ***		

## PIVOT TIRE, MACH II (FIBERGLASS)

**Features**

1. Superior Traction
2. Will Not Go Flat
3. Chemical, Fertilizer & UV Resistant
4. Less Stress on Drive Train Components
5. Price Comparable
6. Improved Tire Track

Type	Description	Size	Part #	Weight	List
Tire Only:		11.2 x 24	9-7560	76.0	<b>535.00</b>
	For 8" Rim	14.9 x 24	9-7561	90.0	<b>599.00</b>
	For 10" Rim	14.9 x 24	9-7562	96.0	<b>690.00</b>
Tire & Rim:		11.2 x 38	9-7563	96.0	<b>662.00</b>
	With 8" Rim	11.2 x 24	9-7564	180.0	<b>785.00</b>
	With 8" Rim	14.9 x 24	9-7565	195.0	<b>850.00</b>
	With 10" Rim	14.9 x 24	9-7566	205.0	<b>960.00</b>
	With 10" Rim	11.2 x 38	9-7567	270.0	<b>1,150.00</b>

## PIVOT OR END TOWER LIGHT KIT



Description	Part #	List
Rough Duty Light Bulb Kit, Complete	2-0536	<b>Call</b>
TOMAR Strobe Light Kit, Complete	2-0538	<b>Call</b>

Universal light kit for installation at the pivot point or end tower. The kit comes complete with the flange adapter, extended gooseneck, shielded cable, globe assembly, and rough duty light assembly or TOMAR strobe light.

### Tomar Pivot Strobe Lights



Type	Description	Part #	List
<b>485 Micro Strobe Light</b> Effective Candela 50 (Screw in Socket)	1.75J Strobe 120V	485S-#-W	<b>Call</b>
	Replacement Bulb	5001-W	<b>Call</b>
	Replacement Lens	470S-L-W	<b>Call</b>
<b>801 Mini I Strobe Light</b> Effective Candela 400 (1/2" FPT)	8 J Strobe 120V	801-110-#-W	<b>Call</b>
	8 J Strobe 12-74VDC	801-1274-#-W	<b>Call</b>
	Replacement Bulb for T801	4001-W	<b>Call</b>
	Replacement Lens	801S-L-W	<b>Call</b>
<b>490 Micro Strobe Light</b> Effective Candela 50 (1/2" FPT)	1.75J Strobe 120V	490S-#-W	<b>Call</b>
	Replacement Bulb	5001-W	<b>Call</b>
	Replacement Lens	470S-L-W	<b>Call</b>
<b>824 Multi Pulse StrobeLight</b> Effective Candela 1200 (1/2" FPT)	23 J Strobe 120V	824-110-#-W	<b>Call</b>
	Replacement Bulb	4001-W	<b>Call</b>
	Replacement Lens	1700-W	<b>Call</b>

"#" Specify Lens Color when ordering (**A**mber, **B**lue, **C**lear, **G**reen, **P**urple, **R**ed)

### Code 3® Pivot Strobe Lights (3/4" FPT)



Type	Description	Part #	List
<b>LI1HD Ultra Lite®</b> Strobe Light Effective Candela 230	4 Joule HD Strobe 110VAC	L1001#TH-W	<b>Call</b>
	3/4" FPT Pipe Mount Kit	LL1-PMK-W	<b>Call</b>
	Replacement Bulb	T15597-W	<b>Call</b>
	Replacement Lens	LL2-#L-LP-W	<b>Call</b>
<b>LI8HD Astro Flash®</b> Strobe Light Effective Candela 575	15 Joule HD Strobe 110VAC	L8001RTH-W	<b>Call</b>
	Replacement Bulb	T13074-W	<b>Call</b>
	Replacement Lens	T130#-W	<b>Call</b>

"#" Specify Lens Color when ordering (**A**mber, **B**lue, **C**lear, **G**reen, **R**ed)

# CENTER PIVOT SPRINKLERS

## R3000 ROTATOR®



Description	Part #	Weight	List
R3000 Rotator Complete	2-1037		31.00

\* Indicate 31N Nozzle Size and Plate type when ordering.  
\* The Orange Plate is considered the corn plate.

## A3000 ACCELERATOR



Description	Part #	Weight	List
A3000 Accelerator Complete	2-1050		20.00

\* Indicate 3TN Nozzle Size and Plate type when ordering.

## D3000 SPRAYHEAD



Description	Part #	Weight	List
D3000 Sprayhead Complete	2-1063		6.50

\* Indicate 3TN Nozzle Size and Plate type when ordering.

## I-WOB™



Description	Part #	List
Standard-angle 9-groove, Black Deflector	iWobSA9GUP3	28.00
Standard-angle 6-groove, Grey Deflector	iWobSA6GUP3	27.00
Low-angle 9-groove, Blue Deflector	iWobLA9GUP3	26.00
Low-angle 6-groove, Blue Deflector	iWobLA6GUP3	25.00
Nozzles, Color Coded (#6-#24)	UP3 Nozzles	2.00

\* Indicate UP3 Nozzle Size when ordering.

## XI-WOB™



Description	Part #	List
6-Grooves, 10°, Blue Deflector	XiWob610UP3	27.00
6-Grooves, 15°, Black Deflector	XiWob615UP3	29.00
9-Grooves, 10°, Grey Deflector	XiWob910UP3	29.00
Top-of-Pipe, 6-Grooves, 5°, White Deflector	XiWob605TOPUP3	29.00
Nozzles, Color Coded (#7-#24)	UP3 Nozzles	2.00

\* Indicate UP3 Nozzle Size when ordering.

## PIVOT-MASTER IMPACT SPRINKLER (6°)



Type	Description	GPM	Nozzle	Part #	List
Single Nozzle	3006H	2.40 - 4.35	#8-9	3006H13/4 M PM	29.00
	4006H	3.80 - 7.70	#10-12	4006H13/4 M PM	29.00
	5006H	6.20 - 16.00	#13-18	5006H13/4 M PM	29.00
Double Nozzle	4006H	4.55 - 15.08	#10-12, #7-12	4006H23/4 M PM	30.50
	5006H	12.32 - 30.47	#13-18, #7-18	5006H23/4 M PM	30.50

\* Specify Nozzle Size when ordering.  
\* With Brass Swivel & Stem



## PRESSURE REGULATOR UNIVERSAL FLOW



Type	PSI	GPM	Part #	Weight	List
3/4" Barb x Square Thread	6	0.5-8	10167-001	-	8.72
	10	0.5-10	10167-002	-	8.72
	15	0.5-12	10167-003	-	8.72
	20	0.5-12	10167-004	-	8.72
	25	0.5-12	10167-005	-	8.72
	30	0.5-12	10167-006	-	8.72
	40	0.5-12	10167-007	-	8.72
	50	0.5-12	10167-008	-	8.72



3/4" FPT x Square Thread	6	0.5-8	9572-001	-	10.00
	10	0.5-10	9572-002	-	10.00
	15	0.5-12	9572-003	-	10.00
	20	0.5-12	9572-004	-	10.00
	25	0.5-12	9572-005	-	10.00
	30	0.5-12	9572-006	-	10.00
	40	0.5-12	9572-007	-	10.00
	50	0.5-12	9572-008	-	10.00



3/4" FPT x FPT	6	0.5-8	9491-001	-	11.00
	10	0.5-10	9491-002	-	11.00
	15	0.5-12	9491-003	-	11.00
	20	0.5-12	9491-004	-	11.00
	25	0.5-12	9491-005	-	11.00
	30	0.5-12	9491-006	-	11.00
	40	0.5-12	9491-007	-	11.00
	50	0.5-12	9491-008	-	11.00



3/4" FHT x MHT	6	0.5-8	9561-001	-	11.00
	10	0.5-10	9561-002	-	11.00
	15	0.5-12	9561-003	-	11.00
	20	0.5-12	9561-004	-	11.00
	25	0.5-12	9561-005	-	11.00
	30	0.5-12	9561-006	-	11.00
	40	0.5-12	9561-007	-	11.00
	50	0.5-12	9561-008	-	11.00



3/4" FPT x MHT	6	0.5-8	9581-001	-	11.00
	10	0.5-10	9581-002	-	11.00
	15	0.5-12	9581-003	-	11.00
	20	0.5-12	9581-004	-	11.00
	25	0.5-12	9581-005	-	11.00
	30	0.5-12	9581-006	-	11.00
	40	0.5-12	9581-007	-	11.00
	50	0.5-12	9581-008	-	11.00

Fittings

## PRESSURE REGULATOR HI-FLOW



Type	PSI	GPM	Part #	Weight	List
3/4" FPT x Square Thread	6	0.5-8	9611-001	-	16.00
	10	0.5-10	9611-002	-	16.00
	15	0.5-12	9611-003	-	16.00
	20	0.5-12	9611-005	-	16.00
	25	0.5-12	9611-006	-	16.00
	30	0.5-12	9611-007	-	16.00
	40	0.5-12	9611-008	-	16.00
	50	0.5-12	9611-009	-	16.00
	3/4" FPT x FPT	6	0.5-8	9071-001	-
10		0.5-10	9071-002	-	17.00
15		0.5-12	9071-003	-	17.00
20		0.5-12	9071-005	-	17.00
25		0.5-12	9071-006	-	17.00
30		0.5-12	9071-007	-	17.00
40		0.5-12	9071-008	-	17.00
50		0.5-12	9071-009	-	17.00

## PRESSURE REGULATOR



Type	PSI	Part #	Weight	List
3/4" FPT x 3/4" FPT	15	7-0310	0.4	14.65
	20	7-0311	0.4	14.65
	25	7-0312	0.4	14.65
	30	7-0313	0.4	14.65
	40	7-0314	0.4	14.65
	50	7-0315	0.4	14.65
1-1/4" FPT x 1" FPT	10	7-0316	0.6	31.00
	15	7-0317	0.6	31.00
	20	7-0318	0.6	31.00
	30	7-0319	0.6	31.00
	40	7-0320	0.6	31.00
	50	7-0321	0.6	31.00

Both ends are Female threaded.  
Male available upon request.  
Also available as 1" x 1". Please call for price.

## PIVOT FLUSHER



Description	GPM	Part #	Weight	List
Low Flow	400-700	9-7900		595.00
Standard Flow	700-1000	9-7901		595.00

- 2" Male Pipe Thread
- Dimensions: 12" x 17"
- Max Operating Pressure: 40 psi
- Min Operation Pressure: 12 psi (15-30 psi recommended)
- Closing Pressure: 7 psi
- Flows: 150 gpm @ 10 psi
- Does not require electricity
- Works automatically using water pressure
- Flushes while pivot pressurizes

## SCREEN, E-Z



Type	Part #	Weight	List
Square Grid	9-7316		2.50
Bar Grid	9-7317		2.50

Features:

- Stops Nozzle Plugging on Even the Smallest Nozzles, 3/64" Hose Size
- Self Flushing Design-Never Needs Cleaning
- Can Be Used on Any System
- Two Sizes to Accommodate Nozzle Flow Rates
- Threaded Mounting

## INLINE SCREEN (STAINLESS STEEL 24 GA.)

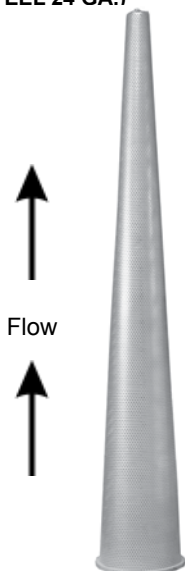

Size	Outside Diameter of inlet of Screen			Length	Part #	Weight	List
	BE Bullnose End	RE Rolled End	OE Open End				
2"	2"	2"	2"	18"	6-1513	0.5	42.00
3"	3"	3"	3"	18"	6-1514	0.5	42.00
4"	4"			36"	6-1510-BE	1.3	62.00
4"		3-7/8"		36"	6-1510-RE	1.3	62.00
4"			4"	36"	6-1510-OE	1.3	62.00
5"	4-7/8"			36"	6-1515-BE	2.0	77.00
5"		4-3/4"		36"	6-1515-RE	2.0	77.00
5"			5"	36"	6-1515-OE	2.0	77.00
6"	5-3/4"			36"	6-1511-BE	3.5	91.00
6"		5-5/8"		36"	6-1511-RE	3.5	90.00
6"			6"	36"	6-1511-OE	3.5	91.00
8"	7-3/4"			36"	6-1512-BE	5.0	112.00
8"		7-5/8"		36"	6-1512-RE	5.0	112.00
8"			8"	36"	6-1512-OE	5.0	112.00
10"	9-3/4"			36"	6-1469-BE	7.0	141.00
10"		9-5/8"		36"	6-1469-RE	7.0	140.00
10"			10"	36"	6-1469-OE	7.0	141.00

Features:

- Keeps sprinkler heads from plugging
- Makes couplers easier to connect and disconnect
- Works with large volumes of water up to 1000 gallons per minute.
- Collects large amounts of sand, gravel, and debris without cleaning.
- Hole size = 3/32" (.09375"). Special order available on smaller .05" hole size.

## SCREEN FILTER, GALVANIZED (FLANGE X FLANGE)

Size	GPM	Screen	Part #	Weight	List
8"	1200	1/16"	9-7312		2,475.00
8"	1200	3/32"	9-7313		2,385.00
8"	1750	1/16"	9-7314		4,210.00
8"	1750	3/32"	9-7315		3,660.00



Fittings

## SOIL MOISTURE TESTER

### IRROMETER

- Features:
- 5 different lengths to choose from
  - Only the gauge is replaceable
  - Conserves water
  - Saves energy from pumping excessive water



Description	Size	Part #	Weight	List
<b>Irrrometer:</b>	6"	6-1504	0.8	<b>137.00</b>
	12"	6-1508	1.0	<b>143.00</b>
	18"	6-1509	1.1	<b>149.00</b>
	24"	6-1516	1.2	<b>155.00</b>
	36"	6-1517	1.5	<b>165.00</b>
<b>Service Unit:</b>		6-1519	1.1	<b>99.00</b>

Recommended by the soil conservation departments of the USDA and local water conservation districts as an easy tool to prevent over-watering. Optional service kit is required with the first installation of a tensiometer. This unit is not recommended for areas where the instrument could get easily hit or where there are a lot of stones in the soil.

## PRESSURE GAUGE 2-1/2" & 4" DIAL FACES



- 1/4" brass male pipe thread base
- Stainless steel case
- Silicone filled gauge (on the liquid filled gauges)
- Glass lens

Dial Face Size	Type	PSI	Part #	Weight	List
<b>2-1/2"</b>	Dry	0-300	6-9768	0.3	<b>7.00</b>
	Dry	0-100	6-1520	0.3	<b>9.00</b>
	Dry	0-200	6-1521	0.3	<b>9.00</b>
<b>2-1/2"</b>	Liquid Filled	0-15	6-9754	0.5	<b>15.00</b>
	Liquid Filled	0-30	6-9755	0.5	<b>15.00</b>
	Liquid Filled	0-60	6-9756	0.5	<b>15.00</b>
	Liquid Filled	0-100	6-9757	0.5	<b>15.00</b>
	Liquid Filled	0-160	6-1522	0.5	<b>12.00</b>
	Liquid Filled	0-200	6-9758	0.5	<b>15.00</b>
	Liquid Filled	0-300	6-9759	0.5	<b>15.00</b>
<b>4"</b>	Liquid Filled	0-15	9-5271	1.5	<b>32.00</b>
	Liquid Filled	0-30	9-5274	1.5	<b>32.00</b>
	Liquid Filled	0-60	9-5276	1.5	<b>32.00</b>
	Liquid Filled	0-100	9-5270	1.5	<b>32.00</b>
	Liquid Filled	0-160	9-5272	1.2	<b>32.00</b>
	Liquid Filled	0-200	9-5273	1.5	<b>32.00</b>
<b>Liquid Manure 2-1/2"</b>	Dry	0-160	6-1578	0.5	<b>62.00</b>
	Liquid Filled	0-160	6-9570	0.5	<b>55.00</b>

## VACUUM GAUGE 2-1/2" DIAL FACE

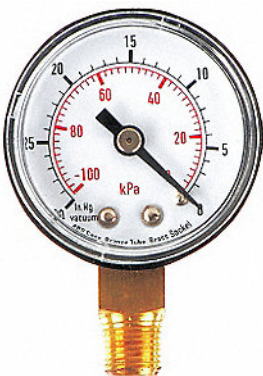

Dial Face Size	Type	PSI	Part #	Weight	List
2-1/2"	Liquid Filled	30" HG/0	9-6810		<b>20.00</b>

## WELD-ON VALVE STUB (BLACK & STAINLESS STEEL)



Size	Black Steel			Stainless Steel		
	Part #	Weight	List	Part #	Weight	List
3"	6-1377	2.0	<b>45.00</b>			
4"	6-1414	2.8	<b>39.00</b>	9-8219		<b>275.00</b>
5"	6-1378	3.8	<b>70.00</b>			
6"	6-1415	5.8	<b>50.00</b>	9-8104		<b>256.00</b>
8"	6-1416	15.0	<b>177.00</b>	9-8105		<b>635.00</b>
10"	6-9846	19.0	<b>397.00</b>	9-8106		<b>975.00</b>

## WELD-ON VALVE STUB (CAST ALUMINUM)



Size	Part #	Weight	List
3"	6-1363	3.5	<b>60.00</b>
4"	6-1364	3.5	<b>58.00</b>
5"	6-1365	3.5	<b>93.00</b>
6"	6-1366	4.5	<b>118.00</b>

## WELD-ON VALVE STUB WITH SADDLE (CAST ALUMINUM)



Size	Part #	Weight	List
4" x 4"	6-1373	3.5	<b>60.00</b>
5" x 4"	6-1374	3.5	<b>60.00</b>
6" x 4"	6-1411	3.5	<b>60.00</b>
7" x 4"	6-1375	3.5	<b>60.00</b>
8" x 4"	6-1412	3.5	<b>60.00</b>
10" x 4"	6-1413	3.5	<b>60.00</b>
12" x 4"	6-1376	3.5	<b>60.00</b>

## THREADED VALVE STUB (GALVANIZED STEEL)



Female



Male

Size	Female Threaded			Male Threaded		
	Part #	Weight	List	Part #	Weight	List
2" x 3"	6-1421	4.0	<b>77.00</b>	6-1427	4.0	<b>77.00</b>
3" x 3"	6-1423	4.5	<b>91.00</b>	6-1428	4.5	<b>80.00</b>
3" x 4"	6-1424	5.0	<b>89.00</b>	6-1429	5.0	<b>83.00</b>
4" x 4"	6-1420	6.0	<b>112.00</b>	6-1399	6.0	<b>93.00</b>
6" x 6"	6-1425	8.5	<b>219.00</b>	6-1388	9.0	<b>177.00</b>
8" x 8"	6-1426	28.0	<b>422.00</b>	6-1387	25.0	<b>379.00</b>

## THREADED VALVE STUB (CAST ALUMINUM)



Female



Male

Size	Female Threaded			Male Threaded		
	Part #	Weight	List	Part #	Weight	List
4" x 4"	6-9612	4.5	<b>74.00</b>	6-9613	3.0	<b>78.00</b>
6" x 6"	6-9614	5.0	<b>222.00</b>	6-9615	5.0	<b>275.00</b>

Fittings

**RISER VALVE DISC**

\* Domed

Size	Hole Size	Part #	Weight	List
3"	5/8"	6-1404	0.4	<b>14.00</b>
4"	5/8"	6-1405	0.6	<b>8.00</b>
5"	5/8"	6-1409	1.0	<b>18.00</b>
6"	5/8"	6-1406	1.3	<b>27.00</b>
8"	1"	6-1410	2.5	<b>70.00</b>
10"	1"	9-7546		<b>89.00</b>

**RISER VALVE STEM**

\* Zinc Plated

Size	Diameter	Length	Part #	Weight	List
4"	5/8"	6-3/4"	6-1407	0.6	<b>8.00</b>
6"	5/8"	9"	6-1408	0.7	<b>10.50</b>
8"	1"	11"	6-1400	2.5	<b>42.00</b>
10"	1"	13"	9-7547		<b>57.00</b>

**WELD-ON SADDLE**  
(CAST ALUMINUM)

Size Outlet x Pipe Dia.	Part #	Weight	List
3" x 3"	6-1592	0.4	<b>11.00</b>
3" x 4"	6-1593	0.4	<b>11.00</b>
3" x 5"	6-1594	0.4	<b>11.00</b>
3" x 6"	6-1595	0.4	<b>11.00</b>
4" x 4"	6-1596	0.5	<b>16.00</b>
4" x 5"	6-1597	0.5	<b>16.00</b>
4" x 6"	6-1598	0.5	<b>16.00</b>
4" x 8"	6-1599	0.5	<b>16.00</b>
5" x 5"	6-1600	0.8	<b>31.00</b>
5" x 6"	6-1601	0.8	<b>29.00</b>
5" x 7"	6-1602	0.8	<b>31.00</b>
5" x 8"	6-1603	0.8	<b>31.00</b>
5" x 10"	6-1604	0.8	<b>31.00</b>
6" x 6"	6-1605	1.0	<b>31.00</b>
6" x 8"	6-1606	0.5	<b>31.00</b>
8" x 8"	6-1607	1.0	<b>62.00</b>
10" x 10"	6-1608	1.0	<b>62.00</b>

**Call For:**

- Flat Discs
- Stainless Steel Stems
- Brass Stems
- 8 Pitch Stems
- Hex Top Stems
- VTC Stems
- RVTC Stems
- Weld-in Spiders
- Replaceable Spiders
- Snap Rings
- Brass Nut

# VALVE OPENERS, INDEPENDENT VALVE TEES

## VALVE OPENER



Cast Alum



Steel Gal.

Also available in Knob style.

Size	Material	Part #	Weight	List
3"	Cast Alum	6-1435	9.0	<b>139.00</b>
4"	Cast Alum	6-1430	10.0	<b>152.00</b>
6"	<b>Steel Gal.</b>	6-1431	15.0	<b>239.00</b>
8"	<b>Steel Gal.</b>	6-1433	27.0	<b>307.00</b>
10"	<b>Steel Gal.</b>	6-9752	34.0	<b>545.00</b>
3" x 2"	Cast Alum	6-1434	8.0	<b>137.00</b>
4" x 2"	Cast Alum	6-1436	10.0	<b>207.00</b>
4" x 3"	Cast Alum	6-1437	10.0	<b>145.00</b>
6" x 4"	<b>Steel Gal.</b>	6-1432	14.0	<b>205.00</b>

## GUN STAND VALVE OPENER



Size	Material	Part #	Weight	List
4" x 3"	Cast Alum	6-1018	13.0	<b>266.00</b>

## VALVE OPENING TEE



Also available in Knob style.

Size	Material	Part #	Weight	List
3" x 2" x 2"	Cast Alum	6-1390	8.0	<b>168.00</b>
3" x 3" x 3"	Cast Alum	6-1391	9.0	<b>169.00</b>
4" x 2" x 2"	Cast Alum	6-1392	10.0	<b>285.00</b>
4" x 3" x 3"	Cast Alum	6-1393	11.0	<b>195.00</b>
4" x 4" x 4"	Cast Alum	6-1394	11.0	<b>220.00</b>
6" x 4" x 4"	<b>Steel Gal.</b>	6-1395	17.0	<b>255.00</b>
6" x 6" x 6"	<b>Steel Gal.</b>	6-1396	18.5	<b>300.00</b>
8" x 6" x 6"	<b>Steel Gal.</b>	6-1397	20.0	<b>425.00</b>
8" x 8" x 8"	<b>Steel Gal.</b>	6-1398	23.0	<b>430.00</b>

## VALVE OPENING PARTS



Roll Pin



5/8" and 7/8"



Yoke



3/4"

Description	Part #	Weight	List
Yoke only	6-1438	0.3	<b>8.00</b>
Roll Pin for Yolk	6-1439		<b>2.00</b>
* Chevron Gasket - 5/8"	6-1240		<b>1.00</b>
**Chevron Gasket - 3/4"	6-1241		<b>1.00</b>
Chevron Gasket - 1"	6-1243		<b>2.00</b>

\* 5/8" is for Alumax, A&amp;M &amp; Felton.

\*\*3/4" is for Ames, Alumax, Bush Hog, Irreco, Pierce, ShurRane &amp; Western.

## INDEPENDENT VALVE TEE (ALUMINUM)



Size	Band & Hook			Ringlock		
	Part #	Weight	List	Part #	Weight	List
4" x 4"	6-1380	6.3	<b>170.00</b>			
6" x 4"	6-1381	9.6	<b>190.00</b>	6-1384	9.0	<b>215.00</b>
8" x 4"	6-1382	11.7	<b>210.00</b>	6-1385	9.9	<b>240.00</b>
8" x 6"				9-8128		<b>350.00</b>
10" x 4"	6-1383	13.6	<b>230.00</b>	6-1386	11.7	<b>270.00</b>

## FLAPPER DRAIN GASKET

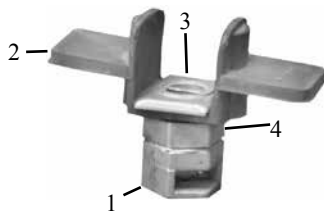

Description	Postion	Part #	Weight	List
Flapper Drain Gasket	Complete	6-1537	0.4	<b>8.50</b>
Splash Nut	1	6-1813	0.1	<b>2.30</b>
Rubber Flapper	2	6-1810	0.1	<b>1.75</b>
Threaded Insert	3	6-1811	0.1	<b>3.00</b>
Jam Nut	4	6-1812	0.1	<b>2.00</b>

## MUSHROOM DRAIN W/CLIP (WESTERN)



Size	Part #	Weight	List
-	6-1525	0.1	<b>1.25</b>

\* Clip (not pictured) is included

## MUSHROOM DRAIN (AMES)



Size	Part #	Weight	List
-	6-1526	0.1	<b>1.30</b>

## 1" DRAIN VALVE

Description	Connection	Postion	Part #	Weight	List
Pierce	1" MPT x 3/4" Male Hose Thread	#1	8-1447	0.1	<b>13.00</b>
Wade Rain	1" MPT w/Slash Plate	#2	6-1538	0.4	<b>11.00</b>
Waterman	1-1/2" MPT x 3/4" MPT	#3	8-1448	0.2	<b>24.00</b>
Pierce Giant Bridge Drain	1" MPT	#4	9-7701		<b>13.00</b>



#1



#2



#3



#4



## WELD-ON HALF COUPLING (ALUMINUM, BLACK STEEL AND STAINLESS STEEL)



Size	Aluminum			Black Steel			Stainless Steel		
	Part #	Weight	List	Part #	Weight	List	Part #	Weight	List
1/8"				9-5879		1.10	9-8151		1.00
1/4"	9-5303	0.1	8.60	9-5016	0.1	2.00	9-8152		1.00
3/8"				9-5279		1.90	9-8153		1.00
1/2"	9-5304	0.3	7.50	9-5278	0.1	1.90	9-8154		1.50
3/4"	6-1740	0.3	8.00	6-1586	0.1	2.00	9-8155		2.00
1"	6-1609	0.3	9.00	6-1669	0.3	3.00	9-8156		2.50
1-1/4"	6-1585	0.4	10.00	6-1587	0.2	4.00	9-8157		3.50
1-1/2"	6-1580	0.5	15.00	6-1588	0.3	5.00	9-8158		4.50
2"	6-1581	1.0	21.00	6-1571	0.5	7.00	9-8159		6.50
2-1/2"	6-1417	1.0	37.00	6-1589	1.0	16.00	9-8160		15.00
3"	6-1582	1.4	36.00	6-1572	1.4	13.00	9-8161		20.50
4"	6-1583	1.5	60.00	6-1573	2.0	20.00	9-8162		33.00
5"	6-1584	1.5	115.00	6-1574	3.6	80.00			
6"	6-1418	1.6	165.00	6-1575	4.9	90.00			
8"				6-1576		105.00			
10"				9-5154		135.00			

## FULL COUPLING (BLACK STEEL)



Size	Part #	Weight	List
1/4"	9-5847	0.1	1.70
3/8"	9-5872	0.1	2.60
1/2"	6-9571	0.2	2.80
3/4"	6-9572	0.3	3.50
1"	6-9573	0.4	4.90
1-1/4"	9-5870	0.5	6.20
1-1/2"	9-5869	0.7	7.90
2"	6-9574	1.1	11.30
2-1/2"	9-5871	2.1	24.00
3"	6-9575	3.4	34.00
3-1/2"	9-5873	4.8	97.00
4"	9-5874	4.6	53.00
6"	9-5875	11.3	132.00

Fittings

## WELD-ON NIPPLE

(ALUMINUM, BLACK STEEL AND STAINLESS STEEL)



Size	Aluminum			Black Steel			Stainless Steel		
	Part #	Weight	List	Part #	Weight	List	Part #	Weight	List
1/2"	9-5821	0.2	<b>6.50</b>	9-5820		<b>1.90</b>	9-8175		<b>11.00</b>
3/4"	6-1703	0.2	<b>8.00</b>	6-1539	0.1	<b>2.00</b>	9-8176		<b>12.00</b>
1"	6-1554	0.3	<b>9.00</b>	6-1540	0.4	<b>3.00</b>	9-8177		<b>13.00</b>
1-1/4"	6-1555	0.3	<b>10.00</b>	6-1541	0.3	<b>4.00</b>	9-8178		<b>14.00</b>
1-1/2"	6-1556	0.3	<b>15.00</b>	6-1542	0.4	<b>7.00</b>	9-8179		<b>15.00</b>
2"	6-1550	0.3	<b>21.00</b>	6-1543	0.6	<b>9.00</b>	9-8180		<b>16.00</b>
2-1/2"	6-1557	0.4	<b>37.00</b>	6-1548	0.9	<b>12.00</b>	9-8181		<b>50.00</b>
3"	6-1551	0.6	<b>18.00</b>	6-1544	1.5	<b>17.00</b>	9-8182		<b>30.00</b>
4"	6-1552	0.9	<b>25.00</b>	6-1545	2.8	<b>25.00</b>	9-8183		<b>60.00</b>
5"	6-1553	1.1	<b>57.00</b>	6-1549	3.9	<b>40.00</b>	9-8184		<b>65.00</b>
6"	6-1558	1.4	<b>81.00</b>	6-1546	5.3	<b>45.00</b>	9-8185		<b>105.00</b>
8"	6-1559	3.0	<b>134.00</b>	6-1547	7.3	<b>90.00</b>	9-8186		<b>150.00</b>
10"				6-9660		<b>172.00</b>	9-8187		<b>210.00</b>
12"				6-9661		<b>210.00</b>	9-8188		<b>250.00</b>

## WHITE TEFLON TAPE



Size	Part #	Weight	List
1/2" x 520"	9-7543		<b>1.60</b>
3/4" x 520"	9-7544		<b>2.70</b>
1" x 520"	9-7545		<b>3.40</b>

\*Industrial Teflon Thread sealing tape.

\*Chemically resistant.

## PIPE THREAD COMPOUND



1-Pint    1-Quart    1/2-Pint

Size	Part #	Weight	List
1/2 Pint, 8 Fl. Oz	9-7442		<b>12.00</b>
1 Pint, 16 Fl. Oz	9-7443		<b>18.00</b>
1 Quart, 32 Fl. Oz	9-7444		<b>28.00</b>

# NIPPLES, TBE, STEEL BLACK

## Black



### Steel Black Nipples

Steel Black	1/8"		1/4"		3/8"		1/2"		3/4"		1"		1-1/4"	
	Diameter		Diameter		Diameter		Diameter		Diameter		Diameter		Diameter	
	Part Number	List Price	Part Number	List Price	Part Number	List Price	Part Number	List Price	Part Number	List Price	Part Number	List Price	Part Number	List Price
<b>Close</b>	9-6348	\$1.50	9-6365	\$1.80	9-6382	\$1.90	9-6399	\$1.60	9-6416	\$1.80	9-6433	\$2.70	9-6449	\$3.40
<b>1-1/2" Long</b>	9-6349	1.90	9-6366	2.00	9-6383	2.20	9-6400	1.60	9-6417	2.00				
<b>2" Long</b>	9-6350	1.90	9-6367	2.00	9-6384	2.20	9-6401	1.60	9-6418	2.00	9-6434	2.90	9-6450	3.80
<b>2-1/2" Long</b>	9-6351	2.20	9-6368	2.50	9-6385	2.80	9-6402	1.90	9-6419	2.20	9-6435	3.10	9-6451	4.10
<b>3" Long</b>	9-6352	2.20	9-6369	2.50	9-6386	2.80	9-6403	1.90	9-6420	2.20	9-6436	3.10	9-6452	4.10
<b>3-1/2" Long</b>	9-6353	2.70	9-6370	2.90	9-6387	3.20	9-6404	2.30	9-6421	2.80	9-6437	3.80	9-6453	4.80
<b>4" Long</b>	9-6354	2.70	9-6371	2.90	9-6388	3.20	9-6405	2.30	9-6422	2.80	9-6438	3.80	9-6454	4.80
<b>4-1/2" Long</b>	9-6355	5.10	9-6372	4.50	9-6389	4.70	9-6406	2.70	9-6423	3.50	9-6439	4.60	9-6455	5.80
<b>5" Long</b>	9-6356	5.10	9-6373	4.50	9-6390	4.70	9-6407	2.70	9-6424	3.50	9-6440	4.60	9-6456	5.80
<b>5-1/2" Long</b>	9-6357	5.50	9-6374	5.30	9-6391	5.20	9-6408	3.00	9-6425	3.90	9-6441	5.40	9-6457	6.80
<b>6" Long</b>	9-6358	5.50	9-6375	5.30	9-6392	5.20	9-6409	3.00	9-6426	3.90	9-6442	5.40	9-6458	6.80
<b>7" Long</b>	9-6359	7.60	9-6376	8.10	9-6393	9.20	9-6410	5.40	9-6427	6.60	9-6443	8.80	9-6459	11.00
<b>8" Long</b>	9-6360	7.60	9-6377	8.10	9-6394	9.20	9-6411	5.40	9-6428	6.60	9-6444	8.80	9-6460	11.00
<b>9" Long</b>	9-6361	8.70	9-6378	9.50	9-6395	10.30	9-6412	6.40	9-6429	7.60	9-6445	10.30	9-6461	13.20
<b>10" Long</b>	9-6362	8.70	9-6379	9.50	9-6396	10.30	9-6413	6.40	9-6430	7.60	9-6446	10.30	9-6462	13.20
<b>11" Long</b>	9-6363	8.90	9-6380	10.50	9-6397	11.70	9-6414	7.70	9-6431	8.50	9-6447	11.80	9-6463	15.00
<b>12" Long</b>	9-6364	8.90	9-6381	10.50	9-6398	11.70	9-6415	7.70	9-6432	8.50	9-6448	11.80	9-6464	15.00

TBE (threaded both ends)

\*\*\*Stainless Steel also available\*\*\*

### Steel Black Nipples

Steel Black	1-1/2"		2"		2-1/2"		3"		4"		6"		8"	
	Diameter		Diameter		Diameter		Diameter		Diameter		Diameter		Diameter	
	Part Number	List Price	Part Number	List Price	Part Number	List Price	Part Number	List Price	Part Number	List Price	Part Number	List Price	Part Number	List Price
<b>Close</b>	9-6465	\$4.20	9-6481	\$5.70	9-6496	\$17.90	9-6510	\$21.30	9-6524	32.10	9-6537	61.40	9-7696	78.00
<b>1-1/2" Long</b>														
<b>2" Long</b>	9-6466	4.50												
<b>2-1/2" Long</b>	9-6467	5.10	9-6482	6.60										
<b>3" Long</b>	9-6468	5.10	9-6483	6.60	9-6497	18.40	9-6511	23.10						
<b>3-1/2" Long</b>	9-6469	5.70	9-6484	8.00	9-6498	21.60	9-6512	27.40						
<b>4" Long</b>	9-6470	5.70	9-6485	8.00	9-6499	21.60	9-6513	27.40	9-6526	37.10				
<b>4-1/2" Long</b>	9-6471	6.90	9-6486	9.20	9-6500	23.80	9-6514	30.20	9-6527	42.40				
<b>5" Long</b>	9-6472	6.90	9-6487	9.20	9-6501	23.80	9-6515	30.20	9-6528	42.40				
<b>5-1/2" Long</b>	9-6473	8.00	9-6488	10.70	9-6502	24.80	9-6516	32.80	9-6529	45.30				
<b>6" Long</b>	9-6474	8.00	9-6489	10.70	9-6503	24.80	9-6517	32.80	9-6530	45.30	9-6541	80.10	9-7697	105.00
<b>7" Long</b>	9-6475	12.60	9-6490	18.00	9-6504	31.50	9-6518	44.30	9-6531	52.30	9-6542	96.60		
<b>8" Long</b>	9-6476	12.60	9-6491	18.00	9-6505	31.50	9-6519	44.30	9-6532	52.30	9-6543	96.60	9-7698	140.00
<b>9" Long</b>	9-6477	14.80	9-6492	21.10	9-6506	35.40	9-6520	49.80	9-6533	59.50	9-6544	111.90		
<b>10" Long</b>	9-6478	14.80	9-6493	21.10	9-6507	35.40	9-6521	49.80	9-6534	59.50	9-6545	111.90	9-7699	150.00
<b>11" Long</b>	9-6479	17.00	9-6494	24.30	9-6508	39.40	9-6522	55.20	9-6535	69.80	9-6546	131.70		
<b>12" Long</b>	9-6480	17.00	9-6495	24.30	9-6509	39.40	9-6523	55.20	9-6536	69.80	9-6547	131.70	9-7700	180.00

TBE (threaded both ends)

\*\*\*Stainless Steel also available\*\*\*

Fittings

## Galvanized



### Steel Galvanized Nipples

Steel Galvanized	1/8"		1/4"		3/8"		1/2"		3/4"		1"		1-1/4"	
	Part Number	List Price	Part Number	List Price	Part Number	List Price	Part Number	List Price	Part Number	List Price	Part Number	List Price	Part Number	List Price
<b>Close</b>	9-6548	1.90	9-6565	2.10	9-6582	2.30	9-6599	1.80	9-6616	2.20	9-6633	3.10	9-6649	4.10
<b>1-1/2" Long</b>	9-6549	2.70	9-6566	2.40	9-6583	2.60	9-6600	1.90	9-6617	2.40				
<b>2" Long</b>	9-6550	2.70	9-6567	2.40	9-6584	2.60	9-6601	1.90	9-6618	2.40	9-6634	3.60	9-6650	4.50
<b>2-1/2" Long</b>	9-6551	3.50	9-6568	3.20	9-6585	3.50	9-6602	2.30	9-6619	2.70	9-6635	3.90	9-6651	4.80
<b>3" Long</b>	9-6552	3.50	9-6569	3.20	9-6586	3.50	9-6603	2.30	9-6620	2.70	9-6636	3.90	9-6652	4.80
<b>3-1/2" Long</b>	9-6553	4.20	9-6570	3.80	9-6587	4.10	9-6604	2.80	9-6621	3.50	9-6637	4.70	9-6653	5.80
<b>4" Long</b>	9-6554	4.20	9-6571	3.80	9-6588	4.10	9-6605	2.80	9-6622	3.50	9-6638	4.70	9-6654	5.80
<b>4-1/2" Long</b>	9-6555	7.10	9-6572	5.20	9-6589	5.70	9-6606	3.40	9-6623	4.10	9-6639	5.80	9-6655	7.10
<b>5" Long</b>	9-6556	7.10	9-6573	5.20	9-6590	5.70	9-6607	3.40	9-6624	4.10	9-6640	5.80	9-6656	7.10
<b>5-1/2" Long</b>	9-6557	8.00	9-6574	5.80	9-6591	6.30	9-6608	3.80	9-6625	5.00	9-6641	6.50	9-6657	8.30
<b>6" Long</b>	9-6558	8.00	9-6575	5.80	9-6592	6.30	9-6609	3.80	9-6626	5.00	9-6642	6.50	9-6658	8.30
<b>7" Long</b>	9-6559	10.50	9-6576	9.90	9-6593	10.10	9-6610	6.70	9-6627	8.60	9-6643	10.90	9-6659	13.40
<b>8" Long</b>	9-6560	10.50	9-6577	9.90	9-6594	10.10	9-6611	6.70	9-6628	8.60	9-6644	10.90	9-6660	13.40
<b>9" Long</b>	9-6561	12.30	9-6578	11.60	9-6595	12.00	9-6612	8.00	9-6629	9.60	9-6645	12.50	9-6661	16.00
<b>10" Long</b>	9-6562	12.30	9-6579	11.60	9-6596	12.00	9-6613	8.00	9-6630	9.60	9-6646	12.50	9-6662	16.00
<b>11" Long</b>	9-6563	13.70	9-6580	12.90	9-6597	13.40	9-6614	9.10	9-6631	10.70	9-6647	14.50	9-6663	19.20
<b>12" Long</b>	9-6564	13.70	9-6581	12.90	9-6598	13.40	9-6615	9.10	9-6632	10.70	9-6648	14.50	9-6664	19.20

TBE (threaded both ends)

\*\*\*Stainless Steel also available\*\*\*

### Steel Galvanized Nipples

Steel Galvanized	1-1/2"		2"		2-1/2"		3"		4"		6"	
	Part Number	List Price	Part Number	List Price	Part Number	List Price	Part Number	List Price	Part Number	List Price	Part Number	List Price
<b>Close</b>	9-6665	\$4.80	9-6681	\$6.80	9-6696	\$20.20	9-6710	24.20	9-6724	36.30	9-6737	122.80
<b>1-1/2" Long</b>												
<b>2" Long</b>	9-6666	5.20										
<b>2-1/2" Long</b>	9-6667	5.80	9-6682	7.60								
<b>3" Long</b>	9-6668	5.80	9-6683	7.60	9-6697	21.00	9-6711	27.60				
<b>3-1/2" Long</b>	9-6669	7.30	9-6684	9.30	9-6698	24.40	9-6712	32.30				
<b>4" Long</b>	9-6670	7.30	9-6685	9.30	9-6699	24.40	9-6713	32.30	9-6726	43.40		
<b>4-1/2" Long</b>	9-6671	8.80	9-6686	11.80	9-6700	27.20	9-6714	37.70	9-6727	48.70		
<b>5" Long</b>	9-6672	8.80	9-6687	11.80	9-6701	27.20	9-6715	37.70	9-6728	48.70		
<b>5-1/2" Long</b>	9-6673	9.90	9-6688	13.80	9-6702	29.80	9-6716	39.80	9-6729	53.80		
<b>6" Long</b>	9-6674	9.90	9-6689	13.80	9-6703	29.80	9-6717	39.80	9-6730	53.80	9-6741	160.30
<b>7" Long</b>	9-6675	15.40	9-6690	22.40	9-6704	38.40	9-6718	53.70	9-6731	64.20	9-6742	221.80
<b>8" Long</b>	9-6676	15.40	9-6691	22.40	9-6705	38.40	9-6719	53.70	9-6732	64.20	9-6743	193.20
<b>9" Long</b>	9-6677	17.90	9-6692	26.20	9-6706	43.80	9-6720	61.20	9-6733	74.40	9-6744	223.90
<b>10" Long</b>	9-6678	17.90	9-6693	26.20	9-6707	43.80	9-6721	61.20	9-6734	74.40	9-6745	223.90
<b>11" Long</b>	9-6679	20.50	9-6694	30.10	9-6708	49.00	9-6722	68.80	9-6735	84.70	9-6746	263.30
<b>12" Long</b>	9-6680	20.50	9-6695	30.10	9-6709	49.00	9-6723	68.80	9-6736	84.70	9-6747	263.30

TBE (threaded both ends)

\*\*\*Stainless Steel also available\*\*\*



# IRON MALLEABLE FITTINGS (CLASS 150 LBS)

## BUSHING (BLACK OR GALVANIZED STEEL)



Size	Black Steel			Galvanized Steel		
	Part #	Weight	List	Part #	Weight	List
1/4" x 1/8"	9-7035	0.1	3.40	9-5479	0.1	4.80
3/8" x 1/8"	9-7210	0.1	3.40	9-5480	0.1	4.80
3/8" x 1/4"	9-7222	0.1	3.40	9-5481	0.1	4.80
1/2" x 1/8"	9-7015	0.1	3.40	9-5482	0.1	4.80
1/2" x 1/4"	9-7013	0.1	3.40	9-5483	0.1	4.80
1/2" x 3/8"	9-7016	0.1	3.40	9-5484	0.1	4.80
3/4" x 1/8"	9-7186	0.2	3.30	9-5485	0.2	4.80
3/4" x 1/4"	9-7199	0.1	3.30	9-5486	0.1	5.00
3/4" x 3/8"	9-7200	0.1	3.30	9-5487	0.1	5.60
3/4" x 1/2"	9-7261	0.1	3.10	8-1214	0.1	4.00
1" x 1/4"	9-6984	0.2	4.10	9-5489	0.2	5.90
1" x 3/8"	9-6987	0.2	4.20	9-5490	0.2	9.30
1" x 1/2"	9-7250	0.2	3.10	8-1215	0.2	5.00
1" x 3/4"	9-7251	0.2	3.10	8-1216	0.2	5.00
1-1/4" x 1/4"	9-7084	0.3	5.30	9-5493	0.3	8.60
1-1/4" x 3/8"	9-7085	0.3	4.70	9-5494	0.3	8.60
1-1/4" x 1/2"	9-7098	0.3	4.50	9-5495	0.3	7.50
1-1/4" x 3/4"	9-7101	0.4	4.10	9-5496	0.4	6.80
1-1/4" x 1"	9-7254	0.3	4.10	8-1217	0.3	7.00
1-1/2" x 1/4"	9-7048	0.4	6.20	9-5498	0.4	10.90
1-1/2" x 3/8"	9-7049	0.2	6.10	9-5499	0.4	9.70
1-1/2" x 1/2"	9-7062	0.4	5.10	9-5500	0.4	9.90
1-1/2" x 3/4"	9-7065	0.4	5.10	9-5501	0.4	9.90
1-1/2" x 1"	9-7252	0.4	4.50	8-1218	0.4	9.00
1-1/2" x 1-1/4"	9-7253	0.3	5.10	8-1219	0.3	8.00
2" x 1/4"	9-7144	0.2	12.90	9-5504	0.5	14.50
2" x 3/8"	9-7128	0.2	7.60	9-5505	0.2	12.40
2" x 1/2"	9-7143	0.5	7.80	9-5506	0.5	12.40
2" x 3/4"	9-7147	0.6	6.60	9-5507	0.6	11.50
2" x 1"	9-7255		6.10	8-1220	0.6	11.00
2" x 1-1/4"	9-7257	0.7	6.10	8-1221	0.7	11.00
2" x 1-1/2"	9-7256	0.6	6.80	8-1222	0.6	10.00
2-1/2" x 1/2"	9-7150		11.20	9-5511		18.00
2-1/2" x 3/4"	9-7157	1.0	11.20	9-5512	1.0	18.00
2-1/2" x 1"	9-7148	1.0	11.20	9-5513	1.0	18.00
2-1/2" x 1-1/4"	9-7153	1.0	11.20	9-5514	1.0	18.00
2-1/2" x 1-1/2"	9-7151	1.1	10.40	9-5515	1.1	17.60
2-1/2" x 2"	9-7258	0.9	10.30	8-1223	0.9	16.00
3" x 1/2"	9-7182	1.1	22.70	9-5517	1.1	50.10
3" x 1"	9-7180	1.4	15.40	9-5518	1.4	23.70
3" x 1-1/4"	9-7184	1.5	15.40	9-5519	1.5	23.70
3" x 1-1/2"	9-7183	1.6	15.10	9-5520	1.6	23.20
3" x 2"	9-7259	1.9	14.20	8-1224	1.9	21.00
3" x 2-1/2"	9-7260	1.8	14.40	8-1225	1.8	22.00
3-1/2" x 3"	9-7319		27.00	9-5962	2.0	41.30
4" x 1"	9-7234	1.3	29.00	9-5523	2.6	48.70
4" x 1-1/4"	9-7236	1.2	29.00	9-5524	2.7	48.70
4" x 1-1/2"	9-7235	1.2	29.00	9-5525	2.8	48.70
4" x 2"	9-7237	2.6	28.00	9-5526	2.6	43.80
4" x 2-1/2"	9-7238	3.0	28.00	9-5527	3.0	49.70
4" x 3"	9-7262	1.7	28.00	6-1760	2.8	46.00
6" x 2"	9-7320		74.00	9-5963	6.2	94.50
6" x 3"	9-7321		74.00	9-5964	6.6	97.30
6" x 4"	9-7322		74.00	9-5965	6.8	95.50

Class 150 Pounds

\*\*\*Stainless Steel also available\*\*\*

# IRON MALLEABLE FITTINGS (CLASS 150 LBS)

## 45° ELBOW (BLACK OR GALVANIZED STEEL)



Class 150 Pounds  
\*\*\*Stainless Steel also available\*\*\*

Size	Black Steel			Galvanized Steel		
	Part #	Weight	List	Part #	Weight	List
1/8"	9-7038	0.1	3.80	9-5579	0.1	5.20
1/4"	9-7024	0.1	3.90	9-5580	0.1	4.60
3/8"	9-7212	0.1	3.50	9-5581	0.1	4.60
1/2"	9-7264	0.2	3.10	8-1227	0.2	4.00
3/4"	9-7270	0.3	3.80	8-1228	0.3	5.00
1"	9-7263	0.5	4.80	8-1229	0.3	6.00
1-1/4"	9-7266	0.8	8.40	8-1230	0.8	10.00
1-1/2"	9-7265	1.0	10.30	8-1231	1.0	12.00
2"	9-7297	2.4	21.10	8-1232	1.6	18.00
2-1/2"	9-7268	2.9	43.90	8-1233	2.9	63.00
3"	9-7269	4.2	57.00	8-1234	4.2	91.00
4"	9-7271	7.0	110.70	8-1235	7.0	152.00
6"	9-7241	16.5	377.10	9-5591	16.5	533.70

## 90° ELBOW (BLACK OR GALVANIZED STEEL)



Class 150 Pounds  
\*\*\*Stainless Steel also available\*\*\*

Size	Black Steel			Galvanized Steel		
	Part #	Weight	List	Part #	Weight	List
1/8"	9-7042	0.1	2.60	9-5566	0.1	3.60
1/4"	9-7028	0.1	2.50	9-5567	0.1	3.40
3/8"	9-7216	0.2	2.50	9-5568	0.2	3.40
1/2"	9-7273	0.2	1.90	8-1237	0.2	2.00
3/4"	9-7276	0.4	2.30	8-1238	0.4	3.00
1"	9-7272	0.6	4.00	8-1239	0.6	5.00
1-1/4"	9-7275	0.9	6.50	8-1240	0.9	8.00
1-1/2"	9-7274	1.1	8.50	8-1241	1.1	10.00
2"	9-7247	1.8	14.60	6-1761	1.8	17.00
2-1/2"	9-7323		31.80	6-1762	3.4	43.00
3"	9-7248	5.0	47.40	6-1763	5.0	73.00
4"	9-7249	8.9	100.80	6-1764	8.9	126.00
6"	9-7244	20.7	377.10	9-5578	20.7	533.70

## TEE (BLACK OR GALVANIZED STEEL)



Class 150 Pounds  
\*\*\*Stainless Steel also available\*\*\*

Size	Black Steel			Galvanized Steel		
	Part #	Weight	List	Part #	Weight	List
1/8"	9-7046	0.1	4.00	9-5776	0.1	5.20
1/4"	9-7033	0.1	3.80	9-5777	0.1	4.50
3/8"	9-7220	0.2	3.80	9-5778	0.2	4.50
1/2"	9-7294	0.3	2.50	8-1243	0.3	3.00
3/4"	9-7300	0.5	3.50	8-1244	0.5	5.00
1"	9-7293	0.8	6.10	8-1245	0.8	8.00
1-1/4"	9-7296	1.2	10.00	8-1246	1.2	12.00
1-1/2"	9-7295	1.6	12.40	8-1247	1.6	15.00
2"	9-7297	2.4	21.10	8-1248	2.4	25.00
2-1/2"	9-7298	4.5	43.40	8-1249	4.5	67.00
3"	9-7299	6.5	65.10	8-1250	6.5	79.00
4"	9-7301	11.3	152.80	8-1251	11.3	186.00
6"	9-7246	27.0	436.50	9-5788	27.0	533.80

## LOCKNUT (BLACK OR GALVANIZED STEEL)



Class 150 Pounds  
\*\*\*Stainless Steel also available\*\*\*

Size	Black Steel			Galvanized Steel		
	Part #	Weight	List	Part #	Weight	List
1/4"	9-7029		2.10	9-5598		2.10
1/2"	9-7008		2.40	9-5599	0.1	2.70
3/4"	9-7193	0.1	2.70	9-5600	0.1	3.00
1"	9-6995	0.1	5.10	9-5601	0.1	5.80
1-1/4"	9-7092	0.1	4.20	9-5602	0.2	5.30
1-1/2"	9-7056	0.2	5.90	9-5603	0.3	6.90
2"	9-7134	0.3	9.70	9-5604	0.4	12.20
2-1/2"	9-7161		13.10	9-5605		22.20

Fittings

## REDUCING COUPLING (BLACK OR GALVANIZED STEEL)



Size	Black Steel			Galvanized Steel		
	Part #	Weight	List	Part #	Weight	List
1/4" x 1/8"	9-7036	0.1	3.10	9-5619	0.1	3.80
3/8" x 1/8"	9-7211	0.1	3.10	9-5620	0.1	3.80
3/8" x 1/4"	9-7289	0.1	3.10	8-1253	0.1	4.00
3/8" x 1/2"	9-7288	0.1	2.60	8-1254	0.1	3.00
1/2" x 1/8"	9-7002	0.1	3.00	9-5622	0.1	4.20
1/2" x 1/4"	9-7014	0.1	2.80	9-5623	0.1	3.40
1/2" x 3/8"	9-7017	0.1	2.60	9-5624	0.1	3.20
3/4" x 1/8"	9-7187	0.2	3.50	9-5625	0.2	4.30
3/4" x 1/4"	9-7185	0.2	3.40	9-5626	0.2	4.30
3/4" x 3/8"	9-7201	0.2	3.40	9-5627	0.2	4.30
3/4" x 1/2"	9-7324		3.00	9-5959	0.2	3.80
1" x 1/4"	9-6985	0.3	5.30	9-5629	0.3	7.50
1" x 3/8"	9-6988	0.3	5.40	9-5630	0.3	7.70
1" x 1/2"	9-7277	0.3	4.70	8-1256	0.3	6.00
1" x 3/4"	9-7278	0.4	4.70	8-1255	0.4	6.00
1-1/4" x 3/8"	9-7086		9.90	9-5633	0.5	15.60
1-1/4" x 1/2"	9-7097	0.5	6.70	9-5634	0.5	9.80
1-1/4" x 3/4"	9-7103	0.5	5.80	9-5635	0.5	8.00
1-1/4" x 1"	9-7281	0.6	5.80	8-1257	0.6	8.00
1-1/2" x 3/8"	9-7050		12.50	9-5637	0.6	13.30
1-1/2" x 1/2"	9-7061	0.6	8.50	9-5638	0.6	11.60
1-1/2" x 3/4"	9-7067	0.7	9.60	9-5639	0.7	10.30
1-1/2" x 1"	9-7279	0.8	8.50	8-1258	0.8	10.00
1-1/2" x 1-1/4"	9-7280	0.8	7.40	8-1259	0.8	10.00
2" x 1/2"	9-7139	1.0	13.90	9-5642	1.0	16.70
2" x 3/4"	9-7141	1.0	12.30	9-5643	1.0	16.70
2" x 1"	9-7282	1.0	11.60	8-1260	1.0	14.00
2" x 1-1/4"	9-7284	1.1	12.30	8-1261	1.1	15.00
2" x 1-1/2"	9-7283	1.2	10.70	8-1262	1.2	14.00
2-1/2" x 1"	9-7149		30.60	9-5960	1.8	43.20
2-1/2" x 1-1/4"	9-7154	1.8	31.20	9-5648	1.8	43.20
2-1/2" x 1-1/2"	9-7152	1.9	31.90	9-5649	1.9	44.10
2-1/2" x 2"	9-7285	2.1	27.30	8-1263	2.1	43.00
3" x 1"	9-7181	2.5	43.40	9-5651	2.5	58.60
3" x 1-1/4"	9-7325		43.40	9-5961	2.6	58.60
3" x 1-1/2"	9-7171	2.7	42.60	9-5652	2.7	57.50
3" x 2"	9-7286	2.8	35.40	8-1264	2.8	54.00
3" x 2-1/2"	9-7287	3.1	42.60	8-1265	3.1	57.00
4" x 2"	9-7290	4.3	85.50	8-1266	4.3	124.00
4" x 2-1/2"	9-7291	4.8	85.50	8-1267	4.8	124.00
4" x 3"	9-7292	5.4	85.50	8-1268	5.4	124.00
6" x 3"	9-7239	9.4	214.00	9-5658	9.4	305.50
6" x 4"	9-7240	10.0	214.00	9-5659	10.0	305.50

Class 150 Pounds

\*\*\*Stainless Steel also available\*\*\*

## COUPLING (BLACK OR GALVANIZED STEEL)



Size	Black Steel			Galvanized Steel		
	Part #	Weight	List	Part #	Weight	List
1/8"	9-7040	0.1	3.70	9-5529	0.1	4.30
1/4"	9-7026	0.1	3.10	9-5530	0.1	4.00
3/8"	9-7214	0.1	3.10	9-5531	0.1	4.00
1/2"	9-7006	0.2	2.60	9-5532	0.2	3.20
3/4"	9-7191	0.3	3.00	9-5533	0.3	3.70
1"	9-6993	0.4	4.60	9-5534	0.4	6.10
1-1/4"	9-7089	0.7	5.80	9-5535	0.7	8.40
1-1/2"	9-7053	0.9	7.80	9-5536	0.9	9.60
2"	9-7131	1.3	11.40	9-5537	1.3	14.00
2-1/2"	9-7159	2.3	30.90	9-5538	2.3	42.70
3"	9-7176	3.4	41.80	9-5539	3.4	57.10
4"	9-7229	5.6	83.40	9-5540	5.6	121.30
6"	9-7243		223.70	9-5541	11.8	316.30

Class 150 Pounds

\*\*\*Stainless Steel also available\*\*\*



# IRON MALLEABLE FITTINGS (CLASS 150 LBS)

## 90° REDUCING ELBOW (BLACK OR GALVANIZED STEEL)



Size	Black Steel			Galvanized Steel		
	Part #	Weight	List	Part #	Weight	List
1/4" x 1/8"	9-7037	0.1	4.90	9-5660	0.1	5.80
3/8" x 1/4"	9-7223	0.1	3.60	9-5661	0.1	5.20
1/2" x 1/4"	9-7023	0.2	3.50	9-5662	0.2	4.30
1/2" x 3/8"	9-7018	0.2	3.40	9-5663	0.2	4.00
3/4" x 1/4"	9-7204	0.2	4.70	9-5664	0.2	6.10
3/4" x 3/8"	9-7209	0.3	4.70	9-5665	0.3	6.10
3/4" x 1/2"	9-7198	0.2	3.60	9-5666	0.3	4.60
1" x 3/8"	9-6989	0.2	7.30	9-5667	0.4	9.40
1" x 1/2"	9-7000	0.4	4.90	9-5668	0.4	6.30
1" x 3/4"	9-7001	0.5	4.60	9-5669	0.5	5.90
1-1/4" x 1/2"	9-7099	0.6	9.90	9-5670	0.6	12.20
1-1/4" x 3/4"	9-7102	0.6	8.40	9-5671	0.6	11.90
1-1/4" x 1"	9-7096	0.8	7.40	9-5672	0.8	9.90
1-1/2" x 1/2"	9-7063	0.7	12.40	9-5673	0.7	15.60
1-1/2" x 3/4"	9-7066	0.7	12.20	9-5674	0.7	15.30
1-1/2" x 1"	9-7060	0.9	12.20	9-5675	0.9	15.30
1-1/2" x 1-1/4"	9-7064	1.1	12.20	9-5676	1.1	15.30
2" x 1/2"	9-7140	0.9	17.90	9-5677	0.9	21.60
2" x 3/4"	9-7142	1.1	17.90	9-5678	1.1	21.60
2" x 1"	9-7138	1.3	17.60	9-5679	1.3	21.20
2" x 1-1/4"	9-7146	1.4	17.60	9-5680	1.4	21.20
2" x 1-1/2"	9-7145	1.6	15.40	9-5681	1.6	18.50
2-1/2" x 1-1/2"	9-7166	2.2	43.10	9-5682	2.2	67.80
2-1/2" x 2"	9-7155	2.5	42.30	9-5683	2.5	60.40
3" x 2"	9-7326		68.40	9-5943	3.3	95.30
3" x 2-1/2"	9-7327		68.40	9-5944	4.1	95.30
4" x 3"	9-7328		117.20	9-5945	6.7	185.30

Class 150 Pounds

\*\*\*Stainless Steel also available\*\*\*

## 90° STREET ELBOW (BLACK OR GALVANIZED STEEL)



Size	Black Steel			Galvanized Steel		
	Part #	Weight	List	Part #	Weight	List
1/8"	9-7044	0.1	3.80	9-5751	0.1	4.90
1/4"	9-7031	0.1	3.80	9-5752	0.1	4.70
3/8"	9-7218	0.1	3.80	9-5753	0.1	4.70
1/2"	9-7010	0.2	3.90	9-5754	0.2	4.90
3/4"	9-7195	0.3	3.80	9-5755	0.3	4.70
1"	9-6997	0.5	5.50	9-5756	0.5	6.40
1-1/4"	9-7094	0.8	8.40	9-5757	0.8	10.80
1-1/2"	9-7058	1.1	11.20	9-5758	1.1	13.40
2"	9-7136	1.8	18.10	9-5759	1.8	23.10
2-1/2"	9-7163	3.3	44.70	9-5760	3.3	62.70
3"	9-7178	4.9	68.20	9-5761	4.9	94.70
4"	9-7232	9.2	111.00	9-5762	9.2	156.30

Class 150 Pounds

\*\*\*Stainless Steel also available\*\*\*

## 45° STREET ELBOW (BLACK OR GALVANIZED STEEL)



Size	Black Steel			Galvanized Steel		
	Part #	Weight	List	Part #	Weight	List
1/8"	9-7045	0.1	5.90	9-5763	0.1	6.80
1/4"	9-7032	0.1	4.40	9-5764	0.1	5.80
3/8"	9-7219	0.1	5.00	9-5765	0.1	6.60
1/2"	9-7004	0.2	4.00	9-5766	0.2	5.10
3/4"	9-7189	0.3	6.20	9-5767	0.3	8.30
1"	9-6991	0.5	7.20	9-5768	0.5	10.20
1-1/4"	9-7087	0.7	12.40	9-5769	0.7	15.30
1-1/2"	9-7051	0.9	15.40	9-5770	0.9	18.60
2"	9-7129	1.5	26.00	9-5771	1.5	31.90
2-1/2"	9-7164	2.6	55.20	9-5772	2.6	75.10
3"	9-7329		84.60	9-5941	3.9	112.30
4"	9-7330		158.50	9-5942	7.0	182.60

Class 150 Pounds

\*\*\*Stainless Steel also available\*\*\*

# IRON MALLEABLE FITTINGS (CLASS 150 LBS)



## REDUCING TEE (BLACK OR GALVANIZED STEEL)



Left, Right, Top Size	Black Steel			Galvanized Steel		
	Part #	Weight	List	Part #	Weight	List
3/8 x 3/8 x 1/4	9-7224		<b>5.00</b>	9-5684		<b>6.50</b>
1/2 x 1/2 x 1/4	9-7020	0.2	<b>4.20</b>	9-5685	0.1	<b>5.30</b>
1/2 x 1/2 x 3/8	9-7022	0.3	<b>5.20</b>	9-5686	0.1	<b>6.80</b>
1/2 x 1/2 x 3/4	9-7021	0.4	<b>6.10</b>	9-5687	0.2	<b>7.30</b>
1/2 x 1/2 x 1	9-7019	0.5	<b>8.90</b>	9-5688	0.3	<b>12.40</b>
3/4 x 1/2 x 1/2	9-7202	0.4	<b>5.60</b>	9-5689	0.2	<b>7.30</b>
3/4 x 1/2 x 3/4	9-7203	0.5	<b>6.10</b>	9-5690	0.2	<b>7.30</b>
3/4 x 1/2 x 1	9-7331		<b>6.10</b>	9-5949		<b>10.80</b>
3/4 x 3/4 x 1/4	9-7207	0.4	<b>5.90</b>	9-5691	0.2	<b>6.70</b>
3/4 x 3/4 x 3/8	9-7208	0.4	<b>6.30</b>	9-5692	0.2	<b>6.70</b>
3/4 x 3/4 x 1/2	9-7206	0.5	<b>5.40</b>	9-5693	0.2	<b>6.40</b>
3/4 x 3/4 x 1	9-7205	0.6	<b>7.80</b>	9-5694	0.3	<b>12.30</b>
1 x 1/2 x 1/2	9-7116	0.5	<b>7.80</b>	9-5695	0.3	<b>10.80</b>
1 x 1/2 x 3/4	9-7117	0.6	<b>9.10</b>	9-5696	0.3	<b>11.10</b>
1 x 1/2 x 1	9-7115	0.7	<b>7.80</b>	9-5697	0.4	<b>10.80</b>
1 x 3/4 x 1/2	9-7120	0.6	<b>7.70</b>	9-5698	0.3	<b>11.00</b>
1 x 3/4 x 3/4	9-7121	0.6	<b>7.20</b>	9-5699	0.3	<b>10.80</b>
1 x 3/4 x 1	9-6986	0.7	<b>7.80</b>	9-5700	0.4	<b>10.80</b>
1 x 1 x 1/4	9-6982	0.5	<b>7.50</b>	9-5701	0.3	<b>10.90</b>
1 x 1 x 1/2	9-6981	0.6	<b>6.80</b>	9-5702	0.3	<b>9.00</b>
1 x 1 x 3/4	9-6983	0.7	<b>6.80</b>	9-5703	0.4	<b>9.00</b>
1 x 1 x 1-1/4	9-7119	1.0	<b>14.40</b>	9-5704	0.5	<b>17.20</b>
1 x 1 x 1-1/2	9-7118	1.1	<b>21.60</b>	9-5705	0.6	<b>29.30</b>
1 x 1 x 2	9-7332		<b>26.40</b>	9-5950		<b>34.00</b>
1-1/4 x 1/2 x 1-1/4	9-7100	0.9	<b>14.20</b>	9-5706	0.5	<b>16.90</b>
1-1/4 x 3/4 x 1/2	9-7113	0.4	<b>20.80</b>	9-5707	0.4	<b>24.90</b>
1-1/4 x 3/4 x 3/4	9-7105	0.7	<b>14.20</b>	9-5708	0.4	<b>18.50</b>
1-1/4 x 3/4 x 1	9-7104	0.5	<b>13.00</b>	9-5709	0.5	<b>17.40</b>
1-1/4 x 3/4 x 1-1/4	9-7114	1.0	<b>12.90</b>	9-5710	0.5	<b>16.00</b>
1-1/4 x 1 x 1/2	9-7110	0.4	<b>12.90</b>	9-5711	0.4	<b>16.60</b>
1-1/4 x 1 x 3/4	9-7112	0.9	<b>12.50</b>	9-5712	0.4	<b>16.90</b>
1-1/4 x 1 x 1	9-7083	1.0	<b>12.50</b>	9-5713	0.5	<b>16.90</b>
1-1/4 x 1 x 1-1/4	9-7111	1.1	<b>14.40</b>	9-5714	0.6	<b>17.20</b>
1-1/4 x 1 x 1-1/2	9-7333		<b>16.90</b>	9-5951		<b>21.40</b>

Left, Right, Top Size	Black Steel			Galvanized Steel		
	Part #	Weight	List	Part #	Weight	List
1-1/4x1-1/4x3/8	9-7109	0.4	<b>12.20</b>	9-5715	0.4	<b>14.40</b>
1-1/4x1-1/4x1/2	9-7107	0.9	<b>12.40</b>	9-5716	0.4	<b>14.70</b>
1-1/4x1-1/4x3/4	9-7108	0.9	<b>10.90</b>	9-5717	0.5	<b>13.90</b>
1-1/4x1-1/4x1	9-7106	1.1	<b>10.90</b>	9-5718	0.6	<b>13.90</b>
1-1/4x1-1/4x1-1/2	9-7334		<b>16.90</b>	9-5952		<b>28.70</b>
1-1/4x1-1/4x2	9-7335		<b>26.40</b>	9-5953		<b>34.00</b>
1-1/2x1/2x1	9-7068	0.7	<b>32.00</b>	9-5719	0.7	<b>36.80</b>
1-1/2x1/2x1-1/2	9-7069	0.7	<b>16.60</b>	9-5720	0.7	<b>22.90</b>
1-1/2x3/4x1-1/2	9-7082	1.3	<b>16.90</b>	9-5721	0.7	<b>21.30</b>
1-1/2x1x3/4	9-7081	0.6	<b>24.80</b>	9-5722	0.6	<b>31.30</b>
1-1/2x1x1	9-7079	1.1	<b>16.90</b>	9-5723	0.6	<b>21.30</b>
1-1/2x1x1-1/2	9-7080	1.4	<b>16.90</b>	9-5724	0.7	<b>21.30</b>
1-1/2x1-1/4x1/2	9-7076	0.6	<b>22.50</b>	9-5725	0.6	<b>29.20</b>
1-1/2x1-1/4x1	9-7075	1.2	<b>14.50</b>	9-5726	0.6	<b>20.90</b>
1-1/2x1-1/4x1-1/4	9-7078	1.3	<b>22.90</b>	9-5727	0.7	<b>29.80</b>
1-1/2x1-1/4x1-1/2	9-7077	1.4	<b>22.90</b>	9-5728	0.7	<b>29.80</b>
1-1/2x1-1/2x1/2	9-7071	1.1	<b>14.50</b>	9-5729	0.6	<b>18.20</b>
1-1/2x1-1/2x3/4	9-7074	1.2	<b>13.80</b>	9-5730	0.6	<b>17.20</b>
1-1/2x1-1/2x1	9-7070	1.3	<b>13.80</b>	9-5731	0.7	<b>17.20</b>
1-1/2x1-1/2x11/4	9-7072	1.4	<b>16.90</b>	9-5732	0.8	<b>21.30</b>
1-1/2x1-1/2x2	9-7073	1.9	<b>26.40</b>	9-5733	1.0	<b>30.20</b>
2x1/2x1-1/4	9-7336		<b>25.90</b>	9-5956		<b>30.20</b>
2x1/2x2	9-7124	2.0	<b>26.40</b>	9-5734	1.0	<b>30.20</b>
2x1x1	9-7122	0.8	<b>38.80</b>	9-5735	0.8	<b>44.20</b>
2x1x2	9-7123	2.1	<b>26.40</b>	9-5736	1.1	<b>30.20</b>
2x1-1/4x1-1/4	9-7337		<b>26.40</b>	9-5954		<b>30.20</b>
2x1-1/2x1	9-7338		<b>25.90</b>	9-5955		<b>29.70</b>
2x1-1/2x1-1/2	9-7168	1.9	<b>22.70</b>	9-5737	1.1	<b>29.20</b>
2x2x1/2	9-7127	1.5	<b>21.50</b>	9-5738	0.9	<b>27.90</b>
2x2x3/4	9-7170	1.7	<b>21.50</b>	9-5739	0.9	<b>25.10</b>
2x2x1	9-7169	1.8	<b>21.50</b>	9-5740	1.0	<b>25.10</b>
2x2x1-1/4	9-7126	2.0	<b>22.70</b>	9-5741	1.1	<b>29.20</b>
2x2x1-1/2	9-7125	1.1	<b>22.30</b>	9-5742	1.1	<b>28.70</b>
2x2x2-1/2	9-7339		<b>56.50</b>	9-5958		<b>88.20</b>
2-1/2x2-1/2x1	9-7167	1.6	<b>55.30</b>	9-5743	1.6	<b>78.60</b>
2-1/2x2-1/2x2	9-7156	3.6	<b>56.40</b>	9-5744	1.8	<b>80.20</b>
3x3x1/2	9-7173	1.8	<b>110.50</b>	9-5745	1.8	<b>166.90</b>
3x3x1	9-7172	4.0	<b>75.30</b>	9-5746	2.0	<b>108.80</b>
3x3x1-1/4	9-7340		<b>76.80</b>	9-5947		<b>110.90</b>
3x3x1-1/2	9-7225	4.5	<b>75.30</b>	9-5747	2.4	<b>108.80</b>
3x3x2	9-7174	5.0	<b>75.30</b>	9-5748	2.7	<b>108.80</b>
4x4x1	9-7341		<b>195.40</b>	9-5948		<b>232.70</b>
4x4x2	9-7226	4.0	<b>152.50</b>	9-5749	4.0	<b>210.10</b>
4x4x3	9-7227		<b>149.50</b>	9-5750		<b>213.50</b>

Class 150 Pounds  
\*\*\*Stainless Steel also available\*\*\*

## STREET TEE (BLACK OR GALVANIZED STEEL)



Size	Black Steel			Galvanized Steel		
	Part #	Weight	List	Part #	Weight	List
1/2"	9-7011	0.2	<b>8.60</b>	9-5773	0.3	<b>13.10</b>
3/4"	9-7196	0.3	<b>11.70</b>	9-5774	0.5	<b>14.20</b>
1"	9-6998	0.4	<b>15.50</b>	9-5775	0.8	<b>22.40</b>

Class 150 Pounds  
\*\*\*Stainless Steel also available\*\*\*

# IRON MALLEABLE FITTINGS (CLASS 150 LBS)

## CROSS (BLACK OR GALVANIZED STEEL)



Class 150 Pounds

\*\*\*Stainless Steel also available\*\*\*

Size	Black Steel			Galvanized Steel		
	Part #	Weight	List	Part #	Weight	List
1/8"	9-7041	0.1	9.10	9-5555	0.1	11.50
1/4"	9-7027	0.2	7.70	9-5556	0.2	11.50
3/8"	9-7215	0.3	7.90	9-5557	0.3	11.50
1/2"	9-7007	0.4	8.90	9-5558	0.4	11.50
3/4"	9-7192	0.6	10.90	9-5559	0.6	14.00
1"	9-6994	0.9	13.40	9-5560	0.9	19.30
1-1/4"	9-7090	1.5	21.80	9-5561	1.5	28.00
1-1/2"	9-7054	1.9	27.00	9-5562	1.9	34.00
2"	9-7132	2.9	44.70	9-5563	2.9	64.80
2-1/2"	9-7160		77.30	9-5564	5.1	121.20
4"	9-7230		213.90	9-5565	12.6	329.80

## UNION (BLACK OR GALVANIZED STEEL)



Class 150 Pounds

\*\*\*Stainless Steel also available\*\*\*

Size	Black Steel			Galvanized Steel		
	Part #	Weight	List	Part #	Weight	List
1/8"	9-7047	0.2	13.60	9-5789	0.2	16.10
1/4"	9-7034	0.2	12.90	9-5790	0.2	15.50
3/8"	9-7221	0.3	8.70	9-5791	0.3	10.30
1/2"	9-7012	0.4	8.40	9-5792	0.4	10.40
3/4"	9-7197	0.60	9.90	9-5793	0.6	12.40
1"	9-6999	0.9	13.00	9-5794	0.9	15.40
1-1/4"	9-7095	1.3	17.20	9-5795	1.3	20.90
1-1/2"	9-7059	1.8	21.00	9-5796	1.8	26.80
2"	9-7137	2.6	31.80	9-5797	2.6	35.80
2-1/2"	9-7165	3.7	76.60	9-5798	3.7	99.50
3"	9-7179	4.7	93.00	9-5799	4.7	141.40
4"	9-7233	8.3	229.90	9-5800	8.3	307.10

## SQUARE HEAD PLUG (BLACK OR GALVANIZED STEEL)



Class 150 Pounds

\* Bar plugs also available in sizes 4", 5", 6" &amp; 8".

\*\*\*Stainless Steel also available\*\*\*

Size	Black Steel			Galvanized Steel		
	Part #	Weight	List	Part #	Weight	List
1/8"	9-7043	0.1	1.60	9-5606	0.1	2.50
1/4"	9-7030	0.1	1.60	9-5607	0.1	2.60
3/8"	9-7217	0.1	1.60	9-5608	0.1	2.60
1/2"	9-7009	0.1	1.70	9-5609	0.1	3.30
3/4"	9-7194	0.1	1.70	9-5610	0.1	3.30
1"	9-6996	0.2	2.20	9-5611	0.2	3.60
1-1/4"	9-7093	0.3	2.70	9-5612	0.3	5.60
1-1/2"	9-7057	0.4	3.80	9-5613	0.4	7.50
2"	9-7135	0.6	5.40	9-5614	0.6	9.60
2-1/2"	9-7162	1.0	9.90	9-5615	1.0	18.70
3"	9-7177	1.4	13.50	9-5616	1.4	26.50
4"	9-7231	2.6	28.40	9-5617	2.6	54.90
6"	9-7245	6.6	75.50	9-5618	6.6	109.00

## FLOOR FLANGE (BLACK OR GALVANIZED STEEL)



Class 150 Pounds

\*\*\*Stainless Steel also available\*\*\*

Size	Black Steel			Galvanized Steel		
	Part #	Weight	List	Part #	Weight	List
1/2"	9-7003	0.3	6.80	9-5592	0.3	14.50
3/4"	9-7188	0.5	7.40	9-5593	0.5	16.20
1"	9-6990	0.6	9.60	9-5594	0.6	17.80
1-1/4"	9-7091	0.8	10.20	9-5595	0.8	20.30
1-1/2"	9-7055	1.1	11.20	9-5596	1.1	25.30
2"	9-7133	1.5	14.60	9-5597	1.5	33.30

## CAP (BLACK OR GALVANIZED STEEL)



Class 150 Pounds

\*\*\*Stainless Steel also available\*\*\*

Size	Black Steel			Galvanized Steel		
	Part #	Weight	List	Part #	Weight	List
1/8"	9-7039	0.1	2.50	9-5542	0.1	3.20
1/4"	9-7025	0.1	2.50	9-5543	0.1	3.20
3/8"	9-7213	0.1	2.50	9-5544	0.1	3.10
1/2"	9-7005	0.1	1.90	9-5545	0.1	2.40
3/4"	9-7190	0.2	2.60	9-5546	0.2	3.40
1"	9-6992	0.3	3.10	9-5547	0.3	3.80
1-1/4"	9-7088	0.4	4.00	9-5548	0.4	5.50
1-1/2"	9-7052	0.6	5.50	9-5549	0.6	7.00
2"	9-7130	0.9	7.20	9-5550	0.9	8.80
2-1/2"	9-7158	1.5	17.80	9-5551	1.5	28.10
3"	9-7175	2.2	26.40	9-5552	2.2	34.10
4"	9-7228	4.0	41.30	9-5553	4.0	67.70
6"	9-7242	9.2	80.10	9-5554	9.2	246.30

## PITOT TUBE



Size	Part #	Weight	List
-	6-1530		17.50

## PLUG (ZAMAC)



- Die cast zinc alloy
- Will not seize, rust or gall
- Precision machined threads to NPT standards
- Clean-Lightweight

Size	Part #	Weight	List
1/2"	3-0371	0.1	2.00
3/4"	3-0372	0.1	2.20
1"	3-0370	0.1	2.30

## BELL REDUCER (ZAMAC)



Female x Female threaded.

- Die cast zinc alloy
- Will not seize, rust or gall
- Precision machined threads to NPT standards
- Clean-Lightweight

Size	Part #	Weight	List
3/4" x 1/2"	6-1568	0.2	3.20
1" x 1/2"	6-1569	0.2	4.00
1" x 3/4"	6-1570	0.2	4.00

## BUSHING (ZAMAC)



Male x Female threaded.

- Die cast zinc alloy
- Will not seize, rust or gall
- Precision machined threads to NPT standards
- Clean-Lightweight

Size	Part #	Weight	List
3/4" x 1/2"	6-1565	0.1	3.00
1" x 1/2"	6-1566	0.2	3.50
1" x 3/4"	6-1567	0.2	3.30

## SLEEVE COUPLING (ZAMAC)



- Die cast zinc alloy
- Will not seize, rust or gall
- Precision machined threads to NPT standard
- Clean-Lightweight

Size	Part #	Weight	List
1/2"	9-6821	0.2	3.20
3/4"	6-1741	0.2	3.00
1"	6-1742	0.2	4.00

# LABOR/REPAIR CHARGES

**Welding (per inch)**  
 (Steel or Aluminum)

Size	Part #	List
-	Weld/Inch	4.50/inch

**Weld Around**  
 (Steel or Aluminum)

Size	Part #	List
2"	WA2	17.00
3"	WA3	17.00
4"	WA4	19.00
5"	WA5	21.00
6"	WA6	21.00
8"	WA8	23.00
10"	WA10	27.00
12"	WA12	29.00
14"	WA14	32.00
15"	WA15	32.00
16"	WA16	38.00
18"	WA18	42.00
20"	WA20	46.00
21"	WA21	48.00
22"	WA22	50.00
24"	WA24	55.00

**Diagonal Weld Around**  
 (Steel or Aluminum)

Size	Part #	List
2"	DWA2	25.50
3"	DWA3	25.50
4"	DWA4	28.50
5"	DWA5	31.50
6"	DWA6	31.50
8"	DWA8	34.50
10"	DWA10	40.50
12"	DWA12	43.50
14"	DWA14	48.00
15"	DWA15	48.00
16"	DWA16	57.00
18"	DWA18	63.00
20"	DWA20	69.00
21"	DWA21	72.00
22"	DWA22	75.00
24"	DWA24	82.50

**Roll Aluminum Pipe End**

Call

**Labor/Hour**

Parts &amp; Valve repair or any miscellaneous labor.

Size	Part #	List
-	LABOR/HOUR	75.00

**Delivery**

Description	Part #	List
Car/pickup without trailer	-	\$1.00/mile, one way
Pickup/diesel with trailer	-	\$3.00/mile, one way

**Saw Cuts**

(Steel or Aluminum)

Description	Part #	List
Straight Steel Cut	CS	15.00
Straight Aluminum Cut	CA	15.00
Diagonal Steel Cut	DCS	22.50
Diagonal Aluminum Cut	DCA	22.50

Fittings

# GASKET CROSS REFERENCE











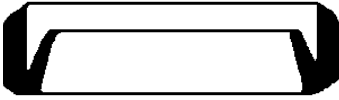

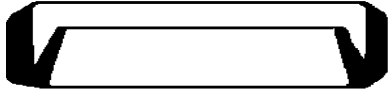

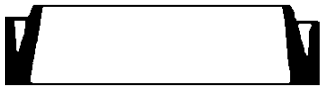
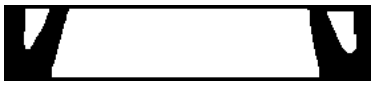

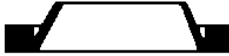

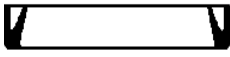



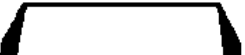

A & M OLD STYLE ROUND BACK	=	PIERCE TYPE
ALUMAX TYPE	=	A & M TYPE
ALUME TYPE	=	STOUT TYPE
AMES QCL TYPE	=	PIERCE TYPE
ATLAS TYPE	=	PIERCE TYPE
AULT TYPE	=	RAINMAKER TYPE (EXCEPT 3")
BEN GAR FULL TYPE	=	A & M TYPE
BOSS TYPE	=	A & M TYPE
BROWN TYPE	=	A & M TYPE
CHAMPION TYPE 3"	=	MOORE RANE/GHEEN TYPE
CROWN AM TYPE	=	RAIN FOR RENT TYPE
DAZOC TYPE	=	MOORE-RANE TYPE, COZAD TYPE, GHEEN TYPE
DECOTO TYPE	=	PIERCE TYPE
DUAL-LOCK TYPE	=	RAINWAY TYPE
FELCO TYPE	=	FELTON TYPE, KROY TYPE
FLEX-O-SEAL TYPE	=	CHICAGO TYPE
FREMONT GATE	=	NUSLIDE GATE
GHEEN TYPE	=	LINDSAY TYPE, COZAD TYPE, MIDWEST BAND & HOOK TYPE
HINESMAN TYPE	=	A & M TYPE
HOMARK TYPE	=	PIERCE TYPE
IRECO ALLUME TYPE	=	STOUT TYPE
KROY TYPE	=	FELTON TYPE
LAKE TYPE	=	WOSCO TYPE, IRECO TYPE, RAIN FOR RENT TYPE
LAKE TORQUE TYPE	=	QUAD RING TYPE
MATTHESON TYPE	=	CHAMPION TYPE
MILLER POSTON TYPE	=	A & M TYPE
MIDWEST TYPE	=	WOSCO TYPE , RAIN FOR RENT TYPE
MOORE RAIN TYPE	=	GHEEN TYPE
PIERCE ROUND BACK TYPE	=	TRAVIS ROUND BACK TYPE
PIERCE FLAT BACK TYPE	=	WESTERN SQUARE BACK TYPE
PORT-ALUME TYPE	=	SHUR RANE TYPE, CHAMPION TYPE
RAIN FOR RENT TYPE	=	IRECO TYPE, WOSCO TYPE, LAKE TYPE, CROWN AM TYPE
RAIN CONTROL TYPE	=	HARDIE TYPE
RAINWAY ROUND TYPE	=	PIERCE TYPE
RAINWAY SQUARE TYPE	=	A & M TYPE
READY RAINE RAIN	=	RAINWAY TYPE
REDI-RAIN TYPE	=	A & M TYPE
ROUND BACK TYPE	=	PIERCE TYPE, TRAVIS TYPE
ROLL-RAIN TYPE	=	SHUR-RANE OLD STYLE TYPE
SHUR-RANE (OLD STYLE) TYPE	=	ROLL-RANE, VERMEER
STOUT TYPE	=	ALLUME TYPE, T-L & IRECO SPEED ROLL TYPE
TELEDYNE TYPE	=	A & M TYPE
TEX FLO-ROUND BACK TYPE	=	PIERCE TYPE (EXCEPT 2 & 3)
TEX FLO-SQUARE BACK	=	HASTINGS
TRAVIS ROUND BACK TYPE	=	PIERCE ROUND BACK TYPE
TRAVIS SQUARE BACK TYPE	=	PIERCE FLAT BACK TYPE, WESTERN SQUARE BACK TYPE
VERMEER TYPE	=	SHUR RANE OLD STYLE TYPE
WOSCO TYPE	=	RAIN FOR RENT TYPE, MIDWEST TYPE, LAKE TYPE
WYSS TYPE	=	CROWN TYPE, MONTGOMERY WARD TYPE, STOUTBILT ALUM. TYPE
WYSS SEAL RING TYPE	=	OLD STYLE STOUT TYPE

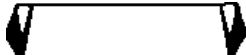
**CAN'T FIND A GASKET LISTED TO MATCH  
YOUR PIPE?**

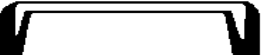
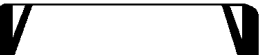
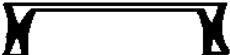

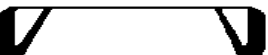

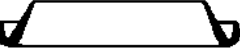
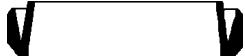
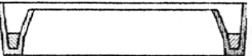

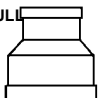









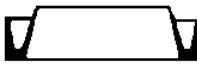

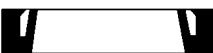
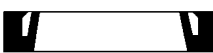
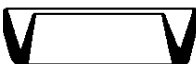



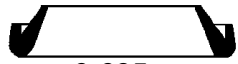

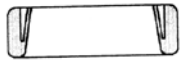

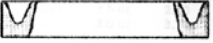
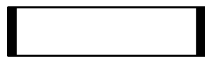
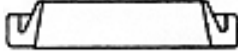
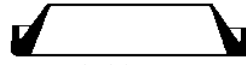
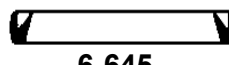
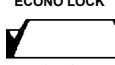
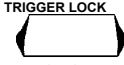
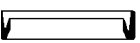
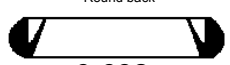
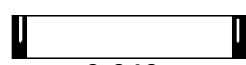
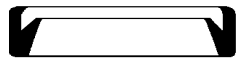
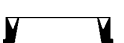
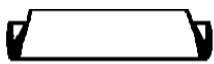
**CALL OR SEND A SAMPLE!**

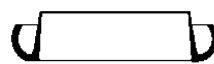
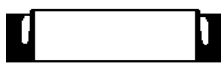
**MOST LIKELY ANOTHER GASKET WILL INTERCHANGE  
WITH YOURS!**

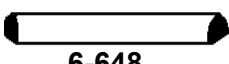
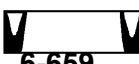
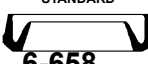
**PRICES AND SIZES ARE ON FOLLOWING PAGES**

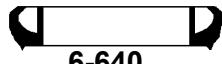
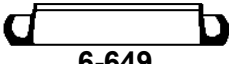
 <p><b>LINDSAY 6-161_</b> (4" LINDSAY SAME AS 4" GHEEN)</p>		 <p><b>PIERCE 6-162_</b> (SAME AS TEX FLO ROUND BACK)</p>		 <p><b>GHEEN 6-163_</b> (4" GHEEN SAME AS 4" LINDSAY) (Cozad)</p>	
 <p><b>A &amp; M 6-164_</b></p>		 <p><b>FELTON 6-165_</b> (4" FELTON SAME AS 4" RAVIT)</p>		 <p><b>RAINWAY 6-166_</b></p>	
<p><b>ACE</b></p>  <p>6-600_</p>	<p><b>BEN GAR</b></p>  <p>6-606_</p>	<p><b>DRAGON</b></p>  <p>6-613_</p>	<p><b>FLEX-O-SEAL</b></p>  <p>6-616_</p>		
<p><b>AKRON</b></p>  <p>6-605_</p>	<p><b>CHAMPION</b></p>  <p>6-607_</p>	<p><b>DRESSER - Gheen</b></p>  <p>6-609_</p>	<p><b>HABCO</b></p>  <p>6-617_</p>		
<p><b>AMES - ABC</b></p>  <p>6-601_</p>	<p><b>CLOUDBURST 6-999_</b></p> 	<p><b>DRESSER - Naco</b></p>  <p>6-610_</p>	<p><b>IRECO - AE</b></p>  <p>6-618_</p>		
<p><b>AMES - Hi-Lo</b></p>  <p>6-602_</p>	<p><b>COBB</b></p>  <p>6-802_</p>	<p><b>FARMLAND - SBS</b></p>  <p>6-614_</p>	<p><b>IRECO - Steelume</b></p>  <p>6-619_</p>		
<p><b>AMES - Suction</b></p>  <p>6-603_</p>	<p><b>COMMETCO</b></p>  <p>6-608_</p>	<p><b>FARMLAND - Green Dot</b></p>  <p>6-615_</p>	<p><b>IRECO - Old Style</b></p>  <p>6-620_</p>		
<p><b>AULT</b></p>  <p>6-604_</p>	<p><b>DIAMOND</b></p>  <p>6-612_</p>	<p><b>FIBERSTRONG</b></p>  <p>6-681_</p>	<p><b>MATHISON</b></p> <p>RING (Same as Race and Race)</p>  <p>6-621_</p>	<p>FULL</p>  <p>6-622_</p>	

Fittings

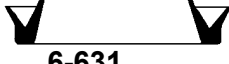
<b>MCDOWELL</b>  STANDARD <b>6-623_</b>  RING LOCK <b>6-670_</b>	<b>RACE &amp; RACE</b> DEMOUNTABLE  CONTRACTOR  <b>6-632_</b> <b>6-701_</b>	<b>SHUR-RANE</b> CHEVRON  <b>6-641_</b>	<b>TEX-FLO (HASTINGS)</b> Square back  <b>6-650_</b>
<b>MIDWEST</b>  <b>6-624_</b>	<b>RAIN-CONTROL</b> 2" only  <b>6-633_</b>	<b>SHUR-RANE</b> OLD STYLE (SAME AS VERMEER)  <b>6-642_</b>	<b>VERMEER</b> (SAME AS SHUR-RANE OLD STYLE)  <b>6-651</b>
<b>MOORE-RANE</b>  <b>6-625_</b>	<b>RAINBO</b>  <b>6-634_</b>	<b>STOUT - New Style</b> - (Ireco) - For male end of pipe  <b>6-643_</b>	<b>WADE RAIN Bolt-On</b>  <b>6-683_</b>
<b>MOULTON 6-626_</b> 	<b>RAIN-OW</b>  <b>6-635_</b>	<b>STOUT - Old</b>  <b>6-644_</b>	<b>WADE RAIN New Style</b>  <b>6-652_</b>
<b>OAKS 6-664_</b> 	<b>RAIN-FOR-RENT</b>  <b>6-636_</b>	<b>STOUT - Old</b> FOR ALUMINUM COUPLERS  <b>6-682_</b>	<b>WADE RAIN Old Style</b>  <b>6-653_</b>
<b>OLIVER 6-663_</b> 	<b>RAINMAKER</b>  <b>6-637_</b>	<b>STOUT - Seal Ring</b>  <b>6-645_</b>	<b>WEBSTER</b> ECONO LOCK  TRIGGER LOCK  <b>6-655_</b> <b>6-654_</b>
<b>PACIFIC 6-627_</b>  Speed lock - new style	<b>RAINWAY</b> Round back  <b>6-638_</b>	<b>STOUT - Towline seal</b>  <b>6-646_</b>	<b>WESTERN</b>  <b>6-656_</b>
<b>PACIFIC 6-628_</b>  Speed lock - old style	<b>RAVIT</b> 4" RAVIT SAME AS 4"  <b>6-662_</b>	<b>STROLYTE</b>  <b>6-647_</b>	<b>WHEEL TRAC</b>  <b>6-657_</b>
<b>PIERCE - Flatback</b>  <b>6-629_</b>	<b>REDI-RAIN</b>  <b>6-639_</b>	<b>SURE-FLO</b>  <b>6-648_</b>	<b>WYSS</b> SEAL RING  STANDARD  <b>6-659_</b> <b>6-658_</b>
<b>PIERCE - Triple Lip</b>  <b>6-678_</b>	<b>SHUR-RANE</b> Drain - New Style  <b>6-640_</b>	<b>TEX-FLO (HASTINGS)</b> Round back SAME AS AUTHENTIC  <b>6-649_</b>	<b>SPRING</b>  ABC  McDowell <b>6-660_</b> <b>6-661_</b>
<b>PORT-ALUM</b>  <b>6-630_</b>	<b>RACE &amp; RACE</b> SAME AS MATHISON RING  <b>6-631_</b>		



To complete the part number for each gasket size, use the part number in the first column and use the size code for the last digit. Examples: 4" Ace = 6-6004; 10" A&M = 6-1640.

Size Code:			2	3	4	5	6	7	8	9	0	1
Part #	Brand Name	Type	2"	3"	4"	5"	6"	7"	8"	9"	10"	12"
6-164_	A&M		\$1.30	\$1.40	\$1.90	\$3.10	\$2.50	\$4.00	\$2.80		\$3.50	
6-600_	Ace				3.40		3.30		4.50		5.00	
6-605_	Akron		5.60	2.20	2.70	10.50	11.50		10.00			
6-601_	Ames	ABC	1.30	1.40	2.50	4.50	7.40	11.20	15.50			
6-602_	Ames	Hi-Lo				4.00	3.70	15.80	4.80	8.50	7.10	8.80
6-603_	Ames	Suction				28.00	18.10		22.60			
6-604_	Ault		2.50	2.20								
6-606_	Ben Gar						2.50	5.50	3.10		5.60	
6-607_	Champion		1.60	2.00	2.50	3.50	4.70		8.50			
6-999_	Cloudburst				4.35	5.00	5.90					
6-802_	Cobb		1.80	2.50	3.20							
6-608_	Commetco		2.40	3.00	3.50	4.00						
6-611_	Decoto				2.30	3.90						
6-612_	Diamond						2.50		3.00		5.00	6.00
6-613_	Dragon			2.20	2.70	3.50	4.10					
6-609_	Dresser	Gheen		3.60	4.60	5.60	4.80	73.00	6.00		7.00	8.00
6-610_	Dresser	Naco					8.00		17.00		18.00	13.00
6-614_	Farmland	SBS	1.30	1.40	2.10	3.30	3.90					
6-615_	Farmland	Green Dot		1.80	2.80	3.90	5.30		6.40			
6-165_	Felton (Felton, General Ind)		1.30	1.30	1.50	3.40	2.70	3.80	3.50		3.70	10.00
6-681_	Fiberstrong								6.00		8.00	10.00
6-616_	Flex-O-Seal			3.20	3.50	5.40	6.50		9.50			
6-163_	Gheen (Cozad)		1.70	1.40	1.90	3.30	3.00	6.60	3.80		4.70	7.50
6-617_	Habco					17.00	9.00		9.00		25.00	
6-618_	Ireco	AE	2.20	2.40	3.00	3.90						
6-619_	Ireco	Steelume	1.60	1.50	2.10	2.50	3.10	2.80	3.90		8.00	
6-620_	Ireco (Columbus)	Old Style	2.25	2.50	2.80	3.70	5.00	12.90	6.50		6.00	
6-161_	Lindsay				3.20		2.50		3.00			
6-622_	Mathison	Full	21.00	32.00	39.50	44.00	52.00					
6-621_	Mathison	Ring	2.50	6.10	6.50	6.70	7.40					
6-623_	McDowell		2.30	1.90	2.50	4.70	5.60	13.50	11.40		11.50	
6-670_	McDowell	Ringlock					20.00		21.00		22.00	
6-624_	Midwest					3.80	2.80		3.20		4.60	8.50
6-625_	Moore-Rain		1.90		2.40	3.80	4.70	6.20	5.50		7.30	12.00
6-626_	Moulton		2.70	2.90	3.80	4.80	5.90	8.90	9.70		12.40	
6-664_	Oaks				3.25	5.00	6.50					
6-663_	Oliver		2.50		3.63	4.30	5.50	6.62				
6-627_	Pacific Speedlock	New Style	2.00	2.40	2.70							
6-628_	Pacific Speedlock	Old Style	2.30	2.80	3.30	4.20	4.80		9.80			
6-629_	Pierce	Flatback	1.60	1.50	2.50	3.60	3.60		4.60		7.10	
6-162_	Pierce	Roundback	1.10	1.10	1.80	2.40	2.20	4.00	3.00	9.00	4.20	7.00
6-678_	Pierce	Triple Lip		1.50	2.00		3.00		6.00		8.00	9.00
6-630_	Port-Alum		2.10	2.40	3.00							
6-631_	Race & Race		2.00	2.50	3.00	3.90	4.30	4.80	6.70			
6-632_	Race & Race	Demountable	1.90	2.10	2.50	3.10	4.00		5.90			
6-701_	Race & Race	Contractor					4.80	5.10	5.50			
6-633_	Rain-Control (Hardie)		1.70		2.90	3.30	4.40		6.10			
6-634_	Rainbow				3.90	4.50	4.90		7.90			
6-635_	Rain-ow		2.00		3.00							
6-636_	Rain-for-Rent	Wosco	1.45	1.50	1.60	3.50	3.20	6.40	4.20		4.20	7.00
6-637_	Rainmaker		1.90	2.20	2.50	3.50	4.80					
6-638_	Rainway	Roundback	3.00	1.90								
6-166_	Rainway	Squareback	1.40	1.30	1.80	2.10	2.00	3.40	2.50		3.50	6.50
6-662_	Ravit		1.80	2.50	2.80	4.50	5.30					

# GASKETS

To complete the part number for each gasket size, use the part number in the first column and use the size code for the last digit. Examples: 4" Redi-Rain = 6-6394; 10" Sure-Flo = 6-6480.

Size Code:			2	3	4	5	6	7	8	9	0	1
Part #	Brand Name	Type	2"	3"	4"	5"	6"	7"	8"	9"	10"	12"
6-639_	Redi-Rain		\$1.30	\$1.40	\$1.60	\$2.10	\$2.80		\$3.50		\$5.00	\$8.70
6-640_	Shur-Rane	Drain-New Style	1.40	1.50	2.10	3.50	4.80	6.00	6.40		7.00	
6-641_	Shur-Rane	Non-Drain(Chevron)		2.10	2.90	4.50	4.10	6.00	7.10		6.50	
6-642_	Shur-Rane	Old Style	1.90	2.10	2.80	3.70	4.60	6.00				
6-643_	Stout	New Style	2.10	2.20	2.80	3.50	4.10					
6-644_	Stout	Old Style	3.20	3.50	3.70	4.90	6.00					
6-682_	Stout	Old Style(Alum Cplr)	1.80	2.00	2.70	3.00	3.60					
6-645_	Stout	Seal Ring	1.50	1.90	2.30	3.20	9.00					
6-646_	Stout (Coover 3-1/2)	Towline Seal			2.50							
6-647_	Strolyte		2.10	2.30	2.80	3.00	3.90					
6-648_	Sure-Flo		3.20	2.40	3.00	4.20	4.70		13.20		18.40	
6-649_	Tex-Flo	Roundback					4.60		8.60	15.00	9.50	
6-650_	Tex-Flo	Squareback		2.00			3.50		3.90	5.00	6.50	7.30
6-651_	Vermeer			4.00	4.20	4.40						
6-683_	Wade Rain	Bolt-on	2.80	2.90	4.00	5.40	5.50					
6-652_	Wade Rain	New Style	1.20	1.30	2.00	3.30	4.00	9.90	5.90		8.60	
6-653_	Wade Rain	Old Style	3.00	3.60	4.70							
6-654_	Webster	Trigger Lock		3.60	4.20	4.70	5.50	8.80	9.60			
6-655_	Webster	Econo Lock	2.00	2.50	3.10	4.50	5.90	8.50	11.00			
6-656_	Western		1.60	1.60	2.10	2.50	3.10	10.50	3.90		7.10	10.00
6-657_	Wheel Trac		3.00	3.70								
6-658_	Wyss	Standard	1.80	2.10	2.50	3.10	3.70					
6-659_	Wyss	Seal Ring	1.80	2.10	2.70	3.60	4.00					
6-8008	Wade Rain Poweroll	4"			1.80							
6-8009	Wade Rain Poweroll	4.5"			2.80							
6-8015	Wade Rain Poweroll	5"				3.50						

### Odd Gasket Sizes:

Part #	Brand	Size	Price
6-6896	A&M	4-1/2"	4.00
6-1612	Pierce, Roundback	1-5/16"	2.00
6-1613	Pierce, Roundback	2-1/4"	1.90
6-1615	Pierce, Roundback	2-1/2"	2.00
6-1617	Pierce, Roundback	6-5/8"	4.50
6-1619	Pierce, Roundback	8-5/8"	22.00
6-6087	Commetco	2-1/2"	2.80
6-6197	Irreco, Steelume	5-1/4"	2.80
6-6371	Rainmaker	1-1/2"	1.00
6-6727	Gheen, Dresser	4-1/2"	7.00
6-6728	Gheen, Dresser	6-5/8"	9.00
6-6729	Gheen, Dresser	8-5/8"	11.00

### Wheeline Gaskets

Part #	Brand	Wall Middle to Middle	Price
6-8000	Western, Round	3/16" x 4-1/2"	2.20
6-8001	Western, WID-E-1	3/16" x 4-7/8"	3.60
6-8002	Alumax, Round	1/4" x 4-3/4"	2.20
6-8003	Alumax, Square	1/4" x 4-3/4"	2.20
6-8004	Trunnell, Quad 4	1/4" x 4-3/8"	1.80
6-8005	Trunnell, Quad 5	1/4" x 5-1/2"	1.80
6-8006	Trunnell, Quad 4	1/4" x 4-3/4"	1.80
6-8007	Western Steel	3/16" x 4-15/16"	3.80

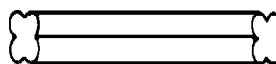

Trunnell

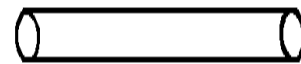

Western



Alumax - Round

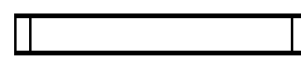

Alumax - Square

### Springs:

Part #	Brand	2"	3"	4"	5"	6"	7"	8"
6-660_	Ames ABC	\$3.50	\$4.20	\$4.80	\$11.50	\$13.00	--	\$14.00
6-661_	McDowell	5.50	5.00	7.00	8.50	10.00	16.10	20.00

### Pierce Wedge-Tite:

For Bolt-on Flange Pack Repair & Dresser Couplers

Part #	Brand	4"	5"	6"	8"	10"	12"	15"
6-669_	NOM (OD)	\$7.00	\$9.00	\$8.00	\$10.00	\$20.00	\$25.00	
6-668_	PIP			8.00	9.00	10.00	15.00	42.00
6-667_	IPS	7.00		8.00	9.00	10.00	21.00	

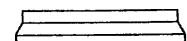

## Section Six



 Pumps	188-201
 Pump Accessories	202
 Dresser Couplers	203
 Suction Pipe	203
 Suction Strainers	204-208
 Foot Valves	206-207
 Discharge Priming Valves	209
 Priming Pumps	210-213
 Murphy Switches	214-215
 Generator, Gearhead, & Accs	216

## SINGLE-STAGE ENGINE MOUNT PUMPS

### BERKELEY

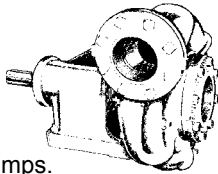

\*Call for other pumps.



Type	Model	GPM @ 2200 RPM	PSI	Part #	Weight	List
Pedestal Mount:	B3ZRM	250-850	60-45	-	120.0	Call
	B3JRMBM	400-900	130-110	-	150.0	Call
	B4JRMBH	600-1500	125-100	-	319.0	Call
Direct Mount:	B3JQBM	300-850	110-85	-	365.0	Call
	B4JQBH	450-1500	100-70	-	400.0	Call
	B4EYQBH	500-1400	190-130	-	620.0	Call
	B6JQBM	750-2250	100-70	-	475.0	Call

\*Call for other pumps. Flywheel coupling NOT included.

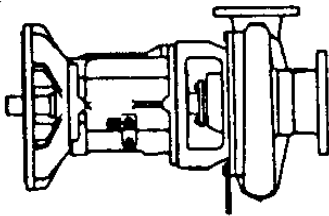

Type	Model	GPM @ 2200 RPM	PSI	Part #	Weight	List
Pedestal Mount:	4RB	300-1500	95-65	-	520.0	Call
	5RB	400-2200	104-70	-	715.0	Call
	6RB	750-4000	100-75	-	815.0	Call
	3HA	300-900	140-115	-	615.0	Call
	5HH	300-1400	120-95	-	695.0	Call
	6HH	1200-3600	155-120	-	845.0	Call

- Call for other pumps. Flywheel coupling included.
- 6HH is rated at 2000 rpm.
- Cornell pumps work well at 3,000 gpm's & higher.

## SLURRY & CHOPPER ENGINE MOUNT PUMPS

### CORNELL-SLURRY

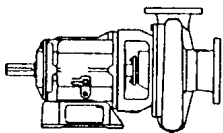

Type	Model	GPM @ 2000 RPM	PSI	Part #	Weight	List
Cornell	3HM	0-800	140-100	-	-	Call
	4x4x14T	300-1500	130-100	-	-	Call

\*3HM has an open impeller & therefore will handle stringy material

\*4x4x14T has a 2-port impeller & therefore will not handle stringy material. (Excellent for hog manure)

### DODA-CHOPPER



Type	Model	GPM @ 2000 RPM	PSI	HP	Part #	Weight	List
Doda	27 PD	300-900	72-10	37-54	-	-	Call
	35 PD	300-1300	120-38	80-115	-	-	Call

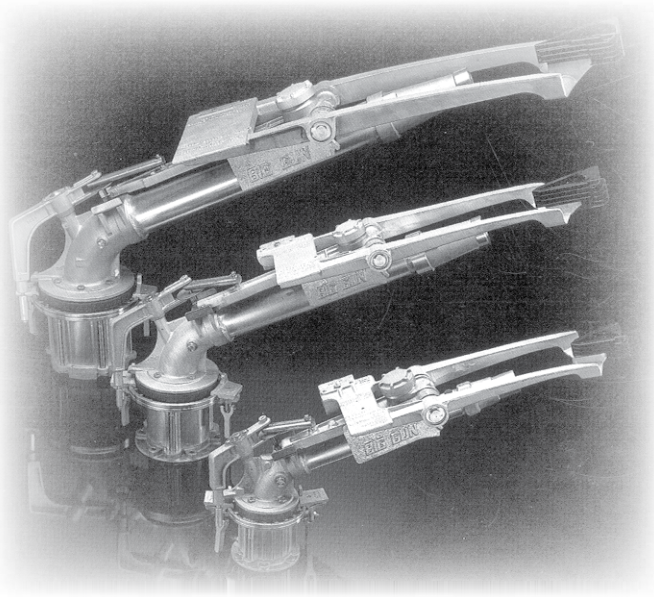

Always Open...  
**SchumacherIrrigation.com**  
*Your Irrigation Superstore*

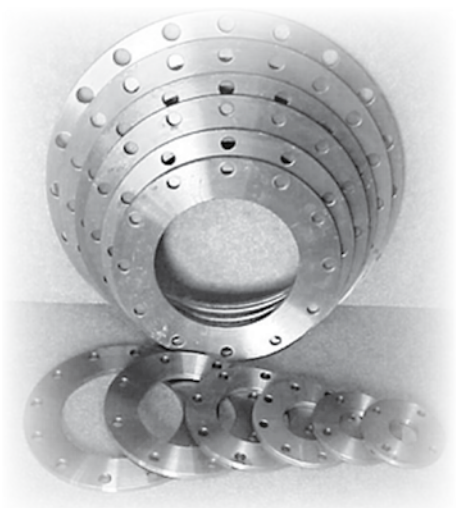

# FLOATS & FLOATING PUMPS

## PUMP/DOCK FLOATS



- Thick-walled Molded Polyethylene Shell
- Encapsulated Expanded Polystyrene Foam
- 12 Year Warranty

WxLxH	Float Capacity	Ship Via	Part #	Weight	List
24"x36"x12"	335 lbs	UPS	9-6918	32.0	<b>117.00</b>
24"x48"x12"	490 lbs	UPS	9-6919	34.0	<b>127.00</b>
36"x48"x12"	470 lbs	CC	9-6920	41.0	<b>169.00</b>
24"x48"x16"	700 lbs	UPS	9-6921	35.0	<b>144.00</b>
24"x36"x18"	600 lbs	UPS	9-6922	32.0	<b>143.00</b>
24"x48"x18"	650 lbs	CC	9-6923	41.0	<b>157.00</b>
36"x48"x18"	1000 lbs	CC	9-6924	52.0	<b>241.00</b>
24"x48"x24"	900 lbs	CC	9-6925	50.0	<b>207.00</b>

## PIPE/HOSE FLOATS



**Suggested spacing is every 20'**

- Tough, impact-resistant polyethylene plastic (HDPE)
- Built-in UV inhibitors reduce degradation caused by sunlight
- Handholds to ease Pipe Float installation
- Molded-in bolt holes allow for easy float installation
- Built-in legs act as alignment guides when installing the Pipe Float
- Floats are also available with foam cores
- Solid one-piece construction
- Pipe Floats (Float Collars) come with a one-year warranty against any-and-all workmanship issues associated with the product.

Size	Dimension WxL	Float Capacity	Part #	Weight	List
4"	13.9" x 20"	26 lbs	9-8336		<b>360.00</b>
6"	21.9" x 30"	83 lbs	9-8337		<b>620.00</b>
8"	24.0" x 40"	167 lbs	9-8338		<b>695.00</b>
10"	33.4" x 24"	212 lbs	9-8339		<b>775.00</b>
12"	28.2" x 44"	235 lbs	9-8340		<b>880.00</b>

## FLOATING PUMPS

### TURBI-FLOAT®

Floating Pumps

CALL



Pump shown with optional wheel kit, which adds to the versatility and user-friendly qualities of the Turbi-Float® system. Further enhances installation and removal for service and site transfers, often eliminating the need for lifting equipment.

Group No.	Discharge Body	GPM	PSI
One	4"	100-525	61-26
Two	4"	100-525	94-10
Three	6"	400-1100	20-11
Four	6" & 8"	400-1200	67-23
Five	4" & 6"	400-1100	135-48
Six	8" & 10"	1100-3250	33-7
Seven	8"	1100-1750	93-28
Eight	10"	2250-3250	14-6
Nine	10"	2300-4000	63-32

#### Applications:

- Irrigation
- Municipal
- Industrial
- Commercial

## DIESEL IRRIGATION PUMPING UNITS

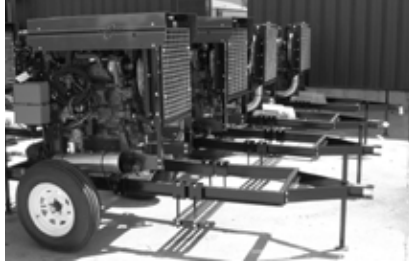

Model	Engine	Pump	GPM @2000 rpm	PSI	List
John Deere	4045T	B4QJBH	400-1500	104-70	Call
John Deere	4039T	B3QJBM	300-860	108-78	Call
John Deere	6059T	B4QJBH	400-1500	104-70	Call
John Deere	6059T	B6QJBM	750-2250	104-70	Call



### Horsepower Chart

MODEL	RPM						CONSUMPTION	SIZE	WEIGHT
	1800	2000	2100	2200	2300	2400			
4039D	57	62	65	67	67	67	.357 @ 1800	SAE4-10	1250
4045D	64	67	71	71	73	74	.347 @ 1800	SAE4-10	1300
4039T	76	82	84	85	88	88	.340 @ 1800	SAE4-10	1350
6059D	84	90	93	96	98	100	.350 @ 1800	SAE3-11	1400
4045T	88	92	93	94	95	96	.342 @ 1800	SAE4-10	1500
6068D	95	102	106	108	111	111	.345 @ 1800	SAE3-11	1500
6059T	112	121	126	128	133	135	.336 @ 1800	SAE3-11	1600
6068T	135	143	145	146	147	147	.344 @ 1800	SAE3-11	1650
6076T	165	165	165	165	--	--	.343 @ 1800	SAE3-11	2100
6076A	206	206	206	206	--	--	.337 @ 1800	SAE2-11	2200
6619A	242	244	246	--	--	--	.353 @ 1800	SAE1-11	2800

### UNITS INCLUDE:

- Engine
- Pump
- Radiator
- Core Guard
- Electric Start (complete w/cables)
- Cables
- Battery Box (without battery)
- Fuel Lift Pump
- 15' Fuel Line
- Standard Duty Air Cleaner
- Muffler
- Mounting Feet
- Vernier Throttle Control & Panel
- OFF Highway Trailer w/USED tires.
- Water Level Safety Switch (L-150)
- Loss of Prime Switch (20PW7)
- Exhaust Primer
- Flywheel Coupling
- Suction Flange (if required)
- Discharge Priming Valve
- Discharge Adapter
- Pressure Gauge
- Suction Adapter
- Dresser Coupler
- Suction Pipe
- Foot Valve w/screen

### OPTIONS:

- Skid Mount
- Battery
- Fuel Tank (30, 62 or 125 gallon)
- Extra Axle
- Screw jack for trailer

# PTO PUMPS

## CAPRARI

# PTO PUMPS



Gear Driven

Model	RPM	Inlet/Outlet	GPM	PSI	Part #	Weight	List
D2/40	540	2"x2"	50-150	146-133	8-0221	200.0	Call
D1/50	540	2"x2"	50-300	90-76	8-0232	365.0	Call
D2/50	540	3"x2"	50-250	135-121	8-0222	215.0	Call
D3/50	540	3"x2"	70-300	170-133	8-0223	230.0	Call
D2/65	540	4"x4"	100-450	107-97	8-0224	360.0	Call
D3/65	540	4"x4"	150-500	161-136	8-0225	270.0	Call
D2/80	540	5"x4"	200-700	110-99	8-0227	275.0	Call
DO4/80	540	5"x4"	200-700	167-143	8-0228	380.0	Call
DMR80 3/2	540	5"x4"	200-800	192-140	8-0230	400.0	Call
D01/125	540	8"x5"	500-1400	37-21	8-0234	430.0	Call



## PUMP PERFORMANCE

Model	GPM	50	60	70	80	90	100	150	200	250	300	350	400	450	500	600	700	800	1000	1200	1400	Discharge NPT (F)	Suction NPT (F)
D2/40	PSI HP	146 13	146 14	145 17	144 16	143 17	142 17	133 21														2"	2"
D1/50	PSI HP	90 9	90 9	90 10	91 10	91 10	91 11	90 13	87 15	87 17	76 19											2"	2"
D2/50	PSI HP	135 17	136 17	137 18	137 18	137 19	136 19	135 22	128 25	121 27												2"	3"
D3/50	PSI HP			170 24	170 25	170 26	170 26	167 30	160 35	150 38	133 41											2"	3"
D2/65	PSI HP						107 18	108 21	108 23	107 27	105 29	103 31	100 34	97 36								4"	4"
D3/65	PSI HP							161 29	160 34	156 38	154 42	151 46	146 50	142 53	136 55							4"	4"
D2/80	PSI HP								110 28	109 31	109 33	108 36	108 38	107 40	105 43	103 47	99 51					4"	5"
DO4/80	PSI HP								167 44	167 49	166 53	165 57	163 62	160 66	159 69	152 77	143 84					4"	5"
DMR80 3/2	PSI HP								193 51	191 54	189 54	186 61	183 64	180 67	178 71	167 77	156 83	142 90				4"	5"
D01/125	PSI HP														37 17	36 19	35 21	34 22	30 23	25 25	21 26	5"	8"
	GPM	50	60	70	80	90	100	150	200	250	300	350	400	450	500	600	700	800	1000	1200	1400		





## BERKELEY

Model	RPM	Inlet/Outlet	GPM	PSI	Part #	Weight	List
T1-B6ZRM-CCW	540	8"x6"	800-2200	4.8-25.5	9-7815	400.0	Call

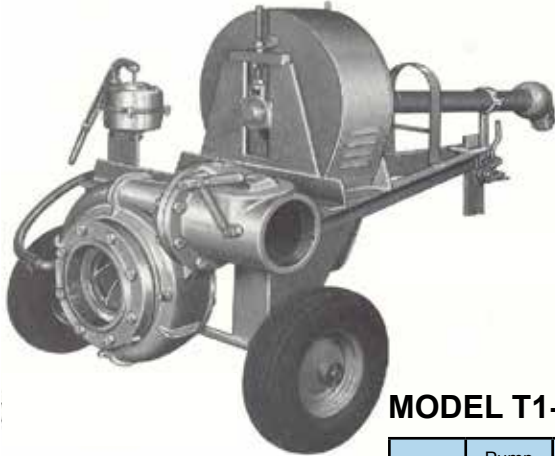

**MODEL T1-B6ZRM CCW (Flood Pump)**

PTO RPM	Pump Pulley Pitch Dia(In)	Pump RPM	Capacity (Gallons Per Minute)								
				800	1000	1200	1400	1600	1800	2000	2200
540	4.6	2150	HEAD (FT)	59	58	56	54	50	46	42	36
1000	5.0		BHP	23	24	26	27	28	29	30	31
540	5.0	2000	HEAD (FT)	51	49	48	45	42	38	32	26
1000	5.4		BHP	19	20	21	22	23	24	25	25
540	5.4	1830	HEAD (FT)	42	40	38	36	32	28	22	15
1000	6.0		BHP	15	16	17	18	18	19	19	19
540	6.0	1650	HEAD (FT)	34	32	30	27	24	19	13	-
			BHP	11	12	13	14	14	15	15	-
NET POSITIVE SUCTION (NPSHR) HEAD REQUIRED (FT.)				11	11	12	12	12	13	13	14

## BERKELEY FLANGE KITS

Description	Size	Part #	Weight	List
Discharge Priming Valve Flange Kit	6"	9-7817		<b>480.00</b>
Suction Flange Kit	8" FPT	9-7818		<b>469.00</b>

**PTO CHOPPER PUMPS**
**DODA-CHOPPER**

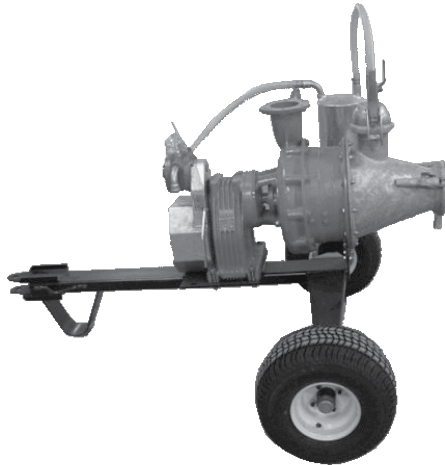

Model	RPM	HP Req.	GPM	PSI	Part #	Weight	List
AFI-27	540	40-60	300-900	80-20	8-0252	-	Call
AFI-27	540	72-105	300-1000	130-55	8-0253	-	Call
AFI-27	1000	135-165	300-700	210-175	8-0254	-	Call
AFI-35	540	90-130	400-1300	135-55	8-0255	-	Call
AFI-35	1000	130-170	400-1300	175-80	8-0256	-	Call



\*Ideal for cattle manure with straw & hay  
 \*Mechanical seal.  
 \*AFI-L20 does not have a cutter blade

## ELECTRIC MOTOR PUMPS

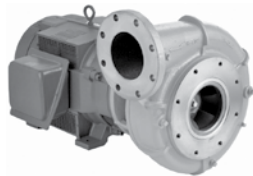
### BERKELEY



Single Phase or Three Phase

Call



### CORNELL

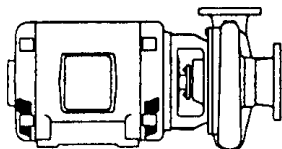

Single Phase or Three Phase

Call



## Submersible Pumps

### GOULDS/BERKELEY



- motor & pump comes disassembled.
- requires a panel box on single & three phase and a control box on single phase.
- heavy duty check valves required on all submersible pumps
- longer wire will be needed to connect to above ground panel.

Call

## Cooling Coil



NOTE:  
Cooling Coil Warranty will be void if there is no Bolted Compression Coupler or Flange between the Cooling Coil and the Pump Discharge.

- Painted Steel Body
- Copper Tubing and Brass Returns
- Standard Length 74"
- Plain Ends for easy customizing
- Pressure Tested

Type	Size	OD	Part #	Weight	List
75 HP:	6"	6-5/8"	9-7711		<b>1,664.00</b>
	8"	8-5/8"	9-7712		<b>1,632.00</b>
	10"	10-3/4"	9-7713		<b>1,689.00</b>
125 HP:	6"	6-5/8"	9-7714		<b>2,183.00</b>
	8"	8-5/8"	9-7715		<b>2,183.00</b>
	10"	10-3/4"	9-7716		<b>2,249.00</b>

## Rubber Expansion Joints

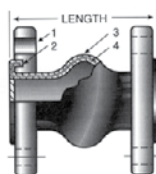

\*To accommodate pressure loads, relieve movement stress, reduce noise, isolate vibration, compensate for misalignments after system goes on stream and prolong the life of motive equipment.

Type	Size	Part #	Weight	List
Single Sphere	4"	6-8031	18.3	<b>115.00</b>
	6"	6-8032	26.8	<b>167.00</b>
	8"	6-8033	40.6	<b>249.00</b>
	10"	6-8034	56.6	<b>350.00</b>
	12"	6-8035	83.0	<b>495.00</b>
Double Sphere	4"	6-8036	20.3	<b>139.00</b>
	6"	6-8037	29.5	<b>229.00</b>
	8"	6-8038	43.8	<b>320.00</b>
	10"	6-8039	64.1	<b>445.00</b>
	12"	6-8040	95.0	<b>679.00</b>

## Gasoline Pumps

### HONDA

Description	Model	Part #	Weight	List
3-1/2 hp, 1-1/2"	WH 15 X	8-0196	48.5	<b>1,125.00</b>
5 hp, 2"	WH 20 X	8-0197	52.0	<b>1,289.00</b>
5.5 hp, 2"	WMP 20 X	8-0198	52.0	<b>1,025.00</b>
8 hp, 3"	WT 30 X	6-9839	132.0	<b>2,499.00</b>
11 hp, 4"	WT 40 X	6-9840	172.0	<b>3,775.00</b>

**WH15X**

- High Pressure, Centrifugal, Self-Priming 1.5" Pump
- East-Start Honda OHV Commercial Engine
- 115 gal./min. Capacity
- Lightweight Aluminum Case
- Cast Iron Volute and Impeller
- Easy Carry Handle

**WH20X**

- High Pressure, Centrifugal, Self-Priming 2" Pump
- Easy-Start Honda OHV Commercial Engine
- 134 gal./min. Capacity
- Lightweight Aluminum Case
- Cast Iron Volute and Impeller
- Easy Carry Handle

**WMP20X**

- Multi-Purpose, Centrifugal Self-Priming 2" Pump
- Easy-Start Honda OHV Commercial Engine
- 220 gal./min. Capacity
- Thermoplastic Pump Housing for Chemical Capability
- Full Frame Protection
- Isolation Mounted Engine and Pump
- Protected by Honda Oil Alert®

# HONDA

---

**GENERATORS & PUMPS**

**WT30X**

- Heavy-Duty 3" Construction Trash Pump
- Easy-Start Honda OHV Commercial Engine
- Full Frame Protection
- 319 gal./min. Capacity
- Solid Handling Capability Up to 1 1/16"
- Easy, Quick Clean-Out Port
- Easy-Service Wear Plate
- Protected by Honda Oil Alert®

**WT40X**

- Heavy-Duty 4" Construction Trash Pump
- Easy-Start Honda OHV Commercial Engine
- Full Frame Protection
- 604 gal./min. Capacity
- Solid Handling Capability Up to 1 1/16"
- Easy, Quick Clean-Out Port
- Easy-Service Wear Plate
- Protected by Honda Oil Alert®
- Self Priming

\*Call for other sizes and brands on these economical self-priming pumps.  
 \*15' max. Suction lift



# **YOUR COMPLETE SUPPLY HOUSE FOR:**

## **POWER UNITS ENGINES MOTORS PUMPS ENGINE & PUMP PARTS & FITTINGS**

**Please call for all of your pumping needs. Just let us know your psi and gpm requirements over the phone, and our computer software will quickly choose the most efficient pump for your conditions.**

**John Deere, Cummins, Perkins, Isuzu, Lister, Deutz and other engines provide quality, dependable service for irrigation use.**

**INSTALLATION**  
**Suction Connection**  
**Suction Lift**

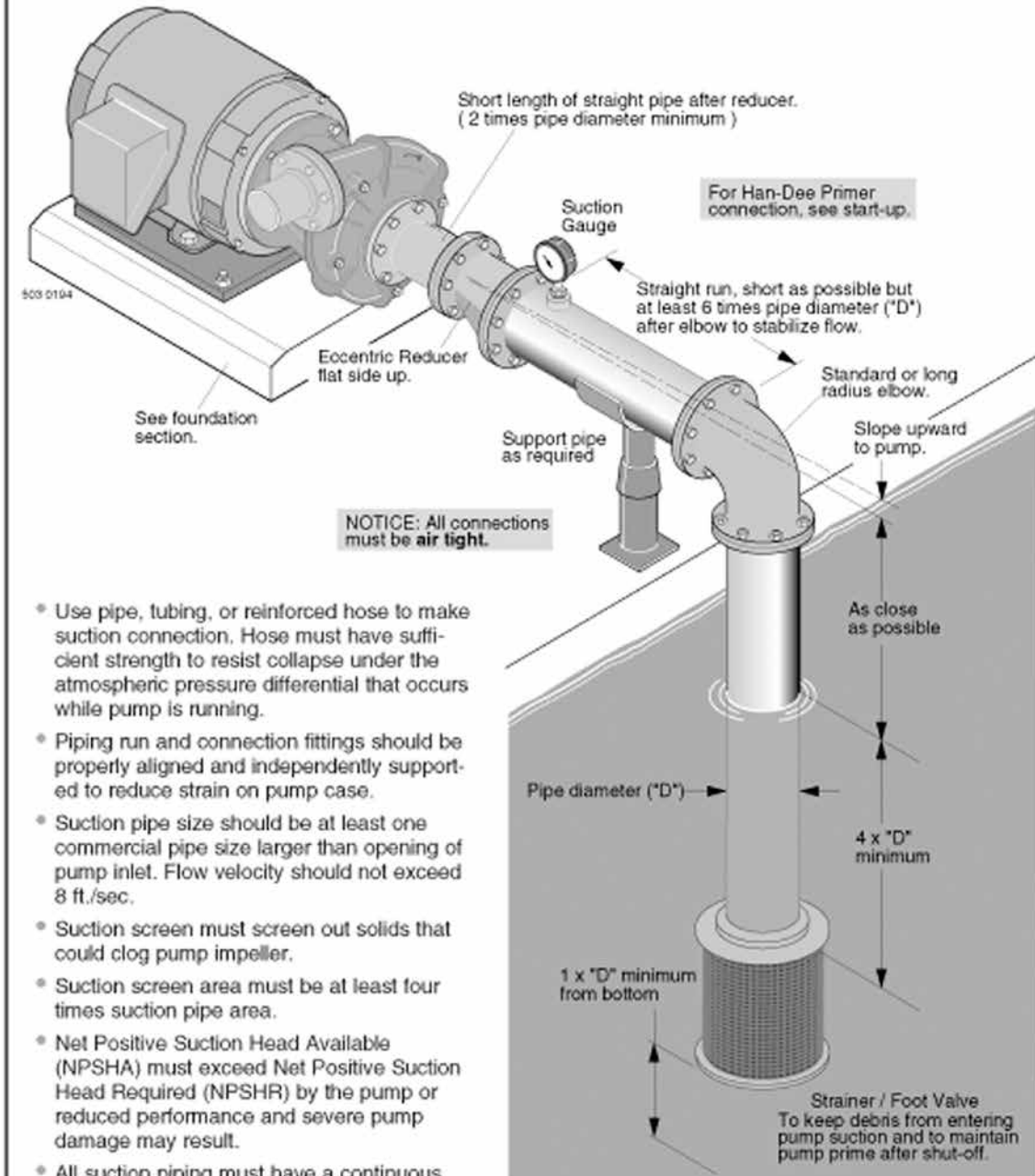

- Use pipe, tubing, or reinforced hose to make suction connection. Hose must have sufficient strength to resist collapse under the atmospheric pressure differential that occurs while pump is running.
- Piping run and connection fittings should be properly aligned and independently supported to reduce strain on pump case.
- Suction pipe size should be at least one commercial pipe size larger than opening of pump inlet. Flow velocity should not exceed 8 ft./sec.
- Suction screen must screen out solids that could clog pump impeller.
- Suction screen area must be at least four times suction pipe area.
- Net Positive Suction Head Available (NPSHA) must exceed Net Positive Suction Head Required (NPSHR) by the pump or reduced performance and severe pump damage may result.
- All suction piping must have a continuous rise to the pump suction inlet. A 1/4 inch per foot minimum slope is recommended.

**Recommended**

Pumps



## TYPE "B" SINGLE STAGE CENTRIFUGAL PUMP Bearing Frame Mount

**CAST IRON IMPELLER**

**B3ZRM**

Threaded Case (NPT)

Packing Construction

TABLE I

B/M No.	Rotation	Volute Case	Impeller	Impeller Diameter
B85480	CW	H00689	M11215	9.00"
B85483	CCW	H00698	M06852	9.00"

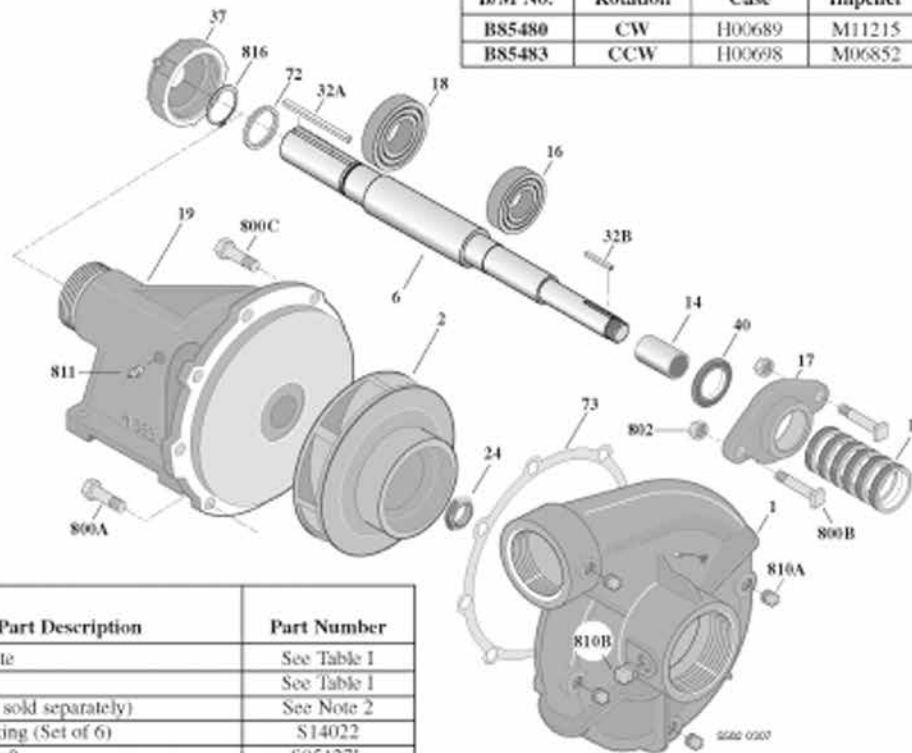

Item No.	Part Description	Part Number
1	Case, Volute	See Table 1
2	Impeller	See Table 1
6	Shaft (Not sold separately)	See Note 2
13	Ring, Packing (Set of 6)	S14022
14	Sleeve, Shaft	S05127L
16	Bearing, Ball	S13270
17	Gland, Packing (See Note 1)	S04948
18	Bearing, Ball	S13271
19	Frame	H00553
24	Locknut, Impeller (CW and CCW)	M10220
32A	Key, 1/4x2-1/8"	S24255
32B	Key, 3/16x1-1/4"	S34383
37	Outer Bearing Cap Assembly*	S19914
40	Slinger, Water	S12260
72	Ring, Thrust	S29218
73	Gasket, Volute	S05126
800A	Capscrew, Hex 3/8-16x7/8" (6 Req.)	S26825
800B	Bolt, Sq. Head 3/8-16x2-1/2" (2 Req.)	S23762
800C	Capscrew, Hex 3/8-16x1-1/8" (2 Req.)	S26827
802	Nut, Hex 3/8-16 (2 Req.)	S23343

\* Includes grease fitting and set screw.

Item No.	Part Description	Part Number
810A	Plug, Pipe 1/4 NPT (4 Req.)	S23715
810B	Plug, Pipe 1/2 NPT	S23717
811	Fitting, Grease	S23670
816	Ring, Retaining	S23010

1. A two piece (split) stainless steel packing gland is available for replacement, order part number **B82468**.
2. **Shaft Replacement Kit** available for this model. Berkeley part number **B85540** for CW, **B85539** for CCW. Pump Shaft sold in shaft replacement kit only.





## TYPE "B" SINGLE STAGE CENTRIFUGAL PUMP Bearing Frame Mount

**CAST IRON IMPELLER**

**B4JRMBH**

Flanged Case

Packing Construction

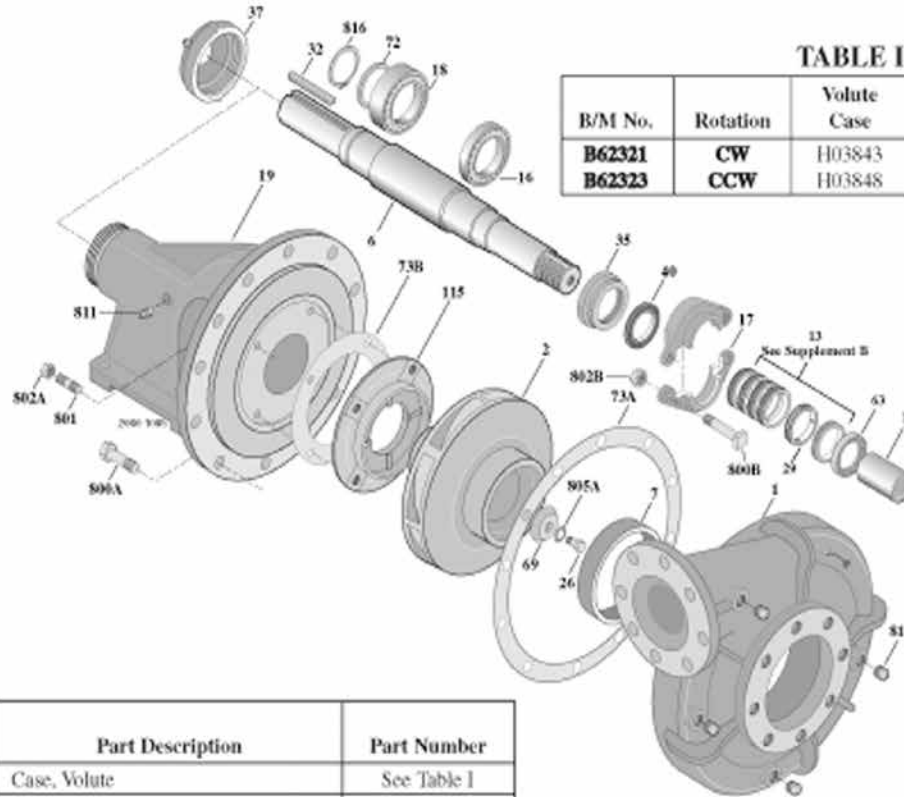

**TABLE I**

B/M No.	Rotation	Volute Case	Impeller	Impeller Diameter
<b>B62321</b>	<b>CW</b>	H03843	L05976	13.50"
<b>B62323</b>	<b>CCW</b>	H03848	L05974	13.50"

Item No.	Part Description	Part Number
1	Case, Volute	See Table I
2	Impeller	See Table I
6	Shaft (Not sold separately)	See Note 1
7	Ring, Wearing	S02894
13	Ring, Packing (Set of 4)	S13436
14	Sleeve, Shaft	S05974
16	Bearing, Ball	S15604
17	Gland, Packing	B82472
18	Bearing, Ball	S13396
19	Frame	H01599
26	Screw, Impeller 1/2-13x1-1/2"	S23623
29	Ring, Lantern	S18993
32	Key, 1/26x4"	S24214
35	Inner Bearing Cap	S05928
37	Outer Bearing Cap Assembly*	S35277
40	Slinger, Water	S10964
63	Bushing, Throat	S18992
69	Washer, Impeller	S19275
72	Ring, Thrust	S06519
73A	Gasket, Volute	S06271
73B	Gasket, Balance Ring	S09943
115	Ring, Balance	S12315

\* Includes grease fitting.

Item No.	Part Description	Part Number
800A	Capscrew, Hex 5/8-11x1-1/2" (12 Req.)	S26999
800B	Bolt, Sq. Head 1/2-13x2-3/4" (2 Req.)	S23794
801	Stud, 3/8-16x1-3/8" (4 Req.)	S09942
802A	Nut, Hex 3/8-16 (4 Req.)	S23103
802B	Nut, Hex 1/2-13x7/16" (2 Req.)	S23347
805A	Washer, Lock	S23038
810	Plug, Pipe 1/2 NPT (4 Req.)	S23717
811	Fitting, Grease (2 Req.)	S23670
816	Ring, Retaining	S23016

1. **Shaft Replacement Kit** available for this model. Berkeley part number **B07596** for CW, **B07597** for CCW. Pump Shaft sold in shaft replacement kit only.

# PUMP ACCESSORIES

## GLAND - BERKELEY



Size	Pump Model	Part #	Weight	List
Small	B3Z & B6Z	8-1000		<b>210.00</b>
Large	B4J	8-1001		<b>339.00</b>

## PACKING - BERKELEY



Size	Pump Model	Berkeley #	Part #	Weight	List
Small - 5/16"	B3ZRM, B6ZRM	S-14022	8-0410	0.2	<b>47.00</b>
Large - 3/8"	B3JQBM, B4JRMBH	S-13436	8-0412	0.7	<b>76.00</b>

## PACKING - PULLER



Size	Part #	Weight	List
-	8-0413		<b>24.00</b>

## PACKING - BRAIDED



Size	Ft/Box	Part #	Weight	List
1/4"	25' Box	9-6859		<b>59.00</b>
5/16"	18' Box	9-6860		<b>55.00</b>
3/8"	12' Box	9-6861		<b>46.00</b>

## SUCTION ADAPTER

(GALVANIZED STEEL)



- Install with eccentric dip downward (as shown).
- With 3/4" FPT outlet on top.
- Ball & sockets may be welded onto plain end.

MPT x OD	Part #	Weight	List
2" x 3"	8-0430	2.9	<b>65.00</b>
3" x 4"	8-0431	4.0	<b>80.00</b>
4" x 5"	8-0432	6.0	<b>100.00</b>
4" x 6"	8-0510	7.0	<b>115.00</b>
4" x 8"	8-0511	12.7	<b>145.00</b>
5" x 6"	8-0512	7.6	<b>130.00</b>
5" x 8"	8-0513	12.6	<b>150.00</b>
6" x 6"	8-0514	12.1	<b>95.00</b>
6" x 8"	8-0515	14.1	<b>140.00</b>
6" x 10"	8-0517	19.3	<b>182.00</b>
8" x 8"	8-0516	16.3	<b>180.00</b>
8" x 10"	8-0518	19.8	<b>260.00</b>

## DISCHARGE ADAPTER

(GALVANIZED STEEL)



MPT x FRL	Part #	Weight	List
2" x 3"	8-0440	2.1	<b>65.00</b>
2" x 4"	8-0441	3.1	<b>75.00</b>
3" x 3"	8-0442	2.5	<b>65.00</b>
3" x 4"	8-0443	3.5	<b>80.00</b>
4" x 4"	8-0520	4.3	<b>65.00</b>
4" x 5"	8-0444	5.4	<b>100.00</b>
4" x 6"	8-0521	6.7	<b>110.00</b>
4" x 8"	8-0522	9.8	<b>140.00</b>
5" x 5"	8-0445	5.9	<b>85.00</b>
5" x 6"	8-0446	9.4	<b>120.00</b>
5" x 8"	8-0526	11.1	<b>175.00</b>
6" x 6"	8-0523	8.1	<b>79.00</b>
6" x 8"	8-0524	12.3	<b>129.00</b>
6" x 10"	8-0525	14.9	<b>220.00</b>

# DRESSER COUPLERS, SUCTION PIPE

## DRESSER COUPLER - 6" LONG

(POWDER COATED)



Size	Part #	Weight	List
3" OD	8-0550	4.0	<b>75.00</b>
4" OD	8-0551	5.5	<b>87.00</b>
5" OD	8-0552	6.5	<b>100.00</b>
6" OD	8-0553	7.5	<b>118.00</b>
8" OD	8-0555	9.0	<b>150.00</b>
10" OD	8-0556	12.0	<b>185.00</b>
12" OD	8-0557	21.0	<b>245.00</b>

## DRESSER COUPLER - 10" LONG

(POWDER COATED)



Complete				Body Only			Flange Pack (Double) For 10" Long Body		
Size	Part #	Weight	List	Part #	Weight	List	Part #	Weight	List
4" OD	8-0530	8.0	<b>84.00</b>	6-2039	4.0	<b>33.00</b>	6-2021	4.0	<b>51.00</b>
5" OD	8-0536	11.0	<b>108.00</b>	6-2040	4.0	<b>38.00</b>	6-2022	7.0	<b>70.00</b>
6" OD	8-0531	13.0	<b>114.00</b>	6-2041	5.0	<b>44.00</b>	6-2023	8.0	<b>70.00</b>
8" OD	8-0532	16.0	<b>134.00</b>	6-2042	7.0	<b>52.00</b>	6-2024	9.0	<b>82.00</b>
10" OD	8-0533	23.0	<b>190.00</b>	6-2043	9.0	<b>66.00</b>	6-2025	14.0	<b>124.00</b>
12" OD	8-0534	27.0	<b>262.00</b>	6-2044	11.0	<b>98.00</b>	6-2026	16.0	<b>164.00</b>

## SUCTION BOOT

(RUBBER)



Size (ID)	OD	Part #	Weight	List
6"	7"	8-0546	3.2	<b>59.00</b>
8"	9"	8-0547	4.1	<b>73.00</b>
10"	11"	8-0548	5.8	<b>110.00</b>
*12"	13-1/2"	8-0549	15.5	<b>248.00</b>

\* For the 12" Boot use the spiral hose clamp.

## SUCTION PIPE

(ALUMINUM)

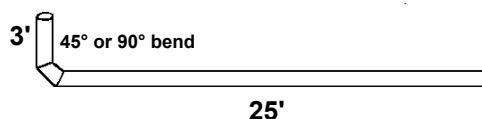

Size	Wall	Part #	Weight	List
6" x 45°	.058	8-0540	37.8	<b>310.00</b>
6" x 90°	.058	8-0541	37.8	<b>360.00</b>
8" x 45°	.072	8-0542	63.3	<b>505.00</b>
8" x 90°	.072	8-0543	63.3	<b>560.00</b>
10" x 90°	.094	8-0545	103.2	<b>900.00</b>

\* See page 36 for suction hoses

Pumps

# SUCTION ELBOW & INTAKE SCREEN



## SUCTION ELBOW - COMPLETE (CAST ALUMINUM)



Size	Part #	45°		90°		
		Weight	List	Part #	Weight	List
4"	8-0729	6.0	<b>160.00</b>	8-0719	7.0	<b>170.00</b>
6"	8-0730	9.0	<b>250.00</b>	8-0720	10.5	<b>259.00</b>
8"	8-0731	12.0	<b>350.00</b>	8-0721	14.5	<b>395.00</b>
10"	8-0732	17.0	<b>620.00</b>	8-0722	23.0	<b>625.00</b>

## SUCTION ELBOW - PARTS



Size	Part #	45°		90°		
		Weight	List	Part #	Weight	List
4"	8-0814		<b>115.00</b>	8-0810		<b>131.00</b>
6"	8-0815		<b>183.00</b>	8-0811		<b>192.00</b>
8"	8-0816		<b>255.00</b>	8-0812		<b>284.00</b>
10"	8-0817		<b>456.00</b>	8-0813		<b>485.00</b>

Description	Size	Part #	Weight	List
Flange:	4"	8-0818		<b>18.00</b>
	6"	8-0819	1.3	<b>31.00</b>
	8"	8-0820	1.6	<b>48.00</b>
	10"	8-0821	2.4	<b>72.00</b>
Ring Gasket:	4"	6-6484		<b>3.00</b>
	6"	6-6486		<b>4.70</b>
	8"	6-6488		<b>13.20</b>
	10"	6-6480		<b>18.40</b>
Nuts & Bolts	5/16" x 2-1/4"	8-0822		<b>2.00</b>
4 Required:	5/16" x 2-1/2"	8-0823		<b>2.00</b>

## INTAKE STRAINER



-0.050 Screen wall thickness  
 -Standard holes are 1/4" round  
 -Also available in 1/8" or 1/2" @ additional cost

Size	Dimension	Part #	Weight	List
4"		6-9793	3.5	<b>66.00</b>
5"		6-9794	4.5	<b>95.00</b>
6"	10 5/8" x 7 1/4"	8-0733	6.0	<b>113.00</b>
8"	16 1/2" x 9 1/4"	8-0734	11.0	<b>192.00</b>
10"	23" x 11 1/2"	8-0735	15.0	<b>256.00</b>

Note: Intake strainers are smaller than Jumbo.

## INTAKE STRAINER PARTS



Description	Size	Dimension	Part #	Weight	List
Ring Casting:	6"		8-0736		<b>32.00</b>
	8"		8-0737		<b>54.00</b>
	10"		8-0738		<b>59.00</b>
Bottom Disc Casting:	6"		8-0739		<b>26.00</b>
	8"		8-0740		<b>52.00</b>
	10"		8-0741		<b>63.00</b>
Strainer Screen:	6"	10-5/8" h x 7-1/4" w	8-0742		<b>27.00</b>
	8"	16-1/2" h x 9-1/4" w	8-0743	1.5	<b>41.00</b>
	10"	23" h x 11-1/2" w	8-0744	2.5	<b>92.00</b>
Strainer Bolt & Nut:	6"	12" long	8-0745		<b>4.00</b>
	8"	18" long	8-0746		<b>10.00</b>
	10"	25-1/4" long	8-0747		<b>11.00</b>
Slide:	6"		8-0748		<b>24.00</b>
	8"		8-0749		<b>43.00</b>
	10"		8-0753		<b>75.00</b>
Ring Bolt:			8-0754		<b>1.50</b>

# JUMBO SCREENS

## JUMBO SCREEN - SINGLE



Size	Dimension	With Slide			Without Slide		
		Part #	Weight	List	Part #	Weight	List
6"	18" x 13-5/8"	8-0750	17.0	<b>399.00</b>	8-0760	14.5	<b>339.00</b>
8"	18" x 13-5/8"	8-0751	18.0	<b>399.00</b>	8-0761	14.0	<b>339.00</b>
10"	18" x 13-5/8"	8-0752	18.5	<b>399.00</b>	8-0762	13.5	<b>339.00</b>

-1/4" Standard Round Holes (also available in 1/8", 1/2", 3/4" or 1" @ additional cost)  
 -0.080 Standard Wall Thickness (also available in .125 in 3/4" & 1" only @ additional cost)  
 -Easily and quickly attaches to the end of the aluminum suction pipe by drilling three holes in the tubing and inserting bolts.

## JUMBO SCREEN - DOUBLE



Size	Dimension	With Slide			Without Slide		
		Part #	Weight	List	Part #	Weight	List
6"	36" x 13 5/8"	8-0770	38.0	<b>659.00</b>	8-0780	21.5	<b>529.00</b>
8"	36" x 13 5/8"	8-0771	38.0	<b>659.00</b>	8-0781	21.0	<b>529.00</b>
10"	36" x 13 5/8"	8-0772	40.0	<b>659.00</b>	8-0782	21.0	<b>529.00</b>

-1/4" Standard Round Holes (also available in 1/8", 1/2", 3/4" or 1" @ additional cost)  
 -0.080 Standard Wall Thickness (also available in .125 in 3/4" & 1" only @ additional cost)  
 -Easily and quickly attaches to the end of the aluminum suction pipe by drilling three holes in the tubing and inserting bolts.

## JUMBO STRAINER PARTS

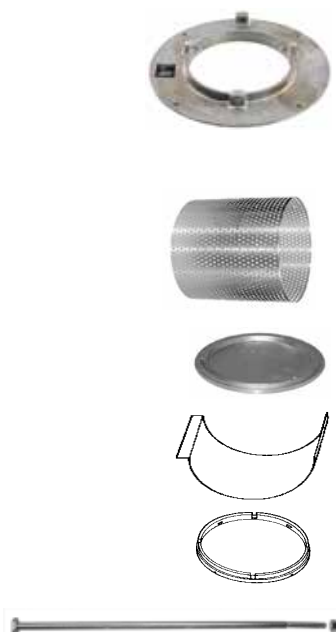

Description	Size	Dimension	Part #	Weight	List
<b>Strainer Ring:</b>	4"		8-0859		<b>134.00</b>
	6"		8-0860		<b>134.00</b>
	8"		8-0861		<b>134.00</b>
	10"		8-0862		<b>134.00</b>
<b>Screen:</b>	-	18" h x 13-5/8" wide	8-0854		<b>109.00</b>
<b>Bottom Disc:</b>	-		8-0858		<b>111.00</b>
<b>Slide:</b>	-	Single Jumbo	8-0855	4.3	<b>62.00</b>
	-	Double Jumbo	8-0856		<b>123.00</b>
<b>D-Ring:</b>	-		8-0863	2.4	<b>117.00</b>
<b>Strainer Bolt:</b> 4 Required	-	1/4" x 19-3/8" Long	8-0857		<b>10.00</b>

Pumps

# FOOT VALVES & PARTS

## FOOT VALVE/SCREEN (CAST IRON)



Size	Part #	Weight	List
1-1/2"	6-9603		<b>32.00</b>
2"	8-0706	4.7	<b>50.00</b>
2-1/2"	8-0707	6.6	<b>59.00</b>
3"	8-0708	9.1	<b>74.00</b>
4"	6-9604	16.5	<b>135.00</b>
6"	6-9605	36.3	<b>295.00</b>
8"	6-9606		<b>468.00</b>

## SCREEN W/FOOT VALVE (45 DEGREE)



Size	Part #	Weight	List
3"	6-9844	7.0	<b>226.00</b>
4"	8-0709	11.0	<b>269.00</b>
5"	6-9845	14.0	<b>365.00</b>
6"	8-0710	17.0	<b>449.00</b>
8"	8-0711	26.5	<b>639.00</b>
10"	8-0712	46.0	<b>1,089.00</b>

Vertical Foot Valves and other sizes are also available. Please call.

- 0.050 Screen wall thickness
- 0.080 Screen available at additional cost
- Standard holes are 1/4" round
- Also available in 1/8" or 1/2" @ additional cost

## DRAIN KIT - FOOT VALVE

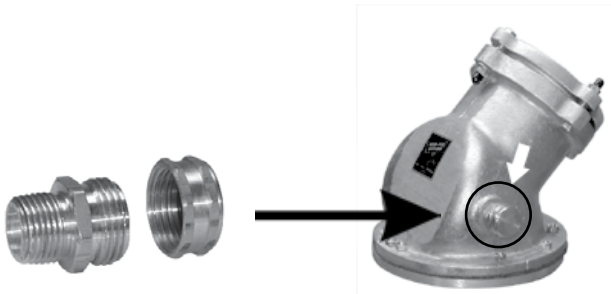

Description	Part #	Weight	List
*Foot Valve Drain Kit w/Cap	9-7666		<b>10.00</b>

\* All Sure-Flo foot valves larger than 3" are provided with a tapped and plugged outlet on the side of the body. By replacing this plug with the optional drain kit, suction line removal becomes much easier. One end of an inexpensive garden hose is attached to the drain fitting, and the other end is capped, with the provided hose cap, and secured near the pump. When ready to remove the suction line, simply remove the cap, and place the hose in the water. This will allow the suction line to drain down to the water surface.

# FOOT VALVE PARTS

## FOOT VALVE PARTS



Description	Size	Dimension	Part #	Weight	List
<b>Suction Flange:</b>	4"		8-0818		18.00
	6"		8-0819	1.3	31.00
	8"		8-0820	1.6	48.00
	10"		8-0821	2.4	72.00
<b>Ring Gasket:</b>	4"		6-6484		3.00
	6"		6-6486		4.70
	8"		6-6488		13.20
	10"		6-6480		18.40
<b>Foot Valve Body:</b>	4" x 45°		8-0824		144.00
	6" x 45°		8-0825		221.00
	8" x 45°		8-0826		349.00
	10" x 45°		8-0827		567.00
<b>Valve Flapper Cover:</b>	4"	4-1/2" OD	8-0828	0.8	10.00
	6"	6-1/2" OD	8-0829		14.00
	8"	8-1/2" OD	8-0830	3.0	24.00
	10"	10-1/2" OD	8-0831		41.00
<b>Valve Flapper Gasket:</b>	2"	5-5/8" OD	8-0713		12.00
	3"	6-3/8" OD	8-0714	0.2	18.00
	4"	7-3/4" OD	8-0715	0.3	25.00
	5"	8-7/8" OD	8-0716	0.3	28.00
	6"	9-3/4" OD	8-0717	0.6	36.00
	8"	11-3/4" OD	8-0718		54.00
	10"	13-7/8" OD	8-0725	1.5	124.00
<b>Valve Flapper Weight:</b>	4"	2-1/2" OD	8-0832	0.2	6.00
	6"	4-1/2" OD	8-0833		10.00
	8"	6-1/2" OD	8-0834		14.00
	10"	8-1/2" OD	8-0835		24.00
<b>Valve Seat Ring:</b>	4"		8-0837		33.00
	6"		8-0838		59.00
	8"		8-0839	3.5	66.00
	10"		8-0840		125.00
<b>Screen:</b>	4"	6-1/2" H x 7-1/4" W	8-0842		18.00
	6"	8-3/8" H x 9-1/4" W	8-0843		28.00
	8"	13-1/2" H x 11-1/4" W	8-0844	1.5	55.00
	10"	21" H x 13-5/8" W	8-0845		80.00
<b>Bottom Disc:</b>	4"		8-0846	1.4	26.00
	6"		8-0847		52.00
	8"		8-0848	3.4	63.00
	10"		8-0849	5.4	111.00
<b>Screen Bolt/Nut:</b>	4"	3 Req. 1/4"x8"	8-0850		3.00
	6"	3 Req. 1/4"x10"	8-0851		4.00
	8"	3 Req. 1/4"x15-3/8"	8-0852		8.00
	10"	4 Req. 1/4"x22-7/8"	8-0853		11.00
<b>Flange Bolt/Nut:</b>	2"-8"	4 Req. 5/16"x2-1/4"	8-0822	-	2.00
	10"	4 Req. 5/16"x2-1/2"	8-0823	-	2.00
<b>Seat Body Bolt/Nut:</b>	4"	5 Req. 1/4"x1-1/2"	8-0841	-	1.00
	6"	8 Req. 1/4"x1-1/2"	8-0841	-	1.00
	8"	11 Req. 1/4"x1-1/2"	8-0841	-	1.00
	10"	12 Req. 1/4"x1-1/2"	8-0841	-	1.00
<b>Cover Weight Bolt/Nut:</b>	-	1/4"x3/4"	8-0836	-	1.10

Pumps

# SPECIALTY & SELF-CLEANING SCREENS



## SELF-CLEANING SCREEN (PERFECTION)



IMPORTANT: A partially closed gate valve on the discharge side of pump is required to provide adequate working pressure to the strainer while filling the irrigation line. Powder epoxy coated aluminum screen .093".

Size	GPM	Ship Via	Part #	Weight	List
2"	50	UPS	9-7623	4.0	<b>260.00</b>
3"	160	UPS	9-7624	15.0	<b>523.00</b>
4"	325	UPS	8-0785	13.0	<b>595.00</b>
6"	625	UPS	8-0786	25.0	<b>1,310.00</b>
8"	1150	UPS	8-0787	34.0	<b>1,640.00</b>
10"	1500	UPS	8-0788	55.0	<b>2,270.00</b>
10" BB	1900	CC	9-7625	65.0	<b>2,675.00</b>
10" XL	2500	CC	9-7626	90.0	<b>3,031.00</b>
12" XL	2500	CC	9-7627	90.0	<b>3,135.00</b>

## SELF-CLEANING SCREEN (RIVERSCREEN)



Floating screen. Requires only 4" of water. Must have current to operate, otherwise order the optional power drive. 8 mesh (.097") stainless steel screen. All SS Screws & Bolts

Size	GPM	Pontoon	Ship Via	Part #	Weight	NET
4"	100-300	4'	CC	9-5428	200.0	<b>2,350.00</b>
6"	300-600	6'	CC	9-5429	225.0	<b>3,225.00</b>
8"	550-1200	8'	CC	9-5430	250.0	<b>3,650.00</b>
10"	825-1700	10'	CC	9-5431	275.0	<b>4,050.00</b>
12"	1200-4000	10'	CC	9-5438	240.0	<b>4,600.00</b>

Item	Part #	Weight	NET
Power Drive	9-5432		<b>230.00</b>
Motor Drive	9-7872		<b>1,000.00</b>
Foot Valve	9-6849		<b>650.00</b>

## LIQUID MANURE SCREEN



- 1" holes, .125" thick screen w/corrosion resistant alloy and stainless steel bolts & nuts.  
-Easily and quickly attaches to the end of the aluminum suction pipe by drilling three holes in the tubing and inserting bolts.

Size	Dimension	Part #	Weight	List
4"	18"long x 14"wide	6-8095	17.0	<b>400.00</b>
6"	18"long x 14"wide	6-8096	17.0	<b>400.00</b>
8"	36"long x 14"wide	6-8097	25.0	<b>635.00</b>

## ROUND HOLE SCREEN



-Female pipe thread connection.

Size	Part #	Weight	List
1-1/2"	6-9590	1.4	<b>18.00</b>
2"	6-9591	1.8	<b>20.00</b>
2-1/2"	6-9592	2.0	<b>22.00</b>
3"	6-9593	2.7	<b>29.00</b>
4"	6-9594	2.9	<b>38.00</b>
6"	6-9595	6.0	<b>97.00</b>
8"	6-9596	7.3	<b>150.00</b>

## SQUARE HOLE SCREEN



-Female pipe thread connection.

Size	Part #	Weight	List
1-1/2"	6-9597	1.1	<b>23.00</b>
2"	6-9598	1.7	<b>29.00</b>
2-1/2"	6-9599	2.0	<b>36.00</b>
3"	6-9600	2.5	<b>43.00</b>
4"	6-9601	2.5	<b>45.00</b>
6"	6-9602	6.3	<b>93.00</b>



## DISCHARGE PRIMING VALVE

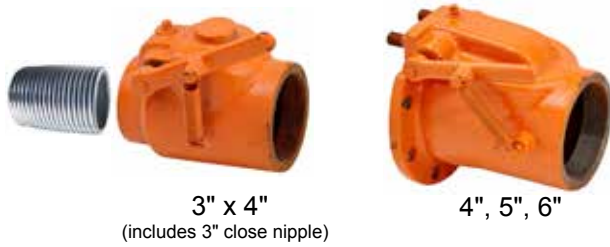

Size	Part #	Weight	List
3" x 4"	8-0640	20.0	775.00
4"	8-0650	36.0	1,055.00
5"	8-0655	55.0	1,235.00
6"	8-0660	70.0	1,258.00

## REPLACEMENT PARTS FOR DISCHARGE PRIMING VALVE

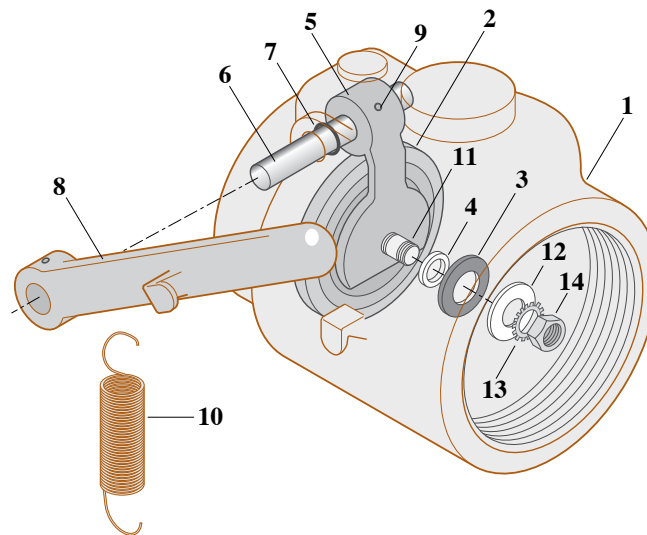

Item	Position	Size	Dimension	Part #	Weight	List
Clack	2	3" x 4"	4.00" OD	8-0641		155.00
	2	4" x 4"	4.75" OD	8-0651		295.00
	2	5" x 5"	5.75" OD	8-0656		340.00
	2	6" x 6"	6.75" OD	8-0661		370.00
Valve Body	1	3" x 4"		8-1002		855.00
	1	4" x 4"		8-1003		889.00
	1	5" x 5"		8-1004		1,695.00
	1	6" x 6"		8-1005		1,615.00
Clack Hinge Handle Assembly	5,6,8	3" x 4"	3.00" C-C	8-1009		415.00
	5,6,8	4" x 4"	3.50" C-C	8-1010		425.00
	5,6,8	5" x 5"	4.00" C-C	8-1011		439.00
	5,6,8	6" x 6"	4.25" C-C	8-1012		447.00
'O' Ring	7	--		8-1013		11.00
Spring Pin (2 required)	9	--		8-1014		11.00
Spring	10	3" x 4"		8-1015		22.00
Spring	10	4"-5"-6"		8-1016		25.00
Grommet	3	--		8-1007		11.00
Spacer	4	--		8-1008		31.00
Bolt Stud	11	--		8-1017		7.60
Nut	14	--		6-0902		0.08
External Tooth Washer	13	--		8-1018		3.30
Flat Washer	12	--		9-6762		3.20

Pumps

## HAN-D PUMPERS



Description	Part #	Weight	List
#700 Han-D Pumper	6-9760	18.0	<b>721.00</b>
#900 Han-D Pumper	6-9762	20.0	<b>832.00</b>

Uses include small or occasional jobs where it takes too long to setup on engine driven pump.

	Inlet / Outlet	Capacity	Max. Suction Lift	Max Discharge Head
Model 700	1.5" FPT	.5 gal/Stroke	20 feet	10 feet
Model 900	2" FPT	1 gal/Stroke	15 feet	10 feet

### Features:

- Complete dewatering portable unit
- Lightweight, easy to use
- Cast aluminum body
- Pumps air, water, sewage, mud and many chemical products
- Ideal for priming large diameter pipes (i.e. 8", 10", 12" sizes)

## PARTS FOR #700 HAN-D PUMPERS

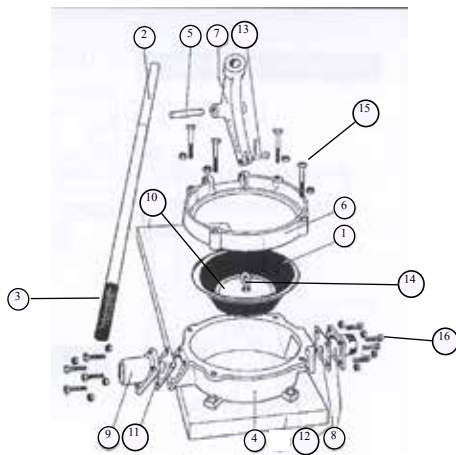

Description	Position	Part #	Weight	List
Diaphragm - #700	1	6-9761		<b>88.00</b>
Handle	2	9-7729		<b>32.00</b>
Grip	3	9-7730		<b>9.00</b>
Pump Body	4	9-7731		<b>302.00</b>
Fulcrum Pin	5	9-7732		<b>16.00</b>
Retainer Ring	6	9-7733		<b>120.00</b>
Fulcrum	7	9-7734		<b>74.00</b>
Suction Flange	8	9-7735		<b>89.00</b>
Discharge Flange	9	9-7736		<b>89.00</b>
Diaphragm Plates (2-required)	10	9-7737		<b>28.00</b>
Discharge Valve	11	9-7738		<b>38.00</b>
Suction Valve	12	9-7739		<b>36.00</b>
Fastpin	13	9-7740		<b>5.00</b>
Eyebolt w/Nuts	14	9-7741		<b>4.00</b>
Bolt, 5/16" x 2" (4-required)	15	9-7742		<b>2.50</b>
Bolt, 5/16" x 1" (8-required)	16	9-7743		<b>2.00</b>
Nut, 5/16" (12-required)		9-7744		<b>1.60</b>

## PARTS FOR #900 HAN-D PUMPERS

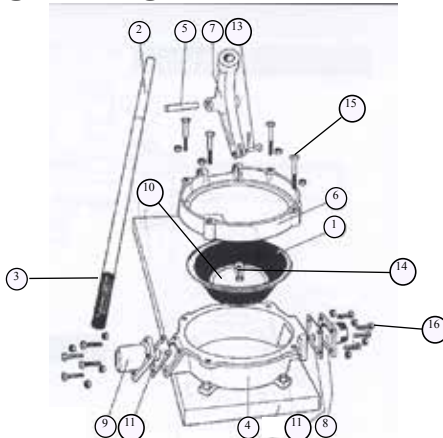

Description	Position	Part #	Weight	List
Diaphragm - #900	1	6-9763		<b>94.00</b>
Handle	2	9-7729		<b>32.00</b>
Grip	3	9-7730		<b>9.00</b>
Pump Body	4	9-7745		<b>366.00</b>
Fulcrum Pin	5	9-7732		<b>16.00</b>
Retainer Ring	6	9-7746		<b>131.00</b>
Fulcrum	7	9-7747		<b>80.00</b>
Suction Flange	8	9-7748		<b>88.00</b>
Discharge Flange	9	9-7749		<b>95.00</b>
Diaphragm Plates (2-required)	10	9-7750		<b>28.00</b>
Suction/Discharge Valve	11	9-7751		<b>37.00</b>
Fastpin	13	9-7740		<b>5.00</b>
Eyebolt w/Nuts	14	9-7741		<b>4.00</b>
Bolt, 5/16" x 2" (4-required)	15	9-7742		<b>2.50</b>
Bolt, 5/16" x 1" (8-required)	16	9-7743		<b>2.00</b>
Nut, 5/16" (12-required)		9-7744		<b>1.60</b>

# POWER & HAND PRIMERS

## HAND PRIMER

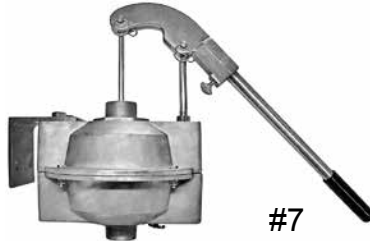

#7

\*3/4" FPT &amp; 1-1/2" MPT Base

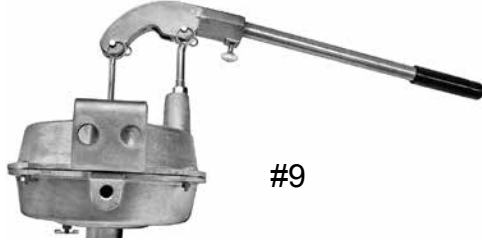

#9

\*3/4" FPT Base

Description	Part #	Weight	List
#7 Hand Pumper	8-0610	7.0	<b>370.00</b>
#9 Hand Pumper	8-0620	20.0	<b>530.00</b>

Call for prices on the #5 Hand Primer, part # DP5

**Features:**

- Quick hand priming of any type of centrifugal pump, siphon tube or pump situation
- Lightweight and easy to install
- Durable and dependable
- Reinforced diaphragms are long-lasting
- Provides up to 20 feet of suction lift with ease and leverage
- New style allows for Fulcrum Bracket to be adjusted at various angles for your convenience.

### Primer Capacity Chart

Primer	# of Strokes to Prime Through 25' of 4" Suction			# of Strokes to Prime Through 25' of 6" Suction			# of Strokes to Prime Through 25' of 8" Suction		
	6.5' Lift	13' Lift	19.5' Lift	6.5' Lift	13' Lift	19.5' Lift	6.5' Lift	13' Lift	19.5' Lift
#7	6	15	32	12	33	65			
#9	4	9	20	10	23	45	17	37	77

### Primer Selection Chart:

Primer	Pipe Size
#7	4", 5", & 6"
#9	6", 8" or larger

**Features:**

Lightweight and durable solid-cast aluminum body.  
 Reinforced diaphragms are long-lasting.  
 Steel mounting bracket allows for easy and dependable installation.  
 Fulcrum eyebolt can be adjusted at various angles for your convenience.

## POWER PRIMER

Description	Part #	Weight	List
35AC	6-9715	88.0	<b>2,675.00</b>
35DC (battery)	6-9716	85.0	<b>5,695.00</b>

**Features:**

- Converts centrifugal pumps to self-primers.
- Fast, efficient primer for pumps with high suction lifts.
- Requires minimum maintenance.
- Ideal for diesel or gasoline-powered engines.



# HAND PRIMERS

## PARTS FOR #7 HAND PRIMER

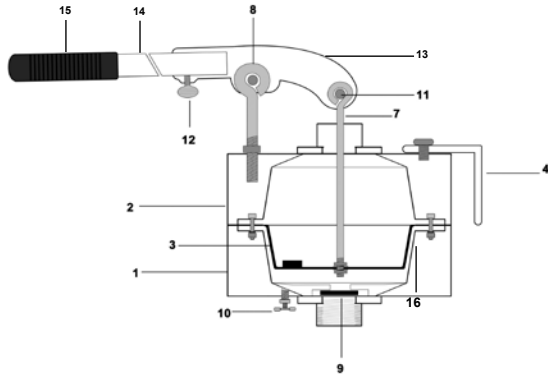

Description	Position	Part #	List
Diaphragm - #7	3	8-0631	<b>75.00</b>
Lower Housing	1	9-5353	<b>149.00</b>
Check Valve (Disc)	9	9-5355	<b>4.50</b>
Drain Cock	10	8-1102	<b>11.00</b>
Upper Housing	2	9-5354	<b>149.00</b>
Connecting Rod Assembly	7	8-1108	<b>19.00</b>
Handle Bracket	13	8-1111	<b>79.00</b>
Fast Pin (2 required)	11	8-1112	<b>4.50</b>
Fulcrum Eyebolt	8	9-5357	<b>19.00</b>
Mounting Bracket	4	9-5358	<b>52.00</b>
Thumb Screw	12	9-5359	<b>4.00</b>
Handle (Pipe)	14	9-5360	<b>28.00</b>
Handle Grip	15	9-5361	<b>10.00</b>
Bolt, Hex, 1/4"-20 x 1" (4 Required)	16	9-7655	<b>1.00</b>
Nut, Hex, 1/4"-20 (4 Required)	16	9-7656	<b>0.20</b>
Washer, Lock, 1/4" (4 Required)	16	9-7657	<b>0.50</b>

## PARTS FOR #9 HAND PRIMER

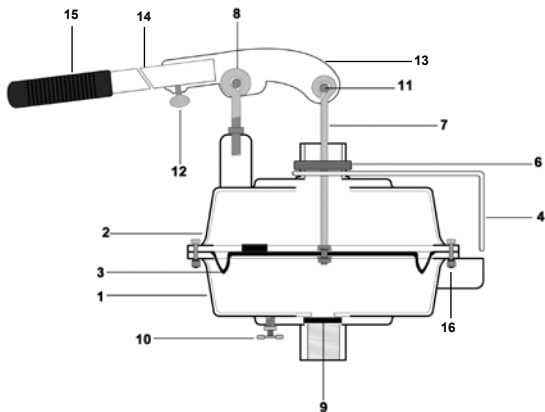

Description	Position	Part #	List
Diaphragm - #9	3	8-0621	<b>99.00</b>
Lower Housing	1	8-1100	<b>166.00</b>
Check Valve (Disc)	9	9-5355	<b>4.50</b>
Drain Cock	10	8-1102	<b>11.00</b>
Upper Housing	2	8-1103	<b>165.00</b>
Connecting Rod Assembly	7	8-1108	<b>19.00</b>
Lock Nut, 1-1/2"	6	8-1109	<b>20.00</b>
Fulcrum Eyebolt	8	8-1110	<b>28.00</b>
Handle Bracket	13	8-1111	<b>79.00</b>
Fast Pin (2 required)	11	8-1112	<b>4.50</b>
Mounting Bracket	4	8-1113	<b>53.00</b>
Thumb Screw	12	9-5359	<b>4.00</b>
Handle (Pipe)	14	9-5360	<b>28.00</b>
Handle Grip	15	9-5361	<b>10.00</b>
Bolt, Hex, 1/4"-20 x 1" (4 Required)	16	9-7655	<b>1.00</b>
Nut, Hex, 1/4"-20 (4 Required)	16	9-7656	<b>0.20</b>
Washer, Lock, 1/4" (4 Required)	16	9-7657	<b>0.50</b>

## PRIMER HOSE KIT

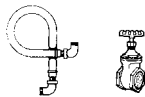

Description	Part #	Weight	List
3/4" MPT x 3/4" MPT	8-0622		<b>71.00</b>

## DIAPHRAGMS

Description	OD	Part #	Weight	List
#5 Diaphragm B-183	5.61"	8-0629	0.2	<b>57.00</b>
#6 Diaphragm		8-0611	0.4	<b>55.00</b>
#7 Diaphragm C-106	7.75"	8-0631	1.0	<b>75.00</b>
#9 Diaphragm B-61	9.84"	8-0621	1.9	<b>99.00</b>
Wade Rain - Travis - Rovatti #9-30-3		8-0613		<b>24.00</b>



# INTAKE MANIFOLD PRIMER EXHAUST PRIMER

## INTAKE MANIFOLD PRIMER

Description	Part #	Weight	List
MP1000 (Old Style)	8-0630	2.7	377.00
MP2000 (New Style)	9-7910		377.00



MP1000 (Old Style)



MP2000 (New Style)

**Features:**

- Fast, efficient priming using engine manifold vacuum while engine runs at low speed.
- All working parts enclosed in fully transparent plastic housing permits observation of primer operation at all times.
- Lightweight plastic float with rubber "cup type" valve provides instant and positive closure as soon as priming is completed.
- Check valve prevents reverse flow during normal pump operation.
- Easy to operate...simply start engine and open one valve to begin priming.
- Can be readily installed on any gasoline or LPG engine of four or more cylinders to provide suction lifts up to 20 feet.
- Complete operation instructions are permanently attached to the primer, and detailed instructions for installation and maintenance are supplied with each unit.
- Connection hoses not included.

## PARTS FOR INTAKE MANIFOLD PRIMER

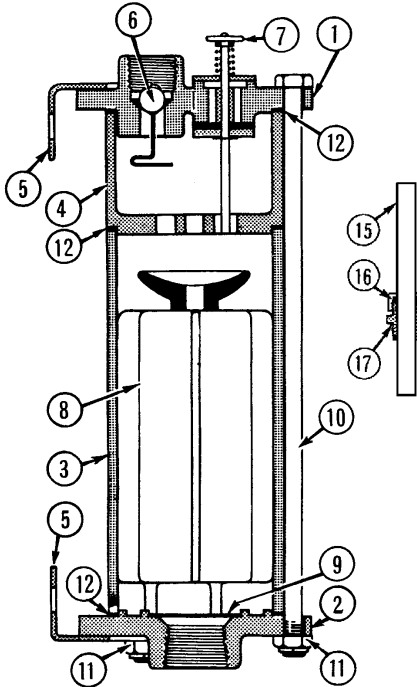

### MP1000 (Old Style)

Description	Position	Part #	List
Upper Housing	4	8-0633	38.00
Lower Housing	3	8-0634	45.00
Gaskets (3 in a set)	12	8-0635	4.00
Top Cover Assembly	1/6/7	8-1120	135.00
Lower Cover Assembly	2/9	8-1121	80.00
Brackets	5	8-1122	16.00
Tie Bolts & Nuts	10/11	8-1123	13.00
Float Assembly	8	8-1124	48.00
Angle Valve	14	8-1125	46.00
Packing Gland Assembly	15/16/17	8-1126	26.00

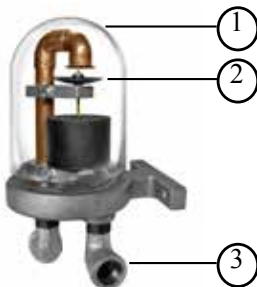

### MP2000 (New Style)

Description	Position	Part #	List
Cover Jar	1	9-7914	136.00
Umbrella Drain Valve	2	9-7915	19.00
Street Elbow, 1/2" (2 Req.)	3	9-5754	4.90

\*Please note that any additional parts not seen here are factory install only. Do not attempt to replace any items not seen in the chart to the right.

**MAGNETIC SWITCH**

Description	Part #	Weight	List
Murphy #117 DC (12/24 Volt)	6-0020	0.8	<b>63.00</b>
Murphy #518APH (12 Volt) (has 6 prongs for Deutz diesels)	6-0021	0.7	<b>75.00</b>

A manually reset magnetic Circuit Breaker which is tripped by a switch gauge when a malfunction is detected. It is commonly used to break the ignition circuit of a distributor ignition engine or break power to a solenoid fuel valve when it receives a signal from the switch gauge.

**OIL PRESSURE GAUGE**

Description	Part #	Weight	List
75 psi Murphy, #20P75	6-0022	0.5	<b>69.00</b>
100 psi Murphy, #20P100	6-0023	0.9	<b>68.00</b>

This is a basic engine or pump oil pressure switch gauge.

**ENGINE TEMPERATURE GAUGE**

Description	Part #	Weight	List
Murphy 20T254, 250°F Water	6-0024	0.8	<b>87.00</b>

This Temperature switch gauge is available in various models and ranges to prevent engine damage from high water oil or cylinder head temperature.

**VACUUM/LOAD GAUGE**

Description	Part #	Weight	List
Murphy 20V3	6-0025	0.6	<b>100.00</b>

Commonly used to monitor manifold vacuum for loss of load or overload on spark ignition engines, vacuum switch gauges are recommended for preset limit shut-down of irrigation engines.

**OIL LEVEL SAFETY GAUGE**

Description	Part #	Weight	List
Murphy L129	6-0026	3.0	<b>195.00</b>

Combination high and low engine oil level switch gauge gives continuous indication of the oil level and condition. No need to shut down to check oil level. Adjustable high and low level contacts operate to shutdown engine or operate alarm when improper level exists.

# MURPHY SWITCHES

## WATER LEVEL SAFETY GAUGE



Description	Part #	Weight	List
Murphy , L150	6-0027	1.8	130.00

Coolant level SWITCHGAUGE can be visually checked with this water level SWITCHGAUGE. If the water level falls too low, contact is made and the engine shutdown system is activated (or alarm is sounded.)

## FUEL STOP SOLENOID



Description	Part #	Weight	List
Murphy, SV12	6-0028	1.4	140.00

- Solenoid Fuel Valve to shut off the fuel to Diesel engines upon engine or driven equipment malfunction.

## TIMER



Description	Part #	Weight	List
Murphy, 12T w/case (12 hour)	6-0019	4.7	750.00
Murphy, 12T wo/case (12 hour)	6-0031	0.8	600.00
Murphy, 24T w/case (24 hour)	6-0017	4.7	750.00
Murphy, 24T wo/case (24 hour)	6-0018	1.5	600.00

- Timer switches are designed to automatically shut down engine when a pre-determined operating time is set.  
 - Weatherproof case

## PUMP PRESSURE GAUGE



Description	Part #	Weight	List
Murphy, 20P7-15	9-5252	0.5	87.00
Murphy, 20P7-30	9-5254		81.00
Murphy, 20P7-50	9-5256		81.00
Murphy, 20P7-75	9-5257	0.5	80.00
Murphy, 20P7-100	9-5251	0.5	80.00
<b>Murphy, 20P7-150</b>	<b>9-5253</b>	0.5	<b>81.00</b>
Murphy, 20P7-300	9-5255		86.00

Monitors Discharge Pressure to detect water supply failure or parted couplings.

## STANDARD MURPHY MOUNT PANEL



Description	Part #	Weight	List
Murphy, WD300-12	6-0030	5.0	469.00

- Designed for mobile equipment such as trucks, tractors, and fork lifts  
 - Open panel for under dash mounting.  
 - Pressure, temperature, visual and audible alarms, before shutdown.

Description	Part #	Weight	List
Murphy Toggle Switch, TF	6-9704		25.00
Murphy Amp Meter, 60060	6-9705		49.00
Murphy Stop Button, PB1285	6-9706		14.00

# GENERATORS - WIRE

## LIMA GENERATOR





Description	Part #	Weight	List
5 KW	6-8010	150.0	<b>4,515.00</b>
7.5 KW	6-8011	165.0	<b>5,250.00</b>
10 KW	6-8012	245.0	<b>5,460.00</b>
12 KW	6-8013	260.0	<b>5,880.00</b>
15 KW	6-8014	275.0	<b>6,615.00</b>
20 KW	9-7687	560.0	<b>8,750.00</b>

## WIRE

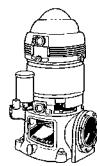

Description	Part #	Weight	List
Aluminum, Single	6-6800	-	<b>Call</b>
Aluminum, Triplexed	6-6801	-	<b>Call</b>
Aluminum, Quadraplexed	6-6802	-	<b>Call</b>
Aluminum, Tuf-Hide	6-6803	-	<b>Call</b>
Underground Feeder, UF	6-6804	-	<b>Call</b>

## ELECTRIC MOTOR



Base is not included.

Description	Part #	Weight	List
Marathon	-	-	<b>Call</b>
Baldor	-	-	<b>Call</b>
Others	-	-	<b>Call</b>

## GEAR HEAD



Description	Part #	Weight	List
Amarillo	-	-	<b>Call</b>
Johnson	-	-	<b>Call</b>
Randolph	-	-	<b>Call</b>

## PROP-SHAFT GUARD



Description	Part #	Weight	List
7" dia x 10" - 18"	6-9822	6.0	<b>60.00</b>
7" dia x 24" - 42"	6-9823	12.0	<b>63.00</b>
7" dia x 36" - 54"	6-9824	15.0	<b>68.00</b>
7" dia x 36" - 66"	6-9825	18.0	<b>75.00</b>
12" dia x 14" - 24"	6-9826	13.0	<b>90.00</b>
12" dia x 36" - 66"	6-9827	27.0	<b>130.00</b>
12" dia x 28" - 54"	6-9828	28.0	<b>142.00</b>

Unprotected prop-shaft on your irrigation wells can maim or kill almost instantly. Prevent potential tragedy, rest easy during pumping season with a Hastings Prop-Shaft guard permanently in place at each of your wells. They are simple and fast to install - using existing bolts on most pumps and engines. Once on, they stay on. You have easy full access for lubrication through a 2" slot on the underside. Formed from heavy-gauge galvanized steel, the guard will give your well a neat, clean appearance - and you will be assured of safety around the clock!

### Special Features:

- Meets OSHA requirements
- Endorsed by farm safety authorities
- Protection against loss of life or limb
- Adapts to any internal combustion engine, gear head installation

- Slips easily over prop-shaft and bolts to engine and pump
- Complete access for lubrication through 2" wide opening running the length of guard
- Rigid construction from galvanized steel. Withstands abuse and stays neat-appearing year after year.

## AUTOMATIC TURBINE PUMP OILER



Description	Part #	Weight	List
4 Gallon	6-8098	11.0	<b>530.00</b>
7 Gallon	6-8099	15.0	<b>602.00</b>
11 Gallon	9-7665		<b>700.00</b>
Brass Needle Valve	9-7554		<b>71.00</b>

Advantages: Automatic operation assures lubrication whenever the pump is pumping, this helps avoid inadequate oil dripping which is the leading cause of turbine pump failure.

- Inadequate drip oiling is the leading cause of pump failure.
- Continuous dripping wastes oil and causes contamination.
- This automatic valve assures lubrication when pump is running.
- Saves costly trips to the well.
- Manual mode for pre-season lubrication.



# Municipal/Industrial Hose & Fittings

Schumacher Irrigation, Inc. is "Your Liquid Solutions Provider"

We fabricate and distribute a full line of hose and accessories, couplings, clamps, fittings, valves, pumps, and suction and vacuum accessories for industry and liquid / waste water handling applications.

We pride ourselves on our same day service on both standard and custom parts. Please call us for quick and quality liquid solutions.

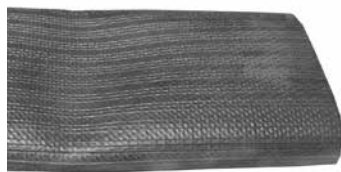

Conversions		
1 U.S. Gallon	=	231.00 cu. In
		0.1370 cu. Ft
		3.7850 liters
		0.0038 cu. Meters
		0.8330 Imp. Gal.
		0.0238 42-gal. Barrel
1 Imperial Gallon	=	1.20 U.S. Gal.
1 Cubic Foot	=	7.48 U.S. Gal.
		0.0283 cu. Meters
1 Barrel (Oil)	=	42.00 U.S. Gal.
1 Litre	=	0.2642 U.S. Gal.
1 Cubic Meter	=	35.3140 cu. Ft
		264.20 U.S. Gal.
1 Acre Foot	=	43,560.00 cu. Ft
		325,829.00 U.S. Gal.
1 Acre Inch	=	3,630.00 cu. Ft
		27,100.00 U.S. Gal.
Capacity		
1 Cubic Foot Per Second	=	449.00 GPM
1 Acre Foot Per Day	=	227.00 GPM
1 Acre Inch Per Hour	=	454.00 GPM
1 Litre Per Second	=	15.85 GPM
1 Cubic Meter Per Min.	=	264.20 GPM
1 Miner's Inch	=	9.00 GPM
1,000,000 Gal. Per Day	=	695.00 GPM
Head		
1 PSI	=	2.31 Ft. Head of Water
		2.04 In. Mercury
		0.07 Kg. Per sq. cm.
1 Foot of Water	=	0.43 PSI
		0.89 In. Mercury
1 Inch of Mercury (Vacuum)	=	1.13 Ft. of Water
1 Kilogram Per Square Cm	=	14.22 PSI
1 Atmosphere (at sea level)	=	14.70 PSI
		34.00 Ft. of Water
		10.35 Meters of Water
Weight		
1 U.S. Gallon of Water	=	8.33 Lbs
1 Cubin Foot of Water	=	62.35 Lbs
1 Kilogram or Litre	=	2.20 Lbs
1 Imperial Gallon	=	10.20 Lbs

Length		
1 Inch	=	2.54 Centimeters
1 Meter	=	3.28 Feet
		39.37 Inches
1 Rod	=	16.50 Feet
1 Mile	=	5,280.00 Feet
Horsepower		
1 Horsepower	=	7.46 Kilowatts or 746 watts
		33,000.00 Ft lbs per minute
		550.00 ft lbs per second
Horsepower Input	=	Horsepower input to motor 1.34 x kilowatts input to motor
Water Horsepower	=	H.P. required to lift water at a definite rate to a given distance assuming 100% efficiency: $\frac{\text{GPM} \times \text{Total Head (in. ft.)}}{3960}$
Brake Horsepower	=	H.P. delivered by motor H.P. required by pump H.P. input x motor efficiency 1.34 x KW input x motor efficiency
		Water H.P.
		Pump efficiency
		$\frac{\text{GPM times total head (ft)}}{3960 \times \text{pump efficiency}}$
		$\frac{\text{GPM times total head (psi)}}{103,000 \times \text{pump efficiency}}$
Efficiency		
Efficiency	=	Power output / Power input
Motor Efficiency	=	H.P. output / K.W. input x 1.34
Pump Efficiency	=	GPM x Total Head (Ft) / 3930 x B.H.P
Plant Efficiency	=	GPM x Total Head (Ft) / 5300 x KW input

Pumps

### PIPE DIMENSION CHART

PIPE TYPE	LHD	80	100	125	CL63	CL100	CL125	CL160	CL200	SCH40 PVC	SCH80 PVC	C-900	SEWER	CASING
O.D. SIZE	PIP	PIP	PIP	PIP	IPS	IPS	IPS	IPS	IPS	IPS	IPS		PVC	PVC
SDR	91	51	41	32.5	64	41	32.5	26	21	DWV/LP	DWV/LP	DR-18	SDR 35	SDR26
4"	O.D.				4.5	4.5	4.5	4.5	4.5	4.5	4.5	4.8	4.215	4.5
	I.D.				4.35	4.26	4.2	4.134	4.046	3.998	3.786	4.22	3.89	4.154
	WALL				0.07	0.11	0.138	0.173	0.214	0.237	0.337	0.267	0.125	0.173
	PSI				63	100	125	160	200	100/130	100/130	150	117.5	160
4 1/2"	O.D.													4.95
	I.D.													4.57
	WALL													0.19
	PSI													160
5"	O.D.				5.563	5.563	5.563	5.563	5.563	5.563	5.563			5.563
	I.D.				5.37	5.27	5.19	5.109	4.99	5.017	4.767			5.135
	WALL				0.087	0.136	0.171	0.214	0.265	0.258	0.375			0.214
	PSI				63	100	125	160	200	100/130	100/130			160
6"	O.D.	6.14	6.14	6.14	6.625	6.625	6.625	6.625	6.625	6.625	6.625	6.9	6.275	6.625
	I.D.	6	5.88	5.81	5.73	6.4	6.27	6.18	6.07	5.94	6.031	6.08	5.742	6.115
	WALL	0.07	0.12	0.15	0.189	0.087	0.162	0.204	0.255	0.316	0.28	0.383	0.18	0.255
	PSI	43	80	100	125	63	100	125	160	200	100/130	150	117.5	160
8"	O.D.	8.16	8.16	8.16	8.625	8.625	8.625	8.625	8.625	8.625	8.625	9.05	8.4	8.625
	I.D.	7.984	7.81	7.73	7.62	8.33	8.17	8.05	7.921	7.74	7.943	7.97	7.665	7.962
	WALL	0.088	0.16	0.199	0.251	0.135	0.21	0.265	0.332	0.41	0.322	0.503	0.24	0.332
	PSI	43	80	100	125	63	100	125	160	200	100/130	150	117.5	160
10"	O.D.	10.2	10.2	10.2	10.75	10.75	10.75	10.75	10.75	10.75	10.75	11.1	10.5	10.75
	I.D.	9.98	9.77	9.66	9.52	10.41	10.18	10.04	9.86	9.65	9.976	11.63	9.563	9.87
	WALL	0.11	0.2	0.249	0.314	0.168	0.262	0.331	0.413	0.511	0.365	0.733	0.3	0.413
	PSI	43	80	100	125	63	100	125	160	200	100/130	150	117.5	160
12"	O.D.	12.24	12.24	12.24	12.75	12.75	12.75	12.75	12.75	12.75	12.75	13.2	12.5	12.75
	I.D.	11.97	11.72	11.6	11.43	12.32	12.08	11.91	11.7	11.45	11.89	11.63	11.36	11.7
	WALL	0.132	0.24	0.299	0.377	0.199	0.311	0.392	0.49	0.606	0.406	0.733	0.36	0.49
	PSI	43	80	100	125	63	100	125	160	200	100	150	117.5	160
14"	O.D.					after 12"		14		14	14	15.3	same	
	I.D.					is pip		12.86		13.07	12.41	13.48	OD as	
	WALL					size		0.538		0.437	0.75	0.85	pip after	
	PSI							160		100	100	235	12"	
15"	O.D.	15.3	15.3	15.3	15.3	15.3							15.3	
	I.D.	14.97	14.65	14.5	14.29	14.82	14.5						13.89	
	WALL	0.165	0.3	0.373	0.471	0.239	0.373						0.44	
	PSI	43	80	100	125	63	100						117.5	
16"	O.D.							16		16	16	17.4		
	I.D.							14.696		14.94	14.21	15.33		
	WALL							0.615		0.5	0.843	0.967		
	PSI							160		100	100	235		
18"	O.D.	18.36	18.701	18.701	18.701		18	18		18	18	19.5	18.701	
	I.D.	17.964	17.91	17.72	17.47		17.07	16.534		16.809	16.014	17.18	17.629	
	WALL	0.198	0.367	0.456	0.575		0.439	0.692		0.562	0.937	1.083	0.536	
	PSI	43	80	100	125		100	160		100	100	235	117.5	
20"	O.D.	20.4					20	20		20	20	21.6		
	I.D.	19.962					18.97	18.37		18.743	17.814	19.03		
	WALL	0.219					0.488	0.769		0.593	1.031	1.2		
	PSI	43					100	160		100	100	235		
21"	O.D.		22.047	22.047	22.047								22.047	
	I.D.		21.12	20.89	20.59								20.783	
	WALL		0.432	0.538	0.678								0.632	
	PSI		80	100	125								117.5	
24"	O.D.		24.803	24.803	24.803		24	24		24	24		24.8	
	I.D.		23.76	23.5	23.17		22.748	22.043		22.54	21.418		23.381	
	WALL		0.486	0.605	0.763		0.585	0.923		0.687	1.218		0.711	
	PSI		80	100	125		100	160		100	100		117.5	

Schumacher Irrigation, Inc.  
205 4th Street - PO Box 289  
Platte Center, NE 68653 USA

**Change Service Requested**

PRESORTED  
BOUND PRINTED MATTER  
U.S. Postage Paid  
Platte Center, NE  
Permit No. 5

Always Open...  
**SchumacherIrrigation.com**  
*Your Irrigation Superstore*



**Schumacher**  
**IRRIGATION**

**IRRIGATION AND LIQUID HANDLING SOLUTIONS**

800.246.3685 or 402.246.3685  
Fax: 402.246.2072

irrigate@schumacherirrigation.com  
www.schumacherirrigation.com

**EFFECTIVE JANUARY 1, 2020**

All prices are subject to  
change without notice.