COMMERCIAL SALES AND REFERENCE GUIDE



The trucking industry is a very competitive and dynamic industry. Today's fleets operate in a fast-moving, ever-changing environment and they need every advantage they can get. Tires are an integral component of fleet vehicles and represent a major investment for any fleet operation. In the past 100 years, our engineers and design teams have consistently pushed the envelope to deliver products to the market that provide a positive return on investment for fleets that choose Yokohama.

This guide was created to serve as a resource for valuable information as well as to highlight the Longevity, Efficiency, Availability and Dependability of our distinctive commercial tire products. These qualities are engineered into every tire we build to prove time and again that Yokohama is indeed the Smart Solution.

We hope you find this information useful and thank you for your support of the Yokohama brand.

A handwritten signature in white ink that reads "Rick Phillips". The signature is fluid and cursive, with the first letters of each name being capitalized and prominent.

Rick Phillips

Vice President of Sales

1 / **Smart Solution**
3 / **The Yokohama Difference**
9 / **Tread Design**
19 / **Tire Vibration**
27 / **Inflation**
31 / **Alignment**

PRODUCT LINE-UP

TRUCK STEEL RADIAL

Steer & All-Position
43 / **101ZL Spec-2**
44 / **RY617**
45 / **104ZR/104ZR Spec-2**
46 / **RY023**

Drive Tires

47 / **709ZL**
48 / **703ZL**
49 / **TY527**
50 / **TY577**
51 / **TY517 /TY517 MC²**
52 / **TY303**
53 / **TY287**
54 / **SY767**

Line Haul Trailer and Other

55 / **RY587**
56 / **RY103**

Ultra Wide Base

57 / **TY517 UWB**
58 / **902L UWB**
59 / **RY407 UWB**

Wide Base

60 / **MY507A**
61 / **RY253**

On/Off-Highway / Mix Service

62 / **MY507**
63 / **MY627W Spec-2**
64 / **LY053**

LIGHT TRUCK COMMERCIAL

Highway All-Position

65 / **Y788R**
66 / **TY213A**
67 / **RY103/RY103A**
68 / **RY215**

Highway Traction

69 / **TY303A**
70 / **Y742S**
71 / **Y735B**
72 / **TY025**

73 / **Original Tread Depth**
74 / **Standard Limited Warranty**
75 / **Special Casing Warranty**

CONTENTS

THE ROAD AHEAD IS CHALLENGING. WE ARE THE SMART SOLUTION.

SmartSolution is the driving force behind Yokohama innovation – the core of our existence. It is our approach to ensure that we are the best partner for you, and it's what sets us apart from other suppliers. Focusing on the things that our customers consider most important: Longevity, Efficiency, Availability and Dependability, we've turned your day-to-day challenges into our primary focus. Developing products and services to help your business run smoother and ultimately improve your bottom line. Yokohama, the Smart Solution.



LONGEVITY

A FULL LINE OF LONG-LASTING, FUEL-EFFICIENT PRODUCTS.

EFFICIENCY

MORE STAFF, IMPROVED LOGISTICS, 24/7 EMERGENCY SERVICE.

AVAILABILITY

NATIONWIDE DEALER NETWORK OFFERING MORE ACCESS POINTS THAN ANY OTHER SUPPLIER.

DEPENDABILITY

THE LOWEST COST OF OWNERSHIP IN THE INDUSTRY.



THE YOKOHAMA DIFFERENCE

As a tire rotates under load, thousands and thousands of times, the forces on the casing steel and rubber compounds are incredibly stressful. This strain energy can take the life out of tires prematurely. Our exclusive technologies help combat this fatigue by reinforcing the casing to extend tire life, allowing for multiple retreads and reducing maintenance costs. Which means you're getting more tire for your dollar.

SMARTER ENGINEERING FROM THE START

Contrary to popular belief, better performance doesn't always come at the expense of the environment. Thanks to an innovative manufacturing process, we've developed tires designed to reduce the things that matter most: pollution, fuel-consumption and, ultimately, your operating costs.



STRAIN ENERGY MINIMIZATION TECHNOLOGY: EXTENDED CASING LIFE



Consider the effects of rapidly bending a paper clip, this is an exaggerated view of what the steel belts of a tire's casing face over the many miles of its life. Over time, the strain of heavy loads, heat, rough roads and everyday operation break down the steel, reducing casing life. Our STEM technology reinforces the casing to help it stand up to these strains allowing for multiple retreads, deeper tread depths and wider tread profiles.

MC² CONSERVATION TO THE NTH DEGREE

When the enemy is fuel consumption, the solution is our Maximized Conservation Concept (MC²) technology. Utilizing advanced technology that minimizes the effects of heat on the casing and tread, MC² tires lower rolling resistance by 10% to reduce your cost-per-mile.



PROUD TO BE SMARTWAY[®] VERIFIED

Yokohama offers a number of tires designed to meet SmartWay's stringent low rolling resistance criteria.

OUR CASING

The life of a tire is dependent on many elements, but perhaps most important is the strength and integrity of its casing. It's the foundation of the tire, the base on which everything rests. At Yokohama, we take pride in our commitment to building casings that maximize original tread longevity, performance, and ensure retreadability.

Building the best casing in the industry is no simple feat. Using Finite Element Method, our engineers can accurately predict the natural growth that occurs during the first 30,000 miles of operation. With that information they're able to design a product that adapts to the operational stresses and strains the tire will encounter in operation.

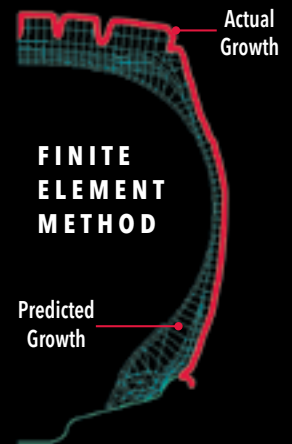

Steel Belts

Effectively increase the stiffness of the tread area, minimize distortion of the ground contact area, provide puncture resistance, and increase fuel-efficiency.

Belt Edge Cushion

Help prevent separation of the belt edges (and therefore the tread) caused by the scissoring effect of the belts.

Bead Assembly

Our unique bead assemblies are combinations of steel and nylon chafers (reinforcing cord layers) wrapped around the bead (a bundle of high-tensile steel wires) and the bead filler (apex rubber). These combinations reinforce the bead area to secure the inflated tire against the rim. In a tubeless tire, this fit must be tight enough that air does not leak from the tire during normal operation.

Body Ply

Allows the tire to maintain inflation pressure, successfully carry the load and resist shocks.

Inner Liner

Specially designed to minimize air seepage into adjacent areas of the tire. The quality of the inner liner is critical to prevent air from penetrating into the casing.

TIRE DIMENSIONS

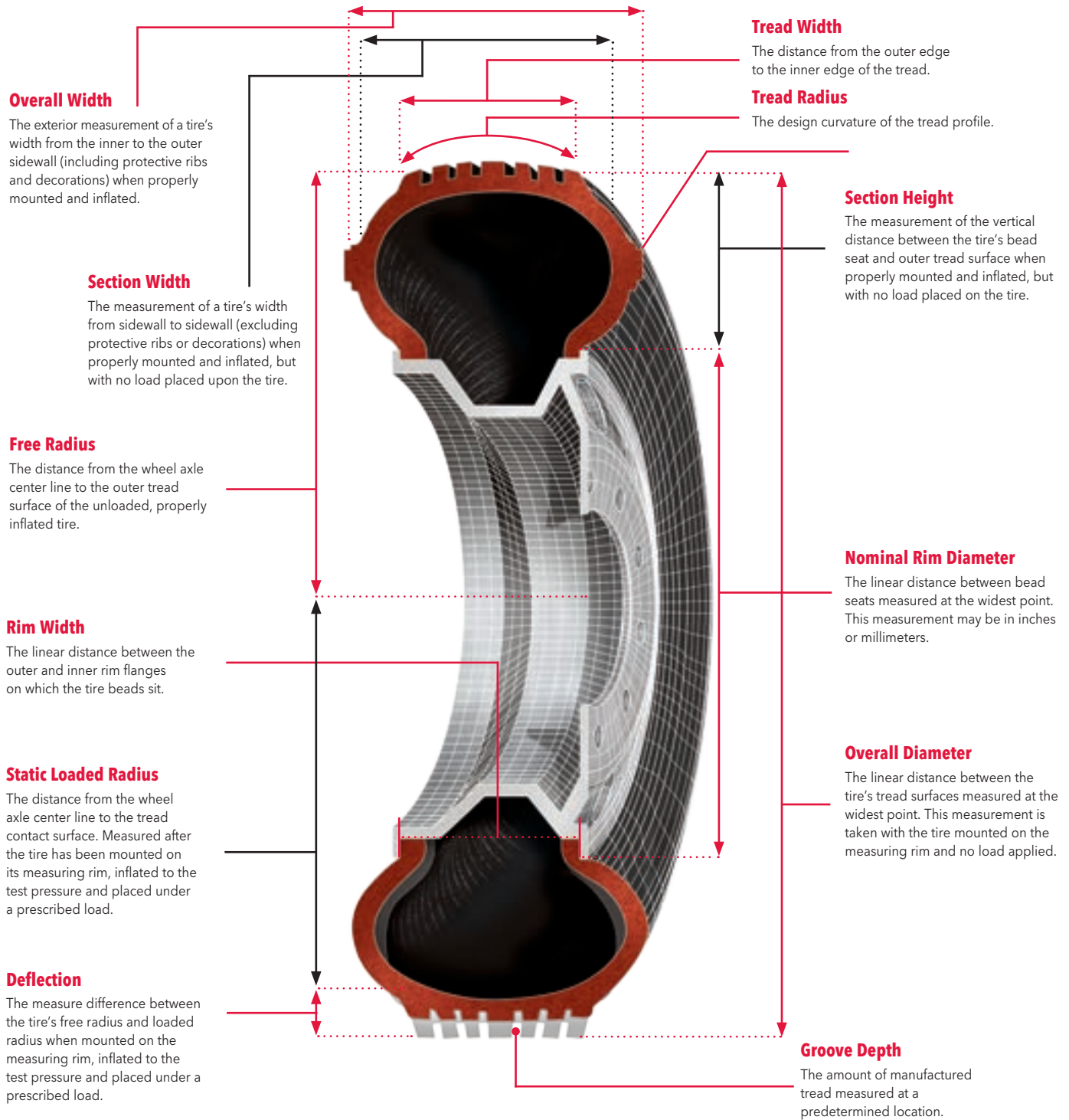

YOKOHAMA TIRE CONSTRUCTION

All radial tires consist of a sidewall, tread, shoulder and bead areas with each individual component contributing to the integrity of the overall product. The technological advancements in our products, including unique combinations of rubber compounds and innovative construction methods, offer better handling, ride comfort, treadwear and fuel-economy than ever before.

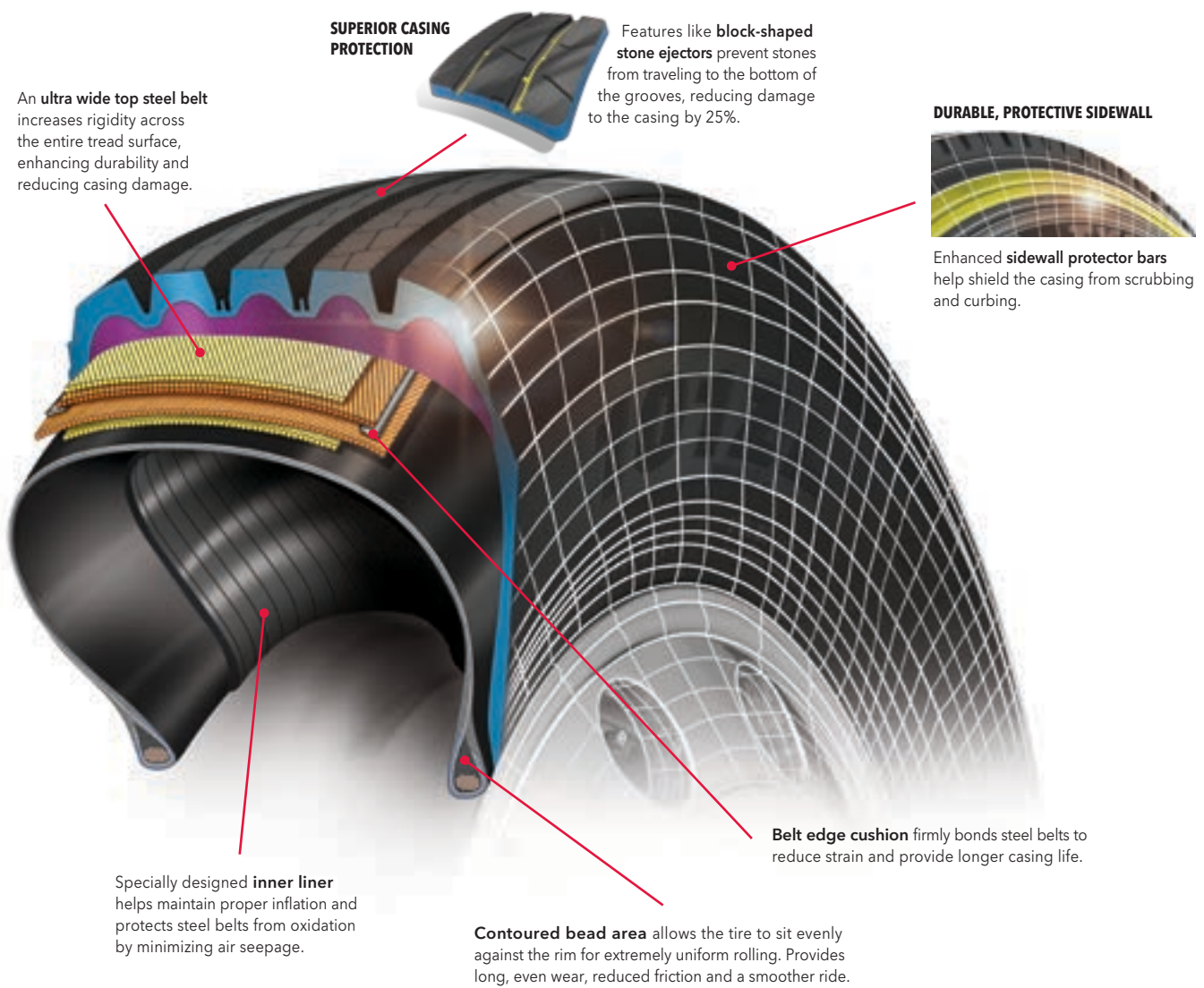

ULTRA WIDE BASE CONSTRUCTION

Fleets around the world have turned to wide base tires to help lower operating expenses. From ease of maintenance to increased cargo capacity and decreased fuel-consumption, these products are built to improve the efficiency of your vehicle.

Durable **five-belt package** allows for better casing design, creating a flatter carcass line, which helps maintain original shape. This creates a shorter, more efficient footprint.

An **advanced profile** is optimized to manage the strain that occurs during normal operation allowing better durability and less casing fatigue.

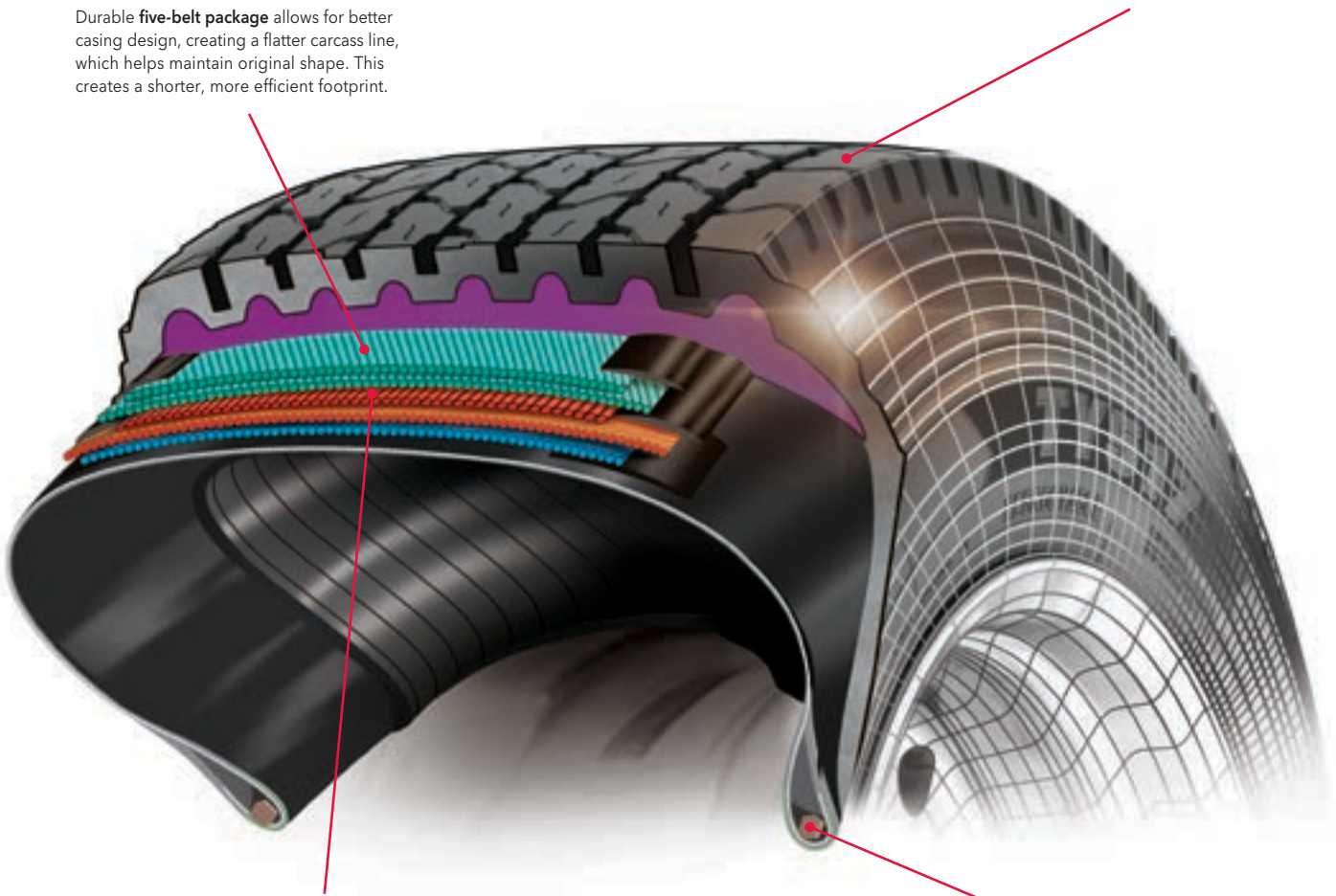

Zero degree belt, engineered specifically to provide even pressure across the contact patch, allows for even weight distribution and vastly increased treadlife.

Oversized hexagonal bead and double nylon chafer allow for easier mounting and provide even pressure along the wheel's circumference to reduce strain and increase the life of the tire.



TREAD DESIGN

It's the pattern of the tread combined with specially formulated rubber compounds that gives each tire its specific performance characteristics. Recognized as a leader in tread design, we're continually researching new and innovative ways to improve tire performance and fuel efficiency.

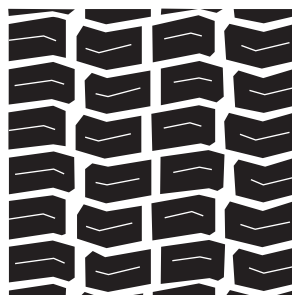

BLOCK TYPE

This tread pattern is composed of independent blocks and has the following advantages:

- Outstanding braking force and traction
- Good traction on snow or in muddy terrain

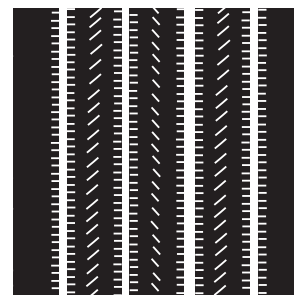

RIB TYPE

In the rib type pattern the tread and grooves follow the circumference of the tire and have the following advantages:

- Low rolling resistance
- Comfortable ride
- Good steering
- Relatively low noise generation

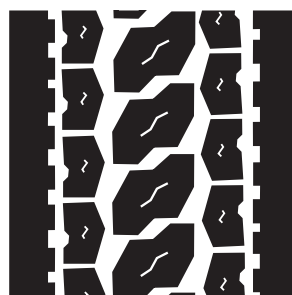

RIB-BLOCK TYPE

This pattern combines a block type tread in the center with a shoulder rib design and has the following advantages:

- Low rolling resistance
- Comfortable ride
- Relatively low noise generation
- Good traction on snow or in muddy terrain

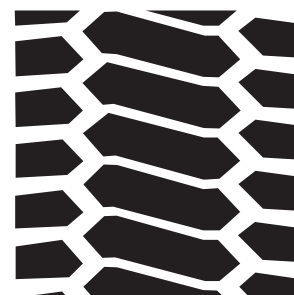

LUG TYPE

In this pattern, the grooves are cut across the tread to provide the following advantages:

- High braking force
- Excellent traction on unpaved surfaces

TIRE APPLICATION

While the components of a tire determine its inherent performance characteristics, it is the correct application of the tire that guarantees a satisfied customer. Because of this, it is important to carefully consider all the factors that affect tire performance in an application: the size of the vehicle, its specific use, weather, road conditions and terrain.

Conventional Tires

The taller sidewall allows for more flexibility to resist sidewall damage. Their higher static load radius allows for a smoother ride, while their higher diameter measurement delivers decreased rolling resistance.

Low-Profile Tire

Engineered with shorter, more responsive sidewalls, our low-profile tires ensure more uniform ground pressure resulting in less tread distortion. The lower height and lighter weight allow you to maximize your payload.

Wide Base Tires

Yokohama has developed wide base tires for on-road as well as off-road applications. They are especially cost efficient in applications for heavy load-carrying vehicles.

Ultra Wide Base Tires

Utilizing a unique casing that optimizes the operating profile to reduce strain energy, our ultra wide base tires provide better fuel efficiency, longer treadlife and unsurpassed retreadability.



YOKOHAMA COMMERCIAL PRODUCT LINE BY APPLICATION

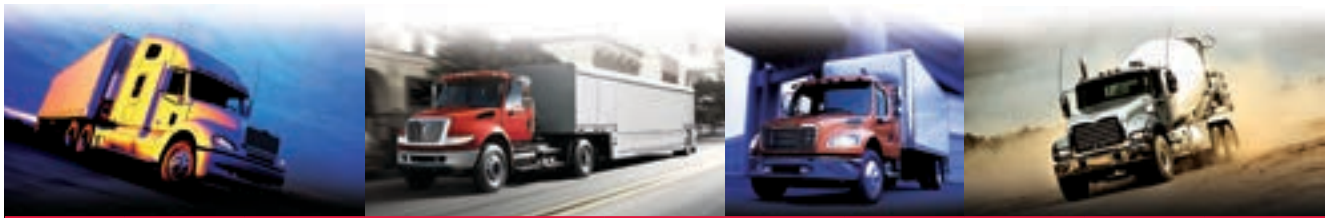

	Long-Haul			Regional-Haul			Pick-Up & Delivery		On/Off-Highway		
Front Axle (All-Position)	Premium	Standard	Wide Base	Premium	Standard	Wide Base	Conventional	Low-Platform	Premium	Standard	Wide Base
	101ZL Spec-2	RY617		104ZR 104ZR Spec-2	RY617 RY023 RY103	RY253 MY507A	RY023 RY103	RY023 RY103	MY507	RY103 MY627W Spec-2	RY253 MY507A
Drive Axle	703ZL 709ZL TY577	TY517 TY517 MC ² SY767	MY507A TY517 UWB 902L UWB	TY527	TY303 TY517 TY517 MC ² TY287 SY767	MY507A TY517 UWB 902L UWB	703ZL 709ZL TY527 TY517 TY517 MC ²	TY303 TY287	MY507	TY303 LY053	MY507A
Trailer Axle	RY587 RY023	RY587 RY023	RY253 RY407 UWB	RY587 RY023	RY587 RY023 RY103	RY253 RY407 UWB			MY507 RY023 RY103	MY507 RY023 RY103	RY253

TIRE IDENTIFICATION

The following letters may be used as part of truck tire size designations to identify the type of service or rim for which the tire is designed.

LT	Identifies a light truck tire for service on trucks, buses, trailers and multipurpose passenger vehicles for normal highway service and to be used on a five degree tapered bead seat or on a 15 degree bead seat rim.
TR	Differentiates certain tires from passenger car, light truck and other vehicles which use similar designations but are designed to fit rims of different bead seat diameters.
ML	Identifies mining and logging tires used in intermittent highway service.
MH	Identifies tires for mobile homes.
NHS	Designates tires "not for highway service."
ST	Indicates special tires for trailers in highway service.
HC	Designates tires for heavy trucks having 15 degree tapered bead seat rims of 17.5" diameter designated "HC". The HC suffix differentiates these tires from light truck tires with 17.5" bead diameter.

EXPLANATION OF TRUCK TIRE DESIGNATIONS

Examples of light truck and commercial truck tire size designations.

TIRE TYPE	TIRE SIZE DESIGNATION			RIM DIAMETER	LOAD IDENTIFICATION	OPTIONAL SERVICE DESCRIPTION	
	NOMINAL SIZE WIDTH (MM)	NOMINAL ASPECT RATIO	CONSTRUCTION CODE R = RADIAL		LOAD RANGE	LOAD INDEX SINGLE/DUAL	SPEED SYMBOL
METRIC SIZES	255	70	R	22.5	G	138/134	M
CONVENTIONAL SIZES	10.00		R	20	H	146/142	L
	11.00		R	22.5	H	146/142	L
	11.00		R	15TR*	H	144/142	
	8.00		R	17.5HC**	F	112/117	L
	10.00		R	20 ML	F		
	11.00		R	22.5 ML	F		

TR* - Indicates a tire for rims having a specified rim diameter plus .156 or .250 • HC** - for use on "HC" rims • ML - Mining and Logging tires

DOT TIRE IDENTIFICATION CODES

All new tires sold in the United States must have a DOT number cured into the lower sidewall of one side of the tire. This code has a standard format which has been designated by the federal government.

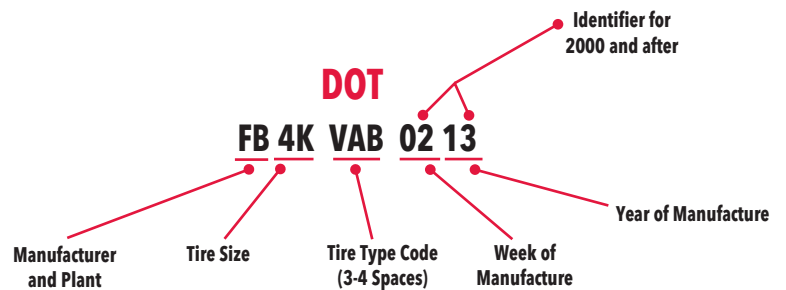

Some manufacturers place an additional code with a specific serial which identifies the specific tire model (a tire type code). This optional number is located on the sidewall opposite the DOT number.

Commercial treads also include codes which are used to detail retread information. This code is generally found on the lower sidewall near the original DOT code.

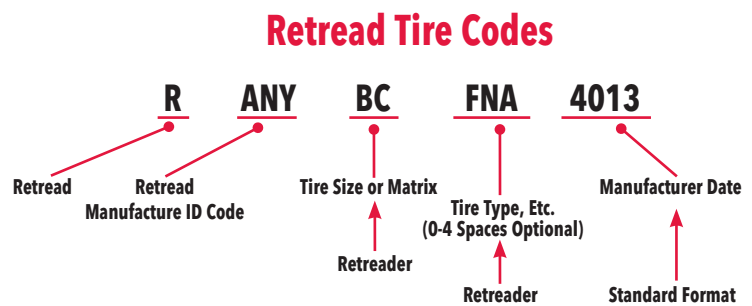

SIZE DESIGNATION AND SERVICE DESCRIPTION

There are many factors that contribute to how your vehicle performs, but few have as direct an impact as its tires. It's vital to have a good understanding of your tires' capabilities, and more importantly, their limitations. A tire's weight and speed limits are indicated by the tire service description: a short code located on the sidewall. This short code, which consists of a two or three digit number along with a single letter, designates just how much weight your tires are capable of carrying safely (**load index**) and the maximum speed the tires are designed for (**speed category**).

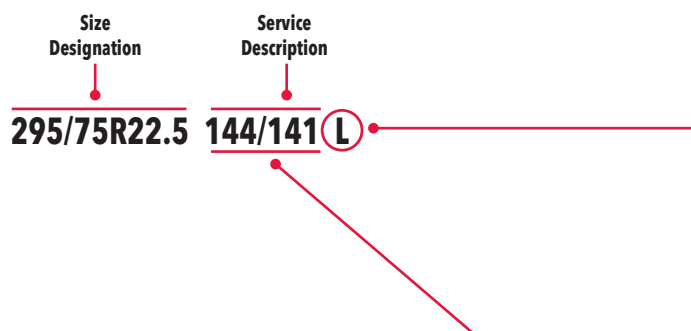

SPEED CATEGORY CHART

Speed Symbol	Speed Category
F	50 mph (80 km/h)
G	55 mph (90 km/h)
J	62 mph (100 km/h)
K	68 mph (110 km/h)
L	75 mph (120 km/h)
M	81 mph (130 km/h)

LOAD INDEX CHART

Load Index	KG	LBS
120	1400	3085
121	1450	3195
122	1500	3305
123	1550	3415
124	1600	3525
125	1650	3640
126	1700	3750
127	1750	3860
128	1800	3970
129	1850	4080
130	1900	4190
131	1950	4300
132	2000	4410
133	2060	4540
134	2120	4675
135	2180	4805
136	2240	4940

Load Index	KG	LBS
137	2300	5070
138	2360	5205
139	2430	5355
140	2500	5510
141	2575	5675
142	2650	5840
143	2725	6005
144	2800	6175
145	2900	6395
146	3000	6610
147	3075	6780
148	3150	6940
149	3250	7160
150	3350	7390
151	3450	7610
152	3550	7830
153	3650	8050

Load Index	KG	LBS
154	3750	8270
155	3875	8540
156	4000	8820
157	4125	9090
158	4250	9370
159	4375	9650
160	4500	9920
161	4625	10200
162	4750	10500
163	4875	10700
164	5000	11000
165	5150	11400
166	5300	11700
167	5450	12000
168	5600	12300
169	5800	12800
170	6000	13200

The maximum load a tire can carry at various cold inflation pressures.

PROPER MATCHING AND SPACING OF DUALS

Paired tires should be of the same size designation, construction, tread design and as close as possible to the same outside diameter. Mismatching duals forces the larger diameter tire to carry an overload, causing it to overdeflect and overheat. The smaller diameter tire, lacking proper road contact, wears faster and irregularly.

MAXIMUM ALLOWABLE DIAMETER DIFFERENCES BETWEEN A TIRE AND ITS DUAL MATE AT EQUAL INFLATION PRESSURES:

Radial Tire Size	Radius (inches)	Diameter (inches)	Circumference (inches)	(+) Depth (-)*
All	0-1/8"	0-1/4"	0-3/4"	4/32

Note: Determine the actual difference in diameter by measuring the tires (with a steel tape) at least 24 hours after initial inflation. Matching should be done before installing tires on the vehicle.

*Applies only if tires are of the same tread.

Tire Mixing

Using the same tire size and construction that was specified as the original equipment for that vehicle will normally produce the best performance from the vehicle and the tires. However, there are times when mixing of different tire sizes and constructions on a vehicle is necessary. Some mixing of tires can be allowed, if certain rules are followed:

1. Never mix different tire sizes or construction types on the same axle.
2. Bias ply tires can be mounted on steer axles and radial tires on single axle drive positions of two axle vehicles. Reversing these positions may result in handling problems.
3. Either bias ply or radial tires can be mounted on the steer axles, if the vehicle has multiple drive axles.
4. All multiple drive axles should have the same size and construction tires.
5. Tires mounted on trailers may be bias or radial, as long as all tires on each individual axle are the same size and construction.
6. No mixing of tire sizes and constructions are allowed on four-wheel-drive type vehicles (4WD).

If there are any other questions about possible tire mixing combinations, the vehicle manufacturer should be consulted before actual changes are made.

DEMOUNTING FOR TUBELESS TRUCK AND BUS TIRES

FOR TIRE SAFETY
PROCEDURES,
WE RECOMMEND
REFERENCING OSHA
STANDARDS, WHICH
CAN BE FOUND AT
THE FOLLOWING:
[HTTP://WWW.OSHA.GOV](http://www.osha.gov)



MOUNTING PROCEDURES

Use of Bead Lubricant

Preferred materials for use as bead lubricants are animal or plant-based and mixed with proper water ratios per manufacturers' instructions. When dry, the lubricant should have no residual lubricity and should not flake from the surface upon which it is applied. To avoid damage to tires and rims, the following should be avoided: petroleum oils or grease, improper ratios of approved lubricants and water, silicone oils and emulsions, and solvent-based lubricants.

Use of Sealants

Yokohama does not recommend or endorse the use of additives installed in the interior chamber of its mounted tires. The use of flammable materials is prohibited. The Yokohama Standard Limited Warranty remains in effect with the use of these additives, providing the additive is not the cause of a tire condition submitted for a warranty claim. Damages attributed to the use of an additive will be denied warranty consideration.

MOUNTING DIRECTIONAL TIRES

When mounted properly, directional treads prevent block squirm, effectively reducing irregular wear and improving treadlife.

Direction of Rotation

When viewed from the top, the tread pattern should face in the following direction:



Directional treads should be mounted facing opposite directions to ensure their "direction of rotation" arrows are each pointed to the front of the vehicle. This arrow can be found on the sidewall.

RUN-OUT AND MATCH-MOUNTING

Yokohama places red and yellow marks on the sidewalls of some truck tires to enable the best possible match-mounting of the tire and wheel assembly. There are two methods to ensure they are mounted properly:

Uniformity Method

When performing uniformity match-mounting, the red mark on the tire, indicating the point of maximum radial run-out, should be aligned with the wheel assembly's point of minimum radial run-out, which is generally indicated by a dimple somewhere on the wheel assembly (consult manufacturer for details).

Weight Method

When performing weight match-mounting, the yellow mark on the tire, indicating the point of lightest weight, should be aligned with the valve stem.



Note: Not all wheel assemblies indicate the point of minimum radial run-out.

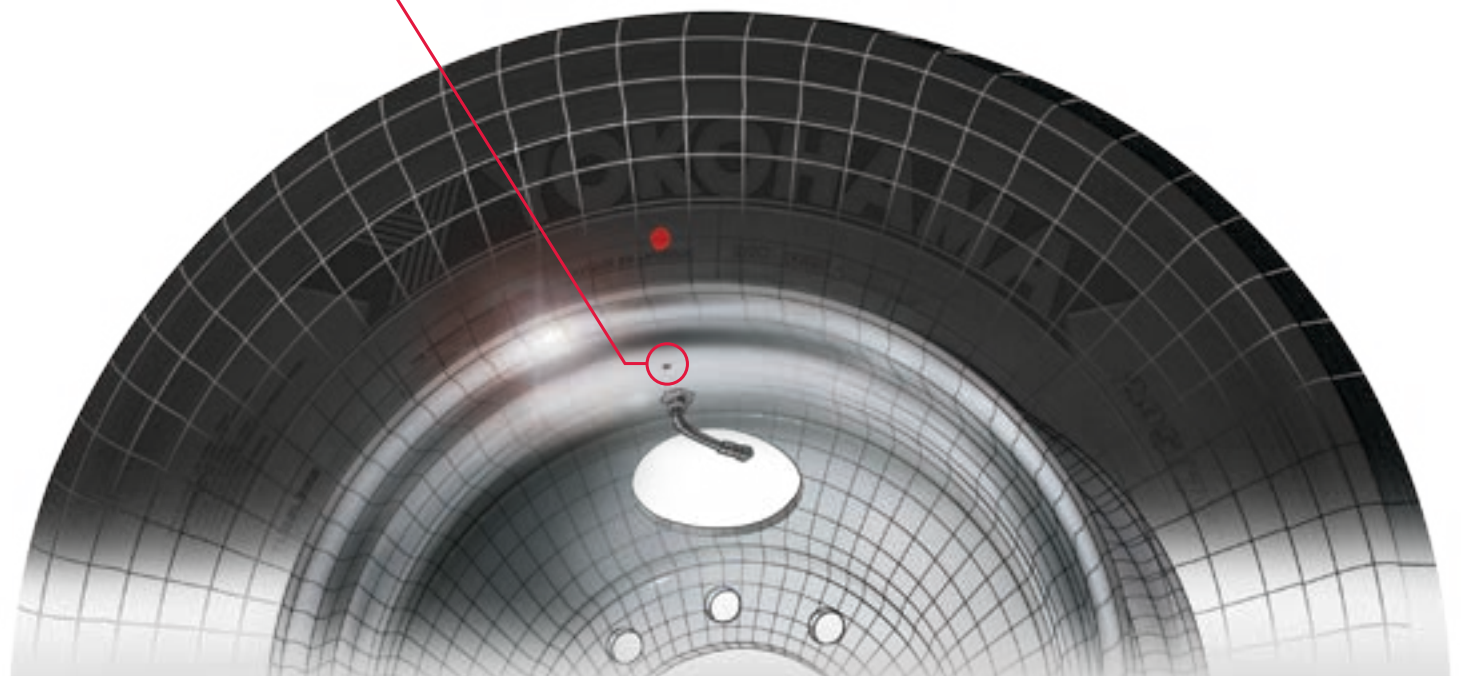

DIAGNOSING VIBRATION

No factor contributes to a negative operating experience more than vehicle vibration. The torment of operators everywhere, it degrades ride quality, shortens tire life and strains vehicle components. Fortunately, steps can be taken to avoid operating under these conditions.



- 1.** Visually inspect tires, wheels/rims and vehicle components for irregular wear and damage. Replace or adjust as required.
- 2.** Check to be certain that tires are inflated according to vehicle manufacturer recommendations and the vehicle suspension is working correctly and vehicle is not tilting. Either bias ply or radial tires can be mounted on the steer axles if the vehicle has multiple drive axles.
- 3.** Check each tire to be certain it is mounted properly on the wheel/rim. The tire fitting line should be concentric with the rim flange. If the tire has a yellow or red mark on the tire, it should be oriented to the rim correctly. See "Run-Out and Match-Mounting" section on page 18.
- 4.** Test drive vehicle on a smooth road surface and diagnose symptoms. A five to ten mile warm-up is recommended to remove any flat spotting. Steering wheel vibration diagnosis should begin with front axle, wheel and tire conditions. Floor or seat vibration diagnosis should begin with drive axle. Power train and brake conditions can be diagnosed by alternate brake application and placing the transmission into neutral during vibration.
- 5.** Check each tire wheel/rim assembly balance and adjust as required. If unable to balance, completely deflate tire, unseat tire beads and rotate tire 180 degrees on the wheel/rim. Inflate, rebalance and reinstall on vehicle.
- 6.** If vibration is not eliminated, measure tire and wheel/rim assembly for excessive lateral or radial run-out. Replace as required.
- 7.** Rebalance tire and wheel/rim assembly and test drive vehicle.

By design, Yokohama's radial tires are constructed with lower aspect ratios than ever before. This allows them to respond to lateral forces more effectively, meaning it takes less time to transmit the steering input from the wheel to tread. This improved steering response means better performance on the

TIRE BALANCE, VEHICLE RIDE AND VIBRATION

road, but requires special attention be paid to proper tire mounting, balancing and installation procedures to ensure that optimal ride quality is achieved. Vigilant attention to these details along with regular maintenance will maximize your vehicle's performance and guarantee a smooth, comfortable ride—mile after mile.

VEHICLE VIBRATION IS THE ENEMY OF COMFORT

Often operators attribute vibration to a faulty tire when the cause might be with a wear issue or the mechanical condition of the vehicle itself.



TIRE BALANCE UNIFORMITY

Day-to-day wear causes changes in the distribution of weight around the tire and wheel assembly which can cause vibration. Balancing your wheels minimizes potential vibration felt in the steering wheel, seat, or floorboard and improves tire longevity.

Types of Imbalance

1. Static Imbalance

Occurs when there is a heavy or light spot in the tire so that the tire won't roll evenly and the tire/wheel assembly undergoes an up-and-down movement.

Correcting Static Balance: Achieved with a bubble or spin balancer.

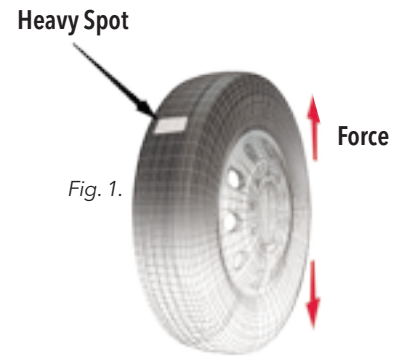

2. Dynamic Imbalance

Occurs when there is unequal weight on both sides of the tire/wheel assembly's circumferential centerline, giving the tire/wheel assembly a side-to-side wobble or wheel shimmy.

Correcting Dynamic Balance: Achieved with a spin balancer where the tire/wheel assembly is balanced both statically and dynamically.

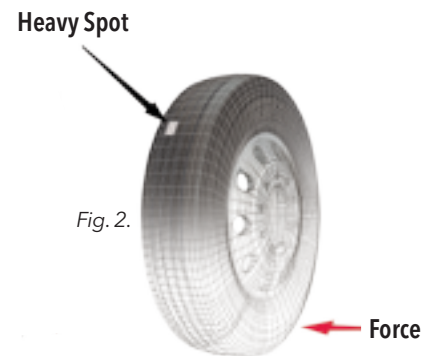

3. Vehicle Imbalance

Vibration due to faulty vehicle components other than the tire or wheel/rim assembly; such as hubs, brake rotors and drums and drive lines.

Correcting Vehicle Imbalance: Correction requires checking for any irregularities and replacement as required.

General guidelines and acceptable limits for radial run-out on truck and bus tires are listed below:

ROTATING ASSEMBLY BALANCE AND RUN-OUT LIMITS:

	Tire Position	19.5	Over The Road	Construction	Wide Base
Maximum correction wheel weights which can be added per rotating assembly	Steer	14 oz	16 oz.	18 oz.	24 oz.
	Drive/Trailer	18 oz.	20 oz.	22 oz.	28 oz.
Lateral run-out for rotating assembly	Steer/Drive	0.095"	0.095"	0.110"	0.125"
	Trailer	0.125"	0.125"	0.125"	0.125"
Radial run-out for rotating assembly	Steer/Drive	0.095"	0.095"	0.110"	0.125"
	Trailer	0.125"	0.125"	0.125"	0.125"

ROTATING DISC WHEEL RUN-OUT LIMITS:

Tubeless steel disc wheels	Radial Run-Out	0.070"	0.075"
	Lateral Run-Out	0.070"	0.075"
Tubeless aluminum disc wheels	Radial Run-Out	0.030"	0.030"
	Lateral Run-Out	0.030"	0.030"

SOURCE: Technology & Maintenance Council (TMC) of American Trucking Associations; 2200 Mill Road, Alexandria, VA 22314 (703) 838-1763; <http://tmc.truckline.com>

4. Run-out Imbalance

Results from poor bead seating on the rim or improper placement of components. Poor bead seating is usually the result of improper mounting or the use of wheels with imperfections. A small degree of this imbalance is acceptable, but too great a run-out causes vibration and excessive tire wear. There are two types of run-out imbalance, Radial and Lateral:

Radial Run-out

An "out-of-round" situation where vibrations are produced as the wheel spindle moves up and down.

Correcting Radial Run-out: Achieved by rotating the wheel and tire assembly two stud positions on the hub, or by rotating the tire 180 degrees on the wheel. If run-out is still over specification, check wheel run-out and mark the low point. Rotate to match the high point of the assembly run-out with the wheel low point. If the assembly run-out is still too high and the wheel is within specification, replace the tire.

Lateral Run-out

A side-to-side or wobbling movement of the tire and wheel. Less common than radial run-out, due to the vehicles being less sensitive to this type of vibration.

Correcting Lateral Run-out: Use a run-out gauge to check both the tire and wheel. Chalk mark the highest point of run-out on both the wheel and tire then replace whichever (wheel, tire or both) is out of specification.



LONGER TIRE WEAR. LOWER OPERATING COSTS.

Today's commercial tires are better than ever, constructed to deliver longer original treadlife, designed with durable casings and built to withstand more retreads. Despite these on-going product improvements there are still things that you can do to get the most out of your tires.



One way to get the most out of your vehicle is to be certain your tires roll smoothly through an optimized footprint. Unfortunately the tiniest of imperfections in one of hundreds of mechanisms involved will make your vehicle operate less efficiently. Vigilant inspection, regular service and prudent operation are paramount to ensuring that your cost per mile stays as low as possible.

There are three primary factors that prevent optimum performance from being achieved with otherwise mechanically sound vehicles:

- Incorrect Air Pressure
- Improper Alignment
- Operational Inefficiencies

TIRE PRESSURE



In general, tires perform best when inflated to match vehicle and axle loads. Steer tires often require maximum inflation pressure to carry the steer axle load, while trailer tires should be set at pressure corresponding to actual tire loading. Included in this guide are the current load/inflation pressure tables for all Yokohama products, only. There are three recommended ways to correctly determine and set operational inflation pressures:

- Yokohama tire load/inflation charts
- Actual vehicle weight
- Yokohama Tire Inflation Pressure Calculator:

<http://www.yokohamatruck.com/commercial/tire-tools/inflation-pressure-calculator>



Proper Air Pressure

How a tire wears depends on the forces that act upon the contact patch of that tire as it meets the road.

Therefore, it is important to maintain proper inflation pressure. If a tire's load is equal on all ribs or elements, it tends to have a square footprint shape.

AIR PRESSURE MATCHED TO LOAD

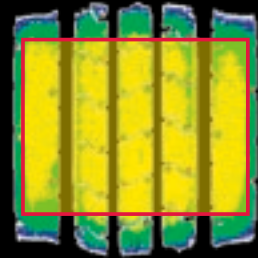

Overinflation

An overinflated tire tends to have a short shoulder rib contact area (shorter than the center rib). As the tire rotates, the footprint center maintains close contact, but the shoulder area does not. This causes scrubbing action and uneven wearing of the shoulder rib while placing more strain on the contact area.

TIRE OVERINFLATED FOR LOAD

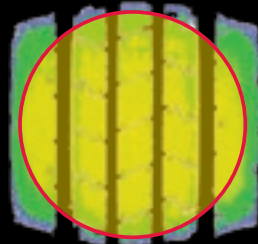

Underinflation

An underinflated tire can't maintain its shape and becomes flatter than intended while in contact with the road. This causes over-deflection, internal heat build-up, increased rolling resistance and reduced fuel economy. Underinflation flexing and heat build-up within the tire components deteriorate tires and reduce casing life and retreadability.

TIRE UNDERINFLATED FOR LOAD

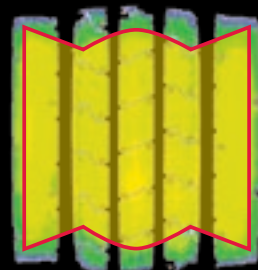

- 20% underinflation can reduce tire life 30%
- 30% underinflation can reduce tire life 40%
- 40% underinflation can reduce tire life 50%

YOKOHAMA TIRE INFLATION RECOMMENDATIONS

Yokohama Tire Load and Inflation Charts

Recommended Cold Inflation Pressures - requires truck to be parked 3-4 hours

Tire Size	Steer Single	Drive Duals	Trailer Duals
295/75R22.5 (14PR)	110 psi	90 psi	90 psi
285/75R24.5 (14PR)	110 psi	90 psi	90 psi
11R22.5 (14PR)	105 psi	90 psi	90 psi
11R24.5 (14PR)	100 psi	90 psi	90 psi

Steer tires in the first three examples are set at maximum cold inflation. In all examples, the drive and trailer duals are set at 80 psi, plus 10 psi for compensation between airing.

Note: Never bleed excessive air from a "hot" tire.

Actual Vehicle Weight

Recommendation for an 80,000 lbs. GVW operation vehicle:
6x4 Tractor, 53 foot long box trailer

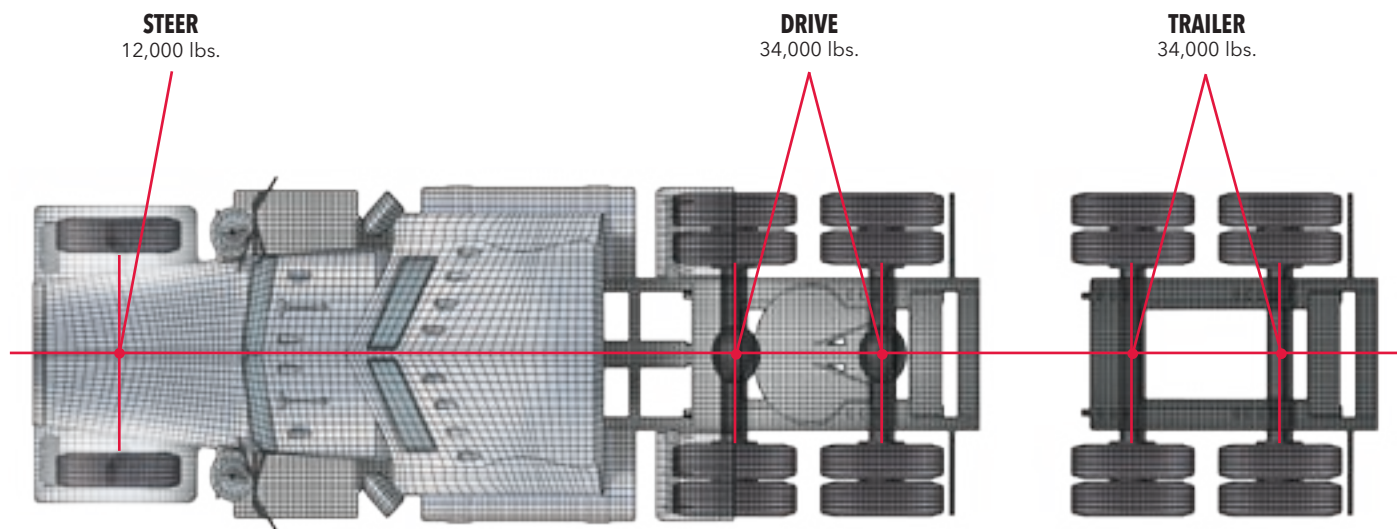

1. Determine actual tire loads.

- Weigh several tractor/trailer vehicle combinations that best represent actual maximum load conditions for these vehicles while in operation.
- Determine average weights per axle of these weights and divide that value by the number of tires on that axle to determine actual tire loading.

2. Determine minimum cold inflation pressures for each tire per axle.

- Use the actual load per tire (per axle) to determine the cold inflation pressures for the tires by size, ply and type.
- The actual tire load should be compared to the tire load limits on the chart for the particular tire size and ply rating.
- The corresponding recommended cold inflation pressure is indicated for the load in the chart heading.
- If the actual tire loads are heavier than the ply rating of the applied tire, it may be necessary to install a tire with a higher ply rating.

3. Use the determined inflation pressures as minimum inflation values to set up the vehicle for improved handling.

- In all cases, the determined inflation pressures based on actual load conditions should be considered minimum pressures.
- Operational air pressures can be set higher, but under no circumstances should they be set lower.

Air Pressure Calculator

These recommendations, as outlined, should be adopted and used for all Yokohama truck/bus tires when the tires are new and first installed on the vehicle. Correcting inflation pressure after irregular wear has begun will not correct the wear pattern.

The pressures will only be effective in preventing wear if used from the point of the original mounting.

For specific recommendations, please refer to the Yokohama Tire Inflation Pressure Calculator at <http://www.yokohamatruck.com/commercial/tire-tools/inflation-pressure-calculator>

* Results are minimum recommended inflation pressures. Recommended PSI are for cold tires; never adjust inflation pressures for hot tires.



ALIGNMENT ISSUES

Proper alignment is an important factor in lowering operational costs. Ideally, when a truck is traveling in a straight line, all of the axles are parallel—and perpendicular to the vehicle centerline—and all the tires are rolling in a straight line, too. Not only will tires on a properly aligned vehicle last longer, but some manufacturers suggest that there are significant improvements in fuel economy, component wear, and even driver fatigue.

It is universally known that alignment plays as critical a role in vehicle efficiency as does any other factor. Still, between 70 and 80 percent of commercial vehicles on the road today are misaligned! Maintaining proper alignment settings is an arduous task but it's one that will reward your bottom line. Most alignment issues can be attributed to one of four factors:

- Ackerman Angle
- Caster/Camber Settings
- Toe Settings
- Axle Alignment

ACKERMAN ANGLE

Ackerman steering geometry is an arrangement of linkages in the steering of a vehicle and is designed to solve the problem of wheels on the inside and outside of a turn needing to trace out circles of a different radius. The intention of Ackerman geometry is to avoid the need for tires to slip sideways when following the path around a curve.

Incorrect Ackerman geometry generally scuffs the tires when driving through corners and might cause tire squeal during sharp turns. The Ackerman Angle should be checked as part of any routine wheel alignment on new vehicles, or when a vehicle's wheelbase is modified or exhibits toe type wear despite a proper toe-in setting.

Ackerman Principle: The inside wheel turns in more sharply than the outside wheel.

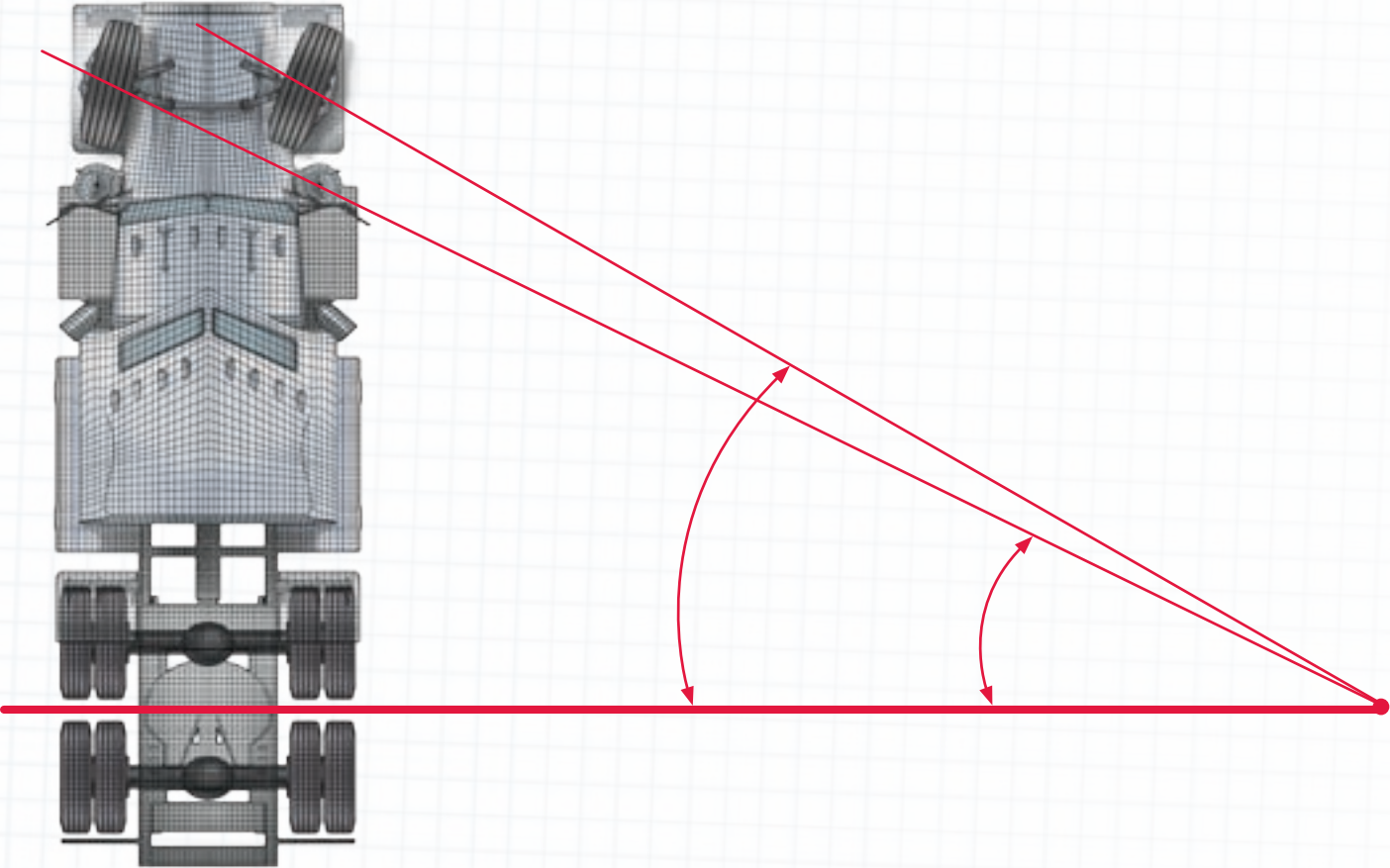

CASTER

Caster is the forward or rearward tilt of the steering's pivot point line in reference to a vertical line. Caster is positive if the line is angled toward the vehicle's rear, and negative if the tilt is forward. Typically, 2 to 5 degrees of positive caster is recommended to make the vehicle more stable at high speeds and improve handling.

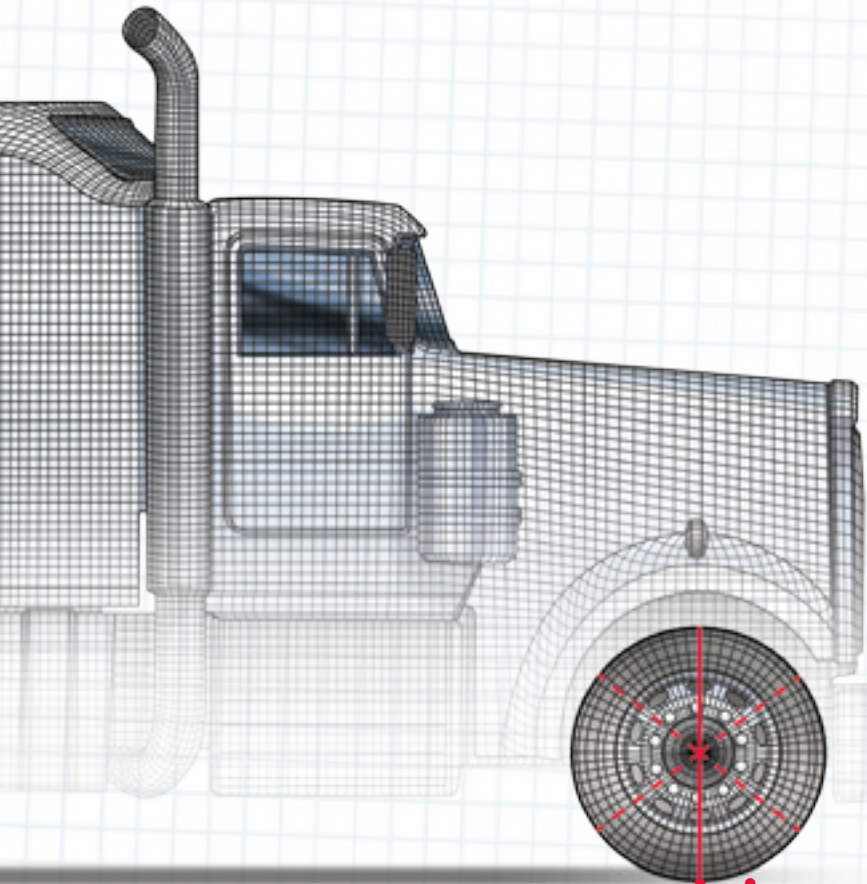

WHEEL CONTACT POINT

LEAD POINT

ANGLE OF WHEEL PIVOT
+2° to +5° IS RECOMMENDED

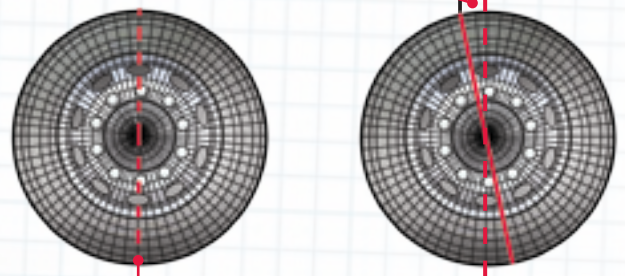

CENTER OF WHEEL

Though generally associated with handling, the caster angle can also affect tire wear. Improper caster can cause shimmy, pulling and shoulder wear on the steer tires.

CAMBER

Camber angle is the measure in degrees of the difference between the wheel's vertical alignment perpendicular to the surface. If a wheel is perfectly perpendicular to the surface, its camber would be 0 degrees. Camber is negative when the tops of the tires tilt inward (towards the vehicle) and positive when the tops of the tires tilt away.

On newer trucks, camber wear should not be a major issue. Most trucks leave the factory with zero to slightly positive camber. Excessive positive camber will result in excessive shoulder wear, while negative camber will wear the inner half of your tire.

Correcting camber settings requires a bending of the front axle (which voids most manufacturer warranties). If an alignment shop indicated that camber is out of spec, the vehicle's front bearing should be checked.

POSITIVE CAMBER WHEEL IS TILTED OUTWARD AT THE TOP

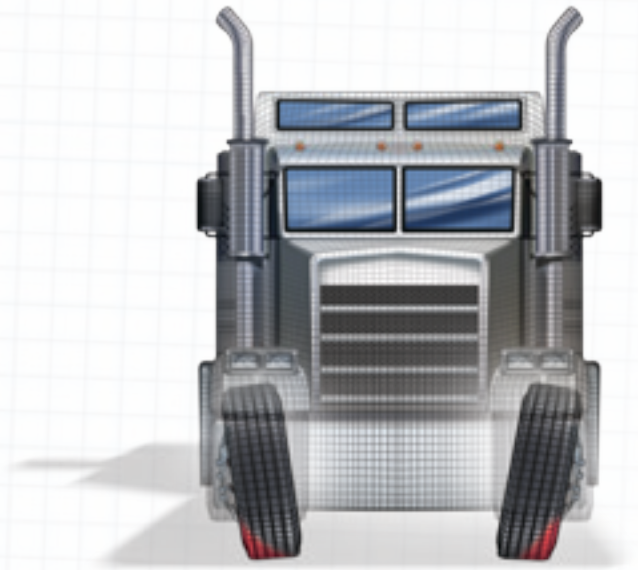

Result: Smooth, fast wear on the outer half of the steer tires.

NEGATIVE CAMBER WHEEL IS TILTED INWARD AT THE TOP

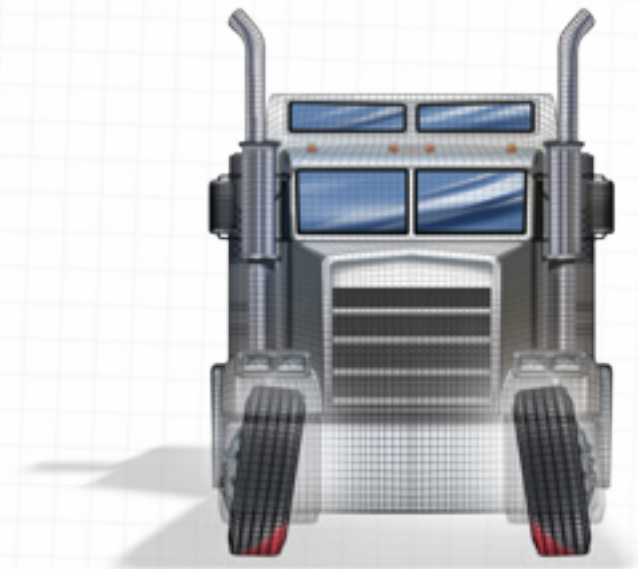

Result: Smooth, fast wear on the inner half of the steer tires.

TOE SETTINGS

The toe angle identifies the direction of the tires compared to the centerline of the vehicle. It is expressed in either degrees or fractions-of-an-inch, and an axle is said to have "positive toe-in" when the imaginary lines created by the tires intersect in front of the vehicle and "negative toe-out" if they diverge. When drive tires propel a vehicle with improper toe settings forward, there is an increase in rolling resistance that negatively impacts fuel-efficiency, ride comfort and ultimately shortens the life of your tires.

The vehicle's toe is the most critical alignment setting relative to tire wear. If the toe setting is just 1/32-inch off of its appropriate setting, each tire on that axle will scrub almost 3 1/2 feet sideways every mile, significantly reducing tire life.

TOE-IN IS THE MOST BASIC FRONT-END SETTING.

Typically toe is set at 1/16" toe-in (+ 1/16").
Measured and set in a static state, toe-in allows the wheels to run straight, when the vehicle is loaded rolling down the highway.

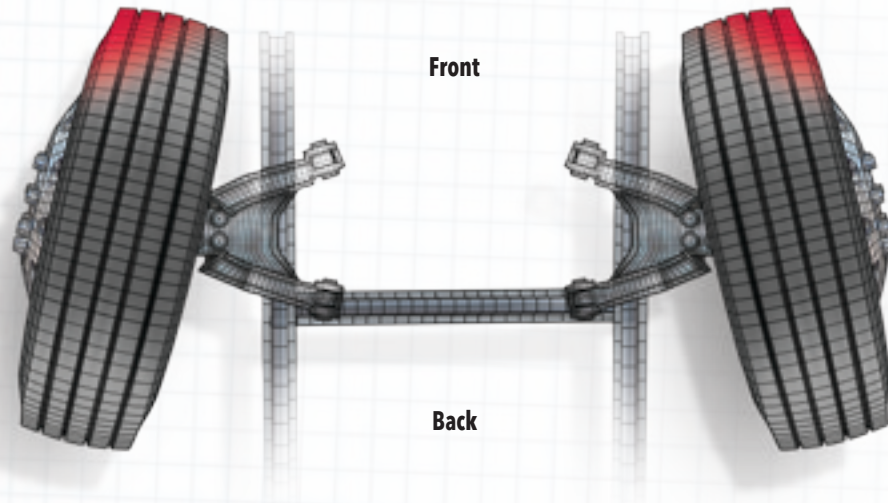

TOE-IN The distance between the front of the tires is less than the distance between the rear of the tires.

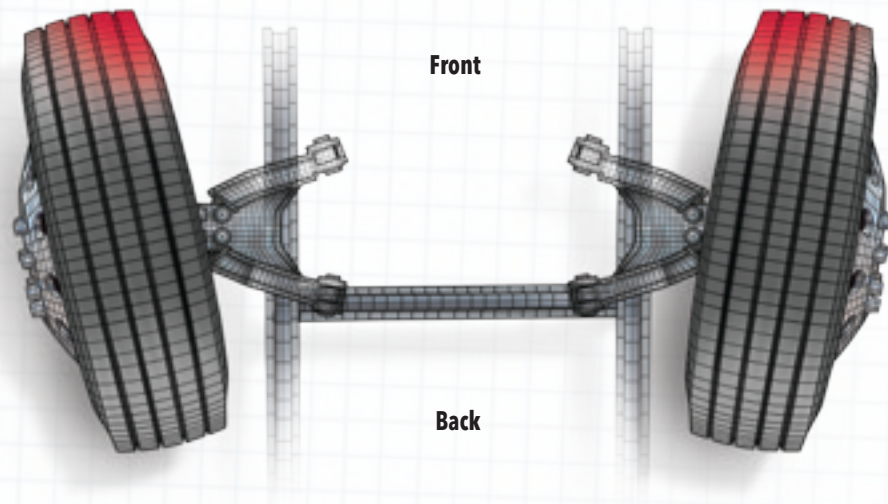

TOE-OUT The distance between the front of the tires is greater than the distance between the rear of the tires.

MISALIGNED DRIVE AXLES

Generally when you think about the benefits of a properly aligned vehicle, you think about lowering operating costs via longer tire life - but that's only the beginning. Not only will proper alignment extend tire life, but it has also shown to improve fuel economy, component wear and even driver fatigue.

Vehicle alignment isn't a matter of just aligning the steer axle. It means aligning the drive and trailing axles, too. In a perfect world, trucks would travel in perfectly straight lines from one location to another. If this were the case, as the truck went down the road the axles would remain parallel, perfectly perpendicular to the vehicle centerline and worries about tire life would be a thing of the past. Unfortunately, driving forces, mechanical complications and other issues can cause axles to fall out of alignment, negatively impacting wear.

STEER TIRE WEAR CAUSED BY MISALIGNED DRIVE AXLES

Geometric Center Line

Thrust Angle

STANDARD RIGHT THRUST

Cause: Occurs if the vehicle's drive axles are pushing the truck to the right.

Result: Wear on the right steer tire will mimic toe-out wear while the left side will exhibit the feathering on the right shoulder associated with toe-in alignment.



STANDARD LEFT THRUST

Cause: Occurs if the vehicle's drive axles are pushing the truck to the left.

Result: Wear on the left steer tire will mimic toe-in wear while the right side will exhibit toe-out wear.



Note: In the US, right thrust complaints are more common than left thrust because of the way our interstate highways are crowned.

RIGHT THRUST, TOE-IN

Cause: There are also combinations of both toe and axle misalignment which will put stress on just one steer tire.

Result: Here, the toe-in setting combined with right thrust misalignment causes the left front to wear normally while the right front feel like toe-in.



RIGHT THRUST, TOE-OUT

Cause: On the other hand, toe-out combined with right thrust will cause the front right to wear normally but places stress on the left.

Result: Standard wear on the right side with wear resembling toe-out.

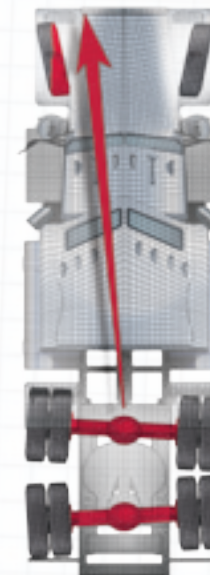



PRODUCT LINE-UP

At Yokohama, we understand that each of our customers presents their own unique set of business challenges and needs products tailored specifically to address their needs. Our engineers are constantly pushing the envelope in an effort to deliver the perfect combinations of specialized compounding, innovative tread features and reliable casing construction. So whether you're hauling through a mountain pass or traversing a debris ridden work site, you can feel confident that Yokohama offers a wide variety of high quality commercial products to fit each of your application specific needs.



PRODUCT LINE-UP

TRUCK STEEL RADIAL

Steer & All-Position

43 / 101ZL Spec-2

44 / RY617

45 / 104ZR/104ZR Spec-2

46 / RY023

Drive Tires

47 / 709ZL

48 / 703ZL

49 / TY527

50 / TY577

51 / TY517 /TY517 MC²

52 / TY303

53 / TY287

54 / SY767

Line Haul Trailer and Other

55 / RY587

56 / RY103

Ultra Wide Base

57 / TY517 UWB

58 / 902L UWB

59 / RY407 UWB

Wide Base

60 / MY507A

61 / RY253

On/Off-Highway / Mix Service

62 / MY507

63 / MY627W Spec-2

64 / LY053

LIGHT TRUCK COMMERCIAL

Highway All-Position

65 / Y788R

66 / TY213A

67 / RY103/R Y103A

68 / RY215

Highway Traction

69 / TY303A

70 / Y742S

71 / Y735B

72 / TY025

101ZL Spec-2

TRUCK STEEL RADIAL

APPLICATION

LONG-HAUL, STEER/ALL-POSITION

SmartWay
Verified



The 101ZL Spec-2 represents our next generation of long-haul steer tire. Built with an advanced tread compound and improved casing design to enable longer treadwear, maximum durability and more retreads.

FEATURES AND BENEFITS

An Advanced Casing Profile that supports a wider belt package and delivers a more uniform footprint.

Pliable High-Elongation Tread Compound helps withstand the wear and tear caused by the lateral forces unique to steer tire positions.

Contact Pressure Equalizer Sipes optimize rib contact pressure to combat uneven wear and improve wet handling and braking.

Stress equalizer ribs ensure even shoulder edge contact pressure to the road and reduce shoulder step down wear.



101ZL Spec-2 replaces: Michelin XZA3+ • Evertread • Goodyear G399 LHS • Bridgestone R283 Ecopia

TIRE SIZE	PART NUMBER	PLY RATING (L.R.)	TIRE WEIGHT (LBS)	RIM SIZE (INCH)		INFLATED DIMENSIONS		TREAD DEPTH (1/32")	LOADED DIMENSIONS		RPM	MAX LOAD CAPACITY AT COLD INFLATION PRESSURE				MAX SPEED (MPH)
				MEASURE	ALT	OVERALL WIDTH (INCH)	OVERALL DIAMETER (INCH)		SECTION WIDTH (INCH)	STATIC RADIUS (INCH)		LB/PSI SINGLE	LB/PSI DUAL	KG/KPA SINGLE	KG/KPA DUAL	
295/75R22.5	71125	14G	117.5	9.00	8.25	11.5	40.0	18	12.5	18.7	522	6175@110	5675@110	2800@760	2575@760	75
295/75R22.5	71121	16H	119.0	9.00	8.25	11.5	40.0	18	12.5	18.7	522	7160@120	6610@120	3250@830	3000@830	75
11R22.5	71126	14G	119.9	8.25	7.50	11.0	41.3	18	12.1	19.3	505	6175@105	5840@105	2800@720	2650@720	75
11R22.5	71122	16H	120.1	8.25	7.50	11.0	41.3	18	12.1	19.3	505	6610@120	6005@120	3000@830	2725@830	75
285/75R24.5	71128	14G	122.4	8.25	NONE	11.1	41.3	18	12.1	19.3	505	6175@110	5675@110	2800@760	2575@760	75
11R24.5	71127	14G	128.0	8.25	7.50	11.1	43.3	18	12.3	20.2	481	6610@105	6005@105	3000@720	2725@720	75
11R24.5	71124	16H	128.1	8.25	7.50	11.1	43.3	18	12.3	20.2	481	7160@120	6610@120	3250@830	3000@830	75

RY617

TRUCK STEEL RADIAL

APPLICATION

LONG-HAUL, STEER/ALL-POSITION

SmartWay
Verified



The RY617 has all the traditional Yokohama qualities that savvy buyers have come to rely upon, along with the latest features that deliver long, even wear, enhanced wet traction and durability.

FEATURES AND BENEFITS

Five-Rib Tread Designs equipped with 6,000 stress control sipes provide excellent water evacuation and uniform wear.

Variable Contour Groove Wall provides added rib stiffness that further combats uneven treadwear.

Stress Wear Control Groove (SCG) reduces contact pressure at the tread edge, providing increased resistance to shoulder step down wear and promoting long even wear, particularly at the shoulder area.

Stone Ejectors deep inside the tread grooves keep stones from embedding into the tire to minimize drill damage for increased tread durability and extended casing life.



RY617 replaces: Michelin XZA-1+ • Goodyear G395 LHS • Bridgestone R280

TIRE SIZE	PART NUMBER	PLY RATING (L.R.)	TIRE WEIGHT (LBS)	RIM SIZE (INCH)		INFLATED DIMENSIONS		TREAD DEPTH (1/32")	LOADED DIMENSIONS		RPM	MAX LOAD CAPACITY AT COLD INFLATION PRESSURE				MAX SPEED (MPH)
				MEASURE	ALT	OVERALL WIDTH (INCH)	OVERALL DIAMETER (INCH)		SECTION WIDTH (INCH)	STATIC RADIUS (INCH)		LB/PSI SINGLE	LB/PSI DUAL	KG/KPA SINGLE	KG/KPA DUAL	
295/75R22.5	61701	14G	108.9	9.00	8.25	10.9	40.1	18	12.0	18.7	520	6175@110	5675@110	2800@760	2575@760	75
295/75R22.5	61721	16H	111.1	9.00	8.25	10.9	40.1	18	12.0	18.7	520	6610@120	6005@120	3000@830	2725@830	75
11R22.5	61702	14G	114.1	8.25	7.50	11.1	41.3	18	12.0	19.5	502	6175@105	5840@105	2800@720	2650@720	75
11R22.5	61722	16H	116.6	8.25	7.50	11.1	41.3	18	12.0	19.5	502	6610@120	6005@120	3000@830	2725@830	75
285/75R24.5	61703	14G	112.1	8.25	NONE	10.8	41.3	18	11.8	19.8	499	6175@110	5675@110	2800@760	2575@760	75
11R24.5	61704	14G	122.3	8.25	7.50	11.1	43.3	18	12.0	20.2	481	6610@105	6005@105	3000@720	2725@720	75
11R24.5	61724	16H	124.9	8.25	7.50	11.1	43.3	18	12.0	20.2	481	7160@120	6610@120	3250@830	3000@830	75

104ZR/104ZR Spec-2

TRUCK STEEL RADIAL

APPLICATION

LONG- AND REGIONAL-HAUL, ALL-POSITION



A true workhorse designed to deliver longer treadwear, low rolling resistance and enhanced traction.

FEATURES AND BENEFITS

Deep original tread depth offers an extremely long treadlife to reduce downtime.

Serpentine Groove Pattern is built specifically to reduce premature shoulder step-down and irregular wear, further preserving overall treadlife.

Block-Shaped Stone Ejectors prevent stones from traveling to the bottom of the grooves, reducing damage to the casing by 25% to ensure greater durability and retreadability.

Ultra-Wide Top Steel Belt increases rigidity across the entire tread surface for enhanced durability and to prevent casing damage.

104ZR Spec-2 315/80R22.5 is the ideal tire for coach and regional/long-haul tour bus applications.



104ZR/104ZR Spec-2 replaces: Michelin XZE-2 • Goodyear G661 HSA, G662 RSA • Bridgestone R268 Ecopia, R260F

TIRE SIZE	PART NUMBER	PLY RATING (L.R.)	TIRE WEIGHT (LBS)	RIM SIZE (INCH)		INFLATED DIMENSIONS		TREAD DEPTH (1/32")	LOADED DIMENSIONS		RPM	MAX LOAD CAPACITY AT COLD INFLATION PRESSURE				MAX SPEED (MPH)
				MEASURE	ALT	OVERALL WIDTH (INCH)	OVERALL DIAMETER (INCH)		SECTION WIDTH (INCH)	STATIC RADIUS (INCH)		LB/PSI SINGLE	LB/PSI DUAL	KG/KPA SINGLE	KG/KPA DUAL	
9R22.5	74731	12F	87.6	6.75	6.00 - 7.50	9.1	38.1	17	9.9	17.9	546	4540@105	4300@105	2060@720	1950@720	75
10R22.5	74732	14G	97.4	7.50	6.75 - 8.25	10.1	40.1	18	11.1	18.7	520	5675@115	5355@115	2575@790	2430@790	75
11R22.5	74737	16H	122.6	8.25	7.50	10.9	41.6	20	12.0	19.4	502	6610@120	6005@120	3000@830	2725@830	75
12R22.5	74733	16H	139.1	9.00	8.25	11.8	42.7	20	13.0	19.8	490	7390@120	6780@120	3350@830	3075@830	75
295/80R22.5	74736	16H	149.1	9.00	8.25	11.9	41.6	20	13.0	19.3	502	7830@123	6945@123	3550@850	3150@850	75
315/80R22.5*	74738	20L	149.1	9.00	9.75	12.4	42.5	21	13.6	19.6	493	9000@130	8255@130	4085@900	3745@900	75

*104ZR Spec-2

RY023

TRUCK STEEL RADIAL

APPLICATION

REGIONAL HIGHWAY, ALL-POSITION

SmartWay
Verified

STEM
StrainEnergy Minimization

Premium performance and durable construction for the most demanding applications.

FEATURES AND BENEFITS

Sidewall Abrasion Guard reduces damage to the sidewall caused by curbing and other accidental scrubbing.

Five-Rib Tread Pattern with semi-rounded shoulders reduces the potential for shoulder ripping and tearing while enhancing lateral stability, water dispersion and traction.

Rock-Ejector Platforms keep stones and debris out of the grooves to help thwart irregular wear.

Hexagonal Bead Base allows for easier mounting and even pressure along the entire circumference of the wheel for smooth rolling as well as increased driver comfort.



RY023 replaces: Michelin XZE • Goodyear G661 HAS • Bridgestone R250F

TIRE SIZE	PART NUMBER	PLY RATING (L.R.)	TIRE WEIGHT (LBS)	RIM SIZE (INCH)		INFLATED DIMENSIONS		TREAD DEPTH (1/32")	LOADED DIMENSIONS		RPM	MAX LOAD CAPACITY AT COLD INFLATION PRESSURE				MAX SPEED (MPH)
				MEASURE	ALT	OVERALL WIDTH (INCH)	OVERALL DIAMETER (INCH)		SECTION WIDTH (INCH)	STATIC RADIUS (INCH)		LB/PSI SINGLE	LB/PSI DUAL	KG/KPA SINGLE	KG/KPA DUAL	
215/75R17.5	02385	16H	62.6	6.00	6.75	8.5	30.6	15	9.1	14.2	674	4805@125	4540@125	3250@830	3000@830	75
235/75R17.5	02386	16H	71.2	6.75	7.50	9.4	31.7	16	10.0	14.6	661	6005@125	5675@125	2725@860	2575@860	75
225/70R19.5	02389	12F	67.6	6.75	6.00	8.7	31.8	16	9.4	14.8	652	3640@95	3415@95	1650@660	1550@660	75
245/70R19.5	02399	14G	79.8	7.50	6.75	9.8	33.3	16	10.6	15.5	628	4540@110	4300@110	2060@760	1950@760	75
265/70R19.5	02398	14G	87.3	7.50	6.75	10.3	34.3	17	11.1	15.8	612	5070@110	4675@110	2300@760	2120@760	75
285/70R19.5	02397	16H	95.7	8.25	7.50	11.1	35.1	17	12.0	16.3	597	6615@131	6175@131	3000@830	2725@830	75
255/70R22.5	02387	16H	90.8	7.50	6.75 - 8.25	10.0	36.7	18	10.8	17.2	568	5510@120	5070@120	2500@830	2300@830	75
295/75R22.5	02396	14G	119.9	9.00	8.25	11.1	40.2	19	12.1	18.7	520	6175@110	5675@100	2800@760	2575@760	75
295/75R22.5	02391	16H	119.9	9.00	8.25	11.1	40.2	19	12.1	18.7	520	6610@120	6005@120	3000@830	2725@830	75
11R22.5	02395	14G	119.5	8.25	7.50	10.8	41.4	19	11.9	19.3	504	6175@105	5840@105	2800@720	2650@720	75
11R22.5	02392	16H	120.4	8.25	7.50	10.8	41.4	19	11.9	19.3	504	6610@120	6005@120	3000@830	2725@830	75
285/75R24.5	02390	14G	118.4	8.25	NONE	10.9	41.4	19	11.9	19.2	505	6175@110	5675@110	2800@760	2575@760	75
11R24.5	02393	14G	127.6	8.25	7.50	10.7	43.4	19	11.9	20.0	483	6610@105	6005@105	3000@720	2725@720	75
11R24.5	02394	16H	127.9	8.25	7.50	10.7	43.4	19	11.9	20.0	483	7160@120	6610@120	3250@830	3000@830	75

709ZL

TRUCK STEEL RADIAL

APPLICATION
LONG-HAUL, DRIVE

SmartWay
Verified



A premium drive tire that's as uncompromising as it is reliable. With its specialized compound and unique tread elements, the 709ZL™ delivers the optimum balance of fuel economy, treadwear and traction.

FEATURES AND BENEFITS

Zenvironment Compound evenly disperses molecular elements, resulting in a longer lasting tread and lower rolling resistance for better fuel economy.

26/32" tread depth minimizes tread block movement for stability on the road and maximum fuel efficiency.

Tie-Bar Connectors increase block rigidity and reduce heel-toe wear for greater stability.

Z-blocks create multiple biting edges, providing aggressive all-season traction without sacrificing treadwear.



709ZL replaces: Michelin X Line Energy D • Goodyear FM G505D LHD, G305 AT LHS • Bridgestone M710 Ecopia

TIRE SIZE	PART NUMBER	PLY RATING (L.R.)	TIRE WEIGHT (LBS)	RIM SIZE (INCH)		INFLATED DIMENSIONS		TREAD DEPTH (1/32")	LOADED DIMENSIONS		RPM	MAX LOAD CAPACITY AT COLD INFLATION PRESSURE				MAX SPEED (MPH)
				MEASURE	ALT	OVERALL WIDTH (INCH)	OVERALL DIAMETER (INCH)		SECTION WIDTH (INCH)	STATIC RADIUS (INCH)		LB/PSI SINGLE	LB/PSI DUAL	KG/KPA SINGLE	KG/KPA DUAL	
295/75R22.5	70901	14G	127.2	9.00	8.25	11.6	40.6	26	12.6	18.9	514	6175@110	5675@110	2800@760	2575@760	75
11R22.5	70902	14G	130.2	8.25	7.50	11.0	41.9	26	12.1	19.5	497	6175@105	5840@105	2800@720	2650@720	75
285/75R24.5	70903	14G	129.4	8.25	NONE	11.1	41.8	26	12.0	19.6	498	6175@110	5675@110	2800@760	2575@760	75
11R24.5	70904	14G	137.0	8.25	7.50	11.0	43.9	26	12.1	20.5	473	6610@105	6005@105	3000@720	2725@720	75

703ZL

TRUCK STEEL RADIAL

APPLICATION
LONG-HAUL, DRIVE

SmartWay
Verified



703ZL was developed with a compound, tread design and casing construction that offer longer treadwear and the lowest rolling resistance in the category.

FEATURES AND BENEFITS

The deepest original tread depth of any line haul drive tire in the industry (32/32") for extremely long original treadwear.

Zenvironment compound reduces heat build-up, improves treadwear and provides the lowest rolling resistance in its category.

Funnel-Shaped Grooves are wider at the top for enhanced traction and narrow at the base to prevent stone penetration for extended casing life.



703ZL replaces: Michelin XDA5+ • Goodyear G572 LHD • Bridgestone M726EL

TIRE SIZE	PART NUMBER	PLY RATING (L.R.)	TIRE WEIGHT (LBS)	RIM SIZE (INCH)		INFLATED DIMENSIONS		TREAD DEPTH (1/32")	LOADED DIMENSIONS		RPM	MAX LOAD CAPACITY AT COLD INFLATION PRESSURE				MAX SPEED (MPH)
				MEASURE	ALT	OVERALL WIDTH (INCH)	OVERALL DIAMETER (INCH)		SECTION WIDTH (INCH)	STATIC RADIUS (INCH)		LB/PSI SINGLE	LB/PSI DUAL	KG/KPA SINGLE	KG/KPA DUAL	
295/75R22.5	77101	14G	129.9	9.00	8.25	11.5	40.9	32	14.0	19.1	510	6175@110	5675@110	2800@760	2575@760	75
295/75R22.5	77121	16H	129.9	9.00	8.25	11.5	40.9	32	12.5	19.1	510	6610@120	6005@120	3000@830	2725@830	75
11R22.5	77102	14G	134.0	8.25	7.50	11.0	42.3	32	12.1	19.7	494	6175@105	5840@105	2800@720	2650@720	75
11R22.5	77122	16H	139.6	8.25	7.50	11.0	42.3	32	12.1	19.7	494	6610@120	6005@120	3000@830	2725@830	75
285/75R24.5	77103	14G	132.1	8.25	NONE	11.1	42.2	32	12.0	19.8	493	6175@110	5675@110	2800@760	2575@760	75
11R24.5	77104	14G	139.8	8.25	7.50	11.0	44.3	32	12.2	20.7	471	6610@105	6005@105	3000@720	2725@720	75
11R24.5	77124	16H	140.4	8.25	7.50	11.0	44.3	32	12.2	20.7	471	7160@120	6610@120	3250@830	3000@830	75

TY527

TRUCK STEEL RADIAL

APPLICATION

LONG- AND REGIONAL-HAUL, DRIVE



Built to meet the needs of today's modern fleets, the TY527 is designed to maximize original tread life, durability, retreadability, and to reduce rolling resistance.

FEATURES AND BENEFITS

32/32" original tread depth and Special Cap Compound ensure long wear without sacrificing durability.

Temperature Controlling Cap Compound fights heat generation.

Distinct Directional Tread promotes even wear and exceptional traction.

Stone Damage Prevention Grooves protect casing integrity to extend casing life.



TY527 replaces: Michelin XDA5+ • Goodyear G572 LHD • Bridgestone M726EL

TIRE SIZE	PART NUMBER	PLY RATING (L.R.)	TIRE WEIGHT (LBS)	RIM SIZE (INCH)		INFLATED DIMENSIONS		TREAD DEPTH (1/32")	LOADED DIMENSIONS		RPM	MAX LOAD CAPACITY AT COLD INFLATION PRESSURE				MAX SPEED (MPH)
				MEASURE	ALT	OVERALL WIDTH (INCH)	OVERALL DIAMETER (INCH)		SECTION WIDTH (INCH)	STATIC RADIUS (INCH)		LB/PSI SINGLE	LB/PSI DUAL	KG/KPA SINGLE	KG/KPA DUAL	
295/75R22.5	52701	14G	129.1	9.00	8.25	11.1	41.0	32	12.2	19.2	512	6175@110	5675@110	2800@760	2575@760	75
11R22.5	52702	14G	132.9	8.25	7.50	10.9	42.4	32	11.9	19.8	494	6175@105	5840@105	2800@720	2650@720	75
285/75R24.5	52703	14G	130.8	8.25	NONE	10.8	42.3	32	11.8	19.8	495	6175@110	5675@110	2800@760	2575@760	75
11R24.5	52704	14G	138.8	8.25	7.50	11.0	44.4	32	12.1	20.9	471	6610@105	6005@105	3000@720	2725@720	75

TY577

TRUCK STEEL RADIAL

APPLICATION
LONG-HAUL, DRIVE



Designed to tackle the needs of the long-haul trucker, TY577 is engineered to promote long wear and fuel-economy while maximizing retreadability.

FEATURES AND BENEFITS

30/32" deep groove depth provides extremely long, original wear and delivers firm road grip while minimizing heat generation.

Stress Wear Control Groove creates an even footprint, reducing the occurrence of shoulder step down wear.

Contoured Bead Shape design allows the tire to sit evenly against the rim for extremely high uniform rolling.

Funnel-Shaped Groove Wall provides enhanced traction while reducing stone retention.

Closed Shoulder Rib creates more rubber on the outside ribs for extended tire life.



TY577 replaces: Michelin XDN-2 • Goodyear G372 • Bridgestone M726

TIRE SIZE	PART NUMBER	PLY RATING (L.R.)	TIRE WEIGHT (LBS)	RIM SIZE (INCH)		INFLATED DIMENSIONS		TREAD DEPTH (1/32")	LOADED DIMENSIONS		RPM	MAX LOAD CAPACITY AT COLD INFLATION PRESSURE				MAX SPEED (MPH)
				MEASURE	ALT	OVERALL WIDTH (INCH)	OVERALL DIAMETER (INCH)		SECTION WIDTH (INCH)	STATIC RADIUS (INCH)		LB/PSI SINGLE	LB/PSI DUAL	KG/KPA SINGLE	KG/KPA DUAL	
295/75R22.5	57701	14G	118.2	9.00	8.25	11.4	40.9	30	12.4	19.1	513	6175@110	5675@110	2800@760	2575@760	75
295/75R22.5	57721	16H	121.9	9.00	8.25	11.4	40.7	30	12.4	19.1	513	6610@120	6005@120	3000@830	2725@830	75
11R22.5	57702	14G	121.7	8.25	7.50	11.1	42.2	30	12.2	19.6	496	6175@105	5840@105	2800@720	2650@720	75
11R22.5	57722	16H	125.7	8.25	7.50	11.1	42.2	30	12.2	19.6	496	6610@120	6005@120	3000@830	2725@830	75
285/75R24.5	57703	14G	128.7	8.25	NONE	10.9	42.2	30	11.9	19.6	497	6175@110	5675@110	2800@760	2575@760	75
11R24.5	57704	14G	131.4	8.25	7.50	10.9	44.3	30	12.2	20.7	472	6610@105	6005@105	3000@720	2725@720	75
11R24.5	57724	16H	136.5	8.25	7.50	11.1	44.0	30	12.2	20.7	472	7160@120	6610@120	3250@830	3000@830	75

TY517/TY517 MC²

TRUCK STEEL RADIAL

APPLICATION

LONG- AND REGIONAL-HAUL, DRIVE

SmartWay
Verified



By combining the maximum drive axle power of our popular TY517™ with our fuel-saving MC² technology, we've engineered a long-haul tire that really drives your profits.

FEATURES AND BENEFITS

28/32" original tread depth delivers long wear and road-grabbing power for the long haul without any compromises in traction.

Extra-Wide Circumferential Grooves are self-cleaning and V-shaped for improved water dispersion, lateral stability and long, even wear.

Advanced Tread Compound Technology reduces heat, provides longer wear and reduces rolling resistance.

Tapered Center Groove promotes stone ejection and reduces tread-stone damage.

Solid Outer Shoulder block contributes to flat, even wear.



TY517/TY517 MC² replaces: Michelin XDA-E, XDA-E • Goodyear G622 RSD, G305 AT LHS, G362 LHD • Bridgestone M710 Ecopia, M760 Ecopia

TIRE SIZE	PART NUMBER	PLY RATING (L.R.)	TIRE WEIGHT (LBS)	RIM SIZE (INCH)		INFLATED DIMENSIONS		TREAD DEPTH (1/32")	LOADED DIMENSIONS		RPM	MAX LOAD CAPACITY AT COLD INFLATION PRESSURE				MAX SPEED (MPH)
				MEASURE	ALT	OVERALL WIDTH (INCH)	OVERALL DIAMETER (INCH)		SECTION WIDTH (INCH)	STATIC RADIUS (INCH)		LB/PSI SINGLE	LB/PSI DUAL	KG/KPA SINGLE	KG/KPA DUAL	
TY517																
295/75R22.5	51721	16H	120.3	9.00	8.25	11.4	40.7	28	12.4	19.1	512	6610@120	6005@120	3000@830	2725@830	75
11R22.5	51722	16H	123.3	8.25	7.50	11.1	42.0	28	12.0	19.6	497	6610@120	6005@120	3000@830	2725@830	75
11R24.5	51724	16H	131.9	8.25	7.50	11.1	44.1	28	12.0	20.6	474	7160@120	6610@120	3250@830	3000@830	75
TY517 MC²																
295/75R22.5	51725	14G	120.3	9.00	8.25	11.4	40.7	28	12.4	19.1	512	6175@110	5675@110	2800@760	2575@760	75
11R22.5	51726	14G	123.3	8.25	7.50	11.1	42.0	28	12.0	19.6	494	6175@105	5840@105	2800@720	2650@720	75
285/75R24.5	51727	14G	123.1	8.25	NONE	10.9	42.0	28	11.9	19.7	495	6175@110	5675@110	2800@760	2575@760	75
11R24.5	51728	14G	131.9	8.25	7.50	11.1	44.1	28	12.0	20.6	473	6610@105	6005@105	3000@720	2725@720	75

TY303

TRUCK STEEL RADIAL

APPLICATION

ON-HIGHWAY, DRIVE

TY303 is a deep-treaded workhorse designed for on-highway operations.

FEATURES AND BENEFITS

Tread Compound generates long, even wear.

Unique arrangement of Shoulder Lug Grooves promotes even treadwear.

Rib Block Tread Design is ultra-durable and provides lower rolling resistance as well as reliable traction in snow.



TY303 replaces: Michelin XDE-MS • Goodyear G182 RSD • Bridgestone M726, M729F

TIRE SIZE	PART NUMBER	PLY RATING (L.R.)	TIRE WEIGHT (LBS)	RIM SIZE (INCH)		INFLATED DIMENSIONS		TREAD DEPTH (1/32")	LOADED DIMENSIONS		RPM	MAX LOAD CAPACITY AT COLD INFLATION PRESSURE				MAX SPEED (MPH)
				MEASURE	ALT	OVERALL WIDTH (INCH)	OVERALL DIAMETER (INCH)		SECTION WIDTH (INCH)	STATIC RADIUS (INCH)		LB/PSI SINGLE	LB/PSI DUAL	KG/KPA SINGLE	KG/KPA DUAL	
225/70R19.5	30319	12F	69.9	6.75	6.00	8.7	32.0	20	9.4	15.0	651	3640@95	3415@95	1650@660	1550@660	75
265/70R19.5	30315	14G	86.9	7.50	8.25	10.3	34.4	21	11.2	15.9	609	5070@110	4675@110	2300@760	2120@760	75
285/70R19.5	30316	16H	98.0	8.25	7.50-9.00	11.1	35.4	21	12.1	16.4	591	6615@131	6175@131	3000@900	2800@900	75
255/70R22.5	30312	16H	96.4	7.50	8.25	10.0	37.0	24	10.8	17.3	563	5510@120	5070@120	2500@830	2300@830	75

TY287

TRUCK STEEL RADIAL

APPLICATION
REGIONAL-HAUL, DRIVE



TY287 combines all-season performance with technology to maximize treadlife.

FEATURES AND BENEFITS

Wide Twin Straight Grooves provide exceptional water evacuation.

Open Shoulder Block Design and uniquely-shaped Center Block enable all-season performance.

Three Pitch Variation reduces road noise for a quiet, comfortable ride.



TY287 replaces: Michelin XDS-2 • Goodyear G622 RSD • Bridgestone M895

TIRE SIZE	PART NUMBER	PLY RATING (L.R.)	TIRE WEIGHT (LBS)	RIM SIZE (INCH)		INFLATED DIMENSIONS		TREAD DEPTH (1/32")	LOADED DIMENSIONS		RPM	MAX LOAD CAPACITY AT COLD INFLATION PRESSURE				MAX SPEED (MPH)
				MEASURE	ALT	OVERALL WIDTH (INCH)	OVERALL DIAMETER (INCH)		SECTION WIDTH (INCH)	STATIC RADIUS (INCH)		LB/PSI SINGLE	LB/PSI DUAL	KG/KPA SINGLE	KG/KPA DUAL	
225/70R19.5	28702	12F	72.1	6.75	6.00	8.9	32.0	20	9.5	15.0	651	3640@95	3415@95	1650@660	1550@660	75

SY767

TRUCK STEEL RADIAL

APPLICATION
ON-HIGHWAY, DRIVE



SY767 sports an all-season compound and optimized tread pattern to overcome inclement conditions and extend treadlife.

FEATURES AND BENEFITS

Multi-Season Rubber Compound provides superior grip and wear resistance.

Extensive Grooving and Siping maximize biting edges for enhanced traction while Closed Sipes increase traction without sacrificing block rigidity.

Deep Wide Grooves efficiently evacuate water to maximize contact with the road surface.

Extra-Wide Tread matched with 26/32" tread depth promotes great handling stability and long even wear.



SY767 replaces: Michelin XDE-MS • Goodyear G362 LHD • Bridgestone M711, M770, M799

TIRE SIZE	PART NUMBER	PLY RATING (L.R.)	TIRE WEIGHT (LBS)	RIM SIZE (INCH)		INFLATED DIMENSIONS		TREAD DEPTH (1/32")	LOADED DIMENSIONS		RPM	MAX LOAD CAPACITY AT COLD INFLATION PRESSURE				MAX SPEED (MPH)
				MEASURE	ALT	OVERALL WIDTH (INCH)	OVERALL DIAMETER (INCH)		SECTION WIDTH (INCH)	STATIC RADIUS (INCH)		LB/PSI SINGLE	LB/PSI DUAL	KG/KPA SINGLE	KG/KPA DUAL	
11R22.5	76722	16H	129.3	8.25	7.50	10.9	41.9	26	12.1	19.6	497	6610@120	6005@120	3000@830	2725@830	75
11R24.5	76724	16H	136.3	8.25	7.50	10.9	43.9	26	12.1	20.5	475	7160@120	6610@120	3250@830	3000@830	75

RY587

TRUCK STEEL RADIAL

APPLICATION

LONG- AND REGIONAL-HAUL, TRAILER

SmartWay
Verified

STEM
StrainEnergy Minimization

With a unique combination of long, even original tread mileage, lower fuel consumption, outstanding durability and trouble-free operation, the RY587 is the perfect choice for today's long-haul trucking fleets.

FEATURES AND BENEFITS

Stress Wear Control Grooves minimize pressure at the edge of the tread, resulting in a dramatic reduction of free-rolling wear.

Advanced tread compound technology provides longer wear and reduces rolling resistance, resulting in lower fuel consumption.

Stone Ejector Ribs prevent stones from reaching the bottom of the groove to prevent premature casing damage.

Belt Edge Cushion and Edge Cover Sheet allow steel belt edge flexibility by bonding tightly for reduced strain and longer casing life.

Distinctive Five-Rib Tread Design allows for effective water evacuation.



RY587 replaces: Michelin X Line Energy T, XTE • Goodyear G316 LHT • Bridgestone R197 Ecopia

TIRE SIZE	PART NUMBER	PLY RATING (L.R.)	TIRE WEIGHT (LBS)	RIM SIZE (INCH)		INFLATED DIMENSIONS		TREAD DEPTH (1/32")	LOADED DIMENSIONS		RPM	MAX LOAD CAPACITY AT COLD INFLATION PRESSURE				MAX SPEED (MPH)
				MEASURE	ALT	OVERALL WIDTH (INCH)	OVERALL DIAMETER (INCH)		SECTION WIDTH (INCH)	STATIC RADIUS (INCH)		LB/PSI SINGLE	LB/PSI DUAL	KG/KPA SINGLE	KG/KPA DUAL	
295/75R22.5	58711	14G	101.0	9.00	8.25	11.4	39.8	13	12.4	18.5	525	6175@110	5675@110	2800@760	2575@760	75
11R22.5	58702	14G	106.9	8.25	7.50	11.1	41.1	13	12.0	19.1	509	6175@105	5840@105	2800@720	2650@720	75
285/75R24.5	58703	14G	106.9	8.25	NONE	10.9	41.0	13	11.9	19.2	508	6175@110	5675@110	2800@760	2575@760	75
11R24.5	58704	14G	115.1	8.25	7.50	10.9	43.0	13	12.0	20.0	485	6610@105	6005@105	3000@720	2725@720	75

RY103

TRUCK STEEL RADIAL

APPLICATION

ON-HIGHWAY/IN-CITY, LOW-PROFILE, ALL-POSITION



The versatile and reliable RY103 incorporates low-profile engineering with quality construction for better mileage, more payload potential, improved handling and better stability.

FEATURES AND BENEFITS

Straight Five-Rib Tread Design with four grooves inhibits stone retention, promotes even wear and provides a smooth ride, improved handling and superior wet traction.

Wide Shoulder Ribs reduce shoulder step wear.

Each size is manufactured with a specific tread depth to meet a greater range of applications.



RY103 replaces: Michelin XZA • Goodyear G114 LHT • Bridgestone R250

TIRE SIZE	PART NUMBER	PLY RATING (L.R.)	TIRE WEIGHT (LBS)	RIM SIZE (INCH)		INFLATED DIMENSIONS		TREAD DEPTH (1/32")	LOADED DIMENSIONS		RPM	MAX LOAD CAPACITY AT COLD INFLATION PRESSURE				MAX SPEED (MPH)
				MEASURE	ALT	OVERALL WIDTH (INCH)	OVERALL DIAMETER (INCH)		SECTION WIDTH (INCH)	STATIC RADIUS (INCH)		LB/PSI SINGLE	LB/PSI DUAL	KG/KPA SINGLE	KG/KPA DUAL	
245/75R22.5	10302	14G	85.1	7.50	6.75	9.7	37.3	17	10.4	17.5	558	4675@110	4300@110	2120@760	1950@760	75
265/75R22.5	10304	14G	98.3	7.50	8.25	10.0	38.4	17	10.8	18.1	541	5205@110	4805@110	2360@760	2180@760	75
275/70R22.5	10382	16H	107.5	8.25	7.50	10.8	37.7	17	11.6	17.6	553	6610@125	6175@125	3000@830	2800@860	75

TY517 UWB

TRUCK STEEL RADIAL

APPLICATION

LONG- AND REGIONAL-HAUL, DRIVE

SmartWay
Verified



The durable, long-lasting TY517 UWB is built with the latest features and technologies to lighten your load without sacrificing performance.

FEATURES AND BENEFITS

Zero Degree Belt provides even pressure around the tire which reduces deflection, decreasing rolling resistance.

Oversized Hexagonal Bead and Double Nylon Chafer allow for easier mounting and provide even pressure along the wheel's circumference to increase tire life.

Ultra Wide Circumferential Grooves offer enhanced wet traction, lateral stability and long, even wear.

Tapered Center Groove promotes stone ejection.

An Advanced Profile is optimized to manage the strain that occurs during normal operation, reducing casing fatigue.



TY517 UWB replaces: Michelin X One Line Energy D • Goodyear G392 SSD • Bridgestone Greatec M835 Ecopia

TIRE SIZE	PART NUMBER	PLY RATING (L.R.)	TIRE WEIGHT (LBS)	RIM SIZE (INCH)		INFLATED DIMENSIONS		TREAD DEPTH (1/32")	LOADED DIMENSIONS		RPM	MAX LOAD CAPACITY AT COLD INFLATION PRESSURE				MAX SPEED (MPH)
				MEASURE	ALT	OVERALL WIDTH (INCH)	OVERALL DIAMETER (INCH)		SECTION WIDTH (INCH)	STATIC RADIUS (INCH)		LB/PSI SINGLE	LB/PSI DUAL	KG/KPA SINGLE	KG/KPA DUAL	
445/50R22.5	51761	20L	204.7	14.00	NONE	17.5	40.2	24	18.6	18.6	522	10200@120	N/A	4625@830	N/A	75

902L UWB

TRUCK STEEL RADIAL

APPLICATION

LONG- AND REGIONAL-HAUL, DRIVE



The 902L UWB offers operators outstanding all-season traction, long original treadlife, low rolling resistance and a casing made to handle more retreads than the competition.

FEATURES AND BENEFITS

27/32" tread depth delivers maximum traction and extra-long treadlife.

Zero Degree Belt provides even weight distribution for a stable footprint and increased treadlife.

Small Block And Sipe Combo is engineered to reduce wear and improve fuel efficiency.

Advanced Rubber Compound reduces heat generation to optimize fuel economy.

Casing is created specifically to reduce tire strain, prevent casing growth and maximize retreadability.

Dual Sipes improve acceleration and braking on ice.



902L UWB replaces: Michelin X One XDN-2 • Goodyear G392 SSD • Bridgestone Greatec M825

TIRE SIZE	PART NUMBER	PLY RATING (L.R.)	TIRE WEIGHT (LBS)	RIM SIZE (INCH)		INFLATED DIMENSIONS		TREAD DEPTH (1/32")	LOADED DIMENSIONS		RPM	MAX LOAD CAPACITY AT COLD INFLATION PRESSURE				MAX SPEED (MPH)
				MEASURE	ALT	OVERALL WIDTH (INCH)	OVERALL DIAMETER (INCH)		SECTION WIDTH (INCH)	STATIC RADIUS (INCH)		LB/PSI SINGLE	LB/PSI DUAL	KG/KPA SINGLE	KG/KPA DUAL	
445/50R22.5	90281	20L	208.6	14.00	NONE	17.5	40.4	27	18.5	18.7	519	10200@120	N/A	4625@830	N/A	75

RY407 UWB

TRUCK STEEL RADIAL

APPLICATION

LONG- AND REGIONAL-HAUL, TRAILER

SmartWay
Verified



The long-lasting, fuel-efficient RY407 UWB is designed to reduce vehicle weight and make your business more efficient.

FEATURES AND BENEFITS

Zero Degree Belt ensures even pressure across the contact patch, allowing for even weight distribution and vastly increased treadlife.

Oversized Hexagonal Bead and Double Nylon Chafer allow for easier mounting and provide even pressure along the wheel's circumference to increase tire life.

Advanced Rubber Compound minimizes heat buildup in the tread area to reduce rolling resistance and allow for deeper tread depths.

Seven Circumferential Grooves and Cross Sipes provide excellent water evacuation and help resist irregular wear.



RY407 UWB replaces: Michelin X One Line Energy T, X One Multi Energy T, One XTE • Goodyear G392 SST • Bridgestone Greatec R135 Ecopia

TIRE SIZE	PART NUMBER	PLY RATING (L.R.)	TIRE WEIGHT (LBS)	RIM SIZE (INCH)		INFLATED DIMENSIONS		TREAD DEPTH (1/32")	LOADED DIMENSIONS		RPM	MAX LOAD CAPACITY AT COLD INFLATION PRESSURE				MAX SPEED (MPH)
				MEASURE	ALT	OVERALL WIDTH (INCH)	OVERALL DIAMETER (INCH)		SECTION WIDTH (INCH)	STATIC RADIUS (INCH)		LB/PSI SINGLE	LB/PSI DUAL	KG/KPA SINGLE	KG/KPA DUAL	
445/50R22.5	40761	20L	185.6	14.00	NONE	17.2	39.6	16	18.3	18.3	528	10200@120	N/A	4625@830	N/A	75

MY507A

TRUCK STEEL RADIAL

APPLICATION

WIDE-BASE, ON/OFF-HIGHWAY, ALL-POSITION



The MY507A is designed to provide outstanding durability and tire life for wide base and on- and off-highway applications.

FEATURES AND BENEFITS

High Strength Belt Construction enhances durability in off-highway applications.

Stone Rejection Blocks in tread grooves improve durability and retreadability.

STEM-2 Casing Profile promotes internal strain reduction and longer casing life.

Special Anti-Chip Tread Compound strengthens on- and off-highway durability.

Additional Steel Reinforcement in the bead area gives added protection against bead damage.

Funnel-Shaped Grooves provide improved traction in off-highway applications.



MY507A replaces: Michelin XZL, XZY3 • Goodyear G296 MSA • Bridgestone M844F

TIRE SIZE	PART NUMBER	PLY RATING (L.R.)	TIRE WEIGHT (LBS)	RIM SIZE (INCH)		INFLATED DIMENSIONS		TREAD DEPTH (1/32")	LOADED DIMENSIONS		RPM	MAX LOAD CAPACITY AT COLD INFLATION PRESSURE				MAX SPEED (MPH)
				MEASURE	ALT	OVERALL WIDTH (INCH)	OVERALL DIAMETER (INCH)		SECTION WIDTH (INCH)	STATIC RADIUS (INCH)		LB/PSI SINGLE	LB/PSI DUAL	KG/KPA SINGLE	KG/KPA DUAL	
385/65R22.5	50751	18J	170.2	11.75	12.25	15.0	42.6	23	16.0	19.7	492	9370@120	N/A	4250@830	N/A	75
425/65R22.5	50752	20L	204.6	13.00	11.75-12.25	16.6	44.6	23	17.9	20.5	471	11400@120	N/A	5150@830	N/A	75
445/65R22.5	50753	20L	220.5	14.00	13.00	17.6	45.7	24	18.9	21.0	460	12300@120	N/A	5600@830	N/A	75

RY253

TRUCK STEEL RADIAL

APPLICATION
ON-HIGHWAY, ALL-POSITION



The low-profile RY253 is a wide base, performer offering lower initial cost, greater payload potential, better fuel economy and easier maintenance.

FEATURES AND BENEFITS

Heat-Resistant Tread Compound minimizes heat generation.

Six-Rib Tread Design provides superior traction on wet roads, a smooth ride and even wear.

Wide, Rigid Shoulder Ribs help prevent sidewall cutting and scuffing.

Special Risers in the groove corners and Stone-Rejection Blocks reduce stone penetration for improved casing life.

Specially Reinforced Bead Construction increases bead area durability for high-load operations and retreadability.



RY253 replaces: Michelin XZUS • Goodyear G296 MSA • Bridgestone M844F

TIRE SIZE	PART NUMBER	PLY RATING (L.R.)	TIRE WEIGHT (LBS)	RIM SIZE (INCH)		INFLATED DIMENSIONS		TREAD DEPTH (1/32")	LOADED DIMENSIONS		RPM	MAX LOAD CAPACITY AT COLD INFLATION PRESSURE				MAX SPEED (MPH)
				MEASURE	ALT	OVERALL WIDTH (INCH)	OVERALL DIAMETER (INCH)		SECTION WIDTH (INCH)	STATIC RADIUS (INCH)		LB/PSI SINGLE	LB/PSI DUAL	KG/KPA SINGLE	KG/KPA DUAL	
385/65R22.5	25301	18J	171.4	11.75	12.25	14.8	42.4	19	15.7	19.6	494	9370@120	N/A	4250@830	N/A	75
425/65R22.5	25304	20L	198.3	13.00	14.00	16.6	44.3	19	17.8	20.9	473	11400@120	N/A	5150@830	N/A	75
445/65R22.5	25302	20L	220.2	14.00	13.00	17.5	45.4	20	18.7	21.0	462	12300@120	N/A	5600@830	N/A	75

MY507

TRUCK STEEL RADIAL

APPLICATION

ON/OFF-HIGHWAY, ALL-POSITION



MY507's sturdy, wide tread construction and thick undertread is tough enough for off-road applications while offering extended treadlife on-road.

FEATURES AND BENEFITS

Ideal for on/off-highway logging, cement and construction operations.

Four Rugged, Contra-Diagonal Ribs with aggressive Buttressed Shoulders give full directional and steering stability, traction and braking.

Wide Block Type Rib Pattern increases block rigidity, provides outstanding wear resistance and delivers excellent traction.

Funnel-Shaped Grooves prevent stone retention, protecting the belt package and extending casing integrity.



MY507 replaces: Michelin XZY-3 • Goodyear G751 MSA • Bridgestone M853

TIRE SIZE	PART NUMBER	PLY RATING (L.R.)	TIRE WEIGHT (LBS)	RIM SIZE (INCH)		INFLATED DIMENSIONS		TREAD DEPTH (1/32")	LOADED DIMENSIONS		RPM	MAX LOAD CAPACITY AT COLD INFLATION PRESSURE				MAX SPEED (MPH)
				MEASURE	ALT	OVERALL WIDTH (INCH)	OVERALL DIAMETER (INCH)		SECTION WIDTH (INCH)	STATIC RADIUS (INCH)		LB/PSI SINGLE	LB/PSI DUAL	KG/KPA SINGLE	KG/KPA DUAL	
255/70R22.5	50705	16H	94.1	7.50	8.25	10.0	36.8	20	10.8	17.2	567	5510@120	5070@120	2500@830	2300@830	65
275/70R22.5	50710	16H	117.5	8.25	7.50	10.9	38.1	22	10.8	17.7	548	6940@130	6395@130	3150@900	2900@900	65
11R22.5	50702	16H	129.3	8.25	7.50	10.8	42.1	26	12.0	19.7	495	6610@120	6005@120	3000@830	2725@830	65
11R24.5	50704	16H	138.0	8.25	7.50	10.9	44.1	26	12.1	20.7	472	7160@120	6610@120	3250@830	3000@830	65

MY627W Spec-2

TRUCK STEEL RADIAL

APPLICATION

WASTE/SANITATION, ALL-POSITION



With its extra-rugged casing, wide tread area and specially-engineered compound, the MY627W Spec-2 is one of the most dependable all-position tires available for residential waste/sanitation vehicles.

FEATURES AND BENEFITS

Staggered Tread Pattern resists uneven wear, promoting long tread life and provides excellent water evacuation, improving wet weather traction.

A Reinforced Bead uses a Double Nylon Chafer to efficiently dissipate heat from critical areas, providing un-paralleled protection during severe stop-and-go operations.

Durable Inner Liner enhances air retention and retreadability by preventing air from migrating to the casing walls.

Sturdy Sidewall Armor protects against damage from curbing and prolongs the life of the casing for extended retreadability.

Wide Outside Rib and Extra-Wide Serpentine Grooves resist tears and increase durability, while significantly improving traction in wet or dry conditions.



MY627W Spec-2 replaces: Michelin XZUS-2 • Goodyear G289 WHA • Bridgestone M860

TIRE SIZE	PART NUMBER	PLY RATING (L.R.)	TIRE WEIGHT (LBS)	RIM SIZE (INCH)		INFLATED DIMENSIONS		TREAD DEPTH (1/32")	LOADED DIMENSIONS		RPM	MAX LOAD CAPACITY AT COLD INFLATION PRESSURE				MAX SPEED (MPH)
				MEASURE	ALT	OVERALL WIDTH (INCH)	OVERALL DIAMETER (INCH)		SECTION WIDTH (INCH)	STATIC RADIUS (INCH)		LB/PSI SINGLE	LB/PSI DUAL	KG/KPA SINGLE	KG/KPA DUAL	
315/80R22.5	62702	20L	157.6	9.00	9.75	12.5	42.8	23	13.9	19.7	491	10000@130	8255@130	4540@900	3745@900	65

LY053

TRUCK STEEL RADIAL

APPLICATION

ON/OFF-HIGHWAY, DRIVE



LY053 is designed to deliver good tire mileage in applications that require outstanding traction and cutting/chipping resistance.

FEATURES AND BENEFITS

Aggressive Lug Design with large blocks at tread center provides excellent traction and braking on rough roads with mud or gravel. It also enhances the self-cleaning ability of the tread.

Wide Tread Footprint combined with a 31/32" tread depth ensures excellent tire mileage.

Thick Undertread helps dissipate heat and allows the casing to operate at cooler temperatures.

Steel-Cord Top Belt helps protect against penetration damage and rust while minimizing tread distortion and heat generation.

Special Compound resists fatigue, chipping and scaling in rugged off-road conditions.



LY053 replaces: Michelin XDY-EX2, X-Works XDY, XDL • Goodyear G177 • Bridgestone L320

TIRE SIZE	PART NUMBER	PLY RATING (L.R.)	TIRE WEIGHT (LBS)	RIM SIZE (INCH)		INFLATED DIMENSIONS		TREAD DEPTH (1/32")	LOADED DIMENSIONS		RPM	MAX LOAD CAPACITY AT COLD INFLATION PRESSURE				MAX SPEED (MPH)
				MEASURE	ALT	OVERALL WIDTH (INCH)	OVERALL DIAMETER (INCH)		SECTION WIDTH (INCH)	STATIC RADIUS (INCH)		LB/PSI SINGLE	LB/PSI DUAL	KG/KPA SINGLE	KG/KPA DUAL	
11R22.5	05305	16H	139.6	8.25	7.50	10.7	42.2	31	11.6	19.8	494	6610@120	6005@120	3000@830	2725@830	65
11R24.5	05306	16H	149.5	8.25	7.50	10.9	44.2	31	11.7	20.7	471	7160@120	6610@120	3250@830	3000@830	65

Y788R

LIGHT TRUCK COMMERCIAL

APPLICATION

HIGHWAY, ALL-POSITION

Designed to stay on course no matter the driving conditions, the Y788R provides unparalleled on-highway stability and high-load durability.

FEATURES AND BENEFITS

Wide Shoulder Ribs maximize tread life.

Five-Rib, Wide-Shoulder-Groove tread design offers superior stability and grip.

Heavy-Duty, Two-Ply Steel Belts deliver better handling, stability and puncture resistance.

Center Rib and Polyester Body Plies ensure a smooth, comfortable ride.



TIRE SIZE	PART NUMBER	PLY RATING (L.R.)	TIRE WEIGHT (LBS)	RIM SIZE (INCH)		INFLATED DIMENSIONS		TREAD DEPTH (1/32")	LOADED DIMENSIONS		RPM	MAX LOAD CAPACITY AT COLD INFLATION PRESSURE				MAX SPEED (MPH)
				MEASURE	ALT	OVERALL WIDTH (INCH)	OVERALL DIAMETER (INCH)		SECTION WIDTH (INCH)	STATIC RADIUS (INCH)		LB/PSI SINGLE	LB/PSI DUAL	KG/KPA SINGLE	KG/KPA DUAL	
LT235/85R16	78809	10E	49.3	6.50	6.0 - 7.5	9.3	31.7	14	10.1	14.7	655	3042@80	2778@80	1380@550	1260@550	75
LT215/85R16	78812	10E	41.6	6.00	5.5 - 7.0	8.5	30.4	13	9.0	14.1	683	2680@80	2470@80	1215@550	1120@550	75

TY213A

LIGHT TRUCK COMMERCIAL

APPLICATION

ON-HIGHWAY/IN-CITY, ALL-POSITION

The TY213A is designed for outstanding stability, reliable water drainage and lasting treadlife for highway and urban applications.

FEATURES AND BENEFITS

Five-Rib Tread Design offers improved handling and excellent all-weather traction.

Combination construction featuring a Polyester Casing and ultra-tough Steel Belts provides outstanding durability.

Load Range E Load Capacity handles heavy duty applications.



OE Fitment on: Isuzu NPR '05, NPR (E) '09 - '14 • Isuzu N-Series '14 • Mitsubishi Fuso FE, HD '04 - '10, Fuso FE, HD (E) '98 - '14 • Isuzu N-Series 2014 -

TIRE SIZE	PART NUMBER	PLY RATING (L.R.)	TIRE WEIGHT (LBS)	RIM SIZE (INCH)		INFLATED DIMENSIONS		TREAD DEPTH (1/32")	LOADED DIMENSIONS		RPM	MAX LOAD CAPACITY AT COLD INFLATION PRESSURE				MAX SPEED (MPH)
				MEASURE	ALT	OVERALL WIDTH (INCH)	OVERALL DIAMETER (INCH)		SECTION WIDTH (INCH)	STATIC RADIUS (INCH)		LB/PSI SINGLE	LB/PSI DUAL	KG/KPA SINGLE	KG/KPA DUAL	
LT215/85R16	21301	10E	39.5	6.00	5.5 - 7.0	8.5	30.5	15	9.0	14.2	686	2680@80	2470@80	1215@550	1120@550	75

RY103/RY103A

LIGHT TRUCK COMMERCIAL

APPLICATION

ON-HIGHWAY/IN-CITY, ALL-POSITION

The versatile, reliable RY103 and RY103A incorporates low-profile engineering with proven quality construction for improved fuel-efficiency, mileage, payload potential, handling and stability.

FEATURES AND BENEFITS

Straight Five-Rib tread design inhibits stone retention, promotes even wear and provides a smooth ride, improved handling and superior wet traction.

Wide Shoulder Ribs reduce shoulder step wear.

Each size is manufactured with a specific tread depth to meet a greater range of applications.

Maintains excellent performance on all free-rolling positions.



OE Fitment on: Hino 155 (Canada) 2015 -

TIRE SIZE	PART NUMBER	PLY RATING (L.R.)	TIRE WEIGHT (LBS)	RIM SIZE (INCH)		INFLATED DIMENSIONS		TREAD DEPTH (1/32")	LOADED DIMENSIONS		RPM	MAX LOAD CAPACITY AT COLD INFLATION PRESSURE				MAX SPEED (MPH)
				MEASURE	ALT	OVERALL WIDTH (INCH)	OVERALL DIAMETER (INCH)		SECTION WIDTH (INCH)	STATIC RADIUS (INCH)		LB/PSI SINGLE	LB/PSI DUAL	KG/KPA SINGLE	KG/KPA DUAL	
215/75R17.5*	10308	14G	56.2	6.00	6.75	8.1	30.2	16	8.9	14.0	694	3750@105	3530@105	1600@720	1700@720	65
245/75R22.5	10302	14G	85.1	7.50	6.75	9.7	37.3	17	10.4	17.5	558	4675@110	4300@110	2120@760	1950@760	75
265/75R22.5	10304	14G	98.3	7.50	8.25	10.0	38.4	17	10.8	18.1	541	5205@110	4805@110	2360@760	2180@760	75
275/70R22.5	10382	16H	107.5	8.25	7.50	10.8	37.7	17	11.6	17.6	553	6610@125	6175@125	3000@830	2800@860	75

*RY103A

RY215

LIGHT TRUCK COMMERCIAL

APPLICATION

ON-HIGHWAY, ALL-POSITION

Designed for better handling, the RY215 is engineered to slice through standing water to provide outstanding wet-road performance.

FEATURES AND BENEFITS

Tapered, Multi-Kerf Shoulders prolong tread life and improve steering stability.

Wide Grooves and Deep Kerfs disperse water more efficiently for wet-weather handling.

High Turn-Up Construction and Bead Filler reduce beadline cracking and improve responsiveness.

Polyester Carcass with Steel Belts increases durability.



TIRE SIZE	PART NUMBER	PLY RATING (L.R.)	TIRE WEIGHT (LBS)	RIM SIZE (INCH)		INFLATED DIMENSIONS		TREAD DEPTH (1/32")	LOADED DIMENSIONS		RPM	MAX LOAD CAPACITY AT COLD INFLATION PRESSURE				MAX SPEED (MPH)
				MEASURE	ALT	OVERALL WIDTH (INCH)	OVERALL DIAMETER (INCH)		SECTION WIDTH (INCH)	STATIC RADIUS (INCH)		LB/PSI SINGLE	LB/PSI DUAL	KG/KPA SINGLE	KG/KPA DUAL	
7.00R15	21501	8D	31.9	5.50	5.0 - 6.5	7.7	29.4	13	8.5	13.6	706	2040@65	1820@65	925@450	825@450	65
7.50R16	21505	12F	44.8	6.00	6.0 - 7.0	8.4	31.5	13	9.3	14.6	659	3175@95	3020@95	1440@650	1370@650	65

TY303A

LIGHT TRUCK COMMERCIAL

APPLICATION

HIGHWAY ALL-STEEL RADIAL TRACTION

Drive-axle radial for on-highway operations for 2-axle tractors. Available in low-profile sizes.

FEATURES AND BENEFITS

Special Tread Compound generates fuel efficiency and long tread life.

Advanced Arrangement of Shoulder Lug Grooves promote flat, even treadwear.

Rib-Block Tread Design combined with a deep tread depth provide low rolling resistance, outstanding traction on snow and muddy terrains and excellent durability.



OE Fitment on: Hino 155 (Canada) 2015 -

TIRE SIZE	PART NUMBER	PLY RATING (L.R.)	TIRE WEIGHT (LBS)	RIM SIZE (INCH)		INFLATED DIMENSIONS		TREAD DEPTH (1/32")	LOADED DIMENSIONS		RPM	MAX LOAD CAPACITY AT COLD INFLATION PRESSURE				MAX SPEED (MPH)
				MEASURE	ALT	OVERALL WIDTH (INCH)	OVERALL DIAMETER (INCH)		SECTION WIDTH (INCH)	STATIC RADIUS (INCH)		LB/PSI SINGLE	LB/PSI DUAL	KG/KPA SINGLE	KG/KPA DUAL	
215/75R17.5	30365	12F	56.2	6.00	6.75	8.1	30.4	18	8.9	14.1	690	3530@100	3420@100	1600@690	1550@690	75
215/75R17.5	30309	14G	57.3	6.00	6.75	8.1	30.4	18	8.9	14.1	690	3750@105	3530@105	1700@720	1600@720	75
215/70R17.5	30302	14G	56.1	6.00	6.75	8.0	29.7	19	8.6	13.9	703	3415@110	3195@110	1550@760	1450@760	75

Y742S

LIGHT TRUCK COMMERCIAL

APPLICATION

ON-HIGHWAY, ALL-POSITION

The rugged, steel-belted construction Y742S delivers long mileage, supreme stability and reliable handling in snow and mud.

FEATURES AND BENEFITS

Buttressed Shoulder Block enhances traction.

Open-Channel, Self-Cleaning Aggressive Block Design cuts through mud and snow.

Special Tread Compound promotes long mileage and excellent traction.

Polyester Body Plies increase driver's comfort on the road.



OE Fitment on: Mitsubishi Fuso FG (E) '02 - '10

TIRE SIZE	PART NUMBER	PLY RATING (L.R.)	TIRE WEIGHT (LBS)	RIM SIZE (INCH)		INFLATED DIMENSIONS		TREAD DEPTH (1/32")	LOADED DIMENSIONS		RPM	MAX LOAD CAPACITY AT COLD INFLATION PRESSURE				MAX SPEED (MPH)
				MEASURE	ALT	OVERALL WIDTH (INCH)	OVERALL DIAMETER (INCH)		SECTION WIDTH (INCH)	STATIC RADIUS (INCH)		LB/PSI SINGLE	LB/PSI DUAL	KG/KPA SINGLE	KG/KPA DUAL	
7.00R15	74210	8D	36.6	5.50	5.0 - 6.5	7.8	29.8	18	8.6	13.8	697	2040@65	1820@65	925@450	825@450	75
LT235/85R16	74250	10E	49.5	6.50	6.0 - 7.0	9.3	31.9	18	10.1	14.8	650	3042@80	2778@80	1380@550	1260@550	75

Y735B

LIGHT TRUCK COMMERCIAL

APPLICATION

ON-HIGHWAY, ALL-POSITION

The Y735B is designed to provide outstanding handling and traction for heavy-duty light truck applications.

FEATURES AND BENEFITS

Outside Tread Blocks provide extra traction on snow and mud-covered roads.

Center Tread Blocks are specially arranged to promote improved stability and handling.

Constant Contact Center Blocks reduce tread noise.

Load Range E Construction provides extra load-carrying capacity.



OE Fitment on: Mitsubishi Fuso FG '06

TIRE SIZE	PART NUMBER	PLY RATING (L.R.)	TIRE WEIGHT (LBS)	RIM SIZE (INCH)		INFLATED DIMENSIONS		TREAD DEPTH (1/32")	LOADED DIMENSIONS		RPM	MAX LOAD CAPACITY AT COLD INFLATION PRESSURE				MAX SPEED (MPH)
				MEASURE	ALT	OVERALL WIDTH (INCH)	OVERALL DIAMETER (INCH)		SECTION WIDTH (INCH)	STATIC RADIUS (INCH)		LB/PSI SINGLE	LB/PSI DUAL	KG/KPA SINGLE	KG/KPA DUAL	
7.50R16	73504	10E	42.1	6.00	5.5 - 7.0	8.5	32.0	18	9.4	14.8	656	2755@80	2470@80	1250@550	1120@550	75

TY025

LIGHT TRUCK COMMERCIAL

APPLICATION

ON-HIGHWAY, ALL-POSITION

The TY025 is a sure-footed traction tire for the roughest highway conditions.

FEATURES AND BENEFITS

Uniform Profile maintains balanced dispersion of stress for easy-rolling, longer life and enhanced fuel economy.

Two-Ply Steel Belts deliver long mileage and handling stability.

All-Steel Construction improves original tread durability and guards against punctures.



TIRE SIZE	PART NUMBER	PLY RATING (L.R.)	TIRE WEIGHT (LBS)	RIM SIZE (INCH)		INFLATED DIMENSIONS		TREAD DEPTH (1/32")	LOADED DIMENSIONS		RPM	MAX LOAD CAPACITY AT COLD INFLATION PRESSURE				MAX SPEED (MPH)
				MEASURE	ALT	OVERALL WIDTH (INCH)	OVERALL DIAMETER (INCH)		SECTION WIDTH (INCH)	STATIC RADIUS (INCH)		LB/PSI SINGLE	LB/PSI DUAL	KG/KPA SINGLE	KG/KPA DUAL	
7.50R16	02501	14G	58.2	6.00	5.5 - 7.0	8.2	32.0	19	9.0	15.0	650	3330@100	3175@100	1510@590	1440@690	75

ORIGINAL TREAD DEPTH CHART

	101ZL Spec-2	RY617	104ZR	104ZR Spec-2	RY023	709ZL	703ZL	TY527	TY577	TY517	TY517 MC2	TY303
215/75R17.5					H/16							
235/75R17.5					H/16							
225/70R19.5					F/16							F/20
245/70R19.5					G/16							
265/70R19.5					G/17							G/21
285/70R19.5					H/17							H/21
255/70R22.5					H/18							H/24
295/75R22.5	G/18	G/18, H/18			G/19, H/19	G/26	G/32, H/32	G/32	G/30, H/30	H/28	G/28	
295/80R22.5					H/20							
315/80R22.5					L/21							
9R22.5					F/17							
10R22.5					G/18							
11R22.5	G/18	G/18, H/18	H/20		G/19, H/19	G/26	G/32, H/32	G/32	G/30, H/30	H/28	G/28	
12R22.5			H/20									
285/75R24.5	G/18	G/18			G/19	G/26	G/32	G/32	G/30		G/28	
11R24.5	G/18	G/18, H/18			G/19, H/19	G/26	G/32, H/32	G/32	G/30, H/30	H/28	G/28	

	TY287	SY767	RY587	RY103	TY517 UWB	902L UWB	RY407	MY507A	RY253	501ZA	MY507	MY627W Spec-2	LY053
225/70R19.5	F/19												
245/75R22.5				G/17									
255/70R22.5											H/20		
265/75R22.5				G/17									
275/70R22.5				H/17							H/22		
295/75R22.5			G/13										
315/80R22.5												L/23	
385/65R22.5								J/23	J/19				
425/65R22.5								L/23	L/19				
445/50R22.5					L/24	L/27	L/16						
445/65R22.5								L/24	L/20				
11R22.5		H/26	G/13							H/26	H/26		H/31
285/75R24.5			G/13										
11R24.5		H/26	G/13							H/26	H/26		H/31

STANDARD LIMITED WARRANTY

TRUCK/BUS TIRES

This limited warranty/adjustment policy provides for tire replacement under certain specified conditions. This policy applies to tires displaying warrantable conditions when used in appropriate service as defined in the Yokohama Commercial Sales and Reference Guide. Tires that become unserviceable or wear out because of misapplication, neglect or mistreatment are excluded from Yokohama warranty coverage. The tire size, load range and speed rating must meet or exceed the specification recommended by the vehicle manufacturer.

WARRANTY ELIGIBILITY

This warranty applies to every Yokohama truck/bus tire bearing the Yokohama brand name and complete D.O.T. serial identification number and operated in appropriate service in the United States. Eligible tires must be on the vehicle on which they were originally installed, in conformance with the vehicle manufacturer's recommendations. This warranty applies only to the original tire purchaser, and is not transferable to any other party. Tires are covered by this warranty for the life of the original usable tread down to the tread depth indicators molded at 2/32" (1.6mm). The tread is worn out when those indicators are at the same level as the worn tread.

WHAT IS NOT WARRANTIED

Tires that have become unserviceable for the following reasons:

- Road hazard injuries or damage caused to the tire by obstacles and debris, such as cuts, punctures (whether repairable or not), snags, bruises, tears or impact breaks.
- Improper repairs or repairs that have failed.
- Improper inflation or other maintenance abuses.
- Improper application of tire size and/or specification.
- Improper mounting/dismounting procedures or tire/wheel assembly balance.
- Mechanical irregularities in the vehicle or wheel, such as bent wheel assemblies, misalignment, worn or faulty components.
- Weather checking/cracking or failures resulting from these conditions on tires purchased more than four years (48 months) prior to a warranty claim. If proof of purchase is not provided, the D.O.T. serial number is used.
- Accident, corrosion, vandalism, fire or damages caused by nature.

ADDITIONAL EXCLUSIONS

- Tires that have had material added after leaving a Yokohama manufacturing plant, such as fillers, sealants, balancing substances or materials of any kind. Additionally, tires that have had external tire treatments which include but are not limited to: tread siping, shaving, carving, regrooving, white sidewall inlay or applying materials or treatments to the tread surface. If the material or treatment is the cause of a failure, vibration, or ride disturbance the tire will not be accepted for warranty, or mileage warranty credit.
- Tires submitted for ride disturbance complaints with more than 2/32" (1.6mm) treadwear.
- Tires on vehicles registered or operated outside of the United

States (refer to applicable Yokohama warranty policies for country of operation).

- Tires not sold in the United States by Yokohama Tire Corporation.
- Tires branded by Yokohama to note special classification at time of purchase, such as "NA" (non-adjustable), or tires altered by notching or buffing.
- Improper storage.

WHAT IS WARRANTIED

Tires that have become unserviceable for reasons other than stated above will be replaced in accordance with this warranty.

ADJUSTMENT POLICY

NO CHARGE ADJUSTMENT

A Yokohama tire accepted for warranty credit during the first 2/32" (1.6mm) of treadwear due to a ride disturbance complaint only, will be replaced on a no-charge basis. During this wear period, tires will be mounted and balanced free of charge. Federal Excise Tax (FET) will not be collected on a no-charge adjustment. Other service charges, such as tire rotation and wheel alignment are payable by the customer.

PRO-RATED ADJUSTMENT

For all other conditions allowable under the warranty, a Yokohama tire will be replaced on a pro-rated basis. The customer will receive credit toward the purchase of the new tire by multiplying the percentage of the tread depth remaining by the dealer's current selling price of the new comparable Yokohama tire at the time of replacement service. The customer pays full Federal Excise Tax (FET) applicable to the comparable new Yokohama tire plus all mounting, balancing and other service charges.

YOKOHAMA'S OBLIGATIONS

Replacements qualifying under the warranty must be made by an authorized Yokohama dealer.

CUSTOMER'S OBLIGATIONS

The customer must present the claim tire to an authorized Yokohama dealer in the United States.

LIMITATIONS AND EXCLUSIONS

All implied warranties, including any warranty of merchantability or fitness for a particular purpose, are expressly limited to the duration of this written warranty.

All obligations or liabilities for loss of time, inconvenience, loss of vehicle use or any other incidental or consequential damages are hereby excluded. Some states do not allow limitations on how long an implied warranty lasts, or the exclusions or limitations of incidental or consequential damages, so the above limitations or exclusions may not apply. This warranty gives the customer legal rights that may vary from state to state. The customer is advised to determine those rights for his/her local area and exercise them as required or deemed appropriate.

SPECIAL CASING WARRANTY

ELIGIBILITY

This policy applies to tires displaying warrantable conditions when used in appropriate service as defined in the Yokohama Commercial Sales and Reference Guide and which meet the following criteria.

- Tires must be or have been retreaded by a Yokohama-approved retreading process. Please reference the approved retread list at www.yokohamatruck.com.
- Tires must be or have been inspected by a Yokohama approved non-destructive tire casing analyzer prior to any retreading, and be so identified.

Truck tires designated by Yokohama as approved for and used in on/off-highway applications are eligible for warranty consideration if they display warrantable conditions.

WHAT IS WARRANTIED AND FOR HOW LONG

Prior to the retreading process, Yokohama radial truck/bus tires are covered by all provisions of the Yokohama Standard Limited Warranty for Truck and Bus Tires. After the retread has been applied on the qualified tire, an additional special casing warranty applies. If a qualified tire becomes unserviceable due to a warrantable condition, the customer will be given a casing credit, as indicated in the chart below. The retread life is defined as beginning with the installation of the new retread stock and ending after buffing for subsequent retread.

WHAT IS NOT COVERED

- Casings retreaded more times than provided by the warranty statement above.
- Casings damaged by road hazard injuries or damages caused by obstacles or debris such as cuts, punctures (whether repairable or not), snags, bruises, tears, abrasions, or impact breaks.
- Casings damaged by improper repairs or repairs that have failed.
- Casings damaged by improper inflation or other maintenance abuses.
- Casings damaged by continued operation while flat or severely underinflated.
- Casings damaged by improper application of tire size and/or specification.
- Casings damaged by improper mounting/dismounting procedures or tire/wheel assembly imbalance.
- Casings damaged by accident, corrosion, vandalism, fire, or nature.
- Casings damaged by use of aftermarket tire additives, such as fillers, sealants, or balancing substances.
- Casings damaged by improper retreading or defective retread materials.
- Casings that cannot be retreaded because of excessive treadwear or buffing.
- Casings retreaded in a facility not using a Yokohama approved retreading process.
- Tires covered by Yokohama Standard Limited Warranty (4/32" or

more of original tread remaining).

- Tires branded by Yokohama to note special classifications at time of purchase, such as "NA" (non-adjustable), or tires altered by notching or buffing.
- Tires on vehicles registered or operated outside the United States.
- Tires not sold in the United States by Yokohama Tire Corporation.

LIMITATIONS AND EXCLUSIONS

All implied warranties, including any warranty of merchantability or fitness for a particular purpose, are expressly limited to the duration of this written warranty. Yokohama Tire Corporation reserves the right to change warranty provisions at anytime without obligation. All obligations or liabilities for loss of time, inconvenience, vehicle use, or any other incidental or consequential damages are hereby excluded. Some states do not allow limitations on how long an implied warranty lasts, or the exclusion or limitation of incidental or consequential damages, so the above limitations and exclusions may not apply. This warranty gives the customer legal rights that may vary from state to state. The customer is advised to determine those rights for their local area and exercise them as required or deemed appropriate.

CUSTOMER'S OBLIGATIONS

The customer must present the claim tire to an authorized Yokohama dealer, with certification that the tire was retreaded by an approved Yokohama retreading process and inspected by a Yokohama approved non-destructive tire casing analyzer. The customer is required to pay the adjusted price of the new tire (dealer's current retail selling price at the time of adjustment, less credit allowance) and taxes. The cost of mounting, balancing, and any other service charges or applicable taxes are also payable by the customer.

Corporate Headquarters
1 MacArthur Place, Suite 800
Santa Ana, California 92707
800.423.4544
yokohamatruck.com

Commercial Customer Service
Dealer Orders Call: 800.423.4544
Dealer Fax Orders: 800.455.9656
Consumer Affairs: 800.722.9888

Remember to register your new Yokohama tires either online at yokohamatruck.com or by mail. Mail-in registration cards are available at authorized Yokohama dealers.

SEVEN YEAR, UNLIMITED RETREAD WARRANTY CREDIT AMOUNTS FOR YOKOHAMA ZENVIRONMENT TIRES

Zenvironment tires include 709ZL, 703ZL, 103ZR, 104ZR, 104ZR Spec-2, 101ZL, 101ZL Spec-2

SIZE	INSPECTION PRIOR TO 1ST RETREAD	ALL SUBSEQUENT RETREADS
ALL SIZES	\$130.00	\$100.00

SIX YEAR, THREE RETREAD WARRANTY CREDIT AMOUNTS FOR YOKOHAMA ULTRA WIDE BASE TIRES

Ultra Wide Base tires include RY407, TY517, 902L

SIZE	INSPECTION PRIOR TO 1ST RETREAD	1ST RETREAD	2ND RETREAD	3RD RETREAD
445/50R22.5	\$150.00	\$120.00	\$80.00	\$80.00

SIX YEAR, THREE RETREAD WARRANTY CREDIT AMOUNTS FOR ALL OTHER YOKOHAMA TRUCK/BUS TIRES

Includes 501ZA

SIZE	INSPECTION PRIOR TO 1ST RETREAD	1ST RETREAD	2ND RETREAD	3RD RETREAD
ALL SIZES	\$110.00	\$90.00	\$70.00	\$40.00

SIX YEAR, UNLIMITED RETREAD WARRANTY CREDIT AMOUNTS FOR MY627W SPEC-2 – PART# 62702

SIZE	INSPECTION PRIOR TO 1ST RETREAD	1ST RETREAD	2ND RETREAD	3RD RETREAD	ALL SUBSEQUENT RETREADS
315/80R22.5	\$110.00	\$110.00	\$90.00	\$70.00	\$40.00

If a warrantable condition is found during the inspection or buffing process, the casing warranty credit will be paid at the amount of the next retread life.



Yokohama Tire Corporation | 800.423.4544 | yokohamatruck.com

Commercial Customer Service: ext. 2889

Credit Department: ext. 3977

Consumer Affairs: ext. 2880

Commercial Customer Service Dealer Order Fax: 800.455.9656

