

SERVICE MANUAL

Troubleshooting Guide and Instructions for Service
(To be performed ONLY by qualified service providers)

Ultra Low NOx Atmospheric Vent Water Heaters with ICON and Integrated Control Systems



Models Covered:

**SECTION 1 (PG. 5): SERIAL NUMBERS
“XF-” (JUN. 2021 AND LATER) WITH
“-NDD” DESIGNATOR**

UCG80H125*(N,X)(A)
UCG(80,100)H199*(N,X)(A)
UCG(80,100)H270*(N,X)(A)
UCG(80,100)H399*(N,X)(A)

**SECTION 2 (PG. 44): SERIAL NUMBERS
“XL-” (NOV. 2021 AND LATER) WITH
“-NDD-895” DESIGNATOR**

UCG80H125*(N,X)(A)
UCG(80,100)H199*(N,X)(A)

(*) Denotes warranty years



As required by the state of California Proposition 65.

— BRADFORD WHITE IS —

**AMERICAN
STRONG**

Products made by Bradford White are
manufactured in the United States using
the finest raw materials and components
from around the world.

Table of Contents

Serial Number Breakdown.....	3
How to Use this Manual	4
Tools Required for Service.....	5
SECTION 1: SERIAL NUMBERS “XF-” (JUN. 2021 AND LATER) WITH “-NDD” DESIGNATOR	
ICON Features	5
Specifications	6
Intake Vent Tables and Approved Venting Materials	8
Sequence of Operation	9
Building Management Systems	11
Troubleshooting	13
Service Procedure I: Thermostat Circuit Testing and Replacement.....	23
Service Procedure II: Combustion System Testing and Replacement.....	27
Service Procedure III: Burner Tube Inspection and Replacement	31
Service Procedure IV: Gas Valve Replacement.....	33
Service Procedure V: Blower Testing and Replacement	34
Service Procedure VI: Flame Sensor Testing and Replacement.....	36
Service Procedure VII: Spark Rod Gap Adjustment and Replacement	38
Service Procedure VIII: Ignition Module/Control Board Replacement.....	40
Service Procedure IX: Anode Inspection and Replacement.....	41
Service Procedure X: Display Module Replacement.....	42
Service Procedure XI: Transformer Replacement.....	43
SECTION 2: SERIAL NUMBERS “XL-” (NOV. 2021 AND LATER) WITH “-NDD-895” DESIGNATOR	
Specifications	44
Intake Vent Tables and Approved Venting.....	46
Sequence of Operation	47
Troubleshooting	49
Service Procedure I: Thermostat Circuit Testing and Replacement.....	64
Service Procedure II: Combustion System Testing and Replacement.....	68
Service Procedure III: Burner Tube Inspection and Replacement	72
Service Procedure IV: Gas Valve Replacement.....	74
Service Procedure V: Blower Testing and Replacement	75
Service Procedure VI: Flame Sensor Testing and Replacement.....	77
Service Procedure VII: Spark Rod Gap Adjustment and Replacement	79
Service Procedure VIII: Ignition Module/Control Board Replacement.....	81
Service Procedure IX: Anode Inspection and Replacement.....	82
Service Procedure X: Display Module Replacement.....	83
Service Procedure XI: Transformer Replacement	84
Water Heater Service Report.....	86
Notes	87

Determining the Age of Your Water Heater

SERIAL NUMBER SECTION: The first two characters represent the year and month of manufacture. The remainder of the serial is a sequential production number, seven digits in length before December 2007 (DM), and eight digits in length after.

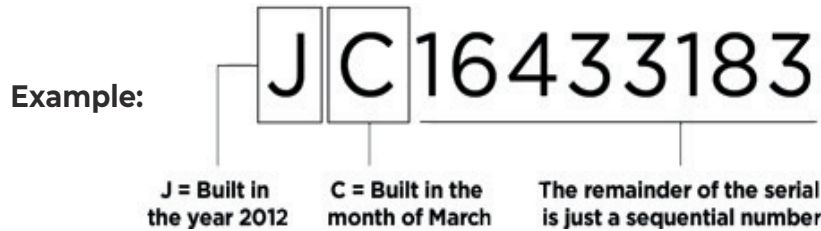

Production Year	
A = 1984 or 2004	L = 1994 or 2014
B = 1985 or 2005	M = 1995 or 2015
C = 1986 or 2006	N = 1996 or 2016
D = 1987 or 2007	P = 1997 or 2017
E = 1988 or 2008	S = 1998 or 2018
F = 1989 or 2009	T = 1999 or 2019
G = 1990 or 2010	W = 2000 or 2020
H = 1991 or 2011	X = 2001 or 2021
J = 1992 or 2012	Y = 2002 or 2022
K = 1993 or 2013	Z = 2003 or 2023

Production Month	
A = January	G = July
B = February	H = August
C = March	J = September
D = April	K = October
E = May	L = November
F = June	M = December

For the year column, we do not use the letters: I, O, Q, R U, V

For the month column we do not use the letters: I & N – Z

Due to a computer error, there were some OA serial water heaters manufactured. They were built in January of 1997.

Determining the Designator of Your Water Heater

DESIGNATOR SECTION: See special product type designator in this location on the rating plate.

If "D/N:" line is blank, then there is no designator.

Example in red box:

BRADFORD WHITE CORPORATION www.bradfordwhite.com 11
 200 LAFAYETTE STREET MIDDLEVILLE MI 49333 USA
 Model No: UCG100H1993N
 Serial No: XK48743747 D/N: -NDD-895
 Capacity : 100 US gal Recovery: 197 gph
 378.5 liters Type: NATURAL GAS
 Input: 199999(Btu/hr)
 Gas Pressure Manifold : 0.00(InWC)
 120V 60 Hz Less than 12 amps
 Alcove Installation, Combustible Floors:
 Min Clearances from Combustible Construction
 0" (Sides/Rear) 0" (Top) 6" (Vent Conn)
 For use only with Automatic Flue Device Part
 No. N/A FOLLOW INSTALLATION INSTRUCTIONS
 AUTOMATIC STORAGE TANK / CIRCULATING TANK
 CATEGORY I FAN ASSISTED
 ANSI Z21.10.3-2017/CSA 4.3-2017
 Pressure: Test 300 psi, Working 150 psi
 COMPLIES W/JURISDICTIONS HAVING 14ng/J NOx REGS

BRADFORD WHITE CORPORATION www.bradfordwhite.com 11
 200 LAFAYETTE STREET MIDDLEVILLE MI 49333 USA
 Model No: EF100T199E3N2
 Serial No: XK48743746 D/N: -895
 Capacity : 100 US gal Recovery: 238.8 gph
 378.5 liters Type: NATURAL GAS
 Input: 199999(Btu/hr)
 Gas Pressure Manifold : -0.05(InWC)
 120V 60 Hz Less than 12 amps
 Alcove Installation, Combustible Floors:
 Min Clearances from Combustible Construction
 0" (Sides/Rear) 0" (Top) 0" (Vent Conn)
 For use only with Automatic Flue Device Part
 No. N/A FOLLOW INSTALLATION INSTRUCTIONS
 AUTOMATIC STORAGE TANK / CIRCULATING TANK
 CATEGORY IV
 ANSI Z21.10.3-2017/CSA 4.3-2017
 Pressure: Test 300 psi, Working 150 psi
 COMPLIES W/JURISDICTIONS HAVING 14ng/J NOx REGS

Introduction

The Bradford White Ultra Low NOx Atmospheric Vent Water Heater is designed to deliver hot water at up to 82% thermal efficiency in a quiet running unit with a top exhaust vent connection that allows for installation in existing locations. While this unit is vented atmospherically, there is no damper required to maintain heat loss during off cycle. Several technologically advanced design features are incorporated that will require additional knowledge on the part of the qualified service provider. The information in this manual will instruct service and maintenance professionals on the function, proper diagnosis, and repair of The Bradford White Ultra Low NOx Atmospheric Vent Water Heater.

This water heater uses an Ultra Low NOx premix power burner located at the top of the water heater to direct a turbulent flame down into the water backed combustion chamber. This turbulence causes a thorough mixing of gas and air for optimum combustion. The combustion gases then travel through a two pass flue system keeping the gases moving at a high velocity. The combination of high turbulence and velocity results in an optimum transfer of heat from the flue gases into the water.

Burner operation is controlled using an electronic ignition module. The module monitors the status of the electronic thermostat, flame sensor, blower motor, spark rod, and gas valve. The module contains programming which determines the sequence of operation and timings for purge periods, trial for ignition, flame sensing, and lockout. The module will also provide diagnostic information to help in determining the cause of system lockouts.

The contents in this manual are detailed informational tools to assist in the proper diagnosis of the water heater's operational faults. Please read this service manual completely and record as much information regarding the Ultra Low NOx Atmospheric Vent Water Heater operation and installation specifics related to any concerns.

How to Use This Manual

It is intended for this manual to be used by qualified service personnel for the primary purpose of troubleshooting analysis and repair of the water heater. Understanding the sequence of operation section of this manual will contribute greatly to troubleshooting this product.

An Installation Checklist is shown towards the end of this manual. Compare the installation against the installation checklist to confirm all requirements are met. A Service Report is shown towards the end of this manual. Completing this form will assist in the troubleshooting efforts. Should you need to call for Technical Support, please provide the information shown on this form to the support technician to help ensure accurate troubleshooting. Troubleshooting begins with System Observation to determine failure mode as indicated by the error code on the system display. Troubleshooting continues with Failure Modes and Probable Cause directing the service provider to a series of test procedures to determine root cause of failure. Component replacement procedures directly follow the test procedures for a given component. In some difficult to diagnose conditions, it may be necessary to isolate the heater from the vent system to determine root cause.

Contact Technical Support immediately if diagnosis is not determined using the methods described in this service manual.

Tools Required for Service

Manometer: Two types available, a liquid “U” tube type or a digital (magna-helic) type. This device is used to measure gas and/or air pressures and vacuum.

Multi-Meter: A digital type is strongly recommended. This device is used to measure electrical values. The meter you select must have the capability to measure volts AC, volts DC, Amps, micro-amps and ohms.

Thermometer: Used to measure water temperature. An accurate thermometer is recommended.

Water Pressure Gauge: Used to measure water supply pressure. Also used to determine tank pressure by adapting to the drain valve of the heater.

Jumper Leads: A length of wire (12" min.) with an alligator clip at both ends.

Various Hand Tools: Pipe wrench, channel locks, open end wrench set, 12" crescent wrench, Allen wrench set, Torx bit set, screwdrivers (common & Philips), long reach (12") magnetic tip Philips head screwdriver #2 tip, ¼" nut driver, pliers (common & needle nose), socket set including a 1-1/16 deep well socket, wire cutters, wire strippers, wire crimpers, torpedo level, small shop vac, step ladder, and flashlight.

SECTION 1: SERIAL NUMBERS “XF-” (JUN. 2021 AND LATER) WITH “-NDD” DESIGNATOR

Features

Features of ICON System Control

- Digital water heater display on control panel for setting and displaying the temperature setpoint. Pressing temperature UP and DOWN buttons changes the temperature setpoint. Temperature format may be displayed in °F or °C.
- Single control board with plug in wiring controls temperature, ignition, and blower operation.
- Reduced number of parts for servicing and wiring.
- Plug in wiring reduces chance of miswiring.
- Burner ignition with direct spark ignition - A high voltage spark jumps from the spark rod to the burner surface to ignite the gas. Eliminates burned out hot surface igniter replacements.
- Water heater display will show diagnostic codes in the event the water heater needs servicing. Aids in diagnosing and servicing the water heater.
- Water heater display can show previous error code history to further aid in servicing the water heater.

Specifications

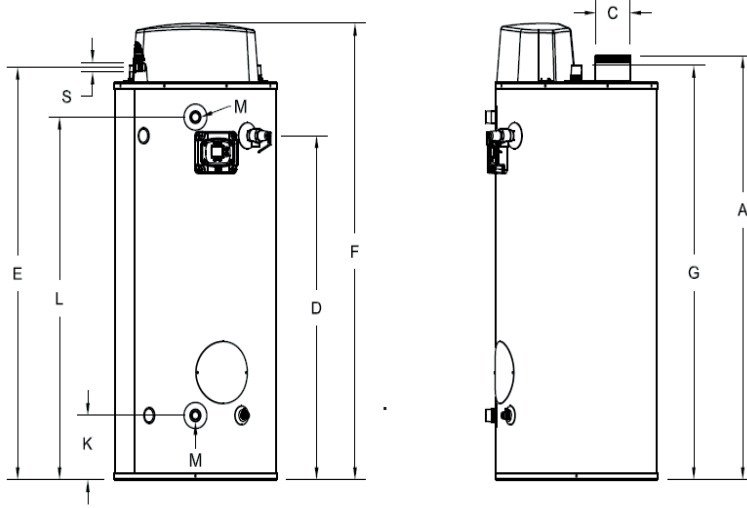
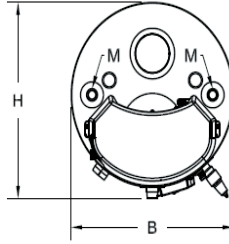

Model Description				Dimensions (inches)																
Model Number	Nominal Gal. Capacity		BTU/Hr. Input	GPH Recovery at Degree Rise			A	B	C	D	E	F	G	H	K	L	M	S	Relief Valve Open in.	Aprox. Shipping Weight lbs.
	US Imp. Gal.	Gal.		40°F	100°F	140°F	Floor to Vent Conn. in.	Jacket Dia. in.	Vent Size in.	Floor to T&P Conn. in.	Floor to Gas Conn. In.	Floor to Top of Heater In.	Floor to Cold Water Conn./Hot Water Conn. In.	Depth in.	Floor to Cold Water Conn. in.	Floor to Hot Water Conn. in.	Water Conn. NPT in.	Gas Conn. Size in.		
UCG80H125	80	67	125,000	308	123	88	57	28	5	44 1/4	54 1/2	61 3/8	55 3/4	30	9 3/4	46 15/16	1 1/2	3/4	3/4	535
UCG80H199	80	67	199,999	493	197	141	57	28	6	44 1/4	54 1/2	61 3/8	55 3/4	30	9 3/4	46 15/16	1 1/2	3/4	3/4	535
UCG80H270	80	67	270,000	665	266	190	57	28	6	44 1/4	54 1/2	61 3/8	55 3/4	30	9 3/4	46 15/16	1 1/2	3/4	1	545
UCG80H399	80	67	399,999	960	384	274	57	28	8	44 1/4	54 1/2	61 3/8	55 3/4	30	9 3/4	46 15/16	1 1/2	3/4	1	545
UCG100H199	100	83	199,999	493	197	141	64 7/8	28	6	52 3/4	62 3/4	70	63 1/4	30	9 3/4	55 3/8	1 1/2	3/4	3/4	632
UCG100H270	100	83	270,000	665	266	190	64 7/8	28	6	52 3/4	62 3/4	70	63 1/4	30	9 3/4	55 3/8	1 1/2	3/4	1	632
UCG100H399	100	83	399,999	994	398	284	64 7/8	28	8	52 3/4	62 3/4	70	63 1/4	30	9 3/4	55 3/8	1 1/2	3/4	1	657

Model Description				Dimensions (millimeters)															
Model Number	Nominal Liter Capacity	Input kW	GPH Recovery at Degree Rise			A	B	C	D	E	F	G	H	K	L	M	S	Relief Valve Open mm.	Aprox. Shipping Weight kgs.
			22°C	56°C	78°C	Floor to Vent Conn. mm.	Jacket Dia. mm.	Vent Size mm.	Floor to T&P Conn. mm.	Floor to Gas Conn. mm.	Floor to Top of Heater mm.	Floor to Water Conn. mm.	Depth mm.	Floor to Space Heating Inlet mm.	Floor to Space Heating Outlet mm.	Water Conn. NPT mm.	Gas Conn. Size mm.		
UCG80H125	303	36.6	1164	466	333	1448	711	127	1124	1384	1569	1416	752	247	1192	38	19	19	243
UCG80H199	303	58.6	1864	746	533	1448	711	152	1124	1384	1569	1416	752	247	1192	38	19	19	243
UCG80H270	303	79.1	2517	1007	719	1448	711	152	1124	1384	1569	1416	752	247	1192	38	19	25	247
UCG80H399	303	117.2	3634	1454	1038	1448	711	203	1124	1384	1569	1416	752	247	1192	38	19	25	247
UCG100H199	379	58.6	1866	745	533	1648	711	152	1340	1594	1778	1606	752	247	1406	38	19	19	286
UCG100H270	379	79.1	2517	1006	719	1648	711	152	1340	1594	1778	1606	752	247	1406	38	19	25	286
UCG100H399	379	117.2	3757	1476	1060	1648	711	203	1340	1594	1778	1606	752	247	1406	38	19	25	298

Specifications

Power Supply	Dedicated 120 VAC, 60 Hz, 15A
Gas Supply	Minimum 3/4" NPT (schedule 40 black iron pipe recommended)
Approved Gas Type	Natural and L.P. Unit must match gas type supplied.
Gas Pressure (Nat.)	14.0" W.C. maximum static, 4.5" W.C. minimum running (recommend 7.0" W.C. min running)
Gas Pressure (L.P.)	14.0" W.C. maximum static, 11.0" minimum static, 8.0" W.C. minimum running (recommend 11.0" W.C. min running)
Venting System	Atmospherically vented, Type B venting system or approved chimney. Follow the current National Fuel Gas Code requirements or in Canada, the Natural Gas and Propane Installation Code.
Minimum Clearance for Servicing	16" from top, 4" from front, 0" sides and rear.
Maximum Water Supply Pressure	150 PSI
Thermostat Sensor	11,900 Ohms @ 70°F, ECO opens @ 207°F (97.2°C) Max. Redundant sensor for ECO. Sensor inside well for easy replacement of sensor.
Control Display	Digital display, 24 volts. temperature Range: 100-180°F (37.8-82°C). Used to set tank temperature (°F or °C), show operating status, display error codes, error code history, limit maximum setpoint temperature.
Control Board	Operates from 24 volt from transformer. Controls tank temperature, ignition functions, combustion blower. See ignition timings in sequence of operation for Integrated Control.
Transformer	120 VAC primary, 24 VAC secondary, 40 VA.
Spark Rod Igniter	0.22" nominal gap to the burner surface.
Flame Sensor Output	Minimum 1 micro amp. Typical range 5 to 30 micro amps.
Gas Valve	Negative regulation, 24 VAC, 1/2" PSI max., 4.5" W.C. natural gas minimum running inlet.
Blower	120 VAC, 60 Hz, 1.5-3.5 amps

Specifications

Vent Tables

(Intake Only)

Model Number	2" Max Intake Vent Length (feet)	3" Max Intake Vent Length (feet)	4" Max Intake Vent Length (feet)
UCG80H125	20	50	75
UCG(80,100)H199	20	50	75
UCG(80,100)H270	20	50	75
UCG(80,100)H399	N/A	75	20

WARNING

The UCG(80,100)H399 model is not approved for 2 inch diameter inlet vent pipe. Venting with 2 inch pipe may result in damage to the water heater or cause an unsafe condition. **DO NOT** use 2 inch vent air intake pipe with UCG(80,100)H399.

Determining Required Intake Vent Length

1. Determine the total length of straight vent pipe (in feet) required for the intake.
2. Add 5 feet of venting for every 90° elbow.
3. Add 2 ½ feet of venting for every 45° elbow.
4. **Total vent length cannot exceed Max Intake Vent Length on the venting table shown above.**

Example of Total Intake Vent Length for UCG100H399 installation:

A 3" venting system has a total of two 90-degree elbows and a total straight pipe length of 10 feet.
Equivalent vent length for elbows: 2 x 5 feet = 10 feet.

Total equivalent vent distance = 10 feet + 10 feet = 20 feet total equivalent vent length. This is below the maximum allowed distance of 25 feet for this model using 3" vent.

Approved Intake Venting Materials

For installations in the US only

- PVC Sch. 40 (ASTM D-1785, ULC 1738, ULC S636)
- DWV PVC Sch. 40 (ASTM-D2665)
- CPVC Sch. 40 (ASTM-F441, ASTM-D2846, ULC S636)
- Polypropylene (UL 1738, ULC S636)
- ABS Sch. 40 DWV (ASTM D2661)

For installations in CANADA

- ULC S636 approved Sch. 40 PVC and CPVC for flue gas venting rated Class II, 65°C (components provided with water heater)
- ULC S636 approved Polypropylene for flue gas venting rated Class II, 65°C

Approved Primers and Cements

For installations in the US only

- PVC and CPVC Primer (ASTM F-656)
- PVC Cement (ASTM D-2564)
- CPVC Cement (ASTM F493)
- ABS Primer and Cement (ASTM D-2235)

For installations in CANADA

- ULC S636 approved PVC Primer and Cement for flue gas venting rated Class II, 65°C

Sequence of Operation

1. Thermostat calls for heat.
2. Combustion blower starts with a “soft” start light off.
3. Blower pre-purge period of approximately 15 seconds.
4. Ignition control board runs an internal verification safety check for approximately 15 seconds.
5. Trial for ignition (approximately 5 seconds per trial, 3 trials total):
 - a. Flame establishing period (3 seconds), gas valve opens, sparks from spark rod to burner surface to ignite the gas.
 - b. Burner on, flame proving period (2 seconds). Requires a minimum of 1 microamp through the flame sense rod to prove flame.
6. Once the flame signal is verified, the blower will remain at the “soft” start RPM for 5 seconds to stabilize the flame.
7. Steady state operation – Burner continues to operate until:
 - a. The thermostat circuit opens, gas valve closes, and blower continues to operate for 30 second post-purge period.
8. Thermostat is satisfied.
9. Gas valve closes and burner is extinguished.
10. Blower post purge for 30 seconds at maximum RPM.

Sequence of Operation

Lockout Conditions

The system will go into lock out mode for the following reasons:

1. Error Code 110 (Ignition failure occurred)
 - a. Control board will go into "Soft Lockout" if the main burner cannot be lit or fails to prove flame after 3 ignition trials. The water heater display indicates a lockout condition by showing an error code number 110 with "Service Needed" in the control display window. Refer to error codes in the diagnostic section of this Service Manual. In a Soft Lockout condition, the control will wait for 15 minutes and then make 3 more attempts to light the main burners. Soft lockout reset is accomplished by depressing the lower right button under "Reset" for 3 seconds.
2. Error Code 80 (High limit overheat condition)
 - a. If the top of the tank should exceed 207°F (97.2°C), then the high limit control will shut off the burner and the water heater will go into a "Hard Lockout." Error code 80 will be shown in the water heater display. The control can only be reset in the Service Mode, which is detailed in the Troubleshooting section (page 13).

Connection/Wiring Diagram

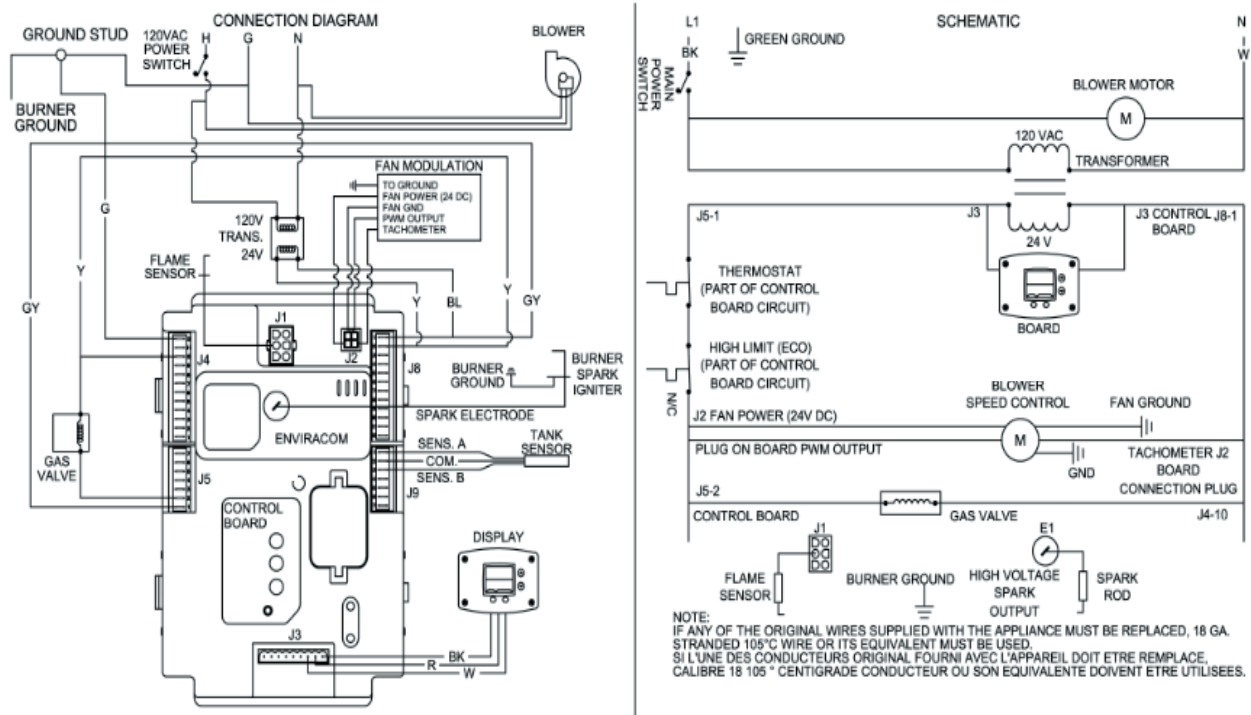

Building Management System (BMS)

All water heaters with serial numbers after XA..... (with ICON Systems) can be equipped with a gateway kit that will facilitate a Building Management System (BMS) connection to Modbus or Bacnet®. This kit is sold separately and is not factory installed. A full installation, operation, and troubleshooting manual is provided with the gateway kit.

BMS Mapping

Map Descriptor Name	Modbus Register	Read/Write	BACnet Object ID	Note
Demand source	00006	Read	001	Current demand source: 0 = Unknown 1 = No source demand 2 = CH 3 = DHW 4 = Lead Lag slave 5 = Lead Lag master 6 = CH frost protection 7 = DHW frost protection 8 = No demand due to burner switch (register 199) turned off 9 = DHW storage 10 = Reserved 11 = Warm weather shutdown 12 = Hot standby
Firing rate	00008	Read	002	Actual firing rate (% or RPM)
Fan speed	00009	Read	003	RPM
Flame signal	00010	Read	004	0.01V or 0.01 µA precision (0.00-50.00V)
Tank temperature sensor	00012	Read	005	-40°-130° (0.1°C precision)
Appliance setpoint	00017	Read	006	-40°-130° (0.1°C precision)
Burner status	00032	Read	007	0 = Disabled 1 = Locked out 2-3 = Reserved 4 = Anti-short cycle 5 = Unconfigured safety data 6-33 = Reserved 34 = Standby Hold 35 = Standby Delay
Lockout code	00034	Read	008	0 = No lockout 1-4096
Appliance status	00080	Read	009	0 = Unknown 1 = Disabled 2 = Normal 3 = Suspended
DHW priority count	00082	Read	010	Countdown of time when DHW has priority over CH (secs). Applicable when DHW priority time is enabled.
Burner run time	00130/00131	Read	011	Hours
Controller cycle count	00142/00145	Read	012	0-999,999
Controller run time	00144/00145	Read	013	Hours
Alarm reason	0035	Read	014	0 = None 1 = Lockout 2 = Alert 3 = Other
DHW setpoint	0453	Read/Write	015	40°-130° (0.1°C precision)

BMS Wiring Diagram

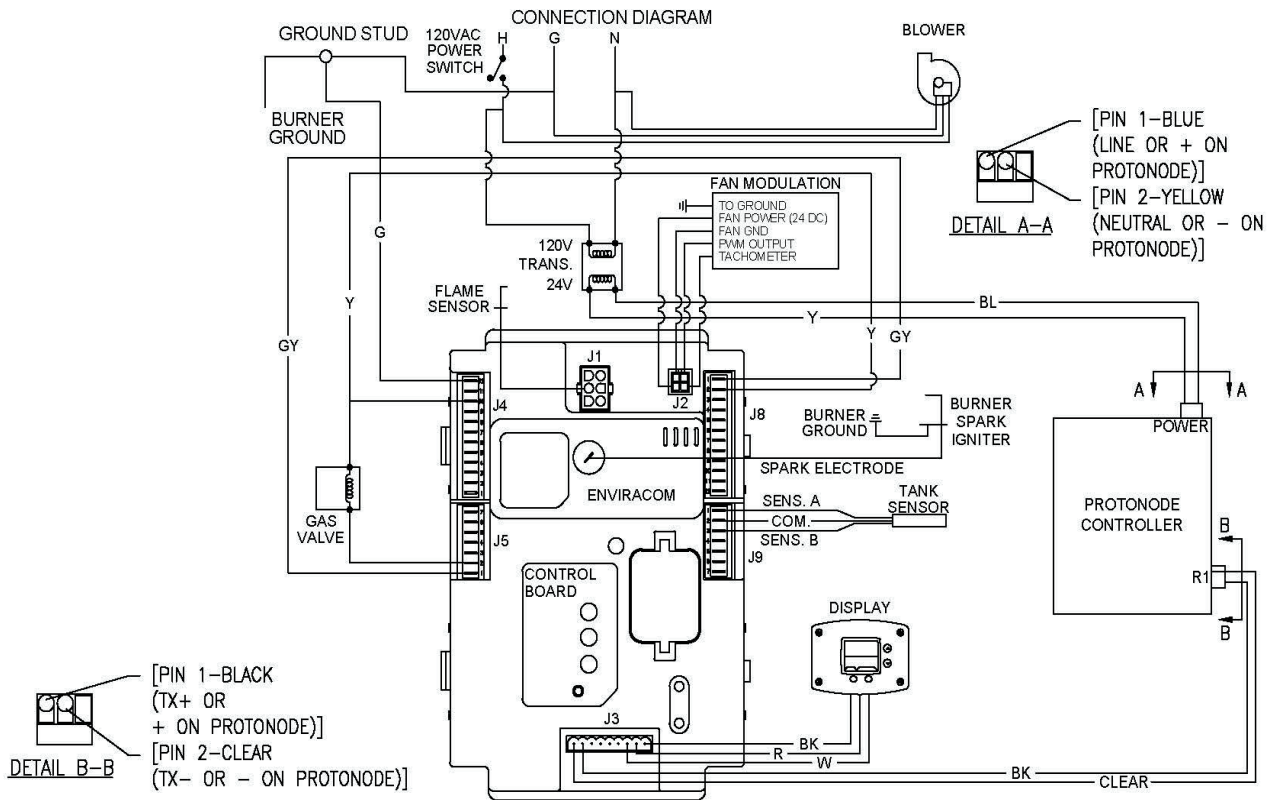

⚠ CAUTION

Before beginning any Troubleshooting operations listed below, please note that the gateway kit and BMS may need to be disconnected from the heater. Please ensure this has been completed before proceeding with any troubleshooting operation that may be impacted by settings in the BMS.

NOTICE

The Building Management System (BMS) is only compatible with units that have ICON controllers.

Part	Bradford White Part Number
BMS Gateway Installation Kit	415-53943-00

Troubleshooting

System Observations

Water Heater Fault: Water heater does not operate

Display Error Code: Water heater display does not operate - blank display

Check main power supply to water heater – fuse, circuit breaker, plug receptacle, line cord or wiring to water heater.

Check to make sure switch on front of control panel is in the ON position.

Verify primary voltage at the transformer.

Verify secondary voltage at the control board.

Does water heater display operate? Increase thermostat setting if tank is warm.

Display operates – see next page.

Is 24VAC present between **RED** and **BLACK** wire pin connections on the back of control display?

Display operates – see next page.

Check wires for proper termination to control display. Are wire terminations connected properly to control display?

Replace control board.

Check wire harness for proper continuity.

Make proper wire terminations.

Replace control board.

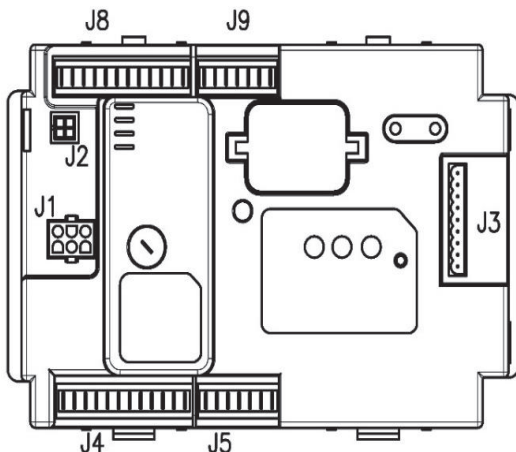

⚠️ WARNING

120 volt potential exposure. Use caution making voltage checks to avoid personal injury.

⚠️ CAUTION

Use caution to not damage connectors when making voltage measurements or jumping terminals.

Refer to control board illustration. Voltage at transformer across black and white wires should be 110-120 VAC. Check line cord with volt meter. Replace line cord if defective.

Refer to control board illustration. Voltage at connector location J8 across blue and yellow wires should be 24VAC. If not, check transformer. Replace transformer if defective.

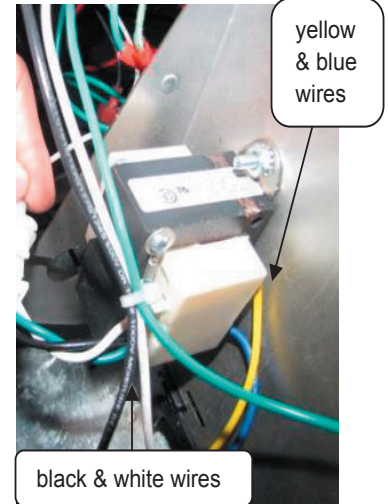

Troubleshooting

CAUTION

Use caution to not damage connectors when making voltage measurements or jumping terminals

WARNING

120 volt potential exposure. Use caution making voltage checks to avoid personal injury.

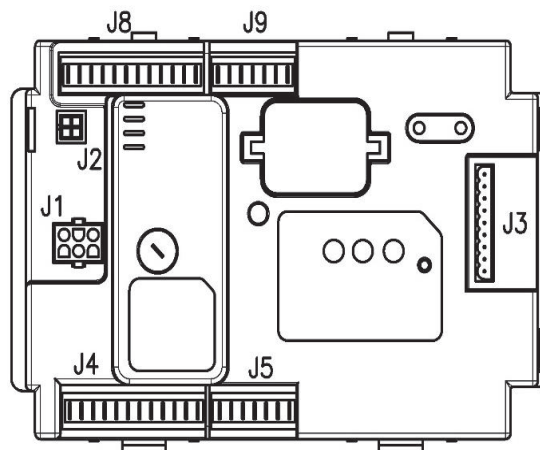
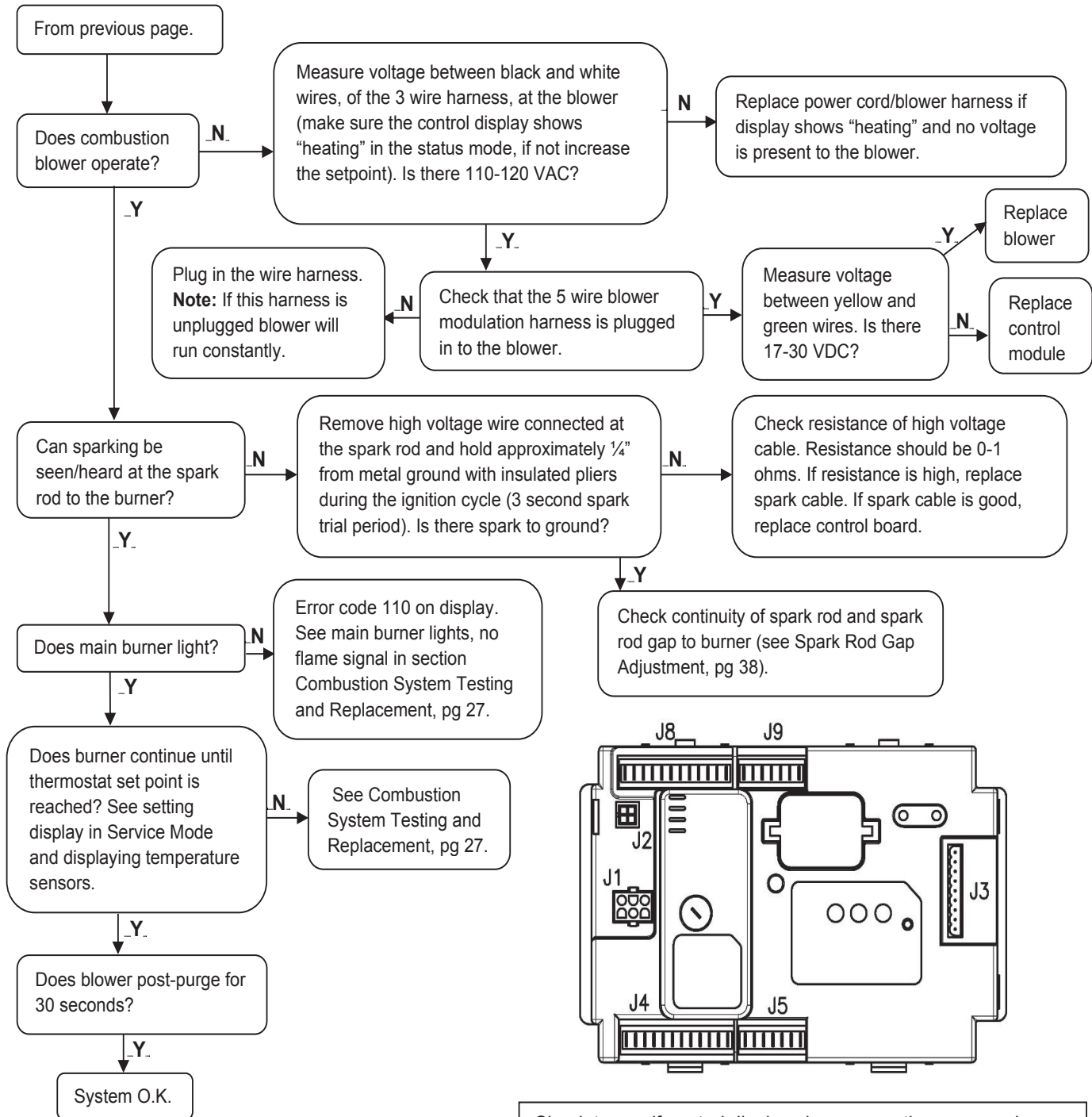

Check to see if control display shows any other error codes (high limit). If so, refer to the appropriate section below for testing and replacement.

Display Control

Water Heater Display and Control Buttons

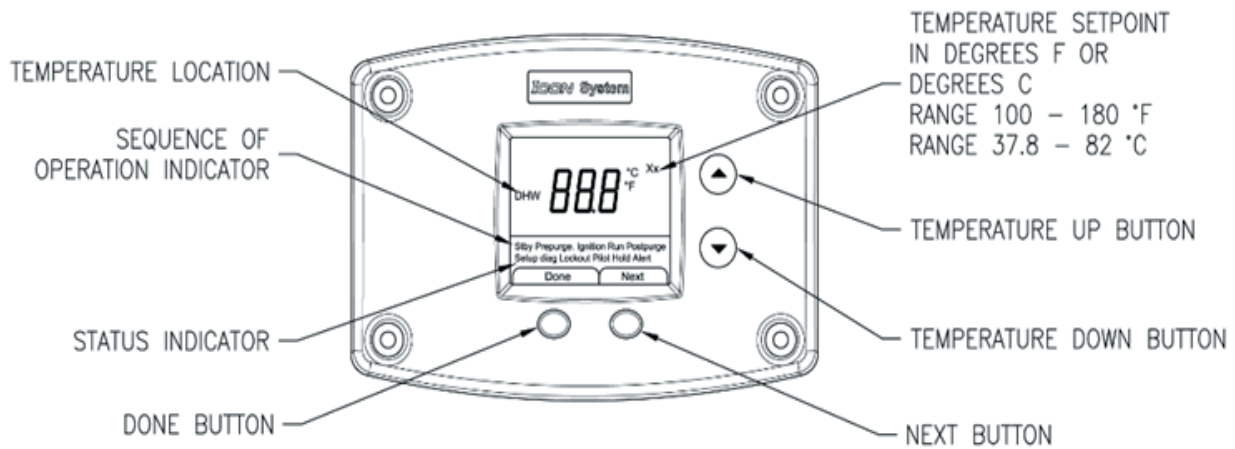

To Increase Temperature Setpoint

Step 1. Press and hold “Temperature Up” button until desired setpoint temperature appears on the display.

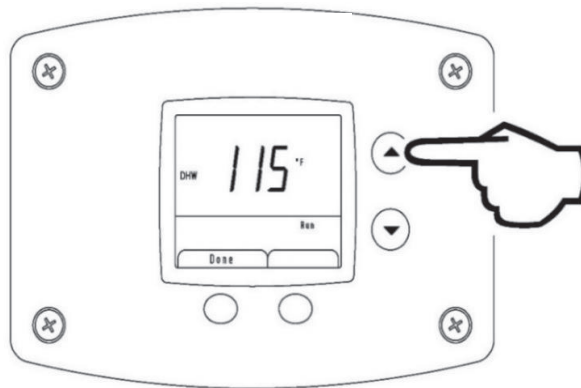

Step 2. Press “DONE” button for new setting to take effect immediately. If the “DONE” button is not pressed, the new temperature setting will take effect in approximately 10 seconds.

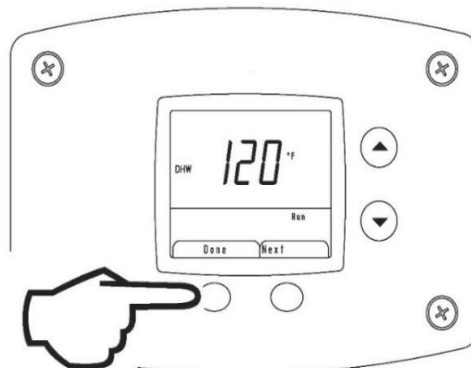

PRESS DONE BUTTON FOR SETTING TO TAKE EFFECT IMMEDIATELY

To Decrease Temperature Setpoint

Step 1. Press and hold “Temperature Down” button until desired setpoint temperature appears on the display.

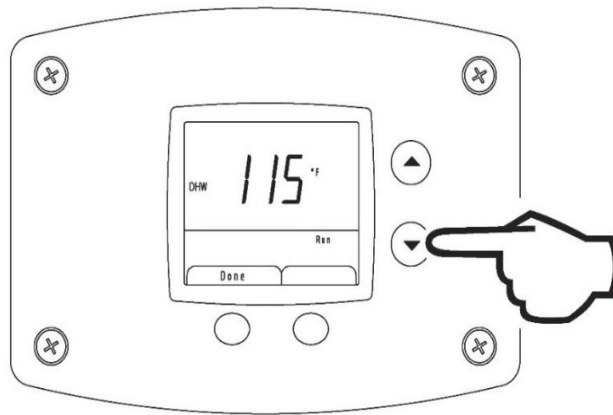

Step 2. Press “DONE” button for new setting to take effect immediately. If the “DONE” button is not pressed, the new temperature setting will take effect in approximately 10 seconds.

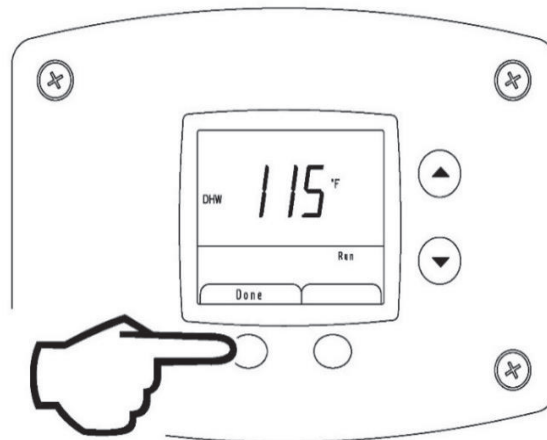

PRESS DONE FOR SETTING TO
TO TAKE EFFECT IMMEDIATELY

To View Combustion Rate

Step 1. Select Next while viewing Setpoint in User Mode to access Rate screen. Rate will only be displayed while the burner is operating.

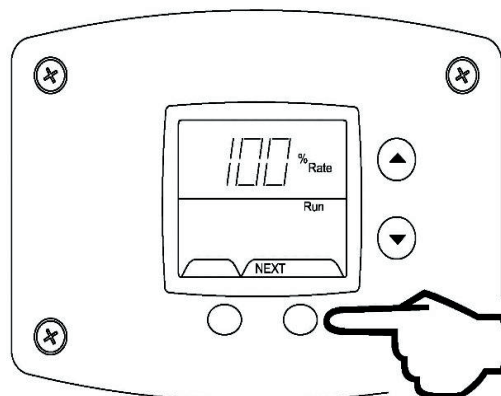

To Change Temperature Format in Display from °F to °C or °C to °F

Step 1. Enter “Set-Up Mode” by pressing both UP/DOWN buttons together for 3 seconds.

Step 2. Use the arrows to select between °F and °C

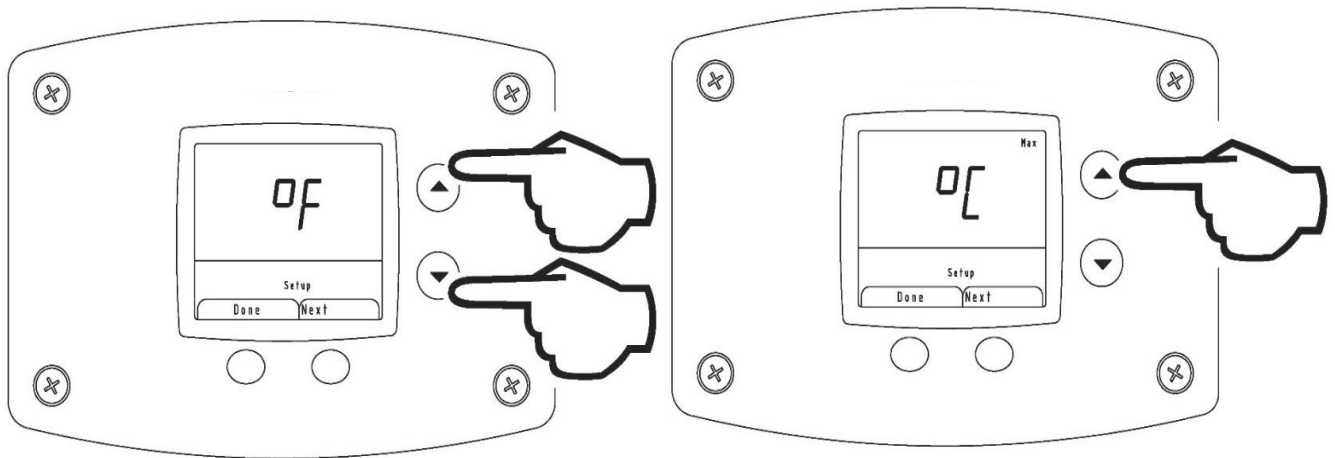

Step 3. Press done to return to main screen or timeout/change will occur in one minute.

An energy cut out (ECO) is incorporated in the sensor and control board which will shut off all gas supply to the burner if the water heater temperature exceeds 207°F (97.2°C). Should the ECO function (open), the water temperature should be reduced to approximately 120°F (49°C) and call a qualified service agent to place the water heater in operation. The water heater must have the problem corrected by a qualified service person before putting the water heater back in operation. It is recommended that all service work be performed by a qualified service agency.

If the water heater is to remain idle for 30 days or more or is subjected to freezing temperatures while shut off, the water heater and piping should be fully drained (See “To Drain the Water Heater”) and the drain valve should be left fully open.

WARNING

Hydrogen gas can be produced in an operating water heater that has not had water drawn from the tank for a long period of time (generally two weeks or more). **HYDROGEN GAS IS EXTREMELY FLAMMABLE.** To prevent the possibility of injury under these conditions, we recommend the hot water faucet to be open for several minutes at the kitchen sink before you use any electrical appliance which is connected to the hot water system. If hydrogen is present, there will be an unusual sound such as air escaping through the pipes as hot water begins to flow. **DO NOT smoke or have open flame near the faucet at the time it is open.**

WARNING

DO NOT run out of propane gas. Damage to the water heater may occur.

Troubleshooting

Accessing Diagnostic Mode on the Water Heater Display

(FOR SERVICE PERSONNEL ONLY)

The display has a Diagnostic Mode to access information in aiding servicing of the water heater. This procedure is for service and installation personnel only. To enter the Diagnostic Mode, follow the steps illustrated below:

WARNING

The following procedure is for **service and installation personnel ONLY**. Resetting lockout conditions without correcting the malfunction can result in a hazardous condition.

Step 1. Press and hold the lower right button under “Next” in the lower right display for at least 3 seconds. You must be in user mode on the DHW temp screen to access diagnostic mode. If in user mode on the view rate screen, you cannot access diagnostic mode.

NOTICE

The screens will stay in the Diagnostic Mode for 12.5 minutes after the last button press for viewing unless “Done” button is pressed to exit Diagnostic Mode.

Step 2. In the first screen of diagnostic mode the display will show the flame sense current in microamps when the burner is operating.

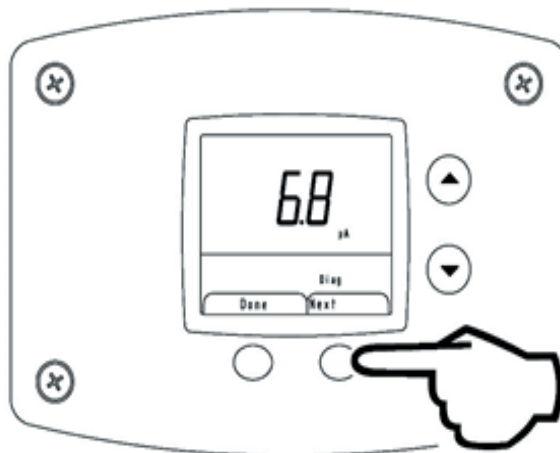

PRESS NEXT BUTTON FOR
3 SECONDS TO ENTER

Step 3. Press the lower right “Next” button. The display will flash and show the number of any alert codes. These are **not** currently used.

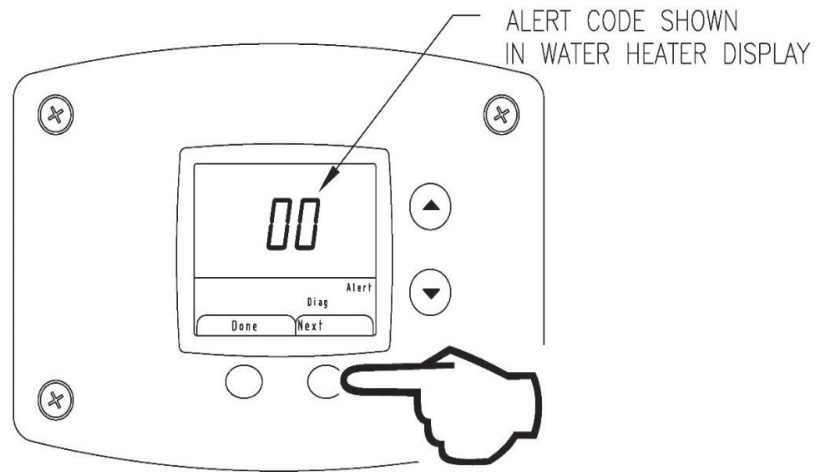

Step 4. Press lower right “Next” button. The display will flash and show the number of any Lockout codes. If there are no lockouts, the display will show 00. If there are multiple lockout codes “Next” will scroll through them.

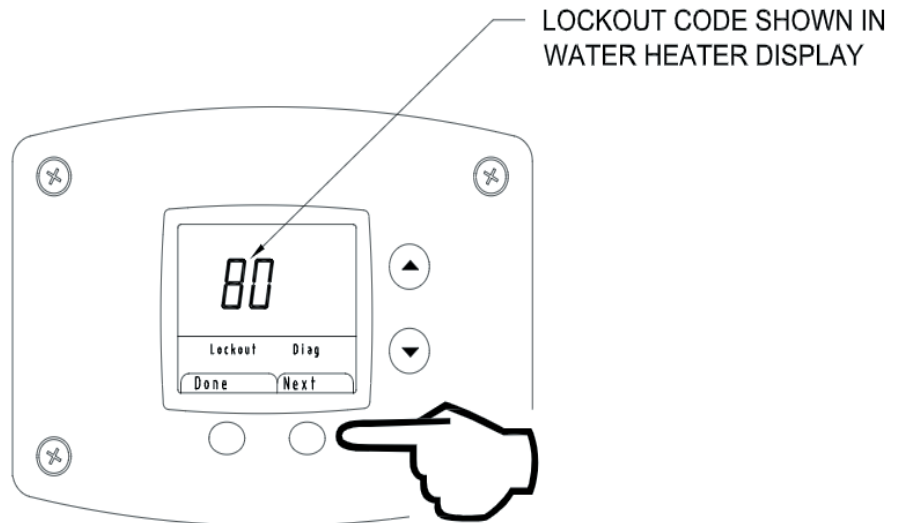

Step 5. Press “Next”, the display will show “DHW MAX”. This is the maximum allowable temperature that the unit can get to before a lockout occurs.

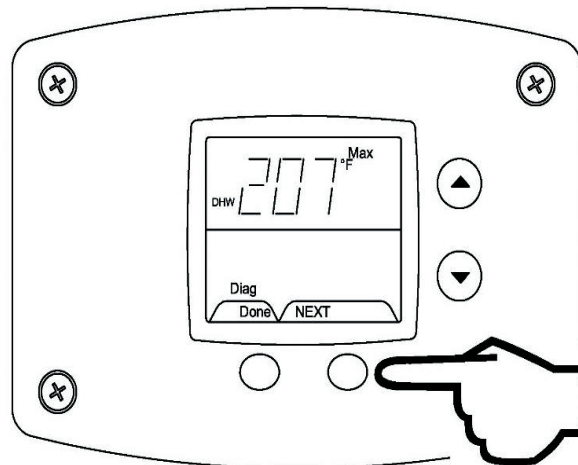

Step 6. Press Next, display will show “DELTA T DHW”, this is the real time temperature reading of the tank.

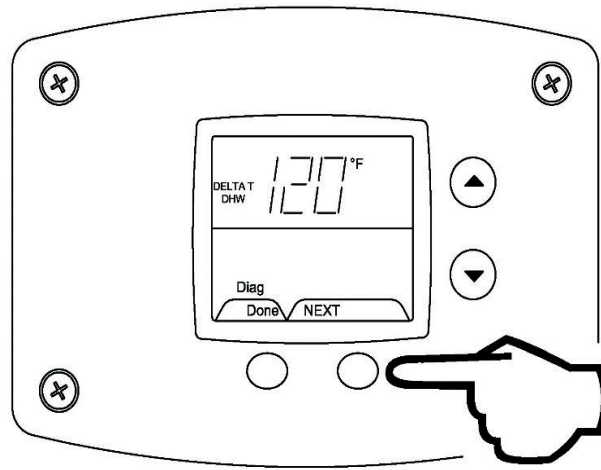

Step 7. Press “Done” to exit Diagnostic Mode and return to the DHW setpoint in User Mode.

NOTICE

The UCG ICON control system can produce soft and hard lockouts. Soft lockouts are displayed if active and are not stored in Diagnostic Mode history. The control will periodically attempt to resume normal operation when in soft lockout conditions. If the system resumes normal operation a soft lockout will clear instantly; hard lockouts will display if active and require manual reset. Up to ten previous Hard lockouts are logged chronologically (newest first) in Diagnostic Mode history.

Error Code	Definition of Code	Cause of Problem and Actions Taken to Correct
No code – blank display	No power to the unit or switch is off.	<ul style="list-style-type: none"> • Check power supply to the water heater. • Make sure water heater is plugged in and the breaker is on. • Check if there is 120 volts power supply to the LINE connections on the control board. • Verify 24 volts at display. • Check for loose wires, defective transformer. • Check wire harness connections from display to the control board.
9,22	Low flame sense signal	<ul style="list-style-type: none"> • Check microamp output of flame sense • Inspect flame sensor and wire • Inspect burner for debris
49	Voltage too low or high	<ul style="list-style-type: none"> • Measure the incoming line voltage. • Voltage should be 115-125 volts. • If the voltage is not within this range or there is drastic fluctuation, then have the incoming power supply checked. • If the line voltage is satisfactory, check the output from the transformer to make sure it is 22-26 volts. • Replace transformer or wiring if defective.
53	AC Inputs phase reversed	<ul style="list-style-type: none"> • Check the module and display connections. • Check the module power supply and make sure that frequency, voltage and VA capacity of the transformer meet specifications. • Check to make sure the wiring connections on the control module from terminals J4-10 and J8-2 are connected together.
62	Fan speed not proved	<ul style="list-style-type: none"> • Check the pulse width modulation (PWM) wire harness connection from the blower to the control module. • Make sure the pin terminals make solid contact. • Measure the resistance of each wire in the wire harness from the terminal ends. • Replace wire harness if defective. • If value remains out of range, this hold will change to lockout 123 (defined below)
80	High Limit (Overheat Condition)	<ul style="list-style-type: none"> • Check the wiring from the water temperature sensor to the control module. • Measure the resistance of each outside wire to the center wire. Measure the tank temperature and compare with the chart below. • If either outside wire has a much different resistance reading, replace the sensor. • Make sure the sensor is securely held inside the well with the clip. • If the problem persists and the sensor and wiring check O.K., then replace the control module.
93	Water temperature sensor fault	<ul style="list-style-type: none"> • Appears after alert 172, defined below. • Check the water temperature sensor wire harness from the sensor to the control module. • Make sure there are no loose connections to the control plug. • Check the resistance reading from each of the outside wires to the center (common) wire. Measure the tank temperature and compare with the chart below. • If the ohm readings are not fairly close, replace the sensor. • Replace the control module if the problem persists and the sensor and wire connections are not defective.

Error Code	Definition of Code	Cause of Problem and Actions Taken to Correct
105	Flame detected out of sequence	<ul style="list-style-type: none"> • Check to see if flame is present inside the combustion chamber before or after the ignition cycle. • If so, check to make sure the gas valve is wired correctly. • Check for voltage at the gas valve connection. • Replace the gas valve if defective. • If no flame is visible outside of the ignition sequence/run cycle, then make sure the flame sensor is wired to the correct terminal. • Make sure the ignition cable is not crossing the flame sensor wire or ignition ground wires. • If problem persists and all other checks have been verified, replace the control module.
109, 110	Ignition Failure Occurred.	<ul style="list-style-type: none"> • Burner failed to light or stay lit after 4 retries. • Hold condition – will reattempt ignition after 15-minute waiting period. A log will be stored in service history. • Check gas valve wiring and gas valve operation during the ignition cycle. • If burner lights but quickly goes out, check the flame sensor wire or the flame sensor. • If the flame sensor rod is badly corroded with deposits, clean with sandpaper or replace. • Check the inlet gas supply to make sure the pressure is sufficient and does not drop after the gas valve opens. • Make sure the combustion blower is operating during the ignition and run cycle. • Check the venting system to make sure the inlet and exhaust terminals and venting system is not blocked.
122,123	Light-off Rate Proving Failed	<ul style="list-style-type: none"> • If blower speed is not verified from the PWM (Pulse Width Modulation) signal within 5 minutes, the previously described error code “62” changes from a hold condition to this lockout code condition • Check the harness and pin terminals for a good connection to the control module. • Replace the blower or control module if the wire harness is good.
172	Water temperature sensor resistance invalid	<ul style="list-style-type: none"> • Hold 93 will be displayed if this value remains out of range • Measure the resistance of the water temperature sensor and compare it with the tank temperature using the chart below.
NOTE		<ul style="list-style-type: none"> • If there is no display, check primary/secondary voltage • Before troubleshooting always verify the following <ul style="list-style-type: none"> ○ Gas inlet pressure ○ Static to dynamic gas pressure drop ○ No vent and intake restrictions ○ All wire connections are tight ○ No grounded wires or missing grounds ○ No water leaks

Service Procedure I: Thermostat Circuit Testing and Replacement

IMPORTANT NOTE: This procedure assumes a cool tank.

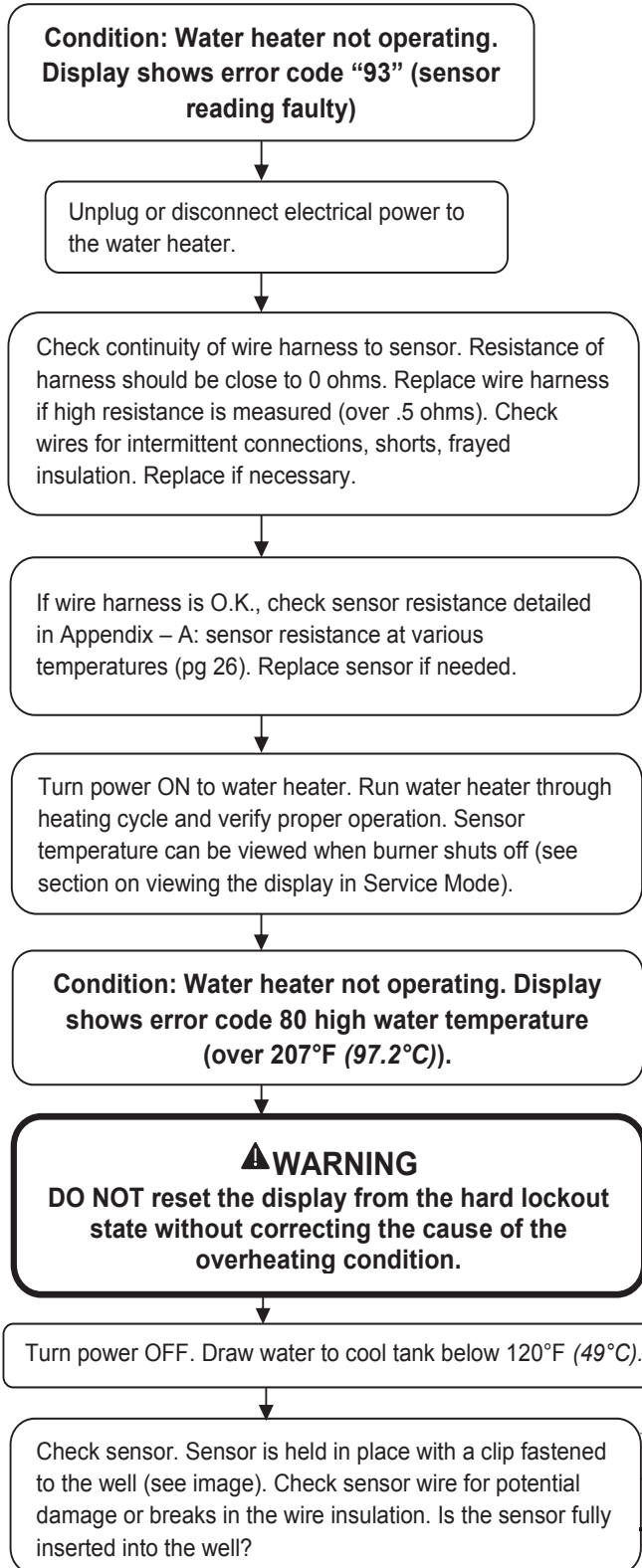

⚠️ WARNING

120 volt potential exposure. Use caution making voltage checks to avoid personal injury.

⚠️ CAUTION

Use caution to not damage connectors when making voltage measurements or jumping terminals.

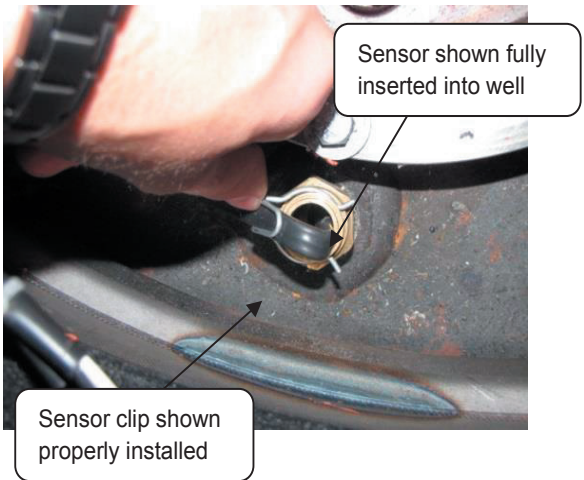
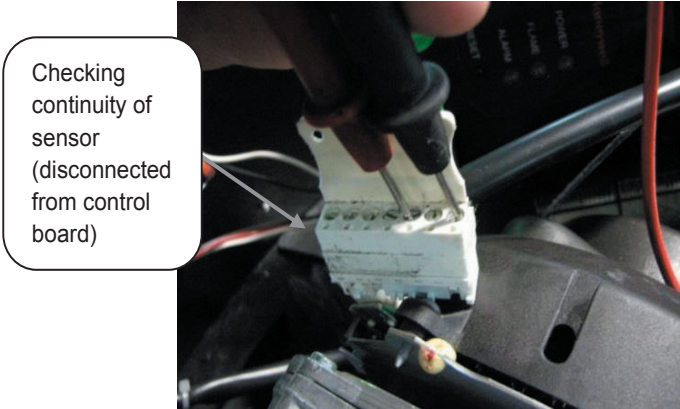

Service Procedure I: Thermostat Circuit Testing and Replacement (Continued)

Condition: Water heater not operating. Display shows error code 80 high water temperature (over 207°F (97.2°C)) (continued from previous page).

! WARNING
DO NOT operate water heater without verifying that the overheating condition has been corrected.

Once cause of overheating condition has been diagnosed and corrected, the control may be reset.

- Reconnect and switch on power to the water heater.
- Press button under "Reset" and hold for 3 seconds.
- Set thermostat to the desired setting.
- Water heater will start.
- Monitor temperatures for one complete heating cycle making sure the maximum tank temperature remains below 207°F (97.2°C).

This water heater is equipped with a manual reset type gas shutoff device designed to shut off the gas to the burners if excessive water temperature occurs. To reset the control, press the lower right button under "RESET" in the display for 3 seconds.

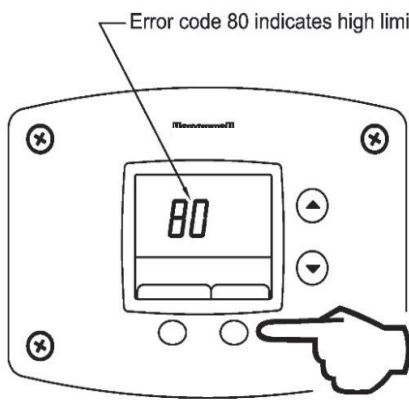

Step 1: Press for 3 seconds to reset control.

Service Procedure I: Thermostat Circuit Testing and Replacement (Continued)

Thermostat Sensor (Thermister) Replacement Procedure

1. Position main power switch to OFF.
2. Disconnect (unplug) water heater from 120 volt power source.
3. Unlatch and remove the top surround cover from top of heater.
4. Disconnect the temperature sensor from control (see images below).
5. Unclip the sensor from well and pull sensor to remove, **DO NOT** remove well (see image).
6. Install new sensor assembly into well and reinstall sensor clip.
7. Reconnect the sensor connector to the control board and route the wire harness through the same path that it was removed.
8. Restore 120 volt power supply and water supply to water heater, check and repair any leaks found. Confirm proper operation following the lighting instructions on the lighting instruction label or the lighting instruction located in the Installation and Operating Instruction Manual.
9. Replace the surround cover on the top of the water heater.

WARNING

120 volt potential exposure.
Isolate the appliance and
reconfirm power is disconnected
using a multi-meter.

Disconnect sensor
harness from
control board

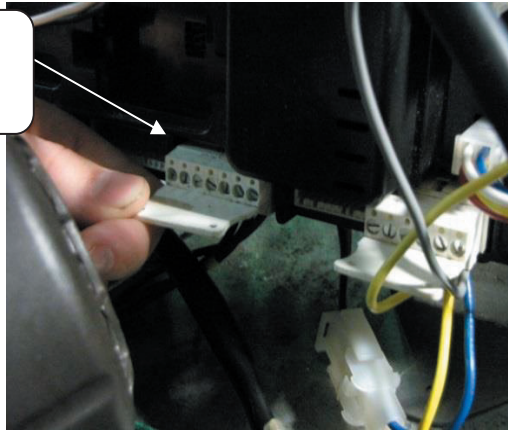

Sensor shown fully
inserted into well



Sensor clip shown
properly installed



Service Procedure I: Thermostat Circuit Testing and Replacement (Continued)

APPENDIX-A Sensor Resistance at Various Temperatures

Be careful when making voltage measurements or jumping terminals not to damage or deform connectors or connector pins.

Draw water from the temperature and pressure relief valve. Compare temperature with temperature ohms chart below.

Example: If the temperature is 84°F, then the resistance through the sensor would be 8449 (see shaded area).
Note: Sensor resistance increases as the temperature falls.

In Degrees F										
°F	0	1	2	3	4	5	6	7	8	9
40	26109	25400	24712	24045	23399	22771	22163	21573	21000	20445
50	19906	19383	18876	18383	17905	17440	16990	16553	16128	15715
60	15314	14925	14548	14180	13823	13477	13140	12812	12494	12185
70	11884	11592	11308	11032	10763	10502	10248	10000	9760	9526
80	9299	9078	8862	8653	8449	8250	8057	7869	7685	7507
90	7333	7165	7000	6839	6683	6531	6383	6238	6098	5961
100	5827	5697	5570	5446	5326	5208	5094	4982	4873	4767
110	4663	4562	4464	4368	4274	4183	4094	4006	3922	3839
120	3758	3679	3602	3527	3453	3382	3312	3244	3177	3112
130	3048	2986	2925	2866	2808	2752	2697	2643	2590	2538
140	2488	2439	2391	2344	2298	2253	2209	2166	2124	2083
150	2043	2004	1966	1928	1891	1856	1820	1786	1753	1720
160	1688	1656	1625	1595	1566	1537	1509	1481	1454	1427
170	1402	1376	1351	1327	1303	1280	1257	1235	1213	1191
180	1170	1150	1129	1110	1090	1071	1053	1035	1017	999
190	982	965	949	933	917	901	886	871	857	842
200	828	814	801	788	775	762	749	737	725	713

In Degrees C										
°C	0	1	2	3	4	5	6	7	8	9
0	32648	31026	29495	28049	26682	25389	24166	23010	21915	20879
10	19898	18968	18088	17253	16461	15710	14998	14322	13680	13071
20	12492	11942	11419	10922	10450	10000	9572	9165	8778	8409
30	8057	7722	7403	7099	6808	6532	6268	6016	5775	5546
40	5327	5117	4917	4726	4543	4368	4201	4042	3889	3742
50	3602	3468	3340	3217	3099	2986	2878	2774	2675	2579
60	2488	2400	2316	2235	2157	2083	2011	1942	1876	1813
70	1752	1693	1637	1582	1530	1480	1432	1385	1340	1297
80	1256	1216	1177	1140	1105	1070	1037	1005	974	944
90	916	888	861	835	810	786	763	741	719	698

Service Procedure II: Combustion System Testing and Replacement

Observe burner operation through the sight glass located on the combustion insert mounting flange. Normal burner operation should ignite smoothly, without evidence of coughing or huffing upon ignition. The burner flame should be a blue flame near the burner surface in a uniform flame pattern. Occasional yellow or white streaks are normal.

Note: On this high input model that uses metal fiber mesh burner a red glow from the burner surface is normal.

! WARNING

120 volt potential exposure. Use caution making voltage checks to avoid personal injury.

! WARNING

Removing screw from inlet gas pressure tap will immediately allow gas to flow from pressure tap.

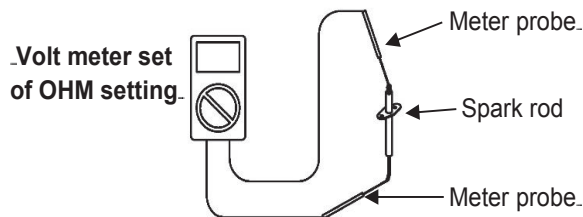
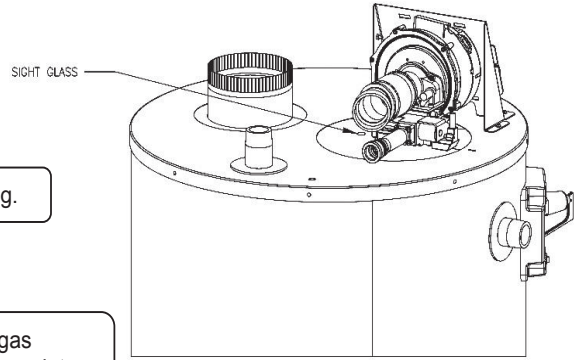
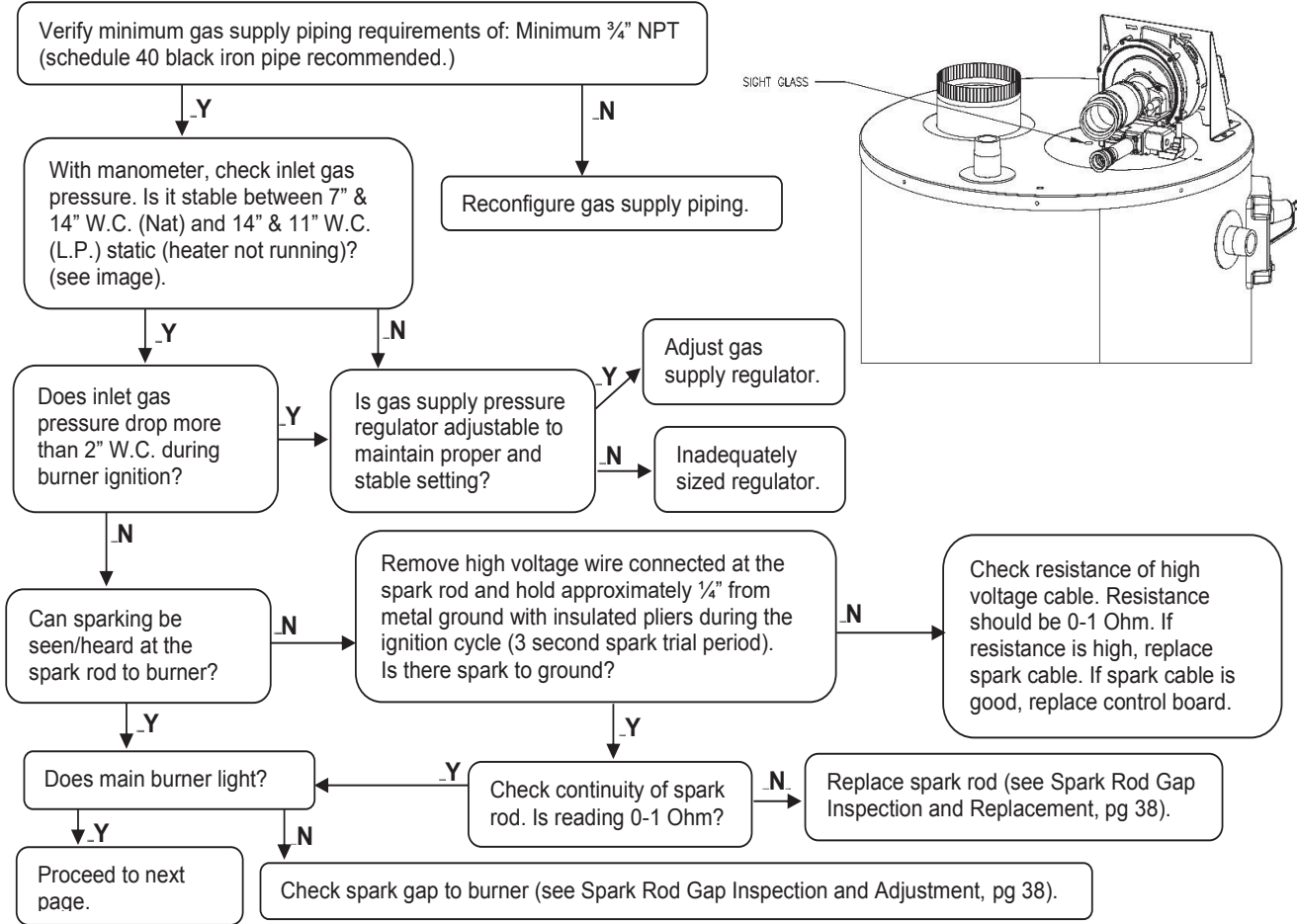

CHECK SPARK ROD RESISTANCE

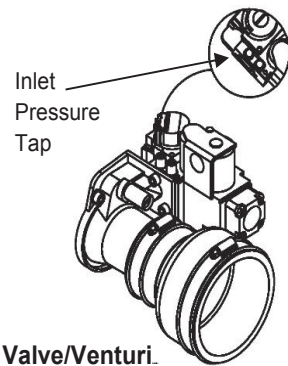

Gas Valve/Venturi.

Service Procedure II: Combustion System Testing and Replacement (Continued)

Observe burner operation through the sight glass located on the combustion insert mounting flange. Normal burner operation should ignite smoothly, without evidence of coughing or huffing upon ignition. The burner flame should be a blue flame near the burner surface in a uniform flame pattern. Occasional yellow or white streaks are normal.

Note: On this high input model that uses metal fiber mesh burner a red glow from the burner surface is normal.

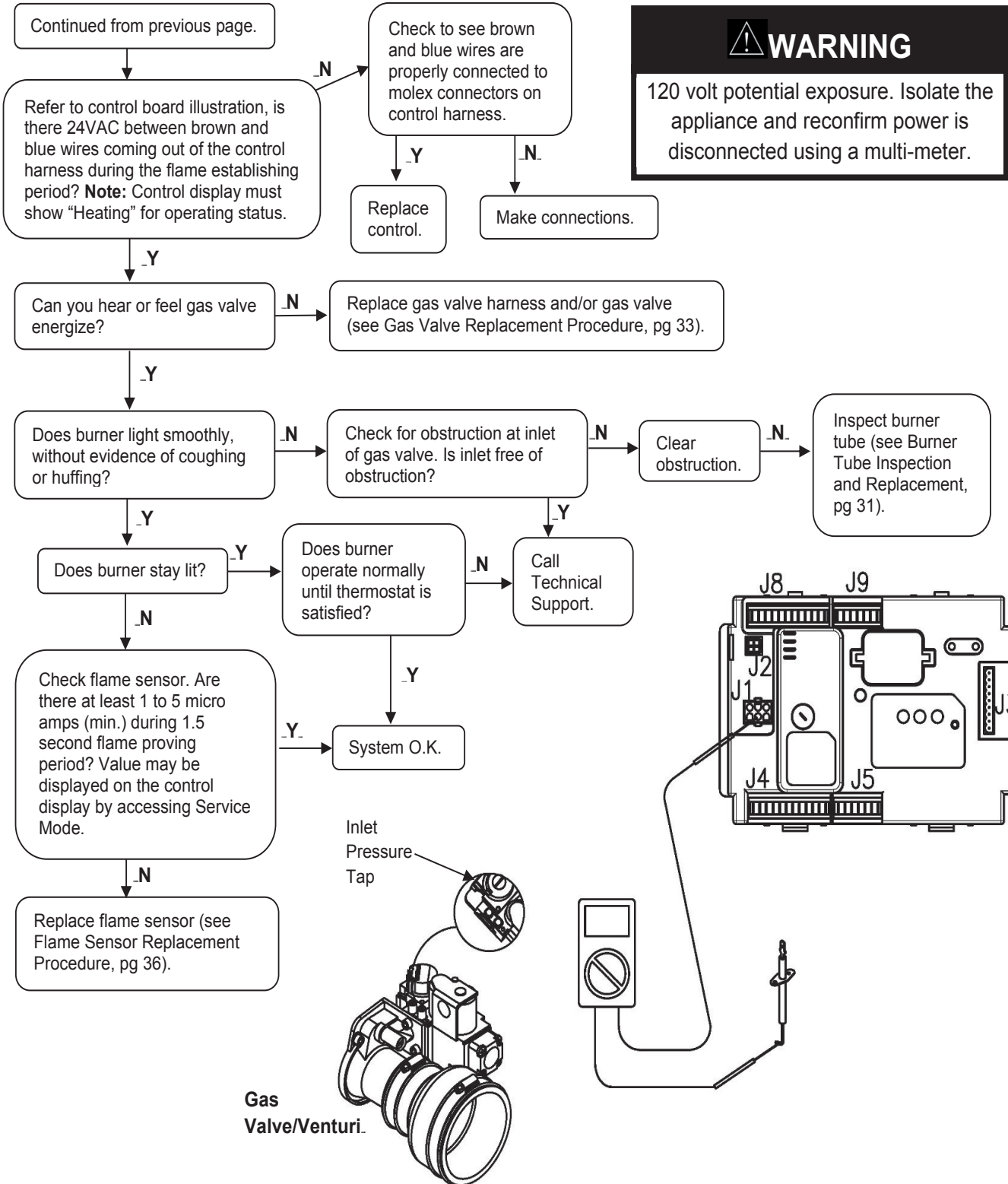

Service Procedure II: Combustion System Testing and Replacement (Continued)

WARNING

Heater components may be **HOT** when performing the following steps in this procedure. Take necessary precaution to prevent personal injury.

WARNING

120 volt potential exposure. Isolate the appliance and reconfirm power is disconnected using a multi-meter.

Combustion System Removal Procedure

1. Position main power switch to OFF.
2. Disconnect (unplug) water heater from 120 volt power source.
3. Turn OFF gas supply to water heater.
4. Unlatch and remove surround cover from top of heater.
5. From the gas valve, disconnect the gas connection, PVC intake venting, silicone tubing, and wire harness.
6. Disconnect wire harnesses flame sensor, gas valve, and blower. Disconnect high voltage cable from spark rod connection.
7. Remove the 5 bolts (1/2" socket) holding the burner mounting insert in place.
8. Carefully remove combustion assembly with gasket from water heater.
9. See next page for combustion system installation procedure.

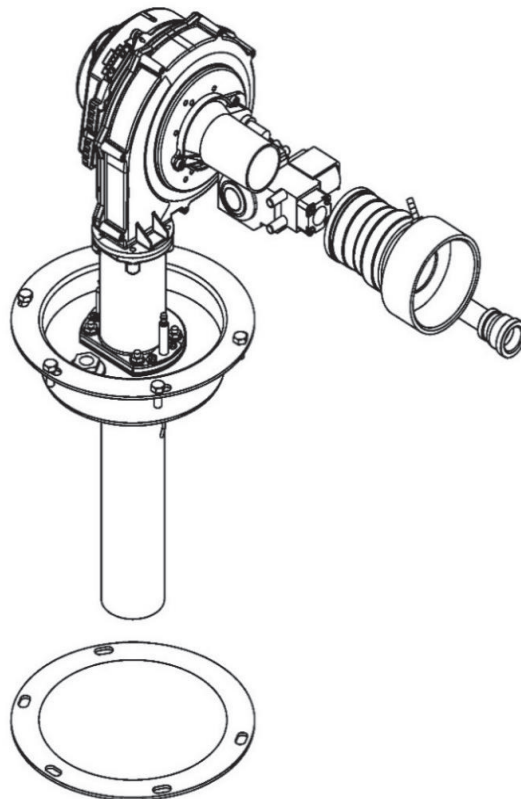

Service Procedure II: Combustion System Testing and Replacement (Continued)

Combustion System Replacement Procedure

1. Fully inspect burner mounting insert gasket for the following:
 - a. Tears
 - b. Missing material
 - c. Cracks
 - d. Dirt or debris
 - e. Other imperfections that would inhibit proper seal

If gasket is NOT affected by any of the above, gasket replacement is not required.

2. Install the combustion assembly using new gasket or fully inspected gasket from Step 1. Secure combustion assembly at the burner mounting insert using screws from Step 7 on previous page. Tighten screws evenly.
3. Reconnect the high voltage cable to spark rod, flame sensor, blower and gas valve.
4. Reconnect the PVC intake venting, gas supply, and silicone tubing to gas valve. Turn ON gas supply to heater and check for gas leaks, repair any gas leaks found.
5. Restore 120 volt power supply to water heater and confirm proper operation following the lighting instructions on the lighting instruction label or the lighting instruction located in the Installation and Operating Instruction Manual.
6. Replace the surround cover on the top of the water heater.

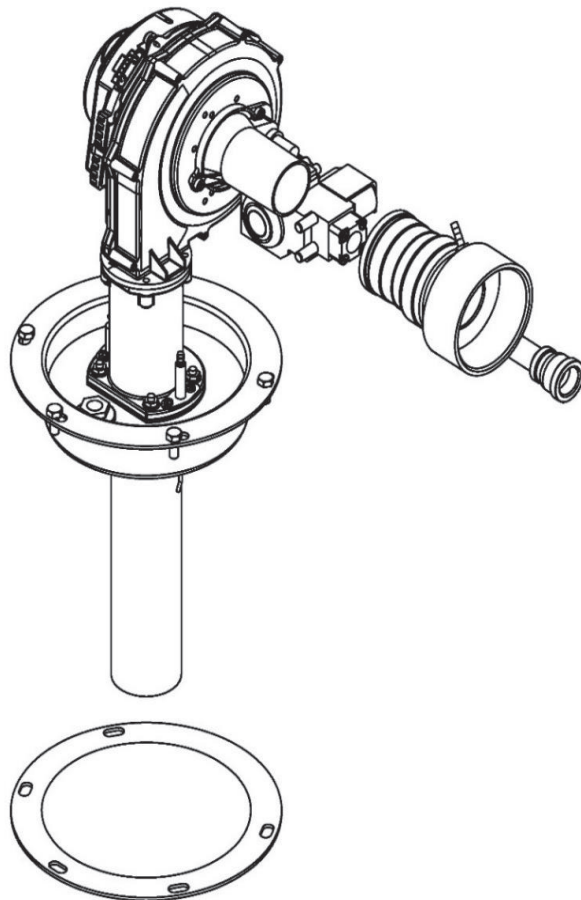

Service Procedure III: Burner Tube Inspection and Replacement

WARNING

Heater components may be **HOT** when performing the following steps in this procedure. Take necessary precaution to prevent personal injury.

WARNING

120 volt potential exposure. Isolate the appliance and reconfirm power is disconnected using a multi-meter.

Burner Tube Removal Procedure

1. Position main power switch to OFF.
2. Disconnect (unplug) water heater from 120 volt power source.
3. Turn OFF gas supply to water heater.
4. Unlatch and remove surround cover from top of heater.
5. From the gas valve, disconnect the PVC intake venting, gas supply connection, wire harness, and silicone tubing.
6. Disconnect wire harness from blower assembly.
7. Remove the screws holding the spark rod and flame sensor in place (long reach magnetic Phillips screwdriver). Carefully remove spark rod and flame sensor from combustion assembly.
8. Remove the 4 nuts (7/16" wrench) holding the burner transition in place. Lift the blower/gas valve transition assembly from burner mounting insert, remove gasket and set aside.
9. Remove burner tube from burner mounting insert. See next page for burner tube inspection procedure.

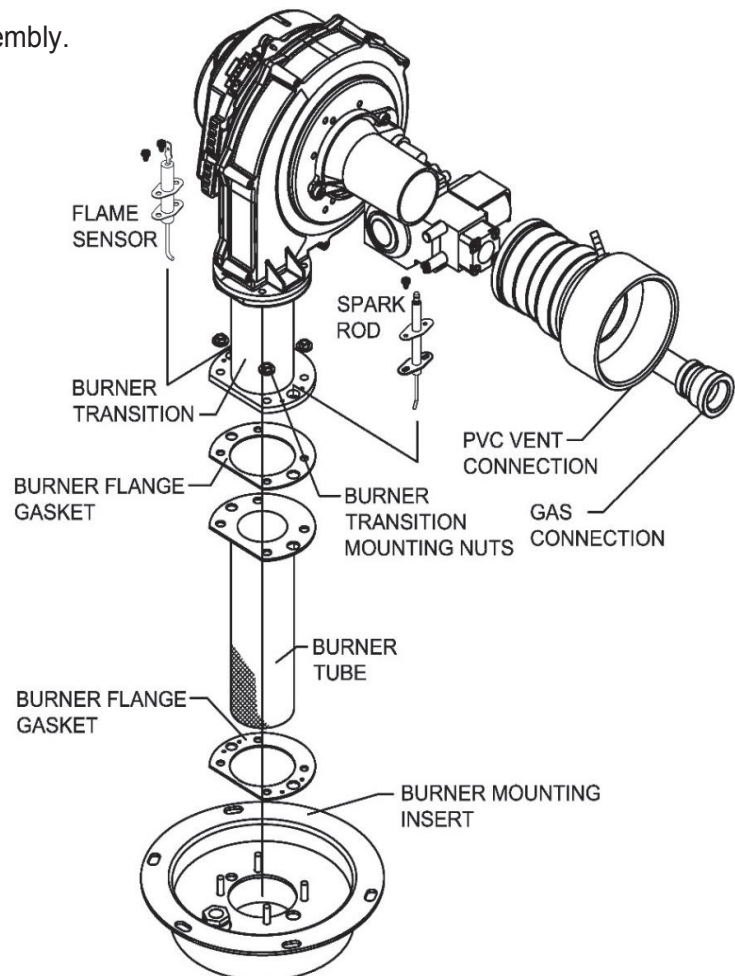

Service Procedure III: Burner Tube Inspection and Replacement (Continued)

WARNING

Heater components may be **HOT** when performing the following steps in this procedure. Take necessary precaution to prevent personal injury.

Burner Tube Inspection

1. **Inspect burner tube as follows (Acotech metal fiber mesh burner).**
 - a. Outer fiber mesh should be uniform with no tears or deterioration.
 - b. Gently squeeze burner tube, Burner tube should feel firm without any soft areas around the sides or at the bottom.
 - c. Visually inspect inside burner tube, Burner tube should be intact with no areas of deterioration. Ports should be free of any debris.
2. If burner tube is affected by any of the above, replacement is required. Refer to burner tube replacement procedure below.

Burner Tube Replacement Procedure

Note: Provide the model and serial number for the correct replacement burner.

1. Fully inspect burner flange gaskets, igniter and flame sensor gaskets for the following:
 - a. Tears
 - b. Missing material
 - c. Cracks
 - d. Dirt or debris
 - e. Other imperfections that would inhibit proper seal

If gaskets are NOT affected by any of the above, gasket replacement is not required.

2. Install burner tube with gaskets into burner mounting insert. Be sure gasket surfaces are free of debris.
3. Reconnect the blower/gas valve/transition assembly to burner mounting insert. Secure using nuts from Step 8 on previous page.
4. Carefully reinstall flame sensor with gasket and spark rod with gasket and secure with screws from Step 7 on previous page. Reconnect wire harnesses to sensor and igniter.
5. Reconnect wire harnesses to blower motor and to gas valve.
6. Reconnect PVC intake venting, gas supply, and silicone tubing to gas valve. Turn ON gas to heater and check for gas leaks, repair any gas leaks found.
7. Restore 120 volt power supply to water heater and confirm proper operation following the lighting instructions on the lighting instruction label or the lighting instruction located in the Installation and Operating Instruction Manual.
8. Replace the surround cover on the top of the water heater.

Service Procedure IV: Gas Valve Replacement

Gas Valve Replacement Procedure

1. Position main power switch to OFF.
2. Disconnect (unplug) water heater from 120 volt power source.
3. Turn OFF gas supply to water heater.
4. Unlatch and remove surround cover from top of heater.
5. From the gas valve, disconnect the gas connection, PVC venting, wire harness, and silicone tubing.
6. Remove the 2 to 3 gas valve mounting screws (Torx bit) located as shown below on the venturi mounting flange and remove gas valve from water heater.
7. Remove any residual gasket material from blower and venturi mounting flange.
8. Install new gas valve with new gasket provided. Secure gas valve in place using screws from Step 6.
9. Reconnect PVC intake venting, gas supply, silicone tubing, and wire harness to gas valve. Turn ON gas supply to heater and check for gas leaks, repair any gas leaks found.
10. Restore 120 volt power supply to water heater and confirm proper operation following the lighting instructions on the lighting instruction label or the lighting instruction located in the Installation and Operating Instruction Manual.
11. Replace

WARNING

120 volt potential exposure. Isolate the appliance and reconfirm power is disconnected using a multi-meter.

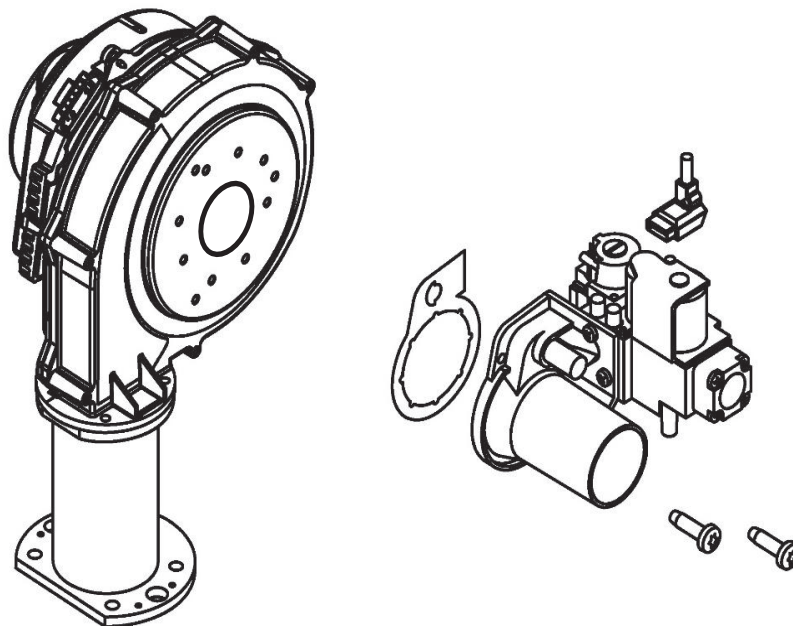

Service Procedure V: Blower Testing and Replacement

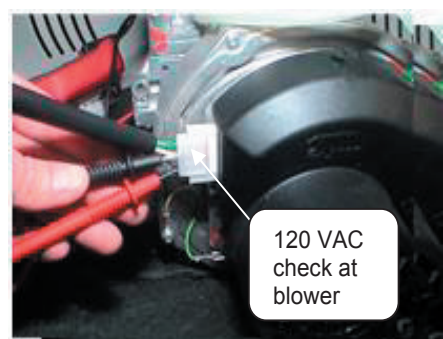
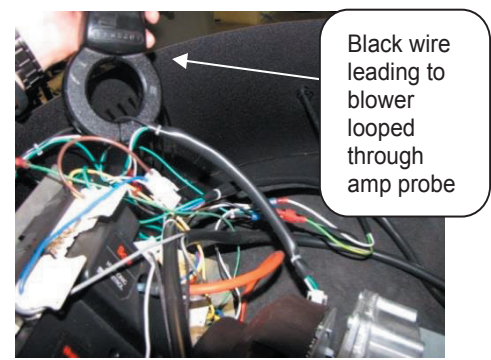
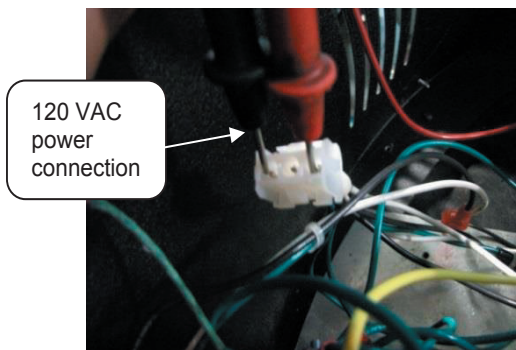
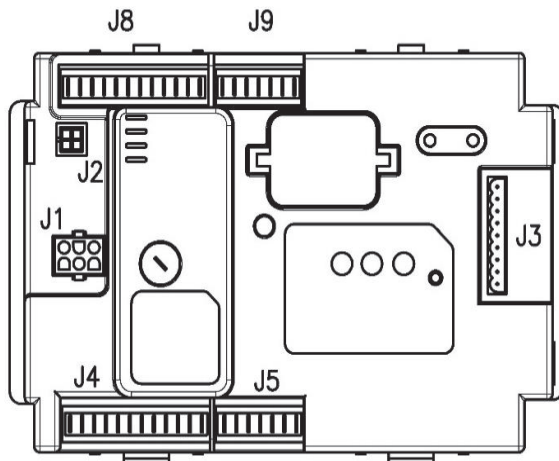
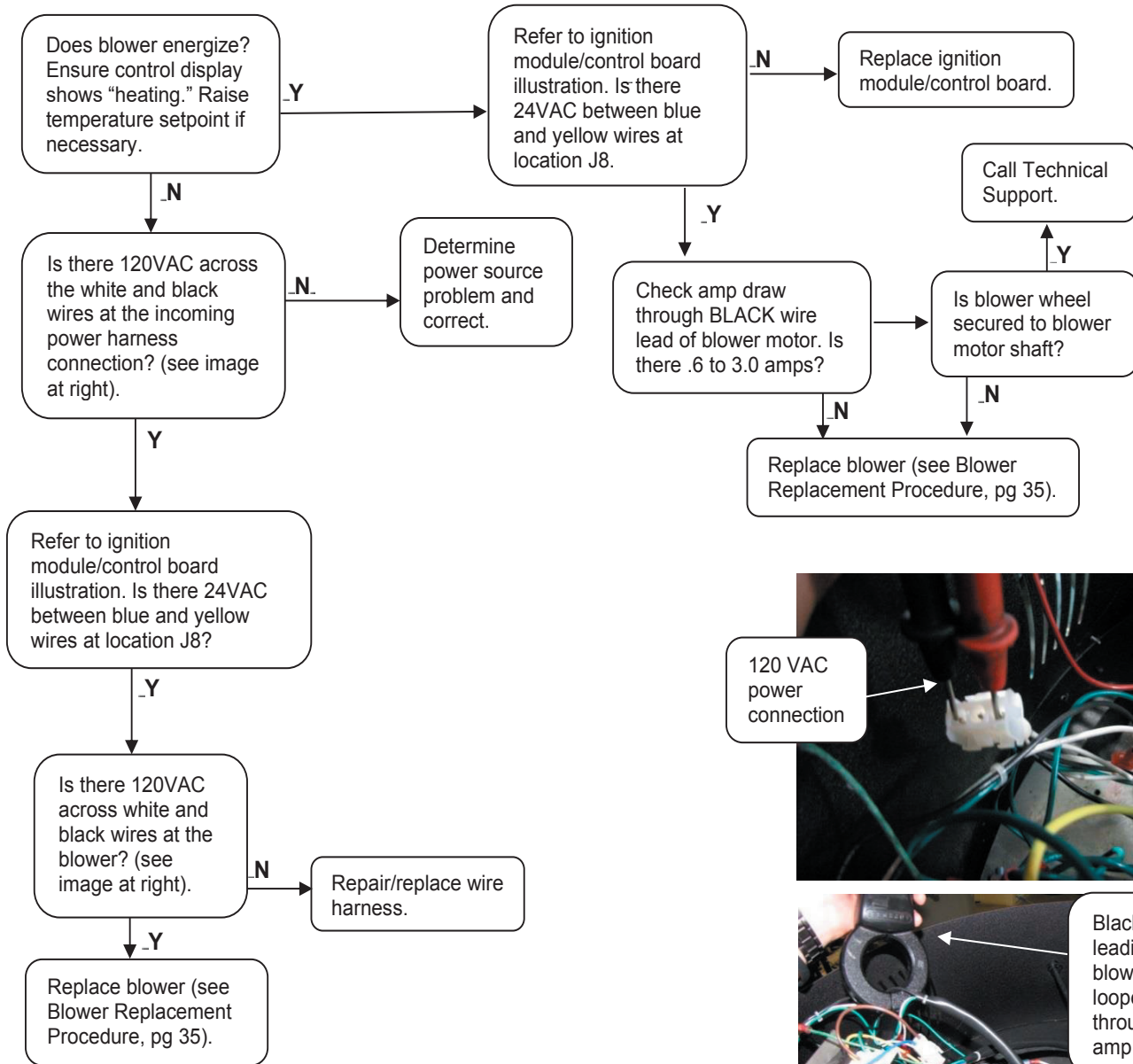

Service Procedure V: Blower Testing and Replacement (Continued)

Blower Replacement Procedure

1. Position main power switch to OFF.
2. Disconnect (unplug) water heater from 120 volt power source.
3. Turn OFF gas supply to water heater.
4. Unlatch and remove surround cover from top of heater.
5. Disconnect the 2 wire harnesses from blower.
6. Disconnect intake vent and gas supply from gas valve assembly.
7. Remove the 2 to 3 gas valve mounting screws (Torx bit) located on the venturi mounting flange (refer to page 33 for more details.)
8. Remove the 4 blower flange mounting screws (5/32 Allen wrench) and remove blower from transition flange.
9. Remove any residual gasket material from venturi mounting flange and transition flange.
10. Install new blower with new gasket provided. Secure blower in place using screws from Step 8.
11. Reconnect gas valve assembly to blower with new gasket provided. Secure gas valve in place using screws from Step 7.
12. Reconnect intake vent and gas line to gas valve assembly and check for gas leaks. Repair any leaks found.
13. Reconnect the 2 wire harnesses to blower assembly. Restore 120 volt power supply and gas supply to water heater and confirm proper operation following the lighting instructions on the lighting instruction label or the lighting instructions located in the Installation and Operating Instruction Manual.
14. Replace the surround cover on the top of the water heater.

WARNING

120 volt potential exposure. Isolate the appliance and reconfirm power is disconnected using a multi-meter.

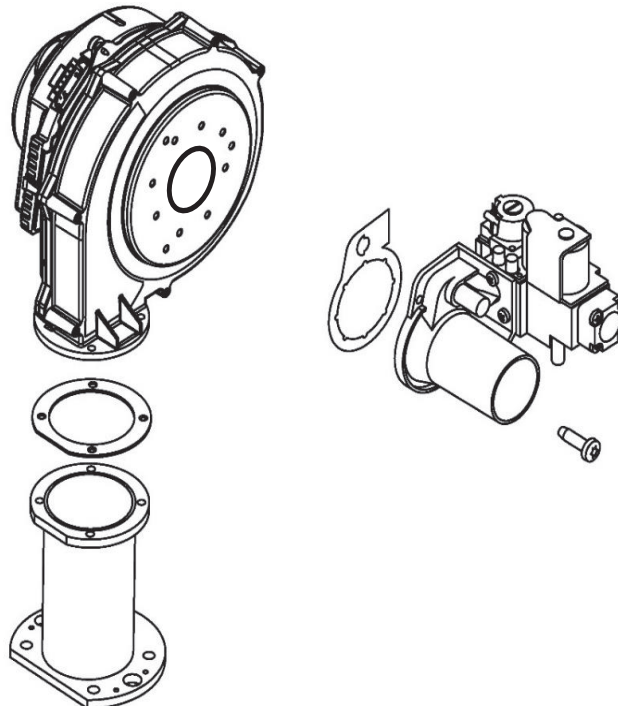

Service Procedure VI: Flame Sensor Testing and Replacement

Flame Sensor Testing Procedure

WARNING

120 volt potential exposure. Use caution making voltage checks to avoid personal injury. Flame sensor may be too hot to handle, take necessary precautions.

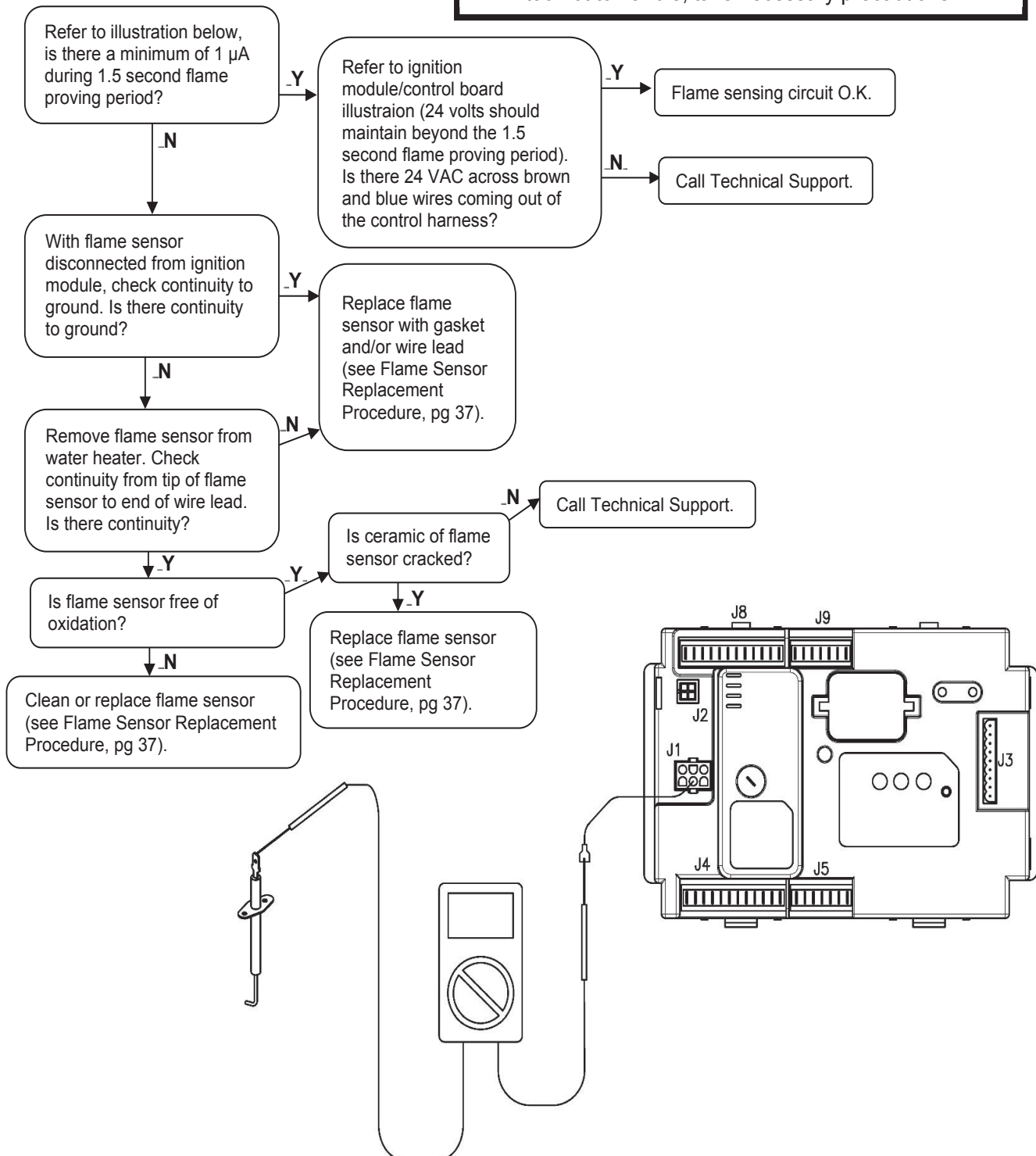

Service Procedure VI: Flame Sensor Testing and Replacement (Continued)

Flame Sensor Replacement Procedure

1. Position main power switch to OFF.
2. Disconnect (unplug) water heater from 120 volt power source.
3. Unlatch and remove surround cover from top of heater.
4. Disconnect the wire lead from flame sensor.
5. Remove the 2 sensor mounting screws (magnetic tip, long reach Phillips screwdriver) and remove flame sensor and gasket from transition base flange.
6. Remove any residual gasket material from transition base flange.
7. Install new flame sensor with new gasket provided using screws from Step 6. Arrange flame sensor with hook towards burner.
8. Reconnect the flame sensor wire.
9. Restore 120 volt power supply to water heater and confirm proper operation following the lighting instructions on the lighting instruction label or the lighting instructions located in the Installation and Operating Instruction Manual.
10. Replace the surround cover on the top of the water heater.

WARNING

120 volt potential exposure. Isolate the appliance and reconfirm power is disconnected using a multi-meter.

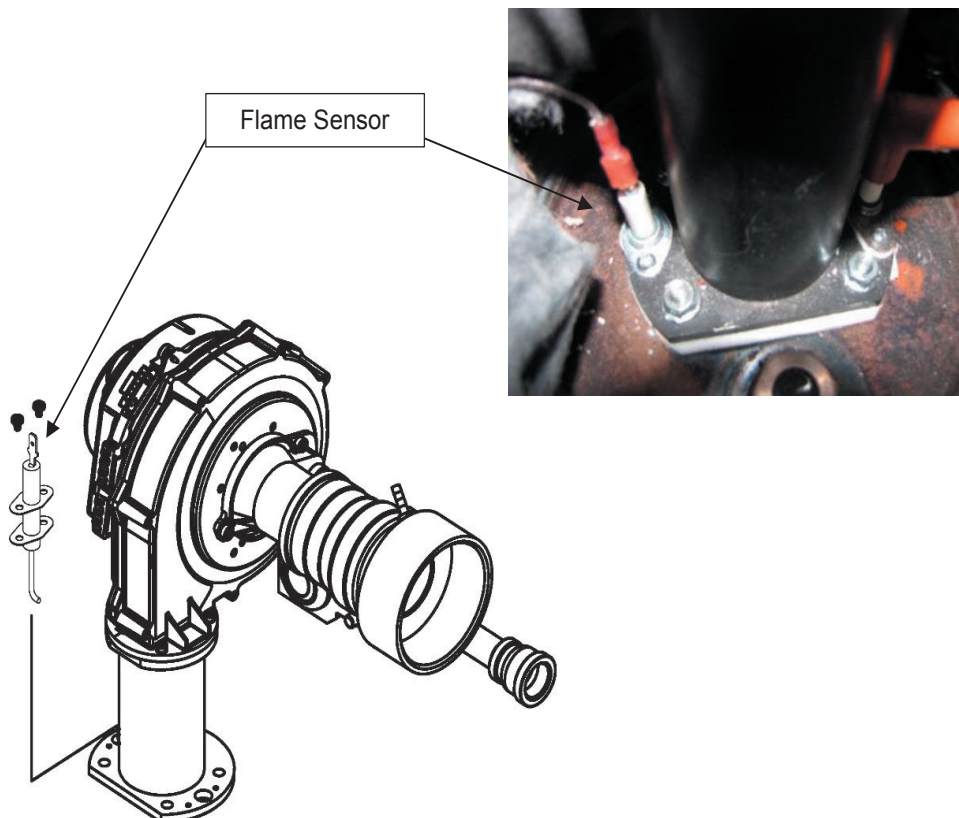

Service Procedure VII: Spark Rod Gap Adjustment and Replacement

Spark Rod Gap Inspection and Adjustment

1. Remove combustion system as described in Combustion System Removal Procedure, pg 27.
2. Measure spark gap between the spark rod and burner tube. Acceptable spark gap is from 3/16" to 1/4" (see image below).
3. If spark gap is not between 3/16" to 1/4", the spark rod may be carefully bent by supporting the end near the ceramic insulator with pliers and bending the end near the burner tube with needle nose pliers (see image below).
4. Re-measure and verify the spark gap is between 3/16" to 1/4" after bending.
5. Verify the integrity of all gaskets and replace where required.
6. Reinstall the combustion system per Combustion System Replacement Procedure (pg 27) and check several ignitions to ensure the burner lights smoothly.

WARNING

Spark gap must be set from 3/16" to 1/4". Failure to set and verify proper spark gap may result in a delayed ignition resulting in damage to the water heater.

CAUTION

Use caution while performing these steps to prevent stressing or cracking the ceramic insulator.

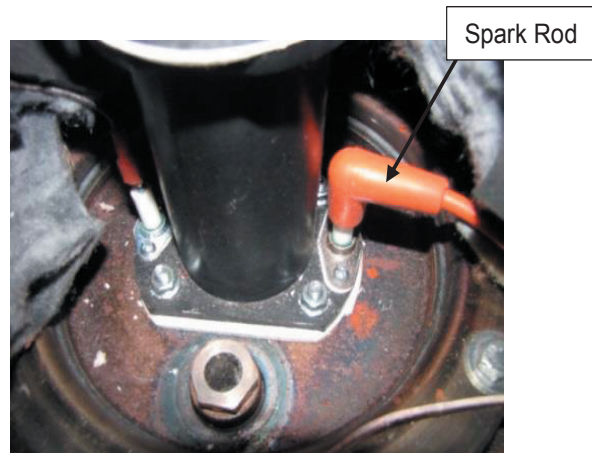
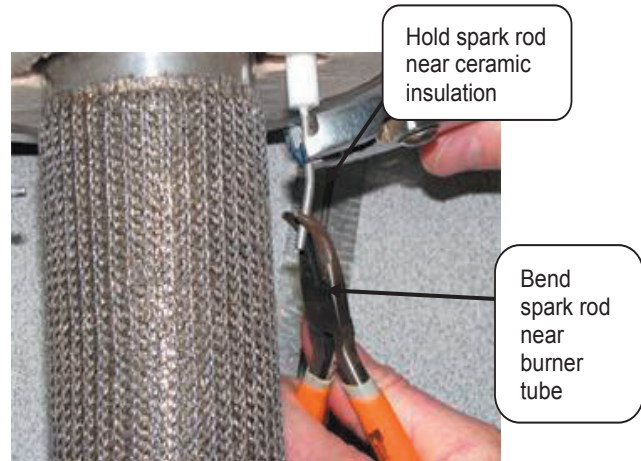
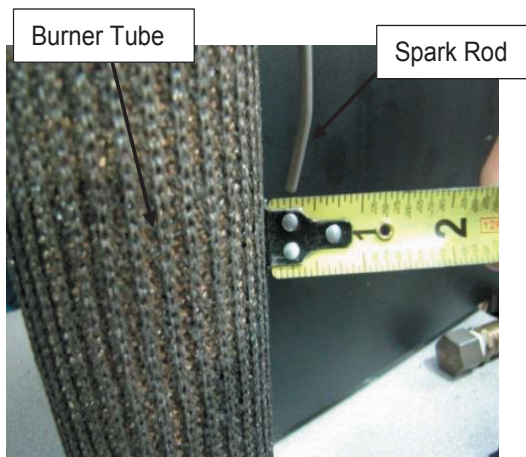

Service Procedure VII: Spark Rod Gap Adjustment and Replacement (Continued)

Spark Rod Replacement Procedure

1. Position main power switch to OFF.
2. Disconnect (unplug) water heater from 120 volt power source.
3. Unlatch and remove surround cover from the top of the water heater.
4. Disconnect wire lead from spark rod.
5. Remove the 2 mounting screws (magnetic tip, long reach Phillips screwdriver) and remove spark rod and gasket from transition base flange.
6. Remove any residual gasket material from transition base flange.
7. Install new spark rod with new gasket provided using screws from Step 5. Arrange spark rod with hook towards burner (off-center mounting hole towards the front of the water heater).
8. Remove combustion system following Combustion System Removal Procedure (pg 27) and verify spark gap following Spark Rod Gap Inspection and Adjustment (pg 38). Reassemble combustion system following Combustion System Replacement Procedure (pg 27).
9. Restore 120 volt power supply to water heater and confirm proper operation following the lighting instructions on the lighting instruction label or the lighting instructions located in the Installation and Operating Instruction Manual.
10. Replace the surround cover on the top of the water heater.

WARNING

120 volt potential exposure. Isolate the appliance and reconfirm power is disconnected using a multi-meter.

WARNING

If the spark rod is replaced for any reason, the combustion system **MUST** be removed and the spark gap to the burner measured and adjusted properly.

WARNING

Spark gap must be set from 3/16" to 1/4". Failure to set and verify proper spark gap may result in a delayed ignition resulting in damage to the water heater.

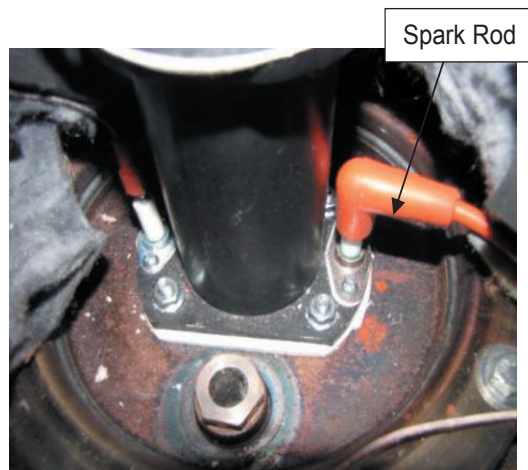
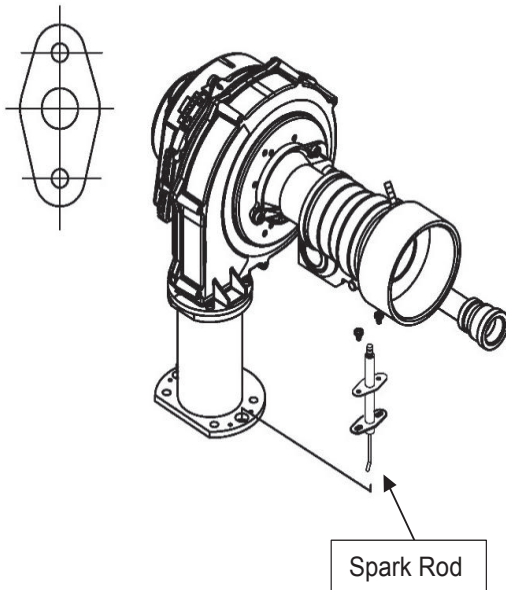

Service Procedure VIII: Ignition Module/Control Board Replacement

Control Board Replacement

1. Position main power switch to OFF.
2. Disconnect (unplug) water heater from 120 volt power source.
3. Unlatch and remove top surround cover from the top of the water heater.
4. Locate the control board.
5. Carefully disconnect all wire connections from the control board.
Note: It may be necessary to identify wires for proper re-connection.
6. Depress the plastic tabs on the bottom side of the control board first.
7. Tilt the control panel and slide control hook tabs from slots in the control panel (see image below).
8. Replace the control board and all wire connections.
9. Restore 120 volt power supply to water heater and confirm proper operation following the lighting instructions on the lighting instruction label, or the lighting instruction located in the Installation and Operating Instruction Manual.
10. Replace the surround cover on the top of the water heater.

WARNING

120 volt potential exposure. Isolate the appliance and reconfirm power is disconnected using a multi-meter.

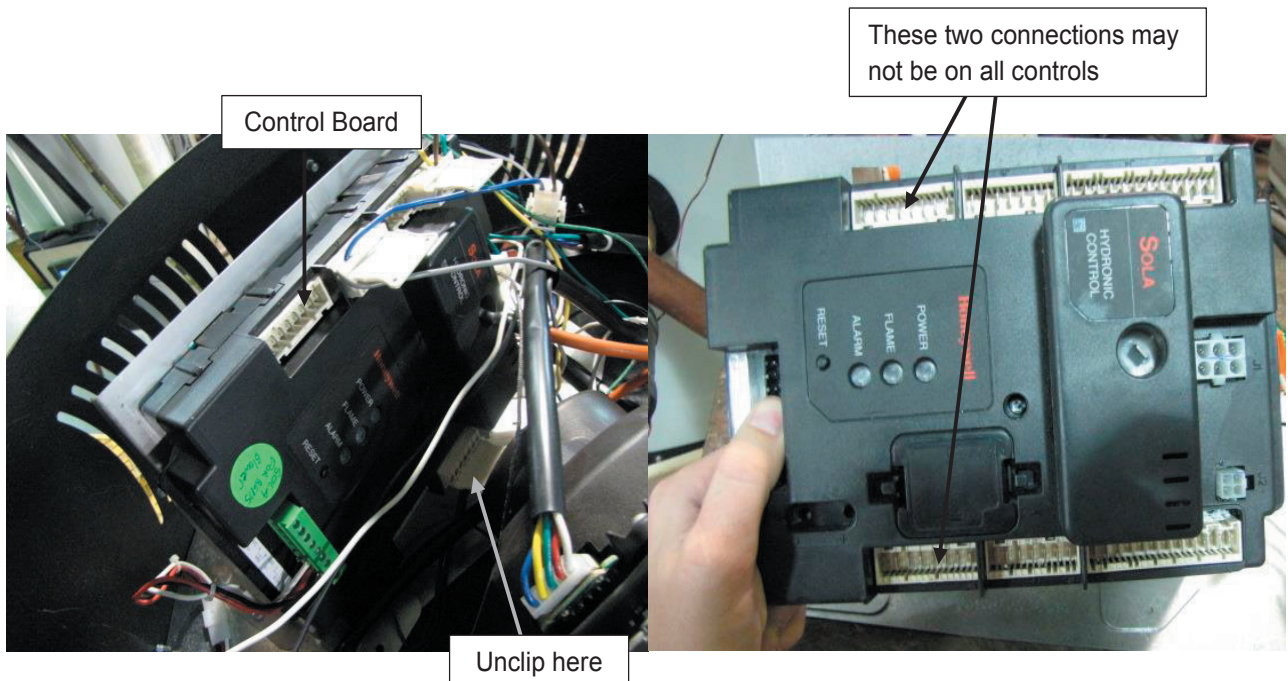

Service Procedure IX: Anode Inspection and Replacement

Anode Replacement Procedure

1. Position main power switch to OFF.
2. Disconnect (unplug) water heater from 120 volt power source.
3. Turn OFF water supply and drain the water heater.
4. Locate (see image below) and remove anode rods from heater (1-1/16 hex socket).
5. Visually inspect anode rod. Anode rod should show signs of depletion, this is normal. If the depletion is 1/2 of the original diameter (approximately 3/4" diameter), replacement is recommended. If any of the steel core of the anode is exposed, replacement is recommended.
6. Upon completion of inspection or subsequent replacement, apply thread sealing tape or other thread compound to threads of anode and reinstall into heater. Restore the water supply and check for and repair any leaks found.
7. Restore 120 volts to water heater and verify proper heater operation following the instructions on the lighting instruction label or the lighting instruction located in the Installation and Operating Instruction Manual.

WARNING

Heater components and stored water may be HOT when performing the following steps in this procedure. Take necessary precaution to prevent personal injury.

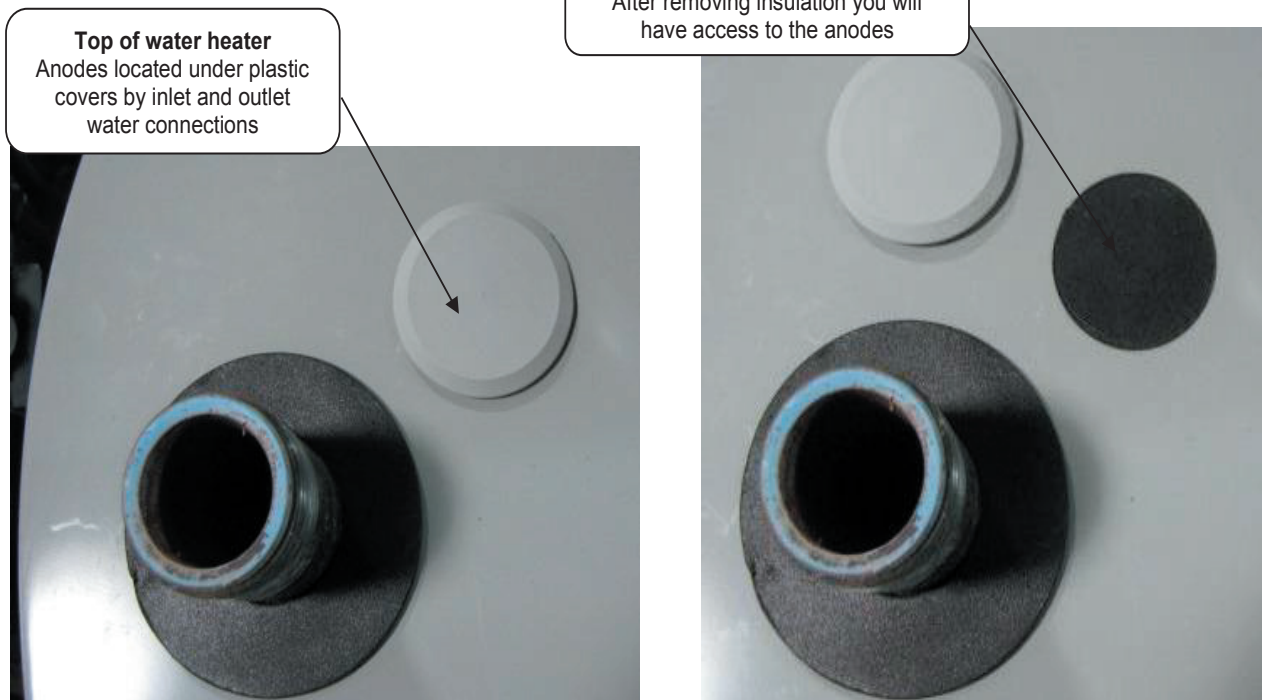

Service Procedure X: Display Module Replacement

Display Module Replacement

1. Position main power switch to OFF.
2. Disconnect (unplug) water heater from 120 volt power source.
3. Remove 4 screws that hold the display into the enclosure (see image below).
4. After removing the screws pull the display out of the enclosure.
5. Once the display is removed, disconnect the two mating plugs.
6. Connect the new display and replace into the enclosure.
7. Use the 4 screws from Step 3 and reinstall the display onto the enclosure.
8. Restore 120 volt power supply to water heater and confirm proper operation following the lighting instructions on the lighting instruction label or the lighting instruction located in the Installation and Operating Instruction Manual.

WARNING

120 volt potential exposure. Isolate the appliance and reconfirm power is disconnected using a multi-meter.

Display and Enclosure



Disconnect



Service Procedure XI: Transformer Replacement

Transformer Replacement Procedure

1. Position main power switch to OFF.
2. Disconnect (unplug) water heater from 120 volt power source.
3. Unlatch and remove surround cover from top of water heater.
4. Disconnect primary leads (black & white) and secondary leads (blue & yellow) from the transformer (connections are different sizes to prevent interchanging).
5. Remove the 2 nuts (7/16 nut driver) holding the transformer in place and remove transformer from control panel (see image below).
6. Install new transformer and secure in place with screws from Step 5.
7. Reconnect primary and secondary wires to transformer (leads are different sizes to prevent interchanging).
8. Restore 120 volt power supply to water heater and confirm proper operation following the lighting instructions on the lighting instruction label or the lighting instruction located in the Installation and Operating Instruction Manual.
9. Replace the surround cover on the top of the water heater.

WARNING

120 volt potential exposure. Isolate the appliance and reconfirm power is disconnected using a multi-meter.

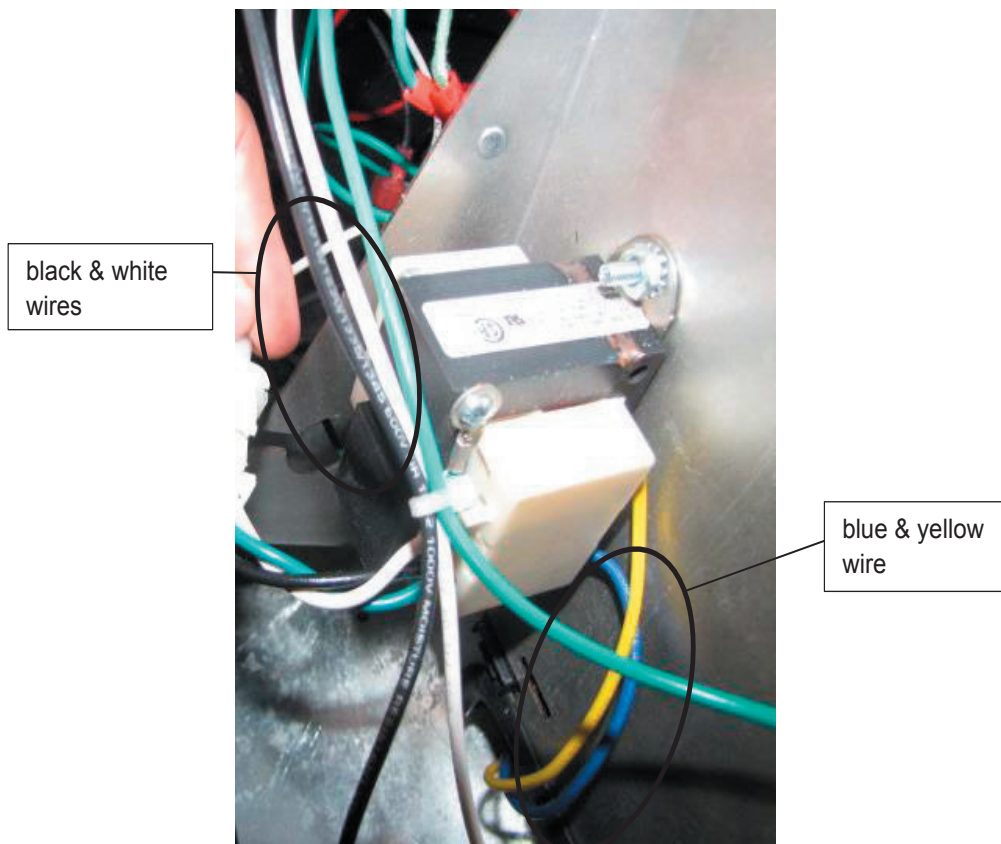

SECTION 2: SERIAL NUMBERS “XL-” (NOV. 2021 AND LATER) WITH “-NDD-895” DESIGNATOR

Specifications

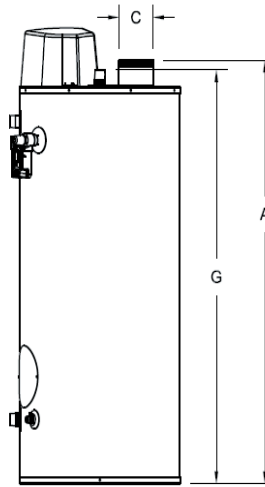
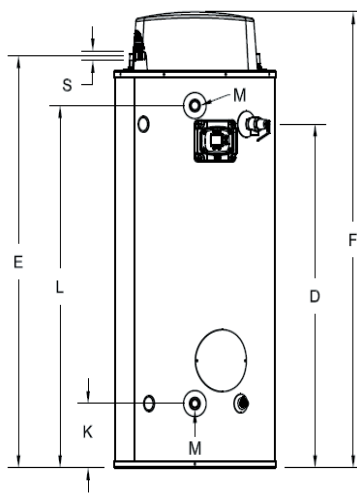
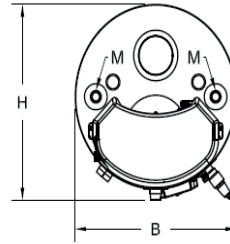

Model Description				Dimensions (inches)																
Model Number	Nominal Gal. Capacity	BTU/Hr. Input	GPH Recovery at Degree Rise			A Floor to Vent Conn. in.	B Jacket Dia. in.	C Vent Size in.	D Floor to T&P Conn. in.	E Floor to Gas Conn. in.	F Floor to Top of Heater in.	G Floor to Cold Water Conn./Hot Water Conn. in.	H Depth in.	K Floor to Cold Water Conn. in.	L Floor to Hot Water Conn. in.	M Water Conn. NPT in.	S Gas Conn. Size in.	Relief Valve Open in.	Aprox. Shipping Weight lbs.	
	US Imp. Gal.	Gal.	40°F	100°F	140°F															
UCG80H125	80	67	125,000	308	123	88	57	28	5	44 1/4	54 1/2	61 3/8	55 3/4	30	9 3/4	46 15/16	1 1/2	3/4	3/4	535
UCG80H199	80	67	199,999	493	197	141	57	28	6	44 1/4	54 1/2	61 3/8	55 3/4	30	9 3/4	46 15/16	1 1/2	3/4	3/4	535
UCG100H199	100	83	199,999	493	197	141	64 7/8	28	6	52 3/4	62 3/4	70	63 1/4	30	9 3/4	55 3/8	1 1/2	3/4	3/4	632

Model Description				Dimensions (millimeters)															
Model Number	Nominal Liter Capacity	Input kW	GPH Recovery at Degree Rise			A Floor to Vent Conn. mm.	B Jacket Dia. mm.	C Vent Size mm.	D Floor to T&P Conn. mm.	E Floor to Gas Conn. mm.	F Floor to Top of Heater mm.	G Floor to Water Conn. mm.	H Depth mm.	K Floor to Space Heating Inlet mm.	L Floor to Space Heating Outlet mm.	M Water Conn. NPT mm.	S Gas Conn. Size mm.	Relief Valve Open mm.	Aprox. Shipping Weight kgs.
			22°C	56°C	78°C														
UCG80H125	303	36.6	1164	466	333	1448	711	127	1124	1384	1569	1416	752	247	1192	38	19	19	243
UCG80H199	303	58.6	1864	746	533	1448	711	152	1124	1384	1569	1416	752	247	1192	38	19	19	243
UCG100H199	379	58.6	1866	745	533	1648	711	152	1340	1594	1778	1606	752	247	1406	38	19	19	286

Specifications

Power Supply	Dedicated 120 VAC, 60 Hz, 15A
Gas Supply	Minimum 3/4" NPT (schedule 40 black iron pipe recommended)
Approved Gas Type	Natural and L.P. Unit must match gas type supplied.
Gas Pressure (Nat.)	14.0" W.C. maximum static, 4.5" W.C. minimum running (recommend 7.0" W.C. min running)
Gas Pressure (L.P.)	14.0" W.C. maximum static, 11.0" minimum static, 4.5" W.C. minimum running (recommend 7.0" W.C. min running)
Venting System	Atmospherically vented, Type B venting system or approved chimney. Follow the current National Fuel Gas Code requirements or in Canada, the Natural Gas and Propane Installation Code.
Minimum Clearance for Servicing	16" from top, 4" from front, 0" sides and rear.
Maximum Water Supply Pressure	150 PSI
Thermostat Sensor	11,900 Ohms @ 70°F, ECO opens @ 200°F (93.3°C) Max. Redundant sensor for ECO. Sensor inside well for easy replacement of sensor.
Control Display	Digital display, 24 volts. temperature Range: 70-180°F (21-82°C). Used to set tank temperature (°F or °C), show operating status, display error codes, error code history, limit maximum setpoint temperature.
Control Board	Operates from 24 volt from transformer. Controls tank temperature, ignition functions, combustion blower. See ignition timings in sequence of operation for Integrated Control.
Transformer	120 VAC primary, 24 VAC secondary, 40 VA.
Spark Rod Igniter	0.22" nominal gap to the burner surface.
Flame Sensor Output	Minimum 1 micro amp. Typical range 5 to 30 micro amps.
Gas Valve	Negative regulation, 24 VAC, 1/2" PSI max., 4.5" W.C. minimum running inlet.
Blower	120 VAC, 60 Hz, 1.5-3.5 amps

Specifications

Vent Tables

(Intake Only)

Model Number	2" Max Intake Vent Length (feet)	3" Max Intake Vent Length (feet)	4" Max Intake Vent Length (feet)
UCG80H125	20	50	75
UCG(80,100)H199	20	50	75

Determining Required Intake Vent Length

5. Determine the total length of straight vent pipe (in feet) required for the intake.
6. Add 5 feet of venting for every 90° elbow.
7. Add 2 ½ feet of venting for every 45° elbow.
8. **Total vent length cannot exceed Max Intake Vent Length on the venting table shown above.**

Example of Total Intake Vent Length for UCG100H199 installation:

A 3" venting system has a total of two 90-degree elbows and a total straight pipe length of 10 feet.

Equivalent vent length for elbows: 2 x 5 feet = 10 feet.

Total equivalent vent distance = 10 feet + 10 feet = 20 feet total equivalent vent length. This is below the maximum allowed distance of 50 feet for this model using 3" vent.

Approved Venting Materials

For installations in the US only

- PVC Sch. 40 (ASTM D-1785, ULC 1738, ULC S636)
- DWV PVC Sch. 40 (ASTM-D2665)
- CPVC Sch. 40 (ASTM-F441, ASTM-D2846, ULC S636)
- Polypropylene (UL 1738, ULC S636)
- ABS Sch. 40 DWV (ASTM D2661)

For installations in CANADA

- ULC S636 approved Sch. 40 PVC and CPVC for flue gas venting rated Class II, 65°C (components provided with water heater)
- ULC S636 approved Polypropylene for flue gas venting rated Class II, 65°C

Approved Primers and Cements

For installations in the US only

- PVC and CPVC Primer (ASTM F-656)
- PVC Cement (ASTM D-2564)
- CPVC Cement (ASTM F493)
- ABS Primer and Cement (ASTM D-2235)

For installations in CANADA

- ULC S636 approved PVC Primer and Cement for flue gas venting rated Class II, 65°C

Sequence of Operation

1. Thermostat calls for heat.
2. Combustion blower starts.
3. Blower pre-purge period of 30 seconds.
4. Trial for Ignition (5 seconds, 3 trials).
 - a. Flame establishing period (3 seconds), gas valve opens, sparks from spark rod to burner surface to ignite the gas.
 - b. Burner on, flame proving period (2 seconds). Requires a minimum of 1 microamp through flame sense rod to prove flame.
5. Steady State Operation: Burner continues to operate until:
 - a. Thermostat circuit opens, gas valve closes, blower continues to operate for 30 second post-purge period.
6. Thermostat satisfied.
7. Gas valve closes, burner extinguished.
8. Blower post purge for 30 seconds.

Sequence of Operation

Lockout Conditions

The system will go into lockout mode for the following reasons:

1. Error Code 62 or 63
 - a. Control board will go into Soft Lockout if the main burner cannot be lit and fails to prove flame after 3 ignition trials. The water heater display indicates a lockout condition by showing an error code number (62 or 63) with "Service Needed" in the control display window. Refer to error codes in the diagnostic section of this Service Manual. In a Soft Lockout condition, the control will wait 60 minutes and then make 3 more attempts to light the main burners. Soft Lockout reset is accomplished by depressing the lower right button under "Reset" for 3 seconds.
2. Error Code 65
 - a. If the top of the tank should exceed 200°F (93.3°C), then the high limit control will shut off the burner and the water heater will go into a Hard Lockout. Error code 65 will be shown in the water heater display. The control can only be reset in Service Mode, which is detailed in the Troubleshooting section of this Service Manual.

Connection/Wiring Diagram

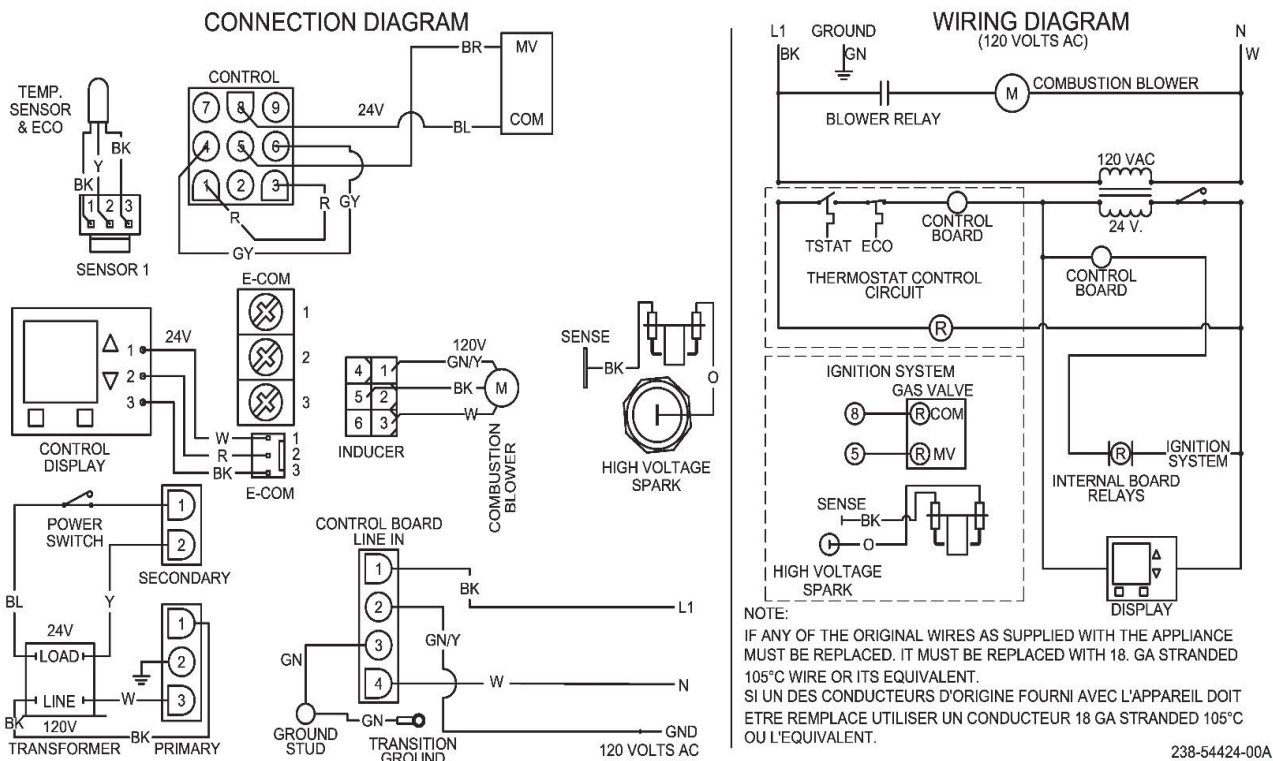

Troubleshooting

System Observations

Water Heater Fault: Water heater does **NOT** operate.

Display Error Code: Water heater display does **NOT** operate – blank display.

⚠ WARNING
120 volt potential exposure. Use caution making voltage checks to avoid personal injury.

⚠ CAUTION
Use caution to **NOT** damage connectors when making voltage measurements or jumping terminals.

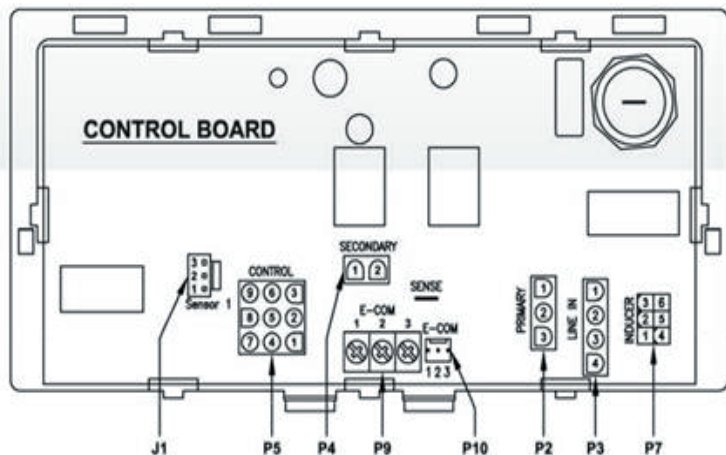
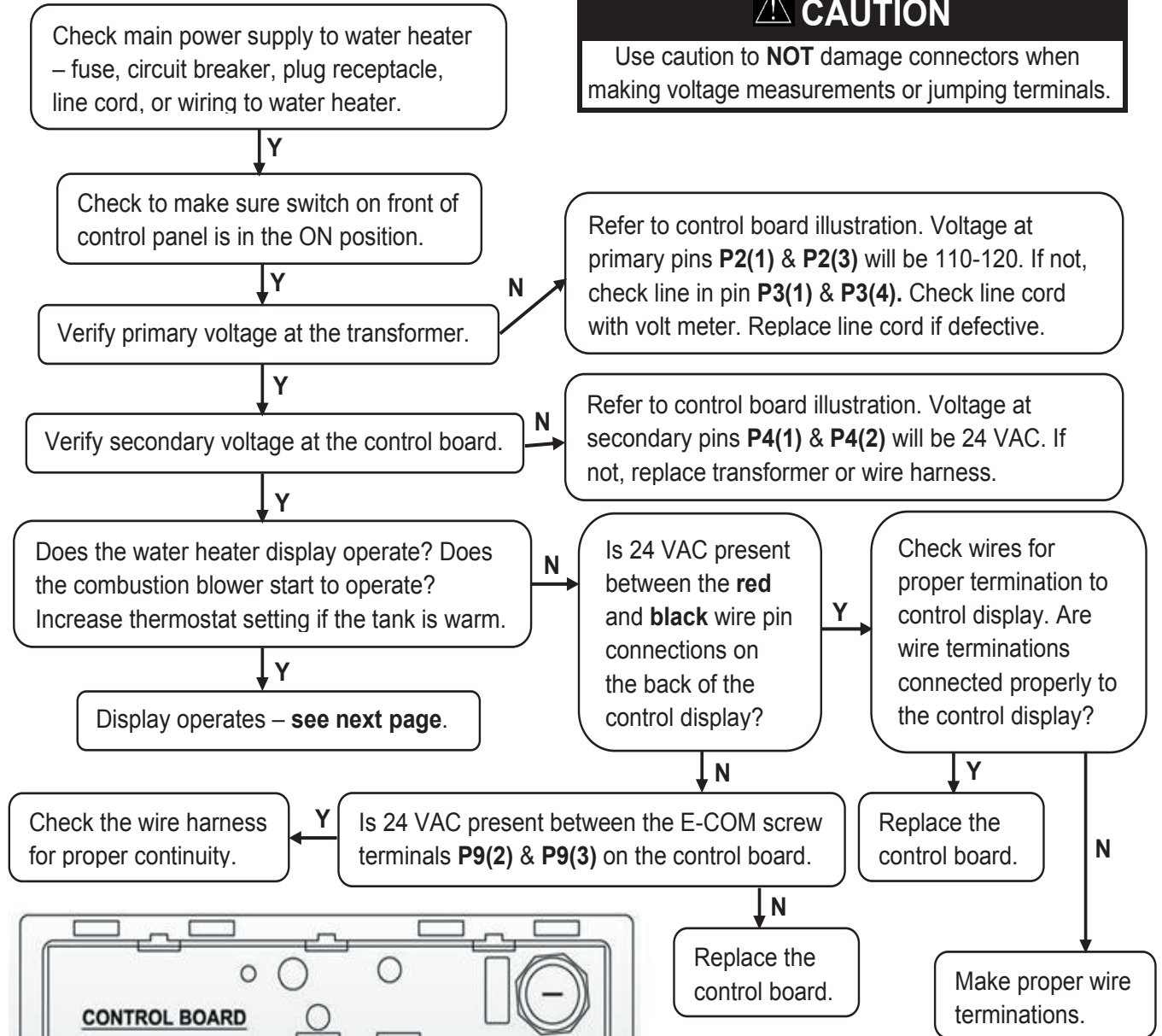

Troubleshooting

⚠ WARNING

120 volt potential exposure. Use caution making voltage checks to avoid personal injury.

⚠ CAUTION

Use caution to **NOT** damage connectors when making voltage measurements or jumping terminals.

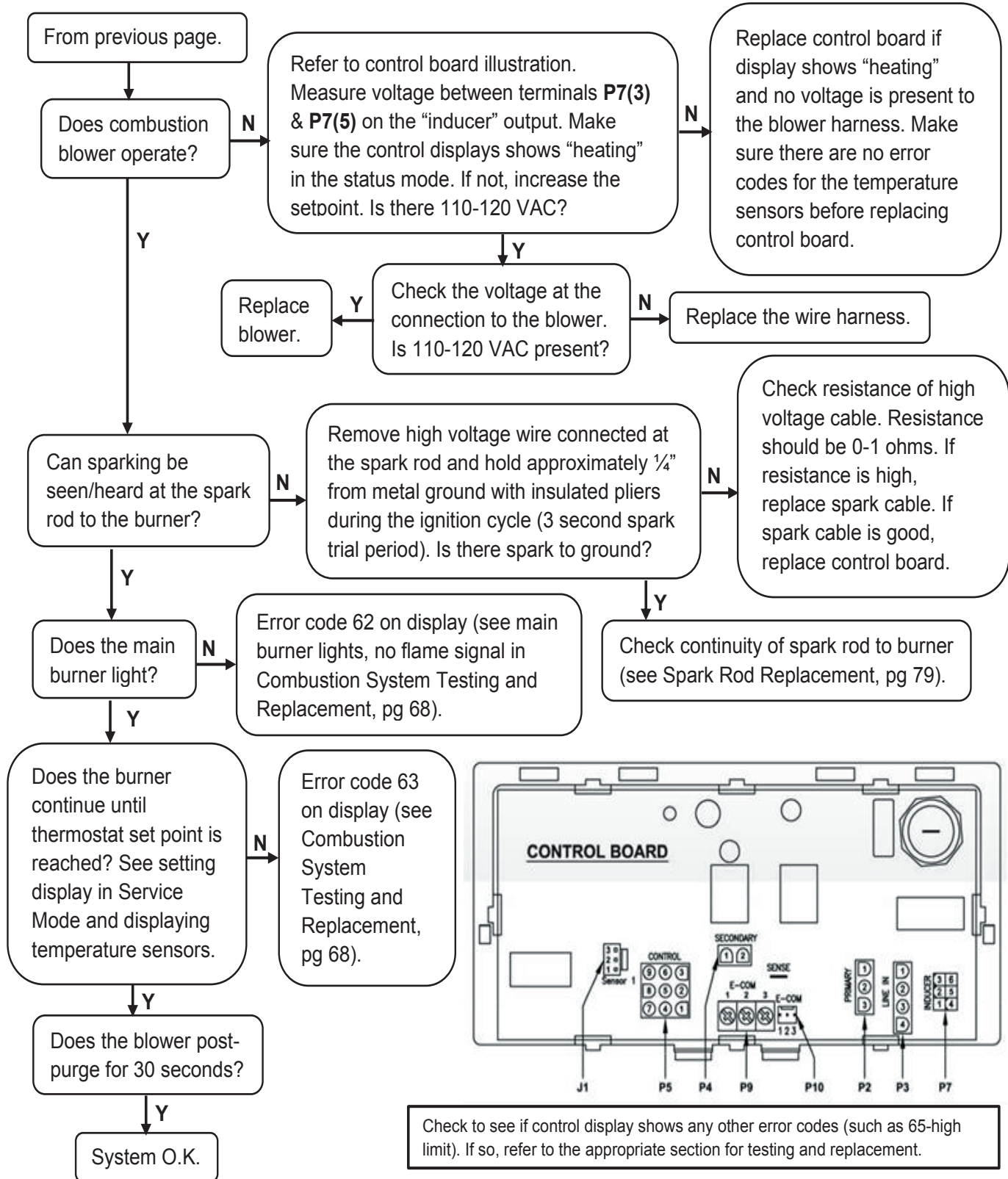

Troubleshooting

This display has a Service Mode for changing the maximum setpoint and accessing information in aiding servicing of the water heater. This procedure is for service and installation personnel only. To enter Service Mode, follow the steps that follow.

Step 1. Press “Select” and “Temperature Up” buttons together and hold for 3 seconds until “Max Setpoint” is shown in the display.

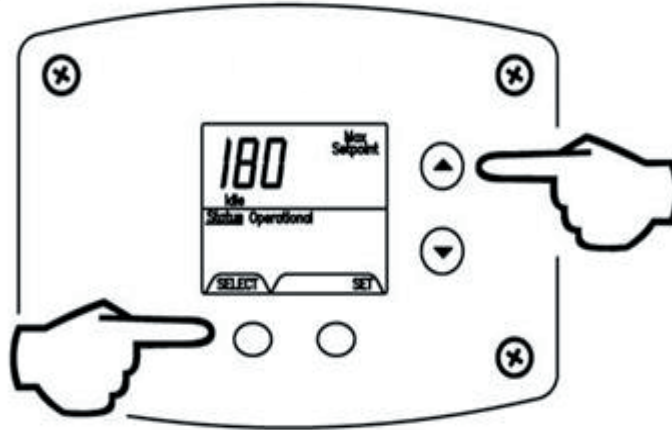

Step 2. Pressing “Select” button will change display to the next mode.

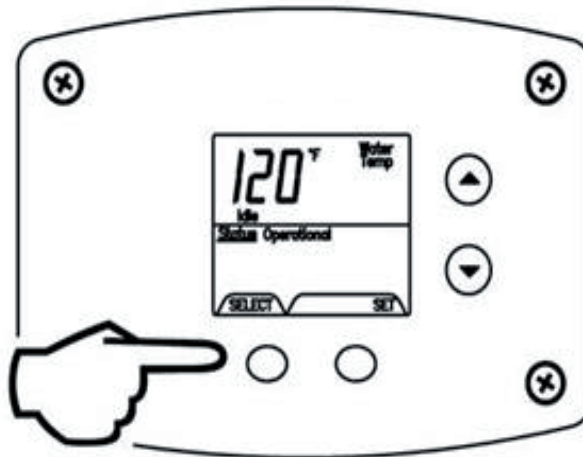

The following is the sequence of modes available in “Service Mode” by pressing the “Select” button: Error Code Number (Display/Reset). This is shown if there is an operating error in the “User Mode.”

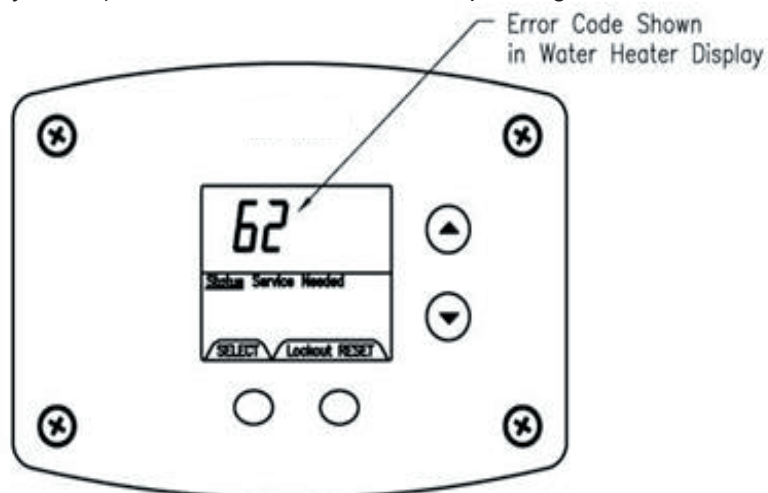

Troubleshooting

Step 1. Max Setpoint (Display/Change).

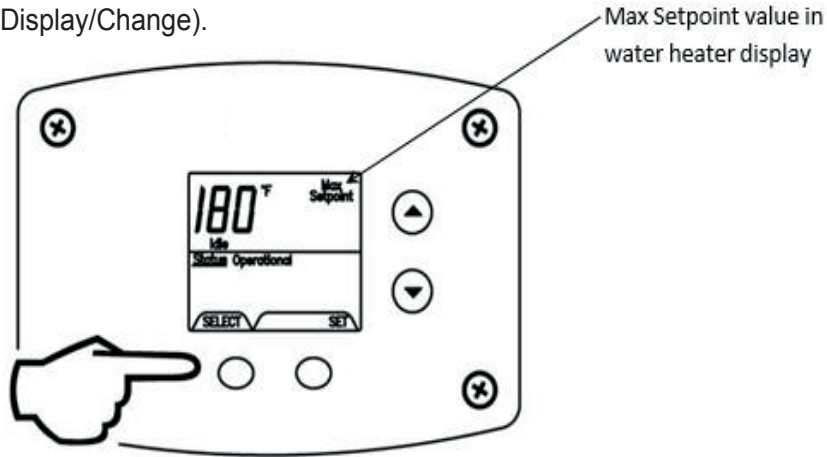

Step 2. Tank Sensor Temperature (displays water temperature average).

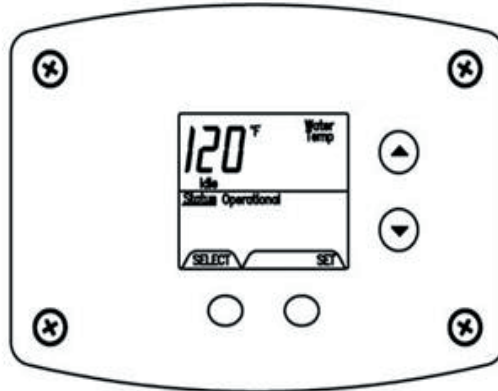

Step 3. Flame Current of Burner Flame Sensor (displays only in the Heating Cycle).

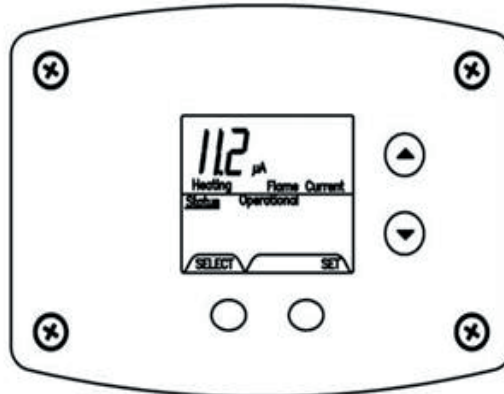

Step 4. Setpoint (Display/Change).

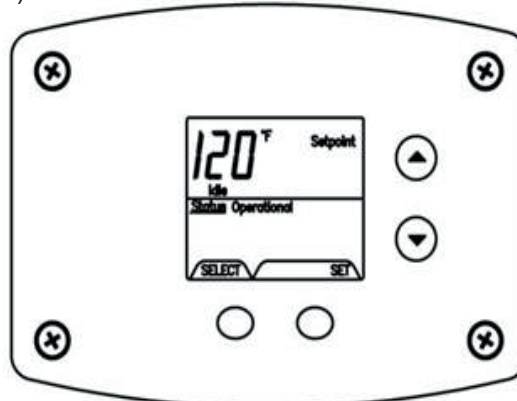

Troubleshooting

Step 5. °F/°C (Display/Change).

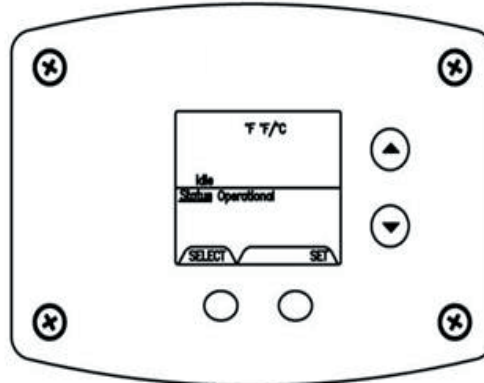

Step 6. Differential (displays only – shows the differential of the thermostat).

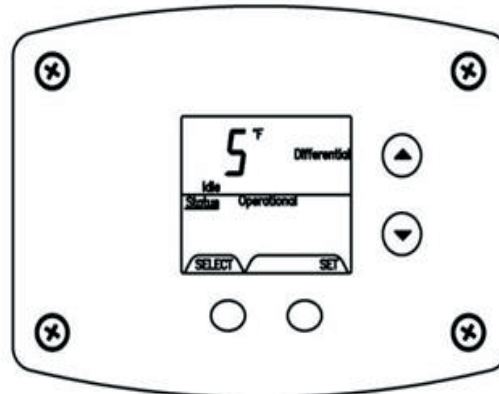

Step 7. Software Version (display only).



Step 8. Error Code History (displays if there are present error codes or up to 10 previous error codes). Water Heater Display will show "--" if there are no error codes.

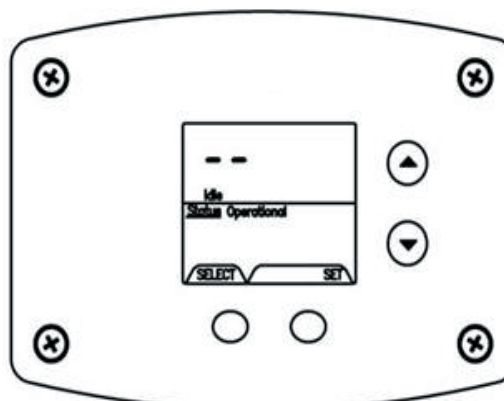

Troubleshooting

To change the Maximum Setpoint Limit (Max Setpoint) for the temperature setpoint:

Step 1. In Service Mode press the “Select” button until “Max Setpoint” is displayed.

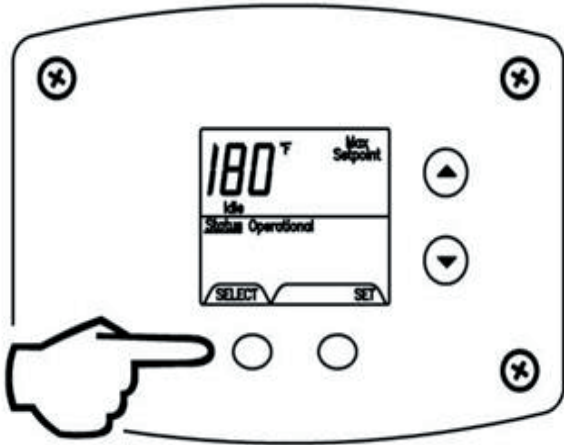

WARNING

Setting the water temperature to the maximum setpoint can result in scalding hot water delivered to the faucets. It is HIGHLY recommended that the maximum setpoint be adjusted to the lowest temperature possible for the needs of installation. Make sure the water heater control display is not in a public area that can result in the temperature settings being improperly adjusted.

Step 2. Press “Set” button to enter setting mode. “Max Setpoint” will flash to indicate setting mode.

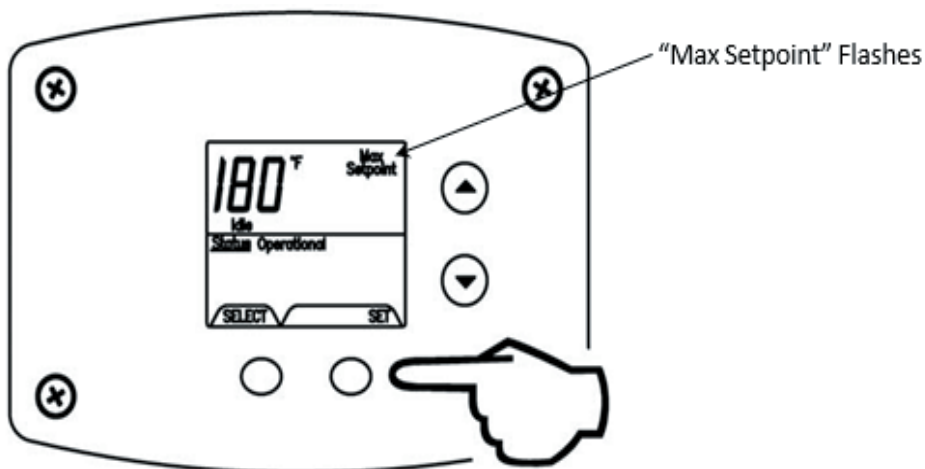

Step 3. Press the “UP” or “DOWN” buttons to change the maximum setpoint value. This will limit the maximum setpoint the user can select. **Note:** The maximum setpoint is approximately 180°F (82°C).

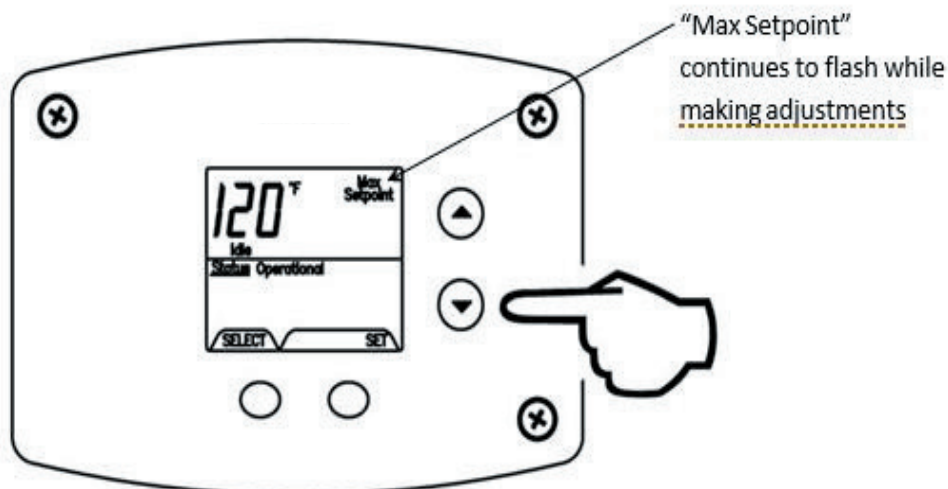

Troubleshooting

Step 4. Press “Set” button to confirm new “Max Setpoint” value and stop setting mode.

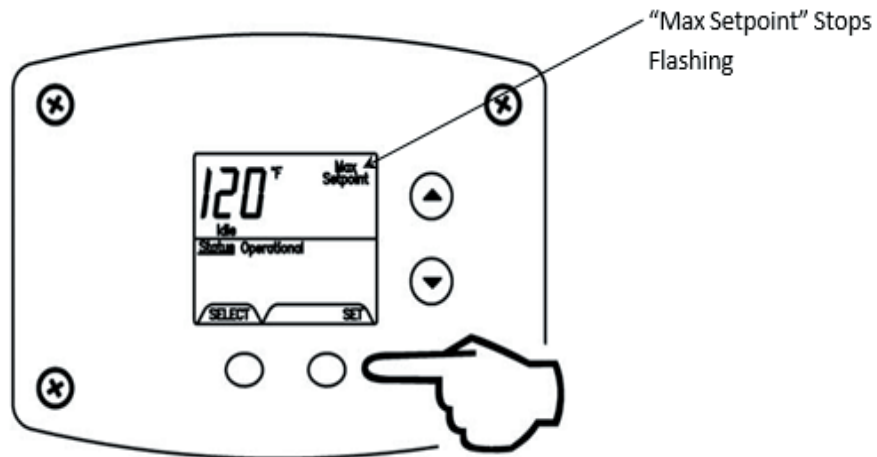

Step 5. 30 seconds after the last button press, the water heater display will go back to “User Mode.” It will read “Max Setpoint” without showing a temperature value if the temperature setpoint is at the maximum setting. The water heater display can be set back to “User Mode” immediately by pressing both the “Temperature Up” and “Select” buttons together for 3 seconds.

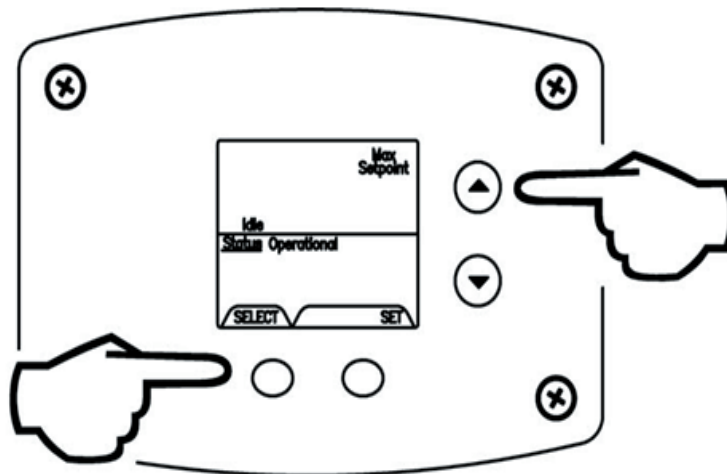

Display of Water Temperature:

In Service Mode, press the “Select” button until “Water Temp” is displayed in the upper right section of the water heater display. This is the reading for the sensor.

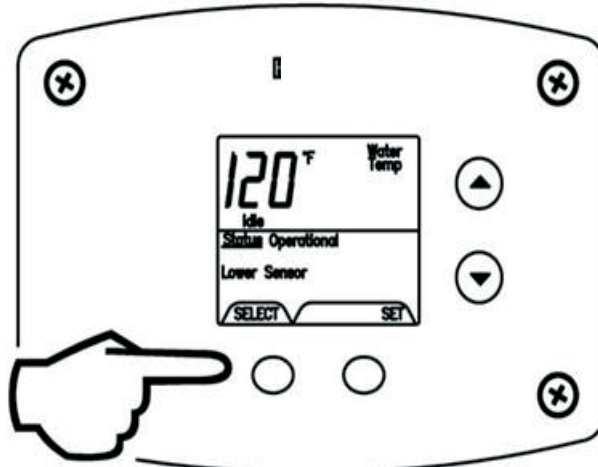

Troubleshooting

To Display Flame Sense Current of the Flame Sensor:

The flame sense current is available only when the burners are in operation. **Step 1.** Make sure the status displays “heating” or draw enough hot water to start the burners. **Step 2.** Enter “Service Mode” described previously. **Step 3.** Press the “Select” button until a number value is displayed with the “Flame Current” to the right of the number. The value displayed is in microamps (μA).

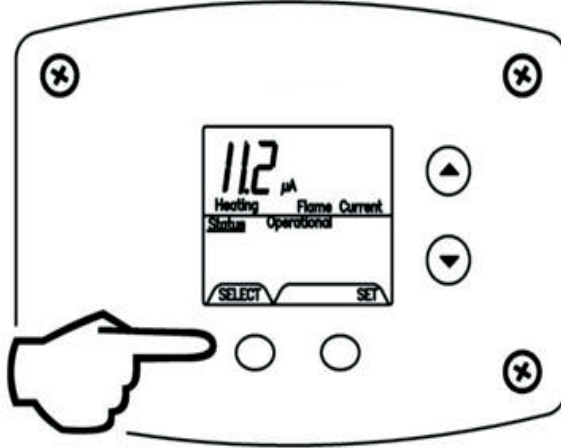

To Display the Current Temperature Setpoint:

Step 1. In “Service Mode” press the “Select” button until “Setpoint” is shown in the water heater display.

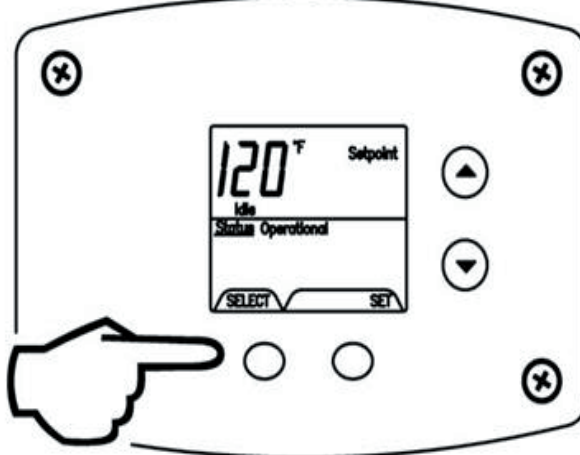

Step 2. Press the “Set” button to enter the setting mode. “Setpoint” will flash in the water heater display.

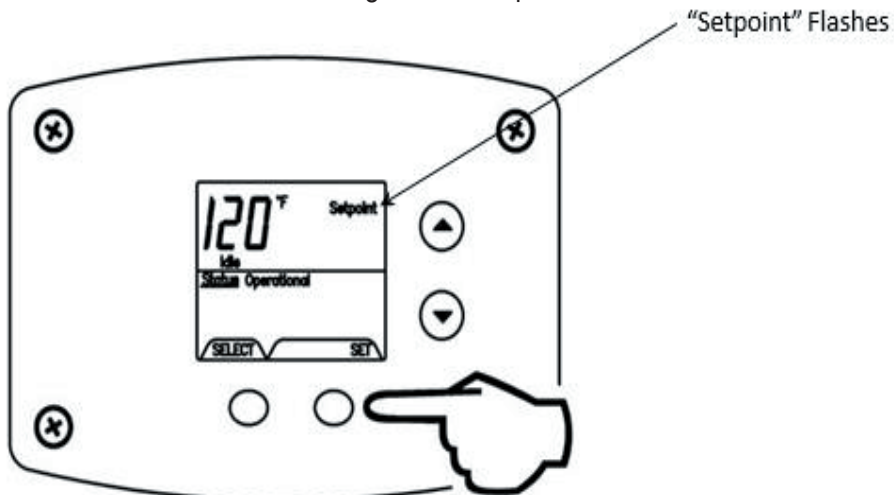

Troubleshooting

Step 3. To raise the temperature setpoint, press the “Temperature Up” button until the desired temperature is shown on the water heater display. **Note:** The maximum temperature that can be set is limited to the “Max Setpoint” described previously.

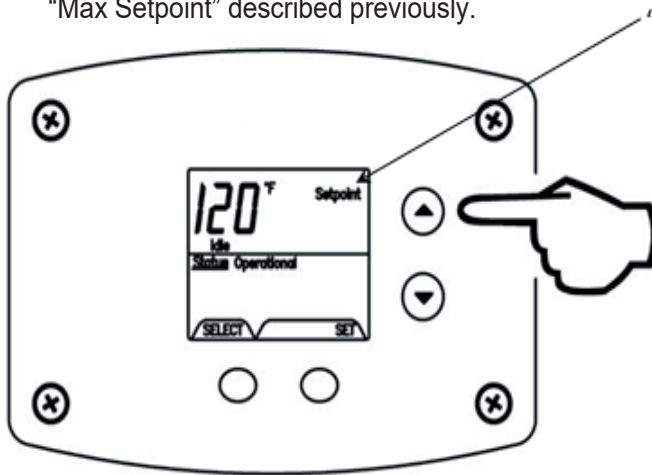

WARNING

Setting the water temperature to the maximum setpoint can result in scalding hot water delivered to the faucets. It is HIGHLY recommended that the maximum setpoint be adjusted to the lowest temperature possible for the needs of installation. Make sure the water heater control display is not in a public area that can result in the temperature settings being improperly adjusted.

Step 4. To lower the temperature setpoint, press the “Temperature Down” button until the desired temperature is shown on the water heater display.

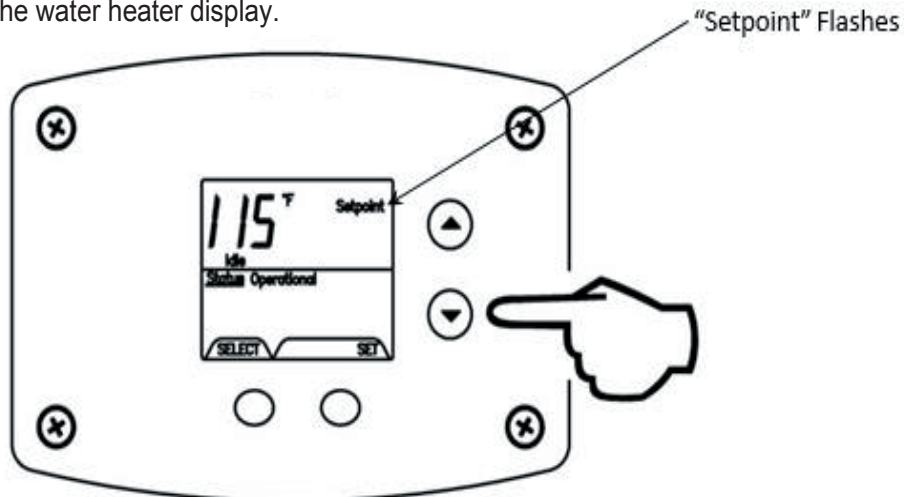

Step 5. When the desired setpoint is reached on the water heater display, press the “Set” button to confirm the new setpoint. “Setpoint” stops flashing in the water heater display.

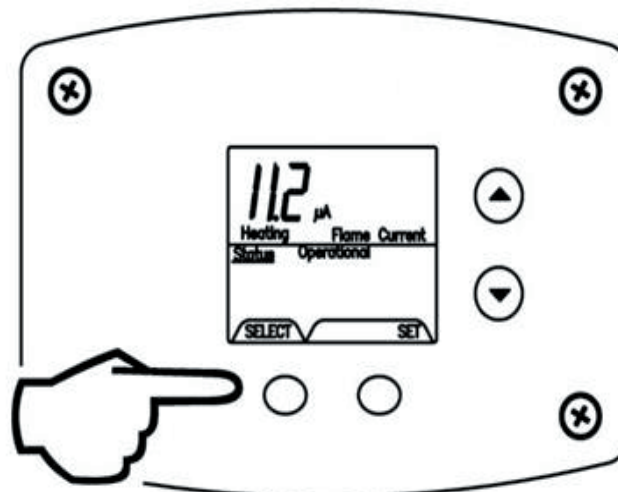

Troubleshooting

To Display and Change Temperature Format (°F/°C)

To change temperature format from °F to °C or °C to °F:

Step 1. While in “Service Mode,” press “Select” button until “°F/°C” is shown in the upper right portion of the water heater display.

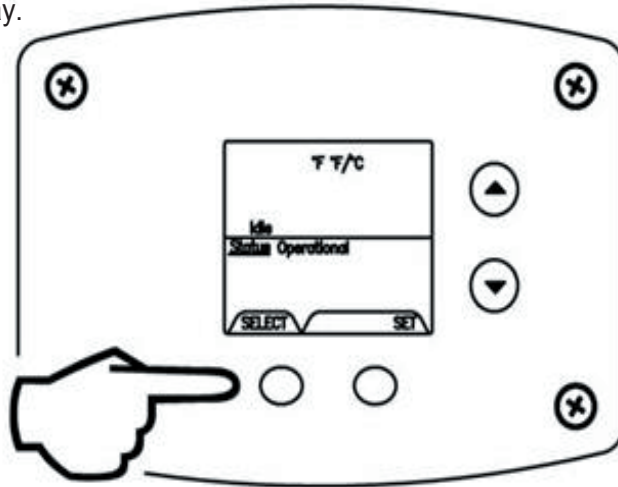

Step 2. Press “Set” button to change temperature format. “°F/°C” symbol will flash in the water heater display.

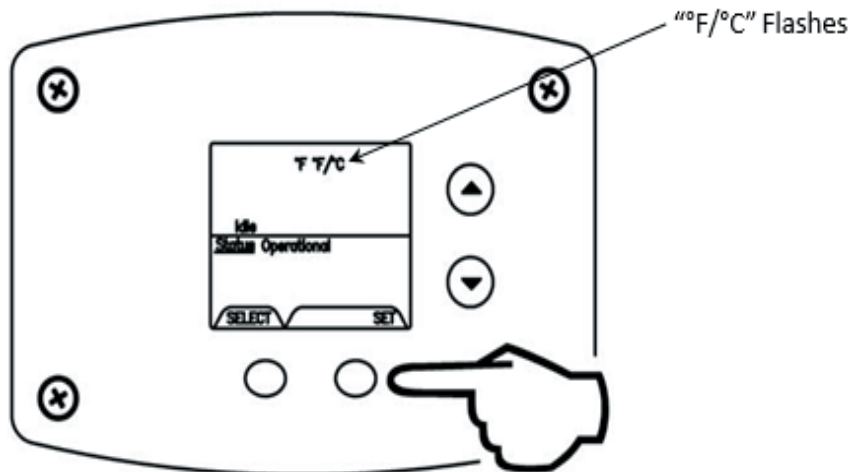

Step 3a. Press “Temperature Up” button to change temperature format to °C.

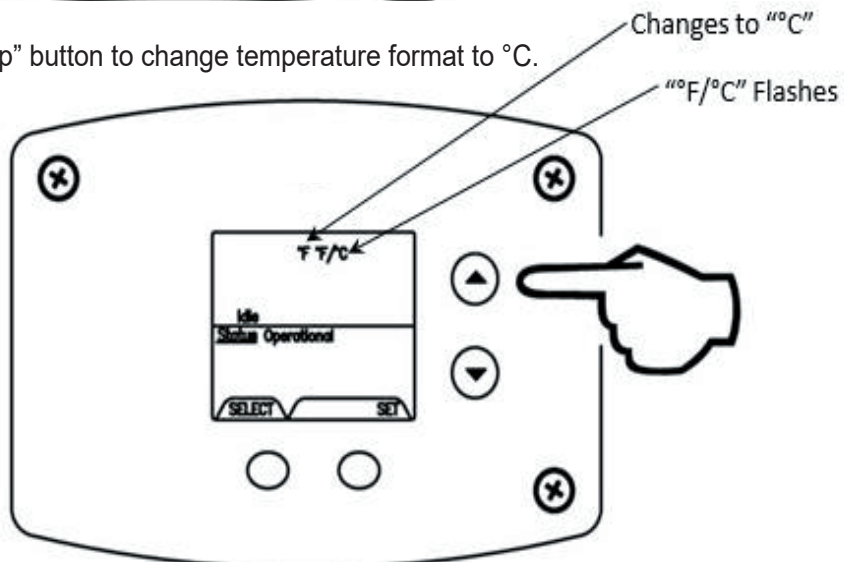

Troubleshooting

Step 3b. Press "Temperature Down" button to change temperature format to °F.

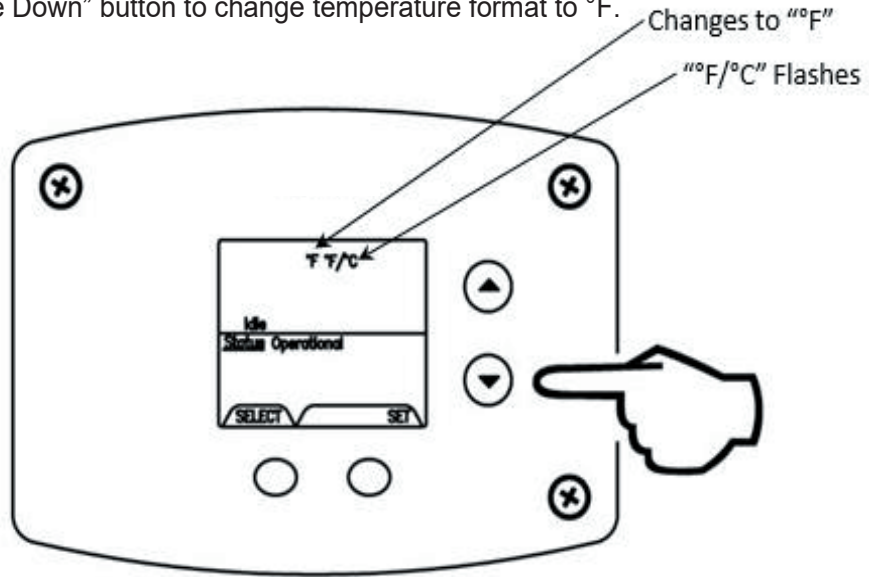

Step 4. Press "Set" button to confirm °F or °C format. °F/°C will stop flashing.

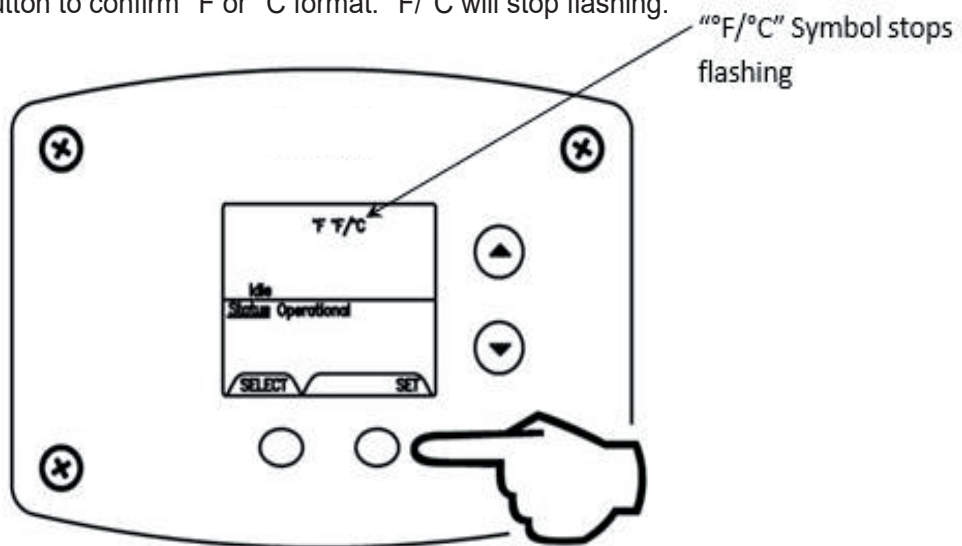

Step 5. Pressing "Select" button will return display to setpoint in format selected (°F/°C) immediately.

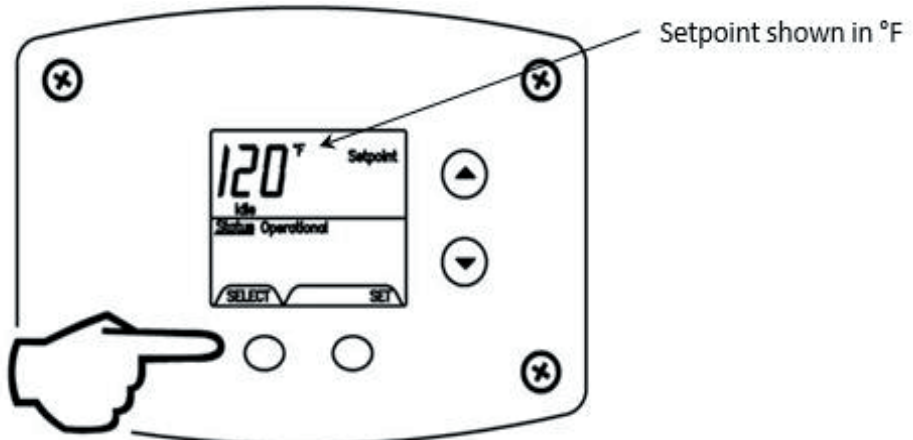

Troubleshooting

Error Codes and Error History Display:

If there is an operating problem with the water heater, an error code number will appear on the water heater display with “Service Needed” to the right of the “Status” indicator. The error code label is located under the water heater display and the following section in this service manual explains the error codes with corrective actions to repair the water heater.

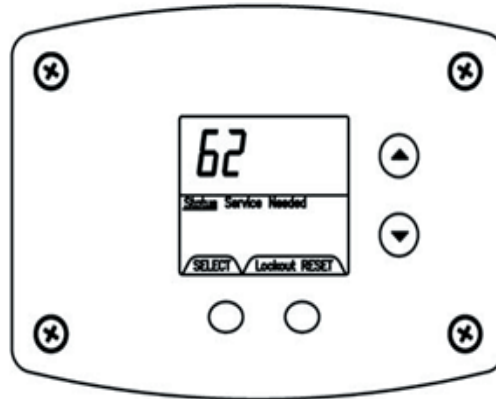

Example of Error Code in the Display

Error Code History:

In “Service Mode” pressing the “Select” button after the “Software Version” (item 8 as previously described sequence of service modes) will show an error code history, if there have been any previous operating problems with the water heater. If the display shows “--”, there is not a current error code. **Note:** The water heater display will provide up to 10 previous error codes. The oldest will be stored in code index #1, and the most recent in code index #10.

To view previous error code:

Step 1. In “Service Mode” press the “Select” button until the next display after the “Software Version.” If there are no current error codes, the display will show “--”.

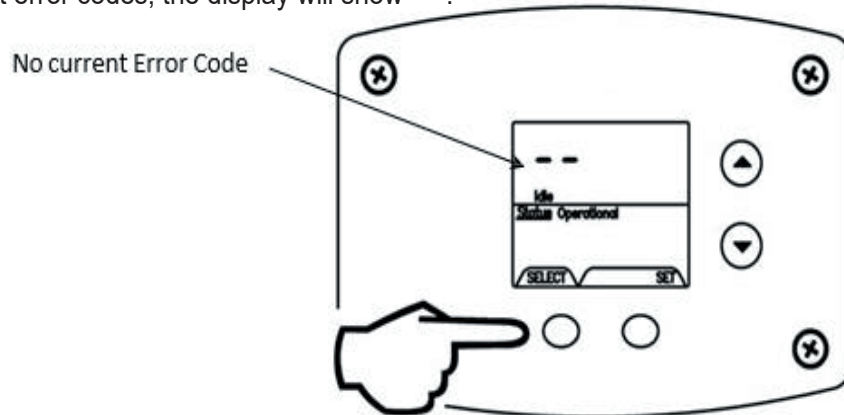

Step 2. Press the “Temperature Down” button to select the error code index, starting with the most recent error code “10”.

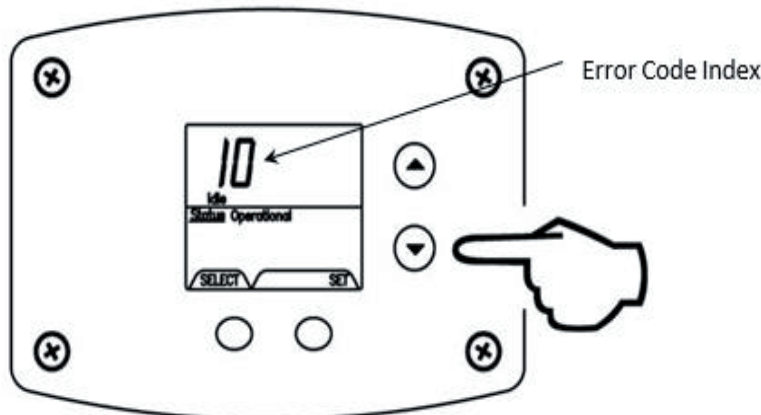

Troubleshooting

Step 3. Press the “Select” button to view the error code for “Code 10.” If there is a number displayed, note what the number is. The label near the water heater display can be used to identify the code number. If no number is displayed on a “--”, then there has not been an error code for index 10.

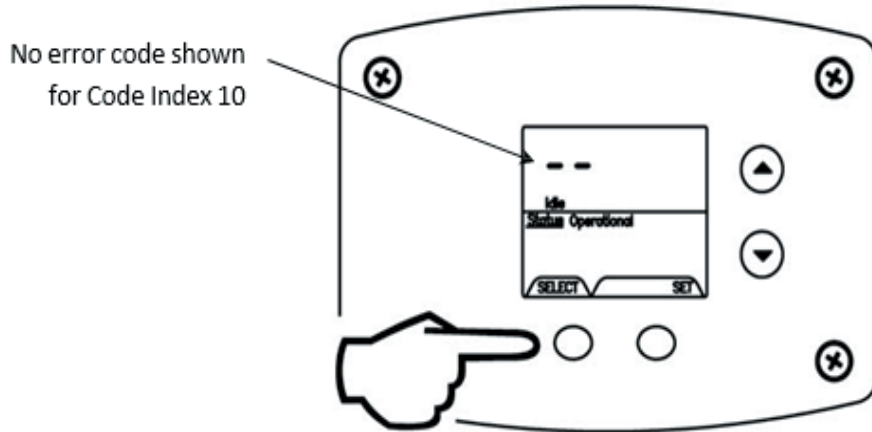

Step 4. Press the “Temperature Down” button to change the previous code index, Code #9.

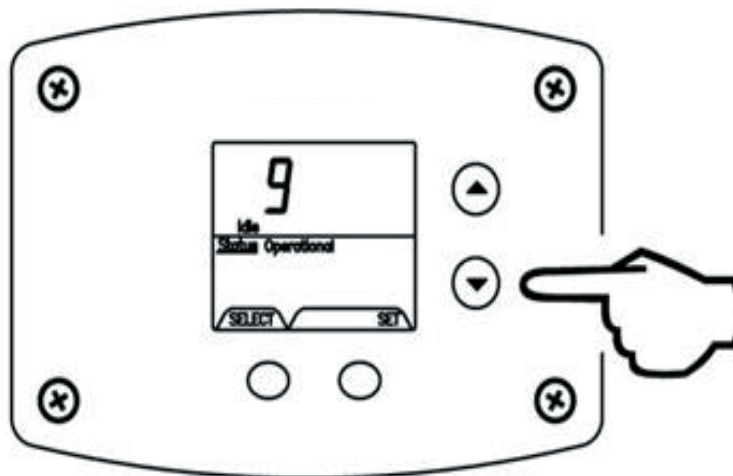

Step 5. Press the “Select” button for code index #9 to view if there are any code numbers.

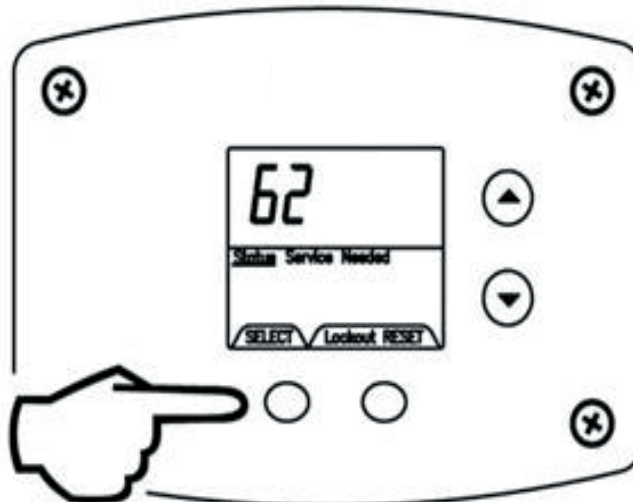

Troubleshooting

Step 6. Continue pressing the “Temperature Down” button to change to the next code error index and press “Select” to view the error code number, if any, for that index number. Continue on index #1 and the most recent in code index #10.

Step 7. 10 seconds after the last button press, the water heater display will revert back to the current error code display. To exit Service Mode, either wait 30 seconds or press “Temperature Up” and “Select” buttons together for 3 seconds.

If an error code is displayed (except for #4, low flame sense current), the water heater will be in a “lockout condition” with the display showing the error code number and “Service Needed” in the status section of the display window. Error codes 62 (maximum number of retries detected) and 63 (maximum number of ignition recycles detected) are “soft” lockouts in which the control can be reset in the User Mode by pressing the lower right button under “Lockout Reset” for 2 seconds shown in the lower right portion of the display. The control will also go through 3 attempts to relight the burners every hour in the soft lockout condition.

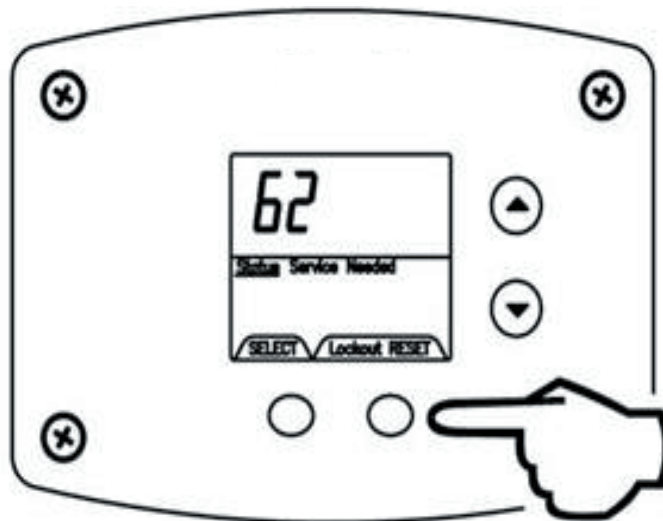

Troubleshooting

All other error codes will put the water heater into “hard” lockout condition, in which the water heater will not operate and cannot be reset in the User Mode. To reset a hard lockout, first enter Service Mode described earlier by pressing both the “Temperature Up” and “Select” buttons at the same time for 3 seconds. Then press the lower right button under “Lockout Reset” in the water heater display and hold for 3 seconds.

Resetting Error Codes in Hard Lockout Condition

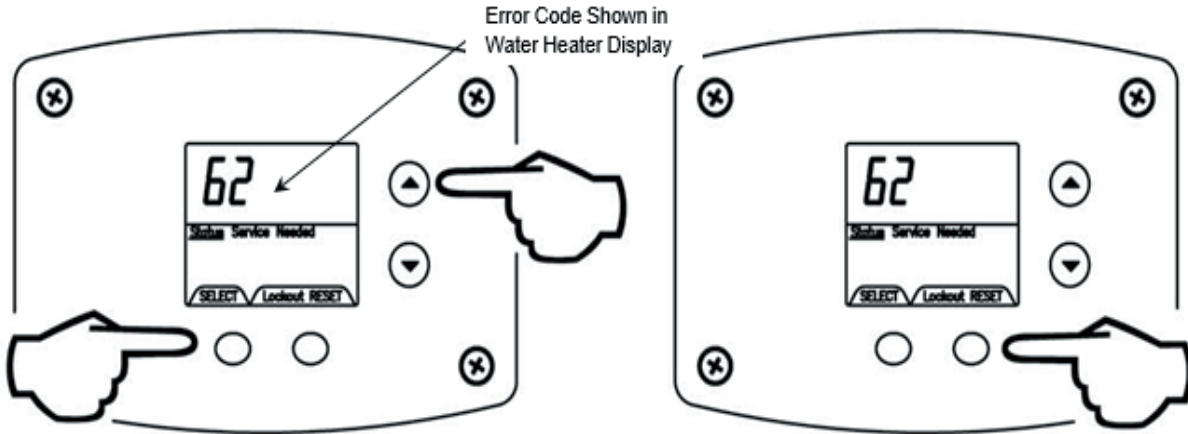

Step 1. Press for 3 seconds to enter Service Mode.

Step 2. Press for 3 seconds to reset the control in Service Mode.

Error Code Definitions

If the water heater has an operating problem, there will be a number in the water heater display with “Service Needed” shown below the error code number. Note the error code and the definition in the chart below. This label appears on the control box under the water heater display. The following sections will provide instructions for servicing each error code.

ICON SYSTEMS™ INTEGRATED CONTROL ERROR CODES

ERROR CODE	DEFINITION
4	LOW FLAME SENSE CURRENT
6	FLAME SENSED OUT OF NORMAL SEQUENCE (BEFORE OPENING GAS VALVE OR AFTER CLOSING GAS VALVE)
23	FLAME DETECTED BEFORE IGNITION
24	FLAME DETECTED AFTER A HEATING CYCLE COMPLETES
26	BLOCKED VENT SWITCH OPENED-VENT BLOCKAGE
32	LOWER SENSOR READINGS FAULTY
57	FLAME ROD SHORTED TO GROUND
58	AC LINE FREQUENCY ERROR – SIGNAL TOO NOISY OR FREQUENCY INCORRECT
59	LINE VOLTAGE TOO LOW OR HIGH
61	DC OUTPUT VOLTAGE UNSTABLE
62	MAXIMUM NUMBER OF RETRIES DETECTED
63	MAXIMUM NUMBER OF IGNITION RECYCLES DETECTED
64	ELECTRONICS FAULT
65	HIGH WATER TEMPERATURE (OVER 200°F)

IF ANY OF THE ABOVE CODES APPEAR ON THE CONTROL DISPLAY, CONTACT YOUR PLUMBER OR QUALIFIED SERVICE AGENT FOR SERVICE OF THIS WATER HEATER.

238-50522-00B

Service Procedure I: Thermostat Circuit Testing and Replacement

IMPORTANT NOTE: This procedure assumes a cool tank.

Condition: Water heater not operating. Display shows error code 32 (sensor reading faulty).

Unplug or disconnect electrical power to water heater.

Check continuity of wire harness to sensor. Resistance of harness should be close to 0 ohms. Replace wire harness if high resistance is measured (over 0.5 ohms). Check wires for intermittent connections, shorts, and frayed insulation. Replace if necessary.

If wire harness is O.K., check sensor resistance detailed in Appendix A: Sensor Resistance At Various Temperatures at the end of the thermostat testing and replacement section (pg 64). Replace sensor if needed.

Turn power ON to water heater. Run water heater through heating cycle and verify proper operation. Sensor temperature can be viewed when burner shuts off (see section on viewing the display in Service Mode).

Condition: Water heater not operating. Display shows error code 65, high water temperature (over 200°F).

⚠ WARNING
DO NOT reset the display from the hard lockout state without correcting the cause of the overheating condition.

Turn power OFF. Draw water to cool tank below 200°F.

Check sensor. Sensor is held in place with a clip fastened to the well (see photo). Check sensor wire for potential damage or breaks in the wire insulation. Is the sensor fully inserted into the well?

N

Replace sensor clip if damaged.
Replace sensor if damaged.

Y

Check sensor resistance (see Sensor Resistance Testing).

Continued on next page.

⚠ WARNING

120 volt potential exposure. Use caution making voltage checks to avoid personal injury.

⚠ CAUTION

Use caution to **NOT** damage connectors when making voltage measurements or jumping terminals.

Checking continuity of sensor (disconnected from control board)

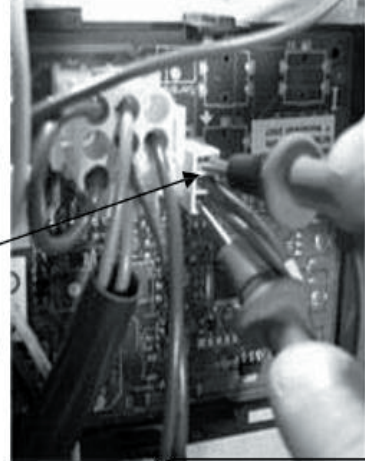

Sensor shown fully inserted into well

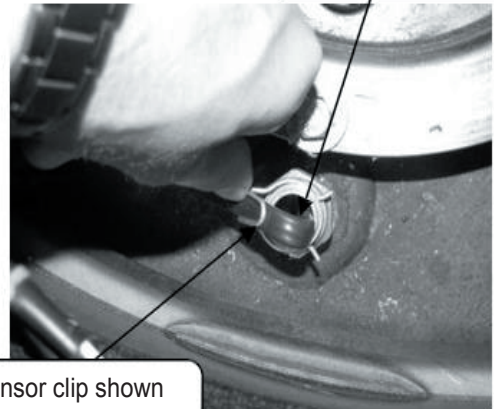

Sensor clip shown properly installed

Service Procedure I: Thermostat Circuit Testing and Replacement (Continued)

Continued from previous page.

**Condition: Water heater not operating.
Display shows error code 65, high water
temperature (over 200°F).**

Once cause of overheating condition has been diagnosed and corrected, the control may be reset.

- Reconnect and switch ON power to the water heater.
- Enter Service Mode on the water heater display (see image).
- Press button under "Lockout Reset" and hold for 3 seconds.
- Set thermostat to the desired setting. Water heater will start.
- Monitor temperatures for one complete heating cycle, making sure the maximum tank temperature remains well below 200°F.

WARNING

DO NOT operate the water heater without verifying that the overheating condition has been corrected.

This water heater is equipped with a manual reset type gas shutoff device designed to shut off the gas to the burners if excessive water temperature occurs. To reset the control, press the lower right button under "RESET" in the display for 3 seconds.

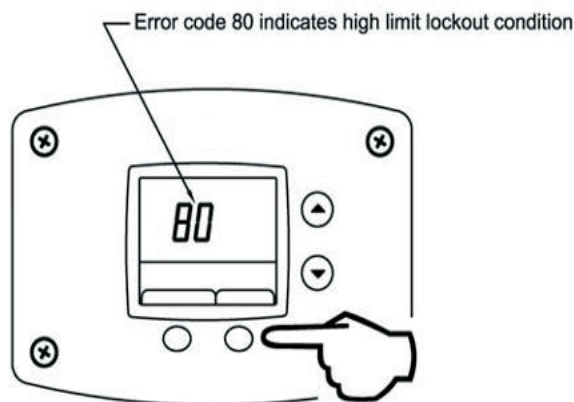

Step 1: Press for 3 seconds
to reset control.

Service Procedure I: Thermostat Circuit Testing and Replacement (Continued)

Thermostat Sensor (Thermistor) Replacement Procedure

WARNING

120 volt potential exposure. Use caution making voltage checks to avoid personal injury.

1. Position main power switch to OFF.
2. Disconnect (unplug) water heater from 120 volt power source.
3. Unlatch and remove the top surround cover from the top of the water heater.
4. Unclip sensor connector from the control board and remove the harness from the control panel (see below images).
5. Unclip sensor from the well and pull the sensor to remove, do **NOT** remove well.
6. Install new sensor assembly into well and reinstall the sensor clip.
7. Reconnect the sensor connector to the control board and route the wire harness through the same path that it was removed.
8. Restore 120 volt power supply and water supply to the water heater, check and repair any leaks found. Confirm proper operation following the lighting instruction label or the lighting instructions located in the Installation and Operating Instruction Manual.
9. Replace the surround cover on the top of the water heater.

Remove sensor
connector from
control board

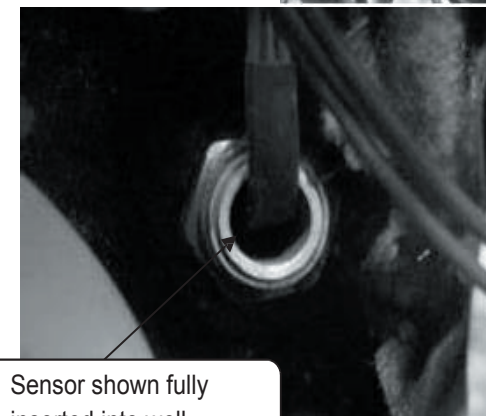
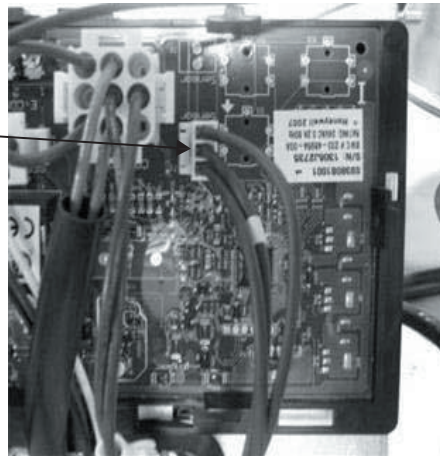

Sensor shown fully
inserted into well

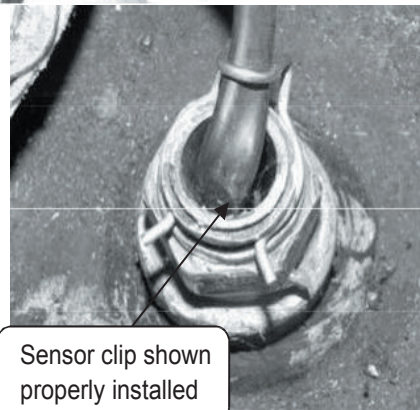

Sensor clip shown
properly installed

Service Procedure I: Thermostat Circuit Testing and Replacement (Continued)

APPENDIX-A

Sensor Resistance at Various Temperatures

Be careful when making voltage measurements or jumping terminals not to damage or deform connectors or connector pins.

Draw water from the temperature and pressure relief valve. Compare temperature with temperature ohms chart below.

Example: If the temperature is 84°F, then the resistance through the sensor would be 8449 (see shaded area).
Note: Sensor resistance increases as the temperature falls.

In Degrees F										
°F	0	1	2	3	4	5	6	7	8	9
40	26109	25400	24712	24045	23399	22771	22163	21573	21000	20445
50	19906	19383	18876	18383	17905	17440	16990	16553	16128	15715
60	15314	14925	14548	14180	13823	13477	13140	12812	12494	12185
70	11884	11592	11308	11032	10763	10502	10248	10000	9760	9526
80	9299	9078	8862	8653	8449	8250	8057	7869	7685	7507
90	7333	7165	7000	6839	6683	6531	6383	6238	6098	5961
100	5827	5697	5570	5446	5326	5208	5094	4982	4873	4767
110	4663	4562	4464	4368	4274	4183	4094	4006	3922	3839
120	3758	3679	3602	3527	3453	3382	3312	3244	3177	3112
130	3048	2986	2925	2866	2808	2752	2697	2643	2590	2538
140	2488	2439	2391	2344	2298	2253	2209	2166	2124	2083
150	2043	2004	1966	1928	1891	1856	1820	1786	1753	1720
160	1688	1656	1625	1595	1566	1537	1509	1481	1454	1427
170	1402	1376	1351	1327	1303	1280	1257	1235	1213	1191
180	1170	1150	1129	1110	1090	1071	1053	1035	1017	999
190	982	965	949	933	917	901	886	871	857	842
200	828	814	801	788	775	762	749	737	725	713

In Degrees C										
°C	0	1	2	3	4	5	6	7	8	9
0	32648	31026	29495	28049	26682	25389	24166	23010	21915	20879
10	19898	18968	18088	17253	16461	15710	14998	14322	13680	13071
20	12492	11942	11419	10922	10450	10000	9572	9165	8778	8409
30	8057	7722	7403	7099	6808	6532	6268	6016	5775	5546
40	5327	5117	4917	4726	4543	4368	4201	4042	3889	3742
50	3602	3468	3340	3217	3099	2986	2878	2774	2675	2579
60	2488	2400	2316	2235	2157	2083	2011	1942	1876	1813
70	1752	1693	1637	1582	1530	1480	1432	1385	1340	1297
80	1256	1216	1177	1140	1105	1070	1037	1005	974	944
90	916	888	861	835	810	786	763	741	719	698

Service Procedure II: Combustion System Testing and Replacement

Observe burner operation through the sight glass located on the combustion insert mounting flange. Normal burner operation should ignite smoothly, without evidence of coughing or huffing upon ignition. The burner flame should be a blue flame near the burner surface in a uniform flame pattern. Occasional yellow or white streaks are normal.

Note: On this high input model that uses metal fiber mesh burner a red glow from the burner surface is normal.

⚠️ WARNING

120 volt potential exposure. Use caution making voltage checks to avoid personal injury.

⚠️ WARNING

Removing screw from inlet gas pressure tap will immediately allow gas to flow from pressure tap.

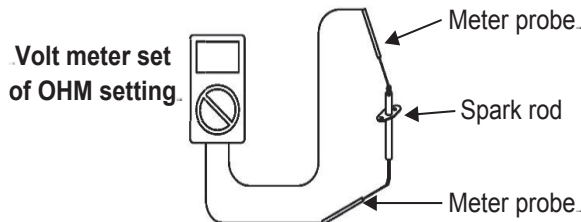
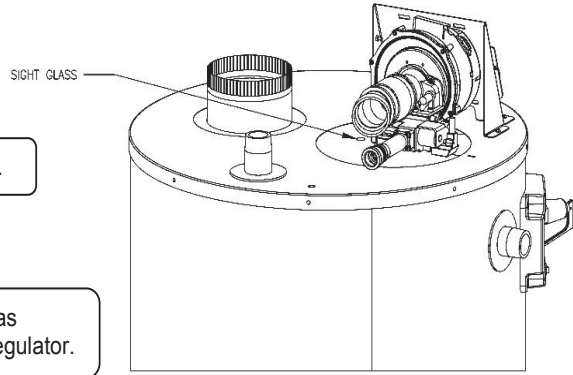
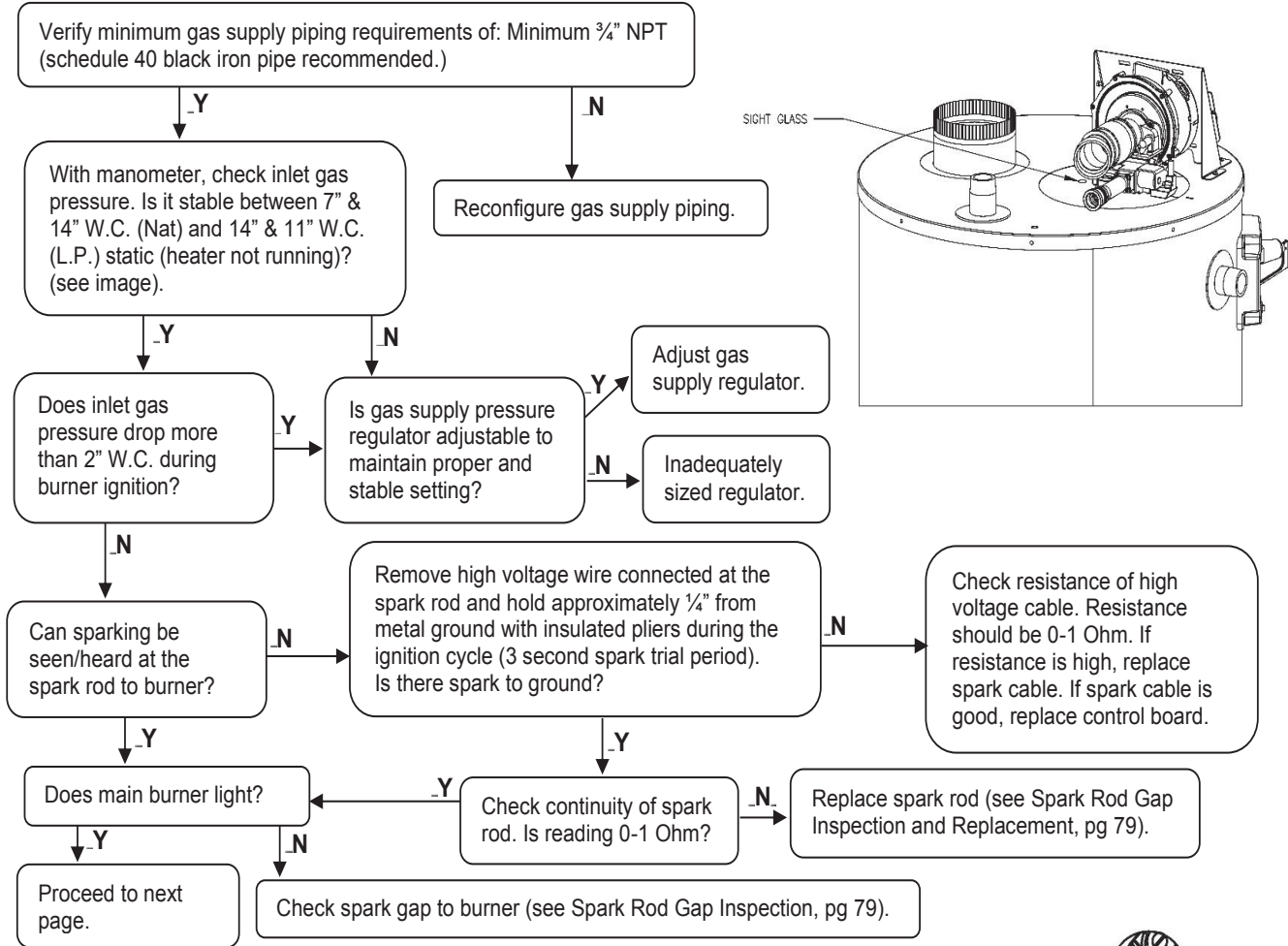

CHECK SPARK ROD RESISTANCE

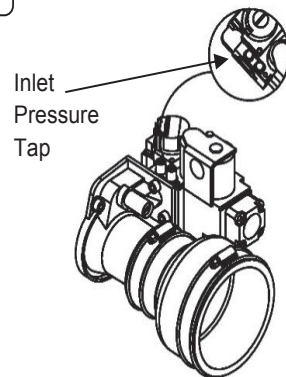

Gas Valve/Venturi.

Service Procedure II: Combustion System Testing and Replacement (Continued)

Observe burner operation through the sight glass located on the combustion insert mounting flange. Normal burner operation should ignite smoothly, without evidence of coughing or huffing upon ignition. The burner flame should be a blue flame near the burner surface in a uniform flame pattern. Occasional yellow or white streaks are normal. **Note: On this high input model that uses metal fiber mesh burner a red glow from the burner surface is normal.**

Continued from page 68.

⚠ WARNING
120 volt potential exposure. Use caution making voltage checks to avoid personal injury.

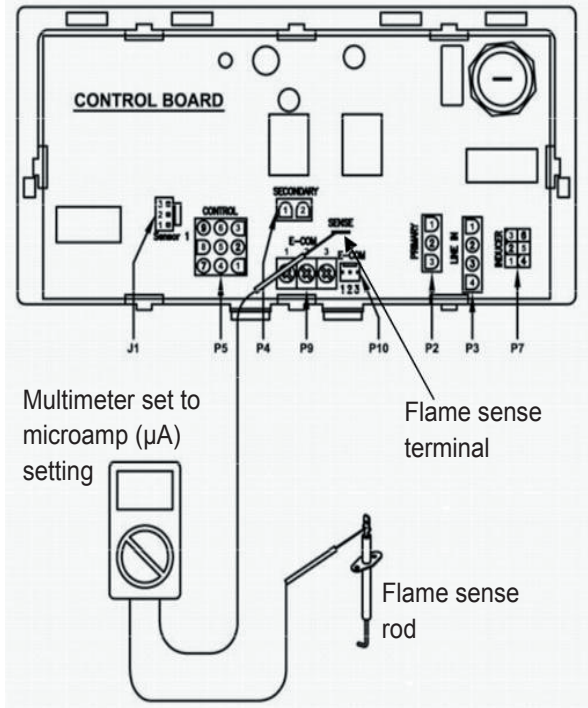
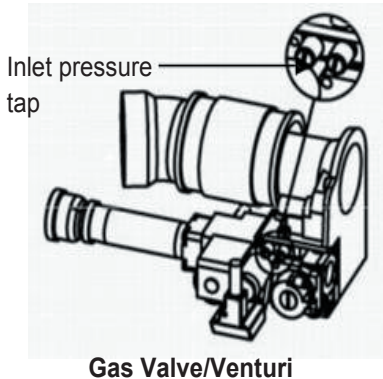
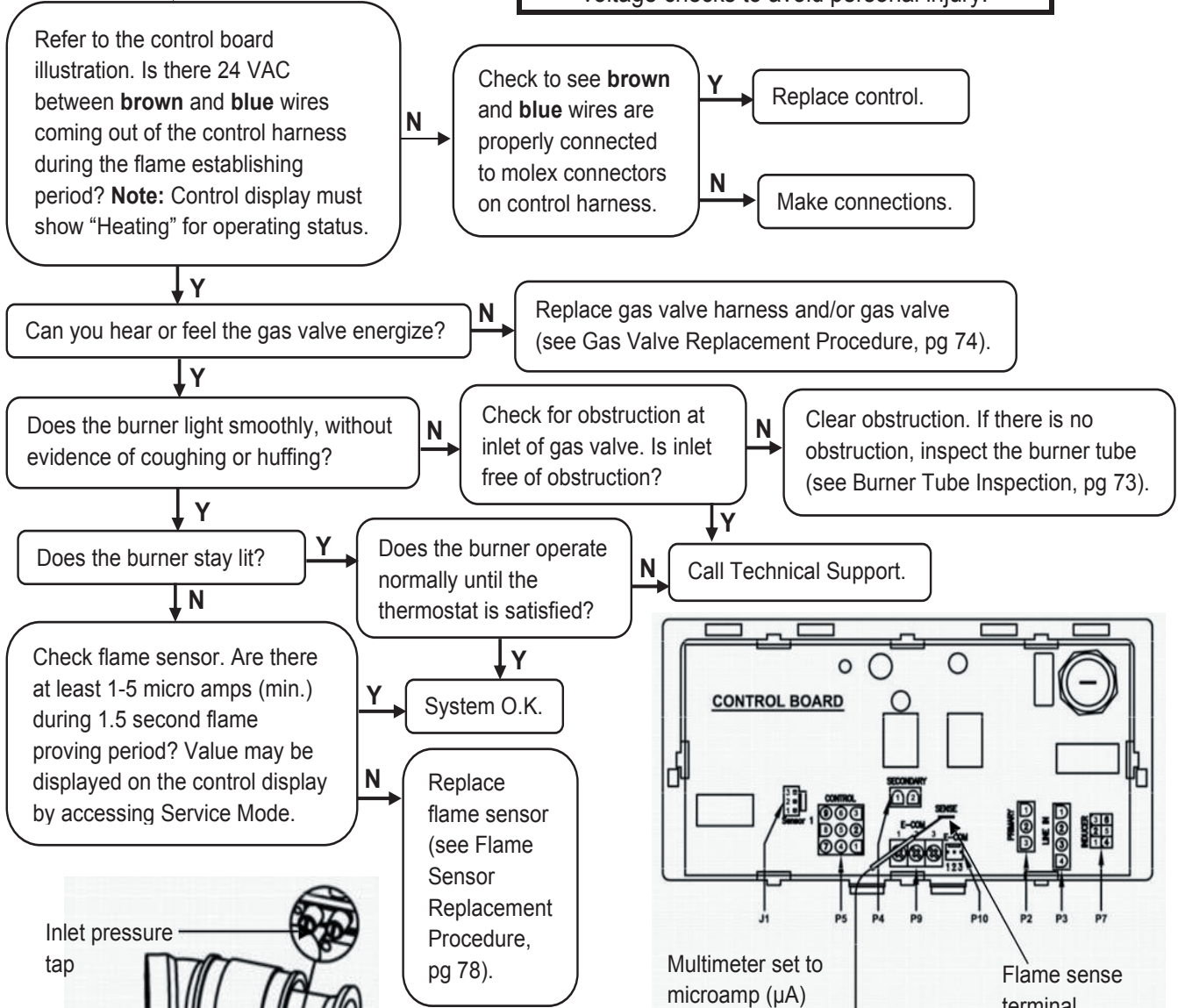

Service Procedure II: Combustion System Testing and Replacement (Continued)

WARNING

Heater components may be **HOT** when performing the following steps in this procedure. Take necessary precaution to prevent personal injury.

WARNING

120 volt potential exposure. Isolate the appliance and reconfirm power is disconnected using a multi-meter.

Combustion System Removal Procedure

1. Position main power switch to OFF.
2. Disconnect (unplug) water heater from 120 volt power source.
3. Turn OFF gas supply to water heater.
4. Unlatch and remove surround cover from top of heater.
5. From the gas valve, disconnect the gas connection, PVC intake venting, silicone tubing, and wire harness.
6. Disconnect flame sensor, gas valve, and blower wire harnesses. Disconnect high voltage cable from spark rod connection.
7. Remove the 5 bolts (1/2" socket) holding the burner mounting insert in place.
8. Carefully remove combustion assembly with gasket from water heater.
9. See next page for combustion system installation procedure.

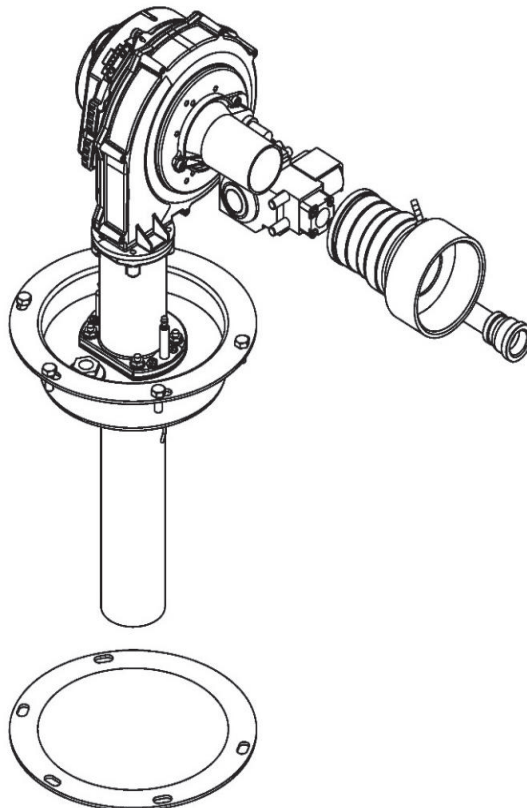

Service Procedure II: Combustion System Testing and Replacement (Continued)

Combustion System Replacement Procedure

1. Fully inspect burner mounting insert gasket for the following:
 - a. Tears
 - b. Missing material
 - c. Cracks
 - d. Dirt or debris
 - e. Other imperfections that would inhibit proper seal

If gasket is NOT affected by any of the above, gasket replacement is not required.

2. Install the combustion assembly using new gasket or fully inspected gasket from Step 1. Secure combustion assembly at the burner mounting insert using bolts from Step 7 on previous page. Tighten screws evenly.
3. Reconnect the spark rod cable, flame sensor, blower and gas valve wire harnesses.
4. Reconnect the PVC intake venting, gas supply, and silicone tubing to gas valve. Turn ON gas supply to heater and check for gas leaks, repair any gas leaks found.
5. Restore 120 volt power supply to water heater and confirm proper operation following the lighting instructions on the lighting instruction label or the lighting instruction located in the Installation and Operating Instruction Manual.
6. Replace the surround cover on the top of the water heater.

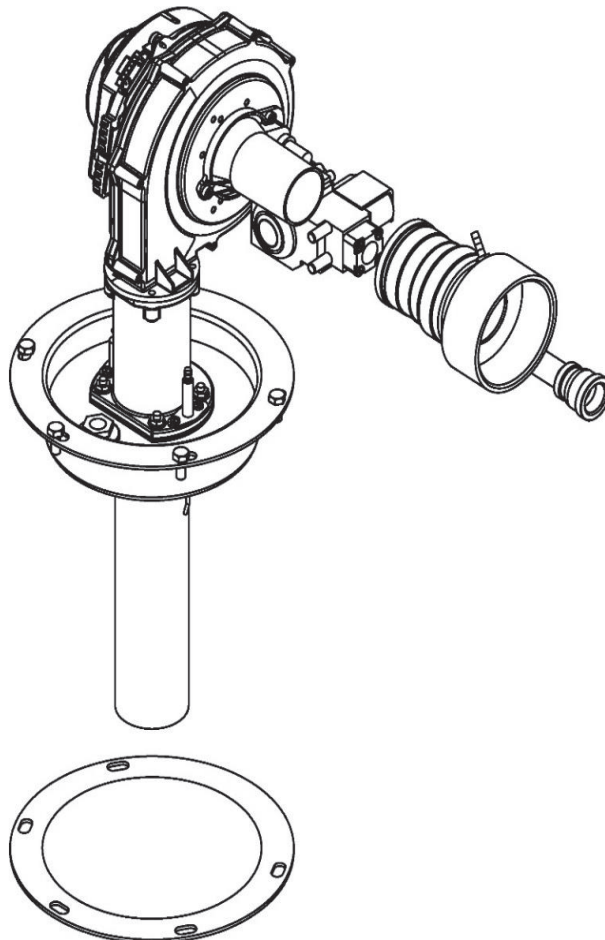

Service Procedure III: Burner Tube Inspection and Replacement

WARNING

Heater components may be **HOT** when performing the following steps in this procedure. Take necessary precaution to prevent personal injury.

WARNING

120 volt potential exposure. Isolate the appliance and reconfirm power is disconnected using a multi-meter.

Burner Tube Removal Procedure

1. Position main power switch to OFF.
2. Disconnect (unplug) water heater from 120 volt power source.
3. Turn OFF gas supply to water heater.
4. Unlatch and remove surround cover from top of heater.
5. From the gas valve, disconnect the PVC intake venting, gas supply connection, wire harness, and silicone tubing.
6. Disconnect wire harness from blower assembly.
7. Remove the screws holding the spark rod and flame sensor in place (long reach magnetic Phillips screwdriver). Carefully remove spark rod and flame sensor from combustion assembly.
8. Remove the 4 nuts (7/16" wrench) holding the burner transition in place. Lift the blower/gas valve transition assembly from burner mounting insert, remove gasket and set aside.
9. Remove burner tube from burner mounting insert. See next page for burner tube inspection procedure.

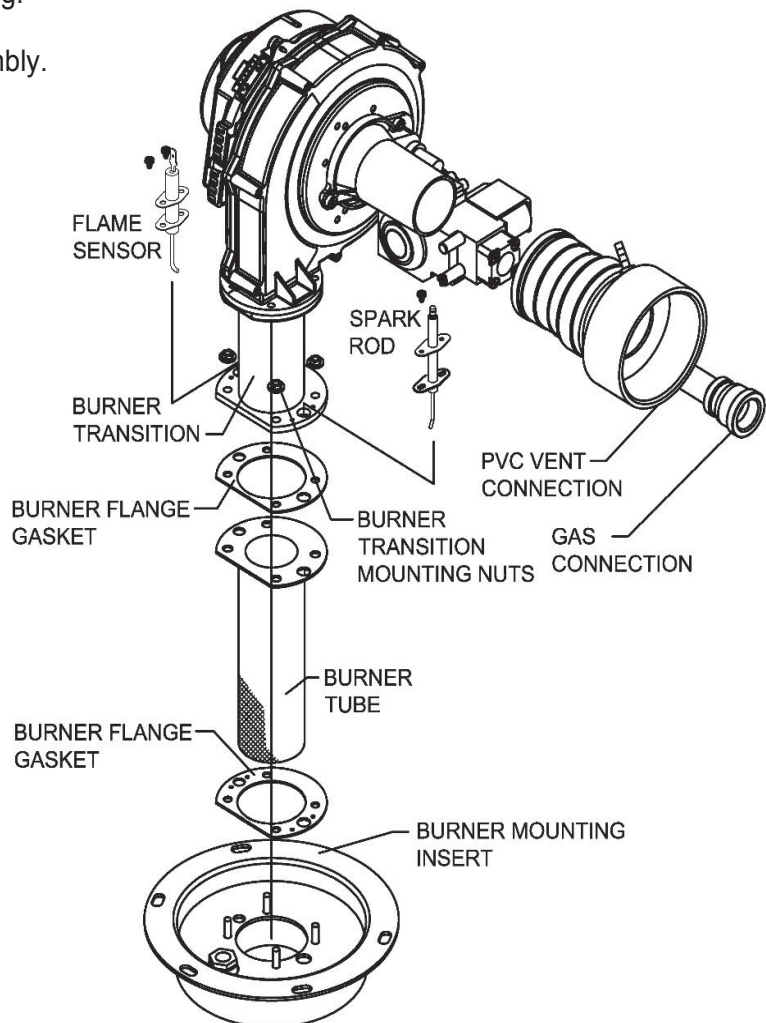

Service Procedure III: Burner Tube Inspection and Replacement (Continued)



Heater components may be **HOT** when performing the following steps in this procedure. Take necessary precaution to prevent personal injury.

Burner Tube Inspection

1. **Inspect burner tube as follows (Acotech metal fiber mesh burner).**
 - d. Outer fiber mesh should be uniform with no tears or deterioration.
 - e. Gently squeeze burner tube, Burner tube should feel firm without any soft areas around the sides or at the bottom.
 - f. Visually inspect inside burner tube, Burner tube should be intact with no areas of deterioration. Ports should be free of any debris.
2. If burner tube is affected by any of the above, replacement is required. Refer to burner tube replacement procedure below.

Burner Tube Replacement Procedure

Note: Provide the model and serial number for the correct replacement burner.

1. Fully inspect burner flange gaskets, igniter and flame sensor gaskets for the following:
 - a. Tears
 - b. Missing material
 - c. Cracks
 - d. Dirt or debris
 - e. Other imperfections that would inhibit proper seal

Note: If gaskets are NOT affected by any of the above, gasket replacement is not required.

2. Install burner tube with gaskets into burner mounting insert. Be sure gasket surfaces are free of debris.
3. Reconnect the blower/gas valve/transition assembly to burner mounting insert. Secure using nuts from Step 8 on previous page.
4. Carefully reinstall flame sensor with gasket and spark rod with gasket and secure with screws from Step 7 on previous page. Reconnect wire harnesses to sensor and igniter.
5. Reconnect wire harnesses to blower motor and to gas valve.
6. Reconnect PVC intake venting, gas supply, and silicone tubing to gas valve. Turn ON gas to heater and check for gas leaks, repair any gas leaks found.
7. Restore 120 volt power supply to water heater and confirm proper operation following the lighting instructions on the lighting instruction label or the lighting instruction located in the Installation and Operating Instruction Manual.
8. Replace the surround cover on the top of the water heater.

Service Procedure IV: Gas Valve Replacement

Gas Valve Replacement Procedure

1. Position main power switch to OFF.
2. Disconnect (unplug) water heater from 120 volt power source.
3. Turn OFF gas supply to water heater.
4. Unlatch and remove surround cover from top of heater.
5. From the gas valve, disconnect the gas connection, PVC venting, wire harness, and silicone tubing.
6. Remove the 2 to 3 gas valve mounting screws (Torx bit) located as shown below on the venturi mounting flange and remove gas valve from water heater.
7. Remove any residual gasket material from blower and venturi mounting flange.
8. Install new gas valve with new gasket provided. Secure gas valve in place using screws from Step 6.
9. Reconnect PVC intake venting, gas supply, silicone tubing, and wire harness to gas valve. Turn ON gas supply to heater and check for gas leaks, repair any gas leaks found.
10. Restore 120 volt power supply to water heater and confirm proper operation following the lighting instructions on the lighting instruction label or the lighting instruction located in the Installation and Operating Instruction Manual.
11. Replace tr

WARNING

120 volt potential exposure. Isolate the appliance and reconfirm power is disconnected using a multi-meter.

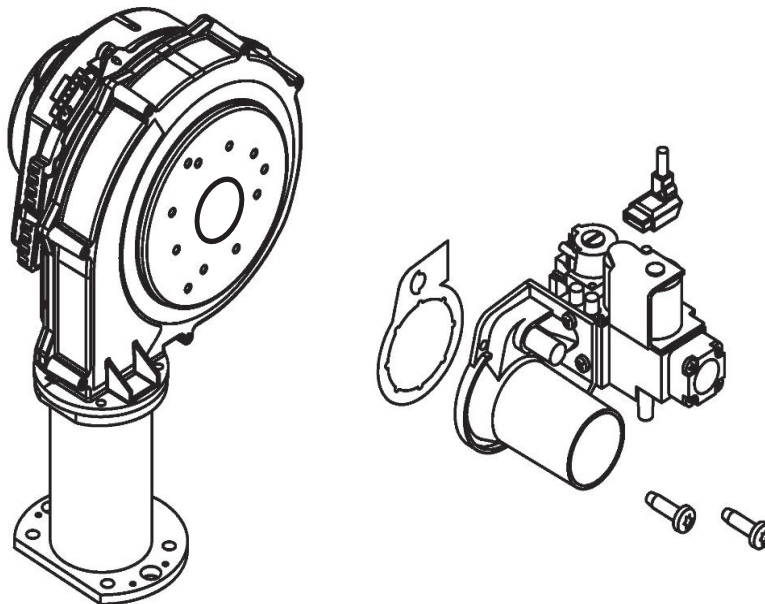

Service Procedure V: Blower Testing and Replacement

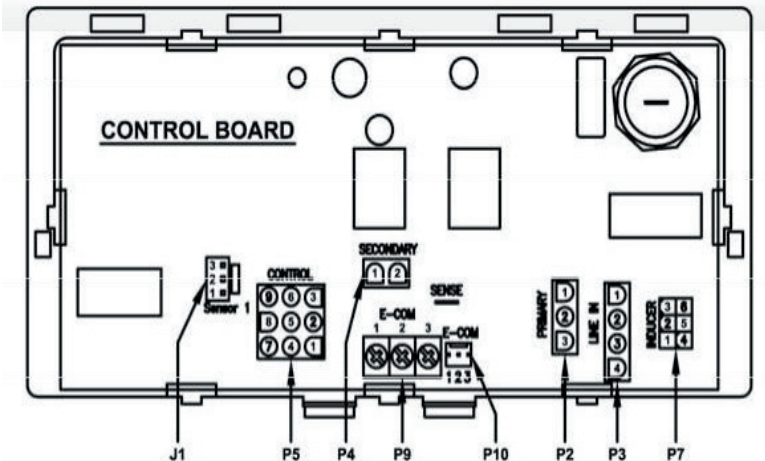
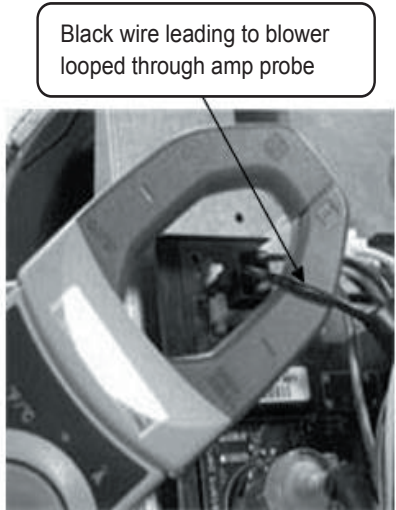
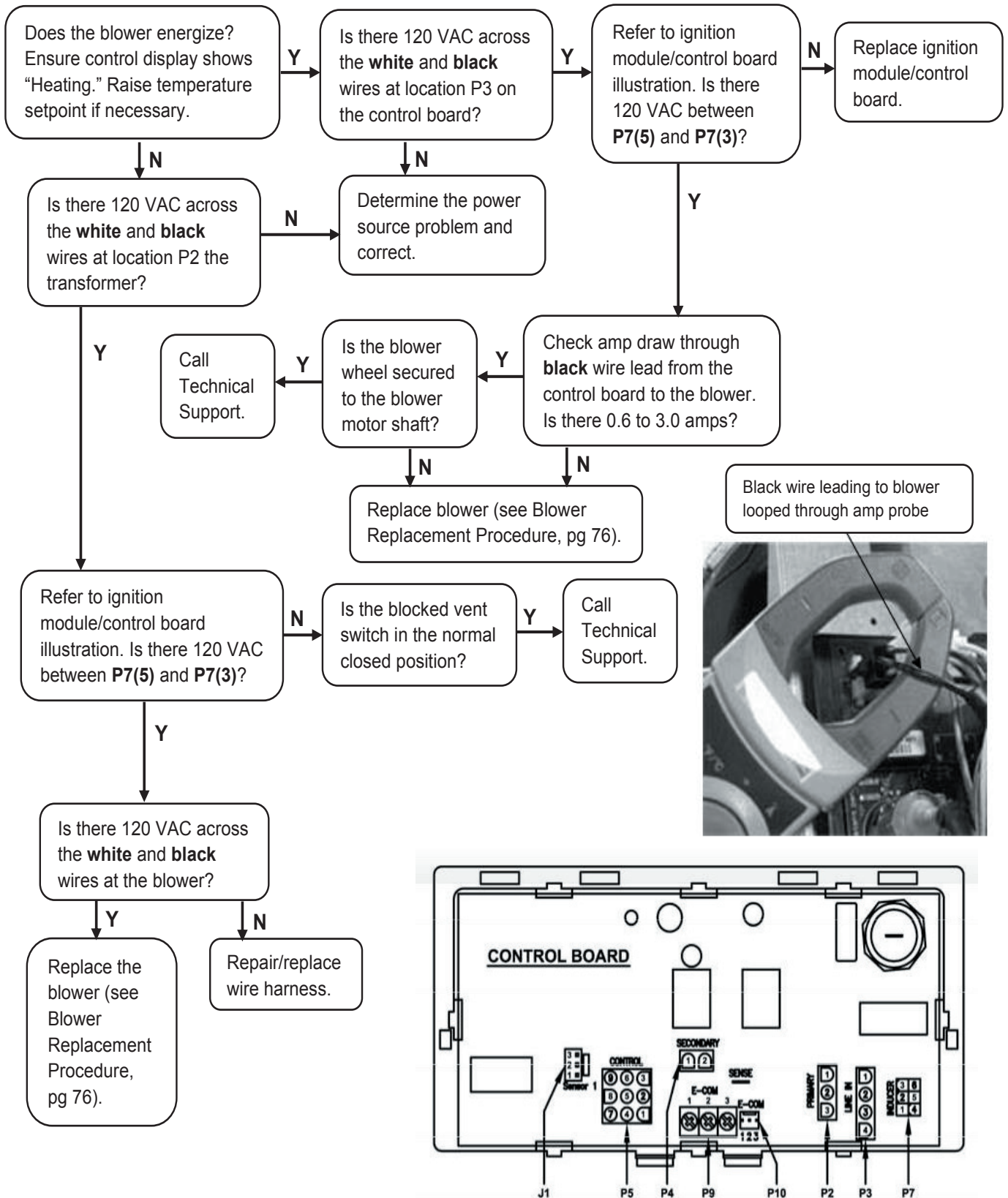

Service Procedure V: Blower Testing and Replacement (Continued)

Blower Replacement Procedure

1. Position main power switch to OFF.
2. Disconnect (unplug) water heater from 120 volt power source.
3. Turn OFF gas supply to water heater.
4. Unlatch and remove surround cover from top of heater.
5. Disconnect the 2 wire harnesses from blower.
6. Disconnect intake vent and gas supply from gas valve assembly.
7. Remove the 2 to 3 gas valve mounting screws (Torx bit) located on the venturi mounting flange.
8. Remove the 4 blower flange mounting screws (5/32 Allen wrench) and remove blower from transition flange.
9. Remove any residual gasket material from venturi mounting flange and transition flange.
10. Install new blower with new gasket provided. Secure blower in place using screws from Step 8.
11. Reconnect gas valve assembly to blower with new gasket provided. Secure gas valve in place using screws from Step 7.
12. Reconnect intake vent and gas line to gas valve assembly and check for gas leaks. Repair any leaks found.
13. Reconnect the 2 wire harnesses to blower assembly, restore 120 volt power supply and gas supply to water heater and confirm proper operation following the lighting instructions on the lighting instruction label or the lighting instructions located in the Installation and Operating Instruction Manual.
14. Replace the surround cover on the top of the water heater.



WARNING

120 volt potential exposure. Isolate the appliance and reconfirm power is disconnected using a multi-meter.

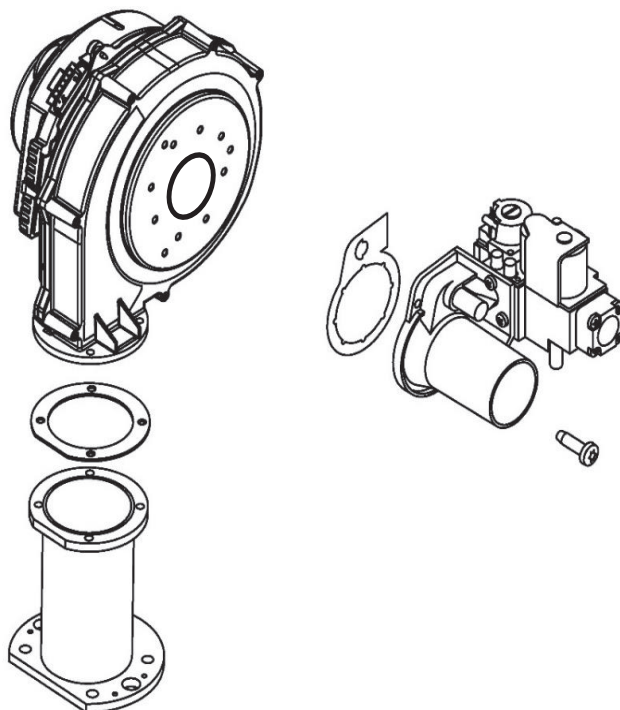

Service Procedure VI: Flame Sensor Testing and Replacement

⚠ WARNING

120 volt potential exposure. Use caution making voltage checks to avoid personal injury.

Flame Sensor Testing Procedure

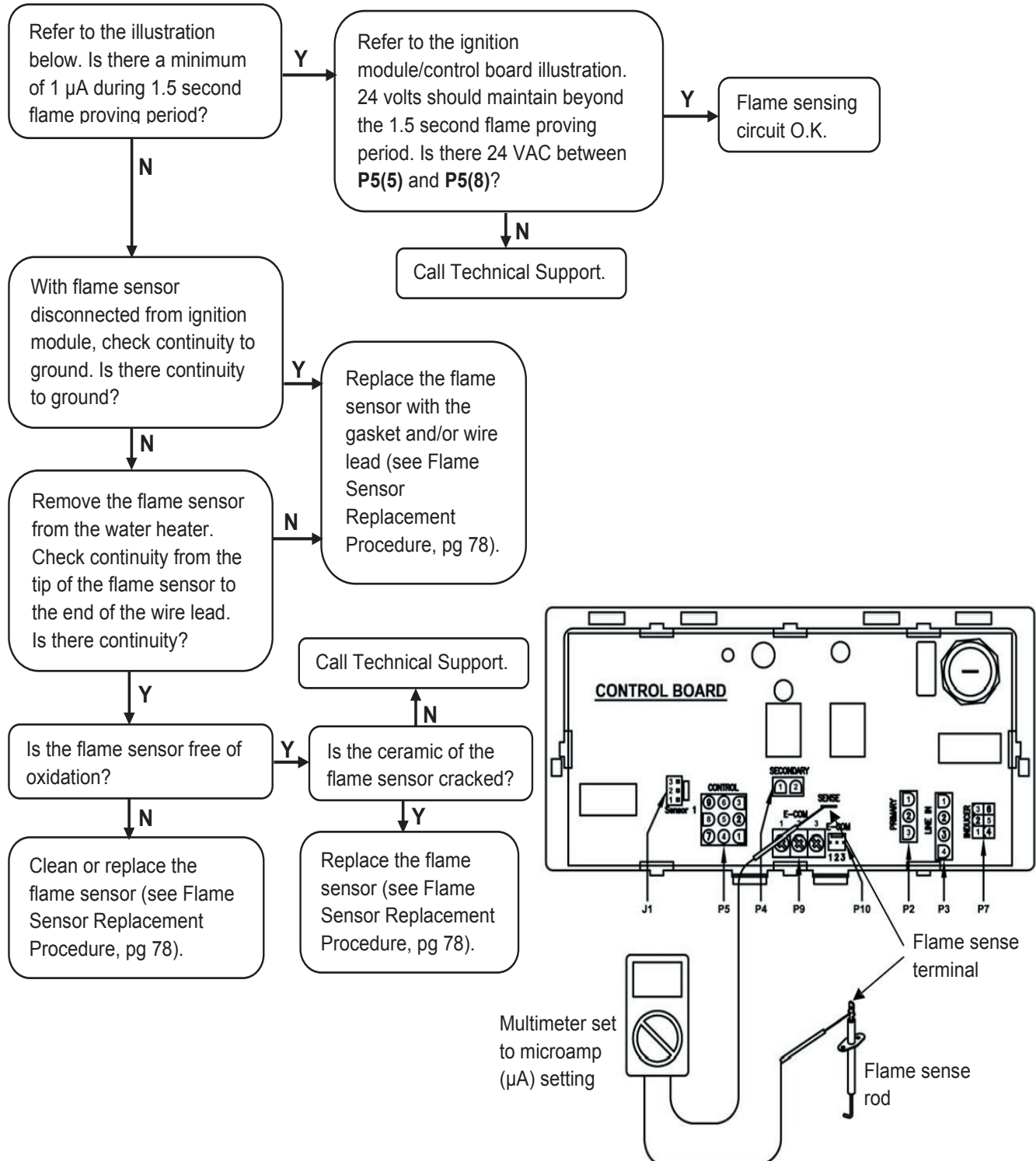

Service Procedure VI: Flame Sensor Testing and Replacement (Continued)

Flame Sensor Replacement Procedure

1. Position main power switch to OFF.
2. Disconnect (unplug) water heater from 120 volt power source.
3. Unlatch and remove surround cover from top of heater.
4. Disconnect the wire lead from flame sensor.
5. Remove the 2 sensor mounting screws (magnetic tip, long reach Phillips screwdriver) and remove flame sensor and gasket from transition base flange.
6. Remove any residual gasket material from transition base flange.
7. Install new flame sensor with new gasket provided using screws from Step 5. Arrange flame sensor with hook towards burner.
8. Reconnect the flame sensor wire.
9. Restore 120 volt power supply to water heater and confirm proper operation following the lighting instructions on the lighting instruction label or the lighting instructions located in the Installation and Operating Instruction Manual.
10. Replace the surround cover on the top of the water heater.

WARNING

120 volt potential exposure. Isolate the appliance and reconfirm power is disconnected using a multi-meter.

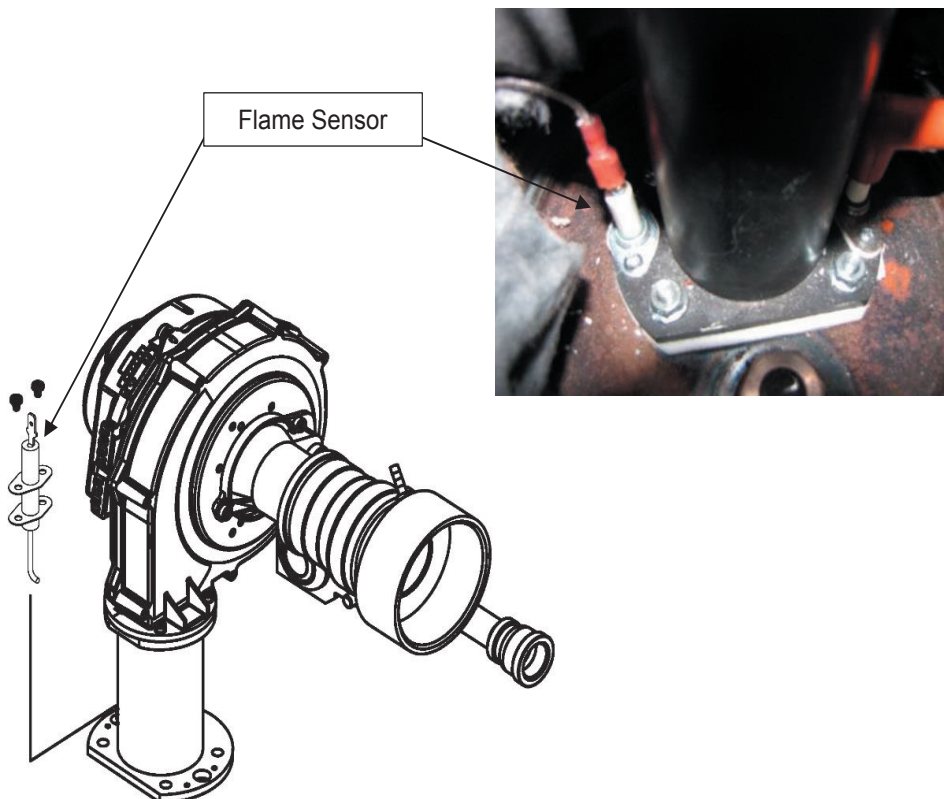

Service Procedure VII: Spark Rod Gap Adjustment and Replacement

Spark Rod Gap Inspection and Adjustment

1. Remove combustion system as described in Combustion System Removal Procedure, pg 68.
2. Measure spark gap between the spark rod and burner tube. Acceptable spark gap is from 3/16" to 1/4" (see image below).
3. If spark gap is not between 3/16" to 1/4", the spark rod may be carefully bent by supporting the end near the ceramic insulator with pliers and bending the end near the burner tube with needle nose pliers (see image below).
4. Re-measure and verify the spark gap is between 3/16" to 1/4" after bending.
5. Verify the integrity of all gaskets and replace where required.
6. Reinstall the combustion system per Combustion System Replacement Procedure (pg 68) and check several ignitions to ensure the burner lights smoothly.

WARNING

Spark gap must be set from 3/16" to 1/4". Failure to set and verify proper spark gap may result in a delayed ignition resulting in damage to the water heater.

CAUTION

Use caution while performing these steps to prevent stressing or cracking the ceramic insulator.

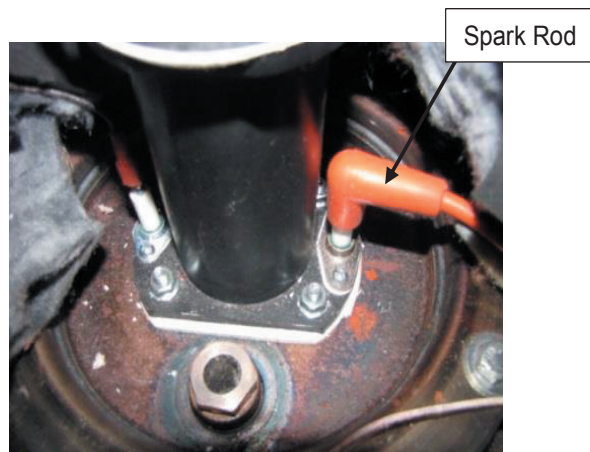
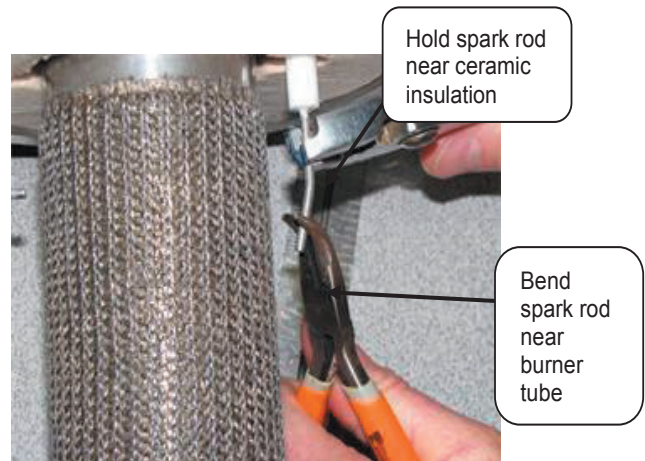
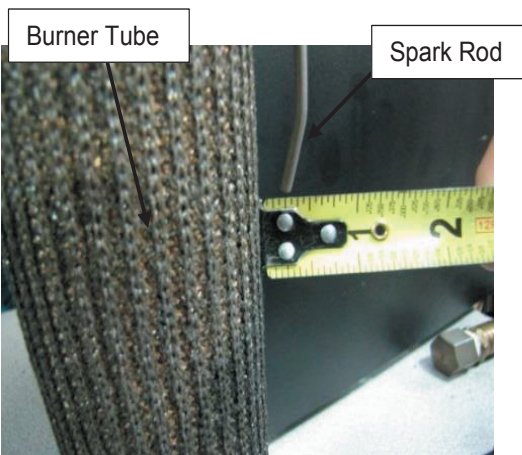

Service Procedure VII: Spark Rod Gap Adjustment and Replacement (Continued)

Spark Rod Replacement Procedure

1. Position main power switch to OFF.
2. Disconnect (unplug) water heater from 120 volt power source.
3. Unlatch and remove surround cover from the top of the water heater.
4. Disconnect wire lead from spark rod.
5. Remove the 2 mounting screws (magnetic tip, long reach Phillips screwdriver) and remove spark rod and gasket from transition base flange.
6. Remove any residual gasket material from transition base flange.
7. Install new spark rod with new gasket provided using screws from Step 5. Arrange spark rod with hook towards burner (off-center mounting hole towards the front of the water heater).
8. Remove combustion system following Combustion System Removal Procedure (pg 68) and verify spark gap following Spark Rod Gap Inspection and Adjustment (pg 79). Reassemble combustion system following Combustion System Replacement Procedure (pg 68).
9. Restore 120 volt power supply to water heater and confirm proper operation following the lighting instructions on the lighting instruction label or the lighting instructions located in the Installation and Operating Instruction Manual.
10. Replace the surround cover on the top of the water heater.

WARNING

120 volt potential exposure. Isolate the appliance and reconfirm power is disconnected using a multi-meter.

WARNING

If the spark rod is replaced for any reason, the combustion system **MUST** be removed and the spark gap to the burner measured and adjusted properly.

WARNING

Spark gap must be set from 3/16" to 1/4". Failure to set and verify proper spark gap may result in a delayed ignition resulting in damage to the water heater.

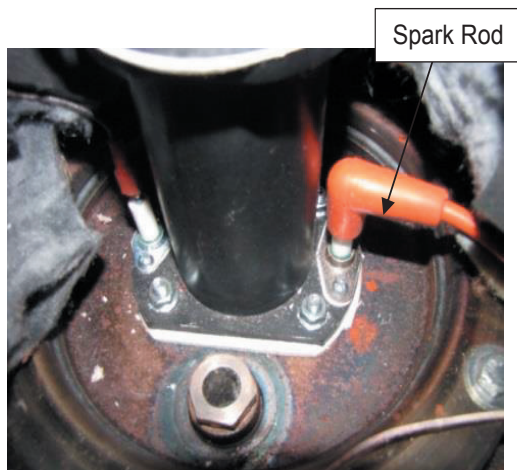
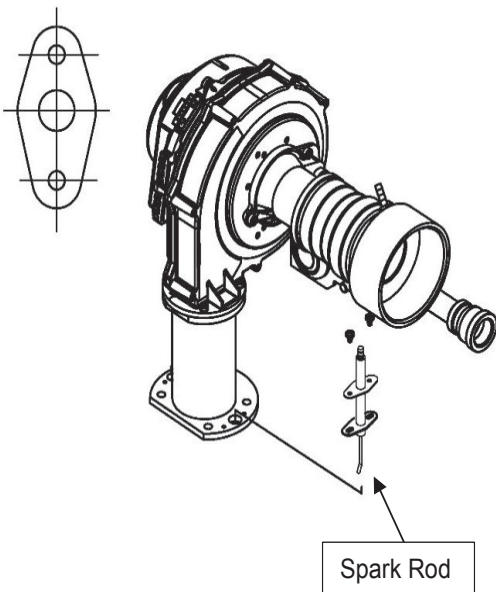

Service Procedure VIII: Ignition Module/Control Board Replacement

Control Board Replacement

1. Position main power switch to OFF.
2. Disconnect (unplug) the water heater from the 120 volt power source.
3. Unlatch and remove the surround cover from the top of the water heater.
4. Locate the control board.
5. Carefully disconnect all wire connections from the control board.
Note: It may be necessary to identify wires for proper re-connection.
6. Depress the plastic tabs on the top of the control first, then tilt the control forward.
7. Unhook the tabs on the control from the slots on the control panel and remove the control.
8. Replace the control board and all wire connections.
9. Restore 120 volt power supply to water heater and confirm proper operation following the lighting instructions on the lighting instruction label, or the lighting instructions located in the Installation and Operating Instruction Manual.
10. Replace the surround cover on the top of the water heater.

WARNING

120 volt potential exposure. Use caution making voltage checks to avoid personal injury.

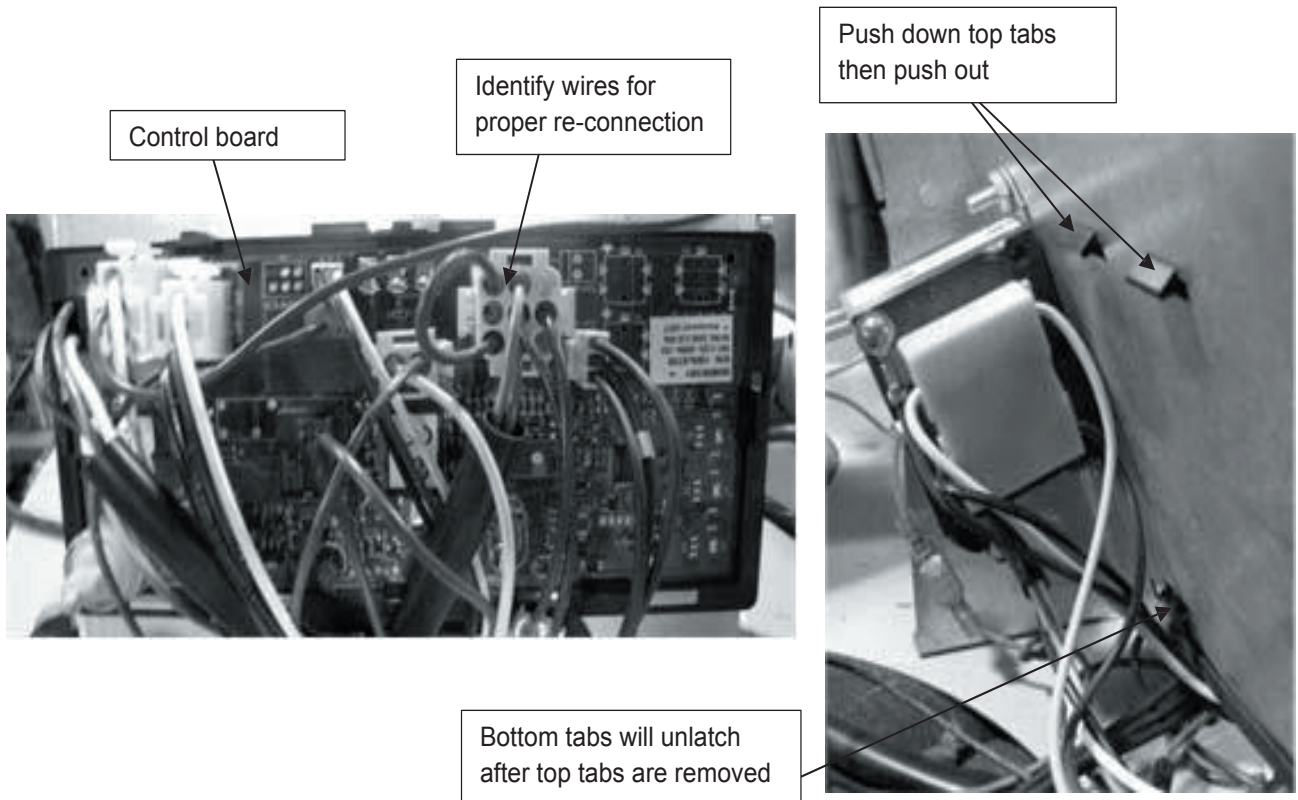

Service Procedure IX: Anode Inspection and Replacement

Anode Replacement Procedure

1. Position main power switch to OFF.
2. Disconnect (unplug) water heater from 120 volt power source.
3. Turn OFF water supply and drain the water heater.
4. Locate (see image below) and remove anode rods from heater (1-1/16 hex socket).
5. Visually inspect anode rod. Anode rod should show signs of depletion, this is normal. If the depletion is 1/2 of the original diameter (approximately 3/4" diameter), replacement is recommended. If any of the steel core of the anode is exposed, replacement is recommended.
6. Upon completion of inspection or subsequent replacement, apply thread sealing tape or other thread compound to threads of anode and reinstall into heater. Restore the water supply and check for and repair any leaks found.
7. Restore 120 volts to water heater and verify proper heater operation following the instructions on the lighting instruction label or the lighting instruction located in the Installation and Operating Instruction Manual.

WARNING

Heater components and stored water may be HOT when performing the following steps in this procedure. Take necessary precaution to prevent personal injury.

Top of water heater
Anodes located under plastic covers by inlet and outlet water connections

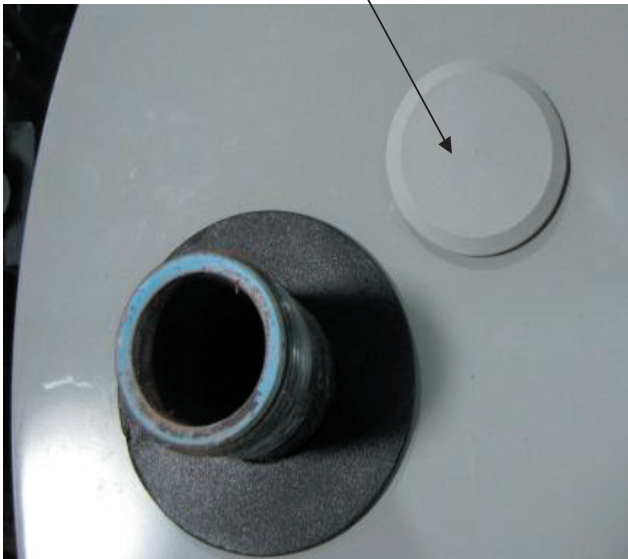

Cut access hole through insulation
After removing insulation you will have access to the anodes



Service Procedure X: Display Module Replacement

Display Module Replacement

1. Position main power switch to OFF.
2. Disconnect (unplug) water heater from 120 volt power source.
3. Remove 4 screws that hold the display into the enclosure (see image below).
4. After removing the screws pull the display out of the enclosure.
5. Once the display is removed, disconnect the two mating plugs.
6. Connect the new display and replace into the enclosure.
7. Use the 4 screws from Step 3 and reinstall the display onto the enclosure.
8. Restore 120 volt power supply to water heater and confirm proper operation following the lighting instructions on the lighting instruction label or the lighting instruction located in the Installation and Operating Instruction Manual.

WARNING

120 volt potential exposure. Isolate the appliance and reconfirm power is disconnected using a multi-meter.

Display and Enclosure



Disconnect



Service Procedure XI: Transformer Replacement

Transformer Replacement Procedure

1. Position main power switch to OFF.
2. Disconnect (unplug) water heater from 120 volt power source.
3. Unlatch and remove surround cover from top of water heater.
4. Disconnect primary leads (black & white) and secondary leads (blue & yellow) from the transformer (connections are different sizes to prevent interchanging).
5. Remove the 2 nuts (7/16 nut driver) holding the transformer in place and remove transformer from control panel (see image below).
6. Install new transformer and secure in place with screws from Step 6.
7. Reconnect primary and secondary wires to transformer (leads are different sizes to prevent interchanging).
8. Restore 120 volt power supply to water heater and confirm proper operation following the lighting instructions on the lighting instruction label or the lighting instruction located in the Installation and Operating Instruction Manual.
9. Replace the surround cover on the top of the water heater.

WARNING

120 volt potential exposure. Isolate the appliance and reconfirm power is disconnected using a multi-meter.

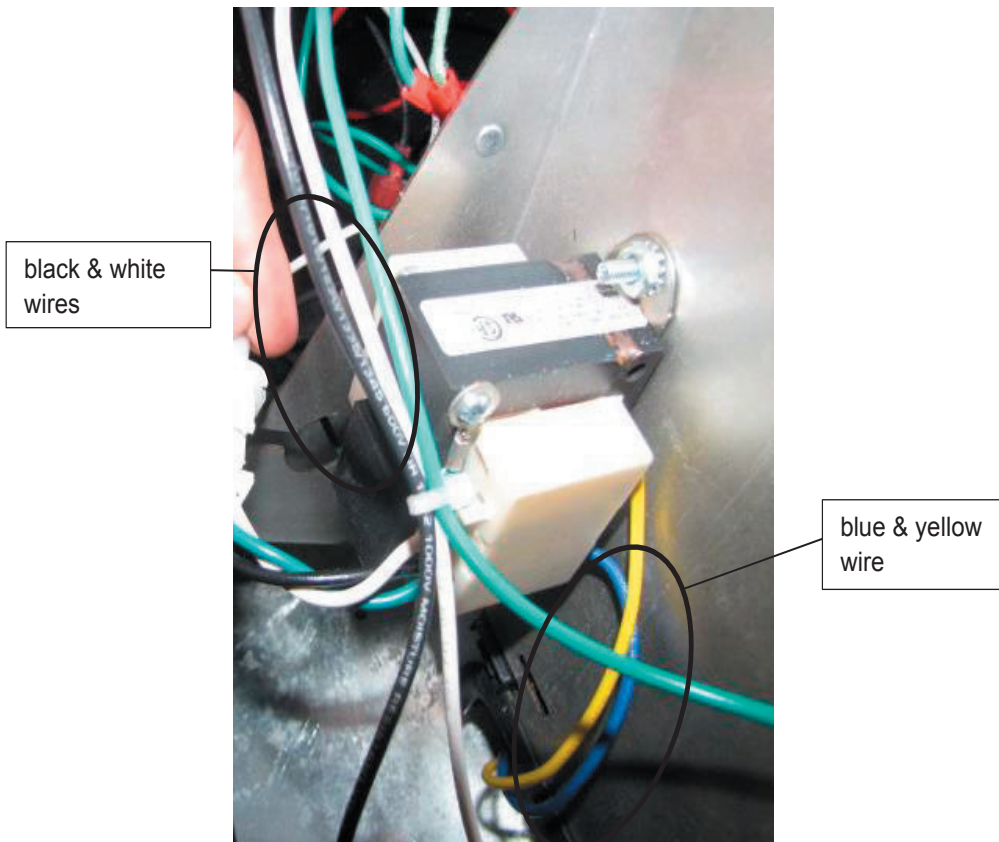

Water Heater Installation Checklist

Product Handling	Carefully uncrate the heater. Move in place with a hand truck (DO NOT use the venting pipes for handles).
Electrical Requirements	Make sure there is 120 volts line voltage. Line voltage must be properly polarized. Adequate ground supplied to the heater.
Venting Requirements	All venting must stay within the required lengths and diameter (see table below). Proper support of the venting pipe is a MUST (every 5 ft (1.5 m) vertical and 3 ft (.92 m) horizontal). Termination must be located to prevent re-circulation of flue gases.
Gas Requirements	Gas piping sized adequately, 3/4". Install a properly sized regulator (if unknown, assure an adequate volume of gas is available). 7" W.C. is required when the unit is running. Gas pressure must stay below 14" W.C. static pressure. Pressure drops between static pressure and operating flow should be less than 3" W.C.
Service/Mechanical Room	Provide adequate space for servicing heater. Leave enough overhead room to remove the anode rods for servicing (18" min).

Glossary of Terms

AC	Alternating Current	NOx	Oxides of Nitrogen
BTU/H	British Thermal Units	NPT	National Pipe Thread
CO	Carbon Monoxide	PSI	Pounds per Square Inch
CO2	Carbon Dioxide	RPM	Revolutions per Minute
DC	Direct Current	VA	Volt Amps
DSI	Direct Spark Ignition	VAC	Volts Alternating Current
ECO	Energy Cut Off	W.C.	Inches of Water Column
GFI	Ground Fault Interrupt	°C	Degrees Centigrade
GPM	Gallons per Minute	°F	Degrees Fahrenheit
Hz	Hertz	μA	Micro Amp
LED	Light Emitting Diode		

Water Heater Service Report

Date: _____

Service Provider: _____

Model Number: _____

Phone Number: _____

Serial Number: _____

Intake Venting:

Intake Vent size 3", 4" _____ Intake 45° Elbows (qty) _____ Length of Straight Pipe (Intake) _____
 Intake 90° Elbows (qty) _____ Exhaust Vent Size 6", 7", 8" _____

Gas Line:

Size & Material _____
 Distance from Meter to Water Heater _____

Gas Pressure:

Static _____
 Running Inlet _____
 Manifold _____

Venturi:

Setting from Bottom in Turns _____

Electrical:

Line Voltage _____ Low Voltage _____ Polarity _____
 Flame Sense (µA) _____ Spark Gap _____

Error Codes on Control Display: _____

Combustion:

CO₂ _____ CO _____

Installation Site Name & Address:

Installation Site Contact Name & Phone Number

Customer must specify complete model number and serial number when ordering service parts.

This product is covered under one or more of the following patents and or patent pending applications:

CA2,430,807 CA2,844,271 EP1369647 GB1369647 NL1369647 TWI276761 US7,559,293 US7,900,589 US7,007,748 CA2,476,685
 US7,063,132 CA2,409,271 US6,684,821 US7,337,517 US7,665,211 US7,665,210 US7,699,026 CA2,504,824 US6,935,280
 AU2007201423 CA2,583,609 EP1840484 GB1840484 NL0840484 US7,634,976 US7,270,087 US7/621,238 US7,334,419
 US7,866,168 CA2,491,181 US7,063,133 CA2,677,549 US8,082,888 AU2007201424 CA2,583,108 EP1840481 GB1840481
 NL1840481 CA2,659,534 US7,971,560 US7,992,526 US8,146,772 US8,707,558 CA2,548,958 MX243220 US6,422,178 TWI649522
 US9,429,337 CA3,001,716 GB2558134 GB2013252.8 US10,866,010 US17/109,618 US10,503,183 US20/42096 CA2,949,830
 DE112015002523.5 GB2540513 US9,574,792 US15/436,425 CA3,059,965 EP18784108.5 MX/a/2019/012268 US15/486,816
 US17/038,087 US7,007,316 US7,243,381 CA2,784,312 US8,787,742 DE112014002713.8 GB2533862 US9,964,241 US6,644,393
 US8,851,022 USD636,857 US8,931,438 CA2,899,271 US10,495,343 CA2,918,211 US10,094,619 US15/621,063 US16/474,833
 US16/281,599

Refer to the parts list on www.bradfordwhite.com for a complete parts listing and expanded views of the models covered in this manual.



United States

General Contact 800-523-2931
Technical Support 800-334-3393
Email techsupport@bradfordwhite.com
Warranty 800-531-2111
Email warranty@bradfordwhite.com
Service Parts 800-538-2020
Email parts@bradfordwhite.com

Canada

General Contact 866-690-0961
Technical Support 800-334-3393
Email techsupport@bradfordwhite.com
Warranty 800-531-2111
Email warranty@bradfordwhite.com
Orders ca.orders@bradfordwhite.com

For field service, please contact your professional installer or local Bradford White sales representative.

Built to be the Best[®]