

**60CM DUAL FUEL
MINI RANGE COOKER**

**INSTRUCTION
MANUAL**

Creda



V 1.0

MODEL/S
C60DFMRCRM
C60DFMRBL
C60DFMRA

INSTRUCTION MANUAL

You'll soon be enjoying your new Creda Freestanding Cooker!

It all begins here, with your instructions. Don't worry, there's nothing too technical coming up. Just simple, step-by-step guidance to get you up and running quickly. Sound good? Then let's get started.

Help and Guidance

We're here to help you get the most from your Freestanding Cooker. Should you require any guidance, a simple solution can often be found online at:

www.creda.co.uk

If you still require further assistance, call one of our experts on **01759 487836**.

If you require any technical guidance or find that your product is not operating as intended, a simple solution can often be found in the **Troubleshooting** section of these instructions, or online at www.creda.co.uk If you still require further assistance, call one of our experts on 01759 487836.

Contents

—	PAGE
Safety Information	4
Getting to Know Your Appliance	7
Installation Advice	10
Using Your Appliance	13
General Oven and Cooking Tips	18
Care and Maintenance	23
Product Support	25



SAFETY INFORMATION

Important: Please read these instructions fully before installing or operating

INSTALLATION WARNINGS

IMPORTANT: Prior to Installation ensure that the local supply conditions (electricity voltage and frequency) are compatible with the requirements of your freestanding cooker.

IMPORTANT: Carefully unpack and examine the appliance for any damage. If you think there is a defect, do not use the appliance and contact Creda Product Support on 01759 487836. Packaging materials should be collected together and disposed of immediately as they may be harmful to children.

IMPORTANT: Keep the electrical cable (not supplied) of your built-in oven away from the hot areas of your appliance, do not let the cable touch the appliance. Keep the cable away from sharp edges and heated surfaces.

IMPORTANT: Ensure that the electric supply cable is not trapped or damaged during installation.

IMPORTANT: In the event that the cable connecting your freestanding cooker becomes damaged, it must be replaced by a suitably qualified person. This cable must not be replaced by an unauthorised person.

IMPORTANT: Protect your freestanding cooker against atmospheric effects. Do not expose your cooker to effects such as sun, rain, snow etc.

IMPORTANT: The materials surrounding the appliance (cabinets) must be able to withstand a minimum temperature of 100°C.

IMPORTANT: When using your oven for the first time your cooker may give off an unusual odour from the heating elements and insulation materials. This is normal for cooking appliances. To eliminate this odour run the oven at 250 degrees for 40-60 mins with the oven empty.

WARNING: Before obtaining access to terminals, all supply circuits must be disconnected.

DURING USAGE

IMPORTANT: This appliance can be used by children aged from 8 years and above and persons with reduced physical, sensory or mental capabilities or lack of experience and knowledge if they have been given supervision or instruction concerning use of the appliance in a safe way and understand the hazards involved. Children shall not play with the appliance.

Cleaning and user maintenance shall not be made by children without supervision.

INSTRUCTION MANUAL

WARNING: The appliance and its accessible parts become hot during use. Care should be taken to avoid touching heating elements. Children less than 8 years of age shall be kept away unless continuously supervised.

WARNING: NEVER try to extinguish a cooking fire with water. Instead switch off the appliance and cover flame e.g with a lid or a fire blanket.

CAUTION: Do not allow children in the kitchen when cooking or after, as the parts may still be hot. Many parts of the cooker will become hot and present a considerable hazard to children.

CAUTION: When the cooker is hot never touch the oven glass by hand or with tools.

CAUTION: Before starting to use your appliance, ensure curtains, paper or flammable items are kept away from your appliance. Do not keep flammable materials inside of or around your cooker.

CAUTION: Take care when closing the oven door that there is nothing obstructing it from closing as this may break the glass door.

IMPORTANT: When using the grill, the oven door must be kept closed.

IMPORTANT: Make sure the oven control knobs are all in the off position when not in use.

IMPORTANT: If you do not intend to use your built- in oven for a long period of time turn off the electric supply to the oven.

GENERAL SAFETY WARNINGS

IMPORTANT: This appliance has been designed for non-professional, domestic use only. Do not use this oven for commercial use or any other application e.g. room heating.

WARNING: Danger of fire: do not store flammable items on or near the cooking surfaces or inside the oven.

IMPORTANT: Do not try to lift or move this appliance by pulling on the door handle.

WARNING: Ensure that the appliance is switched off before replacing the lamp to avoid the possibility of electric shock.

IMPORTANT: Your appliance is produced in accordance with all applicable local and international standards and regulations.

IMPORTANT: Maintenance and repair work must only be performed by authorised service technicians. Installation and repair work that is carried out by unauthorised technicians is dangerous and could invalidate your guarantee.

IMPORTANT: When the door of the oven is open, do not hang or lean anything on it. You may unbalance your appliance or damage the door or door hinges.

IMPORTANT: Do not hang towels, dishcloths or clothes from the built-in oven or its handles.

INSTRUCTION MANUAL

CLEANING AND MAINTENANCE

IMPORTANT: Always turn the appliance off before operations such as cleaning or maintenance. You can do this by switching the built-in oven off using cooker isolation switch.

IMPORTANT: Do not remove the control knobs to clean the control panel.

WARNING: Do not use harsh abrasive cleaners or sharp metal scrapers to clean the oven door glass since they can scratch the surface, which may result in shattering of the glass.

TO MAINTAIN THE EFFICIENCY AND SAFETY OF YOUR APPLIANCE, WE RECOMMEND YOU ALWAYS USE OUR AUTHORISED SERVICE AGENTS AND ORIGINAL SPARE PARTS.
FOR ASSISTANCE CALL CREDA PRODUCT SUPPORT **01759 487836**.

Getting to Know Your Appliance

You'll be up and running in no time!

Ready? Let's begin...

Please read these instructions carefully. They contain important information which will help you get the best from your freestanding cooker and ensure safe and correct installation and operation.

If you require any further assistance, our technical experts are happy to help. For full details, refer to the product support section at the end of these instructions.

INSTRUCTION MANUAL

OVERVIEW

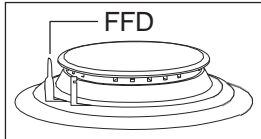

Flame failure device (FFD) - is a part of the gas burner system that ensures that the fuel supply to the gas hob is cut off automatically and immediately if for any reason the flame goes out or becomes unstable.

Wok Burner - Offers a double ring flame system which delivers high temperatures that are ideal for hot / fast cooking.

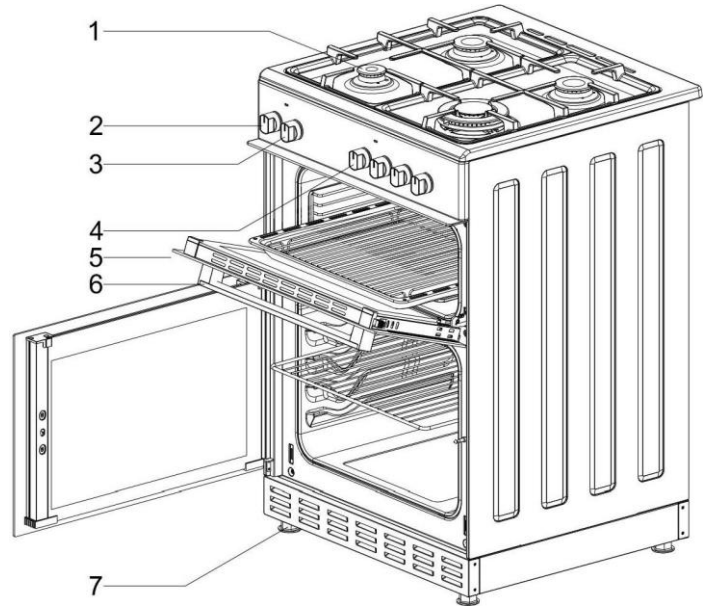
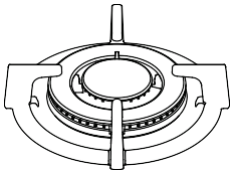

1. Gas Hob (4 Burners) Auxiliary Burner
2. Thermostat Knob
3. Oven Function Knob
4. Hob temperature Knob
5. Oven Door
6. Handle
7. Adjustable Feet
8. Oven Tray
9. Lamp
10. Grill Tray Insert

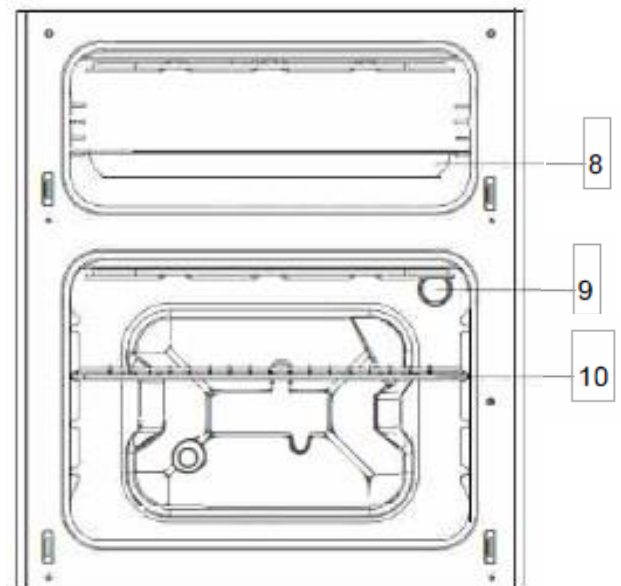

INSTRUCTION MANUAL

Accessories

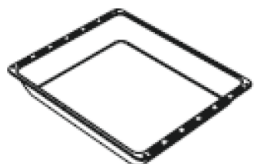

Deep tray *

Used for pastry, big roasts, watery foods. It can also be used as oil collecting container if you roast directly on grill with cake, frozen foods and meat dishes.

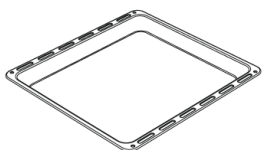

Tray / Glass tray *

Used for pastry (cookie, biscuit etc.), frozen foods.

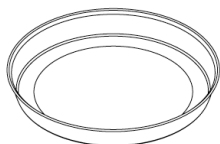

Circular tray *

Used for pastry frozen foods.

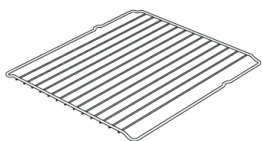

Wire grill

Used for roasting or placing foods to be baked, roasted and frozen into desired rack.



Telescopic rail *

Trays and wire racks can be removed and installed easily thanks to telescopic rails.

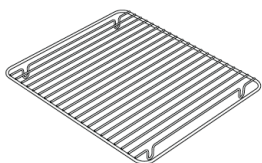

In tray wire grill *

Foods to stick while cooking such as steak are placed on in tray grill. Thus contact of food with tray and sticking are prevented.

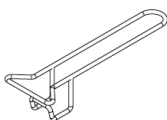

Tray handle *

It is used to hold hot trays.

* Not all accessories are included with your purchase

Installing your Freestanding Cooker

Bringing it all together

Installation requirements

THIS COOKER MUST BE INSTALLED BY A QUALIFIED INSTALLER IN ACCORDANCE WITH LOCAL REGULATIONS



IMPORTANT: CONTACT AN AUTHORISED SERVICE AGENT FOR INSTALLATION OF YOUR OVEN!

First Use

IMPORTANT: When using your oven for the first time your cooker may give off an unusual odour from the heating elements and insulation materials. This is normal for new cookers. To eliminate this odour run the oven at 250 degrees for 40-60 mins with the oven empty.

Unpacking

Carefully unpack and examine the appliance for any damage. If you think there is a defect, do not use the appliance and contact Product Support on 01759 487836.

Positioning

1. Make sure that there are no combustible or flammable materials, such as curtains, in the vicinity of the installation.
2. Furniture and cabinets surrounding the cooker must be of material resistant to temperatures greater than 50°C.
3. Surrounding furniture, cabinets and extractor fans should be positioned in accordance with the diagram shown in the figure
4. There must be at least 2cm of free space between the back wall and the rear of the appliance to allow for ventilation and air circulation.
5. If fitted, the extractor fan must be at least 65cm above the hotplates. If no fan is fitted the minimum distance between the hotplates and any cabinet or other structure must be 75cm.

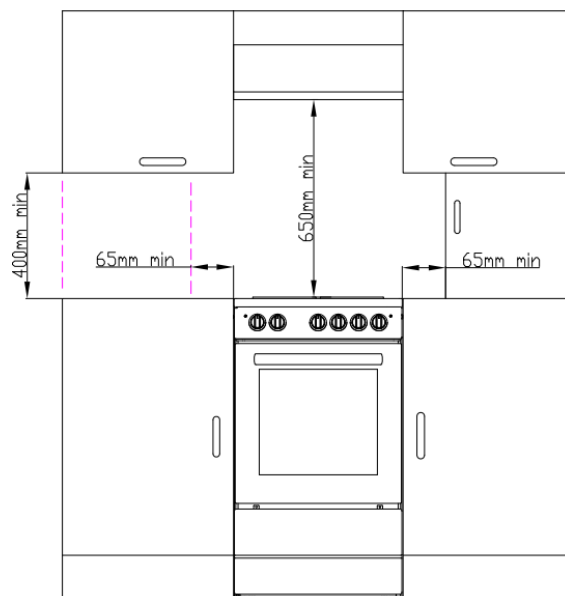

INSTRUCTION MANUAL

Levelling Feet

The height and level of the appliance can be adjusted by rotating the feet located underneath the appliance at each corner. Rotate the feet to decrease or increase the height.

Safety Chain

The appliance must be secured against overbalancing by using the supplied two safety chains on your oven. Fasten hook (1) by using a proper peg to the kitchen wall (5) and connect safety chain (3) to the hook via the locking mechanism (2).

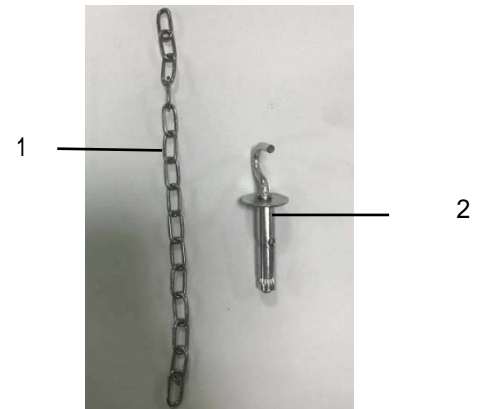
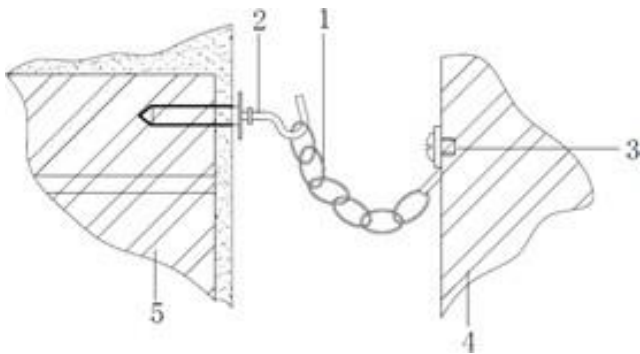

1. Safety chain (supplied and mounted to oven)
2. Stability hook
3. Firmly fix chain to cooker rear
4. Rear of cooker
5. Kitchen wall

INSTRUCTION MANUAL

Electrical Connection

IMPORTANT: Electrical connections must be carried out by a suitably qualified person and in accordance with all relevant local building and installation regulations.

Fitting on a Power Supply Cable

Connecting appropriate power supply terminal board/ connector block:

- Using a screwdriver, prize open tabs of the Terminal board cover.
- Remove the wire clamp screw.
- Fasten the wires beneath the corresponding screw heads, using brass 'bridge' for single phase supply.
- Fasten cable clamp and close the cover of the terminal board.
- The ac power supply should be 220-240 V, 50/60 Hz. For electric cookers, the minimum 45A fuse, or at least 45A a distribution circuit breaker.

ELECTRICAL CONNECTION AND SAFETY

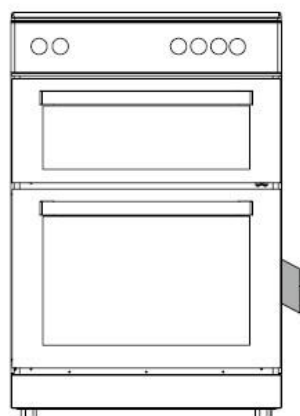

CAUTION!

DO NOT completely remove the screws on the connecting terminals. They should only be loosened sufficiently to insert wires or connectors – if completely removed; the threaded backing plate may become displaced inside the cooker.

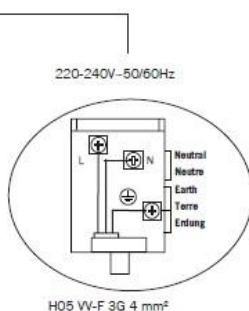

Connecting the supply cable to the mains

Install an approved circuit breaker with a minimum contact opening of 3 mm, between the appliance and the mains fuse box. The circuit breaker should be sized according to the load and should comply with current regulations (the earth wire should not be interrupted by the circuit breaker).

The supply cable should be positioned so that it does not reach a temperature of more than 50°C with respect to the room temperature, anywhere along its length. Before switching fuse ON in meter-box check:

- Earth continuity. The electrical safety of this appliance can only be guaranteed if the cooker is correctly installed and earthed, in compliance with regulations on electrical installations.
- The electrical capacity of the system and sockets will support the maximum power of the appliance, as indicated on the data plate.

Using Your Appliance

Control panel

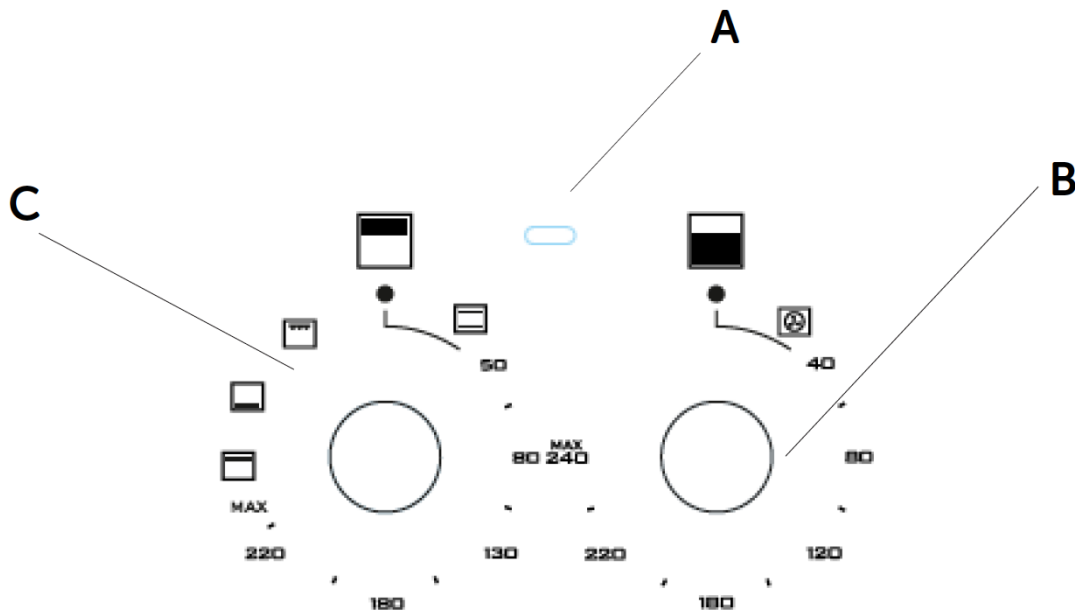

A Indicator lamp for oven

- Lamp is on when oven element is heating up oven or cycling on.

B Function switch Control Knob Main Oven

- Sets Oven Temperature

C Function switch Control Knob Top Oven

- Sets Oven Function and temperature

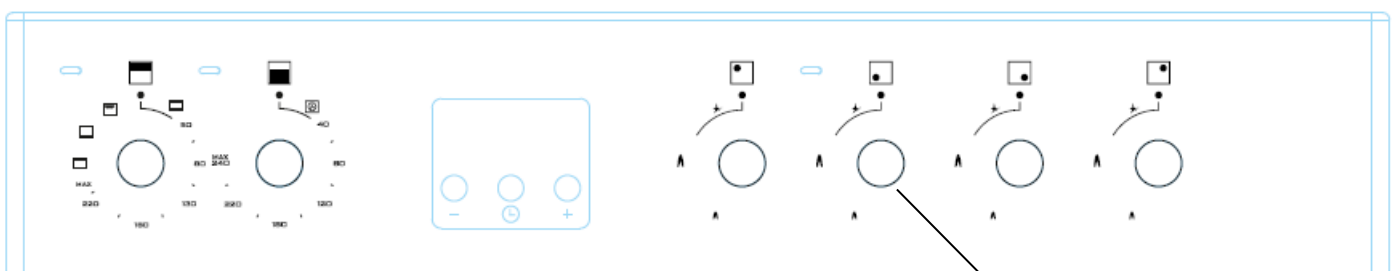

D Hotplate Control Knobs - can be rotated in either direction

- Adjusts temperature of hotplate.

INSTRUCTION MANUAL

Oven Functions



Grill



Top & Bottom Element



Bottom Element



Fan Oven



Oven Light

Grill: The top central heating elements comes on. The extremely high and direct temperature of the grill makes it possible to brown the surface of meats and roasts while locking the juices in to keep them tender. The grill is also highly recommended for dishes that require a high temperature on the surface: beef steaks, veal, rib steak, fillets, hamburgers etc.

Top & Bottom Element: Hot air comes from the upper and lower element in the oven. This is called Conventional cooking and is ideal for joints of meat.

Bottom Element: Bottom element cooking is used for foods that typically need cooking with heat from underneath - Cakes and Bread are examples of where this function would be useful.





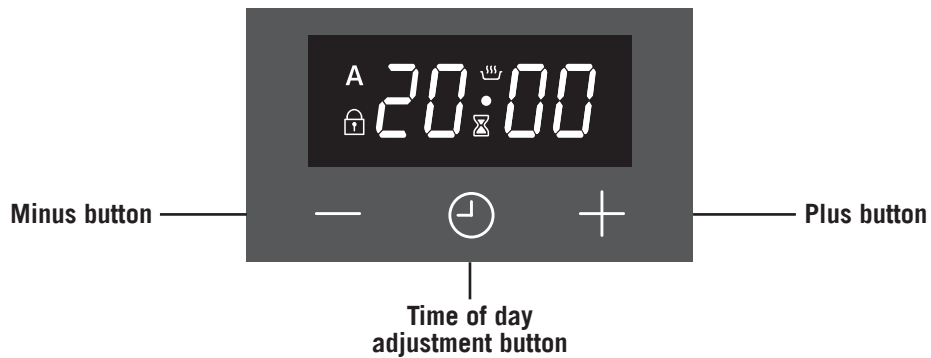

Fan Oven: When set to Fan mode, the element and the fan operate providing a consistent heat distributed uniformly throughout the oven. This mode is ideal for baking and cooking foods on multiple shelves at the same temperature.
Oven light -The oven light will operate on all oven functions.

Using your Appliance for the First Time

The first time you use your appliance, we recommend that you set the temperature setting to the highest mark. Set the function switch control knob to a cooking mode and leave the oven on for about 40-60 minutes with nothing in it and the oven door shut. Then, open the oven door and allow the oven to cool Any odour that may be detected during this initial use is due to the evaporation of substances used to protect the oven during storage.



SCREEN SYMBOLS

	<p>Oven status indication</p> <ul style="list-style-type: none"> • On: Cooking or ready for cooking. • Off: No cooking.
	<p>Minute minder status indication</p> <ul style="list-style-type: none"> • On: Minute minder alarm active. • Flashing: Minute minder adjustment mode, adjustment possible by  or  buttons or current minute minder alarm completed. • Off: Minute minder is not active.
	<p>Child lock indication</p> <ul style="list-style-type: none"> • On: Child Lock is active. • Off: Child Lock is inactive.
	<p>Automatic cooking status indication</p> <ul style="list-style-type: none"> • On: Full or semi auto-cooking active. • Flashing: Auto cooking completed or power on condition. • Off: No auto cooking active.

It is an electronic timing module enabling your food you have put in the oven to be ready for service at any time you like. The only thing you need to do is to programme the cooking time of the food and also the time when you would like your food to be ready.

It is also possible to use a minute-programmed alarm clock independent from the oven.

The case where the time clock is behind or ahead is not a malfunction. The oven time clock may be put back or ahead according to mains frequency as it runs directly with mains voltage. This is not a malfunction.

POWER ON

At power on, oven is inactive, time of day and **A** symbols are flashing. The indicated time of day is not correct and has to be adjusted. Press **⏻** to activate the oven and proceed adjusting the time of day as below.

TIME OF DAY ADJUSTMENT

Time of Day adjustment is only possible when no cooking program is in progress. Press **+** and **-** simultaneously for 3 seconds to enter the adjustment mode and then the dot symbol in between hours and minutes digits will start to flash. Using either **+** and **-** adjust the desired duration. The maximum adjustable duration is 23h 59 minutes. Adjustment mode will be abandoned within 6 seconds after the last button press or can be terminated immediately by pressing the **⏻** button.

Note: Time of day adjustment is also activated in first 7 seconds after power on.

SETTING THE MINUTE MINDER

With this function, you can adjust a duration in minutes. After the adjusted time has been elapsed, an alarm sound will be produced.

Press **⏻** button once to enter the minute minder adjustment mode, **⌚** symbol will start flashing on the screen. Using either **+** or **-**, adjust the desired duration. The maximum adjustable duration is 10 hour. Adjustment mode will be abandoned within 6 seconds after the last button press or can be terminated immediately by pressing the **⏻** button.

CANCELLING THE ALARM BUZZER SOUND

Once the adjusted minute minder duration is elapsed, the buzzer alarm will start to sound, accompanied by the flashing **⌚** symbol on the screen. Any button press will stop the alarm sound and this indication. If no button is pressed, the alarm sound will end automatically after 5 minutes, but the flashing symbol will go on.

SEMI AUTOMATIC COOKING

This cooking program is intended to start cooking immediately for a specified duration. After the oven is set to the desired function and temperature via the oven knobs:

1. Press the **⏻** button twice, **A** symbol will flash on the screen. **dur** and duration of cooking will show on the screen one after another.
2. Using **+** or **-** buttons, adjust the desired cooking duration.
3. After 6 seconds of the last button press or by pressing **⏻** twice, the adjustment is completed. **A** will be steady on the screen and the display shows the current time of day.

END OF AUTO COOKING

When the cooking is finished automatically, the **A** icon starts to flash. Alarm may be turned off by pressing any key. To disable the key lock, press the **⏻** key for 2 seconds. Oven is taken to the manual mode by pressing the **⏻** key. Audible alarm shall sound for 7 minutes if you do not press any key.

FULL AUTOMATIC COOKING

This cooking program is intended to perform a delayed cooking by programming the time of day, when the food should be ready. In other words, the oven will start cooking not immediately but will automatically calculate the time to start cooking.

1. Perform step 1 and 2 of the semi auto cooking as above **End** (cooking duration adjustment).
2. Press **⏸** button once again, **A** symbol will flash on the screen and duration of cooking will show on the screen one after another.
3. Using **+** or **-** buttons, adjust the desired end of cooking time. **🔊** symbol will disappear but **A** symbol will be still flashing on the screen. This indicates that an automatic cooking is programmed but cooking has not started yet.
4. After 6 seconds of the last button press or by pressing **⏸**, the adjustment will be completed, the display shows the current time of day.

POWER INTERRUPTS

Product is not affected by short power failures (up to 50 seconds approximately), and the timer and the clock shall resume working at this period.

Your oven shall be deactivated on other failures than short term power failures (that is, more than 50 seconds) due to safety reasons. This is indicated with the flashing of the clock and the **A** on the screen. The clock shall be displayed as **12:00** and it should be set again. (See power on)

Note: The flashing **A** symbol indicates that the oven is inactive and you have to enter the manual mode.

CHILD LOCK

This function is intended to prevent any unauthorized modification of the timer settings. This function will be active, within 30 seconds after the last button press. **🔒** will appear. To deactivate it, press the **⏸** button for 3 seconds. **🔒** will disappear.

PROGRAMMABLE OPTIONS

Alarm tone:

Pressing and holding the **-** button for 3 seconds will result in the currently valid buzzer tone being produced. By pressing **+** and **-** buttons, you may scroll through 3 available buzzer tones. The last heard buzzer tone will be automatically recorded as the selected tone. After 6 seconds of the last button press or by pressing **⏸**, the adjustment is completed.

Brightness setting:

Pressing and holding the **+** button for 3 seconds will result in the currently valid brightness setting being showed. By pressing **+** and **-** buttons, you may scroll through 8 available brightness setting. The last seen brightness setting will be automatically recorded as the selected setting. After 6 seconds of the last button press or by pressing **⏸**, the adjustment is completed.

Note: Default settings are highest.

Note: Programmable options are nonvolatile and will be resident after any power failure.

General Oven and Cooking Tips

General Oven Tips

The wire shelves should always be pushed firmly to the back of the oven.

Baking trays with food cooking on them should be placed level with the front edge of the oven's wire shelves. Other containers should be placed centrally. Keep all trays and containers away from the back of the oven, as over-browning of the food may occur.

For even browning, the maximum recommended size of a baking tray is 340 mm (13½") by 340 mm (13½").

When the oven is on, do not leave the door open for longer than necessary, otherwise the knobs may get very hot.

- Always leave a "finger's width" between dishes on the same shelf. This allows the heat to circulate freely around them.
- To reduce fat splashing when you add vegetables to hot fat around a roast, dry them thoroughly or brush lightly with cooking oil.
- Where dishes may boil and spill over during cooking, place them on a baking tray.

Practical Cooking Advice

The oven offers a wide range of alternatives which allow you to cook any type of food in the best possible way. With time you will learn to make the best use of this versatile cooking appliance and the following directions are only a guideline which may be varied according to your own personal experience.

Preheating

The oven must be preheated (this is generally the case when cooking leavened foods).

Once the food has been placed in the oven, the most appropriate cooking mode can then be selected.

Using the Grill

Use the "grill" mode, placing the food under the center of the grill (situated on the 3rd or 4th rack from the bottom) because only the central part of the top heating element is turned on.

Use the bottom rack (1st from the bottom), placing the dripping pan provided to collect any sauce and /or grease and prevent the same from dripping onto the oven bottom. When using this mode, we recommend you set the thermostat to the highest setting. However, this does not mean you cannot use lower temperatures, simply by adjusting the thermostat knob to the desired temperature.

When using this mode, we advise you to set the thermostat to 200°C, as it is the most efficient way to use the grill, which is based on the use of infrared rays. However, this does not mean you cannot use lower temperatures, simply by adjusting the thermostat knob to the desired temperature.

Therefore, the best results when using the grill modes are obtained by placing the grid on the lower racks (see cooking table) then, to prevent fat and grease from dripping onto the bottom of the oven and smoke from forming, place a dripping-pan on the 1st oven rack from the bottom.

Baking Cakes

When baking cakes, always place them in a preheated oven. Make sure you wait until the oven has been preheated thoroughly (the pilot lamp will turn off). Do not open the oven door during baking to prevent the cake from dropping.

INSTRUCTION MANUAL

In general...

Pastry is too dry

Increase the temperature by 10°C and reduce the cooking time.

Pastry dropped

Use less liquid or lower the temperature by 10°C.

Pastry is too dark on top

Place it on a lower rack, lower the temperature, and increase the cooking time.

Cooked well on the inside but sticky on the outside

Use less liquid, lower the temperature, and increase the cooking time.

The Pastry sticks to the pan

Grease the pan well and sprinkle it with a dusting of flour or use greaseproof paper. If using more than one level and they are not all at the same cooking point, use a lower temperature setting. It is not necessary to remove the food from all the racks at the same time.

Cooking Fish and Meat

When cooking white meat, fowl and fish, use temperature setting from 180°C to 200°C.

For red meat that should be well done on the outside while tender and juicy in the inside, it is a good idea to start with a high temperature setting (200°C-220°C) for a short time, then turn the oven down afterwards.

In general, the larger the roast, the lower the temperature setting. Place the meat on the center of the grid and place the dripping pan beneath it to catch the fat.

Make sure that the grid is inserted so that it is in the center of the oven. If you would like to increase the amount of heat from below, use the low rack heights. For savory roasts (especially duck and wild game), dress the meat with lard or bacon on the top.

INSTRUCTION MANUAL

Selector Knob	Food to be cooked	Weight (kg)	Cooking Rack Position (from bottom)	Preheating Time (mins)	Thermostat Knob Setting	Cooking Time (mins)
Fan	Duck	1	3	15	200	65–75
	Roast Beef	1	3	15	200	70–75
	Pork Roast	1	3	15	200	70–80
	Biscuits	—	3	15	200	15–20
	Tarts	1	3	15	200	30–35
Grill	Fish	1	4	5	Max	8–10
	Squid	1	4	5	Max	6–8
	Mackerel	1	4	5	Max	15–20
	Steak	1	4	5	Max	15–20
	Cutlets	1	4	5	Max	15–20
	Hamburgers	1	4	5	Max	7–10
	Chicken	1.5	4	5	Max	30–40
	Lamb	1	4	5	Max	30–40
	Toasties	—	4	5	Max	2–3
	Vegetables	1	$\frac{3}{4}$	5	Max	10–15

NB: cooking times are approximate and may vary according to personal taste. Shelf position is counted from the bottom shelf up. Bottom shelf position is 1. Turn down temperatures shown.

INSTRUCTION MANUAL

Using the Gas Hob

Each hob burner is regulated by a selector knob.

The control allows for the efficient transfer of heat to the cooking pan.

The knob can be turned in both directions, to numbers 1 to 6.

These numbers correspond to the power of each burner where 6 is the highest setting and 1 is the lowest.

Turn the hob control knob to off (I) when finished.

Flame cut-off safety device (FFD)

This operates instantly when safety mechanism activates due to overflow liquid over upper hobs.

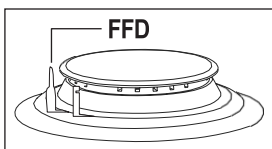

1. The valves controlling the gas burners have the above mentioned flame failure device. When flame of the cooker is extinguished, control valve cuts off the gas automatically. To light the burners, press the control knob inwards and rotate anti-clockwise towards the flame symbol. keep the control knob pressed in for approximately 5-10 seconds or until the flame stays lit continuously.
2. Do not continuously operate the igniter for more than 15 seconds. If the burner does not ignite, wait minimum one minute before try again.
3. If the burner is extinguished for any reason, close the gas control valve and wait a minimum of one minute before trying again.

● Closed



Fully open



Half open

4. Before operating your hob please make sure that the burner caps are well positioned. The right placement of the burner caps is shown as below.

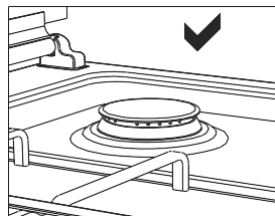
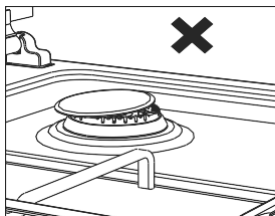

INSTRUCTION MANUAL

SAFETY ADVICE IN THE CASE OF A COOKING PAN FIRE

In the event of a cooking pan fire:

1. Turn off the cooker at the wall switch.
2. Cover the pan with a fire blanket damp cloth. This will smother the flames and extinguish the fire.
3. Leave the pan to cool for at least hour before attempting to move it. Injuries are often caused by picking up a hot pan and rushing outside with it.
4. Never use water to extinguish oil or fat pan fires.
5. NEVER USE A FIRE EXTINGUISHER TO PUT OUT A PAN FIRE as the force of the extinguisher could tip the pan over.

COOKWARE SELECTION

- Any cookware should have a thick, flat and dry base of the same diameter or slightly bigger than the hob. If the cookware diameter is smaller than the hob, heat will be wasted.
- Cookware with uneven bases is very inefficient making the cooking time longer and wasting electricity.
- Always use the pan with its lid on. This prevents the accumulation of vapour in the kitchen.

IMPORTANT!

Use flat bottomed saucepans which fully contact with the heat as much as you can, so that you can use the energy more productively.



Incorrect



Correct

Pot Diameter	50*60	60*60
Aux Burner:	12–18cm	12–18cm
Semi Rapid:	18–20cm	18–20cm
Rapid:	22–26cm	22–26cm
Wok Burner:	—	24–26cm

Care and Maintenance

Cleaning

WARNING! Isolate the power supply to the appliance and make sure that the cooker is cool.

Before cleaning your cooker or performing maintenance, make sure that the cooking mode selection knob and the cooking temperature selection knob is set to 'OFF'. To extend the life of your cooker, it must be cleaned frequently. The inside of the cooker should preferably be cleaned immediately after use, when it is still warm (but not hot), with warm water and soap. The soap should be rinsed away and the interior dried thoroughly. Avoid using abrasive detergents, scourers, acidic cleaners such as lime scale remover, etc, as these could damage the enamel, and can result in development of rust and corrosion. If stains are particularly tough to remove, use cleaners specifically recommended to clean cookers and follow the instructions provided with the cleaner.

Never use steam cleaner for cleaning inside the cooker.

Do not clean using caustic creams, abrasive cleaning powders, thick wire wool or hard tools. Enamelled parts of the cooker can be damaged if excess cleaning liquids are not immediately removed.

After cleaning the interior parts of the cooker with a soapy cloth, rinse it and then dry thoroughly with a soft cloth. Clean the glass surfaces with special glass cleaning agents.

Never use flammable agents like acid, thinner or petrol when cleaning your appliance. Do not clean your cooker with a steam cleaner.

Do not wash any part of your cooker in a dishwasher.

Enamelled Parts

In order to keep enamelled parts as new, it is necessary to clean them frequently with mild warm soapy water and then dry with a cloth. Do not wash them while hot and never use abrasive powders or abrasive cleaning materials. Do not leave anything spilled onto enamelled parts for long periods of time.

Stainless Steel

Stainless steel parts must be cleaned frequently with mildly warm soapy water and a soft sponge and then dried with a soft cloth. Do not use abrasive powders or abrasive cleaning materials. Do not leave anything spilled onto stainless steel parts for long periods of time.

INSTRUCTION MANUAL

Replacing the oven lamps

- Disconnect the oven from the power supply at the fuse-box by means of the switch used to connect the appliance to the electrical mains; or unplug the appliance (gas)
- Remove the glass cover of the lamp-holder by rotating anti-clockwise
- Remove the lamp and replace with a lamp resistant to high temperatures (300°C) with the following characteristics:

- Voltage: 220-240V
- Wattage: 25W
- Type: E G9

Replace the glass cover. Reconnect the appliance to the mains power supply.

Type G9 Lamp

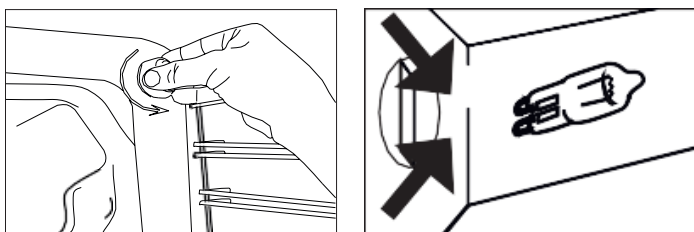

220-240 V, AC

15-25 W

Technical Specification

Model	C60DFMRCRM	C60DFMRBL	C60DFMRA
Voltage and Frequency	220-240V AC 50Hz	220-240V AC 50Hz	220-240V AC 50Hz
Oven Power - Main Oven	2240W	2240W	2240W
Oven Power - Top Cavity	1415W	1415W	1415W
Oven Usable Capacity - Main Oven	64L	64L	64L
Oven Usable Capacity - Top Cavity	30L	30L	30L
Gas Burner Power	7.85 kW	7.85 kW	7.85 kW
Total Power	3655W	3655W	3655W
Energy Rating	A	A	A

Product Support

Troubleshooting

If you have a problem with your appliance, check the table below before calling service. You may be able to avoid a service call by and avoid unnecessary inconvenience and expense.

For cooking problems, refer to Handling Baking Problems.

Problem	Causes	What to Do
Oven or grill not working	Digital clock not set properly 120min timer not in "Manual" position Power not turned on Household fuse blown Controls incorrectly set Circuit breaker tripped	Refer to digital timer instructions Refer to 120min timer instructions Switch on electricity Check fuses Reset controls Check circuit breaker
Oven light not working	Power not turned on Household fuse blown Circuit breaker tripped Lamp blown or loose in socket	Switch on electricity Check fuses Check circuit breaker Replace or tighten globe
Oven not hot enough	Heat escaping through incorrectly sealed door Door seal is worn or has moved	Check shelves or dishes are not preventing door closing properly, check that door is fitted properly after door removal for cleaning Replace seal or refit it
Unit smoking when first used	Unit smoking when first used	This is normal
Odour on first use of oven	—	This is normal
120 minute timer buzzer not audible	Timer not wound sufficiently	Turn timer knob past 15 minute mark Then turn to the required number of minutes
Oven shelf tight	Oven shelf not inserted correctly, may be upside down or back to front	Remove shelf and insert as per diagram

Note: Only service centers should carry out servicing. Otherwise, warranty may be void.

INSTRUCTION MANUAL

Help and Assistance

If you require any technical guidance or find that your Freestanding Cooker is not operating as intended, a simple solution can often be found in the Troubleshooting section of these instructions or online at www.creda.co.uk

If you still require further assistance, call one of our experts on 01759 487836. To help give us give you a fast and efficient service please have the following information ready:

You can find the following on the rating plate - a small information panel (usually a sticker or metal plate) on the rear of your appliance.

Model Ref.

Serial Number

Date of Purchase (this will be on your receipt)

Local call rates apply*

Lines open 9am-5:30pm Monday to Friday

*Calls to Creda enquiry lines may attract a charge and set up fee from residential lines depending on your call plan/tariff. Mobile and other providers costs may vary, see www.bt.com/pricing for details.

For Security and training purposes, telephone calls to and from customer service centres maybe recorded and monitored. Calls from Republic of Ireland will attract international call charges.

Creda

Call us now and activate your 12 months guarantee

Thank you for choosing Creda. Your new product is guaranteed against faults and breakdowns for 12 months. Don't forget to register it with us today so we can provide you with our best possible after-sales service and useful updates.

www.creda.co.uk

01759 487836

Your Creda Guarantee

This product is guaranteed for 12 months from the date of original purchase. Any defect that arises due to faulty materials or workmanship will be repaired free of charge (or if applicable the product will be replaced or the purchase price refunded) where possible during this period by the dealer from who you purchased the unit.

The guarantee is subject to the following provisions:

- The guarantee does not cover accidental damage, misuse, cabinet parts, knobs or consumable items.
- The product must be correctly installed and operated in accordance with the instructions contained in the manual.
- It must be used solely for domestic purposes. The guarantee will be rendered invalid if the product is re-sold or has been damaged by inexpert repair.
- Specifications are subject to change without notice.
- Creda disclaim any liability for loss or damage arising from the breakdown of the product.
- This guarantee is in addition to and does not diminish your statutory or legal rights.

Important Data Protection Information

To find out how we use your data please refer to the guarantee registration material or visit www.creda.co.uk

Declaration of conformance to product standards

This appliance conforms to all relevant standards applicable to domestic appliances sold in the UK.

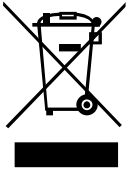

Disposal

This appliance/fitting is marked according to the European directive 2012/19/EU on Waste Electrical and Electronic Equipment (WEEE).

By ensuring this product is disposed of correctly, you will help prevent potential negative consequences for the environment and human health, which could otherwise be caused by inappropriate waste handling of this product.

The symbol on the product, or on the documents accompanying the product, the **crossed out wheelie bin** symbol, indicates that this appliance/fitting may not be treated as household waste. Instead, it shall be handed over to the applicable collection point for the recycling of electrical and electronic equipment.

Disposal must be carried out in accordance with local environmental regulations for waste disposal.

For more detailed information about treatment, recovery and recycling of this product, please contact your local authority, your household waste disposal service or the retailer where you purchased the product.

This page is intentionally blank.

This page is intentionally blank.

This page is intentionally blank.

Creda