

10500 SERIES™



10500 SERIES™

Endlessly adaptable and unexpectedly affordable, our 10500 Series offers truly lasting value. The versatile design and options give you an even wider range of layout possibilities and the flexibility to maximize footprints — even smaller ones. And with more ways to customize your personal storage, the 10500 Series simply gives you more for less.



FEATURES

- The 10500 Series' fresh aesthetic includes **airy H- or O-legs and frosted modesty panels.**
- Available in **25** durable mix-and-match laminates, including new textured styles.
- With so many convenient and compact storage options, even the smallest footprints feel big.
- The versatile 10500 Series™ offers a variety of components to accommodate any size workspace.
- Support today's healthy work styles by offering the choice of sitting or standing while working, with storage options that fit your needs.

10500 SERIES™ ORDERING INFORMATION

LAMINATE TOP, CHASSIS, AND WORKSURFACES

L1 LAMINATES CODES

Woodgrain

◆ Bourbon Cherry	H
◆ Cognac	COGN
◆ Florence Walnut	LFW1
◆ Harvest	C
◆ Kingswood Walnut	LK11
◆ Mahogany	N
◆ Mocha	MOCH
◆ Natural Maple	D
◆ Pinnacle	PINC
◆ Shaker Cherry	F
◆ Sterling Ash	LSA1

Solid

◆ Black	P
◆ Charcoal	S
◆ Designer White	LDW1
◆ Loft	LOFT

Patterned Top

◆ Grey Tigris	L6
◆ Sheer Mesh	A5
◆ Silver Mesh	B9
◆ Canyon Zephyr	K9
◆ Desert Zephyr	K8

L2 LAMINATES CODES

Woodgrain

◆ Lowell Ash	LLA1
◆ Natural Recon	LNRI
◆ Phantom Ecreu	LPE1
◆ Portico Teak	LPT1
◆ Skyline Walnut	LSW1

EDGE BAND

EDGE BAND COLORS CODES

Woodgrain

◆ Bourbon Cherry	H
◆ Cognac	COGN
◆ Florence Walnut	FW
◆ Harvest	C
◆ Kingswood Walnut	KI
◆ Lowell Ash	DL
◆ Mahogany	N
◆ Mocha	MOCH
◆ Natural Maple	D
◆ Natural Recon	NR
◆ Phantom Ecreu	PE
◆ Pinnacle	PINC
◆ Portico Teak	DP
◆ Shaker Cherry	F
◆ Skyline Walnut	SW
◆ Sterling Ash	SA

Solid

◆ Black	P
◆ Charcoal	S
◆ Designer White	DW
◆ Loft	LOFT

10500 SERIES™ MOBILE TABLES

PAINTS CODES

P1

◆ Black	P
◆ Brownstone	P7D
◆ Charcoal	S
◆ Designer White	PJW
◆ Fossil	P28
◆ Greige	T5
◆ Loft	LOFT
◆ Muslin	T3
◆ Titanium	P8T

P2

◆ Champagne Metallic	T4
◆ Platinum Metallic	T1
◆ Silver	PR6

H-LEGS, O-LEGS, POST LEGS, STORAGE CUBE

PAINTS CODES

P1

◆ Black	P
◆ Brownstone	P7D
◆ Charcoal	S
◆ Designer White	PJW
◆ Fossil	P28
◆ Greige	T5
◆ Loft	LOFT
◆ Muslin	T3
◆ Shadow*	SHDW
◆ Titanium	P8T

P2

◆ Champagne Metallic	T4
◆ Platinum Metallic	T1
◆ Silver	PR6
◆ Solar Black	P8X

P3

◆ Atom	P8S
◆ Blossom	P8K
◆ Bullseye	PJF
◆ Cabernet	P7T
◆ Conifer	P8H
◆ Ember	P8P
◆ Ion	P8N
◆ Iris	P8J
◆ Krypton	P8F
◆ Regatta	P8M
◆ Succulent	P8A

◆◆◆ For lead time information see page 19.

* De-emphasized

Patterned Top

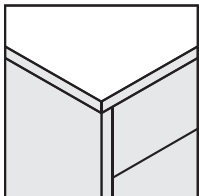

Edgeband Around Top / Laminate Chassis

- Edgebanding on patterned laminates matches the laminate **chassis** selected.
- Patterned top laminates are available with the following edgeband laminate selection: C, COGN, D, F, FW, H, KI, DW, MOCH, N, P, PINC, SA, and S.
- For 10500 Series™ worksurface models, the finish specification options include matching the top and edgeband colors or choosing a two-tone combination.

LAMINATE DESKS

SPECIFY: Model Number.
Laminate

EXAMPLE: H105413.NN

WORKSURFACES

SPECIFY: Model Number.
Top Laminate
Edgeband

- **All specifications in this publication are based on the latest product information available at the time of print.**

! Tops with a patterned color are not available with a matching edgeband.

10500 SERIES™ ORDERING INFORMATION

TWO-TONE LAMINATE TOP / CHASSIS

L1 LAMINATES CODES

Two-Tone Top/Chassis

- ◆ Black/Charcoal **PS**
- ◆ Black/Designer White ... **PLDW1**
- ◆ Black/Loft **PLOFT**
- ◆ Bourbon Cherry/Black **HP**
- ◆ Bourbon Cherry/Charcoal ... **HS**
- ◆ Bourbon Cherry/Designer White **HLDW1**
- ◆ Bourbon Cherry/Loft **HLOFT**
- ◆ Charcoal/Black **SP**
- ◆ Charcoal/Designer White **SLDW1**
- ◆ Charcoal/Loft **SLOFT**
- ◆ Cognac/Black **COGNP**
- ◆ Cognac/Charcoal **COGNS**
- ◆ Cognac/Designer White **COGNLDW1**
- ◆ Cognac/Loft **COGNLOFT**
- ◆ Designer White/Black ... **LDW1P**
- ◆ Designer White/Bourbon Cherry **LDW1H**
- ◆ Designer White/Charcoal **LDW1S**
- ◆ Designer White/Cognac **LDW1COGN**
- ◆ Designer White/Florence Walnut **LDW1LFW1**
- ◆ Designer White/Harvest **LDW1C**
- ◆ Designer White/Kingswood Walnut **LDW1LKI1**
- ◆ Designer White/Loft **LDW1LOFT**
- ◆ Designer White/Mahogany **LDW1N**
- ◆ Designer White/Mocha **LDW1MOCH**
- ◆ Designer White/Natural Maple **LDW1D**
- ◆ Designer White/Pinnacle **LDW1PINC**

TWO-TONE LAMINATE TOP / CHASSIS

continued

L1 LAMINATES CODES

Two-Tone Top/Chassis

- ◆ Designer White/Shaker Cherry **LDW1F**
- ◆ Designer White/Sterling Ash **LDW1LSA1**
- ◆ Harvest/Black **CP**
- ◆ Harvest/Charcoal **CS**
- ◆ Harvest/Designer White **CLDW1**
- ◆ Harvest/Loft **CLOFT**
- ◆ Loft/Black **LOFTP**
- ◆ Loft/Charcoal **LOFTS**
- ◆ Loft/Designer White **LOFTLDW1**
- ◆ Mahogany/Black **NP**
- ◆ Mahogany/Charcoal **NS**
- ◆ Mahogany/Designer White **NLDW1**
- ◆ Mahogany/Loft **NLOFT**
- ◆ Mocha/Black **MOCHP**
- ◆ Mocha/Charcoal **MOCHS**
- ◆ Mocha/Designer White **MOCHLDW1**
- ◆ Mocha/Loft **MOCHLOFT**
- ◆ Natural Maple/Black **DP**
- ◆ Natural Maple/Charcoal **DS**
- ◆ Natural Maple/Designer White **DLDW1**
- ◆ Natural Maple/Loft **DLOFT**
- ◆ Pinnacle/Black **PINCP**
- ◆ Pinnacle/Charcoal **PINCS**
- ◆ Pinnacle/Designer White **PINCLDW1**
- ◆ Pinnacle/Loft **PINCLLOFT**
- ◆ Shaker Cherry/Black **FP**
- ◆ Shaker Cherry/Charcoal **FS**
- ◆ Shaker Cherry/Designer White **FLDW1**
- ◆ Shaker Cherry/Loft **FLOFT**

TWO-TONE LAMINATE TOP / CHASSIS

continued

L2 LAMINATES CODES

Two-Tone Top/Chassis

- ◆ Designer White/Lowell Ash **LDW1LLA1**
- ◆ Designer White/Natural Recon **LDW1LNR1**
- ◆ Designer White/Phantom Ecru **LDW1LPE1**
- ◆ Designer White/Portico Teak **LDW1LPT1**
- ◆ Designer White/Skyline Walnut **LDW1LSW1**
- ◆ Florence Walnut/Black **LFW1P**
- ◆ Florence Walnut/Charcoal **LFW1S**
- ◆ Florence Walnut/Designer White **LFW1LDW1**
- ◆ Florence Walnut/Loft **LFW1LOFT**
- ◆ Kingswood Walnut/Black **LKI1P**
- ◆ Kingswood Walnut/Charcoal **LKI1S**
- ◆ Kingswood Walnut/Designer White **LKI1LDW1**
- ◆ Kingswood Walnut/Loft **LKI1LOFT**
- ◆ Lowell Ash/Black **LLA1P**
- ◆ Lowell Ash/Charcoal **LLA1S**
- ◆ Lowell Ash/Designer White **LLA1LDW1**
- ◆ Lowell Ash/Loft **LLA1LOFT**
- ◆ Natural Recon/Black **LNR1P**
- ◆ Natural Recon/Charcoal **LNR1S**
- ◆ Natural Recon/Designer White **LNR1LDW1**
- ◆ Natural Recon/Loft **LNR1LOFT**
- ◆ Phantom Ecru/Black **LPE1P**
- ◆ Phantom Ecru/Charcoal **LPE1S**
- ◆ Phantom Ecru/Designer White **LPE1LDW1**
- ◆ Phantom Ecru/Loft **LPE1LOFT**

TWO-TONE LAMINATE TOP / CHASSIS

continued

L2 LAMINATES CODES

Two-Tone Top/Chassis

- ◆ Portico Teak/Black **LPT1P**
- ◆ Portico Teak/Charcoal **LPT1S**
- ◆ Portico Teak/Designer White **LPT1LDW1**
- ◆ Portico Teak/Loft **LPT1LOFT**
- ◆ Skyline Walnut/Black **LSW1P**
- ◆ Skyline Walnut/Charcoal **LSW1S**
- ◆ Skyline Walnut/Designer White **LSW1LDW1**
- ◆ Skyline Walnut/Loft **LSW1LOFT**
- ◆ Sterling Ash/Black **LSA1P**
- ◆ Sterling Ash/Charcoal **LSA1S**
- ◆ Sterling Ash/Designer White **LSA1LDW1**
- ◆ Sterling Ash/Loft **LSA1LOFT**

HLAM3772RD, HLAM3348RR

EDGE BAND COLORS CODES

Woodgrain

- ◆ Bourbon Cherry **H**
- ◆ Cognac **COGN**
- ◆ Florence Walnut **FW**
- ◆ Harvest **C**
- ◆ Kingswood Walnut **KI**
- ◆ Lowell Ash **DL**
- ◆ Mahogany **N**
- ◆ Mocha **MOCH**
- ◆ Natural Maple **D**
- ◆ Natural Recon **NR**
- ◆ Phantom Ecru **PE**
- ◆ Pinnacle **PINC**
- ◆ Portico Teak **DP**
- ◆ Shaker Cherry **F**
- ◆ Skyline Walnut **SW**
- ◆ Sterling Ash **SA**

Solid

- ◆ Black **P**
- ◆ Charcoal **S**
- ◆ Designer White **DW**
- ◆ Loft **LOFT**

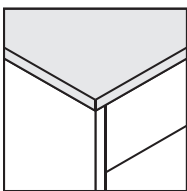

Laminate Chassis

Two-tone laminates: Top and edgebanding are the same, *chassis* is different laminate color.

The following 10500 Series™ products are not available as two-tone. They are one color and require only one color code:

- Modular pedestals — box/file, box/box/file, file/file, lateral file, multi file, and cabinet (also applies to Valido/11500 Series).
- Access strip and end panel kits
- Back enclosures
- Wall mounted open shelf
- Reception stations for return
- T-shaped end panels
- L-shaped end panels

Storage chassis that are specified in L2 laminates and are longer than 60" W will ship with back panels that are horizontal grain.

- Edgebanding on two-tone laminates matches top, *chassis* is a different laminate color.
- A complete selection of Conference Room and Occasional Tables is shown under Tables on pages 714-716, 718-719, 722, and 734-750.

LAMINATE DESKS

SPECIFY: Model Number.

Laminate

EXAMPLE: H10596.HP

- All specifications in this publication are based on the latest product information available at the time of print.

◆◆◆ For lead time information see page 19.

10500 SERIES™

Typicals



Icon Legend on page 19

Components used are listed on pages 244-288. Order components individually. Other configurations are possible, including various sizes of some components.

QTY	DESCRIPTION	MODEL	LIST PRICE	PRICE EXTENSION
1	Rectangle Worksurface 78"W x 30"D	H105R3078	\$429	\$429
1	O-Leg 30"D x 28½"H	HLSL30280	\$346	\$346
1	Low Credenza 72"W x 20"D x 21½"H, Drawers Right, Bookcase Left	H105975R	\$1,324	\$1,324
1	O-Leg Support over Low Credenza 30"D x 7"H	HLSL3070	\$271	\$271
1	Multi-Use Stack-On Storage 36"W x 18"D x 45½"H	H105310	\$1,059	\$1,059
TOTAL:			\$3,429	

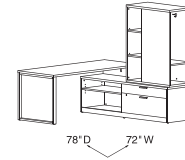

DESK L-WORKSTATION
72\"/>

QTY	DESCRIPTION	MODEL	LIST PRICE	PRICE EXTENSION
1	Rectangle Worksurface 72"W x 30"D	H105R3072	\$402	\$402
1	Modesty/Back Panels - Full Length 72"W x 27⅞"H	HNLMP7228	\$285	\$285
1	Coordinate™ Height Adjustable Base	HHAB2S2L	\$1,006	\$1,006
2	Shroud for Height Adjustable Base	HLAMSHB30	\$848	\$1,696
1	Credenza with Doors 72"W x 24"D x 29½"H	H105909	\$1,827	\$1,827
1	Stack-On Storage 72"W x 14⅝"D x 37⅞"H, 4 Doors	H10534	\$1,011	\$1,011
TOTAL:			\$6,227	

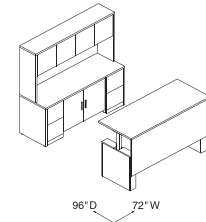

HEIGHT ADJUSTABLE TABLE
WORKSTATION WITH STACK-ON
STORAGE
72\"/>

QTY	DESCRIPTION	MODEL	LIST PRICE	PRICE EXTENSION
1	Single Pedestal Desk, Left - B/F 66"W x 30"D x 29½"H	H10584L	\$1,039	\$1,039
1	Return, Right - B/F 42"W x 24"D x 29½"H	H10511R	\$819	\$819
1	Stack-on Storage 72"W x 14⅝"D x 37⅞"H	H10534	\$1,011	\$1,011
TOTAL:			\$2,869	

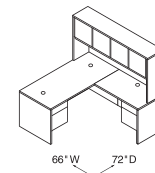

DESK "L" WORKSTATION - RIGHT
66\"/>

QTY	DESCRIPTION	MODEL	LIST PRICE	PRICE EXTENSION
1	Double Full Pedestal Desk - 3/2 72"W x 36"D x 29½"H	H105890	\$1,702	\$1,702
1	Credenza with Kneespace - 2/0/2 72"W x 24"D x 29½"H	H105900	\$1,493	\$1,493
1	Stack-on Storage, Frosted Doors with Silver Frame 72"W x 14⅝"D x 37⅞"H	H10534G	\$1,611	\$1,611
TOTAL:			\$4,806	

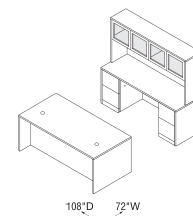

DESK/CREDENZA/STACK-ON STORAGE
WITH FROSTED DOORS
72\"/>



Icon Legend on page 19

10500 SERIES™ Typicals

DESKS

Components used are listed on pages 244-288. Order components individually. Other configurations are possible, including various sizes of some components.

QTY	DESCRIPTION	MODEL	LIST PRICE	PRICE EXTENSION
1	Storage/File Cabinet 18"W x 24"D x 66 ⁵ / ₈ "H, Hinged Right	H105297R	\$1,692	\$1,692
1	Open Credenza 36"W x 24"D x 21 ¹ / ₂ "H	H105LCHAT3024S	\$220	\$220
1	Open/Lateral Credenza 30"W x 24"D x 21 ¹ / ₂ "H	H105LC3024SF	\$490	\$490
1	Modular Credenza Top 60"W x 24"D	H105CTHAT6024L	\$683	\$683
1	Wall Mounted Open Hutch, Cubby w/Glass Doors 60"W x 14 ⁵ / ₈ "D x 20"H	H105WMH60PCG	\$1,661	\$1,661
1	Height Adjustable Base 24"D	HHAB3S2L	\$1,120	\$1,120
1	Shroud for Height Adjustable Base 5 ¹ / ₈ "W x 26"D x 26 ¹ / ₄ "H	HLAMSHB30	\$848	\$848
1	Rectangle Worksurface 66"W x 30"D	H105R3066	\$374	\$374
1	Mixed Material Floating Modesty Panel 36"W x 14"H	HLSL3614MM	\$726	\$726
TOTAL:			\$7,814	

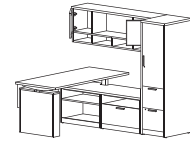

**HEIGHT ADJUSTABLE
"L" WORKSTATION**
66"W x 78"D

QTY	DESCRIPTION	MODEL	LIST PRICE	PRICE EXTENSION
1	H-Leg Support 30"W x 28 ³ / ₈ "H	H105HLEG3028	\$352	\$352
1	Rectangle Worksurface 66"W x 30"D	H105R3066	\$374	\$374
1	External Channel 54"W	HLSLZ5SC66	\$101	\$101
1	Flat Bracket 24"D	HHN831124	\$64	\$64
1	Return Shell w/Full Modesty Panel 72"W x 24"D x 29 ¹ / ₂ "H	H105686	\$696	\$696
1	Multi File Pedestal, Floor-Standing 36"W x 20"D x 28"H	H10505	\$1,249	\$1,249
1	Personal Storage Tower, Hinged Right 24"W x 24"D x 66 ⁵ / ₈ "H	H105301R	\$2,139	\$2,139
1	Wall Mounted Open Hutch 72"W x 14 ⁵ / ₈ "D x 15"H	H105WMH72P	\$1,400	\$1,400
1	Laminate Floating Modesty Panel 54"W x 14"H	HLSL5414L	\$232	\$232
TOTAL:			\$6,607	

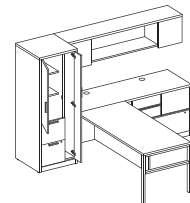

**EXTENDED STORAGE
"L" WORKSTATION**
66"W x 96"D

QTY	DESCRIPTION	MODEL	LIST PRICE	PRICE EXTENSION
1	Single Full Pedestal Desk, Right - B/B/F 72"W x 36"D x 29 ¹ / ₂ "H	H105895R	\$1,361	\$1,361
1	Bridge 47"W x 24"D x 29 ¹ / ₂ "H	H10570	\$364	\$364
1	Single Full Pedestal Credenza, Left - F/F 72"W x 24"D x 29 ¹ / ₂ "H	H105904L	\$1,210	\$1,210
1	Stack-on Storage 72"W x 14 ⁵ / ₈ "D x 37 ¹ / ₈ "H	H10534	\$1,011	\$1,011
TOTAL:			\$3,946	

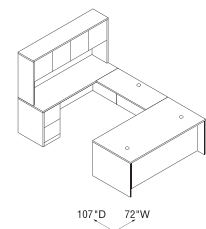

**"U" WORKSTATION
WITH FULL PEDESTALS**
72"W x 107"D

10500 SERIES™

Typicals



Icon Legend on page 19

Components used are listed on pages 244-288. Order components individually. Other configurations are possible, including various sizes of some components.

QTY	DESCRIPTION	MODEL	LIST PRICE	PRICE EXTENSION
1	Rudder Peninsula with End Panel, Right 72"W x 30/38"D x 29½"H	H105205R	\$1,113	\$1,113
1	Return, Left - F/F 42"W x 24"D x 29½"H	H105908L	\$941	\$941
1	Stack-on Storage 72"W x 14⅝"D x 37⅞"H	H10534	\$1,011	\$1,011
TOTAL:			\$3,065	

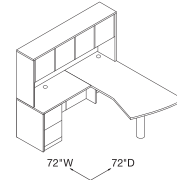

PENINSULA "L" WORKSTATION

72" W x 72" D

QTY	DESCRIPTION	MODEL	LIST PRICE	PRICE EXTENSION
1	Peninsula with End Panel 72"W x 36"D x 29½"H	H10521	\$877	\$877
1	Bridge 42"W x 24"D x 29½"H	H10560	\$350	\$350
1	Extended Corner Unit, Left 72"W x 24"-36"D x 29½"H	H105816L	\$1,074	\$1,074
1	Mobile Pedestal - B/B/F 15¾"W x 22¾"D x 28"H	H105102	\$854	\$854
1	Stack-on Storage 72"W x 14⅝"D x 37⅞"H	H10534	\$1,011	\$1,011
1	Storage Cabinet/Lateral File 36"W x 24"D x 66⅝"H	H105293	\$2,278	\$2,278
TOTAL:			\$6,444	

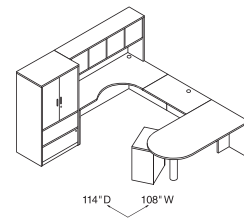

PENINSULA "U" WORKSTATION - LEFT

108" W x 114" D

QTY	DESCRIPTION	MODEL	LIST PRICE	PRICE EXTENSION
1	Slide Out Tower, Left Hinged 12"W x 24"D x 50"H	H105ST122450L	\$2,705	\$2,705
1	Open Credenza 30"W x 24"D x 21½"H	H105LCHAT3024S	\$220	\$220
1	Open/Lateral Credenza 30"W x 24"D x 21½"H	H105LC3024SF	\$490	\$490
1	Modular Credenza Top 60"W x 24"D	H105CTHAT6024R	\$683	\$683
1	Height Adjustable Base 24"D	HHAB3S2L	\$1,120	\$1,120
1	Shroud for Height Adjustable Base 5⅞"W x 26"D x 26¼"H	HLAMSHB30	\$848	\$848
1	Rectangle Worksurface 66"W x 30"D	H105R3066	\$374	\$374
1	Laminate Floating Modesty Panel 30"W x 14"H	HLSL3014L	\$169	\$169
1	2-Drawer Credenza 30"W x 24"D x 21½"H	H105LC3024BF	\$556	\$556
1	Modular Credenza Top 30"W x 24"D	H105CT3024	\$395	\$395
1	Fabric Credenza Top 30"W x 24"D	HLAMSEAT3024	\$405	\$405
TOTAL:			\$7,965	

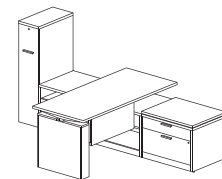

**HEIGHT ADJUSTABLE "L" WORKSTATION
WITH SLIDE OUT STORAGE**

66" W x 102" D



Icon Legend on page 19

10500 SERIES™ Bundles Typicals

Mahogany
H105LL7284N

Harvest
H105LL7284C

QTY	DESCRIPTION	MODEL	LIST PRICE	PRICE EXTENSION
1	Left Pedestal Desk	H10586L	\$1,182	\$1,182
1	Right Return	H10515R	\$837	\$837
TOTAL:			\$2,019	

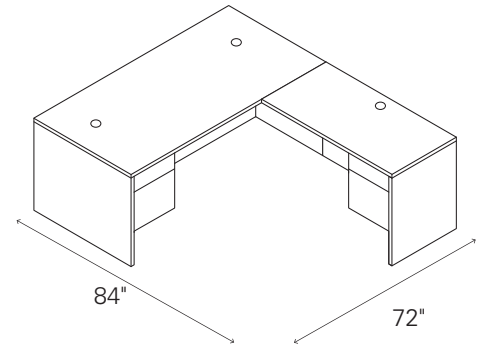

L-STATION (LEFT DESK/RIGHT RETURN)

Mahogany
H105LR7284N

Harvest
H105LR7284C

QTY	DESCRIPTION	MODEL	LIST PRICE	PRICE EXTENSION
1	Right Pedestal Desk	H10585R	\$1,182	\$1,182
1	Left Return	H10516L	\$837	\$837
TOTAL:			\$2,019	

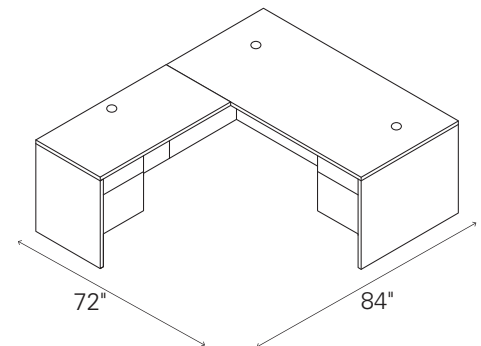

L-STATION (RIGHT DESK/LEFT RETURN)

Mahogany
H105LLH7284N

Harvest
H105LLH7284C

QTY	DESCRIPTION	MODEL	LIST PRICE	PRICE EXTENSION
1	Left Pedestal Desk	H10586L	\$1,182	\$1,182
1	Right Return	H10515R	\$837	\$837
1	Stack-on Storage	H105323	\$850	\$850
TOTAL:			\$2,869	

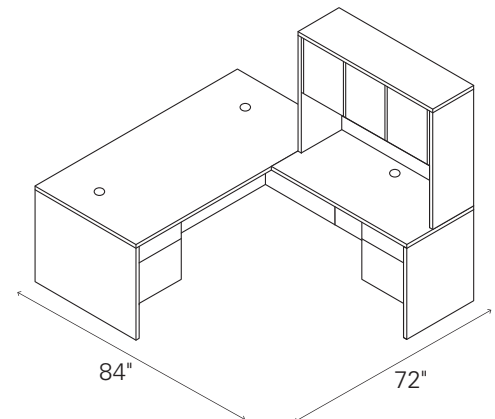

**L-STATION WITH STACK-ON STORAGE
(LEFT DESK/RIGHT RETURN)**

10500 SERIES™ Bundles Typicals



Icon Legend on page 19

Mahogany
H105LRH7284N

Harvest
H105LRH7284C

QTY	DESCRIPTION	MODEL	LIST PRICE	PRICE EXTENSION
1	Right Pedestal Desk	H10585R	\$1,182	\$1,182
1	Left Return	H10516L	\$837	\$837
1	Stack-on Storage	H105323	\$850	\$850
TOTAL:			\$2,869	

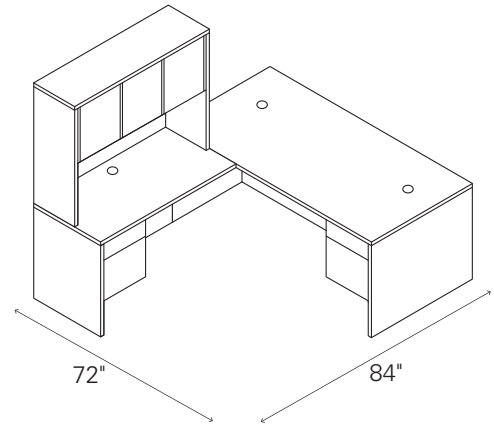

**L-STATION WITH STACK-ON STORAGE
(RIGHT DESK/LEFT RETURN)**

Mahogany
H105ULH72108N

Harvest
H105ULH72108C

QTY	DESCRIPTION	MODEL	LIST PRICE	PRICE EXTENSION
1	Left Pedestal Desk	H10586L	\$1,182	\$1,182
1	Right Pedestal Credenza	H10545R	\$1,023	\$1,023
1	Bridge	H10570	\$364	\$364
1	Stack-on Storage	H10534	\$1,011	\$1,011
TOTAL:			\$3,580	

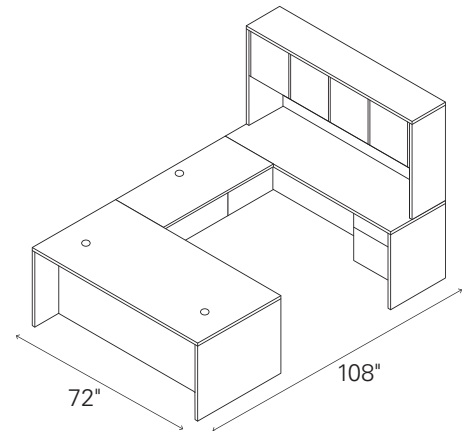

**U-STATION WITH STACK-ON STORAGE
(LEFT DESK/RIGHT CREDENZA)**

Mahogany
H105URH72108N

Harvest
H105URH72108C

QTY	DESCRIPTION	MODEL	LIST PRICE	PRICE EXTENSION
1	Right Pedestal Desk	H10585R	\$1,182	\$1,182
1	Left Pedestal Credenza	H10546L	\$1,023	\$1,023
1	Bridge	H10570	\$364	\$364
1	Stack-on Storage	H10534	\$1,011	\$1,011
TOTAL:			\$3,580	

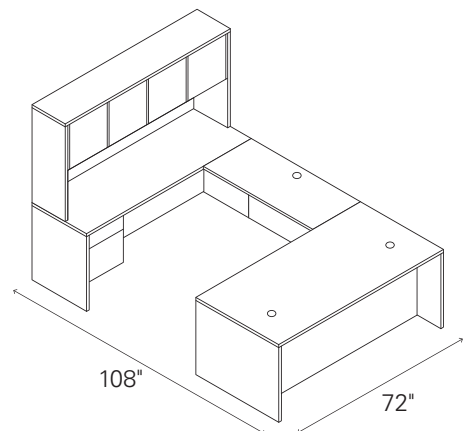

**U-STATION WITH STACK-ON STORAGE
(RIGHT DESK/LEFT CREDENZA)**



Icon Legend on page 19

10500 SERIES™ Bundles Typicals

DESKS

Mahogany
H105DLH7298N

Harvest
H105DLH7298C

QTY	DESCRIPTION	MODEL	LIST PRICE	PRICE EXTENSION
1	Double Pedestal Desk	H10593	\$1,391	\$1,391
2	Bookcase Hutch	H105292	\$570	\$1,140
1	2-Drawer Lateral File	H10563	\$973	\$973
1	Storage Cabinet with Doors	H105291	\$781	\$781
TOTAL:			\$4,285	

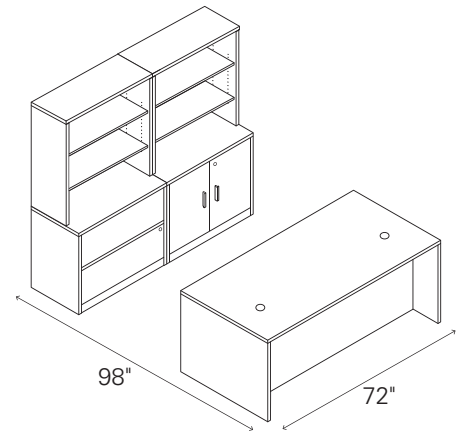

STORAGE WORKSTATION

Mahogany
H105DCH6098N

Harvest
H105DCH6098C

QTY	DESCRIPTION	MODEL	LIST PRICE	PRICE EXTENSION
1	Double Pedestal Desk	H10573	\$1,172	\$1,172
1	Double Pedestal Credenza	H10565	\$1,172	\$1,172
1	Stack-on Storage	H105324	\$943	\$943
TOTAL:			\$3,287	

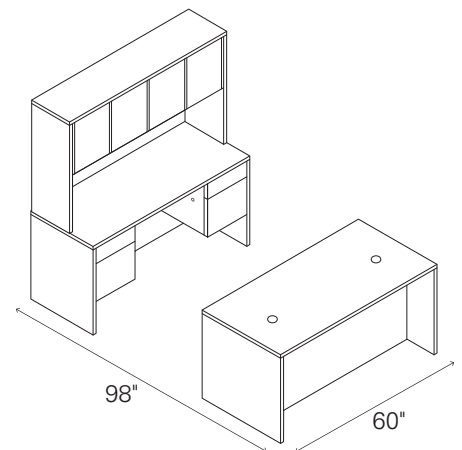

DESK CREDENZA STACK-ON #1

Mahogany
H105DCH7298N

Harvest
H105DCH7298C

QTY	DESCRIPTION	MODEL	LIST PRICE	PRICE EXTENSION
1	Double Pedestal Desk	H10593	\$1,391	\$1,391
1	Double Pedestal Credenza	H10543	\$1,240	\$1,240
1	Stack-on Storage	H10534	\$1,011	\$1,011
TOTAL:			\$3,642	

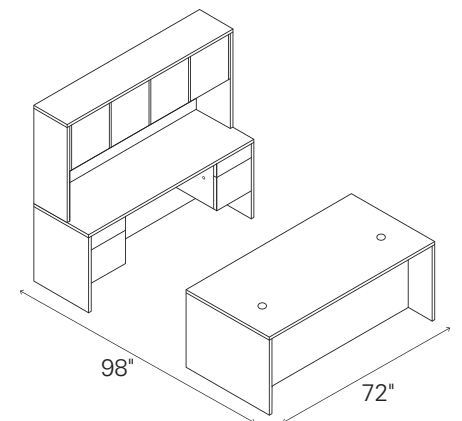

DESK CREDENZA STACK-ON #2

10500 SERIES™

Laminate Modular Components

GSA SIN 33721



Icon Legend on page 19

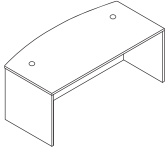

Model H10596 shown

DESCRIPTION	INSIDE DIMENSIONS	FULL WIDTH OVERHANG	MODEL	SHIP WEIGHT	CUBE	LIST PRICE BY LAMINATE GRADE	
						L1	L2
Desk Shell (with full modesty panel and 2 grommets)							
72"W x 36"D x 29½"H, Bow Top (end panels 30"D)	69½"W x 24⅝"D	10½"	H10596	192	6.9	\$894	\$944
72"W x 36"D x 29½"H, Rectangle Top	69½"W x 24⅝"D	10½"	H10594	209	6.9	\$807	\$857
72"W x 30"D x 29½"H, Rectangle Top	69½"W x 24⅝"D	4½"	H10592	182	5.8	\$765	\$805
66"W x 30"D x 29½"H, Rectangle Top	63½"W x 24⅝"D	4½"	H10579	172	5.4	\$725	\$765
60"W x 30"D x 29½"H, Rectangle Top	57½"W x 24⅝"D	4½"	H10578	161	5.0	\$674	\$714
48"W x 30"D x 29½"H, Rectangle Top (1 grommet)	45½"W x 24⅝"D	4½"	H10598	141	5.0	\$626	\$656
NOTES: See page 288 for optional center drawers.							
Desk Shell (with 10"H modesty panel and 2 grommets)							
72"W x 36"D x 29½"H, Bow Top (end panels 30"D)	69½"W x 24⅝"D	10½"	H10596X	155	6.1	\$894	\$944
72"W x 36"D x 29½"H, Rectangle Top	69½"W x 24⅝"D	10½"	H10594X	153	6.1	\$807	\$857
72"W x 30"D x 29½"H, Rectangle Top	69½"W x 24⅝"D	4½"	H10592X	143	5.1	\$765	\$805
66"W x 30"D x 29½"H, Rectangle Top	63½"W x 24⅝"D	4½"	H10579X	134	4.7	\$725	\$765
60"W x 30"D x 29½"H, Rectangle Top	57½"W x 24⅝"D	4½"	H10578X	125	4.4	\$674	\$714
48"W x 30"D x 29½"H, Rectangle Top (1 grommet)	45½"W x 24⅝"D	4½"	H10598X	115	4.4	\$626	\$656
NOTES: Makes reaching wall electrical outlets quick and easy. Provides more than 18" of clearance. See pages 269-270 for optional stack-on storage and page 288 for optional center drawers.							

NOTES:

- Non-handed desk, credenza, and return shells, combined with a variety of under-the-worksurface storage solutions, maximize office layout flexibility. Products can be reconfigured quickly and easily when user preferences or space needs change.
- For under-surface storage options, see pages 258-260.
- For additional components see pages 265-288.
- Tops and end panels are abrasion- and stain-resistant laminate over durable 1⅝" solid core high-performance particleboard; resists warping.
- Cord management grommets, for routing and hiding wires and cables, are located in the tops of desks and return shells.
- 3" round worksurface grommet can be replaced with optional Power Hub (model HGRMTAC) or Power/USB Hub (model HGRMTUSB2) to bring the ease of plug-and-play to the desktop. See page 287.
- Adjustable hex leveling glides allow floor-standing furniture to be easily leveled without lifting the unit; glides have ¾" adjustable range.
- For standing, 42"H shells, see page 247.

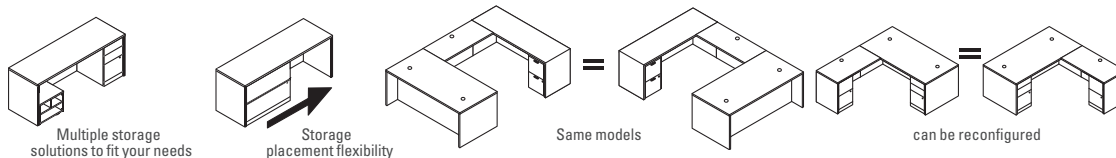
**HOW TO SPECIFY**

Select
Model Number

H 1 0 5 9 6 .

Select
Laminate Top and Chassis Color

See pages 236-237

N N



Icon Legend on page 19

10500 SERIES™ Laminate Modular Components

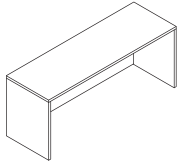

DESCRIPTION	INSIDE DIMENSIONS	MODEL	SHIP WEIGHT	CUBE	LIST PRICE BY LAMINATE GRADE	
					L1	L2
Credenza Shell (with full modesty panel)						
72"W x 24"D x 29½"H	69½"W x 22¾"D	H10541	153	5.6	\$696	\$736
66"W x 24"D x 29½"H	63½"W x 22¾"D	H10542	144	5.1	\$681	\$721
60"W x 24"D x 29½"H	57½"W x 22¾"D	H10564	135	4.7	\$637	\$672
48"W x 24"D x 29½"H	45½"W x 22¾"D	H105692	124	3.9	\$610	\$640
42¼"W x 24"D x 29½"H	39¾"W x 22¾"D	H105691	110	3.8	\$590	\$620
72"W x 20"D x 29½"H	69½"W x 18¾"D	H105581	138	5.6	\$657	\$692
66"W x 20"D x 29½"H	63½"W x 18¾"D	H105582	130	5.1	\$641	\$676
60"W x 20"D x 29½"H	57½"W x 18¾"D	H105583	122	4.7	\$608	\$638

NOTES: Cord pass-through in top center of modesty panel. See pages 269-270 for optional stack-on storage.

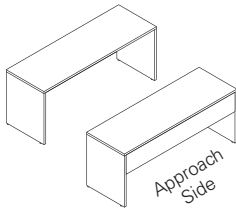

DESCRIPTION	INSIDE DIMENSIONS	MODEL	SHIP WEIGHT	CUBE	LIST PRICE BY LAMINATE GRADE	
					L1	L2
Credenza Shell (with 10" H modesty panel)						
72"W x 24"D x 29½"H	69½"W x 22¾"D	H10541X	114	4.8	\$696	\$736
66"W x 24"D x 29½"H	63½"W x 22¾"D	H10542X	107	4.4	\$681	\$721
60"W x 24"D x 29½"H	57½"W x 22¾"D	H10564X	105	4.0	\$637	\$672
48"W x 24"D x 29½"H	45½"W x 22¾"D	H105692X	95	3.8	\$610	\$640
42¼"W x 24"D x 29½"H	39¾"W x 22¾"D	H105691X	87	3.8	\$590	\$620
72"W x 20"D x 29½"H	69½"W x 18¾"D	H105581X	107	4.8	\$657	\$692
66"W x 20"D x 29½"H	63½"W x 18¾"D	H105582X	101	4.4	\$641	\$676
60"W x 20"D x 29½"H	57½"W x 18¾"D	H105583X	96	4.0	\$608	\$638

NOTES: Makes reaching wall electrical outlets quick and easy. Provides more than 18" of clearance. See pages 269-270 for optional stack-on storage.



Not available in two-tone laminate

DESCRIPTION	MODEL	SHIP WEIGHT	CUBE	L1	L2
				LIST PRICE	LIST PRICE
Kneespace Clearance End Panel Kits (field installable)					
1½"W x 11¼"D x 28½"H	H105098	13	0.9	\$210	\$220
For use at either end of 10500, 10700 or Valido Series® 24"D Credenza Shells (with full or 10" modesty panel) or non-pedestal end of single pedestal credenzas or credenzas with lateral files.					
1½"W x 17¼"D x 28½"H	H105099	11	0.8	\$220	\$230
For use at either end of 10500, 10700 or Valido Series® 30"D Desk Shells or non-pedestal end of 30"D single pedestal desks.					
Kits include: (1) support panel; European fastening hardware; flat connector bracket; joint connector bolts with sleeve nuts (for ganging credenza to adjacent worksurface); and adjustable leveling glides. Allows conversion of units currently in the field.					
NOTES: Can be used to connect up to three 24"D credenzas or 30"D desks in line (requires 4 kits).					
⚠ Not designed to be used freestanding. Not designed to be used with returns, 36"D desks or desk shells.					
SPECIFYING EXAMPLE: H105098.N					

NOTES:

- Non-handed desk, credenza, and return shells, combined with a variety of under-the-worksurface storage solutions, maximize office layout flexibility. Products can be reconfigured quickly and easily when user preferences or space needs change.
- For 78", 84", 90", and 96"W credenza shells, see page 246.
- For under-surface storage options, see pages 258-260.
- Tops and end panels are abrasion- and stain-resistant laminate over durable 1/8" solid core high-performance particleboard; resists warping.
- For additional components see pages 265-288.
- For work-in-process paper management tools, see pages 282-283.
- Cord management grommets, for routing and hiding wires and cables, are located in the tops of desks and return shells.
- Credenza shells have a cord pass-through grommet in the top center of the modesty panel.
- Kneespace Clearance End Panel Kit model H105098, can be used to create "L" configurations with leg clearance, by connecting credenzas to single pedestal desks or credenzas, desk or credenza shells, corners, extended corners or peninsulas.
- Adjustable hex leveling glides allow floor-standing furniture to be easily leveled without lifting the unit; glides have 3/4" adjustable range.

HOW TO SPECIFY

Select Model Number

H 1 0 5 4 1 .

Select Laminate Top and Chassis Color

See pages 236-237

N N

10500 SERIES™

Laminate Modular Components

GSA SIN 33721



Icon Legend on page 19

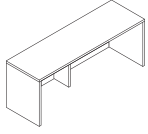

DESCRIPTION	INSIDE DIMENSIONS	MODEL	SHIP WEIGHT	CUBE	LIST PRICE BY LAMINATE GRADE	
					L1	L2
Credenza Shell (with full modesty panel)						
96"W x 24"D x 29½"H	93½"W x 22¾"D	H105413	215	7.0	\$991	\$1046
90"W x 24"D x 29½"H	87½"W x 22¾"D	H105412	202	6.6	\$964	\$1014
84"W x 24"D x 29½"H	81½"W x 22¾"D	H105411	189	6.2	\$855	\$905
78"W x 24"D x 29½"H	75½"W x 22¾"D	H105410	176	5.8	\$832	\$877

NOTES: Larger sizes can be used in conjunction with a 10500 Series rectangle- or bullet-shaped worksurface, supported by an end panel, column or leg, to achieve a space efficient work wall configuration. Shells wider than 72" include an internal, 10½"D vertical support leg. The internal leg can be removed if it is replaced with a 10500 Series 28"H modular pedestal that is adjusted to support the credenza shell top. Cord pass-through in top center of modesty panel. See pages 269-270 for optional stack-on storage and the stack-on storage end panel kit (model H105349).

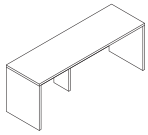

Credenza Shell (with 10"H modesty panel)						
96"W x 24"D x 29½"H	93½"W x 22¾"D	H105413X	163	6.1	\$991	\$1046
90"W x 24"D x 29½"H	87½"W x 22¾"D	H105412X	152	5.7	\$964	\$1014
84"W x 24"D x 29½"H	81½"W x 22¾"D	H105411X	141	5.4	\$855	\$905
78"W x 24"D x 29½"H	75½"W x 22¾"D	H105410X	130	5.0	\$832	\$877

NOTES: Makes reaching wall electrical outlets quick and easy. Provides more than 18" of clearance. Larger sizes can be used in conjunction with a 10500 Series rectangle- or bullet-shaped worksurface, supported by an end panel, column or leg, to achieve a space efficient work wall configuration. Shells wider than 72" include an internal, 10½"D vertical support leg. The internal leg can be removed if it is replaced with a 10500 Series 28"H modular pedestal that is adjusted to support the credenza shell top. See pages 269-270 for optional stack-on storage and the stack-on storage end panel kit (model H105349).

NOTES:

- Non-handed desk, credenza, and return shells, combined with a variety of under-the-worksurface storage solutions, maximize office layout flexibility. Products can be reconfigured quickly and easily when user preferences or space needs change.
- For under-surface storage options, see pages 258-260.
- For additional components see pages 265-288.
- Tops and end panels are abrasion- and stain-resistant laminate over durable 1½" solid core high-performance particleboard; resists warping.
- Credenza shells have a cord pass-through grommet in the top center of the modesty panel.
- Kneespace Clearance End Panel Kit model H105098, can be used to create "L" configurations with leg clearance, by connecting credenzas to single pedestal desks or credenzas, desk or credenza shells, corners, extended corners or peninsulas.
- Adjustable hex leveling glides allow floor-standing furniture to be easily leveled without lifting the unit; glides have ¾" adjustable range.

HOW TO SPECIFY

Select
Model Number

H 1 0 5 4 1 3 .

Select
Laminate Top and Chassis Color

See pages 236-237

N N

10500 SERIES™

Laminate Modular Components

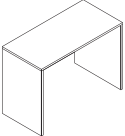
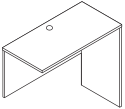
	DESCRIPTION	INSIDE DIMENSIONS	MODEL	SHIP WEIGHT	CUBE	LIST PRICE BY LAMINATE GRADE	
						L1	L2
	Standing-Height Desk Shell						
	60"W x 30"D x 42"H	57½"W x 24½"D x 41⅝"H	H105397	185	6.2	\$837	\$877
	60"W x 24"D x 42"H	57½"W x 22¾"D x 41⅝"H	H105393	154	5.1	\$772	\$812
	48"W x 24"D x 42"H	45⅞"W x 22¾"D x 41⅝"H	H105392	143	4.2	\$722	\$757
	NOTES: Fixed height surface is 42"H. When combined with a stool-height task chair, provides users the benefit of alternating their work between a seated or standing position without the additional cost of an adjustable-height mechanism. Short, 22⅝" modesty panel provides over 18" of wall access; makes reaching wall electrical outlets quick and easy. Box/File Pedestal (H10501) attaches to the underside of the worksurface top to position supplies and files within easy reach.						
	Standing-Height Return Shell						
	48"W x 24"D x 42"H	47"W x 22¾"D x 41⅝"H	H105663	96	3.1	\$606	\$641
	NOTES: Non-handed design. Attaches to sit/stand desk shells to form an L-shaped workstation. Short, 22⅝" modesty panel makes reaching wall electrical outlets quick and easy. One cord management grommet in top for routing and hiding wires and cables. Grommet can be replaced with optional Power Hub (model HGRMTAC). Box/File Pedestal (H10501) attaches to the underside of the worksurface top to position supplies and files within easy reach.						

NOTES:

- 42"H shells help support a healthy work style by allowing users to switch between sitting and standing.
- Non-handed desk and return shells maximize office layout flexibility. Products can be reconfigured quickly and easily when user preferences or space needs change.
- Tops and end panels are abrasion- and stain-resistant laminate over durable 1⅝" solid core high-performance particleboard; resists warping.
- For additional components see pages 265-288.
- Mobile pedestals, shown on page 276, work well in a variety of applications and configurations.
- Adjustable hex leveling glides allow floor-standing furniture to be easily leveled without lifting the unit; glides have ¾" adjustable range.

HOW TO SPECIFY

Select Model Number H 1 0 5 3 9 7 .	Select Laminate Top and Chassis Color See pages 236-237 N N
---	--

10500 SERIES™

Laminate Modular Components

GSA SIN 33721



Icon Legend on page 19

Model H105686
shown

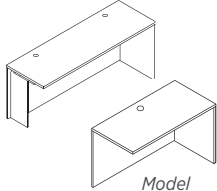

Model
H105686
shown

DESCRIPTION	INSIDE DIMENSIONS	MODEL	SHIP WEIGHT	CUBE	LIST PRICE BY LAMINATE GRADE	
					L1	L2
Return Shell (with full modesty panel)						
72"W x 24"D x 29½"H, (w/support; 2 grommets)	67"W x 22¾"D	H105686	145	5.4	\$696	\$736
60"W x 24"D x 29½"H, (w/support; 2 grommets)	55"W x 22¾"D	H105684	129	4.4	\$637	\$672
48"W x 24"D x 29½"H, (1 grommet)	47"W x 22¾"D	H10561	86	3.7	\$524	\$554
42"W x 24"D x 29½"H, (1 grommet)	41"W x 22¾"D	H105681	89	2.5	\$492	\$522
36"W x 24"D x 29½"H, (1 grommet)	34⅞"W x 22¾"D	H105680	83	3.2	\$492	\$517
30"W x 24"D x 29½"H, (1 grommet)	28⅞"W x 22¾"D	H10568	69	2.6	\$470	\$495

NOTES: Shells are non-handed. No pre-drilled grommet in modesty panel (field installable grommet included). Woodgrain direction on modesty/back panel runs vertical on 30"W-60"W sizes and horizontal on 72"W unit. 36"W return shell can be used to achieve a 6' x 6' L-shaped footprint when connected to either a 72"W x 36"D single pedestal desk, desk shell, or peninsula, or when two are connected to 36"W corner unit model H105811. 30"W return shell can be used to accomplish a 5' x 5' L-shaped footprint when connected to a 60"W x 30"D desk shell or peninsula. See pages 269-270 for optional stack-on storage.

ⓘ Not designed to attach to corner units manufactured prior to 5/24/99.

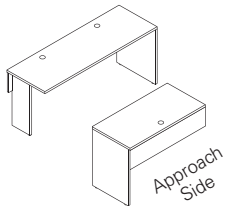

DESCRIPTION	INSIDE DIMENSIONS	MODEL	SHIP WEIGHT	CUBE	LIST PRICE BY LAMINATE GRADE	
					L1	L2
Return Shell (with 10"H modesty panel)						
72"W x 24"D x 29½"H, (w/support; 2 grommets)	67"W x 22¾"D	H105686X	106	4.6	\$696	\$736
60"W x 24"D x 29½"H, (w/support; 2 grommets)	55"W x 22¾"D	H105684X	93	3.9	\$637	\$672
48"W x 24"D x 29½"H, (1 grommet)	47"W x 22¾"D	H10561X	78	3.1	\$524	\$554
42"W x 24"D x 29½"H, (1 grommet)	41"W x 22¾"D	H105681X	69	3.8	\$492	\$522
36"W x 24"D x 29½"H, (1 grommet)	34⅞"W x 22¾"D	H105680X	67	3.8	\$492	\$517
30"W x 24"D x 29½"H, (1 grommet)	28⅞"W x 22¾"D	H10568X	56	2.6	\$470	\$495

NOTES: Makes reaching wall electrical outlets quick and easy. Provides more than 18" of clearance. See pages 269-270 for optional stack-on storage.

NOTES:

- Non-handed desk, credenza, and return shells, combined with a variety of under-the-worksurface storage solutions, maximize office layout flexibility. Products can be reconfigured quickly and easily when user preferences or space needs change.
- For additional components see pages 265-288.
- Tops and end panels are abrasion- and stain-resistant laminate over durable 1½" solid core high-performance particleboard; resists warping.
- Cord management grommets, for routing and hiding wires and cables, are located in the tops of desks and return shells.
- Adjustable hex leveling glides allow floor-standing furniture to be easily leveled without lifting the unit; glides have ¾" adjustable range.
- 36"W and 30"W return shells enable L-shaped layouts for smaller spaces.
- One cord management grommet in tops of Return Shell models, H10568 and H10568X, is used for routing and hiding wires and cables. The 3" round grommet can be replaced with optional Power Hub or Power/USB Hub — see page 287.

HOW TO SPECIFY

Select
Model Number

H 1 0 5 6 8 6 .

Select
Laminate Top and Chassis Color

See pages 236-237

N N



Icon Legend on page 19

10500 SERIES™ Worksurfaces

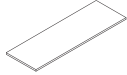
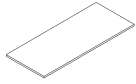

DESCRIPTION

Rectangle Worksurface

84"W x 30"D
78"W x 30"D
72"W x 30"D
66"W x 30"D
60"W x 30"D
48"W x 30"D

84"W x 24"D
78"W x 24"D
72"W x 24"D
66"W x 24"D
60"W x 24"D
48"W x 24"D
42"W x 24"D
36"W x 24"D
30"W x 24"D

MODEL	SHIP WEIGHT	CUBE	LIST PRICE BY LAMINATE GRADE	
			L1	L2
H105R3084	88	6.5	\$475	\$500
H105R3078	81	6.1	\$429	\$454
H105R3072	83	6.1	\$402	\$422
H105R3066	76	6.1	\$374	\$394
H105R3060	69	5.2	\$349	\$369
H105R3048	55	4.1	\$286	\$301
H105R2484	70	5.3	\$437	\$462
H105R2478	65	4.9	\$389	\$409
H105R2472	66	4.9	\$342	\$362
H105R2466	61	4.9	\$331	\$351
H105R2460	55	4.2	\$311	\$331
H105R2448	44	3.4	\$264	\$279
H105R2442	39	3.0	\$239	\$254
H105R2436	30	2.4	\$207	\$222
H105R2430	25	2.0	\$207	\$222

NOTES: Underside of rectangle worksurfaces includes pilot mounting holes for end panels, support columns, post legs, H-legs, and O-legs, and height adjustable base. Applications for 24"D worksurfaces include desks, credenzas, returns, and bridges. For Above Privacy Screen sizes, see page 201.

Bullet Worksurface

72"W x 30"D
66"W x 30"D
60"W x 30"D

60"W x 24"D

H105B3072	79	6.1	\$417	\$437
H105B3066	73	6.1	\$394	\$414
H105B3060	66	5.2	\$376	\$396
H105B2460	45	4.2	\$322	\$337

NOTES: Applications include use as a peninsula in a U- or L-shaped workstation or as an island extension. One flat bracket (mounting plate) ships with each worksurface for applications requiring connection to an adjoining worksurface. Underside includes pilot mounting holes for T- and L-shaped end panels, H-leg, O-leg, support column, post leg, or flat bracket. Grain direction runs horizontal.

ⓘ When specifying 60"W Floating Modesty Panel, it is not necessary to specify an external channel.

DESCRIPTION

External Support Channel

42"W for a 54" Worksurface
48"W for a 60" Worksurface
54"W for a 66" Worksurface
60"W for a 72" Worksurface
72"W for an 84" Worksurface

ⓘ Available in Graphite paint only.

ⓘ When specifying panel-hung worksurfaces, specify external channel as if supported by two H-legs or O-legs via selection chart.

ⓘ When specifying a 54"W or 60"W Floating Modesty Panel, it is not necessary to specify an external channel.

MODEL	SHIP WEIGHT	CUBE	LIST PRICE
HLSLZ5SC54	5	0.5	\$93
HLSLZ5SC60	6	0.5	\$98
HLSLZ5SC66	7	0.5	\$101
HLSLZ5SC72	7	0.5	\$110
HLSLZ5SC84	12	0.7	\$110

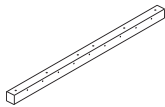

NOTES:

- Easy-care, scratch-, spill- and stain-resistant laminate over 1/8" solid core high-performance particleboard.
- Grain direction on all worksurfaces runs horizontal.
- One flat bracket (mounting plate) ships with each worksurface for applications requiring connection to an adjoining worksurface.
- For standing-height requirements, use worksurface with 41"H laminate L-shaped end panel or metal O-leg.
- For 30", 36", 42" and 48"W x 24"D mobile desks and tables, use post leg with casters model HMBPOST.C.
- For end panels, legs, columns and bases, see the Worksurface Supports listing on pages 250-251.
- When using a floating modesty panel or an external channel under the worksurface, the depth clearance for keyboard trays and center drawers decreases by 8". See accessory matrix in accessory section of the pricer.

- ⓘ 84"W worksurfaces are for 29 1/2"H applications only (not 42"H) and require a T-support brace or other weight-bearing floor support to be positioned between the O-legs or L-shaped end panels.
- ⓘ Worksurfaces are subject to slight bowing. The magnitude of the deflection is dependent upon the weight, placement, and duration of the load.
- ⓘ When using a worksurface as a bridge, no additional supports are needed. One support is required for returns, two supports are required for desks and credenzas.
- ⓘ External channel support is recommended for extended unsupported spans or heavily loaded worksurfaces. See above for details.

EXTERNAL SUPPORT CHANNEL (Model HLSLZ5SCxx) — RECOMMENDED USE							
	Support Combination		Rectangle Worksurface Width				
	Support 1	Support 2	60"	66"	72"	78"	84"
O-Leg	O-Leg	O-Leg	66	72	78	84	NA
	O-Leg	4 1/2" Dia. Support Column	NR	60	66	72	78
	O-Leg	2" Square Post Leg	NR	60	66	72	78
L-Shaped End Panel	L End Panel	L End Panel	NR	60	66	72	78
	L End Panel	O-Leg	60	66	72	78	84
	L End Panel	4 1/2" Dia. Support Column	NR	60	66	72	78
	L End Panel	2" Square Post Leg	NR	60	66	72	78
T-Shaped End Panel	T End Panel	O-Leg	60	66	72	78	84
	T End Panel	4 1/2" Dia. Support Column	NR	60	66	72	78
	T End Panel	2" Square Post Leg	NR	60	66	72	78
Return Config End Panel	None	O-Leg	66	72	78	84	NA
	None	L End Panel	60	66	72	78	84

HOW TO SPECIFY

<p>Select Model Number</p> <p>H 1 0 5 R 3 0 7 2</p>	<p>Select Worksurface Laminate and Edge Color</p> <p>See pages 236-237</p> <p>N N</p>
--	--

10500 SERIES™

Worksurface Supports

GSA SIN 33721



Icon Legend on page 19

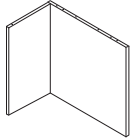

Not available in
two-tone laminate

DESCRIPTION	MODEL	SHIP WEIGHT	CUBE	LIST PRICE BY LAMINATE GRADE	
				L1	L2
L-shaped End Panel					
15 $\frac{3}{4}$ "W x 29 $\frac{7}{8}$ "D x 28 $\frac{1}{2}$ "H	H10530LEP	49	4.1	\$288	\$300
15 $\frac{3}{4}$ "W x 23 $\frac{7}{8}$ "D x 28 $\frac{1}{2}$ "H	H10524LEP	43	3.7	\$270	\$282
15 $\frac{3}{4}$ "W x 29 $\frac{7}{8}$ "D x 41"H	H1053041LEP	68	4.2	\$364	\$384
15 $\frac{3}{4}$ "W x 23 $\frac{7}{8}$ "D x 41"H	H1052441LEP	60	3.4	\$329	\$349

NOTES: Non-handed. 29 $\frac{7}{8}$ "D for use with 48"-78"W x 30"D worksurfaces; 23 $\frac{7}{8}$ "D for use with 30"-78"W x 24"D worksurfaces. Not for use with 84"W unless additional floor supports are placed between the end panels. Design facilitates easy, open access to wall electrical outlets. Adjustable hex glides allow floor-standing units to be easily leveled without lifting to compensate for uneven floors. Glides have $\frac{3}{4}$ " adjustable range. Two pieces; 1 $\frac{1}{8}$ " end panel and $\frac{3}{4}$ " back panel. 10500 Series™ modular and mobile pedestals fit flush to the end panel. Simple assembly.

⚠ Not designed to be used freestanding.

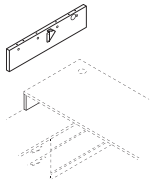

HNLEP307L shown

Laminate End Panel — 7"H Support for Worksurfaces

1 $\frac{1}{8}$ "W x 30"D x 7"H, Right	HNLEP307R	7	0.7	\$133	\$10
1 $\frac{1}{8}$ "W x 30"D x 7"H, Left	HNLEP307L	7	0.7	\$133	\$10
1 $\frac{1}{8}$ "W x 24"D x 7"H, Right	HNLEP247R	6	0.7	\$133	\$10
1 $\frac{1}{8}$ "W x 24"D x 7"H, Left	HNLEP247L	6	0.7	\$133	\$10

NOTES: Specifically for layered surface applications; used to support a 29 $\frac{1}{2}$ "H component worksurface over a 21 $\frac{1}{2}$ "H low credenza unit. 1 $\frac{1}{8}$ " thick. Handed design (left and right models). Includes cord routing notch. Bottom of end panel is edgebanded for added strength and to seal out moisture. Attaches to underside of worksurface via cam fasteners and L-bracket; attaches to top of low credenza with double-sided tape. Can be specified in a woodgrain or solid laminate color only. For 7"H metal O-leg support see page 94.

SPECIFYING EXAMPLE: HNLEP307R.H

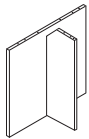

Not available in
two-tone laminate

T-shaped End Panel

11 $\frac{5}{8}$ "W x 29 $\frac{7}{8}$ "D x 28 $\frac{1}{2}$ "H	H10530TEP	45	3.7	\$265	\$277
11 $\frac{5}{8}$ "W x 23 $\frac{7}{8}$ "D x 28 $\frac{1}{2}$ "H	H10524TEP	38	3.2	\$248	\$260

NOTES: Non-handed. For use with 30"D and 24"D 10500 Series worksurfaces. Two 1 $\frac{1}{8}$ " thick pieces; one end and one brace panel. Cord routing notch in brace panel. Simple assembly.

⚠ Not designed to be used freestanding.

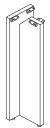

Not available in
two-tone laminate

T-Support Brace

8"W x 23 $\frac{3}{4}$ "D x 28 $\frac{1}{2}$ "H	H10524TSUPP	14	0.8	\$224	\$239
---	--------------------	----	-----	--------------	--------------

NOTES: Intermediate support option for 29 $\frac{1}{2}$ "H workstations. Designed for 24"D and 30"D worksurfaces without a modesty or back panel, with an unsupported span greater than 48"W. Can be used to support the junction of two 24"D adjoining linear worksurfaces. Adjustable hex glides allow floor-standing units to be easily leveled without lifting to compensate for uneven floors; glides have $\frac{3}{4}$ " adjustable range. Simple assembly.

NOTES:

- Adjustable hex leveling glides allow floor-standing furniture to be easily leveled without lifting the unit; glides have $\frac{3}{4}$ " adjustable range.

⚠ Laminate L- and T-shaped end panels can be specified as one color only; not available in two-tone laminate combination or in a pattern laminate.

HOW TO SPECIFY

Select Model Number	Select Laminate
H 1 0 5 3 0 T E P .	See pages 236-237
N	



10500 SERIES™ Worksurface Supports



DESCRIPTION

Support Column for 10500 Series Rectangle and Bullet Worksurfaces

4½" Diameter
For **Black**, specify HPC190X.P.
For **Silver**, specify HPC191X.X.

MODEL SHIP WEIGHT CUBE LIST PRICE

HPC190X	12 Ⓞ	1.0	\$161
HPC191X	12 Ⓞ	1.0	\$161

NOTES: Can only be used as the outbound support in a peninsula or island extension worksurface application. Glides have ¾" adjustable range.

! Support column must be specified for worksurfaces used as peninsulas or as an island extension.

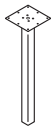

DESCRIPTION

Post Leg Base
28½"H x 2" square

MODEL SHIP WEIGHT CUBE LIST PRICE BY PAINT GRADE

HLSL28P	15	1.0	\$292	\$296	\$312
----------------	----	-----	--------------	--------------	--------------

NOTES: Can only be used as the outbound support in a peninsula or island extension worksurface application. Glides have 2" of adjustability. Ship 1/pack.

! Post leg can only be used to support peninsula, not as primary supports for a top.

SPECIFYING EXAMPLE: HLSL28P.T1

24"D Rectangle Worksurface Support Options				
Product Application	Support Combination		Support Model Numbers for 72"W, 66"W, or 60"W Worksurfaces	Support Model Numbers for 48"W or 42"W Worksurfaces
	Support 1	Support 2		
Desk or Credenza	O-Leg	O-Leg	HLSL24280 (2)	HLSL24280 (2)
	O-Leg	L-Shaped End Panel	HLSL24280 / H10524LEP	HLSL24280 / H10524LEP
	L-Shaped End Panel	L-Shaped End Panel	H10524LEP (2)	H10524LEP (2)
	T-Shaped End Panel	O-Leg	H10524TEP / HLSL24280	H10524TEP / HLSL24280
	T-Shaped End Panel	L-Shaped End Panel	H10524TEP / H10524LEP	H10524TEP / H10524LEP
Peninsula for U- or L-Configuration; Not Freestanding	O-Leg	4½" Diameter Support Column	HLSL24280 / HPC190X-191X	NA
	O-Leg	2" Square Post Leg	HLSL24280 / HLSL28P	NA
	L-Shaped End Panel	4½" Diameter Support Column	H10524LEP / HPC190X-191X	NA
	L-Shaped End Panel	2" Square Post Leg	H10524LEP / HLSL28P	NA
	T-Shaped End Panel	4½" Diameter Support Column	H10524TEP / HPC190X-191X	NA
Desk, Credenza, or Freestanding Return or Bridge	Adjustable Height Base - Electric		HHAB3S2L	HHAB3S2L (48"W min.)
Return (requires one support)	O-Leg	—	HLSL24280	HLSL24280
	L-Shaped End Panel	—	H10524LEP	H10524LEP
	T-Shaped End Panel	—	H10524TEP	H10524TEP
	4½" Diameter Support Column	—	HPC190X or HPC191X	HPC190X or HPC191X
	2" Square Post Leg	—	HLSL28P	HLSL28P
Island Extension (requires one support)	O-Leg	—	HLSL24280	HLSL24280
	4½" Diameter Support Column	—	HPC190X or HPC191X	HPC190X or HPC191X
	2" Square Post Leg	—	HLSL28P	HLSL28P

72"W, 66"W, or 60"W x 30"D Bullet Worksurface Support Options			
Product Application	Support Combination		Support Model Numbers
	Support 1	Support 2	
Peninsula for U- or L-Configuration; Not Freestanding	O-Leg	4½" Diameter Support Column	HLSL30280 / HPC190X or HPC191X
	O-Leg	2" Square Post Leg	HLSL30280 / HLSL28P
	L-Shaped End Panel	4½" Diameter Support Column	H10530LEP / HPC190X or HPC191X
	L-Shaped End Panel	2" Square Post Leg	H10530LEP / HLSL28P
	T-Shaped End Panel	4½" Diameter Support Column	H10530TEP / HPC190X or HPC191X
	T-Shaped End Panel	2" Square Post Leg	H10530TEP / HLSL28P
Island Extension	4½" Diameter Support Column	—	HPC190X or HPC191X
	2" Square Post Leg	—	HLSL28P

HOW TO SPECIFY

Select Model Number

HPC190X

Select Paint Color

See page 171

T1



10500 SERIES™ Worksurface Supports

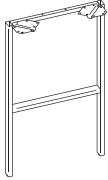

DESCRIPTION	MODEL	SHIP WEIGHT	CUBE	LIST PRICE BY PAINT GRADE		
				P1	P2	P3
H-Leg Support for Worksurfaces 30"W x 28 ³ / ₈ "H 24"W x 28 ³ / ₈ "H	H105HLEG3028	13.6	5.1	\$352	\$356	\$372
	H105HLEG2428	12.5	3.7	\$316	\$320	\$336
Standing-Height H-Leg Support for Worksurfaces 30"W x 41"H 24"W x 41"H	H105HLEG3041	16.5	6.5	\$474	\$482	\$494
	H105HLEG2441	15.4	5.3	\$424	\$432	\$444

NOTES:

- Legs ship fully assembled with mounting hardware, 1 per pack. Non-handed. H-leg glides have 2" adjustability. Will have 6" overhang when using 30"D H-legs with a 36"D worksurface.
- ! The H-leg attachment bracket interferes with placement of 10500 Series™ modular pedestals and 28³/₈"H mobile pedestals, preventing them from being positioned directly next to (flush with) the H-leg. Box/File mobile pedestal model H105106 and mobile printer/fax cart model H105679 can be positioned along side the H-leg.
- ! O- and H-legs may only be attached to worksurfaces, not storage units.

HOW TO SPECIFY

<p>Select Model Number</p> <p>H 1 0 5 H L E G 2 4 4 1 . T 1</p>	<p>Select Paint Color</p> <p>See page 171</p>
---	---

10500 SERIES™ Worksurface Supports

GSA SIN 33721 EXCEPT AS NOTED

ABI

Icon Legend on page 19

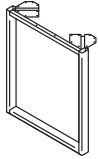
**DESCRIPTION****O-Leg**

30"D x 28½"H
24"D x 28½"H

MODEL

HLSL30280
HLSL24280

SHIP WEIGHT

19.0
17.0

CUBE

5.4
3.7

LIST PRICE BY PAINT GRADE

P1	P2	P3
\$352	\$356	\$372
\$316	\$320	\$336

NOTES: Ship fully assembled with mounting hardware, 1/pack. Non-handed. O-leg glides have 2" adjustability. Shared O-legs create a cleaner aesthetic in all applications where two legs are used side-by-side. Will have 6" overhang when using 30"D O-legs with a 36"D worksurface.

IMPORTANT: The O-leg attachment bracket interferes with placement of 10500 Series modular pedestals and 28¾"H mobile pedestals, preventing them from being positioned directly next to (flush with) the O-leg. Box/file mobile pedestal (model H105106) and mobile printer/fax cart model (H105679) can be positioned along side the O-leg.

! O-legs may only be attached to worksurfaces, not storage units.

SPECIFYING EXAMPLE: HLSL24280.T1

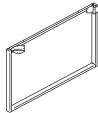
**Double-Depth O-Leg Support for Worksurfaces**

60"D x 28½"H
48"D x 28½"H

HLSL60280
HLSL48280

19.0
18.0

8.7
7.0

\$665	\$673	\$685
\$597	\$605	\$617

NOTES: Ship fully assembled with mounting hardware, 1/package. Non-handed. 48"D and 60"D sizes span back-to-back 24"D and 30"D worksurfaces, respectively. O-leg glides have 2" adjustability. Shared O-legs create a cleaner aesthetic in all applications where two legs are used side-by-side. Will have 6" overhang when using 30"D O-legs with a 36"D worksurface.

! O-legs may only be attached to worksurfaces, not storage units.

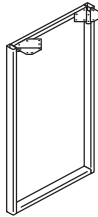
**Standing-Height O-Leg Support for Worksurfaces**

30"D x 41"H
24"D x 41"H

HLSL30410
HLSL24410

17.0
16.0

6.5
5.3

\$474	\$480	\$494
\$424	\$430	\$444

NOTES: Ship fully assembled with mounting hardware, 1/package. Non-handed. O-leg glides have 2" adjustability. O-leg installation requires 6" of clearance from the worksurface end. Shared O-legs create a cleaner aesthetic in all applications where two legs are used side-by-side. Will have 6" overhang when using 30"D O-legs with a 36"D worksurface.

Coordinate™ Power Modules will work with standing-height applications for 10500™ and Voi® desks.

! O-legs may only be attached to worksurfaces, not storage units.

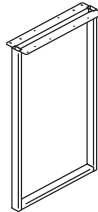
**Standing-Height O-Leg Shared Support for Worksurfaces**

30"D x 41"H
24"D x 41"H

HLSL3041SL
HLSL2441SL

17.0
16.0

6.5
5.3

\$529	\$535	\$549
\$478	\$484	\$498

NOTES: Ship fully assembled with mounting hardware, 1/package. Non-handed. For use with two 24"D or 30"D worksurfaces positioned side-by-side along the depth dimension. O-leg glides have 2" adjustability. O-leg installation requires 6" of clearance from the worksurface end. Shared O-legs create a cleaner aesthetic in all applications where two legs are used side-by-side. Will have 6" overhang when using 30"D O-legs with a 36"D worksurface.

Coordinate™ Power Modules will work with standing-height applications for 10500™ and Voi® desks. Please see Coordinate™ Accessories Stand-Alone Pricer pages for more information.

! O-legs may only be attached to worksurfaces, not storage units.



OPEN MARKET

O-Leg Cord Clips

Clips for 28½" Worksurface O-Legs — 8-Pack

HWMCLIPG

0.8 ☹

0.1

\$99**N/A****N/A**

NOTES: Wire clips work with 7" Low Credenza O-leg and 29"H Support O-leg. Wire clips also work with the 50" and 65" Hutch O-legs. For additional information see page 852.

! Available in frosted plastic material only.

NOTES:

! For shared components such as modesty panels and Privacy Screens see pages 199-201.

HOW TO SPECIFY

Select
Model Number

Select
Paint Color

See page 171

HLSL30280

T1



Icon Legend on page 19

10500 SERIES™ Worksurface Supports

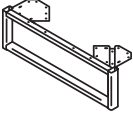
	DESCRIPTION	MODEL	SHIP WEIGHT	CUBE	LIST PRICE BY PAINT GRADE		
					P1	P2	P3
	O-Leg Shared Support for Worksurfaces						
	30"D x 28½"H 24"D x 28½"H	HLSL3028SL HLSL2428SL	19 17	5.4 3.7	\$438 \$394	\$442 \$398	\$458 \$414
	NOTES: Ship fully assembled, 1/pack. Non-handed. ! Specify paint only. SPECIFYING EXAMPLE: HLSL2028SL.T1						
	O-Leg Support for Low Credenzas						
	30"D x 7"H 24"D x 7"H	HLSL3070 HLSL2470	7 6	1.0 1.0	\$271 \$213	\$275 \$217	\$291 \$233
	NOTES: Ship fully assembled, 1/pack. Non-handed. For 7"H laminate support see page 92. ! Specify paint only. SPECIFYING EXAMPLE: HLSL2070.T1						
	DESCRIPTION	MODEL	SHIP WEIGHT	CUBE	LIST PRICE		
 <i>HVPWLBK24 shown</i>	Worksurface Wall Mount Bracket						
	For 30" For 24"	HVPWLBK30 HVPWLBK24	2 2	0.3 0.3	\$83 \$76		
	NOTES: Can be used in place of an end panel or O-leg to support a worksurface. Cannot be used as a support when placing a stack-on storage unit on worksurface over bracket; must have two full-sized floor supports when using stack-on storage. Finish option not required. SPECIFYING EXAMPLE: HVPWLBK30						
OPEN MARKET							
	DESCRIPTION	MODEL	SHIP WEIGHT	CUBE	LIST PRICE BY PAINT GRADE		
	Worksurface to Tower Bracket Kit						
	18½" long bracket for attaching 24"D worksurface directly to storage tower, wardrobe/bookcase, wardrobe/storage cabinet, storage cabinet/lateral file, storage cabinet, or lateral file.	HSTB2W1	4	0.6	\$76	\$89	\$100
	NOTES: Can be used in place of end panel or O-leg to support worksurfaces. ! Bracket not designed for use as a support if placing Stack-on Storage on worksurface over/above bracket. Two full-sized supports required when using Stack-on Storage.						

NOTES:

- O-leg glides have 2" adjustability.
- For shared components such as modesty panels and Privacy Screens see pages 199-201.
- O-leg ships fully assembled with mounting hardware.
- For standing-height O-leg sizes, see page 252.
- Shared O-legs create a cleaner aesthetic in all applications where two legs are used side-by-side.
- Will have 6" overhang when using 30"D O-legs with a 36"D worksurface.

- ! O-legs may only be attached to worksurfaces, not storage units.
- ! O-leg installation requires 6" of clearance from the worksurface end.

HOW TO SPECIFY

<p>Select Model Number</p> <p>HVPWLBK30</p>	<p>Select Paint Color</p> <p>See page 171</p> <p>T1</p>
---	---

10500 SERIES™

Components — Supports

GSA SIN 33721

ABI

Icon Legend on page 19

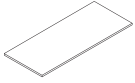
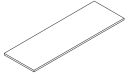
	DESCRIPTION	MODEL	SHIP WEIGHT	CUBE	LIST PRICE BY LAMINATE GRADE	
					L1	L2
	Rectangle Worksurface					
	72"W x 30"D	H105R3072	83	6.1	\$402	\$422
	66"W x 30"D	H105R3066	76	6.1	\$374	\$394
	60"W x 30"D	H105R3060	69	5.2	\$349	\$369
	48"W x 30"D	H105R3048	55	4.1	\$286	\$301
	72"W x 24"D	H105R2472	66	4.9	\$342	\$362
	66"W x 24"D	H105R2466	61	4.9	\$331	\$351
	60"W x 24"D	H105R2460	55	4.2	\$311	\$331
	48"W x 24"D	H105R2448	44	3.4	\$264	\$279
	42"W x 24"D	H105R2442	39	3.0	\$239	\$254

NOTES: Underside of rectangle worksurfaces includes pilot mounting holes for end panels, support columns, post and O-legs, and height adjustable base. Applications for 24"D worksurfaces include desks, credenzas, returns, and bridges. The 42"W x 24"D size is not compatible with Height Adjustable Base model HHAB3S2L; it can however, be used in combination with the 72"W x 30"D worksurface on 3-Leg Height Adjustable Base model HHAB3S3L. For Above Privacy Screen sizes, see page 201.

NOTES:

- Height Adjustable Base is a 3-stage column design.
 - Frame rises from 21 $\frac{1}{8}$ " to 47 $\frac{3}{4}$ " for a sit-to-stand desk option.
 - Height Adjustable Bases shipped complete with a pre-assembled motor.
 - Base telescopes to accommodate any worksurface between 48"W and 72"W.
 - Height Adjustable Base accommodates rectangular worksurfaces between 24"D x 48"W and 30"D x 72"W. Systems, Voi®, 10500, and Preside® all have worksurfaces within this range.
 - Comes standard with one-touch, four memory controller with digital display; no specification needed, available in black finish only.
 - Standard height adjustable control ships with base.
 - Dynamic load capacity when worksurface is moving is 250 lbs.
- ⓘ Worksurfaces used with Coordinate™ Height Adjustable Bases should have 1" perimeter gap on each side to provide clearance between other furniture. Failure to do so risks injury or product damage (not covered by warranty).

HOW TO SPECIFY

Select Model Number

H 1 0 5 R 3 0 7 2 .

Select Laminate

See pages 236-237

N N



10500 SERIES™ Height Adjustable Bases

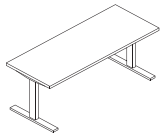

Base shown with worksurface attached.

OPEN MARKET

DESCRIPTION

MODEL

SHIP WEIGHT

CUBE

LIST PRICE

Coordinate™ Height Adjustable Base – 3 Stage

24”D Feet and Worksurface Brackets

HHAB3S2L

67.0

2.4

\$1120

NOTES: Base is a dual motor 3-stage design with standard anti-collision. Legs raise from 21⁵/₈” to 47³/₄”. Base telescopes to accommodate any rectangular worksurface between 24”D x 48”W and 30”D x 72”W. Supports weight capacity of 250 lbs. (excluding worksurface weight). Foundation™, Systems, Voi®, 10500, and Preside® all have worksurfaces within this range. Comes standard with one-touch, four memory controller with digital display; no specification needed, available in black finish only. UL Certified. **HON 5-Year Limited Warranty.**

ⓘ Telescoping horizontal frame will extend just over 2” from underside of the worksurface.

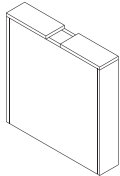

Not available in two-tone laminate.

SIN 33721

Shroud for Height Adjustable Base

5¹/₈”W x 26”D x 26¹/₄”H for Base with 30”D Top

HLAMSHB30

39.0

3.7

\$848

NOTES: Decorative laminate enclosure covers the Coordinate™ metal leg and foot. Lowest base adjustment position when the shroud is installed is 29¹/₂”H; memory controller must be set at that height to avoid interference. For use with standard 10500 Series™, Concinity™, and Voi® rectangle worksurfaces, 48-72”W x 30”D, supported by Height Adjustable Base models HHAB3S2L or HHAB2S2L. For height adjustable desks requiring a modesty panel, options include: 14”H laminate (HLSLXX14L) or mixed material (HLSLXX14MM) floating modesty panels, laminate full length (HNLMPXX28) or short (HNLMPXX10) modesty/back panel plus external support channel (HLSLZ5SCXX). External support channel attachment screws and modesty/back panel cover caps are included in the shroud hardware pack. External support channel size recommendation, specific to worksurface attached to Height Adjustable Base with optional laminate full-length or short modesty back/panel (HNLMPXX28/10) see below. Ships one per carton. To conceal both metal legs on the Height Adjustable Base order two.

Specify: Model.Laminate; see pages 236-237.

SPECIFYING EXAMPLE: HLAMSHB30.N

ⓘ The Height Adjustable Base must be reset at the time of installation, after every loss of power, if the unit is not functioning properly, or if the legs are uneven. To reset the base requires removing the laminate shroud(s), as well as the full-length modesty panel if one is being used, then adjusting the base to its lowest position. Disassembly of the shroud is quick and easy.

ⓘ \$25 upcharge for L2 laminates.

Worksurface Width	Modesty/Back Panel Width	External Support Channel
72”W	72”W	HLSLZ5SC78
66”W	66”W	HLSLZ5SC72
60”W	60”W	HLSLZ5SC66
54”W	54”W	HLSLZ5SC60
48”W	48”W	HLSLZ5SC54

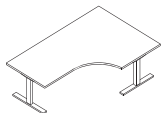

Base shown with worksurface attached.

OPEN MARKET

Coordinate™ 3-Leg Height Adjustable Base – 3 Stage

24”D Feet and Worksurface Brackets

HHAB3S3L

91.0

3.6

\$1896

NOTES: Base is a three motor 3-stage design with standard anti-collision. Legs raise from 21⁵/₈” to 47³/₄”. **The 3-leg base supports corner coves or two-piece worksurfaces 41”-72”W x 35”-72”L x 23¹/₄”-30”D. 48”W 120 degree corner worksurfaces are also supported. When using two worksurfaces, the connection between the two must be over the telescoping frame. Supports weight capacity of 375 lbs.** (excluding worksurface weight). Can be used with 48” 120 degree and worksurface models. Comes standard with one-touch, four memory controller with digital display; no specification needed, available in black finish only. UL Certified. **HON 5-Year Limited Warranty.**

ⓘ When using two worksurfaces, a flat bracket is required. Bracket purchased separately – HHN831124, HHN831130 – see page 589.

ⓘ Telescoping horizontal frame will extend just over 2” from underside of the worksurface.

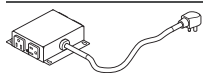

SIN 33721

Under Worksurface Power Module – 4 Outlets, 10’ Cord

HPWRMOD2

1.5

0.2

\$401

- Includes 10’ cord with three-prong plug.
- Fits in cable management troughs. See page 232.
- 4 outlets on side create easy access.

NOTES: Power Modules will also work with standing-height applications for 10500 Series™ and Voi® desks. For additional information see page 849.

ⓘ Available in black finish only, no specification needed.

NOTES:

ⓘ Coordinate™ Height Adjustable Bases not compatible with 36”D rectangular worksurfaces.

HOW TO SPECIFY

Select Model Number

HHAB3S2L

Select Finish

P71 Black
P8L Nickel
PDB White

P8L

10500 SERIES™

Shared Components

GSA SIN 33721



Icon Legend on page 19

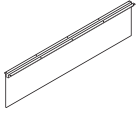

DESCRIPTION	MODEL	SHIP WEIGHT	CUBE	LIST PRICE BY LAMINATE GRADE	
				L1	L2
Laminate Floating Modesty Panel					
60"W x 14"H	HLSL6014L	20	1.1	\$250	\$262
54"W x 14"H	HLSL5414L	18	1.1	\$232	\$244
48"W x 14"H	HLSL4814L	16	1.1	\$212	\$224
42"W x 14"H	HLSL4214L	14	0.8	\$193	\$203
36"W x 14"H	HLSL3614L	12	0.8	\$179	\$189
30"W x 14"H	HLSL3014L	10	0.8	\$169	\$179

NOTES: The attachment bracket and modesty panel are packaged separately.

Specify: Model.Laminate.Paint

SPECIFYING EXAMPLE: HLSL3014L.N.P (Black is the only paint option for this model)

⚠ When specifying the 54"W or 60"W Laminate Floating Modesty Panel, it is not necessary to specify an external channel.

⚠ 30"W and 36"W screens attach with L-brackets, not the external channel.

NOTES:

- Laminate or mixed material floating modesty panels options are available for attachment under 10500 Series worksurfaces. The modesty panel and attachment bracket are packaged separately.
- If using a 54"W or 60"W floating modesty panel, it is not necessary to specify an external support channel under the worksurface.
- When using a floating modesty panel under the worksurface, the depth clearance for center drawers and keyboard platforms decreases by 8".

FLOATING MODESTY PANELS - MODEL SELECTION GUIDE						
Support Combination		Rectangle Worksurface Width				
Support 1	Support 2	72 in	66 in	60 in	48 in	42 in
O-Leg	O-Leg	HLSL6014	HLSL5414	HLSL4814	HLSL3614	HLSL3014
O-Leg	L-Shaped End Panel	HLSL4814	HLSL4214	HLSL3614	NA	NA
O-Leg	4½" Diameter Support Column	HLSL4814	HLSL4814	HLSL4814	HLSL3614	HLSL3014
O-Leg	2" Square Post Leg	HLSL4814	HLSL4814	HLSL4814	HLSL3614	HLSL3014
L-Shaped End Panel	L-Shaped End Panel	HLSL3614	HLSL3014	NA	NA	NA
L-Shaped End Panel	4½" Diameter Support Column	HLSL3614	HLSL3614	HLSL3614	NA	NA
L-Shaped End Panel	2" Square Post Leg	HLSL3614	HLSL3614	HLSL3614	NA	NA
T-Shaped End Panel	O-Leg	HLSL5414	HLSL4814	HLSL4214	HLSL3014	NA
T-Shaped End Panel	L-Shaped End Panel	HLSL3614	HLSL3014	NA	NA	NA
T-Shaped End Panel	4½" Diameter Support Column	HLSL3614	HLSL3014	NA	NA	NA
T-Shaped End Panel	2" Square Post Leg	HLSL3614	HLSL3014	NA	NA	NA

Support Combination		Bullet Worksurface Width		
Support 1	Support 2	72 in	66 in	60 in
O-Leg	4½" Diameter Support Column	HLSL4814	HLSL4814	HLSL4814
O-Leg	2" Square Post Leg	HLSL4814	HLSL4814	HLSL4814
L-Shaped End Panel	4½" Diameter Support Column	HLSL3614	HLSL3614	HLSL3614
L-Shaped End Panel	2" Square Post Leg	HLSL3614	HLSL3614	HLSL3614
T-Shaped End Panel	4½" Diameter Support Column	HLSL3614	HLSL3614	HLSL3614
T-Shaped End Panel	2" Square Post Leg	HLSL3614	HLSL3614	HLSL3614

HOW TO SPECIFY

Select Model Number

H L S L 3 0 1 4 L . N

Select Laminate

See pages 236-237



10500 SERIES™

Shared Components

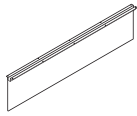
**DESCRIPTION****Mixed Material Floating Modesty Panel**

60"W x 14"H
54"W x 14"H
48"W x 14"H
42"W x 14"H
36"W x 14"H
30"W x 14"H

MODEL

HLSL6014MM
HLSL5414MM
HLSL4814MM
HLSL4214MM
HLSL3614MM
HLSL3014MM

SHIP WEIGHT

13
13
11
9
8
8

CUBE

3.3
3.3
2.6
2.3
2.0
2.0

LIST PRICE

\$1113
\$974
\$898
\$811
\$726
\$676

NOTES: The attachment bracket and modesty panel are packaged separately. Laminate or mixed material floating modesty panels options are available for attachment under 10500 Series worksurfaces. The modesty panel and attachment bracket are packaged separately. If using a 54"W or 60"W floating modesty panel, it is not necessary to specify an external support channel under the worksurface. When using a floating modesty panel under the worksurface, the depth clearance for center drawers and keyboard platforms decreases by 8". See charts on previous page.

Specify: Model.Mixed Material.Paint

SPECIFYING EXAMPLE: HLSL3014MM.FT01.P (Frosted Translucent mixed material and Black paint are the only options for this model)

! When specifying the 54"W or 60"W Mixed Material Floating Modesty Panel, it is not necessary to specify an external channel.

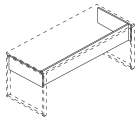

Not available in two-tone laminate

Modesty Panels for Desks with O-Legs

68³/₈"W x 3³/₄"D x 10"H — For 72" x 30" Desks
56³/₈"W x 3³/₄"D x 10"H — For 60" x 30" Desks

HLAMMP7230
HLAMMP6030

26
23

2.1
1.8

\$289
\$264

NOTES: For use with 60"W or 72"W worksurfaces supported by O-legs. Comprised of three panels: one approach side and one for each end. Length below bottom of worksurface is 10". Steel external support channel (ordered separately) is recommended for unsupported spans greater than 54"W (i.e.: a distance in which there is not a vertical support between the underside of the worksurface and floor). Grain direction is vertical on approach and side panels for 56³/₈"W (all laminate colors) and 68³/₈"W (L1 laminate except Florence Walnut and Kingswood Walnut). Vertical on 27⁵/₈" end panels (all laminate colors). Horizontal on all panels for L2 laminates as well as Florence Walnut and Kingswood Walnut.

Specify: Model.Laminate

SPECIFYING EXAMPLE: HLAMMP7230.N

! \$15 upcharge for L2 laminates. See pages 236-237 for laminate options.

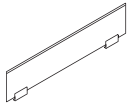
**Above Privacy Screen**

60"W x 13"H
54"W x 13"H
48"W x 13"H
42"W x 13"H
36"W x 13"H
30"W x 13"H

HLSL1260
HLSL1254
HLSL1248
HLSL1242
HLSL1236
HLSL1230

24
22
20
18
15
13

2.9
2.9
2.3
2.3
1.8
1.5

\$453
\$421
\$394
\$344
\$308
\$279

NOTES: Ships complete with attachment bracket. Bracket is Platinum only, no need to specify. Attaches to top of rectangle worksurfaces; requires a minimum overhang of 1¹/₂".

! Available in Frosted Glass ONLY HLSL1230.G.

! Above only Privacy Screen clamps onto worksurface and cannot be installed where support storage will be attached.

HOW TO SPECIFY

Select
Model Number

H L S L 3 0 1 4 M M .

Select
Mixed Material

FT01 Frosted Translucent

F T 0 1



10500 SERIES™

Laminate Modular Components

GSA SIN 33721

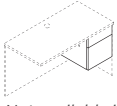

Icon Legend on page 19

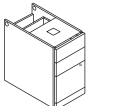
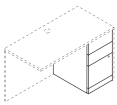
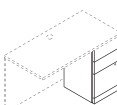
	DESCRIPTION	MODEL	SHIP WEIGHT	CUBE	LIST PRICE BY LAMINATE GRADE	
					L1	L2
 Not available in two-tone laminate	Box/File Pedestal (with core removable lock) 15 $\frac{5}{8}$ "W x 22 $\frac{3}{4}$ "D x 17 $\frac{3}{4}$ "H — for use under 24"D, 30"D and 36"D desk, credenza and return shells NOTES: Attaches to underside of worksurface top. Lock can be positioned on either the right or left side. File drawer includes integrated hangrails for letter- or legal-sized folders. Not for use under 20"D shells. ⓘ Not designed to be used freestanding. Unfinished top and back.	H10501	57	5.5	\$523	\$543
 Not available in two-tone laminate	Narrow Box/Box/File Pedestal (with core removable lock) — floor-standing 9 $\frac{1}{2}$ "W x 22 $\frac{3}{4}$ "D x 28"H — for use under 24"D, 30"D and 36"D desk, credenza and return shells NOTES: Space-saving design supports smaller footprints. Middle box drawer and file drawer lock; top box drawer does not lock. File drawer includes integrated hangrails for side-to-side letter or legal filing. Not for use under 20"D shells. ⓘ Not designed to be used freestanding. Unfinished top and back.	H105093	61	5.6	\$676	\$701
 Not available in two-tone laminate	Box/Box/File Pedestal — floor-standing 15 $\frac{5}{8}$ "W x 28 $\frac{3}{4}$ "D x 28"H — for use under 10500 Series 30"D worksurfaces supported by 29 $\frac{7}{8}$ "D L-shaped end panel model H10530LEP NOTES: Top box drawer does not lock. File drawer includes integrated hangrails for letter- or legal-sized folders. Not for use under shells, per "Inside Dimensions" listings. ⓘ Not designed to be used freestanding. Unfinished top and back.	H105062	105	10.5	\$743	\$773
 Not available in two-tone laminate	Box/Box/File Pedestal (with core removable lock) — floor-standing 15 $\frac{5}{8}$ "W x 22 $\frac{3}{4}$ "D x 28"H — for use under 24"D, 30"D and 36"D desk, credenza and return shells or worksurface supported by 23 $\frac{7}{8}$ "D L-shaped end panel(s) NOTES: Top box drawer does not lock. File drawer includes integrated hangrails for letter- or legal-sized folders. Not for use under 20"D shells. ⓘ Not designed to be used freestanding. Unfinished top and back.	H10502	90	8.4	\$686	\$711
 Not available in two-tone laminate	Box/Box/File Pedestal (with core removable lock) — floor-standing 15 $\frac{5}{8}$ "W x 18 $\frac{3}{4}$ "D x 28"H — for use under 20"D, 24"D, 30"D and 36"D desk, credenza and return shells NOTES: Top box drawer does not lock. File drawer includes integrated hangrails for letter- or legal-sized hanging folders. ⓘ Not designed to be used freestanding. Unfinished top and back.	H105012	73	7.3	\$647	\$667

NOTES:



- Pedestals can be reconfigured quickly and easily when user preferences or space needs change.
 - Locking units equipped with interchangeable core removable locks.
 - Pedestal models ship assembled unless designated .
 - Mobile pedestals shown on page 276, work well in a variety of configurations.
 - Narrow Pedestal features a compact design that is ideal for use in U- and L-shaped layouts for smaller spaces such as a 5' x 8' U-shaped workstation or a 5' x 5' L-shaped workstation.
 - 10500 Series™ modular pedestals are for use with desk, credenza and return shells (see pages 244-248), as well as L-shaped end panels (page 250).
- ⓘ Keyed alike cores must be ordered separately — see model HF23B on page 853 — makes re-keying quick and easy.
- ⓘ Access strip (filler) required when box/box file, file/file, and/or narrow box/box/file pedestals are configured side-by-side to allow access for opening the drawers.
- ⓘ Modular pedestals can be specified as one color only; not available in two-tone laminate combination or in a pattern laminate.

HOW TO SPECIFY

Select Model Number <input type="text" value="H105093"/>	Select Laminate Chassis Color <input type="text" value="N"/>
See pages 236-237	

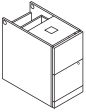
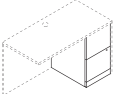
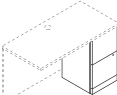

10500 SERIES™ Laminate Modular Components

	DESCRIPTION	MODEL	SHIP WEIGHT	CUBE	LIST PRICE BY LAMINATE GRADE	
					L1	L2
 Not available in two-tone laminate	File/File Pedestal — floor-standing 15 ⁵ / ₈ "W x 28 ³ / ₄ "D x 28"H — for use under 10500 Series 30"D worksurfaces supported by 29 ⁷ / ₈ "D L-shaped end panel model H10530LEP NOTES: File drawer includes integrated hangrails for letter- or legal-sized folders. Not for use under shells, per "Inside Dimensions" listings. ! Not designed to be used freestanding. Unfinished top and back.	H105064	104	10.5	\$743	\$773
 Not available in two-tone laminate	File/File Pedestal (with core removable lock) — floor-standing 15 ⁵ / ₈ "W x 22 ³ / ₄ "D x 28"H — for use under 24"D, 30"D and 36"D desk, credenza and return shells or worksurface supported by 23 ⁷ / ₈ "D L-shaped end panel(s) NOTES: File drawers include integrated hangrails for letter- or legal-sized folders. Not for use under 20"D shells. ! Not designed to be used freestanding. Unfinished top and back.	H10504	85	8.2	\$686	\$711
 Not available in two-tone laminate	File/File Pedestal (with core removable lock) — floor-standing 15 ⁵ / ₈ "W x 18 ³ / ₄ "D x 28"H — for use under 20"D, 24"D, 30"D and 36"D desk, credenza and return shells NOTES: File drawers include integrated hangrails for letter- or legal-sized folders. ! Not designed to be used freestanding. Unfinished top and back.	H105014	72	7.3	\$647	\$667
 Not available in two-tone laminate	Access Strip (Filler) 1 ¹ / ₈ "W x 20 ¹ / ₂ "D x 28"H NOTES: For use under 24"D, 30"D and 36"D desk, credenza or return shells when B/B/F, F/F, and or narrow B/B/F pedestals are configured side-by-side. Not required when pedestals are used in conjunction with lateral file pedestals, multi file pedestals or cabinet pedestal. Not sized for use with 20"D modular shells. NOTE: See pages 244-248 for desk, credenza and return shells.	H10524	21	0.9	\$176	\$186

NOTES:

- Pedestals can be reconfigured quickly and easily when user preferences or space needs change.
- Locking units equipped with interchangeable core removable locks.
- Pedestal models ship assembled unless designated .
- Mobile pedestals shown on page 276, work well in a variety of configurations.
- Narrow Pedestal features a compact design that is ideal for use in U- and L-shaped layouts for smaller spaces such as a 5' x 8' U-shaped workstation or a 5' x 5' L-shaped workstation.
- 10500 Series™ modular pedestals are for use with desk, credenza and return shells (see pages 244-248), as well as L-shaped end panels (page 250).
- ! Keyed alike cores must be ordered separately — see model HF23B on page 853 — makes re-keying quick and easy.
- ! Access strip (filler) required when box/box file, file/file, and or narrow box/box/file pedestals are configured side-by-side to allow access for opening the drawers.
- ! Modular pedestals can be specified as one color only; not available in two-tone laminate combination or in a pattern laminate.

HOW TO SPECIFY

Select Model Number H 1 0 5 0 4 . N	Select Laminate Chassis Color See pages 236-237
---	---

10500 SERIES™

Laminate Modular Components

GSA SIN 33721



Icon Legend on page 19

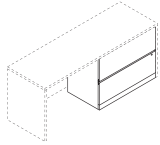

Not available in two-tone laminate

DESCRIPTION	MODEL	SHIP WEIGHT	CUBE	LIST PRICE BY LAMINATE GRADE	
				L1	L2
Lateral File Pedestal (with core removable lock) — Floor-standing 36"W x 20"D x 28"H — For use under 24"D, 30"D and 36"D desk, credenza and return shells NOTES: Drawers include integrated hangrails for letter- or legal-sized folders. Mechanical interlock inhibits extension of more than one drawer at a time. Not for use under 20"D shells. ! Not designed to be used freestanding. Unfinished top and back.	H10503	127	15.6	\$1042	\$1082

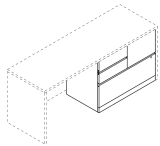

Not available in two-tone laminate

Multi File Pedestal (with core removable lock) — Floor-standing 36"W x 20"D x 28"H — For use under 24"D, 30"D and 36"D desk, credenza and return shells NOTES: Versatile four drawer unit features a lateral file, vertical file, and two box drawers. Box drawers do not lock. File drawers include integrated hangrails for letter- or legal-sized folders. Mechanical interlock in lateral drawer inhibits extension of more than one drawer at a time. Not for use under 20"D shells. ! Not designed to be used freestanding. Unfinished top and back.	H10505	155	15.6	\$1249	\$1289
--	---------------	-----	------	---------------	---------------

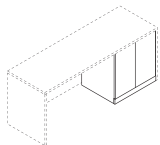

Not available in two-tone laminate

Cabinet Pedestal — Floor-standing 26"W x 21¼"D x 28"H — For use under 24"D, 30"D and 36"D desk, credenza and return shells NOTES: One adjustable shelf at 2½" increments. Doors are non-locking. Not for use under 20"D shells. ! Not designed to be used freestanding. Unfinished top and back.	H10508	78	12.2	\$777	\$817
--	---------------	----	------	--------------	--------------

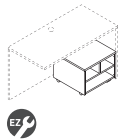

Mobile Printer/Fax Cart 20"W x 19¼"D x 14½"H — For use under 24"D, 30"D and 36"D desk, credenza and return shells NOTES: Holds laser printers, inkjet printers or fax machines. Ideal for limited space. Low profile cart stores conveniently and easily under desks and workstations. Interior compartment shelving is Black. Four casters. Specify laminate top and chassis color. Not for use under 20"D shells. SPECIFYING EXAMPLE: H105679.NN	H105679	52	2.9	\$420	\$440
---	----------------	----	-----	--------------	--------------

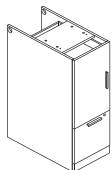

Not available in two-tone laminate

Box/Shelf/File Pedestal 15½"W x 28¾"D x 41"H — For 30"D worksurfaces 15½"W x 22¾"D x 41"H — For 24"D or 30"D worksurfaces NOTES: For 42"H standing-height desks. Designed to be used under a component worksurface supported on the pedestal end(s) by 41"H L-shaped end panel(s). For single pedestal workstations, the non-pedestal end can be supported by a 41"H L-shaped end panel, H-leg, or O-leg. Adjustable hex glides allow floor-standing units to be easily leveled without lifting to compensate for uneven floors; glides have ¼" adjustable range. Cabinet includes one box (supply) drawer and two shelves (one fixed, one adjustable); shelf adjusts in 1¼" increments with a range of 5". Not to be used freestanding, top and back are not enclosed. Pedestal depth is less than the depth of the respective component top to accommodate L-shaped end panel. File drawer includes integrated hangrails. Standard with linear handles in black finish.	H105077	104	14.7	\$1434	\$1489
	H105076	89	11.9	\$1384	\$1434

NOTES:

- Pedestals can be reconfigured quickly and easily when user preferences or space needs change.
- File drawers accept hanging folders in letter or legal size.
- Mobile pedestals shown on page 276, work well in a variety of configurations.
- Locking units equipped with interchangeable core removable locks.
- Pedestal models ship assembled unless designated
- See pages 244-248 for desk, credenza and return shells.

! Keyed alike cores must be ordered separately — see model HF23B on page 853 — makes re-keying quick and easy.

! Access strip (filler) required when box/box file, file/file, and/or narrow box/box/file pedestals are configured side-by-side to allow access for opening the drawers.

HOW TO SPECIFY

Select Model Number H 1 0 5 0 3 . N	Select Laminate Chassis Color See pages 236-237
---	---



10500 SERIES™

Laminate Wood Desks — Full Pedestals

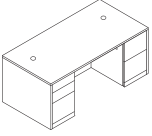
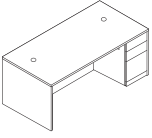
	DESCRIPTION	FULL WIDTH OVERHANG	MODEL	SHIP WEIGHT	CUBE	LIST PRICE BY LAMINATE GRADE		
						L1	L2	
	Double Pedestal Desk							
	72"W x 36"D x 29½"H, Bow Top, 3/2	10½"	H105899	315	50.9	\$1867	\$1947	
	72"W x 36"D x 29½"H, Rectangle Top, 3/2	10½"	H105890	340	50.9	\$1702	\$1777	
	66"W x 30"D x 29½"H, Rectangle Top, 3/2	4½"	H105891	290	39.4	\$1586	\$1651	
	60"W x 30"D x 29½"H, Rectangle Top, 3/2	4½"	H105892	278	35.9	\$1491	\$1551	
	NOTES: All drawers lock. Two cord grommets in top for routing and hiding wires and cables. Bow top models measure 36"D at crest and 30"D along the end panels. See page 282 for optional center drawers.							
	Single Pedestal Desk							
	72"W x 36"D x 29½"H, Bow Top, Right	10½"	H105893R	292	50.9	\$1530	\$1600	
	72"W x 36"D x 29½"H, Rectangle Top, Right	10½"	H105895R	278	50.9	\$1361	\$1431	
	66"W x 30"D x 29½"H, Rectangle Top, Right	4½"	H105897R	226	39.4	\$1229	\$1284	
	72"W x 36"D x 29½"H, Bow Top, Left	10½"	H105894L	292	50.9	\$1530	\$1600	
	72"W x 36"D x 29½"H, Rectangle Top, Left	10½"	H105896L	278	50.9	\$1361	\$1431	
	66"W x 30"D x 29½"H, Rectangle Top, Left	4½"	H105898L	226	39.4	\$1229	\$1284	
		NOTES: Box/box/file drawers. Drawers lock. Two cord grommets in top for routing and hiding wires and cables. Bow top models measure 36"D at crest and 30"D along the end panels. See page 282 for optional center drawers.						

NOTES:

- Factory-configured desks, credenzas and returns ship fully assembled for ease and speed of installation.
- Full-to-floor pedestals maximize storage space.
- Smooth, flat edges provide a clean look.
- Tops are easy-care, scratch-, spill- and stain-resistant laminate over 1⅞" solid core high-performance particleboard.
- 3" round cord management grommets, for routing and hiding wires and cables, are located in the tops of desks, returns, bridges, and corner units. Grommet cutout accepts optional Power Hub (model HGRMTAC) or Power/USB Hub (model HGRMTUSB2) — see page 287.
- For work-in-process paper management tools, see pages 282-283.
- Drawers operate on full extension, ball-bearing suspensions to ensure smooth, quiet, long-lasting operation.
- File drawer design includes integrated hangrails for side-to-side letter or legal filing; and front-to-back for letter filing.
- For field installable decorative handle options, see page 285.
- All drawers are five-sided construction for added strength and easy alignment or replacement of drawer fronts.
- Center drawers conveniently store writing instruments, paper and other miscellaneous items. Includes pencil tray. See page 288.

HOW TO SPECIFY

Select Model Number

H 1 0 5 8 9 9 .

Select Laminate Top and Chassis Color

See pages 236-237

N N

10500 SERIES™

Laminate Wood Desks — Full Pedestals

GSA SIN 33721



Icon Legend on page 19

	DESCRIPTION	FULL WIDTH OVERHANG	MODEL	SHIP WEIGHT	CUBE	LIST PRICE BY LAMINATE GRADE	
						L1	L2
	Return, file/file						
	48"W x 24"D x 29½"H, Right		H105905R	167	24.2	\$962	\$1002
	42"W x 24"D x 29½"H, Right		H105907R	147	21.4	\$941	\$981
	48"W x 24"D x 29½"H, Left		H105906L	167	24.2	\$962	\$1002
	42"W x 24"D x 29½"H, Left		H105908L	147	21.4	\$941	\$981
	NOTES: Return is for use with single pedestal desks, desk shells, peninsulas or corner units. One worksurface grommet and one cord pass-through grommet in top center of modesty panel to reach wall electrical outlets. Drawers lock. Not to be used freestanding. Will not attach to Corner Units manufactured prior to 5/24/99. See pages 269-270 for optional Stack-on Storage.						
	Credenza with Doors						
	72"W x 24"D x 29½"H	3½"	H105909	323	34.8	\$1762	\$1827
	NOTES: All drawers lock. Doors are non-locking. Includes a fixed shelf located at the bottom of the center storage area. No intermittent shelf. See pages 269-270 for optional Stack-on Storage.						
	Credenza with Kneespace, file/file						
	72"W x 24"D x 29½"H	3½"	H105900	274	34.8	\$1493	\$1553
	66"W x 24"D x 29½"H	3½"	H105901	262	32.0	\$1478	\$1538
	60"W x 24"D x 29½"H	3½"	H105902	248	29.2	\$1423	\$1478
	NOTES: All drawers lock. One cord pass-through grommet in top center of modesty panel to reach wall electrical outlets. Not designed for use with 22¾"D modular or mobile pedestals. Modesty/back panel is inset 3½". See pages 269-270 for optional Stack-on Storage.						
	Single Pedestal Credenza, file/file						
	72"W x 24"D x 29½"H, Right (shown)	3½"	H105903R	226	34.8	\$1210	\$1265
	72"W x 24"D x 29½"H, Left	3½"	H105904L	226	34.8	\$1210	\$1265
	NOTES: Drawers lock. One cord pass-through grommet in top center of modesty panel to reach wall electrical outlets. Not designed for use with 22¾"D modular or mobile pedestals. Modesty/back panel is inset 3½". See pages 269-270 for optional Stack-on Storage.						
	Low Credenza						
	72"W x 20"D x 21½"H, Drawers Right, Bookcase Left		H105975R	219	23.5	\$1324	\$1384
	72"W x 20"D x 21½"H, Drawers Left, Bookcase Right		H105976L	219	23.5	\$1324	\$1384
	60"W x 20"D x 21½"H, Drawers Right, Bookcase Left		H105973R	187	19.7	\$1219	\$1274
	60"W x 20"D x 21½"H, Drawers Left, Bookcase Right		H105974L	187	19.7	\$1219	\$1274
	NOTES: Combines with overlapping, 29½"H worksurfaces to create a multi-level workstation for a modern aesthetic. For use in open plan spaces or private offices. Two locking drawers (1 box and 1 file) and open shelving. File drawers include integrated hangrails for letter- or legal-sized folders. Bookcase has one adjustable shelf; adjusts in 1¼" increments with a range of 6". Overlapping surfaces can be supported by a 28½"H H-leg or O-leg, or 7"H O-leg, or by 7"H laminate end panel. On 60"W models, grain on back panel runs vertical for all woodgrain laminates. On 72", grain on back panel runs vertical for L1 woodgrains except for Florence and Kingswood Walnuts and horizontal on L2 laminates and Florence and Kingswood Walnuts. Optional seat cushions HLSL2036CH2 for 72"W and HLSL2030CH2 for 60"W.						

NOTES:

- Factory-configured desks, credenzas and returns ship fully assembled for ease and speed of installation.
- Formal, full-length modesty panels.
- Tops are easy-care, scratch-, spill- and stain-resistant laminate over 1½" solid core high-performance particleboard.
- 3" round cord management grommets, for routing and hiding wires and cables, are located in the tops of desks, returns, bridges, and corner units. Grommet cutout accepts optional Power Hub (model HGRMTAC) or Power/USB Hub (model HGRMTUSB2) — see page 287.
- Drawers operate on full extension, ball-bearing suspensions to ensure smooth, quiet, long-lasting operation.
- All drawers are five-sided construction for added strength and easy alignment or replacement of drawer fronts.
- File drawer design includes integrated hangrails for side-to-side letter or legal filing; and front-to-back for letter filing.
- For field installable decorative handle options, see page 285.
- 10500 Series™ 18¾"D modular and mobile pedestals can be positioned under credenza with kneespace and single pedestal credenza models.

① Keyed alike cores must be ordered separately — see model HF23B on page 853 — makes re-keying quick and easy.

HOW TO SPECIFY

Select Model Number	Select Laminate Top and Chassis Color
	See pages 236-237
	Kickplates will match chassis color
H 1 0 5 9 0 5 R .	N N

10500 SERIES™

Laminate Wood Desks — Full Pedestals

OPEN MARKET

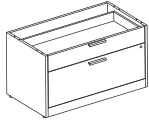

Icon Legend on page 19

**DESCRIPTION****2-Drawer Credenza, No Top**

36"W x 24"D x 19⁷/₈"H
 36"W x 20"D x 19⁷/₈"H
 30"W x 24"D x 19⁷/₈"H
 30"W x 20"D x 19⁷/₈"H

MODEL

H105LC3624BF
H105LC3620BF
H105LC3024BF
H105LC3020BF

SHIP WEIGHT

105.5
 97.9
 92.3
 85.4

CUBE

13.9
 11.7
 11.7
 9.9

L1 LIST

\$525
\$525
\$556
\$505

L2 UPCHARGES

CHASSIS	FRONTS
\$35	\$20
\$30	\$20
\$30	\$15
\$25	\$15

NOTES: Use in conjunction with Modular Credenza tops on page 262B.

🔑 Keyed alike cores must be ordered separately — see model HF23B on page 853 — makes re-keying quick and easy.

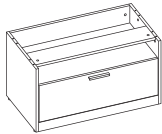
**Open/Lateral Credenza, No Top**

36"W x 24"D x 19⁷/₈"H
 36"W x 20"D x 19⁷/₈"H
 30"W x 24"D x 19⁷/₈"H
 30"W x 20"D x 19⁷/₈"H

H105LC3624SF
H105LC3620SF
H105LC3024SF
H105LC3020SF

117.2
 106.1
 101.7
 91.8

13.9
 11.7
 11.7
 9.9

\$505
\$505
\$490
\$490

CHASSIS	FRONTS
\$35	\$20
\$30	\$20
\$30	\$15
\$25	\$15

NOTES: Use in conjunction with Modular Credenza tops on page 262B. Drawer is non-locking.

**DESCRIPTION****Open HAT Credenza, No Top**

36"W x 24"D x 19⁷/₈"H
 36"W x 20"D x 19⁷/₈"H
 30"W x 24"D x 19⁷/₈"H
 30"W x 20"D x 19⁷/₈"H

MODEL

H105LCHAT3624S
H105LCHAT3620S
H105LCHAT3024S
H105LCHAT3020S

SHIP WEIGHT

82.3
 71.2
 72.2
 62.3

CUBE

13.9
 11.7
 11.7
 9.9

LIST PRICE BY LAMINATE GRADE**L1**

\$240
\$240
\$220
\$220

L2

\$275
\$270
\$250
\$245

NOTES: False back allows HAT base leg to be concealed. Use in conjunction with Modular Credenza tops with HAT cutout on page 262B.

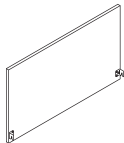
**Back for Open Storage Cabinet**

36"W x 19⁷/₈"H
 30"W x 19⁷/₈"H

H105LCHAT3620B
H105LCHAT3020B

25.0
 25.0

2.1
 1.8

\$220
\$200

\$235
\$215

NOTES: Optional model to conceal HAT base leg when used in open office settings. Use with Open HAT Credenzas, No Top when the back of the unit will be visible in an open plan office.

NOTES:

- Units can be combined to create 60"W, 66"W, and 72"W low credenzas utilizing Modular Credenzas.
- Units have unfinished tops.
- File drawers include integrated hangrails for letter- or legal-sized folders.
- Open Credenzas have one adjustable shelf; adjusts 1¹/₄" increments with a range of 6".
- Overlapping surfaces can be supported by a 28¹/₂"H or 7"H O-leg or by 7"H laminate end panel.

HOW TO SPECIFY

Select Model Number H 1 0 5 L C 3 6 2 0 B F .	Select Chassis Laminate See page 236 Kickplates will match chassis color L F W 1 .	Select Door Front Laminate See page 236 L F W 1 .	Select Pull and Color L Linear P Black L P .	Select Lock Option Only available on 2-Drawer Credenzas L Lock X Omit Lock (deduct \$20) L
---	--	--	--	---

Select Model Number H 1 0 5 L C H A T 3 6 2 0 B .	Select Chassis Laminate See page 236 Kickplates will match chassis color L F W 1
---	--

10500 SERIES™

Laminate Wood Desks — Full Pedestals

OPEN MARKET

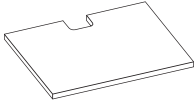
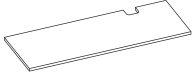
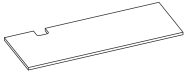
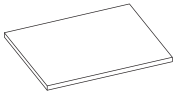

Icon Legend on page 19

	DESCRIPTION	MODEL	SHIP		LIST PRICE BY LAMINATE GRADE	
			WEIGHT	CUBE	L1	L2
	Modular Credenza Tops, Height Adjustable Base					
	30"W x 24"D, Non-handed	H105CTHAT3620	23.5	2.3	\$395	\$410
	30"W x 20"D, Non-handed	H105CTHAT3020	19.6	1.9	\$395	\$410
	72"W x 24"D, Right	H105CTHAT7224R	72.3	5.0	\$802	\$822
	72"W x 20"D, Right	H105CTHAT7220R	72.3	4.2	\$802	\$822
	66"W x 24"D, Right	H105CTHAT6624R	66.3	4.6	\$744	\$764
	66"W x 20"D, Right	H105CTHAT6620R	60.3	3.9	\$744	\$764
	60"W x 24"D, Right	H105CTHAT6024R	60.3	4.2	\$683	\$703
	60"W x 20"D, Right	H105CTHAT6020R	66.3	3.6	\$683	\$703
	36"W x 24"D, Right	H105CTHAT3624R	36.1	2.6	\$495	\$510
	36"W x 20"D, Right	H105CTHAT3620R	36.1	2.3	\$495	\$510
	72"W x 24"D, Left	H105CTHAT7224L	72.3	5.0	\$802	\$822
	72"W x 20"D, Left	H105CTHAT7220L	72.3	4.2	\$802	\$822
	66"W x 24"D, Left	H105CTHAT6624L	66.3	4.6	\$744	\$764
	66"W x 20"D, Left	H105CTHAT6620L	66.3	3.9	\$744	\$764
	60"W x 24"D, Left	H105CTHAT6024L	60.3	4.2	\$683	\$703
	60"W x 20"D, Left	H105CTHAT6020L	60.3	3.6	\$683	\$703
	36"W x 24"D, Left	H105CTHAT3624L	36.1	2.6	\$495	\$510
	36"W x 20"D, Left	H105CTHAT3020L	36.1	2.3	\$495	\$510
	Modular Credenza Tops					
	30"W x 20"D	H105CT3020	19.6	1.9	\$395	\$410
	36"W x 20"D	H105CT3620	36.1	2.3	\$495	\$510
	30"W x 24"D	H105CT3024	23.5	2.3	\$395	\$410
	36"W x 24"D	H105CT3624	36.1	2.6	\$495	\$510

NOTES:

- Easy care, scratch-, spill- and stain-resistant laminate over 1/8" solid core high-performance particleboard.
- Grain direction on all worksurfaces runs horizontal.
- Tops are intended to be used with modular low credenzas on page 262A.
- Tops come with hardware to attach to low credenzas.
- Tops have a right or left notch to accommodate HON's Height Adjustable Base legs.

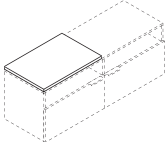
	DESCRIPTION	MODEL	SHIP		LIST PRICE BY FABRIC GRADE						
			WEIGHT	CUBE	1	2	3	4	5	6	
	Fabric Credenza Tops										
	36"W x 24"D x 1"H for 36"W Credenzas	HLAMSEAT3624	12	2.6	\$435	\$473	\$511	\$549	\$587	\$625	
	30"W x 24"D x 1"H for 36"W Credenzas	HLAMSEAT3024	10	2.3	\$405	\$441	\$477	\$513	\$549	\$585	
	36"W x 20"D x 1"H for 72"W Credenzas	HLSL2036CH2	11	2.2	\$402	\$440	\$478	\$517	\$566	\$616	
	36"W x 20"D x 1"H for 60"W Credenzas	HLSL2030CH2	9	1.9	\$372	\$408	\$444	\$480	\$526	\$573	
	NOTES: See pages 22-24 for available fabrics.										
	COM: .75										
	SPECIFYING EXAMPLE: HLAMSEAT3624.APN23										

HOW TO SPECIFY

Select Model Number

H105CTHAT3620.

Select Laminate and Edge Color



See page 236

LFW1FW

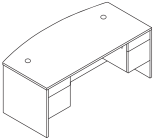
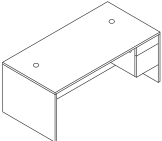
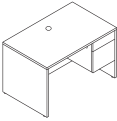
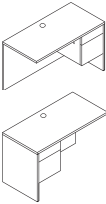

10500 SERIES™

Laminate Wood Desks — 3/4 Pedestals

	DESCRIPTION	FULL WIDTH OVERHANG	MODEL	SHIP WEIGHT	CUBE	LIST PRICE BY LAMINATE GRADE	
						L1	L2
	Double Pedestal Desk						
	72"W x 36"D x 29½"H, Bow Top, 2-2	10½"	H10595	300	52.9	\$1560	\$1640
	72"W x 36"D x 29½"H, Rectangle Top, 2-2	10½"	H10593	320	52.9	\$1391	\$1466
	66"W x 30"D x 29½"H, Rectangle Top, 2-2	4½"	H10571	286	40.9	\$1273	\$1338
	60"W x 30"D x 29½"H, Rectangle Top, 2-2	4½"	H10573	271	37.4	\$1172	\$1232
NOTES: All drawers lock. Two cord grommets in top for routing and hiding wires and cables. Bow top models measure 36"D at crest and 30"D along the end panels. See page 288 for optional center drawers.							
	Single Pedestal Desk						
	72"W x 36"D x 29½"H, Bow Top, Right	10½"	H10587R	238	52.9	\$1347	\$1417
	72"W x 36"D x 29½"H, Rectangle Top, Right	10½"	H10585R	279	52.9	\$1182	\$1247
	66"W x 30"D x 29½"H, Rectangle Top, Right	4½"	H10583R	229	41.0	\$1039	\$1094
	72"W x 36"D x 29½"H, Bow Top, Left	10½"	H10588L	238	52.9	\$1347	\$1417
	72"W x 36"D x 29½"H, Rectangle Top, Left	10½"	H10586L	279	52.9	\$1182	\$1247
66"W x 30"D x 29½"H, Rectangle Top, Left	4½"	H10584L	229	41.0	\$1039	\$1094	
NOTES: Box/file drawers. Drawers lock. Two cord grommets in top for routing and hiding wires and cables. Bow top models measure 36"D at crest and 30"D along the end panels. See page 288 for optional center drawers.							
	Small Office Desk						
	48"W x 30"D x 29½"H, 3/4 Pedestal, Right box/file	4½"	H105885R	168	30.5	\$923	\$963
NOTES: Small footprint makes this desk ideal for limited space. Drawers lock. One cord grommet in top for routing and hiding wires and cables. 3/4 height modesty panel facilitates reaching wall electrical outlets. Optional stack-on storage model H105323 maximizes storage space; see page 269.							
	Return, box/file						
	48"W x 24"D x 29½"H, Right		H10515R	147	25.6	\$837	\$877
	42"W x 24"D x 29½"H, Right		H10511R	138	20.5	\$819	\$859
	48"W x 24"D x 29½"H, Left		H10516L	147	25.6	\$837	\$877
	42"W x 24"D x 29½"H, Left		H10512L	138	20.5	\$819	\$859
NOTES: Return is for use with single pedestal desks, desk shells, peninsulas or corner units. One worksurface grommet and one cord pass-through grommet in top center of modesty panel to reach wall electrical outlets. Drawers lock. See pages 269-270 for optional stack-on storage.							
 Not designed to be used freestanding. Will not attach to Corner Units manufactured prior to 5/24/99.							

NOTES:

- For components that can be shared with 10500 Series™, see pages 265-288.
- Tops and end panels are abrasion- and stain-resistant laminate over durable 1½" solid core high-performance particleboard; resists warping.
- Formal, full height modesty panels.
- 3/4 pedestal design increases budget flexibility.
- 3" round cord management grommets, for routing and hiding wires and cables, are located in the tops of desks, returns, bridges, and corner units. Grommet cutout accepts optional Power Hub (model HGRMTAC) or Power/USB Hub (model HGRMTUSB2) — see page 287.
- All drawers are 5-sided construction, which allows easy drawer alignment or replacement of drawer fronts.
- Drawers operate on full extension, ball-bearing suspensions to ensure smooth, quiet, long-lasting operation.
- File drawer design includes integrated handrails for side-to-side letter or legal filing; and front-to-back for letter filing.
- For field installable decorative handle options, see page 285.
- Desk, credenza, and return models ship assembled.
- See stack-on storage and stack-on PC organizer options on pages 268-270.
- Use with Above Worksurface Privacy Screens. See page 257.
- Mobile table quickly provides additional worksurface space, see page 266.

HOW TO SPECIFY

Select Model Number <input type="text" value="H10595"/>	Select Laminate Top and Chassis Color See pages 236-237 <input type="text" value="NN"/>
---	--

10500 SERIES™

Laminate Wood Desks — 3/4 Pedestals

GSA SIN 33721

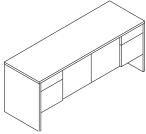
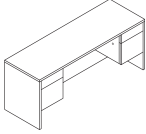
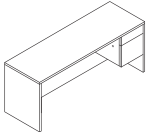

Icon Legend on page 19

	DESCRIPTION	FULL WIDTH OVERHANG	MODEL	SHIP WEIGHT	CUBE	LIST PRICE BY LAMINATE GRADE	
						L1	L2
	Credenza with Doors 72"W x 24"D x 29½"H NOTES: All drawers lock. Doors are non-locking. Includes a fixed shelf located at the bottom of the center storage area. No intermittent shelf. See pages 269-270 for optional stack-on storage.	3½"	H10544	278	36.0	\$1512	\$1577
	Credenza with Kneespace — box/file 72"W x 24"D x 29½"H 66"W x 24"D x 29½"H 60"W x 24"D x 29½"H NOTES: All drawers lock. One cord pass-through grommet in top center of modesty panel to reach wall electrical outlets. ⓘ Not designed to be used with 22¾"D modular or mobile pedestals. Modesty/back panel is inset 3½".	3½" 3½" 3½"	H10543 H10566 H10565	243 234 229	36.3 33.4 28.8	\$1240 \$1228 \$1172	\$1300 \$1288 \$1227
	Single Pedestal Credenza — box/file 72"W x 24"D x 29½"H, Right (shown) 72"W x 24"D x 29½"H, Left NOTES: Drawers lock. One cord pass-through grommet in top center of modesty panel to reach wall electrical outlets. See page 269 for optional stack-on storage. ⓘ Not designed to be used with 22¾"D modular or mobile pedestals. Modesty/back panel is inset 3½".	3½" 3½"	H10545R H10546L	212 212	36.0 36.0	\$1023 \$1023	\$1078 \$1078

NOTES:

- For components that can be shared with 10500 Series™, see pages 265-288.
- Tops and end panels are abrasion- and stain-resistant laminate over durable 1/8" solid core high-performance particleboard; resists warping.
- Formal, full height modesty panels.
- 3/4 pedestal design increases budget flexibility.
- 3" round cord management grommets, for routing and hiding wires and cables, are located in the tops of desks, returns, bridges, and corner units. Accepts optional Power Hub Grommet model HGRMTAC — page 287.
- All drawers are 5-sided construction, which allows easy drawer alignment or replacement of drawer fronts.
- Drawers operate on full extension, ball-bearing suspensions to ensure smooth, quiet, long-lasting operation.
- File drawer design includes integrated hangrails for side-to-side letter or legal filing; and front-to-back for letter filing.
- For field installable decorative handle options, see page 285.
- Desk, credenza, and return models ship assembled.
- See stack-on storage and stack-on PC organizer options on pages 268-270.
- Use with Above Worksurface Privacy Screens. See page 257.
- Mobile table quickly provides additional worksurface space, see page 266.

HOW TO SPECIFYSelect
Model Number

H 1 0 5 4 4 .

Select
Laminate Top and Chassis Color

See pages 236-237

N N

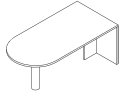

DESCRIPTION

Peninsula w/End Panel

72"W x 36"D x 29½"H
 72"W x 30"D x 29½"H
 66"W x 30"D x 29½"H
 60"W x 30"D x 29½"H

MODEL	SHIP WEIGHT	CUBE	LIST PRICE BY LAMINATE GRADE	
			L1	L2
H10521	150	15.1	\$877	\$922
H105209	130	12.8	\$819	\$864
H10522	125	11.8	\$808	\$853
H10523	100	10.7	\$757	\$802

NOTES: Use for "U" or "L" configuration. 60"W size ideal for smaller spaces. Cord routing notch in brace panel. Accepts field installable modesty panel model H10528. Accepts center drawer model H1526 and H1522. Model H1522 can be used in conjunction with the laminate modesty panel model H10528. Round support column is black.

ⓘ Not designed to be used freestanding.

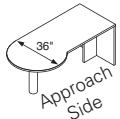

72"W x 30/36"D x 29½"H, P-shaped Right (shown)
 72"W x 36/30"D x 29½"H, P-shaped Left

H10525R	142	13.4	\$1026	\$1071
H10526L	142	13.4	\$1026	\$1071

NOTES: Use for "U" or "L" configuration. Cord routing notch in brace panel. Accept field installable modesty panel model H10528 (see page 266). See page 288 for optional center drawers. Round support column is black.

ⓘ Not designed to be used freestanding.

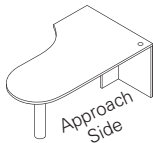

Right-hand model H105201R shown

Jetty Peninsula w/End Panel

72"W x 30/42"D x 29½"H, Right (shown)
 72"W x 42/30"D x 29½"H, Left

H105201R	156	16.9	\$1138	\$1193
H105202L	156	16.9	\$1138	\$1193

NOTES: For use in "U" or "L" configuration. Designed and sized to efficiently serve as both a computing and conferencing space. One cord management grommet in the top; cord routing notch in brace panel. Round support column is black.

ⓘ Not designed to be used freestanding. Jetty units manufactured on or after 10/24/2005 accept field installable modesty panel H10528 (see page 266).

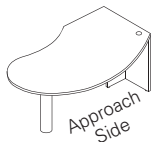
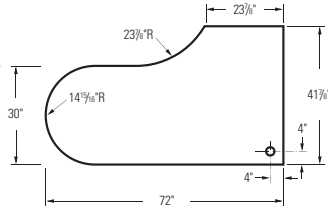

Right-hand model H105203R shown

Boomerang Peninsula w/End Panel

72"W x 30/42"D x 29½"H, Right (shown)
 72"W x 42/30"D x 29½"H, Left

H105203R	152	16.9	\$1138	\$1193
H105204L	152	16.9	\$1138	\$1193

NOTES: For use in "U" or "L" configuration. Designed and sized to efficiently serve as both a computing and conferencing space. One cord management grommet in the top; cord routing notch in brace panel. Round support column is black.

ⓘ Not designed to be used freestanding. Accept field installable modesty panel H10528 (see page 266).

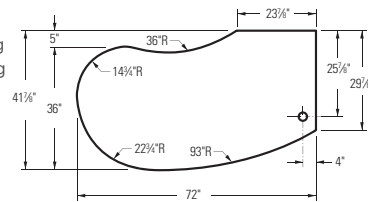

NOTES:

- Shared components shown on this page can be used with modular components shown on pages 244-260, full pedestal models shown on pages 261-262 and 3/4 pedestal models shown on pages 263-264.
- Jetty, boomerang and rudder peninsulas are designed and sized to efficiently serve as both a computing and conferencing space.
- Peninsulas ship complete with end panel and black 4½" diameter support column. For a silver support column option, please see model HPC191X on page 251 (ordered separately).
- Mobile pedestals shown on page 276 work well in a variety of configurations.
- Adjustable hex leveling glides allow floor-standing furniture to be easily leveled without lifting the unit; glides have ¾" adjustable range.
- See pages 265-288 for shared components.

HOW TO SPECIFY

<p>Select Model Number</p> <p>H 1 0 5 2 5 R .</p>	<p>Select Laminate Top and Chassis Color</p> <p>See pages 236-237</p> <p>N N</p>
---	--

10500 SERIES™

Shared Components & Accessories

GSA SIN 33721



Icon Legend on page 19

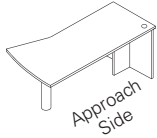

Model H105205R shown



DESCRIPTION	MODEL	SHIP WEIGHT	CUBE	LIST PRICE BY LAMINATE GRADE	
				L1	L2
Rudder Peninsula with End Panel 72"W x 30/38"D x 29½"H, Right (shown)	H105205R	142	15.8	\$1113	\$1158
72"W x 30/38"D x 29½"H, Left	H105206L	142	15.8	\$1113	\$1158

NOTES: Use for "U" or "L" configuration. One cord management grommet in top; cord routing notch in brace panel. 30"D along end panel. Round support column is black.

ⓘ Not designed to be used freestanding.



Field Installable Laminate Modesty Panel for Peninsulas

50¼"W x ¾"Thick x 18"H

MODEL	SHIP WEIGHT	CUBE	L1	L2
H10528	25	1.3	\$188	\$198

NOTES: Center drawer model H1522 can be used in conjunction with the laminate modesty panel. Laminate modesty panel has a cord pass-through notch in top corner.

ⓘ Not compatible with Peninsula models H10525R, H10526L, H10621, H10721, H10722 manufactured prior to 12/1/2001 or jetty models H105201R and H105202L manufactured prior to 10/24/2005.

SPECIFYING EXAMPLE: H10528.N



Field Installable Modesty Panel, Frosted with Silver Frame

50¼"W x ¾"Thick x 18"H — for use on 72"W peninsulas

MODEL	SHIP WEIGHT	CUBE	LIST PRICE
HPC180G	33 Ⓞ	1.5	\$694

ⓘ Center drawers not designed to be used with the frosted/silver modesty panel. Cord pass-through notch is not available on the Frosted/Silver model HPC180G. Notch is on laminate model H10528 only.

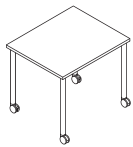

DESCRIPTION	MODEL	SHIP WEIGHT	CUBE	LIST PRICE BY LAMINATE GRADE	
				L1	L2
Mobile Table 36"W x 30"D x 29½"H	H105T3036C	56	11.0	\$640	\$655
30"W x 24"D x 29½"H	H105T2430C	42	7.1	\$573	\$585

NOTES: Rectangle-shaped top. Versatile design quickly provides additional worksurface space; ideal for work-in-process, meetings, and special projects. Choose from two sizes to align with either 30" and 36"D or 24" and 30"D worksurfaces. Roll easily on 4 casters; 2 locking, 2 non-locking. Top and legs ship together in one carton. Simple assembly. Easy-care, scratch-, spill- and stain-resistant laminate over 1½" solid core high-performance particleboard.

Specify: Model.Worksurface Laminate.Edge Color.Base Paint Color

SPECIFYING EXAMPLE: H105T3036C.N.N.S

NOTES:

Panels

- Shared components shown on this page can be used with modular components shown on pages 244-260, full pedestal models shown on pages 261-262 and 3/4 pedestal models shown on pages 263-264.
- Jetty, boomerang and rudder peninsulas are designed and sized to efficiently serve as both a computing and conferencing space.
- Peninsulas ship complete with end panel and black 4½" diameter support column. For a silver support column option, please see model HPC191X on page 251 (ordered separately).
- Mobile pedestals shown on page 276 work well in a variety of configurations.
- Adjustable hex leveling glides allow floor-standing furniture to be easily leveled without lifting the unit; glides have ¾" adjustable range.
- See pages 265-288 for shared components.

HOW TO SPECIFY

Select Model Number <input type="text" value="H105205R"/>	Select Laminate Top and Chassis Color See pages 236-237 <input type="text" value="NN"/>		
Select Model Number <input type="text" value="H105T3036C"/>	Select Worksurface Laminate See pages 236-237 <input type="text" value="N"/>	Select Edge Color See pages 236-237 <input type="text" value="N"/>	Select Base Paint Color See page 236 <input type="text" value="S"/>



10500 SERIES™

Shared Components & Accessories

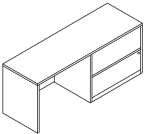
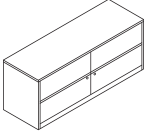
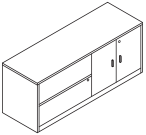
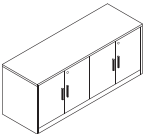
	DESCRIPTION	MODEL	SHIP WEIGHT	CUBE	LIST PRICE BY LAMINATE GRADE	
					L1	L2
	Bridge (Single Ped. Desk, Desk Shell, or Peninsula, to Corner Unit, Single Ped. Credenza or Credenza Shell) 47"W x 24"D x 29½"H (Clear inside depth = 21⅞"D)	H10570	76	2.8	\$364	\$394
	42"W x 24"D x 29½"H (Clear inside depth = 21⅞"D)	H10560	72	2.6	\$350	\$380
	Bridge (for use with Corner or Extended Corner Units or Jetty or Boomerang Peninsulas) 36"W x 24"D x 29½"H (Clear inside depth = 21⅞"D)	H105599	61	2.6	\$350	\$380
	Bridge (for use with Corner or Extended Corner Units) 30"W x 24"D x 29½"H (Clear inside depth = 21⅞"D)	H105598	50	1.9	\$350	\$380
	NOTES: One cord grommet in top; one pass-through grommet in top center of modesty panel. Grommet can be replaced with optional Power Hub or Power/USB Hub for easy plug-and-play (see page 287). Kneespace of desk limited to 24¾"W if bridge is used with 66"W single pedestal desk.					
	ⓘ Not designed to attach to corner units manufactured prior to 5/24/99.					
	Bridge (Single Ped. Desk, Desk Shell, or Peninsula to Single Ped. Credenza or Credenza Shell) 47"W x 20"D x 29½"H (Clear inside depth = 17⅞"D)	H105699	61	2.8	\$350	\$380
	42"W x 20"D x 29½"H (Clear inside depth = 17⅞"D)	H105698	54	2.6	\$325	\$355
	NOTES: One cord grommet in top; one pass-through grommet in top center of modesty panel.					
	ⓘ Models H105699 and H105698 cannot be connected to corner or extended corner units or to the jetty or boomerang peninsulas, due to the 20"D "hook-up".					
	Credenza with 36" Lateral (with core removable lock) 72"W x 24"D x 29½"H, Right (shown)	H10547R	248	35.6	\$1400	\$1460
	72"W x 24"D x 29½"H, Left	H10548L	248	35.6	\$1400	\$1460
	NOTES: One cord pass-through grommet in top center of modesty panel. Includes hangrails. Mechanical interlock inhibits the extension of more than one drawer at a time. Accepts optional stack-on storage model H10534 (page 269) or PC Organizer model H105388 (page 268).					
	ⓘ Not designed to be used with 10500 Series™ 22¾"D modular or mobile pedestals. Modesty/back panel is inset 3½".					
	Credenza with two Lateral Files (4 locking drawers. Each core removable lock secures 2 drawers) 72"W x 24"D x 29½"H	H105491	314	34.7	\$2021	\$2096
	NOTES: Includes hangrails; mechanical interlock inhibits the extension of more than one drawer at a time. If side-by-side drawers are opened or closed simultaneously, one drawer may interfere with the other. Two locks (keyed alike). Accepts optional stack-on storage model H10534 (page 269) or PC Organizer model H105388 (page 268).					
	Credenza with Lateral File, left and Storage Cabinet, right (with core removable locks) 72"W x 24"D x 29½"H	H105492	307	34.7	\$1768	\$1843
	NOTES: Includes hangrails; mechanical interlock inhibits the extension of more than one drawer at a time. Storage cabinet locks and includes one adjustable interior shelf. Shelf adjusts in 1¼" increments with a total range of 5"H. Two locks (keyed alike). Accepts optional stack-on storage model H10534 (page 269) or PC Organizer model H105388 (page 268).					
	Credenza with Two Storage Cabinets (with core removable locks) 72"W x 24"D x 29½"H	H105493	302	34.8	\$1648	\$1723
	NOTES: Each storage cabinet has one interior shelf which adjusts in 1¼" increments over a total range of 5". Each cabinet locks independently; locks are keyed alike. Accepts optional stack-on storage model H10534 (page 269) or PC Organizer model H105388 (page 268).					

NOTES:

- Shared components shown on this page can be used with modular components shown on pages 244-260, full pedestal models shown on pages 261-262, and 3/4 pedestal models shown on pages 263-264.
- Locking units equipped with interchangeable core removable locks.
- File drawers accept hanging folders in letter or legal size.
- Mobile pedestals shown on page 276 work well in a variety of configurations.
- Work Organizer models accept 3-ring binders and organizer model HTC0L52. See page 280.
- See stack-on storage and organizer options for desks, credenzas and returns, pages 268-270.
- See pages 265-288 for shared components.

ⓘ Keyed alike cores must be ordered separately — see model HF23B on page 853.

HOW TO SPECIFY

Select Model Number <input type="text" value="H10570"/>	Select Laminate Top and Chassis Color See pages 236-237 <input type="text" value="NN"/>
---	--

10500 SERIES™

Shared Components & Accessories

GSA SIN 33721

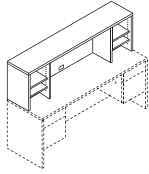

Icon Legend on page 19

**DESCRIPTION****Stack-on PC Organizer**72"W x 14⁵/₈"D x 22"H (for 72"W desks, credenzas and shells)60"W x 14⁵/₈"D x 22"H (for 60"W desks, credenzas and shells)

MODEL	SHIP WEIGHT	CUBE	LIST PRICE BY LAMINATE GRADE	
			L1	L2
H105388	124	5.0	\$814	\$849
H105386	111	4.3	\$755	\$790

NOTES: Features two adjustable paper management shelves both left and right; shelves are adjustable in 1/4" increments. Shelves keep papers, files, and books within easy reach from a seated position. One cord management grommet located in the bottom center of the back panel. Design allows 20³/₄" of vertical clearance for computer equipment.

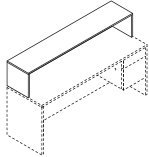
**Work Organizer (shell only)**72"W x 14⁵/₈"D x 14¹/₈"H (for 72"W unit)66"W x 14⁵/₈"D x 14¹/₈"H (for 66"W unit)

H10537	73	2.9	\$421	\$451
H10536	68	2.7	\$400	\$430

NOTES: Space below counter accepts 3-ring binders and organizer model HTC0L52. See page 280.

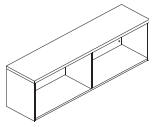
**Open Shared Storage**60"W x 14⁵/₈"D x 16⁷/₈"H48"W x 14⁵/₈"D x 16⁷/₈"H

H105368	81	14.2	\$769	\$799
H105367	68	11.5	\$749	\$774

NOTES: Attaches to laminate end panels with horizontally mounted interlocking brackets. Mounting applications include: 60"W — two 30"D desks/desk shells, 60"W — two 48"W (minimum) x 30"D rectangle worksurfaces supported by 28¹/₂"H L-shaped end panels, 48"W — two 24"D credenzas/credenza shells, 48"W — two 24"D returns/return shells, 48"W — two 60"W (minimum) x 24"D rectangle worksurfaces supported by 28¹/₂"H L-shaped end panels. Can also be positioned on the worksurface; double-sided tape included. Grain direction is vertical on top, back, end panels, and shelf. Ships fully assembled. Not designed for attachment to a worksurface supported by H-legs or O-legs. Inside dimensions for 60"W: each compartment 28³/₄"W x 13¹/₂"D x 15¹/₂"H. Inside dimensions for 48"W: each compartment 22³/₄"W x 13¹/₂"D x 15¹/₂"H.

NOTES:

- Shared components shown on this page can be used with modular components shown on pages 244-260, full pedestal models shown on pages 261-262, and 3/4 pedestal models shown on pages 263-264.
- Mobile pedestals shown on page 276 work well in a variety of configurations.
- See stack-on storage and organizer options for desks, credenzas and returns, pages 268-270.
- See pages 265-288 for shared components.
- Locking units equipped with interchangeable core removable locks.

ⓘ Keyed alike cores must be ordered separately — see model HF23B on page 853.

HOW TO SPECIFY

Select Model Number H 1 0 5 3 8 8 .	Select Laminate Top and Chassis Color See pages 236-237 N N
---	--

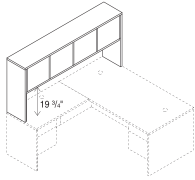
**DESCRIPTION**

Stack-on Storage for an "L" Workstation
78"W x 14⁵/₈"D x 37¹/₈"H

MODEL	SHIP WEIGHT	CUBE	LIST PRICE BY LAMINATE GRADE	
			L1	L2

H105327	198	17.6	\$1144	\$1209
----------------	-----	------	---------------	---------------

Stack-on Storage for an "L" Workstation, Locking 
78"W x 14⁵/₈"D x 37¹/₈"H

H105327K	198	17.6	\$1224	\$1289
-----------------	-----	------	---------------	---------------

NOTES: Spans the total depth dimension of configurations comprised of: 48"W return or return shell attached to a 30"D single pedestal desk, desk shell or peninsula (78"D); 42"W return or return shell attached to a 36"D single pedestal desk or desk shell with a rectangle top, or to a peninsula (78"D). 42"W return or return shell attached to a 36" corner unit (78"D); or 42"W curved return attached to 36" curved corner unit (78"D). Use back enclosure model H105857 and tackboard model H90057. Use task light models HH870960 or HH870960CH (see page 545). For vertical paper manager model HLVP1, see page 282.

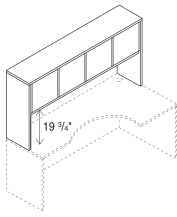
**Stack-on Storage**

72"W x 14⁵/₈"D x 37¹/₈"H, 4 doors
(Use Task Light HH870960, see page 274)
66"W x 14⁵/₈"D x 37¹/₈"H, 4 doors
(Use Task Light HH870960, see page 274)
60"W x 14⁵/₈"D x 37¹/₈"H, 4 doors
(Use Task Light HH870960, see page 274)
48"W x 14⁵/₈"D x 37¹/₈"H, 3 doors
(Use Task Light HH870942, see page 274)
42"W x 14⁵/₈"D x 37¹/₈"H, 2 doors
(Use Task Light HH870942, see page 274)
36"W x 14⁵/₈"D x 37¹/₈"H, 2 doors
(Use Task Light HH870930, see page 274)

H10534	185	17.1	\$1011	\$1051
H10533	175	15.3	\$983	\$1038
H105324	164	14.0	\$943	\$998
H105323	141	11.3	\$850	\$895
H105322	135	4.0	\$696	\$741
H105321	102	3.5	\$657	\$687

Stack-on Storage, Locking 

72"W x 14⁵/₈"D x 37¹/₈"H, 4 doors
(Use Task Light HH870960, see page 274)
66"W x 14⁵/₈"D x 37¹/₈"H, 4 doors
(Use Task Light HH870960, see page 274)
60"W x 14⁵/₈"D x 37¹/₈"H, 4 doors
(Use Task Light HH870960, see page 274)
48"W x 14⁵/₈"D x 37¹/₈"H, 3 doors
(Use Task Light HH870942, see page 274)
42"W x 14⁵/₈"D x 37¹/₈"H, 2 doors
(Use Task Light HH870942, see page 274)
36"W x 14⁵/₈"D x 37¹/₈"H, 2 doors
(Use Task Light HH870930, see page 274)

H10534K	185	17.1	\$1091	\$1146
H10533K	175	15.3	\$1063	\$1118
H105324K	164	14.0	\$1023	\$1078
H105323K	141	11.3	\$890	\$935
H105322K	135	4.0	\$736	\$781
H105321K	102	3.5	\$697	\$737

NOTES: For use on respective desk, credenza or return widths. Model H10534 can be used for "L" configuration comprised of 30"D desk, desk shell or peninsula and 42"W return or return shell; or a 36"D desk, desk shell, peninsula, or corner unit and 36"W return shell. Model **H105323K** has one lock which secures two of the three doors. See vertical paper manager model HLVP1 on page 282.

NOTES:

- Shared components shown on this page can be used with modular components shown on pages 244-260, full pedestal models shown on pages 261-262, and 3/4 pedestal models shown on pages 263-264.
- Rich woodgrain laminate and frosted doors with silver frames adds a contemporary mixed materials option to the 10500 Series™.
- Stack-on storage models are equipped with self-closing, adjustable hinged doors and valance to hide task light.
- See page 272 for stack-on storage back enclosures and tackboards, and page 274 for task lights.
- For work-in-process paper management tools, see pages 282-283.
- See pages 265-288 for shared components.
- **Removable lock core kit for locking stack-on storage is model HF27B. See page 853.**

HOW TO SPECIFY

Select Model Number

H	1	0	5	3	2	7
---	---	---	---	---	---	---

Select Laminate Top and Chassis Color

See pages 236-237

N	N
---	---

10500 SERIES™

Shared Components & Accessories

GSA SIN 33721

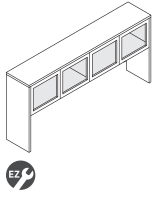

Icon Legend on page 19

**DESCRIPTION****Stack-on Storage for an "L" Workstation, Frosted Doors with Silver Frame**78"W x 14⁵/₈"D x 37¹/₈"H**MODEL****SHIP WEIGHT****CUBE****LIST PRICE BY LAMINATE GRADE****L1****L2****H105327G**

198

17.3

\$1744**\$1794**

NOTES: Spans the total depth dimension of configurations comprised of: 48"W return or return shell attached to a 30"D single pedestal desk, desk shell or peninsula (78"D); 42"W return or return shell attached to a 36"D single pedestal desk or desk shell with a rectangle top, or to a peninsula (78"D); 42"W return or return shell attached to a 36" corner unit (78"D); 42"W curved return attached to 36" curved corner unit (78"D); or 36"W return shell attached to a jetty peninsula (78"D). Use back enclosure model H105857 and tackboard model H90057. Use task light models HH870960 or HH870960CH. For vertical paper manager model HLVPM1, see page 282.

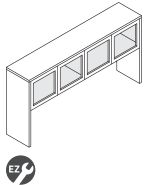
**Stack-on Storage, Frosted Doors with Silver Frame**72"W x 14⁵/₈"D x 37¹/₈"H, 4 doors

(Use Task Light HH870960, see page 274)

66"W x 14⁵/₈"D x 37¹/₈"H, 4 doors

(Use Task Light HH870960, see page 274)

60"W x 14⁵/₈"D x 37¹/₈"H, 4 doors

(Use Task Light HH870960, see page 274)

48"W x 14⁵/₈"D x 37¹/₈"H, 3 doors

(Use Task Light HH870942, see page 274)

42"W x 14⁵/₈"D x 37¹/₈"H, 2 doors

(Use Task Light HH870942, see page 274)

36"W x 14⁵/₈"D x 37¹/₈"H, 2 doors

(Use Task Light HH870930, see page 274)

H10534G

185

15.9

\$1611**\$1651****H10533G**

175

14.6

\$1583**\$1623****H105324G**

164

13.3

\$1543**\$1583****H105323G**

141

10.8

\$1300**\$1330****H105322G**

135

3.6

\$996**\$1026****H105321G**

102

3.1

\$957**\$982**

NOTES: For respective desk, credenza or return widths. Model 10534 can be used for "L" configuration comprised of a 42"W return or return shell attached to a 30"D single pedestal desk, desk shell or peninsula (72"); 36"W return shell attached to a 36"D single pedestal desk, desk shell or peninsula (72"); or 30"W return shell attached to a jetty peninsula (72"). Back enclosures, tackboards for use with back enclosures and task lights are available as options. See vertical paper manager model HLVPM1 on page 282.

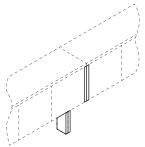
**Stack-on Storage Clearance End Panel Kit**1¹/₈"W x 4⁵/₈-14⁵/₈"D x 36"H**H105349**

29

3.4

\$360**\$375**

Two field installable end panels (1-right; 1-left) for use in ganging two 10500 or Valido® Series stack-on storage units. Narrow design replaces the full 14⁵/₈"D end panels to expand worksurface space. The narrow right end panel replaces the standard 14⁵/₈"D right end panel on one stack-on storage unit, the narrow left end panel replaces the standard 14⁵/₈"D left end panel on a separate, adjacent stack-on storage unit that is in linear alignment with the first unit. Kit includes: (2) narrow end panel supports; European-style fasteners; dowels; joint connector bolts with sleeve nuts (for ganging stack-on storage units).

NOTES: Can be used to connect up to two stack-on storage units in a line (requires 1 kit). Not available in two-tone laminate.

SPECIFYING EXAMPLE: H105349.N**NOTES:**

- Shared components shown on this page can be used with modular components shown on pages 244-260, full pedestal models shown on pages 261-262, and 3/4 pedestal models shown on pages 263-264.
- Rich woodgrain laminate and frosted doors with silver frames adds a contemporary mixed materials option to the 10500 Series™.
- Stack-on storage models are equipped with self-closing, adjustable hinged doors and valance to hide task light.
- See page 272 for stack-on storage back enclosures and tackboards, and page 274 for task lights.
- For work-in-process paper management tools, see pages 282-283.
- See pages 265-288 for shared components.
- Removable lock core kit for locking stack-on storage is model HF27B. See page 853.**

HOW TO SPECIFY

Select Model Number

H 1 0 5 3 2 7 G .

Select Laminate Top and Chassis Color

See pages 236-237

N N

10500 SERIES™

Shared Components & Accessories

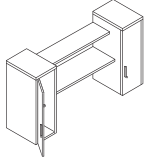
**DESCRIPTION****Stack-on Cabinets with Open Shelves, Center**Overall measures: 72"W x 20"D x 37¹/₈"HCabinet measures: 13¹/₂"W x 19⁷/₈"D x 37¹/₈"H

NOTES: Contemporary, light scale design blends open and closed storage. Features two locking cabinets bridged by two open shelves. The clearance between the worksurface and underside of the lower shelf is 18⁵/₈". Top shelf is 45"W x 11"D, bottom shelf is 45"W x 14"D; space between the shelves is 12¹/₄". Some assembly required; cabinets are fully assembled; simple shelf attachment. For two-tone color combinations, the first color designator defines the top of the storage cabinet(s), the second designator defines the color of the cabinet vertical panels and the open (exterior) shelves.

MODEL	SHIP WEIGHT	CUBE	L1 LIST	L2 UPCHARGES	
				CHASSIS	SHELF
H105319	218	20.3	\$1758	\$60	\$20

NOTES:

- Stack-on Cabinets with Open Shelves, Center is sized to fit on 72" desk, credenza, return, or desk with return worksurfaces.
- Easy-care, scratch-, spill- and stain-resistant laminate over 1/8" solid core high-performance particleboard.
- Cabinets have three shelves, two are adjustable.
- Removable lock core kit for the cabinet models above is HF23B. See page 853.
- Back of cabinet door has a convenient double coat hook; the lower peg is for jackets and lighter items, the upper peg for heavier coats and bags.
- Open shelves display books, photos, and mementos, shelves are fixed height; top shelf is 3/4" thick, lower shelf is 1/8".
- Task light can be attached to underside of the bottom shelf.

HOW TO SPECIFY

Select
Model Number

H 1 0 5 3 1 9 .

Select
Cabinet Top and Chassis Color

See pages 236-237

H H .

Select
Open Shelf Laminate

See pages 236-237

H

10500 SERIES™

Shared Components & Accessories

GSA SIN 33721



Icon Legend on page 19

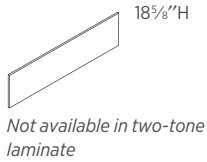

DESCRIPTION	MODEL	SHIP WEIGHT	CUBE	LIST PRICE BY LAMINATE GRADE	
				L1	L2
Back Enclosure for Stack-on Storage					
75 3/4"W - for 78"W model #H105327/H105327K/H105327G	H105857	39	1.4	\$259	\$269
69 3/4"W - for 72"W model #H10534/H10534K/H10534G	H105856	33	1.3	\$237	\$247
63 3/4"W - for 66"W model #H10533/H10533K/H10533G	H105855	31	1.3	\$221	\$231
57 3/4"W - for 60"W model #H105324/H105324K/H105324G	H105854	29	1.3	\$211	\$221
45 3/4"W - for 48"W model #H105323/H105323K/H105323G	H105853	23	0.9	\$211	\$221
39 3/4"W - for 42"W model #H105322/H105322K/H105322G	H105852	21	0.9	\$201	\$211
33 3/4"W - for 36"W model #H105321/H105321K/H105321G	H105851	18	0.9	\$190	\$200

NOTES: Non-tackable.

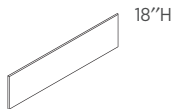

DESCRIPTION	MODEL	COM	SHIP WEIGHT	CUBE	LIST PRICE
Tackboards for use with Stack-on Back Enclosures (Back Enclosures must be ordered separately.)					
75"W - for 78"W model #H105327 Hutch with #H105857 Enclosure	H90057	3.0	13	3.2	\$317
68 3/4"W - for 72"W model #H10534 Hutch with #H105856 Enclosure	H90056	2.0	12	2.7	\$301
62 3/4"W - for 66"W model #H10533 Hutch with #H105855 Enclosure	H90055	2.0	11	2.5	\$286
56 3/4"W - for 60"W model #H105324 Hutch with #H105854 Enclosure	H90054	2.0	10	2.2	\$252
44 3/4"W - for 48"W model #H105323 Hutch with #H105853 Enclosure	H90053	2.0	8	1.8	\$242
39"W - for 42"W model #H105322 Hutch with #H105852 Enclosure	H90052	2.0	7	1.6	\$223
33"W - for 36"W model #H105321 Hutch with #H105851 Enclosure	H90051	1.0	6	1.4	\$196
26 3/4"W	H90050	1.0	5	1.2	\$196

NOTES: Specify fabric, see pages 25-26. Upcharges may apply to premium fabric grades.

ⓘ Disperse (DISP) fabric not available on sizes wider than 60". Analog (ANLG) and Exchange (EXG) not available on sizes wider than 72".

SPECIFYING EXAMPLE: H90057.APN15**NOTES:**

- When connected to the stack-on storage unit, back enclosure features full-width 1 1/8" slot at the bottom to facilitate routing cords and reaching wall electrical outlets.
- Tackboard is sized 3/4" narrower than stack-on storage back enclosure, allowing 3/8" on each side to route task light cord.
- Tackboard includes adhesive tape to secure to back enclosure and hardware for wall attachment.
- See pages 265-288 for shared components.

HOW TO SPECIFY

Select Model Number <div style="border: 1px solid black; padding: 2px; display: flex; gap: 5px;"> H105857 </div>	Select Laminate See pages 236-237 <div style="border: 1px solid black; padding: 2px; display: flex; gap: 5px;"> N </div>
---	--



10500 SERIES™

Shared Components & Accessories

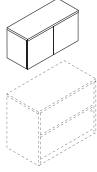

DESCRIPTION	MODEL	SHIP WEIGHT	CUBE	LIST PRICE BY LAMINATE GRADE	
				L1	L2
Wall Mounted Storage Cabinet 48"W x 14 ⁵ / ₈ "D x 17 ¹ / ₂ "H, 3 doors (Use task light model HH870942, see page 274)	H105383	114	13.2	\$878	\$913
42"W x 14 ⁵ / ₈ "D x 17 ¹ / ₂ "H, 2 doors (Use task light model HH870942, see page 274)	H105382	97	11.7	\$821	\$856
36"W x 14 ⁵ / ₈ "D x 17 ¹ / ₂ "H, 2 doors (Use task light model HH870930, see page 274)	H105381	87	10.2	\$748	\$783
30"W x 14 ⁵ / ₈ "D x 17 ¹ / ₂ "H, 2 doors (Use task light model HH870930, see page 274)	H105380	73	8.7	\$697	\$732
Wall Mounted Storage Cabinet, Locking 48"W x 14 ⁵ / ₈ "D x 17 ¹ / ₂ "H, 3 doors (Use task light model HH870942, see page 274)	H105383K	114	13.2	\$918	\$953
42"W x 14 ⁵ / ₈ "D x 17 ¹ / ₂ "H, 2 doors (Use task light model HH870942, see page 274)	H105382K	97	11.7	\$861	\$896
36"W x 14 ⁵ / ₈ "D x 17 ¹ / ₂ "H, 2 doors (Use task light model HH870930, see page 274)	H105381K	87	10.2	\$788	\$823
30"W x 14 ⁵ / ₈ "D x 17 ¹ / ₂ "H, 2 doors (Use task light model HH870930, see page 274)	H105380K	73	8.7	\$737	\$772

NOTES: Horizontal interlocking rails are included; due to varying types of walls, installers are responsible for selecting and supplying the appropriate fasteners. Tackboard widths differ slightly from wall mounted storage cabinet widths. For applications where multiple wall mounted storage cabinets are placed side-by-side, the preferred tackboard solution may be to utilize a larger tackboard size. For wall mounted storage cabinets with frosted doors, see page 274.

SPECIFYING EXAMPLE: H105380.NN
If Specifying with Lock Option: **H105380K.NN**

NOTES:

- Tackboard is sized ³/₄" narrower than stack-on storage back enclosure, allowing ³/₈" on each side to route task light cord.
- Wall attachment methodology: horizontally mounted, interlocking brackets.
- Wall mounted storage cabinet door design overlaps end panels so that when multiple units are placed side-by-side they appear as one continuous unit.
- Wall mounted storage cabinets available with laminate doors, locking laminate doors or frosted doors.
- Removable lock core kit for locking stack-on and wall mounted storage is model HF27B. See page 853.
- See pages 265-288 for shared components.

- ! Wall mounted storage cabinet attachment requires individual cabinets be secured by a minimum of two wall mounting locations/studs.
- ! Wall mounted storage cabinets are designed for interior and perimeter walls that are constructed with wood or metal studs.
- ! The HON Company is not responsible for any liabilities resulting from wall mounted storage cabinets that are not properly installed.

HOW TO SPECIFYSelect
Model Number

H 1 0 5 3 8 0 K .

Select
Laminate Top and Chassis Color

See pages 236-237

N N



Icon Legend on page 29

10500 SERIES™ Shared Components & Accessories

	DESCRIPTION	MODEL	SHIP WEIGHT	CUBE	L1 LIST	L2 UPCHARGES	
						CHASSIS	FRONTS
	Wall Mounted Hutch						
	66"W x 14 5/8"D x 15"H, 4 doors	H105WMH66	120	16.1	\$1282	\$30	\$30
	48"W x 14 5/8"D x 15"H, 3 doors	H105WMH48	97	12.6	\$918	\$25	\$30
	42"W x 14 5/8"D x 15"H, 2 doors	H105WMH42	77	10.7	\$861	\$25	\$20
	36"W x 14 5/8"D x 15"H, 2 doors	H105WMH36	67	9.8	\$788	\$25	\$20
	30"W x 14 5/8"D x 15"H, 2 doors	H105WMH30	57	8.3	\$737	\$25	\$20
	Wall Mounted Cubby Hutch						
	66"W x 14 5/8"D x 20"H, 4 doors	H105WMH66C	155	19.6	\$1282	\$30	\$30
	48"W x 14 5/8"D x 20"H, 3 doors	H105WMH48C	128	15.2	\$918	\$25	\$30
	42"W x 14 5/8"D x 20"H, 2 doors	H105WMH42C	114	13.0	\$861	\$25	\$20
	36"W x 14 5/8"D x 20"H, 2 doors	H105WMH36C	89	11.8	\$788	\$25	\$20
	30"W x 14 5/8"D x 20"H, 2 doors	H105WMH30C	76	10.0	\$737	\$25	\$20
	Wall Mounted Open Hutch						
	72"W x 14 5/8"D x 15"H, 2 Doors	H105WMH72P	119	17.5	\$1400	\$35	\$35
	66"W x 14 5/8"D x 15"H, 2 Doors	H105WMH66P	111	16.1	\$1282	\$30	\$30
	60"W x 14 5/8"D x 15"H, 2 Doors	H105WMH60P	104	14.7	\$1161	\$30	\$30
	48"W x 14 5/8"D x 15"H, 2 Doors	H105WMH48P	89	12.6	\$1040	\$25	\$30
	Wall Mounted Open Hutch with Cubby						
	72"W x 14 5/8"D x 20"H, 2 Doors	H105WMH72PC	162	21.3	\$1400	\$35	\$35
	66"W x 14 5/8"D x 20"H, 2 Doors	H105WMH66PC	151	19.6	\$1282	\$30	\$30
	60"W x 14 5/8"D x 20"H, 2 Doors	H105WMH60PC	140	14.7	\$1161	\$30	\$30
	48"W x 14 5/8"D x 20"H, 2 Doors	H105WMH48PC	117	12.6	\$1040	\$25	\$30

NOTES:

- Wall attachment methodology: horizontally mounted, interlocking brackets.
- Wall mounted storage cabinet door design overlaps end panels so that when multiple units are placed side-by-side they appear as one continuous unit.
- Laminate doors are non-locking.
- Horizontal interlocking rails are included; due to varying types of walls, installers are responsible for selecting and supplying the appropriate fasteners. Tackboard widths differ slightly from wall mounted storage cabinet widths. For applications where multiple wall mounted storage cabinets are placed side-by-side, the preferred tackboard solution may be to utilize a larger tackboard size.
- ! Wall mounted storage cabinet attachment requires individual cabinets be secured by a minimum of two wall mounting locations/studs.
- ! Wall mounted storage cabinets are designed for interior and perimeter walls that are constructed with wood or metal studs.
- ! The HON Company is not responsible for any liabilities resulting from wall mounted storage cabinets that are not properly installed.

HOW TO SPECIFY

<p>Select Model Number</p> <p>H 1 0 5 W M H 4 8</p>	<p>Select Laminate Top and Chassis Color</p> <p>See page 236</p> <p>N N</p>	<p>Select Door Front Laminate</p> <p>See page 236</p> <p>N</p>
--	--	---

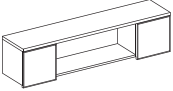
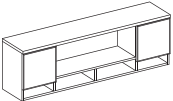

10500 SERIES™ Shared Components & Accessories

	DESCRIPTION	MODEL	SHIP WEIGHT	CUBE	LIST PRICE BY LAMINATE GRADE	
					L1	L2
	Wall Mounted Open Hutch, Glass Doors					
	72"W x 14 ⁵ / ₈ "D x 15"H, 2 Doors	H105WMH72PG	162	17.5	\$1900	\$1935
	66"W x 14 ⁵ / ₈ "D x 15"H, 2 Doors	H105WMH66PG	115	16.1	\$1782	\$1812
	60"W x 14 ⁵ / ₈ "D x 15"H, 2 Doors	H105WMH60PG	108	14.7	\$1661	\$1691
	48"W x 14 ⁵ / ₈ "D x 15"H, 2 Doors	H105WMH48PG	93	12.6	\$1540	\$1570
	Wall Mounted Open Hutch with Cubby, Glass Doors					
	72"W x 14 ⁵ / ₈ "D x 20"H, 2 Doors	H105WMH72PCG	166	21.3	\$1900	\$1935
	66"W x 14 ⁵ / ₈ "D x 20"H, 2 Doors	H105WMH66PCG	155	19.6	\$1782	\$1812
	60"W x 14 ⁵ / ₈ "D x 20"H, 2 Doors	H105WMH60PCG	144	17.9	\$1661	\$1691
	48"W x 14 ⁵ / ₈ "D x 20"H, 2 Doors	H105WMH48PCG	121	15.2	\$1540	\$1570

NOTES:

- Wall attachment methodology: horizontally mounted, interlocking brackets.
 - Wall mounted storage cabinet door design overlaps end panels so that when multiple units are placed side-by-side they appear as one continuous unit.
 - Rich woodgrain laminate and frosted doors with silver frames adds a contemporary mixed materials option to the 10500 Series™.
 - Horizontal interlocking rails are included; due to varying types of walls, installers are responsible for selecting and supplying the appropriate fasteners. Tackboard widths differ slightly from wall mounted storage cabinet widths. For applications where multiple wall mounted storage cabinets are placed side-by-side, the preferred tackboard solution may be to utilize a larger tackboard size.
- ❗ Wall mounted storage cabinet attachment requires individual cabinets be secured by a minimum of two wall mounting locations/studs.
 - ❗ Wall mounted storage cabinets are designed for interior and perimeter walls that are constructed with wood or metal studs.
 - ❗ The HON Company is not responsible for any liabilities resulting from wall mounted storage cabinets that are not properly installed.

HOW TO SPECIFY

<p>Select Model Number</p> <p>H 1 0 5 W M H 6 6 P G .</p>	<p>Select Laminate Top and Chassis Color</p> <p>See page 236</p> <p>N N</p>
---	---

10500 SERIES™

Storage

GSA SIN 33721 EXCEPT AS NOTED



Icon Legend on page 19

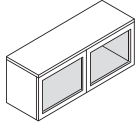

DESCRIPTION	MODEL	SHIP WEIGHT	CUBE	LIST PRICE BY LAMINATE GRADE	
				L1	L2
Wall Mounted Storage Cabinet, Frosted Doors with Silver Frame					
48"W x 14 ⁵ / ₈ "D x 17 ¹ / ₂ "H	H105383G	114.0	13.9	\$1328	\$1353
42"W x 14 ⁵ / ₈ "D x 17 ¹ / ₂ "H	H105382G	97.0	12.3	\$1121	\$1146
36"W x 14 ⁵ / ₈ "D x 17 ¹ / ₂ "H	H105381G	87.0	10.7	\$1048	\$1073
30"W x 14 ⁵ / ₈ "D x 17 ¹ / ₂ "H	H105380G	73.0	9.1	\$997	\$1022

NOTES: Door design overlaps end panels so that when multiple units are placed side-by-side they appear as one continuous unit. Product placement can be aligned to match the height of storage cabinets, wardrobes and towers. Equipped with self-closing, adjustable side-hinged doors. The 30", 36", and 42"W units have two doors; the 48"W has three doors. Frosted door units do not have a lock option. Wall attachment methodology: horizontally mounted, interlocking brackets.

Tackboard widths differ slightly from wall mounted storage cabinet widths. For applications where multiple wall mounted storage cabinets are placed side-by-side, the preferred tackboard width may be to utilize a larger tackboard size.

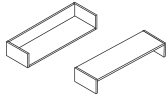

Not available in two-tone laminate

**Wall Mounted Open Shelf**

48"W x 9 ⁷ / ₈ "D x 4 ³ / ₄ "H	H105363	18.0	1.2	\$309	\$329
42"W x 9 ⁷ / ₈ "D x 4 ³ / ₄ "H	H105362	16.0	0.8	\$280	\$300
36"W x 9 ⁷ / ₈ "D x 4 ³ / ₄ "H	H105361	14.0	0.8	\$254	\$269
30"W x 9 ⁷ / ₈ "D x 4 ³ / ₄ "H	H105360	12.0	0.8	\$241	\$256

NOTES: Ideal for books, photographs, and mementos up to 9"D. Two attachment orientation options, open ended shelf or shelf with book ends. Available in woodgrain or solid color laminates only. No patterns. No two-tone combinations. Simple assembly.

SPECIFYING EXAMPLE: H105363.N

NOTES:

- Easy-care, scratch-, spill- and stain-resistant laminate over solid core high-performance particleboard.
- Stacked paper management (model HLVPM2), which is 32¹/₂"W, is compatible with the 30"W and 36"W wall mounted storage cabinets.
- ! Wall mounted storage cabinet attachment requires individual cabinets be secured by a minimum of two wall mounting locations/studs.
- ! Wall mounted storage cabinets are designed for interior and perimeter walls that are constructed with wood or metal studs.
- ! The HON Company is not responsible for any liabilities resulting from wall mounted storage cabinets that are not properly installed.

DESCRIPTION	MODEL	SHIP WEIGHT	CUBE	LIST PRICE
LED Task Lights				
31" LED Light with Power Supply (Single)	HLED31AS	1.5 Ⓞ	0.09	\$565
17" LED Light with Power Supply (Single)	HLED17AS	1.2 Ⓞ	0.05	\$420
OPEN MARKET				
31" LED Light with Power Supply for Daisy-chain (Starter)	HLED31A	1.4 Ⓞ	0.09	\$620
17" LED Light with Power Supply for Daisy-chain (Starter)	HLED17A	1.0 Ⓞ	0.05	\$462
31" LED Light with 8" Jumper Cord for Daisy-chain (Follower)	HLED31AUO	1.0 Ⓞ	0.05	\$502
17" LED Light with 8" Jumper Cord for Daisy-chain (Follower)	HLED17AUO	1.0 Ⓞ	0.03	\$377
Undercabinet Occupancy Sensor with 1" End to End Connector	HLEDOSA	0.2 Ⓞ	0.01	\$89

NOTES: To use the daisy chain application, must start with model HLED17A or HLED31A. No finish specification required. Attaches magnetically to underside of overhead storage, or attaches with provided screws or double-sided tape. Occupancy sensor attaches to a single or starter LED light and will automatically turn the light off after no motion is detected for 30 minutes. Just like all the LED light models, the occupancy sensor features a soft-touch on/off switch. LED task lights have a lifetime of 50,000 hours and have a dimmer feature that allows the user to adjust the amount of light output. For additional information see page 842.



Refer to page 842

OPEN MARKET

Recessed Task Light , 46 ¹ / ₂ "W x 3 ¹ / ₈ "D, for Models H105327, H10534, H10533 and H105324	HH870960	12.0 Ⓞ	1.1	\$270
Recessed Task Light , 34 ⁵ / ₈ "W x 3 ¹ / ₈ "D, for Models H105323, H105322, H105382 and H105383	HH870942	10.0 Ⓞ	0.9	\$250
Recessed Task Light , 22 ⁷ / ₈ "W x 3 ¹ / ₈ "D, for Models H105321, H105380 and H105381	HH870930	7.0 Ⓞ	0.6	\$231

NOTES: For additional information see page 842.

HOW TO SPECIFY

Select Model Number	Select Laminate Top and Chassis Color
H 1 0 5 3 8 3 G .	See pages 236-237
H H	



10500 SERIES™ Shared Components & Accessories

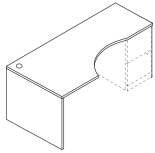

Right-hand model
H105815R shown



DESCRIPTION

Extended Corner Unit

24"W x 36"D x 72"W x 24"D x 29½"H, Right (shown)
24"D x 72"W x 36"D x 24"W x 29½"H, Left

MODEL

H105815R
H105816L

SHIP WEIGHT

184
184

CUBE

7.0
7.0

LIST PRICE BY LAMINATE GRADE

L1

\$1074
\$1074

L2

\$1119
\$1119

NOTES: Intended for use with returns or bridges. Can be used freestanding. The 17" user side dimension is designed to accommodate 10500 Series™ modular or mobile pedestals up to 15¾"W. One grommet in top and one cord pass-through grommet in modesty panel. See pages 268-272 for optional stack-ons and tackboards. Extended corner units (H105815R and H105816L) can be used with 36"W return shell (H105680) to achieve a 6' x 6' layout.

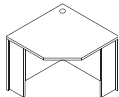
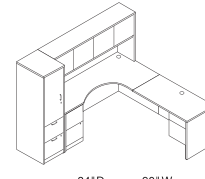
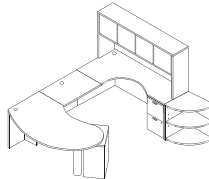
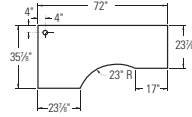

Corner Unit

24" x 36" x 36" x 24" x 29½"H

H105811

130

3.1

\$773

\$808

NOTES: Intended for use with 24"D x 29½"H returns or bridges. Can be used freestanding. 36" corner unit (H105811) can be used with two 36"W return shells (H105680) to achieve a 6' x 6' layout.

⚠ Not designed to attach to returns or bridges manufactured prior to 5/24/99.

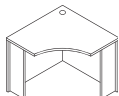
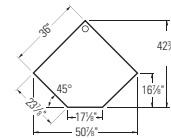

Curved Corner Unit

18" x 36" x 36" x 18" x 29½"H

H105810

128

5.4

\$773

\$808

NOTES: Can be used freestanding.

⚠ Designed to be used with curved returns only.

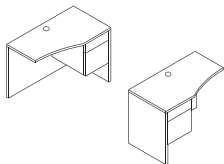

Curved Return — box/file

42"W x 18-24"D x 29½"H, Right
42"W x 24-18"D x 29½"H, Left

H105817R
H105818L

134
134

20.5
20.5

\$837
\$837

\$877
\$877

NOTES: Pedestal locks. One cord grommet in top; one pass-through grommet in top center of modesty panel. H105327 stack-on storage (78"W) can be used to span corner unit and return. H105322 stack-on storage (42"W) can be used on return. See page 269.

⚠ Designed to be used with curved corner unit only.

⚠ Not designed to be used freestanding.

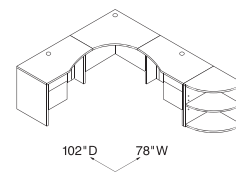
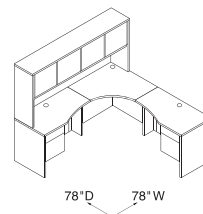

NOTES:

- Shared components shown on this page can be used with modular components shown on pages 244-260, full pedestal models shown on pages 261-262, and 3/4 pedestal models shown on pages 263-264.
- Mobile pedestals, shown on page 276, work well in a variety of configurations.
- End cap bookshelf units are ideal for books and personal items — see page 279.
- For work-in-process paper management tools, see pages 282-283.
- For 10500 Series™ matching occasional tables, use the H80191, H80192, and H80193 on page 284.
- For conference table options, see the Preside® table tops and bases on pages 774-779.
- Mobile table quickly provides additional worksurface space, see page 266.
- See pages 265-288 for shared components.

HOW TO SPECIFY

Select Model Number

H 1 0 5 8 1 5 R .

Select Laminate Top and Chassis Color

See pages 236-237

N N





10500 SERIES™

Shared Components & Accessories

GSA SIN 33721

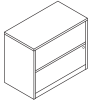
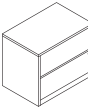
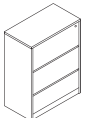
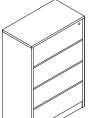

Icon Legend on page 19

	DESCRIPTION	MODEL	SHIP WEIGHT	CUBE	LIST PRICE BY LAMINATE GRADE	
					L1	L2
	Box/Box/File Mobile Pedestal (with core removable lock) 15 $\frac{3}{4}$ "W x 22 $\frac{3}{4}$ "D x 28 $\frac{3}{8}$ "H — use freestanding or under 24"D, 30"D and 36"D modular shells NOTES: Top box drawer does not lock. File drawer includes hangrails.	H105102	121	8.5	\$854	\$894
	File/File Mobile Pedestal (with core removable lock) 15 $\frac{3}{4}$ "W x 22 $\frac{3}{4}$ "D x 28 $\frac{3}{8}$ "H — use freestanding or under 24"D, 30"D and 36"D modular shells NOTES: File drawers include hangrails.	H105104	121	8.4	\$854	\$894
	Box/File Mobile Pedestal (with core removable lock) 15 $\frac{3}{4}$ "W x 18 $\frac{7}{8}$ "D x 21 $\frac{1}{8}$ "H — use freestanding or under 20"D, 24"D, 30"D and 36"D modular shells	H105106	65	5.8	\$714	\$744
	Shelf/Box/File Mobile Pedestal (with core removable lock) 15 $\frac{3}{4}$ "W x 18 $\frac{7}{8}$ "D x 28 $\frac{3}{8}$ "H — use freestanding or under 20"D, 24"D, 30"D and 36"D modular shells NOTES: Interior dimensions of the open storage area of the Shelf/Box/File model are 14 $\frac{1}{8}$ "W x 16 $\frac{3}{4}$ "D x 6 $\frac{5}{8}$ "H.	H105109	73	7.3	\$786	\$826
	Lateral File (with core removable lock) 36"W x 20"D x 59 $\frac{1}{8}$ "H — four drawer 36"W x 20"D x 45 $\frac{1}{2}$ "H — three drawer 36"W x 24"D x 29 $\frac{1}{2}$ "H — two drawer 36"W x 20"D x 29 $\frac{1}{2}$ "H — two drawer NOTES: Includes hangrails, mechanical interlock and in H10563 and H105690, a counterweight. Stack-on storage (H105321) and bookcase hutch (H105292) can be used with H10563 and H105690. Interlock inhibits the extension of more than one drawer from opening at a time. Model H105690 aligns with 24"D credenzas and returns.	H10516	305	31.0	\$2105	\$2175
		H10517	240	23.2	\$1598	\$1663
		H105690	191	17.6	\$1023	\$1078
		H10563	170	15.6	\$973	\$1023

NOTES:

- For additional components that can be shared with 10500 Series™, see pages 265-288.
- Mobile pedestals feature clean styling with hidden casters. Versatile designs roll easily and work well in a variety of configurations. Can be used freestanding, under modular shells, or with 10500 Series™ component worksurfaces and supports.
- 24"D lateral file, storage cabinet, and bookcase models align evenly with credenzas and returns to provide linear layout continuity.
- At 45 $\frac{1}{2}$ "H, the three-drawer lateral file can be used as a standing-height worksurface or to support office equipment.
- Drawers operate on full extension, ball-bearing suspensions to ensure smooth, quiet, long-lasting operation.
- File drawer design includes integrated hangrails for side-to-side letter or legal filing; and front-to-back for letter filing.
- Mobile printer/fax cart shown on page 260 is ideal for limited space.

HOW TO SPECIFY

Select Model Number

H 1 0 5 1 0 2 .

Select Laminate Top and Chassis Color

See pages 236-237

N N

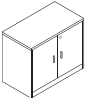
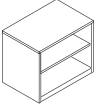
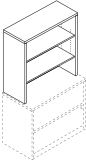
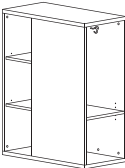

10500 SERIES™ Shared Components & Accessories

	DESCRIPTION	MODEL	SHIP WEIGHT	CUBE	LIST PRICE BY LAMINATE GRADE	
					L1	L2
	Storage Cabinet with Doors (with core removable lock) 36"W x 24"D x 29½"H	H105290	168	17.6	\$927	\$982
	36"W x 20"D x 29½"H	H105291	147	15.0	\$781	\$831
	NOTES: Includes one adjustable shelf. Shelf adjusts in ¼" increments with a total range of 5"H. Stack-on storage (H105321), and bookcase hutch (H105292) can be used with H105291 or H105290. Model H105290 aligns with 24"D credenzas and returns.					
	Bookcase 36"W x 24"D x 29½"H, 2-Shelf, 1-Adjustable	H105531	102	18.4	\$757	\$772
	NOTES: Adjustable shelf is 22"D and adjusts in ¼" increments, with a total range of 5". 24" depth aligns evenly with 24"D credenzas, credenza shells, returns, return shells, and wardrobe/storage cabinets to provide linear layout continuity. Adjustable leveling glides. Accommodates the 36"W stack-on storage or bookcase hutch. Ships fully assembled.					
	Bookcase Hutch (for use with lateral file models H10563/H105690, storage cabinet models H105291/H105290, and bookcase model H105531) 36"W x 14⅝"D x 37⅝"H	H105292	103	3.6	\$570	\$585
	NOTES: Cord pass-through gap behind shelves and a 1⅝"H full-width cord management slot at the bottom of the back panel. Two shelves are adjustable in ¼" increments with a total range of 17½"H.					
	Multi-Use Stack-On Storage 36"W x 18"D x 45⅝"H	H105310	142	21.9	\$1059	\$1094
	NOTES: Non-handed. Design features user's side bookcase and end access mixed storage compartment. Three fixed bookcase compartments, each 12"W x 13¾"H. Versatile mixed storage area includes two coat hooks and two shelves; one adjustable in ¼"H increments with a total range of 5" (shelf count includes bottom of the unit). For use on worksurfaces 36" or wider and 18" or deeper. Total height, in combination with low credenza, is 66⅝". Accepts markerboard models HLSL1536SOMB or HLSL1530SOMB (sold separately). Ships fully assembled.					

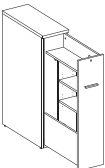
	DESCRIPTION	MODEL	SHIP WEIGHT	CUBE	L1 LIST	L2 UPCHARGES	
						CHASSIS	FRONTS
	Slide Out Tower 12"W x 30"D x 50"H, Right	H105ST123050R	215	13.8	\$3000	\$60	\$20
	12"W x 30"D x 50"H, Left	H105ST123050L	215	13.8	\$3000	\$60	\$20
	12"W x 24"D x 50"H, Right	H105ST122450R	182	11.4	\$2705	\$50	\$20
	12"W x 24"D x 50"H, Left	H105ST122450L	182	11.4	\$2705	\$50	\$20
	NOTES: Wardrobe space contains one coat hook. Storage space includes three shelves; two are adjustable in 2½" increments. Door access left or right models available. Equipped with HON "One Key" interchangeable core removable locks. Standard with Black linear pull.						

OPEN MARKET

NOTES:

- For additional components that can be shared with 10500 Series™, see pages 265-288.
- Versatile mobile pedestals roll easily and work well in a variety of configurations. Can be used freestanding, under modular shells, or with 10500 Series™ component worksurfaces and supports.
- 24"D lateral file, storage cabinet, and bookcase models align evenly with credenzas and returns to provide linear layout continuity.
- Mobile printer/fax cart shown on page 260 is ideal for limited space.

HOW TO SPECIFY

<p>Select Model Number</p> <p>H 1 0 5 2 9 1 .</p>	<p>Select Laminate Top and Chassis Color</p> <p>See pages 236-237</p> <p>N N</p>			
<p>Select Model Number</p> <p>H 1 0 5 S T 1 2 3 0 5 0 R .</p>	<p>Select Laminate Top and Chassis Color</p> <p>See page 236</p> <p>N N .</p>	<p>Select Door Front Laminate</p> <p>See page 236</p> <p>N .</p>	<p>Select Pull and Color</p> <p>L Linear P Black</p> <p>L P .</p>	<p>Select Lock Option</p> <p>Not available on Open Credenzas</p> <p>L Lock X Omit Lock (deduct \$20)</p> <p>L</p>



Icon Legend on page 19

10500 SERIES™ Shared Components & Accessories

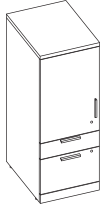

DESCRIPTION

Storage Wardrobe

24"W x 24"D x 50"H, Right
24"W x 24"D x 50"H, Left
24"W x 20"D x 50"H, Right
24"W x 20"D x 50"H, Left
18"W x 24"D x 50"H, Right
18"W x 24"D x 50"H, Left
18"W x 20"D x 50"H, Right
18"W x 20"D x 50"H, Left

MODEL

H105LT242450CBFR
H105LT242450CBFL
H105LT242050CBFR
H105LT242050CBFL
H105LT182450CBFR
H105LT182450CBFL
H105LT182050CBFR
H105LT182050CBFL

SHIP WEIGHT **CUBE** **L1 LIST** **L2 UPCHARGES**
CHASSIS **FRONTS**

202 21.3 **\$2050** **\$60** **\$35**
202 21.3 **\$2050** **\$60** **\$35**
178 17.9 **\$2000** **\$50** **\$35**
178 17.9 **\$2000** **\$50** **\$35**
168 16.2 **\$1950** **\$50** **\$30**
168 16.2 **\$1950** **\$50** **\$30**
147 13.7 **\$1728** **\$45** **\$30**
147 13.7 **\$1728** **\$45** **\$30**

NOTES: Spacious design includes a wardrobe closet, storage cabinet, one box drawer, and one file drawer in one compact unit. Wardrobe closet contains a coat rod. Storage cabinet includes two shelves, one is adjustable in 2½" increments. Door hinged left or right models available. Box and file drawers operate on ball-bearing suspensions with full extension. File drawers have high sides to accept hanging folders in letter or legal size. Drawers standard with hangrails. Equipped with HON "One Key" interchangeable core removable locks. Upper lock secures storage cabinet and wardrobe closet doors; lower lock secures file drawers.

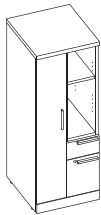

Open Wardrobe

24"W x 24"D x 50"H, Right
24"W x 24"D x 50"H, Left
24"W x 20"D x 50"H, Right
24"W x 20"D x 50"H, Left
18"W x 24"D x 50"H, Right
18"W x 24"D x 50"H, Left
18"W x 20"D x 50"H, Right
18"W x 20"D x 50"H, Left

H105LT242450BFR
H105LT242450BFL
H105LT242050BFR
H105LT242050BFL
H105LT182450BFR
H105LT182450BFL
H105LT182050BFR
H105LT182050BFL

190 21.3 **\$2000** **\$60** **\$35**
190 21.3 **\$2000** **\$60** **\$35**
167 17.9 **\$1800** **\$50** **\$35**
167 17.9 **\$1800** **\$50** **\$35**
161 16.2 **\$1900** **\$50** **\$30**
161 16.2 **\$1900** **\$50** **\$30**
141 13.7 **\$1678** **\$45** **\$30**
141 13.7 **\$1678** **\$45** **\$30**

NOTES: Spacious design includes a wardrobe closet, open storage, one box drawer, and one file drawer in one compact unit. Wardrobe closet contains a coat rod. Storage cabinet includes two shelves, one is adjustable in 2½" increments. Door hinged left or right models available. Box and file drawers operate on ball-bearing suspensions with full extension. File drawers have high sides to accept hanging folders in letter or legal size. Drawers standard with hangrails. Equipped with HON "One Key" interchangeable core removable locks. Lock secures box and file drawers; wardrobe is non-locking.



Side Access Wardrobe

24"W x 24"D x 50"H, Right
24"W x 24"D x 50"H, Left
24"W x 20"D x 50"H, Right
24"W x 20"D x 50"H, Left
18"W x 24"D x 50"H, Right
18"W x 24"D x 50"H, Left
18"W x 20"D x 50"H, Right
18"W x 20"D x 50"H, Left

H105LT242450SBFR
H105LT242450SBFL
H105LT242050SBFR
H105LT242050SBFL
H105LT182450SBFR
H105LT182450SBFL
H105LT182050SBFR
H105LT182050SBFL

187 21.3 **\$2078** **\$60** **\$35**
187 21.3 **\$2078** **\$60** **\$35**
166 17.9 **\$1900** **\$50** **\$35**
166 17.9 **\$1900** **\$50** **\$35**
153 16.2 **\$1966** **\$50** **\$30**
153 16.2 **\$1966** **\$50** **\$30**
135 13.7 **\$1728** **\$45** **\$30**
135 13.7 **\$1728** **\$45** **\$30**

NOTES: Spacious design includes a wardrobe closet, open side access storage, one box drawer, and one file drawer in one compact unit. Wardrobe closet contains a coat rod. Storage cabinet includes two shelves, one is adjustable in 2½" increments. Door hinged left or right models available. Box and file drawers operate on ball-bearing suspensions with full extension. File drawers have high sides to accept hanging folders in letter or legal size. Drawers standard with hangrails. Equipped with HON "One Key" interchangeable core removable locks. Lock secures box and file drawers; wardrobe is non-locking.

NOTES:

- Broad family of storage components beyond the confines of a desk drawer.
- Locking units equipped with interchangeable core removable locks.
- Adjustable hex leveling glides allow floor-standing furniture to be easily leveled without lifting the unit; glides have ¾" adjustable range.

HOW TO SPECIFY

<p>Select Model Number</p> <p>H 1 0 5 L T 1 8 2 4 5 0 B F R .</p>	<p>Select Laminate Top and Chassis Color</p> <p>See page 236 Kickplates will match chassis color</p> <p>N N .</p>	<p>Select Door Front Laminate</p> <p>See page 236</p> <p>N .</p>	<p>Select Pull and Color</p> <p>L Linear P Black</p> <p>L P .</p>	<p>Select Lock Option</p> <p>L Lock X Omit Lock (deduct \$20)</p> <p>L</p>
--	--	---	--	---



Icon Legend on page 19

10500 SERIES™ Shared Components & Accessories

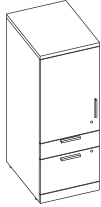

DESCRIPTION

Storage Cabinet
18"W x 24"D x 50"H, Right
18"W x 24"D x 50"H, Left

MODEL

H105LT182450SCBFR
H105LT182450SCBFL

SHIP WEIGHT

158
158

CUBE

16.2
16.2

L1 LIST

\$1575
\$1575

L2 UPCHARGES
CHASSIS FRONTS

\$50 \$30
\$50 \$30

NOTES:

- Versatile unit features a storage cabinet, one box drawer, and one file drawer.
- Storage cabinet includes two shelves, one is adjustable in 2½" increments.
- Door hinged left or right models available.
- File drawers operate on ball-bearing suspensions with full extension.
- File drawers have high sides to accept hanging folders in letter or legal size.
- Drawers standard with hangrails.
- Both the storage cabinet and the file drawers are equipped with a HON "One Key" interchangeable core removable lock.
- Upper lock secures storage cabinet; lower lock secures box and file drawers.
- Broad family of storage components beyond the confines of a desk drawer.
- Locking units equipped with interchangeable core removable locks.
- Adjustable hex leveling glides allow floor-standing furniture to be easily leveled without lifting the unit; glides have ¾" adjustable range.

HOW TO SPECIFY

<p>Select Model Number</p> <p>H 1 0 5 L T 1 8 2 4 5 0 S C B F R .</p>	<p>Select Laminate Top and Chassis Color</p> <p>See page 236 Kickplates will match chassis color</p> <p>N N .</p>	<p>Select Door Front Laminate</p> <p>See page 236</p> <p>N .</p>	<p>Select Pull and Color</p> <p>L Linear P Black</p> <p>L P .</p>	<p>Select Lock Option</p> <p>L Lock X Omit Lock (deduct \$20)</p> <p>L</p>
--	--	---	--	---

10500 SERIES™

Shared Components & Accessories

GSA SIN 33721



Icon Legend on page 19



Right-hand model
H105297R shown

DESCRIPTION	MODEL	SHIP WEIGHT	CUBE	LIST PRICE BY LAMINATE GRADE	
				L1	L2
Storage/File Cabinet (with core removable locks)					
18"W x 24"D x 66 $\frac{5}{8}$ "H, Hinged Right (shown)	H105297R	258	22.7	\$1692	\$1767
18"W x 24"D x 66 $\frac{5}{8}$ "H, Hinged Left	H105298L	258	22.7	\$1692	\$1767
NOTES: Versatile unit features a storage cabinet and two file drawers. Storage cabinet includes three shelves, two are adjustable in 2 $\frac{1}{2}$ " increments. Door hinged left or right models available. File drawers operate on ball-bearing suspensions with full extension. File drawers have high sides to accept hanging folders in letter or legal size. Drawers standard with hangrails. Both the storage cabinet and the file drawers are equipped with a HON "One Key" interchangeable core removable lock. Unit height is designed to match credenza or return plus stack-on storage height.					

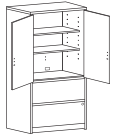

Doors open 110 degrees
from closed position.

Storage Cabinet/Lateral File (with core removable lock)					
36"W x 24"D x 66 $\frac{5}{8}$ "H	H105293	365	41.0	\$2278	\$2378
NOTES: Storage cabinet is standard with one fixed and two full-width adjustable shelves in top compartment; adjustable shelves can be removed. Overall storage compartment measures 31 $\frac{1}{4}$ "W x 22"D x 36 $\frac{5}{8}$ "H and will accommodate supplies, books and binders, as well as business machines and electronic equipment. Cord pass-through gap behind shelves and grommet in back of the cabinet to facilitate routing cords and reaching wall electrical outlets. Two drawer lateral file on bottom. Lateral file comes with mechanical interlock and hangrails. Cabinet and lateral file lock independently. Unit height is designed to match credenza or return plus stack-on storage height.					



Doors open 110 degrees
from closed position.

Storage Cabinet with Full-width Shelves (with core removable lock)					
36"W x 24"D x 66 $\frac{5}{8}$ "H	H105299	341	39.6	\$2126	\$2226
NOTES: Large storage area includes five, full-width (side-to-side) shelves; three are adjustable in 2 $\frac{1}{2}$ " increments. Unit height matches credenza or return plus stack-on storage height.					

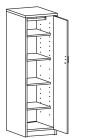

Right-hand model
H105295R shown

Personal Wardrobe/Storage Cabinet (with core removable lock)					
18"W x 24"D x 66 $\frac{5}{8}$ "H, Hinged Right (shown)	H105295R	223	22.9	\$1533	\$1608
18"W x 24"D x 66 $\frac{5}{8}$ "H, Hinged Left	H105296L	223	22.9	\$1533	\$1608
NOTES: Unit is standard with four adjustable shelves, coat rod, and core removable lock. Shelves adjust in 2 $\frac{1}{2}$ " increments. Cabinet can be used as a wardrobe by removing four adjustable shelves. Coat rod can be removed from cabinet for storage only applications. Unit height is designed to match credenza or return plus stack-on storage height.					

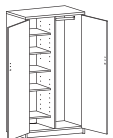

Doors open 110 degrees
from closed position.

Personal Wardrobe/Storage Cabinet (with core removable lock)					
36"W x 24"D x 66 $\frac{5}{8}$ "H	H10530	341	41.0	\$2278	\$2290
NOTES: Spacious design is standard with four adjustable shelves (one shelf is fixed), coat rod and core removable lock which locks both doors. Shelves adjust in 2 $\frac{1}{2}$ " increments. Unit height is designed to match credenza or return plus stack-on storage height.					

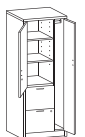

Right-hand model
H105301R shown

Personal Storage Tower (with core removable locks)					
24"W x 24"D x 66 $\frac{5}{8}$ "H, wardrobe Hinged Right, storage cabinet Hinged Left (shown)	H105301R	299	27.9	\$2139	\$2234
24"W x 24"D x 66 $\frac{5}{8}$ "H, wardrobe Hinged Left, storage cabinet Hinged Right	H105302L	299	27.9	\$2139	\$2234
NOTES: Spacious design includes a wardrobe closet, storage cabinet, and two file drawers in one compact unit. Wardrobe closet contains a coat rod. Storage cabinet includes three shelves, two are adjustable in 2 $\frac{1}{2}$ " increments. Door hinged left or right models available. File drawers operate on ball-bearing suspensions with full extension. File drawers have high sides to accept hanging folders in letter or legal size. Drawers standard with hangrails. Equipped with HON "One Key" interchangeable core removable locks. Upper lock secures storage cabinet and wardrobe closet doors; lower lock secures file drawers. Unit height is designed to match credenza or return plus stack-on storage height.					

NOTES:

- Broad family of storage components takes organization way beyond the confines of a desk drawer.
- Locking units equipped with interchangeable core removable locks.
- Adjustable hex leveling glides allow floor-standing furniture to be easily leveled without lifting the unit; glides have $\frac{3}{4}$ " adjustable range.
- See pages 265-288 for shared components.

🔑 Keyed alike cores must be ordered separately — see model HF23B on page 853 — makes re-keying quick and easy.







HOW TO SPECIFY

Select Model Number	Select Laminate Top and Chassis Color
H 1 0 5 2 9 7 R .	See pages 236-237
	N N

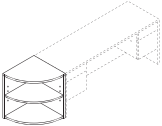

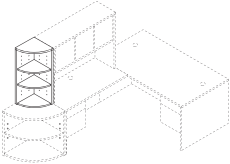
10500 SERIES™

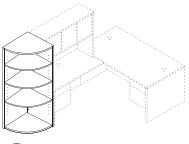
Shared Components & Accessories

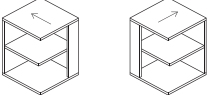
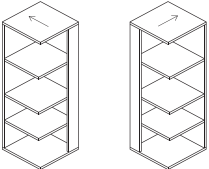
	DESCRIPTION	MODEL	SHIP WEIGHT	CUBE	LIST PRICE BY LAMINATE GRADE	
					L1	L2
 H105532 shown	Bookcase					
	5 Shelf, 36"W x 13 ¹ / ₈ "D x 71"H	H105535	187	25.1	\$825	\$855
	4 Shelf, 36"W x 13 ¹ / ₈ "D x 57 ¹ / ₈ "H	H105534	156	20.2	\$710	\$735
	3 Shelf, 36"W x 13 ¹ / ₈ "D x 43 ³ / ₈ "H	H105533	122	15.6	\$602	\$622
	2 Shelf, 36"W x 13 ¹ / ₈ "D x 29 ⁵ / ₈ "H	H105532	90	11.0	\$474	\$489
	NOTES: Fixed shelves. Inside shelf dimensions on all units is 33 ³ / ₄ "W x 12"D x 13"H. No assembly required.					
 	End Cap Bookshelf (2 shelves, 1 fixed, 1 adjustable. Adjusts in 2¹/₂" increments with a total range of 10"H)					
	24"W x 24"D x 29 ¹ / ₂ "H	H105520	84	2.6	\$603	\$618
	NOTES: Unit is freestanding. Designed to be positioned at the end of 24"D credenzas and returns. Ideal for books, photos, plants and mementos.					
 	End Cap Bookshelf (3 shelves, 1 fixed, 2 adjustable. Adjusts in 2¹/₂" increments with a total range of 25"H)					
	15"W x 15"D x 37 ¹ / ₈ "H	H105523	53	2.2	\$519	\$534
	NOTES: Unit is designed to be positioned at the end of stack-on storage and on top of model H105520. Combined height of models H105520 and H105523 matches credenza or return plus stack-on storage height. Can be used freestanding.					
 	End Cap Bookshelf					
	24"W x 24"D x 66 ⁵ / ₈ "H	H105524	164	4.8	\$1005	\$1030
	NOTES: Designed to be positioned at the end of 24"D credenzas with stack-on storage, 24"D returns with stack-on storage, 24"D storage/file cabinet, 24"D storage cabinet/lateral file, 24"D wardrobe/storage cabinets, or the 24"D personal storage tower. Unit has four shelves, three are adjustable in 2 ¹ / ₂ " increments, with a total range of 45"H; bottom shelf is fixed.					
 Model H105525R Model H105526L	Square End Cap Bookshelf — 2-Fixed Shelves					
	24"W x 24"D x 29 ¹ / ₂ "H, Right	H105525R	92	3.6	\$598	\$613
	24"W x 24"D x 29 ¹ / ₂ "H, Left	H105526L	92	3.6	\$598	\$613
 Model H105527R Model H105528L	Square End Cap Bookshelf — 4-Fixed Shelves					
	24"W x 24"D x 66 ⁵ / ₈ "H, Right	H105527R	172	5.9	\$959	\$984
	24"W x 24"D x 66 ⁵ / ₈ "H, Left	H105528L	172	5.9	\$959	\$984
	NOTES: Units are freestanding. Designed to be positioned next to 24"D models or as a corner bookcase. End cap, left: grain direction on top aligns with grain direction on tops of left pedestal returns and left credenza models or when positioned to the left side of credenzas with doors or kneespace models. End cap, right: grain direction on top aligns with grain direction on tops of right pedestal returns and right credenza models or when positioned to the right side of credenzas with doors or kneespace models.					

NOTES:

- For 36"W x 24"D x 29¹/₂"H two-shelf bookcase, to align evenly with credenzas and returns, see page 277.

HOW TO SPECIFY

Select Model Number H 1 0 5 5 3 2	Select Laminate Top and Chassis Color See pages 236-237 N N
---	--

10500 SERIES™

Shared Components & Accessories

GSA SIN 33721



Icon Legend on page 19

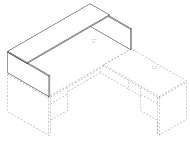

DESCRIPTION	MODEL	SHIP WEIGHT	CUBE	LIST PRICE BY LAMINATE GRADE	
				L1	L2
Reception Station with Transaction Counter, for 72" W x 36" D Desk, or Desk Shell, with rectangle top 72"W x 36"D x 14¼"H	H105720	92	3.0	\$504	\$539

NOTES: For desk tops without grommets, see field installable grommet kit, model HFLDGRMT on page 287. Transaction counter organizer (HTCOL52) fits under/inside of transaction counter (see below).

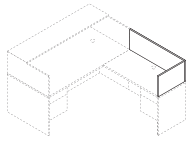

Reception Station for 42" W x 24" D Return or Return Shell 42"W x 24"D x 13"H	H105722	2	1.0	\$253	\$273
Reception Station for 48" W x 24" D Return or Return Shell 48"W x 24"D x 13"H	H105721	25	3.6	\$288	\$308

NOTES: For return tops without grommets, see field installable grommet kit, model HFLDGRMT on page 287. Not available in two-tone laminate. Designed specifically for use with Reception Station with Transaction Counter, model H105720.
SPECIFYING EXAMPLE: H105722.N

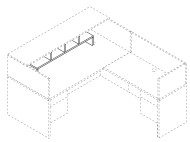

DESCRIPTION	MODEL	SHIP WEIGHT	CUBE	LIST PRICE
Transaction Counter Organizer 48¾"W x 11⅞"D x 13"H	HTCOL52	24	1.1	\$283

NOTES: Fits under reception station with transaction counter model H105720 reception desk shell (H105724), and work organizer models H10537 and H10536.
Black only.
SPECIFYING EXAMPLE: HTCOL52.P

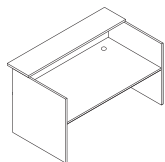

DESCRIPTION	MODEL	SHIP WEIGHT	CUBE	LIST PRICE BY LAMINATE GRADE	
				L1	L2
Reception Desk Shell, with rectangle top 72"W x 39⅞"D x 44⅞"H	H105724	294	17.0	\$1077	\$1132

NOTES: Non-handed design. Integrated 18⅝"D transaction counter with a 4" full-width overhang. Two cord management grommets in top for routing and hiding wires and cables. Transaction counter organizer model TCOL52 fits under/inside transaction counter. When a two-tone color combination is specified, the first designator defines the transaction countertop and the desk worksurface.

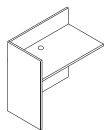

Reception Station Return Shell 42"W x 24⅜"D x 42⅝"H	H105726	131	17.0	\$750	\$785
---	----------------	-----	------	--------------	--------------

NOTES: Non-handed design for use with reception desk shell. One cord management grommet in top for routing and hiding wires and cables. Woodgrain on approach side is vertical to match grain direction on end panels of reception station desk. Designed specifically for use with Reception Desk Shell, model H105724.

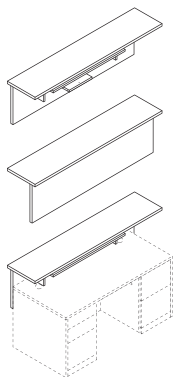

Transaction Counter for Reception Desk 66"W x 14⅝"D x 14¼"H	H105729	100	4.2	\$626	\$651
---	----------------	-----	-----	--------------	--------------

NOTES: Off-the-worksurface solution designed for use with 72"W or 66"W desks or desk shells with a 1⅞" thick rectangle top and a full-width conference (approach-side) overhang of 4½"D minimum. Choose from two height options at time of installation; 13⅞"H (upper position) or 5½"H (lower position) above the desktop. Attaches easily and securely without any drilling or double-sided tape on the worksurface. Grain direction: side-to-side on countertop; horizontal on approach and users side vertical panel.

NOTES:

- Three welcoming reception station designs to choose from — stack-on enclosure, full-to-floor shell, or front-suspended counter.
- Versatile mobile office table is ideal for additional worksurface space, meetings, and special projects. See page 266.
- For 10500 Series™ matching reception area furniture, see Occasional Tables on page 284.
- See pages 265-288 for shared components.

HOW TO SPECIFY

Select Model Number	Select Laminate Top and Chassis Color
H 1 0 5 7 2 0 .	See pages 236-237 N N

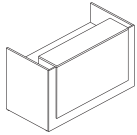

DESCRIPTION	MODEL	SHIP WEIGHT	CUBE	L1 LIST	L2 UPCHARGES		ACCENT PANEL
					WORKSURFACE	CHASSIS	
Reception Desk with Transaction Counter 72"W x 36¾"D x 44"H	HLAM3772RD	324	13.5	\$1474	\$35	\$70	\$25

NOTES: Non-handed. Counter measures 60"W x 15¼"D. Flat edge (G) matches 10500 Series™. For beaded (B) and tri-oval (V) edge shapes, the transaction counter is profiled on the approach and user sides, and the desk worksurface is profiled on the user's side. Beaded (B) and tri-oval (V) edges are available in L1 woodgrains colors only. Smooth and flat (G) edge available in all woodgrains and solid colors. Vertical grain on approach side and front accent panel for L1 laminates except Kingswood Walnut and Florence Walnut. Horizontal grain on L2 laminates and Kingswood and Florence Walnut. Vertical grain on end panels and horizontal grain on worksurface and transaction counter. Two worksurface cord management grommets for routing and hiding wires and cables; can be specified in Black (P) or Platinum (TI) finish.

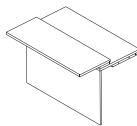

Reception Return with 32'H Transaction Counter 48¾"W x 32⅞"D x 32"H	HLAM3348RR	145	3.7	\$829	\$35	\$35	N/A
---	-------------------	-----	-----	--------------	-------------	-------------	------------

NOTES: Non-handed. For use with HLAM3772RD and Reception Desk Shell (H105724). Counter facilitates accessibility; measures 48"W x 12"D x 32"H. Flat edge (G) matches 10500 Series™. For beaded (B) and tri-oval (V) edge shapes, the transaction counter is profiled on the approach side, and the return worksurface is profiled on the user's side. All other edges are flat banded. Beaded (B) and tri-oval (V) available in L1 woodgrain colors only. Flat edge (G) available in all woodgrains and solid colors. Pattern laminates do not have matching edge color; patterns can be specified with woodgrain or solid edge. Vertical grain on approach side, end panel, worksurface, and transaction counter. Assembly required.

Specify: Model.Edge Profile & EdgeColor.Worksurface & Counter Color.Chassis Color

SPECIFYING EXAMPLE: HLAM3348RR.GN.N.N

HOW TO SPECIFY

<p>Select Model Number</p> <p>HLAM3772RD</p>	<p>Select Edge Profile and Edge Color</p> <p>See page 237</p> <p>GN</p>	<p>Select Grommet Color</p> <p>P Black TI Platinum Not specified for model HLAM3348RR</p> <p>P</p>	<p>Select Worksurface Laminate</p> <p>See page 236</p> <p>N</p>	<p>Select Chassis Laminate</p> <p>See page 236</p> <p>N</p>	<p>Select Accent Panel Laminate</p> <p>See page 236 Not specified for model HLAM3348RR</p> <p>LDW1</p>
---	--	---	--	--	---

10500 SERIES™

Shared Components & Accessories

GSA SIN 33721

ABI

Icon Legend on page 19

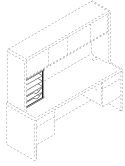

Not available in two-tone laminate



DESCRIPTION	MODEL	SHIP WEIGHT	CUBE	LIST PRICE BY LAMINATE GRADE	
				L1	L2
Vertical Paper Manager 14 ⁷ / ₈ "W x 10 ⁷ / ₈ "D x 19 ³ / ₈ "H NOTES: Keeps papers, files, and books neatly organized and within easy reach from a seated position. Designed for desk, credenza, and return tops. Fits under stack-on storage models. Two pullout drawers and three fixed shelves. Unit can also be used with 10700 Series™, Valido®, and 94000 Series™. When used in conjunction with wall mounted storage cabinets, the top of the wall mounted storage cabinets must be positioned a minimum of 68" above the floor. For additional information see page 844. SPECIFYING EXAMPLE: HLVPM1.N	HLVPM1	27	2.8	\$327	\$337

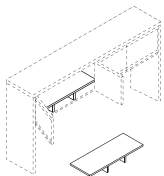

DESCRIPTION	MODEL	SHIP WEIGHT	CUBE	LIST PRICE	
Stacked Paper Management 32 ¹ / ₂ "W x 12 ⁵ / ₈ "D x 4 ¹ / ₄ "H NOTES: Segments and organizes stack-on and wall mount storage compartments, as well as bookcase shelves. In some cases, installation may require removing the stack-on or wall mount storage doors. For additional information see page 845. ! Black only.	HLVPM2	22	1.25	\$163	

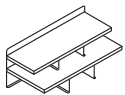

Not available in two-tone laminate



DESCRIPTION	MODEL	SHIP WEIGHT	CUBE	LIST PRICE BY LAMINATE GRADE	
				L1	L2
Desktop Storage Terrace 26 ¹ / ₂ "W x 12 ⁵ / ₈ "D x 10 ¹ / ₄ "H NOTES: Keeps work-in-process, priority files, loose pages, and mail neatly organized and in view. Mixed material design comprised of sturdy laminate shelves with metal back and support panels. Not available in two-tone laminate combination or pattern laminate colors. Choose from Platinum Metallic (TI), Black (P), and Charcoal (S) for the metal components. Sized to fit in stack-on and wall mounted storage cabinets in 10500, 10700, Valido, 94000, and 38000 Series. Fits in Voi stack-on and overhead cabinets except for 48"W or smaller sliding door models. For additional information see page 844. Specify: Model.Laminate.Paint SPECIFYING EXAMPLE: HLDST1.N.T1	HLDST1	24	1.1	\$306	\$316



Refer to page 106 for Center Drawer compatibility information

DESCRIPTION	MODEL	SHIP WEIGHT	CUBE	L1	L2
				LIST PRICE	LIST PRICE
Angled Wood Center Drawer 26" x 15 ³ / ₈ " 22" x 15 ³ / ₈ " NOTES: Specify laminate for drawer. Model H1522 can be used on peninsulas with modesty panel, model H10528. For additional information see page 832.	H1526	12	1.2	\$198	\$213
	H1522	11	1.1	\$184	\$199

NOTES:

- For 10500 Series™ matching Occasional Tables, see page 284.
- Vertical paper manager designed for desk, credenza, and return tops. Fits under stack-on storage.
- Stacked paper management segments and organizes stack-on and wall mount storage compartments, as well as bookcase shelves. Unit can be used in models H105327, H10534, H105322, H105321, H105382 and H105381.
- Desktop Storage Terrace is for use on the tops of 29¹/₂"H desks, credenzas, and returns.
- Desktop Storage Terrace features six storage sections plus top display shelf.
- Desktop Storage Terrace includes protective, non-slip pads on the base.
- See pages 265-288 for shared components.

! In some cases, installation of Stacked Paper Management may require removing the stack-on or wall mount storage doors.

HOW TO SPECIFY

Select Model Number H L V P M 1 . N	Select Laminate See pages 236-237
---	---



10500 SERIES™

Shared Components & Accessories

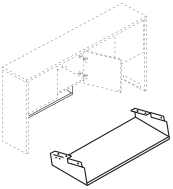
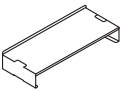
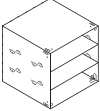
	DESCRIPTION	MODEL	SHIP WEIGHT	CUBE	LIST PRICE
	<p>Hanging Paper Shelf 28¹/₁₆"W x 11⁷/₁₆"D x 4⁵/₁₆"H</p> <p>NOTES: Maximizes worksurface space; de-clutters desktop while placing priority communications and active project folders within easy reach. Angled design allows contents to be distinguished at a glance. Mixed material styling features strong painted metal frame with a frosted shelf.</p> <p>Attaches quickly and easily to stack-on and wall mount storage models in the following series: 10500, 10700, Valido, 94000, and Voi (except the 36"W overhead hutch with O-legs or panel mount brackets). Not for use with 38000 Series.</p> <p>For additional information see page 824. Specify: Model.Paint</p> <p>SPECIFYING EXAMPLE: HHPS1.T1</p>	HHPS1	7	2.9	\$198
	<p>Desktop Paper Shelf 28¹/₁₆"W x 11⁵/₁₆"D x 5"H</p> <p>NOTES: Organizer shelf provides a place and space for work-in-process and piling to keep worksurfaces neat and tidy. Convenient, scalable design with interlocking side supports allow two units to be stacked and integrated. Durable painted metal frame with a frosted shelf; mixed material styling matches hanging paper shelf.</p> <p>Can also be used inside select overhead storage, including the following stack-on with hinged door models: 10500 and Valido 36", 42", 66", 72", 78"W and 10700 68⁵/₁₆"W.</p> <p>For additional information see page 824. Specify: Model.Paint</p> <p>SPECIFYING EXAMPLE: HDPS1.T1</p>	HDPS1	7	2.9	\$198
	<p>Storage Cube 12"W x 12"D</p> <p>NOTES: For additional information see page 846.</p> <p>SPECIFYING EXAMPLE: HL1212.P8S</p>	HL1212	1	0.3	\$294

**NOTES:**

- For 10500 Series™ matching Occasional Tables, see page 284.
- Desktop Paper Shelf includes protective, non-slip pads on the base.
- Paper Shelf can stack two-high.
- Hanging Paper Shelf attaches quickly and easily (screws included).
- See pages 265-288 for shared components.
- For additional information see pages 845-846.

HOW TO SPECIFY

<p>Select Model Number</p> <p>HHPS1.T1</p>	<p>Select Paint Color</p> <p>See page 171</p> <p>T1</p>
---	--

10500 Series™ Laminate Occasional Tables

GSA SIN 33721



Icon Legend on page 19

	DESCRIPTION	MODEL	SHIP WEIGHT	CUBE	LIST PRICE
	Coffee Table 48"W x 20"D x 16"H	H80191	48 Ⓢ	3.4	\$475
	Corner Table 24"W x 24"D x 20"H	H80192	35 Ⓢ	2.1	\$410
	End Table 24"W x 20"D x 20"H	H80193	29 Ⓢ	1.8	\$392

Laminate Occasional Tables (H80191, H80192 and H80193)

Woodgrain	Solid	Patterned	Two-Tone	
Bourbon Cherry (HH) Cognac (COGNCOGN) Florence Walnut (LFWILFW1) Harvest (CC) Kingswood Walnut (LKIILKI1) Mahogany (NN) Mocha (MOCHMOCH) Natural Maple (DD) Pinnacle (PINCPINC) Shaker Cherry (FF) Sterling Ash (LSA1LSA1)	Black (PP) Charcoal (SS) Designer White (LDWILDW1) Loft (LOFTLOFT)	Canyon Zephyr (K9) Desert Zephyr (K8) Grey Tigris (L6*) Sheer Mesh (A5) Silver Mesh (B9) *Select edge/apron/leg color Black (P) Bourbon Cherry (H) Charcoal (S) Cognac (COGN) Designer White (LDW1) Florence Walnut (LFW1) Harvest (C) Kingswood Walnut (LKI1) Mahogany (N) Mocha (MOCH) Natural Maple (D) Pinnacle (PINC) Shaker Cherry (F) Sterling Ash (LSA1)	Black/Charcoal (PS) Black/Designer White (PLDW1) Bourbon Cherry/Black (HP) Bourbon Cherry/Charcoal (HS) Bourbon Cherry/Designer White (HLDW1) Charcoal/Black (SP) Charcoal/Designer White (SLDW1) Cognac/Black (COGNP) Cognac/Charcoal (COGNS) Cognac/Designer White (COGNLDW1) Designer White/Black (LDW1P) Designer White/Bourbon Cherry (LDWIH) Designer White/Charcoal (LDWIS) Designer White/Cognac (LDWICOGN) Designer White/Florence Walnut (LDWILFW1) Designer White/Harvest (LDWIC) Designer White/Kingswood Walnut (LDWILKI1) Designer White/Mahogany (LDWIN) Designer White/Mocha (LDWIMOCH) Designer White/Natural Maple (LDWID) Designer White/Pinnacle (LDWIPINC) Designer White/Sterling Ash (LDWILSA1)	Designer White/Shaker Cherry (LDWIF) Florence Walnut/Black (LFW1P) Florence Walnut/Charcoal (LFWIS) Florence Walnut/Designer White (LFWILDW1) Florence Walnut/Loft (LFWILOFT) Harvest/Black (CP) Harvest/Charcoal (CS) Harvest/Designer White (CLDW1) Kingswood Walnut/Black (LKIIP) Kingswood Walnut/Charcoal (LKIIS) Kingswood Walnut/Designer White (LKIILDW1) Kingswood Walnut/Loft (LKILOFT) Mahogany/Black (NP) Mahogany/Charcoal (NS) Mahogany/Designer White (NLDW1) Mocha/Black (MOCHP) Mocha/Charcoal (MOCHS) Mocha/Designer White (MOCHLDW1) Natural Maple/Black (DP) Natural Maple/Charcoal (DS) Natural Maple/Designer White (DLDW1) Pinnacle/Black (PINCP) Pinnacle/Charcoal (PINCS) Pinnacle/Designer White (PINCLDW1) Shaker Cherry/Black (FP) Shaker Cherry/Charcoal (FS) Shaker Cherry/Designer White (FLDW1) Sterling Ash/Black (LSA1P) Sterling Ash/Charcoal (LSAIS) Sterling Ash/Designer White (LSAILDW1)

NOTES:

- Durable material and construction make laminate occasional tables ideal for high traffic areas such as lobbies, reception rooms and lounges. Versatile design is also well suited to private offices.
- Tables accommodate lamps, magazines, telephones, plants, laptops and more.
- Coffee, Corner and End Tables feature top-over-apron styling with square corner detail, which complements many interiors and furniture designs.
- Tops are abrasion- and stain-resistant laminate over 1/8" thick solid core high-performance particleboard.
- For 10500 Series™ mobile tables, see page 266.
- See pages 265-288 for shared components.

HOW TO SPECIFY

<p>Select Model Number</p> <p>H 8 0 1 9 1 .</p> <p>H 8 0 1 9 1 .</p>	<p>Select Laminate</p> <p>See above</p> <p>N N</p> <p>L 6 N</p>
---	--



10500 Series™ Shared Components & Accessories

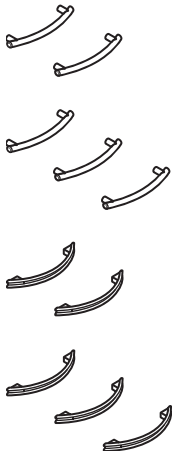

DESCRIPTION

Field Installable Drawer/Door Handle Kits

Sweep Black, 2-pack
Sweep Satin Nickel, 2-pack

Sweep Black, 3-pack
Sweep Satin Nickel, 3-pack

Crescent Black, 2-pack
Crescent Satin Nickel, 2-pack

Crescent Black, 3-pack
Crescent Satin Nickel, 3-pack

MODEL

SHIP WEIGHT

CUBE

LIST PRICE

HSWEEPA2	0.4 Ⓢ	0.3	\$43
HSWEEPC2	0.4 Ⓢ	0.3	\$43
HSWEEPA3	0.5 Ⓢ	0.3	\$56
HSWEEPC3	0.5 Ⓢ	0.3	\$56
HCRESCENTA2	0.4 Ⓢ	0.3	\$43
HCRESCENTC2	0.4 Ⓢ	0.3	\$43
HCRESCENTA3	0.5 Ⓢ	0.3	\$56
HCRESCENTC3	0.5 Ⓢ	0.3	\$56

NOTES: Handles are for purchase and field installation on 10500 or 10700 Series™ desks, credenzas, returns, and lateral files, as well as for the modular pedestals used with 10700 and 10500.

Applications include:

- box/file and file/file pedestals = one 2-pack per pedestal
- box/box/file and pencil/media/file pedestals = one 3-pack per pedestal
- two drawer lateral file = two 2-packs per unit
- four drawer lateral file = four 2-packs per unit

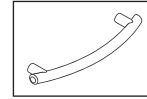

Sweep Handle

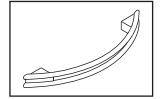

Crescent Handle

The hole spacing for the Sweep and Crescent handles is 96mm (approx. 3 3/4"). Important note: effective January 1, 2007, the holes used for the black drawer/door handle that comes standard on several HON 10500 and 10700 Series™ products, including mobile pedestals, storage cabinet with doors, storage/file cabinet, storage cabinet/lateral file, personal wardrobe/storage cabinets, and personal storage towers, will accept the Sweep and Crescent handles. Units manufactured prior to January 1, 2007, have 64mm (approx. 2 1/2") hole spacing and will not accept the Sweep and Crescent handles. Instructions include mounting hardware and paper template.

! Must be ordered with a configurable end product. If ordered separately, not on GSA contract.

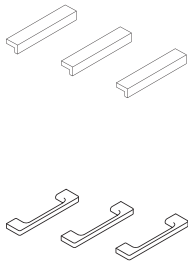

Field Installable Drawer/Door Handle Kits

Linear, Black, 2-pack
Linear, Matte Chrome, 2-pack

Linear, Black, 3-pack
Linear, Matte Chrome, 3-pack

Specify Linear handles in black to coordinate with 10500 Series™ models that ship standard with a decorative handle, such as mobile pedestals, storage cabinets and wardrobes.

Arch, Black, 2-pack
Arch, Matte Chrome, 2-pack

Arch, Black, 3-pack
Arch, Matte Chrome, 3-pack

HLINEARA2	0.4 Ⓢ	0.3	\$56
HLINEARC2	0.4 Ⓢ	0.3	\$56
HLINEARA3	0.5 Ⓢ	0.3	\$64
HLINEARC3	0.5 Ⓢ	0.3	\$64
HARCHA2	0.4 Ⓢ	0.3	\$56
HARCHC2	0.4 Ⓢ	0.3	\$56
HARCHA3	0.5 Ⓢ	0.3	\$64
HARCHC3	0.5 Ⓢ	0.3	\$64

NOTES: Handles are for purchase and field installation on 10500 or 10700 Series™ desks, credenzas, returns, lateral files and modular pedestals. Instructions include mounting hardware and paper template for drilling holes.

Applications include:

- box/file and file/file pedestals = one 2-pack per pedestal
- box/box/file and pencil/media/file pedestals = one 3-pack per pedestal
- two drawer lateral file = two 2-packs per unit
- four drawer lateral file = four 2-packs per unit

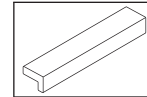

Linear Handle

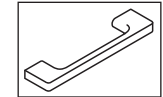

Arch Handle

The Linear and Arch handles can be attached using 96mm (approx. 3 3/4") or 128mm (approx. 5") hole spacing. Important note: effective January 1, 2007, the holes used for the black drawer/door handle that comes standard on several HON 10500 and 10700 Series™ products, including mobile pedestals, storage cabinet with doors, storage/file cabinet, storage cabinet/lateral file, personal wardrobe/storage cabinets, and personal storage towers, will accept the Linear and Arch handles. Units manufactured prior to January 1, 2007, have 64mm (approx. 2 1/2") hole spacing and will not accept the Linear and Arch handles.

! Must be ordered with a configurable end product. If ordered separately, not on GSA contract.

NOTES:

- Field Installable Drawer/Door Handle Kits for use on 10500 Series™ desks, credenzas, returns and lateral files.
- A metal template is available to facilitate field installation of the Linear, Arch, Sweep and Crescent decorative handles on 10500 and 10700 Series™ drawer fronts; order model SPLH-SYST-DRKNB.M263164.
- See pages 265-288 for shared components.

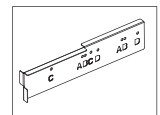

Metal Template

HOW TO SPECIFY

Select Model Number

H S W E E P A 2

10500 SERIES™

Shared Components & Accessories

OPEN MARKET EXCEPT AS NOTED

ABI

Icon Legend on page 19

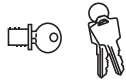

SIN 33721

**DESCRIPTION**
Black Removable Lock Core Kit
Satin Removable Lock Core Kit

- Specify quantity of each key number from 101E-225E.
- Includes: 1-core, 2-keys, 1-core removal tool, and instructions.

NOTES: Lock with a removable cylinder that can be interchanged as needed; allows users to access all furniture pieces in an office with a single key for convenience and security. Makes re-keying quick and easy. For use in all 10500 Series™ product lock cores, except the stack-on and wall mounted storage "K" models. For the latter use model HF27B or HF27S, listed below.

MODEL**SHIP WEIGHT****CUBE****LIST PRICE****HF23B**

0.1 Ⓞ

0.1

\$32**HF23S**

0.1 Ⓞ

0.1

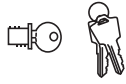
\$40**Removable Lock Core Kit**Black
Satin**HF27B**

0.2

0.02

\$32**HF27S**

0.2

0.02

\$32

- For stack-on and wall mounted storage laminate models (with locks) in 10500, 10700, Valido, Voi, Concinnity, and 94000 Series.
- Specify quantity of each key number from 101E to 225E.
- Includes: 1-core, 2-keys, 1-core removal tool, and instructions.

NOTES: If key number isn't specified, number will be at random.

NOTES:

- See pages 265-288 for shared components.
- For master key, see model HF22 on page 853.

HOW TO ORDER CORE REMOVABLE LOCK KITS:

Specify: Model Number.X
Key Number

Examples: HF23S.X121E
HF23S.X (Key number not specified)

NOTES: Key orders without numbers specified will be keyed at random.
Numbers 101E-225E are available.

SAMPLE ORDER:

Quantity	Model	Key Code
4	HF23B.	X121E

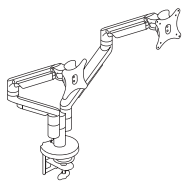
**DESCRIPTION****Dual Dynamic Monitor Arm**

- 150° of rotation at base with optional 360° rotation.
- Arms extend 22" and retract up to 3".
- Monitor mount rotates 180° and tilts +/-30°.
- Monitor can be rotated from landscape to portrait position.

! Arms hold monitors from 6.2-18 lbs. Optional counterweight HPACW available to support monitors as low as 5 lbs. (see page 827).

MODEL**SHIP WEIGHT****CUBE****LIST PRICE****HMASD**

17.0 Ⓞ

1.1

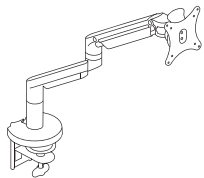
\$750**Single Dynamic Monitor Arm**

- 180° of rotation at base with optional 360° rotation.
- Arms extend 22" and retract up to 3".
- Monitor mount rotates 180° and tilts +/-30°.
- Monitor can be rotated from landscape to portrait position.

! Arms hold monitors from 6.2-18 lbs. Optional counterweight HPACW available to support monitors as low as 5 lbs. (see page 827).

HMAST

11.5 Ⓞ

0.8







\$390**HOW TO SPECIFY**
**Select
Model Number**
**Select
Finish**
Specify for models HMASD and HMAST only
SVR Silver
BLK Black

H M A S D
S V R

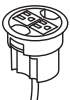

Icon Legend on page 19

10500 Series™ Shared Components & Accessories

	DESCRIPTION	MODEL	SHIP WEIGHT	CUBE	LIST PRICE
 SIN 33721	<p>Field Installable Grommet</p> <ul style="list-style-type: none"> Intended for use in tops and end panels to route/hide cords and in modesty panels to facilitate reaching wall electrical outlets. Grommet is field installable. Grommet shape is round. Includes grommet cap and sleeve. Grommet cap measures 3" diameter and includes a 3/4" diameter cord access hole. Grommet sleeve measures 2 1/2" O.D. x 3/4" thick. Includes instructions to locate grommet position for desks, credenzas, returns and bridges. <p>NOTES: For additional information see page 848.</p> <ul style="list-style-type: none"> ❗ Black Finish ❗ Requires a 2 1/2" diameter hole saw and drill for installation (not included). 	HFLDGRMT	0.1 Ⓢ	0.01	\$32
 SIN 33721	<p>Field Installable Grommet</p> <ul style="list-style-type: none"> Intended for use in tops and end panels to route/hide cords and in modesty panels to facilitate reaching wall electrical outlets. Grommet is field installable. Grommet shape is round. Includes grommet cap and sleeve. Grommet outside dimensions measure 3 1/2" diameter and includes two cord access holes. Grommet sleeve measures 3" O.D. x 1" thick. Includes instructions to locate grommet position for desks, credenzas, returns and bridges. <p>NOTES: For additional information see page 848.</p> <ul style="list-style-type: none"> ❗ Black Finish ❗ Requires a 3" diameter hole saw and drill for installation (not included). 	HFLDGRMT3	0.1 Ⓢ	0.3	\$32
	<p>Power Hub, 3" Grommet Mount, 6' Cord</p> <ul style="list-style-type: none"> Brings the ease of plug-and-play to the desktop. Fits in 3" round grommet holes in 10500 Series™ desks, credenzas and returns; not compatible with 10500 Series™ 2 1/2" round grommets. Two grounded AC power outlets. Two cord pass-through holes in cap. Includes 6' cord with three-prong plug. For field installation. UL Listed. <p>NOTES: For additional information see page 848.</p> <ul style="list-style-type: none"> ❗ Available in Black only (no color designation – Specify: HGRMTAC.X). 	HGRMTAC	1.3	0.2	\$111
 	<p>3" Round Power Grommet – 2 Outlets, 10' Cord</p> <ul style="list-style-type: none"> Includes 10' cord with three-prong plug. Fits in 3" round grommet holes on the following product lines: Coordinate, Huddle, Motivate, all laminate and veneer casegoods series, and Systems Worksurfaces. Two grounded AC power outlets. Field installed with Plug-and-play ease. <p>NOTES: Power Modules will also work with standing-height applications for 10500 Series™ and Voi® desks. Optional Memory Control allows preset worksurface heights for consistency. Ships separately. Dynamic load capacity when worksurface is moving is 300 lbs.</p> <ul style="list-style-type: none"> ❗ Available in black finish only, no specification needed. 	HGRMTAC2	1.5	0.2	\$148
	<p>Power/USB Hub, 3" Grommet Mount</p> <ul style="list-style-type: none"> Brings the ease of plug-and-play to the desktop. Fits in 3" round grommet holes in 10500 Series™ desks, credenzas and returns; not compatible with 10500 Series™ 2 1/2" round grommets. One grounded AC power outlet with 2 USB ports. Two cord pass-through holes in cap. Includes 6' cord with three-prong plug. For field installation. UL Listed. <p>NOTES: For additional information see page 848.</p> <ul style="list-style-type: none"> ❗ Available in black only (no color designation so use .X – Specify: HGRMTUSB2.X). 	HGRMTUSB2	1.3 Ⓢ	0.02	\$224

NOTES:

- See pages 265-288 for shared components.

HOW TO SPECIFY

Select Model Number

H	F	L	D	G	R	M	T
---	---	---	---	---	---	---	---

10500 SERIES™

Shared Components & Accessories

GSA SIN AS NOTED

ABI

Icon Legend on page 19



SIN 33721

DESCRIPTION

Articulating Desk Lamp
Articulating Desk Lamp w/ Occupancy Sensor

NOTES: For additional information see page 841.

! Silver finish only, no specification needed.

MODEL

HLED1
HLED1OC

SHIP WEIGHT

1.2 Ⓢ
1.2 Ⓢ

CUBE

6.5
6.5

LIST PRICE

\$402
\$490



SIN 33721

Task Desk Lamp

NOTES: For additional information see page 841.

! Brushed nickel finish only, no specification needed.

HLED2

0.7 Ⓢ

3.0

\$348

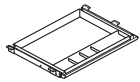

OPEN MARKET

Polymer Center Drawer

- Color: Black.
- Material: ABS.
- Opening Requirements: 23"W x 16¼"D x 2"H.
- Retracts on 16" ball-bearing slides.
- Can be used on worksurfaces with Coordinate™ Height Adjustable Bases as long as it is attached with spacer model HKBS.
- Can store up to 25 lbs.

NOTES: For additional information see page 833.

! Black finish only, no specification needed.

HCD1

7.0

0.5

\$108

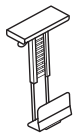

OPEN MARKET

CPU Holder

- Vertically mounts to underside of worksurface.
- 360° swivel.
- Supports up to 55 lbs.
- Height adjustable from 16" to 22" below worksurface.
- Width adjustable to accept units from 3¼" to 6".

! Silver finish only, no specification needed.

HCPU *

16.0 Ⓢ

0.5

\$259

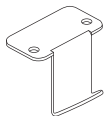

OPEN MARKET

Back Pack Hook (10 per carton)

12"W x 14½"D x 1½"H

NOTES: Assembly; attaches to bottom of desk with (2) screws, included. For additional information see page 846.

! Available in Platinum Metallic finish only, no specification needed.

HCLA65

10.0 Ⓢ

0.1

\$94

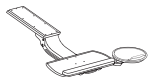
**DESCRIPTION****MODEL****SHIP WEIGHT****CUBE****LIST PRICE BY PAINT GRADE****P1****P2**

Refer to pages 829-830 for
additional product
information

SIN 33721



Sit to Stand Arm with Convertible Keyboard Platform

H2516 OPEN MARKET *

17 Ⓢ

1.6

\$618

Articulating Arm with Convertible Keyboard Platform

H2107 OPEN MARKET *

16 Ⓢ

1.3

\$529

Articulating Arm with Keyboard Platform

H1706 OPEN MARKET *

16 Ⓢ

1.4

\$493

Slide-Away Keyboard Platform (Specify: Laminate)

H4022

10 Ⓢ

0.6

\$213

Extended Tray Slide-Away Keyboard Platform
(Specify: Laminate)

HE4022

12 Ⓢ

0.7

\$302

Metal Keyboard and Mouse Tray (Specify paint)

H4028 OPEN MARKET

11 Ⓢ

1.5

\$153

\$163

Metal Keyboard Tray (Specify paint)

H4029 OPEN MARKET

11 Ⓢ

1.5

\$138

\$148

NOTES: For additional information see pages 829-830.

NOTES:

- See pages 265-288 for shared components.

* De-emphasized.

HOW TO SPECIFY

Select
Model Number

HLED1

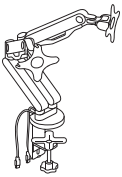
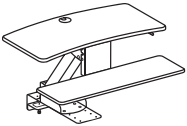
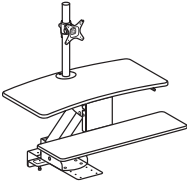
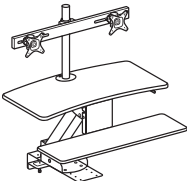
	DESCRIPTION	MODEL	SHIP WEIGHT	CUBE	LIST PRICE
	<p>Coordinate™ Portable Desktop Riser 31"D x 5"-16½"H x 35"W</p> <p>NOTES: Available in Black (BLK) or White (WHT) finish. Desktop riser dimensions (without keyboard tray): 22"D x 5"-16½"H x 35"W. Keyboard tray dimensions: 9"D x 30"W. Max loading capacity is 33 lbs for the desktop riser surface and 4 lbs for the keyboard tray. Easily transition from seated to standing positions throughout the workday. Sits atop an existing desk to create sit-to-stand functionality by raising the computer. Includes keyboard tray and surface for computer monitors. HON 5-Year Limited Warranty.</p> <p>ⓘ Not intended for use on mobile workstations.</p>	HBXRISER	54.0	4.1	\$619
	<p>Dual Monitor Arm with 2 USB Ports</p> <p>NOTES: Easy adjustment. Height adjusts to 17" tall. Monitor tilt and swivel capability. Enclosed cable management. Grommet or desktop mounting. Clean appearance. In some applications the Monitor Arms may extend 12 or more inches into the worksurface. For additional information see page 825. HON 5-Year Limited Warranty.</p> <p>ⓘ No specification needed.</p>	HBDMAUSB	41.9	2.6	\$441
	<p>Coordinate™ Mounted Desktop Riser</p> <p>NOTES: Does not include a monitor arm and is suitable for laptops and/or monitors on their original stands.</p> <p>ⓘ No specification needed.</p>	HS1100	60.0 ⓘ	3.2	\$664
	<p>Coordinate™ Mounted Desktop Riser with Single Monitor Arm</p> <p>NOTES: Includes a monitor arm for a single monitor.</p> <p>ⓘ No specification needed.</p>	HS1101	62.0 ⓘ	3.2	\$777
	<p>Coordinate™ Mounted Desktop Riser with Dual Monitor Arm</p> <p>NOTES: Includes a monitor arm for dual monitors.</p> <p>ⓘ No specification needed.</p>	HS1102	63.0 ⓘ	3.2	\$883

NOTES FOR HS1100, HS1101, HS1102:

- These products are designed to allow the user to transition from seating position to standing position throughout the workday.
- Gas-assist lever-operated mechanism with positive stop.
- Clamp mount compatible with worksurfaces depths of 20"-30". 20" is for systems only.
- Clamp requires 3.5" of clearance along back edge of worksurface.
- Black seamless worksurfaces.
- Silver powder coated metal components.
- Lowers below worksurface level on 24" and 30"D worksurfaces.
- All models contain a large primary worksurface and a smaller keyboard / mouse surface.
- Beveled edges for sleek appearance and comfort while typing.
- Monitor arms include height, width, and swivel adjustment.
- For additional information see page 838.

- Not for use under overhead storage, with flush mounted modesty panels, or worksurfaces thinner than 1".

ⓘ Not recommended for use on mobile (castered) worksurfaces.

MOUNTING AND COMPATIBILITY FOR HS1100, HS1101, HS1102:

- This product is intended to be installed on commercial-grade worksurfaces in good condition.
- Compatible with freestanding worksurfaces 24"-30"D or panel-supported worksurfaces 24"-30"D.
- Not for use on mobile worksurfaces.

Clamp Mount

Use when 3.5" minimum overhang is available

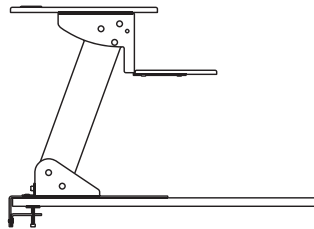

Screw Mount

Use when no overhang is available. Worksurface must be minimum 1" thick.

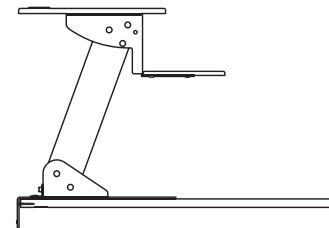

HOW TO SPECIFY

<p>Select Model Number</p> <p>HBXRISER.</p>	<p>Select Finish</p> <p>BLK Black WHT White</p> <p>BLK</p>
---	--



10500 SERIES™

Accessories

OPEN MARKET

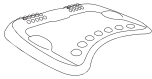
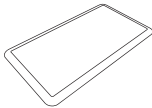
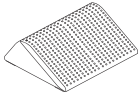

Icon Legend on page 19

	DESCRIPTION	MODEL	SHIP WEIGHT	CUBE	LIST PRICE
	Rectangle Wobble Board — Anti-Fatigue Mat 18"D x 3"H x 22½"W ⓘ Available in Black (T) finish ONLY. Recommended weight capacity not to exceed 250 pounds. HON 5-Year Limited Warranty. SPECIFYING EXAMPLE: HVL981.T	HVL981	10.0 Ⓢ	0.9	\$120
	Round Wobble Board — Anti-Fatigue Mat 18½"D x 2½"H x 18½"W ⓘ Available in Black (T) finish ONLY. Recommended weight capacity not to exceed 250 pounds. HON 5-Year Limited Warranty. SPECIFYING EXAMPLE: HVL982.T	HVL982	5.8 Ⓢ	0.6	\$102
	Ergonomic Anti-Fatigue Mat 25"D x 2¾"H x 29⅞"W ⓘ Available in Black ONLY. No specification needed. SPECIFYING EXAMPLE: HBEAFM1	HBEAFM1	7.0	1.4	\$219
	Rectangle Anti-Fatigue Mat 20"D x ¾"H x 36"W ⓘ Available in Black ONLY. No specification needed. SPECIFYING EXAMPLE: HBAFM2036	HBAFM2036	5.4	0.4	\$100
	Footrest — Anti-Slip Cover 13¾"D x 5½"H x 16"W ⓘ Available in Black (T) finish ONLY. Recommended weight capacity not to exceed 250 pounds. HON 5-Year Limited Warranty. SPECIFYING EXAMPLE: HVL991.T	HVL991	7.0 Ⓢ	0.9	\$82

HOW TO SPECIFY

Select
Model Number

H V L 9 8 1 .

Select
Finish

T Black

T

