

Lenovo™ **ThinkServer**

PSREF



Product Specifications Reference

Version 496, October 2016

EMEA

Visit <http://psref.lenovo.com> for the latest version

Contents

Cover		
Contents		
Summary Of Change		
Racks		
ThinkServer RD350		
ThinkServer RD350 Platform Specifications	1	37
ThinkServer RD350 - TopSeller - 70D6 - 1 of 2	2	38
ThinkServer RD350 - TopSeller - 70D6 - 2 of 2	4	39
ThinkServer RD350 - TopSeller - 70D8 - 1 of 2	6	40
ThinkServer RD350 - TopSeller - 70D8 - 2 of 2	6	41
ThinkServer RD350 - TopSeller - 70QK - 1 of 2	7	42
ThinkServer RD350 - TopSeller - 70QK - 2 of 2	8	43
ThinkServer RD350 - TopSeller - 70QM - 1 of 2	9	44
ThinkServer RD350 - TopSeller - 70QM - 2 of 2	10	45
ThinkServer RD450	11	46
ThinkServer RD450 Platform Specifications	12	47
ThinkServer RD450 - TopSeller - 70DA - 1 of 2	13	48
ThinkServer RD450 - TopSeller - 70DA - 2 of 2	14	49
ThinkServer RD450 - TopSeller - 70DC - 1 of 2	15	50
ThinkServer RD450 - TopSeller - 70DC - 2 of 2	16	51
ThinkServer RD450 - TopSeller - 70DE	17	52
ThinkServer RD450 - TopSeller - 70DV	18	53
ThinkServer RD450 - TopSeller - 70Q9 - 1 of 2	19	54
ThinkServer RD450 - TopSeller - 70Q9 - 2 of 2	20	55
ThinkServer RD450 - TopSeller - 70QQ - 1 of 2	21	56
ThinkServer RD450 - TopSeller - 70QQ - 2 of 2	22	57
ThinkServer RD450 - TopSeller - 70QW	23	57
ThinkServer RD550	24	58
ThinkServer RD550 Platform Specifications	25	59
ThinkServer RD550 - TopSeller - 70CV - 1 of 2	26	60
ThinkServer RD550 - TopSeller - 70CV - 2 of 2	27	61
ThinkServer RD550 - TopSeller - 70CX - 1 of 3	28	62
ThinkServer RD550 - TopSeller - 70CX - 2 of 3	29	63
ThinkServer RD550 - TopSeller - 70CX - 3 of 3	30	64
ThinkServer RD650	31	65
ThinkServer RD650 Platform Specifications	32	66
ThinkServer RD650 - TopSeller - 70D0 - 1 of 2	33	67
ThinkServer RD650 - TopSeller - 70D0 - 2 of 2	34	68
ThinkServer RD650 - TopSeller - 70D2 - 1 of 2	35	69
ThinkServer RD650 - TopSeller - 70D2 - 2 of 2	36	70
ThinkServer RD650 - TopSeller - 70D4 - 1 of 2		
ThinkServer RD650 - TopSeller - 70D4 - 2 of 2		
ThinkServer RD650 - TopSeller - 70DR - 1 of 3		
ThinkServer RD650 - TopSeller - 70DR - 2 of 3		
ThinkServer RD650 - TopSeller - 70DR - 3 of 3		
ThinkServer RS140		
ThinkServer RS140 Platform Specifications		
ThinkServer RS140 - TopSeller - 70F3 - 1 of 2		
ThinkServer RS140 - TopSeller - 70F3 - 2 of 2		
ThinkServer RS140 - TopSeller - 70F9 - 1 of 2		
ThinkServer RS140 - TopSeller - 70F9 - 2 of 2		
ThinkServer RS160		
ThinkServer RS160 Platform Specifications		
ThinkServer RS160 - TopSeller - 70TE		
ThinkServer RS160 - TopSeller - 70TG		
Towers		
ThinkServer TD340		
ThinkServer TD340 Platform Specifications		
ThinkServer TD340 - TopSeller - 70B5 - 1 of 2		
ThinkServer TD340 - TopSeller - 70B5 - 2 of 2		
ThinkServer TD340 - TopSeller - 70B7 - 1 of 3		
ThinkServer TD340 - TopSeller - 70B7 - 2 of 3		
ThinkServer TD340 - TopSeller - 70B7 - 3 of 3		
ThinkServer TD350		
ThinkServer TD350 Platform Specifications		
ThinkServer TD350 - TopSeller - 70DG - 1 of 2		
ThinkServer TD350 - TopSeller - 70DG - 2 of 2		
ThinkServer TD350 - TopSeller - 70DJ - 1 of 3		
ThinkServer TD350 - TopSeller - 70DJ - 2 of 3		
ThinkServer TD350 - TopSeller - 70DJ - 3 of 3		

Contents

ThinkServer TS140	71
ThinkServer TS140 Platform Specifications	72
ThinkServer TS140 - TopSeller - 70A4 - 1 of 3	73
ThinkServer TS140 - TopSeller - 70A4 - 2 of 3	74
ThinkServer TS140 - TopSeller - 70A4 - 3 of 3	75
ThinkServer TS140 - TopSeller - 70A5 - 1 of 4	76
ThinkServer TS140 - TopSeller - 70A5 - 2 of 4	77
ThinkServer TS140 - TopSeller - 70A5 - 3 of 4	78
ThinkServer TS140 - TopSeller - 70A5 - 4 of 4	79
ThinkServer TS140 - 70A0	80
ThinkServer TS140 - 70A1	81
ThinkServer TS150	82
ThinkServer TS150 Platform Specifications	82
ThinkServer TS150 - TopSeller - 70LV	83
ThinkServer TS150 - TopSeller - 70LX	84
ThinkServer TS440	85
ThinkServer TS440 Platform Specifications	86
ThinkServer TS440 - TopSeller - 70AN - 1 of 2	87
ThinkServer TS440 - TopSeller - 70AN - 2 of 2	88
ThinkServer TS440 - TopSeller - 70AQ - 1 of 2	89
ThinkServer TS440 - TopSeller - 70AQ - 2 of 2	90
ThinkServer TS440 - 70AL	91
ThinkServer TS440 - 70AM	92
Info Of Law	93

Summary of Changes

This section describes the changes made in this version of ThinkServer PSREF and in previous version
This edition might also include minor corrections and editorial changes which are not identified

October 12, 2016 - Version 496

Additions in this update

- ▶ New ThinkServer RS160 product announced September 2016
- ▶ New ThinkServer TS150 models announced August and October 2016

September 14, 2016 - Version 495

Additions in this update

- ▶ New ThinkServer RS160 product announced September 2016
- ▶ New ThinkServer TS140 models announced September 2016

April 6, 2016 - Version 487

Additions in this update

- ▶ New ThinkServer TD350, RD350, and RD450 models announced April 2016
- ▶ Add Intel Xeon E5-2600 v4 processors

March 23, 2016 - Version 486

Additions in this update

- ▶ New ThinkServer TS140 models announced March 2016

February 24, 2016 - Version 485

Additions in this update

- ▶ Add 8TB SATA and SAS 72K 6Gbs hard drive on ThinkServer RD350/RD450/RD550/RD650/TD350

December 30, 2015 - Version 483

Additions in this update

- ▶ Updates ThinkServer RS140, TD340 specifications
- ▶ Updates the most recent ThinkServer RS140, TD340 models

December 9, 2015 - Version 482

Additions in this update

- ▶ Updates ThinkServer TS140, TS440 specifications
- ▶ Updates the most recent ThinkServer TS140, TS440, RD350, RD450, RD550, RD650 models

October 28, 2015 - Version 480

Additions in this update

- ▶ New ThinkServer TS140 models announced October 2015

July 30, 2015 - Version 476

Additions in this update

- ▶ New ThinkServer TD350, RD550, and RD650 models announced July 2015

May 6, 2015 - Version 473

Additions in this update

- ▶ Add 95mm optical support on TD350
- ▶ Add Red Hat Enterprise Linux 7 support on RD350/RD450/RD550/RD650/TD350
- ▶ Add 32 x 25" bay support on TD350
- ▶ Add AnyBay and 25" PCIe SSD support on RD550/RD650

April 15, 2015 - Version 471

Additions in this update

- ▶ New ThinkServer TD350 models announced March 2015

March 25, 2015 - Version 470

Additions in this update

- ▶ New ThinkServer TS140 and TS440 models announced March 2015



ThinkServer RD350 Platform Specifications

Product Specifications Reference (PSREF)

Components	Specification																																								
Dimensions	1U rack. Height: 43 mm (1.7 in), width: 482 mm (19 in), depth: 781.5 mm (30.77 in)																																								
Weight	Minimum configuration: 13 kg (28.66 lb), maximum: 19.1 kg (42.11 lb)																																								
Processor	Up to two 105W Intel Xeon E5-2600 v4 or E5-2600 v3 family processors.																																								
	<table border="1"> <tbody> <tr><td>E5-2660 v4</td><td>14C/2GHz/35MB/105W/DDR4-2400</td></tr> <tr><td>E5-2650 v4</td><td>12C/2.2GHz/30MB/105W/DDR4-2400</td></tr> <tr><td>E5-2640 v4</td><td>10C/2.4GHz/25MB/90W/DDR4-2133</td></tr> <tr><td>E5-2630 v4</td><td>10C/2.2GHz/20MB/85W/DDR4-2133</td></tr> <tr><td>E5-2623 v4</td><td>4C/2.6GHz/10MB/85W/DDR4-2133</td></tr> <tr><td>E5-2620 v4</td><td>8C/2.1GHz/20MB/85W/DDR4-2133</td></tr> <tr><td>E5-2609 v4</td><td>8C/1.7GHz/20MB/85W/DDR4-1866</td></tr> <tr><td>E5-2603 v4</td><td>6C/1.7GHz/15MB/85W/DDR4-1866</td></tr> <tr><td>E5-2650L v4</td><td>14C/1.7GHz/35MB/65W/DDR4-2400</td></tr> <tr><td>E5-2630L v4</td><td>10C/1.8GHz/25MB/55W/DDR4-2133</td></tr> <tr><td>E5-2660 v3</td><td>10C/2.6GHz/25MB/105W/DDR4-2133</td></tr> <tr><td>E5-2650 v3</td><td>10C/2.3GHz/25MB/105W/DDR4-2133</td></tr> <tr><td>E5-2640 v3</td><td>8C/2.6GHz/20MB/90W/DDR4-1866</td></tr> <tr><td>E5-2630 v3</td><td>8C/2.4GHz/20MB/85W/DDR4-1866</td></tr> <tr><td>E5-2623 v3</td><td>4C/3GHz/10MB/105W/DDR4-1866</td></tr> <tr><td>E5-2620 v3</td><td>6C/2.4GHz/15MB/85W/DDR4-1866</td></tr> <tr><td>E5-2609 v3</td><td>6C/1.9GHz/15MB/85W/DDR4-1600</td></tr> <tr><td>E5-2603 v3</td><td>6C/1.6GHz/15MB/85W/DDR4-1600</td></tr> <tr><td>E5-2650L v3</td><td>12C/1.8GHz/30MB/65W/DDR4-2133</td></tr> <tr><td>E5-2630L v3</td><td>8C/1.8GHz/20MB/55W/DDR4-1866</td></tr> </tbody> </table>	E5-2660 v4	14C/2GHz/35MB/105W/DDR4-2400	E5-2650 v4	12C/2.2GHz/30MB/105W/DDR4-2400	E5-2640 v4	10C/2.4GHz/25MB/90W/DDR4-2133	E5-2630 v4	10C/2.2GHz/20MB/85W/DDR4-2133	E5-2623 v4	4C/2.6GHz/10MB/85W/DDR4-2133	E5-2620 v4	8C/2.1GHz/20MB/85W/DDR4-2133	E5-2609 v4	8C/1.7GHz/20MB/85W/DDR4-1866	E5-2603 v4	6C/1.7GHz/15MB/85W/DDR4-1866	E5-2650L v4	14C/1.7GHz/35MB/65W/DDR4-2400	E5-2630L v4	10C/1.8GHz/25MB/55W/DDR4-2133	E5-2660 v3	10C/2.6GHz/25MB/105W/DDR4-2133	E5-2650 v3	10C/2.3GHz/25MB/105W/DDR4-2133	E5-2640 v3	8C/2.6GHz/20MB/90W/DDR4-1866	E5-2630 v3	8C/2.4GHz/20MB/85W/DDR4-1866	E5-2623 v3	4C/3GHz/10MB/105W/DDR4-1866	E5-2620 v3	6C/2.4GHz/15MB/85W/DDR4-1866	E5-2609 v3	6C/1.9GHz/15MB/85W/DDR4-1600	E5-2603 v3	6C/1.6GHz/15MB/85W/DDR4-1600	E5-2650L v3	12C/1.8GHz/30MB/65W/DDR4-2133	E5-2630L v3	8C/1.8GHz/20MB/55W/DDR4-1866
	E5-2660 v4	14C/2GHz/35MB/105W/DDR4-2400																																							
	E5-2650 v4	12C/2.2GHz/30MB/105W/DDR4-2400																																							
	E5-2640 v4	10C/2.4GHz/25MB/90W/DDR4-2133																																							
	E5-2630 v4	10C/2.2GHz/20MB/85W/DDR4-2133																																							
	E5-2623 v4	4C/2.6GHz/10MB/85W/DDR4-2133																																							
	E5-2620 v4	8C/2.1GHz/20MB/85W/DDR4-2133																																							
	E5-2609 v4	8C/1.7GHz/20MB/85W/DDR4-1866																																							
	E5-2603 v4	6C/1.7GHz/15MB/85W/DDR4-1866																																							
	E5-2650L v4	14C/1.7GHz/35MB/65W/DDR4-2400																																							
	E5-2630L v4	10C/1.8GHz/25MB/55W/DDR4-2133																																							
	E5-2660 v3	10C/2.6GHz/25MB/105W/DDR4-2133																																							
	E5-2650 v3	10C/2.3GHz/25MB/105W/DDR4-2133																																							
	E5-2640 v3	8C/2.6GHz/20MB/90W/DDR4-1866																																							
	E5-2630 v3	8C/2.4GHz/20MB/85W/DDR4-1866																																							
	E5-2623 v3	4C/3GHz/10MB/105W/DDR4-1866																																							
	E5-2620 v3	6C/2.4GHz/15MB/85W/DDR4-1866																																							
	E5-2609 v3	6C/1.9GHz/15MB/85W/DDR4-1600																																							
	E5-2603 v3	6C/1.6GHz/15MB/85W/DDR4-1600																																							
E5-2650L v3	12C/1.8GHz/30MB/65W/DDR4-2133																																								
E5-2630L v3	8C/1.8GHz/20MB/55W/DDR4-1866																																								
Chipset	Intel C612 Platform Controller Hub (PCH)																																								
Memory DIMMs	16 DIMM sockets. 4 channels per processor, 2 DIMMs per channel. RDIMM or LRDIMM (cannot be intermixed), DDR4-2133 or DDR4-2400																																								
Memory capacity	512GB (RDIMM, 32GB x 16)/1024GB (LRDIMM, 64GB x 16), 2nd CPU is needed																																								
Memory protection	ECC, memory mirroring, lockstep, and memory sparing																																								
RAID controller	<table border="1"> <thead> <tr> <th>RAID controller</th> <th>Drive type</th> <th>RAID support</th> <th>Compatible models</th> </tr> </thead> <tbody> <tr> <td>Onboard RAID110i</td> <td>6Gbs SATA</td> <td>0/1/10, 5 with optional key</td> <td>4x3.5" HS/ES, 8x2.5" HS</td> </tr> <tr> <td>RAID500 PCIe</td> <td>6Gbs SAS/SATA</td> <td>0/1/10, 5/50 with optional key</td> <td>4x3.5" HS, 8x2.5" HS</td> </tr> <tr> <td>RAID520i PCIe</td> <td>12Gbs SAS/SATA</td> <td>0/1/10, 5/50 with optional key</td> <td>4x3.5" HS/ES, 8x2.5" HS</td> </tr> <tr> <td>RAID710 PCIe (1GB memory)</td> <td>6Gbs SAS/SATA</td> <td>0/1/10/5/50/6/60</td> <td>4x3.5" HS, 8x2.5" HS</td> </tr> <tr> <td>RAID720i PCIe</td> <td>12Gbs SAS/SATA</td> <td>0/1/10/5/50, 6/60 with optional cache</td> <td>4x3.5" HS/ES, 8x2.5" HS</td> </tr> </tbody> </table>	RAID controller	Drive type	RAID support	Compatible models	Onboard RAID110i	6Gbs SATA	0/1/10, 5 with optional key	4x3.5" HS/ES, 8x2.5" HS	RAID500 PCIe	6Gbs SAS/SATA	0/1/10, 5/50 with optional key	4x3.5" HS, 8x2.5" HS	RAID520i PCIe	12Gbs SAS/SATA	0/1/10, 5/50 with optional key	4x3.5" HS/ES, 8x2.5" HS	RAID710 PCIe (1GB memory)	6Gbs SAS/SATA	0/1/10/5/50/6/60	4x3.5" HS, 8x2.5" HS	RAID720i PCIe	12Gbs SAS/SATA	0/1/10/5/50, 6/60 with optional cache	4x3.5" HS/ES, 8x2.5" HS																
	RAID controller	Drive type	RAID support	Compatible models																																					
	Onboard RAID110i	6Gbs SATA	0/1/10, 5 with optional key	4x3.5" HS/ES, 8x2.5" HS																																					
	RAID500 PCIe	6Gbs SAS/SATA	0/1/10, 5/50 with optional key	4x3.5" HS, 8x2.5" HS																																					
	RAID520i PCIe	12Gbs SAS/SATA	0/1/10, 5/50 with optional key	4x3.5" HS/ES, 8x2.5" HS																																					
	RAID710 PCIe (1GB memory)	6Gbs SAS/SATA	0/1/10/5/50/6/60	4x3.5" HS, 8x2.5" HS																																					
RAID720i PCIe	12Gbs SAS/SATA	0/1/10/5/50, 6/60 with optional cache	4x3.5" HS/ES, 8x2.5" HS																																						
	Optional cache for RAID 710: CacheVault flash cache with super capacitor, CacheCade Pro, or FastPath.																																								
	Optional cache for RAID 720/AnyRAID 720i and 720ix: 1GB read-only memory or 1GB/2GB/4GB flash with super capacitor. Flash options include CacheVault, CacheCade Pro, and FastPath. 720ix must have cache.																																								
	<i>Note: RAID 50 and 60 are available on 8 x 2.5" models only.</i>																																								
Disk drive bays	Up to 4x3.5" hot-swap, 4x3.5" easy-swap, or 8x2.5" hot-swap disk bays on front. Supports external RDX tape drive via USB.																																								
Maximum internal storage	3.5" model: up to 32TB with 7.2K SATA or SAS HDD, up to 7.2TB with 10K SAS HDD, up to 2.4TB with 15K SAS HDD, or up to 6.4TB with SATA SSD. 3.5" ES model: up to 12TB with 7.2K SATA, up to 24TB with 7.2K SAS. 2.5" model: up to 16TB with 7.2K SATA HDD, up to 14.4TB with 10K SAS HDD, up to 4.8TB with 15K SAS HDD, or up to 12.8TB with SATA or SAS SSD																																								
SD module	Up to 2 SDHC flash cards via optional SD module, 8GB or 32GB each																																								
Optical drive	Optional one 9.5mm optical, DVD-ROM or DVD±RW.																																								
Network interfaces	One dedicated management port, two Gigabit Ethernet ports (RJ-45). Supports optional discrete network adapters via PCIe slots																																								
Security features	Power-on and administrator password. Optional TPM (TCG 1.2-compliant) Supports ThinkServer System Manager (TSM), optional TSM Premium. UEFI. Onboard Aspeed AST2400 graphics/management processor, IPMI 2.0-compliant baseboard management controller (BMC).																																								
Systems management	Control Panel LEDs shows the status of power, ID, network, system. Supports ThinkServer management software: Diagnostics, Deployment Manager, Energy Manager, System Manager, Partner Pack for VMware vCenter and Microsoft System Center Operations Manager, Power Planner																																								

Components	Specification														
Operating systems supported	Microsoft Windows Server 2012 R2/2012/2008 R2. Windows Small Business Server 2011. Red Hat Enterprise Linux 6.5/6.6/7. SUSE Linux Enterprise Server 11. VMware vSphere (ESXi) 5.1 P5/5.5 U2/6.0														
Base warranty	1 or 3-year limited onsite service with 9x5/NBD														
Power supply	Up to two redundant hot-swap 450W/550W/750W power supplies. 450 W is 80 PLUS Gold qualified. 550W is 80 PLUS Platinum qualified. 750W is 80 PLUS Platinum or Titanium qualified. 750W Titanium is 200V - 240V, others are 110V - 240V.														
	<table border="1"> <thead> <tr> <th rowspan="2">Disk bay configuration</th> <th colspan="3">PSU requirements</th> </tr> <tr> <th>450W</th> <th>550W</th> <th>750W</th> </tr> </thead> <tbody> <tr> <td>4x3.5"</td> <td>•</td> <td>•</td> <td>•</td> </tr> <tr> <td>8x2.5"</td> <td>•</td> <td>•</td> <td>•</td> </tr> </tbody> </table>	Disk bay configuration	PSU requirements			450W	550W	750W	4x3.5"	•	•	•	8x2.5"	•	•
Disk bay configuration	PSU requirements														
	450W	550W	750W												
4x3.5"	•	•	•												
8x2.5"	•	•	•												
Graphics	Onboard Aspeed AST2400 with 16MB memory, one DisplayPort on front, one VGA on rear.														
Front ports	Two USB 2.0. One DisplayPort (one VGA on E5-2600 v4 models instead)														
Rear ports	One VGA, two USB 3.0, one RJ-45 (dedicated mgmt), two ethernet, one serial (9-pin)														
Cooling	6 (5+1, dual processors) or 4 (3+1, single processor) fans, non-hot swap														
Noise emissions	Operating: < 6.5 Bels. Idle: < 5.4 Bels (Maximum configuration)														
Environmental specification	Temperature - operating	50 °F to 95 °F (10 °C to 35 °C)													
	Temperature - non operating (no package)	-10 °C to 60 °C													
	Temperature - non operating (with package)	-40 °C to 70 °C													
	Altitude - operating	(Unpressurized): 0-10000ft (0-3048m)													
	Humidity - operating	8%-90%, non-condensing													
	Humidity - storage (with package)	8%-90%, non-condensing													

Expansion slots

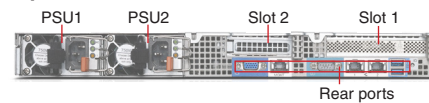

Up to two PCIe 3.0 x 16 slots:

Slot 1	PCIe 3.0 x16, half length, full height, by CPU1
Slot 2 for dual processors model	PCIe 3.0 x16, low-profile, half length, requires 2nd riser card and 2nd CPU
Slot 2 for single processor model	PCIe 3.0 x16 (x8 electrical), low-profile, half length, by CPU1, requires 2nd riser card

For a list of all supported options, please see https://download.lenovo.com/pccbbs/options_iso/ocm_may_2016_thinkserver.xlsx sheet

Model	Region	Processor	2nd CPU	Memory	RAID Controller	Disk Bays	Storage	Slots	Optical	Add-on NIC	TPM	System Mgmt	OS	Warranty	Power Supply	Ann Date (m/y)
70D60000EA	EMEA	1xE5-2609 v3 6C/1.9GHz/15MB/85W/DDR4-1600	4XG0F28847	1x4GB RDIMM DDR4-2133 ECC	RAID 110i+key	4x3.5" HS	Open	1xFHHL	9.5mm DVD±RW	None	TPM	TSM Premium	None	3-year	450Wx1 Gold	12/14
70D60001EA	EMEA	1xE5-2620 v3 6C/2.4GHz/15MB/85W/DDR4-1866	4XG0F28846	1x8GB RDIMM DDR4-2133 ECC	500 PCIe	4x3.5" HS	Open	1xFHHL	9.5mm DVD±RW	None	TPM	TSM Premium	None	3-year	450Wx2 Gold	12/14
70D60002EA	EMEA	1xE5-2650 v3 10C/2.3GHz/25MB/105W/DDR4-2133	4XG0F28843	1x16GB RDIMM DDR4- 2133 ECC	710 PCIe+Super Cap	4x3.5" HS	Open	1xFHHL	9.5mm DVD±RW	None	TPM	TSM Premium	None	3-year	450Wx2 Gold	12/14
70D60007EA	EMEA	1xE5-2603 v3 6C/1.6GHz/15MB/85W/DDR4-1600	4XG0F28848	1x8GB RDIMM DDR4-2133 ECC	RAID 110i	4x3.5" HS	Open	1xFHHL	9.5mm DVD±RW	None	None	TSM	None	1-year	750Wx1 Platinum	12/14
70D60008EA	EMEA	1xE5-2609 v3 6C/1.9GHz/15MB/85W/DDR4-1600	4XG0F28847	1x8GB RDIMM DDR4-2133 ECC	RAID 110i	4x3.5" HS	Open	1xFHHL	9.5mm DVD±RW	None	None	TSM	None	1-year	750Wx1 Platinum	12/14
70D60009EA	EMEA	1xE5-2620 v3 6C/2.4GHz/15MB/85W/DDR4-1866	4XG0F28846	1x8GB RDIMM DDR4-2133 ECC	RAID 110i	4x3.5" HS	Open	1xFHHL	9.5mm DVD±RW	None	None	TSM	None	1-year	750Wx1 Platinum	12/14
70D6000AEA	EMEA	1xE5-2630 v3 8C/2.4GHz/20MB/85W/DDR4-1866	4XG0F28845	1x8GB RDIMM DDR4-2133 ECC	RAID 110i	4x3.5" HS	Open	1xFHHL	9.5mm DVD±RW	None	None	TSM	None	1-year	750Wx1 Platinum	12/14
70D6000BEA	EMEA	1xE5-2640 v3 8C/2.6GHz/20MB/90W/DDR4-1866	4XG0F28844	1x8GB RDIMM DDR4-2133 ECC	RAID 110i	4x3.5" HS	Open	1xFHHL	9.5mm DVD±RW	None	None	TSM	None	1-year	750Wx1 Platinum	12/14
70D6000CEA	EMEA	1xE5-2650 v3 10C/2.3GHz/25MB/105W/DDR4-2133	4XG0F28843	1x8GB RDIMM DDR4-2133 ECC	RAID 110i	4x3.5" HS	Open	1xFHHL	9.5mm DVD±RW	None	None	TSM	None	1-year	750Wx1 Platinum	12/14
70D6000DEA	EMEA	1xE5-2660 v3 10C/2.6GHz/25MB/105W/DDR4-2133	4XG0F28842	1x8GB RDIMM DDR4-2133 ECC	RAID 110i	4x3.5" HS	Open	1xFHHL	9.5mm DVD±RW	None	None	TSM	None	1-year	750Wx1 Platinum	12/14
70D6000EEA	EMEA	1xE5-2603 v3 6C/1.6GHz/15MB/85W/DDR4-1600	4XG0F28848	1x8GB RDIMM DDR4-2133 ECC	500 PCIe	4x3.5" HS	Open	1xFHHL	9.5mm DVD±RW	None	None	TSM	None	1-year	750Wx1 Platinum	12/14
70D6000FEA	EMEA	1xE5-2609 v3 6C/1.9GHz/15MB/85W/DDR4-1600	4XG0F28847	1x8GB RDIMM DDR4-2133 ECC	500 PCIe	4x3.5" HS	Open	1xFHHL	9.5mm DVD±RW	None	None	TSM	None	1-year	750Wx1 Platinum	12/14
70D6000GEA	EMEA	1xE5-2620 v3 6C/2.4GHz/15MB/85W/DDR4-1866	4XG0F28846	1x8GB RDIMM DDR4-2133 ECC	500 PCIe	4x3.5" HS	Open	1xFHHL	9.5mm DVD±RW	None	None	TSM	None	1-year	750Wx1 Platinum	12/14
70D6000HEA	EMEA	1xE5-2630 v3 8C/2.4GHz/20MB/85W/DDR4-1866	4XG0F28845	1x8GB RDIMM DDR4-2133 ECC	500 PCIe	4x3.5" HS	Open	1xFHHL	9.5mm DVD±RW	None	None	TSM	None	1-year	750Wx1 Platinum	12/14
70D6000JEA	EMEA	1xE5-2640 v3 8C/2.6GHz/20MB/90W/DDR4-1866	4XG0F28844	1x8GB RDIMM DDR4-2133 ECC	500 PCIe	4x3.5" HS	Open	1xFHHL	9.5mm DVD±RW	None	None	TSM	None	1-year	750Wx1 Platinum	12/14
70D6000KEA	EMEA	1xE5-2650 v3 10C/2.3GHz/25MB/105W/DDR4-2133	4XG0F28843	1x8GB RDIMM DDR4-2133 ECC	500 PCIe	4x3.5" HS	Open	1xFHHL	9.5mm DVD±RW	None	None	TSM	None	1-year	750Wx1 Platinum	12/14
70D6000LEA	EMEA	1xE5-2660 v3 10C/2.6GHz/25MB/105W/DDR4-2133	4XG0F28842	1x8GB RDIMM DDR4-2133 ECC	500 PCIe	4x3.5" HS	Open	1xFHHL	9.5mm DVD±RW	None	None	TSM	None	1-year	750Wx1 Platinum	12/14

Model	Region	Processor	2nd CPU	Memory	RAID Controller	Disk Bays	Storage	Slots	Optical	Add-on NIC	TPM	System Mgmt	OS	Warranty	Power Supply	Ann Date (m/y)
70D6000MEA	EMEA	1xE5-2603 v3 6C/1.6GHz/15MB/85W/DDR4-1600	4XG0F28848	1x8GB RDIMM DDR4-2133 ECC	710 PCIe+Super Cap	4x3.5" HS	Open	1xFHHL	9.5mm DVD±RW	None	None	TSM Premium	None	1-year	750Wx1 Platinum	12/14
70D6000NEA	EMEA	1xE5-2609 v3 6C/1.9GHz/15MB/85W/DDR4-1600	4XG0F28847	1x8GB RDIMM DDR4-2133 ECC	710 PCIe+Super Cap	4x3.5" HS	Open	1xFHHL	9.5mm DVD±RW	None	None	TSM Premium	None	1-year	750Wx1 Platinum	12/14
70D6000PEA	EMEA	1xE5-2620 v3 6C/2.4GHz/15MB/85W/DDR4-1866	4XG0F28846	1x8GB RDIMM DDR4-2133 ECC	710 PCIe+Super Cap	4x3.5" HS	Open	1xFHHL	9.5mm DVD±RW	None	None	TSM Premium	None	1-year	750Wx1 Platinum	12/14
70D6000QEA	EMEA	1xE5-2603 v3 6C/1.6GHz/15MB/85W/DDR4-1600	4XG0F28848	1x16GB RDIMM DDR4-2133 ECC	710 PCIe+Super Cap	4x3.5" HS	Open	1xFHHL	9.5mm DVD±RW	None	None	TSM Premium	None	1-year	750Wx1 Platinum	12/14
70D6000REA	EMEA	1xE5-2609 v3 6C/1.9GHz/15MB/85W/DDR4-1600	4XG0F28847	1x16GB RDIMM DDR4-2133 ECC	710 PCIe+Super Cap	4x3.5" HS	Open	1xFHHL	9.5mm DVD±RW	None	None	TSM Premium	None	1-year	750Wx1 Platinum	12/14
70D6000SEA	EMEA	1xE5-2620 v3 6C/2.4GHz/15MB/85W/DDR4-1866	4XG0F28846	1x16GB RDIMM DDR4-2133 ECC	710 PCIe+Super Cap	4x3.5" HS	Open	1xFHHL	9.5mm DVD±RW	None	None	TSM Premium	None	1-year	750Wx1 Platinum	12/14
70D6000TEA	EMEA	1xE5-2640 v3 8C/2.6GHz/20MB/90W/DDR4-1866	4XG0F28844	1x8GB RDIMM DDR4-2133 ECC	710 PCIe+Super Cap	4x3.5" HS	Open	1xFHHL	9.5mm DVD±RW	None	None	TSM Premium	None	1-year	750Wx1 Platinum	12/14
70D6000UEA	EMEA	2xE5-2640 v3 8C/2.6GHz/20MB/90W/DDR4-1866	-	2x8GB RDIMM DDR4-2133 ECC	710 PCIe+Super Cap	4x3.5" HS	Open	1xFHHL+1xLP (2x16)	9.5mm DVD±RW	None	None	TSM Premium	None	1-year	750Wx1 Platinum	12/14
70D6000VEA	EMEA	1xE5-2650 v3 10C/2.3GHz/25MB/105W/DDR4-2133	4XG0F28843	1x8GB RDIMM DDR4-2133 ECC	710 PCIe+Super Cap	4x3.5" HS	Open	1xFHHL	9.5mm DVD±RW	None	None	TSM Premium	None	1-year	750Wx1 Platinum	12/14
70D6000WEA	EMEA	2xE5-2650 v3 10C/2.3GHz/25MB/105W/DDR4-2133	-	2x8GB RDIMM DDR4-2133 ECC	710 PCIe+Super Cap	4x3.5" HS	Open	1xFHHL+1xLP (2x16)	9.5mm DVD±RW	None	None	TSM Premium	None	1-year	750Wx1 Platinum	12/14
70D60036EA	EMEA	1xE5-2609 v3 6C/1.9GHz/15MB/85W/DDR4-1600	4XG0F28847	1x8GB RDIMM DDR4-2133 ECC	RAID 110i	4x3.5" HS	Open	1xFHHL	9.5mm DVD±RW	None	None	TSM	None	3-year	450Wx1 Gold	04/15
70D6003GEA	EMEA	1xE5-2609 v3 6C/1.9GHz/15MB/85W/DDR4-1600	4XG0F28847	1x8GB RDIMM DDR4-2133 ECC	710 PCIe+Super Cap	4x3.5" HS	Open	1xFHHL	9.5mm DVD±RW	None	None	TSM Premium	None	3-year	750Wx1 Platinum	10/15

Model	Region	Processor	2nd CPU	Memory	RAID Controller	Disk Bays	Storage	Slots	Optical	Add-on NIC	TPM	System Mgmt	OS	Warranty	Power Supply	Ann Date (m/y)
70D80000EA	EMEA	1xE5-2609 v3 6C/1.9GHz/15MB/85W/DDR4-1600	4XG0F28847	1x8GB RDIMM DDR4-2133 ECC	710 PCIe+Super Cap	8x2.5" HS	Open	1xFHHL	9.5mm DVD±RW	None	TPM	TSM Premium	None	3-year	550Wx1 Platinum	12/14
70D80001EA	EMEA	1xE5-2620 v3 6C/2.4GHz/15MB/85W/DDR4-1866	4XG0F28846	1x16GB RDIMM DDR4-2133 ECC	710 PCIe+Super Cap	8x2.5" HS	Open	1xFHHL	9.5mm DVD±RW	None	TPM	TSM Premium	None	3-year	550Wx1 Platinum	12/14
70D80003EA	EMEA	1xE5-2603 v3 6C/1.6GHz/15MB/85W/DDR4-1600	4XG0F28848	1x8GB RDIMM DDR4-2133 ECC	RAID 110i	8x2.5" HS	Open	1xFHHL	9.5mm DVD±RW	None	None	TSM	None	1-year	750Wx1 Platinum	12/14
70D80004EA	EMEA	1xE5-2609 v3 6C/1.9GHz/15MB/85W/DDR4-1600	4XG0F28847	1x8GB RDIMM DDR4-2133 ECC	RAID 110i	8x2.5" HS	Open	1xFHHL	9.5mm DVD±RW	None	None	TSM	None	1-year	750Wx1 Platinum	12/14
70D80005EA	EMEA	1xE5-2620 v3 6C/2.4GHz/15MB/85W/DDR4-1866	4XG0F28846	1x8GB RDIMM DDR4-2133 ECC	RAID 110i	8x2.5" HS	Open	1xFHHL	9.5mm DVD±RW	None	None	TSM	None	1-year	750Wx1 Platinum	12/14
70D80008EA	EMEA	1xE5-2650 v3 10C/2.3GHz/25MB/105W/DDR4-2133	4XG0F28843	1x8GB RDIMM DDR4-2133 ECC	RAID 110i	8x2.5" HS	Open	1xFHHL	9.5mm DVD±RW	None	None	TSM	None	1-year	750Wx1 Platinum	12/14
70D80009EA	EMEA	1xE5-2660 v3 10C/2.6GHz/25MB/105W/DDR4-2133	4XG0F28842	1x8GB RDIMM DDR4-2133 ECC	RAID 110i	8x2.5" HS	Open	1xFHHL	9.5mm DVD±RW	None	None	TSM	None	1-year	750Wx1 Platinum	12/14
70D8000AEA	EMEA	1xE5-2603 v3 6C/1.6GHz/15MB/85W/DDR4-1600	4XG0F28848	1x8GB RDIMM DDR4-2133 ECC	500 PCIe	8x2.5" HS	Open	1xFHHL	9.5mm DVD±RW	None	None	TSM	None	1-year	750Wx1 Platinum	12/14
70D8000BEA	EMEA	1xE5-2609 v3 6C/1.9GHz/15MB/85W/DDR4-1600	4XG0F28847	1x8GB RDIMM DDR4-2133 ECC	500 PCIe	8x2.5" HS	Open	1xFHHL	9.5mm DVD±RW	None	None	TSM	None	1-year	750Wx1 Platinum	12/14
70D8000CEA	EMEA	1xE5-2620 v3 6C/2.4GHz/15MB/85W/DDR4-1866	4XG0F28846	1x8GB RDIMM DDR4-2133 ECC	500 PCIe	8x2.5" HS	Open	1xFHHL	9.5mm DVD±RW	None	None	TSM	None	1-year	750Wx1 Platinum	12/14
70D8000DEA	EMEA	1xE5-2630 v3 8C/2.4GHz/20MB/85W/DDR4-1866	4XG0F28845	1x8GB RDIMM DDR4-2133 ECC	500 PCIe	8x2.5" HS	Open	1xFHHL	9.5mm DVD±RW	None	None	TSM	None	1-year	750Wx1 Platinum	12/14
70D8000EEA	EMEA	1xE5-2640 v3 8C/2.6GHz/20MB/90W/DDR4-1866	4XG0F28844	1x8GB RDIMM DDR4-2133 ECC	500 PCIe	8x2.5" HS	Open	1xFHHL	9.5mm DVD±RW	None	None	TSM	None	1-year	750Wx1 Platinum	12/14
70D8000FEA	EMEA	1xE5-2650 v3 10C/2.3GHz/25MB/105W/DDR4-2133	4XG0F28843	1x8GB RDIMM DDR4-2133 ECC	500 PCIe	8x2.5" HS	Open	1xFHHL	9.5mm DVD±RW	None	None	TSM	None	1-year	750Wx1 Platinum	12/14
70D8000GEA	EMEA	1xE5-2660 v3 10C/2.6GHz/25MB/105W/DDR4-2133	4XG0F28842	1x8GB RDIMM DDR4-2133 ECC	500 PCIe	8x2.5" HS	Open	1xFHHL	9.5mm DVD±RW	None	None	TSM	None	1-year	750Wx1 Platinum	12/14
70D8000HEA	EMEA	1xE5-2603 v3 6C/1.6GHz/15MB/85W/DDR4-1600	4XG0F28848	1x8GB RDIMM DDR4-2133 ECC	710 PCIe+Super Cap	8x2.5" HS	Open	1xFHHL	9.5mm DVD±RW	None	None	TSM Premium	None	1-year	750Wx1 Platinum	12/14
70D8000JEA	EMEA	1xE5-2609 v3 6C/1.9GHz/15MB/85W/DDR4-1600	4XG0F28847	1x8GB RDIMM DDR4-2133 ECC	710 PCIe+Super Cap	8x2.5" HS	Open	1xFHHL	9.5mm DVD±RW	None	None	TSM Premium	None	1-year	750Wx1 Platinum	12/14
70D8000KEA	EMEA	1xE5-2620 v3 6C/2.4GHz/15MB/85W/DDR4-1866	4XG0F28846	1x8GB RDIMM DDR4-2133 ECC	710 PCIe+Super Cap	8x2.5" HS	Open	1xFHHL	9.5mm DVD±RW	None	None	TSM Premium	None	1-year	750Wx1 Platinum	12/14

Model	Region	Processor	2nd CPU	Memory	RAID Controller	Disk Bays	Storage	Slots	Optical	Add-on NIC	TPM	System Mgmt	OS	Warranty	Power Supply	Ann Date (m/y)
70D8000LEA	EMEA	1xE5-2603 v3 6C/1.6GHz/15MB/85W/DDR4-1600	4XG0F28848	1x16GB RDIMM DDR4-2133 ECC	710 PCIe+Super Cap	8x2.5" HS	Open	1xFHHL	9.5mm DVD±RW	None	None	TSM Premium	None	1-year	750Wx1 Platinum	12/14
70D8000MEA	EMEA	1xE5-2609 v3 6C/1.9GHz/15MB/85W/DDR4-1600	4XG0F28847	1x16GB RDIMM DDR4-2133 ECC	710 PCIe+Super Cap	8x2.5" HS	Open	1xFHHL	9.5mm DVD±RW	None	None	TSM Premium	None	1-year	750Wx1 Platinum	12/14
70D8000NEA	EMEA	1xE5-2620 v3 6C/2.4GHz/15MB/85W/DDR4-1866	4XG0F28846	1x16GB RDIMM DDR4-2133 ECC	710 PCIe+Super Cap	8x2.5" HS	Open	1xFHHL	9.5mm DVD±RW	None	None	TSM Premium	None	1-year	750Wx1 Platinum	12/14
70D8000PEA	EMEA	1xE5-2640 v3 8C/2.6GHz/20MB/90W/DDR4-1866	4XG0F28844	1x8GB RDIMM DDR4-2133 ECC	710 PCIe+Super Cap	8x2.5" HS	Open	1xFHHL	9.5mm DVD±RW	None	None	TSM Premium	None	1-year	750Wx1 Platinum	12/14
70D8000QEA	EMEA	2xE5-2640 v3 8C/2.6GHz/20MB/90W/DDR4-1866	-	2x8GB RDIMM DDR4-2133 ECC	710 PCIe+Super Cap	8x2.5" HS	Open	1xFHHL+1xLP (2x16)	9.5mm DVD±RW	None	None	TSM Premium	None	1-year	750Wx1 Platinum	12/14
70D8000REA	EMEA	1xE5-2650 v3 10C/2.3GHz/25MB/105W/DDR4-2133	4XG0F28843	1x8GB RDIMM DDR4-2133 ECC	710 PCIe+Super Cap	8x2.5" HS	Open	1xFHHL	9.5mm DVD±RW	None	None	TSM Premium	None	1-year	750Wx1 Platinum	12/14
70D8000SEA	EMEA	2xE5-2650 v3 10C/2.3GHz/25MB/105W/DDR4-2133	-	2x8GB RDIMM DDR4-2133 ECC	710 PCIe+Super Cap	8x2.5" HS	Open	1xFHHL+1xLP (2x16)	9.5mm DVD±RW	None	None	TSM Premium	None	1-year	750Wx1 Platinum	12/14
70D80022EA	EMEA	1xE5-2620 v3 6C/2.4GHz/15MB/85W/DDR4-1866	4XG0F28846	1x8GB RDIMM DDR4-2133 ECC	RAID 110i	8x2.5" HS	Open	1xFHHL	9.5mm DVD±RW	None	None	TSM	None	3-year	450Wx2 Gold	04/15
70D8002XEA	EMEA	1xE5-2620 v3 6C/2.4GHz/15MB/85W/DDR4-1866	4XG0F28846	1x8GB RDIMM DDR4-2133 ECC	710 PCIe+Super Cap	8x2.5" HS	Open	1xFHHL	9.5mm DVD±RW	None	None	TSM Premium	None	3-year	750Wx1 Platinum	10/15

Model	Region	Processor	2nd CPU	Memory	RAID Controller	Disk Bays	Storage	Slots	Optical	Add-on NIC	TPM	System Mgmt	OS	Warranty	Power Supply	Ann Date (m/y)
70QK0000EA	EMEA	1xE5-2609 v4 8C/1.7GHz/20MB/85W/DDR4-1866	4XG0G89084	1x8GB RDIMM DDR4-2400 ECC	520i PCIe	4x3.5" HS	2x1TB HDD 7.2K 3.5" SATA6Gbs	1xFHHL+1xLP (16+8)	9.5mm DVD±RW	None	None	TSM	None	1-year	450Wx1 Gold	04/16
70QK0001EA	EMEA	1xE5-2603 v4 6C/1.7GHz/15MB/85W/DDR4-1866	4XG0G89089	1x8GB RDIMM DDR4-2400 ECC	RAID 110i	4x3.5" HS	2x1TB HDD 7.2K 3.5" SATA6Gbs	1xFHHL+1xLP (16+8)	9.5mm DVD±RW	None	None	TSM	None	1-year	450Wx1 Gold	04/16
70QK0009EA	EMEA	1xE5-2603 v4 6C/1.7GHz/15MB/85W/DDR4-1866	4XG0G89089	1x8GB RDIMM DDR4-2400 ECC	RAID 110i	4x3.5" HS	Open	1xFHHL	9.5mm DVD±RW	None	None	TSM	None	3-year	450Wx1 Gold	04/16
70QK000AEA	EMEA	1xE5-2609 v4 8C/1.7GHz/20MB/85W/DDR4-1866	4XG0G89084	1x8GB RDIMM DDR4-2400 ECC	RAID 110i	4x3.5" HS	Open	1xFHHL	9.5mm DVD±RW	None	None	TSM	None	3-year	450Wx1 Gold	04/16
70QK000BEA	EMEA	1xE5-2620 v4 8C/2.1GHz/20MB/85W/DDR4-2133	4XG0G89079	1x8GB RDIMM DDR4-2400 ECC	RAID 110i	4x3.5" HS	Open	1xFHHL	9.5mm DVD±RW	None	None	TSM	None	3-year	450Wx1 Gold	04/16
70QK000CEA	EMEA	1xE5-2603 v4 6C/1.7GHz/15MB/85W/DDR4-1866	4XG0G89089	1x8GB RDIMM DDR4-2400 ECC	520i PCIe	4x3.5" HS	Open	1xFHHL	9.5mm DVD±RW	None	None	TSM	None	3-year	450Wx1 Gold	04/16
70QK000DEA	EMEA	1xE5-2609 v4 8C/1.7GHz/20MB/85W/DDR4-1866	4XG0G89084	1x8GB RDIMM DDR4-2400 ECC	520i PCIe	4x3.5" HS	Open	1xFHHL	9.5mm DVD±RW	None	None	TSM	None	3-year	450Wx1 Gold	04/16
70QK000EEA	EMEA	1xE5-2620 v4 8C/2.1GHz/20MB/85W/DDR4-2133	4XG0G89079	1x8GB RDIMM DDR4-2400 ECC	520i PCIe	4x3.5" HS	Open	1xFHHL	9.5mm DVD±RW	None	None	TSM	None	3-year	450Wx1 Gold	04/16
70QK000FEA	EMEA	1xE5-2603 v4 6C/1.7GHz/15MB/85W/DDR4-1866	4XG0G89089	1x16GB RDIMM DDR4-2400 ECC	520i PCIe	4x3.5" HS	Open	1xFHHL	9.5mm DVD±RW	None	None	TSM	None	3-year	450Wx1 Gold	04/16
70QK000GEA	EMEA	1xE5-2609 v4 8C/1.7GHz/20MB/85W/DDR4-1866	4XG0G89084	1x16GB RDIMM DDR4-2400 ECC	520i PCIe	4x3.5" HS	Open	1xFHHL	9.5mm DVD±RW	None	None	TSM	None	3-year	450Wx1 Gold	04/16
70QK000HEA	EMEA	1xE5-2620 v4 8C/2.1GHz/20MB/85W/DDR4-2133	4XG0G89079	1x16GB RDIMM DDR4-2400 ECC	520i PCIe	4x3.5" HS	Open	1xFHHL	9.5mm DVD±RW	None	None	TSM	None	3-year	450Wx1 Gold	04/16
70QK000JEA	EMEA	1xE5-2630 v4 10C/2.2GHz/20MB/85W/DDR4-2133	4XG0G89074	1x16GB RDIMM DDR4-2400 ECC	520i PCIe	4x3.5" HS	Open	1xFHHL	9.5mm DVD±RW	None	None	TSM	None	3-year	450Wx1 Gold	04/16
70QK000KEA	EMEA	1xE5-2603 v4 6C/1.7GHz/15MB/85W/DDR4-1866	4XG0G89089	1x16GB RDIMM DDR4-2400 ECC	720i PCIe	4x3.5" HS	Open	1xFHHL	9.5mm DVD±RW	None	None	TSM	None	3-year	450Wx1 Gold	04/16
70QK000LEA	EMEA	1xE5-2609 v4 8C/1.7GHz/20MB/85W/DDR4-1866	4XG0G89084	1x16GB RDIMM DDR4-2400 ECC	720i PCIe	4x3.5" HS	Open	1xFHHL	9.5mm DVD±RW	None	None	TSM	None	3-year	450Wx1 Gold	04/16
70QK000MEA	EMEA	1xE5-2620 v4 8C/2.1GHz/20MB/85W/DDR4-2133	4XG0G89079	1x16GB RDIMM DDR4-2400 ECC	720i PCIe	4x3.5" HS	Open	1xFHHL	9.5mm DVD±RW	None	None	TSM	None	3-year	450Wx1 Gold	04/16
70QK000NEA	EMEA	1xE5-2630 v4 10C/2.2GHz/20MB/85W/DDR4-2133	4XG0G89074	1x16GB RDIMM DDR4-2400 ECC	720i PCIe	4x3.5" HS	Open	1xFHHL	9.5mm DVD±RW	None	None	TSM	None	3-year	450Wx1 Gold	04/16
70QK000PEA	EMEA	1xE5-2603 v4 6C/1.7GHz/15MB/85W/DDR4-1866	4XG0G89089	1x16GB RDIMM DDR4-2400 ECC	720i PCIe+2GB Flash	4x3.5" HS	Open	1xFHHL	9.5mm DVD±RW	None	None	TSM	None	3-year	450Wx1 Gold	04/16

Model	Region	Processor	2nd CPU	Memory	RAID Controller	Disk Bays	Storage	Slots	Optical	Add-on NIC	TPM	System Mgmt	OS	Warranty	Power Supply	Ann Date (m/y)
70QK000QEA	EMEA	1xE5-2609 v4 8C/1.7GHz/20MB/85W/DDR4-1866	4XG0G89084	1x16GB RDIMM DDR4-2400 ECC	720i PCIe+2GB Flash	4x3.5" HS	Open	1xFHHL	9.5mm DVD±RW	None	None	TSM	None	3-year	450Wx1 Gold	04/16
70QK000REA	EMEA	1xE5-2620 v4 8C/2.1GHz/20MB/85W/DDR4-2133	4XG0G89079	1x16GB RDIMM DDR4-2400 ECC	720i PCIe+2GB Flash	4x3.5" HS	Open	1xFHHL	9.5mm DVD±RW	None	None	TSM	None	3-year	450Wx1 Gold	04/16
70QK000SEA	EMEA	1xE5-2630 v4 10C/2.2GHz/20MB/85W/DDR4-2133	4XG0G89074	1x16GB RDIMM DDR4-2400 ECC	720i PCIe+2GB Flash	4x3.5" HS	Open	1xFHHL	9.5mm DVD±RW	None	None	TSM	None	3-year	450Wx1 Gold	04/16

Model	Region	Processor	2nd CPU	Memory	RAID Controller	Disk Bays	Storage	Slots	Optical	Add-on NIC	TPM	System Mgmt	OS	Warranty	Power Supply	Ann Date (m/y)
70QM0000EA	EMEA	1xE5-2609 v4 8C/1.7GHz/20MB/85W/DDR4-1866	4XG0G89084	1x16GB RDIMM DDR4-2400 ECC	520i PCIe	8x2.5" HS	2x300GB HDD 10K 2.5" SAS12Gbs	1xFHHL+1xLP (16+8)	9.5mm DVD±RW	None	None	TSM	None	1-year	450Wx1 Gold	04/16
70QM0001EA	EMEA	1xE5-2620 v4 8C/2.1GHz/20MB/85W/DDR4-2133	4XG0G89079	1x16GB RDIMM DDR4-2400 ECC	720i PCIe	8x2.5" HS	2x300GB HDD 10K 2.5" SAS12Gbs	1xFHHL+1xLP (16+8)	9.5mm DVD±RW	None	None	TSM	None	1-year	750Wx1 Platinum	04/16
70QM0009EA	EMEA	1xE5-2603 v4 6C/1.7GHz/15MB/85W/DDR4-1866	4XG0G89089	1x8GB RDIMM DDR4-2400 ECC	RAID 110i	8x2.5" HS	Open	1xFHHL	9.5mm DVD±RW	None	None	TSM	None	3-year	450Wx1 Gold	04/16
70QM000AEA	EMEA	1xE5-2609 v4 8C/1.7GHz/20MB/85W/DDR4-1866	4XG0G89084	1x8GB RDIMM DDR4-2400 ECC	RAID 110i	8x2.5" HS	Open	1xFHHL	9.5mm DVD±RW	None	None	TSM	None	3-year	450Wx1 Gold	04/16
70QM000BEA	EMEA	1xE5-2620 v4 8C/2.1GHz/20MB/85W/DDR4-2133	4XG0G89079	1x8GB RDIMM DDR4-2400 ECC	RAID 110i	8x2.5" HS	Open	1xFHHL	9.5mm DVD±RW	None	None	TSM	None	3-year	450Wx1 Gold	04/16
70QM000CEA	EMEA	1xE5-2603 v4 6C/1.7GHz/15MB/85W/DDR4-1866	4XG0G89089	1x8GB RDIMM DDR4-2400 ECC	520i PCIe	8x2.5" HS	Open	1xFHHL	9.5mm DVD±RW	None	None	TSM	None	3-year	450Wx1 Gold	04/16
70QM000DEA	EMEA	1xE5-2609 v4 8C/1.7GHz/20MB/85W/DDR4-1866	4XG0G89084	1x8GB RDIMM DDR4-2400 ECC	520i PCIe	8x2.5" HS	Open	1xFHHL	9.5mm DVD±RW	None	None	TSM	None	3-year	450Wx1 Gold	04/16
70QM000EEA	EMEA	1xE5-2620 v4 8C/2.1GHz/20MB/85W/DDR4-2133	4XG0G89079	1x8GB RDIMM DDR4-2400 ECC	520i PCIe	8x2.5" HS	Open	1xFHHL	9.5mm DVD±RW	None	None	TSM	None	3-year	450Wx1 Gold	04/16
70QM000FEA	EMEA	1xE5-2603 v4 6C/1.7GHz/15MB/85W/DDR4-1866	4XG0G89089	1x16GB RDIMM DDR4-2400 ECC	520i PCIe	8x2.5" HS	Open	1xFHHL	9.5mm DVD±RW	None	None	TSM	None	3-year	450Wx1 Gold	04/16
70QM000GEA	EMEA	1xE5-2609 v4 8C/1.7GHz/20MB/85W/DDR4-1866	4XG0G89084	1x16GB RDIMM DDR4-2400 ECC	520i PCIe	8x2.5" HS	Open	1xFHHL	9.5mm DVD±RW	None	None	TSM	None	3-year	450Wx1 Gold	04/16
70QM000HEA	EMEA	1xE5-2620 v4 8C/2.1GHz/20MB/85W/DDR4-2133	4XG0G89079	1x16GB RDIMM DDR4-2400 ECC	520i PCIe	8x2.5" HS	Open	1xFHHL	9.5mm DVD±RW	None	None	TSM	None	3-year	450Wx1 Gold	04/16
70QM000JEA	EMEA	1xE5-2630 v4 10C/2.2GHz/20MB/85W/DDR4-2133	4XG0G89074	1x16GB RDIMM DDR4-2400 ECC	520i PCIe	8x2.5" HS	Open	1xFHHL	9.5mm DVD±RW	None	None	TSM	None	3-year	450Wx1 Gold	04/16
70QM000KEA	EMEA	1xE5-2620 v4 8C/2.1GHz/20MB/85W/DDR4-2133	4XG0G89079	1x8GB RDIMM DDR4-2400 ECC	720i PCIe	8x2.5" HS	Open	1xFHHL	9.5mm DVD±RW	None	None	TSM	None	3-year	450Wx1 Gold	04/16
70QM000LEA	EMEA	1xE5-2620 v4 8C/2.1GHz/20MB/85W/DDR4-2133	4XG0G89079	1x16GB RDIMM DDR4-2400 ECC	720i PCIe+2GB Flash	8x2.5" HS	Open	1xFHHL	9.5mm DVD±RW	None	None	TSM	None	3-year	450Wx1 Gold	04/16
70QM000MEA	EMEA	1xE5-2630 v4 10C/2.2GHz/20MB/85W/DDR4-2133	4XG0G89074	1x8GB RDIMM DDR4-2400 ECC	720i PCIe+2GB Flash	8x2.5" HS	Open	1xFHHL	9.5mm DVD±RW	None	None	TSM	None	3-year	450Wx1 Gold	04/16
70QM000NEA	EMEA	1xE5-2630 v4 10C/2.2GHz/20MB/85W/DDR4-2133	4XG0G89074	1x16GB RDIMM DDR4-2400 ECC	720i PCIe+2GB Flash	8x2.5" HS	Open	1xFHHL	9.5mm DVD±RW	None	None	TSM	None	3-year	450Wx1 Gold	04/16
70QM000PEA	EMEA	1xE5-2603 v4 6C/1.7GHz/15MB/85W/DDR4-1866	4XG0G89089	1x8GB RDIMM DDR4-2400 ECC	720i PCIe+2GB Flash	8x2.5" HS	Open	1xFHHL	9.5mm DVD±RW	None	None	TSM	None	3-year	450Wx1 Gold	04/16

Model	Region	Processor	2nd CPU	Memory	RAID Controller	Disk Bays	Storage	Slots	Optical	Add-on NIC	TPM	System Mgmt	OS	Warranty	Power Supply	Ann Date (m/y)
70QM000QEA	EMEA	1xE5-2609 v4 8C/1.7GHz/20MB/85W/DDR4-1866	4XG0G89084	1x8GB RDIMM DDR4-2400 ECC	720i PCIe+2GB Flash	8x2.5" HS	Open	1xFHHL	9.5mm DVD±RW	None	None	TSM	None	3-year	450Wx1 Gold	04/16
70QM000REA	EMEA	1xE5-2620 v4 8C/2.1GHz/20MB/85W/DDR4-2133	4XG0G89079	1x8GB RDIMM DDR4-2400 ECC	720i PCIe+2GB Flash	8x2.5" HS	Open	1xFHHL	9.5mm DVD±RW	None	None	TSM	None	3-year	450Wx1 Gold	04/16
70QM000SEA	EMEA	1xE5-2603 v4 6C/1.7GHz/15MB/85W/DDR4-1866	4XG0G89089	1x8GB RDIMM DDR4-2400 ECC	720i PCIe	8x2.5" HS	Open	1xFHHL	9.5mm DVD±RW	None	None	TSM	None	3-year	450Wx1 Gold	04/16
70QM000TEA	EMEA	1xE5-2609 v4 8C/1.7GHz/20MB/85W/DDR4-1866	4XG0G89084	1x8GB RDIMM DDR4-2400 ECC	720i PCIe	8x2.5" HS	Open	1xFHHL	9.5mm DVD±RW	None	None	TSM	None	3-year	450Wx1 Gold	04/16
70QM000UEA	EMEA	1xE5-2620 v4 8C/2.1GHz/20MB/85W/DDR4-2133	4XG0G89079	1x16GB RDIMM DDR4-2400 ECC	720i PCIe	8x2.5" HS	Open	1xFHHL	9.5mm DVD±RW	None	None	TSM	None	3-year	450Wx1 Gold	04/16
70QM000VEA	EMEA	1xE5-2630 v4 10C/2.2GHz/20MB/85W/DDR4-2133	4XG0G89074	1x8GB RDIMM DDR4-2400 ECC	720i PCIe	8x2.5" HS	Open	1xFHHL	9.5mm DVD±RW	None	None	TSM	None	3-year	450Wx1 Gold	04/16
70QM000WEA	EMEA	1xE5-2603 v4 6C/1.7GHz/15MB/85W/DDR4-1866	4XG0G89089	1x16GB RDIMM DDR4-2400 ECC	720i PCIe+2GB Flash	8x2.5" HS	Open	1xFHHL	9.5mm DVD±RW	None	None	TSM	None	3-year	450Wx1 Gold	04/16
70QM000XEA	EMEA	1xE5-2609 v4 8C/1.7GHz/20MB/85W/DDR4-1866	4XG0G89084	1x16GB RDIMM DDR4-2400 ECC	720i PCIe+2GB Flash	8x2.5" HS	Open	1xFHHL	9.5mm DVD±RW	None	None	TSM	None	3-year	450Wx1 Gold	04/16



ThinkServer RD450 Platform Specifications

Product Specifications Reference (PSREF)

Components	Specification																																								
Dimensions	2U rack. Height: 87 mm (3.4 in), width: 482 mm (19 in), depth: 764 mm (30 in)																																								
Weight	Minimum configuration: 16 kg (35.3 lb), maximum: 27 kg (59.52 lb)																																								
Processor	Up to two 105W Intel Xeon E5-2600 v4 or E5-2600 v3 family processors.																																								
	E5-2660 v4	14C/2GHz/35MB/105W/DDR4-2400																																							
	E5-2650 v4	12C/2.2GHz/30MB/105W/DDR4-2400																																							
	E5-2640 v4	10C/2.4GHz/25MB/90W/DDR4-2133																																							
	E5-2630 v4	10C/2.2GHz/20MB/85W/DDR4-2133																																							
	E5-2623 v4	4C/2.6GHz/10MB/85W/DDR4-2133																																							
	E5-2620 v4	8C/2.1GHz/20MB/85W/DDR4-2133																																							
	E5-2609 v4	8C/1.7GHz/20MB/85W/DDR4-1866																																							
	E5-2603 v4	6C/1.7GHz/15MB/85W/DDR4-1866																																							
	E5-2650L v4	14C/1.7GHz/35MB/65W/DDR4-2400																																							
	E5-2630L v4	10C/1.8GHz/25MB/55W/DDR4-2133																																							
	E5-2660 v3	10C/2.6GHz/25MB/105W/DDR4-2133																																							
	E5-2650 v3	10C/2.3GHz/25MB/105W/DDR4-2133																																							
	E5-2640 v3	8C/2.6GHz/20MB/90W/DDR4-1866																																							
	E5-2630 v3	8C/2.4GHz/20MB/85W/DDR4-1866																																							
	E5-2623 v3	4C/3GHz/10MB/105W/DDR4-1866																																							
	E5-2620 v3	6C/2.4GHz/15MB/85W/DDR4-1866																																							
	E5-2609 v3	6C/1.9GHz/15MB/85W/DDR4-1600																																							
E5-2603 v3	6C/1.6GHz/15MB/85W/DDR4-1600																																								
E5-2650L v3	12C/1.8GHz/30MB/65W/DDR4-2133																																								
E5-2630L v3	8C/1.8GHz/20MB/55W/DDR4-1866																																								
Chipset	Intel C612 Platform Controller Hub (PCH)																																								
Memory DIMMs	16 DIMM sockets with 8 channels. 4 channels per processor, 2 DIMMs per channel. RDIMM or LRDIMM (cannot be intermixed), DDR4, DDR4-2133 or DDR4-2400																																								
Memory capacity	512GB (RDIMM, 32GB x 16)/1024GB (LRDIMM, 64GB x 16), 2nd CPU is needed																																								
Memory protection	ECC, memory mirroring, lockstep, and memory sparing																																								
RAID controller	<table border="1"> <thead> <tr> <th>RAID controller</th> <th>Drive type</th> <th>RAID support</th> <th>Compatible models</th> </tr> </thead> <tbody> <tr> <td>Onboard RAID110i</td> <td>6Gbs SATA</td> <td>0/1/10, 5 with optional key</td> <td>8x3.5" HS/ES, 8x2.5" HS</td> </tr> <tr> <td>RAID500 PCIe</td> <td>6Gbs SAS/SATA</td> <td>0/1/10, 5/50 with optional key</td> <td>8x3.5" HS</td> </tr> <tr> <td>RAID520i PCIe</td> <td>12Gbs SAS/SATA</td> <td>0/1/10, 5/50 with optional key</td> <td>8x3.5" HS/ES, 8x2.5" HS</td> </tr> <tr> <td>RAID710 PCIe (1GB memory)</td> <td>6Gbs SAS/SATA</td> <td>0/1/10/5/50/6/60</td> <td>8x3.5" HS</td> </tr> <tr> <td>RAID720i PCIe</td> <td>12Gbs SAS/SATA</td> <td>0/1/10/5/50, 6/60 with optional cache</td> <td>8x3.5" HS/ES, 8x2.5" HS</td> </tr> <tr> <td>AnyRAID 110i</td> <td>6Gbs SATA</td> <td>0/1/10, 5 with optional key</td> <td>8x2.5" HS</td> </tr> <tr> <td>AnyRAID 510i</td> <td>6Gbs SAS/SATA</td> <td>0/1/10, 5/50 with optional key</td> <td>8x2.5" HS</td> </tr> <tr> <td>AnyRAID 720i</td> <td>12Gbs SAS/SATA</td> <td>0/1/10/5/50, 6/60 with optional cache</td> <td>8x2.5" HS</td> </tr> <tr> <td>AnyRAID 720ix</td> <td>12Gbs SAS/SATA</td> <td>0/1/10/5/50/6/60</td> <td>16/24x2.5" HS, 8x2.5" HS+optional tape</td> </tr> </tbody> </table>	RAID controller	Drive type	RAID support	Compatible models	Onboard RAID110i	6Gbs SATA	0/1/10, 5 with optional key	8x3.5" HS/ES, 8x2.5" HS	RAID500 PCIe	6Gbs SAS/SATA	0/1/10, 5/50 with optional key	8x3.5" HS	RAID520i PCIe	12Gbs SAS/SATA	0/1/10, 5/50 with optional key	8x3.5" HS/ES, 8x2.5" HS	RAID710 PCIe (1GB memory)	6Gbs SAS/SATA	0/1/10/5/50/6/60	8x3.5" HS	RAID720i PCIe	12Gbs SAS/SATA	0/1/10/5/50, 6/60 with optional cache	8x3.5" HS/ES, 8x2.5" HS	AnyRAID 110i	6Gbs SATA	0/1/10, 5 with optional key	8x2.5" HS	AnyRAID 510i	6Gbs SAS/SATA	0/1/10, 5/50 with optional key	8x2.5" HS	AnyRAID 720i	12Gbs SAS/SATA	0/1/10/5/50, 6/60 with optional cache	8x2.5" HS	AnyRAID 720ix	12Gbs SAS/SATA	0/1/10/5/50/6/60	16/24x2.5" HS, 8x2.5" HS+optional tape
	RAID controller	Drive type	RAID support	Compatible models																																					
	Onboard RAID110i	6Gbs SATA	0/1/10, 5 with optional key	8x3.5" HS/ES, 8x2.5" HS																																					
	RAID500 PCIe	6Gbs SAS/SATA	0/1/10, 5/50 with optional key	8x3.5" HS																																					
	RAID520i PCIe	12Gbs SAS/SATA	0/1/10, 5/50 with optional key	8x3.5" HS/ES, 8x2.5" HS																																					
	RAID710 PCIe (1GB memory)	6Gbs SAS/SATA	0/1/10/5/50/6/60	8x3.5" HS																																					
	RAID720i PCIe	12Gbs SAS/SATA	0/1/10/5/50, 6/60 with optional cache	8x3.5" HS/ES, 8x2.5" HS																																					
	AnyRAID 110i	6Gbs SATA	0/1/10, 5 with optional key	8x2.5" HS																																					
	AnyRAID 510i	6Gbs SAS/SATA	0/1/10, 5/50 with optional key	8x2.5" HS																																					
	AnyRAID 720i	12Gbs SAS/SATA	0/1/10/5/50, 6/60 with optional cache	8x2.5" HS																																					
AnyRAID 720ix	12Gbs SAS/SATA	0/1/10/5/50/6/60	16/24x2.5" HS, 8x2.5" HS+optional tape																																						
Optional cache for RAID 710: CacheVault flash cache with super capacitor, CacheCade Pro, or FastPath.																																									
Optional cache for RAID 720/AnyRAID 720i and 720ix: 1GB read-only memory or 1GB/2GB/4GB flash with super capacitor. Flash options include CacheVault, CacheCade Pro, and FastPath. 720ix must have cache.																																									
Disk drive bays	Up to 8x3.5" hot-swap, 8x3.5" easy-swap, or 24x2.5" hot-swap disk bays on front. Up to one internal LTO-6 SAS tape drive on 8x2.5" and 720ix model, or external RDX tape drive via USB.																																								
Maximum internal storage	3.5" HS model: up to 64TB with 7.2K SATA or SAS HDD, up to 14.4TB with 10K SAS HDD, up to 4.8TB with 15K SAS HDD, or up to 12.8TB with SATA SSD. 3.5" ES model: up to 24TB with 7.2K SATA, up to 48TB with 7.2K SAS. 2.5" HS model: up to 48TB with 7.2K SATA HDD, up to 43.2TB with 10K SAS HDD, up to 14.4TB with 15K SAS HDD, or up to 38.4TB with SATA or SAS SSD																																								
SD module	Up to 2 SDHC flash cards via optional SD module, 8GB or 32GB each																																								
PCIe SSD adapter	Supports 1.6TB or 3.2TB SSD via PCIe adapter																																								
Optical drive	Optional one 9.5mm optical on 3.5" or 8/16 x 2.5" models, DVD-ROM or DVD±RW.																																								

Components	Specification																																		
Network interfaces	One dedicated management port, two Gigabit Ethernet ports. Supports optional discrete network adapters via PCIe slots																																		
Security features	Power-on and administrator password. Optional TPM (TCG 1.2-compliant)																																		
Systems management	Supports ThinkServer System Manager (TSM), optional TSM Premium. UEFI. Onboard Aspeed AST2400 graphics/management processor, IPMI 2.0-compliant baseboard management controller (BMC). Control Panel LEDs shows the status of power, ID, network, system. Supports ThinkServer management software: Diagnostics, Deployment Manager, Energy Manager, System Manager, Partner Pack for VMware vCenter and Microsoft System Center Operations Manager, Power Planner																																		
Operating systems supported	Microsoft Windows Server 2012 R2/2012/2008 R2. Windows Small Business Server 2011. Red Hat Enterprise Linux 6.5/6.6/7. SUSE Linux Enterprise Server 11. VMware vSphere (ESXi) 5.1 P5/5.5 U2/6.0																																		
Base warranty	1 or 3-year limited onsite service with 9x5/NBD																																		
Power supply	Up to two redundant hot-swap 450W/550W/750W/1100W power supplies. 450 W is 80 PLUS Gold qualified. 550W and 1100W are 80 PLUS Platinum qualified. 750W is 80 PLUS Platinum or Titanium qualified. 750W Titanium is 200V - 240V, others are 110V - 240V.																																		
	<table border="1"> <thead> <tr> <th rowspan="2">Disk bay configuration</th> <th colspan="4">PSU requirements</th> </tr> <tr> <th>450W</th> <th>550W</th> <th>750W</th> <th>1100W</th> </tr> </thead> <tbody> <tr> <td>8x3.5"</td> <td>•</td> <td>•</td> <td>•</td> <td>•</td> </tr> <tr> <td>8x2.5"</td> <td>•</td> <td>•</td> <td>•</td> <td>•</td> </tr> <tr> <td>8x2.5"+ Tape</td> <td>•</td> <td>•</td> <td>•</td> <td>•</td> </tr> <tr> <td>16x2.5"</td> <td>•</td> <td>•</td> <td>•</td> <td>•</td> </tr> <tr> <td>24x2.5"</td> <td>•</td> <td>•</td> <td>•</td> <td>•</td> </tr> </tbody> </table>	Disk bay configuration	PSU requirements				450W	550W	750W	1100W	8x3.5"	•	•	•	•	8x2.5"	•	•	•	•	8x2.5"+ Tape	•	•	•	•	16x2.5"	•	•	•	•	24x2.5"	•	•	•	•
	Disk bay configuration		PSU requirements																																
		450W	550W	750W	1100W																														
	8x3.5"	•	•	•	•																														
8x2.5"	•	•	•	•																															
8x2.5"+ Tape	•	•	•	•																															
16x2.5"	•	•	•	•																															
24x2.5"	•	•	•	•																															
Graphics	Onboard Aspeed AST2400 with 16MB memory																																		
Front ports	Two USB 2.0. One DisplayPort (one VGA on E5-2600 v4 models instead)																																		
Rear ports	One VGA, two USB 3.0, one RJ-45 (dedicated mgmt), two ethernet, one serial (9-pin)																																		
Cooling	4 (3+1, dual processors) or 3 (2+1, single processor) fans, non-hot swap																																		
Noise emissions	Operating: < 6.5 Bels. Idle: < 5.6 Bels (Maximum configuration)																																		
Environmental specification	Temperature - operating	50 °F to 95 °F (10 °C to 35 °C)																																	
	Temperature - non operating (no package)	-10 °C to 60 °C																																	
	Temperature - non operating (with package)	-40 °C to 70 °C																																	
	Altitude - operating	(Unpressurized): 0-10000ft (0-3048m)																																	
	Humidity - operating	8%-90%, non-condensing																																	
Humidity - storage (with package)	8%-90%, non-condensing																																		

Expansion slots

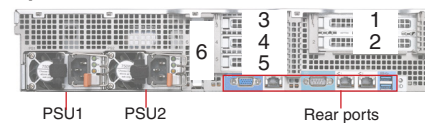

Slot 1 (riser card 1)	PCIe 3.0 x8, half length, full height, CPU1
Slot 2 (riser card 1)	PCIe 3.0 x8, half length, full height, CPU1
Slot 3 (riser card 2)	PCIe 3.0 x8, low-profile, half length, CPU2, requires 2nd riser card and 2nd CPU
Slot 4 (riser card 2)	PCIe 3.0 x8, low-profile, half length, CPU2, requires 2nd riser card and 2nd CPU
Slot 5 (riser card 2)	PCIe 3.0 x8, low-profile, half length, CPU1, requires 2nd riser card
Slot 6 (onboard)	PCIe 3.0 x16 (x8 elec), low-profile, half length, requires 2nd CPU

For a list of all supported options, please see https://download.lenovo.com/pccbbs/options_iso/ocm_may_2016_thinkserver.xlsx sheet

Model	Region	Processor	2nd CPU	Memory	RAID Controller	Disk Bays	Storage	Slots	Optical	Add-on NIC	TPM	System Mgmt	OS	Warranty	Power Supply	Ann Date (m/y)
70DA0000EA	EMEA	1xE5-2609 v3 6C/1.9GHz/15MB/85W/DDR4-1600	4XG0F28859	1x8GB RDIMM DDR4-2133 ECC	110i+Key (AnyRAID)	8x2.5" HS	Open	2xFH HL	9.5mm DVD±RW	None	TPM	TSM Premium	None	3-year	550Wx1 Platinum	12/14
70DA0002EA	EMEA	1xE5-2603 v3 6C/1.6GHz/15MB/85W/DDR4-1600	4XG0F28860	1x8GB RDIMM DDR4-2133 ECC	110i (AnyRAID)	8x2.5" HS	Open	2xFH HL	9.5mm DVD±RW	None	None	TSM	None	1-year	750Wx1 Platinum	12/14
70DA0003EA	EMEA	1xE5-2609 v3 6C/1.9GHz/15MB/85W/DDR4-1600	4XG0F28859	1x8GB RDIMM DDR4-2133 ECC	110i (AnyRAID)	8x2.5" HS	Open	2xFH HL	9.5mm DVD±RW	None	None	TSM	None	1-year	750Wx1 Platinum	12/14
70DA0004EA	EMEA	1xE5-2620 v3 6C/2.4GHz/15MB/85W/DDR4-1866	4XG0F28858	1x8GB RDIMM DDR4-2133 ECC	110i (AnyRAID)	8x2.5" HS	Open	2xFH HL	9.5mm DVD±RW	None	None	TSM	None	1-year	750Wx1 Platinum	12/14
70DA0005EA	EMEA	1xE5-2630 v3 8C/2.4GHz/20MB/85W/DDR4-1866	4XG0F28857	1x8GB RDIMM DDR4-2133 ECC	110i (AnyRAID)	8x2.5" HS	Open	2xFH HL	9.5mm DVD±RW	None	None	TSM	None	1-year	750Wx1 Platinum	12/14
70DA0006EA	EMEA	1xE5-2640 v3 8C/2.6GHz/20MB/90W/DDR4-1866	4XG0F28856	1x8GB RDIMM DDR4-2133 ECC	110i (AnyRAID)	8x2.5" HS	Open	2xFH HL	9.5mm DVD±RW	None	None	TSM	None	1-year	750Wx1 Platinum	12/14
70DA0007EA	EMEA	1xE5-2650 v3 10C/2.3GHz/25MB/105W/DDR4-2133	4XG0F28855	1x8GB RDIMM DDR4-2133 ECC	110i (AnyRAID)	8x2.5" HS	Open	2xFH HL	9.5mm DVD±RW	None	None	TSM	None	1-year	750Wx1 Platinum	12/14
70DA0008EA	EMEA	1xE5-2660 v3 10C/2.6GHz/25MB/105W/DDR4-2133	4XG0F28854	1x8GB RDIMM DDR4-2133 ECC	110i (AnyRAID)	8x2.5" HS	Open	2xFH HL	9.5mm DVD±RW	None	None	TSM	None	1-year	750Wx1 Platinum	12/14
70DA0009EA	EMEA	1xE5-2603 v3 6C/1.6GHz/15MB/85W/DDR4-1600	4XG0F28860	1x8GB RDIMM DDR4-2133 ECC	510i (AnyRAID)	8x2.5" HS	Open	2xFH HL	9.5mm DVD±RW	None	None	TSM	None	1-year	750Wx1 Platinum	12/14
70DA000AEA	EMEA	1xE5-2609 v3 6C/1.9GHz/15MB/85W/DDR4-1600	4XG0F28859	1x8GB RDIMM DDR4-2133 ECC	510i (AnyRAID)	8x2.5" HS	Open	2xFH HL	9.5mm DVD±RW	None	None	TSM	None	1-year	750Wx1 Platinum	12/14
70DA000BEA	EMEA	1xE5-2620 v3 6C/2.4GHz/15MB/85W/DDR4-1866	4XG0F28858	1x8GB RDIMM DDR4-2133 ECC	510i (AnyRAID)	8x2.5" HS	Open	2xFH HL	9.5mm DVD±RW	None	None	TSM	None	1-year	750Wx1 Platinum	12/14
70DA000CEA	EMEA	1xE5-2630 v3 8C/2.4GHz/20MB/85W/DDR4-1866	4XG0F28857	1x8GB RDIMM DDR4-2133 ECC	510i (AnyRAID)	8x2.5" HS	Open	2xFH HL	9.5mm DVD±RW	None	None	TSM	None	1-year	750Wx1 Platinum	12/14
70DA000DEA	EMEA	1xE5-2640 v3 8C/2.6GHz/20MB/90W/DDR4-1866	4XG0F28856	1x8GB RDIMM DDR4-2133 ECC	510i (AnyRAID)	8x2.5" HS	Open	2xFH HL	9.5mm DVD±RW	None	None	TSM	None	1-year	750Wx1 Platinum	12/14
70DA000EEA	EMEA	1xE5-2650 v3 10C/2.3GHz/25MB/105W/DDR4-2133	4XG0F28855	1x8GB RDIMM DDR4-2133 ECC	510i (AnyRAID)	8x2.5" HS	Open	2xFH HL	9.5mm DVD±RW	None	None	TSM	None	1-year	750Wx1 Platinum	12/14
70DA000FEA	EMEA	1xE5-2660 v3 10C/2.6GHz/25MB/105W/DDR4-2133	4XG0F28854	1x8GB RDIMM DDR4-2133 ECC	510i (AnyRAID)	8x2.5" HS	Open	2xFH HL	9.5mm DVD±RW	None	None	TSM	None	1-year	750Wx1 Platinum	12/14
70DA000GEA	EMEA	1xE5-2603 v3 6C/1.6GHz/15MB/85W/DDR4-1600	4XG0F28860	1x8GB RDIMM DDR4-2133 ECC	720i+1GB Flash (AnyRAID)	8x2.5" HS	Open	2xFH HL	9.5mm DVD±RW	None	None	TSM	None	1-year	750Wx1 Platinum	12/14
70DA000HEA	EMEA	1xE5-2609 v3 6C/1.9GHz/15MB/85W/DDR4-1600	4XG0F28859	1x8GB RDIMM DDR4-2133 ECC	720i+1GB Flash (AnyRAID)	8x2.5" HS	Open	2xFH HL	9.5mm DVD±RW	None	None	TSM	None	1-year	750Wx1 Platinum	12/14

Model	Region	Processor	2nd CPU	Memory	RAID Controller	Disk Bays	Storage	Slots	Optical	Add-on NIC	TPM	System Mgmt	OS	Warranty	Power Supply	Ann Date (m/y)
70DA000JEA	EMEA	1xE5-2620 v3 6C/2.4GHz/15MB/85W/DDR4-1866	4XG0F28858	1x8GB RDIMM DDR4-2133 ECC	720i+1GB Flash (AnyRAID)	8x2.5" HS	Open	2xFH HL	9.5mm DVD±RW	None	None	TSM	None	1-year	750Wx1 Platinum	12/14
70DA000KEA	EMEA	1xE5-2630 v3 8C/2.4GHz/20MB/85W/DDR4-1866	4XG0F28857	1x8GB RDIMM DDR4-2133 ECC	720i+1GB Flash (AnyRAID)	8x2.5" HS	Open	2xFH HL	9.5mm DVD±RW	None	None	TSM	None	1-year	750Wx1 Platinum	12/14
70DA000LEA	EMEA	1xE5-2640 v3 8C/2.6GHz/20MB/90W/DDR4-1866	4XG0F28856	1x8GB RDIMM DDR4-2133 ECC	720i+1GB Flash (AnyRAID)	8x2.5" HS	Open	2xFH HL	9.5mm DVD±RW	None	None	TSM	None	1-year	750Wx1 Platinum	12/14
70DA000MEA	EMEA	1xE5-2650 v3 10C/2.3GHz/25MB/105W/DDR4-2133	4XG0F28855	1x8GB RDIMM DDR4-2133 ECC	720i+1GB Flash (AnyRAID)	8x2.5" HS	Open	2xFH HL	9.5mm DVD±RW	None	None	TSM	None	1-year	750Wx1 Platinum	12/14
70DA000NEA	EMEA	1xE5-2660 v3 10C/2.6GHz/25MB/105W/DDR4-2133	4XG0F28854	1x8GB RDIMM DDR4-2133 ECC	720i+1GB Flash (AnyRAID)	8x2.5" HS	Open	2xFH HL	9.5mm DVD±RW	None	None	TSM	None	1-year	750Wx1 Platinum	12/14
70DA000PEA	EMEA	1xE5-2603 v3 6C/1.6GHz/15MB/85W/DDR4-1600	4XG0F28860	1x8GB RDIMM DDR4-2133 ECC	720i+1GB Flash (AnyRAID)	8x2.5" HS	Open	2xFH HL	9.5mm DVD±RW	None	None	TSM Premium	None	1-year	750Wx1 Platinum	12/14
70DA000QEA	EMEA	1xE5-2609 v3 6C/1.9GHz/15MB/85W/DDR4-1600	4XG0F28859	1x8GB RDIMM DDR4-2133 ECC	720i+1GB Flash (AnyRAID)	8x2.5" HS	Open	2xFH HL	9.5mm DVD±RW	None	None	TSM Premium	None	1-year	750Wx1 Platinum	12/14
70DA000REA	EMEA	1xE5-2620 v3 6C/2.4GHz/15MB/85W/DDR4-1866	4XG0F28858	1x8GB RDIMM DDR4-2133 ECC	720i+1GB Flash (AnyRAID)	8x2.5" HS	Open	2xFH HL	9.5mm DVD±RW	None	None	TSM Premium	None	1-year	750Wx1 Platinum	12/14
70DA000SEA	EMEA	2xE5-2640 v3 8C/2.6GHz/20MB/90W/DDR4-1866	-	2x8GB RDIMM DDR4-2133 ECC	720i+1GB Flash (AnyRAID)	8x2.5" HS	Open	2xFH HL+4xLP HL	9.5mm DVD±RW	None	None	TSM Premium	None	1-year	750Wx1 Platinum	12/14
70DA000TEA	EMEA	2xE5-2650 v3 10C/2.3GHz/25MB/105W/DDR4-2133	-	2x8GB RDIMM DDR4-2133 ECC	720i+1GB Flash (AnyRAID)	8x2.5" HS	Open	2xFH HL+4xLP HL	9.5mm DVD±RW	None	None	TSM Premium	None	1-year	750Wx1 Platinum	12/14
70DA000UEA	EMEA	1xE5-2609 v3 6C/1.9GHz/15MB/85W/DDR4-1600	4XG0F28859	1x4GB RDIMM DDR4-2133 ECC	110i+Key (AnyRAID)	8x2.5" HS	Open	2xFH HL	9.5mm DVD±RW	None	TPM	TSM Premium	None	3-year	550Wx2 Platinum	12/14
70DA000VEA	EMEA	1xE5-2620 v3 6C/2.4GHz/15MB/85W/DDR4-1866	4XG0F28858	1x8GB RDIMM DDR4-2133 ECC	510i+Key (AnyRAID)	8x2.5" HS	Open	2xFH HL	9.5mm DVD±RW	None	TPM	TSM Premium	None	3-year	550Wx2 Platinum	12/14
70DA000WEA	EMEA	2xE5-2650 v3 10C/2.3GHz/25MB/105W/DDR4-2133	-	8x16GB RDIMM DDR4-2133 ECC	720i+1GB RAM (AnyRAID)	8x2.5" HS	6x300GB HDD 10K 2.5" SAS6Gbs	2xFH HL+4xLP HL	9.5mm DVD±RW	None	TPM	TSM Premium	None	3-year	550Wx2 Platinum	12/14
70DA0015EA	EMEA	1xE5-2620 v3 6C/2.4GHz/15MB/85W/DDR4-1866	4XG0F28858	1x8GB RDIMM DDR4-2133 ECC	110i (AnyRAID)	8x2.5" HS	Open	2xFH HL	9.5mm DVD±RW	None	None	TSM	None	3-year	550Wx2 Platinum	04/15

Model	Region	Processor	2nd CPU	Memory	RAID Controller	Disk Bays	Storage	Slots	Optical	Add-on NIC	TPM	System Mgmt	OS	Warranty	Power Supply	Ann Date (m/y)
70DC0000EA	EMEA	1xE5-2609 v3 6C/1.9GHz/15MB/85W/DDR4-1600	4XG0F28859	1x4GB RDIMM DDR4-2133 ECC	Onboard 110i+Key (PCIe)	8x3.5" HS	Open	2xFH HL	9.5mm DVD±RW	None	TPM	TSM Premium	None	3-year	550Wx1 Platinum	12/14
70DC0001EA	EMEA	1xE5-2620 v3 6C/2.4GHz/15MB/85W/DDR4-1866	4XG0F28858	1x8GB RDIMM DDR4-2133 ECC	500+Key (PCIe)	8x3.5" HS	Open	2xFH HL	9.5mm DVD±RW	None	TPM	TSM Premium	None	3-year	550Wx1 Platinum	12/14
70DC0006EA	EMEA	1xE5-2603 v3 6C/1.6GHz/15MB/85W/DDR4-1600	4XG0F28860	1x8GB RDIMM DDR4-2133 ECC	Onboard 110i (PCIe)	8x3.5" HS	Open	2xFH HL	9.5mm DVD±RW	None	None	TSM	None	1-year	750Wx1 Platinum	12/14
70DC0007EA	EMEA	1xE5-2609 v3 6C/1.9GHz/15MB/85W/DDR4-1600	4XG0F28859	1x8GB RDIMM DDR4-2133 ECC	Onboard 110i (PCIe)	8x3.5" HS	Open	2xFH HL	9.5mm DVD±RW	None	None	TSM	None	1-year	750Wx1 Platinum	12/14
70DC0008EA	EMEA	1xE5-2620 v3 6C/2.4GHz/15MB/85W/DDR4-1866	4XG0F28858	1x8GB RDIMM DDR4-2133 ECC	Onboard 110i (PCIe)	8x3.5" HS	Open	2xFH HL	9.5mm DVD±RW	None	None	TSM	None	1-year	750Wx1 Platinum	12/14
70DC0009EA	EMEA	1xE5-2630 v3 8C/2.4GHz/20MB/85W/DDR4-1866	4XG0F28857	1x8GB RDIMM DDR4-2133 ECC	Onboard 110i (PCIe)	8x3.5" HS	Open	2xFH HL	9.5mm DVD±RW	None	None	TSM	None	1-year	750Wx1 Platinum	12/14
70DC000AEA	EMEA	1xE5-2640 v3 8C/2.6GHz/20MB/90W/DDR4-1866	4XG0F28856	1x8GB RDIMM DDR4-2133 ECC	Onboard 110i (PCIe)	8x3.5" HS	Open	2xFH HL	9.5mm DVD±RW	None	None	TSM	None	1-year	750Wx1 Platinum	12/14
70DC000BEA	EMEA	1xE5-2650 v3 10C/2.3GHz/25MB/105W/DDR4-2133	4XG0F28855	1x8GB RDIMM DDR4-2133 ECC	Onboard 110i (PCIe)	8x3.5" HS	Open	2xFH HL	9.5mm DVD±RW	None	None	TSM	None	1-year	750Wx1 Platinum	12/14
70DC000CEA	EMEA	1xE5-2660 v3 10C/2.6GHz/25MB/105W/DDR4-2133	4XG0F28854	1x8GB RDIMM DDR4-2133 ECC	Onboard 110i (PCIe)	8x3.5" HS	Open	2xFH HL	9.5mm DVD±RW	None	None	TSM	None	1-year	750Wx1 Platinum	12/14
70DC000DEA	EMEA	1xE5-2603 v3 6C/1.6GHz/15MB/85W/DDR4-1600	4XG0F28860	1x8GB RDIMM DDR4-2133 ECC	500 (PCIe)	8x3.5" HS	Open	2xFH HL	9.5mm DVD±RW	None	None	TSM	None	1-year	750Wx1 Platinum	12/14
70DC000EEA	EMEA	1xE5-2609 v3 6C/1.9GHz/15MB/85W/DDR4-1600	4XG0F28859	1x8GB RDIMM DDR4-2133 ECC	500 (PCIe)	8x3.5" HS	Open	2xFH HL	9.5mm DVD±RW	None	None	TSM	None	1-year	750Wx1 Platinum	12/14
70DC000FEA	EMEA	1xE5-2620 v3 6C/2.4GHz/15MB/85W/DDR4-1866	4XG0F28858	1x8GB RDIMM DDR4-2133 ECC	500 (PCIe)	8x3.5" HS	Open	2xFH HL	9.5mm DVD±RW	None	None	TSM	None	1-year	750Wx1 Platinum	12/14
70DC000GEA	EMEA	1xE5-2630 v3 8C/2.4GHz/20MB/85W/DDR4-1866	4XG0F28857	1x8GB RDIMM DDR4-2133 ECC	500 (PCIe)	8x3.5" HS	Open	2xFH HL	9.5mm DVD±RW	None	None	TSM	None	1-year	750Wx1 Platinum	12/14
70DC000HEA	EMEA	1xE5-2640 v3 8C/2.6GHz/20MB/90W/DDR4-1866	4XG0F28856	1x8GB RDIMM DDR4-2133 ECC	500 (PCIe)	8x3.5" HS	Open	2xFH HL	9.5mm DVD±RW	None	None	TSM	None	1-year	750Wx1 Platinum	12/14
70DC000JEA	EMEA	1xE5-2650 v3 10C/2.3GHz/25MB/105W/DDR4-2133	4XG0F28855	1x8GB RDIMM DDR4-2133 ECC	500 (PCIe)	8x3.5" HS	Open	2xFH HL	9.5mm DVD±RW	None	None	TSM	None	1-year	750Wx1 Platinum	12/14
70DC000KEA	EMEA	1xE5-2660 v3 10C/2.6GHz/25MB/105W/DDR4-2133	4XG0F28854	1x8GB RDIMM DDR4-2133 ECC	500 (PCIe)	8x3.5" HS	Open	2xFH HL	9.5mm DVD±RW	None	None	TSM	None	1-year	750Wx1 Platinum	12/14
70DC000LEA	EMEA	1xE5-2603 v3 6C/1.6GHz/15MB/85W/DDR4-1600	4XG0F28860	1x8GB RDIMM DDR4-2133 ECC	710+Super Cap (PCIe)	8x3.5" HS	Open	2xFH HL	9.5mm DVD±RW	None	None	TSM	None	1-year	750Wx1 Platinum	12/14

Model	Region	Processor	2nd CPU	Memory	RAID Controller	Disk Bays	Storage	Slots	Optical	Add-on NIC	TPM	System Mgmt	OS	Warranty	Power Supply	Ann Date (m/y)
70DC000MEA	EMEA	1xE5-2609 v3 6C/1.9GHz/15MB/85W/DDR4-1600	4XG0F28859	1x8GB RDIMM DDR4-2133 ECC	710+Super Cap (PCIe)	8x3.5" HS	Open	2xFH HL	9.5mm DVD±RW	None	None	TSM	None	1-year	750Wx1 Platinum	12/14
70DC000NEA	EMEA	1xE5-2620 v3 6C/2.4GHz/15MB/85W/DDR4-1866	4XG0F28858	1x8GB RDIMM DDR4-2133 ECC	710+Super Cap (PCIe)	8x3.5" HS	Open	2xFH HL	9.5mm DVD±RW	None	None	TSM	None	1-year	750Wx1 Platinum	12/14
70DC000PEA	EMEA	1xE5-2630 v3 8C/2.4GHz/20MB/85W/DDR4-1866	4XG0F28857	1x8GB RDIMM DDR4-2133 ECC	710+Super Cap (PCIe)	8x3.5" HS	Open	2xFH HL	9.5mm DVD±RW	None	None	TSM	None	1-year	750Wx1 Platinum	12/14
70DC000QEA	EMEA	1xE5-2640 v3 8C/2.6GHz/20MB/90W/DDR4-1866	4XG0F28856	1x8GB RDIMM DDR4-2133 ECC	710+Super Cap (PCIe)	8x3.5" HS	Open	2xFH HL	9.5mm DVD±RW	None	None	TSM	None	1-year	750Wx1 Platinum	12/14
70DC000REA	EMEA	1xE5-2650 v3 10C/2.3GHz/25MB/105W/DDR4-2133	4XG0F28855	1x8GB RDIMM DDR4-2133 ECC	710+Super Cap (PCIe)	8x3.5" HS	Open	2xFH HL	9.5mm DVD±RW	None	None	TSM	None	1-year	750Wx1 Platinum	12/14
70DC000SEA	EMEA	1xE5-2660 v3 10C/2.6GHz/25MB/105W/DDR4-2133	4XG0F28854	1x8GB RDIMM DDR4-2133 ECC	710+Super Cap (PCIe)	8x3.5" HS	Open	2xFH HL	9.5mm DVD±RW	None	None	TSM	None	1-year	750Wx1 Platinum	12/14
70DC000TEA	EMEA	1xE5-2603 v3 6C/1.6GHz/15MB/85W/DDR4-1600	4XG0F28860	1x8GB RDIMM DDR4-2133 ECC	710+Super Cap (PCIe)	8x3.5" HS	Open	2xFH HL	9.5mm DVD±RW	None	None	TSM Premium	None	1-year	750Wx1 Platinum	12/14
70DC000UEA	EMEA	1xE5-2609 v3 6C/1.9GHz/15MB/85W/DDR4-1600	4XG0F28859	1x8GB RDIMM DDR4-2133 ECC	710+Super Cap (PCIe)	8x3.5" HS	Open	2xFH HL	9.5mm DVD±RW	None	None	TSM Premium	None	1-year	750Wx1 Platinum	12/14
70DC000VEA	EMEA	1xE5-2620 v3 6C/2.4GHz/15MB/85W/DDR4-1866	4XG0F28858	1x8GB RDIMM DDR4-2133 ECC	710+Super Cap (PCIe)	8x3.5" HS	Open	2xFH HL	9.5mm DVD±RW	None	None	TSM Premium	None	1-year	750Wx1 Platinum	12/14
70DC000WEA	EMEA	2xE5-2640 v3 8C/2.6GHz/20MB/90W/DDR4-1866	-	2x8GB RDIMM DDR4-2133 ECC	710+Super Cap (PCIe)	8x3.5" HS	Open	2xFH HL+4xLP HL	9.5mm DVD±RW	None	None	TSM Premium	None	1-year	750Wx1 Platinum	12/14
70DC000XEA	EMEA	2xE5-2650 v3 10C/2.3GHz/25MB/105W/DDR4-2133	-	2x8GB RDIMM DDR4-2133 ECC	710+Super Cap (PCIe)	8x3.5" HS	Open	2xFH HL+4xLP HL	9.5mm DVD±RW	None	None	TSM Premium	None	1-year	750Wx1 Platinum	12/14
70DC002FEA	EMEA	1xE5-2620 v3 6C/2.4GHz/15MB/85W/DDR4-1866	4XG0F28858	1x8GB RDIMM DDR4-2133 ECC	Onboard 110i (PCIe)	8x3.5" HS	Open	2xFH HL	9.5mm DVD±RW	None	None	TSM	None	3-year	550Wx1 Platinum	04/15
70DC002VEA	EMEA	1xE5-2620 v3 6C/2.4GHz/15MB/85W/DDR4-1866	4XG0F28858	1x8GB RDIMM DDR4-2133 ECC	710+Super Cap (PCIe)	8x3.5" HS	Open	2xFH HL	9.5mm DVD±RW	None	None	TSM Premium	None	3-year	750Wx1 Platinum	11/15

Model	Region	Processor	2nd CPU	Memory	RAID Controller	Disk Bays	Storage	Slots	Optical	Add-on NIC	TPM	System Mgmt	OS	Warranty	Power Supply	Ann Date (m/y)
70DE0000EA	EMEA	1xE5-2650 v3 10C/2.3GHz/25MB/105W/DDR4-2133	4XG0F28855	1x16GB RDIMM DDR4-2133 ECC	720ix+1GB Flash (AnyRAID)	24x2.5" HS	Open	2xFH HL	None	None	TPM	TSM Premium	None	3-year	750Wx1 Platinum	12/14
70DE0002EA	EMEA	1xE5-2603 v3 6C/1.6GHz/15MB/85W/DDR4-1600	4XG0F28860	1x8GB RDIMM DDR4-2133 ECC	720ix+1GB Flash (AnyRAID)	24x2.5" HS	Open	2xFH HL	None	None	None	TSM	None	1-year	750Wx1 Platinum	12/14
70DE0003EA	EMEA	1xE5-2609 v3 6C/1.9GHz/15MB/85W/DDR4-1600	4XG0F28859	1x8GB RDIMM DDR4-2133 ECC	720ix+1GB Flash (AnyRAID)	24x2.5" HS	Open	2xFH HL	None	None	None	TSM	None	1-year	750Wx1 Platinum	12/14
70DE0004EA	EMEA	1xE5-2620 v3 6C/2.4GHz/15MB/85W/DDR4-1866	4XG0F28858	1x8GB RDIMM DDR4-2133 ECC	720ix+1GB Flash (AnyRAID)	24x2.5" HS	Open	2xFH HL	None	None	None	TSM	None	1-year	750Wx1 Platinum	12/14
70DE0005EA	EMEA	1xE5-2630 v3 8C/2.4GHz/20MB/85W/DDR4-1866	4XG0F28857	1x8GB RDIMM DDR4-2133 ECC	720ix+1GB Flash (AnyRAID)	24x2.5" HS	Open	2xFH HL	None	None	None	TSM	None	1-year	750Wx1 Platinum	12/14
70DE0006EA	EMEA	1xE5-2640 v3 8C/2.6GHz/20MB/90W/DDR4-1866	4XG0F28856	1x8GB RDIMM DDR4-2133 ECC	720ix+1GB Flash (AnyRAID)	24x2.5" HS	Open	2xFH HL	None	None	None	TSM	None	1-year	750Wx1 Platinum	12/14
70DE0007EA	EMEA	1xE5-2650 v3 10C/2.3GHz/25MB/105W/DDR4-2133	4XG0F28855	1x8GB RDIMM DDR4-2133 ECC	720ix+1GB Flash (AnyRAID)	24x2.5" HS	Open	2xFH HL	None	None	None	TSM	None	1-year	750Wx1 Platinum	12/14
70DE0008EA	EMEA	1xE5-2660 v3 10C/2.6GHz/25MB/105W/DDR4-2133	4XG0F28854	1x8GB RDIMM DDR4-2133 ECC	720ix+1GB Flash (AnyRAID)	24x2.5" HS	Open	2xFH HL	None	None	None	TSM	None	1-year	750Wx1 Platinum	12/14
70DE0009EA	EMEA	2xE5-2640 v3 8C/2.6GHz/20MB/90W/DDR4-1866	-	2x8GB RDIMM DDR4-2133 ECC	720ix+1GB Flash (AnyRAID)	24x2.5" HS	Open	2xFH HL+4xLP HL	None	None	None	TSM Premium	None	1-year	750Wx1 Platinum	12/14
70DE000AEA	EMEA	2xE5-2650 v3 10C/2.3GHz/25MB/105W/DDR4-2133	-	2x8GB RDIMM DDR4-2133 ECC	720ix+1GB Flash (AnyRAID)	24x2.5" HS	Open	2xFH HL+4xLP HL	None	None	None	TSM Premium	None	1-year	750Wx1 Platinum	12/14

Model	Region	Processor	2nd CPU	Memory	RAID Controller	Disk Bays	Storage	Slots	Optical	Add-on NIC	TPM	System Mgmt	OS	Warranty	Power Supply	Ann Date (m/y)
70DV0000EA	EMEA	1xE5-2620 v3 6C/2.4GHz/15MB/85W/DDR4-1866	4XG0F28858	1x8GB RDIMM DDR4-2133 ECC	720ix+1GB RAM (AnyRAID)	16x2.5" HS	Open	2xFH HL	9.5mm DVD±RW	None	TPM	TSM Premium	None	3-year	750Wx1 Platinum	12/14

Model	Region	Processor	2nd CPU	Memory	RAID Controller	Disk Bays	Storage	Slots	Optical	Add-on NIC	TPM	System Mgmt	OS	Warranty	Power Supply	Ann Date (m/y)
70Q90000EA	EMEA	1xE5-2609 v4 8C/1.7GHz/20MB/85W/DDR4-1866	4XG0G89085	1x16GB RDIMM DDR4-2400 ECC	520i (PCIe)	8x2.5" HS	2x300GB HDD 10K 2.5" SAS12Gbs	2xFH HL	9.5mm DVD±RW	None	None	TSM	None	1-year	550Wx1 Platinum	03/16
70Q90001EA	EMEA	1xE5-2620 v4 8C/2.1GHz/20MB/85W/DDR4-2133	4XG0G89080	1x16GB RDIMM DDR4-2400 ECC	720i+2GB Flash (PCIe)	8x2.5" HS	2x300GB HDD 10K 2.5" SAS12Gbs	2xFH HL	9.5mm DVD±RW	None	None	TSM	None	1-year	550Wx1 Platinum	03/16
70Q90000REA	EMEA	1xE5-2603 v4 6C/1.7GHz/15MB/85W/DDR4-1866	4XG0G89090	1x8GB RDIMM DDR4-2400 ECC	110i (PCIe)	8x2.5" HS	Open	2xFH HL	9.5mm DVD±RW	None	None	TSM	None	3-year	450Wx1 Gold	03/16
70Q90000SEA	EMEA	1xE5-2609 v4 8C/1.7GHz/20MB/85W/DDR4-1866	4XG0G89085	1x8GB RDIMM DDR4-2400 ECC	110i (PCIe)	8x2.5" HS	Open	2xFH HL	9.5mm DVD±RW	None	None	TSM	None	3-year	450Wx1 Gold	03/16
70Q90000TEA	EMEA	1xE5-2620 v4 8C/2.1GHz/20MB/85W/DDR4-2133	4XG0G89080	1x8GB RDIMM DDR4-2400 ECC	110i (PCIe)	8x2.5" HS	Open	2xFH HL	9.5mm DVD±RW	None	None	TSM	None	3-year	450Wx1 Gold	03/16
70Q90000UEA	EMEA	1xE5-2603 v4 6C/1.7GHz/15MB/85W/DDR4-1866	4XG0G89090	1x8GB RDIMM DDR4-2400 ECC	520i (PCIe)	8x2.5" HS	Open	2xFH HL	9.5mm DVD±RW	None	None	TSM	None	3-year	450Wx1 Gold	03/16
70Q90000VEA	EMEA	1xE5-2609 v4 8C/1.7GHz/20MB/85W/DDR4-1866	4XG0G89085	1x8GB RDIMM DDR4-2400 ECC	520i (PCIe)	8x2.5" HS	Open	2xFH HL	9.5mm DVD±RW	None	None	TSM	None	3-year	450Wx1 Gold	03/16
70Q90000WEA	EMEA	1xE5-2620 v4 8C/2.1GHz/20MB/85W/DDR4-2133	4XG0G89080	1x8GB RDIMM DDR4-2400 ECC	520i (PCIe)	8x2.5" HS	Open	2xFH HL	9.5mm DVD±RW	None	None	TSM	None	3-year	450Wx1 Gold	03/16
70Q90000XEA	EMEA	1xE5-2603 v4 6C/1.7GHz/15MB/85W/DDR4-1866	4XG0G89090	1x16GB RDIMM DDR4-2400 ECC	520i (PCIe)	8x2.5" HS	Open	2xFH HL	9.5mm DVD±RW	None	None	TSM	None	3-year	450Wx1 Gold	03/16
70Q90000YEA	EMEA	1xE5-2609 v4 8C/1.7GHz/20MB/85W/DDR4-1866	4XG0G89085	1x16GB RDIMM DDR4-2400 ECC	520i (PCIe)	8x2.5" HS	Open	2xFH HL	9.5mm DVD±RW	None	None	TSM	None	3-year	450Wx1 Gold	03/16
70Q90010EA	EMEA	1xE5-2620 v4 8C/2.1GHz/20MB/85W/DDR4-2133	4XG0G89080	1x16GB RDIMM DDR4-2400 ECC	520i (PCIe)	8x2.5" HS	Open	2xFH HL	9.5mm DVD±RW	None	None	TSM	None	3-year	450Wx1 Gold	03/16
70Q90011EA	EMEA	1xE5-2630 v4 10C/2.2GHz/20MB/85W/DDR4-2133	4XG0G89075	1x16GB RDIMM DDR4-2400 ECC	520i (PCIe)	8x2.5" HS	Open	2xFH HL	9.5mm DVD±RW	None	None	TSM	None	3-year	450Wx1 Gold	03/16
70Q90012EA	EMEA	1xE5-2620 v4 8C/2.1GHz/20MB/85W/DDR4-2133	4XG0G89080	1x8GB RDIMM DDR4-2400 ECC	720i (PCIe)	8x2.5" HS	Open	2xFH HL	9.5mm DVD±RW	None	None	TSM	None	3-year	450Wx1 Gold	03/16
70Q90013EA	EMEA	1xE5-2620 v4 8C/2.1GHz/20MB/85W/DDR4-2133	4XG0G89080	1x16GB RDIMM DDR4-2400 ECC	720i (PCIe)	8x2.5" HS	Open	2xFH HL	9.5mm DVD±RW	None	None	TSM	None	3-year	450Wx1 Gold	03/16
70Q90014EA	EMEA	1xE5-2630 v4 10C/2.2GHz/20MB/85W/DDR4-2133	4XG0G89075	1x8GB RDIMM DDR4-2400 ECC	720i (PCIe)	8x2.5" HS	Open	2xFH HL	9.5mm DVD±RW	None	None	TSM	None	3-year	450Wx1 Gold	03/16
70Q90015EA	EMEA	1xE5-2630 v4 10C/2.2GHz/20MB/85W/DDR4-2133	4XG0G89075	1x16GB RDIMM DDR4-2400 ECC	720i (PCIe)	8x2.5" HS	Open	2xFH HL	9.5mm DVD±RW	None	None	TSM	None	3-year	450Wx1 Gold	03/16
70Q90016EA	EMEA	1xE5-2609 v4 8C/1.7GHz/20MB/85W/DDR4-1866	4XG0G89085	1x8GB RDIMM DDR4-2400 ECC	720i (PCIe)	8x2.5" HS	Open	2xFH HL	9.5mm DVD±RW	None	None	TSM	None	3-year	450Wx1 Gold	03/16

Model	Region	Processor	2nd CPU	Memory	RAID Controller	Disk Bays	Storage	Slots	Optical	Add-on NIC	TPM	System Mgmt	OS	Warranty	Power Supply	Ann Date (m/y)
70Q90017EA	EMEA	1xE5-2609 v4 8C/1.7GHz/20MB/85W/DDR4-1866	4XG0G89085	1x16GB RDIMM DDR4-2400 ECC	720i (PCIe)	8x2.5" HS	Open	2xFH HL	9.5mm DVD±RW	None	None	TSM	None	3-year	450Wx1 Gold	03/16
70Q90018EA	EMEA	1xE5-2620 v4 8C/2.1GHz/20MB/85W/DDR4-2133	4XG0G89080	1x16GB RDIMM DDR4-2400 ECC	720i+4GB Flash (PCIe)	8x2.5" HS	Open	2xFH HL	9.5mm DVD±RW	None	None	TSM	None	3-year	450Wx1 Gold	03/16
70Q90019EA	EMEA	1xE5-2620 v4 8C/2.1GHz/20MB/85W/DDR4-2133	4XG0G89080	1x16GB RDIMM DDR4-2400 ECC	720i+2GB Flash (PCIe)	8x2.5" HS	Open	2xFH HL	9.5mm DVD±RW	None	None	TSM	None	3-year	450Wx1 Gold	03/16
70Q9001AEA	EMEA	1xE5-2630 v4 10C/2.2GHz/20MB/85W/DDR4-2133	4XG0G89075	1x16GB RDIMM DDR4-2400 ECC	720i+2GB Flash (PCIe)	8x2.5" HS	Open	2xFH HL	9.5mm DVD±RW	None	None	TSM	None	3-year	450Wx1 Gold	03/16
70Q9001BEA	EMEA	1xE5-2630 v4 10C/2.2GHz/20MB/85W/DDR4-2133	4XG0G89075	1x16GB RDIMM DDR4-2400 ECC	720i+4GB Flash (PCIe)	8x2.5" HS	Open	2xFH HL	9.5mm DVD±RW	None	None	TSM	None	3-year	450Wx1 Gold	03/16
70Q9001CEA	EMEA	1xE5-2609 v4 8C/1.7GHz/20MB/85W/DDR4-1866	4XG0G89085	1x16GB RDIMM DDR4-2400 ECC	720i+2GB Flash (PCIe)	8x2.5" HS	Open	2xFH HL	9.5mm DVD±RW	None	None	TSM	None	3-year	450Wx1 Gold	03/16

Model	Region	Processor	2nd CPU	Memory	RAID Controller	Disk Bays	Storage	Slots	Optical	Add-on NIC	TPM	System Mgmt	OS	Warranty	Power Supply	Ann Date (m/y)
70QQ0000EA	EMEA	1xE5-2603 v4 6C/1.7GHz/15MB/85W/DDR4-1866	4XG0G89090	1x8GB RDIMM DDR4-2400 ECC	110i (PCIe)	8x3.5" HS	2x1TB HDD 7.2K 3.5" SATA6Gbs	2xFH HL	9.5mm DVD±RW	None	None	TSM	None	1-year	450Wx1 Gold	03/16
70QQ0001EA	EMEA	1xE5-2609 v4 8C/1.7GHz/20MB/85W/DDR4-1866	4XG0G89085	1x16GB RDIMM DDR4-2400 ECC	520i (PCIe)	8x3.5" HS	2x1TB HDD 7.2K 3.5" SATA6Gbs	2xFH HL	9.5mm DVD±RW	None	None	TSM	None	1-year	550Wx1 Platinum	03/16
70QQ0009EA	EMEA	1xE5-2603 v4 6C/1.7GHz/15MB/85W/DDR4-1866	4XG0G89090	1x8GB RDIMM DDR4-2400 ECC	110i (PCIe)	8x3.5" HS	Open	2xFH HL	None	None	None	TSM	None	3-year	450Wx1 Gold	03/16
70QQ0000AEA	EMEA	1xE5-2609 v4 8C/1.7GHz/20MB/85W/DDR4-1866	4XG0G89085	1x8GB RDIMM DDR4-2400 ECC	110i (PCIe)	8x3.5" HS	Open	2xFH HL	None	None	None	TSM	None	3-year	450Wx1 Gold	03/16
70QQ0000BEA	EMEA	1xE5-2620 v4 8C/2.1GHz/20MB/85W/DDR4-2133	4XG0G89080	1x8GB RDIMM DDR4-2400 ECC	110i (PCIe)	8x3.5" HS	Open	2xFH HL	None	None	None	TSM	None	3-year	450Wx1 Gold	03/16
70QQ0000CEA	EMEA	1xE5-2603 v4 6C/1.7GHz/15MB/85W/DDR4-1866	4XG0G89090	1x8GB RDIMM DDR4-2400 ECC	520i (PCIe)	8x3.5" HS	Open	2xFH HL	None	None	None	TSM	None	3-year	450Wx1 Gold	03/16
70QQ0000DEA	EMEA	1xE5-2609 v4 8C/1.7GHz/20MB/85W/DDR4-1866	4XG0G89085	1x8GB RDIMM DDR4-2400 ECC	520i (PCIe)	8x3.5" HS	Open	2xFH HL	None	None	None	TSM	None	3-year	450Wx1 Gold	03/16
70QQ0000EEA	EMEA	1xE5-2620 v4 8C/2.1GHz/20MB/85W/DDR4-2133	4XG0G89080	1x8GB RDIMM DDR4-2400 ECC	520i (PCIe)	8x3.5" HS	Open	2xFH HL	None	None	None	TSM	None	3-year	450Wx1 Gold	03/16
70QQ0000FEA	EMEA	1xE5-2603 v4 6C/1.7GHz/15MB/85W/DDR4-1866	4XG0G89090	1x16GB RDIMM DDR4-2400 ECC	520i (PCIe)	8x3.5" HS	Open	2xFH HL	None	None	None	TSM	None	3-year	450Wx1 Gold	03/16
70QQ0000GEA	EMEA	1xE5-2609 v4 8C/1.7GHz/20MB/85W/DDR4-1866	4XG0G89085	1x16GB RDIMM DDR4-2400 ECC	520i (PCIe)	8x3.5" HS	Open	2xFH HL	None	None	None	TSM	None	3-year	450Wx1 Gold	03/16
70QQ0000HEA	EMEA	1xE5-2620 v4 8C/2.1GHz/20MB/85W/DDR4-2133	4XG0G89080	1x16GB RDIMM DDR4-2400 ECC	520i (PCIe)	8x3.5" HS	Open	2xFH HL	None	None	None	TSM	None	3-year	450Wx1 Gold	03/16
70QQ0000JEA	EMEA	1xE5-2630 v4 10C/2.2GHz/20MB/85W/DDR4-2133	4XG0G89075	1x16GB RDIMM DDR4-2400 ECC	520i (PCIe)	8x3.5" HS	Open	2xFH HL	None	None	None	TSM	None	3-year	450Wx1 Gold	03/16
70QQ0000KEA	EMEA	1xE5-2620 v4 8C/2.1GHz/20MB/85W/DDR4-2133	4XG0G89080	1x8GB RDIMM DDR4-2400 ECC	720i (PCIe)	8x3.5" HS	Open	2xFH HL	None	None	None	TSM	None	3-year	450Wx1 Gold	03/16
70QQ0000LEA	EMEA	1xE5-2620 v4 8C/2.1GHz/20MB/85W/DDR4-2133	4XG0G89080	1x16GB RDIMM DDR4-2400 ECC	720i (PCIe)	8x3.5" HS	Open	2xFH HL	None	None	None	TSM	None	3-year	450Wx1 Gold	03/16
70QQ0000MEA	EMEA	1xE5-2630 v4 10C/2.2GHz/20MB/85W/DDR4-2133	4XG0G89075	1x8GB RDIMM DDR4-2400 ECC	720i (PCIe)	8x3.5" HS	Open	2xFH HL	None	None	None	TSM	None	3-year	450Wx1 Gold	03/16
70QQ0000NEA	EMEA	1xE5-2630 v4 10C/2.2GHz/20MB/85W/DDR4-2133	4XG0G89075	1x16GB RDIMM DDR4-2400 ECC	720i (PCIe)	8x3.5" HS	Open	2xFH HL	None	None	None	TSM	None	3-year	450Wx1 Gold	03/16
70QQ0000PEA	EMEA	1xE5-2609 v4 8C/1.7GHz/20MB/85W/DDR4-1866	4XG0G89085	1x8GB RDIMM DDR4-2400 ECC	720i (PCIe)	8x3.5" HS	Open	2xFH HL	None	None	None	TSM	None	3-year	450Wx1 Gold	03/16

Model	Region	Processor	2nd CPU	Memory	RAID Controller	Disk Bays	Storage	Slots	Optical	Add-on NIC	TPM	System Mgmt	OS	Warranty	Power Supply	Ann Date (m/y)
70QQ000QEA	EMEA	1xE5-2609 v4 8C/1.7GHz/20MB/85W/DDR4-1866	4XG0G89085	1x16GB RDIMM DDR4-2400 ECC	720i (PCIe)	8x3.5" HS	Open	2xFH HL	None	None	None	TSM	None	3-year	450Wx1 Gold	03/16
70QQ000REA	EMEA	1xE5-2620 v4 8C/2.1GHz/20MB/85W/DDR4-2133	4XG0G89080	1x8GB RDIMM DDR4-2400 ECC	720i+2GB Flash (PCIe)	8x3.5" HS	Open	2xFH HL	None	None	None	TSM	None	3-year	450Wx1 Gold	03/16
70QQ000SEA	EMEA	1xE5-2620 v4 8C/2.1GHz/20MB/85W/DDR4-2133	4XG0G89080	1x16GB RDIMM DDR4-2400 ECC	720i+4GB Flash (PCIe)	8x3.5" HS	Open	2xFH HL	None	None	None	TSM	None	3-year	450Wx1 Gold	03/16
70QQ000TEA	EMEA	1xE5-2609 v4 8C/1.7GHz/20MB/85W/DDR4-1866	4XG0G89085	1x8GB RDIMM DDR4-2400 ECC	720i+2GB Flash (PCIe)	8x3.5" HS	Open	2xFH HL	None	None	None	TSM	None	3-year	450Wx1 Gold	03/16
70QQ000UEA	EMEA	1xE5-2603 v4 6C/1.7GHz/15MB/85W/DDR4-1866	4XG0G89090	1x8GB RDIMM DDR4-2400 ECC	720i+2GB Flash (PCIe)	8x3.5" HS	Open	2xFH HL	None	None	None	TSM	None	3-year	450Wx1 Gold	03/16
70QQ000VEA	EMEA	1xE5-2609 v4 8C/1.7GHz/20MB/85W/DDR4-1866	4XG0G89085	1x16GB RDIMM DDR4-2400 ECC	720i+2GB Flash (PCIe)	8x3.5" HS	Open	2xFH HL	None	None	None	TSM	None	3-year	450Wx1 Gold	03/16
70QQ000WEA	EMEA	1xE5-2603 v4 6C/1.7GHz/15MB/85W/DDR4-1866	4XG0G89090	1x16GB RDIMM DDR4-2400 ECC	720i+2GB Flash (PCIe)	8x3.5" HS	Open	2xFH HL	None	None	None	TSM	None	3-year	450Wx1 Gold	03/16
70QQ000XEA	EMEA	1xE5-2630 v4 10C/2.2GHz/20MB/85W/DDR4-2133	4XG0G89075	1x8GB RDIMM DDR4-2400 ECC	720i+2GB Flash (PCIe)	8x3.5" HS	Open	2xFH HL	None	None	None	TSM	None	3-year	450Wx1 Gold	03/16
70QQ000YEA	EMEA	1xE5-2630 v4 10C/2.2GHz/20MB/85W/DDR4-2133	4XG0G89075	1x16GB RDIMM DDR4-2400 ECC	720i+2GB Flash (PCIe)	8x3.5" HS	Open	2xFH HL	None	None	None	TSM	None	3-year	450Wx1 Gold	03/16
70QQ0010EA	EMEA	1xE5-2620 v4 8C/2.1GHz/20MB/85W/DDR4-2133	4XG0G89080	1x16GB RDIMM DDR4-2400 ECC	720i+2GB Flash (PCIe)	8x3.5" HS	Open	2xFH HL	None	None	None	TSM	None	3-year	450Wx1 Gold	03/16

Model	Region	Processor	2nd CPU	Memory	RAID Controller	Disk Bays	Storage	Slots	Optical	Add-on NIC	TPM	System Mgmt	OS	Warranty	Power Supply	Ann Date (m/y)
70QW0000EA	EMEA	1xE5-2603 v4 6C/1.7GHz/15MB/85W/DDR4-1866	4XG0G89090	1x16GB RDIMM DDR4-2400 ECC	720ix+2GB Flash (AnyRAID)	16x2.5" HS	Open	2xFH HL	9.5mm DVD±RW	None	None	TSM	None	3-year	550Wx1 Platinum	03/16
70QW0001EA	EMEA	1xE5-2609 v4 8C/1.7GHz/20MB/85W/DDR4-1866	4XG0G89085	1x16GB RDIMM DDR4-2400 ECC	720ix+2GB Flash (AnyRAID)	16x2.5" HS	Open	2xFH HL	9.5mm DVD±RW	None	None	TSM	None	3-year	550Wx1 Platinum	03/16
70QW0002EA	EMEA	1xE5-2620 v4 8C/2.1GHz/20MB/85W/DDR4-2133	4XG0G89080	1x16GB RDIMM DDR4-2400 ECC	720ix+2GB Flash (AnyRAID)	16x2.5" HS	Open	2xFH HL	9.5mm DVD±RW	None	None	TSM	None	3-year	550Wx1 Platinum	03/16
70QW0003EA	EMEA	1xE5-2630 v4 10C/2.2GHz/20MB/85W/DDR4-2133	4XG0G89075	1x16GB RDIMM DDR4-2400 ECC	720ix+2GB Flash (AnyRAID)	16x2.5" HS	Open	2xFH HL	9.5mm DVD±RW	None	None	TSM	None	3-year	550Wx1 Platinum	03/16

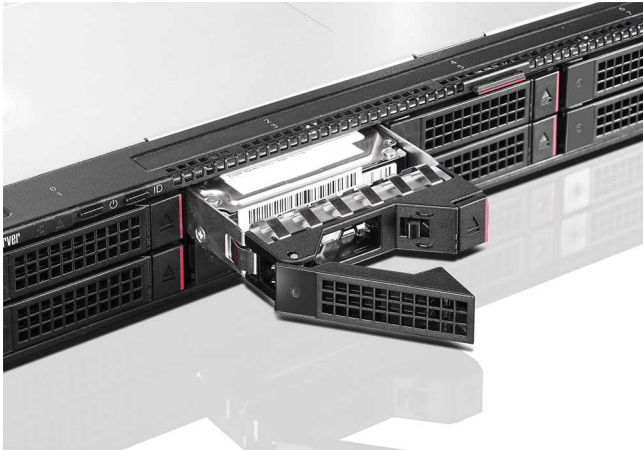

ThinkServer RD550 Platform Specifications

Product Specifications Reference (PSREF)

Components	Specification																								
Dimensions	1U rack. Height: 43 mm (1.7 in), width: 482 mm (19 in), depth: 780 mm (30.7 in)																								
Weight	Minimum configuration: 13.5 kg (29.76 lb), maximum: 21 kg (46.3 lb)																								
Processor	Up to two 145W Intel Xeon E5-2600 v3 family (code name: Haswell) processors with 18 cores up to 2.3GHz, 16 cores up to 2.3GHz, 14 cores up to 2.6GHz, 12 cores up to 2.6GHz, 10 cores up to 2.6GHz, 8 cores up to 3.2GHz, 6 cores up to 3.4GHz, 4 cores up to 3.5GHz. Two QPI link up to 9.6 GT/s. Up to 2133MHz memory speed. Up to 45MB cache																								
Chipset	Intel C612 Platform Controller Hub (PCH)																								
Memory DIMMs	24 DIMM sockets (12 DIMMs per processor), 8-channel capable (4-channel per processor). RDIMM and LRDIMM (cannot be intermixed), DDR4, up to 2133MHz																								
Memory capacity	384GB (RDIMM, 16GB x 24)/768GB (LRDIMM, 32GB x 24)																								
Memory protection	ECC, memory mirroring, lockstep, and memory sparing																								
AnyRAID support	RAID 0, 1, 10 with AnyRAID 110i. 6Gb/s SATA, optional key for RAID 5. RAID 0, 1, 10 with AnyRAID 510i, 6Gb/s SAS/SATA, optional key for RAID 5/50. RAID 0, 1, 10, 5, 50, 6, 60 with AnyRAID 720i/720ix. 12Gb/s SAS/SATA. 720i needs cache for RAID 6/60 support. 720ix must have cache. Optional cache for 720i/720ix: 1GB read-only memory. 1GB/2GB/4GB flash with super capacitor. Flash options include CacheVault, CacheCade Pro, and FastPath <i>Note: At least 6 disk drives is required for RAID 50 and 60.</i>																								
Disk drive bays	Up to 4 3.5" or 12 2.5" hot-swap disk bays on front. Up to 2 of 12 2.5" bays can support easy-swap PCIe SSD via optional Anybay kit (consumes one PCIe slot). Up to 2 2.5" rear mounted hot-swap disk bays on 3.5" models, optional. Up to 2 M.2 SSD drives via optional M.2 module. Supports external RDX tape drive via USB. <table border="1"> <thead> <tr> <th rowspan="2">Disk bay configuration</th> <th colspan="4">AnyRAID requirements and optional drives supported</th> </tr> <tr> <th>RAID110i</th> <th>RAID510i</th> <th>RAID720i</th> <th>RAID720ix</th> </tr> </thead> <tbody> <tr> <td>4x3.5"</td> <td>• (optional rear bay/M.2)</td> <td>• (optional rear bay/M.2)</td> <td>• (optional rear bay/M.2)</td> <td></td> </tr> <tr> <td>8x2.5"</td> <td>•</td> <td>•</td> <td>•</td> <td></td> </tr> <tr> <td>12x2.5"</td> <td></td> <td></td> <td></td> <td>• (optional Anybay/M.2)</td> </tr> </tbody> </table> <i>Note: 1. Rear disk drive and M.2 SSD can not be supported simultaneously. Only one can be selected per system. 2. On AnyRAID 110i and 8x2.5" model, 6 of 8 drives can be configured as RAID</i>	Disk bay configuration	AnyRAID requirements and optional drives supported				RAID110i	RAID510i	RAID720i	RAID720ix	4x3.5"	• (optional rear bay/M.2)	• (optional rear bay/M.2)	• (optional rear bay/M.2)		8x2.5"	•	•	•		12x2.5"				• (optional Anybay/M.2)
Disk bay configuration	AnyRAID requirements and optional drives supported																								
	RAID110i	RAID510i	RAID720i	RAID720ix																					
4x3.5"	• (optional rear bay/M.2)	• (optional rear bay/M.2)	• (optional rear bay/M.2)																						
8x2.5"	•	•	•																						
12x2.5"				• (optional Anybay/M.2)																					
Internal disk drive	3.5" HDD up to 8TB (SATA/SAS). 2.5" HDD up to 1.8TB (SAS)/2TB (SATA). 2.5" SSD up to 1.6TB (SATA/SAS). Easy-swap PCIe SSD up to 1.6TB. M.2 SSD up to 120GB. 2.5" SSD and HDD are compatible with 3.5" bay																								
SD module	Up to 2 SDHC flash cards via optional SD module, 8GB or 32GB each																								
Optical drive	Optional one 9.5mm optical drive on 3.5" model. DVD-ROM or DVD±RW																								
Network interfaces	One dedicated management port. One (3.5" model) or two (2.5" model) AnyFabric slots for customized LOM. Optional discrete network adapters via PCIe slots																								
Security features	Power-on and administrator password. Optional TPM (TCG 1.2-compliant)																								
Systems management	Supports ThinkServer System Manager (TSM), optional TSM Premium. UEFI. Onboard Aspeed AST2400 graphics/management processor, IPMI 2.0-compliant baseboard management controller (BMC). Control Panel LEDs shows the status of power, ID, network, system. Supports ThinkServer management software: Diagnostics, Deployment Manager, Energy Manager, System Manager, Partner Pack for VMware vCenter and Microsoft System Center Operations Manager, Power Planner																								

Components	Specification															
Operating systems supported	Microsoft Windows Server 2012 R2/2012/2008 R2. Windows Small Business Server 2011. Red Hat Enterprise Linux 6.5/6.6/7. SUSE Linux Enterprise Server 11. VMware vSphere (ESXi) 5.1 P5/5.5 U2/6.0															
Base warranty	3-year limited onsite service with 9x5/NBD. Some parts are Customer Replaceable Units															
Power supply	Up to two redundant hot-swap 550W/750W/1100W power supplies. 550W and 1100W are 80 PLUS Platinum qualified. 750W is 80 PLUS Platinum or Titanium qualified. <table border="1"> <thead> <tr> <th rowspan="2">Disk bay configuration</th> <th colspan="3">PSU requirements</th> </tr> <tr> <th>550W</th> <th>750W</th> <th>1100W</th> </tr> </thead> <tbody> <tr> <td>4x3.5"</td> <td>•</td> <td>•</td> <td>•</td> </tr> <tr> <td>12x2.5"</td> <td>•</td> <td>•</td> <td>•</td> </tr> </tbody> </table> <i>Note: 750W Titanium is 200V - 240V, others are 110V - 240V.</i>	Disk bay configuration	PSU requirements			550W	750W	1100W	4x3.5"	•	•	•	12x2.5"	•	•	•
Disk bay configuration	PSU requirements															
	550W	750W	1100W													
4x3.5"	•	•	•													
12x2.5"	•	•	•													
Graphics	Onboard Aspeed AST2400 with 16MB memory, one DisplayPort on front, one DisplayPort on rear. Maximum resolution: 1920x1200@60Hz															
Front ports	(Only 3.5" model) Two USB 2.0, one DisplayPort															
Rear ports	One DisplayPort, two USB 3.0, one RJ-45 (dedicate mgmt), one serial (9-pin)															
Cooling	8 (7+1, dual processors) or 6 (5+1, single processor), hot-swap															
Noise emissions	Operating: < 6.5 Bels. Idle: < 6 Bels (Maximum configuration)															
Environmental specification	<table border="1"> <tbody> <tr> <td>Temperature - operating</td> <td>41 °F to 113 °F (5 °C to 45 °C)</td> </tr> <tr> <td>Temperature - non operating (no package)</td> <td>-10 °C to 60 °C</td> </tr> <tr> <td>Temperature - non operating (with package)</td> <td>-40 °C to 60 °C</td> </tr> <tr> <td>Altitude - operating</td> <td>(Unpressurized): 0-10000ft (0-3048m)</td> </tr> <tr> <td>Humidity - operating</td> <td>8%-90%, non-condensing</td> </tr> <tr> <td>Humidity - storage (with package)</td> <td>8%-90%, non-condensing</td> </tr> </tbody> </table> <i>Note: 45 °C continuous operation configuration limitation: no 145W CPU/no 135W 4, 6, or 8 cores CPU/no GPU card/redundant PSU/no FLFH card/no PCIe SSD adapter/no 1100W PSU.</i>	Temperature - operating	41 °F to 113 °F (5 °C to 45 °C)	Temperature - non operating (no package)	-10 °C to 60 °C	Temperature - non operating (with package)	-40 °C to 60 °C	Altitude - operating	(Unpressurized): 0-10000ft (0-3048m)	Humidity - operating	8%-90%, non-condensing	Humidity - storage (with package)	8%-90%, non-condensing			
Temperature - operating	41 °F to 113 °F (5 °C to 45 °C)															
Temperature - non operating (no package)	-10 °C to 60 °C															
Temperature - non operating (with package)	-40 °C to 60 °C															
Altitude - operating	(Unpressurized): 0-10000ft (0-3048m)															
Humidity - operating	8%-90%, non-condensing															
Humidity - storage (with package)	8%-90%, non-condensing															

Expansion slots

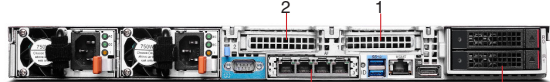
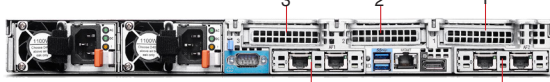
3.5" model	 <p>AnyFabric slot 1 (Network adapter is optional) Optional 2 x 2.5" rear bays</p>
Slot 1 (riser card 1)	PCIe 3.0 x 16, low-profile, half length
Slot 2 (riser card 2)	PCIe 3.0 x 16, low-profile, half length, requires 2nd riser card and 2nd CPU
2.5" model	 <p>AnyFabric slot 1 (Network adapter is optional) AnyFabric slot 2 (Network adapter is optional)</p>
Slot 1 (riser card 1)	PCIe 3.0 x 16 (x8 wired), low-profile, half length
Slot 2 (riser card 1)	PCIe 3.0 x 16 (x8 wired), low-profile, half length
Slot 3 (riser card 2)	PCIe 3.0 x 16, low-profile, half length, requires 2nd riser card and 2nd CPU

Model	Region	Processor	2nd CPU	Memory	RAID Controller	Disk Bays	Storage	Slots	Optical	Add-on NIC	TPM	System Mgmt	OS	Warranty	Power Supply	Ann Date (m/y)
70CV0005EA	EMEA	1xXeon E5-2603 v3 6C/1.6GHz/15MB/85W/DDR4-1600	4XG0F28804	1x8GB RDIMM DDR4-2133 ECC	AnyRAID 720i	4x3.5" HS	Open	1xLP HL	9.5mm DVD±RW	GbEx4 RJ-45 AnyFabric	None	TSM	None	3-year	750Wx1 Platinum	09/14
70CV0006EA	EMEA	1xXeon E5-2609 v3 6C/1.9GHz/15MB/85W/DDR4-1600	4XG0F28803	1x8GB RDIMM DDR4-2133 ECC	AnyRAID 720i	4x3.5" HS	Open	1xLP HL	9.5mm DVD±RW	GbEx4 RJ-45 AnyFabric	None	TSM	None	3-year	750Wx1 Platinum	09/14
70CV0007EA	EMEA	1xXeon E5-2620 v3 6C/2.4GHz/15MB/85W/DDR4-1866	4XG0F28802	1x8GB RDIMM DDR4-2133 ECC	AnyRAID 720i	4x3.5" HS	Open	1xLP HL	9.5mm DVD±RW	GbEx4 RJ-45 AnyFabric	None	TSM	None	3-year	750Wx1 Platinum	09/14
70CV0008EA	EMEA	1xXeon E5-2630L v3 8C/1.8GHz/20MB/55W/DDR4-1866	4XG0F28806	1x8GB RDIMM DDR4-2133 ECC	AnyRAID 720i	4x3.5" HS	Open	1xLP HL	9.5mm DVD±RW	GbEx4 RJ-45 AnyFabric	None	TSM	None	3-year	750Wx1 Platinum	09/14
70CV0009EA	EMEA	1xXeon E5-2630 v3 8C/2.4GHz/20MB/85W/DDR4-1866	4XG0F28801	1x8GB RDIMM DDR4-2133 ECC	AnyRAID 720i	4x3.5" HS	Open	1xLP HL	9.5mm DVD±RW	GbEx4 RJ-45 AnyFabric	None	TSM	None	3-year	750Wx1 Platinum	09/14
70CV000AEA	EMEA	1xXeon E5-2637 v3 4C/3.5GHz/15MB/135W/DDR4-2133	4XG0F28831	1x8GB RDIMM DDR4-2133 ECC	AnyRAID 720i	4x3.5" HS	Open	1xLP HL	9.5mm DVD±RW	GbEx4 RJ-45 AnyFabric	None	TSM	None	3-year	750Wx1 Platinum	09/14
70CV000BEA	EMEA	1xXeon E5-2640 v3 8C/2.6GHz/20MB/90W/DDR4-1866	4XG0F28800	1x8GB RDIMM DDR4-2133 ECC	AnyRAID 720i	4x3.5" HS	Open	1xLP HL	9.5mm DVD±RW	GbEx4 RJ-45 AnyFabric	None	TSM	None	3-year	750Wx1 Platinum	09/14
70CV000CEA	EMEA	1xXeon E5-2643 v3 6C/3.4GHz/20MB/135W/DDR4-2133	4XG0F28830	1x8GB RDIMM DDR4-2133 ECC	AnyRAID 720i	4x3.5" HS	Open	1xLP HL	9.5mm DVD±RW	GbEx4 RJ-45 AnyFabric	None	TSM	None	3-year	750Wx1 Platinum	09/14
70CV000DEA	EMEA	1xXeon E5-2650L v3 12C/1.8GHz/30MB/65W/DDR4-2133	4XG0F28805	1x8GB RDIMM DDR4-2133 ECC	AnyRAID 720i	4x3.5" HS	Open	1xLP HL	9.5mm DVD±RW	GbEx4 RJ-45 AnyFabric	None	TSM	None	3-year	750Wx1 Platinum	09/14
70CV000EEA	EMEA	1xXeon E5-2650 v3 10C/2.3GHz/25MB/105W/DDR4-2133	4XG0F28799	1x8GB RDIMM DDR4-2133 ECC	AnyRAID 720i	4x3.5" HS	Open	1xLP HL	9.5mm DVD±RW	GbEx4 RJ-45 AnyFabric	None	TSM	None	3-year	750Wx1 Platinum	09/14
70CV000FEA	EMEA	1xXeon E5-2660 v3 10C/2.6GHz/25MB/105W/DDR4-2133	4XG0F28798	1x8GB RDIMM DDR4-2133 ECC	AnyRAID 720i	4x3.5" HS	Open	1xLP HL	9.5mm DVD±RW	GbEx4 RJ-45 AnyFabric	None	TSM	None	3-year	750Wx1 Platinum	09/14
70CV000GEA	EMEA	1xXeon E5-2667 v3 8C/3.2GHz/20MB/135W/DDR4-2133	4XG0F28829	1x8GB RDIMM DDR4-2133 ECC	AnyRAID 720i	4x3.5" HS	Open	1xLP HL	9.5mm DVD±RW	GbEx4 RJ-45 AnyFabric	None	TSM	None	3-year	750Wx1 Platinum	09/14
70CV000HEA	EMEA	1xXeon E5-2670 v3 12C/2.3GHz/30MB/120W/DDR4-2133	4XG0F28797	1x8GB RDIMM DDR4-2133 ECC	AnyRAID 720i	4x3.5" HS	Open	1xLP HL	9.5mm DVD±RW	GbEx4 RJ-45 AnyFabric	None	TSM	None	3-year	750Wx1 Platinum	09/14
70CV000JEA	EMEA	1xXeon E5-2680 v3 12C/2.5GHz/30MB/120W/DDR4-2133	4XG0F28796	1x8GB RDIMM DDR4-2133 ECC	AnyRAID 720i	4x3.5" HS	Open	1xLP HL	9.5mm DVD±RW	GbEx4 RJ-45 AnyFabric	None	TSM	None	3-year	750Wx1 Platinum	09/14
70CV000KEA	EMEA	1xXeon E5-2683 v3 14C/2GHz/35MB/120W/DDR4-2133	4XG0F28795	1x8GB RDIMM DDR4-2133 ECC	AnyRAID 720i	4x3.5" HS	Open	1xLP HL	9.5mm DVD±RW	GbEx4 RJ-45 AnyFabric	None	TSM	None	3-year	750Wx1 Platinum	09/14
70CV000LEA	EMEA	1xXeon E5-2685 v3 12C/2.6GHz/30MB/120W/DDR4-2133	4XG0F28833	1x8GB RDIMM DDR4-2133 ECC	AnyRAID 720i	4x3.5" HS	Open	1xLP HL	9.5mm DVD±RW	GbEx4 RJ-45 AnyFabric	None	TSM	None	3-year	750Wx1 Platinum	09/14
70CV000MEA	EMEA	1xXeon E5-2690 v3 12C/2.6GHz/30MB/135W/DDR4-2133	4XG0F28794	1x8GB RDIMM DDR4-2133 ECC	AnyRAID 720i	4x3.5" HS	Open	1xLP HL	9.5mm DVD±RW	GbEx4 RJ-45 AnyFabric	None	TSM	None	3-year	750Wx1 Platinum	09/14

Model	Region	Processor	2nd CPU	Memory	RAID Controller	Disk Bays	Storage	Slots	Optical	Add-on NIC	TPM	System Mgmt	OS	Warranty	Power Supply	Ann Date (m/y)
70CV000NEA	EMEA	1xXeon E5-2695 v3 14C/2.3GHz/35MB/120W/DDR4-2133	4XG0F28793	1x8GB RDIMM DDR4-2133 ECC	AnyRAID 720i	4x3.5" HS	Open	1xLP HL	9.5mm DVD±RW	GbEx4 RJ-45 AnyFabric	None	TSM	None	3-year	750Wx1 Platinum	09/14
70CV000PEA	EMEA	1xXeon E5-2697 v3 14C/2.6GHz/35MB/145W/DDR4-2133	4XG0F28792	1x8GB RDIMM DDR4-2133 ECC	AnyRAID 720i	4x3.5" HS	Open	1xLP HL	9.5mm DVD±RW	GbEx4 RJ-45 AnyFabric	None	TSM	None	3-year	750Wx1 Platinum	09/14
70CV000QEA	EMEA	1xXeon E5-2698 v3 16C/2.3GHz/40MB/135W/DDR4-2133	4XG0F28791	1x8GB RDIMM DDR4-2133 ECC	AnyRAID 720i	4x3.5" HS	Open	1xLP HL	9.5mm DVD±RW	GbEx4 RJ-45 AnyFabric	None	TSM	None	3-year	750Wx1 Platinum	09/14
70CV000REA	EMEA	1xXeon E5-2699 v3 18C/2.3GHz/45MB/145W/DDR4-2133	4XG0F28790	1x8GB RDIMM DDR4-2133 ECC	AnyRAID 720i	4x3.5" HS	Open	1xLP HL	9.5mm DVD±RW	GbEx4 RJ-45 AnyFabric	None	TSM	None	3-year	750Wx1 Platinum	09/14
70CV000SEA	EMEA	1xXeon E5-2609 v3 6C/1.9GHz/15MB/85W/DDR4-1600	4XG0F28803	1x8GB RDIMM DDR4-2133 ECC	AnyRAID 510i+Key	4x3.5" HS	Open	1xLP HL	9.5mm DVD±RW	GbEx4 RJ-45 AnyFabric	None	TSM	None	3-year	750Wx1 Platinum	09/14
70CV000TEA	EMEA	1xXeon E5-2620 v3 6C/2.4GHz/15MB/85W/DDR4-1866	4XG0F28802	1x8GB RDIMM DDR4-2133 ECC	AnyRAID 510i+Key	4x3.5" HS	Open	1xLP HL	9.5mm DVD±RW	GbEx4 RJ-45 AnyFabric	None	TSM	None	3-year	750Wx1 Platinum	09/14
70CV000UEA	EMEA	1xXeon E5-2630 v3 8C/2.4GHz/20MB/85W/DDR4-1866	4XG0F28801	1x8GB RDIMM DDR4-2133 ECC	AnyRAID 510i+Key	4x3.5" HS	Open	1xLP HL	9.5mm DVD±RW	GbEx4 RJ-45 AnyFabric	None	TSM	None	3-year	750Wx1 Platinum	09/14
70CV000VEA	EMEA	1xXeon E5-2640 v3 8C/2.6GHz/20MB/90W/DDR4-1866	4XG0F28800	1x8GB RDIMM DDR4-2133 ECC	AnyRAID 510i+Key	4x3.5" HS	Open	1xLP HL	9.5mm DVD±RW	GbEx4 RJ-45 AnyFabric	None	TSM	None	3-year	750Wx1 Platinum	09/14
70CV000WEA	EMEA	1xXeon E5-2609 v3 6C/1.9GHz/15MB/85W/DDR4-1600	4XG0F28803	1x8GB RDIMM DDR4-2133 ECC	AnyRAID 510i	4x3.5" HS	Open	1xLP HL	9.5mm DVD±RW	GbEx4 RJ-45 AnyFabric	TPM	TSM	None	3-year	750Wx1 Platinum	09/14

Model	Region	Processor	2nd CPU	Memory	RAID Controller	Disk Bays	Storage	Slots	Optical	Add-on NIC	TPM	System Mgmt	OS	Warranty	Power Supply	Ann Date (m/y)
70CX000BEA	EMEA	1xXeon E5-2603 v3 6C/1.6GHz/15MB/85W/DDR4-1600	4XG0F28804	1x8GB RDIMM DDR4-2133 ECC	AnyRAID 720ix+1GB RAM	12x2.5" HS	Open	2xLP HL	None	GbEx4 RJ-45 AnyFabric	None	TSM	None	3-year	750Wx1 Platinum	09/14
70CX000CEA	EMEA	1xXeon E5-2609 v3 6C/1.9GHz/15MB/85W/DDR4-1600	4XG0F28803	1x8GB RDIMM DDR4-2133 ECC	AnyRAID 720ix+1GB RAM	12x2.5" HS	Open	2xLP HL	None	GbEx4 RJ-45 AnyFabric	None	TSM	None	3-year	750Wx1 Platinum	09/14
70CX000DEA	EMEA	1xXeon E5-2620 v3 6C/2.4GHz/15MB/85W/DDR4-1866	4XG0F28802	1x8GB RDIMM DDR4-2133 ECC	AnyRAID 720ix+1GB RAM	12x2.5" HS	Open	2xLP HL	None	GbEx4 RJ-45 AnyFabric	None	TSM	None	3-year	750Wx1 Platinum	09/14
70CX000EEA	EMEA	1xXeon E5-2630 v3 8C/2.4GHz/20MB/85W/DDR4-1866	4XG0F28801	1x8GB RDIMM DDR4-2133 ECC	AnyRAID 720ix+1GB RAM	12x2.5" HS	Open	2xLP HL	None	GbEx4 RJ-45 AnyFabric	None	TSM	None	3-year	750Wx1 Platinum	09/14
70CX000FEA	EMEA	1xXeon E5-2630L v3 8C/1.8GHz/20MB/55W/DDR4-1866	4XG0F28806	1x8GB RDIMM DDR4-2133 ECC	AnyRAID 720ix+1GB RAM	12x2.5" HS	Open	2xLP HL	None	GbEx4 RJ-45 AnyFabric	None	TSM	None	3-year	750Wx1 Platinum	09/14
70CX000GEA	EMEA	1xXeon E5-2640 v3 8C/2.6GHz/20MB/90W/DDR4-1866	4XG0F28800	1x8GB RDIMM DDR4-2133 ECC	AnyRAID 720ix+1GB RAM	12x2.5" HS	Open	2xLP HL	None	GbEx4 RJ-45 AnyFabric	None	TSM	None	3-year	750Wx1 Platinum	09/14
70CX000HEA	EMEA	1xXeon E5-2650 v3 10C/2.3GHz/25MB/105W/DDR4-2133	4XG0F28799	1x8GB RDIMM DDR4-2133 ECC	AnyRAID 720ix+1GB RAM	12x2.5" HS	Open	2xLP HL	None	GbEx4 RJ-45 AnyFabric	None	TSM	None	3-year	750Wx1 Platinum	09/14
70CX000JEA	EMEA	1xXeon E5-2660 v3 10C/2.6GHz/25MB/105W/DDR4-2133	4XG0F28798	1x8GB RDIMM DDR4-2133 ECC	AnyRAID 720ix+1GB RAM	12x2.5" HS	Open	2xLP HL	None	GbEx4 RJ-45 AnyFabric	None	TSM	None	3-year	750Wx1 Platinum	09/14
70CX000KEA	EMEA	1xXeon E5-2667 v3 8C/3.2GHz/20MB/135W/DDR4-2133	4XG0F28829	1x8GB RDIMM DDR4-2133 ECC	AnyRAID 720ix+1GB RAM	12x2.5" HS	Open	2xLP HL	None	GbEx4 RJ-45 AnyFabric	None	TSM	None	3-year	750Wx1 Platinum	09/14
70CX000LEA	EMEA	1xXeon E5-2670 v3 12C/2.3GHz/30MB/120W/DDR4-2133	4XG0F28797	1x8GB RDIMM DDR4-2133 ECC	AnyRAID 720ix+1GB RAM	12x2.5" HS	Open	2xLP HL	None	GbEx4 RJ-45 AnyFabric	None	TSM	None	3-year	750Wx1 Platinum	09/14
70CX000MEA	EMEA	1xXeon E5-2680 v3 12C/2.5GHz/30MB/120W/DDR4-2133	4XG0F28796	1x8GB RDIMM DDR4-2133 ECC	AnyRAID 720ix+1GB RAM	12x2.5" HS	Open	2xLP HL	None	GbEx4 RJ-45 AnyFabric	None	TSM	None	3-year	750Wx1 Platinum	09/14
70CX000NEA	EMEA	1xXeon E5-2683 v3 14C/2GHz/35MB/120W/DDR4-2133	4XG0F28795	1x8GB RDIMM DDR4-2133 ECC	AnyRAID 720ix+1GB RAM	12x2.5" HS	Open	2xLP HL	None	GbEx4 RJ-45 AnyFabric	None	TSM	None	3-year	750Wx1 Platinum	09/14
70CX000PEA	EMEA	1xXeon E5-2685 v3 12C/2.6GHz/30MB/120W/DDR4-2133	4XG0F28833	1x8GB RDIMM DDR4-2133 ECC	AnyRAID 720ix+1GB RAM	12x2.5" HS	Open	2xLP HL	None	GbEx4 RJ-45 AnyFabric	None	TSM	None	3-year	750Wx1 Platinum	09/14
70CX000QEA	EMEA	1xXeon E5-2690 v3 12C/2.6GHz/30MB/135W/DDR4-2133	4XG0F28794	1x8GB RDIMM DDR4-2133 ECC	AnyRAID 720ix+1GB RAM	12x2.5" HS	Open	2xLP HL	None	GbEx4 RJ-45 AnyFabric	None	TSM	None	3-year	750Wx1 Platinum	09/14
70CX000REA	EMEA	1xXeon E5-2695 v3 14C/2.3GHz/35MB/120W/DDR4-2133	4XG0F28793	1x8GB RDIMM DDR4-2133 ECC	AnyRAID 720ix+1GB RAM	12x2.5" HS	Open	2xLP HL	None	GbEx4 RJ-45 AnyFabric	None	TSM	None	3-year	750Wx1 Platinum	09/14
70CX000SEA	EMEA	1xXeon E5-2697 v3 14C/2.6GHz/35MB/145W/DDR4-2133	4XG0F28792	1x8GB RDIMM DDR4-2133 ECC	AnyRAID 720ix+1GB RAM	12x2.5" HS	Open	2xLP HL	None	GbEx4 RJ-45 AnyFabric	None	TSM	None	3-year	750Wx1 Platinum	09/14
70CX000TEA	EMEA	1xXeon E5-2698 v3 16C/2.3GHz/40MB/135W/DDR4-2133	4XG0F28791	1x8GB RDIMM DDR4-2133 ECC	AnyRAID 720ix+1GB RAM	12x2.5" HS	Open	2xLP HL	None	GbEx4 RJ-45 AnyFabric	None	TSM	None	3-year	750Wx1 Platinum	09/14

Model	Region	Processor	2nd CPU	Memory	RAID Controller	Disk Bays	Storage	Slots	Optical	Add-on NIC	TPM	System Mgmt	OS	Warranty	Power Supply	Ann Date (m/y)
70CX000UEA	EMEA	1xXeon E5-2699 v3 18C/2.3GHz/45MB/145W/DDR4-2133	4XG0F28790	1x8GB RDIMM DDR4-2133 ECC	AnyRAID 720ix+1GB RAM	12x2.5" HS	Open	2xLP HL	None	GbEx4 RJ-45 AnyFabric	None	TSM	None	3-year	750Wx1 Platinum	09/14
70CX000VEA	EMEA	1xXeon E5-2630 v3 8C/2.4GHz/20MB/85W/DDR4-1866	4XG0F28801	2x8GB RDIMM DDR4-2133 ECC	AnyRAID 720ix+1GB Flash	12x2.5" HS	Open	2xLP HL	None	GbEx4 RJ-45 AnyFabric	None	TSM	None	3-year	750Wx1 Platinum	09/14
70CX000WEA	EMEA	1xXeon E5-2630 v3 8C/2.4GHz/20MB/85W/DDR4-1866	4XG0F28801	4x8GB RDIMM DDR4-2133 ECC	AnyRAID 720ix+1GB Flash	12x2.5" HS	Open	2xLP HL	None	GbEx4 RJ-45 AnyFabric	None	TSM	None	3-year	750Wx1 Platinum	09/14
70CX000XEA	EMEA	1xXeon E5-2640 v3 8C/2.6GHz/20MB/90W/DDR4-1866	4XG0F28800	4x8GB RDIMM DDR4-2133 ECC	AnyRAID 720ix+1GB Flash	12x2.5" HS	Open	2xLP HL	None	GbEx4 RJ-45 AnyFabric	None	TSM	None	3-year	750Wx1 Platinum	09/14
70CX000YEA	EMEA	2xXeon E5-2650 v3 10C/2.3GHz/25MB/105W/DDR4-2133	-	4x16GB RDIMM DDR4- 2133 ECC	AnyRAID 720ix+2GB Flash	12x2.5" HS	Open	3xLP HL	None	GbEx4 RJ-45 AnyFabric	None	TSM	None	3-year	750Wx2 Platinum	09/14
70CX0010EA	EMEA	2xXeon E5-2690 v3 12C/2.6GHz/30MB/135W/DDR4-2133	-	4x16GB RDIMM DDR4- 2133 ECC	AnyRAID 720ix+2GB Flash	12x2.5" HS	Open	3xLP HL	None	GbEx4 RJ-45 AnyFabric	None	TSM	None	3-year	750Wx2 Platinum	09/14
70CX0011EA	EMEA	1xXeon E5-2620 v3 6C/2.4GHz/15MB/85W/DDR4-1866	4XG0F28802	1x8GB RDIMM DDR4-2133 ECC	AnyRAID 720ix+1GB Flash	12x2.5" HS	Open	2xLP HL	None	GbEx4 RJ-45 AnyFabric	None	TSM	None	3-year	750Wx2 Platinum	09/14
70CX0012EA	EMEA	1xXeon E5-2620 v3 6C/2.4GHz/15MB/85W/DDR4-1866	4XG0F28802	2x8GB RDIMM DDR4-2133 ECC	AnyRAID 720ix+1GB Flash	12x2.5" HS	Open	2xLP HL	None	GbEx4 RJ-45 AnyFabric	None	TSM	None	3-year	750Wx1 Platinum	09/14
70CX0013EA	EMEA	1xXeon E5-2620 v3 6C/2.4GHz/15MB/85W/DDR4-1866	4XG0F28802	1x8GB RDIMM DDR4-2133 ECC	AnyRAID 510i+Key	8x2.5" HS	Open	2xLP HL	None	GbEx4 RJ-45 AnyFabric	None	TSM	None	3-year	750Wx1 Platinum	09/14
70CX0014EA	EMEA	1xXeon E5-2620 v3 6C/2.4GHz/15MB/85W/DDR4-1866	4XG0F28802	1x8GB RDIMM DDR4-2133 ECC	AnyRAID 720i	8x2.5" HS	Open	2xLP HL	None	GbEx4 RJ-45 AnyFabric	None	TSM	None	3-year	750Wx1 Platinum	09/14
70CX0015EA	EMEA	1xXeon E5-2630 v3 8C/2.4GHz/20MB/85W/DDR4-1866	4XG0F28801	1x8GB RDIMM DDR4-2133 ECC	AnyRAID 720ix+1GB Flash	12x2.5" HS	Open	2xLP HL	None	GbEx4 RJ-45 AnyFabric	None	TSM	None	3-year	750Wx2 Platinum	09/14
70CX0016EA	EMEA	1xXeon E5-2609 v3 6C/1.9GHz/15MB/85W/DDR4-1600	4XG0F28803	1x8GB RDIMM DDR4-2133 ECC	AnyRAID 510i+Key	8x2.5" HS	Open	2xLP HL	None	GbEx4 RJ-45 AnyFabric	None	TSM	None	3-year	750Wx1 Platinum	09/14
70CX0017EA	EMEA	1xXeon E5-2609 v3 6C/1.9GHz/15MB/85W/DDR4-1600	4XG0F28803	1x8GB RDIMM DDR4-2133 ECC	AnyRAID 720ix+1GB RAM	12x2.5" HS	Open	2xLP HL	None	GbEx4 RJ-45 AnyFabric	None	TSM	None	3-year	750Wx1 Platinum	09/14
70CX0018EA	EMEA	1xXeon E5-2609 v3 6C/1.9GHz/15MB/85W/DDR4-1600	4XG0F28803	1x16GB RDIMM DDR4- 2133 ECC	AnyRAID 720ix+1GB RAM	12x2.5" HS	Open	2xLP HL	None	GbEx4 RJ-45 AnyFabric	None	TSM	None	3-year	750Wx1 Platinum	09/14
70CX0019EA	EMEA	1xXeon E5-2609 v3 6C/1.9GHz/15MB/85W/DDR4-1600	4XG0F28803	1x16GB RDIMM DDR4- 2133 ECC	AnyRAID 720ix+1GB RAM	12x2.5" HS	Open	2xLP HL	None	GbEx4 RJ-45 AnyFabric	TPM	TSM Premium	None	3-year	750Wx2 Platinum	09/14
70CX001AEA	EMEA	1xXeon E5-2609 v3 6C/1.9GHz/15MB/85W/DDR4-1600	4XG0F28803	1x32GB LRDIMM DDR4-2133 ECC	AnyRAID 720ix+2GB Flash	12x2.5" HS	Open	2xLP HL	None	GbEx4 RJ-45 AnyFabric	TPM	TSM Premium	None	3-year	750Wx2 Platinum	09/14
70CX002BEA	EMEA	1xXeon E5-2609 v3 6C/1.9GHz/15MB/85W/DDR4-1600	4XG0F28803	1x8GB RDIMM DDR4-2133 ECC	AnyRAID 720ix+1GB Flash	8x2.5" HS	Open	2xLP HL	None	GbEx4 RJ-45 AnyFabric	None	TSM	None	3-year	750Wx1 Platinum	12/14

Model	Region	Processor	2nd CPU	Memory	RAID Controller	Disk Bays	Storage	Slots	Optical	Add-on NIC	TPM	System Mgmt	OS	Warranty	Power Supply	Ann Date (m/y)
70CX002CEA	EMEA	1xXeon E5-2620 v3 6C/2.4GHz/15MB/85W/DDR4-1866	4XG0F28802	1x8GB RDIMM DDR4-2133 ECC	AnyRAID 720i+1GB Flash	8x2.5" HS	Open	2xLP HL	None	GbEx4 RJ- 45 AnyFabric	None	TSM	None	3-year	750Wx1 Platinum	12/14
70CX002DEA	EMEA	1xXeon E5-2630 v3 8C/2.4GHz/20MB/85W/DDR4-1866	4XG0F28801	1x8GB RDIMM DDR4-2133 ECC	AnyRAID 720i+1GB Flash	8x2.5" HS	Open	2xLP HL	None	GbEx4 RJ- 45 AnyFabric	None	TSM	None	3-year	750Wx1 Platinum	12/14
70CX002EEA	EMEA	1xXeon E5-2640 v3 8C/2.6GHz/20MB/90W/DDR4-1866	4XG0F28800	1x8GB RDIMM DDR4-2133 ECC	AnyRAID 720i+1GB Flash	8x2.5" HS	Open	2xLP HL	None	GbEx4 RJ- 45 AnyFabric	None	TSM	None	3-year	750Wx1 Platinum	12/14
70CX002FEA	EMEA	1xXeon E5-2650 v3 10C/2.3GHz/25MB/105W/DDR4-2133	4XG0F28799	1x8GB RDIMM DDR4-2133 ECC	AnyRAID 720i+1GB Flash	8x2.5" HS	Open	2xLP HL	None	GbEx4 RJ- 45 AnyFabric	None	TSM	None	3-year	750Wx1 Platinum	12/14
70CX002GEA	EMEA	1xXeon E5-2660 v3 10C/2.6GHz/25MB/105W/DDR4-2133	4XG0F28798	1x8GB RDIMM DDR4-2133 ECC	AnyRAID 720i+1GB Flash	8x2.5" HS	Open	2xLP HL	None	GbEx4 RJ- 45 AnyFabric	None	TSM	None	3-year	750Wx1 Platinum	12/14
70CX002HEA	EMEA	1xXeon E5-2670 v3 12C/2.3GHz/30MB/120W/DDR4-2133	4XG0F28797	1x8GB RDIMM DDR4-2133 ECC	AnyRAID 720i+1GB Flash	8x2.5" HS	Open	2xLP HL	None	GbEx4 RJ- 45 AnyFabric	None	TSM	None	3-year	750Wx1 Platinum	12/14
70CX002JEA	EMEA	1xXeon E5-2690 v3 12C/2.6GHz/30MB/135W/DDR4-2133	4XG0F28794	1x8GB RDIMM DDR4-2133 ECC	AnyRAID 720i+1GB Flash	8x2.5" HS	Open	2xLP HL	None	GbEx4 RJ- 45 AnyFabric	None	TSM	None	3-year	750Wx1 Platinum	12/14
70CX002KEA	EMEA	1xXeon E5-2697 v3 14C/2.6GHz/35MB/145W/DDR4-2133	4XG0F28792	1x8GB RDIMM DDR4-2133 ECC	AnyRAID 720i+1GB Flash	8x2.5" HS	Open	2xLP HL	None	GbEx4 RJ- 45 AnyFabric	None	TSM	None	3-year	750Wx1 Platinum	12/14
70CX002LEA	EMEA	1xXeon E5-2630 v3 8C/2.4GHz/20MB/85W/DDR4-1866	4XG0F28801	1x16GB RDIMM DDR4- 2133 ECC	AnyRAID 720i	8x2.5" HS	Open	2xLP HL	None	GbEx4 RJ- 45 AnyFabric	None	TSM	None	3-year	750Wx1 Platinum	11/14
70CX002MEA	EMEA	1xXeon E5-2620 v3 6C/2.4GHz/15MB/85W/DDR4-1866	4XG0F28802	1x16GB RDIMM DDR4- 2133 ECC	AnyRAID720i+2GB Flash	8x2.5" HS	Open	2xLP HL	None	GbEx4 RJ- 45 AnyFabric	None	TSM	None	3-year	750Wx1 Platinum	07/15
70CX002NEA	EMEA	1xXeon E5-2620 v3 6C/2.4GHz/15MB/85W/DDR4-1866	4XG0F28802	1x16GB RDIMM DDR4- 2133 ECC	AnyRAID 720ix+2GB Flash	12x2.5" HS	Open	2xLP HL	None	GbEx4 RJ- 45 AnyFabric	None	TSM	None	3-year	750Wx1 Platinum	07/15
70CX002PEA	EMEA	1xXeon E5-2630 v3 8C/2.4GHz/20MB/85W/DDR4-1866	4XG0F28801	1x16GB RDIMM DDR4- 2133 ECC	AnyRAID720i+2GB Flash	8x2.5" HS	Open	2xLP HL	None	GbEx4 RJ- 45 AnyFabric	None	TSM	None	3-year	750Wx1 Platinum	07/15
70CX002QEA	EMEA	1xXeon E5-2630 v3 8C/2.4GHz/20MB/85W/DDR4-1866	4XG0F28801	1x16GB RDIMM DDR4- 2133 ECC	AnyRAID 720ix+2GB Flash	12x2.5" HS	Open	2xLP HL	None	GbEx4 RJ- 45 AnyFabric	None	TSM	None	3-year	750Wx1 Platinum	07/15
70CX002REA	EMEA	1xXeon E5-2620 v3 6C/2.4GHz/15MB/85W/DDR4-1866	4XG0F28802	1x16GB RDIMM DDR4- 2133 ECC	AnyRAID720i+2GB Flash	8x2.5" HS	2x300GB HDD 10K 2.5" SAS6Gbs	2xLP HL	None	GbEx4 RJ- 45 AnyFabric	None	TSM	None	3-year	750Wx1 Platinum	07/15
70CX002SEA	EMEA	1xXeon E5-2620 v3 6C/2.4GHz/15MB/85W/DDR4-1866	4XG0F28802	1x16GB RDIMM DDR4- 2133 ECC	AnyRAID 720ix+2GB Flash	12x2.5" HS	2x300GB HDD 10K 2.5" SAS6Gbs	2xLP HL	None	GbEx4 RJ- 45 AnyFabric	None	TSM	None	3-year	750Wx1 Platinum	07/15
70CX002TEA	EMEA	1xXeon E5-2630 v3 8C/2.4GHz/20MB/85W/DDR4-1866	4XG0F28801	1x16GB RDIMM DDR4- 2133 ECC	AnyRAID720i+2GB Flash	8x2.5" HS	2x300GB HDD 10K 2.5" SAS6Gbs	2xLP HL	None	GbEx4 RJ- 45 AnyFabric	None	TSM	None	3-year	750Wx1 Platinum	07/15
70CX002UEA	EMEA	1xXeon E5-2630 v3 8C/2.4GHz/20MB/85W/DDR4-1866	4XG0F28801	1x16GB RDIMM DDR4- 2133 ECC	AnyRAID 720ix+2GB Flash	12x2.5" HS	2x300GB HDD 10K 2.5" SAS6Gbs	2xLP HL	None	GbEx4 RJ- 45 AnyFabric	None	TSM	None	3-year	750Wx1 Platinum	07/15

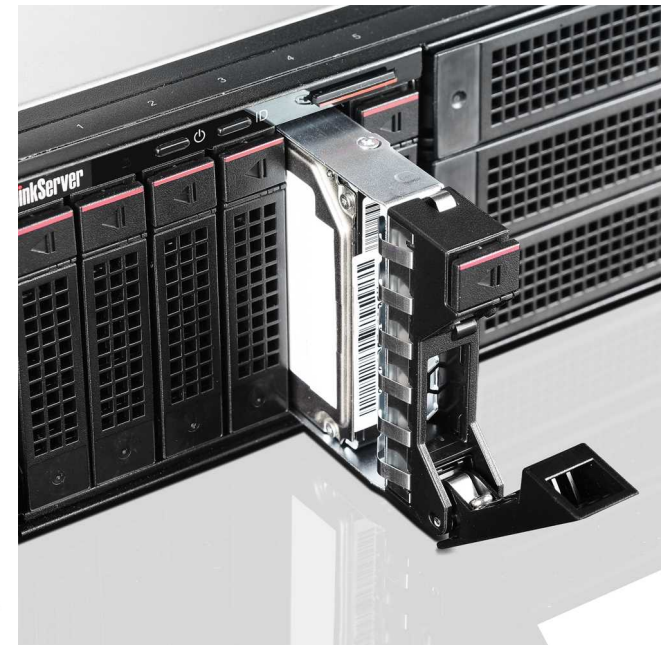
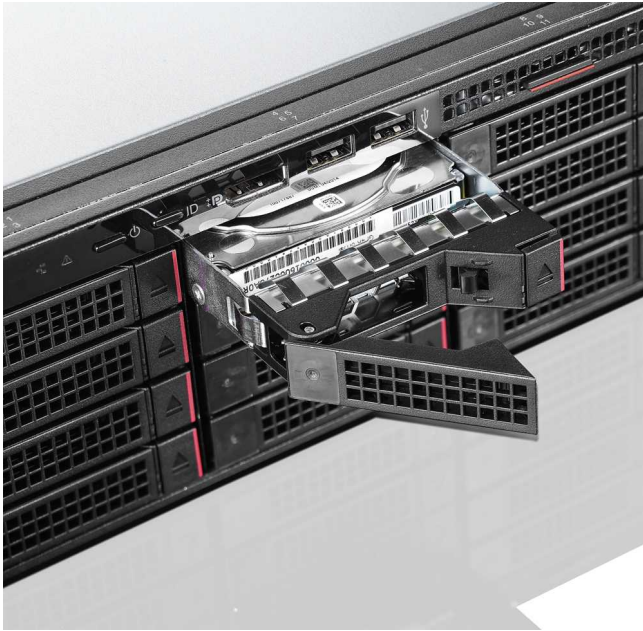

ThinkServer RD650 Platform Specifications

Product Specifications Reference (PSREF)

Components	Specification																																							
Dimensions	2U rack. Height: 87 mm (3.4 in), width: 482 mm (19 in), depth: 764 mm (30 in)																																							
Weight	Minimum configuration: 16 kg (35.3 lb), maximum: 32 kg (70.5 lb)																																							
Processor	Up to two 145W Intel Xeon E5-2600 v3 family (code name: Haswell) processors with 18 cores up to 2.3GHz, 16 cores up to 2.3GHz, 14 cores up to 2.6GHz, 12 cores up to 2.6GHz, 10 cores up to 2.6GHz, 8 cores up to 3.2GHz, 6 cores up to 3.4GHz, 4 cores up to 3.5GHz. Two QPI link up to 9.6 GT/s. Up to 2133MHz memory speed. Up to 45MB cache																																							
Chipset	Intel C612 Platform Controller Hub (PCH)																																							
Memory DIMMs	24 DIMM sockets (12 DIMMs per processor), 8-channel capable (4-channel per processor). RDIMM and LRDIMM (cannot be intermixed), DDR4, 2133MHz																																							
Memory capacity	384GB (RDIMM, 16GB x 24)/768GB (LRDIMM, 32GB x 24)																																							
Memory protection	ECC, memory mirroring, lockstep, and memory sparing																																							
AnyRAID support	RAID 0, 1, 10 with AnyRAID 110i. 6Gb/s SATA, optional key for RAID 5. RAID 0, 1, 10 with AnyRAID 510i. 6Gb/s SAS/SATA, optional key for RAID 5/50. RAID 0, 1, 10, 5, 50, 6, 60 with AnyRAID 720i/720ix. 12Gb/s SAS/SATA. 720i needs cache for RAID 6/60 support. 720ix must have cache. Optional cache for 720i/720ix: 1GB read-only memory. 1GB/2GB/4GB flash with super capacitor. Flash options include CacheVault, CacheCade Pro, and FastPath																																							
Disk drive bays	Up to 12 3.5", 24 2.5", or 6 2.5" plus 9 3.5" hot-swap disk bays on front. Up to 4 2.5" bays on 24 2.5" or 2.5" + 3.5" models can support easy-swap PCIe SSD via optional Anybay kit (consumes two PCIe slots). Up to 2 2.5" rear mounted hot-swap disk bays, optional. Up to 2 M.2 SSD drives via optional M.2 module. Up to one internal LTO-6 SAS tape drive on 8 x 2.5" and 720ix model, or external RDX tape drive via USB.																																							
	<table border="1"> <thead> <tr> <th rowspan="2">Disk bay configuration</th> <th colspan="4">AnyRAID requirements and optional drives supported</th> </tr> <tr> <th>RAID110i</th> <th>RAID510i</th> <th>RAID720i</th> <th>RAID720ix</th> </tr> </thead> <tbody> <tr> <td>6x3.5"</td> <td>•</td> <td>•</td> <td>•</td> <td></td> </tr> <tr> <td>12x3.5"</td> <td></td> <td></td> <td></td> <td>• (optional rear bay/M.2)</td> </tr> <tr> <td>8x2.5"</td> <td></td> <td>•</td> <td>•</td> <td>• (optional tape/rear bay/M.2)</td> </tr> <tr> <td>16x2.5"</td> <td></td> <td></td> <td></td> <td>• (optional rear bay/M.2)</td> </tr> <tr> <td>24x2.5"</td> <td></td> <td></td> <td></td> <td>• (optional Anybay/rear bay/M.2)</td> </tr> <tr> <td>6x2.5"+9x3.5"</td> <td></td> <td></td> <td></td> <td>• (optional Anybay/rear bay/M.2)</td> </tr> </tbody> </table>	Disk bay configuration	AnyRAID requirements and optional drives supported				RAID110i	RAID510i	RAID720i	RAID720ix	6x3.5"	•	•	•		12x3.5"				• (optional rear bay/M.2)	8x2.5"		•	•	• (optional tape/rear bay/M.2)	16x2.5"				• (optional rear bay/M.2)	24x2.5"				• (optional Anybay/rear bay/M.2)	6x2.5"+9x3.5"				• (optional Anybay/rear bay/M.2)
Disk bay configuration	AnyRAID requirements and optional drives supported																																							
	RAID110i	RAID510i	RAID720i	RAID720ix																																				
6x3.5"	•	•	•																																					
12x3.5"				• (optional rear bay/M.2)																																				
8x2.5"		•	•	• (optional tape/rear bay/M.2)																																				
16x2.5"				• (optional rear bay/M.2)																																				
24x2.5"				• (optional Anybay/rear bay/M.2)																																				
6x2.5"+9x3.5"				• (optional Anybay/rear bay/M.2)																																				
Internal disk drive	3.5" HDD up to 8TB (SATA/SAS). 2.5" HDD up to 1.8TB (SAS)/2TB (SATA). 2.5" SSD up to 1.6TB (SATA/SAS). Easy-swap PCIe SSD up to 1.6TB. PCIe SSD adapter up to 3.2TB. M.2 SSD up to 120GB. 2.5" SSD and HDD are compatible with 3.5" bay																																							
SD module	Up to 2 SDHC flash cards via optional SD module, 8GB or 32GB each																																							
Optical drive	Optional one 9.5mm optical drive on 8 or 16 x 2.5" model, DVD-ROM or DVD±RW																																							
Network interfaces	One dedicated management port, one AnyFabric slot for customized LOM. Discrete network options is also available via PCIe slots																																							
Security features	Power-on and administrator password. Optional TPM (TCG 1.2-compliant) Supports ThinkServer System Manager (TSM), optional TSM Premium. UEFI. Onboard Aspeed AST2400 graphics/management processor, IPMI 2.0-compliant baseboard management controller (BMC). Control Panel LEDs shows the status of power, ID, network, system. Supports ThinkServer management software: Diagnostics, Deployment Manager, Energy Manager, System Manager, Partner Pack for VMware vCenter and Microsoft System Center Operations Manager, Power Planner																																							
Systems management																																								

Components	Specification																																							
Operating systems supported	Microsoft Windows Server 2012 R2/2012/2008 R2. Windows Small Business Server 2011. Red Hat Enterprise Linux 6.5/6.6/7. SUSE Linux Enterprise Server 11. VMware vSphere (ESXi) 5.1 P5/5.5 U2/6.0																																							
Base warranty	3-year limited onsite service with 9x5/NBD.																																							
Power supply	Up to two redundant hot-swap 550W/750W/1100W/1600W power supplies. 550W, 1100W, and 1600W are 80 PLUS Platinum qualified. 750W is 80 PLUS Platinum or Titanium qualified.																																							
	<table border="1"> <thead> <tr> <th rowspan="2">Disk bay configuration</th> <th colspan="4">PSU requirements</th> </tr> <tr> <th>550W</th> <th>750W</th> <th>1100W</th> <th>1600W</th> </tr> </thead> <tbody> <tr> <td>6x3.5"</td> <td>•</td> <td>•</td> <td>•</td> <td>•</td> </tr> <tr> <td>12x3.5"</td> <td colspan="4">• (up to 135W CPU)</td> </tr> <tr> <td>8x2.5"</td> <td>•</td> <td>•</td> <td>•</td> <td>•</td> </tr> <tr> <td>16x2.5"</td> <td colspan="4">• (up to 105W CPU+24 DIMMs or 135W+16 DIMMs)</td> </tr> <tr> <td>24x2.5"</td> <td>•</td> <td>•</td> <td>•</td> <td>•</td> </tr> <tr> <td>2.5"+3.5"</td> <td>•</td> <td>•</td> <td>•</td> <td>•</td> </tr> </tbody> </table>	Disk bay configuration	PSU requirements				550W	750W	1100W	1600W	6x3.5"	•	•	•	•	12x3.5"	• (up to 135W CPU)				8x2.5"	•	•	•	•	16x2.5"	• (up to 105W CPU+24 DIMMs or 135W+16 DIMMs)				24x2.5"	•	•	•	•	2.5"+3.5"	•	•	•	•
	Disk bay configuration		PSU requirements																																					
		550W	750W	1100W	1600W																																			
	6x3.5"	•	•	•	•																																			
12x3.5"	• (up to 135W CPU)																																							
8x2.5"	•	•	•	•																																				
16x2.5"	• (up to 105W CPU+24 DIMMs or 135W+16 DIMMs)																																							
24x2.5"	•	•	•	•																																				
2.5"+3.5"	•	•	•	•																																				
	Note: 1. 750W Titanium is 200V - 240V, others are 110V - 240V. 2. 1600W will automatically operate in 1100W if the system line input is 100-127V.																																							
Graphics	Onboard Aspeed AST2400 with 16MB memory, one DisplayPort on rear																																							
Front ports	(Only 2.5" bay models) Two USB 2.0, one DisplayPort																																							
Rear ports	One DisplayPort, two USB 3.0, one RJ-45 (dedicate mgmt), one serial (9-pin)																																							
Cooling	Six (5+1, dual processors) or four (3+1, single processor), hot-swap																																							
Noise emissions	Operating: < 6.5 Bels. Idle: < 6 Bels (Maximum configuration)																																							
Environmental specification	<table border="1"> <tbody> <tr> <td>Temperature - operating</td> <td>41 °F to 113 °F (5 °C to 45 °C)</td> </tr> <tr> <td>Temperature - non operating (no package)</td> <td>-10 °C to 60 °C</td> </tr> <tr> <td>Temperature - non operating (with package)</td> <td>-40 °C to 60 °C</td> </tr> <tr> <td>Altitude - operating</td> <td>(Unpressurized): 0-10000ft (0-3048m)</td> </tr> <tr> <td>Humidity - operating</td> <td>8%-90%, non-condensing</td> </tr> <tr> <td>Humidity - storage (with package)</td> <td>8%-90%, non-condensing</td> </tr> </tbody> </table>	Temperature - operating	41 °F to 113 °F (5 °C to 45 °C)	Temperature - non operating (no package)	-10 °C to 60 °C	Temperature - non operating (with package)	-40 °C to 60 °C	Altitude - operating	(Unpressurized): 0-10000ft (0-3048m)	Humidity - operating	8%-90%, non-condensing	Humidity - storage (with package)	8%-90%, non-condensing																											
Temperature - operating	41 °F to 113 °F (5 °C to 45 °C)																																							
Temperature - non operating (no package)	-10 °C to 60 °C																																							
Temperature - non operating (with package)	-40 °C to 60 °C																																							
Altitude - operating	(Unpressurized): 0-10000ft (0-3048m)																																							
Humidity - operating	8%-90%, non-condensing																																							
Humidity - storage (with package)	8%-90%, non-condensing																																							
	Note: 45 °C continuous operation configuration limitation: no 135W or 145W CPU/no GPU card/redundant PSU/no FLFH card/no PCIe SSD adapter.																																							

Expansion slots

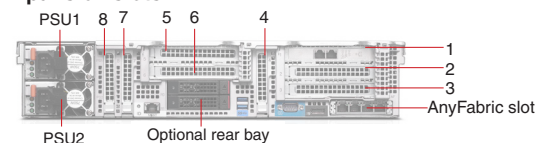

Slot 1 (riser card 1)	PCIe 3.0 x 16, half length, full height
Slot 2 (riser card 1)	PCIe 3.0 x 16, half length, full height
Slot 3 (riser card 1)	PCIe 3.0 x 16, half length, full height
Slot 4 (onboard)	PCIe 3.0 x 16, low-profile, half length, requires 2nd CPU
Slot 5 (riser card 2)	PCIe 3.0 x 16, half length, full height, requires 2nd riser card and 2nd CPU
Slot 6 (riser card 2)	PCIe 3.0 x 16, half length, full height, requires 2nd riser card and 2nd CPU
Slot 7 (onboard)	PCIe 3.0 x 16, low-profile, half length, requires 2nd CPU
Slot 8 (onboard)	PCIe 3.0 x 16, low-profile, half length, requires 2nd CPU

Notes:

On 2.5" disk bay models, slots 1 and 2 can be replaced with one PCIe 3.0 x 16 slot, double wide, full length, full height. Slots 5 and 6 can be replaced with one PCIe 3.0 x 16 slot, double wide, full length, full height.

Model	Region	Processor	2nd CPU	Memory	RAID Controller	Disk Bays	Storage	Slots	Optical	Add-on NIC	TPM	System Mgmt	OS	Warranty	Power Supply	Ann Date (m/y)
70D00005EA	EMEA	1xE5-2609 v3 6C/1.9GHz/15MB/85W/DDR4-1600	4XG0F28820	1x16GB RDIMM DDR4-2133 ECC	AnyRAID 720ix+1GB Flash	12x3.5" HS	Open	3xFH HL	None	GbEx4 RJ-45 AnyFabric	TPM	TSM Premium	None	3-year	750Wx1 Platinum	09/14
70D00006EA	EMEA	1xE5-2609 v3 6C/1.9GHz/15MB/85W/DDR4-1600	4XG0F28820	1x8GB RDIMM DDR4-2133 ECC	AnyRAID 720ix+1GB Flash	12x3.5" HS	Open	3xFH HL	None	GbEx4 RJ-45 AnyFabric	TPM	TSM	None	3-year	750Wx1 Platinum	09/14
70D0001CEA	EMEA	1xE5-2603 v3 6C/1.6GHz/15MB/85W/DDR4-1600	4XG0F28821	1x8GB RDIMM DDR4-2133 ECC	AnyRAID 720ix+1GB RAM	12x3.5" HS	Open	3xFH HL	None	GbEx4 RJ-45 AnyFabric	None	TSM	None	3-year	750Wx1 Platinum	09/14
70D0001DEA	EMEA	1xE5-2609 v3 6C/1.9GHz/15MB/85W/DDR4-1600	4XG0F28820	1x8GB RDIMM DDR4-2133 ECC	AnyRAID 720ix+1GB RAM	12x3.5" HS	Open	3xFH HL	None	GbEx4 RJ-45 AnyFabric	None	TSM	None	3-year	750Wx1 Platinum	09/14
70D0001EEA	EMEA	1xE5-2620 v3 6C/2.4GHz/15MB/85W/DDR4-1866	4XG0F28819	1x8GB RDIMM DDR4-2133 ECC	AnyRAID 720ix+1GB RAM	12x3.5" HS	Open	3xFH HL	None	GbEx4 RJ-45 AnyFabric	None	TSM	None	3-year	750Wx1 Platinum	09/14
70D0001FEA	EMEA	1xE5-2630L v3 8C/1.8GHz/20MB/55W/DDR4-1866	4XG0F28823	1x8GB RDIMM DDR4-2133 ECC	AnyRAID 720ix+1GB RAM	12x3.5" HS	Open	3xFH HL	None	GbEx4 RJ-45 AnyFabric	None	TSM	None	3-year	750Wx1 Platinum	09/14
70D0001GEA	EMEA	1xE5-2630 v3 8C/2.4GHz/20MB/85W/DDR4-1866	4XG0F28818	1x8GB RDIMM DDR4-2133 ECC	AnyRAID 720ix+1GB RAM	12x3.5" HS	Open	3xFH HL	None	GbEx4 RJ-45 AnyFabric	None	TSM	None	3-year	750Wx1 Platinum	09/14
70D0001HEA	EMEA	1xE5-2637 v3 4C/3.5GHz/15MB/135W/DDR4-2133	4XG0F28836	1x8GB RDIMM DDR4-2133 ECC	AnyRAID 720ix+1GB RAM	12x3.5" HS	Open	3xFH HL	None	GbEx4 RJ-45 AnyFabric	None	TSM	None	3-year	750Wx1 Platinum	09/14
70D0001JEA	EMEA	1xE5-2640 v3 8C/2.6GHz/20MB/90W/DDR4-1866	4XG0F28817	1x8GB RDIMM DDR4-2133 ECC	AnyRAID 720ix+1GB RAM	12x3.5" HS	Open	3xFH HL	None	GbEx4 RJ-45 AnyFabric	None	TSM	None	3-year	750Wx1 Platinum	09/14
70D0001KEA	EMEA	1xE5-2643 v3 6C/3.4GHz/20MB/135W/DDR4-2133	4XG0F28835	1x8GB RDIMM DDR4-2133 ECC	AnyRAID 720ix+1GB RAM	12x3.5" HS	Open	3xFH HL	None	GbEx4 RJ-45 AnyFabric	None	TSM	None	3-year	750Wx1 Platinum	09/14
70D0001LEA	EMEA	1xE5-2650L v3 12C/1.8GHz/30MB/65W/DDR4-2133	4XG0F28822	1x8GB RDIMM DDR4-2133 ECC	AnyRAID 720ix+1GB RAM	12x3.5" HS	Open	3xFH HL	None	GbEx4 RJ-45 AnyFabric	None	TSM	None	3-year	750Wx1 Platinum	09/14
70D0001MEA	EMEA	1xE5-2650 v3 10C/2.3GHz/25MB/105W/DDR4-2133	4XG0F28816	1x8GB RDIMM DDR4-2133 ECC	AnyRAID 720ix+1GB RAM	12x3.5" HS	Open	3xFH HL	None	GbEx4 RJ-45 AnyFabric	None	TSM	None	3-year	750Wx1 Platinum	09/14
70D0001NEA	EMEA	1xE5-2660 v3 10C/2.6GHz/25MB/105W/DDR4-2133	4XG0F28815	1x8GB RDIMM DDR4-2133 ECC	AnyRAID 720ix+1GB RAM	12x3.5" HS	Open	3xFH HL	None	GbEx4 RJ-45 AnyFabric	None	TSM	None	3-year	750Wx1 Platinum	09/14
70D0001PEA	EMEA	1xE5-2667 v3 8C/3.2GHz/20MB/135W/DDR4-2133	4XG0F28834	1x8GB RDIMM DDR4-2133 ECC	AnyRAID 720ix+1GB RAM	12x3.5" HS	Open	3xFH HL	None	GbEx4 RJ-45 AnyFabric	None	TSM	None	3-year	750Wx1 Platinum	09/14
70D0001QEA	EMEA	1xE5-2670 v3 12C/2.3GHz/30MB/120W/DDR4-2133	4XG0F28814	1x8GB RDIMM DDR4-2133 ECC	AnyRAID 720ix+1GB RAM	12x3.5" HS	Open	3xFH HL	None	GbEx4 RJ-45 AnyFabric	None	TSM	None	3-year	750Wx1 Platinum	09/14
70D0001REA	EMEA	1xE5-2680 v3 12C/2.5GHz/30MB/120W/DDR4-2133	4XG0F28813	1x8GB RDIMM DDR4-2133 ECC	AnyRAID 720ix+1GB RAM	12x3.5" HS	Open	3xFH HL	None	GbEx4 RJ-45 AnyFabric	None	TSM	None	3-year	750Wx1 Platinum	09/14
70D0001SEA	EMEA	1xE5-2683 v3 14C/2GHz/35MB/120W/DDR4-2133	4XG0F28812	1x8GB RDIMM DDR4-2133 ECC	AnyRAID 720ix+1GB RAM	12x3.5" HS	Open	3xFH HL	None	GbEx4 RJ-45 AnyFabric	None	TSM	None	3-year	750Wx1 Platinum	09/14

Model	Region	Processor	2nd CPU	Memory	RAID Controller	Disk Bays	Storage	Slots	Optical	Add-on NIC	TPM	System Mgmt	OS	Warranty	Power Supply	Ann Date (m/y)
70D0001TEA	EMEA	1xE5-2690 v3 12C/2.6GHz/30MB/135W/DDR4-2133	4XG0F28811	1x8GB RDIMM DDR4-2133 ECC	AnyRAID 720ix+1GB RAM	12x3.5" HS	Open	3xFH HL	None	GbEx4 RJ-45 AnyFabric	None	TSM	None	3-year	750Wx1 Platinum	09/14
70D0001UEA	EMEA	1xE5-2695 v3 14C/2.3GHz/35MB/120W/DDR4-2133	4XG0F28810	1x8GB RDIMM DDR4-2133 ECC	AnyRAID 720ix+1GB RAM	12x3.5" HS	Open	3xFH HL	None	GbEx4 RJ-45 AnyFabric	None	TSM	None	3-year	750Wx1 Platinum	09/14
70D0001VEA	EMEA	1xE5-2697 v3 14C/2.6GHz/35MB/145W/DDR4-2133	4XG0F28809	1x8GB RDIMM DDR4-2133 ECC	AnyRAID 720ix+1GB RAM	12x3.5" HS	Open	3xFH HL	None	GbEx4 RJ-45 AnyFabric	None	TSM	None	3-year	750Wx1 Platinum	09/14
70D0001WEA	EMEA	1xE5-2698 v3 16C/2.3GHz/40MB/135W/DDR4-2133	4XG0F28808	1x8GB RDIMM DDR4-2133 ECC	AnyRAID 720ix+1GB RAM	12x3.5" HS	Open	3xFH HL	None	GbEx4 RJ-45 AnyFabric	None	TSM	None	3-year	750Wx1 Platinum	09/14
70D0001XEA	EMEA	1xE5-2699 v3 18C/2.3GHz/45MB/145W/DDR4-2133	4XG0F28807	1x8GB RDIMM DDR4-2133 ECC	AnyRAID 720ix+1GB RAM	12x3.5" HS	Open	3xFH HL	None	GbEx4 RJ-45 AnyFabric	None	TSM	None	3-year	750Wx1 Platinum	09/14
70D0001YEA	EMEA	1xE5-2620 v3 6C/2.4GHz/15MB/85W/DDR4-1866	4XG0F28819	1x8GB RDIMM DDR4-2133 ECC	AnyRAID 720ix+1GB Flash	12x3.5" HS	Open	3xFH HL	None	GbEx4 RJ-45 AnyFabric	None	TSM	None	3-year	750Wx1 Platinum	09/14
70D00020EA	EMEA	1xE5-2609 v3 6C/1.9GHz/15MB/85W/DDR4-1600	4XG0F28820	1x8GB RDIMM DDR4-2133 ECC	AnyRAID 110i+RAID5	6x3.5" HS	Open	3xFH HL	None	GbEx4 RJ-45 AnyFabric	None	TSM	None	3-year	750Wx1 Platinum	09/14
70D00021EA	EMEA	1xE5-2620 v3 6C/2.4GHz/15MB/85W/DDR4-1866	4XG0F28819	1x8GB RDIMM DDR4-2133 ECC	AnyRAID 110i+RAID5	6x3.5" HS	Open	3xFH HL	None	GbEx4 RJ-45 AnyFabric	None	TSM	None	3-year	750Wx1 Platinum	09/14
70D00022EA	EMEA	1xE5-2640 v3 8C/2.6GHz/20MB/90W/DDR4-1866	4XG0F28817	1x8GB RDIMM DDR4-2133 ECC	AnyRAID 110i+RAID5	6x3.5" HS	Open	3xFH HL	None	GbEx4 RJ-45 AnyFabric	None	TSM	None	3-year	750Wx1 Platinum	09/14

Model	Region	Processor	2nd CPU	Memory	RAID Controller	Disk Bays	Storage	Slots	Optical	Add-on NIC	TPM	System Mgmt	OS	Warranty	Power Supply	Ann Date (m/y)
70D20007EA	EMEA	1xE5-2609 v3 6C/1.9GHz/15MB/85W/DDR4-1600	4XG0F28820	1x32GB LRDIMM DDR4-2133 ECC	AnyRAID 720ix+1GB Flash	24x2.5" HS	Open	3xFH HL	None	GbEx4 RJ-45 AnyFabric	TPM	TSM Premium	None	3-year	750Wx1 Platinum	09/14
70D20008EA	EMEA	1xE5-2609 v3 6C/1.9GHz/15MB/85W/DDR4-1600	4XG0F28820	1x8GB RDIMM DDR4-2133 ECC	AnyRAID 720ix+2GB Flash	24x2.5" HS	Open	3xFH HL	None	GbEx4 RJ-45 AnyFabric	TPM	TSM Premium	None	3-year	750Wx2 Platinum	09/14
70D20009EA	EMEA	1xE5-2609 v3 6C/1.9GHz/15MB/85W/DDR4-1600	4XG0F28820	1x16GB RDIMM DDR4-2133 ECC	AnyRAID 720ix+2GB Flash	24x2.5" HS	Open	3xFH HL	None	GbEx4 RJ-45 AnyFabric	TPM	TSM Premium	None	3-year	750Wx2 Platinum	09/14
70D2001DEA	EMEA	1xE5-2603 v3 6C/1.6GHz/15MB/85W/DDR4-1600	4XG0F28821	1x8GB RDIMM DDR4-2133 ECC	AnyRAID 720ix+1GB RAM	24x2.5" HS	Open	3xFH HL	None	GbEx4 RJ-45 AnyFabric	None	TSM	None	3-year	750Wx1 Platinum	09/14
70D2001EEA	EMEA	1xE5-2609 v3 6C/1.9GHz/15MB/85W/DDR4-1600	4XG0F28820	1x8GB RDIMM DDR4-2133 ECC	AnyRAID 720ix+1GB RAM	24x2.5" HS	Open	3xFH HL	None	GbEx4 RJ-45 AnyFabric	None	TSM	None	3-year	750Wx1 Platinum	09/14
70D2001FEA	EMEA	1xE5-2620 v3 6C/2.4GHz/15MB/85W/DDR4-1866	4XG0F28819	1x8GB RDIMM DDR4-2133 ECC	AnyRAID 720ix+1GB RAM	24x2.5" HS	Open	3xFH HL	None	GbEx4 RJ-45 AnyFabric	None	TSM	None	3-year	750Wx1 Platinum	09/14
70D2001GEA	EMEA	1xE5-2630L v3 8C/1.8GHz/20MB/55W/DDR4-1866	4XG0F28823	1x8GB RDIMM DDR4-2133 ECC	AnyRAID 720ix+1GB RAM	24x2.5" HS	Open	3xFH HL	None	GbEx4 RJ-45 AnyFabric	None	TSM	None	3-year	750Wx1 Platinum	09/14
70D2001HEA	EMEA	1xE5-2630 v3 8C/2.4GHz/20MB/85W/DDR4-1866	4XG0F28818	1x8GB RDIMM DDR4-2133 ECC	AnyRAID 720ix+1GB RAM	24x2.5" HS	Open	3xFH HL	None	GbEx4 RJ-45 AnyFabric	None	TSM	None	3-year	750Wx1 Platinum	09/14
70D2001JEA	EMEA	1xE5-2637 v3 4C/3.5GHz/15MB/135W/DDR4-2133	4XG0F28836	1x8GB RDIMM DDR4-2133 ECC	AnyRAID 720ix+1GB RAM	24x2.5" HS	Open	3xFH HL	None	GbEx4 RJ-45 AnyFabric	None	TSM	None	3-year	750Wx1 Platinum	09/14
70D2001KEA	EMEA	1xE5-2640 v3 8C/2.6GHz/20MB/90W/DDR4-1866	4XG0F28817	1x8GB RDIMM DDR4-2133 ECC	AnyRAID 720ix+1GB RAM	24x2.5" HS	Open	3xFH HL	None	GbEx4 RJ-45 AnyFabric	None	TSM	None	3-year	750Wx1 Platinum	09/14
70D2001LEA	EMEA	1xE5-2643 v3 6C/3.4GHz/20MB/135W/DDR4-2133	4XG0F28835	1x8GB RDIMM DDR4-2133 ECC	AnyRAID 720ix+1GB RAM	24x2.5" HS	Open	3xFH HL	None	GbEx4 RJ-45 AnyFabric	None	TSM	None	3-year	750Wx1 Platinum	09/14
70D2001MEA	EMEA	1xE5-2650L v3 12C/1.8GHz/30MB/65W/DDR4-2133	4XG0F28822	1x8GB RDIMM DDR4-2133 ECC	AnyRAID 720ix+1GB RAM	24x2.5" HS	Open	3xFH HL	None	GbEx4 RJ-45 AnyFabric	None	TSM	None	3-year	750Wx1 Platinum	09/14
70D2001NEA	EMEA	1xE5-2650 v3 10C/2.3GHz/25MB/105W/DDR4-2133	4XG0F28816	1x8GB RDIMM DDR4-2133 ECC	AnyRAID 720ix+1GB RAM	24x2.5" HS	Open	3xFH HL	None	GbEx4 RJ-45 AnyFabric	None	TSM	None	3-year	750Wx1 Platinum	09/14
70D2001PEA	EMEA	1xE5-2660 v3 10C/2.6GHz/25MB/105W/DDR4-2133	4XG0F28815	1x8GB RDIMM DDR4-2133 ECC	AnyRAID 720ix+1GB RAM	24x2.5" HS	Open	3xFH HL	None	GbEx4 RJ-45 AnyFabric	None	TSM	None	3-year	750Wx1 Platinum	09/14
70D2001QEA	EMEA	1xE5-2667 v3 8C/3.2GHz/20MB/135W/DDR4-2133	4XG0F28834	1x8GB RDIMM DDR4-2133 ECC	AnyRAID 720ix+1GB RAM	24x2.5" HS	Open	3xFH HL	None	GbEx4 RJ-45 AnyFabric	None	TSM	None	3-year	750Wx1 Platinum	09/14
70D2001REA	EMEA	1xE5-2670 v3 12C/2.3GHz/30MB/120W/DDR4-2133	4XG0F28814	1x8GB RDIMM DDR4-2133 ECC	AnyRAID 720ix+1GB RAM	24x2.5" HS	Open	3xFH HL	None	GbEx4 RJ-45 AnyFabric	None	TSM	None	3-year	750Wx1 Platinum	09/14
70D2001SEA	EMEA	1xE5-2680 v3 12C/2.5GHz/30MB/120W/DDR4-2133	4XG0F28813	1x8GB RDIMM DDR4-2133 ECC	AnyRAID 720ix+1GB RAM	24x2.5" HS	Open	3xFH HL	None	GbEx4 RJ-45 AnyFabric	None	TSM	None	3-year	750Wx1 Platinum	09/14

Model	Region	Processor	2nd CPU	Memory	RAID Controller	Disk Bays	Storage	Slots	Optical	Add-on NIC	TPM	System Mgmt	OS	Warranty	Power Supply	Ann Date (m/y)
70D2001TEA	EMEA	1xE5-2683 v3 14C/2GHz/35MB/120W/DDR4-2133	4XG0F28812	1x8GB RDIMM DDR4-2133 ECC	AnyRAID 720ix+1GB RAM	24x2.5" HS	Open	3xFH HL	None	GbEx4 RJ-45 AnyFabric	None	TSM	None	3-year	750Wx1 Platinum	09/14
70D2001UEA	EMEA	1xE5-2685 v3 12C/2.6GHz/30MB/120W/DDR4-2133	4XG0F28838	1x8GB RDIMM DDR4-2133 ECC	AnyRAID 720ix+1GB RAM	24x2.5" HS	Open	3xFH HL	None	GbEx4 RJ-45 AnyFabric	None	TSM	None	3-year	750Wx1 Platinum	09/14
70D2001VEA	EMEA	1xE5-2690 v3 12C/2.6GHz/30MB/135W/DDR4-2133	4XG0F28811	1x8GB RDIMM DDR4-2133 ECC	AnyRAID 720ix+1GB RAM	24x2.5" HS	Open	3xFH HL	None	GbEx4 RJ-45 AnyFabric	None	TSM	None	3-year	750Wx1 Platinum	09/14
70D2001WEA	EMEA	1xE5-2695 v3 14C/2.3GHz/35MB/120W/DDR4-2133	4XG0F28810	1x8GB RDIMM DDR4-2133 ECC	AnyRAID 720ix+1GB RAM	24x2.5" HS	Open	3xFH HL	None	GbEx4 RJ-45 AnyFabric	None	TSM	None	3-year	750Wx1 Platinum	09/14
70D2001XEA	EMEA	1xE5-2697 v3 14C/2.6GHz/35MB/145W/DDR4-2133	4XG0F28809	1x8GB RDIMM DDR4-2133 ECC	AnyRAID 720ix+1GB RAM	24x2.5" HS	Open	3xFH HL	None	GbEx4 RJ-45 AnyFabric	None	TSM	None	3-year	750Wx1 Platinum	09/14
70D2001YEA	EMEA	1xE5-2698 v3 16C/2.3GHz/40MB/135W/DDR4-2133	4XG0F28808	1x8GB RDIMM DDR4-2133 ECC	AnyRAID 720ix+1GB RAM	24x2.5" HS	Open	3xFH HL	None	GbEx4 RJ-45 AnyFabric	None	TSM	None	3-year	750Wx1 Platinum	09/14
70D20020EA	EMEA	1xE5-2699 v3 18C/2.3GHz/45MB/145W/DDR4-2133	4XG0F28807	1x8GB RDIMM DDR4-2133 ECC	AnyRAID 720ix+1GB RAM	24x2.5" HS	Open	3xFH HL	None	GbEx4 RJ-45 AnyFabric	None	TSM	None	3-year	750Wx1 Platinum	09/14
70D20021EA	EMEA	2xE5-2650 v3 10C/2.3GHz/25MB/105W/DDR4-2133	-	4x8GB RDIMM DDR4-2133 ECC	AnyRAID 720ix+2GB Flash	24x2.5" HS	Open	5xFH HL+3xLP HL	None	10GbEx2 SFP+ AnyFabric	None	TSM	None	3-year	750Wx2 Platinum	09/14
70D20022EA	EMEA	2xE5-2690 v3 12C/2.6GHz/30MB/135W/DDR4-2133	-	4x8GB RDIMM DDR4-2133 ECC	AnyRAID 720ix+2GB Flash	24x2.5" HS	Open	5xFH HL+3xLP HL	None	10GbEx2 SFP+ AnyFabric	None	TSM	None	3-year	750Wx2 Platinum	09/14
70D20023EA	EMEA	2xE5-2667 v3 8C/3.2GHz/20MB/135W/DDR4-2133	-	4x8GB RDIMM DDR4-2133 ECC	AnyRAID 720ix+2GB Flash	24x2.5" HS	Open	5xFH HL+3xLP HL	None	10GbEx2 SFP+ AnyFabric	None	TSM	None	3-year	750Wx2 Platinum	09/14

Model	Region	Processor	2nd CPU	Memory	RAID Controller	Disk Bays	Storage	Slots	Optical	Add-on NIC	TPM	System Mgmt	OS	Warranty	Power Supply	Ann Date (m/y)
70D40014EA	EMEA	1xE5-2603 v3 6C/1.6GHz/15MB/85W/DDR4-1600	4XG0F28821	1x8GB RDIMM DDR4-2133 ECC	AnyRAID 720ix+1GB RAM	6+9 HS	Open	3xFH HL	None	GbEx4 RJ-45 AnyFabric	None	TSM	None	3-year	750Wx1 Platinum	09/14
70D40015EA	EMEA	1xE5-2609 v3 6C/1.9GHz/15MB/85W/DDR4-1600	4XG0F28820	1x8GB RDIMM DDR4-2133 ECC	AnyRAID 720ix+1GB RAM	6+9 HS	Open	3xFH HL	None	GbEx4 RJ-45 AnyFabric	None	TSM	None	3-year	750Wx1 Platinum	09/14
70D40016EA	EMEA	1xE5-2620 v3 6C/2.4GHz/15MB/85W/DDR4-1866	4XG0F28819	1x8GB RDIMM DDR4-2133 ECC	AnyRAID 720ix+1GB RAM	6+9 HS	Open	3xFH HL	None	GbEx4 RJ-45 AnyFabric	None	TSM	None	3-year	750Wx1 Platinum	09/14
70D40017EA	EMEA	1xE5-2630L v3 8C/1.8GHz/20MB/55W/DDR4-1866	4XG0F28823	1x8GB RDIMM DDR4-2133 ECC	AnyRAID 720ix+1GB RAM	6+9 HS	Open	3xFH HL	None	GbEx4 RJ-45 AnyFabric	None	TSM	None	3-year	750Wx1 Platinum	09/14
70D40018EA	EMEA	1xE5-2630 v3 8C/2.4GHz/20MB/85W/DDR4-1866	4XG0F28818	1x8GB RDIMM DDR4-2133 ECC	AnyRAID 720ix+1GB RAM	6+9 HS	Open	3xFH HL	None	GbEx4 RJ-45 AnyFabric	None	TSM	None	3-year	750Wx1 Platinum	09/14
70D40019EA	EMEA	1xE5-2637 v3 4C/3.5GHz/15MB/135W/DDR4-2133	4XG0F28836	1x8GB RDIMM DDR4-2133 ECC	AnyRAID 720ix+1GB RAM	6+9 HS	Open	3xFH HL	None	GbEx4 RJ-45 AnyFabric	None	TSM	None	3-year	750Wx1 Platinum	09/14
70D4001AEA	EMEA	1xE5-2640 v3 8C/2.6GHz/20MB/90W/DDR4-1866	4XG0F28817	1x8GB RDIMM DDR4-2133 ECC	AnyRAID 720ix+1GB RAM	6+9 HS	Open	3xFH HL	None	GbEx4 RJ-45 AnyFabric	None	TSM	None	3-year	750Wx1 Platinum	09/14
70D4001BEA	EMEA	1xE5-2643 v3 6C/3.4GHz/20MB/135W/DDR4-2133	4XG0F28835	1x8GB RDIMM DDR4-2133 ECC	AnyRAID 720ix+1GB RAM	6+9 HS	Open	3xFH HL	None	GbEx4 RJ-45 AnyFabric	None	TSM	None	3-year	750Wx1 Platinum	09/14
70D4001CEA	EMEA	1xE5-2650L v3 12C/1.8GHz/30MB/65W/DDR4-2133	4XG0F28822	1x8GB RDIMM DDR4-2133 ECC	AnyRAID 720ix+1GB RAM	6+9 HS	Open	3xFH HL	None	GbEx4 RJ-45 AnyFabric	None	TSM	None	3-year	750Wx1 Platinum	09/14
70D4001DEA	EMEA	1xE5-2650 v3 10C/2.3GHz/25MB/105W/DDR4-2133	4XG0F28816	1x8GB RDIMM DDR4-2133 ECC	AnyRAID 720ix+1GB RAM	6+9 HS	Open	3xFH HL	None	GbEx4 RJ-45 AnyFabric	None	TSM	None	3-year	750Wx1 Platinum	09/14
70D4001EEA	EMEA	1xE5-2660 v3 10C/2.6GHz/25MB/105W/DDR4-2133	4XG0F28815	1x8GB RDIMM DDR4-2133 ECC	AnyRAID 720ix+1GB RAM	6+9 HS	Open	3xFH HL	None	GbEx4 RJ-45 AnyFabric	None	TSM	None	3-year	750Wx1 Platinum	09/14
70D4001FEA	EMEA	1xE5-2667 v3 8C/3.2GHz/20MB/135W/DDR4-2133	4XG0F28834	1x8GB RDIMM DDR4-2133 ECC	AnyRAID 720ix+1GB RAM	6+9 HS	Open	3xFH HL	None	GbEx4 RJ-45 AnyFabric	None	TSM	None	3-year	750Wx1 Platinum	09/14
70D4001GEA	EMEA	1xE5-2670 v3 12C/2.3GHz/30MB/120W/DDR4-2133	4XG0F28814	1x8GB RDIMM DDR4-2133 ECC	AnyRAID 720ix+1GB RAM	6+9 HS	Open	3xFH HL	None	GbEx4 RJ-45 AnyFabric	None	TSM	None	3-year	750Wx1 Platinum	09/14
70D4001HEA	EMEA	1xE5-2680 v3 12C/2.5GHz/30MB/120W/DDR4-2133	4XG0F28813	1x8GB RDIMM DDR4-2133 ECC	AnyRAID 720ix+1GB RAM	6+9 HS	Open	3xFH HL	None	GbEx4 RJ-45 AnyFabric	None	TSM	None	3-year	750Wx1 Platinum	09/14
70D4001JEA	EMEA	1xE5-2683 v3 14C/2GHz/35MB/120W/DDR4-2133	4XG0F28812	1x8GB RDIMM DDR4-2133 ECC	AnyRAID 720ix+1GB RAM	6+9 HS	Open	3xFH HL	None	GbEx4 RJ-45 AnyFabric	None	TSM	None	3-year	750Wx1 Platinum	09/14
70D4001KEA	EMEA	1xE5-2685 v3 12C/2.6GHz/30MB/120W/DDR4-2133	4XG0F28838	1x8GB RDIMM DDR4-2133 ECC	AnyRAID 720ix+1GB RAM	6+9 HS	Open	3xFH HL	None	GbEx4 RJ-45 AnyFabric	None	TSM	None	3-year	750Wx1 Platinum	09/14
70D4001LEA	EMEA	1xE5-2690 v3 12C/2.6GHz/30MB/135W/DDR4-2133	4XG0F28811	1x8GB RDIMM DDR4-2133 ECC	AnyRAID 720ix+1GB RAM	6+9 HS	Open	3xFH HL	None	GbEx4 RJ-45 AnyFabric	None	TSM	None	3-year	750Wx1 Platinum	09/14

Model	Region	Processor	2nd CPU	Memory	RAID Controller	Disk Bays	Storage	Slots	Optical	Add-on NIC	TPM	System Mgmt	OS	Warranty	Power Supply	Ann Date (m/y)
70D4001MEA	EMEA	1xE5-2695 v3 14C/2.3GHz/35MB/120W/DDR4-2133	4XG0F28810	1x8GB RDIMM DDR4-2133 ECC	AnyRAID 720ix+1GB RAM	6+9 HS	Open	3xFH HL	None	GbEx4 RJ-45 AnyFabric	None	TSM	None	3-year	750Wx1 Platinum	09/14
70D4001NEA	EMEA	1xE5-2697 v3 14C/2.6GHz/35MB/145W/DDR4-2133	4XG0F28809	1x8GB RDIMM DDR4-2133 ECC	AnyRAID 720ix+1GB RAM	6+9 HS	Open	3xFH HL	None	GbEx4 RJ-45 AnyFabric	None	TSM	None	3-year	750Wx1 Platinum	09/14
70D4001PEA	EMEA	1xE5-2698 v3 16C/2.3GHz/40MB/135W/DDR4-2133	4XG0F28808	1x8GB RDIMM DDR4-2133 ECC	AnyRAID 720ix+1GB RAM	6+9 HS	Open	3xFH HL	None	GbEx4 RJ-45 AnyFabric	None	TSM	None	3-year	750Wx1 Platinum	09/14
70D4001QEA	EMEA	1xE5-2699 v3 18C/2.3GHz/45MB/145W/DDR4-2133	4XG0F28807	1x8GB RDIMM DDR4-2133 ECC	AnyRAID 720ix+1GB RAM	6+9 HS	Open	3xFH HL	None	GbEx4 RJ-45 AnyFabric	None	TSM	None	3-year	750Wx1 Platinum	09/14

Model	Region	Processor	2nd CPU	Memory	RAID Controller	Disk Bays	Storage	Slots	Optical	Add-on NIC	TPM	System Mgmt	OS	Warranty	Power Supply	Ann Date (m/y)
70DR001PEA	EMEA	1xE5-2620 v3 6C/2.4GHz/15MB/85W/DDR4-1866	4XG0F28819	1x8GB RDIMM DDR4-2133 ECC	AnyRAID 720i	8x2.5" HS	Open	3xFH HL	9.5mm DVD±RW	GbEx4 RJ-45 AnyFabric	None	TSM	None	3-year	750Wx1 Platinum	09/14
70DR001QEA	EMEA	1xE5-2620 v3 6C/2.4GHz/15MB/85W/DDR4-1866	4XG0F28819	1x8GB RDIMM DDR4-2133 ECC	AnyRAID 720i+1GB RAM	8x2.5" HS	Open	3xFH HL	9.5mm DVD±RW	GbEx4 RJ-45 AnyFabric	None	TSM	None	3-year	750Wx1 Platinum	09/14
70DR001REA	EMEA	1xE5-2640 v3 8C/2.6GHz/20MB/90W/DDR4-1866	4XG0F28817	1x8GB RDIMM DDR4-2133 ECC	AnyRAID 720i+1GB RAM	8x2.5" HS	Open	3xFH HL	9.5mm DVD±RW	GbEx4 RJ-45 AnyFabric	None	TSM	None	3-year	750Wx1 Platinum	09/14
70DR001SEA	EMEA	1xE5-2630 v3 8C/2.4GHz/20MB/85W/DDR4-1866	4XG0F28818	1x8GB RDIMM DDR4-2133 ECC	AnyRAID 720i+1GB RAM	8x2.5" HS	Open	3xFH HL	9.5mm DVD±RW	GbEx4 RJ-45 AnyFabric	None	TSM	None	3-year	750Wx1 Platinum	09/14
70DR001TEA	EMEA	1xE5-2620 v3 6C/2.4GHz/15MB/85W/DDR4-1866	4XG0F28819	2x8GB RDIMM DDR4-2133 ECC	AnyRAID 720i+1GB Flash	8x2.5" HS	Open	3xFH HL	9.5mm DVD±RW	GbEx4 RJ-45 AnyFabric	None	TSM	None	3-year	750Wx1 Platinum	09/14
70DR001UEA	EMEA	1xE5-2630 v3 8C/2.4GHz/20MB/85W/DDR4-1866	4XG0F28818	2x8GB RDIMM DDR4-2133 ECC	AnyRAID 720i+1GB Flash	8x2.5" HS	Open	3xFH HL	9.5mm DVD±RW	GbEx4 RJ-45 AnyFabric	None	TSM	None	3-year	750Wx1 Platinum	09/14
70DR001VEA	EMEA	1xE5-2640 v3 8C/2.6GHz/20MB/90W/DDR4-1866	4XG0F28817	2x8GB RDIMM DDR4-2133 ECC	AnyRAID 720i+1GB Flash	8x2.5" HS	Open	3xFH HL	9.5mm DVD±RW	GbEx4 RJ-45 AnyFabric	None	TSM	None	3-year	750Wx1 Platinum	09/14
70DR001WEA	EMEA	1xE5-2683 v3 14C/2GHz/35MB/120W/DDR4-2133	4XG0F28812	1x8GB RDIMM DDR4-2133 ECC	AnyRAID 720i	8x2.5" HS	Open	3xFH HL	None	GbEx4 RJ-45 AnyFabric	None	TSM	None	3-year	750Wx1 Platinum	09/14
70DR001XEA	EMEA	1xE5-2630L v3 8C/1.8GHz/20MB/55W/DDR4-1866	4XG0F28823	1x8GB RDIMM DDR4-2133 ECC	AnyRAID 720i	8x2.5" HS	Open	3xFH HL	None	GbEx4 RJ-45 AnyFabric	None	TSM	None	3-year	750Wx1 Platinum	09/14
70DR001YEA	EMEA	1xE5-2699 v3 18C/2.3GHz/45MB/145W/DDR4-2133	4XG0F28807	1x8GB RDIMM DDR4-2133 ECC	AnyRAID 720i	8x2.5" HS	Open	3xFH HL	None	GbEx4 RJ-45 AnyFabric	None	TSM	None	3-year	750Wx1 Platinum	09/14
70DR0020EA	EMEA	1xE5-2697 v3 14C/2.6GHz/35MB/145W/DDR4-2133	4XG0F28809	1x8GB RDIMM DDR4-2133 ECC	AnyRAID 720i	8x2.5" HS	Open	3xFH HL	None	GbEx4 RJ-45 AnyFabric	None	TSM	None	3-year	750Wx1 Platinum	09/14
70DR0021EA	EMEA	1xE5-2685 v3 12C/2.6GHz/30MB/120W/DDR4-2133	4XG0F28838	1x8GB RDIMM DDR4-2133 ECC	AnyRAID 720i	8x2.5" HS	Open	3xFH HL	None	GbEx4 RJ-45 AnyFabric	None	TSM	None	3-year	750Wx1 Platinum	09/14
70DR0022EA	EMEA	1xE5-2660 v3 10C/2.6GHz/25MB/105W/DDR4-2133	4XG0F28815	1x8GB RDIMM DDR4-2133 ECC	AnyRAID 720i	8x2.5" HS	Open	3xFH HL	None	GbEx4 RJ-45 AnyFabric	None	TSM	None	3-year	750Wx1 Platinum	09/14
70DR0023EA	EMEA	1xE5-2630 v3 8C/2.4GHz/20MB/85W/DDR4-1866	4XG0F28818	1x8GB RDIMM DDR4-2133 ECC	AnyRAID 720i	8x2.5" HS	Open	3xFH HL	None	GbEx4 RJ-45 AnyFabric	None	TSM	None	3-year	750Wx1 Platinum	09/14
70DR0024EA	EMEA	1xE5-2603 v3 6C/1.6GHz/15MB/85W/DDR4-1600	4XG0F28821	1x8GB RDIMM DDR4-2133 ECC	AnyRAID 720i	8x2.5" HS	Open	3xFH HL	None	GbEx4 RJ-45 AnyFabric	None	TSM	None	3-year	750Wx1 Platinum	09/14
70DR0025EA	EMEA	1xE5-2698 v3 16C/2.3GHz/40MB/135W/DDR4-2133	4XG0F28808	1x8GB RDIMM DDR4-2133 ECC	AnyRAID 720i	8x2.5" HS	Open	3xFH HL	None	GbEx4 RJ-45 AnyFabric	None	TSM	None	3-year	750Wx1 Platinum	09/14
70DR0026EA	EMEA	1xE5-2670 v3 12C/2.3GHz/30MB/120W/DDR4-2133	4XG0F28814	1x8GB RDIMM DDR4-2133 ECC	AnyRAID 720i	8x2.5" HS	Open	3xFH HL	None	GbEx4 RJ-45 AnyFabric	None	TSM	None	3-year	750Wx1 Platinum	09/14

Model	Region	Processor	2nd CPU	Memory	RAID Controller	Disk Bays	Storage	Slots	Optical	Add-on NIC	TPM	System Mgmt	OS	Warranty	Power Supply	Ann Date (m/y)
70DR0027EA	EMEA	1xE5-2643 v3 6C/3.4GHz/20MB/135W/DDR4-2133	4XG0F28835	1x8GB RDIMM DDR4-2133 ECC	AnyRAID 720i	8x2.5" HS	Open	3xFH HL	None	GbEx4 RJ-45 AnyFabric	None	TSM	None	3-year	750Wx1 Platinum	09/14
70DR0028EA	EMEA	1xE5-2667 v3 8C/3.2GHz/20MB/135W/DDR4-2133	4XG0F28834	1x8GB RDIMM DDR4-2133 ECC	AnyRAID 720i	8x2.5" HS	Open	3xFH HL	None	GbEx4 RJ-45 AnyFabric	None	TSM	None	3-year	750Wx1 Platinum	09/14
70DR0029EA	EMEA	1xE5-2637 v3 4C/3.5GHz/15MB/135W/DDR4-2133	4XG0F28836	1x8GB RDIMM DDR4-2133 ECC	AnyRAID 720i	8x2.5" HS	Open	3xFH HL	None	GbEx4 RJ-45 AnyFabric	None	TSM	None	3-year	750Wx1 Platinum	09/14
70DR002AEA	EMEA	1xE5-2690 v3 12C/2.6GHz/30MB/135W/DDR4-2133	4XG0F28811	1x8GB RDIMM DDR4-2133 ECC	AnyRAID 720i	8x2.5" HS	Open	3xFH HL	None	GbEx4 RJ-45 AnyFabric	None	TSM	None	3-year	750Wx1 Platinum	09/14
70DR002BEA	EMEA	1xE5-2609 v3 6C/1.9GHz/15MB/85W/DDR4-1600	4XG0F28820	1x8GB RDIMM DDR4-2133 ECC	AnyRAID 720i	8x2.5" HS	Open	3xFH HL	None	GbEx4 RJ-45 AnyFabric	None	TSM	None	3-year	750Wx1 Platinum	09/14
70DR002CEA	EMEA	1xE5-2650L v3 12C/1.8GHz/30MB/65W/DDR4-2133	4XG0F28822	1x8GB RDIMM DDR4-2133 ECC	AnyRAID 720i	8x2.5" HS	Open	3xFH HL	None	GbEx4 RJ-45 AnyFabric	None	TSM	None	3-year	750Wx1 Platinum	09/14
70DR002DEA	EMEA	1xE5-2680 v3 12C/2.5GHz/30MB/120W/DDR4-2133	4XG0F28813	1x8GB RDIMM DDR4-2133 ECC	AnyRAID 720i	8x2.5" HS	Open	3xFH HL	None	GbEx4 RJ-45 AnyFabric	None	TSM	None	3-year	750Wx1 Platinum	09/14
70DR002EEA	EMEA	1xE5-2640 v3 8C/2.6GHz/20MB/90W/DDR4-1866	4XG0F28817	1x8GB RDIMM DDR4-2133 ECC	AnyRAID 720i	8x2.5" HS	Open	3xFH HL	None	GbEx4 RJ-45 AnyFabric	None	TSM	None	3-year	750Wx1 Platinum	09/14
70DR002FEA	EMEA	1xE5-2620 v3 6C/2.4GHz/15MB/85W/DDR4-1866	4XG0F28819	1x8GB RDIMM DDR4-2133 ECC	AnyRAID 720i	8x2.5" HS	Open	3xFH HL	None	GbEx4 RJ-45 AnyFabric	None	TSM	None	3-year	750Wx1 Platinum	09/14
70DR002GEA	EMEA	1xE5-2695 v3 14C/2.3GHz/35MB/120W/DDR4-2133	4XG0F28810	1x8GB RDIMM DDR4-2133 ECC	AnyRAID 720i	8x2.5" HS	Open	3xFH HL	None	GbEx4 RJ-45 AnyFabric	None	TSM	None	3-year	750Wx1 Platinum	09/14
70DR002HEA	EMEA	1xE5-2650 v3 10C/2.3GHz/25MB/105W/DDR4-2133	4XG0F28816	1x8GB RDIMM DDR4-2133 ECC	AnyRAID 720i	8x2.5" HS	Open	3xFH HL	None	GbEx4 RJ-45 AnyFabric	None	TSM	None	3-year	750Wx1 Platinum	09/14
70DR002QEA	EMEA	1xE5-2630 v3 8C/2.4GHz/20MB/85W/DDR4-1866	4XG0F28818	1x16GB RDIMM DDR4-2133 ECC	AnyRAID 720i	8x2.5" HS	Open	3xFH HL	9.5mm DVD±RW	GbEx4 RJ-45 AnyFabric	None	TSM	None	3-year	750Wx1 Platinum	11/14
70DR002TEA	EMEA	1xE5-2620 v3 6C/2.4GHz/15MB/85W/DDR4-1866	4XG0F28819	1x16GB RDIMM DDR4-2133 ECC	AnyRAID 720i+2GB Flash	8x2.5" HS	Open	3xFH HL	9.5mm DVD±RW	GbEx4 RJ-45 AnyFabric	None	TSM	None	3-year	750Wx1 Platinum	07/15
70DR002UEA	EMEA	1xE5-2620 v3 6C/2.4GHz/15MB/85W/DDR4-1866	4XG0F28819	1x16GB RDIMM DDR4-2133 ECC	AnyRAID 720i+2GB Flash	8x2.5" HS	Open	3xFH HL	None	GbEx4 RJ-45 AnyFabric	None	TSM	None	3-year	750Wx1 Platinum	07/15
70DR002VEA	EMEA	1xE5-2630 v3 8C/2.4GHz/20MB/85W/DDR4-1866	4XG0F28818	1x16GB RDIMM DDR4-2133 ECC	AnyRAID 720i+2GB Flash	8x2.5" HS	Open	3xFH HL	9.5mm DVD±RW	GbEx4 RJ-45 AnyFabric	None	TSM	None	3-year	750Wx1 Platinum	07/15
70DR002WEA	EMEA	1xE5-2630 v3 8C/2.4GHz/20MB/85W/DDR4-1866	4XG0F28818	1x16GB RDIMM DDR4-2133 ECC	AnyRAID 720i+2GB Flash	8x2.5" HS	Open	3xFH HL	None	GbEx4 RJ-45 AnyFabric	None	TSM	None	3-year	750Wx1 Platinum	07/15
70DR002XEA	EMEA	1xE5-2620 v3 6C/2.4GHz/15MB/85W/DDR4-1866	4XG0F28819	1x16GB RDIMM DDR4-2133 ECC	AnyRAID 720i+2GB Flash	8x2.5" HS	2x300GB HDD 10K 2.5" SAS6Gbs	3xFH HL	9.5mm DVD±RW	GbEx4 RJ-45 AnyFabric	None	TSM	None	3-year	750Wx1 Platinum	07/15

Model	Region	Processor	2nd CPU	Memory	RAID Controller	Disk Bays	Storage	Slots	Optical	Add-on NIC	TPM	System Mgmt	OS	Warranty	Power Supply	Ann Date (m/y)
70DR002YEA	EMEA	1xE5-2620 v3 6C/2.4GHz/15MB/85W/DDR4-1866	4XG0F28819	1x16GB RDIMM DDR4-2133 ECC	AnyRAID 720i+2GB Flash	8x2.5" HS	2x300GB HDD 10K 2.5" SAS6Gbs	3xFH HL	None	GbEx4 RJ-45 AnyFabric	None	TSM	None	3-year	750Wx1 Platinum	07/15
70DR0030EA	EMEA	1xE5-2630 v3 8C/2.4GHz/20MB/85W/DDR4-1866	4XG0F28818	1x16GB RDIMM DDR4-2133 ECC	AnyRAID 720i+2GB Flash	8x2.5" HS	2x300GB HDD 10K 2.5" SAS6Gbs	3xFH HL	9.5mm DVD±RW	GbEx4 RJ-45 AnyFabric	None	TSM	None	3-year	750Wx1 Platinum	07/15
70DR0031EA	EMEA	1xE5-2630 v3 8C/2.4GHz/20MB/85W/DDR4-1866	4XG0F28818	1x16GB RDIMM DDR4-2133 ECC	AnyRAID 720i+2GB Flash	8x2.5" HS	2x300GB HDD 10K 2.5" SAS6Gbs	3xFH HL	None	GbEx4 RJ-45 AnyFabric	None	TSM	None	3-year	750Wx1 Platinum	07/15



ThinkServer RS140 Platform Specifications

Components	Specification												
Dimensions	1U rack. Height: 43.5 mm (1.71 in), width: 430 mm (16.9 in), depth: 411 mm (16.2 in)												
Weight	Maximum configuration: 16.2 lb (7.36kg)												
Processor	Supports one of the following Intel processors (code name: Haswell): <ul style="list-style-type: none"> Xeon E3-1200 v3: up to 4C/3.7GHz/8MB/84W/1600MHz Core i3: up to 2C/3.7GHz/4MB/54W/1600MHz Pentium: up to 2C/3.4GHz/3MB/53W/1600MHz Celeron: up to 2C/2.9GHz/2MB/53W/1333MHz <i>Note: Supports processors with integrated graphics only.</i>												
Chipset	Intel C226 Platform Controller Hub (PCH)												
Memory DIMMs	4 DIMM sockets, 2-channel capable. UDIMM, DDR3												
Memory capacity	32GB (4 x 8GB)												
Memory protection	ECC												
RAID controller	RAID 0, 1, 5, 10 with onboard RAID 100, 6Gb/s SATA. RAID 0, 1, 10 with RAID 500, PCIe adapter, 6Gb/s SAS/SATA, optional key for RAID5. RAID 0, 1, 10, 5, 6 with RAID 700, PCIe adapter, 6Gb/s SAS/SATA, optional Intelligent Battery Backup Unit (iBBU08) <i>Note: RAID 5, 6, and 10 needs 4 x 2.5" bays.</i>												
Disk drive bays	Up to 2 3.5" disk bays or up to 4 2.5" disk bays. Direct cabled, non-hot swap. Supports optional external USB RDX tape drive												
Supporting disk drives	<table border="1"> <tbody> <tr> <td rowspan="2">For 3.5" bay</td> <td>3.5" SATA HDD</td> <td>7.2K 6Gbs: 500GB/1TB/2TB/3TB/4TB/6TB</td> </tr> <tr> <td>3.5" SAS HDD</td> <td>7.2K 6Gbs: 1TB/2TB/3TB/4TB</td> </tr> <tr> <td rowspan="3">For 2.5" bay</td> <td>2.5" SATA HDD</td> <td>7.2K 6Gbs: 500GB/1TB</td> </tr> <tr> <td>2.5" SAS HDD</td> <td>10K 6Gbs: 300GB/600GB/900GB. 15K 6Gbs: 146GB/300GB</td> </tr> <tr> <td>2.5" SATA SSD</td> <td>6Gbs: 120GB/240GB/300GB/480GB/600GB</td> </tr> </tbody> </table>	For 3.5" bay	3.5" SATA HDD	7.2K 6Gbs: 500GB/1TB/2TB/3TB/4TB/6TB	3.5" SAS HDD	7.2K 6Gbs: 1TB/2TB/3TB/4TB	For 2.5" bay	2.5" SATA HDD	7.2K 6Gbs: 500GB/1TB	2.5" SAS HDD	10K 6Gbs: 300GB/600GB/900GB. 15K 6Gbs: 146GB/300GB	2.5" SATA SSD	6Gbs: 120GB/240GB/300GB/480GB/600GB
For 3.5" bay	3.5" SATA HDD		7.2K 6Gbs: 500GB/1TB/2TB/3TB/4TB/6TB										
	3.5" SAS HDD	7.2K 6Gbs: 1TB/2TB/3TB/4TB											
For 2.5" bay	2.5" SATA HDD	7.2K 6Gbs: 500GB/1TB											
	2.5" SAS HDD	10K 6Gbs: 300GB/600GB/900GB. 15K 6Gbs: 146GB/300GB											
	2.5" SATA SSD	6Gbs: 120GB/240GB/300GB/480GB/600GB											
Optical drive	Up to one 9.5mm optical. DVD-ROM or DVD±RW												
Network interfaces	Two Gigabit Ethernet ports by Intel I210, on riser card. One Gigabit Ethernet port by Intel I217, dedicate/share management												
Security features	Power-on and administrator password. TPM (TCG 1.2-compliant).												
Systems management	Intel Active Management Technology 9 on models with Xeon processor. Remote presence is supported on models with Xeon processors. Supports ThinkServer EasyStartup/EasyUpdate												
Operating systems supported	Microsoft Windows Server 2012 R2/2012/2008 R2. Windows Small Business Server 2011. Red Hat Enterprise Linux 6.5. SUSE Linux Enterprise Server 11 SP3. VMware vSphere (ESXi) 5.5 <i>Note: VMware requires add-on network adapter.</i>												

Components	Specification	
Base warranty	1 or 3-year limited onsite service with 9x5/NBD.	
Power supply	One fixed 300 watts power supply, 80 PLUS Gold qualified	
Graphics	Integrated Intel HD Graphics in processor	
Front ports	Two USB 2.0	
Rear ports	Four USB 3.0, two USB 2.0, one serial (9-pin), two ethernet (RJ-45), one RJ-45 (dedicate/share mgmt), one VGA, one DisplayPort. Optional two serial ports via PCIe adapter	
Noise emissions	Operating: < 5.2 Bels. Idle: < 5.0 Bels (Mainstream configuration)	
Environmental specification	RoHS-compliant.	
	Temperature - operating	50 °F to 95 °F (10 °C to 35 °C)
	Temperature - storage (with package)	-40 o C to 70 o C
	Altitude - operating	Supported Altitude (unpressurized): 0-10000ft (0-3048m)
	Humidity - operating	10%-80%, non-condensing
	Humidity - storage (with package)	10%-90%, non-condensing

Expansion slots and disk bays

Supports one PCI-Express slot via riser card, half-length, full-height, PCIe 3.0 x8

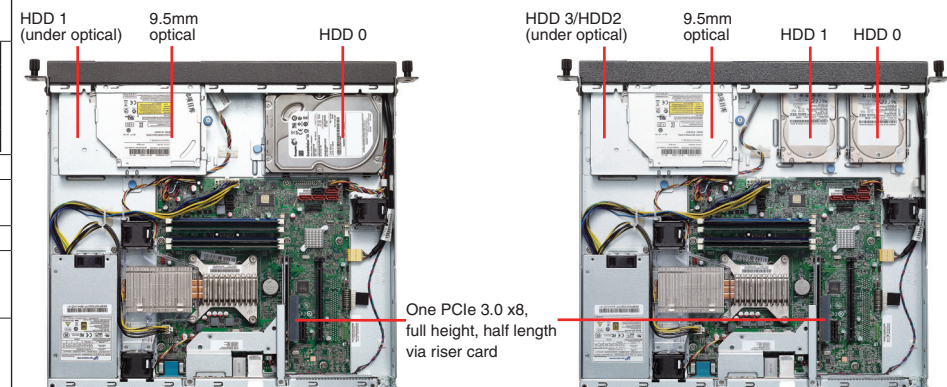

Model	Region	Processor	Memory	RAID Controller	Disk Bays	Storage	Optical	Add-on NIC	Add-on Ports	System Mgmt	OS	Warranty	Power Supply	Ann Date (m/y)
70F30002++	EMEA	Xeon E3-1245 v3 4C/3.4GHz/8MB/84W/DDR3-1600	1x8GB UDIMM DDR3-1600 ECC	RAID 700+Battery	4x2.5" DC	Open	9.5mm DVD±RW	None	None	AMT9	None	1-year	300W Gold Fixed	06/14
70F30003++	EMEA	Xeon E3-1225 v3 4C/3.2GHz/8MB/84W/DDR3-1600	2x4GB UDIMM DDR3-1600 ECC	RAID 100	4x2.5" DC	Open	9.5mm DVD±RW	None	None	AMT9	None	1-year	300W Gold Fixed	06/14
70F30004++	EMEA	Xeon E3-1245 v3 4C/3.4GHz/8MB/84W/DDR3-1600	1x8GB UDIMM DDR3-1600 ECC	RAID 100	4x2.5" DC	Open	9.5mm DVD±RW	None	None	AMT9	None	3-year	300W Gold Fixed	06/14
70F30005++	EMEA	Xeon E3-1245 v3 4C/3.4GHz/8MB/84W/DDR3-1600	1x8GB UDIMM DDR3-1600 ECC	RAID 500	4x2.5" DC	Open	9.5mm DVD±RW	None	None	AMT9	None	3-year	300W Gold Fixed	06/14
70F3000A++	EMEA	Xeon E3-1245 v3 4C/3.4GHz/8MB/84W/DDR3-1600	1x4GB UDIMM DDR3-1600 ECC	RAID 500	4x2.5" DC	Open	9.5mm DVD±RW	None	None	AMT9	None	1-year	300W Gold Fixed	06/14
70F3000R++	EMEA	Xeon E3-1245 v3 4C/3.4GHz/8MB/84W/DDR3-1600	1x8GB UDIMM DDR3-1600 ECC	RAID 700+Battery	4x2.5" DC	Open	9.5mm DVD±RW	None	None	AMT9	None	1-year	300W Gold Fixed	07/14
70F3000S++	EMEA	Xeon E3-1245 v3 4C/3.4GHz/8MB/84W/DDR3-1600	1x4GB UDIMM DDR3-1600 ECC	RAID 500	4x2.5" DC	Open	9.5mm DVD±RW	None	None	AMT9	None	1-year	300W Gold Fixed	07/14
70F3000T++	EMEA	Xeon E3-1225 v3 4C/3.2GHz/8MB/84W/DDR3-1600	2x4GB UDIMM DDR3-1600 ECC	RAID 100	4x2.5" DC	Open	9.5mm DVD±RW	None	None	AMT9	None	1-year	300W Gold Fixed	07/14
70F3000U++	EMEA	Xeon E3-1245 v3 4C/3.4GHz/8MB/84W/DDR3-1600	1x8GB UDIMM DDR3-1600 ECC	RAID 100	4x2.5" DC	Open	9.5mm DVD±RW	None	None	AMT9	None	3-year	300W Gold Fixed	07/14
70F3000V++	EMEA	Xeon E3-1245 v3 4C/3.4GHz/8MB/84W/DDR3-1600	1x8GB UDIMM DDR3-1600 ECC	RAID 500	4x2.5" DC	Open	9.5mm DVD±RW	None	None	AMT9	None	3-year	300W Gold Fixed	07/14
70F3000W++	EMEA	Xeon E3-1246 v3 4C/3.5GHz/8MB/84W/DDR3-1600	1x8GB UDIMM DDR3-1600 ECC	RAID 700+Battery	4x2.5" DC	Open	9.5mm DVD±RW	None	None	AMT9	None	1-year	300W Gold Fixed	09/14
70F3000X++	EMEA	Xeon E3-1246 v3 4C/3.5GHz/8MB/84W/DDR3-1600	1x4GB UDIMM DDR3-1600 ECC	RAID 500	4x2.5" DC	Open	9.5mm DVD±RW	None	None	AMT9	None	1-year	300W Gold Fixed	09/14
70F3000Y++	EMEA	Xeon E3-1226 v3 4C/3.3GHz/8MB/84W/DDR3-1600	2x4GB UDIMM DDR3-1600 ECC	RAID 100	4x2.5" DC	Open	9.5mm DVD±RW	None	None	AMT9	None	1-year	300W Gold Fixed	09/14
70F30010++	EMEA	Xeon E3-1246 v3 4C/3.5GHz/8MB/84W/DDR3-1600	1x8GB UDIMM DDR3-1600 ECC	RAID 100	4x2.5" DC	Open	9.5mm DVD±RW	None	None	AMT9	None	3-year	300W Gold Fixed	09/14
70F30011++	EMEA	Xeon E3-1246 v3 4C/3.5GHz/8MB/84W/DDR3-1600	1x8GB UDIMM DDR3-1600 ECC	RAID 500	4x2.5" DC	Open	9.5mm DVD±RW	None	None	AMT9	None	3-year	300W Gold Fixed	09/14
70F30012++	EMEA	Xeon E3-1226 v3 4C/3.3GHz/8MB/84W/DDR3-1600	1x4GB UDIMM DDR3-1600 ECC	RAID 100	4x2.5" DC	Open	9.5mm DVD±RW	None	None	AMT9	None	1-year	300W Gold Fixed	09/14
70F30013++	EMEA	Xeon E3-1246 v3 4C/3.5GHz/8MB/84W/DDR3-1600	1x4GB UDIMM DDR3-1600 ECC	RAID 100	4x2.5" DC	Open	9.5mm DVD±RW	None	None	AMT9	None	1-year	300W Gold Fixed	09/14

Model	Region	Processor	Memory	RAID Controller	Disk Bays	Storage	Optical	Add-on NIC	Add-on Ports	System Mgmt	OS	Warranty	Power Supply	Ann Date (m/y)
70F30014++	EMEA	Core i3-4150 2C/3.5GHz/3MB/54W/DDR3-1600	1x4GB UDIMM DDR3-1600 ECC	RAID 100	4x2.5" DC	Open	9.5mm DVD±RW	None	None	AMT9	None	1-year	300W Gold Fixed	09/14
70F30015++	EMEA	Pentium G3240 2C/3.1GHz/3MB/53W/DDR3-1333	1x4GB UDIMM DDR3-1600 ECC	RAID 100	4x2.5" DC	Open	9.5mm DVD±RW	None	None	AMT9	None	1-year	300W Gold Fixed	09/14
70F30016++	EMEA	Celeron G1850 2C/2.9GHz/2MB/53W/DDR3-1333	1x4GB UDIMM DDR3-1600 ECC	RAID 100	4x2.5" DC	Open	9.5mm DVD±RW	None	None	AMT9	None	1-year	300W Gold Fixed	09/14

Model	Region	Processor	Memory	RAID Controller	Disk Bays	Storage	Optical	Add-on NIC	Add-on Ports	System Mgmt	OS	Warranty	Power Supply	Ann Date (m/y)
70F90003++	EMEA	Pentium G3220 2C/3GHz/3MB/53W/DDR3-1333	1x4GB UDIMM DDR3-1600 ECC	RAID 100	2x3.5" DC	Open	9.5mm DVD±RW	None	None	AMT9	None	1-year	300W Gold Fixed	06/14
70F90004++	EMEA	Celeron G1830 2C/2.8GHz/2MB/53W/DDR3-1333	1x4GB UDIMM DDR3-1600 ECC	RAID 100	2x3.5" DC	Open	9.5mm DVD±RW	None	None	AMT9	None	1-year	300W Gold Fixed	06/14
70F90005++	EMEA	Xeon E3-1225 v3 4C/3.2GHz/8MB/84W/DDR3-1600	2x4GB UDIMM DDR3-1600 ECC	RAID 100	2x3.5" DC	2x500GB HDD 7.2K 3.5" SATA6Gbs	9.5mm DVD±RW	None	None	AMT9	None	1-year	300W Gold Fixed	06/14
70F90006++	EMEA	Xeon E3-1225 v3 4C/3.2GHz/8MB/84W/DDR3-1600	1x4GB UDIMM DDR3-1600 ECC	RAID 100	2x3.5" DC	2x500GB HDD 7.2K 3.5" SATA6Gbs	9.5mm DVD±RW	None	None	AMT9	None	3-year	300W Gold Fixed	06/14
70F90007++	EMEA	Core i3-4130 2C/3.4GHz/3MB/54W/DDR3-1600	1x4GB UDIMM DDR3-1600 ECC	RAID 100	2x3.5" DC	Open	9.5mm DVD±RW	None	None	AMT9	None	1-year	300W Gold Fixed	06/14
70F90008++	EMEA	Xeon E3-1225 v3 4C/3.2GHz/8MB/84W/DDR3-1600	1x4GB UDIMM DDR3-1600 ECC	RAID 100	2x3.5" DC	Open	9.5mm DVD±RW	None	None	AMT9	None	1-year	300W Gold Fixed	06/14
70F90009++	EMEA	Xeon E3-1245 v3 4C/3.4GHz/8MB/84W/DDR3-1600	1x4GB UDIMM DDR3-1600 ECC	RAID 100	2x3.5" DC	Open	9.5mm DVD±RW	None	None	AMT9	None	1-year	300W Gold Fixed	06/14
70F9000Y++	EMEA	Xeon E3-1225 v3 4C/3.2GHz/8MB/84W/DDR3-1600	1x4GB UDIMM DDR3-1600 ECC	RAID 100	2x3.5" DC	Open	9.5mm DVD±RW	None	None	AMT9	None	1-year	300W Gold Fixed	07/14
70F90010++	EMEA	Pentium G3220 2C/3GHz/3MB/53W/DDR3-1333	1x4GB UDIMM DDR3-1600 ECC	RAID 100	2x3.5" DC	Open	9.5mm DVD±RW	None	None	AMT9	None	1-year	300W Gold Fixed	07/14
70F90011++	EMEA	Core i3-4130 2C/3.4GHz/3MB/54W/DDR3-1600	1x4GB UDIMM DDR3-1600 ECC	RAID 100	2x3.5" DC	Open	9.5mm DVD±RW	None	None	AMT9	None	1-year	300W Gold Fixed	07/14
70F90012++	EMEA	Celeron G1830 2C/2.8GHz/2MB/53W/DDR3-1333	1x4GB UDIMM DDR3-1600 ECC	RAID 100	2x3.5" DC	Open	9.5mm DVD±RW	None	None	AMT9	None	1-year	300W Gold Fixed	07/14
70F90013++	EMEA	Xeon E3-1245 v3 4C/3.4GHz/8MB/84W/DDR3-1600	1x4GB UDIMM DDR3-1600 ECC	RAID 100	2x3.5" DC	Open	9.5mm DVD±RW	None	None	AMT9	None	1-year	300W Gold Fixed	07/14
70F90014++	EMEA	Xeon E3-1225 v3 4C/3.2GHz/8MB/84W/DDR3-1600	2x4GB UDIMM DDR3-1600 ECC	RAID 100	2x3.5" DC	2x500GB HDD 7.2K 3.5" SATA6Gbs	9.5mm DVD±RW	None	None	AMT9	None	1-year	300W Gold Fixed	07/14
70F90015++	EMEA	Xeon E3-1225 v3 4C/3.2GHz/8MB/84W/DDR3-1600	1x4GB UDIMM DDR3-1600 ECC	RAID 100	2x3.5" DC	2x500GB HDD 7.2K 3.5" SATA6Gbs	9.5mm DVD±RW	None	None	AMT9	None	3-year	300W Gold Fixed	07/14
70F90016++	EMEA	Xeon E3-1225 v3 4C/3.2GHz/8MB/84W/DDR3-1600	2x4GB UDIMM DDR3-1600 ECC	RAID 100	2x3.5" DC	2x1TB HDD 7.2K 3.5" SATA6Gbs	9.5mm DVD±RW	None	None	AMT9	None	1-year	300W Gold Fixed	07/14
70F90017++	EMEA	Xeon E3-1225 v3 4C/3.2GHz/8MB/84W/DDR3-1600	1x4GB UDIMM DDR3-1600 ECC	RAID 100	2x3.5" DC	2x1TB HDD 7.2K 3.5" SATA6Gbs	9.5mm DVD±RW	None	None	AMT9	None	3-year	300W Gold Fixed	07/14
70F9001A++	EMEA	Xeon E3-1225 v3 4C/3.2GHz/8MB/84W/DDR3-1600	2x4GB UDIMM DDR3-1600 ECC	RAID 500	2x3.5" DC	2x1TB HDD 7.2K 3.5" SATA6Gbs	9.5mm DVD±RW	None	None	AMT9	None	1-year	300W Gold Fixed	07/14

Model	Region	Processor	Memory	RAID Controller	Disk Bays	Storage	Optical	Add-on NIC	Add-on Ports	System Mgmt	OS	Warranty	Power Supply	Ann Date (m/y)
70F9001B++	EMEA	Xeon E3-1225 v3 4C/3.2GHz/8MB/84W/DDR3-1600	1x4GB UDIMM DDR3-1600 ECC	RAID 500	2x3.5" DC	2x1TB HDD 7.2K 3.5" SATA6Gbs	9.5mm DVD±RW	None	None	AMT9	None	3-year	300W Gold Fixed	07/14
70F9001C++	EMEA	Xeon E3-1226 v3 4C/3.3GHz/8MB/84W/DDR3-1600	1x4GB UDIMM DDR3-1600 ECC	RAID 100	2x3.5" DC	Open	9.5mm DVD±RW	None	None	AMT9	None	1-year	300W Gold Fixed	09/14
70F9001D++	EMEA	Pentium G3240 2C/3.1GHz/3MB/53W/DDR3-1333	1x4GB UDIMM DDR3-1600 ECC	RAID 100	2x3.5" DC	Open	9.5mm DVD±RW	None	None	AMT9	None	1-year	300W Gold Fixed	09/14
70F9001E++	EMEA	Core i3-4150 2C/3.5GHz/3MB/54W/DDR3-1600	1x4GB UDIMM DDR3-1600 ECC	RAID 100	2x3.5" DC	Open	9.5mm DVD±RW	None	None	AMT9	None	1-year	300W Gold Fixed	09/14
70F9001F++	EMEA	Celeron G1850 2C/2.9GHz/2MB/53W/DDR3-1333	1x4GB UDIMM DDR3-1600 ECC	RAID 100	2x3.5" DC	Open	9.5mm DVD±RW	None	None	AMT9	None	1-year	300W Gold Fixed	09/14
70F9001G++	EMEA	Xeon E3-1246 v3 4C/3.5GHz/8MB/84W/DDR3-1600	1x4GB UDIMM DDR3-1600 ECC	RAID 100	2x3.5" DC	Open	9.5mm DVD±RW	None	None	AMT9	None	1-year	300W Gold Fixed	09/14
70F9001H++	EMEA	Xeon E3-1226 v3 4C/3.3GHz/8MB/84W/DDR3-1600	2x4GB UDIMM DDR3-1600 ECC	RAID 100	2x3.5" DC	2x1TB HDD 7.2K 3.5" SATA6Gbs	9.5mm DVD±RW	None	None	AMT9	None	1-year	300W Gold Fixed	09/14
70F9001J++	EMEA	Xeon E3-1226 v3 4C/3.3GHz/8MB/84W/DDR3-1600	1x4GB UDIMM DDR3-1600 ECC	RAID 100	2x3.5" DC	2x1TB HDD 7.2K 3.5" SATA6Gbs	9.5mm DVD±RW	None	None	AMT9	None	3-year	300W Gold Fixed	09/14
70F9001K++	EMEA	Xeon E3-1226 v3 4C/3.3GHz/8MB/84W/DDR3-1600	2x4GB UDIMM DDR3-1600 ECC	RAID 500	2x3.5" DC	2x1TB HDD 7.2K 3.5" SATA6Gbs	9.5mm DVD±RW	None	None	AMT9	None	1-year	300W Gold Fixed	09/14
70F9001L++	EMEA	Xeon E3-1226 v3 4C/3.3GHz/8MB/84W/DDR3-1600	1x4GB UDIMM DDR3-1600 ECC	RAID 500	2x3.5" DC	2x1TB HDD 7.2K 3.5" SATA6Gbs	9.5mm DVD±RW	None	None	AMT9	None	3-year	300W Gold Fixed	09/14



ThinkServer RS160 Platform Specifications

Product Specifications Reference (PSREF)

Components	Specification																
Dimensions	1U rack. Height: 43.2 mm (1.7 in), width: 438.5 mm (17.26 in), depth: 393.7 mm (15.5 in)																
Weight	Minimum configuration: 6.2 kg (13.67 lb), maximum: 7.6 kg (16.76 lb)																
Processor	Up to one Intel Xeon E3-1200 v5, Core i3, Pentium, or Celeron family processor. <i>Processors in italic will be available on November 2016.</i>																
	Xeon E3-1280 v5	4C/3.7GHz/8MB/80W/DDR4-2133															
	Xeon E3-1270 v5	4C/3.6GHz/8MB/80W/DDR4-2133															
	Xeon E3-1240 v5	4C/3.5GHz/8MB/80W/DDR4-2133															
	Xeon E3-1230 v5	4C/3.4GHz/8MB/80W/DDR4-2133															
	Xeon E3-1220 v5	4C/3GHz/8MB/80W/DDR4-2133															
	Core i3-6320	2C/3.9GHz/4MB/51W/DDR4-2133															
	Core i3-6300	2C/3.8GHz/4MB/51W/DDR4-2133															
	Core i3-6100	2C/3.7GHz/3MB/51W/DDR4-2133															
	Pentium G4520	2C/3.6GHz/3MB/51W/DDR4-2133															
	Pentium G4500	2C/3.5GHz/3MB/51W/DDR4-2133															
	Pentium G4400	2C/3.3GHz/3MB/54W/DDR4-2133															
	<i>Xeon E3-1260L v5</i>	<i>4C/2.9GHz/8MB/45W/DDR4-2133</i>															
	<i>Xeon E3-1240L v5</i>	<i>4C/2.1GHz/8MB/25W/DDR4-2133</i>															
	<i>Xeon E3-1225 v5</i>	<i>4C/3.3GHz/8MB/80W/DDR4-2133</i>															
	<i>Celeron G3920</i>	<i>2C/2.9GHz/2MB/51W/DDR4-2133</i>															
	<i>Celeron G3900</i>	<i>2C/2.8GHz/2MB/51W/DDR4-2133</i>															
<i>Celeron G3900T</i>	<i>2C/2.6GHz/2MB/35W/DDR4-2133</i>																
Chipset	Intel C232 Platform Controller Hub (PCH)																
Memory DIMMs	4 DIMM sockets with 2 channels, 2 DIMMs per channel. UDIMM . DDR4-2133																
Memory capacity	64GB (16GB x 4)																
Memory protection	ECC																
RAID controller	<table border="1"> <thead> <tr> <th>RAID controller</th> <th>Drive type</th> <th>RAID support</th> <th>Compatible models</th> </tr> </thead> <tbody> <tr> <td>Onboard RAID12i</td> <td>6Gbs SATA</td> <td>0/1/5/10</td> <td>2x3.5", 4x2.5"</td> </tr> <tr> <td>RAID520i PCIe</td> <td>12Gbs SAS/SATA</td> <td>0/1/10, 5 with optional key</td> <td>2x3.5", 4x2.5"</td> </tr> <tr> <td>RAID720i PCIe</td> <td>12Gbs SAS/SATA</td> <td>0/1/10/5, 6 with optional cache</td> <td>2x3.5", 4x2.5"</td> </tr> </tbody> </table>	RAID controller	Drive type	RAID support	Compatible models	Onboard RAID12i	6Gbs SATA	0/1/5/10	2x3.5", 4x2.5"	RAID520i PCIe	12Gbs SAS/SATA	0/1/10, 5 with optional key	2x3.5", 4x2.5"	RAID720i PCIe	12Gbs SAS/SATA	0/1/10/5, 6 with optional cache	2x3.5", 4x2.5"
	RAID controller	Drive type	RAID support	Compatible models													
	Onboard RAID12i	6Gbs SATA	0/1/5/10	2x3.5", 4x2.5"													
RAID520i PCIe	12Gbs SAS/SATA	0/1/10, 5 with optional key	2x3.5", 4x2.5"														
RAID720i PCIe	12Gbs SAS/SATA	0/1/10/5, 6 with optional cache	2x3.5", 4x2.5"														
Optional cache for RAID720i: 1GB DDR3 memory. 1GB, 2GB, or 4GB flash with super capacitor. Flash options include CacheVault, CacheCade Pro, and FastPath.																	
Disk drive bays	Supports two 3.5" or four 2.5" disk drive bays. Non-hot swap. Cables are connected to onboard SATA connectors or PCIe RAID controller. Also supports one M.2 SATA SSD																
Supporting storage	3.5" HDD, 7.2K SATA6Gbs	1TB/2TB/4TB/6TB/8TB															
	3.5" HDD, 7.2K SAS12Gbs	1TB/2TB/4TB/6TB/8TB															
	2.5" HDD, 7.2K SATA6Gbs	1TB/2TB															
	2.5" HDD, 10K SAS12Gbs	300GB/600GB/900GB/1.2TB															
	2.5" SSD, SATA6Gbs	120GB/240GB/480GB/960GB															
	M.2 SATA SSD	32GB/128GB (128GB M.2 SATA SSD will be available on November 2016)															
Optical drive	Optional one 9.5mm optical. DVD-ROM or DVD±RW																
Network interfaces	One dedicated management port, two Gigabit Ethernet ports. Supports optional discrete network adapters via riser card																
Security features	Power-on and administrator password. Optional TPM (TCG 1.2-compliant)																
Systems management	UEFI. Onboard Aspeed AST2400 graphics/management processor, IPMI 2.0-compliant baseboard management controller (BMC). Control Panel LEDs shows the status of power, ID, disk drives, network, system. Supports the following management software: EasyStartup, Power Planner. On November 2016, EasyUpdate, Lenovo ThinkServer Diagnostics Standalone, ToolsCenter Suite CLI inventory module on ThinkServer, and Lenovo xClarity Administrator will be available																
Operating systems	Microsoft Windows Server 2012 R2/2012. Red Hat Enterprise Linux 6.7/6.8/7.2. SUSE Linux Enterprise Server 11/12. VMware vSphere (ESXi) 6.0Ub/U2																
Base warranty	1 or 3-year limited onsite service with 9x5/NBD																

Components	Specification	
Power supply	One fixed 300 watts power supply, Non-hot swap. 80 PLUS Gold qualified	
Graphics	Onboard Aspeed AST2400	
Front ports	Two USB 2.0	
Rear ports	One VGA, four USB 3.0, one RJ-45 (dedicated mgmt), two ethernet, one serial (9-pin)	
Cooling	3 fans for processor, PCIe slot, and disk drives	
Noise emissions	Operating: < 5.9 Bels. Idle: < 5.2 Bels (Maximum configuration)	
Environmental specification	Temperature - operating	50 °F to 95 °F (10 °C to 35 °C)
	Temperature - non operating (with package)	-40 °C to 60 °C
	Altitude - operating	(Unpressurized): 0-10000ft (0-3048m)
	Humidity - operating	8%-80%, non-condensing
	Humidity - storage (with package)	10%-90%, non-condensing

Expansion slots

Supports one PCIe slot via optional riser card

Slot 1 (riser card 1) PCIe 3.0 x16, half length, half height

Model	Region	Processor	Memory	RAID Controller	Disk Bays	Storage(HDD/SSD)	Optical	Add-on NIC	Slots	TPM	OS	Warranty	Power Supply	Ann Date (m/y)
70TE0008EA	EMEA	Xeon E3-1220 v5 4C/3GHz/8MB/80W/DDR4-2133	1x8GB UDIMM DDR4-2133 ECC	RAID 121i	4x2.5" NHS	Open	None	None	1xHHHL	None	None	3-year	300W 85% Fixed	09/16
70TE0009EA	EMEA	Xeon E3-1230 v5 4C/3.4GHz/8MB/80W/DDR4-2133	1x8GB UDIMM DDR4-2133 ECC	RAID 121i	4x2.5" NHS	Open	None	None	1xHHHL	None	None	3-year	300W 85% Fixed	09/16
70TE000AEA	EMEA	Xeon E3-1270 v5 4C/3.6GHz/8MB/80W/DDR4-2133	1x8GB UDIMM DDR4-2133 ECC	RAID 121i	4x2.5" NHS	Open	None	None	1xHHHL	None	None	3-year	300W 85% Fixed	09/16
70TE000BEA	EMEA	Xeon E3-1230 v5 4C/3.4GHz/8MB/80W/DDR4-2133	1x8GB UDIMM DDR4-2133 ECC	RAID 121i	4x2.5" NHS	2x1TB HDD 7.2K 2.5" SATA6Gbs	None	None	1xHHHL	None	None	3-year	300W 85% Fixed	09/16
70TE000CEA	EMEA	Xeon E3-1240 v5 4C/3.5GHz/8MB/80W/DDR4-2133	1x16GB UDIMM DDR4-2133 ECC	RAID 121i	4x2.5" NHS	2x2TB HDD 7.2K 2.5" SATA6Gbs	None	None	1xHHHL	None	None	3-year	300W 85% Fixed	09/16

ThinkServer RS160 - TopSeller - 70TG

Product Specifications Reference (PSREF)

Model	Region	Processor	Memory	RAID Controller	Disk Bays	Storage(HDD/SSD)	Optical	Add-on NIC	Slots	TPM	OS	Warranty	Power Supply	Ann Date (m/y)
70TG000DEA	EMEA	Pentium G4400 2C/3.3GHz/3MB/54W/DDR4-2133	1x8GB UDIMM DDR4-2133 ECC	RAID 121i	2x3.5" NHS	Open	None	None	1xHHHL	None	None	3-year	300W 85% Fixed	09/16
70TG000EEA	EMEA	Xeon E3-1220 v5 4C/3GHz/8MB/80W/DDR4-2133	1x8GB UDIMM DDR4-2133 ECC	RAID 121i	2x3.5" NHS	Open	None	None	1xHHHL	None	None	3-year	300W 85% Fixed	09/16
70TG000FEA	EMEA	Xeon E3-1230 v5 4C/3.4GHz/8MB/80W/DDR4-2133	1x8GB UDIMM DDR4-2133 ECC	RAID 121i	2x3.5" NHS	Open	None	None	1xHHHL	None	None	3-year	300W 85% Fixed	09/16
70TG000GEA	EMEA	Xeon E3-1220 v5 4C/3GHz/8MB/80W/DDR4-2133	1x16GB UDIMM DDR4-2133 ECC	RAID 121i	2x3.5" NHS	2x2TB HDD 7.2K 3.5" SATA6Gbs	None	None	1xHHHL	None	None	3-year	300W 85% Fixed	09/16
70TG000HEA	EMEA	Xeon E3-1220 v5 4C/3GHz/8MB/80W/DDR4-2133	1x8GB UDIMM DDR4-2133 ECC	RAID 121i	2x3.5" NHS	2x1TB HDD 7.2K 3.5" SATA6Gbs	None	None	1xHHHL	None	None	3-year	300W 85% Fixed	09/16

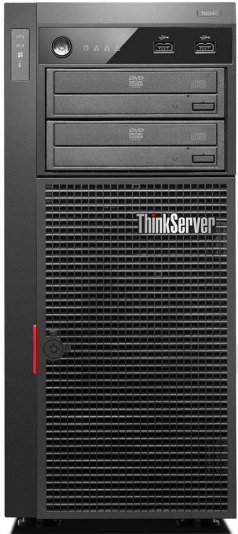

ThinkServer TD340 Platform Specifications

Components	Specification																																									
Dimensions	Tower or 5U rack. Height: 430 mm (16.9 in), width: 195 mm (7.68 in), depth: 595 mm (23.4 in)																																									
Weight	Maximum: 26 kg (57.3 lb)																																									
Processor	Up to two 95W Intel Xeon E5-2400 v2 family (code name: Ivy Bridge EN) processors with 10 cores up to 2.4GHz, 8 cores up to 2.5GHz, 6 cores up to 2.5GHz, 4 cores up to 2.4GHz. One QPI link up to 8.0 GT/s. Up to 1600MHz memory speed. Up to 25MB cache. Or up to two Intel Xeon E5-2420 (code name: Sandy Bridge EN) processors with 6 cores, 1.9GHz, 15MB cache, 95W, up to 1333MHz memory speed, one 7.2GT/s QPI link																																									
Chipset	Intel C606 Platform Controller Hub (PCH)																																									
Memory DIMMs	12 DIMM sockets (6 DIMMs per processor). 6-channel capable (3-channel per processor). RDIMM, LV RDIMM and LV UDIMM (cannot be intermixed). DDR3. Up to 1866MHz (RDIMM), 1600MHz (LV RDIMM) or 1600MHz (LV UDIMM)																																									
Memory capacity	192GB (RDIMM and LV RDIMM), 16GB x 12/48GB (LV UDIMM, 4GB x 12)																																									
Memory protection	ECC, memory mirroring, memory sparing																																									
AnyRAID support	Supports one of the following: RAID 0, 1, 10 with onboard RAID 100, 6Gb/s SATA, optional key for RAID 5. RAID 0, 1, 10 with onboard RAID 300, 6Gb/s SAS/SATA, optional key for RAID 5. RAID 0, 1, 10 with RAID 500, PCIe adapter, 6Gb/s SAS/SATA, optional key for RAID 5, 50. RAID 0, 1, 10, 5, 50, 6, 60 with RAID 700, PCIe adapter, 512MB cache, optional intelligent Battery Backup Unit (iBBU08). RAID 0, 1, 10, 5, 50, 6, 60 with RAID 710, PCIe adapter, 1GB cache, optional CacheVault flash cache with super capacitor/CacheCade Pro 2.0/FastPath key <i>Note: At least 6 disk drives is required for RAID 50 and 60.</i>																																									
Disk drive bays	Up to 8 3.5" hot-swap bays, or up to 16 2.5" hot-swap bays, or up to 4 3.5" non-hot swap bays. On front. Supports internal RDX tape drive, consumes 5.25" bay, also supports optional external SAS tape drive, additional SAS HBA card is needed. <table border="1"> <thead> <tr> <th rowspan="2">Disk bay configuration</th> <th colspan="5">RAID controller requirements</th> </tr> <tr> <th>RAID100</th> <th>RAID300</th> <th>RAID500</th> <th>RAID700</th> <th>RAID710</th> </tr> </thead> <tbody> <tr> <td>4x3.5" non-hot swap</td> <td>•</td> <td></td> <td></td> <td></td> <td></td> </tr> <tr> <td>4x3.5" HS</td> <td>•</td> <td>•</td> <td>•</td> <td>•</td> <td>•</td> </tr> <tr> <td>8x3.5" HS</td> <td></td> <td>•</td> <td>•</td> <td>•</td> <td>•</td> </tr> <tr> <td>8x2.5" HS</td> <td></td> <td>•</td> <td>•</td> <td>•</td> <td>•</td> </tr> <tr> <td>16x2.5" HS</td> <td></td> <td></td> <td>•</td> <td>•</td> <td>•</td> </tr> </tbody> </table>	Disk bay configuration	RAID controller requirements					RAID100	RAID300	RAID500	RAID700	RAID710	4x3.5" non-hot swap	•					4x3.5" HS	•	•	•	•	•	8x3.5" HS		•	•	•	•	8x2.5" HS		•	•	•	•	16x2.5" HS			•	•	•
Disk bay configuration	RAID controller requirements																																									
	RAID100	RAID300	RAID500	RAID700	RAID710																																					
4x3.5" non-hot swap	•																																									
4x3.5" HS	•	•	•	•	•																																					
8x3.5" HS		•	•	•	•																																					
8x2.5" HS		•	•	•	•																																					
16x2.5" HS			•	•	•																																					
Supporting disk drives	<table border="1"> <tbody> <tr> <td>3.5" SATA HDD (both HS and NHS)</td> <td>7.2K 6Gbs: 7.2K 6Gbs: 500GB/1TB/2TB/3TB/4TB</td> </tr> <tr> <td>3.5" SAS HDD (HS)</td> <td>7.2K 6Gbs: 1TB/2TB/3TB/4TB. 15K 6Gbs: 300GB/600GB</td> </tr> <tr> <td>2.5" SATA HDD (HS)</td> <td>7.2K 6Gbs: 500GB/1TB. 10K 6Gbs: 300GB/600GB/900GB</td> </tr> <tr> <td>2.5" SAS HDD (HS)</td> <td>15K 6Gbs: 146GB/300GB/600GB</td> </tr> <tr> <td>2.5" SATA SSD (HS, also supports 3.5" HS bay)</td> <td>6Gbs: 120GB/240GB/300GB/480GB/600GB</td> </tr> <tr> <td>2.5" SAS SSD (HS, also supports 3.5" HS bay)</td> <td>12Gbs: 200GB/400GB/800GB</td> </tr> <tr> <td>PCIe SSD</td> <td>1.4TB, via PCIe 2.0 x8 adapter</td> </tr> </tbody> </table> <p><i>Note: Supports up to 2 SSD drives on 8 x 3.5" HS model, up to 4 SSD drives on 16 x 2.5" HS model.</i></p>	3.5" SATA HDD (both HS and NHS)	7.2K 6Gbs: 7.2K 6Gbs: 500GB/1TB/2TB/3TB/4TB	3.5" SAS HDD (HS)	7.2K 6Gbs: 1TB/2TB/3TB/4TB. 15K 6Gbs: 300GB/600GB	2.5" SATA HDD (HS)	7.2K 6Gbs: 500GB/1TB. 10K 6Gbs: 300GB/600GB/900GB	2.5" SAS HDD (HS)	15K 6Gbs: 146GB/300GB/600GB	2.5" SATA SSD (HS, also supports 3.5" HS bay)	6Gbs: 120GB/240GB/300GB/480GB/600GB	2.5" SAS SSD (HS, also supports 3.5" HS bay)	12Gbs: 200GB/400GB/800GB	PCIe SSD	1.4TB, via PCIe 2.0 x8 adapter																											
3.5" SATA HDD (both HS and NHS)	7.2K 6Gbs: 7.2K 6Gbs: 500GB/1TB/2TB/3TB/4TB																																									
3.5" SAS HDD (HS)	7.2K 6Gbs: 1TB/2TB/3TB/4TB. 15K 6Gbs: 300GB/600GB																																									
2.5" SATA HDD (HS)	7.2K 6Gbs: 500GB/1TB. 10K 6Gbs: 300GB/600GB/900GB																																									
2.5" SAS HDD (HS)	15K 6Gbs: 146GB/300GB/600GB																																									
2.5" SATA SSD (HS, also supports 3.5" HS bay)	6Gbs: 120GB/240GB/300GB/480GB/600GB																																									
2.5" SAS SSD (HS, also supports 3.5" HS bay)	12Gbs: 200GB/400GB/800GB																																									
PCIe SSD	1.4TB, via PCIe 2.0 x8 adapter																																									
Optical drive	Two 5.25" bays for optical drive. DVD-ROM or DVD±RW. Half-height																																									
Network interfaces	Two Gigabit Ethernet port via two Intel 82574L. One port is shared with ThinkServer Management Module. Supports optional discrete network adapters via PCIe slots																																									

Components	Specification	
Security features	Power-on and administrator password. Optional TPM (TCG 1.2-compliant)	
Intelligent Diagnostics Module (IDM)	Supports IDM or IDM Premium on selected models, IDM LED lights indicate failing component category, IDM Premium LED lights indicate individual failing part	
Systems management	Supports ThinkServer Management Module (TMM), optional TMM Premium for remote presence. Onboard Aspeed AST2300 graphics/management processor, IPMI 2.0-compliant baseboard management controller (BMC). Front control panel LEDs shows the status of power, hard drive activity, network, system. Supports EasyStartup, EasyManage, EasyUpdate.	
Operating systems supported	Microsoft Windows Server 2012 R2/2012/2008 R2/2008. Windows Small Business Server 2011. Red Hat Enterprise Linux 7.1/7/6.7/6.5/6.4/5.10/5.9. SUSE Linux Enterprise Server 11/10. VMware vSphere (ESXi) 5.5/5.1	
Base warranty	1 or 3-year limited onsite service with 9x5/NBD.	
Power supply	One fixed 625 watts, universal, 80 PLUS Bronze qualified. Or up to two redundant 800 watts, two maximum, rear access, hot-swap, 80 PLUS Gold qualified, redundant with two power supplies	
Graphics	Onboard Aspeed AST2300 graphics/management processor	
Front ports	Two USB 2.0	
Rear ports	Four USB 2.0, one serial (9-pin), two ethernet (RJ-45, one for dedicate/share mgmt), one analog VGA DB-15 connector	
Noise emissions	Operating: < 42 dB(A). Idle: < 38 dB(A) (Maximum configuration)	
Environmental specification	Energy Star Server 1.1 qualified for 625W models, Energy Star Server 2.0 qualified for 800W models. RoHS-compliant.	
	Temperature - operating	50 °F to 95 °F (10 °C to 35 °C)
	Temperature - storage (with package)	-40 °C to 60 °C
	Altitude - operating	Supported Altitude (unpressurized): 0-10000ft (0-3048m)
	Humidity - operating	10%~80%, non-condensing
Humidity - storage (with package)	8%~90%, non-condensing	

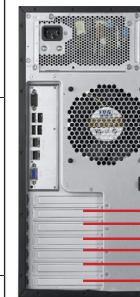

- Slot 6
- Slot 5
- Slot 4
- Slot 3
- Slot 2
- Slot 1

Expansion slots

Slot 1 (PCH)	32-bit PCI 2.3, half-length, full-height
Slot 2 (CPU1)	PCIe 3.0 x8 (x4 elec), half-length, full-height
Slot 3 (CPU2)	PCIe 3.0 x8, half-length, full-height
Slot 4 (CPU2)	PCIe 3.0 x8, half-length, full-height
Slot 5 (CPU1)	PCIe 3.0 x16, half-length, full-height
Slot 6 (CPU2)	PCIe 3.0 x8, half-length, full-height

Model	Region	Processor	Memory	RAID Controller	Disk Bays	Storage	Optical	Add-on NIC	TPM	Diagnostics	System Mgmt	OS	Warranty	Power Supply	Ann Date (m/y)
70B50007++	EMEA	1xE5-2403 v2 4C/1.8GHz/10MB/80W/DDR3-1333	1x4GB RDIMM DDR3-1600 ECC	RAID 100+Key	4x3.5" DC	Open	HH DVD±RW	None	None	IDM Premium	TMM	None	3-year	625W Bronze Fixed	01/14
70B50008++	EMEA	1xE5-2407 v2 4C/2.4GHz/10MB/80W/DDR3-1333	1x4GB RDIMM DDR3-1600 ECC	RAID 100+Key	4x3.5" DC	Open	HH DVD±RW	None	None	IDM Premium	TMM	None	3-year	625W Bronze Fixed	01/14
70B50009++	EMEA	1xE5-2420 v2 6C/2.2GHz/15MB/80W/DDR3-1600	1x4GB RDIMM DDR3-1600 ECC	RAID 100+Key	4x3.5" DC	Open	HH DVD±RW	None	None	IDM Premium	TMM	None	3-year	625W Bronze Fixed	01/14
70B5000A++	EMEA	1xE5-2430 v2 6C/2.5GHz/15MB/80W/DDR3-1600	1x4GB RDIMM DDR3-1600 ECC	RAID 100+Key	4x3.5" DC	Open	HH DVD±RW	None	None	IDM Premium	TMM	None	3-year	625W Bronze Fixed	01/14
70B5000B++	EMEA	1xE5-2450 v2 8C/2.5GHz/20MB/95W/DDR3-1600	1x4GB RDIMM DDR3-1600 ECC	RAID 100+Key	4x3.5" DC	Open	HH DVD±RW	None	None	IDM Premium	TMM	None	3-year	625W Bronze Fixed	01/14
70B5000C++	EMEA	1xE5-2403 v2 4C/1.8GHz/10MB/80W/DDR3-1333	1x4GB RDIMM DDR3-1600 ECC	RAID 300	4x3.5" HS	Open	HH DVD±RW	None	None	IDM Premium	TMM	None	3-year	625W Bronze Fixed	01/14
70B5000D++	EMEA	1xE5-2407 v2 4C/2.4GHz/10MB/80W/DDR3-1333	1x4GB RDIMM DDR3-1600 ECC	RAID 300	4x3.5" HS	Open	HH DVD±RW	None	None	IDM Premium	TMM	None	3-year	625W Bronze Fixed	01/14
70B5000E++	EMEA	1xE5-2420 v2 6C/2.2GHz/15MB/80W/DDR3-1600	1x4GB RDIMM DDR3-1600 ECC	RAID 300	4x3.5" HS	Open	HH DVD±RW	None	None	IDM Premium	TMM	None	3-year	625W Bronze Fixed	01/14
70B5000F++	EMEA	1xE5-2430 v2 6C/2.5GHz/15MB/80W/DDR3-1600	1x4GB RDIMM DDR3-1600 ECC	RAID 300	4x3.5" HS	Open	HH DVD±RW	None	None	IDM Premium	TMM	None	3-year	625W Bronze Fixed	01/14
70B5000G++	EMEA	1xE5-2450 v2 8C/2.5GHz/20MB/95W/DDR3-1600	1x4GB RDIMM DDR3-1600 ECC	RAID 300	4x3.5" HS	Open	HH DVD±RW	None	None	IDM Premium	TMM	None	3-year	625W Bronze Fixed	01/14
70B5000H++	EMEA	1xE5-2407 v2 4C/2.4GHz/10MB/80W/DDR3-1333	1x4GB RDIMM DDR3-1600 ECC	RAID 500	4x3.5" HS	Open	HH DVD±RW	None	None	IDM Premium	TMM	None	3-year	625W Bronze Fixed	01/14
70B5000J++	EMEA	1xE5-2407 v2 4C/2.4GHz/10MB/80W/DDR3-1333	1x4GB RDIMM DDR3-1600 ECC	RAID 700	4x3.5" HS	Open	HH DVD±RW	None	None	IDM Premium	TMM	None	3-year	625W Bronze Fixed	01/14
70B5000K++	EMEA	1xE5-2407 v2 4C/2.4GHz/10MB/80W/DDR3-1333	1x4GB RDIMM DDR3-1600 ECC	RAID 710+CacheVault	4x3.5" HS	Open	HH DVD±RW	None	None	IDM Premium	TMM	None	3-year	625W Bronze Fixed	01/14
70B5000L++	EMEA	1xE5-2430 v2 6C/2.5GHz/15MB/80W/DDR3-1600	1x8GB RDIMM DDR3-1600 ECC	RAID 300	8x3.5" HS	Open	HH DVD±RW	None	None	IDM Premium	TMM	None	3-year	625W Bronze Fixed	01/14
70B5000M++	EMEA	1xE5-2450 v2 8C/2.5GHz/20MB/95W/DDR3-1600	1x8GB RDIMM DDR3-1600 ECC	RAID 300	8x3.5" HS	Open	HH DVD±RW	None	None	IDM Premium	TMM	None	3-year	625W Bronze Fixed	01/14
70B5000N++	EMEA	1xE5-2403 v2 4C/1.8GHz/10MB/80W/DDR3-1333	1x8GB RDIMM DDR3-1600 ECC	RAID 300	8x3.5" HS	Open	HH DVD±RW	None	None	IDM Premium	TMM	None	3-year	625W Bronze Fixed	01/14
70B5000P++	EMEA	1xE5-2407 v2 4C/2.4GHz/10MB/80W/DDR3-1333	1x4GB RDIMM DDR3-1600 ECC	RAID 300	8x3.5" HS	Open	HH DVD±RW	None	None	IDM Premium	TMM	None	3-year	625W Bronze Fixed	01/14

Model	Region	Processor	Memory	RAID Controller	Disk Bays	Storage	Optical	Add-on NIC	TPM	Diagnostics	System Mgmt	OS	Warranty	Power Supply	Ann Date (m/y)
70B5000Q++	EMEA	1xE5-2420 v2 6C/2.2GHz/15MB/80W/DDR3-1600	1x4GB RDIMM DDR3-1600 ECC	RAID 300	8x3.5" HS	Open	HH DVD±RW	None	None	IDM Premium	TMM	None	3-year	625W Bronze Fixed	01/14
70B5000R++	EMEA	1xE5-2430 v2 6C/2.5GHz/15MB/80W/DDR3-1600	1x4GB RDIMM DDR3-1600 ECC	RAID 300	8x3.5" HS	Open	HH DVD±RW	None	None	IDM Premium	TMM	None	3-year	625W Bronze Fixed	01/14
70B5000S++	EMEA	1xE5-2450 v2 8C/2.5GHz/20MB/95W/DDR3-1600	1x4GB RDIMM DDR3-1600 ECC	RAID 300	8x3.5" HS	Open	HH DVD±RW	None	None	IDM Premium	TMM	None	3-year	625W Bronze Fixed	01/14
70B5000T++	EMEA	1xE5-2420 v2 6C/2.2GHz/15MB/80W/DDR3-1600	1x4GB RDIMM DDR3-1600 ECC	RAID 300	8x2.5" HS	Open	HH DVD±RW	None	None	IDM Premium	TMM	None	3-year	625W Bronze Fixed	01/14
70B5000U++	EMEA	1xE5-2430 v2 6C/2.5GHz/15MB/80W/DDR3-1600	1x4GB RDIMM DDR3-1600 ECC	RAID 300	8x2.5" HS	Open	HH DVD±RW	None	None	IDM Premium	TMM	None	3-year	625W Bronze Fixed	01/14
70B5000V++	EMEA	1xE5-2450 v2 8C/2.5GHz/20MB/95W/DDR3-1600	1x4GB RDIMM DDR3-1600 ECC	RAID 300	8x2.5" HS	Open	HH DVD±RW	None	None	IDM Premium	TMM	None	3-year	625W Bronze Fixed	01/14

Model	Region	Processor	Memory	RAID Controller	Disk Bays	Storage	Optical	Add-on NIC	TPM	Diagnostics	System Mgmt	OS	Warranty	Power Supply	Ann Date (m/y)
70B70006++	EMEA	1xE5-2403 v2 4C/1.8GHz/10MB/80W/DDR3-1333	1x4GB RDIMM DDR3-1600 ECC	RAID 100+Key	4x3.5" DC	Open	HH DVD±RW	None	None	IDM Premium	TMM	None	3-year	800Wx1 Gold	01/14
70B70007++	EMEA	1xE5-2407 v2 4C/2.4GHz/10MB/80W/DDR3-1333	1x4GB RDIMM DDR3-1600 ECC	RAID 100+Key	4x3.5" DC	Open	HH DVD±RW	None	None	IDM Premium	TMM	None	3-year	800Wx1 Gold	01/14
70B70008++	EMEA	1xE5-2420 v2 6C/2.2GHz/15MB/80W/DDR3-1600	1x4GB RDIMM DDR3-1600 ECC	RAID 100+Key	4x3.5" DC	Open	HH DVD±RW	None	None	IDM Premium	TMM	None	3-year	800Wx1 Gold	01/14
70B70009++	EMEA	1xE5-2403 v2 4C/1.8GHz/10MB/80W/DDR3-1333	1x4GB RDIMM DDR3-1600 ECC	RAID 300	4x3.5" HS	Open	HH DVD±RW	None	None	IDM Premium	TMM	None	3-year	800Wx1 Gold	01/14
70B7000A++	EMEA	1xE5-2407 v2 4C/2.4GHz/10MB/80W/DDR3-1333	1x4GB RDIMM DDR3-1600 ECC	RAID 300	4x3.5" HS	Open	HH DVD±RW	None	None	IDM Premium	TMM	None	3-year	800Wx1 Gold	01/14
70B7000B++	EMEA	1xE5-2420 v2 6C/2.2GHz/15MB/80W/DDR3-1600	1x4GB RDIMM DDR3-1600 ECC	RAID 300	4x3.5" HS	Open	HH DVD±RW	None	None	IDM Premium	TMM	None	3-year	800Wx1 Gold	01/14
70B7000C++	EMEA	1xE5-2430 v2 6C/2.5GHz/15MB/80W/DDR3-1600	1x4GB RDIMM DDR3-1600 ECC	RAID 300	4x3.5" HS	Open	HH DVD±RW	None	None	IDM Premium	TMM	None	3-year	800Wx1 Gold	01/14
70B7000D++	EMEA	1xE5-2450 v2 8C/2.5GHz/20MB/95W/DDR3-1600	1x4GB RDIMM DDR3-1600 ECC	RAID 300	4x3.5" HS	Open	HH DVD±RW	None	None	IDM Premium	TMM	None	3-year	800Wx1 Gold	01/14
70B7000E++	EMEA	1xE5-2403 v2 4C/1.8GHz/10MB/80W/DDR3-1333	1x4GB RDIMM DDR3-1600 ECC	RAID 300	8x3.5" HS	Open	HH DVD±RW	None	None	IDM Premium	TMM	None	3-year	800Wx1 Gold	01/14
70B7000F++	EMEA	1xE5-2407 v2 4C/2.4GHz/10MB/80W/DDR3-1333	1x4GB RDIMM DDR3-1600 ECC	RAID 300	8x3.5" HS	Open	HH DVD±RW	None	None	IDM Premium	TMM	None	3-year	800Wx1 Gold	01/14
70B7000G++	EMEA	1xE5-2420 v2 6C/2.2GHz/15MB/80W/DDR3-1600	1x4GB RDIMM DDR3-1600 ECC	RAID 300	8x3.5" HS	Open	HH DVD±RW	None	None	IDM Premium	TMM	None	3-year	800Wx1 Gold	01/14
70B7000H++	EMEA	1xE5-2430 v2 6C/2.5GHz/15MB/80W/DDR3-1600	1x4GB RDIMM DDR3-1600 ECC	RAID 300	8x3.5" HS	Open	HH DVD±RW	None	None	IDM Premium	TMM	None	3-year	800Wx1 Gold	01/14
70B7000J++	EMEA	1xE5-2450 v2 8C/2.5GHz/20MB/95W/DDR3-1600	1x4GB RDIMM DDR3-1600 ECC	RAID 300	8x3.5" HS	Open	HH DVD±RW	None	None	IDM Premium	TMM	None	3-year	800Wx1 Gold	01/14
70B7000K++	EMEA	1xE5-2407 v2 4C/2.4GHz/10MB/80W/DDR3-1333	1x4GB RDIMM DDR3-1600 ECC	RAID 500	8x3.5" HS	Open	HH DVD±RW	None	None	IDM Premium	TMM	None	3-year	800Wx1 Gold	01/14
70B7000L++	EMEA	1xE5-2420 v2 6C/2.2GHz/15MB/80W/DDR3-1600	1x4GB RDIMM DDR3-1600 ECC	RAID 500	8x3.5" HS	Open	HH DVD±RW	None	None	IDM Premium	TMM	None	3-year	800Wx1 Gold	01/14
70B7000M++	EMEA	1xE5-2430 v2 6C/2.5GHz/15MB/80W/DDR3-1600	1x4GB RDIMM DDR3-1600 ECC	RAID 500	8x3.5" HS	Open	HH DVD±RW	None	None	IDM Premium	TMM	None	3-year	800Wx1 Gold	01/14
70B7000N++	EMEA	1xE5-2450 v2 8C/2.5GHz/20MB/95W/DDR3-1600	1x4GB RDIMM DDR3-1600 ECC	RAID 500	8x3.5" HS	Open	HH DVD±RW	None	None	IDM Premium	TMM	None	3-year	800Wx1 Gold	01/14

Model	Region	Processor	Memory	RAID Controller	Disk Bays	Storage	Optical	Add-on NIC	TPM	Diagnostics	System Mgmt	OS	Warranty	Power Supply	Ann Date (m/y)
70B7000P++	EMEA	1xE5-2407 v2 4C/2.4GHz/10MB/80W/DDR3-1333	1x4GB RDIMM DDR3-1600 ECC	RAID 500	8x2.5" HS	Open	HH DVD±RW	None	None	IDM Premium	TMM	None	3-year	800Wx1 Gold	01/14
70B7000Q++	EMEA	1xE5-2420 v2 6C/2.2GHz/15MB/80W/DDR3-1600	1x4GB RDIMM DDR3-1600 ECC	RAID 500	8x2.5" HS	Open	HH DVD±RW	None	None	IDM Premium	TMM	None	3-year	800Wx1 Gold	01/14
70B7000R++	EMEA	1xE5-2430 v2 6C/2.5GHz/15MB/80W/DDR3-1600	1x4GB RDIMM DDR3-1600 ECC	RAID 500	8x2.5" HS	Open	HH DVD±RW	None	None	IDM Premium	TMM	None	3-year	800Wx1 Gold	01/14
70B7000S++	EMEA	1xE5-2450 v2 8C/2.5GHz/20MB/95W/DDR3-1600	1x4GB RDIMM DDR3-1600 ECC	RAID 500	8x2.5" HS	Open	HH DVD±RW	None	None	IDM Premium	TMM	None	3-year	800Wx1 Gold	01/14
70B7000T++	EMEA	1xE5-2407 v2 4C/2.4GHz/10MB/80W/DDR3-1333	1x4GB RDIMM DDR3-1600 ECC	RAID 300	8x2.5" HS	Open	HH DVD±RW	None	None	IDM Premium	TMM	None	3-year	800Wx1 Gold	01/14
70B7000U++	EMEA	1xE5-2420 v2 6C/2.2GHz/15MB/80W/DDR3-1600	1x4GB RDIMM DDR3-1600 ECC	RAID 300	8x2.5" HS	Open	HH DVD±RW	None	None	IDM Premium	TMM	None	3-year	800Wx1 Gold	01/14
70B7000V++	EMEA	1xE5-2430 v2 6C/2.5GHz/15MB/80W/DDR3-1600	1x4GB RDIMM DDR3-1600 ECC	RAID 300	8x2.5" HS	Open	HH DVD±RW	None	None	IDM Premium	TMM	None	3-year	800Wx1 Gold	01/14
70B7000W++	EMEA	1xE5-2450 v2 8C/2.5GHz/20MB/95W/DDR3-1600	1x4GB RDIMM DDR3-1600 ECC	RAID 300	8x2.5" HS	Open	HH DVD±RW	None	None	IDM Premium	TMM	None	3-year	800Wx1 Gold	01/14
70B7000X++	EMEA	1xE5-2420 v2 6C/2.2GHz/15MB/80W/DDR3-1600	1x4GB RDIMM DDR3-1600 ECC	RAID 700+Battery	8x3.5" HS	Open	HH DVD±RW	None	None	IDM Premium	TMM	None	3-year	800Wx1 Gold	01/14
70B7000Y++	EMEA	1xE5-2430 v2 6C/2.5GHz/15MB/80W/DDR3-1600	1x4GB RDIMM DDR3-1600 ECC	RAID 700+Battery	8x3.5" HS	Open	HH DVD±RW	None	None	IDM Premium	TMM	None	3-year	800Wx1 Gold	01/14
70B70010++	EMEA	1xE5-2450 v2 8C/2.5GHz/20MB/95W/DDR3-1600	1x4GB RDIMM DDR3-1600 ECC	RAID 700+Battery	8x3.5" HS	Open	HH DVD±RW	None	None	IDM Premium	TMM	None	3-year	800Wx1 Gold	01/14
70B70011++	EMEA	1xE5-2420 v2 6C/2.2GHz/15MB/80W/DDR3-1600	1x4GB RDIMM DDR3-1600 ECC	RAID 700+Battery	8x2.5" HS	Open	HH DVD±RW	None	None	IDM Premium	TMM	None	3-year	800Wx1 Gold	01/14
70B70012++	EMEA	1xE5-2430 v2 6C/2.5GHz/15MB/80W/DDR3-1600	1x4GB RDIMM DDR3-1600 ECC	RAID 700+Battery	8x2.5" HS	Open	HH DVD±RW	None	None	IDM Premium	TMM	None	3-year	800Wx1 Gold	01/14
70B70013++	EMEA	1xE5-2450 v2 8C/2.5GHz/20MB/95W/DDR3-1600	1x4GB RDIMM DDR3-1600 ECC	RAID 700+Battery	8x2.5" HS	Open	HH DVD±RW	None	None	IDM Premium	TMM	None	3-year	800Wx1 Gold	01/14
70B70014++	EMEA	1xE5-2420 v2 6C/2.2GHz/15MB/80W/DDR3-1600	1x8GB RDIMM DDR3-1600 ECC	RAID 710+CacheVault	8x2.5" HS	Open	HH DVD±RW	None	None	IDM Premium	TMM	None	3-year	800Wx1 Gold	01/14
70B70015++	EMEA	1xE5-2430 v2 6C/2.5GHz/15MB/80W/DDR3-1600	1x8GB RDIMM DDR3-1600 ECC	RAID 710+CacheVault	8x2.5" HS	Open	HH DVD±RW	None	None	IDM Premium	TMM	None	3-year	800Wx1 Gold	01/14
70B70016++	EMEA	1xE5-2450 v2 8C/2.5GHz/20MB/95W/DDR3-1600	1x8GB RDIMM DDR3-1600 ECC	RAID 710+CacheVault	8x2.5" HS	Open	HH DVD±RW	None	None	IDM Premium	TMM	None	3-year	800Wx1 Gold	01/14

Model	Region	Processor	Memory	RAID Controller	Disk Bays	Storage	Optical	Add-on NIC	TPM	Diagnostics	System Mgmt	OS	Warranty	Power Supply	Ann Date (m/y)
70B70017++	EMEA	1xE5-2420 v2 6C/2.2GHz/15MB/80W/DDR3-1600	1x8GB RDIMM DDR3-1600 ECC	RAID 710+CacheVault	8x3.5" HS	Open	HH DVD±RW	None	None	IDM Premium	TMM	None	3-year	800Wx1 Gold	01/14
70B70018++	EMEA	1xE5-2430 v2 6C/2.5GHz/15MB/80W/DDR3-1600	1x8GB RDIMM DDR3-1600 ECC	RAID 710+CacheVault	8x3.5" HS	Open	HH DVD±RW	None	None	IDM Premium	TMM	None	3-year	800Wx1 Gold	01/14
70B70019++	EMEA	1xE5-2450 v2 8C/2.5GHz/20MB/95W/DDR3-1600	1x8GB RDIMM DDR3-1600 ECC	RAID 710+CacheVault	8x3.5" HS	Open	HH DVD±RW	None	None	IDM Premium	TMM	None	3-year	800Wx1 Gold	01/14
70B7002E++	EMEA	1xE5-2407 v2 4C/2.4GHz/10MB/80W/DDR3-1333	1x8GB RDIMM DDR3-1600 ECC	RAID 300+Key	8x2.5" HS	Open	HH DVD±RW	None	None	IDM Premium	TMM Premium	None	3-year	800Wx2 Gold	01/14
70B7002F++	EMEA	1xE5-2420 v2 6C/2.2GHz/15MB/80W/DDR3-1600	1x8GB RDIMM DDR3-1600 ECC	RAID 700	8x2.5" HS	Open	HH DVD±RW	None	None	IDM Premium	TMM Premium	None	3-year	800Wx2 Gold	01/14



ThinkServer TD350 Platform Specifications

Product Specifications Reference (PSREF)

Components	Specification
Dimensions	Tower or 4U rack. Tower: Height: 459 mm (18.1 in), width: 251 mm (9.9 in), depth: 686 mm (27 in) Rack: height: 173 mm (6.8 in), width: 482 mm (19 in), depth: 686 mm (27 in)
Weight	Minimum configuration: 22 kg (48.5 lb), maximum: 41.4 kg (91.27 lb)
Processor	Up to two 135W Intel Xeon E5-2600 v4 or E5-2600 v3 family processors.
	E5-2698 v4 20C/2.2GHz/50MB/135W/DDR4-2400
	E5-2695 v4 18C/2.1GHz/45MB/120W/DDR4-2400
	E5-2690 v4 14C/2.6GHz/35MB/135W/DDR4-2400
	E5-2683 v4 16C/2.1GHz/40MB/120W/DDR4-2400
	E5-2680 v4 14C/2.4GHz/35MB/120W/DDR4-2400
	E5-2667 v4 8C/3.2GHz/25MB/135W/DDR4-2400
	E5-2660 v4 14C/2GHz/35MB/105W/DDR4-2400
	E5-2650L v4 14C/1.7GHz/35MB/65W/DDR4-2400
	E5-2650 v4 12C/2.2GHz/30MB/105W/DDR4-2400
	E5-2643 v4 6C/3.4GHz/20MB/135W/DDR4-2400
	E5-2640 v4 10C/2.4GHz/25MB/90W/DDR4-2133
	E5-2637 v4 4C/3.5GHz/15MB/135W/DDR4-2400
	E5-2630L v4 10C/1.8GHz/25MB/55W/DDR4-2133
	E5-2630 v4 10C/2.2GHz/20MB/85W/DDR4-2133
	E5-2623 v4 4C/2.6GHz/10MB/85W/DDR4-2133
	E5-2620 v4 8C/2.1GHz/20MB/85W/DDR4-2133
	E5-2609 v4 8C/1.7GHz/20MB/85W/DDR4-1866
	E5-2603 v4 6C/1.7GHz/15MB/85W/DDR4-1866
	E5-2698 v3 16C/2.3GHz/40MB/135W/DDR4-2133
	E5-2695 v3 14C/2.3GHz/35MB/120W/DDR4-2133
	E5-2690 v3 12C/2.6GHz/30MB/135W/DDR4-2133
	E5-2685 v3 12C/2.6GHz/30MB/120W/DDR4-2133
	E5-2683 v3 14C/2GHz/35MB/120W/DDR4-2133
	E5-2680 v3 12C/2.5GHz/30MB/120W/DDR4-2133
	E5-2670 v3 12C/2.3GHz/30MB/120W/DDR4-2133
	E5-2667 v3 8C/3.2GHz/20MB/135W/DDR4-2133
	E5-2660 v3 10C/2.6GHz/25MB/105W/DDR4-2133
	E5-2650L v3 12C/1.8GHz/30MB/65W/DDR4-2133
	E5-2650 v3 10C/2.3GHz/25MB/105W/DDR4-2133
	E5-2643 v3 6C/3.4GHz/20MB/135W/DDR4-2133
	E5-2640 v3 8C/2.6GHz/20MB/90W/DDR4-1866
	E5-2637 v3 4C/3.5GHz/15MB/135W/DDR4-2133
E5-2630L v3 8C/1.8GHz/20MB/55W/DDR4-1866	
E5-2630 v3 8C/2.4GHz/20MB/85W/DDR4-1866	
E5-2623 v3 4C/3GHz/10MB/105W/DDR4-1866	
E5-2620 v3 6C/2.4GHz/15MB/85W/DDR4-1866	
E5-2609 v3 6C/1.9GHz/15MB/85W/DDR4-1600	
E5-2603 v3 6C/1.6GHz/15MB/85W/DDR4-1600	
Chipset	Intel C612 Platform Controller Hub (PCH)
Memory DIMMs	16 DIMM sockets (8 DIMMs per processor), 8-channel capable (4-channel per processor). RDIMM and LRDIMM (cannot be intermixed), DDR4, up to 2400MHz
Memory capacity	512GB (RDIMM, 32GB x 16)/1024GB (LRDIMM, 64GB x 16), 2nd CPU is needed
Memory protection	ECC, memory mirroring, lockstep, and memory sparing
RAID controller	RAID controller Drive type RAID support Compatible models
	Onboard RAID110i 6Gbs SATA 0/1/10,5 with optional key 5x3.5" HS/ES, 8x2.5" HS
	RAID520i PCIe 12Gbs SAS/SATA 0/1/10,5/50 with optional key 5x3.5" HS, 8x2.5" HS
	RAID720i PCIe 12Gbs SAS/SATA 0/1/10/5/50,6/60 with optional cache 5x3.5" HS, 8x2.5" HS
	AnyRAID 510i 6Gbs SAS/SATA 0/1/10,5/50 with optional key 5x3.5" HS, 8x2.5" HS
	AnyRAID 720i 12Gbs SAS/SATA 0/1/10/5/50,6/60 with optional cache 5x3.5" HS, 8x2.5" HS
AnyRAID 720ix 12Gbs SAS/SATA 0/1/10/5/50/6/60 15x3.5" HS, 16/32x2.5" HS	
	Optional cache for RAID 720/AnyRAID 720i and 720ix: 1GB read-only memory or 1GB/2GB/4GB flash with super capacitor. Flash options include CacheVault, Cache-Cade Pro, and FastPath. 720ix must have cache.
Disk drive bays	Up to 15 3.5" or 32 2.5" hot-swap bays, or up to 5 3.5" easy-swap bays, on front. Up to 2 M.2 SSD drives via optional M.2 module. Up to one internal LTO-6 SAS tape drive on 720ix model, or external RDX tape drive via USB.

Components	Specification			
Maximum internal storage	3.5" model: up to 120TB with 7.2K SATA or SAS HDD, up to 27TB with 10K SAS HDD, up to 9TB with 15K SAS HDD, or up to 24TB with SATA or SAS SSD. 2.5" model: up to 64TB with 7.2K SATA HDD, up to 57.6TB with 10K SAS HDD, up to 19.2TB with 15K SAS HDD, or up to 51.2TB with SATA or SAS SSD			
SD module	Up to 2 SDHC flash cards via optional SD module, 8GB or 32GB each			
Optical drive	Two 5.25" bays for optical drive. DVD-ROM or DVD±RW. Half-height or 9.5mm			
Network interfaces	One dedicate management port, two gigabit ethernet ports. Supports optional discrete network adapters via PCIe slots			
Security features	Power-on and administrator password. Optional TPM (TCG 1.2 or 2.0-compliant)			
Systems management	Supports ThinkServer System Manager (TSM), optional TSM Premium for remote presence. UEFI. Onboard Aspeed AST2400 graphics/management processor, IPMI 2.0-compliant baseboard management controller (BMC). Control Panel LEDs shows the status of power, ID, network, system. Supports ThinkServer Diagnostics, ThinkServer Deployment Manager, ThinkServer Energy Manager, ThinkServer System Manager CLI, Lenovo ThinkServer Partner Pack for VMware vCenter and Microsoft System Center Operations Manager, ThinkServer Power Planner.			
	Operating systems supported	Microsoft Windows Server 2012 R2/2012/2008 R2. Windows Small Business Server 2011. Red Hat Enterprise Linux 6.5/6.6/7. SUSE Linux Enterprise Server 11. VMware vSphere (ESXi) 5.1 P5/5.5 U2/6.0		
Base warranty	1 or 3-year limited onsite service with 9x5/NBD.			
Power supply	Up to two redundant hot-swap 450W/550W/750W/1100W power supplies. 450 W is 80 PLUS Gold qualified. 550W and 1100W are 80 PLUS Platinum qualified. 750W is 80 PLUS Platinum or Titanium qualified. 750W Titanium is 200V - 240V, others are 110V - 240V.			
	Disk bay configuration	PSU requirements		
	450W	550W	750W	1100W
	5x3.5" ES • (up to 1 CPU)	•	•	•
	5x3.5" HS • (up to 1 CPU)	•	•	•
15x3.5" HS	•	•	•	
8x2.5" HS • (up to 1 CPU)	•	•	•	
16x2.5" HS • (up to 1 CPU)	•	•	•	
32x2.5" HS	•	•	•	
Graphics	Onboard Aspeed AST2400 with 16MB memory, one VGA on rear			
Front ports	Two USB 2.0			
Rear ports	One VGA, four USB 3.0, one RJ-45 (dedicate/share mgmt), two ethernet (RJ-45), one serial (9-pin)			
Cooling	4 (3+1), hot-swap			
Noise emissions	Operating: < 6.5 Bels. Idle: < 6 Bels (Maximum configuration)			
Environmental specification	ASHRAE Class	A4	A3	A2
	Temperature - operating	41 °F to 113 °F (5 °C to 45 °C)	41 °F to 104 °F (5 °C to 40 °C)	50 °F to 95 °F (10 °C to 35 °C)
	Temperature - storage (with package)	-40 °C to 60 °C		
	Altitude - operating	(Unpressurized): 0-10000ft (0-3048m)		
	Humidity - operating (non-condensing)	8%~90%	8%~85%	20%~80%
Humidity - storage (with package)	8%~90%, non-condensing			
	ASHRAE Class A4: ES or 8x2.5" HS bays/Lenovo-qualified CPU; maximum of 120W thermal design power; not low-power type (no L-suffix in the CPU name)/No internal tape/Two PSU installed for redundancy/Lenovo-qualified PCIe card; power consumption of each PCIe card does not exceed 15W. 32 x 2.5" models support ASHRAE Class A2, the other models support ASHRAE Class A3.			

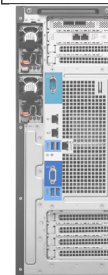

Expansion slots	
Slot 1 (CPU1)	PCIe 3.0 x16, full height, full length, double-wide
Slot 2 (CPU1)	PCIe 3.0 x16 (x8 elec), full height, full length
Slot 3 (CPU1)	PCIe 3.0 x16 (x8 elec), full height, full length
Slot 4 (CPU2)	PCIe 3.0 x16 (x8 elec), full height, full length
Slot 5 (CPU2)	PCIe 3.0 x16, full height, full length
Slot 6 (CPU2)	PCIe 3.0 x16 (x8 elec), full height, full length
Slot 7 (CPU2)	PCIe 3.0 x16 (x8 elec), full height, full length

For a list of all supported options, please see https://download.lenovo.com/pccbbs/options_iso/ocm_september_2016_thinkserver.xlsx sheet

Model	Region	Processor	2nd CPU	Memory	RAID Controller	Disk Bays	Storage	Optical	Add-on NIC	Add-on Ports	TPM	System Mgmt	OS	Warranty	Power Supply	Ann Date (m/y)
70DG000E++	EMEA	1xE5-2620 v3 6C/2.4GHz/15MB/85W/DDR4-1866	4XG0F28785	1x8GB RDIMM DDR4-2133 ECC	AnyRAID 720ix+1GB RAM	15x3.5" HS	Open	HH DVD±RW	None	None	None	TSM	None	1-year	750Wx1 Platinum	09/14
70DG000F++	EMEA	1xE5-2609 v3 6C/1.9GHz/15MB/85W/DDR4-1600	4XG0F28786	1x8GB RDIMM DDR4-2133 ECC	AnyRAID 110i+Key	5x3.5" HS	Open	HH DVD±RW	None	None	None	TSM	None	3-year	750Wx1 Platinum	09/14
70DG000H++	EMEA	1xE5-2620 v3 6C/2.4GHz/15MB/85W/DDR4-1866	4XG0F28785	1x8GB RDIMM DDR4-2133 ECC	AnyRAID 720ix+1GB Flash	15x3.5" HS	Open	HH DVD±RW	None	None	None	TSM	None	3-year	750Wx1 Platinum	09/14
70DG000M++	EMEA	1xE5-2603 v3 6C/1.6GHz/15MB/85W/DDR4-1600	4XG0F28787	1x8GB RDIMM DDR4-2133 ECC	AnyRAID 110i+Key	5x3.5" HS	Open	HH DVD±RW	None	None	None	TSM	None	3-year	750Wx1 Platinum	09/14
70DG0010++	EMEA	1xE5-2640 v3 8C/2.6GHz/20MB/90W/DDR4-1866	4XG0F28783	1x8GB RDIMM DDR4-2133 ECC	AnyRAID 720ix+1GB RAM	15x3.5" HS	Open	HH DVD±RW	None	None	None	TSM	None	3-year	750Wx1 Platinum	09/14
70DG0024++	EMEA	1xE5-2620 v3 6C/2.4GHz/15MB/85W/DDR4-1866	4XG0F28785	1x8GB RDIMM DDR4-2133 ECC	AnyRAID 720ix+1GB RAM	15x3.5" HS	Open	HH DVD±RW	None	None	None	TSM	None	3-year	750Wx1 Platinum	03/15
70DG002E++	EMEA	1xE5-2609 v3 6C/1.9GHz/15MB/85W/DDR4-1600	4XG0F28786	1x8GB RDIMM DDR4-2133 ECC	AnyRAID 720ix+1GB RAM	15x3.5" HS	Open	HH DVD±RW	None	None	None	TSM	None	3-year	750Wx1 Platinum	03/15
70DG002L++	EMEA	1xE5-2603 v3 6C/1.6GHz/15MB/85W/DDR4-1600	4XG0F28787	1x8GB RDIMM DDR4-2133 ECC	AnyRAID 720ix+1GB RAM	15x3.5" HS	Open	HH DVD±RW	None	None	None	TSM	None	3-year	750Wx1 Platinum	03/15
70DG0061++	EMEA	1xE5-2603 v4 6C/1.7GHz/15MB/85W/DDR4-1866	4XG0G89088	1x8GB RDIMM DDR4-2400 ECC	Onboard 110i	5x3.5" HS	Open	HH DVD±RW	None	None	None	TSM	None	3-year	550Wx1 Platinum	04/16
70DG0062++	EMEA	1xE5-2609 v4 8C/1.7GHz/20MB/85W/DDR4-1866	4XG0G89083	1x8GB RDIMM DDR4-2400 ECC	Onboard 110i	5x3.5" HS	Open	HH DVD±RW	None	None	None	TSM	None	3-year	550Wx1 Platinum	04/16
70DG0063++	EMEA	1xE5-2620 v4 8C/2.1GHz/20MB/85W/DDR4-2133	4XG0G89078	1x8GB RDIMM DDR4-2400 ECC	Onboard 110i	5x3.5" HS	Open	HH DVD±RW	None	None	None	TSM	None	3-year	550Wx1 Platinum	04/16
70DG0064++	EMEA	1xE5-2603 v4 6C/1.7GHz/15MB/85W/DDR4-1866	4XG0G89088	1x8GB RDIMM DDR4-2400 ECC	520i PCIe	5x3.5" HS	Open	HH DVD±RW	None	None	None	TSM	None	3-year	550Wx1 Platinum	04/16
70DG0065++	EMEA	1xE5-2609 v4 8C/1.7GHz/20MB/85W/DDR4-1866	4XG0G89083	1x8GB RDIMM DDR4-2400 ECC	520i PCIe	5x3.5" HS	Open	HH DVD±RW	None	None	None	TSM	None	3-year	550Wx1 Platinum	04/16
70DG0066++	EMEA	1xE5-2620 v4 8C/2.1GHz/20MB/85W/DDR4-2133	4XG0G89078	1x8GB RDIMM DDR4-2400 ECC	520i PCIe	5x3.5" HS	Open	HH DVD±RW	None	None	None	TSM	None	3-year	550Wx1 Platinum	04/16
70DG0067++	EMEA	1xE5-2603 v4 6C/1.7GHz/15MB/85W/DDR4-1866	4XG0G89088	1x16GB RDIMM DDR4-2400 ECC	520i PCIe	5x3.5" HS	Open	HH DVD±RW	None	None	None	TSM	None	3-year	550Wx1 Platinum	04/16
70DG0068++	EMEA	1xE5-2609 v4 8C/1.7GHz/20MB/85W/DDR4-1866	4XG0G89083	1x16GB RDIMM DDR4-2400 ECC	520i PCIe	5x3.5" HS	Open	HH DVD±RW	None	None	None	TSM	None	3-year	550Wx1 Platinum	04/16
70DG0069++	EMEA	1xE5-2620 v4 8C/2.1GHz/20MB/85W/DDR4-2133	4XG0G89078	1x16GB RDIMM DDR4-2400 ECC	520i PCIe	5x3.5" HS	Open	HH DVD±RW	None	None	None	TSM	None	3-year	550Wx1 Platinum	04/16

Model	Region	Processor	2nd CPU	Memory	RAID Controller	Disk Bays	Storage	Optical	Add-on NIC	Add-on Ports	TPM	System Mgmt	OS	Warranty	Power Supply	Ann Date (m/y)
70DG006A++	EMEA	1xE5-2603 v4 6C/1.7GHz/15MB/85W/DDR4-1866	4XG0G89088	1x16GB RDIMM DDR4-2400 ECC	720i PCIe	5x3.5" HS	Open	HH DVD±RW	None	None	None	TSM	None	3-year	550Wx1 Platinum	04/16
70DG006B++	EMEA	1xE5-2609 v4 8C/1.7GHz/20MB/85W/DDR4-1866	4XG0G89083	1x16GB RDIMM DDR4-2400 ECC	720i PCIe	5x3.5" HS	Open	HH DVD±RW	None	None	None	TSM	None	3-year	550Wx1 Platinum	04/16
70DG006C++	EMEA	1xE5-2620 v4 8C/2.1GHz/20MB/85W/DDR4-2133	4XG0G89078	1x16GB RDIMM DDR4-2400 ECC	720i PCIe	5x3.5" HS	Open	HH DVD±RW	None	None	None	TSM	None	3-year	550Wx1 Platinum	04/16
70DG006D++	EMEA	1xE5-2630 v4 10C/2.2GHz/20MB/85W/DDR4-2133	4XG0G89073	1x16GB RDIMM DDR4-2400 ECC	720i PCIe	5x3.5" HS	Open	HH DVD±RW	None	None	None	TSM	None	3-year	550Wx1 Platinum	04/16
70DG006E++	EMEA	1xE5-2603 v4 6C/1.7GHz/15MB/85W/DDR4-1866	4XG0G89088	1x16GB RDIMM DDR4-2400 ECC	720i PCIe+2GB Flash	5x3.5" HS	Open	HH DVD±RW	None	None	None	TSM	None	3-year	550Wx1 Platinum	04/16
70DG006F++	EMEA	1xE5-2609 v4 8C/1.7GHz/20MB/85W/DDR4-1866	4XG0G89083	1x16GB RDIMM DDR4-2400 ECC	720i PCIe+2GB Flash	5x3.5" HS	Open	HH DVD±RW	None	None	None	TSM	None	3-year	550Wx1 Platinum	04/16
70DG006G++	EMEA	1xE5-2620 v4 8C/2.1GHz/20MB/85W/DDR4-2133	4XG0G89078	1x16GB RDIMM DDR4-2400 ECC	720i PCIe+2GB Flash	5x3.5" HS	Open	HH DVD±RW	None	None	None	TSM	None	3-year	550Wx1 Platinum	04/16
70DG006H++	EMEA	1xE5-2630 v4 10C/2.2GHz/20MB/85W/DDR4-2133	4XG0G89073	1x16GB RDIMM DDR4-2400 ECC	720i PCIe+2GB Flash	5x3.5" HS	Open	HH DVD±RW	None	None	None	TSM	None	3-year	550Wx1 Platinum	04/16
70DG006J++	EMEA	1xE5-2609 v4 8C/1.7GHz/20MB/85W/DDR4-1866	4XG0G89083	1x8GB RDIMM DDR4-2400 ECC	AnyRAID 720ix+1GB Flash	15x3.5" HS	Open	HH DVD±RW	None	None	None	TSM	None	3-year	750Wx1 Platinum	04/16
70DG006K++	EMEA	1xE5-2609 v4 8C/1.7GHz/20MB/85W/DDR4-1866	4XG0G89083	1x8GB RDIMM DDR4-2400 ECC	AnyRAID 720ix+2GB Flash	15x3.5" HS	Open	HH DVD±RW	None	None	None	TSM	None	3-year	750Wx1 Platinum	04/16
70DG006L++	EMEA	1xE5-2603 v4 6C/1.7GHz/15MB/85W/DDR4-1866	4XG0G89088	1x8GB RDIMM DDR4-2400 ECC	Onboard 110i	5x3.5" HS	1x1TB HDD 7.2K 3.5" SATA6Gbs	HH DVD±RW	None	None	None	TSM	None	3-year	550Wx1 Platinum	04/16
70DG006M++	EMEA	1xE5-2609 v4 8C/1.7GHz/20MB/85W/DDR4-1866	4XG0G89083	1x8GB RDIMM DDR4-2400 ECC	Onboard 110i	5x3.5" HS	1x1TB HDD 7.2K 3.5" SATA6Gbs	HH DVD±RW	None	None	None	TSM	None	3-year	550Wx1 Platinum	04/16

Model	Region	Processor	2nd CPU	Memory	RAID Controller	Disk Bays	Storage	Optical	Add-on NIC	Add-on Ports	TPM	System Mgmt	OS	Warranty	Power Supply	Ann Date (m/y)
70DJ000B++	EMEA	1xE5-2620 v3 6C/2.4GHz/15MB/85W/DDR4-1866	4XG0F28785	1x8GB RDIMM DDR4-2133 ECC	AnyRAID 720i+1GB Flash	8x2.5" HS	Open	HH DVD±RW	None	None	None	TSM	None	3-year	750Wx1 Platinum	09/14
70DJ000R++	EMEA	1xE5-2630 v3 8C/2.4GHz/20MB/85W/DDR4-1866	4XG0F28784	2x8GB RDIMM DDR4-2133 ECC	AnyRAID 720ix+1GB Flash	16x2.5" HS	Open	HH DVD±RW	None	None	TPM 1.2	TSM Premium	None	3-year	750Wx2 Platinum	09/14
70DJ001G++	EMEA	1xE5-2609 v3 6C/1.9GHz/15MB/85W/DDR4-1600	4XG0F28786	1x8GB RDIMM DDR4-2133 ECC	AnyRAID 720ix+1GB RAM	16x2.5" HS	Open	HH DVD±RW	None	None	None	TSM	None	3-year	750Wx1 Platinum	09/14
70DJ001J++	EMEA	1xE5-2620 v3 6C/2.4GHz/15MB/85W/DDR4-1866	4XG0F28785	1x8GB RDIMM DDR4-2133 ECC	AnyRAID 720ix+1GB RAM	16x2.5" HS	Open	HH DVD±RW	None	None	None	TSM	None	3-year	750Wx1 Platinum	09/14
70DJ001N++	EMEA	1xE5-2640 v3 8C/2.6GHz/20MB/90W/DDR4-1866	4XG0F28783	1x8GB RDIMM DDR4-2133 ECC	AnyRAID 720ix+1GB RAM	16x2.5" HS	Open	HH DVD±RW	None	None	None	TSM	None	3-year	750Wx1 Platinum	09/14
70DJ003G++	EMEA	1xE5-2609 v3 6C/1.9GHz/15MB/85W/DDR4-1600	4XG0F28786	1x8GB RDIMM DDR4-2133 ECC	AnyRAID 720ix+1GB Flash	8x2.5" HS	Open	HH DVD±RW	None	None	None	TSM	None	3-year	750Wx1 Platinum	03/15
70DJ005S++	EMEA	1xE5-2603 v4 6C/1.7GHz/15MB/85W/DDR4-1866	4XG0G89088	1x8GB RDIMM DDR4-2400 ECC	Onboard 110i	8x2.5" HS	Open	HH DVD±RW	None	None	None	TSM	None	3-year	550Wx1 Platinum	04/16
70DJ005T++	EMEA	1xE5-2609 v4 8C/1.7GHz/20MB/85W/DDR4-1866	4XG0G89083	1x8GB RDIMM DDR4-2400 ECC	Onboard 110i	8x2.5" HS	Open	HH DVD±RW	None	None	None	TSM	None	3-year	550Wx1 Platinum	04/16
70DJ005U++	EMEA	1xE5-2620 v4 8C/2.1GHz/20MB/85W/DDR4-2133	4XG0G89078	1x8GB RDIMM DDR4-2400 ECC	Onboard 110i	8x2.5" HS	Open	HH DVD±RW	None	None	None	TSM	None	3-year	550Wx1 Platinum	04/16
70DJ005V++	EMEA	1xE5-2603 v4 6C/1.7GHz/15MB/85W/DDR4-1866	4XG0G89088	1x8GB RDIMM DDR4-2400 ECC	520i PCIe	8x2.5" HS	Open	HH DVD±RW	None	None	None	TSM	None	3-year	550Wx1 Platinum	04/16
70DJ005W++	EMEA	1xE5-2609 v4 8C/1.7GHz/20MB/85W/DDR4-1866	4XG0G89083	1x8GB RDIMM DDR4-2400 ECC	520i PCIe	8x2.5" HS	Open	HH DVD±RW	None	None	None	TSM	None	3-year	550Wx1 Platinum	04/16
70DJ005X++	EMEA	1xE5-2620 v4 8C/2.1GHz/20MB/85W/DDR4-2133	4XG0G89078	1x8GB RDIMM DDR4-2400 ECC	520i PCIe	8x2.5" HS	Open	HH DVD±RW	None	None	None	TSM	None	3-year	550Wx1 Platinum	04/16
70DJ005Y++	EMEA	1xE5-2603 v4 6C/1.7GHz/15MB/85W/DDR4-1866	4XG0G89088	1x16GB RDIMM DDR4-2400 ECC	520i PCIe	8x2.5" HS	Open	HH DVD±RW	None	None	None	TSM	None	3-year	550Wx1 Platinum	04/16
70DJ0060++	EMEA	1xE5-2609 v4 8C/1.7GHz/20MB/85W/DDR4-1866	4XG0G89083	1x16GB RDIMM DDR4-2400 ECC	520i PCIe	8x2.5" HS	Open	HH DVD±RW	None	None	None	TSM	None	3-year	550Wx1 Platinum	04/16
70DJ0061++	EMEA	1xE5-2620 v4 8C/2.1GHz/20MB/85W/DDR4-2133	4XG0G89078	1x16GB RDIMM DDR4-2400 ECC	520i PCIe	8x2.5" HS	Open	HH DVD±RW	None	None	None	TSM	None	3-year	550Wx1 Platinum	04/16
70DJ0062++	EMEA	1xE5-2603 v4 6C/1.7GHz/15MB/85W/DDR4-1866	4XG0G89088	1x16GB RDIMM DDR4-2400 ECC	720i PCIe	8x2.5" HS	Open	HH DVD±RW	None	None	None	TSM	None	3-year	550Wx1 Platinum	04/16
70DJ0063++	EMEA	1xE5-2609 v4 8C/1.7GHz/20MB/85W/DDR4-1866	4XG0G89083	1x16GB RDIMM DDR4-2400 ECC	720i PCIe	8x2.5" HS	Open	HH DVD±RW	None	None	None	TSM	None	3-year	550Wx1 Platinum	04/16

Model	Region	Processor	2nd CPU	Memory	RAID Controller	Disk Bays	Storage	Optical	Add-on NIC	Add-on Ports	TPM	System Mgmt	OS	Warranty	Power Supply	Ann Date (m/y)
70DJ0064++	EMEA	1xE5-2620 v4 8C/2.1GHz/20MB/85W/DDR4-2133	4XG0G89078	1x16GB RDIMM DDR4-2400 ECC	720i PCIe	8x2.5" HS	Open	HH DVD±RW	None	None	None	TSM	None	3-year	550Wx1 Platinum	04/16
70DJ0065++	EMEA	1xE5-2630 v4 10C/2.2GHz/20MB/85W/DDR4-2133	4XG0G89073	1x16GB RDIMM DDR4-2400 ECC	720i PCIe	8x2.5" HS	Open	HH DVD±RW	None	None	None	TSM	None	3-year	550Wx1 Platinum	04/16
70DJ0066++	EMEA	1xE5-2603 v4 6C/1.7GHz/15MB/85W/DDR4-1866	4XG0G89088	1x16GB RDIMM DDR4-2400 ECC	AnyRAID 720ix+2GB Flash	16x2.5" HS	Open	HH DVD±RW	None	None	None	TSM	None	3-year	750Wx1 Platinum	04/16
70DJ0067++	EMEA	1xE5-2609 v4 8C/1.7GHz/20MB/85W/DDR4-1866	4XG0G89083	1x16GB RDIMM DDR4-2400 ECC	AnyRAID 720ix+2GB Flash	16x2.5" HS	Open	HH DVD±RW	None	None	None	TSM	None	3-year	750Wx1 Platinum	04/16
70DJ0068++	EMEA	1xE5-2620 v4 8C/2.1GHz/20MB/85W/DDR4-2133	4XG0G89078	1x16GB RDIMM DDR4-2400 ECC	AnyRAID 720ix+2GB Flash	16x2.5" HS	Open	HH DVD±RW	None	None	None	TSM	None	3-year	750Wx1 Platinum	04/16
70DJ0069++	EMEA	1xE5-2630 v4 10C/2.2GHz/20MB/85W/DDR4-2133	4XG0G89073	1x16GB RDIMM DDR4-2400 ECC	AnyRAID 720ix+2GB Flash	16x2.5" HS	Open	HH DVD±RW	None	None	None	TSM	None	3-year	750Wx1 Platinum	04/16
70DJ006A++	EMEA	1xE5-2640 v4 10C/2.4GHz/25MB/90W/DDR4-2133	4XG0G89068	1x16GB RDIMM DDR4-2400 ECC	720i PCIe	8x2.5" HS	Open	HH DVD±RW	None	None	None	TSM	None	3-year	550Wx1 Platinum	04/16
70DJ006B++	EMEA	1xE5-2650 v4 12C/2.2GHz/30MB/105W/DDR4-2400	4XG0G89063	1x16GB RDIMM DDR4-2400 ECC	720i PCIe	8x2.5" HS	Open	HH DVD±RW	None	None	None	TSM	None	3-year	550Wx1 Platinum	04/16
70DJ006C++	EMEA	1xE5-2640 v4 10C/2.4GHz/25MB/90W/DDR4-2133	4XG0G89068	1x16GB RDIMM DDR4-2400 ECC	AnyRAID 720ix+2GB Flash	16x2.5" HS	Open	HH DVD±RW	None	None	None	TSM	None	3-year	750Wx1 Platinum	04/16
70DJ006D++	EMEA	1xE5-2650 v4 12C/2.2GHz/30MB/105W/DDR4-2400	4XG0G89063	1x16GB RDIMM DDR4-2400 ECC	AnyRAID 720ix+2GB Flash	16x2.5" HS	Open	HH DVD±RW	None	None	None	TSM	None	3-year	750Wx1 Platinum	04/16
70DJ006E++	EMEA	1xE5-2620 v4 8C/2.1GHz/20MB/85W/DDR4-2133	4XG0G89078	1x16GB RDIMM DDR4-2400 ECC	720i PCIe+2GB Flash	8x2.5" HS	2x300GB HDD 10K 2.5" SAS12Gbs	HH DVD±RW	None	None	None	TSM	None	3-year	550Wx1 Platinum	04/16
70DJ006F++	EMEA	1xE5-2620 v4 8C/2.1GHz/20MB/85W/DDR4-2133	4XG0G89078	1x16GB RDIMM DDR4-2400 ECC	720i PCIe+2GB Flash	8x2.5" HS	2x600GB HDD 10K 2.5" SAS12Gbs	HH DVD±RW	None	None	None	TSM	None	3-year	550Wx1 Platinum	04/16
70DJ006G++	EMEA	1xE5-2620 v4 8C/2.1GHz/20MB/85W/DDR4-2133	4XG0G89078	1x16GB RDIMM DDR4-2400 ECC	720i PCIe+2GB Flash	8x2.5" HS	2x300GB HDD 10K 2.5" SAS12Gbs	HH DVD±RW	None	None	None	TSM	None	3-year	550Wx2 Platinum	04/16
70DJ006H++	EMEA	1xE5-2620 v4 8C/2.1GHz/20MB/85W/DDR4-2133	4XG0G89078	1x16GB RDIMM DDR4-2400 ECC	720i PCIe+2GB Flash	8x2.5" HS	2x600GB HDD 10K 2.5" SAS12Gbs	HH DVD±RW	None	None	None	TSM	None	3-year	550Wx2 Platinum	04/16
70DJ006J++	EMEA	1xE5-2620 v4 8C/2.1GHz/20MB/85W/DDR4-2133	4XG0G89078	1x16GB RDIMM DDR4-2400 ECC	720i PCIe+2GB Flash	8x2.5" HS	Open	HH DVD±RW	None	None	None	TSM	None	3-year	550Wx1 Platinum	04/16
70DJ006K++	EMEA	1xE5-2620 v4 8C/2.1GHz/20MB/85W/DDR4-2133	4XG0G89078	1x8GB RDIMM DDR4-2400 ECC	720i PCIe+2GB Flash	8x2.5" HS	2x300GB HDD 10K 2.5" SAS12Gbs	HH DVD±RW	None	None	None	TSM	None	3-year	550Wx1 Platinum	04/16
70DJ006L++	EMEA	1xE5-2609 v4 8C/1.7GHz/20MB/85W/DDR4-1866	4XG0G89083	1x8GB RDIMM DDR4-2400 ECC	720i PCIe+2GB Flash	8x2.5" HS	Open	HH DVD±RW	None	None	None	TSM	None	3-year	550Wx1 Platinum	04/16

Model	Region	Processor	2nd CPU	Memory	RAID Controller	Disk Bays	Storage	Optical	Add-on NIC	Add-on Ports	TPM	System Mgmt	OS	Warranty	Power Supply	Ann Date (m/y)
70DJ006M++	EMEA	1xE5-2620 v4 8C/2.1GHz/20MB/85W/DDR4-2133	4XG0G89078	1x8GB RDIMM DDR4-2400 ECC	720i PCIe+2GB Flash	8x2.5" HS	Open	HH DVD±RW	None	None	None	TSM	None	3-year	550Wx1 Platinum	04/16



ThinkServer TS140 Platform Specifications

Product Specifications Reference (PSREF)

Components	Specification
Dimensions	Tower or 4U rack. Height: 375 mm (14.76 in), width: 175 mm (6.89 in), depth: 431 mm (16.97 in)
Weight	Maximum configuration: 28.66 lb (13kg)
Processor	Supports one of the following Intel processors (code name: Haswell): <ul style="list-style-type: none"> Xeon E3-1200 v3: up to 4C/3.7GHz/8MB/84W/1600MHz Core i3: up to 2C/3.7GHz/4MB/54W/1600MHz Pentium: up to 2C/3.4GHz/3MB/53W/1600MHz Celeron: up to 2C/2.9GHz/2MB/53W/1333MHz
Chipset	Intel C226 Platform Controller Hub (PCH)
Memory DIMMs	4 DIMM sockets, 2-channel capable. UDIMM, DDR3, up to 1600MHz
Memory capacity	32GB
Memory protection	ECC
RAID controller	Supports one of the following onboard or PCIe RAID adapters <ul style="list-style-type: none"> RAID 0, 1, 5, 10 with onboard RAID 100, 6Gb/s SATA. RAID 0, 1, 10 with RAID 500, PCIe adapter, 6Gb/s SAS/SATA, optional key for RAID5. RAID 0, 1, 5, 10 with RAID 700, PCIe adapter, 6Gb/s SAS/SATA
Disk drive bays	Two external 5.25" bays, two internal 3.5" bays (see right). Up to one 9.5mm optical plus 4 3.5" or 2.5" disk drives. Supports internal RDX tape drive, consumes 5.25" bay, also support optional external USB RDX tape drive. All disk drive bays are direct cabled, non-hot swap
Maximum internal storage	Up to 24TB with 7.2K SATA HDD, up to 16TB with 7.2K SAS HDD, up to 1.92TB with SATA SSD
Optical drive	Two 5.25" bays for optical. DVD-ROM or DVD±RW. Half-height or 9.5mm
Network interfaces	One onboard gigabit ethernet, Intel I217, shared with AMT. Supports optional discrete network adapters via PCIe slots
Security features	Power-on and administrator password. TPM (TCG 1.2-compliant). Optional padlock loop, Kensington cable lock
Systems management	Intel Active Management Technology 9 on models with Xeon processors. Intel Standard Manageability on models with Core i3, Pentium, or Celeron processors. KVM is supported on models with Xeon E3-12x5 v3 processors
Operating systems supported	Microsoft Windows Server 2012 R2/2012/2008 R2. Windows Small Business Server 2011. Windows 8.1/8/7(except Home edition). Red Hat Enterprise Linux 6.5/6.7/7/7.1. SUSE Linux Enterprise Server 11 SP4. VMware vSphere (ESXi) 5.1 U2/5.5 U1/5.5 U2/5.5 U3 <i>Note: VMware requires processors with Intel HD, add-on network adapters, and PCIe RAID adapters</i>
Base warranty	1 or 3-year limited onsite service with 9x5/NBD.
Power supply	Supports one of the following: <ul style="list-style-type: none"> One fixed 280 watts, autosensing, 85%, 80 PLUS Bronze qualified One fixed 450 watts, autosensing, 92%, 80 PLUS Platinum qualified
Graphics	Integrated Intel HD Graphics on Xeon E3-12x6 v3, Xeon E3-12x5 v3, Core i3, Pentium, and Celeron processors. Uses main memory, works along with discrete graphics to support multi-display, enables three display connectors (2 DP, 1 VGA) on rear ports. Also supports the following optional discrete graphics adapters: <ul style="list-style-type: none"> NVIDIA Quadro NVS 300, PCIe adapter, 512MB NVIDIA Quadro K600, PCIe adapter, 1GB

Components	Specification	
Front ports	Two USB 3.0 (blue)	
Rear ports	1 VGA and 2 DisplayPort (for Intel HD Graphics models only), two USB 2.0, four USB 3.0 (blue), one serial (9-pin), one ethernet (RJ-45), three analog audio ports (line-in, line-out, mic-in). Optional parallel or serial ports via PCI or PCIe adapters	
Noise emissions	Operating: < 35 dB(A). Idle: < 34 dB(A) (Maximum configuration) GREENGUARD certified, Energy Star Server 1.1 qualified, RoHS-compliant	
Environmental specification	Temperature - operating	50 °F to 95 °F (10 °C to 35 °C)
	Temperature - storage (with package)	-40 °C to 70 °C
	Altitude - operating	Supported Altitude (unpressurized): 0-10000ft (0-3048m)
	Humidity - operating	10%-80%, non-condensing
	Humidity - storage (with package)	10%-90%, non-condensing

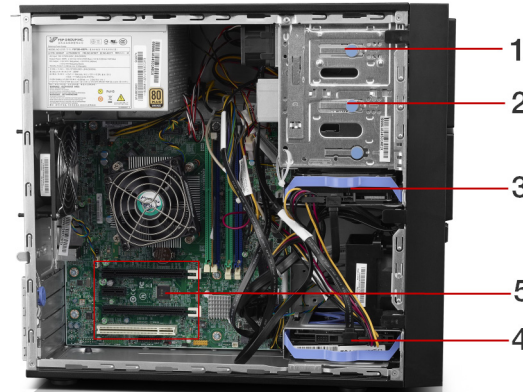

Drive Bays and PCIe Slots

Bay 1	5.25", supports one of the following: HH optical, 9.5mm optical+3.5"/2.5" drive
Bay 2	5.25", supports one of the following: 3.5"/2.5" drive, tape drive
Bay 3	Standard 3.5"/2.5" disk drive bay
Bay 4	Standard 3.5"/2.5" disk drive bay
5 -Slots	Four PCIe slots (top-down):
	Slot 1: PCIe 3.0 x16, full height, half length (near CPU)
	Slot 2: PCIe 2.0 x1, full height, half length
	Slot 3: PCIe 2.0 x16 (x4 elec), full height, half length
	Slot 4: PCI 2.3, full height, half length

Model	Region	Processor	Memory	RAID Controller	Disk Bays	Storage	Optical	Add-on NIC	Add-on Ports	System Management	Operating System	Warranty	Power Supply	Ann Date (mm/yy)
70A4000K++	EMEA	Pentium G3220 2C/3GHz/3MB/53W/DDR3-1333	1x4GB UDIMM DDR3-1600 ECC	RAID 100	4x3.5" DC	2x500GB HDD 7.2K 3.5" SATA6Gbs	9.5mm DVD±RW	None	None	ISM	None	1-year	280W 85% Fixed	09/13
70A4000L++	EMEA	Pentium G3220 2C/3GHz/3MB/53W/DDR3-1333	1x4GB UDIMM DDR3-1600 ECC	RAID 100	4x3.5" DC	1x500GB HDD 7.2K 3.5" SATA6Gbs	9.5mm DVD±RW	None	None	ISM	None	1-year	280W 85% Fixed	09/13
70A4000M++	EMEA	Xeon E3-1225 v3 4C/3.2GHz/8MB/84W/DDR3-1600	1x4GB UDIMM DDR3-1600 ECC	RAID 100	4x3.5" DC	1x500GB HDD 7.2K 3.5" SATA6Gbs	9.5mm DVD±RW	None	None	AMT	None	1-year	280W 85% Fixed	09/13
70A4000N++	EMEA	Xeon E3-1225 v3 4C/3.2GHz/8MB/84W/DDR3-1600	1x8GB UDIMM DDR3-1600 ECC	RAID 100	4x3.5" DC	2x500GB HDD 7.2K 3.5" SATA6Gbs	9.5mm DVD±RW	None	None	AMT	None	1-year	280W 85% Fixed	09/13
70A4000P++	EMEA	Xeon E3-1225 v3 4C/3.2GHz/8MB/84W/DDR3-1600	2x8GB UDIMM DDR3-1600 ECC	RAID 100	4x3.5" DC	2x1TB HDD 7.2K 3.5" SATA6Gbs	9.5mm DVD±RW	None	None	AMT	None	1-year	280W 85% Fixed	09/13
70A4000Q++	EMEA	Xeon E3-1225 v3 4C/3.2GHz/8MB/84W/DDR3-1600	1x4GB UDIMM DDR3-1600 ECC	RAID 100	4x3.5" DC	2x500GB HDD 7.2K 3.5" SATA6Gbs	9.5mm DVD±RW	None	None	AMT	None	1-year	280W 85% Fixed	09/13
70A4000R++	EMEA	Core i3-4330 2C/3.5GHz/4MB/54W/DDR3-1600	1x4GB UDIMM DDR3-1600 ECC	RAID 100	4x3.5" DC	1x500GB HDD 7.2K 3.5" SATA6Gbs	9.5mm DVD±RW	None	None	ISM	None	1-year	280W 85% Fixed	09/13
70A4000S++	EMEA	Core i3-4330 2C/3.5GHz/4MB/54W/DDR3-1600	1x8GB UDIMM DDR3-1600 ECC	RAID 100	4x3.5" DC	2x500GB HDD 7.2K 3.5" SATA6Gbs	9.5mm DVD±RW	None	None	ISM	None	1-year	280W 85% Fixed	09/13
70A4000T++	EMEA	Core i3-4330 2C/3.5GHz/4MB/54W/DDR3-1600	1x4GB UDIMM DDR3-1600 ECC	RAID 100	4x3.5" DC	1x1TB HDD 7.2K 3.5" SATA6Gbs	9.5mm DVD±RW	None	None	ISM	None	1-year	280W 85% Fixed	09/13
70A4000U++	EMEA	Core i3-4330 2C/3.5GHz/4MB/54W/DDR3-1600	1x4GB UDIMM DDR3-1600 ECC	RAID 100	4x3.5" DC	Open	9.5mm DVD±RW	None	None	ISM	None	1-year	280W 85% Fixed	09/13
70A4000V++	EMEA	Xeon E3-1225 v3 4C/3.2GHz/8MB/84W/DDR3-1600	1x4GB UDIMM DDR3-1600 ECC	RAID 100	4x3.5" DC	Open	9.5mm DVD±RW	None	None	AMT	None	1-year	280W 85% Fixed	09/13
70A4001K++	EMEA	Pentium G3220 2C/3GHz/3MB/53W/DDR3-1333	1x4GB UDIMM DDR3-1600 ECC	RAID 100	4x3.5" DC	Open	9.5mm DVD±RW	None	None	ISM	None	1-year	280W 85% Fixed	09/13
70A4002L++	EMEA	Pentium G3220 2C/3GHz/3MB/53W/DDR3-1333	1x4GB UDIMM DDR3-1600 ECC	RAID 100	4x3.5" DC	2x500GB HDD 7.2K 3.5" SATA6Gbs	9.5mm DVD±RW	None	None	ISM	None	1-year	280W 85% Fixed	01/14
70A4002M++	EMEA	Pentium G3220 2C/3GHz/3MB/53W/DDR3-1333	1x4GB UDIMM DDR3-1600 ECC	RAID 100	4x3.5" DC	1x500GB HDD 7.2K 3.5" SATA6Gbs	9.5mm DVD±RW	None	None	ISM	None	1-year	280W 85% Fixed	01/14
70A4002N++	EMEA	Xeon E3-1225 v3 4C/3.2GHz/8MB/84W/DDR3-1600	1x4GB UDIMM DDR3-1600 ECC	RAID 100	4x3.5" DC	1x500GB HDD 7.2K 3.5" SATA6Gbs	9.5mm DVD±RW	None	None	AMT	None	1-year	280W 85% Fixed	01/14
70A4002P++	EMEA	Xeon E3-1225 v3 4C/3.2GHz/8MB/84W/DDR3-1600	1x8GB UDIMM DDR3-1600 ECC	RAID 100	4x3.5" DC	2x500GB HDD 7.2K 3.5" SATA6Gbs	9.5mm DVD±RW	None	None	AMT	None	1-year	280W 85% Fixed	01/14
70A4002Q++	EMEA	Xeon E3-1225 v3 4C/3.2GHz/8MB/84W/DDR3-1600	2x8GB UDIMM DDR3-1600 ECC	RAID 100	4x3.5" DC	2x1TB HDD 7.2K 3.5" SATA6Gbs	9.5mm DVD±RW	None	None	AMT	None	1-year	280W 85% Fixed	01/14

Model	Region	Processor	Memory	RAID Controller	Disk Bays	Storage	Optical	Add-on NIC	Add-on Ports	System Management	Operating System	Warranty	Power Supply	Ann Date (mm/yy)
70A4002R++	EMEA	Xeon E3-1225 v3 4C/3.2GHz/8MB/84W/DDR3-1600	1x4GB UDIMM DDR3-1600 ECC	RAID 100	4x3.5" DC	2x500GB HDD 7.2K 3.5" SATA6Gbs	9.5mm DVD±RW	None	None	AMT	None	1-year	280W 85% Fixed	01/14
70A4002S++	EMEA	Core i3-4330 2C/3.5GHz/4MB/54W/DDR3-1600	1x4GB UDIMM DDR3-1600 ECC	RAID 100	4x3.5" DC	1x500GB HDD 7.2K 3.5" SATA6Gbs	9.5mm DVD±RW	None	None	ISM	None	1-year	280W 85% Fixed	01/14
70A4002T++	EMEA	Core i3-4330 2C/3.5GHz/4MB/54W/DDR3-1600	1x8GB UDIMM DDR3-1600 ECC	RAID 100	4x3.5" DC	2x500GB HDD 7.2K 3.5" SATA6Gbs	9.5mm DVD±RW	None	None	ISM	None	1-year	280W 85% Fixed	01/14
70A4002U++	EMEA	Core i3-4330 2C/3.5GHz/4MB/54W/DDR3-1600	1x4GB UDIMM DDR3-1600 ECC	RAID 100	4x3.5" DC	1x1TB HDD 7.2K 3.5" SATA6Gbs	9.5mm DVD±RW	None	None	ISM	None	1-year	280W 85% Fixed	01/14
70A4002V++	EMEA	Core i3-4330 2C/3.5GHz/4MB/54W/DDR3-1600	1x4GB UDIMM DDR3-1600 ECC	RAID 100	4x3.5" DC	Open	9.5mm DVD±RW	None	None	ISM	None	1-year	280W 85% Fixed	01/14
70A4002W++	EMEA	Xeon E3-1225 v3 4C/3.2GHz/8MB/84W/DDR3-1600	1x4GB UDIMM DDR3-1600 ECC	RAID 100	4x3.5" DC	Open	9.5mm DVD±RW	None	None	AMT	None	1-year	280W 85% Fixed	01/14
70A4002X++	EMEA	Pentium G3220 2C/3GHz/3MB/53W/DDR3-1333	1x4GB UDIMM DDR3-1600 ECC	RAID 100	4x3.5" DC	Open	9.5mm DVD±RW	None	None	ISM	None	1-year	280W 85% Fixed	01/14
70A4003A++	EMEA	Xeon E3-1226 v3 4C/3.3GHz/8MB/84W/DDR3-1600	1x4GB UDIMM DDR3-1600 ECC	RAID 100	4x3.5" DC	Open	9.5mm DVD±RW	None	None	AMT	None	1-year	280W 85% Fixed	09/14
70A4003J++	EMEA	Xeon E3-1226 v3 4C/3.3GHz/8MB/84W/DDR3-1600	1x4GB UDIMM DDR3-1600 ECC	RAID 100	4x3.5" DC	1x1TB HDD 7.2K 3.5" SATA6Gbs	9.5mm DVD±RW	None	None	AMT	None	1-year	280W 85% Fixed	09/14
70A4003K++	EMEA	Pentium G3240 2C/3.1GHz/3MB/53W/DDR3-1333	1x4GB UDIMM DDR3-1600 ECC	RAID 100	4x3.5" DC	Open	9.5mm DVD±RW	None	None	ISM	None	1-year	280W 85% Fixed	09/14
70A4003L++	EMEA	Core i3-4350 2C/3.6GHz/4MB/54W/DDR3-1600	1x8GB UDIMM DDR3-1600 ECC	RAID 100	4x3.5" DC	2x1TB HDD 7.2K 3.5" SATA6Gbs	9.5mm DVD±RW	None	None	ISM	None	1-year	280W 85% Fixed	09/14
70A4003M++	EMEA	Xeon E3-1226 v3 4C/3.3GHz/8MB/84W/DDR3-1600	1x8GB UDIMM DDR3-1600 ECC	RAID 100	4x3.5" DC	2x1TB HDD 7.2K 3.5" SATA6Gbs	9.5mm DVD±RW	None	None	AMT	None	1-year	280W 85% Fixed	09/14
70A4003N++	EMEA	Xeon E3-1226 v3 4C/3.3GHz/8MB/84W/DDR3-1600	1x4GB UDIMM DDR3-1600 ECC	RAID 100	4x3.5" DC	2x1TB HDD 7.2K 3.5" SATA6Gbs	9.5mm DVD±RW	None	None	AMT	None	1-year	280W 85% Fixed	09/14
70A4003P++	EMEA	Pentium G3240 2C/3.1GHz/3MB/53W/DDR3-1333	1x4GB UDIMM DDR3-1600 ECC	RAID 100	4x3.5" DC	1x1TB HDD 7.2K 3.5" SATA6Gbs	9.5mm DVD±RW	None	None	ISM	None	1-year	280W 85% Fixed	09/14
70A4003Q++	EMEA	Xeon E3-1226 v3 4C/3.3GHz/8MB/84W/DDR3-1600	2x8GB UDIMM DDR3-1600 ECC	RAID 100	4x3.5" DC	2x1TB HDD 7.2K 3.5" SATA6Gbs	9.5mm DVD±RW	None	None	AMT	None	1-year	280W 85% Fixed	09/14
70A4003R++	EMEA	Core i3-4350 2C/3.6GHz/4MB/54W/DDR3-1600	1x4GB UDIMM DDR3-1600 ECC	RAID 100	4x3.5" DC	Open	9.5mm DVD±RW	None	None	ISM	None	1-year	280W 85% Fixed	09/14
70A4003S++	EMEA	Pentium G3240 2C/3.1GHz/3MB/53W/DDR3-1333	1x4GB UDIMM DDR3-1600 ECC	RAID 100	4x3.5" DC	2x1TB HDD 7.2K 3.5" SATA6Gbs	9.5mm DVD±RW	None	None	ISM	None	1-year	280W 85% Fixed	03/15

Model	Region	Processor	Memory	RAID Controller	Disk Bays	Storage	Optical	Add-on NIC	Add-on Ports	System Management	Operating System	Warranty	Power Supply	Ann Date (mm/yy)
70A4003T++	EMEA	Core i3-4350 2C/3.6GHz/4MB/54W/DDR3-1600	1x4GB UDIMM DDR3-1600 ECC	RAID 100	4x3.5" DC	1x1TB HDD 7.2K 3.5" SATA6Gbs	9.5mm DVD±RW	None	None	ISM	None	1-year	280W 85% Fixed	03/15
70A4003U++	EMEA	Celeron G1850 2C/2.9GHz/2MB/53W/DDR3-1333	1x4GB UDIMM DDR3-1600 ECC	RAID 100	4x3.5" DC	Open	9.5mm DVD±RW	None	None	ISM	None	1-year	280W 85% Fixed	03/15
70A4006D++	EMEA	Pentium G3240 2C/3.1GHz/3MB/53W/DDR3-1333	1x4GB UDIMM DDR3-1600 ECC	RAID 100	3x3.5" DC	2x1TB HDD 7.2K 3.5" SATA6Gbs	HH DVD±RW	None	None	ISM	None	1-year	280W 85% Fixed	12/14
70A4007H++	EMEA	Xeon E3-1226 v3 4C/3.3GHz/8MB/84W/DDR3-1600	2x8GB UDIMM DDR3-1600 ECC	RAID 100	4x3.5" DC	2x1TB HDD 7.2K 3.5" SATA6Gbs	9.5mm DVD±RW	None	None	AMT	None	3-year	280W 85% Fixed	10/15
70A4007J++	EMEA	Pentium G3260 2C/3.3GHz/3MB/53W/DDR3-1333	1x4GB UDIMM DDR3-1600 ECC	RAID 100	3x3.5" DC	Open	HH DVD	None	1xSerial	ISM	None	1-year	280W 85% Fixed	10/15
70A4007K++	EMEA	Pentium G3260 2C/3.3GHz/3MB/53W/DDR3-1333	1x4GB UDIMM DDR3-1600 ECC	RAID 100	3x3.5" DC	Open	HH DVD	None	2xSerial	ISM	None	1-year	280W 85% Fixed	10/15
70A4007L++	EMEA	Pentium G3260 2C/3.3GHz/3MB/53W/DDR3-1333	1x4GB UDIMM DDR3-1600 ECC	RAID 100	3x3.5" DC	Open	HH DVD	None	None	ISM	None	1-year	280W 85% Fixed	10/15
70A4007X++	EMEA	Xeon E3-1246 v3 4C/3.5GHz/8MB/84W/DDR3-1600	2x8GB UDIMM DDR3-1600 ECC	RAID 100	4x3.5" DC	Open	None	1xGbE	None	AMT	None	1-year	280W 85% Fixed	03/16
70A4007Y++	EMEA	Xeon E3-1276 v3 4C/3.6GHz/8MB/84W/DDR3-1600	4x8GB UDIMM DDR3-1600 ECC	RAID 100	4x3.5" DC	Open	None	1xGbE	None	AMT	None	1-year	280W 85% Fixed	03/16

Model	Region	Processor	Memory	RAID Controller	Disk Bays	Storage	Optical	Add-on NIC	Add-on Ports	System Management	Operating System	Warranty	Power Supply	Ann Date (mm/yy)
70A50000++	EMEA	Xeon E3-1225 v3 4C/3.2GHz/8MB/84W/DDR3-1600	1x4GB UDIMM DDR3-1600 ECC	RAID 100	4x3.5" DC	2x500GB HDD 7.2K 3.5" SATA6Gbs	9.5mm DVD±RW	None	None	AMT	2012 Foundations	1-year	450W 92% Fixed	09/13
70A50001++	EMEA	Xeon E3-1225 v3 4C/3.2GHz/8MB/84W/DDR3-1600	1x4GB UDIMM DDR3-1600 ECC	RAID 100	4x3.5" DC	2x500GB HDD 7.2K 3.5" SATA6Gbs	9.5mm DVD±RW	None	None	AMT	2012 Foundations	3-year	450W 92% Fixed	09/13
70A50005++	EMEA	Xeon E3-1225 v3 4C/3.2GHz/8MB/84W/DDR3-1600	2x4GB UDIMM DDR3-1600 ECC	RAID 100	4x3.5" DC	2x500GB HDD 7.2K 3.5" SATA6Gbs	9.5mm DVD±RW	None	None	AMT	2012 Foundations	3-year	450W 92% Fixed	09/13
70A50007++	EMEA	Xeon E3-1225 v3 4C/3.2GHz/8MB/84W/DDR3-1600	1x4GB UDIMM DDR3-1600 ECC	RAID 100	4x3.5" DC	2x500GB HDD 7.2K 3.5" SATA6Gbs	9.5mm DVD±RW	None	None	AMT	2012 Essentials	3-year	450W 92% Fixed	09/13
70A50008++	EMEA	Xeon E3-1225 v3 4C/3.2GHz/8MB/84W/DDR3-1600	1x4GB UDIMM DDR3-1600 ECC	RAID 100	4x3.5" DC	2x1TB HDD 7.2K 3.5" SATA6Gbs	9.5mm DVD±RW	None	None	AMT	2012 Foundations	3-year	450W 92% Fixed	09/13
70A5000H++	EMEA	Xeon E3-1225 v3 4C/3.2GHz/8MB/84W/DDR3-1600	1x4GB UDIMM DDR3-1600 ECC	RAID 100	4x3.5" DC	Open	9.5mm DVD±RW	None	None	AMT	None	1-year	450W 92% Fixed	09/13
70A5000J++	EMEA	Xeon E3-1225 v3 4C/3.2GHz/8MB/84W/DDR3-1600	1x4GB UDIMM DDR3-1600 ECC	RAID 100	4x3.5" DC	Open	9.5mm DVD±RW	None	None	AMT	None	3-year	450W 92% Fixed	09/13
70A5000K++	EMEA	Xeon E3-1225 v3 4C/3.2GHz/8MB/84W/DDR3-1600	1x4GB UDIMM DDR3-1600 ECC	RAID 100	4x3.5" DC	1x500GB HDD 7.2K 3.5" SATA6Gbs	9.5mm DVD±RW	None	None	AMT	None	1-year	450W 92% Fixed	09/13
70A5000P++	EMEA	Xeon E3-1225 v3 4C/3.2GHz/8MB/84W/DDR3-1600	1x4GB UDIMM DDR3-1600 ECC	RAID 100	4x3.5" DC	2x500GB HDD 7.2K 3.5" SATA6Gbs	9.5mm DVD±RW	None	None	AMT	2012 Foundations	1-year	450W 92% Fixed	09/13
70A5000Q++	EMEA	Xeon E3-1225 v3 4C/3.2GHz/8MB/84W/DDR3-1600	1x4GB UDIMM DDR3-1600 ECC	RAID 100	4x3.5" DC	2x500GB HDD 7.2K 3.5" SATA6Gbs	9.5mm DVD±RW	None	None	AMT	2012 Foundations	3-year	450W 92% Fixed	09/13
70A5000R++	EMEA	Xeon E3-1225 v3 4C/3.2GHz/8MB/84W/DDR3-1600	2x4GB UDIMM DDR3-1600 ECC	RAID 100	4x3.5" DC	2x500GB HDD 7.2K 3.5" SATA6Gbs	9.5mm DVD±RW	None	None	AMT	2012 Foundations	3-year	450W 92% Fixed	09/13
70A5000S++	EMEA	Xeon E3-1225 v3 4C/3.2GHz/8MB/84W/DDR3-1600	1x4GB UDIMM DDR3-1600 ECC	RAID 100	4x3.5" DC	2x500GB HDD 7.2K 3.5" SATA6Gbs	9.5mm DVD±RW	None	None	AMT	2012 Essentials	3-year	450W 92% Fixed	09/13
70A5000T++	EMEA	Xeon E3-1225 v3 4C/3.2GHz/8MB/84W/DDR3-1600	1x4GB UDIMM DDR3-1600 ECC	RAID 100	4x3.5" DC	2x1TB HDD 7.2K 3.5" SATA6Gbs	9.5mm DVD±RW	None	None	AMT	2012 Foundations	3-year	450W 92% Fixed	09/13
70A5000V++	EMEA	Xeon E3-1225 v3 4C/3.2GHz/8MB/84W/DDR3-1600	1x4GB UDIMM DDR3-1600 ECC	RAID 100	4x3.5" DC	2x500GB HDD 7.2K 3.5" SATA6Gbs	9.5mm DVD	None	None	AMT	2012 Foundations	1-year	450W 92% Fixed	09/13
70A5000W++	EMEA	Xeon E3-1245 v3 4C/3.4GHz/8MB/84W/DDR3-1600	1x4GB UDIMM DDR3-1600 ECC	RAID 100	4x3.5" DC	2x500GB HDD 7.2K 3.5" SATA6Gbs	9.5mm DVD±RW	None	None	AMT	None	3-year	450W 92% Fixed	09/13
70A5000X++	EMEA	Xeon E3-1245 v3 4C/3.4GHz/8MB/84W/DDR3-1600	1x4GB UDIMM DDR3-1600 ECC	RAID 100	4x3.5" DC	2x500GB HDD 7.2K 3.5" SATA6Gbs	9.5mm DVD±RW	None	None	AMT	None	1-year	450W 92% Fixed	09/13
70A5000Y++	EMEA	Xeon E3-1275 v3 4C/3.5GHz/8MB/84W/DDR3-1600	2x4GB UDIMM DDR3-1600 ECC	RAID 100	4x3.5" DC	2x1TB HDD 7.2K 3.5" SATA6Gbs	9.5mm DVD±RW	None	None	AMT	None	3-year	450W 92% Fixed	09/13

Model	Region	Processor	Memory	RAID Controller	Disk Bays	Storage	Optical	Add-on NIC	Add-on Ports	System Management	Operating System	Warranty	Power Supply	Ann Date (mm/yy)
70A50010++	EMEA	Xeon E3-1225 v3 4C/3.2GHz/8MB/84W/DDR3-1600	2x4GB UDIMM DDR3-1600 ECC	RAID 100	4x3.5" DC	2x500GB HDD 7.2K 3.5" SATA6Gbs	9.5mm DVD±RW	None	None	AMT	None	3-year	450W 92% Fixed	09/13
70A50011++	EMEA	Xeon E3-1225 v3 4C/3.2GHz/8MB/84W/DDR3-1600	1x4GB UDIMM DDR3-1600 ECC	RAID 100	4x3.5" DC	2x500GB HDD 7.2K 3.5" SATA6Gbs	9.5mm DVD±RW	None	None	AMT	None	3-year	450W 92% Fixed	09/13
70A50012++	EMEA	Xeon E3-1225 v3 4C/3.2GHz/8MB/84W/DDR3-1600	1x4GB UDIMM DDR3-1600 ECC	RAID 100	4x3.5" DC	2x500GB HDD 7.2K 3.5" SATA6Gbs	9.5mm DVD±RW	None	None	AMT	None	1-year	450W 92% Fixed	09/13
70A50013++	EMEA	Xeon E3-1225 v3 4C/3.2GHz/8MB/84W/DDR3-1600	1x4GB UDIMM DDR3-1600 ECC	RAID 100	4x3.5" DC	2x1TB HDD 7.2K 3.5" SATA6Gbs	9.5mm DVD±RW	None	None	AMT	None	3-year	450W 92% Fixed	09/13
70A50014++	EMEA	Xeon E3-1275 v3 4C/3.5GHz/8MB/84W/DDR3-1600	2x4GB UDIMM DDR3-1600 ECC	RAID 100	4x3.5" DC	Open	9.5mm DVD±RW	None	None	AMT	None	3-year	450W 92% Fixed	09/13
70A50015++	EMEA	Xeon E3-1225 v3 4C/3.2GHz/8MB/84W/DDR3-1600	1x4GB UDIMM DDR3-1600 ECC	RAID 100	4x3.5" DC	1x500GB HDD 7.2K 3.5" SATA6Gbs	9.5mm DVD±RW	None	None	AMT	None	1-year	450W 92% Fixed	01/14
70A50016++	EMEA	Xeon E3-1225 v3 4C/3.2GHz/8MB/84W/DDR3-1600	2x4GB UDIMM DDR3-1600 ECC	RAID 100	4x3.5" DC	2x500GB HDD 7.2K 3.5" SATA6Gbs	9.5mm DVD±RW	None	None	AMT	None	3-year	450W 92% Fixed	01/14
70A50017++	EMEA	Xeon E3-1225 v3 4C/3.2GHz/8MB/84W/DDR3-1600	1x4GB UDIMM DDR3-1600 ECC	RAID 100	4x3.5" DC	2x500GB HDD 7.2K 3.5" SATA6Gbs	9.5mm DVD±RW	None	None	AMT	None	3-year	450W 92% Fixed	01/14
70A50018++	EMEA	Xeon E3-1225 v3 4C/3.2GHz/8MB/84W/DDR3-1600	1x4GB UDIMM DDR3-1600 ECC	RAID 100	4x3.5" DC	2x500GB HDD 7.2K 3.5" SATA6Gbs	9.5mm DVD±RW	None	None	AMT	None	1-year	450W 92% Fixed	01/14
70A50019++	EMEA	Xeon E3-1225 v3 4C/3.2GHz/8MB/84W/DDR3-1600	1x4GB UDIMM DDR3-1600 ECC	RAID 100	4x3.5" DC	2x1TB HDD 7.2K 3.5" SATA6Gbs	9.5mm DVD±RW	None	None	AMT	None	3-year	450W 92% Fixed	01/14
70A5001A++	EMEA	Xeon E3-1275 v3 4C/3.5GHz/8MB/84W/DDR3-1600	2x4GB UDIMM DDR3-1600 ECC	RAID 100	4x3.5" DC	Open	9.5mm DVD±RW	None	None	AMT	None	3-year	450W 92% Fixed	01/14
70A5001B++	EMEA	Xeon E3-1225 v3 4C/3.2GHz/8MB/84W/DDR3-1600	1x4GB UDIMM DDR3-1600 ECC	RAID 100	4x3.5" DC	2x1TB HDD 7.2K 3.5" SATA6Gbs	9.5mm DVD±RW	None	None	AMT	2012 Foundations	3-year	450W 92% Fixed	01/14
70A5001C++	EMEA	Xeon E3-1225 v3 4C/3.2GHz/8MB/84W/DDR3-1600	1x4GB UDIMM DDR3-1600 ECC	RAID 100	4x3.5" DC	2x500GB HDD 7.2K 3.5" SATA6Gbs	9.5mm DVD±RW	None	None	AMT	2012 Foundations	1-year	450W 92% Fixed	01/14
70A5001D++	EMEA	Xeon E3-1225 v3 4C/3.2GHz/8MB/84W/DDR3-1600	1x4GB UDIMM DDR3-1600 ECC	RAID 100	4x3.5" DC	2x500GB HDD 7.2K 3.5" SATA6Gbs	9.5mm DVD±RW	None	None	AMT	2012 Essentials	3-year	450W 92% Fixed	01/14
70A5001E++	EMEA	Xeon E3-1225 v3 4C/3.2GHz/8MB/84W/DDR3-1600	2x4GB UDIMM DDR3-1600 ECC	RAID 100	4x3.5" DC	2x500GB HDD 7.2K 3.5" SATA6Gbs	9.5mm DVD±RW	None	None	AMT	2012 Foundations	3-year	450W 92% Fixed	01/14
70A5001F++	EMEA	Xeon E3-1225 v3 4C/3.2GHz/8MB/84W/DDR3-1600	1x4GB UDIMM DDR3-1600 ECC	RAID 100	4x3.5" DC	2x500GB HDD 7.2K 3.5" SATA6Gbs	9.5mm DVD±RW	None	None	AMT	2012 Foundations	3-year	450W 92% Fixed	01/14
70A5001G++	EMEA	Xeon E3-1225 v3 4C/3.2GHz/8MB/84W/DDR3-1600	1x4GB UDIMM DDR3-1600 ECC	RAID 100	4x3.5" DC	Open	9.5mm DVD±RW	None	None	AMT	None	1-year	450W 92% Fixed	01/14

Model	Region	Processor	Memory	RAID Controller	Disk Bays	Storage	Optical	Add-on NIC	Add-on Ports	System Management	Operating System	Warranty	Power Supply	Ann Date (mm/yy)
70A5001H++	EMEA	Xeon E3-1225 v3 4C/3.2GHz/8MB/84W/DDR3-1600	1x4GB UDIMM DDR3-1600 ECC	RAID 100	4x3.5" DC	Open	9.5mm DVD±RW	None	None	AMT	None	3-year	450W 92% Fixed	01/14
70A5001J++	EMEA	Xeon E3-1245 v3 4C/3.4GHz/8MB/84W/DDR3-1600	1x4GB UDIMM DDR3-1600 ECC	RAID 100	4x3.5" DC	2x500GB HDD 7.2K 3.5" SATA6Gbs	9.5mm DVD±RW	None	None	AMT	None	3-year	450W 92% Fixed	01/14
70A5001K++	EMEA	Xeon E3-1245 v3 4C/3.4GHz/8MB/84W/DDR3-1600	1x4GB UDIMM DDR3-1600 ECC	RAID 100	4x3.5" DC	2x500GB HDD 7.2K 3.5" SATA6Gbs	9.5mm DVD±RW	None	None	AMT	None	1-year	450W 92% Fixed	01/14
70A5001L++	EMEA	Xeon E3-1275 v3 4C/3.5GHz/8MB/84W/DDR3-1600	2x4GB UDIMM DDR3-1600 ECC	RAID 100	4x3.5" DC	2x1TB HDD 7.2K 3.5" SATA6Gbs	9.5mm DVD±RW	None	None	AMT	None	3-year	450W 92% Fixed	01/14
70A5001M++	EMEA	Xeon E3-1225 v3 4C/3.2GHz/8MB/84W/DDR3-1600	1x4GB UDIMM DDR3-1600 ECC	RAID 100	4x3.5" DC	2x500GB HDD 7.2K 3.5" SATA6Gbs	9.5mm DVD	None	None	AMT	2012 Foundations	1-year	450W 92% Fixed	01/14
70A5001N++	EMEA	Xeon E3-1226 v3 4C/3.3GHz/8MB/84W/DDR3-1600	1x4GB UDIMM DDR3-1600 ECC	RAID 100	4x3.5" DC	Open	9.5mm DVD±RW	None	None	AMT	None	1-year	450W 92% Fixed	09/14
70A5001R++	EMEA	Xeon E3-1226 v3 4C/3.3GHz/8MB/84W/DDR3-1600	1x4GB UDIMM DDR3-1600 ECC	RAID 100	4x3.5" DC	Open	9.5mm DVD±RW	None	None	AMT	None	3-year	450W 92% Fixed	09/14
70A5001S++	EMEA	Xeon E3-1226 v3 4C/3.3GHz/8MB/84W/DDR3-1600	1x4GB UDIMM DDR3-1600 ECC	RAID 100	4x3.5" DC	2x1TB HDD 7.2K 3.5" SATA6Gbs	9.5mm DVD±RW	None	None	AMT	2012 Foundations	3-year	450W 92% Fixed	09/14
70A5001T++	EMEA	Xeon E3-1246 v3 4C/3.5GHz/8MB/84W/DDR3-1600	1x4GB UDIMM DDR3-1600 ECC	RAID 100	4x3.5" DC	2x1TB HDD 7.2K 3.5" SATA6Gbs	9.5mm DVD±RW	None	None	AMT	None	3-year	450W 92% Fixed	03/15
70A5001U++	EMEA	Xeon E3-1246 v3 4C/3.5GHz/8MB/84W/DDR3-1600	1x4GB UDIMM DDR3-1600 ECC	RAID 100	4x3.5" DC	2x1TB HDD 7.2K 3.5" SATA6Gbs	9.5mm DVD±RW	None	None	AMT	None	1-year	450W 92% Fixed	03/15
70A5001V++	EMEA	Xeon E3-1226 v3 4C/3.3GHz/8MB/84W/DDR3-1600	2x4GB UDIMM DDR3-1600 ECC	RAID 100	4x3.5" DC	2x1TB HDD 7.2K 3.5" SATA6Gbs	9.5mm DVD±RW	None	None	AMT	None	3-year	450W 92% Fixed	09/14
70A5001W++	EMEA	Xeon E3-1276 v3 4C/3.6GHz/8MB/84W/DDR3-1600	2x4GB UDIMM DDR3-1600 ECC	RAID 100	4x3.5" DC	Open	9.5mm DVD±RW	None	None	AMT	None	3-year	450W 92% Fixed	09/14
70A5001X++	EMEA	Xeon E3-1226 v3 4C/3.3GHz/8MB/84W/DDR3-1600	2x4GB UDIMM DDR3-1600 ECC	RAID 100	4x3.5" DC	2x1TB HDD 7.2K 3.5" SATA6Gbs	9.5mm DVD±RW	None	None	AMT	2012 Foundations	3-year	450W 92% Fixed	09/14
70A5001Y++	EMEA	Xeon E3-1226 v3 4C/3.3GHz/8MB/84W/DDR3-1600	1x4GB UDIMM DDR3-1600 ECC	RAID 100	4x3.5" DC	2x1TB HDD 7.2K 3.5" SATA6Gbs	9.5mm DVD±RW	None	None	AMT	None	3-year	450W 92% Fixed	03/15
70A50020++	EMEA	Xeon E3-1226 v3 4C/3.3GHz/8MB/84W/DDR3-1600	1x4GB UDIMM DDR3-1600 ECC	RAID 100	4x3.5" DC	2x1TB HDD 7.2K 3.5" SATA6Gbs	9.5mm DVD±RW	None	None	AMT	2012 Foundations	1-year	450W 92% Fixed	09/14
70A50021++	EMEA	Xeon E3-1276 v3 4C/3.6GHz/8MB/84W/DDR3-1600	2x4GB UDIMM DDR3-1600 ECC	RAID 100	4x3.5" DC	2x1TB HDD 7.2K 3.5" SATA6Gbs	9.5mm DVD±RW	None	None	AMT	None	3-year	450W 92% Fixed	09/14
70A50022++	EMEA	Xeon E3-1226 v3 4C/3.3GHz/8MB/84W/DDR3-1600	1x4GB UDIMM DDR3-1600 ECC	RAID 100	4x3.5" DC	1x1TB HDD 7.2K 3.5" SATA6Gbs	9.5mm DVD±RW	None	None	AMT	None	1-year	450W 92% Fixed	09/14

Model	Region	Processor	Memory	RAID Controller	Disk Bays	Storage	Optical	Add-on NIC	Add-on Ports	System Management	Operating System	Warranty	Power Supply	Ann Date (mm/yy)
70A50023++	EMEA	Xeon E3-1226 v3 4C/3.3GHz/8MB/84W/DDR3-1600	1x4GB UDIMM DDR3-1600 ECC	RAID 100	4x3.5" DC	2x1TB HDD 7.2K 3.5" SATA6Gbs	9.5mm DVD±RW	None	None	AMT	2012 Essentials	3-year	450W 92% Fixed	09/14
70A50024++	EMEA	Xeon E3-1226 v3 4C/3.3GHz/8MB/84W/DDR3-1600	1x4GB UDIMM DDR3-1600 ECC	RAID 100	4x3.5" DC	2x1TB HDD 7.2K 3.5" SATA6Gbs	9.5mm DVD±RW	None	None	AMT	None	1-year	450W 92% Fixed	09/14
70A50025++	EMEA	Xeon E3-1226 v3 4C/3.3GHz/8MB/84W/DDR3-1600	1x4GB UDIMM DDR3-1600 ECC	RAID 100	4x3.5" DC	2x1TB HDD 7.2K 3.5" SATA6Gbs	9.5mm DVD±RW	None	None	AMT	2012 R2 Foundations	3-year	450W 92% Fixed	03/15
70A50026++	EMEA	Xeon E3-1226 v3 4C/3.3GHz/8MB/84W/DDR3-1600	2x4GB UDIMM DDR3-1600 ECC	RAID 100	4x3.5" DC	2x1TB HDD 7.2K 3.5" SATA6Gbs	9.5mm DVD±RW	None	None	AMT	2012 R2 Foundations	3-year	450W 92% Fixed	03/15
70A50027++	EMEA	Xeon E3-1226 v3 4C/3.3GHz/8MB/84W/DDR3-1600	1x4GB UDIMM DDR3-1600 ECC	RAID 100	4x3.5" DC	2x1TB HDD 7.2K 3.5" SATA6Gbs	9.5mm DVD±RW	None	None	AMT	2012 R2 Foundations	1-year	450W 92% Fixed	03/15
70A50028++	EMEA	Xeon E3-1226 v3 4C/3.3GHz/8MB/84W/DDR3-1600	1x4GB UDIMM DDR3-1600 ECC	RAID 100	4x3.5" DC	2x1TB HDD 7.2K 3.5" SATA6Gbs	9.5mm DVD±RW	None	None	AMT	2012 R2 Essentials	3-year	450W 92% Fixed	03/15
70A5002Q++	EMEA	Xeon E3-1226 v3 4C/3.3GHz/8MB/84W/DDR3-1600	1x8GB UDIMM DDR3-1600 ECC	RAID 100	4x3.5" DC	2x1TB HDD 7.2K 3.5" SATA6Gbs	9.5mm DVD±RW	None	None	AMT	None	3-year	450W 92% Fixed	03/16
70A5002R++	EMEA	Xeon E3-1226 v3 4C/3.3GHz/8MB/84W/DDR3-1600	1x8GB UDIMM DDR3-1600 ECC	RAID 100	4x3.5" DC	2x1TB HDD 7.2K 3.5" SATA6Gbs	9.5mm DVD±RW	None	None	AMT	2012 R2 Foundations	3-year	450W 92% Fixed	03/16
70A5002S++	EMEA	Xeon E3-1246 v3 4C/3.5GHz/8MB/84W/DDR3-1600	1x8GB UDIMM DDR3-1600 ECC	RAID 100	4x3.5" DC	2x1TB HDD 7.2K 3.5" SATA6Gbs	9.5mm DVD±RW	None	None	AMT	None	3-year	450W 92% Fixed	03/16

Model	Region	Processor	Memory	RAID Controller	Disk Bays	Storage	Optical	Add-on NIC	Add-on Ports	System Management	Operating System	Warranty	Power Supply	Ann Date (mm/yy)
70A00003++	EMEA	Xeon E3-1225 v3 4C/3.2GHz/8MB/84W/DDR3-1600	4x2GB UDIMM DDR3-1600 ECC	RAID 100	4x3.5" DC	4x500GB HDD 7.2K 3.5" SATA6Gbs	9.5mm DVD±RW	2xGbE	1xParallel	AMT	2012 Foundations	1-year	280W 85% Fixed	09/13
70A00006++	EMEA	Xeon E3-1225 v3 4C/3.2GHz/8MB/84W/DDR3-1600	4x2GB UDIMM DDR3-1600 ECC	RAID 100	4x3.5" DC	4x500GB HDD 7.2K 3.5" SATA6Gbs	9.5mm DVD±RW	2xGbE	None	AMT	2012 Foundations	1-year	280W 85% Fixed	09/13
70A00007++	EMEA	Xeon E3-1230 v3 4C/3.3GHz/8MB/80W/DDR3-1600	3x4GB UDIMM DDR3-1600 ECC	RAID 100	3x3.5" DC	2x4TB HDD 7.2K 3.5" SATA6Gbs	HH DVD±RW	4xGbE	None	AMT	None	1-year	280W 85% Fixed	09/13
70A0001B++	EMEA	Xeon E3-1225 v3 4C/3.2GHz/8MB/84W/DDR3-1600	4x2GB UDIMM DDR3-1600 ECC	RAID 100	4x3.5" DC	4x500GB HDD 7.2K 3.5" SATA6Gbs	9.5mm DVD±RW	2xGbE	1xParallel	AMT	2012 Foundations	1-year	280W 85% Fixed	09/13

Model	Region	Processor	Memory	RAID Controller	Disk Bays	Storage	Optical	Add-on NIC	Add-on Ports	System Management	Operating System	Warranty	Power Supply	Ann Date (mm/yy)
70A10000++	EMEA	Xeon E3-1280 v3 4C/3.6GHz/8MB/82W/DDR3-1600	4x8GB UDIMM DDR3-1600 ECC	RAID 100	4x3.5" DC	4x4TB HDD 7.2K 3.5" SATA6Gbs	9.5mm DVD±RW	2xGbE	1xParallel	AMT	2012 Foundations	1-year	450W 92% Fixed	09/13
70A10001++	EMEA	Xeon E3-1280 v3 4C/3.6GHz/8MB/82W/DDR3-1600	4x8GB UDIMM DDR3-1600 ECC	RAID 100	4x3.5" DC	4x2TB HDD 7.2K 3.5" SATA6Gbs	9.5mm DVD±RW	1xGbE	None	AMT	2012 Foundations	1-year	450W 92% Fixed	09/13
70A10002++	EMEA	Xeon E3-1285 v3 4C/3.6GHz/8MB/84W/DDR3-1600	4x4GB UDIMM DDR3-1600 ECC	RAID 100	3x3.5" DC	3x3TB HDD 7.2K 3.5" SATA6Gbs	HH DVD±RW	5xGbE	None	AMT	None	1-year	450W 92% Fixed	09/13
70A10005++	EMEA	Xeon E3-1280 v3 4C/3.6GHz/8MB/82W/DDR3-1600	4x8GB UDIMM DDR3-1600 ECC	RAID 100	4x3.5" DC	4x4TB HDD 7.2K 3.5" SATA6Gbs	9.5mm DVD±RW	2xGbE	1xParallel	AMT	2012 Foundations	1-year	450W 92% Fixed	09/13

ThinkServer TS150 Platform Specifications

Product Specifications Reference (PSREF)

Components	Specification																																										
Dimensions	Tower or 4U rack. Height: 375 mm (14.76 in), width: 175 mm (6.89 in), depth: 431 mm (16.97 in)																																										
Weight	Maximum configuration: 27.6 lb (12.5kg)																																										
Processor	Up to one Intel Xeon E3-1200 v5, Core i3, Pentium, or Celeron family processor.																																										
	<table border="1"> <tbody> <tr><td>Xeon E3-1280 v5</td><td>4C/3.7GHz/8MB/80W/DDR4-2133</td></tr> <tr><td>Xeon E3-1270 v5</td><td>4C/3.6GHz/8MB/80W/DDR4-2133</td></tr> <tr><td>Xeon E3-1240 v5</td><td>4C/3.5GHz/8MB/80W/DDR4-2133</td></tr> <tr><td>Xeon E3-1230 v5</td><td>4C/3.4GHz/8MB/80W/DDR4-2133</td></tr> <tr><td>Xeon E3-1220 v5</td><td>4C/3GHz/8MB/80W/DDR4-2133</td></tr> <tr><td>Xeon E3-1275 v5</td><td>4C/3.6GHz/8MB/80W/DDR4-2133</td></tr> <tr><td>Xeon E3-1245 v5</td><td>4C/3.5GHz/8MB/80W/DDR4-2133</td></tr> <tr><td>Xeon E3-1225 v5</td><td>4C/3.3GHz/8MB/80W/DDR4-2133</td></tr> <tr><td>Core i3-6320</td><td>2C/3.9GHz/4MB/51W/DDR4-2133</td></tr> <tr><td>Core i3-6300</td><td>2C/3.8GHz/4MB/51W/DDR4-2133</td></tr> <tr><td>Core i3-6300T</td><td>2C/3.3GHz/4MB/35W/DDR4-2133</td></tr> <tr><td>Core i3-6100</td><td>2C/3.7GHz/3MB/51W/DDR4-2133</td></tr> <tr><td>Core i3-6100T</td><td>2C/3.2GHz/3MB/35W/DDR4-2133</td></tr> <tr><td>Pentium G4520</td><td>2C/3.6GHz/3MB/51W/DDR4-2133</td></tr> <tr><td>Pentium G4500</td><td>2C/3.5GHz/3MB/51W/DDR4-2133</td></tr> <tr><td>Pentium G4500T</td><td>2C/3GHz/3MB/35W/DDR4-2133</td></tr> <tr><td>Pentium G4400</td><td>2C/3.3GHz/3MB/54W/DDR4-2133</td></tr> <tr><td>Pentium G4400T</td><td>2C/2.9GHz/3MB/35W/DDR4-2133</td></tr> <tr><td>Celeron G3920</td><td>2C/2.9GHz/2MB/51W/DDR4-2133</td></tr> <tr><td>Celeron G3900</td><td>2C/2.8GHz/2MB/51W/DDR4-2133</td></tr> <tr><td>Celeron G3900T</td><td>2C/2.6GHz/2MB/35W/DDR4-2133</td></tr> </tbody> </table>	Xeon E3-1280 v5	4C/3.7GHz/8MB/80W/DDR4-2133	Xeon E3-1270 v5	4C/3.6GHz/8MB/80W/DDR4-2133	Xeon E3-1240 v5	4C/3.5GHz/8MB/80W/DDR4-2133	Xeon E3-1230 v5	4C/3.4GHz/8MB/80W/DDR4-2133	Xeon E3-1220 v5	4C/3GHz/8MB/80W/DDR4-2133	Xeon E3-1275 v5	4C/3.6GHz/8MB/80W/DDR4-2133	Xeon E3-1245 v5	4C/3.5GHz/8MB/80W/DDR4-2133	Xeon E3-1225 v5	4C/3.3GHz/8MB/80W/DDR4-2133	Core i3-6320	2C/3.9GHz/4MB/51W/DDR4-2133	Core i3-6300	2C/3.8GHz/4MB/51W/DDR4-2133	Core i3-6300T	2C/3.3GHz/4MB/35W/DDR4-2133	Core i3-6100	2C/3.7GHz/3MB/51W/DDR4-2133	Core i3-6100T	2C/3.2GHz/3MB/35W/DDR4-2133	Pentium G4520	2C/3.6GHz/3MB/51W/DDR4-2133	Pentium G4500	2C/3.5GHz/3MB/51W/DDR4-2133	Pentium G4500T	2C/3GHz/3MB/35W/DDR4-2133	Pentium G4400	2C/3.3GHz/3MB/54W/DDR4-2133	Pentium G4400T	2C/2.9GHz/3MB/35W/DDR4-2133	Celeron G3920	2C/2.9GHz/2MB/51W/DDR4-2133	Celeron G3900	2C/2.8GHz/2MB/51W/DDR4-2133	Celeron G3900T	2C/2.6GHz/2MB/35W/DDR4-2133
	Xeon E3-1280 v5	4C/3.7GHz/8MB/80W/DDR4-2133																																									
	Xeon E3-1270 v5	4C/3.6GHz/8MB/80W/DDR4-2133																																									
	Xeon E3-1240 v5	4C/3.5GHz/8MB/80W/DDR4-2133																																									
	Xeon E3-1230 v5	4C/3.4GHz/8MB/80W/DDR4-2133																																									
	Xeon E3-1220 v5	4C/3GHz/8MB/80W/DDR4-2133																																									
	Xeon E3-1275 v5	4C/3.6GHz/8MB/80W/DDR4-2133																																									
	Xeon E3-1245 v5	4C/3.5GHz/8MB/80W/DDR4-2133																																									
	Xeon E3-1225 v5	4C/3.3GHz/8MB/80W/DDR4-2133																																									
	Core i3-6320	2C/3.9GHz/4MB/51W/DDR4-2133																																									
	Core i3-6300	2C/3.8GHz/4MB/51W/DDR4-2133																																									
	Core i3-6300T	2C/3.3GHz/4MB/35W/DDR4-2133																																									
	Core i3-6100	2C/3.7GHz/3MB/51W/DDR4-2133																																									
	Core i3-6100T	2C/3.2GHz/3MB/35W/DDR4-2133																																									
	Pentium G4520	2C/3.6GHz/3MB/51W/DDR4-2133																																									
	Pentium G4500	2C/3.5GHz/3MB/51W/DDR4-2133																																									
	Pentium G4500T	2C/3GHz/3MB/35W/DDR4-2133																																									
	Pentium G4400	2C/3.3GHz/3MB/54W/DDR4-2133																																									
	Pentium G4400T	2C/2.9GHz/3MB/35W/DDR4-2133																																									
Celeron G3920	2C/2.9GHz/2MB/51W/DDR4-2133																																										
Celeron G3900	2C/2.8GHz/2MB/51W/DDR4-2133																																										
Celeron G3900T	2C/2.6GHz/2MB/35W/DDR4-2133																																										
Chipset	Intel C236 Platform Controller Hub (PCH)																																										
Memory DIMMs	4 DIMM sockets with 2 channels, 2 DIMMs per channel. UDIMM . DDR4-2133																																										
Memory capacity	64GB (16GB x 4)																																										
Memory protection	ECC																																										
RAID controller	<table border="1"> <thead> <tr> <th>RAID controller</th> <th>Drive type</th> <th>RAID support</th> </tr> </thead> <tbody> <tr> <td>Onboard RAID12i</td> <td>6Gbs SATA</td> <td>0/1/5/10</td> </tr> <tr> <td>RAID520i PCIe</td> <td>12Gbs SAS/SATA</td> <td>0/1/10, 5 with optional key</td> </tr> </tbody> </table>	RAID controller	Drive type	RAID support	Onboard RAID12i	6Gbs SATA	0/1/5/10	RAID520i PCIe	12Gbs SAS/SATA	0/1/10, 5 with optional key																																	
	RAID controller	Drive type	RAID support																																								
Onboard RAID12i	6Gbs SATA	0/1/5/10																																									
RAID520i PCIe	12Gbs SAS/SATA	0/1/10, 5 with optional key																																									
Disk bays	Supports up to four 3.5" or hybrid 3.5" + 2.5" disk drives , or up to five 2.5" disk drives. one 9.5mm optical (see right). Non-hot swap. Cables are connected to onboard SATA connectors or PCIe RAID controller. Supports one optional internal USB RDX Tape drive																																										
Supporting storage	<table border="1"> <tbody> <tr> <td>3.5" HDD, 7.2K SATA6Gbs</td> <td>500GB/1TB/2TB/3TB/4TB/5TB/6TB</td> </tr> <tr> <td>2.5" HDD, 7.2K SATA6Gbs</td> <td>500GB/1TB/2TB</td> </tr> <tr> <td>2.5" SSD, SATA6Gbs</td> <td>120GB/240GB/480GB/600GB/800GB/960GB</td> </tr> </tbody> </table>	3.5" HDD, 7.2K SATA6Gbs	500GB/1TB/2TB/3TB/4TB/5TB/6TB	2.5" HDD, 7.2K SATA6Gbs	500GB/1TB/2TB	2.5" SSD, SATA6Gbs	120GB/240GB/480GB/600GB/800GB/960GB																																				
	3.5" HDD, 7.2K SATA6Gbs	500GB/1TB/2TB/3TB/4TB/5TB/6TB																																									
	2.5" HDD, 7.2K SATA6Gbs	500GB/1TB/2TB																																									
2.5" SSD, SATA6Gbs	120GB/240GB/480GB/600GB/800GB/960GB																																										
SD module	Optional. Up to 2 SDHC flash cards via SD module, 8GB each																																										
Optical drive	Up to two half-height optical drives or one 9.5mm optical. DVD-ROM or DVD±RW																																										
Network interfaces	One Gigabit Ethernet port, Intel i219LM. Supports optional discrete network adapters via PCIe slots																																										
Security features	Power-on and administrator password. TPM (TCG 1.2-compliant)																																										
Systems management	UEFI, system LEDs, EasyStartup, EasyUpdate, Power Planner, and Diagnostics. Intel Active Management Technology 11 on models with Xeon processors. Intel Standard Manageability on models with Core i3, Pentium, or Celeron processors. KVM is supported on models with Xeon E3-12x5 v5 processors																																										
Operating systems	Microsoft Windows Server 2012 R2/2012, Windows MultiPoint Server 2012, Windows 10 Pro. Red Hat Enterprise Linux 6.7/7.2. SUSE Linux Enterprise Server 11/12. VMware vSphere (ESXi) 5.5U3/6.0U2																																										
Base warranty	1 or 3-year limited onsite service with 9x5/NBD																																										
Power supply	Supports one of the following: <ul style="list-style-type: none"> One fixed 250 watts, autosensing, 85%, 80 PLUS Bronze qualified One fixed 400 watts, autosensing, 92%, 80 PLUS Platinum qualified 																																										
	<table border="1"> <thead> <tr> <th rowspan="2">CPU</th> <th colspan="4">Up to 80W</th> </tr> <tr> <th colspan="2">Not supported</th> <th colspan="2">Support</th> </tr> </thead> <tbody> <tr> <td>Discrete graphics adapter</td> <td></td> <td></td> <td></td> <td></td> </tr> <tr> <td>Disk drives</td> <td>2 x 3.5"</td> <td>4 x 3.5" + 1 x 2.5"</td> <td>2 x 3.5"</td> <td>4 x 3.5" + 1 x 2.5"</td> </tr> <tr> <td>250W fixed PSU</td> <td>•</td> <td>•</td> <td>•</td> <td>•</td> </tr> <tr> <td>400W fixed PSU</td> <td>•</td> <td>•</td> <td>•</td> <td>•</td> </tr> </tbody> </table>	CPU	Up to 80W				Not supported		Support		Discrete graphics adapter					Disk drives	2 x 3.5"	4 x 3.5" + 1 x 2.5"	2 x 3.5"	4 x 3.5" + 1 x 2.5"	250W fixed PSU	•	•	•	•	400W fixed PSU	•	•	•	•													
	CPU		Up to 80W																																								
		Not supported		Support																																							
	Discrete graphics adapter																																										
Disk drives	2 x 3.5"	4 x 3.5" + 1 x 2.5"	2 x 3.5"	4 x 3.5" + 1 x 2.5"																																							
250W fixed PSU	•	•	•	•																																							
400W fixed PSU	•	•	•	•																																							

Components	Specification	
Graphics	Integrated Intel HD Graphics on Xeon E3-12x5 v5, Core i3, Pentium, and Celeron processors. Uses main memory, works along with discrete graphics to support multi-display, enables two display connectors (1 DP, 1 VGA) on rear ports. Also supports the following discrete graphics adapter options: <ul style="list-style-type: none"> NVIDIA Quadro NVS 315, 1GB NVIDIA Quadro K620, 2GB 	
HD Audio	Realtek ALC662 codec	
Front ports	Two USB 3.0	
Rear ports	One VGA, one DisplayPort, six USB 3.0, one RJ-45, one serial (9-pin), three analog audio ports (line-in, line-out, mic-in). Optional parallel or serial ports via PCIe adapters	
Noise emissions	Operating: < 35 dB(A). Idle: < 34 dB(A) (Maximum configuration)	
Environmental specification	Temperature - operating	50 °F to 95 °F (10 °C to 35 °C)
	Temperature - non operating (with package)	-40 °C to 60 °C
	Altitude - operating	(Unpressurized): 0-10000ft (0-3048m)
	Humidity - operating	8%-80%, non-condensing
	Humidity - storage (with package)	10%-90%, non-condensing

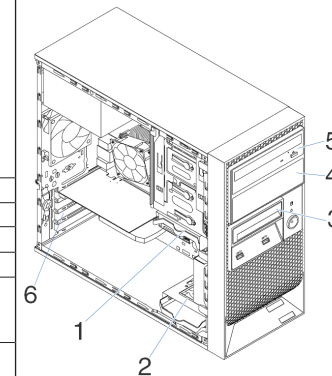

Disk Bays and PCIe Slots

Disk bays configuration	4 x 3.5"	4 x 2.5"	4 x hybrid 3.5" + 2.5"
Bay 1	1st HDD bay	1st HDD bay	1st HDD bay, 3.5"/2.5"
Bay 2	2nd HDD bay	2nd HDD bay	2nd HDD bay, 3.5"/2.5"
Bay 3	Not supported	3rd HDD bay	Not supported on standard models. Supports one 2.5" disk drive for special bid only
Bay 4	2nd half-height optical, or RDX tape drive, or 3rd HDD bay	2nd half-height optical, or RDX tape drive, or 4th HDD bay	2nd half-height optical, or RDX tape drive, or 3rd HDD bay (3.5"/2.5")
Bay 5	1st half-height optical, or 9.5mm optical + 4th HDD bay	1st half-height optical, or 9.5mm optical +5th HDD bay	1st half-height optical, or 9.5mm optical + 4th HDD bay (3.5"/2.5")
6	Four PCIe slots (top-down): Slot 1: PCIe 3.0 x16, full height, half length (near CPU) Slot 2: PCIe 3.0 x1, full height, half length Slot 3: PCIe 3.0 x16 (x4 elec), full height, half length Slot 4: PCIe 3.0 x1, full height, half length		

Model	Region	Processor	Memory	RAID Controller	Disk Bays	Storage	Optical	Add-on NIC	Add-on Ports	System Mgmt	OS	Warranty	Power Supply	Ann Date (m/y)
70LV003DEA	EMEA	Celeron G3920 2C/2.9GHz/2MB/51W/DDR4-2133	1x8GB UDIMM DDR4-2133 ECC	RAID 121i	4x3.5"	Open	9.5mm DVD±RW	None	None	ISM	None	1-year	250W 85% Fixed	10/16
70LV003EEA	EMEA	Pentium G4400 2C/3.3GHz/3MB/54W/DDR4-2133	1x8GB UDIMM DDR4-2133 ECC	RAID 121i	4x3.5"	Open	9.5mm DVD±RW	None	None	ISM	None	1-year	250W 85% Fixed	10/16
70LV003FEA	EMEA	Core i3-6320 2C/3.9GHz/4MB/51W/DDR4-2133	1x8GB UDIMM DDR4-2133 ECC	RAID 121i	4x3.5"	Open	9.5mm DVD±RW	None	None	ISM	None	1-year	250W 85% Fixed	10/16
70LV003GEA	EMEA	Xeon E3-1225 v5 4C/3.3GHz/8MB/80W/DDR4-2133	1x8GB UDIMM DDR4-2133 ECC	RAID 121i	4x3.5"	Open	9.5mm DVD±RW	None	None	AMT	None	1-year	250W 85% Fixed	10/16
70LV003HEA	EMEA	Xeon E3-1225 v5 4C/3.3GHz/8MB/80W/DDR4-2133	1x8GB UDIMM DDR4-2133 ECC	RAID 121i	4x3.5"	1x1TB HDD 7.2K 3.5" SATA6Gbs	9.5mm DVD±RW	None	None	AMT	None	1-year	250W 85% Fixed	10/16
70LV003JEA	EMEA	Xeon E3-1225 v5 4C/3.3GHz/8MB/80W/DDR4-2133	1x8GB UDIMM DDR4-2133 ECC	RAID 121i	4x3.5"	2x1TB HDD 7.2K 3.5" SATA6Gbs	9.5mm DVD±RW	None	None	AMT	None	1-year	250W 85% Fixed	10/16
70LV003KEA	EMEA	Xeon E3-1225 v5 4C/3.3GHz/8MB/80W/DDR4-2133	1x16GB UDIMM DDR4-2133 ECC	RAID 121i	4x3.5"	2x1TB HDD 7.2K 3.5" SATA6Gbs	9.5mm DVD±RW	None	None	AMT	None	1-year	250W 85% Fixed	10/16
70LV003LEA	EMEA	Pentium G4400 2C/3.3GHz/3MB/54W/DDR4-2133	1x8GB UDIMM DDR4-2133 ECC	RAID 121i	4x3.5"/3 available	Open	HH DVD	None	None	ISM	None	1-year	250W 85% Fixed	10/16
70LV003MEA	EMEA	Xeon E3-1245 v5 4C/3.5GHz/8MB/80W/DDR4-2133	1x16GB UDIMM DDR4-2133 ECC	RAID 121i	4x3.5"	Open	None	None	None	AMT	None	1-year	250W 85% Fixed	10/16
70LV003NEA	EMEA	Xeon E3-1275 v5 4C/3.6GHz/8MB/80W/DDR4-2133	2x16GB UDIMM DDR4-2133 ECC	RAID 121i	4x3.5"	Open	None	None	None	AMT	None	1-year	250W 85% Fixed	10/16

Model	Region	Processor	Memory	RAID Controller	Disk Bays	Storage	Optical	Add-on NIC	Add-on Ports	System Mgmt	OS	Warranty	Power Supply	Ann Date (m/y)
70LX001HEA	EMEA	Xeon E3-1225 v5 4C/3.3GHz/8MB/80W/DDR4-2133	1x8GB UDIMM DDR4-2133 ECC	RAID 121i	4x3.5"	Open	9.5mm DVD±RW	None	None	AMT	None	1-year	400W 92% Fixed	10/16
70LX001JEA	EMEA	Xeon E3-1225 v5 4C/3.3GHz/8MB/80W/DDR4-2133	1x8GB UDIMM DDR4-2133 ECC	RAID 121i	4x3.5"	1x1TB HDD 7.2K 3.5" SATA6Gbs	9.5mm DVD±RW	None	None	AMT	None	1-year	400W 92% Fixed	10/16
70LX001KEA	EMEA	Xeon E3-1225 v5 4C/3.3GHz/8MB/80W/DDR4-2133	1x8GB UDIMM DDR4-2133 ECC	RAID 121i	4x3.5"	2x1TB HDD 7.2K 3.5" SATA6Gbs	9.5mm DVD±RW	None	None	AMT	None	1-year	400W 92% Fixed	10/16
70LX001LEA	EMEA	Xeon E3-1245 v5 4C/3.5GHz/8MB/80W/DDR4-2133	1x8GB UDIMM DDR4-2133 ECC	RAID 121i	4x3.5"	2x1TB HDD 7.2K 3.5" SATA6Gbs	9.5mm DVD±RW	None	None	AMT	None	1-year	400W 92% Fixed	10/16
70LX001MEA	EMEA	Xeon E3-1275 v5 4C/3.6GHz/8MB/80W/DDR4-2133	1x8GB UDIMM DDR4-2133 ECC	RAID 121i	4x3.5"	2x1TB HDD 7.2K 3.5" SATA6Gbs	9.5mm DVD±RW	None	None	AMT	None	1-year	400W 92% Fixed	10/16



ThinkServer TS440 Platform Specifications

Components	Specification																							
Dimensions	Tower or 5U rack. Height: 430 mm (16.9 in), width: 195 mm (7.68 in), depth: 595 mm (23.4 in)																							
Weight	Maximum configuration: 61.7 lb (28kg)																							
Processor	Supports one of the following Intel processors (code name: Haswell): • Xeon E3-1200 v3: up to 4C/3.7GHz/8MB/84W/1600MHz																							
Chipset	Intel C226 Platform Controller Hub (PCH)																							
Memory DIMMs	4 DIMM sockets, 2-channel capable. UDIMM, DDR3, up to 1600MHz																							
Memory capacity	32GB																							
Memory protection	ECC																							
RAID controller	Supports one of the following onboard or PCIe RAID adapters: • RAID 0, 1, 5, 10 with onboard RAID 100, 6Gb/s SATA. • RAID 0, 1, 10 with RAID 500, PCIe adapter, 6Gb/s SAS/SATA, optional key for RAID5/50. • RAID 0, 1, 5, 6, 10, 50, 60 with RAID 700, PCIe adapter, 6Gb/s SAS/SATA, optional Intelligent Battery Backup Unit (iBBU08). <i>Note: RAID 50 and 60 are supported on 8 hard drive bays models only.</i>																							
Disk drive bays	Up to 4 3.5" disk bays, non-hot swap, direct cable. Or up to 8 3.5" disk bays, hot-swap. Or up to 8 2.5" disk bays, hot-swap. On front. Supports internal RDX tape drive, consumes 5.25" bay, also support optional external USB RDX tape drive. <table border="1" data-bbox="283 581 919 695"> <thead> <tr> <th rowspan="2">Disk bay configuration</th> <th colspan="3">RAID controller requirements and optional drives supported</th> </tr> <tr> <th>RAID100</th> <th>RAID500</th> <th>RAID700</th> </tr> </thead> <tbody> <tr> <td>4x3.5" non-hot swap</td> <td>•</td> <td></td> <td></td> </tr> <tr> <td>4x3.5" HS</td> <td>•</td> <td>•</td> <td>•</td> </tr> <tr> <td>8x3.5" HS</td> <td></td> <td>•</td> <td>•</td> </tr> <tr> <td>8x2.5" HS</td> <td></td> <td>•</td> <td>•</td> </tr> </tbody> </table>	Disk bay configuration	RAID controller requirements and optional drives supported			RAID100	RAID500	RAID700	4x3.5" non-hot swap	•			4x3.5" HS	•	•	•	8x3.5" HS		•	•	8x2.5" HS		•	•
Disk bay configuration	RAID controller requirements and optional drives supported																							
	RAID100	RAID500	RAID700																					
4x3.5" non-hot swap	•																							
4x3.5" HS	•	•	•																					
8x3.5" HS		•	•																					
8x2.5" HS		•	•																					
Maximum internal storage	3.5" non-hot swap model: up to 24TB with 7.2K SATA HDD. 3.5" hot swap model: up to 48TB with 7.2K SATA HDD, up to 32TB with 7.2K SAS HDD, up to 4.8TB with 15K SAS HDD, up to 2.4TB with SATA SSD 2.5" hot swap model: up to 8TB with 7.2K SATA HDD, up to 7.2TB with 10K SAS HDD, up to 4.8TB with 15K SAS HDD, up to 2.4TB with SATA SSD <i>Note: Supports up to 4 SSD drives.</i>																							
Optical drive	Two 5.25" bays for optical. DVD-ROM or DVD±RW. Half-height																							
Network interfaces	One onboard gigabit ethernet, Intel I217, shared with AMT. Supports optional discrete network adapters via PCIe slots																							
Security features	Power-on and administrator password. TPM (TCG 1.2-compliant). Optional padlock loop, Kensington cable lock																							
Systems management	Intel Active Management Technology 9 on models with Xeon processor. Remote presence is supported on models with Xeon E3-12x5 v3 or E3-12x6 v3 processor																							
Operating systems supported	Microsoft Windows Server 2012 R2/2012/2008 R2. Windows Small Business Server 2011. Windows 8.1/8/7(except Home edition). Red Hat Enterprise Linux 6.4/6.5/6.7/7/7.1. SUSE Linux Enterprise Server 11/12. VMware vSphere (ESXi) 5.1 U1/5.1 U2/5.5/5.5 U1/5.5 U2/5.5 U3, Citrix Xen server 6.2 <i>Note: VMware requires processors with Intel HD, add-on network adapters, and PCIe RAID adapters.</i>																							

Components	Specification	
Base warranty	1 or 3-year limited onsite service with 9x5/NBD.	
Power supply	Supports one of the following, depending on models: • One fixed 450 watts, universal, 80 PLUS Platinum qualified. • Up to two redundant 450 watts, two maximum, rear access, hot-swap, 80 PLUS Gold qualified, redundant with two power supplies	
Graphics	Integrated Intel HD Graphics on Xeon E3-12x6 v3, Xeon E3-12x5 v3 processors. Uses main memory, works along with discrete graphics to support multi-display, enables one VGA connector on rear. Also supports the following optional discrete graphics adapters: • NVIDIA Quadro NVS 300, PCIe adapter, 512MB • NVIDIA Quadro NVS 315, PCIe adapter, 1GB	
Front ports	Two USB 3.0 (blue)	
Rear ports	One VGA for models with Intel HD Graphics, two USB 2.0, four USB 3.0 (blue), one serial (9-pin), one ethernet (RJ-45). Optional parallel or serial ports via PCI or PCIe adapters	
Noise emissions	Operating: < 42 dB(A). Idle: < 38 dB(A) (Maximum configuration)	
Environmental specification	GREENGUARD certified, Energy Star Server 1.1 qualified, RoHS-compliant	
	Temperature - operating	50 °F to 95 °F (10 °C to 35 °C)
	Temperature - storage (with package)	-40 °C to 70 °C
	Altitude - operating	Supported Altitude (unpressurized): 0-10000ft (0-3048m)
	Humidity - operating	10%-80%, non-condensing
	Humidity - storage (with package)	10%-90%, non-condensing



Expansion slots

- Four PCIe slots (top-down):
Slot 1: PCIe 3.0 x16, full height, half length (near CPU)
Slot 2: PCIe 3.0 x1, full height, half length
Slot 3: PCIe 2.0 x16 (x4 elec), full height, half length
Slot 4: PCI 2.3, full height, half length
Note: All PCI/PCIe adapters are optional.

Model	Region	Processor	Memory	RAID Controller	Disk Bays	Storage	Optical	Add-on NIC	System Mgmt	OS	Warranty	Power Supply	Ann Date (m/y)
70AN0000++	EMEA	Xeon E3-1225 v3 4C/3.2GHz/8MB/84W/DDR3-1600	1x4GB UDIMM DDR3-1600 ECC	RAID 100	4x3.5" DC	Open	HH DVD±RW	None	AMT9	None	1-year	450W Platinum Fixed	09/13
70AN0003++	EMEA	Xeon E3-1225 v3 4C/3.2GHz/8MB/84W/DDR3-1600	1x4GB UDIMM DDR3-1600 ECC	RAID 100	4x3.5" DC	2x500GB HDD 7.2K 3.5" SATA6Gbs	HH DVD±RW	None	AMT9	None	1-year	450W Platinum Fixed	09/13
70AN0004++	EMEA	Xeon E3-1225 v3 4C/3.2GHz/8MB/84W/DDR3-1600	1x4GB UDIMM DDR3-1600 ECC	RAID 100	4x3.5" DC	2x500GB HDD 7.2K 3.5" SATA6Gbs	HH DVD±RW	None	AMT9	None	3-year	450W Platinum Fixed	09/13
70AN0005++	EMEA	Xeon E3-1275 v3 4C/3.5GHz/8MB/84W/DDR3-1600	1x8GB UDIMM DDR3-1600 ECC	RAID 100	4x3.5" DC	Open	HH DVD±RW	None	AMT9	None	3-year	450W Platinum Fixed	09/13
70AN0006++	EMEA	Xeon E3-1275 v3 4C/3.5GHz/8MB/84W/DDR3-1600	1x8GB UDIMM DDR3-1600 ECC	RAID 100	4x3.5" DC	Open	HH DVD±RW	None	AMT9	None	1-year	450W Platinum Fixed	09/13
70AN0007++	EMEA	Xeon E3-1225 v3 4C/3.2GHz/8MB/84W/DDR3-1600	1x4GB UDIMM DDR3-1600 ECC	RAID 100	4x3.5" DC	Open	HH DVD±RW	None	AMT9	None	1-year	450W Platinum Fixed	11/13
70AN0008++	EMEA	Xeon E3-1225 v3 4C/3.2GHz/8MB/84W/DDR3-1600	1x4GB UDIMM DDR3-1600 ECC	RAID 100	4x3.5" DC	2x500GB HDD 7.2K 3.5" SATA6Gbs	HH DVD±RW	None	AMT9	None	1-year	450W Platinum Fixed	11/13
70AN0009++	EMEA	Xeon E3-1225 v3 4C/3.2GHz/8MB/84W/DDR3-1600	1x4GB UDIMM DDR3-1600 ECC	RAID 100	4x3.5" DC	2x500GB HDD 7.2K 3.5" SATA6Gbs	HH DVD±RW	None	AMT9	None	3-year	450W Platinum Fixed	11/13
70AN000A++	EMEA	Xeon E3-1275 v3 4C/3.5GHz/8MB/84W/DDR3-1600	1x8GB UDIMM DDR3-1600 ECC	RAID 100	4x3.5" DC	Open	HH DVD±RW	None	AMT9	None	3-year	450W Platinum Fixed	11/13
70AN000B++	EMEA	Xeon E3-1275 v3 4C/3.5GHz/8MB/84W/DDR3-1600	1x8GB UDIMM DDR3-1600 ECC	RAID 100	4x3.5" DC	Open	HH DVD±RW	None	AMT9	None	1-year	450W Platinum Fixed	11/13
70AN000C++	EMEA	Xeon E3-1225 v3 4C/3.2GHz/8MB/84W/DDR3-1600	1x4GB UDIMM DDR3-1600 ECC	RAID 100	4x3.5" DC	Open	HH DVD±RW	None	AMT9	None	1-year	450W Platinum Fixed	01/14
70AN000D++	EMEA	Xeon E3-1225 v3 4C/3.2GHz/8MB/84W/DDR3-1600	1x4GB UDIMM DDR3-1600 ECC	RAID 100	4x3.5" DC	2x500GB HDD 7.2K 3.5" SATA6Gbs	HH DVD±RW	None	AMT9	None	1-year	450W Platinum Fixed	01/14
70AN000E++	EMEA	Xeon E3-1225 v3 4C/3.2GHz/8MB/84W/DDR3-1600	1x4GB UDIMM DDR3-1600 ECC	RAID 100	4x3.5" DC	2x500GB HDD 7.2K 3.5" SATA6Gbs	HH DVD±RW	None	AMT9	None	3-year	450W Platinum Fixed	01/14
70AN000F++	EMEA	Xeon E3-1275 v3 4C/3.5GHz/8MB/84W/DDR3-1600	1x8GB UDIMM DDR3-1600 ECC	RAID 100	4x3.5" DC	Open	HH DVD±RW	None	AMT9	None	3-year	450W Platinum Fixed	01/14
70AN000G++	EMEA	Xeon E3-1275 v3 4C/3.5GHz/8MB/84W/DDR3-1600	1x8GB UDIMM DDR3-1600 ECC	RAID 100	4x3.5" DC	Open	HH DVD±RW	None	AMT9	None	1-year	450W Platinum Fixed	01/14
70AN000L++	EMEA	Xeon E3-1276 v3 4C/3.6GHz/8MB/84W/DDR3-1600	1x8GB UDIMM DDR3-1600 ECC	RAID 100	4x3.5" DC	Open	HH DVD±RW	None	AMT9	None	3-year	450W Platinum Fixed	09/14
70AN000M++	EMEA	Xeon E3-1276 v3 4C/3.6GHz/8MB/84W/DDR3-1600	1x8GB UDIMM DDR3-1600 ECC	RAID 100	4x3.5" DC	Open	HH DVD±RW	None	AMT9	None	1-year	450W Platinum Fixed	09/14

Model	Region	Processor	Memory	RAID Controller	Disk Bays	Storage	Optical	Add-on NIC	System Mgmt	OS	Warranty	Power Supply	Ann Date (m/y)
70AN000N++	EMEA	Xeon E3-1226 v3 4C/3.3GHz/8MB/84W/DDR3-1600	1x4GB UDIMM DDR3-1600 ECC	RAID 100	4x3.5" DC	2x1TB HDD 7.2K 3.5" SATA6Gbs	HH DVD±RW	None	AMT9	None	1-year	450W Platinum Fixed	09/14
70AN000P++	EMEA	Xeon E3-1226 v3 4C/3.3GHz/8MB/84W/DDR3-1600	1x4GB UDIMM DDR3-1600 ECC	RAID 100	4x3.5" DC	Open	HH DVD±RW	None	AMT9	None	1-year	450W Platinum Fixed	09/14
70AN000Q++	EMEA	Xeon E3-1226 v3 4C/3.3GHz/8MB/84W/DDR3-1600	1x4GB UDIMM DDR3-1600 ECC	RAID 100	4x3.5" DC	2x1TB HDD 7.2K 3.5" SATA6Gbs	HH DVD±RW	None	AMT9	None	3-year	450W Platinum Fixed	09/14

Model	Region	Processor	Memory	RAID Controller	Disk Bays	Storage	Optical	Add-on NIC	System Mgmt	OS	Warranty	Power Supply	Ann Date (m/y)
70AQ000A++	EMEA	Xeon E3-1225 v3 4C/3.2GHz/8MB/84W/DDR3-1600	1x4GB UDIMM DDR3-1600 ECC	RAID 100	4x3.5" HS	Open	HH DVD±RW	None	AMT9	None	3-year	450Wx1 Gold	09/13
70AQ000B++	EMEA	Xeon E3-1245 v3 4C/3.4GHz/8MB/84W/DDR3-1600	1x4GB UDIMM DDR3-1600 ECC	RAID 100	4x3.5" HS	Open	HH DVD±RW	None	AMT9	None	3-year	450Wx1 Gold	09/13
70AQ000C++	EMEA	Xeon E3-1245 v3 4C/3.4GHz/8MB/84W/DDR3-1600	1x4GB UDIMM DDR3-1600 ECC	RAID 500	8x3.5" HS	Open	HH DVD±RW	None	AMT9	None	3-year	450Wx1 Gold	12/13
70AQ000D++	EMEA	Xeon E3-1225 v3 4C/3.2GHz/8MB/84W/DDR3-1600	1x4GB UDIMM DDR3-1600 ECC	RAID 500	8x3.5" HS	Open	HH DVD±RW	None	AMT9	None	3-year	450Wx1 Gold	12/13
70AQ000J++	EMEA	Xeon E3-1245 v3 4C/3.4GHz/8MB/84W/DDR3-1600	1x4GB UDIMM DDR3-1600 ECC	RAID 500	4x3.5" HS	Open	HH DVD±RW	None	AMT9	None	3-year	450Wx1 Gold	09/13
70AQ000K++	EMEA	Xeon E3-1275 v3 4C/3.5GHz/8MB/84W/DDR3-1600	1x8GB UDIMM DDR3-1600 ECC	RAID 700+Battery	4x3.5" HS	Open	HH DVD±RW	None	AMT9	None	3-year	450Wx1 Gold	09/13
70AQ000L++	EMEA	Xeon E3-1245 v3 4C/3.4GHz/8MB/84W/DDR3-1600	1x4GB UDIMM DDR3-1600 ECC	RAID 100	4x3.5" HS	Open	HH DVD±RW	None	AMT9	None	1-year	450Wx1 Gold	09/13
70AQ000M++	EMEA	Xeon E3-1225 v3 4C/3.2GHz/8MB/84W/DDR3-1600	1x4GB UDIMM DDR3-1600 ECC	RAID 500	8x2.5" HS	Open	HH DVD±RW	None	AMT9	None	3-year	450Wx2 Gold	09/13
70AQ000X++	EMEA	Xeon E3-1225 v3 4C/3.2GHz/8MB/84W/DDR3-1600	1x4GB UDIMM DDR3-1600 ECC	RAID 500	8x3.5" HS	Open	HH DVD±RW	None	AMT9	None	1-year	450Wx1 Gold	12/13
70AQ000Y++	EMEA	Xeon E3-1245 v3 4C/3.4GHz/8MB/84W/DDR3-1600	1x4GB UDIMM DDR3-1600 ECC	RAID 500	8x3.5" HS	Open	HH DVD±RW	None	AMT9	None	1-year	450Wx1 Gold	12/13
70AQ0010++	EMEA	Xeon E3-1225 v3 4C/3.2GHz/8MB/84W/DDR3-1600	1x4GB UDIMM DDR3-1600 ECC	RAID 500	8x2.5" HS	Open	HH DVD±RW	None	AMT9	None	3-year	450Wx2 Gold	11/13
70AQ0011++	EMEA	Xeon E3-1245 v3 4C/3.4GHz/8MB/84W/DDR3-1600	1x4GB UDIMM DDR3-1600 ECC	RAID 100	4x3.5" HS	Open	HH DVD±RW	None	AMT9	None	3-year	450Wx1 Gold	11/13
70AQ0012++	EMEA	Xeon E3-1225 v3 4C/3.2GHz/8MB/84W/DDR3-1600	1x4GB UDIMM DDR3-1600 ECC	RAID 100	4x3.5" HS	Open	HH DVD±RW	None	AMT9	None	3-year	450Wx1 Gold	11/13
70AQ0013++	EMEA	Xeon E3-1275 v3 4C/3.5GHz/8MB/84W/DDR3-1600	1x8GB UDIMM DDR3-1600 ECC	RAID 700+Battery	4x3.5" HS	Open	HH DVD±RW	None	AMT9	None	3-year	450Wx1 Gold	11/13
70AQ0014++	EMEA	Xeon E3-1245 v3 4C/3.4GHz/8MB/84W/DDR3-1600	1x4GB UDIMM DDR3-1600 ECC	RAID 500	4x3.5" HS	Open	HH DVD±RW	None	AMT9	None	3-year	450Wx1 Gold	11/13
70AQ0015++	EMEA	Xeon E3-1245 v3 4C/3.4GHz/8MB/84W/DDR3-1600	1x4GB UDIMM DDR3-1600 ECC	RAID 100	4x3.5" HS	Open	HH DVD±RW	None	AMT9	None	1-year	450Wx1 Gold	11/13
70AQ0017++	EMEA	Xeon E3-1225 v3 4C/3.2GHz/8MB/84W/DDR3-1600	1x4GB UDIMM DDR3-1600 ECC	RAID 100	4x3.5" HS	Open	HH DVD±RW	None	AMT9	None	3-year	450Wx1 Gold	01/14

Model	Region	Processor	Memory	RAID Controller	Disk Bays	Storage	Optical	Add-on NIC	System Mgmt	OS	Warranty	Power Supply	Ann Date (m/y)
70AQ0018++	EMEA	Xeon E3-1245 v3 4C/3.4GHz/8MB/84W/DDR3-1600	1x4GB UDIMM DDR3-1600 ECC	RAID 500	4x3.5" HS	Open	HH DVD±RW	None	AMT9	None	3-year	450Wx1 Gold	01/14
70AQ0019++	EMEA	Xeon E3-1275 v3 4C/3.5GHz/8MB/84W/DDR3-1600	1x8GB UDIMM DDR3-1600 ECC	RAID 700+Battery	4x3.5" HS	Open	HH DVD±RW	None	AMT9	None	3-year	450Wx1 Gold	01/14
70AQ001A++	EMEA	Xeon E3-1245 v3 4C/3.4GHz/8MB/84W/DDR3-1600	1x4GB UDIMM DDR3-1600 ECC	RAID 100	4x3.5" HS	Open	HH DVD±RW	None	AMT9	None	1-year	450Wx1 Gold	01/14
70AQ001B++	EMEA	Xeon E3-1225 v3 4C/3.2GHz/8MB/84W/DDR3-1600	1x4GB UDIMM DDR3-1600 ECC	RAID 500	8x2.5" HS	Open	HH DVD±RW	None	AMT9	None	3-year	450Wx2 Gold	01/14
70AQ001C++	EMEA	Xeon E3-1245 v3 4C/3.4GHz/8MB/84W/DDR3-1600	1x4GB UDIMM DDR3-1600 ECC	RAID 100	4x3.5" HS	Open	HH DVD±RW	None	AMT9	None	3-year	450Wx1 Gold	01/14
70AQ001D++	EMEA	Xeon E3-1225 v3 4C/3.2GHz/8MB/84W/DDR3-1600	1x4GB UDIMM DDR3-1600 ECC	RAID 500	8x3.5" HS	Open	HH DVD±RW	None	AMT9	None	3-year	450Wx1 Gold	01/14
70AQ001E++	EMEA	Xeon E3-1245 v3 4C/3.4GHz/8MB/84W/DDR3-1600	1x4GB UDIMM DDR3-1600 ECC	RAID 500	8x3.5" HS	Open	HH DVD±RW	None	AMT9	None	3-year	450Wx1 Gold	01/14
70AQ001F++	EMEA	Xeon E3-1225 v3 4C/3.2GHz/8MB/84W/DDR3-1600	1x4GB UDIMM DDR3-1600 ECC	RAID 500	8x3.5" HS	Open	HH DVD±RW	None	AMT9	None	1-year	450Wx1 Gold	01/14
70AQ001G++	EMEA	Xeon E3-1245 v3 4C/3.4GHz/8MB/84W/DDR3-1600	1x4GB UDIMM DDR3-1600 ECC	RAID 500	8x3.5" HS	Open	HH DVD±RW	None	AMT9	None	1-year	450Wx1 Gold	01/14
70AQ001Q++	EMEA	Xeon E3-1246 v3 4C/3.5GHz/8MB/84W/DDR3-1600	1x4GB UDIMM DDR3-1600 ECC	RAID 100	4x3.5" HS	Open	HH DVD±RW	None	AMT9	None	1-year	450Wx1 Gold	09/14
70AQ001R++	EMEA	Xeon E3-1246 v3 4C/3.5GHz/8MB/84W/DDR3-1600	1x4GB UDIMM DDR3-1600 ECC	RAID 500	8x3.5" HS	Open	HH DVD±RW	None	AMT9	None	1-year	450Wx1 Gold	09/14
70AQ001V++	EMEA	Xeon E3-1226 v3 4C/3.3GHz/8MB/84W/DDR3-1600	1x4GB UDIMM DDR3-1600 ECC	RAID 100	4x3.5" HS	Open	HH DVD±RW	None	AMT9	None	3-year	450Wx1 Gold	09/14
70AQ001W++	EMEA	Xeon E3-1226 v3 4C/3.3GHz/8MB/84W/DDR3-1600	1x4GB UDIMM DDR3-1600 ECC	RAID 500	8x2.5" HS	Open	HH DVD±RW	None	AMT9	None	3-year	450Wx2 Gold	09/14
70AQ001X++	EMEA	Xeon E3-1246 v3 4C/3.5GHz/8MB/84W/DDR3-1600	1x4GB UDIMM DDR3-1600 ECC	RAID 500	8x3.5" HS	Open	HH DVD±RW	None	AMT9	None	3-year	450Wx1 Gold	09/14
70AQ001Y++	EMEA	Xeon E3-1246 v3 4C/3.5GHz/8MB/84W/DDR3-1600	1x4GB UDIMM DDR3-1600 ECC	RAID 100	4x3.5" HS	Open	HH DVD±RW	None	AMT9	None	3-year	450Wx1 Gold	09/14
70AQ0020++	EMEA	Xeon E3-1276 v3 4C/3.6GHz/8MB/84W/DDR3-1600	1x8GB UDIMM DDR3-1600 ECC	RAID 700+Battery	4x3.5" HS	Open	HH DVD±RW	None	AMT9	None	3-year	450Wx1 Gold	09/14
70AQ0021++	EMEA	Xeon E3-1246 v3 4C/3.5GHz/8MB/84W/DDR3-1600	1x4GB UDIMM DDR3-1600 ECC	RAID 500	4x3.5" HS	Open	HH DVD±RW	None	AMT9	None	3-year	450Wx1 Gold	09/14

Model	Region	Processor	Memory	RAID Controller	Disk Bays	Storage	Optical	Add-on NIC	System Mgmt	OS	Warranty	Power Supply	Ann Date (m/y)
70AL0000++	EMEA	Xeon E3-1225 v3 4C/3.2GHz/8MB/84W/DDR3-1600	3x8GB UDIMM DDR3-1600 ECC	RAID 100	4x3.5" HS	3x3TB HDD 7.2K 3.5" SATA6Gbs	HH DVD±RW	2xGbE	AMT9	2012 Foundations	1-year	450W Platinum Fixed	09/13
70AL0001++	EMEA	Xeon E3-1245 v3 4C/3.4GHz/8MB/84W/DDR3-1600	1x4GB UDIMM DDR3-1600 ECC	RAID 500	8x2.5" HS	1x500GB HDD 7.2K 2.5" SATA6Gbs	2xHH DVD±RW	4xGbE	AMT9	2012 Foundations	1-year	450W Platinum Fixed	09/13
70AL000H++	EMEA	Xeon E3-1225 v3 4C/3.2GHz/8MB/84W/DDR3-1600	3x8GB UDIMM DDR3-1600 ECC	RAID 100	4x3.5" HS	3x3TB HDD 7.2K 3.5" SATA6Gbs	HH DVD±RW	2xGbE	AMT9	2012 Foundations	1-year	450W Platinum Fixed	01/14
70AL000J++	EMEA	Xeon E3-1245 v3 4C/3.4GHz/8MB/84W/DDR3-1600	1x4GB UDIMM DDR3-1600 ECC	RAID 500	8x2.5" HS	1x500GB HDD 7.2K 2.5" SATA6Gbs	2xHH DVD±RW	4xGbE	AMT9	2012 Foundations	1-year	450W Platinum Fixed	01/14

Model	Region	Processor	Memory	RAID Controller	Disk Bays	Storage	Optical	Add-on NIC	System Mgmt	OS	Warranty	Power Supply	Ann Date (m/y)
70AM0000++	EMEA	Xeon E3-1225 v3 4C/3.2GHz/8MB/84W/DDR3-1600	2x2GB UDIMM DDR3-1600 ECC	RAID 100	4x3.5" DC	2x500GB HDD 7.2K 3.5" SATA6Gbs	HH DVD	1xGbE	AMT9	2012 Foundations	1-year	450Wx1 Gold	09/13
70AM0001++	EMEA	Xeon E3-1275 v3 4C/3.5GHz/8MB/84W/DDR3-1600	4x2GB UDIMM DDR3-1600 ECC	RAID 500+Key	8x3.5" HS	8x2TB HDD 7.2K 3.5" SATA6Gbs	2xHH DVD±RW	1xGbE	AMT9	2012 Foundations	1-year	450Wx2 Gold	09/13
70AM0002++	EMEA	Xeon E3-1280 v3 4C/3.6GHz/8MB/82W/DDR3-1600	3x4GB UDIMM DDR3-1600 ECC	RAID 700	8x2.5" HS	3x600GB HDD 10K 2.5" SAS6Gbs	HH DVD	4xGbE	AMT9	None	1-year	450Wx1 Gold	09/13
70AM0003++	EMEA	Xeon E3-1285 v3 4C/3.6GHz/8MB/84W/DDR3-1600	4x8GB UDIMM DDR3-1600 ECC	RAID 700	8x2.5" HS	8x900GB HDD 10K 2.5" SAS6Gbs	HH DVD±RW	2xGbE	AMT9	2012 Foundations	1-year	450Wx2 Gold	09/13
70AM000P++	EMEA	Xeon E3-1225 v3 4C/3.2GHz/8MB/84W/DDR3-1600	2x2GB UDIMM DDR3-1600 ECC	RAID 100	4x3.5" DC	2x500GB HDD 7.2K 3.5" SATA6Gbs	HH DVD	1xGbE	AMT9	2012 Foundations	1-year	450Wx1 Gold	01/14
70AM000Q++	EMEA	Xeon E3-1280 v3 4C/3.6GHz/8MB/82W/DDR3-1600	3x4GB UDIMM DDR3-1600 ECC	RAID 700	8x2.5" HS	3x600GB HDD 10K 2.5" SAS6Gbs	HH DVD	4xGbE	AMT9	None	1-year	450Wx1 Gold	01/14
70AM000R++	EMEA	Xeon E3-1275 v3 4C/3.5GHz/8MB/84W/DDR3-1600	4x2GB UDIMM DDR3-1600 ECC	RAID 500+Key	8x3.5" HS	8x2TB HDD 7.2K 3.5" SATA6Gbs	2xHH DVD±RW	1xGbE	AMT9	2012 Foundations	1-year	450Wx2 Gold	01/14
70AM000S++	EMEA	Xeon E3-1285 v3 4C/3.6GHz/8MB/84W/DDR3-1600	4x8GB UDIMM DDR3-1600 ECC	RAID 700	8x2.5" HS	8x900GB HDD 10K 2.5" SAS6Gbs	HH DVD±RW	2xGbE	AMT9	2012 Foundations	1-year	450Wx2 Gold	01/14

Availability: All offers subject to availability. Lenovo reserves the right to alter product offerings and specifications at any time, without notice. Lenovo is not responsible for photographic or typographic errors.

Warranty: For a copy of applicable product warranties, write to: Warranty Support Dept., EMEA Services, Lenovo, Eisteinova 21, 851 01 Bratislava, Slovakia. Lenovo makes no representation or warranty regarding third party products or services.

¹ **Limited warranty:** Support unrelated to a warranty issue may be subject to additional charges.

² **Hard drive:** GB = billion bytes, TB = trillion bytes. Accessible capacity is less.

³ **Systems with limited onsite service** are designed to be repaired during the applicable warranty period primarily with customer-replaceable parts provided by Lenovo. Lenovo will only send a technician onsite to perform a repair if (a) remote telephone diagnosis and/or customer part replacement are unable to resolve the problem, or (b) the part is one of the few designated by Lenovo for onsite replacement. For a list of onsite replaceable parts, contact Lenovo. Support unrelated to a warranty issue may be subject to additional charges. Support phone list available at www-307.ibm.com/pc/support/site.wss/document.do?Indocid=MIGR-70552

⁴ **SATA/SAS:** The system configuration supports the installation of either SATA or SAS disks. A configuration including both SATA and SAS disks is not supported.

⁷ **Lenovo Services:** These services are available for machines normally used for business, professional, or trade purposes, rather than personal, family, or household purposes. Not all machine types and models are covered. Service period begins with the equipment date of purchase. Service must be purchased during the original limited product warranty period. Service levels are response time objectives and are not guarantees. If the machine problem turns out to be a Customer Replaceable Unit (CRU), a part will be express shipped to you for quick replacement. See Lenovo Warranty Services terms and conditions for complete details and restrictions.

⁸ **RAID:** Supported RAID levels for a system will vary from the stated capabilities of the RAID controller due to dependencies on the number and capacity of physical disks in the system and on customer requirements for performance, fault tolerance, or data redundancy.

RAID levels and requirements:

- **RAID 0 (striping)** provides increased performance by writing data across multiple drives.
- **RAID 1 (mirroring)** provides fault tolerance by writing the data on two drives.
- **RAID 5 (striping with parity)** uses distributed parity data to provide fault tolerance more efficiently than RAID 1. Requires three or more drives.
- **RAID 6 (striped set with dual distributed parity)** provides fault tolerance from two drive failures; array continues to operate with up to two failed drives. Requires four drives.
- **RAID 10 (or RAID 1+0)** combines RAID 1 and RAID 0 to create a stripe of mirrors that is fault tolerant while offering increased performance. Requires four drives.
- **RAID 50 (or RAID 5+0)** combines RAID 5 and RAID 0 to create block-level striping with distributed parity improving performance over RAID 5. Requires six drives.
- **RAID 60 (or RAID 6+0)** combines RAID 6 and RAID 0 to create block-level striping with distributed double parity improving performance over RAID 6. Requires eight drives.

¹⁴ **Response times may vary.** Response time is an average target and omitted service level. May exclude some holidays. Telephone support may be subject to additional charges.

ThinkServer™

This publication was developed for products and services offered in Europe, Middle East, and Africa. Lenovo may not offer the products, services or features discussed in this document in other countries. Lenovo may withdraw an offering at any time. Information is subject to change without notice. Consult your local representative for information on offerings available in your area.

Lenovo reserves the right to change specifications and other product information at any time without prior notice. Lenovo is not responsible for photographic or typographical errors. **LENOVO PROVIDES THIS PUBLICATION "AS IS" WITHOUT WARRANTY OF ANY KIND, EITHER EXPRESS OR IMPLIED, INCLUDING THE IMPLIED WARRANTIES OF MERCHANTABILITY OR FITNESS FOR A PARTICULAR PURPOSE.** Some jurisdictions do not allow disclaimer of express or implied warranties in certain transactions; therefore this disclaimer may not apply to you.

Trademarks: Lenovo, the Lenovo logo, New World, New Thinking., Access Connections, Rescue and Recovery, ThinkCentre, ThinkPad, ThinkServer, ThinkStation, ThinkVantage, and ThinkVision are trademarks of Lenovo. Microsoft, Windows, and Vista are registered trademarks of Microsoft Corporation. Intel, the Intel logo, Intel Inside logo, Intel Core and Core Inside are trademarks of Intel Corporation in the US and other countries. Other company, product, or service names may be trademarks or service marks of others.

Visit www.lenovo.com/safecomputing periodically for the latest information on safe and effective computing.

Visit www.lenovo.com/psref for the latest version of Product Specifications Reference.

© Lenovo
All rights reserved.

Lenovo
1009 Think Place
Morrisville, NC 27560
U.S.A.