

SIEMENS



Motion Control Drives

# SINAMICS Inverters for Single-Axis Drives Distributed Inverters

Catalog  
D 31.2

Edition  
2018

[siemens.com/drives](http://siemens.com/drives)

## Related catalogs

<p><b>Motion Control Drives</b> D 31.1 SINAMICS Inverters for Single-Axis Drives Built-In Units</p> <p>E86060-K5531-A111-A1-7600</p>		<p><b>Industrial Controls</b> IC 10 SIRIUS</p> <p>E86060-K1010-A101-A7-7600</p>	
<p><b>SINAMICS Drives</b> D 35 SINAMICS G120P and SINAMICS G120P Cabinet pump, fan, compressor converters</p> <p>E86060-K5535-A101-A4-7600</p>		<p><b>Industrial Controls</b> IC 10 AO SIRIUS Classic</p> <p>PDF (E86060-K1010-A191-A5-7600)</p>	
<p><b>SINAMICS S120</b> D 21.3 Chassis Format Converter Units Cabinet Modules</p> <p><b>SINAMICS S150</b> Converter Cabinet Units E86060-K5521-A131-A6-7600</p>		<p><b>Low-Voltage Power Distribution and Electrical Installation Technology</b> LV 10 SENTRON • SIVAICON • ALPHA Protection, Switching, Measuring and Monitoring Devices, Switchboards and Distribution Systems PDF (E86060-K8280-A101-A4-7600) Print (E86060-K8280-A101-A3-7600)</p>	
<p><b>Motion Control Drives</b> D 21.4 SINAMICS S120 and SIMOTICS</p> <p>E86060-K5521-A141-A1-7600</p>		<p><b>SIMATIC</b> ST 70 Products for Totally Integrated Automation</p> <p>E86060-K4670-A101-B6-7600</p>	
<p><b>SIMOTICS S-1FG1</b> D 41 <b>Servo geared motors</b> Helical, Parallel shaft, Bevel and Helical worm geared motors</p> <p>E86060-K5541-A101-A3-7600</p>		<p><b>SIMATIC HMI / PC-based Automation</b> ST 80/ST PC Human Machine Interface Systems PC-based Automation</p> <p>E86060-K4680-A101-C5-7600</p>	
<p><b>SIMOTICS GP, SD, XP, DP</b> D 81.1 <b>Low-Voltage Motors</b> Type series 1FP1, 1LE1, 1MB1 and 1PC1 Frame sizes 71 to 315 Power range 0.09 to 200 kW E86060-K5581-A111-A9-7600</p>		<p><b>Industrial Communication</b> IK PI SIMATIC NET</p> <p>E86060-K6710-A101-B8-7600</p>	
<p><b>FLENDER Couplings</b> MD 10.1 Standard Couplings</p> <p>E86060-K5710-A111-A5-7600</p>		<p><b>SITRAIN</b> Training for Industry</p> <p><a href="http://www.siemens.com/sitrain">www.siemens.com/sitrain</a></p>	
<p><b>SIMOGEAR</b> MD 50.1 <b>Geared Motors</b> Helical, parallel shaft, bevel, helical worm and worm geared motors</p> <p>E86060-K5250-A111-A5-7600</p>		<p><b>Products for Automation and Drives</b> CA 01 Interactive Catalog DVD</p> <p>E86060-D4001-A510-D8-7600</p>	
<p><b>Motion Control System</b> PM 21 SIMOTION Equipment for Production Machines</p> <p>E86060-K4921-A101-A4-7600</p>		<p><b>Industry Mall</b> Information and Ordering Platform on the Internet:</p> <p><a href="http://www.siemens.com/industrymall">www.siemens.com/industrymall</a></p>	

# SINAMICS Inverters for Single-Axis Drives

## Distributed Inverters

### Motion Control Drives



#### Catalog D 31.2 · 2018

Supersedes:

Catalog D 31 · 2015

Catalog News D 31 N · March 2016

Refer to the Industry Mall for current updates of this catalog:

[www.siemens.com/industrymall](http://www.siemens.com/industrymall)

The products contained in this catalog can also be found in the Interactive Catalog CA 01.

Article No.: E86060-D4001-A510-D8-7600

Please contact your local Siemens branch.

#### **NEW**

Click on an Article No. in the catalog PDF to call it up in the Industry Mall and to obtain all the information.

Article No.

**6SL3070-0AA00-0AG0**  
**6SL3072-0AA00-0AG0**

Or directly on the Internet, e.g.

[www.siemens.com/product?6SL3070-0AA00-0AG0](http://www.siemens.com/product?6SL3070-0AA00-0AG0)



The products and systems described in this catalog are distributed under application of a certified quality management system in accordance with DIN EN ISO 9001. The certificate is recognized by all IQNet countries.

System overview	1
Firmware functionality	2
Safety Integrated	3
Energy efficiency	4
Communication	5
Technology functions	6
<b>SINAMICS G110M distributed inverters</b>	<b>7</b>
<b>SINAMICS G110D distributed inverters</b>	<b>8</b>
<b>SINAMICS G120D distributed inverters</b>	<b>9</b>
<b>SIMATIC ET 200pro FC-2 frequency converters</b>	<b>10</b>
<b>SIMOTICS motors and geared motors</b>	<b>11</b>
Engineering tools	12
Drive applications	13
Services and documentation	14
Appendix	15

# Integrated Drive Systems

Faster on the market and in the black with Integrated Drive Systems

SINAMICS is an important element of a Siemens Integrated Drive System, contributing significantly to increased efficiency, productivity, and availability in industrial production processes.

Integrated Drive Systems are Siemens' trendsetting answer to the high degree of complexity that characterizes drive and automation technology today. The world's only true one-stop solution for entire drive systems is characterized in particular by its threefold integration: Horizontal, vertical,

and lifecycle integration ensure that every drive system component fits seamlessly into the whole system, into any automation environment, and even into the entire lifecycle of a plant.

The outcome is an optimal workflow – from engineering all the way to service that entails more productivity, increased efficiency, and better availability. That's how Integrated Drive Systems reduce time to market and time to profit.

## Horizontal integration

**Integrated drive portfolio:** The core elements of a fully integrated drive portfolio are frequency converters, motors, couplings, and gear units. At Siemens, they're all available from a single source. Perfectly integrated, perfectly interacting. For all power and performance classes. As standard solutions or fully customized. No other player in the market can offer a comparable portfolio. Moreover, all Siemens drive components are perfectly matched, so they are optimally interacting.

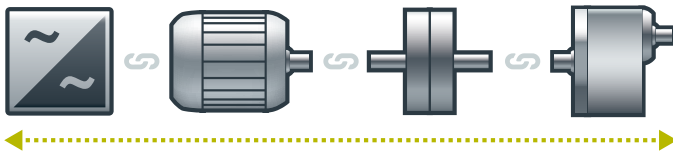

You can boost the availability of your application or plant to up to

**99%\***

\*e.g., conveyor application

## Vertical integration

Thanks to **vertical integration**, the complete drive train is seamlessly integrated in the entire automation environment – an important prerequisite for production with maximum value added. Integrated Drive Systems are part of Totally Integrated Automation (TIA), which means that they are perfectly embedded into the system architecture of the entire industrial production process. This enables optimal processes through maximum communication and control.

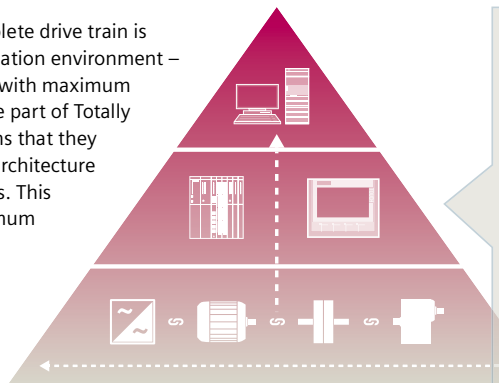

With TIA Portal you can cut your engineering time by up to

**30%**

## Lifecycle integration

**Lifecycle integration** adds the factor of time: Software and service are available for the entire lifecycle of an Integrated Drive System. That way, important optimization potential for maximum productivity, increased efficiency, and highest availability can be leveraged throughout the system's lifecycle – from planning, design, and engineering to operation, maintenance, and all the way even to modernization.

With Integrated Drive Systems, assets become important success factors. They ensure shorter time to market, maximum productivity and efficiency in operation, and shorter time to profit.

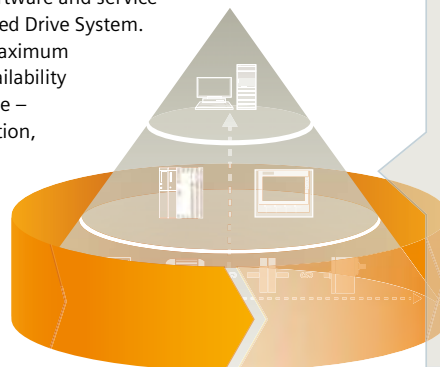

With Integrated Drive Systems you can reduce your maintenance costs by up to

**15%**

## System overview



1/2	<b>The SINAMICS drive family</b>
1/6	<b>Drive selection</b>
1/7	<b>SIMOTICS motors</b>
1/7	<b>SIMOGEAR geared motors</b>
1/8	<b>Motion Control Encoder measuring systems</b>

Further information about SINAMICS, SIMOTICS and SIMOGEAR can be found on the Internet at  
[www.siemens.com/sinamics](http://www.siemens.com/sinamics)  
[www.siemens.com/simotics](http://www.siemens.com/simotics)  
[www.siemens.com/simogear](http://www.siemens.com/simogear)

# System overview

## The SINAMICS drive family

### Overview

#### Integration in automation

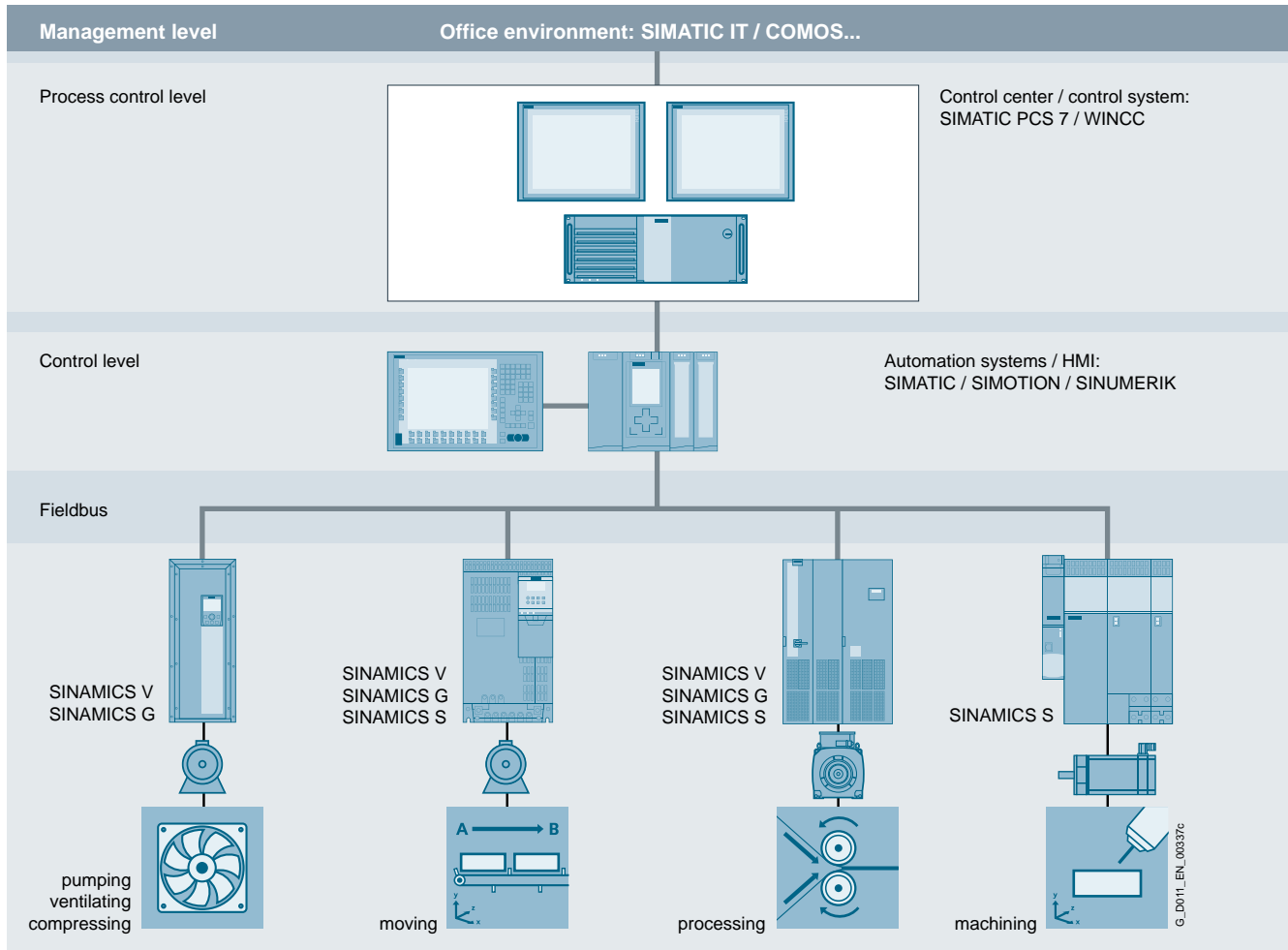

#### Totally Integrated Automation and communication

SINAMICS is an integral component of the Siemens "Totally Integrated Automation" concept. Integrated SINAMICS systems covering configuration, data storage, and communication at automation level ensure low-maintenance solutions with the SIMATIC, SIMOTION and SINUMERIK control systems.

Depending on the application, the appropriate variable frequency drives can be selected and incorporated in the automation concept. With this in mind, the drives are clearly subdivided into their different applications. A wide range of communication options (depending on the drive type) are available for establishing a communication link to the automation system:

- PROFINET
- PROFIBUS
- EtherNet/IP
- Modbus TCP
- Modbus RTU
- AS-Interface
- BACnet MS/TP

#### Applications

SINAMICS is the comprehensive family of drives from Siemens designed for machine and plant engineering applications. SINAMICS offers solutions for all drive tasks:

- Simple pump and fan applications in the process industry
- Demanding single drives in centrifuges, presses, extruders, elevators, as well as conveyor and transport systems
- Drive line-ups in textile, plastic film, and paper machines as well as in rolling mill plants
- Highly dynamic servo drives for machine tools, as well as packaging and printing machines

**Overview** (continued)*SINAMICS as part of the Siemens modular automation system****Innovative, energy-efficient and reliable drive systems and applications as well as services for the entire drive train***

The solutions for drive technology place great emphasis on the highest productivity, energy efficiency and reliability for all torque ranges, performance and voltage classes.

Siemens offers not only the right innovative variable frequency drive for every drive application, but also a wide range of energy-efficient low voltage motors, geared motors, explosion-protected motors and high-voltage motors for combination with SINAMICS.

Furthermore, Siemens supports its customers with global pre-sales and after-sales services, with over 295 service points in 130 countries – and with special services e.g. application consulting or motion control solutions.

***Energy efficiency******Energy management process***

Efficient energy management consultancy identifies the energy flows, determines the potential for making savings and implements them with focused activities.

Almost two thirds of the industrial power requirement is from electric motors. This makes it all the more important to use drive technology permitting energy consumption to be reduced effectively even in the configuration phase, and consequently to optimize plant availability and process stability. With SINAMICS, Siemens offers powerful energy efficient solutions which, depending on the application, enable a significant reduction in electricity costs.

G\_D011\_XX\_00615

## System overview

1

### The SINAMICS drive family

#### Overview (continued)

##### Up to 70 % potential for savings using variable speed operation

SINAMICS enables great potential for savings to be realized by controlling the motor speed. In particular, huge potential savings can be recovered from pumps, fans and compressors which are operated with mechanical throttle and valves. Here, changing to variable-speed drives brings enormous economic advantages. In contrast to mechanical control systems, the power consumption at partial load operation is always immediately adjusted to the demand at that time. So energy is no longer wasted, permitting savings of up to 60 % – in exceptional cases even up to 70 %. Variable-speed drives also offer clear advantages over mechanical control systems when it comes to maintenance and repair. Current spikes when starting up the motor and strong torque surges become things of the past – and the same goes for pressure waves in pipelines, cavitation or vibrations which cause sustainable damage to the plant. Smooth starting and ramp-down relieve the load on the mechanical system, ensuring a significantly longer service life of the entire drive train.

##### Regenerative feedback of braking energy

In conventional drive systems, the energy produced during braking is converted to heat using braking resistors. Energy produced during braking is efficiently recovered to the supply system by versions of SINAMICS G and SINAMICS S drives with regenerative feedback capability and these devices do not therefore need a braking resistor. This permits up to 60 % of the energy requirement to be saved, e.g. in lifting applications. Energy which can be reused at other locations on a machine. Furthermore, this reduced power loss simplifies the cooling of the system, enabling a more compact design.

##### Energy transparency in all configuration phases

Early on, in the configuration phase, the SIZER for Siemens Drives engineering tool provides information on the specific energy requirement. The energy consumption across the entire drive train is visualized and compared with different plant concepts.

##### SINAMICS in combination with energy-saving motors

Engineering integration stretches beyond the SINAMICS drive family to higher-level automation systems, and to a broad spectrum of energy-efficient motors with a wide range of performance classes, which, compared to previous motors, are able to demonstrate up to 10 % greater efficiency.

#### Variants

Depending on the application, the SINAMICS range offers the ideal variant for any drive task.

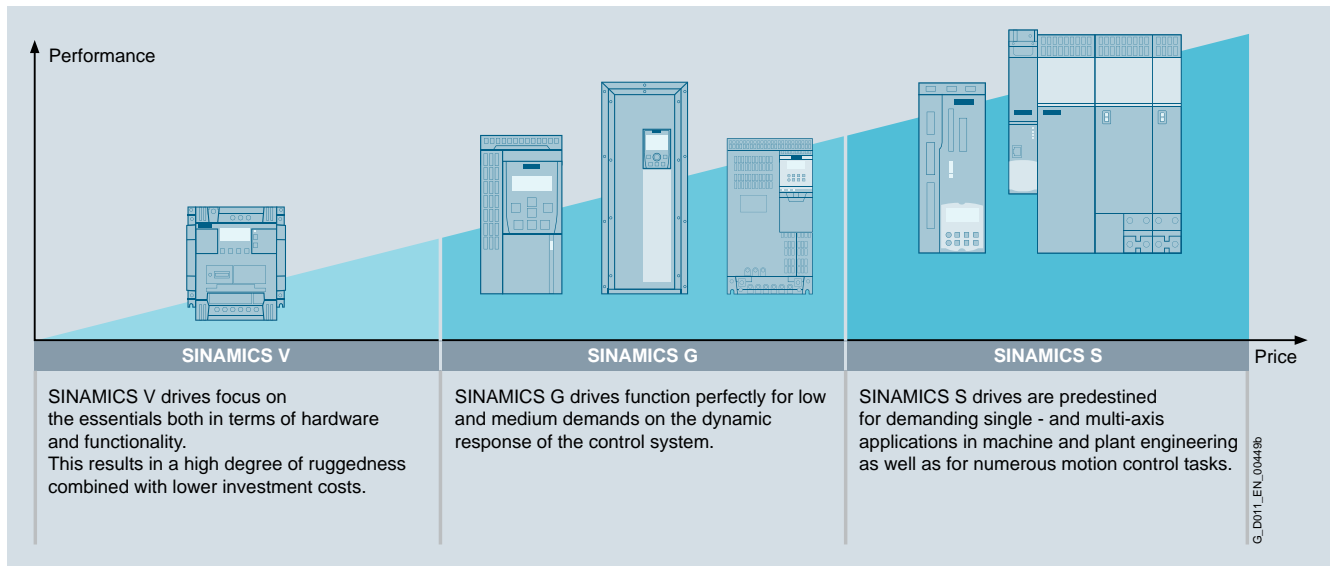



**Overview** (continued)**Platform concept**

All SINAMICS variants are based on a platform concept. Joint hardware and software components, as well as standardized tools for dimensioning, configuration, and commissioning tasks ensure high-level integration across all components. SINAMICS handles a wide variety of drive tasks with no system gaps. The different SINAMICS variants can be easily combined with each other.













**Quality management according to EN ISO 9001**

SINAMICS conforms to the most exacting quality requirements. Comprehensive quality assurance measures in all development and production processes ensure a consistently high level of quality.

Of course, our quality management system is certified by an independent authority in accordance with EN ISO 9001.

**IDS – Integration at its very best**

The Siemens Integrated Drive Systems (IDS) solution offers perfectly matched drive components with which you can meet your requirements. The drive components reveal their true strengths as an Integrated Drive System over the full range from engineering and commissioning through to operation: Integrated system configuration is performed using the Drive Technology Configurator: Just select a motor and an inverter and design them with the SIZER for Siemens Drives engineering tool. The STARTER and SINAMICS Startdrive commissioning tools integrate the motor data and at the same time simplify efficient commissioning. Integrated Drive Systems are incorporated in the TIA Portal – this simplifies engineering, commissioning and diagnostics.

Low voltage										DC voltage	Medium voltage
Basic performance		General performance					High performance			DC applications	Applications with high outputs
											
SINAMICS V20	SINAMICS V90	SINAMICS G120C G120 G120P G120P Cabinet	SINAMICS G110D G120D G110M SIMATIC ET 200pro FC-2	SINAMICS G130 G150	SINAMICS G180	SINAMICS S110	SINAMICS S210	SINAMICS S120 S120M	SINAMICS S150	SINAMICS DCM	SINAMICS GH150 GH180 GM150 SM150 GL150 SL150 SM120CM
0.12 kW to 30 kW	0.05 kW to 7 kW	0.37 kW to 630 kW	0.37 kW to 7.5 kW	75 kW to 2700 kW	2.2 kW to 6600 kW	0.55 kW to 132 kW	0.05 kW to 0.75 kW	0.55 kW to 5700 kW	75 kW to 1200 kW	6 kW to 30 MW	0.15 MW to 85 MW
Pumps, fans, compressors, conveyor belts, mixers, mills, spinning machines, textile machines, refrigerated display counters, fitness equipment, ventilation systems	Handling machines, packaging machines, automatic assembly machines, metal forming machines, printing machines, winding and unwinding units	Pumps, fans, compressors, conveyor belts, mixers, mills, extruders, building management systems, process industry, HVAC, single-axis positioning applications in machine and plant engineering	Conveyor technology, single-axis positioning applications (G120D)	Pumps, fans, compressors, conveyor belts, mixers, mills, extruders	Sector-specific for pumps, fans, compressors, conveyor belts, extruders, mixers, mills, kneaders, centrifuges, separators	Single-axis positioning applications in machine and plant engineering	Packaging machines, handling equipment, feed and withdrawal devices, stacking units, automatic assembly machines, laboratory automation, wood, glass and ceramics industry, digital printing machines	Production machines (packaging, textile and printing machines, paper machines, plastic processing machines), machine tools, plants, process lines and rolling mills, marine drives, test bays	Test bays, cross cutters, centrifuges	Rolling mill drives, wire-drawing machines, extruders and kneaders, cableways and lifts, test bay drives	Pumps, fans, compressors, mixers, extruders, mills, crushers, rolling mills, conveyor technology, excavators, test bays, marine drives, blast furnace fans, retrofit
Catalog D 31.1	Brochure V90	Catalogs D 31.1, D 35	Catalog D 31.2	Catalog D 11	Catalog D 18.1	Catalog D 31.1	Brochure S210	Catalogs D 21.3, D 21.4 NC 62	Catalog D 21.3	Catalog D 23.1	Catalogs D 15.1, D 12

Engineering tools (e.g. Drive Technology Configurator, SIZER for Siemens Drives, STARTER and SINAMICS Startdrive)

G\_D011\_EN\_004501



# System overview

## Drive selection

1

### Overview

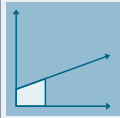
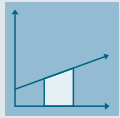
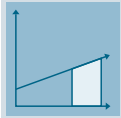
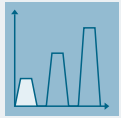
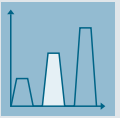
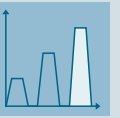
#### SINAMICS selection guide – typical applications

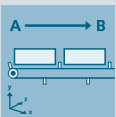
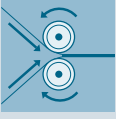
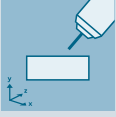
Use	Requirements for torque accuracy/speed accuracy/position accuracy/coordination of axes/functionality					
	Continuous motion			Non-continuous motion		
	Basic	Medium	High	Basic	Medium	High
						
<b>Pumping, ventilating, compressing</b>	Centrifugal pumps Radial / axial fans Compressors	Centrifugal pumps Radial / axial fans Compressors	Eccentric screw pumps	Hydraulic pumps Metering pumps	Hydraulic pumps Metering pumps	Descaling pumps Hydraulic pumps
	V20 G120C G120P	G120P G130/G150 G180 <sup>1)</sup>	S120	G120	S110	S120
<b>Moving</b>	Conveyor belts Roller conveyors Chain conveyors	Conveyor belts Roller conveyors Chain conveyors Lifting/lowering devices Elevators Escalators/moving walkways Indoor cranes Marine drives Cable railways	Elevators Container cranes Mining hoists Excavators for open-cast mining Test bays	Acceleration conveyors Storage and retrieval machines	Acceleration conveyors Storage and retrieval machines Cross cutters Reel changers	Storage and retrieval machines Robotics Pick & place Rotary indexing tables Cross cutters Roll feeds Engagers/disengagers
	V20 G110D G110M G120C ET 200pro FC-2 <sup>2)</sup>	G120 G120D G130/G150 G180 <sup>1)</sup>	S120 S150 DCM	V90 G120 G120D	S110 S210 DCM	S120 S210 DCM
<b>Processing</b>	Mills Mixers Kneaders Crushers Agitators Centrifuges	Mills Mixers Kneaders Crushers Agitators Centrifuges Extruders Rotary furnaces	Extruders Winders/unwinders Lead/follower drives Calenders Main press drives Printing machines	Tubular bagging machines Single-axis motion control such as • Position profiles • Path profiles	Tubular bagging machines Single-axis motion control such as • Position profiles • Path profiles	Servo presses Rolling mill drives Multi-axis motion control such as • Multi-axis positioning • Cams • Interpolations
	V20 G120C	G120 G130/G150 G180 <sup>1)</sup>	S120 S150 DCM	V90 G120	S110 S210	S120 S210 DCM
<b>Machining</b>	Main drives for • Turning • Milling • Drilling	Main drives for • Drilling • Sawing	Main drives for • Turning • Milling • Drilling • Gear cutting • Grinding	Axis drives for • Turning • Milling • Drilling	Axis drives for • Drilling • Sawing	Axis drives for • Turning • Milling • Drilling • Lasering • Gear cutting • Grinding • Nibbling and punching
	S110	S110 S120	S120	S110	S110 S120	S120

#### Using the SINAMICS selection guide

The varying range of demands on modern variable frequency drives requires a large number of different types. Selecting the optimum drive has become a significantly more complex process. The application matrix shown simplifies this selection process considerably, by suggesting the ideal SINAMICS drive for examples of typical applications and requirements.

- The application type is selected from the vertical column
  - Pumping, ventilating, compressing
  - Moving
  - Processing
  - Machining
- The quality of the motion type is selected from the horizontal row
  - Basic
  - Medium
  - High

#### More information







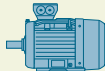

Further information about SINAMICS is available on the Internet at [www.siemens.com/sinamics](http://www.siemens.com/sinamics)

Practical application examples and descriptions are available on the Internet at [www.siemens.com/sinamics-applications](http://www.siemens.com/sinamics-applications)

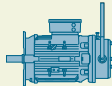
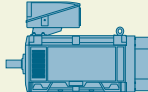
<sup>1)</sup> Industry-specific inverters.

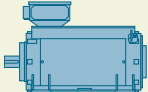
<sup>2)</sup> Information on the SIMATIC ET 200pro FC-2 frequency converter is available at [www.siemens.com/et200pro-fc](http://www.siemens.com/et200pro-fc)

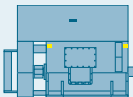
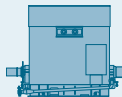
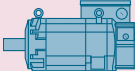
## Overview

SIMOTICS						
Low-voltage motors for line and converter operation						
General Purpose SIMOTICS GP	Severe Duty SIMOTICS SD	Explosion-proof SIMOTICS XP	Definite Purpose SIMOTICS DP	Flexible Duty SIMOTICS FD	Non standard SIMOTICS TN	High Torque SIMOTICS HT
						
DC motors		High-voltage motors				
Direct current SIMOTICS DC		High Voltage SIMOTICS HV				
						
Motors for motion control						
SIMOTICS S servomotors		SIMOTICS M main motors		SIMOTICS L linear motors		SIMOTICS T torque motors
Servomotors	Servo geared motors					

G\_D011\_EN\_00491

**SIMOTICS stands for**

- 150 years of experience in building electric motors
- The most comprehensive range of motors worldwide
- Optimum solutions in all industries, regions and power/performance classes
- Innovative motor technologies of the highest quality and reliability
- Highest dynamic performance, precision and efficiency together with the optimum degree of compactness
- Our motors can be integrated into the drive train as part of the overall system
- A global network of skill sets and worldwide service around the clock

**A clearly structured portfolio**

The entire SIMOTICS product portfolio is transparently organized according to application-specific criteria in order to help users select the optimum motor for their application.

The product range extends from standard motors for pumps, fans and compressors to highly dynamic, precise motion control motors for positioning tasks and motion control in handling applications, as well as production machinery and machine tools, to DC motors and powerful high-voltage motors. Whatever it is that you want to move – we can supply the right motor for the task.

[www.siemens.com/simotics](http://www.siemens.com/simotics)

**An outstanding performance for any job**

A key characteristic of all SIMOTICS motors is their quality. They are robust, reliable, dynamic and precise to assure the requisite performance level for any process and deliver exactly the capabilities demanded by the application in hand. Thanks to their compact design, they can be integrated as space-saving units into installations. Furthermore, their impressive energy efficiency makes them effective as a means of reducing operating costs and protecting the environment.

**A dense network of skill sets and servicing expertise around the world**

SIMOTICS offers not only a wealth of sound experience gleaned from a development history which stretches back over around 150 years, but also the know-how of hundreds of engineers. This knowledge and our worldwide presence form the basis for a unique proximity to industries which feeds through in tangible terms to the specific motor configuration which is tailored to suit your application.

Our specialists are available to answer all your queries regarding any aspect of motor technology. At any time – wherever you are in the world. When you choose SIMOTICS, therefore, you reap the benefits of a global service network which is continuously accessible, thereby helping to optimize response times and minimize downtimes.

**Perfection of the complete drive train**

SIMOTICS is perfectly coordinated with other Siemens product families. In combination with the SINAMICS integrated drives family and the SIRIUS complete portfolio of industrial controls, SIMOTICS fits seamlessly as part of the complete drive train into automation solutions which are based on the SIMATIC, SIMOTION and SINUMERIK control systems.

## SIMOGEAR geared motors

## Overview

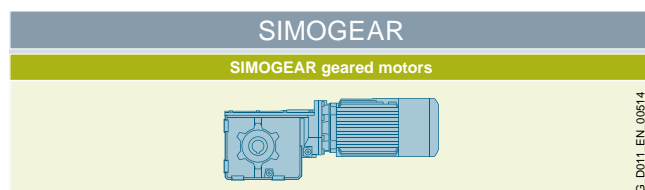

G\_D011\_EN\_00514





The SIMOGEAR range of geared motors covers all common types such as helical, parallel shaft, bevel and worm geared motors and covers a power range from 0.09 kW to 55 kW and gearbox torques up to 19500 Nm. SIMOGEAR geared motors are fully compatible with many other manufacturers thanks to their market-standard connection dimensions.

[www.siemens.com/simogear](http://www.siemens.com/simogear)

# System overview

## Motion Control Encoder measuring systems

### Overview

Motion Control Encoder measuring systems								
Encoder type	Incremental encoders			Absolute encoders				
								
Interface	sin/cos 1V <sub>pp</sub>	RS422 (TTL)	HTL	DRIVE-CLIQ	SSI	EnDat	PROFIBUS DP	PROFINET IO
Resolution	1000 S/R 1024 S/R 2500 S/R	500 S/R 1000 S/R 1024 S/R 1250 S/R 1500 S/R 2000 S/R 2048 S/R 2500 S/R 3600 S/R 5000 S/R	100 S/R 500 S/R 1000 S/R 2500 S/R	Single-turn 24-bit Multi-turn 36-bit (24-bit single-turn + 12-bit multi-turn)	Single-turn 13-bit (8192 steps)  Multi-turn 25-bit (8192 steps × 4096 revolutions)	Single-turn 13-bit (8192 steps)  Multi-turn 25-bit (8192 steps × 4096 revolutions)	Single-turn 13-bit (8192 steps)  Multi-turn 27-bit (8192 steps × 16384 revolutions)	Single-turn 13-bit (8192 steps)  Multi-turn 27-bit (8192 steps × 16384 revolutions)
Catalog	D 21.4							

Motion control encoders are optoelectronic built-on encoders that detect the traversing distances, angles of rotation, speeds or positions of machine axes. Motion control encoders are direct measuring systems that are built-on to shafts, axes or motors. They can be used in conjunction with numerical and programmable logic controllers, drives and position displays. Motion control encoders are system-tested, certified components that have been harmonized for use with the following systems:

- SINUMERIK CNC controls
- SIMOTION Motion Control Systems
- SIMATIC programmable logic controllers
- SINAMICS drive systems

Motion control encoders are used with machine tools and production machines as additional external measuring systems. They are available as incremental or absolute encoders.

- In the case of incremental encoders, the machine must travel to a reference point after each power-off state, as the position is not usually stored in the controller, and movements of the machine while the power is off are not recorded.
- Absolute encoders, on the other hand, also record movements while the power is off and return the actual position after power on. Travel to a reference point is not necessary.

All motion control encoders are available as Synchro flange and clamp flange versions. The absolute encoders are also available with a hollow shaft and torque arm.

The motion control encoders are driven via a plug-in coupling or spring disk coupling. Alternatively, pulleys can also be used.

The motor control encoder supply voltage is 5 V DC or alternatively 10 V to 30 V DC. The 10 V to 30 V DC version supports longer cable lengths. Most control systems supply the voltage directly at the measuring circuit connector. With SINAMICS, the measuring systems are provided with power via the inverters or the Sensor Modules.

For motion control encoders with cables, the cable length including the connector is 1 m.

The following bending radii must be observed for the cable to the built-on encoder:

- One-time bending:  $\geq 20$  mm
- Continuous bending:  $\geq 75$  mm

#### More information

- Catalogs D 21.4, NC 62, NC 82, PM 21
- Interactive catalog CA 01
- Internet:  
[www.siemens.com/drive-cliq](http://www.siemens.com/drive-cliq)  
[www.siemens.com/industrymall](http://www.siemens.com/industrymall)

## Firmware functionality

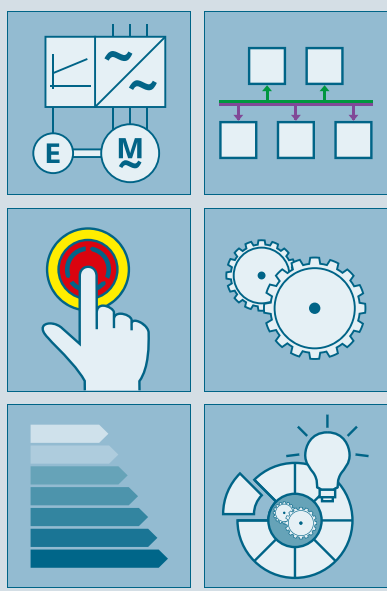

2/2

### Firmware functionality

2/2

Introduction

2/2

Basic Drive Functions

2/4

Standard Technology Functions

2/5

Advanced Technology Functions

2/6

Common Engineering

2/6

Applications &amp; Branch know-how

Further information about  
firmware functionality can be found  
on the Internet at  
[www.siemens.com/sinamics-firmware](http://www.siemens.com/sinamics-firmware)

## Firmware functionality

### Firmware functionality

#### Overview

The major part of the functionality of SINAMICS drives is implemented in software. This "embedded" **software** delivers the function of the product and is therefore a significant component of the overall product. The embedded software is also known as **firmware**, because it is firmly connected to specific hardware.

In the case of SINAMICS drives, the firmware is subdivided into the **operating system (OS)** with drivers for the hardware and the inverter functions, which are also referred to as the **runtime (RT) functions**.

#### Introduction

The available firmware functions are so extensive that the overall functional scope has been structured into function groups corresponding to their main applications.

The 8 main groups are:

- Basic Drive Functions
- Standard Technology Functions
- Advanced Technology Functions
- Communication Functions
- Safety Integrated Functions
- Energy Efficiency Functions
- Common Engineering
- Applications & Branch know-how

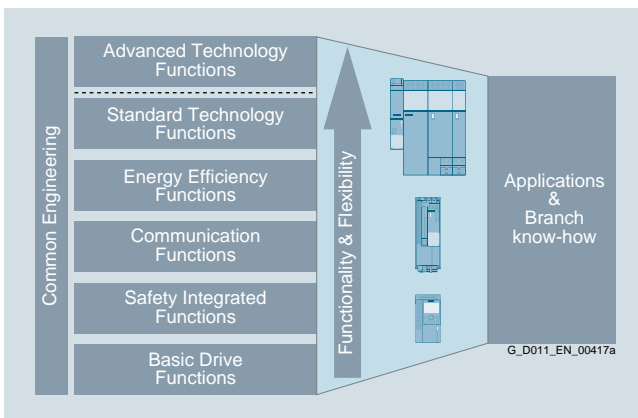

Functionality, including technology and configuration

#### Basic Drive Functions

The main groups, especially the "Basic Drive Functions", are divided up into further subgroups.

- Control modes
- Availability
- Setpoints and commands
- Limiters, timers and monitoring functions
- Diagnostics
- Protection

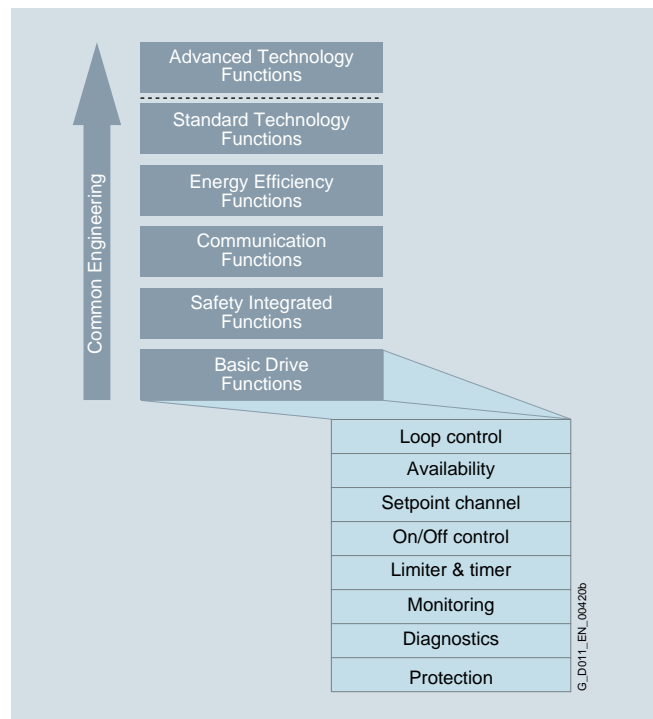

Basic Drive Functions – Control Functions

#### Control modes

The control methods are the core of the entire inverter firmware. They are responsible for optimum movement of the connected motor and the attached machines. The better the control functions, the faster, better and more smoothly the machine operates, thereby significantly enhancing the quality of the production output.

A distinction is made between the following methods:

- U/f control (open-loop control)
- Vector control (closed-loop control)
- Servo control (closed-loop control)

Further classification refers to the control variables:

- Current control
- Speed control
- Torque control
- Position control
- Technological process control (pressure, flow rate, temperature, fill level, etc.)

**Overview** (continued)Availability

Availability refers to the frequency ratio, namely how often or seldom a single device restricts the entire production process due to a problem. That is why it is important in terms of availability that a drive enters the faulty state only when it is essential for self-protection. Moreover, it is important that the cause of the pending problem is identified and eliminated as quickly as possible.

Features and measures to increase availability:

- Parallel connections, for example, to maintain emergency operation (possibly also at a lower rating), if a power unit fails
- Automatic restart
- Flying restart
- $V_{dc}$  control with kinetic buffering
- Redundancy (hardware, communication, etc.)

Setpoints and commands

The setpoint channel is the link between the setpoint source and the motor control. The inverter has a special feature that supports simultaneous input of two setpoints. Generation and subsequent modification of the total setpoint (influencing the direction, skip frequency, up/down ramp) take place in the setpoint channel.

Different sources of command usually result from the requirements to operate a drive from different places (on-site/remote), in different situations (standard/emergency mode) and/or different operating. The BICO binector connector technology allows SINAMICS to configure and combine the command and setpoint sources completely individually.

The following can be used for switching:

- Dataset switchover
- Switching elements among the Free Function Blocks (FFB)
- Fixed values

Limiters and monitoring functions

Limiters or limits are used to constrain input and/or output variables as appropriate to the connected machine; this means that not all positioning variables are used over their full range but are limited judiciously to enhance the safety and quality of the production process.

Timers/runtime counters are used to obtain information or make statements about the temporal course of a process.

- Recording application information for manufacturers
- Recording operating times for users
- Configurable timers for monitoring intervals
- Configurable timers for triggering activities at certain intervals (e.g. maintenance work)

Monitoring is used for early detection of conditions that may be detrimental or even dangerous to the connected machine, so that they can be counteracted expediently. If an appropriate countermeasure is not initiated, a protective response of the inverter with probable fault shutdown will ultimately result.

Diagnostics

The "Diagnostics" subgroup comprises all those functions that provide assistance with determining the possible causes of a problem.

If problems occur in a process, or in the driven machine, further interpretation of the measured variables in the inverter is required. To this end, different signals should be correlated with respect to time and then observed.

This includes:

- Error and alarm buffer
- Diagnostic buffer
- List of missing signals that interrupt operation
- Tracing for temporal assignment of signal profiles
- I/O simulation
- Telegram content diagnoses
- Terminal status

Protection

All protection functions counteract any possible damage to the inverter and/or motor. This is why the shutdown thresholds cannot be parameterized but are factory-tuned and permanently set to match the built-in components. Alarm thresholds may be parameterized as a relative variable for shutdown threshold of some monitoring processes. Thus, a countermeasure that is sensitive to the process may still be initiated upon occurrence of the alarm.

Apart from protection of the hardware, protection of the parameterization and therefore protection of the intellectual expertise of the customer from unauthorized access and copying is also an important part of the protection functions.

- Write protection
- Know-how protection
- Copy protection

## Firmware functionality

### Firmware functionality

#### Overview (continued)

##### Standard Technology Functions

The Standard Technology Functions are not restricted to a specific SINAMICS product family, but they are available in full or at least partially in SINAMICS S120 as well as in SINAMICS G120.

- BICO technology
- Free function blocks (FFB)
- Basic positioner (EPos)
- Technology controller (PID)

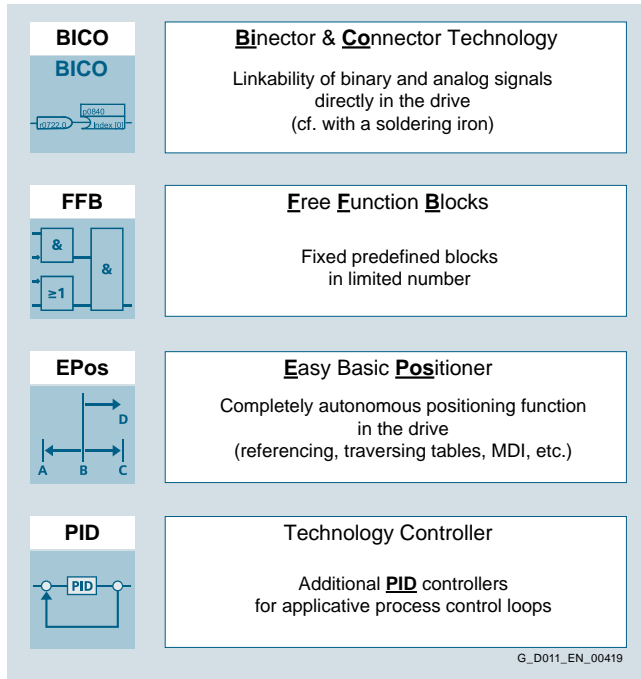

Standard Technology Functions

The Standard Technology Functions significantly expand the application spectrum of the SINAMICS drives because the functions are not permanently and unalterably interconnected; rather, they are interrupted at defined access points and can be connected or wired differently. The BICO technology makes it possible.

The FFBs enable additional, freely interpretable adaptations of the binary and analog signal flow to the given machine application. However, the FFBs are limited in terms of the absolute quantity and the computing intervals (sampling times) that can be selected. These blocks are NOT multi-instance capable.

With Epos, comprehensive positioning tasks are autonomous in SINAMICS (i.e. their solution does not need a higher-level control). And moreover, this integrated functionality is also extremely flexible: It can be used for highly dynamic servo control as well as for simple applications with vector-controlled asynchronous motors. Up to 64 target positions, as well as the respective traversing speeds, can be permanently stored in the drive during commissioning. Axes can be positioned either absolutely or relatively.

It is, however, also possible to transfer these parameters as required from a higher-level controller. This means that target positions and velocities can even be changed on-the-fly during a positioning run.

The technology controller (PID controller) permits all types of simple process controls to be implemented. It can be used, for example, to control the line pressure, fill level, temperature, flow or also tension control or load balancing.

For more information, see [section Technology functions](#).



Overview (continued)

Advanced Technology Functions

The Advanced Technology Functions are the clear differentiating feature between the SINAMICS product families of SINAMICS G120 with the CU2xx-2 Control Units and SINAMICS S120 with the CU3x0-2 Control Units. The Advanced Technology Functions are only available for SINAMICS S120:

- SINAMICS Drive Control Chart (DCC)
- SINAMICS Technology Extensions (TEC)

The Advanced Technology Functions are characterized by maximum flexibility and performance whereby extremely individual and, at the same time, efficient solutions can be achieved.

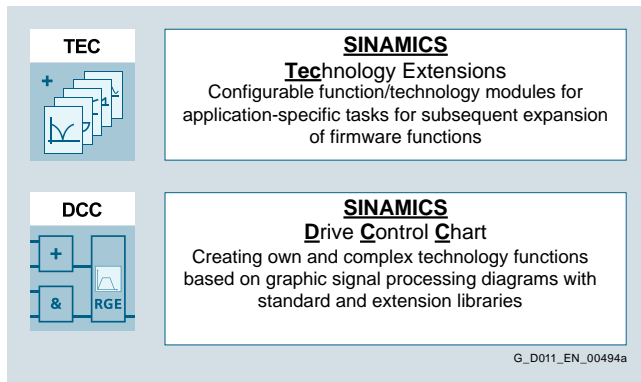

Advanced Technology Functions

SINAMICS DCC comprises the block library, so-called DCB Drive Control Blocks and the DCC Editor for graphical interconnection of blocks. SINAMICS DCC is primarily employed to solve arithmetic and control-related tasks or logic functions associated with complex applications.

In addition to the DCB Standard library, the DCB Extension library can also be used to create applications. The DCB Extension library is comprised of freely programmable blocks which are created for specific applications using DCB Studio and are then graphically interconnected with the DCC Editor in a similar fashion to standard blocks.

SINAMICS Technology Extensions (TECs) are configurable firmware expansions that are specifically created for use in a customized application with special requirements. This functionality can therefore be subsequently installed as an add-on to the standard scope of firmware functions. One example of a SINAMICS TEC is the VIBX vibration extinction for storage and retrieval systems.

For more information, see section Technology functions.

The functional scope of Advanced Technology Functions is scalable and flexible. Depending on the task, you can choose between configurable solutions provided by Siemens or freely created proprietary solutions in the drive.

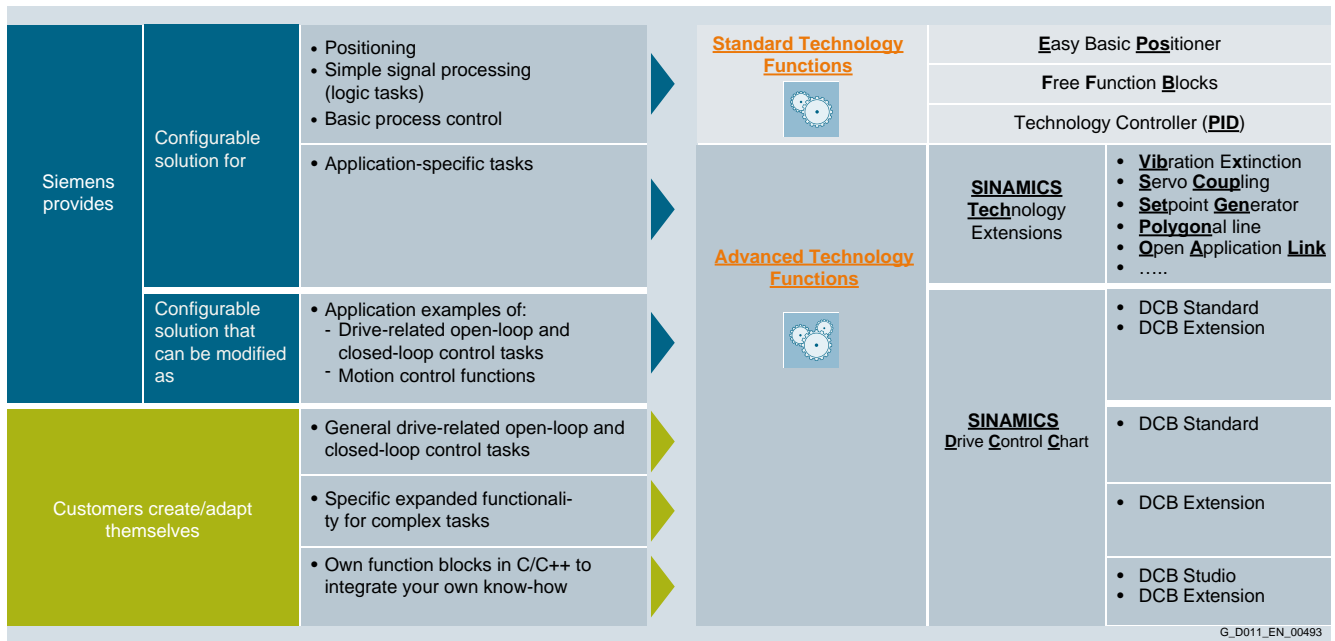

Depending on the technology function, a license may be required for the application.

## Firmware functionality

### Firmware functionality

#### Overview (continued)

##### **Safety Integrated Functions**

See section Safety Integrated

##### **Communication Functions**

See section Communication

##### **Energy Efficiency Functions**

See section Energy efficiency

##### **Common Engineering**

All functions of the inverters are implemented to enable a common engineering approach to their handling no matter which type of drive is selected; i.e. if a function is used in drive x, it can be configured intuitively and commissioned in the same way in drive y. Knowledge gained can therefore be reused easily and efficiently. The configuration and commissioning tools in particular (such as SIZER for Siemens Drives, STARTER and SINAMICS Startdrive) reflect this approach.

For more information, see section [Engineering tools](#).

##### **Applications & Branch know-how**

Siemens has applied these technology functions (standard and/or advanced) to generate numerous application solutions. These applications can be downloaded from the Siemens application support website at [www.siemens.com/sinamics-applications](http://www.siemens.com/sinamics-applications)

The STARTER and SINAMICS Startdrive commissioning tools can then be used to activate and configure the applications and download them to the Control Units.

#### More information

Further information about firmware functionality can be found on the Internet at [www.siemens.com/sinamics-firmware](http://www.siemens.com/sinamics-firmware)

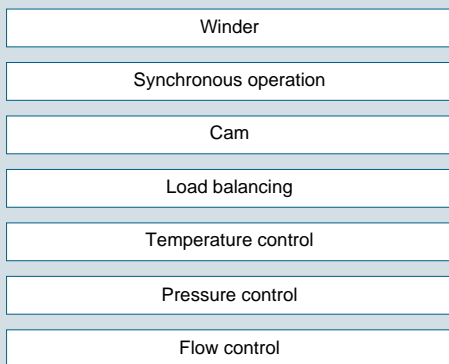

#### Applications & Branch know-how

Depending on the technology function, a license may be required for the application.

In some branch-specific Control Units (e.g. CU230P-2) branch-specific functions are also an integral part of the firmware.

For more information, see section [Drive applications](#).

## Safety Integrated

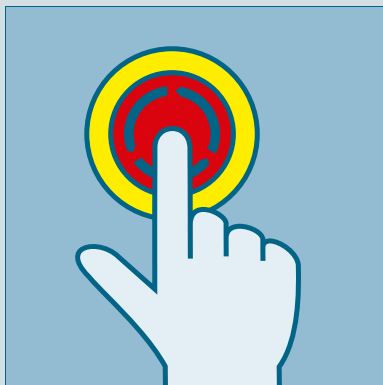

### 3/2 Safety Integrated

3/2 Overview

3/3 Function

3/8 More information

### 3/9 Safety Integrated for SINAMICS G110M

3/9 Overview

3/9 Function

### 3/10 Safety Integrated for SINAMICS G110D

3/10 Overview

3/10 Function

### 3/11 Safety Integrated for SINAMICS G120D

3/11 Overview

3/11 Benefits

3/13 Function

### 3/14 Safety Integrated for SIMATIC ET 200pro FC-2

3/14 Overview

3/14 Function

The Safety Integrated Function Manual contains detailed information about the safety functions.

<https://support.industry.siemens.com/cs/document/99668646>

Further manuals pertaining to Safety Integrated in drive systems can be found on the Internet at

<https://support.industry.siemens.com/cs/ww/en/ps/13231/man>

Further information about Safety Integrated in SINAMICS can be found on the Internet at [www.siemens.com/safety-drives](http://www.siemens.com/safety-drives)

## Safety Integrated

### Safety Integrated

#### Overview

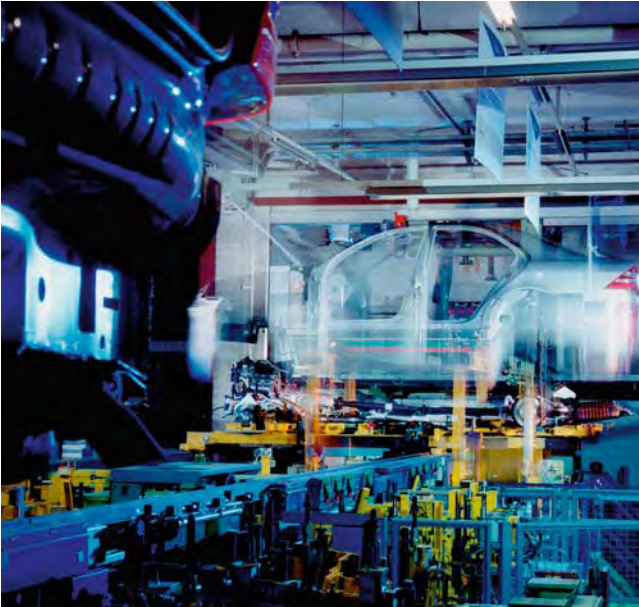

#### Legal framework

Machine manufacturers and manufacturing plants must ensure that their machines or plants cannot cause danger due to malfunctions in addition to the general risks of electric shock, heat or radiation.

In Europe, for example, compliance with the Machinery Directive 2006/42/EC is legally stipulated by the EU work safety directive. In order to ensure compliance with this directive, it is recommended that the corresponding harmonized European standards are applied. This triggers the "assumption of conformity" and gives manufacturers and operators the legal security in terms of compliance with both national regulations and EU directives. The machine manufacturer uses the CE marking to document the compliance with all relevant directives and regulations in the free movement of goods.

#### Safety-related standards

Functional safety is specified in various standards. For example, EN ISO 12100 specifies standards pertaining to machine safety (risk assessment and risk reduction). IEC 61508 specifies basic requirements for electronic and programmable safety-related systems. EN 62061 (only applicable for electrical and electronic control systems) and EN ISO 13849-1, which has replaced EN 954-1, define the functional and safety-related requirements of safety-oriented control systems.

The above-mentioned standards define different safety requirements that the machine has to satisfy in accordance with the risk, frequency of a dangerous situation, probability of occurrence and the opportunities for recognizing impending danger.

- EN ISO 13849-1:  
Performance Level PL a ... e; Category B, 1 ... 4
- EN 62061:  
Safety Integrity Level SIL 1 ... 3

#### Trend toward integrated safety systems

The trend toward greater complexity and higher modularity of machines has seen a shift in safety functions away from the classical central safety functions (for example, shutdown of the complete machine using a main disconnecting means) and into the machine control system and the drives. This is often accompanied by a significant increase in productivity because the equipping times are shortened. Depending on the type of machine, it may even be possible to continue manufacturing other parts while equipping is in progress.

Integrated safety functions act much faster than those of a conventional design. The safety of a machine is increased further with Safety Integrated. Furthermore, thanks to the faster method of operation, safety measures controlled by integrated safety systems are perceived as less of a hindrance by the machine operator, therefore significantly reducing the motivation to consciously bypass safety functions.

## Function

The safety functions integrated in SINAMICS drives, including SIMATIC ET 200pro FC-2 frequency converters, are described below.

Functions	SINAMICS V		SINAMICS G							SINAMICS S			SIMATIC ET 200pro FC-2		
	V20	V90	G110	G110D	G120C	G120P/G120	G120		G110M	G120D		S110		S120	
STO	-	✓	-	✓	✓	-	✓	✓	✓	✓	✓	✓	✓	✓	✓
SS1	-	-	-	-	-	-	✓ <sup>1)</sup>	✓	-	✓ <sup>1)</sup>	✓	✓	✓	✓	-
SS2	-	-	-	-	-	-	-	-	-	-	-	✓ <sup>2)</sup>	✓ <sup>2)</sup>	✓ <sup>2)</sup>	-
SOS	-	-	-	-	-	-	-	-	-	-	-	✓ <sup>2)</sup>	✓ <sup>2)</sup>	✓ <sup>2)</sup>	-
SBC	-	-	-	-	-	-	-	✓	-	-	-	✓	✓	✓	-
SBT	-	-	-	-	-	-	-	-	-	-	-	-	✓ <sup>2)</sup>	✓ <sup>2)</sup>	-
SLS	-	-	-	-	-	-	✓ <sup>1)</sup>	✓ <sup>2)</sup>	-	✓ <sup>1)</sup>	✓ <sup>1)</sup>	✓ <sup>2)</sup>	✓ <sup>2)</sup>	✓ <sup>2)</sup>	-
SSM	-	-	-	-	-	-	✓ <sup>1)</sup>	✓ <sup>2)</sup>	-	✓ <sup>1)</sup>	✓ <sup>1)</sup>	✓ <sup>2)</sup>	✓ <sup>2)</sup>	✓ <sup>2)</sup>	-
SDI	-	-	-	-	-	-	✓ <sup>1)</sup>	✓ <sup>2)</sup>	-	✓ <sup>1)</sup>	✓ <sup>1)</sup>	✓ <sup>2)</sup>	✓ <sup>2)</sup>	✓ <sup>2)</sup>	-
SLP	-	-	-	-	-	-	-	-	-	-	-	-	✓ <sup>3)</sup>	✓ <sup>3)</sup>	-
SP	-	-	-	-	-	-	-	-	-	-	-	-	✓ <sup>3)</sup>	✓ <sup>3)</sup>	-
<b>Control</b>															
PROFIsafe	-	-	-	-	✓	-	✓	✓	✓	✓	✓	✓	✓	✓	-
F-DI	-	✓	-	-	✓	-	✓	✓	✓	✓	✓	✓	✓	✓	-

### Safety functions integral to the SINAMICS drives

SINAMICS drives are characterized by a large number of integrated safety functions. In combination with the sensors and safety control required for the safety functionality, they ensure that highly-effective protection for persons and machines is implemented in a practice-oriented manner.

They comply with the requirements of the following safety categories:

- PL d and Category 3 according to EN ISO 13849-1
- SIL 2 according to IEC 61508 and IEC 61800-5-2

#### Note:

The Safe Brake Test (SBT) diagnostic function meets the requirements for Category 2 according to EN ISO 13849-1.

The Safety Integrated functions are generally certified by independent institutes. You can obtain the corresponding test certificates and manufacturer's declarations from your Siemens contacts.

The integrated safety functions that are currently available are described below. Their functional safety satisfies the requirements defined in the international standard IEC 61800-5-2 for variable-speed drive systems.

The safety functions integrated into the SINAMICS drive system can be roughly divided into four categories:

- **Functions for safely stopping a drive**
  - Safe Torque Off (STO)
  - Safe Stop 1 (SS1)
  - Safe Stop 2 (SS2)
  - Safe Operating Stop (SOS)
- **Functions for safe brake management**
  - Safe Brake Control (SBC)
  - Safe Brake Test (SBT) (this diagnostic function exceeds the scope of IEC 61800-5-2)
- **Functions for safely monitoring the motion of a drive**
  - Safely-Limited Speed (SLS)
  - Safe Speed Monitor (SSM)
  - Safe Direction (SDI)
- **Functions for safely monitoring the position of a drive**
  - Safely-Limited Position (SLP)
  - Safe Position (SP) (this function exceeds the scope of IEC 61800-5-2)

<sup>1)</sup> With fail-safe Control Unit.

<sup>2)</sup> With Safety Extended license.

<sup>3)</sup> With Safety Advanced license.

## Safety Integrated

### Safety Integrated

#### Function (continued)

##### Safe Torque Off (STO)

The STO function is the most common and basic drive-integrated safety function. It ensures that no torque-generating energy can continue to affect a motor and prevents unintentional start-ups.

##### Effect

This function is a mechanism that prevents the drive from restarting unexpectedly, in accordance with EN 60204-1, Section 5.4. The STO function suppresses the drive pulses (corresponds to Stop Category 0 according to EN 60204-1). The drive is reliably torque-free. This state is monitored internally in the drive.

##### Application

STO has the immediate effect that the drive cannot supply any torque-generating energy. STO can be used wherever the drive will naturally reach a standstill due to load torque or friction in a sufficiently short time or when "coasting down" of the drive will not have any relevance for safety.

STO makes it possible for persons to work safely when the protective door is open (restart interlock) and is used on machines/installations with moving axes, e.g. on handling or conveyor systems.

##### Customer benefits

Some of the advantages of the integrated STO safety function over conventional safety technology with electromechanical switchgear include the elimination of separate components as well as of the work that would be required to wire and service them, i.e. no wearing parts as a result of the electronic shutdown. Because of the fast electronic switching times, the function provides a shorter reaction time than the conventional solution comprising electromechanical components. When STO is triggered, the converter remains connected to the network and can be fully diagnosed.

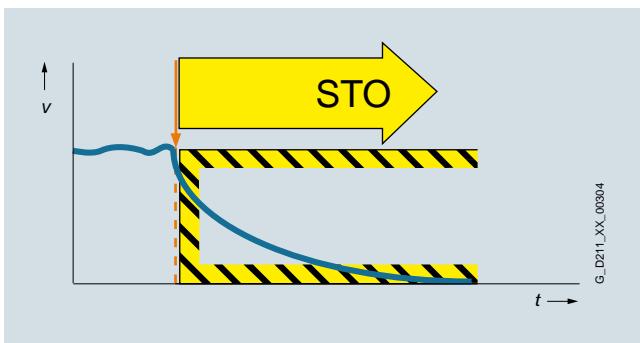

##### Safe Stop 1 (SS1)

The SS1 function causes a motor to stop rapidly and safely and switches the motor to torque-free mode after coming to a standstill by activating STO.

##### Effect

The SS1 function can safely stop the drive in accordance with EN 60204-1, Stop Category 1. When the SS1 function is selected, the drive brakes autonomously along a quick-stop ramp and automatically activates the Safe Torque Off and Safe Brake Control functions (if configured) when the parameterized safety delay time expires.

If the variant "SS1 with external stop (SS1E)" is parameterized, the drive does not brake autonomously when the function is selected. In this case, the higher-level control must bring the drive to a standstill within a parameterized STO transition time. The SBR (Safe Brake Ramp) and SAM (Safe Acceleration Monitor) functions are not active. SS1E is a useful function for drives that need to be stopped as a group by the Motion Control system in order to prevent potential damage to the machine or product.

##### Application

The SS1 function is used when, in the event of a safety-relevant incident, the drive must stop as quickly as possible with a subsequent transition into the STO state (e.g. EMERGENCY STOP). It is thus used to bring large centrifugal masses to a stop as quickly as possible for the safety of the operating personnel, or to brake motors at high speeds as quickly as possible. Examples of typical applications are saws, grinding machine spindles, centrifuges, winders and storage and retrieval machines.

##### Customer benefits

The targeted stopping of a drive by means of SS1 reduces the risk of danger, increases the productivity of a machine, and allows the safety clearances in a machine to be reduced. The principle is to bring the drive actively to a standstill, compared with just using the STO function. Complex mechanical brakes that are susceptible to wear are not normally required to brake the motor.

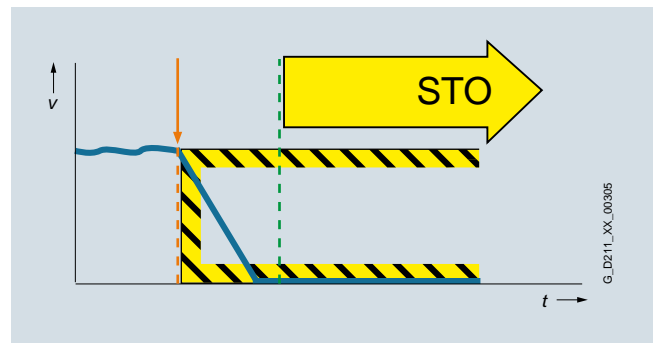

**Function** (continued)**Safely-Limited Speed (SLS)**

The SLS function monitors the drive to ensure that it does not exceed a preset speed or velocity limit.

**Effect**

The SLS function monitors the drive against a parameterized speed limit. Four different limit values can be selected. As in the case of SOS, the speed setpoint is not influenced independently. After SLS has been selected, the higher-level control must bring the drive down below the selected speed limit within a parameterizable time. If the speed limit is exceeded, a customizable drive-integrated fault reaction occurs.

The SLS limit stage 1 can be multiplied by a factor that is transferred in 16-bit resolution via PROFIsafe. This allows an almost unlimited number of limits to be specified.

**Application**

The SLS function is used if people are in the danger zone of a machine and their safety can only be guaranteed by reduced speed. Typical application cases include those in which an operator must enter the danger zone of the machine for the purposes of maintenance or setting up, such as a winder in which the material is manually threaded by the operator. To prevent injury to the operator, the roller may only spin at a safely reduced speed. SLS is often also used as part of a two-stage safety concept. While a person is in a less critical zone, the SLS function is activated, and the drives are only stopped in a smaller area with higher potential risk. SLS can be used not only for operator protection, but also for machinery protection, e.g. if a maximum speed must not be exceeded.

**Customer benefits**

The SLS function can contribute to a significant reduction in downtime, or greatly simplify or even accelerate setup. The overall effect achieved is a higher availability of the machine. Moreover, external components such as speed monitors can be omitted.

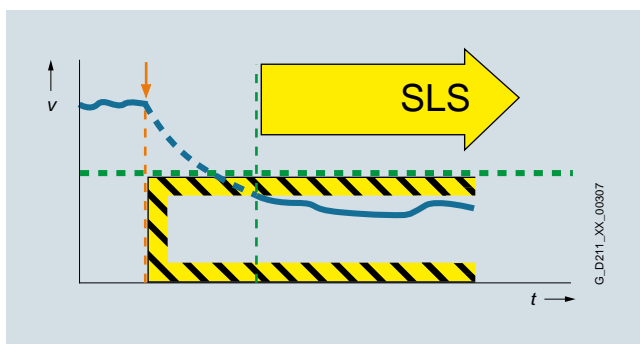
**Safe Speed Monitor (SSM)**

The SSM function warns when a drive is working below an adjustable speed limit. As long as it remains below the threshold, the function issues a safety-related signal.

**Effect**

If a speed value drops below a parameterized limit, a safety-related signal is generated. This can, for example, be processed in a safety controller to respond to the event by programming, depending on the situation.

**Application**

With the SSM function, in the simplest case, a safety door can be unlocked if the speed drops below a non-critical level. Another typical example is that of a centrifuge that may be filled only when it is operating below a configured speed limit.

**Customer benefits**

Unlike SLS, there is no drive-integrated fault reaction when the speed limit is exceeded. The safe feedback can be evaluated in a safety control unit, allowing the user to respond appropriately to the situation.

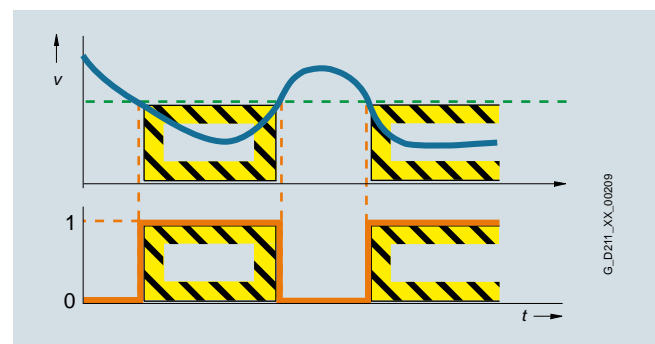

## Safety Integrated

### Safety Integrated

#### Function (continued)

##### Safe Direction (SDI)

The SDI function ensures that the drive can only move in the selected direction.

##### Effect

Deviation from the direction of motion currently being monitored is detected reliably and the configured drive-integrated fault reaction is initiated. It is possible to select which direction of rotation is to be monitored.

##### Application

The SDI function is used when the drive may only move in one direction. A typical application is to permit the operator access to a danger zone, as long as the machine is rotating in the safe direction, i.e. away from the operator. In this state, the operator can feed material into the work zone / remove material from the work zone without danger.

##### Customer benefits

The function saves the use of external components such as speed monitors and the associated wiring. The release of a danger zone while the machine is moving away from the operator increases productivity. Without the SDI function, the machine must be safely stopped during material loading and removal.

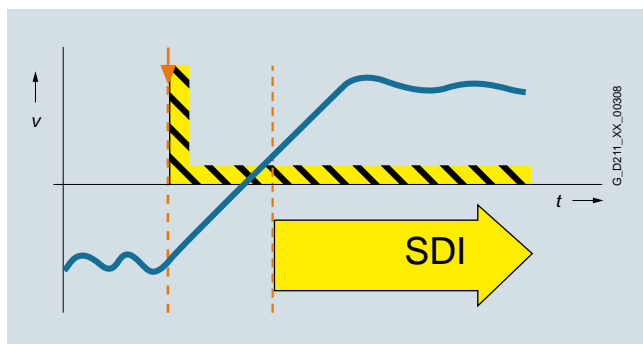

##### Basic Functions, Extended Functions, and Advanced Functions

With SINAMICS G inverters, the safety functions are basically implemented without encoders.

With SINAMICS S converters, the safety functions are implemented with encoders – individual safety functions can also be operated without encoders.

The Safety Integrated functions are grouped into Basic Functions, Extended Functions, and Advanced Functions.

The Basic Functions are included in the standard scope of supply.

The Extended Functions must be activated by a license <sup>1)</sup>.

The Advanced Functions for SINAMICS S120 must also be activated via a license.

- Basic Functions
  - Safe Torque Off (STO)
  - Safe Brake Control (SBC)
  - Safe Stop 1 (SS1)
- Extended Functions
  - Safe Stop 1 (SS1) with SBR or SAM
  - Safe Stop 2 (SS2) with SBR or SAM
  - Safe Operating Stop (SOS)
  - Safely-Limited Speed (SLS)
  - Safe Speed Monitor (SSM)
  - Safe Direction (SDI)
  - Safe Brake Test (SBT) diagnostic function
- Advanced Functions
  - Safely-Limited Position (SLP)
  - Safe Position (SP)

For the Extended Functions SS1 and SS2 with SAM, safe acceleration monitoring (SAM) is performed during braking to identify any faults already during the braking phase.

With SS1 and SS2, a Safe Brake Ramp (SBR) can be configured as an alternative.

The Basic Functions – activated via on-board terminals on the device, TM54F Terminal Module (only for SINAMICS S) or via PROFIsafe – do not require an encoder.

##### Activation of the integrated safety functions

The safety functions for SINAMICS drives can be activated via terminals, e.g. for use of a conventional safety circuit.

For standalone safety solutions for small to medium sized applications, it is frequently sufficient that the various sensing components are directly hardwired to the drive.

For integrated safety solutions, the safety-relevant sequences are generally processed and coordinated in the fail-safe SIMATIC controller. Here, the system components communicate via the PROFINET or PROFIBUS fieldbus. The safety functions are controlled via the safe PROFIsafe communication protocol.

SINAMICS drives can be easily integrated into the plant or system topology.

<sup>1)</sup> Only applies to SINAMICS G Control Unit CU250S-2 and SINAMICS S. Available for SINAMICS G via hardware versions "-F".



**Function** (continued)**PROFIsafe**

SINAMICS drives support the PROFIsafe profile based on PROFINET as well as on PROFIBUS.

PROFIsafe is an open communications standard that supports standard and safety-related communication over the same communication path (wired or wireless). A second, separate bus system is therefore not necessary. The telegrams that are sent are continually monitored to ensure safety-relevant communication.

Possible errors such as telegrams that have been lost, repeated or received in the incorrect sequence are avoided. This is done by consecutively numbering the telegrams in a safety-relevant fashion, monitoring their reception within a defined time and transferring an ID for transmitter and receiver of a telegram. A CRC (cyclic redundancy check) data security mechanism is also used.

**The operating principle of Safety Integrated**Two independent switch-off signal paths

Two independent switch-off signal paths are available. All switch-off signal paths are low active. This ensures that the system is always switched to a safe state if a component fails or in the event of cable breakage. If a fault is discovered in the switch-off signal paths, the STO or SS1 function (depending on parameter settings) is activated and a system restart inhibited.

Two-channel monitoring structure

All the main hardware and software functions for Safety Integrated are implemented in two independent monitoring channels (e.g. switch-off signal paths, data management, data comparison). A cyclic crosswise comparison of the safety-relevant data in the two monitoring channels is carried out.

The monitoring functions in each monitoring channel work on the principle that a defined state must prevail before each action is carried out and a specific acknowledgement must be made after each action. If these expectations of a monitoring channel are not fulfilled, the drive coasts to a standstill (two channel) and an appropriate message is output.

Forced dormant error detection using test stop

The functions and switch-off signal paths must be tested at least once within a defined time in order to meet requirements as per EN ISO 13849-1 and IEC 61508 in terms of timely fault detection. This must be implemented either in cyclic manual mode or the test stop must be automatically initiated as part of the process. The test stop cycle is monitored, and after a specific time has been exceeded, an alarm is output. A test stop does not require a POWER ON. The acknowledgment is set by canceling the test stop request.

Examples of when forced dormant error detection must be performed:

- When the drives are at a standstill after the system has been switched on
- Before the protective door is opened
- At defined intervals (e.g. every 8 hours)
- In automatic mode, time and event-driven

**Safe speed/position acquisition without/with encoder**Safe actual value acquisition without encoder

A drive monitor with encoder is necessary for operation of a series of safety functions.

For applications with encoderless mode or with encoders that have no safety capability, the safety functions can also be implemented without encoder. It is not possible to use all safety functions in this case.

In operation without encoder, the actual speed values are calculated from the measured electrical actual values. This means that speed monitoring is also possible during operation without an encoder.

Safety Integrated Extended Functions "without encoder" must not be used if the motor, after it has been switched off, can still be accelerated by the mechanical elements of the connected machine component.

Safe actual value acquisition with encoder

Incremental encoders or absolute encoders can be used for safe sensing of the position values on a drive.

Safe actual value sensing relies on redundant evaluation of the incremental tracks A/B that supply sin/cos signals of  $1 V_{pp}$ . Only encoders of the type whose A/B track signals are created and processed using purely analog techniques can be used.

HTL/TTL incremental encoders may also be used. In this case, safe actual value sensing is achieved by using two independent encoders. The minimum possible speed resolution must also be taken into account.

The encoder signals are input via Sensor Modules.

As an alternative, motors with an integrated DRIVE-CLiQ interface can be used. The speed or position actual values are generated directly in the motor as safe values and are transferred to the Control Unit over safe communication via DRIVE-CLiQ.

Certified built-on rotary encoders with DRIVE-CLiQ interface may also be used (see <https://support.industry.siemens.com/cs/document/65402168>).

The encoder must be mechanically attached in such a manner that the encoder shaft is unable to unplug or slide off. For notes on this, see IEC 61800-5-2: 2016, Table D.16.

A list of Siemens motors that fulfill the electrical and mechanical requirements is available at:

<https://support.industry.siemens.com/cs/document/33512621>

## Safety Integrated

### Safety Integrated

#### Function (continued)

The following can be used for safe speed/position sensing:

- Single-encoder systems or
- Dual-encoder systems

#### Single-encoder system

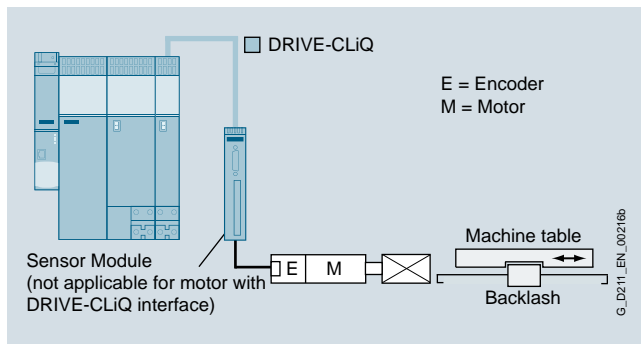

Example: Single-encoder system

In a single-encoder system, the motor encoder is used exclusively for safe actual value sensing.

#### Dual-encoder system

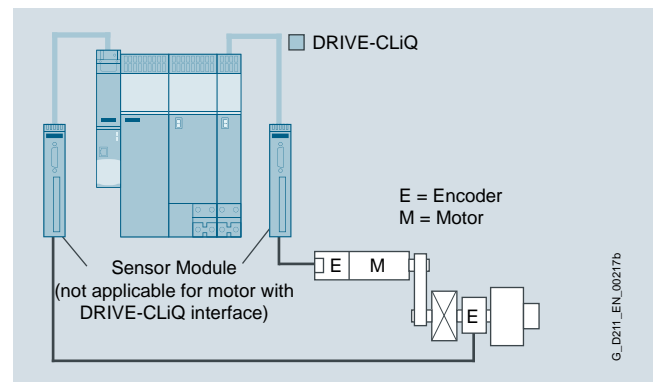

Example: Dual-encoder system

In the case of the dual-encoder system, the safe actual values for a drive are provided by two separate encoders. The actual values are transferred to the Control Unit over DRIVE-CLiQ. When motors without a DRIVE-CLiQ connection are used, a Sensor Module must be provided.

HTL/TTL incremental encoders can be used as an alternative with a dual-encoder system. Either two HTL/TTL encoders, one dual-HTL/TTL encoder or one HTL/TTL encoder and one sin/cos encoder can be used.

The safety functions are listed below with criteria for actual value sensing

	Functions	Abbreviation	With encoder	Without encoder	Description
<b>Basic Functions</b>	Safe Torque Off	STO	Yes	Yes	Safe Torque Off
	Safe Stop 1	SS1	Yes	Yes	Safe stopping process in accordance with stop category 1
	Safe Brake Control	SBC	Yes	Yes	Safe Brake Control
<b>Extended Functions</b>	Safe Torque Off	STO	Yes	Yes	Safe Torque Off
	Safe Stop 1	SS1	Yes	Yes <sup>1)</sup>	Safe stopping process in accordance with stop category 1
	Safe Brake Control	SBC	Yes	Yes	Safe Brake Control
	Safe Operating Stop	SOS	Yes	No	Safe monitoring of the standstill position
	Safe Stop 2	SS2	Yes	No	Safe stopping process in accordance with stop category 2
	Safely-Limited Speed	SLS	Yes	Yes <sup>1)</sup>	Safe monitoring of the maximum speed
	Safe Speed Monitor	SSM	Yes	Yes <sup>1)</sup>	Safe monitoring of the minimum speed
	Safe Direction	SDI	Yes	Yes <sup>1)</sup>	Safe monitoring of the direction of motion
	Safe Brake Test	SBT	Yes	No	Diagnostic function for safe testing of the required holding torque of a brake
<b>Advanced Functions</b>	Safely-Limited Position	SLP	Yes	No	Safely-limited position
	Safe Position	SP	Yes	Yes <sup>2)</sup>	Safe transfer of position values

#### More information

The Safety Integrated Function Manual contains detailed information about the safety functions  
<https://support.industry.siemens.com/cs/document/109744795>

Further manuals pertaining to Safety Integrated in drive systems can be found on the Internet at  
<https://support.industry.siemens.com/cs/ww/en/ps/13206/man>

Further information about Safety Integrated in SINAMICS can be found on the Internet at  
[www.siemens.com/safety-drives](http://www.siemens.com/safety-drives)

Further information about Safety Integrated in SIMOTION can be found on the Internet at  
[www.siemens.com/simotion-d-safety-integrated](http://www.siemens.com/simotion-d-safety-integrated)

<sup>1)</sup> The use of this safety function without encoder is permitted for asynchronous (induction) motors or synchronous motors of the SIEMOSYN series.

<sup>2)</sup> Only for the transmission of relative position values. An encoder is required to transmit absolute position values.

## Overview



The SINAMICS G110M frequency inverter offers the Safe Torque Off (STO) function as a standard feature.

The Safety Integrated function is completely integrated into the drive system. It can be activated via fail-safe digital inputs on the inverter or via PROFINET or PROFIBUS with PROFSafe.

The Safety Integrated function is implemented electronically and therefore offers short response times in comparison to solutions with externally implemented monitoring functions.

3

## Function

Function	Control	Encoder required	License required
<b>STO</b>	<ul style="list-style-type: none"> <li>• F-DI</li> <li>• PROFSafe</li> </ul>	No	No

## Safety Integrated

### Safety Integrated for SINAMICS G110D

#### Overview



The SINAMICS G110D distributed frequency inverter offers the Safe Torque Off (STO) function as a standard feature. The safety function is controlled via the safe disconnection of the AS-Interface supply voltage.

#### Function

Function	Control	Encoder required	License required
<b>STO <sup>1)</sup></b>	<ul style="list-style-type: none"> <li>• F-DI</li> <li>• PROFIsafe</li> </ul>	No	No

<sup>1)</sup> Control by safety-related shutdown of the AS-Interface cable.

## Overview



The PM250D Power Modules are generally prepared for Safety Integrated.

In conjunction with a standard Control Unit, the drive provides the safety function STO.

In conjunction with a fail-safe Control Unit, the drive can be turned into a Safety Integrated Drive with comprehensive safety functions.

The Safety Integrated functions are fully integrated in the drive system. They can be activated via fail-safe digital inputs on the Control Unit or via PROFINET or PROFIBUS with PROFIsafe.

The Safety Integrated functions are implemented electronically and therefore offer short response times compared to solutions with externally implemented monitoring functions.

### Safety Integrated encoderless

The safety functions do not require a motor encoder; the implementation effort is minimal. Existing machines in particular can be updated with integrated safety technology without the need to change the motor or mechanical system.

The STO function can be used without any restrictions for all applications.

The SS1, SLS, SSM and SDI functions are only permissible for applications where the load can never cause acceleration. An encoder that is used for the purposes of motor control has no significance for the safety functions here.

### Control Units

The availability of Safety Integrated functions depends on the type of Control Unit. Standard Control Units and fail-safe Control Units are available. All standard Control Units have STO.

The fail-safe Control Units offer Extended Functions (SLS, SDI, SSM) in addition to the Basic Functions (STO, SS1).

## Benefits

### Comparison between conventional and integrated safety systems

The safety functions integrated into the drive can greatly reduce the effort required to implement safety concepts.

The integrated safety functions provide support when setting up tailored safety concepts. Configurations of safety concepts are given below based on the example of the SINAMICS G120D.

### Safe Torque Off (STO)

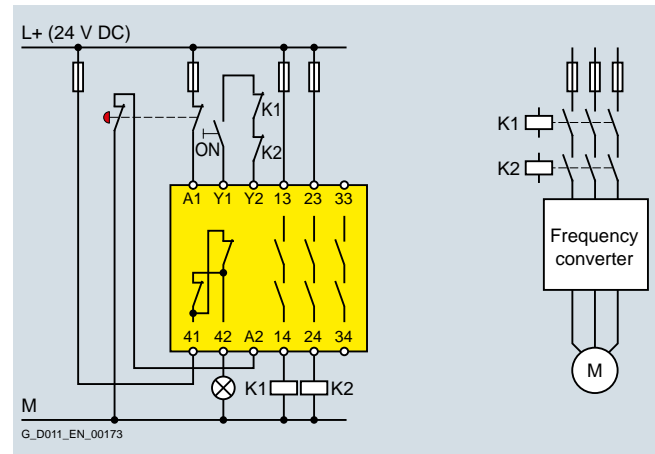

Classic implementation using an external circuit

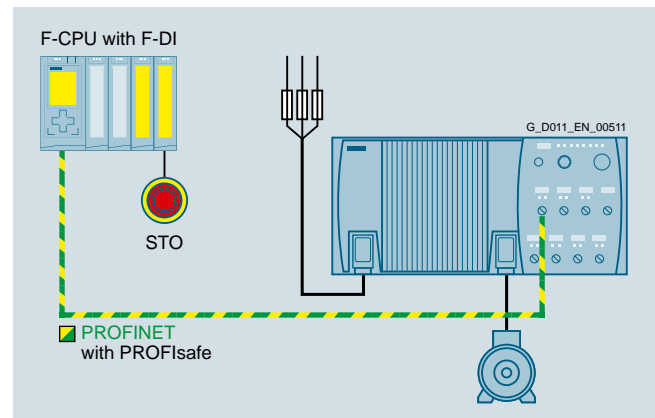

Integrated safety solution via PROFIsafe

# Safety Integrated

## Safety Integrated for SINAMICS G120D

### Benefits (continued)

#### Safe Stop 1 (SS1)

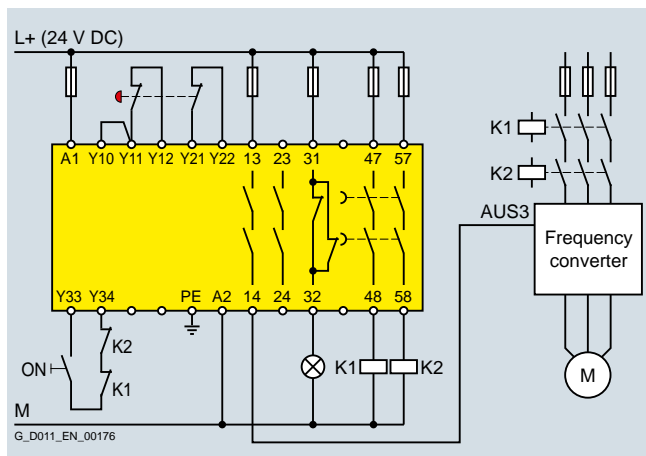

Classic implementation using an external circuit

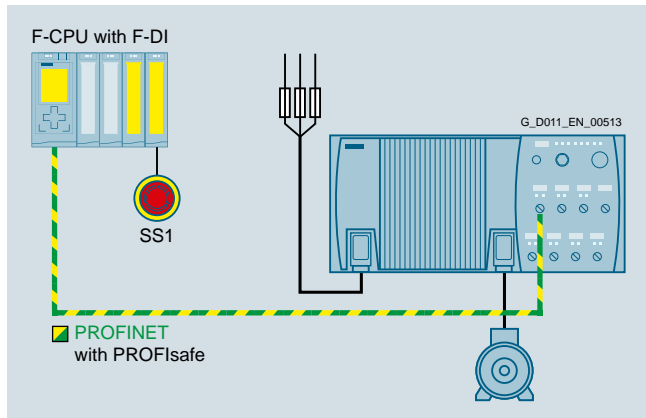

Integrated safety solution via PROFINET

#### Safely-Limited Speed (SLS)

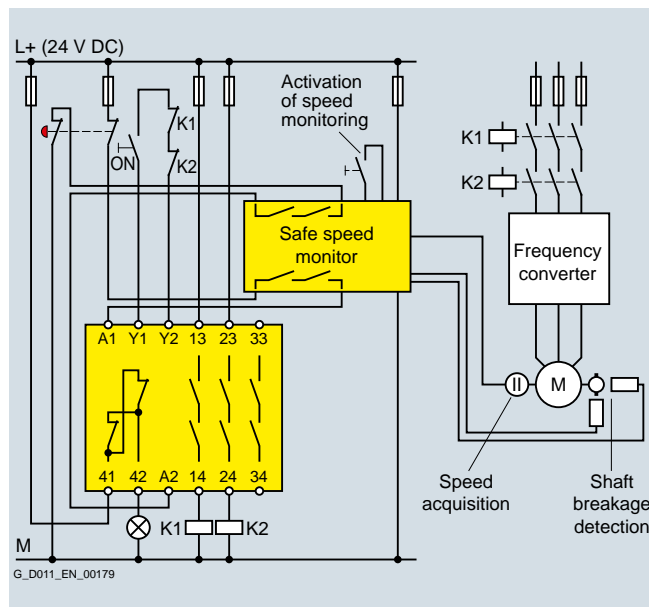

Classic implementation using an external circuit

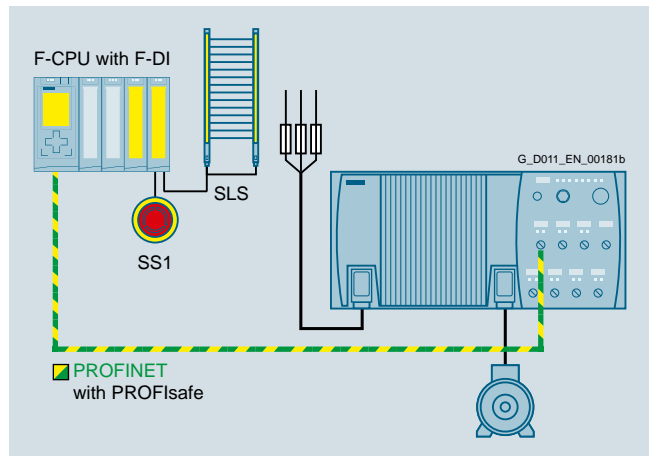

Integrated safety solution via PROFINET

3

## Function

Function	Control	Underlying function	Reaction to limit overshoot	Encoder required	License required	Available in
<b>Basic Functions</b>						
<b>STO</b>	<ul style="list-style-type: none"> <li>F-DI</li> <li>PROFIsafe</li> </ul>	–	–	No	No	<ul style="list-style-type: none"> <li>CU240D-2 DP</li> <li>CU240D-2 PN</li> <li>CU240D-2 DP-F</li> <li>CU240D-2 PN-F</li> <li>CU240D-2 PN-F PP</li> <li>CU240D-2 PN-F FO</li> <li>CU250D-2 DP-F</li> <li>CU250D-2 PN-F</li> <li>CU250D-2 PN-F PP</li> <li>CU250D-2 PN-F FO</li> </ul>
<b>SS1 time-controlled</b>	<ul style="list-style-type: none"> <li>F-DI</li> <li>PROFIsafe</li> </ul>	Following expiry of the parameterized delay time or if the speed falls below the minimum speed limit STO	STO	No	No	<ul style="list-style-type: none"> <li>CU240D-2 DP-F</li> <li>CU240D-2 PN-F</li> <li>CU240D-2 PN-F PP</li> <li>CU240D-2 PN-F FO</li> <li>CU250D-2 DP-F</li> <li>CU250D-2 PN-F</li> <li>CU250D-2 PN-F PP</li> <li>CU250D-2 PN-F FO</li> </ul>
<b>Extended Functions</b>						
<b>SS1 with SBR/SAM</b>	<ul style="list-style-type: none"> <li>F-DI</li> <li>PROFIsafe</li> </ul>	Safe Acceleration Monitor (SAM) or Safe Brake Ramp (SBR) during braking. Following expiry of the parameterized delay time or if the speed falls below the minimum speed limit STO	STO	No	No	<ul style="list-style-type: none"> <li>CU240D-2 DP-F</li> <li>CU240D-2 PN-F</li> <li>CU240D-2 PN-F PP</li> <li>CU240D-2 PN-F FO</li> <li>CU250D-2 DP-F</li> <li>CU250D-2 PN-F</li> <li>CU250D-2 PN-F PP</li> <li>CU250D-2 PN-F FO</li> </ul>
<b>SLS</b>	<ul style="list-style-type: none"> <li>F-DI</li> <li>PROFIsafe</li> </ul>	–	STO, SS1 (can be parameterized)	No	No	<ul style="list-style-type: none"> <li>CU240D-2 DP-F</li> <li>CU240D-2 PN-F</li> <li>CU240D-2 PN-F PP</li> <li>CU240D-2 PN-F FO</li> <li>CU250D-2 DP-F</li> <li>CU250D-2 PN-F</li> <li>CU250D-2 PN-F PP</li> <li>CU250D-2 PN-F FO</li> </ul>
<b>SDI</b>	<ul style="list-style-type: none"> <li>F-DI</li> <li>PROFIsafe</li> </ul>	–	STO, SS1 (can be parameterized)	No	No	<ul style="list-style-type: none"> <li>CU240D-2 DP-F</li> <li>CU240D-2 PN-F</li> <li>CU240D-2 PN-F PP</li> <li>CU240D-2 PN-F FO</li> <li>CU250D-2 DP-F</li> <li>CU250D-2 PN-F</li> <li>CU250D-2 PN-F PP</li> <li>CU250D-2 PN-F FO</li> </ul>
<b>SSM</b>	<ul style="list-style-type: none"> <li>Always active</li> </ul>	–	Signals that the speed has fallen below a specified value	No	No	<ul style="list-style-type: none"> <li>CU240D-2 DP-F</li> <li>CU240D-2 PN-F</li> <li>CU240D-2 PN-F PP</li> <li>CU240D-2 PN-F FO</li> <li>CU250D-2 DP-F</li> <li>CU250D-2 PN-F</li> <li>CU250D-2 PN-F PP</li> <li>CU250D-2 PN-F FO</li> </ul>

## Safety Integrated

### Safety Integrated for SIMATIC ET 200pro FC-2

#### Overview



SIMATIC ET 200pro FC-2

The SIMATIC ET 200pro FC-2 frequency converter offers the Safe Torque Off (STO) function as a standard feature.

The Safety Integrated function is completely integrated into the drive system. It is controlled via the SIMATIC ET 200pro system. The SIMATIC ET 200pro F-RSM Safety local isolator and PROFIsafe F-Switch Safety modules can be used to control the F0 Safety rail. The converter evaluates the F0 safety rail.

The Safety Integrated function is implemented electronically and therefore offers short response times in comparison to solutions with externally implemented monitoring functions.

#### Function

Function	Control	Encoder required	License required
<b>STO</b>	<ul style="list-style-type: none"> <li>via SIMATIC ET 200pro system</li> </ul>	No	No



## Energy efficiency



4/2	<b>Energy efficiency</b>
4/2	Success factor Energy Efficiency
4/3	<b>SIMATIC Energy Suite – integrated energy management</b>
4/4	<b>Energy-efficient drives</b>
4/5	Overview of energy-saving functions for SINAMICS drives
4/6	<b>Energy efficiency classes in accordance with EN 50598</b>

Further information about energy efficiency including references from industrial production can be found at [www.siemens.com/energy-efficiency](http://www.siemens.com/energy-efficiency) [www.siemens.com/energysaving](http://www.siemens.com/energysaving)

# Energy efficiency

## Energy efficiency

### Overview

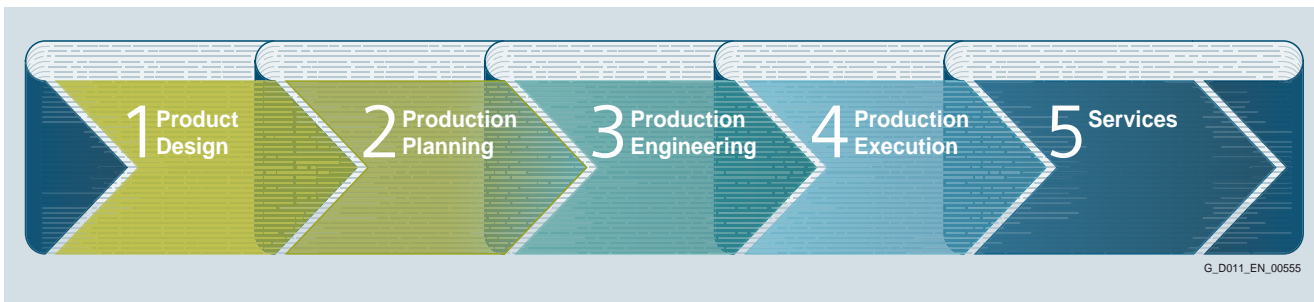

4

#### Success factor Energy Efficiency

Siemens helps you to optimize your energy demand, reduce your energy costs and increase your competitive advantage

Industry is facing enormous challenges: Production processes need to be highly productive, energy-efficient, and resource-saving. Siemens is offering an energy efficiency concept that continually and systematically reduces the power consumption of machines and equipment and thereby boosts the competitive advantage of industrial producers. When implementing energy-efficient solutions, Siemens not only assesses the production process as a whole, but also evaluates each individual production step.

##### 1 Product Design

Improve your confidence in planning outcomes! It is important to know the costs associated with the operation of a production machine so that these can be taken into account in the machine design. For example, the SinaSave software application can help you to calculate how soon you will recoup your investment if you purchase an energy-efficient drive. The Mechatronic Support simulation package will also provide you with the means to test and optimize your machine concept, Helping you to save time, energy and operating expenses. See also the SIZER for Siemens Drives engineering tool.

SinaSave: [www.siemens.com/sinasave](http://www.siemens.com/sinasave)

SIZER for Siemens Drives: [www.siemens.com/sizer](http://www.siemens.com/sizer)

##### 2 Production Planning

Make your plant more profitable! It is possible to carry out an on-screen simulation of individual machines and even the entire production process. By doing this, you can optimize the efficiency and productivity of production processes. For example, you can use the digital models and analysis functions provided by the Plant Simulation tool in order to optimize the motion sequences of your machines, prevent load peak overlaps, recover energy and optimize speeds.

Plant Simulation: [www.siemens.com/tecnomatix](http://www.siemens.com/tecnomatix)

##### 3 Production Engineering

Optimize the workflow! The SIMATIC Energy Manager PRO management tool helps you to achieve efficient control of energy and costs. But this requires perfectly coordinated communication and operation between hardware and software. Using the TIA Portal engineering framework, for example, it is easy to set up and optimize every single engineering process. You can then see at a glance the areas in your plant that can be made more productive and environmentally friendly. See also the STARTER commissioning tool and the SINAMICS Startdrive commissioning tool.

SIMATIC Energy Manager PRO:

[www.siemens.com/energymanagerpro](http://www.siemens.com/energymanagerpro)

TIA-Portal: [www.siemens.com/tia-portal](http://www.siemens.com/tia-portal)

STARTER: [www.siemens.com/starter](http://www.siemens.com/starter)

SINAMICS Startdrive: [www.siemens.com/startdrive](http://www.siemens.com/startdrive)

##### 4 Production Execution

Use innovative drive technology to reduce your energy consumption! The energy-efficient components and systems developed by Siemens can cut the energy consumption of a plant. Important components in an energy-efficient plant are, for example, frequency inverters with regenerative feedback functions for applications with variable speeds or soft starters for fixed-speed drives. With its PROFenergy system, Siemens is also offering solutions that permit centralized shutdown of loads or entire production units during production breaks – a vendor- and device-neutral interface for flexible use over short or long production breaks.

##### 5 Services

Improve your productivity and efficiency while reducing total costs! With its Energy & Environmental Services, Siemens is offering a tailored consultancy that will provide you with the necessary support in designing and implementing systematic energy and environmental management solutions. It will give you the satisfaction of achieving maximum energy efficiency throughout your company.

### More information

Further information about energy efficiency including references from industrial production can be found at

[www.siemens.com/energy-efficiency](http://www.siemens.com/energy-efficiency)

[www.siemens.com/energysaving](http://www.siemens.com/energysaving)

## Overview

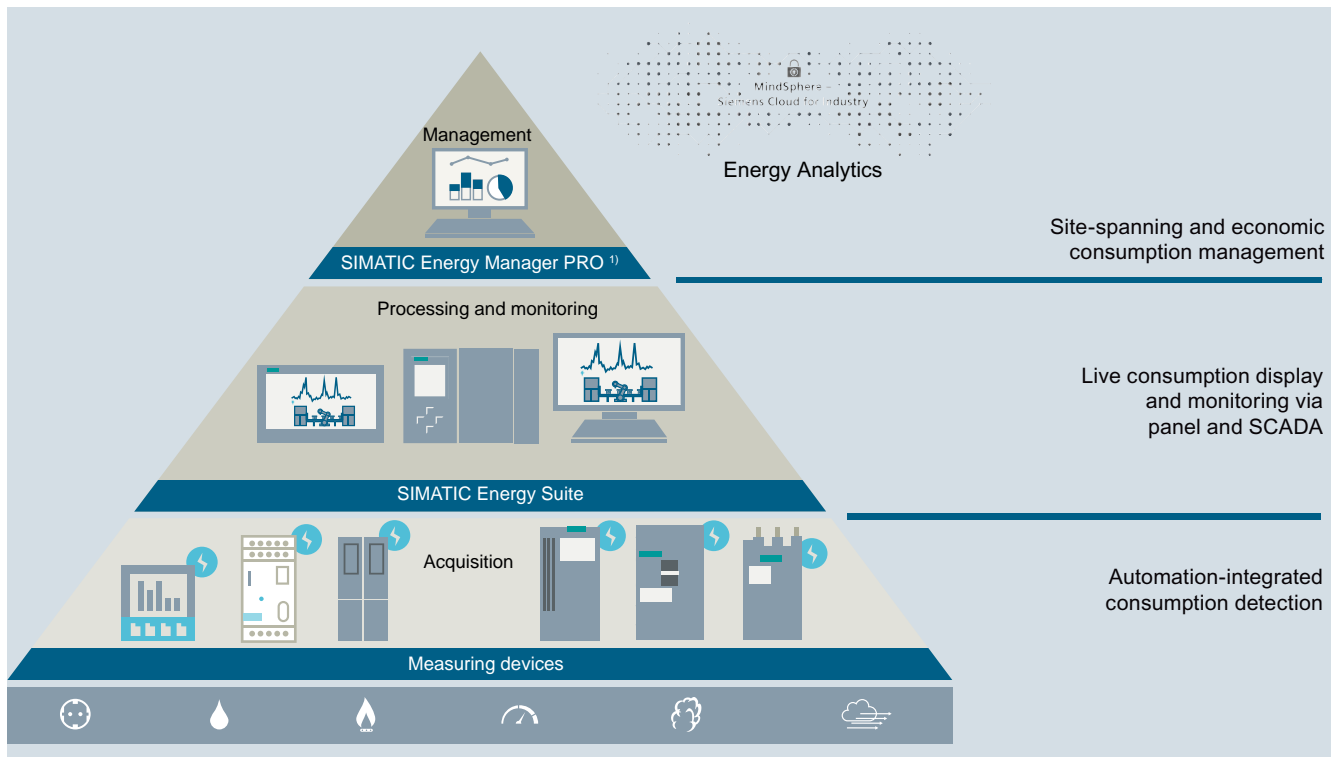

A high energy consumption and automated production are typical for many industries.

If you want to keep your energy costs under control in the long term and you are already focusing on the digital future, you will equip your plant with integrated energy measuring technology, thus anchoring your energy management in the automation of your production processes – which is where most energy is consumed. SIMATIC Energy Suite as an integrated option for the TIA Portal efficiently links energy management with automation, thus creating energy transparency in production. The considerably simplified configuration of energy measuring components from the product families<sup>2)</sup> SIMATIC, SENTRON, SINAMICS, SIRIUS and SIMOCODE significantly reduces the configuration costs. Thanks to the end-to-end connection to SIMATIC Energy Manager PRO<sup>1)</sup> or cloud-based Service Energy Analytics, you can seamlessly expand the recorded energy data to create a cross-site energy management system.

This additionally enables companies to satisfy all the required economic and energy management aspects – from the purchasing of energy and planning all the way to energy controlling.

The advantages at a glance:

- Automatic generation of energy management data
- Integration into TIA Portal and into automation
- Simple configuration

## Highlights

- Simple and intuitive configuration instead of programming
- Automatic generation of the PLC energy program
- Convenient integration of measuring components from the Siemens portfolio and from the portfolio of other vendors
- Integrated into the TIA Portal and automation
- Archiving on WinCC Professional or PLC
- Seamless connection to Energy Manager PRO and Energy Analytics

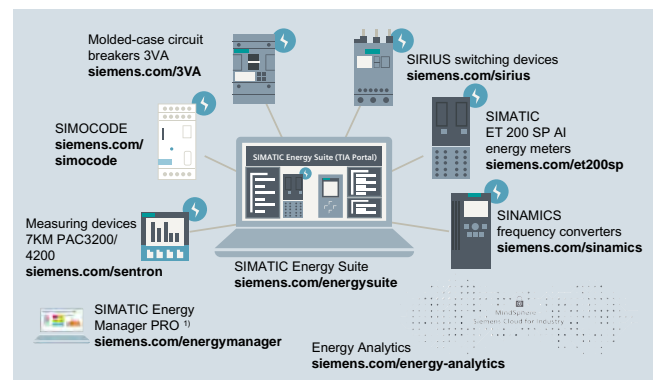

Further information on SIMATIC Energy Suite:

[www.siemens.com/energysuite](http://www.siemens.com/energysuite)

Ready for  
SIMATIC  
Energy Suite

<sup>1)</sup> SIMATIC Energy Manager PRO is the innovative successor to SIMATIC B.Data.

<sup>2)</sup> Products of the SIMATIC, SENTRON, SINAMICS, SIRIUS and SIMOCODE product families. You can find details on the currently supported devices here:  
[www.siemens.com/energysuite-hardware](http://www.siemens.com/energysuite-hardware)

## Energy efficiency

### Energy-efficient drives

#### Overview

##### *Energy-efficient SINAMICS drives save energy in an intelligent way*

Exploit energy-saving potential and optimize energy consumption: You can – with intelligent SINAMICS drives. Depending on the application in question, energy consumption can be controlled by motor speed adjustment to suit the individual process and achieve the greatest possible energy savings. The energy consumption of drives for turbo machines can be cut by as much as 60 %. Regenerative feedback is also an option for many applications. Our portfolio of frequency inverters is the most comprehensive and standardized range on the market and the first choice for anyone seeking an energy-efficient drive – at low-voltage or medium-voltage level.

##### *Energy-efficient drives with intelligent functions*

Depending on the application and load profile, the intelligent energy-saving functions of SINAMICS drives can cut energy consumption.

##### PROFenergy



Provides energy-related status data for the system components to create transparency for the energy management; energy savings by selective shut-down of plants or plant sections.

##### ECO mode



In ECO mode, the operating point of the motor in the partial-load range is automatically adjusted and optimized. This reduces motor losses, for example, in machines that do not need a high torque over the entire operating range.

##### Hibernation mode



Variable-speed drives that are not required to operate continuously are switched to standby or "Hibernation mode". The drive is restarted again as soon as it is needed.

##### Bypass mode

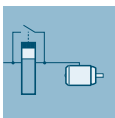

In bypass mode it is possible to "bypass" the inverter electrically as soon as the motor is frequently operating close to its rated speed. This solution helps to reduce inverter losses and so increase overall efficiency.

##### Cascading

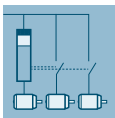

In pump, fan and compressor applications involving high outputs, the entire power demand is distributed among several motors. Phased connection and disconnection by means of partially or fully controlled cascades in combination with inverters make a drive system more energy-efficient.

##### Energy balancing

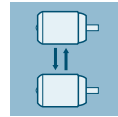

Through the use of inverters with coupled drives, energy is exchanged through the common DC link. Through the direct energy exchange from one inverter to the next, it is possible to minimize power losses in the system.

##### Reactive power compensation

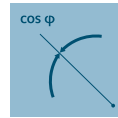

The use of SINAMICS inverters with Active Line Modules reduces the capacitive and/or inductive reactive power in the machine. It is then possible to dispense with costly reactive power compensation systems.

##### Kinetic energy buffering

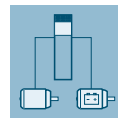

With dynamic reversing operations in single-axis and multi-axis systems, the kinetic energy available in the system is reused. A motor connected to the common DC link is used to buffer kinetic energy.

##### Electrical energy buffering



With dynamic reversing operations in single-axis and multi-axis systems, the kinetic energy available in the system is reused. A capacitor module connected to the common DC link is used to buffer electrical energy.

##### Optimized pulse patterns



Thanks to optimized clock frequency and pulse pattern, SINAMICS G and SINAMICS S are perfectly suited to SIMOTICS motors and SIMOGEAR geared motors. The benefits: Optimization of performance and system efficiency, reduced system losses as well as lower temperature and noise levels.

##### Energy usage counter/Energy saving counter



Actual energy usage can be displayed during operation. Furthermore, an energy saving counter can be installed to indicate the cumulative energy savings during machine operation as compared to a fixed-speed application.

##### Regenerative feedback

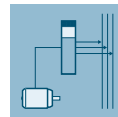

In conventional drive systems, the energy produced during braking is converted to heat using braking resistors. SINAMICS G and SINAMICS S inverters with regenerative feedback capability need no braking resistor, and supply the resulting braking energy back into the line.

## Overview (continued)

## Overview of the energy-saving functions for SINAMICS drives including SIMATIC ET 200pro FC-2 frequency converters

Energy-saving function	SINAMICS V	SINAMICS G							SINAMICS S		SIMATIC ET 200pro FC-2
	V20	G110	G110D	G120C	G120P	G120	G110M	G120D	S110	S120	
ECO mode	✓	-	-	✓	✓	✓	✓	✓	✓	✓	✓
Hibernation mode	✓	-	-	-	✓	with CU230P-2 Control Unit	-	-	-	-	-
Bypass mode	-	-	-	-	✓	with CU230P-2 Control Unit	-	-	-	✓	-
Cascading	✓	-	-	-	✓	with CU230P-2 Control Unit	-	-	-	-	-
Energy balancing	✓	-	-	-	-	-	-	-	-	✓ for multi- axis drives only	-
Reactive power compensation	-	-	-	-	-	-	-	-	-	✓ with Active Line Module	-
Kinetic energy buffering	-	-	-	-	-	-	-	-	-	✓ for multi- axis drives only	-
Electrical energy buffering	-	-	-	-	-	-	-	-	-	✓ for multi- axis drives only	-
Optimized pulse patterns	-	-	-	-	-	-	-	-	-	✓	-
Energy usage counter/Energy saving counter	✓	-	✓	✓	✓	✓	✓	✓	-	✓	✓
Regenerative feedback	-	-	-	-	-	with PM250 Power Module	-	✓	-	with Smart Line Module or Active Line Module	✓
<b>Communication protocol and profile</b>											
PROFINET	-	-	-	✓	✓	✓	✓	✓	✓	✓	✓
• PROFinergy	-	-	-	✓	✓	✓	✓	✓	-	✓	✓
<b>Ready for SIMATIC Energy Suite</b>											
Integrated energy management	-	✓	✓	✓	✓	✓	✓	✓	-	with CU310-2 Control Unit	-

## Energy efficiency

### Energy efficiency classes in accordance with EN 50598

#### Overview

##### Step by step to more efficiency

One of the core objectives of the European Union is a sustainable power industry. In industrial plants today, around 70 % of the power demand is from electrically driven systems. This high percentage contains huge potential for saving energy in electrical drives. For that reason, the European Union introduced minimum requirements for the energy efficiency of electric motors in the form of a statutory motor regulation as early as 2011.

However, measures aimed solely at the motor are not enough to achieve the mandatory energy-saving targets. The European legislation fills this gap with the standard series EN 50598 and extends the focus from individual drive components to entire drive systems, even enabling consideration of specific use cases.

The European standard series EN 50598 defines the ecodesign requirements for drive systems in the low-voltage range with an electrically driven machine. It consists of definitions for energy efficiency (parts 1 and 2) and an ecobalance calculation (part 3).

To take account of the different use cases, consideration of eight application-relevant operating points has been introduced as mandatory for the first time. Determination of loss values at these eight points and definition of efficiency classes are laid down by the standard in a uniform way. This enables data relevant to operation, such as application-specific load profiles, to now be taken into account more easily in the energy efficiency analysis.

The standard is especially important for variable-speed drives of the following types:

- for AC/AC converters without energy recovery functionality
- for motors with integrated converters
- for supply voltages of 100 V to 1000 V
- for power ratings of 0.12 kW to 1000 kW

To cover all applications of driven machines, the new standard defines operating points in full-load and partial-load operation, at which the losses of the motor and drive systems have to be determined. Based on the loss data at the operating points in partial-load operation, variable-speed drives can be explicitly considered in more detail. This makes their advantages especially clear.

#### Centrifugal pumps, fans

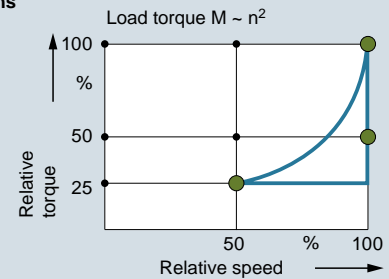

#### Hoisting gear, extruders, conveyor belts

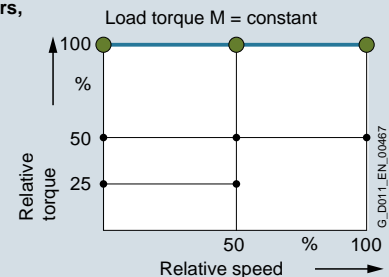

#### Winders, coilers

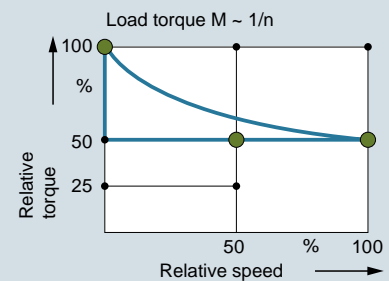

Duty cycles for different driven machines

Moreover, frequency converters and motor systems are classified in efficiency classes, which permit an initial rough estimate of the potential saving. Definition of reference systems is a key aspect of this because they provide standard reference values. The positioning of these reference systems defines the efficiency class. The relative distance from the reference system can be used as an absolute measure of the efficiency at the operating point in question.

**Overview** (continued)**Advantages of the detailed loss consideration of EN 50598 over the previous consideration of efficiencies and maximum loss values**

For motors, the efficiency consideration was previously only defined for operation without a converter at 50/60 Hz. It provides a good way of comparing the energy efficiency of motors from different manufacturers for this use case.

The more detailed loss analysis of EN 50598, on the other hand, is aimed at speed-controlled operation and therefore now also includes motors especially designed for converter operation in the energy analysis. These were previously not covered by the applicable standards.

Moreover, a loss analysis over the entire setting and load range of the motor is possible. This is done in accordance with the standard EN 50598 with typical values.

For holistic consideration, it is essential to include all the relevant components of a drive system. The EN 50598 standard defines this in detail. The standardized expression of power loss data as a percentage makes comparison considerably easier and more transparent.

The method also makes it possible to consider a motor that produces a holding torque at speed zero, for example. In this case, the efficiency is zero, but a power loss from current producing magnetization and holding torque does occur. In summary, the key advantage of standard EN 50598 is the ability to perform the energy analysis of an electrical drive system based on standardized load profiles in all operating ranges due to uniform general conditions. This provides the user with complete transparency irrespective of the manufacturer.

**Establishing efficiency classes of frequency converters (Complete Drive Modules CDM)**

To avoid overmodulation and to ensure comparability between makes, which cannot be achieved otherwise, the efficiency classes of CDMs refer to the 90/100 operating point (90 % motor stator frequency, 100 % torque current).

Standard EN 50598-2 defines the relative losses of a CDM in efficiency classes IE0 to IE2. With reference to the value of a CDM of efficiency class IE1 (reference converter), a CDM of efficiency class IE2 has 25 % lower losses and a CDM of efficiency class IE0 has 25 % higher losses.

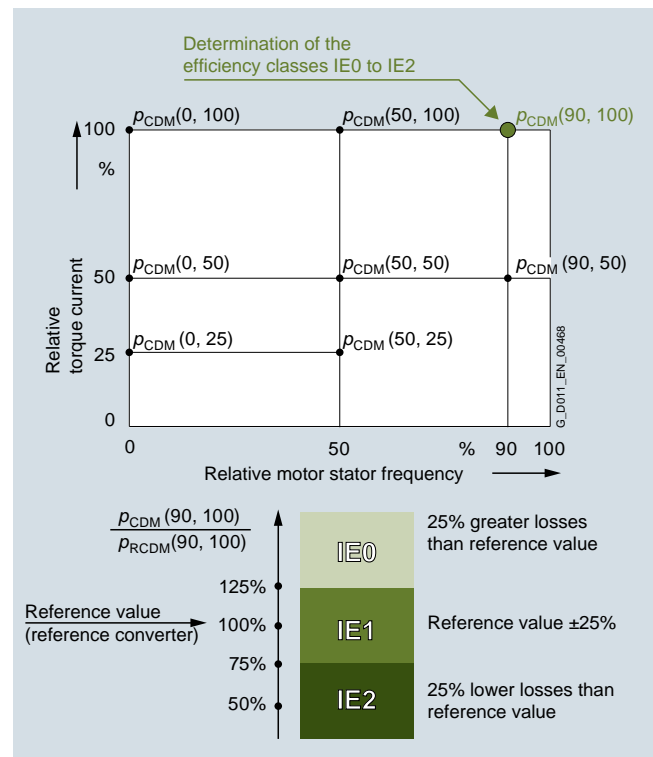
**Operating points for CDMs**

Complete Drive Module (CDM) – determining the efficiency class

**Establishing the efficiency classes of drive systems (Power Drive Systems PDS)**

What is possible for the individual systems, of course, also applies to the entire electrical PDS (frequency converter plus motor). Detailed comparisons are now possible at this level, too. The reference values for the reference system provide clear indications of the energy performance of the PDS.

Because targeted matching of the motor and CDM provides additional potential for optimization in electrical drive systems, it is especially important for the user to consider the entire drive system.

For the efficiency class of a PDS, too, a specific load point is defined. In this case, the reference point used is the 100/100 operating point (100 % motor stator frequency, 100 % torque).

Standard EN 50598-2 defines the relative losses of a PDS in efficiency classes IES0 to IES2. With reference to the value of a PDS of efficiency class IES1 (reference drive), a PDS of efficiency class IES2 has 20 % lower losses and a PDS of efficiency class IES0 has 20 % higher losses.

# Energy efficiency

## Energy efficiency classes in accordance with EN 50598

### Overview (continued)

#### Operating points for PDS

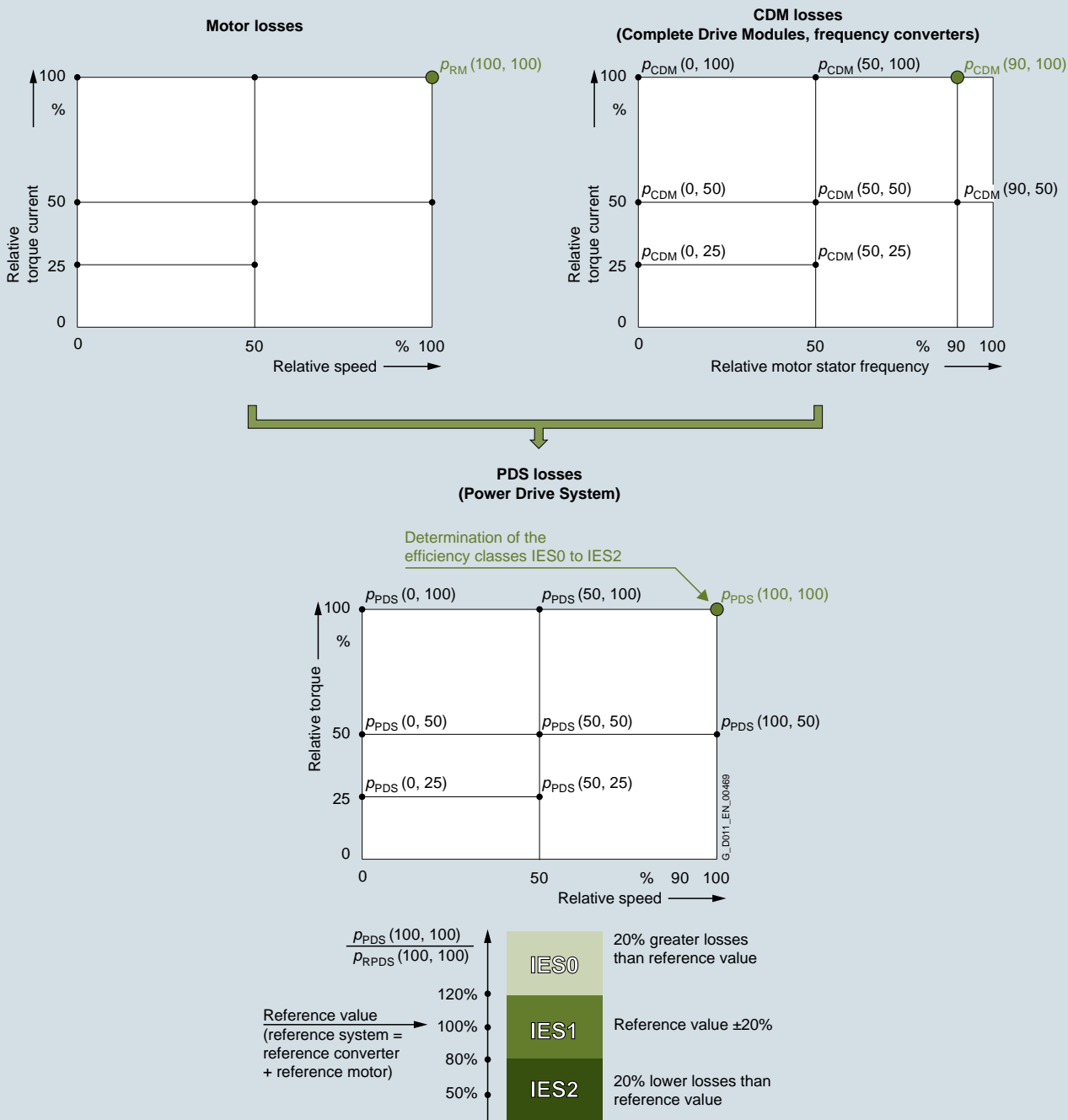

Power Drive System (PDS) – determining the efficiency class

### More information

An example of a highly efficient drive system with efficiency class IES2 is the new synchronous inductance drive system with SIMOTICS reluctance motors and SINAMICS drives. More information is available on the Internet at [www.siemens.com/drivesystem-reluctance](http://www.siemens.com/drivesystem-reluctance), [www.siemens.com/simotics-gp](http://www.siemens.com/simotics-gp), [www.siemens.com/simotics-sd](http://www.siemens.com/simotics-sd)

Power loss data of SINAMICS converters for single-axis drives are available on the Internet at <https://support.industry.siemens.com/cs/document/94059311>

More information on current laws and standards, new standards, and mandatory guidelines is available on the Internet at [www.siemens.com/legislation-and-standards](http://www.siemens.com/legislation-and-standards)



## Communication

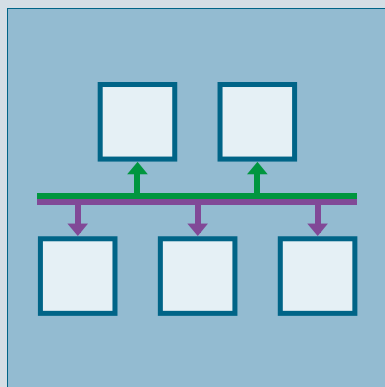

5/2	<b>Communication</b>
5/2	Communication overview
5/3	<b>PROFINET</b>
5/7	<b>PROFIdrive</b>
5/8	<b>PROFIBUS</b>
5/9	<b>Industrial Ethernet</b>
5/10	<b>EtherNet/IP</b>
5/10	<b>Modbus RTU</b>
5/10	<b>AS-Interface</b>
5/10	<b>USS</b>

Further information regarding PROFINET and PROFIBUS can be found at [www.profibus.com](http://www.profibus.com)

# Communication

## Communication

### Overview

#### Communication overview

Digital bus systems are commonly used in industrial automation today. These handle communication between the control level, the machine control, the sensors and actuators. The SINAMICS product family offers integrated communication interfaces in all product groups – which can be used to connect the most important fieldbus systems in the simplest possible way.

The properties and special application areas of the various bus systems for SINAMICS converters incl. SIMATIC ET 200pro FC-2 frequency converters are briefly described in the following.

Protocol	SINAMICS V		SINAMICS G						SINAMICS S			SIMATIC ET 200pro FC-2 <sup>1)</sup>				
	V20	V90	G110	G110D	G120C	G120P/ G120	G120 CU230P-2	G120 CU240E-2	G120 CU250S-2	G110M CU240M	G120D CU240D-2		G120D CU250D-2	S110 CU305	S120 CU310-2	S120 CU320-2
<b>PROFINET</b>	-	✓	-	-	✓	✓	✓	✓	✓	✓	✓	✓	✓	✓	✓	✓
- PROFINET RT	-	✓	-	-	✓	✓	✓	✓	✓	✓	✓	✓	✓	✓	✓	✓
- PROFINET IRT isochronous	-	✓	-	-	-	-	-	-	-	-	-	✓	✓	✓	-	-
- PROFINET IRT not isochronous	-	✓	-	-	✓	✓	✓	✓	✓	✓	✓	✓	✓	✓	✓	✓
- PROFINET Shared Device	-	-	-	-	✓	✓	✓	✓	✓	✓	✓	✓	✓	✓	✓	✓
- PROFINET media redundancy MRP (non-seamless)	-	-	-	-	✓	✓	✓	✓	✓	✓	✓	✓	✓	✓	✓	✓
- PROFINET media redundancy MRPD (seamless)	-	-	-	-	✓	✓	✓	✓	✓	✓	✓	✓	✓	✓	✓	-
- System redundancy S2	-	-	-	-	-	-	-	-	-	-	-	-	✓	✓	✓	-
- PROFI-safe	-	-	-	-	✓	-	✓	✓	✓	✓	✓	✓	✓	✓	✓	✓
- PROFInergy	-	-	-	-	✓	✓	✓	✓	✓	✓	✓	-	✓	✓	✓	✓
- PROFIdrive application class 1	-	✓	-	-	✓	✓	✓	✓	✓	✓	-	✓	✓	✓	✓	✓
- PROFIdrive application class 3	-	✓	-	-	-	-	-	✓	-	-	✓	✓	✓	✓	✓	-
- PROFIdrive application class 4	-	✓	-	-	-	-	-	-	-	-	-	✓	✓	✓	✓	-
<b>PROFIBUS DP</b>	-	-	-	-	✓	✓	✓	✓	✓	✓	✓	✓	✓	✓	✓	✓
- PROFIBUS DP equidistance and isochronous mode	-	-	-	-	-	-	-	-	-	-	-	✓	✓	✓	✓	-
- PROFIBUS DP slave-to-slave communication	-	-	-	-	✓	✓	✓	✓	✓	✓	✓	✓	✓	✓	✓	-
<b>EtherNet/IP</b>	-	-	-	-	✓	✓	✓	✓	✓	✓	✓	-	-	✓	-	-
<b>Modbus TCP</b>	-	-	-	-	-	-	-	-	-	-	-	-	✓	✓	-	-
<b>Modbus RTU</b>	✓	✓	-	-	✓	✓	✓	✓	✓	-	-	-	-	-	-	-
<b>AS-Interface</b>	-	-	-	✓	-	-	-	-	✓	-	-	-	-	-	-	-
<b>BACnet MS/TP</b>	-	-	-	-	-	✓	-	-	-	-	-	-	-	-	-	-
<b>CANopen</b>	-	-	-	-	-	-	-	✓	-	-	-	-	-	-	✓	-
<b>USS</b>	✓	✓	✓	✓	✓	✓	✓	✓	✓	-	-	✓	✓	✓	-	-
<b>FLN P1</b>	-	-	-	-	-	✓	-	-	-	-	-	-	-	-	-	-
<b>Web server</b>	-	-	-	-	-	-	-	-	-	-	-	-	✓	✓	-	-

#### More information

Further information about SINAMICS V90 can be found at [www.siemens.com/sinamics-v90](http://www.siemens.com/sinamics-v90)

Information on SINAMICS V20, SINAMICS G120C, SINAMICS G120 and SINAMICS S110 can be found in Catalog D 31.1.

Further information on SINAMICS S120 can be found in Catalog D 21.4.

<sup>1)</sup> Information on the SIMATIC ET 200pro FC-2 frequency converter with PROFINET or PROFIBUS DP or EtherNet/IP – depending on the SIMATIC ET 200pro station – are available at [www.siemens.com/et200pro-fc](http://www.siemens.com/et200pro-fc)

## Overview

*PROFINET – the Ethernet standard for automation*

PROFINET is the world's leading Industrial Ethernet standard for automation with more than 10 million nodes installed worldwide.

PROFINET makes companies more successful, because it speeds up processes and raises both productivity and plant availability.

## Your advantages at a glance

## Flexibility

Tailor-made plant concepts

- ▶ Industrial Wireless LAN
- ▶ Safety
- ▶ Flexible topologies
- ▶ Open standard
- ▶ Web tools
- ▶ Expandability

## Efficiency

Optimal use of resources

- ▶ One cable for everything
- ▶ Device/network diagnostics
- ▶ Energy efficiency
- ▶ Simple wiring
- ▶ Fast device replacement
- ▶ Ruggedness/stability

## Performance

Increased productivity

- ▶ Speed
- ▶ High precision
- ▶ Large quantity structures
- ▶ High transmission rate
- ▶ Redundancy
- ▶ Fast start-up

G\_IK10\_XX\_10304

## Communication

### PROFINET

#### Overview (continued)

##### Flexibility

Short response times and optimized processes are the basic requirements for competitiveness in global markets because the product lifecycles are becoming shorter and shorter.

PROFINET ensures maximum flexibility in plant structures and production processes, and it enables you to implement innovative machine and plant concepts. For example, mobile devices can also be integrated at locations that are difficult to access.

##### Flexible topologies

In addition to the linear structure characterized by the established fieldbuses, PROFINET also enables the use of star, tree and ring structures. This is made possible by switching technology via active network components, such as Industrial Ethernet switches and media converters, or by integrating switch functionality into the field devices. This results in increased flexibility in the planning of machines and plants, as well as savings in cabling.

The PROFINET network can be installed without any specialist knowledge at all and meets all requirements that are relevant to the industrial environment. The "PROFINET Installations Guidelines" assist manufacturers and users with network planning, installation and commissioning. Symmetrical copper cables or RFI-resistant fiber-optic cables are used, depending on the application. Devices from different manufacturers are easily connected via standardized and rugged plug-in connectors (up to IP65/IP67 degree of protection).

By integrating switch functionality into the devices, linear topologies can be created that are directly oriented toward an existing machine or plant structure. This reduces cabling overhead and cuts down on components such as external switches.

##### IWLAN

PROFINET also supports wireless communication with Industrial Wireless LAN, thus opening up new fields of application. For example, technologies subject to wear, such as trailing cables, can be replaced and automated guided vehicle systems and mobile operator panels can be used.

##### Safety

The PROFIsafe safety profile, which has been tried and tested with PROFIBUS and which permits the transmission of standard and safety-related data on a single bus cable, can also be used with PROFINET. No special network components are necessary for fail-safe communication, which means that standard switches and standard network transitions can continue to be used without any restrictions. In addition, fail-safe communication is equally possible via Industrial Wireless LAN (IWLAN).

##### Open standard

PROFINET, the open multi-vendor standard (IEC 61158/IEC 61784), is supported by PROFIBUS and PROFINET International (PI). It stands for maximum transparency, open IT communication, network security and simultaneous real-time communication.

Thanks to its openness, PROFINET provides the basis for a standardized automation network in the plant, to which all other machines and devices can be connected. Even the integration of existing plant components, for example using PROFIBUS, presents no problems due to the use of network transitions.

##### Use of web tools

Thanks to the unrestricted support of TCP/IP, PROFINET permits the use of standard web services in the device, such as web servers. Irrespective of the tool used, information from the automation level can be accessed from virtually any location using a commercially available Internet browser. This considerably simplifies commissioning and diagnostics. Users can then decide for themselves how much openness to the IT world they want to allow for their machine or plant. This means that PROFINET can be used simply as an isolated plant network or connected via appropriate security modules, such as the SCALANCE S modules, to the office network or the Internet. In this way, new remote maintenance concepts or the high-speed exchange of production data become possible.

##### Expandability

On the one hand, PROFINET facilitates the integration of existing systems and networks without any great effort. In this way, PROFINET safeguards investments in existing plant components that communicate via PROFIBUS and other fieldbuses such as AS-Interface. On the other hand, additional PROFINET nodes can be added at any time. By using additional network components, network infrastructures can be expanded using cabling or wireless methods – even while the plant is operating.

**Overview** (continued)**Efficiency**

Greater global competition means that companies must use their resources economically and efficiently. This applies in particular to production. This is where PROFINET ensures greater efficiency. Simple engineering guarantees fast commissioning, while reliable devices ensure a high level of plant availability. Comprehensive diagnostic and maintenance concepts help to reduce plant downtimes and keep maintenance costs to a minimum.

One cable for everything

PROFINET permits simultaneous fieldbus communication with isochronous mode and standard IT communication (TCP/IP) on one cable. This real-time communication for the transmission of user/process data and diagnostic data takes place on a single cable. Specific profile communication (PROFIsafe, PROFIdrive and PROFlenergy) can be integrated without any additional cabling. This solution offers a wide scope of functions at a low level of complexity.

Device and network diagnostics

By retaining the tried and tested PROFIBUS device model, the same diagnostics information is available with PROFINET. In addition, module-specific and channel-specific data can also be read out from the devices during device diagnosis, enabling faults to be located quickly and easily. Apart from the availability of device information, the reliability of network operation has top priority in the network management.

In existing networks the Simple Network Management Protocol (SNMP) has established itself as the de facto standard for the maintenance and monitoring of the network components and their functions. PROFINET uses this standard and gives users the opportunity to maintain their networks with tools that are familiar to them, such as the SINEMA Server network management software.

For easier maintenance of PROFINET devices, both on-site and remotely via a secure VPN connection, application-specific web-sites can be set up on the integrated web server of the field devices using the familiar HTML standard.

Energy efficiency

Moving toward the green factory: PROFlenergy is a profile that provides functions and mechanisms for PROFINET field devices that support energy-efficient production.

The profile, which is defined by the PNO and is independent of any manufacturers or devices, enables energy demand and costs to be significantly reduced: Using PROFlenergy, any specific loads that are not currently being used can be switched off. This achieves a noticeable reduction in energy costs during breaks in production. PROFlenergy permits the simple, automated activation and deactivation of technologically related plant components. It is coordinated centrally by means of a higher-level controller and is networked via PROFINET. This ensures that as much energy as possible is saved during long breaks. Temporarily switching off plant components contributes to the even distribution and most efficient use of energy.

The use of PROFlenergy is made easy for the machine builder by its integration into familiar series of products. In addition, PROFlenergy is defined in such a way that the necessary function blocks can easily be integrated into existing automation systems at a later stage.

Simple wiring

Particularly stringent demands are made on the installation of cables in the industrial environment. In addition, there is a requirement to set up industry-standard networks in the shortest possible time without any special knowledge.

With FastConnect, Siemens offers a high-speed installation system that meets all of these requirements. FastConnect is the standard-compliant, industry-standard cabling system consisting of cables, connectors and assembly tools for PROFINET networks. The time required for connecting terminals is minimized by the simple installation method using just a single tool, while installation errors are prevented by the practical color-coding. Both copper cables and glass fiber optic cables can be easily assembled on site in this way.

Fast device replacement

PROFINET devices are identified by means of a name assigned during configuration. When replacing a defective device, a new device can be recognized from its topology information by the IO controller and a new name can be assigned to it automatically. This means that no engineering tool is necessary for the replacement of equipment.

This mechanism can even be used for the initial commissioning of a complete system. This speeds up commissioning, particularly in the case of series machines.

Ruggedness

An automation network must be able to withstand most external sources of interference. The use of Switched Ethernet prevents faults in one section of the network from affecting the entire plant network. For areas that are particularly prone to radio frequency interference (RFI), PROFINET allows the use of fiber optic cables.

Performance

Productivity and product quality determine the level of success in the market. Precise motion control, dynamic drives, high-speed controllers and the deterministic synchronization of devices are therefore key factors in achieving superior production. They facilitate high production rates and optimum product quality at the same time.

Speed and precision

Fast motion control applications demand precise and deterministic exchange of data. This is implemented by means of drive controllers using isochronous real time (IRT).

With IRT and isochronous mode, PROFINET permits fast and deterministic communication. This synchronizes the various cycles of a system (input, network, CPU processing and output), even in the case of parallel TCP/IP traffic. The short cycle times of PROFINET make it possible to raise the productivity of machines and plants and to guarantee the product quality and high level of precision.

The standardized PROFIdrive profile permits vendor-independent communication between CPUs and drives.

## Communication

### PROFINET

#### Overview (continued)

##### Large quantity structures

The use of PROFINET makes it possible to overcome the existing restrictions regarding the scope of machines and systems that can be implemented. In one network, several different controllers can interact with their assigned field devices. The number of field devices per PROFINET network is virtually unlimited – the entire range of IP addresses is available.

##### High data rate

By using 100 Mbit/s in full duplex mode, PROFINET achieves a significantly higher data rate than previous fieldbuses. This means that other plant data can be transmitted over TCP/IP without any problems, in addition to the process data. PROFINET therefore meets the combined industrial demands for simultaneously transmitting high-speed IO data and large volumes of data for additional sections of the application. Even the transmission of large volumes of data, such as that from cameras, has no adverse effect on the speed and precision of the IO data transmission, thanks to PROFINET mechanisms.

##### Media redundancy

A higher plant availability can be achieved with a redundant installation (ring topology). The media redundancy can be implemented not only with the aid of external switches, but also by means of integrated PROFINET interfaces. Using the media redundancy protocol (MRP), reconfiguration times of 200 ms can be achieved. If the communication is interrupted in just one part of the ring installation this means that a plant standstill is prevented and any necessary maintenance or repair work can be performed without any time pressure.

For motion control applications, PROFINET with IRT in ring topologies offers extended media redundancy for planned duplication (MRPD) which operates in a bumpless mode without any reconfiguration time. If communication is interrupted (e.g. a cable break) the process can continue operating without interruption.

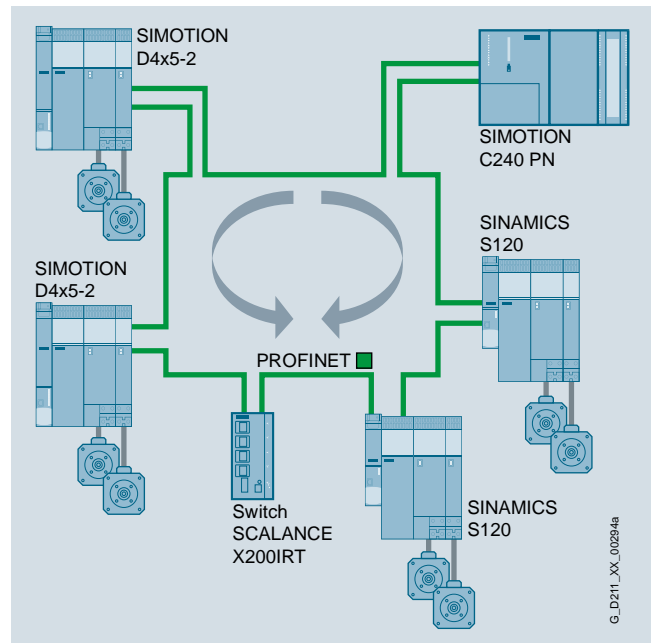

Bumpless media redundancy illustrated by example of SINAMICS S120 with SIMOTION and SCALANCE X200IRT

#### Benefits

- PROFINET is the open Industrial Ethernet standard for automation
- PROFINET is based on Industrial Ethernet
- PROFINET uses TCP/IP and IT standards
- PROFINET is real-time Ethernet
- PROFINET enables seamless integration of fieldbus systems
- PROFINET supports fail-safe communication via PROFI-safe and also via IWLAN

#### More information

More information is available at [www.siemens.com/profinet](http://www.siemens.com/profinet)

## Overview



### PROFIdrive – the standardized drive interface for PROFINET and PROFIBUS

PROFIdrive defines the device behavior and technique to access internal device data for electric drives connected to PROFINET and PROFIBUS – from basic frequency converters up to high-performance servo controllers.

It describes in detail the practical use of communication functions – slave-to-slave communication, equidistance and clock cycle synchronization (isochronous mode) in drive applications. In addition, it specifies all device characteristics which influence interfaces connected to a controller over PROFINET or PROFIBUS. This also includes the state machine (sequence control), the encoder interface, scaling of values, definition of standard telegrams, access to drive parameters etc.

The PROFIdrive profile supports both central as well as distributed motion control concepts.

#### What are profiles?

For devices and systems used in automation technology, profiles define properties and modes of behavior. This allows manufacturers and users to define common standards. Devices and systems that comply with such a cross-manufacturer profile, are interoperable on a fieldbus and, to a certain degree, can be interchanged.

#### Are there different types of profiles?

A distinction is made between what are known as application profiles (general or specific) and system profiles:

- Application profiles (also device profiles) predominantly refer to devices (e.g. drives) and include an agreed selection regarding bus communication as well as specific device applications.
- System profiles describe classes of systems, including master functionality, program interfaces and integration resources.

#### Is PROFIdrive fit for the future?

PROFIdrive has been specified by the PROFIBUS and PROFINET International (PI) user organization, and is specified as a standard that is fit for the future through standard IEC 61800-7.

#### The basic philosophy: Keep it simple

The PROFIdrive profile tries to keep the drive interface as simple as possible and free from technology functions. As a result of this philosophy, referencing models as well as the functionality and performance of the PROFINET/PROFIBUS master have either no influence or only a low influence on the drive interface.

### One drive profile – different application classes

The integration of drives into automation solutions depends very strongly on the particular drive application. In order to be able to address the complete, huge bandwidth of drive applications – from basic frequency converters up to synchronized multi-axis systems with a high dynamic performance – using just one profile, PROFIdrive defines six application classes, to which most drive applications can be assigned:

- Class 1 – standard drives (pumps, fans, agitators, etc.)
- Class 2 – standard drives with technological functions
- Class 3 – positioning drives
- Class 4 – motion control drives with central, higher-level motion control intelligence and the patented "Dynamic Servo Control" positioning concept
- Class 5 – motion control drives with central, higher-level motion control intelligence and position setpoint interface
- Class 6 – motion control drives with distributed motion control intelligence integrated in the drives

## Design

### The device model of PROFIdrive

PROFIdrive defines a device model comprising function modules, which interoperate inside the device and which reflect the intelligence of the drive system. These modules have objects assigned to them which are described in the profile and are defined with respect to their functions. The overall functionality of a drive is therefore described through the sum of its parameters.

In contrast to other drive profiles, PROFIdrive defines only the access mechanisms to the parameters as well as a subset of profile parameters (approx. 30) such as the fault buffer, drive control and device identification.

All other parameters are vendor-specific which gives drive manufacturers great flexibility with respect to implementing control functions. The elements of a parameter are accessed acyclically over data records.

As a communication protocol, PROFIdrive uses DP-V0, DP-V1, and the DP-V2 expansions for PROFIBUS including the functions "Slave-to-Slave Communication" and "Isochronous Operation", or PROFINET IO with real-time classes RT and IRT.

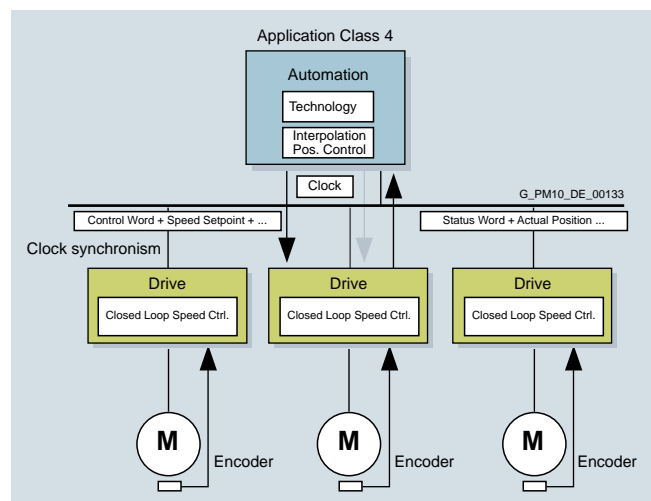

## More information

More information on PROFINET and PROFIBUS is available at [www.profibus.com](http://www.profibus.com)

## Communication

### PROFIBUS

#### Overview



#### *PROFIBUS – the proven, rugged bus system for automation engineering applications*

The requirements of users for an open, non-proprietary communication system have resulted in the specification and standardization of the PROFIBUS protocol.

PROFIBUS defines the technical and functional features of a serial fieldbus system, with which the distributed field automation devices in the lower area (sensor/actuator level) can be networked up to the mid performance range (cell level).

Standardization according to IEC 61158/EN 50170 secures your investments for the future.

Using the conformity and interoperability test performed by the test laboratories authorized by PROFIBUS & PROFINET International (PI) and the certification of the devices by PI, users have the security of knowing that the quality and functionality is guaranteed, even in multi-vendor installations.

#### *PROFIBUS versions*

Two different PROFIBUS versions have been defined in order to comply with the widely varying requirements at field level:

- PROFIBUS PA (Process Automation) – the version for applications in process automation. PROFIBUS PA uses the intrinsically safe transmission technology specified in IEC 61158-2.
- PROFIBUS DP (Distributed Periphery) – this version, which is optimized for speed, is specifically tailored to the communication of automation systems with distributed I/O stations and drives. PROFIBUS DP sets itself apart as a result of very short response times and high noise immunity, and replaces cost-intensive, parallel signal transfer with 24 V and measured value transfer utilizing 0/4 ... 20 mA technology.

#### Design

##### *Bus participants on PROFIBUS DP*

PROFIBUS DP makes a distinction between two different master classes and one slave class:

##### DP master class 1

For PROFIBUS DP, DP master class 1 is the central component. In a defined and continually repeating message cycle the central master station exchanges information with distributed stations (DP slaves).

##### DP master class 2

Devices of this type (programming, configuring or operator control devices) are used during commissioning, for configuring the DP system, for diagnostics or for operating the active plant or system. A DP master class 2 can, for example, read input, output, diagnostic and configuration data of the slaves.

##### DP slave

A DP slave is an I/O device which receives output information or setpoints from the DP master, and as response, returns input information, measured values and actual values to the DP master. A DP slave never sends data automatically, but only when requested by the DP master.

The quantity of input and output information depends on the device, and for each DP slave in each send direction can be a maximum of 244 bytes.

#### Function

##### *Functional scope in DP masters and DP slaves*

The functional scope can differ between DP masters and DP slaves. The different functional scopes are classified as DP-V0, DP-V1 and DP-V2.

##### DP-V0 communication functions

The DP-V0 master functions consist of "Configuration", "Parameter Assignment" and "Reading Diagnostics Data", as well as cyclic reading of input data/actual values and writing output data/setpoints.

##### DP-V1 communication functions

The DP-V1 function expansions make it possible to perform acyclic read and write functions as well as processing cyclic data communication. This type of slave must be supplied with extensive parameterization data during start-up and during normal operation. These acyclically transferred parameterization data are only rarely changed in comparison to the cyclic setpoints, actual values, and measured values, and are transferred at lower priority in parallel with the cyclic high-speed user data transfer. Detailed diagnostic information can be transferred in the same way.

##### DP-V2 communication functions

The extended DP-V2 master functions mainly comprise functions for isochronous operation and slave-to-slave communication between DP slaves.

- Isochronous mode:  
Isochronous mode is implemented by means of an equidistant signal in the bus system. This cyclic, equidistant cycle is sent by the DP master to all bus nodes in the form of a Global Control Telegram. Master and slaves can then synchronize their applications with this signal. The signal jitter between cycles is less than 1  $\mu$ s.
- Slave-to-slave communication:  
The "publisher/subscriber" model is used to implement slave-to-slave communication. Slaves declared as publishers make their input data/actual values and measured values available to other slaves, the subscribers, for reading. This is performed by sending the response frame to the master as a broadcast. Slave-to-slave communication is therefore a cyclic process.

#### Integration

##### *PROFIBUS with SINAMICS*

SINAMICS uses the PROFIBUS DP protocol. SINAMICS drives can only be used as DP slaves.



## Overview



Ethernet is the basic Internet technology for worldwide networking. The many possibilities of intranet and Internet, which have been available for office applications for a long time, are now utilized for production automation with Industrial Ethernet.

Apart from the use of information technology, the deployment of distributed automation systems is also on the increase. This entails breaking up complex control tasks into smaller, manageable and drive-based control systems. This increases the demand for communication and consequently a comprehensive and powerful communication system.

Industrial Ethernet provides a powerful area and cell network for the industrial field, compliant with the IEEE 802.3 (ETHERNET) standard.

## Benefits

Ethernet enables a very fast data transfer (10/100 Mbit/s, 1/10 Gbit/s) and at the same time has full-duplex capability. It therefore provides an ideal basis for communication tasks in the industrial field. With a share of over 90 %, Ethernet is the number one network worldwide and offers important features which have essential advantages:

- Fast commissioning thanks to the simplest connection method
- High availability since existing networks can be extended without any adverse effects
- Almost unlimited communication performance because scalable performance is available through switching technology and high data rates when required
- Networking of different application areas such as office and production areas
- Company-wide communication based on WAN (Wide Area Network) technology or the Internet
- Investment protection due to continuous compatibility with further developments
- Wireless communication using Industrial Wireless LAN

In order to make Ethernet suitable for industrial applications, considerable expansions with respect to functionality and design are required:

- Network components for use in harsh industrial environments
- Fast assembly of the RJ45 connectors
- Fail-safety through redundancy
- Expanded diagnostics and message concept
- Use of future-oriented network components (e.g. switches)

SIMATIC NET offers corresponding network components and products.

## Communication

### EtherNet/IP

#### Overview



Ethernet Industrial Protocol (EtherNet/IP) is an open standard for industrial networks. EtherNet/IP is used to transmit cyclic I/O data and acyclic parameter data. EtherNet/IP was developed by the ODVA (Open DeviceNet Vendor Association) and belongs to the international standard series IEC 61158.

### Modbus RTU

#### Overview



As a simple fieldbus protocol, Modbus RTU can be used both cyclically and acyclically. Based on RS485 physical bus characteristics, up to 32 nodes can be networked to one bus segment and connected to a higher-level controller. This protocol is generally used when there are limited demands on data throughput.

### AS-Interface

#### Overview



AS-Interface serves as a cost-effective system for the lower field level of automation. AS-Interface was specially developed to meet the demands of connecting binary sensors and actuators as well as interfacing to the higher control level. A straightforward, cost-effective installation with minimal connection costs was of paramount importance to the developers. The AS-Interface is often used in systems where numerous actuators and sensors, installed across a wide area, need to be networked cost-effectively. Examples include conveyor and handling systems in airports, automated postal sorting, and the food and beverage industry.

### USS

#### Overview

As a simple fieldbus protocol, USS (**U**niversal **S**erial **I**nterface protocol of Siemens AG, 1992) can be used both cyclically and acyclically. Based on RS485 physical bus characteristics, up to 32 nodes can be networked to one bus segment and connected to a higher-level controller. This protocol is generally used when there are limited demands on data throughput.

## Technology functions

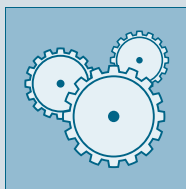
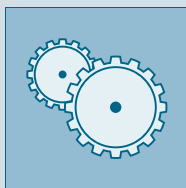
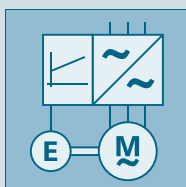

## 6/2 Free function blocks (FFB)

## 6/3 Basic positioner EPos

6/3 Function module basic positioner EPos

6/4 Functionality of the EPos basic positioner

## Technology functions

### Free function blocks (FFB)

#### Overview

On specific SINAMICS devices, free function blocks (FFB) are available as a standard technology function, which can be called up as an additively activatable function module. The FFB can be used to connect simple binary states or several input signals to a control signal (e.g. ON command). Furthermore, analog signals can also be adapted.

In addition to logical operations such as AND/OR, arithmetic functions as well as more complex blocks such as smoothing elements, limit monitors, or storing elements are also available. All of the blocks can be flexibly interconnected with one another using BICO (Binector-Connector technology).

In the SINAMICS Startdrive engineering tool, the FFB can be comfortably parameterized via screens.

The user-friendly overview for parameter assignment is shown below, based on the example of the SINAMICS G120 inverter. In this example, three digital inputs which are linked to each other via a logical AND function block are acquired. The drive can only be released when all inputs have a HIGH signal.

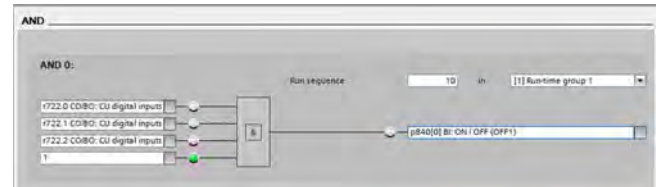

#### Supported functions in the function module of the free function blocks (FFB)

Logical functions	Programming of Boolean logic and logic operations
Arithmetic functions	Programming of mathematical functions
Timer functions	Generating of pulses and switching delays
Memory functions	Programming of binary flip-flops
Switch functions	Programming of binary and numerical switches
Control functions	Programming of functions for open-loop and closed-loop control
Complex functions	Programming of threshold value monitors and control units

The table above shows an overview of the supported functions of the FFB. Depending on the SINAMICS inverter, up to 25 different block types are available. The number of available blocks per module type is limited. The blocks are not multi-instance-capable.

The sequence and calculation intervals (sampling times) can be selected for each block, but the calculation intervals are limited by the performance of the Control Unit.

## Overview

### Function module basic positioner EPos

The basic positioner EPos is available as a standard technology function for the following SINAMICS Control Units and can be called as a function module that can be activated additionally.

- SINAMICS S120 CU310-2 and CU320-2 Control Units
- SINAMICS S110 CU305 Control Units
- SINAMICS G120 CU250S-2 Control Units
- SINAMICS G120D CU250D-2 Control Units

The basic positioner can be used to resolve basic motion control tasks without additional external technological outlay from the drive itself.

### Integrated functionality for absolute and relative positioning of linear and rotary axes with motor encoders or machine encoders.

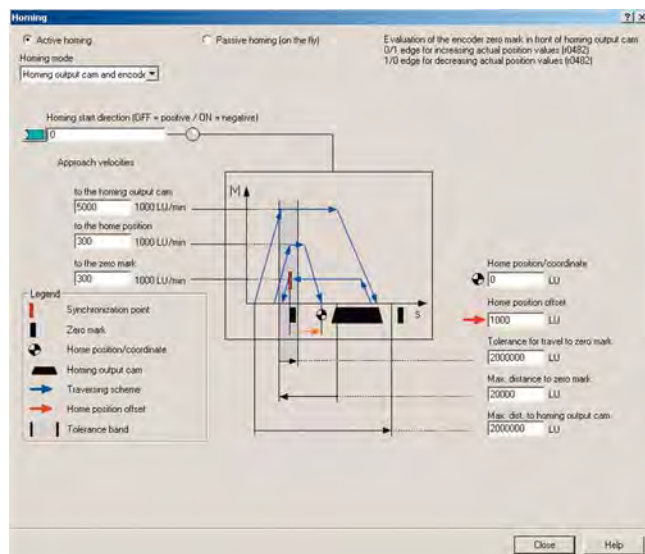
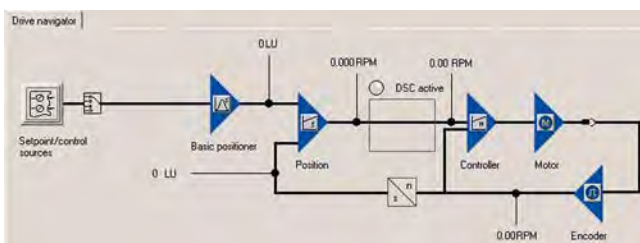

The EPos basic positioner in the SINAMICS drive system provides powerful and precise positioning functions. Due to its flexibility and adaptability, the basic positioner can be used for a wide range of positioning tasks.

The functions are easy to handle both during commissioning and during operation, and the comprehensive monitoring functions are outstanding.

Many applications can be carried out without external position controllers.

The EPos basic positioner is used to position linear and rotary axes (modulo) in absolute/relative terms with rotary as well as linear motor encoder or machine encoder (indirect or direct measuring system).

EPos is a function module that can be activated additionally in Servo Control and in Vector Control.

User-friendly configuring and commissioning, including control panel (operation using PC) and diagnostics, are possible with the STARTER and SINAMICS Startdrive commissioning tools.

In addition to extremely flexible positioning functions, EPos offers a high degree of user-friendliness and reliability thanks to integral monitoring and compensation functions.

Different operating modes and their functionality increase flexibility and plant productivity, for example, by means of "on-the-fly" and bumpless correction of the motion control.

Preconfigured PROFIdrive positioning frames are available which, when selected, automatically establish the internal "connection" to the basic positioner.

## Technology functions

### Basic positioner EPos

#### Overview (continued)

##### *Functionality of the EPos basic positioner*

##### Lower-level closed-loop position control with the following essential components

- Position actual value sensing (including the lower-level measuring probe evaluation and reference mark search)
- Position controller (including limits, adaptation and pre-control calculation)
- Monitoring functions (standstill, positioning and dynamic following error monitoring, cam signals)

##### Mechanical system

- Backlash compensation
- Modulo offset

##### Limitations

- Speed/acceleration/delay/jerk limitation
- Software limit switches (traversing range limitation by means of position setpoint evaluation)
- Stop cams (traversing range limitation using hardware limit switch evaluation)

##### Referencing or adjustment

- Set reference point (for an axis at standstill)
- Search for reference (separate mode including reversing cam functionality, automatic reversal of direction, homing to "output cam and encoder zero mark" or only "encoder zero mark" or "external zero mark (BERO)")
- Flying referencing (seamless referencing possible during "normal" traversing with the aid of the measuring input evaluation; generally evaluation, e.g. of a BERO. Subordinate function for the modes "jog", "direct setpoint input/MDI" and "traversing blocks")
- Absolute encoder alignment

##### Traversing block mode

- 64 traversing blocks for
  - SINAMICS S120 CU310-2 and CU320-2 Control Units
- 16 traversing blocks for
  - SINAMICS S110 CU305 Control Units
  - SINAMICS G120 CU250S-2 Control Units
  - SINAMICS G120D CU250D-2 Control Units
- Positioning using traversing blocks that can be stored in the drive unit including continuation conditions and specific jobs for homed axis
- Configuring traversing blocks using the traversing block editor in the relevant commissioning tool of the SINAMICS drive family
- A traversing block contains the following information:
  - Job number and job (e.g. positioning, waiting, GOTO block jump, setting of binary outputs, travel to fixed endstop)
  - Motion parameters (target position, velocity, override for acceleration and deceleration)
  - Mode (e.g.: hide block, continuation conditions such as "Continue\_with\_stop", "Continue\_flying" and "Continue\_externally using high-speed measuring inputs")
  - Job parameters (e.g. wait time, block step conditions)

##### Direct setpoint specification (MDI) mode

- Positioning (absolute, relative) and setting-up (endless closed-loop position control) using direct setpoint inputs (e.g. via the PLC using process data)
- It is always possible to influence the motion parameters during traversing (on-the-fly setpoint acceptance) as well as for on-the-fly changes between the setup and positioning modes.
- The direct setpoint specification mode (MDI) can also be used in the relative positioning or setup mode if the axis is not referenced. This means that on-the-fly synchronization and re-referencing can be carried out using "flying referencing".

##### Jog mode

- Closed-loop position controlled traversing of the axis with "endless position controlled" or "jog incremental" modes (traverse through a "step width"), which can be toggled between

## SINAMICS G110M distributed inverters

### 0.37 kW to 4 kW (0.5 hp to 5 hp)

7



#### 7/2 Introduction

- 7/2 Application
- 7/2 More information

#### 7/3 SINAMICS G110M distributed frequency inverters

- 7/3 Overview
- 7/4 Benefits
- 7/5 Design
- 7/6 Configuration
- 7/7 Technical specifications

#### 7/8 CU240M Control Units

- 7/8 Overview
- 7/9 Selection and ordering data
- 7/10 Design
- 7/11 Integration
- 7/15 Technical specifications

#### 7/17 PM240M Power Modules

- 7/17 Overview
- 7/17 Selection and ordering data
- 7/18 Integration
- 7/19 Technical specifications
- 7/22 Characteristic curves
- 7/23 Dimensional drawings

#### 7/24 Repair switch

- 7/24 Overview
- 7/24 Selection and ordering data

#### 7/25 Recommended line-side power components

- 7/25 Selection and ordering data

#### 7/26 DC link components

- 7/26 Braking resistors
- 7/26 Overview
- 7/26 Selection and ordering data
- 7/26 Technical specifications
- 7/27 24 V DC power supply
- 7/27 Overview
- 7/27 Selection and ordering data
- 7/27 Technical specifications

#### 7/28 Compatible motors for SINAMICS G110M

- 7/28 Overview

#### 7/29 Supplementary system components

- 7/29 Intelligent Operator Panel
- 7/29 IOP-2 Handheld
- 7/30 Memory card
- 7/30 PC inverter connection kit 2 (mini USB interface cable for communication with a PC)
- 7/31 Wall mounting kit
- 7/32 Installation kits
- 7/32 STARTER commissioning tool
- 7/32 SINAMICS Startdrive commissioning tool
- 7/32 Connecting cables for the Control Unit
- 7/32 PROFINET connecting cable
- 7/33 PROFIBUS connecting cable
- 7/33 AS-Interface connecting cable
- 7/33 Connecting cables/connectors for supplying the Control Unit with power
- 7/34 Connecting cables and connectors for digital inputs and outputs
- 7/34 Connecting cables and connectors for analog inputs
- 7/34 Connecting cables for Power Modules
- 7/34 Connecting cables pre-assembled at one end and connector sets to connect to the line supply
- 7/34 Connector insert for power loop-through
- 7/34 Power bus distribution 400 V in IP65 degree of protection
- 7/34 More information

#### 7/34 Spare parts

- 7/34 Spare Parts Kit
- 7/34 Overview
- 7/34 Selection and ordering data

# SINAMICS G110M distributed inverters

0.37 kW to 4 kW (0.5 hp to 5 hp)

## Introduction

## Application

Use	Requirements for torque accuracy/speed accuracy/position accuracy/coordination of axes/functionality					
	Continuous motion			Non-continuous motion		
	Basic	Medium	High	Basic	Medium	High
<b>Pumping, ventilating, compressing</b> 	Centrifugal pumps Radial / axial fans Compressors	Centrifugal pumps Radial / axial fans Compressors	Eccentric screw pumps	Hydraulic pumps Metering pumps	Hydraulic pumps Metering pumps	Descaling pumps Hydraulic pumps
	V20 G120C G120P	G120P G130/G150 G180 <sup>1)</sup>	S120	G120	S110	S120
<b>Moving</b> 	Conveyor belts Roller conveyors Chain conveyors	Conveyor belts Roller conveyors Chain conveyors Lifting/lowering devices Elevators Escalators/moving walkways Indoor cranes Marine drives Cable railways	Elevators Container cranes Mining hoists Excavators for open-cast mining Test bays	Acceleration conveyors Storage and retrieval machines	Acceleration conveyors Storage and retrieval machines Cross cutters Reel changers	Storage and retrieval machines Robotics Pick & place Rotary indexing tables Cross cutters Roll feeds Engagers/disengagers
	V20 G110D <b>G110M</b> G120C ET 200pro FC-2 <sup>2)</sup>	G120 G120D G130/G150 G180 <sup>1)</sup>	S120 S150 DCM	V90 G120 G120D	S110 S210 DCM	S120 S210 DCM
<b>Processing</b> 	Mills Mixers Kneaders Crushers Agitators Centrifuges	Mills Mixers Kneaders Crushers Agitators Centrifuges Extruders Rotary furnaces	Extruders Winders/unwinders Lead/follower drives Calenders Main press drives Printing machines	Tubular bagging machines Single-axis motion control such as • Position profiles • Path profiles	Tubular bagging machines Single-axis motion control such as • Position profiles • Path profiles	Servo presses Rolling mill drives Multi-axis motion control such as • Multi-axis positioning • Cams • Interpolations
	V20 G120C	G120 G130/G150 G180 <sup>1)</sup>	S120 S150 DCM	V90 G120	S110 S210	S120 S210 DCM
<b>Machining</b> 	Main drives for • Turning • Milling • Drilling	Main drives for • Drilling • Sawing	Main drives for • Turning • Milling • Drilling • Gear cutting • Grinding	Axis drives for • Turning • Milling • Drilling	Axis drives for • Drilling • Sawing	Axis drives for • Turning • Milling • Drilling • Lasering • Gear cutting • Grinding • Nibbling and punching
	S110	S110 S120	S120	S110	S110 S120	S120

SINAMICS G110M fulfills all requirements that plant manufacturers demand from their frequency inverters in drives for conveyor system applications. The inverter is supplied as a motor-integrated unit in degree of protection up to IP66 and sets standards in efficiency – from the installation phase to commissioning and handling. SINAMICS G110M is also suitable for pump and fan applications in which a motor integrated inverter is required as a distributed system.

Practical application examples and descriptions are available on the Internet at

[www.siemens.com/sinamics-applications](http://www.siemens.com/sinamics-applications)  
[www.siemens.com/conveyor-technology](http://www.siemens.com/conveyor-technology)

## More information

You may also be interested in these drives:

- Simple applications with AS-Interface in IP65 degree of protection ⇒ SINAMICS G110D
- More performance for the control cabinet in IP20 degree of protection ⇒ SINAMICS G120, SINAMICS G120C (Catalog D 31.1)
- With enhanced functionality, with positioning function in IP65 degree of protection ⇒ SINAMICS G120D
- With positioning function in the control cabinet in IP20 degree of protection ⇒ SINAMICS G120 (Catalog D 31.1)

<sup>1)</sup> Industry-specific inverters.

<sup>2)</sup> Information on the SIMATIC ET 200pro FC-2 frequency converter is available at [www.siemens.com/et200pro-fc](http://www.siemens.com/et200pro-fc)



## SINAMICS G110M distributed inverters

0.37 kW to 4 kW (0.5 hp to 5 hp)

### SINAMICS G110M distributed frequency inverters

#### Overview

The SINAMICS G110M distributed frequency inverters are the solution for drive tasks in which a motor integrated frequency inverter is required. With different device versions (frame sizes FSA to FSB) in a power range from 0.37 kW to 4 kW, the SINAMICS G110M is suitable for a wide variety of drive solutions. SINAMICS G110M supports continuous speed control of three-phase asynchronous motors and fulfills all the requirements of conveyor system applications from simple speed control through to demanding sensorless vector control. It can be integrated seamlessly into the system thanks to its compact design in IP65/IP66 degree of protection.

Through the integrated functions such as Quick Stop and the limit switch function, the SINAMICS G110M is particularly suited for conveyor system applications.

For applications that require safety engineering, the SINAMICS G110M has the integrated STO (Safe Torque Off <sup>1)</sup>) function, which can be implemented without further external components. Integration via PROFINET, PROFIBUS, Ethernet/IP, Modbus RTU, AS-Interface or USS into a higher-level SIMATIC controller is very easy thanks to complete TIA Portal integration <sup>1)</sup> – one tool and one operating and data storage concept.



SINAMICS G110M CU240M PN Control Unit, cable gland and PM240M Power Module FSA 1.5 kW



SINAMICS G110M CU240M PN Control Unit, plug-in and PM240M Power Module FSA 1.5 kW

#### Reasons for using distributed drive systems

- Modular drive solutions – therefore standardized mechatronic elements that can be individually tested
- No need for a cabinet, resulting in a smaller space requirement and less cooling
- Long cables between the inverter and motor can be avoided (which means lower power losses, reduced interference emission and lower costs for shielded cables and additional filters)
- Considerable benefits for conveyor systems with their extensive coverage (e.g. in the automotive and logistics industries)

#### Siemens family of distributed drives

Siemens offers an innovative portfolio of frequency inverters to optimally implement distributed drive solutions. The strengths of the individual members of the drive family permit simple adaptation to the widest range of application demands:

- Identical connection systems
- Standard commissioning and configuration tools

Products from the family of distributed drives:

- SINAMICS G110M frequency inverters
- SINAMICS G110D frequency inverters
- SINAMICS G120D frequency inverters
- SIMATIC ET 200pro FC-2 frequency converters
- SIRIUS M200D motor starters

#### Modularity

SINAMICS G110M is a modular, motor integrated inverter system with IP65/66 degree of protection comprising various function units. The main units are:

- Control Unit (CU)
- Power Module (PM)

The Control Unit controls and monitors the Power Module and the connected motor using several different closed-loop control types that can be selected. The digital and analog inputs and digital outputs on the device support the simple wiring of sensors and actuators directly at the drive. The input signals can either be directly linked within the Control Unit and initiate local responses independently or they can be transferred to the central control via PROFIBUS, PROFINET or AS-Interface for further processing within the context of the overall plant.

The Power Module supplies the motor in a performance range from 0.37 kW to 4 kW. The Power Module is controlled by a microprocessor in the Control Unit. State-of-the-art IGBT technology with pulse width modulation is used for highly reliable and flexible motor operation. Comprehensive protection functions provide a high degree of protection for the Power Module and the motor. The latest technical documentation (catalogs, dimensional drawings, certificates, manuals and operating instructions) is available on the Internet at the following address:

[www.siemens.com/sinamics-g110m](http://www.siemens.com/sinamics-g110m)

and offline in the DT Configurator integrated in Catalog CA 01 on DVD-ROM. In addition, the DT Configurator can be used on the Internet without requiring any installation. The DT Configurator can be found in the Siemens Industry Mall at the following address:

[www.siemens.com/dt-configurator](http://www.siemens.com/dt-configurator)

<sup>1)</sup> Available for firmware version V4.7 or higher.

## SINAMICS G110M distributed inverters

0.37 kW to 4 kW (0.5 hp to 5 hp)

### SINAMICS G110M distributed frequency inverters

#### Overview (continued)

##### **Safety Integrated**

The distributed SINAMICS G110M inverters are already equipped with the integrated STO safety function (Safe Torque Off <sup>1)</sup>, certified in accordance with IEC 61508 SIL 2 as well as EN ISO 13849-1 PL d and Category 3). It can be activated either over PROFIsafe or over the safety input.

Further information can be found in the section [Safety Integrated](#).

##### **STARTER commissioning tool**

The STARTER commissioning tool (V4.3 SP3 and higher) supports the commissioning and maintenance of SINAMICS G110M inverters <sup>2)</sup>. The operator guidance combined with comprehensive, user-friendly functions for the relevant drive solution allow you to commission the device quickly and easily.

##### **SINAMICS Startdrive commissioning tool (V13 and higher)**

SINAMICS Startdrive is a tool for configuring, commissioning, and diagnosing the SINAMICS family of drives and is integrated into the TIA Portal. SINAMICS Startdrive can be used to implement drive tasks with the SINAMICS G110M <sup>3)</sup>, SINAMICS G120, SINAMICS G120C, SINAMICS G120D and SINAMICS G120P inverter series. The commissioning tool has been optimized with regard to user friendliness and consistent use of the TIA Portal benefits of a common working environment for PLC, HMI and drives.

#### Benefits

##### **Fast commissioning**

- Preconfigured with SIMOGEAR
- Loop-through of 24 V DC and 400 V 3 AC and communication – no T-distributors necessary
- Internal braking resistors – typical applications can be implemented without external braking resistors
- Rugged, with IP65/66 degree of protection, up to 55 °C ambient temperature
- Commissioning via fieldbus or on site via standard USB interface/optical interface for IOP-2 Handheld

##### **Fast commissioning on site**

- Local commissioning via DIP switch and potentiometer, standard USB interface, or IOP-2 Handheld Intelligent Operator Panel.
- Plug-in connections for 400 V 3 AC and 24 V DC, plug-in I/Os and communication
- Local diagnostics with LEDs
- Uploading, saving and cloning of parameters with SINAMICS SD card and IOP-2 Handheld Intelligent Operator Panel

##### **Full functionality**

- Integrated safety functions (STO locally via F-DI or via PROFIsafe)
- PROFINET communication to PROFIBUS at no extra cost
- Integrated communication: USS, Modbus RTU, PROFIBUS, PROFINET / EtherNet/IP and AS-Interface
- Basic PLC functions and additional conveyor technology functions
- I/Os can be used as distributed I/Os of the PLC

##### **Efficient engineering**

- Fully integrated in Totally Integrated Automation, Totally Integrated Automation Portal and Integrated Drive System
- Automatic diagnostics in combination with SIMATIC controller

##### **Flexible commissioning**

- Integrated, specific software functionality for conveyor systems:
  - Quick Stop function for fast response times for the sensors, e.g. roller conveyor, belt conveyor
  - Limit switch functionality, e.g. for rotary table, corner transfer unit
- Use of the same software tools (STARTER and SINAMICS Startdrive) as for all SINAMICS drives

<sup>1)</sup> Available for firmware version V4.7 or higher.

<sup>2)</sup> SINAMICS G110M with AS-Interface is available from STARTER V4.4 SP1.

<sup>3)</sup> SINAMICS G110M with AS-Interface is available from SINAMICS Startdrive V13 SP1.

## SINAMICS G110M distributed inverters

0.37 kW to 4 kW (0.5 hp to 5 hp)

### SINAMICS G110M distributed frequency inverters

#### Design

The SINAMICS G110M distributed inverters are modular frequency inverters for standard drives. Each SINAMICS G110M comprises two operative units – a Power Module and a Control Unit.



SINAMICS G110M CU240M PN Control Unit plug-in and PM240M Power Module FSA 1.5 kW

#### Power Modules

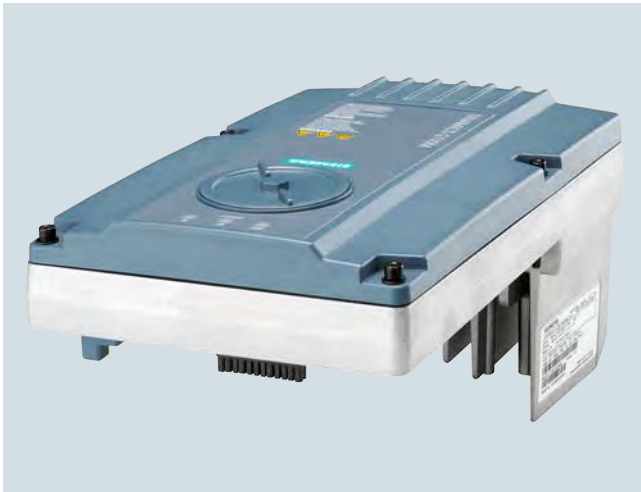

SINAMICS G110M PM240M Power Module FSA 1.5 kW

The following PM240M Power Modules are available for the SINAMICS G110M distributed inverters:

PM240M Power Modules Rated power	Frame size
0.37 kW (0.5 hp)	FSA
0.75 kW (1 hp)	FSA
1.1 kW (1.5 hp)	FSA
1.5 kW (2 hp)	FSA
2.2 kW (3 hp)	FSB
3 kW (4 hp)	FSB
4 kW (5 hp)	FSB

#### Control Units

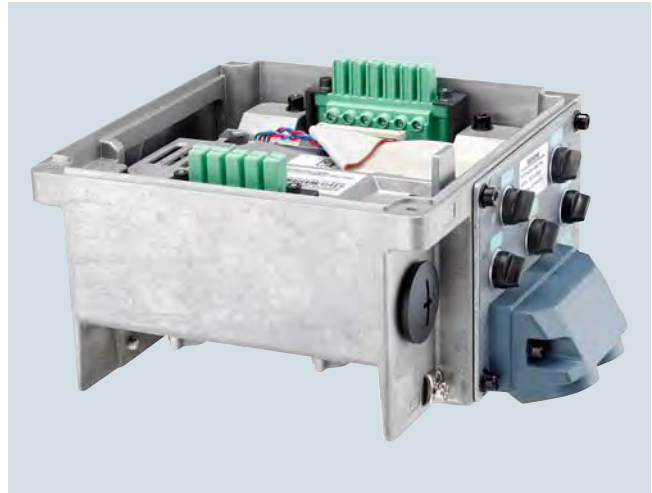

SINAMICS G110M CU240M PN Control Unit cable gland

A Control Unit performs closed-loop control functions for the inverter. In addition to the closed-loop control, it has additional functions that can be adapted to the particular application through parameterization.

The following Control Units are available for SINAMICS G110M distributed inverters:

#### CU240M Control Units

Several Control Units are available in different versions:

Control Unit	Fieldbus communication via	Connection system	for motor shaft heights
CU240M	USS/Modbus RTU	Screw-type version	71, 80/90, 100/112
CU240M AS-i	AS-Interface	Screw-type version	71, 80/90, 100/112
CU240M AS-i	AS-Interface	Plug-in version	71, 80/90, 100/112
CU240M DP	PROFIBUS	Screw-type version	71, 80/90, 100/112
CU240M DP	PROFIBUS	Plug-in version	71, 80/90, 100/112
CU240M PN	PROFINET, EtherNet/IP	Screw-type version	71, 80/90, 100/112
CU240M PN	PROFINET, EtherNet/IP	Plug-in version	71, 80/90, 100/112

#### Supplementary system components

##### Intelligent Operator Panel IOP-2 Handheld

The IOP-2 Handheld supports both newcomers and drive experts. Thanks to the large plain text display, menu-based operation and the application wizards, it is easy to commission, diagnose and locally control standard drives.

##### Memory card

The parameter settings for the inverter and the firmware can be stored on the SINAMICS SD memory card. When service is required, e.g. after the inverter has been replaced and the data have been downloaded from the memory card, the system is immediately ready for use again.

## SINAMICS G110M distributed inverters

0.37 kW to 4 kW (0.5 hp to 5 hp)

### SINAMICS G110M distributed frequency inverters

#### Design (continued)

##### PC inverter connection kit (mini USB interface cable) for communication with a PC

For controlling and commissioning an inverter directly from a PC if the appropriate software (STARTER commissioning tool V4.3 and higher or SINAMICS Startdrive V13 and higher) has been installed.

##### Internal braking resistors

Excess energy in the DC link is dissipated in the internal braking resistor.

##### 24 V DC power supply

A 24 V DC power supply is also available for SINAMICS G110M. This is mounted directly on the inverter and supplies the device with 24 V DC, so there is no need to connect an external 24 V DC power supply.

##### Wall mounting kit

If a SINAMICS G110M distributed inverter should not or cannot be mounted on the motor, a wall mounting kit is available. With the wall mounting kit SINAMICS G110M can be mounted close to the motor – according to the conditions of the plant.

##### Repair switch

For SINAMICS G110M a repair switch is available. This is mounted directly on the inverter and separates SINAMICS G110M on the input side from the 400 V line supply.

##### Connecting cables for the Control Units

Flexible plug-in cables to transfer data between the Industrial Ethernet stations or PROFIBUS stations, as well as to supply power to the Control Unit.

##### Connecting cables for the Power Modules

Connector sets and pre-assembled cables for the line supply can be ordered as accessories.

##### Installation kits

Different installation kits can be ordered as accessories for the Control Units with plug-in connections and Control Units with cable gland connections.

These kits include covers or cable glands for protecting or connecting the 400 V 3 AC supply, the 24 V DC supply and the mechanical motor brake.

##### Spare Parts Kit

A Spare Parts Kit is available which comprises small parts such as seals, caps and screws.

#### Configuration

The following electronic configuring aids and engineering tools are available for the SINAMICS G110M distributed inverters:

##### **Drive Technology Configurator (DT Configurator) within the CA 01**

The interactive catalog CA 01 – the offline Industry Mall of Siemens on DVD-ROM – contains over 100000 products with approximately 5 million possible drive system product variants. The Drive Technology Configurator (DT Configurator) has been developed to facilitate selection of the correct motor and/or converter from the wide spectrum of drives. It is integrated as a selection tool in Catalog CA 01.

##### **Online DT Configurator**

In addition, the DT Configurator can be used on the Internet without requiring any installation. The DT Configurator can be found in the Siemens Industry Mall at the following address:

[www.siemens.com/dt-configurator](http://www.siemens.com/dt-configurator)

##### **SIZER for Siemens Drives engineering tool**

The SIZER for Siemens Drives engineering tool makes it easy to configure the SINAMICS drive family. It provides support when selecting the hardware and firmware components necessary to implement a drive task. SIZER for Siemens Drives is designed to support configuring of the entire drive system.

You can find further information on the SIZER for Siemens Drives engineering tool in the section [Engineering tools](#).

The SIZER for Siemens Drives engineering tool is available free on the Internet at

[www.siemens.com/sizer](http://www.siemens.com/sizer)

##### **STARTER commissioning tool**

The STARTER commissioning tool allows menu-prompted commissioning, optimization and diagnostics. Apart from for SINAMICS drives, STARTER is also suitable for MICROMASTER 4 devices; for SINAMICS G110M from STARTER V4.3 SP3 and higher<sup>1)</sup>.

You can find further information about the STARTER commissioning tool in the section [Engineering tools](#).

Additional information about the STARTER commissioning tool is available on the Internet at

[www.siemens.com/starter](http://www.siemens.com/starter)

##### **SINAMICS Startdrive commissioning tool (V13 and higher)**

SINAMICS Startdrive is a tool for configuring, commissioning, and diagnosing the SINAMICS family of drives and is integrated into the TIA Portal. SINAMICS Startdrive can be used to implement drive tasks with the SINAMICS G110M<sup>2)</sup>, SINAMICS G120, SINAMICS G120C, SINAMICS G120D and SINAMICS G120P inverter series. The commissioning tool has been optimized with regard to user friendliness and consistent use of the TIA Portal benefits of a common working environment for PLC, HMI and drives.

You can find further information about the SINAMICS Startdrive commissioning tool in the section [Engineering tools](#).

The SINAMICS Startdrive commissioning tool is available free on the Internet at

[www.siemens.com/startdrive](http://www.siemens.com/startdrive)

##### **Drive ES engineering system**

Drive ES is the engineering system that can be used to integrate the communication, configuration and data management functions of Siemens drive technology into the SIMATIC automation world easily, efficiently and cost-effectively. Two software packages are available for SINAMICS – Drive ES Basic Maintenance and Drive ES PCS.

You can find more information about the Drive ES engineering system in the section [Engineering tools](#).

Additional information about the Drive ES engineering system is available on the Internet at

[www.siemens.com/drive-es](http://www.siemens.com/drive-es)

<sup>1)</sup> SINAMICS G110M with AS-Interface is available from STARTER V4.4 SP1.

<sup>2)</sup> SINAMICS G110M with AS-Interface is available from SINAMICS Startdrive V13 SP1.

## SINAMICS G110M distributed inverters

0.37 kW to 4 kW (0.5 hp to 5 hp)

### SINAMICS G110M distributed frequency inverters

#### Technical specifications

Unless explicitly specified otherwise, the following technical specifications are valid for all the following SINAMICS G110M distributed inverter components listed here.

SINAMICS G110M	
<b>Mechanical specifications</b>	
<b>Vibratory load</b>	
• Transport acc. to EN 60721-3-2 <sup>1)</sup>	Class 1M2
• Operation acc. to EN 60721-3-3	Class 3M3
<b>Shock load</b>	
• Transport acc. to EN 60721-3-2 <sup>1)</sup>	Class 1M2
• Operation acc. to EN 60721-3-3	Class 3M3
<b>Ambient conditions</b>	
<b>Protection class according to EN 61800-5-1</b>	Class III (PELV)
<b>Touch protection acc. to EN 61800-5-1</b>	Class I (with protective conductor system)
<b>Permissible ambient/coolant temperature (air) during operation</b>	-10 ... +40 °C (14 ... 104 °F) without derating >40 ... 55 °C (104 ... 131 °F) <a href="#">see derating characteristics</a>
<b>Humidity, max.</b>	95 % at 40 °C (104 °F)
<b>Ambient temperature</b>	
• Storage <sup>1)</sup> acc. to EN 60068-2-1	-40 ... +70 °C (-40 ... +158 °F)
• Transport <sup>1)</sup> acc. to EN 60068-2-1	-40 ... +70 °C (-40 ... +158 °F)
• Operation acc. to EN 60068-2-2	-10 ... +40 °C (14 ... 104 °F) without derating
<b>Environmental class/harmful chemical substances</b>	
Operation acc. to EN 60721-3-3	Class 3C2
<b>Degree of pollution acc. to EN 61800-5-1</b>	2
<b>Certification for fail-safe versions</b>	
• According to IEC 61508	SIL 2
• According to EN ISO 13849-1	PL d and Category 3
<b>Standards</b>	
<b>Compliance with standards</b>	UR, cUR, CE, RCM
<b>CE marking, according to</b>	Low Voltage Directive 2014/35/EU
<b>EMC Directive</b>	
• Frame sizes FSA to FSB with integrated line filter class A	Category C2 <sup>2)</sup> according to EN 61800-3
	<b>Note:</b> The EMC product standard EN 61800-3 does not apply directly to a frequency inverter but to a PDS (Power Drive System), which comprises the complete circuitry, motor and cables in addition to the inverter. The frequency inverters on their own do not generally require identification according to the EMC Directive.

<sup>1)</sup> In product packaging.

<sup>2)</sup> With shielded motor cable up to 5 m (16.41 ft).

## SINAMICS G110M distributed inverters

0.37 kW to 4 kW (0.5 hp to 5 hp)

### CU240M Control Units

#### Overview

The Control Unit performs closed-loop control functions for the inverter. In addition to the primary closed-loop control function, it has many additional functions that can be adapted to the particular application through parameterization.

The Control Units are available in two versions for connection to 400 V 3 AC and 24 V DC – screw-type or plug-in. The version in USS fieldbus communication is only available as screw-type. The differences between the screw-type and plug-in versions are presented in the following pictures:

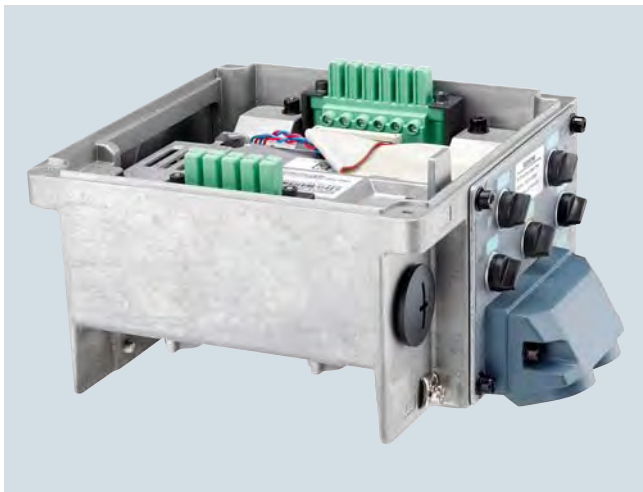

SINAMICS G110M CU240M PN Control Unit cable gland

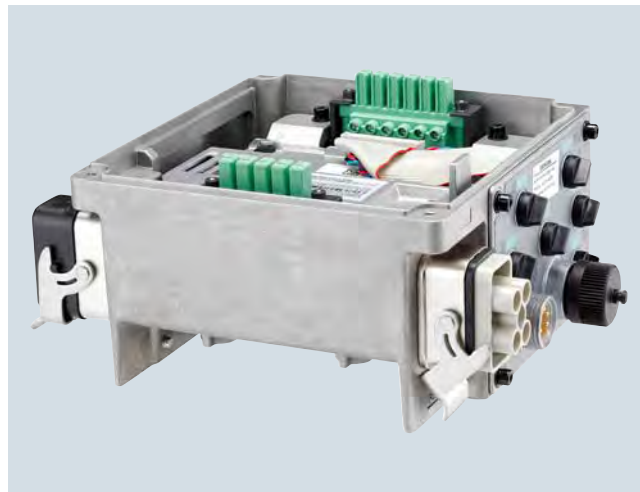

SINAMICS G110M CU240M PN Control Unit plug-in

Several Control Units are available in different versions:

Control Unit		Communications via	Connection system	For motor shaft heights
CU240M Control Unit, screw-type	CU240M	USS, Modbus RTU	Screw-type version	71, 80/90, 100/112
CU240M AS-i Control Unit, screw-type	CU240M AS-i	AS-Interface	Screw-type version	71, 80/90, 100/112
CU240M AS-i Control Unit, plug-in	CU240M AS-i	AS-Interface	Plug-in version	71, 80/90, 100/112
CU240M DP Control Unit, screw-type	CU240M DP	PROFIBUS	Screw-type version	71, 80/90, 100/112
CU240M DP Control Unit, plug-in	CU240M DP	PROFIBUS	Plug-in version	71, 80/90, 100/112
CU240M PN Control Unit, screw-type	CU240M PN	PROFINET, EtherNet/IP	Screw-type version	71, 80/90, 100/112
CU240M PN Control Unit, plug-in	CU240M PN	PROFINET, EtherNet/IP	Plug-in version	71, 80/90, 100/112

#### Safety Integrated functions

The safety function "Safe Torque Off" (STO<sup>1)</sup>) (certified according to IEC 61508 SIL 2 and EN ISO 13849-1 PL d and Category 3) is already integrated into the basic versions of the CU240M series (CU240M, CU240M DP and CU240M PN). It prevents active movement of the drive. It can be activated either over PROFIsafe or over the safety input.

Existing systems in particular can be simply updated with safety technology without the need to change the motor or mechanical system.

<sup>1)</sup> Available for firmware version V4.7 or higher

# SINAMICS G110M distributed inverters

0.37 kW to 4 kW (0.5 hp to 5 hp)

## CU240M Control Units

### Selection and ordering data

Communication	Digital inputs (number which can be parameterized as fail-safe given below)	Analog inputs (of which can be used optionally as digital input (10 V))	Digital outputs	Safety Integrated functions <sup>1)</sup>	Designation of Control Unit	Motor	Control Unit
						Shaft height	Article No.
<b>CU240M – screw-type version</b>							
USS, Modbus RTU	4 (1)	2 (2)	2	STO	CU240M	71	<b>6SL3544-0LB02-1BA0</b>
	4 (1)	2 (2)	2			80/90	<b>6SL3544-0MB02-1BA0</b>
	4 (1)	2 (2)	2			100/112	<b>6SL3544-0NB02-1BA0</b>
<b>CU240M AS-i – screw-type version</b>							
AS-Interface	4 (1)	2 (2)	2	STO	CU240M AS-i	71	<b>6SL3544-0LB02-1MA0</b>
	4 (1)	2 (2)	2			80/90	<b>6SL3544-0MB02-1MA0</b>
	4 (1)	2 (2)	2			100/112	<b>6SL3544-0NB02-1MA0</b>
<b>CU240M AS-i – plug-in version</b>							
AS-Interface	4 (1)	2 (2)	2	STO	CU240M AS-i	71	<b>6SL3544-0TB02-1MA0</b>
	4 (1)	2 (2)	2			80/90	<b>6SL3544-0PB02-1MA0</b>
	4 (1)	2 (2)	2			100/112	<b>6SL3544-0QB02-1MA0</b>
<b>CU240M DP – screw-type version</b>							
PROFIBUS DP	4 (1)	2 (2)	2	STO	CU240M DP	71	<b>6SL3544-0LB02-1PA0</b>
	4 (1)	2 (2)	2			80/90	<b>6SL3544-0MB02-1PA0</b>
	4 (1)	2 (2)	2			100/112	<b>6SL3544-0NB02-1PA0</b>
<b>CU240M DP – plug-in version</b>							
PROFIBUS DP	4 (1)	2 (2)	2	STO	CU240M DP	71	<b>6SL3544-0TB02-1PA0</b>
	4 (1)	2 (2)	2			80/90	<b>6SL3544-0PB02-1PA0</b>
	4 (1)	2 (2)	2			100/112	<b>6SL3544-0QB02-1PA0</b>
<b>CU240M PN – screw-type version</b>							
PROFINET, EtherNet/IP	4 (1)	2 (2)	2	STO	CU240M PN	71	<b>6SL3544-0LB02-1FA0</b>
	4 (1)	2 (2)	2			80/90	<b>6SL3544-0MB02-1FA0</b>
	4 (1)	2 (2)	2			100/112	<b>6SL3544-0NB02-1FA0</b>
<b>CU240M PN – plug-in version</b>							
PROFINET, EtherNet/IP	4 (1)	2 (2)	2	STO	CU240M PN	71	<b>6SL3544-0TB02-1FA0</b>
	4 (1)	2 (2)	2			80/90	<b>6SL3544-0PB02-1FA0</b>
	4 (1)	2 (2)	2			100/112	<b>6SL3544-0QB02-1FA0</b>

For optional memory cards, see section Supplementary system components.

<sup>1)</sup> Available for firmware version V4.7 or higher

# SINAMICS G110M distributed inverters

0.37 kW to 4 kW (0.5 hp to 5 hp)

## CU240M Control Units

### Design

**Control Unit and Power Module  
(view from right)**

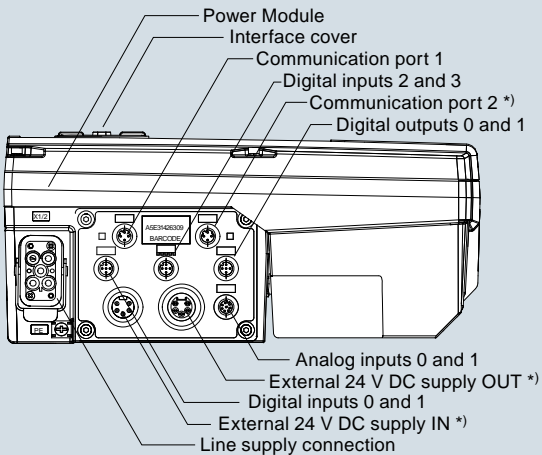

**Control Unit and Power Module  
(view from left)**

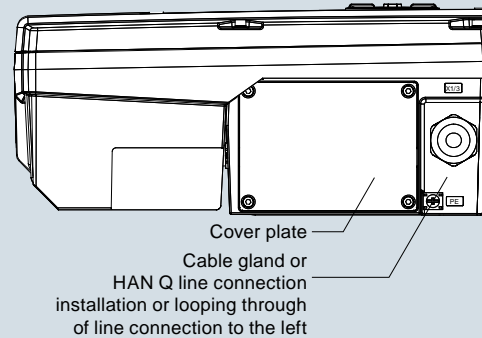

**Power Module (top view)**

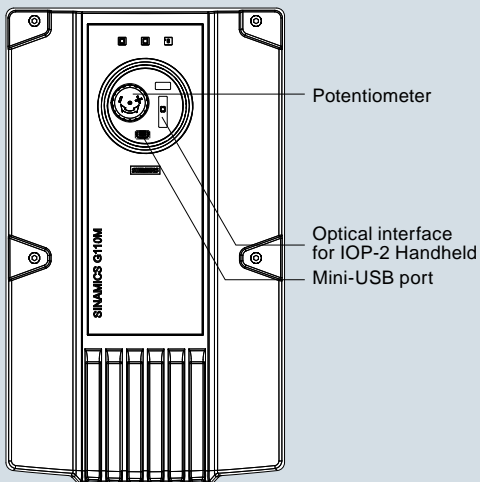

**Power Module (internal view)**

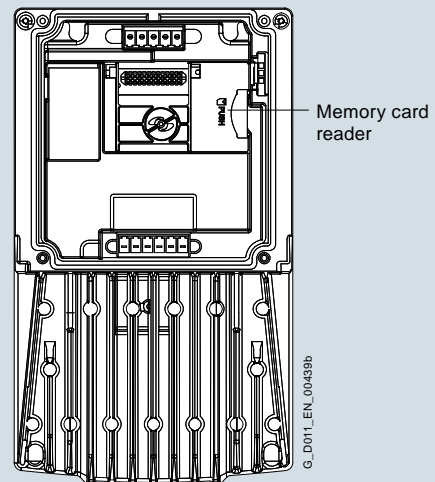

**Control Unit  
(top/internal view)**

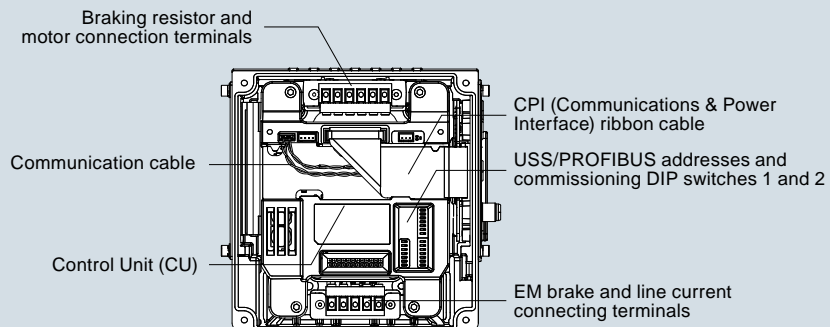

\*) Not available for AS-Interface.



**Integration**

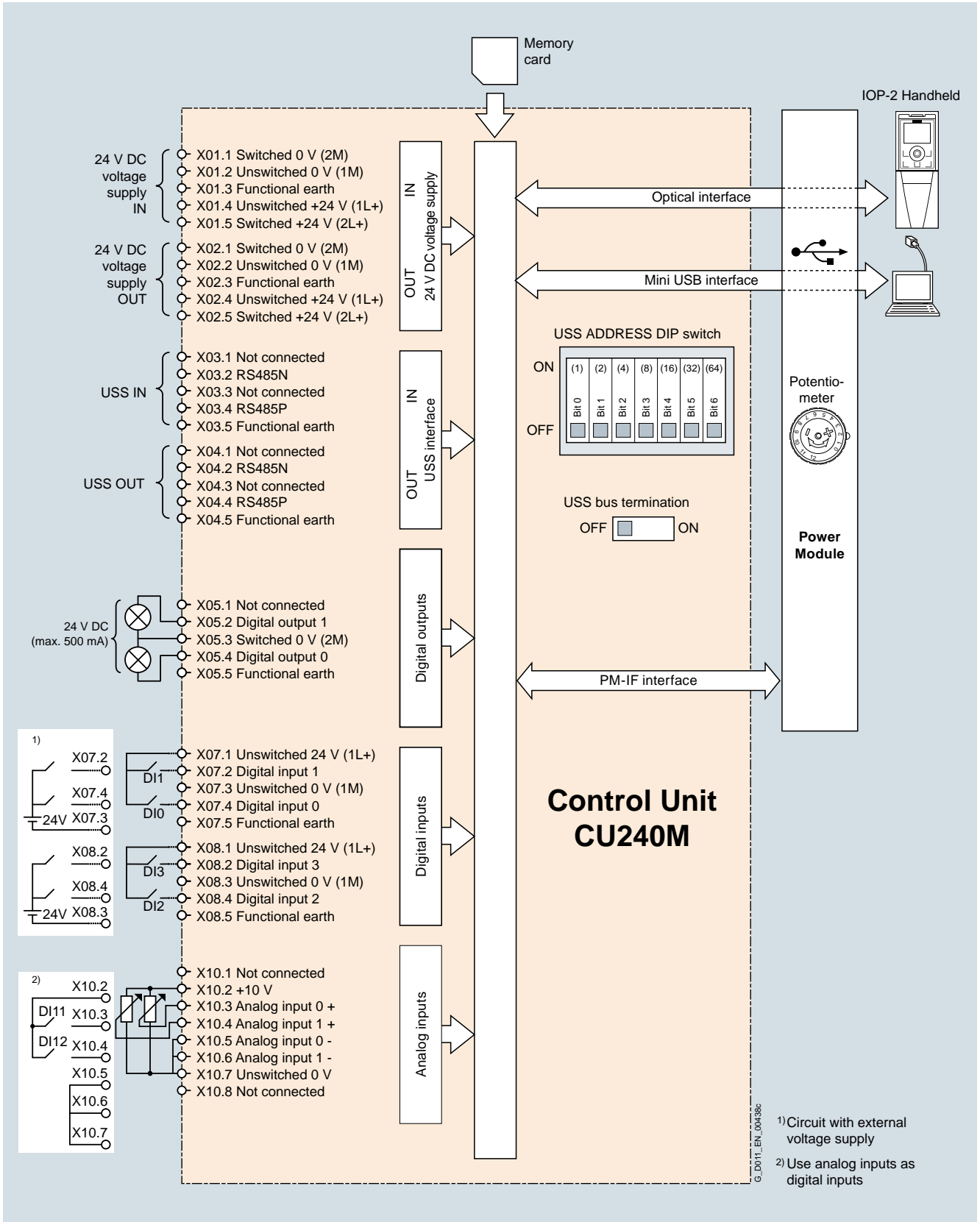

Connection example for CU240M Control Units

# SINAMICS G110M distributed inverters

0.37 kW to 4 kW (0.5 hp to 5 hp)

## CU240M Control Units

### Integration (continued)

7

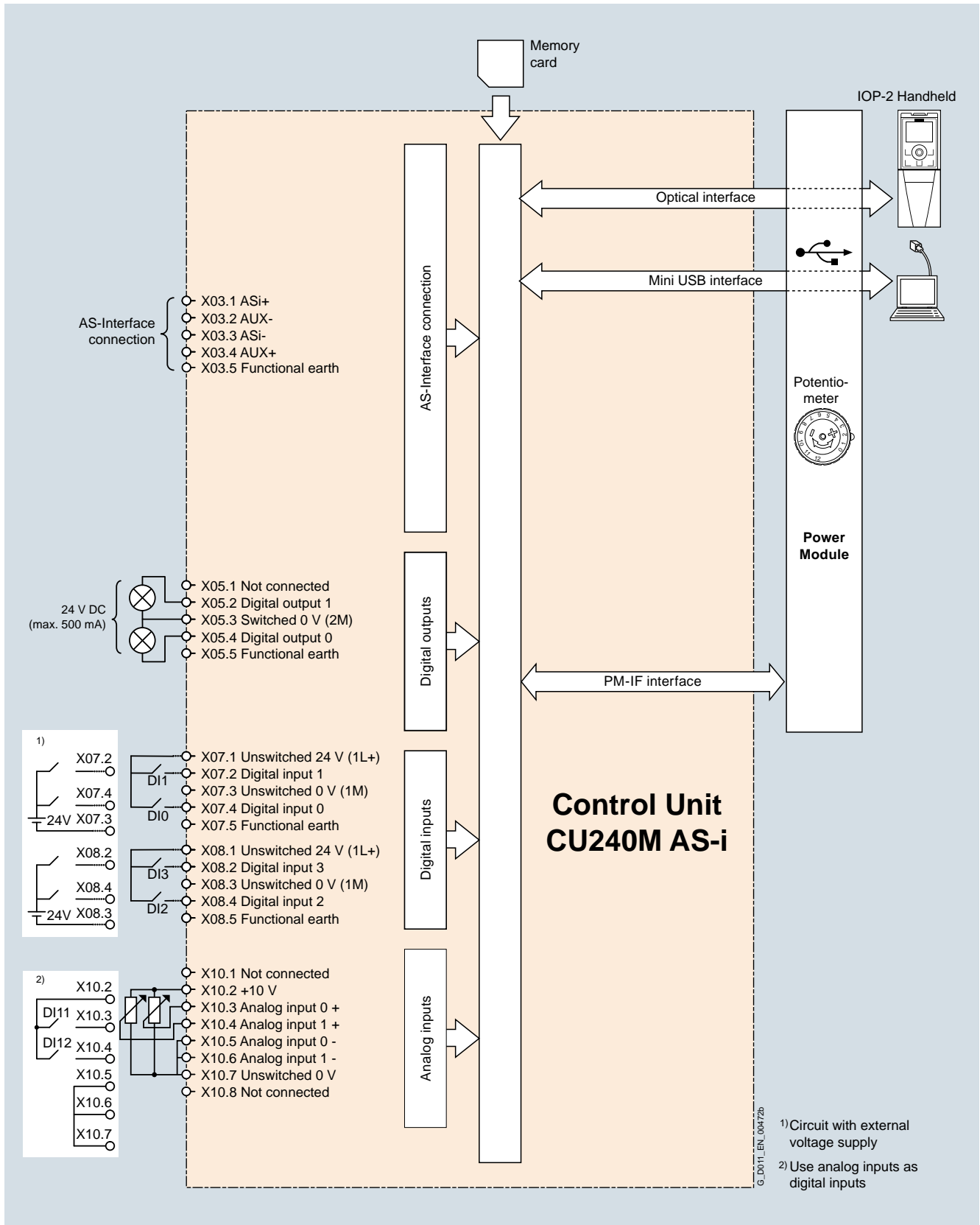

Connection example for CU240M AS-i Control Units

**Integration** (continued)

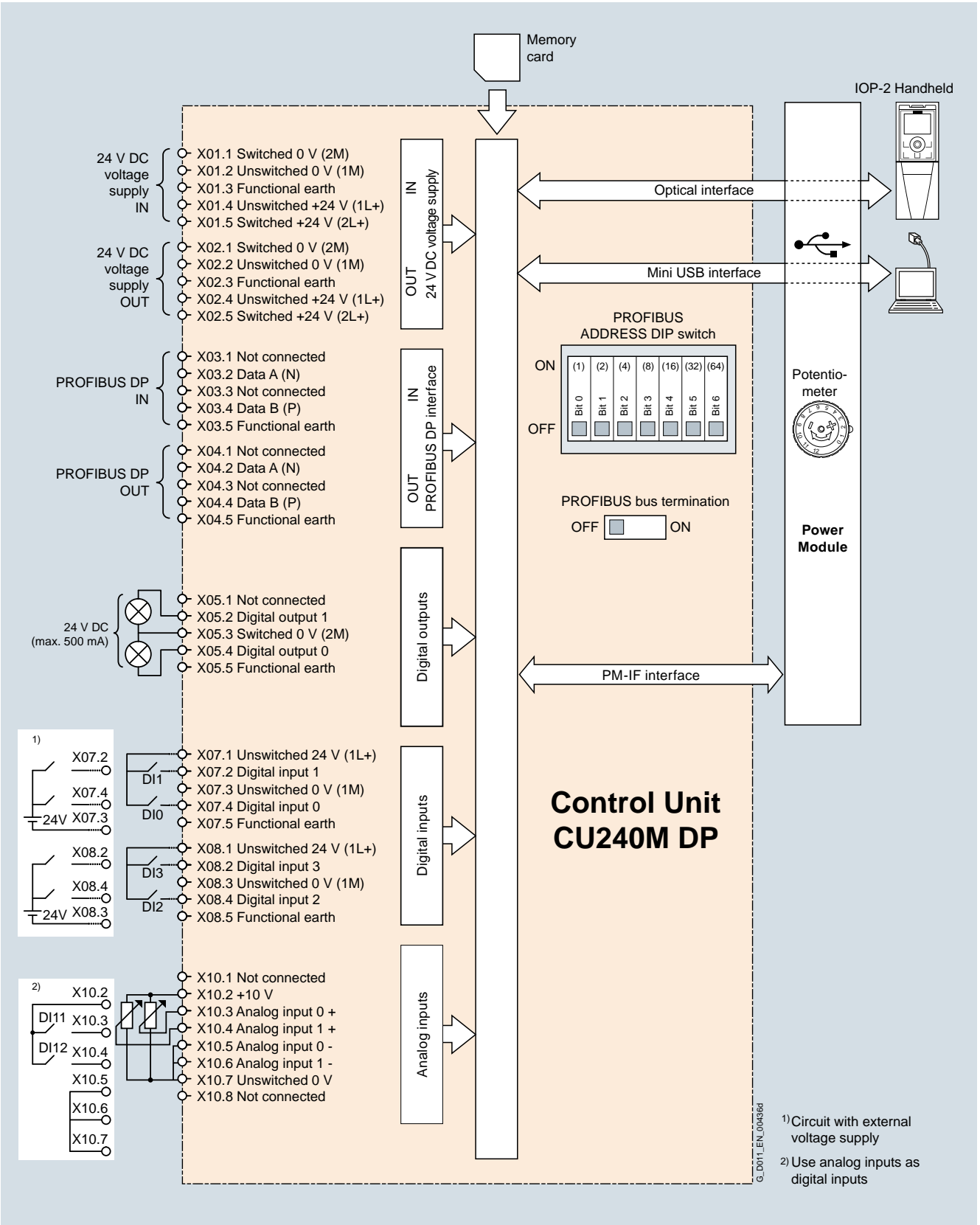

Connection example for CU240M DP Control Units

# SINAMICS G110M distributed inverters

0.37 kW to 4 kW (0.5 hp to 5 hp)

## CU240M Control Units

### Integration (continued)

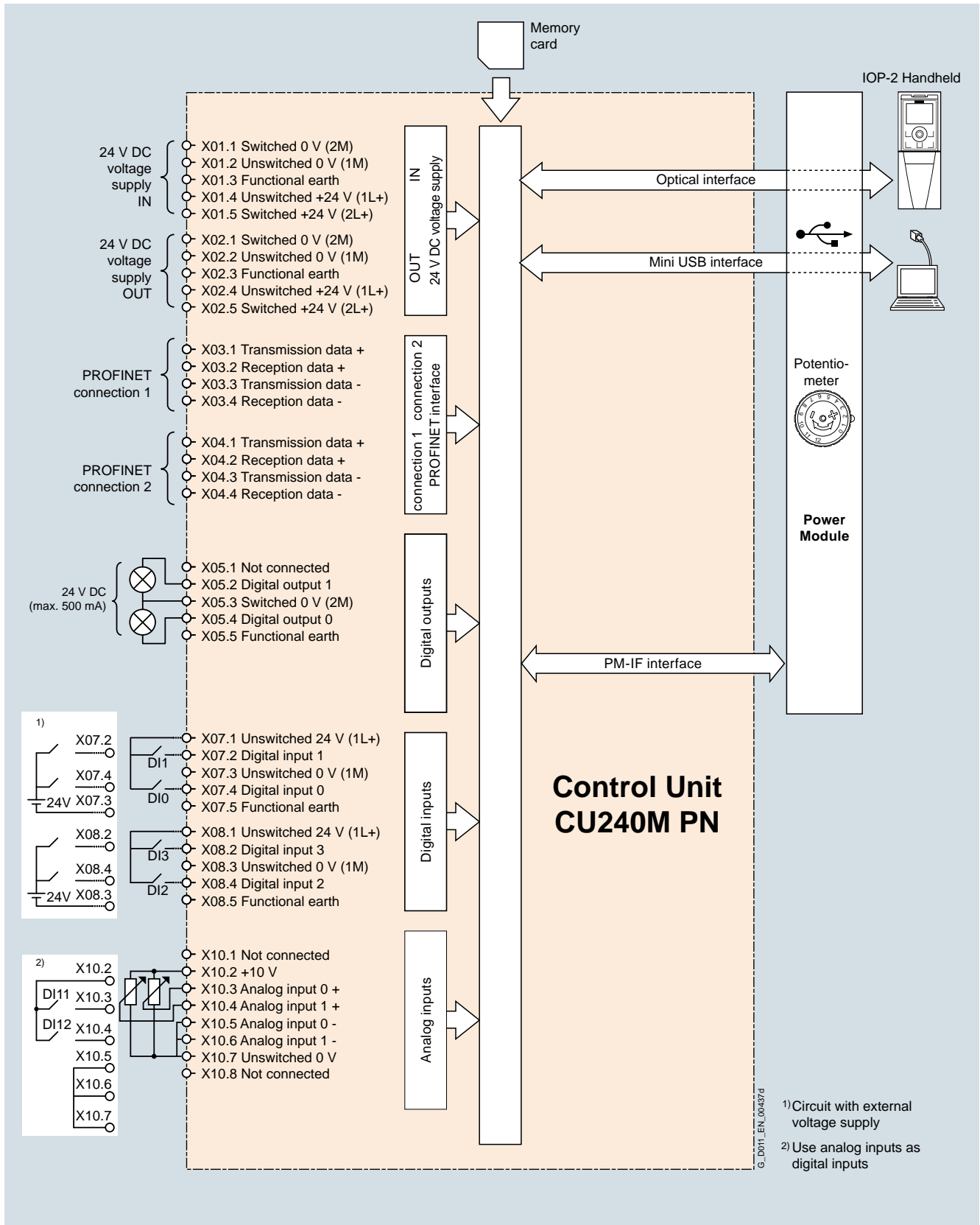

Connection example for CU240M PN Control Units

7

# SINAMICS G110M distributed inverters

0.37 kW to 4 kW (0.5 hp to 5 hp)

## CU240M Control Units

### Technical specifications

Control Unit	CU240M	CU240M AS-i	CU240M AS-i	CU240M PROFIBUS	CU240M PROFIBUS	CU240M PROFINET	CU240M PROFINET
	Screw-type version	Screw-type version	Plug-in version	Screw-type version	Plug-in version	Screw-type version	Plug-in version
6SL3544...	-0LB02-1BA0 -0MB02-1BA0 -0NB02-1BA0	-0LB02-1MA0 -0MB02-1MA0 -0NB02-1MA0	-0TB02-1MA0 -0PB02-1MA0 -0QB02-1MA0	-0LB02-1PA0 -0MB02-1PA0 -0NB02-1PA0	-0TB02-1PA0 -0PB02-1PA0 -0QB02-1PA0	-0LB02-1FA0 -0MB02-1FA0 -0NB02-1FA0	-0TB02-1FA0 -0PB02-1FA0 -0QB02-1FA0
<b>Electrical specifications</b>							
<b>Operating voltage</b>	External 24 V DC $\pm$ 15 % power supply with protective extra low voltage PELV acc. to EN 61800-5-1 must be used.						
<b>Current consumption <sup>1)</sup></b> (from the 24 V DC supply)							
• With Power Module frame size FSA	235 mA	290 mA	290 mA	235 mA	235 mA	290 mA	290 mA
• With Power Module frame size FSB	235 mA	290 mA	290 mA	235 mA	235 mA	290 mA	290 mA
<b>Interfaces</b>							
<b>Digital inputs</b> (non-isolated)	4 programmable, PNP, SIMATIC compatible						
• Optionally parameterizable as safe inputs	1						
<b>Analog inputs</b> (0 ... 10 V or 0 ... 20 mA with 12-bit resolution)	2						
<b>Digital outputs</b> 24 V DC (0 ... 0.5 A)	2, programmable						
<b>Bus interface</b>	USS	AS-Interface	AS-Interface	PROFIBUS DP	PROFIBUS DP	PROFINET	PROFINET
• Fieldbus protocols	USS Modbus RTU	AS-Interface	AS-Interface	PROFIBUS DP incl. PROFI-safe	PROFIBUS DP incl. PROFI-safe	PROFINET incl. PROFI-safe EtherNet/IP	PROFINET incl. PROFI-safe EtherNet/IP
• Profiles	–	3.0	3.0	PROFI-drive	PROFI-drive	PROFI-drive PROFI-energy	PROFI-drive PROFI-energy
<b>PTC/KTY interface</b> (connection via Power Module)	✓						
• Motor temperature sensor	1 input, sensors that can be connected: PTC, KTY, bimetal or Pt1000						
<b>Control of a mechanical motor brake</b> (connection via the Control Unit)	✓						
<b>Slot for SINAMICS SD memory card</b>	✓						
<b>Commissioning interface (mini USB)</b>	✓						
<b>Safety functions</b>							
<b>Integrated safety functions <sup>2)</sup></b> acc. to IEC 61508 SIL 2 and EN ISO 13849-1 PL d and Category 3	Safe Torque Off (STO)						
<b>Open-loop/closed-loop control techniques</b>							
<b>V/f linear/quadratic/parameterizable</b>	✓						
<b>V/f with flux current control (FCC)</b>	✓						
<b>Vector control, sensorless</b>	✓						
<b>Torque control, sensorless</b>	✓						

<sup>1)</sup> The current consumption of connected sensors (total, max. 200 mA) as well as the current drawn from the digital outputs (total, max. 500 mA).

<sup>2)</sup> Available for firmware version V4.7 or higher

## SINAMICS G110M distributed inverters

0.37 kW to 4 kW (0.5 hp to 5 hp)

### CU240M Control Units

#### Technical specifications (continued)

Control Unit	CU240M	CU240M AS-i	CU240M AS-i	CU240M PROFIBUS	CU240M PROFIBUS	CU240M PROFINET	CU240M PROFINET
	Screw-type version	Screw-type version	Plug-in version	Screw-type version	Plug-in version	Screw-type version	Plug-in version
6SL3544...	-0LB02-1BA0 -0MB02-1BA0 -0NB02-1BA0	-0LB02-1MA0 -0MB02-1MA0 -0NB02-1MA0	-0TB02-1MA0 -0PB02-1MA0 -0QB02-1MA0	-0LB02-1PA0 -0MB02-1PA0 -0NB02-1PA0	-0TB02-1PA0 -0PB02-1PA0 -0QB02-1PA0	-0LB02-1FA0 -0MB02-1FA0 -0NB02-1FA0	-0TB02-1FA0 -0PB02-1FA0 -0QB02-1FA0
<b>Software functions</b>							
<b>Fixed frequencies</b>	✓						
<b>Signal interconnection with BICO technology</b>	✓						
<b>Automatic restart after line supply failure or operational fault</b>	✓						
<b>Slip compensation</b>	✓						
<b>Free function blocks (FFB) for logical and arithmetic operations</b>	✓						
<b>Ramp smoothing</b>	✓						
<b>Selectable drive data sets</b>	✓ (4)						
<b>Selectable command data sets (CDS) (manual/auto)</b>	✓ (4)						
<b>Flying restart</b>	✓						
<b>JOG</b>	✓						
<b>Cyclic recording of ramp-up and ramp-down</b>	✓						
<b>Technology controller (PID)</b>	✓						
<b>Quick stop</b>	✓						
<b>Limit switch logic</b>	✓						
<b>Thermal motor protection</b>	✓						
<b>Thermal inverter protection</b>	✓						
<b>Setpoint input</b>	✓						
<b>Motor identification</b>	✓						
<b>Motor holding brake</b>	✓						
<b>Mechanical specifications and ambient conditions</b>							
<b>Degree of protection <sup>1)</sup></b>	IP66/UL Type 3 IP66/UL Type 12 (with wall mounting kit)	IP66/UL Type 3 IP66/UL Type 12 (with wall mounting kit)	IP65/UL Type 3 IP65/UL Type 12 (with wall mounting kit)	IP66/UL Type 3 IP66/UL Type 12 (with wall mounting kit)	IP65/UL Type 3 IP65/UL Type 12 (with wall mounting kit)	IP66/UL Type 3 IP66/UL Type 12 (with wall mounting kit)	IP65/UL Type 3 IP65/UL Type 12 (with wall mounting kit)
<b>Operating temperature</b>	-10 ... +40 °C (14 ... 104 °F) without derating >40 ... 55 °C (104 ... 131 °F) <a href="#">see derating characteristics</a>						
<b>Air temperature</b>	-40 ... +70 °C (-40 ... 158 °F)						
<b>Relative humidity</b>	<95 % RH, condensation not permissible						
<b>Dimensions</b>	<ul style="list-style-type: none"> <li>• Width 205 mm (8.07 in)</li> <li>• Height 105 mm (4.13 in)</li> <li>• Depth 171 mm (6.73 in)</li> </ul>						
<b>Weight, approx.</b>	1.75 kg (3.86 lb)	1.85 kg (4.08 lb)	1.85 kg (4.08 lb)	1.85 kg (4.08 lb)	1.85 kg (4.08 lb)	1.85 kg (4.08 lb)	1.85 kg (4.08 lb)

<sup>1)</sup> Applies to Power Modules and Control Units in mounted state.

## SINAMICS G110M distributed inverters

0.37 kW to 4 kW (0.5 hp to 5 hp)

### PM240M Power Modules

#### Overview

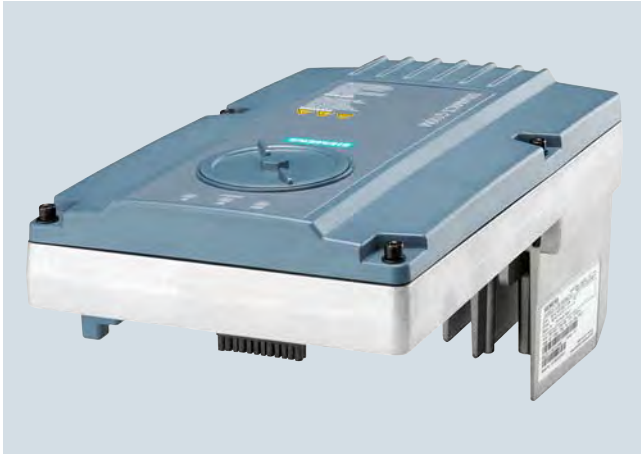

SINAMICS G110M PM240M Power Module FSA 1.5 kW

The PM240M Power Modules are suitable for safety-related applications. In conjunction with the CU240M Control Unit, the drive can be transformed into a Safety Integrated drive (see Control Units).



SINAMICS G110M PM240M Power Module FSB 4 kW

The PM240M Power Modules with integrated line filter class A are suitable for connection to TN and TT supply systems.

#### Selection and ordering data

Rated power <sup>1)</sup>		Rated output current <sup>2)</sup>	Rated input current <sup>2)</sup>	Frame size	PM240M Power Modules Article No.
kW	hp				
0.37	0.5	1.3	1.3	FSA	<b>6SL3517-1BE11-3AM0</b>
0.75	1	2.2	2	FSA	<b>6SL3517-1BE12-3AM0</b>
1.1	1.5	3.1	2.8	FSA	<b>6SL3517-1BE13-3AM0</b>
1.5	2	4.1	3.6	FSA	<b>6SL3517-1BE14-3AM0</b>
2.2	3	5.6	5.3	FSB	<b>6SL3517-1BE16-3AM0</b>
3	4	7.3	6.9	FSB	<b>6SL3517-1BE17-7AM0</b>
4	5	8.8	8	FSB	<b>6SL3517-1BE21-0AM0</b>

<sup>1)</sup> Rated power based on the rated output current  $I_{rated}$ . The rated output current  $I_{rated}$  is based on the duty cycle for high overload (HO).

<sup>2)</sup> The rated output current  $I_{rated}$  is based on the duty cycle for high overload (HO). These current values are valid for 400 V and are specified on the rating plate of the Power Module.

## SINAMICS G110M distributed inverters

0.37 kW to 4 kW (0.5 hp to 5 hp)

### PM240M Power Modules

#### Integration

PM240M Power Modules feature the following interfaces as standard:

- PM-IF interface for connection of the PM240M Power Module and Control Unit
- Motor connection including control of the motor brake and temperature sensor
- Line supply connection via cable gland or HAN Q4/2 (connector)
- Line supply loop-through via cable gland/terminal or HAN Q4/2 (socket)
- USB connection for connection of a PC
- Analog potentiometer for setting a speed
- SD card slot for the use of memory cards

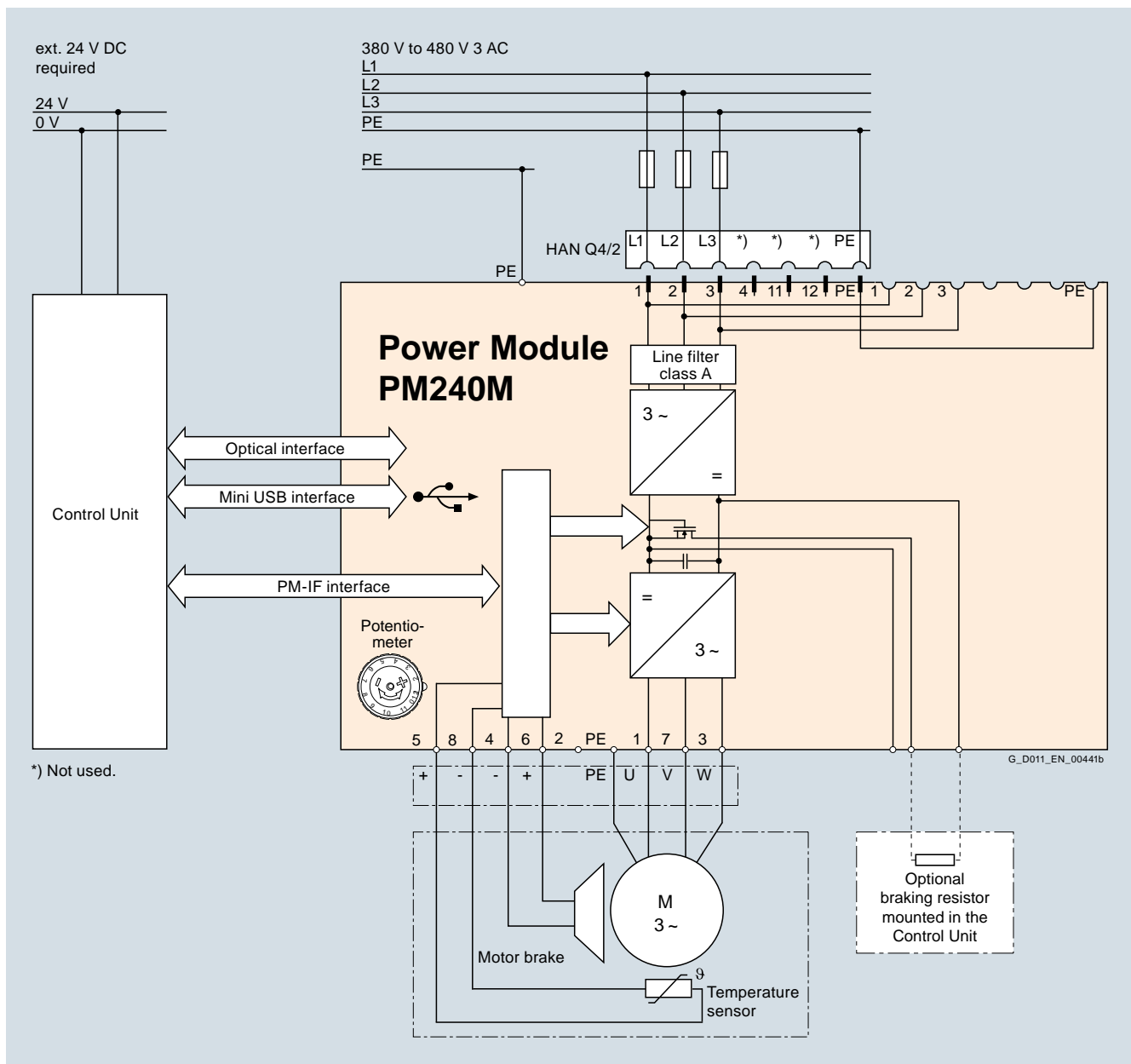

Connection example for PM240M Power Module with integrated line filter class A



**Technical specifications**
**General technical specifications**

PM240M Power Modules											
<b>System operating voltage</b>	380 V (-10 %) ... 480 V (+10 %) 3 AC										
<b>Line supply requirements</b>	>100										
<b>Short-circuit power ratio <math>R_{SC}</math></b>											
<b>Input frequency</b>	47 ... 63 Hz										
<b>Output frequency</b>											
• Control mode V/f	0 ... 550 Hz										
• Control type Vector	0 ... 200 Hz										
<b>Pulse frequency</b>	4 kHz (standard); 4 ... 16 Hz (in steps of 2 kHz) <a href="#">see derating data</a>										
<b>Power factor</b>	0.95										
<b>Inverter efficiency</b>	95 ... 97 %										
<b>Output voltage, max.</b> in % of the input voltage	87 %										
<b>Overload capability</b>											
• High overload (HO)	0.37 ... 3 kW (0.5 ... 4 hp): 2 × rated output current for 3 s, followed by 1.5 × rated output current for 57 s, over a cycle time of 300 s (110 % on average) 4 kW (5 hp): 1.6 × rated output current for 3 s, followed by 1.5 × rated output current for 57 s, over a cycle time of 300 s (110 % on average)										
<b>Electromagnetic compatibility</b>	Integrated line filter class A according to EN 55011										
<b>Possible braking methods</b>	Dynamic brake with internal braking resistors (accessories) Dynamic brake with external braking resistors $R_{min} = 200 \Omega$ (for FSA), $R_{min} = 60 \Omega$ (for FSB) DC brake Integrated brake control supplies DC power supply for the brake										
	<table border="1"> <thead> <tr> <th>Line input voltage</th> <th>380 V AC</th> <th>400 V AC</th> <th>440 V AC</th> <th>480 V AC</th> </tr> </thead> <tbody> <tr> <td>Resulting brake voltage</td> <td>171 V DC</td> <td>180 V DC</td> <td>198 V DC</td> <td>216 V DC</td> </tr> </tbody> </table>	Line input voltage	380 V AC	400 V AC	440 V AC	480 V AC	Resulting brake voltage	171 V DC	180 V DC	198 V DC	216 V DC
Line input voltage	380 V AC	400 V AC	440 V AC	480 V AC							
Resulting brake voltage	171 V DC	180 V DC	198 V DC	216 V DC							
	Disconnection on the DC side permits "fast" braking (max. output current 1 A)										
<b>Degree of protection <sup>1)</sup></b>	IP66 (for Control Unit, screw-type version) IP65 (for Control Units, plug-in version)										
<b>Operating temperature</b>	-10 ... +40 °C (14 ... 104 °F) without derating >40 ... 55 °C (104 ... 131 °F) <a href="#">see derating characteristics</a>										
<b>Storage temperature</b>	-40 ... +70 °C (-40 ... +158 °F)										
<b>Permissible mounting positions</b>	All										
<b>Relative humidity</b>	<95 % RH, condensation not permissible										
<b>Cooling</b>	External cooling with motor fan										
<b>Installation altitude</b>	Up to 1000 m (3281 ft) above sea level without derating Over 1000 m (3281 ft) <a href="#">see derating data</a>										
<b>Short Circuit Current Rating (SCCR) <sup>2)</sup></b>	40 kA										
<b>Protection functions</b>	<ul style="list-style-type: none"> <li>• Undervoltage</li> <li>• Phase failure detection</li> <li>• Overvoltage</li> <li>• Overload</li> <li>• Ground fault</li> <li>• Short-circuit</li> <li>• Stall protection</li> <li>• Motor blocking protection</li> <li>• Motor overtemperature</li> <li>• Inverter overtemperature</li> <li>• Parameter locking</li> </ul>										
<b>Compliance with standards</b>	UR, cUR, CE, RCM										
<b>CE marking, according to</b>	Low Voltage Directive 2014/35/EU Filtered variants also: EMC Directive 2014/30/EU										

<sup>1)</sup> Applies to Power Modules and Control Units in the mounted state.

<sup>2)</sup> Applies to industrial control panel installations to NEC article 409 or UL 508A.

## SINAMICS G110M distributed inverters

0.37 kW to 4 kW (0.5 hp to 5 hp)

### PM240M Power Modules

#### Technical specifications (continued)

Line voltage 380 ... 480 V 3 AC	PM240M Power Modules				
		6SL3517-1BE11-3AM0	6SL3517-1BE12-3AM0	6SL3517-1BE13-3AM0	6SL3517-1BE14-3AM0
Rated output current $I_{rated}^{1)}$	A	1.3	2.2	3.1	4.1
Maximum output current $I_{max}$	A	2.6	4.4	6.2	8.2
Rated power	kW (hp)	0.37 (0.5)	0.75 (1)	1.1 (1.5)	1.5 (2)
Rated pulse frequency	kHz	4	4	4	4
Efficiency $\eta$	%	96.8	98.1	98.2	97.3
Power loss <sup>2)</sup> At rated output current	kW	0.025	0.032	0.041	0.052
Cooling air requirement	m <sup>3</sup> /s (ft <sup>3</sup> /s)	0.0048 (0.17)	0.0048 (0.17)	0.0048 (0.17)	0.0048 (0.17)
Sound pressure level $L_{pA}$ (1 m)	dB	–	–	–	–
Rated input current <sup>3)</sup>	A	1.3	2	2.8	3.6
<b>Line supply connection</b> U1/L1, V1/L2, W1/L3, PE					
• Conductor cross-section (recommended)	mm <sup>2</sup>	1 ... 2.5 18 ... 14 AWG	1 ... 2.5 18 ... 14 AWG	1 ... 2.5 18 ... 14 AWG	1 ... 2.5 18 ... 14 AWG
<b>PE connection</b> (external connection)					
• Conductor cross-section (recommended)	mm <sup>2</sup>	10	10	10	10
<b>Motor connection</b> U2, V2, W2, PE, motor brake, temperature sensor					
• Conductor cross-section	mm <sup>2</sup>	1 ... 2.5 18 ... 14 AWG	1 ... 2.5 18 ... 14 AWG	1 ... 2.5 18 ... 14 AWG	1 ... 2.5 18 ... 14 AWG
Motor cable length (with wall mounting kit), max. Shielded	m (ft)	5 (16.41)	5 (16.41)	5 (16.41)	5 (16.41)
Degree of protection		IP66	IP66	IP66	IP66
<b>Dimensions</b>					
• Width	mm (in)	161 (6.34)	161 (6.34)	161 (6.34)	161 (6.34)
• Height	mm (in)	135 (5.31)	135 (5.31)	135 (5.31)	135 (5.31)
• Depth	mm (in)	270 (10.63)	270 (10.63)	270 (10.63)	270 (10.63)
Frame size		FSA	FSA	FSA	FSA
Weight, approx.	kg (lb)	2.1 (4.63)	2.1 (4.63)	2.1 (4.63)	2.1 (4.63)

<sup>1)</sup> The rated output current  $I_{rated}$  is based on the duty cycle for high overload (HO).

<sup>2)</sup> Typical values. You can find additional information on the Internet at <https://support.industry.siemens.com/cs/document/94059311>.

<sup>3)</sup> The input current depends on the motor load and line impedance. The input currents apply for loading at rated power with a line impedance corresponding to  $u_k = 1\%$ .

## SINAMICS G110M distributed inverters

0.37 kW to 4 kW (0.5 hp to 5 hp)

### PM240M Power Modules

#### Technical specifications (continued)

Line voltage 380 ... 480 V 3 AC	PM240M Power Modules			
		6SL3517-1BE16-3AM0	6SL3517-1BE17-7AM0	6SL3517-1BE21-0AM0
Rated output current $I_{rated}^{1)}$	A	5.6	7.3	8.8
Maximum output current $I_{max}$	A	11.2	14.6	14.1
Rated power	kW (hp)	2.2 (3)	3 (4)	4 (5)
Rated pulse frequency	kHz	4	4	4
Efficiency $\eta$	%	97.6	97.6	97.7
Power loss <sup>2)</sup> At rated output current	kW	0.078	0.103	0.126
Cooling air requirement	m <sup>3</sup> /s (ft <sup>3</sup> /s)	0.024 (0.85)	0.024 (0.85)	0.024 (0.85)
Sound pressure level $L_{pA}$ (1 m)	dB	–	–	–
Rated input current <sup>3)</sup>	A	5.3	6.9	8
<b>Line supply connection</b> <b>U1/L1, V1/L2, W1/L3, PE</b>				
• Conductor cross-section (recommended)	mm <sup>2</sup>	1 ... 2.5 18 ... 14 AWG	1 ... 2.5 18 ... 14 AWG	1 ... 2.5 18 ... 14 AWG
<b>PE connection</b> (external connection)				
• Conductor cross-section (recommended)	mm <sup>2</sup>	10	10	10
<b>Motor connection</b> <b>U2, V2, W2, PE, motor brake, temperature sensor</b>				
• Conductor cross-section	mm <sup>2</sup>	1 ... 2.5 18 ... 14 AWG	1 ... 2.5 18 ... 14 AWG	1 ... 2.5 18 ... 14 AWG
<b>Motor cable length (with wall mounting kit), max.</b> Shielded	m (ft)	5 (16.41)	5 (16.41)	5 (16.41)
<b>Degree of protection</b>		IP66	IP66	IP66
<b>Dimensions</b>				
• Width	mm (in)	181 (7.13)	181 (7.13)	181 (7.13)
• Height	mm (in)	135 (5.31)	135 (5.31)	135 (5.31)
• Depth	mm (in)	309 (12.17)	309 (12.17)	309 (12.17)
<b>Frame size</b>		FSB	FSB	FSB
<b>Weight, approx.</b>	kg (lb)	3.4 (7.50)	3.4 (7.50)	3.4 (7.50)

<sup>1)</sup> The rated output current  $I_{rated}$  is based on the duty cycle for high overload (HO).

<sup>2)</sup> Typical values. You can find additional information on the Internet at <https://support.industry.siemens.com/cs/document/94059311>.

<sup>3)</sup> The input current depends on the motor load and line impedance. The input currents apply for loading at rated power with a line impedance corresponding to  $u_k = 1\%$ .

# SINAMICS G110M distributed inverters

0.37 kW to 4 kW (0.5 hp to 5 hp)

## PM240M Power Modules

### Characteristic curves

#### Derating data

Rated power at 400 V 3 AC		Rated output current in A for a pulse frequency of (derating as a function of the pulse frequency <sup>1)</sup> )						
kW	hp	4 kHz	6 kHz	8 kHz	10 kHz	12 kHz	14 kHz	16 kHz
0.37	0.5	1.3	1.11	0.91	0.78	0.65	0.59	0.52
0.75	1	2.2	1.9	1.5	1.3	1.1	1	0.9
1.1	1.5	3.1	2.6	2.2	1.9	1.6	1.4	1.2
1.5	2	4.1	3.5	2.9	2.5	2.1	1.8	1.6
2.2	3	5.6	4.8	3.9	3.4	2.8	2.5	2.2
3	4	7.3	6.2	5.1	4.4	3.7	3.3	2.9
4	5	8.8	7.5	6.2	5.3	4.4	4	3.5

#### Ambient temperature

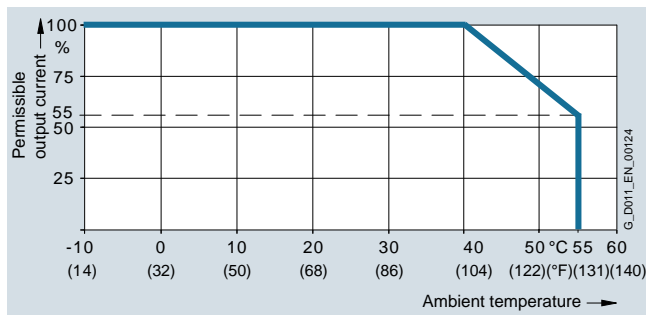

Permissible output current as a function of ambient temperature for PM240M Power Modules, frame sizes FSA and FSB

#### Installation altitude

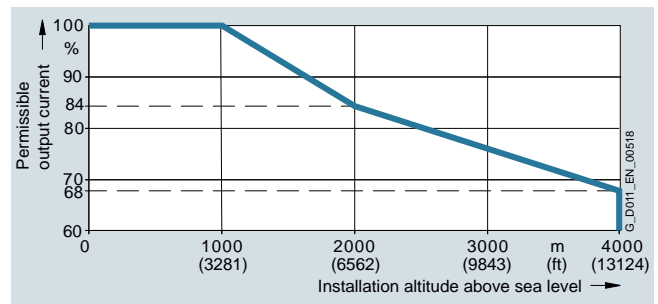

Permissible output current as a function of installation altitude for PM240M Power Modules, frame sizes FSA and FSB

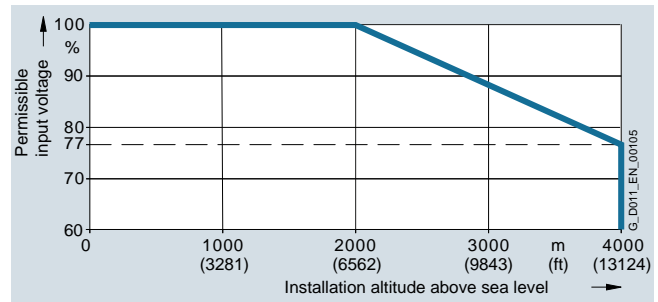

Permissible input voltage as a function of installation altitude for PM240M Power Modules, frame sizes FSA and FSB

#### Motor frequency

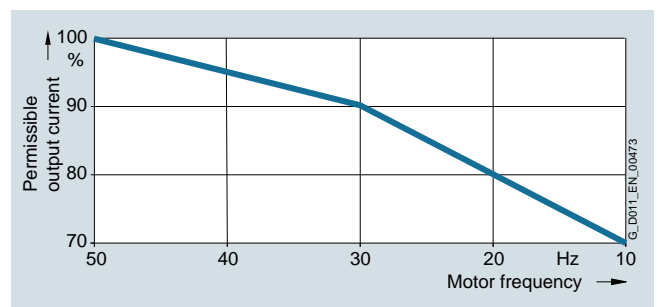

Permissible output current as a function of motor frequency for PM240M Power Modules, frame sizes FSA and FSB

<sup>1)</sup> The permissible motor cable length also depends on the cable type and the selected pulse frequency.

## SINAMICS G110M distributed inverters

0.37 kW to 4 kW (0.5 hp to 5 hp)

PM240M Power Modules

### Dimensional drawings

*Dimensions of PM240M Power Modules (including CU240M Control Unit)*

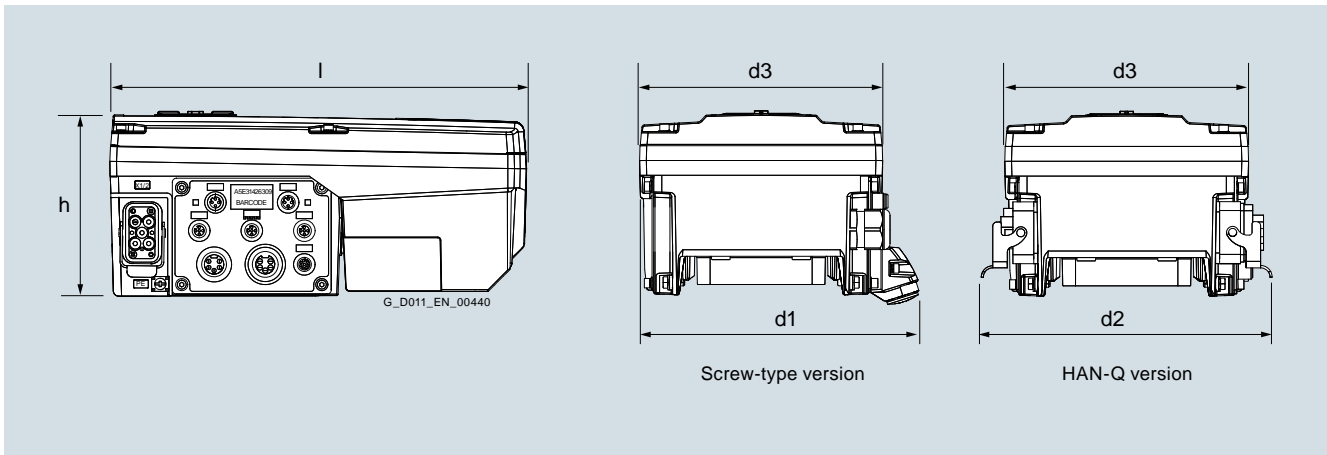

Frame size	Dimensions in mm (inches)				
	h	l	d1	d2	d3
FSA	135 (5.31)	270 (10.63)	208 (8.19)	216 (8.5)	161 (6.34)
FSB	135 (5.31)	309 (12.17)	208 (8.19)	216 (8.5)	181 (7.13)

**SINAMICS G110M distributed inverters**

0.37 kW to 4 kW (0.5 hp to 5 hp)

**Repair switch****Overview**

SINAMICS G110M repair switch

With the optional repair switch SINAMICS G110M can be separated from the line supply in a simple manner. No additional external components are required in the 400 V supply line.

The repair switch can be locked with three locks. SINAMICS G110M can thus be prevented from being unintentionally switched on.



SINAMICS G110M repair switch, installed

The repair switch is delivered as standard with three pre-assembled cables for connecting to the line input terminals of SINAMICS G110M.

Note:

Either a 24 V DC power supply or a repair switch can be installed. The simultaneous use of both options is not possible.

**Selection and ordering data**

Description	Article No.
<b>Repair switch</b>	<b>6SL3555-0PR01-0AA0</b>

## SINAMICS G110M distributed inverters

0.37 kW to 4 kW (0.5 hp to 5 hp)

### Recommended line-side power components

#### Selection and ordering data

The following table lists recommendations for additional line-side components such as fuses.

Note for use in compliance with IEC standards:

3NA3 fuses are recommended for European countries. The values in the table take into account the overload capability of the inverter.

Note for use in compliance with UL regulations:

Fuses for use in North America must be UL-certified, Class J or Class CC fuses with a rated voltage of 600 V AC.

#### Short Circuit Current Rating (SCCR)

according to UL

Applies to industrial control panel installations according to NEC Article 409 or UL 508A.

- PM240M: 40 kA

Additional information about the listed fuses is available in the Catalogs LV 10, IC 10 and IC 10 AO as well as in the Industry Mall.

#### Individual protection

Rated power		SINAMICS G110M PM240M Power Modules		IEC-compliant		UL/cUL-compliant	
kW	hp	Type	Frame size	Fuse Current A	Article No.	Fuse type Rated voltage 600 V AC Class	Current A
<b>380 ... 480 V 3 AC</b>							
0.37	0.5	6SL3517-1BE11-3AM0	FSA	10	<b>3NA3803</b>	J, CC	10
0.75	1	6SL3517-1BE12-3AM0	FSA	10	<b>3NA3803</b>	J, CC	10
1.1	1.5	6SL3517-1BE13-3AM0	FSA	10	<b>3NA3803</b>	J, CC	10
1.5	2	6SL3517-1BE14-3AM0	FSA	10	<b>3NA3803</b>	J, CC	10
2.2	3	6SL3517-1BE16-3AM0	FSB	20	<b>3NA3807</b>	J, CC	20
3	4	6SL3517-1BE17-7AM0	FSB	20	<b>3NA3807</b>	J, CC	20
4	5	6SL3517-1BE21-0AM0	FSB	20	<b>3NA3807</b>	J, CC	20

The SINAMICS G110M system supports an inverter loop-through of line current to several inverters connected in series.

Further information can be found in the operating instructions on the Internet at

[www.siemens.com/sinamics-g110m/documentation](http://www.siemens.com/sinamics-g110m/documentation)

#### Group protection (installation on power bus)

For installations with several inverters, the inverters are normally supplied from a 400 V power bus.

Further information can be found in the operating instructions on the Internet at

[www.siemens.com/sinamics-g110m/documentation](http://www.siemens.com/sinamics-g110m/documentation)

## SINAMICS G110M distributed inverters

0.37 kW to 4 kW (0.5 hp to 5 hp)

DC link components > Braking resistors

### Overview

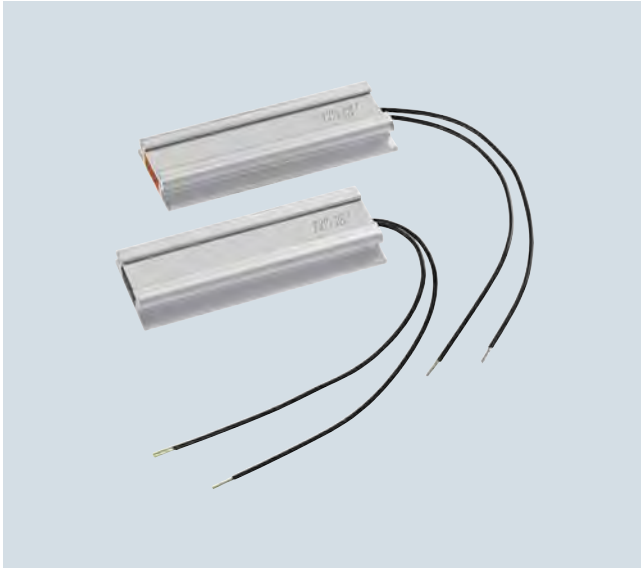

SINAMICS G110M braking resistors FSA and FSB

Excess energy in the DC link is dissipated in the braking resistors in regenerative operation.

The braking resistors are intended for use with SINAMICS G110M, which have an integrated braking chopper, but cannot regenerate energy to the line supply. For regenerative operation, e.g. the braking of a rotating mass with high moment of inertia, a braking resistor must be connected to convert the resulting energy into heat.

The braking resistors can be mounted on the side of the Control Unit housing at the bottom. The heat from the braking resistor is dissipated over the Control Unit housing. Every braking resistor is equipped with thermal protection. The thermal protection prevents the braking resistor from being thermally overloaded.

All braking resistors are provided as standard with a cable for connecting to the internal terminals.

### Characteristic curves

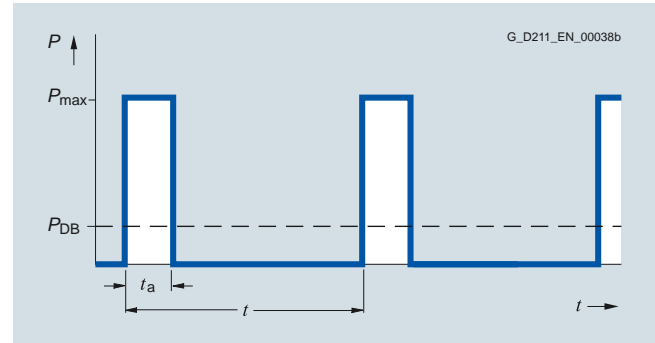

Load diagram for the braking resistors

$t_a = 12$  s  
 $t = 240$  s

### Selection and ordering data

Rated power		SINAMICS G110M		Braking resistor
kW	hp	Type 6SL3517-...	Frame size	Article No.
<b>380 ... 480 V 3 AC</b>				
0.37	0.5	1BE11-3AM0	FSA	<b>6SL3501-0BE18-8AA0</b>
0.75	1	1BE12-3AM0	FSA	
1.1	1.5	1BE13-3AM0	FSA	
1.5	2	1BE14-3AM0	FSA	
2.2	3	1BE16-3AM0	FSB	<b>6SL3501-0BE22-0AA0</b>
3	4	1BE17-7AM0	FSB	
4	5	1BE21-0AM0	FSB	

### Technical specifications

Line voltage 380 ... 480 V 3 AC		Braking resistor	
		6SL3501-0BE18-8AA0	6SL3501-0BE22-0AA0
Resistance	$\Omega$	350	175
Rated power $P_{DB}$ (continuous braking power)	kW	0.0075	0.02
Peak power $P_{max}$ (load duration $t_a = 12$ s with period $t = 240$ s)	kW	0.075	0.2
Degree of protection		IP20	IP20
Dimensions			
• Width	mm (in)	11 (0.43)	11 (0.43)
• Height	mm (in)	34 (1.34)	34 (1.34)
• Length	mm (in)	84 (3.31)	84 (3.31)
Weight, approx.	kg (lb)	0.1 (0.22)	0.1 (0.22)
Suitable for SINAMICS G110M (frame size)		6SL3517-1BE11-3AM0 (FSA) 6SL3517-1BE12-3AM0 (FSA) 6SL3517-1BE13-3AM0 (FSA) 6SL3517-1BE14-3AM0 (FSA)	6SL3517-1BE16-3AM0 (FSB) 6SL3517-1BE17-7AM0 (FSB) 6SL3517-1BE21-0AM0 (FSB)



## SINAMICS G110M distributed inverters

0.37 kW to 4 kW (0.5 hp to 5 hp)

DC link components > 24 V DC power supply

### Overview



24 V DC power supply



24 V DC power supply, installed

The optional 24 V DC power supply enables the internal electronics to be supplied with 24 V DC directly from the DC link. No external cable is needed for the 24 V DC supply and only the 400 V 3 AC line supply has to be connected. The optional 24 V DC power supply supplies power to the internal circuitry of the Control Unit, the low-voltage circuits of the Power Module and all inputs and outputs.

#### Note:

Either a 24 V DC power supply or a repair switch can be installed.  
The simultaneous use of both options is not possible.

### Selection and ordering data

Description	Article No.
<b>24 V DC power supply</b>	<b>6SL3555-0PV00-0AA0</b>

### Technical specifications

24 V DC power supply	
<b>Operating voltage</b>	24 V DC $\pm 10$ %
<b>Current consumption</b> (from DC link at full operation of Power Modules and Control Units including digital outputs)	1.2 A
<b>Output current, max.</b>	2 A

## SINAMICS G110M distributed inverters

0.37 kW to 4 kW (0.5 hp to 5 hp)

Compatible motors for SINAMICS G110M

### Overview

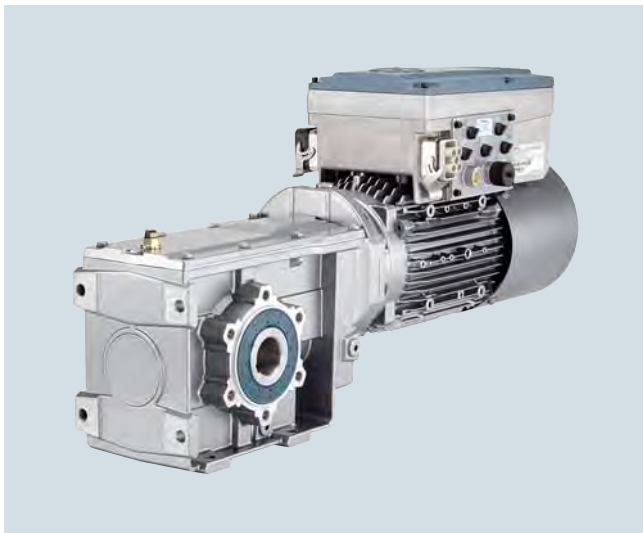

SINAMICS G110M CU240M PN Control Unit, plug-in, PM240M Power Module FSA 1.5 kW (2 hp) and SIMOGEAR geared motor shaft height 90

The SINAMICS G110M distributed inverter is designed for mounting on SIMOGEAR geared motors. It is compatible with the SIMOGEAR geared motors with shaft heights 71 to 112.

An overview of the motor types that can be operated with SINAMICS G110M in combination with SIMOGEAR can be found under the following link:

<https://support.industry.siemens.com/cs/document/109738577>

### More information

You can find details on the possible combinations of SIMOGEAR geared motors with SINAMICS G110M in the Catalog MD 50.1 and in the DT Configurator.

## SINAMICS G110M distributed inverters

0.37 kW to 4 kW (0.5 hp to 5 hp)

### Supplementary system components

#### Accessories

##### Intelligent Operator Panel IOP-2 Handheld



IOP-2 Handheld for mobile use

The Intelligent Operator Panel IOP-2 Handheld is a very user-friendly and powerful operator panel for commissioning and diagnostics as well as local operator control and monitoring of SINAMICS G110D, SINAMICS G120D, SINAMICS G110M and SIMATIC ET 200pro FC-2 distributed inverters.

The IOP-2 Handheld supports both newcomers and drive experts. Thanks to the membrane keyboard with a central sensor control field, the high-contrast color displays, the menu-based operation and the application wizards, it is easy to commission standard drives. A drive can be essentially commissioned without having to use a printed parameter list – as the parameters are displayed in plain text, and explanatory help texts and a parameter filtering function are provided.

Application wizards interactively guide you when commissioning important applications such as conveyor technology, pumps, fans and compressors. There is a basic commissioning wizard for general commissioning.

Up to two process values can be graphically visualized and up to four process values can be numerically visualized on the status screen/display. Process values can also be displayed in technological units.

The IOP-2 Handheld supports standard commissioning of identical drives. For this purpose, a parameter list can be copied from an inverter into the IOP-2 Handheld and downloaded into other drive units of the same type as required.

In addition to the IOP-2, the IOP-2 Handheld includes a housing with rechargeable batteries, a charging unit, an RS232 connecting cable, and a USB cable. The charging unit is supplied with connector adapters for Europe, the US and UK. When the batteries are fully charged, the operating time is up to 10 hours.

To connect the IOP-2 Handheld to SINAMICS G110D, SINAMICS G120D, SINAMICS G110M and SIMATIC ET 200pro FC-2, the RS232 connecting cable with optical interface is required in addition.

#### Updating the IOP-2 Handheld

The IOP-2 Handheld can be updated and expanded using the integrated USB interface.

Data to support future drive systems can be transferred from the PC to the IOP-2 Handheld. Further, the USB interface allows user languages and wizards that will become available in the future to be subsequently downloaded and the firmware to be updated for the IOP-2 Handheld <sup>1)</sup>.

#### Selection and ordering data

Description	Article No.
<b>IOP-2 Handheld</b> For use with SINAMICS G120 SINAMICS G120C SINAMICS G120P SINAMICS G110D SINAMICS G120D SINAMICS G110M SIMATIC ET 200pro FC-2 Included in the scope of delivery: • IOP-2 • Handheld housing • Rechargeable batteries (4 × AA) • Charging unit (international) • RS232 connecting cable 3 m (9.84 ft) long, can be used in combination with SINAMICS G120 SINAMICS G120C SINAMICS G120P • USB cable 1 m (3.28 ft) long	<b>NEW</b> <b>6SL3255-0AA00-4HA1</b>
<b>RS232 connecting cable</b> 2.5 m (8.20 ft) long, with optical interface for connect- ing the IOP-2 Handheld to SINAMICS G110D SINAMICS G120D SINAMICS G110M SIMATIC ET 200pro FC-2	<b>3RK1922-2BP00</b>

#### Technical specifications

	IOP-2 Handheld
	6SL3255-0AA00-4HA1
<b>Display</b>	High-contrast color display, a variety of display options
• Resolution	320 × 240 pixels
<b>Operator panel</b>	Membrane keyboard with central sensor control field
<b>Operating languages</b>	English, German, French, Italian, Spanish, Portuguese, Dutch, Swedish, Finnish, Russian, Czech, Polish, Turkish, Chinese Simplified
<b>Ambient temperature</b>	
• During transport and storage	-20 ... +55 °C (-4 ... +131 °F)
• During operation	0 ... 40 °C (32 ... 104 °F)
<b>Humidity</b>	Relative humidity < 95 %, non-condensing
<b>Degree of protection</b>	IP20
<b>Dimensions (H × W × D)</b>	195.04 × 70 × 37.58 mm (7.68 × 2.76 × 1.48 in)
<b>Weight, approx.</b>	0.724 kg (1.6 lb)
<b>Compliance with standards</b>	CE, RCM, cULus, EAC, KCC-REM-S49-SINAMICS

<sup>1)</sup> Information on updates for the IOP-2 Handheld is available at <https://support.industry.siemens.com/cs/document/67273266>

## SINAMICS G110M distributed inverters

0.37 kW to 4 kW (0.5 hp to 5 hp)

### Supplementary system components

#### Accessories (continued)

##### Memory card



SINAMICS SD memory card

The parameter settings for an inverter can be stored on the SINAMICS SD memory card. When service is required, e.g. after the inverter has been replaced and the data have been downloaded from the memory card, the drive system is immediately ready for use again.

- Parameter settings can be written from the memory card to the inverter or saved from the inverter to the memory card.
- Up to 100 parameter sets can be stored.
- The memory card supports standard commissioning without the use of the Intelligent Operator Panel IOP-2 Handheld or the STARTER and SINAMICS Startdrive commissioning tools.

##### Note:

The memory card is optional, but it facilitates inverter replacement.

##### Selection and ordering data

Description	Article No.
<b>SINAMICS SD card 512 MB</b>	<b>6SL3054-4AG00-2AA0</b>
<i>Optional firmware memory cards</i>	
<b>SINAMICS SD card 512 MB + firmware V4.7 SP3</b> (Multicard V4.7 SP3)	<b>6SL3054-7TB00-2BA0</b>
<b>SINAMICS SD card 512 MB + firmware V4.7 SP6</b> (Multicard V4.7 SP6)	<b>6SL3054-7TD00-2BA0</b>
<b>SINAMICS SD card 512 MB + firmware V4.7 SP9</b> (Multicard V4.7 SP9)	<b>NEW 6SL3054-7TE00-2BA0</b>

For an overview and more information on all available firmware versions, see

<https://support.industry.siemens.com/cs/document/67364620>

##### PC inverter connection kit 2 (mini USB interface cable for communication with a PC)

For controlling and commissioning an inverter directly from a PC via a point-to-point connection if the appropriate software (STARTER commissioning tool<sup>1)</sup>, V4.3 SP3 and higher or SINAMICS Startdrive V13 and higher) has been installed.

##### Selection and ordering data

Description	Article No.
<b>PC inverter connection kit 2</b> USB cable (3 m/9.84 ft long) for	<b>6SL3255-0AA00-2CA0</b>
• SINAMICS G120C	
• SINAMICS G120 Control Units	
- CU230P-2	
- CU240E-2	
- CU250S-2	
• SINAMICS G110M Control Units	
- CU240M	
• SINAMICS G120D Control Units	
- CU240D-2	
- CU250D-2	

<sup>1)</sup> The STARTER commissioning tool is also available on the Internet at [www.siemens.com/starter](http://www.siemens.com/starter)

## SINAMICS G110M distributed inverters

0.37 kW to 4 kW (0.5 hp to 5 hp)

### Supplementary system components

#### Accessories (continued)

##### Wall mounting kit



SINAMICS G110M wall mounting kit

A wall mounting kit is available if SINAMICS G110M should not be mounted on a (geared) motor. With the wall mounting kit the SINAMICS G110M frequency inverter can be mounted close to the motor in the application and can thus be used flexibly, adapted to the conditions of the application.

The wall mounting kit contains a metal cable gland for connecting the motor cable (max. 5 m/16.41 ft shielded) and a fan including connecting cable for cooling the Power Module.

#### Notes:

Only one of the CU240M Control Units for motors with shaft height 71 fits on a wall mounting kit.  
All Power Modules from 0.37 kW to 4 kW can be mounted.  
The degree of protection with a wall mounting kit is IP66/UL Type 12.

#### Compatible CU240M Control Units

Control Unit	Communications via	Connection system	Control Unit for motors with shaft height 71
CU240M	USS, Modbus RTU	Screw-type version	6SL3544-0LB02-1BA0
CU240M AS-i	AS-Interface	Screw-type version	6SL3544-0LB02-1MA0
		Plug-in version	6SL3544-0TB02-1MA0
CU240M DP	PROFIBUS	Screw-type version	6SL3544-0LB02-1PA0
		Plug-in version	6SL3544-0TB02-1PA0
CU240M PN	PROFINET, EtherNet/IP	Screw-type version	6SL3544-0LB02-1FA0
		Plug-in version	6SL3544-0TB02-1FA0

#### Selection and ordering data

Description	Article No.
<b>Wall mounting kit</b>	<b>6SL3566-1GA00-0GA0</b>
<i>Spare part</i>	
<b>Replacement fan for wall mounting kit (includes fan, connecting cable and cable gland)</b>	<b>6SL3500-0TF02-0AA0</b>

#### Dimensional drawings

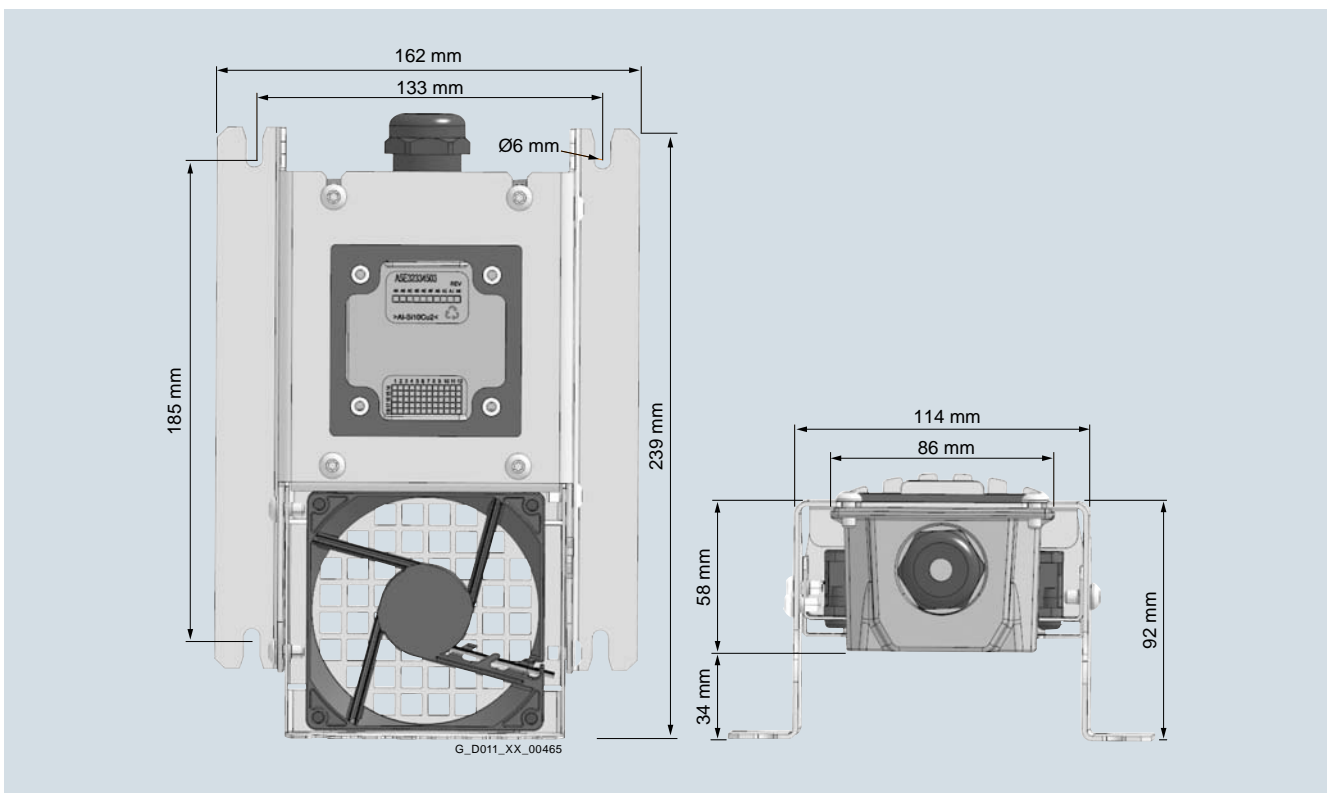

SINAMICS G110M wall mounting kit

## SINAMICS G110M distributed inverters

0.37 kW to 4 kW (0.5 hp to 5 hp)

### Supplementary system components

#### Accessories (continued)

##### Installation kits

Different installation kits can be ordered as accessories for the Control Units with plug-in connections and Control Units with cable gland connections.

These kits include covers or cable glands for protecting or connecting the 400 V 3 AC supply, the 24 V DC supply and the mechanical motor brake.

##### Selection and ordering data

Description	Article No.
<b>Installation kit for Control Units with cable gland connections</b> Includes cable glands for connecting the 400 V 3 AC supply, the 24 V DC supply and the mechanical motor brake	<b>6SL3566-2VA00-0GA0</b>
<b>Installation kit for Control Units with plug-in connections</b> Includes covers for protecting the 400 V 3 AC and 24 V DC input connectors and a cable gland for connecting the mechanical motor holding brake	<b>6SL3566-2LA00-0GA0</b>

##### STARTER commissioning tool

The STARTER commissioning tool (V4.3 SP3 and higher) supports the commissioning and maintenance of SINAMICS G110M inverters. The operator guidance combined with comprehensive, user-friendly functions for the relevant drive solution allow you to commission the device quickly and easily.

##### Selection and ordering data

Description	Article No.
<b>STARTER commissioning tool <sup>1)</sup></b> on DVD-ROM	<b>6SL3072-0AA00-0AG0</b>

##### SINAMICS Startdrive commissioning tool

The SINAMICS Startdrive commissioning tool (V13 and higher) supports the commissioning and maintenance of SINAMICS G110M inverters. SINAMICS Startdrive is part of the TIA Portal engineering platform. It supports the intuitive integration of SINAMICS drives in automation. The same operator control concept, the elimination of interfaces and a high degree of user-friendliness make it possible to quickly integrate SINAMICS into an automation process and start it up with the TIA Portal. The TIA Portal with SINAMICS Startdrive offers you a totally integrated engineering platform for the complete application from the project engineering phase through to commissioning and diagnostics.

##### Selection and ordering data

Description	Article No.
<b>SINAMICS Startdrive commissioning tool <sup>2)</sup></b> on DVD-ROM	<b>6SL3072-4DA02-0XG0</b>

An overview of all available accessories (e.g. connectors and cables) can be found under the following link:  
[www.siemens.com/distributeddrives-supplementaryproducts](http://www.siemens.com/distributeddrives-supplementaryproducts)

##### Connecting cables for the Control Unit

##### PROFINET connecting cable

Flexible plug-in cables and plug-in connectors that can be assembled in the field for transmission of data (up to 100 Mbit/s) between Industrial Ethernet stations with IP65 degree of protection.

##### Selection and ordering data

Description	Article No.
<b>IE connecting cable M12-180/M12-180, axial outlet</b> Pre-assembled IE FC TP trailing cable GP 2 x 2 PROFINET type C with two 4-pole M12 plugs (4-pole, D-coded), IP65/IP67 degree of protection, UL, plug/plug connector (IN/OUT) Length: <ul style="list-style-type: none"> <li>• 0.3 m (0.98 ft)</li> <li>• 0.5 m (1.64 ft)</li> <li>• 1 m (3.28 ft)</li> <li>• 1.5 m (4.92 ft)</li> <li>• 2 m (6.56 ft)</li> <li>• 3 m (9.84 ft)</li> <li>• 5 m (16.41 ft)</li> <li>• 10 m (32.81 ft)</li> <li>• 15 m (49.22 ft)</li> </ul>	<b>6XV1870-8AE30</b> <b>6XV1870-8AE50</b> <b>6XV1870-8AH10</b> <b>6XV1870-8AH15</b> <b>6XV1870-8AH20</b> <b>6XV1870-8AH30</b> <b>6XV1870-8AH50</b> <b>6XV1870-8AN10</b> <b>6XV1870-8AN15</b>
<b>IE connecting cable M12-180/IE FC RJ45 Plug 145 axial outlet</b> Pre-assembled IE FC TP Trailing Cable GP 2 x 2 (PROFINET Type C) with M12 plugs (D-coded) and IE FC RJ45 plug, IP65/IP67 degree of protection Length: <ul style="list-style-type: none"> <li>• 2 m (6.56 ft)</li> <li>• 3 m (9.84 ft)</li> <li>• 5 m (16.41 ft)</li> <li>• 10 m (32.81 ft)</li> <li>• 15 m (49.22 ft)</li> </ul>	<b>6XV1871-5TH20</b> <b>6XV1871-5TH30</b> <b>6XV1871-5TH50</b> <b>6XV1871-5TN10</b> <b>6XV1871-5TN15</b>
<b>IE M12 Plug PRO axial outlet</b> For assembly in the field, M12 plug-in connector (D-coded), metal enclosure, UL, fast connection method, plug connector <ul style="list-style-type: none"> <li>• 1 unit</li> <li>• 8 units</li> </ul>	<b>6GK1901-0DB20-6AA0</b> <b>6GK1901-0DB20-6AA8</b>

<sup>1)</sup> The STARTER commissioning tool is also available on the Internet at [www.siemens.com/starter](http://www.siemens.com/starter)

<sup>2)</sup> The SINAMICS Startdrive commissioning tool is also available on the Internet at <https://support.industry.siemens.com/cs/document/68034568>

## SINAMICS G110M distributed inverters

0.37 kW to 4 kW (0.5 hp to 5 hp)

### Supplementary system components

#### Accessories (continued)

##### PROFIBUS connecting cable

Flexible plug-in cables/connectors for transmission of data (up to 12 Mbit/s) from PROFIBUS stations.

##### Selection and ordering data

Description	Article No.
<b>PROFIBUS M12 plug-in cable axial outlet</b> Pre-assembled with two 5-pole M12 plug/socket connectors, UL Length:	
• 0.3 m (0.98 ft)	<b>6XV1830-3DE30</b>
• 0.5 m (1.64 ft)	<b>6XV1830-3DE50</b>
• 1 m (3.28 ft)	<b>6XV1830-3DH10</b>
• 1.5 m (4.92 ft)	<b>6XV1830-3DH15</b>
• 2 m (6.56 ft)	<b>6XV1830-3DH20</b>
• 3 m (9.84 ft)	<b>6XV1830-3DH30</b>
• 5 m (16.41 ft)	<b>6XV1830-3DH50</b>
• 10 m (32.81 ft)	<b>6XV1830-3DN10</b>
• 15 m (49.22 ft)	<b>6XV1830-3DN15</b>
<b>PROFIBUS M12 plug connector axial outlet</b> 5-pole, B-coded, metal enclosure, 1 package = 5 units	
• Pin insert	<b>6GK1905-0EA00</b>
• Female contact insert	<b>6GK1905-0EB00</b>

##### AS-Interface connecting cable

##### Selection and ordering data

Description	Article No.
<b>AS-Interface M12 branch</b> To connect the AS-Interface and the U <sub>AUX</sub> cable to an M12 socket, UL	
• 1 m (3.28 ft)	<b>3RK1901-1NR21</b>
• 2 m (6.56 ft)	<b>3RK1901-1NR22</b>

##### Connecting cables/connectors for supplying the Control Unit with power

##### Selection and ordering data

Description	Article No.
<b>7/8" plug-in cable, axial outlet</b> For 24 V switched and unswitched, pre-assembled with 2 × 7/8" at both ends (axial), 5 × 1.5 mm <sup>2</sup> , 5-pole plug/socket connectors Length:	
• 0.3 m (0.98 ft)	<b>6XV1822-5BE30</b>
• 0.5 m (1.64 ft)	<b>6XV1822-5BE50</b>
• 1 m (3.28 ft)	<b>6XV1822-5BH10</b>
• 1.5 m (4.92 ft)	<b>6XV1822-5BH15</b>
• 2 m (6.56 ft)	<b>6XV1822-5BH20</b>
• 3 m (9.84 ft)	<b>6XV1822-5BH30</b>
• 5 m (16.41 ft)	<b>6XV1822-5BH50</b>
• 10 m (32.81 ft)	<b>6XV1822-5BN10</b>
• 15 m (49.22 ft)	<b>6XV1822-5BN15</b>
<b>7/8" power cable, angled outlet, pre-assembled at one end</b> For 24 V switched and unswitched, pre-assembled with 1 × 7/8" angled at one end, 5 × 1.5 mm <sup>2</sup> 5-pole socket connector Length:	
• 3 m (9.84 ft)	<b>3RK1902-3GB30</b>
• 5 m (16.41 ft)	<b>3RK1902-3GB50</b>
• 10 m (32.81 ft)	<b>3RK1902-3GC10</b>
<b>7/8" power cable, angled outlet</b> For 24 V switched and unswitched, pre-assembled with 2 × 7/8" angled at both ends, 5 × 1.5 mm <sup>2</sup> , 5-pole plug/socket connectors Length:	
• 3 m (9.84 ft)	<b>3RK1902-3NB30</b>
• 5 m (16.41 ft)	<b>3RK1902-3NB50</b>
• 10 m (32.81 ft)	<b>3RK1902-3NC10</b>
<b>7/8" plug-in connector, axial outlet</b> 5-pole, B-coded, plastic enclosure, 1 package = 5 units	
• Pin insert (OUT)	<b>6GK1905-0FA00</b>
• Female contact insert (IN)	<b>6GK1905-0FB00</b>
<b>7/8" plug-in connector, angled outlet</b> 5-pole, B-coded, plastic enclosure, 1 package = 5 units	
• Pin insert (OUT)	<b>3RK1902-3BA00</b>
• Female contact insert (IN)	<b>3RK1902-3DA00</b>

**SINAMICS G110M distributed inverters**

0.37 kW to 4 kW (0.5 hp to 5 hp)

**Supplementary system components****Accessories** (continued)**Connecting cables and connectors for digital inputs and outputs****Selection and ordering data**

Description	Article No.
<b>M12 plug-in cable pre-assembled at both ends, axial outlet</b> M12 straight plug, M12 straight socket, screw mounting, 3-pole, 3 x 0.34 mm <sup>2</sup> , A-coded, black PUR sheath, max. 4 A Length: <ul style="list-style-type: none"> <li>• 1.5 m (4.92 ft)</li> </ul>	<b>3RK1902-4PB15-3AA0</b>
<b>M12 connector</b> Y cable for distributed I/Os for dual connection of I/Os using single 5-pole M12 cables, 200 mm (7.87 in) <ul style="list-style-type: none"> <li>• Straight</li> </ul>	<b>6ES7194-6KA00-0XA0</b>

**Connecting cables and connectors for analog inputs****Selection and ordering data**

Description	Ordering (see Solution Partner)
<b>M12 cable connector</b> 8-pole plug connector <ul style="list-style-type: none"> <li>• Straight cable outlet</li> </ul>	Ordered from and supplied by KnorrTec
<b>T distribution piece</b> To connect two analog inputs 8-pole M12 male connector to 2 x 4-pole M12 socket, angled	Ordered from and supplied by KnorrTec

**Connecting cables for Power Modules****Connecting cables pre-assembled at one end and connector sets to connect to the line supply****Selection and ordering data**

Description	Article No.
<b>Connecting cable pre-assembled at one end</b> Power supply cable, open at one end, for HAN Q4/2, angled, 4 x 4 mm <sup>2</sup> <ul style="list-style-type: none"> <li>• 1.5 m (4.92 ft) long</li> <li>• 5 m (16.41 ft) long</li> </ul>	<b>3RK1911-0DB13</b> <b>3RK1911-0DB33</b>
<b>Connector set for the power supply</b> Female contact insert HAN Q4/2, 5 socket contacts, grommet housing, angled outlet including screw connection <ul style="list-style-type: none"> <li>• 2.5 mm<sup>2</sup></li> <li>• 4 mm<sup>2</sup></li> <li>• 6 mm<sup>2</sup></li> </ul>	<b>3RK1911-2BE50</b> <b>3RK1911-2BE10</b> <b>3RK1911-2BE30</b>

**Connector insert for power loop-through****Selection and ordering data**

Description	Article No.
Connector set for power loop-through Plug insert HAN Q4/2, 4 socket contacts, grommet housing, angled outlet including screw connection <ul style="list-style-type: none"> <li>• 2.5 mm<sup>2</sup></li> <li>• 4 mm<sup>2</sup></li> </ul>	<b>3RK1911-2BF50</b> <b>3RK1911-2BF10</b>

**Power bus distribution 400 V in IP65 degree of protection****Selection and ordering data**

Not essential (daisy chaining within device); use is optional.

Description	Ordering (see Solution Partner)
<b>Power T clamp connector for 2.5 ... 6 mm<sup>2</sup></b> With attached 7-pole connector, female contact insert, grommet housing, UL Seals for various cable cross-sections must be ordered separately	Ordered from and supplied by Harting
<b>T clamp connector</b> Completely pre-assembled	Ordered from and supplied by KnorrTec
<b>T distributor box, IDC connection power cable</b> Pre-assembled, UL, uncut power cable, 2.5 ... 6 mm <sup>2</sup> Push-in connection: 1.5 ... 6 mm <sup>2</sup> Seals for various cable cross-sections must be ordered separately	Ordered from and supplied by Weidmüller
<b>Y distributor</b> For direct connection of 400 V supply line, HAN Q4/2, conductor cross-section 1.5 ... 4 mm <sup>2</sup>	Ordered from and supplied by Harting

**More information**

A comprehensive range of supplementary products is provided for the distributed drive technology, e.g. pre-assembled cables and connectors. An overview is provided at the following link: [www.siemens.com/distributeddrives-supplementaryproducts](http://www.siemens.com/distributeddrives-supplementaryproducts)

Further selected accessories are available from Siemens Solution Partners. Select "Distributed Field Installation System" as the technology in the "Solution Partner Finder". [www.siemens.com/automation/partnerfinder](http://www.siemens.com/automation/partnerfinder)

For more information about connecting cables and plug-in connectors, please refer to Catalog IK PI.

**Spare parts > Spare Parts Kit****Overview**

A Spare Parts Kit can be ordered, comprising small parts such as replacement seals, caps, PROFIBUS address windows and screws.

**Selection and ordering data**

Description	Article No.
<b>Spare Parts Kit for SINAMICS G110M</b> Comprising replacement seals, caps, connectors and screws	<b>6SL3500-0TK02-0AA0</b>



## SINAMICS G110D distributed inverters 0.75 kW to 7.5 kW (1 hp to 10 hp)



<b>8/2</b>	<b>Introduction</b>
8/2	Application
8/2	More information
<b>8/3</b>	<b>SINAMICS G110D distributed inverters</b>
8/3	Overview
8/4	Selection and ordering data
8/4	Benefits
8/5	Design
8/6	Integration
8/7	Configuration
8/7	Technical specifications
8/11	Characteristic curves
8/12	Dimensional drawings
<b>8/14</b>	<b>Recommended line-side power components</b>
<b>8/15</b>	<b>DC link components</b>
8/15	Braking resistors
<b>8/16</b>	<b>Supplementary system components</b>
8/16	Intelligent Operator Panel
	IOP-2 Handheld
8/17	Manual local control with keyswitch
8/17	Memory card
8/18	Card holder for memory card
8/18	RS232 interface cable for communication with a PC
8/18	USB interface cable for communication with a PC
8/18	Adapter for mounting SINAMICS G110D instead of SIRIUS M200D motor starter
8/18	STARTER commissioning tool
8/18	Connector kit for braking resistor
8/19	UL connector kit
8/19	Protection bar
8/19	Connecting cable and socket for AS-Interface
8/19	Connecting cables and connectors for digital inputs
8/19	Connecting cables pre-assembled at one end and connector sets to connect to the line supply
8/19	Motor cables pre-assembled at one end and connector sets to connect the inverter to the motor
8/20	Power bus distribution 400 V in IP65 degree of protection
8/20	More information
<b>8/20</b>	<b>Spare parts</b>
8/20	Spare Parts Kit
8/20	Replacement fans

# SINAMICS G110D distributed inverters

0.75 kW to 7.5 kW (1 hp to 10 hp)

## Introduction

## Application

Use	Requirements for torque accuracy/speed accuracy/position accuracy/coordination of axes/functionality					
	Continuous motion			Non-continuous motion		
	Basic	Medium	High	Basic	Medium	High
<b>Pumping, ventilating, compressing</b>	Centrifugal pumps Radial / axial fans Compressors	Centrifugal pumps Radial / axial fans Compressors	Eccentric screw pumps	Hydraulic pumps Metering pumps	Hydraulic pumps Metering pumps	Descaling pumps Hydraulic pumps
	V20 G120C G120P	G120P G130/G150 G180 <sup>1)</sup>	S120	G120	S110	S120
<b>Moving</b>	Conveyor belts Roller conveyors Chain conveyors	Conveyor belts Roller conveyors Chain conveyors Lifting/lowering devices Elevators Escalators/moving walkways Indoor cranes Marine drives Cable railways	Elevators Container cranes Mining hoists Excavators for open-cast mining Test bays	Acceleration conveyors Storage and retrieval machines	Acceleration conveyors Storage and retrieval machines Cross cutters Reel changers	Storage and retrieval machines Robotics Pick & place Rotary indexing tables Cross cutters Roll feeds Engagers/disengagers
	V20 <b>G110D</b> G110M G120C ET 200pro FC-2 <sup>2)</sup>	G120 G120D G130/G150 G180 <sup>1)</sup>	S120 S150 DCM	V90 G120 G120D	S110 S210 DCM	S120 S210 DCM
<b>Processing</b>	Mills Mixers Kneaders Crushers Agitators Centrifuges	Mills Mixers Kneaders Crushers Agitators Centrifuges Extruders Rotary furnaces	Extruders Winders/unwinders Lead/follower drives Calenders Main press drives Printing machines	Tubular bagging machines Single-axis motion control such as • Position profiles • Path profiles	Tubular bagging machines Single-axis motion control such as • Position profiles • Path profiles	Servo presses Rolling mill drives Multi-axis motion control such as • Multi-axis positioning • Cams • Interpolations
	V20 G120C	G120 G130/G150 G180 <sup>1)</sup>	S120 S150 DCM	V90 G120	S110 S210	S120 S210 DCM
<b>Machining</b>	Main drives for • Turning • Milling • Drilling	Main drives for • Drilling • Sawing	Main drives for • Turning • Milling • Drilling • Gear cutting • Grinding	Axis drives for • Turning • Milling • Drilling	Axis drives for • Drilling • Sawing	Axis drives for • Turning • Milling • Drilling • Lasering • Gear cutting • Grinding • Nibbling and punching
	S110	S110 S120	S120	S110	S110 S120	S120

SINAMICS G110D is ideally suited for conveyor system applications in the industrial environment for which a distributed drive with communications capability and AS-Interface is required. This applies in particular to distribution logistics and airports.

SINAMICS G110D is also suitable for many additional low-performance applications in many sectors, e.g. in the automotive sector, in the food and beverage industry (without surfactants) and in the packaging industry.

Practical application examples and descriptions are available on the Internet at [www.siemens.com/sinamics-applications](http://www.siemens.com/sinamics-applications)

## More information

You may also be interested in these drives:

- Simple applications in degree of protection IP65, integrated in motor ⇒ SINAMICS G110M
- With positioning function in degree of protection IP65 ⇒ SINAMICS G120D
- More performance, higher functionality for the control cabinet in IP20 degree of protection ⇒ SINAMICS G120, SINAMICS G120C (Catalog D 31.1)
- With positioning function in the control cabinet in IP20 degree of protection ⇒ SINAMICS S110 (Catalog D 31.1)

<sup>1)</sup> Industry-specific inverters.

<sup>2)</sup> Information on the SIMATIC ET 200pro FC-2 frequency converter is available at [www.siemens.com/et200pro-fc](http://www.siemens.com/et200pro-fc)

## SINAMICS G110D distributed inverters

0.75 kW to 7.5 kW (1 hp to 10 hp)

### SINAMICS G110D distributed inverters

#### Overview

The SINAMICS G110D distributed inverter series is the solution for basic drive tasks, especially in the field of conveyor systems. The inverter allows the speed of three-phase asynchronous (induction) motors to be continually controlled and fulfills the requirements of conveyor-related applications with open-loop frequency control. It can be optimally integrated into the system thanks to its compact and low-profile design in an IP65 degree of protection. It can be optimally integrated into the Siemens TIA world of automation via AS-Interface.

With its wide power range from 0.75 kW to 7.5 kW, it is suitable for a wide range of distributed drive solutions.



Example: SINAMICS G110D, frame size FSA

#### Reasons for using distributed drive systems

- Modular drive solutions – therefore standardized mechatronic elements that can be individually tested
- A control cabinet is not required, resulting in a smaller space requirement and lower cooling requirements
- Long cables between the inverter and motor can be avoided (which means lower power losses, reduced noise emission and lower costs for shielded cables and additional filters)
- Distributed configurations offer considerable benefits for conveyor systems with their extensive coverage (e.g. in the automotive and logistics sectors)

#### Siemens family of distributed drives

Siemens offers an innovative portfolio of inverters to optimally implement distributed drive solutions. The strengths of the individual members of the drive family permit simple adaptation to the widest range of application demands:

- Identical connection systems
- Identical mounting dimensions for SINAMICS G110D and SINAMICS G120D
- Standard commissioning and configuration tool

Products from the family of distributed drives:

- SINAMICS G110D frequency inverters
- SINAMICS G110M frequency inverters
- SIMATIC ET 200pro FC-2 frequency converters
- SINAMICS G120D frequency inverters
- SIRIUS M200D motor starters

#### Device design

SINAMICS G110D is a compact inverter in IP65 degree of protection where the Control Unit (CU) and Power Module (PM) function units are combined in one device.

The closed-loop control electronics controls and monitors the power electronics and the connected motor in several different control types that can be selected. The digital inputs and analog inputs on the device mean that sensors can be simply and directly connected at the drive. The input signals can either be directly linked within the inverter and initiate local responses independently or they can be transferred to the central control via AS-Interface for further processing within the context of the overall plant.

The power electronics supplies the motor in the power range from 0.75 kW to 7.5 kW. It is controlled (open-loop) from the microprocessor-based control. State-of-the-art IGBT technology with pulse-width-modulation is used for highly reliable and flexible motor operation. Comprehensive protection functions provide a high degree of protection for the inverter and motor. The unusually low profile mechanical design is optimized so that the device can be directly used in the plant or system. The compact inverter has the same drilling dimensions for all power ratings (standard footprint). Further, the dimensions are identical to those of the SINAMICS G120D inverter. This significantly simplifies the mechanical design, installation and retrofit of a system.

The latest technical documentation (catalogs, dimension drawings, certificates, manuals and operating instructions), is available on the Internet at the following address:

[www.siemens.com/sinamics-g110d/documentation](http://www.siemens.com/sinamics-g110d/documentation)

and offline in the DT Configurator integrated in Catalog CA 01 on DVD-ROM. In addition, the DT Configurator can be used on the Internet without requiring any installation. The DT Configurator can be found in the Siemens Industry Mall at the following address:

[www.siemens.com/dt-configurator](http://www.siemens.com/dt-configurator)

#### STARTER commissioning tool

The STARTER commissioning tool (V4.1.3 and higher) allows menu-prompted commissioning and maintenance of SINAMICS G110D inverters. The operator guidance combined with comprehensive, user-friendly functions for the relevant drive solution allow you to commission the device quickly and easily.

## SINAMICS G110D distributed inverters

0.75 kW to 7.5 kW (1 hp to 10 hp)

### SINAMICS G110D distributed inverters

#### Selection and ordering data

Rated power <sup>1)</sup>		Rated output current <sup>2)</sup>	Input current	Frame size	SINAMICS G110D with integrated line filter class A	SINAMICS G110D with integrated line filter class A and integrated maintenance switch
kW	hp	A	A		Article No.	Article No.
380 ... 500 V 3 AC <sup>3)</sup>						
0.75	1	2.3	2	FSA	<b>6SL3511-0PE17-5AM0</b>	<b>6SL3511-1PE17-5AM0</b>
1.5	1.5 <sup>4)</sup>	4.3	3.8	FSA	<b>6SL3511-0PE21-5AM0</b>	<b>6SL3511-1PE21-5AM0</b>
3	4	7.7	7	FSA	<b>6SL3511-0PE23-0AM0</b>	<b>6SL3511-1PE23-0AM0</b>
4	5	10.2	9.1	FSB	<b>6SL3511-0PE24-0AM0</b>	<b>6SL3511-1PE24-0AM0</b>
5.5	7.5	13.2	12.2	FSC	<b>6SL3511-0PE25-5AM0</b>	<b>6SL3511-1PE25-5AM0</b>
7.5	10	19	17.9	FSC	<b>6SL3511-0PE27-5AM0</b>	<b>6SL3511-1PE27-5AM0</b>

#### Benefits

- Wide power range from 0.75 kW to 7.5 kW
- Fast commissioning and maintenance as well as extended diagnostic functions and communications capability with AS-Interface according to specification 3.0:
  - Reduced number of interfaces
  - Plant-wide engineering
  - Easy to handle
- Mechanical design, installation and retrofit of systems are significantly simplified as a result of the compact and space-saving design with an extremely low profile and with the same drilling dimensions for all power ratings; further, the dimensions are identical with those of the SINAMICS G120D inverter.
- Easy commissioning and maintenance as a result of the same, standardized connectors for the bus, power and I/O connections (ISO 23570) for the complete range of power ratings of SINAMICS G110D and SINAMICS G120D.
- The same connectors are used as for the SIRIUS M200D motor starter
- Simple, standard implementation of completely distributed plant and system concepts by using products in a scalable fashion:
  - SIRIUS M200D (motor starter)
  - SINAMICS G110D (inverter for basic conveyor-related applications)
  - SINAMICS G110M (inverter for conveyor-related applications)
  - SIMATIC ET 200pro FC-2 (converter for distributed I/O)
  - SINAMICS G120D (inverter for demanding conveyor-related applications)
- High degree of operator friendliness by using the Intelligent Operator Panel (IOP-2) to parameterize, diagnose, control (open-loop) and copy drive parameters
- Easy to replace thanks to a plug-in design and the use of a memory card, providing the highest degree of service friendliness
- Simple connection, engineering, data management as well as control of the inverter in sophisticated plants and systems as a result of the consequential integration in TIA (Totally Integrated Automation)
- Using the optional maintenance switch, the inverter can be simply disconnected from the line supply when service is required, without any additional components or without additional wiring costs when configuring the system
- Using the optional manual local control, commissioning is fast and can be limited to specific areas, the application can be manually pre-tested on site and the system can be cleared or emptied without requiring comprehensive options.
- By being able to connect up to 5 sensors directly at the unit, practically all of the drive-relevant information can be directly managed; local pre-processing of the signals takes the load off the fieldbus and ensures a fast and reproducible response time
- Integrated EMC filter class A (acc. to EN 55011)
- Integrated brake control, brake voltages supported: 180 V DC and 205 V DC
- Integrated motor protection using a thermal motor model and evaluation of PTC, KTY, bimetal or Pt1000 temperature sensors
- Easy replacement of devices and fast copying of parameters to the memory card using the optional memory card holder and the optional memory card
- Engineering and commissioning with standard engineering tools such as SIZER for Siemens Drives (V3.2 and higher), STARTER (V4.1.3 and higher) and Drive ES ensure fast engineering and simple commissioning – STARTER is integrated into STEP 7 with Drive ES Basic, with all the advantages of central data storage and totally integrated communication
- Software parameters for simple adaptation to 50 Hz or 60 Hz motors (IEC or NEMA motors)
- Increased degree of ruggedness and longer service life as the electronic modules are coated
- Globally certified acc. to CE, UL, RCM

<sup>1)</sup> Rated power based on the rated output current  $I_{rated}$ . The rated output current  $I_{rated}$  is based on the duty cycle for high overload (HO).

<sup>2)</sup> The rated output current  $I_{rated}$  is based on the duty cycle for high overload (HO). These current values apply at 400 V and are specified on the rating plate.

<sup>3)</sup> With the exception of UL operation, 500 V + 10 % is possible.

<sup>4)</sup> It is not possible to make any assignment to a particular standard.

## SINAMICS G110D distributed inverters

0.75 kW to 7.5 kW (1 hp to 10 hp)

### SINAMICS G110D distributed inverters

#### Design

The SINAMICS G110D distributed inverters are compact frequency inverters for standard drives. Each SINAMICS G110D includes both the Control Unit as well as the Power Module in one unit.



SINAMICS G110D with integrated maintenance switch and manual local control with keyswitch

SINAMICS G110D features an integrated brake chopper and is suitable for distributed drives without energy recovery capability. If generator energy is produced then this is dissipated in the externally connected braking resistors. The communication is realized via the local inputs (digital and analog) or via the AS-Interface bus integrated as standard.



SINAMICS G110D with integrated maintenance switch

The inverter is available in two versions: With and without maintenance switch. Thanks to the optional maintenance switch (this cannot be retrofitted), when service is required, the inverter can be simply disconnected from the line supply without having to have any additional components or additional wiring costs when configuring.

#### Accessories

##### Braking resistors

Excess energy in the DC link is dissipated in the braking resistors. The braking resistors are designed for use with the SINAMICS G110D. This has an integrated brake chopper (electronic switch).

##### Intelligent Operator Panel IOP-2 Handheld

User-friendly and powerful operator panel for commissioning and diagnostics as well as local operator control and monitoring of SINAMICS G110D.

##### Manual local control with keyswitch

Master control can be toggled between automatic mode (PLC) and manual local mode using the manual local control. This can also be used to switch off the inverter. Additional functions include switching over between continuous and jog mode, starting the motor including direction of rotation and deactivating the Quick Stop in the manual mode.

##### Memory card

The parameter settings for an inverter can be stored on the SINAMICS SD memory card. When service is required, e.g. after the inverter has been replaced and the data have been downloaded from the memory card, the drive system is immediately ready for use again. The associated memory card holder is not included in the scope of supply of the inverter and must be separately ordered.

##### Card holder for memory card

To use the SINAMICS SD memory card, a card holder is required that is inserted under the blanking cover or under the manual/automatic control operator panel on the inverter.

##### RS232 interface cable for communication with a PC

For controlling and commissioning an inverter directly from a PC if the appropriate software (STARTER commissioning tool V4.1.3 and higher) has been installed.

##### USB interface cable for communication with a PC

For controlling and commissioning an inverter directly from a PC if the appropriate software (STARTER commissioning tool V4.1.3 and higher) has been installed.

##### Adapter for mounting the SINAMICS G110D instead of a SIRIUS M200D motor starter

Connection board kit to mount a SINAMICS G110D inverter on the connection holes of the SIRIUS M200D motor starter (assuming that there is enough space).

##### Connector kit for braking resistor

Connector kit for using or connecting different braking resistors.

##### UL connector kit

Special UL connector kit for UL-compatible applications.

##### Protection bar

Protection bar for protecting the connector against shearing due to mechanical stress

##### Connecting cable

Connector sets to connect to the line supply and the outgoing motor feeder are available as accessories as well as pre-assembled motor cables for connection to the motor.

Flexible plug-in cables to transfer data between AS-Interface participants as well as to supply the Control Unit and the Power Module with power.

##### Spare Parts Kit

A Spare Parts Kit is available which comprises small parts such as seals, caps and screws.

##### Replacement fan

A replacement fan is available, which comprises a pre-mounted unit with cover, fan and screws.

## SINAMICS G110D distributed inverters

0.75 kW to 7.5 kW (1 hp to 10 hp)

### SINAMICS G110D distributed inverters

#### Integration

The SINAMICS G110D distributed inverters feature the following interfaces as standard:

- Motor connection via HAN Q8 (connector) including control of the motor brake and temperature sensor
- Line supply connection via HAN Q4/2 (socket)
- Connection for a braking resistor in IP65 degree of protection through a 3-pin connector
- AS-Interface connection via M12 (connector)
- Connection for 4 digital inputs via M12 (socket)
- Connection for an analog input via M12 (socket); this can also be used as digital input
- Connection for an AS-Interface addressing device via jack socket

The interfaces are identical to those of the SINAMICS G120D distributed inverter and those of the SIRIUS M200D motor starter.

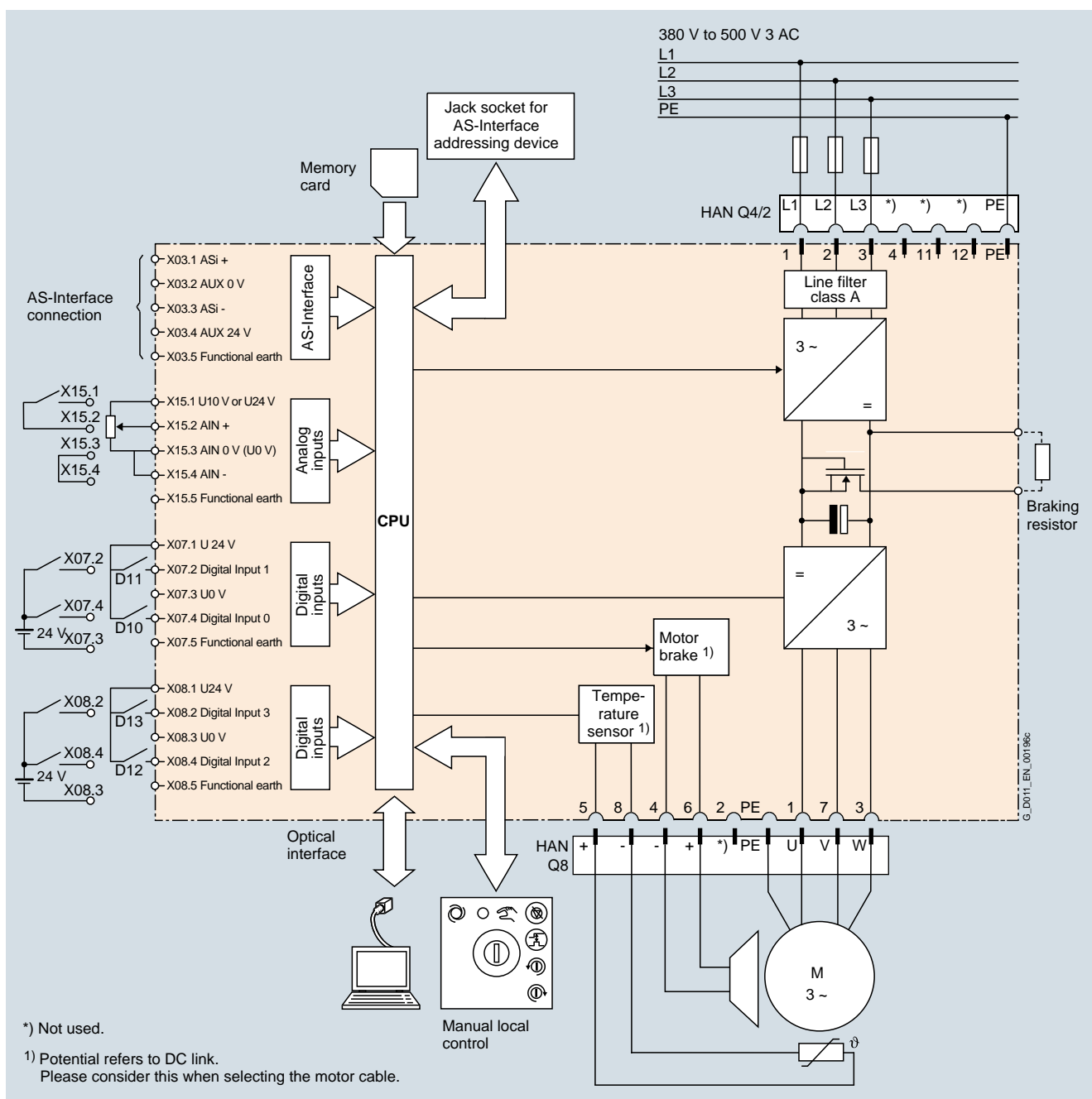

Connection example for SINAMICS G110D with integrated line filter class A

## Configuration

The following electronic configuring aids and engineering tools are available for the SINAMICS G110D distributed inverters:

### Drive Technology Configurator (DT Configurator) within the CA 01

The interactive catalog CA 01 – the offline Industry Mall of Siemens on DVD-ROM – contains over 100000 products with approximately 5 million possible drive system product variants. The Drive Technology Configurator (DT Configurator) has been developed to facilitate selection of the correct motor and/or inverter from the wide spectrum of drives. It is integrated as a selection tool in Catalog CA 01.

### Online DT Configurator

In addition, the DT Configurator can be used on the Internet without requiring any installation. The DT Configurator can be found in the Siemens Industry Mall at the following address:

[www.siemens.com/dt-configurator](http://www.siemens.com/dt-configurator)

### STARTER commissioning tool

The STARTER commissioning tool allows menu-prompted commissioning, optimization and diagnostics. Apart from the SINAMICS drives, STARTER is also suitable for the MICROMASTER 4 devices and for SINAMICS G110D with STARTER V4.1.3 and higher.

You can find further information about the STARTER commissioning tool in the section [Engineering tools](#).

Additional information about the STARTER commissioning tool is available on the Internet at [www.siemens.com/starter](http://www.siemens.com/starter)

### Drive ES engineering system

Drive ES is the engineering system that can be used to integrate the communication, configuration and data management functions of Siemens drive technology into the SIMATIC automation world easily, efficiently and cost-effectively. Two software packages are available for SINAMICS – Drive ES Basic Maintenance and Drive ES PCS.

You can find more information about the Drive ES engineering system in the section [Engineering tools](#).

Additional information about the Drive ES engineering system is available on the Internet at [www.siemens.com/drive-es](http://www.siemens.com/drive-es)

## Technical specifications

Unless explicitly specified otherwise, the following technical specifications are valid for all SINAMICS G110D distributed inverters.

General technical specifications	
<b>Mechanical specifications</b>	
<b>Vibratory load</b>	
• Transport acc. to EN 60721-3-2 <sup>1)</sup>	Class 1M2
• Operation acc. to EN 60721-3-3	Class 3M2
<b>Shock load</b>	
• Transport acc. to EN 60721-3-2 <sup>1)</sup>	Class 1M2
• Operation acc. to EN 60721-3-3	Class 3M2
<b>Ambient conditions</b>	
<b>Degree of protection</b>	IP65/UL Type 3
<b>Protection class</b> According to EN 61800-5-1	Class III (PELV)
<b>Touch protection</b> According to EN 61800-5-1	Class I (with protective conductor system)
<b>Humidity, max.</b>	95 % at 40 °C (104 °F)
<b>Ambient temperature</b>	
• Storage <sup>1)</sup> acc. to EN 60068-2-1	-40 ... +70 °C (-40 ... +158 °F)
• Transport <sup>1)</sup> acc. to EN 60068-2-1	-40 ... +70 °C (-40 ... +158 °F)
• Operation acc. to EN 60068-2-2	-10 ... +40 °C (14 ... +104 °F) without derating >40 ... 55 °C (104 ... +131 °F), <a href="#">see derating characteristics</a>
<b>Environmental class/harmful chemical substances</b>	
• Operation acc. to EN 60721-3-3	Class 3C2
<b>Degree of pollution</b> According to EN 61800-5-1	2
<b>Standards</b>	
<b>Compliance with standards</b>	UL 508C (UL list number E121068), CE, RCM
<b>CE marking, according to</b>	Low Voltage Directive 2014/35/EU
<b>EMC Directive</b>	
• Frame sizes FSA to FSC with integrated line filter class A	Category C2 <sup>2)</sup> according to EN 61800-3
	<b>Note:</b> The EMC product standard EN 61800-3 does not apply directly to a frequency inverter but to a PDS (Power Drive System), which comprises the complete circuitry, motor and cables in addition to the inverter. The frequency inverters on their own do not generally require identification according to the EMC Directive.

<sup>1)</sup> In product packaging.

<sup>2)</sup> With shielded motor cable up to 15 m (49 ft).

## SINAMICS G110D distributed inverters

0.75 kW to 7.5 kW (1 hp to 10 hp)

### SINAMICS G110D distributed inverters

#### Technical specifications (continued)

Technical specifications, control electronics	
<b>Electrical specifications</b>	
<b>Operating voltage</b>	External 24 V DC necessary
<b>Current consumption, max.</b> <sup>1)</sup> (from the non-switched 24 V DC supply, yellow AS-Interface cable)	320 mA
<b>Current consumption, max.</b> (from the switched 24 V DC supply, black AS-Interface cable)	
• Without supplementary fan	180 mA
• With supplementary fan	350 mA
<b>Fixed frequencies</b>	6, parameterizable
<b>Interfaces</b>	
<b>Digital inputs</b>	4
<b>Analog inputs</b> (0 ... 10 V)	1
<b>Bus interface</b>	AS-Interface
<b>PTC/KTY interface</b>	Connection via Power Modules
• Motor temperature sensor	1 input, sensors that can be connected: PTC, KTY, bimetal or Pt1000
<b>Control of a mechanical motor brake</b>	Connection via Power Modules
<b>Memory card slot</b>	Optional
<b>RS232 interface</b>	Connection with RS232 interface cable via the optical inverter interface
<b>USB interface</b>	Connection with USB interface cable via the optical inverter interface
<b>Open-loop/closed-loop control techniques and software</b>	
<b>V/f linear/quadratic/parameterizable</b>	✓
<b>V/f with flux current control (FCC)</b>	✓
<b>Software functions</b>	<ul style="list-style-type: none"> <li>• Signal interconnection with BICO technology</li> <li>• Automatic restart after line supply failure or operational fault</li> <li>• Slip compensation</li> <li>• Free function blocks (FFB) for logical operations</li> <li>• Ramp smoothing</li> <li>• 3 selectable drive data sets</li> <li>• 3 selectable command data sets (CDS) (manual/auto)</li> <li>• Flying restart</li> <li>• JOG</li> <li>• Technology controller (PID)</li> <li>• Thermal motor protection</li> <li>• Thermal inverter protection</li> <li>• Setpoint input</li> <li>• Motor identification</li> <li>• Motor holding brake</li> </ul>

<sup>1)</sup> Includes the current consumption of connected sensors. Analog input as voltage input, 0 V to 10 V.



## SINAMICS G110D distributed inverters

0.75 kW to 7.5 kW (1 hp to 10 hp)

### SINAMICS G110D distributed inverters

#### Technical specifications (continued)

General technical specifications, power electronics						
<b>System operating voltage</b>	380 ... 500 V AC 3 AC ±10 %					
<b>Line supply requirements</b>	No restriction					
<b>Short-circuit power ratio <math>R_{SC}</math></b>						
<b>Input frequency</b>	47 ... 63 Hz					
<b>Output frequency</b>	0 ... 550 Hz <sup>1)</sup>					
• Control mode V/f						
<b>Pulse frequency</b>	4 kHz (standard), for higher pulse frequencies up to 16 kHz, <a href="#">see derating data</a>					
<b>Power factor <math>\lambda</math></b>	0.7 ... 0.85					
<b>Inverter efficiency <math>\eta</math></b>	95 %					
<b>Output voltage, max. as % of input voltage</b>	0 ... 87 %					
<b>Overload capability</b>	<ul style="list-style-type: none"> <li>High overload (HO) <ul style="list-style-type: none"> <li>Average maximum rated output current during a cycle time of 300 s</li> <li>1.5 × rated output current (i.e. 150 % overload) over 60 s at a cycle time of 300 s</li> <li>2 × rated output current (i.e. 200 % overload) over 3 s at a cycle time of 300 s</li> </ul> </li> </ul>					
<b>Electromagnetic compatibility</b>	Integrated class A line filter according to EN 55011					
<b>Possible braking methods</b>	DC braking Integrated brake control supplies DC power supply for the brake					
	Line voltage	380 V AC	400 V AC	440 V AC	480 V AC	500 V AC
	Rectified brake voltage	171 V DC	180 V DC	198 V DC	216 V DC	225 V DC
	Recommended brake coil voltage for Siemens motors	170 ... 200 V DC	170 ... 200 V DC 184 ... 218 V DC <sup>2)</sup>	184 ... 218 V DC <sup>2)</sup>	184 ... 218 V DC <sup>2)</sup>	–
	Disconnection on the DC side permits "fast" braking.					
• Output current, max.	<ul style="list-style-type: none"> <li>600 mA (with UL approval)</li> <li>1 A (without UL approval)</li> </ul>					
<b>Permissible mounting position</b>	Horizontal wall mounting and mounting in the horizontal position					
<b>Relative humidity</b>	<95 % RH, condensation not permissible					
<b>Cooling</b>	<ul style="list-style-type: none"> <li>FSA: Convection</li> <li>FSB and FSC: Air cooling as required using the integrated fan</li> </ul>					
<b>Installation altitude</b>	<ul style="list-style-type: none"> <li>Up to 1000 m (3281 ft) above sea level without derating</li> <li>&gt;1000 m (3281 ft) <a href="#">see derating characteristics</a></li> </ul>					
<b>Short-Circuit Current Rating SCCR<sup>3)</sup></b>	40 kA					
<b>Protection functions</b>	<ul style="list-style-type: none"> <li>Undervoltage</li> <li>Overvoltage</li> <li>Overload</li> <li>Ground fault</li> <li>Short-circuit</li> <li>Stall protection</li> <li>Motor blocking protection</li> <li>Motor overtemperature</li> <li>Inverter overtemperature</li> <li>Parameter locking</li> </ul>					
<b>Compliance with standards</b>	UL 508C (UL list number E121068), CE, RCM					
<b>CE marking, according to</b>	Low Voltage Directive 2014/35/EU					

<sup>1)</sup> For further information, see <https://support.industry.siemens.com/cs/document/107669667>

<sup>2)</sup> With voltage boost activated.

<sup>3)</sup> Applies to industrial control panel installations to NEC article 409 or UL 508A.

## SINAMICS G110D distributed inverters

0.75 kW to 7.5 kW (1 hp to 10 hp)

### SINAMICS G110D distributed inverters

#### Technical specifications (continued)

Line voltage 380 ... 500 V 3 AC		SINAMICS G110D					
		6SL3511- .PE17-5AM0	6SL3511- .PE21-5AM0	6SL3511- .PE23-0AM0	6SL3511- .PE24-0AM0	6SL3511- .PE25-5AM0	6SL3511- .PE27-5AM0
<b>Rated output current</b> $I_{rated}^{1)}$	A	2.3	4.3	7.7	10.2	13.2	19
<b>Maximum output current</b> $I_{max}$	A	4.6	8.6	15.4	20.4	26.4	38
<b>Rated power</b>	kW (hp)	0.75 (1)	1.5 (1.5 <sup>4)</sup> )	3 (4)	4 (5)	5.5 (7.5)	7.5 (10)
<b>Rated pulse frequency</b>	kHz	4	4	4	4	4	4
<b>Efficiency</b> $\eta$	%	95	95	95	95	95	95
<b>Power loss</b> <sup>2)</sup> At rated output current	kW	0.044	0.068	0.105	0.168	0.196	0.261
<b>Rated input current</b> <sup>3)</sup>	A	2	3.8	7	9.1	12.2	17.9
<b>Line supply connection</b> U1/L1, V1/L2, W1/L3, PE		HAN Q4/2 (connector)	HAN Q4/2 (connector)	HAN Q4/2 (connector)	HAN Q4/2 (connector)	HAN Q4/2 (connector)	HAN Q4/2 (connector)
• Conductor cross-section	mm <sup>2</sup>	1.5 ... 6	1.5 ... 6	2.5 ... 6	2.5 ... 6	4 ... 6	4 ... 6
<b>Motor connection</b> U2, V2, W2, PE, motor brake, temperature sensor		HAN Q8 (socket)	HAN Q8 (socket)	HAN Q8 (socket)	HAN Q8 (socket)	HAN Q8 (socket)	HAN Q8 (socket)
• Conductor cross-section	mm <sup>2</sup>	1 ... 4	1 ... 4	2.5 ... 4	2.5 ... 4	4	4
<b>Motor cable length, max.</b>	m (ft)	15 (49)	15 (49)	15 (49)	15 (49)	15 (49)	15 (49)
<b>Degree of protection</b>		IP65	IP65	IP65	IP65	IP65	IP65
<b>Dimensions</b>							
• Width	mm (in)	445 (17.52)	445 (17.52)	445 (17.52)	445 (17.52)	445 (17.52)	445 (17.52)
• Height	mm (in)	210 (8.27)	210 (8.27)	210 (8.27)	210 (8.27)	210 (8.27)	210 (8.27)
• Depth							
- Without maintenance switch	mm (in)	125 (4.92)	125 (4.92)	125 (4.92)	165 (6.50)	240 (9.45)	240 (9.45)
- With maintenance switch	mm (in)	145 (5.71)	145 (5.71)	145 (5.71)	165 (6.50)	240 (9.45)	240 (9.45)
<b>Frame size</b>		FSA	FSA	FSA	FSB	FSC	FSC
<b>Weight, approx.</b>							
• Without maintenance switch	kg (lb)	6.7 (14.8)	6.7 (14.8)	6.9 (15.2)	7.4 (16.3)	9.4 (20.7)	9.5 (20.9)
• With maintenance switch	kg (lb)	7 (15.4)	7 (15.4)	7.2 (15.9)	7.7 (17)	9.7 (21.4)	9.8 (21.6)

<sup>1)</sup> The rated output current  $I_{rated}$  is based on the duty cycle for high overload (HO).

<sup>2)</sup> Typical values. You can find additional information on the Internet at <https://support.industry.siemens.com/cs/document/94059311>

<sup>3)</sup> The input current depends on the motor load and line impedance. The input currents apply for load at rated power for a line impedance corresponding to  $u_k = 1\%$ .

<sup>4)</sup> It is not possible to make any assignment to a particular standard.

**Characteristic curves**

**Derating data**

Pulse frequency

Rated power at 400 V 3 AC		Rated output current in A for a pulse frequency of						
kW	hp	4 kHz	6 kHz	8 kHz	10 kHz	12 kHz	14 kHz	16 kHz
0.75	1	2.3	1.9	1.5	1.3	1.1	1	0.9
1.5	1.5 <sup>1)</sup>	4.3	3.5	2.9	2.5	2.1	1.8	1.6
3	4	7.7	6.5	5.4	4.6	3.9	3.5	3.1
4	5	10.2	8.7	7.1	6.1	5.1	4.6	4.1
5.5	7.5	13.2	11.2	9.2	7.9	6.6	5.9	5.3
7.5	10	19	16.2	13.3	11.4	9.5	8.6	7.6

Ambient temperature

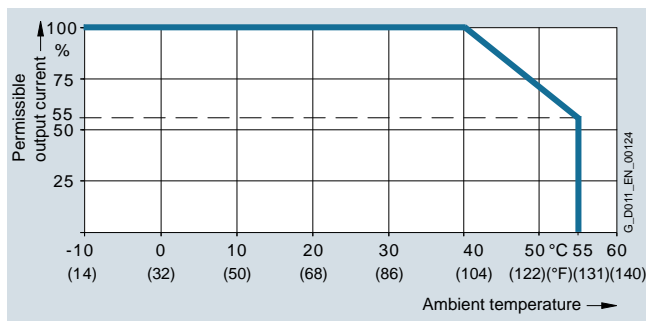

Permissible output current as a function of ambient temperature for frame sizes FSA to FSC

Installation altitude

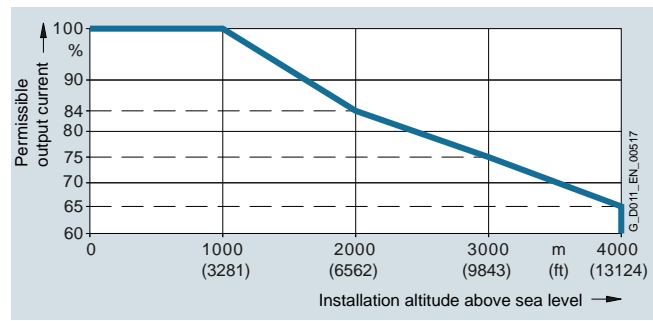

Permissible output current as a function of installation altitude for frame sizes FSA to FSC

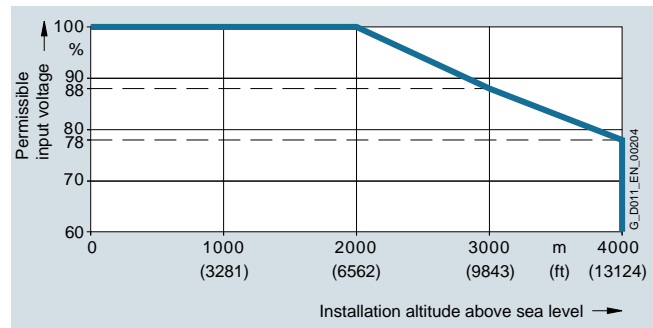

Permissible input voltage as a function of installation altitude for frame sizes FSA to FSC

<sup>1)</sup> It is not possible to make any assignment to a particular standard.

**SINAMICS G110D distributed inverters**

0.75 kW to 7.5 kW (1 hp to 10 hp)

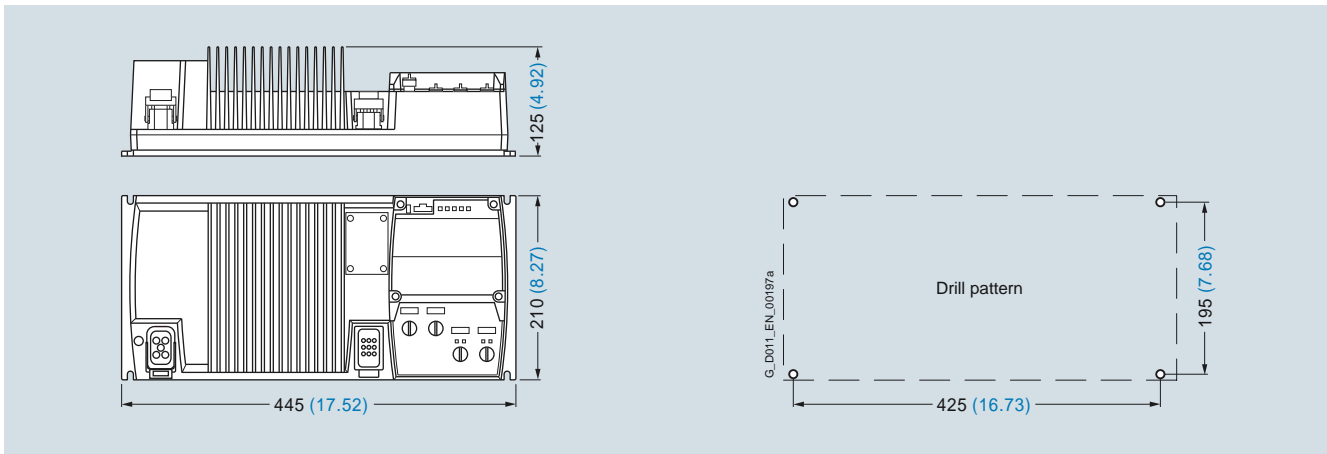
**SINAMICS G110D distributed inverters****Dimensional drawings**

SINAMICS G110D, frame size FSA, with integrated line filter class A

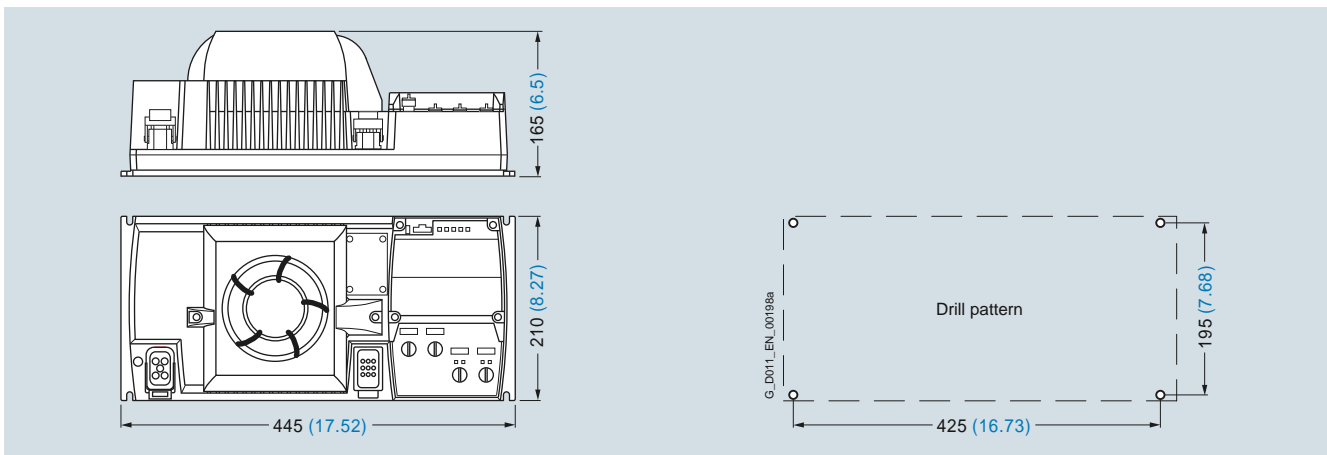

SINAMICS G110D, frame size FSB, with integrated line filter class A

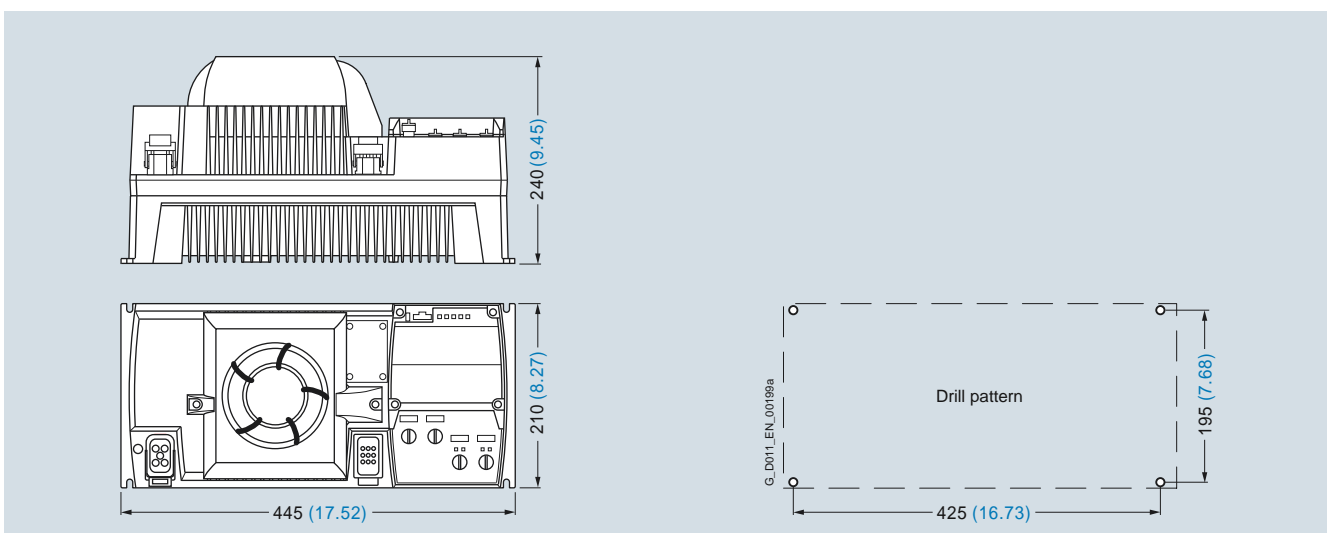

SINAMICS G110D, frame size FSC, with integrated line filter class A

Mounted with 4 M5 studs, 4 M5 nuts, 4 M5 washers.

Ventilation clearance required (for wall mounting) at top and bottom: 150 mm (5.9 inches).

All dimensions in mm (values in brackets are in inches).

## SINAMICS G110D distributed inverters 0.75 kW to 7.5 kW (1 hp to 10 hp)

### SINAMICS G110D distributed inverters

#### Dimensional drawings (continued)

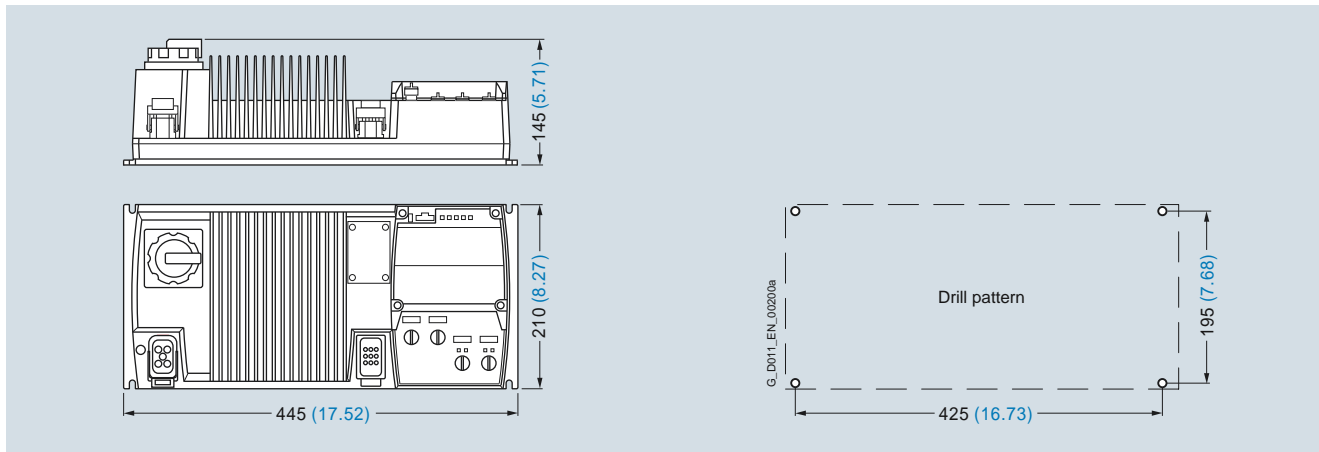

SINAMICS G110D, frame size FSA, with integrated line filter class A and maintenance switch

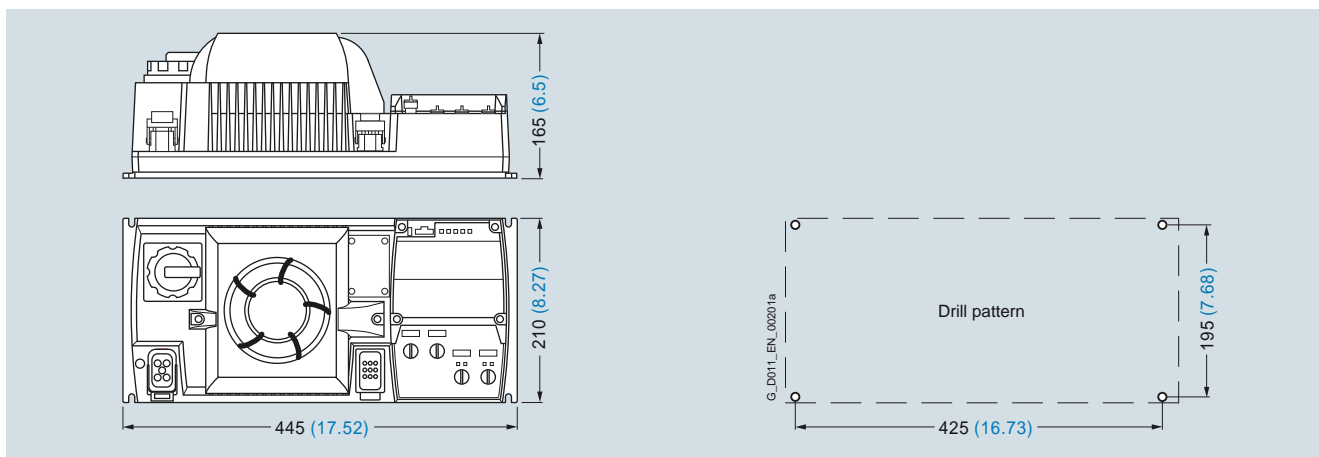

SINAMICS G110D, frame size FSB, with integrated line filter class A and maintenance switch

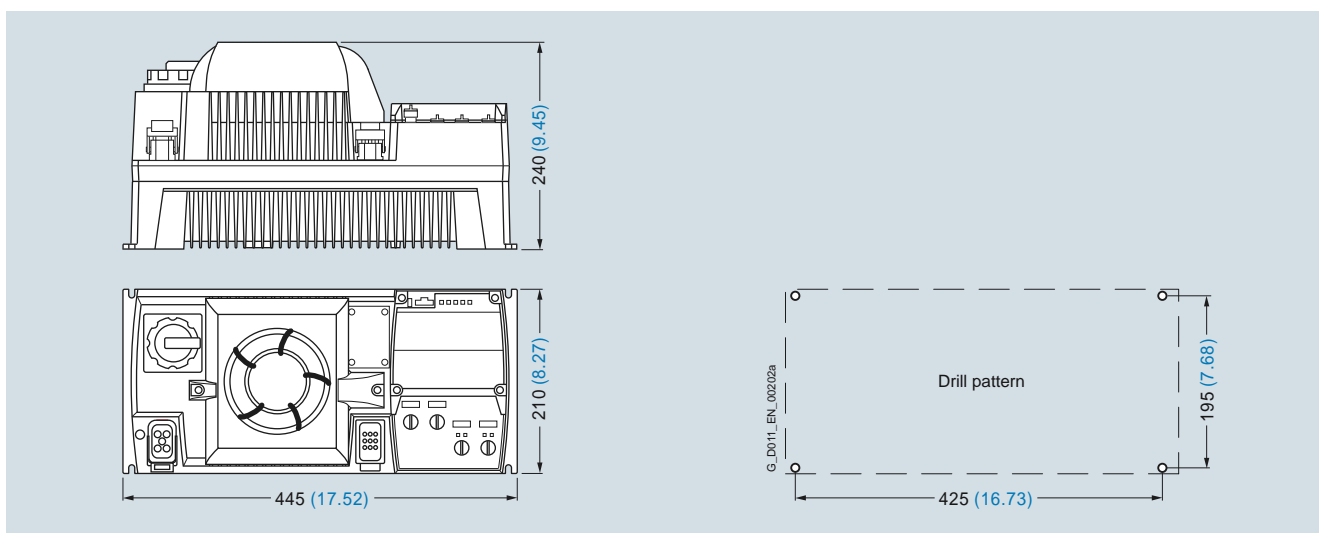

SINAMICS G110D, frame size FSC, with integrated line filter class A and maintenance switch

Mounted with 4 M5 studs, 4 M5 nuts, 4 M5 washers.

Ventilation clearance required (for wall mounting) at top and bottom: 150 mm (5.9 inches).

All dimensions in mm (values in brackets are in inches).

## SINAMICS G110D distributed inverters

0.75 kW to 7.5 kW (1 hp to 10 hp)

### Recommended line-side power components

#### Selection and ordering data

The following table lists recommendations for additional line-side components, such as fuses and circuit breakers.

Note for use in compliance with IEC standards:

3NA3 type fuses and 3RV type circuit breakers are recommended for European countries. The values in the table take into account the overload capability of the inverter.

Note for use in compliance with UL regulations:

Fuses for use in North America must be UL-certified, Class J fuses with a rated voltage of 600 V AC.

#### Short Circuit Current Rating (SCCR)

according to UL

Applies to industrial control panel installations according to NEC Article 409 or UL 508A

- SINAMICS G110D: 100 kA (480 V 3 AC)

Additional information about the listed fuses and circuit breakers is available in the Catalogs LV 10, IC 10 and IC 10 AO as well as in the Industry Mall.

#### Individual protection

Rated power		SINAMICS G110D		IEC-compliant				UL-compliant (according to UL category JDDZ)	
kW	hp	Type 6SL3511-...	Frame size	Fuse		Circuit breaker		Fuse type Rated voltage 600 V AC	
				Current A	Article No.	Article No.	Class	Current A	
<b>380 ... 500 V 3 AC</b>									
0.75	1	. PE17-5AM0	FSA	10	<b>3NA3803</b>		<b>3RV2011-1JA10</b>	J	10
1.5	1.5 <sup>1)</sup>	. PE21-5AM0	FSA	10	<b>3NA3803</b>		<b>3RV2011-1JA10</b>	J	25
3	4	. PE23-0AM0	FSA	16	<b>3NA3805</b>		<b>3RV2011-4AA10</b>	J	25
4	5	. PE24-0AM0	FSB	20	<b>3NA3807</b>		<b>3RV2011-4AA10</b>	J	30
5.5	7.5	. PE25-5AM0	FSC	20	<b>3NA3807</b>		<b>3RV2021-4BA10</b>	J	30
7.5	10	. PE27-5AM0	FSC	32	<b>3NA3812</b>		<b>3RV2021-4EA10</b>	J	30

#### Group protection (installation on power bus)

For installations with several inverters, the inverters are normally supplied from a 400 V power bus. Further information can be found in the operating instructions on the Internet at [www.siemens.com/sinamics-g110d/documentation](http://www.siemens.com/sinamics-g110d/documentation)

<sup>1)</sup> It is not possible to make any assignment to a particular standard.

## SINAMICS G110D distributed inverters

0.75 kW to 7.5 kW (1 hp to 10 hp)

### DC link components > Braking resistors

#### Overview

Excess energy in the DC link is dissipated in the braking resistors. The braking resistors are intended for use with SINAMICS G110D, which have an integrated brake chopper, but cannot regenerate energy to the line supply. For regenerative operation, e.g. the braking of a rotating mass with high moment of inertia, a braking resistor must be connected to convert the resulting energy into heat.

The braking resistors can be mounted above and to the side of the SINAMICS G110D distributed inverter. The heat dissipated by the braking resistor must not diminish the inverter cooling.

This is the reason that a minimum clearance of 150 mm must be maintained between the inverter and braking resistor.

Every braking resistor is equipped with thermal protection. The thermal protection prevents the braking resistor from being thermally overloaded.

All of the braking resistors are provided as standard with a cable that is pre-assembled and 500 mm long.

#### Technical specifications

Line voltage 380 ... 500 V 3 AC		Braking resistor		
		6SL3501-0BE08-6AA0	6SL3501-0BE12-1AA0	6SL3501-0BE14-1AA0
Resistance	Ω	400	160	80
Rated power $P_{DB}$ (Continuous braking power)	kW	0.075	0.2	0.375
Peak power $P_{max}$ (load duration $t_a = 12$ s with period $t = 240$ s)	kW	1.5	4	7.5
Degree of protection		IP65	IP65	IP65
Dimensions				
• Width	mm (in)	465 (18.31) <sup>1)</sup>	465 (18.31) <sup>1)</sup>	465 (18.31) <sup>1)</sup>
• Height	mm (in)	199 (7.83)	199 (7.83)	259 (10.20)
• Depth	mm (in)	120 (4.72)	120 (4.72)	120 (4.72)
Weight, approx.	kg (lb)	3.5 (7.7)	4.5 (9.9)	7 (15.4)
Suitable for SINAMICS G110D (Frame size)		6SL3511- . PE17-5AM0 (FSA) 6SL3511- . PE21-5AM0 (FSA)	6SL3511- . PE23-0AM0 (FSA) 6SL3511- . PE24-0AM0 (FSB)	6SL3511- . PE25-5AM0 (FSC) 6SL3511- . PE27-5AM0 (FSC)

#### Selection and ordering data

Rated power		Suitable for SINAMICS G110D		Braking resistor
kW	hp	Type 6SL3511-...	Frame size	Article No.
380 ... 500 V 3 AC				
0.75	1	. PE17-5AM0	FSA	<b>6SL3501-0BE08-6AA0</b>
1.5	1.5 <sup>2)</sup>	. PE21-5AM0	FSA	
3	4	. PE23-0AM0	FSA	<b>6SL3501-0BE12-1AA0</b>
4	5	. PE24-0AM0	FSB	
5.5	7.5	. PE25-5AM0	FSC	<b>6SL3501-0BE14-1AA0</b>
7.5	10	. PE27-5AM0	FSC	

#### Characteristic curves

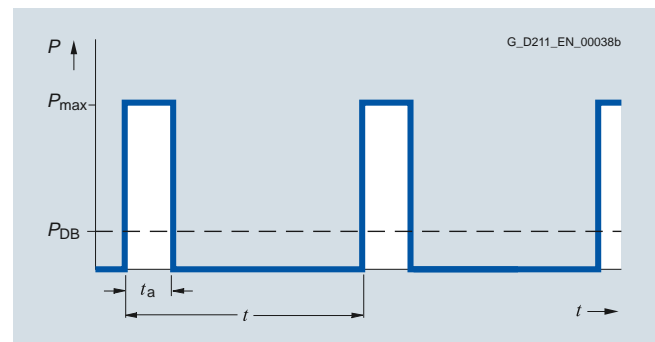

Load diagram for the braking resistors

$$t_a = 12 \text{ s}$$

$$t = 240 \text{ s}$$

<sup>1)</sup> For the specified width (465 mm) the required bending radius of the braking resistor connecting cable to the SINAMICS G110D has not been taken into account.

<sup>2)</sup> It is not possible to make any assignment to a particular standard.

## SINAMICS G110D distributed inverters

0.75 kW to 7.5 kW (1 hp to 10 hp)

### Supplementary system components

#### Accessories

##### Intelligent Operator Panel IOP-2 Handheld



IOP-2 Handheld for mobile use

The Intelligent Operator Panel IOP-2 Handheld is a very user-friendly and powerful operator panel for commissioning and diagnostics as well as local operator control and monitoring of SINAMICS G110D, SINAMICS G120D, SINAMICS G110M and SIMATIC ET 200pro FC-2 distributed inverters.

The IOP-2 Handheld supports both newcomers and drive experts. Thanks to the membrane keyboard with a central sensor control field, the high-contrast color displays, the menu-based operation and the application wizards, it is easy to commission standard drives. A drive can be essentially commissioned without having to use a printed parameter list – as the parameters are displayed in plain text, and explanatory help texts and the parameter filtering function are provided.

Application wizards interactively guide you when commissioning important applications such as conveyor technology, pumps, fans and compressors. There is a basic commissioning wizard for general commissioning.

Up to two process values can be graphically visualized and up to four process values can be numerically visualized on the status screen/display. Process values can also be displayed in technological units.

The IOP-2 Handheld supports standard commissioning of identical drives. For this purpose, a parameter list can be copied from an inverter into the IOP-2 Handheld and downloaded into other drive units of the same type as required.

In addition to the IOP-2, the IOP-2 Handheld includes a housing with rechargeable batteries, a charging unit, an RS232 connecting cable, and a USB cable. The charging unit is supplied with connector adapters for Europe, the US and UK. When the batteries are fully charged, the operating time is up to 10 hours.

To connect the IOP-2 Handheld to SINAMICS G110D, SINAMICS G120D, SINAMICS G110M and SIMATIC ET 200pro FC-2, the RS232 connecting cable with optical interface is required in addition.

##### Updating the IOP-2 Handheld

The IOP-2 Handheld can be updated and expanded using the integrated USB interface.

Data to support future drive systems can be transferred from the PC to the IOP-2 Handheld. Further, the USB interface allows user languages and wizards that will become available in the future to be subsequently downloaded and the firmware to be updated for the IOP-2 Handheld <sup>1)</sup>.

##### Selection and ordering data

Description	Article No.
<b>IOP-2 Handheld</b> For use with SINAMICS G120 SINAMICS G120C SINAMICS G120P SINAMICS G110D SINAMICS G120D SINAMICS G110M SIMATIC ET 200pro FC-2 Included in the scope of delivery: • IOP-2 • Handheld housing • Rechargeable batteries (4 × AA) • Charging unit (international) • RS232 connecting cable 3 m (9.84 ft) long, can be used in combination with SINAMICS G120 SINAMICS G120C SINAMICS G120P • USB cable 1 m (3.28 ft) long	<b>NEW</b> <b>6SL3255-0AA00-4HA1</b>
<b>RS232 connecting cable</b> 2.5 m (8.20 ft) long, with optical interface for connect- ing the IOP-2 Handheld to SINAMICS G110D SINAMICS G120D SINAMICS G110M SIMATIC ET 200pro FC-2	<b>3RK1922-2BP00</b>

##### Technical specifications

	IOP-2 Handheld
	6SL3255-0AA00-4HA1
<b>Display</b>	High-contrast color display, a variety of display options
• Resolution	320 × 240 pixels
<b>Operator panel</b>	Membrane keyboard with central sensor control field
<b>Operating languages</b>	English, German, French, Italian, Spanish, Portuguese, Dutch, Swedish, Finnish, Russian, Czech, Polish, Turkish, Chinese Simplified
<b>Ambient temperature</b>	
• During transport and storage	-20 ... +55 °C (-4 ... +131 °F)
• During operation	0 ... 40 °C (32 ... 104 °F)
<b>Humidity</b>	Relative humidity < 95 %, non-condensing
<b>Degree of protection</b>	IP20
<b>Dimensions (H × W × D)</b>	195.04 × 70 × 37.58 mm (7.68 × 2.76 × 1.48 in)
<b>Weight, approx.</b>	0.724 kg (1.6 lb)
<b>Compliance with standards</b>	CE, RCM, cULus, EAC, KCC-REM-S49-SINAMICS

<sup>1)</sup> Information on updates for the IOP-2 Handheld is available at <https://support.industry.siemens.com/cs/document/67273266>



## SINAMICS G110D distributed inverters

0.75 kW to 7.5 kW (1 hp to 10 hp)

### Supplementary system components

#### Accessories (continued)

##### Manual local control with keyswitch



Example: SINAMICS G110D and manual local control with integrated keyswitch

The manual local control is a simple method to locally control and commission the SINAMICS G110D distributed inverter.

To switch over from the automatic to the manual mode or to switch off the inverter, there is a keyswitch from which the key can be withdrawn in each of the three operating modes (Auto/Off/Local).

- The inverter is controlled via the PLC in "Auto" mode
- In the "Off" state, the device is shut down (however, the line supply voltage is still connected)
- The drive is locally and directly controlled in the "Local" setting. The device is simply controlled using directly assigned buttons. The following functions can be selected:
  - Switching over between continuous operation/jog mode
  - On/Counter-clockwise
  - On/Clockwise
  - Deactivate Quick Stop

The manual local control is mounted on the inverter instead of the standard blanking cover. This means that it can be retrofitted at a later date.

##### Selection and ordering data

Description	Article No.
<b>Manual local control with keyswitch</b>	<b>6SL3555-0PL00-2AA0</b>

##### Memory card



SINAMICS SD memory card

The parameter settings for an inverter can be stored on the SINAMICS SD memory card. When service is required, e.g. after the inverter has been replaced and the data have been downloaded from the memory card, the drive system is immediately ready for use again. The card, holder is not included in the scope of supply of the inverter and must be separately ordered.

##### Selection and ordering data

Description	Article No.
<b>SINAMICS SD card 512 MB</b>	<b>6SL3054-4AG00-2AA0</b>

**SINAMICS G110D distributed inverters**

0.75 kW to 7.5 kW (1 hp to 10 hp)

**Supplementary system components****Accessories** (continued)**Card holder for memory card**

Use of the SINAMICS SD memory card requires a card holder. This can be subsequently inserted under the blanking cover or under the optional manual local control on the inverter – where it can also remain. In addition, a Secure Digital card (SD) of up to max. 1 GB can also be used.



SINAMICS G110D with integrated card holder (in the open state)

**Selection and ordering data**

Description	Article No.
<b>Card holder</b> For memory card	<b>6SL3555-0PM00-0AA0</b>

**RS232 interface cable for communication with a PC**

For controlling and commissioning an inverter directly from a PC via a point-to-point connection if the appropriate software (STARTER commissioning tool <sup>1)</sup>, V4.1.3 and higher) has been installed.

**Selection and ordering data**

Description	Article No.
<b>RS232 interface cable</b> For communication with a PC	<b>3RK1922-2BP00</b>

**USB interface cable for communication with a PC**

For controlling and commissioning an inverter directly from a PC via a point-to-point connection if the appropriate software (STARTER commissioning tool <sup>1)</sup>, V4.1.3 and higher) has been installed.

**Selection and ordering data**

Description	Article No.
<b>USB interface cable</b> For communication with a PC (2.5 m/8.20 ft long)	<b>6SL3555-0PA00-2AA0</b>

**Adapter for mounting SINAMICS G110D instead of SIRIUS M200D motor starter**

For adaptation, there are connection boards that allow SINAMICS G110D to be mounted onto existing connection holes of the SIRIUS M200D motor starter (provided there is sufficient space). This means that a system can be adapted to future changes in requirements.

**Selection and ordering data**

Description	Article No.
<b>Adapter</b> For mounting SINAMICS G110D instead of SIRIUS M200D motor starter	<b>6SL3263-1GA20-0GA0</b>

**STARTER commissioning tool**

The STARTER commissioning tool (STARTER V4.1.3 and higher) supports the commissioning and maintenance of SINAMICS G110D inverters. The operator guidance combined with comprehensive, user-friendly functions for the relevant drive solution allow you to commission the device quickly and easily.

**Selection and ordering data**

Description	Article No.
<b>STARTER commissioning tool <sup>1)</sup></b> On DVD-ROM	<b>6SL3072-0AA00-0AG0</b>

An overview of all available accessories (e.g. connectors and cables) can be found under the following link:

[www.siemens.com/distributeddrives-supplementaryproducts](http://www.siemens.com/distributeddrives-supplementaryproducts)

**Connector kit for braking resistor**

A connector kit is available for connecting other braking resistors to SINAMICS G110D.

**Selection and ordering data**

Description	Article No.
<b>Connector kit</b> For braking resistor	<b>6SL3563-4RA00-0GA0</b>

<sup>1)</sup> The STARTER commissioning tool is also available on the Internet at [www.siemens.com/starter](http://www.siemens.com/starter)

## Accessories (continued)

### UL connector kit

A special UL connector kit is required for using SINAMICS G110D in UL-compatible applications. This comprises all parts that are needed to connect power and the motor (contacts, contact housing, metal connector housing and a cable of about 7 m (23 ft) in length).

#### Selection and ordering data

Description	Article No.
<b>UL connector kit</b> For power and motor	<b>6SL3563-4UA00-0GA0</b>

### Protection bar

Protection bars are available for the various frame sizes for protecting the connectors from shearing off in response to mechanical forces. These are mounted above and to the side of the SINAMICS G110D and protect the connectors and the keyswitch of the optional manual local control.

#### Selection and ordering data

Description	Article No.
<b>Protection bar</b>	
• For frame sizes FSA and FSB	<b>6SL3263-1HA20-0GA0</b>
• For frame size FSC	<b>6SL3263-1HC20-0GA0</b>

### Connecting cable and socket for AS-Interface

#### Selection and ordering data

Description	Article No.
<b>AS-Interface M12 branch</b> To connect the AS-Interface and the $V_{Aux}$ cable to an M12 socket, UL Length:	
• 1 m (3.28 ft)	<b>3RK1901-1NR21</b>
• 2 m (6.56 ft)	<b>3RK1901-1NR22</b>
<b>M12 socket</b> For screw mounting, 4-pole screw-type connection max. 0.75 mm <sup>2</sup> , A-coded, max. 4 A, UL	
• Angled	<b>3RK1902-4CA00-4AA0</b>

### Motor cables pre-assembled at one end and connector sets to connect the inverter to the motor

#### Selection and ordering data

Motor cables pre-assembled at one end For motors with brake and temperature sensor with HAN Q8 connector, shielded	Article No.		
	(HTG: supplied by Harting) (ZKT: supplied by KnorrTec)		
Cross-section	4 × 1.5 mm <sup>2</sup> 2 × (2 × 0.75 mm <sup>2</sup> )	4 × 2.5 mm <sup>2</sup> 2 × (2 × 0.75 mm <sup>2</sup> )	4 × 4 mm <sup>2</sup> 2 × 1 mm <sup>2</sup> + 2 × 1.5 mm <sup>2</sup>
• 1.5 m (4.92 ft) long	<b>HTG: 61 88 201 0288</b> <b>ZKT: 70020501000150</b>	<b>HTG: 61 88 201 0291</b> <b>ZKT: 70009601000150</b>	<b>HTG: 61 88 201 0303</b> <b>ZKT: 70017001000150</b>
• 3 m (9.84 ft) long	<b>HTG: 61 88 201 0289</b> <b>ZKT: 70020501000300</b>	<b>HTG: 61 88 201 0292</b> <b>ZKT: 70009601000300</b>	<b>HTG: 61 88 201 0304</b> <b>ZKT: 70017001000300</b>
• 5 m (16.41 ft) long	<b>HTG: 61 88 201 0290</b> <b>ZKT: 70020501000500</b>	<b>HTG: 61 88 201 0293</b> <b>ZKT: 70009601000500</b>	<b>HTG: 61 88 201 0305</b> <b>ZKT: 70017001000500</b>
• 10 m (32.81 ft) long	<b>HTG: 61 88 201 0299</b> <b>ZKT: 70020501001000</b>	<b>HTG: 61 88 201 0301</b> <b>ZKT: 70009601001000</b>	<b>HTG: 61 88 201 0306</b> <b>ZKT: 70017001001000</b>
<b>Connector set for motor cable</b> HAN Q8, shielded			
	<b>HTG: 61 83 401 0131</b> <b>ZKT: 10032001</b>	<b>HTG: 61 83 401 0132</b> <b>ZKT: 10032011</b>	<b>HTG: 61 83 401 0133</b> <b>ZKT: 10032021</b>

### Connecting cables and connectors for digital inputs

#### Selection and ordering data

Description	Article No.
<b>M12 plug-in cable</b> With PUR sheath, to connect digital sensors and actuators, pre-assembled at one end, angled, plug connector, 5-pole, 5 × 0.34 mm <sup>2</sup> , UL Length:	
• 1.5 m (4.92 ft)	<b>3RK1902-4HB15-5AA0</b>
• 5 m (16.41 ft)	<b>3RK1902-4HB50-5AA0</b>
• 10 m (32.81 ft)	<b>3RK1902-4HC01-5AA0</b>
<b>M12 connector</b> For screw mounting, 5-pole screw-type connection max. 0.75 mm <sup>2</sup> , A-coded, max. 4 A, UL, plug connector	
• Straight	<b>3RK1902-4BA00-5AA0</b>
• Angled	<b>3RK1902-4DA00-5AA0</b>

### Connecting cables pre-assembled at one end and connector sets to connect to the line supply

#### Selection and ordering data

Description	Article No.
<b>Connecting cable pre-assembled at one end</b> Power supply cable, open at one end, for HAN Q4/2, angled, 4 × 4 mm <sup>2</sup>	
• 1.5 m (4.92 ft) long	<b>3RK1911-0DB13</b>
• 5 m (16.41 ft) long	<b>3RK1911-0DB33</b>
<b>Connector set for the power supply</b> HAN Q4/2	
• 2.5 mm <sup>2</sup>	<b>3RK1911-2BE50</b>
• 4 mm <sup>2</sup>	<b>3RK1911-2BE10</b>
• 6 mm <sup>2</sup>	<b>3RK1911-2BE30</b>

## SINAMICS G110D distributed inverters

0.75 kW to 7.5 kW (1 hp to 10 hp)

### Supplementary system components

#### Accessories (continued)

#### Power bus distribution 400 V in IP65 degree of protection

##### Selection and ordering data

Description	Ordering (see Solution Partner)
<b>Power T clamp connector for 2.5 ... 6 mm<sup>2</sup></b> With attached 7-pole connector, female contact insert, grommet housing, UL Seals for various cable cross-sections must be ordered separately	Ordered from and supplied by Harting
<b>T clamp connector</b> Completely pre-assembled	Ordered from and supplied by KnorrTec
<b>T distributor box, IDC connection power cable</b> Pre-assembled, UL, uncut power cable, 2.5 ... 6 mm <sup>2</sup> Push-in connection: 1.5 ... 6 mm <sup>2</sup> Seals for various cable cross-sections must be ordered separately	Ordered from and supplied by Weidmüller
<b>Y distributor</b> For direct connection of 400 V supply line, HAN Q4/2, conductor cross-section 1.5 ... 4 mm <sup>2</sup>	Ordered from and supplied by Harting

#### More information

A comprehensive range of supplementary products is provided for the distributed drive technology, e.g. pre-assembled cables and connectors. An overview is provided at the following link:  
[www.siemens.com/distributeddrives-supplementaryproducts](http://www.siemens.com/distributeddrives-supplementaryproducts)

Further selected accessories are available from Siemens Solution Partners. Select "Distributed Field Installation System" as the technology in the "Solution Partner Finder".  
[www.siemens.com/automation/partnerfinder](http://www.siemens.com/automation/partnerfinder)

For more information about connecting cables and plug-in connectors, please refer to Catalog IK PI.

### Spare parts > Spare Parts Kit

#### Overview

A Spare Parts Kit can be ordered which comprises small parts such as replacement seals, caps and screws.

#### Selection and ordering data

Description	Article No.
<b>Spare Parts Kit for SINAMICS G110D</b> Comprising replacement seals, caps and screws	<b>6SL3500-0TK01-0AA0</b>

### Spare parts > Replacement fans

#### Overview

The fans are designed for extra long service life. Replacement fans can be ordered for special applications.

#### Selection and ordering data

Rated power		SINAMICS G110D		Replacement fan (pre-mounted unit with cover, fan and screws)
kW	hp	Type 6SL3511-...	Frame size	
<b>380 ... 500 V 3 AC</b>				
4	5	. PE24-0AM0	FSB	<b>6SL3500-0TF01-0AA0</b>
5.5	7.5	. PE25-5AM0	FSC	
7.5	10	. PE27-5AM0		

## SINAMICS G120D distributed inverters 0.75 kW to 7.5 kW (1 hp to 10 hp)



<b>9/2</b>	<b>Introduction</b>	<b>9/33</b>	<b>Recommended line-side power components</b>
9/2	Application	<b>9/34</b>	<b>Supplementary system components</b>
9/2	More information	9/35	Intelligent Operator Panel
<b>9/3</b>	<b>SINAMICS G120D distributed inverters</b>	9/36	IOP-2 Handheld
9/3	Overview	9/36	Memory cards
9/5	Benefits	9/36	PC inverter connection kit 2
9/6	Design	9/36	(mini USB interface cable for communication with a PC)
9/7	Configuration	9/36	STARTER commissioning tool
9/8	Technical specifications	9/36	SINAMICS Startdrive commissioning tool
<b>9/9</b>	<b>CU240D-2 and CU250D-2 Control Units</b>	9/37	<u>Connecting cables for the Control Unit</u>
9/9	Overview	9/37	PROFINET connecting cable
9/10	Selection and ordering data	9/37	PROFIBUS connecting cable
9/11	Design	9/37	Connecting cables/connectors for supplying the Control Unit with 24 V DC power
9/13	Function	9/38	Connecting cables and connectors for digital inputs and outputs
9/15	Integration	9/38	Connecting cables and connectors for encoders and analog inputs
9/23	Technical specifications	9/38	<u>Connecting cables for Power Modules</u>
<b>9/26</b>	<b>PM250D Power Modules</b>	9/38	Connecting cables pre-assembled at one end and connector sets to connect to the line supply
9/26	Overview	9/39	Motor cables pre-assembled at one end and connector sets to connect the Power Module to the motor
9/26	Selection and ordering data	9/39	Power bus distribution 400 V in IP65 degree of protection
9/27	Integration	9/39	More information
9/28	Technical specifications	<b>9/40</b>	<b>Spare parts</b>
9/31	Characteristic curves	9/40	Spare Parts Kit
9/32	Dimensional drawings	9/40	Replacement fans

# SINAMICS G120D distributed inverters

0.75 kW to 7.5 kW (1 hp to 10 hp)

## Introduction

### Application

Use	Requirements for torque accuracy/speed accuracy/position accuracy/coordination of axes/functionality					
	Continuous motion			Non-continuous motion		
	Basic	Medium	High	Basic	Medium	High
<b>Pumping, ventilating, compressing</b>	Centrifugal pumps Radial / axial fans Compressors	Centrifugal pumps Radial / axial fans Compressors	Eccentric screw pumps	Hydraulic pumps Metering pumps	Hydraulic pumps Metering pumps	Descaling pumps Hydraulic pumps
	V20 G120C G120P	G120P G130/G150 G180 <sup>1)</sup>	S120	G120	S110	S120
<b>Moving</b>	Conveyor belts Roller conveyors Chain conveyors	Conveyor belts Roller conveyors Chain conveyors Lifting/lowering devices Elevators Escalators/moving walkways Indoor cranes Marine drives Cable railways	Elevators Container cranes Mining hoists Excavators for open-cast mining Test bays	Acceleration conveyors Storage and retrieval machines	Acceleration conveyors Storage and retrieval machines Cross cutters Reel changers	Storage and retrieval machines Robotics Pick & place Rotary indexing tables Cross cutters Roll feeds Engagers/disengagers
	V20 G110D G110M G120C ET 200pro FC-2 <sup>2)</sup>	G120 <b>G120D</b> G130/G150 G180 <sup>1)</sup>	S120 S150 DCM	V90 G120 <b>G120D</b>	S110 S210 DCM	S120 S210 DCM
<b>Processing</b>	Mills Mixers Kneaders Crushers Agitators Centrifuges	Mills Mixers Kneaders Crushers Agitators Centrifuges Extruders Rotary furnaces	Extruders Winders/unwinders Lead/follower drives Calenders Main press drives Printing machines	Tubular bagging machines Single-axis motion control such as • Position profiles • Path profiles	Tubular bagging machines Single-axis motion control such as • Position profiles • Path profiles	Servo presses Rolling mill drives Multi-axis motion control such as • Multi-axis positioning • Cams • Interpolations
	V20 G120C	G120 G130/G150 G180 <sup>1)</sup>	S120 S150 DCM	V90 G120	S110 S210	S120 S210 DCM
<b>Machining</b>	Main drives for • Turning • Milling • Drilling	Main drives for • Drilling • Sawing	Main drives for • Turning • Milling • Drilling • Gear cutting • Grinding	Axis drives for • Turning • Milling • Drilling	Axis drives for • Drilling • Sawing	Axis drives for • Turning • Milling • Drilling • Lasering • Gear cutting • Grinding • Nibbling and punching
	S110	S110 S120	S120	S110	S110 S120	S120

SINAMICS G120D is ideally suited for demanding conveyor system applications in the industrial environment for which a distributed drive with communications capability is required. This applies in particular to the automotive sector, e.g. for assembly lines.

SINAMICS G120D is also suitable for many additional high-performance applications, e.g. in the airport sector, the food and beverage industry (without surfactants) and in distribution logistics (e.g. electric monorail systems).

Practical application examples and descriptions are available on the Internet at [www.siemens.com/sinamics-applications](http://www.siemens.com/sinamics-applications)

### More information

You may also be interested in these drives:

- Simple applications with AS-Interface in IP65 degree of protection ⇒ SINAMICS G110D
- Simple applications in degree of protection IP65, integrated in motor ⇒ SINAMICS G110M
- More performance for the control cabinet in IP20 degree of protection ⇒ SINAMICS G120, SINAMICS G120C (Catalog D 31.1)
- With positioning function in the control cabinet in IP20 degree of protection ⇒ SINAMICS S110 (Catalog D 31.1)

<sup>1)</sup> Industry-specific inverters.

<sup>2)</sup> Information on the SIMATIC ET 200pro FC-2 frequency converter is available at [www.siemens.com/et200pro-fc](http://www.siemens.com/et200pro-fc)

## SINAMICS G120D distributed inverters

0.75 kW to 7.5 kW (1 hp to 10 hp)

### SINAMICS G120D distributed inverters

#### Overview

The SINAMICS G120D distributed inverters are the solution for demanding drive tasks especially in the field of conveyor systems. SINAMICS G120D inverters continuously control the speed of three-phase asynchronous (induction) motors and fulfill all the requirements of conveyor system applications from simple frequency control through to demanding vector control and positioning requirements. With its intelligent modular design with IP65 degree of protection, it can be seamlessly integrated into the plant or system and supports a high plant availability and low stocks of spare parts. The innovative power unit concept capable of energy recovery helps to save energy. The patented implementation concept of the integrated safety functions is unique worldwide and has been extended further, without the use of external components. This drive can be optimally integrated into the Siemens TIA world of automation via PROFIBUS or PROFINET / EtherNet/IP.

With different device versions (frame sizes FSA to FSC) in a power range from 0.75 kW to 7.5 kW, it is suitable for a wide variety of drive solutions.



Example: SINAMICS G120D, frame size FSA, comprising PM250D Power Module and fail-safe CU250D-2 PN-F Control Unit

#### Reasons for using distributed drive systems

- Modular drive solutions – therefore standardized mechatronic elements that can be individually tested
- A control cabinet is not required, resulting in a smaller space requirement and lower cooling requirements
- Long cables between the inverter and motor can be avoided (which means lower power losses, reduced noise emission and lower costs for shielded cables and additional filters)
- Distributed configurations offer considerable benefits for conveyor systems with their extensive coverage (e.g. in the automotive and logistics sectors)

#### Siemens family of distributed drives

Siemens offers an innovative portfolio of frequency inverters to optimally implement distributed drive solutions. The strengths of the individual members of the drive family permit simple adaptation to the widest range of application demands:

- Identical connection systems
- Identical mounting dimensions for SINAMICS G110D and SINAMICS G120D
- Standard commissioning and configuration tool

Products from the family of distributed drives:

- SINAMICS G110D frequency inverters
- SINAMICS G110M frequency inverters
- SINAMICS G120D frequency inverters
- SIMATIC ET 200pro FC-2 frequency converters
- SIRIUS M200D motor starters

#### Modularity

SINAMICS G120D is a modular inverter system with IP65 degree of protection comprising various function units. The main units are

- Control Unit (CU)
- Power Module (PM)

The Control Unit controls and monitors the Power Module and the connected motor using several different closed-loop control types that can be selected. The digital inputs, analog inputs and digital outputs on the device support the simple wiring of sensors and actuators directly at the drive. The input signals can either be directly linked within the Control Unit and initiate local responses independently or they can be transferred to the central control via PROFIBUS or PROFINET / EtherNet/IP for further processing within the context of the overall plant.

The Power Module supplies the motor in a power range from 0.75 kW to 7.5 kW. The Power Module is controlled by a micro-processor in the Control Unit. State-of-the-art IGBT technology with pulse-width-modulation is used for highly reliable and flexible motor operation. Comprehensive protection functions provide a high degree of protection for the Power Module and the motor. The unusually low profile mechanical design is optimized so that the device can be directly used in the plant or system. The Power Module also has the same drilling dimensions for all power ratings (standard footprint). Further, the dimensions are identical to those of SINAMICS G110D. This significantly simplifies the mechanical design, installation and retrofit of a system.

The latest technical documentation (catalogs, dimension drawings, certificates, manuals and operating instructions) is available on the Internet at the following address:

[www.siemens.com/sinamics-g120d/documentation](http://www.siemens.com/sinamics-g120d/documentation)

and offline in the DT Configurator integrated in Catalog CA 01 on DVD-ROM. In addition, the DT Configurator can be used on the Internet without requiring any installation. The DT Configurator can be found in the Siemens Industry Mall at the following address:

[www.siemens.com/dt-configurator](http://www.siemens.com/dt-configurator)

## SINAMICS G120D distributed inverters

0.75 kW to 7.5 kW (1 hp to 10 hp)

### SINAMICS G120D distributed inverters

#### Overview (continued)

##### **Safety Integrated**

The SINAMICS G120D distributed inverters include versions for safety-oriented applications. All Power Modules are already designed for Safety Integrated.

The safety function "Safe Torque Off" (STO) (certified according to IEC 61508 SIL 2, EN ISO 13849-1 PL d and Category 3) is already integrated into the standard versions of the CU240D-2 series (CU240D-2 DP and CU240D-2 PN). It can be activated either over PROFIsafe or over the safety input.

With the fail-safe variants of the CU240D-2 series (CU240D-2 DP-F xx and CU240D-2 PN-F xx) and with the entire CU250D-2 series, the fail-safe SINAMICS G120D inverter provides five safety functions which are certified according to IEC 61508 SIL 2, EN ISO 13849-1 PL d and Category 3:

- Safe Torque Off (STO)  
to protect against active movement of the drive
- Safe Stop 1 (SS1)  
for continuous monitoring of a safe braking ramp
- Safely-Limited Speed (SLS)  
for protection against dangerous movements on exceeding a speed limit
- Safe direction (SDI)  
This function ensures that the drive can only rotate in the selected direction.
- Safe speed monitoring (SSM)  
This function signals if a drive is operating below a specific speed/feed velocity.

These functions can be activated by means of PROFIsafe or via the safety inputs. A safety output is provided in addition.

All safety functions can be implemented without having to use a motor encoder; the implementation costs are minimal. Existing systems in particular can be simply updated with safety technology without the need to change the motor or mechanical system.

The Safe Torque Off (STO) function can be used without restriction for all applications. The SS1, SLS, SSM and SDI functions are only permissible for applications where the load can never accelerate when the inverter is switched off. They are therefore not permitted for applications involving pull-through loads such as hoisting gear and unwinders.

[Further information can be found in the section Safety Integrated.](#)

##### **Efficient Infeed Technology**

The innovative Efficient Infeed Technology is employed in PM250D Power Modules. This technology allows the energy produced by motors operating in generator mode connected to standard inverters to be fed back into the supply system. At the same time, considerable savings can be achieved in terms of energy consumption and operating costs.

##### **STARTER commissioning tool**

The STARTER commissioning tool (V4.3 and higher) supports the commissioning and maintenance of SINAMICS G120D inverters. The operator guidance combined with comprehensive, user-friendly functions for the relevant drive solution allow you to commission the device quickly and easily.



## SINAMICS G120D distributed inverters

0.75 kW to 7.5 kW (1 hp to 10 hp)

### SINAMICS G120D distributed inverters

#### Benefits

- Mechanical design, installation and retrofit of systems are significantly simplified as a result of the compact and space-saving design with an extremely low profile and with the same drilling dimensions for all power ratings; further, the dimensions are identical to those of the SINAMICS G110D distributed inverter
- Wide power range from 0.75 kW to 7.5 kW
- The safety functions make it easier to integrate drives into safety-oriented machines or plants
- The innovative circuit design (bidirectional input rectifier with "pared-down" DC link) allows the kinetic energy of a load to be fed back into the line supply system. This feedback capability provides enormous potential for energy saving because generated energy no longer has to be converted into heat in a braking resistor. Braking resistors and reactors are not necessary – this is a particular advantage in terms of the project engineering outlay, space requirement and installation costs for the high IP65 degree of protection
- Easy commissioning and maintenance via a fieldbus or point-to-point via a mini USB parameterization interface and screen-based parameterization software and wizards
- The same, standardized plug-in connections for the bus, power and I/O connections (ISO 23570) for the complete range of power ratings of SINAMICS G110D, SINAMICS G110M, SINAMICS G120D and SIRIUS M200D (motor starter)
- Integrated positioning functionality supports process-related implementation of positioning tasks with a high dynamic response. Positioning can be implemented with an incremental or absolute encoder (SSI)
- Increased degree of ruggedness and longer service life as the electronic modules are coated
- Flexibility due to modularity for a future-oriented distributed drive concept with a high IP65 degree of protection
  - Module replacement under voltage (hot swapping)
  - The modules can be easily replaced, which makes the system extremely service friendly.
- Simple, standard implementation of completely distributed plant and system concepts by using products in a scalable fashion:
  - SIRIUS M200D (motor starter)
  - SIMATIC ET 200pro FC-2 (converter for distributed I/O)
  - SINAMICS G110D (inverter for basic, conveyor-related applications)
  - SINAMICS G110M (inverter for conveyor-related applications)
  - SINAMICS G120D (inverter for demanding, conveyor-related applications)
- Communications-capable via PROFINET / EtherNet/IP or PROFIBUS with PROFIdrive profile 4.1:
 

PROFINET features:

  - Neighbor recognition (LLDP)
  - Ring topology possible (MRP (Media redundancy protocol), MRPD (media redundancy with planned duplication)
  - Isochronous real-time communication (IRT)
  - PROFenergy
  - PROFIsafe
  - Diagnostics, interrupts
  - Shared Device
  - Attenuation meter (for FO variant)
- Integrated fiber-optic interfaces (with CU240D-2 PN-F FO and CU250D-2 PN-F FO) for use in environments with harsh EMC conditions. These help to maintain stable communication and allow preventive maintenance of the connected PROFINET communication cable by means of an integrated attenuation meter.
- Simple connection, engineering, data management as well as control of the inverter in sophisticated plants and systems as a result of the consequential integration in TIA (Totally Integrated Automation)
- High degree of operator friendliness by using the Intelligent Operator Panel (IOP-2) to parameterize, diagnose, control (open-loop) and copy drive parameters
- The ability to connect up to 6 sensors and up to 2 actuators to the Control Unit directly ensures that almost all the information relevant to the drive can be managed directly. Fail-safe Control Units can process signals from up to three fail-safe sensors and one fail-safe actuator. The CU240D-2 Control Units are also equipped with two analog inputs, which can also be used as digital inputs. Local pre-processing of the signals relieves the fieldbus of the task and ensures a faster and more reproducible response time
- Integrated EMC filter class A (acc. to EN 55011)
- Integrated brake control, supported brake voltage 180 V DC (at line voltage of 400 V AC – otherwise  $U_{\text{line}} \times 0.45 = \text{brake voltage}$ )
- Integrated motor protection using a thermal motor model and evaluation of PTC, KTY, bimetal or Pt1000 temperature sensors
- Software parameters for simple adaptation to 50 Hz or 60 Hz motors (IEC or NEMA motors)
- Easy replacement of devices and time-saving copying of parameters to optional memory card
- Engineering and commissioning with standard engineering tools such as SIZER for Siemens Drives (V2.9 and higher), STARTER (V4.3 and higher) and Drive ES ensure fast engineering and easy commissioning – STARTER is integrated in STEP 7 with Drive ES Basic with all the advantages of central data storage and totally integrated communication
- Certified worldwide for compliance with CE, UL, cUL, RCM and Safety Integrated according to IEC 61508 SIL 2 and EN ISO 13849-1 PL d and Category 3

## SINAMICS G120D distributed inverters

0.75 kW to 7.5 kW (1 hp to 10 hp)

### SINAMICS G120D distributed inverters

#### Design

The SINAMICS G120D distributed inverters are modular inverters for standard drives. Each SINAMICS G120D comprises two operative units – a Power Module and a Control Unit.

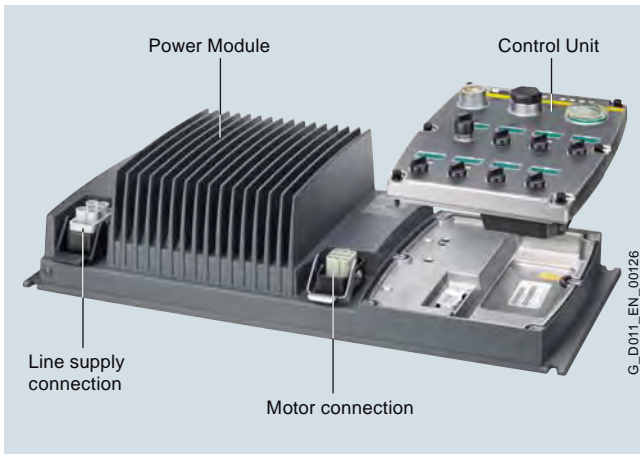

PM250D Power Module with line supply and motor connections and CU240D-2 Control Unit

#### Power Modules

The following PM250D Power Modules are available for the SINAMICS G120D distributed inverters:

##### PM250D Power Modules

PM250D Power Modules (0.75 kW to 7.5 kW) have an innovative circuit design which allows line-commutated energy recovery back into the line supply. This innovative circuit permits generated energy to be fed back into the supply system and therefore saves energy.

#### Control Units

A Control Unit performs closed-loop control functions for the inverter. In addition to the closed-loop control, it has additional functions that can be adapted to the particular application through parameterization.

The following Control Units are available for SINAMICS G120D distributed inverters:

##### CU240D-2 Control Units

The CU240D-2 Control Units can be used to implement applications with speed/torque control. Several Control Units are available in different versions:

- CU240D-2 DP → PROFIBUS
- CU240D-2 DP-F → PROFIBUS fail-safe
- CU240D-2 PN → PROFINET
- CU240D-2 PN-F → PROFINET fail-safe
- CU240D-2 PN-F PP → PROFINET fail-safe Push Pull
- CU240D-2 PN-F FO → PROFINET Fail-safe fiber optic

##### CU250D-2 Control Units

CU250D-2 Control Units can be used to implement applications with positioning requirements in the drive. Several Control Units are available in different versions:

- CU250D-2 DP-F → PROFIBUS fail-safe
- CU250D-2 PN-F → PROFINET fail-safe
- CU250D-2 PN-F PP → PROFINET fail-safe Push Pull
- CU250D-2 PN-F FO → PROFINET fail-safe fiber optic

#### Supplementary system components

##### Intelligent Operator Panel IOP-2 Handheld

The IOP-2 Handheld supports both newcomers and drive experts. Thanks to the large plain text display, the menu-based operation and the application wizards, it is easy to commission, diagnose and locally control standard drives.

##### Memory card

The parameter settings for an inverter can be stored on the SINAMICS SD memory card. When service is required, e.g. after the inverter has been replaced and the data have been downloaded from the memory card the drive system is immediately ready for use again. The associated slot is located on the rear of the Control Unit.

##### Mini USB interface cable for communication with a PC

For controlling and commissioning an inverter directly from a PC if the appropriate software (STARTER commissioning tool V4.3 and higher or SINAMICS Startdrive) has been installed.

##### Connecting cables for the Control Units

Flexible plug-in cables to transfer data between the Industrial Ethernet stations or PROFIBUS stations, as well as to supply power to the Control Unit.

##### Connecting cables for the Power Modules

Connector sets to connect to the line supply and the outgoing motor feeder are available as accessories as well as pre-assembled motor cables for connection to the motor.

##### Spare Parts Kit

A Spare Parts Kit is available which comprises small parts such as seals, caps, PROFIBUS address windows and screws.

##### Replacement fan

A replacement fan is available, which comprises a pre-mounted unit with cover, fan and screws.

## Configuration

The following electronic configuring aids and engineering tools are available for the SINAMICS G120D distributed inverters:

### **Drive Technology Configurator (DT Configurator) within the CA 01**

The interactive catalog CA 01 – the offline Industry Mall of Siemens on DVD-ROM – contains over 100000 products with approximately 5 million possible drive system product variants. The Drive Technology Configurator (DT Configurator) has been developed to facilitate selection of the correct motor and/or inverter from the wide spectrum of drives. It is integrated as a selection tool in Catalog CA 01.

### **Online DT Configurator**

In addition, the DT Configurator can be used on the Internet without requiring any installation. The DT Configurator can be found in the Siemens Industry Mall at the following address:  
[www.siemens.com/dt-configurator](http://www.siemens.com/dt-configurator)

### **SIZER for Siemens Drives engineering tool**

The PC-based SIZER for Siemens Drives engineering tool makes it easy to configure the SINAMICS drive family. It provides support when selecting the hardware and firmware components necessary to implement a drive task. SIZER for Siemens Drives supports the complete configuration of the drive system, from basic single drives to demanding multi-axis applications.

You can find further information on the SIZER for Siemens Drives engineering tool in the section [Engineering tools](#).

The SIZER for Siemens Drives engineering tool is available free on the Internet at  
[www.siemens.com/sizer](http://www.siemens.com/sizer)

### **STARTER commissioning tool**

The STARTER commissioning tool allows menu-prompted commissioning, optimization and diagnostics. Apart from the SINAMICS drives, STARTER is also suitable for MICROMASTER 4 devices.

The new CU240D-2 PN-F FO and CU250D-2 PN-F FO Control Units can be commissioned with STARTER V4.4 and higher.

You can find further information about the STARTER commissioning tool in the section [Engineering tools](#).

Additional information about the STARTER commissioning tool is available on the Internet at  
[www.siemens.com/starter](http://www.siemens.com/starter)

### **SINAMICS Startdrive commissioning tool**

SINAMICS Startdrive is a tool for configuring, commissioning, and diagnosing the SINAMICS family of drives and is integrated into the TIA Portal. SINAMICS Startdrive can be used to implement drive tasks with the SINAMICS G120, SINAMICS G120C, SINAMICS G110M, SINAMICS G120D and SINAMICS G120P inverter series. The commissioning tool has been optimized with regard to user friendliness and consistent use of the TIA Portal benefits of a common working environment for PLC, HMI and drives.

You can find further information about the SINAMICS Startdrive commissioning tool in the section [Engineering tools](#).

The SINAMICS Startdrive commissioning tool is available free on the Internet at  
[www.siemens.com/startdrive](http://www.siemens.com/startdrive)

### **Drive ES engineering system**

Drive ES is the engineering system that can be used to integrate the communication, configuration and data management functions of Siemens drive technology into the SIMATIC automation world easily, efficiently and cost-effectively. Two software packages are available for SINAMICS – Drive ES Basic Maintenance and Drive ES PCS.

You can find more information about the Drive ES engineering system in the section [Engineering tools](#).

Additional information about the Drive ES engineering system is available on the Internet at  
[www.siemens.com/drive-es](http://www.siemens.com/drive-es)

## SINAMICS G120D distributed inverters

0.75 kW to 7.5 kW (1 hp to 10 hp)

### SINAMICS G120D distributed inverters

#### Technical specifications

Unless explicitly specified otherwise, the following technical specifications are valid for all the following SINAMICS G120D distributed inverter components listed here.

SINAMICS G120D	
<b>Mechanical specifications</b>	
<b>Vibratory load</b>	
• Transport acc. to EN 60721-3-2 <sup>1)</sup>	Class 1M2
• Operation acc. to EN 60721-3-3	Class 3M2
<b>Shock load</b>	
• Transport acc. to EN 60721-3-2 <sup>1)</sup>	Class 1M2
• Operation acc. to EN 60721-3-3	Class 3M2
<b>Ambient conditions</b>	
<b>Degree of protection</b>	IP65/UL Type 3
<b>Protection class</b> According to EN 61800-5-1	Class III (PELV)
<b>Touch protection</b> According to EN 61800-5-1	Class I (with protective conductor system)
<b>Permissible ambient/coolant temperature (air) during operation</b>	-10 ... +40 °C (14 ... 104 °F) without derating >40 ... 55 °C (104 ... 131 °F), <a href="#">see derating characteristics</a>
<b>Humidity, max.</b>	95 % at 40 °C (104 °F)
<b>Ambient temperature</b>	
• Storage <sup>1)</sup> acc. to EN 60068-2-1	-40 ... +70 °C (-40 ... +158 °F)
• Transport <sup>1)</sup> acc. to EN 60068-2-1	-40 ... +70 °C (-40 ... +158 °F)
• Operation acc. to EN 60068-2-2	-10 ... +40 °C (14 ... 104 °F) without derating
<b>Environmental class/harmful chemical substances</b>	
• Operation acc. to EN 60721-3-3	Class 3C2
<b>Degree of pollution acc. to EN 61800-5-1</b>	2
<b>Certification for fail-safe versions</b>	
• According to IEC 61508	SIL 2
• According to EN ISO 13849-1	PL d and Category 3
<b>Standards</b>	
<b>Compliance with standards</b>	UL 508C (UL list number E121068), cUL, CE, RCM
<b>CE marking, according to</b>	Low Voltage Directive 2014/35/EU
<b>EMC Directive</b>	
• Frame sizes FSA to FSC with integrated line filter class A	Category C2 <sup>2)</sup> according to EN 61800-3 <b>Note:</b> The EMC product standard EN 61800-3 does not apply directly to a frequency inverter but to a PDS (Power Drive System), which comprises the complete circuitry, motor and cables in addition to the inverter. The frequency inverters on their own do not generally require identification according to the EMC Directive.

<sup>1)</sup> In product packaging.

<sup>2)</sup> With shielded motor cable up to 15 m (49 ft).

## SINAMICS G120D distributed inverters

0.75 kW to 7.5 kW (1 hp to 10 hp)

### CU240D-2 and CU250D-2 Control Units

#### Overview

The Control Unit performs closed-loop control functions for the inverter. In addition to the closed-loop control, it has additional functions that can be adapted to the particular application through parameterization. The CU240D-2 Control Units supersede the CU240D Control Units, whereby both versions can be operated with PM250D Power Modules.

CU250D-2 Control Units can be used to implement applications with positioning requirements in the drive. This expansion opens up their use in lifting, swiveling, traversing or rotating applications. The positioning functionality is comparable to that of SINAMICS S110 servo drives.

Two points must be noted in this context:

- Vector control (VC) and sensorless vector control (SLVC) are possible (but not servo control)
- Positioning using one encoder (HTL/SSI) or using two encoders simultaneously (HTL for speed control and SSI for positioning)

Control Units are available in different versions:

- CU240D-2 DP
- CU240D-2 DP-F
- CU240D-2 PN
- CU240D-2 PN-F
- CU240D-2 PN-F PP (Push Pull)
- CU240D-2 PN-F FO (fiber optic)
- CU250D-2 DP-F
- CU250D-2 PN-F
- CU250D-2 PN-F PP (Push Pull)
- CU250D-2 PN-F FO (fiber optic)

The Push Pull version comprises an alternative connection method for the 24 V DC supply voltage and the PN communication.



CU240D-2 DP Control Unit



CU250D-2 DP-F Control Unit



CU240D-2 PN Control Unit



CU250D-2 PN-F Control Unit



CU250D-2 PN-F PP and CU250D-2 PN-F FO Control Units

## SINAMICS G120D distributed inverters

0.75 kW to 7.5 kW (1 hp to 10 hp)

### CU240D-2 and CU250D-2 Control Units

#### Overview (continued)

##### Safety Integrated functions

The safety function "Safe Torque Off" (STO) (certified according to IEC 61508 SIL 2, EN ISO 13849-1 PL d and Category 3) is already integrated into the standard versions of the CU240D-2 series (CU240D-2 DP and CU240D-2 PN). It can be activated either over PROFIsafe or over the safety input.

With the fail-safe variants of the CU240D-2 series (CU240D-2 DP-F xx and CU240D-2 PN-F xx) and with the entire CU250D-2 series, the fail-safe SINAMICS G120D inverter provides five safety functions which are certified according to IEC 61508 SIL 2, EN ISO 13849-1 PL d and Category 3:

- Safe Torque Off (STO)  
to protect against active movement of the drive
- Safe Stop 1 (SS1)  
for continuous monitoring of a safe braking ramp
- Safely-Limited Speed (SLS)  
for protection against dangerous movements on exceeding a speed limit
- Safe direction (SDI)  
This function ensures that the drive can only rotate in the selected direction.
- Safe speed monitoring (SSM)  
This function signals if a drive is operating below a specific speed/feed velocity.

These functions can be activated by means of PROFIsafe or via the safety inputs. A safety output is provided in addition.

None of the safety functions require a motor encoder and they are thus much cheaper and easier to implement. Existing systems in particular can be simply updated with safety technology without the need to change the motor or mechanical system.

The Safe Torque Off (STO) function can be used without restriction for all applications. The SS1, SLS, SSM and SDI functions are only permissible for applications where the load can never accelerate when the inverter is switched off. They are therefore not permitted for applications involving pull-through loads such as hoisting gear and unwinders.

Further information can be found in the section [Safety Integrated](#).

#### Selection and ordering data

Communication	Digital inputs (number which can be parameterized as fail-safe given below)	Analog inputs	Digital outputs (number which can be parameterized as fail-safe given below)	Encoder interfaces HTL/SSI	Safety Integrated functions	Description	Control Unit Article No.
<b>CU240D-2 series – standard</b>							
PROFIBUS DP	6 (1)	2	2	1/–	STO	CU240D-2 DP	<b>6SL3544-0FB20-1PA0</b>
PROFINET, EtherNet/IP	6 (1)	2	2	1/–	STO	CU240D-2 PN	<b>6SL3544-0FB20-1FA0</b>
<b>CU240D-2 series – fail-safe for Safety Integrated</b>							
PROFIBUS DP	6 (3)	2	2 (1)	1/–	STO, SLS, SS1, SSM, SDI	CU240D-2 DP-F	<b>6SL3544-0FB21-1PA0</b>
PROFINET, EtherNet/IP	6 (3)	2	2 (1)	1/–	STO, SLS, SS1, SSM, SDI	CU240D-2 PN-F	<b>6SL3544-0FB21-1FA0</b>
						CU240D-2 PN-F PP	<b>6SL3544-0FB21-1FB0</b>
						CU240D-2 PN-F FO	<b>6SL3544-0FB21-1FC0</b>
<b>CU250D-2 series – basic positioner (EPos) and fail-safe for Safety Integrated</b>							
PROFIBUS DP	6 (3)	–	2 (1)	1/1	STO, SLS, SS1, SSM, SDI	CU250D-2 DP-F	<b>6SL3546-0FB21-1PA0</b>
PROFINET, EtherNet/IP	6 (3)	–	2 (1)	1/1	STO, SLS, SS1, SSM, SDI	CU250D-2 PN-F	<b>6SL3546-0FB21-1FA0</b>
						CU250D-2 PN-F PP	<b>6SL3546-0FB21-1FB0</b>
						CU250D-2 PN-F FO	<b>6SL3546-0FB21-1FC0</b>

#### Note:

An external 24 V DC power supply is required in order to operate the Control Unit. For information about suitable connecting cables, refer to section Supplementary system components, Connecting cables/connectors for supplying the Control Unit with 24 V DC power.

For optional memory cards, see section Supplementary system components.

# SINAMICS G120D distributed inverters

0.75 kW to 7.5 kW (1 hp to 10 hp)

## CU240D-2 and CU250D-2 Control Units

### Design

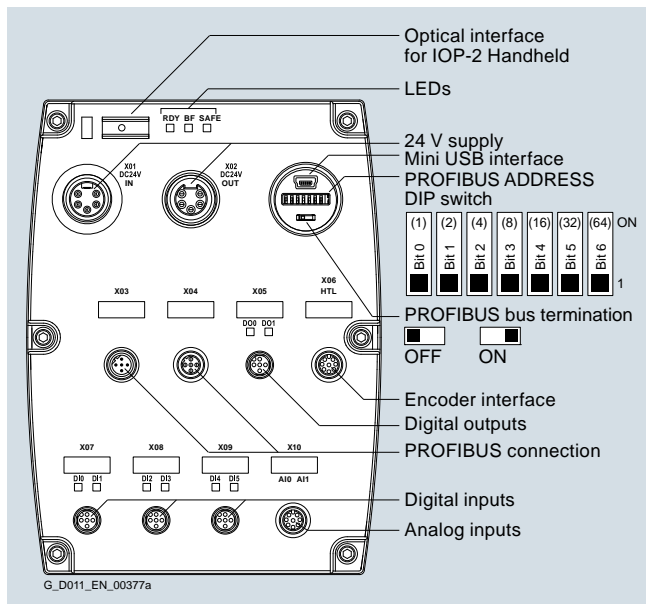

CU240D-2 DP Control Unit

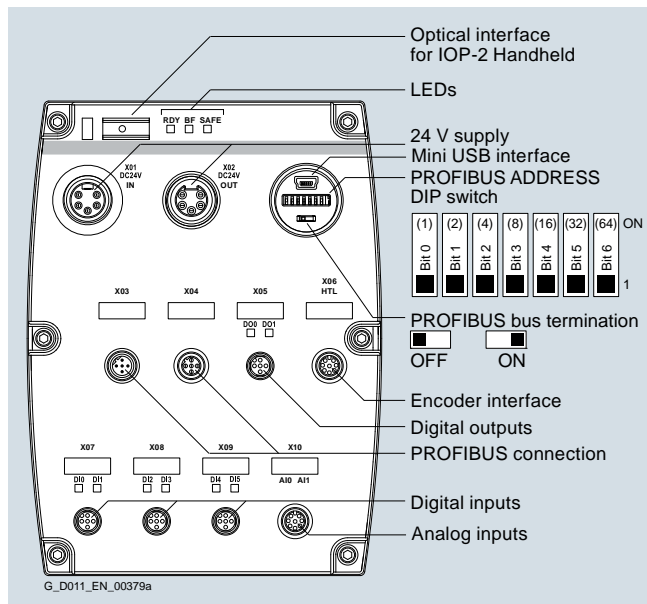

CU240D-2 DP-F Control Unit

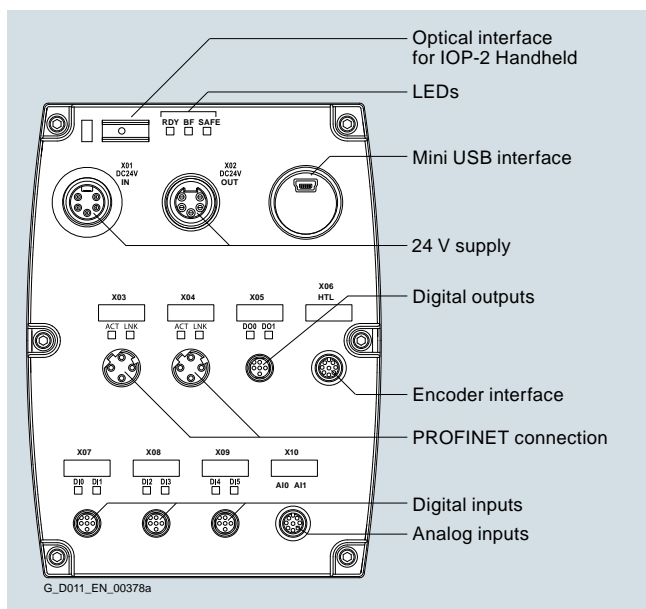

CU240D-2 PN Control Unit

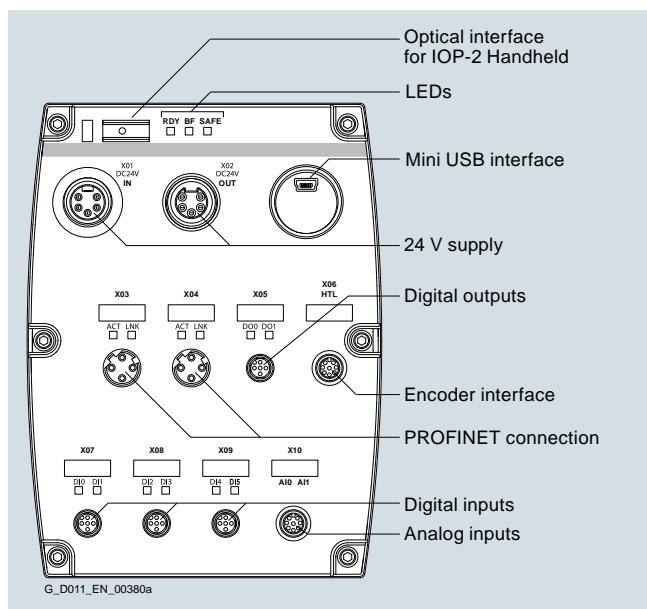

CU240D-2 PN-F Control Unit

# SINAMICS G120D distributed inverters

0.75 kW to 7.5 kW (1 hp to 10 hp)

## CU240D-2 and CU250D-2 Control Units

### Design (continued)

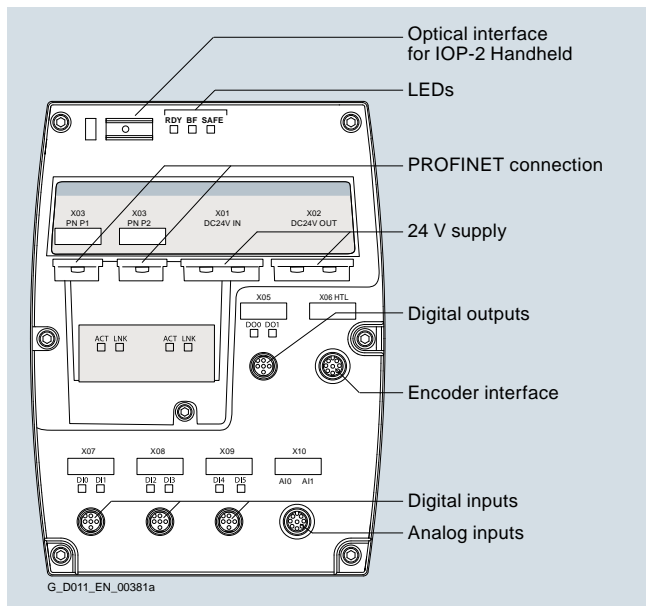

CU240D-2 PN-F PP and CU240D-2 PN-F FO Control Units

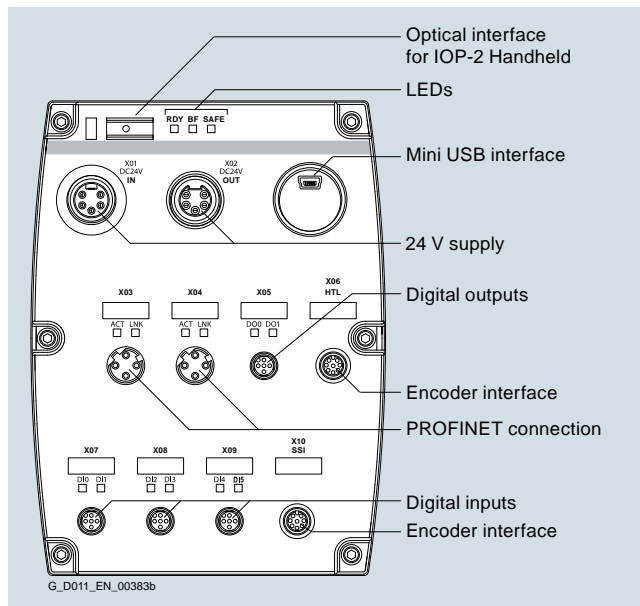

CU250D-2 PN-F Control Unit

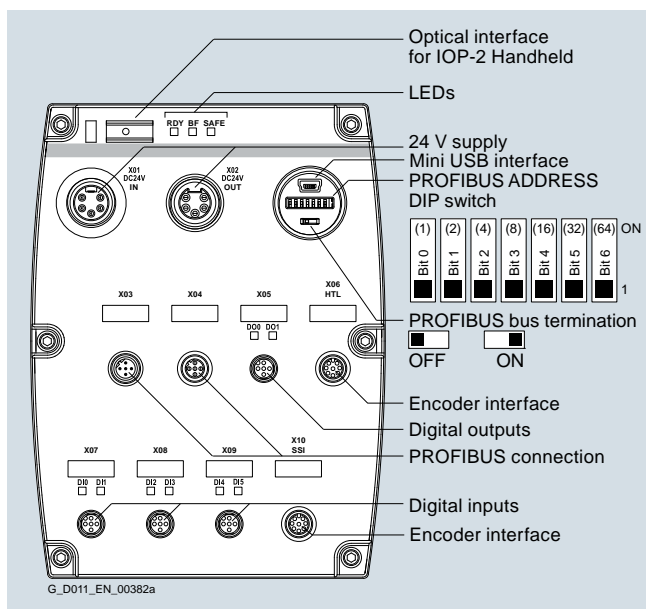

CU250D-2 DP-F Control Unit

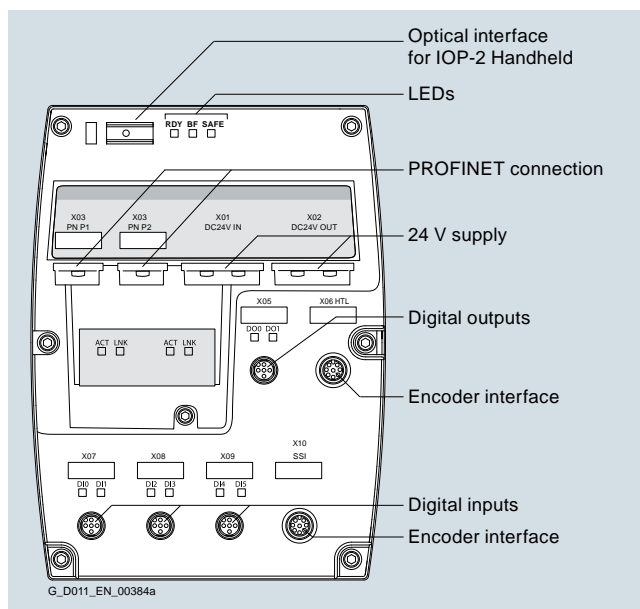

CU250D-2 PN-F PP and CU250D-2 PN-F FO Control Units



Control Unit, view from the rear, memory card slot at the top and PM-IF interface at bottom center



### Function

#### Function module basic positioner EPos

The basic positioner EPos is available as a standard technology function for the following SINAMICS Control Units and can be called as a function module that can be activated additionally.

- SINAMICS S120 CU310-2 and CU320-2 Control Units
- SINAMICS S110 CU305 Control Units
- SINAMICS G120 CU250S-2 Control Units
- SINAMICS G120D CU250D-2 Control Units

The basic positioner can be used to resolve basic motion control tasks without additional external technological outlay from the drive itself.

#### Integrated functionality for absolute and relative positioning of linear and rotary axes with motor encoders or machine encoders.

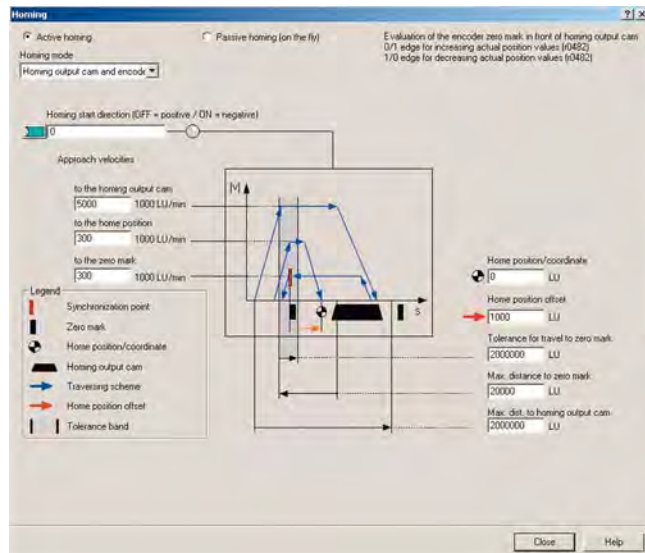
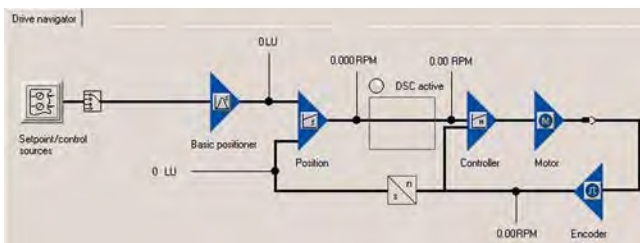

The EPos basic positioner in the SINAMICS drive system provides powerful and precise positioning functions. Due to its flexibility and adaptability, the basic positioner can be used for a wide range of positioning tasks.

The functions are easy to handle both during commissioning and during operation, and the comprehensive monitoring functions are outstanding.

Many applications can be carried out without external position controllers.

The EPos basic positioner is used to position linear and rotary axes (modulo) in absolute/relative terms with rotary as well as linear motor encoder or machine encoder (indirect or direct measuring system).

EPos is a function module that can be activated additionally in Servo Control and in Vector Control.

User-friendly configuring and commissioning, including control panel (operation using PC) and diagnostics, are possible with the STARTER and SINAMICS Startdrive commissioning tools.

In addition to extremely flexible positioning functions, EPos offers a high degree of user-friendliness and reliability thanks to integral monitoring and compensation functions.

Different operating modes and their functionality increase flexibility and plant productivity, for example, by means of "on-the-fly" and bumpless correction of the motion control.

Preconfigured PROFIdrive positioning frames are available which, when selected, automatically establish the internal "connection" to the basic positioner.

## SINAMICS G120D distributed inverters

0.75 kW to 7.5 kW (1 hp to 10 hp)

### CU240D-2 and CU250D-2 Control Units

#### Function (continued)

##### *Functionality of the EPos basic positioner*

Lower-level closed-loop position control with the following essential components

- Position actual value sensing (including the lower-level measuring probe evaluation and reference mark search)
- Position controller (including limits, adaptation and pre-control calculation)
- Monitoring functions (standstill, positioning and dynamic following error monitoring, cam signals)

##### Mechanical system

- Backlash compensation
- Modulo offset

##### Limitations

- Speed/acceleration/delay/jerk limitation
- Software limit switches (traversing range limitation by means of position setpoint evaluation)
- Stop cams (traversing range limitation using hardware limit switch evaluation)

##### Referencing or adjustment

- Set reference point (for an axis at standstill)
- Search for reference (separate mode including reversing cam functionality, automatic reversal of direction, homing to "output cam and encoder zero mark" or only "encoder zero mark" or "external zero mark (BERO)")
- Flying referencing (seamless referencing possible during "normal" traversing with the aid of the measuring input evaluation; generally evaluation, e.g. of a BERO. Subordinate function for the modes "jog", "direct setpoint input/MDI" and "traversing blocks")
- Absolute encoder alignment

##### Traversing block mode

- 64 traversing blocks for
  - SINAMICS S120 CU310-2 and CU320-2 Control Units
- 16 traversing blocks for
  - SINAMICS S110 CU305 Control Units
  - SINAMICS G120 CU250S-2 Control Units
  - SINAMICS G120D CU250D-2 Control Units
- Positioning using traversing blocks that can be stored in the drive unit, including continuation conditions and specific jobs for previously homed axis
- Configuring traversing blocks using the traversing block editor in the relevant commissioning tool of the SINAMICS drive family
- A traversing block contains the following information:
  - Job number and job (e.g. positioning, waiting, GOTO block jump, setting of binary outputs, travel to fixed endstop)
  - Motion parameters (target position, velocity, override for acceleration and deceleration)
  - Mode (e.g.: hide block, continuation conditions such as "Continue\_with\_stop", "Continue\_flying" and "Continue\_externally using high-speed measuring inputs")
  - Job parameters (e.g. wait time, block step conditions)

##### Direct setpoint specification mode (MDI)

- Positioning (absolute, relative) and setting-up (endless closed-loop position control) using direct setpoint inputs (e.g. via the PLC using process data)
- It is always possible to influence the motion parameters during traversing (on-the-fly setpoint acceptance) as well as for on-the-fly changes between the setup and positioning modes.
- The direct setpoint specification mode (MDI) can also be used in the relative positioning or setup mode if the axis is not referenced. This means that on-the-fly synchronization and re-referencing can be carried out using "flying referencing".

##### Jog mode

- Closed-loop position controlled traversing of the axis with "endless position controlled" or "jog incremental" modes (traverse through a "step width"), which can be toggled between

Further information can be found in the section [Technology functions](#).

# SINAMICS G120D distributed inverters

0.75 kW to 7.5 kW (1 hp to 10 hp)

## CU240D-2 and CU250D-2 Control Units

### Integration

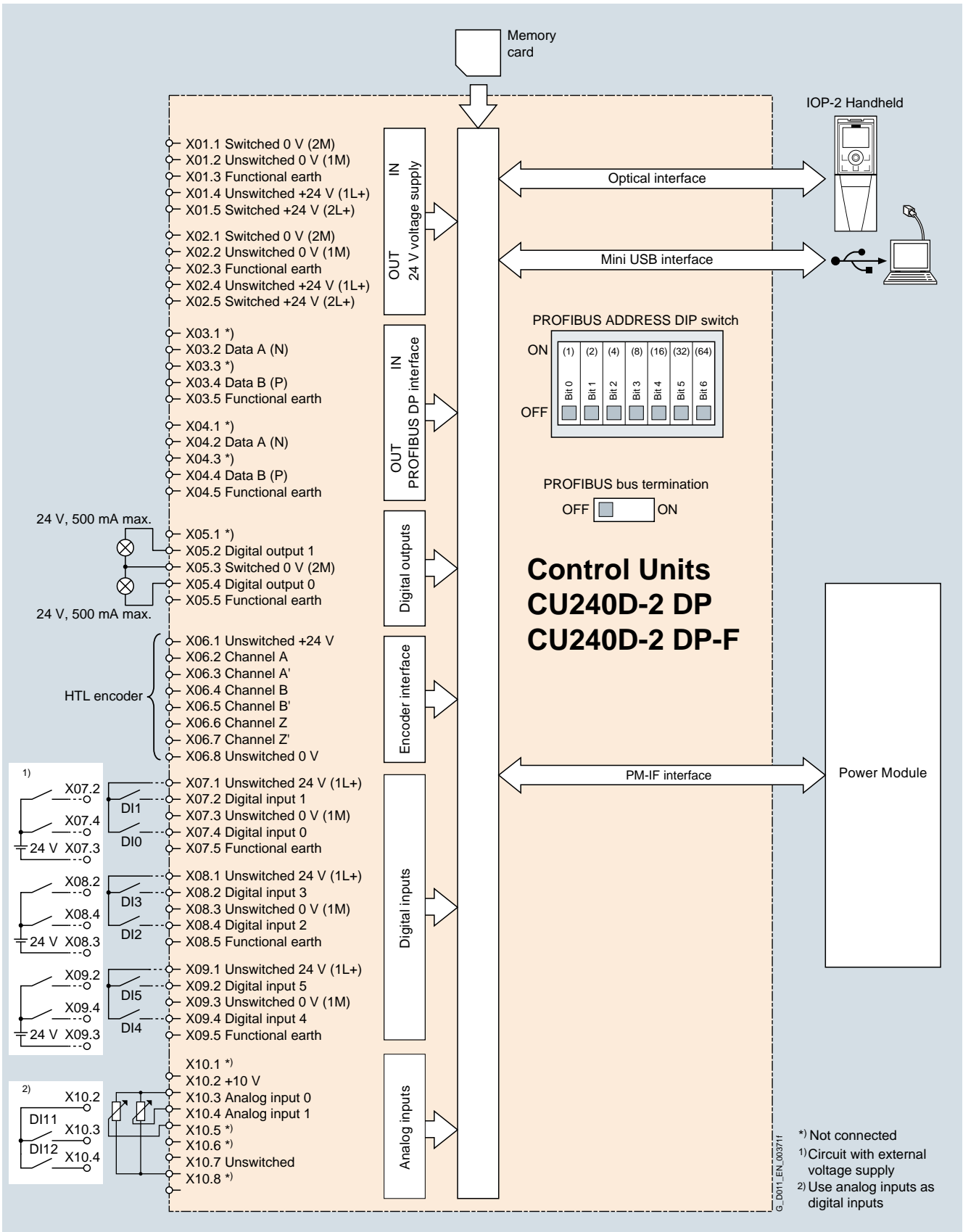

Connection example for CU240D-2 DP and CU240D-2 DP-F Control Units

# SINAMICS G120D distributed inverters

0.75 kW to 7.5 kW (1 hp to 10 hp)

## CU240D-2 and CU250D-2 Control Units

### Integration (continued)

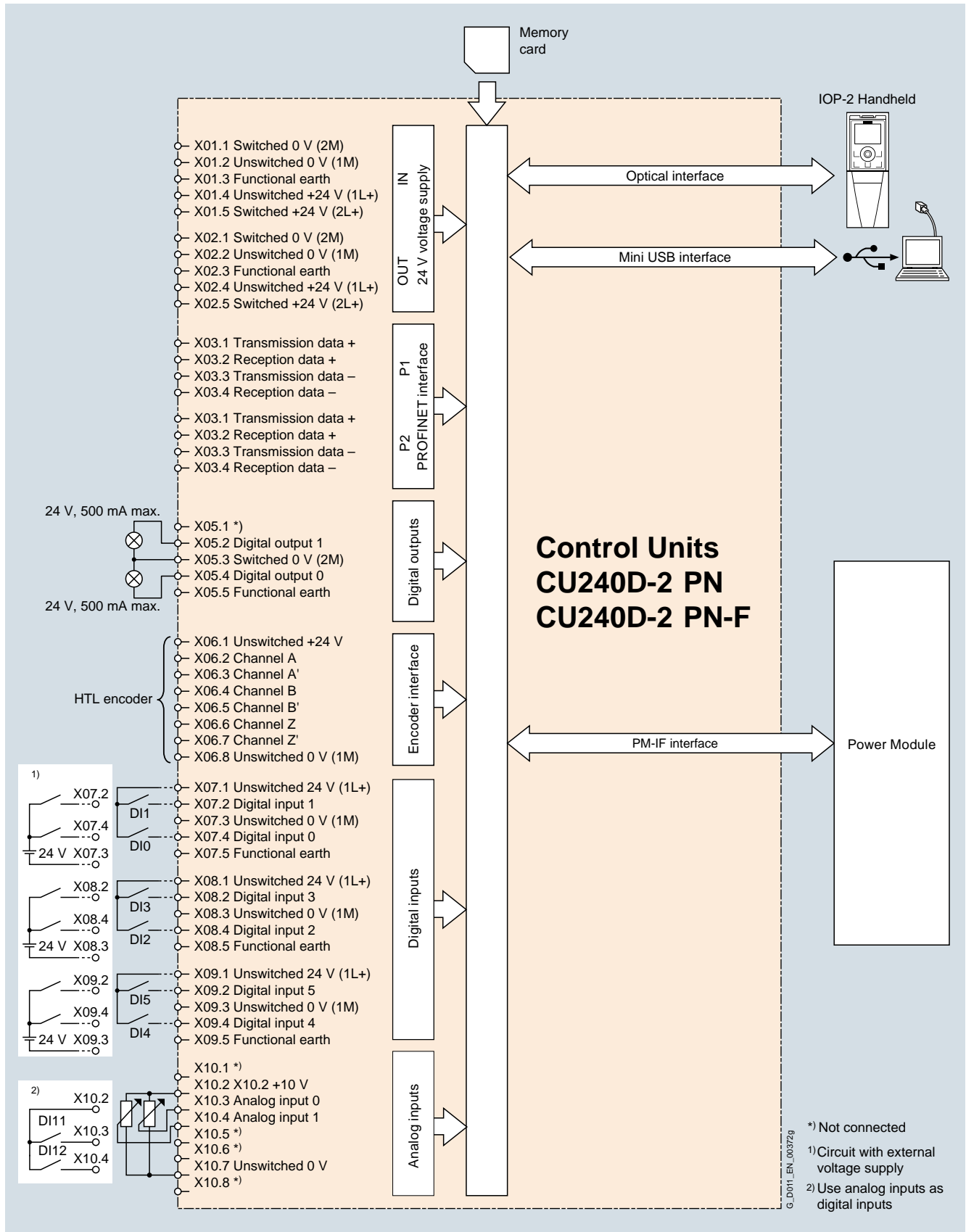

Connection example for CU240D-2 PN and CU240D-2 PN-F Control Units

**SINAMICS G120D distributed inverters**  
0.75 kW to 7.5 kW (1 hp to 10 hp)

CU240D-2 and CU250D-2 Control Units

**Integration (continued)**

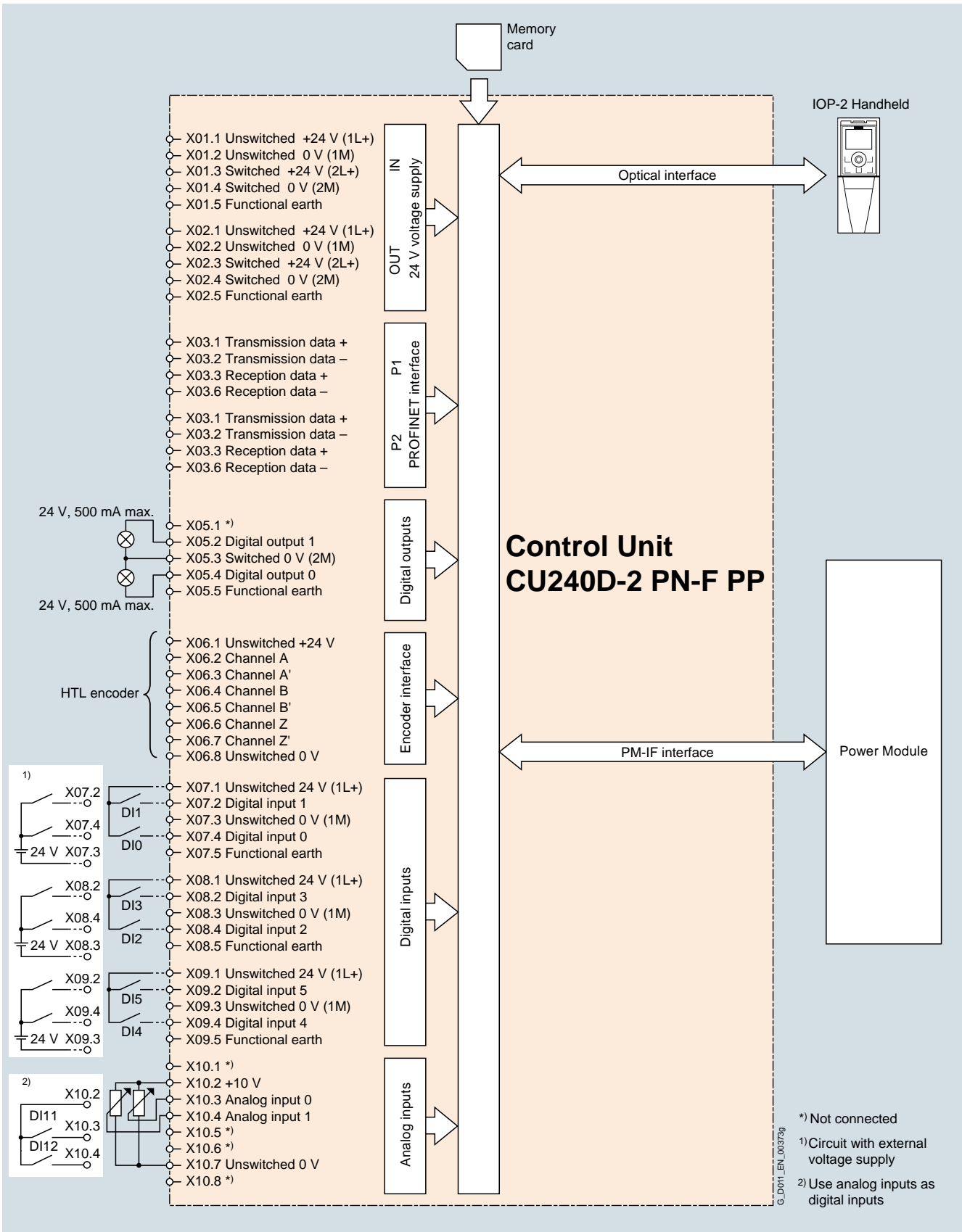

Connection example for CU240D-2 PN-F PP Control Unit

# SINAMICS G120D distributed inverters

0.75 kW to 7.5 kW (1 hp to 10 hp)

## CU240D-2 and CU250D-2 Control Units

### Integration (continued)

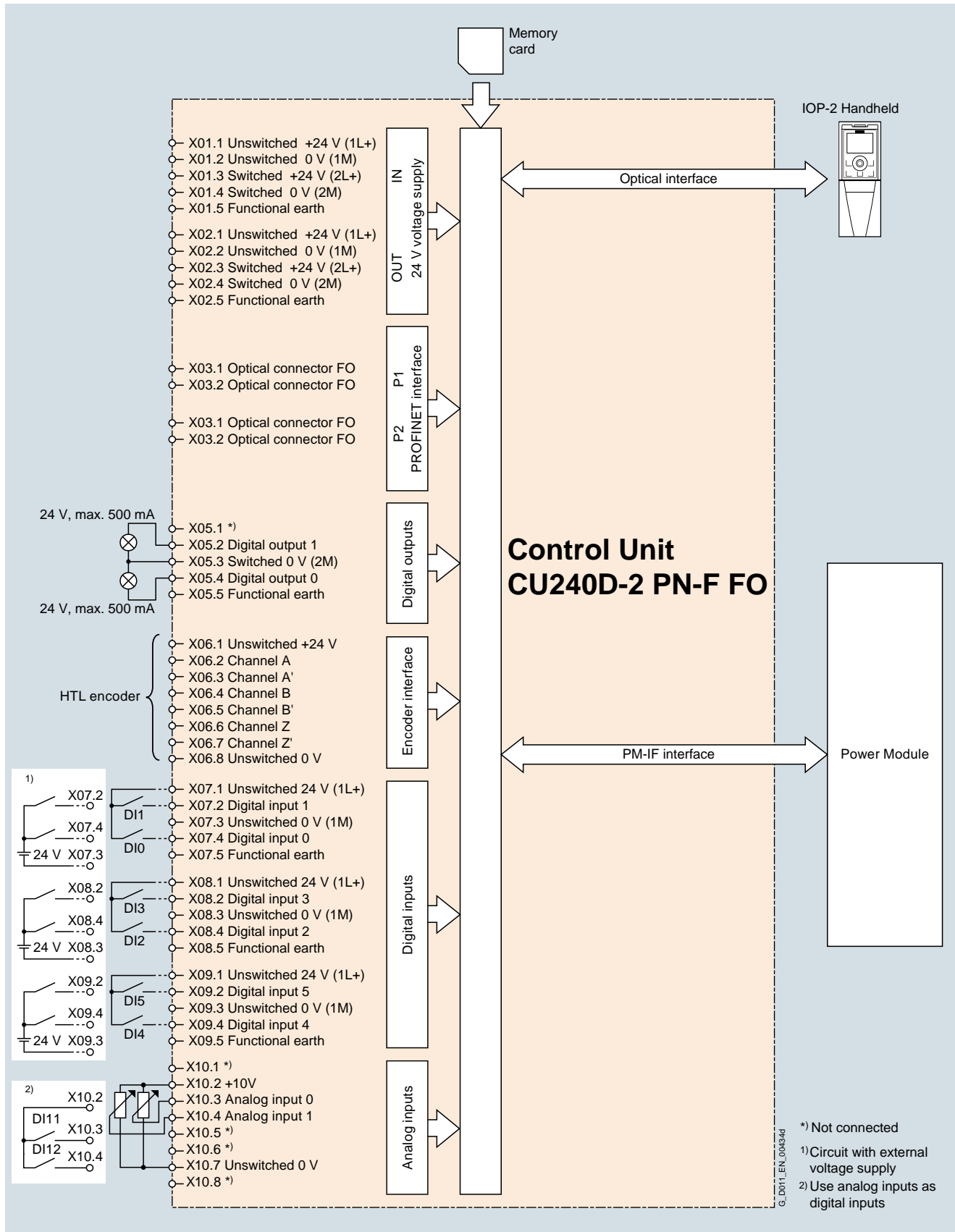

Connection example for CU240D-2 PN-F FO Control Unit

# SINAMICS G120D distributed inverters

0.75 kW to 7.5 kW (1 hp to 10 hp)

CU240D-2 and CU250D-2 Control Units

## Integration (continued)

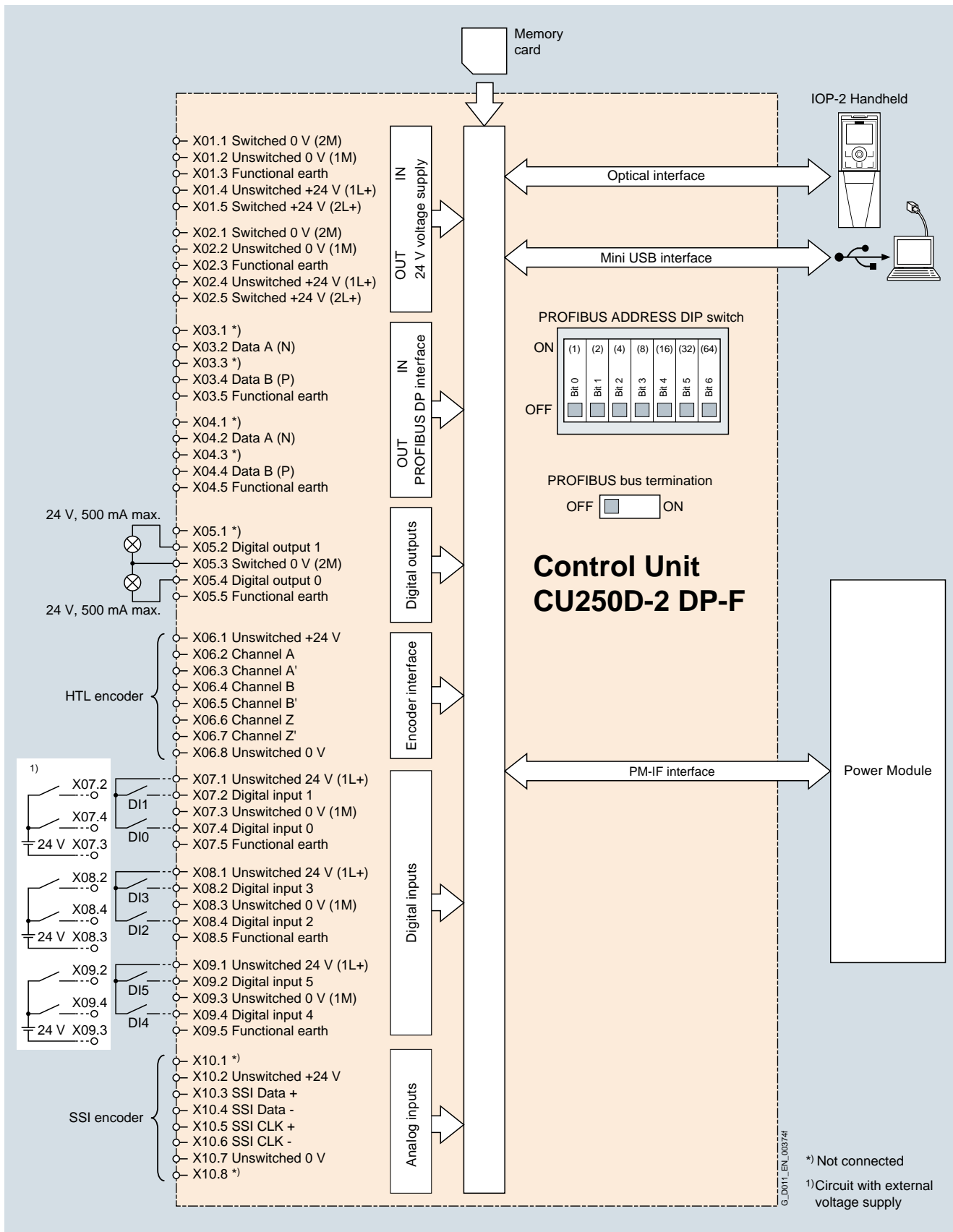

Connection example for CU250D-2 DP-F Control Unit

# SINAMICS G120D distributed inverters

0.75 kW to 7.5 kW (1 hp to 10 hp)

## CU240D-2 and CU250D-2 Control Units

### Integration (continued)

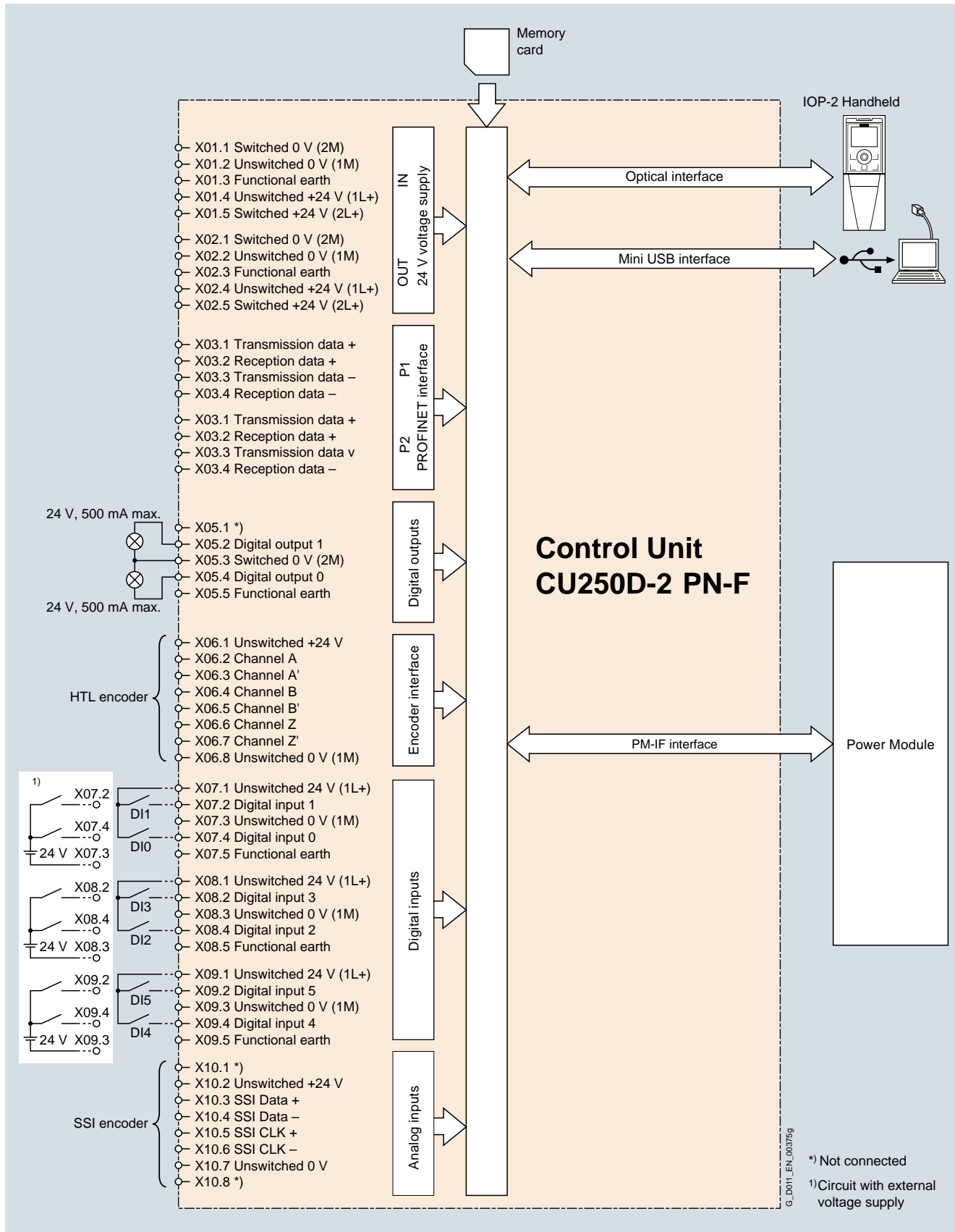

Connection example for CU250D-2 PN-F Control Unit



**Integration** (continued)

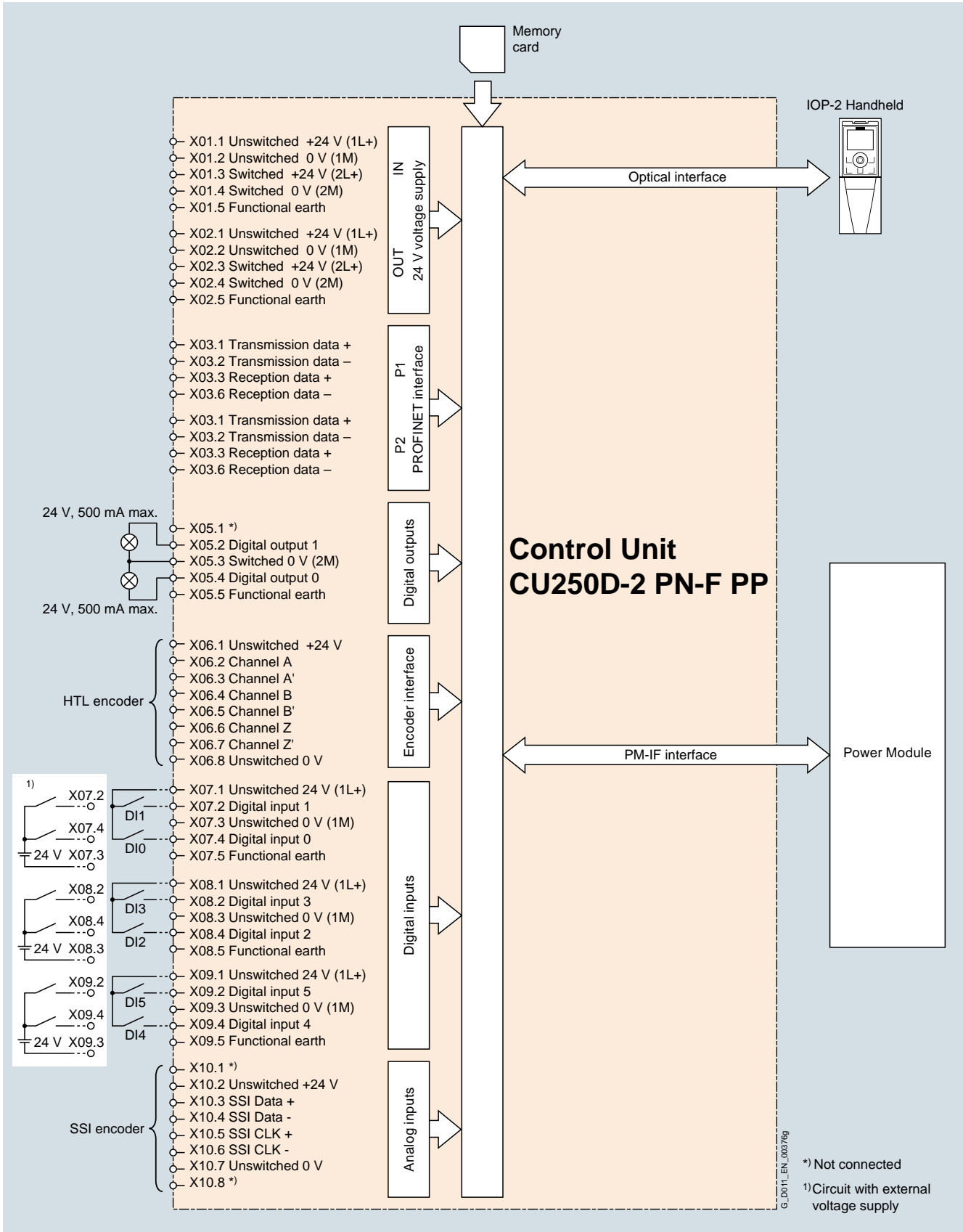

Connection example for CU250D-2 PN-F PP Control Unit

# SINAMICS G120D distributed inverters

0.75 kW to 7.5 kW (1 hp to 10 hp)

## CU240D-2 and CU250D-2 Control Units

### Integration (continued)

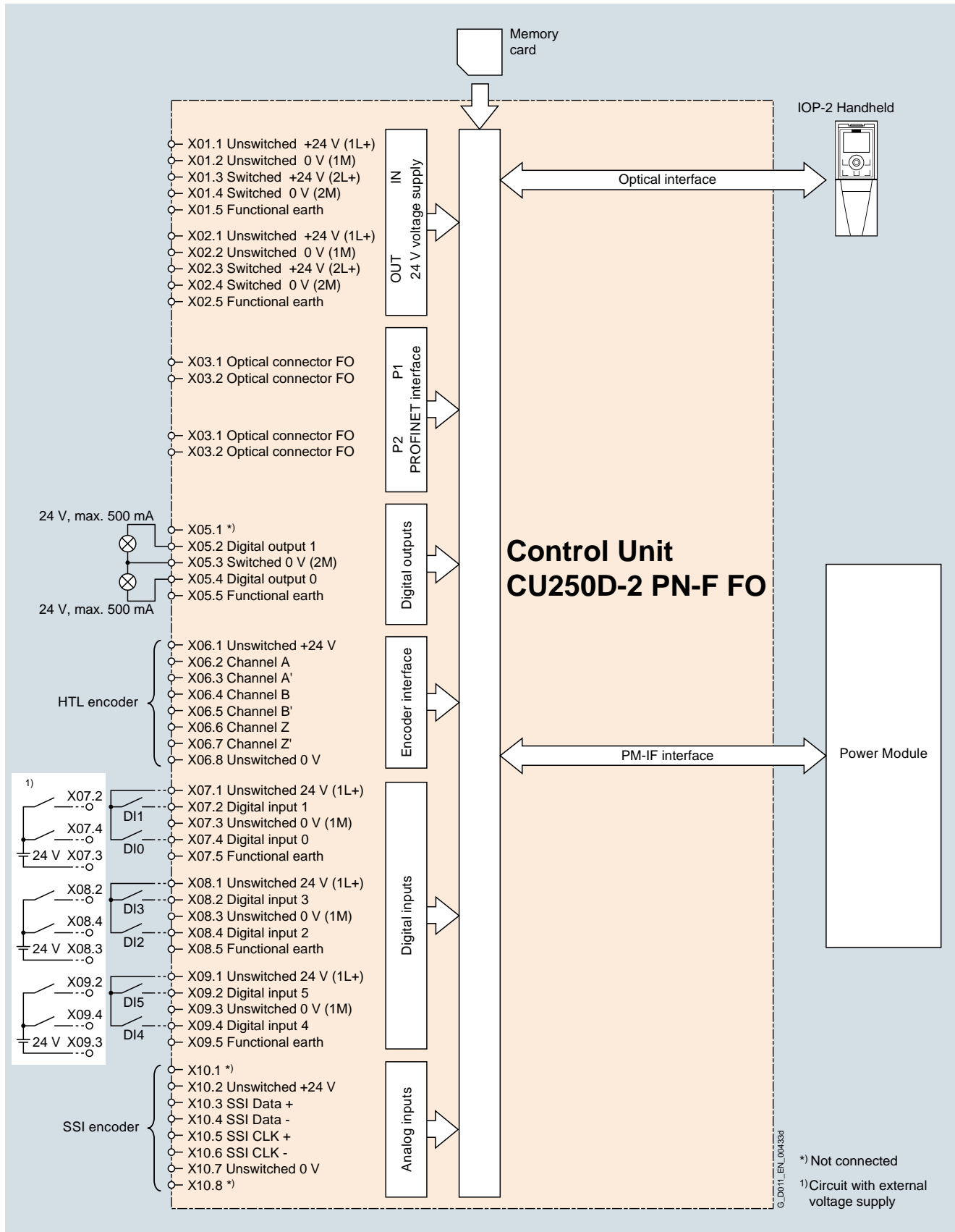

Connection example for CU250D-2 PN-F FO Control Unit

# SINAMICS G120D distributed inverters

0.75 kW to 7.5 kW (1 hp to 10 hp)

## CU240D-2 and CU250D-2 Control Units

### Technical specifications

Control Unit	CU240D-2 DP 6SL3544-0FB20-1PA0	CU240D-2 PN 6SL3544-0FB20-1FA0	CU240D-2 DP-F 6SL3544-0FB21-1PA0	CU240D-2 PN-F 6SL3544-0FB21-1FA0  CU240D-2 PN-F PP 6SL3544-0FB21-1FB0  CU240D-2 PN-F FO 6SL3544-0FB21-1FC0	CU250D-2 DP-F 6SL3546-0FB21-1PA0	CU250D-2 PN-F 6SL3546-0FB21-1FA0  CU250D-2 PN-F PP 6SL3546-0FB21-1FB0  CU250D-2 PN-F FO 6SL3546-0FB21-1FC0
<b>Electrical specifications</b>						
<b>Operating voltage</b>	External 24 V DC necessary	External 24 V DC necessary	External 24 V DC necessary	External 24 V DC necessary	External 24 V DC necessary	External 24 V DC necessary
<b>Current consumption <sup>1)</sup></b> (from the 24 V DC supply)						
• With Power Module frame sizes FSA and FSB	300 mA	400 mA	300 mA	400 mA (FO variant: 520 mA)	300 mA	400 mA (FO variant: 520 mA)
• With Power Module frame size FSC	450 mA	550 mA	450 mA	550 mA (FO variant: 670 mA)	450 mA	550 mA (FO variant: 670 mA)
<b>Interfaces</b>						
<b>Digital inputs</b> (non-isolated)	6	6	6	6	6	6
• Optionally parameterizable as safe inputs	1	1	3	3	3	3
<b>Analog inputs</b> (0 ... 10 V)	2	2	2	2	–	–
<b>Digital outputs</b> (0.5 A, fed through switched 24 V DC, isolated)	2	2	2	2	2	2
• Optionally parameterizable as safe digital output	–	–	1	1	1	1
<b>Bus interface</b>						
• Fieldbus protocols	PROFIBUS DP	PROFINET EtherNet/IP	PROFIBUS DP	PROFINET EtherNet/IP	PROFIBUS DP	PROFINET EtherNet/IP
• Profiles	PROFIdrive PROFIsafe	PROFIdrive PROFIsafe PROFInergy	PROFIdrive PROFIsafe	PROFIdrive PROFIsafe PROFInergy	PROFIdrive PROFIsafe	PROFIdrive PROFIsafe PROFInergy
<b>HTL encoder interface</b> (incremental interface, bipolar up to 2048 pulses, max. 150 mA)	1	1	1	1	1	1
<b>SSI encoder interface</b> (absolute encoder, single-turn and multi-turn 4096 pulses, 24 V, max. 250 mA)	–	–	–	–	1	1
<b>PTC/KTY interface</b> (connection via Power Module)	✓	✓	✓	✓	✓	✓
• Motor temperature sensor	1 input, sensors that can be connected: PTC, KTY, bimetal or Pt1000	1 input, sensors that can be connected: PTC, KTY, bimetal or Pt1000	1 input, sensors that can be connected: PTC, KTY, bimetal or Pt1000	1 input, sensors that can be connected: PTC, KTY, bimetal or Pt1000	1 input, sensors that can be connected: PTC, KTY, bimetal or Pt1000	1 input, sensors that can be connected: PTC, KTY, bimetal or Pt1000
<b>Control of a mechanical motor brake</b> (connection via Power Module)	✓	✓	✓	✓	✓	✓
<b>Slot for SINAMICS SD memory card</b>	✓	✓	✓	✓	✓	✓
<b>Commissioning interface (mini USB)</b>	✓	✓	✓	✓ Not with PP and FO variants	✓	✓ Not with PP and FO variants

<sup>1)</sup> The current consumption of connected encoders (HTL ≤ 100 mA or SSI ≤ 250 mA), sensors (total, max. 300 mA) as well as the current drawn from the digital outputs (total, max. 500 mA) must be added, where applicable.

## SINAMICS G120D distributed inverters

0.75 kW to 7.5 kW (1 hp to 10 hp)

### CU240D-2 and CU250D-2 Control Units

#### Technical specifications (continued)

Control Unit	CU240D-2 DP 6SL3544- 0FB20-1PA0	CU240D-2 PN 6SL3544- 0FB20-1FA0	CU240D-2 DP-F 6SL3544- 0FB21-1PA0	CU240D-2 PN-F 6SL3544- 0FB21-1FA0	CU240D-2 PN-F 6SL3544- 0FB21-1FA0	CU250D-2 DP-F 6SL3546- 0FB21-1PA0	CU250D-2 PN-F 6SL3546- 0FB21-1FA0	
				<b>CU240D-2 PN-F PP</b> 6SL3544- 0FB21-1FB0	<b>CU240D-2 PN-F FO</b> 6SL3544- 0FB21-1FC0		<b>CU250D-2 PN-F PP</b> 6SL3546- 0FB21-1FB0	<b>CU250D-2 PN-F FO</b> 6SL3546- 0FB21-1FC0
<b>Safety functions</b>								
<b>Integrated safety functions</b> acc. to IEC 61508 SIL 2, EN ISO 13849-1 PL d and Category 3	• Safe Torque Off (STO)	• Safe Torque Off (STO)	• Safe Torque Off (STO) • Safe Stop 1 (SS1) • Safely-Limited Speed (SLS) • Safe Direction (SDI) • Safe Speed Monitor (SSM)	• Safe Torque Off (STO) • Safe Stop 1 (SS1) • Safely-Limited Speed (SLS) • Safe Direction (SDI) • Safe Speed Monitor (SSM)	• Safe Torque Off (STO) • Safe Stop 1 (SS1) • Safely-Limited Speed (SLS) • Safe Direction (SDI) • Safe Speed Monitor (SSM)	• Safe Torque Off (STO) • Safe Stop 1 (SS1) • Safely-Limited Speed (SLS) • Safe Direction (SDI) • Safe Speed Monitor (SSM)	• Safe Torque Off (STO) • Safe Stop 1 (SS1) • Safely-Limited Speed (SLS) • Safe Direction (SDI) • Safe Speed Monitor (SSM)	• Safe Torque Off (STO) • Safe Stop 1 (SS1) • Safely-Limited Speed (SLS) • Safe Direction (SDI) • Safe Speed Monitor (SSM)
<b>Open-loop/closed-loop control techniques</b>								
<b>V/f linear/quadratic/parameterizable</b>	✓	✓	✓	✓	✓	✓	✓	✓
<b>V/f with flux current control (FCC)</b>	✓	✓	✓	✓	✓	✓	✓	✓
<b>Vector control, sensorless</b>	✓	✓	✓	✓	✓	✓	✓	✓
<b>Vector control, with sensor</b>	✓	✓	✓	✓	✓	✓	✓	✓
<b>Torque control, sensorless</b>	✓	✓	✓	✓	✓	–	–	–
<b>Torque control, with sensor</b>	✓	✓	✓	✓	✓	–	–	–
<b>Software functions</b>								
<b>Basic positioner (EPos)</b>	–	–	–	–	–	✓	✓	✓
<b>Fixed frequencies</b>	16, parameterizable	16, parameterizable	16, parameterizable	16, parameterizable	16, parameterizable	16, parameterizable	16, parameterizable	16, parameterizable
<b>Signal interconnection with BICO technology</b>	✓	✓	✓	✓	✓	✓	✓	✓
<b>Automatic restart after line supply failure or operational fault</b>	✓	✓	✓	✓	✓	✓	✓	✓
<b>Slip compensation</b>	✓	✓	✓	✓	✓	✓	✓	✓
<b>Free function blocks (FFB) for logical and arithmetic operations</b>	✓	✓	✓	✓	✓	–	–	–
<b>Ramp smoothing</b>	✓	✓	✓	✓	✓	✓	✓	✓
<b>4 selectable drive datasets</b>	✓	✓	✓	✓	✓	✓	✓	✓
<b>4 selectable command data sets (CDS) (manual/auto)</b>	✓	✓	✓	✓	✓	✓	✓	✓
<b>Flying restart</b>	✓	✓	✓	✓	✓	–	–	–
<b>JOG</b>	✓	✓	✓	✓	✓	–	–	–
<b>Cyclic recording of ramp-up and ramp-down</b>	✓	✓	✓	✓	✓	✓	✓	✓
<b>Technology controller (PID)</b>	✓	✓	✓	✓	✓	–	–	–
<b>Thermal motor protection</b>	✓	✓	✓	✓	✓	✓	✓	✓

## SINAMICS G120D distributed inverters

0.75 kW to 7.5 kW (1 hp to 10 hp)

### CU240D-2 and CU250D-2 Control Units

#### Technical specifications (continued)

Control Unit	CU240D-2 DP 6SL3544- 0FB20-1PA0	CU240D-2 PN 6SL3544- 0FB20-1FA0	CU240D-2 DP-F 6SL3544- 0FB21-1PA0	CU240D-2 PN-F 6SL3544- 0FB21-1FA0  CU240D-2 PN-F PP 6SL3544- 0FB21-1FB0  CU240D-2 PN-F FO 6SL3544- 0FB21-1FC0	CU250D-2 DP-F 6SL3546- 0FB21-1PA0	CU250D-2 PN-F 6SL3546- 0FB21-1FA0  CU250D-2 PN-F PP 6SL3546- 0FB21-1FB0  CU250D-2 PN-F FO 6SL3546- 0FB21-1FC0
<b>Software functions (continued)</b>						
<b>Thermal inverter protection</b>	✓	✓	✓	✓	✓	✓
<b>Setpoint input</b>	✓	✓	✓	✓	✓	✓
<b>Motor identification</b>	✓	✓	✓	✓	✓	✓
<b>Motor holding brake</b>	✓	✓	✓	✓	✓	✓
<b>Mechanical specifications and ambient conditions</b>						
<b>Operating temperature</b>	-10 ... +55 °C (14 ... 131 °F)	-10 ... +50 °C (14 ... 122 °F)	0 ... 55 °C (32 ... 131 °F)	0 ... 50 °C (32 ... 122 °F) (FO variant: 0 ... 45 °C (32 ... 113 °F))	0 ... 55 °C (32 ... 131 °F)	0 ... 50 °C (32 ... 122 °F) (FO variant: 0 ... 45 °C (32 ... 113 °F))
<b>Storage temperature</b>	-40 ... +70 °C (-40 ... +158 °F)	-40 ... +70 °C (-40 ... +158 °F)	-40 ... +70 °C (-40 ... +158 °F)	-40 ... +70 °C (-40 ... +158 °F)	-40 ... +70 °C (-40 ... +158 °F)	-40 ... +70 °C (-40 ... +158 °F)
<b>Relative humidity</b>	< 95 % RH, condensation not permissible	< 95 % RH, condensation not permissible	< 95 % RH, condensation not permissible	< 95 % RH, condensation not permissible	< 95 % RH, condensation not permissible	< 95 % RH, condensation not permissible
<b>Dimensions</b>						
• Width	153 mm (6.02 in)	153 mm (6.02 in)	153 mm (6.02 in)	153 mm (6.02 in)	153 mm (6.02 in)	153 mm (6.02 in)
• Height	208 mm (8.19 in)	208 mm (8.19 in)	208 mm (8.19 in)	208 mm (8.19 in)	208 mm (8.19 in)	208 mm (8.19 in)
• Depth	55 mm (2.17 in)	55 mm (2.17 in)	55 mm (2.17 in)	55 mm (2.17 in) (PP variant: 118 mm (4.65 in))	55 mm (2.17 in)	55 mm (2.17 in) (PP variant: 118 mm (4.65 in))
<b>Weight, approx.</b>	0.8 kg (1.76 lb)	0.8 kg (1.76 lb)	0.8 kg (1.76 lb)	0.8 kg (1.76 lb) (PP and FO variants: 1.3 kg (2.87 lb))	0.8 kg (1.76 lb)	0.8 kg (1.76 lb) (PP and FO variants: 1.3 kg (2.87 lb))

## SINAMICS G120D distributed inverters

0.75 kW to 7.5 kW (1 hp to 10 hp)

### PM250D Power Modules

#### Overview

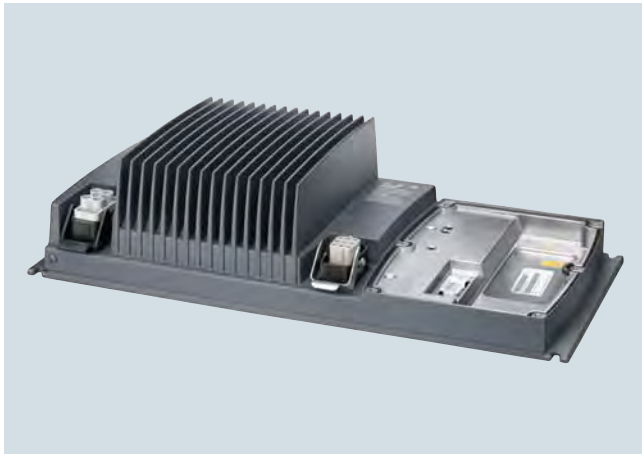

Example of PM250D Power Module, frame size FSA

The regenerative feedback capability of the PM250D Power Module in generating mode (electronic braking) means that energy is returned to the supply system and is not converted into heat in a braking resistor. This saves space, time-consuming dimensioning of the braking resistor as well as its wiring. Generated heat is also reduced. [Further information can be found in the section Energy efficiency.](#)

An innovative circuit design reduces the supply harmonics. A line reactor is not required. This saves space and costs for engineering and procurement.

The PM250D Power Module is also designed for safety-oriented applications. In conjunction with a fail-safe Control Unit, the drive can be transformed into a Safety Integrated Drive ([see Control Units](#)).

The PM250D Power Modules with integrated line filter class A are suitable for connection to TN and TT supply systems.

#### Selection and ordering data

Rated power <sup>1)</sup>		Rated output current <sup>2)</sup>	Input current	Frame size	PM250D Power Module with integrated line filter class A
kW	hp	A	A		Article No.
<b>380 ... 500 V 3 AC</b>					
0.75	1	2.2	2.1	FSA	<b>6SL3525-0PE17-5AA1</b>
1.5	1.5 <sup>3)</sup>	4.1	3.8	FSA	<b>6SL3525-0PE21-5AA1</b>
3	4	7.7	7.2	FSB	<b>6SL3525-0PE23-0AA1</b>
4	5	10.2	9.5	FSC	<b>6SL3525-0PE24-0AA1</b>
5.5	7.5	13.2	12.2	FSC	<b>6SL3525-0PE25-5AA1</b>
7.5	10	19	17.7	FSC	<b>6SL3525-0PE27-5AA1</b>

<sup>1)</sup> Rated power based on the rated output current  $I_{rated}$ . The rated output current  $I_{rated}$  is based on the duty cycle for high overload (HO).

<sup>2)</sup> The rated output current  $I_{rated}$  is based on the duty cycle for high overload (HO). These current values are valid for 400 V and are specified on the rating plate of the Power Module.

<sup>3)</sup> It is not possible to make any assignment to a particular standard.

## SINAMICS G120D distributed inverters

0.75 kW to 7.5 kW (1 hp to 10 hp)

### PM250D Power Modules

#### Integration

PM250D Power Modules communicate with the Control Unit via the PM-IF interface.

PM250D Power Modules feature the following interfaces as standard:

- PM-IF interface to connect the PM250D Power Module to the Control Unit.
- Motor connection via a HAN Q8 (connector) including control of the motor brake and temperature sensor
- Line supply connection via HAN Q4/2 (socket)

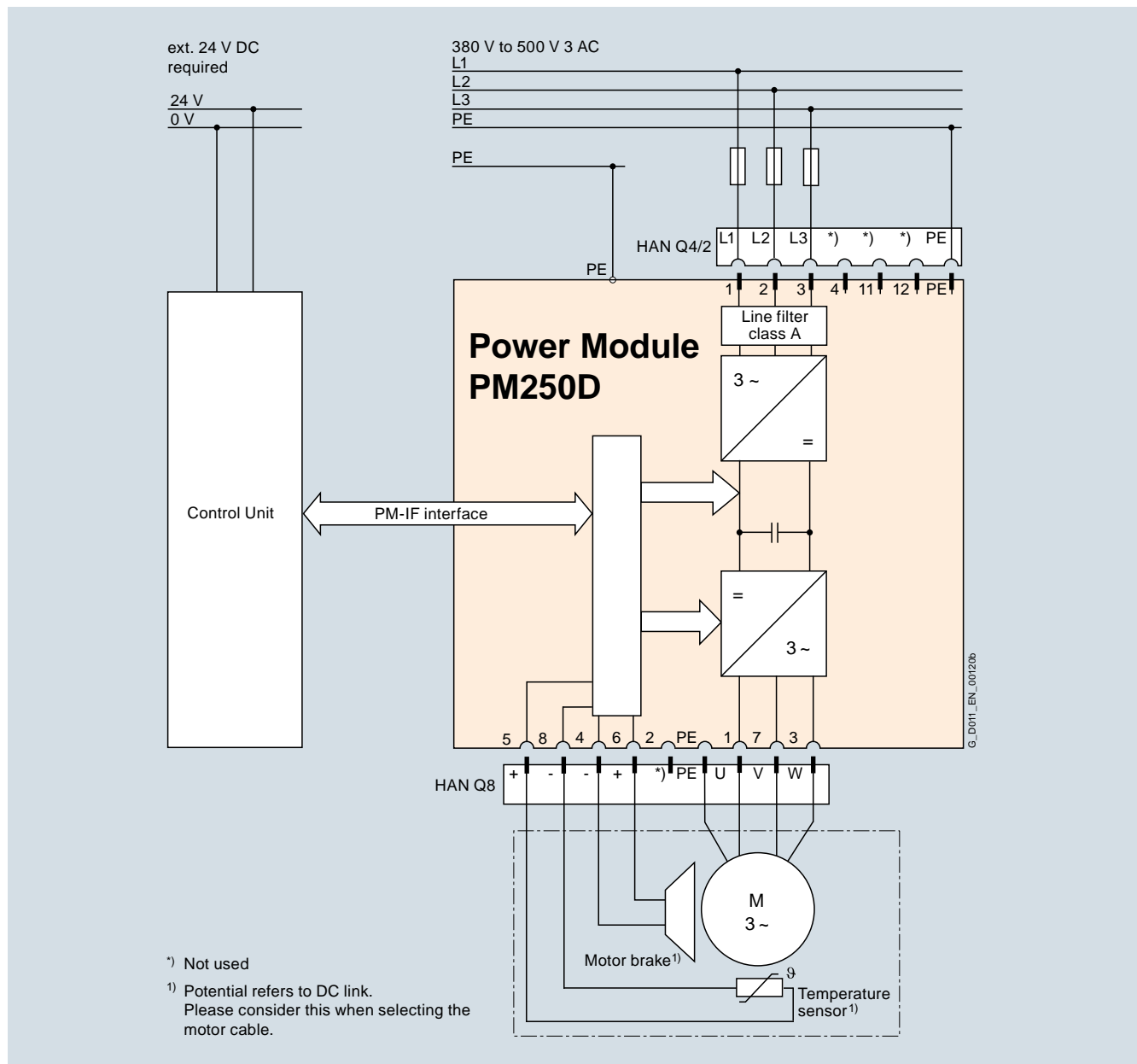

Connection example for PM250D Power Module with integrated line filter class A

# SINAMICS G120D distributed inverters

0.75 kW to 7.5 kW (1 hp to 10 hp)

## PM250D Power Modules

### Technical specifications

#### General technical specifications

PM250D Power Modules													
<b>System operating voltage</b>	380 ... 500 V 3 AC $\pm 10\%$												
<b>Line supply requirements</b> <b>Short-circuit power ratio <math>R_{SC}</math></b>	> 100												
<b>Input frequency</b>	47 ... 63 Hz												
<b>Output frequency</b>													
• Control mode V/f	0 ... 550 Hz <sup>1)</sup>												
• Control type Vector	0 ... 200 Hz												
<b>Pulse frequency</b>	4 kHz (standard), for higher pulse frequencies up to 16 kHz, <a href="#">see derating data</a>												
<b>Power factor <math>\lambda</math></b>	0.95												
<b>Inverter efficiency <math>\eta</math></b>	95 ... 97 %												
<b>Output voltage, max.</b> as % of input voltage	87 %												
<b>Overload capability</b>													
• High overload (HO)	Maximum duty cycle of a total cycle time of 300 s: <ul style="list-style-type: none"> <li>• 2 × rated output current <math>I_{rated}</math> (i.e. 200 % overload) for 3 s and</li> <li>• 1.5 × rated output current <math>I_{rated}</math> (i.e. 150 % overload) for 57 s and</li> <li>• 0.87 × rated output current <math>I_{rated}</math> for the remaining 240 s</li> </ul>												
<b>Electromagnetic compatibility</b>	Integrated line filter class A according to EN 55011												
<b>Possible braking methods</b>	Energy recovery in regenerative mode (max. with rated power possible); Integrated brake control supplies the DC supply voltage for the brake												
	<table border="1"> <thead> <tr> <th>Line input voltage</th> <th>380 V AC</th> <th>400 V AC</th> <th>440 V AC</th> <th>480 V AC</th> <th>500 V AC</th> </tr> </thead> <tbody> <tr> <td>Resulting brake voltage</td> <td>171 V DC</td> <td>180 V DC</td> <td>198 V DC</td> <td>216 V DC</td> <td>225 V DC</td> </tr> </tbody> </table>	Line input voltage	380 V AC	400 V AC	440 V AC	480 V AC	500 V AC	Resulting brake voltage	171 V DC	180 V DC	198 V DC	216 V DC	225 V DC
Line input voltage	380 V AC	400 V AC	440 V AC	480 V AC	500 V AC								
Resulting brake voltage	171 V DC	180 V DC	198 V DC	216 V DC	225 V DC								
	Disconnection on the DC side permits "fast" braking (max. output current 1 A)												
<b>Operating temperature</b>	-10 ... +55 °C (14 ... 131 °F) (operating temperature ranges of the Control Units must be taken into account)												
<b>Storage temperature</b>	-40 ... +70 °C (-40 ... +158 °F)												
<b>Permissible mounting position</b>	Horizontal wall mounting and mounting in the horizontal position												
<b>Relative humidity</b>	< 95 % RH, condensation not permissible												
<b>Cooling</b>	FSA and FSB: Convection FSC: Air cooling as required using the integrated fan												
<b>Installation altitude</b>	Up to 1000 m (3281 ft) above sea level without derating, > 1000 m (3281 ft) <a href="#">see derating characteristics</a>												
<b>Short Circuit Current Rating (SCCR)<sup>2)</sup></b>	40 kA												
<b>Protection functions</b>	<ul style="list-style-type: none"> <li>• Undervoltage</li> <li>• Phase failure detection</li> <li>• Overvoltage</li> <li>• Overload</li> <li>• Ground fault</li> <li>• Short-circuit</li> <li>• Stall protection</li> <li>• Motor blocking protection</li> <li>• Motor overtemperature</li> <li>• Inverter overtemperature</li> <li>• Parameter locking</li> </ul>												
<b>Compliance with standards</b>	UL 508C (UL list number E121068), cUL, CE, RCM												
<b>CE marking, according to</b>	Low Voltage Directive 2014/35/EU												

<sup>1)</sup> For further information, see <https://support.industry.siemens.com/cs/document/107669667>

<sup>2)</sup> Applies to industrial control panel installations to NEC article 409 or UL 508A.



# SINAMICS G120D distributed inverters

0.75 kW to 7.5 kW (1 hp to 10 hp)

## PM250D Power Modules

### Technical specifications (continued)

Line voltage 380 ... 500 V 3 AC		PM250D Power Modules		
		6SL3525-OPE17-5AA1	6SL3525-OPE21-5AA1	6SL3525-OPE23-0AA1
Rated output current $I_{\text{rated}}^{1)}$	A	2.2	4.1	7.7
Maximum output current $I_{\text{max}}$	A	4.4	8.2	15.4
Rated power	kW (hp)	0.75 (1)	1.5 (1.5 <sup>4)</sup> )	3 (4)
Rated pulse frequency	kHz	4	4	4
Efficiency $\eta$	%	>95	>95	>95
Power loss <sup>2)</sup> At rated output current	kW	0.046	0.068	0.125
Cooling air requirement	m <sup>3</sup> /s (ft <sup>3</sup> /s)	0.004 (0.14)	0.005 (0.18)	0.009 (0.32)
Sound pressure level $L_{\text{pA}}$ (1 m)	dB	–	–	–
Rated input current <sup>3)</sup>	A	2.1	3.8	7.2
Line supply connection U1/L1, V1/L2, W1/L3, PE		HAN Q4/2 (connector)	HAN Q4/2 (connector)	HAN Q4/2 (connector)
• Conductor cross-section	mm <sup>2</sup>	1.5 ... 6	1.5 ... 6	2.5 ... 6
PE connection (external connection)		On housing with M5 screw	On housing with M5 screw	On housing with M5 screw
• Conductor cross-section (recommended)	mm <sup>2</sup>	10 ... 16	10 ... 16	10 ... 16
Motor connection U2, V2, W2, PE, motor brake, temperature sensor		HAN Q8 (socket)	HAN Q8 (socket)	HAN Q8 (socket)
• Conductor cross-section	mm <sup>2</sup>	1 ... 4	1 ... 4	2.5 ... 4
Motor cable length, max. Shielded	m (ft)	15 (49)	15 (49)	15 (49)
Degree of protection		IP65/UL Type 3	IP65/UL Type 3	IP65/UL Type 3
Dimensions				
• Width	mm (in)	445 (17.52)	445 (17.52)	445 (17.52)
• Height	mm (in)	210 (8.27)	210 (8.27)	210 (8.27)
• Depth	mm (in)	110 (4.33)	110 (4.33)	180 (7.09)
Frame size		FSA	FSA	FSB
Weight, approx.	kg (lb)	5.7 (12.6)	5.7 (12.6)	8 (17.64)

<sup>1)</sup> The rated output current  $I_{\text{rated}}$  is based on the duty cycle for high overload (HO).

<sup>2)</sup> Typical values. You can find additional information on the Internet at <https://support.industry.siemens.com/cs/document/94059311>

<sup>3)</sup> The input current depends on the motor load and line impedance. The input currents apply for load at rated power for a line impedance corresponding to  $u_k = 1\%$ .

<sup>4)</sup> It is not possible to make any assignment to a particular standard.

**SINAMICS G120D distributed inverters**

0.75 kW to 7.5 kW (1 hp to 10 hp)

**PM250D Power Modules****Technical specifications** (continued)

Line voltage 380 ... 500 V 3 AC	PM250D Power Modules			
		6SL3525-OPE24-0AA1	6SL3525-OPE25-5AA1	6SL3525-OPE27-5AA1
<b>Rated output current</b> $I_{rated}^{1)}$	A	10.2	13.2	19
<b>Maximum output current</b> $I_{max}$	A	20.4	26.4	38
<b>Rated power</b>	kW (hp)	4 (5)	5.5 (7.5)	7.5 (10)
<b>Rated pulse frequency</b>	kHz	4	4	4
<b>Efficiency</b> $\eta$	%	>95	>95	>95
<b>Power loss</b> <sup>2)</sup> At rated output current	kW	0.167	0.218	0.291
<b>Cooling air requirement</b>	m <sup>3</sup> /s (ft <sup>3</sup> /s)	0.012 (0.42)	0.018 (0.64)	0.025 (0.88)
<b>Sound pressure level</b> $L_{pA}$ (1 m)	dB	74.5	74.5	74.5
<b>Rated input current</b> <sup>3)</sup>	A	9.5	12.2	17.7
<b>Line supply connection</b> <b>U1/L1, V1/L2, W1/L3, PE</b>		HAN Q4/2 (connector)	HAN Q4/2 (connector)	HAN Q4/2 (connector)
• Conductor cross-section	mm <sup>2</sup>	2.5 ... 6	4 ... 6	4 ... 6
<b>PE connection</b> (external connection)		On housing with M5 screw	On housing with M5 screw	On housing with M5 screw
• Conductor cross-section (recommended)	mm <sup>2</sup>	10 ... 16	10 ... 16	10 ... 16
<b>Motor connection</b> <b>U2, V2, W2, PE, motor brake, temperature sensor</b>		HAN Q8 (socket)	HAN Q8 (socket)	HAN Q8 (socket)
• Conductor cross-section	mm <sup>2</sup>	2.5 ... 4	4	4
<b>Motor cable length, max.</b> Shielded	m (ft)	15 (49)	15 (49)	15 (49)
<b>Degree of protection</b>		IP65/UL Type 3	IP65/UL Type 3	IP65/UL Type 3
<b>Dimensions</b>				
• Width	mm (in)	445 (17.52)	445 (17.52)	445 (17.52)
• Height	mm (in)	210 (8.27)	210 (8.27)	210 (8.27)
• Depth	mm (in)	220 (8.66)	220 (8.66)	220 (8.66)
<b>Frame size</b>		FSC	FSC	FSC
<b>Weight, approx.</b>	kg (lb)	8.5 (18.7)	8.5 (18.7)	8.5 (18.7)

<sup>1)</sup> The rated output current  $I_{rated}$  is based on the duty cycle for high overload (HO).

<sup>2)</sup> Typical values. You can find additional information on the Internet at <https://support.industry.siemens.com/cs/document/94059311>

<sup>3)</sup> The input current depends on the motor load and line impedance. The input currents apply for load at rated power for a line impedance corresponding to  $u_k = 1\%$ .

## Characteristic curves

### Derating data

#### Pulse frequency

Rated power at 400 V 3 AC		Rated output current in A for a pulse frequency of						
kW	hp	4 kHz	6 kHz	8 kHz	10 kHz	12 kHz	14 kHz	16 kHz
0.75	1	2.2	1.9	1.5	1.3	1.1	1	0.9
1.5	1.5 <sup>1)</sup>	4.1	3.5	2.9	2.5	2.1	1.8	1.6
3	4	7.7	6.5	5.4	4.6	3.9	3.5	3.1
4	5	10.2	8.7	7.1	6.1	5.1	4.6	4.1
5.5	7.5	13.2	11.2	9.2	7.9	6.6	5.9	5.3
7.5	10	19	16.2	13.3	11.4	9.5	8.6	7.6

#### Ambient temperature

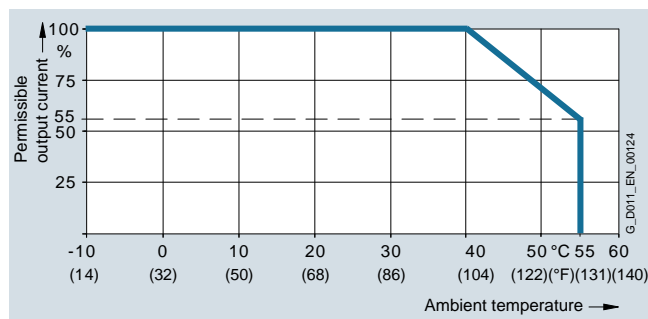

Permissible output current as a function of ambient temperature for PM250D Power Modules, frame sizes FSA to FSC

#### Note:

The operating temperature ranges of the Control Units should be taken into account. The temperature ranges are specified in the technical specifications under Control Units.

#### Installation altitude

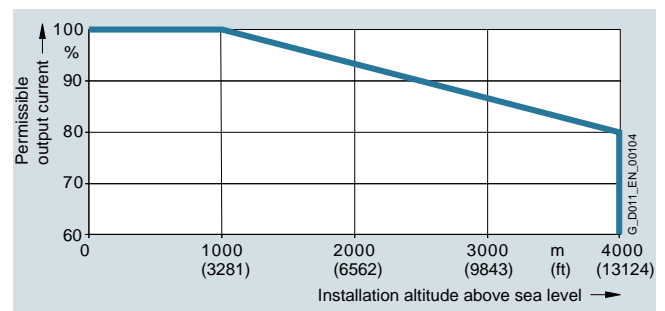

Permissible output current as a function of installation altitude for PM250D Power Modules, frame sizes FSA to FSC

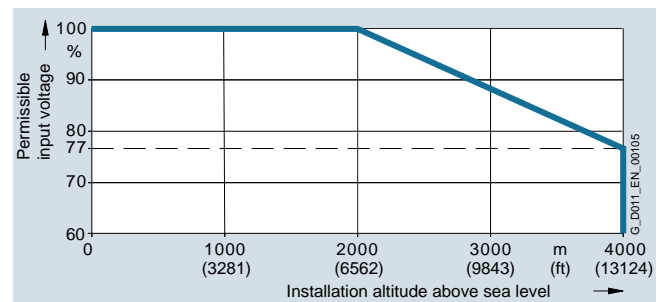

Permissible input voltage as a function of installation altitude for PM250D Power Modules, frame sizes FSA to FSC

<sup>1)</sup> It is not possible to make any assignment to a particular standard.

**SINAMICS G120D distributed inverters**

0.75 kW to 7.5 kW (1 hp to 10 hp)

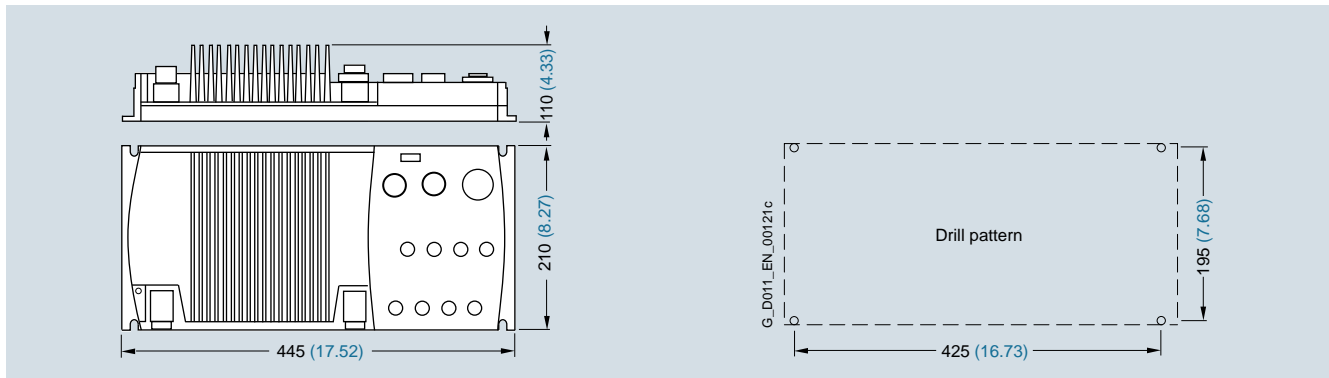
**PM250D Power Modules****Dimensional drawings**

PM250D Power Module, frame size FSA, with integrated line filter class A and plugged-in Control Unit  
 With a CU2x0D-2 PN-F PP/FO Control Unit, the height increases to 128.3 mm (5.05 inches).

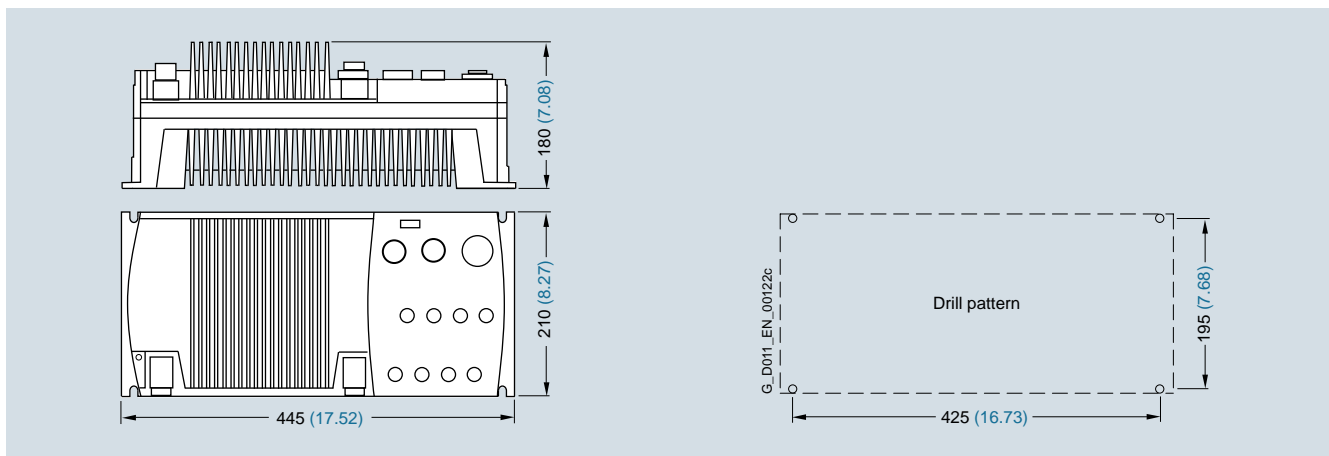

PM250D Power Module, frame size FSB, with integrated line filter class A and plugged-in Control Unit  
 With a CU2x0D-2 PN-F PP/FO Control Unit, the height increases to 198.3 mm (7.81 inches).

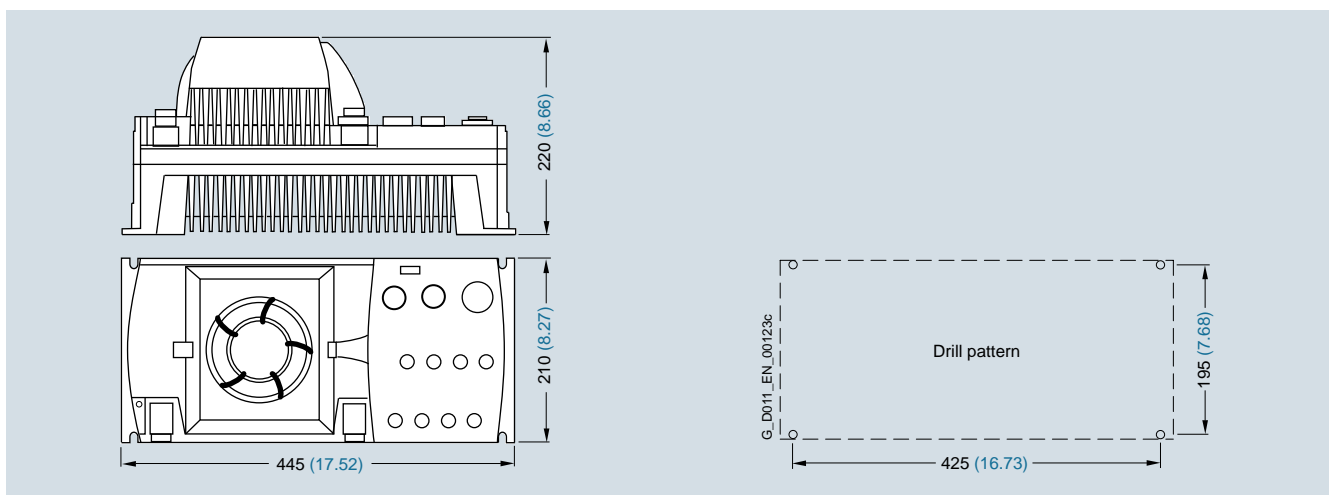

PM250D Power Module, frame size FSC, with integrated line filter class A and plugged-in Control Unit  
 Mounted with M5 or M6 screwed joints with a maximum washer diameter of 12 mm (0.47 inches).  
 3 mm (0.12 inches) Allen screw for the Control Unit.  
 Ventilation clearance required (for wall mounting) at top and bottom: 150 mm (5.9 inches).  
 All dimensions in mm (values in brackets are in inches).

## SINAMICS G120D distributed inverters

0.75 kW to 7.5 kW (1 hp to 10 hp)

### Recommended line-side power components

#### Selection and ordering data

The following table lists recommendations for additional line-side components, such as fuses and circuit breakers.

Note for use in compliance with IEC standards:

3NA3 type fuses and 3RV type circuit breakers are recommended for European countries. The values in the table take into account the overload capability of the inverter.

Note for use in compliance with UL regulations:

Fuses for use in North America must be UL-certified, Class J fuses with a rated voltage of 600 V AC.

**Short Circuit Current Rating (SCCR)** according to UL

Applies to industrial control panel installations according to NEC Article 409 or UL 508A

- PM250D: 100 kA (480 V 3 AC)

Additional information about the listed fuses and circuit breakers is available in the Catalogs LV 10, IC 10 and IC 10 AO as well as in the Industry Mall.

#### Individual protection

Rated power		SINAMICS G120D PM250D Power Modules		IEC-compliant			UL-compliant (according to UL category JDDZ)	
kW	hp	Type 6SL3525-...	Frame size	Fuse		Circuit breaker	Fuse type Rated voltage 600 V AC	
				Current A	Article No.		Class	Current A
<b>380 ... 500 V 3 AC</b>								
0.75	1	0PE17-5AA1	FSA	10	<b>3NA3803</b>	<b>3RV2011-1JA10</b>	J	10
1.5	1.5 <sup>1)</sup>	0PE21-5AA1	FSA	10	<b>3NA3803</b>	<b>3RV2011-1JA10</b>	J	15
3	4	0PE23-0AA1	FSB	16	<b>3NA3805</b>	<b>3RV2011-4AA10</b>	J	25
4	5	0PE24-0AA1	FSC	20	<b>3NA3807</b>	<b>3RV2021-4BA10</b>	J	35
5.5	7.5	0PE25-5AA1	FSC	20	<b>3NA3807</b>	<b>3RV2021-4BA10</b>	J	45
7.5	10	0PE27-5AA1	FSC	32	<b>3NA3812</b>	<b>3RV2021-4PA10</b>	J	60

#### Group protection (installation on power bus)

For installations with several inverters, the inverters are normally supplied from a 400 V power bus. Further information can be found in the operating instructions on the Internet at [www.siemens.com/sinamics-g120d/documentation](http://www.siemens.com/sinamics-g120d/documentation)

<sup>1)</sup> It is not possible to make any assignment to a particular standard.

## SINAMICS G120D distributed inverters

0.75 kW to 7.5 kW (1 hp to 10 hp)

### Supplementary system components

#### Accessories

For SINAMICS G120D distributed frequency inverters, the following supplementary system components are always required or are available depending on the intended application.

Description	Order	See page
<b>Intelligent Operator Panel IOP-2 Handheld <sup>1)</sup></b>	Application-dependent	9/35
• RS232 connecting cable <sup>1)</sup>	Application-dependent	9/35
<b>Memory cards</b>	Application-dependent	9/36
<b>PC inverter connection kit 2</b> (mini USB interface cable for communication with a PC)	Application-dependent	9/36
<b>STARTER commissioning tool</b>	Application-dependent	9/36
<b>SINAMICS Startdrive commissioning tool</b>	Application-dependent	9/36
<b>Connecting cables for the Control Unit</b>		
• PROFINET connecting cable	Application-dependent	9/37
• PROFIBUS connecting cable	Application-dependent	9/37
• Connecting cables/connectors for supplying the Control Unit with 24 V DC power	<b>Always required</b>	9/37
• Connecting cables and connectors for digital inputs and outputs	Application-dependent	9/38
• Connecting cables and connectors for encoders and analog inputs	Application-dependent	9/38
<b>Connecting cables for Power Modules</b>		
• Connecting cables pre-assembled at one end and connector sets to connect to the line supply	<b>Always required</b>	9/38
• Motor cables pre-assembled at one end and connector sets to connect the Power Module to the motor	<b>Always required</b>	9/39
• Power bus distribution 400 V in IP65 degree of protection	Application-dependent	9/39

<sup>1)</sup> For use of the IOP-2 Handheld in combination with SINAMICS G110D, SINAMICS G120D, SINAMICS G110M and SIMATIC ET 200pro FC-2, the RS232 connecting cable with optical interface is required (Article No.: 3RK1922-2BP00). The cable must be ordered separately.

## Accessories (continued)

### Intelligent Operator Panel IOP-2 Handheld



IOP-2 Handheld for mobile use

The Intelligent Operator Panel IOP-2 Handheld is a very user-friendly and powerful operator panel for commissioning and diagnostics as well as local operator control and monitoring of SINAMICS G110D, SINAMICS G120D, SINAMICS G110M and SIMATIC ET 200pro FC-2 distributed inverters.

The IOP-2 Handheld supports both newcomers and drive experts. Thanks to the membrane keyboard with a central sensor control field, the high-contrast color displays, the menu-based operation and the application wizards, it is easy to commission standard drives. A drive can be essentially commissioned without having to use a printed parameter list – as the parameters are displayed in plain text, and explanatory help texts and a parameter filtering function are provided.

Application wizards interactively guide you when commissioning important applications such as conveyor technology, pumps, fans and compressors. There is a basic commissioning wizard for general commissioning.

Up to two process values can be graphically visualized and up to four process values can be numerically visualized on the status screen/display. Process values can also be displayed in technological units.

The IOP-2 Handheld supports standard commissioning of identical drives. For this purpose, a parameter list can be copied from an inverter into the IOP-2 Handheld and downloaded into other drive units of the same type as required.

In addition to the IOP-2, the IOP-2 Handheld includes a housing with rechargeable batteries, a charging unit, an RS232 connecting cable, and a USB cable. The charging unit is supplied with connector adapters for Europe, the US and UK. When the batteries are fully charged, the operating time is up to 10 hours.

To connect the IOP-2 Handheld to SINAMICS G110D, SINAMICS G120D, SINAMICS G110M and SIMATIC ET 200pro FC-2, the RS232 connecting cable with optical interface is required in addition.

### Updating the IOP-2 Handheld

The IOP-2 Handheld can be updated and expanded using the integrated USB interface.

Data to support future drive systems can be transferred from the PC to the IOP-2 Handheld. Further, the USB interface allows user languages and wizards that will become available in the future to be subsequently downloaded and the firmware to be updated for the IOP-2 Handheld <sup>1)</sup>.

### Selection and ordering data

Description	Article No.
<b>IOP-2 Handheld</b> For use with SINAMICS G120 SINAMICS G120C SINAMICS G120P SINAMICS G110D SINAMICS G120D SINAMICS G110M SIMATIC ET 200pro FC-2 Included in the scope of delivery: • IOP-2 • Handheld housing • Rechargeable batteries (4 × AA) • Charging unit (international) • RS232 connecting cable 3 m (9.84 ft) long, can be used in combination with SINAMICS G120 SINAMICS G120C SINAMICS G120P • USB cable 1 m (3.28 ft) long	<b>NEW</b> <b>6SL3255-0AA00-4HA1</b>
<b>RS232 connecting cable</b> 2.5 m (8.20 ft) long, with optical interface for connecting the IOP-2 Handheld to SINAMICS G110D SINAMICS G120D SINAMICS G110M SIMATIC ET 200pro FC-2	<b>3RK1922-2BP00</b>

### Technical specifications

	IOP-2 Handheld
	6SL3255-0AA00-4HA1
<b>Display</b>	High-contrast color display, a variety of display options
• Resolution	320 × 240 pixels
<b>Operator panel</b>	Membrane keyboard with central sensor control field
<b>Operating languages</b>	English, German, French, Italian, Spanish, Portuguese, Dutch, Swedish, Finnish, Russian, Czech, Polish, Turkish, Chinese Simplified
<b>Ambient temperature</b>	
• During transport and storage	-20 ... +55 °C (-4 ... +131 °F)
• During operation	0 ... 40 °C (32 ... 104 °F)
<b>Humidity</b>	Relative humidity < 95 %, non-condensing
<b>Degree of protection</b>	IP20
<b>Dimensions (H × W × D)</b>	195.04 × 70 × 37.58 mm (7.68 × 2.76 × 1.48 in)
<b>Weight, approx.</b>	0.724 kg (1.6 lb)
<b>Compliance with standards</b>	CE, RCM, cULus, EAC, KCC-REM-S49-SINAMICS

<sup>1)</sup> Information on updates for the IOP-2 Handheld is available at <https://support.industry.siemens.com/cs/document/67273266>

## SINAMICS G120D distributed inverters

0.75 kW to 7.5 kW (1 hp to 10 hp)

### Supplementary system components

#### Accessories (continued)

##### Memory cards



SINAMICS SD memory card

The parameter settings for an inverter can be stored on the SINAMICS SD memory card. When service is required, e.g. after the inverter has been replaced and the data have been downloaded from the memory card, the drive system is immediately ready for use again.

- Parameter settings can be written from the memory card to the inverter or saved from the inverter to the memory card.
- Up to 100 parameter sets can be stored.
- The memory card supports standard commissioning without the use of the Intelligent Operator Panel IOP-2 Handheld or the STARTER and SINAMICS Startdrive commissioning tools.
- If firmware is stored on the memory card and a Control Unit is installed, the firmware can be upgraded/downgraded during power-up<sup>1)</sup>.

##### Note:

The memory card is optional, but it facilitates inverter replacement.

##### Selection and ordering data

Description	Article No.
<b>SINAMICS SD memory card 512 MB</b>	<b>6SL3054-4AG00-2AA0</b>
<i>Optional firmware memory cards</i>	
<b>SINAMICS SD card 512 MB + firmware V4.7 SP3 (Multicard V4.7 SP3)</b>	<b>6SL3054-7TB00-2BA0</b>
<b>SINAMICS SD card 512 MB + firmware V4.7 SP6 (Multicard V4.7 SP6)</b>	<b>6SL3054-7TD00-2BA0</b>
<b>SINAMICS SD card 512 MB + firmware V4.7 SP9 (Multicard V4.7 SP9)</b>	<b>NEW 6SL3054-7TE00-2BA0</b>

For an overview and more information on all available firmware versions, see <https://support.industry.siemens.com/cs/document/67364620>

##### PC inverter connection kit 2 (mini USB interface cable for communication with a PC)

For controlling and commissioning an inverter directly from a PC via a point-to-point connection if the appropriate software (STARTER commissioning tool<sup>2)</sup>, V4.3 and higher, or SINAMICS Startdrive) has been installed.

##### Selection and ordering data

Description	Article No.
<b>PC inverter connection kit 2</b>	<b>6SL3255-0AA00-2CA0</b>
USB cable (3 m/9.84 ft long) for	
• SINAMICS G120C	
• SINAMICS G120 Control Units	
- CU230P-2	
- CU240E-2	
- CU250S-2	
• SINAMICS G110M Control Units	
- CU240M	
• SINAMICS G120D Control Units	
- CU240D-2	
- CU250D-2	

##### STARTER commissioning tool

The STARTER commissioning tool (V4.3 and higher) supports the commissioning and maintenance of SINAMICS G120D inverters. The operator guidance combined with comprehensive, user-friendly functions for the relevant drive solution allow you to commission the device quickly and easily.

##### Selection and ordering data

Description	Article No.
<b>STARTER commissioning tool<sup>2)</sup> on DVD-ROM</b>	<b>6SL3072-0AA00-0AG0</b>

##### SINAMICS Startdrive commissioning tool

The SINAMICS Startdrive commissioning tool (V13 and higher) supports the commissioning and maintenance of SINAMICS G120D inverters. SINAMICS Startdrive is part of the TIA Portal engineering platform. It supports the intuitive integration of SINAMICS drives in automation. The same operator control concept, the elimination of interfaces and a high degree of user-friendliness make it possible to quickly integrate SINAMICS into an automation process and start it up with the TIA Portal. The TIA Portal with SINAMICS Startdrive offers you a totally integrated engineering platform for the complete application from the project engineering phase through to commissioning and diagnostics.

##### Selection and ordering data

Description	Article No.
<b>SINAMICS Startdrive commissioning tool<sup>3)</sup> on DVD-ROM</b>	<b>6SL3072-4DA02-0XG0</b>

<sup>1)</sup> You can find more information about firmware upgrades/downgrades on the Internet at <https://support.industry.siemens.com/cs/document/67364620>

<sup>2)</sup> The STARTER commissioning tool is also available on the Internet at [www.siemens.com/starter](http://www.siemens.com/starter)

<sup>3)</sup> The SINAMICS Startdrive commissioning tool is also available on the Internet at <https://support.industry.siemens.com/cs/document/68034568>



## Accessories (continued)

An overview of all available accessories (e.g. connectors and cables) can be found under the following link:  
[www.siemens.com/distributeddrives-supplementaryproducts](http://www.siemens.com/distributeddrives-supplementaryproducts)

### Connecting cables for the Control Unit

#### PROFINET connecting cable

Flexible plug-in cables and plug-in connectors that can be assembled in the field for transmission of data (up to 100 Mbit/s) between Industrial Ethernet stations with IP65 degree of protection.

#### Selection and ordering data

Description	Article No.
<b>IE connecting cable M12-180/M12-180</b> Pre-assembled IE FC TP trailing cable GP 2 x 2 PROFINET type C with two 4-pole M12 plugs (4-pole, D-coded), IP65/IP67 degree of protection, UL, plug/plug connector (IN/OUT) Length: <ul style="list-style-type: none"> <li>• 0.3 m (0.98 ft)</li> <li>• 0.5 m (1.64 ft)</li> <li>• 1 m (3.28 ft)</li> <li>• 1.5 m (4.92 ft)</li> <li>• 2 m (6.56 ft)</li> <li>• 3 m (9.84 ft)</li> <li>• 5 m (16.41 ft)</li> <li>• 10 m (32.81 ft)</li> <li>• 15 m (49.22 ft)</li> </ul>	<b>6XV1870-8AE30</b> <b>6XV1870-8AE50</b> <b>6XV1870-8AH10</b> <b>6XV1870-8AH15</b> <b>6XV1870-8AH20</b> <b>6XV1870-8AH30</b> <b>6XV1870-8AH50</b> <b>6XV1870-8AN10</b> <b>6XV1870-8AN15</b>
<b>IE M12 Plug PRO</b> For assembly in the field, M12 plug-in connector (D-coded), metal enclosure, UL, fast connection method, plug connector <ul style="list-style-type: none"> <li>• 1 unit</li> <li>• 8 units</li> <li>• 1 unit (angled)</li> </ul>	<b>6GK1901-0DB20-6AA0</b> <b>6GK1901-0DB20-6AA8</b> <b>3RK1902-2DA00</b>
<b>RJ45 PLUG PRO connector</b> For on-site assembly for CU240D-2 PN-F PP or CU250D-2 PN-F PP Control Unit, UL 1 package = 1 unit <ul style="list-style-type: none"> <li>• 1 unit</li> </ul>	<b>6GK1901-1BB10-6AA0</b>
<b>SIMATIC NET POF/PCF cables (fiber optic)</b> For CU240D-2 PN-F FO and CU250D-2 PN-F FO Coded cables for assembly in the field (sold by the meter) <ul style="list-style-type: none"> <li>• POF standard cable GP 980/1000                Minimum order quantity: 20 m (66 ft)</li> <li>• POF trailing cable 980/1000                Minimum order quantity: 20 m (66 ft)</li> <li>• PCF standard cable GP 200/230                With UL approval                Minimum order quantity: 20 m (66 ft)</li> <li>• PCF trailing cable 200/230                With UL approval                Minimum order quantity: 20 m (66 ft)</li> </ul>	<b>6XV1874-2A</b> <b>6XV1874-2B</b> <b>6XV1861-2D</b> <b>6XV1861-2C</b>
<b>Connectors for fiber-optic cables</b> POF/PCF plug-in connectors for assembly in the field <ul style="list-style-type: none"> <li>• IE SC RJ POF PLUG PRO (1 unit)</li> <li>• IE SC RJ PCF PLUG PRO (1 unit)</li> </ul>	<b>6GK1900-0MB00-6AA0</b> <b>6GK1900-0NB00-6AA0</b>

#### PROFIBUS connecting cable

Flexible plug-in cables/connectors for transmission of data (up to 12 Mbit/s) from PROFIBUS stations.

#### Selection and ordering data

Description	Article No.
<b>PROFIBUS M12 plug-in cable</b> Pre-assembled with two 5-pole M12 plug/socket connectors, UL Length: <ul style="list-style-type: none"> <li>• 0.3 m (0.98 ft)</li> <li>• 0.5 m (1.64 ft)</li> <li>• 1 m (3.28 ft)</li> <li>• 1.5 m (4.92 ft)</li> <li>• 2 m (6.56 ft)</li> <li>• 3 m (9.84 ft)</li> <li>• 5 m (16.41 ft)</li> <li>• 10 m (32.81 ft)</li> <li>• 15 m (49.22 ft)</li> </ul>	<b>6XV1830-3DE30</b> <b>6XV1830-3DE50</b> <b>6XV1830-3DH10</b> <b>6XV1830-3DH15</b> <b>6XV1830-3DH20</b> <b>6XV1830-3DH30</b> <b>6XV1830-3DH50</b> <b>6XV1830-3DN10</b> <b>6XV1830-3DN15</b>
<b>PROFIBUS M12 connector</b> 5-pole, B-coded, metal enclosure, 1 package = 5 units <ul style="list-style-type: none"> <li>• Pin insert</li> <li>• Female contact insert</li> </ul>	<b>6GK1905-0EA00</b> <b>6GK1905-0EB00</b>

#### Connecting cables/connectors for supplying the Control Unit with 24 V DC power

#### Selection and ordering data

Description	Article No.
<b>7/8" plug-in cable</b> For power supply, pre-assembled with two 5-pole 7/8" plug/socket connectors, UL 5 x 1.5 mm <sup>2</sup> Length: <ul style="list-style-type: none"> <li>• 0.3 m (0.98 ft)</li> <li>• 0.5 m (1.64 ft)</li> <li>• 1 m (3.28 ft)</li> <li>• 1.5 m (4.92 ft)</li> <li>• 2 m (6.56 ft)</li> <li>• 3 m (9.84 ft)</li> <li>• 5 m (16.41 ft)</li> <li>• 10 m (32.81 ft)</li> <li>• 15 m (49.22 ft)</li> </ul>	<b>6XV1822-5BE30</b> <b>6XV1822-5BE50</b> <b>6XV1822-5BH10</b> <b>6XV1822-5BH15</b> <b>6XV1822-5BH20</b> <b>6XV1822-5BH30</b> <b>6XV1822-5BH50</b> <b>6XV1822-5BN10</b> <b>6XV1822-5BN15</b>
<b>7/8" plug-in connector</b> 5-pole, B-coded, plastic enclosure, 1 package = 5 units <ul style="list-style-type: none"> <li>• Pin insert (OUT)</li> <li>• Female contact insert (IN)</li> </ul>	<b>6GK1905-0FA00</b> <b>6GK1905-0FB00</b>
<b>POWER PLUG PRO plug-in connector</b> For the CU2x0D-2 PN-F PP/FO 5-pole push-pull power-plug for on-site assembly 1 Pack = 1 unit <ul style="list-style-type: none"> <li>• 1 unit</li> </ul>	<b>6GK1907-0AB10-6AA0</b>

## SINAMICS G120D distributed inverters

0.75 kW to 7.5 kW (1 hp to 10 hp)

### Supplementary system components

#### Accessories (continued)

##### Connecting cables and connectors for digital inputs and outputs

###### Selection and ordering data

Description	Article No.
<b>M12 plug-in cable</b> With PUR sheath, to connect digital sensors and actuators, pre-assembled at one end, angled, plug connector, 5-pole, 5 × 0.34 mm <sup>2</sup> , UL Length: <ul style="list-style-type: none"> <li>• 1.5 m (4.92 ft)</li> <li>• 5 m (16.41 ft)</li> <li>• 10 m (32.81 ft)</li> </ul>	<b>3RK1902-4HB15-5AA0</b> <b>3RK1902-4HB50-5AA0</b> <b>3RK1902-4HC01-5AA0</b>
<b>M12 connector</b> For screw mounting, 5-pole screw-type connection max. 0.75 mm <sup>2</sup> , A-coded, max. 4 A, UL, plug connector <ul style="list-style-type: none"> <li>• Straight</li> <li>• Angled</li> </ul>	<b>3RK1902-4BA00-5AA0</b> <b>3RK1902-4DA00-5AA0</b>

##### Connecting cables and connectors for encoders and analog inputs

###### Selection and ordering data

Description	Ordering (see Solution Partner)
<b>M12 cable connector</b> 8-pole plug connector <ul style="list-style-type: none"> <li>• Straight cable outlet</li> <li>• Angled cable outlet</li> </ul>	Ordered from and supplied by KnorrTec Ordered from and supplied by KnorrTec
<b>M12 plug-in cable</b> Pre-assembled at one end, straight, plug connector, 8-pole, 4 × 2 × AWG24, shielded, PUR gray, suitable for trailing cables, for HTL and SSI encoders Length: <ul style="list-style-type: none"> <li>• 1.5 m (4.92 ft)</li> <li>• 5 m (16.41 ft)</li> <li>• 10 m (32.81 ft)</li> </ul>	Ordered from and supplied by KnorrTec Ordered from and supplied by KnorrTec Ordered from and supplied by KnorrTec
<b>M12 plug-in cable</b> Pre-assembled at both ends, 8-pole M12 male connector to 12-pole M23 socket, 4 × 2 × AWG24, shielded, PUR gray, suitable for trailing cables <ul style="list-style-type: none"> <li>• HTL plug-in cable</li> <li>• SSI plug-in cable</li> </ul> Length: <ul style="list-style-type: none"> <li>• 1.5 m (4.92 ft)</li> <li>• 5 m (16.41 ft)</li> <li>• 10 m (32.81 ft)</li> </ul>	Ordered from and supplied by KnorrTec Ordered from and supplied by KnorrTec Ordered from and supplied by KnorrTec
<b>T distribution piece</b> To connect two analog inputs 8-pole M12 male connector to 2 × 4-pole M12 socket, angled	Ordered from and supplied by KnorrTec

##### Connecting cables for Power Modules

##### Connecting cables pre-assembled at one end and connector sets to connect to the line supply

###### Selection and ordering data

Description	Article No.
<b>Connecting cable pre-assembled at one end</b> Power supply cable, open at one end, for HAN Q4/2, angled, 4 × 4 mm <sup>2</sup> <ul style="list-style-type: none"> <li>• 1.5 m (4.92 ft) long</li> <li>• 5 m (16.41 ft) long</li> </ul>	<b>3RK1911-0DB13</b> <b>3RK1911-0DB33</b>
<b>Connector set for the power supply</b> HAN Q4/2 <ul style="list-style-type: none"> <li>• 2.5 mm<sup>2</sup></li> <li>• 4 mm<sup>2</sup></li> <li>• 6 mm<sup>2</sup></li> </ul>	<b>3RK1911-2BE50</b> <b>3RK1911-2BE10</b> <b>3RK1911-2BE30</b>

## SINAMICS G120D distributed inverters

0.75 kW to 7.5 kW (1 hp to 10 hp)

### Supplementary system components

#### Accessories (continued)

#### Motor cables pre-assembled at one end and connector sets to connect the Power Module to the motor

##### Selection and ordering data

Motor cables pre-assembled at one end For motors with brake and temperature sensor with HAN Q8 connector, shielded	Article No. (HTG: supplied by Harting) (ZKT: supplied by KnorrTec)		
Cross-section	4 × 1.5 mm <sup>2</sup> 2 × (2 × 0.75 mm <sup>2</sup> )	4 × 2.5 mm <sup>2</sup> 2 × (2 × 0.75 mm <sup>2</sup> )	4 × 4 mm <sup>2</sup> 2 × 1 mm <sup>2</sup> + 2 × 1.5 mm <sup>2</sup>
• 1.5 m (4.92 ft) long	HTG: 61 88 201 0288 ZKT: 70020501000150	HTG: 61 88 201 0291 ZKT: 70009601000150	HTG: 61 88 201 0303 ZKT: 70017001000150
• 3 m (9.84 ft) long	HTG: 61 88 201 0289 ZKT: 70020501000300	HTG: 61 88 201 0292 ZKT: 70009601000300	HTG: 61 88 201 0304 ZKT: 70017001000300
• 5 m (16.41 ft) long	HTG: 61 88 201 0290 ZKT: 70020501000500	HTG: 61 88 201 0293 ZKT: 70009601000500	HTG: 61 88 201 0305 ZKT: 70017001000500
• 10 m (32.81 ft) long	HTG: 61 88 201 0299 ZKT: 70020501001000	HTG: 61 88 201 0301 ZKT: 70009601001000	HTG: 61 88 201 0306 ZKT: 70017001001000
<b>Connector set for motor cable</b> HAN Q8, shielded			
	HTG: 61 83 401 0131 ZKT: 10032001	HTG: 61 83 401 0132 ZKT: 10032011	HTG: 61 83 401 0133 ZKT: 10032021

#### Power bus distribution 400 V in IP65 degree of protection

##### Selection and ordering data

Description	Ordering (see Solution Partner)
<b>Power T clamp connector for 2.5 ... 6 mm<sup>2</sup></b> With attached 7-pole connector, female contact insert, grommet housing, UL Seals for various cable cross-sections must be ordered separately	Ordered from and supplied by Harting
<b>T clamp connector</b> Completely pre-assembled	Ordered from and supplied by KnorrTec
<b>T distributor box, IDC connection power cable</b> Pre-assembled, UL, uncut power cable, 2.5 ... 6 mm <sup>2</sup> Push-in connection: 1.5 ... 6 mm <sup>2</sup> Seals for various cable cross-sections must be ordered separately	Ordered from and supplied by Weidmüller
<b>Y distributor</b> For direct connection of 400 V supply line, HAN Q4/2, conductor cross-section 1.5 ... 4 mm <sup>2</sup>	Ordered from and supplied by Harting

##### More information

A comprehensive range of supplementary products is provided for the distributed drive technology, e.g. pre-assembled cables and connectors. An overview is provided at the following link: [www.siemens.com/distributeddrives-supplementaryproducts](http://www.siemens.com/distributeddrives-supplementaryproducts)

Further selected accessories are available from Siemens Solution Partners. Select "Distributed Field Installation System" as the technology in the "Solution Partner Finder". [www.siemens.com/automation/partnerfinder](http://www.siemens.com/automation/partnerfinder)

For more information about connecting cables and plug-in connectors, please refer to Catalog IK PI.

**SINAMICS G120D distributed inverters**

0.75 kW to 7.5 kW (1 hp to 10 hp)

**Spare parts > Spare Parts Kit****Overview**

A Spare Parts Kit can be ordered, comprising small parts such as replacement seals, caps, PROFIBUS address windows and screws.

**Selection and ordering data**

Description	Article No.
<b>Spare Parts Kit for SINAMICS G120D</b> Comprising replacement seals, caps, PROFIBUS address windows and screws	<b>6SL3500-0SK01-0AA0</b>
<b>Replacement caps for CU2x0D-2 PN-F PP/FO</b>	
• 24 V push-pull PLUG PRO caps 1 package = 5 units	<b>6ES7194-4JA50-0AA0</b>
• RJ45 PLUG PRO caps 1 package = 5 units	<b>6ES7194-4JD50-0AA0</b>

**Spare parts > Replacement fans****Overview**

The Power Module fans are designed for extra long service life. Replacement fans can be ordered for special applications.

**Selection and ordering data**

Rated power		SINAMICS G120D PM250D Power Module		Replacement fan (pre-mounted unit with cover, fan and screws)
kW	hp	Type 6SL3525-...	Frame size	
<b>380 ... 500 V 3 AC</b>				
4	5	OPE24-0AA1	FSC	<b>6SL3500-0SF01-0AA0</b>
5.5	7.5	OPE25-5AA1		
7.5	10	OPE27-5AA1		

## SIMATIC ET 200pro FC-2 frequency converters 1.5 kW (2 hp)



10/2	<b>Introduction</b>
10/2	Application
10/2	More information

	<b>SIMATIC ET 200pro FC-2 frequency converter</b>
10/3	Overview
10/3	Selection and ordering data
10/4	Benefits
10/4	Application
10/5	Design
10/6	Integration
10/7	Technical specifications
10/8	Characteristic curves
10/8	Dimensional drawings
10/9	Accessories
10/10	More information

Further information about  
SIMATIC ET 200pro FC-2  
can be found in Catalog ST 70

# SIMATIC ET 200pro FC-2 frequency converters

1.5 kW (2 hp)

## Introduction

## Application

Use	Requirements for torque accuracy/speed accuracy/position accuracy/coordination of axes/functionality					
	Continuous motion			Non-continuous motion		
	Basic	Medium	High	Basic	Medium	High
<b>Pumping, ventilating, compressing</b>	Centrifugal pumps Radial / axial fans Compressors	Centrifugal pumps Radial / axial fans Compressors	Eccentric screw pumps	Hydraulic pumps Metering pumps	Hydraulic pumps Metering pumps	Descaling pumps Hydraulic pumps
	V20 G120C G120P	G120P G130/G150 G180 <sup>1)</sup>	S120	G120	S110	S120
<b>Moving</b>	Conveyor belts Roller conveyors Chain conveyors	Conveyor belts Roller conveyors Chain conveyors Lifting/lowering devices Elevators Escalators/moving walkways Indoor cranes Marine drives Cable railways	Elevators Container cranes Mining hoists Excavators for open-cast mining Test bays	Acceleration conveyors Storage and retrieval machines	Acceleration conveyors Storage and retrieval machines Cross cutters Reel changers	Storage and retrieval machines Robotics Pick & place Rotary indexing tables Cross cutters Roll feeds Engagers/disengagers
	V20 G110D G110M G120C <b>ET 200pro FC-2<sup>2)</sup></b>	G120 G120D G130/G150 G180 <sup>1)</sup>	S120 S150 DCM	V90 G120 G120D	S110 S210 DCM	S120 S210 DCM
<b>Processing</b>	Mills Mixers Kneaders Crushers Agitators Centrifuges	Mills Mixers Kneaders Crushers Agitators Centrifuges Extruders Rotary furnaces	Extruders Winders/unwinders Lead/follower drives Calenders Main press drives Printing machines	Tubular bagging machines Single-axis motion control such as • Position profiles • Path profiles	Tubular bagging machines Single-axis motion control such as • Position profiles • Path profiles	Servo presses Rolling mill drives Multi-axis motion control such as • Multi-axis positioning • Cams • Interpolations
	V20 G120C	G120 G130/G150 G180 <sup>1)</sup>	S120 S150 DCM	V90 G120	S110 S210	S120 S210 DCM
<b>Machining</b>	Main drives for • Turning • Milling • Drilling	Main drives for • Drilling • Sawing	Main drives for • Turning • Milling • Drilling • Gear cutting • Grinding	Axis drives for • Turning • Milling • Drilling	Axis drives for • Drilling • Sawing	Axis drives for • Turning • Milling • Drilling • Lasering • Gear cutting • Grinding • Nibbling and punching
	S110	S110 S120	S120	S110	S110 S120	S120

The SIMATIC ET 200pro FC-2 frequency converter for a cabinet-free configuration with a high IP65 degree of protection and a power rating of up to 1.5 kW designed as a SIMATIC module, with an integrated safety function and regenerative feedback capability. It supplements the SIMATIC ET 200pro system range with distributed, speed-controlled drives. The frequency converter offers, in combination with the other modules of the

modular SIMATIC ET 200pro system, solutions which have been exactly tailored to the plant/system.

Practical application examples and descriptions are available on the Internet at [www.siemens.com/sinamics-applications](http://www.siemens.com/sinamics-applications)

## More information

You may also be interested in these drives:

- Simple applications in degree of protection IP65, integrated in motor ⇒ SINAMICS G110M
- With positioning function in degree of protection IP65 ⇒ SINAMICS G120D
- More performance, higher functionality for the control cabinet in IP20 degree of protection ⇒ SINAMICS G120, SINAMICS G120C (Catalog D 31.1)
- With positioning function in the control cabinet in IP20 degree of protection ⇒ SINAMICS S110 (Catalog D 31.1)

<sup>1)</sup> Industry-specific inverters.

<sup>2)</sup> Information on the SIMATIC ET 200pro FC-2 frequency converter is available at [www.siemens.com/et200pro-fc](http://www.siemens.com/et200pro-fc)

# SIMATIC ET 200pro FC-2 frequency converters

## 1.5 kW (2 hp)

### SIMATIC ET 200pro FC-2 frequency converter

#### Overview



SIMATIC ET 200pro FC-2 frequency converter

The SIMATIC ET 200pro FC-2 frequency converter has the design of a SIMATIC ET 200pro module. It supplements the SIMATIC ET 200pro system range with distributed, speed-controlled drives. It is suitable for the open-loop and closed-loop control of asynchronous (induction) motors in a wide range of industrial applications. It is predestined for conveyor technology applications using drives networked via PROFIBUS and PROFINET, in particular in distributed designs without control cabinet with high degree of protection (IP65), when combining several drives. The modular, service-friendly concept is ideally suited to manufacturing processes with high plant standstill costs.

#### Reasons for using distributed drive systems:

- Modular drive solutions – therefore standardized mechatronic elements that can be individually tested
- A control cabinet is not required, resulting in a smaller space requirement and lower cooling requirements
- Long motor cables between converter and motor are not required
  - Less power losses
  - Reduced noise radiation
  - Reduced costs for shielded cables
  - No additional filters
- Distributed configurations offer considerable benefits for conveyor systems with their extensive coverage (e.g. in the automotive and logistics industries)

#### Siemens family of distributed drives

Siemens offers an innovative portfolio of frequency converters to optimally implement distributed drive solutions. The strengths of the individual members of the drive family permit simple adaptation to the widest range of application demands:

- Identical connection systems
- Standard commissioning and engineering tools for the family of distributed drives:
  - SINAMICS G110M frequency inverters
  - SINAMICS G110D frequency inverters
  - SINAMICS G120D frequency inverters
  - SIMATIC ET 200pro FC-2 frequency converters
  - SIRIUS M200D motor starters

#### Safety Integrated

The distributed SIMATIC ET 200pro FC-2 frequency converters are already equipped with the integrated STO (Safe Torque Off) safety function, certified in accordance with IEC 61508 SIL 2 as well as EN ISO 13849-1 PL d and Category 3. It can be activated locally via the F-RSM or by means of PROFI-safe.

Further information can be found in the section [Safety Integrated](#).

#### STARTER commissioning tool

The STARTER commissioning tool (V4.4 and higher) plus the corresponding SINAMICS Support Package (SSP) supports the commissioning and maintenance of SIMATIC ET 200pro FC-2 frequency converters.

The operator guidance combined with comprehensive, user-friendly functions for the relevant drive solution allow you to commission the device quickly and easily.

#### Engineering Framework STEP 7 classic (V5.5 and higher)

Hardware Support Packages (HSP) are available to integrate SIMATIC ET 200pro FC-2 in STEP7 classic.

#### Engineering Framework TIA Portal (as from V13 SP1)

TIA Portal is a powerful engineering framework providing full access to the whole digitized automation.

Hardware Support Packages (HSP) are available to integrate SIMATIC ET 200pro FC-2 in TIA Portal.

#### Selection and ordering data

	Article No.
<b>SIMATIC ET 200pro FC-2 frequency converter</b> with integrated safety function STO (Safe Torque Off)	<b>6SL3514-1KE13-5AE0</b>
<b>Backplane bus module</b> for mounting the frequency converter (absolutely essential for operation of the converter)	<b>6SL3260-2TA00-0AA0</b>

## SIMATIC ET 200pro FC-2 frequency converters

1.5 kW (2 hp)

### SIMATIC ET 200pro FC-2 frequency converter

#### Benefits

- Quick and easy installation
  - Flexibility as SIMATIC ET 200pro modules can be freely combined with the frequency converter
  - No wiring outlay due to self-assembling communication and supply rails in the backplane bus with each additional module
  - The load voltage is routed to downstream frequency converters or motor starters with minimal installation costs through pre-assembled power jumper plugs (max. 25 A).
- Accelerated engineering, fast installation and commissioning
  - Easy combination and expansion of converter functionality using I/O modules or RSM isolator modules within the distributed station
  - Module replacement possible without interrupting communication to the SIMATIC ET 200pro station and the other modules within SIMATIC ET 200pro
  - No configuration effort required or reduction of space requirements and installation expenditure for the braking resistor due to line-commutated energy recovery
  - Parameter assignment via IOP-2 Handheld, STARTER and optional memory card as parameter storage medium
  - Standard mini USB interface for commissioning
- Low-cost and uniform solutions
  - Communication via PROFIBUS and PROFINET (copper or POF fiber-optic cables) including the corresponding interface module
  - Safety Integrated functionality (STO) already integrated as standard
  - Activation of the fail-safe function (STO) of the frequency converter locally via the Safety Local isolator module F-RSM or via PROFIsafe with the F-Switch PROFIsafe module

#### Application

- The frequency converter controls the speed of induction motors steplessly.
- The modular, service-friendly concept of the frequency converter is ideally suited to manufacturing processes with high plant standstill costs.
- Ideal solutions can be created using several frequency converters combined in one distributed station when drives are operated in the same area or for the same purposes.
- The frequency converter handles both frequency control for simple applications and sensorless vector control (SLVC) for more complex drive tasks. It also handles the optimum control of a motor brake, if used.
- The converter also supports torque control, for example, for applications with mechanically coupled drives.
- The benefits of regenerative feedback lie primarily in the reduction in configuring overhead (no braking resistor necessary), reduced installation costs and lower space requirements.
- The STO safety function integrated as standard significantly reduces the overhead for drive solutions in plant sections where there is a hazard potential.



## SIMATIC ET 200pro FC-2 frequency converters 1.5 kW (2 hp)

### SIMATIC ET 200pro FC-2 frequency converter

#### Design

The SIMATIC ET 200pro FC-2 distributed frequency converter is a compact frequency converter for standard drives which has the design of a SIMATIC ET 200pro module. Each SIMATIC ET 200pro FC-2 frequency converter includes both the Control Unit as well as the Power Module in one unit. In addition, there is a backplane bus module for integrating the frequency converter in the SIMATIC ET 200pro system bus.



SIMATIC ET 200pro FC-2 frequency converter

The SIMATIC ET 200pro FC-2 frequency converter supplements the SIMATIC ET 200pro system range with distributed, speed-controlled drives. The frequency converter offers, in combination with the other modules of the modular SIMATIC ET 200pro system, solutions which have been exactly tailored to the plant/system and allows, through the combination of several frequency converters in one distributed station, ideal solutions when drives are operated in the same area or for the same purposes.



SIMATIC ET 200pro station with two SIMATIC ET 200pro FC-2 converters

It is completely embedded in the SIMATIC ET 200pro system and offers all the system advantages such as cabinet-free installation, easy mounting on the module rack, reduction of the wiring outlay due to self-assembling communication and supply rails in the backplane bus, comprehensive diagnostic mechanisms and high availability thanks to replaceability without affecting other modules in the SIMATIC ET 200pro station.

The certified STO safety function integrated as standard ensures that persons and machines are protected from the dangerous movement of machines. Integration of the safety system into the drive also simplifies the machine architecture and supports system-wide diagnostics.

Active and dynamic braking of the motor is possible without incurring any additional costs. The generated braking energy is fed back into the power supply, so there is no need for a braking chopper and braking resistors. To ensure full motor protection, a temperature sensor of the PTC type, bimetal, KTY or Pt1000 can be connected. The integrated 180 V DC brake control at 400 V line voltage ( $U_{\text{line}} \times 0.45 = \text{brake voltage}$ ) allows the direct activation of a motor holding brake and makes a rectifier in the motor terminal box superfluous.

In combination with an SD memory card, the slot for the optional memory card can be used to save the parameter settings in order to facilitate fast replacement of modules with automatic reparameterization.

SIMATIC ET 200pro FC-2 frequency converters use the control modes frequency control and sensorless vector control. The SIMATIC ET 200pro FC-2 frequency converter also supports torque control, for example, for applications with mechanically coupled drives. The innovative power unit concept capable of energy recovery helps save energy.

Options for parameter assignment:

- STARTER, the graphical parameterization tool for Siemens drives
- The fieldbus
- A point-to-point connection via a mini USB interface
- The optical interface for connection of an IOP-2 Handheld

A parameter set download from the SIMATIC controller is also possible.

## SIMATIC ET 200pro FC-2 frequency converters

1.5 kW (2 hp)

### SIMATIC ET 200pro FC-2 frequency converter

#### Integration

The distributed SIMATIC ET 200pro FC-2 frequency converters feature the following interfaces as standard:

- Line supply connection via HAN Q4/2 (socket)
- Motor connection via a HAN Q8 (connector) including control of the motor brake and temperature sensor
- Power output via HAN Q4/2 (connector) for looping the 400 V 3 AC further to a subsequent frequency converter or motor starter from the SIMATIC ET 200pro system

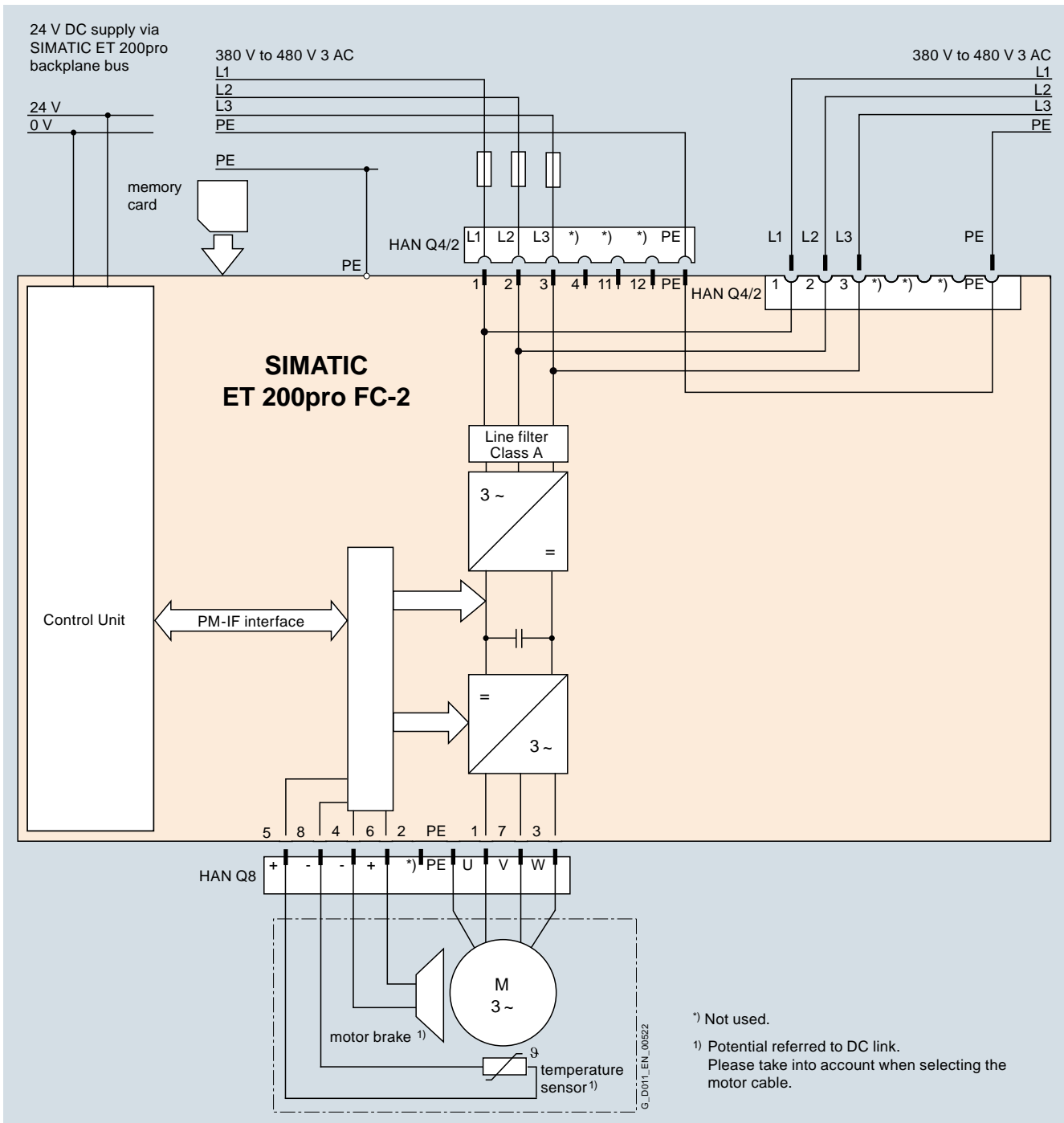

Connection example for SIMATIC ET 200pro FC-2

# SIMATIC ET 200pro FC-2 frequency converters

## 1.5 kW (2 hp)

### SIMATIC ET 200pro FC-2 frequency converter

#### Technical specifications

<b>Distributed frequency converter</b>	<b>SIMATIC ET 200pro FC-2</b>				
<b>Selection features</b>					
<b>Integrated safety functions acc. to IEC 61508 SIL 2 and EN ISO 13849-1 PL d and Category 3</b>	<ul style="list-style-type: none"> <li>• Safe Torque Off (STO)</li> <li>• Control of the integrated safety function via the Safety Local isolator module F-RSM or via F-Switch PROFIsafe</li> </ul>				
<b>Electrical data</b>					
<b>Line voltage</b>	380 ... 480 V 3 AC ±10 %				
<b>Power</b>	<ul style="list-style-type: none"> <li>• With an ambient temperature of 0 ... 55 °C 1.1 kW</li> <li>• With an ambient temperature of 0 ... 45 °C 1.5 kW</li> </ul>				
<b>Rated input current/output current</b>	<ul style="list-style-type: none"> <li>• With an ambient temperature of 0 ... 55 °C 2 A/3.5 A</li> <li>• With an ambient temperature of 0 ... 45 °C 2.5 A/3.9 A</li> </ul>				
<b>Line frequency</b>	47 ... 63 Hz				
<b>Overload capability</b>	<ul style="list-style-type: none"> <li>• Overload current 1.5 x rated output current (i.e. 150 % overload) for 60 s, cycle time 300 s</li> <li>• Overload current 2 x rated output current (i.e. 200 % overload) for 3 s, cycle time 300 s</li> </ul>				
<b>Output frequency</b>	0 ... 550 Hz				
<b>Pulse frequency</b>	4 kHz (standard), 4 ... 16 kHz (in 2-kHz increments)				
<b>Standard SCCR (Short Circuit Current Rating)</b>	10 kA				
<b>Skipped frequency range</b>	1, programmable				
<b>Converter efficiency</b>	95 ... 97 %				
<b>Interfaces</b>	<ul style="list-style-type: none"> <li>• Connection to PROFIBUS and PROFINET over the SIMATIC ET 200pro backplane bus</li> <li>• Mini USB interface for commissioning via PC (as from STARTER V4.4 plus SSP)</li> <li>• Optical interface for commissioning via the IOP-2 Handheld</li> <li>• Slot for an optional memory card (SD) for uploading or downloading parameter settings. Facilitates easy device replacement.</li> <li>• PTC, bimetal, KTY84, Pt1000 interface for motor temperature monitoring</li> </ul>				
<b>Functions</b>					
<b>Open-loop/closed-loop control techniques</b>	<ul style="list-style-type: none"> <li>• V/f control – linear (<math>M \sim n</math>) with/without flux current control (FCC), quadratic (<math>M \sim n^2</math>) or parameterizable</li> <li>• Vector control – sensorless</li> <li>• Closed-loop torque control</li> </ul>				
<b>Operating functions</b>	<ul style="list-style-type: none"> <li>• Jogging</li> <li>• BICO technology</li> <li>• Automatic restart following interruptions in operation due to a power failure</li> <li>• Smooth connection of converter to rotating motor</li> </ul>				
<b>Braking functions</b>	<ul style="list-style-type: none"> <li>• Integrated regenerative feedback functionality</li> <li>• Control of an electromagnetic holding brake</li> </ul>				
	Integrated brake control supplies DC power supply to the brake				
	Line voltage	380 V AC	400 V AC	440 V AC	480 V AC
	Rectified brake voltage	171 V DC	180 V DC	198 V DC	216 V DC
	Recommended brake coil voltage for Siemens motors	170 ... 200 V DC	170 ... 200 V DC	184 ... 218 V DC	184 ... 218 V DC
	Disconnection on the DC side permits "fast" braking.				
<b>Protective functions</b>	<ul style="list-style-type: none"> <li>• Undervoltage</li> <li>• Overvoltage</li> <li>• Ground fault</li> <li>• Short-circuit</li> <li>• Stall protection</li> <li>• Thermal motor protection (<math>I^2t</math> or sensor)</li> <li>• Converter overtemperature</li> <li>• Motor blocking protection</li> <li>• Phase failure detection</li> </ul>				
<b>Connectable motors</b>	<ul style="list-style-type: none"> <li>• Low-voltage asynchronous (induction) motors</li> <li>• Motor cable lengths: max. 15 m (49 ft) (shielded)</li> </ul>				
<b>Mechanical data</b>					
<b>Degree of protection</b>	IP65				
<b>Operating temperature</b>	0 ... 55 °C (32 ... 131 °F)				
<b>Mounting position</b>	Vertical wall mounting (vertical alignment of the cooling fins)				
<b>Dimensions (W x H x D)</b>	155 mm x 246 mm x 248 mm (6.10 in x 9.69 in x 9.76 in)				
<b>Weight, approx.</b>	4 kg (8.8 lb)				
<b>Standards</b>					
<b>Certificates of suitability</b>	UL508C, cUL, CE, Low Voltage Directive 2014/35/EU, EMC Directive 2014/30/EU				

# SIMATIC ET 200pro FC-2 frequency converters

1.5 kW (2 hp)

## SIMATIC ET 200pro FC-2 frequency converter

### Characteristic curves

#### Derating data

##### Pulse frequency

Ambient temperature °C	Rated output current in A at a pulse frequency of						
	4 kHz	6 kHz	8 kHz	10 kHz	12 kHz	14 kHz	16 kHz
0 ... 55 (1.1 kW)	3.5	2.8	2.2	1.6	1.1	0.5	0.0
0 ... 45 (1.5 kW)	3.9	3.9	3.9	3.6	3.3	2.7	2.2

Rated output current as a function of the pulse frequency

##### Installation altitude

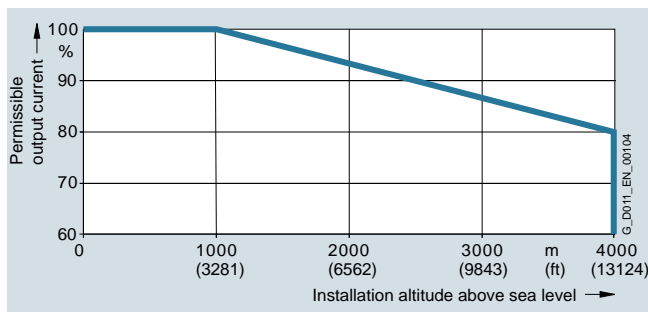

Permissible output current as a function of the installation altitude

##### Relationship between pulse frequency, temperature and output base-load current

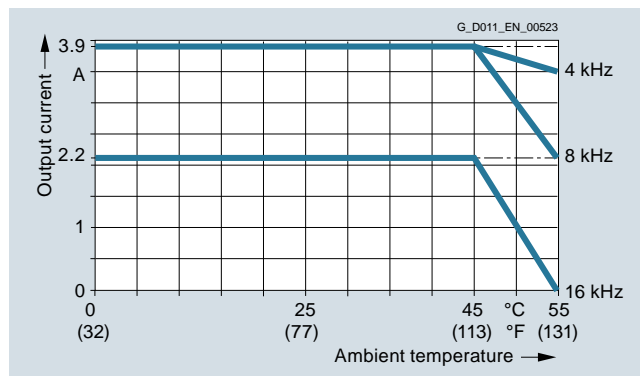

Output current as a function of the pulse frequency and ambient temperature

### Dimensional drawings

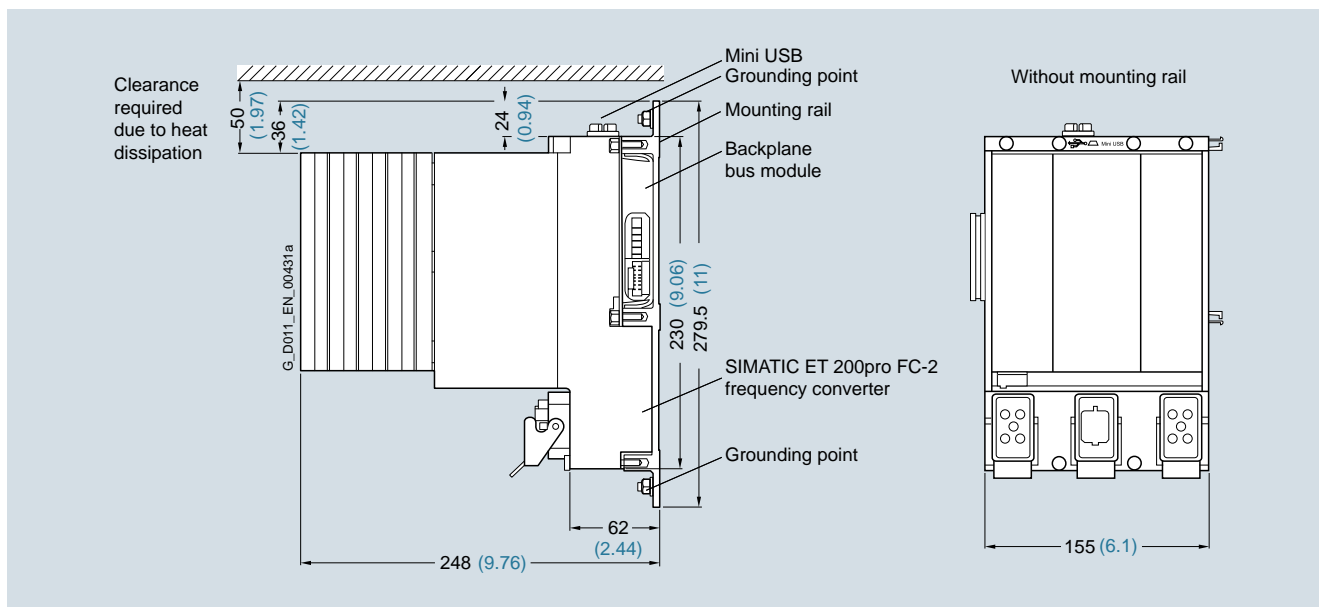

SIMATIC ET 200pro FC-2 frequency converter with backplane bus module and mounting rail

All dimensions in mm (values in brackets are in inches).

### Accessories

#### Intelligent Operator Panel IOP-2 Handheld



IOP-2 Handheld for mobile use

The Intelligent Operator Panel IOP-2 Handheld is a very user-friendly and powerful operator panel for commissioning and diagnostics as well as local operator control and monitoring of SINAMICS G110D, SINAMICS G120D, SINAMICS G110M and SIMATIC ET 200pro FC-2 distributed inverters.

The IOP-2 Handheld supports both newcomers and drive experts. Thanks to the membrane keyboard with a central sensor control field, the high-contrast color displays, the menu-based operation and the application wizards, it is easy to commission standard drives. A drive can be essentially commissioned without having to use a printed parameter list – as the parameters are displayed in plain text, and explanatory help texts and the parameter filtering function are provided.

Application wizards interactively guide you when commissioning important applications such as conveyor technology, pumps, fans and compressors. There is a basic commissioning wizard for general commissioning.

Up to two process values can be graphically visualized and up to four process values can be numerically visualized on the status screen/display. Process values can also be displayed in technological units.

The IOP-2 Handheld supports standard commissioning of identical drives. For this purpose, a parameter list can be copied from a frequency converter into the IOP-2 Handheld and downloaded into other drive units of the same type as required.

In addition to the IOP-2, the IOP-2 Handheld includes a housing with rechargeable batteries, a charging unit, an RS232 connecting cable, and a USB cable. The charging unit is supplied with connector adapters for Europe, the US and the UK. When the batteries are fully charged, the operating time is up to 10 hours.

To connect the IOP-2 Handheld to SINAMICS G110D, SINAMICS G120D, SINAMICS G110M and SIMATIC ET 200pro FC-2, the RS232 connecting cable with optical interface is required in addition.

#### Updating the IOP-2 Handheld

The IOP-2 Handheld can be updated and expanded using the integrated USB interface.

Data to support future drive systems can be transferred from the PC to the IOP-2 Handheld. Further, the USB interface allows you languages and wizards that will become available in the future to be subsequently downloaded and the firmware to be updated for the IOP-2 Handheld <sup>1)</sup>.

#### Selection and ordering data

Description	Article No.
<b>IOP-2 Handheld</b> For use with SINAMICS G120 SINAMICS G120C SINAMICS G120P SINAMICS G110D SINAMICS G120D SINAMICS G110M SIMATIC ET 200pro FC-2  Included in the scope of delivery: <ul style="list-style-type: none"> <li>• IOP-2</li> <li>• Handheld housing</li> <li>• Rechargeable batteries (4 × AA)</li> <li>• Charging unit (international)</li> <li>• RS232 connecting cable 3 m (9.84 ft) long, can be used in combination with SINAMICS G120 SINAMICS G120C SINAMICS G120P</li> <li>• USB cable 1 m (3.28 ft) long</li> </ul>	<b>NEW</b> <b>6SL3255-0AA00-4HA1</b>
<b>RS232 connecting cable</b> 2.5 m (8.20 ft) long, with optical interface for connecting the IOP-2 Handheld to SINAMICS G110D SINAMICS G120D SINAMICS G110M SIMATIC ET 200pro FC-2	<b>3RK1922-2BP00</b>

#### Technical specifications

	IOP-2 Handheld
	6SL3255-0AA00-4HA1
<b>Display</b>	High-contrast color display, variety of display options
• Resolution	320 × 240 pixels
<b>Operator panel</b>	Membrane keyboard with central sensor control field
<b>Operating languages</b>	English, German, French, Italian, Spanish, Portuguese, Dutch, Swedish, Finnish, Russian, Czech, Polish, Turkish, Chinese Simplified
<b>Ambient temperature</b>	
• During transport and storage	-20 ... +55 °C (-4 ... +131 °F)
• During operation	0 ... 40 °C (32 ... 104 °F)
<b>Humidity</b>	Relative humidity < 95 %, non-condensing
<b>Degree of protection</b>	IP20
<b>Dimensions (H × W × D)</b>	195.04 × 70 × 37.58 mm (7.68 × 2.76 × 1.48 in)
<b>Weight, approx.</b>	0.724 kg (1.6 lb)
<b>Compliance with standards</b>	CE, RCM, cULus, EAC, KCC-REM-S49-SINAMICS

<sup>1)</sup> Information on updates for the IOP-2 Handheld is available at <https://support.industry.siemens.com/cs/document/67273266>

## SIMATIC ET 200pro FC-2 frequency converters

1.5 kW (2 hp)

### SIMATIC ET 200pro FC-2 frequency converter

#### Accessories (continued)

##### Memory cards



SINAMICS SD memory card

The parameter settings for a converter can be stored on the SINAMICS SD memory card. When service is required, e. g. after the converter has been replaced and the data have been downloaded from the memory card, the drive system is immediately ready for use again.

- Parameter settings can be written from the memory card to the converter or saved from the converter to the memory card.
- Up to 100 parameter sets can be stored.
- The memory card supports standard commissioning without the use of the Intelligent Operator Panel IOP-2 Handheld or the STARTER and SINAMICS Startdrive commissioning tools.
- If firmware is stored on the memory card and a Control Unit is installed, the firmware can be upgraded/downgraded during power-up<sup>1)</sup>.

##### Note:

The memory card is optional, but it facilitates converter replacement.

##### Selection and ordering data

Description	Article No.
<b>SINAMICS SD card 512 MB</b>	<b>6SL3054-4AG00-2AA0</b>
<i>Optional firmware memory cards</i>	
<b>SINAMICS SD card 512 MB + firmware V4.7 SP3</b> (Multicard V4.7 SP3)	<b>6SL3054-7TB00-2BA0</b>
<b>SINAMICS SD card 512 MB + firmware V4.7 SP6</b> (Multicard V4.7 SP6)	<b>6SL3054-7TD00-2BA0</b>
<b>SINAMICS SD card 512 MB + firmware V4.7 SP9</b> (Multicard V4.7 SP9) NEW	<b>NEW 6SL3054-7TE00-2BA0</b>

For an overview and more information on all available firmware versions, see

<https://support.industry.siemens.com/cs/document/67364620>

##### PC inverter connection kit 2

The mini USB interface cable is used to control and commission a converter directly from a PC via a point-to-point connection if the appropriate software (STARTER commissioning tool version 4.4 and higher, plus SSP) has been installed.

Description	Article No.
<b>PC inverter connection kit 2</b> Mini USB interface cable for communication with a PC, 3 m (9.84 ft) long	<b>6SL3255-0AA00-2CA0</b>

<sup>1)</sup> You can find more information about firmware upgrades/downgrades on the Internet at:  
<https://support.industry.siemens.com/cs/document/67364620>

<sup>2)</sup> The STARTER commissioning tool is also available on the Internet at [www.siemens.com/starter](http://www.siemens.com/starter)

##### STARTER commissioning tool

The STARTER commissioning tool (V4.4 and higher) plus SSP supports the commissioning and maintenance of SIMATIC ET 200pro FC-2 frequency converters. The operator guidance combined with comprehensive, user-friendly functions for the relevant drive solution allow you to commission the device quickly and easily.

You can find further information about the STARTER commissioning tool in the section Engineering tools.

Description	Article No.
<b>STARTER commissioning tool<sup>2)</sup></b> on DVD-ROM	<b>6SL3072-0AA00-0AG0</b>

##### Connecting cables pre-assembled at one end and connector sets to connect to the line supply

Description	Article No.
<b>Connecting cable pre-assembled at one end</b> Power supply cable, open at one end, for HAN Q4/2, angled, 4 × 4 mm <sup>2</sup>	
• Length 1.5 m (4.92 ft)	<b>3RK1911-0DB13</b>
• Length 5 m (16.41 ft)	<b>3RK1911-0DB33</b>
<b>Connector set for the power supply</b> HAN Q4/2	
• 2.5 mm <sup>2</sup>	<b>3RK1911-2BE50</b>
• 4 mm <sup>2</sup>	<b>3RK1911-2BE10</b>
• 6 mm <sup>2</sup>	<b>3RK1911-2BE30</b>

##### Motor cables pre-assembled at one end and connector sets to connect the converter to the motor

Motor cables pre-assembled at one end For motors with brake and temperature sensor with HAN Q8 connector, shielded	Article No.
Cross-section	(HTG: supplied by Harting) (ZKT: supplied by KnorrTec)
	4 × 1.5 mm <sup>2</sup> 2 × (2 × 0.75 mm <sup>2</sup> )
• Length 1.5 m (4.92 ft)	<b>HTG: 61 88 201 0288</b> <b>ZKT: 70020501000150</b>
• Length 3 m (9.84 ft)	<b>HTG: 61 88 201 0289</b> <b>ZKT: 70020501000300</b>
• Length 5 m (16.41 ft)	<b>HTG: 61 88 201 0290</b> <b>ZKT: 70020501000500</b>
• Length 10 m (32.81 ft)	<b>HTG: 61 88 201 0299</b> <b>ZKT: 70020501001000</b>
<b>Connector set for motor cable</b> HAN Q8, shielded	<b>HTG: 61 83 401 0131</b> <b>ZKT: 10032001</b>

##### Power jumper connector

The power jumper connector is used for 400 V power transmission to following 400 V modules.

Description	Article No.
<b>Power jumper connector</b>	<b>3RK1922-2BQ00</b>

##### More information

A comprehensive range of supplementary products is provided for the distributed drive technology, e.g. pre-assembled cables and connectors. An overview is provided at the following link:  
[www.siemens.com/distributeddrives-supplementaryproducts](http://www.siemens.com/distributeddrives-supplementaryproducts)

Further selected accessories are available from the Siemens Solution Partners. Select "Distributed Field Installation System" as the technology in the "Solution Partner Finder".

[www.siemens.com/automation/partnerfinder](http://www.siemens.com/automation/partnerfinder)

For further information about the connecting cables and plug-in connectors, please refer to Catalog IK PI.

## SIMOTICS motors and geared motors



11/2

Overview

You can find more information on motors/  
geared motors on the Internet at:  
[www.siemens.com/industrymall](http://www.siemens.com/industrymall)

### **Drive Technology Configurator**

Product selection via selectors  
[www.siemens.com/dt-configurator](http://www.siemens.com/dt-configurator)

### **SIZER for Siemens Drives**



Engineering tool  
[www.siemens.com/sizer](http://www.siemens.com/sizer)

### **CAD CREATOR**

Dimensional drawing and  
2D/3D CAD generator  
[www.siemens.com/cadcreator](http://www.siemens.com/cadcreator)

**SIMOTICS motors and geared motors**

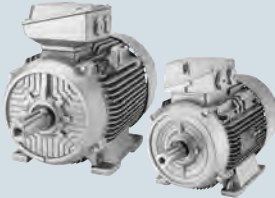
## Overview

Motor type	Features	Degree of protection	Cooling method
<b>SIMOTICS GP and SD low-voltage motors</b>			
 <p><b>SIMOTICS GP 1LE10 and VSD10-Line 1LE10 standard motors</b> <b>SIMOTICS GP VSD4000-Line 1FP10 reluctance motors</b></p> <p><b>SIMOTICS SD 1LE15, 1LE16 and VSD10-Line 1LE15 standard motors</b> <b>SIMOTICS SD VSD4000-Line 1FP15 reluctance motors</b></p>	For general purpose applications Motors with an aluminum housing	IP55	Natural cooling/ forced ventilation
	For severe duty applications Motors with cast-iron housing	IP55	Natural cooling
Motor type	Features	Degree of protection	Gear unit designation
<b>SIMOGEAR 2KJ geared motors</b>			
 <p><b>SIMOGEAR 2KJ geared motors</b></p>	Helical geared motors	IP55	<i>Z19 ... Z189</i> (2-stage) <i>D19 ... D189</i> (3-stage)  <i>E39 ... E149</i> (1-stage) <i>D29-Z19 ... D189-D69</i> (double geared motors 4-stage to 6-stage)
	Parallel shaft geared motors	IP55	<i>FZ29 ... FZ189</i> (2-stage) <i>FD29 ... FD189</i> (3-stage)  <i>FD29 ... FD149</i> (3-stage) <i>FZ29-Z19 ... FD189-D69</i> (double geared motors 4-stage to 6-stage)
	Bevel geared motors	IP55	<i>B19 ... B49</i> (2-stage) <i>K39 ... K129</i> (3-stage)  <i>K39-D/Z19 ... K189-D/Z69</i> (double geared motors 5-stage and 6-stage)
	Helical worm geared motors	IP55	<i>C29 ... C89</i> (2-stage)  <i>C29-D/Z19 ... C89-D/Z39</i> (double geared motors 4-stage and 5-stage)
	Worm geared motors	IP55	<i>S09 ... S29</i> (1-stage)



Shaft height (SH)	Rated power $P_{\text{rated}}$ for S1 duty kW (hp)							Rated torque $M_{\text{rated}}$	Catalog
	0.01	0.1	1	10	100	1000	10000		
80, 90, 100, 112, 132, 160, 180, 200			0.37 (0.50)		52 (69.7)			2.1 ... 294 Nm (1.55 ... 217 lb <sub>f</sub> -ft)	D 81.1
70, 80, 90, 100, 112, 132, 160, 180, 200, 225, 250, 280, 315		0.09 (0.12)				230 (308)		1.0 ... 1703 Nm (0.74 ... 1256 lb <sub>f</sub> -ft)	
Gear unit size	Maximum output torque $M_{2\text{max}}$ Nm (lb <sub>f</sub> -ft)					Gear ratio $i$	Catalog		
	10	100	1000	10000	100000				
19, 29, 39, 49, 59, 69, 79, 89, 109, 129, 149, 169, 189			30 (22.1)		19000 (14014)	1.29 ... 27816	MD 50.1		
29, 39, 49, 69, 79, 89, 109, 129, 149, 169, 189			150 (111)		19000 (14014)	4 ... 29900			
39, 49, 69, 79, 89, 109, 129, 149, 169, 189			50 (36.9)		19500 (14383)	3.6 ... 14900			
29, 39, 49, 69, 89			61 (45.0)		1450 (1070)	6.5 ... 19000			
09, 19, 29			33 (24.3)		116 (85.6)	5.0 ... 100			

## SIMOTICS motors and geared motors

### Notes

11

## Engineering tools



### Security information

Siemens provides products and solutions with industrial security functions that support the secure operation of plants, systems, machines and networks.

In order to protect plants, systems, machines and networks against cyber threats, it is necessary to implement – and continuously maintain – a holistic, state-of-the-art industrial security concept. Siemens' products and solutions constitute one element of such a concept.

Customers are responsible for preventing unauthorized access to their plants, systems, machines and networks. Such systems, machines and components should only be connected to an enterprise network or the internet if and to the extent such a connection is necessary and only when appropriate security measures (e.g. firewalls and/or network segmentation) are in place.

For additional information on industrial security measures that may be implemented, please visit

<https://www.siemens.com/industrialsecurity>

Siemens' products and solutions undergo continuous development to make them more secure. Siemens strongly recommends that product updates are applied as soon as they are available and that the latest product versions are used. Use of product versions that are no longer supported, and failure to apply the latest updates may increase customer's exposure to cyber threats.

To stay informed about product updates, subscribe to the Siemens Industrial Security RSS Feed under

<https://www.siemens.com/industrialsecurity>

12/2	<b>SinaSave energy efficiency tool</b>
12/3	<b>Drive Technology Configurator</b>
12/4	<b>SIZER for Siemens Drives engineering tool</b>
12/5	<b>STARTER commissioning tool</b>
12/7	<b>SINAMICS Startdrive commissioning tool</b>
12/10	<b>Drive ES engineering software</b>

## Engineering tools

### SinaSave energy efficiency tool

#### Overview

The SinaSave energy efficiency tool calculates potential energy savings and amortization times based on your individual conditions of use and therefore offers practical assistance in making decisions about investments in energy-efficient technologies.

From SinaSave Version 6.0 and higher, the drive systems to be compared and the relevant drive component parameters are displayed graphically. An additional expansion are the numerous comparison possibilities for different control types and comprehensive product combinations for drive solutions for pump and fan applications. In addition to SIMOTICS motors and SINAMICS drives, the product portfolio comprises SIRIUS switching devices, offering a comprehensive range of comparison possibilities – according to your individual requirements.



SinaSave offers numerous comparison scenarios:

- Comparison of drive systems for pump and fan applications in the output range from 0.55 kW (low voltage) to 5.5 MW (medium voltage) for
  - Reactor control (fixed speed; motor and switching device)
  - Bypass control (fixed speed; motor and switching device)
  - Speed control (variable speed; motor and frequency converter)
- Comparison and evaluation of standard motors (incl. ignition protection motors) in different energy efficiency classes

SinaSave supports the evaluation of the various comparisons of product and system by

- Displaying the potential savings for energy and energy costs, as well as CO<sub>2</sub> emissions
- Estimation of the amortization time
- Estimation of the individual total lifecycle costs
- Representation of the system power losses according to EN 50598-2 for full load and partial load
- Direct comparison of Siemens drives with the reference Power Drive System (PDS) described in EN 50598-2



[Access to the SinaSave energy efficiency tool](http://www.automation.siemens.com/sinasave)

SinaSave can be accessed without the need for registration or logging in:

[www.automation.siemens.com/sinasave](http://www.automation.siemens.com/sinasave)

#### More information

For more information about the amortization calculator for energy-efficient drive systems, visit [www.siemens.com/sinasave](http://www.siemens.com/sinasave)

More information about services for energy saving is available on the Internet at [www.siemens.com/energysaving](http://www.siemens.com/energysaving)

## Overview

The Drive Technology Configurator (DT Configurator) helps you to configure the optimum drive technology products for your application – starting with gear units, motors, inverters as well as the associated options and components and ending with controllers, software licenses and connection systems. Whether with little or detailed knowledge of products: preselected product groups, deliberate navigation through selection menus and direct product selection through entry of the article number support quick, efficient and convenient configuration.

In addition, comprehensive documentation comprising technical data sheets, 2D dimensional drawings/3D CAD models, operating instructions, certificates, etc. can be selected in the DT Configurator. Immediate ordering is possible by simply transferring a parts list to the shopping cart of the Industry Mall.



### Drive Technology Configurator for efficient drive configuration with the following functions

- Quick and easy configuration of drive products and associated components – gear units, motors, inverters, controllers, connection systems
- Configuration of drive systems for pumps, fans and compressor applications from 1 kW to 2.6 MW
- Retrievable documentation for configured products and components, such as
  - Data sheets in up to 9 languages in PDF or RTF format
  - 2D dimensional drawings/3D CAD models in various formats
  - Terminal box drawing and terminal connection diagram
  - Operating instructions
  - Certificates
  - Start-up calculation for SIMOTICS motors
  - EPLAN macros
- Support with retrofitting in conjunction with Spares On Web ([www.siemens.com/sow](http://www.siemens.com/sow))
- Ability to order products directly through the Siemens Industry Mall

### Access to the Drive Technology Configurator

The Drive Technology Configurator can be called up without registration and without a login:

[www.siemens.com/dt-configurator](http://www.siemens.com/dt-configurator)

## Selection and ordering data

Description	Article No.
<b>Interactive catalog CA 01</b> on DVD-ROM including Drive Technology Configurator, English	<b>E86060-D4001-A510-D8-7600</b>

## More information

[Online access to the Drive Technology Configurator](#)

More information about the Drive Technology Configurator is available on the Internet at [www.siemens.com/dtconfigurator](http://www.siemens.com/dtconfigurator)

[Offline access to the Drive Technology Configurator in the Interactive Catalog CA 01](#)

In addition, the Drive Technology Configurator is also included in the Interactive Catalog CA 01 on DVD-ROM – the offline version of the Siemens Industry Mall.

The Interactive Catalog CA 01 can be ordered from the relevant Siemens sales office or via the Internet:

[www.siemens.com/automation/CA01](http://www.siemens.com/automation/CA01)

## Engineering tools

### SIZER for Siemens Drives engineering tool

#### Overview

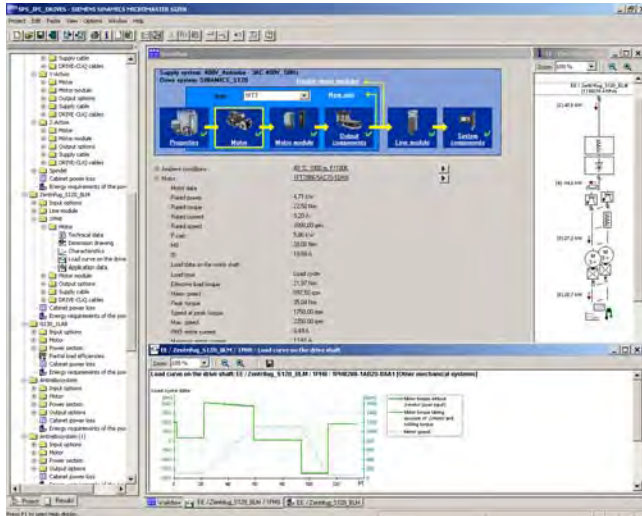

The following drives and controls can be engineered in a user-friendly way using the SIZER for Siemens Drives engineering tool:

- SIMOTICS low-voltage motors, including servo geared motors
- SINAMICS low-voltage drive systems
- Motor starters
- SINUMERIK CNC
- SIMOTION Motion Control controller
- SIMATIC controller

It provides support when selecting the technologies involved in the hardware and firmware components required for a drive task. SIZER for Siemens Drives covers the full range of operations required to configure a complete drive system, from basic single drives to demanding multi-axis applications.

SIZER for Siemens Drives supports all of the engineering steps in one workflow:

- Configuring the power supply
- Designing the motor and gearbox, including calculation of mechanical transmission elements
- Configuring the drive components
- Compiling the required accessories
- Selecting the line-side and motor-side power options, e.g. cables, filters, and reactors

When SIZER for Siemens Drives was being designed, particular importance was placed on a high degree of usability and a universal, function-based approach to the drive application. The extensive user guidance makes it easy to use the tool. Status information keeps you continually informed about the progress of the configuration process.

The drive configuration is saved in a project. In the project, the components and functions used are displayed in a hierarchical tree structure.

The project view permits the configuration of drive systems and the copying/inserting/modifying of drives already configured.

The configuration process produces the following results:

- A parts list of the required components (export to Excel, use of the Excel data sheet for import to SAP)
- Technical specifications of the system
- Characteristic curves
- Comments on system reactions
- Mounting arrangement of drive and control components and dimensional drawings of motors
- Energy requirements of the configured application

These results are displayed in a results tree and can be reused for documentation purposes.

Support is provided by the technological online help menu:

- Detailed technical specifications
- Information about the drive systems and their components
- Decision-making criteria for the selection of components
- Online help in English, French, German, Italian, Chinese and Japanese

#### System requirements

- PG or PC with Pentium III min. 800 MHz (recommended > 1 GHz)
- 512 MB RAM (1 GB RAM recommended)
- At least 4.1 GB of free hard disk space
- An additional 100 MB of free hard disk space on Windows system drive
- Screen resolution 1024 × 768 pixels (1280 × 1024 pixels recommended)
- Operating system:
  - Windows 7 Professional (32/64-bit)
  - Windows 7 Enterprise (32/64-bit)
  - Windows 7 Ultimate (32/64-bit)
  - Windows 7 Home (32/64-bit)
  - Windows 8.1 Professional (32/64-bit)
  - Windows 8.1 Enterprise (32/64-bit)
- Microsoft Internet Explorer V5.5 SP2

#### Selection and ordering data

Description	Article No.
<b>SIZER for Siemens Drives engineering tool</b> on DVD-ROM	<b>6SL3070-0AA00-0AG0</b>
English, French, German, Italian	

#### More information

The SIZER for Siemens Drives engineering tool is available free on the Internet at [www.siemens.com/sizer](http://www.siemens.com/sizer)

## Overview

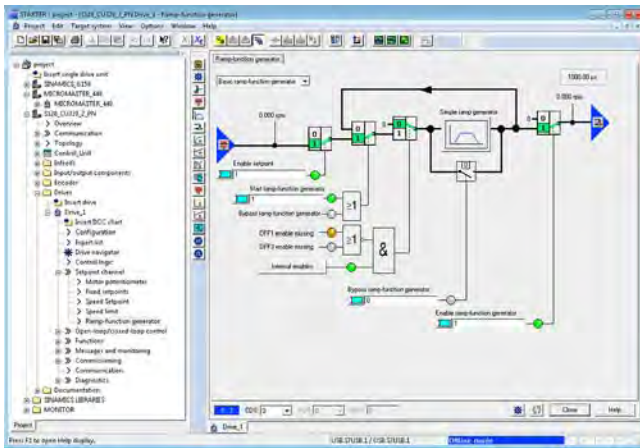

The user-friendly STARTER commissioning tool can be used for:

- Commissioning
- Optimization
- Diagnostics

This software can be operated as a standalone PC application, or integrated as a TIA-compatible program in SIMATIC STEP 7, or highly integrated into the SCOUT Engineering System (for SIMOTION). The basic functions and handling are the same in both cases.

In addition to the SINAMICS drives, STARTER also supports MICROMASTER 4 devices.

The project wizards can be used to create the drives within the structure of the project tree.

Beginners are supported by solution-based dialog guidance, whereby a standard graphics-based display maximizes clarity when setting the drive parameters.

First commissioning is guided by a wizard which makes all the basic settings in the drive. Therefore, getting a motor up and running is merely a question of setting a few of the drive parameters as part of the drive configuration process.

The individual settings required are made using graphics-based parameterization screens, which also precisely visualize the principle of operation of the drive.

Examples of individual settings that can be made include:

- How terminals are used
- Bus interface
- Setpoint channel (e.g., fixed setpoints)
- Closed-loop speed control (e.g., ramp-function generator, limits)
- BICO interconnections
- Diagnostics

For experts, the expert list can be used to specifically and quickly access individual parameters at any time. An individual compilation of frequently used parameters can be saved in dedicated user lists and watch tables.

In addition, the following functions are available for optimization purposes:

- Self-optimization of the controller settings (depending on drive unit)
- Setup and evaluation of trace recordings<sup>1)</sup>
  - Tool function for recording 2 × 8 signals with
  - Measuring cursor function
  - Extensive trigger functions
  - Several Y scales
  - Sampling times in the current controller cycle clock

Diagnostics functions provide information about:

- Control/status words
- Parameter status
- Operating conditions
- Communication states

### Performance features

- User-friendly: Only a small number of settings need to be made for successful first commissioning: The motor starts to rotate
- Solution-oriented dialog-based user guidance simplifies commissioning
- Self-optimization functions reduce manual effort for optimization.

### System requirements

The following minimum requirements must be complied with:

- Hardware
  - PG or PC with Pentium III min. 1 GHz (recommended >1 GHz)
  - Work memory 2 GB (4 GB recommended)
  - Screen resolution 1024 × 768 pixels, 16-bit color depth
  - Free hard disk memory: min. 5 GB
- Software
  - Microsoft Internet Explorer V6.0 or higher
  - 64-bit operating systems:
    - Microsoft Windows 7 Professional SP1
    - Microsoft Windows 7 Ultimate SP1
    - Microsoft Windows 7 Enterprise SP1 (standard installation)
    - Microsoft Windows Server 2008 R2 SP1
    - Microsoft Windows Server 2016
    - Microsoft Windows 10 Pro
    - Microsoft Windows 10 Enterprise

### Supported virtualization platforms

STARTER (V5.1 SP1 and higher) can be installed in a virtual machine. For this purpose, one of the following virtualization platforms in the specified version or a newer version can be used:

- VMware vSphere Hypervisor (ESXi) 6.0
- VMware workstation 11 V12.5.2
- VMware player Pro 7.0 V12.5.2
- Microsoft Windows Server 2012 Hyper-V

You can use the following guest operating systems to install STARTER within the selected virtualization platform:

- Windows 7 Professional/Ultimate/ Enterprise (64-bit)
- Windows 10 Professional/Enterprise (64-bit)

<sup>1)</sup> Depending on drive unit.  
Not supported for MICROMASTER 4, SINAMICS G110, SINAMICS G120 <firmware V4.4, SINAMICS G110D and SINAMICS G120D <firmware V4.5.

## Engineering tools

### STARTER commissioning tool

#### Integration

Data can be exchanged (depending on the version) via PROFIBUS or PROFINET/Ethernet or via a serial interface.

For commissioning and service, a PG/PC can be connected to the CU320-2 Control Unit via PROFIBUS. A PROFIBUS connection must be available with a connecting cable at the PG/PC.

Further, communication between a CU320-2 Control Unit and PG/PC can also be established via Ethernet, either via an (optional) CBE20 Communication Board or the Ethernet interface -X127 on the CU320-2 Control Unit.

#### Note:

The terminal strip -X127 is suitable as a communication link to the PG/PC only for the purposes of servicing and commissioning.

#### Selection and ordering data

Description	Article No.
<b>STARTER commissioning tool</b> for SINAMICS and MICROMASTER English, French, German, Italian, Spanish	<b>6SL3072-0AA00-0AG0</b>

#### Accessories

Depending on the version of the Control Unit (CU), the Control Unit of the drive unit can communicate with the programming device (PG) or PC via PROFIBUS or PROFINET/Ethernet or via a serial interface. The following accessories are available for the particular drive system as listed in the following table.

Description	Recommended accessories
	For communication between the drive unit and the programming device or PC Article No.
<b>SIMATIC ET 200pro FC-2</b>	
• USB	<b>PC inverter connection kit 2</b> Mini USB interface cable for communication with a PC, 3 m (9.84 ft) <b>6SL3255-0AA00-2CA0</b>
• PROFIBUS	Connection to the PROFIBUS system in the plant See supplementary products <sup>1)</sup>
• PROFINET/ Ethernet	Connection to the PROFINET system in the plant See supplementary products <sup>1)</sup>
<b>SINAMICS G110M</b>	
• USB	<b>PC inverter connection kit 2</b> Mini USB interface cable for communication with a PC, 3 m (9.84 ft) <b>6SL3255-0AA00-2CA0</b>
• PROFIBUS	Connection to the PROFIBUS system in the plant See supplementary products <sup>1)</sup>
• PROFINET/ Ethernet	Connection to the PROFINET system in the plant See supplementary products <sup>1)</sup>
<b>SINAMICS G110D</b>	
• Optical USB	<b>USB interface cable</b> For communication with a PC, 2.5 m (8.2 ft) <b>6SL3555-0PA00-2AA0</b>
<b>SINAMICS G120D</b>	
• USB	<b>PC inverter connection kit 2</b> Mini USB interface cable for communication with a PC, 3 m (9.84 ft) <b>6SL3255-0AA00-2CA0</b>
• PROFIBUS	Connection to the PROFIBUS system in the plant See supplementary products <sup>1)</sup>
• PROFINET/ Ethernet	Connection to the PROFINET system in the plant See supplementary products <sup>1)</sup>

#### More information

The STARTER commissioning tool is also available on the Internet at

[www.siemens.com/starter](http://www.siemens.com/starter)

<sup>1)</sup> An overview of all the supplementary products (e.g. cables and connectors) that are available for the distributed drives family can be found at the following link:

[www.siemens.com/distributeddrives-supplementaryproducts](http://www.siemens.com/distributeddrives-supplementaryproducts)



## Overview

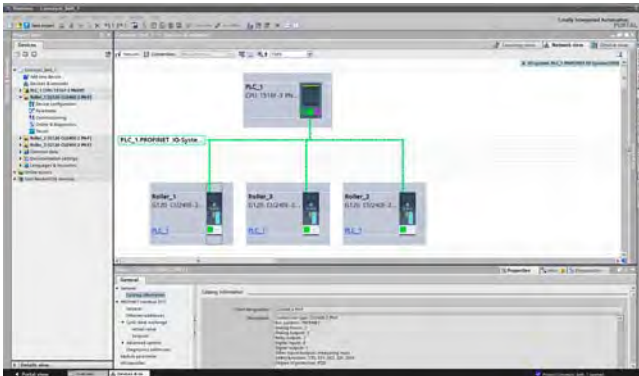

SINAMICS Startdrive is a tool for configuring, commissioning, and diagnosing the SINAMICS family of drives and is integrated into the TIA Portal.

SINAMICS Startdrive can be used to implement drive applications involving the following drives:

- SINAMICS G120
- SINAMICS G120C
- SINAMICS G120D
- SINAMICS G120P
- SINAMICS G110M

The SINAMICS Startdrive commissioning tool has been optimized with regard to user friendliness and consistent use of the TIA Portal benefits of a common working environment for PLC, HMI and drives.

## Performance features

Efficient commissioning with easy configuration and powerful tools:

- High degree of usability thanks to task-based navigation through the engineering workflow
  - Hardware configuration
  - Parameterization
  - Commissioning
  - Diagnostics
- Time-saving and guided step-by-step commissioning
- User-friendly graphic function view for all drive functions
- List of drive parameters structured according to functions
- Easy integration of SIMOTICS motors
- Integrated control panel for direct operation of the drive from the TIA Portal
- Powerful realtime trace for commissioning and drive diagnostics
- Intuitive and efficient drive diagnostics through automatic display of messages
- Context-sensitive online help, e.g. for drive messages
- Integrated detailed drive diagnostic functions
  - Control/status words
  - Parameter status
  - Operating conditions
  - Communication states
- Simple configuration for drive-end Safety Integrated and the drive-internal basic positioning function (EPos)
- Graphic configuration of drive-internal free function blocks (FFB)
- Online work on the drive
  - Without previous creation of an offline project
  - With the new SINAMICS firmware without the need to perform a tool update.
  - Available online functions without project: Commissioning with wizard and control panel, full parameter access with graphic function view and structured parameter list with complete drive diagnostics

## Engineering tools

### SINAMICS Startdrive commissioning tool

#### Integration

##### Integration of SINAMICS drives with SIMATIC in the TIA Portal

The software packages based on the TIA Portal are harmonized with each other and offer important benefits. The TIA Portal enables simple integration of SINAMICS drives in your automation solution:

- Reduction in the familiarization overhead thanks to cross-tool uniformity of the operator inputs
- Device configuration and network connection of the drives in the TIA Portal-wide configuration/network editor
- Device access to the drives via the PLC across network boundaries (dataset routing)
- Automatic frame comparison between converters/inverters and SIMATIC S7 PLC
- Reduction of standstill times through the integration of converter/inverter messages in the SIMATIC S7 system diagnostics:
  - The drive messages are part of the SIMATIC S7 system diagnostics without previous configuration
  - The drive messages are therefore automatically available as plain text in the TIA Portal, the web server of the SIMATIC S7 PLC and the HMI
- Time savings thanks to simple and guided configuration of the drives for operation with SIMATIC S7 Motion Control
- Short familiarization time for SIMATIC STEP 7 users due to common use of editors. Realtime trace and the drive control panel are identical to the editors in STEP 7
- Reuse of the drive configuration and parameterization is possible with the assistance of the TIA Portal library
- Standard TIA Portal functions for converters/inverters, e.g. Undo, Redo
- Block library supplied for easy integration of SINAMICS drives into the user programs of the SIMATIC S7-300, S7-400, S7-1200, S7-1500
- Shared project storage for all devices in the project

##### Supported drives

Integration of the SINAMICS drives into the TIA Portal is carried out in steps. The following drives can be configured in SINAMICS Startdrive:

- SINAMICS G120
- SINAMICS G120C
- SINAMICS G120D
- SINAMICS G120P
- SINAMICS G110M

All of the available Control Units from SINAMICS Firmware V4.4 are supported for these devices (including PROFINET, PROFIBUS, Safety Integrated). All combinable Power Modules up to 400 kW can be configured.

##### Installation versions

SINAMICS Startdrive can be installed as an optional package to SIMATIC STEP 7 or as a stand-alone application (without SIMATIC STEP 7).

##### Requirements for the installation

The following table shows the minimum hardware and software requirements that must be met for installation:

Hardware/software	Requirement
<b>Processor</b>	Intel Core i3-6100U, 2.3 GHz
<b>RAM</b>	4 GB
<b>Hard disk</b>	S-ATA with at least 8 GB available memory
<b>Network</b>	From 100 Mbit
<b>Screen resolution</b>	1024 × 768
<b>Operating systems</b>	<b>Windows 7 (64-bit)</b> <ul style="list-style-type: none"> <li>• Windows 7 Professional SP1</li> <li>• Windows 7 Enterprise SP1</li> <li>• Windows 7 Ultimate SP1</li> </ul> <b>Windows 8.1 (64-bit)</b> <ul style="list-style-type: none"> <li>• Windows 8.1 Professional</li> <li>• Windows 8.1 Enterprise</li> </ul> <b>Windows 10 (64-bit)</b> <ul style="list-style-type: none"> <li>• Windows 10 Professional Version 1607</li> <li>• Windows 10 Enterprise Version 1607</li> <li>• Windows 10 Enterprise 2016 LTSB</li> <li>• Windows 10 Enterprise 2015 LTSB</li> </ul> <b>Windows Server (64-bit)</b> <ul style="list-style-type: none"> <li>• Windows Server 2008 R2 StdE SP1 (full installation)</li> <li>• Windows Server 2012 R2 StdE (full installation)</li> <li>• Windows Server 2016 Standard (full installation)</li> </ul>

##### Recommended PC hardware

The following table shows the recommended hardware for the operation of SINAMICS Startdrive.

Hardware	Recommendation
<b>Computer</b>	As of SIMATIC FIELD PG M5 Advanced (or comparable PC)
<b>Processor</b>	Intel Core i5-6440EQ (up to 3.4 GHz)
<b>RAM</b>	16 GB or more (32 GB for large projects)
<b>Hard disk</b>	SSD with at least 50 GB available memory
<b>Screen resolution</b>	15.6" Full HD display (1920 × 1080 or larger)

**Integration** (continued)**Compatibility with other products**

- SINAMICS Startdrive can be installed alongside STARTER
- SINAMICS Startdrive V14 SP1 operates with STEP 7 Basic/Professional V14 SP1 and WinCC V14 SP1 in a framework
- SINAMICS Startdrive V14 SP1 can be installed on a computer alongside other versions of Startdrive, STEP 7, STEP 7 V5.4 or V5.5, STEP 7 Micro/WIN, WinCC flexible (2008 and above) and WinCC (V7.0 SP2 and above)

**Supported virtualization platforms**

SINAMICS Startdrive can be installed in a virtual machine. For this purpose, one of the following virtualization platforms in the specified version or a newer version can be used:

- VMware vSphere Hypervisor (ESXi) 6.0
- VMware Workstation 12.5
- VMware Player 12.5
- Microsoft Hyper-V Server 2016

The following operating systems can host these virtualization platforms:

- Windows 7 Professional/Ultimate/Enterprise (64-bit)
- Windows Server 2008 R2 (64-bit)
- Windows Server 2012 R2 (64-bit)
- Windows 8.1 Professional/Enterprise (64-bit)
- Windows 10 Professional/Enterprise (64-bit)

You can use the following guest operating systems to install SINAMICS Startdrive within the selected virtualization platform:

- Windows 7 Professional/Ultimate/ Enterprise (64-bit)
- Windows 8.1 Professional/Enterprise (64-bit)

**Supported security programs**

The following security programs are compatible with SINAMICS Startdrive V14 SP1:

- Virus scanners:
  - Symantec Endpoint Protection 12.1
  - Trend Micro Office Scan Corporate Edition 11.0
  - McAfee VirusScan Enterprise 8.8
  - Kaspersky Anti-Virus 2016
  - Windows Defender (Windows version 8.1 and above)
  - Qihoo "360 Safe Guard" 9.7
- Encryption software:
  - Microsoft Bitlocker
- Host-based Intrusion Detection System:
  - McAfee Application Control 6.2.0

**Selection and ordering data**

Description	Article No.
<b>SINAMICS Startdrive commissioning tool</b> incl. single license and Certificate of License English, French, German, Italian, Spanish, Chinese Simplified • On DVD-ROM • Software download/ online software delivery	<b>6SL3072-4EA02-0XA0</b> <b>6SL3072-4EA02-0XG0</b>

**Accessories**

Depending on the version of the Control Unit (CU), the Control Unit of the drive unit can communicate with the programming device (PG) or PC via PROFIBUS or PROFINET/Ethernet or via a serial interface. The following accessories are available for the particular drive system as listed in the following table.

Description	Recommended accessories
	For communication between the drive unit and the programming device or PC
	Article No.
<b>SINAMICS G110M</b>	
• USB <b>PC inverter connection kit 2</b> Mini USB interface cable for communication with a PC, 3 m (9.84 ft)	<b>6SL3255-0AA00-2CA0</b>
• PROFIBUS Connection to the PROFIBUS system in the plant	See supplementary products <sup>1)</sup>
• PROFINET/Ethernet Connection to the PROFINET system in the plant	See supplementary products <sup>1)</sup>
<b>SINAMICS G120D</b>	
• USB <b>PC inverter connection kit 2</b> Mini USB interface cable for communication with a PC, 3 m (9.84 ft)	<b>6SL3255-0AA00-2CA0</b>
• PROFIBUS Connection to the PROFIBUS system in the plant	See supplementary products <sup>1)</sup>
• PROFINET/Ethernet Connection to the PROFINET system in the plant	See supplementary products <sup>1)</sup>

**More information**

The SINAMICS Startdrive commissioning tool is available free on the Internet at

[www.siemens.com/startdrive](http://www.siemens.com/startdrive)

<sup>1)</sup> An overview of all the supplementary products (e.g. cables and connectors) that are available for the distributed drives family can be found at the following link:  
[www.siemens.com/distributeddrives-supplementaryproducts](http://www.siemens.com/distributeddrives-supplementaryproducts)

## Engineering tools

### Drive ES engineering software

#### Overview

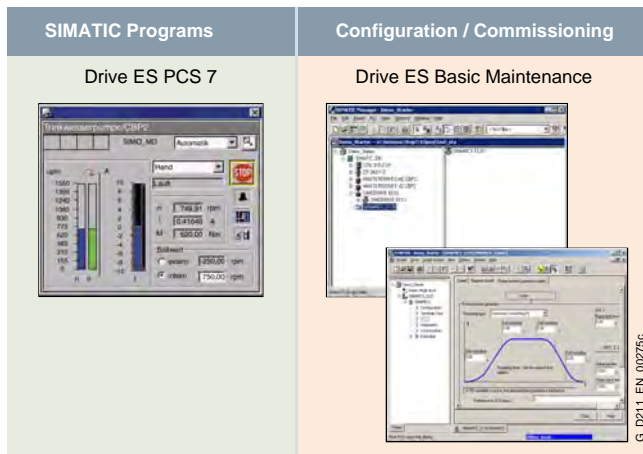

Drive ES is the engineering system used to integrate the communication, configuration and data management functions of Siemens drive technology into the SIMATIC automation world easily, efficiently and cost-effectively.

The following software packages are available for selection:

- Drive ES Basic Maintenance
- Drive ES PCS 7

Drive ES (**D**rive **E**ngineering **S**oftware) fully integrates drives from Siemens into the world of Totally Integrated Automation.

#### Design

The following software packages are available for selection:

- **Drive ES Basic Maintenance**
- **Drive ES PCS 7** (APL Style or Classic Style)

##### *Drive ES Basic Maintenance*

This software product will ensure TIA functionality for the previous drive systems not supported by STARTER.

Drive ES Basic Maintenance is for first-time users of the world of Totally Integrated Automation and the basic software for setting the parameters of all drives online and offline in this environment. Drive ES Basic Maintenance enables both the automation system and the drives to be handled using the SIMATIC Manager software. Drive ES Basic Maintenance is the starting point for common data archiving for complete projects and for extending the use of the SIMATIC teleservice to drives. Drive ES Basic Maintenance provides the configuration tools for the new Motion Control functions – slave-to-slave communication, equidistance and isochronous operation with PROFIBUS DP and ensures that drives with PROFINET IO are simply integrated into the SIMATIC environment.

##### Note:

For SINAMICS and MICROMASTER 4 drives, this TIA functionality is provided with the STARTER commissioning tool (V4.3.2 and higher).

##### *Drive ES PCS 7 (APL Style or Classic Style)*

Drive ES PCS 7 links the drives with a PROFIBUS DP interface into the SIMATIC PCS 7 process control system, and it requires that SIMATIC PCS 7, V6.1 and higher has first been installed. Drive ES PCS 7 provides a block library with blocks for the drives and the corresponding faceplates for the operator station, which enables the drives to be operated from the PCS 7 process control system. From V6.1 and higher, drives will also be able to be represented in the PCS 7 Maintenance Station.

From Drive ES PCS 7 V8.0 and higher, two versions of the library are available: The APL (Advanced Process Library) variant and the previous version in the so-called Classic Style.

##### Detailed contents of the Drive ES PCS 7 (APL Style or Classic Style)

- **Block library for SIMATIC PCS 7** Faceplates and control blocks for SIMOVERT MASTERDRIVES VC and MC, as well as MICROMASTER/MIDIMASTER of the third and fourth generation and SIMOREG DC MASTER and SINAMICS
- **STEP 7 slave object manager** for convenient configuration of drives and non-cyclic PROFIBUS DP communication with the drives
- **STEP 7 device object manager** for easy configuration of drives with PROFINET-IO interfaces (V8.0 SP1 and higher)
- **SETUP program** for installing the software in the PCS 7 environment

## Selection and ordering data

Description	Article No.
<b>Drive ES Basic Maintenance V5.6</b> Configuration software for the integration of drives into TIA (Totally Integrated Automation) Requirement: STEP 7 V5.4 SP4 or higher Type of delivery: on DVD-ROM Languages: Eng, Fr, Ger, It, Sp with electronic documentation <ul style="list-style-type: none"> <li>Floating license, 1 user</li> </ul>	<b>6SW1700-5JA00-6AA0</b>
<b>Drive ES PCS 7 V8.0 SPx<sup>1)</sup></b> Block library for PCS 7 for the integration of drives in Classic Style (as predecessor) Requirement: PCS 7 V8.0 and higher Type of delivery: CD-ROM Languages: Eng, Fr, Ger, It, Sp with electronic documentation <ul style="list-style-type: none"> <li>Single-user license incl. 1 runtime license</li> <li>Runtime license (without data carrier)</li> <li>Update service for single-user license</li> <li>Upgrade from V6.x to V8.0 SPx<sup>1)</sup></li> </ul>	<b>6SW1700-8JD00-0AA0</b> <b>6SW1700-5JD00-1AC0</b> <b>6SW1700-0JD00-0AB2</b> <b>6SW1700-8JD00-0AA4</b>
<b>Drive ES PCS 7 APL V8.0 SPx<sup>1)</sup></b> Block library for PCS 7 for the integration of drives in APL Style (Advanced Process Library) Requirement: PCS 7 V8.0 and higher Type of delivery: CD-ROM Languages: Eng, Fr, Ger, It, Sp with electronic documentation <ul style="list-style-type: none"> <li>Single-user license incl. 1 runtime license</li> <li>Runtime license (without data carrier)</li> <li>Update service for single-user license</li> <li>Upgrade of APL V8.0 to V8.0 SP1 or Drive ES PCS7 V6.x, V7.x, V8.x classic to Drive ES PCS7 APL V8.0 SPx<sup>1)</sup></li> </ul>	<b>6SW1700-8JD01-0AA0</b> <b>6SW1700-5JD00-1AC0</b> <b>6SW1700-0JD01-0AB2</b> <b>6SW1700-8JD01-0AA4</b>
<b>Drive ES PCS 7 V8.1 SPx<sup>1)</sup></b> Block library for PCS 7 for the integration of drives in Classic Style (as predecessor) Requirement: PCS 7 V8.1 and higher Type of delivery: CD-ROM Languages: Eng, Fr, Ger, It, Sp with electronic documentation <ul style="list-style-type: none"> <li>Single-user license incl. 1 runtime license</li> <li>Runtime license (without data carrier)</li> <li>Update service for single-user license</li> <li>Upgrade from V6.x/V7.x/V8.x to V8.1 SPx<sup>1)</sup></li> </ul>	<b>6SW1700-8JD00-1AA0</b> <b>6SW1700-5JD00-1AC0</b> <b>6SW1700-0JD00-0AB2</b> <b>6SW1700-8JD00-1AA4</b>
<b>Drive ES PCS 7 APL V8.1 SPx<sup>1)</sup></b> Block library for PCS 7 for the integration of drives in APL Style (Advanced Process Library) Requirement: PCS 7 V8.1 and higher Type of delivery: CD-ROM Languages: Eng, Fr, Ger, It, Sp with electronic documentation <ul style="list-style-type: none"> <li>Single-user license incl. 1 runtime license</li> <li>Runtime license (without data carrier)</li> <li>Update service for single-user license</li> <li>Upgrade of APL V8.x to V8.1 SPx<sup>1)</sup> or Drive ES PCS 7 V6.x, V7.x, V8.x classic to Drive ES PCS 7 APL V8.1 SPx<sup>1)</sup></li> </ul>	<b>6SW1700-8JD01-1AA0</b> <b>6SW1700-5JD00-1AC0</b> <b>6SW1700-0JD01-0AB2</b> <b>6SW1700-8JD01-1AA4</b>
<b>Drive ES PCS 7 V8.2 SPx<sup>1)</sup></b> Block library for PCS 7 for the integration of drives in Classic Style (as predecessor) Requirement: PCS 7 V8.2 and higher Type of delivery: CD-ROM Languages: Eng, Fr, Ger, It, Sp with electronic documentation <ul style="list-style-type: none"> <li>Single-user license incl. 1 runtime license</li> <li>Runtime license (without data carrier)</li> <li>Update service for single-user license</li> <li>Upgrade from V6.x/V7.x/V8.x to V8.2 SPx<sup>1)</sup></li> </ul>	<b>6SW1700-8JD00-2AA0</b> <b>6SW1700-5JD00-1AC0</b> <b>6SW1700-0JD00-0AB2</b> <b>6SW1700-8JD00-2AA4</b>

Description	Article No.
<b>Drive ES PCS 7 APL V8.2 SPx<sup>1)</sup></b> Block library for PCS 7 for the integration of drives in APL Style (Advanced Process Library) Requirement: PCS 7 V8.2 and higher Type of delivery: CD-ROM Languages: Eng, Fr, Ger, It, Sp with electronic documentation <ul style="list-style-type: none"> <li>Single-user license incl. 1 runtime license</li> <li>Runtime license (without data carrier)</li> <li>Update service for single-user license</li> <li>Upgrade of APL V8.x to V8.2 SPx<sup>1)</sup> or Drive ES PCS 7 V6.x, V7.x, V8.x classic to Drive ES PCS 7 APL V8.2 SPx<sup>1)</sup></li> </ul>	<b>6SW1700-8JD01-2AA0</b> <b>6SW1700-5JD00-1AC0</b> <b>6SW1700-0JD01-0AB2</b> <b>6SW1700-8JD01-2AA4</b>
<b>Drive ES PCS 7 V9.0 SPx<sup>1)</sup></b> Block library for PCS 7 for the integration of drives in Classic Style (as predecessor) Requirement: PCS 7 V9.0 and higher Type of delivery: CD-ROM Languages: Eng, Fr, Ger, It, Sp with electronic documentation <ul style="list-style-type: none"> <li>Single-user license incl. 1 runtime license</li> <li>Runtime license (without data carrier)</li> <li>Update service for single-user license</li> <li>Upgrade from V6.x/V7.x/V8.x to V9.0 SPx<sup>1)</sup></li> </ul>	<b>6SW1700-1JD00-0AA0</b> <b>6SW1700-5JD00-1AC0</b> <b>6SW1700-0JD00-0AB2</b> <b>6SW1700-1JD00-0AA4</b>
<b>Drive ES PCS 7 APL V9.0 SPx<sup>1)</sup></b> Block library for PCS 7 for the integration of drives in APL Style (Advanced Process Library) Requirement: PCS 7 V9.0 and higher Type of delivery: CD-ROM Languages: Eng, Fr, Ger, It, Sp with electronic documentation <ul style="list-style-type: none"> <li>Single-user license incl. 1 runtime license</li> <li>Runtime license (without data carrier)</li> <li>Update service for single-user license</li> <li>Upgrade of APL V8.x to V9.0 SPx<sup>1)</sup> or Drive ES PCS 7 V6.x, V7.x, V8.x classic to Drive ES PCS 7 APL V9.0 SPx<sup>1)</sup></li> </ul>	<b>6SW1700-1JD01-0AA0</b> <b>6SW1700-5JD00-1AC0</b> <b>6SW1700-0JD01-0AB2</b> <b>6SW1700-1JD01-0AA4</b>

## Options

*Drive ES software update service*

A software update service can also be purchased for the Drive ES software. The user will automatically receive the latest software, service packs and full versions for one year after ordering.

The update service can only be ordered in addition to an existing (i.e. previously ordered) full version.

- Period of update service: 1 year

The update service is automatically extended by 1 further year unless canceled up to 6 weeks prior to expiration.

Description	Article No.
<b>Drive ES PCS 7</b> <ul style="list-style-type: none"> <li>Update service for single-user license</li> </ul>	<b>6SW1700-0JD00-0AB2</b>
<b>Drive ES PCS 7 APL</b> <ul style="list-style-type: none"> <li>Update service for single-user license</li> </ul>	<b>6SW1700-0JD01-0AB2</b>

## More information

More information is available on the Internet at [www.siemens.com/drive-es](http://www.siemens.com/drive-es)

<sup>1)</sup> Orders are automatically supplied with the latest Service Pack (SP).

## Engineering tools

### Notes

## Drive applications

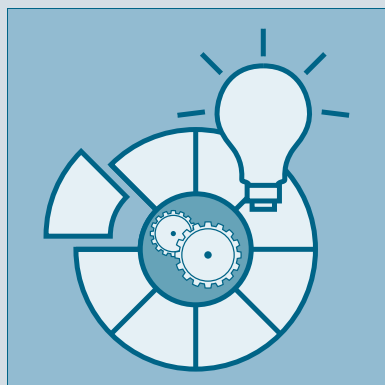

13/2 **Drive applications**

13/4 **Conveyor technology**

You can find additional information on the Internet at  
[www.siemens.com/sinamics-applications](http://www.siemens.com/sinamics-applications)  
<https://support.industry.siemens.com>

# Drive applications

## Drive applications

### Overview

Overview of drive applications for SINAMICS converters including SIMATIC ET 200pro FC-2 frequency converters

Drive application	SINAMICS V	SINAMICS G							SINAMICS S		SIMATIC ET 200pro FC-2
	V20	G110	G110D	G120C	G120P	G120	G110M	G120D	S110	S120	
<b>Standard technology functions</b>											
<b>BICO technology</b>	✓	-	✓	✓	✓	✓	✓	✓	✓	✓	✓
<b>Free Function Blocks (FFB)</b>	✓	-	✓	-	✓	✓	✓	✓	✓	✓	-
<b>Basic positioner (EPos)</b>	-	-	-	-	-	✓ with CU250S-2 Control Unit	-	✓ with CU250D-2 Control Unit	✓	✓	-
<b>Technology controller (PID)</b>	✓	-	✓	✓	✓	✓	✓	✓	✓	✓	-
<b>Advanced technology functions</b>											
<b>SINAMICS Drive Control Chart (DCC)</b>	-	-	-	-	-	-	-	-	-	✓	-
<b>SINAMICS Technology Extensions (TEC)</b>	-	-	-	-	-	-	-	-	-	✓	-

#### Applications & Branch know-how

Siemens has applied these technology functions (standard and/or advanced) to generate numerous application solutions. These applications can be downloaded from the Siemens application support website at [www.siemens.com/sinamics-applications](http://www.siemens.com/sinamics-applications)

### Standard applications: Understanding and profiting from know-how

The development of standard applications is a major area of activity within the Siemens automation and drive environment. The scope of these standard applications ranges from clearly organized documentation that focuses on one or several technologies (e.g. Safety Integrated) to complete, comprehensive, standardized solutions for complex tasks (e.g. cross cutters).

#### Standard application requirements

One feature that all application examples have in common is that they are designed to help users help themselves. They have been created by developers with extensive tool, commissioning and application know-how to make them as user-friendly as possible. Standard applications generally provide the user with reusable components.

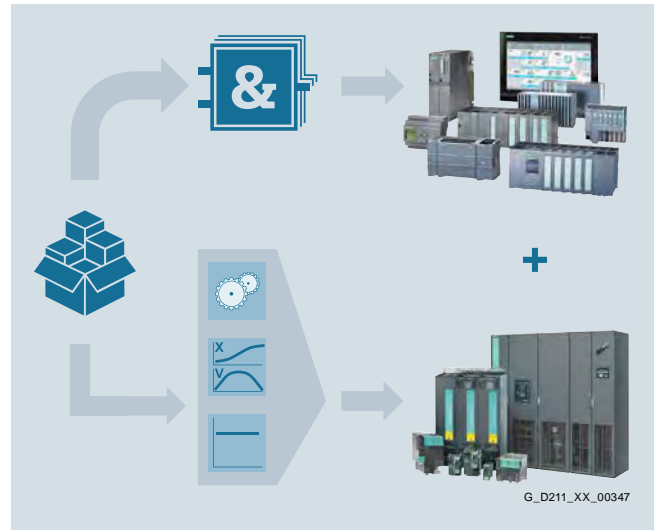

- Technology functions in the drive
- Tested SIMATIC PLC blocks
  - Reusable HMIs and faceplates
  - Application-specific Drive Control Charts (DCC)

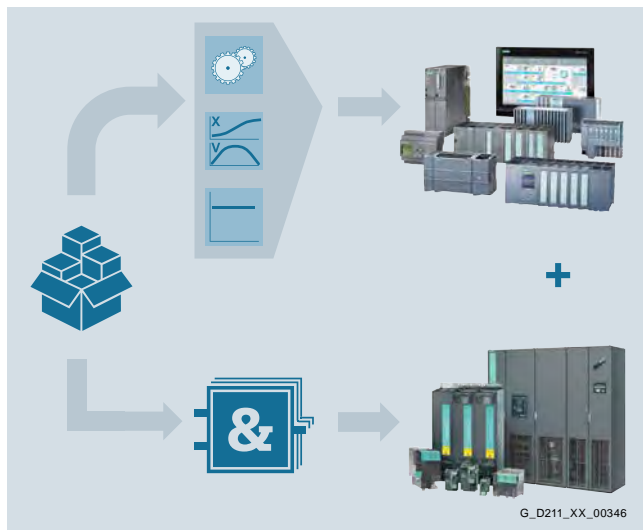

Technology functions in the higher-level control system

- Tested SIMATIC PLC blocks
- Reusable HMIs and faceplates



## Overview (continued)

## Expandable drive technologies

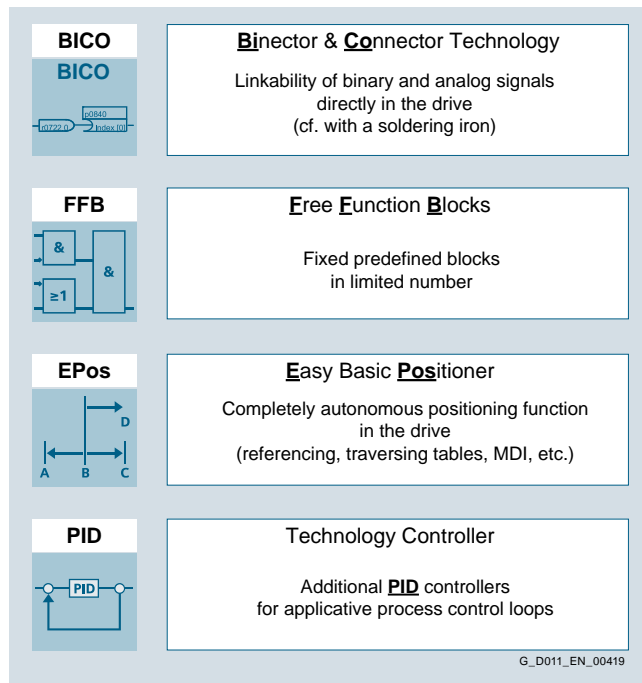

Standard technology functions

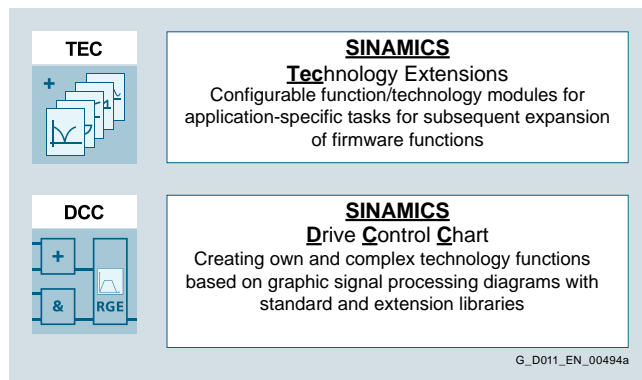

Advanced technology functions

The development of standard technological applications is a dedicated area of activity within the Siemens automation and drive environment. Owing to the generally large size of the applications, they are supplied with detailed documentation and example codes.

These applications focus on the use of product features such as SINAMICS Drive Control Chart (DCC) with its Drive Control Block (DCB) libraries of DCB Standard and DCB Extension, SINAMICS Technology Extensions (TEC) and Free Function Blocks (FFB).

This enables extensive, complete and standardized solutions to be developed for complex drive tasks.

These solutions can be flexibly adapted while at the same time allowing the user to expand them with additional elements or special functions as required.

## Application examples

Freely available application examples offer:

- Explanation of the necessary configuring steps with Siemens engineering tools
- Reusable standardized blocks for SIMATIC PLC
- Functionally coordinated programs and blocks
- Significantly shorter commissioning times

Various application examples also explain how to use Free Function Blocks (FFB), logic processing integrated in the drive with Drive Control Chart (DCC) and Safety Integrated.

The following application examples are just a selection of some of the many applications that are available on the Internet at:

- SINAMICS G: Controlling the speed of a G110M/G120 (Startdrive) with S7-1500 (TO) via PROFINET or PROFIBUS with Safety Integrated (via terminal) and HMI  
<https://support.industry.siemens.com/cs/document/78788716>
- SINAMICS G: Positioning a G110M/G120 (Startdrive) with S7-1500 (TO) via PROFINET/PROFIBUS with Safety Integrated and HMI  
<https://support.industry.siemens.com/cs/document/81666970>
- SINAMICS S: Controlling the speed of a SINAMICS S120 with SIMATIC S7-300/400F (STEP 7 V5) via PROFINET/PROFIBUS with Safety Integrated (via PROFIsafe) and HMI  
<https://support.industry.siemens.com/cs/document/68624711>
- SINAMICS S: SINAMICS S120 web server – user-defined sample pages  
<https://support.industry.siemens.com/cs/document/78388880>
- SIMATIC – Fail-safe LDrvSafe library for controlling Safety Integrated functions for the SINAMICS drive family  
<https://support.industry.siemens.com/cs/document/109485794>

You can find additional information on the Internet at:

[www.siemens.com/sinamics-applications](http://www.siemens.com/sinamics-applications)  
<https://support.industry.siemens.com>

## Drive applications

### Conveyor technology

#### Overview



#### *Optimal conveyor technology with Siemens products, systems and solutions*

Siemens provides what is probably the most comprehensive modular system for conveyor applications. Everything from a single source, from the control level, visualization, identification and fieldbus components all the way to motor starters, frequency converters, and geared motors.

Siemens provides flexible, future-oriented solutions both for standard and for highly complex applications – individually tailored to your requirements.

#### The integrated modular system

As a partner for everything relating to warehouse and conveyor technology, we can provide you with a quotation for conveyor and warehouse-related equipment up to complete plants for the transport of piece goods or bulk goods that precisely fit your requirements.

- Optimum products and systems – everything from drive and automation technology to safety technology and power distribution
- Competent technical guidance and extensive support to draw-up concepts that are truly fit for the future
- Global service, locally available in over 130 countries

#### Conveyor systems with value added

In conveyor systems, efficiency and productivity is dependent on the level of integration across all industries. Siemens provides you with everything needed for implementing integrated solutions.

#### More information

You can find additional information on the Internet at [www.siemens.com/conveyor-technology](http://www.siemens.com/conveyor-technology)

## Services and documentation

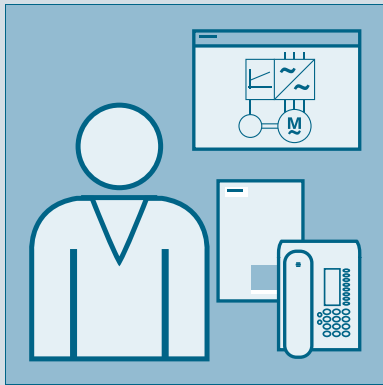

<b>14/2</b>	<b>Partner at Siemens</b>
<b>14/3</b>	<b>Online Services</b>
14/3	Information and ordering options on the Internet and DVD
14/4	Information and Download Center Social Media, Mobile Media
<b>14/5</b>	<b>Industry Services</b>
14/6	Industry Services – Portfolio overview
14/8	Online Support
<b>14/9</b>	<b>Training</b>
14/9	SITRAIN – Training for Industry
14/10	Training courses for SINAMICS low-voltage converters
14/11	SINAMICS G110M training case
14/12	SINAMICS G120D training case
<b>14/13</b>	<b>Siemens Automation Cooperates with Education</b>
14/13	Automation and drive technology training made easy
<b>14/15</b>	<b>Control cabinets</b>
<b>14/17</b>	<b>Repair service contract RSC</b>
14/19	Types of contract for production machines
<b>14/20</b>	<b>Mechatronic Support</b>
<b>14/21</b>	<b>Applications</b>
<b>14/22</b>	<b>Spare parts services</b>
14/22	Spare parts services during the lifecycle
14/22	Delivery of spare parts
14/23	Delivery as exchange product
14/23	Repair
14/24	Product upgrade service
14/24	General overhaul
14/25	Function check
14/25	Return of diagnostic parts
14/26	Stock reduction in spare parts store
14/26	Extended spare part availability
<b>14/27</b>	<b>Spares on Web</b>
<b>14/28</b>	<b>Supplementary products for distributed drive technology</b>
<b>14/29</b>	<b>mySupport documentation</b>
<b>14/30</b>	<b>Documentation</b>
14/30	General documentation

## Services and documentation

### Partner at Siemens

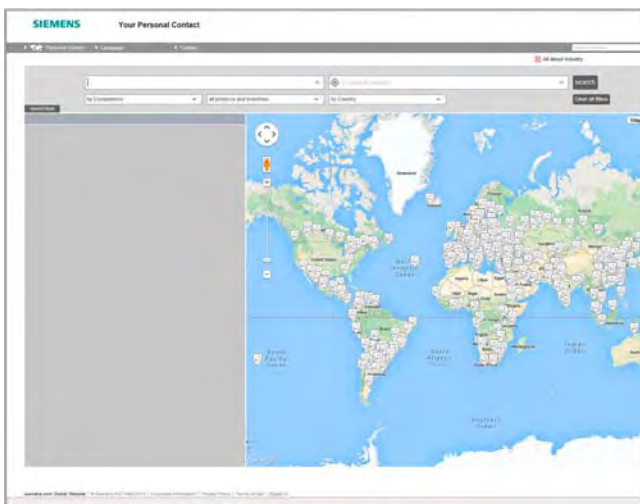

At Siemens we are resolutely pursuing the same goal: long-term improvement of your competitive ability. We are committed to this goal. Thanks to our commitment, we continue to set new standards in automation and drive technology. In all industries – worldwide.

At your service locally, around the globe for consulting, sales, training, service, support, spare parts on the entire portfolio of Digital Factory and Process Industries and Drives.

Your partner can be found in our Personal Contacts Database at: [www.siemens.com/automation-contact](http://www.siemens.com/automation-contact)

You start by selecting

- the required competence,
- products and branches,
- a country,
- a city

or by a

- location search or
- person search.

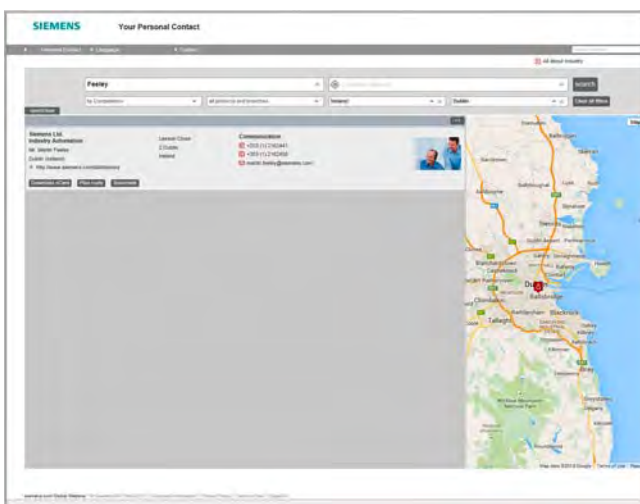
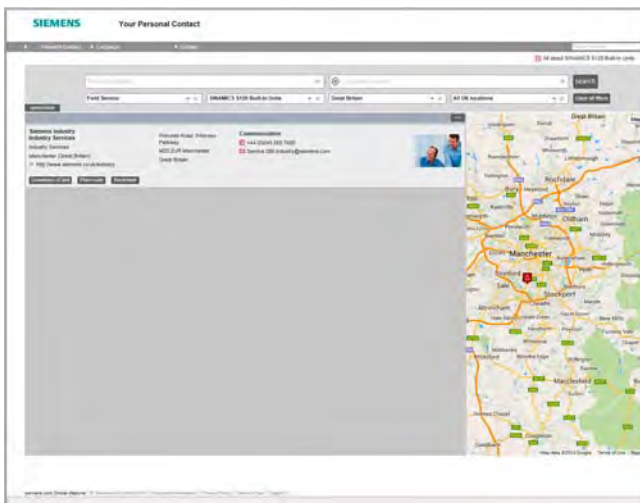

#### The Future of Manufacturing on the Internet

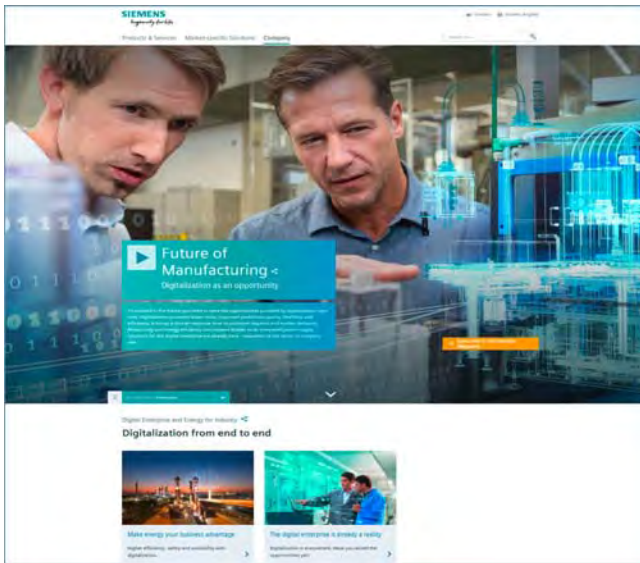

Detailed knowledge of the range of products and services available is essential when planning and engineering automation systems. It goes without saying that this information must always be as up-to-date as possible.

Industry is on the threshold of the fourth industrial revolution as digitization now follows after the automation of production. The goals are to increase productivity and efficiency, speed, and quality. In this way, companies can remain competitive on the path to the future of industry.

You will find everything you need to know about products, systems and services on the internet at:

[www.siemens.com/industry](http://www.siemens.com/industry)

#### Product Selection Using the Interactive CA 01 Automation and Drives Catalog

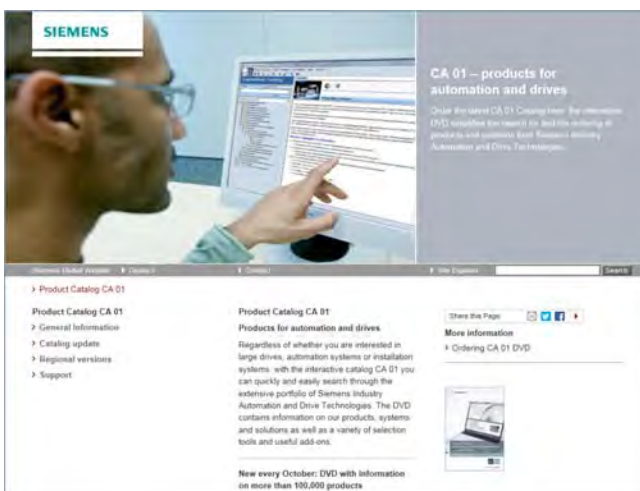

Detailed information together with user-friendly interactive functions:

The CA 01 interactive catalog covers more than 100,000 products, thus providing a comprehensive overview of the product range provided by Siemens.

You will find everything you need here for solving tasks in the fields of automation, switching, installation and drives. All information is provided over a user interface that is both user-friendly and intuitive.

You can order the CA 01 product catalog from your Siemens sales contact or in the Information and Download Center:

[www.siemens.com/industry/infocenter](http://www.siemens.com/industry/infocenter)

Information about the CA 01 interactive catalog can be found on the Internet at:

[www.siemens.com/automation/ca01](http://www.siemens.com/automation/ca01)

or on DVD.

#### Easy Shopping with the Industry Mall

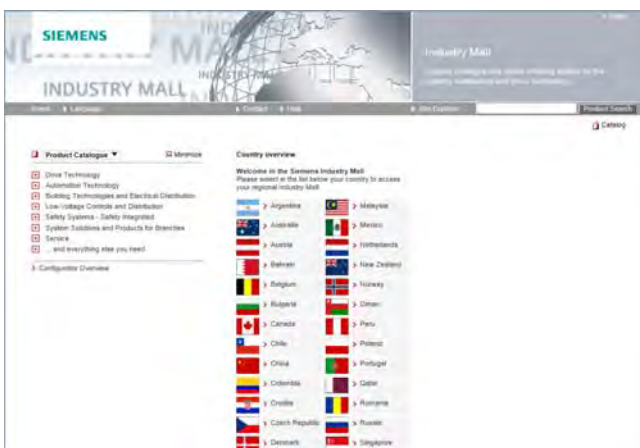

The Industry Mall is the electronic ordering platform of Siemens AG on the Internet. Here you have online access to a huge range of products presented in an informative and attractive way.

Data transfer via EDIFACT allows the whole procedure, from selection through ordering to tracking and tracing, to be carried out online. Availability checks, customer-specific discounts and bid creation are also possible.

Numerous additional functions are provided for your support. For example, powerful search functions make it easy to select the required products. Configurators enable you to configure complex product and system components quickly and easily. CAx data types are also provided here.

You can find the Industry Mall on the Internet at:

[www.siemens.com/industrymall](http://www.siemens.com/industrymall)

## Services and documentation

### Online Services

#### Information and Download Center, Social Media, Mobile Media

#### Downloading Catalogs

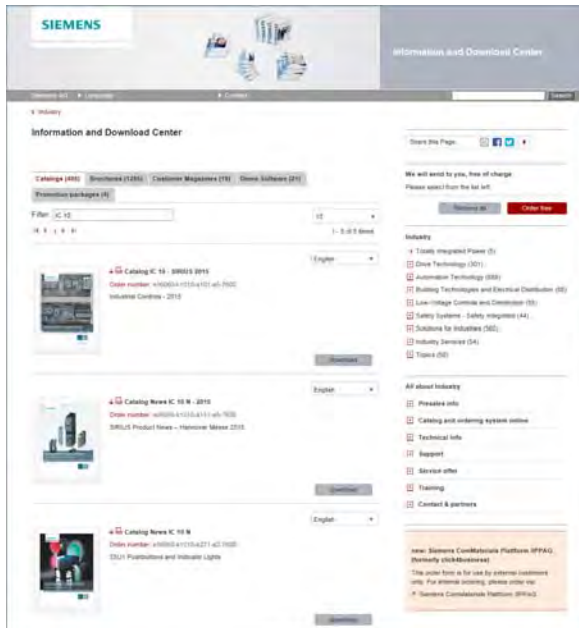

In addition to numerous other useful documents, you can also find the catalogs listed on the back inside cover of this catalog in the Information and Download Center. You can download these catalogs in PDF format without having to register.

The filter dialog above the first catalog displayed makes it possible to carry out targeted searches. If you enter "MD 3" for example, you will find both the MD 30.1 and MD 31.1 catalogs. If you enter "IC 10", both the IC 10 catalog and the associated news or add-ons are displayed.

Visit us at:

[www.siemens.com/industry/infocenter](http://www.siemens.com/industry/infocenter)

#### Social and Mobile Media

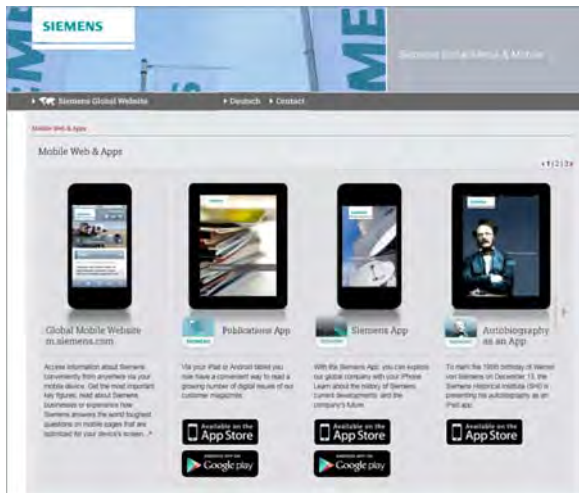

Connect with Siemens through social media: visit our social networking sites for a wealth of useful information, demos on products and services, the opportunity to provide feedback, to exchange information and ideas with customers and other Siemens employees, and much, much more. Stay in the know and follow us on the ever-expanding global network of social media.

To find out more about Siemens' current social media activities, visit us at:

[www.siemens.com/socialmedia](http://www.siemens.com/socialmedia)

Or via our product pages at:

[www.siemens.com/automation](http://www.siemens.com/automation) or [www.siemens.com/drives](http://www.siemens.com/drives)

Here you can read all the news on the future of the industry, watch current videos and obtain information about all the latest industry developments.

[www.siemens.com/future-of-manufacturing](http://www.siemens.com/future-of-manufacturing)

Discover the world of Siemens.

We are also constantly expanding our offering of cross-platform apps for smartphones and tablets. You will find the current Siemens apps at the App Store (iOS) or at Google Play (Android):

<https://itunes.apple.com/en/app/siemens/id452698392?mt=8>

<https://play.google.com/store/search?q=siemens>

The Siemens app, for example, tells you all about the history, latest developments and future plans of the company – with informative pictures, fascinating reports and the most recent press releases.

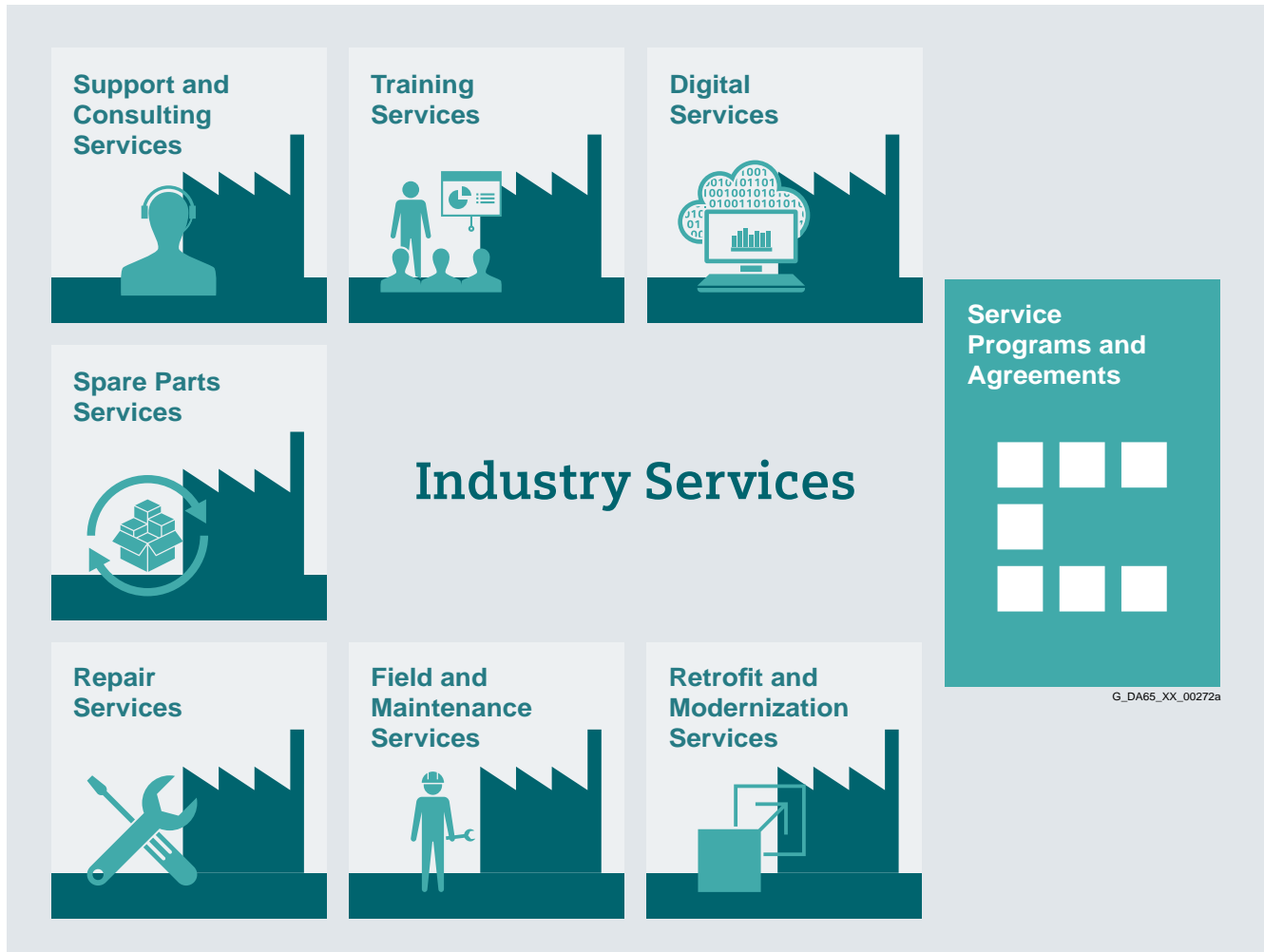

**Overview**

**Keep your business running and shaping your digital future – with Industry Services**

Optimizing the productivity of your equipment and operations can be a challenge, especially with constantly changing market conditions. Working with our service experts makes it easier. We understand your industry's unique processes and provide the services needed so that you can better achieve your business goals.

You can count on us to maximize your uptime and minimize your downtime, increasing your operations' productivity and reliability. When your operations have to be changed quickly to meet a new demand or business opportunity, our services give you the flexibility to adapt. Of course, we take care that your production is protected against cyber threats. We assist in keeping your operations as energy and resource efficient as possible and reducing your total cost of ownership. As a trendsetter, we ensure that you can capitalize on the opportunities of digitalization and by applying data analytics to enhance decision making: You can be sure that your plant reaches its full potential and retains this over the longer lifespan.

You can rely on our highly dedicated team of engineers, technicians and specialists to deliver the services you need – safely, professionally and in compliance with all regulations. We are there for you, where you need us, when you need us.

<https://www.siemens.com/global/en/home/products/services/industry.html>

## Services and documentation

### Industry Services

#### Industry Services – Portfolio overview

##### Overview

#### Digital Services



Digital Services make your industrial processes transparent to gain improvements in productivity, asset availability, and energy efficiency.

Production data is generated, filtered and translated with intelligent analytics to enhance decision-making.

This is done whilst taking data security into consideration and with continuous protection against cyber-attack threats.

<https://www.siemens.com/global/en/home/products/services/industry/digital-services.html>

#### Training Services

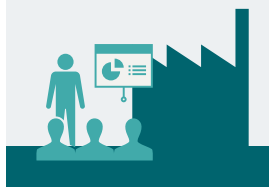

From the basics and advanced to specialist skills, SITRAIN courses provide expertise right from the manufacturer – and encompass the entire spectrum of Siemens products and systems for the industry.

Worldwide, SITRAIN courses are available wherever you need a training course in more than 170 locations in over 60 countries.

<https://support.industry.siemens.com/cs/ww/en/sc/2226>

#### Support and Consulting Services



**Industry Online Support** site for comprehensive information, application examples, FAQs and support requests.

**Technical and Engineering Support** for advice and answers for all inquiries about functionality, handling, and fault clearance. The Service Card as prepaid support for value added services such as Priority Call Back or Extended Support offers the clear advantage of quick and easy purchasing.

**Information & Consulting Services**, e.g. SIMATIC System Audit; clarity about the state and service capability of your automation system or Lifecycle Information Services; transparency on the lifecycle of the products in your plants.

<https://support.industry.siemens.com/cs/ww/en/sc/2235>

#### Spare Parts Services



Spare Parts Services are available worldwide for smooth and fast supply of spare parts – and thus optimal plant availability. Genuine spare parts are available for up to ten years. Logistic experts take care of procurement, transport, custom clearance, storage and order management. Reliable logistics processes ensure that components reach their destination as needed.

Since not all spare parts can be kept in stock at all times, Siemens offers a preventive measure for spare parts provisioning on the customer's premises with optimized **Spare Parts Packages** for individual products, custom-assembled drive components and entire integrated drive trains – including risk consulting.

**Asset Optimization Services** help you design a strategy for parts supply where your investment and carrying costs are reduced and the risk of obsolescence is avoided.

<https://support.industry.siemens.com/cs/ww/en/sc/2110>



### Overview (continued)

#### Repair Services



Repair Services are offered on-site and in regional repair centers for fast restoration of faulty devices' functionality.

Also available are extended repair services, which include additional diagnostic and repair measures, as well as emergency services.

<https://support.industry.siemens.com/cs/ww/en/sc/2154>

#### Retrofit and Modernization Services



Provide a cost-effective solution for the expansion of entire plants, optimization of systems or upgrading existing products to the latest technology and software, e.g. migration services for automation systems.

Service experts support projects from planning through commissioning and, if desired over the entire extended lifespan, e.g. Retrofit for Integrated Drive Systems for an extended lifetime of your machines and plants.

<https://support.industry.siemens.com/cs/ww/de/sc/2286>

#### Field and Maintenance Services

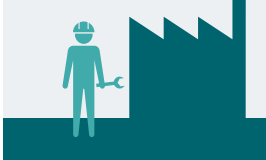

Siemens specialists are available globally to provide expert field and maintenance services, including commissioning, functional testing, preventive maintenance and fault clearance.

All services can be included in customized service agreements with defined reaction times or fixed maintenance intervals.

<https://support.industry.siemens.com/cs/ww/en/sc/2265>

#### Service Programs and Agreements

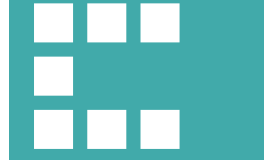

A technical Service Program or Agreement enables you to easily bundle a wide range of services into a single annual or multi-year agreement.

You pick the services you need to match your unique requirements or fill gaps in your organization's maintenance capabilities.

Programs and agreements can be customized as KPI-based and/or performance-based contracts.

<https://support.industry.siemens.com/cs/ww/de/sc/2275>

## Services and documentation

Industry Services

### Online Support

#### Overview

Online Support – fast, intuitive, whenever you want, wherever you need



**Web**  
support.industry.siemens.com

**App**

GET IT ON Google Play | Learn on the App Store | @microsoft.com Microsoft

Scan the QR code for information on our Online Support app.



-  **FAQ / Application examples**  
Information about industrial products, programming and configuration as well as application examples
-  **Technical Information**  
Videos, documentation, manuals, updates, product notes, compatibility tool, certificates, planning data such as dimensional drawings, product data, 3D models
-  **Forum**  
Exchange information and experience with other users and experts

## Online Support for Siemens Products for Industry

Siemens Industry and Online Support with some 1.7 million visitors per month is one of the most popular web services provided by Siemens. It is the central access point for comprehensive technical know-how about products, systems and services for automation and drives applications as well as for process industries.

In connection with the challenges and opportunities related to digitalization you can look forward to continued support with innovative offerings.

**Overview**

***Your benefit from practical training directly from the manufacturer***

SITRAIN – Training for Industry – provides you with comprehensive support in solving your tasks.

Training directly from the manufacturer enables you to make correct decisions with confidence.

***Increased profits and lower costs:***

- Shorter times for commissioning, maintenance and servicing
- Optimized production operations
- Reliable configuration and commissioning
- Shortened startup times, reduced downtimes, and faster troubleshooting
- Exclude expensive faulty planning right from the start.
- Flexible plant adaptation to market requirements
- Compliance with quality standards in production
- Increased employee satisfaction and motivation
- Shorter familiarization times following changes in technology and staff

***Contact***

Visit our site on the Internet at:  
[www.siemens.com/sitrain](http://www.siemens.com/sitrain)

or let us advise you personally. You can request our latest training catalog from:

**SITRAIN – Training for Industry**  
**SITRAIN Customer Support Germany:**

Tel.: +49 911 895-7575

Fax: +49 911 895-7576

Email: [info@sitrain.com](mailto:info@sitrain.com)

***Your benefits with SITRAIN – Training for Industry***
Certified top trainers

Our trainers are skilled specialists with practical experience. Course developers have close contact with product development, and pass on their knowledge to the trainers and then to you.

Practical application with practice

Practice, practice, practice! We have designed the trainings with an emphasis on practical exercises. They take up to half of the course time in our trainings. You can therefore implement your new knowledge in practice even faster.

300 courses in more than 60 countries

We offer a total of about 300 classroom-based courses. You can find us at more than 50 locations in Germany, and in 62 countries worldwide. You can find which course is offered at which location at:

[www.siemens.com/sitrain](http://www.siemens.com/sitrain)

Skills development

Do you want to develop skills and fill in gaps in your knowledge? Our solution: We will provide a program tailored exactly to your personal requirements. After an individual requirements analysis, we will train you in our training centers near you or directly at your offices. You will practice on the most modern training equipment with special exercise units. The individual training courses are optimally matched to each other and help with the continuous development of knowledge and skills. After finishing a training module, the follow-up measures make success certain, as well as the refreshment and deepening of the knowledge gained.

## Services and documentation

### Training

#### Training courses for SINAMICS low-voltage converters

##### Overview

##### Training courses for SINAMICS drive system



This provides an overview of the training courses available for the SINAMICS drive system.

The courses are modular in design and are directed at a variety of target groups as well as individual customer requirements.

The system overview will acquaint decision-makers and sales personnel with the system very quickly.

The engineering course provides all the information you need to configure the drive system.

The courses dedicated to diagnostics and servicing, parameterization and commissioning, communication as well as extended functions such as Safety Integrated are sure to provide all the technical knowledge service engineers will need.

All courses contain as many practical exercises as possible to enable intensive and direct training on the drive system and with the tools in small groups.

Please also take note of the training options available for SIMOTICS motors. You will find more information about course contents and dates in Catalog ITC and on the Internet.

Title (all courses are available in English and German)	Target group			Duration	Order code
	Planners, decision-makers, sales personnel	Commissioning engineers, configuring engineers	Service personnel, maintenance technicians		
<b>Courses Fundamentals and overview</b>					
SINAMICS and SIMOTICS – Basics of drive technology	✓	✓	✓	5 days	DR-GAT
SINAMICS and SIMOTICS – System overview	✓	–	–	3 days	DR-SYS
SINAMICS System Overview	✓	–	–	2 days	DR-SN-UEB
<b>Courses SINAMICS S120</b>					
Planning and engineering	✓	–	–	5 days	DR-S12-PL
Parameterizing and commissioning	–	✓	–	5 days	DR-S12-PM
Parameterization Advanced Course	–	✓	–	5 days	DR-S12-PA
Parameterizing and optimization	–	✓	–	3 days	DR-S12-OPT
Parameterizing Safety Integrated	–	✓	–	4 days	DR-S12-SAF
Diagnostics and service	–	–	✓	5 days	DR-S12-DG
Diagnostics at chassis and cabinet units	–	✓	✓	3 days	DR-S12-CHA
Diagnostics PROFINET and PROFIBUS	–	✓	✓	3 days	DR-S12-NET
<b>Courses SINAMICS G120</b>					
Planning and engineering	✓	–	–	2 days	DR-G12-PL
Parameterizing and commissioning	–	✓	–	2 days	DR-G12-PM
Parameterization Advanced Course	–	✓	–	3 days	DR-G12-PA
Parameterizing Safety Integrated	–	✓	–	2 days	DR-G12-SAF
<b>Courses SINAMICS G130/G150/G180/S150</b>					
DYNAVERT – commissioning and diagnostics	–	✓	✓	2 days	DR-DYNA
SINAMICS G150/G130/S150 – diagnostics and service	–	✓	✓	5 days	DR-G15-DG
SINAMICS G180 – diagnostics and service	–	–	✓	2.5 days	DR-G18-DG

**Overview**

SINAMICS G110M training case

The SINAMICS G110M training case is a convincing demonstration system thanks to its compact design. It is suitable for direct customer presentations as well as for tests in technical departments. The functions of SINAMICS G110M in combination with a SIMOGEAR geared motor can be demonstrated and tested quickly and easily with this case.

It contains the following components:

- SINAMICS G110M frequency inverter comprising PROFINET / EtherNet/IP CU240M PN Control Unit with integrated braking resistor and PM240M Power Module
- SIMOGEAR helical geared motor

The SINAMICS G110M training case is supplied in the form of a trolley case.

**Technical specifications**

<b>SINAMICS G110M training case</b>	
	6AG1067-3AB00-0AA0
<b>Supply voltage</b>	110 V / 230 V 1 AC
<b>Dimensions</b>	
• Width	600 mm (23.62 in)
• Height	450 mm (17.72 in)
• Depth	450 mm (17.72 in)
<b>Weight, approx.</b>	34 kg (74.9 lb)

**Selection and ordering data**

Description	Article No.
<b>SINAMICS G110M training case</b>	<b>6AG1067-3AB00-0AA0</b>
<i>Accessories</i>	
<b>IOP Handheld</b>	<b>6SL3255-0AA00-4HA0</b>
<b>RS232 connecting cable</b>	<b>3RK1922-2BP00</b>

## Services and documentation

### Training

#### SINAMICS G120D training case

##### Overview



SINAMICS G120D training case

The SINAMICS G120D training case contains the following components:

- SINAMICS G120D distributed frequency inverter
  - PM250D Power Module
  - CU250D Control Unit
- SIMATIC S7-300 controller
- SIMATIC Touch Panel KTP600
- SIMOGEAR helical geared motor with HTL encoder

The SINAMICS G120D training case is supplied in the form of a trolley case.

##### Technical specifications

<b>SINAMICS G120D training case</b>	
	6AG1067-2AA00-0AA2
<b>Supply voltage</b>	400 V 3 AC
<b>Protection</b>	16 A
<b>Dimensions</b>	
• Width	720 mm (28.35 in)
• Height	380 mm (14.96 in)
• Depth	300 mm (11.81 in)
<b>Weight, approx.</b>	47 kg (104 lb)

##### Selection and ordering data

Description	Article No.
<b>SINAMICS G120D training case</b>	<b>6AG1067-2AA00-0AA2</b>

#### Unique support for educators and students in educational institutions

Cooperates  
with Education

Automation

SIEMENS

#### Siemens Automation Cooperates with Education (SCE)

offers a global system for sustained support of technical skills. SCE supports educational institutions in their teaching assignment in the industrial automation sector and offers added value in the form of partnerships, technical expertise, and know-how. As the technological leader, our comprehensive range of services can support you in the knowledge transfer for Industry 4.0.

#### Our services at a glance

- Training curriculums for your lessons
- Trainer packages for hands-on learning
- Courses convey up-to-date specialist knowledge
- Support for your projects / textbooks
- Complete didactic solutions from our partners
- Personal contact for individual support

#### Training curriculums for your lessons



Use our profound industrial know-how for practice-oriented and individual design of your course. We offer you more than 100 didactically prepared training curriculums on the topics of automation and drives technology free of charge. These materials are perfectly matched to your curricula and syllabuses, and optimally suited for use with our trainer packages. This takes into account all aspects of a modern industrial solution: installation, configuration, programming, and commissioning. All documents, including projects, can be individually matched to your specific requirements.

#### Particular highlights:

- The new SIMATIC PCS 7 curriculums and trainer packages. Using plant simulation, you can pass on basic, practice-oriented PCS 7 knowledge at universities within about 60 hours (= 1 semester).
- The new TIA Portal training materials for SIMATIC S7-1500 / S7-1200 / S7-300 are available in English, German, French, Italian, Spanish, Portuguese and Chinese for download.

[www.siemens.com/sce/curriculum](http://www.siemens.com/sce/curriculum)

#### Trainer packages for hands-on learning



Our SCE trainer packages offer a specific combination of original industrial automation and drives components which are perfectly matched to your requirements and can be conveniently used in your course. These price-reduced bundles available exclusively to schools include innovative and flexible hardware and software packages.

We currently offer more than 80 SCE trainer packages including the complete accessories. These cover both the factory and process automation sectors. You can use them to impart the complete course contents on industrial automation at a very low cost.

#### Trainer packages are available for:

- Introduction to automation technology with LOGO! logic module
- PLC engineering with SIMATIC S7 hardware and STEP 7 software (S7-1500, S7-1200, S7-300 and TIA Portal)
- Operator control and monitoring with SIMATIC HMI
- Industrial networking over bus systems with SIMATIC NET (PROFINET, PROFIBUS, IO-Link)
- Sensor systems with VISION, RFID and SIWAREX
- Process automation with SIMATIC PCS 7
- Networked drive and motion technologies with SINAMICS/SIMOTION
- Power Monitoring Devices SENTRON PAC 4200
- Motor Management SIMOCODE
- CNC programming with SinuTrain

#### Important ordering notes:

Only the following institutions are authorized to obtain trainer packages: vocational colleges, vocational training institutes, schools for technicians, technical schools, universities and universities of applied sciences, non-profit research institutions and in-house initial vocational training centers.

To purchase a trainer package, you require a specific end-use certificate, which you can obtain from your regional sales office.

[www.siemens.com/sce/tp](http://www.siemens.com/sce/tp)

## Services and documentation

### Siemens Automation Cooperates with Education

#### Automation and drive technology training made easy

#### Unique support for educators and students in educational institutions (continued)

##### *Courses convey up-to-date specialist knowledge*



Profit from our excellent know-how as the leader in industrial technologies. We offer you specific courses for automation and drive technology worldwide. These support you in the practice-oriented transferring of product and system know-how, are in conformance with curriculums, and derived from the training fields. Compact technical courses especially for use at universities are also available.

Our range of courses comprises a wide variety of training modules based on the principle of Totally Integrated Automation (TIA). The focus is on the same subject areas as with the SCE trainer packages.

Every PLC and drive course is oriented on state-of-the-art technology. Your graduates can thus be prepared optimally for their future professional life.

In some countries we are offering classes based on our training curriculums. Please inquire with your SCE contact partner.

[www.siemens.com/sce/courses](http://www.siemens.com/sce/courses)

##### *Support for your projects/textbooks*



Automation and drive technology is characterized by continuous and rapid developments. Service and Support therefore play an important role.

We can provide you with consulting for selected projects and support from your personal SCE contact as well as our regional Customer Support.

As a particular service, SCE supports technical authors with our know-how as well as with intensive technical consulting. Siemens library of special textbooks covering the industrial automation sector provides an additional resource for you and your students. These can be found at the SCE web site.

[www.siemens.com/sce/contact](http://www.siemens.com/sce/contact)  
[www.siemens.com/sce/books](http://www.siemens.com/sce/books)

##### *Complete didactic solutions from our partners*



Our partners for learning systems offer a wide range of training systems and solutions for use in your courses or laboratory.

These models have been designed based on our trainer packages and thus save you the time and cost of self-construction of individual components. The Partner systems provide you with simple and effective help in the fulfillment of your teaching assignment.

[www.siemens.com/sce/partner](http://www.siemens.com/sce/partner)

##### *Contact for individual support*

You can find your personal SCE contact on our Internet site. Your local SCE Promoter will answer all your questions concerning the complete SCE offering, and provide you with timely and competent information about innovations. When you encounter challenges, you can profit from our global team of excellence.

If a direct SCE contact is not listed for your country, please contact your local Siemens office.

[www.siemens.com/sce/contact](http://www.siemens.com/sce/contact)

##### *SCE Support Finder for your Internet request*

You are an educator and need support on the topic of industry automation? Send us your request:

[www.siemens.com/sce/supportfinder](http://www.siemens.com/sce/supportfinder)

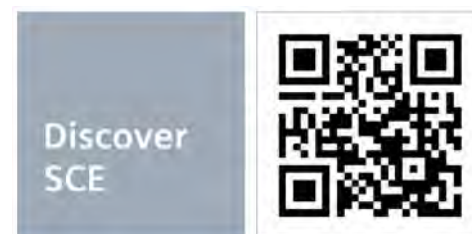



#### Overview

##### *Complete equipment for machine tools and production systems*

Our supplied range of products and services also includes complete equipment for machine tools and production systems with all services in the process chain from consulting through to after-sales service.

We support you in the areas of engineering, production and logistics.

##### *Engineering support*

Siemens supports you with advice on design in accordance with standards and concepts for drive systems, control, operation and safety.

Our engineers configure for you in EPLAN P8 and other commonly used CAD systems, execute projects designed to cost and adapt your documents where necessary to UL or new systems.

Our Technical Competence Center Cabinets in Chemnitz supports you with selecting and optimizing the suitable control cabinet air-conditioning system. Apart from calculation and simulation, we also use instrumentation testing in our heat laboratory with load simulation.

We also offer the following services:

- Vibration measurements and control cabinet certification in the field
- Measurement of conducted interference voltages in our laboratory



Cabinet engineering

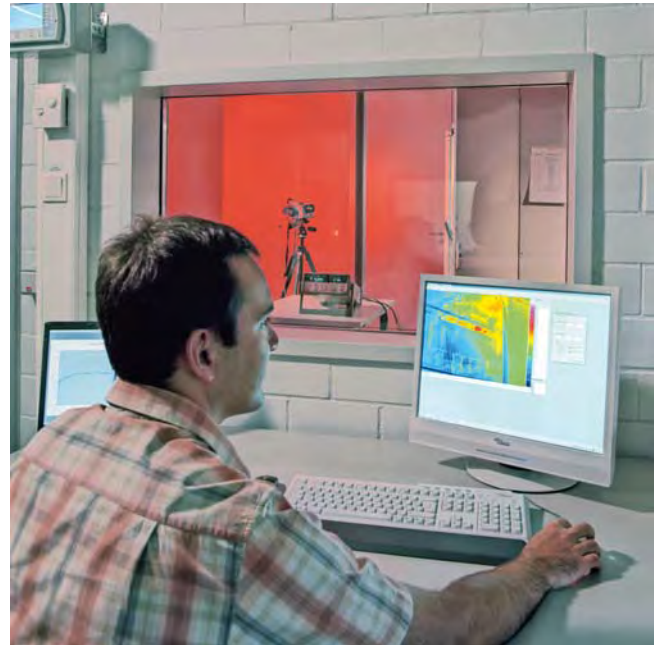

Testing in the heat laboratory

##### *Production at a high level of quality*

Complete equipment is manufactured at a high industrial level. This means:

- Examining consistency of the order documentation
- Checking for adherence to current regulations
- Collision check in 3D layout, taking into account the free space required thermally and electrically
- Automatic preparation of enclosures, cables and cable bundles
- Automated inspection and shipment free of faults
- Documentation and traceability
- Declaration of conformity regarding the Low-Voltage Directive and manufacturer's declaration on machinery directive
- UL label on request

##### *Superior logistics*

Everything from a single source offers you the following advantages:

- Cost savings for procurement, stockkeeping, financing
- Reduction in throughput times
- Just-in-time delivery

##### *Individual support and maximum flexibility*

Our technical consultants for complete equipment support customers and sales departments in the various regions. Our control cabinet customers are supported in the Systems Engineering Plant Chemnitz (WKC) by ordering centers and production teams that are permanently assigned to customers.

Distance does not present a problem; we also use web cams for consulting our customers.

## Services and documentation

### Control cabinets

#### Overview (continued)



Worldwide repair service

Customer-specific logistics models, flexible production capacity and production areas as well as change management in all process phases ensure maximum flexibility.

#### *Customized supplementary products*

As part of its complete equipment program, Siemens also offers the development and construction of customized supplementary products, e.g. special operator panels and power supply systems.

#### *Liability for defects*

Of course we accept the same liability for defects for our complete equipment as for our SINUMERIK and SINAMICS products.

Furthermore, you can use our worldwide repair service anywhere and at any time.

#### *Your benefits*

One partner, one quotation, one order, one delivery, one invoice, and one contact partner for liability of defects.

For series production or individual items, Siemens is your competent partner for complete equipment.

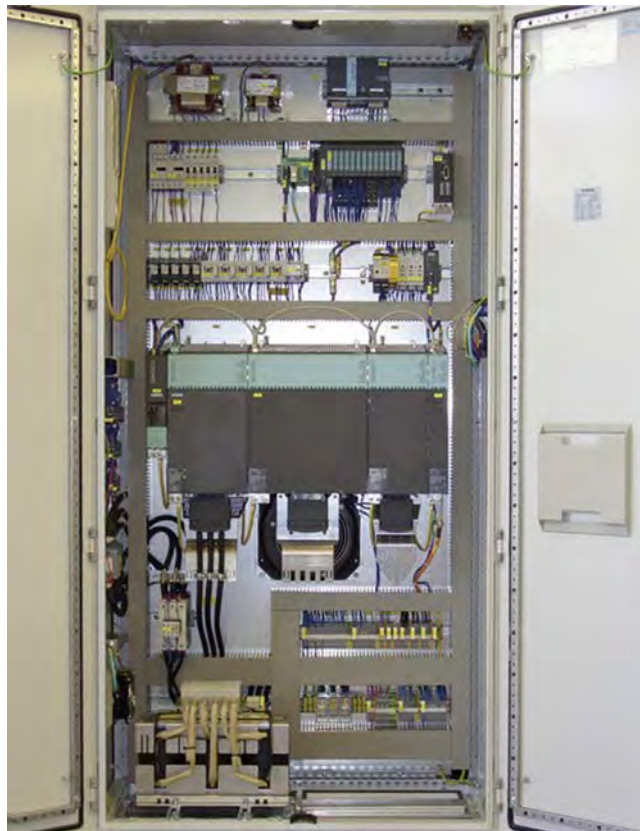

Control cabinet with SINAMICS S120 in booksize format

#### Overview

##### *RSC description of performance*

Siemens AG provides for the machine manufacturer and dealer (in the following referred to as the "Customer") at the installation site of the machine the services specified below under Scope of services for components from Siemens DF & PD contained in the parts list of the RSC Certificate.

The RSC is ordered by the Customer who states the required article numbers that can be obtained from the Siemens sales partners or found in catalogs and the Industry Mall. The Customer receives from Siemens a certificate of delivery, which thus signifies the conclusion of the RSC.

After the Customer has provided the final destination notification, Siemens sends the Customer an RSC Certificate detailing the place of performance and the service period.

The services to be provided by Siemens are requested via a service order from the Customer. The service order must be submitted within the service period of the RSC.

##### *Place of performance*

The specified service is provided at the installation site of the machine (hereinafter referred to as "on-site"). This corresponds to the country of the end customer and the latter's full address, as specified in the final destination notification. Services covered by this RSC shall only be provided in those countries named in the RSC country list.

##### *Scope of services*

The following services shall be provided:

- Provision of service personnel  
Siemens provides qualified personnel for the purpose of fault diagnostics and/or fault correction. The services are provided during the normal regional working hours in the country of installation.
- On-site fault diagnostics  
Fault diagnostics applies to components from Siemens DF & PD as stated in the parts list in the RSC Certificate.
- Fault correction on-site  
Fault correction is carried out by repairing and/or replacing defective components from Siemens DF & PD.
- Documentation of the fault correction  
A service report is prepared on-site in the language of the end customer and shall be signed by the end customer. A copy of the report remains with the end customer.

##### *Contract periods / service period*

The RSC is offered for the period of liability (warranty period) of the Siemens customers to their end customers. Different RSC periods permit various market requirements to be addressed.

The service period of the RSC begins on the date notified to Siemens in the final destination notification when commissioning has been completed at the end customer's site and ends on expiry of the selected RSC term. The beginning and end of the service period are stated in the RSC Certificate <sup>1)</sup>.

##### *RSC Certificate*

The Customer is provided with an RSC Certificate once the final destination notification has been handed over. This certificate shall contain the contract number and essential contract data such as machine number, machine type, parts list, beginning and end of the service period and the place of performance (address for the provision of services).

##### *Service exclusions*

The following is not included in the services:

- Complete motor spindles
- Services cannot be provided for wearing parts after the first 12 months of the service period.
- Machine commissioning or optimization
- Masonry work, metalwork, breaking work and other non-electrical work
- Fault diagnostics and fault correction relating to faults that have occurred as a result of
  - Non-compliance with the Siemens engineering and user guidelines, e.g. incorrect installation or grounding and incorrect operation or other improper treatment
  - Function-critical contamination, e.g. oil, conductive materials, rust
  - Mechanical damage
  - External electrical influences, e.g. effects of overvoltage, non-reactor-protected power factor correction systems and/or line harmonics
  - Wanton destruction
  - Force majeure

<sup>1)</sup> For example, in the case of an RSC with 12 months contract period, maximum of 24 months from the transfer of risk (delivery of the components).

## Services and documentation

### Repair service contract RSC

#### Overview (continued)

##### Country list

A repair service is offered for the following countries:

Continent	Country/region
<b>Country group 1</b>	
Americas	Mexico, USA
Asia	China, India, Japan, South Korea, Taiwan, Thailand
Australia	Australia
Europe	Andorra, Austria, Belgium, Czech Republic, Denmark, Finland, France, Germany, Great Britain, Hungary, Italy, Liechtenstein, Luxembourg, Monaco, the Netherlands, Poland, Portugal, Rumania, Slovak Republic, Spain, Sweden, Switzerland, Turkey
<b>Country group 2</b>	
Africa	South Africa
Americas	Brazil, Canada
Asia	Indonesia, Israel, Malaysia, Singapore
Australia	New Zealand
Europe	Bosnia-Herzegovina, Bulgaria, Croatia, Estonia, Ireland, Latvia, Lithuania, Norway, Slovenia
<b>Country group 3</b>	
Africa	Egypt
Americas	Argentina, Chile, Columbia, Ecuador, Peru, Venezuela
Asia	Bahrain, Hong Kong, Kuwait, Oman, Qatar, Saudi Arabia, United Arab Emirates (Dubai), Vietnam
Europe	Belarus, Greece, Malta, Russia, Serbia and Montenegro, Ukraine

**Countries not listed, for customers with framework contracts only.**

##### Response time

The following response times apply in general whenever services are provided under the RSC in the event of a machine standstill:

Country group	
CG 1	Next working day
CG 2	Within two working days
CG 3	Depending on country-specific conditions
Countries not listed	Depending on country-specific conditions, only for customers with framework contracts for the price of the individual contract.

The response time is defined as the time between Siemens receiving the service order, technically clarified in advance by the Customer, and the Siemens service personnel commencing his travel to the place of performance or until troubleshooting commences using teleservice. The response times given apply to technically clarified service orders within the normal working hours of the region (e.g. Monday to Friday 8:00 to 17:00) excluding public holidays.

##### Spare parts

Spare parts are provided from our central spare parts warehouse or from regional spare parts warehouses using our worldwide spare parts logistics infrastructure. All of the essential spare parts are stocked in our central spare parts stores. Regional spare parts warehouses are adapted to include the components specified in the final destination certificate <sup>1)</sup>.

The following components are not defined as spare parts:

- Motors: They are repaired at an authorized repair workshop. For selected motors, Siemens in Germany stocks components for express delivery. These motors can be manufactured and delivered within a few working days. You can obtain the current list from your Siemens sales partner.
- Cables: The delivery times known to you usually apply.
- Special or customer-specific modules and components not available from Siemens as spare parts.

The RSC shall only be processed in accordance with the terms and conditions applying to repair service contracts (RSC).

[www.siemens.com/automation/rscagb](http://www.siemens.com/automation/rscagb)

##### Benefits

- Protection against unknown costs for a fixed price
- RSC can be synchronized with the machine warranty period
- Planning certainty and calculable costs
- Easier processing of servicing jobs
- High machine availability thanks to a fast response to machine faults (contract priority)
- Reduced downtime thanks to stored product, final destination and contract information
- RSC can be ordered for machine deliveries to numerous countries
- Worldwide service infrastructure with experienced service personnel

<sup>1)</sup> Since the export of standard versions (components/system) is subject to a time-consuming official approval procedure, which applies in equal measure to the supply of such components for the purpose of servicing and spare parts supply, we offer **an export version** for individual components. This has usually less options than the standard version of the component and is not subject to an export authorization. Please note the **information about export**.

### Overview



#### Data handling

To improve the service availability, Siemens DF & PD offers users the opportunity to register machines online and to save what is known as an identSNAPSHOT file. In addition to the component list and the software requirements of machines, this also includes information on machine manufacturers/and where relevant, dealers and end customers.

To simplify data handling, information about the final destination certificate can be saved using the XML function of identSNAPSHOT and transferred to Siemens using an online registration. This data can also be kept with the machine as data backup.

[www.siemens.com/identsnapshot](http://www.siemens.com/identsnapshot)

### Selection and ordering data

Description	Article No.
<b>Repair service contract RSC</b>	
For Siemens DF & PD components on production machines for countries in country groups 1 to 3	
• 12 month contract period <sup>1)</sup>	<b>6FC8507-0RX12-■■■■0</b>
• 24 month contract period <sup>2)</sup>	<b>6FC8507-0RX24-■■■■0</b>
Equipment value in €	↑
0.–	<b>0</b>
100000.–	<b>1</b>
200000.–	<b>2</b>
300000.–	<b>3</b>
400000.–	<b>4</b>
500000.–	<b>5</b>
600000.–	<b>6</b>
700000.–	<b>7</b>
800000.–	<b>8</b>
900000.–	<b>9</b>
	↑
0.–	<b>A</b>
10000.–	<b>B</b>
20000.–	<b>C</b>
30000.–	<b>D</b>
40000.–	<b>E</b>
50000.–	<b>F</b>
60000.–	<b>G</b>
70000.–	<b>H</b>
80000.–	<b>J</b>
90000.–	<b>K</b>
	↑
0.–	<b>A</b>
1000.–	<b>B</b>
2000.–	<b>C</b>
3000.–	<b>D</b>
4000.–	<b>E</b>
5000.–	<b>F</b>
6000.–	<b>G</b>
7000.–	<b>H</b>
8000.–	<b>J</b>
9000.–	<b>K</b>

Ordering example:

Contract period of 12 months and equipment value 96000.– €  
6FC8507-0RX12-0K**G0**

<sup>1)</sup> Max. 24 months from the transfer of risk (delivery of components).

<sup>2)</sup> Max. 36 months from the transfer of risk (delivery of components).

## Services and documentation

### Mechatronic Support

#### Overview

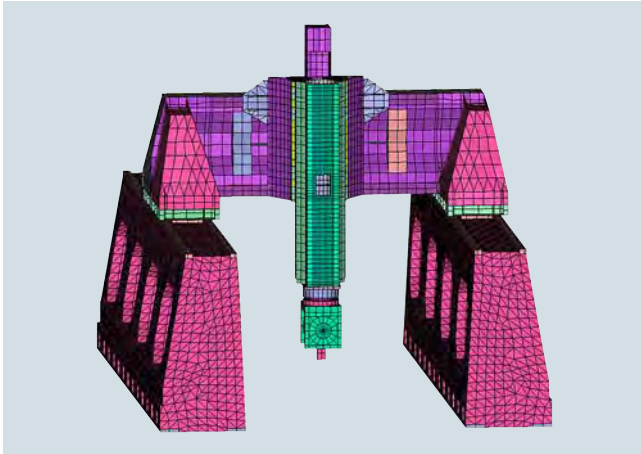

#### *Achieve the optimum machine quicker and more efficiently with Mechatronic Support*

The Mechatronic Support service ensures that already at the design stage of new machines, all the systems involved in mechanics, electronics, and IT are tested and optimized in a simulation environment in terms of their functionality and interaction, before they are actually built.

Mechatronic Support is thus the intelligent alternative to "trial and error". Innovative machine concepts are mutually compared, modified and optimized at the outset – a process which of course also takes account of your ideas for new mechatronic components.

#### *Virtual simulation, real construction*

With the help of the Mechatronic Support service, machinery ideas and new developments can be mechatronically tested and modified in a short time at low expense. The first real prototype can be built immediately afterwards as a functioning machine.

As the machine manufacturer, you have the benefit of shorter development phases and faster time-to-market; or as the end customer, you benefit from an optimized high-performance machine solution.

#### Benefits

- Shorter development times – shorter time to market
- Reliable achievement of development objectives
- Risk-free testing of innovative machine concepts
- Higher quality and productivity from the outset
- Get to the finished machine more quickly with specialist support

#### Selection and ordering data

Description	Type
<b>Consultation</b> Technical consultation with customer	<b>6FC5088-1....</b>
<b>Machine analysis and optimization</b> <ul style="list-style-type: none"> <li>• Analysis of the existing machine and its limits</li> <li>• Recommendations for manufacturer</li> </ul>	<b>6FC5088-3....</b>
<b>Machine simulation</b> <ul style="list-style-type: none"> <li>• Simulation of individual axes and complete machines</li> <li>• Analysis of dynamic behavior in the simulation</li> </ul>	<b>6FC5088-4....</b>

#### More information

Please contact your local Siemens sales office or representative for more information.

Contact information is available on the Internet at:

[www.siemens.com/automation-contact](http://www.siemens.com/automation-contact)

### Overview



Our understanding of an application is the customer-specific solution of an automation task based on standard hardware and software components. In this respect, industry knowledge and technological expertise are just as important as expert knowledge about how our products and systems work. We are setting ourselves this challenge with more than 280 application engineers in 20 countries.

#### Application centers

We currently have application centers in:

- Germany: Head Office in Erlangen and in other German regions, e.g. in Munich, Nuremberg, Stuttgart, Mannheim, Frankfurt, Chemnitz, Cologne, Bielefeld, Bremen, Hanover, Hamburg
- Belgium: Brussels
- Brazil: Sao Paulo
- China: Beijing and 12 regions
- Denmark: Ballerup
- France: Paris
- Great Britain: Manchester
- India: Mumbai
- Italy: Bologna, Milan
- Japan: Tokyo, Osaka
- The Netherlands: The Hague
- Austria: Vienna
- Poland: Warsaw
- Sweden: Göteborg
- Switzerland: Zurich, Lausanne
- Spain: Madrid
- South Korea: Seoul
- Taiwan: Taipei
- Turkey: Istanbul
- USA: Atlanta

These application centers specialize in the use of SIMATIC/SIMOTION/SINAMICS. You therefore can rely on automation and drive specialists for implementing successful applications. By involving your personnel at an early stage in the process, we can provide a solid basis for rapid knowledge transfer, maintenance and further development of your automation solution.

#### Advice on applications and implementation

We offer a variety of consultation services to help you find the optimum solution for the SIMATIC/SIMOTION/SINAMICS application you want to implement:

The quotation phase includes

- clarification of technical questions,
- discussion of machine concepts and customer-specific solutions,
- selection of suitable technology and
- suggestions for implementation.

A technical feasibility study is also performed at the outset. In this way, difficult points of the application can be identified and solved early on. We can also configure and implement your application as a complete solution from a single source.

A large number of proven standard applications are available for use during the implementation phase. This saves engineering costs.

The system can be commissioned by experienced, competent personnel, if required. This saves time and trouble.

If servicing is required, we can support you on site or remotely. For further information about servicing, please see the section "Industry Services".

#### On-site application training

Training for the implemented applications can also be organized and carried out on site. This training for machine manufacturers and their customers does not deal with individual products, but the entire hardware and software system (for example, automation, drives and visualization).

From an initial concept to successful installation and commissioning: We provide complete support for SIMATIC/SIMOTION/SINAMICS! Contact your Siemens representative.

You can find further information at [www.siemens.com/machinebuilding](http://www.siemens.com/machinebuilding)

## Services and documentation

### Spare parts services

#### Spare parts services during the lifecycle

##### Overview

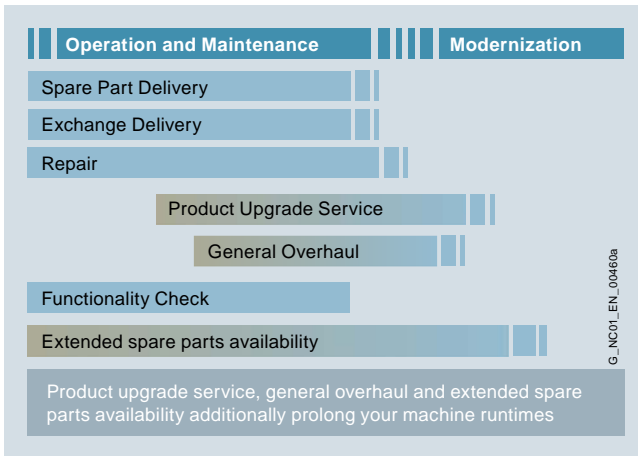

Spare parts services during the lifecycle

Siemens also provides constant support to customers after delivery of the machines or plant. This includes spare parts, repairs, as well as other supplementary services, and has a positive effect on machine operating times, inventories and costs.

When customers purchase a high-quality machine or plant, they intend to use it as intensively as possible, preferably for three shifts a day over many years. Under such circumstances, it is normal for parts to fail eventually. It is essential to replace the part as quickly as possible, because every hour of a plant stoppage costs money. To satisfy the multi-faceted requirements in the different areas, we have created comprehensive spare parts services.

##### Overview (continued)

You can sign up for the spare parts service that suits your requirements perfectly:

- Delivery of spare parts
- Delivery as exchange product
- Repair
- Product upgrade service
- General overhaul
- Function check
- Return of diagnostic parts
- Stock reduction of your spare parts store
- Extended spare parts availability

##### Benefits

- Optimum price/performance ratio and top quality
- Lifecycle management over the complete lifecycle
- Outstanding quality and availability of your machines and plant using Siemens original spare parts
- Global network and optimized logistics chains – 24 hours a day, 365 days a year
- Additional services from Siemens

##### More information

More information is available on the Internet at:

[www.siemens.com/motioncontrol/spareparts](http://www.siemens.com/motioncontrol/spareparts)

For further information, please approach your contact at your local Siemens office.

Contact information is available on the Internet at:

[www.siemens.com/automation-contact](http://www.siemens.com/automation-contact)

#### Delivery of spare parts

##### Overview

In every industry worldwide, plants and systems are required to operate with constantly increasing reliability. Lack of a specific spare part can result in considerable costs. We will provide you with the support you need to prevent a standstill from occurring in the first place: with a worldwide network and optimum logistics chains.

Ordering mode	Logistics service	Note
Standard	Cost-optimized: Contracted shipping company	Delivery within the normal national delivery times through the contracted shipping company
Plant stoppage	Time-optimized: Express, courier, collection	You choose the shortest possible delivery time for your own benefit: <ul style="list-style-type: none"> <li>• Delivery by means of collection or courier service</li> <li>• Delivery by express service</li> </ul>
Emergency service	Special logistics: Courier	You can also order the spare parts from us outside normal working hours, as well as on weekends or national holidays round-the-clock. Your delivery will arrive by courier

##### Benefits

- New liability for defects for the spare part
- Long-term spare parts availability
- Optimum system compatibility



#### Overview

In addition to the simple delivery of spare parts, with many products, we also offer you the option of an exchange. This has the advantage that you not only receive the spare part quickly, but are able to return the defective device to us for a credit. You therefore receive our spare part at the lower exchange price.

A credit will be awarded on condition that the repair code indicates that repurchasing is admissible, a replacement is obtained from the spare parts store, and that the returned product is repairable.

The ordering mode and logistics service determine the delivery of spare parts:

Ordering mode	Logistics service	Note
Standard	Cost-optimized: Contracted shipping company	Delivery within the normal national delivery times through the contracted shipping company
Plant stoppage	Time-optimized: Express, courier, collection	You choose the shortest possible delivery time for your own benefit: <ul style="list-style-type: none"> <li>• Delivery by means of collection or courier service</li> <li>• Delivery by express service</li> </ul>
Emergency service	Special logistics: Courier	You can also order the spare parts from us outside normal working hours, as well as on weekends or national holidays round-the-clock. Your delivery will arrive by courier

#### Overview (continued)

##### Return

For returns, we require the following information:

- Reason for return
- If defective: detailed description of the fault
- Machine number
- Machine/system manufacturer
- End customer

We will then be able to provide you with additional information in the repair report/inspection report regarding the diagnosis/inspection as well as information about the completed repair.

#### Benefits

- Savings thanks to the option of returning defective parts
- A spare part is available immediately in the event of failure
- New liability for defects for the spare part
- Long-term spare parts availability
- Optimum system compatibility

## Repair

#### Overview

Downtimes cause problems in the plant as well as unnecessary costs. We can help you to reduce both to a minimum – with our worldwide repair facilities. The advantage for you: Defects can be rectified before they cause further harm.

Repair is a favorable option when you have specific reasons for not replacing the defective device or part with a new one (delivery as exchange product).

We maintain a global network of Siemens repair shops and certified partners to ensure that we will always be able to process your repairs quickly.

We can offer you different types of repair depending on your requirements:

##### Normal repair

Normal repair at standard conditions normally takes 10 working days following receipt of the defective item at our repair shop.

##### Fast repair

In particularly urgent cases, we offer you the option of a fast repair within 1 or 2 working days for many products at additional cost.

##### Turnaround repair

With a turnaround repair, we organize on your behalf collection of the device/component to be repaired.

##### Mobile repair service

We come to you and perform the required repairs on site, for example, when the device/component cannot be removed due to its weight.

#### Overview (continued)

##### Function repair

A function repair is the same as a normal repair but excludes the repair of cosmetic defects, e.g. scratches, labels, discoloration. The conditions applicable to function repairs should be observed in this case. The function repair service is only available for machine manufacturers or machine operators. Please ask your regional Siemens contact.

For repairs, we require the following information:

- Reason for return
- If defective: detailed fault report
- Machine number
- Machine/system manufacturer
- End customer

#### Benefits

- Short downtimes for machines and plants
- Only certified original parts are used
- Additional services from Siemens:
  - Longer availability of your machine/plant through the preventive replacement of wear parts and aging parts
  - Highest standards of quality
  - Use of the comprehensive test concept of series production, including software, firmware, ASICs, complex function blocks, etc.
  - Implementation of all the hardware and software/firmware enhancements known by development, production, service and quality management departments, as well as suppliers
- Information supplied by repair report/inspection report

## Services and documentation

### Spare parts services

#### Product upgrade service

##### Overview



Product upgrade service: From OLD to NEW

A long service life is expected from machines and plants. The service life of the electronic components is, however, limited and normally shorter than the planned machine/plant operating times. To ensure that the required extended availability of the machine/plant is achieved, we offer you the product upgrade service at an attractive price.

In the course of their lifecycle, electronic components are normally redesigned/upgraded several times. With the product upgrade service, you will always receive the latest technology.

##### Overview (continued)

A planned product upgrade from OLD to NEW helps to prevent unplanned machine stoppages and supports a safer and longer machine/plant availability. The upgrade service is mainly offered for older components that will soon be discontinued.

For information about potential upgrades from the latest upgrade list, please ask your regional Siemens contact. The product upgrade service is only available for machine manufacturers or machine operators.

##### Benefits

- Price benefit through upgrade service
- New liability for defects for the new component
- Extended availability of your machine/plant
- Prevention of component failures due to wear and aging
- Prevention of machine stoppages due to unavailability of spare parts
- Reduced spare parts inventories
- Latest technology
- Easier servicing due to fewer variants
- Industry Services through Siemens are assured for the future

#### General overhaul

##### Overview

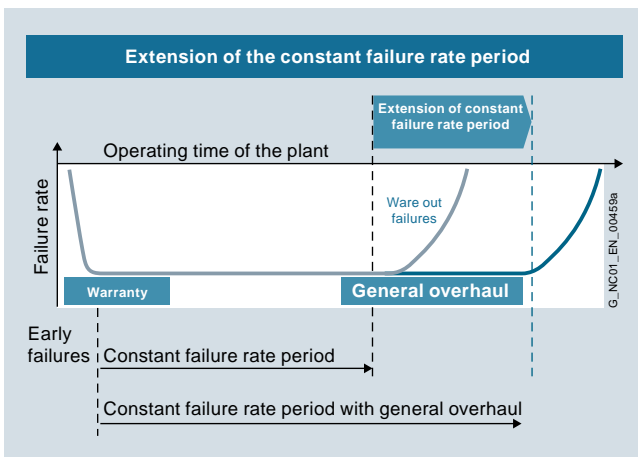

Extension of the period with a constant failure rate

A long service life is expected from machines and plants. The service life of electronic components and mechanical parts is, however, limited and normally shorter than the planned machine/plant operating times. For higher availability of the machines or plants, we offer a general overhaul (preventive maintenance) for electronic components and motors at favorable conditions.

##### Overview (continued)

During the planned general overhaul, wear parts and aging parts are replaced in accordance with their stated service life so as to reduce unplanned downtimes. In the case of motors, in addition to a general overhaul, replacement of bearings and encoders is also offered.

If a fault is detected during a general overhaul, troubleshooting and repair will be performed at the repair price without requesting confirmation or interrupting the process. In the case of extensive wear or damage, a general overhaul/repair will not be performed. A fixed lump sum for expenses will be charged in this case.

##### Benefits

- Preventive replacement of wear parts and aging parts in accordance with their stated service life
- Reduction in unplanned plant stoppages
- Enhanced production reliability
- Extended availability of your machine/plant
- New liability for defects for 12 months for the components subjected to a general overhaul
- Low price

#### Overview

It is checked that the components function reliably.

The first step involves cleaning the component. Then all the hardware and software/firmware enhancements are implemented that are known by development, production, service and quality management departments, as well as suppliers. Using the comprehensive test concept of series production, all the functions of the software, firmware, ASICs, complex and less complex function blocks are checked.

If a fault is detected during the function check, troubleshooting and repair will be performed at the repair price without requesting confirmation or interrupting the process. In the case of extensive wear or damage, no repairs will be performed. A fixed lump sum for expenses will be charged.

#### Benefits

- The component is checked and can be deployed again
- The component contains all the known improvements
- The customer's own spare parts stock is up-to-date
- Low price

## Return of diagnostic parts

#### Overview



Spare parts used for diagnostic purposes from the spare parts store can be returned within 3 months and a credit note for up to 85 % is issued.

For unused spare parts in their original packaging, you will receive a credit of 100 % in which case you will be charged a fixed price for handling.

#### Benefits

- Can be used for diagnostics
- Reduced spare parts inventories
- Low costs

## Services and documentation

### Spare parts services

#### Stock reduction in spare parts store

##### Overview



Thanks to fast delivery of spare parts from Siemens, manufacturers and plant operators are able to reduce their spare parts inventories. Siemens offers an analysis for this purpose to indicate exactly which parts must be available in the customer's stores for a specific combination of machines and which should be obtained directly from Siemens.

##### Benefits

- Reduced costs
- Stock optimization
- Minimization of fault downtimes

#### Extended spare part availability

##### Overview

We normally retain spare parts for all products and systems for a period of 10 years after discontinuation of product marketing.

In individual cases, when we do not carry spare parts, we will offer a repair.

For a wide range of products and systems, we extend the availability of spare parts. We can provide you with the current spare parts availability for your machine/plant as a service once you have registered online with identSNAPSHOT.

[www.siemens.com/identsnapshot](http://www.siemens.com/identsnapshot)

If you require longer availability of spare parts, please contact your regional sales representative.

##### Benefits

- Higher plant availability
- Investment protection
- Reduction of lifecycle costs



## Overview

### Spares on Web – online identification of spare parts



© Siemens AG 2014 | [About Us](#) | [Privacy Policy](#) | [Term of Use](#) | [Digital ID](#) | [GDPR](#)

Spares on Web is a web-based tool for identifying spare parts. After you have entered the Article No. and serial number, the spare parts available for the relevant unit are displayed.

[www.siemens.com/sow](http://www.siemens.com/sow)

## Services and documentation

### Supplementary products for distributed drive technology

#### Overview

A comprehensive range of supplementary products is provided for the distributed drive technology, e.g. pre-assembled cables and connectors. An overview is provided at the following link:  
[www.siemens.com/distributeddrives-supplementaryproducts](http://www.siemens.com/distributeddrives-supplementaryproducts)

Further selected accessories are available from Siemens Solution Partners.  
Select "Distributed Field Installation System" as the technology in the "Solution Partner Finder".  
[www.siemens.com/automation/partnerfinder](http://www.siemens.com/automation/partnerfinder)

For more information about connecting cables and plug-in connectors, please refer to Catalog IK PI.

### Overview

#### mySupport documentation – Compiling personal documents



mySupport documentation is a web-based system for generating personalized documentation based on standard documents and is part of the Siemens Industry Online Support portal.

In mySupport, a personal document library can be created in the "Documentation" category. This library can be accessed online in mySupport or also be generated in various formats for offline use.

Previously, this functionality was available in the My Documentation Manager for configurable manuals. Due to the integration in mySupport, all entries of the Industry Online Support can now be imported into the personal document library, including FAQs or product notifications.

If you have already worked with the My Documentation Manager, all of the previously created libraries will continue to be available without restrictions in mySupport.

In addition, the personal library in mySupport can be shared with other mySupport users. In this way, a collection of relevant documents can be created very effectively and used together with other mySupport users all over the world.

You must register/log in for configuring and generating/managing.

### Benefits

- Display  
View, print or download standard documents or personalized documents
- Configure  
Transfer standard documents or parts of them to personalized documents
- Generate/Manage  
Generate and manage personalized documents in the formats PDF, RTF or XML in all available languages

### Function

#### Opening mySupport documentation in the Industry Online Support portal

- About the product support, entry type "Manual":  
<https://support.industry.siemens.com/cs/ww/en/ps/manual>  
By clicking on the required version of the manual and then "Show and configure", the manual opens in a modular view, where you can navigate from topic to topic. Here the direct link to a topic can be used and made available to other users. The selected document can be added to the personal library via "mySupport Cockpit" > "Add to mySupport documentation".
- Via the direct link  
<https://support.industry.siemens.com/my/ww/en/documentation/advanced>  
After logon/registration, the online help is displayed as the current document.

### More information

You can find additional information on the Internet at

- <https://support.industry.siemens.com/my/ww/en/documentation>
- [https://support.industry.siemens.com/cs/helpcenter/en/index.htm?#persoenliche\\_bibliothek\\_aufbauen.htm](https://support.industry.siemens.com/cs/helpcenter/en/index.htm?#persoenliche_bibliothek_aufbauen.htm)

## Services and documentation

### Documentation

#### General documentation

##### Overview

A high-quality programmable control or drive system can be used to maximum effect only if the user is aware of the performance of the products used as a result of intensive training and good technical documentation.

This is becoming more important due to the shorter innovation cycles of modern automation products and the convergence of electronics and mechanical engineering.

A comprehensive range of documentation is available which includes a Getting Started guide, operating instructions, installation manuals and a list manual.

The documents are available in hardcopy form or as a PDF file for downloading from the Internet.

Information and documentation relating to SINUMERIK, SINAMICS, SIMOTION and SIMOTICS are available on the Internet at <https://support.industry.siemens.com/cs/document/109476679>

In addition to many other useful documents, the Information and Download Center also contains catalogs about the following systems:

- SINUMERIK: NC 62, NC 81.1, NC 82
- SINAMICS: D 11, D 12, D 21.3, D 21.4, D 23.1, D 23.2, D 31.1, D 31.2, D 35
- SIMOTION: PM 21
- SIMOTICS: D 21.4, D 41, D 81.1, D 81.8, D 83.1

You can download these catalogs in PDF format – you don't need to log on. You can perform a targeted search using the filter box above the first displayed catalog. By entering the search term "NC 8", for example, you can locate Catalog NC 81.1 and Catalog NC 82, and by entering "ST 70" you will find Catalog ST 70 as well as the relevant news and add-ons (if available). [www.siemens.com/industry/infocenter](http://www.siemens.com/industry/infocenter)

##### Application

###### Explanations of the manuals:

- **Operating Instructions**  
contain all the information needed to install the device and make electrical connections, information about commissioning and a description of the inverter functions.  
Phases of use: Control cabinet construction, commissioning, operation, maintenance and servicing.
- **Hardware Installation Manual**  
contains all relevant information about the intended use of the components of a system (technical specifications, interfaces, dimensional drawings, characteristics, or possible applications), information about installation and electrical connections and information about maintenance and servicing.  
Phases of use: Control cabinet configuration/construction, maintenance and servicing.
- **Operating and Installation Instructions** (for inverter and accessories)  
contain all relevant information about the intended use of the components, such as technical specifications, interfaces, dimensional drawings, characteristics, or possible applications.  
Phases of use: Control cabinet configuration/construction.

- **Manual/Configuration Manual**

contains all necessary information about the intended use of the components of a system, e.g. technical specifications, interfaces, dimensional drawings, characteristics, or possible applications.

Phases of use: Cabinet configuration/setup, circuit diagram configuration/drawing.

- **Commissioning Manual**

contains all information relevant to commissioning after installation and wiring. It also contains all safety and warning notices relevant to commissioning in addition to overview drawings.

Phases of use: Commissioning of components that have already been connected, configuration of system functions.

- **List Manual**

contains all parameters, function diagrams, and faults/alarms for the product/system as well as their meanings and setting options. It contains parameter data and fault/alarm descriptions with functional correlations.

Phases of use: Commissioning of components that have already been connected, configuration of system functions, fault cause/diagnosis.

- **Getting Started**

provides information about getting started for the first-time user as well as references to additional information. It contains information about the basic steps to be taken during commissioning. The information in the other documentation should be carefully observed for all of the other work required.

Phases of use: Commissioning of components that have already been connected.

- **Function Manual Drive Functions**

contains all the relevant information about individual drive functions: Description, commissioning and integration in the drive system.

Phases of use: Commissioning of components that have already been connected, configuration of system functions.

##### Overview

Description	Article No.
<b>Decentralization with PROFIBUS DP/DPV1</b>	Via bookstore
• German	<b>ISBN 978-3-89578-189-6</b>
• English	<b>ISBN 978-3-89578-218-3</b>
<b>Automating with PROFINET: Industrial Communication Based on Industrial Ethernet</b>	Via bookstore
• German	<b>ISBN 978-3-89578-293-0</b>
• English	<b>ISBN 978-3-89578-294-7</b>
<b>Configuration Manual EMC Installation Guideline SIMOCRANE, SIMOTICS, SIMOTION, SINAMICS, SINUMERIK</b>	
• German	<b>6FC5297-0AD30-0AP3</b>
• English	<b>6FC5297-0AD30-0BP3</b>
• Italian	<b>6FC5297-0AD30-0CP3</b>
• French	<b>6FC5297-0AD30-0DP3</b>
• Spanish	<b>6FC5297-0AD30-0EP3</b>
• Chinese Simplified	<b>6FC5297-0AD30-0RP3</b>



## Appendix



15/2	<b>Certificates of suitability</b>
15/4	<b>Software licenses</b>
15/6	<b>Subject index</b>
15/9	<b>Conversion tables</b>
15/11	<b>Metal surcharges</b>
15/14	<b>Conditions of sale and delivery/ Export regulations</b>

## Appendix

### Certificates of suitability







#### Overview

Many of the products in this Catalog fulfill requirements, e.g. for UL, CSA or FM and are labeled with the corresponding approval designation.





All of the certificates of suitability, approvals, certificates, declarations of conformity, test certificates, e.g. CE, UL, Safety Integrated etc. have been performed with the associated system components as they are described in the Catalogs and Configuration Manuals.

The certificates are only valid if the products are used with the described system components, are installed according to the Installation Guidelines and used for their intended purpose.

In other cases, the vendor of these products is responsible for arranging for the issue of new certificates.

Test code	Tested by	Device series/ Component	Test standard	Product category/ File-No.
<b>UL: Underwriters Laboratories</b> <i>Independent public testing body in North America</i>				
	UL according to UL standard	SINUMERIK	Standard UL 508, CSA C22.2 No. 142	NRAQ/7.E164110 NRAQ/7.E217227
		SIMOTION	Standard UL 508, CSA C22.2 No. 142	NRAQ/7.E164110
	UL according to CSA standard	SINAMICS	Standard UL 508, 508C, 61800-5-1 CSA C22.2 No. 142, 274	NRAQ/7.E164110, NMMS/2/7/8.E192450, NMMS/2/7/8.E203250, NMMS/7.E214113, NMMS/7.E253831
	UL according to UL and CSA standards			NMMS/2/7/8.E121068 NMMS/7.E355661 NMMS/7.E323473
	UL according to UL standard	SIMODRIVE	Standard UL 508C, CSA C22.2 No. 274	NMMS/2/7/8.E192450 NMMS/7.E214113
	UL according to CSA standard	SIMOTICS	Standard UL 1004-1, 1004-6, 1004-8, CSA C22.2 No. 100	PRGY2/8.E227215 PRHZ2/8.E93429 PRHJ2/8.E342747 PRGY2/8.E253922 PRHZ2/8.E342746
	UL according to UL and CSA standards			
		Line/motor reactors	Standard UL 508, 506, 5085-1, 5085-2, 1561, CSA C22.2 No. 14, 47, 66.1-06, 66.2-06	XQNX2/8.E257859 NMTR2/8.E219022 NMMS2/8.E333628 XPTQ2/8.E257852 XPTQ2/8.E103521 NMMS2/8.E224872 XPTQ2/8.E354316 XPTQ2/8.E198309 XQNX2/8.E475972
		Line filters, dv/dt filters, sine-wave filters	UL 1283, CSA C22.2 No. 8	FOKY2/8.E70122
		Resistors	UL 508, 508C, CSA C22.2 No. 14, 274	NMTR2/8.E224314 NMMS2/8.E192450 NMTR2/8.E221095 NMTR2/8.E226619
<b>TUV: TÜV Rheinland of North America Inc.</b> <i>Independent public testing body in North America, Nationally Recognized Testing Laboratory (NRTL)</i>				
<b>TÜV: TÜV SÜD Product Service</b> <i>Independent public testing body in Germany, Nationally Recognized Testing Laboratory (NRTL) for North America</i>				
	TUV according to UL and CSA standards	SINAMICS	NRTL listing according to standard UL 508C	U7V 12 06 20078 013 U7 11 04 20078 009 U7 11 04 20078 010 U7 11 04 20078 011
		SIMOTION	NRTL listing according to standard UL 508	U7V 13 03 20078 01
		SIMODRIVE	NRTL listing according to standard UL 508C, CSA C22.2. No. 14	CU 72090702
		Motion Control Encoder	NRTL listing according to UL 61010-1 CSA C22.2 No. 61010-1	U8V 10 06 20196 024

## Overview (continued)

Test code	Tested by	Device series/ Component	Test standard	Product category/ File-No.
<b>CSA: Canadian Standards Association</b> <i>Independent public testing body in Canada</i>				
	CSA according to CSA standard	SINUMERIK	Standard CSA C22.2 No. 142	2252-01 : LR 102527
<b>FMRC: Factory Mutual Research Corporation</b> <i>Independent public testing body in North America</i>				
	FM according to FM standard	SINUMERIK	Standard FMRC 3600, FMRC 3611, FMRC 3810, ANSI/ISA S82.02.1	–
<b>EAC: Ivanovo-Certificate</b> <i>Independent public testing body in the Russian Federation</i>				
	EAC in accordance with the EAC Directive	SINAMICS SINUMERIK SIMOTION	Standard IEC 61800-5-1/-2, IEC 61800-3	–
<b>RCM: Australian Communications and Media Authority</b> <i>Independent public testing body in Australia</i>				
	RCM according to EMC standard	SINAMICS SINUMERIK SIMOTION	Standard IEC AS 61800-3, EN 61800-3	–
<b>KC: National Radio Research Agency</b> <i>Independent public testing body in South Korea</i>				
	KC according to EMC standard	SINAMICS SINUMERIK SIMOTION	Standard KN 11	–
<b>BIA</b> <i>Federal Institute for Occupational Safety</i>				
–	Functional safety	SINAMICS SINUMERIK SIMOTION	Standard EN 61800-5-2	–
<b>TÜV SÜD Rail</b>				
–	Functional safety	SINAMICS SINUMERIK SIMOTION	Standard EN 61800-5-2	–

More information about certificates can be found online at:  
<https://support.industry.siemens.com/cs/ww/en/ps/cert>

## Appendix

### Software licenses

#### Overview

##### Software types

Software requiring a license is categorized into types. The following software types have been defined:

- Engineering software
- Runtime software

##### Engineering software

This includes all software products for creating (engineering) user software, e.g. for configuring, programming, parameterizing, testing, commissioning or servicing.

Data generated with engineering software and executable programs can be duplicated for your own use or for use by third-parties free-of-charge.

##### Runtime software

This includes all software products required for plant/machine operation, e.g. operating system, basic system, system expansions, drivers, etc.

The duplication of the runtime software and executable programs created with the runtime software for your own use or for use by third-parties is subject to a charge.

You can find information about license fees according to use in the ordering data (e.g. in the catalog). Examples of categories of use include per CPU, per installation, per channel, per instance, per axis, per control loop, per variable, etc.

Information about extended rights of use for parameterization/configuration tools supplied as integral components of the scope of delivery can be found in the readme file supplied with the relevant product(s).

##### License types

Siemens Industry Automation & Drive Technologies offers various types of software license:

- Floating license
- Single license
- Rental license
- Rental floating license
- Trial license
- Demo license
- Demo floating license

##### Floating license

The software may be installed for internal use on any number of devices by the licensee. Only the concurrent user is licensed. The concurrent user is the person using the program. Use begins when the software is started. A license is required for each concurrent user.

##### Single license

Unlike the floating license, a single license permits only one installation of the software per license.

The type of use licensed is specified in the ordering data and in the Certificate of License (CoL). Types of use include for example per instance, per axis, per channel, etc.

One single license is required for each type of use defined.

##### Rental license

A rental license supports the "sporadic use" of engineering software. Once the license key has been installed, the software can be used for a specific period of time (the operating hours do not have to be consecutive).

One license is required for each installation of the software.

##### Rental floating license

The rental floating license corresponds to the rental license, except that a license is not required for each installation of the software. Rather, one license is required per object (for example, user or device).

##### Trial license

A trial license supports "short-term use" of the software in a non-productive context, e.g. for testing and evaluation purposes. It can be transferred to another license.

##### Demo license

The demo license support the "sporadic use" of engineering software in a non-productive context, for example, use for testing and evaluation purposes. It can be transferred to another license. After the installation of the license key, the software can be operated for a specific period of time, whereby usage can be interrupted as often as required.

One license is required per installation of the software.

##### Demo floating license

The demo floating license corresponds to the demo license, except that a license is not required for each installation of the software. Rather, one license is required per object (for example, user or device).

##### Certificate of License (CoL)

The CoL is the licensee's proof that the use of the software has been licensed by Siemens. A CoL is required for every type of use and must be kept in a safe place.

##### Downgrading

The licensee is permitted to use the software or an earlier version/release of the software, provided that the licensee owns such a version/release and its use is technically feasible.

##### Delivery versions

Software is constantly being updated. The following delivery versions

- PowerPack
- Upgrade

can be used to access updates.

Existing bug fixes are supplied with the ServicePack version.

##### PowerPack

PowerPacks can be used to upgrade to more powerful software. The licensee receives a new license agreement and CoL (Certificate of License) with the PowerPack. This CoL, together with the CoL for the original product, proves that the new software is licensed.

A separate PowerPack must be purchased for each original license of the software to be replaced.

**Overview** (continued)**Upgrade**

An upgrade permits the use of a new version of the software on the condition that a license for a previous version of the product is already held.

The licensee receives a new license agreement and CoL with the upgrade. This CoL, together with the CoL for the previous product, proves that the new version is licensed.

A separate upgrade must be purchased for each original license of the software to be upgraded.

**ServicePack**

ServicePacks are used to debug existing products. ServicePacks may be duplicated for use as prescribed according to the number of existing original licenses.

**License key**

Siemens Industry Automation & Drive Technologies supplies software products with and without license keys.

The license key serves as an electronic license stamp and is also the "switch" for activating the software (floating license, rental license, etc.).

The complete installation of software products requiring license keys includes the program to be licensed (the software) and the license key (which represents the license).

**Software Update Service (SUS)**

As part of the SUS contract, all software updates for the respective product are made available to you free of charge for a period of one year from the invoice date. The contract will automatically be extended for one year if it is not canceled three months before it expires.

The possession of the current version of the respective software is a basic condition for entering into an SUS contract.

You can download explanations concerning license conditions from [www.siemens.com/automation/salesmaterial-as/catalog/en/terms\\_of\\_trade\\_en.pdf](http://www.siemens.com/automation/salesmaterial-as/catalog/en/terms_of_trade_en.pdf)

# Appendix

## Subject index

	Page		Page
<b>Numeric</b>			
24 V DC power supply for SINAMICS G110M .....	7/27		
<b>A</b>			
Absolute encoders .....	1/8		
Activation of the integrated safety functions .....	3/6		
Advanced Functions .....	3/6		
Advanced Technology Functions .....	2/5		
Appendix .....	15/1		
Applications .....	14/21		
Applications & Branch know-how .....	2/6		
Approvals (certificates of suitability) .....	15/2		
AS-Interface .....	5/10		
<b>B</b>			
Basic Drive Functions .....	2/2		
Basic Functions .....	3/6		
Basic positioner EPos .....	6/3		
Braking resistors			
• for SINAMICS G110D .....	8/15		
• for SINAMICS G110M .....	7/26		
<b>C</b>			
CA 01 .....	12/3, 14/3		
Card holder for memory card for SINAMICS G110D .....	8/18		
Catalog CA 01 .....	12/3, 14/3		
Certificates of suitability (approvals) .....	15/2		
Commissioning tool SINAMICS Startdrive .....	12/7		
Commissioning tool STARTER .....	12/5		
Common Engineering .....	2/6		
Communication .....	5/1		
Communication overview .....	5/2		
Compatible motors for SINAMICS G110M .....	7/28		
Conditions of sale and delivery .....	15/14		
Connecting cables			
• for SINAMICS G110D .....	8/18		
• for SINAMICS G110M .....	7/32		
• for SINAMICS G120D .....	9/37		
Control cabinets .....	14/15		
Control Units			
• CU240D-2 and CU250D-2 for SINAMICS G120D .....	9/9		
• CU240M .....	7/8		
Conversion tables .....	15/9		
Conveyor technology, drive application .....	13/4		
<b>D</b>			
DC link components			
• for SINAMICS G110D .....	8/15		
• for SINAMICS G110M .....	7/26		
Distributed inverters			
• SINAMICS G110D .....	8/1		
• SINAMICS G110M .....	7/1		
• SINAMICS G120D .....	9/1		
Documentation .....	14/30		
Download Center .....	14/4		
Drive applications .....	13/1		
Drive ES .....	12/10		
Drive ES engineering software .....	12/10		
Drive family SINAMICS .....	1/2		
Drive selection .....	1/6		
Drive Technology Configurator .....	12/3		
Dual-encoder system .....	3/8		
<b>E</b>			
Efficiency classes, establishing .....	4/7		
Encoders, system overview .....	1/8		
Energy efficiency .....	4/1		
Energy efficiency classes in accordance with EN 50598 .....	4/6		
Energy efficiency tool SinaSave .....	12/2		
Energy management process .....	1/3		
Energy-efficient drives with intelligent functions .....	4/4		
Energy-saving functions for SINAMICS converters, overview .....	4/5		
Engineering software Drive ES .....	12/10		
Engineering tool SIZER for Siemens Drives .....	12/4		
Engineering tools .....	12/1		
EPos .....	6/3		
EPos basic positioner .....	6/3		
EtherNet/IP .....	5/10		
Extended Functions .....	3/6		
<b>F</b>			
Firmware functionality .....	2/1		
Free function blocks (FFB) .....	6/2		
Frequency converter SIMATIC ET 200pro FC-2 .....	10/1		
Function module basic positioner EPos .....	6/3, 9/13		
Functionality of the EPos basic positioner .....	6/4, 9/14		
Functions for			
• safe brake management .....	3/3		
• safely stopping a drive .....	3/3		
• safely monitoring the motion of a drive .....	3/3		
• safely monitoring the position of a drive .....	3/3		

	Page		Page
<b>G</b>			
Geared motors SIMOGEAR, overview .....	11/2		
Geared motors SIMOGEAR, system overview .....	1/7		
<b>I</b>			
IDS – Integration at its very best .....	1/5		
Incremental encoders .....	1/8		
Industrial Ethernet .....	5/9		
Industry Mall .....	14/3		
Industry Services .....	14/5		
Information and Download Center .....	14/4		
Installation kits for SINAMICS G110M .....	7/32		
Integrated energy management – SIMATIC Energy Suite .....	4/3		
Integration in automation .....	1/2		
Intelligent Operator Panel IOP-2 Handheld			
• for SIMATIC ET 200pro FC-2 .....	10/9		
• for SINAMICS G110D .....	8/16		
• for SINAMICS G110M .....	7/29		
• for SINAMICS G120D .....	9/35		
Interactive catalog CA 01 .....	12/3, 14/3		
<b>M</b>			
Manual local control with keyswitch for SINAMICS G110D .....	8/17		
Measuring systems Motion Control Encoder, system overview .....	1/8		
Mechatronic Support .....	14/20		
Memory card			
• for SIMATIC ET 200pro FC-2 .....	10/10		
• for SINAMICS G110D .....	8/17		
• for SINAMICS G110M .....	7/30		
• for SINAMICS G120D .....	9/36		
Metal surcharges .....	15/11		
Mobile Media .....	14/4		
Modbus RTU .....	5/10		
Motion Control Encoder measuring systems, system overview .....	1/8		
Motors for SINAMICS G110M .....	7/28		
Motors SIMOTICS, overview .....	11/2		
Motors SIMOTICS, system overview .....	1/7		
mySupport documentation .....	14/29		
<b>O</b>			
Online Services .....	14/3		
Online Support .....	14/8		
Operating principle of Safety Integrated .....	3/7		
<b>P</b>			
Partner at Siemens .....	14/2		
PC inverter connection kit 2			
• for SIMATIC ET 200pro FC-2 .....	10/10		
• for SINAMICS G110M .....	7/30		
• for SINAMICS G120D .....	9/36		
Platform concept .....	1/5		
Position acquisition without/with encoder .....	3/7		
Power Modules			
• PM240M .....	7/17		
• PM250D for SINAMICS G120D .....	9/26		
PROFIBUS .....	5/8		
PROFIdrive .....	5/7		
PROFINET .....	5/3		
<b>Q</b>			
Quality management according to EN ISO 9001 .....	1/5		
<b>R</b>			
Recommended line-side power components			
• for SINAMICS G110D .....	8/14		
• for SINAMICS G110M .....	7/25		
• for SINAMICS G120D .....	9/33		
Repair service contract RSC .....	14/17		
Repair switch for SINAMICS G110M .....	7/24		
Replacement fans			
• for SINAMICS G110D .....	8/20		
• for SINAMICS G120D .....	9/40		
<b>S</b>			
Safe Direction (SDI) .....	3/6		
Safe Speed Monitor (SSM) .....	3/5		
Safe speed/position acquisition without/with encoder .....	3/7		
Safe Stop 1 (SS1) .....	3/4		
Safe Torque Off (STO) .....	3/4		
Safely-Limited Speed (SLS) .....	3/5		
Safety functions in SINAMICS drives .....	3/3		
Safety Integrated .....	3/1		
Safety Integrated			
• for SIMATIC ET 200pro FC-2 .....	3/14		
• for SINAMICS G110D .....	3/10		
• for SINAMICS G110M .....	3/9		
• for SINAMICS G120D .....	3/11		
Safety Integrated, operating principle .....	3/7		
Safety-related standards .....	3/2		
SDI (Safe Direction) .....	3/6		
Security information .....	12/1		
Selection guide – typical applications .....	1/6		
Services and documentation .....	14/1		
Siemens Automation Cooperates with Education .....	14/13		
Siemens family of distributed drives .....	7/3		

# Appendix

## Subject index

	Page		Page
<i>S (continued)</i>		<i>T</i>	
SIMATIC Energy Suite – integrated energy management .....	4/3	Technology functions.....	6/1
SIMATIC ET 200pro FC-2 frequency converters.....	10/1	The operating principle of Safety Integrated.....	3/7
SIMOGEAR geared motors, overview .....	11/2	Totally Integrated Automation.....	1/2
SIMOGEAR geared motors, system overview .....	1/7	Training.....	14/9
SIMOTICS motors and geared motors .....	11/1	Training cases	
SIMOTICS motors, overview .....	11/2	• SINAMICS G110M .....	14/11
SIMOTICS motors, system overview.....	1/7	• SINAMICS G120D .....	14/12
SINAMICS as part of the Siemens modular automation system.....	1/3	Training courses for SINAMICS low-voltage converters.....	14/10
SINAMICS drive family.....	1/2	Typical applications – SINAMICS selection guide .....	1/6
SINAMICS G110D distributed inverters.....	8/1	<i>U</i>	
SINAMICS G110M distributed inverters.....	7/1	USS.....	5/10
SINAMICS G120D distributed inverters.....	9/1	<i>V</i>	
SINAMICS selection guide – typical applications .....	1/6	Variants of the SINAMICS family .....	1/4
SINAMICS Startdrive commissioning tool.....	12/7	<i>W</i>	
SinaSave energy efficiency tool.....	12/2	Wall mounting kit for SINAMICS G110M .....	7/31
Single-encoder system .....	3/8		
SITRAIN – Training for Industry.....	14/9		
SIZER for Siemens Drives engineering tool.....	12/4		
SLS (Safely-Limited Speed).....	3/5		
Social and Mobile Media .....	14/4		
Software licenses .....	15/4		
Spare Parts Kit			
• for SINAMICS G110D .....	8/20		
• for SINAMICS G110M.....	7/34		
• for SINAMICS G120D .....	9/40		
Spare parts services.....	14/22		
Spares on Web .....	14/27		
Speed/position acquisition without/with encoder .....	3/7		
SS1 (Safe Stop 1).....	3/4		
SSM (Safe Speed Monitor) .....	3/5		
Standard Technology Functions .....	2/4		
STARTER commissioning tool.....	12/5		
STO (Safe Torque Off).....	3/4		
Supplementary products for distributed drive technology .....	14/28		
Supplementary system components			
• for SINAMICS G110D .....	8/16		
• for SINAMICS G110M.....	7/29		
• for SINAMICS G120D .....	9/34		
System overview .....	1/1		



## Conversion tables

**Rotary inertia** (to convert from A to B, multiply by entry in table)

A \ B	lb-in <sup>2</sup>	lb-ft <sup>2</sup>	lb-in-s <sup>2</sup>	lb-ft-s <sup>2</sup> slug-ft <sup>2</sup>	kg-cm <sup>2</sup>	kg-cm-s <sup>2</sup>	gm-cm <sup>2</sup>	gm-cm-s <sup>2</sup>	oz-in <sup>2</sup>	oz-in-s <sup>2</sup>
lb-in <sup>2</sup>	1	$6.94 \times 10^{-3}$	$2.59 \times 10^{-3}$	$2.15 \times 10^{-4}$	2.926	$2.98 \times 10^{-3}$	$2.92 \times 10^3$	2.984	16	$4.14 \times 10^{-2}$
lb-ft <sup>2</sup>	144	1	0.3729	$3.10 \times 10^{-2}$	421.40	0.4297	$4.21 \times 10^5$	429.71	2304	5.967
lb-in-s <sup>2</sup>	386.08	2.681	1	$8.33 \times 10^{-2}$	$1.129 \times 10^3$	1.152	$1.129 \times 10^6$	$1.152 \times 10^3$	$6.177 \times 10^3$	16
lb-ft-s <sup>2</sup> slug-ft <sup>2</sup>	$4.63 \times 10^3$	32.17	12	1	$1.35 \times 10^4$	13.825	$1.355 \times 10^7$	$1.38 \times 10^4$	$7.41 \times 10^4$	192
kg-cm <sup>2</sup>	0.3417	$2.37 \times 10^{-3}$	$8.85 \times 10^{-4}$	$7.37 \times 10^{-5}$	1	$1.019 \times 10^{-3}$	1000	1.019	5.46	$1.41 \times 10^{-2}$
kg-cm-s <sup>2</sup>	335.1	2.327	0.8679	$7.23 \times 10^{-2}$	980.66	1	$9.8 \times 10^5$	1000	$5.36 \times 10^3$	13.887
gm-cm <sup>2</sup>	$3.417 \times 10^{-4}$	$2.37 \times 10^{-6}$	$8.85 \times 10^{-7}$	$7.37 \times 10^{-8}$	$1 \times 10^{-3}$	$1.01 \times 10^{-6}$	1	$1.01 \times 10^{-3}$	$5.46 \times 10^{-3}$	$1.41 \times 10^{-5}$
gm-cm-s <sup>2</sup>	0.335	$2.32 \times 10^{-3}$	$8.67 \times 10^{-4}$	$7.23 \times 10^{-5}$	0.9806	$1 \times 10^{-3}$	980.6	1	5.36	$1.38 \times 10^{-2}$
oz-in <sup>2</sup>	0.0625	$4.34 \times 10^{-4}$	$1.61 \times 10^{-4}$	$1.34 \times 10^{-5}$	0.182	$1.86 \times 10^{-4}$	182.9	0.186	1	$2.59 \times 10^{-3}$
oz-in-s <sup>2</sup>	24.13	0.1675	$6.25 \times 10^{-2}$	$5.20 \times 10^{-3}$	70.615	$7.20 \times 10^{-2}$	$7.09 \times 10^4$	72.0	386.08	1

**Torque** (to convert from A to B, multiply by entry in table)

A \ B	lb-in	lb-ft	oz-in	N-m	kg-cm	kg-m	gm-cm	dyne-cm
lb-in	1	$8.333 \times 10^{-2}$	16	0.113	1.152	$1.152 \times 10^{-2}$	$1.152 \times 10^3$	$1.129 \times 10^6$
lb-ft	12	1	192	1.355	13.825	0.138	$1.382 \times 10^4$	$1.355 \times 10^7$
oz-in	$6.25 \times 10^{-2}$	$5.208 \times 10^{-3}$	1	$7.061 \times 10^{-3}$	$7.200 \times 10^{-2}$	$7.200 \times 10^{-4}$	72.007	$7.061 \times 10^4$
N-m	8.850	0.737	141.612	1	10.197	0.102	$1.019 \times 10^4$	$1 \times 10^7$
kg-cm	0.8679	$7.233 \times 10^{-2}$	13.877	$9.806 \times 10^{-2}$	1	$10^{-2}$	1000	$9.806 \times 10^5$
kg-m	86.796	7.233	$1.388 \times 10^3$	9.806	100	1	$1 \times 10^5$	$9.806 \times 10^7$
gm-cm	$8.679 \times 10^{-4}$	$7.233 \times 10^{-5}$	$1.388 \times 10^{-2}$	$9.806 \times 10^{-5}$	$1 \times 10^{-3}$	$1 \times 10^{-5}$	1	980.665
dyne-cm	$8.850 \times 10^{-7}$	$7.375 \times 10^{-8}$	$1.416 \times 10^{-5}$	$10^{-7}$	$1.0197 \times 10^{-6}$	$1.019 \times 10^{-8}$	$1.019 \times 10^{-3}$	1

**Length** (to convert from A to B, multiply by entry in table)

A \ B	inches	feet	cm	yd	mm	m
inches	1	0.0833	2.54	0.028	25.4	0.0254
feet	12	1	30.48	0.333	304.8	0.3048
cm	0.3937	0.03281	1	$1.09 \times 10^{-2}$	10	0.01
yd	36	3	91.44	1	914.4	0.914
mm	0.03937	0.00328	0.1	$1.09 \times 10^{-3}$	1	0.001
m	39.37	3.281	100	1.09	1000	1

**Power** (to convert from A to B, multiply by entry in table)

A \ B	hp	Watts
hp (English)	1	745.7
(lb-in) (deg./s)	$2.645 \times 10^{-6}$	$1.972 \times 10^{-3}$
(lb-in) (rpm)	$1.587 \times 10^{-5}$	$1.183 \times 10^{-2}$
(lb-ft) (deg./s)	$3.173 \times 10^{-5}$	$2.366 \times 10^{-2}$
(lb-ft) (rpm)	$1.904 \times 10^{-4}$	0.1420
Watts	$1.341 \times 10^{-3}$	1

**Force** (to convert from A to B, multiply by entry in table)

A \ B	lb	oz	gm	dyne	N
lb	1	16	453.6	$4.448 \times 10^5$	4.4482
oz	0.0625	1	28.35	$2.780 \times 10^4$	0.27801
gm	$2.205 \times 10^{-3}$	0.03527	1	$1.02 \times 10^{-3}$	N.A.
dyne	$2.248 \times 10^{-6}$	$3.59 \times 10^{-5}$	980.7	1	0.00001
N	0.22481	3.5967	N.A.	100000	1

**Mass** (to convert from A to B, multiply by entry in table)

A \ B	lb	oz	gm	kg	slug
lb	1	16	453.6	0.4536	0.0311
oz	$6.25 \times 10^{-2}$	1	28.35	0.02835	$1.93 \times 10^{-3}$
gm	$2.205 \times 10^{-3}$	$3.527 \times 10^{-2}$	1	$10^{-3}$	$6.852 \times 10^{-5}$
kg	2.205	35.27	$10^3$	1	$6.852 \times 10^{-2}$
slug	32.17	514.8	$1.459 \times 10^4$	14.59	1

**Rotation** (to convert from A to B, multiply by entry in table)

A \ B	rpm	rad/s	degrees/s
rpm	1	0.105	6.0
rad/s	9.55	1	57.30
degrees/s	0.167	$1.745 \times 10^{-2}$	1

## Appendix

### Conversion tables

#### Temperature Conversion

°F	°C	°C	°F
0	-17.8	-10	14
32	0	0	32
50	10	10	50
70	21.1	20	68
90	32.2	30	86
98.4	37	37	98.4
212	100	100	212
subtract 32 and multiply by $\frac{5}{9}$		multiply by $\frac{9}{5}$ and add 32	

#### Mechanism Efficiencies

Acme-screw with brass nut	~0.35–0.65
Acme-screw with plastic nut	~0.50–0.85
Ball-screw	~0.85–0.95
Chain and sprocket	~0.95–0.98
Preloaded ball-screw	~0.75–0.85
Spur or bevel-gears	~0.90
Timing belts	~0.96–0.98
Worm gears	~0.45–0.85
Helical gear (1 reduction)	~0.92

#### Friction Coefficients

Materials	$\mu$
Steel on steel (greased)	~0.15
Plastic on steel	~0.15–0.25
Copper on steel	~0.30
Brass on steel	~0.35
Aluminum on steel	~0.45
Steel on steel	~0.58
Mechanism	$\mu$
Ball bushings	<0.001
Linear bearings	<0.001
Dove-tail slides	~0.2++
Gibb ways	~0.5++

#### Material Densities

Material	lb-in <sup>3</sup>	gm-cm <sup>3</sup>
Aluminum	0.096	2.66
Brass	0.299	8.30
Bronze	0.295	8.17
Copper	0.322	8.91
Hard wood	0.029	0.80
Soft wood	0.018	0.48
Plastic	0.040	1.11
Glass	0.079–0.090	2.2–2.5
Titanium	0.163	4.51
Paper	0.025–0.043	0.7–1.2
Polyvinyl chloride	0.047–0.050	1.3–1.4
Rubber	0.033–0.036	0.92–0.99
Silicone rubber, without filler	0.043	1.2
Cast iron, gray	0.274	7.6
Steel	0.280	7.75

#### Wire Gauges<sup>1)</sup>

Cross-section mm <sup>2</sup>	Standard Wire Gauge (SWG)	American Wire Gauge (AWG)
0.2	25	24
0.3	23	22
0.5	21	20
0.75	20	19
1.0	19	18
1.5	17	16
2.5	15	13
4	13	11
6	12	9
10	9	7
16	7	6
25	5	3
35	3	2
50	0	1/0
70	000	2/0
95	00000	3/0
120	0000000	4/0
150	–	6/0
185	–	7/0

<sup>1)</sup> The table shows approximate SWG/AWG sizes nearest to standard metric sizes; the cross-sections do not match exactly.

## Explanation of the raw material/metal surcharges <sup>1)</sup>

### Surcharge calculation

To compensate for variations in the price of the raw materials silver, copper, aluminum, lead, gold, dysprosium <sup>2)</sup> and/or neodym <sup>2)</sup>, surcharges are calculated on a daily basis using the so-called metal factor for products containing these raw materials. A surcharge for the respective raw material is calculated as a supplement to the price of a product if the basic official price of the raw material in question is exceeded.

The surcharges are calculated in accordance with the following criteria:

- Basic official price of the raw material  
Basic official price from the day prior to receipt of the order or prior to release order (daily price) for <sup>3)</sup>  
- Silver (sales price, processed)  
- Gold (sales price, processed)  
and for <sup>4)</sup>  
- Copper (lower DEL notation + 1 %)  
- Aluminum (aluminum in cables)  
- Lead (lead in cables)
- Metal factor of the products  
Certain products are displayed with a metal factor. The metal factor determines the official price (for those raw materials concerned) as of which the metal surcharges are applied and the calculation method used (weight or percentage method). An exact explanation is given below.

### Structure of the metal factor

The metal factor consists of several digits; the first digit indicates whether the percentage method of calculation refers to the list price or a possible discounted price (customer net price) (L = list price / N = customer net price).

The remaining digits indicate the method of calculation used for the respective raw material. If no surcharge is added for a raw material, a "-" is used.

1st digit	List or customer net price using the percentage method
2nd digit	for silver (AG)
3rd digit	for copper (CU)
4th digit	for aluminum (AL)
5th digit	for lead (PB)
6th digit	for gold (AU)
7th digit	for dysprosium (Dy) <sup>2)</sup>
8th digit	for neodym (Nd) <sup>2)</sup>

### Weight method

The weight method uses the basic official price, the daily price and the raw material weight. In order to calculate the surcharge, the basic official price must be subtracted from the daily price. The difference is then multiplied by the raw material weight.

The basic official price can be found in the table below using the number (1 to 9) of the respective digit of the metal factor. The raw material weight can be found in the respective product descriptions.

### Percentage method

Use of the percentage method is indicated by the letters A-Z at the respective digit of the metal factor.

The surcharge is increased - dependent on the deviation of the daily price compared with the basic official price - using the percentage method in "steps" and consequently offers surcharges that remain constant within the framework of this "step range". A higher percentage rate is charged for each new step. The respective percentage level can be found in the table below.

### Metal factor examples

<b>L E A - - - - -</b>	<ul style="list-style-type: none"> <li>Basis for % surcharge: List price</li> <li>Silver Basis 150 €, Step 50 €, 0.5 %</li> <li>Copper Basis 150 €, Step 50 €, 0.1 %</li> <li>No surcharge for aluminum</li> <li>No surcharge for lead</li> <li>No surcharge for gold</li> <li>No surcharge for dysprosium</li> <li>No surcharge for neodym</li> </ul>
<b>N - A 6 - - - - -</b>	<ul style="list-style-type: none"> <li>Basis for % surcharge: Customer net price</li> <li>No surcharge for silver</li> <li>Copper Basis 150 €, Step 50 €, 0.1 %</li> <li>Aluminum acc. to weight, basic offic. price 225 €</li> <li>No surcharge for lead</li> <li>No surcharge for gold</li> <li>No surcharge for dysprosium</li> <li>No surcharge for neodym</li> </ul>
<b>- - 3 - - - - -</b>	<ul style="list-style-type: none"> <li>No basis necessary</li> <li>No surcharge for silver</li> <li>Copper acc. to weight, basic official price 150 €</li> <li>No surcharge for aluminum</li> <li>No surcharge for lead</li> <li>No surcharge for gold</li> <li>No surcharge for dysprosium</li> <li>No surcharge for neodym</li> </ul>

<sup>1)</sup> Refer to the separate explanation on the next page regarding the raw materials dysprosium and neodym (= rare earths).

<sup>2)</sup> For a different method of calculation, refer to the separate explanation for these raw materials on the next page.

<sup>3)</sup> Source: Umicore, Hanau ([www.metalsmanagement.umicore.com](http://www.metalsmanagement.umicore.com)).

<sup>4)</sup> Source: Schutzvereinigung DEL-Notiz e.V. ([www.del-notiz.org](http://www.del-notiz.org)).

## Appendix

### Metal surcharges

#### Explanation of the raw material/metal surcharges for dysprosium and neodym (rare earths)

##### Surcharge calculation

To compensate for variations in the price of the raw materials silver <sup>1)</sup>, copper <sup>1)</sup>, aluminum <sup>1)</sup>, lead <sup>1)</sup>, gold <sup>1)</sup>, dysprosium and/or neodym, surcharges are calculated on a daily basis using the so-called metal factor for products containing these raw materials. The surcharge for dysprosium and neodym is calculated as a supplement to the price of a product if the basic official price of the raw material in question is exceeded.

The surcharge is calculated in accordance with the following criteria:

- Basic official price of the raw material <sup>2)</sup>  
Three-month basic average price (see below) in the period before the quarter in which the order was received or the release order took place (= average official price) for  
- dysprosium (Dy metal, 99 % min. FOB China; USD/kg)  
- neodym (Nd metal, 99 % min. FOB China; USD/kg)
- Metal factor of the products  
Certain products are displayed with a metal factor. The metal factor indicates (for those raw materials concerned) the basic official price as of which the surcharges for dysprosium and neodym are calculated using the weight method. An exact explanation of the metal factor is given below.

##### Three-month average price

The prices of rare earths vary according to the foreign currency, and there is no freely accessible stock exchange listing. This makes it more difficult for all parties involved to monitor changes in price. In order to avoid continuous adjustment of the surcharges, but to still ensure fair, transparent pricing, an average price is calculated over a three-month period using the average monthly foreign exchange rate from USD to EUR (source: European Central Bank). Since not all facts are immediately available at the start of each month, a one-month buffer is allowed before the new average price applies.

Examples of calculation of the average official price:

Period for calculation of the average price:	Period during which the order/release order is effected and the average price applies:
Sep 2012 - Nov 2012	Q1 in 2013 (Jan - Mar)
Dec 2012 - Feb 2013	Q2 in 2013 (Apr - Jun)
Mar 2013 - May 2013	Q3 in 2013 (Jul - Sep)
Jun 2013 - Aug 2013	Q4 in 2013 (Oct - Dec)

##### Structure of the metal factor

The metal factor consists of several digits; the first digit is not relevant to the calculation of dysprosium and neodym.

The remaining digits indicate the method of calculation used for the respective raw material. If no surcharge is added for a raw material, a "-" is used.

1st digit	List or customer net price using the percentage method
2nd digit	for silver (AG) <sup>1)</sup>
3rd digit	for copper (CU) <sup>1)</sup>
4th digit	for aluminum (AL) <sup>1)</sup>
5th digit	for lead (PB) <sup>1)</sup>
6th digit	for gold (AU) <sup>1)</sup>
7th digit	for dysprosium (Dy)
8th digit	for neodym (Nd)

##### Weight method

The weight method uses the basic official price, the average price and the raw material weight. In order to calculate the surcharge, the basic official price must be subtracted from the average price. The difference is then multiplied by the raw material weight.

The basic official price can be found in the table below using the number (1 to 9) of the respective digit of the metal factor. Your Sales contact can inform you of the raw material weight.

##### Metal factor examples

-----71	No basis necessary
↑	No surcharge for silver
↑	No surcharge for copper
↑	No surcharge for aluminum
↑	No surcharge for lead
↑	No surcharge for gold
↑	Dysprosium acc. to weight, basic official price 300 €
↑	Neodym acc. to weight, basic official price 50 €

<sup>1)</sup> For a different method of calculation, refer to the separate explanation for these raw materials on the previous page.

<sup>2)</sup> Source: Asian Metal Ltd ([www.asianmetal.com](http://www.asianmetal.com))

## Values of the metal factor

Percentage method	Basic official price in €	Step range in €	% surcharge 1st step	% surcharge 2nd step	% surcharge 3rd step	% surcharge 4th step	% surcharge per additional step	
			Price in €	Price in €	Price in €	Price in €		
			150.01 - 200.00	200.01 - 250.00	250.01 - 300.00	300.01 - 350.00		
A	150	50	0.1	0.2	0.3	0.4	0.1	
B	150	50	0.2	0.4	0.6	0.8	0.2	
C	150	50	0.3	0.6	0.9	1.2	0.3	
D	150	50	0.4	0.8	1.2	1.6	0.4	
E	150	50	0.5	1.0	1.5	2.0	0.5	
F	150	50	0.6	1.2	1.8	2.4	0.6	
G	150	50	1.0	2.0	3.0	4.0	1.0	
H	150	50	1.2	2.4	3.6	4.8	1.2	
I	150	50	1.6	3.2	4.8	6.4	1.6	
J	150	50	1.8	3.6	5.4	7.2	1.8	
			175.01 - 225.00	225.01 - 275.00	275.01 - 325.00	325.01 - 375.00		
O	175	50	0.1	0.2	0.3	0.4	0.1	
P	175	50	0.2	0.4	0.6	0.8	0.2	
R	175	50	0.5	1.0	1.5	2.0	0.5	
			225.01 - 275.00	275.01 - 325.00	325.01 - 375.00	375.01 - 425.00		
S	225	50	0.2	0.4	0.6	0.8	0.2	
U	225	50	1.0	2.0	3.0	4.0	1.0	
V	225	50	1.0	1.5	2.0	3.0	1.0	
W	225	50	1.2	2.5	3.5	4.5	1.0	
			150.01 - 175.00	175.01 - 200.00	200.01 - 225.00	225.01 - 250.00		
Y	150	25	0.3	0.6	0.9	1.2	0.3	
			400.01 - 425.00	425.01 - 450.00	450.01 - 475.00	475.01 - 500.00		
Z	400	25	0.1	0.2	0.3	0.4	0.1	
<b>Price basis (1st digit)</b>								
L	Calculation based on the list price							
N	Calculation based on the customer net price (discounted list price)							
<b>Weight method</b>	<b>Basic official price in €</b>							
1	50	Calculation based on raw material weight						
2	100							
3	150							
4	175							
5	200							
6	225							
7	300							
8	400							
9	555							
<b>Miscellaneous</b>								
-	No metal surcharge							

## Appendix

### Conditions of sale and delivery/Export regulations

#### 1. General Provisions

By using this catalog you can acquire hardware and software products described therein from Siemens AG subject to the following Terms and Conditions of Sale and Delivery (hereinafter referred to as "T&C"). Please note that the scope, the quality and the conditions for supplies and services, including software products, by any Siemens entity having a registered office outside Germany, shall be subject exclusively to the General Terms and Conditions of the respective Siemens entity. The following T&C apply exclusively for orders placed with Siemens Aktiengesellschaft, Germany.

##### 1.1 For customers with a seat or registered office in Germany

For customers with a seat or registered office in Germany, the following applies subordinate to the T&C:

- the "General Terms of Payment"<sup>1)</sup> and,
- for software products, the "General License Conditions for Software Products for Automation and Drives for Customers with a Seat or Registered Office in Germany"<sup>1)</sup> and,
- for other supplies and services, the "General Conditions for the Supply of Products and Services of the Electrical and Electronics Industry"<sup>1)</sup>.

##### 1.2 For customers with a seat or registered office outside Germany

For customers with a seat or registered office outside Germany, the following applies subordinate to the T&C:

- the "General Terms of Payment"<sup>1)</sup> and,
- for software products, the "General License Conditions for Software Products for Automation and Drives for Customers with a Seat or Registered Office outside of Germany"<sup>1)</sup> and
- for other supplies and/or services, the "General Conditions for Supplies of Siemens Industry for Customers with a Seat or Registered Office outside of Germany"<sup>1)</sup>.

#### 2. Prices

The prices are in € (Euro) ex point of delivery, exclusive of packaging.

The sales tax (value added tax) is not included in the prices. It shall be charged separately at the respective rate according to the applicable statutory legal regulations.

Prices are subject to change without prior notice. We will charge the prices valid at the time of delivery.

To compensate for variations in the price of raw materials (e.g. silver, copper, aluminum, lead, gold, dysprosium and neodym), surcharges are calculated on a daily basis using the so-called metal factor for products containing these raw materials. A surcharge for the respective raw material is calculated as a supplement to the price of a product if the basic official price of the raw material in question is exceeded.

The metal factor of a product indicates the basic official price (for those raw materials concerned) as of which the surcharges on the price of the product are applied, and with what method of calculation.

You will find a detailed explanation of the metal factor on the page headed "Metal surcharges".

To calculate the surcharge (except in the cases of dysprosium and neodym), the official price from the day prior to that on which the order was received or the release order was effected is used.

To calculate the surcharge applicable to dysprosium and neodym ("rare earths"), the corresponding three-month basic average price in the quarter prior to that in which the order was received or the release order was effected is used with a one-month buffer (details on the calculation can be found in the explanation of the metal factor).

#### 3. Additional Terms and Conditions

The dimensions are in mm. In Germany, according to the German law on units in measuring technology, data in inches apply only to devices for export.

Illustrations are not binding.

Insofar as there are no remarks on the individual pages of this catalog – especially with regard to data, dimensions and weights given – these are subject to change without prior notice.

#### 4. Export regulations

We shall not be obligated to fulfill any agreement if such fulfillment is prevented by any impediments arising out of national or international foreign trade or customs requirements or any embargoes and/or other sanctions.

Export of goods listed in this catalog may be subject to licensing requirements. We will indicate in the delivery details whether licenses are required under German, European and US export lists. Goods labeled with "AL" not equal to "N" are subject to European or German export authorization when being exported out of the EU. Goods labeled with "ECCN" not equal to "N" are subject to US re-export authorization.

The export indications can be viewed in advance in the description of the respective goods on the Industry Mall, our online catalog system. Only the export labels "AL" and "ECCN" indicated on order confirmations, delivery notes and invoices are authoritative.

Even without a label, or with label "AL:N" or "ECCN:N", authorization may be required i.a. due to the final disposition and intended use of goods.

If you transfer goods (hardware and/or software and/or technology as well as corresponding documentation, regardless of the mode of provision) delivered by us or works and services (including all kinds of technical support) performed by us to a third party worldwide, you must comply with all applicable national and international (re-)export control regulations.

If required for the purpose of conducting export control checks, you (upon request by us) shall promptly provide us with all information pertaining to the particular end customer, final disposition and intended use of goods delivered by us respectively works and services provided by us, as well as to any export control restrictions existing in this relation.

The products listed in this catalog may be subject to European/German and/or US export regulations. Any export requiring approval is therefore subject to authorization by the relevant authorities.

Errors excepted and subject to change without prior notice.

<sup>1)</sup> The text of the Terms and Conditions of Siemens AG can be downloaded at:  
[www.siemens.com/automation/salesmaterial-as/catalog/en/terms\\_of\\_trade\\_en.pdf](http://www.siemens.com/automation/salesmaterial-as/catalog/en/terms_of_trade_en.pdf)

Further information can be obtained from our branch offices listed at [www.siemens.com/automation-contact](http://www.siemens.com/automation-contact)

<b>Interactive Catalog on DVD</b>	<i>Catalog</i>	<b>Process Instrumentation and Analytics</b>	<i>Catalog</i>
Products for Automation and Drives	<b>CA 01</b>	<i>Digital: Field Instruments for Process Automation</i>	FI 01
<b>Building Control</b>		<i>Digital: Display Recorders SIREC D</i>	MP 20
GAMMA Building Control	ET G1	<i>Digital: SIPART Controllers and Software</i>	MP 31
<b>Drive Systems</b>		Products for Weighing Technology	WT 10
SINAMICS G130 Drive Converter Chassis Units	D 11	<i>Digital: Process Analytical Instruments</i>	AP 01
SINAMICS G150 Drive Converter Cabinet Units		<i>Digital: Process Analytics, Components for Continuous Emission Monitoring</i>	AP 11
SINAMICS GM150, SINAMICS SM150 Medium-Voltage Converters	D 12	<b>Low-Voltage Power Distribution and Electrical Installation Technology</b>	
SINAMICS PERFECT HARMONY GH180 Medium-Voltage Air-Cooled Drives (Germany Edition)	D 15.1	SENTRON · SIVACON · ALPHA Protection, Switching, Measuring and Monitoring Devices, Switchboards and Distribution Systems	LV 10
SINAMICS G180 Converters – Compact Units, Cabinet Systems, Cabinet Units Air-Cooled and Liquid-Cooled	D 18.1	Standards-Compliant Components for Photovoltaic Plants	LV 11
SINAMICS S120 Chassis Format Units and Cabinet Modules	D 21.3	Electrical Components for the Railway Industry	LV 12
SINAMICS S150 Converter Cabinet Units		Power Monitoring Made Simple	LV 14
SINAMICS S120 and SIMOTICS	D 21.4	Components for Industrial Control Panels according to UL Standards	LV 16
SINAMICS DCM DC Converter, Control Module	D 23.1	3WT Air Circuit Breakers up to 4000 A	LV 35
SINAMICS Inverters for Single-Axis Drives · Built-In Units	D 31.1	3VT Molded Case Circuit Breakers up to 1600 A	LV 36
SINAMICS Inverters for Single-Axis Drives · Distributed Inverters	D 31.2	<i>Digital: SIVACON System Cubicles, System Lighting and System Air-Conditioning</i>	LV 50
<i>Digital: SINAMICS G120P and SINAMICS G120P Cabinet pump, fan, compressor converters</i>	D 35	<i>Digital: ALPHA Distribution Systems</i>	LV 51
LOHER VARIO High Voltage Motors Flameproof, Type Series 1PS4, 1PS5, 1MV4 and 1MV5 Frame Size 355 to 1000, Power Range 80 to 7100 kW	D 83.2	ALPHA FIX Terminal Blocks	LV 52
Three-Phase Induction Motors	D 84.1	SIVACON S4 Power Distribution Boards	LV 56
SIMOTICS HV, SIMOTICS TN		SIVACON 8PS Busbar Trunking Systems	LV 70
High Voltage Three-phase Induction Motors	D 84.9	<i>Digital: DELTA Switches and Socket Outlets</i>	ET D1
SIMOTICS HV Series A-compact PLUS		Vacuum Switching Technology and Components for Medium Voltage	HG 11.01
<i>Digital: Modular Industrial Generators SIGENTICS M</i>	D 85.1	<b>Motion Control</b>	
Three-Phase Induction Motors SIMOTICS HV, Series H-compact	D 86.1	SINUMERIK 840 Equipment for Machine Tools	NC 62
Synchronous Motors with Permanent-Magnet Technology, HT-direct	D 86.2	SINUMERIK 808 Equipment for Machine Tools	NC 81.1
DC Motors	DA 12	SINUMERIK 828 Equipment for Machine Tools	NC 82
SIMOREG DC MASTER 6RA70 Digital Chassis Converters	DA 21.1	SIMOTION Equipment for Production Machines	PM 21
SIMOREG K 6RA22 Analog Chassis Converters	DA 21.2	<i>Digital: Drive and Control Components for Cranes</i>	CR 1
<i>Digital: SIMOREG DC MASTER 6RM70 Digital Converter Cabinet Units</i>	DA 22	<b>Power Supply</b>	
SIMOVERT PM Modular Converter Systems	DA 45	SITOP Power supply	KT 10.1
MICROMASTER 420/430/440 Inverters	DA 51.2	<b>Safety Integrated</b>	
MICROMASTER 411/COMBIMASTER 411	DA 51.3	Safety Technology for Factory Automation	SI 10
<b>Low-Voltage Three-Phase-Motors</b>		<b>SIMATIC HMI / PC-based Automation</b>	
SIMOTOCS S-1FG1 Servo geared motors	D 41	Human Machine Interface Systems/ PC-based Automation	ST 80/ ST PC
SIMOTICS Low-Voltage Motors	D 81.1	<b>SIMATIC Ident</b>	
SIMOTICS FD Low-Voltage Motors	D 81.8	Industrial Identification Systems	ID 10
LOHER Low-Voltage Motors	D 83.1	<b>SIMATIC Industrial Automation Systems</b>	
<i>Digital: MOTOX Geared Motors</i>	D 87.1	Products for Totally Integrated Automation	ST 70
SIMOGEAR Geared Motors	MD 50.1	SIMATIC PCS 7 Process Control System System components	ST PCS 7
SIMOGEAR Electric-monorail geared motors Light-load and heavy-load applications	MD 50.8	SIMATIC PCS 7 Process Control System Technology components	ST PCS 7 T
SIMOGEAR Gearboxes with adapter	MD 50.11	Add-ons for the SIMATIC PCS 7 Process Control System	ST PCS 7 AO
<b>Mechanical Driving Machines</b>		SIMATIC S7-400 advanced controller	ST 400
FLENDER Standard Couplings	MD 10.1	<b>SIMATIC NET</b>	
FLENDER High Performance Couplings	MD 10.2	Industrial Communication	IK PI
FLENDER Backlash-free Couplings	MD 10.3	<b>SIRIUS Industrial Controls</b>	
FLENDER SIP Standard industrial planetary gear units	MD 31.1	SIRIUS Industrial Controls	IC 10

*Digital: These catalogs are only available as a PDF.***Information and Download Center**

Digital versions of the catalogs are available on the Internet at:

[www.siemens.com/industry/infocenter](http://www.siemens.com/industry/infocenter)

There you'll find additional catalogs in other languages.

Please note the section "Downloading catalogs" on page "Online services" in the appendix of this catalog.

## Get more information

The SINAMICS drives family:  
[www.siemens.com/sinamics](http://www.siemens.com/sinamics)

Integrated Drive Systems:  
[www.siemens.com/ids](http://www.siemens.com/ids)

Motion Control Systems and Solutions for production machine and machine tool equipment:  
[www.siemens.com/motioncontrol](http://www.siemens.com/motioncontrol)

Local partners worldwide:  
[www.siemens.com/automation-contact](http://www.siemens.com/automation-contact)

Siemens AG  
Digital Factory Division  
Motion Control  
Postfach 31 80  
91050 ERLANGEN  
GERMANY

© Siemens AG 2017  
Subject to change without prior notice  
Article No. E86060-K5531-A121-A1-7600  
V6.MKKATA.GMC.101 / Dispo 18404  
KG 1117 11.0 HOF/VOG 220 En  
Printed in Germany

The information provided in this catalog contains merely general descriptions or characteristics of performance which in case of actual use do not always apply as described or which may change as a result of further development of the products. An obligation to provide the respective characteristics shall only exist if expressly agreed in the terms of contract. Availability and technical specifications are subject to change without notice.

All product designations may be trademarks or product names of Siemens AG or supplier companies whose use by third parties for their own purposes could violate the rights of the owners.

Token fee: 5.00 €

## Security information

Siemens provides products and solutions with industrial security functions that support the secure operation of plants, systems, machines and networks.

In order to protect plants, systems, machines and networks against cyber threats, it is necessary to implement – and continuously maintain – a holistic, state-of-the-art industrial security concept. Siemens' products and solutions constitute one element of such a concept.

Customers are responsible for preventing unauthorized access to their plants, systems, machines and networks. Such systems, machines and components should only be connected to an enterprise network or the internet if and to the extent such a connection is necessary and only when appropriate security measures (e.g. firewalls and/or network segmentation) are in place.

For additional information on industrial security measures that may be implemented, please visit  
<https://www.siemens.com/industrialsecurity>

Siemens' products and solutions undergo continuous development to make them more secure. Siemens strongly recommends that product updates are applied as soon as they are available and that the latest product versions are used. Use of product versions that are no longer supported, and failure to apply the latest updates may increase customer's exposure to cyber threats.

To stay informed about product updates, subscribe to the Siemens Industrial Security RSS Feed under  
<https://www.siemens.com/industrialsecurity>

Discover the  
advantages of  
Integrated Drive  
Systems at a glance

