

Supporting care everywhere

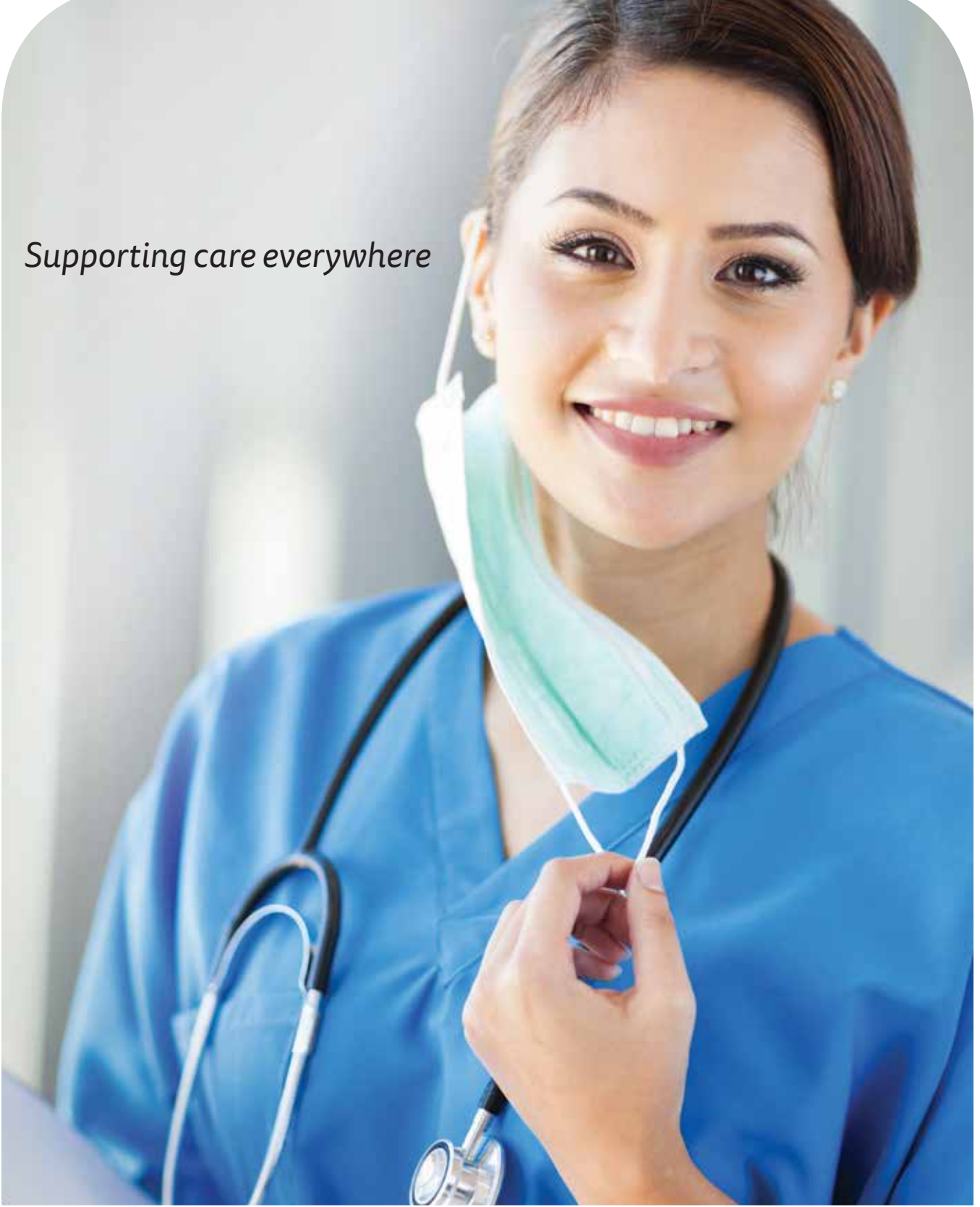

Enhance personal interaction • Expand reach • Improve operational efficiency

ERGOTRON[®]
HEALTHCARE

Flexible mounting • Sit-stand mobility • Charging systems

Quality products for every area in the facility – and beyond

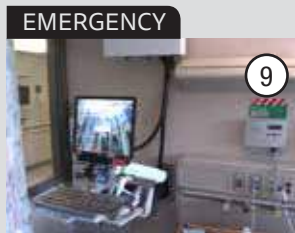
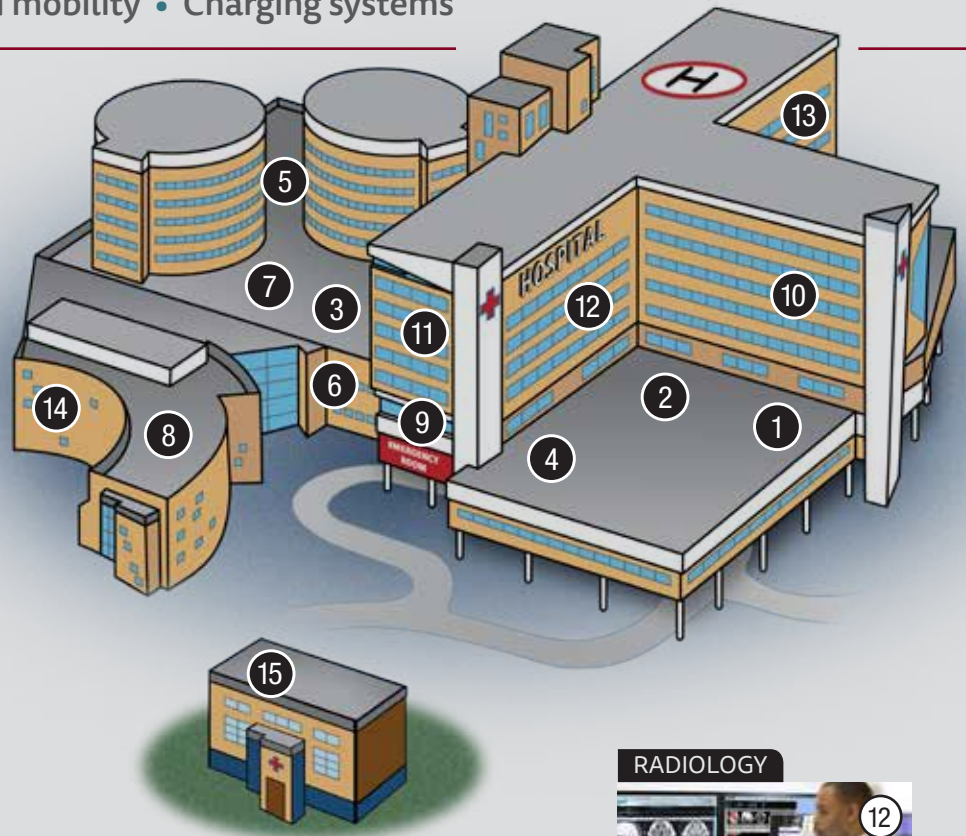

Supporting care everywhere



Serving the healthcare industry for more than 20 years

With more than 30 years of designing ergonomic solutions for computer users worldwide – *and 20 years specifically in healthcare* – Ergotron is uniquely qualified to help your entire facility enhance personal interaction, expand the reach of care and improve operational efficiency.

Innovations for home and work



Like other members of the Nortek family, Ergotron is driven by constant innovation with a singular, unified purpose: *to make our customers' lives better.*

Enhance personal interaction, expand the reach of care and improve operational efficiency

StyleView® Carts

- Designed for nurses and personalized to enhance workflow and caregiving
- Choices for mounting displays: LCD arms and pivots, secure laptop, and single or dual displays
- Unsurpassed ergonomics whether sitting, standing or maneuvering
- Carts evolve as your needs change – several accessories are available to improve productivity
- Carts and power systems fully certified to UL 60601-1



StyleView Telehealth Carts

- Various cart configurations are available for both telepresence and telemedicine solutions
- Open architecture – easy to integrate and implement
- Our integration specialists can help you determine the best solution to support your objectives and fit within your budget



Point-of-Care Wall Mount Products

- Enhances personal interaction between caregivers, their patients and patient data
- Ergonomic designs and added features provide ease of motion and proper positioning for optimal workplace comfort
- Choose from a wide range of wall mount products to meet various user, budgetary and space requirements



Charging Systems

- Charge, sync and/or secure multiple mobile devices
- Available as carts, wall mounts or desktop stations
- Choose from universal, open-architecture designs or products made for Apple®
- Certified for safety
- Lightweight and agile designs



Sit-Stand Workstations

- Promotes a healthier way to work with ergonomic comfort and sit-stand mobility
- Choose from desks, mobile workstations, wall mount and desk mounts
- Additional accessories also available to improve productivity and comfort



Service and Product Support Programs

- Expect a superior customer experience
- Quality products are backed by specially trained support professionals and optional extended service programs
- Extended Global Service Programs protect your investment and ensure optimal product performance
- Customer Care includes live support via phone, chat and email





Caregivers, meet your StyleView® Cart

Choose the StyleView medical cart that best meets your caregiving needs, style and workflow. Ergotron offers the broadest range of options so you can experience a super functional, fully adjustable medical cart.

Our market-leading, 6th-generation StyleView Carts are designed to include all the features that caregivers have asked for, with all the open architecture and quality construction that IT departments require.

StyleView Carts offer effortless sit-stand height adjustment using patented Constant Force™ Technology, independent screen positioning and an adjustable back-tilt keyboard tray for comfortable ergonomics. With ultra-smooth gliding casters and a small footprint, carts travel easily across various flooring types.



For patient, caregiver and facility safety, the entire carts are tested and fully certified.

Point-of-care carts facilitate documentation, access to medical records and medication delivery anywhere in the facility



StyleView 41 Series
Laptop version
Non-powered
Without drawers

StyleView 43 Series
Laptop version
Non-powered
Added drawers

StyleView 43 Series
LCD Pivot version
Non-powered
Added drawers

StyleView 44 Series
LCD Arm version
SLA battery powered
Added tall drawers

StyleView 44 Series
LCD Pivot version
LiFe battery powered
Added drawers

Mobility, proper ergonomics and the ability to sit and stand throughout long shifts lets caregivers experience a much healthier way to work – with greater comfort and less fatigue.



Your workflow. Your cart. Your way.



Light-duty point-of-care carts also are ideal for tablets or laptop use anywhere in the facility

Telehealth carts are designed for telemedicine and videoconferencing



StyleView 10 Series
Microsoft Surface
version



StyleView 10 Series
Tablet version



StyleView 10 Series
Laptop version
Optional DC Power
System and
Sani-Wipes Holder



StyleView Telemedicine
LCD Arm version
Non-powered
Primary drawer and
Telemedicine Storage Bin



StyleView Telemedicine
Dual monitor version
SLA battery powered
Primary drawer and
Telemedicine Storage Bin

Need help determining which StyleView Cart is right for you? Use our helpful Finder Tool at styleview.ergotron.com/finder

Or consult with an Ergotron healthcare expert

+ Determine your application:
 Point-of-Care Carts facilitate access to medical records and provide medication delivery anywhere in the facility
 Telehealth Carts designed for telemedicine and videoconferencing anywhere in the facility

+ Determine the primary use:
 Access to medical records and the delivery of medication
 Access to medical records and medication delivery/management with controlled access
 Mobile deployment of tablets or laptops

+ Choose display mount type: LCD Arm, LCD Pivot, Laptop, and Tablets & Microsoft Surface



+ Choose powered, non-powered or add-on power upgrades:
 Lithium Iron Phosphate (LiFe), Sealed Lead Acid (SLA), non-powered, power upgrade options (see page 10)



+ Choose drawers, storage & accessories: Drawers, Bins, Sani-Wipes Holder, Scanner Shelf and more



+ Add a service program: Extended Global Service Programs protect your investment, ensure optimal product performance and can provide additional support and benefits, such as:



- Site readiness • Fast, efficient product installation and integration
- Preventive maintenance and extended warranties • Improved asset management
- Enhanced in-house product expertise • Equipment audit and health assessment
- Next-Business-Day service contracts • Annual contracts and planned services

Our SV Medical Carts finder tool makes it easy to determine which StyleView configuration will best meet your workflow needs

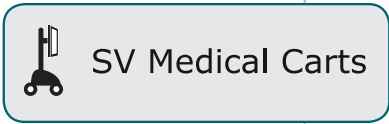

Find Your StyleView®

Start by choosing your application. Answer each question to find the right cart for you.









Application	<input checked="" type="radio"/> Point of Care	<input type="radio"/> Telehealth
Primary Use	<input checked="" type="radio"/> Documentation	<input type="radio"/> Medication Delivery
Form Factor	<input checked="" type="radio"/> Full Workstation	<input type="radio"/> Light Duty
Power System	<input checked="" type="radio"/> Onboard Power	<input type="radio"/> Non-powered
Battery Type	<input checked="" type="radio"/> LiFe	<input type="radio"/> SLA
Viewing Screen	<input checked="" type="radio"/> Monitor	<input type="radio"/> Laptop
Display Mount	<input type="radio"/> Lift Pivot	<input checked="" type="radio"/> Arm
Add Drawers	<input type="radio"/> No	<input checked="" type="radio"/> Yes
# of Drawers	<input type="radio"/> 1 Drawer	<input checked="" type="radio"/> 6 Drawers
	<input type="radio"/> 2 Drawers	<input type="radio"/> 9 Drawers
	<input type="radio"/> 4 Drawers	<input type="radio"/>



Add compatible accessories to customize a cart.

Options	<input type="checkbox"/> Storage Bin	<input type="checkbox"/> Front Tray
	<input type="checkbox"/> Utility Shelf	<input type="checkbox"/> Large Utility Shelf
	<input type="checkbox"/> Telemedicine Bin	<input type="checkbox"/> Envelope Bin
	<input type="checkbox"/> K-Slot Lock Kit	<input type="checkbox"/> Task Light
	<input type="checkbox"/> Fan Pivot Kit	<input type="checkbox"/> IV Pole Clamp Kit
	<input type="checkbox"/> Rear VESA Mount Kit	<input checked="" type="checkbox"/> CPU Holder
	<input type="checkbox"/> Camera Shelf	<input checked="" type="checkbox"/> Scanner Shelf
	<input type="checkbox"/> Medical-Grade Power Strip	<input type="checkbox"/> Sani-wipes Holder
Add-on Power	<input type="checkbox"/> DC Power System	<input type="checkbox"/> LiFe Power Upgrade
		<input type="checkbox"/> Hot Swap System

[See Selection](#)

Choose from multiple drawer options

	
One drawer: 1 Primary Drawer, single	Two drawers: 1 Primary Drawer, single 1 Supplemental, single
	
Four drawers: 1 Primary Drawer, triple 1 Supplemental, single	Six drawers: 1 Primary Drawer, triple 1 Supplemental, triple
	
Nine drawers: 1 Primary Drawer, triple 2 Supplemental, triple	Three drawers: 1 Primary Drawers, single 2 Supplemental, single
	
Two tall drawers: 1 Primary Drawer, double tall	Fifteen drawers: 1 Primary Drawer, triple 4 Supplemental, triple

	
Two drawers: 1 Primary Drawers, double	One tall drawer: 1 Primary Drawers, single tall

 Choose from manual key lock drawers or electronic locking drawer systems (with PINs) which enable secure and efficient management of non-controlled medication, reducing the chance for errors. Also supports "Pharmacy mode," allowing all drawers to be unlocked simultaneously.

 styleview.ergotron.com/finder

Choose from a variety of add-on products to enhance the StyleView® experience



SV Envelope Drawer 97-853



Storage Bin 97-740



Task Light 97-754-002



Extended Service Programs



SV LCD Pan Pivot Kit 97-985



SV Dual Display Kit* 97-574



Utility Shelf 97-507-216



Large Utility Shelf* 97-540-053



SV Scanner Shelf* 97-780-194



SV Front Tray 97-777-062



SV Camera Shelf* 97-776-194



SV Sani-Wipes Holder 97-828



Thin Client Mount*
80-107-200



Universal CPU Holder*
80-105-064



SV IV Pole Clamp Kit 97-632



StyleView Tracking Caster
97-889



SV Telemedicine Bin* 97-854



T-Slot Wire Scanner Holder
97-543-207



Many Drawer Replacement Kits



K-Slot CPU Lock Kit 97-702



SV Height-Adjustable Keyboard
Arm for SV LCD Carts 97-827



SV Ethernet Side Cover
LCD: 97-855 Laptop: 97-856



SV Rear VESA Mount Kit
97-512-009

Use our helpful Finder Tool to determine accessories:

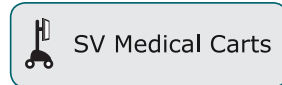

styleview.ergotron.com/finder

* Displays, cameras and components shown are sold separately.

LiFe

Why choose a StyleView® powered with Lithium Iron Phosphate (LiFe)?



Certified. Lightweight.
Ultrafast recharge. Long battery LiFe.

Extremely lightweight and adjustable

The LiFe power system and compact, lightweight base combine with StyleView's ergonomic adjustability to decrease caregiver fatigue and enhance overall wellness and productivity

Ultrafast recharge ensures caregiver and cart uptime

A full recharge from full discharge can be completed in around two hours for typical loads.

Long battery 'LiFe' minimizes time and cost for maintenance and replacement

Proven to achieve thousands of cycles per lifetime and to last several years in a typical healthcare setting

Safe and certified

For patient and caregiver safety, the FULL cart and power system are certified to UL 60601-1

Includes FREE StyleLink with enterprise capabilities

Install, access and manage your StyleView power systems from a remote location across WAN, LAN or VPN

Proven safe battery chemistry

Through extensive testing, Lithium Iron Phosphate is proven to be a very safe battery chemistry

Free, industry-leading StyleLink software with enterprise capabilities



StyleLink's three-part software package (Enterprise, Client, Graphing Tool) offers broad system and platform compatibility for global healthcare customers deploying Ergotron StyleView Carts with power.

Extend Asset Life Cycle

Optimizes balance between runtime and cycle life

Proactive Power System Management

Eliminate surprises through use of diagnostic tools, simplifying power system management and reducing time required to fix problems

Reduce Total Cost of Ownership

Reduce costs for maintenance; eliminate need for expensive onsite technical support by leveraging diagnostic capabilities. Simply email StyleLink's history data file to Ergotron Tech Support and they will help troubleshoot power system performance issues

- Dynamic Icon**
 - Green • Yellow • Red Corresponds to Charge Remaining
- Time Remaining**
 - Hours, Minutes
 - No Load
 - Charging
- Charge Remaining**
 - 0-100%
 - Color Coded to Match RUI
- Percent Load**
 - 0-100%
 - Color Coded to Show Preferred Load Range
- Power Source**
 - Line Mode
 - Battery Mode
 - Not Connected
- Real-time System Metrics**
- Battery**
 - Good
 - Replace
 - Unknown
- System Fault**
 - No Fault
 - Temperature High
 - Not Connected

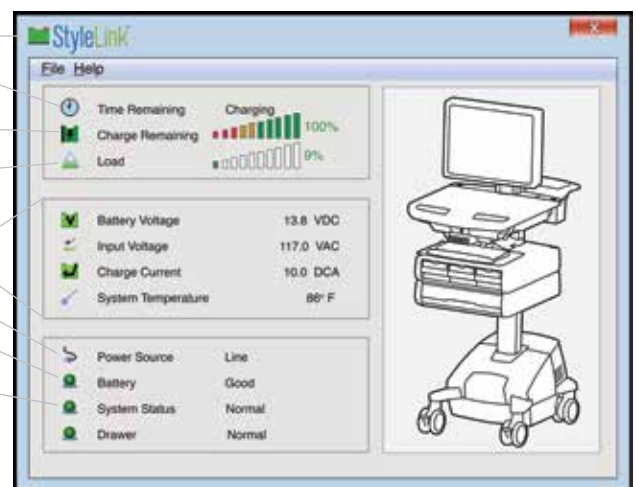

Enterprise Capabilities

Remote enterprise monitor: access your carts across WAN, LAN or VPN to get real-time information

Advanced Drawer Management

Each drawer individually controlled with PIN; program locally or remotely via enterprise

Add dependable power to non-powered StyleView® Carts*

Enhancing productivity in healthcare environments is our goal. Ergotron partners with three manufacturers to offer add-on power options for existing non-powered StyleView carts. Choose the product that best fits your workflow and budgetary requirements.

PREMIUM SV LiFe Power Upgrade System



LiFe

AC
330Wh

- Manufactured by Scott Clark
- High capacity, flexible, portable
- Ultra-fast, built-in charging on board
- Powers everything on the cart
- Lithium-Iron Phosphate is the safest battery chemistry
- State-of-charge LED indicators
- Availability:
US/CA/MX 97-837
UK/HK/MY/SG 97-893 Saudi/UK 97-895
EU 97-894 Saudi/EU 97-896

MID-LEVEL SV Hot Swap Power System



AC
240Wh

- Manufactured by Anton Bauer
- Charges battery on or off the cart
- Powers everything on the cart
- Wall cabinet charger uses UV LED to disinfect batteries
- Charge up to three batteries
- Includes Battery Pain Scale™
- Available NORTH AMERICA only:
Battery 97-929/Charging Cabinet 97-930
Interface 97-931/Power Supply 97-932

ENTRY-LEVEL SV DC Power System



DC
300Wh

- Manufactured by Amstron
- Low-cost DC power
- Small form factor
- On-board, all-in-one charger
- Selectable output voltage
- Mounts on the front or back
- Available WORLDWIDE:
Laptop version 97-943
LCD+CPU version 97-942
Remote User Interface 97-953
(Country-specific power cords sold separately)

* If you need a cart with a built-in power system, choose a LiFe-powered or SLA-powered StyleView Cart. Purchasing an Ergotron powered cart is the most cost-effective solution and instantly reduces the total cost of ownership.

Secure medication delivery with StyleView® Transfer Cart

A multi-purpose healthcare cart designed to streamline caregiver workflow and complement StyleView carts. From pharmacy to patient floor, the StyleView Transfer Cart securely stores, transports and dispenses medications and other supplies. (24-421-062)

Key features include:

- Holds up to 120 small or 40 large drawers, accessible from either side of cart
- Supports 20 or more StyleView carts depending on drawer configuration
- 36 shelves are removeable or repositionable to accommodate envelope drawer or taller items
- Top cover supports 25 lbs (11.3 kg) and its 41"-high (105 cm) surface is a convenient operational height when standing; raised edges prevent spills
- Secure: doors unlock electronically using programmable 5-digit PIN or via manual lock
- Premium, 5" (13 cm) swiveling casters move the cart with ease over thresholds and any floor type
- Includes a scanner holder and can support an Ergotron LX LCD Arm or laptop tray
- Smooth exterior surface makes cleaning easy



Where productivity meets style



Light-duty, point-of-need carts for laptop, tablet and Microsoft® Surface™ devices

StyleView® 10 (SV10) carts let caregivers easily move their mobile devices to the point of need. Super petite, lightweight and agile, SV10 carts glide effortlessly across various flooring types and fit nicely into small work areas, like exam rooms and offices.

Designed with ergonomics in mind, carts offer 15" (38 cm) of effortless vertical height adjustment so users can choose to sit or stand as they work. Keyboards and displays can be properly positioned for comfortable data entry and screen viewing.

Accessories can easily be added to enhance functionality.



Integrated hand-brake secures platform height to provide an ultra-stable workspace



All SV10 carts include a scanner holder



A bracket holds the laptop in place; inconspicuous design allows easy tilting of the screen without any occlusion of keys or views

StyleView® Laptop Cart, SV10





Install tablet in landscape or portrait mode; tilt the tablet to a preferred input position—work with screen angled vertically, horizontally or anywhere in between

StyleView® Tablet Cart, SV10



Special design of work-surface uses embedded magnets for click-in stability of Surface tablet. Place the Surface in three possible positions: left, right or center

StyleView® S-Tablet Cart, SV10 for Microsoft® Surface™

Part #	SV10-1100-0	SV10-1400-0	SV10-1800-0
 Typical LCD Size	Maximum outside width of laptop = 17" (43 cm), which accommodates laptops with 17" screens, as well as some larger models	Versatile interface accommodates almost any tablet	Compatible with all Surface tablet sizes and models
Worksurface Dims	18" x 12.5" (45,7 x 31,8 cm)	18" x 12.5" (45,7 x 31,8 cm)	23" x 17" (58 x 43 cm)
Base Footprint	19" x 19" (48,3 x 48,3 cm)		
 Weight Capacity	Laptop ≤ 10 lbs (4,5 kg); cable management storage ≤ 2 lbs (1 kg); column ≤ 20 lbs (9,1 kg), including accessories added to T-slot channel interface and storage hook	Tablet ≤ 2.5 lbs (1,1 kg); cable management storage ≤ 2 lbs (1 kg); column ≤ 20 lbs (9,1 kg), including accessories added to T-slot channel interface and storage hook	Worksurface ≤ 10 lbs (4,5 kg); cable management storage ≤ 2 lbs (1 kg); column ≤ 20 lbs (9,1 kg), including accessories added to T-slot channel interface and storage hook
 Lift	15" (38 cm) Minimum worksurface height = 33" (84 cm); Maximum worksurface height = 48" (122 cm)		
Tilt	—	128°	—
VESA	—	MIS-D	—
Warranty	7 years		



Connect.
Consult.
Collaborate.

Easy and affordable telehealth options from Ergotron Healthcare

Healthcare services delivered at anytime, from anywhere

- Expands access by allowing physicians and health facilities to extend their reach without geographic or socioeconomic limitations
- Brings specialization to rural, remote, underserved and/or senior populations
- Manage costs – can provide consistent, lower-cost care to patients with chronic diseases
- Promotes sharing of staff; reduces travel
- Increases patient satisfaction and trust because it may help to lower stress, replace travel, reduce costs of care and deliver remote expertise



Displays, cameras and CPU components shown are sold separately.

Learn more about expanding the reach of care at

 healthcare.ergotron.com

StyleView® Telemedicine Carts

StyleView Telemedicine Carts are specifically designed and configured to support the increasing demands of telehealth – the use of telecommunication technologies for remote patient care. Telemedicine can expand care by enabling connection and collaboration with specialists or teams, regardless of their physical locations.

Open architecture

Allows for easy integration of standard equipment

Lots of connectivity

A total of 5 USB ports are integrated into cart (3 within bin and 2 on the back side); 1 ethernet port is available on the side of the head unit

Everything you need

Camera and Codec/CPU support, secure and ample storage, connectivity and power outlets

StyleView quality

Hospital-grade construction, ergonomic and secure

Worldwide availability

Safety certified

Entire cart and power system is certified to UL/EN/IEC 60601-1 and CAN/CSA C22.2 No. 601.1 M90. (Other country-specific certifications currently pending)

Camera shelf holds web or videoconferencing camera

Dual monitor configuration shown

Also available as single monitor and back-to-back monitor configurations

Ethernet port connectivity

Secure, auto-locking drawer system

Codec/CPU Holder

Medical-grade power cord

Large, configurable bin provides 3 USB ports, adjustable dividers and secure storage for several diagnostic devices with cables

Cart designed for neat and compact cable management

Two additional USB ports are accessible on the back side of bin for connecting additional devices

Rechargeable SLA (Sealed Lead Acid) battery provides dependable, safe and low-cost power

Use our helpful Finder Tool:



SV Medical Carts

styleview.ergotron.com/finder



SLA-battery Powered SV Telepresence Cart

StyleView® Telepresence Carts

(North America only)

Telepresence allows medical professionals to conduct 'virtual' patient appointments easily and cost-effectively. This capability is particularly effective for patients with physical limitations, chronic illnesses and/or transportation issues, so it's ideal for in-home care or care facilities.



Non-powered SV Telepresence Cart



Single Monitor
SV43-53E0-1 (non-powered)
SV44-53E1-1 (SLA powered)



Dual Monitor
SV43-56E0-1 (non-powered)
SV44-56E1-1 (SLA powered)



Back-to-Back Monitors
SV44-57E1-1 (SLA powered)



Transform an existing StyleView Cart* into a low-cost telepresence cart

(Available worldwide)

Telepresence Kits let you easily convert an existing StyleView cart* for use in telepresence applications—combining the power of videoconferencing with the point-of-care benefits of StyleView. Upgrade kits include a large storage drawer (with divider and keys), travel stop, camera shelf for video/web camera, and a Codec/CPU holder. Then choose from single, dual or back-to-back monitor options.

StyleView Telepresence Upgrade Kits:

- 97-870 SINGLE MONITOR
- 97-871 DUAL MONITOR
- 97-872 BACK-TO-BACK MONITOR

* Cart requirements:

Non-powered / LCD pivot with 1 drawer / SV43-1310-0
SLA-battery powered / LCD pivot with 1 drawer / SV44-1311-1

StyleView Cart Specifications

	Typical Size	Weight Capacity	Lift	Tilt	Pan	Rotation	VESA	
Life Powered	LCD	≤ 24"	See website	Arm 27" (68,6 cm) Lift Pivot 25" (63,5 cm)	Arm 65° Lift Pivot 25°	Arm 180° Lift Pivot 24°	Arm 360° P/L Lift Pivot 90° P/L	MIS-D
	Laptop	≤ 17"	See website	20" (51 cm)	—	—	—	—
<p>Life Cart features include worksurface, four-port USB hub, scanner holder bracket, mouse holder, wrist rest, back-tilt keyboard tray, left/right mouse tray, rear handle, storage basket, cable storage, four casters (two locking)</p> <p>Warranty: 5 years for cart, 2 years on all power supply components; 5 years on Life battery, including 2-year capacity guarantee</p>								
SLA Powered	LCD	≤ 24"	See website	Arm 27" (68,6 cm) Lift Pivot 25" (63,5 cm)	Arm 65° Lift Pivot 25°	Arm 180° Lift Pivot 24°	Arm 360° P/L Lift Pivot 90° P/L	MIS-D
	Laptop	≤ 17"	See website	20" (51 cm)	—	—	—	—
<p>SLA Cart features include worksurface, four-port USB hub, scanner holder bracket, mouse holder, wrist rest, back-tilt keyboard tray, left/right mouse tray, rear handle, storage basket, cable storage, four casters (two locking)</p> <p>5-year warranty, excluding electrical/electronic components</p>								



Compliant with EN 60601-1



	Certification Standard	Certification Mark	Grounded Plug & Outlet
US	UL 60601-1	cTUVus	North American NEMA 5-15P Hospital Grade
Canada	CAN/CSA C22.2 No. 601.1 M90	cTUVus	North American NEMA 5-15P Hospital Grade
Mexico	As Needed	As Needed	North American NEMA 5-15P Hospital Grade
Europe	EN 60601-1	CE	European CEE 7
Ireland/United Kingdom	EN 60601-1	CE	United Kingdom BS 1363
Hong Kong/Malaysia/Singapore	IEC 60601-1	Not Applicable	United Kingdom BS 1363
China	IEC 60601-1	Not Applicable	GB2009-1 GB1002-1
Australia/New Zealand	IEC 60601-1	C-Tick	Australian AS NZS 3112
Saudi Arabia (EMR SLA)	EN 60601-1	Not Applicable	United Kingdom BS 1363 European CEE 7

Mobile MediaCenter: mobility with versatility

Stretch your investment by supporting a range of projection and videoconferencing needs throughout the facility – from boardroom to the surgery center.



Neo-Flex® MediaCenters feature ease of mobility, 90° display rotation, 20" (51 cm) of effortless height adjustment and 20° independent display tilt.

Optional Camera Shelf Kit creates a mobile videoconferencing solution that the entire facility can easily use.



Optional Camera Shelf Kit
97-491-085



Cable Shelf shown with optional Power Strip







Carts feature 4" (10, 2 cm) locking casters









Neo-Flex Mobile MediaCenter LD

Neo-Flex Mobile MediaCenter VHD

Neo-Flex Mobile MediaCenter UHD

Part # (color)	24-190-085 (black)	24-191-085 (black)	24-192-085 (black)
Optional Accessories: Camera Shelf Kit 97-491-085; 660/700/800 mm Kit 97-489; VESA CPU Kit 97-527-009			
 Typical LCD Size	27–55"	37–65"	50–70"
<small>LCD SIZE IS APPROXIMATION. DIMENSION IS DIAGONAL MEASUREMENT OF SCREEN. LCD SIZE MAY BE EXCEEDED AS LONG AS SCREEN WEIGHT DOES NOT EXCEED MAXIMUM WEIGHT CAPACITY OF THE MOUNT.</small>			
 Weight Capacity	25–50 lbs (11,4–22,7 kg)	50–90 lbs (22,7–40,9 kg)	90–120 lbs (40,9–54,4 kg)
 Lift	20" (51 cm)		
 Tilt	20°		
 Rotation	90° See website for details		
 VESA	MIS-D/E/F See website for details	MIS-D/F See website for details	MIS-D/F See website for details
Warranty	3 years		

	 Typical Size	 Weight Capacity	 Lift	 Tilt	 Pan	 Rotation	 VESA	
Non-Powered	LCD	≤ 24"	See website	Arm 27" (68,6 cm) Lift Pivot 25" (63,5 cm)	Arm 65° Lift Pivot 25°	Arm 180° Lift Pivot 24°	Arm 360° P/L Lift Pivot 90° P/L	MIS-D
		Includes secure CPU compartment						
	Laptop	≤ 17"	See website	20" (51 cm)	—	—	—	—
	SV40-40004 does not include four-port USB hub, rear handle, storage basket							
Non-powered Cart features includes worksurface, secure compartment, four-port USB hub, scanner holder bracket, mouse holder, wrist rest, back-tilt keyboard tray, left/right mouse tray, rear handle, storage basket, cable storage, four casters (two locking)								
5-year warranty								

EXPERIENCE the difference with our Global Service Programs
Visit ergotron.com for details about all of our service options



Healthy computing that brings EMR, eMAR, PACS and CPOE to the point of care



LX Sit-Stand Wall Mount System

LX Wall Mount System

Part # (color)	Medium CPU Holder (silver): 45-358-026 (polished aluminum) Small CPU Holder (black): 45-359-026 (polished aluminum)	Medium CPU Holder (silver): 45-247-026 (polished aluminum) Small CPU Holder (black): 45-253-026 (polished aluminum)
Includes	10" and 34" (25.4 and 86.4 cm) Wall Tracks with (2) black track covers, LX Sit-Stand Wall Mount LCD Arm, LX Sit-Stand Keyboard Arm, wrist rest, mouse holder, CPU Holder, two (2) 10" (25.4 cm) cable channels, mounting kits for hollow-wall and wall-stud installation	LX Wall Mount LCD Arm, LX Keyboard Arm, CPU Holder and 10" (25.4 cm) Wall Track, wrist rest, mouse holder, 34" (86.4 cm) Wall Track, two (2) 10" (25.4 cm) cable channels, anchor hardware kit
Typical LCD Size	≤ 42"	≤ 32"
<small>LCD SIZE IS APPROXIMATION. DIMENSION IS DIAGONAL MEASUREMENT OF SCREEN. LCD SIZE MAY BE EXCEEDED AS LONG AS SCREEN WEIGHT DOES NOT EXCEED MAXIMUM WEIGHT CAPACITY OF THE MOUNT.</small>		
Depth	Folds to 6.8" (17.3 cm)	Folds to 5.3" (13.5 cm)
Warranty	10 years	10 years

Visit ergotron.com for complete information on LX Wall Mount Systems

LX Sit-Stand Wall Mount Highlights

- Ultimate flexibility of monitor and keyboard positioning enhances personal interaction between the caregiver, patient and the patient's data
- 20" (51 cm) height range allows users to switch between sitting and standing positions for a healthier way to work
- Ergonomic back-tilt keyboard tray ensures wrists remain in a neutral position to increase comfort and help avoid repetitive-stress injuries
- Keyboard platform is very stable for extensive data entry and tested to be 3X more rigid than other keyboard arms
- Rotation Stop on wall mount base limits turn of extension base connection to 180°, preventing extension from contacting wall
- Secure installation – locking connections between arm, extension and base



LX HD Sit-Stand Wall Mount LCD Arm

LX Sit-Stand Wall Mount LCD Arm

LX Wall Mount LCD Arm

LX Sit-Stand Keyboard Arm

LX Keyboard Arm

Part # (color)	45-383-026 (polished aluminum)	45-353-026 (polished aluminum)	45-243-026 (polished aluminum)	45-354-026 (polished aluminum)	45-246-026 (polished aluminum)
Typical LCD Size	≤ 46"	≤ 42"	≤ 32"	—	—
<small>LCD SIZE IS APPROXIMATION. DIMENSION IS DIAGONAL MEASUREMENT OF SCREEN. LCD SIZE MAY BE EXCEEDED AS LONG AS SCREEN WEIGHT DOES NOT EXCEED MAXIMUM WEIGHT CAPACITY OF THE MOUNT.</small>					
Keyboard Size	—	—	—	≤ 17.7" x 7.8" (45 x 20 cm)	≤ 17.5" x 10.1" (44.5 x 25.7 cm)
Weight Capacity	14–30 lbs (6.3–13.6 kg)	5–25 lbs (2.3–11.3 kg)	5–25 lbs (2.3–11.3 kg)	≤ 5 lbs (2.2 kg)	≤ 5 lbs (2.2 kg)
Lift	20" (51 cm)	20" (51 cm)	13" (33 cm)	20" (51 cm)	13" (33 cm)
Tilt	80° ↑ 75° / ↓ 5°	75° ↑ 70° / ↓ 5°	75° ↑ 70° / ↓ 5°	When in down position, tray features a back-tilt of 5°; folds upright 90° in storage position	
Pan	360° Rotation Stop on wall-mount base limits turn of extension-base connection to 180°, preventing extension from contacting wall	360° Rotation Stop on wall-mount base limits turn of extension-base connection to 180°, preventing extension from contacting wall	360°	360° Rotation Stop on wall-mount base limits turn of extension-base connection to 180°, preventing extension from contacting wall	
Rotation	90°	360°	360°	—	—
VESA	MIS-D/E/F See website for details	75 x 75, 100 x 100, 200 x 100, 200 x 200 See website for details	MIS-D	—	—
Depth	Folds to 4.5" (11.4 cm)	Folds to 4.5" (11.4 cm)	Folds to 4.3" (10.9 cm)	Folds to 5.8" (15 cm)	Folds to 3.5" (9 cm)
Extension	≤ 33" (84 cm)	33" (85 cm)	25" (64 cm)	42" (107 cm)	35" (89 cm)
Warranty	10 years	10 years	10 years	10 years	10 years

Sit-stand ergonomics – secure, compact and enclosed

Perfect for space-constrained patient rooms

StyleView Enclosures provide a smooth vertical height adjustment and folds up into a slim, compact unit when not in use.

Sit-stand ergonomics

Move from a sitting to a standing position whenever you want. True ergonomic designs provide a healthier, more comfortable way to work.

Extreme security and stability

A keyless locking mechanism protects patient data for compliance with privacy requirements and a unique cable management system conceals and organizes the cords, making cleaning a snap! Its stable, slide-out keyboard can support extensive data entry.



Folds to less than 4" (9,7cm)



Neo-Flex Dual Monitor Wall Mount and Keyboard Wall Mount

Maximize your space! This low-profile system enhances PACS implementation by providing convenient access to digital records. Tilting dual monitors reduce glare and improve sight lines. The wall-mounted keyboard tray lets you enter data at the point of care, then folds up flat (just 5" / 13 cm from wall) when not in use.



Neo-Flex Dual Monitor Wall Mount
28-514-800 (grey & black)

Neo-Flex Keyboard Wall Mount
45-403-062 (grey)

Neo-Flex Wall Mount Lift

Add greater range of movement to your LCD display: raise or lower it 5", pan, tilt and rotate 90°. Its slim profile makes it perfect for areas where space is at a premium.



60-577-195 (black)

200 Series Combo Arm

Attach your LCD and keyboard to free up space. This wall unit solution features 3-point telescoping motion, providing greater reach to bring the system to where it is needed.

45-230-216 (white)
45-230-200 (black)



StyleView Sit-Stand Enclosure



StyleView VL Enclosure

Part # (color)	60-610-062 (white) 60-610-060 (black)	60-595-062 (white)
Includes	Enclosure, velcro kit (attaches keyboard to keyboard tray), cable management wrap, antimicrobial wrist rest. Wall footprint 38.2"H x 26.6"W (97 x 67,5 cm)	Enclosure, wall plate, mounting template, vertical lift, slide-out keyboard tray, wrist rest, mouse pouch, scanner holder, internal cable management, batteries, monitor mounting hardware, wall mounting hardware, keys
Typical LCD Size	≤ 22" Maximum monitor physical dimensions 20.5"W x 13.5"H x 2.5"D (52,1 x 34,3 x 6,4 cm). Monitor depth greater than 2.5" (6,4 cm) is allowable, however screen will protrude beyond profile of unit in such cases	≤ 22" Maximum monitor physical dimensions 20.7" W x 14.7" H x 2.8" D (52,6 x 37,3 x 7 cm). Assumes VESA hole pattern is centered on the back of the display
<small>LCD SIZE IS APPROXIMATION. DIMENSION IS DIAGONAL MEASUREMENT OF SCREEN. LCD SIZE MAY BE EXCEEDED AS LONG AS SCREEN WEIGHT DOES NOT EXCEED MAXIMUM WEIGHT CAPACITY OF THE MOUNT.</small>		
Weight Capacity	12–24 lbs (5,4–10,9 kg) Listed weight capacity represents total load. Thin client device 3–10 lbs (1,4–4,5 kg); monitor 7–12,5 lbs (3,2–5,7 kg); keyboard and worksurface 0,5–1,5 lbs (0,2–0,7 kg)	8–33 lbs (3,6–14,9 kg) Listed weight capacity represents total load, including monitor and contents of keyboard tray, mouse pouch and scanner holder. Maximum load capacity: monitor pivot 18 lbs (8,2 kg); thin client device compartment 20 lbs (9,1 kg); door/worksurface 50 lbs (22,6 kg)
Lift	20" (51 cm)	9" (23 cm)
Pan	—	LCD 10° Display size may restrict motion. Keyboard 120°
VESA	MIS-D	MIS-D
Depth	3.8" (9,7 cm) closed 19.3" (49,9 cm) open	6.75" (17 cm) closed 20.6" (53 cm) open
Warranty	5 years 1-year warranty on all electronic components (excludes AA batteries)	5 years 1-year warranty on all electronic components (excludes AA batteries)

Worksurface with pull-out keyboard tray facilitates caregiver workflow



- ① Patented Constant Force™ lift-and-pivot motion technology provides premium 25" (63,5 cm) LCD height adjustment, portrait-to-landscape rotation and 30° tilt
- ② Durable, easy-to-clean exterior composed of aluminum and high-grade plastic
- ③ Integrated mouse and barcode scanner holder provide easy access
- ④ Fold-down worksurface/keyboard tray to support workflow needs. Worksurface is 22.75" W x 10.6" D (57,8 x 26,9 cm). Keyboard tray is 18.6" W x 9" D (47,2 x 22,8 cm)
- ⑤ Ergonomic back-tilt keyboard tray ensures wrists remain in a neutral position during data entry. Includes slide-out mouse tray



SV Sit-Stand Combo Extender Arm
45-261-026 (aluminum)
45-261-216 (white)



CPU Holder
Small:
45-272-026 (aluminum)
80-063-216 (white)
Medium:
97-468-202 (aluminum)
97-468-216 (white)



Mouse Tray Upgrade Kit
97-805-055 (black)
For older versions of Sit-Stand Combo Arm with Worksurface



Scanner Shelf, VESA Attach
97-815 (black)
97-815-062 (white)



Thin Client Mount
80-107-200 (black)
80-107-216 (white)



	StyleView Sit-Stand Combo Arm with Worksurface	StyleView Sit-Stand Combo Arm	StyleView Sit-Stand Combo System with Worksurface	StyleView Sit-Stand Combo System
Part # (color)	45-260-026 (polished aluminum) 45-260-216 (white) Optional Extender Arm 45-261-026 (polished aluminum) 45-261-216 (white)	45-266-026 (polished aluminum) 45-266-216 (white) Optional Extender Arm 45-261-026 (polished aluminum) 45-261-216 (white)	Medium CPU holder and wall track: 45-270-026 (polished aluminum) Small CPU holder and wall track: 45-272-026 (polished aluminum) Medium CPU holder and wall track: 45-270-216 (white) Small CPU holder and wall track: 45-272-216 (white) Optional Extender Arm 45-261-026 (polished aluminum) 45-261-216 (white)	Medium CPU holder and wall track: 45-271-026 (polished aluminum) Small CPU holder and wall track: 45-273-026 (polished aluminum) Medium CPU holder and wall track: 45-271-216 (white) Small CPU holder and wall track: 45-273-216 (white) Optional Extender Arm 45-261-026 (polished aluminum) 45-261-216 (white)
Includes	Sit-Stand Combo Arm with worksurface, wall mount bracket, track mount bracket kit, height-adjustable LCD mount, wrist rest, scanner and mouse holder, worksurface with integrated keyboard tray, VESA monitor mounting kit, cable ties	Sit-Stand Combo Arm, wall mount bracket, track mount bracket kit, height-adjustable LCD mount, wrist rest, scanner and mouse holder, integrated keyboard tray with left/right mouse tray, handle, VESA monitor mounting kit, cable ties	Sit-Stand Combo Arm with worksurface, 34" Wall Track with (2) black track covers, CPU Holder, CPU spacer, (2) 10" cable channels, CPU and Arm track mount bracket kits, Wall Track fasteners for concrete and wood, CPU direct wall mount kit, height-adjustable LCD mount, wrist rest, scanner and mouse holders, integrated keyboard tray, handle, VESA monitor mounting kit, cable ties	Sit-Stand Combo Arm, 34" Wall Track with (2) black track covers, CPU Holder, CPU spacer, (2) 10" cable channels, CPU and Arm track mount bracket kits, Wall Track fasteners for concrete and wood, CPU direct wall mount kit, height-adjustable LCD mount, wrist rest, scanner and mouse holders, integrated keyboard tray with left/right mouse tray, handle, VESA monitor mounting kit, cable ties
Typical LCD Size	≤ 24"	≤ 24"	≤ 24"	≤ 24"
<small>LCD SIZE IS APPROXIMATION. DIMENSION IS DIAGONAL MEASUREMENT OF SCREEN. LCD SIZE MAY BE EXCEEDED AS LONG AS SCREEN WEIGHT DOES NOT EXCEED MAXIMUM WEIGHT CAPACITY OF THE MOUNT.</small>				
Weight Capacity	Display 6–18 lbs (2,7–8,2 kg); keyboard, mouse and barcode scanner 4 lbs (1,8 kg) and up to 10 lbs (4,5 kg) on worksurface	Display 6–18 lbs (2,7–8,2 kg) or up to 25 lbs (11,4 kg) with tilt and lift lock out features engaged; keyboard, mouse and barcode scanner 4 lbs (1,8 kg)	Display 6–18 lbs (2,7–8,2 kg); keyboard, mouse and barcode scanner 4 lbs (1,8 kg) and up to 10 lbs (4,5 kg) on worksurface; 45-270-026: CPU 50 lbs (22,7 kg) 45-272-026: CPU 40 lbs (18 kg)	Display 6–18 lbs (2,7–8,2 kg) or up to 25 lbs (11,4 kg) with tilt and lift lock-out features engaged; keyboard, mouse and barcode scanner 4 lbs (1,8 kg); 45-271-026: CPU 50 lbs (22,7 kg) 45-273-026: CPU 40 lbs (18 kg)
Lift	LCD and keyboard adjust 20" (51 cm) in tandem with single-motion; LCD adjusts 5" (13 cm) independently; maximum LCD height adjustment 25" (64 cm)	LCD and keyboard adjust 20" (51 cm) in tandem with single-motion; LCD adjusts 5" (13 cm) independently; maximum LCD height adjustment 25" (64 cm)	LCD and keyboard adjust 20" (51 cm) in tandem with single-motion; LCD adjusts 5" (13 cm) independently; maximum LCD height adjustment 25" (64 cm)	LCD and keyboard adjust 20" (51 cm) in tandem with single-motion; LCD adjusts 5" (13 cm) independently; maximum LCD height adjustment 25" (64 cm)
Tilt	LCD 30° ↑ 25° / ↓ 5°	LCD 30° ↑ 25° / ↓ 5°	LCD 30° ↑ 25° / ↓ 5°	LCD 30° ↑ 25° / ↓ 5°
Pan	360°	360°	360°	360°
Rotation	90°	360°	90°	360°
VESA	MIS-D	MIS-D	MIS-D	MIS-D
Depth	Folds to 8" (20,3 cm)	Folds to 12" (30,5 cm)	Folds to 8" (20,3 cm)	Folds to 12" (30,5 cm)
Extension	≤ 43" (109 cm) with Extender ≤ 60" (152 cm)	≤ 39.75" (101 cm) with Extender ≤ 56.75" (144 cm)	≤ 43" (109 cm) with Extender ≤ 60" (152 cm)	≤ 39.75" (101 cm) with Extender ≤ 56.75" (144 cm)
Warranty	5 years	5 years	5 years	5 years

- ⑥ Clean, concealed and neat routing of cables through the expansive cable management system
- ⑦ Extend LCD and keyboard up to 43" (109 cm) from wall; fold equipment back out of the way when not in use. With worksurface in storage position, system depth is as little as 8" (20,3 cm). With keyboard in storage position, system depth is as little as 12" (30,5 cm)
- ⑧ Optional Extender Arm increases range of motion for even greater reach



StyleView Sit-Stand Combo System with Worksurface and Extender Arm folds to 8" (20,3 cm)



StyleView Vertical Lift for high-traffic areas folds up into a slim, compact unit when not in use.



Compact ergonomics; extremely low profile

Ideal for patient rooms and high-traffic areas, StyleView® Vertical Lifts give caregivers ergonomic comfort in a compact, low-profile wall mounted workstation. In a patient room setting, the pan of the keyboard and display promotes interaction, and the slide-out keyboard tray provides caregiver with comfortable data entry. Units fold up to as little as 4" (10,2 cm) deep when not in use.

Sit-Stand Vertical Lifts allow users to adjust between sitting and standing working heights. The entire system – monitor, keyboard and mouse – moves vertically 18" (46 cm) with a single, smooth motion to accommodate the heights of multiple users.



Part # (color)	61-080-062 (white) 61-080-085 (black)	60-609-216 (white) 60-609-195 (black)	61-081-062 (white) 61-081-085 (black)	60-593-216 (white) 60-593-195 (black)	97-487-800 (black/white/grey), available US/CA/MX For use with Vertical Lift High Traffic models 60-593-216 and 60-593-195
Includes	Sit-stand lift chassis, monitor pivot, covers, shelf, retractable keyboard tray, slide-out mouse tray, wrist rest, mouse pouch, scanner holder	Vertical Lift, slide out panning keyboard tray, mouse pad (built into keyboard tray) wrist rest, mouse pouch, mouse and scanner holder	Sit-stand lift chassis, monitor pivot, covers, auto-retractable keyboard tray, slide-out mouse tray, wrist rest, mouse pouch	Vertical Lift, mouse pad, wrist rest, mouse pouch	Keyboard tray lift assembly, wrist rest, multiple covers (grey, black, white), Velcro and adhesive strips
Optional Accessories: Vertical CPU Holder 97-468-202 (silver); Vertical Small CPU Holder 80-063-200 (black)					
Typical LCD Size	≤ 24"	≤ 24"	≤ 24"	≤ 24"	—
LCD SIZE IS APPROXIMATION. DIMENSION IS DIAGONAL MEASUREMENT OF SCREEN. LCD SIZE MAY BE EXCEEDED AS LONG AS SCREEN WEIGHT DOES NOT EXCEED MAXIMUM WEIGHT CAPACITY OF THE MOUNT.					
Weight Capacity	5–30 lbs (2,2–13,6 kg)	8–33 lbs (3,6–14,3 kg)	5–30 lbs (2,2–13,6 kg)	5–30 lbs (2,3–13,6 kg)	.75–2.5 lbs (0,34–1,13 kg)
Lift	18" (46 cm)	9" (23 cm)	18" (46 cm)	9" (23 cm)	—
Tilt	10°	LCD 10° Back-tilt keyboard tray 10°	10°	LCD 10° Back-tilt keyboard tray 10°	—
Pan	LCD 50° Keyboard 120° See website for details	50° Display size may restrict motion Keyboard 120°	—	—	—
VESA	MIS-D	MIS-D	MIS-D	MIS-D	—
Depth	6" (15,2 cm)	4.5" (11,4 cm)	4" (10,2 cm)	4" (10,2 cm)	—
Extension	—	18.8" (47,9 cm)	—	12" (30,5 cm)	—
Warranty	5 years	5 years	5 years	5 years	5 years

Specialty healthcare products from Anthro

Ergotron offers a wide variety of specialty healthcare products and solutions – through our Anthro brand – with all the essential features you want and need.

Radiology & Imaging Tables include advanced technology for effective image reading and ergonomic features for multiple users' comfort. Available as fixed height or height-adjustable models.

Zido Carts designed for EKG, Ultrasound, EHR and Phlebotomy supplies are compact and easy to steer. They carry all relevant supplies right to the patient and include plenty of built-in storage.

Wide range of desks, carts and trolleys are offered to serve myriad needs in various healthcare environments.

Visit anthro.com









Optimal viewing for large displays

Get unprecedented height adjustability in an extremely low profile module. The revolutionary design of our Glide Wall Mounts lets users effortlessly raise and lower large displays by up to 18" (46 cm) and tilt the screen up to 10° to avoid glare.

Similarly, our Interactive Arms let you easily lift, swing or turn displays for optimal viewing while relieving eye, neck and back strain.

Glide Wall Mount & Interactive Arm

	 Glide Wall Mount LD-X	 Glide Wall Mount HD	 Glide Wall Mount VHD	 Interactive Arm LD	 Interactive Arm HD	 Interactive Arm VHD
Part # (color)	61-113-085 (black)	61-061-085 (black)	61-128-085 (black)	45-361-026 (polished aluminum)	45-296-026 (polished aluminum)	45-304-026 (polished aluminum)
Typical LCD Size	27–42"	30–55"	≥ 46"	≤ 42"	30–55"	30–60+"
<small>LCD SIZE IS APPROXIMATION. DIMENSION IS DIAGONAL MEASUREMENT OF SCREEN. LCD SIZE MAY BE EXCEEDED AS LONG AS SCREEN WEIGHT DOES NOT EXCEED MAXIMUM WEIGHT CAPACITY OF THE MOUNT.</small>						
Weight Capacity	12–30 lbs (5,4–13,6 kg)	20–40 lbs (9–18 kg)	45–70 lbs (20,4–32 kg)	7–25 lbs (3,2–11,3 kg)	18–40 lbs (8,2–18,2 kg)	35–70 lbs (15,9–31,8 kg)
Lift	10" (25,4 cm)	18" (46 cm)	16" (40,6 cm)	20" (51 cm)	20" (51 cm)	20" (51 cm)
Tilt	10°	10°	10°	75° ↑ 70° / ↓ 5°	25° ↑ 10° / ↓ 15°	20° ↑ 5° / ↓ 15°
Pan	—	—	—	180°	180°	180°
Rotation	—	—	—	360°	10° ← 5° / → 5°	10° ← 5° / → 5°
VESA	MIS-D/E/F See website for details	MIS-E/F See website for details	MIS-D/E/F See website for details	MIS-D/E/F See website for details	MIS-E/F See website for details	MIS-E/F See website for details
Depth	4.3" (10,9 cm)	2" (5 cm)	2.7" (6,9 cm)	4.5" (11 cm)	5.5" (14 cm)	6.5" (16,5 cm)
Extension	—	—	—	17" (43 cm)	24" (61 cm)	28" (71 cm)
Warranty	5 years	5 years	5 years	5 years	5 years	5 years

The broadest and best selection of charging systems!



ZIP 40 Charging Cart & ZIP 12 Charging Desktop Cabinet

Ergotron and Anthro Corporation have teamed up to offer the broadest and best selection of charging systems in the industry!

Manufactured in the USA, Anthro-DNA YES® charging carts and wall cabinets are a perfect complement to existing Ergotron charging system products.

Ergotron and Anthro-DNA strengths include:

- Fastest charging times with PowerShuttle® technology
- Universal designs fit all devices: tablets, laptops, Chromebooks and more
- Sleek, compact designs; carts have small footprints and easy maneuverability
- Durable, solid construction with security and separate IT locking areas
- Managed & unmanaged versions
- UL or ETL certified and tested for safety to UL 60950 standard



YES Charging Wall Cabinet



The quickest charge for your tablets and laptops

Ergotron PowerShuttle® technology is a patented, embedded control system that monitors incoming current from the wall outlet and distributes it to microprocessor-controlled outlets inside the charging cart to quickly, efficiently and safely charge your devices.

- PowerShuttle charges up to 40% faster than competitors' round-robin charging systems.
- Doesn't require manually switching between outlets or adjusting timers.
- Limits inrush current — the instantaneous current draw when you first power on.
- Prevents nuisance tripping of site circuit breakers and electromagnetic interference with other devices.
- Keeps you safe from arc at the plug and hazardous touch currents.

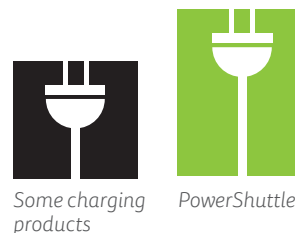

Some charging products

PowerShuttle

Why should you care about safety certification for charging systems: the risks of using non-certified products

- 1 Critical materials are not fire resistant – This is a fire hazard if a battery or electrical fault occurs
- 2 Electrical hazards are not physically enclosed – Shock hazards exist if energized circuitry can potentially be touched either directly or if exposed metal is not safely grounded or properly isolated. Fire hazards can exist if the enclosure can potentially let out flames or molten metal if an electrical fault occurs inside of the enclosure
- 3 Mechanical hazards are not mitigated – If not properly tested and certified, pinch points, tip, crush or cut, sharp edges, and moving parts can injure users
- 4 Equipment ratings must meet National Electrical Code – Non-evaluated systems may exceed allowable load limits causing electrical arcing, facility problems and/or interaction and interference with other equipment
- 5 No manufacturing factory quality surveillance – Product quality and consistency must be managed and ensured

 Safety Certification
UL 60950 Safety of Information Technology Equipment, CAN/CSA C22 2 No. 60950
UL 1667 Tall Institutional Carts for use with Audio, Video and Television Type Equipment
ICES-003 Issue 4, Class A
FCC Part 15 Class A
Country-specific certification as required
RoHS and Reach compliant material used

Carts and cabinets for tablets, laptops & Chromebooks



YES Charging Cart for Mini-laptops-Junior

YES Charging Cart for Mini-laptops

Tablet Management Cart

ZIP Charging Wall Cabinet

Visit the web site landing page at charging.ergotron.com

How PowerShuttle works

- 1 A sensor constantly measures the current coming into the cart from the wall outlet. This helps determine the geographic region where you are (various current limits are used throughout the world) and applies the current limit that is specific to your region.
- 2 PowerShuttle's inrush protection uses microprocessor controls to gradually increase current to the devices as the cart is initially switched on or plugged in, to prevent spikes.

- 5 As devices reach full charge, they'll draw less and less current until all device outlets can be "on" to minimize charge time.



ZIP40 Charging and Management Cart



- 3 As devices charge, PowerShuttle stays vigilant with a sensor continuously monitoring the amount of current from the wall outlet into the cart.
- 4 If the current from the wall outlet is about to exceed the cart's regional limit, PowerShuttle immediately divides the device outlets into groups. This "measure and divide" process (steps 3 and 4) will repeat until all outlets can be on at the same time.



Find the right charging cart or cabinet for your devices:

charging.ergotron.com/finder

Laptop & Chromebook solutions



Charging Systems Finder
Find the right charging cart or cabinet for your device:
charging.ergotron.com/finder



PowerShuttle Laptop Charging Cart



PowerShuttle Laptop Management Cart



Zip12 Charging Wall Cabinet



Zip12 Charging Desktop Cabinet



Zip40 Charging Cart and Zip40 Charging & Management Cart

US/CA/MX	24-291-085	24-246-085	DM12-1006-1	DM12-1012-1	DM40-1009-1	DM40-1008-1
EU			DM12-1006-2	DM12-1012-2	DM40-1009-2	DM40-1008-2
UK/HK/MY/SG			DM12-1006-3	DM12-1012-3	DM40-1009-3	DM40-1008-3
AU/NZ			DM12-1006-4	DM12-1012-4	DM40-1009-4	DM40-1008-4
CN			DM12-1006-5	DM12-1012-5	DM40-1009-5	DM40-1008-5
JP				DM12-1012-6	DM40-1009-6	DM40-1008-6
Screen Size	≤ 15.6"	≤ 15.6"	≤ 12"	≤ 14"	≤ 15.6"	
# of Devices	20	20	12	8 or 12 (depending on divider configuration)	30 or 40 (depending on divider configuration)	
Cables	No	Ethernet CAT6	No	No	No	Ethernet CAT6
Slot Size W x D x H	1.9" x 15.7" x 12.3"	1.9" x 15.7" x 12.3"	1.0" x 11.9" x 8.9" (2,5 x 30,2 x 22,6 cm)	1.9" x 15.3" x 9.7" (4,8 x 38,9 x 24,6 cm)	1.1" x 15.3" x 9.7" (2,7 x 38,9 x 24,6 cm)	1.9" x 17.1" x 11.2" (4,8 x 43,4 x 28,4 cm)
Unit Size W x D x H	28" x 24.4" x 40.5"	28" x 24.4" x 40.5"	26.4" x 5.9" x 35.6" (67 x 15 x 91 cm)	22" x 24.5" x 14" (56 x 62 x 35,6 cm)	30.3" x 26.1" x 45.4" (77 x 66 x 115 cm)	
Power System	PowerShuttle	PowerShuttle	Power Strip	PowerShuttle	PowerShuttle	
Tablet compatible	✓	✓	✓	✓	✓	
UL 60950 certified	✓	✓	✓	✓	✓	
Warranty	5 years; 2 years power module; 1 year other electrical components	5 years; 2 years power module; 1 year other electrical components	Lifetime mechanical; 3 years electrical; 1 year cables	Lifetime mechanical; 3 years electrical; 1 year cables	Lifetime mechanical; 3 years electrical; 1 year cables	

Tablet solutions



Tablet Management Wall Mount 10 Lightning



Tablet Management Desktop 16 for Samsung Galaxy Tab Active



Tablet Management Cart 32 for Samsung Galaxy Tab Active



Tablet Management Desktop 16 with ISI / Lightning



Tablet Management Desktop 16 without ISI



Tablet Management Cart 32 with ISI / Lightning



Tablet Management Cart 48 with ISI / Lightning



Tablet Management Cart 48 with ISI

US/CA/MX		DM16-1015-1	DM32-1016-1	DM16-1004-1		DM32-1004-1		
EU	DM10-1007-2	DM16-1015-2	DM32-1016-2	DM16-1004-2		DM32-1004-2	DM48-1004-2	
UK/HK/MY/SG	HK DM10-1007-3	DM16-1015-3	DM16-1015-3	DM16-1004-3	UK 24-375-085	DM32-1004-3		HK/MY/SG 24-335-085
AU/NZ		DM16-1015-4	DM16-1015-4	DM16-1004-4		DM32-1004-4	DM48-1004-4	
CN		DM16-1015-5	DM16-1015-5	DM16-1004-5		DM32-1004-5	DM48-1004-5	24-353-085
JP				DM16-1004-6		DM32-1004-6	DM48-1004-6	24-359-085
Screen Size	≤ 10.1"	≤ 8.0"	≤ 8.0"	≤ 10.1"	≤ 10.1"	≤ 10.1"	≤ 10.1"	≤ 10.1"
# of Devices	10	16	32	16	16	32	48	48
Cables	Lightning	POGO	POGO	Lightning	No	Lightning	Lightning	No
Slot Size W x D x H	0.9" x 10.9" x 7.9" (2,3 x 27,7 x 20,1 cm)	—	—	.85" x 11.3" x 7.9" (2,2 x 28,8 x 20 cm)	.85" x 11.3" x 7.9" (2,2 x 28,8 x 20 cm)	.85" x 11.3" x 7.9" (2,2 x 28,8 x 20 cm)	.85" x 11.3" x 7.9" (2,2 x 28,8 x 20 cm)	.85" x 11.3" x 7.9" (2,2 x 28,8 x 20 cm)
Unit Size W x D x H	23.2" x 4.0" x 31.8" (59 x 80,9 x 10,2 cm)	18.3" x 16.2" x 10.4" (46,5 x 41,1 x 26,4 cm)	23" x 18.4" x 39.3" (58,4 x 46,7 x 100 cm)	18.3" x 16.2" x 10.4" (46,5 x 41,1 x 26,4 cm)	18.3" x 16.2" x 10.4" (46,5 x 41,1 x 26,4 cm)	23" x 18.4" x 39.3" (58,4 x 46,7 x 100 cm)	23" x 18.4" x 39.3" (58,4 x 46,7 x 100 cm)	23" x 18.4" x 39.3" (58,4 x 46,7 x 100 cm)
Power System	iPad Only USB/Sync 2.4A	USB POGO Charging	USB POGO Charging	iPad Only USB/Sync 2.4A	USB/Sync 2.1A	iPad Only USB/Sync 2.4A	iPad Only USB/Sync 2.4A	USB/Sync 2.1A
Made for iPad certified		—	—		—			—
UL 60950 certified	✓	✓	✓	✓	✓	✓	✓	✓
Warranty	5 years; 2 years power module; 1 year other electrical components	5 years; 2 years power module; 1 year other electrical components	5 years; 2 years power module; 1 year other electrical components	5 years; 2 years power module; 1 year other electrical components	5 years; 2 years power module; 1 year other electrical components	5 years; 2 years power module; 1 year other electrical components	5 years; 2 years power module; 1 year other electrical components	5 years; 2 years power module; 1 year other electrical components

Laptop & Chromebook solutions

Built with Anthro-DNA



US/CA/MX	YESMJUGMPW4	YESMUSGMPW4	YESMOR2GMPW4	LTSC20WH/SM	LTSC30WH/SM	YESMLCGMPW
EU						
UK/HK/MY/SG						
AU/NZ						
CN						
JP						
Screen Size	≤ 14"	≤ 14"	≤ 15.5"	≤ 15.5"	≤ 14"	
# of Devices	15 or 20 (depending on divider configuration)	30 or 36 (depending on divider configuration)	20	30	12	
Cables	No	No	No	No	No	
Slot Size W x D x H	1.9" x 14.25" x 10" (4,8 x 36,1 x 25,4 cm) 1.6" x 14.25" x 10" (4 x 36,1 x 25,4 cm)	For up to 36 devices: 1.25" x 14.25" x 10" For up to 30 devices: 1.6" x 14.25" x 10"	15.5" x 12" x 3"	16" x 12" x 3"	1.25" x 14.25" x 10"	
Unit Size W x D x H	24.25" x 27.75" x 42" (61,5 x 70,4 x 106,6 cm)	28.75" x 25" x 41.5"	23" x 28.5" x 45.75"	43.5" x 29.75" x 38"	22.25" x 16.75" x 24"	
Power System	Power Strip	PowerShuttle	Power Strip	Power Timer	Power Strip	
Tablet compatible	✓	✓	✓	✓	✓	
UL 60950 certified	✓	✓	✓	✓	✓	
Warranty	Lifetime mechanical; 3 years electrical; 1 year cables	Lifetime mechanical; 3 years electrical; 1 year cables	Lifetime warranty on body; 1 year on electrical; cords & plugs not warranted	Lifetime warranty on body; 1 year on electrical; cords & plugs not warranted	Lifetime mechanical; 3 years electrical; 1 year cables	
TAA Compliant	✓	✓	✓	✓	✓	



Charging Systems Finder
Find the right charging cart or cabinet for your device:
charging.ergotron.com/finder

Tablet solutions

Built with Anthro-DNA



US/CA/MX	DM12-1006-1	DM12-1012-1	DM40-1009-1	DM40-1008-1	YESTABGMPW4	YESCABGMPW
EU	DM12-1006-2	DM12-1012-2	DM40-1009-2	DM40-1008-2		
UK/HK/MY/SG	DM12-1006-3	DM12-1012-3	DM40-1009-3	DM40-1008-3		
AU/NZ	DM12-1006-4	DM12-1012-4	DM40-1009-4	DM40-1008-4		
CN	DM12-1006-5	DM12-1012-5	DM40-1009-5	DM40-1008-5		
JP		DM12-1012-6	DM40-1009-6	DM40-1008-6		
Screen Size	≤ 12"	≤ 14"	≤ 15.6"	≤ 10"	≤ 10"	
# of Devices	12	8 or 12 (depending on divider configuration)	30 or 40 (depending on divider configuration)	32 or 40 (depending on divider configuration)	16 or 20 (depending on divider configuration)	
Cables	No	No	No	No	No	
Slot Size W x D x H	1.0" x 11.9" x 8.9" (2,5 x 30,2 x 22,6 cm)	1.9" x 15.3" x 9.7" (4,8 x 38,9 x 24,6 cm) 1.1" x 15.3" x 9.7" (2,8 x 38,9 x 24,6 cm)	1.9" x 17.1" x 11.2" (4,8 x 43,4 x 28,4 cm) 1.1" x 17.1" x 11.2" (2,8 x 43,4 x 28,4 cm)	1.25" x 10.5" x 8" (3,2 x 26,6 x 20,3 cm) 0.87" x 10.5" x 8" (2,2 x 26,6 x 20,3 cm)	1.25" x 10.5" x 8.5" (3,2 x 26,6 x 20,3 cm) .87" x 10.5" x 8.5" (2,2 x 26,6 x 20,3 cm)	
Unit Size W x D x H	26.4" x 5.9" x 35.6" (67 x 15 x 91 cm)	22" x 24.5" x 14" (56 x 62 x 35,6 cm)	30.3" x 26.1" x 45.4" (77 x 66 x 115 cm)	23.75" x 24.75" x 46.25" (60,3 x 62,8 x 117,4 cm)	22" x 12.75" x 24"	
Power System	Power Strip	PowerShuttle	PowerShuttle	Power Strip	Power Strip	
Made for iPad certified	—	—	—	—	—	
UL 60950 certified	✓	✓	✓	✓	✓	
Warranty	Lifetime mechanical; 3 years electrical; 1 year cables	Lifetime mechanical; 3 years electrical; 1 year cables	Lifetime mechanical; 3 years electrical; 1 year cables	Lifetime mechanical; 3 years electrical; 1 year cables	Lifetime mechanical; 3 years electrical; 1 year cables	
TAA Compliant				✓	✓	

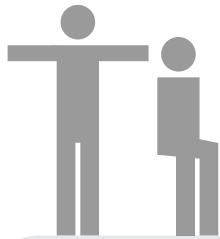

The science behind the need to stand



The American Medical Association (AMA) agrees that sitting for extended periods of time can be bad for personal health. Their newly adopted policy recommends business organizations offer sitting alternatives, including standing desks.



A recent study published by the CDC (Centers for Disease Control) indicates adjustable sit-to-stand products are an effective solution for reducing prolonged sitting. Sit or stand, instantly, while remaining effectively engaged with your computer.

A 2010 University of Queensland, Australia study found that even when adults meet physical activity guidelines, sitting for prolonged periods can compromise metabolic health.

Sit less. Stand more. Start now!

Take a stand against illnesses linked to prolonged sitting

For more than three decades, Ergotron has designed ergonomic workstations to make computing more comfortable and better for you. Our extensive line of sit-stand workstations and desks gives computer users a much healthier and more productive way to work.

Sit-stand workstations are:

FLEXIBLE – a solution for every computer user and every computing configuration

ERGONOMIC – effortless height adjustability for sit-stand comfort; accessories also available

AFFORDABLE – many economical ways to fight "sitting disease"

WorkFit-T/-TL Sit-Stand Desktop Workstation

Invigorate your work day with this ultra simple and flexible workstation!

- Stable workstation sits right on top of most surfaces 24" (61 cm) deep or larger; no mounting or clamping required
- System easily lifts straight up and down to minimize intrusion into the workspace
- Ships fully assembled – no tool adjustments needed – making it easy to retrofit existing spaces

WorkFit-T: BLACK 33-397-085
WHITE 33-397-062

WorkFit-TL: BLACK 33-406-085
WHITE 33-406-062



WorkFit-T/-TL arrives fully assembled and sits right on top of virtually any surface; it easily moves vertically 15" (38 cm) to provide sit-stand comfort for a broad range of users

Other popular WorkFit® Sit-Stand Workstations



WorkFit-P, Platinum
24-408-227



WorkFit-A, Platinum
24-422-227
WorkFit-A, for Apple®
24-414-227



WorkFit-A with Worksurface+
Single LD 24-317-026
Single HD 24-314-026
Dual 24-316-026



WorkFit-A with Suspended Keyboard
Single LD 24-390-026
Single HD 24-391-026
Dual 24-392-026



WorkFit-S
BLACK
Single, LD 33-342-200
Single, HD 33-344-200
Dual 33-341-200



WorkFit-S with Worksurface+
BLACK
Single, LD 24-317-026
Single, HD 24-314-026
Dual 33-349-200
WHITE
Single, LD 33-350-211
Single, HD 33-351-211
Dual 33-349-211

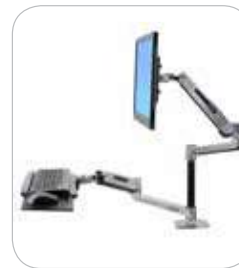

WorkFit-LX, Sit-Stand Desk Mount System
45-405-026



WorkFit-D Sit-Stand Desk
Light Grey 24-271-926
Walnut 24-271-927
Birch 24-271-928

Customer service and product support that's second to none

Expect a superior customer experience when you choose Ergotron. Our quality products are backed by specially trained support professionals and optional extended service programs that protect your investment and optimize your on-going product performance.

Customer care includes:

800# support line

Live 24/7 support in English; support during country hours in English, Spanish, French, Dutch, Italian, Russian, German, Greek, Mandarin and Japanese

Chat and email support

Our specialists connect with you real-time via live chat and email

Technical support

Rigorously trained technicians work with you to troubleshoot product and installation issues, manage service contracts, handle dispatching and answer/resolve warranty questions and issues



Sales support for resellers

Our field service group supports regional territory sales, and also participate in customer events with TESS (Ergotron's Traveling Equipment Solutions Showroom)

Extended Global Service Programs protect your investment and ensure optimal product performance

A wide range of extended Global Service Programs are available to provide additional support and benefits:



Site readiness

Fast, efficient equipment installation and integration

Certified technicians conduct and manage every phase of product installation (including hardware integration, adjustments and computer installation with cable management)

Preventive maintenance and extended warranties

Optimal product performance for increased uptime

Improved asset management

Lower total cost of ownership; extended product life

Enhanced in-house product expertise

Training and transfer of technical knowledge to your internal staff

Equipment audit and health assessment

Receive an accurate inventory and health assessment of all deployed Ergotron equipment and assets.

Next-business-day (NBD) service contracts

Receive NBD service from our network of certified providers to minimize equipment downtime. Various contract levels are available to meet your unique needs: Bronze, Silver, Silver+, Gold and Platinum

Annual contracts and planned services

Options range from a single preventive maintenance visit to a 5-year complete service contract

100% satisfaction – guaranteed!

LX & MX desk mounts offer flexibility and independent movement of display(s)



LX Dual Side-by-Side Arm
45-245-026



LX Dual Stacking Arm
45-248-026



LX Sit-Stand Desk Mount
45-360-026
HD 45-384-026



LX Desk Mount LCD Arm
45-241-026
with Tall Pole 45-295-026



NEW! LX Mini Desk Mount
45-436-026
(Available in NA: polished aluminum)
45-436-216
(Available in EMEA: white)
45-436-231
(Available in APAC: silver)

Burn extra calories • Tone muscles • Improve posture • Ramp up your metabolism • Be more productive

 research.juststand.org

Supporting care everywhere

Enhance personal interaction • Expand reach • Improve operational efficiency



Point-of-Care and Telehealth
StyleView Carts

Charging Systems



Ergonomic
Sit-Stand Workstations



Mobile Display and
Videoconferencing
Solutions



Point-of-Care
Wall Mount Products



Display and Digital
Signage Mounts



© 2016 Ergotron, Inc. Literature made in U.S.A. 870-01-012-EA rev. 03/15/16
Content is subject to change without notification.
 Ergotron devices are not intended to cure, treat, mitigate or prevent any disease.
 StyleView, Neo-Flex, PowerShuttle and WorkFit are registered trademarks of Ergotron
 in the U.S.A. and China.

**Americas Sales and
Corporate Headquarters**

St. Paul, MN USA
 (800) 888-8458
 +1-651-681-7600
 www.ergotron.com
 sales@ergotron.com

EMEA Sales

Amersfoort, The Netherlands
 +31 33 45 45 600
 www.ergotron.com
 info.eu@ergotron.com

APAC Sales

Tokyo, Japan
 www.ergotron.com
 apaccustomerservice@ergotron.com

Worldwide OEM Sales

www.ergotron.com
 info.oem@ergotron.com

ERGOTRON®

A Nortek Company

