



Level



Pressure



Flow



Temperature



Liquid  
Analysis



Registration



Systems  
Components



Services



Solutions

## Description of Instrument Functions

# Prosonic S FMU90

## Ultrasonic Transmitter

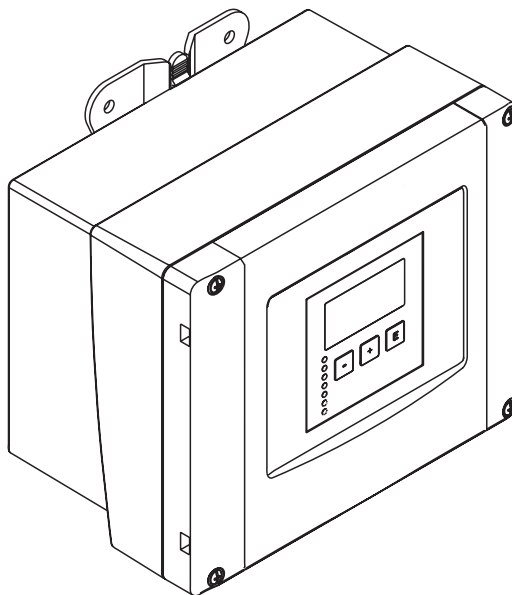
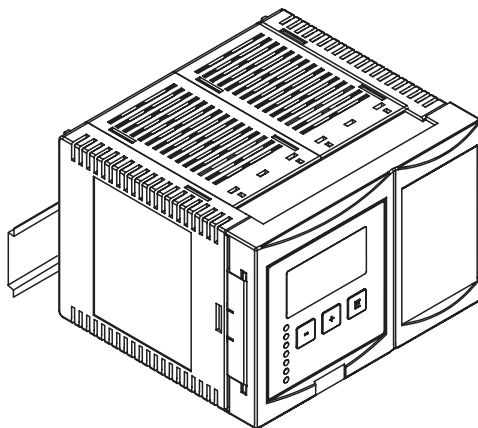

BA290F/00/EN/07.09  
71098302

Valid as of software version  
V02.01.00



## Table of Contents

<b>1</b>	<b>Notes on use</b> .....	<b>4</b>	8.3	The "language" submenu .....	138
1.1	Theory of operation .....	4	8.4	The "password/reset" submenu .....	139
1.2	First setup .....	17	<b>9</b>	<b>The "system information" menu</b> ....	<b>140</b>
<b>2</b>	<b>The "level" menu</b> .....	<b>18</b>	9.1	The "device information" submenu .....	140
2.1	The "basic setup" submenu .....	18	9.2	The "in/output info" submenu .....	142
2.2	The "extended calibration" submenu .....	33	9.3	The "trend display" submenu (for HART instruments only) .....	144
2.3	The "simulation" submenu .....	36	9.4	The "min/max values" submenu .....	145
<b>3</b>	<b>The "flow" menu</b> .....	<b>37</b>	9.5	The "envelope curve" submenu .....	147
3.1	The "flow N" submenu (N = 1 or 2) .....	37	9.6	The "error list" submenu .....	148
3.2	The "backwater" submenu .....	51	9.7	The "diagnosotics" submenu .....	149
3.3	The "flow counter" submenu .....	61	<b>10</b>	<b>The "display" menu</b> .....	<b>151</b>
<b>4</b>	<b>The "safety settings" menu</b> .....	<b>65</b>	10.1	"display" .....	151
4.1	"output on alarm" (only for HART instruments) ...	65	10.2	"display format" .....	152
4.2	"output echo loss" .....	66	10.3	"back to home" .....	153
4.3	"delay echo loss" .....	67	<b>11</b>	<b>The "sensor management" menu</b> ...	<b>154</b>
4.4	"safety distance" .....	67	11.1	The "sensor management" submenu .....	154
4.5	"in safety distance" .....	68	11.2	The "external temperature sensor" submenu .....	159
4.6	"reaction high temperature" .....	69	11.3	The "external digin" submenu .....	161
4.7	"defective temperature sensor" .....	70	<b>12</b>	<b>Operating menu</b> .....	<b>162</b>
4.8	"relay delay" .....	70	12.1	"Level" .....	162
<b>5</b>	<b>The "relays/controls" menu</b> .....	<b>71</b>	12.2	"Flow" .....	164
5.1	The "relay configuration" submenu .....	71	12.3	"Safety settings" .....	166
5.2	The "pump control N" submenu - standard (N = 1 or 2) .....	81	12.4	"Relay/Controls" .....	168
5.3	The "pump control N" submenu - enhanced (N = 1 or 2) .....	94	12.5	"Output/calculations" .....	(HART) 176
5.4	The "rake control" submenu .....	119	12.6	"Output/calculations" (Profibus DP) .....	177
5.5	The "relay simulation" submenu .....	124	12.7	"Device properties" .....	178
<b>6</b>	<b>The "output/calculations" menu (for HART instruments)</b> .....	<b>125</b>	12.8	"System information" .....	180
6.1	The "allocation/calculations" submenu .....	126	12.9	"Display" .....	182
6.2	The "extended calibration" submenu .....	127	12.10	"Sensor management" .....	182
6.3	"HART settings" submenu (only for current output 1) .....	130	<b>13</b>	<b>Appendix</b> .....	<b>183</b>
6.4	"Simulation" submenu .....	132	13.1	Pre-programmed flow curves .....	183
<b>7</b>	<b>The "output/calculations" menu (for Profibus DP instruments)</b> .....	<b>133</b>	13.2	The formula for flow calculation .....	197
7.1	"analog input" (AI) .....	133	13.3	System error messages .....	201
7.2	"digital input" (DI) .....	134	13.4	Default block configuration (HART) .....	205
7.3	"Profibus DP" .....	135	13.5	Default block configuration (Profibus DP) .....	209
<b>8</b>	<b>The "device properties" menu</b> .....	<b>136</b>			
8.1	The "operating parameters" submenu .....	136			
8.2	The "tag marking" submenu .....	137			

# 1 Notes on use

## 1.1 Theory of operation



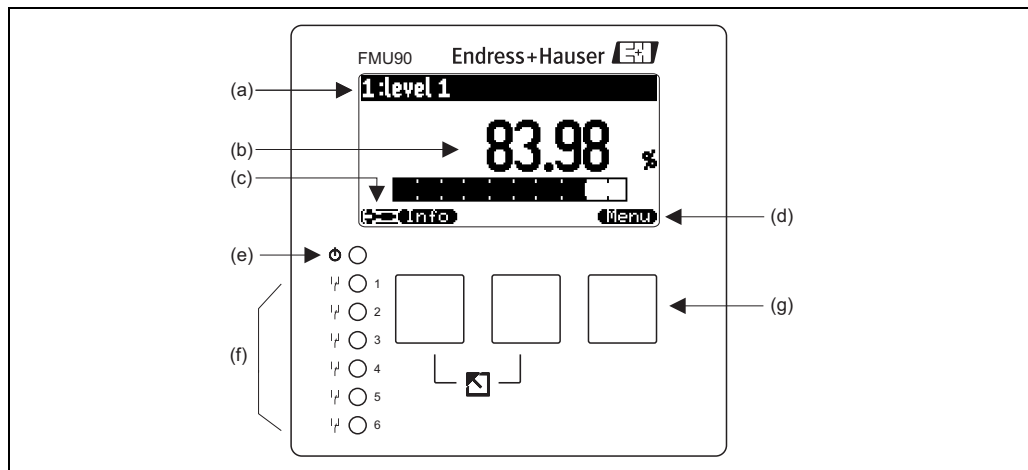









### 1.1.1 Display and operating elements



100-FMU90xxx-07-00-00-xx-002

**(a):** name of the parameter; **(b):** value of the parameter, including unit; **(c):** display symbols; **(d):** softkey symbol; **(e):** LED indicating the operating state; **(f):** LEDs indicating the switching states of the relays; **(g):** keys

## Display symbols

Symbol	Meaning
<b>Operating mode of the instrument</b>	
	<b>User</b> User parameters can be edited. Service parameters are locked.
	<b>Diagnosis</b> The service interface is connected.
	<b>Service</b> User and service parameters can be edited.
	<b>Locked</b> All parameters are locked.
<b>Locking state of the currently displayed parameter</b>	
	<b>Display parameter</b> The parameter can <b>not</b> be edited in the current operating mode of the instrument.
	<b>Editable parameter</b> The parameter can be edited.
<b>Scroll symbols</b>	
	<b>Scroll list available</b> Indicates that the list contains more parameters than can be represented on the display. By pressing  or  repeatedly, all parameters of the list can be accessed.
<b>Navigation in the envelope curve display</b>	
	<b>Move left</b>
	<b>Move right</b>
	<b>Zoom in</b>
	<b>Zoom out</b>













## LEDs

LED indicating the operating state (pos. (e) in the figure)	
green	normal measuring mode; no error detected
red (flashing)	Warning: An error is detected but the measurement continues. Reliability of the measured value is no longer ensured.
red	Alarm: An error is detected. The measurement is interrupted. The measured value assumes the value specified by the user (parameter "output on alarm").
off	supply voltage missing

LEDs for the relays (pos. (f) in the figure)	
yellow	The relay is activated.
off	The relay is de-activated (idle state).



## Keys (softkey operation)

The function of the keys depends on the current position within the operating menu (softkey functionality). The key functions are indicated by softkey symbols in the bottom line of the display.

Symbol	Meaning
	<b>Move downwards</b> Moves the marking bar downwards within a selection list.
	<b>Move upwards</b> Moves the marking bar upwards within a selection list.
	<b>Enter</b> <ul style="list-style-type: none"> <li>Opens the marked submenu, the marked parameter set or the marked parameter</li> <li>Confirms the edited parameter value</li> </ul>
	<b>Previous parameter set</b> Reopens the previous parameter set within the submenu.
	<b>Next parameter set</b> Opens the next parameter set within the submenu.
	<b>Confirm selection</b> Selects the option of a selection list which is currently marked by the bar.
	<b>Increase value</b> Increases the active digit of an alphanumeric parameter.
	<b>Decrease value</b> Decreases the active digit of an alphanumeric parameter
	<b>Error list</b> Opens the list of all errors which are currently detected. If a warning is present, this symbol flashes. If an alarm is present, the symbol is displayed continuously.
	<b>Change Display</b> Change to the next page of measured values (only available if more than one pages of measured values have been defined; see "display" menu)
	<b>Info</b> Opens the Shortcut Menu, which contains the most important information about the current state of the instrument
	<b>Menu</b> Opens the Main Menu, which contains <b>all</b> parameters of the Prosonic S

## General key combinations

The following key combinations do not depend on the menu position:

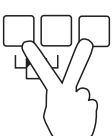
Key combination	Meaning
	<b>Escape</b> <ul style="list-style-type: none"> <li>While editing a parameter: Exit the editing mode without accepting the changes.</li> <li>Within the navigation: Move upwards to the previous layer of the menu.</li> </ul>
	<b>Increase contrast</b> Increases the contrast of the display module.
	<b>Decrease contrast</b> Decreases the contrast of the display module.

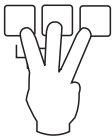
Key combination	Meaning
	<b>Locking</b> Locks the instrument against parameter changes. The instrument can only be unlocked again by the keys.

## 1.1.2 The operating menu

### Structure of the menu

The parameters of the Prosonic S are organized in an operating menu (consisting of a main menu and several submenus). Parameters which are related to each other are comprised in a common parameter set. To simplify the navigation within the menu, a five-digit position code is displayed with each parameter set.

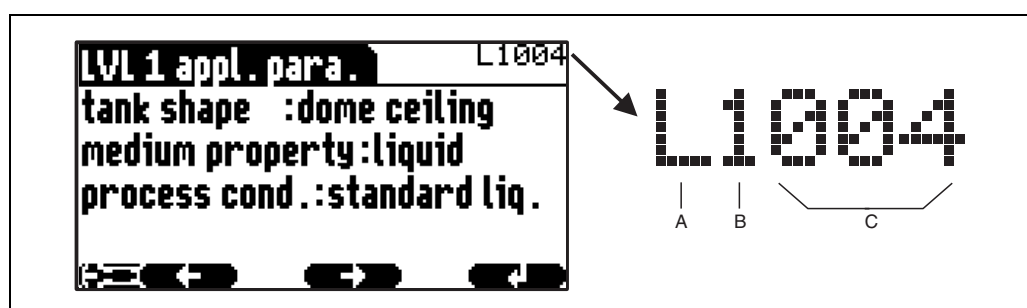

Identification of the parameter sets; **A**: submenu; **B**: number of the associated input or output; **C**: number of the parameter set within the submenu

- The **first digit (A)** specifies the submenu<sup>1)</sup>:
  - **L**: "level"
  - **F**: "flow"
  - **A**: "safety settings"
  - **R**: "relay/controls"
  - **O**: "output/calculations"
  - **D**: "device properties", "calibr. display" and "sensor management"
  - **I**: "system information"
  - **S**: "service" (only available if the service password has been entered)

Diagrams of the submenus can be found in the chapter "Operating menu".

- The **second digit (B)** is used if the parameter set occurs several times within the Prosonic S (e.g. for different inputs or outputs).

#### Example:

- O1201: "allocation current" for output 1
- O2201: "allocation current" for output 2

If the parameter set occurs only once within the Prosonic S, "X" is indicated at this position.

- The **last three digits (C)** specify the individual parameter sets within the submenu.

1) Depending on the instrument version, the installation environment and the selected operating mode, some of the submenus may not be present.

## Parameter types

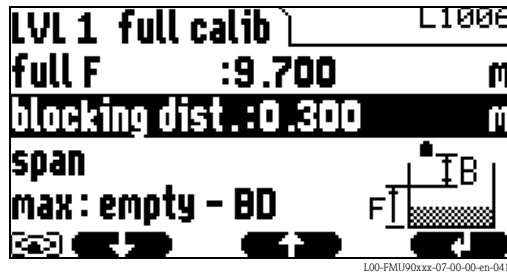

### Display parameters

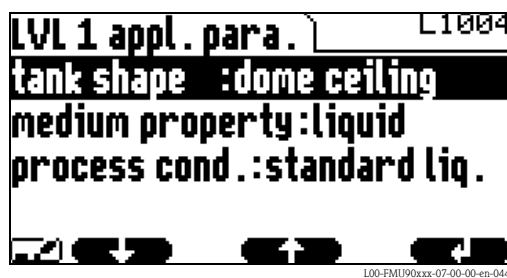

Parameters for which the  symbol is displayed in the left bottom corner of the display module, are either locked or display-only parameters.

### Editable parameters



Parameters, for which the  symbol is displayed in the left bottom corner of the display module, can be entered for editing by pressing .

The editing procedure depends on the type of parameter:

- when entering a **selection parameter**, the associated selection list appears (see below: "Editing a parameter with selection list").
- when entering a **numerical or alphanumeric parameter**, the text and number editor appears (see below: "Entering numbers and characters").



### Navigation within the menu (Example)

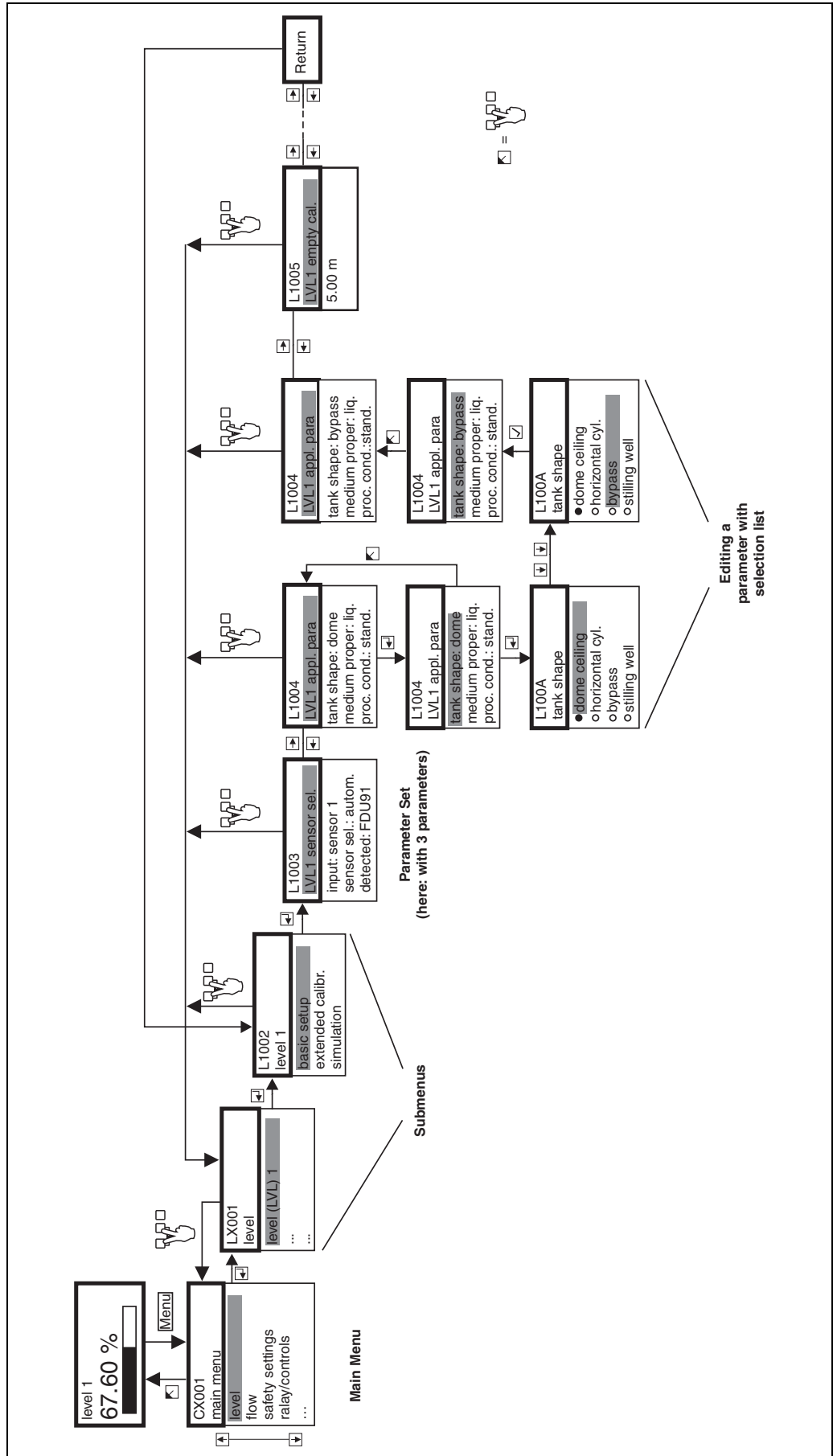

## Entering the menu

The navigation always starts from the main screen (measured value display<sup>2)</sup>). From there, the following menus can be opened by the keys:

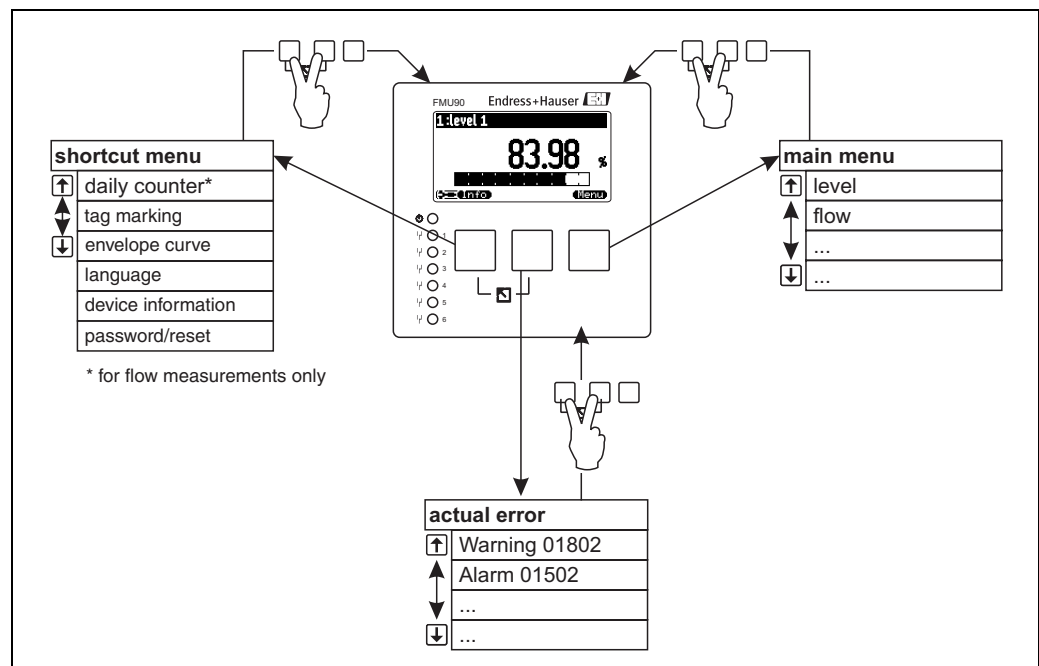

L00-FM190ccc-19-00-00-yy-038

### ■ shortcut menu

The shortcut menu is accessed via the **"Info"** key. It allows quick access to device information:

- daily counter (for flow measurements)
- tag marking
- envelope curve: used to check the signal quality
- language: sets the display language
- device information: serial number, versions of software and hardware
- password/reset: used to enter the password or reset code

All parameters of the shortcut menu are contained in the main menu as well.

### ■ main menu

The main menu is accessed via the **"Menu"** key. It contains all parameters of the Prosonic S. It is divided into submenus. Some of the submenus consist of further submenus. Which submenus are actually present, depends on the instrument version and the installation environment.

An overview of all submenus and parameters is given in the chapter "Operating menu".

### ■ actual error

If the self-monitoring of the Prosonic S detects an error, the  softkey symbol appears above the middle key.

If the softkey symbol flashes, only "warnings" are present.

If the softkey symbol is displayed permanently, at least one "alarm" is present.

After pressing the key, a list of all currently present errors appears.

2) Note: Depending on the configuration, the appearance of the measured value display may be different from the example in the figure.

## Selecting a submenu

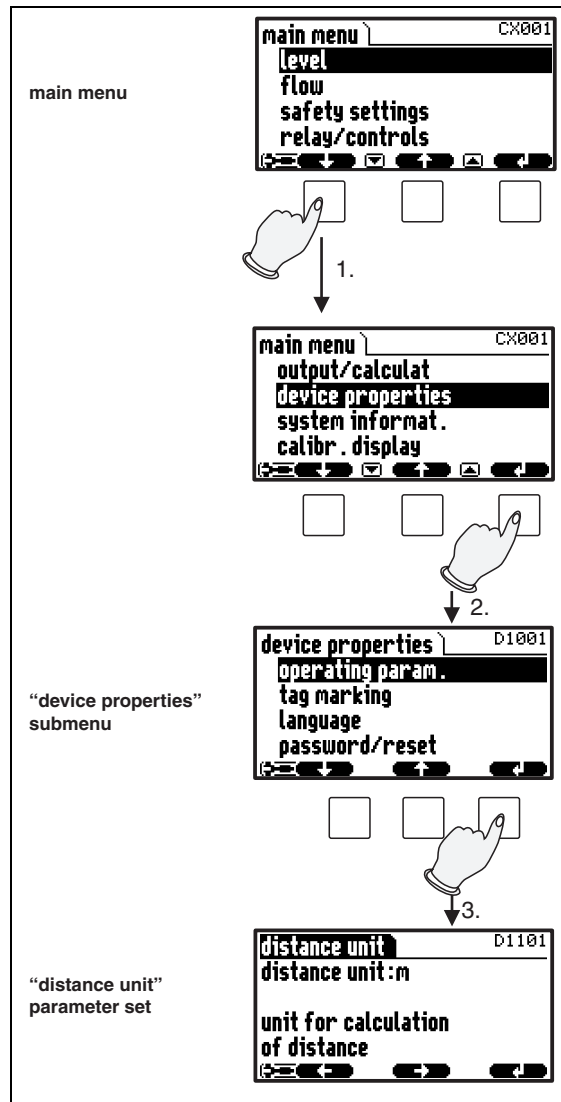

L00-FMU90xxx-19-00-00-yy-039

1. In the main menu, press or until the required submenu is marked by the bar.

Note!

The symbols indicate that the selection list contains more items than can be displayed on the module. Press or several times, to mark one of the hidden items.

2. Press , in order to enter the marked submenu.

3. If the submenu contains further submenus, continue until you reach the level of the parameter sets. This level is reached if the softkey symbols and appear.



Note!

If necessary, you can return to the previous level of the menu by pressing .

## Selecting a parameter

By pressing  $\leftarrow$  or  $\rightarrow$  you can switch between the parameter sets of the current submenu. For each parameter set the values of all its parameters are displayed. In order to change one of the values, proceed as follows:

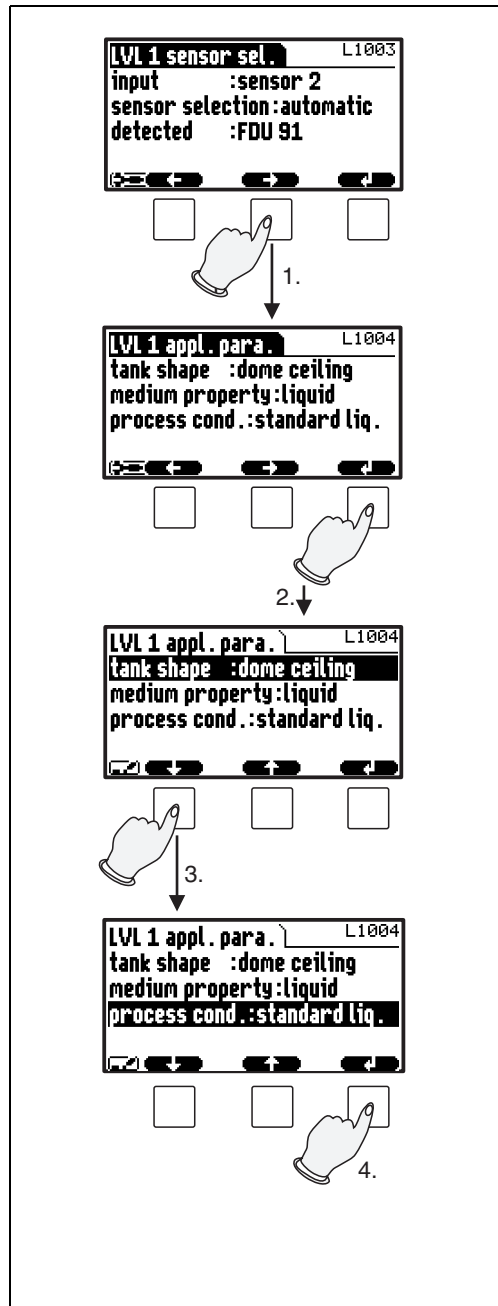

L00-FMU90xxx-19-00-00-en-040

1. Press  $\leftarrow$  or  $\rightarrow$ , until you have reached the required parameter set.
2. Press  $\downarrow$ , in order to enter the parameter set.
3. Select the required parameter by pressing  $\uparrow$  or  $\downarrow$ .  
(This step is not required if the set contains only one parameter.)
4. Press  $\downarrow$ , in order to enter the editing mode of the parameter.  
The editing method depends on the type of parameter (selection list, numeric or alphanumeric parameter). For details refer to the following sections.



Note!

If necessary, you can exit the parameter and parameter set by pressing  .

## Editing a parameter with selection list

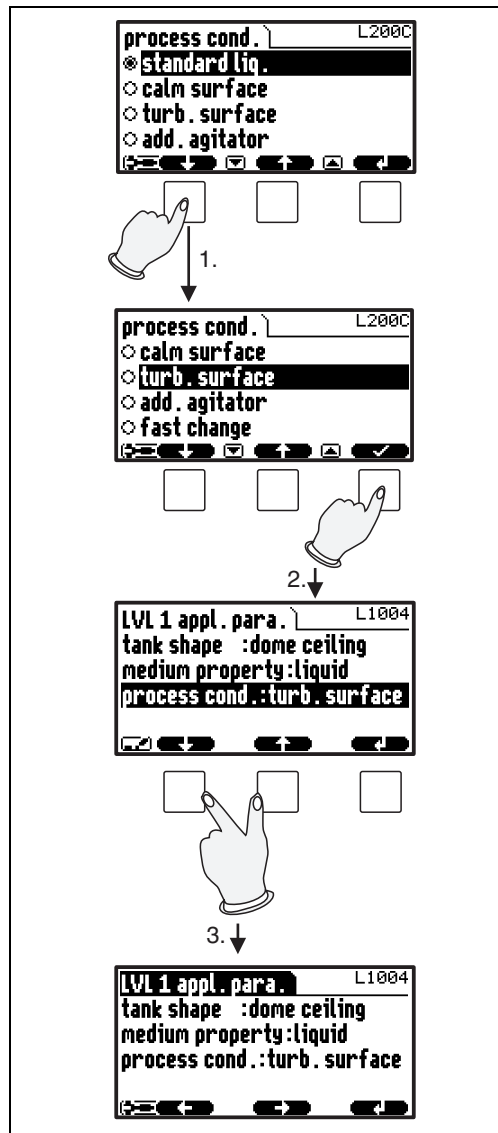

L00-FMI190xxx-19-00-00-en-041

1. Press or , until the required option is marked by the bar (in the example: "turb. surface").

Note!

The symbols indicate that the selection list contains more items than can be displayed on the module. Press or several times, to mark one of the hidden items.

2. Press , in order to select the marked option. It is then stored in the instrument.

3. Press the left and middle keys simultaneously in order to quit the parameter.  
The software key symbols and reappear and you can switch to the next parameter set.



Note!

By pressing before you can quit the parameter without accepting your changes.

### Entering numbers and characters

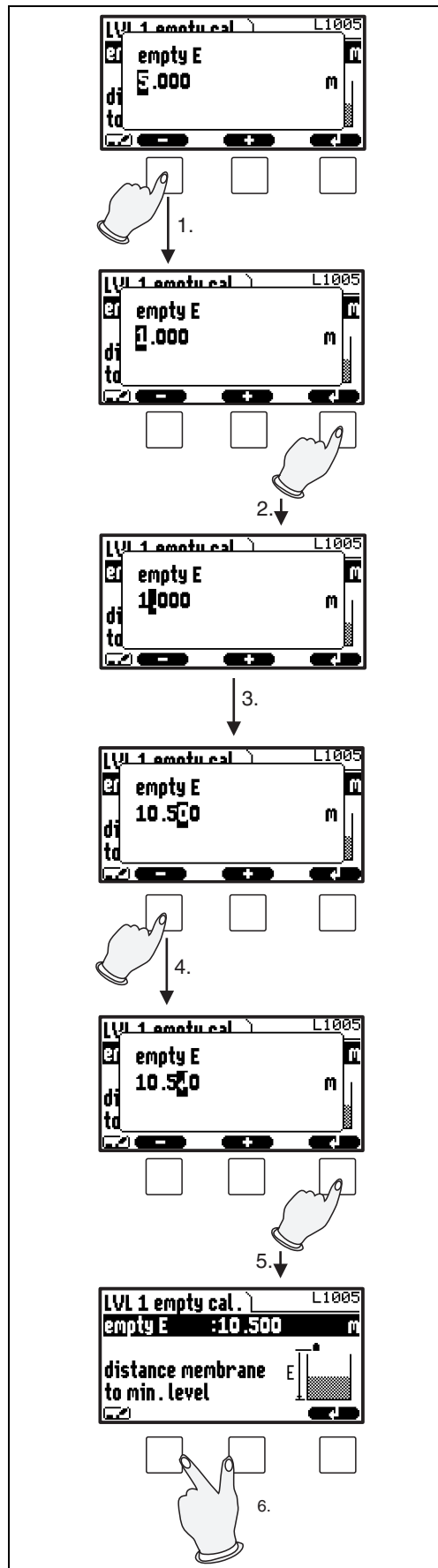

When you select a numeric parameter ("empty calibration", "full calibration" etc.) or an alpha-numeric parameter ("device marking" etc.), the editor for numbers and text strings appears. Enter the desired value in the following way:

1. The cursor is at the first digit. Press  $\square$  or  $\square$  until this digit has the required value.
2. Press  $\downarrow$  in order to confirm the value and to jump to the next digit.
3. Repeat the procedure for all relevant digits.
4. If all relevant digits have been entered: Press  $\square$  or  $\square$ , until  $\downarrow$  appears at the cursor.
5. Press  $\downarrow$  to store the complete value in the device.
6. Press the left and middle keys simultaneously in order to quit the parameter.

L00-FM190xxx-19-00-00-yy-042

### Special editing functions

Within the editor for alphanumeric characters, pressing  $\square$  or  $\oplus$  does not only lead to numbers and characters but also to the following symbols for special editing functions. They simplify the editing procedure.

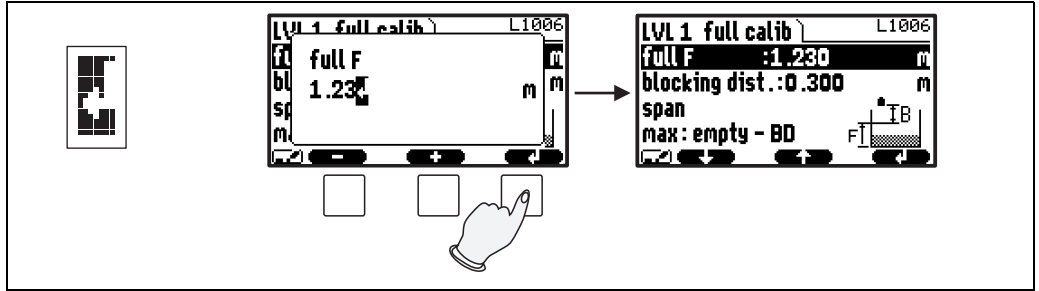

L00-FM190xxx-19-00-00-yy-043

**Enter:** The number left of the cursor is transferred to the instrument.

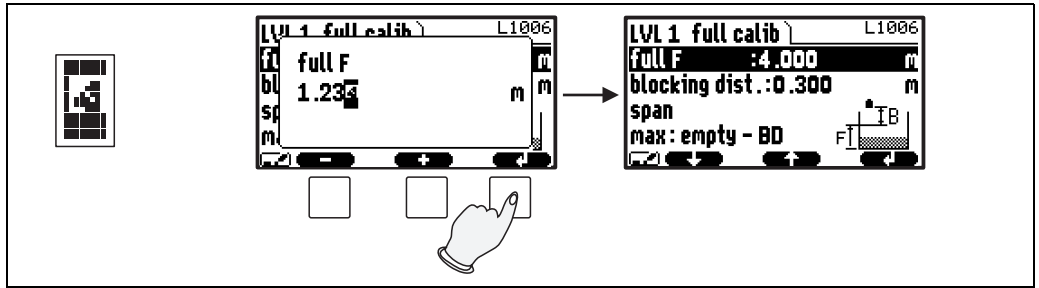

L00-FM190xxx-19-00-00-yy-044

**Escape:** The editor is closed. The parameter maintains its former value. The same behavior can be achieved by pressing the left and the middle key simultaneously ( $\square$ ).

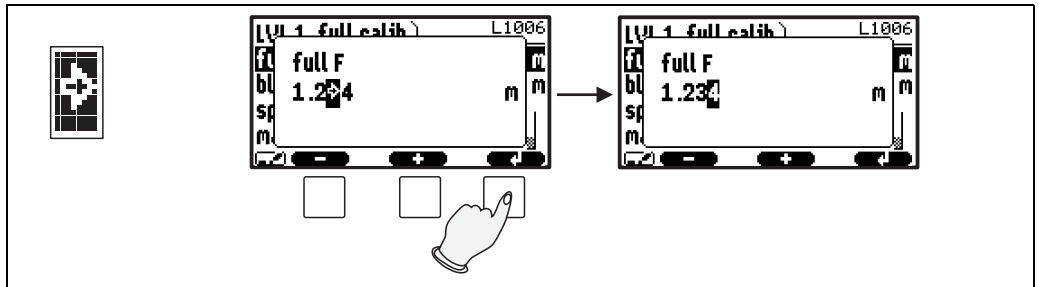

L00-FM190xxx-19-00-00-yy-045

**Next digit:** The cursor moves on to the next digit.

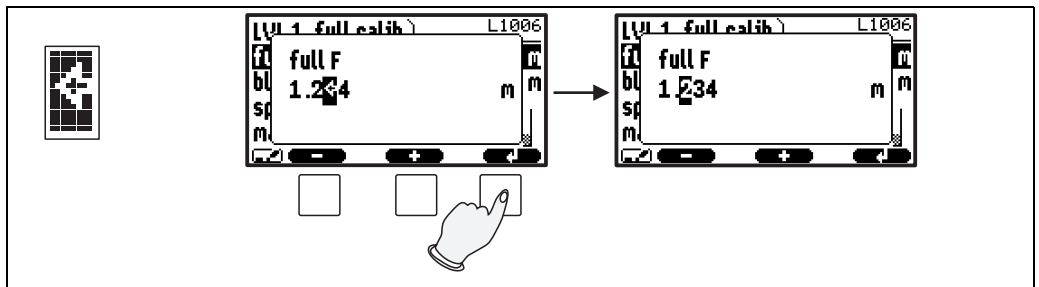

L00-FM190xxx-19-00-00-yy-046

**Previous digit:** The cursor moves back to the previous digit.

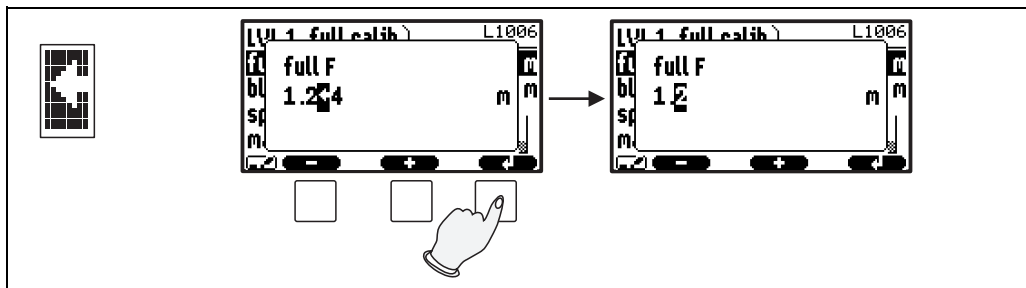

L00-FMU190xxx-19-00-00-yy-047

**Delete:** The current digit and all digits to its right are deleted.

### Return to the measured value display

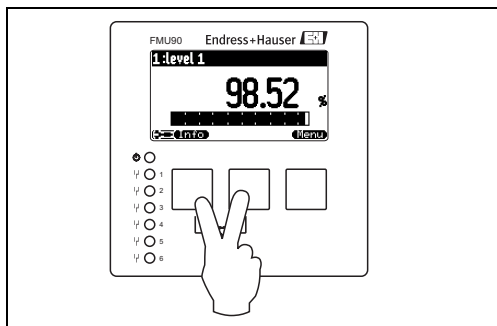

L00-FMU190xxx-19-00-00-en-048

By pressing the left and middle keys simultaneously you can return

- from a parameter to the parameter set
- from the parameter set to the submenu
- from the submenu to the main menu
- from the main menu to the measured value display



## 1.2 First setup



Note!

This chapter describes the commissioning of the Prosonic S via the display and operating module. Commissioning via ToF Tool, FieldCare or the HART handheld terminal DXR375 is similar. For further instructions refer to the ToF Tool Operating Instructions, the FieldCare Online Help or the Operating Instructions supplied with the DXR375.

After switching on the power supply for the first time, the instrument asks for a number of operating parameters:

1. Select the display language.
  - a. Press ↓ or ↑ to move the marking bar to the desired language.
  - b. Press ↵ to confirm your selection.

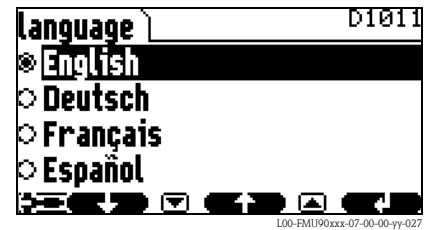

2. Select the unit for distance measurements.

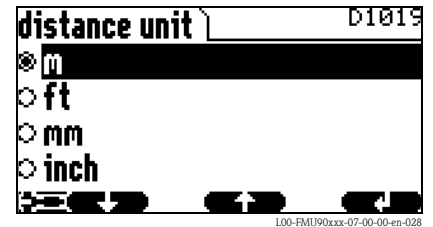

3. Select the temperature unit.

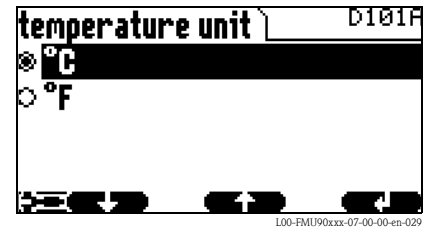

4. Select the operating mode.



Note!

The available options depend on the instrument version and the installation environment.

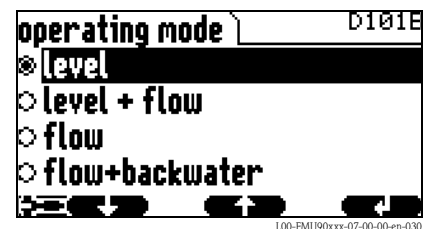

5. For level measurements:  
Select the control functions, which you are going to use.



Note!



**By pressing** you can return to the previous parameter (e.g. in order to correct the value). All these parameters can also be changed at a later point of time in the "device properties/operating parameters" and "device properties/language" parameter sets.

## 2 The "level" menu

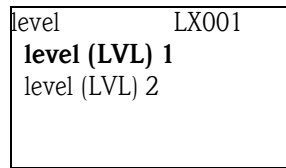
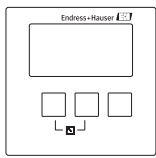

### "level" selection list

Use this list to select the level channel you are going to configure.

### 2.1 The "basic setup" submenu

#### 2.1.1 "LVL N sensor selection" (N = 1 or 2)

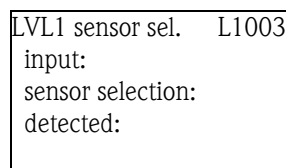
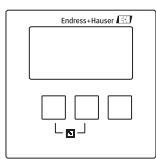

#### "input"

Use this parameter to assign a sensor to the channel.

#### Selection:

- no sensor
- sensor 1
- sensor 2 (only for 2-channel instruments)

#### "sensor selection"

Use this parameter to specify the type of the connected ultrasonic sensor.



#### Note!

- For the sensors **FDU9x** the option "automatic" is recommended (default setting). With this setting the Prosonic S recognizes the type of sensor automatically.
- For the sensors **FDU8x** the type has to be assigned explicitly. The automatic sensor recognition does not work for these sensors.



#### Caution!

After **exchanging a sensor**, observe the following:

The automatic sensor recognition is also active after a sensor has been exchanged<sup>3)</sup>. The Prosonic S recognizes the type of the new sensor automatically and changes the "detected" parameter if required. The measurement continues without a break.

Nevertheless, in order to ensure perfect measurement, the following checks are required:

- Check the **"empty calibration"** and **"full calibration"** parameters. Adjust these values if required. Take into account the blocking distance of the new sensor.
- Go to the **"distance correction"** parameter set and check the displayed distance. If required, perform a new interference echo suppression.

#### "detected" (only available for "sensor selection" = "automatic")

Indicates the type of the automatically detected sensor.

3) if the new sensor is of the type FDU9x

## 2.1.2 "LVL N application parameters" (N = 1 or 2)

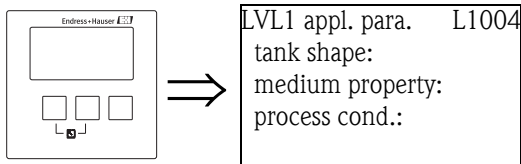

### "tank shape"

Use this parameter to specify the tank shape of your application.

#### Selection:

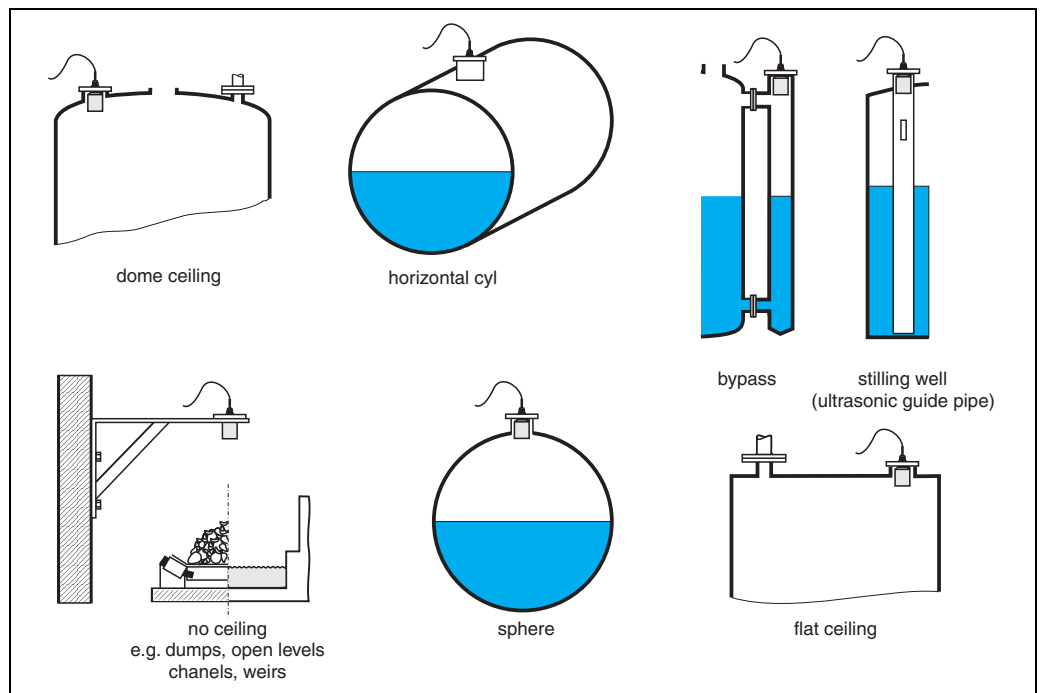

### "medium property"

Use this parameter to specify the type of medium.

#### Selection:

- liquid
- paste like
- solid < 4 mm
- solid > 4 mm
- unknown







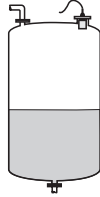
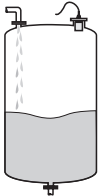

Note!

If the medium does not fit into one of the groups, select "unknown".

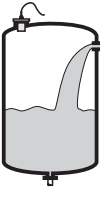
### "process conditions"

Use this parameter to specify the process conditions of your application. The filters of the signal evaluation are automatically adjusted to the selected conditions.

"process conditions"	for the following situations	Example	filter settings
standard liquid	for all fluid applications which do not fit in any of the following groups		The filters and output damping are set to average values.
calm surface	Storage tanks with immersion tube or bottom filling		The averaging filters and output damping are set to large values. -> stable measured value -> accurate measurement -> slow reaction time
turbulent surface	Storage/accumulation tanks with uneven surface due to free filling, mixing nozzles or small bottom stirrers		Special filters for stabilizing the input signal are activated. -> stable measured value -> medium reaction time
additional agitator	Moving surfaces (possibly with vortex formation) due to agitators		Special filters for stabilizing the input signal are set to large values. -> stable measured value -> medium reaction time
fast change	Rapid level change, particularly in small tanks		The averaging filters are set to small values. -> rapid reaction time -> possibly unstable measured value
standard solid	For all bulk solid applications which do not fit in any of the following groups.		The filter and output damping are set to average values.
solid dusty	Dusty bulk solids		The averaging filters are set to detect even relatively weak signals.
conveyor belt	Bulk solids with rapid level change		The averaging filters are set to small values. -> rapid reaction time -> possibly unstable measured value
test: no filter	For service and diagnosis only		All filters are switched off.

### 2.1.3 "LVL N empty calibration" (N = 1 or 2)

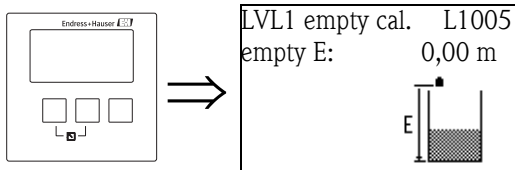

#### "empty E"

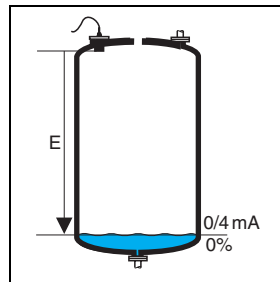

L00-FMU90xxx-19-00-00-yy-007

Use this parameter to specify the empty distance E, i.e. the distance between the sensor membrane and the minimum level (zero point).

- Default: max. measuring range of the respective sensor
- Range of values: depending on sensor type



Caution!

The zero point should not be deeper than the point at which the ultrasonic wave impinges on the tank bottom

### 2.1.4 "LVL N full calibration" (N = 1 or 2)

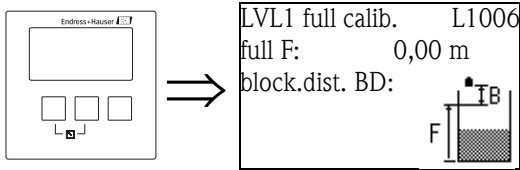

#### "full F"

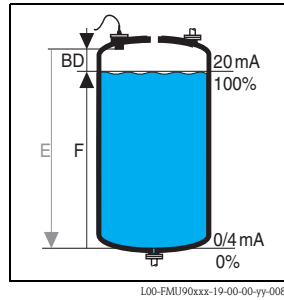

Use this parameter to specify the span F, i.e. the distance from the minimum level to the maximum level.

- Default setting: depending on sensor type
- Range of values: depending on sensor type
- blocking distance BD: depending on sensor type (see table)

Caution!

The maximum level may not project into the blocking distance:

$$F_{\max} = E - BD$$

#### "blocking distance"

Indicates the blocking distance of the respective sensor. The blocking distance is measured from the sensor membrane.

Type of sensor	blocking distance (BD)	maximum measuring distance <sup>1)</sup>
FDU90	0.07 m	3 m (for liquids)
FDU91/FDU91F	0.3 m	10 m (for liquids)
FDU92	0.4 m	20 m (for liquids)
FDU93	0.6 m	25 m (for liquids)
FDU95 - *1*** (low temperature version)	0.7 m	45 m (for solids)
FDU95 - *2*** (high temperature version)	0.9 m	45 m (for solids)
FDU96	1.6 m	70 m (for solids)
FDU80/FDU80F	0.3 m	5 m (for liquids)
FDU81/81F	0.5 m	10 m (for liquids)
FDU82	0.8 m	20 m (for liquids)
FDU83	1 m	25 m (for liquids)
FDU84	0.8 m	25 m (for solids)
FDU85	0.8 m	45 m (for solids)
FDU86	1.6 m	70 m (for solids)

1) valid for optimum process conditions

## 2.1.5 "LVL N unit" (N = 1 or 2)

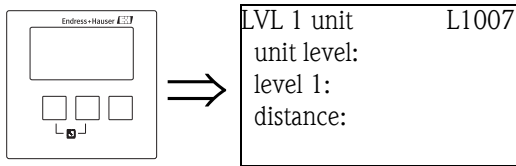

### "unit level"

Use this parameter to select the level unit.  
If no linearization is performed, the level is displayed in this unit.

#### Selection:

- m
- ft
- inch
- mm
- % (Default)



#### Caution!

After a change of the level unit, the switching points of the limit and pump control relays have to be checked and to be adjusted if required.

### "level N" (N = 1 or 2)

Displays the currently measured level F (from the zero point to the product surface) in the selected unit.

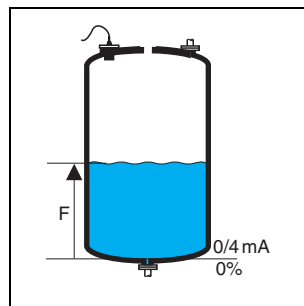

L00-FMU90xxxx-19-00-00-yy-021

### "distance"

Displays the currently measured distance D (from the sensor membrane to the product surface) in the distance unit. If the display value does not match the real distance, an interference echo suppression must be performed prior to linearization.

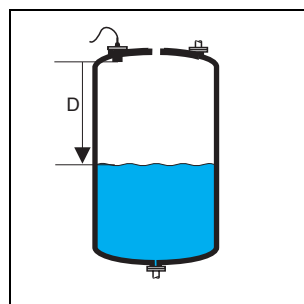

L00-FMU90xxxx-19-00-00-yy-022



Note!

The distance unit is defined during the first setup of the instrument. If required, it can be changed in the "device properties/operating params" menu.

### 2.1.6 "LVL N linearisation" (N = 1 or 2)

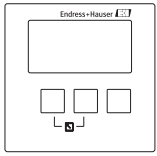

LVL 1 linearisat. L1008  
 type:  
 mode:



Note!

Number and type of the parameters in this set depend on the selected linearization type. Only the parameters "type" and "mode" are always present.

The "linearization" is used to convert the level into other quantities. Especially, it can calculate the volume or mass within a vessel of arbitrary shape. The Prosonic S provides different linearization modes for the most common types of vessels. Additionally, a linearization table for arbitrarily shaped vessels can be entered.

#### "type"

Use this parameter to select the type of linearisation.

#### Selection:

##### ■ none

In this linearization type the measured level is not converted but displayed in the selected level unit (see above, "unit level").

##### ■ linear

In this linearization type the displayed value is proportional to the measured level.

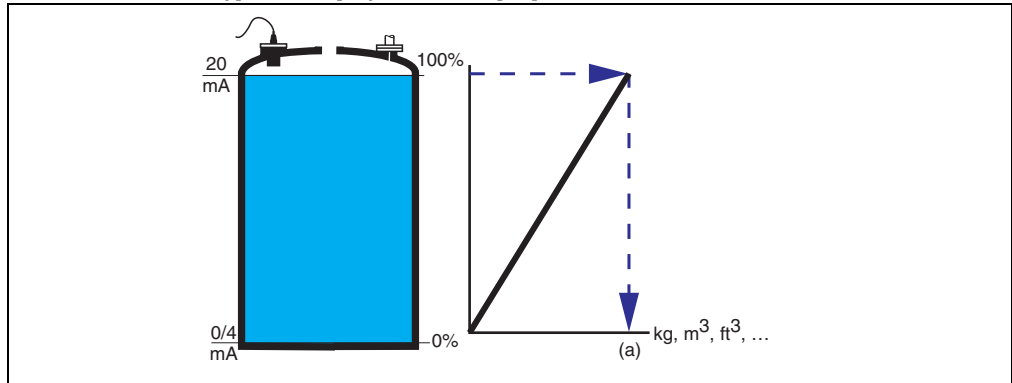

The following additional parameter have to be specified:

- the unit for the linearized value, e.g. kg, m<sup>3</sup>, ft<sup>3</sup>, ... ("**customer unit**")
- the maximum capacity (a) of the vessel, measured in the customer unit ("**maximum scale**").



- horizontal cylinder<sup>4)</sup>
- sphere

In these linearization types the measured level is converted to the volume in a horizontal cylinder or a spherical tank.

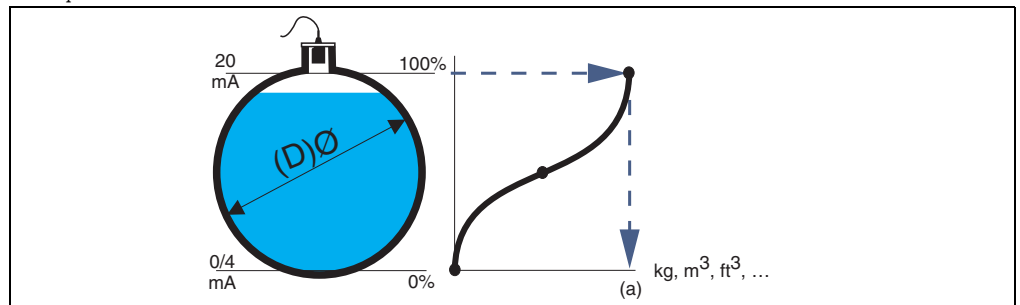

The following additional parameters have to be specified:

- the unit of the linearized value, e.g. kg, m<sup>3</sup>, ft<sup>3</sup>, ... ("**customer unit**")
- the diameter (D) of the tank ("**diameter**")
- the maximum capacity (a) of the tank, measured in the customer unit ("**maximum scale**").

- angled bottom (A)
- pyramid bottom (B)
- conical bottom (B)

In these linearisation modes the measured level is converted to the volume in the respective type of vessel.

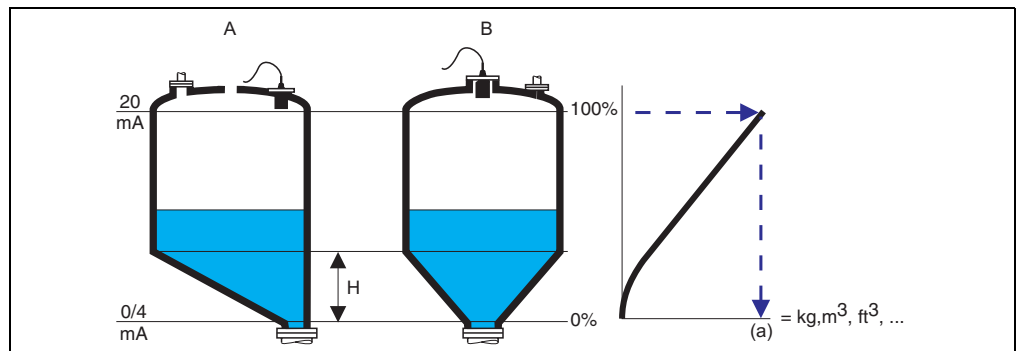

The following additional parameters have to be specified:

- the unit for the linearized value, e.g. kg, m<sup>3</sup>, ft<sup>3</sup>, ... ("**customer unit**")
- the intermediate height H according to the diagram ("**intermediate height**")
- the maximum capacity (a) of the tank, measured in the customer unit ("**maximum scale**").

4) This option is only valid for horizontal cylinders without dome ceiling. For tanks with dome ceiling ToF Tool or FieldCare can be used to calculate a linearisation table and to upload it into the instrument.

■ **table**

In this linearization mode the measured value is calculated from a linearization table. The table may consist of up to 32 pairs of values (level - volume). The table must be monotonically increasing or decreasing.

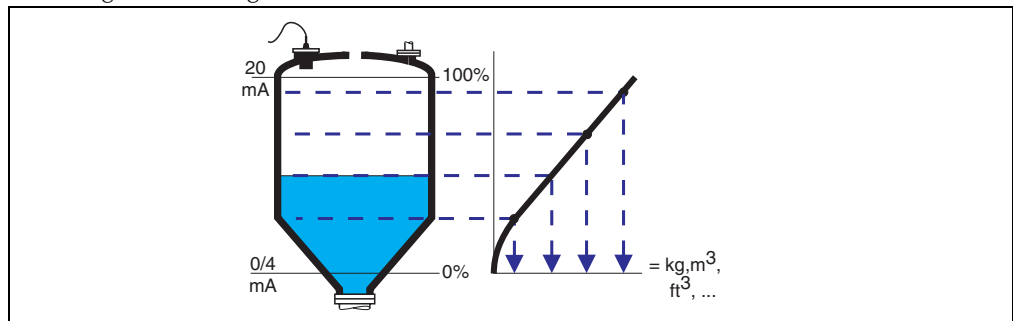

The following additional parameters have to be specified:

- the unit of the linearized value, e.g. kg, m<sup>3</sup>, ft<sup>3</sup>, ... ("**customer unit**")
- the linearization table ("**edit**")

**"customer unit"**

Use this parameter to select the desired unit for the linearized values (e.g. kg, m<sup>3</sup>, ft<sup>3</sup>, ...). This unit is only indicated on the display. It does not cause a conversion of the measured value.



Note!

After selecting the option "customer specific", the parameter "customized text" appears. An arbitrary string (consisting of up to 5 alphanumeric characters) can be entered into this parameter.

**"maximum scale"**

Use this parameter to specify the maximum content of the vessel in the customer unit.

**"diameter"**

Use this parameter to specify the diameter of the horizontal cylinder or the spherical tank respectively.

**"intermediate height"**

Use this parameter to specify the intermediate height of the vessel.

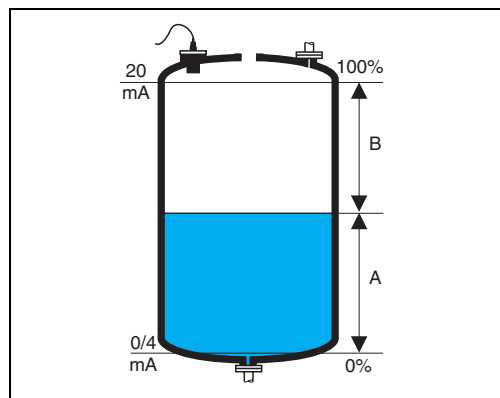
**"mode"**

Use this parameter to specify if the measurement refers to the **"level"** (A) or to the **"ullage"** (B).

### "edit"

Use this parameter to enter, change or read a linearization table. There are the following options:

- **read:**  
The table editor is opened. The existing table can be read but not changed.
- **manual:**  
The table editor is opened. Table values can be entered and changed.
- **semi-automatic:**  
The table editor is opened. The level is automatically read by the Prosonic S. The measured value (volume, weight or flow) must be entered by the user.
- **delete:**  
The linearization table is deleted.

### The table editor

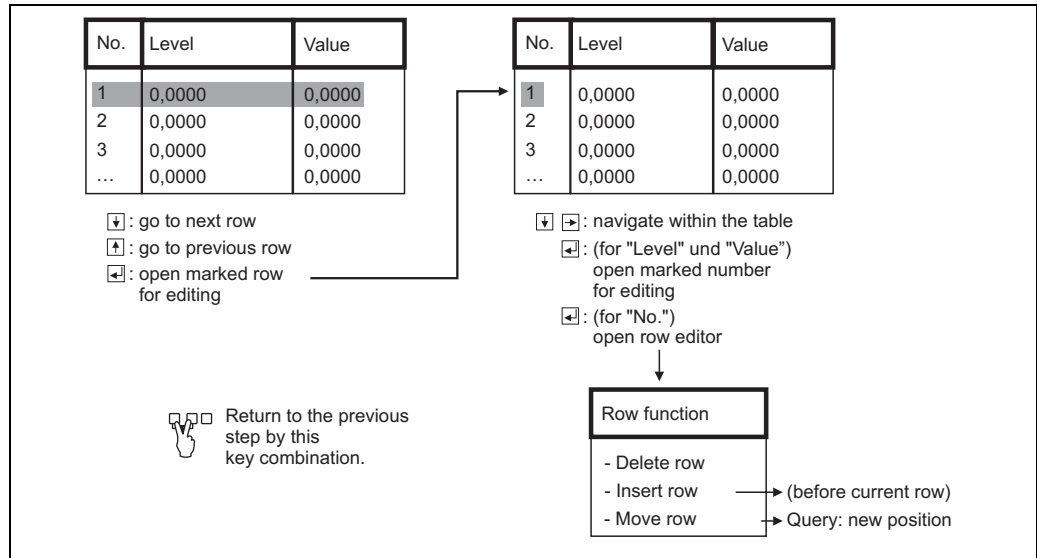

### "status table"

Use this parameter to enable or disable the linearization table.

#### Selection:

- **enabled**  
The table is used.
- **disabled**  
The table is **not** used. The measured value is transferred to the output without linearization.

### 2.1.7 Interference echo suppression: Basic principles

The "check value" and "distance mapping" parameters are used to configure the interference echo suppression of the Prosonic S.

The following picture shows the operating principle of the interference echo suppression:

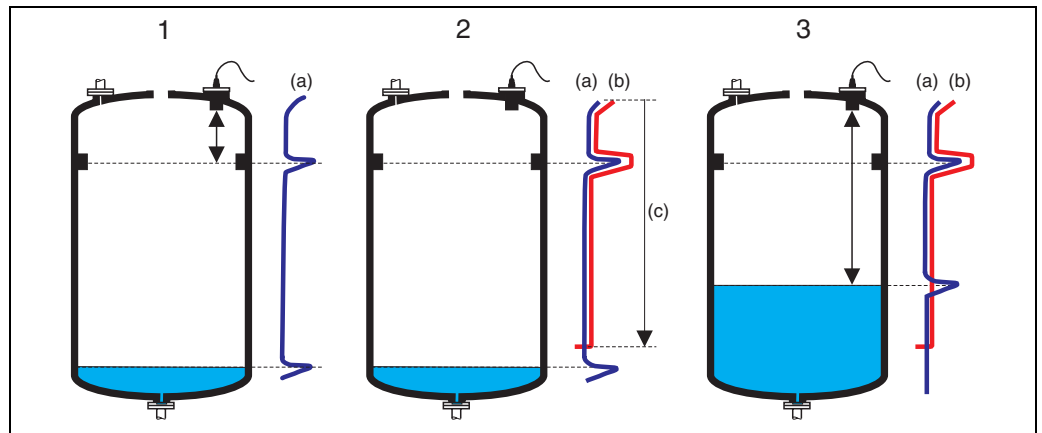

L00-FMU90xxx-19-00-00-yy-017

**1:** The envelope curve (a) contains the level echo and an interference echo. Without interference echo suppression, the interference echo is evaluated.

**2:** The interference echo suppression generates the mapping curve (b). This curve suppresses all echos within the range of mapping (c).

**3:** From now on, only those echos are evaluated, which are higher than the mapping curve. The interference echo is below the mapping curve and is therefore ignored.



Note!

In order to include all interference echos, the interference echo suppression should be performed with the level as low as possible. If during commissioning the vessel can not be sufficiently emptied, it is advisable to repeat the interference echo suppression at a later point of time (as soon as the level reaches nearly 0%).

## 2.1.8 "LVL N check value" (N = 1 or 2)

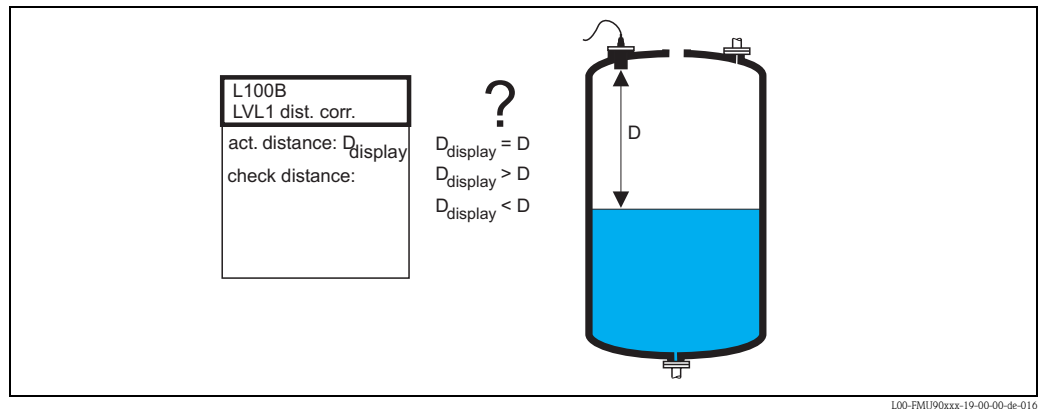
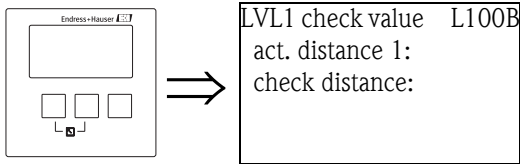

L00-FM190xxx-19-00-00-de-016

### "actual distance N" (N = 1 or 2)

Displays the currently measured distance  $D_{display}$ .

### "check distance"

Use this parameter to state if the displayed distance  $D_{display}$  matches the real distance  $D$  (measured by a rule for example). Based on your selection, the Prosonic S automatically proposes a suitable range of mapping.

You have got the following options:

#### ■ distance = ok

Choose this option if the displayed value  $D_{display}$  matches the real distance  $D$ .

After selecting this option, the Prosonic S changes to the "**LVL N distance mapping**" parameter set. The preset range of mapping is identical to  $D$ . That means: all interference echos above the current product surface will be suppressed by the mapping curve.

#### ■ distance too small

Choose this option if the displayed value  $D_{display}$  is smaller than the real distance  $D$ .

In this case the currently evaluated echo is an interference echo.

After selecting this option, the Prosonic S changes to the "**LVL N distance mapping**" parameter set. The preset range of mapping is slightly larger than  $D_{display}$ . Therefore, the currently evaluated interference echo is suppressed by the mapping curve.

If after the mapping  $D_{display}$  is still too small, repeat the mapping until  $D_{display}$  matches the real distance  $D$ .

#### ■ distance too big

Choose this option if the displayed value  $D_{display}$  exceeds the real distance  $D$ .

This error is not caused by interference echos. Therefore, no interference echo suppression is performed and the Prosonic S returns to the "level 1(2)" submenu. Check the calibration parameters, especially the "**empty calibration**" and the "**application parameters**".

#### ■ distance unknown

Choose this option if you do not know the real distance  $D$ .

In this case, an interference echo suppression can not be performed and the Prosonic S returns to the "level 1(2)" submenu.

#### ■ manual

Choose this option if you want to define the range of mapping manually.

The Prosonic S changes to the "**LVL N distance mapping**" function, where you can define the required range of mapping.

### 2.1.9 "LVL N distance mapping" (N = 1 or 2)

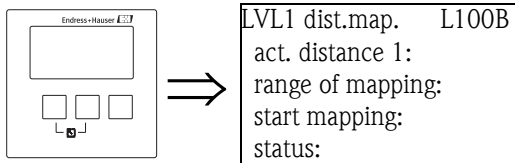

#### "actual distance N" (N = 1 or 2)

Displays the currently measured distance between the sensor membrane and the product surface. Compare this value to the real distance in order to find out if currently an interference echo is evaluated.

#### "range of mapping"

Use this parameter to specify the range of the mapping curve. Normally, a suitable value has already been entered automatically. Nevertheless, you can change this value if required.

#### "start mapping"

Select "**yes**" in this parameter in order to start the mapping. When the mapping is finished, the state is automatically changed to "**enable map**".

The "**LVL N state**" parameter set appears, in which the currently measured level and distance are displayed. Compare the displayed distance to the real distance in order to decide if a further mapping is necessary.

If yes: Press the left-arrow key (←) in order to return to the "**LVL N dist. map**" parameter set.

If no: Press the right-arrow key (→), in order to return to the "**level (LVL) N**" submenu.

#### "status"

see below, "LVL N State" parameter set

### 2.1.10 "LVL N state" (N = 1 or 2)

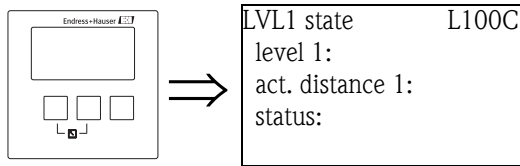

#### "level N" (N = 1 or 2)

Displays the currently measured level.

#### "act. distance N" (N = 1 or 2)

Displays the currently measured distance.

#### "status"

Use this parameter to define the status of the interference echo suppression.

- **enable map**

Choose this option in order to activate the interference echo suppression. The mapping is then used for signal evaluation.

- **disable map**

Choose this option in order to deactivate the interference echo suppression. The mapping is then no longer used for signal evaluation but it can be reactivated if required.

- **delete map**

Choose this option in order to delete the mapping. It can not be reactivated again and the instrument uses the preprogrammed default mapping.



## 2.2 The "extended calibration" submenu

### 2.2.1 "LVL N distance mapping" (N = 1 or 2)

Is identical to the "LVL N distance mapping" parameter set in the "basic setup" submenu, see above.

### 2.2.2 "LVL N check value" (N = 1 or 2)

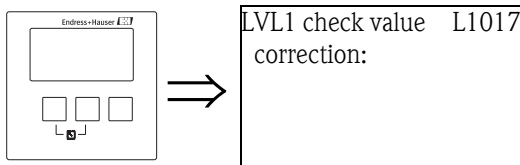

#### "correction"

This parameter can be used to shift the measured distance (between the sensor membrane and the product surface) by a constant value. The distance entered into this parameter is added to the measured distance.

### 2.2.3 "LVL N correction" (N = 1 or 2)

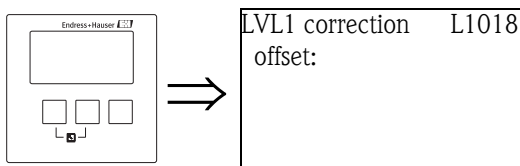

#### "offset"

This parameter can be used to shift the measured level by a constant value. The level entered into this parameter is added to the measured level.



Note!

The level correction is applied before the linearisation.

### 2.2.4 "LVL N blocking distance" (N = 1 or 2)

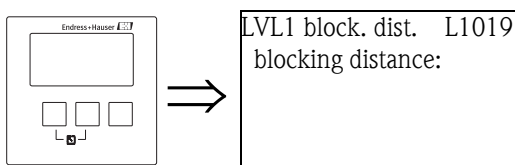

#### "blocking distance"

Indicates the blocking distance of the respective sensor.

## 2.2.5 "LVL N limitation" (N = 1 or 2)

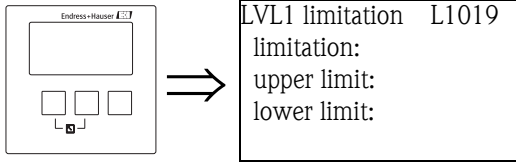

### "limitation"

Use this parameter to specify if the measured value has a lower and/or upper limit.

#### Selection:

- off
- low limit
- high limit
- low/high limit

### "upper limit"

Defines the upper limit for the measured value.  
(only available for the options "high limit" and "low/high limit")

### "lower limit"

Defines the lower limit for the measured value.  
(only available for the options "low limit" and "low/high limit")

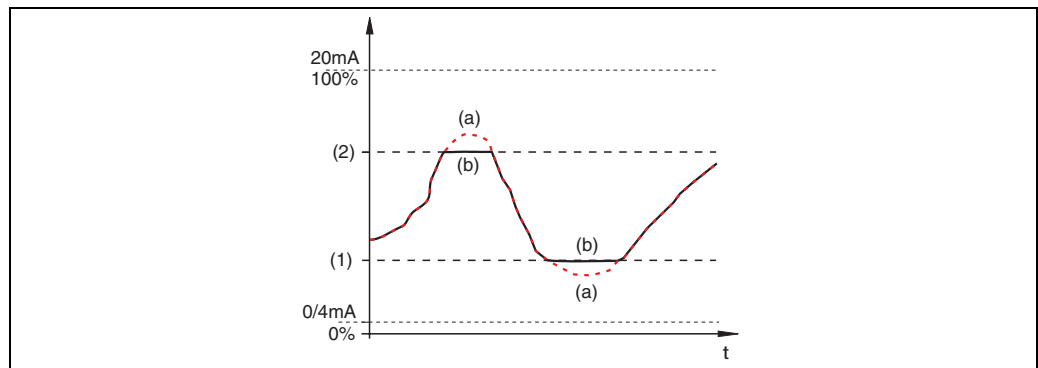

(1): lower limit; (2): upper limit  
(a): limitation switched off; (b): limitation switched on

## 2.2.6 "LVL N external input 1" "LVL N external input 2" (N = 1 or 2)

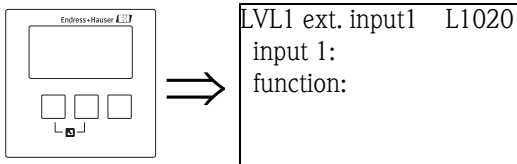

### Note!

These parameters are only available for instruments with external limit switches (FMU90-\*\*\*\*\*B\*\*\*).

These parameters are used to allocate up to 2 external limit switches to the level channel (e.g. one minimum safety and one maximum safety switch). If one of these switches gives a signal, the level assumes a specified value irrespective of the current echo signal.

### "input N" (N = 1 or 2)

This parameter allocates an external limit switch to the level channel.

#### Selection:

- **disabled (default)**  
no switch allocated
- **ext. digin 1**  
external limit switch at the terminals 71, 72, 73
- **ext. digin 2**  
external limit switch at the terminals 74, 75, 76
- **ext. digin 3**  
external limit switch at the terminals 77, 78, 79
- **ext. digin 4**  
external limit switch at the terminals 80, 81, 82

### "function"

This parameter determines which value the level assumes if the limit switch sends a signal.

#### Selection:

- **off (default)**  
no influence on the level value
- **Min (0%)**  
If the limit switch sends a signal, a level value of 0% is generated.
- **Max (100%)**  
If the limit switch sends a signal, a level value of 100% is generated.
- **hold**  
If the limit switch sends a signal, the level is held on its current value.
- **customer specific**  
If the limit switch sends a signal, the level assumes the value as defined by the customer in the "value" parameter.

### "value"

This parameter is only available for "function" = "customer specific".

It determines which value the level assumes if the limit switch sends a signal.

## 2.3 The "simulation" submenu

### 2.3.1 "LVL N simulation" (N = 1 or 2)

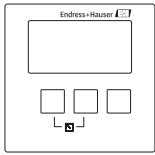

LVL1 Simulation L1022  
simulation:  
(sim. level value:)  
(sim. vol. value:)

The parameters of this set are used to simulate a level or a measured value in order to check the linearisation, the signal output and the connected switching units.

#### "simulation"

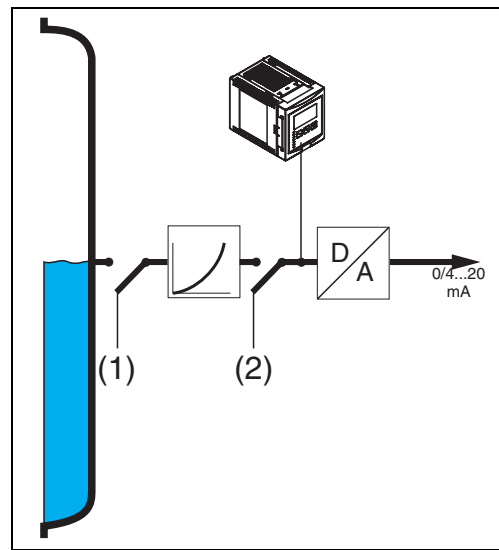

(1): simulation of level; (2): simulation of volume

Use this parameter to select the simulation mode:

- **sim off.**  
This is the normal mode used for measurement. No simulation is performed in this mode.
- **sim. level**  
After selection of this mode, the "sim. level value" parameter appears, where you can specify a level value (1). The display and the output signal assume values according to this level.  
Use this mode to check the linearisation.
- **sim. volume**  
After selection of this mode, the "siml vol. value" parameter appears, where you can specify a volume value (2). The output assumes a value according to this volume.  
Use this mode to check the signal output and the connected switching units.

#### Note!

An error message is generated as long as one of the modes "sim. level" or "sim. volume" is active.

#### "sim. level value"

This parameter is available for a level simulation. It is used to specify the desired level value. The display and the output signal assume values according to this level.

#### "sim. vol. value"

This parameter is available for a volume simulation (more general: a simulation of the linearized value). It is used to specify the desired volume (or linearized value). The output signal assumes a value according to this volume.

### 3 The "flow" menu

The "flow" submenu is used for the calibration of

- flow measurements (1 or 2 channels)
- back water alarm
- flow counters

The structure of the submenu depends on the selected operating mode<sup>5)</sup>:

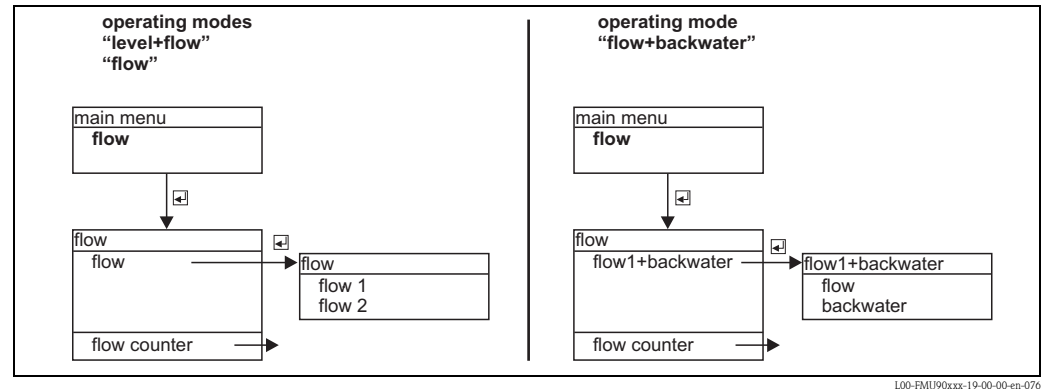

Always start by calibrating the first flow channel ("flow 1" submenu).

Thereafter, you can calibrate the following as required:

- the second flow channel ("flow 2" submenu)
- the backwater detection ("backwater" submenu)
- the flow counters ("flow counter" submenu)

#### 3.1 The "flow N" submenu (N = 1 or 2)

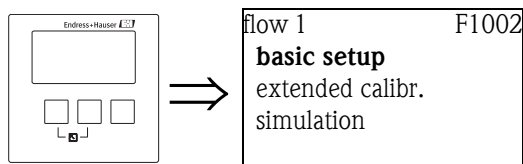

Note!

The "flow 2" submenu is only available for instruments with 2 sensor inputs. It is identical to the "flow 1" submenu.

5) The operating mode is selected during the first setup. Nevertheless, it can be changed at any time if required ("device properties" menu, "operating params" submenu, "operating mode" parameter set).

### 3.1.1 The "basic setup" submenu

#### "flow N sensor selection" (N = 1 or 2)

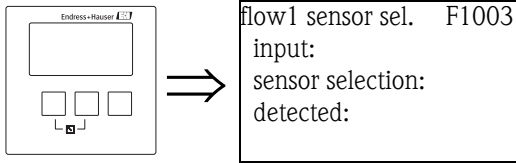

##### "input"

Use this parameter to allocate a sensor to the channel.

##### Selection

- no sensor
- sensor 1
- sensor 2 (for instruments with 2 sensor inputs)
- average level<sup>6)</sup>

##### "sensor selection"

Use this parameter to specify the type of the connected ultrasonic sensor.



##### Note!

- For the sensors **FDU9x**, the option "automatic" is recommended (default setting). With this setting the Prosonic S recognizes the type of sensor automatically.
- For the sensors **FDU8x**, the type has to be assigned explicitly. The automatic sensor recognition does not work for these sensors.



##### Caution!

After exchanging a sensor, observe the following:

The automatic sensor recognition is also active if a sensor has been exchanged<sup>7)</sup>. The Prosonic S recognizes the type of the new sensor automatically and changes the "detected" parameter to fit the new sensor. The measurement continues without break.

Nevertheless, in order to ensure perfect measurement, the following checks are required:

- Check the **"empty calibration"** parameter. Adjust this value if required. Take into account the blocking distance of the new sensor.
- Go to the **"flow N check value"** parameter set and check the displayed distance. If required, perform a new interference echo suppression.

##### "detected" (only available for "sensor selection" = "automatic")

Indicates the type of the automatically detected sensor.

#### "flow N linearization" (N = 1 or 2)

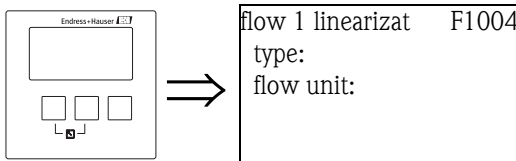

##### Note!

The selected linearization type determines which parameters are present.

Only the parameters "type" and "flow unit" are always present.

6) This option is only available if two level measurements have been calibrated. This is only possible for the "leve+flow" operating mode and a two channel instrument.

7) if the sensor is of the type FDU9x.

The "linearization" parameter set is used to calculate the flow from the measured level. The Prosonic S provides the following linearization types:

- pre-programmed flow curves for commonly used flumes and weirs
- a freely editable linearization table (up to 32 points)
- a flow formula  $Q = C(h^\alpha + \gamma h^\beta)$  with freely selectable parameters



Caution!

Flow measurement **always** requires a linearization.

"type"

Use this parameter to select the type of linearization.

**Selection:**

■ **none**

No flow linearization is performed.



Note!

If this option has been selected, nor further parameters are available. A flow measurement is only possible with one of the other options.

■ **flume/weir**

In this type, the linearization is performed according to a preprogrammed linearization curve. The type of curve is selected in the "**curve**" parameter. Additionally, the "**flow unit**" has to be specified. The "**max. flow**" parameter displays the max. flow of the respective flume or weir. If required, this value can be adjusted (as well as the "**width**" of the weir).

■ **table**

In this type, a linearization table consisting of up to 32 pairs of values "level - flow" is used. Additionally, the "**flow unit**" has to be specified. To enter and activate the table use the "**edit**" and "**status table**" parameters.

■ **formula**

In this type, the linearization is performed according to the formula  
 $Q = C(h^\alpha + \gamma h^\beta)$ .

The "**alpha**", "**beta**", "**gamma**" and "**C**" parameters appear, which are used to specify the details of the curve. Additionally, the "**flow unit**" and the "**max. flow**" of the weir or flume have to be specified.

"flow unit"

Use this parameter to select the desired flow unit.



Note!

After a change of the flow unit, the switching points of the limit relays have to be checked and adjusted if required.

"curve"

This parameter is available for the "**flume/weir**" linearization type.

It is used to select the type of flume or weir. After the selection, a second list appears with different sizes of the flume or weir<sup>8)</sup>. When you have confirmed your selection, the Prosonic S returns to the "**linearization**" function.

"width"

This parameter appears for the curves "**rectangular weir**", "**NFX**" and "**trapezoidal weir**". It is used to specify the width of the respective weir.

"edit"

This parameter is used to enter or to view the linearization table. You have got the following options:

8) Tables of the flume and weir parameters can be found in the Appendix.

- **read:**  
The table editor appears. An existing table can be viewed but not changed.
- **manual:**  
The table editor appears. Table values can be entered and changed.
- **delete:**  
The linearization table is deleted.

*The table editor*

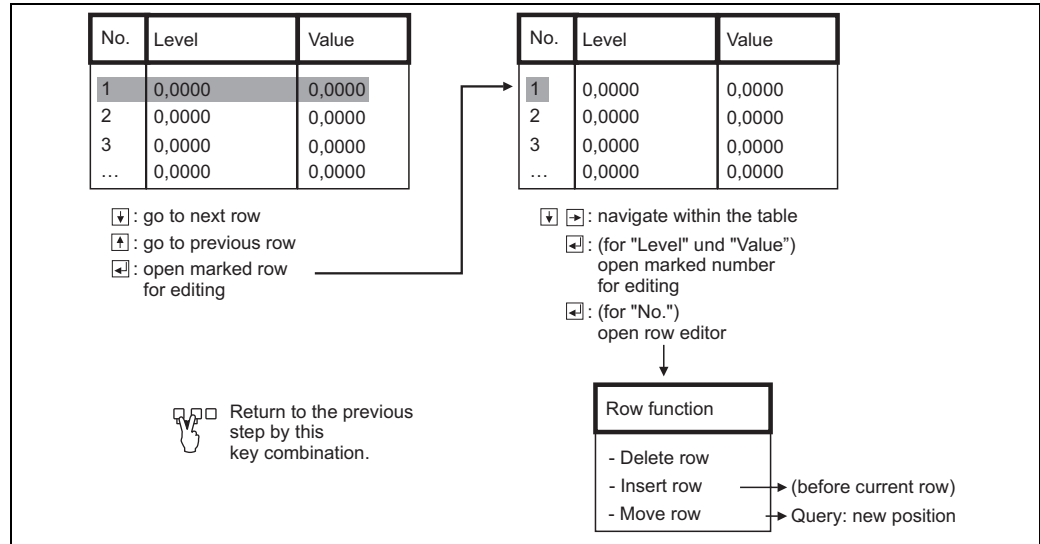

L00-FM190xxx-19-00-00-de-006

*"status"*

Use this parameter to specify if the linearization table is to be used or not.

**Selection:**

- **enabled**  
The table is used.
- **disabled**  
The table is not used. A flow value is not calculated.

*"alpha", "beta", "gamma" and "C"*

These parameters are available for the **"formula"** linearization type. They are used to specify the parameters of the flow formula:

$$Q = C(h^\alpha + \gamma h^\beta)$$

*"max flow"*

This parameter is available for the linearization types **"flume/weir"** and **"formula"**. It is used to specify the maximum flow of the respective weir or flume. For each of the preprogrammed curves, a default value is preset. However, this value can be adjusted, e.g. if the weir/flume is applied for lower flows. The maximum flow corresponds to an output current of 20 mA.



**"flow N empty calibration" (N = 1 or 2)**

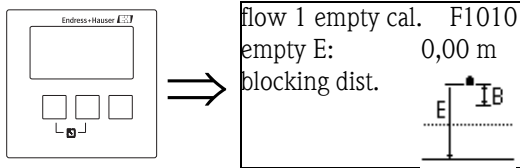

**"empty E"**

Use this parameter to enter the empty distance E, i.e. the distance between the sensor membrane and the zero point of the flume or weir.

For flumes, the zero point is the bottom of the flume at the narrowest position:

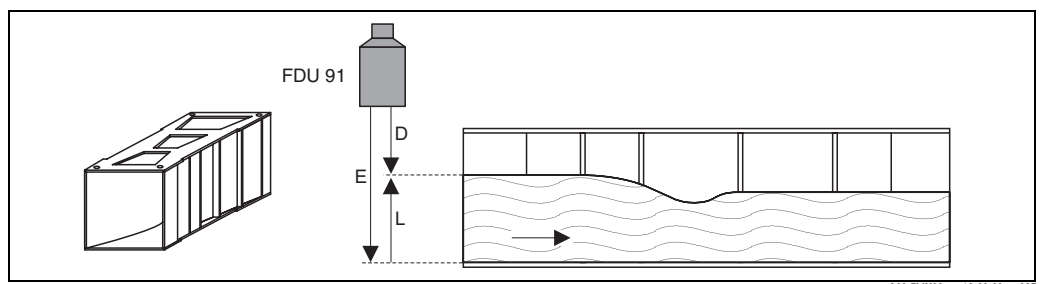

Example: Khafagi-Venturi flume  
**E:** empty distance; **D:** measured distance; **L:** level

For weirs, the zero point is the lowest point of the weir crest:

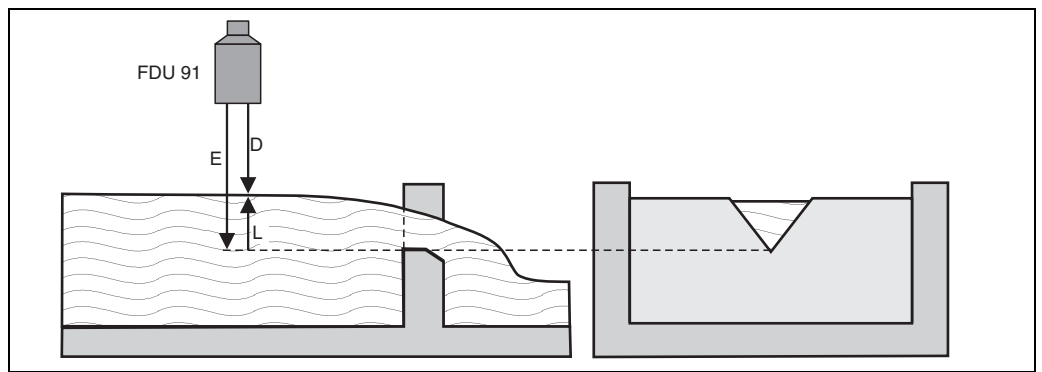

Example: Triangular weir  
**E:** empty distance; **D:** measured distance; **L:** level

**"blocking distance"**

Indicates the blocking distance of the respective sensor. The blocking distance is measured from the sensor membrane. The maximum level may not project into the blocking distance.

Type of sensor	blocking distance (BD)	maximum measuring distance <sup>1)</sup>
FDU90	0.07 m	3 m (for liquids)
FDU91/FDU91F	0.3 m	10 m (for liquids)
FDU92	0.4 m	20 m (for liquids)
FDU93	0.6 m	25 m (for liquids)

Type of sensor	blocking distance (BD)	maximum measuring distance <sup>1)</sup>
FDU95 - *1*** (low temperature version)	0.7 m	45 m (for solids)
FDU95 - *2*** (high temperature version)	0.9 m	45 m (for solids)
FDU96	1.6 m	70 m (for solids)
FDU80/FDU80F	0. m	5 m (for liquids)
FDU81/81F	0.5 m	10 m (for liquids)
FDU82	0.8 m	20 m (for liquids)
FDU83	1 m	25 m (for liquids)
FDU84	0.8 m	25 m (for solids)
FDU85	0.8 m	45 m (for solids)
FDU86	1.6 m	70 m (for solids)

1) valid for optimum process conditions

### "flow N" (N = 1 or 2)

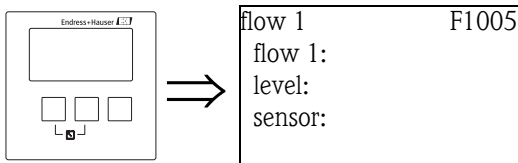

#### "flow N" (N = 1 or 2)

Displays the currently measured flow Q.

If the displayed value does not match the real flow, it is recommended to check the linearisation.

#### "level"

Displays the currently measured level L.

If the displayed value does not match the real level, it is recommended to check the empty calibration.

#### "sensor"

Displays the currently measured distance D between the sensor membrane and the liquid surface.

If the displayed value does not match the real distance, it is recommended to perform an interference echo suppression.

### Interference echo suppressio: Basic principles

The "flow N check value" and "flow N mapping" parameter sets are used to configure the interference echo suppression of the Prosonic S.

The following picture shows the operating principle of the interference echo suppression:

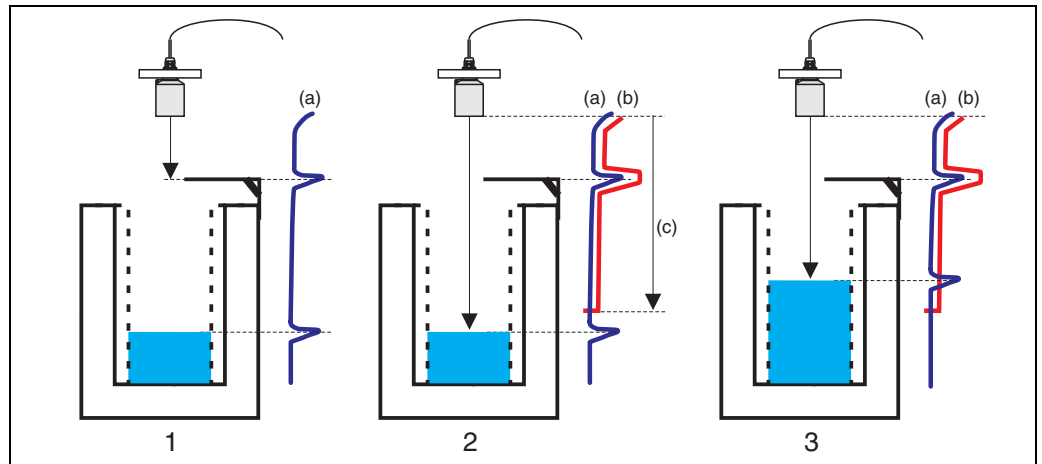

L00-FMU190xxx-19-00-00-yy-030

**1:** The envelope curve (a) contains the level echo and an interference echo. Without interference echo suppression, the interference echo is evaluated.

**2:** The interference echo suppression generates the mapping curve (b). This curve contains all echos which are located within the range of mapping (c).

**3:** From now on, only those echos are evaluated, which are higher than the mapping curve. The interference echo is ignored because it is lower than the mapping curve.



Note!

In order to include all interference echos, the interference echo suppression should be performed with the level as low as possible. If during the commissioning the channel can not be sufficiently emptied, it is advisable to repeat the interference echo suppression at a later point of time (as soon as the level reaches nearly 0%).

### "flow N check value" (N = 1 or 2)

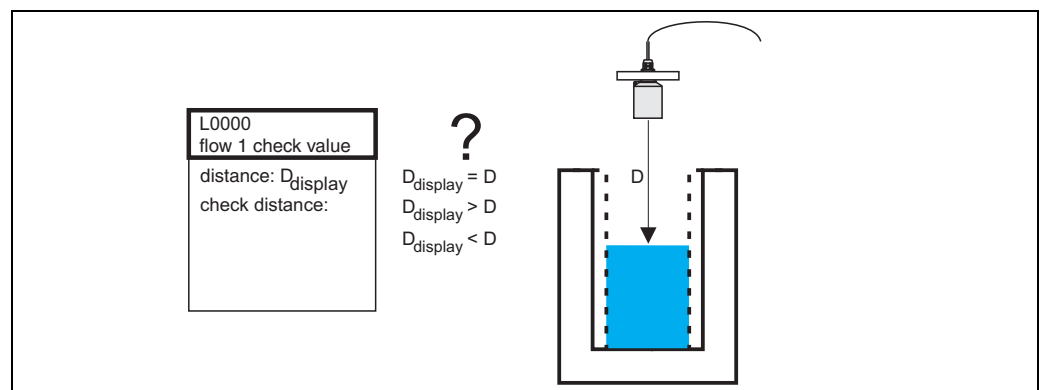
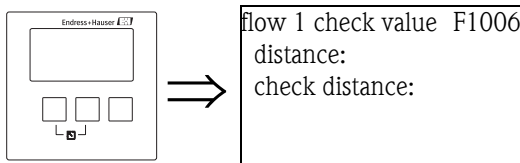

L00-FMU190xxx-19-00-00-de-031

*"distance"*

Displays the currently measured distance  $D_{display}$ .

*"check distance"*

Use this parameter to state if the displayed distance  $D_{display}$  matches the real distance  $D$ . Based on your selection, the Prosonic S automatically proposes a suitable range of mapping.

You have got the following options:

■ **distance = ok**

Choose this option if the displayed value matches the real distance.

After selecting this option, the **"flow N mapping"** parameter set appears. The preset range of mapping is equal to  $D$ . That means: all interference echos which are above the current product surface will be mapped out in the interference echo suppression.

■ **distance too small**

Choose this option if the displayed value is smaller than the real distance  $D$ .

In this case, the currently evaluated echo is an interference echo.

After selecting this option, the **"flow N mapping"** parameter set appears. The preset range of mapping is slightly larger than  $D_{display}$ . Therefore, the currently evaluated interference echo will be mapped out by the interference echo suppression.

■ **distance too big**

Choose this option if the displayed value  $D_{display}$  is larger than the real distance  $D$ .

This error is not caused by interference echos. Therefore, no interference echo suppression is performed and the Prosonic S returns to the "flow N" parameter set. Check the calibration parameters, especially the **"empty calibration"**.

■ **distance unknown**

Choose this option if you do not know the real distance  $D$ .

In this case, an interference echo suppression can not be performed and the Prosonic S returns to the "flow N" parameter set.

■ **manual**

Choose this option if you want to define the range of mapping manually.

The **"flow N mapping"** parameter set appears, where you can define the required range of mapping.

**"flow N mapping" (N = 1 or 2)**

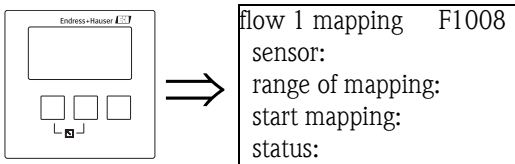

*"sensor"*

Displays the currently measured distance between the sensor membrane and the water surface. Compare this value to the real distance in order to find out if currently an interference echo is evaluated.

*"range of mapping"*

Use this parameter to specify the range of the mapping curve. Normally, a suitable value has already been entered automatically. Nevertheless, you can change this value if required.

*"start mapping"*

Select **"yes"** in this parameter in order to start the mapping. When the mapping is finished, the state is automatically changed to **"enable map"**.

The **"flow N state"** parameter set appears, in which the currently measured level, distance and flow are displayed. Compare the displayed distance to the real distance in order to decide if a further mapping is necessary.

If yes: Press the left-arrow key (←) in order to return to the "flow N mapping" parameter set.

If no: Press the right key (→) in order to return to the "flow N" submenu.

*"status"*

see below ("flow N status")

### **"flow N state" (N = 1 or 2)"**

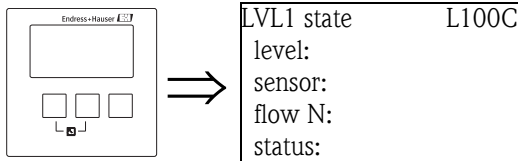

*"level"*

Displays the currently measured level.

*"sensor"*

Displays the currently measured distance between the sensor membrane and the liquid surface.

*"flow N" (N = 1 or 2)*

Displays the currently measured flow.

*"status"*

Use this parameter to define the status of the interference echo suppression.

- **enable map**

Choose this option in order to activate the interference echo suppression. The mapping is then used for signal evaluation.

- **disable map**

Choose this option in order to deactivate the interference echo suppression. The mapping is then no longer used for signal evaluation but it can be reactivated if required.

- **delete map**

Choose this option in order to delete the mapping. It can not be reactivated again and the instrument uses the preprogrammed default mapping.

### 3.1.2 The "extended calibration" submenu

#### "flow N mapping" (N = 1 or 2)

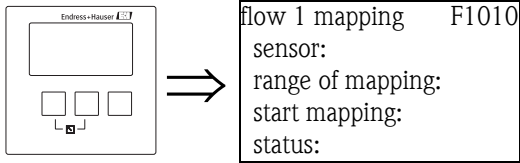

Is identical to the "flow N mapping" parameter set in the "basic setup" submenu, see page 44.

#### "flow N low cut off" (N = 1 or 2)

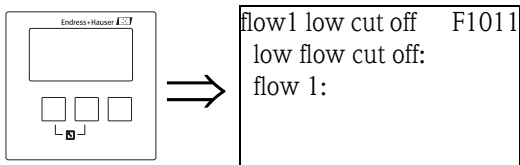

##### "low flow cut off"

Use this function to enter a lower limit for the flow (percentage of the "maximum flow"). If the flow falls below this cut off limit, it is not taken into account for the flow counters (which are parameterized in the "flow counter" submenu, see below).

##### "flow N" (N = 1 or 2)

Displays the currently measured flow.

#### "flow N distance correction"

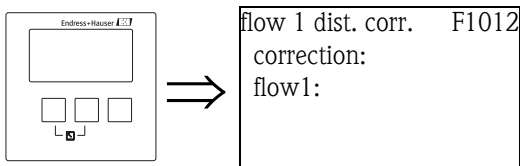

##### "correction"

This parameter can be used to shift the measured distance (from the sensor membrane to the water surface) by a constant value. The distance entered into this parameter is added to the measured distance.

##### "flow N" (N = 1 or 2)

Displays the currently measured flow in order to show the influence of the distance correction on the flow.

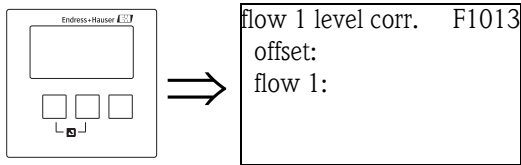
**"flow N level correction" (N = 1 or 2)****"offset"**

This parameter can be used to shift the level by a constant value. The level entered into this parameter is added to the measured level.

**"flow N" (N = 1 or 2)**

Displays the currently measured flow in order to show the influence of the level correction on the flow.

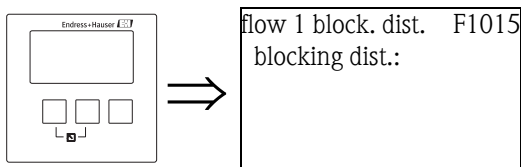
**"flow N blocking distance" (N = 1 or 2)****"blocking distance"**

Displays the blocking distance of the connected sensor.

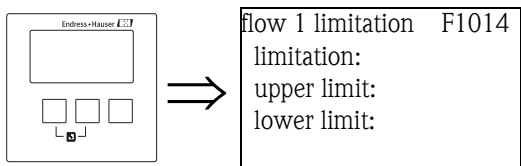
**"flow N limitation" (N = 1 or 2)****"limitation"**

Use this parameter to specify if the measured value has a lower and/or upper limit.

**Selection:**

- off
- low limit
- high limit
- low/high limit

**"upper limit"**

Defines the upper limit for the measured value.  
(only available for the options "high limit" and "low/high limit")

*"lower limit"*

Defines the lower limit for the measured value.  
(only available for the options "low limit" and "low/high limit")

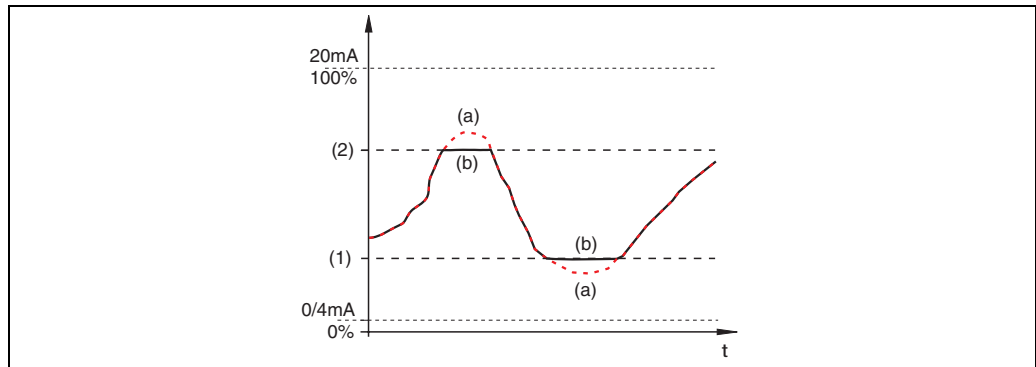

100-FMU90xxx-19-00-00-yy-019

**(1):** lower limit; **(2):** upper limit  
**(a):** limitation switched off; **(b):** limitation switched on



"flow N external input 1"  
 "flow N external input 2"  
 (N = 1 or 2)

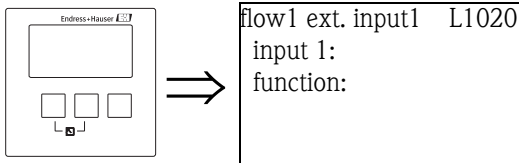

Note!

These parameters are only available for instruments with external limit switches (FMU90-\*\*\*\*\*B\*\*\*).

These parameters are used to allocate up to 2 external limit switches to the flow channel (e.g. one minimum safety and one maximum safety switch). If one of these switches gives a signal, the flow assumes a specified value irrespective of the current echo signal.

"input N" (N = 1 or 2)

This parameter allocates an external limit switch to the flow channel.

**Selection:**

- **disabled (default)**  
no switch allocated
- **ext. digin 1**  
external limit switch at the terminals 71, 72, 73
- **ext. digin 2**  
external limit switch at the terminals 74, 75, 76
- **ext. digin 3**  
external limit switch at the terminals 77, 78, 79
- **ext. digin 4**  
external limit switch at the terminals 80, 81, 82

"function"

This parameter determines which value the flow assumes if the limit switch sends a signal.

**Selection:**

- **off (default)**  
no influence on the flow value
- **Min (0%)**  
If the limit switch sends a signal, a flow value of 0% is generated.
- **Max (100%)**  
If the limit switch sends a signal, the maximum flow value of the respective flume or weir is generated.
- **hold**  
If the limit switch sends a signal, the flow is held on its current value.
- **customer specific**  
If the limit switch sends a signal, the flow assumes the value as defined by the customer in the "value" parameter.

"value"

This parameter is only available for "function" = "customer specific".  
 It determines which value the flow assumes if the limit switch sends a signal.

### 3.1.3 The "simulation" submenu

#### "flow N simulation" (N = 1 or 2)

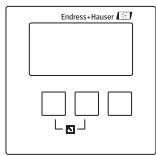

flow 1 simulation F1020  
simulation:  
(sim. level value:)  
(sim. flow value:)

The parameters of this set are used to simulate a level or a flow in order to check the linearisation, the signal output and the connected switching units.

#### "simulation"

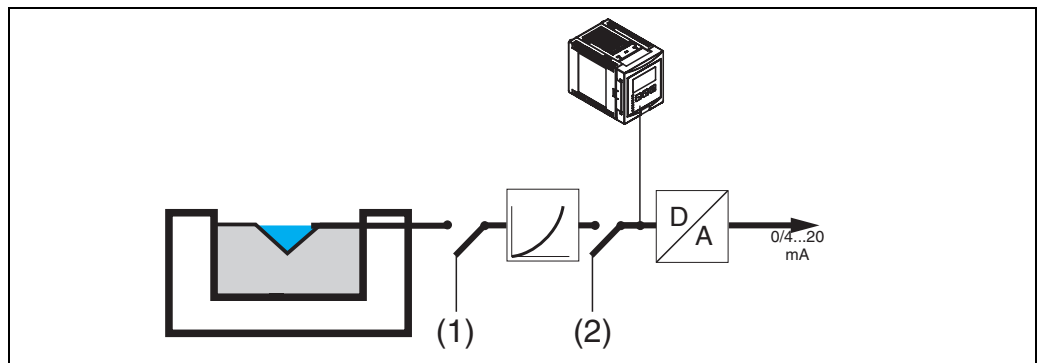

L00-FMU90xxxx-19-00-00-yy-032

Use this parameter to select the simulation mode:

- **sim. off**

This is the normal mode used for measurement. No simulation is performed in this mode.

- **sim. level**

After selection of this mode, the "sim. level value" parameter appears, where you can specify a level value (1). The display and the output signal assume values according to this level.

Use this mode to check the linearization.

- **flow**

After selection of this mode, the "sim. flow value" parameter appears, where you can specify a flow value (2). The output signal assumes a value according to this flow.

Use this mode to check the signal output and the connected switching units.



Note!

An error message is generated as long as one of the modes "sim. level" or "flow" is active.

#### "sim. level value"

This parameter is available for a level simulation. It is used to specify the desired level value. The display and the output signal assume values according to this level.

#### "sim. flow value"

This parameter is available for a flow simulation. It is used to specify the desired flow value. The output signal assumes a value according to this flow.

## 3.2 The "backwater" submenu

### 3.2.1 Basics

The flow measurement can be impaired by backwater on the downstream side or by dirt within the flume. The backwater and dirt detection function can detect these errors and ensure that the Prosonic S reacts appropriately.

Two sensors are required for backwater and dirt detection. The first sensor is mounted above the upstream water, the second above the downstream water. The Prosonic S evaluates the ratio of the downstream level  $h_2$  and the upstream level  $h_1$ .

#### Backwater detection

Backwater is detected if the ratio  $h_2/h_1$  exceeds a critical value (typically 0,8 for Venturi flumes). In this case, the flow is continuously reduced to 0. An alarm relay can be configured which indicates the backwater alarm.

#### Dirt detection

Dirt within the flume is detected if the ratio  $h_2/h_1$  falls below a critical value (typically 0,1). An alarm relay can be configured which indicates the dirt alarm.

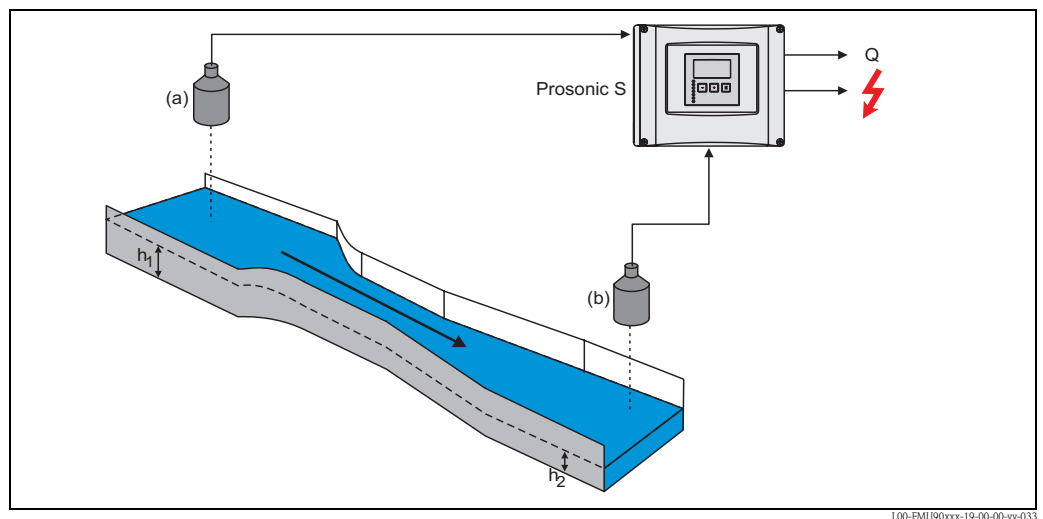

(a): Upstream sensor; (b): Downstream sensor



Note!

The ultrasonic sensor for the measurement of the downstream water level should be installed at a sufficient distance from the discharge of the flume. The measuring point must be selected in such a way that the surface of the water is calmed down and the level is not influenced by the flume anymore.

### 3.2.2 The "basic setup" submenu

#### "backwater sensor selection"

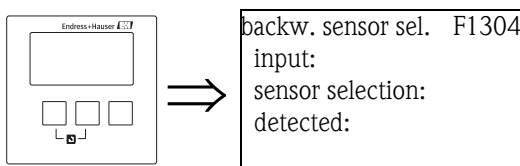

*"input"*

Use this parameter to allocate the downstream sensor to the channel.  
The available options depend on the instrument version and the connected sensors.

*"sensor selection"*

Use this parameter to specify the type of the connected ultrasonic sensor.



Note!

- For the sensors **FDU9x**, the option "automatic" is recommended (default setting). With this setting the Prosonic S recognizes the type of sensor automatically.
- For the sensors **FDU8x**, the type has to be assigned explicitly. The automatic sensor recognition does not work for these sensors.



Caution!

After exchanging a sensor, observe the following:

The automatic sensor recognition is also active if a sensor has been exchanged<sup>9)</sup>. The Prosonic S recognizes the type of the new sensor automatically and changes the "detected" parameter to fit the new sensor. The measurement continues without break.

Nevertheless, in order to ensure perfect measurement, the following checks are required:

- Check the **"backwater empty calibration"**. Adjust this value if required. Take into account the blocking distance of the new sensor.
- Go to the **"backwater check value"** parameter and check the displayed distance. If required, perform a new interference echo suppression.

*"detected" (only available for "sensor selection" = "automatic")*

Indicates the type of the automatically detected sensor.

**"backwater empty calibration"**

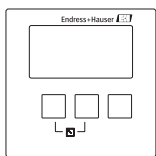

```
backw. empty cal. F1305
empty E:
blocking dist.:
```

*"empty E"*

Use this parameter to enter the empty distance for the downstream sensor.

*"blocking distance"*

Displays the blocking distance BD of the downstream sensor.

---

9) if the sensor is of the type FDU9x.

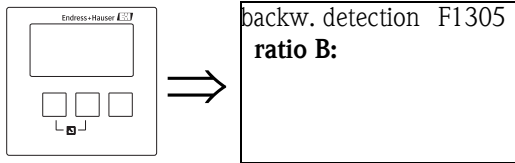
**"backwater detection"****"ratio B"**

Use this parameter to specify the upper limit for the ratio  $h_2/h_1$ .

If during the measurement the ratio exceeds this limit, the backwater alarm becomes active, i.e.:

- the warning W 00 692 appears
- the backwater alarm relay is de-energized<sup>10)</sup>
- if the backwater level continues to rise, the flow (indicated on the display and registered by the counters) is continuously reduced to 0.

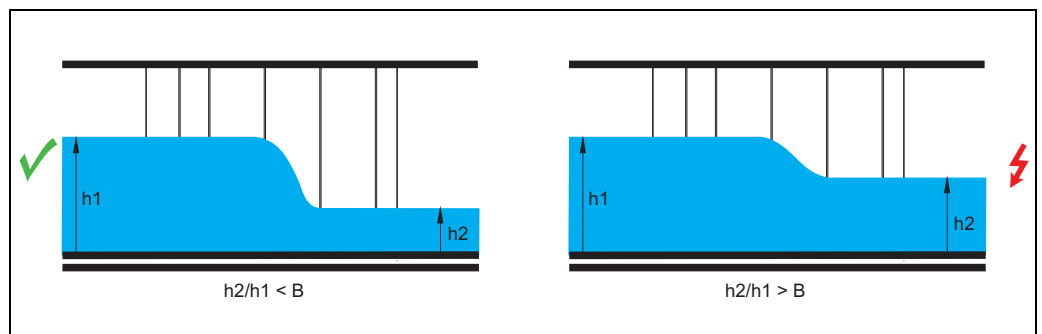

L00-FM1/90xxxx-19-00-00-yy-035

**Note!**

The default setting is  $B = 0,8$ .

This is the optimum value for Venturi flumes. To ensure reliable measurement it should not be exceeded.

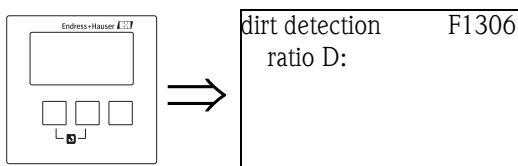
**"dirt detection"****"ratio D"**

Use this parameter to specify the lower limit for the ratio  $h_2/h_1$ .

If during the measurement the ratio falls below this level, the dirt alarm becomes active, i.e.

- the warning W 00 693 appears
- the dirt alarm relay is de-energized<sup>11)</sup>.

10) In the "relay/controls" menu, one of the relays can be defined to be the backwater alarm relay.

11) In the "relay/controls" menu, one of the relays can be defined to be the dirt alarm relay

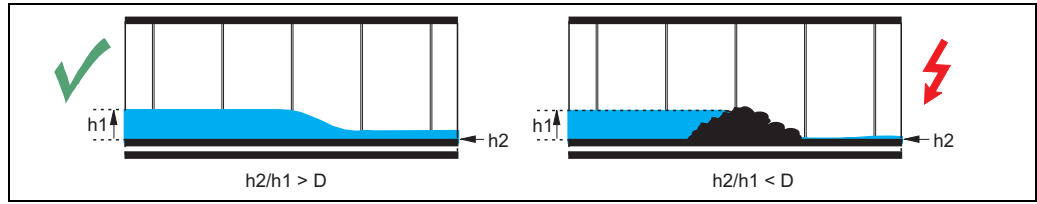

L00-FM190xxx-19-00-00-yy-036

**"backwater"**

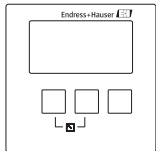

backwater F1307  
 act. backw. level:  
 act. flow level:  
 actual ratio:  
 flow 1:

The following is displayed in this parameter set:

- the current backwater level  $h_2$  (downstream level)
- the current flow level  $h_1$  (upstream level)
- the current ratio  $h_2/h_1$
- the current flow  $Q$

Use these values to check the flow calibration as well as the calibration of the backwater and dirt detection.

**"backwater check value"**

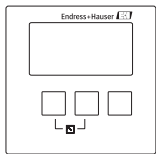

backw check value F1308  
 distance:  
 check distance:

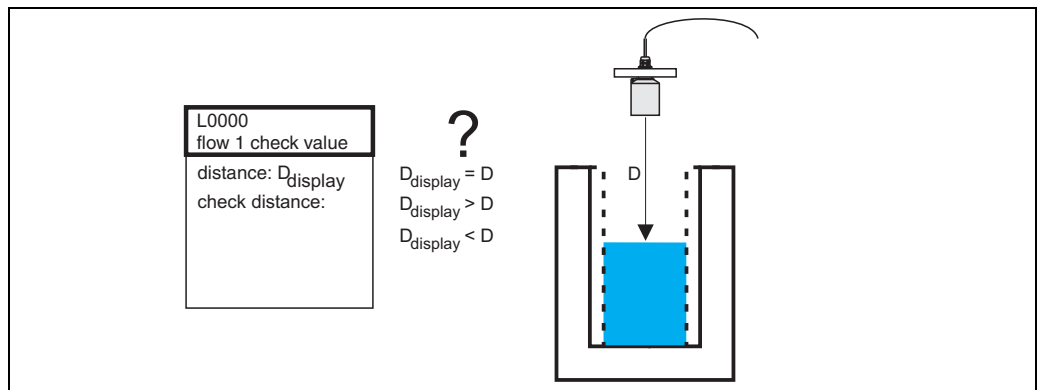

L00-FM190xxx-19-00-00-de-031

**"distance"**

Displays the currently measured distance  $D_{display}$ .

**"check distance"**

Use this parameter to state if the displayed distance  $D_{display}$  matches the real distance  $D$ . Based on your selection, the Prosonic S automatically proposes a suitable range of mapping.

You have got the following options:

■ **distance = ok**

Choose this option if the displayed value matches the real distance.

After selecting this option, the **"backwater mapping"** parameter set appears. The preset range of mapping is equal to D. That means: all interference echos which are above the current product surface will be mapped out in the interference echo suppression.

■ **distance too small**

Choose this option if the displayed value is smaller than the real distance D.

In this case, the currently evaluated echo is an interference echo.

After selecting this option, the **"backwater mapping"** parameter set appears. The preset range of mapping is slightly larger than  $D_{\text{display}}$ . Therefore, the currently evaluated interference echo will be mapped out by the interference echo suppression.

■ **distance too big**

Choose this option if the displayed value  $D_{\text{display}}$  is larger than the real distance D.

This error is not caused by interference echos. Therefore, no interference echo suppression is performed and the Prosonic S returns to the "backwater" parameter set. Check the calibration parameters, especially the **"empty calibration"**.

■ **distance unknown**

Choose this option if you do not know the real distance D.

In this case, an interference echo suppression can not be performed and the Prosonic S returns to the "backwater" parameter set.

■ **manual**

Choose this option if you want to define the range of mapping manually.

The **"backwater mapping"** parameter set appears, where you can define the required range of mapping.

**"backwater mapping"**

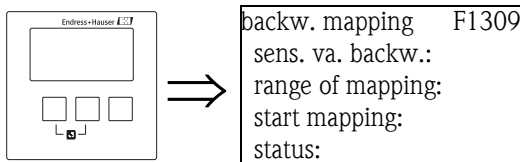

*"sensor value backwater"*

Displays the currently measured distance between the sensor membrane and the water surface. Compare this value to the real distance in order to find out if currently an interference echo is evaluated.

*"range of mapping"*

Use this parameter to specify the range of the mapping curve. Normally, a suitable value has already been entered automatically. Nevertheless, you can change this value if required.

*"start mapping"*

Select **"yes"** in this parameter in order to start the mapping. When the mapping is finished, the status is automatically changed to **"enable map"**.

The "backwater status" parameter set appears, in which the currently measured level, distance and flow are displayed. Compare the displayed distance to the real distance in order to decide if a further mapping is necessary.

If yes: Press the left-arrow key (←) in order to return to the "backwater mapping" parameter set.

If no: Press the right-arrow key (→) in order to return to the "backwater" submenu.

*"status"*

see below ("backwater status" parameter set).

### "backwater status"

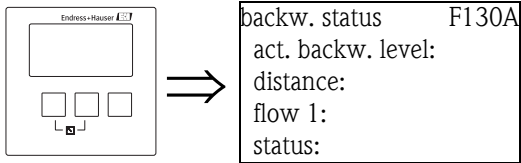

#### "actual backwater level"

Displays the currently measured level of the backwater sensor.

#### "distance"

Displays the currently measured distance between the backwater sensor membrane and the liquid surface.

#### "flow 1"

Displays the currently measured flow.

#### "status"

Use this parameter to define the status of the interference echo suppression.

##### ■ enable map

Choose this option in order to activate the interference echo suppression. The mapping is then used for signal evaluation.

##### ■ disable map

Choose this option in order to deactivate the interference echo suppression. The mapping is then no longer used for signal evaluation but it can be reactivated if required.

##### ■ delete map

Choose this option in order to delete the mapping. It can not be reactivated again and the instrument uses the preprogrammed default mapping.



### 3.2.3 The "extended calibration" submenu

#### "backwater mapping"

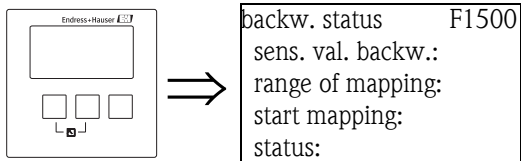

Is identical to the "backwater mapping" parameter set in the "basic setup" submenu, see above.

#### "backwater distance correction"

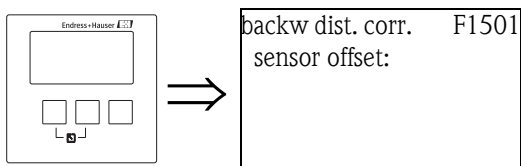

##### "sensor offset"

This parameter can be used to shift the measured distance (from the sensor membrane to the water surface) by a constant value. The distance entered into this parameter is added to the measured distance.

#### "backwater correction"

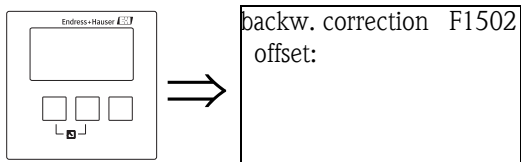

##### "offset"

This parameter can be used to shift the measured downwater level by a constant value. The level entered into this parameter is added to the measured downwater level.

#### "backwater blocking distance"

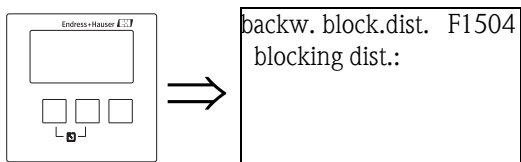

##### "blocking distance"

Displays the blocking distance of the connected sensor.

### "backwater limitation"

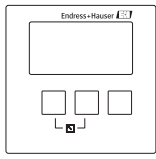

backw limitation F1503  
limitation:  
upper limit:  
lower limit:

#### "limitation"

Use this parameter to specify if the measured downstream level has a lower and/or upper limit.

#### Selection:

- off
- low limit
- high limit
- low/high limit

#### "upper limit"

Defines the upper limit for the downstream level.  
(only available for the options "high limit" and "low/high limit")

#### "lower limit"

Defines the lower limit for the downstream level.  
(only available for the options "low limit" and "low/high limit")

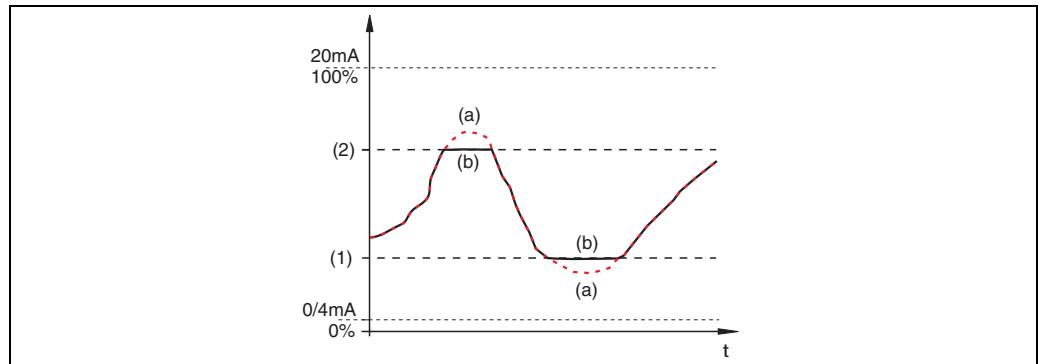

(1): lower limit; (2): upper limit  
(a): limitation switched off; (b): limitation switched on

**"backwater external input 1"**  
**"backwater external input 2"**

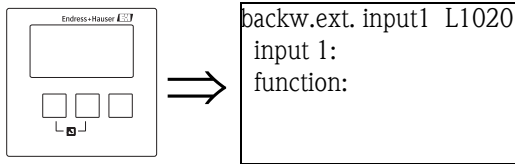

**Note!**

These parameters are only available for instruments with external limit switches (FMU90-\*\*\*\*\*B\*\*\*).

These parameters are used to allocate up to 2 external limit switches to the backwater channel (e.g. one minimum safety and one maximum safety switch). If one of these switches gives a signal, the backwater level assumes a specified value irrespective of the current echo signal.

*"input N" (N = 1 or 2)*

This parameter allocates an external limit switch to the backwater channel.

**Selection:**

- **disabled (default)**  
no switch allocated
- **ext. digin 1**  
external limit switch at the terminals 71, 72, 73
- **ext. digin 2**  
external limit switch at the terminals 74, 75, 76
- **ext. digin 3**  
external limit switch at the terminals 77, 78, 79
- **ext. digin 4**  
external limit switch at the terminals 80, 81, 82

*"function"*

This parameter determines which value the backwater level assumes if the limit switch sends a signal.

**Selection:**

- **off (default)**  
no influence on the backwater level
- **Min (0%)**  
If the limit switch sends a signal, a backwater level value of 0% is generated.
- **Max (100%)**  
If the limit switch sends a signal, the maximum backwater level is generated.
- **hold**  
If the limit switch sends a signal, the backwater level is held on its current value.
- **customer specific**  
If the limit switch sends a signal, the backwater level assumes the value as defined by the customer in the "value" parameter.

*"value"*

This parameter is only available for "function" = "customer specific".

It determines which value the backwater level assumes if the limit switch sends a signal.

### 3.2.4 The "simulation" submenu

#### "backwater simulation"

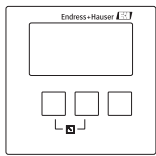

backw simulation F1600  
simulation:  
(sim. level value:)

The parameters of this set are used to simulate a downstream water level in order to check the parametrisation of the backwater and dirt detection.

#### "simulation"

Use this parameter to select the simulation mode:

- **sim. off**

This is the normal mode used for measurement. No simulation is performed in this mode.

- **sim. level**

After selection of this mode, the "sim. level value" parameter appears, where you can specify a level value. The backwater and dirt detection generate a ratio  $h_2/h_1$  according to this level.



Note!

An error message is generated as long as the "sim. level" mode is active.

#### "sim. level value"

This parameter is available for a level simulation. It is used to specify the desired level value.

### 3.3 The "flow counter" submenu

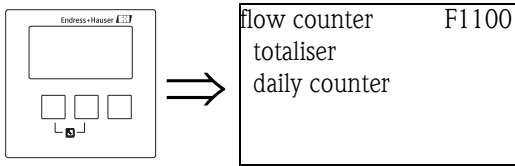

In this submenu, select which type of counter you are going to parametrize.

**Selection:**

- totaliser (not resettable)
- daily counter (resettable)

A selection of up to three totalisers or daily counters appears<sup>12)</sup>. Select the totaliser or daily counter you are going to parametrize.

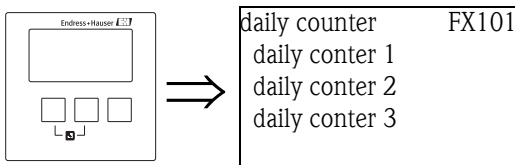
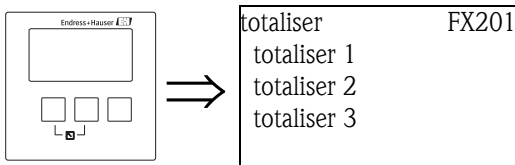

12) The number of totalisers and daily conters depends on the instrument version and the installation environment.

### 3.3.1 "totalizer N/daily counter N" (N = 1 -3)

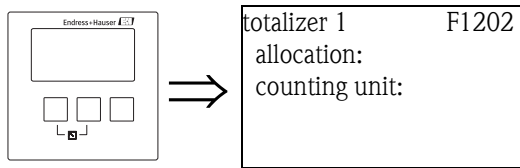

#### "allocation"

Use this parameter to allocate a flow to the counter.

##### Selection:

- none (default)
- flow 1, Q1
- flow 2, Q2 (for 2-channel instruments only)
- average flow,  $(Q1 + Q2)/2$ , (for 2-channel instruments only)
- flow 1-2,  $Q1 - Q2$ , (for 2-channel instruments only)
- flow 2-1,  $Q2 - Q1$ , (for 2-channel instruments only)
- flow 1+2,  $Q1 + Q2$ , (for 2-channel instruments only)

#### "counting unit"

Use this parameter to select the unit for the flow volume.

##### Selection:

- m<sup>3</sup>
- l
- hl
- igal
- usgal
- barrels
- inch<sup>3</sup>
- ft<sup>3</sup>
- USmgal
- MI

### 3.3.2 "totalizer N/daily counter N" (N = 1 - 3)

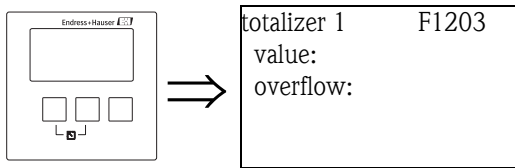

#### "value"

Displays the current flow volume.

#### "overflow"

Whenever the counter passes the overflow, this parameter is incremented by 1. The total flow volume thus is:

$$V_{\text{total}} = \text{overflow} \times 10^7 + \text{value}$$

#### "reset" (only for the daily counters)

Use this parameter to reset the counter to "0".

#### Selection:

- **no (default)**

"value" and "overflow" retain their values.

- **yes**

"value" und "overflow" are reset to "0".

### 3.3.3 "totalizer N/daily counter N" (N = 1 - 3)

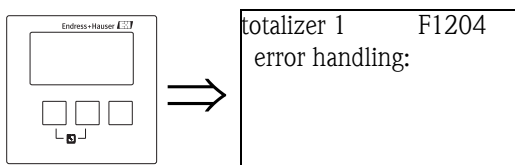

#### "error handling"

Use this parameter to define the reaction of the Prosonic S in the case of an error.

#### Selection:

- **stop**

The Prosonic S stops counting.

- **hold**

The Prosonic S continues counting. It uses the flow value which was present at the moment the error occurred.

- **actual value**

The Prosonic S continues counting. It uses the current flow value (although its reliability is no longer ensured).

### 3.3.4 "daily counter N" (N = 1 - 3)

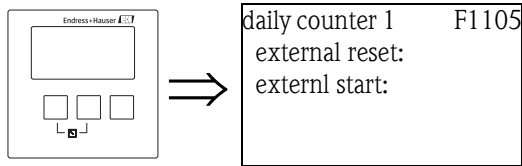

Note!

This parameter set is only available in instruments with external limit switches (FMU90-\*\*\*\*\*B\*\*\*).

#### "external reset"

This parameter allocates one of the external switch inputs to the counter by which it can be reset.

##### Selection:

- disabled
- ext. digin 1
- ...
- ext. digin 4

#### "external start"

This parameter allocates one of the external switch inputs to the counter by which it can be started.

##### Selection:

- disabled
- ext. digin 1
- ...
- ext. digin 4



## 4 The "safety settings" menu

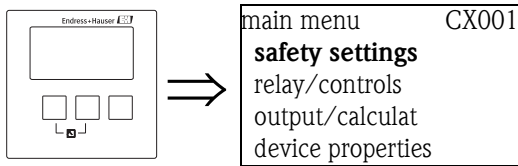

### 4.1 "output on alarm" (only for HART instruments)

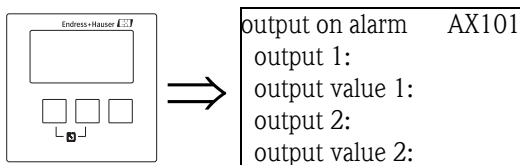

#### 4.1.1 "output N" (N = 1 or 2) (only for HART instruments)

Defines the output current in the case of an alarm.

##### Selection:

- min (3.6 mA)
- max (22 mA) (Default)
- user specific (as defined in the "output value N" parameter)
- hold (the last value is held)

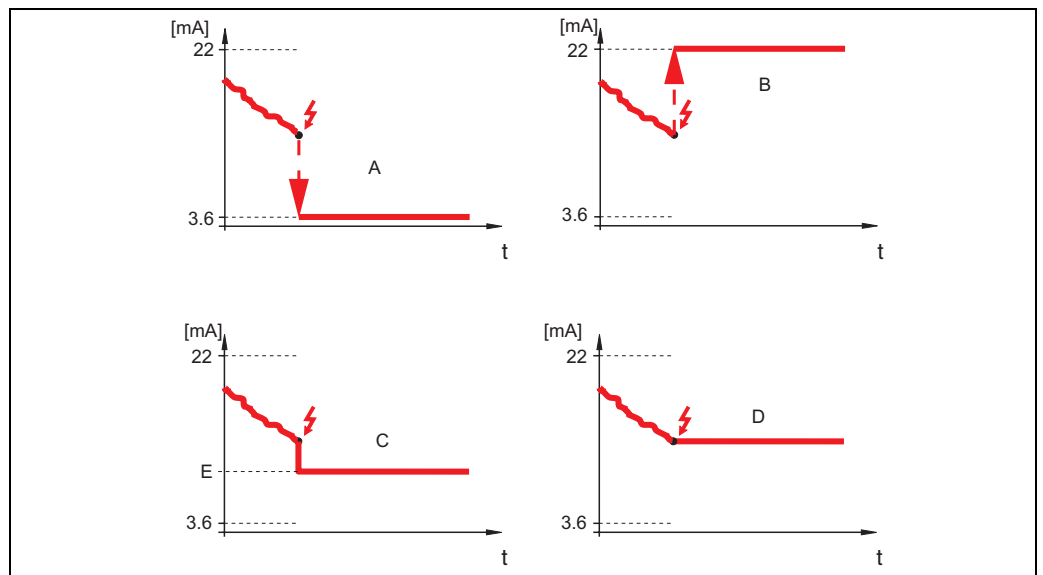

*A: min.; B: max.; C: user specific; D: hold; E: output value*

#### 4.1.2 "output value N" (N = 1 or 2) (only for HART instruments)

Defines the output current in the case of an alarm.  
(only available for "output N" = "user specific")

- range of values: 3.6 ... 22 mA

## 4.2 "output echo loss"

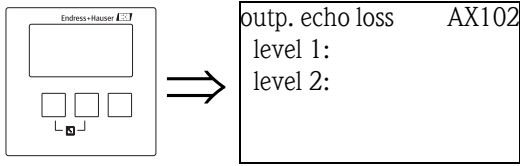

Note!

The parameter set "output echo loss" (AX102) is valid only for level measurements. For flow measurements there is an additional parameter set with a different code: "output echo loss" (AX112).

The parameters of both sets are described in this section.

### 4.2.1 "level N" or "flow N" (N = 1 or 2)

Defines the output value in the case of an echo loss.

**Selection:**

- **hold (Default)**

The current value is held.

- **ramp %/min**

After the time defined in "delay echo loss" (see below), the output value is continuously shifted towards 0% (for a negative ramp) or towards 100% (for a positive ramp). The ramp must be specified as a percentage of the measuring range per minute ("ramp level N" parameter).



Note!

This option is **not** available for flow measurements.

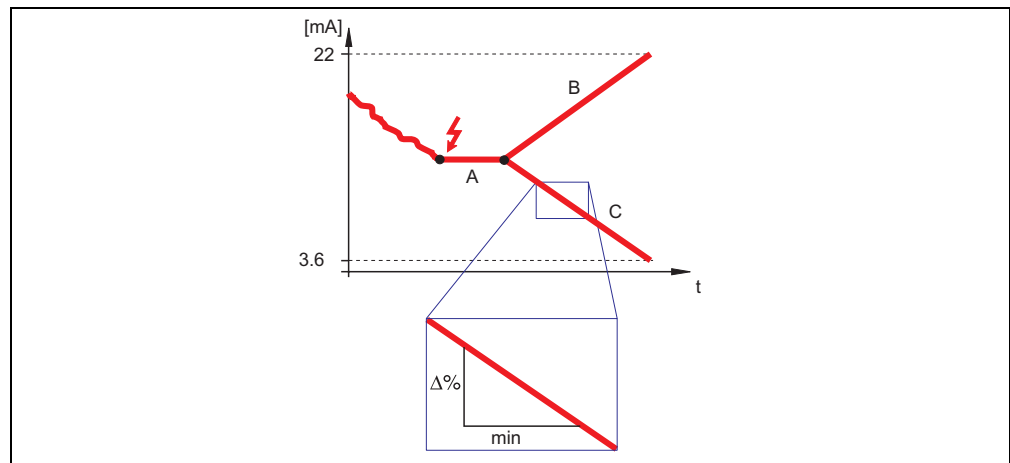

100-FMI190xxx-19-00-00-yy-070

*A: delay echo loss; B: ramp (positive); C: ramp (negative)*

- **customer specific**

After the time defined in "delay echo loss" (see below), the output assumes the value which has been defined in the "value level N" or "value flow N" parameter.

- **alarm**

After the time defined in "delay echo loss" (see below), the instrument generates an alarm. The output assumes the value defined in "output on alarm" (see above).

### 4.2.2 "ramp level N" (N = 1 or 2)

(only available for the option "ramp %/min")

Use this parameter to specify the ramp (percentage of the measuring range per minute).

### 4.2.3 "value level N" or "value flow N" (N = 1 or 2)

(only available for the option "customer specific")

Use this parameter to specify the output value in the case of an echo loss.

## 4.3 "delay echo loss"

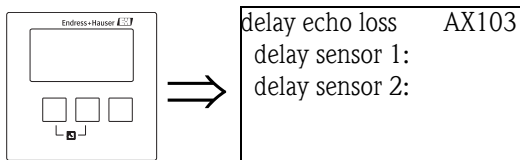

### 4.3.1 "delay sensor N" (N = 1 or 2)

Use this parameter to define the delay time for echo loss.

After an echo loss, the instrument waits for the time specified in this parameter before generating an alarm. Thus the measurement is not interrupted by short-time interferences.

## 4.4 "safety distance"

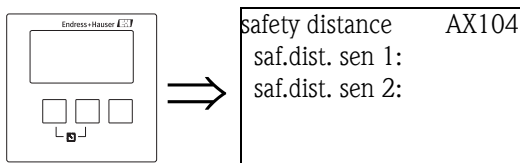

### 4.4.1 "safety distance sensor N" (N = 1 or 2)

Use this parameter to specify a safety distance for the sensor.

The safety distance is located immediately below the blocking distance. If the level projects into the safety distance, an alarm is generated.

- Default: 0 m

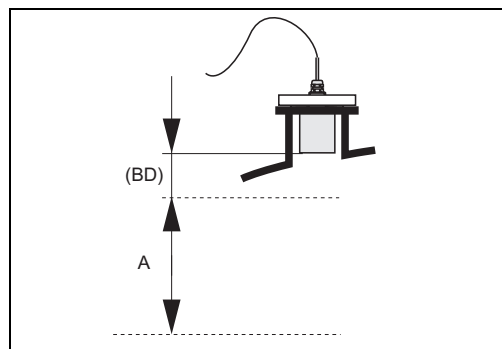

L00-FMU90xxxx-19-00-00-yy-071

**BD:** blocking distance (depending on the type of sensor);  
**A:** safety distance

**Application example**

The safety distance can be used to detect flooding if a FDU90 sensor with flooding protection tube is applied. In this case the safety distance must be chosen in a way that it ends slightly below the lower edge of the flooding protection tube:

SD = min. 4 cm

In order to indicate the flooding, a diagnostic relay can be parametrized with the allocation "safety distance channel 1/2" (see section 5.1.8).

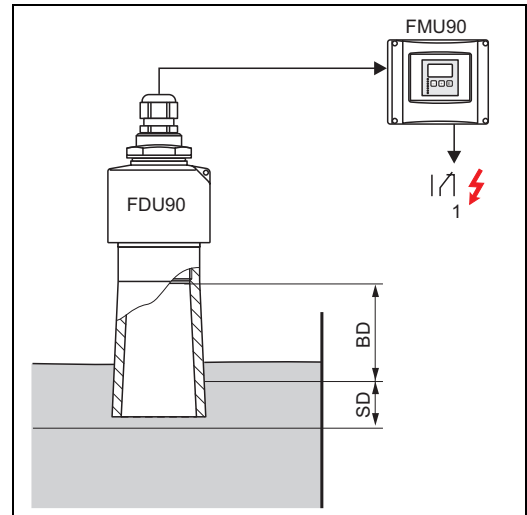

L00-FDU90xxx-05-00-00-xx-001

1: A detected flooding can generate an alarm and can be indicated via a relay

BD: Blocking distance = 7cm(2.8")

SD: safety distance to be defined: 4cm / 1.6")

**4.5 "in safety distance"**

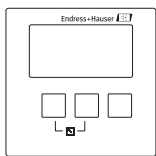

```

in safety dist.    AX105
in saf. dist. s 1:
in saf. dist. s 2:
    
```

**4.5.1 "in safety distance sensor N" (N = 1 or 2)**

Defines the reaction of the instrument if the level is in the safety distance.

**Selection:**

■ **warning (default)**

A warning (A01651 or A02651) is generated but the instrument continues to measure. If the level drops out of the safety distance, the warning disappears.

■ **alarm**

The instrument enters the defined alarm state ("output on alarm"). Additionally, an error message (A01651 or A02651) is generated. If the level drops out of the safety distance, the alarm disappears and the instrument continues to measure.

■ **self holding**

The instrument enters the defined alarm state ("output on alarm"). Additionally, an error message (A01651 or A02651) is generated.

If the level drops out of the safety distance, the alarm remains active. The measurement is continued only after a reset of the self holding.

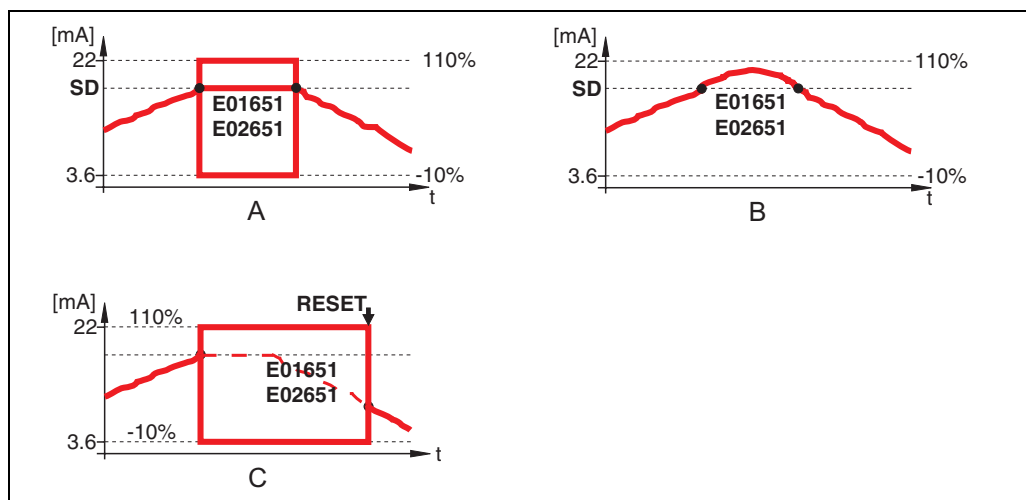

A: alarm; B: warning; C: self holding

#### 4.5.2 "reset sensor N" (N = 1 or 2)

(only available for the option "self holding")

This parameter is used to reset the alarm in the case of a self holding.

**Selection:**

- **no (default)**  
The alarm is **not** reset.
- **yes**  
The alarm is reset. The measurement is resumed.

#### 4.6 "reaction high temperature"

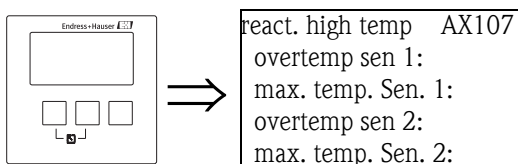

##### 4.6.1 "overtemperature sensor N" (N = 1 or 2)

Defines how the instrument reacts if the maximum temperature of the sensor is exceeded.

**Selection:**

- **warning (default)**  
If the maximum temperature is exceeded, an error message (A01 661 or A02 661) is generated but the measurement is continued.
- **alarm**  
If the maximum sensor temperature is exceeded, the output assumes a defined value ("output on alarm", see above). Additionally an error message (A01 661 or A02 661) is generated.

##### 4.6.2 "maximum temperature sensor N" (N = 1 or 2)

Displays the maximum temperature of the respective sensor.

## 4.7 "defective temperature sensor"

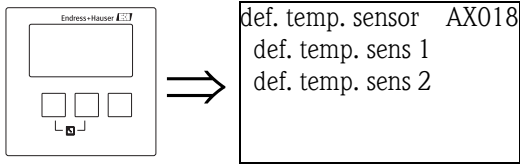

### 4.7.1 "defective temperature sensor N" (N = 1 or 2)

Defines how the instrument reacts in the case of a defective temperature sensor.

**Selection:**

■ **warning**

If the temperature sensor is defective, an error message (A01 661 or A02 661) is generated but the measurement is continued.

■ **alarm (default)**

If the temperature sensor is defective, the output assumes a defined value ("output on alarm", see above). Additionally an error message (A01 661 or A02 661) is generated.

## 4.8 "relay delay"

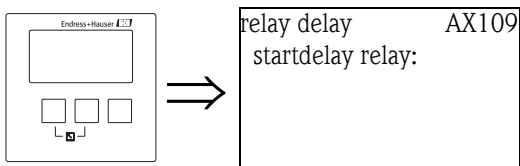

### 4.8.1 "startdelay relay"

Use this function to define a start delay for the relays of the Prosonic S. When the supply voltage is switched on, the relays do not switch immediately but one after another with the specified delay time in between. This helps to avoid overloads of the power supply system.

- Default: 1 s

## 5 The "relays/controls" menu

### 5.1 The "relay configuration" submenu

#### 5.1.1 "relay allocation"

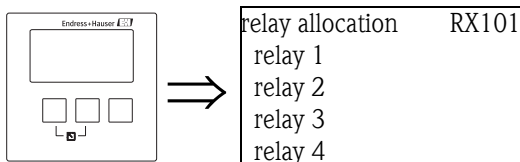

Use this parameter to select the relay you are going to configure.

#### Selection:

- All relays of the instrument version at hand



#### Note!

If a function has already been allocated to one of the relays, the name of this function is displayed next to the relay number.

#### 5.1.2 "relay 1...6" (relay function)

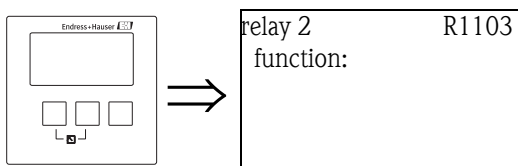

After selecting a relay, the "**relay N**" (N = 1 ... 6) parameter set appears, which is used to configure the relay.

To configure the relay, proceed according to the following steps:

1. Select the "function" parameter. The "**select function**" screen appears.
2. Select one of the following functions:
  - a. **limit**  
After selecting this option, a further selection list appears. Select the measuring value to which the limit relay is to be allocated.  
Continue by sections 5.1.3 and 5.1.11.
  - b. **time pulse (only for flow measurements)**  
(outputs a short pulses at regular time intervals)  
After selecting this option, a further selection list appears. Select the option "time pulse".  
Continue by sections 5.1.4 and 5.1.11.
  - c. **counting pulse (only for flow measurements)**  
(outputs a short pulse after a defined flow volume)  
After selecting this option, a further selection list appears. Select the measuring value to which the pulses refer.  
Continue by sections 5.1.5, 5.1.6 and 5.1.11.
  - d. **alarm/diagnostics**

After selecting this option, a further selection list appears. Select the alarm to which the relay is allocated.

**Selection:**

- **alarm relay**  
the relay is energized if an "alarm" type error is detected.  
Continue by sections 5.1.7 and 5.1.11.
  - **diagnostics**  
a specific state of the instrument (e.g. loss of echo) can be allocated to the relay. The relay becomes energized as soon as this state occurs.  
Continue by sections 5.1.8 and 5.1.11.
  - **backwater alarm**  
The relay is energized if a backwater alarm is active.  
This option is only available if the operating mode is "flow+backwater"<sup>13)</sup>.  
Continue by sections 5.1.9 and 5.1.11.
  - **dirt alarm**  
The relay is energized if a dirt alarm is active.  
This option is only available if the operating mode is "flow+backwater"<sup>13)</sup>.  
Continue by sections 5.1.10 and 5.1.11.
- e. **fieldbus (DO relay)**<sup>14)</sup> (for Profibus DP instruments only)  
After selecting this option, a further selection list appears. Select the DO block to which the relay is to be connected.  
No additional parametrization is required.
- f. **none**  
The relay is not used.

3. Now, the instrument switches back to the "**relay N**" (N= 1 ... 6) parameter set. Depending on your selections, further parameters are now available which you can use to complete the configuration. Details are described in the following sections.

### 5.1.3 "relay N" (N = 1 - 6) (Parametrization of a limit relay)

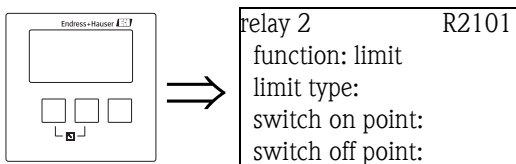

#### "Limit type"

Use this parameter to define the type of limit.

**Selection:**

■ **standard**

For this limit type, a switch on point and a switch off point have to be defined. The switching behaviour depends on the relative position of these switching points.

- a. **switch on point > switch off point**  
The relay is energized if the measured value rises above the switch on point.  
The relay is de-energized if the measured value falls below the switch off point.
- b. **switch on point < switch off point**  
The relay is energized if the measured value falls below the switch on point.  
The relay is de-energized if the measured value rises above the switch off point.

13) The operating mode is set during the first setup of the instrument. It can be changed by "device properties/operating parameters/operating mode".  
14) A fieldbus relay (DO relay) switches according to a binary value (e.g. from a SPS) which is connected to the DO block of the instrument.



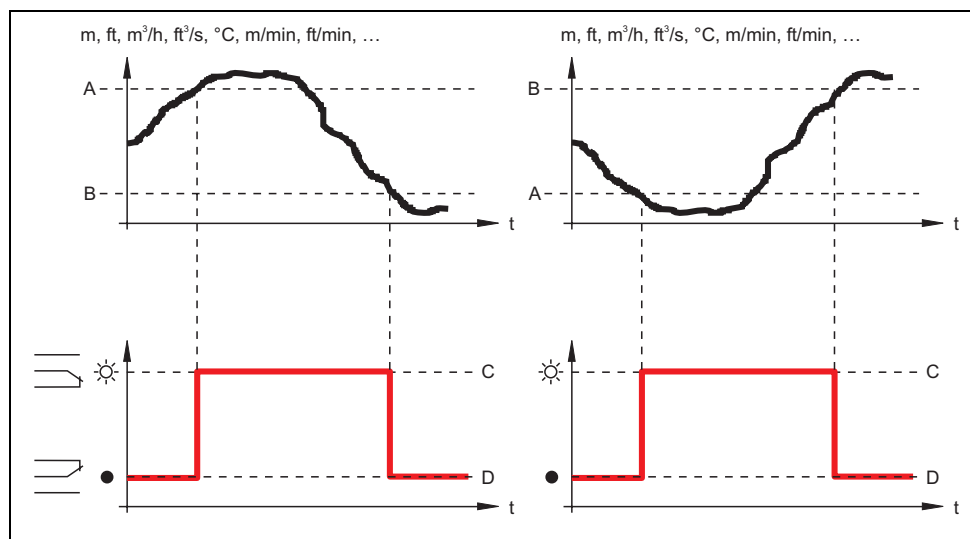

*A: switch on point; B: switch off point; C: relay energized; D: relay de-energized*

- **tendency/speed**

This limit type is similar to the "standard" type. The only difference is that variations with time of the measured value are examined instead of the measured value itself. Therefore, the unit for the switching points is "measuring value unit per minute".

- **inband**

For this limit type, an upper and a lower switching point have to be defined.

The relay is energized if the measured value is between the two switching points.

The relay is de-energized if the measured value is above the upper or below the lower switching point.

Additionally, a hysteresis can be defined, which affects both switching points.

- **out of band**

For this limit type, an upper and a lower switching point have to be defined.

The relay is energized if the measured value is above the upper or below the lower switching point.

The relay is de-energized if the measured value is between the two switching points.

Additionally, a hysteresis can be defined, which affects both switching points.

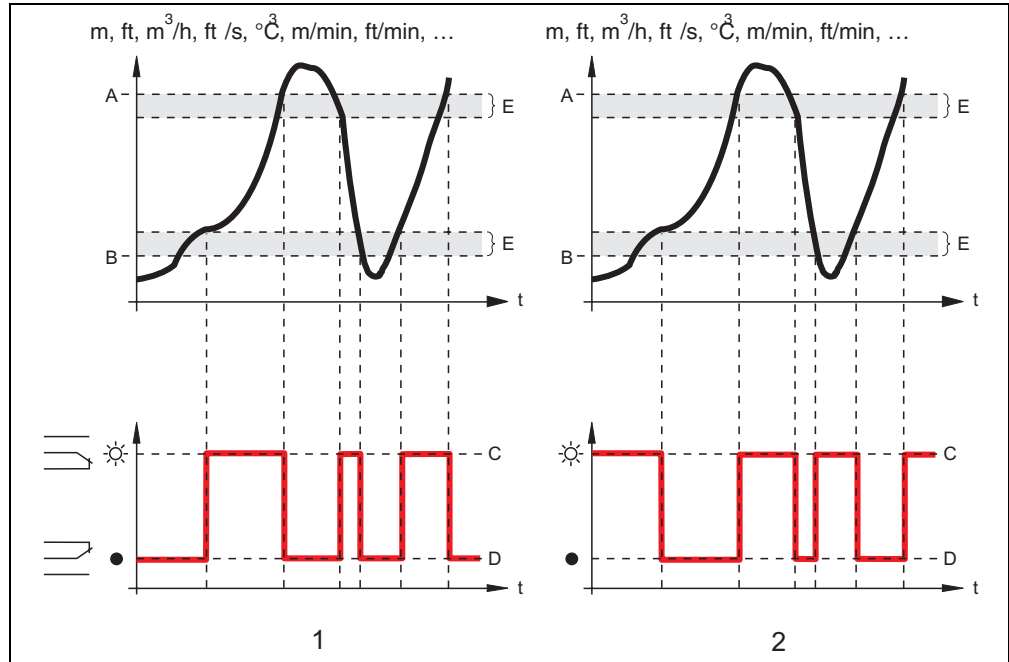

1: "inband" limit relay; 2: "out of band" limit relay  
 A: upper switching point; B: lower switching point; C: relay energized; D: relay de-energized; E: hysteresis

**"switch on point" and "switch off point"**  
 (for the "standard" limit type)

Define the switching points in these parameters.  
 They have the same unit as the measured value.



Caution!

After a change of the "unit level" or "flow unit" the switching points have to be checked and adjusted if required.

**"switch on /min" and "switch off /min"**  
 (for the "tendency/speed" limit type)

Define the switching points in these parameters.  
 Their unit is the measured value unit per minute.



Caution!

After a change of the "unit level" or "flow unit" the switching points have to be checked and adjusted if required.

**"upper switching point" and "lower switching point"**  
 (for the "inband" and "out of band" limit types)

Define the switching points in these parameters.  
 They have the same unit as the measured value.



Caution!

After a change of the "unit level" or "flow unit" the switching points have to be checked and adjusted if required.

**"hysteresis"**  
 (for the "inband" and "out of band" limit types)

Define the hysteresis in this parameter. It has the same unit as the measured value.  
 The hysteresis affects the upper and the lower switching point.

### 5.1.4 relay N (N = 1 - 6) (Parametrization of a time pulse relay)

(only for instrument versions with flow functionality:  
FMU90 - \*2\*\*\*\*\* and FMU90 - \*4\*\*\*\*\*)

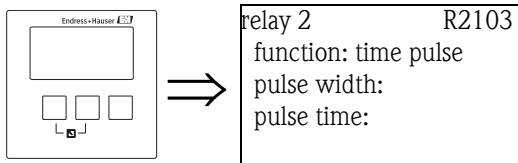

#### "pulse width" and "pulse time"

Use these parameters to specify the time interval between two pulses (pulse time) and the duration of each pulse (pulse width).

#### pulse time

- unit: min
- default: 1 min
- range of values: 1 to 65000 min

#### pulse width

- unit: ms
- default: 200 ms
- range of values: 200 to 60000 ms

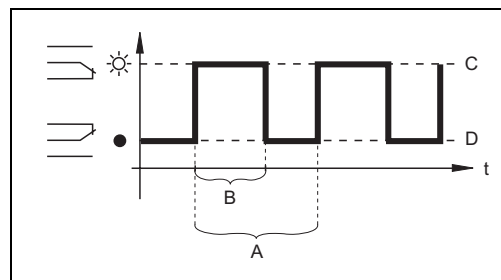

L00-FMU90xxx-19-00-00-yy-063

A: pulse time; B: pulse width;  
C: relay energized; D: relay de-energized

### 5.1.5 "relay N" (N = 1 - 6) (Parametrization of a counting pulse relay)

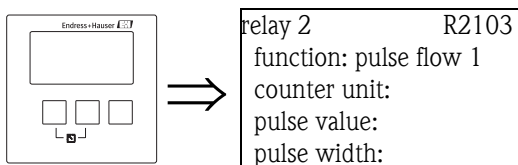

#### "counter unit"

Use this parameter to select the unit for the flow volume.

#### Selection:

- l (default)
- hl
- Ml
- m<sup>3</sup>
- dm<sup>3</sup>
- cm<sup>3</sup>
- ft<sup>3</sup>
- inch<sup>3</sup>
- us gal
- us mgal
- i gal
- barrels

### "pulse value"

Use this parameter to specify the flow volume after which a pulse is generated.  
Default: 100 m<sup>3</sup>

### "pulse width"

Use this parameter to specify the width of each pulse.

#### Default:

- HART: 200 ms
- Profibus DP: 1000 ms

#### Range of values:

- 200 to 60000 ms



Note!

If a relay is used in a Profibus DP instrument to transmit the pulses, the pulse width can be reduced.  
If the DI block is used, 1000 ms is the smallest possible value.

## 5.1.6 "relay N " (N = 1 - 6) (Display of the counting value)

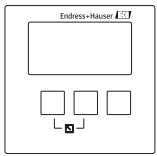

relay 2	R2105
pulse counter:	
overflow x 10 <sup>7</sup> :	
reset counter:	
start counter:	

### "pulse counter"

Displays the number of pulses which have been generated since the last overflow.

### "overflow"

Displays, how many times the pulse counter has already passed the overflow.



Note!

The total flow volume is:

$$V_{\text{total}} = (\text{overflow} \times 10^7 + \text{pulse counter}) \times \text{pulse value}$$

### "reset counter"

Use this parameter to reset the counter.

#### Selection:

- no (default)  
"pulse counter" and "overflow" retain their values.
- yes  
"pulse counter" and "overflow" are reset to "0".

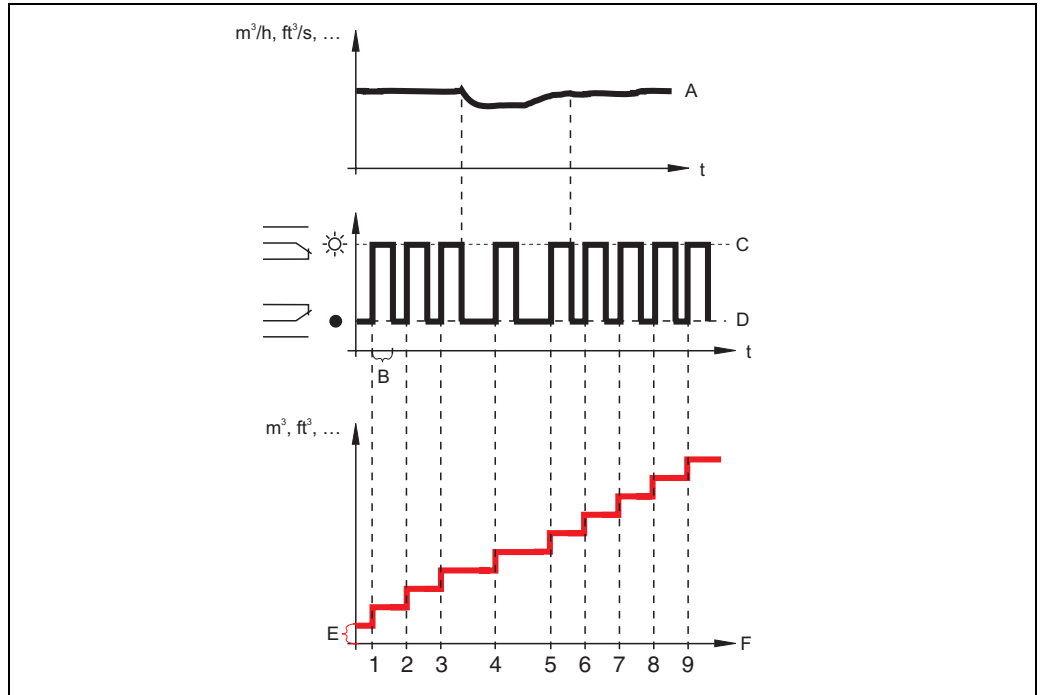

100-FM1/90xxxx-19-00-00-yy-064

**A:** flow; **B:** pulse width; **C:** relay energized; **D:** relay de-energized; **E:** pulse value; **F:** pulse counter

### "start counter" and "stop counter"

You can use these parameters to exclude very small and very large flows from being counted. If the flow is below "start counter" or above "stop counter" no pulses are generated. Both values are to be specified as a percentage of the maximum flow ( $Q_{max}$ ).

- Default of "start counter": 0%
- Default of "stop counter": 100%

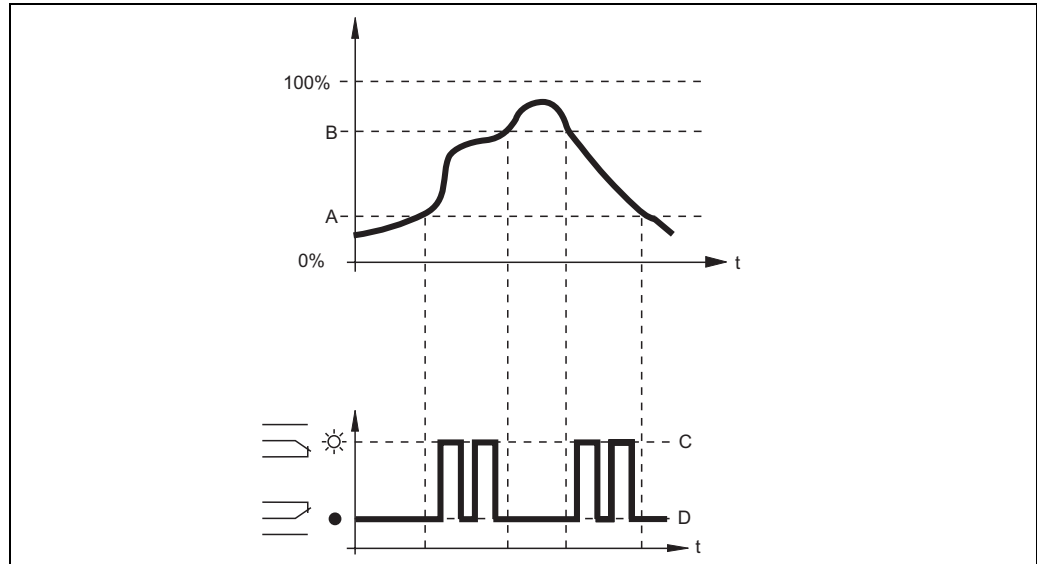

L00-FMU90xxx-19-00-00-yy-005

*A: start counter; B: stop counter; C: relay energized; D: relay de-energized*

### 5.1.7 "relay N" (N = 1 ...6) (Parametrization of an alarm relay)

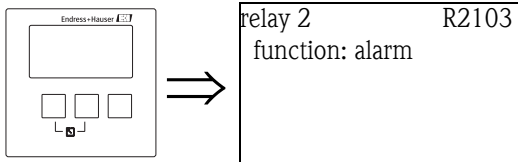

For an alarm relay, no additional parameters are required. Press "→" in order to proceed to the next parameter set.

### 5.1.8 "relay N" (N = 1 - 6) (Parametrization of a diagnostic relay)

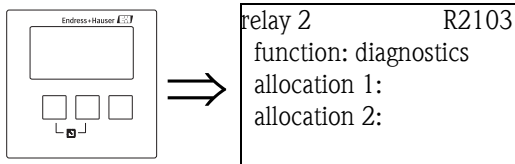

#### "allocation 1/2"

A specific instrument state or event can be allocated to each of these parameters. The relay is de-energized as soon as one of these states or events occurs.

#### Selection:

- echoloss sensor 1/2/1+2
- defective temperature sensor1/2
- defective external temperature sensor
- Accumulated alarm: defective temperature sensor
- overtemp. sensor 1/2
- Accumulated Alarm: overtemp.
- safety distance channel 1/2
- Accumulated Alarm: safety distance

### 5.1.9 "relay N" (N = 1 ...6) (Parametrization of a backwater alarm relay)

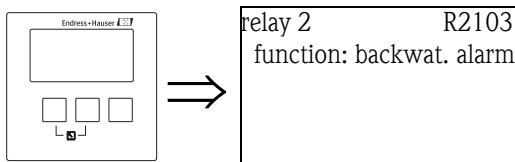

For a backwater alarm relay, no additional parameters are required. Press "→" in order to proceed to the next parameter set.

### 5.1.10 "relay N" (N = 1 ...6) (Parametrization of a dirt alarm relay)

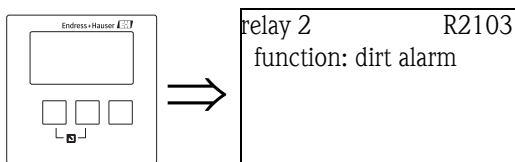

For a dirt alarm relay, no additional parameters are required. Press "→" in order to proceed to the next parameter set.

### 5.1.11 "relay N (N = 1 - 6)" (Relay behavior)

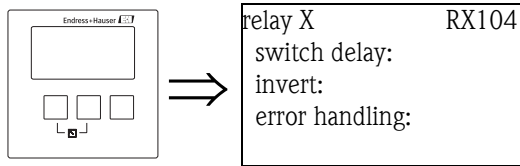

#### "switch delay" (only available for limit relays)

Use this parameter to specify the switch delay (in seconds).

The relay does not switch immediately after the switch-on point has been exceeded but only after the specified delay.

The measured value must exceed the switch-on point during the entire delay time.

#### "invert"

Use this parameter to specify if the switching direction of the relay is to be inverted.

##### Selection:

###### ■ no (default)

The switching direction of the relay is **not** inverted. The relay switches as described in the above sections.

###### ■ yes

The switching direction of the relay **is** inverted. The states "energized" and "de-energized" are interchanged.

#### "error handling" (not available for alarm and diagnostic relays)

Use this parameter to specify the reaction of the relay in the case of an error.

##### Selection:

###### ■ actual value

The relay switches according to the currently measured value (although its reliability is not ensured).

###### ■ hold (default)

– Limit relay: The current switching state of the relay is maintained.

– Counting pulse relay: The counter uses the flow value which was present when the error occurred.

###### ■ switch on

(only available for limit relays)

The relay is energized.

###### ■ switch off

(only available for limit relays)

The relay is de-energized.

###### ■ stop

(only available for counting pulse and time pulse relays)

No pulses are generated as long as the error is present.



## 5.2 The "pump control N" submenu - standard (N = 1 or 2)



Note!

Depending on the order code of the instrument, different functionalities can be configured for the pump control. The order code of the instrument can be found on the nameplate and in the operating menu at "system information/device information".

This chapter is only valid for instruments with standard pump control (FMU90-\*1\*\*\*\*\* and FMU90-\*2\*\*\*\*\*).

For the enhanced pump control see chapter 5.3 (FMU90-\*3\*\*\*\*\* and FMU90-\*4\*\*\*\*\*).



Note!

The "pump control N" submenus are only present if "pump control" has been selected in "device properties/operating parameters/controls".

### 5.2.1 Basic principles

#### Switch points

The pump control is used to start or stop pumps depending on the measured level. To do this, a switch-on point and a switch-off point is defined for each pump. Additionally, a relay is assigned to the pump and the switching is performed by this relay.

Two cases can be distinguished for the switching behaviour of this relay:

#### a. Switch-on point > Switch-off point

The pump is switched on if the level rises above the switch-on point (A). It is switched off if the level drops below the switch-off point (B).

**Example:** Emptying of a flood control reservoir.

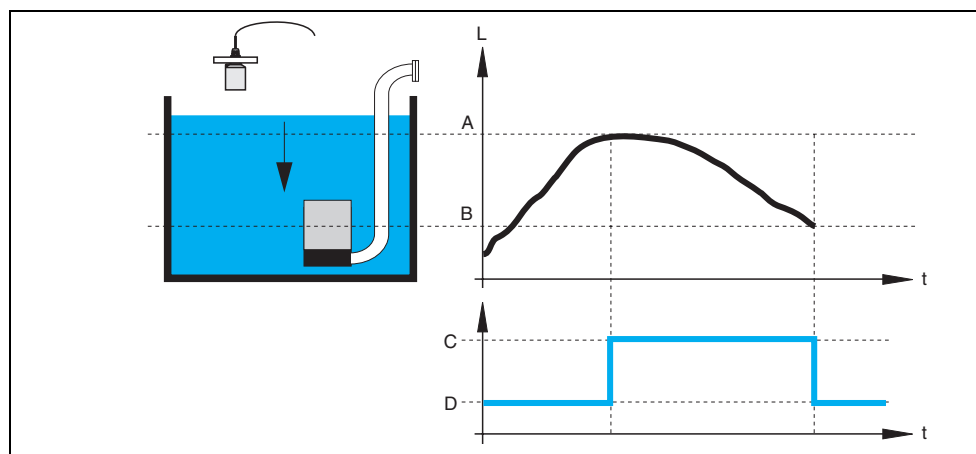

A: switch-on point; B: switch-off point; C: pump on; D: pump off

#### b. Switch-on point < Switch-off point

The pump is switched on if the level drops below the switch-on point (A). It is switched off if the level rises above the switch-off point (B).

**Example:** Filling of a storage vessel

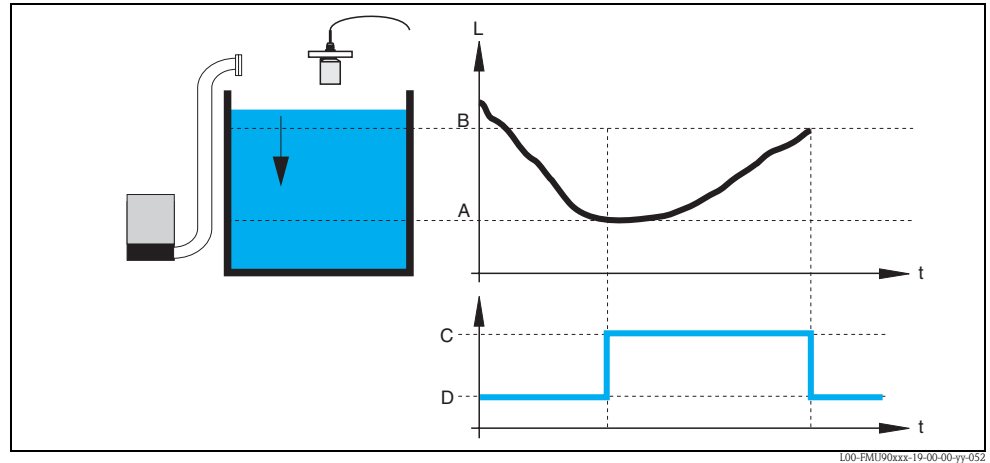

*A: switch-on point; B: switch-off point; C: pump on; D: pump off*

100-FMU90xxx-19-00-00-yy-052

### Operating mode

The Prosonic S can control several pumps simultaneously - depending on the number of relays (s. feature 70 of the product structure). If two or more pumps are applied for one level channel, you can choose between two different operating modes:

a. **Non-alternating pump control**

In this mode, each pump is switched according to the switching points allocated to it.

b. **Alternating pump control**

In this mode, the switching points are not allocated to the individual pumps. Instead, the relays are switched in a way that ensures uniform usage of all pumps. This is achieved by the following rules:

1. If the level rises above one of the switch-on points, that relay switches on, which at that moment has been switched off the longest time. This is not necessarily the relay to which the switch-on point belongs.
2. If the level drops below one of the switch-off points, that relay switches off, which at that moment has been switched on the longest time. This is not necessarily the relay to which the switch-off point belongs.

However, there are two restrictions to these rules:

3. Rising of the level above a switch-on point effects switching on of a relay only if the corresponding switch-off point has been reached before.
4. Dropping of the level below a switch-off points effects switching-off of a relay only if the corresponding switch-on point has been reached before.

 **Note!**

If two pumps in the same range are to operate alternately, their switch-on and switch-off points are identical. This switching response can be achieved by assigning switch points to the second relay which can never be reached.

### Example

In the switching range between 60% and 40%, two pumps should be operated alternately, i.e. when pump 1 is running, pump 2 is switched off and vice versa. These relays are programmed as follows:

- Relay 1: switch-on point: 60%; switch-off point: 40%
- Relay 2: switch-on point: e.g. 160%; switch-off point: e.g. 120%.

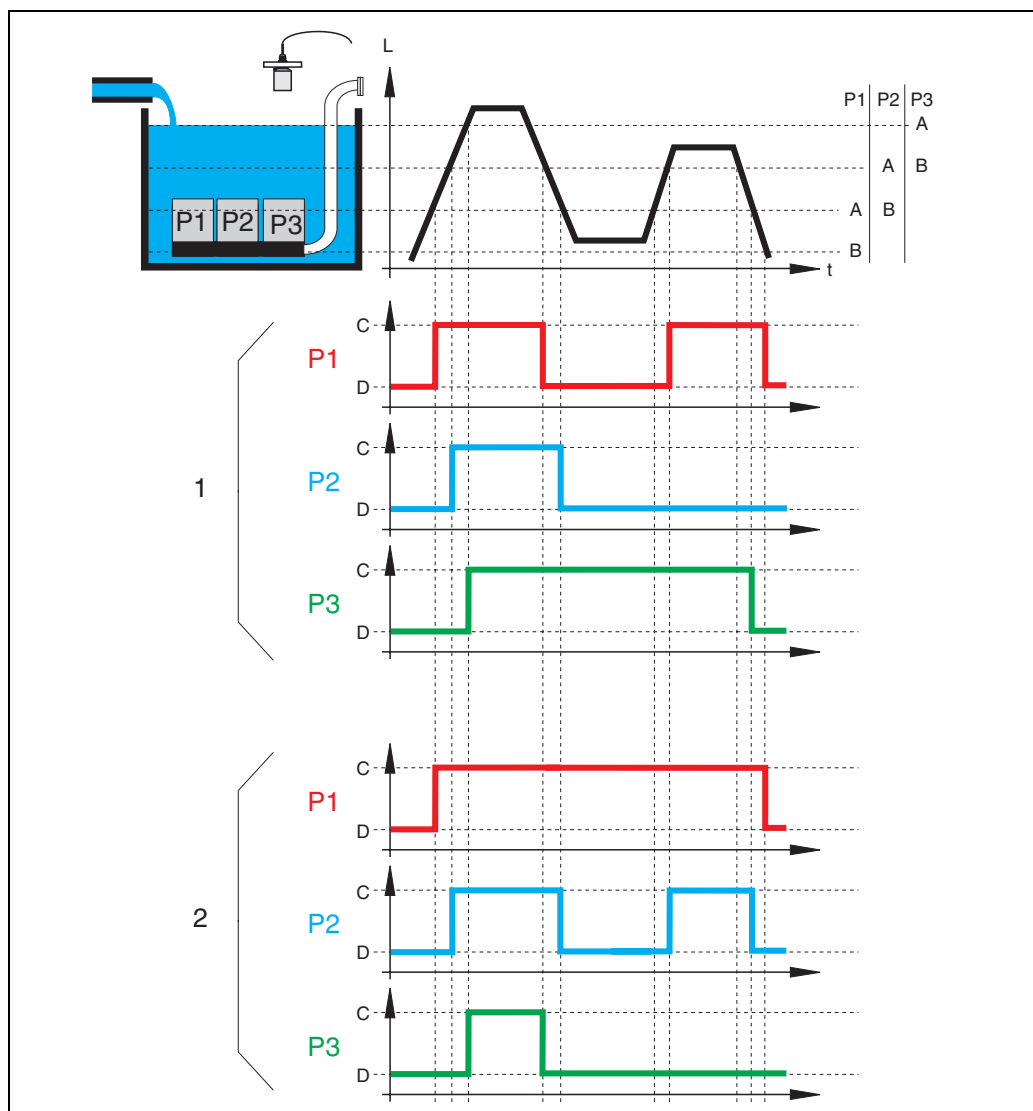

100-FM190xxx-19-00-00-yy-053

**1:** Alternating pump control; that pump is switched on (switched off), which has been switched off (switched on) the longest time.

**2:** Non-alternating pump control; each switching point is allocated to a different pump.

**A:** switch-on point of the pump; **B:** switch-off point of the pump; **C:** pump on; **D:** pump off;

### Limit control versus pump rate control

If several pumps are connected, you can choose between limit control (as described above) and pump rate control.

#### Limit control

If limit control has been selected, the relays are switched according to the switching points as described above.

#### Pump rate control

If pump rate control has been selected, there is only one switch-on point and one switch-off point, which are valid for all relays. Additionally, a desired **pump rate** has to be specified.

If the level rises above (or falls below) the switch-on point, initially only one pump is switched on. If the desired pump rate has not been achieved after the selected **hook-up interval**, an additional pump is switched on. Similarly, further pumps are switched on in intervals until the desired pump rate has been achieved.

However, if the level is already near to the switch-off point (distance < **switch-on barrier**), no further pumps are switched on, even if the pump rate has not yet been achieved.

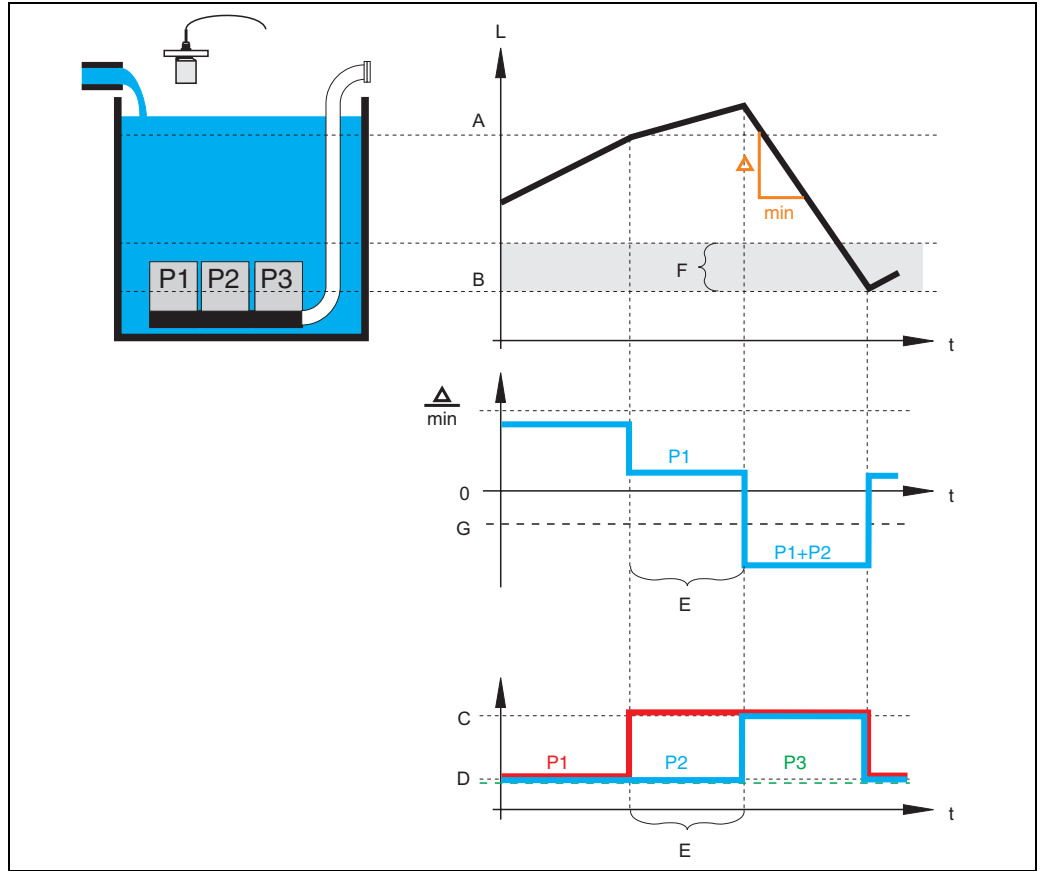

100-FM190xxx-19-00-00-yy-054

**A:** switch-on point; **B:** switch-off point; **C:** pump on; **D:** pump off; **E:** hook-up interval; **F:** switch-on barrier  
**G:** pump rate



Note!  
 If both the alternating pump control and the pump rate control are active, the pumps are alternately used as first pump.

## 5.2.2 Overview

### Parametrization of a pump control (type: limit control)

Step	Parameter set or submenu	Parameter	Remarks	see section
1	"relay/controls" menu		Select "pump control1" or "pump control 2".	
2	pump control N (N = 1 or 2)	reference	Select the level according to which the pumps are controlled.	5.2.3
		number of pumps	Select the number of pumps. Note: A relay must be available for each of the pumps.	
3	pump control N (N = 1 or 2)	function	Select "limit control".	5.2.4
4	pump control N (N = 1 or 2)		Select a pump. (Each pump must be configured individually.)	5.2.5
5	pump M control N (M = 1 - 6) (N = 1 or 2)	switch on point	Define the switch on point for this pump.	5.2.6
		switch off point	Define the switch off point for this pump.	
		switch on delay	Define the switch on delay for this pump.	
		alternate	Select if the pump is to take part in the alternating pump control (Default: no).	
		crust reduction	Define the inaccuracy of the switching points (to reduce crust formation).	
6	pump M control N (M = 1 - 6) (N = 1 or 2)	backlash interval	Define the backlash interval	5.2.7
		backlash time	Define the backlash time	
		error handling	Define the error handling	
7	relay allocation		Allocate a relay to the pump. Note: By default, relay 1 is configured as alarm relay.	5.2.8
8	relay N (N = 1 - 6)	function	Select "pump M/control N"	5.2.9
		invert	Select if the switching signal is inverted (default: no)	
9	pump control N		Select the next pump and continue with step 5 until all pumps have been configured. If all pumps are configured: Press  to return to the "relay/controls" menu.	

### Parametrization of a pump control (type: pump rate control)

Step	Parameter set or submenu	Parameter	Remarks	see section
1	"relay/controls" submenu		Select "pump control 1" or "pump control 2".	
2	pump control N (N = 1 or 2)	reference	Select the level according to which the pumps are controlled.	5.2.3
		number of pumps	Select the number of pumps. Note: A relay must be available for each of the pumps.	
3	pump control N (N = 1 or 2)	function	Select "rate control"	5.2.4
4	pump control N (N = 1 or 2)	switch on point	Define the switch on point.	5.2.10
		switch off point	Define the switch off point.	
		min. pumprate/min	Define the minimum pump rate.	
		crust reduction	Define the inaccuracy for the switching points (to reduce crust formation).	
		switch on border	Define the switch on border.	
		hook up interval	Define the hook-up interval.	
		alternate	Select if an alternating pump control is to be performed.	
5	pump control N (N = 1 or 2)		Select a pump. (The following parameters must be configured for each pump individually.)	5.2.5
6	pump M control N (M = 1 - 6) (N = 1 or 2)	switch on delay	Define the switch on delay.	5.2.11
		backlash interval	Define the backlash interval.	
		backlash time	Define the backlash time.	
		error handling	Define the error handling.	
7	relay allocation		Allocate a relay to the pump. Note: By default, relay 1 is configured as alarm relay.	5.2.8
8	relay N (N = 1 - 6)	function	Select "pump M/control N".	5.2.9
		invert	Select if the switching signal is inverted (default: no).	
9	pump control N		Select the next pump and continue with step 6 until all pumps have been configured. If all pumps are configured: Press  to return to the "relay/controls" menu.	

### 5.2.3 "pump control N" (N = 1 or 2)

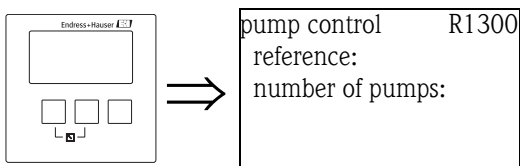

#### "reference"

Defines the level channel to which the pump control refers.

#### Selection:

- none (default)
- level 1
- level 2 (for instrument versions with 2 level inputs)

#### "number of pumps"

Defines the number of pumps participating in the pump control. At the end of the configuration procedure a relay must be allocated to each of the pumps ("relay allocation" parameter set).

- Range of values : 1 ... 6 (depending on the number of relays)
- Default: 1

#### 5.2.4 "pump control N" (N = 1 or 2)

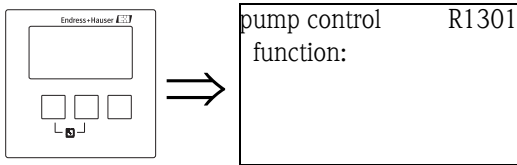

##### "function"

Determines the type of pump control.

##### Selection:

- **limit control (Default)**

Each pump has its own switch-on point and switch-off point

- **rate control**

There is only one switch-on point and one switch-off point for all pumps. If the switch-on point has been exceeded, several pumps are switched on in intervals until the defined pumprate is obtained. For details refer to the chapter "Limit control and rate control".

#### 5.2.5 "pump control N" (N = 1 or 2)

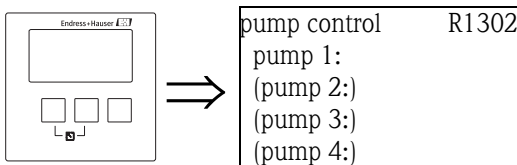

Determines, to which pump the following specifications refer.

##### Selection

- depending on the selected "number of pumps"

#### 5.2.6 "pump M/control N" (M = 1 - 6; N = 1 or 2) (Part 1: Switching points for limit control)

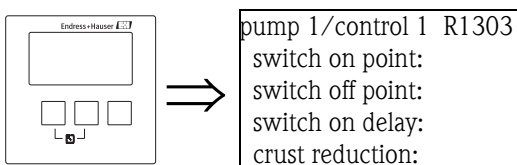

##### "switch on point"

Specifies the switch-on point of the respective pump. Use the selected level unit.



Caution!

After a change of the "unit level" the switch on point has to be checked and adjusted if required.

##### "switch off point"

Specifies the switch-off point of the respective pump. Use the selected level unit.



**Caution!**

After a change of the "unit level" the switch off point has to be checked and adjusted if required.

**"switch-on delay"**

Specifies the switch-on delay of the respective pump (in seconds).

When the level has risen above the switch-on point, the relay does not switch immediately but only after the specified switch-on delay. Assign different delays to the individual pumps in order to avoid simultaneous switching-on of several pumps (which could cause an overload of the power supply system).

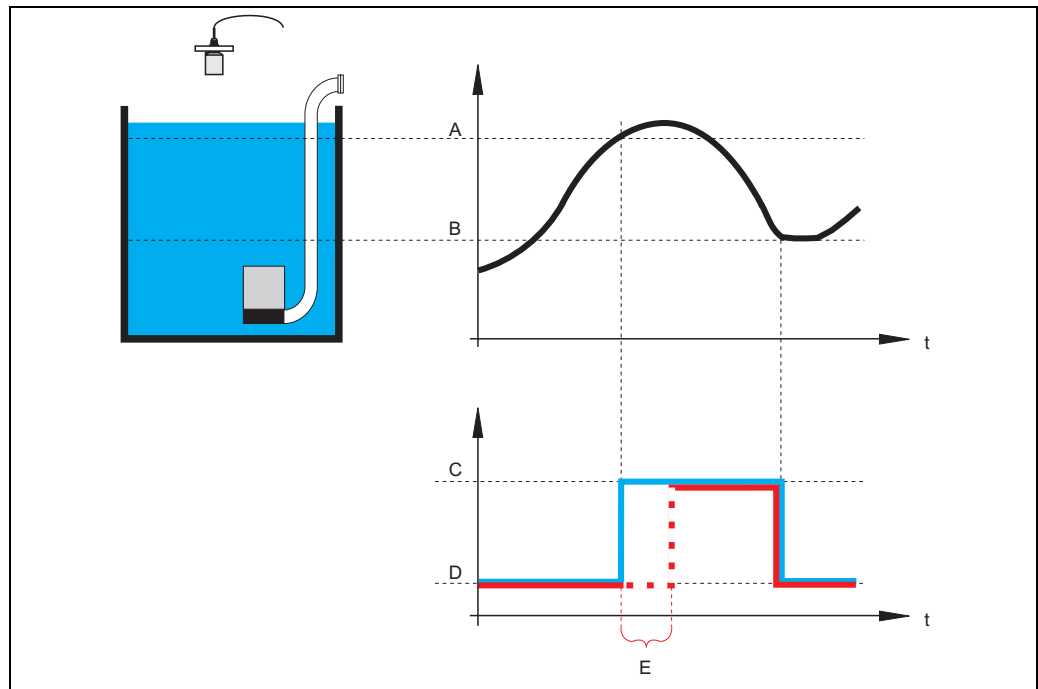

*A: switch-on point; B: switch-off point; C: pump on; D: pump off; E: switch-on delay*

100-FMU90xxx-19-00-00-yy-055

**"alternate"**

Specifies if the pump should be included in the alternating pump control.

**Selection**

■ **no (default)**

The pump is not included in the alternating pump control. Instead, it switches according to its own switch points.

■ **yes**

The pump is included in the alternating pump control.

**"crust reduction"**

Specifies a range of inaccuracy (percentage of the measuring range) for the switching points of the pump. If this value is larger than "0", the switching points are not exactly constant. Instead, they vary within the specified range of inaccuracy.

This helps to avoid crust formation, which often occurs at fixed switching points.



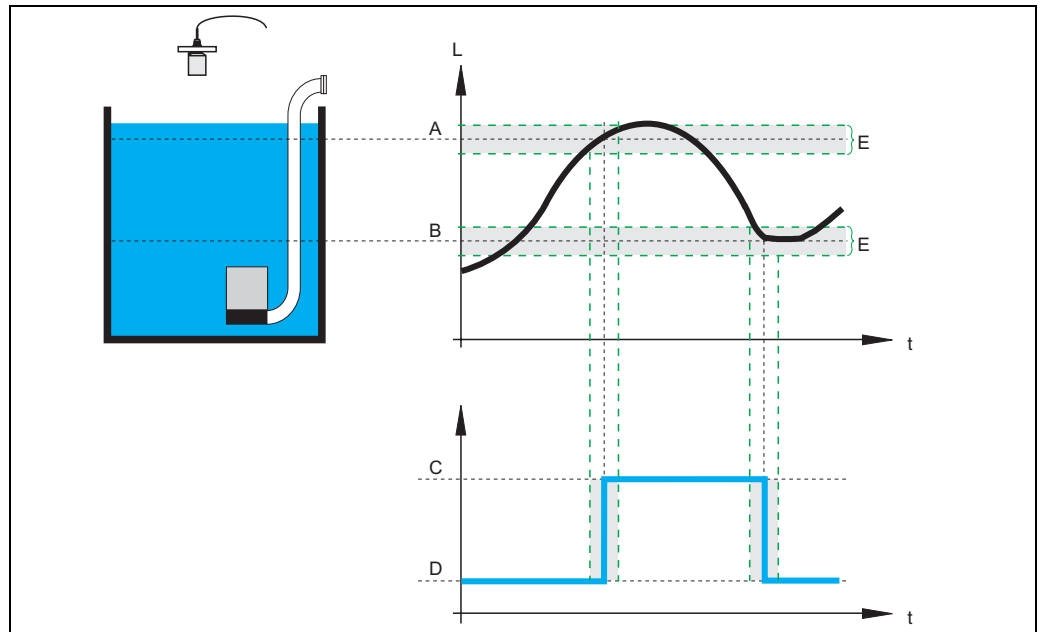

*A: switch-on point; B: switch-off point; C: pump on; D: pump off; E: inaccuracy ("crust reduction")*

### 5.2.7 "pump M/control N" (M = 1 - 6, N = 1 or 2) (Part 2: Switching behavior for limit control)

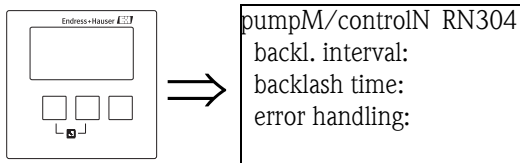

#### "backlash interval" and "backlash time"

Use these parameters if, you want to empty a vessel beyond the switch-off point in regular intervals. The "**backlash interval**" determines after which time this extended pumping will occur. The "**backlash time**" determines how long this additional pumping lasts.

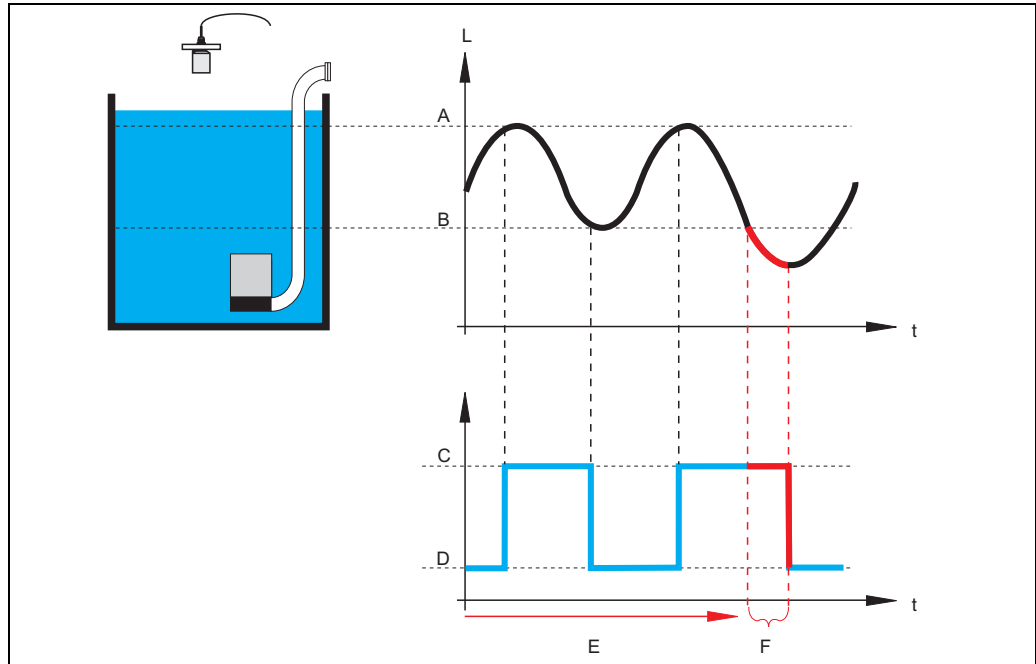

*A: switch-on point; B: switch-off point; C: pump on; D: pump off  
E: backlash interval; F: backlash time*

L00-FM190xxx-19-00-00-yy-057

### "error handling"

This parameter defines the reaction of the relay in the case of an error.

#### Selection:

- **hold (default)**

The current switching state of the relay is held.

- **switch on**

The relay is energized (i.e. the pump is switched on).

- **switch off**

The relay is de-energized (i.e. the pump is switched off).

- **actual value**

The relay switches according to the current measuring value (although its reliability is not ensured).

### 5.2.8 "relay allocation"

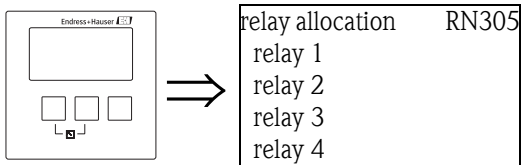

Allocates a relay to the pump.

#### Selection:

- All relays of the instrument version at hand

### 5.2.9 "relay N" (N = 1 - 6)

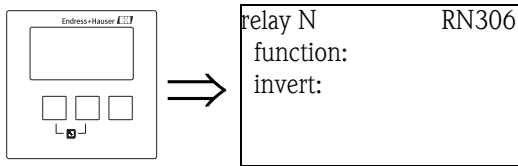

#### "function"

Allocates the desired function to the relay.

#### Selection:

- none (default)
- pump M/control N

#### "invert"

Determines if the switching behavior of the relay is inverted.

#### Selection:

- **no (default)**  
The switching behavior of the relay is **not** inverted. The relay is energized if the pump should be switched on.
- **yes**  
The switching behavior of the relay **is** inverted. The relay is energized if the pump should be switched off.

### 5.2.10 "pump control N" (N = 1 or 2) (Switching points for rate control)

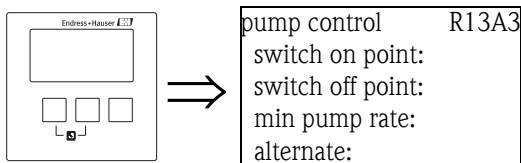

#### "switch on point"

Specifies the switch-on point. Use the selected level unit.



Caution!

After a change of the "unit level", the switch on point has to be checked and adjusted if required.

#### "switch off point"

Specifies the switch-off point. Use the selected level unit.



Caution!

After a change of the "unit level", the switch off point has to be checked and adjusted if required.

#### "min pump rate"

Specifies the desired minimum pump rate (for details see section "limit control and rate control").



Note!

If the vessel is to be emptied, a negative pump rate has to be specified.

**"crust reduction" subfunction**

Specifies a range of inaccuracy (percentage of the measuring range) for the switching points. If this value is larger than "0", the switching points are not exactly constant. Instead, they vary within the specified range of inaccuracy.

This helps to avoid crust formation, which often occurs at fixed switching points.

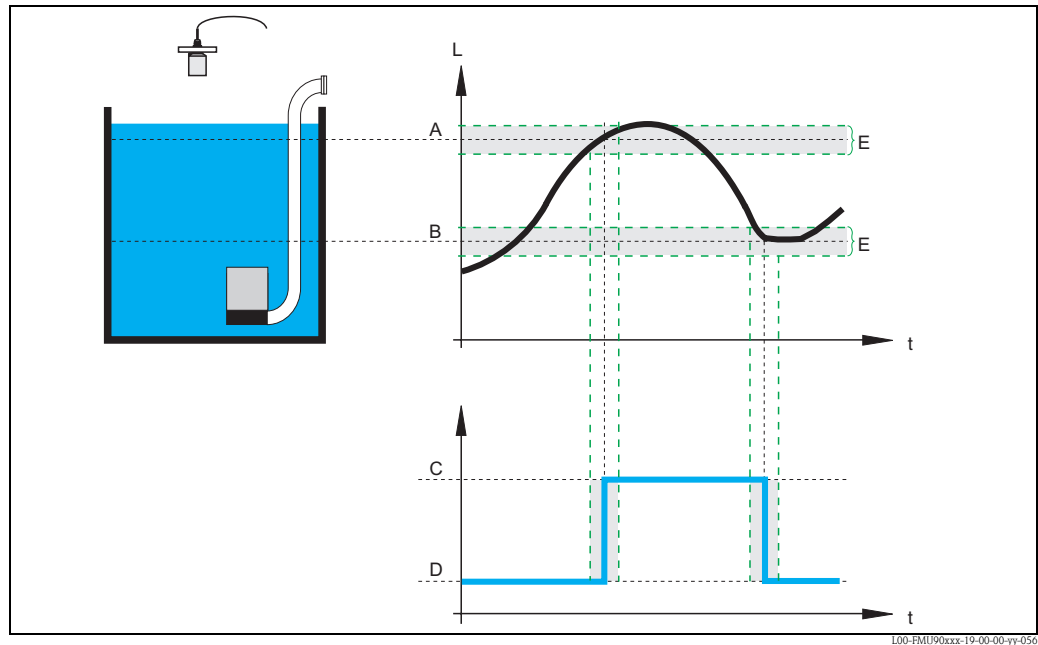

*A: switch-on point; B: switch-off point; C: pump on; D: pump off; E: inaccuracy ("crust reduction")*

**"switch on border"**

Specifies the switch-on border for the rate control (for details see section "limit control and rate control").

**"hook up interval"**

Specifies the time interval between the switching-on of the different pumps (for details see section "limit control and rate control").

**"alternate"**

Determines if an alternating pump control is to be performed.

### 5.2.11 "pump M/control N (M = 1 - 6, N = 1 or 2) (Switching behavior for rate control)

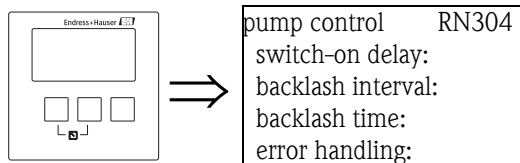

#### "switch-on delay"

see page 88

#### "backlash interval" and "backlash time"

see page 89

#### "error handling"

see page 90

## 5.3 The "pump control N" submenu - enhanced (N = 1 or 2)



Note!

Depending on the order code of the instrument, different functionalities can be configured for the pump control. The order code of the instrument can be found on the nameplate and in the operating menu at "system information/device information".

This chapter is only valid for instruments with enhanced pump control (FMU90-\*3\*\*\*\*\* and FMU90-\*4\*\*\*\*\*).

For the standard pump control see chapter 5.2 (FMU90-\*1\*\*\*\*\* and FMU90-\*2\*\*\*\*\*).



Note!

The "pump control N" submenus are only present if "pump control" has been selected in "device properties/operating parameters/controls".

### 5.3.1 Basic principles

The pump control is used to start or stop pumps depending on the measured level. Up to two pump controls can be defined. One or more pumps can be allocated to each pump control. The pumps are switched on and off by the relays of the Prosonic S.

The switching behavior depends on:

- the selected "function"
- the selected type of "load control" (only relevant for alternating pump control)

#### Functions "limit simple" and "limit parallel"

For these functions, a switch-on point and a switch-off point is defined for each pump. The switching behaviour depends on the relative position of these two switching points:

a. **Switch-on point > Switch-off point ("Emptying")**

The pump is switched on if the level rises above the switch-on point (A). It is switched off if the level drops below the switch-off point (B).

b. **Switch-on point < Switch-off point ("Filling")**

The pump is switched on if the level drops below the switch-on point (A). It is switched off if the level rises above the switch-off point (B).

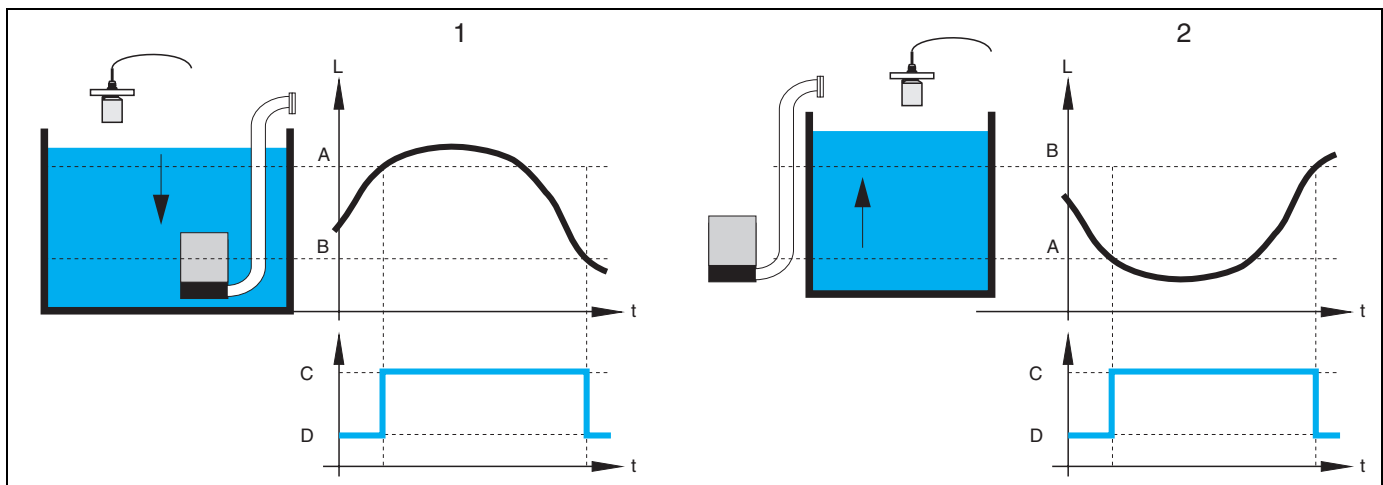

1: "Emptying" (switch-on point > switch-off point); 2: "Filling" (switch-on point < switch-off point)  
 A: switch-on point; B: switch-off point; C: pump on; D: pump off



**Note!**

If several pumps are allocated to a pump control, the switching direction of all these pumps must be the same. Mixing of "filling" and "emptying" is not allowed.

The difference between "limit simple" and "limit parallel" relates to the control of more than one pump:

■ **limit simple (A)**

With this function, only one pump can be running at a time. Before a pump is switched on, the previously running pump is switched off automatically. Details depend on the relative position of the switching points, especially on the fact if the switching ranges of different pumps are overlapping. (Refer to the example in the diagram below).

■ **limit parallel (B)**

With this function, several pumps can be switched on at the same time.

**Example ("Emptying" with three pumps)**

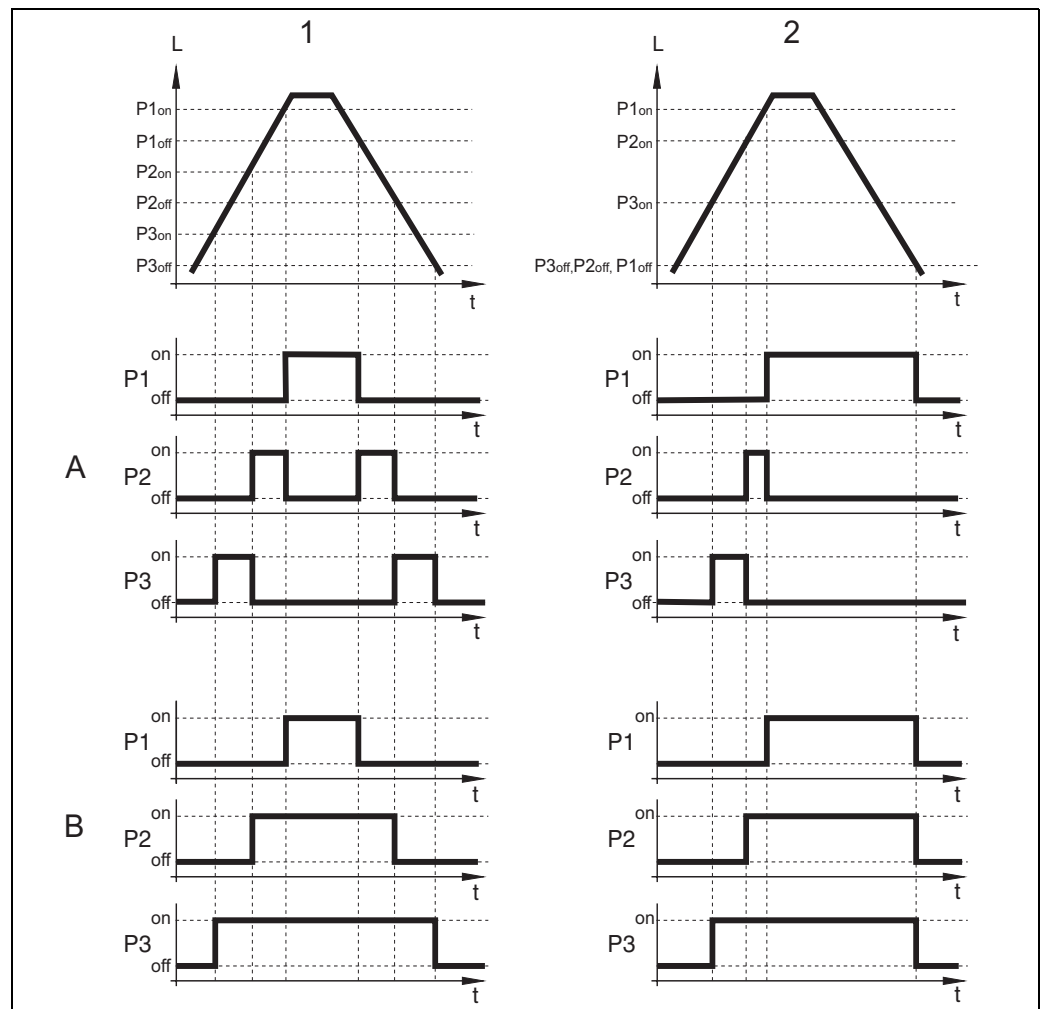

L00-FMU90xxx-19-00-00-yy-107

A: "limit simple"; B: "limit parallel"

1: Separated switching ranges; 2: Overlapping switching ranges;

P1<sub>on</sub>, P2<sub>on</sub>, P3<sub>on</sub>: switch-on points for the pumps P1, P2 and P3

P1<sub>off</sub>, P2<sub>off</sub>, P3<sub>off</sub>: switch-off points for the pumps P1, P2 and P3

### Function "pump rate control"

If pump rate control has been selected, there is only one switch-on point and one switch-off point, which are valid for all relays. Additionally, a desired **pump rate** has to be specified.

If the level rises above (or falls below) the switch-on point, initially only one pump is switched on. If the desired pump rate has not been achieved after the selected **hook-up interval**, an additional pump is switched on. Similarly, further pumps are switched on in intervals until the desired pump rate has been achieved.

However, if the level is already near to the switch-off point (distance < **switch-on barrier**), no further pumps are switched on, even if the pump rate has not yet been achieved.

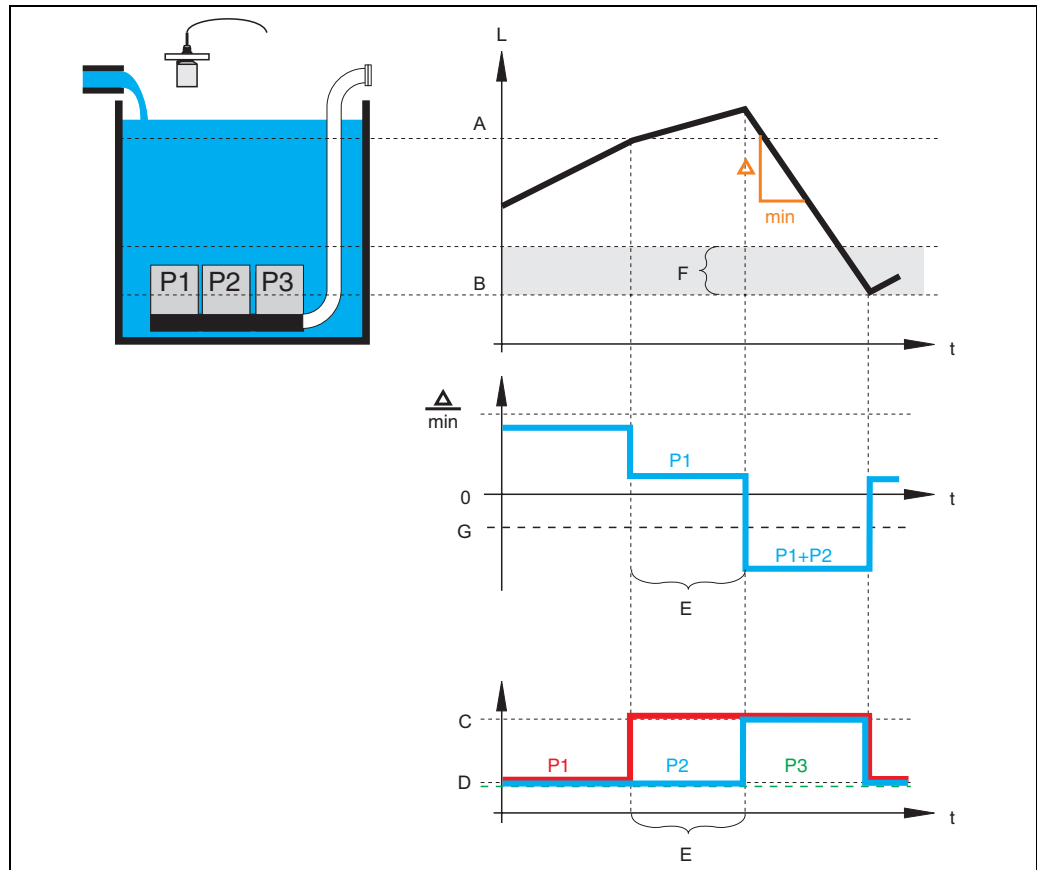

*A: switch-on point; B: switch-off point; C: pump on; D: pump off; E: hook-up interval; F: switch-on barrier  
G: pump rate*

### Alternating pump control

Optionally, a number of pumps can be allocated to the alternating pump control. In this mode, the switching points are no longer allocated to the individual pumps. Instead, a desired degree of use must be defined for each pump (e.g. equal usage of all pumps).

If the level rises above (or falls below) the switch-on point and a pump has to be switched on, the Prosonic S selects the pump according to an algorithm which ensures that in the course of time the desired degrees of use are obtained for all pumps.

The same is valid for the switching-off of pumps.



Note!

For the limit control (simple or parallel) it can be defined for each pump individually if it is to take part in the alternating pump control.

For pump rate control, it is only possible to allocate all pumps or no pump to the alternating pump control.



### 5.3.2 Basic setup

#### Overview: Parametrization of a limit control (simple/parallel)

Step	Parameter set or submenu	Parameter	Remarks	see page
1	"relay/controls" menu		1. Select "pump control 1" or "pump control 2". 2. Select "basic setup".	
2	pump control N (N = 1 or 2)	reference	Select the level according to which the pumps are controlled.	99
		number of pumps	Select the number of pumps. Note: A relay must be available for each pump.	99
		standby pump <sup>1)</sup>	Define, if one of the pumps is to be a standby pump.	99
		reset	Restarts an existing pump control; is not used during the parametrization.	99
3	pump control N (N = 1 or 2)	function	Select "rate control".	100
		load control	Select the type of load control (only relevant for alternating pump control)	100
4	pump control N (N = 1 or 2)		Select a pump. (Each pump must be configured individually.)	
5	pump M control N (M = 1 - 6) (N = 1 or 2)	switch on point	Define the switch on point for this pump.	101
		switch off point	Define the switch off point for this pump.	101
		switch on delay	Define the switch on delay for this pump.	101
		alternate	Select if the pump is to take part in the alternating pump control (Default: no).	102
		degree of use	Define the desired degree of use (percentage) for this pump; (only relevant for alternating pump control)	102
		max. use time	Define the maximum use time for this pump (only relevant for alternating pump control with "load control" = "starts+time")	102
		crust reduction	Define the inaccuracy of the switching points (to reduce crust formation).	102
6	pump M control N (M = 1 - 6) (N = 1 or 2)	backlash interval	Define the backlash interval.	103
		backlash time	Define the backlash time.	103
		error handling	Define the error handling.	103
7	pump M control N (M = 1 - 6) (N = 1 or 2)	pump feedback	Select the digital input used for pump feedback.	104
		feedback delay	Define the time interval in which a feedback is required.	104
		feedback meaning	Define the meaning of the pump feedback.	104
8	relay allocation		Allocate a relay to the pump. Note: By default, relay 1 is configured as alarm relay.	
9	relay N (N = 1 - 6)	function	Select "pump M/control N"	105
		invert	Select if the switching signal is inverted (default: no)	105
10	pump control N		Select the next pump and continue with step 5 until all pumps have been configured. If all pumps are configured: Press  to return to the "relay/controls" menu.	

1) only for instruments with external limit switches; the stand-by pump always is the last of the M pumps.

### Overview: Parametrization of a pump rate control

Step	Parameter set or submenu	Parameter	Remarks	see section
1	"relay/controls" submenu		Select "pump control 1" or "pump control 2".	
2	pump control N (N = 1 or 2)	reference	Select the level according to which the pumps are controlled.	99
		number of pumps	Select the number of pumps. Note: A relay must be available for each pump.	99
		standby pump <sup>1)</sup>	Define, if one of the pumps is to be a standby pump.	99
		reset	Restarts an existing pump control; is not used during the parametrization.	99
3	pump control N (N = 1 or 2)	function	Select "rate control".	100
		load control	Select the type of load control (only relevant for alternating pump control)	100
4	pump control N (N = 1 or 2)	switch on point	Define the switch on point.	106
		switch off point	Define the switch off point.	106
		min. pumprate/min	Define the minimum pump rate.	106
		crust reduction	Define the inaccuracy for the switching points (to reduce crust formation).	106
		switch on border	Define the switch on border.	107
		hook up interval	Define the hook-up interval.	107
		alternate	Select if an alternating pump control is to be performed.	107
5	pump control N (N = 1 or 2)		Select a pump. (The following parameters must be configured for each pump individually.)	
6	pumpe M control N (M = 1 - 6) (N = 1 or 2)	switch on delay	Define the switch on delay.	101
		degree of use	Define the desired degree of use (percentage) for this pump; (only relevant for alternating pump control)	102
		max. use time	Define the maximum use time for this pump (only relevant for alternating pump control with "load control" = "starts+time")	102
7	pump M control N (M = 1 - 6) (N = 1 or 2)	backlash interval	Define the backlash interval.	103
		backlash time	Define the backlash time.	103
		error handling	Define the error handling.	103
8	pump M control N (M = 1 - 6) (N = 1 or 2)	pump feedback	Select the digital input used for pump feedback.	104
		feedback delay	Define the time interval in which a feedback is required.	104
		feedback meaning	Define the meaning of the pump feedback.	104
9	relay allocation		Allocate a relay to the pump. Note: By default, relay 1 is configured as alarm relay.	
10	relay N (N = 1 - 6)	function	Select "pump M/control N".	105
		invert	Select if the switching signal is inverted (default: no).	105
11	pump control N		Select the next pump and continue with step 6 until all pumps have been configured. If all pumps are configured: Press  to return to the "relay/controls" menu.	

1) only for instruments with external limit switches; the stand-by pump always is the last of the M pumps.

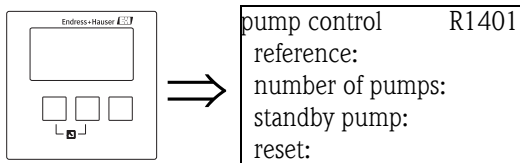
**"pump control N" (N = 1 or 2)***"reference"*

Defines the level channel to which the pump control refers.

**Selection:**

- **none (default)**
- level 1
- level 2 (for instrument versions with 2 level inputs)

*"number of pumps"*

Defines the number of pumps participating in the pump control. At the end of the configuration procedure a relay must be allocated to each of the pumps ("relay allocation" parameter set).

- Range of values : 1 ... 6 (depending on the number of relays)
- Default: 1

*"standby pump"*

*(only for instruments with external limit switches)*

Determines if one of the pumps is a standby pump.

**Selection:**

- **no (default)**  
There is no standby pump.
- **yes**  
The last of the pumps is a standby pump. It can not be configured individually. If a failure of one of the other pumps is reported to the Prosonic S, the standby pump substitutes for this pump.

Example:

number of pumps: 5

standby pump: yes

=> pump control for pumps 1 to 4; pump 5 is the standby pump

*"reset"*

This parameter is used to restart the pump control (e.g. after a failed pump has been repaired).



Note!

The reset has the same effect as a disconnection of the supply voltage. It does not influence the parametrization of the pump control.

**Selection:**

- **no (default)**  
The pump control is **not** reset.
- **yes**  
The pump control **is** reset.

**"pump control N" (N = 1 or 2)**

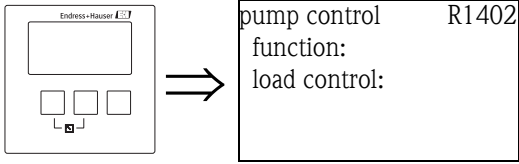

*"function"*

Determines the type of pump control.

**Selection:**

■ **limit parallel (Default)**

Each pump has its own switch-on point and switch-off point. Several pumps can be running at the same time.

■ **limit simple**

Each pump has its own switch-on point and switch-off point. Only one pump can be running at a time.

■ **rate control**

There is only one switch-on point and one switch-off point for all pumps. If the switch-on point has been exceeded, several pumps are switched on in intervals until the defined pump rate is obtained. For details refer to the chapter "Limit control and rate control".

*"load control"*

Determines, how the load of the pumps is measured for the alternating pump control.

**Selection:**

■ **in order**

- If a pump is to be switched on, the Prosonic S selects the pump which currently has been idle longer than any other pump.
- If a pump is to be switched off, the Prosonic S selects the pump which currently has been running longer than any other pump.

■ **time of use**

The total running time is considered for each pump.

■ **starts (default)**

The number of starts is considered for each pump, irrespective of the time the pump has been running after each start.

■ **starts+time**

Identical to the option "starts".

Additionally, a maximum use time is defined for each pump. After it has been running for this time, a pump is automatically replaced by another pump.

**"pump control N" (N = 1 or 2)**

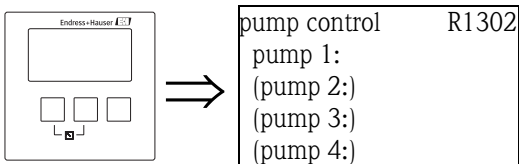

Determines, to which pump the following specifications refer.

**Selection**

- depending on the selected "number of pumps"

**"pump M/control N" (M = 1 - 6; N = 1 or 2)**  
**(Part 1: Switching points for limit control)**

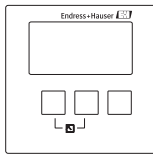

pump 1/control 1 R1303  
 switch on point:  
 switch off point:  
 switch on delay:  
 crust reduction:

*"switch on point"*

Specifies the switch-on point of the respective pump. Use the selected level unit.



**Caution!**

After a change of the "unit level" the switch-on point has to be checked and adjusted if required.

*"switch off point"*

Specifies the switch-off point of the respective pump. Use the selected level unit.



**Caution!**

After a change of the "unit level" the switch-off point has to be checked and adjusted if required.

*"switch-on delay"*

Specifies the switch-on delay of the respective pump (in seconds).

When the level has risen above the switch-on point, the relay does not switch immediately but only after the specified switch-on delay. Assign different delays to the individual pumps in order to avoid simultaneous switching-on of several pumps (which could cause an overload of the power supply system).

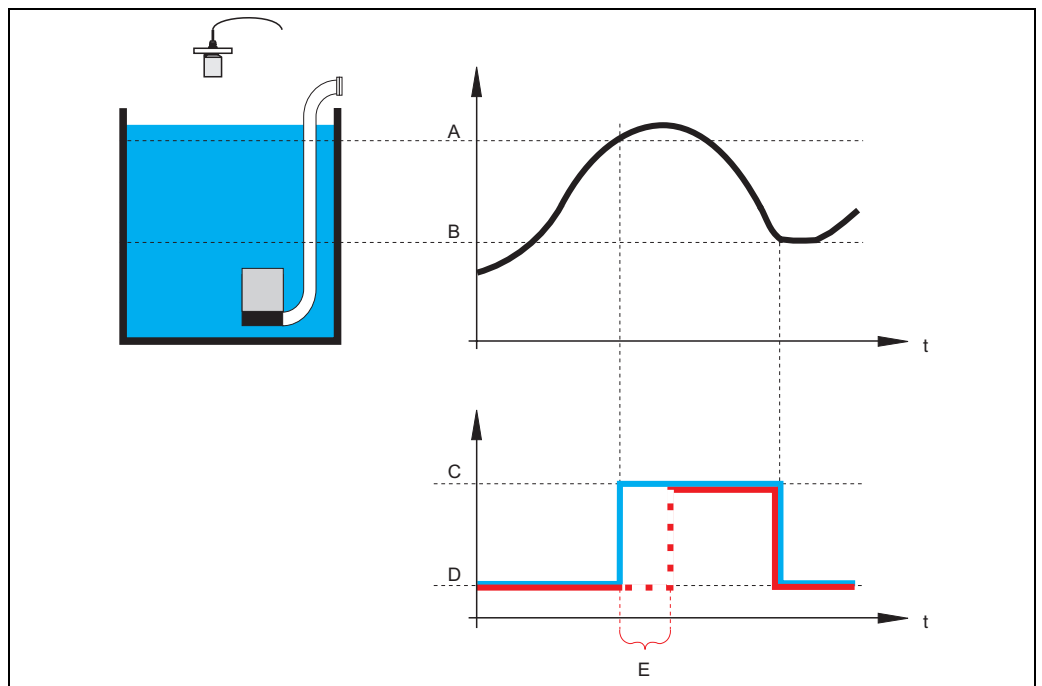

**A:** switch-on point; **B:** switch-off point; **C:** pump on; **D:** pump off; **E:** switch-on delay

L00-FM190xxxx-19-00-00-yy-055

*"alternate"*

Specifies if the pump should be included in the alternating pump control.

**Selection**

■ **no (default)**

The pump is not included in the alternating pump control. Instead, it switches according to its own switch points.

■ **yes**

The pump is included in the alternating pump control.

*"degree of use"*

(for "load control" = "time of use" or "starts")

Defines the desired degree of use (percentage) of this pump for an alternating pump control. The degree of use is only obtained, if the pump has been allocated to the alternating pump control.



Note!

The total degree of use of all pumps participating in the alternating pump control should be 100%.

*"maximum use time"*

(for "load control" = "starts+time")

Defines the maximum use time for this pump which is valid for the alternating pump control and for "load control" = "starts+time". After it has been running for this time, the pump is automatically replaced by another pump.

*"crust reduction"*

Specifies a range of inaccuracy (percentage of the measuring range) for the switching points of the pump. If this value is larger than "0", the switching points are not exactly constant. Instead, they vary within the specified range of inaccuracy.

This helps to avoid crust formation, which often occurs at fixed switching points.

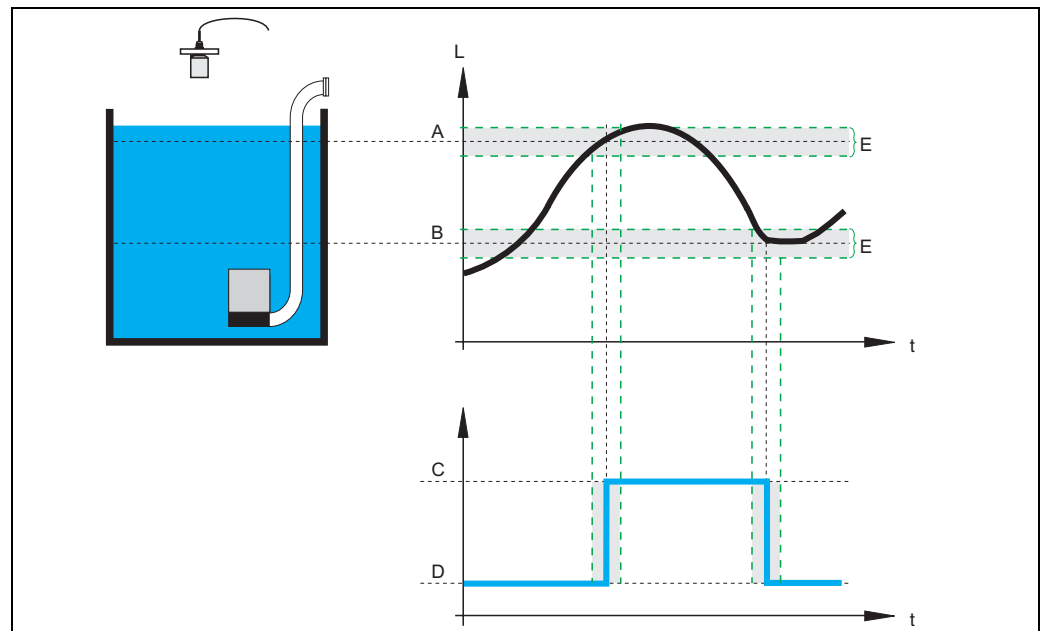

**A:** switch-on point; **B:** switch-off point; **C:** pump on; **D:** pump off; **E:** inaccuracy ("crust reduction")

100-FMU90xxx-19-00-00-yy-056

**"pump M/control N" (M = 1 - 6, N = 1 or 2)**  
**(Part 2: Switching behavior for limit control)**

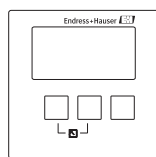

pumpM/controlN RN304  
 backl. interval:  
 backlash time:  
 error handling:

*"backlash interval" and "backlash time"*

Use these parameters if you want to empty a vessel beyond the switch-off point in regular intervals. The **"backlash interval"** determines after which time this extended pumping will occur. The **"backlash time"** determines how long this additional pumping lasts.

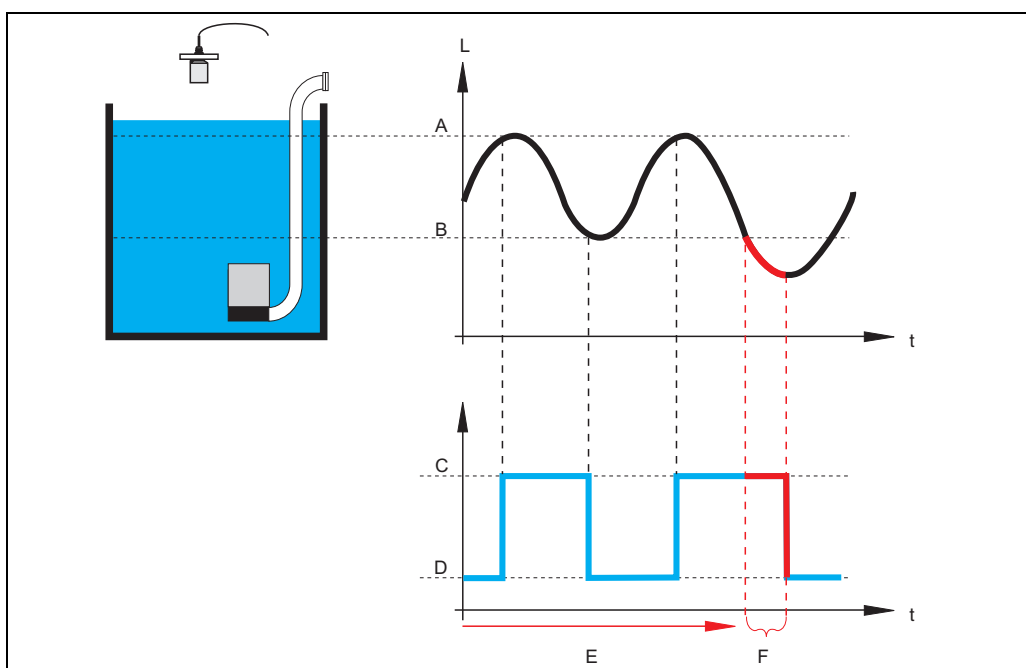

*A: switch-on point; B: switch-off point; C: pump on; D: pump off*  
*E: backlash interval; F: backlash time*

*"error handling"*

This parameter defines the reaction of the relay in the case of an error.

**Selection:**

- **hold (default)**  
The current switching state of the relay is held.
- **switch on**  
The relay is energized (i.e. the pump is switched on).
- **switch off**  
The relay is de-energized (i.e. the pump is switched off).
- **actual value**  
The relay switches according to the current measuring value (although its reliability is not ensured).

**"pump M/control N" (M = 1 - 6, N = 1 or 2)**  
**(Part 3: Parametrization of the associated switch inputs)**

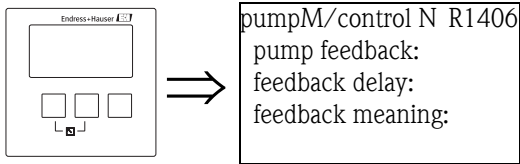

Note!

This parameter exists only for instruments with external limit switches.

*"pump feedback"*

Defines which digital input is used for pump feedback.

**Selection:**

- **disabled (default)**  
no feedback
- **ext. digin 1**  
terminals 71, 72, 73
- **ext. digin 2**  
terminals 74, 75, 76
- **ext. digin 3**  
terminals 77, 78, 79
- **ext. digin 4**  
terminals 80, 81, 82

*"feedback delay"*

Defines in which time interval after a pump start a feedback is required.

Feedback messages after this time are ignored.

Default: 30 s



Note!

When setting the feedback delay, the startdelay of the relay (which is defined in the safety settings menu) has to be taken into account. Depending on the number of connected pumps the feedback delay must be at least "number of pumps x startdelay relay".

*"feedback meaning"*

Defines the meaning of the feedback signal.

**Selection:**

- **pump start (default)**  
The feedback signals the start of the pump.  
If no feedback is given within the feedback delay, the standby pump is started (if one has been defined).
- **pump failure**  
The feedback signals a failure of the pump. If a standby pump has been defined it is used to replace the failed pump.



Caution!

If the connected pumps are shut down as a consequence of an error message, it is advisable for security reasons to switch off the control unit Prosonic S as well.

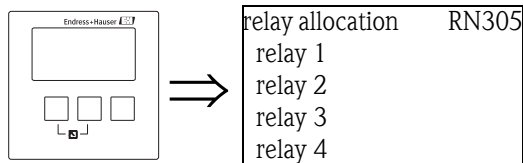

**"relay allocation"**

Allocates a relay to the pump.

**Selection:**

- All relays of the instrument version at hand

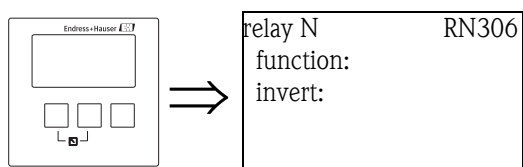
**"relay N" (N = 1 - 6)****"function"**

Allocates the desired function to the relay.

**Selection:**

- none (default)
- pump M/control N

**Note!**

If a standby pump has been parametrized: The standby pump is always the last of the pumps. Therefore, during the relay allocation the last pump must be selected in the "function" parameter.

**Example:**

number of pumps: 5

stand by pump: yes

=> for the standby pump: "function" = pump 5/control N

**"invert"**

Determines if the switching behavior of the relay is inverted.

**Selection:**

- **no (default)**

The switching behavior of the relay is **not** inverted. The relay is energized if the pump should be switched on.

- **yes**

The switching behavior of the relay **is** inverted. The relay is energized if the pump should be switched off.

**"pump control N" (N = 1 or 2)  
(Switching points for rate control)**

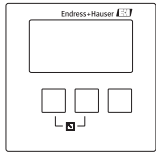

pump control R13A3  
 switch on point:  
 switch off point:  
 min pump rate:  
 alternate:

*"switch on point"*

Specifies the switch-on point. Use the selected level unit.



Caution!

After a change of the "unit level", the switch on point has to be checked and adjusted if required.

*"switch off point"*

Specifies the switch-off point. Use the selected level unit.



Caution!

After a change of the "unit level", the switch off point has to be checked and adjusted if required.

*"min pump rate"*

Specifies the desired minimum pump rate (for details see section "limit control and rate control").



Note!

If the vessel is to be emptied, a negative pump rate has to be specified.

*"crust reduction" subfunction*

Specifies a range of inaccuracy (percentage of the measuring range) for the switching points. If this value is larger than "0", the switching points are not exactly constant. Instead, they vary within the specified range of inaccuracy.

This helps to avoid crust formation, which often occurs at fixed switching points.

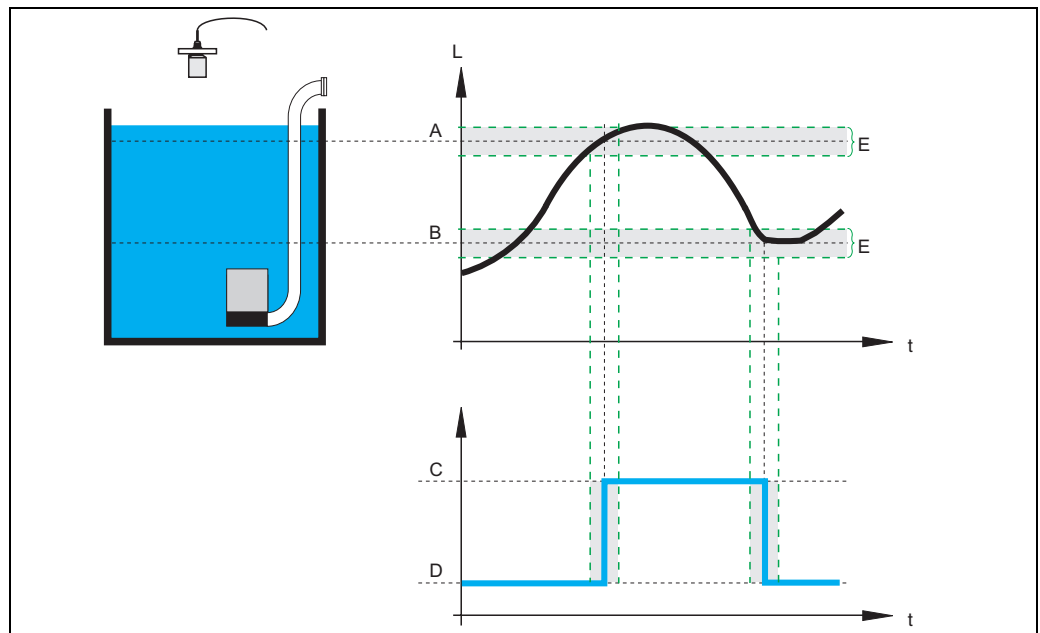

L100-FMU90xxx-19-00-00-yy-056

**A:** switch-on point; **B:** switch-off point; **C:** pump on; **D:** pump off; **E:** inaccuracy ("crust reduction")

*"switch on border"*

Specifies the switch-on border for the rate control (for details see section "limit control and rate control").

*"hook up interval"*

Specifies the time interval between the switching-on of the different pumps (for details see section "limit control and rate control").

*"alternate"*

Determines if an alternating pump control is to be performed.

### 5.3.3 The "storm function" submenu

The storm function is used to avoid unnecessary running of the pump if the plant is flooded for a short time (e.g. in the case of strong rainfall).

#### "storm function N" ( N = 1 or 2)

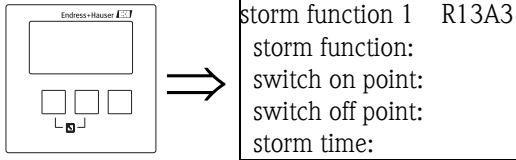

#### "storm function"

Use this parameter to switch the storm function on and off.

#### Selection:

- off (default)
- on

#### "switch on point"

Defines the switch on point for the storm function. If the level rises above this value, the storm function becomes active, i.e. all pumps are switched off.

Default: 95%



Note!

Storm detection is **not** indicated by an alarm.

#### "switch off point"

Defines the switch off point for the storm function. If the level falls below this value, the storm function is deactivated, i.e. the normal pump control becomes valid again.

Default: 90%



Note!

The switch off point must always be lower than the switch on point. It must be ensured that the switch off point is reached without the pumps (e.g. by an outlet).

#### "storm time"

Defines the maximum duration of a storm.

If the storm function has been activate for this time, it is automatically deactivated, even if the level has not fallen below the switch off point or has risen above the switch on point a second time.

Default: 60 min

### 5.3.4 The "function test" submenu

The function test is used to avoid incrustations which may occur if pumps are switched off for a long time. If a pump has not been running for a defined time (max downtime), it is automatically switched on for a short time (max test time).



Note!

The function test affects all pumps, even the standby pump.

#### "function test N" ( N = 1 or 2)

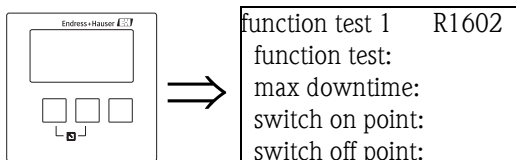

#### "function test"

Use this parameter to switch the automatic function test on and off.

#### Selection:

- off (default)
- on

#### "max. downtime" und "max. test time"

These parameters define when and how long a pump is switched on for the function test:

If a pump has not been running for the "**max. downtime**", it is switched on (even if momentarily other pumps are running).

It is automatically switched off after the "**max test time**".

#### Default:

- max. downtime: 0h
- max. test time: 60 s

#### "switch on point" and "switch off point"

These parameters define a condition for the function test. A pump is only switched on for the function test, if these conditions are met. Details depend on the relative position of the switching points:

#### ■ switch on point > switch off point ("Emptying")

The function test is only performed if the level is above the switch on point.

If the level falls below the switch off point, the function test is terminated, even if the "maximum test time" has not yet elapsed.

#### ■ switch on point < switch off point ("Filling")

The function test is only performed if the level is below the switch on point.

If the level rises above the switch off point, the function test is terminated, even if the "maximum test time" has not yet elapsed.

#### Default:

- switch on point: 20%
- switch off point: 10%

### 5.3.5 The "flush control" submenu

The flush control is used to switch a pump on for a number of cycles (flush cycles) for a defined time (flush time). This switching-on takes place within the defined number of pump cycles. The figure below shows an example with 5 pump cycles and 2 flush cycles. The last two of the five pump cycles are used for flushing.

A pump cycle always starts with the first pump being switched on and ends if all pumps are switched off again.

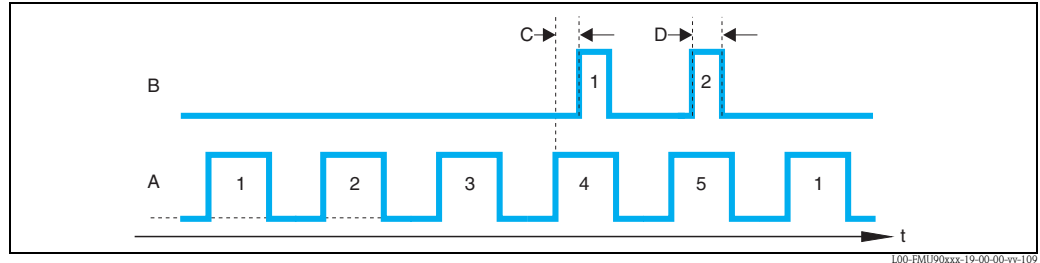

A: 5 pump cycles; B: 2 flush cycles; C: flush delay; D: flush time

#### "flush control N" ( N = 1 or 2)

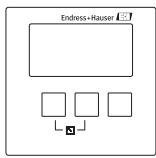

```
flush control 1 R1603
flush control:
pump cycles:
flush cycles:
flush time:
```

#### "flush control"

Use this parameter to switch the flush control on and off.

#### Selection:

- off (default)
- on

#### "pump cycles"

Defines the number of pump cycles after which the flush cycles are started.

Default: 0

#### "flush cycles"

Defines the number of flush cycles within the number of pump cycles.

Default: 0



Note!

The number of flush cycles must be equal or less than the number of pump cycles.

#### "flush time"

Defines, how long the flush relay is switched on.

Default: 0 s

#### "flush delay"

Defines the interval between the start of the pump cycle and the start of the flush relay.

Default: 0 s

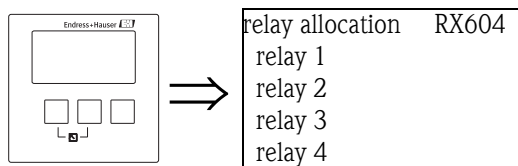
**"relay allocation"**

Defines which relay is the flush relay.

**Selection:**

- All relays of the instrument version at hand.

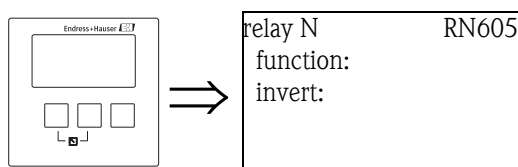
**"relay N" (N = 1 - 6)****"function"**

Allocates the desired function to the relay.

**Selection:**

- none (default)
- flush control N

**"invert"**

Determines if the switching behavior of the relay is inverted.

**Selection:**

- **no (default)**  
The switching behavior of the relay is **not** inverted. The relay is energized in the flush cycles.
- **yes**  
The switching behavior of the relay **is** inverted. The relay is de-energized in the flush cycles.

### 5.3.6 The "tariff control" submenu



Note!

The tariff control is only available for instruments with external limit switches (FMU90-\*\*\*\*\*B\*\*\*).

The tariff control allows to define two different switch-on and switch-off points for each pump. An external switch determines which of these switching points are currently valid. By connecting a time switch to the Prosonic S this allows to use low priced tariff times preferentially for pumping.

#### "tariff control N" (N = 1 or 2)

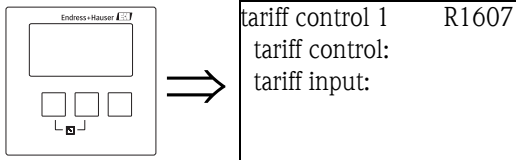

#### "tariff control"

Determines if a tariff control is to be performed.

**Selection:**

- no (default)
- yes

#### "tariff input"

Allocates one of the switch inputs to the tariff control.

**Selection:**

- disabled
- ext. digin 1 (terminals 71, 72, 73)
- ext. digin 2 (terminals 74, 75, 76)
- ext. digin 3 (terminals 77, 78, 79)
- ext. digin 4 (terminals 80, 81, 82)

#### "tariff control N" (N = 1 or 2) (pump selection)

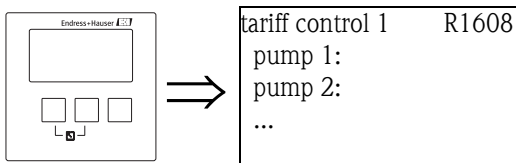

Select the pump for which you are going to configure the tariff control from this list.

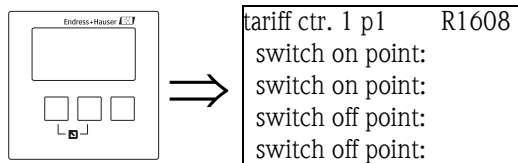

**"tariff ctrl N pump M" (N = 1 or 2, M = 1 - 6)***"switch on point"*

Displays the switch on point which is valid as long as no signal is present at the tariff switch input. (Is equal to the switch-on point defined in the basic setup.)

*"switch on point tariff"*

Defines the switch of point which is valid if a signal is present at the tariff switch input.

*"switch off point"*

Displays the switch off point which is valid as long as no signal is present at the tariff switch input. (Is equal to the switch-off point defined in the basic setup.)

*"switch off point tariff"*

Defines the switch off point which is valid if a signal is present at the tariff switch input.

**Note!**

By selecting appropriate tariff switch points preferential pumping during the low-price tariff times can be achieved.

**Example for emptying:**

The switch points for tariff control are considerably below those of the basic setup. This results in a preferred pumping and emptying of the vessel during the low-price tariff time. During the high price tariff time on the other hand, as much water as possible is buffered in the vessel.

### 5.3.7 The "pump data" submenu

The most important operating data of the pumps can be displayed in this submenu.

#### "pump data N" (N = 1 or 2) (pump selection)

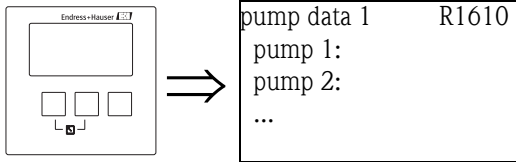

Select a pump from this list. The operating data of this pump will be displayed in the following parameter set.

#### "pump data N" (N = 1 or 2)

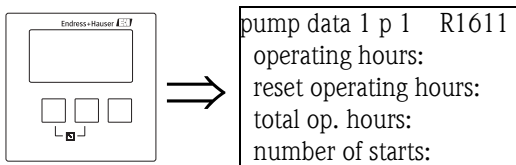

Note!

All pump data displayed in this parameter set are affected by a reset of the Prosonic S.

#### "operating hours"

Indicates how long the pump has been running since the last reset.

#### "reset operating hours"

Resets the "operating hours" to 0.

#### Selection:

##### ■ no

"operating hours" keeps its value.

##### ■ yes

"operating hours" is reset to 0.

#### "total operating hours"

Indicates the total time the pump has been running since commissioning. This value can not be reset.

#### "number of starts"

Indicates the number of times the pump has been started.

#### "starts per hour"

Indicates the average number of starts per hour.

#### "backlash starts"

Indicates the number of times the backlash time has been active for this pump.

*reset backlash starts*

Resets the number of backlash starts to 0.

**Selection:**

- **no**  
"backlash starts" keeps its value.
- **yes**  
"backlash starts" is reset to 0.

*last run time*

Indicates how long the pump has been running since the last switch-on.

### 5.3.8 The "operating hours alarm" submenu

A maximum run time can be defined for each pump. The operating hours alarm becomes active as soon as this run time is exceeded.

#### "operating hours alarm N" (N = 1 or 2)

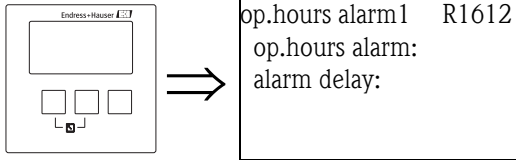

##### "operating hours alarm"

Use this parameter to switch the operating hours control on and off.

##### Selection:

- off (default)
- on

##### "alarm delay"

Defines the delay for the operating hours alarm. This delay is the same for all pumps. Default: 0s.

#### "operating hours alarm N" (N = 1 or 2) (pump selection)

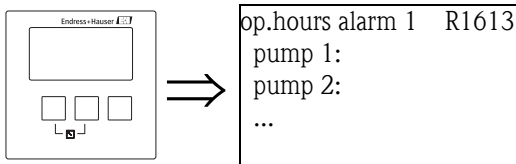

Select the pump for which you are going to configure the operating hours alarm.

#### "operating hours N pump M" (N = 1 or 2, M = 1 - 6)

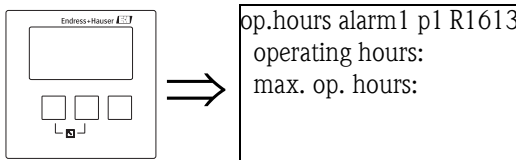

##### "operating hours"

Indicates how long the pump has been running since the last reset.

##### "maximum operating hours"

Defines the maximum running time of the pump. The operating hours alarm becomes active as soon as "operating hours" exceeds this value.

Default: 10000 h

**Note!**

The alarm is deactivated by a reset of the operating hours in the "pump data" submenu (e.g. after the maintenance of the pump has been completed).

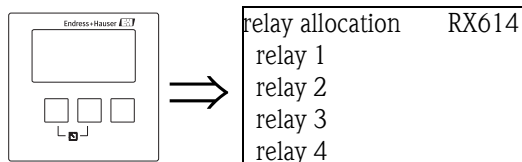
**"relay allocation"**

Defines a relay which is associated with the operating hours alarm.

**Selection:**

- All relays of the instrument version at hand.

**Note!**

The relay is not allocated to a specific pump. It only indicates that the operating hours alarm is active for one of the pumps. At the same time an error message is generated which states the number of the affected pump.

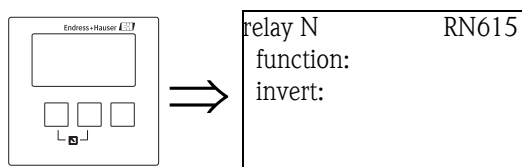
**"relay N" (N = 1 - 6)****"function"**

Allocates the desired function to the relay.

**Selection:**

- none (default)
- Operating hours alarm N (N = 1 or 2)

**"invert"**

Determines if the switching behavior of the relay is inverted.

**Selection:**

- **no (default)**

The switching behavior of the relay is **not** inverted. The relay is de-energized if an operating hours alarm is active.

- **yes**

The switching behavior of the relay **is** inverted. The relay is energized if an operating hours alarm is active.

### 5.3.9 The "pump alarm" submenu



Note!

This submenu is only available for instruments with external switches (FMU90-\*\*\*\*\*B\*\*\*).

The pump alarm is used to indicate a pump failure by one of the relays. This is only possible if a pump monitoring system is connected to one of the switch inputs and if "pump feedback" has been parametrized in the "basic setup" submenu.

#### "pump alarm N" (N = 1 or 2)

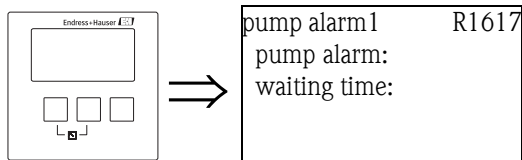

#### "pump alarm"

Use this parameter to switch the pump alarm function on and off.

#### Selection:

- off (default)
- on

#### "waiting time"

Defines the waiting time for the pump alarm. It is the same for all pumps. Default: 0s.

#### "relay allocation"

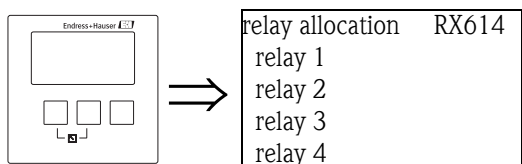

Defines which relay is used to indicate a pump alarm.

#### Selection:

- All relays of the instrument version at hand.



Note!

The relay is not allocated to a specific pump. It only indicates that one of the pumps has generated an alarm. At the same time an error message is generated which states the number of the affected pump.

## 5.4 The "rake control" submenu



Note!

The "rake control" submenu is only present if "rake control" has been selected in "device properties/operating parameters/controls".

### 5.4.1 Basics

In order to detect clogging of a rake, the Prosonic S measures the upstream level L1 and the downstream level L2. Rake clogging causes L2 to become much lower than L1. Therefore, the rake control function evaluates either the difference  $L1 - L2$  or the ratio  $L2/L1$ .

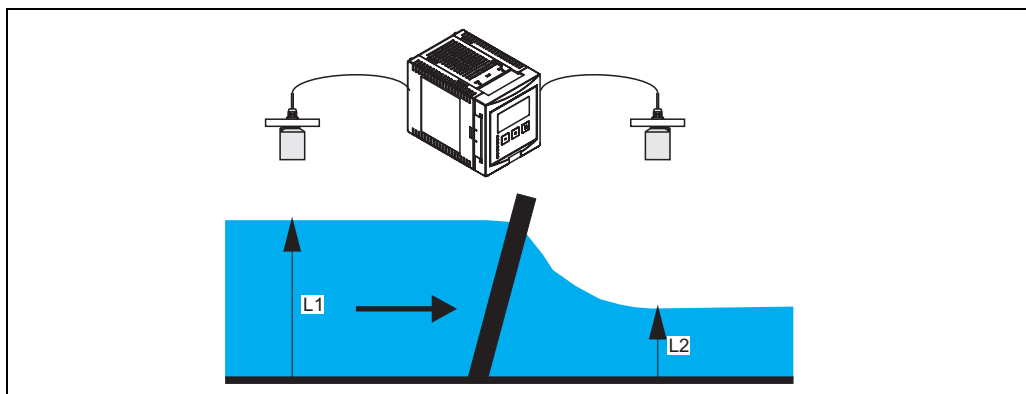

L00-FM190xxx-19-00-00-yy-058

Rake clogging is indicated by a relay, which can be used, for example, to trigger a rake cleaning device.

### 5.4.2 Overview

Step	Parameter set or submenu	Parameter	Remarks	see section
1	"relay/controls" menu		Select "rake control"	
2	rake control	upstream water	Select the upstream water level signal (L1)	5.4.3
		downstream water	Select the downstream water level signal (L2)	
		function	Select the criterion for rake clogging: <ul style="list-style-type: none"> <li>■ difference: <math>L1 - L2</math></li> <li>■ ratio: <math>L2/L1</math></li> </ul>	
3	rake control	switch on point	Define the switch on point	5.4.4
		switch off point	Define the switch off point	
4	rake control	switch delay	Define the switch delay.	5.4.5
		error handling	Define the error handling	
5	relay allocation		Select the relay for rake control	5.4.6
6	relay N (N = 1 - 6)	function	Select "rake control"	5.4.7
		invert	Select if the switching delay is to be inverted (default: no)	



Note!

In the "output/calculations" and "calibrate display" menus it is possible to define that the difference  $L1-L2$  or the ratio  $L2/L1$  is displayed by the analog output and/or the display.

### 5.4.3 "rake control" (Part 1: Allocation)

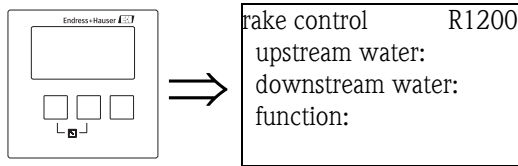

#### "upstream water"

Specifies, which signal refers to the upstream level.

#### Selection:

- level 1 (default)
- level 2

#### "downstream water"

Specifies, which signal refers to the downstream level.

#### Selection:

- level 1
- level 2 (default)

#### "function"

Used to select the criterion for the detection of rake clogging.

#### Selection:

- **difference (default)**  
Rake clogging is indicated if the difference  $L1 - L2$  exceeds a critical value.
- **ratio**  
Rake clogging is indicated if the ratio  $L2/L1$  falls below a critical value.

### 5.4.4 "rake control" (Part 2: Switching points)

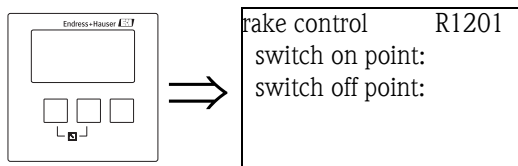

#### "switch on point" and "switch off point"

Used to specify the limit values for detection of rake clogging. The meaning of these limit values depends on the selected function.



Caution!

After a change of the "unit level" the switching points have to be checked and adjusted if required.

*function = "difference"*

In this case, the switch on and switch off points have to be specified in the level unit. The switch on point must be larger than the switch off point.

The rake control relay is energized if the difference  $L1 - L2$  rises above the switch on point. It is de-energized if the difference falls below the switch off point.



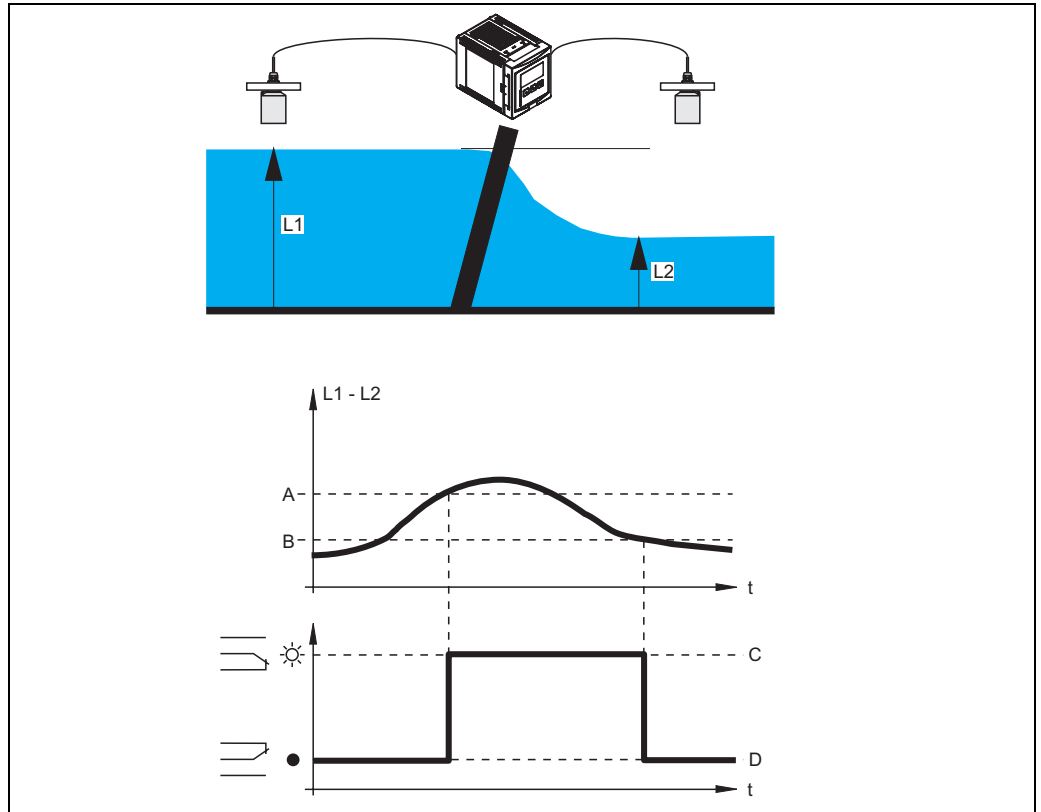

L00-FMU90xxx-19-00-00-yy-059

**A:** switch on point; **B:** switch off point;  
**C:** relay energized (i.e. rake cleaning on); **D:** relay de-energized (i.e. rake cleaning off)

*function = "ratio"*

In this case, the switch on and switch off points are numbers between 0 and 1. The switch on point must be smaller than the switch off point.

The rake control relay is energized if the ratio  $L2/L1$  falls below the switch on point. It is de-energized if the ratio rises above the switch off point.

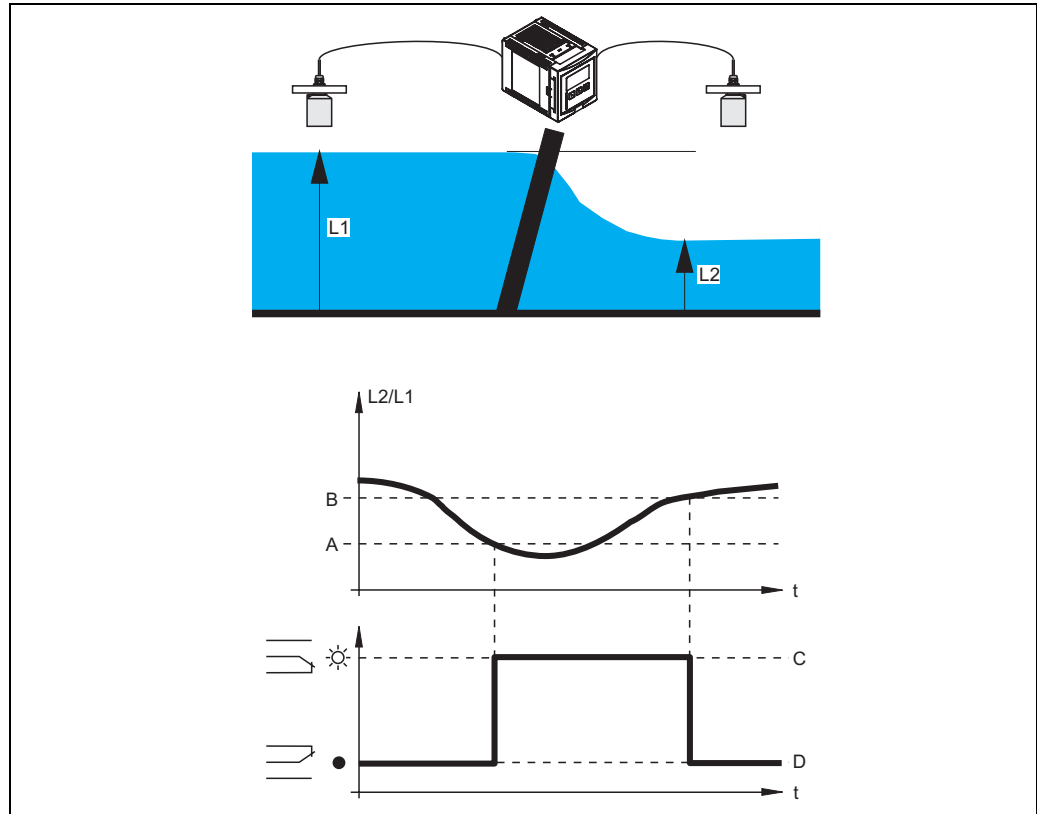

L00-FMU90xxx-19-00-00-yy-060

**A:** switch on point; **B:** switch off point;

**C:** relay energized (i.e. rake cleaning on); **D:** relay de-energized (i.e. rake cleaning off)

### 5.4.5 "rake control" (Part 3: Switching parameters)

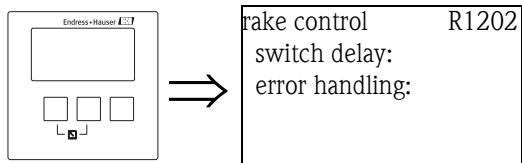

#### "switch delay"

Specifies the switch delay for the rake control.

The relay does not switch immediately after the switch on point has been exceeded but only after the specified switch delay. This is to prevent that random fluctuations of L1 or L2 activate the rake cleaning unnecessarily.

#### "error handling"

Specifies the behavior of the rake control relay in case of an error.

**Selection:**

- **actual value (default)**

The relay switches according to the current measuring value (although its reliability is not ensured).

- **hold**

The current switching state of the relay is held.

- **switch on**

The relay is energized.

- **switch off**

The relay is de-energized.

### 5.4.6 "relay allocation"

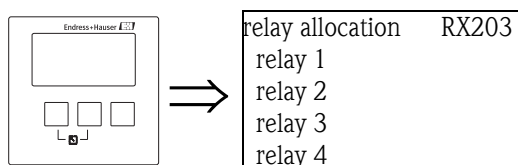

Allocates a relay to the rake control function.

**Selection:**

- All relays of the instrument version at hand.

### 5.4.7 "relay N" (N = 1 ... 6)

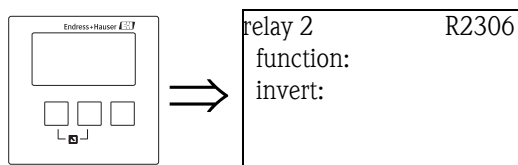
**"function" parameter**

The relay function is defined by this parameter.

**Selection:**

- none (default)
- rake control

**"invert" parameter**

In this parameter, specify if the switching behaviour of the relay is to be inverted.

**Selection:**

- **no (default)**

The switching behaviour of the relay is **not** inverted. The relay is energized if the rake cleaning should be active.

- **yes**

The switching behaviour of the relay **is** inverted. The relay is energized if the rake cleaning should be inactive.

## 5.5 The "relay simulation" submenu

### 5.5.1 "relay simulation"

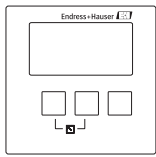

```
relay simulation  RX120
relay 1
relay 2
relay 3
relay 4
```

In this list, select the relay you are going to simulate.

### 5.5.2 "relay N" (N = 1 - 6)

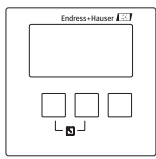

```
relay 2          R2106
simulation:
simulation value:
```

#### "simulation"

Used to switch the simulation on and off.

#### Selection:

- on (default)
- off

#### "simulation value"

(only available if the simulation is switched on)

Use this parameter to define the switching state of the relay.

#### Selection:

- switch off (default)
- switch on

## 6 The "output/calculations" menu (for HART instruments)

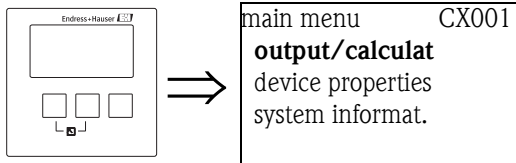

The "output/calculations" menu can be used to

- configure calculations such as averaging and subtraction
- configure the current outputs and the HART interface.

After entering the "output/calculations" menu, a selection screen appears in which you must choose the output you are going to configure.

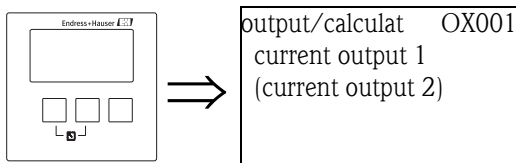

After this selection, additional submenus appear, which can be used to configure the output:

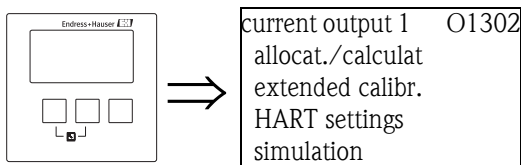

## 6.1 The "allocation/calculations" submenu

### 6.1.1 "allocation current N " (N = 1 or 2)

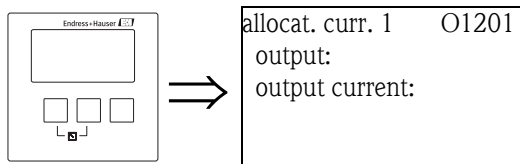

#### "output"

Allocates a measured or calculated value to the current output.

#### Selection:

The available options depend on the instrument version, the connected sensors and the instrument configuration. The following measured and calculated values may occur:

- level 1
- level 2
- flow 1
- flow 2
- average level:  $(\text{level1} + \text{level2})/2$
- level 1-2
- level 2-1
- level 1+2
- average flow
- flow 1-2
- flow 2-1
- flow 1+2
- backwater ratio  
downstream/upstream
- rake control ratio  
downstream/upstream

#### "output current"

Displays the output current (mA).

## 6.2 The "extended calibration" submenu

### 6.2.1 "mode current N" (N = 1 or 2)

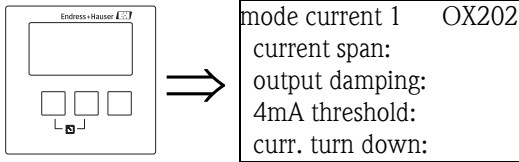

#### "current span"

Used to select the current span to which the measuring range is mapped.

##### Selection:

- **4-20 mA (default)**

The measuring range (0%-100%) is mapped to the current range 4-20 mA.

- **0-20 mA**

The measuring range (0%-100%) is mapped to the current range 0-20 mA.

- **fixed current HART**

A fixed current is output. The value can be defined in the "mA value" parameter. The measured value is transmitted by the HART signal.

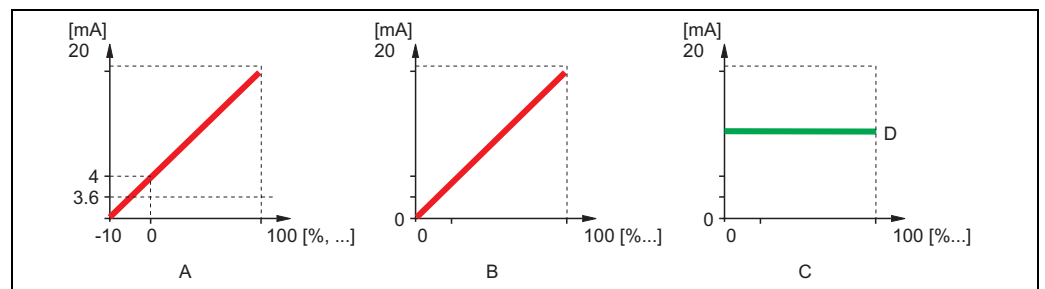

**A:** current span = 4-20 mA; **B:** current span = 0-20 mA; **C:** current span = fixed current HART;  
**D:** mA value

#### "mA value" (only available for "current span" = "fixed current HART")

Specifies the value of the fixed current.

- range of values: 3,6 - 22 mA
- default: 4 mA

### "output damping"

Specifies the output damping  $\tau$  by which changes of the measured value are attenuated. After a surge in the level it takes  $5 \times \tau$  until the new measured value is reached.

- range of values: in preparation
- default: 0 s

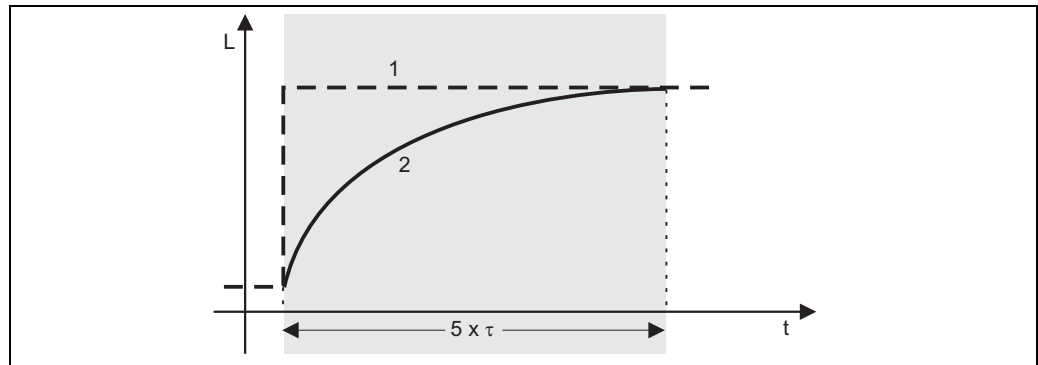

1: measured value; 2: output current

100-FMG60xxx-05-00-00-xx-012

### "4 mA threshold" (only available for "current span" = "4-20mA")

Used to switch on the 4mA threshold. The 4-mA threshold makes sure that the current never falls below 4 mA, even if the measured value is negative.

#### Selection:

- **off (default)**  
The threshold is switched off. Currents less than 4 mA may occur.
- **on**  
The threshold is switched on. The current never falls below 4 mA.

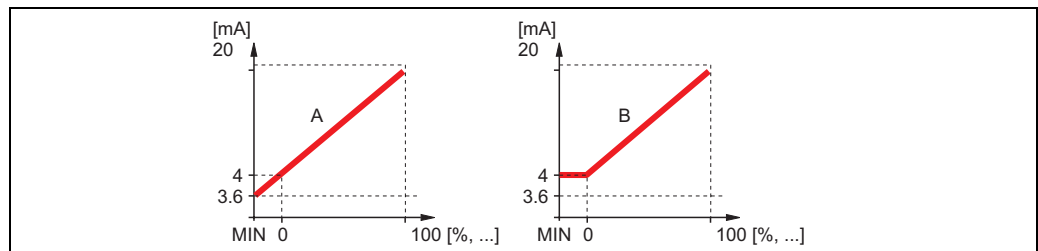

A: 4mA threshold off; B: 4mA threshold on

100-FMU90xxx-19-00-00-yy-007



**"current turn down" (not present for "current span" = "fixed current HART")**

Used to map only a part of the measuring range to the current output. The selected part is enlarged by this mapping.

**"turn down 0/4 mA" (only for "current turn down" = "on")**

Specifies the measured value for which the current is 0 or 4 mA (depending on the selected current span).

**"turn down 20 mA" (only for "current turn down" = "on")**

Specifies the measured value for which the current is 20 mA.

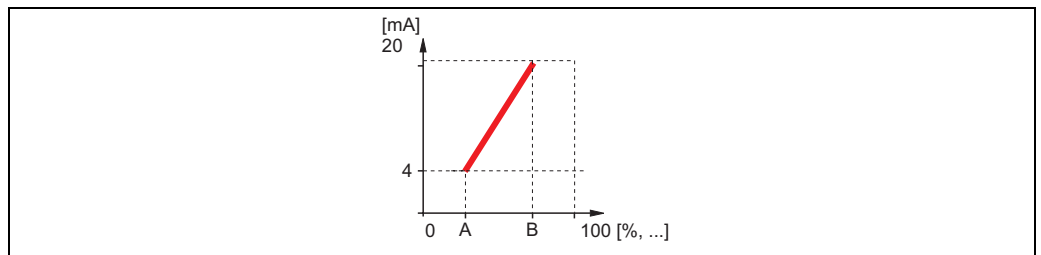

L00-FMU190xxx-19-00-00-yy-068

**A:** turn down 4mA ; **B:** turn down 20 mA

## 6.3 "HART settings" submenu (only for current output 1)

### 6.3.1 "HART settings"

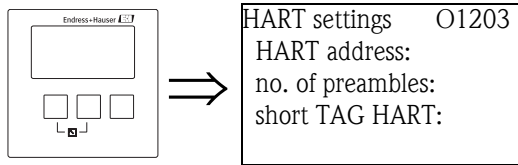

#### "HART address"

Defines the communication address for the instrument.

#### Range of values:

- for standard operation: **0 (default)**
- for multidrop operation: **1 - 15**



Note!

In multidrop operation, the output current is 4 mA by default. However, it can be adjusted in the "mA value" parameter of the "mode current" parameter set (see above).

#### "no. of preambles"

Specifies the number of preambles for the HART protocol. For lines with communication problems a slight increase of this value is recommended.

#### "short TAG HART"

in preparation

### 6.3.2 "additional HART value 2/3/4"

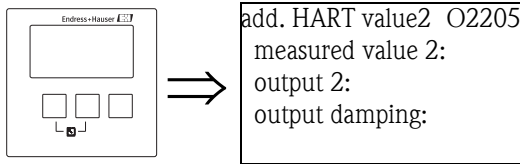

Use these parameter sets to configure the additional values transmitted by the HART protocol:

- measured value 2
- measured value 3
- measured value 4

The parameters are the same for all three measured values.



Note!

"measured value 1" is identical to the main value, which is linked to current output 1.

#### "measured value 2/3/4"

Specifies which measured value is transmitted.

##### **Selection:**

The selection depends on the instrument version, the connected sensors and the configuration. The following options may occur:

- none (default)
- level 1/2
- flow 1/2
- average level
- level 1-2 / 2-1 / 1+2
- rake control ratio
- backwater ratio
- temperature external sensor
- temperature sensor 1/2
- counter 1/2/3
- totalizer 1/2/3
- average flow
- flow 1-2 / 2-1 / 1+2
- distance sensor 1/2



Note!

If "temperature sensor 1/2" is selected, it always refers to the temperature which has been assigned to the respective sensor in "sensor management/FDU sensor N". Possible temperatures are:

- sensor temperature
- average of sensor temperature and temperature of an external temperature sensor
- temperature of an external temperature sensor

#### "output damping 2/3/4"

Specifies the output damping  $\tau$  by which a change of the measured value is attenuated.

After a surge of the measured value it takes  $5 \times \tau$  till the HART value has adopted the new value.

- range of values: in preparation
- default: 0 s

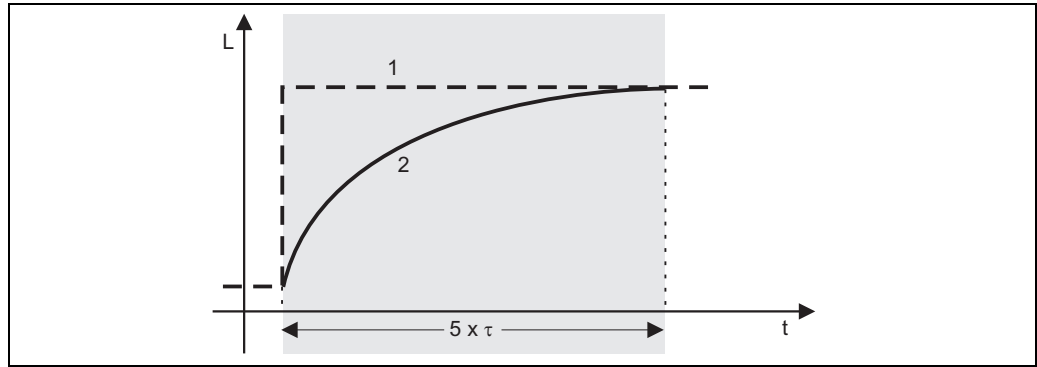

L00-FMG60xxx-05-00-00-xx-012

1: measured value; 2: HART output value

## 6.4 "Simulation" submenu

### 6.4.1 "simulation"

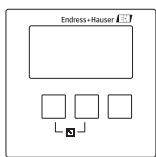

```
simulation      O1204
simulation:
simulation value:
```

#### "simulation"

Used to switch on the simulation of the current.

##### Selection:

##### ■ off (default)

No simulation is performed. The instrument is in the measuring mode.

##### ■ on

The instrument is in the simulation mode. No measured value is transmitted to the output.

Instead, the current output assumes the value specified in the "simulation value" subfunction.

#### "simulation value" (only for "simulation" = "on")

Specifies the value of the simulated output current (in mA).

## 7 The "output/calculations" menu (for Profibus DP instruments)

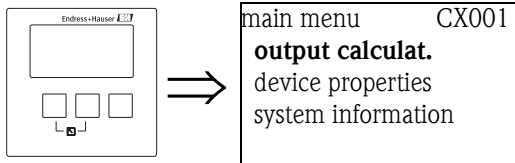

The "output/calculations" menu is used to configure the Analog Input blocks (AI) and the Digital Input blocks (DI). These blocks transfer analog or digital values to a SPS.

### 7.1 "analog input" (AI)

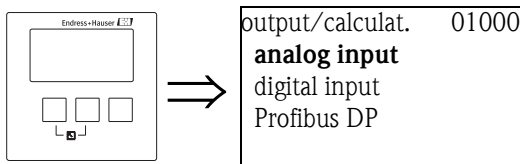

#### 7.1.1 "output/calculations"

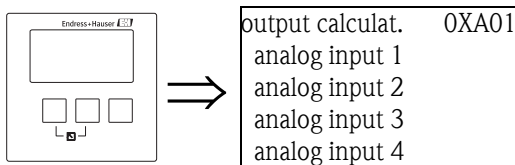

Use this list to select the AI block you are going to configure.

#### 7.1.2 "analog input N" (N = 1 - 10)

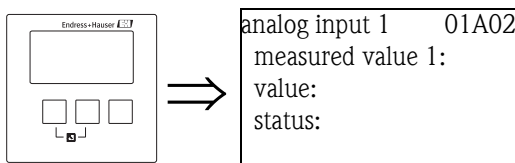

#### "measured value N" (N = 1 - 10)

Use this parameter to select the measured or calculated variable which is transferred by the AI block.

#### "value"

Displays the current value of the measured or calculated variable.

#### "status"

Displays the status which is transferred with the measured value.

## 7.2 "digital input" (DI)

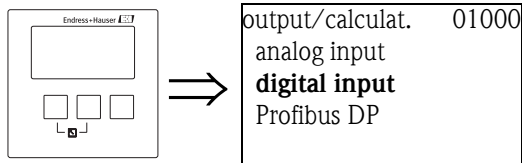

### 7.2.1 "output calculations"

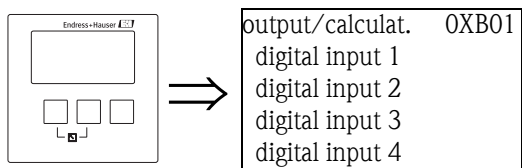

Use this list to select the DI block you are going to configure.

### 7.2.2 "digital input N" (N = 1 - 10)

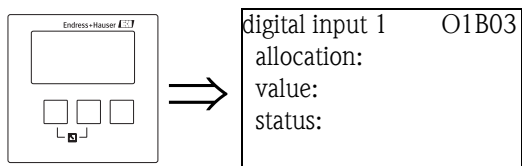

#### "allocation"

Use this parameter to select a switching state. Occurrence of this state will be indicated by the DI block.

#### Selection

##### ■ relay

The DI block is connected to one of the relays of the instrument. After selection of this option, the "relay" function appears, where you can select one of the relays.

##### ■ pump control N (N = 1 or 2)

is only available if a pump control has been configured. After selection of this option, an additional selection list appears which is used to allocate the DI block to one of the pump relays.

##### ■ rake control

is only available if a rake control has been configured. After selection of this option, an additional selection list appears, which is used to allocate the DI block to the rake control relay.

##### ■ none

No value is transferred via the DI block.

#### "value"

Displays the current switching state of the selected relay.

#### "status"

Displays the status which is transferred with the binary value.

## 7.3 "Profibus DP"

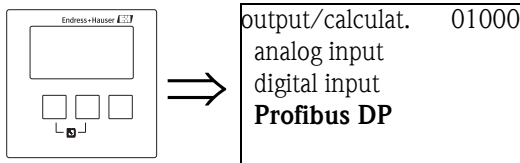

This submenu is used to configure the general properties of the Profibus DP interface.

### 7.3.1 "Profibus DP"

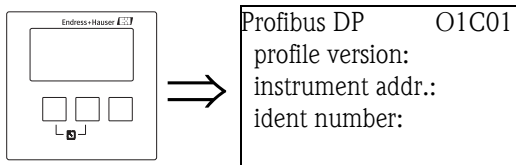

#### "profile version"

Displays the version of the Profibus profiles used.

#### "instrument address"

Displays the instrument address.



Note!

There are two options for setting the instrument address:

- by the DIP switches in the terminal compartment
- by a configuration tool (e.g. FieldCare)

#### "ident number"

Defines the ident number of the instrument.

#### Selection:

- **profile**  
The ident number of the profibus profiles is used.
- **manufacturer (default)**  
The ident number of the instrument specific GSD files is used.

## 8 The "device properties" menu

### 8.1 The "operating parameters" submenu

#### 8.1.1 "distance unit"

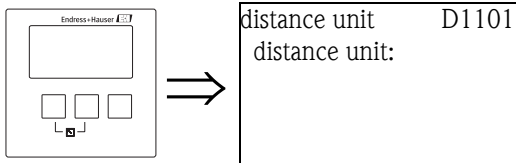

Defines the distance unit.

**Selection:**

- m (default)
- ft
- mm
- inch

#### 8.1.2 "temperature unit"

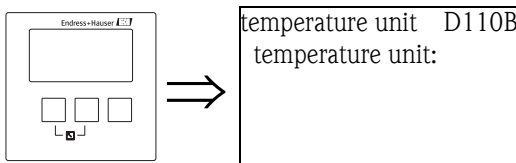

Defines the temperature unit.

**Selection:**

- °C (default)
- °F

#### 8.1.3 "operating mode"

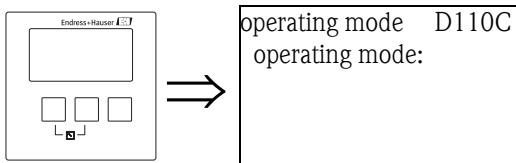

Use this parameter to select the operating mode. The available selection depends on the instrument version.

**Selection:**

- level
- level + flow<sup>15)</sup>
- flow<sup>15)</sup>
- flow + backwater<sup>15,16)</sup>

---

15) only for instruments with flow measurement software (FMU90 - \*2\*\*\*\*\* and FMU90-\*4\*\*\*\*\*)

16) only for instruments with 2 sensor inputs



### 8.1.4 "controls"

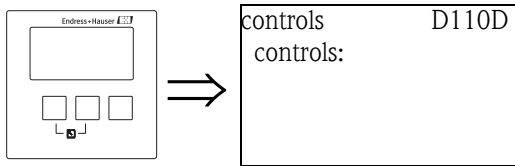

(only available for the "level" and "level + flow" operating modes)

Use this parameter to specify which controls the Prosonic S is to perform.

**Selection:**

- no (default)
- pump control
- rake control

## 8.2 The "tag marking" submenu

### 8.2.1 "tag marking"

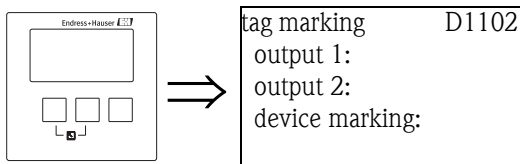

**"output N" (N = 1 or 2) (only for HART instruments)**

Use these parameters to define a tag (designation) for the current output. The tag may consist of up to 16 alphanumeric characters.

**"device marking"**

Use this parameter to define a tag (designation) for the entire instrument. The tag may consist of up to 16 alphanumeric characters.

## 8.3 The "language" submenu

### 8.3.1 "language"

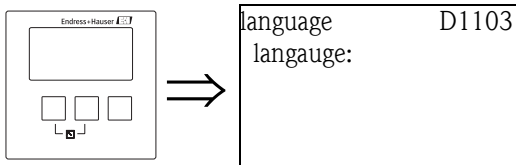

Defines the language for the display module. The feature "language" of the product structure determines which languages are available:

**"language" = 1:**

- Deutsch
- English
- Nederlands
- Français
- Español
- Italiano
- Nederlands
- Portugese

**"language" = 2:**

- English
- Russian
- Polish
- Czech

**"language" = 3:**

- English
- Chinese
- Japanese
- Korean
- Thai
- Bahasa (Indonesia, Malaysia)

## 8.4 The "password/reset" submenu"

### 8.4.1 "password/reset"

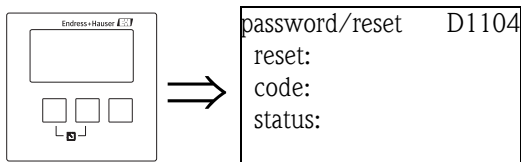

#### "reset"

Enter the reset code into this parameter in order to reset all parameters to their default values.

Reset Code

- HART: 333
- Profibus DP: 33333



Note!

- The default values of all parameters are printed in bold in the menu diagrams at the end of this document.
- The linearisation type is set to "none". However, the linearisation table (if present) is not deleted. If required, it can be reactivated at a later point of time

#### "code"

This parameter is used to lock the instrument against unauthorized or unintentional changes.

- Enter a number other than the release code in order to lock the instrument. Parameters can no longer be changed.
- Enter the release code in order to unlock the instrument. Parameters can be changed again.

Release code

- HART: 100
- Profibus DP: 2457

#### "status"

Displays the current locking state of the instrument. The following states may occur:

- **unlocked**  
All parameters (except of service parameters) can be changed.
- **code locked**  
The instrument has been locked via the operating menu. It can be unlocked by entering the release code into the "code" parameter.
- **key locked**  
The key has been locked by a key combination. It can only be unlocked by pressing all three keys simultaneously.
- **switch locked**  
The instrument has been locked by the switch in the terminal compartment. It can only be unlocked by this switch.

## 9 The "system information" menu

### 9.1 The "device information" submenu

#### 9.1.1 "device family"

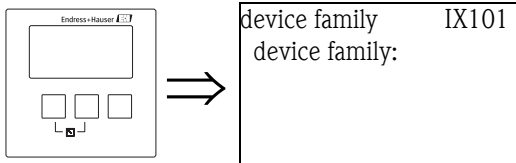

#### "device family"

Displays the device family.

#### 9.1.2 "device name"

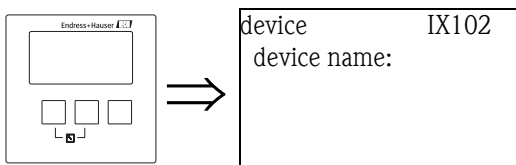

#### "device name"

Displays the device name.

#### 9.1.3 "order code"

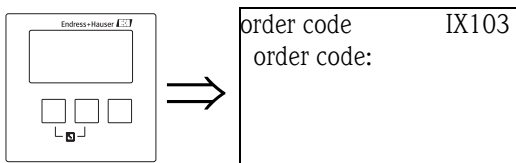

#### "order code"

Displays the order code of the instrument.

#### 9.1.4 "serial number"

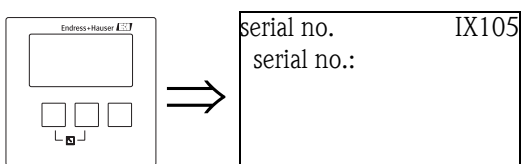

**"serial no."**

Displays the serial number of the instrument.

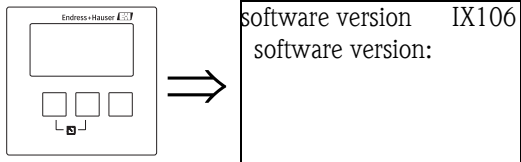
**9.1.5 "software version"****"software version"**

Displays the software version of the instrument.

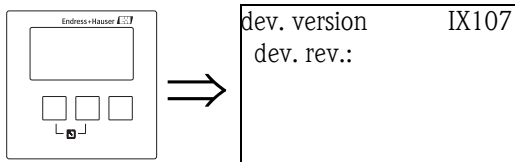
**9.1.6 "device version"****"dev. rev."**

Displays the device revision.

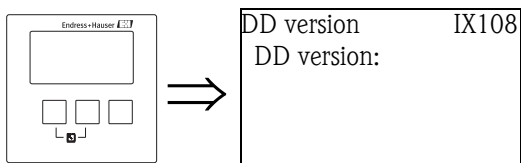
**9.1.7 "DD version"****"DD version"**

Displays the DD version which is required to operate the instrument by the ToF Tool.

## 9.2 The "in/output info" submenu<sup>17)</sup>

### 9.2.1 "level (LVL) N" (N = 1 or 2)

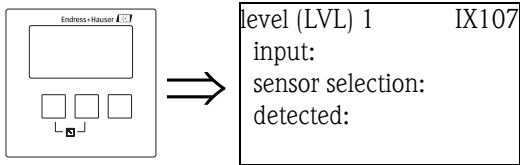

#### "input"

Indicates, which sensor input is connected to the level channel.

#### "sensor selection"

Displays the type of the connected sensor. For the sensors FDU9x, "automatic" is displayed, as these sensors are automatically detected by the transmitter (They have not to be specified by the user.)

#### "detected"

(only for "sensor selection" = automatic)

Displays the type of the automatically detected sensor.

### 9.2.2 "flow N" (N = 1 or 2)

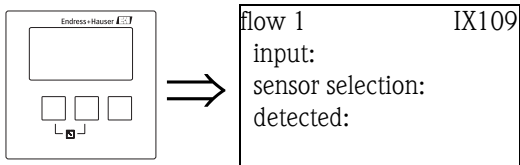

#### "input"

Indicates, which sensor input is connected to the flow channel.

#### "sensor selection"

Displays the type of the connected sensor. For the sensors FDU9x, "automatic" is displayed, as these sensors are automatically detected by the transmitter (They have not to be specified by the user.)

#### "detected"

(only for "sensor selection" = automatic)

Displays the type of the automatically detected sensor.

---

<sup>17)</sup> This submenu can be accessed only by the display module (not by an operating software).

### 9.2.3 "current output N" (N = 1 or 2) (for HART instruments only)

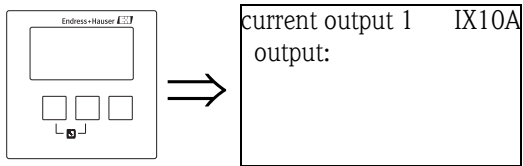

#### "output"

Displays the present value of the output current.

### 9.2.4 "relay N" (N = 1 ... 6)

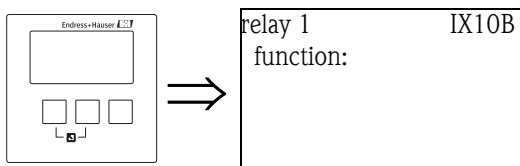

#### "function"

Indicates, which function has been allocated to the relay.

### 9.3 The "trend display" submenu<sup>18)</sup> (for HART instruments only)

Use this submenu to plot the temporal change of an output value.

#### 9.3.1 "trend display" (for HART instruments only)

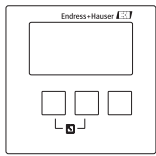

```
trend display      IX10E
trend output 1:
trend output 2:
```

From this list, select the output you are going to plot.

#### 9.3.2 "trend output N" (N = 1 or 2) (for HART instruments only)

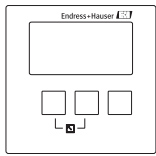

```
trend output 1    IX10F
time interval:
```

#### "time interval"

Use this parameter to specify the time interval for the plot.

#### 9.3.3 "trend output N" (N = 1 or 2) (for HART instruments only)

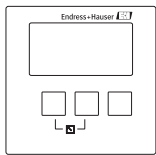

```
trend output 1    IX10G
```

A plot of the trend is shown on this screen.  
In order to exit the display, press the left and middle key simultaneously (ESC).

---

18) This submenu can be accessed only by the display module (not by an operating software).



## 9.4 The "min/max values" submenu

Use this submenu to display the minimum and maximum values a certain parameter has reached during the measurement (drag indicator functionality).

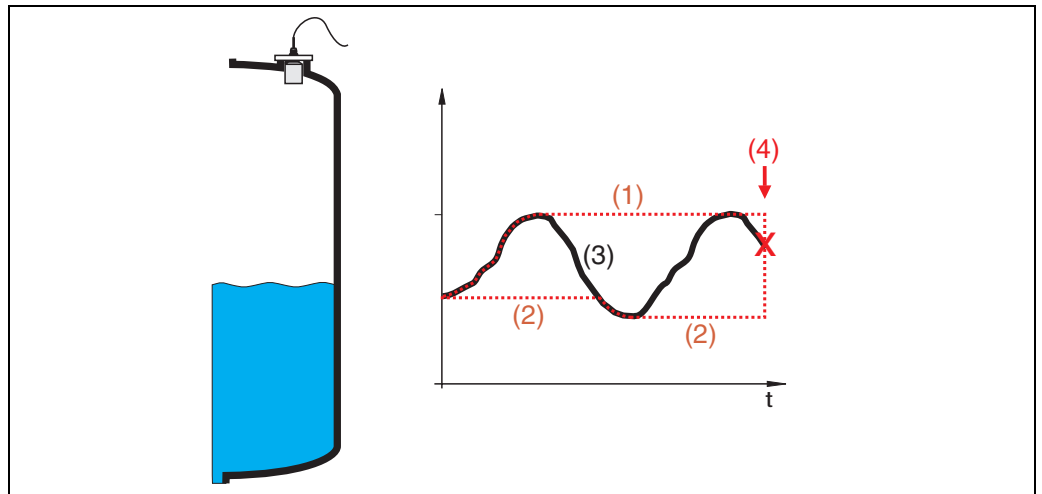

(1): max value; (2): min value; (3): measured value; (4): reset

L00-FM190xxx-19-00-00-yy-074

### 9.4.1 "min/max values"

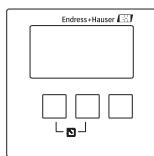

min/max values IX300  
level  
flow  
temperature

From this list, select a quantity (level, flow or temperature) for the display of the min/max values.

### 9.4.2 "level", "flow" or "temperature"

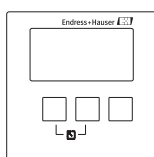

level IX301  
level (LVL) 1  
level (LVL) 2

From this list, select the level, flow or temperature channel for the display of the min/max values.

### 9.4.3 "level (LVL) N", "flow N" or "temperatures sen. N" (N = 1 or 2)

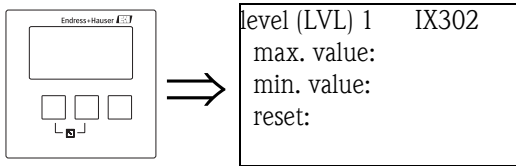

#### "max. value"

Displays the maximum value which has been reached by the selected parameter.

#### "min. value"

Displays the minimum value which has been reached by the selected parameter.

#### "reset"

Use this parameter to reset the min and max drag indicators.

#### Selection:

- **keep (default)**

The drag indicators are **not** reset.

- **erase**

The minimum and maximum values are reset, i.e. they assume the current value of the respective parameter.

- **reset min.**

The minimum value is reset, i.e. it assumes the current value of the respective parameter. The maximum value is **not** reset.

- **reset max.**

The maximum value is reset, i.e. it assumes the current value of the respective parameter. The minimum value is **not** reset.



#### Note!

- The min/max values of the sensor temperature can only be reset by the Endress+Hauser service.
- The min/max values of the temperature always refer to the internal temperature probe of the ultrasonic sensors FDU8x/FDU9x.

## 9.5 The "envelope curve" submenu

This submenu can be used to display the envelope curve of the connected sensor on the display module.

### 9.5.1 "envelope curve"

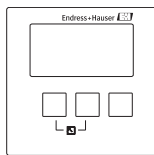

```
envelope curve    IX126
en. curve sen. 1
en. curve sen. 2
```

In this list, select a sensor for the envelope curve display.

### 9.5.2 "Plot settings" (Part 1: curve selection)

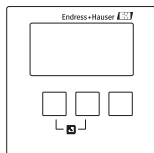

```
Plot settings    IX127
Envelope curve
Env.curve+FAC
Env.curve+cust.map
```

In this list, select which curves are to be displayed.

**Selection:**

- Envelop curve (default)
- Env. curve + FAC
- Envelope curve + customer map

### 9.5.3 "Plot settings" (Part 2: single curve <-> cyclic change)

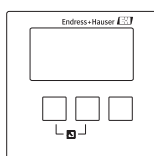

```
Plot settings    IX128
single curve
cyclic
```

In this list, select the type of plotting.

**Selection:**

- **single curve (default)**  
The envelope curve is plotted once.
- cyclic  
The envelope curve display is updated in regular intervals.



**Note!**

If the cyclical envelope curve display is still active on the display, the measured value is updated at a slower cycle time. We therefore advise you to exit the envelope curve display after optimising the measuring point.

### 9.5.4 "envelope curve"

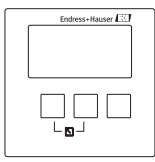

```
envelope curve    IX128
```

The envelope curve is displayed in this screen. In order to exit the display, press the left and middle key simultaneously (ESC).

## 9.6 The "error list" submenu

### 9.6.1 "error list"

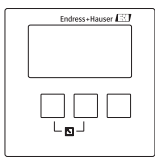

```
error list        E1000  
actual error  
last error
```

From this list, select if the currently active errors or the previous errors are to be displayed.

### 9.6.2 "actual error"

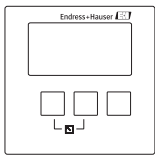

```
actual error      E1002  
1:  
2:  
3:  
4:
```

A list of the currently active errors is displayed in this screen. Select an error to get an error description. By pressing the left and middle key simultaneously you can return from the error description to the error list.

### 9.6.3 "last error"

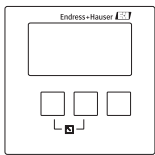

```
last error        E1003  
1:  
2:  
3:  
4:
```

A list of the previously rectified errors is displayed in this screen. Select an error to get an error description. By pressing the left and middle key simultaneously you can return from the error description to the error list.

## 9.7 The "diagnsotics" submenu

### 9.7.1 "operating hours"

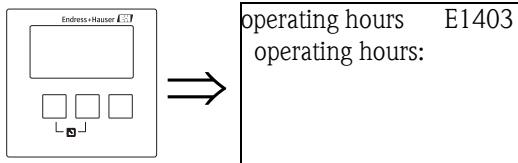

#### "operating hours"

Indicates, how long the instrument has been in operation.

### 9.7.2 "actual distance"

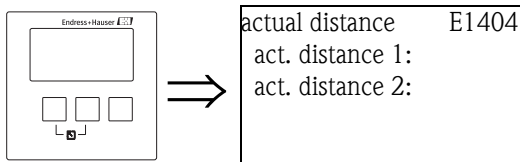

#### "act. distance N" (N = 1 or 2)

Displays the currently measured distance (between the sensor membrane and the product surface).

### 9.7.3 "actual measured value"

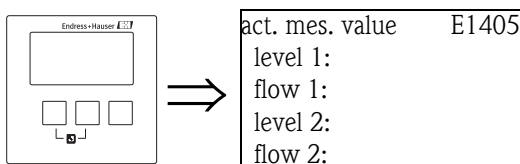

#### "level N" (N = 1 or 2)

Displays the currently measured level or (if a linearisation has been performed) the currently measured volume of the respective channel.

#### "flow N" (N = 1 or 2)

Displays the currently measured flow of the respective channel.

### 9.7.4 "application parameter"

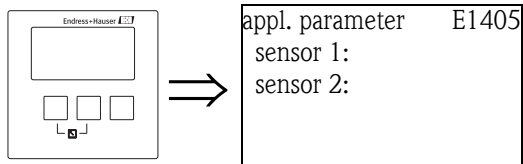

#### "sensor N" (N = 1 or 2)

Indicates if a setting which depends on the application parameters ("tank shape", "medium property", "process condition") has been changed after the setting of the application parameters in the service menu.

### 9.7.5 "echo quality sensor"

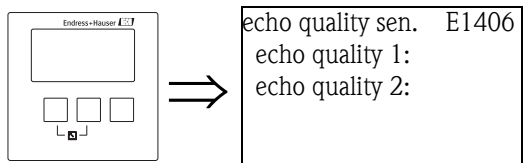

#### "echo quality N" (N = 1 or 2)

Displays the echo quality of the respective sensor.  
The echo quality is the distance (in dB) between the level echo and the Floating Average Curve (FAC).

## 10 The "display" menu

### 10.1 "display"

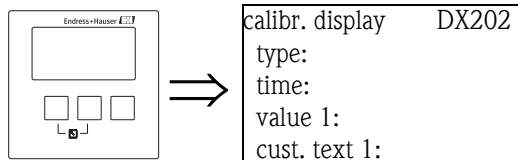

#### "type"

Use this parameter to select the format of the measured value display.

#### Selection:

- 1x value+bargraph (default for instruments with 1 current output)

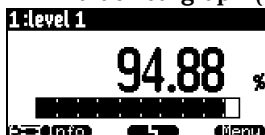

- 2x value+bargraph (default for instruments with 2 current outputs)

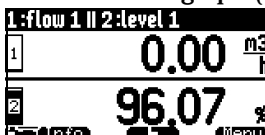

- value max. size

Up to two values are displayed alternately using the entire display:

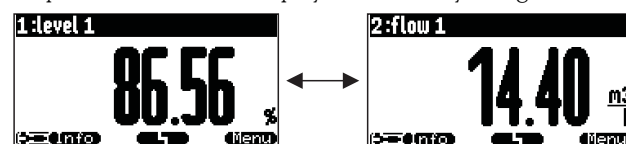

- alter 3x2 values

Up to 6 values can be displayed on three alternating pages. Each pages contains two values.

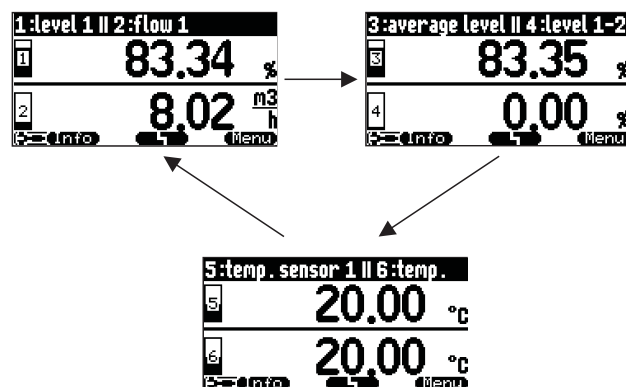

**"time"**

This parameter is used for the options "value max. size" and "alter 3x2 values". It specifies the time after which the next page appears.



Note!

To change to the next page immediately, press  .

**"value 1" ... "value 6"**

Use these parameters to allocate a measured or calculated value to each of the display values. The selection depends on the instrument version and installation environment.



Note!

If "temp. sensor 1/2" is selected, depending on the setting in "sensor management/FDU sensor N" one of the following is displayed:

- the sensor temperature
- the average of the sensor temperature and the temperature of the external temperature probe
- the temperature of the external temperature probe

**"cust. text 1" ... "cust. text 6"**

These parameters can be used to allocate a text string to each of the display values. This text is displayed together with the value if "**customized text**" (in the "display format" parameter set) has been set to "**yes**".

## 10.2 "display format"

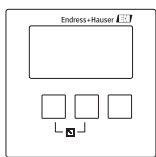

```
display format   DX201
format:
no. of decimals:
sep. character:
customized text:
```

**"format"**

Use this parameter to select the display format for numbers.

**Selection:**

- decimal (Default)
- ft-in-1/16"

**"no. of decimals"**

Use this parameter to select the number of decimals for the representation of numbers.

**Selection:**

- x
- x.x
- x.xx (Default)
- x.xxx

**"sep. character"**

Use this parameter to select the separation character for the representation of decimal numbers.

**Selection:**

- point (.) (Default)
- comma (,)

**"customized text"**



Determines if "text 1" to "text 6" from the "calibration display" parameter set are displayed.

**Selection:**

- no (Default)
- yes

### 10.3 "back to home"

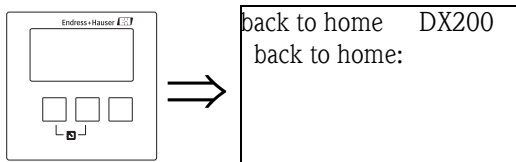

**"back to home"**

Use this parameter to specify the return time. If no entry is made during the specified time, the display returns to the measured value display.

- Range of values: 3 ... 9999 s
- Default: 100 s

## 11 The "sensor management" menu

### 11.1 The "sensor management" submenu

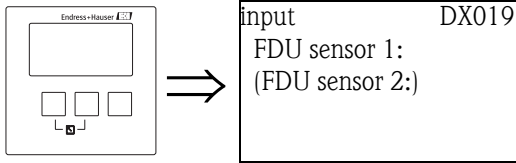

Upon entering this menu, a selection list appears, from which you can select a sensor for parametrization.

#### 11.1.1 "US sensor N" (N = 1 or 2) (sensor settings)

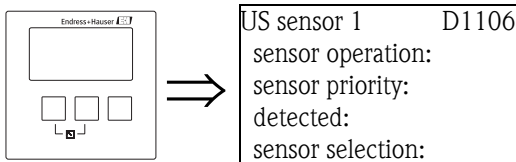

##### "sensor operation"

This parameter is used to switch the sensor on and off.

##### Selection:

- **on (default)**  
The sensor is switched on.
- **hold**  
The sensor is switched off. The last measured value is held.
- **off**  
The sensor is switched off. No measured value is transmitted.  
On the display, connected values are set to "\_\_\_\_\_".

**"sensor priority" (only for 2-channel instruments)**

This parameter is used to define the sensor priority. A sensor with high priority sends pulses more often than a sensor with low priority.

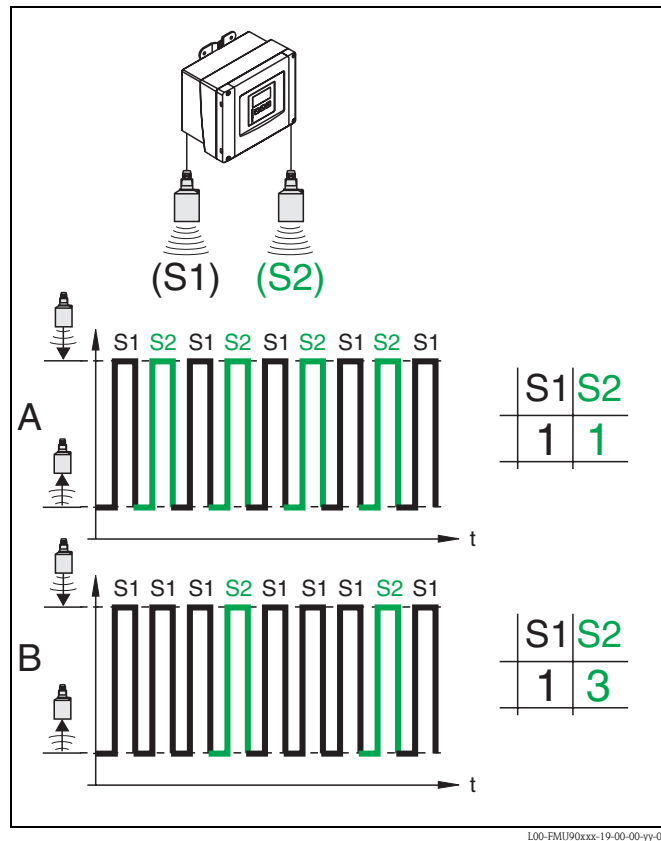
*Example*

A:  
 priority sensor 1: 1  
 priority sensor 2: 1

⇒ both sensors send the same number of pulses

B:  
 priority sensor 1: 1  
 priority sensor 2: 3

⇒ Sensor 1 sends **three** pulses. Then, sensor 2 send **one** pulse.

**"detected" (only available for automatic sensor detection)**

Indicates the type of the automatically detected sensor.

**"sensor selection"**

Use this parameter to specify the type of the connected ultrasonic sensor.



Note!

- For the sensors **FDU9x** the option "automatic" is recommended (default setting). With this setting the Prosonic S recognizes the type of sensor automatically.
- For the sensors **FDU8x** the type has to be assigned explicitly. The automatic sensor recognition does not work for these sensors.



Caution!

After **exchanging a sensor**, observe the following:

The automatic sensor recognition is also active after a sensor has been exchanged<sup>19)</sup>. The Prosonic S recognizes the type of the new sensor automatically and changes the "detected" parameter if required. The measurement continues without a break.

Nevertheless, in order to ensure perfect measurement, the following checks are required:

- Check the **"empty calibration"** and **"full calibration"** parameters. Adjust these values if required. Take into account the blocking distance of the new sensor.
- Go to the **"distance correction"** parameter set and check the displayed distance. If required, perform a new interference echo suppression.

19) if the new sensor is of the type FDU9x

### "detection window"

Is used to switch the detection window on and off and to reset an existing detection window. If this function is switched on, a window is defined surrounding the current level echo (typical width: 1 to 2.5 m; depending on the application parameters).

The window always moves together with a rising or falling echo.

Echos beyond the limits of the window are ignored for a certain time.



Note!

This parameter is set automatically according to the application parameters.

#### **Selection:**

- **off**
- on
- reset

After selection of this option, the current window is reset, the level echo is looked for in the complete measuring range and a new window is defined surrounding the current level echo.

### 11.1.2 "US sensor N" (N = 1 or 2) (allocation of external inputs)

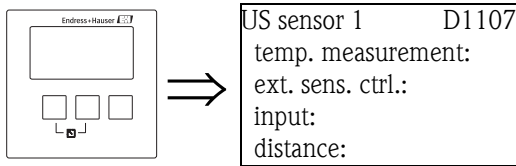

Note!

This submenu is only available for instruments with external inputs (FMU90-\*\*\*\*\*B\*\*\*).

#### "temperature measurement"

Defines which temperature sensor is used for time-of-flight correction.

##### Selection:

- **US sensor (default)**  
The integrated temperature probe of the ultrasonic sensor is used.
- **external temperature**  
The external temperature probe is used (terminals 83 - 85).
- **average US sens/ext.**  
The average temperature of the integrated and the external probe is used.

#### "external sensor control"

Determines if (and how) the sensor is controlled by an external switch.

##### Selection:

- **off (default)**  
The sensor is not controlled by an external switch.
- **hold**  
If the external switch sends a signal, the current measured value is held.
- **value**  
If the external switch sends a signal, the distance assumes an user defined value (see the "distance" parameter).



Note!

This parameter can be used to influence the measuring function of the instrument by an external signal, e.g. in order to synchronize the measurement with very slow agitators.



Note!

- If additionally a level limitation has been defined, the upper and lower limits are defined by this limitation even if the external input gives a signal.
- The external sensor control is disabled if one of the following functions has been configured:
  - "level (LVL) N/extended calibration/LVL N ext. input M" (N,M = 1 or 2)
  - "flow N/extended calibration/flow N ext. input M" (N,M = 1 or 2)
  - "backwater/extended calibration/backwater ext. input M" (M = 1 or 2)

#### "input"

Determines which external switch input is used for the sensor control.

##### Selection:

- disabled (default)
- ext. digin 1 (terminals 71, 72, 73)
- ext. digin 2 (terminals 74, 75, 763)
- ext. digin 3 (terminals 77, 78, 79)
- ext. digin 4 (terminals 80, 81, 82)

**"distance" (only for "external sensor control" = "value")**

Defines the distance value if an signal is active at the external switch input.

## 11.2 The "external temperature sensor" submenu



Note!

This submenu is only available for instruments with external temperature input (FMU90-\*\*\*\*\*B\*\*\*).

### 11.2.1 "external temperature sensor" (parametrization)

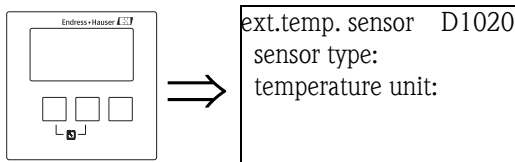

#### "sensor type"

Defines the type of the connected sensor.

##### Selection:

- no sensor (default)
- FMT131
- PT100

#### "temperature unit"

Displays the temperature unit.



Note!

The temperature unit can be changed in "device properties/operating parameters/temperature unit".

### 11.2.2 "external temperature sensor" (index pointer)

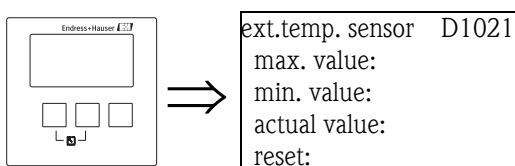

#### "max. value"

Displays the highest temperature which has been reached until now.

#### "min. value"

Displays the lowest temperature which has been reached until now.

#### "actual value"

Displays the currently measured temperature.

### "reset"

Is used to reset the index pointers for the external temperature sensor.

#### Selection:

- **keep (default)**

The index pointers are not reset.

- **delete**

Both index pointers are reset to the current temperature.

- **reset min.**

"min. value" is reset to the current temperature.

"max. value" keeps its value.

- **reset max.**

"max. value" is reset to the current temperature.

"min. value" keeps its value.

### 11.2.3 "external temperature sensor" (error handling)

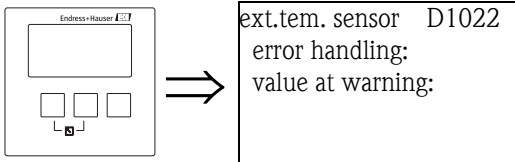

### "error handling"

Determines the reaction of the Prosonic S in the case of a failure of the external temperature sensor.

#### Selection:

- **alarm (default)**

An error message is generated.

The output signal assumes a defined value ("output on alarm" in the "safety settings" menu).

- **warning**

An error message is generated, but the measurement continues.

The signal evaluation algorithm uses the temperature as defined in "value at warning".

### "value at warning"

Defines the temperature which is used for signal evaluation in the case of a failure of the temperature sensor (only valid for "error handling" = "warning").



## 11.3 The "external digin" submenu

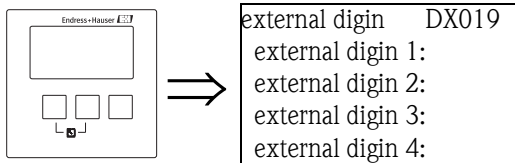

Note!

This submenu is only available for instruments with external switches (FMU90-\*\*\*\*\*B\*\*\*).

After entering this submenu, select the external switch input you are going to configure.

### 11.3.1 "external digin N" (N = 1 - 4)

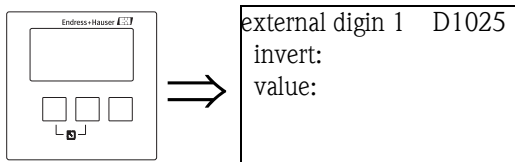

**"invert"**

Determines if the switching behavior of the input (open - closed) is inverted.

**Selection:**

■ **no (default)**

The Prosonic S detects a closed switch (from 0 to 1).

■ **yes**

The Prosonic S detects an open switch (from 1 to 0).



Note!

The switching states can be realized in the following way:

- 0: voltage  $\leq 8V$  at the input, or + and  $\square$  not interconnected
- 1: voltage  $\geq 16 V$  at the input, or + and  $\square$  interconnected

**"value"**

Indicates the current switching state of the external input ("0" or "1").

## 12 Operating menu

### 12.1 "Level"

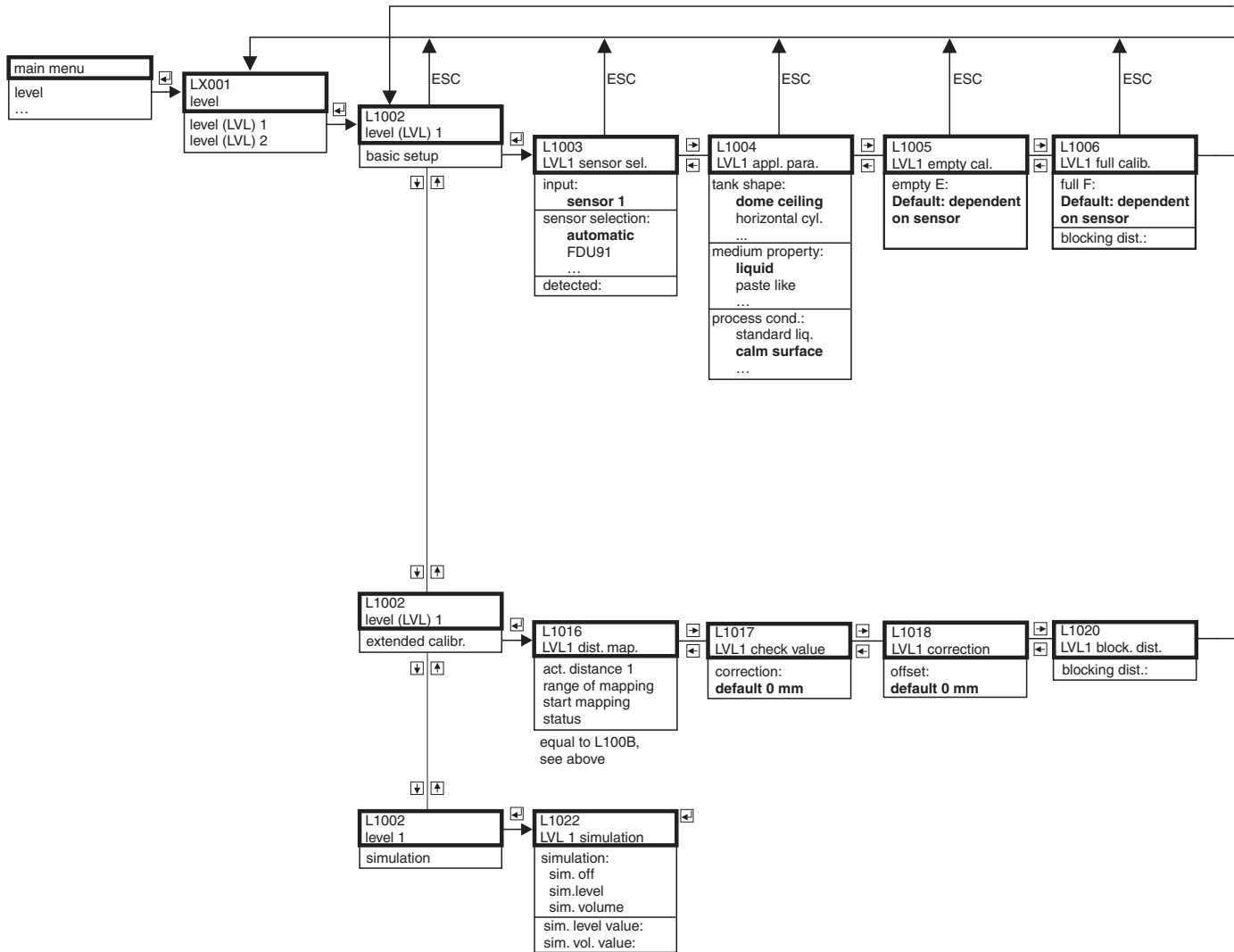

L100-FMU90xxx-19-01-01-en-106



**Note!**

The menu diagrams contain all submenus which may occur in the Prosonic S. Which of these submenus actually are present depends on the instrument version, the installation environment and the parametrization.

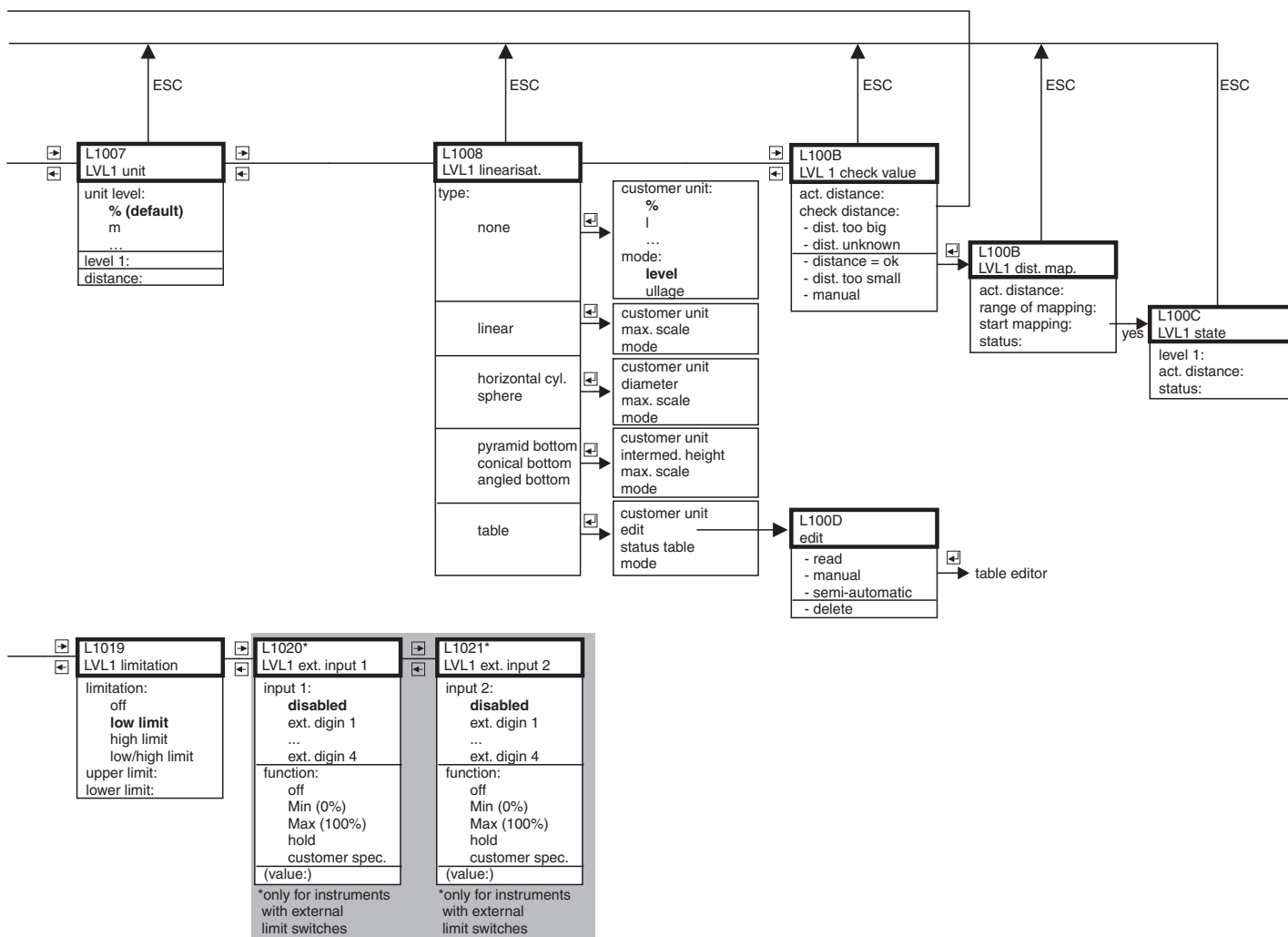

## 12.2 "Flow"

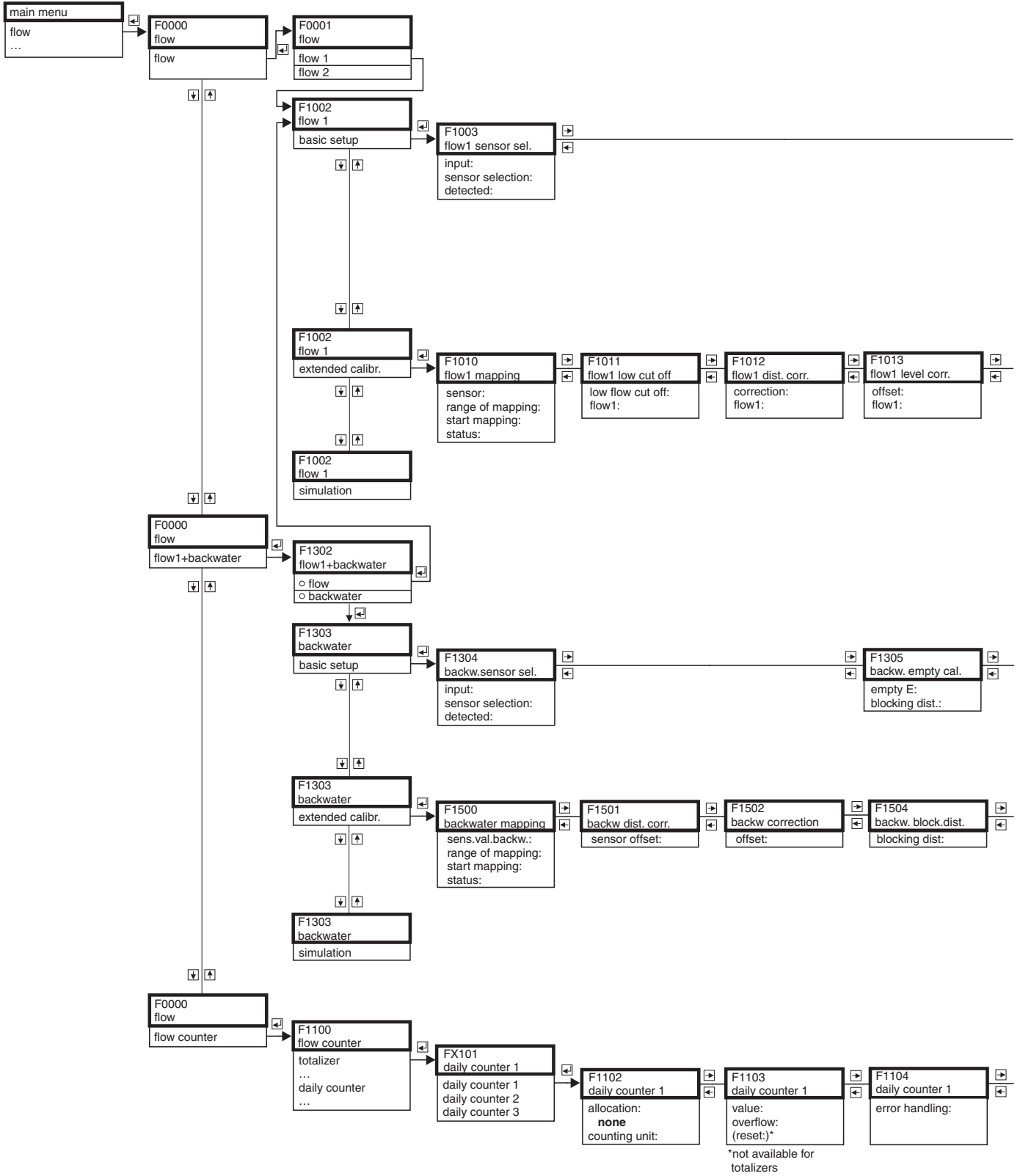

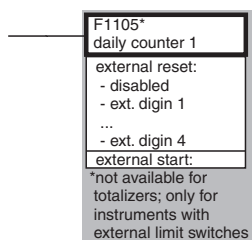
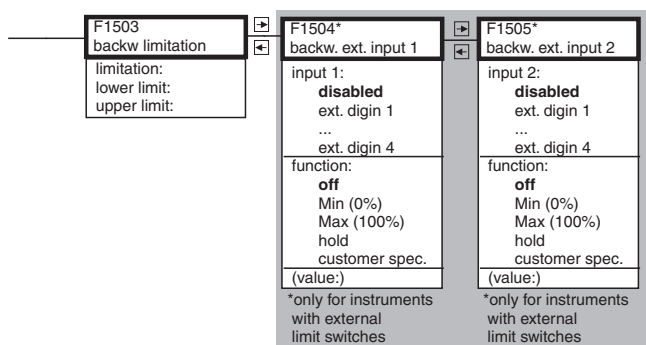
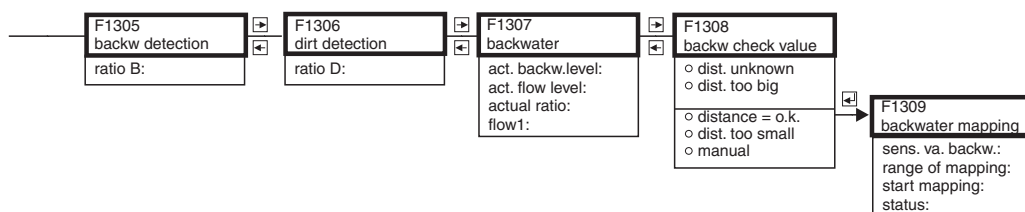
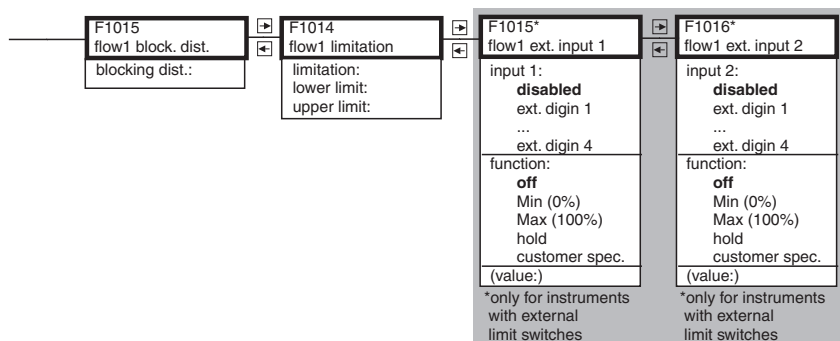
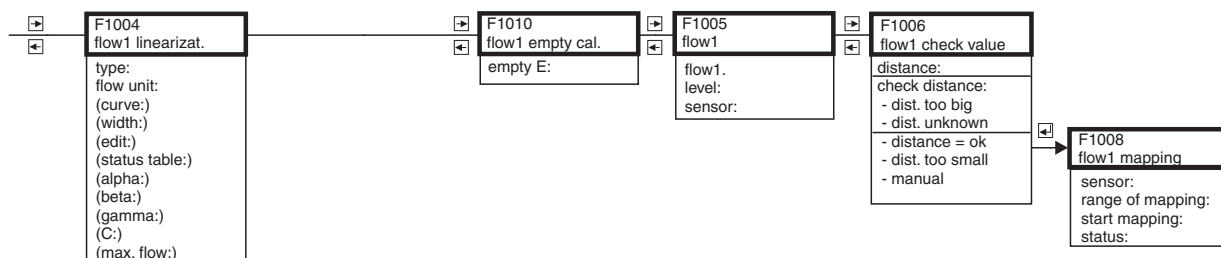

## 12.3 "Safety settings"

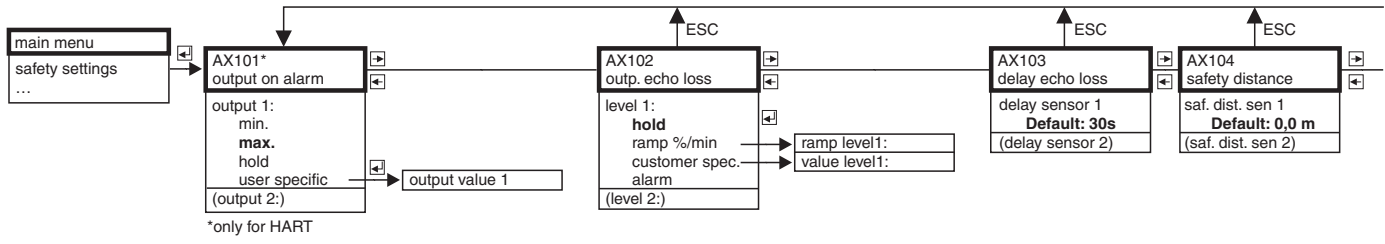

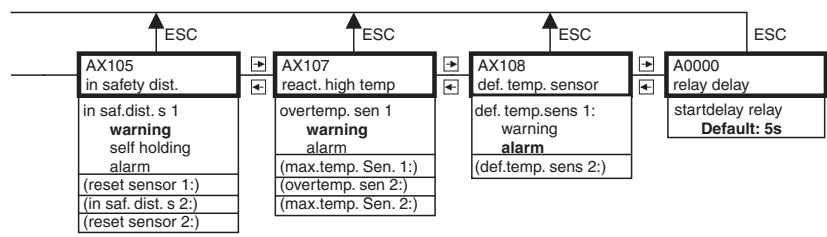

## 12.4 "Relay/Controls"

### 12.4.1 Pump control - standard (FMU90-\*1\*\*\*\*\* und FMU90-\*2\*\*\*\*\*)

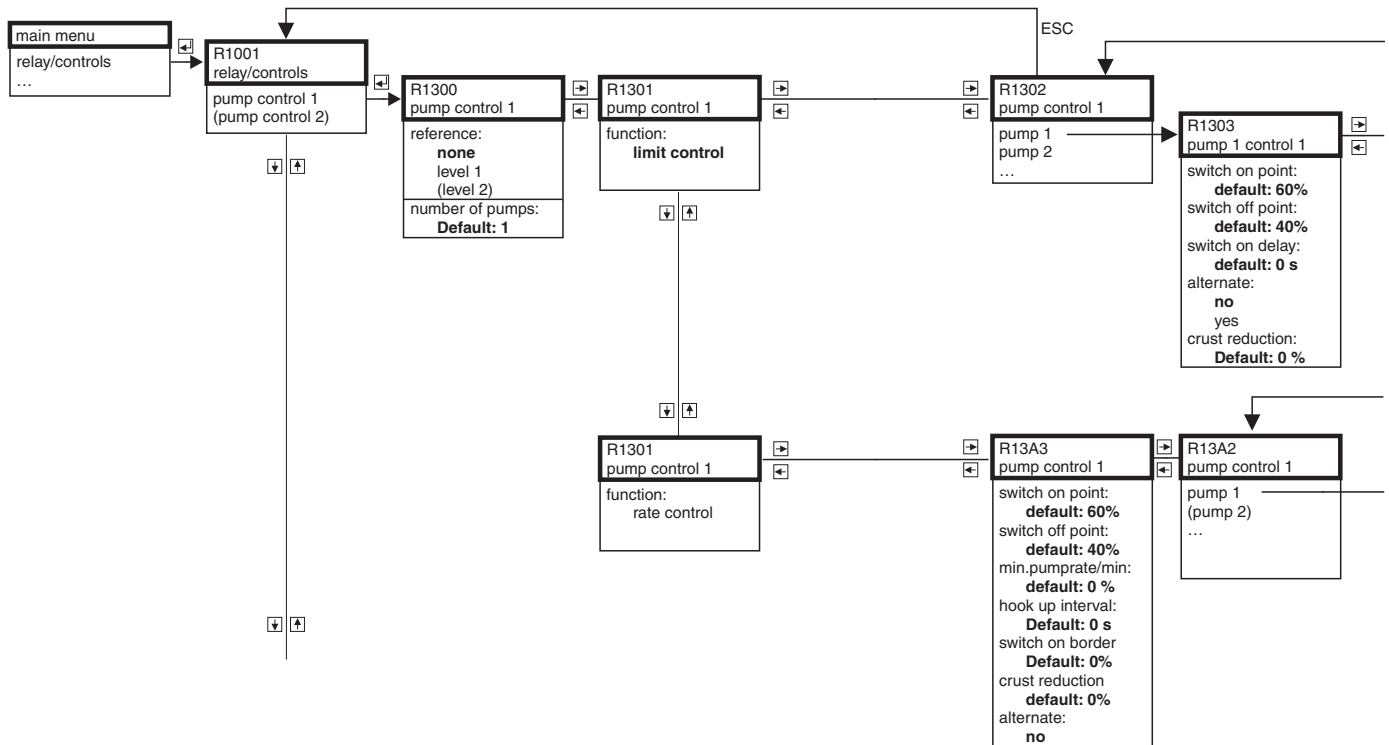



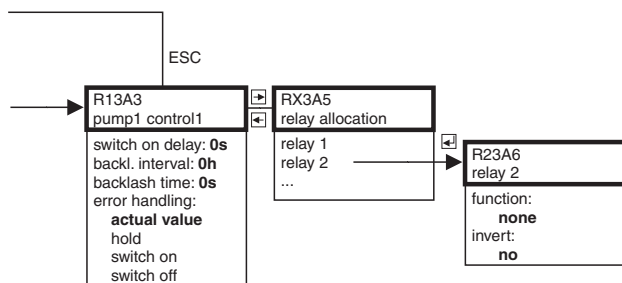
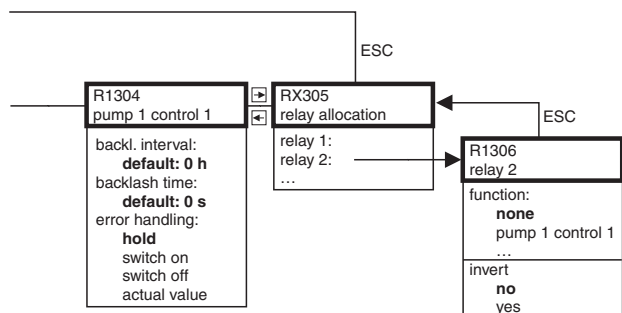

### 12.4.2 Pump control - enhanced: Basic setup (FMU90-3\*\*\*\*\* and FMU90-4\*\*\*\*\*)

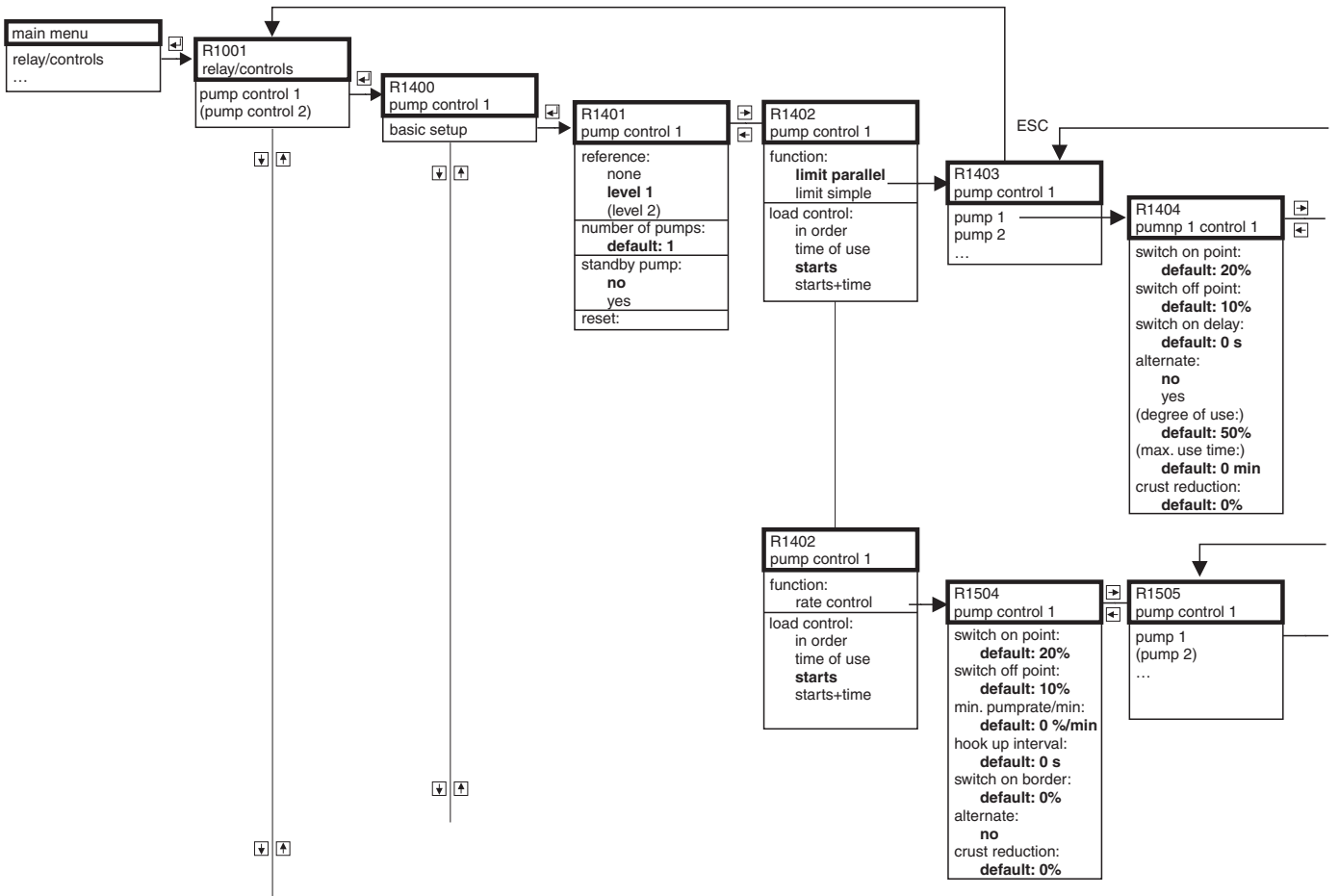

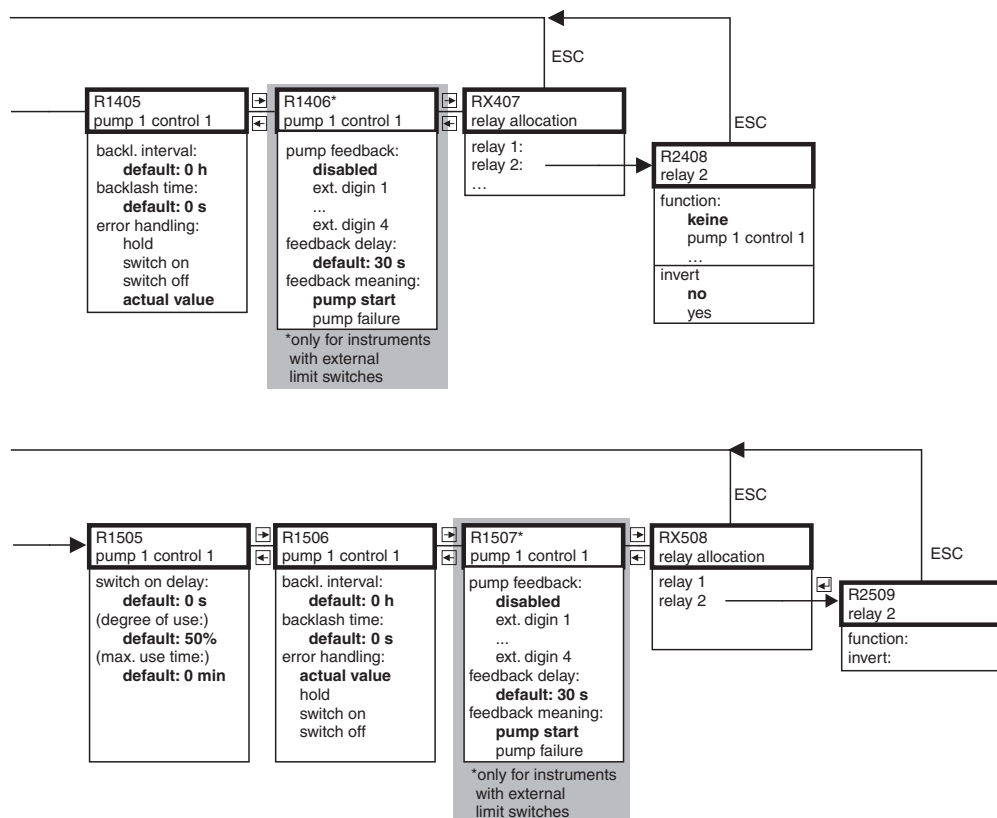

### 12.4.3 Pump control - enhanced: additional functions (FMU90\*3\*\*\*\*\* and FMU90-\*4\*\*\*\*\*)

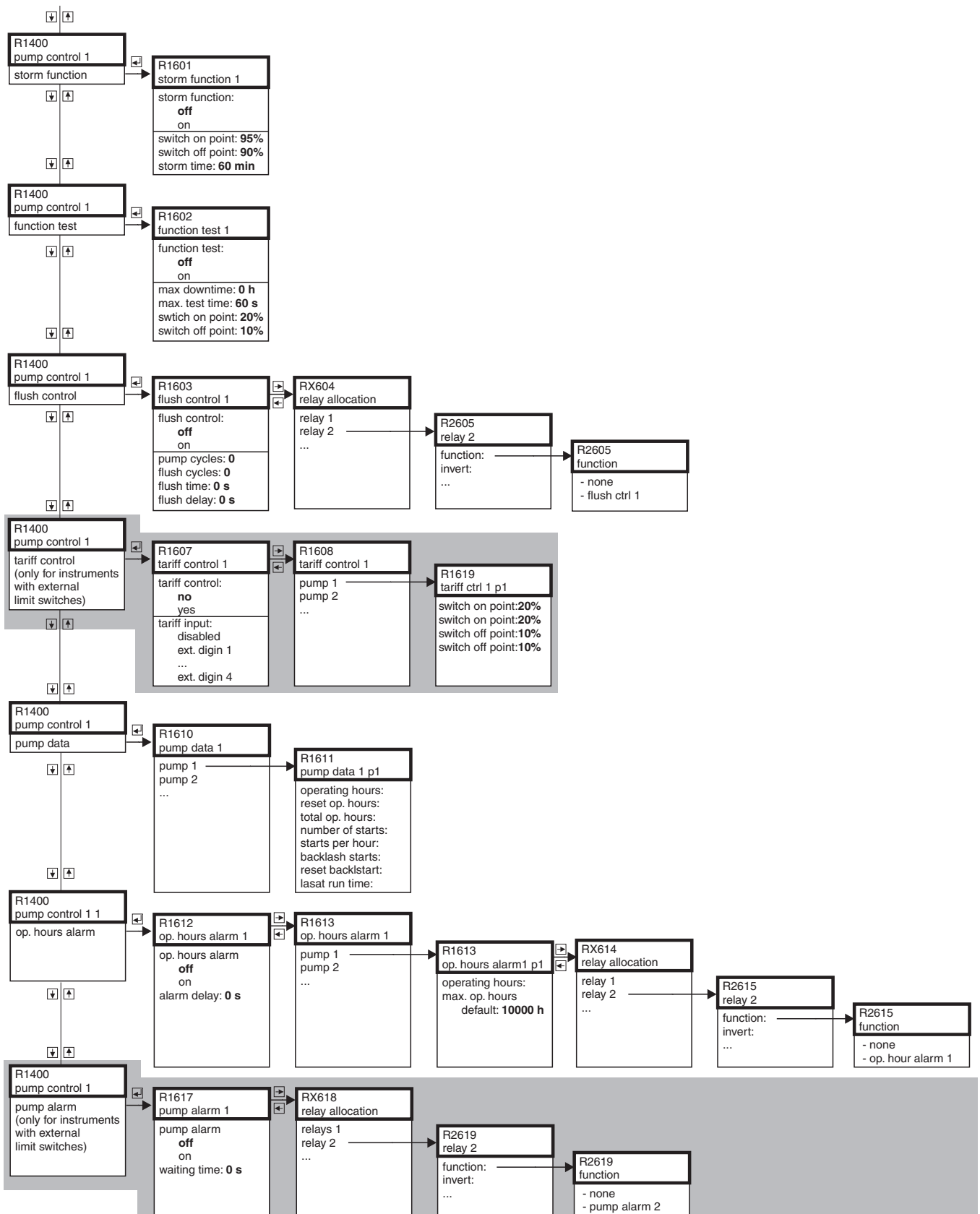



### 12.4.4 Rake control/Relay configuration/Simulation

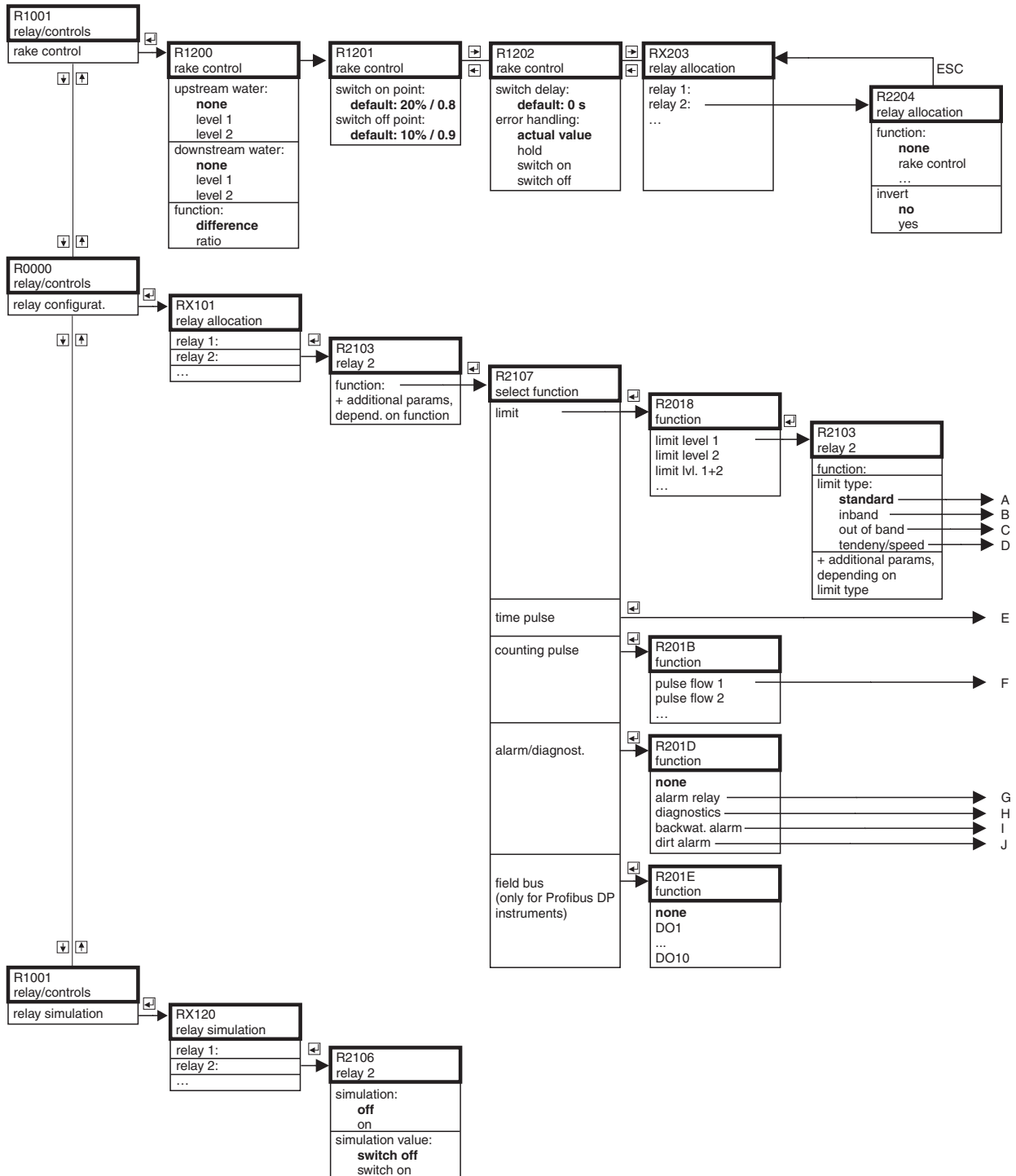

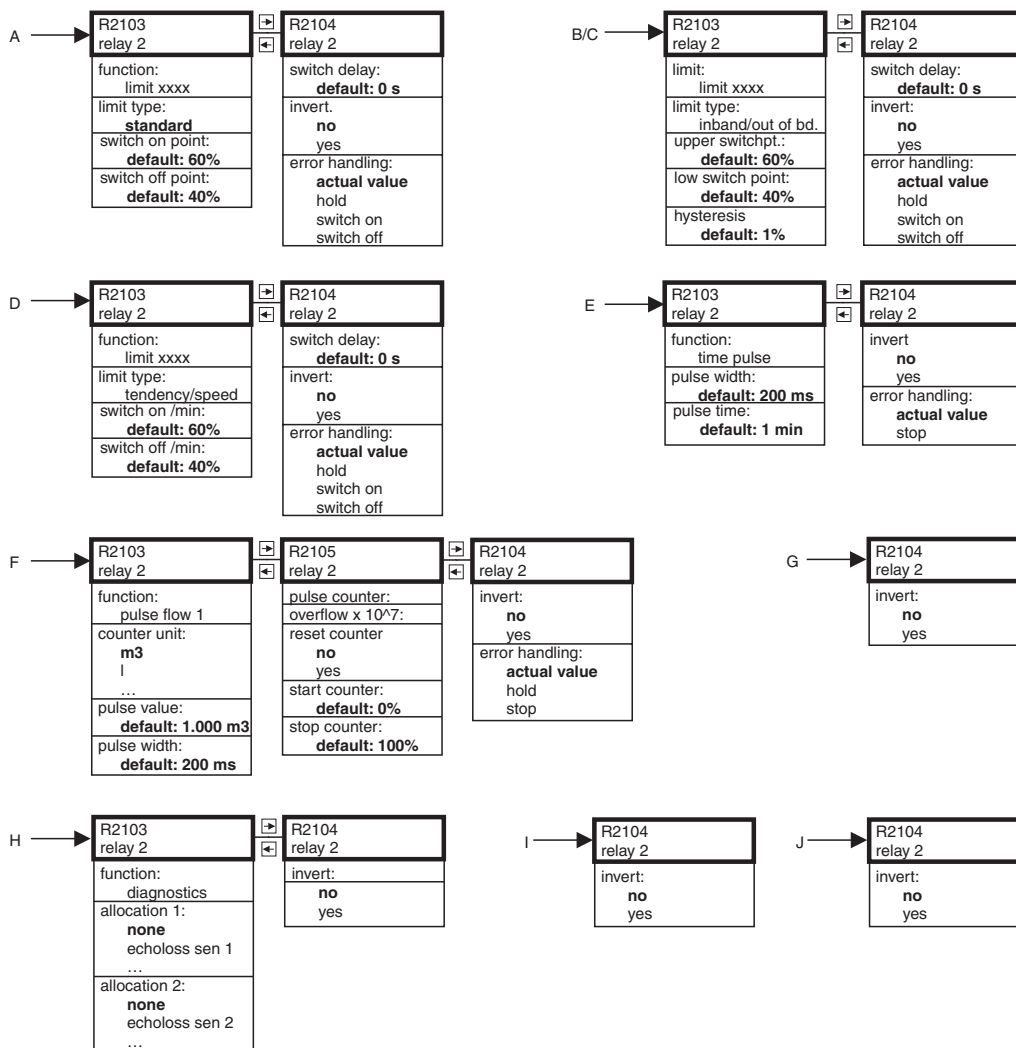

## 12.5 "Output/calculations" (HART)

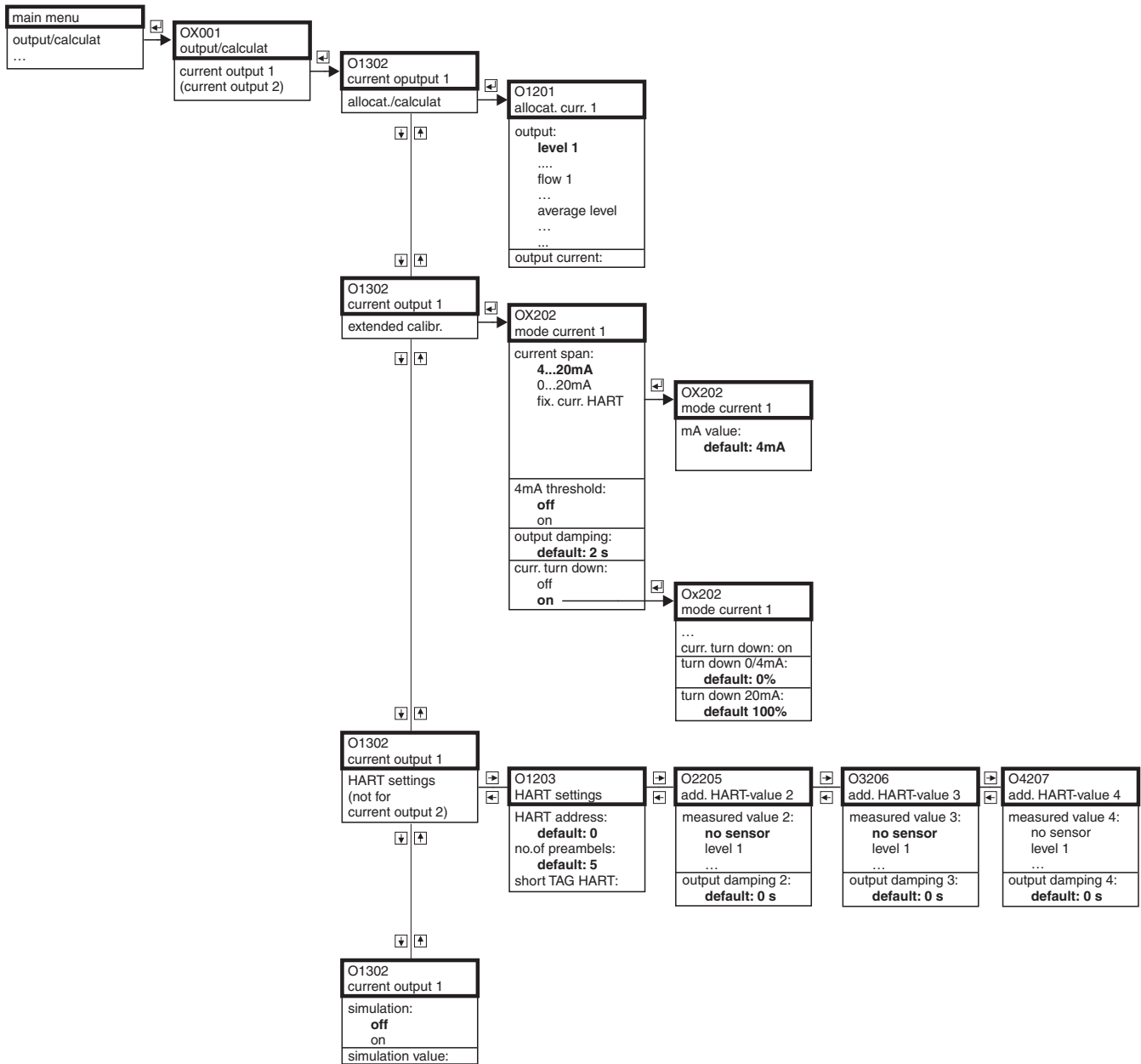



## 12.6 "Output/calculations" (Profibus DP)

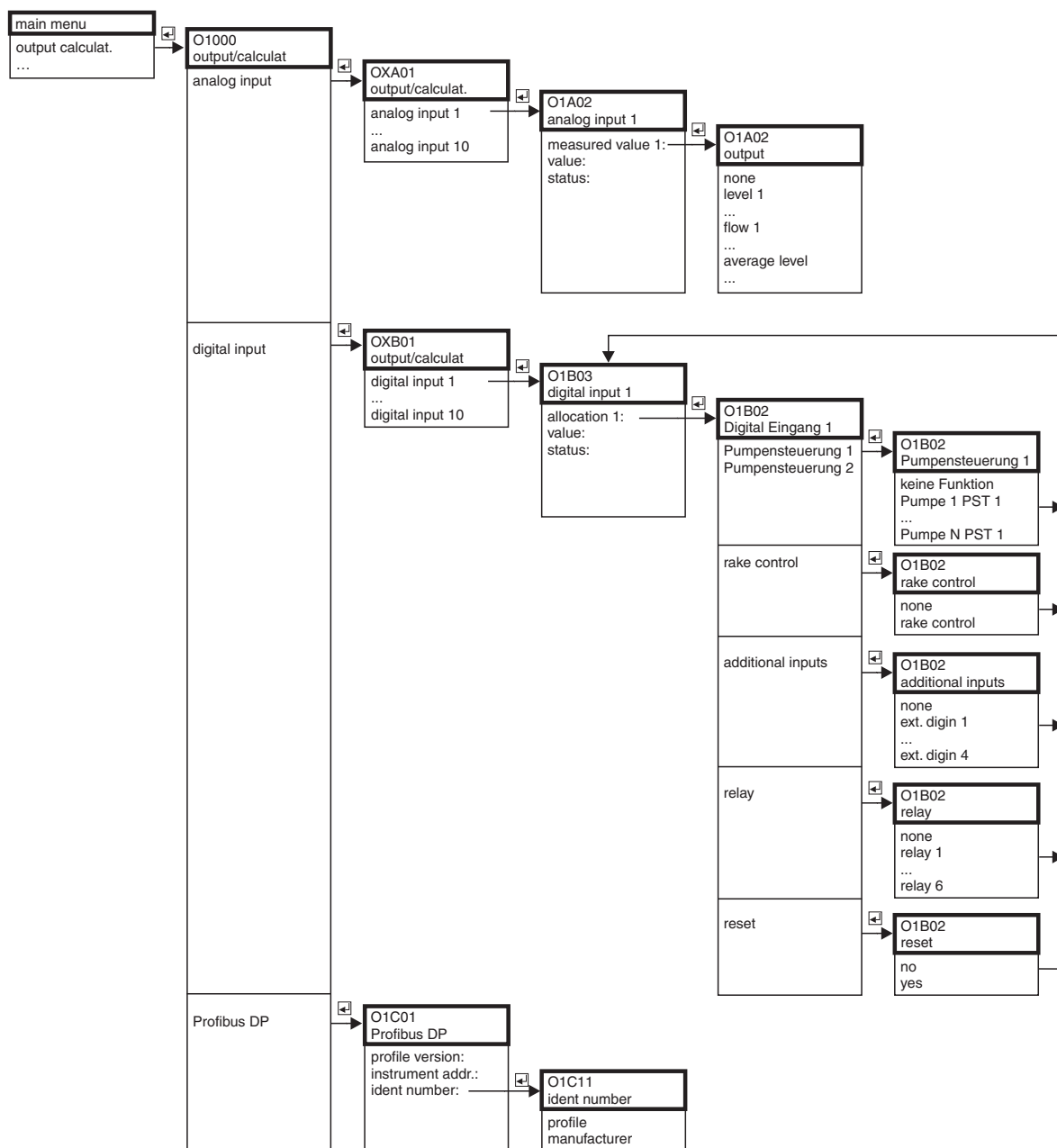

## 12.7 "Device properties"

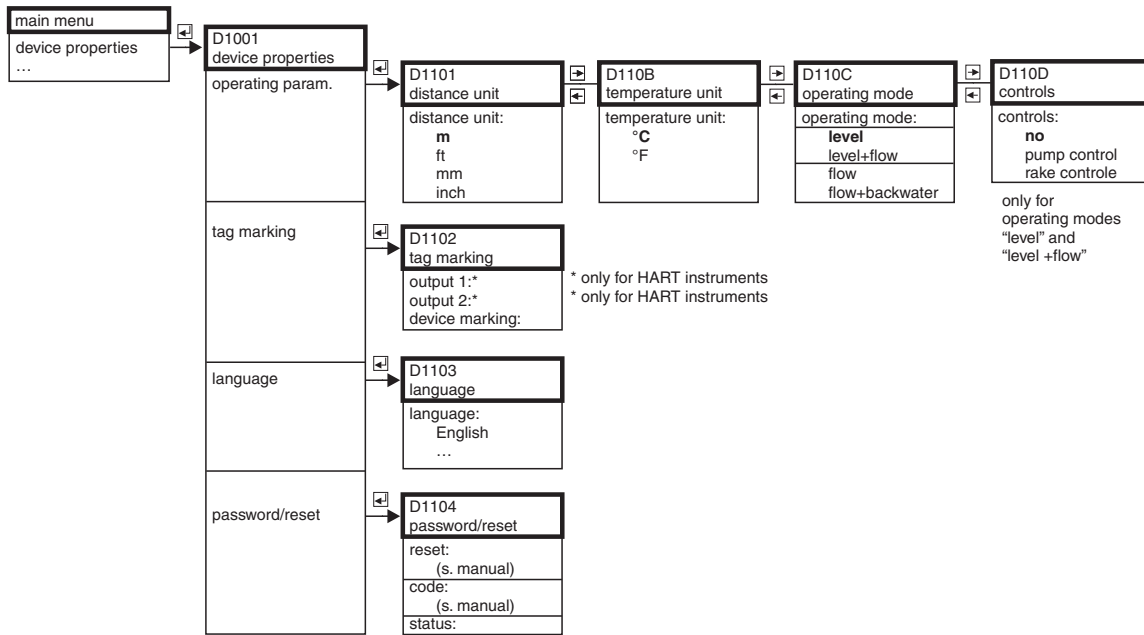



## 12.8 "System information"

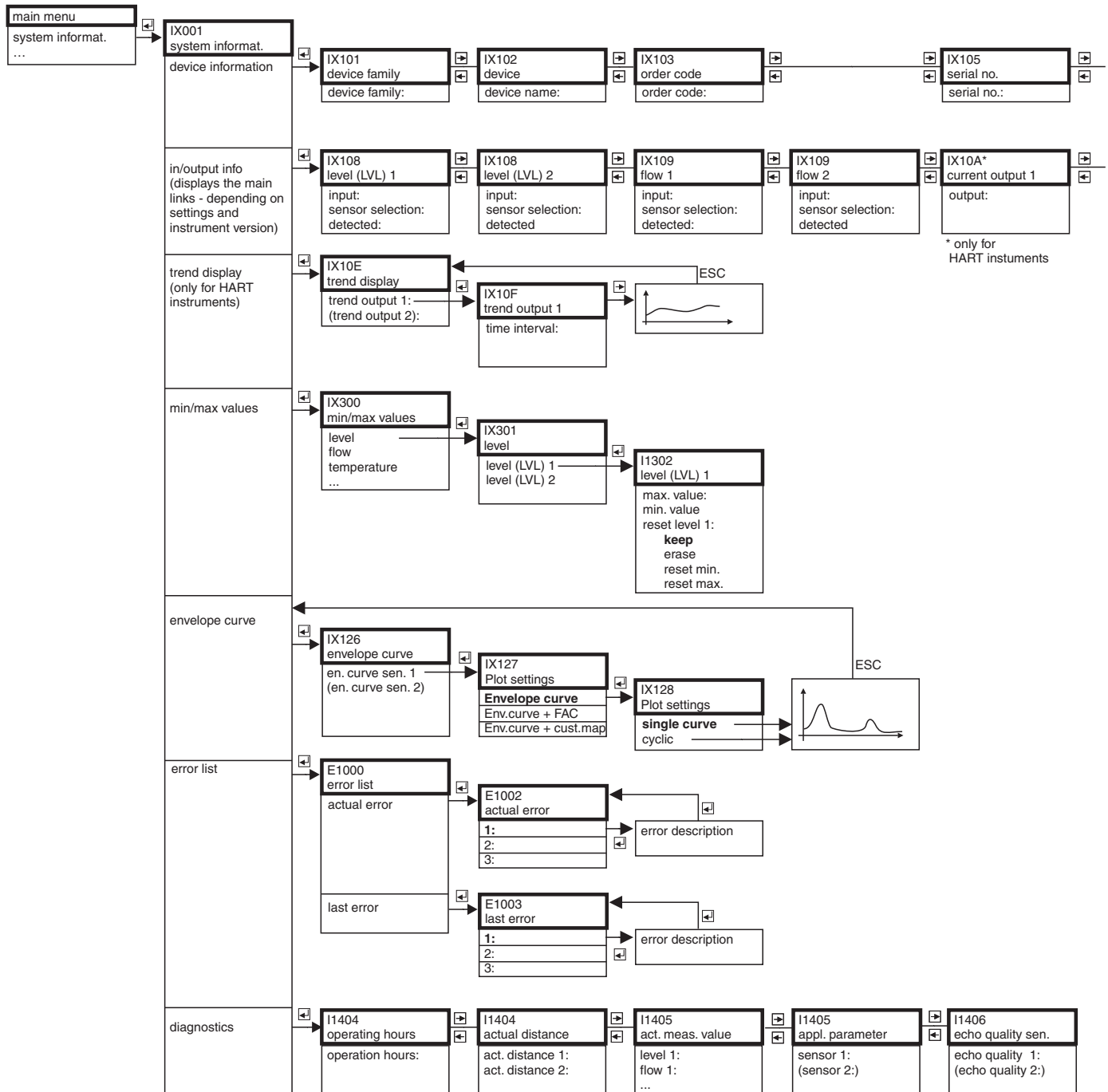

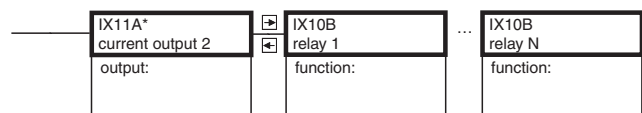
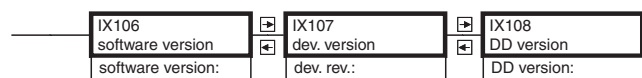

\* only for  
HART instruments

## 12.9 "Display"

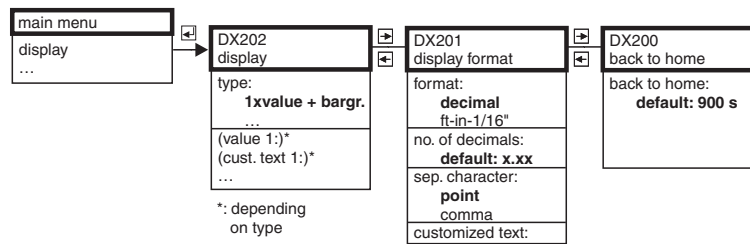

L00-FMU90xxx-19-09-01-es-106

## 12.10 "Sensor management"

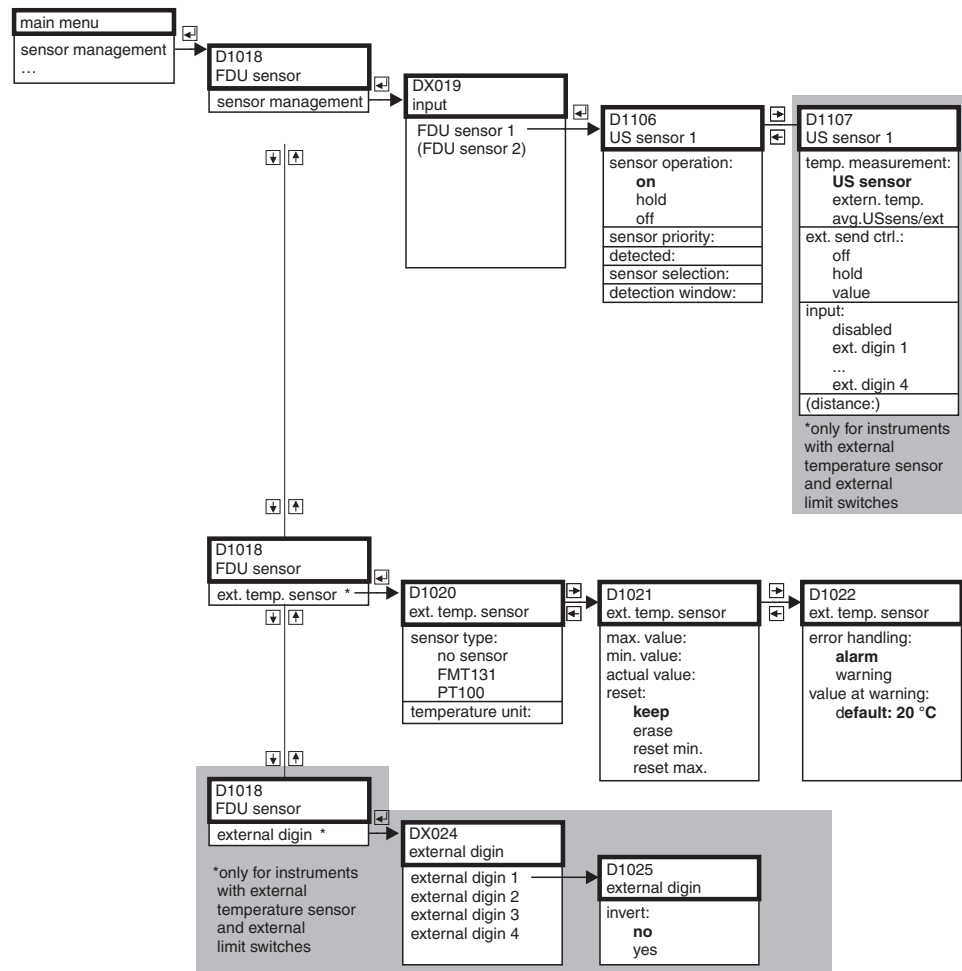

L00-FMU90xxx-19-10-01-es-106

## 13 Appendix

### 13.1 Pre-programmed flow curves

#### 13.1.1 Khafagi-Venturi flumes

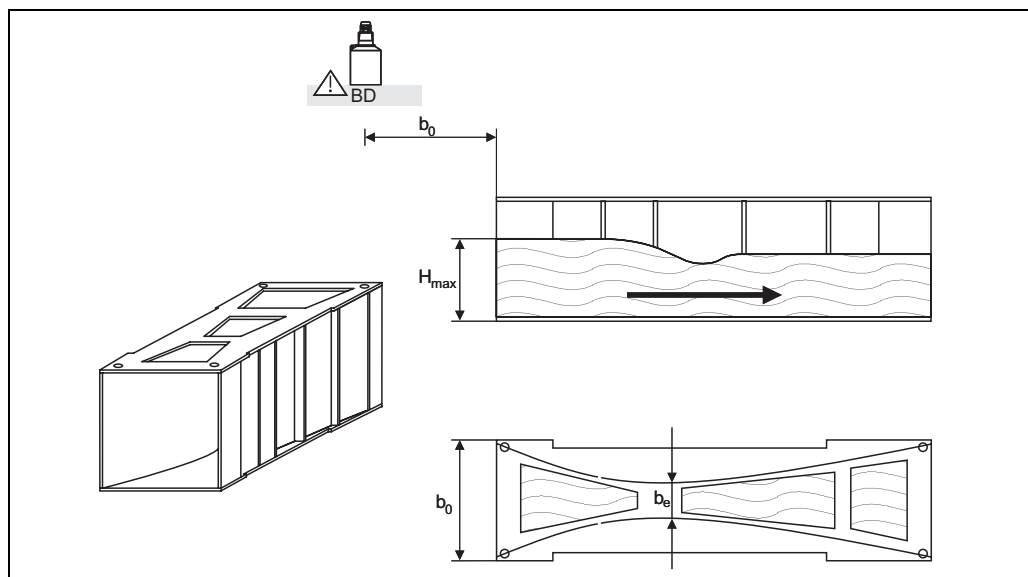

**BD:** blocking distance of the sensor

Type of flume	$b_0$ [mm]	$b_e$ [mm]	$H_{max}$ [mm]	$Q_{max}$ [m <sup>3</sup> /h]
Khafagi-Venturi QV 302	120	48	220	40,09
Khafagi-Venturi QV 303	300	120	250	104,3
Khafagi-Venturi QV 304	400	160	350	231,5
Khafagi-Venturi QV 305	500	200	380	323,0
Khafagi-Venturi QV306	600	240	400	414,0
Khafagi-Venturi QV 308	800	320	600	1024
Khafagi-Venturi QV 310	1000	400	800	1982
Khafagi-Venturi QV 313	1300	520	950	3308
Khafagi-Venturi QV 316	1600	640	1250	6181

The pre-programmed curves can also be used for Khafagi-Venturi flumes with elevated walls. To do so,  $Q_{\max}$  has to be adjusted ("**linearization**" function, "**max. flow**" subfunction):

Type of flume	$H_{\max}$ [mm]	$Q_{\max}$ [m <sup>3</sup> /h]
Khafagi-Venturi QV 302	330	81,90
Khafagi-Venturi QV 303	360	187,9
Khafagi-Venturi QV 304	460	359,9
Khafagi-Venturi QV 305	580	637,7
Khafagi-Venturi QV 306	580	748,6
Khafagi-Venturi QV 308	850	1790
Khafagi-Venturi QV 310	1200	3812
Khafagi-Venturi QV313	1350	5807
Khafagi-Venturi QV 316	1800	11110



Note!

After selecting the type of flume,  $Q_{\max}$  can be adjusted to the flow conditions.  $Q_{\max}$  defines the flow at which the output current is 20 mA.



### 13.1.2 ISO-Venturi flumes

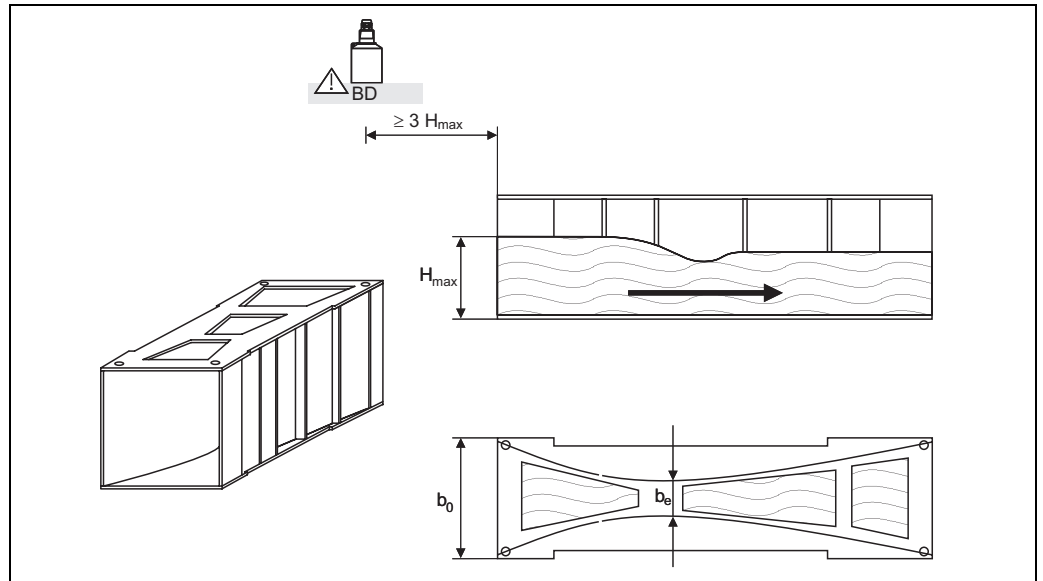

**BD:** blocking distance of the sensor

Type of flume	$b_0$ [mm]	$b_e$ [mm]	$H_{max}$ [mm]	$Q_{max}$ [m <sup>3</sup> /h]
ISO-Venturi 415	150	75	200	42,5
ISO-Venturi 425	250	125	300	130,3
ISO-Venturi 430	400	200	400	322,2
ISO-Venturi 440	400	267	625	893,6
ISO-Venturi 450	500	333	700	1318,9
ISO-Venturi 480	800	480	800	2200



Note!

After selecting the type of flume,  $Q_{max}$  can be adjusted to the flow conditions.  $Q_{max}$  defines the flow at which the output current is 20 mA.

### 13.1.3 British standard Venturi flumes (BS 3680)

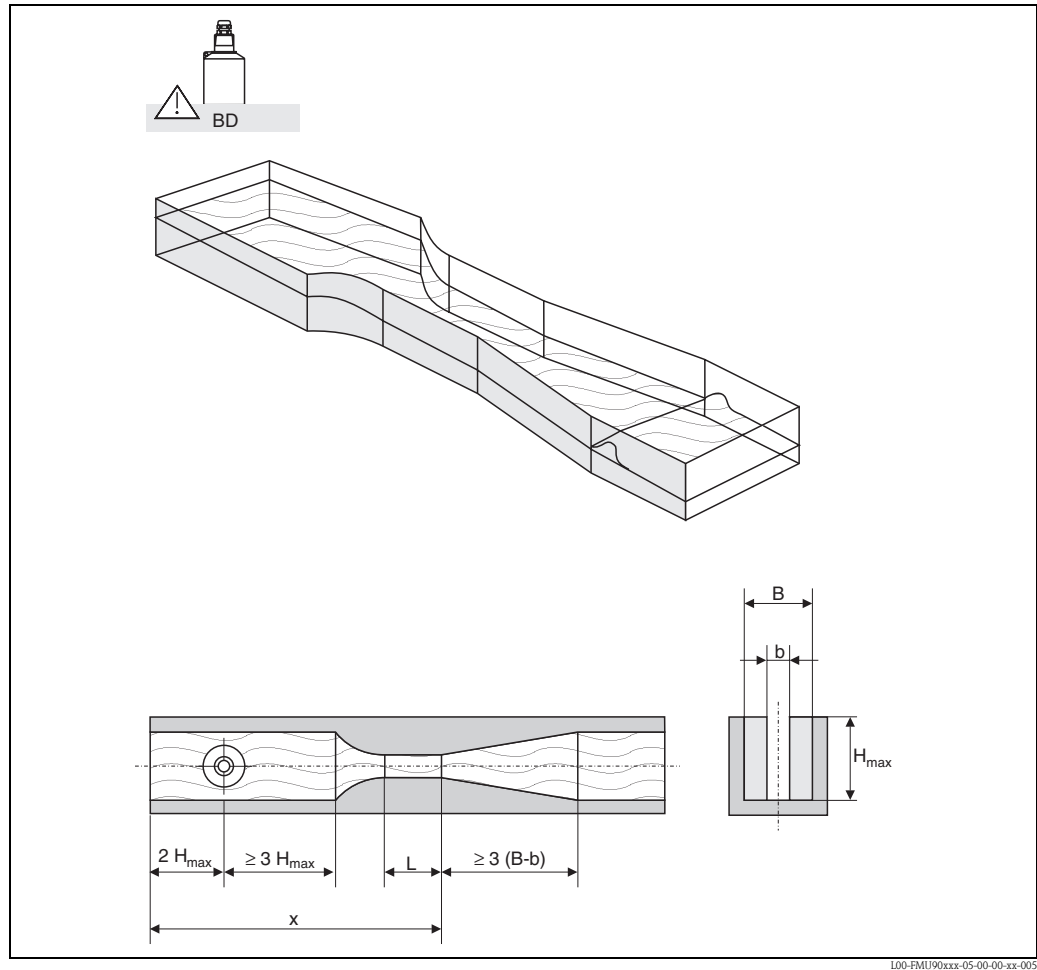

L00-FMU90xxx-05-00-00-xx-005

**BD:** blocking distance of the sensor

The bottom of the flume may not have any slope throughout the length  $x$ . (no measuring flume with data threshold)

Type of flume	b	$H_{\max}$ [mm]	$Q_{\max}$ [m <sup>3</sup> /h]
BST Venturi 4"	4"	150	36,25
BST Venturi 7"	7"	190	90,44
BST Venturi 12"	12"	340	371,1
BST Venturi 18"	18"	480	925,7
BST Venturi 30"	30"	840	3603



Note!

After selecting the type of flume,  $Q_{\max}$  can be adjusted to the flow conditions.  $Q_{\max}$  defines the flow at which the output current is 20 mA.

### 13.1.4 Parshall flumes

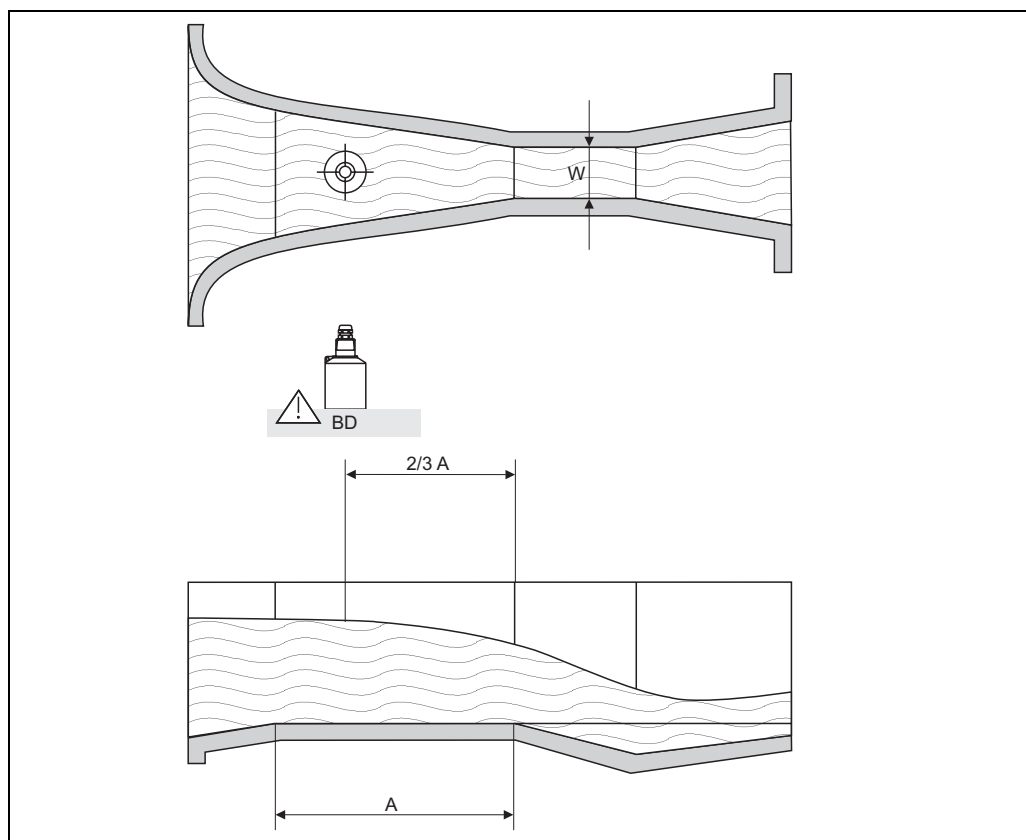

**BD:** blocking distance of the sensor  
**A:** horizontal bottom of the channel

Type of flume	W	H <sub>max</sub> [mm]	Q <sub>max</sub> [m <sup>3</sup> /h]
Parshall 1"	1"	180	15,23
Parshall 2"	2"	180	30,46
Parshall 3"	3"	480	204,2
Parshall 6"	6"	480	430,5
Parshall 9"	9"	630	950,5
Parshall 1 ft	1,0 ft	780	1704
Parshall 1,5 ft	1,5 ft	780	2595
Parshall 2 ft	2,0 ft	780	3498
Parshall 3 ft	3,0 ft	780	5328
Parshall 4 t	4,0 ft	780	7185
Parshall 5 ft	5,0 ft	780	9058
Parshall 6 ft	6 ft	780	10951
Parshall 8 ft	8,0	780	14767



Note!

After selecting the type of flume, Q<sub>max</sub> can be adjusted to the flow conditions. Q<sub>max</sub> defines the flow at which the output current is 20 mA.

### 13.1.5 Palmer-Bowlus flumes

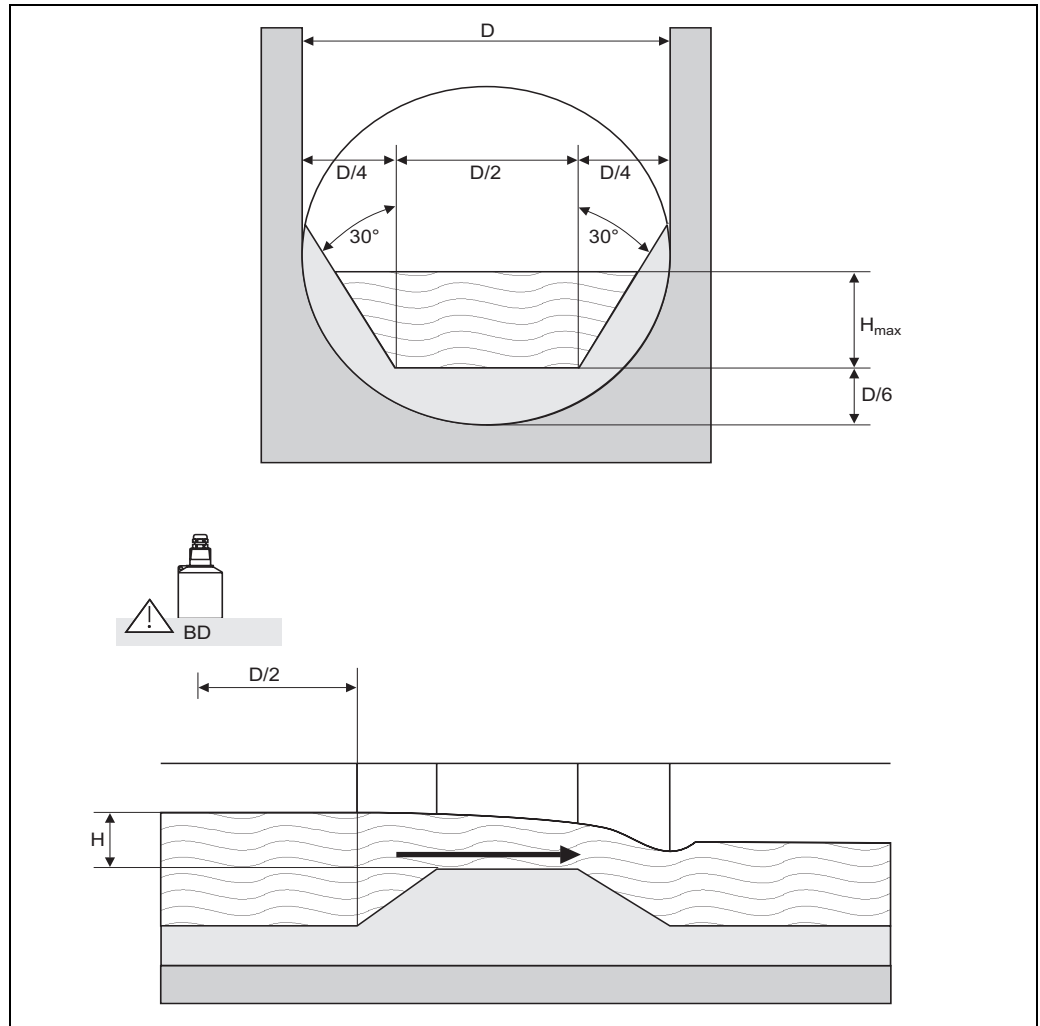

100-FMU90xxx-05-00-00-xx-007

Type of flume	D	$H_{\max}$ [mm]	$Q_{\max}$ [m <sup>3</sup> /h]
Palmer-Bowlus 6"	6"	120	37,94
Palmer-Bowlus 8"	8"	150	68,62
Palmer-Bowlus 10"	10"	210	150,55
Palmer-Bowlus 12"	12"	240	215,83
Palmer-Bowlus 15"	15"	300	376,97
Palmer-Bowlus 18"	18"	330	499,86
Palmer-Bowlus 21"	21"	420	871,05
Palmer-Bowlus 24"	24"	450	1075,94
Palmer-Bowlus 27"	27"	540	1625,58
Palmer-Bowlus 30"	30"	600	2136,47



Note!

After selecting the type of flume,  $Q_{\max}$  can be adjusted to the flow conditions.  $Q_{\max}$  defines the flow at which the output current is 20 mA.

### 13.1.6 Rectangular weirs

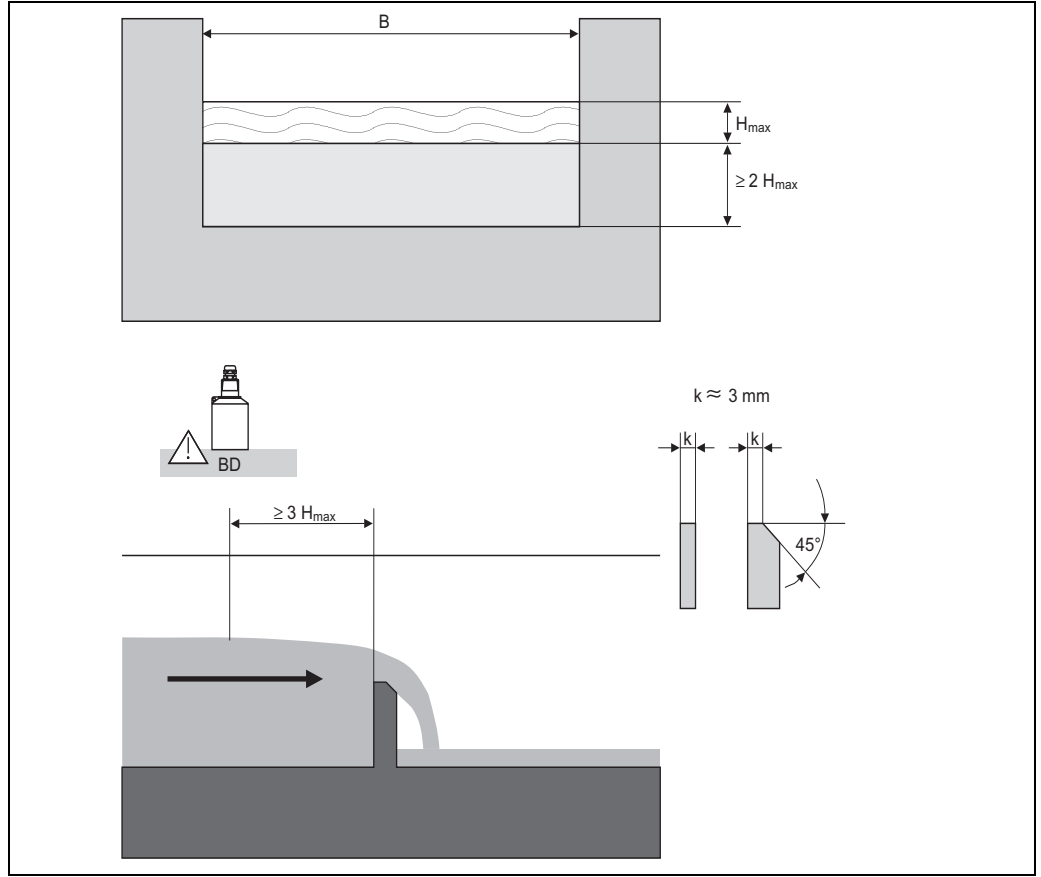

L00-FMU/90xxx-05-00-00-xx-008

Type of weir	B [mm]	H <sub>max</sub> [mm]	Q <sub>max</sub> [m <sup>3</sup> /h]
RectWT0/5H	1000	500	2418
RectWT0/T5	1000	1500	12567



Note!

In the "width" parameter, the width of the weir can be adjusted. The corresponding change of the flow curve is automatically performed by the Prosonic S.



Note!

After selecting the type of weir, Q<sub>max</sub> can be adjusted to the flow conditions. Q<sub>max</sub> defines the flow at which the output current is 20 mA.

### 13.1.7 Constricted rectangular weirs

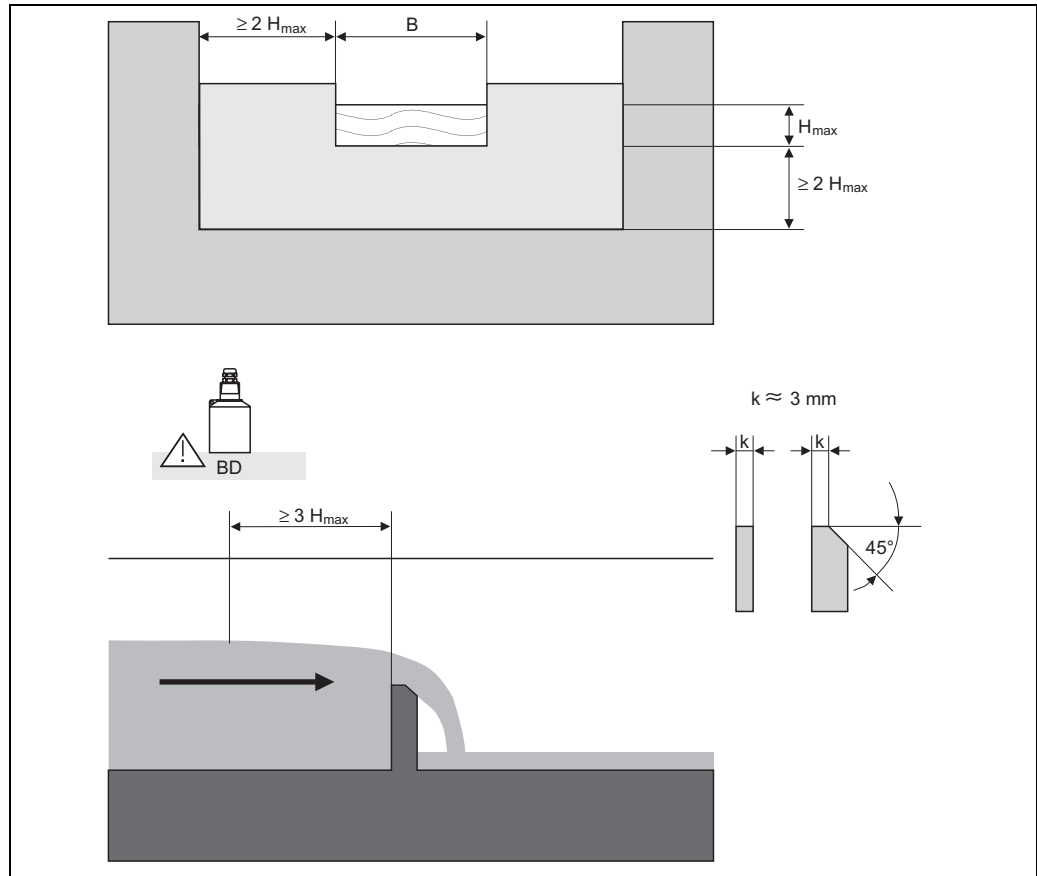

L00-FMU90xxx-05-00-00-xx-009

Type of weir	B [mm]	H <sub>max</sub> [mm]	Q <sub>max</sub> [m <sup>3</sup> /h]
RectWThr 2H	200	120	51,18
RectWThr 3H	300	150	108,4
RectWThr 4H	400	240	289,5
RectWThr 5H	500	270	434,6
RectWThr 6H	600	300	613,3
RectWThr 8H	800	450	1493
RectWThr T0	1000	600	2861
RectWThr T5	1500	725	6061
RectWThr 2T	2000	1013	13352



Note!

In the "width" parameter, the width of the weir can be adjusted. The corresponding change of the flow curve is automatically performed by the Prosonic S.



Note!

After selecting the type of weir, Q<sub>max</sub> can be adjusted to the flow conditions. Q<sub>max</sub> defines the flow at which the output current is 20 mA.

### 13.1.8 Rectangular weirs according to French standard NFX

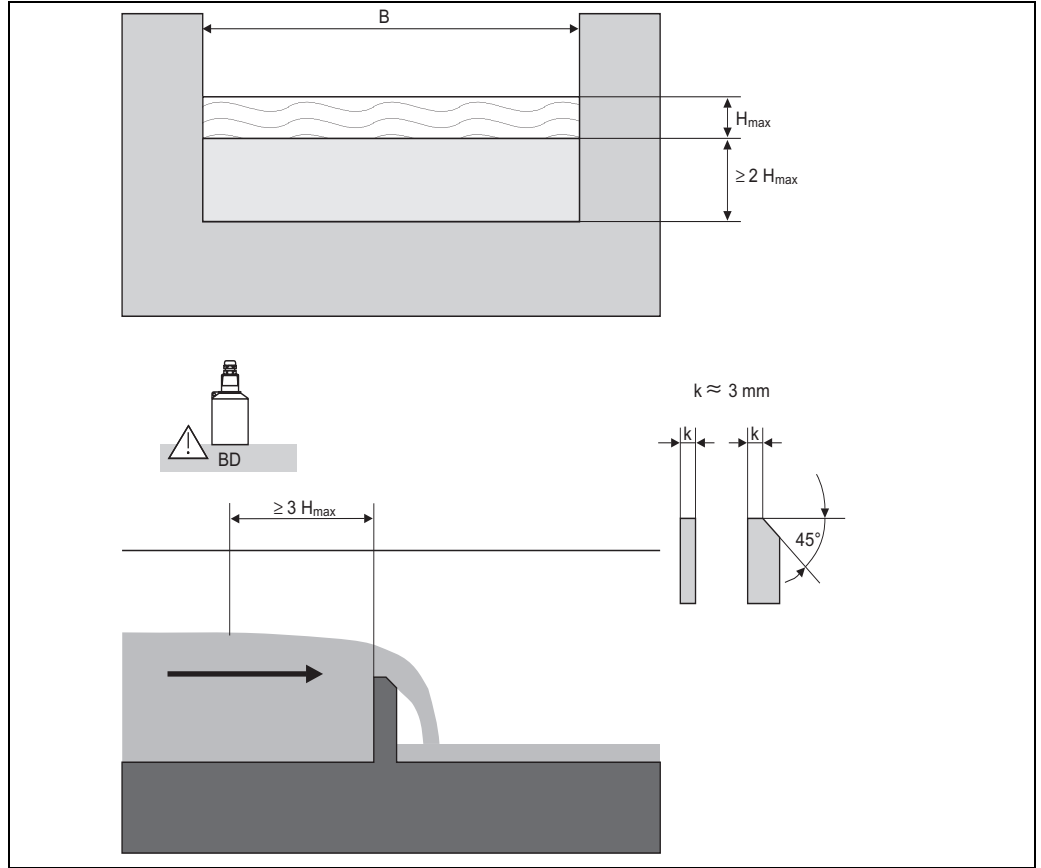

Type of weir	B [mm]	H <sub>max</sub> [mm]	Q <sub>max</sub> [m <sup>3</sup> /h]
NFX Rect T0/5H	1000	500	2427,3
NFX Rect T0/T5	1000	1500	12582,5



Note!

In the "width" parameter, the width of the weir can be adjusted. The corresponding change of the flow curve is automatically performed by the Prosonic S.



Note!

After selecting the type of weir, Q<sub>max</sub> can be adjusted to the flow conditions. Q<sub>max</sub> defines the flow at which the output current is 20 mA.

### 13.1.9 Constricted rectangular weirs according to French standard NFX

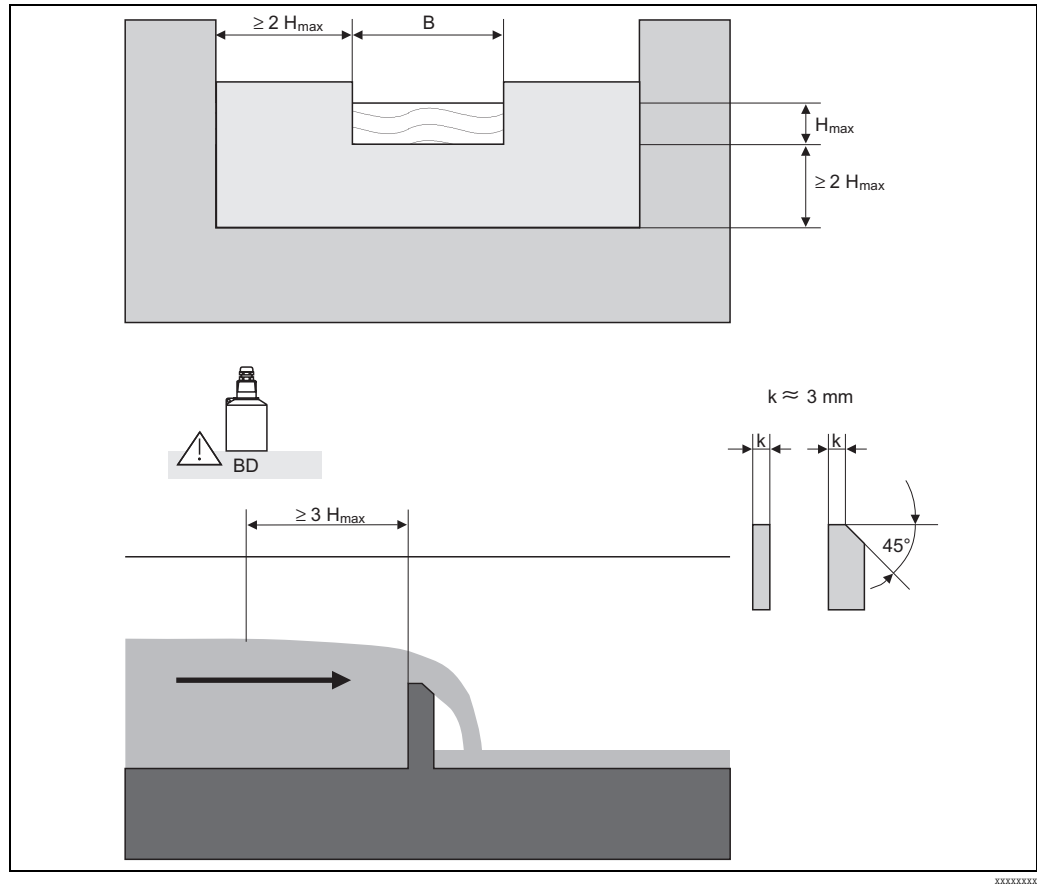

Type of weir	B [mm]	H <sub>max</sub> [mm]	Q <sub>max</sub> [m <sup>3</sup> /h]
NFX Rect WThr 2H	200	120	53,5
NFX Rect WThr 3H	300	150	111,7
NFX Rect WThr 4H	400	240	299,1
NFX Rect WThr 5H	500	270	445,8
NFX Rect WThr 6H	600	300	626,2
NFX Rect WThr 8H	800	450	1527,8
NFX Rect WThr T0	1000	600	2933,8



Note!

After selecting the type of weir, Q<sub>max</sub> can be adjusted to the flow conditions. Q<sub>max</sub> defines the flow at which the output current is 20 mA.



### 13.1.10 Trapezoidal weirs

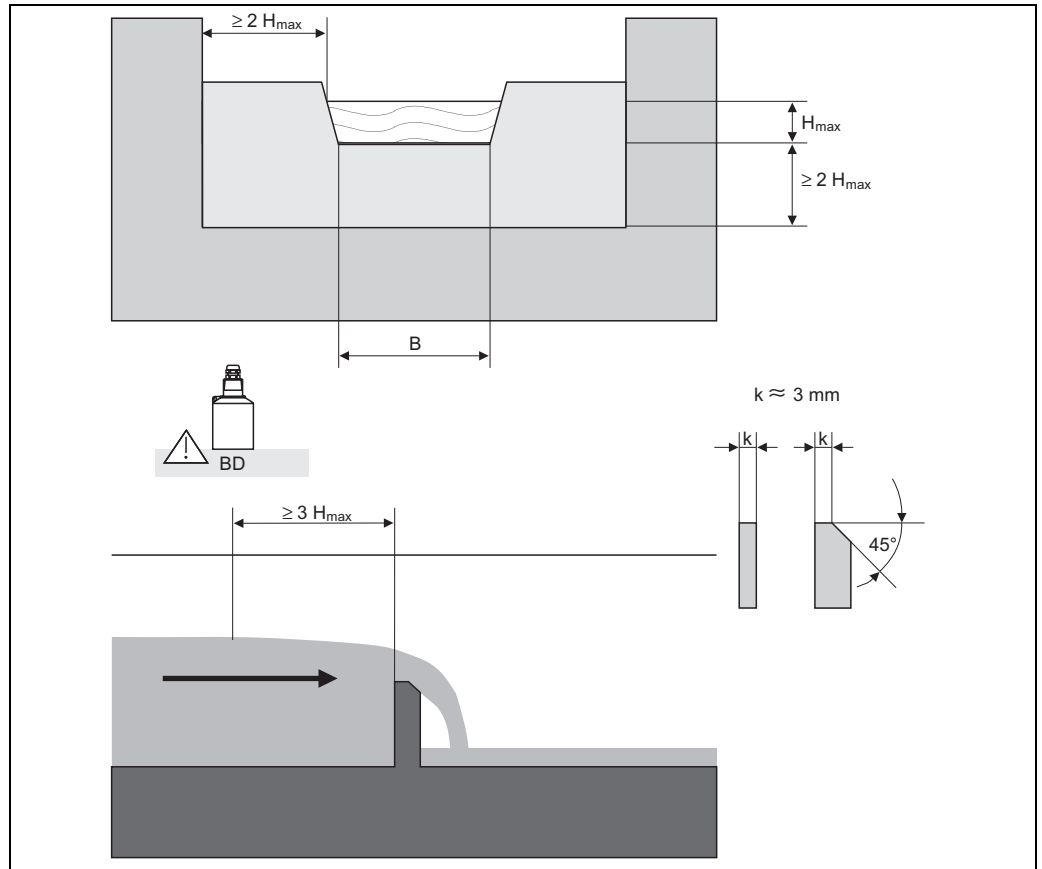

100-FMU90xxxx-05-00-00-xx-010

Type of weir	B [mm]	$H_{\max}$ [mm]	$Q_{\max}$ [m <sup>3</sup> /h]
Trap.W T0/3H	1000	300	1049
Trap.W T0/T5	1000	1500	11733



Note!

In the "width" parameter, the width of the weir can be adjusted. The corresponding change of the flow curve is automatically performed by the Prosonic S.



Note!

After selecting the type of weir,  $Q_{\max}$  can be adjusted to the flow conditions.  $Q_{\max}$  defines the flow at which the output current is 20 mA.

## 13.1.11 Triangular weirs

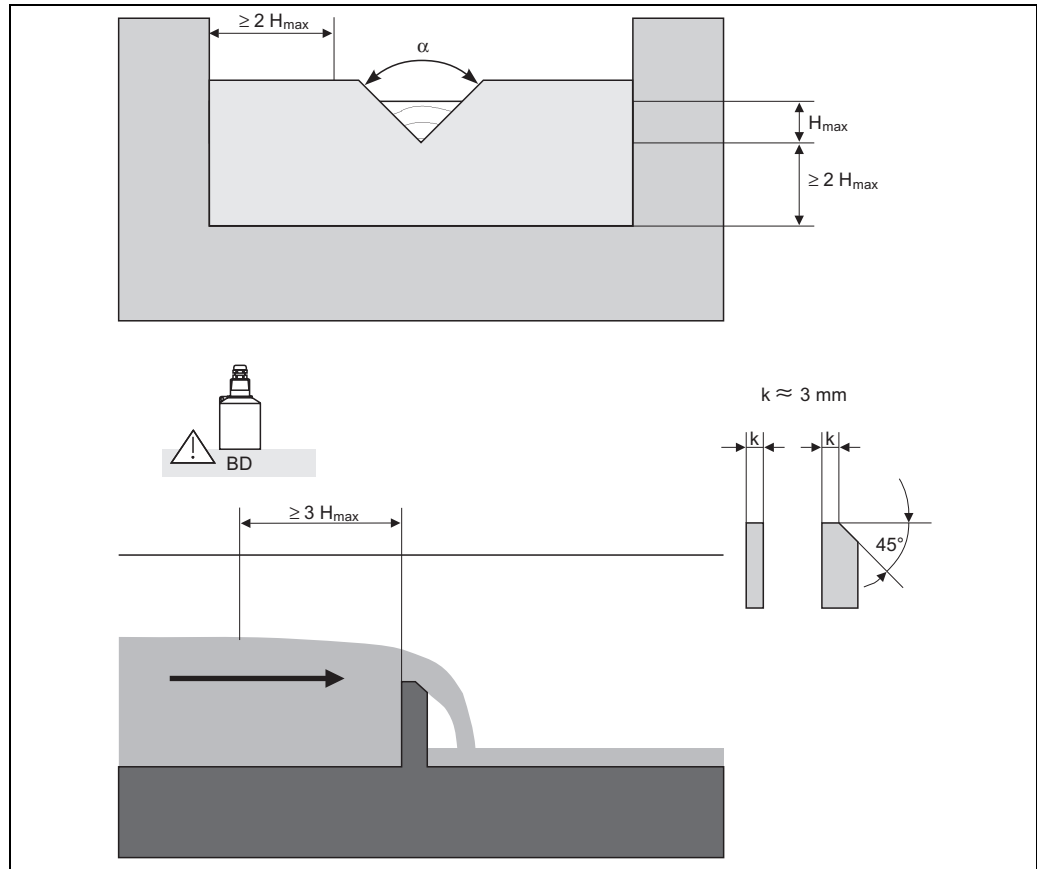

100-FM190xxx-05-00-00-xx-011

Type of weir	$\alpha$	$H_{\max}$ [mm]	$Q_{\max}$ [m <sup>3</sup> /h]
V-Weir 22,5	22,5°	600	276,0
V-Weir 30	30°	600	371,2
V-Weir 45	45°	600	574,1
V-Weir 60	60°	600	799,8
V-Weir 90	90°	600	1385



Note!

After selecting the type of weir,  $Q_{\max}$  can be adjusted to the flow conditions.  $Q_{\max}$  defines the flow at which the output current is 20 mA.

### 13.1.12 British standard triangular weirs (BS 3680)

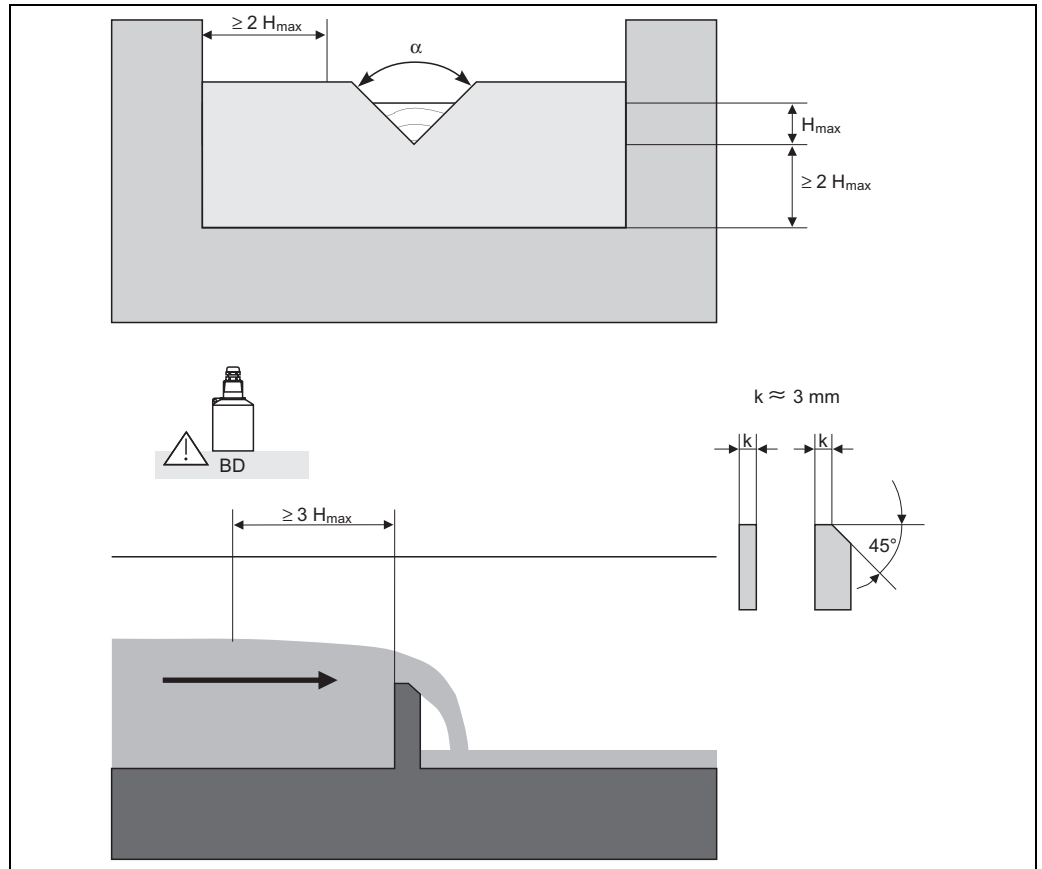

L00-FM1/90xxxx-05-00-00-xx-011

Type of weir	$\alpha$	$H_{\max}$ [mm]	$Q_{\max}$ [m <sup>3</sup> /h]
BST V-Weir 22,5 (1/4 90°)	1/4 90°	390	120,1
BST V-Weir 45 (1/2 90°)	1/2 90°	390	237,0
BST V-Weir 90	90°	390	473,2



Note!

After selecting the type of weir,  $Q_{\max}$  can be adjusted to the flow conditions.  $Q_{\max}$  defines the flow at which the output current is 20 mA.

## 13.1.13 Triangular weirs according to the French standard NFX

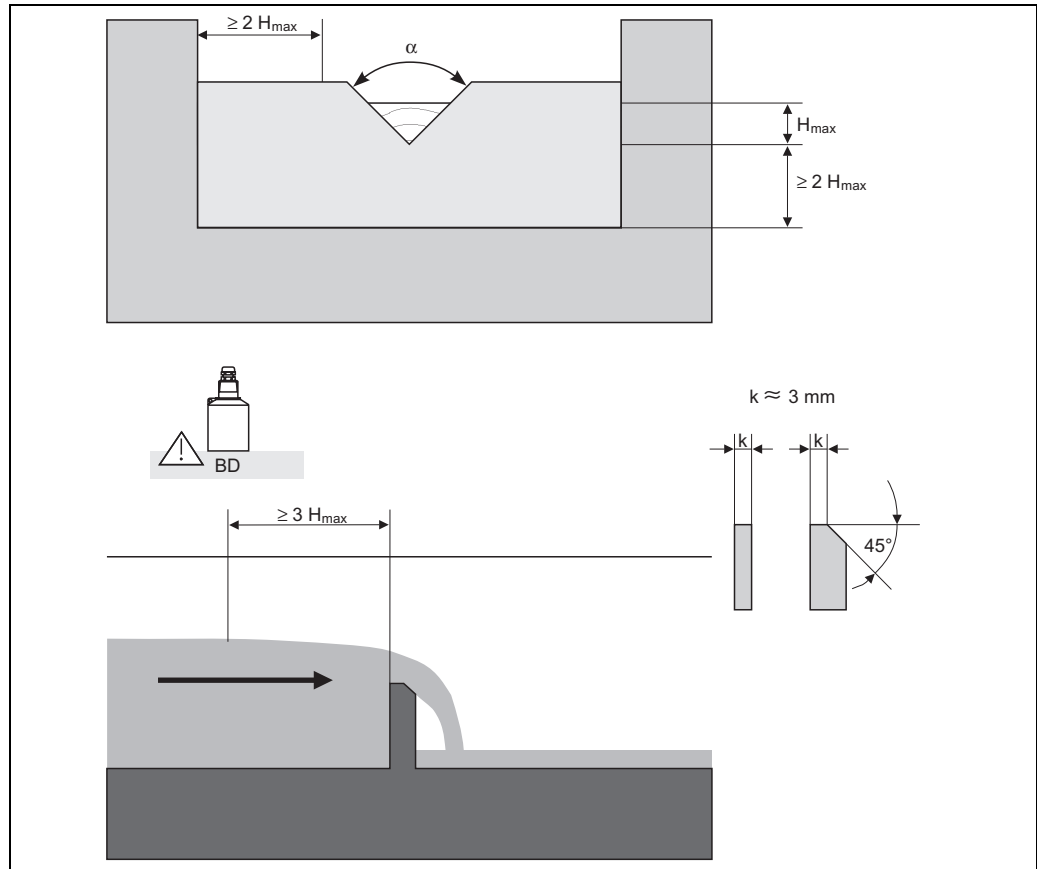

100-FM190xxx-05-00-00-xx-011

Type of weir	$\alpha$	$H_{\max}$ [mm]	$Q_{\max}$ [m <sup>3</sup> /h]
NFX V-Weir 30	30°	600	375,9
NFX V-Weir 45	45°	600	573,1
NFX V-Weir 60	60°	600	793,1
NFX V-Weir 90	90°	600	1376,7



Note!

After selecting the type of weir,  $Q_{\max}$  can be adjusted to the flow conditions.  $Q_{\max}$  defines the flow at which the output current is 20 mA.

## 13.2 The formula for flow calculation

If you have selected the "formula" linearization type, the flow calculation is performed according to:

$$Q = C (h^\alpha + \gamma h^\beta)$$

where:

- Q: the flow in m<sup>3</sup>/h
- C: a scaling parameter
- h: the upstream level
- $\alpha, \beta$ : the flow exponents
- $\gamma$ : a weighting constant

Appropriate values of  $\alpha$ ,  $\beta$ ,  $\gamma$  and C for the different types of flumes and weirs can be taken from the following tables.

Khafagi-Venturi flumes					
Type	$Q_{\max}$ [m <sup>3</sup> /h]	$\alpha$	$\beta$	$\gamma$	C
QV 302	40,09	1,500	2,500	0,0013140	0,0095299
QV 303	104,3	1,500	2,500	0,0004301	0,0238249
QV 304	231,5	1,500	2,500	0,0003225	0,0317665
QV 305	323,0	1,500	2,500	0,0002580	0,0397081
QV 306	414,0	1,500	2,500	0,0002150	0,0476497
QV 308	1024	1,500	2,500	0,0001613	0,0635329
QV 310	1982	1,500	2,500	0,0001290	0,0794162
QV 313	3308	1,500	2,500	0,0000992	0,1032410
QV 316	6181	1,500	2,500	0,0000806	0,1270659

ISO-Venturi flumes					
Type	$Q_{\max}$ [m <sup>3</sup> /h]	$\alpha$	$\beta$	$\gamma$	C
ISO 415	42,5	1,500	2,100	0,0009336	0,0146865
ISO 425	130,3	1,500	1,600	0,0959719	0,0214406
ISO 430	322,2	1,500	2,000	0,0032155	0,0379104
ISO 440	893,6	1,600	1,700	-0,2582633	0,0590888
ISO 450	1318,9	1,600	1,800	-0,0895791	0,0553654
ISO 480	1862,5	1,600	1,800	-0,0928186	0,0795737

British standard Venturi flumes (BS 3680)					
Type	$Q_{\max}$ [m <sup>3</sup> /h]	$\alpha$	$\beta$	$\gamma$	C
BST Venturi 4"	36,25	1,500	1,000	0,0000000	0,019732
BST Venturi 7"	90,44	1,500	1,000	0,0000000	0,034532
BST Venturi 12"	371,2	1,500	1,000	0,0000000	0,059201
BST Venturi 18"	925,7	1,500	1,000	0,0000000	0,088021
BST Venturi 30"	3603	1,500	1,000	0,0000000	0,148003

Parshall flumes					
Type	$Q_{\max}$ [m <sup>3</sup> /h]	$\alpha$	$\beta$	$\gamma$	C
Parshall 1"	15,23	1,550	1,000	0,0000000	0,0048651
Parshall 2"	30,46	1,550	1,000	0,0000000	0,0097302
Parshall 3"	203,8	1,547	1,000	0,0000000	0,0144964
Parshall 6"	430,5	1,580	1,000	0,0000000	0,0249795
Parshall 9"	950,5	1,530	1,000	0,0000000	0,0495407
Parshall 1 ft	1704	1,522	1,000	0,0000000	0,0675749
Parshall 1,5 ft	2595	1,538	1,000	0,0000000	0,0924837
Parshall 2 ft	3498	1,550	1,000	0,0000000	0,1151107
Parshall 3 ft	5328	1,566	1,000	0,0000000	0,1575984
Parshall 4 ft	7185	1,578	1,000	0,0000000	0,1962034
Parshall 5 ft	9058	1,587	1,000	0,0000000	0,2329573
Parshall 6 ft	10951	1,595	1,000	0,0000000	0,2670383
Parshall 8 ft	14767	1,607	1,000	0,0000000	0,3324357

Palmer-Bowlus flumes					
Type	$Q_{\max}$ [m <sup>3</sup> /h]	$\alpha$	$\beta$	$\gamma$	C
Palmer-Bowlus 6"	37,94	0,200	2,000	0,01176	0,22063
Palmer-Bowlus 8"	68,62	0,200	2,000	0,00661	0,45306
Palmer-Bowlus 10"	150,55	0,200	2,000	0,00512	0,65826
Palmer-Bowlus 12"	215,83	0,200	2,000	0,0033	1,11787
Palmer-Bowlus 15"	376,97	0,200	2,000	0,00213	1,93489
Palmer-Bowlus 18"	499,86	0,200	2,000	0,00152	2,96269
Palmer-Bowlus 21"	871,05	0,200	2,000	0,00113	4,29769
Palmer-Bowlus 24"	1075,94	0,200	2,000	0,00091	5,73322
Palmer-Bowlus 27"	1625,58	0,200	2,000	0,00073	7,51238
Palmer-Bowlus 30"	2136,47	0,200	2,000	0,00061	9,57225

Rectangular weirs					
Type	$Q_{\max}$ [m <sup>3</sup> /h]	$\alpha$	$\beta$	$\gamma$	C
RectWT0/5H	1049	1,500	1,000	0,0000000	0,2067454
RectWT0/T5	11733	1,500	1,000	0,0000000	0,2067454

Constricted rectangular weirs					
Type	$Q_{\max}$ [m <sup>3</sup> /h]	$\alpha$	$\beta$	$\gamma$	C
RectWThr 2H	51,18	1,500	1	0,0000000	0,038931336
RectWThr 3H	108,4	1,500	1	0,0000000	0,059018248
RectWThr 4H	289,5	1,500	1	0,0000000	0,077862671
RectWThr 5H	434,6	1,500	1	0,0000000	0,097949584
RectWThr 6H	613,3	1,500	1	0,0000000	0,118036497
RectWThr 8H	1493	1,500	1	0,0000000	0,156346588
RectWThr T0	2861	1,500	1	0,0000000	0,194656679
RectWThr T5	6061	1,500	1	0,0000000	0,3106200
RectWThr 2T	13352	1,500	1	0,0000000	0,4141600

Rectangular weirs according to French standard NFX					
Type	$Q_{\max}$ [m <sup>3</sup> /h]	$\alpha$	$\beta$	$\gamma$	C
NFX Rect T0/5H	2427,3	1,400	2,000	0,0107097	0,2801013
NFX Rect T0/T5	12582,5	1,500	0,000	0,0000000	0,1951248

Constricted rectangular weirs according to French standard NFX					
Type	$Q_{\max}$ [m <sup>3</sup> /h]	$\alpha$	$\beta$	$\gamma$	C
NFX RectWThr 2H	53,5	1,500	1,600	-0,1428487	0,0528094
NFX RectWThr 3H	111,7	1,500	1,600	-0,1115842	0,0744722
NFX RectWThr 4H	299,1	1,500	1,600	-0,0975777	0,0966477
NFX RectWThr 5H	445,8	1,500	1,600	-0,0884398	0,1187524
NFX RectWThr 6H	626,2	1,500	1,600	-0,0816976	0,1407481
NFX RectWThr 8H	1527,8	1,500	1,600	-0,0634245	0,1810272
NFX RectWThr T0	2933,8	1,500	1,600	-0,0671398	0,2285268

Trapezoidal weirs					
Type	$Q_{\max}$ [m <sup>3</sup> /h]	$\alpha$	$\beta$	$\gamma$	C
Trap.W T0/3H	1049	1,500	1,000	0,0000000	0,2067454
Trap.W T0/T5	11733	1,500	1,000	0,0000000	0,2067454

Triangular weirs					
Type	$Q_{\max}$ [m <sup>3</sup> /h]	$\alpha$	$\beta$	$\gamma$	C
V-Weir 22,5	276,0	2,500	1,000	0,0000000	0,0000313
V-Weir 30	371,2	2,500	1,000	0,0000000	0,0000421
V-Weir 45	574,1	2,500	1,000	0,0000000	0,0000651
V-Weir 60	799,8	2,500	1,000	0,0000000	0,0000907
V-Weir 90	1385	2,500	1,000	0,0000000	0,0001571

British standard triangular weirs (BS 3680)					
Type	$Q_{\max}$ [m <sup>3</sup> /h]	$\alpha$	$\beta$	$\gamma$	C
BST V-Weir 22,5	120,1	2,314	2,649,000	0,1430720	0,0000590
BST -Weir 45	237,3	2,340	2,610	0,2659230	0,0000880
BST V-Weir 90	473,2	2,314	2,650	0,1904230	0,0001980

Triangular weirs according to French standard NFX					
Type	$Q_{\max}$ [m <sup>3</sup> /h]	$\alpha$	$\beta$	$\gamma$	C
NFX V-Weir 30	375,9	2,400	2,800	0,0241095	0,0000616
NFX V-Weir 45	573,1	2,476	0,000	0,0000000	0,0000757
NFX V-Weir 60	793,1	2,486	0,000	0,0000000	0,0000983
NFX V-Weir 90	1376,7	2,491	0,000	0,0000000	0,0001653



## 13.3 System error messages

### 13.3.1 Error signal



Errors occurring during commissioning or operation are signalled in the following way:

- Error symbol, error code and error description on the display and operating module
- Current output, configurable ("output on alarm" function).
  - MAX, 110%, 22mA
  - MIN, -10%, 3,6mA
  - HOLD (the last value is held)
  - user-specific value
- In the menu: "system information/error list/actual error"

### 13.3.2 Last error

To access a list of the last errors which have been cleared, go to "system information/error list/last error".

### 13.3.3 Types of errors

Type of error	Display symbol	Meaning
Alarm (A)	 continuous	The output signal assumes a value which can be defined by the "output on alarm" function: <ul style="list-style-type: none"> <li>■ MAX: 100%, 22mA</li> <li>■ MIN: -10%, 3,8mA</li> <li>■ Hold: last value is held</li> <li>■ user-specific value</li> </ul> Additionally, an error message appears on the display.
Warning (W)	 flashing	The instrument continues to measure. An error message is displayed.

### 13.3.4 Error codes

The error code consists of 6 digits with the following meaning:

- Digit 1: Type of error
  - A: alarm
  - W: warning
  - E: error (the user can define if the error behaves like an alarm or a warning.)
- Digits 2 and 3:
  - indicate the input channel, output channel or the relay to which the error refers. "00" means that the error does not refer to a specific channel or relay.
- Digits 4-6:
  - indicate the error according to the following table.

#### Example:

W 01 641	<ul style="list-style-type: none"> <li>■ W: Warning</li> <li>■ 01: sensor input 1</li> <li>■ 641: loss of echo</li> </ul>
----------	---

Code	Description of error	Remedy
A 00 100	software version does not fit to hardware version	
A 00 101	checksum error	full reset and recalibration required
A 00 102	checksum error	full reset and recalibration required
W 00 103	initializing - please wait	if the message does not disappear after a couple of seconds: replace electronics
A 00 106	downloading - please wait	wait for completion of the download
A 00 110	checksum error	full reset and recalibration required
A 00 111 A 00 112 A 00 114 A 00 115	electronics defective	switch instrument off/on; if the error persists: call Endress+Hauser service
A 00 116	download error	repeat download
A 00 117	hardware not recognised after exchange	
A 01 121 A 02 121	current output 01 or 02 not calibrated	call Endress+Hauser service
A 00 125	electronics defective	replace electronics
A 00 152	checksum error	full reset and recalibration required
W 00 153	initializing	if the message does not disappear after a couple of seconds: replace electronics
A 00 155	electronics defective	replace electronics
A 00 164	electronics defective	replace electronics
A 00 171	electronics defective	replace electronics
A 00 180	synchronization faulty	check synchronization wiring (s. chapter "Wiring")
A 00 183	hardware not supported	check if the installed board complies with the order code of the instrument; call Endress+Hauser service
A 01 231 A 02 231	sensor 01 or 02 defective - check connection	check for correct connection of the sensor (s. chapter "Wiring")
A 00 250	failure in external temperature sensor	check external temperature sensor and connection
A 01 281 A 02 281	temperature measurement 01 or 02 defective - check connection	check for correct connection of the sensor (s. chapter "Wiring")

Code	Description of error	Remedy
W 01 501 W 02 501	no sensor selected for channel 01 or 02	allocate sensor (s. "level" or "flow" menu)
A 01 502 A 02 502	Sensor 01 or 02 not recognized	Enter type of sensor manually ("level" or "flow" menu, submenu "basic calibration".
A 00 511	no factory calibration present	
A 01 512 A 02 512	mapping in process	wait for completion of mapping
W01 521 W02 521	new sensor 01 or 02 detected	
W01 601 W02 601	non-monotonic linearisation curve for level 01 or 02	re-enter linearisation (s. "level" menu")
W 01 602 W 02 602 W 01 603 W 02 603	non-monotonic linearisation for flow 01 or 02	re-enter linearisation (s. "flow" menu)
A 01 604 A 02 604	faulty calibration for level 01 or 02	adjust calibration (s. "level" menu)
A 01 605 A 02 605 A 01 606 A 02 606	faulty calibration flow 01 or 02	adjust calibration (s. "flow" menu)
W01 611 W02 611	linearisation points level 01 or 02: number < 2	enter further linearisation points (s. "level" menu)
W01 612 W02 612 W01 613 W02 613	linearisation points flow 01 or 02: number < 2	enter further linearisation points (s. "flow" menu)
W 01 620 ... W 06 620	pulse value too low for relay 01 - 06	check counting unit (see "flow" menu, "flow counter" submenu)
E 01 641 E 02 641	no usable echo sensor 01 or 02	check basic calibration for the respective sensor (s. "level" or "flow" menu)
A 01 651 A 02 651	Safety distance reached for sensor 01 or 02 - danger of overflowing	Error disappears if the level is out of the safety distance again. Possibly, the function "acknowledge alarm" must be used (s. "safety settings" menu)
E 01 661 E 02 661	temperature sensor 01 or 02 too high	
W 01 682 W 02 682	Current 01 or 02 out of measuring range	Perform basic calibration; check linearisation
W01 691 W02 691	filling noise detected sensor 01 or 02	
W00 692	backwater detected (if backwater detection is active)	
W00 693	dirt detected (if dirt detection is active)	
W 01 701	Operating hours alarm pump 1 ctrl 1	Reset operating hours
W 02 701	Operating hours alarm pump 1 ctrl 2	Reset operating hours
W 01 702	Operating hours alarm pump 2 ctrl 1	Reset operating hours
W 02 702	Operating hours alarm pump 2 ctrl 2	Reset operating hours
W 01 703	Operating hours alarm pump 3 ctrl 1	Reset operating hours
W 02 703	Operating hours alarm pump 3 ctrl 2	Reset operating hours
W 01 704	Operating hours alarm pump 4 ctrl 1	Reset operating hours
W 02 704	Operating hours alarm pump 4 ctrl 2	Reset operating hours

Code	Description of error	Remedy
W 01 705	Operating hours alarm pump 5 ctrl 1	Reset operating hours
W 02 705	Operating hours alarm pump 5 ctrl 2	Reset operating hours
W 01 706	Operating hours alarm pump 6 ctrl 1	Reset operating hours
W 02 706	Operating hours alarm pump 6 ctrl 2	Reset operating hours
W 01 711	Failure of pump 1 ctrl 1	check pump <sup>1)</sup>
W 02 711	Failure of pump 1 ctrl 2	check pump <sup>1)</sup>
W 01 712	Failure of pump 2 ctrl 1	check pump <sup>1)</sup>
W 02 712	Failure of pump 2 ctrl 2	check pump <sup>1)</sup>
W 01 713	Failure of pump 3 ctrl 1	check pump <sup>1)</sup>
W 02 713	Failure of pump 3 ctrl 2	check pump <sup>1)</sup>
W 01 714	Failure of pump 4 ctrl 1	check pump <sup>1)</sup>
W 02 714	Failure of pump 4 ctrl 2	check pump <sup>1)</sup>
W 01 715	Failure of pump 5 ctrl 1	check pump <sup>1)</sup>
W 02 715	Failure of pump 5 ctrl 2	check pump <sup>1)</sup>
W 01 716	Failure of pump 6 ctrl 1	check pump <sup>1)</sup>
W 02 716	Failure of pump 6 ctrl 2	check pump <sup>1)</sup>
W00 801	simulation level switched on	switch off level simulation (s. "level" menu)
W01 802 W02 802	simulation sensor 01 or 02 switched on	switch off simulation
W01 803 W02 803 W01 804 W02 804	simulation flow switched on	switch off simulation (see "flow" menu)
W01 805	simulation current 01 switched on	switch off simulation (s. "output/calculations" menu)
W02 806	simulation current 02 switched on	switch off simulation (see "output/calculations" menu)
W01 807 ... W06 807	simulation relay 01 - 06 switched on	switch off simulation
W01 808 W02 808	sensor 01 or 02 switched off	switch on sensor (see "device properties/sensor management" menu)
W01 809 W02 809	current calibration D/A active	
A 00 820 ... A 00 832	Different units for calculation of average value, sum, difference or rake control	Check the units of the respective basic calibrations (s. "level" or "flow" menu)

- 1) After a repair of the pump the pump control must be reset (chapter 5.3.2) or the FMU90 must be switched off and on.

## 13.4 Default block configuration (HART)

### 13.4.1 Function blocks

The Prosonic S contains various function blocks. During the commissioning procedure the blocks are linked to each other in order to perform the desired measuring task. Depending on the instrument version and installation environment, the following function blocks may occur:

#### Signal inputs

- Sensor 1
- Sensor 2 (if selected in the product structure)

#### Signal evaluation (calculation of the measured value)

- Level 1
- Level 2 (for instruments with 2 current outputs)
- Flow 1 (for flow instruments)
- Flow 2 (for flow instruments)

#### Controls

- Pump control
- Rake control
- Backwater detection

#### Signal output

- Display
- Current output 1 with HART
- Current output 2 (if selected in the product structure)
- Relay 1
- Relay 2 (for instruments with 3 or 6 relays)
- Relay 3 (for instruments with 3 or 6 relays)
- Relay 4 (for instruments with 6 relays)
- Relay 5 (for instruments with 6 relays)
- Relay 6 (for instruments with 6 relays)

### 13.4.2 Operating mode = "level"

**1 sensor input / 1 current output**  
(FMU90 - \*\*\*\*\*1\*1\*\*\*\*\*)

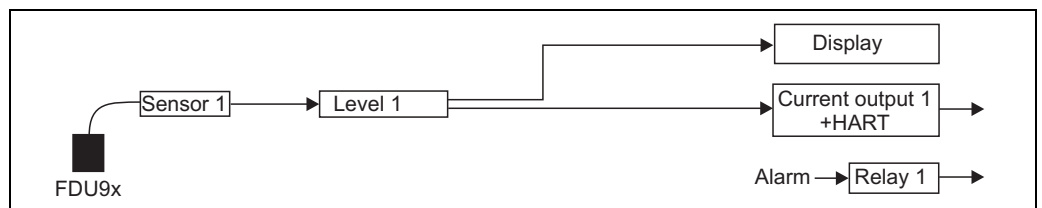

L00-FMU90xxx-19-00-00-de-079

**1 sensor input / 2 current outputs**  
**(FMU90 - \*\*\*\*\*1\*2\*\*\*\*\*)**

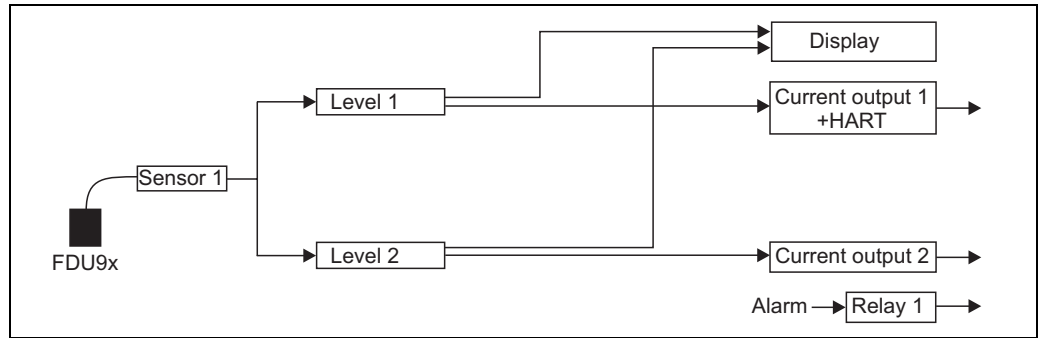

L00-FMU90xxx-19-00-00-de-088

**2 sensor inputs / 2 current outputs**  
**(FMU90 - \*\*\*\*\*2\*2\*\*\*\*\*)**

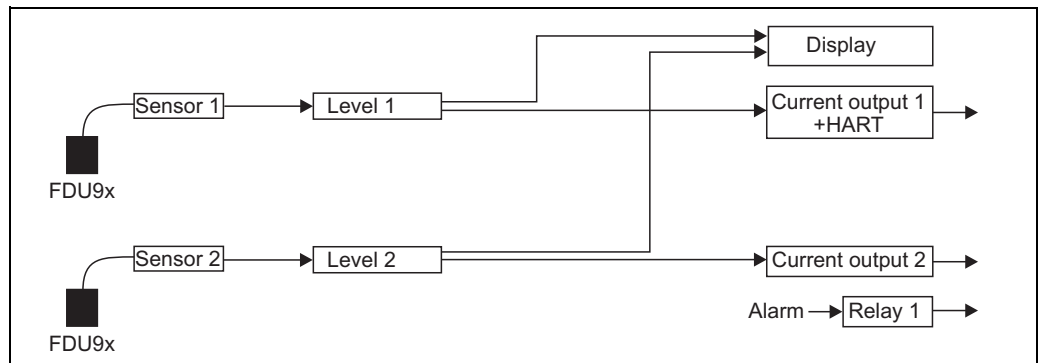

L00-FMU90xxx-19-00-00-de-080

**13.4.3 Operating mode = "level + flow"**

**1 sensor input / 2 current outputs**  
**(FMU90 - \*\*\*\*\*1\*2\*\*\*\*\*)**

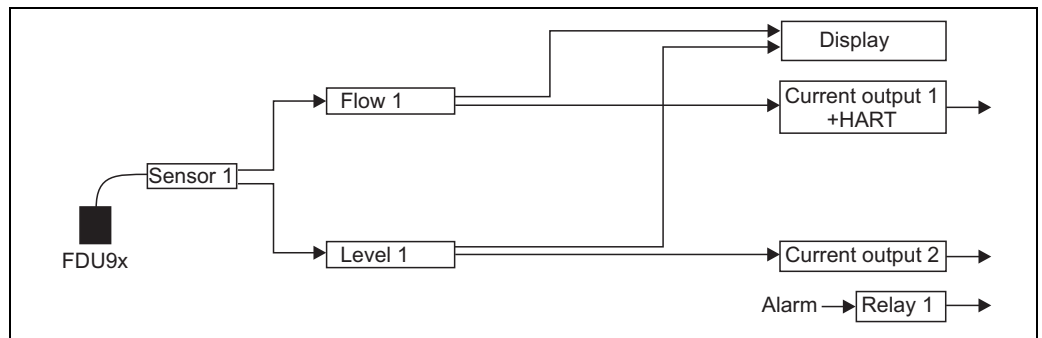

L00-FMU90xxx-19-00-00-de-092

**2 sensor inputs / 2 current outputs**  
(FMU90 - \*\*\*\*\*2\*2\*\*\*\*\*)

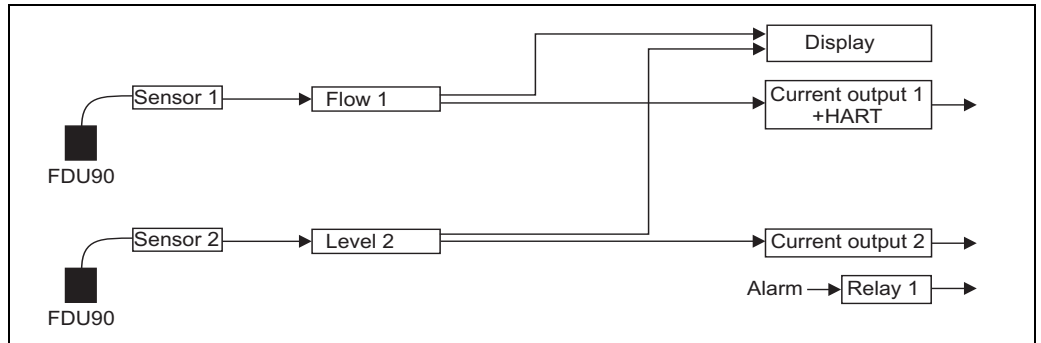

**13.4.4 Operating mode = "flow"**

**1 sensor input / 1 current output**  
(FMU90 - \*\*\*\*\*1\*1\*\*\*\*\*)

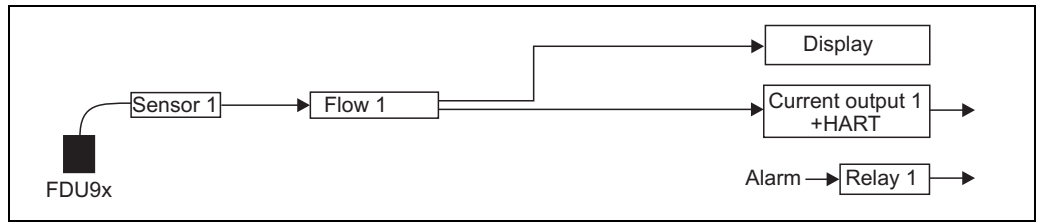

**1 sensor input / 2 current outputs**  
(FMU90 - \*\*\*\*\*1\*2\*\*\*\*\*)

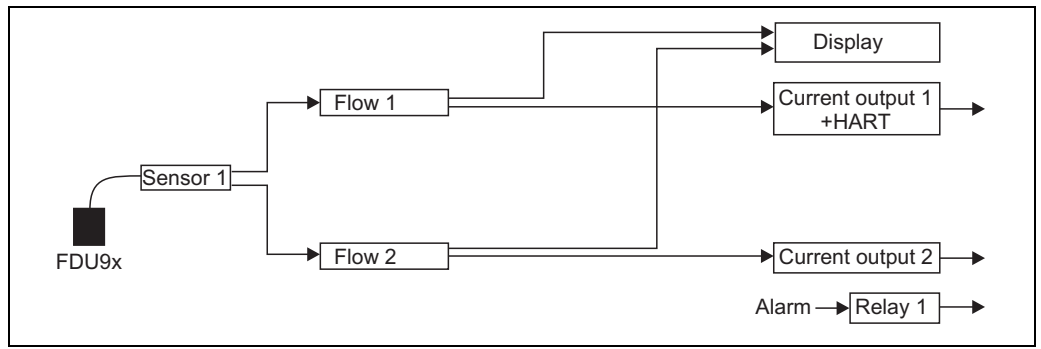

**2 sensor inputs / 2 current outputs**  
**(FMU90 - \*\*\*\*\*2\*2\*\*\*\*\*)**

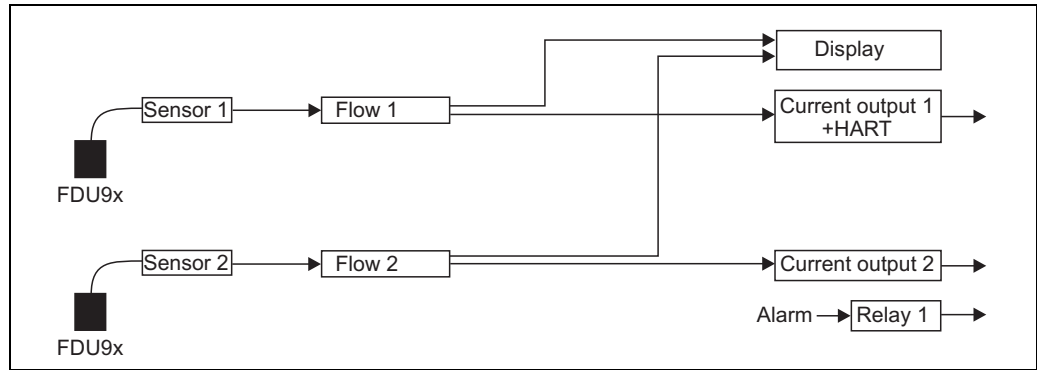

L00-FMU90xxx-19-00-00-de-091

**13.4.5 Operating mode = "flow + backwater"**

**2 sensor inputs / 2 current outputs**

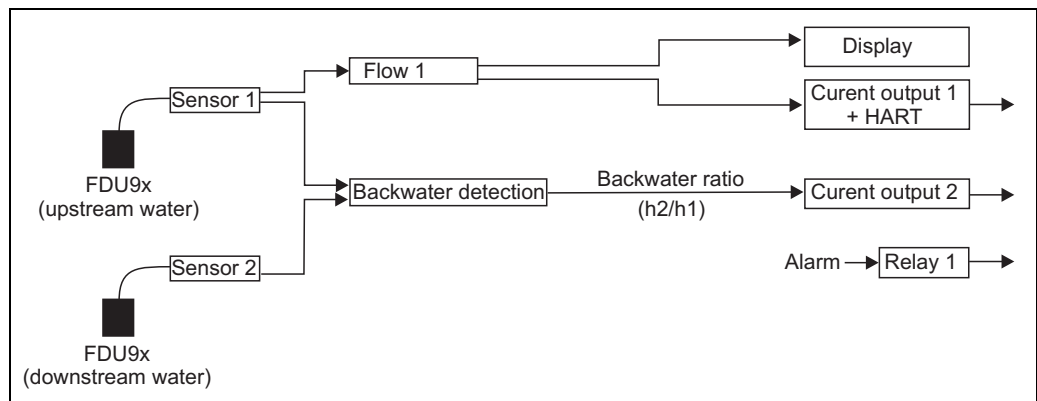

L00-FMU90xxx-19-00-00-de-096



## 13.5 Default block configuration (Profibus DP)

The Prosonic S contains various function blocks. During the commissioning procedure the blocks are linked to each other in order to perform the desired measuring task. Depending on the instrument version and installation environment, the following function blocks may occur:

### Signal input

- Ultrasonic Sensor Block (US)
- Digital Output Block (DO)

### Measured value calculation

- Level Block (LE)
- Flow Block (FS)
- Flow Block with BACKwater Detection (FB)
- Flow Block with Averaged Level (FA)

### Signal output

- Analog Input Block (AI)
- Digital Input Block (DI)

### Calculations

- Sum Block Level (SL)
- Average Block Level (AL)
- Difference Block Level 1 - 2 (DL)
- Difference Block Level 2 - 1 (LD)
- Sum Block Flow (SF)
- Average Block Flow (AF)
- Difference Block Flow 1 - 2 (DF)
- Difference Block Flow 2 - 1 (FD)

### Counters

- Totalizator Block (TO)
- Daily Counter Block (DC)
- Impulse Counter (IC)

### Limits

- Limit Block (LS)

### 13.5.1 Operating Mode = " Level"

#### 1 sensor input

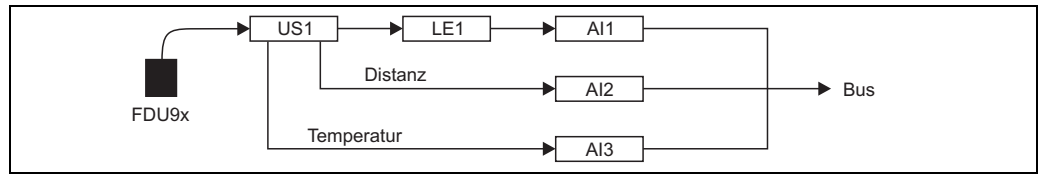

L00-FMU90xxx-19-00-00-yy-097

#### 2 sensor inputs

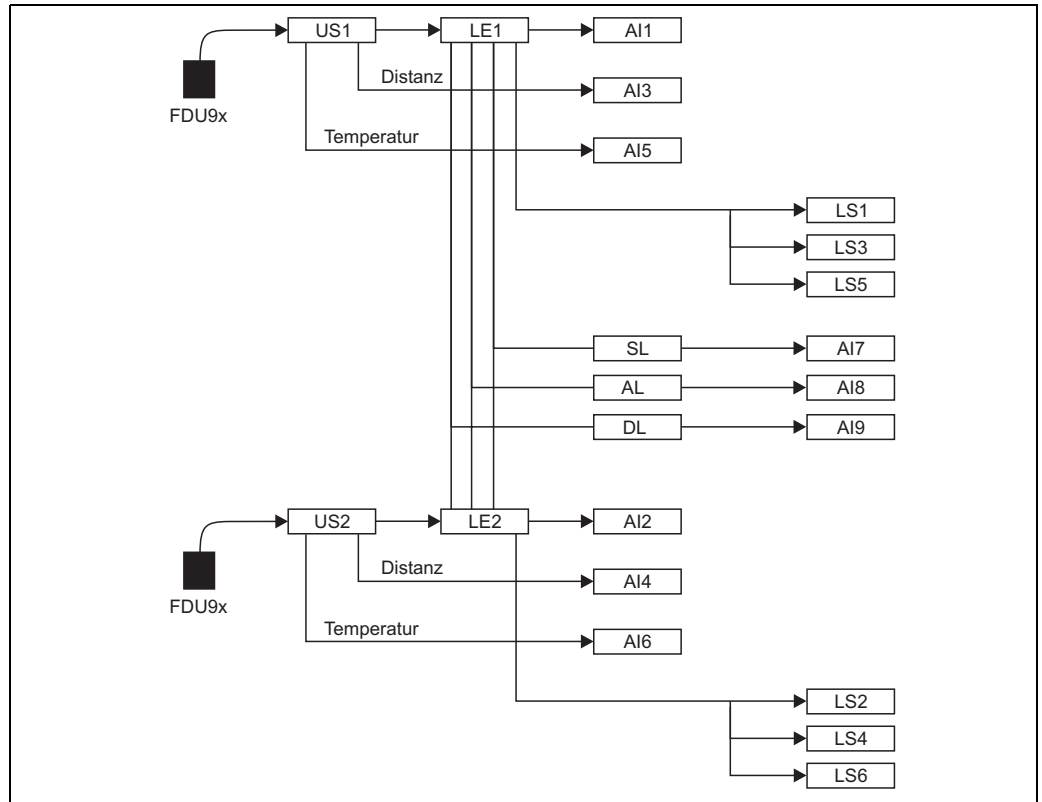

L00-FMU90xxx-19-00-00-yy-100

### 13.5.2 Operating Mode = "Flow"

1 sensor input

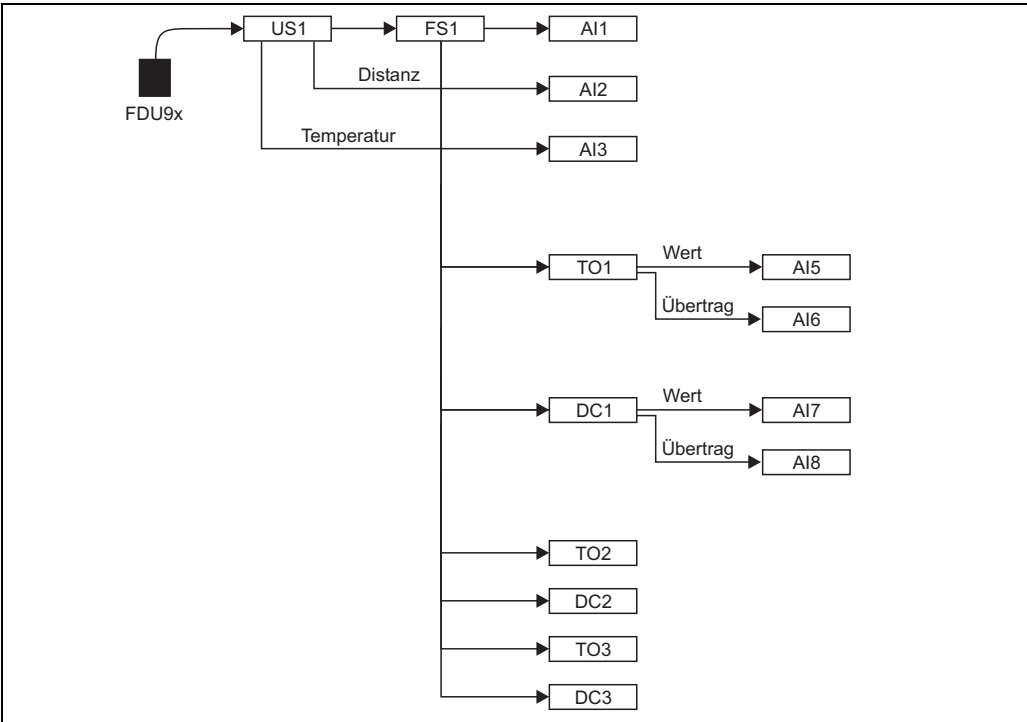

L00-FMU90xxx-19-00-00-yy-098

## 2 sensor inputs

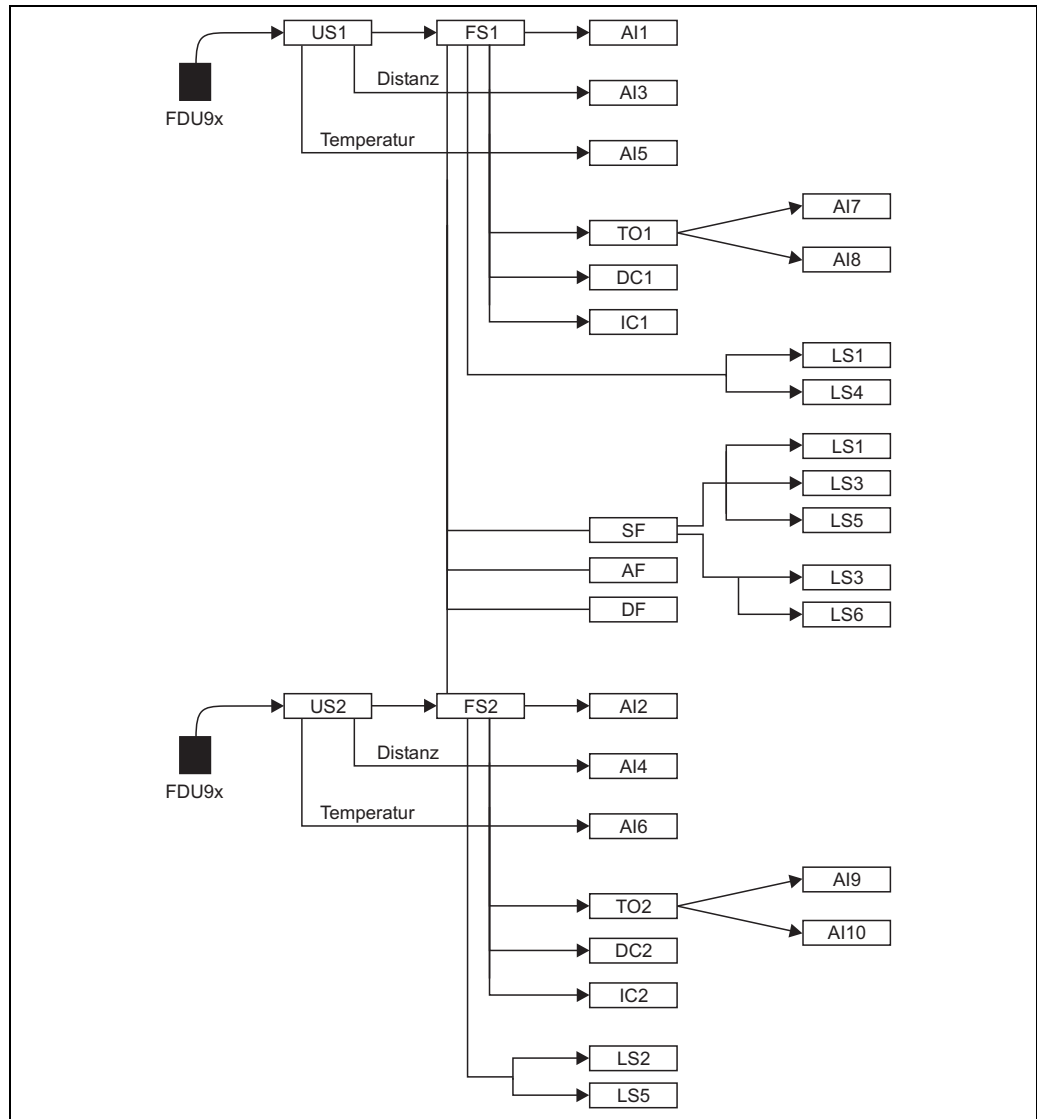

L00-FMU90xxx-19-00-00-yy-102

### 13.5.3 Operating Mode = " Flow + Level"

1 sensor input

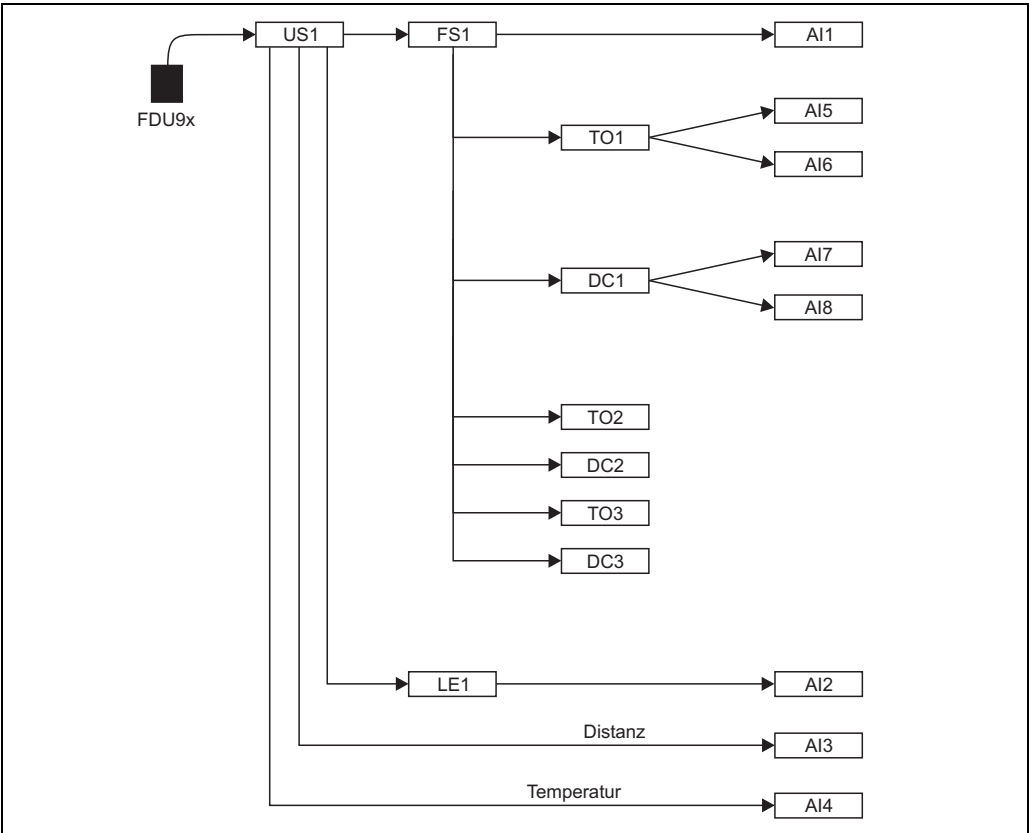

L00-FMU190xxx-19-00-00-yy-099

## 2 sensor inputs

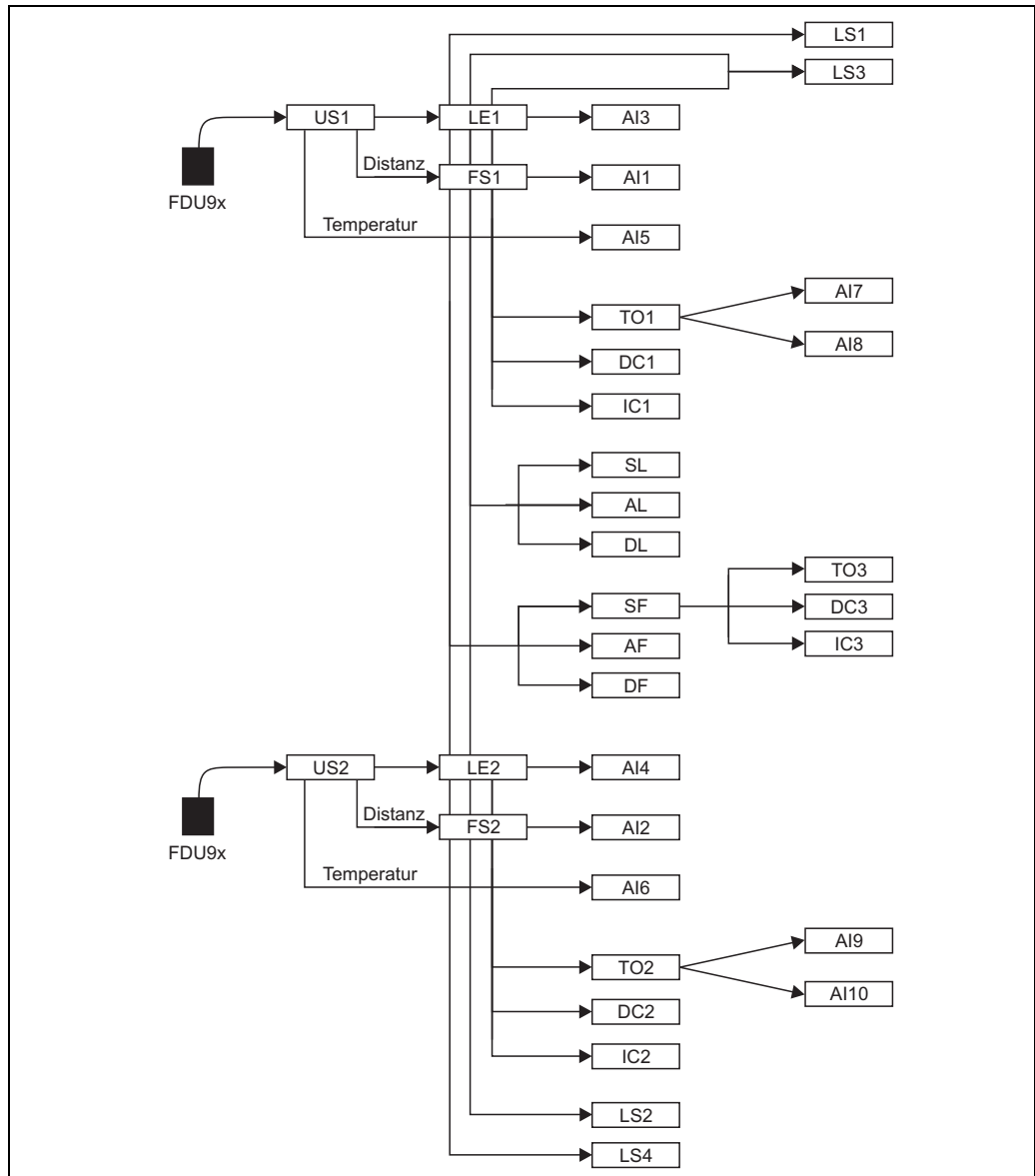

L00-FMU90xxx-19-00-00-yy-103

### 13.5.4 Operating Mode = "Flow + Backwater"

2 sensor inputs

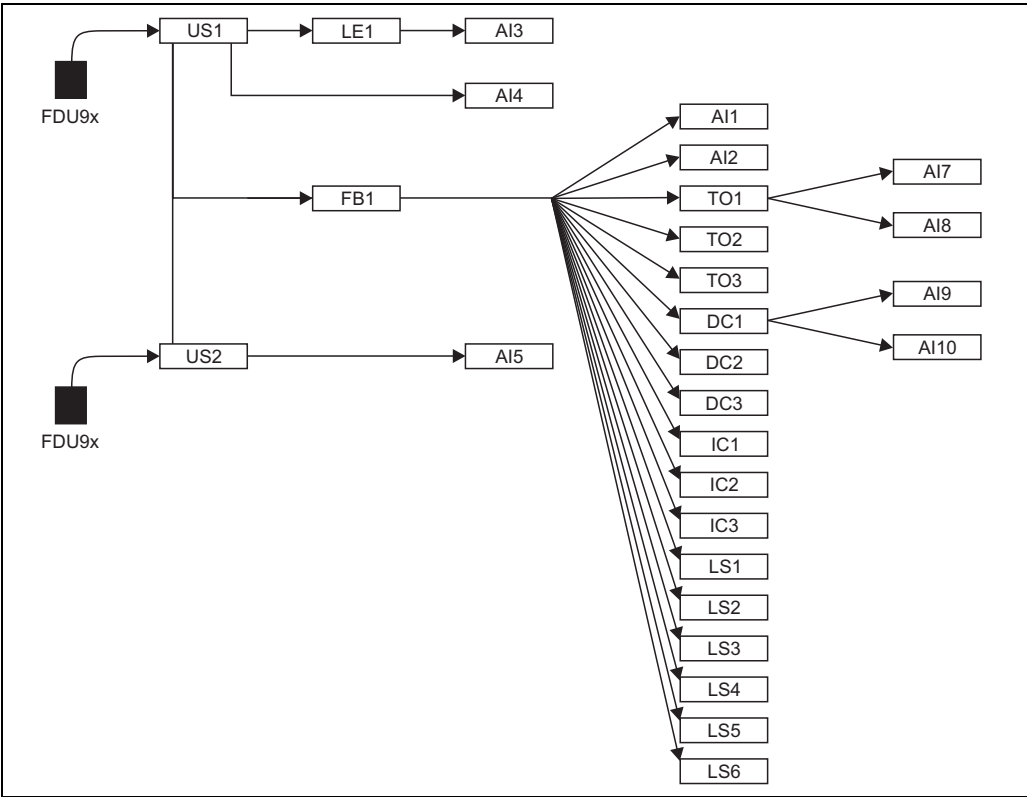

L00-FMU90xxx-19-00-00-yy-104

[www.endress.com/worldwide](http://www.endress.com/worldwide)

---

**Endress+Hauser**   
People for Process Automation

---

