



Helping Students Learn Engineering Mechanics Concepts Through Integration of Simulation Software in Undergraduate Courses

Lt. Col. Jakob C Bruhl P.E., U.S. Military Academy

Lieutenant Colonel Jakob Bruhl is an Assistant Professor in the Department of Civil and Mechanical Engineering at the United States Military Academy, West Point, NY. He received his B.S. from Rose-Hulman Institute of Technology, M.S. Degrees from the University of Missouri at Rolla and the University of Illinois at Urbana/Champaign, and Ph.D. from Purdue University. He is a registered Professional Engineer in Missouri. His research interests include resilient infrastructure, protective structures, and engineering education.

Lt. Col. Richard J. Gash P.E., U.S. Military Academy

Lieutenant Colonel Richard Gash is an Engineer Officer in the United States Army. He is currently assigned as an assistant professor in the Department of Civil and Mechanical Engineering at the United States Military Academy at West Point, New York. He has earned PhD in Structural Engineering from the University of California, Los Angeles and is a Registered Professional Engineer.

Dr. Aaron Freidenberg, U.S. Military Academy

Dr. Christopher H Conley, U.S. Military Academy

Mr. Paul M. Moody P.E., U.S. Military Academy

Lieutenant Colonel Paul Moody is an Associate Professor at the U.S. Military Academy, West Point, NY. He received his B.S. and M.S. from Massachusetts Institute of Technology and Ph.D. from the University of Massachusetts, Amherst. He is an active member of ASEE and a registered Professional Engineer in Virginia. His research areas include climate change impact on water resource systems and infrastructure.

Helping Students Learn Engineering Mechanics Concepts through Integration of Simulation Software in Undergraduate Courses

ABSTRACT

This paper describes recent experience within the civil engineering program at the U.S. Military Academy (USMA) to integrate simulation tools to assist students in understanding concepts. Students are introduced to SOLIDWORKS Simulation in their first two engineering courses. This tool provides students with opportunities to develop a sense for structural behavior and visualize load effects on structures. This paper describes several examples of how this software has been integrated into statics and mechanics of materials courses as well as a structural analysis course. In addition to describing examples of how simulation software can be used to improve students' ability to visualize engineering mechanics concepts, this paper reports initial assessment data and discusses ideas for ways to better integrate these tools to improve student learning and assess the influence on students' conceptual understanding.

INTRODUCTION

As has been required for decades, the future engineers being educated in our classrooms must be equipped to creatively apply the concepts they learn in school to solve problems. As computer-aided design tools are automating much of the calculations and detailing work traditionally accomplished by entry-level engineers, our graduates will be asked to take on higher-level tasks earlier in their career. To do so effectively requires them to visualize the problems they face and have a firm understanding of how engineering mechanics principles apply to those problems.

One way to help accelerate this development is to provide students with more opportunities to visualize the effects of engineering mechanics concepts. ABET student outcome (k) recognizes this need for engineering instruction related to modern computer-based methods and much of the focus of the civil engineering program at the US Military Academy at West Point (USMA) has been on helping our students learn how to use various engineering software tools to solve problems. This approach misses an opportunity to integrate these tools into courses in ways similar to physical hands-on learning opportunities or in-class demonstrations. Computer technology can be used not just as a tool to solve cumbersome problems in upper division courses, but to enhance the learning experiences in every course.

It is not the intent of the authors to suggest that emphasizing accurate engineering calculations is no longer necessary in undergraduate courses. On the contrary, it is essential. But even more essential is the development of a deep understanding of engineering mechanics and the ability to visualize the problems they face in order to correctly apply those engineering mechanics concepts. Additionally, our graduates must be well-equipped to use these computer-aided design tools effectively – not blindly trusting them but having an ability to judge reasonableness of outputs based on a strong understanding of structure or component behavior.

This challenge is something the civil engineering program at USMA has been wrestling with for several years. Part of the approach has been increasing the number of hands-on student activities

in foundational engineering mechanics courses.^{1,2} These exercises are aimed at increasing understanding of mechanics concepts and developing engineering judgment by creating experiences for students. This paper describes another aspect of programmatic changes that makes increasing use of computer simulation tools to help students visualize and understand concepts. As this is part of an ongoing effort, the paper focuses on the background and motivation for better integration within several courses. It describes several examples of how software has been integrated into statics and mechanics of materials courses and explains how a few guiding principles used in developing inquiry-based learning activities (IBLA) apply to integrating software into class.

BACKGROUND

As Bruhl, Klosky, and Hanus (2017)¹ describe, a methodical assessment resulted in the radical overhaul of two courses: MC300 (Fundamentals of Engineering Mechanics and Design, which combines statics and introductory mechanics of material topics) and MC364 (Mechanics of Materials). This redesign centered around creating learning activities that inspired student engagement with engineering concepts. In many cases, these activities were designed so that students would discover mechanics principles resulting in class discussion about the principle rather than have them first described by an instructor and then applied by students. An important part of this overhaul was the integration of computer aided design (CAD) software in courses. Specifically, SOLIDWORKS³ was used. It is important to note that MC300 is a course taken by engineering students and non-engineering majors as part of a broad education required of all students at USMA. MC364, on the other hand, is required only of engineering students. This difference in population is important when considering how to use software effectively.

Part of the motivation to overhaul these courses came from the “survival skills” that Tony Wagner describes in the book The Global Achievement Gap. Among these skills that he argues must be developed during undergraduate education are: critical thinking, analytic reasoning, and problem solving⁴. He also describes how effective learning experiences require opportunities for student discovery and creativity. Discovery learning is an aspect of active learning, which has been shown to improve student learning^{5,6}. These improvements to student learning are due, in part, to the development of metacognitive and critical process skills. When coupled with mastery of technical content, engineers with stronger metacognitive and critical process skills can more creatively apply knowledge. Creativity is a foundational requirement for innovation and recent literature suggests that while engineering programs may be improving in developing creativity in engineering curricula, additional focus is needed to ensure graduates are properly equipped for their careers^{7,8}. Innovative, creative, design thinking has been identified as one of four categories of engineering competence in the Transforming Undergraduate Education in Engineering (TUEE) initiative sponsored by ASEE⁹.

Additional motivation came from the preface to a book by Lee (2015) which provides 16 examples of how SOLIDWORKS can be used to help teach statics¹⁰. The preface is titled “A New Way of Thinking in Engineering Mechanics Curricula” and is also included in another of Lee’s books which provides 34 examples of integrating SOLIDWORKS into a mechanics of materials course¹¹. He describes how, in his view, the basic engineering mechanics curriculum has not changed much over the past 30 years despite the development of CAD and computer aided engineering (CAE) tools. In many programs, CAD and CAE are left to their own courses

while mechanics courses are taught using unchanged methods. Instead, Lee suggests, CAD and CAE should be introduced early and then integrated into each mechanics course for three reasons: (1) more time using these tools will improve proficiency, (2) knowing how to use the tools will help students solve problems, thereby improving confidence and knowledge about what mechanics concepts to further study, and (3) students can use these tools as a learning tool, just like we do with mathematics, to improve understanding of mechanics concepts.

To create effective learning experiences which integrate SOLIDWORKS, the authors applied the same guiding principles as they did when creating hands-on learning experiences. As Bruhl et al (2017b)² describe, these principles were inspired by work done by others, particularly focused on inquiry-based learning. The five guiding principles and a brief description of how they apply to designing effective software-enhanced inquiry-based learning activities are:

1. **Reality.** The problems solved in class or homework should be rooted in real engineering applications as much as possible. Ideally, these applications are familiar to the students.
2. **Let the problem lead.** Do not feel obligated to have provided all background information needed to solve the problem. The students' discovery of a need for background and theory can be a powerful motivator for further learning.
3. **Use lesson objectives to guide, in a specific way, what the activity should be.** Just like any other learning activity, the choice to integrate software must be connected coherently to specific learning objectives. It must not be viewed by students as an add-on. Ideally these activities are enjoyable; more importantly, they must achieve the desired learning objective.
4. **Test, test, test!** This principle is understandable when using a hands-on learning activity but applies equally to integrating software. Instructors must be comfortable enough with the software that they are prepared to help students who have made "wrong clicks." This requires a time investment by faculty to learn the specific software program being used.
5. **Make sure the timing works.** This is particularly important when integrating software into the classroom. One or two students who encounter problems modifying or running a model can bring the entire class to a halt. Preparing for this through detailed instruction (maybe even tutorials) is vital to ensure the learning objective is met.

EXAMPLES OF INTEGRATING SOFTWARE INTO MECHANICS COURSES

SOLIDWORKS has historically been taught in one course within the department: ME370 (Computer Aided Design). This required course for mechanical engineering students is an elective for civil engineering students (which is rarely selected). In coordination with the course director for ME370, elements of SOLIDWORKS were integrated into MC300 and MC364 which are both taken during the sophomore year. The intent was not to train students in the intricacies of the software but to introduce them to its value in solving problems and completing simple parametric studies. In some cases, the computer models facilitate classroom examples. In other cases, students manipulate the models as part of homework assignments. The following examples illustrate a variety of ways in which SOLIDWORKS was integrated and the desired learning effect. For a more complete understanding of the student-centered approach to these courses, including some discussion of SOLIDWORKS, see Bruhl et al (2017a)¹. For other examples of integrating computational software across the curriculum, see Freidenberg et al (2018)¹².

Examining the effect of moving loads (MC300)

The effect of moving loads on the internal forces within a structure is important for engineers to understand. For simple cases, requiring students to complete truss-analysis by hand can illustrate this important point. Doing so may consume a large amount of time developing mathematical equations leaving some students so focused on the mathematics involved that they miss the broader learning point. Using software can save time, maintain focus on the main point of the exercise, provide useful visualizations that can be more memorable than a page of calculations, and demonstrate the value of software tools to engineering work.

As part of a homework assignment, students were required to solve for internal truss forces by hand for the load at one location and then use a SOLIDWORKS model to solve for the internal forces as the load moves to other locations (see Figure 1). By the time this homework assignment was issued, students were familiar with the basics of creating and analyzing a truss using SOLIDWORKS. The first semester we implemented this assignment, students were required to create their own truss as explained in Figure 1. In following semesters, to ensure time was spent on completing the analysis and reflecting on the results rather than consumed creating the model, SOLIDWORKS models were provided to students who were then required only to modify the loads and record the results.

Without teaching about influence lines in class, this assignment introduced students to the concept and reinforced the idea that some truss members may be in tension for one load case but in compression in another. This reality was revisited later in the course when discussing basic design principles and the students now had a specific example to remember.

Examining the internal forces in beams (MC300)

Creating shear and moment diagrams can become quite tedious as loads become complex. While the skill of creating them by hand is important, developing an understanding of how shear and moment diagrams change as loads change requires the creation of diagrams for many different cases. To speed this development and reinforce the value of computer simulations to investigate “what if” scenarios, SOLIDWORKS was used in MC300 to (1) check shear and moment diagrams drawn by hand and (2) modify loads to investigate how these internal load effects change. Eventually, the relationship between hand calculations and the computer model changes: students are required to use hand calculations to check computer output.

During the third lesson in a three-lesson sequence about shear and moment diagrams, students completed three problems as shown in Figure 2. Students worked as individuals or in teams of two as the instructor led the class through the first two problems. Students worked on the third problem as the instructor circulated in the classroom, answered questions, and helped troubleshoot software challenges.

c. **Part 3: Changing Internal Force (20 Points)**. A "deck" truss is one in which the traffic surface is on top of the truss, as opposed to a thru truss where the deck is typically supported at the lower chord joints (see https://en.wikipedia.org/wiki/Truss_bridge for more). Engineers must design these structures to accommodate moving loads. While for one load position the force in a member might be tensile, with the load in a different position a compressive force could be developed. To see this, determine the force in member BF for a single 20 kip load placed consecutively at joints A, B, and C – you have already done the calculations for the case with the load at joint D in Part 1 of this problem set. A plot of the results of an analysis of this type is known as an "influence line diagram." Plot your results in the space provided in Encl. 4 to develop such a diagram. All other calculations and corresponding results should be presented on engineering paper. **Check your solution using SolidWorks:** create a model using the Weldments tools and analyze it using a Static Simulation Study. Include screen shots of the axial forces for each of the four load cases. Confirm that the SolidWorks results match your hand calculations; address any discrepancies.

Enclosure 4

MC300: 17-1

PS#4 (Due: LSN 14)

CDT _____

Instructor: _____

Part 3: Changing Internal Force

Page ___ / ___

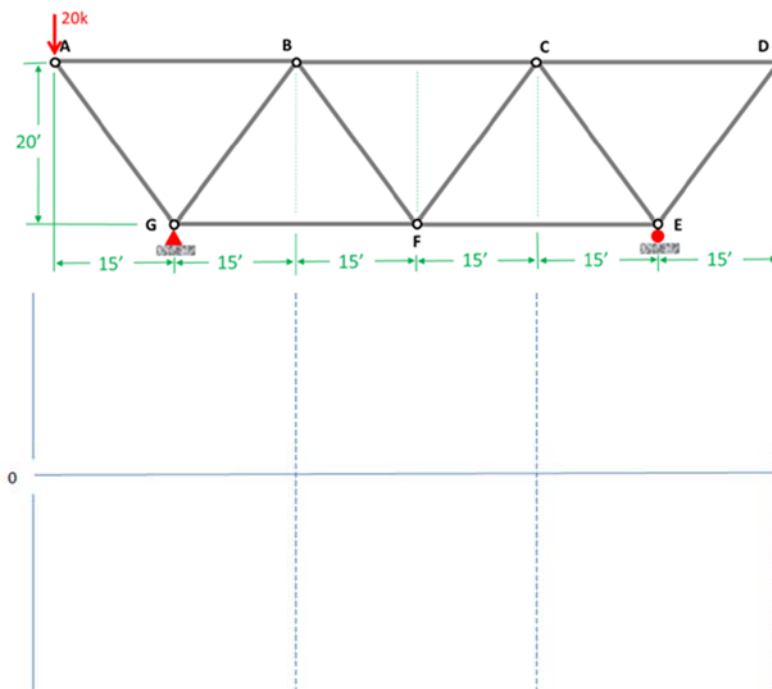

The vertical axis is the load in member BF, with compressive force being negative. The horizontal axis is the position of the 20k moving load, which by definition of a truss, can only be placed at a joint.

Create a SolidWorks model of this truss analyze it for each of the load cases (the 20k load at joints A, B, C, and D) and submit screenshots of the internal force for each case. Confirm that the SolidWorks results match your hand calculations.

Figure 1 Homework assignment to examine the effect of moving loads

IN-CLASS PROBLEMS

The following problems will be solved in class to apply the concepts from this lesson.

PROBLEM 1

Refer back to Problem 2 from Lesson 25 (loading diagram shown below). Create shear and moment diagrams using SolidWorks and compare the computer output to the diagrams you created in Lesson 26. Are there any discrepancies? If so, what and why?

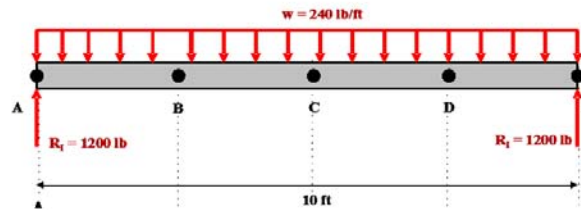

PROBLEM 2

Draw the shear and moment diagrams for the beam and loading shown below. Check your solutions using SolidWorks.

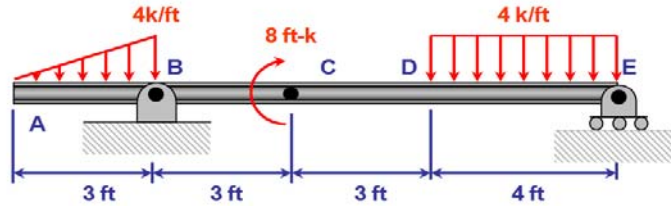

PROBLEM 3

Use SolidWorks to create the shear and moment diagrams for the beam and loading shown below. Record the computer output on the axes provided below and perform hand calculations to check the computer solution.

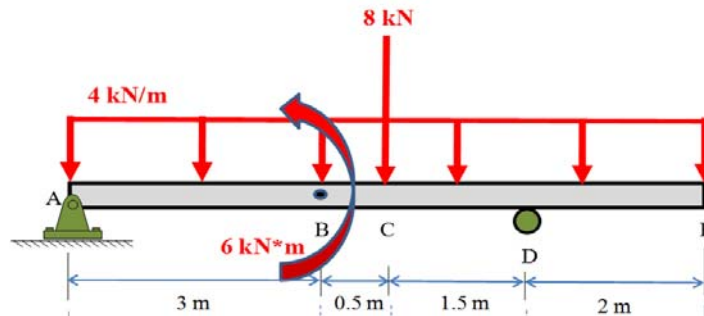

Figure 2 In-class shear and moment diagrams incorporating SOLIDWORKS

Following this in-class exercise, students were assigned a homework problem to prepare shear and moment diagrams for a rather complicated loading (see Figure 3). They were encouraged, but not required to use SOLIDWORKS and check their work by hand. To showcase the value of using software in the analysis of engineering problems, for bonus points, the students were asked to investigate what the effect would be one of the loads was in the opposite direction. Over half the students elected to use SOLIDWORKS to solve this problem and of those who did, nearly all completed the bonus question.

You are a platoon leader in the 101st Airborne Division (Air Assault). During a training mission, a storm is forecast to deliver extremely high winds. You know your company commander, along with the guidon, will want to hold up with your platoon for the night. After ensuring completion of all the priorities of work, you prepare to settle down for some much needed rest, but worry that the guidon may snap when the storm rolls in. Rather than simply recommend to not display the guidon, you recall what you learned in MC300 and decide to calculate if the 1.25-in diameter Select Structural Douglas Fir-Larch guidon can survive the storm. You estimate:

1. The company's "Most Hooah Company Ever" streamer, tied to the tip of the staff, will exert a horizontal force of 3 lbs due to the wind.
2. The guidon will pull the staff laterally with a uniform distributed load of 2 lb/ft.
3. The 101st traces their lineage to the 8th Wisconsin Volunteer Infantry Regiment, which actually charged in to battle with a bald eagle tethered to a stand next to their guidon (see Figure 1). Your commander takes this history very seriously; attaching an eagle perch halfway up the guidon and submitting a supply request for an actual bald eagle as the company mascot. You estimate the perch will catch wind gusts and exert an applied moment of 25 lb-ft counterclockwise on the staff.
4. In previous wind storms, the commander's trusty guidon bearer, positions ammo cans at the base to keep it from toppling over. The cans, placed opposite the wind, exert a 10 lb/ft uniform distributed load along the bottom 2 ft of the guidon.
5. The guidon bearer always plunges the guidon firmly into the ground, effectively creating a fixed support at the end.



Figure 1. "Old Abe" and the 8th Wisconsin at Vicksburg, 1862 (Wikipedia)

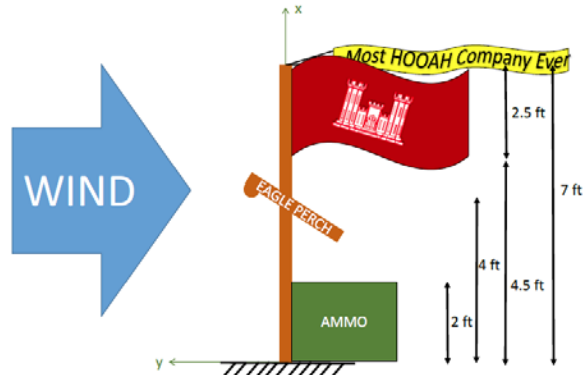

Figure 2 Your initial sketch of the guidon with estimates of dimensions

Working on green engineering paper while under a poncho with a red lens flashlight, you create the shear and moment the guidon will experience in the windstorm. Thankfully you had your well-worn MC300 notes, textbook, and a copy of the course admin memo handy.

What advice do you give your commander regarding the survivability of his guidon? Support your recommendation with the following:

1. The shear and moment diagrams for the guidon. You may complete these using SOLIDWORKS or by hand. If you use SOLIDWORKS, you must calculate the reactions by hand to confirm your SOLIDWORKS model.
2. Calculation of the maximum flexural stress and a comparison to the wood's bending strength.
3. BONUS (5 points): How does your analysis change if the applied moment from the eagle perch is actually clockwise? Would this change your recommendation? HINT: If you use SOLIDWORKS to create your shear and moment diagrams this is a pretty easy bonus question.

You assume all relevant forces act laterally (parallel to the wind) and self-weight is negligible. You create the sketch shown in Figure 2.

Figure 3 Homework assignment incorporating SOLIDWORKS to create shear and moment diagrams

Discovering stresses generated by combined loads (MC364)

The examples above were implemented using traditional teaching methods: provide instruction in class and opportunity to practice out of class. Applying IBLA principles, SOLIDWORKS can also take the place of physical equipment to create an opportunity for student discovery. In this example, students in MC364 used a SOLIDWORKS model (Figure 4(a)) to discover the principle of superposition for stresses due to combined loading. To assist in student visualization of the problem, students were provided with a 3D printed offset link (Figure 4(b)) that was printed using the SOLIDWORKS model. In addition to enhancing student engagement, this provided an opportunity to briefly discuss current 3D printing technology.

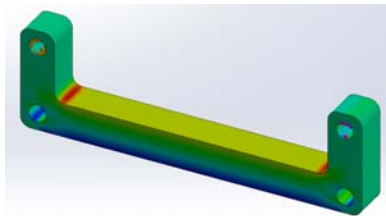

(a)

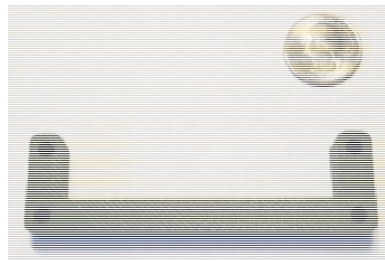

(b)

Figure 4 Offset link for MC364 combined loads exercise: (a) SOLIDWORKS model and (b) 3d printed component (quarter shown for scale)

This lesson occurs early in the semester before combined loading was introduced. Therefore, it relied on their prior knowledge from MC300, provided an opportunity to review axial and

bending load cases, and demonstrated how a structure responds when subjected to simultaneous axial and bending loads. In this exercise students subjected the link to three loading conditions using SOLIDWORKS static simulations. The goal was to determine an algebraic relation between the stress profiles induced by each of the load cases. In addition to the SOLIDWORKS model and printed part, the students were provided with a handout to guide them through the exercise.

The students began by measuring the link and predicting the stress profile on a plane at the link's midsection due to the first load case, a uniaxial tensile load applied through the part's lower set of holes. They then used the SOLIDWORKS model to verify their prediction. The model had three sensors embedded at its midsection: one centered on the top outermost fiber, one at the cross-section's midpoint (or neutral axis for elastic bending) and one centered on the bottom outermost fiber. The sensors allowed students to sample the stress induced by the given loading at each of these locations. They annotated these values as shown in the appropriate section of the worksheet and sketched the stress profile, as depicted in Figure 5.

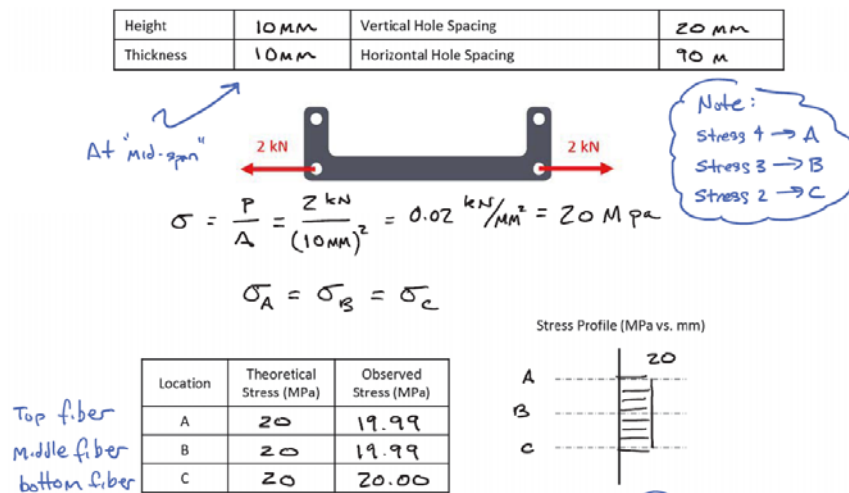

Figure 5 Axial load applied to offset link

Next the students predicted the stress profile that would result from the second load case, pure bending. They again verified their prediction using a SOLIDWORKS static simulation and sketched the stress profile, as shown in Figure 6.

The students ran a final SOLIDWORKS static simulation with an axial load through the upper holes of the offset link. The loading for this simulation was such that the internal moment caused was equal to that of the second load case and the axial load was the same as the first. The students read the sensors and sketched a final stress profile (Figure 7).

Armed with the stress profiles from each simulation, they were left to discover superposition as shown in the algebraic relation in Figure 8.

In addition to introducing the concept of superposition for stresses induced by combined loading, the SOLIDWORKS simulation results served as a preview of concepts such as stress concentrations and failure theory that are covered later in the course.

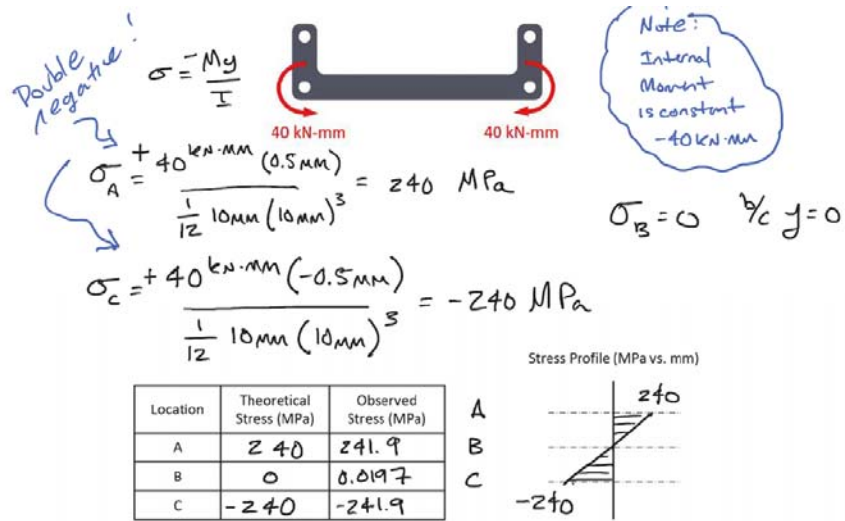

Figure 6 Bending moment applied to offset link

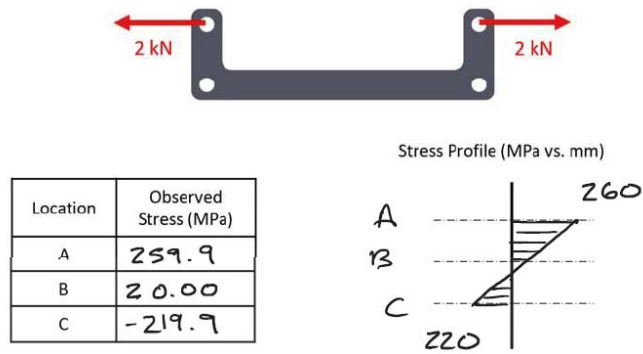

Figure 7 Load applied to offset link (combined stress effects)

Algebraic relation between results:

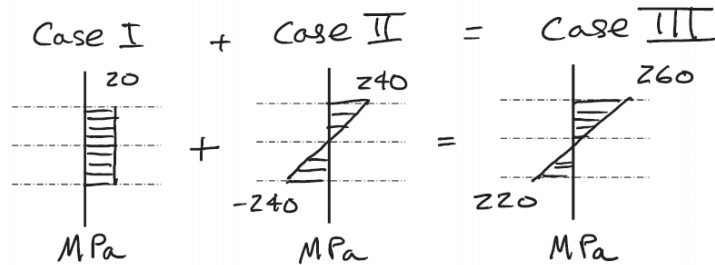

Figure 8 Discovering relationship between stress states

Investigating stresses in connections (CE403)

In a subsequent course, CE403 (Structural Analysis), the software of choice has been Robot Structural Analysis (RSA)¹³. While this software is excellent for performing structural analysis and provides opportunities for parametric studies, it focuses on global behavior while neglecting details of behavior within connections. This is certainly common among structural engineering software and offers an opportunity for students to develop an appreciation for having a working knowledge of a variety of software programs to use in the engineering design process.

As part of a course culmination engineering design project (EDP), students were required to design a floor truss, build it, and test it to failure. The students were limited to 8-ft long 2x4s, plywood, and common nails. Therefore, connections would require plywood gusset plates nailed to the 2x4 structural components. Part of the design process required RSA simulations to quantify internal forces throughout the structure and required the students to decide if modeling the connections as perfect pins was a reasonable assumption. Figure 9 provides an example of RSA output for a floor truss.



Figure 9 Example RSA output for truss design (this example is of axial force and units are in pounds)

Using the forces from this analysis (Figure 10(a)), the students were required to generate a model of one connection using SOLIDWORKS to investigate the stresses generated within the gusset plate (Figure 10(b)). The results were best displayed by hiding all other parts in the model except for one of the gusset plates. By investigating output such as principle stresses (see Figure 11 for example), students could understand the complex stress distribution in a gusset plate, apply knowledge gained in previous courses about principal stresses and failure theories, and investigate the limitations of the assumption that all connections in a truss act as pins.

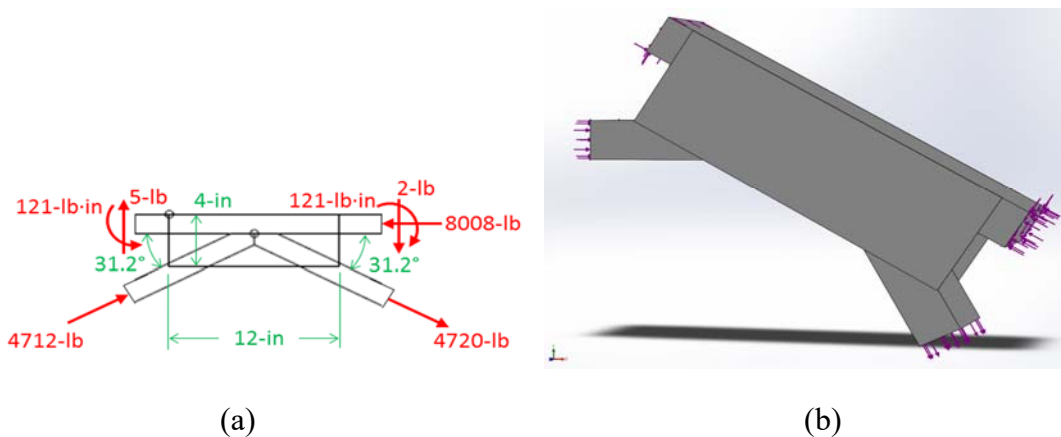

Figure 10 Model of a single connection in an example truss: (a) summary of forces acting on the connection (from RSA analysis) and (b) SOLIDWORKS assembly with applied loads depicted

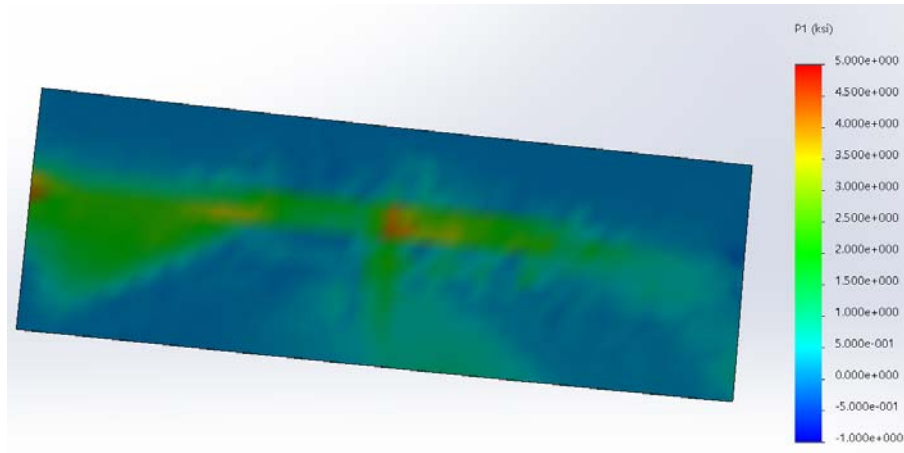

Figure 11 Example output for stress distribution in a gusset plate (first principle stress)

INITIAL ASSESSMENT

Students agree that using SOLIDWORKS helps them better understand concepts. The results shown in Figure 12 are for one question from the anonymous course-end-survey. The question was asked identically in all three terms included in Figure 12. Response rates were over 85% for each semester (227 / 249 in 17-1; 79 / 91 in 17-2; and 266 / 278 in 18-1). As faculty have learned from their experience incorporating SOLIDWORKS into courses, the response by students has improved as Figure 12 shows. For MC300, in the Fall 2016 semester (17-1 in Figure 12), nearly half the students disagreed or strongly disagreed that SOLIDWORKS helped them better understand course concepts. Two semesters later in the Fall 2017 semester (18-1), Over half agreed or strongly agreed that it helped.

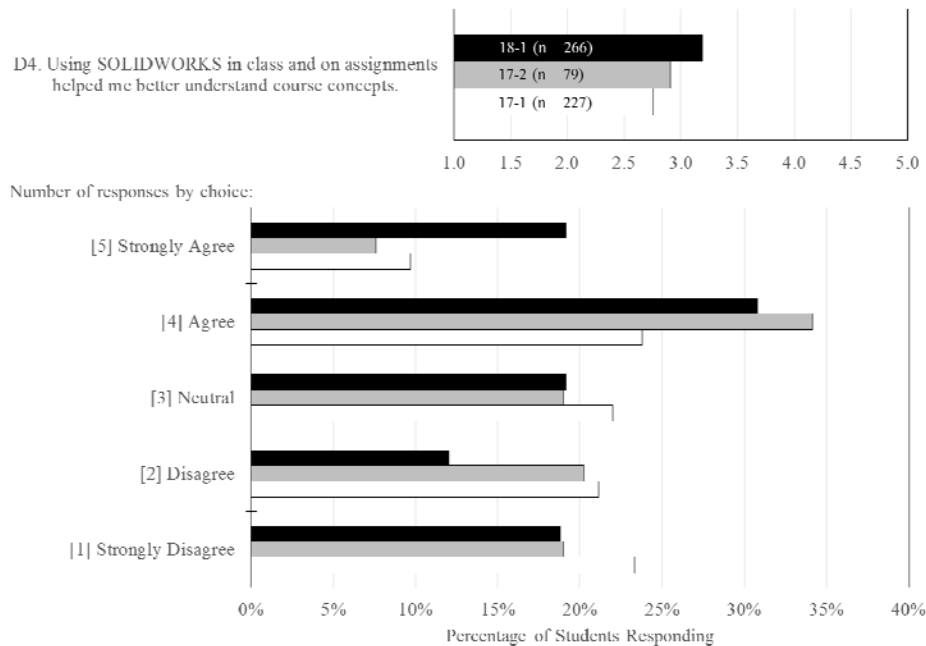

Figure 12 Student feedback from MC300 course-end-surveys

This gradual increase in student opinion suggests that the modifications the faculty have made have helped reduce the frustration connected with learning the software and better emphasized the connection to course concepts. Many of the changes centered around one idea: rather than have students create every model from a blank screen, provide them with working models that they can modify in class or on homework assignments. The example of the offset link in MC364 described above is representative of the type of integration of SOLIDWORKS that we are moving to.

Student response to the inclusion of RSA and SOLIDWORKS for the EDP in CE403 was slightly more positive than observed in MC300. This EDP has only been included in the course one semester (Fall 2017, 18-1). As part of the course-end-survey, students were asked several questions about the EDP. Results from the question related to software are provided in Figure 13. Response rate was 75% (36 / 48 enrolled students). As shown, half of the respondents agreed or strongly agreed that the EDP improved their ability to use software to analyze and design a real structure. It is important to note that only one student in each design group had to create and run the simulations. From faculty anecdotes, this contributes to the improved opinion about software when compared to MC300 in which all students were required to use the software throughout the course. By creating teams that included at least one student who self-reported as being comfortable with RSA and SOLIDWORKS, the instructors were able to reduce the frustration and help students focus on the benefits that software simulation provides. Of course, the students also had more experience with the software by the time they took CE403 which likely contributes to their more positive opinion of using software.

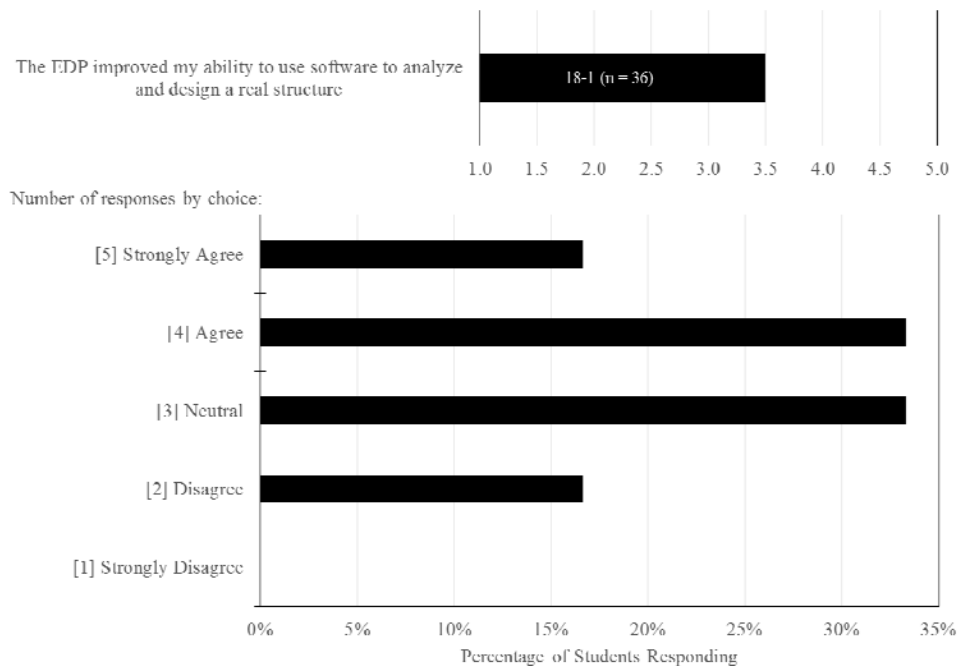

Figure 13 Student feedback from CE403 course-end-survey

FUTURE WORK

As the initial assessment data suggests, using SOLIDWORKS can be frustrating for students. This frustration distracts from the desired learning outcome and is important to consider. Some frustration is reasonable as students learn new tools but managing this carefully is vital going forward. In the future, most of the integrated exercises (in class or for homework) will include providing a working model to the students and requiring them to manipulate various aspects of that model. Removing the requirement to create new models is expected to reduce frustration and help students focus on the desired learning outcome. Additionally, rather than requiring each student to manipulate the SOLIDWORKS models in MC300, we will perform many of these exercises in groups of 3 or 4 students. Recall that we also teach MC300 to non-engineering students; anecdotally, about 1 in 3 students have been comfortable using SOLIDWORKS in MC300 and those who are most comfortable are typically engineering students. By forming teams, it is more likely that those students frustrated by the software will be working with other students who are not. This is expected to improve student focus on the desired learning outcomes, possibly even allowing us to increase the scope or complexity of the problems being considered. This group requirement will not be used in MC364 because it is composed of engineering students who are more comfortable with the software and have greater need to continue developing competence using it.

Additional assessment will be conducted in future semesters to measure the impact on learning. To date, assessment has been focused on student opinions about using the software and how they believe it has influenced their learning. Methods such as pre- and post-tests and concept inventories will be considered. At this point, the authors do not intend to study the influence of using software in comparison to control groups of students who do not use the software. It is the authors' belief that including software early in the curriculum strengthens intuition and highlights from the start of their engineering education that using computer software effectively is an important part of being able to creatively solve problems and plays a role in developing the skills to judge validity of solutions developed by others.

The role that the integration of simulation software in engineering courses can play in the development of effective judgment is of interest. Further study is planned to investigate how these simulations may improve judgment, critical thinking, and decision making by students.

While the exercises using software described in this paper were not designed to develop spatial visualization skills (SVS), it is expected that the exercises like these may be used to do so. The ENGAGE project sponsored by NSF has a library of resources that are being considered for use in assessing the role that computer simulation integration may play in the continuing development of SVS skills within engineering students¹⁴. These skills are known to be critical to success in STEM programs and for practicing engineers.

Finally, the program leadership is encouraging the faculty to create opportunities to integrate SOLIDWORKS into other courses. This will make use of the students' skills using the software and provide opportunities to keep those skills fresh. The exercise of finding ways to integrate software more comprehensively across the curriculum adds to curricular coherence and encourages faculty to develop parametric study problems to further develop student understanding of concepts beyond simply being able to complete sets of calculations.

SUMMARY

The integration of simulation software into engineering mechanics courses provides a way for students to better visualize these foundational concepts. Students agree that these simulations help them learn the course material but work remains to assess the influence simulation software has on their performance in the courses and on recall of the concepts in later courses. This integration of software into the mechanics courses has had frustrations for students and faculty primarily because of the learning curve associated with a versatile software like SOLIDWORKS. The authors assert that this frustration and time required is acceptable for the learning that it eventually enables. If faculty deliberately choose the concepts they use the software to explore, carefully design the learning exercise using the five guiding principles adapted from IBLA principles, and showcase the powerful investigations that simulation software allows, the learning experiences for students will be positive. The exercises described in this paper have been tested in real classrooms with real students from a variety of backgrounds and have been improved over several semesters. Additional notes including tutorials, lecture notes, and student handouts can be obtained from the authors. Please contact them if you wish to try any of these activities in your own classroom or as assigned homework.

REFERENCES

-
- ¹ Jakob C. Bruhl, James Ledlie Klosky, and Joseph P. Hanus, 'Let's Break Stuff! A Refit of the Mechanics Sequence of Courses to Inspire Student Inquiry', in *ASEE Annual Conference and Exposition* (Columbus, OH: American Society for Engineering Education, 2017) <<https://peer.asee.org/28626>>.
 - ² Jakob C. Bruhl and others, 'Accelerating the Development of Engineering Judgment in Students through Inquiry-Based Learning Activities', in *ASEE Annual Conference and Exposition* (Columbus, OH: American Society for Engineering Education, 2017) <<https://peer.asee.org/27532>>.
 - ³ Dassault Systemes SolidWorks Corporation, 'SOLIDWORKS Student Edition' (Waltham, MA, 2017) <www.solidworks.com>.
 - ⁴ Tony Wagner, *The Global Achievement Gap: Why Even Our Best Schools Don't Teach the New Survival Skills Our Children Need and What We Can Do About It*. (New York, NY: Basic Books, 2014).
 - ⁵ M. Prince, "Does Active Learning Work? A Review of the Research," *Journal of Engineering Education* 93, no. 3 (2004): 223–232.
 - ⁶ Scott Freeman and others, 'Active Learning Increases Student Performance in Science, Engineering, and Mathematics.', *Proceedings of the National Academy of Sciences of the United States of America*, 111.23 (2014), 8410–15 <<https://doi.org/10.1073/pnas.1319030111>>.
 - ⁷ Shanna R. Daly, Erika A. Mosyjowski, and Colleen M. Seifert, 'Teaching Creativity in Engineering Courses', *Journal of Engineering Education*, 103.3 (2014), 417–49 <<https://doi.org/10.1002/jee.20048>>.
 - ⁸ David H Cropley, 'Promoting Creativity and Innovation in Engineering Education', *Psychology of Aesthetics, Creativity, and the Arts*, 9.2 (2015), 161–71 <<https://doi.org/10.1037/aca0000008>>.

-
- ⁹ Don Millard and Ashok Agrawal. 'Mapping Engineering Competencies' (presentation slides). Transforming Undergraduate Education in Engineering Phase IV: Views of Faculty and Professional Societies. (Washington, DC: American Society for Engineering Education, 2017) <<http://docs.asee.org/public/TUEE/TUEEIV/Slides/DonMillard.pdf>>
- ¹⁰ Huei-Huang Lee. Engineering Statics Labs with SOLIDWORKS Motion 2015. (Mission, KS: SDC Publications, 2015)
- ¹¹ Huei-Huang Lee. Mechanics of Materials Labs with SOLIDWORKS Simulation 2015. (Mission, KS: SDC Publications, 2015)
- ¹² Aaron Freidenberg and others, 'High Fidelity Structural Analysis for Undergrad Structural Engineering Students (Paper Accepted for Proceedings)', in *Structures Congress 2018* (American Society of Civil Engineers, 2018).
- ¹³ Autodesk Inc., 'Robot Structural Analysis Professional 2018' (San Rafael, CA, 2017) <<https://www.autodesk.com/products/robot-structural-analysis/overview>>.
- ¹⁴ ENGAGE Engineering, 'Spatial Visualization Skills (SVS)' <https://www.engageengineering.org/spatial/whyitworks>, Accessed February 1, 2018.