

SONY



Corporate & education solutions range guide

February 2017

www.pro.sony.eu

The Sony Solution 3

Service & Support  4-5

Education and Business Projectors  6-35

Professional Displays  36-41

Collaboration System  42-45

Visual Imaging Cameras  46-57

Visual Simulation and Visual Entertainment  58-67

The Sony Solution

When it comes to professional AV technology, Sony provides more than just products – **we create solutions.**

Solutions that empower all kinds of organisations, with advanced audio-visual tools that help them go further. Solutions designed for every industry and sector, from schools to universities, small business to big business, retail to automotive and more.

Solutions like our Laser Light Source Projectors, delivering powerful images, virtually maintenance-free. Our Collaboration System, taking active learning and sharing material to new levels. BRAVIA Professional Displays enabling dynamic, digital signage. Desktop and portable projectors providing uncompromised quality at a low TCO for businesses and education.

Whatever size the organisation, whatever the requirement, we have the perfect solution. And always with our full support.

For full product features and specifications please visit pro.sony.eu



Looking after you and
your professional product

You've got our support

Your business can't afford unscheduled interruptions. We're here to help with responsive service and support for your Sony Professional product.

PrimeSupport Pro

Included at no extra cost, our initial **PrimeSupportPro** packages go beyond a standard warranty with access to expert technical assistance. Our multilingual helpdesk can answer everyday questions on setting up and using your product by phone or email. And if you do need repairs, we'll organise things quickly and efficiently, with free shipping and no hidden costs.

PrimeSupport Elite

If you're looking for even more peace of mind, upgrading to **PrimeSupportElite** could be the option for your business. We'll keep you up and running with our fast-track repair service that includes all shipping costs. And – depending on your product – we may offer to loan a replacement unit while yours is being repaired.

PrimeSupport Bespoke

PrimeSupport On-Demand

Everybody's business is different. A selected number of our products are also eligible for **PrimeSupportBespoke**, and **PrimeSupportOn Demand**, tailored solutions for organisations with the most demanding requirements for service and support. With options like next working day spares and on-site technical assistance, there's no better choice when dependable performance of your AV communications infrastructure is most crucial.



Contact our technical support team on **00800 7898 7898**

Monday - Friday 09:00 – 18:00 (Central European Time), excluding local national holidays.

Support is available in English, French, Italian, German & Spanish and is free for most European countries.

Or e-mail: primesupport@sony.com



Captivating, bright presentations for every size room



Projectors

From classrooms and offices to lecture halls and auditoriums, Sony projectors deliver outstanding quality, reliability and energy-efficiency in every kind of venue.

Installation projectors

Outstanding image quality whatever the light source - the world's first and brightest 3LCD laser projectors

Our laser projectors are ideal for a wide range of high-end business, education or large-scale applications. The powerful Z-Phosphor laser light source is teamed with Sony's advanced 3LCD projection engine to deliver extremely bright, rich, and stable colours.

For everyday applications and environments, our lamp projectors offer the same advanced 3LCD projection engine with cost-effective features that deliver the same high-quality performance.

Highlights - laser or lamp technology

- Powerful, WUXGA & WXGA resolution images
- Models range from 4,100 to 7,000 colour and white light output
- Easy, flexible installation
- Energy-saving features

Business and education projectors

Including portable and Ultra Short Throw

For classrooms or meeting spaces, our portable and desktop projectors are lightweight, durable and easy-to-use, combining outstanding performance with cost-efficiency. Wireless connectivity enables presentation direct from PC, Mac, smartphone or tablet, and greater opportunities for audience sharing and interaction. If space is limited, our Short Throw and Ultra Short Throw models produce big, bright images without needing to be far from the screen, whiteboard or wall.

Highlights

- 3LCD BrightEra™ technology
- Smart ECO features
- Long lamp life
- Options with XGA or WXGA resolution
- Models range from 2,600 to 4,300 colour and white light output

PrimeSupport



PrimeSupport Pro

Included at no extra cost, our initial **PrimeSupportPro** packages go beyond a standard warranty with access to expert technical assistance. Our multilingual helpdesk can answer everyday questions on setting up and using your product by phone or email. And if you do need repairs, we'll organise things quickly and efficiently, with free shipping and no hidden costs.

PrimeSupport Elite

If you're looking for even more peace of mind, upgrading to **PrimeSupportElite** could be the option for your business. We'll keep you up and running with our fast-track repair service that includes all shipping costs. And – depending on your product – we may offer to loan a replacement unit* while yours is being repaired.

D-200 Series

4 compact and lightweight economical desktop projectors for office and classroom, offering high performance, superior quality and ease of use.



High Image Quality

XGA and WXGA resolution, our new D-200 Series projectors feature new Vivid Mode for a much more brilliant, richer and stable colour experience.

Easy Connectivity

Two HDMI ports and a USB power supply port (5V 2A max) simplify connection with laptops plus other devices like 'stick' computers and smart dongles.

Auto On and Quick Off

Connecting to a PC automatically turns the projector on and Quick Off feature makes the projectors extremely easy to use.

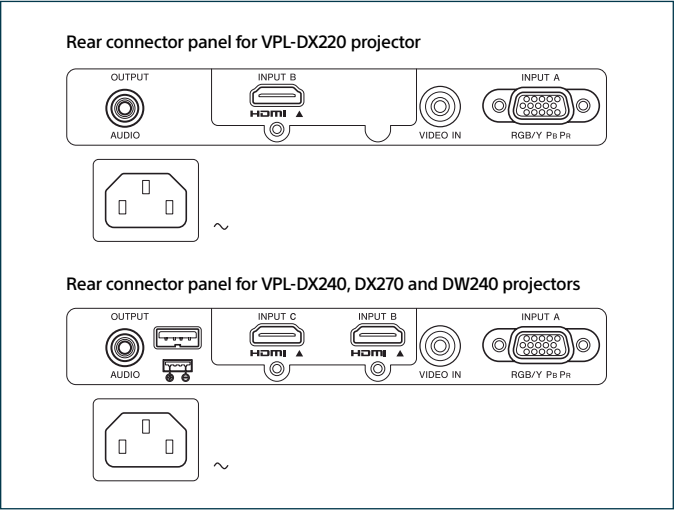

PrimeSupportPro

PrimeSupportElite



Our **PrimeSupportPro** and **PrimeSupportElite** packages go beyond standard levels of warranty with varying support options either at no extra cost or optional upgrade. **PrimeSupportPro** gives you free initial access to expert technical assistance from our multilingual helpdesk while optional **PrimeSupportElite** upgrades go further with our fast-track repair service and – depending on your product - a replacement loan unit*. Both packages include free shipping and no hidden costs so we'll always keep you up and running.

	PrimeSupportPro		PrimeSupportElite	
Service reference	Included Service PS.VPLB1.12X.L1		PS.VPL.DSERIES.1Y	PS.VPL.DSERIES.3Y
Scope of support	Projector	Lamp	Projector	
Duration	2 year swap service	1 year or 1000 h	+1 year (Total 3 years)	+3 years (Total 5 years)
			Lamp	
			+ 2 years or 2000 h (Total 3 years or 3000h)	

D-200 Series
Optional Accessories

LMP-D214
Replacement projector lamp



PAM-210
Ceiling mount



PAM-0.5M
Extension pole & ceiling plate



PAM-1.0M
Extension pole & ceiling plate



PAM-1.5M
Extension pole & ceiling plate





BrightEra
Long Lasting Optics



		VPL-DW240	VPL-DX220	VPL-DX240	VPL-DX270
Display system		3 LCD system			
Display device	Size of effective display area	0.59" (15 mm) x 3 BrightEra Aspect ratio: 16:10	0.63"(16mm) x 3 Aspect ratio: 4:3		
	Number of pixels	3,072,000 (1280 x 800 x 3) pixels	2,359,296 (1024x768 x 3) pixels		
Projection lens	Zoom	Optical: Manual (Approx. x 1.3)	Optical: Manual (Approx. x 1.2)	Optical: Manual (Approx. x 1.3)	
	Focus	Manual			
	Throw Ratio	1.36:1 to 1.77:1	1.47:1 to 1.77:1	1.37:1 to 1.80:1	
Light source	Type	Ultra high pressure mercury lamp 215 W type			
Recommended lamp replacement time ^{*1}	Lamp mode: High / Standard / Low	3000 H / 5000 H / 10000 H	3000 H / 5000 H / 6000 H	3000 H / 5000 H / 10000 H	
Filter cleaning cycle ^{*1}		Max. 1,000 H			
Screen size		30" to 300" (0.76 m to 7.62 m)			
White and colour light output ^{*2}	Lamp mode: High / Standard / Low	3000 lm / 2200 lm / 1900 lm	2700 lm / 2000 lm / 1700 lm	3200 lm / 2300 lm / 2000 lm	3500 lm / 2600 lm / 2200 lm
Contrast ratio (full white / full black) ^{*3}		4000:1	3000:1	4000:1	
Displayable scanning frequency	Horizontal	19 kHz to 92 kHz			
	Vertical	48 Hz to 92 Hz			
Display resolution	Computer signal input	Maximum display resolution: UXGA 1600 x 1200 dots ^{*4} Panel display resolution: 1280 x 800 dots	Maximum display resolution: UXGA 1600 x 1200 dots ^{*4} Panel display resolution: 1024 x 768 dots		
	Video signal input	NTSC, PAL, SECAM, 480/60i, 576/50i, 480/60p, 576/50p, 720/60p, 720/50p, 1080/60i, 1080/50i, The following items are available for digital signal (HDMI input) only: 1080/60p, 1080/50p			
Colour system		NTSC3.58, PAL, SECAM, NTSC4.43, PAL-M, PAL-N			
Keystone correction (Max.) - Vertical		Max. Vertical: +/- 30 degrees			
OSD language		27-languages (English, Dutch, French, Italian, German, Spanish, Portuguese, Turkish, Polish, Russian, Swedish, Norwegian, Japanese, Simplified Chinese, Traditional Chinese, Korean, Thai, Vietnamese, Arabic, Farsi, Finnish, Indonesian, Hungarian, Greek, Czech, Slovak, Romanian)			
Computer and video signal input/output	INPUT A	RGB / Y PB PR input connector: Mini D-sub 15-pin (female)			
	INPUT B	HDMI input connector: HDMI 19-pin, HDCP support, audio support			
	INPUT C ^{*5}	HDMI input connector: HDMI 19-pin, HDCP support, audio support	-	HDMI input connector: HDMI 19-pin, HDCP support, audio support	
	VIDEO IN	Video input connector: Phono jack			
	OUTPUT	Audio output connector: Stereo mini jack			
Power Supply		5V 2A (USB Type-A)	-	5V 2A (USB Type-A)	
Speaker		1 W x 1 (monaural)			
Operating temperature (Operating humidity)		0°C to 35°C / 32°F to 95°F (20% to 80%; no condensation)			
Storage temperature (Storage humidity)		-10°C to +60°C / 14°F to +140°F (20% to 80%; no condensation)			
Outside dimensions ^{*3}		W 325.1 x H 79.8 x D 230.5 mm (W 12 13/16 x H 3 5/32 x D 9 1/16 inches) (without protrusions)			
Mass ³		2.7 kg / 5.9 lb			
Supplied accessories		RM-PJ8 Remote Commander (1), Lithium battery: CR2025 (1), AC Power Cord (1), Operating Instructions (CDROM) (1), Quick Reference Manual (1), Mini D-sub 15-pin cable (1), Lens cap (1), Carrying case (1)			
Replacement lamp		LMP-D214			

*1 The figures are the expected maintenance time and not guaranteed. They will depend on the environment or how the projector is used.

*2 The values are estimate.

*3 The value is average.

*4 Available for the VESA Reduced Blanking signal.

*5 Maximum resolution of the INPUT C terminal is up to 720p.

*14-day repair service is indicative only; actual turnaround time not guaranteed.

For full product specifications and features please visit
pro.sony.eu/projectors-desktop

E-400 Series

Ideal for education, these compact, energy efficient portable projectors offer excellent image quality plus affordable running costs.



Bright, high contrast images

- Fill classrooms and meeting rooms with bright, detail-packed images. High 20,000:1 contrast ratio ensures crisp, images and text that stand out in any environment.

Wider connectivity options

- Project from a networked computer, or present wirelessly from laptops, tablets and smartphones.
- Dual HDMI ports for standard and latest wireless adaptors and direct USB display connection.

Affordable ownership costs

- Smart energy-saving features plus up to 10,000 hours lamp replacement intervals contribute to low ownership costs and reduced maintenance.

Rear connector panel for the VPL-EX435, VPL-EX455, VPL-EW435 and VPL-EW455 projectors

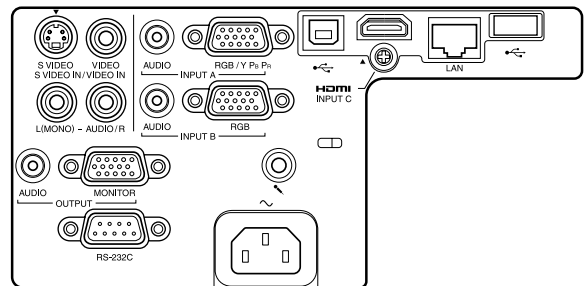

PrimeSupportPro PrimeSupportElite



Our **PrimeSupportPro** and **PrimeSupportElite** packages go beyond standard levels of warranty with varying support options either at no extra cost or optional upgrade. **PrimeSupportPro** gives you free initial access to expert technical assistance from our multilingual helpdesk while optional **PrimeSupportElite** upgrades go further with our fast-track repair service and – depending on your product - a replacement loan unit*. Both packages include free shipping and no hidden costs so we'll always keep you up and running.

	PrimeSupportPro		PrimeSupportElite		
Service reference	Included Service PS.VPLB3.123.L3		PS.VPL.SESERIES.2Y	PS.VPL.SESERIES.3YL	PS.VPL.SESERIES.5YL
Scope of support	Projector	Lamp	Projector		
Duration	3 years	3 years or 3000 h	+2 years (Total 5 years)	3 years repair & loan	+2 years repair extension & 5 years loan product

E-400 Series

Optional Accessories

IFU-WLM3
USB wireless module



LMP-E221
Replacement
Projector Lamp



PAM-210
Ceiling mount



PAM-0.5M
Extension Poles



PAM-1.0M
Extension Poles



PAM-1.5M
Extension Poles



Oi/Android APP
Connect your devices to projectors via a WiFi network with the VueMagic™ app*



*Available to download until end of December 2017



BrightEra
Long Lasting Optics



		VPL-EW455	VPL-EW435	VPL-EX455	VPL-EX435
Display system		3 LCD system			
Display device	Size of effective display area	0.59"(15mm) x 3 BrightEra LCD Panel Aspect ratio 16:10		0.63"(16 mm) x 3 BrightEra LCD Panel Aspect ratio 4:3	
	Number of pixels	3,072,000 (1280x800 x 3) pixels		2,359,296 (1024x768 x 3) pixels	
Projection lens	Focus	Manual			
	Throw Ratio	1.37:1 to 1.80:1		1.47:1 to 1.77:1	
Light source	Type / Wattage	Ultra high pressure mercury lamp 225W type			
Recommended lamp replacement time*1	Lamp mode: High	4,000 H			
	Lamp mode: Standard	6,000 H			
	Lamp mode: Low	10,000 H			
Filter cleaning / replacement cycle (Max.)*1		10,000 H			
Screen size		30" to 300" (0.76 m to 7.62 m)			
Light output*2	Lamp mode: High	3500 lm	3100 lm	3600 lm	3200 lm
	Lamp mode: Standard	2500 lm	2200 lm	2500 lm	2300 lm
	Lamp mode: Low	2100 lm	1900 lm	1900 lm	1800 lm
Colour light output*2	Lamp mode: High	3500 lm	3100 lm	3600 lm	3200 lm
	Lamp mode: Standard	2500 lm	2200 lm	2500 lm	2300 lm
	Lamp mode: Low	2100 lm	1900 lm	1900 lm	1800 lm
Contrast ratio (full white / full black)*3		20000:1 (SYQ) / 12000:1 (C1)			
Speaker		16W (monaural)			
Displayable scanning frequency	Horizontal	15 kHz to 92 kHz			
	Vertical	48 Hz to 92 Hz			
Display resolution	Computer signal input	Maximum display resolution: 1600 x 1200 dots, fV:60Hz			
	Video signal input	NTSC, PAL, SECAM, 480/60i, 576/50i, 480/60p, 576/50p, 720/60p, 720/50p, 1080/60i, 1080/50i, 1080/60p, 1080/50p			
Colour system		NTSC3.58, PAL, SECAM, NTSC4.43, PAL-M, PALN, PAL60			
Keystone correction*4 (Max.) - Vertical		+/-20 degrees		+/-30 degrees	
OSD language		'27-language (English, French, German, Italian, Spanish, Portuguese, Japanese, Chinese, Korean, Russian, Dutch, Norwegian, Swedish, Thai, Arabic, Turkish, Polish, Vietnamese, Farsi, Finnish, Indonesian, Hungary, Greek, Czech, Slovakia, Romania)			
INPUT OUTPUT (Computer / Video / Control)	INPUT A	RGB / Y PB PR input connector: Mini D-sub 15 pin female, Audio input connector: Stereo mini jack			
	INPUT B	RGB input connector: Mini Dsub 15 pin female, Audio input connector: Stereo mini jack			
	INPUT C	HDMI input connector: HDMI 19-pin, HDCP support, Audio input connector: HDMI audio support			
	INPUT D	HDMI input connector: HDMI 19-pin, HDCP support, Audio input connector: HDMI audio support			
	S VIDEO IN	S Video input connector: Mini DIN 4-pin			
	VIDEO IN	Video input connector: Phono jack			
	OUTPUT	MONITOR output connector: Mini D-sub 15 pin female, Audio output connector: Stereo mini			
	Y PB/CB PR/CR	Component: Mini D-sub 15 pin female			
	REMOTE	D-sub 9-pin male/RS232C			
	LAN	RJ-45, 10BASE-T/100BASE-TX			
USB	Type-A & Type-B				
MICROPHONE IN	Microphone jack: Mini Jack				
Acoustic noise*5	Lamp mode: Low	29dB			
Operating temperature / Operating humidity		0°C to 40°C / 32°F to 104°F (20% to 80%; no condensation)			
Storage temperature / Storage humidity		-10°C to +60°C / 14°F to +140°F (20% to 80%; no condensation)			
Power requirements		AC 100 V to 240 V, 3.4 A to 1.5 A, 50 Hz / 60 Hz	AC 100 V to 240 V, 3.2A to 1.4 A, 50 Hz / 60 Hz	AC 100 V to 240 V, 3.4 A to 1.5 A, 50 Hz / 60 Hz	
Power consumption	AC 100 V to 120 V	332 W (High) 270 W (Standard) 233 W (Low)	318 W (High) 260 W (Standard) 232 W (Low)	333 W (High) 270 W (Standard) 233 W (Low)	
	AC 220 V to 240 V	319 W (High) 261 W (Standard) 225 W (Low)	306 W (High) 252 W (Standard) 226 W (Low)	320 W (High) 260 W (Standard) 225 W (Low)	
Power Consumption (Standby Mode)	AC 100 V to 120 V	0.50W (when "Standby mode" is set to "Low")			
	AC 220 V to 240 V	0.50W (when "Standby mode" is set to "Low")			
Power Consumption (Networked Standby Mode)	AC 100 V to 120 V	5.5W(LAN) / 6.0W (optional WLAN module) / 6.2W (ALL Terminals and Networks Connected, when "Standby Mode" is set to "Standard")			
	AC 220 V to 240 V	5.8W(LAN) / 6.3W (optional WLAN module) / 6.6W (ALL Terminals and Networks Connected, when "Standby Mode" is set to "Standard")			
Standby Mode / Networked Standby Mode Activated		Approx. 10 Minutes			
Wireless Network(s) On/Off Switch		Press the MENU button, then select [Connection/Power] > [WLAN Settings] > [WLAN Connection] > Select On or Off			
Heat dissipation	AC 100 V to 120 V	1133 BTU	1085 BTU	1136 BTU	
	AC 220 V to 240 V	1088 BTU	1044 BTU	1092 BTU	
Dimensions (W x H x D) (without protrusions)		Aprox. 365 x 96.2 x 252 mm (14 3/8 X3 25/32 X9 29/32 ")			
Mass		Approx. 3.9kg (8.6 lb)			
Supplied accessories		RM-PJ8 Remote Commander (1), Lithium battery: CR2025 (1), AC Power Cord (1), Operating Instructions (CDROM) (1), Quick Reference Manual (1) Lens cap (1)			
Optional Accessories		LMP-E221, IFU-WLM3 (WLAN module)			

*1 This figure is expected maintenance time, not guaranteed time. The actual value depends on the environment and how the projector is used. | *2 The values are estimate. | *3 The value is average. | *4 The picture quality may deteriorate when the V Keystone function is used for it is an electrical correction. | *5 The figures are approximate. They vary depending on the environment or how the projector is used.

For full product specifications and features please visit
pro.sony.eu/projectors-desktop

E-500 Series

These portable projectors fill larger rooms with bright, high-impact images. Smart features make the most of today's integrated AV/IT environments.



High brightness, high contrast images

- Fill larger classrooms and meeting rooms with powerful output up to 4300 lumen brightness. High 20,000:1 contrast ratio ensures crisp, images and text.

Wider connectivity options

- Project from a networked computer, or present wirelessly from laptops, tablets and smartphones.
- Dual HDMI ports for standard and latest wireless adaptors and direct USB display connection.

Affordable ownership costs

- Smart energy-saving features like Auto Mode and Lamp Dimming, plus up to 10,000 hours lamp replacement intervals contribute to low ownership costs and reduced maintenance.

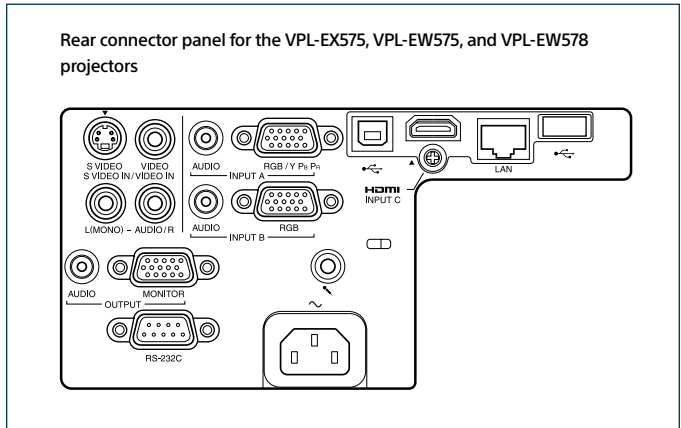

PrimeSupportPro PrimeSupportElite



Our **PrimeSupportPro** and **PrimeSupportElite** packages go beyond standard levels of warranty with varying support options either at no extra cost or optional upgrade. **PrimeSupportPro** gives you free initial access to expert technical assistance from our multilingual helpdesk while optional **PrimeSupportElite** upgrades go further with our fast-track repair service and – depending on your product - a replacement loan unit*. Both packages include free shipping and no hidden costs so we'll always keep you up and running.

	PrimeSupportPro		PrimeSupportElite	
Service reference	Included Service PS.VPLB3.123.L3		PS.VPL.SESERIES.2Y	PS.VPL.SESERIES.3YL
Scope of support	Projector	Lamp	Projector	
Duration	3 years	3 years or 3000 h	+2 years (Total 5 years)	+2 years repair extension & 5 years loan product

E-500 Series

Optional Accessories

IFU-WLM3
USB wireless module



LMP-E221
Replacement
Projector Lamp



PAM-210
Ceiling mount



PAM-0.5M
Extension Poles



PAM-1.0M
Extension Poles



PAM-1.5M
Extension Poles



Oi/Android APP
Connect your devices to projectors via a WiFi network with the VueMagic™ app*



*Available to download until end of December 2017



BrightEra
Long Lasting Optics



		VPL-EW578	VPL-EW575	VPL-EX575	VPL-EX570
Display system		3 LCD system			
Display device	Size of effective display area	0.75"(19mm) x 3 BrightEra LCD Panel Aspect ratio 16:10		0.63"(16 mm) x 3 BrightEra LCD Panel, Aspect ratio: 4:3	
	Number of pixels	3,072,000 (1280x800 x 3) pixels		2,359,296 (1024x768 x 3) pixels	
Projection lens	Focus	Manual			
	Throw Ratio	1.10:1 to 1.79:1		1.40:1 to 2.27:1	
Light source	Type / Wattage	Ultra high pressure mercury lamp 225W type			
	Lamp mode: High	4,000 H			
Recommended lamp replacement time*1	Lamp mode: Standard	6,000 H			
	Lamp mode: Low	10,000 H			
	Filter cleaning / replacement cycle (Max.)*1	10,000 H			
Screen size		30" to 300" (0.76 m to 7.62 m)			
Light output*2	Lamp mode: High	4300 lm		4200 lm	
	Lamp mode: Standard	3200 lm		3000 lm	
	Lamp mode: Low	2400 lm		2300 lm	
Colour light output*2	Lamp mode: High	4300 lm		4200 lm	
	Lamp mode: Standard	3200 lm		3000 lm	
	Lamp mode: Low	2400 lm		2300 lm	
Contrast ratio (full white / full black)*3		20000:1(SYQ) 12000:1(C1)			
Speaker		16W (monaural)		-	
Displayable scanning frequency	Horizontal	15 kHz to 92 kHz			
	Vertical	48 Hz to 92 Hz			
Display resolution	Computer signal input	Maximum display resolution: 1600 x 1200 dots, fV:60Hz			
	Video signal input	NTSC, PAL, SECAM, 480/60i, 576/50i, 480/60p, 576/50p, 720/60p, 720/50p, 1080/60i, 1080/50i, 1080/60p, 1080/50p			
Colour system		NTSC3.58, PAL, SECAM, NTSC4.43, PAL-M, PAL-N,PAL60			
Keystone correction*4 (Max.) - Vertical		+/-20 degrees		+/-30 degrees	
OSD language		'27-language (English, French, German, Italian, Spanish, Portuguese, Japanese, Chinese, Korean, Russian, Dutch, Norwegian, Swedish, Thai, Arabic, Turkish, Polish, Vietnamese, Farsi, Finnish, Indonesian, Hungary, Greek, Czech, Slovakia, Romania)			
INPUT OUTPUT (Computer / Video / Control)	INPUT A	RGB / Y PB PR input connector: Mini D-sub 15 pin female Audio input connector: Stereo mini jack		RGB / Y PB PR input connector: Mini D-sub 15 pin female	
	INPUT B	RGB input connector: Mini D-sub 15 pin female Audio input connector: Stereo mini jack		RGB input connector: Mini D-sub 15 pin female	
	INPUT C	HDMI input connector: HDMI 19-pin, HDCP support, Audio input connector: HDMI audio support		HDMI input connector: HDMI 19-pin, HDCP support,	
	INPUT D	HDMI input connector: HDMI 19-pin, HDCP support, Audio input connector: HDMI audio support		HDMI input connector: HDMI 19-pin, HDCP support,	
	S VIDEO IN	S Video input connector: Mini DIN 4-pin			
	VIDEO IN	Video input connector: Phono jack			
	OUTPUT	MONITOR output connector: Mini D-sub 15 pin female Audio output connector: Stereo mini		MONITOR output connector: Mini D-sub 15 pin female	
	Y PB/CB PR/CR	Component: Mini D-sub 15 pin female			
	REMOTE	D-sub 9-pin male/RS232C			
	LAN	RJ45,100BASE-TX (Shared with HDBaseT)	RJ-45, 10BASE-T/100BASE-TX		
	USB	Type-A & Type-B			
	MICROPHONE IN	Microphone jack: Mini Jack		-	
Acoustic noise*5	Lamp mode: Low	29dB			
Operating temperature / Operating humidity		0°C to 40°C / 32°F to 104°F (20% to 80%; no condensation)			
Storage temperature / Storage humidity		-10°C to +60°C / 14°F to +140°F (20% to 80%; no condensation)			
Power requirements		AC 100 V to 240 V, 3.5 A to 1.5 A, 50 Hz / 60 Hz	AC 100 V to 240 V, 3.4 A to 1.5 A, 50 Hz / 60 Hz		AC 100 V to 240 V, 3.1 A to 1.4 A, 50 Hz / 60 Hz
Power consumption	AC 100 V to 120 V	344 W (High) 278 W (Standard) 241W (Low)	332 W (High) 270 W (Standard) 233 W (Low)	333 W (High) 270 W (Standard) 233 W (Low)	303 W (High) 240 W (Standard) 202 W (Low)
	AC 220 V to 240 V	328 W (High) 270 W (Standard) 234 W (Low)	319 W (High) 261 W (Standard) 225 W (Low)	320 W (High) 260 W (Standard) 225 W (Low)	291 W (High) 231 W (Standard) 197 W (Low)
Power Consumption (Standby Mode)	AC 100 V to 120 V	0.50W (when "Standby mode" is set to "Low")			
	AC 220 V to 240 V	0.50W (when "Standby mode" is set to "Low")			
Power Consumption (Networked Standby Mode)	AC 100 V to 120 V	5.5W(LAN) / 6.0W (optional WLAN module) / 6.2W (ALL Terminals and Networks Connected, when "Standby Mode" is set to "Standard")			
	AC 220 V to 240 V	5.8W(LAN) / 6.3W (optional WLAN module) / 6.6W (ALL Terminals and Networks Connected, when "Standby Mode" is set to "Standard")			
Standby Mode/Networked Standby Mode Activated		Approx. 10 Minutes			
Wireless Network(s) On/Off Switch		Press the MENU button, then select [Connection/Power] > [WLAN Settings] > [WLAN Connection] > Select On or Off			
Heat dissipation	AC 100 V to 120 V	1174 BTU	1133 BTU	1136 BTU	1034 BTU
	AC 220 V to 240 V	1119 BTU	1088 BTU	1092 BTU	993 BTU
Dimensions (W x H x D) (without protrusions)		Approx. 365 x 96.2 x 252 mm (14 3/8 X3 25/32 X9 29/32 ")			
Mass		Approx. 4.1kg (9 lb)		Approx. 4 kg (8.8 lb)	
Supplied accessories		RM-PJ8 Remote Commander (1), Lithium battery: CR2025 (1), AC Power Cord (1), Operating Instructions (CDROM) (1), Quick Reference Manual (1) Lens cap (1)			
Optional Accessories		LMP-E221, IFU-WLM3 (WLAN module)			

*1 This figure is expected maintenance time, not guaranteed time. The actual value depends on the environment and how the projector is used. | *2 The values are estimate. | *3 The value is average. | *4 The picture quality may deteriorate when the V Keystone function is used for it is an electrical correction. | *5 The figures are approximate. They vary depending on the environment or how the projector is used.

For full product specifications and features please visit
pro.sony.eu/projectors-desktop

Short Throw Series

4 short throw projectors that create an 80-inch image from only 75-79cm away with less glare or shadow during presentations. Energy-efficient, wireless-ready with Eco-friendly capabilities.



Short throw distance

- Produces a 2.03m (80-inch) diagonal screen size image from only 75cm (29-inch) or 79cm (31-inch) away from the screen.

USB Media viewer

- Insert a USB drive to effortlessly display photos, images and graphics with no PC needed.

Networked control

- Projector functions and status can be managed and monitored remotely from any user's PC on the network. "Projector Station for Network Control" is provided.

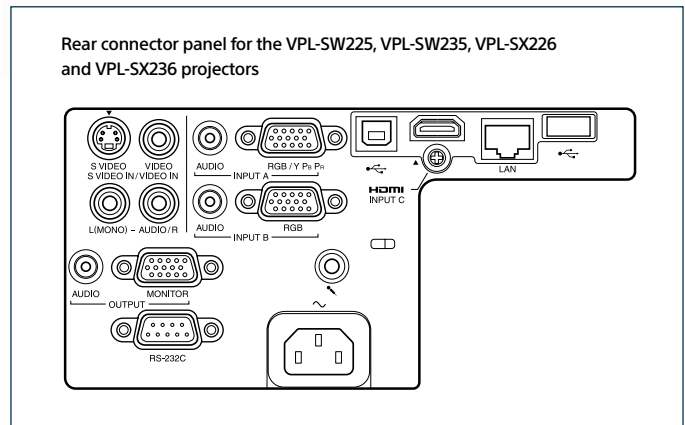

PrimeSupportPro PrimeSupportElite



Our **PrimeSupportPro** and **PrimeSupportElite** packages go beyond standard levels of warranty with varying support options either at no extra cost or optional upgrade. **PrimeSupportPro** gives you free initial access to expert technical assistance from our multilingual helpdesk while optional **PrimeSupportElite** upgrades go further with our fast-track repair service and – depending on your product - a replacement loan unit*. Both packages include free shipping and no hidden costs so we'll always keep you up and running.

	PrimeSupportPro		PrimeSupportElite		
Service reference	Included Service PS.VPLB3.123.L3		PS.VPL.SESERIES.2Y	PS.VPL.SESERIES.3YL	PS.VPL.SESERIES.5YL
Scope of support	Projector	Lamp	Projector		
Duration	3 years	3 years or 3000 h	+2 years (Total 5 years)	3 years repair & loan	+2 years repair extension & 5 years loan product

S-Series

Optional Accessories

LMP-E212
Replacement projector lamp



IFU-WLM3
USB wireless module



PAM-210
Ceiling mount



PAM-0.5M
Extension pole & ceiling plate



PAM-1.0M
Extension pole & ceiling plate



PAM-1.5M
Extension pole & ceiling plate

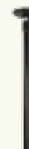

Oi/Android APP
Connect your devices to projectors via a WiFi network with the VueMagic™ app*



*Available to download until end of December 2017



BrightEra
Long Lasting Optics



		VPL-SW225	VPL-SW235	VPL-SX226	VPL-SX236
Display system		3 LCD system			
Display device	Size of effective display area	0.59" (15 mm) x 3 BrightEra LCD Panel, Aspect ratio: 16:10		0.63" (16 mm) x 3 BrightEra, Aspect ratio: 4:3	
	Number of pixels	3,072,000 (1280 x 800 x 3) pixels		2,359,296 (1024 x 768 x 3) pixels	
Projection lens	Focus	Manual			
	Throw Ratio	0.46:1		0.46:1	
Light source	Type / Wattage	Ultra high pressure mercury lamp / 210 W type			
Recommended lamp replacement time*1	Lamp mode: High	4,000 H			
	Lamp mode: Standard	6,000 H			
	Lamp mode: Low	10,000 H			
Filter cleaning / replacement cycle (Max.)*1		7,000 H			
Screen size		57" to 103" (1.45 m to 2.62 m) (measured diagonally)		60" to 110" (1.52 m to 2.79 m) (measured diagonally)	
Light output	Lamp mode: High	2600 lm	3000 lm	2800 lm	3300 lm
	Lamp mode: Standard	2100 lm	2100 lm	2000 lm	2400 lm
	Lamp mode: Low	1700 lm	1700 lm	1600 lm	1900 lm
Colour light output	Lamp mode: High	2600 lm	3000 lm	2800 lm	3300 lm
	Lamp mode: Standard	2100 lm	2100 lm	2000 lm	2400 lm
	Lamp mode: Low	1700 lm	1700 lm	1600 lm	1900 lm
Contrast ratio (full white / full black)*2		2000:1		3000:1	
Speaker		16 W x 1 (monaural)			
Displayable scanning frequency	Horizontal	14 kHz to 93 kHz		15 kHz to 92 kHz	
	Vertical	47 Hz to 93 Hz		48 Hz to 92 Hz	
Display resolution	Computer signal input	Maximum display resolution: UXGA 1600 x 1200 dots*3			
	Video signal input	NTSC, PAL, SECAM, 480/60i, 576/50i, 480/60p, 576/50p, 720/60p, 720/50p, 1080/60i, 1080/50i, The following items are available for digital signal (HDMI input) only; 1080/60p, 1080/50p			
Colour system		NTSC3.58, PAL, SECAM, NTSC4.43, PAL-M, PAL-N			
Keystone correction (Max.) - Vertical		+/- 7.5 degrees			
OSD language		24-languages (English, Dutch, French, Italian, German, Spanish, Portuguese, Turkish, Polish, Russian, Swedish, Norwegian, Japanese, Simplified Chinese, Traditional Chinese, Korean, Thai, Vietnamese, Arabic, Farsi, Finnish, Indonesian, Hungarian, Greek)			
INPUT OUTPUT (Computer / Video / Control)	INPUT A	RGB / Y PB PR input connector: Mini D-sub 15-pin (female), Audio input connector: Stereo mini jack			
	INPUT B	RGB input connector: Mini D-sub 15-pin (female), Audio input connector: Stereo mini jack			
	INPUT C	HDMI input connector: HDMI 19-pin, HDCP support			
	S VIDEO IN	S video input connector: Mini DIN 4-pin, Audio input connector: Pin jack (x2) (shared with VIDEO IN)			
	VIDEO IN	Video input connector: Pin jack, Audio input connector: Pin jack (x2) (shared with S VIDEO IN)			
	OUTPUT	Monitor output connector*4: Mini D-sub 15-pin (female), Audio output connector*5: Stereo mini jack (variable out)			
	REMOTE	RS-232C connector: D-sub 9-pin (female)			RS-232C connector: D-sub 9-pin (male)
	LAN	RJ-45, 10BASE-T/100BASE-TX			
USB	Type-A, Type-B				
MICROPHONE IN	Microphone input: Mini Jack				
Acoustic noise	Lamp mode: Low	Lamp mode: Low: 30 dB			
Operating temperature / Operating humidity		0°C to 40°C (32°F to 104°F) / 20% to 80% (no condensation)			
Storage temperature / Storage humidity		-10°C to +60°C (14°F to +140°F) / 20% to 80% (no condensation)			
Power requirements		AC 100 V to 240 V, 3.2 A to 1.3 A, 50 Hz / 60 Hz			
Power consumption	AC 100 V to 120 V	Lamp mode: High: 291 W	Lamp mode: High: 315 W	Lamp mode: High: 305 W	Lamp mode: High: 308 W
	AC 220 V to 240 V	Lamp mode: High: 281 W	Lamp mode: High: 302 W	Lamp mode: High: 294 W	Lamp mode: High: 297 W
Power Consumption (Standby Mode)	AC 100 V to 120 V	0.5 W (when "Standby mode" is set to "Low")			
	AC 220 V to 240 V	0.5 W (when "Standby mode" is set to "Low")			
Power Consumption (Networked Standby Mode)	AC 100 V to 120 V	5.0 W (LAN), 5.6 W (optional WLAN module), 5.8 W (All Terminals and Networks Connected) (when "Standby Mode" is set to "Standard")			
	AC 220 V to 240 V	5.3 W (LAN), 5.9 W (optional WLAN module), 6.0 W (All Terminals and Networks Connected) (when "Standby Mode" is set to "Standard")			
Standby Mode / Networked Standby Mode Activated		After about 10 Minutes			
Wireless Network(s) On/Off Switch		1) Press the MENU button, then select [Connection/Power], 2) [WLAN Settings], 3) [WLAN Connection], 4) Select On or Off			
Heat dissipation	AC 100 V to 120 V	993 BTU/h	1075 BTU/h	1041 BTU	1051 BTU
	AC 220 V to 240 V	959 BTU/h	1031 BTU/h	1004 BTU	1014 BTU
Dimensions (W x H x D) (without protrusions)		Approx. 365 x 138.7 x 310 mm (14 3/8 x 5 15/32 x 12 7/32 inches)			
Mass		Approx. 4.4 kg (9 lb)			
Supplied accessories		Remote commander (RM-PJ8)			
Optional Accessories		Replacement lamp (LMP-E212), Wireless LAN Module (IFU-WLM3)			

*1 This figure is expected maintenance time, not guaranteed time. The actual value depends on the environment and how the projector is used. | *2 The value is average. | *3 Available for VESA Reduced Blanking signal. | *4 From INPUT A and INPUT B. | *5 Works as an audio switcher function. Output from a selected channel; not available in standby.

For full product specifications and features please visit
pro.sony.eu/short-throw

Ultra Short Throw Series

3 ultra short throw projectors that create shadowless presentations. Dual Pen Interactivity and PC-less functionality available.* Energy efficient, wireless-ready with Eco-friendly capabilities.



Ultra Short throw distance

- Produces a 2.03m (80-inch) diagonal screen size image from only 43cm (17.1-inch) or 46cm (18.2-inch) away from the screen.

Easy to adjust to any whiteboard

- Adjustable optical zoom and lens shift for speedy, fuss-free installation in any classroom. Generous connections simplify hook-ups with PCs, DVD players, microphones and other AV devices.

Rear connector panel for the VPL-SX631, VPL-SW631, VPL-SW636C

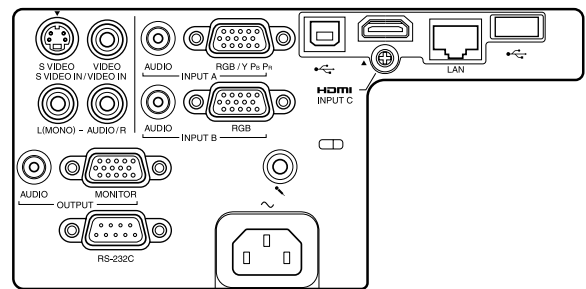

PrimeSupportPro PrimeSupportElite



Our **PrimeSupportPro** and **PrimeSupportElite** packages go beyond standard levels of warranty with varying support options either at no extra cost or optional upgrade. **PrimeSupportPro** gives you free initial access to expert technical assistance from our multilingual helpdesk while optional **PrimeSupportElite** upgrades go further with our fast-track repair service and – depending on your product - a replacement loan unit*. Both packages include free shipping and no hidden costs so we'll always keep you up and running.

	PrimeSupportPro		PrimeSupportElite		
Service reference	Included Service PS.VPLB3.123.L3		PS.VPL.SESERIES.2Y	PS.VPL.SESERIES.3YL	PS.VPL.SESERIES.5YL
Scope of support	Projector	Lamp	Projector		
Duration	3 years	3 years or 3000 h	+2 years (Total 5 years)	3 years repair & loan	+2 years repair extension & 5 years loan product

S-Series

Optional Accessories

LMP-E220
Replacement projector lamp



IFU-WLM3
USB wireless module



Oi/Android APP
Connect your devices to projectors via a WiFi network with the VueMagic™ app*



IFU-PN250A
Interactive Pen replacement for VPL-SW636C model only



IFU-PN250B
Interactive Pen replacement for VPL-SW636C model only



*Available to download until end of December 2017



BrightEra™
Long Lasting Optics



	VPL-SX631	VPL-SW631	VPL-SW636C
Light output / color light output	3,300 lumens (High mode)		
Display device	0.63"(16 mm) x 3 BrightEra LCD Panel, Aspect ratio: 4:3	0.59" (15 mm) x 3 BrightEra LCD Panel, Aspect ratio 16:10	
	2,359,296 (1024x768 x 3) pixels	3,072,000 (1280x800 x 3) pixels	
Contrast ratio (full white / full black) ^{*1}	3,000:1		
Light source	UHP mercury Lamp 225 W type		
Recommended lamp replacement time ^{*2}	4,000 H (Hi) / 6,000 H (Std) / 10,000 H (Low)		
Filter cleaning cycle ^{*2}	Same time as the lamp replacement is recommended		
Projection lens - Zoom	Optional: Manual (Approx. x1.03)		
Projection lens - Focus	Manual		
Projection lens - Lens shift	Manual, Vertical: +/- 3.1% Horizontal: +/- 2.3%	Manual, Vertical: +/- 3.7% Horizontal: +/- 2.3%	
Projection lens - Throw ratio	0.27:1 (0.267 - 0.274:1)		
Keystone correction	Max. Vertical: +/- 5 degrees		Max. Vertical: +4/- 1 degrees
Acoustic noise	High 35dB / Standard 32dB / Low 28dB		
OSD language	27-languages (English, French, German, Italian Spanish, Portuguese, Japanese, Chinese, Traditional Chinese, Korean, Russian, Dutch, Norwegian, Swedish, Thai, Arabic, Turkish, Polish, Vietnamese, Farsi, Finnish, Indonesian, Hungarian, Greek, Czech, Slovakia, Romanian)		
	Computer and video input / output		
INPUT A	RGB / Y PB PR input connector: Mini D-sub 15 pin female / Audio input connector: Stereo mini jack		
INPUT B	RGB input connector: Mini D-sub 15 pin female / Audio input connector: Stereo mini jack		
INPUT C	HDMI input connector: HDMI 19-pin, HDCP support, Audio input connector: HDMI audio support		
VIDEO IN	Video input connector: Phono jack		
S VIDEO IN	S Video input connector: Mini DIN 4-pin		
Monitor OUT	Monitor output connector: Mini D-sub 15-pin		
Audio OUT	Stereo mini		
Built in Interactive capability	-	-	Yes
Dual Pen	-	-	Yes
Auto Calibration	-	-	Yes
PC Free Interactive	-	-	Yes
Driver less	-	-	Yes
Display resolution	Maximum display resolution: UXGA 1600 x 1200 dots ^{*3} 480/60i, 480/60p, 575/50p, 720/60p, 720/50p, 1080/60i, 1080/50i, 1080/60p, 1080/50p		
	Control signal input / output, Others		
RS-232C	D-sub 9-pin male		
LAN	RJ-45 10BASE-T / 100BASE-TX		
USB	Type-A, Type-B		
Microphone input	Mini jack		
Speaker	Speaker 16 W (monaural)		
Operating temperature (Operating humidity)	0°C to 40°C / 32°F to 104°F (20% to 80%; no condensation)		
Storage temperature (Storage humidity)	-10°C to +60°C / -4°F to +140°F (20% to 80%; no condensation)		
Power requirements	AC 100V to 240V, 3.3 A to 1.5 A, 50 Hz / 60 Hz		AC 100V to 240V, 3.5 A to 1.6 A, 50 Hz / 60 Hz
Power consumption (Hi / Std / Low) AC 100 V - 120 V	305 W / 261 W / 232 W	330 W / 261 W / 231 W	341 W / 274 W / 266 W
Power consumption (Hi / Std / Low) AC 220 V - 240 V	294 W / 252 W / 225 W	320 W / 252 W / 224 W	328 W / 245 W / 239 W
Power Consumption (Standby Mode)	0.5W (standby in Low)		
Network Standby (LAN/WLAN) mode power consumption (Std / Low) AC 100 V - 120 V	5.6 W / 5.9 W		
Network Standby (LAN/WLAN) mode power consumption (Std / Low) AC 220 V - 240 V	5.6 W / 6.2 W		
Heat dissipation AC 100 V to 120 V	1041 BTU	1126 BTU	1163 BTU
Heat dissipation AC 220 V to 240 V	1003 BTU	1092 BTU	1119 BTU
Outside dimensions (W x H x D)	Approx: 372 x 138 x 382mm (14 21/32 x 5 7/16 x 15 1/32 inches) (without protrusions)		
Mass	6.0kg (13 lb)		6.3kg (14 lb)
Supplied accessories	PSS-645 Wall Mount, RM-PJ8 Remote Commander (1), Lithium battery: CR2025 (1), AC Power Cord (1), Operating Instructions (CD-ROM) (1), Quick Reference Manual (1), Application Software (CD-ROM) (1), Warranty card (1), Safety Regulations/QRM (1), Security Label (1)		PSS-645 Wall Mount, RM-PJ8 Remote Commander (1), Lithium battery: CR2025 (1), AC Power Cord (1), 5m USB Cable (1), Operating Instructions (CD-ROM) (1), Quick Reference Manual (1), Application Software (CD-ROM) (1), Warranty card (1), Safety Regulations/QRM (1), Security Label (1)
Wireless module (WLAN)	IFU-WLM3 (optional)		
Interactive Pens	-	-	IFU-PN250A (1), IFU-PN250B (1)
Replacement lamp	LMP-E220		

*1 This value is average.

*2 The figures are the expected maintenance time and not guaranteed. They will depend on the environment or how the projector is used.

*3 The figures are approximate. They vary depending on the environment or how the projector is.

For full product specifications and features please visit
pro.sony.eu/ultra-short-throw

C-Series

3 energy-efficient Installation models that offer best in class TCO. High image quality and high brightness in a stylish design that blend into any decor.



Higher resolution lens

- The high resolution Advanced Crisp Focus (ACF) lens offers a large diameter and fine pitch to ensure clear, sharp pictures.

Advanced Geometric Correction

- Perfect fit every time. Each image corner and side can be adjusted to any screen - invaluable when projecting from an offset position.

Auto Input Search

- Automatically switches to the correct input, simplifying set-up and saving time.

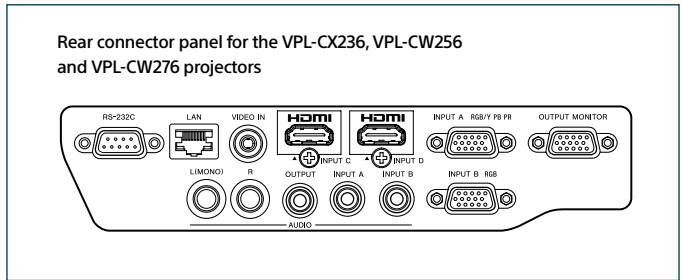

PrimeSupportPro

PrimeSupportElite



Our **PrimeSupportPro** and **PrimeSupportElite** packages go beyond standard levels of warranty with varying support options either at no extra cost or optional upgrade. **PrimeSupportPro** gives you free initial access to expert technical assistance from our multilingual helpdesk while optional **PrimeSupportElite** upgrades go further with our fast-track repair service and – depending on your product - a replacement loan unit[†]. Both packages include free shipping and no hidden costs so we'll always keep you up and running.

	PrimeSupportPro				PrimeSupportElite	
Service reference	Included Service PS.VPLB3.123.L3	PS.VPL.FCSERIES.2Y	PS.VPL.FCSERIES.3YL	PS.VPL.FCSERIES.5YL	PS.LMP.FCSERIES.2Y	
Scope of support	Projector	Lamp	Projector		Lamp	
Duration	3 years	1 years or 1000 h	+2 years (Total 5 years)	3 years repair & loan	+2 years repair extension & 5 years loan product (Total 3 years or 3000h)	

C-Series
Optional Accessories

LMP-C240
Replacement projector lamp (CX236/CW256)



LMP-C280
Replacement projector lamp (CW276)



PAM-210
Ceiling mount



PAM-0.5M
Extension pole & ceiling plate



PAM-1.0M
Extension pole & ceiling plate



PAM-1.5M
Extension pole & ceiling plate





BrightEra™
Long Lasting Optics



		VPL-CX236	VPL-CW256	VPL-CW276
Display system		3 LCD system		
Display device	Size of effective display area	0.63" (16 mm) x 3, BrightEra, Aspect ratio: 4:3	0.75" (19 mm) x 3 BrightEra LCD Panel, Aspect ratio: 16:10	
	Number of pixels	6,912,000 (1920 x 1200 x 3) pixels	3,072,000 (1280 x 800 x 3) pixels	
Projection lens	Focus	Manual		
	Zoom - Powered/Manual	Manual		
	Zoom - Ratio	Approx. x1.45		
	Throw Ratio	1.66:1 to 2.41:1	1.32:1 to 1.91:1	
Lens shift	Powered/Manual	Manual		
	Range Vertical	+/- 5%		
	Range Horizontal	+/- 4%		
Light source		Ultra high pressure mercury lamp, 245 W type		Ultra high pressure mercury lamp, 280 W type
Recommended lamp replacement time ^{*1}	Lamp mode: High	3,000 H		
	Lamp mode: Standard	4,000 H		
	Lamp mode: Low	5,000 H	-	
Filter cleaning / replacement cycle (Max.) ^{*1}		Same time as the lamp replacement is recommended		
Screen size		40" to 300" (1.02 m to 7.62 m) (measured diagonally)		
Light output	Lamp mode: High	4100 lm	4500 lm	5200 lm
	Lamp mode: Standard	3100 lm	3400 lm	4200 lm
	Lamp mode: Low	2200 lm	2500 lm	-
Colour light output	Lamp mode: High	4100 lm	4500 lm	5200 lm
	Lamp mode: Standard	3100 lm	3400 lm	4200 lm
	Lamp mode: Low	2200 lm	2500 lm	-
Contrast ratio (full white / full black) ^{*2}		3100:1	3700:1	3100:1
Speaker		10 W x 1 (monaural)		
Displayable scanning frequency	Horizontal	19 kHz to 92 kHz		
	Vertical	48 Hz to 92 Hz		
Display resolution	Computer signal input	Maximum display resolution: UXGA 1600 x 1200 dots ^{*3}		
	Video signal input	NTSC, PAL, SECAM, 480/60i, 576/50i, 480/60p, 576/50p, 720/60p, 720/50p, 1080/60i, 1080/50i		
Colour system		NTSC3.58, PAL, SECAM, NTSC4.43, PAL-M, PAL-N, PAL60		
Keystone correction (Max.)	Vertical	+/- 30°		
	Horizontal	+/- 20°		
OSD language		24-language (English, French, German, Italian, Spanish, Portuguese, Japanese, Simplified Chinese, Traditional Chinese, Korean, Russian, Dutch, Norwegian, Swedish, Thai, Arabic, Turkish, Polish, Vietnamese, Farsi, Indonesian, Finnish, Hungarian, Greek)		
INPUT OUTPUT (Computer/Video/Control)	INPUT A	RGB / Y PB PR input connector: Mini D-sub 15-pin (female), Audio input connector: Stereo mini jack		
	INPUT B	RGB input connector: Mini D-sub 15-pin (female), Audio input connector: Stereo mini jack		
	INPUT C	HDMI input connector: HDMI 19-pin, HDCP support		
	INPUT D	HDMI input connector: HDMI 19-pin, HDCP support		
	VIDEO IN	Video input connector: Pin jack, Audio input connector: Pin jack (x2)		
	OUTPUT	Monitor output connector ^{*4} : Mini D-sub 15-pin (female), Audio output connector ^{*5} : Stereo mini jack (variable out)		
	REMOTE	RD-sub 9pin (male)/RS232C		
LAN	RJ-45, 10BASE-T/100BASE-TX			
Acoustic noise		Lamp mode: Standard: 29 dB		Lamp mode: Standard: 34 dB
Operating temperature / Operating humidity		0°C to 40°C (32°F to 104°F) / 20% to 80% (no condensation)		
Storage temperature / Storage humidity		-10°C to +60°C (14°F to +140°F) / 20% to 80% (no condensation)		
Power requirements		AC 100 V to 240 V 3.5 A to 1.5 A, 50/60 Hz		AC 100 V to 240 V 4.0 A to 1.7 A, 50/60 Hz
Power consumption	AC 100 V to 120 V	Lamp mode: High : 350 W	Lamp mode: High : 346 W	Lamp mode: High : 395 W
	AC 220 V to 240 V	Lamp mode: High : 330 W	Lamp mode: High : 326 W	Lamp mode: High : 372 W
Power Consumption (Standby Mode)	AC 100 V to 120 V	0.5 W (when "Standby mode" is set to "Low")		
	AC 220 V to 240 V	0.5 W (when "Standby mode" is set to "Low")		
Power Consumption (Networked Standby Mode)	AC 100 V to 120 V	3.0 W (LAN) (when "Standby Mode" is set to "Standard")		
	AC 220 V to 240 V	3.0 W (LAN) (when "Standby Mode" is set to "Standard")		
Standby Mode / Networked Standby Mode Activated		After about 10 Minutes		
Heat dissipation	AC 100 V to 120 V	1194 BTU/h	1180 BTU/h	1348 BTU/h
	AC 220 V to 240 V	1126 BTU/h	1112 BTU/h	1269 BTU/h
Dimensions (W x H x D) (without protrusions)		Approx. 406 x 113 x 330.5 mm (15 31/32 x 4 7/16 x 13 inches)		
Mass		Approx. 5.6 kg (12 lb)		Approx. 5.7 kg (13 lb)
Supplied accessories		Remote commander (RM-PJ8)		
Optional Accessories		Replacement lamp (LMP-C240)		Replacement lamp (LMP-C280)

^{*1} This figure is expected maintenance time, not guaranteed time. The actual value depends on the environment and how the projector is used. | ^{*2} The value is average. | ^{*3} Available for VESA Reduced Blanking signal. | ^{*4} From INPUT A and INPUT B. | ^{*5} Works as an audio switcher function. Output from a selected channel; not available in standby.

For full product specifications and features please visit
pro.sony.eu/installation

CH-Series

4 Installation models that raise the bar with higher resolution images and the same energy efficiency, TCO, image quality, brightness and stylish design that comes with our other C-Series range.



HDBaseT

- Allows simple connectivity using an HDBaseT digital interface, multi signal transmission system, providing a single cable, cost-effective, long-distance, and high-quality digital transmission solution*.

Audio / Speaker bypass

- When set to "Always On," the speaker / microphone is available via Audio Input A.

WUXGA resolution installation projectors

- 4000 – 5000 lumens brightness

* VPL-CH355 and VPL-CH375 only

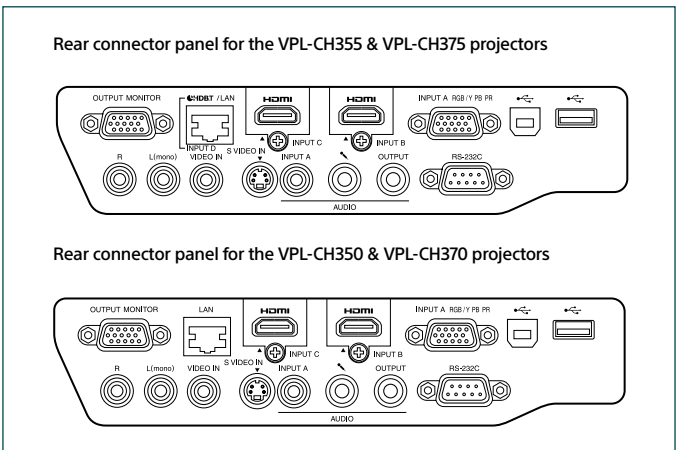

PrimeSupportPro PrimeSupportElite



Our **PrimeSupportPro** and **PrimeSupportElite** packages go beyond standard levels of warranty with varying support options either at no extra cost or optional upgrade. **PrimeSupportPro** gives you free initial access to expert technical assistance from our multilingual helpdesk while optional **PrimeSupportElite** upgrades go further with our fast-track repair service and – depending on your product - a replacement loan unit†. Both packages include free shipping and no hidden costs so we'll always keep you up and running.

	PrimeSupportPro			PrimeSupportElite	
Service reference	Included Service PS.VPLB3.123.L3	PS.VPL.FCSERIES.2Y	PS.VPL.FCSERIES.3YL	PS.VPL.FCSERIES.5YL	PS.LMP.FCSERIES.2Y
Scope of support	Projector	Lamp	Projector		Lamp
Duration	3 years	1 years or 1000 h	+2 years (Total 5 years)	3 years repair & loan	+2 years repair extension & 5 years loan product (Total 3 years or 3000h)

CH-Series Optional Accessories

<p>LMP-C250 Replacement projector lamp (CH350/CH355)</p> 	<p>LMP-C281 Replacement projector lamp (CH370/CH375)</p> 	<p>IFU-WLM3 USB wireless module</p> 	<p>PAM-210 Ceiling mount</p> 	<p>PAM-0.5M Extension pole & ceiling plate</p> 	<p>PAM-1.0M Extension pole & ceiling plate</p> 	<p>PAM-1.5M Extension pole & ceiling plate</p> 	<p>Oi/Android APP Connect your devices to projectors via a WiFi network with the VueMagic™ app*</p> 
---	---	--	---	---	---	---	--

*Available to download until end of December 2017



		VPL-CH350	VPL-CH355	VPL-CH370	VPL-CH375
Display system		3 LCD system			
Display device	Size of effective display area	0.64" (16.3 mm) × 3, Aspect ratio: 16:10			
	Number of pixels	6,912,000 (1920 × 1200 × 3) pixels			
	Aspect ratio	16: 10			
Projection lens	Zoom	Manual (Ratio: Approx. x 1.45)			
	Focus	Manual			
	Lens Shift	Manual (Vertical: +/- 5%, Horizontal: +/- 4%)			
	Throw Ratio	1.5:1 to 2.2:1			
Light source		Ultra high pressure mercury lamp 250 W type		Ultra high pressure mercury lamp 280 W type	
Recommended lamp replacement time		3,000 H / 4,000 H / 5,000 H (Lamp mode: High / Standard / Low) Synchronized filter with lamp replacement		2,500 H / 3,000 H / 3,500 H (Lamp mode: High / Standard / Low) Synchronized filter with lamp replacement	
Screen size		40" to 300" (1.02 m to 7.62 m) (measured diagonally)			
Light output (Mode: High / Standard / Low)		4000 lm / 3200 lm / 2600 lm		5000 lm / 3600 lm / 3100 lm	
Color light output (Mode: High / Standard / Low)		4000 lm / 3200 lm / 2600 lm		5000 lm / 3600 lm / 3100 lm	
Contrast ratio (full white / full black)		2500: 1			
Acoustic noise (Lamp mode: High / Standard / Low)		36dB / 33dB / 29dB		38dB / 35dB / 29dB	
	Displayable scanning frequency	Horizontal: 19 kHz - 92 kHz Vertical: 48 Hz - 92 Hz			
Display resolution	Computer signal input	Maximum display resolution: 1920 × 1200 dots ^{*1} / Panel display resolution: 1920 × 1200 dots			
	Video signal input	480/60i, 576/50i, 480/60p, 576/50p, 720/60p, 720/50p, 1080/60i, 1080/50i, 1080/60p, 1080/50p, 1080/24p			
Colour system		NTSC3.58, PAL, SECAM, NTSC4.43, PAL-M, PAL-N			
Keystone correction		Vertical: Max. +/- 30 degrees, Horizontal: Max. +/- 20 degrees			
OSD language		24-language (English, French, German, Italian, Spanish, Portuguese, Japanese, Simplified Chinese, Traditional Chinese, Korean, Russian, Dutch, Norwegian, Swedish, Thai, Arabic, Turkish, Polish, Vietnamese, Farsi, Indonesian, Finnish, Hungarian, Greek)			
INPUT OUTPUT (Computer/Video/Control)	INPUT A	RGB / YPbPr input connector: Mini D-sub 15 pin female, Audio input connector: Stereo mini jack			
	INPUT B / INPUT C	HDMI input connector: HDMI 19-pin, HDCP support			
	S VIDEO IN	S-video input connector: Mini DIN 4-pin			
	VIDEO IN	Video input connector: Phono jack			
	OUTPUT	Monitor output connector ² : Mini D-sub 15-pin (female), Audio output connector ² : Stereo mini jack			
	REMOTE	D-sub 9-pin (male)			
	LAN	RJ45, 100BASE-TX	RJ45, 100BASE-TX (Shared with HDBaseT)	RJ45, 100BASE-TX	RJ45, 100BASE-TX (Shared with HDBaseT)
	HDBaseT	-	RJ45, 4 Play	-	RJ45, 4 Play
	USB	Type-A, Type-B			
MICROPHONE IN	Mini jack				
Speaker		12W × 1 (monaural)			
Operating temperature (Operating humidity)		0°C to 40°C / 32°F to 104°F (20% to 80%; no condensation)			
Storage temperature (Storage humidity)		-10°C to +60°C / -14°F to +140°F (20% to 80%; no condensation)			
Power requirements		AC 100 V to 240 V, 3.6 A to 1.6 A, 50/60 Hz		AC 100 V to 240 V, 3.9 A to 1.7 A, 50/60 Hz	
Power consumption (Lamp mode: High / Standard / Low)	AC 100 V to 120 V	353W / 285W / 265W		388W / 315W / 279W	
	AC 220 V to 240 V	334W / 272W / 254W		367W / 299W / 266W	
Standby mode power consumption (Standby mode: Standard / Low)	AC 100 V to 120 V	4.7W / 0.5W	6.1W / 0.5W	4.7 / 0.3W	6.1W / 0.3W
	AC 220 V to 240 V	4.9W / 0.5W	6.2W / 0.5W	4.9 / 0.5W	6.2W / 0.5W
Heat dissipation	AC 100 V to 120 V	1204 BTU		1323 BTU	
	AC 220 V to 240 V	1139 BTU		1252 BTU	
Outside dimensions (W × H × D)		Approx. 406 × 113 × D 330.5 mm (15 31/32 × 4 7/16 × 13 in) (without protrusions)			
Mass		Approx. 5.7 kg / 12 lb			
Supplied accessories		RM-PJ8 Remote Commander (1), Lithium battery: CR2025 (1), AC Power Cord (1), Lens cap (1), Quick Reference Manual (1), Operating Instructions (CD-ROM) (1), Presentation Station for Network Presentation application (CDROM) (1)			

*1 Available for VESA Reduced Blanking signal. | *2 From INPUT A.

For full product specifications and features please visit
pro.sony.eu/installation

P-Series Laser projectors

Compact, versatile laser projectors with excellent picture quality and easy maintenance: the bright choice for education and corporate environments.



Spectacular image quality

- Powerful Z-Phosphor laser light source and advanced BrightEra 3LCD projection engine deliver detail-packed images with high 5000 lumens brightness.

Long life, less maintenance

- Reliable, long-lasting laser light source offers up to 20,000 hours virtually maintenance-free operation without lamp exchange.
- New filter cleaning system cuts routine maintenance.

Flexible installation

- Position the projector freely at any angle, on its side or even upside down.
- HDBaseT reduces cabling for simpler integration.

Discreet partner for any presentation space

- Stylish blend-in design with tidy cable management and low fan noise.

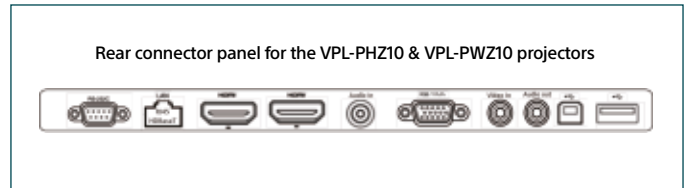

PrimeSupportPro

PrimeSupportElite



Our **PrimeSupportPro** and **PrimeSupportElite** packages go beyond standard levels of warranty with varying support options either at no extra cost or optional upgrade. **PrimeSupportPro** gives you free initial access to expert technical assistance from our multilingual helpdesk while optional **PrimeSupportElite** upgrades go further with our fast-track repair service and – depending on your product - a replacement loan unit*. Both packages include free shipping and no hidden costs so we'll always keep you up and running.

	PrimeSupportPro		PrimeSupportElite					
Service reference	Included Service PS.LASERPROJ.5		PSP.LPROJHVY.5		PSP.LPROJ.5YL		PSP.LPROJHVY.5YL	
Scope of support	Projector	Laser	Projector	Laser	Projector	Laser	Projector	Laser
Duration	5 years	12000 hours	5 years	20000 hours	5 years	12,000 hours with loan unit	5 years	20,000 hours with loan unit

P-Series
Optional Accessories

- PAM-210
Ceiling mount
- PAM-0.5M
Extension pole & ceiling plate
- PAM-1.0M
Extension pole & ceiling plate
- PAM-1.5M
Extension pole & ceiling plate





		VPL-PHZ10	VPL-PWZ10
Display system		3 LCD system	
Display device	Size of effective display area	0.76" (19.3 mm) x 3 BrightEra LCD Panel	
	Number of pixels	WUXGA: 6,912,000 (1920 x 1200 x 3) pixels	WXGA: 3,072,000 (1280 x 800 x 3) pixels
	Aspect ratio	16: 10	
Projection lens	Zoom	Manual (Ratio: Approx. x 1.45)	
	Focus	Manual	
	Lens Shift	Manual (Vertical: +20%~+55%, Horizontal: +/- 10%)	
	Throw Ratio	1.27:1 to 1.89:1	
Light source		Laser diode	
Filter cleaning / replacement cycle (Max.)		20,000 H (service maintenance)	
Light output (Mode: High / Standard)		5,000 lm / 4,000 lm	
Colour light output (Mode: High / Standard)		5,000 lm / 4,000 lm	
Contrast ratio (full white / full black)		Over 500,000:1 (TBD)	
Acoustic noise (Light output mode: High / Standard)		36 dB (TBD) / 28 dB (TBD)	
INPUT OUTPUT (Computer/Video/ Control)	INPUT A	RGB / Y PB PR input connector: Mini D-sub 15 pin (female) Audio input connector: Stereo mini jack	
	INPUT B	HDMI input connector: HDMI 19-pin, HDCP support Audio input connector: HDMI audio support	
	INPUT C	HDMI input connector: HDMI 19-pin, HDCP support Audio input connector: HDMI audio support	
	INPUT D	HDBaseT interface connector: RJ45, 4 play (Video, Audio, LAN, Control)	
	VIDEO IN	Video input connector: BNC Audio input connector: Shared with INPUT A	
	OUTPUT	Audio output connector: Stereo mini jack	
	REMOTE	D-sub 9-pin (male) / RS232C	
	LAN	RJ45, 100BASE-TX (Shared with INPUT D)	
	USB	TYPE-A	
	USB	TYPE-B	
Power consumption (Lamp mode: High / Standard / Low)	AC 100 V to 120 V	Mode: High: 415 W (TBD)	
	AC 220 V to 240 V	Mode: High: (TBD)	
Dimensions (W x H x D) (without protrusions)		510 x 113 x 354.6 mm (TBD)	
Mass		Approx. 10 kg (TBD)	
Supplied accessories		Remote commander RM-PJ8	

Preliminary information as of February 2017. Subject to change.

FX-Series

XGA resolution replacement models for upgrading your AV projection. For venues requiring brighter projections, the FX-Series delivers powerful performance, optional lenses, multi input / output, longer life and low maintenance.



Model: VPL-FX30/35

Quad Filter System

- To extend the cleaning cycle and efficiently trap dust.

One-way airflow intake

- The one-way intake hole keeps all the internal parts clean.

Award winning Blend-in Design

- Combining the best of style and functionality, the FX-Series design is clean and understated, and gives the impression that the projector is blended into the ceiling. The connector panel is placed on the lower front face to hide the connectors and cables from the audience's sight.

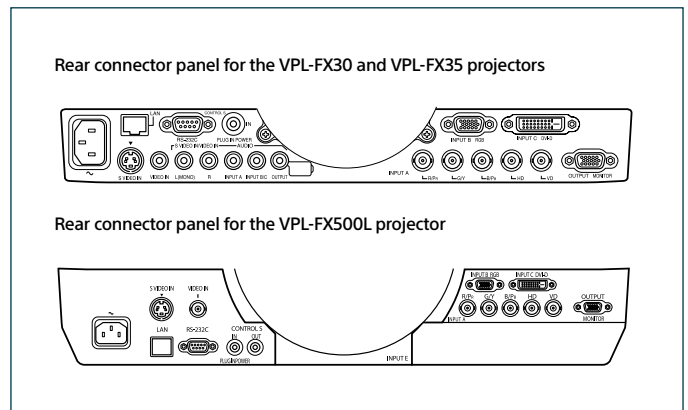

PrimeSupportPro PrimeSupportElite



Our **PrimeSupportPro** and **PrimeSupportElite** packages go beyond standard levels of warranty with varying support options either at no extra cost or optional upgrade. **PrimeSupportPro** gives you free initial access to expert technical assistance from our multilingual helpdesk while optional **PrimeSupportElite** upgrades go further with our fast-track repair service and – depending on your product - a replacement loan unit[†]. Both packages include free shipping and no hidden costs so we'll always keep you up and running.

	PrimeSupportPro		PrimeSupportElite			
Service reference	Included Service PS.VPLB3.123.L3		PS.VPL.FCSERIES.2Y	PS.VPL.FCSERIES.3YL	PS.VPL.FCSERIES.5YL	PS.LMP.FCSERIES.2Y
Scope of support	Projector	Lamp	Projector			Lamp
Duration	3 years	1 years or 1000 h	+2 years (Total 5 years)	3 years repair & loan	+2 years repair extension & 5 years loan product	+ 2 years or 2000 h (Total 3 years or 3000h)

FX-Series

Optional Accessories

LMP-F330
Replacement projector lamp (FX500L)



PAM-310
Ceiling mount



PSS-650
Projector Ceiling Bracket (FX30/FX35)



PSS-650P
Projector Ceiling Bracket (FX30/FX35)



PAM-0.5M
Extension pole & ceiling plate



PAM-1.0M
Extension pole & ceiling plate



PAM-1.5M
Extension pole & ceiling plate





BrightEra™
Long Lasting Optics



		VPL-FX30	VPL-FX35	VPL-FX500L
Display system		3 LCD system		
Display device	Size of effective display area	0.79 inches (20.1 mm) x 3 BrightEra LCD Panel, Aspect ratio: 4:3		0.99" (25.0 mm) x 3 BrightEra LCD Panel, Aspect ratio: 4:3
	Number of pixels	2,359,296 (1024 x 768 x 3) pixels		
Projection lens*1	Focus	Manual		Powered / Manual (Depending on lens)
	Zoom - Powered / Manual	Manual		Powered / Manual (Depending on lens)
	Zoom - Ratio	Approx. x 1.6		
	Throw Ratio	1.42:1 to 2.27:1		
Lens shift	Powered/Manual	Manual		Powered / Manual (Depending on lens)
	Range Vertical	+ 51%		-
	Range Horizontal	+/- 33%		-
Light source	Type/Wattage	Ultra high pressure mercury lamp / 230 W type	Ultra high pressure mercury lamp / 275 W type	Ultra high pressure mercury lamp / 330 W type
	System	-		
Recommended lamp replacement time*1	Lamp mode: High	4,000 H	3,000 H	6,000 H (With twin lamp sequence use)
	Lamp mode: Standard	5,000 H	4,000 H	8,000 H (With twin lamp sequence use)
Filter cleaning / replacement cycle (Max.)*2		15000 H (Cleaning) Same as the lamp replacement is recommended		
Screen size*1		40" to 600" (1.02 m to 15.24 m) (measured diagonally)		
Light output	Lamp mode: High	4200 lm	5000 lm	7000 lm
	Lamp mode: Standard	3000 lm	4000 lm	5600 lm
Colour light output	Lamp mode: High	4200 lm	5000 lm	7000 lm
	Lamp mode: Standard	3000 lm	4000 lm	5600 lm
Contrast ratio (full white / full black)*3		2000:1		
Displayable scanning frequency	Horizontal	14 kHz to 93 kHz		
	Vertical	47 Hz to 93 Hz		
Display resolution	Computer signal input	Maximum display resolution: 1920 x 1200 dots *4		Maximum display resolution: UXGA 1600 x 1200 dots*4
	Video signal input	NTSC, PAL, SECAM, 480/60i, 576/50i, 480/60p, 576/50p, 720/60p, 720/50p, 1080/60i, 1080/50i, 1080/60p, 1080/50p		
Colour system		NTSC3.58, PAL, SECAM, NTSC4.43, PAL-M, PAL-N, PAL60		
Keystone correction (Max.)	Vertical	+/- 30 degrees		
OSD language		20-languages (English, Dutch, French, Italian, German, Spanish, Portuguese, Turkish, Polish, Russian, Swedish, Norwegian, Japanese, Simplified Chinese, Traditional Chinese, Korean, Thai, Vietnamese, Arabic, Farsi)		
INPUT OUTPUT (Computer / Video / Control)	INPUT A	RGB / YPbPr input connector: 5BNC (female), Audio input connector: Stereo mini jack		RGB / Y PB PR input connector: 5BNC (female)
	INPUT B	RGB input connector: Mini D-sub 15-pin (female), Audio input connector: Stereo mini jack (shared with INPUT C)		RGB input connector: Mini D-sub 15-pin (female)
	INPUT C	DVI-D input connector: DVI-D 24-pin (Single link), HDCP support, Audio input connector: Stereo mini jack (shared with INPUT B)		DVI-D input connector: DVI-D 24-pin (Single link), supported HDCP
	S VIDEO IN	S video input connector: Mini DIN 4-pin, Audio input connector: Pin jack (x2) (shared with VIDEO IN)		S-video input connector: Mini DIN 4-pin
	VIDEO IN	Video input connector: Pin jack, Audio input connector: Pin jack (x2) (shared with S VIDEO IN)		Video input connector: BNC
	OUTPUT	Monitor output connector*5: Mini D-sub 15-pin (female), Audio output connector*6: Stereo mini jack (variable out)		Monitor output connector*5: Mini D-sub 15-pin (female)
	REMOTE	RS-232C connector: D-sub 9-pin (female)		
	LAN	RJ-45, 10BASE-T/100BASE-TX		
Acoustic noise	Lamp mode: Standard	29 dB	31 dB	
	Operating temperature / Operating humidity			
Operating temperature / Operating humidity		0°C to 40°C (32°F to 104°F) / 35% to 85% (no condensation)		
Storage temperature / Storage humidity		-20°C to +60°C (-4°F to +140°F) / 10% to 90% (no condensation)		
Power requirements		AC 100 V to 240 V, 3.3 A to 1.3 A, 50/60 Hz	AC 100 V to 240 V, 3.8 A to 1.6 A, 50/60 Hz	AC 100 V to 240 V, 4.8 A to 2.0 A, 50 Hz / 60 Hz
Power consumption	AC 100 V to 120 V	Lamp mode: High : 330 W	Lamp mode: High : 380 W	Lamp mode: High: 480 W
	AC 220 V to 240 V	Lamp mode: High : 310 W	Lamp mode: High : 360 W	Lamp mode: High: 460 W
Power Consumption (Standby Mode)	AC 100 V to 120 V	0.2 W (when "Standby mode" is set to "Low")		0.1 W (when "Standby mode" is set to "Low")
	AC 220 V to 240 V	0.3 W (when "Standby mode" is set to "Low")		0.2 W (when "Standby mode" is set to "Low")
Power Consumption (Networked Standby Mode)	AC 100 V to 120 V	11.0 W (LAN) (when "Standby Mode" is set to "Standard")		13.0 W (LAN) (when "Standby Mode" is set to "Standard")
	AC 220 V to 240 V	12.0 W (LAN) (when "Standby Mode" is set to "Standard")		
Standby Mode / Networked Standby Mode Activated		After about 10 Minutes		
Heat dissipation	AC 100 V to 120 V	1126 BTU/h	1297 BTU/h	1638 BTU/h
	AC 220 V to 240 V	1058 BTU/h	1228 BTU/h	1569 BTU/h
Dimensions (W x H x D) (without protrusions)		Approx. 390 x 134 x 463 mm (15 11/32 x 5 9/32 x 18 7/32 inches)		Approx. 530 x 204 x 545 mm (20 7/8 x 8 1/32 x 21 15/32 inches)
Mass		Approx. 7.9 kg (17 lb)	Approx. 8.0 kg (17 lb)	Approx. 20 kg (44 lb)
Supplied accessories		Remote commander (RM-PJ19)		

*1 With supplied standard lens. | *2 This figure is expected maintenance time, not guaranteed time. The actual value depends on the environment and how the projector is used. | *3 The value is average. | *4 Available for VESA Reduced Blanking signal. | *5 From INPUT A and INPUT B. | *6 Works as an audio switcher function. Output from a selected channel; not available in standby.

For full product specifications and features please visit
pro.sony.eu/installation

F-Series Lamp projectors

WUXGA and WXGA resolution for the most demanding venues that require the highest resolutions, brightest projections and highly sophisticated features. The F-Series delivers powerful performance, optional lenses, longer life and low maintenance.



Model: VPL-FH60/65

Edge-Blend and Warp capabilities

- Built-in GUI and PC software for multi projector image blending with warping.

Reality creation

- Clarity in every pixel. Sony's process technology and proprietary algorithm creates pixel mapping that is as close to the original you can get. (VPL-FW60/65 and VPL-FH60/56 projectors)

DICOM capabilities

- Display X-ray and MRI images that conform to GSDF (Grayscale Standard Display Function).

Side by Side content

- Displays two different images / content from two different input sources.

Twin Lamp System

- Two lamps, redundancy for a fail safe system. The VPL-FH500L will never be down due to lamp failure.

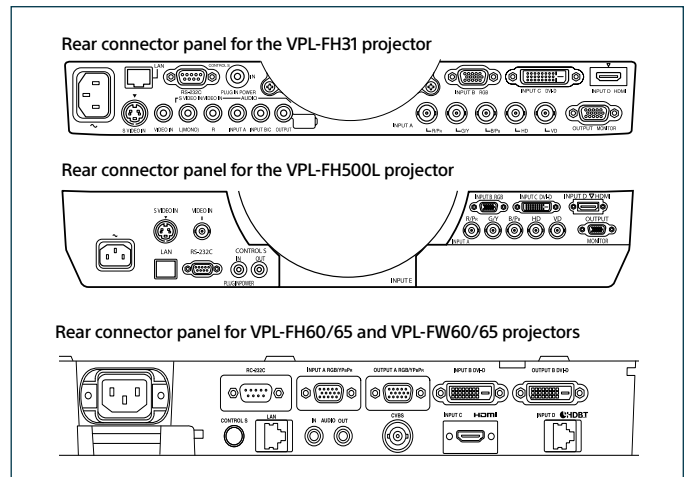



Our **PrimeSupportPro** and **PrimeSupportElite** packages go beyond standard levels of warranty with varying support options either at no extra cost or optional upgrade. **PrimeSupportPro** gives you free initial access to expert technical assistance from our multilingual helpdesk while optional **PrimeSupportElite** upgrades go further with our fast-track repair service and – depending on your product - a replacement loan unit*. Both packages include free shipping and no hidden costs so we'll always keep you up and running.

	PrimeSupportPro		PrimeSupportElite			
Service reference	Included Service PS.VPLB3.123.L3		PS.VPL.FCSERIES.2Y	PS.VPL.FCSERIES.3YL	PS.VPL.FCSERIES.5YL	PS.LMP.FCSERIES.2Y
Scope of support	Projector	Lamp	Projector			Lamp
Duration	3 years	1 years or 1000 h	+2 years (Total 5 years)	3 years repair & loan	+2 years repair extension & 5 years loan product	+ 2 years or 2000 h (Total 3 years or 3000h)

For full product specifications and features please visit pro.sony.eu/installation



		VPL-FW60	VPL-FW65	VPL-FH31
Display system		3 LCD system		
Display device	Size of effective display area	0.76" (19 mm) x 3 BrightEra LCD Panel, Aspect ratio: 16:10		0.76"(19.3 mm) x 3 BrightEra LCD Panel, Aspect ratio: 16:10
	Number of pixels	3,072,000 (1280 x 800 x 3) pixels		6,912,000 (1920 x 1200 x 3) pixels
Projection lens*1	Focus	Powered		Manual
	Zoom - Powered/Manual	Powered (Approx. 1.6 x)		Manual
	Zoom - Ratio	-		Approx. x 1.6
	Throw Ratio	1.39:1 to 2.23:1		1.39:1 to 2.23:1
Lens shift	Powered/Manual	Powered		Manual
	Range Vertical	-5.0%, +60%		+60%
	Range Horizontal	+/- 32%		
Light source	Type/Wattage	Ultra high pressure mercury lamp		Ultra high pressure mercury lamp / 330 W type
	System	280 W type	370 W type	330 W type
Recommended lamp replacement time*2	Lamp mode: High	3,000 H		
	Lamp mode: Standard	4,000 H		
Filter cleaning / replacement cycle (Max.)*2		20000 H (service maintenance)		15000 H (Cleaning) Same as the lamp replacement is recommended
Screen size*1		40" to 600" (1.02 m to 15.24 m) (measured diagonally)		
Light output	Lamp mode: High	5200 lm	6300 lm	4300 lm
	Lamp mode: Standard	3400 lm	4780 lm	3400 lm
Colour light output	Lamp mode: High	5200 lm	6300 lm	4300 lm
	Lamp mode: Standard	3400 lm	4780 lm	3400 lm
Contrast ratio (full white / full black)*3		2000:1		
Displayable scanning frequency	Horizontal	15 kHz to 92 kHz		14 kHz to 93 kHz
	Vertical	48 Hz to 92 Hz		47 Hz to 93 Hz
Display resolution	Computer signal input	Maximum display resolution: 1920 x 1200 dots **4		Maximum display resolution: 1920 x 1200 dots **4
	Video signal input	NTSC, PAL, SECAM, 480/60i, 576/50i, 480/60p, 576/50p, 720/60p, 720/50p, 1080/60i, 1080/50i The following items are available for digital signal (HDMI input) only; 1080/60P, 1080/50p, 1080/24p		NTSC, PAL, SECAM, 480/60i, 576/50i, 480/60p, 576/50p, 720/60p, 720/50p, 1080/60i, 1080/50i, 1080/60p, 1080/50p, 1080/24p
Colour system		NTSC3.58, PAL, SECAM, NTSC4.43, PAL-M, PAL-N, PAL60		
Keystone correction (Max.)	Vertical	+/- 30 degrees		
	Horizontal	+/- 30 degrees		
OSD language		24-language (English, Dutch, French, Italian, German, Spanish, Portuguese, Turkish, Polish, Russian, Swedish, Norwegian, Japanese, Simplified Chinese, Traditional Chinese, Korean, Thai, Vietnamese, Arabic, Farsi, Finnish, Indonesian, Hungarian, Greek)		23-languages (English, Dutch, French, Italian, German, Spanish, Portuguese, Turkish, Polish, Russian, Swedish, Norwegian, Japanese, Simplified Chinese, Traditional Chinese, Korean, Thai, Vietnamese, Arabic, Farsi, Indonesian, Finnish, Hungarian)
INPUT OUTPUT (Computer / Video / Control)	INPUT A	RGB / Y PB PR input connector: Mini D-sub 15-pin (female) Audio input connector: Stereo mini jack		RGB / Y PB PR input connector: 5BNC (female), Audio input connector: Stereo mini jack
	INPUT B	DVI input connector: DVI-D 24-pin (single link), HDCP support Audio input connector: Shared with INPUT A		RGB input connector: Mini D-sub 15-pin (female), Audio input connector: Stereo mini jack (shared with INPUT C)
	INPUT C	HDMI input connector: HDMI 19-pin, HDCP support Audio input connector: HDMI audio support		DVI-D input connector: DVI-D 24-pin (Single link), HDCP support, Audio input connector: Stereo mini jack (shared with INPUT B)
	INPUT D	HDBaseT interface connector: RJ45, 4 play (Video, Audio, LAN, Control)		HDMI input connector: HDMI 19-pin, HDCP support
	S VIDEO IN	-		S video input connector: Mini DIN 4-pin, Audio input connector: Pin jack (x2) (shared with VIDEO IN)
	VIDEO IN	Video input connector: BNC Audio input connector: Shared with INPUT A		Video input connector: Pin jack, Audio input connector: Pin jack (x2) (shared with S VIDEO IN)
	OUTPUT A	Monitor output for INPUT A connector: Mini D-sub 15-pin (female) Audio output connector: Stereo mini jack		Monitor output connector*5: Mini D-sub 15-pin (female), Audio output connector*6: Stereo mini jack (variable out)
	OUTPUT B	Monitor output for INPUT B connector: DVD-D 24-pin (single link), HDCP not supported Audio output Monitor out connector: Stereo mini jack		-
	REMOTE	D-sub 9-pin (male) / RS232C		RS-232C connector: D-sub 9-pin (female)
	LAN	RJ45, 10BASE-T/100BASE-TX		RJ-45, 10BASE-T/100BASE-TX
IR (Control S)	Stereo mini jack, Plug in power DC5V		Control S input connector: Stereo mini jack	
Acoustic noise (Lamp mode: Standard)		28 dB		
Operating temperature / Operating humidity		0°C to 40°C (32°F to 104°F) / 20% to 80% (no condensation)		30 dB 0°C to 40°C (32°F to 104°F) / 35% to 85% (no condensation)
Storage temperature / Storage humidity		-10°C to +60°C (14°F to +140°F) / 20% to 80% (no condensation)		-20°C to +60°C (-4°F to +140°F) / 10% to 90% (no condensation)
Power requirements		AC 100 V to 240 V, 4.3 A to 1.8 A, 50 Hz / 60 Hz	AC 100 V to 240 V, 5.0 A to 2.1 A, 50 Hz / 60 Hz	AC 100 V to 240 V, 4.0 A to 1.6 A, 50/60 Hz
Power consumption (Lamp mode: High)	AC 100 V to 120 V	Lamp mode: High: 416 W	Lamp mode: High: 470 W	Lamp mode: High : 400 W
	AC 220 V to 240 V	Lamp mode: High: 404 W	Lamp mode: High: 455 W	Lamp mode: High : 380 W
Power Consumption (Standby Mode)	AC 100 V to 120 V	0.5 W (when "Standby mode" is set to "Low")		0.2 W (when "Standby mode" is set to "Low")
	AC 220 V to 240 V	0.5 W (when "Standby mode" is set to "Low")		0.3 W (when "Standby mode" is set to "Low")
Power Consumption (Networked Standby Mode)	AC 100 V to 120 V	15.0 W (All Terminals and Networks Connected) (when "Standby Mode" is set to "Standard")		9.2 W (LAN) (when "Standby Mode" is set to "Standard")
	AC 220 V to 240 V	13.3 W (All Terminals and Networks Connected) (when "Standby Mode" is set to "Standard")		10.4 W (LAN) (when "Standby Mode" is set to "Standard")
Standby Mode / Networked Standby Mode Activated		Approx. 10 Minutes		
Heat dissipation	AC 100 V to 120 V	1419 BTU/h		1365 BTU/h
	AC 220 V to 240 V	1378 BTU/h		1297 BTU/h
Dimensions (W x H x D) (without protrusions)		460 x 169 x 515 mm 18 1/8 x 6 21/32 x 20 9/32 inches	460 x 169 x 515 mm 18 1/8 x 6 21/32 x 20 9/32 inches	Approx. 390 x 134 x 463 mm (15 11/32 x 5 9/32 x 18 7/32 inches)
Mass		Approx. 13 kg (28 lb)		Approx. 8.3 kg (18 lb)
Supplied accessories		RM-PJ27		
Optional accessories		VPLL-3003 / 3007 / Z3009/ Z3024 / Z3032		

For full product specifications and features please visit pro.sony.eu/installation



		VPL-FH60	VPL-FH65	VPL-FH500L
Display system		3 LCD system		
Display device	Size of effective display area	0.76"(19 mm) x 3 BrightEra LCD Panel, Aspect ratio: 16:10		0.95" (24.1 mm) x 3 BrightEra LCD Panel, Aspect ratio: 16:10
	Number of pixels	6,912,000 (1920 x 1200 x 3) pixels		
Projection lens*1	Focus	Powered		Powered / Manual (Depending on lens)
	Zoom - Powered/Manual	Powered		Powered / Manual (Depending on lens)
	Zoom - Ratio	Powered (Approx. 1.6 x)		-
	Throw Ratio	1.39:1 to 2.23:1		-
Lens shift	Powered/Manual	Powered		Powered / Manual (Depending on lens)
	Range Vertical	-5%, +60%		-
	Range Horizontal	+/- 32%		-
Light source	Type/Wattage	High pressure mercury lamp / 280 W type	High pressure mercury lamp / 370 W type	Ultra high pressure mercury lamp / 330 W type
	System	-		Twin lamp system
Recommended lamp replacement time**	Lamp mode: High	3,000 H		6,000 H (With twin lamp sequence use)
	Lamp mode: Standard	4,000 H		8,000 H (With twin lamp sequence use)
Filter cleaning / replacement cycle (Max.)**		20,000 H (service maintenance)		Same as the lamp replacement
Screen size*1		40" to 600" (1.02 m to 15.24 m) (measured diagonally)		
Light output	Lamp mode: High	5000 lm	6000 lm	7000 lm
	Lamp mode: Standard	3200 lm	4400 lm	5600 lm
Colour light output	Lamp mode: High	5000 lm	6000 lm	7000 lm
	Lamp mode: Standard	3200 lm	4400 lm	5600 lm
Contrast ratio (full white / full black)**		2000:1		
Displayable scanning frequency	Horizontal	15 kHz to 92 kHz		14 kHz to 93 kHz
	Vertical	48 kHz to 92 kHz		47 Hz to 93 Hz
Display resolution	Computer signal input	Maximum display resolution: 1920 x 1200 dots **		Maximum display resolution: UXGA 1600 x 1200 dots**
	Video signal input	NTSC, PAL, SECAM, 480/60i, 576/50i, 480/60p, 576/50p, 720/60p, 720/50p, 1080/60i, 1080/50i The following items are available for digital signal only; 1080/60p, 1080/50p, 1080/24p		NTSC, PAL, SECAM, 480/60i, 576/50i, 480/60p, 576/50p, 720/60p, 720/50p, 1080/60i, 1080/50i, 1080/60p, 1080/50p, 1080/24p, 1080/30p**
Colour system		NTSC3.58, PAL, SECAM, NTSC4.43, PAL-M, PAL-N, PAL60		
Keystone correction (Max.)	Vertical	+/- 30 degrees		+/- 5 degrees
	Horizontal	+/- 30 degrees		-
OSD language		24-languages (English, Dutch, French, Italian, German, Spanish, Portuguese, Turkish, Polish, Russian, Swedish, Norwegian, Japanese, Simplified Chinese, Traditional Chinese, Korean, Thai, Vietnamese, Arabic, Farsi, Finnish, Indonesian, Hungarian, Greek)		20-languages (English, Dutch, French, Italian, German, Spanish, Portuguese, Turkish, Polish, Russian, Swedish, Norwegian, Japanese, Simplified Chinese, Traditional Chinese, Korean, Thai, Vietnamese, Arabic, Persian)
INPUT OUTPUT (Computer / Video / Control)	INPUT A	RGB / Y PB PR input connector: Mini D-sub 15-pin (female), Audio input connector: Stereo mini jack		RGB / Y PB PR input connector: 5BNC (female)
	INPUT B	DVI input connector: DVI-D 24-pin (single link), HDCP support, Audio input connector: Shared with Input A		RGB input connector: Mini D-sub 15-pin (female)
	INPUT C	HDMI input connector: HDMI 19-pin, HDCP support, Audio input connector: HDMI Audio Support		DVI-D input connector: DVI-D 24-pin (Single link), supported HDCP
	INPUT D	HDBaseT interface connector: RJ45, 4 play (Video, Audio, LAN, Control)		HDMI input connector: HDMI 19-pin, HDCP support
	S VIDEO IN	Video input connector: BNC, Audio input connector: Shared with input A		S-video input connector: Mini DIN 4-pin
	VIDEO IN	Monitor output for Input A Connector: Mini D-sub 15-pin (female) Audio output connector: Stereo mini jack-		Video input connector: BNC
	OUTPUT	Monitor output for Input B Connector: DVI-D 24-pin (single link), HDCP not supported Audio output, Monitor out connector: Stereo mini jack		Monitor output connector**5: Mini D-sub 15-pin (female)
	REMOTE LAN	D-sub 9-pin (male) / RS232C		RS-232C connector: D-sub 9-pin (female)
	IR (Control S)	RJ45, 10BASE-T/100BASE-TX		Control S input connector: Stereo mini jack, Plug in power DC 5V, Control S output connector: Stereo mini jack
Acoustic noise (Lamp mode: Standard)		28 dB		
Operating temperature / Operating humidity		0°C to 40°C (32°F to 104°F) / 20% to 80% (no condensation)		0°C to 40°C (32°F to 104°F) / 35% to 85% (no condensation)
Storage temperature / Storage humidity		-10°C to +60°C (14°F to +140°F) / 20% to 80% (no condensation)		-20°C to +60°C (-4°F to +140°F) / 10% to 90% (no condensation)
Power requirements		AC 100 V to 240 V, 4.3A to 1.8A, 50 Hz / 60 Hz	AC 100 V to 240 V, 5.0A to 2.1A, 50 Hz / 60 Hz	AC 100 V to 240 V, 4.8 A to 2.0 A, 50 Hz/60 Hz
Power consumption (Lamp mode: High)	AC 100 V to 120 V	Lamp mode: High/Standard: 429 / 268 W	Lamp mode: High/Standard: 498/346 W	Lamp mode: High: 490 W
	AC 220 V to 240 V	Lamp mode: High/Standard: 416/261 W	Lamp mode: High/Standard: 483 / 337 W	Lamp mode: High: 460 W
Power Consumption (Standby Mode)	AC 100 V to 120 V	0.5 W (when "Standby mode" is set to "Low")		0.1 W (when "Standby mode" is set to "Low")
	AC 220 V to 240 V			0.2 W (when "Standby mode" is set to "Low")
Power Consumption (Networked Standby Mode)	AC 100 V to 120 V	15.0 W (LAN) / 15.0 W (HDBaseT) / 15.0 W (All Terminals and Networks Connected) (when "Standby Mode" is set to "Standard")		11.0 W (LAN) (when "Standby Mode" is set to "Standard")
	AC 220 V to 240 V	13.3 W (LAN) / 13.3 W (HDBaseT) / 13.3 W (All Terminals and Networks Connected) (when "Standby Mode" is set to "Standard")		10.0 W (LAN) (when "Standby Mode" is set to "Standard")
Heat dissipation	AC 100 V to 120 V	1464 BTU/h	1699 BTU/h	1672 BTU/h
	AC 220 V to 240 V	1419 BTU/h	1648 BTU/h	1569 BTU/h
Dimensions (W x H x D) (without protrusions)		Approx. 460 x 169 x 515 mm (18 1/8 x 6 21/32 x 20 9/32 inches)		Approx. 530 x 204 x 545 mm (20 7/8 x 8 1/32 x 21 15/32 inches)
Mass		Approx. 13 kg (28 lb)		Approx. 20 kg (44 lb)
Supplied accessories		RM-PJ27 Remote RM-PJ27 Remote Commander (1), Size AA (R6) batteries (2), AC Power Cord (1), Plug holder (1), Terminal (1) RM-PJ27 Remote Commander (1), Size AA (R6) batteries (2), AC Power Cord (1), Plug holder (1), Terminal, Size AA (R6) batteries (2), AC Power Cord (1), Plug holder (1), Terminal Cover (1), Quick Reference Manual (1), Operating Instructions (CD-ROM) (1)		

*1 With supplied standard lens. | ** This figure is expected maintenance time, not guaranteed time. The actual value depends on the environment and how the projector is used. | ** The value is average. | ** Available for VESA Reduced Blanking signal. | ** From INPUT A and INPUT B. | ** Works as an audio switcher function. Output from a selected channel; not available in standby. | ** Available via BKM-FW16.

For full product specifications and features please visit pro.sony.eu/installation

F-Series Laser projectors

Sony's flagship Laser projectors for larger and more demanding venues requiring the best in technology, resolution and highly sophisticated features. Delivers powerful performance, optional lenses, up to 20,000 hours of life and attractive TCO.



Model: VPL-FHZ57/60/65/FWZ60/65

Laser light projectors with Sony 3LCD BrightEra™ Panel Technology

- In a world first, Sony has combined a highly efficient laser light source with 3LCD BrightEra™ technology. This unique combination delivers exceptionally bright, high contrast pictures with excellent colour accuracy and stability, plus high efficiency and significantly greater durability for reduced lifetime ownership costs.

Reality Creation

- Clarity in every pixel. Sony's process technology and proprietary algorithm creates pixel mapping that is as close to the original as you can get. (VPL-FHZ57, FHZ60, FHZ65 and VPL-FWZ60 FWZ65)

Contrast Enhancer

- Analyses every image to make dark scenes darker and light scenes brighter to create even better contrast. (VPL-FHZ57, FHZ60, FHZ65 and VPL-FWZ60 FWZ65)

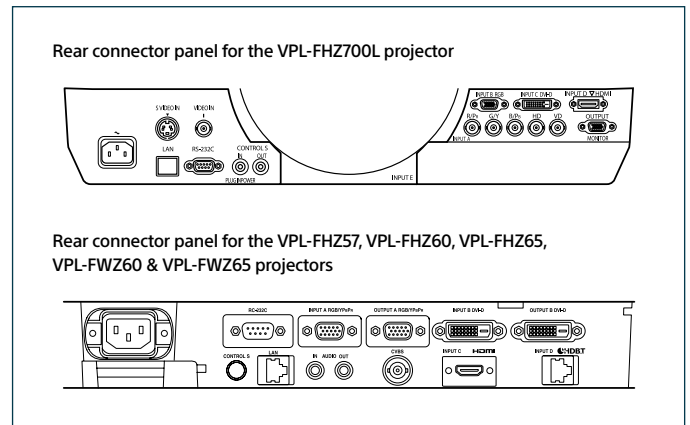



PrimeSupportPro

PrimeSupportElite

Our **PrimeSupportPro** and **PrimeSupportElite** packages go beyond standard levels of warranty with varying support options either at no extra cost or optional upgrade. **PrimeSupportPro** gives you free initial access to expert technical assistance from our multilingual helpdesk while optional **PrimeSupportElite** upgrades go further with our fast-track repair service and – depending on your product - a replacement loan unit*. Both packages include free shipping and no hidden costs so we'll always keep you up and running.

	PrimeSupportPro		PrimeSupportElite					
	Included Service PS.LASERPROJ.5		PSP.LPROJHVY.5		PSP.LPROJ.5YL		PSP.LPROJHVY.5YL	
Service reference								
Scope of support	Projector	Laser	Projector	Laser	Projector	Laser	Projector	Laser
Duration	5 years	12000 hours	5 years	20000 hours	5 years	12,000 hours with loan unit	5 years	20,000 hours with loan unit

For full product specifications and features please visit pro.sony.eu/laser



3D Plan



Plan



		VPL-FWZ60	VPL-FWZ65	VPL-FHZ57	
Display system		3 LCD system			
Display device	Size of effective display area	0.76" (19 mm) x 3 BrightEra LCD Panel, Aspect ratio: 16:10			
	Number of pixels	3,072,000 (1280 x 800 x 3) pixels		6,912,000 (1920 x 1200 x 3) pixels	
Projection lens*1	Focus		Powered		
	Zoom – Powered/Manual		Powered		
	Zoom – Ratio		Approx. x 1.6		
	Throw ratio		1.39:1 to 2.23:1		
	Lens shift – Powered/Manual		Powered		
	Lens shift – Range Vertical	-5%, +60%			-5% / +60% ¹⁵
	Lens shift – Range Horizontal	+/- 32%			+/- 32% ¹⁵
Light source	Type	Laser diode			
Filter cleaning / replacement cycle (Max.) ¹²	Filter cleaning / replacement cycle (Max.)	20,000 H (service maintenance)		20,000 H (cleaning)	
Screen size	Screen size (measured diagonally)	40" to 600" (1.02 m to 15.24 m) (measured diagonally)			
Light output	Mode: High	5000 lm	6000 lm	4100 lm	
	Mode: Standard	3500 lm	4000 lm	3000 lm	
Color light output	Mode: High	5000 lm	6000 lm	4100 lm	
	Mode: Standard	3500 lm	4000 lm	3000 lm	
Contrast ratio (full white / full black) ¹³		10000:1			
Displayable scanning frequency	Horizontal	15 kHz to 92 kHz			
	Vertical	48 Hz to 92 Hz			
Display resolution	Computer signal input	Maximum display resolution: 1920 x 1200 dots ¹⁴	Maximum display resolution: 1280 x 800 dots ¹⁴	Maximum display resolution: 1920 x 1200 dots ¹⁴	
	Video signal input	NTSC, PAL, SECAM, 480/60i, 576/50i, 480/60p, 576/50p, 720/60p, 720/50p, 1080/60i, 1080/50i The following items are available for digital signal (HDMI input) only; 1080/60P, 1080/50p, 1080/24p			
Color system		NTSC3.58, PAL, SECAM, NTSC4.43, PAL-M, PAL-N, PAL60			
Keystone correction (Max.)	Vertical	+/- 30 degrees			
	Horizontal	+/- 30 degrees			
OSD language		24-languages (English, Dutch, French, Italian, German, Spanish, Portuguese, Turkish, Polish, Russian, Swedish, Norwegian, Japanese, Simplified Chinese, Traditional Chinese, Korean, Thai, Vietnamese, Arabic, Farsi, Finnish, Indonesian, Hungarian, Greek)			
INPUT OUTPUT (Computer/ Video/Control)	INPUT A	RGB / Y PB PR input connector: Mini D-sub 15 pin (female) Audio input connector: Stereo mini jack			
	INPUT B	DVI input connector: DVI-D 24-pin (single link), HDCP support Audio input connector: Shared with input A			
	INPUT C	HDMI input connector: HDMI 19-pin, HDCP support Audio input connector: HDMI audio support			
	INPUT D	HDBaseT interface connector: RJ45, 4 play (Video, Audio, LAN, Control)			
	INPUT E	-			
	VIDEO IN	Video input connector: BNC Audio input connector: Shared with input A			
	OUTPUT A	Monitor output for Input A Connector: Mini D-sub 15-pin (female) Audio output connector: Stereo mini jack			
	OUTPUT B	Monitor output for Input B Connector: DVI-D 24-pin (single link), HDCP not supported Audio output, Monitor out connector: Stereo mini jack			
	REMOTE	D-sub 9-pin (male) / RS232C			
	LAN	RJ45, 10BASE-T/100BASE-TX			
IR (Control S)	Stereo mini jack, Plug in power DC5V				
Acoustic noise	Lamp mode: Standard	28 dB		32 dB	
Operating temperature / Operating humidity		0°C to 40°C (32°F to 104°F) / 20% to 80% (no condensation)			
Storage temperature / Storage humidity		-10°C to +60°C (14°F to +140°F) / 20% to 80% (no condensation)		-20°C to +60°C / -4°F to +140°F / 20% to 80% (no condensation)	
Power requirements		AC 100 V to 240 V, 5.5 A to 2.3 A, 50 Hz / 60 Hz			
Power consumption	AC 100 V to 120 V	Mode: High: 383 W	Mode: High: 464 W	Lamp mode: High: 370 W	
	AC 220 V to 240 V	Mode: High: 372 W	Mode: High: 453 W	Lamp mode: High: 355 W	
Power consumption (Standby Mode)	AC 100 V to 120 V	0.5W (when "Standby mode" is set to "Low")			
	AC 220 V to 240 V	0.5W (when "Standby mode" is set to "Low")			
Power consumption (Networked Standby Mode)	AC 100 V to 120 V	15.0 W (All Terminals and Networks Connected) (when "Standby Mode" is set to "Standard")			
	AC 220 V to 240 V	13.3 W (All Terminals and Networks Connected) (when "Standby Mode" is set to "Standard")			
Standby Mode / Networked Standby Mode Activated		Approx. 10 Minutes			
Heat dissipation	AC 100 V to 120 V	1307 BTU/h	1583 BTU/h	1262 BTU/h	
	AC 220 V to 240 V	1269 BTU/h	1546 BTU/h	1211 BTU/h	
Dimensions (W x H x D) (without protrusions)		Approx. 460 x 169 x 515 mm, 18 1/8 x 6 21/32 x 20 9/32 inches			
Mass		16 kg (34 lb)			
Supplied accessories	Remote commander	RM-PJ27			
Optional accessories		VPLL-3003 / 3007 / Z3009 / Z3024 / Z3032		PAM 310 PAM-0.5M / PAM-1.0M / PAM-1.5M	



		VPL-FHZ60	VPL-FHZ65	VPL-FHZ700L
Display system		3 LCD system		
Display device	Size of effective display area	0.76" (19 mm) x 3 BrightEra LCD Panel, Aspect ratio: 16:10		0.95" (24.1 mm) x 3 BrightEra LCD Panel, Aspect ratio 16:10
	Number of pixels	6,912,000 (1920 x 1200 x 3) pixels		
Projection lens	Focus	Powered		
	Zoom – Powered/Manual	Powered		
	Zoom – Ratio	Approx. x 1.6		
	Throw ratio	1.39:1 to 2.23:1		
	Lens shift – Powered/Manual	Powered		
	Lens shift – Range Vertical	-5% / +60% *5		
Lens shift – Range Horizontal	+/- 32% *5			
Light source	Type	Laser diode		
Filter cleaning / replacement cycle (Max.)**2	Filter cleaning / replacement cycle (Max.)	20,000 H (cleaning)		
Screen size*1	Screen size (measured diagonally)	40" to 600" (1.02 m to 15.24 m)		
Light output	Mode: High	5000 lm	6000 lm	7000 lm
	Mode: Standard	3500 lm	4000 lm	5600 lm
Color light output	Mode: High	5000 lm	6000 lm	7000 lm
	Mode: Standard	3500 lm	4000 lm	5600 lm
Contrast ratio (full white / full black)**3		10000:1		
Displayable scanning frequency	Horizontal	15 kHz to 92 kHz		
	Vertical	48 Hz to 92 Hz		
Display resolution	Computer signal input	Maximum display resolution: 1920 x 1200 dots *4		
	Video signal input	NTSC, PAL, SECAM, 480/60i, 576/50i, 480/60p, 576/50p, 720/60p, 720/50p, 1080/60i, 1080/50i The following items are available for digital signal (HDMI input) only; 1080/60p, 1080/50p, 1080/24p		NTSC, PAL, SECAM, 480/60i, 576/50i, 480/60p, 576/50p, 720/60p, 720/50p, 1080/60i, 1080/50i, 1080/60p, 1080/50p, 1080/24p
Color system		NTSC3.58, PAL, SECAM, NTSC4.43, PAL-M, PAL-N, PAL60		
Keystone correction (Max.)	Vertical	+/- 30 degrees		
	Horizontal	+/- 30 degrees		
OSD language		24-languages (English, Dutch, French, Italian, German, Spanish, Portuguese, Turkish, Polish, Russian, Swedish, Norwegian, Japanese, Simplified Chinese, Traditional Chinese, Korean, Thai, Vietnamese, Arabic, Farsi, Finnish, Indonesian, Hungarian, Greek)		
INPUT OUTPUT (Computer/Video/Control)	INPUT A	RGB / Y PB PR input connector: Mini D-sub 15 pin (female) Audio input connector: Stereo mini jack		RGB / Y PB PR input connector: 5BNC (female)
	INPUT B	DVI input connector: DVI-D 24-pin (single link), HDCP support Audio input connector: Shared with input A		RGB input connector: Mini D-sub 15 pin female
	INPUT C	HDMI input connector: HDMI 19-pin, HDCP support Audio input connector: HDMI audio support		DVI-D input connector: DVI-D 24-pin (Single link), supported HDCP
	INPUT D	HDBaseT interface connector: RJ45, 4 play (Video, Audio, LAN, Control)		HDMI input connector: HDMI 19-pin, HDCP support, Digital RGB / Y PB PR / Y CB CR
	INPUT E			Optional adaptor slot (For HDBaseT and 3G-SDI Adaptor BKM-PJ10 & BKM-PJ20)
	VIDEO IN	Video input connector: BNC Audio input connector: Shared with input A		Video input connector: BNC
	OUTPUT A	Monitor output for Input A Connector: Mini D-sub 15-pin (female) Audio output connector: Stereo mini jack		Monitor output connector: Mini D-sub 15-pin (female)
	OUTPUT B	Monitor output for Input B Connector: DVI-D 24-pin (single link), HDCP not supported Audio output, Monitor out connector: Stereo mini jack		
	REMOTE	RS-232C connector: D-sub 9-pin (male)		RS-232C connector: D-sub 9-pin (female)
	LAN	RJ45, 10BASE-T/100BASE-TX		RJ45, 10BASE-T/100BASE-TX
Acoustic noise	Mode: High	34 dB		
	Mode: Low	28 dB		
Operating temperature / Operating humidity		0°C to 40°C / 32°F to 104°F / 20% to 80% (no condensation)		0°C to 40°C / 32°F to 104°F / 35% to 85% (no condensation)
Storage temperature / Storage humidity		-20°C to +60°C / -4°F to +140°F / 20% to 80% (no condensation)		-20°C to +60°C / -4°F to +140°F / 10% to 90% (no condensation)
Power requirements		AC 100 V to 240 V, 4.5 A to 1.9 A, 50/60 Hz	AC 100 V to 240 V, 5.5 A to 2.3 A, 50/60 Hz	AC 100 V to 240 V, 5.0 A to 2.1 A, 50/60 Hz
Power consumption	AC 100 V to 120 V	Mode: High: 420 W	Mode: High: 509 W	497 W / 404 W
	AC 220 V to 240 V	Mode: High: 408 W	Mode: High: 492 W	476 W / 387 W
Power consumption (Standby Mode)	AC 100 V to 120 V	0.5W (when "Standby mode" is set to "Low")		12.2 W / 0.1 W
	AC 220 V to 240 V	0.5W (when "Standby mode" is set to "Low")		8.4 W / 0.5 W
Power consumption (Networked Standby Mode)	AC 100 V to 120 V	15.0 W (All Terminals and Networks Connected) (when "Standby Mode" is set to "Standard")		12.2 W (LAN) 13.8 W (optional HDBaseT adaptor) 13.8 W (All Terminals and Networks Connected) (when "Standby Mode" is set to "Standard")
	AC 220 V to 240 V	13.3 W (All Terminals and Networks Connected) (when "Standby Mode" is set to "Standard")		8.4 W (LAN) 10.0 W (optional HDBaseT adaptor) 10.0 W (All Terminals and Networks Connected) (when "Standby Mode" is set to "Standard")
Heat dissipation	AC 100 V to 120 V	1433 BTU/h	1737 BTU/h	1696 BTU/h
	AC 220 V to 240 V	1393 BTU/h	1679 BTU/h	1624 BTU/h
Dimensions (W x H x D) (without protrusions)		460 x 169 x 515 mm 18 1/8 x 6 21/32 x 20 9/32 inches		Approx. W 530 x H 204 x D 545 mm (W 20 7/8 x H 8 1/32 x D 21 15/32 in)
Mass		16 kg (34 lb)		
Supplied accessories	Remote commander	RM-PJ27		
Optional accessories		PAM 310		N/A
		PAM-0.5M / PAM-1.0M / PAM-1.5M		N/A

*1 With supplied standard lens. | ** This figure is expected maintenance time, not guaranteed time. The actual value depends on the environment and how the projector is used. | ** The value is average. | ** Available for VESA Reduced Blanking signal. | ** Standard lens.

F-Series

Optional Accessories

LMP-F272
(FH31/FX35)
Replacement lamp



LMP-F370
(VPL-FH65)
Replacement lamp



LMP-F280
(VPL-FH60)
Replacement lamp



LMP-F230
(FX30)
Replacement lamp



LMP-F330
(FX500L / FH500L)
Replacement lamp



Ceiling mount and extension poles for VPL-FX30/35, VPL-FW60/65, VPL-FH31/60/65, VPL-FWZ60/65 and VPL-FHZ57/60/65

PAM-310
Ceiling mount



PAM-0.5M
Extension pole
& ceiling plate



PAM-1.0M
Extension pole
& ceiling plate



PAM-1.5M
Extension pole
& ceiling plate



Backward compatibility table for optional lenses (discontinued & current)

Optional Lens	Throw Ratio	Compatible with FHZ55, FH31, FX30, FX35	Compatible with FHZ57/60/65, FWZ60/65, FH60/65 and FW60/65
VPLL-Z1032*	3.18-4.84:1 (WUXGA), 3.24-4.95:1 (XGA)	Yes (+PK-F30LA1)	Yes (+PK-F60LA1)
VPLL-Z1024*	2.34-3.19:1 (WUXGA), 2.38-3.26:1 (XGA)	Yes (+PK-F30LA1)	Yes (+PK-F60LA2)
VPLL-Z2009	0.85-1.0:1 (WUXGA), 0.86-1.01:1 (XGA)	Yes	Yes (+PK-F60LA3)
VPLL-2007	0.65:1 (WUXGA), 0.66:1 (XGA)	Yes	Yes (+PK-F60LA4)
VPLL-Z3032	3.18-4.84:1 (WUXGA), 3.24-4.95:1 (XGA)	Yes (+PK-F30LA1)	Yes
VPLL-Z3024	2.34-3.19:1 (WUXGA), 2.38-3.26:1 (XGA)	Yes (+PK-F30LA1)	Yes
VPLL-Z3009	0.85-1.0:1 (WUXGA)	N/A	Yes
VPLL-3007	0.65:1 (WUXGA)	N/A	Yes
VPLL-3003	0.33:1 (WUXGA)	N/A	Yes

*Discontinued optional lenses

PK-F60LA1
Lens Adaptor



PK-F60LA2
Lens Adaptor

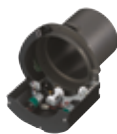

PK-F60LA3
Lens Adaptor



PK-F60LA4
Lens Adaptor



PK-F30LA1
Lens Adaptor



For full product specifications and features please visit pro.sony.eu/installation



F-Series Optional Lenses

Optional bayonet Lenses for VPL-FW60/65, FH60/65 and FHZ57/60/65 projectors.



	VPLL-3003	VPLL-3007	VPLL-Z3009	VPLL-3010	VPLL-Z3024	VPLL-Z3032
WUXGA	0.33:1	0.65:1	0.85 - 1.0	1.0-1.39:1	2.34 - 3.19	3.18 - 4.84

Optional Lenses for FX30, FX35, FH31.



	VPLL-2007	VPLL-Z2009	VPLL-Z3024*	VPLL-Z3032*
WUXGA	0.65:1	0.85 - 1.0	2.34 - 3.19	3.18 - 4.84
XGA	0.66:1	0.86 - 1.01	2.38 - 3.26	3.24 - 4.95

Value Series - Optional Lenses for FX500L, FH500L and FHZ700L.



	VPLL-FM22	VPLL-ZM42	VPLL-ZM102
WUXGA	0.87	1.83 to 2.32	3.28 to 4.83
XGA	0.89	1.87 to 2.30	3.35 to 4.92

Premium Series - Optional Lenses for FX500L, FH500L and FHZ700L.



	VPLL-Z4007	VPLL-4008	VPLL-Z4011	VPLL-Z4015	VPLL-Z4019	VPLL-Z4025	VPLL-Z4045
WUXGA	0.68 - 0.8	1.08	1.38 - 2.06	2.02 - 2.67	2.62 - 3.36	3.30 - 6.11	6.08 - 10.52
XGA	0.69 - 0.81	1.1	1.4 - 2.1	2.06 - 2.72	2.67 - 3.42	3.36 - 6.23	6.19 - 10.72

*Purchase with PK-F30LA1 adapter



A smarter way to engage

BRAVIA Professional Displays



Create the perfect image for your digital signage, communal areas and meeting rooms with our strongest line-up of ultra-slim, energy efficient BRAVIA Professional Displays. There are 11 models to choose from, in detailed Full HD and immersive 4K. Screen sizes range from 40" to 100".

Do more with our BRAVIA built-in solutions

Look no further with BRAVIA. Our new range features a number of fantastic built-in solutions to customise your BRAVIA exactly the way you want. From Security Viewer/Recorder, TDM Digital Signage, Smart Automation System and the Applications Store, there's no need for any external devices or players.

Superior displays designed for business

Portrait, advanced control, professional mode, optional interactive compatibility, 17/7 operation or an embedded HTML5 platform for easy digital signage creation; our BRAVIA 4K Displays are designed to suit all your professional needs so you always present a clear image.

Widest choice in 4K

With over 8 million pixels, 4K resolution offers incredible realism with four times the detail of Full HD. BRAVIA offers the widest selection of 4K Professional Displays around, with screen sizes in 43", 49", 55", 65", 75", 85" and 100".

Highlights

- New 4K X1 processor
- Portrait/Landscape compatibility
- Interactivity option
- Built-in IP and RS232C control

PrimeSupport



PrimeSupport Pro

Included at no extra cost for 3 years, **PrimeSupportPro** goes beyond a standard warranty with access to expert technical assistance. Our multilingual helpdesk can answer everyday questions on setting up and using your product by phone or email. And if a screen failure is diagnosed, we'll organise a replacement model quickly and efficiently, with free shipping and no hidden costs. Support can also be optionally extended up to 5 years.

For full product specifications and features please visit pro.sony.eu/BRAVIA



		FW-43XD8001	FW-49XD8001	FW-55XD8501	FW-65XD8501	FW-75XD8501	FW-85XD8501	FWD-100ZD9501		
Display specifications	Screen size (diagonal)	43"	49"	55"	65"	75"	85"	100"		
	Brightness (cd/m ²)**	400						Up to 2,000 cd/m ² 5,000:1		
	Native contrast ratio	4,000:1						5,000:1		
	Response time (ms)	8	8	5	5	5	6	4		
	Dynamic contrast ratio	over 1 million								
	Display resolution	4K (3840x2160)								
	Aspect ratio	16:9								
	Portrait compatibility	Yes								
Display features	Android system	Yes								
	Dimming type	Frame Dimming						Individual LED control		
	Display device	LCD								
	Backlight type	Edge LED						Direct LED X1 Extreme		
	Processor	TBC						X1		
TV System	Operation time	17/7								
	TV Tuner	DVB-T/T2/C/S/S2								
Video specs	Number of tuners	2								
	Wide Mode	Full/Normal/Wide Zoom/Zoom/Caption/14:9 for Video Normal/Full1/Full2 for PC								
	4:3 Default	Yes								
	Video Processing	4K X-Reality PRO						4K X-Reality PRO, with X-tended Dynamic Range PRO		
	Motionflow	Motionflow XR 200Hz			Motionflow XR 800Hz			Motionflow XR 1200Hz		
	Triluminos	Yes								
	Viewing angle (Right/Left/Up/Down)	178 (89/89/89/89)								
	Compatible with HDR	Yes								
Audio specs	Video Signal	4096x2160p(24, 50, 60Hz), 3840x2160p(24, 25, 30, 50, 60Hz), 1080p(30, 50, 60Hz), 1080/24p, 1080i(50, 60Hz), 720p(30, 50, 60Hz), 720/24p, 576p, 576i 480p, 480i								
	4K 60P quality format	Up to 18Gbps;4K 60p 4:4:4(8bit), 4:2:2(8,10,12bit), 4:2:0(8,10bit) HDR included for HDMI 1/2/3/4								
	HDMI auto wake-up	Yes								
	3D							Active TDG-BT500A		
	3D glasses									
	Speaker position	Down Firing								
	Audio Power Output	10W+10W			7.5W+7.5W+7.5W+7.5W			10W+10W		
	Invisible speaker	Yes								
	Signage Built-in Solutions	Built-in Digital Signage Platform	Yes* (16 GB storage available)							
		Built-in Media Player	Yes							
Built-in Android Applications Store		Yes								
Corporate Built-in Solutions	Built-in Mirroring Google Cast solution	Yes								
	Built-in Smart Automation System	Yes								
	Built-in Meeting-Room solution	Yes†								
Security Built-in Solutions	Built-in IPTV player	Yes (UDP/RTP)								
	Built-in Security Camera Solution	Yes								
Interactivity	10 point IR touch overlay*	PT-1143-IR10	PT-1149-IR10	PT-1155-IR10	PT-1165-IR10	PT-1175-IR10	PT-1185-IR10	PT-11100-IR10		
Network specs	Wi-Fi direct / Wi-Fi Certified	Yes								
	DLNA / Miracast (screen mirroring)	Yes								
	Firmware update	Yes (network or USB)								
	Internet Browser	Yes (Opera)								
	Wireless LAN	Integrated								
	USB HDD REC	Yes								
Convenience features	USB Play (contents)	*MPEG1 / MPEG2PS / MPEG2TS / AVCHD / MP4Part10 / MP4Part2 / AVI(XVID) / AVI(MotionJpeg) / MOV / WMV / MKV / WEBM / 3GPP / MP3 / WMA / WAV / JPEG / MPO / RAW(ARW)*								
	On screen clock	Yes								
	Sleep timer / On/Off timer	Yes								
Control specs	IP Control	Yes								
	RS-232C Control	Yes (jack 3,5)						Yes (optional accessory)		
	MHL	Yes (v3)								
Inputs and outputs	HDCP	2.2								
	RF Connection Input(s)	1 (Side)								
	IF (BS/CS) Input(s)	2 (Side)								
	Composite Video Input(s)	1 (Side Analog Conversion)			1 (Rear Hybrid w/Component)			1 (Side Analog Conversion)		
	Component Video (Y/Pb/Pr) Input(s)	-						-		
	SCART (without Smartlink)	1 (Rear)								
	HDMI™ Connection(s) (Total)	4(side3, rear1)			4(outside1, center3)					
	Analog Audio Input(s) (Total)	2 (1Analog Conversion/1Rear)			2 Rear			2 (1Analog Conversion/1Rear)		
	Digital Audio Output(s)	1 (Rear)			1 (Side)					
	Audio Out	1 (Side/Hybrid w/HP and Subwoofer Out)								
Design features	USB	3 (Side)								
	Ethernet Connection(s)	1 (Side)								
	PCMCIA Slot(s)	1 (Top)								
	Finish (Surface Color)	Black								
	Table Top Stand	Included (assembly required)								
	VESA Hole Spacing Compatible	Yes (100 x 200 mm)	Yes (200 x 300 mm)	Yes (200 x 200 mm)	Yes (300 x 300 mm)	Yes (400 x 300 mm)		Yes		
	Light Sensor	Yes								
Environment specs	Energy Label	A	A	A	A+	A+	A+	A		
	Screen size (measured diagonally)	65"(64.5") / 163.9cm								
	Power Consumption (In Standby)	0.5W								
	Power Consumption (in Operation)	82W	80W	103W	119W	147W	168W	413W		
	Dynamic Backlight Control	Yes								
Measurements	Power Saving Mode / Back Light Off Mode	Yes								
	AC Power Input	1 (Pigtail)			AC Adapter			1 (Pigtail)		
	Display Only (WxHxD) (Approx.)	96.0x56.4x4.5 (1.03) cm	109.3x63.9x4.4 (1.05) cm	123.1x71.7x4.4 (1.12) cm	145.4x84.2x4.4 (1.12) cm	167.7x96.9x4.9 (1.57) cm	191.7x110.9x7.3 (2.00) cm	225.8x130.3x9.8 cm		
	Display with Stand (WxHxD) (Approx.)	96.0x61.2x 21.6 cm	109.3x68.6x21.6 cm	123.1x77.0x26.3 cm	145.4x89.4x27.9 cm	167.7x102.6x28.6 cm	191.7x118.2x40.2 cm	225.8 (225.8)x139.3 (171.8)x50.4 (67.5) cm		
Weight	Package Carton (WxHxD) (Approx.)	107.8 x 70.5 x 15.8 cm	121.3 x 78.0 x 16.9 cm	155.2 x 82.5 x 18.2 cm	176.3 x 95.9 x 19.0 cm	206.2 x 109.1 x 22.8 cm	209.5 x 124.6 x 40.3 cm	245.0 x 165.7 x 76.0 cm		
	Display Only	12.3 Kg	13.2 Kg	15.1 Kg	20.3 Kg	33.4 Kg	60.2 Kg	118.6 kg		
	Display with Stand	13.2 Kg	14.2 Kg	18.6 Kg	23.9 Kg	38.7 Kg	65.6 Kg	132.3 kg		
Service and Warranty	Package Carton	17 Kg	20 Kg	27 Kg	35 Kg	55 Kg	83 Kg	225 kg		
Standard Warranty	3 Years with Advanced Exchange by a new model									

*Peak brightness.

4K / HD

Optional Accessories

CAB-VGAHDMI1

VGA to HDMI cable



CAB-RSJA1

RS232 jack cable



TDM digital signage software licenses*

TDM-DSY1: 1 year
TDM-DSY3: 3 years

Mount solutions

PT-KIOSK-4065
PT-LIFTHL-4075

SU-WL450/PSE

Wall Mount



SU-WL500/PSE

Wall Mount

** +5V source detection
*** Typical value of panel spec
**** SU-WL500 wall mount is recommended
†Chargeable options

For full product specifications and features please visit

pro.sony.eu/BRAVIA



		FWL-40W705C	FWL-48W705C	FWL-55W805C	FWL-65W855C	FWL-75W855C	
Display specifications	Screen size (diagonal)	40"	48"	55"	65"	75"	
	Brightness (cd/m ²)*	330		400		400	
	Native contrast ratio	5,000:1		4,000:1		4,000:1	
	Response time (ms)	6.8	8	6.5		8	
	Dynamic contrast ratio	over 1 million					
	Display resolution	Full HD					
	Aspect ratio	16:9					
Display features	Portrait compatibility	-	-	Yes****	Yes****	Yes****	
	Android system	No		Yes		Yes****	
	Dimming type	Frame Dimming					
	Display device	LCD					
	Backlight type	Edge LED			Direct LED		
	Operation time	17/7					
	TV System	No					
Video specs	Wide Mode	Full/Normal/Wide Zoom/Zoom/Caption/14:9 for Video Normal/Full1/Full2 for PC					
	4:3 Default	Yes					
	Video Processing	X-Reality PRO					
	Motionflow	Motionflow XR 200Hz		Motionflow XR 800Hz		Motionflow XR 800Hz	
	Viewing angle (Right/Left/Up/Down)	178 (89/89/89/89)					
	Video Signal	1080/24p (HDMI only); 1080/60i; 1080/60p (HDMI/Component); 1080/50i; 1080/50p (HDMI/Component); 480/60i; 480/60p; 576/50i; 576/50p; 720/60p; 576/50p; 1080/30p (HDMI only); 720/30p (HDMI only); 720/24p (HDMI only)					
	HDMI auto wake-up	Yes**					
Audio specs	3D	-	-	Active		Active	
	3D glasses	-	-	TDG-BT500A		TDG-BT500A	
	Speaker position	Down Firing					
	Audio Power Output	5W+5W		10W+10W		10W+10W	
Signage Built-in Solutions	Invisible speaker	Yes		Yes		Yes	
	Built-in Digital Signage Platform	Yes		Yes		Yes (8 GB storage available)	
	Built-in Media Player	-		Yes		Yes	
	Built-in Android Applications Store	-		Yes		Yes	
Corporate Built-in Solutions	Built-in Mirroring Google Cast solution	-		Yes		Yes	
	Built-in Smart Automation System	-		Yes		Yes	
	Built-in Meeting-Room solution	-		Yes		Yes	
Security Built-in Solutions	Built-in IPTV player	Yes (UDP/RTP)					
	Built-in Security Camera Solution	Yes					
Interactivity	10 point IR touch overlay*	PT-1140-IR10	PT-1148-IR10	PT-1155-IR10	PT-1165-IR10	PT-1175-IR10	
	Wi-Fi direct / Wi-Fi Certified	Yes					
Network specs	DLNA / Miracast (screen mirroring)	Yes					
	Firmware update	Yes (network or USB)					
	Internet Browser	Yes (Opera)					
	Wireless LAN	Integrated					
Control specs	USB Play (contents)	MPEG1/MPEG2PS/MPEG2TS/AVCHD/MP4Part0/MP4Part2/AVI(XVID)/AVI(MotionJpeg)/MOV/WMV/MKV/WEBM/3GPP/MP3/WMA/WAV/JPEG/MPO/RAW(ARW)					
	On screen clock	Yes					
	Sleep timer / On/Off timer	Yes					
	IP Control	Yes					
Inputs and outputs	RS-232C Control	Yes (by CBX-H11/1 optional accessory)		Yes	Yes	Yes	
	MHL	Yes (v2.1)					
	RF Connection Input(s)	1 (Bottom)					
	IF (BS/CS) Input(s)	2 (Bottom)					
	Composite Video Input(s)	1 (Rear Hybrid w/Component)					
	Component Video (Y/Pb/Pr) Input(s)	1 (Bottom/Hybrid)					
	SCART (without Smartlink)	1 (Rear)					
	PC In (D-Sub)	1					
	HDMI™ Connection(s) (Total)	4 (1Side/3Bottom)		4		4	
	Analog Audio Input(s) (Total)	2 (Rear)					
	Digital Audio Output(s)	1 (Rear)					
Audio Out	1 (Side/Hybrid w/HP)						
USB	2 (Side)		3		3		
Design features	Ethernet Connection(s)	1 (Rear)					
	PCMCIA Slot(s)	1 (Up)					
	Finish (Surface Color)	Black					
Environment specs	Table Top Stand	Included (assembly required)					
	VESA Hole Spacing Compatible	Yes (300 x 200 mm)		Yes (400 x 300 mm)		Yes (400 x 300 mm)	
	Light Sensor	Yes					
Measurements	Energy Label	A+	A++	A+	A+	A+	
	Screen size (measured diagonally)	40"	48"	55"	65"	75"	
	Power Consumption (in Standby)	0.5W	0.5W	0.5W	0.5W	0.5W	
	Power Consumption (in Operation)	44W	46W	75W	123W	163W	
	Dynamic Backlight Control	Yes					
	Power Saving Mode / Back Light Off Mode	Yes					
	AC Power Input	1 (Pigtail)					
Weight	Display Only (WxHxD) (Approx.)	92.4x54.0x5.7(1.6) cm	108.9x63.2x5.7(1.6) cm	123.0x71.5x6.1(1.38) cm	145.5x84.3x7.8(1.42) cm	167.7x96.9x7.9(1.44) cm	
	Display with Stand (WxHxD) (Approx.)	92.4x57.9x17.9 cm	108.9x67.1x19.5 cm	123.0x75.3x21.0 cm	145.5x89.1x26.5 cm	167.7x101.6x33.0 cm	
	Package Carton (WxHxD) (Approx.)	102.2 x 64.0 x 15.8 cm	118.7 x 73.2 x 15.8 cm	132.8 x 82.8 x 16.9 cm	155.3 x 94.3 x 22.4 cm	177.5 x 106.8 x 22.4 cm	
Service and Warranty	Display Only	8.8 Kg	11.3 Kg	17.0 Kg	23.4 Kg	33.7 Kg	
	Display with Stand	91 Kg	11.7 Kg	18.0 Kg	24.5 Kg	34.9 Kg	
	Package Carton	12.0 Kg	16.0 Kg	31.0 kg	35.0 Kg	47.0 Kg	
		3 Years with Advanced Exchange					

*1 Please contact your Sony dealer for more information | *2 +5V source detection

PrimeSupport Pro

Included at no extra cost for 3 years, **PrimeSupportPro** goes beyond a standard warranty with access to expert technical assistance. Our multilingual helpdesk can answer everyday questions on setting up and using your product by phone or email. And if a screen failure is diagnosed, we'll organise a replacement model quickly and efficiently, with free shipping and no hidden costs. Support can also be optionally extended up to 5 years.



Service reference	Included Service PS.B2B.3	PSP.FW-4K.43.5	PSP.FW-4K.49.5	PSP.FW-4K.55.5	PSP.FW-4K.65.5	PSP.FW-4K.75.5	PSP.FW-4K.85.5
Screen type & size	All	FW-43XD8001 & FW-43XD8001/UK	FW-49XD8001 & FW-49XD8001/UK	FW-55XD8501 & FW-55XD8501/UK	FW-65XD8501 & FW-65XD8501/UK	FW-75XD8501 & FW-75XD8501/UK	FW-85XD8501 & FW-85XD8501/UK
Duration	3 years	2 years extension (total 5 years)	2 years extension (total 5 years)	2 years extension (total 5 years)	2 years extension (total 5 years)	2 years extension (total 5 years)	2 years extension (total 5 years)
Service reference	Included Service PS.B2B.3	PSP.FW-4K.100.5	PSP.FWL-HD.40.5	PSP.FWL-HD.48.5	PSP.FWL-HD.55.5	PSP.FWL-HD.65.5	PSP.FWL-HD.75.5
Screen type & size	All	FWD-100ZD9501	FWL-40W705C	FWL-48W705C	FWL-55W805C & FWL-55W805C/T	FWL-65W855C	FWL-75W855C & FWL-75W855C/T
Duration	3 years	2 years extension (total 5 years)	2 years extension (total 5 years)	2 years extension (total 5 years)	2 years extension (total 5 years)	2 years extension (total 5 years)	2 years extension (total 5 years)



Touchscreen models:

- PT-1140-IR10
- PT-1143-IR10
- PT-1148-IR10
- PT-1149-IR10
- PT-1155-IR10
- PT-1165-IR10
- PT-1175-IR10
- PT-1185-IR10

The total touchscreen solution with BRAVIA Professional Displays

Our touchscreen overlay solution is compatible with a wide range of BRAVIA 4K and Full HD Professional Display models. Custom screen bezel colours and other options can also be specified* for a totally bespoke solution to suit every environment.

Engage audiences with a touch

Transform your BRAVIA Professional Display into a super-size touch enabled interactive terminal.

Responsive, accurate multi-touch performance

Audience engagement is right at your fingertips. Customers can't keep their hands off these big, beautiful screens: 10 multi-touch IR points ensure accurate, lag-free performance across the entire display area.

Wide range of screen size options

Go as large as you like. There's a full range of touch-enabled BRAVIA Professional Display solutions in screen sizes from 40" right up to 85" – all offering fabulous contrast, rich colours and exquisite detail in 4K or Full HD.

Big audience appeal, low running costs

Powered by direct USB connection, the energy-efficient touch overlay keeps running costs down.*

In touch with your customers everywhere

Touch-enabled BRAVIA Professional Displays are ideal for a wide range of interactive signage and information kiosk applications – from schools, universities, museums, libraries, boardrooms and offices to hotel lobbies, hospitality zones, retail stores and visitor attractions.

Looks great in every light

The screen overlay's tough anti-glare surface ensures optimum visibility, even in the sunniest environments.

Quick and easy to install and set up

Simple, fuss-free installation and set up allows deployment of your interactive touchscreen solution in minutes.

* Custom options at additional cost. BRAVIA display is powered separately.

TEMPLATE: EXAMPLE-TEXT

Name: Resolution: SAVE RIGHTS EXPORT TEMPLATE

TDM Digital Signage models:
TDM-DS1Y: 1 year
TDM-DS3Y: 3 years

TDM Digital Signage

Inspire customers with affordable, effective digital signage

Operate your screens from a centralised or decentralised location with the content you want – anytime and anyplace. You can now do it all with our new generation of digital signage software.



Multiple screens and locations simultaneously

You can place content both centrally and decentrally on a single or even a cluster of screens from one operating system



Alerts

Possibility to send alerts centrally



RSS feeds

Keep up on all the latest news, weather forecasts, traffic reports and stock market information



Show images

Show your favourite images via a media library



Show websites

Ability to show websites



Interactive

Possibility to show specific content based on an action



Streaming video

YouTube, Vimeo, RTSP. It is even possible to show parts of videos



Social media

Feeds from e.g. Twitter, Facebook and LinkedIn



Live statistics

Based on emotion detection

TDM Digital Signage is developed for **SONY**



PrimeSupport On-Demand

Support for TDM Digital Signage is available with **PrimeSupportOn-Demand**. One working day (PSP.CE.TDM.INIT.1), initial solution setup (PSP.CE.TDM.TRAIN.1), training delivery (PSP.CE.TDM.SITE.1) or maintenance. We can also deliver resource to adapt the solution to your requirements (PSP.CE.TDM.CUST.1) Scope of work must be agreed before intervention.



Monument Valley Tribal Park



Crystal



Sandstone



Ammonite



Marble



Land's End



Tectonic Plate Boundaries



Combine everything
Inspire everyone





Collaboration System

Enhance teaching and learning with intuitive, cost effective solutions for real-time knowledge sharing.

Vision Exchange

Inspire active learning in universities, colleges and corporate meeting rooms.

Share and learn

Let workgroups share multimedia presentation content, bringing in other participants at remote locations to join the discussion as needed.

Get everyone involved

Students and teams can collaborate in small workgroups, connecting wirelessly to a shared network with their own laptops, tablets or mobile devices. Lecturers or team leaders can interact and control each workgroup connection, using on-screen annotation tools and digital tags to help learning, all displayed via BRAVIA Professional Displays or projection.

Vision Presenter

A complete and intuitive solution for dynamic multi-media presentations. It's the perfect way to enhance audience engagement and bring your presentations to life.

Create captivating displays

Sony's powerful projection and camera technology are united with a simple user interface that lets presenters create truly captivating presentations. Share a wide range of content sources – from video and live web feeds to PowerPoint slides - with a huge variety of layout options.

Show all kinds of content

You're in control of multiple input sources including cameras, PCs, video conferencing systems, USB flash drives, DVD and Blu-ray players, PlayStation4, smartphones, tablets and PCs.

PrimeSupport



PrimeSupport On-Demand

Support for our Collaboration Systems is available with **PrimeSupportOn-Demand**. One working day (**PSP.CE.INITDAY.1**), initial solution setup (**PSP.CE.TRAINDAY.1**), training delivery (**PSP.CE.ONSITEDAY.1**) or maintenance. We can also deliver resource to adapt the solutions to your requirements (**PSP.CE.CUSTOMDAY.1**) Scope of work must be agreed before intervention.

PrimeSupportPro

Included at no extra cost, our initial **PrimeSupportPro** packages go beyond a standard warranty with access to expert technical assistance. Our multilingual helpdesk can answer everyday questions on setting up and using your product by phone or email. And if you do need repairs, we'll organise things quickly and efficiently, with free shipping and no hidden costs.

PrimeSupportElite

If you're looking for even more peace of mind, upgrading to **PrimeSupportElite** could be the option for your business. We'll keep you up and running with our fast-track repair service that includes all shipping costs. And – depending on your product – we may offer to loan a replacement unit* while yours is being repaired.

PrimeSupportBespoke

Everybody's business is different. A selected number of our products are also eligible for **PrimeSupportBespoke**, and **PrimeSupportOn-Demand**, tailored solutions for organisations with the most demanding requirements for service and support. With options like next working day spares and on-site technical assistance, there's no better choice when dependable performance of your AV communications infrastructure is most crucial.

For full product specifications and features please visit pro.sony.eu/installation

Dynamic and flexible Active Learning solution

Sony's collaboration system is a solution that brings together students, lecturers and presenters in a workgroup-based collaborative environment. Cost-effective, easy to configure and intuitive for every user, this total active learning solution is ideal for universities and colleges of higher education.

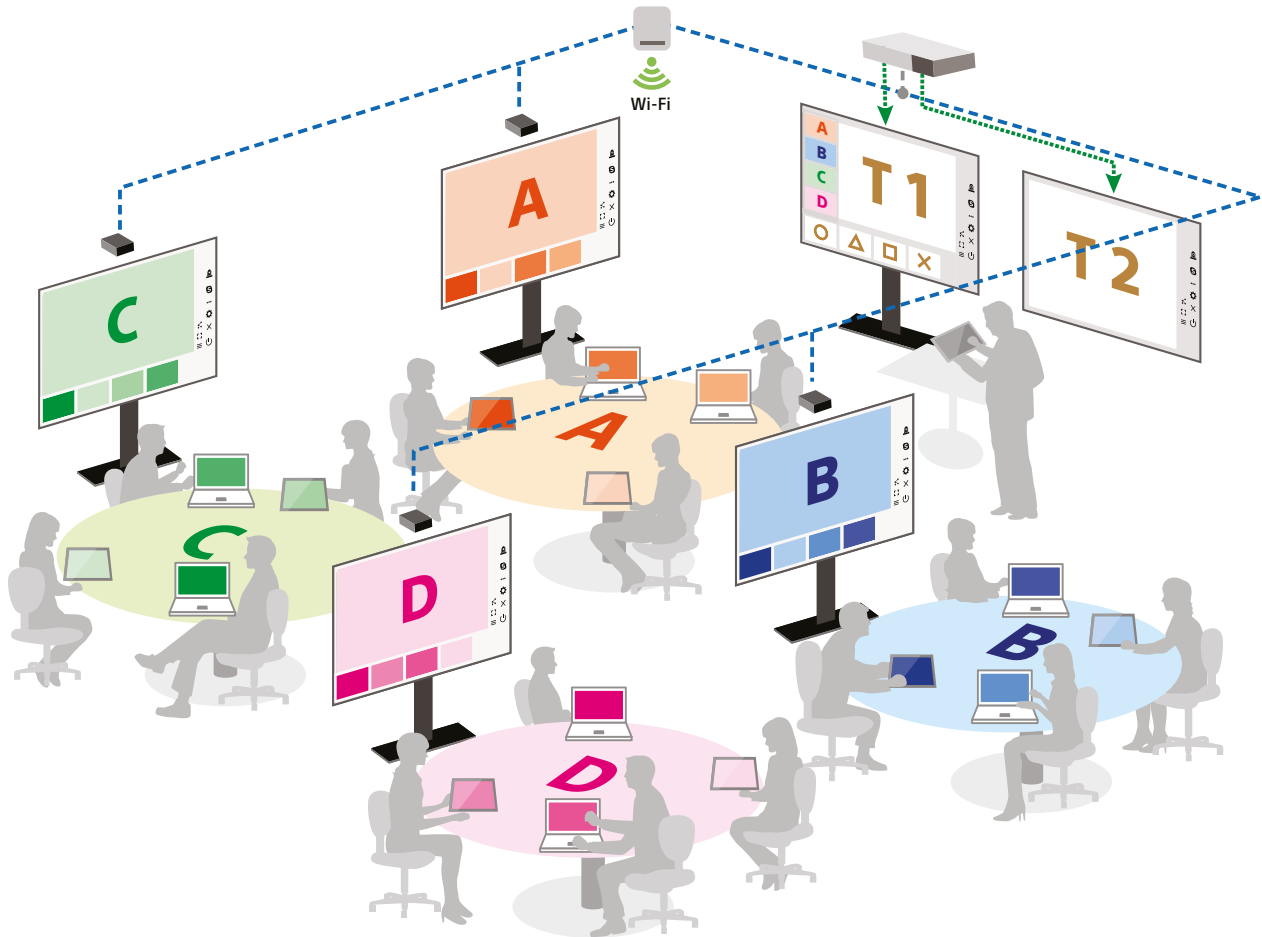

Active Learning class workflow

Share to class

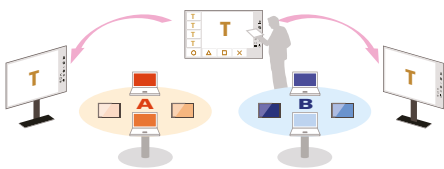

- Easy sharing for teacher's materials (Laptop/tablet images, documents, camera, HDMI inputs, etc.)
- Any image on the main view will be shown to all work group POD displays in full screen when "Pod share" button is pressed

Active group discussion

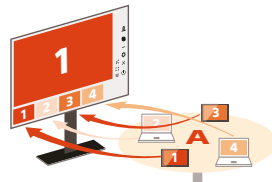

- Any student can easily mirror their BYOD content. Enhance discussion by simple switching, annotation/digital tag whiteboard mode
- Teacher can monitor and select any group's information, then share to all other group screens

Present and feedback

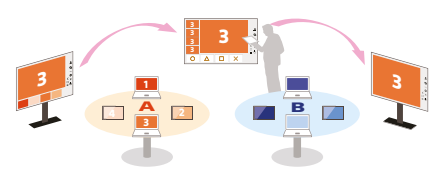

- Quickly drag & drop to share anyone's screen
- Promptly reflect teacher or student comments with annotation to feedback

For full product specifications and features please visit pro.sony.eu/installation



Main room collaboration system		
Vision Exchange platform	HDMI x2 input	PEQ-C100
Vision Exchange platform	HDMI x 4 input	PEQ-C130
Software option 1	Active Learning connection	PEQA-C10
Software option 2	Video collaboration	PEQA-C20
Software option 3	Streaming output	PEQA-C30
Workgroup Active Learning system		
Pod PC software (mini PC not provided)	Active Learning software	PES-C10

Vision Presenter	PWA-VP100
------------------	-----------

Interactive presentation solution

Sony's presentation solution allows users to share numerous multimedia sources, providing an exciting and engaging presentation and learning experience for everyone.

Features	
Number of Simultaneous Video Playback	5 x Full HD
Layout Configuration	Preinstalled layout templates (6 templates for 4K/HD screen, 13 templates for blending projector screen, 11 templates for x2/x3 separate screen)
Playable Content	<ul style="list-style-type: none"> • Still Image:JPG, GIF, PNG, BMP • Native control movie file:MP4 & MOV (H.264/AAC) • Other Document File:PPT, XLS, Word, PDF, WMV, MOV etc •Web:Website, FLASH
Live Video Input	<ul style="list-style-type: none"> • Capture card (x2) e.g., 3G-SDI (x4) + HDMI (x2) or HDMI (x2) + HDMI (x2) • Wi-Fi Mirroring • Remote Camera (IP) • Supporting HDMI HDCP • Supporting PTZ control
Output*2	• Video:DVI or DisplayPort or HDMI (Up to 4K/60P 8-bit 4:2:0), • Audio:PC Line Out, HDMI Embedded Audio
Video Playback Control	• Still Image Slideshow • Pause/Play • Loop Play
Remote Control	<ul style="list-style-type: none"> • Mouse (Wired, Wireless) • Tablet Control (Android, iOS) • PC/MAC (Chrome/Safari) • Integrates with third party gesture control or control systems.

Vision Presenter kitted system		
PWA-VP100K1	4x HDMI Input with HDCP support	4x Display output (>3 audience displays plus 1 secondary output for recording or streaming)
PWA-VP100K2	8x 3G-SDI Input	4x Display output (>3 audience displays plus 1 secondary output for recording or streaming)
PWA-VP100K3	2x HDMI Input with HDCP support plus 4x 3G-SDI Input	4x Display output (>3 audience displays plus 1 secondary output for recording or streaming)

*1 Installation of Microsoft Office programs are required for native presentation animation support and other office files to be opened. Alternatively connect presentation PC to HDMI input when either animation is required or native programs to be supported. For better image quality, higher-resolution files are recommended. | *2 Output interface varies by graphic cards.

PrimeSupport Pro

PrimeSupport Elite

Our **PrimeSupportPro** and **PrimeSupportElite** packages go beyond standard levels of warranty with varying support options either at no extra cost or optional upgrade. **PrimeSupportPro** gives you free initial access to expert technical assistance from our multilingual helpdesk while optional **PrimeSupportElite** upgrades go further with our fast-track repair service and – depending on your product - a replacement loan unit*. Both packages include free shipping and no hidden costs so we'll always keep you up and running.

	PrimeSupportPro			PrimeSupportElite					
Products	PWA-VP100			PWA-VP100K1 / PWA-VP100-K2 / PWA-VP100-K3					
Service reference	Included service PS.VISIONPRES.1	PSP.VISPRESSW.3	PSP.VISPRESSW.5	PSP.VPHPBOSO.1*		PSP.VPHPBOSO.3		PSP.VPHPBOSO.5	
Scope of support	Software	software	software	Software	HP hardware server support	Software	HP hardware server support	Software	HP hardware server support
Duration	1 year	3 years	5 years	1 years		3 years		5 years	

*chargeable package for kits

For full product specifications and features please visit pro.sony.eu/installation





Visual Imaging Cameras

Sony's professional video conferencing systems and Full HD visual imaging cameras take your communications to a new level. Unite everyone in your organisation with multi-point virtual meetings, share video, voice and PC presentations, effortlessly, for truly global collaboration.

Visual Imaging Cameras

Smooth, silent operation combined with a powerful zoom range: you'll capture every presenter and contributor in crisp, high definition with our PTZ colour cameras. The SRGs feature Sony's unique View-DR and XDNR technology, ensuring complete clarity even in very poor light. Control is easy, over standard IP networks with intuitive PC software, including the option to stream content over the internet (SRG-300SE).

Highlights

- Powerful 30x optical zoom (SRG-300H and SRG-300SE)
- View-DR and XDNR – unique Sony technologies for clarity in poor light (SRG range)
- IP streaming – stream (live or recorded) conferences, lectures and events (SRG-300SE & SRG-360SHE)

Video Conference

Sony's video conferencing systems empower effective communication for business, distance learning, remote consulting and more. With desktop and portable options, mobile integration and wireless connectivity, they're easy to use and enable sharing of video and PC presentation across multiple sites.

Highlights

- Up to 9-point MCU – connect as many as nine conferences with the PCS-XG100H
- Record – share video and presentations so more people can benefit
- HD and Full HD options, all with clear, sharp audio
- Wireless connectivity (PCS-XC1)

PrimeSupport



PrimeSupport Pro

Included at no extra cost, our initial **PrimeSupportPro** packages go beyond a standard warranty with access to expert technical assistance. Our multilingual helpdesk can answer everyday questions on setting up and using your product by phone or email. And if you do need repairs, we'll organise things quickly and efficiently, with free shipping and no hidden costs.

PrimeSupport Elite

If you're looking for even more peace of mind, upgrading to **PrimeSupportElite** could be the option for your business. We'll keep you up and running with our fast-track repair service that includes all shipping costs. And – depending on your product – we may offer to loan a replacement unit* while yours is being repaired.

For full product specifications and features please visit pro.sony.eu/visual-comms



Camera (SRG-120DH)	
Image Sensor	1/2.8-type "Exmor" CMOS image sensor
Output Pixels (H x V)	1920 x 1080
Frame Rate	59.94 fps
S/N Ratio	50 dB
Brightness Control	Auto/Manual
Zoom Ratio	x144 zoom (12X optical zoom, 12X digital zoom)
Focusing System	Auto/Manual
Horizontal Viewing Angle	Approx. 71°
Focal Length	f = 3.9 mm to 46.8 mm
F-Number	F1.8 to F2.0
Pan/Tilt Angle	Pan ±100°/Tilt +25°
Preset Position	100 positions
Power Supply	Supplied from View-DR Codec Unit
Other Features	Auto Gain Control, Auto White Balance, Backlight Compensation
Key Features	
Data Sharing	PC images up to 1080p resolution is supported (with option) Video annotation function
View-DR Function	Yes
Lip Synchronization	AUTO/OFF
Mic Off Function	ON/OFF
Recording Feature	HD 720p
Video	
Maximum Frame Rate	H.263 QCIF 30 fps, CIF 30 fps, 4CIF 30 fps, w432p 30 fps, w4CIF 30 fps, 720p 60 fps, 1080p 60 fps (with option)
Communication Protocol Standards	H.263, H.263+, H.263++, H.264, H.264 High profile, MPEG-4 SP@L3 4:3 QCIF (176 x 144), CIF (352 x 288), 4CIF (704 x 576)
Resolution	16:9 wCIF/w288p (512 x 288), w432p (768 x 432), w4CIF (1024 x 576), 720p (1280 x 720), 1080p (1920 x 1080) (with option)
Bit Rate	64 kbps to 4,096 kbps
Screen Layout	Full Screen, PinP, PandP, SideBySide, PandPandP
Audio	
Bandwidth and Coding	MPEG-4 AAC Mono: 11 kHz at 64 kbps, 96 kbps / MPEG-4 AAC Mono: 22 kHz at 64 kbps, 96 kbps / G.711: 3.4 kHz at 56 kbps, 64 kbps G.722: 7.0 kHz at 48 kbps, 56 kbps, 64 kbps / G.728: 3.4 kHz at 16 kbps
Other Features	Monaural echo-cancelling (ON/OFF), Auto Gain Control, Noise Reduction
Network	
Protocols	TCP/IP, UDP/IP, DHCP, DNS, HTTP, TELNET, SSH, SNMP, NTP, ARP, RTP/RTCP
QoS (Quality of Service)	Adaptive FEC (Forward Error Correction), Real-time ARQ (Auto Repeat reQuest), ARC (Adaptive Rate Control), IP Precedence, DiffServe
Other Network Features	Packet reordering, TCP/UDP port setting, NAT, PPPoE, UDP shaping, Encryption, Auto gatekeeper discovery, UPnP, URI Dialing, IPv6
Interface	
Video Input	External video input (HDMI x1)
Video Output	HDMI x1
Control Input	mini USB x1
Audio Input	External analog microphone input Mini-jack (Plug in power) x1
Audio Output	HDMI (video, audio) x1
Network Port	10BASE-T/100BASE-TX/1000BASE-T x1
USB Slots	2 (Pen Tablet, USB Memory)
Maintenance Interface	-
Standard	
Communication Protocol Standards	ITU-T H.323, IETF SIP
ITU-T (excluding audio/ video standards)	H.245, H.460.18, H.460.19
IETF	RFC2190, RFC3016, RFC3047, RFC3261, RFC3264, RFC3550, RFC3984, RFC4573, RFC4587, RFC4629, RFC4856, RFC4628, RFC5168
Encryption	H.235 ver.3, H.241, H.243
Far End Camera Control	H.281
Frame Format	H.225.0
Dual Stream	H.239 (video and presentation data)
General	
Power Requirements	DC 19.5 V (AC Adapter : AC 100 V to 240 V, 50/60 Hz)
Power Consumption	26 W (typical)
Power Consumption (Standby)	TBD
Operating Temperature	5°C to 35°C / 41°F to 95°F
Storage Temperature	-20°C to +60°C / -4°F to +140°F
Operating Humidity	20% to 80% (no condensation)
Storage Humidity	20% to 80% (no condensation)
Dimensions (W x H x D)	Approx. 206 x 174 x 152 mm
Mass	Approx. 1.8kg
Supplied Accessories	PCS-A1 microphones (1), AC adapter (1), HDMI cable (3m) (1), RF Remote Commander Unit (1), Before using this unit Installation Guide (1), Warranty booklet (1)

PCS-XC1

Optional Accessories

Optional Licenses

PCS-A1
Omnidirectional
Microphone



PCS-MEP
IPELA Communication Mobile app for Android,
iPhone®, iPad®, iPad Air™ and iPad mini™



PCSA-RXC1
Full HD update

PCSA-WXC1
WiFi update

For full product specifications and features please visit
pro.sony.eu/visual-comms

	PCS-XG100H	PCS-XG77H
Camera (SRG-120DH)		
Image Sensor	1/2.8-type "Exmor" CMOS image sensor	
Image Sensor (Number of effective pixels)	Approx. 2.1 Megapixels	
Output Pixels (H x V)	1920 x 1080	
Frame Rate	59.94 fps	
S/N Ratio	50 dB	
Brightness Control	Auto/Manual	
Zoom Ratio	x144 zoom (12X optical zoom, 12X digital zoom)	
Focusing System	Auto/Manual	
Horizontal Viewing Angle	Approx. 71°	
Focal Length	f = 3.9 mm to 46.8 mm	
F-Number	F1.8 to F2.0	
Pan/Tilt Angle	Pan ±100°/Tilt +25°	
Preset Position	16 positions	
Power Supply	Supplied from Codec Unit	
Other Features	Auto Gain Control, View-DR, XDNR, Backlight Compensation	
Key Features		
Multipoint Capability	Up to 6 sites (H.320/H.323) with optional software PCSA-MCG106. Up to 9 sites (H.323) with optional software PCSA-MCG109. 10 to 16 sites requires two PCS-XG100S units cascaded with optional software (10 sites with H.320) (16 sites with H.323)	-
Data Sharing	PC images up to 1080p resolution is supported	PC images up to 1080p resolution is supported with optional license (SXGA standard)
	Video annotation function	
Lip Synchronization	AUTO/OFF	
Mic Off Function	ON/OFF	
Recording Feature	HD 720p	
Video		
Maximum Frame Rate	H.261 QCIF 30 fps, CIF 30 fps, H.263 QCIF 30 fps, CIF 30 fps, 4CIF 30 fps	
	H.264 QCIF 30 fps, CIF 30 fps, 4CIF 30 fps, wCIF 30 fps, w432p 30 fps, w4CIF 30 fps, 720p 60 fps, 1080p 60 fps	H.264 QCIF 30 fps, CIF 30 fps, 4CIF 30 fps, wCIF 30 fps, w432p 30 fps, w4CIF 30 fps, 720p 60 fps, 1080p 60 fps
Communication Protocol Standards	H.261*, H.263, H.263+, H.263++, H.264, H.264 High profile, MPEG-4 SP@L3	
	4:3 QCIF (176 x 144), CIF (352 x 288), 4CIF (704 x 576)	
Resolution	16:9 wCIF/w288p (512 x 288), w432p (768 x 432), w4CIF (1024 x 576), 720p (1280 x 720), 1080p (1920 x 1080)	16:9 wCIF/w288p (512 x 288), w432p (768 x 432), w4CIF (1024 x 576), 720p (1280 x 720), 1080p (1920 x 1080) with software option
Bit Rate	64 kbps to 16,000 kbps	64 kbps to 4,096 kbps
Screen Layout	Full Screen, PinP, PandP, SideBySide, PandPandP	
Audio		
Bandwidth and Coding	MPEG-4 AAC Stereo: 22 kHz at 192 kbps (IP only) MPEG-4 AAC Mono: 14 kHz at 48 kbps, 64 kbps, 96 kbps MPEG-4 AAC Mono: 22 kHz at 64 kbps, 96 kbps (IP only) G.711: 3.4 kHz at 56 kbps, 64 kbps G.722: 7.0 kHz at 48 kbps, 56 kbps, 64 kbps G.728: 3.4 kHz at 16 kbps	
Other Features	Stereo echo-cancelling (ON/OFF), Auto Gain Control, Noise Reduction	

*1 H.261 in H.323 will be available as V2.0

	PCS-XG100H	PCS-XG77H
Network		
Protocols	TCP/IP, UDP/IP, DHCP, DNS, HTTP, TELNET, SSH, SNMP, NTP, ARP, RTP/RTCP	
QoS (Quality of Service)	Adaptive FEC (Forward Error Correction), Real-time ARQ (Auto Repeat reQuest), ARC (Adaptive Rate Control), IP Precedence, DiffServe	
Other Network Features	Packet reordering, TCP/UDP port setting, NAT, PPPoE, UDP shaping, Encryption, Auto gatekeeper discovery, UPnP, URI Dialing, IPv6	
Interface		
Video Input	External video inputs (HDMI x 1, DVI-I x 2)	External video inputs (DVI-I x 2)
Video Output	HDMI x 2, DVI-I x 1	HDMI x 1, DVI-I x 1
Control Input	RS-232C x 1	
Audio Input	External analog microphone input Mini-jack (Plug in power) x 6 (L/R)	-
	HDMI (video, audio) x 1	-
	Audio Input (MIC/AUX) x 2 (Phono jack, stereo)	
Audio Output	HDMI (video, audio) x 1, Line Output (Phono jack, stereo) x 1, REC Output (Phono jack, stereo) x 1	
Network Port	10BASE-T/100BASE-TX/1000BASE-T x 2, ISDN Unit Interface x 1	10BASE-T/100BASE-TX/1000BASE-T x 1, ISDN Unit Interface x 1
USB Slots	2 (Pen Tablet, USB Memory)	
Maintenance Interface	RS-232C x 1	
Standard		
Communication Protocol Standards	ITU-T H.320 ¹ , H.323, IETF SIP	
ITU-T (excluding audio/video standards)	H.231, H.241 H.242, H.243, H.245, H.350, H.460.18, H.460.19	
IETF	RFC2190, RFC3016, RFC3047, RFC3261, RFC3264, RFC3550, RFC3984, RFC4573, RFC4587, RFC4629, RFC4856, RFC4628, RFC5168	
Encryption	H.233, H.234, H.235 ver.3	
Far End Camera Control	H.224, H.281	
Frame Format	H.221, BONDING, H.225.0	
Dual Stream	H.239 (video and presentation data)	
General		
Power Requirements	DC 19.5 V (AC Adapter : AC 100 V to 240 V, 50/60 Hz)	
Power Consumption	58.5W	
Power Consumption (Standby)	23.4W	
Operating Temperature	5°C to 35°C / 41°F to 95°F	
Storage Temperature	-20°C to +60°C / -4°F to +140°F	
Operating Humidity	20% to 80% (no condensation)	
Storage Humidity	20% to 80% (no condensation)	
Dimensions (W x H x D)	Codec: Approx. 370 x 60 x 244 mm (excluding protrusions) Camera unit (SRG-120DH): Approx. 153 x 156 x 153 mm (excluding protrusions)	
Mass	Codec: Approx. 2.3 kg Camera Unit (SRG-120DH) (not optional only in "H" version): Approx. 1.45 kg (3 lb 3.1 oz)	
Supplied Accessories	PCS-A1 microphones (2) (PCS-XG100H), PCS-A1 microphones (1) (PCS-XG77H), AC adapter (1), HDMI cable (3m) (1), RF Remote Commander Unit (1), Batteries for Remote Commander unit (2), CD-ROM (Operating instructions, Before using this unit, Quick connection guide) (1), Before using this unit (1), Installation Guide (1), Quick connection guide (1), Warranty booklet (1), Camera cable (3m) for HD camera (1)	

PCS-XG100H / PCS-XG77H

Optional Accessories

Optional Licenses

PCS-A1
Omnidirectional
Microphone



SRG-300H
1080p/60 HD
Pan/Tilt/Zoom
Camera



PCSA-B384S
3-line ISDN unit
(up to 6B channels)



PCSA-B768S
6-line ISDN unit
(up to 12B channels)



PCS-MEP
IPELA Communication
Mobile app



PCSA-MCG106 6 site
internal MCU for XG100/77

PCSA-MCG109 9 site
internal MCU for XG100

PCSA-RXG77 HD update
for XG77

PCSA-SAG1/8 License update
for MEP client connection

For full product specifications and features please visit
pro.sony.eu/visual-comms



General	
Power Requirements	DC 12V (AC Adapter : AC 100V to 240V, 50/60Hz)
Power Consumption	13 Watts
Operating Temperature	5 C to 35 C 41 F to 95 F
Storage Temperature	-20 C to + 60 C -4 F to +140 F
Operating Humidity	20% to 80% (no condensation)
Storage Humidity	20% to 80% (no condensation)
Dimensions (W x H x D)	Approx. 170 x 44 x 125 mm (excluding protrusions)
Mass	Approx. 0.65 kg
Formats	
Communication Protocol	ITU-T H.323
Video Encoding	H.263, H.263+, H.263++, H.264 Baseline Profile, H.264 High Profile
Audio Encoding	G.711 (3.4kHz@56/64kbps), G.722 (7.0kHz@48/56/64kbps), G.728 (3.4kHz@16kbps), MPEG-4 AAC-LC Mono (14kHz@64/96kbps) ¹ , MPEG-4 AAC-LC Mono (22kHz@64/96kbps) ²
Frame Format	H.225
Dual Stream	H.239 (video and presentation data) (transmission and reception)
Encryption	H.235 version 3
Other	H.460.18, H.460.19
Video and Audio	
Video Codec - Resolution	[4:3] QCIF (176x144), CIF (352x288), 4CIF (704x576) [16:9] WCIF (W288p) (512x288), W432p (768x432), W4CIF (1024x576), 720p (1280x720), 1080p (1920x1080)
Video Codec - Frame Rate	Up to 60fps (H.264@720p, H.264@1080p) Up to 30fps (H.264, H.263, H.263+, H.263++, except for H.263 4CIF)
Screen Layout	3 screens, 4 screens, 6 screens, 9 screens, 10 screens, 13 screens, 16 screens
Communication Parameter Settings	YES (Auto / Manual) (Resolution, Bitrate, Frame Rate)
Multi-stream Transmission/ Reception	YES (A/V only) 3 streams (2x video + 1x PC)
Audio Channel	Mono
Mic ON/OFF	NO
Network and Multipoint	
Network Protocol	TCP/IP, UDP/IP, DHCP, DNS, HTTP, TELNET, SSH, SNMP, NTP, ARP, RTP/RTCP, PPPoE, UPnP
QoS (Quality of Service)	Real-time ARQ (Auto Repeat reQuest), ARC (Adaptive Rate Control), Adaptive FEC (Forward Error Correction), IP Precedence, DiffServe
Network Function	UDP Shaping, TCP/UDP Port Setting, NAT Support, Auto Gatekeeper Discovery, URI Dialing, IPv6
Protocol Stack	IPv4, IPv6
Bitrate	64 kbps to 16,000 kbps
H.239 Presentation	YES
Multipoint Capability	Up to 4 terminals (H.323) as standard Up to 10 terminals (H.323) with optional software PCSA-MPE1 Up to 16 terminals (H.323) with optional software PCSA-MPE1 and PCSA-MPE2
Interfaces	
Network Interface	Gigabit Ethernet (10BASE-T/100BASE-TX/1000BASE-T) x 2
External Control	YES (mini-USB typed terminal) ³ .
Other	USB x 1 Kensington Security Slot x 1
Language	
Language on web UI	English, Japanese, Chinese

¹: In the case that the echo canceller is activated. | ²: In the case that the echo canceller is deactivated |
³: the mini-USB typed terminal is NOT compliant with USB

PrimeSupportPro PrimeSupportElite



Our **PrimeSupportPro** and **PrimeSupportElite** packages go beyond standard levels of warranty with varying support options either at no extra cost or optional upgrade. **PrimeSupportPro** gives you free initial access to expert technical assistance from our multilingual helpdesk while optional **PrimeSupportElite** upgrades go further with our fast-track repair service and – depending on your product - a replacement loan unit¹. Both packages include free shipping and no hidden costs so we'll always keep you up and running.

	PrimeSupportPro			PrimeSupportElite		
Service reference	Included service PS.VIDEOCONF.3	PSP. VIDCONFYSYSM.4	PSP. VIDCONFYSYSM.5	PSP. HDCONFYSYS.RL3	PSP. HDCONFYSYS.RL4	PSP. HDCONFYSYS.RL5
Duration	3 years	1 year repair extension Total 4 years	2 years repair extension Total 5 years	3 years repair & loan	4 years repair & loan	5 years repair & loan

For full product specifications and features please visit
pro.sony.eu/visual-comms





	SRG-360SHE	SRG-300SE	SRG-300H
Camera			
Image Sensor	1/2.8" Exmor CMOS		
Image Sensor (Number of Effective Pixels)	Approx. 2.1 Megapixels		
Signal System	1080/59.94p,50p 1080/59.94i,50i 720/59.94p,50p	1080/59.94p (A/B), 50p (A/B), 29.97p, 25p 1080/59.94i, 50i 720/59.94p, 50p, 29.97p, 25p	1080/59.94p, 50p, 29.97p, 25p 1080/59.94i, 50i 720/59.94p, 50p, 29.97p, 25p
Minimum Illumination (50 IRE)	High Sensitivity Mode: 0.35lx (50IRE, F1.6, 30fps) High Sensitivity Mode: 0.7 lux (50IRE, F1.6, 60fps) Normal Mode: 1.4lx (50IRE, F1.6, 30fps) Normal Mode: 2.8lx (50IRE, F1.6, 60fps)		
S/N Ratio	50 dB		
Gain	Auto/Manual (0 to +43 dB)		
Day/Night Mode	Yes		
Shutter Speed	1/1 to 1/10000		
Exposure Control	Auto, Manual, Priority AE (Shutter, Iris), Exposure Compensation, Bright		
White Balance	Auto, Indoor, Outdoor, One-push Auto, ATW, Manual		
Optical Zoom	30x		
Digital Zoom	12x		
Focusing System	Auto/Manual		
Horizontal Viewing Angle	65° (Wide)		
Focal Length	f = 4.3mm (Wide) to 129mm (Tele) F1.6 to 4.7		
Minimum Object Distance	10 mm (Wide) to 1200 mm (Tele)		
Pan/Tilt Angle	Pan: ±170° Tilt: +90°/-30°		Pan: ±170° Tilt: +90°/-20°
Pan/Tilt Speed (Max.)	Pan: 60°/sec Tilt: 60°/sec		Pan: 100°/sec Tilt: 90°/sec
Preset Position	256		16
Camera Features			
Wide-D	View-DR (59.94fps 90dB/29.97fps 130db)		
Noise Reduction	Yes		
Image Stabilizer	Yes		
Image Flip	Yes		
PTZ Sync	Yes	No	No
PTZ Trace	Yes	No	No
Interface			
Video Output	3G-SDI, HDMI, IP	3G-SDI, IP	HDMI
MIC Input	Mini-phone (3.5φ)×2 (MIC/Line Selectable)	RCA x 1 (LINE), Mini-phone (3.5φ) x 1 (MIC) (selectable)	No
Line Input	Mini-phone (3.5φ)×2 (MIC/Line Selectable)	RCA x 1	No
Network Port		Yes	
Camera Control Interface	RJ-45	RJ-45, 9-Pin PHOENIX Block	RJ-45, 8-Pin DIN, 9-Pin PHOENIX Block
Camera Control IR	Yes	No	Yes
Camera Control Protocol	RS-422, VISCA over IP, CGI, S700PTP	RS-422, VISCA over IP, CGI	RS-422, RS-232, VISCA over IP
Sync System	INT		
General			
Power Requirements	DC 12V (DC 10.8 to 13.2V)		
Power Consumption	25.5W		16.8 W
PoE	PoE+		No
Operating Temperature	0 °C to 40 °C		
Storage Temperature	-20 °C to 60 °C		
Dimensions* (W x H x D)	159 x 187.5 x 200.5mm		157 x 164 x 163mm
Mass	Approx. 2.1kg		Approx. 1.4kg
Body Color	White with black		White/Black
Mountable Angle	≤15°		
Ceiling Mount	Yes		
Supplied Accessories	IR Remote Commander (1), AC Power Adaptor (1), Ceiling Bracket (2), Wire Rope (1), HDMI Cable Retainer (1), Screw M3 x8 (9), Screw M2.6 x6 (1)	AC Power Adaptor (1), AC Power Cable (1), Ceiling Bracket (2), RS-422 Connector Plug (1), Wire Rope (1), Screw M3 x8 (9)	AC Power Adaptor (1), AC Power Cable (1), IR Remote Commander (1), CD-ROM (Operating Instructions) (1), Ceiling Bracket (2), RS-422 Connector Plug (1), Wire Rope (1), Screw M3 x8 (8)
IP streaming / Video			
Resolution	1920 x 1080, 1280 x 720, 960 x 540, 720 x 480	1920 x 1080, 1280 x 720, 1024 x 576, 960 x 536, 720 x 576, 720 x 480, 704 x 576, 640 x 480, 640 x 360, 352 x 288, 320 x 184	-
Compression Format	H.264	H.264, JPEG	-
Maximum Frame Rate	H.264: 60 fps (1920 x 1080)		
Bitrate Compression Mode	CBR/VBR (selectable)		
Range of Bitrate Setting	Up to 32 Mbps		
Adaptive Rate Control	No	Yes	-
Multi Streaming Capability	3		
Maximum Number of Clients	5		
Protocols	IPv4, TCP, UDP, ARP, ICMP, IGMP, HTTP, DHCP, DNS, RTP/RTCP, RTSP, HTTPS, SNMP, VISCA over IP	IPv4, TCP, UDP, ARP, ICMP, IGMP, HTTP, DHCP, DNS, NTP, RTP/RTCP, RTSP over TCP, RTSP over HTTP, IPv6, HTTPS, SNMP (v1, v2c, v3), SSL	-
Audio			
Channel	2	1	-
Codec	AAC LC		
Audio Setting Option	Auto Gain Control (ALC), Equalizer		
Network			
Multicast Streaming Support	Yes		
ONVIF Conformance	No		
Wireless Network	No		
Authentication	No	IEEE802.1X	-
System Requirements			
Operating System	Windows 7 (32/64bit), Windows 8.1 Pro (32/64bit) ¹ , Windows 10 Pro (32/64bit) ² Authorized editions: Windows 7: Ultimate, Professional, Windows 8.1: Pro, Windows 10: Pro	Microsoft Windows Vista (32bit), Windows 7 (32/64bit), Windows 8 Pro (32/64bit) ³ , Windows 8.1 Pro (32/64bit) ³ Authorized editions: Windows Vista: Ultimate, Business, Windows 7: Ultimate, Professional, Windows 8: Pro, Windows 8.1: Pro, Microsoft DirectX 9.0c or higher	-
Processor	Intel Core i7, 2.8 GHz or higher. Or Intel Core i3 / Intel Core i5 / Intel Core i7 (with built-in Intel HD Graphics)		
Memory	2GB or more		
Web Browser	Windows Internet Explorer Ver. 11.0 ¹ , Google Chrome Ver. 50.0	Windows Internet Explorer Ver. 7.0, Ver. 8.0, Ver. 9.0, Ver. 10.0 ² , Ver. 11.0 ³ Firefox Ver.19.0, Safari Ver.5.1, Google Chrome Ver.25.0	-

*The values for dimensions are approximate. ¹ If you use Windows 8.1, use the Internet Explorer for the desktop user interface (desktop UI). ² If you use Windows 10, turn off the tablet mode. ³ In case of Windows 8 or Windows 8.1, use the Internet Explorer desktop user interface (desktop UI) edition.

For full product specifications and features please visit pro.sony.eu/visual-comms



	SRG-120DH	SRG-120DS	SRG-120DU
Camera			
Image Sensor	1/2.8" Exmor CMOS		
Image Sensor (Number of Effective Pixels)	Approx. 2.1 Megapixels		
Signal System	1080/59.94p, 50p, 29.97p, 25p 1080/59.94i, 50i 720/59.94p, 50p, 29.97p, 25p	1080/59.94p (A/B), 50p (A/B), 29.97p, 25p 1080/59.94i, 50i 720/59.94p, 50p, 29.97p, 25p	1080/59.94p, 50p, 29.97p, 25p 720/59.94p, 50p, 29.97p, 25p
Minimum Illumination (50 IRE)	High Sensitivity Mode: 0.4lx (50IRE, F1.8, 30fps) High Sensitivity Mode: 0.9lx (50IRE, F1.8, 60fps) Normal Mode: 1.8lx (50IRE, F1.8, 30fps) Normal Mode: 3.6lx (50IRE, F1.8, 60fps)		
S/N Ratio	50 dB		
Gain	Auto/Manual (0 to +43 dB)		
Day/Night Mode	No		
Shutter Speed	1/1 to 1/10000		
Exposure Control	Auto, Manual, Priority AE (Shutter, Iris), Exposure Compensation, Bright		
White Balance	Auto, Indoor, Outdoor, One-push Auto, ATW, Manual		
Optical Zoom	12x		
Digital Zoom	12x		
Focusing System	Auto/Manual		
Horizontal Viewing Angle	71° (Wide)		
Focal Length	f = 3.9mm (wide) to 46.8 mm (Tele) F1.8 to 2.0		
Minimum Object Distance	10 mm (Wide) to 1500 mm (Tele)		
Pan/Tilt Angle	Pan: ±100° Tilt: ±25°		
Pan/Tilt Speed (Max.)	Pan: 300°/sec Tilt: 126°/sec		
Preset Position	16		
Camera Features			
Wide-D	View-DR (59.94fps 90dB/29.97fps 130db)		
Noise Reduction	Yes		
Image Stabilizer	No		
Image Flip	No		
PTZ Sync	No		
PTZ Trace	No		
Interface			
Video Output	HDMI	3G-SDI	USB
MIC Input	No		
Line Input	No		
Network Port	Yes		
Camera Control Interface	8-Pin DIN, RJ-45		8-Pin DIN, RJ-45, USB
Camera Control IR	Yes		
Camera Control Protocol	RS-232, VISCA, VISCA over IP		RS-232, VISCA, VISCA over IP, UVC
Sync System	INT		
General			
Power Requirements	DC 12V (DC 10.8 to 13.2V)		
Power Consumption	16.8 W		
PoE	No		
Operating Temperature	0 °C to 40 °C		
Storage Temperature	-20 °C to 60 °C		
Dimensions* (W x H x D)	153 x 156 x 153 mm		
Mass	Approx. 1.6kg		
Body Color	Silver		
Mountable Angle	<±15°		
Ceiling Mount	No		
Supplied Accessories	AC Power Adaptor (1), AC Power Cable (1) IR Remote Commander (1), CD-ROM (Operating Instructions) (1)	AC Power Adaptor (1), AC Power Cable (1) IR Remote Commander (1), CD-ROM (Operating Instructions) (1)	AC Power Adaptor (1), AC Power Cable (1) IR Remote Commander (1), CD-ROM (Operating Instructions) (1)

*The values for dimensions are approximate.

Visual Imaging Cameras

SRG Series Optional Accessories

PCS-A1
Omnidirectional
Microphone



RC4 Remote
Digital PTZ Camera
Extension Solution for
RS-232 control; HDMI or DVI



RC5 Remote
Digital PTZ Camera
Extension Solution for
Ethernet control



PrimeSupportPro
PrimeSupportElite



Our **PrimeSupportPro** and **PrimeSupportElite** packages go beyond standard levels of warranty with varying support options either at no extra cost or optional upgrade. **PrimeSupportPro** gives you free initial access to expert technical assistance from our multilingual helpdesk while optional **PrimeSupportElite** upgrades go further with our fast-track repair service and – depending on your product - a replacement loan unit*. Both packages include free shipping and no hidden costs so we'll always keep you up and running.

	PrimeSupportPro			PrimeSupportElite		
Service reference	Included service PS.VIDEOCONF.3	PSP.HDCAMERA.4	PSP.HDCAMERA.5	PSP. HDCAMERA.RL3	PSP. HDCAMERA.RL4	PSP. HDCAMERA.RL5
Duration	3 years	1 year repair extension Total 4 years	2 years repair extension Total 5 years	3 years repair & loan	4 years repair & loan	5 years repair & loan



RM-IP10

Control of up to 112 SRG/BRC cameras via IP

- The RM-IP10 remote control panel gives you control of up to 112 BRC cameras over an IP network.

Additional ability to use VISCA control

- The RM-IP10 can also control up to 7 SRG/BRC cameras over a traditional VISCA (Video System Control Architecture) network.

Simple RJ-45 (10Base-T/100Base-TX) connection for easy connection

- The RM-IP10 links to an IP network with via a RJ-45 connector providing very easy, low cost and speedy installation.

PC configuration software supplied

- The RM-IP10 provides for convenient configuration of system IPs and BRCs numbers, with location free configuration of a network.

Up to 5 controllers can operate on a single network

- Up to 5 RM-IP10 control panels can be used on a single network allowing shared control and simultaneous multi-operator control of large camera systems.

Simultaneous Preset recall to all cameras under control

- Instantaneous set-up of multiple cameras provides a big time saving for camera adjustments.



RM-IP500

Simple IP connection and control of up to 100 cameras

- Auto IP setting without PC and DIP switch.
- Auto assign camera number while keeping camera's IP address.
- Save/load/copy settings via PC.

Sensitive Pan/Tilt/Zoom operation for high-quality productions

- Zoom seesaw lever separately (zoom in two ways, joystick/seesaw lever.)
- Speed controls for sensitive PTZF operation.
- 10-key numeric keypad for preset selection.
- Tally indicator, and normal tally/on-air tally/contact mode.

Adjust paint functions for brilliant colours*

- Adjust master black and more functions without camera menu.
- Assign buttons (back light on/off, flicker cancel on/off, detail level, knee point etc.)

*Available functions depend on camera



For full product specifications and features please visit
pro.sony.eu/visual-comms



BRC-Series

From TV studios and sports stadiums to auditoriums, lecture theatres and houses of worship – our sophisticated, dependable BRC remote cameras capture and stream broadcast-quality video footage in detail-packed 4K or Full HD.

BRC-X1000

The BRC-X1000 is Sony's first 4K remote camera, combining uncompromising broadcast picture quality and smooth, silent PTZ operation with the flexibility of 3G-SDI and HDMI connections.

BRC-H900

The BRC-H900 remote studio camera combines uncompromising broadcast picture quality with the flexibility of PTZ operation.

BRC-H800

The BRC-H800 remote camera combines uncompromising broadcast picture quality and smooth, silent PTZ operation with the flexibility of 3G-SDI and HDMI connections.



BRC-X1000



BRC-H900



BRC-H800



	BRC-X1000 (4K)	BRC-H900 (HD)	BRC-H800 (HD)
Camera			
Image Sensor	1" Exmor R CMOS	1/2" Exmor 3CMOS	1" Exmor R CMOS
Minimum Illumination (50 IRE)	1.7lx (50IRE, 1/30s, Iris/Gain Auto)	4lx (50IRE, F1.9, +24 dB)	1.7lx (50IRE, 1/30s, Iris/Gain Auto)
Optical Zoom	12x	14x	12x
Clear Image Zoom*	2x *1.5x at 4K resolution	-	2x
Signal System	2160/29.97P, 1080/59.94P, 1080/59.94i, 720/59.94P, 2160/25P, 1080/50P, 1080/50i, 720/50P	60 Hz: 1080/59.94i, 720/59.94P, NTSC 50 Hz: 1080/50i, 720/50P, PAL	1080/59.94P, 1080/59.94i, 720/59.94P, 1080/50P, 1080/50i, 720/50P
Pan Angle		±170°	
Tilt Angle		+90° to -30°	
PTZ Preset		16	
PTZ Sync	Yes (v1.5)	No	Yes (v1.5)
PTZ Trace	Yes (v1.5)	No	Yes (v1.5)
PoE+	Yes	No	Yes



PrimeSupportPro Included at no extra cost, our initial **PrimeSupportPro** packages go beyond a standard warranty with access to expert technical assistance. Our multilingual helpdesk can answer everyday questions on setting up and using your product by phone or email. And if you do need repairs, we'll organise things quickly and efficiently, with free shipping and no hidden costs.

Product	RM-IP10 / RM-IP500 BRC-X1000 / BRC-H800 / BRC-H900		
Service reference	PS.PACK2.12X.1	PSPA.OAPOMP.1ER	PSPA.OAPOMP.2ER
Duration	2 years Included service	1 year extension	2 years extension

For full product specifications and features please visit pro.sony.eu/visual-comms



UMC-S3C

With an ultra-high sensitivity of ISO 409600* and internal recording, this compact 4K video camera is ideal for a wide range of remote shooting applications in almost total darkness.



This lens is optional

Crisp, clear 4K video and still images, even in near darkness

With an ultra-high sensitivity of ISO 409600*, the UMC-S3C captures crisp, clear 4K/29.97P/25P colour video and low-noise 12 megapixel still images in minimum illumination conditions of 0.004 lx.

The 35 mm full-frame Exmor™ sensor captures significantly more incident light than conventional cameras, while the image processing extremely enhances the high sensitivity with very low noise. Area-specific noise reduction selectively divides the image into areas based on patterns (such as edges, textures and evenly coloured areas like blue skies) to efficiently reduce noise and improve image quality. Detail reproduction technology helps to accurately depict details with a more natural sense of dimension.

Greater shooting flexibility with choice of E-mount FE lenses

The camera's versatility in a wide range of shooting applications is enhanced by compatibility with a wide range of interchangeable E-mount FE lenses (available separately)**. These maximise the performance of the 35 mm full-frame sensor, maintaining high resolution across the entire image area from centre to edges.

Small and light enough to go anywhere

Ideal for use in space-limited situations, the compact camera measures approximately 104.0 mm x 84.0 mm x 48.0 mm (4 1/8 inches x 3 3/8 inches x 1 15/16 inches). With a light weight of approximately 390 g (13.8 oz), it's ideal for installation in mobile environments such as vehicles and robots.

Easy operation even on the move

4K video or still images can be recorded internally to an SD card, or fed via HDMI to an external recorder or monitor, even when the camera is on the move. The camera's multi terminal can connect to Micro USB-compatible devices, allowing remote control of functions such as zoom and shutter release, Rec Start/Stop, and Zoom using widely-available consumer accessories.

High quality internal recording

The camera can continuously record 4K/29.97P/25P colour video in the XAVC S format at up to 100 Mbps, and 12 megapixel colour still images in JPEG or RAW format at 14 bits to an SD memory card. For example, a 64 GB SD card can record up to 125 minutes of continuous 4K footage with standard quality (29.97P/60 Mbps).

Recorded video files can be reviewed on a wide range of ordinary PC media players compatible with the MP4 format such as Windows Media Player.

* Standard ISO 100-102400, expandable to 50-409600

** Compatible E mount FE lenses include the SEL35F14Z (35 mm, F1.4), SEL35F28 (35 mm, F2.8), SEL28F20 (28 mm, F2.0), and SEL55F18Z (55 mm, F1.8).

UMC-S3C

Optional Accessories

SEL2870

35mm full frame E-mount zoom lens FE 28-70mm F3.5-5.6 OSS



SEL35F28Z

ZEISS Sonnar T* FE 35mm F2.8 ZA wide-angle Prime lens



SEL55F18Z

ZEISS 35mm full frame E-mount standard prime lens Sonnar T* FE 55mm F1.8 ZA



SEL70200G

35mm full frame E-mount telephoto zoom lens FE 70-200mm F4 G OSS



For full product specifications and features please visit pro.sony.eu/visual-comms



Visual Simulation and Visual Entertainment

Every projector in our simulation and visualisation line-up delivers stunning 4K images. At more than four times the resolution of Full HD, it guarantees an astonishingly detail-packed experience, with richer colour and unbeatable image quality. Whether you're creating a flight simulation for pilot training, a Planetarium, or sharing a finely-detailed visualisation for an automotive design, all projectors can provide you with the very best picture.

For full product specifications and features please visit pro.sony.eu/visualisation



PrimeSupport

PrimeSupportPro

Included at no extra cost, our initial **PrimeSupportPro** packages go beyond a standard warranty with access to expert technical assistance. Our multilingual helpdesk can answer everyday questions on setting up and using your product by phone or email. And if you do need repairs, we'll organise things quickly and efficiently, with free shipping and no hidden costs.

PrimeSupportElite

If you're looking for even more peace of mind, upgrading to **PrimeSupportElite** could be the option for your business. We'll keep you up and running with our fast-track repair service that includes all shipping costs. And – depending on your product – we may offer to loan a replacement unit* while yours is being repaired.

PrimeSupportBespoke

Everybody's business is different. A selected number of our products are also eligible for **PrimeSupportBespoke**, and **PrimeSupportOn-Demand**, tailored solutions for organisations with the most demanding requirements for service and support. With options like next working day spares and on-site technical assistance, there's no better choice when dependable performance of your AV communications infrastructure is most crucial.

PrimeSupportOn-Demand

Support for our Visual Simulation and Entertainment solutions is available with **PrimeSupportOn-Demand**. One working day (**PSP.CE.INITDAY.1**), initial solution setup (**PSP.CE.TRAINDAY.1**), training delivery (**PSP.CE.ONSITEDAY.1**) or maintenance. We can also deliver resource to adapt the solutions to your requirements (**PSP.CE.CUSTOMDAY.1**) Scope of work must be agreed before intervention.

For full product specifications and features please visit
pro.sony.eu/visualisation



CLEDIS

Display Technology

A blank canvas comes to life

The ultimate big-screen display solution, delivering ultra-real visual experiences on virtually any scale.

A blank canvas comes to life. CLEDIS turns the world's biggest ideas into thrilling visual reality – from automotive and industrial product design, theme parks, museums and galleries to corporate lobbies, boardrooms and broadcast studios.

- Ultrafine surface-mounted RGB LEDs create pixels with 99% black area for extremely high contrast images in any lighting conditions.
- Energy-efficient borderless display modules can be tiled seamlessly to create displays with virtually any dimensions or aspect ratio.
- Extended colour range (140% of sRGB) and impressive 1000 nit brightness for maximum impact.
- Speedy video response accurately reproduces fast-moving content.
- Extremely wide viewing angle (virtually 180°).

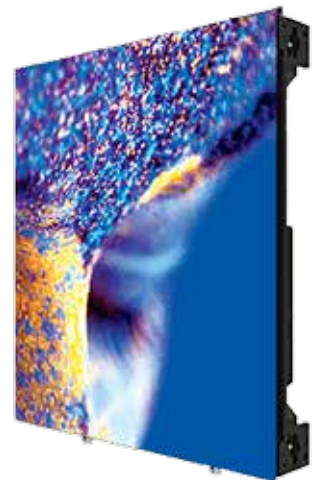

For full product specifications and features please visit pro.sony.eu/CLEDIS



CLEDIS Display Unit

Method	Self Light Emitting Display
Light Emission Device	Sony Original Developed Super Micro LED (RGB in 1pixel)
Pixel Pitch	1.26mm
Black Area	>99% (Ratio of display area except lighting point area)
Unit Resolution (W x H)	320 x 360 (115,200pixels)
Unit Size (mm/inch) (W x H x D)	403.2 x 453.6 x 100 / 15 7/8 x 17 7/8 x 4
Unit Area (sqm/sqft)	0.18 / 1.97
Unit Weight (kg/lb)	10.0 kg / 22 lb. 0.74 oz.
Cell Module Resolution (W x H)	80 x 120 (9,600pixels)
Cell Module Size (mm/inch) (W x H)	100.8 x 151.2 / 3 31/32 x 5 15/16
Cell Module Configuration (W x H)	4 x 3 in 1 unit (12 Cell Modules in 1 unit)
Brightness (nit = cd/m2)	Maximum 1,000 ,Color Temp D93
Contrast Ratio	more than 1,000,000:1
Viewing Angle	Almost 180°(H/V)
Display Native Color Space	140% wider than sRGB
Input signal	10bit
Signal Interface	1 in 1out (2x RJ45) (Unit-Controller or Unit-Unit)
Signal Cable (Unit-Controller, Unit-Unit)	Cat.7 Ethernet Cable
Power In/Out	1 AC Inlet, 1 AC Outlet (AC Inlet: IEC C13, AC Outlet: IEC C14 x1)
Power Requirements	AC200-240V, 50/60 Hz, Single Phase
Average Power Consumption (per Unit)	100W
Average Power Consumption (per sqm)	550W (approx.)
LED Lifespan (Half Brightness)	87,600hour
Storage Temperature	-20°C-60°C
Operation Humidity	20-80% (No condensation)
Storage Humidity	20-80% (No condensation)



CLEDIS Display Controller

Maximum Control Number of Display Unit	72(6unit/1port x 12port)
Maximum Input Resolution	W1920 x H2160
Maximum Input Frame Rate	120p
Video Input	DVI-D (Single Link) x 4 *HDCP Compliant, DisplayPort (DP1.2) x 2
Unit Output	RJ45 x 12
Maximum Power Consumption	90W
Controller Size (mm) (W x D x H)	440 x 349 x 65 (without protrusions) 440 x 367.3 x 75 (incl. protrusions) *1.5U 19inch Rack
Controller Size (inch) (W x H x D)	17 3/8 x 13 3/4 x 2 5/8 (without protrusions) 17 3/8 x 14 15/32 x 2 15/16 (incl. protrusions) *1.5U 19inch Rack
Storage Temperature	-20°C-60°C
Operation Humidity	20-80% (No condensation)
Storage Humidity	20-80% (No condensation)



PrimeSupport Bespoke

This product is eligible for **PrimeSupportBespoke**, a tailored solution for organisations with the most demanding requirements for service and support. With options like next working day spares and on-site technical assistance, there's no better choice when dependable performance of your AV communications infrastructure is most crucial.



VPL-GTZ280

4K SXR D up to 5000 lumens Laser Light Source Projector

Sony combines the best of its projection technologies, 4K SXR D imagery and laser light source technology, to create a projector with native 4K resolution, high-speed signal processing, fast motion blur reduction, infrared light output for night vision, and vibration resistance - all ideal for visualisation, simulation and training applications.

- Exclusive SXR D chip provides native 4K resolution and high contrast ratio
- 4K 3D capability for reliable simulation*
- Deep blacks reduce white band visibility for multi-projector blending
- Long life optics, up to 20,000h (up to 40,000h in low brightness mode)
- Dust resistance by sealed optics
- Constant brightness mode and periodic auto calibration for enduring image quality



- High speed motion functions: 4K 120Hz input, smear reduction, transport delay reduction*
- Infrared light output for night vision simulation*
- Angle-free installation and vibration endurance for motion based system
- Whisper quiet operation less than 35dB
- HDR (High Dynamic Range) Gamma*

*Configurable function.



VPL-GTZ270

4K SXR D 5000 lumens Laser Light Source Projector

Sony combines the best of its projection technologies, 4K SXR D imagery and laser light source technology, to create a projector with native 4K resolution, an extremely high contrast ratio, high dynamic range and wide colour space - ideal for visual entertainment applications including planetariums, theme parks, and museums.

- Exclusive SXR D chip provides native 4K resolution and high contrast ratio
- 'Reality Creation' upscaling
- HDR (High Dynamic Range)*
- Wide Colour Space - covers full DCI range and simulated BT2020
- 4K 3D capability
- Deep blacks reduce white band visibility for multi-projector blending
- Less maintenance



- Long life optics, up to 20,000h (up to 40,000h in low brightness mode)
- Dust resistance by sealed optics
- Constant brightness mode and periodic auto calibration for enduring image quality
- Angle-free installation
- Robust chassis for easy handling and self stack capability
- Whisper quiet operation less than 35dB

*Configurable function.

This data projector is classified as a CLASS 2 LASER PRODUCT. (Laser radiation IEC60825-1:2007)



LASER RADIATION DO NOT STARE INTO BEAM CLASS 2 LASER PRODUCT LASERSTRALUNG TITÄ INTE I STRÄLEN LASERPROJEKTOR KLASS 2 クラス 2 レーザ製品	WAVE LENGTH: 455-470nm VÄGLÄNGD: 455-470nm	MAX OUTPUT < 20mW MAX UTEFFEKT < 20mW	IEC60825-1:2007 JIS C5802:2005 4-141-411-01
---	---	--	---

For full product specifications and features please visit pro.sony.eu/visualisation

		VPL-GTZ280	VPL-GTZ270
Display system		4K SXRD panel, projection system	4K SXRD panel, projection system
Display device	Size of effective display area	0.74" x 3	0.74" x 3
	Number of pixels	26,542,080 (4096 x 2160 x 3) pixels	26,542,080 (4096 x 2160 x 3) pixels
Projection lens ^{*2}	Focus	Powered	Powered
	Zoom	Powered	Powered
Light source		Laser diode	Laser diode
Light output		2,000 lm 5,000 lm using the LSM-BRIN1 optional upgrade	5,000 lm
Colour light output		2,000 lm 5,000 lm using the LSM-BRIN1 optional upgrade	5,000 lm
Contrast ratio	Native	Up to 20,000:1 ^{*1} (native contrast)	Up to 20,000:1 ^{*1}
	Dynamic	-	Up to 30,000:1 ^{*1}
Accepted digital signals ^{*3}		VGA, SVGA, XGA, WXGA (1280x768), Quad-VGA, SXGA, 720x480/60p, 720x576/50p, 1280x720/50p, 1280x720/60p, 1920x1080/24p, 1920x1080/50p, 1920x1080/60p, 3840x2160/24p, 3840x2160/50p, 3840x2160/60p, 3840x2160/100P, 3840x2160/120P, 4096x2160/24p, 4096x2160/50p, 4096x2160/60p, 4096x2160/100P, 4096x2160/120P	VGA, SVGA, XGA, WXGA (1280x768), Quad-VGA, SXGA, 720x480/60p, 720x576/50p, 1280x720/50p, 1280x720/60p, 1920x1080/50i ^{*4} , 1920x1080/60i ^{*4} , 1920x1080/24p, 1920x1080/50p, 1920x1080/60p, 3840x2160/24p, 3840x2160/25p ^{*4} , 3840x2160/30p ^{*4} , 3840x2160/50p, 3840x2160/60p, 4096x2160/24p, 4096x2160/25p ^{*4} , 4096x2160/30p ^{*4} , 4096x2160/50p, 4096x2160/60p
Color bit depth		Up to 10 bit	Up to 12 bit via HDMI / Up to 10 bit via Display Port
INPUT OUTPUT (Computer/Video/ Control)	HDMI	-	2 inputs (HDCP 2.2 x 2), Digital (RGB/Y Pb/Cb Pr/Cr)
	Display Port	4 inputs (HDCP 1.3 x 2, HDCP 1.3 for V Split x 2), Digital (RGB)	2 inputs (HDCP 1.3 x 1, HDCP 1.3 for V Split x 1), Digital (RGB)
	TRIGGER	2 connectors, Mini jack, DC 12V Max:100 mA	2 connectors, Mini jack, DC 12V Max:100 mA
	REMOTE	RS-232C, D-sub 9-pin (female)	RS-232C, D-sub 9-pin (female)
	LAN	RJ45, 10BASE-T/100BASE-TX	RJ45, 10BASE-T/100BASE-TX
	IR IN / OUT	IN:1, Out:1, Mini jack	IN:1, Out:1, Mini jack
	SYNC	IN:1, Out:1	IN:1, Out:1
OSD languages		Type A	Type A
		18-languages (English, Dutch, French, Italian, German, Spanish, Portuguese, Turkish, Russian, Swedish, Norwegian, Japanese, Simplified Chinese, Traditional Chinese, Korean, Thai, Arabic, Polish)	18-languages (English, Dutch, French, Italian, German, Spanish, Portuguese, Turkish, Russian, Swedish, Norwegian, Japanese, Simplified Chinese, Traditional Chinese, Korean, Thai, Arabic, Polish)
Acoustic noise		30 dB ~ 35 dB ^{*1}	30 dB ~ 35 dB ^{*1}
Operating temperature (Operating humidity)		5°C to 40°C (41°F to +104°F)/20% to 80% (no condensation)	5° to 40° (41°F to +104°F)/20% to 80% (no condensation)
Storage temperature (Storage humidity)		-10° to + 60° (14°F to +140°F)/20% to 80% (no condensation)	-10° to + 60° (14°F to +140°F)/20% to 80% (no condensation)
Power requirements		AC 220 V to 240 V, 6 A, 50/60 Hz (For Europe and China) AC 100 V to 240 V, 12 A to 6 A, 50/60 Hz (For the other countries)	AC 220 V to 240 V, 6 A, 50/60 Hz (For Europe and China) AC 100 V to 240 V, 12 A to 6 A, 50/60 Hz (For the other countries)
Power consumption		MAX. 1.2 kW	MAX. 1.2 kW
Power consumption (Standby Mode)		0.4 W (When "Remote Start" is set to "Off")	0.4 W (When "Remote Start" is set to "Off")
Power consumption (Networked Standby Mode)		0.6 W (LAN) (When "Remote Start" is set to "On")	0.6 W (LAN) (When "Remote Start" is set to "On")
Heat dissipation		4092 BTU/h	4092 BTU/h
Dimensions (W x H x D)		550 x 228 x 750 mm (21 21/32 x 8 31/32 x 29 17/32 in) (without protrusions) 550 x 262 x 750 mm (21 21/32 x 10 5/16 x 29 17/32 in)	550 x 228 x 750 mm (21 21/32 x 8 31/32 x 29 17/32 in) (without protrusions) 550 x 262 x 750 mm (21 21/32 x 10 5/16 x 29 17/32 in)
Mass		Approx. 40 kg / 88 lb (excluding lens)	Approx. 40 kg / 88 lb (excluding lens)
Supplied accessories		RM-PJ29 Remote Commander (1), Size AA (R6), Manganese Batteries (2), AC Power Cord (1), Operating Instructions (CD-ROM) (1)	RM-PJ29 Remote Commander (1), Size AA (R6) Manganese Batteries (2), AC Power Cord (1), Operating Instructions (CD-ROM) (1)

*1 This value is approximate. Depends on the projector setting condition and usage environment

*2 The lenses are optional accessories

*3 60p,30p,24p include 59.94/60Hz, 29.97Hz/30Hz, 23.98Hz/24Hz

*4 Available via HDMI input

PrimeSupport Pro

PrimeSupport Elite

PrimeSupport Bespoke

PrimeSupport On-Demand

Our **PrimeSupport** packages go beyond standard levels of warranty with varying support options either at no extra cost or optional upgrade. **PrimeSupportPro** gives you free initial access to expert technical assistance from our multilingual helpdesk while optional **PrimeSupportElite** upgrades go further with our fast-track repair service and – depending on your product - a replacement loan unit[†]. Both packages include free shipping and no hidden costs so we'll always keep you up and running.

These products are also eligible for **PrimeSupportBespoke** and **PrimeSupportOn-Demand**, tailored solutions for organisations with the most demanding requirements for service and support. With options like next working day spares and on-site technical assistance, there's no better choice when dependable performance of your AV communications infrastructure is most crucial.

	PrimeSupportPro				PrimeSupportElite			
Service reference	PS.LASPROJPD.3		PSP.VPLGTZ270280.5		PSP.VPLGTZ270280.PREM.3		PSP.VPLGTZ270280.PREM.5	
Scope of support	Projector	Optical Block & Laser	Projector	Optical Block & Laser	Projector	Optical Block & Laser	Projector	Optical Block & Laser
Duration	3 year	7000h	2 years repair extension Total: 5 years	12000h	Premium 3 years contract	7000h	Premium 5 years contract	12000h

For full product specifications and features please visit pro.sony.eu/visualisation



VPL-GTZ1



Professional 4K SXRD projectors for visualisation and simulation

Combining the best Sony technologies, the VPL-GTZ1 is a 4K Ultra-Short Throw projector with a laser light source for 20,000 hours of high performance, virtually zero maintenance without the need for a lamp exchange. At 2,000 lumens brightness, it's perfect for museums, design simulation, industry, education, business and can be used to create stunning video walls.

- Detail-packed 4K image quality
- Projected image size: 66" to 147"
- No lamp: 20,000 hours virtually zero maintenance requirements
- Quick on/off
- Floor standing or ceiling mount with front and rear projection
- 'Blend in' design to suit any environment

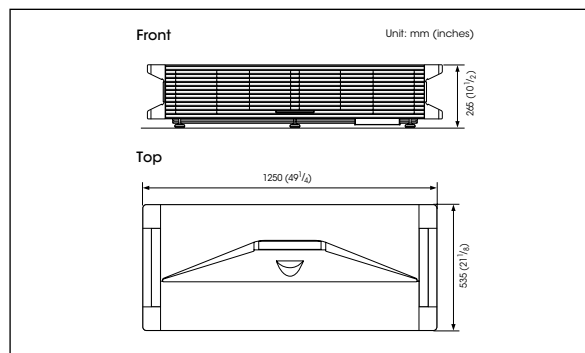

This data projector is classified as a CLASS 2 LASER PRODUCT. (Laser radiation IEC60825-1:2007)

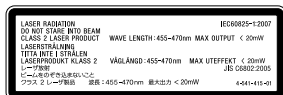

		VPL-GTZ1
Display System		SXRD panel, projection system
Display device		SXRD 0.74" (18.8 mm) x 3
Projection lens	Number of pixels	26,542,080 (4096 x 2160 x 3) pixels
	Zoom	Powered (Approx. x1.6)
	Focus	Powered
Projection lens	Corner correction adjustment	Powered
	Throw Ratio	0.16:1 to 0.25:1
Light source		Laser diode
Projection image size		66" to 147" (1,676 mm to 3,734 mm)
Light output		2000 lm
Color light output		2000 lm
Contrast ratio		∞:1 (dynamic contrast)
Accepted digital signals**		VGA, SVGA, XGA, WXGA(1280x768), Quad-VGA, SXGA, SXGA+, 480/60p, 576/50p, 720/60p, 720/50p, 1080/60i, 1080/50i, 1080/60p, 1080/50p, 1080/24p, 3840x2160/24p, 3840x2160/25p, 3840x2160/30p, 3840x2160/50p*, 3840x2160/60p*, 4096x2160/24p, 4096x2160/25p, 4096x2160/30p, 4096x2160/50p*, 4096 x 2160/60p*
Inputs/Outputs (Video/Audio/Control)	HDMI Inputs	4
	REMOTE	RS-232C, D-sub 9-pin
	LAN	RJ45, 10BASE-T/100BASE-TX
	IR IN	Mini Jack
	USB	Type A, DC 5 V, Max. 500 mA
Operating temperature (Operating humidity)		5°C to 35°C (41°F to 95°F) (35% to 85% (no condensation))
Storage temperature (Storage humidity)		-20°C to +60°C (-4°F to +140°F) (10% to 90% (no condensation))
Power requirements		AC 100 V to 240 V, 5.9 A to 2.5 A, 50/60 Hz
Power consumption		520 W
Standby mode power consumption		0.5 W
Standby mode / Networked Standby mode activated		After about 10 minutes
Acoustic noise		26 dB
Dimensions (WxHxD)		1,250 mm x 265 mm x 535 mm (49.2 inches x 10.4 inches x 21.1 inches)
		1,100 mm x 265 mm x 535 mm (43.3 inches x 10.4 inches x 21.1 inches) (without handle)
Mass		55 kg (121 lb)
Optional accessories		Active 3D Glasses: TDG-BT500A

*1 60p,30p,24p include 59.94/60Hz, 29.97Hz/30Hz, 23.98Hz/24Hz | *2 YCbCr 4:2:0 / 8 bit format signal. Design of this unit is subject to change without notice.



PrimeSupport Pro

Service reference	PS.LASPROJJD.3	
Scope of support	Projector	Optical Block & Laser
Duration	3 years	7000 hours

Included at no extra cost, our initial **PrimeSupportPro** packages go beyond a standard warranty with access to expert technical assistance. Our multilingual helpdesk can answer everyday questions on setting up and using your product by phone or email. And if you do need repairs, we'll organise things quickly and efficiently, with free shipping and no hidden costs.

For full product specifications and features please visit pro.sony.eu/visualisation



VPL-VZ1000ES



Compact 4K Ultra Short Throw laser light source projector, suited to corporate environments, retail spaces, galleries, museums and home cinema use.



- Project 4K images up to 305cm diagonal size onto a screen or wall
- Z-Phosphor laser light source and SXRD panel technology for stunning images with 2,500 lumens brightness
- Up to 20,000 hours operation with virtually no maintenance.
- TRILUMINOS™ Display for cinema-like colour gamut.
- HDR compatible for wider brightness level range.
- Can be operated floor-standing, ceiling mounted or used for rear projection.
- Extensive connectivity with 4x HDMI inputs.
- Quiet operation with low fan noise.

		VPL-VZ1000ES
Display System		4K SXRD panel, projection system
Display device		0.74" x 3 SXRD
	Number of pixels	26,542,080 (4096 x 2160 x 3) pixels
	Zoom	Powered (Approx. x1.02)
Projection lens	Focus	Powered
	Lens shift	Powered, Vertical: +/- 6%, Horizontal: +/- 3%
Light source		Laser diode
Screen size		80" to 120" (2030 mm to 3050 mm)
Light output (Lamp mode: High)		2500 lm
Color light output (Lamp mode: High)		2500 lm
Contrast ratio		∞:1 (dynamic contrast)
Accepted digital signals*		VVGA, SVGA, XGA, WXGA(1280x768), Quad-VGA, SXGA, 720x480/60p, 720x576/50p, 1280x720/50p, 1280x720/60p, 1920x1080/50i, 1920x1080/60i, 1920x1080/24p, 1920x1080/50p, 1920x1080/60p, 3840x2160/24p, 3840x2160/25p, 3840x2160/30p, 3840x2160/50p, 3840x2160/60p, 4096x2160/24p, 4096x2160/25p, 4096x2160/30p, 4096x2160/50p, 4096x2160/60p
Inputs/Outputs (Computer/Video/Control)	HDMI (HDCP 2.2)	HDMI (x4)
	REMOTE	RS-232C, D-sub 9-pin
	LAN	RJ-45, 10Base-T/100BASE-TX
	IR IN	Mini Jack
	USB	Type A, DC 5V, Max. 500 mA
Operating temperature (Operating humidity)		5°C to 35°C (41°F to 95°F) (20% to 80% (no condensation))
Storage temperature (Storage humidity)		-10°C to +60°C (14°F to +140°F) (20% to 80% (no condensation))
Power requirements		AC 100 V to 240 V, 4.2 A to 1.8 A, 50/60 Hz
Power consumption		420 W
Standby mode power consumption		0.5 W (when "Remote Start" is set to "Off")
Networked Standby		0.6 W (LAN) (when "Remote Start" is set to "On") When a LAN terminal is not connected, it becomes a low power consumption mode (0.5 W).
Dimensions (WxHxD)		925 mm x 218.5 mm x 493.8 mm (36 13/32 x 8 19/32 x 19 7/16 inches)
Mass		Approx. 35kg (77 lb) (without side and top covers)
Optional accessories		Active 3D Glasses: TDG-BT500A

*1 60p,30p,24p include 59.94/60Hz, 29.97Hz/30Hz, 23.98Hz/24Hz



PrimeSupport Pro

Included at no extra cost, our initial **PrimeSupportPro** packages go beyond a standard warranty with access to expert technical assistance. Our multilingual helpdesk can answer everyday questions on setting up and using your product by phone or email. And if you do need repairs, we'll organise things quickly and efficiently, with free shipping and no hidden costs.

Service reference	PS.LASPROJPD.3	
Scope of support	Projector	Optical Block & Laser
Duration	3 years	7000 hours

For full product specifications and features for the VPL-VZ1000ES please visit pro.sony.eu/VZ1000ES



SRX-T615

HDMI 4K SXR

SRX-T series for professional and industrial visualisation

- Detail with true 4K SXR picture quality
- Best in class 12,000:1 contrast ratio and 18,000 centre lumens combined
- Efficient, easy to handle HPM multi-lamp array
- Interleaved lamp control for longer life
- Lamp fail-safe for resilient operation
- Easy-on-the-eye 3D
- Create super-sized images with edge blending
- Flexible throw distance with interchangeable lens



	SRX-T615
Resolution	4096 x 2160
Display device	3 x 1.48" 4K SXR
Brightness	18,000 Centre lumens
Contrast ratio	12,000:1
Lamp technology	6 x HMP lamp 450W/330W

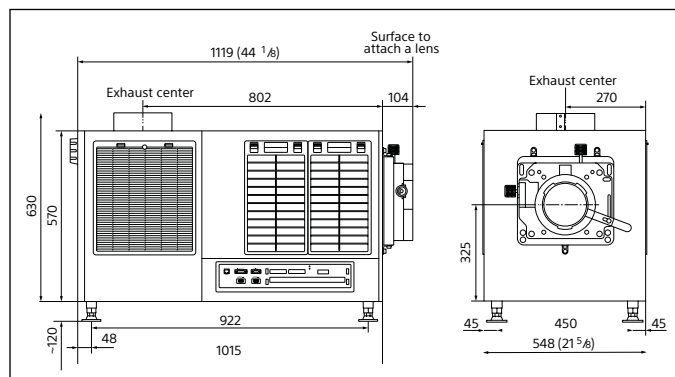

PrimeSupport Elite PrimeSupport On-Demand

Our **PrimeSupportElite** packages go beyond standard levels of warranty with various optional upgrades available including our fast track repair service and – depending on your product - a replacement loan unit†, free shipping and no hidden costs so we'll always keep you up and running.

Further support for this product is also available with **PrimeSupportOn-Demand** with one working day initial product setup (PSP.CE.INITDAY.1). Scope of work must be agreed before intervention.



Service reference	Warranty	PrimeSupport Elite				PrimeSupport On-Demand
		PSP.TECHSUP.3	PSP.TECHSUP.5	PSP.EXPRESSPARTS.3	PSP.EXPRESSPARTS.5	PSP.CE.INITDAY.1
Duration	1 year	3 years	5 years	3 years	5 years	1 day onsite engineer

For full product specifications and features please visit pro.sony.eu/visualisation



VPL-GT100

VPL-GT100 is a compact professional 4K SXRD projector with 2,000 lumens brightness, ideal for simulation. It features a dual display port input for outstanding native 4096 x 2160 resolution at 60 frames per second, while Sony's latest generation SXRD panel and advanced Iris3 technology achieve an incredible dynamic contrast ratio of 1,000,000:1.

- Richer pictures with Wide Colour Space (DCI, Adobe RGB)
- Transport delay reduction, for smooth images
- Portrait or landscape installation
- Smear reduction with Sony's Dark Frame Insertion technology
- Compact – 20kg



	VPL-GT100
Resolution	4096 x 2160
Display device	3 x 0.74" 4K SXRD
Brightness	2,000 lumens
Dynamic contrast ratio	1,000,000:1
Lamp technology	330W HMP lamp



PrimeSupport Pro

Included at no extra cost, our initial **PrimeSupportPro** packages go beyond a standard warranty with access to expert technical assistance. Our multilingual helpdesk can answer everyday questions on setting up and using your product by phone or email. And if you do need repairs, we'll organise things quickly and efficiently, with free shipping and no hidden costs.

Service reference	Included Service PS.VPLGT100.3.L1		PSP.VPLGT100.5
Scope of support	Projector	Lamp	Projector
Duration	3 years	1 year or 1000 h	+2 years (Total 5 years)



LKRL-Z519



LKRL-Z514



LKRL-Z211



LKRL-Z511

Lamp

	SRX-T615	SRX-T420
Lamp	LKRM-U450 LKRM-U330 LKRM-U331	LKRX-2042A

Interface board

	SRX-T615
DVI Board	QMCB-DVI
HD-SDI Board	QMCB-SDI

Interchangeable lens

	SRX-T615	LKRL-Z511	SRX-T420	LKRL-Z519
Throw ratio		1.05-1.75	1.35-2.34	1.80-4.00
3D Lens for SRX-T615		LKRL-A502	LKRL-A503	
Throw ratio		1.03-1.85	1.70-3.76	

For full product specifications and features please visit pro.sony.eu/visualisation

© 2017 Sony Corporation.

All rights reserved. Reproduction in whole or in part without permission is prohibited. Features and specifications are subject to change without notice. All non-metric weights and measurements are approximate. 'Sony' is a registered trademark of Sony Corporation. All other trademarks are the property of their respective owners.

Errors and omissions excepted.

*Specific product cover may vary. Please visit pro.sony.eu/primesupport for full details.

P&C Range Guide EN 25/01/2017

www.pro.sony.eu  [@SonyDisplays](https://twitter.com/SonyDisplays)

Follow us on [LinkedIn](#) 

SONY

Distributed by