

First Team
®

2021-2022

1-800-649-3688

WWW.FIRSTTEAMINC.COM

**MANUFACTURING SUPERIOR
ATHLETIC EQUIPMENT**



WARRANTY INFORMATION FOR FIRST TEAM PRODUCTS

BASKETBALL EQUIPMENT WARRANTY INFORMATION:

All First Team basketball products are warranted against manufacturers defects at delivery. Additionally, First Team warrants most products to the original retail customer for a given period of time as stated in the literature. Below is an explanation of First Team's warranty levels.

Limited Warranty -

Covers any damage caused by normal basketball activity and normal player contact with the goal. "Normal basketball activity" and "Normal player contact" shall be described as any action that is necessary for participation in the game of basketball. Deliberate hanging on the rim, multiple player hanging, and vandalism are not covered under the Limited Warranty.

Any normal wear and tear caused by weathering or UV exposure is not covered under any First Team warranty. All painted items carry a one year limited warranty on coating.

Some basketball products carry a warranty valid only when used in a residential setting. "Residential" is defined as a "single family dwelling." Products covered by this warranty stipulation are indicated in First Team's product literature with a 🏠 symbol next to the warranty. Under no circumstances shall any basketball product carrying a strictly residential warranty be covered for non-residential use.

Superior Warranty -

Covers any damage or failure caused by any type of basketball activity or related contact with the unit. This includes deliberate hanging on the rim as well as multiple player hanging. The Superior Warranty does not cover vandalism.

Unconditional Warranty

Covers any damage or failure that occurs for any reason. Any product carrying an Unconditional Warranty is exempt from the above stated limitations.

Due to the abusive nature of amusement facilities, unless specifically agreed to in writing, First Team products carry no warranty except for obvious manufacturing defects when used in an entertainment facility where players pay a fee to use the equipment.

VOLLEYBALL & TENNIS EQUIPMENT WARRANTY:

All First Team volleyball & tennis products are warranted against manufacturers defects at delivery. Additionally, most products are warranted to the original retail customer for a given period of time as stated in the literature. Below is an explanation of First Team's warranty levels for volleyball & tennis products.

Limited Warranty -

Covers any damage or failure that occurs during the course of "normal or intended use" of the product. Normal or intended use of the product shall be described as activity that is necessary for participation in the sport for which the equipment is designed. Malicious or deliberate damage caused by vandalism is not covered under First Team's Limited Warranty.

Any normal wear and tear caused by weathering, or UV exposure is not covered under any First Team warranty. All painted items carry a one year limited warranty on coating. All volleyball & tennis nets carry a 2-Year Limited Warranty.

Some volleyball or tennis products carry a warranty valid only when used in a residential setting. "Residential" is defined as a "single family dwelling." Products covered by this warranty stipulation are indicated in First Team's product literature with a 🏠 symbol next to the warranty. Under no circumstances shall any volleyball or tennis product carrying a strictly residential warranty be covered for non-residential use.

Superior Warranty -

Covers any damage or failure caused by any type of volleyball or tennis activity, contact with the unit or associated use of the product. "Associated use" of the product includes but is not limited to setup and teardown of volleyball & tennis systems.

WARRANTY INFORMATION FOR FIRST TEAM PRODUCTS

SOCCER EQUIPMENT WARRANTY INFORMATION:

All First Team soccer products are warranted against manufacturers defects at delivery. Additionally, most products are warranted to the original retail customer for a given period of time as stated in the literature. Below is an explanation of First Team's warranty levels for soccer products.

Limited Warranty -

Covers any damage or failure that occurs during the course of "normal or intended use" of the product. Normal or intended use of the product shall be described as activity that is necessary for participation in the sport for which the equipment is designed. Malicious or deliberate damage caused by vandalism is not covered under First Team's Limited Warranty.

Any normal wear and tear caused by weathering, or UV exposure is not covered under any First Team warranty. All painted items carry a one year limited warranty on coating. All soccer nets carry a 1-Year Limited Warranty.

Some soccer products carry a warranty valid only when used in a residential setting. "Residential" is defined as a "single family dwelling." Products covered by this warranty stipulation are indicated in First Team's product literature with a  symbol next to the warranty. Under no circumstances shall any soccer product carrying a strictly residential warranty be covered for non-residential use.

Superior Warranty -

Covers any damage or failure caused by any type of soccer activity, contact with the unit or associated use of the product. "Associated use" of the product includes but is not limited to transport of portable goals.

FOOTBALL AND LACROSSE EQUIPMENT WARRANTY INFORMATION:

All First Team football/lacrosse products are warranted against manufacturer's defects at delivery. Additionally, most products are warranted to the original retail customer for a given period of time as stated in the literature. Below is an explanation of First Team's warranty levels for football/lacrosse products.

Limited Warranty -

Covers any damage or failure that occurs during the course of "normal or intended use" of the product. Normal or intended use of the product shall be described as activity that is necessary for participation in the sport for which the equipment is designed. Malicious or deliberate damage caused by vandalism is not covered under First Team's Limited Warranty.

Any normal wear and tear caused by weathering or UV exposure is not covered under any First Team warranty. All painted items carry a one year limited warranty on coating.

Some football products carry a warranty valid only when used in a residential setting. "Residential" is defined as a "single family dwelling." Products covered by this warranty stipulation are indicated in First Team's product literature with a  symbol next to the warranty. Under no circumstances shall any football product carrying a strictly residential warranty be covered for non-residential use.

Superior Warranty -

Covers any damage or failure caused by any type of football/lacrosse activity or associated use of the product. "Associated use" of the product includes but is not limited to player contact with the goal. All lacrosse nets carry a 1-Year Limited Warranty.



First Team Sports, Inc.
902 Corey Rd.
Hutchinson, KS 67501

Sales: 800-649-3688
Customer Service: 888-884-6677
Fax: 620-663-6055

Website: www.firstteaminc.com
e-mail: firstteam@firstteaminc.com

www.firstteaminc.com

First Team, Inc. • Hutchinson, Kansas • Toll-Free 1-800-649-3688

the HURRICANE™

PORTABLE BASKETBALL SYSTEM

First Team

HURRICANE TRIUMPH

- All First Team goals are direct mounted to eliminate backboard breakage when players hang on the rim
- Bolt-on TuffGuard™ backboard padding
- Boom Pad Included
- Upper and Lower boom supports

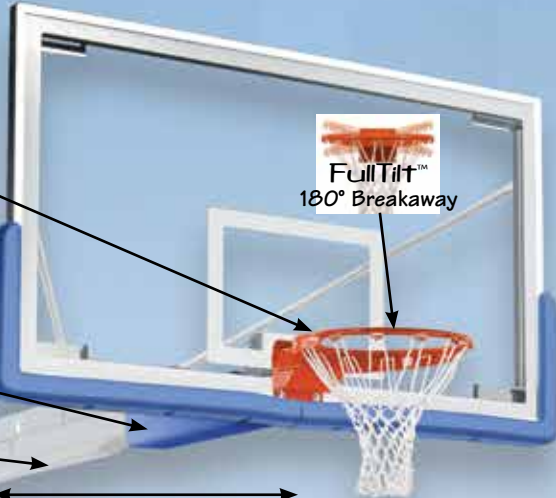

FullTilt™
180° Breakaway

• Base to backboard extension distance is 96"

• Rim height adjusts for smaller players

• Compact & Easy to roll

FREE!

LTR 86 Base Pad Lettering Upon Request

- Safety padding covers front, sides and back of base unit

- Rolls on 8" diameter non-marking wheels
- 5" non-marking foot pads lock unit into position for play

WARNING!

Failure to install customer supplied ballast according to instructions could result in serious injury.

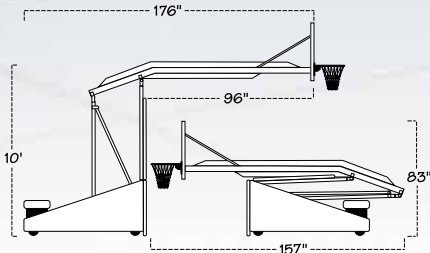

The Hurricane competition style portable basketball goal is designed for use in a fieldhouse, gymnasium or anywhere upper end, aggressive basketball is played.

The Hurricane's massive extension arm features an upper and lower boom support. The extension distance from base to backboard is 96" meeting all NCAA and National High School Federation requirements. The unit comes equipped with First Team's top of the line FT235 Unbreakable 42"x72" competition tempered glass basketball backboard, FT196 Full-Tilt 180 degree breakaway basketball goal and FT72C TuffGuard bolt-on backboard padding. These are the same components used in high schools and colleges throughout the country.

The Hurricane portable basketball hoop is also height adjustable. Rim height adjustments from 10' down to 6' are made easily with its low maintenance extension spring design. To adjust the unit, simply pull the pin located on the adjustment rod, raise or lower the unit as needed and replace the pin. One person can easily roll the unit into place and set up easily.

Heavy foam padding, available in an array of colors, protects players on the front, sides and back of the base unit. A boom extension pad is also included. The unit is extremely stable as well as durable and will not tip over when players hang on the rim. For additional support, rear hold downs are included as required by the NCAA and NHSF for competition portable goals. Choose the Hurricane Triumph-FL package for installations on floating floors or Hurricane Triumph-ST for all other flooring surfaces.

Floor load on the wheels is: 350 psi.

All Hurricane portable basketball goals are covered by First Team's unmatched Lifetime Superior Warranty!

HURRICANE PACKAGE OPTIONS

Order Hurricane Triumph-ST for standard floor anchors

Order Hurricane Triumph-FL for floating floor anchors

HURRICANE TRIUMPH-ST

- FT3050 Hurricane Portable Base Unit
- FT86 Hurricane Base Padding (Any Color)
- FT235 42"x72" Tempered Glass Backboard
- FT196 Full-Tilt Breakaway Goal
- FT72C Backboard Pad (any color)
- Lifetime Superior Warranty
- Approx. Shipping Weight: 1590 lbs.

HURRICANE TRIUMPH-FL

- FT3050 Hurricane Portable Base Unit
- FT86 Hurricane Base Padding (Any Color)
- FT235 42"x72" Tempered Glass Backboard
- FT196 Full-Tilt Breakaway Goal
- FT72C Backboard Pad (any color)
- Lifetime Superior Warranty
- Approx. Shipping Weight: 1590 lbs.

RY Royal Blue	SC Scarlet	GL Gold	PR Purple	KG Kelly Green	BK Black	CB Columbia Blue	MR Maroon	GR Grey	NY Navy Blue	OR Orange	FG Forest Green	BR Brick Red	SO Sienna Orange	DG Desert Gold	SB Saddle Brown
------------------	---------------	------------	--------------	-------------------	-------------	---------------------	--------------	------------	-----------------	--------------	--------------------	-----------------	---------------------	-------------------	--------------------

Hurricane base padding is available in these colors. Shades may vary slightly from color chart.

the TEMPEST™

PORTABLE BASKETBALL SYSTEM



- Rim height adjusts for smaller players

- All First Team goals are direct mounted to eliminate backboard breakage when players hang on the rim

FullTilt™
180° Breakaway

- Bolt-on TuffGuard™ backboard padding

- Compact & Easy to roll

- Upper and Lower boom supports

- Boom Pad Included

- Base to backboard extension distance is 66"

The Tempest competition style portable basketball goal is designed for use in a fieldhouse, gymnasium or anywhere upper end, aggressive basketball is played.

The Tempest's massive extension arm features an upper and lower boom support. The extension distance from base to backboard is 66". The unit comes equipped with First Team's top of the line FT235 Unbreakable 42"x72" competition tempered glass backboard, FT196 Full-Tilt 180 degree breakaway goal and FT72C TuffGuard bolt-on backboard padding. These are the same components used in high schools and colleges throughout the country.

The Tempest portable basketball unit is also height adjustable. Rim height adjustments from 10' down to 6' are made easily and quickly with its low maintenance extension spring design. To adjust the Tempest portable basketball goal, simply pull the pin located on the adjustment rod, raise or lower the unit as needed and replace the pin. One person can easily roll the unit into place and set up quickly.

Heavy foam padding, available in an array of colors, protects players on the front, sides and back of the base unit.

A boom extension pad is also included. The unit is extremely stable as well as durable and will not tip over when players hang on the rim. Though rear hold downs are not necessary, they are available upon request. Choose the Tempest Triumph for installations where rear hold down kits are not wanted. If rear hold downs are desired choose from Tempest Triumph-FL package for installations on floating floors or Tempest Triumph-ST for all other flooring surfaces.

Floor load on the wheels is: 350 psi.

All Tempest portable basketball goals are covered by First Team's unmatched Lifetime Superior Warranty!

FREE!
LTR 86
Base Pad
Lettering
Upon
Request

- Safety padding covers front, sides and back of base unit

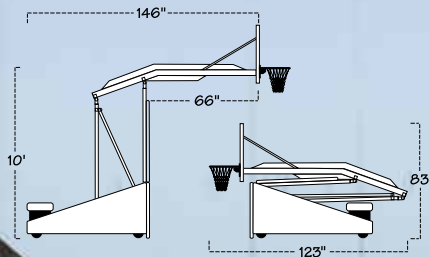

- 8" non-marking wheels

- 5" non-marking locking foot pads

WARNING!

Failure to install customer supplied ballast according to instructions could result in serious injury.

TEMPEST PACKAGE OPTIONS

Order Tempest Triumph-ST for standard floor anchors

Order Tempest Triumph-FL for floating floor anchors

TEMPEST TRIUMPH

- FT3045 Tempest Portable Base Unit
- FT86 Tempest Base Padding (Any Color)
- FT235 42"x72" Tempered Glass Bkbd.
- FT196 Full-Tilt Breakaway Goal
- FT72C Backboard Pad (any color)
- Lifetime Superior Warranty
- Approx. Shipping Weight: 1550 lbs.

TEMPEST TRIUMPH-ST

- FT3045 Tempest Portable Base Unit
- FT86 Tempest Base Padding (Any Color)
- FT235 42"x72" Tempered Glass Bkbd.
- FT196 Full-Tilt Breakaway Goal
- FT72C Backboard Pad (any color)
- Lifetime Superior Warranty
- Approx. Shipping Weight: 1550 lbs.

TEMPEST TRIUMPH-FL

- FT3045 Tempest Portable Base Unit
- FT86 Tempest Base Padding (Any Color)
- FT235 42"x72" Tempered Glass Bkbd.
- FT196 Full-Tilt Breakaway Goal
- FT72C Backboard Pad (any color)
- Lifetime Superior Warranty
- Approx. Shipping Weight: 1550 lbs.

RY Royal Blue	SC Scarlet	GL Gold	PR Purple	KG Kelly Green	BK Black	CB Columbia Blue	MR Maroon	GR Grey	NY Navy Blue	OR Orange	FG Forest Green	BR Brick Red	SO Sienna Orange	DG Desert Gold	SB Saddle Brown
------------------	---------------	------------	--------------	-------------------	-------------	---------------------	--------------	------------	-----------------	--------------	--------------------	-----------------	---------------------	-------------------	--------------------

Hurricane base padding is available in these colors. Shades may vary slightly from color chart.

www.firstteaminc.com

First Team, Inc. • Hutchinson, Kansas • Toll-Free 1-800-649-3688

the STORM™

PORTABLE BASKETBALL SYSTEM



- Adjustable overhang extension

- Extensive backboard selection in acrylic or tempered glass
- Rim height adjusts

- for smaller players
- Compact & Easy to roll

- Direct rim mount design

- Optional bolt-on TuffGuard™ backboard padding

- Post to backboard extension distance is adjustable from 54" - 66"

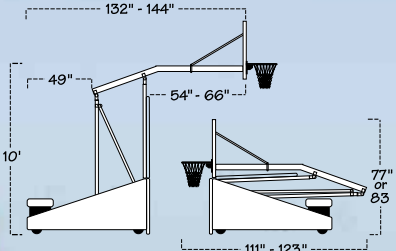

FREE!
LTR 85
Base Pad Lettering
Upon Request

- Safety padding covers front, sides and back of base unit

- 8" non-marking casters lock unit into position for play

The Storm is a portable basketball goal designed for use in a gymnasium, fieldhouse, multipurpose facility or recreational complex.

The Storm is adjustable. Height adjustments from 10' down to 6' are made easily with the Storm's spring-aided design. To adjust, simply pull the pin located on the adjustment rod, raise or lower the unit as needed and replace the pin.

The distance from the backboard to the base of the unit is variable from 54" to 66" allowing the Storm to fit into your facility. Heavy foam padding, available in an array of colors, protects players on the front, sides and back of the base. The unit is extremely stable as well as durable, and will not tip over when players hang on the rim.

Floor load on the wheels is:

Rolling - 325 psi

Stationary - 325 psi

A variety of backboards ranging in size from 36"x60" to 42"x72" are available on the Storm. This allows the unit to be customized for a wide scope of applications and budgets.

Every Storm package comes with a Lifetime Superior Warranty.

WARNING!

Failure to install customer supplied ballast according to instructions could result in serious injury.

STORM PACKAGE OPTIONS

STORM
SELECT

STORM
PRO

STORM
SUPREME

STORM
ARENA

- FT3040 Storm Portable Base Unit
- FT85 Base Padding (Any Color)
- FT220 36"x60" Acrylic Backboard
- FT186 Heavy Duty Flex Goal
- Lifetime Superior Warranty
- Approx. Shipping Weight: 1165 lbs.

- FT3040 Storm Portable Base Unit
- FT85 Base Padding (Any Color)
- FT230 36"x60" Temp. Glass Backboard
- FT186 Heavy Duty Flex Goal
- Lifetime Superior Warranty
- Approx. Shipping Weight: 1210 lbs.

- FT3040 Storm Portable Base Unit
- FT85 Base Padding (Any Color)
- FT222 42"x72" Acrylic Backboard
- FT186 Heavy Duty Flex Goal
- Lifetime Superior Warranty
- Approx. Shipping Weight: 1210 lbs.

- FT3040 Storm Portable Base Unit
- FT85 Base Padding (Any Color)
- FT232 42"x72" Temp. Glass Backboard
- FT186 Heavy Duty Flex Goal
- Lifetime Superior Warranty
- Approx. Shipping Weight: 1290 lbs.

RY Royal Blue	SC Scarlet	GL Gold	PR Purple	KG Kelly Green	BK Black	CB Columbia Blue	MR Maroon	GR Grey	NY Navy Blue	OR Orange	FG Forest Green	BR Brick Red	SO Sienna Orange	DG Desert Gold	SB Saddle Brown
------------------	---------------	------------	--------------	-------------------	-------------	---------------------	--------------	------------	-----------------	--------------	--------------------	-----------------	---------------------	-------------------	--------------------

Hurricane base padding is available in these colors. Shades may vary slightly from color chart.

the THUNDER™

PORTABLE BASKETBALL SYSTEM



- Extensive backboard selection in acrylic or tempered glass
- All First Team goals are direct mounted to eliminate backboard breakage when players hang on the rim
- Additional H-Frame backboard support for extra ball response
- Rim height adjusts for smaller players
- Compact & Easy to roll
- Simple hand crank adjusts rim height from 10' - 6'6"



- Optional bolt-on TuffGuard™ backboard padding
- Post to backboard extension distance is 48"
- Rim Height Indicator
- Safety padding covers front of base unit

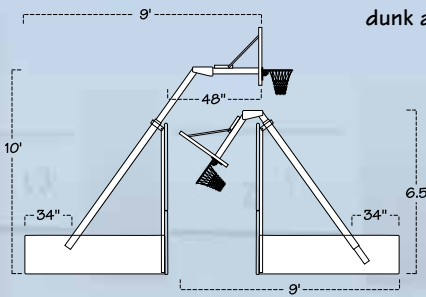

The Thunder portable basketball goal is an excellent choice for any school gymnasium, recreation complex, multipurpose facility or church in need of a high quality portable while working within a budget.

The Thunder is adjustable. Its simple to use hand crank allows for infinite height adjustments from regulation 10' down to 6'6". An easy to crank adjustment handle on the backside of the unit telescopes the backboard and rim to the desired playing height.

One person can easily move the Thunder portable goal. An easy to grip release crank unlocks the brake and six roller wheels contact the playing surface for smooth portability. The extension arm can quickly drop down to allow the unit to pass under any standard height double doors.

The distance from the backboard to the base of the unit is 4' with the rim at the regulation 10' height. This allows the base of the unit to sit "off the court" for player safety. Heavy foam padding covers the entire front of the unit for additional safety. Padding is available in several colors.

The unit is durable and stable enough to withstand slam dunk action and will not tip over when players hang on the rim.

Floor load on the wheels is:

- Rolling - 275 psi
- Stationary - 210 psi

A variety of backboards ranging from 36"x54" to 42"x72" are available on the Thunder. This allows the unit to meet an array of facilities and budget needs.

Every Thunder package comes with a Lifetime Superior Warranty.

FREE!
LTR 84
Base Pad
Lettering
Upon Request

- Wheel brake locks unit in playing position

WARNING!

Failure to install customer supplied ballast according to instructions could result in serious injury.

THUNDER PACKAGE OPTIONS



- | | | | | |
|--|--|--|--|--|
| <ul style="list-style-type: none"> • FT3030 Thunder Portable Base Unit • FT84 Base Padding (Any Color) • FT220 36"x60" Acrylic Bkbd. • FT186 Heavy Duty Flex Goal • Lifetime Superior Warranty • Approx. Shipping Weight: 810 lbs. | <ul style="list-style-type: none"> • FT3030 Thunder Portable Base Unit • FT84 Base Padding (Any Color) • FT225 36"x54" Temp. Glass Bkbd. • FT186 Heavy Duty Flex Goal • Lifetime Superior Warranty • Approx. Shipping Weight: 850 lbs. | <ul style="list-style-type: none"> • FT3030 Thunder Portable Base Unit • FT84 Base Padding (Any Color) • FT230 36"x60" Temp. Glass Bkbd. • FT186 Heavy Duty Flex Goal • Lifetime Superior Warranty • Approx. Shipping Weight: 855 lbs. | <ul style="list-style-type: none"> • FT3030 Thunder Portable Base Unit • FT84 Base Padding (Any Color) • FT222 42"x72" Acrylic Bkbd. • FT186 Heavy Duty Flex Goal • Lifetime Superior Warranty • Approx. Shipping Weight: 855 lbs. | <ul style="list-style-type: none"> • FT3030 Thunder Portable Base Unit • FT84 Base Padding (Any Color) • FT232 42"x72" Temp. Glass Bkbd. • FT186 Heavy Duty Flex Goal • Lifetime Superior Warranty • Approx. Shipping Weight: 935 lbs. |
|--|--|--|--|--|

RY Royal Blue	SC Scarlet	GL Gold	PR Purple	KG Kelly Green	BK Black	CB Columbia Blue	MR Maroon	GR Grey	NY Navy Blue	OR Orange	FG Forest Green	BR Brick Red	SO Sienna Orange	DG Desert Gold	SB Saddle Brown
------------------	---------------	------------	--------------	-------------------	-------------	---------------------	--------------	------------	-----------------	--------------	--------------------	-----------------	---------------------	-------------------	--------------------

Hurricane base padding is available in these colors. Shades may vary slightly from color chart.

www.firstteaminc.com

First Team, Inc. • Hutchinson, Kansas • Toll-Free 1-800-649-3688

the FURY™

PORTABLE BASKETBALL SYSTEM



- Selection of various clear acrylic and tempered glass backboards in sizes ranging from 36"x48" to 36"x60"
- Optional bolt-on TuffGuard™ backboard padding
- Rim height adjusts for smaller players
- All First Team goals are direct mounted to eliminate backboard breakage when players hang on the rim



- Neck drops down to pass through doorway

- Rim Height Indicator
- Hand crank easily adjusts rim height from 10' - 6'6"

- Post to backboard extension distance is 48" with rim at 10' (Extension distance decreases as rim height is lowered)

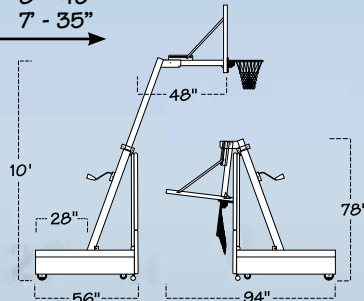

FREE!

LTR 83

Base Pad Lettering Upon Request

- Safety padding covers front of base unit
- Tough powder coat paint

- Front pad flips forward to roll

The Fury portable basketball goal is designed to withstand the demands of adult recreation centers while providing the flexibility necessary for many churches and elementary grade levels.

The Fury is infinitely adjustable. Simply turn the adjustment crank handle behind the unit to lower the rim height anywhere from 10' down to 6'6". The Fury's exclusive crank adjustment design is vastly superior in overall rigidity compared to similar goals using inferior "spring-slide" methods.

The Fury is engineered to be extremely easy to move. One person can transport the goal by flipping the lower pad forward and rolling into position. Return pad to upright position to lock base in place for play. The extension arm can be dropped without tools to allow the Fury to pass under doorways.

The backboard to base extension is 48" with the rim at regular height. This allows the Fury to sit "off-court" for player safety. Heavy padding, available in several colors, protects the player from contact with the base unit.

Floor load on the wheels is:

Rolling - 180 psi

Stationary - 140 psi

A variety of acrylic backboards are available on the Fury. Each package includes a high quality flex goal with net. Let the Fury help you make the most out of your facility and your budget.

Every Fury package comes with a Lifetime Limited Warranty.

WARNING!

Failure to install customer supplied ballast according to instructions could result in serious injury.

FURY PACKAGE OPTIONS



- | | | | | | |
|--------------------------------------|--------------------------------------|--------------------------------------|---|---|--|
| • FT3020 Fury Portable Base Unit | • FT3020 Fury Portable Base Unit | • FT3020 Fury Portable Base Unit | • FT3020 Fury Portable Base Unit | • FT3020 Fury Portable Base Unit | • FT3020 Fury Portable Base Unit |
| • FT83 Fury Base Padding (Any Color) | • FT83 Fury Base Padding (Any Color) | • FT83 Fury Base Padding (Any Color) | • FT83 Fury Base Padding (Any Color) | • FT83 Fury Base Padding (Any Color) | • FT83 Fury Base Padding (Any Color) |
| • FT210 36"x48" Acrylic Bkbd. | • FT215 36"x54" Acrylic Bkbd. | • FT220 36"x60" Acrylic Bkbd. | • FT216 36"x54" Temp. Glass Bkbd. | • FT221 36"x60" Temp. Glass Bkbd. | • FT221SM 36"x60" Smoked Temp. Glass Bkbd. |
| • FT184 Flex Goal | • FT186 Flex Goal | • FT186 Flex Goal | • FT3010-HFM Supplemental Bkbd. Support | • FT3010-HFM Supplemental Bkbd. Support | • FT3010-HFM Supplemental Bkbd. Support |
| • Lifetime Limited Warranty | • Lifetime Limited Warranty | • Lifetime Limited Warranty | • FT186 Flex Goal | • FT186 Flex Goal | • FT186 Flex Goal |
| • Approx. Shipping Wt: 485 lbs. | • Approx. Shipping Wt: 495 lbs. | • Approx. Shipping Wt: 505 lbs. | • Lifetime Limited Warranty | • Lifetime Limited Warranty | • Lifetime Limited Warranty |

RY Royal Blue	SC Scarlet	GL Gold	PR Purple	KG Kelly Green	BK Black	CB Columbia Blue	MR Maroon	GR Grey	NY Navy Blue	OR Orange	FG Forest Green	BR Brick Red	SO Sienna Orange	DG Desert Gold	SB Saddle Brown
------------------	---------------	------------	--------------	-------------------	-------------	---------------------	--------------	------------	-----------------	--------------	--------------------	-----------------	---------------------	-------------------	--------------------

Hurricane base padding is available in these colors. Shades may vary slightly from color chart.

the RAMPAGE™

PORTABLE BASKETBALL SYSTEM



- Selection of various clear acrylic and tempered glass backboards in sizes ranging from 36"x48" to 36"x60"

- All First Team goals are direct mounted to eliminate backboard breakage when players hang on the rim

- Optional bolt-on TuffGuard™ backboard padding

- Neck drops down to pass through doorway

- Compact & Easy to roll

- Simple hand crank easily adjusts rim height from 10' - 6.5'

- Optional FT82BC Ballast Box Cover Padding

- Foot lever raises unit onto castors for rolling

- Tough powder coat paint

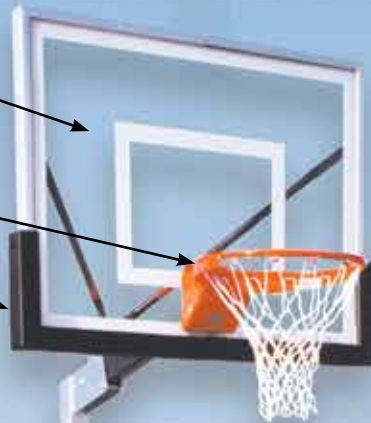

- Rim height adjusts for smaller players

- Safety padding covers front of base unit

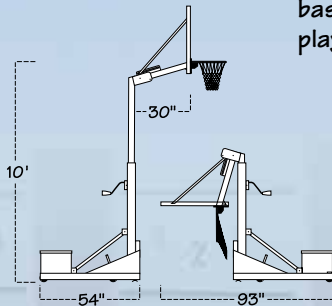

The Rampage portable basketball goal is by far the best performing unit in its class. No other portable goal offers this level of rigidity, portability and simple height adjustment at such an affordable price.

Infinite rim height adjustment can be made with the easy crank handle located on the back of the vertical mast. The rim height indicator labels determine rim heights from 10' to 6'6". The Rampage uses our exclusive crank-up design, which is far superior to similar goals using "spring-slide" methods.

The Rampage can easily be transported across a gym floor or up a driveway. Simply depress the foot lever located on the base unit for transport. Flip the lever back up for play. The extension arm drops down easily without tools to allow the Rampage to pass under doorways for storage rooms or garages. The backboard to base extension is 30" at all rim heights. The front base and stem are covered with thick vinyl padding for player safety. Padding is available in several choices of colors.

A selection of acrylic backboards is available on the Rampage. Each package includes a high quality flex goal with net. Get in the game with First Team's Rampage.

Every Rampage package comes with a Lifetime Limited Warranty.

WARNING!

Failure to install customer supplied ballast according to instructions could result in serious injury.

RAMPAGE PACKAGE OPTIONS

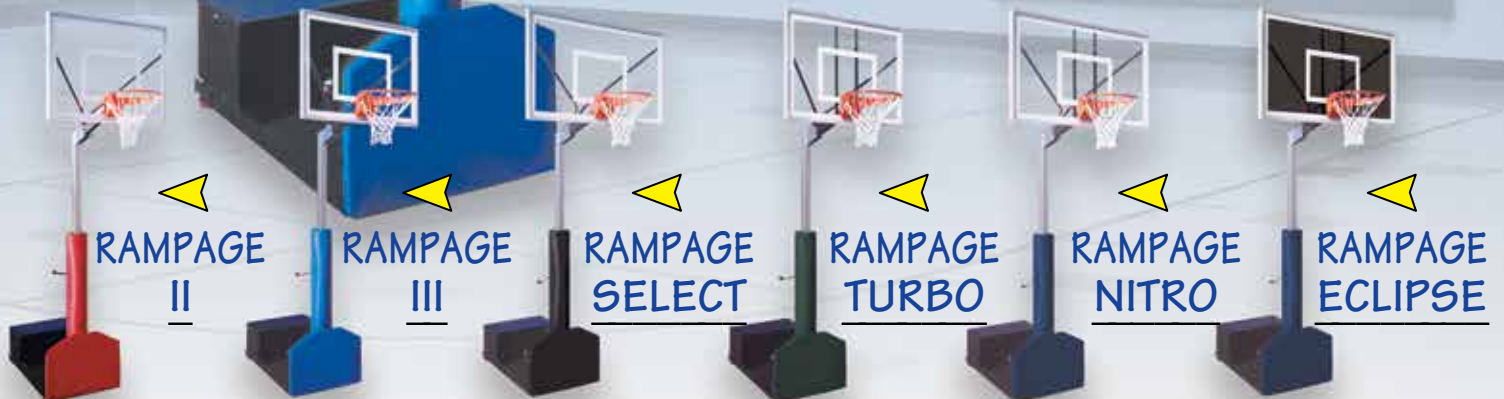

- | | | | | | |
|---|---|---|---|---|--|
| • FT3010 Rampage Portable Base Unit | • FT3010 Rampage Portable Base Unit | • FT3010 Rampage Portable Base Unit | • FT3010 Rampage Portable Base Unit | • FT3010 Rampage Portable Base Unit | • FT3010 Rampage Portable Base Unit |
| • FT82 Rampage Base Padding (Any Color) | • FT82 Rampage Base Padding (Any Color) | • FT82 Rampage Base Padding (Any Color) | • FT82 Rampage Base Padding (Any Color) | • FT82 Rampage Base Padding (Any Color) | • FT82 Rampage Base Padding (Any Color) |
| • FT210 36"x48" Acrylic Backboard | • FT215 36"x54" Acrylic Backboard | • FT220 36"x60" Acrylic Backboard | • FT216 36"x54" Temp. Glass Bkbd. | • FT221 36"x60" Temp. Glass Bkbd. | • FT221SM 36"x60" Smoked Temp. Glass Bkbd. |
| • FT184 Flex Goal | • FT186 Flex Goal | • FT186 Flex Goal | • FT3010-HFM Supplemental Bkbd. Support | • FT3010-HFM Supplemental Bkbd. Support | • FT3010-HFM Supplemental Bkbd. Support |
| • Lifetime Limited Warranty | • Lifetime Limited Warranty | • Lifetime Limited Warranty | • FT186 Flex Goal | • FT186 Flex Goal | • FT186 Flex Goal |
| • Approx. Shipping Weight: 395 lbs. | • Approx. Shipping Weight: 395 lbs. | • Approx. Shipping Weight: 405 lbs. | • Lifetime Limited Warranty | • Lifetime Limited Warranty | • Lifetime Limited Warranty |
| | | | • Approx. Shipping Weight: 395 lbs. | • Approx. Shipping Weight: 405 lbs. | • Approx. Shipping Weight: 405 lbs. |

RY Royal Blue	SC Scarlet	GL Gold	PR Purple	KG Kelly Green	BK Black	CB Columbia Blue	MR Maroon	GR Grey	NY Navy Blue	OR Orange	FG Forest Green	BR Brick Red	SO Sienna Orange	DG Desert Gold	SB Saddle Brown
------------------	---------------	------------	--------------	-------------------	-------------	---------------------	--------------	------------	-----------------	--------------	--------------------	-----------------	---------------------	-------------------	--------------------

Hurricane base padding is available in these colors. Shades may vary slightly from color chart.

www.firstteaminc.com

First Team, Inc. • Hutchinson, Kansas • Toll-Free 1-800-649-3688

the ROLLAJAM™

PORTABLE BASKETBALL SYSTEM



- Selection of various clear acrylic and tempered glass backboards in sizes ranging from 36"x48" to 36"x60"

- All First Team goals are direct mounted to eliminate backboard breakage when players hang on the rim

- Optional bolt-on TuffGuard™ backboard padding

- Spring aided crank design makes adjustment effortless

- Rim Height Indicator shows height of rim

- Simple hand crank adjustment easily adjusts rim height from 10' - 6'6"

- Safety padding covers front of base unit

- Powder coat finish protects against the elements

- Post actuator retracts vertical post for rolling and storage

- Compact & Easy to roll

- Optional FT81BC Ballast Box Cover Padding

There is **nothing** like the RollaJam! The RollaJam's unique design is the first premium grade, portable goal with the residential player in mind.

The RollaJam is crank adjustable from regulation height of 10' down to 7'. The crank handle is spring-aided to make adjustments easy for all ages. The rim height indicator accurately shows rim location.

To transport the RollaJam, simply retract the vertical post, using the post actuator located on the base unit. As the post pitches back, the unit lowers onto the transport wheel. Return the post to its vertical position for play. The goal rolls easily into any garage, or through any set of double doors. A high quality post pad covers the front of the unit.

Customize the RollaJam by selecting the backboard and rim combo that fits your game! Choose First Team's RollaJam for your court. With no hole to dig and no concrete to pour, you'll be "Jammin" in no time with the RollaJam!

Every RollaJam package comes with a Lifetime Limited Warranty.

WARNING!

Failure to install customer supplied ballast according to instructions could result in serious injury.

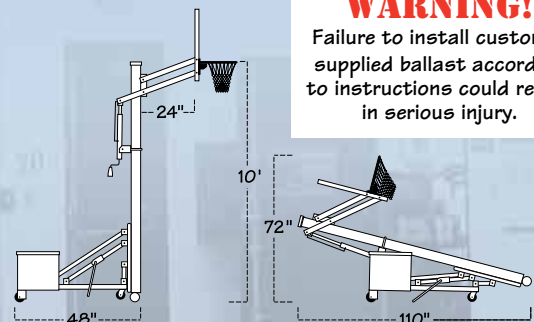

RollaJam base padding is available in these colors:



Shades may vary slightly from color chart.

ROLLAJAM PACKAGE OPTIONS

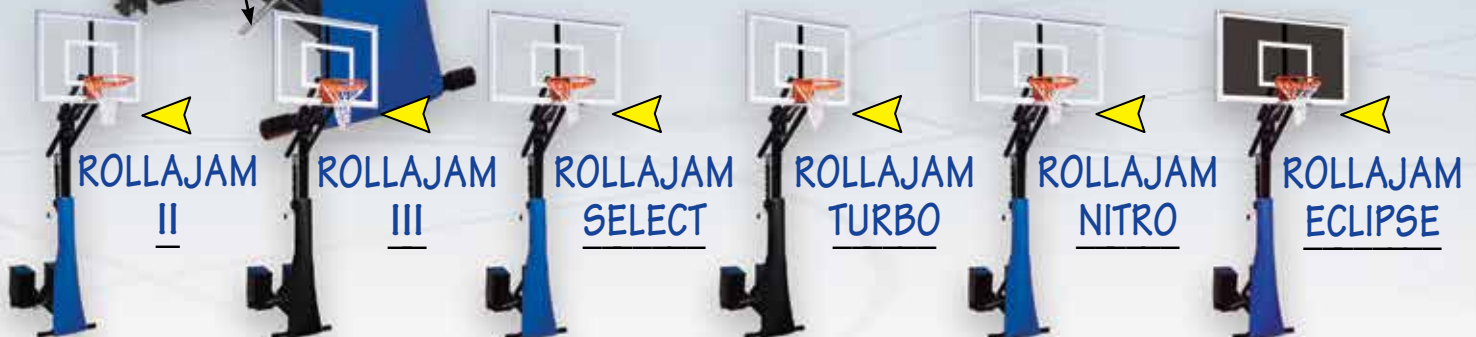

- | | | | | | |
|--|--|--|--|--|--|
| <ul style="list-style-type: none"> • Rollabout Portable Base Unit • Rollabout Base Padding • FT1300 Jam Arm System • FT210 36"x48" Acrylic Backboard • FT184 Recreational Flex Goal • Lifetime Limited Warranty • Approx. Shipping Weight: 385 lbs. | <ul style="list-style-type: none"> • Rollabout Portable Base Unit • Rollabout Base Padding • FT1300 Jam Arm System • FT215 36"x54" Acrylic Backboard • FT186 Heavy Duty Flex Goal • Lifetime Limited Warranty • Approx. Shipping Weight: 395 lbs. | <ul style="list-style-type: none"> • Rollabout Portable Base Unit • Rollabout Base Padding • FT1300 Jam Arm System • FT220 36"x60" Acrylic Backboard • FT186 Heavy Duty Flex Goal • Lifetime Limited Warranty • Approx. Shipping Weight: 405 lbs. | <ul style="list-style-type: none"> • Rollabout Portable Base Unit • Rollabout Base Padding • FT1300 Jam Arm System • FT216 36"x54" Temp. Glass Bkbd. • FT186 Heavy Duty Flex Goal • Lifetime Limited Warranty • Approx. Shipping Weight: 405 lbs. | <ul style="list-style-type: none"> • Rollabout Portable Base Unit • Rollabout Base Padding • FT1300 Jam Arm System • FT221 36"x60" Temp. Glass Bkbd. • FT186 Heavy Duty Flex Goal • Lifetime Limited Warranty • Approx. Shipping Weight: 405 lbs. | <ul style="list-style-type: none"> • Rollabout Portable Base Unit • Rollabout Base Padding • FT1300 Jam Arm System • FT221SM 36"x60" Smoked Temp Glass Bkbd. • FT186 Heavy Duty Flex Goal • Lifetime Limited Warranty • Approx. Shipping Weight: 405 lbs. |
|--|--|--|--|--|--|

the ROLLASPORT™

PORTABLE BASKETBALL SYSTEM



• Selection of various clear acrylic backboards in sizes ranging from 36"x48" to 36"x60"

• Optional bolt-on TuffGuard™ backboard padding

• Fixed height extension arm secures to post using U-bolts

• Powder coat finish protects against the elements

• Safety padding covers front of base unit

• Post actuator retracts vertical post for rolling and storage

• All First Team goals are direct mounted to eliminate backboard breakage when players hang on the rim

• Compact & Easy to roll

• Optional FT81BC Ballast Box Cover Padding

The RollaSport is the clear choice in portable goals when frequent rim height adjustments are not necessary.

The extension arm on the RollaSport is attached to the vertical post using two heavy duty U-bolts. Though the RollaSport is considered a "fixed-height" portable goal, the U-bolts can be loosened, allowing the arm to be re-attached at any given height along the post.

To transport the RollaSport, simply retract the vertical post, using the post actuator located on the base unit. As the post pitches back, the RollaSport lowers onto the transport wheel. Return the post to its vertical position for play. The goal rolls easily into any garage, or through any set of double doors. A high quality post pad covers the front of the unit.

Backboards are available from 36" x 48" to 36" x 60", giving you a choice for your home court. No portable goal offers the same quality court time at such an excellent value as the RollaSport.

Every RollaSport package comes with a Lifetime Limited Warranty.

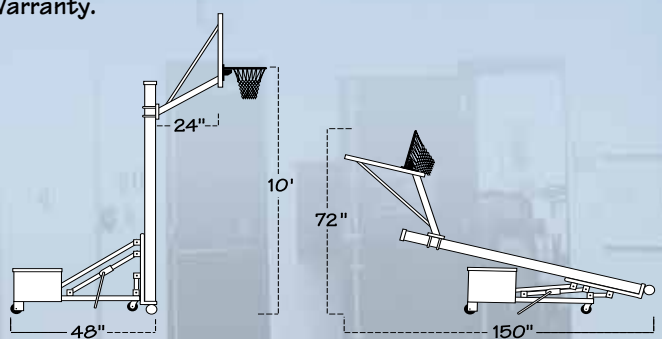

WARNING!

Failure to install customer supplied ballast according to instructions could result in serious injury.

ROLLASPORT PACKAGE OPTIONS

RollaSport base padding is available in these colors:



Shades may vary slightly from color chart.

See Accessories Section for Backboard Padding Options.



ROLLASPORT II

- Rollabout Portable Base Unit
- Rollabout Base Padding
- FT1150 Sport Arm System
- FT210 36"x48" Acrylic Backboard
- FT184 Recreational Flex Goal
- Lifetime Limited Warranty
- Approx. Shipping Weight: 335 lbs.



ROLLASPORT III

- Rollabout Portable Base Unit
- Rollabout Base Padding
- FT1150 Sport Arm System
- FT215 36"x54" Acrylic Backboard
- FT186 Heavy Duty Flex Goal
- Lifetime Limited Warranty
- Approx. Shipping Weight: 345 lbs.



ROLLASPORT SELECT

- Rollabout Portable Base Unit
- Rollabout Base Padding
- FT1150 Sport Arm System
- FT220 36"x60" Acrylic Backboard
- FT186 Heavy Duty Flex Goal
- Lifetime Limited Warranty
- Approx. Shipping Weight: 355 lbs.

www.firstteaminc.com

First Team, Inc. • Hutchinson, Kansas • Toll-Free 1-800-649-3688

the OMNICHAMP™

PORTABLE BASKETBALL SYSTEM



- Backboards available in acrylic or glass
- Optional bolt-on TuffGuard™ backboard padding available in several colors
- Insta-Just™ height adjustment. No need for tools or a ladder. A simple broom handle allows you to adjust rim height from 10'-7" 6" in 6" increments.
- Optional all-weather post padding for added safety (See padding section for available colors)

Note: OmniChamp may be too tall to fit under your storage room door. Check associated storage dims to make sure the unit will fit in your storage facility.

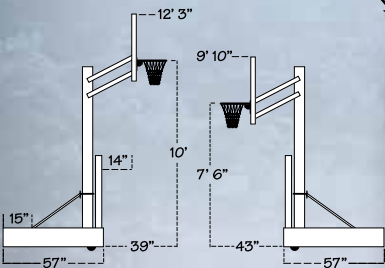

- Base to backboard extension distance is 14" with rim at 10' (Extension distance increases as rim height is lowered)



- Easy, quick adjustment



- Pull handle for transport



- Large ballast plug for easy loading

WARNING!

Failure to install customer supplied ballast according to instructions could result in serious injury.

The OmniChamp is an adjustable portable basketball goal designed to provide a higher level of performance than those commonly found at standard retail chain stores, yet it does not carry the hefty price tag associated with gymnasium level units. For use indoors or outdoors the large poly base is designed to hold up to 500 lbs. of sand, making the unit extremely stable.

The post is one-piece 4" square 11 gauge, far superior to sectional posts. The cam lever handle located on the front of the base makes one person transport easy on any hard, smooth and level surface. To adjust the OmniChamp to various rim heights, simply release the InstaJust bracket located behind the backboard using a broom handle. The unit easily adjusts from 10' down to 7 1/2' in six inch increments. Various backboard sizes and materials are available to choose from. For added safety, a contoured post pad is also available in an array of colors.

To dress up your home court, choose First Team's post pad custom lettering option. Because it comes from First Team, you know it's 100% Made In the USA and that means quality. When you are looking for a portable basketball hoop to fit your performance demands that won't break your budget, choose First Team's affordable portable, OmniChamp!

OMNICHAMP PACKAGES



- FT1101 4" Square Post
- FT3003 Omni Base Tank
- FT1200 Champ Arm System
- FT210 36"x48" Acrylic Backboard
- FT184 Recreational Flex Goal
- Lifetime Limited Warranty
- Approx. Shipping Weight: 250 lbs.

- FT1101 4" Square Post
- FT3003 Omni Base Tank
- FT1200 Champ Arm System
- FT215 36"x54" Acrylic Backboard
- FT186 Heavy Duty Flex Goal
- Lifetime Limited Warranty
- Approx. Shipping Weight: 260 lbs.

- FT1101 4" Square Post
- FT3003 Omni Base Tank
- FT1200 Champ Arm System
- FT220 36"x60" Acrylic Backboard
- FT186 Heavy Duty Flex Goal
- Lifetime Limited Warranty
- Approx. Shipping Weight: 270 lbs.

- FT1101 4" Square Post
- FT3003 Omni Base Tank
- FT1200 Champ Arm System
- FT216 36"x54" Temp. Glass Bkbd.
- FT186 Heavy Duty Flex Goal
- Lifetime Limited Warranty
- Approx. Shipping Weight: 260 lbs.

- FT1101 4" Square Post
- FT3003 Omni Base Tank
- FT1200 Champ Arm System
- FT221 36"x60" Temp. Glass Bkbd.
- FT186 Heavy Duty Flex Goal
- Lifetime Limited Warranty
- Approx. Shipping Weight: 270 lbs.

- FT1101 4" Square Post
- FT3003 Omni Base Tank
- FT1200 Champ Arm System
- FT221SM 36"x60" Smoked Temp. Glass Bkbd.
- FT186 Heavy Duty Flex Goal
- Lifetime Limited Warranty
- Approx. Shipping Weight: 270 lbs.

the OMNISLAM™

PORTABLE BASKETBALL SYSTEM



- Backboards available in acrylic or glass
- Optional bolt-on TuffGuard™ backboard padding available in several colors
- Springs located in the extension assembly counter balance the weight of the backboard and rim. Adjustment is effortless.
- Optional all-weather post padding for added safety (See padding section for available colors)
- Quik-Pin™ height adjustment design makes adjusting the OMNISLAM effortless and safe. Unit adjusts from 10'-7" in 6" increments.

Note: OmniSlam may be too tall to fit under your storage room door. Check associated storage dims to make sure the unit will fit in your storage facility.

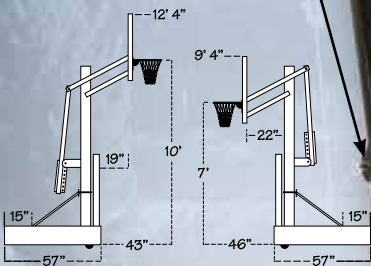

- Base to backboard extension distance is 19" with rim at 10' (Extension distance increases as rim height is lowered)

- Easy, quick adjustment

- Pull handle for transport

- Large ballast plug for easy loading

WARNING!

Failure to install customer supplied ballast according to instructions could result in serious injury.

The OmniSlam is a great way to upgrade your court. Indoors or out, OmniSlam is a premium quality performing portable basketball hoop! The OmniSlam is significantly better in performance and durability than portables found at large sporting goods chain stores. The large poly base is designed to hold up to 500 lbs. of sand for maximum stability. No more flimsy portables that blow over in the wind! The rugged 4" square one piece 11 gauge post will not wobble and separate like sectional posts. The handy cam lever handle on the front makes one person transport simple over any hard, smooth surface. The OmniSlam is adjustable from 10' down to 7' in six inch increments. Adjustments are very quick by removing the slide pin on the back of the post, the spring balanced design makes rim height adjustments quick and easy. Replace the pin for play. Various backboard sizes and materials are available to choose from. For added safety, a contoured post pad is also available in an array of colors. To dress up your home court, choose First Team's post pad custom lettering option. Because it comes from First Team, you know it's 100% Made In the USA and that means quality. When you are looking for a portable basketball hoop to fit your performance demands that won't break your budget, choose First Team's affordable portable, OmniSlam!

OMNISLAM PACKAGES



- | | | | | | |
|-------------------------------------|-------------------------------------|-------------------------------------|-------------------------------------|-------------------------------------|--|
| • FT1101 4" Square Post | • FT1101 4" Square Post | • FT1101 4" Square Post | • FT1101 4" Square Post | • FT1101 4" Square Post | • FT1101 4" Square Post |
| • FT3003 Omni Base Tank | • FT3003 Omni Base Tank | • FT3003 Omni Base Tank | • FT3003 Omni Base Tank | • FT3003 Omni Base Tank | • FT3003 Omni Base Tank |
| • FT1250 Slam Arm System | • FT1250 Slam Arm System | • FT1250 Slam Arm System | • FT1250 Slam Arm System | • FT1250 Slam Arm System | • FT1250 Slam Arm System |
| • FT210 36"x48" Acrylic Backboard | • FT215 36"x54" Acrylic Backboard | • FT220 36"x60" Acrylic Backboard | • FT216 36"x54" Temp. Glass Bkhd. | • FT221 36"x60" Temp. Glass Bkhd. | • FT221SM 36"x60" Smoked Temp. Gs. Bkhd. |
| • FT184 Recreational Flex Goal | • FT186 Heavy Duty Flex Goal | • FT186 Heavy Duty Flex Goal | • FT186 Heavy Duty Flex Goal | • FT186 Heavy Duty Flex Goal | • FT186 Heavy Duty Flex Goal |
| • Lifetime Limited Warranty | • Lifetime Limited Warranty | • Lifetime Limited Warranty | • Lifetime Limited Warranty | • Lifetime Limited Warranty | • Lifetime Limited Warranty |
| • Approx. Shipping Weight: 295 lbs. | • Approx. Shipping Weight: 305 lbs. | • Approx. Shipping Weight: 315 lbs. | • Approx. Shipping Weight: 305 lbs. | • Approx. Shipping Weight: 315 lbs. | • Approx. Shipping Weight: 315 lbs. |

www.firstteaminc.com

First Team, Inc. • Hutchinson, Kansas • Toll-Free 1-800-649-3688

the

OMNIJAM™

PORTABLE BASKETBALL SYSTEM



- Backboards available in acrylic or glass
- Optional bolt-on TuffGuard™ backboard padding available in several colors
- Springs located in the extension assembly counterbalance the weight of the backboard and rim. Adjustment is effortless.
- Simple hand crank adjustment easily adjusts rim height from 10' - 7"
- Optional all-weather post padding for added safety (See padding section for available colors)

Note: OmniJam may be too tall to fit under your storage room door. Check associated storage dims to make sure the unit will fit in your storage facility.

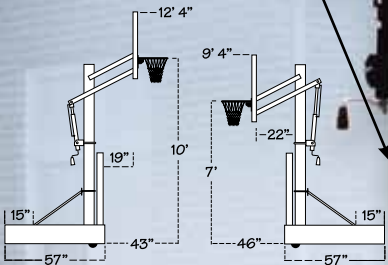

• Effortless adjustment

• Pull handle for transport

• Large ballast plug for easy loading

• Base to backboard extension distance is 19" with rim at 10' (Extension distance increases as rim height is lowered)

WARNING!

Failure to install customer supplied ballast according to instructions could result in serious injury.

The OmniJam portable basketball goal brings gymnasium quality style and performance to any home court, primary school or recreation facility. The OmniJam outperforms any portable in its price category. The unit's high durability, stability and performance are built in to the unit's design. First Team is proud to manufacture its products in the USA, and this commitment shows in the OmniJam. The large poly base has a 500 lbs. sand capacity. The base unit has a large plug on the back for easy ballast (sand) loading during assembly. The unit has a durable 4" square one-piece post that will not separate or wobble like common sectional posts. The crank handle on the back of the post makes rim height adjustment easy for any age. By turning the hand crank, the rim height can easily be adjusted infinitely between 10' and 7". An easy to read height regulator is located on the back. Transport is also simple. The large cam lever handle design makes moving the unit over any hard, smooth surface a breeze. Pull handle forward to roll, lift handle for play. Various backboard sizes and materials are available to choose from. For added safety, a contoured post pad is also available in an array of colors. To really dress up your home court, choose First Team's post pad custom lettering option. Because it comes from First Team, you know it's 100% Made in the USA and

that means quality. When you are looking for a portable basketball hoop to fit your performance demands that won't break your budget, choose First Team's affordable portable, OmniJam!

OMNIJAM PACKAGES



- | | | | | | |
|-------------------------------------|-------------------------------------|-------------------------------------|-------------------------------------|-------------------------------------|--|
| • FT1101 4" Square Post | • FT1101 4" Square Post | • FT1101 4" Square Post | • FT1101 4" Square Post | • FT1101 4" Square Post | • FT1101 4" Square Post |
| • FT3003 Omni Base Tank | • FT3003 Omni Base Tank | • FT3003 Omni Base Tank | • FT3003 Omni Base Tank | • FT3003 Omni Base Tank | • FT3003 Omni Base Tank |
| • FT1300 Jam Arm System | • FT1300 Jam Arm System | • FT1300 Jam Arm System | • FT1300 Jam Arm System | • FT1300 Jam Arm System | • FT1300 Jam Arm System |
| • FT210 36"x48" Acrylic Backboard | • FT215 36"x54" Acrylic Backboard | • FT220 36"x60" Acrylic Backboard | • FT216 36"x54" Temp. Glass Bkhd. | • FT221 36"x60" Temp. Glass Bkhd. | • FT221SM 36"x60" Sm. Temp. Gls. Bkhd. |
| • FT184 Recreational Flex Goal | • FT186 Heavy Duty Flex Goal | • FT186 Heavy Duty Flex Goal | • FT186 Heavy Duty Flex Goal | • FT186 Heavy Duty Flex Goal | • FT186 Heavy Duty Flex Goal |
| • Lifetime Limited Warranty | • Lifetime Limited Warranty | • Lifetime Limited Warranty | • Lifetime Limited Warranty | • Lifetime Limited Warranty | • Lifetime Limited Warranty |
| • Approx. Shipping Weight: 295 lbs. | • Approx. Shipping Weight: 305 lbs. | • Approx. Shipping Weight: 315 lbs. | • Approx. Shipping Weight: 305 lbs. | • Approx. Shipping Weight: 315 lbs. | • Approx. Shipping Weight: 315 lbs. |

the WALLMONSTER™

ADJUSTABLE WALLMOUNT STRUCTURE



- Selection of various clear acrylic, tempered glass and steel backboards. Sizes vary from 42"x60" to 42"x72".

- Backboard braces for superior backboard rigidity

- Optional bolt-on TuffGuard™ backboard padding

- Spring-Aided for Easy Adjustment

- Easy adjustment from the ground with included handle

- 4' Extension Setup
10' rim height - 48" offset
8' rim height - 51" offset

- 3' Extension Setup
10' rim height - 36" offset
8' rim height - 50" offset

- Heavy Duty Flex or Fixed Goals

- Super strength goals are "direct mounted" to eliminate backboard stress

First Team's WallMonster adjustable basketball goal is a convenient, cost effective choice when an adjustable wall mounted basketball unit is needed. The WallMonster is great for all ages. The built in adjustment mechanism can be operated from ground level using the removable crank handle provided. Adjustments can be made without the use of a ladder.

The WallMonster is extremely versatile. It can be installed with either a 36" offset or a 48" offset making it a perfect choice for a wide variety of indoor or outdoor basketball courts. The all steel construction is powder coated black for weather protection and a sleek look. An easy to read rim height indicator shows the height of the rim as the unit is adjusted. For 48" offset installations, the rim height is adjustable from 10' down to 7 1/2' while 36" offset installation can lower down to 6'.

Choose from First Team's WallMonster package options listed below. For added protection, backboard safety padding is available for all WallMonster package options. Each WallMonster system is covered by First Team's Lifetime Limited Warranty.

WALLMONSTER PACKAGE OPTIONS



WALLMONSTER SUPREME

- FT1660 WallMonster Structure
- FT222 42"x72" Acrylic Backboard
- FT186 Heavy Duty Flex Goal
- Lifetime Limited Warranty
- Approx. Shipping Weight: 350 lbs.



WALLMONSTER ARENA

- FT1660 WallMonster Structure
- FT232 42"x72" Tempered Glass Backboard
- FT186 Heavy Duty Flex Goal
- Lifetime Limited Warranty
- Approx. Shipping Weight: 430 lbs.



WALLMONSTER PLAYGROUND

- FT1660 WallMonster Structure
- FT260 42"x60" Steel Backboard
- FT172D Unbreakable Fixed Goal
- Lifetime Limited Warranty
- Approx. Shipping Weight: 370 lbs.



WALLMONSTER EXCEL

- FT1660 WallMonster Structure
- FT265 42"x72" Steel Backboard
- FT172D Unbreakable Fixed Goal
- Lifetime Limited Warranty
- Approx. Shipping Weight: 400 lbs.



WALLMONSTER INTENSITY

- FT1660 WallMonster Structure
- FT267 42"x72" Perf. Alum. Bkdb.
- FT172D Unbreakable Fixed Goal
- Lifetime Limited Warranty
- Approx. Shipping Weight: 400 lbs.

www.firstteaminc.com

First Team, Inc. • Hutchinson, Kansas • Toll-Free 1-800-649-3688

the

UNI-SPORT™

FIXED HEIGHT WALLMOUNT STRUCTURE



- Selection of various

clear acrylic backboards. Sizes vary from 36"x48" to 36"x60".

- Optional bolt-on TuffGuard™ backboard padding

- Heavy-Duty UNI-STRUT – This all steel structure is provided to allow easy wall mount attachment and may be installed for indoor or outdoor use. No wooden boards to weather or rot.

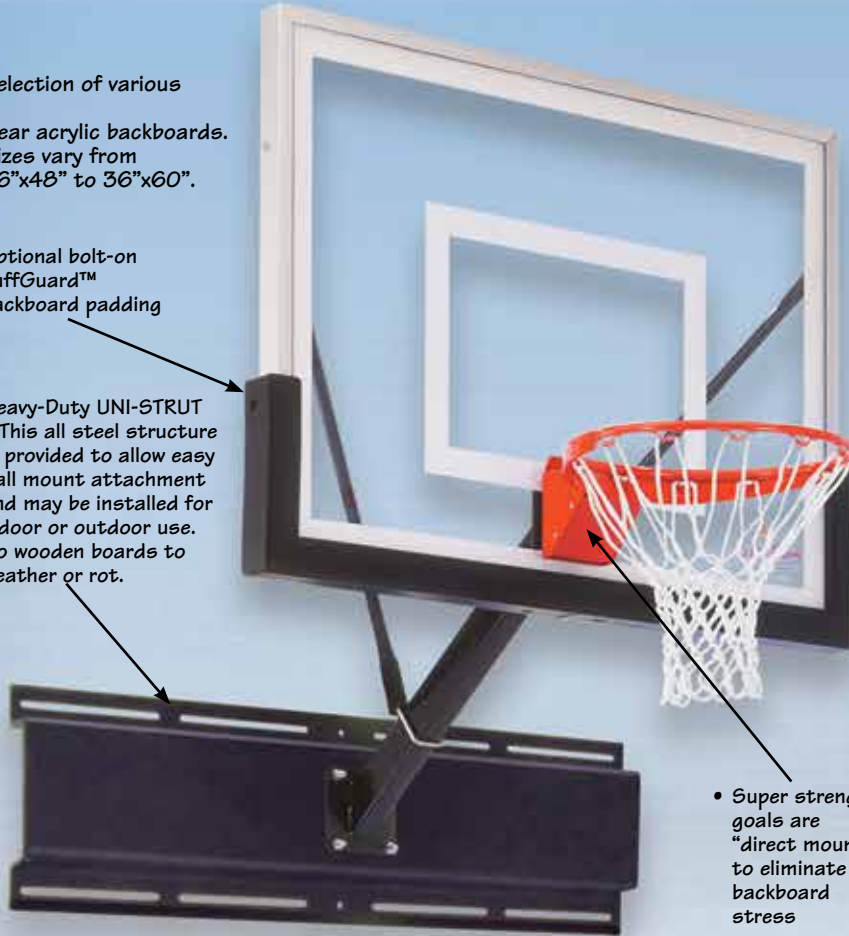

- Super strength goals are "direct mounted" to eliminate backboard stress

- Wall to backboard extension distance is 26"

First Team's Uni-Sport series offers a solid, affordable wall mount option when rim height adjustability is not needed.

The fixed height extension arm is bolted to First Team's unique Uni-Strut structure using 4 carriage bolts. The Uni-Strut wall mount has a variety of slotted attachment holes that may be used to allow the structure to be secured to the wall. Customer is responsible to provide hardware to secure Uni-Strut to the wall, all other assembly hardware is provided. The unit is designed with 26" wall to backboard extension.

A variety of backboards and rims are offered with the Uni-Sport series so you can choose the Uni-Sport package that's right for you. For additional safety, backboard padding is available for each Uni-Sport package in a variety of colors.

Every Uni-Sport package is covered by First Team's Lifetime Limited Warranty.

UNI-SPORT PACKAGE OPTIONS



UNI-SPORT II

- FT1991 Uni-Strut Wall Structure
- FT1150 Sport Arm System
- FT210 36"x48" Acrylic Backboard
- FT184 Recreational Flex Goal
- Lifetime Limited Warranty
- Approx. Shipping Weight: 150 lbs.



UNI-SPORT III

- FT1991 Uni-Strut Wall Structure
- FT1150 Sport Arm System
- FT215 36"x54" Acrylic Backboard
- FT186 Heavy Duty Flex Goal
- Lifetime Limited Warranty
- Approx. Shipping Weight: 170 lbs.



UNI-SPORT SELECT

- FT1991 Uni-Strut Wall Structure
- FT1150 Sport Arm System
- FT220 36"x60" Acrylic Backboard
- FT186 Heavy Duty Flex Goal
- Lifetime Limited Warranty
- Approx. Shipping Weight: 180 lbs.

the

UNI-CHAMP™

ADJUSTABLE WALLMOUNT STRUCTURE



- Selection of various clear acrylic and tempered glass backboards. Sizes vary from 36"x48" to 36"x60".

- Optional bolt-on TuffGuard™ backboard padding

- Heavy-Duty UNI-STRUT – This all steel structure is provided to allow easy wall mount attachment and may be installed for indoor or outdoor use. No wooden boards to weather or rot.

- Super strength goals are "direct mounted" to eliminate backboard stress

- Wall to backboard extension distance is 20" with rim at 10' (Extension distance increases as rim height is lowered)

- Insta-Just™ height adjustment. No need for tools or a ladder. A simple broom handle allows you to adjust rim height from 10'-7'6" in 6" increments.

The Uni-Champ series offers wall mount adjustability indoors or out!
 First Team's Insta-Just™ height adjustment mechanism allows the Uni-Champ to adjust from 10' to 7'6" in six inch increments. To adjust, use a broom handle to release the Insta-Just™ height regulator. No tools or ladders required.

The adjustable arm system is bolted to First Team's unique Uni-Strut structure using 4 carriage bolts. The Uni-Strut wall mount has a variety of slotted attachment holes that may be used to allow the structure to be secured to the wall. Customer is responsible to provide hardware to secure Uni-Strut to the wall, all other assembly hardware is provided. The unit is designed with 20" wall to backboard extension when rim is at 10' height.

A variety of backboards and rims are offered with the Uni-Champ series so you can choose the Uni-Champ package that's right for you. For additional safety, backboard padding is available in a variety of colors for any Uni-Champ package.

Every Uni-Champ package is covered by First Team's Lifetime Limited Warranty.

UNI-CHAMP PACKAGE OPTIONS



UNI-CHAMP II

- FT1991 Uni-Strut Wall Structure
- FT1200 Champ Arm System
- FT210 36"x48" Acrylic Bkbd.
- FT184 Recreational Flex Goal
- Lifetime Limited Warranty
- Approx. Shipping Wt: 170 lbs.

UNI-CHAMP III

- FT1991 Uni-Strut Wall Structure
- FT1200 Champ Arm System
- FT215 36"x54" Acrylic Bkbd.
- FT186 Heavy Duty Flex Goal
- Lifetime Limited Warranty
- Approx. Shipping Wt: 180 lbs.

UNI-CHAMP SELECT

- FT1991 Uni-Strut Wall Structure
- FT1200 Champ Arm System
- FT220 36"x60" Acrylic Bkbd.
- FT186 Heavy Duty Flex Goal
- Lifetime Limited Warranty
- Approx. Shipping Wt: 200 lbs.

UNI-CHAMP TURBO

- FT1991 Uni-Strut Wall Structure
- FT1200 Champ Arm System
- FT216 36"x54" Temp. Glass Bkbd.
- FT186 Heavy Duty Flex Goal
- Lifetime Limited Warranty
- Approx. Shipping Wt: 190 lbs.

UNI-CHAMP NITRO

- FT1991 Uni-Strut Wall Structure
- FT1200 Champ Arm System
- FT221 36"x60" Temp. Glass Bkbd.
- FT186 Heavy Duty Flex Goal
- Lifetime Limited Warranty
- Approx. Shipping Wt: 200 lbs.

UNI-CHAMP ECLIPSE

- FT1991 Uni-Strut Wall Structure
- FT1200 Champ Arm System
- FT221SM 36"x60" Sm. Temp. Gl. Bkbd.
- FT186 Heavy Duty Flex Goal
- Lifetime Limited Warranty
- Approx. Shipping Wt: 200 lbs.

www.firstteaminc.com

First Team, Inc. • Hutchinson, Kansas • Toll-Free 1-800-649-3688

the
POWERMOUNT™
STATIONARY WALLMOUNT STRUCTURE

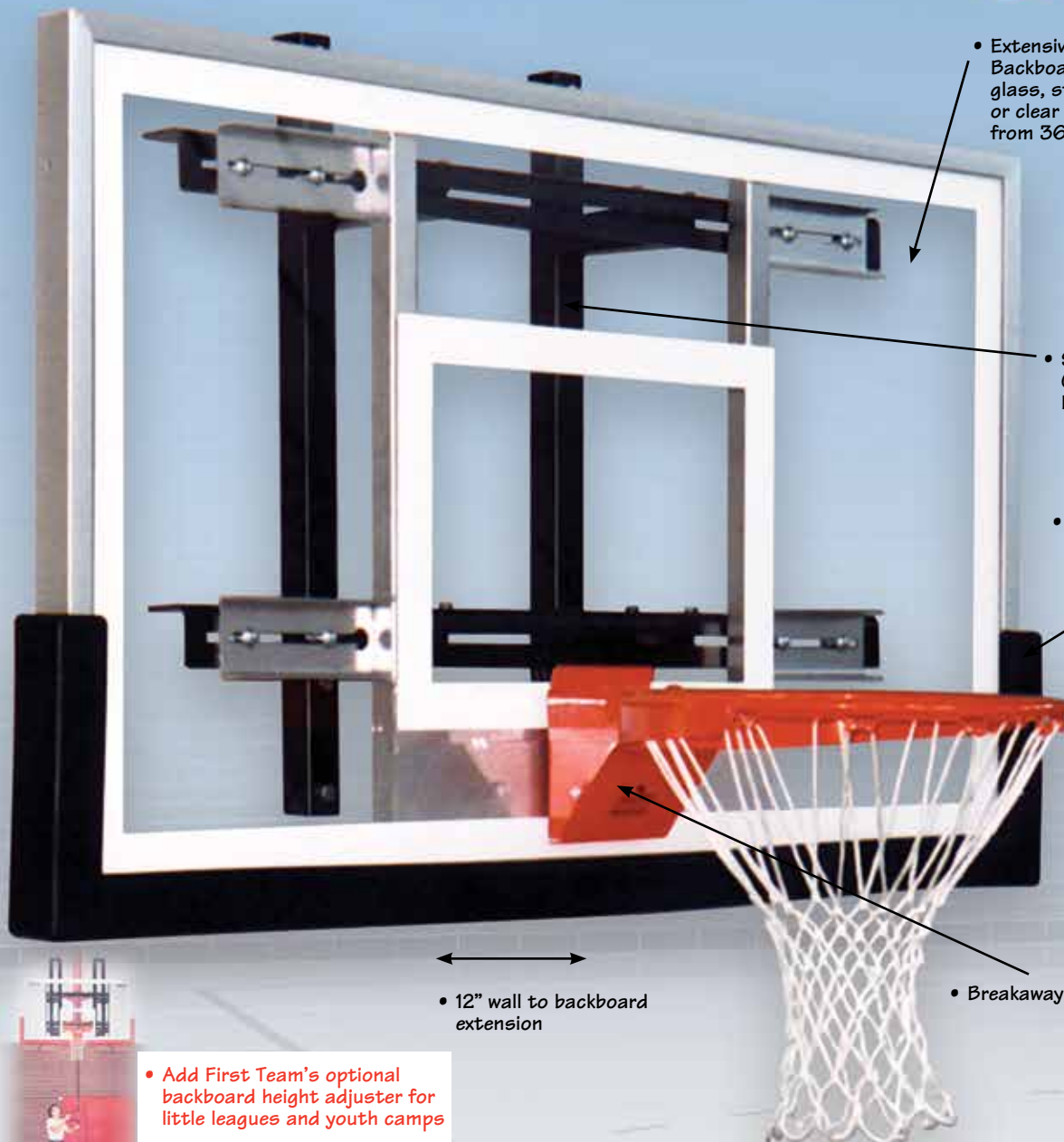

- Extensive backboard selection. Backboards are available in glass, steel, fiberglass or clear acrylic. Sizes vary from 36"x60" to 42"x72".

- Solid Square Tubing Construction With Black Powdercoat Finish

- Optional bolt-on TuffGuard™ backboard padding

- Breakaway Rims

- 12" wall to backboard extension

- Add First Team's optional backboard height adjuster for little leagues and youth camps

The PowerMount shooting station is designed to allow backboard installations in tight spaces where playing area is at a premium. If your facility requires a backboard installation close to a wall, call on First Team's PowerMount series!

The PowerMount structure provides quick and easy installation of a backboard on a wall with a minimal 12" of wall-to-backboard distance. First Team provides an array of prepackaged PowerMount options to choose from. The PowerMount can

be used with ANY backboard having a standard 20" x 35" mounting. However, selecting a PowerMount package is easy and guarantees component compatibility.

All PowerMount packages come with a Limited Lifetime Warranty.

POWERMOUNT PACKAGE OPTIONS

POWERMOUNT COMPETITOR



Shown with optional bolt-on
TuffGuard™ backboard padding

- FT1990 PowerMount System
- FT240 42"x72" Tempered Glass Backboard
- FT192 Competition Breakaway Goal
- Approx. Shipping Weight: 275 lbs.

POWERMOUNT CONTENDER



- FT1990 PowerMount System
- FT239 42"x72" Tempered Glass Backboard
- FT190 Competition Breakaway Goal
- Approx. Shipping Weight: 265 lbs.

POWERMOUNT SELECT



- FT1990 PowerMount System
- FT36 Silver Support Structure
- FT220 36"x60" Acrylic Backboard
- FT186 Heavy Duty Flex Goal
- Approx. Shipping Weight: 130 lbs.

POWERMOUNT PRO



- FT1990 PowerMount System
- FT36 Silver Support Structure
- FT230 36"x60" Tempered Glass Backboard
- FT186 Heavy Duty Flex Goal
- Approx. Shipping Weight: 180 lbs.

POWERMOUNT SUPREME



- FT1990 PowerMount System
- FT42 Silver Support Structure
- FT222 42"x72" Acrylic Backboard
- FT186 Heavy Duty Flex Goal
- Approx. Shipping Weight: 180 lbs.

POWERMOUNT ADVANTAGE



- FT1990 PowerMount System
- FT233 39"x54" Tempered Glass Backboard
- FT190 Competition Breakaway Goal
- Approx. Shipping Weight: 180 lbs.

POWERMOUNT AGGRESSOR



- FT1990 PowerMount System
- FT260B 42"x60" Steel Backboard
- FT186 Heavy Duty Flex Goal
- Approx. Shipping Weight: 200 lbs.

POWERMOUNT REBOUND



- FT1990 PowerMount System
- FT275 39"x54" Fiberglass Backboard
- FT186 Heavy Duty Flex Goal
- Approx. Shipping Weight: 180 lbs.

POWERMOUNT PERFORMANCE



- FT1990 PowerMount System
- FT280 42"x72" Fiberglass Backboard
- FT186 Heavy Duty Flex Goal
- Approx. Shipping Weight: 255 lbs.

the
SUPERMOUNT 23TM
 STATIONARY WALLMOUNT STRUCTURE

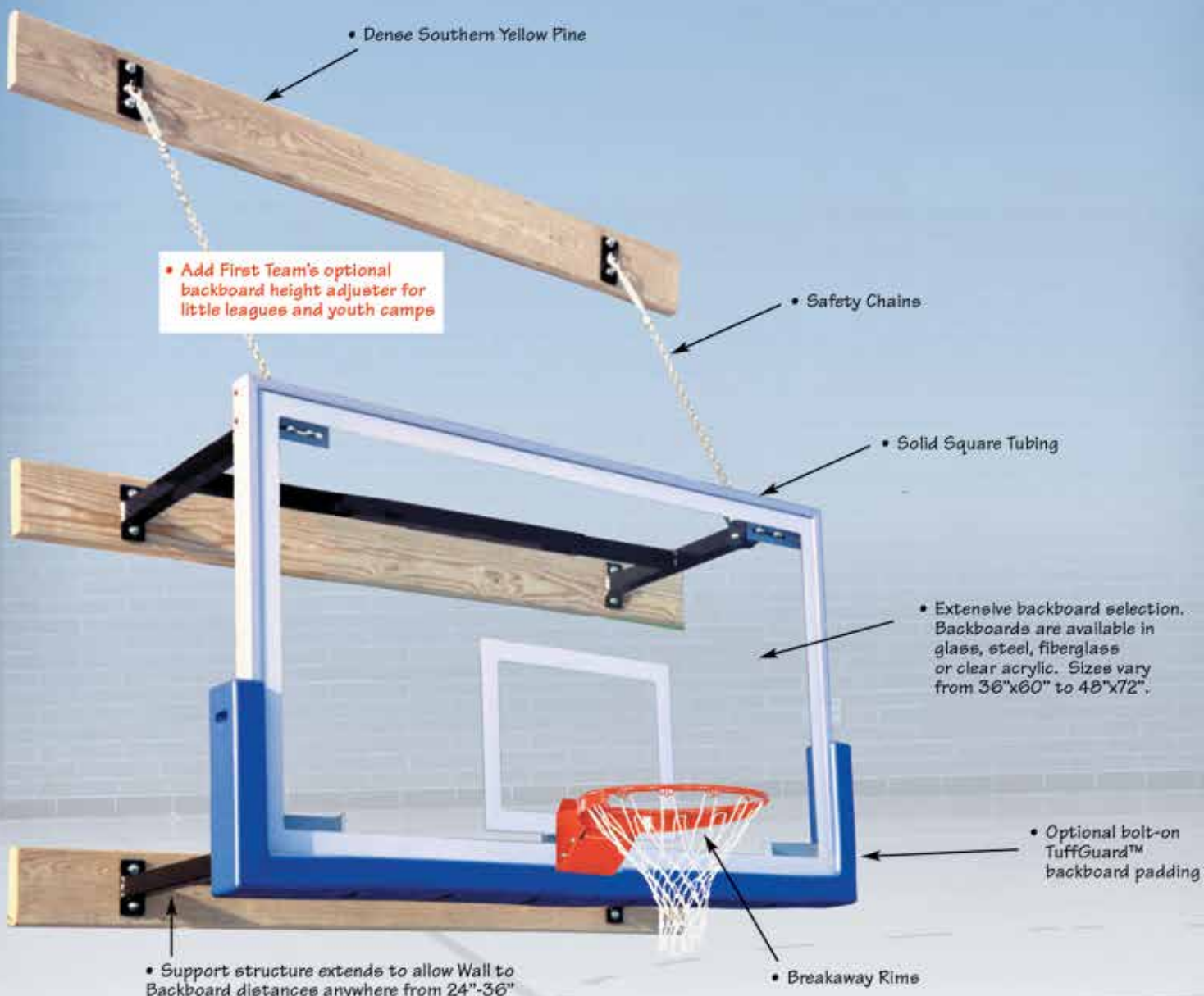

Great for basketball courts with limited space! First Team's new SuperMount23 simplifies the task of installing a top-quality wall-mounted basketball structure where space is tight.

Never before has it been so simple to purchase and install a commercial quality wall-mounted basketball system. With First Team's SuperMount23 there is no need to calculate exact extension requirements before ordering. The SuperMount23 is specifically

designed to provide wall-to-backboard extension distances anywhere from 2' - 3' during installation. This allows the unit to be "fine-tuned" to match the court markings on the floor. You will avoid costly rework and field modifications commonly caused by measurement errors.

Additionally, the SuperMount23 Wall Mounted Basketball Hoop is so versatile it can be configured to match up to any basketball backboard. So, no matter what basketball

backboard you prefer, you know the SuperMount23 Wall Mount is compatible.

Select from First Team's broad array of package configurations to satisfy the needs of your facility or home court. Remember, for additional safety, First Team offers optional bolt-on padding for most SuperMount23 packages.

Every SuperMount23 Wall Mount Basketball Goal System comes with a Lifetime Limited Warranty.

SUPERMOUNT 23 PACKAGE OPTIONS

**SUPERMOUNT 23
VICTORY**



Shown with optional bolt-on
TuffGuard™ backboard padding

- FT1999 SuperMount 23 System
- FT234 42"x72" Glass Backboard
- FT190 Competition Breakaway Goal
- Approx. Shipping Weight: 443 lbs.

**SUPERMOUNT 23
TRIUMPH**



- FT1999 SuperMount 23 System
- FT235 42"x72" Glass Backboard
- FT192 Competition Breakaway Goal
- Approx. Shipping Weight: 453 lbs.

**SUPERMOUNT 23
TRADITION**



- FT1999 SuperMount 23 System
- FT236 48"x72" Glass Backboard
- FT192 Competition Breakaway Goal
- Approx. Shipping Weight: 463 lbs.

**SUPERMOUNT 23
SELECT**



- FT1999 SuperMount 23 System
- FT36 Silver Support Structure
- FT220 36"x60" Acrylic Backboard
- FT186 Heavy Duty Flex Goal
- Approx. Shipping Weight: 340 lbs.

**SUPERMOUNT 23
PRO**



- FT1999 SuperMount 23 System
- FT36 Silver Support Structure
- FT230 36"x60" Glass Backboard
- FT186 Heavy Duty Flex Goal
- Approx. Shipping Weight: 385 lbs.

**SUPERMOUNT 23
SUPREME**



- FT1999 SuperMount 23 System
- FT42 Silver Support Structure
- FT222 42"x72" Acrylic Backboard
- FT186 Heavy Duty Flex Goal
- Approx. Shipping Weight: 385 lbs.

**SUPERMOUNT 23
ADVANTAGE**



- FT1999 SuperMount 23 System
- FT233 39"x54" Glass Backboard
- FT190 Competition Breakaway Goal
- Approx. Shipping Weight: 375 lbs.

**SUPERMOUNT 23
MAVERICK**



- FT1999 SuperMount 23 System
- FT231 40"x54" Glass Backboard
- FT186 Heavy Duty Flex Goal
- Approx. Shipping Weight: 403 lbs.

**SUPERMOUNT 23
AGGRESSOR**



- FT1999 SuperMount 23 System
- FT260B 42"x60" Steel Backboard
- FT186 Heavy Duty Flex Goal
- Approx. Shipping Weight: 403 lbs.

**SUPERMOUNT 23
MAGNUM**



- FT1999 SuperMount 23 System
- FT265B 42"x72" Steel Backboard
- FT186 Heavy Duty Flex Goal
- Approx. Shipping Weight: 443 lbs.

**SUPERMOUNT 23
REBOUND**



- FT1999 SuperMount 23 System
- FT275 39"x54" Fiberglass Backboard
- FT186 Heavy Duty Flex Goal
- Approx. Shipping Weight: 360 lbs.

**SUPERMOUNT 23
PERFORMANCE**



- FT1999 SuperMount 23 System
- FT280 42"x72" Fiberglass Backboard
- FT186 Heavy Duty Flex Goal
- Approx. Shipping Weight: 373 lbs.

www.firstteaminc.com

First Team, Inc. • Hutchinson, Kansas • Toll-Free 1-800-649-3688

the SUPERMOUNT™ 46

STATIONARY WALLMOUNT STRUCTURE

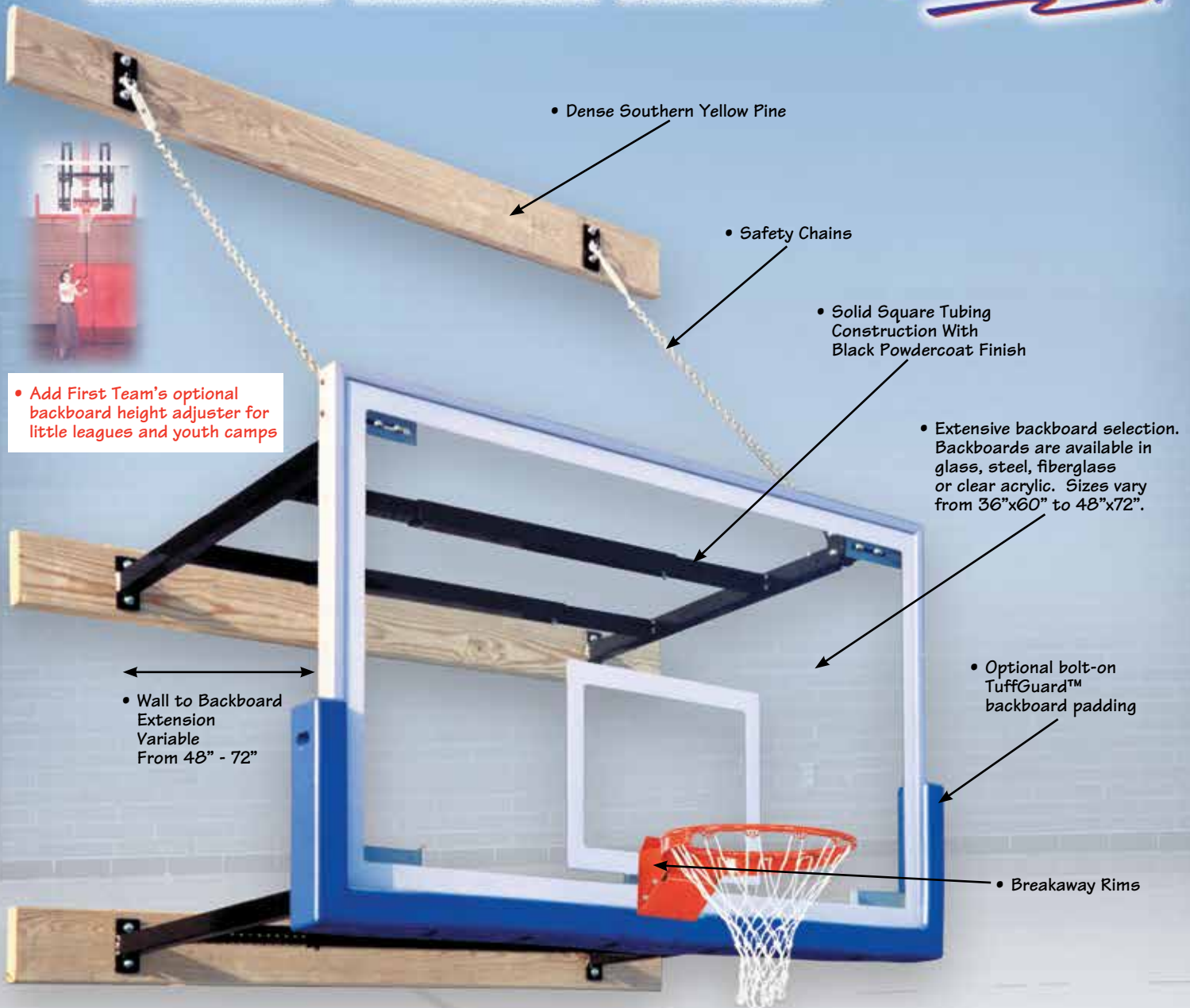

• Add First Team's optional backboard height adjuster for little leagues and youth camps

• Dense Southern Yellow Pine

• Safety Chains

• Solid Square Tubing Construction With Black Powdercoat Finish

• Extensive backboard selection. Backboards are available in glass, steel, fiberglass or clear acrylic. Sizes vary from 36"x60" to 48"x72".

• Wall to Backboard Extension Variable From 48" - 72"

• Optional bolt-on TuffGuard™ backboard padding

• Breakaway Rims

The SuperMount46 simplifies the task of installing a top quality wall-mounted basketball structure.

Never before has it been so simple to purchase and install a commercial quality wall-mounted basketball system. With First Team's SuperMount46 there is no need to calculate exact extension requirements before ordering. The SuperMount46 is specifically

designed to provide wall-to-backboard extension distances anywhere from 4' - 6' during installation. This allows the unit to be "fine-tuned" to match the court markings on the floor. You will avoid costly rework and field modifications commonly caused by measurement errors.

Additionally, the SuperMount46 is so versatile it can be configured to match up to any basketball

backboard. So no matter what backboard you prefer, you know the SuperMount46 is compatible.

Select from First Team's broad array of package configurations to satisfy the needs of your facility. Remember, for additional safety, First Team offers optional bolt-on padding for most SuperMount46 packages.

Every SuperMount46 System comes with a Lifetime Limited Warranty.

SUPERMOUNT 46 PACKAGE OPTIONS

**SUPERMOUNT 46
VICTORY**



**SUPERMOUNT 46
TRIUMPH**



**SUPERMOUNT 46
TRADITION**



**SUPERMOUNT 46
SELECT**



Shown with optional bolt-on
TuffGuard™ backboard padding

- FT2000 SuperMount 46 System
- FT234 42"x72" Glass Backboard
- FT190 Competition Breakaway Goal
- Approx. Shipping Weight: 493 lbs.

- FT2000 SuperMount 46 System
- FT235 42"x72" Glass Backboard
- FT192 Competition Breakaway Goal
- Approx. Shipping Weight: 503 lbs.

- FT2000 SuperMount 46 System
- FT236 48"x72" Glass Backboard
- FT192 Competition Breakaway Goal
- Approx. Shipping Weight: 513 lbs.

- FT2000 SuperMount 46 System
- FT36 Silver Support Structure
- FT220 36"x60" Acrylic Backboard
- FT186 Heavy Duty Flex Goal
- Approx. Shipping Weight: 390 lbs.

**SUPERMOUNT 46
PRO**



**SUPERMOUNT 46
SUPREME**



**SUPERMOUNT 46
ADVANTAGE**



**SUPERMOUNT 46
MAVERICK**



- FT2000 SuperMount 46 System
- FT36 Silver Support Structure
- FT230 36"x60" Glass Backboard
- FT186 Heavy Duty Flex Goal
- Approx. Shipping Weight: 435 lbs.

- FT2000 SuperMount 46 System
- FT42 Silver Support Structure
- FT222 42"x72" Acrylic Backboard
- FT186 Heavy Duty Flex Goal
- Approx. Shipping Weight: 435 lbs.

- FT2000 SuperMount 46 System
- FT233 39"x54" Glass Backboard
- FT190 Competition Breakaway Goal
- Approx. Shipping Weight: 423 lbs.

- FT2000 SuperMount 46 System
- FT231 40"x54" Glass Backboard
- FT186 Heavy Duty Flex Goal
- Approx. Shipping Weight: 453 lbs.

**SUPERMOUNT 46
AGGRESSOR**



**SUPERMOUNT 46
MAGNUM**



**SUPERMOUNT 46
REBOUND**



**SUPERMOUNT 46
PERFORMANCE**



- FT2000 SuperMount 46 System
- FT260B 42"x60" Steel Backboard
- FT186 Heavy Duty Flex Goal
- Approx. Shipping Weight: 453 lbs.

- FT2000 SuperMount 46 System
- FT265B 42"x72" Steel Backboard
- FT186 Heavy Duty Flex Goal
- Approx. Shipping Weight: 493 lbs.

- FT2000 SuperMount 46 System
- FT275 39"x54" Fiberglass Backboard
- FT186 Heavy Duty Flex Goal
- Approx. Shipping Weight: 410 lbs.

- FT2000 SuperMount 46 System
- FT280 42"x72" Fiberglass Backboard
- FT186 Heavy Duty Flex Goal
- Approx. Shipping Weight: 446 lbs.

www.firstteaminc.com

First Team, Inc. • Hutchinson, Kansas • Toll-Free 1-800-649-3688

the SUPERMOUNT™ 68

STATIONARY WALLMOUNT STRUCTURE

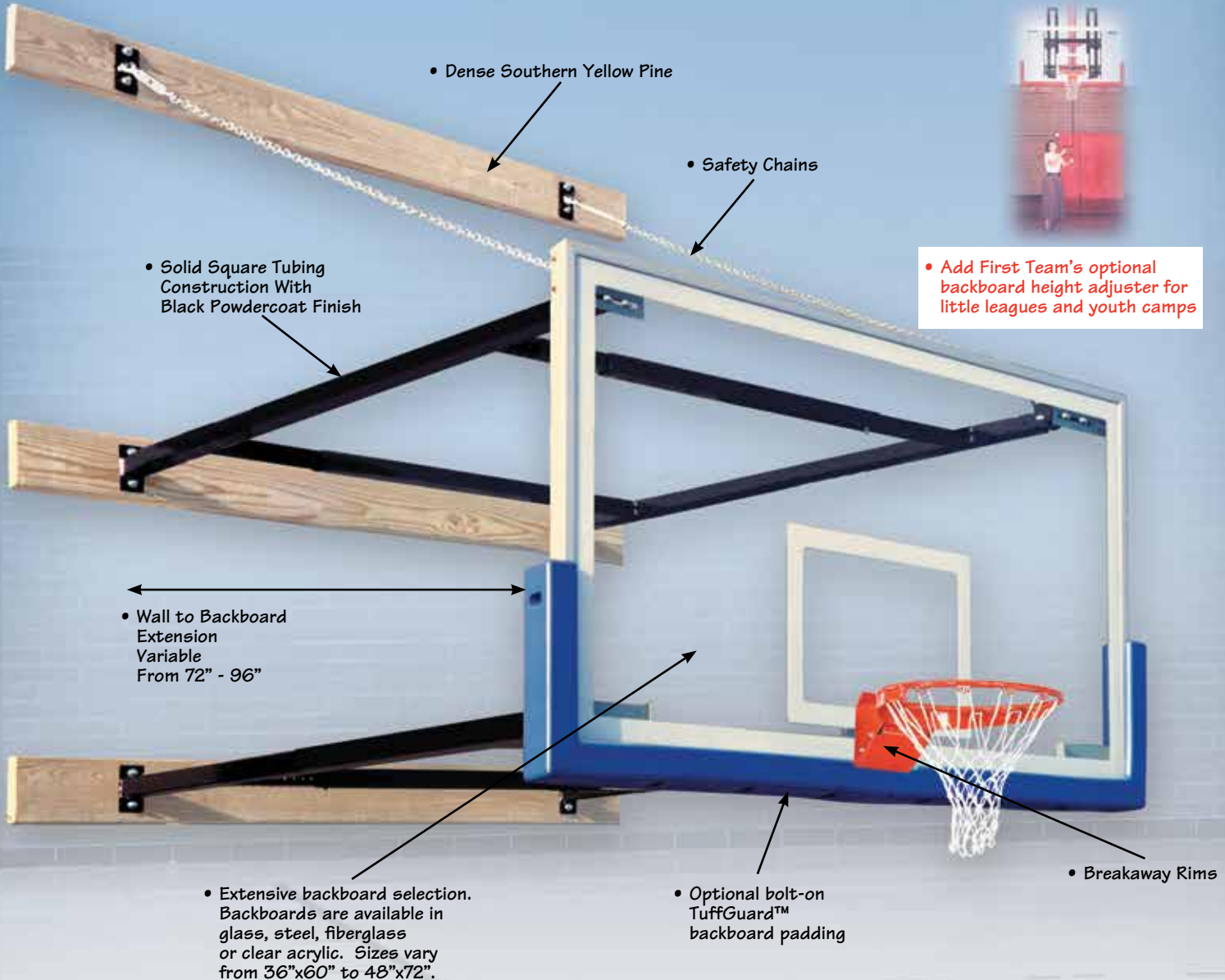

• Dense Southern Yellow Pine

• Safety Chains

• Solid Square Tubing Construction With Black Powdercoat Finish

• Add First Team's optional backboard height adjuster for little leagues and youth camps

• Wall to Backboard Extension Variable From 72" - 96"

• Extensive backboard selection. Backboards are available in glass, steel, fiberglass or clear acrylic. Sizes vary from 36"x60" to 48"x72".

• Optional bolt-on TuffGuard™ backboard padding

• Breakaway Rims

The SuperMount68 simplifies the task of installing a top quality wall-mounted basketball structure.

Never before has it been so simple to purchase and install a commercial quality wall-mounted basketball system. With First Team's SuperMount68 there is no need to calculate exact extension requirements before ordering. The SuperMount68 is specifically

designed to provide wall-to-backboard extension distances anywhere from 6' - 8' during installation. This allows the unit to be "fine-tuned" to match the court markings on the floor. You will avoid costly rework and field modifications commonly caused by measurement errors.

Additionally, the SuperMount68 is so versatile it can be configured to match up to any basketball backboard. So no

matter what backboard you prefer, you know the SuperMount68 is compatible.

Select from First Team's broad array of package configurations to satisfy the needs of your facility. Remember, for additional safety, First Team offers optional bolt-on padding for most SuperMount68 packages.

Every SuperMount68 System comes with a Lifetime Limited Warranty.

SUPERMOUNT 68 PACKAGE OPTIONS

**SUPERMOUNT 68
VICTORY**



Shown with optional bolt-on
TuffGuard™ backboard padding

- FT2010 SuperMount 68 System
- FT234 42"x72" Glass Backboard
- FT190 Competition Breakaway Goal
- Approx. Shipping Weight: 513 lbs.

**SUPERMOUNT 68
TRIUMPH**



- FT2010 SuperMount 68 System
- FT235 42"x72" Glass Backboard
- FT192 Competition Breakaway Goal
- Approx. Shipping Weight: 523 lbs.

**SUPERMOUNT 68
TRADITION**



- FT2010 SuperMount 68 System
- FT236 48"x72" Glass Backboard
- FT192 Competition Breakaway Goal
- Approx. Shipping Weight: 533 lbs.

**SUPERMOUNT 68
SELECT**



- FT2010 SuperMount 68 System
- FT36 Silver Support Structure
- FT220 36"x60" Acrylic Backboard
- FT186 Heavy Duty Flex Goal
- Approx. Shipping Weight: 410 lbs.

**SUPERMOUNT 68
PRO**



- FT2010 SuperMount 68 System
- FT36 Silver Support Structure
- FT230 36"x60" Glass Backboard
- FT186 Heavy Duty Flex Goal
- Approx. Shipping Weight: 455 lbs.

**SUPERMOUNT 68
SUPREME**



- FT2010 SuperMount 68 System
- FT42 Silver Support Structure
- FT222 42"x72" Acrylic Backboard
- FT186 Heavy Duty Flex Goal
- Approx. Shipping Weight: 455 lbs.

**SUPERMOUNT 68
ADVANTAGE**



- FT2010 SuperMount 68 System
- FT233 39"x54" Glass Backboard
- FT190 Competition Breakaway Goal
- Approx. Shipping Weight: 443 lbs.

**SUPERMOUNT 68
MAVERICK**



- FT2010 SuperMount 68 System
- FT231 40"x54" Glass Backboard
- FT186 Heavy Duty Flex Goal
- Approx. Shipping Weight: 473 lbs.

**SUPERMOUNT 68
AGGRESSOR**



- FT2010 SuperMount 68 System
- FT260B 42"x60" Steel Backboard
- FT186 Heavy Duty Flex Goal
- Approx. Shipping Weight: 473 lbs.

**SUPERMOUNT 68
MAGNUM**



- FT2010 SuperMount 68 System
- FT265B 42"x72" Steel Backboard
- FT186 Heavy Duty Flex Goal
- Approx. Shipping Weight: 513 lbs.

**SUPERMOUNT 68
REBOUND**



- FT2010 SuperMount 68 System
- FT275 39"x54" Fiberglass Backboard
- FT186 Heavy Duty Flex Goal
- Approx. Shipping Weight: 430 lbs.

**SUPERMOUNT 68
PERFORMANCE**



- FT2010 SuperMount 68 System
- FT280 42"x72" Fiberglass Backboard
- FT186 Heavy Duty Flex Goal
- Approx. Shipping Weight: 466 lbs.

www.firstteaminc.com

First Team, Inc. • Hutchinson, Kansas • Toll-Free 1-800-649-3688

the SUPERMOUNT™ 82

STATIONARY WALLMOUNT STRUCTURE

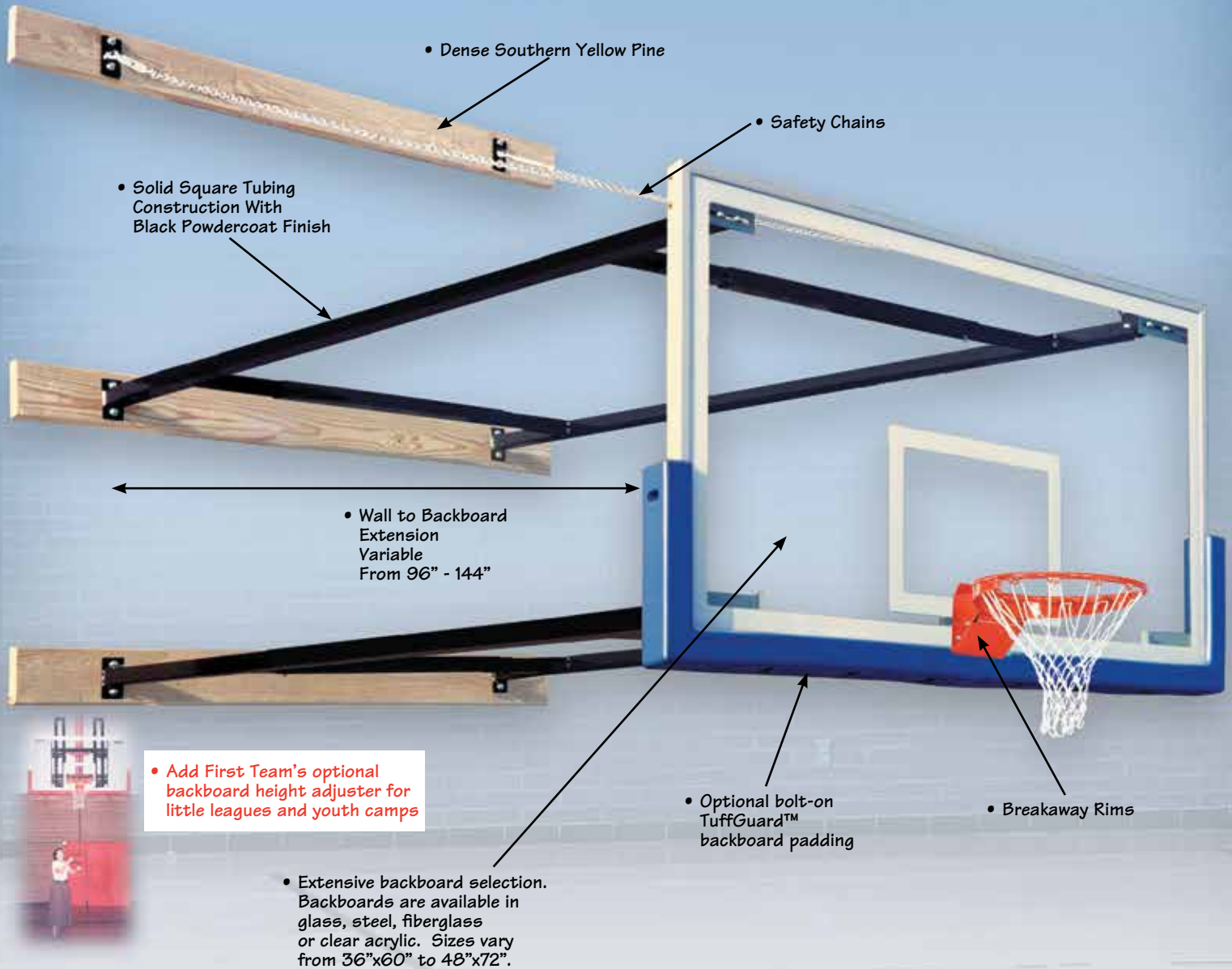

• Add First Team's optional backboard height adjuster for little leagues and youth camps

• Extensive backboard selection. Backboards are available in glass, steel, fiberglass or clear acrylic. Sizes vary from 36"x60" to 48"x72".

• Optional bolt-on TuffGuard™ backboard padding

• Breakaway Rims

The SuperMount82 simplifies the task of installing a top quality wall-mounted basketball structure.

Never before has it been so simple to purchase and install a commercial quality wall-mounted basketball system. With First Team's SuperMount82 there is no need to calculate exact extension requirements before ordering. The SuperMount82 is specifically designed to provide wall-to-

backboard extension distances anywhere from 8' - 12' during installation. This allows the unit to be "fine-tuned" to match the court markings on the floor. You will avoid costly rework and field modifications commonly caused by measurement errors.

Additionally, the SuperMount82 is so versatile it can be configured to match up to any basketball backboard. So no matter what

backboard you prefer, you know the SuperMount82 is compatible.

Select from First Team's broad array of package configurations to satisfy the needs of your facility. Remember, for additional safety, First Team offers optional bolt-on padding for most SuperMount82 packages.

Every SuperMount82 System comes with a Lifetime Limited Warranty.

SUPERMOUNT 82 PACKAGE OPTIONS

SUPERMOUNT 82 VICTORY



Shown with optional bolt-on TuffGuard™ backboard padding

- FT2020 SuperMount82 System
- FT234 42"x72" Glass Backboard
- FT190 Competition Breakaway Goal
- Approx. Shipping Weight: 533 lbs.

SUPERMOUNT 82 TRIUMPH



- FT2020 SuperMount82 System
- FT235 42"x72" Glass Backboard
- FT192 Competition Breakaway Goal
- Approx. Shipping Weight: 543 lbs.

SUPERMOUNT 82 TRADITION



- FT2020 SuperMount82 System
- FT236 48"x72" Glass Backboard
- FT192 Competition Breakaway Goal
- Approx. Shipping Weight: 553 lbs.

SUPERMOUNT 82 SELECT



- FT2020 SuperMount82 System
- FT36 Silver Support Structure
- FT220 36"x60" Acrylic Backboard
- FT186 Heavy Duty Flex Goal
- Approx. Shipping Weight: 435 lbs.

SUPERMOUNT 82 PRO



- FT2020 SuperMount82 System
- FT36 Silver Support Structure
- FT230 36"x60" Glass Backboard
- FT186 Heavy Duty Flex Goal
- Approx. Shipping Weight: 475 lbs.

SUPERMOUNT 82 SUPREME



- FT2020 SuperMount82 System
- FT42 Silver Support Structure
- FT222 42"x72" Acrylic Backboard
- FT186 Heavy Duty Flex Goal
- Approx. Shipping Weight: 475 lbs.

SUPERMOUNT 82 ADVANTAGE



- FT2020 SuperMount82 System
- FT233 39"x54" Glass Backboard
- FT190 Competition Breakaway Goal
- Approx. Shipping Weight: 463 lbs.

SUPERMOUNT 82 MAVERICK



- FT2020 SuperMount82 System
- FT231 40"x54" Glass Backboard
- FT186 Heavy Duty Flex Goal
- Approx. Shipping Weight: 493 lbs.

SUPERMOUNT 82 AGGRESSOR



- FT2020 SuperMount82 System
- FT260B 42"x60" Steel Backboard
- FT186 Heavy Duty Flex Goal
- Approx. Shipping Weight: 493 lbs.

SUPERMOUNT 82 MAGNUM



- FT2020 SuperMount82 System
- FT265B 42"x72" Steel Backboard
- FT186 Heavy Duty Flex Goal
- Approx. Shipping Weight: 533 lbs.

SUPERMOUNT 82 REBOUND



- FT2020 SuperMount82 System
- FT275 39"x54" Fiberglass Backboard
- FT186 Heavy Duty Flex Goal
- Approx. Shipping Weight: 450 lbs.

SUPERMOUNT 82 PERFORMANCE



- FT2020 SuperMount82 System
- FT280 42"x72" Fiberglass Backboard
- FT186 Heavy Duty Flex Goal
- Approx. Shipping Weight: 486 lbs.

www.firstteaminc.com

First Team, Inc. • Hutchinson, Kansas • Toll-Free 1-800-649-3688

the FOLDAMOUNT™ 46

SIDE-FOLDING WALLMOUNT STRUCTURE

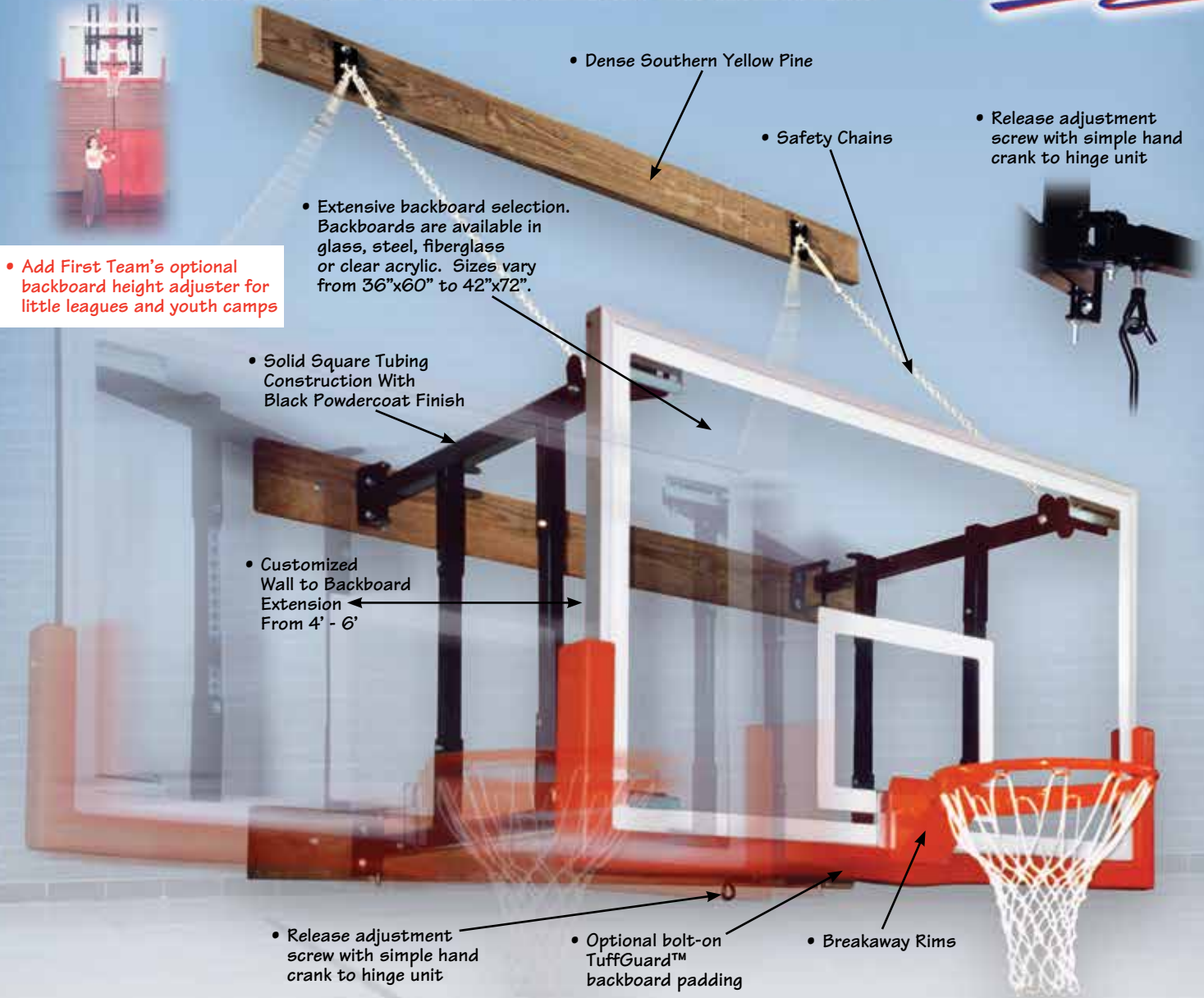

• Add First Team's optional backboard height adjuster for little leagues and youth camps

- Dense Southern Yellow Pine
- Safety Chains
- Release adjustment screw with simple hand crank to hinge unit
- Extensive backboard selection. Backboards are available in glass, steel, fiberglass or clear acrylic. Sizes vary from 36"x60" to 42"x72".
- Solid Square Tubing Construction With Black Powdercoat Finish
- Customized Wall to Backboard Extension From 4' - 6'
- Release adjustment screw with simple hand crank to hinge unit
- Optional bolt-on TuffGuard™ backboard padding
- Breakaway Rims

The FoldaMount46 side-folding wall mount structure simplifies the task of ordering and installing top quality side-fold wall-mounted basketball systems.

When your facility requires that the basketball goals be folded against the wall to make room for volleyball or other activities, call on First Team's FoldaMount46 series. The unit swings left or right for storage close to the wall without tools or ladders! Ordering is simple. Simply choose the FoldaMount46 package that best suits your needs and budget.

No more guesswork about which backboard and rim to choose. Compatibility is guaranteed!

Installing the FoldaMount46 is simple as well. The FoldaMount46 is specifically designed to provide wall-to-backboard extension distances from 4' to 6' during installation. This allows the unit to be "fine-tuned" to match the court markings on the floor. You will avoid costly rework and field modifications commonly caused by measurement errors.

Folding the unit is easy. Simply use the adjustment crank provided with

each unit to loosen the adjustment screw. Grab the rim with the hook on the crank and tug on the unit to slide it against the wall. Then tighten the adjustment screw to secure the unit. Reverse the process to set up for play! It's that simple!

Pick from First Team's broad array of package configurations to satisfy the needs of your facility. Remember, for additional safety, First Team offers optional bolt-on padding for most FoldaMount46 packages.

All FoldaMount46 packages come with a Lifetime Limited Warranty.

FOLDAMOUNT 46 PACKAGE OPTIONS

**FOLDAMOUNT 46
VICTORY**



Shown with optional bolt-on
TuffGuard™ backboard padding

- FT2030 FoldaMount 46 System
- FT234 42"x72" Glass Backboard
- FT190 Competition Breakaway Goal
- Approx. Shipping Weight: 503 lbs.

**FOLDAMOUNT 46
TRIUMPH**



- FT2030 FoldaMount 46 System
- FT235 42"x72" Glass Backboard
- FT192 Competition Breakaway Goal
- Approx. Shipping Weight: 513 lbs.

**FOLDAMOUNT 46
SELECT**



- FT2030 FoldaMount 46 System
- FT36 Silver Support Structure
- FT220 36"x60" Acrylic Backboard
- FT186 Heavy Duty Flex Goal
- Approx. Shipping Weight: 400 lbs.

**FOLDAMOUNT 46
PRO**



- FT2030 FoldaMount 46 System
- FT36 Silver Support Structure
- FT230 36"x60" Glass Backboard
- FT186 Heavy Duty Flex Goal
- Approx. Shipping Weight: 445 lbs.

**FOLDAMOUNT 46
SUPREME**



- FT2030 FoldaMount 46 System
- FT42 Silver Support Structure
- FT222 42"x72" Acrylic Backboard
- FT186 Heavy Duty Flex Goal
- Approx. Shipping Weight: 445 lbs.

**FOLDAMOUNT 46
ADVANTAGE**



- FT2030 FoldaMount 46 System
- FT233 39"x54" Glass Backboard
- FT190 Competition Breakaway Goal
- Approx. Shipping Weight: 433 lbs.

**FOLDAMOUNT 46
MAVERICK**



- FT2030 FoldaMount 46 System
- FT231 40"x54" Glass Backboard
- FT186 Heavy Duty Flex Goal
- Approx. Shipping Weight: 463 lbs.

**FOLDAMOUNT 46
AGGRESSOR**



- FT2030 FoldaMount 46 System
- FT260B 42"x60" Steel Backboard
- FT186 Heavy Duty Flex Goal
- Approx. Shipping Weight: 463 lbs.

**FOLDAMOUNT 46
MAGNUM**



- FT2030 FoldaMount 46 System
- FT265B 42"x72" Steel Backboard
- FT186 Heavy Duty Flex Goal
- Approx. Shipping Weight: 503 lbs.

**FOLDAMOUNT 46
REBOUND**



- FT2030 FoldaMount 46 System
- FT275 39"x54" Fiberglass Backboard
- FT186 Heavy Duty Flex Goal
- Approx. Shipping Weight: 420 lbs.

**FOLDAMOUNT 46
PERFORMANCE**



- FT2030 FoldaMount 46 System
- FT280 42"x72" Fiberglass Backboard
- FT186 Heavy Duty Flex Goal
- Approx. Shipping Weight: 456 lbs.

www.firstteaminc.com

First Team, Inc. • Hutchinson, Kansas • Toll-Free 1-800-649-3688

the

FOLDAMOUNT™ 68

SIDE-FOLDING WALLMOUNT STRUCTURE

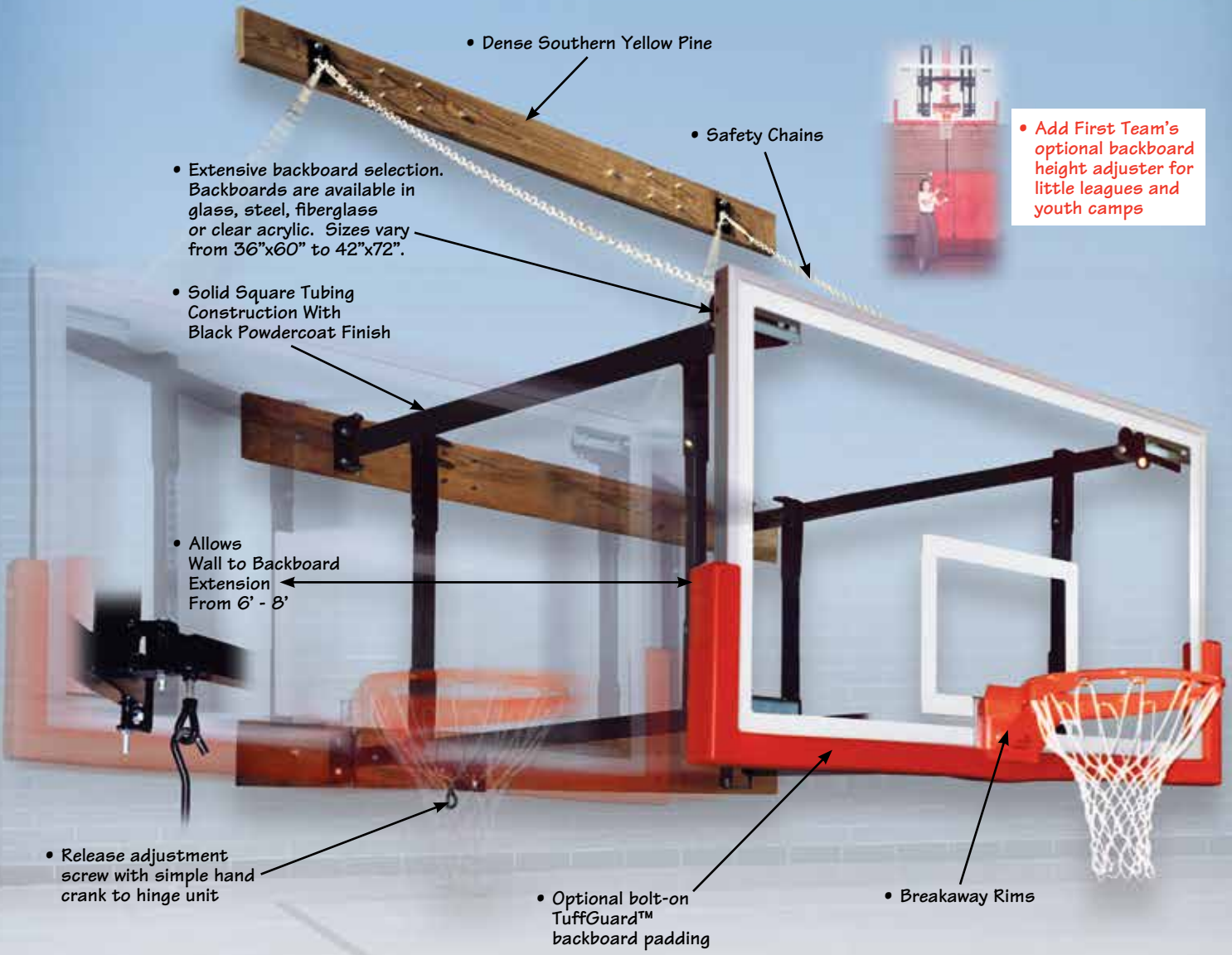

• Dense Southern Yellow Pine

• Safety Chains

• Extensive backboard selection. Backboards are available in glass, steel, fiberglass or clear acrylic. Sizes vary from 36"x60" to 42"x72".

• Solid Square Tubing Construction With Black Powdercoat Finish

• Allows Wall to Backboard Extension From 6' - 8'

• Release adjustment screw with simple hand crank to hinge unit

• Optional bolt-on TuffGuard™ backboard padding

• Breakaway Rims

• Add First Team's optional backboard height adjuster for little leagues and youth camps

The FoldaMount68 side-folding wall mount structure simplifies the task of ordering and installing top quality side-fold wall-mounted basketball systems.

When your facility requires that the basketball goals be folded against the wall to make room for volleyball or other activities, call on First Team's FoldaMount68 series. The unit swings left or right for storage close to the wall without tools or ladders! Ordering is simple. Simply choose the FoldaMount68 package that best suits your needs and budget.

No more guesswork about which backboard and rim to choose. Compatibility is guaranteed!

Installing the FoldaMount68 is simple as well. The FoldaMount68 is specifically designed to provide wall-to-backboard extension distances from 6' to 8' during installation. This allows the unit to be "fine-tuned" to match the court markings on the floor. You will avoid costly rework and field modifications commonly caused by measurement errors.

Folding the unit is easy. Simply use the adjustment crank provided with

each unit to loosen the adjustment screw. Grab the rim with the hook on the crank and tug on the unit to slide it against the wall. Then tighten the adjustment screw to secure the unit. Reverse the process to set up for play! It's that simple!

Pick from First Team's broad array of package configurations to satisfy the needs of your facility. Remember, for additional safety, First Team offers optional bolt-on padding for most FoldaMount68 packages.

All FoldaMount68 packages come with a Lifetime Limited Warranty.

FOLDAMOUNT 68 PACKAGE OPTIONS

FOLDAMOUNT 68
VICTORY



- FT2040 FoldaMount 68 System
- FT234 42"x72" Glass Backboard
- FT190 Competition Breakaway Goal
- Approx. Shipping Weight: 607 lbs.

FOLDAMOUNT 68
TRIUMPH



- FT2040 FoldaMount 68 System
- FT235 42"x72" Glass Backboard
- FT192 Competition Breakaway Goal
- Approx. Shipping Weight: 619 lbs.

FOLDAMOUNT 68
SELECT



- FT2040 FoldaMount 68 System
- FT36 Silver Support Structure
- FT220 36"x60" Acrylic Backboard
- FT186 Heavy Duty Flex Goal
- Approx. Shipping Weight: 529 lbs.

FOLDAMOUNT 68
PRO



- FT2040 FoldaMount 68 System
- FT36 Silver Support Structure
- FT230 36"x60" Glass Backboard
- FT186 Heavy Duty Flex Goal
- Approx. Shipping Weight: 574 lbs.

Shown with optional bolt-on
TuffGuard™ backboard padding

FOLDAMOUNT 68
SUPREME



- FT2040 FoldaMount 68 System
- FT42 Silver Support Structure
- FT222 42"x72" Acrylic Backboard
- FT186 Heavy Duty Flex Goal
- Approx. Shipping Weight: 570 lbs.

FOLDAMOUNT 68
ADVANTAGE



- FT2040 FoldaMount 68 System
- FT233 39"x54" Glass Backboard
- FT190 Competition Breakaway Goal
- Approx. Shipping Weight: 546 lbs.

FOLDAMOUNT 68
MAVERICK



- FT2040 FoldaMount 68 System
- FT231 40"x54" Glass Backboard
- FT186 Heavy Duty Flex Goal
- Approx. Shipping Weight: 560 lbs.

FOLDAMOUNT 68
AGGRESSOR



- FT2040 FoldaMount 68 System
- FT260B 42"x60" Steel Backboard
- FT186 Heavy Duty Flex Goal
- Approx. Shipping Weight: 575 lbs.

FOLDAMOUNT 68
MAGNUM



- FT2040 FoldaMount 68 System
- FT265B 42"x72" Steel Backboard
- FT186 Heavy Duty Flex Goal
- Approx. Shipping Weight: 612 lbs.

FOLDAMOUNT 68
REBOUND



- FT2040 FoldaMount 68 System
- FT275 39"x54" Fiberglass Backboard
- FT186 Heavy Duty Flex Goal
- Approx. Shipping Weight: 457 lbs.

FOLDAMOUNT 68
PERFORMANCE



- FT2040 FoldaMount 68 System
- FT280 42"x72" Fiberglass Backboard
- FT186 Heavy Duty Flex Goal
- Approx. Shipping Weight: 477 lbs.

www.firstteaminc.com

First Team, Inc. • Hutchinson, Kansas • Toll-Free 1-800-649-3688

the FOLDAMOUNT™ 82

SIDE-FOLDING WALLMOUNT STRUCTURE



• Add First Team's optional backboard height adjuster for little leagues and youth camps

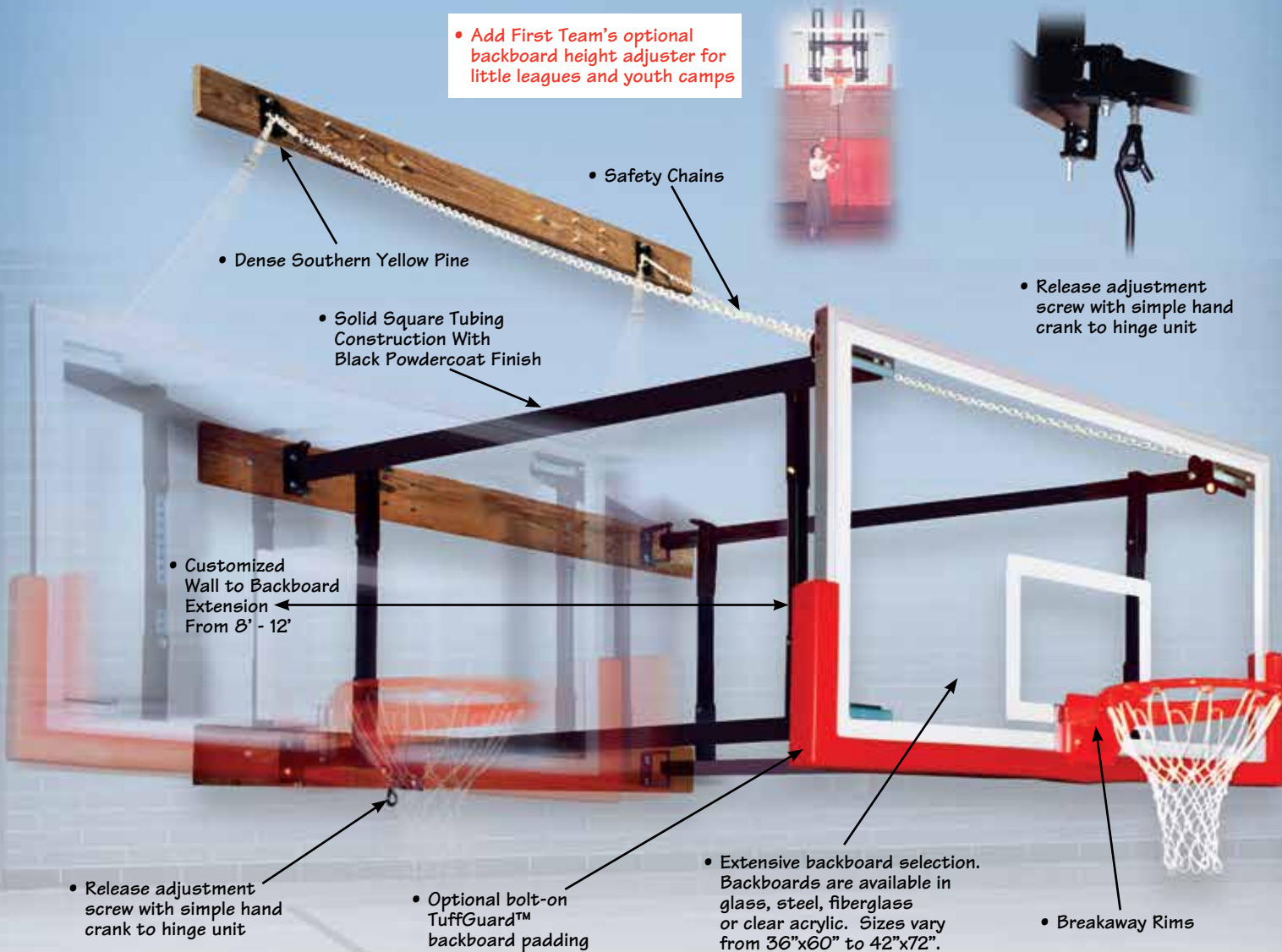

• Release adjustment screw with simple hand crank to hinge unit

• Optional bolt-on TuffGuard™ backboard padding

• Extensive backboard selection. Backboards are available in glass, steel, fiberglass or clear acrylic. Sizes vary from 36"x60" to 42"x72".

• Breakaway Rims

The FoldaMount82 side-folding wall mount structure simplifies the task of ordering and installing top quality side-fold wall-mounted basketball systems.

When your facility requires that the basketball goals be folded against the wall to make room for volleyball or other activities, call on First Team's FoldaMount82 series. The unit swings left or right for storage close to the wall without tools or ladders! Ordering is simple. Simply choose the FoldaMount82 package that best suits your needs and

budget. No more guesswork about which backboard and rim to choose. Compatibility is guaranteed!

Installing the FoldaMount82 is simple as well. The FoldaMount82 is specifically designed to provide wall-to-backboard distances from 8' to 12' during installation. This allows the unit to be "fine-tuned" to match the court markings on the floor. You will avoid costly rework and field modifications commonly caused by measurement errors.

Folding the unit is easy. Simply use the adjustment crank provided with

each unit to loosen the adjustment screw. Grab the rim with the hook on the crank and tug on the unit to slide it against the wall. Then tighten the adjustment screw to secure the unit. Reverse the process to set up for play! It's that simple!

Pick from First Team's broad array of package configurations to satisfy the needs of your facility. Remember, for additional safety, First Team offers optional bolt-on padding for most FoldaMount82 packages.

All FoldaMount82 packages come with a Lifetime Limited Warranty.

FOLDAMOUNT 82 PACKAGE OPTIONS

FOLDAMOUNT 82 VICTORY



Shown with optional bolt-on TuffGuard™ backboard padding

- FT2050 FoldaMount 82 System
- FT234 42"x72" Glass Backboard
- FT190 Competition Breakaway Goal
- Approx. Shipping Weight: 573 lbs.

FOLDAMOUNT 82 TRIUMPH

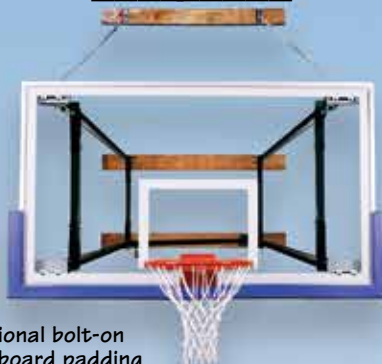

- FT2050 FoldaMount 82 System
- FT235 42"x72" Glass Backboard
- FT192 Competition Breakaway Goal
- Approx. Shipping Weight: 583 lbs.

FOLDAMOUNT 82 SELECT



- FT2050 FoldaMount 82 System
- FT36 Silver Support Structure
- FT220 36"x60" Acrylic Backboard
- FT186 Heavy Duty Flex Goal
- Approx. Shipping Weight: 470 lbs.

FOLDAMOUNT 82 PRO



- FT2050 FoldaMount 82 System
- FT36 Silver Support Structure
- FT230 36"x60" Glass Backboard
- FT186 Heavy Duty Flex Goal
- Approx. Shipping Weight: 515 lbs.

FOLDAMOUNT 82 SUPREME



- FT2050 FoldaMount 82 System
- FT42 Silver Support Structure
- FT222 42"x72" Acrylic Backboard
- FT186 Heavy Duty Flex Goal
- Approx. Shipping Weight: 515 lbs.

FOLDAMOUNT 82 ADVANTAGE



- FT2050 FoldaMount 82 System
- FT233 39"x54" Glass Backboard
- FT190 Competition Breakaway Goal
- Approx. Shipping Weight: 503 lbs.

FOLDAMOUNT 82 MAVERICK



- FT2050 FoldaMount 82 System
- FT231 40"x54" Glass Backboard
- FT186 Heavy Duty Flex Goal
- Approx. Shipping Weight: 533 lbs.

FOLDAMOUNT 82 AGGRESSOR



- FT2050 FoldaMount 82 System
- FT260B 42"x60" Steel Backboard
- FT186 Heavy Duty Flex Goal
- Approx. Shipping Weight: 533 lbs.

FOLDAMOUNT 82 MAGNUM



- FT2050 FoldaMount 82 System
- FT265B 42"x72" Steel Backboard
- FT186 Heavy Duty Flex Goal
- Approx. Shipping Weight: 573 lbs.

FOLDAMOUNT 82 REBOUND



- FT2050 FoldaMount 82 System
- FT275 39"x54" Fiberglass Backboard
- FT186 Heavy Duty Flex Goal
- Approx. Shipping Weight: 490 lbs.

FOLDAMOUNT 82 PERFORMANCE



- FT2050 FoldaMount 82 System
- FT280 42"x72" Fiberglass Backboard
- FT186 Heavy Duty Flex Goal
- Approx. Shipping Weight: 526 lbs.

www.firstteaminc.com

First Team, Inc. • Hutchinson, Kansas • Toll-Free 1-800-649-3688

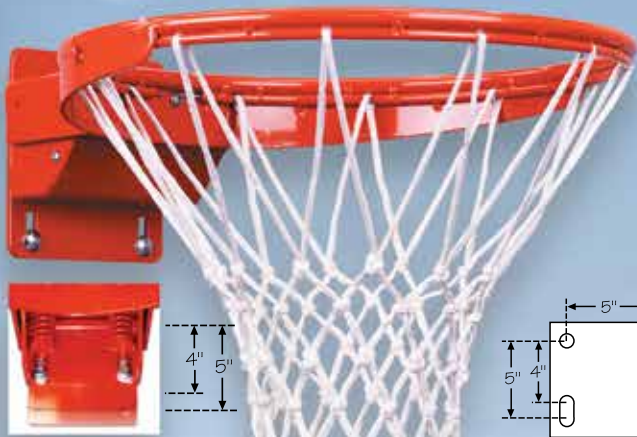

FT196T

FullTilt™
180° Breakaway
Action

- Breakaway action from any angle
- Long lasting positive lock mechanism
- Durable Tuff-Tie net hanger design
- Fits all standard backboards
- Durable powdercoat finish
- Excellent goal for college or high school use
- Meets all NCAA and H.S. specifications
- Anti-whip net and mounting hardware included
- 8-Year Superior Warranty
- Approx. Shipping Weight: 26 lbs.

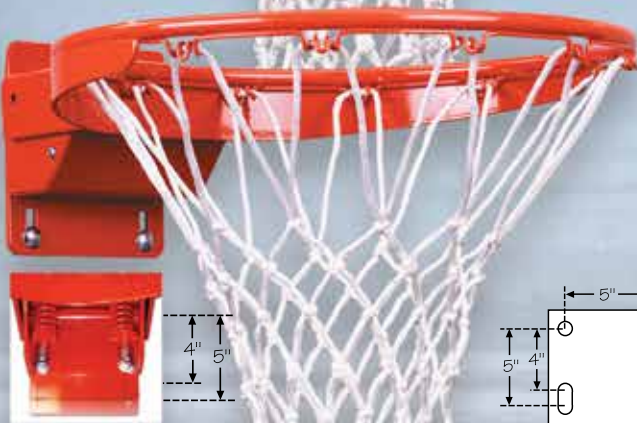

FT196

FullTilt™
180° Breakaway
Action

- Breakaway action from any angle
- Long lasting positive lock mechanism
- Durable continuous net-locks
- Fits all standard backboards
- Durable powdercoat finish
- Excellent goal for college or high school use
- Meets all NCAA and H.S. specifications
- Anti-whip net and mounting hardware included
- 8-Year Superior Warranty
- Approx. Shipping Weight: 26 lbs.



- Flush-Mount™ Adjustable backplate design eliminates below board protrusion by allowing the backplate to be custom-fit to the backboard



FT194TA

- Most durable positive lock mechanism available
- "Tuff-Tie" tubular net hanger design
- Breakaway tension adjustable from 170-230 lbs.
- Fits all standard backboards
- Durable powdercoat finish
- Recommended for the most demanding conditions
- Meets all NCAA and H.S. specifications
- Anti-whip net and mounting hardware included
- **Lifetime Superior Warranty** (Indoor Use Only)
- Approx. Shipping Weight: 26 lbs.

- Flush-Mount™ Adjustable backplate design eliminates below board protrusion by allowing the backplate to be custom-fit to the backboard



BREAKAWAY GOALS

FT192TA

- Long lasting positive lock mechanism
- "Tuff-Tie" tubular net hanger design
- Breakaway tension fully adjustable from 170-230 lbs.
- Fits all standard backboards
- Durable powdercoat finish
- Excellent goal for college or high school competition
- Meets all NCAA and H.S. specifications
- Anti-whip net and mounting hardware included
- 5-Year Superior Warranty
- Approx. Shipping Weight: 26 lbs.

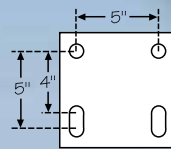

- Flush-Mount™ Adjustable backplate design eliminates below board protrusion by allowing the backplate to be custom-fit to the backboard

FT192

- Long lasting positive lock mechanism
- Durable continuous net-locks
- Fits all standard backboards
- Durable powdercoat finish
- Excellent goal for college or high school use
- Meets all NCAA and H.S. specifications
- Anti-whip net and mounting hardware included
- 2-Year Superior Warranty
- Approx. Shipping Weight: 26 lbs.

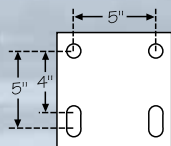

- Flush-Mount™ Adjustable backplate design eliminates below board protrusion by allowing the backplate to be custom-fit to the backboard

FT190

- Durable breakaway goal built for economy
- Continuous net-locks
- Fits all standard backboards
- Powdercoat finish
- Great goal for Junior High, YMCA, Rec Center or Church
- Meets all NCAA and H.S. specifications
- Anti-whip net and mounting hardware included
- 1-Year Limited Warranty
- Approx. Shipping Weight: 23 lbs.



FT186

- Heavy duty flex goal
- See FLEX GOALS section for details

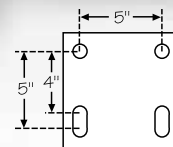

www.firstteaminc.com

First Team, Inc. • Hutchinson, Kansas • Toll-Free 1-800-649-3688



COMPETITION GLASS BACKBOARDS



FT235

- Official 42"x72" tempered glass backboard
- Rim mount design eliminates goal-to-glass contact
- Guaranteed to be unbreakable during play
- Built-in goal leveling feature
- Board is pre-drilled for FT72C TuffGuard backboard padding (goal and padding not included)
- Cushioned 1/2" tempered glass
- Regulation white border and shooters square fired into glass
- Meets all NCAA and H.S. specifications
- **Lifetime Superior Warranty**
- Approx. Shipping Weight: 200 lbs.

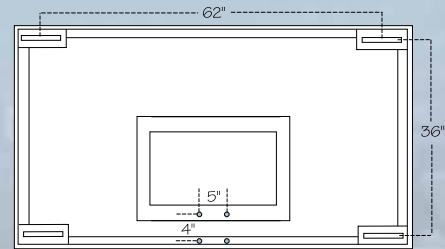

FT240

- Official 42"x72" tempered glass conversion backboard
- Mounts directly to structures where fan-shaped boards previously existed
- Unbreakable design like our popular FT235 board
- Built-in goal leveling feature
- Board is pre-drilled for FT72C TuffGuard backboard padding (goal and padding not included)
- Cushioned 1/2" tempered glass
- Regulation white border and shooters square fired into glass
- Meets all NCAA and H.S. specifications
- **Lifetime Superior Warranty**
- Approx. Shipping Weight: 230 lbs.

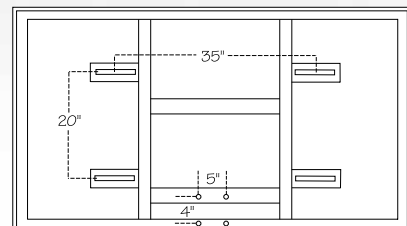

COMPETITION GLASS BACKBOARDS



FT234

- Official 42"x72" tempered glass backboard
- Board is pre-drilled for FT72C TuffGuard backboard padding (goal and padding not included)
- Cushioned 1/2" tempered glass
- Regulation white border and shooters square fired into glass
- Great for use where rough play is not expected
- Meets all NCAA and H.S. specifications
- **Lifetime Limited Warranty**
- Approx. Shipping Weight: 190 lbs.

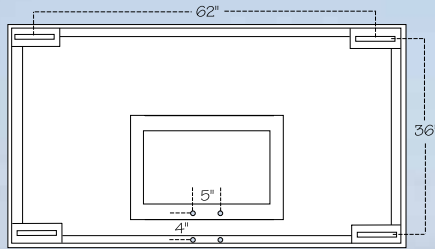

FT239

- Official 42"x72" tempered glass conversion backboard
- Mounts directly to structures where fan-shaped boards previously existed
- Board is pre-drilled for FT72C TuffGuard backboard padding (goal and padding not included)
- Cushioned 1/2" tempered glass
- Regulation white border and shooters square fired into glass
- Great for use where rough play is not expected
- Meets all NCAA and H.S. specifications
- **Lifetime Limited Warranty**
- Approx. Shipping Weight: 220 lbs.

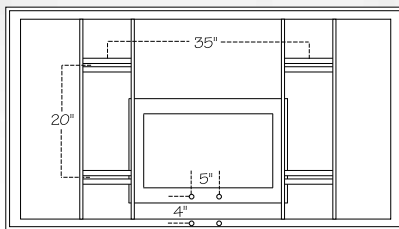

OTHER GYMNASIUM BACKBOARDS



FT236

- Traditional 48"x72" competition glass backboard
- Cushioned 1/2" tempered glass
- Regulation white border and shooters square fired into glass
- Meets all NCAA and H.S. specifications
- 10-Year Limited Warranty
- Approx. Shipping Weight: 210 lbs.

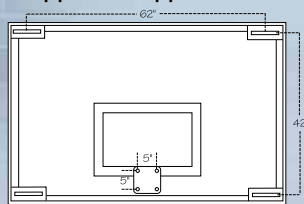

Note: Traditional 48"x72" backboards are still used in many high schools and colleges today. The FT236 should be purchased for replacement only. For new installations or complete gym conversions, First Team recommends the newer 42"x72" backboards because of reduced risk of player injury due to contact with the board.



FT241

- Traditional 48"x72" competition glass backboard
- Mounts directly to structures where fan-shaped boards previously existed
- Cushioned 1/2" tempered glass
- Regulation white border and shooters square fired into glass
- Meets all NCAA and H.S. specifications
- 10-Year Limited Warranty
- Approx. Shipping Weight: 230 lbs.

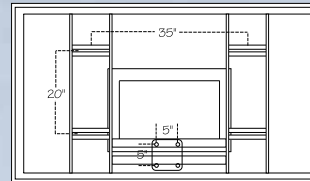

Note: Traditional 48"x72" backboards are still used in many high schools and colleges today. The FT241 should be purchased for replacement only. For new installations or complete gym conversions, First Team recommends the newer 42"x72" backboards because of reduced risk of player injury due to contact with the board.



FT231

- Down-sized 40"x54" tempered glass backboard
- Same quality construction as our FT234 competition board
- Cushioned 1/2" tempered glass
- Heavy duty aluminum framework
- White border and shooters square
- Great for use anywhere regulation sized boards are not needed
- 10-Year Limited Warranty
- Approx. Shipping Weight: 150 lbs.

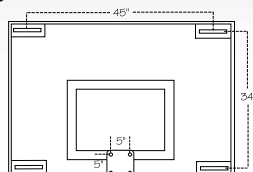

FT233

- Traditional fan-shaped 39"x54" competition glass backboard
- Cushioned 1/2" tempered glass
- Heavy duty aluminum framework
- Regulation white border and shooters square fired into glass
- Meets all NCAA and H.S. specifications
- 10-Year Limited Warranty
- Approx. Shipping Weight: 120 lbs.

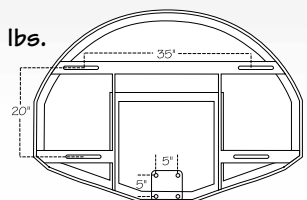

OTHER GYMNASIUM BACKBOARDS



FT220H

- 36"x60" acrylic backboard
- All weather 1/2" thick clear acrylic
- Heavy anodized aluminum framework
- FT36HFM H-Frame provides rim support
- 10-Year Limited Warranty
- Approx. Shipping Weight: 100 lbs.

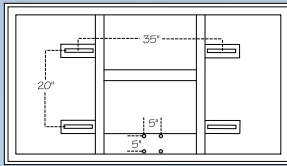

FT222H

- 42"x72" acrylic backboard
- All weather 1/2" thick clear acrylic
- Competition grade anodized alum. frame
- FT42HFM H-Frame provides rim support
- 10-Year Limited Warranty
- Approx. Shipping Weight: 145 lbs.

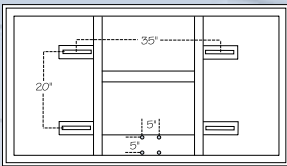

FT230H

- 36"x60" Response™ tempered glass backboard
- All weather 3/8" thick tempered glass
- Competition grade aluminum framework
- Provides gymnasium quality ball reaction off board
- FT36HFM H-Frame provides rim support
- 10-Year Limited Warranty
- Approx. Shipping Weight: 145 lbs.

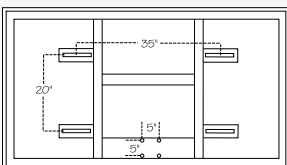

VICTORY UPGRADE PACKAGE



- FT234 Competition Glass Backboard
- FT190 Breakaway Rim
- FT72C TuffGuard Bolt-On Padding (Any Color)
- Approx. Shipping Weight: 235 lbs.

TRIUMPH UPGRADE PACKAGE



- FT235 Competition Glass Backboard
- FT194TA Breakaway Rim
- FT72C TuffGuard Bolt-On Padding (Any Color)
- Approx. Shipping Weight: 245 lbs.

CONTENDER UPGRADE PACKAGE



- FT239 Competition Glass Backboard
- FT190 Breakaway Rim
- FT72C TuffGuard Bolt-On Padding (Any Color)
- Approx. Shipping Weight: 265 lbs.

TRADITION UPGRADE PACKAGE



- FT236 Competition Glass Backboard
- FT190 Breakaway Rim
- FT72C TuffGuard Bolt-On Padding (Any Color)
- Approx. Shipping Weight: 255 lbs.



GYMNASIUM UPGRADE PACKAGES

When it's time to upgrade your existing backboards and rims, trust First Team to provide top-notch equipment for your facility. Choosing from one of our four package options saves money and guarantees compatibility of all components. All product is manufactured in the USA and backed by First Team's unmatched warranties!

COMPETITOR UPGRADE PACKAGE



- FT240 Competition Glass Backboard
- FT194TA Breakaway Rim
- FT72C TuffGuard Bolt-On Padding (Any Color)
- Approx. Shipping Weight: 275 lbs.

COLOSSUS UPGRADE PACKAGE



- FT241 Competition Glass Backboard
- FT190 Breakaway Rim
- FT72C TuffGuard Bolt-On Padding (Any Color)
- Approx. Shipping Weight: 275 lbs.

SCORING EQUIPMENT



FT810

- Portable Scoreboard with Cable Controller
- Includes controller, 10' control cable and extension
- Built-in horn
- Bonus and possession dots
- Dimensions: 48" x 24" x 4"
- Digit Sizes: 9" x 6" digits
- Color: Black powdercoat
- Electrical: 110V AC Power, cord included
- Shipping weight 70 lbs.
- 2-Year Warranty



FT805

- Tabletop Portable Scoreboard
- Will score basketball, wrestling, volleyball, lacrosse
- Dimensions: 22" x 15" x 8"
- Digit Sizes: 4"
- Trouble-free LED bulbs
- Loud built-in horn
- Easy-to-read control panel on back
- Electrical: 110-volt
- Shipping weight 12 lbs.
- 1-Year Warranty

FT805B (Not Shown)

- Same features as FT805, but includes battery power module



FT800SC

- Portable 30-Second Shot Clock
- Cable controller
- Reset button
- Dimensions: 28" x 26" x 8" each
- Digit Sizes: 13"
- Electrical: 20-amp, 120-volt, 60-hertz, grounded AC
- Includes 5' power cord
- Requires (4) AA batteries
- Shipping weight 22 lbs. each
- 2-Year Warranty

FT800SCW (Not Shown)

- Same features as FT800SC, but includes handheld wireless controller
- Requires (4) AA batteries

FT800SCWB (Not Shown)

- Same features as FT800SC, but includes handheld wireless controller and battery power module for clocks

FT810W (Not Shown)

- Same features as FT810, but includes wireless controller

FT810WB (Not Shown)

- Same features as FT810, but includes wireless controller and battery power module



FT800PA

- Possession Arrow
- Thin streamline design
- Bright red illuminated arrows
- Dimensions: 6"h x 20"w x 2"d
- Electrical: 120-volt
- 1-Year Warranty
- Shipping weight 5 lbs.

www.firstteaminc.com

First Team, Inc. • Hutchinson, Kansas • Toll-Free 1-800-649-3688

GYMNASIUM EQUIPMENT & ACCESSORIES

the BALL HOG™ PREMIUM BALL CARRIER



FT24

- Holds up to 24 Mens or Womens Basketballs
- Tote Handle for Easy Transport
- FREE LTR24 Lettering On Request
- Durable Powder Coated Steel
- Lifetime Superior Warranty
- Approx. Shipping Weight: 92 lbs.

First Team's Ball Hog is the last ball carrier you'll ever need to buy!



FT15

- Economy Ball Carrier
- Holds up to 12 Men's or Women's Basketballs
- Swivel casters on all four corners
- Value pricing
- 1-Year Limited Warranty
- Approx. Shipping Weight: 13 lbs.



FT13

- Basketball Dry Erase Clipboard
- Front - Full Court Diagram
- Back - Half Court Diagram
- 9" x 13" Size
- Includes Dry Erase Marker
- Header Card with Hole for Retail Display
- Approx. Shipping Weight: 1 lb.

FT14

- Basketball Scorebook
- Scores 30 Games
- 8 1/2" x 11" Size
- Approx. Shipping Weight: 1 lb.

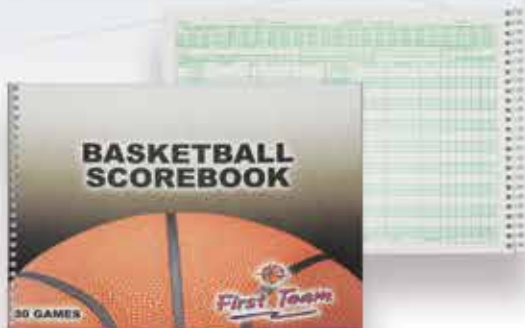

FT23

First Team's Block-Aid rebounder training aid requires no tools or ladders to install. Simply toss it into place or lift up with a broom handle. Tip out to remove or use broom handle to remove. The Block-Aid is molded of lightweight urethane and will not damage floors or injure players. Get the most out of your practice sessions. Block-Aid will improve rebounding skills without wasting precious time on made shots. Ball rebounds off naturally in all directions. Lifetime Limited Warranty. Approx. shipping weight 8 lbs.

FT72C 

TUFFGUARD™

BOLT-ON COMPETITION BACKBOARD PADS

- Fits all manufacturers 72" backboards
- Meets or exceeds all NCAA, FIBA and NFHS specifications
- Available in 16 Colors
- Molded-In Goal Relief
- Center Pin Connectors
- Attachment Hardware Included
- One Set Covers One Backboard
- All First Team Competition Backboards are Pre-Drilled for Easy TuffGuard Installation
- Superior to Glue-On, Vinyl-Dipped or Other Safety Pads
- 10-Year Superior Warranty
- Approx. Shipping Weight: 15 lbs.

• Contoured Shape Reduces Ball Interference

• Molded-In Goal Relief

• Superior Pins Style Center Connectors

Available in **16 Colors!**

Available Colors & Color Codes

(Specify Color by Color Code When Ordering)

RY Royal Blue	SC Scarlet	GL Gold	PR Purple	KG Kelly Green	BK Black	CB Columbia Blue	MR Maroon
GR Grey	NY Navy Blue	OR Orange	FG Forest Green	BR Brick Red	SO Sienna Orange	DG Desert Gold	SB Saddle Brown



FT300

- Backboard Height Adjuster
- Adjusts from 10' down to 8'
- Fits 20"x35" mounting bracket spacing
- Operates from floor level with hand crank
- Warranted against dunking
- 10-Year Superior Warranty
- Approx. Shipping Weight: 125 lbs.

FT310 (Not Shown)

- Same features as FT300, fits 36"x62" spaced mounting brackets
- Approx. Shipping Weight: 150 lbs.

the **SIX-SHOOTER™**

6-IN-1 YOUTH TRAINING GOAL

First Team's Six-Shooter youth training goal is the most versatile youth training goal on the market! Only Six-Shooter is capable of being configured for six different rim heights. When installed on a standard 10' high goal, Six-Shooter can be set up for 6½', 7', 7½', 8', 8½', and 9' rim heights. Requiring only two minutes to change unit from one goal height to another, Six-Shooter accommodates programs running multiple leagues at different age levels. No tools required!

Six-Shooter will fit any style rim, regardless of age or manufacturer. A Six-Shooter unit lowers rim and moves rim 24" closer to the free-throw line. A regulation size rim is included. High impact white ABS plastic backboard measures 39" high and 48" wide and has red shooter's square and border machined into face. Entire system weight is 49# allowing one person standing no more than 24" above playing surface to quickly and easily attach unit to a 10' high goal. Unit is not suitable for dunking or hanging from goal. Entire unit is covered by a Lifetime Limited Warranty.



• Adjusts to 6 playing heights

- 49# lifting weight



www.firstteaminc.com

First Team, Inc. • Hutchinson, Kansas • Toll-Free 1-800-649-3688

43



Energize your facility with First Team's High Impact graphic wall padding! First Team's unique digital printing process allows us to print any image you desire on our safety pads. Our graphics team will work with you to develop the perfect look for your facility. We can use customer supplied artwork (see artwork specifications) or develop your art from scratch. High Impact pads are priced including one hour of in house art design. High Impact pads are priced including one hour of in house art design. Two inch thick foam pads are available in standard 2'x6' and 2'x8' sizes. Odd size panels are available and are priced per square foot. Pads are mounted permanently to the wall through 7/16" thick plywood backing. A 1" lip top and bottom is provided for wall attachment. Fastening hardware is not provided. If cutouts are required for outlets, etc. simply order field cutout FT449 shown, specify size and color. Common applications require 8 panels, 16' to protect the 12' wide free throw lane. 1-Year Limited Warranty.

FT456-WB-GPH

- Min. Order: 4 Panels
- 2' x 6' Panel
- 1-Year Limited Warranty
- App. Wt. 26 lbs./Panel

FT458-WB-GPH

- Min. Order: 4 Panels
- 2' x 8' Panel
- 1-Year Limited Warranty
- App. Wt. 36 lbs./Panel

FT450-WB-GPH

- Odd Sized Panel
- Specify Size Up To 2' x 8'
- 1-Year Limited Warranty
- Priced Per Sq. Ft.



Now Available in 16 Colors!

FT449

- Field Cutout Insert for two-plug outlet (specify color)
- 1-Year Ltd. Warr.
- App. Ship. Wt: 1lb.

FT450-WB

- Odd Sized Panel
- Size Up To 2' x 8'
- 1-Year Ltd. Warr.
- Priced Per Sq. Ft.

FT455-WB

- 2' x 5' Panel
- 1-Year Ltd. Warr.

FT456-WB

- 2' x 6' Panel
- 1-Year Ltd. Warr.

FT457-WB

- 2' x 7' Panel
- 1-Year Ltd. Warr.

FT458-WB

- 2' x 8' Panel
- 1-Year Ltd. Warr.

BODYGUARD™

PROTECTIVE WALL PADDING

First Team's BodyGuard wall padding is a great choice anywhere there is potential for participant injury due to wall collision. BodyGuard wall padding is available in 16 colors and includes 2" thick foam wrapped in a 14 oz. vinyl covering. Panels are available in four standard sizes as well as odd size panels for custom situations. Pads are mounted permanently to the wall through 7/16" thick plywood backing. A 1" lip top and bottom is provided for wall attachment. Fastening hardware is not provided. If cutouts are required for outlets, etc. simply order field cutout FT449 shown, specify size and color. Common applications require 8 panels, 16' to protect the 12' wide free throw lane. 1-Year Limited Warranty.

PROTECTIVE COLUMN PADDING

FT403CLM-WB

- Three-Sided Column Pad
- 2" Thick Foam with Wood Backing
- FT403CLM-FO (Not shown)
- Three-Sided Column Pad
- 2" Thick Foam With Velcro Attach.
- FT404CLM-WB (Not shown)
- Four-Sided Column Pad
- 2" Thick Foam With Wood Backing
- FT404CLM-FO (Not shown)
- Four-Sided Column Pad
- 2" Thick Foam With Velcro Attach.



Custom Pricing Applies, Call For Quote

FT400CLM-RC

- Pad for Round Columns
- 1 1/2" Thick Foam
- 360 Degree Coverage
- Velcro Closure
- FT400CNR-WB (Not shown)
- Corner Pad
- 2" Thick Foam/Wood Back
- FT400CNR-FO (Not shown)
- Corner Pad
- 2" Foam/Velcro Attach.



Custom Pricing Applies, Call For Quote

FT400-I

- I-Beam Pad
- 1 1/2" Thick Foam
- Protects Front and Sides
- Velcro Attachment
- Custom Pricing Applies, Call For Quote



RY Royal Blue	SC Scarlet	GL Gold	PR Purple	KG Kelly Green	BK Black	CB Columbia Blue	MR Maroon	GR Grey	NY Navy Blue	OR Orange	FG Forest Green	BR Brick Red	SO Sienna Orange	DG Desert Gold	SB Saddle Brown
------------------	---------------	------------	--------------	-------------------	-------------	---------------------	--------------	------------	-----------------	--------------	--------------------	-----------------	---------------------	-------------------	--------------------

Hurricane base padding is available in these colors. Shades may vary slightly from color chart.

the ROOFMASTER™

ADJUSTABLE ROOF/WALLMOUNT SYSTEM



See Accessories Section for Backboard Padding Options.

- Selection of various clear acrylic and tempered glass backboards. Sizes vary from 36"x48" to 36"x60".
- Backboard braces for superior backboard rigidity
- Mount on vertical wall
- Mount on sloped rooftop
- Easy adjustment from the ground with included handle
- Super strength flex goals are "direct mounted" to eliminate backboard stress
- Optional bolt-on TuffGuard™ backboard padding available in several colors
- Extension at various heights:
 - 10' height - 38" extension
 - 9' height - 43" extension
 - 8' height - 44" extension
 - 7' height - 38" extension
 - 6' height - 25" extension

The RoofMaster offers infinite adjustability for the customer who has no place for a pole mounted system.

No other system compares to the RoofMaster from First Team. The unit is versatile enough to mount to any roof pitch or vertical wall surface. The RoofMaster is infinitely

adjustable with the industry's widest range of height adjustment. With a simple turn of the hand-crank the RoofMaster offers an adjustment range of up to 4-feet (10' - 6').

An easy-to-read rim height indicator displays the exact height of the rim.

We offer several backboards and

rims with the RoofMaster so you can choose the package that's right for you and your budget.

For player safety, First Team offers optional backboard padding for each RoofMaster system.

Every RoofMaster package comes with a Lifetime Limited Warranty.

ROOFMASTER PACKAGE OPTIONS



- ROOFMASTER II
- ROOFMASTER III
- ROOFMASTER SELECT
- ROOFMASTER TURBO
- ROOFMASTER NITRO
- ROOFMASTER ECLIPSE
- ROOFMASTER ENDURA

- FT1650 RoofMaster Mount System
- FT210 36"x48" Acrylic Backboard
- FT184 Recreational Flex Goal
- Lifetime Limited Warranty
- Approx. Shipping Weight: 238 lbs.
- FT1650 RoofMaster Mount System
- FT215 36"x54" Acrylic Backboard
- FT186 Heavy Duty Flex Goal
- Lifetime Limited Warranty
- Approx. Shipping Weight: 248 lbs.
- FT1650 RoofMaster Mount System
- FT220 36"x60" Acrylic Backboard
- FT188 Heavy Duty Flex Goal
- Lifetime Limited Warranty
- Approx. Shipping Weight: 258 lbs.
- FT1650 RoofMaster Mount System
- FT216 36"x54" Temp. Glass Bkhd.
- FT186 Heavy Duty Flex Goal
- Lifetime Limited Warranty
- Approx. Shipping Weight: 248 lbs.
- FT1650 RoofMaster Mount System
- FT221 36"x60" Temp. Glass Bkhd.
- FT186 Heavy Duty Flex Goal
- Lifetime Limited Warranty
- Approx. Shipping Weight: 258 lbs.
- FT1650 RoofMaster Mount System
- FT221SM 36"x60" Smoked Tempered Glass Backboard
- FT186 Heavy Duty Flex Goal
- Lifetime Limited Warranty
- Approx. Shipping Weight: 258 lbs.
- FT1650 RoofMaster Mount System
- FT257 36"x60" Aluminum Bkhd.
- FT172D Unbreakable Fixed Goal
- Lifetime Limited Warranty
- Approx. Shipping Weight: 258 lbs.

www.firstteaminc.com

First Team, Inc. • Hutchinson, Kansas • Toll-Free 1-800-649-3688

the CHAMP™

ADJUSTABLE BASKETBALL SYSTEM



- Backboards available in acrylic or glass
- Super strength flex goals are "direct mounted" to eliminate backboard stress
- Optional bolt-on TuffGuard™ backboard padding available in several colors
- Insta-Just™ height adjustment. No need for tools or a ladder. A simple broom handle allows you to adjust rim height from 10'-7"6" in 6" increments.

- Optional all-weather velcro wrap-around post padding for added safety (See padding section for available colors)

- Post is buried 36" below playing surface (FT16 ground sleeve option can be purchased to make post removable)

- Post to backboard extension distance is 18" with rim at 10' (Extension distance increases as rim height is lowered)

- Optional Bolt-down Baseplate

The Champ offers adjustability at an affordable price!

The Champ's 4"x4" 11 ga. steel post is 50% heavier than any goal of its kind.

Our one piece post design eliminates wobbling, rusting joints common with sectional type posts.

Our Insta-Just™ height adjustment mechanism allows the Champ to adjust from 10' to 7'6" in six inch increments. To adjust, use a broom handle to release the Insta-Just™ height regulator.

A variety of backboards and rims are offered with the Champ so you can choose the Champ package that's right for you.

For additional safety, pole padding and backboard padding can be added to any Champ package.

Every Champ package comes with a Lifetime Superior Warranty.

CHAMP PACKAGE OPTIONS



- FT1100 4" Square Post
- FT1200 Champ Arm System
- FT210 36"x48" Acrylic Backboard
- FT184 Recreational Flex Goal
- Lifetime Superior Warranty
- Approx. Shipping Weight: 150 lbs.

- FT1100 4" Square Post
- FT1200 Champ Arm System
- FT215 36"x54" Acrylic Backboard
- FT186 Heavy Duty Flex Goal
- Lifetime Superior Warranty
- Approx. Shipping Weight: 160 lbs.

- FT1100 4" Square Post
- FT1200 Champ Arm System
- FT220 36"x60" Acrylic Backboard
- FT186 Heavy Duty Flex Goal
- Lifetime Superior Warranty
- Approx. Shipping Weight: 170 lbs.

- FT1100 4" Square Post
- FT1200 Champ Arm System
- FT216 36"x54" Temp. Glass Bkhd.
- FT186 Heavy Duty Flex Goal
- Lifetime Superior Warranty
- Approx. Shipping Weight: 160 lbs.

- FT1100 4" Square Post
- FT1200 Champ Arm System
- FT221 36"x60" Temp. Glass Bkhd.
- FT186 Heavy Duty Flex Goal
- Lifetime Superior Warranty
- Approx. Shipping Weight: 170 lbs.

- FT1100 4" Square Post
- FT1200 Champ Arm System
- FT221SM 36"x60" Smoked Temp. Glass Bkhd.
- FT186 Heavy Duty Flex Goal
- Lifetime Superior Warranty
- Approx. Shipping Weight: 170 lbs.

the SLAM™

ADJUSTABLE BASKETBALL SYSTEM



- Backboards available in acrylic or glass
- Super strength flex goals are "direct mounted" to eliminate backboard stress
- Optional bolt-on TuffGuard™ backboard padding available in several colors
- Springs located in the extension assembly counter balance the weight of the backboard and rim. Adjustment is effortless.
- Optional all-weather velcro wrap-around post padding for added safety (See padding section for available colors)
- Quik-Pin™ height adjustment design makes adjusting the SLAM effortless and safe. Unit adjusts from 10'-7" in 6" increments.
- Post is buried 36" below playing surface (FT16 ground sleeve option can be purchased to make post removable)

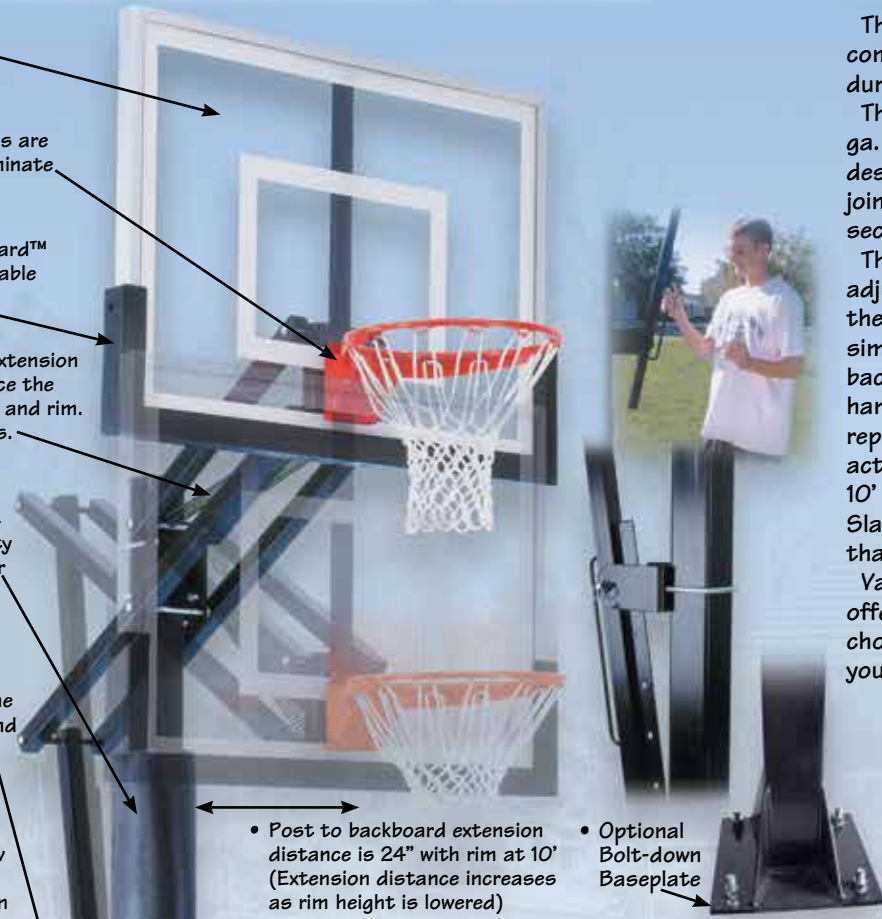

The Slam offers a unique combination of adjustability, durability and affordability! The Slam includes a heavy 4"x4" 11 ga. steel post. Our one piece post design eliminates the potential for joint deterioration common with sectional posts.

The Quik-Pin™ rim height adjustment design makes adjusting the Slam quick and easy. To adjust, simply pull the pin located on the back of the unit, lift the adjustment handle to the desired rim height, replace the pin and you're ready for action. The Slam is adjustable from 10' to 7' in six inch increments. The Slam's spring aided design insures that adjustment is effortless.

Various backboards and rims are offered with the Slam so you can choose the Slam package that fits your family.

- Post to backboard extension distance is 24" with rim at 10' (Extension distance increases as rim height is lowered)
- Optional Bolt-down Baseplate

For additional safety, pole padding and backboard padding can be added to any Slam package. Every Slam package comes with a Lifetime Superior Warranty.

SLAM PACKAGE OPTIONS



- | | | | | | |
|---|---|---|---|---|--|
| <ul style="list-style-type: none"> • FT1100 4" Square Post • FT1250 Slam Arm System • FT210 36"x48" Acrylic Backboard • FT184 Recreational Flex Goal • Lifetime Superior Warranty • Approx. Shipping Weight: 195 lbs. | <ul style="list-style-type: none"> • FT1100 4" Square Post • FT1250 Slam Arm System • FT215 36"x54" Acrylic Backboard • FT186 Heavy Duty Flex Goal • Lifetime Superior Warranty • Approx. Shipping Weight: 205 lbs. | <ul style="list-style-type: none"> • FT1100 4" Square Post • FT1250 Slam Arm System • FT220 36"x60" Acrylic Backboard • FT186 Heavy Duty Flex Goal • Lifetime Superior Warranty • Approx. Shipping Weight: 215 lbs. | <ul style="list-style-type: none"> • FT1100 4" Square Post • FT1250 Slam Arm System • FT216 36"x54" Temp. Glass Bkhd. • FT186 Heavy Duty Flex Goal • Lifetime Superior Warranty • Approx. Shipping Weight: 205 lbs. | <ul style="list-style-type: none"> • FT1100 4" Square Post • FT1250 Slam Arm System • FT221 36"x60" Temp. Glass Bkhd. • FT186 Heavy Duty Flex Goal • Lifetime Superior Warranty • Approx. Shipping Weight: 215 lbs. | <ul style="list-style-type: none"> • FT1100 4" Square Post • FT1250 Slam Arm System • FT221SM 36"x60" Smoked Temp. Glass Bkhd. • FT186 Heavy Duty Flex Goal • Lifetime Superior Warranty • Approx. Shipping Weight: 215 lbs. |
|---|---|---|---|---|--|

www.firstteaminc.com

First Team, Inc. • Hutchinson, Kansas • Toll-Free 1-800-649-3688

the VECTOR™

ADJUSTABLE BASKETBALL SYSTEM



- Backboards available in acrylic or glass
- Optional bolt-on TuffGuard™ backboard padding available in several colors
- Optional all-weather velcro wrap-around post padding for added safety (See padding section for available colors)
- Springs located in the extension assembly counterbalance the weight of the backboard and rim. Adjustment is effortless.
- Simple hand crank adjustment easily adjusts rim height from 10' - 7'
- Hand crank is removable
- Post is buried 36" below playing surface. (FT16 ground sleeve option can be purchased to make post removable.)
- Optional Bolt-down Baseplate



- Super strength flex goals are "direct mounted" to eliminate any chance of backboard breakage
- Post to backboard extension distance is 32" with rim at 10' (Extension distance increases as rim height is lowered)

The Vector provides the easiest and most economical way to get infinite height adjustment and great performance in one affordable package.

First Team's Vector basketball system includes our heavy one piece 11 ga. 4"x 4" post design that eliminates the risk of joint deterioration common with sectional type posts.

The Vector's unique front-mount EZ Crank is a great choice, especially when a wall or other obstruction makes installing a rear-cranking unit impossible. First Team is the ONLY manufacturer to offer a front-mount EZ Crank with SPRING-ASSIST. Our spring-aided crank design is the easiest to operate in the industry and allows the rim height to quickly be adjusted anywhere from 10' down to 7'. The crank handle is removable to prevent unwanted adjustment. The clear and precise rim height indicator shows the rim height at all times.

All Vector packages include a breakaway goal and net. A variety of backboards are available ranging from 36"x48" to 36"x60". Choose the package that's right for your home court.

For additional safety, pole padding and backboard padding can be added to any Vector package.

Each Vector system comes with a Lifetime Superior Warranty.

VECTOR PACKAGE OPTIONS

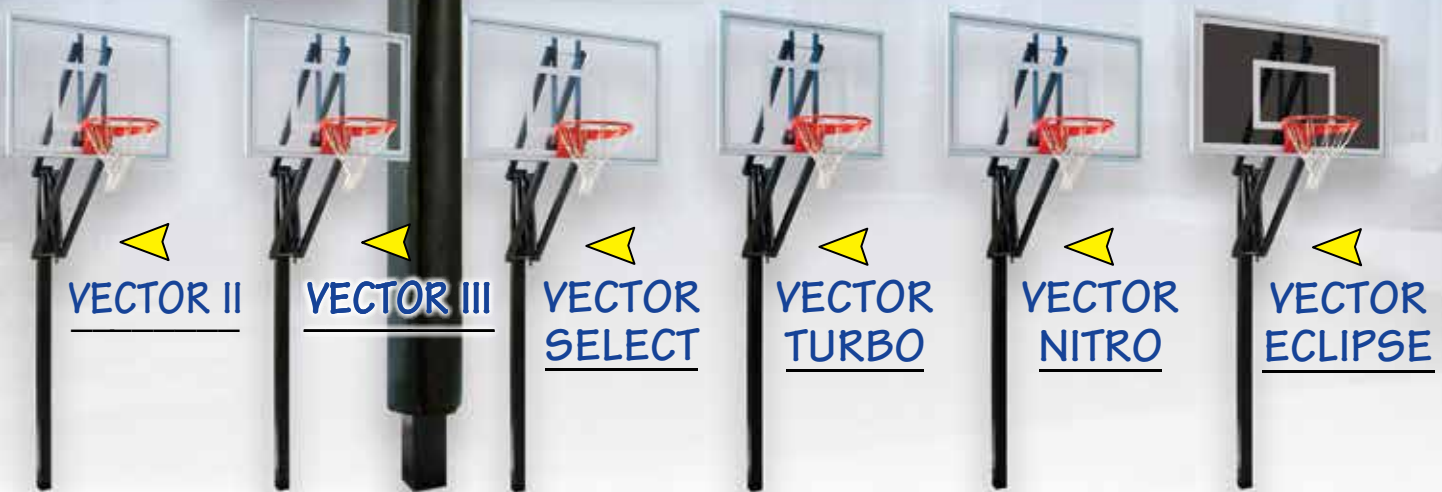

- | | | | | | |
|-------------------------------------|-------------------------------------|-------------------------------------|-------------------------------------|-------------------------------------|--|
| • FT1100 4" Square Post | • FT1100 4" Square Post | • FT1100 4" Square Post | • FT1100 4" Square Post | • FT1100 4" Square Post | • FT1100 4" Square Post |
| • FT1275 Vector Arm System | • FT1275 Vector Arm System | • FT1275 Vector Arm System | • FT1275 Vector Arm System | • FT1275 Vector Arm System | • FT1275 Vector Arm System |
| • FT210 36"x48" Acrylic Backboard | • FT215 36"x54" Acrylic Backboard | • FT220 36"x60" Acrylic Backboard | • FT216 36"x54" Temp. Glass Bkhd. | • FT221 36"x60" Temp. Glass Bkhd. | • FT221SM 36"x60" Sm. Temp. Gls. Bkhd. |
| • FT184 Recreational Flex Goal | • FT186 Heavy Duty Flex Goal | • FT186 Heavy Duty Flex Goal | • FT186 Heavy Duty Flex Goal | • FT186 Heavy Duty Flex Goal | • FT186 Heavy Duty Flex Goal |
| • Lifetime Superior Warranty | • Lifetime Superior Warranty | • Lifetime Superior Warranty | • Lifetime Superior Warranty | • Lifetime Superior Warranty | • Lifetime Superior Warranty |
| • Approx. Shipping Weight: 195 lbs. | • Approx. Shipping Weight: 205 lbs. | • Approx. Shipping Weight: 215 lbs. | • Approx. Shipping Weight: 205 lbs. | • Approx. Shipping Weight: 215 lbs. | • Approx. Shipping Weight: 215 lbs. |

the JAM™

ADJUSTABLE BASKETBALL SYSTEM



- Backboards available in acrylic or glass
- Super strength flex goals are "direct mounted" to eliminate any chance of backboard breakage
- Optional bolt-on TuffGuard™ backboard padding available in several colors
- Springs located in the extension assembly counterbalance the weight of the backboard and rim. Adjustment is effortless.
- Simple hand crank adjustment easily adjusts rim height from 10' - 7'
- Post is buried 36" below playing surface. (FT16 ground sleeve option can be purchased to make post removable.)



See Accessories Section for Backboard & Pole Padding Options.

- Optional Bolt-down Baseplate

- Post to backboard extension distance is 24" with rim at 10' (Extension distance increases as rim height is lowered)

- Optional all-weather velcro wrap-around post padding for added safety (See padding section for available colors)

The Jam offers infinite height adjustability at a price to suit any budget.

First Team's Jam basketball system includes our heavy 11ga. 4"x4" post design that eliminates the risk of joint deterioration common with sectional type posts.

Our spring-aided EZ-Crank™ allows effortless rim height adjustment anywhere from 10' down to 7'. The rim height indicator located on the back of the unit accurately shows rim height.

All Jam packages include a breakaway goal and a net. A variety of backboards are available, ranging in size from 36"x48" to 36"x60". Choose the package that best suits your court.

For additional safety, pole padding and backboard padding can be added to any Jam package.

Every Jam package comes with a Lifetime Superior Warranty.

JAM PACKAGE OPTIONS



- | | | | | | |
|-------------------------------------|-------------------------------------|-------------------------------------|-------------------------------------|-------------------------------------|--|
| • FT1100 4" Square Post | • FT1100 4" Square Post | • FT1100 4" Square Post | • FT1100 4" Square Post | • FT1100 4" Square Post | • FT1100 4" Square Post |
| • FT1300 Jam Arm System | • FT1300 Jam Arm System | • FT1300 Jam Arm System | • FT1300 Jam Arm System | • FT1300 Jam Arm System | • FT1300 Jam Arm System |
| • FT210 36"x48" Acrylic Backboard | • FT215 36"x54" Acrylic Backboard | • FT220 36"x60" Acrylic Backboard | • FT216 36"x54" Temp. Glass Bkdb. | • FT221 36"x60" Temp. Glass Bkdb. | • FT221SM 36"x60" Sm. Temp. Gls. Bkdb. |
| • FT184 Recreational Flex Goal | • FT186 Heavy Duty Flex Goal | • FT186 Heavy Duty Flex Goal | • FT186 Heavy Duty Flex Goal | • FT186 Heavy Duty Flex Goal | • FT186 Heavy Duty Flex Goal |
| • Lifetime Superior Warranty | • Lifetime Superior Warranty | • Lifetime Superior Warranty | • Lifetime Superior Warranty | • Lifetime Superior Warranty | • Lifetime Superior Warranty |
| • Approx. Shipping Weight: 195 lbs. | • Approx. Shipping Weight: 205 lbs. | • Approx. Shipping Weight: 215 lbs. | • Approx. Shipping Weight: 205 lbs. | • Approx. Shipping Weight: 215 lbs. | • Approx. Shipping Weight: 215 lbs. |

www.firstteaminc.com

First Team, Inc. • Hutchinson, Kansas • Toll-Free 1-800-649-3688

the

ATTACK™

ADJUSTABLE BASKETBALL SYSTEM



- Extensive backboard selection
- All First Team goals are "direct mounted" to eliminate backboard breakage when players hang on the rim.
- Optional all-weather velcro wrap-around post padding for added safety (See padding section for available colors)
- Unique anchor system allows perfect pole leveling and easy pole removal if you move.
- Spring Assist™ makes goal adjustments effortless. Rim height indicator shows exact height.
- Stainless Steel EZ Crank™ allows infinite height adjustment from 10' to 5'6"
- Optional TuffGuard™ bolt-on backboard padding available in several colors
- Post to backboard extension distance is 36" with rim at 10' (Extension distance increases as rim height is lowered)

NOW WITH WEATHERGUARD™ RUSTPROOF UNDERCOAT PROTECTION

The Attack offers infinite adjustability and maximum durability all rolled into one!

The Attack's 4" square post is 3/16" thick. That's 50% heavier than any other goal in its category. The bolt down anchor system allows you to take the goal with you when you move.

Our EZ-Crank™ adjustment means players of any age, size or ability can change the rim height. To adjust, simply turn the crank handle. The Attack is infinitely adjustable from 10' down to 5'6". The rim height indicator shows the height of the rim.

First Team developed the "Spring Assist" which reduces the effort required to crank the goal. This is particularly beneficial for families with young children adjusting the unit.

We offer a large selection of backboards and rims with the Attack so you can customize the unit to suit your needs and style of play. Our Response™ tempered glass backboards offer the same look and authentic ball rebound enjoyed by college and professional players.

For additional safety, pole padding and backboard padding are available for most Attack packages.

All Attack packages have a Lifetime Superior Warranty.

ATTACK PACKAGE OPTIONS



- | | | | | | | |
|-------------------------------------|-------------------------------------|-------------------------------------|-------------------------------------|-------------------------------------|-------------------------------------|-------------------------------------|
| • FT1400 Attack Pole System | • FT1400 Attack Pole System | • FT1400 Attack Pole System | • FT1400 Attack Pole System | • FT1400 Attack Pole System | • FT1400 Attack Pole System | • FT1400 Attack Pole System |
| • FT210 36"x48" Acrylic Bkbd. | • FT215 36"x54" Acrylic Bkbd. | • FT220 36"x60" Acrylic Bkbd. | • FT225 36"x54" Temp. Glass Bkbd. | • FT230 36"x60" Temp. Glass Bkbd. | • FT256 36"x60" Steel Bkbd. | • FT257 36"x60" Aluminum Bkbd. |
| • FT184 Recreational Flex Goal | • FT186 Heavy Duty Flex Goal | • FT186 Heavy Duty Flex Goal | • FT186 Heavy Duty Flex Goal | • FT186 Heavy Duty Flex Goal | • FT172D Unbreakable Fixed Goal | • FT172D Unbreakable Fixed Goal |
| • Lifetime Superior Warranty | • Lifetime Superior Warranty | • Lifetime Superior Warranty | • Lifetime Superior Warranty | • Lifetime Superior Warranty | • Lifetime Superior Warranty | • Lifetime Superior Warranty |
| • Approx. Shipping Weight: 275 lbs. | • Approx. Shipping Weight: 285 lbs. | • Approx. Shipping Weight: 295 lbs. | • Approx. Shipping Weight: 335 lbs. | • Approx. Shipping Weight: 345 lbs. | • Approx. Shipping Weight: 340 lbs. | • Approx. Shipping Weight: 290 lbs. |

the FORCE™

ADJUSTABLE BASKETBALL SYSTEM



- Extensive backboard selection
- All First Team goals are "direct mounted" to eliminate backboard breakage when players hang on the rim.
- Optional bolt-on TuffGuard™ backboard padding available in several colors
- Large welded base support gussets for maximum post rigidity
- Unique anchor system allows perfect pole leveling and easy pole removal if you move.
- Optional all-weather velcro wrap-around post padding for added safety (See padding section for available colors)
- Our trademarked Spring Assist™ aids crank, making goal adjustments effortless. The rim height indicator shows exact height of basket.
- Stainless Steel EZ Crank™ allows infinite height adjustment from 10' to 5'6"

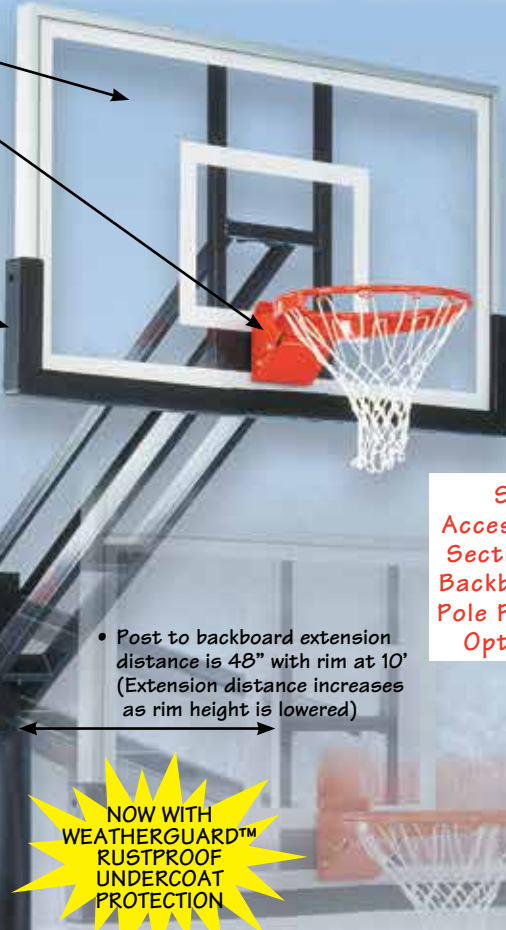

• Post to backboard extension distance is 48" with rim at 10' (Extension distance increases as rim height is lowered)

NOW WITH WEATHERGUARD™ RUSTPROOF UNDERCOAT PROTECTION

See Accessories Section for Backboard & Pole Padding Options.

The Force offers infinite adjustability, exceptional rigidity and maximum durability for those serious about basketball!

The Force's tough 5" square, 3/16" thick vertical post and dual-strut extension arm make this system a real powerhouse. The bolt down anchor system allows you to take the goal with you when you move.

Our EZ-Crank™ adjustment means players of any age, size or ability can change the rim height. To adjust, simply turn the crank handle. The Force is infinitely adjustable from 10' down to 5'6". The rim height indicator shows the height of the rim.

The unit features our "Spring-Assist" which reduces the effort required to crank the goal. This is particularly beneficial for families with young children adjusting the unit.

First Team offers a large selection of backboards and rims with the Force. Choose a Force package with one of our Response™ tempered glass backboards if you are wanting authentic gymnasium style ball reaction off the board.

For additional safety, pole padding and backboard padding are available for most Force packages.

Every Force package comes with a Lifetime Superior Warranty.

FORCE PACKAGE OPTIONS



FORCE III

FORCE SELECT

FORCE ULTRA

FORCE PRO

FORCE EXTREME

FORCE ENDURA

- | | | | | | |
|-------------------------------------|-------------------------------------|-------------------------------------|-------------------------------------|-------------------------------------|-------------------------------------|
| • FT1500 Force Pole System | • FT1500 Force Pole System | • FT1500 Force Pole System | • FT1500 Force Pole System | • FT1500 Force Pole System | • FT1500 Force Pole System |
| • FT215 36"x54" Acrylic Backboard | • FT220 36"x60" Acrylic Backboard | • FT225 36"x54" Temp. Glass Bkbd. | • FT230 36"x60" Temp. Glass Bkbd. | • FT256 36"x60" Steel Bkbd. | • FT257 36"x60" Aluminum Bkbd. |
| • FT186 Heavy Duty Flex Goal | • FT186 Heavy Duty Flex Goal | • FT186 Heavy Duty Flex Goal | • FT186 Heavy Duty Flex Goal | • FT172D Unbreakable Fixed Goal | • FT172D Unbreakable Fixed Goal |
| • Lifetime Superior Warranty | • Lifetime Superior Warranty | • Lifetime Superior Warranty Ⓢ | • Lifetime Superior Warranty Ⓢ | • Lifetime Superior Warranty | • Lifetime Superior Warranty |
| • Approx. Shipping Weight: 305 lbs. | • Approx. Shipping Weight: 315 lbs. | • Approx. Shipping Weight: 355 lbs. | • Approx. Shipping Weight: 365 lbs. | • Approx. Shipping Weight: 360 lbs. | • Approx. Shipping Weight: 310 lbs. |

www.firstteaminc.com

First Team, Inc. • Hutchinson, Kansas • Toll-Free 1-800-649-3688

the TITAN™

ADJUSTABLE BASKETBALL SYSTEM



- Extensive backboard selection
- Optional bolt-on TuffGuard™ backboard padding available in several colors
- Unique anchor system allows perfect pole leveling and easy pole removal if you move.
- Optional all-weather velcro wrap-around post padding for added safety (See padding section for available colors)
- Our trademarked Spring Assist™ aids the crank, making goal adjustments effortless. The rim height indicator shows exact height of basket.

FREE!

LTR 78
Post Pad Lettering
Upon Request
With Purchase of
Complete System

- Stainless Steel EZ Crank™ allows infinite height adjustment from 10' to 5'6"

- All First Team goals are "direct mounted" to eliminate backboard breakage when players hang on the rim.
- Post to backboard extension distance is 48" with rim at 10' (Extension distance increases as rim height is lowered)

NOW WITH
WEATHERGUARD™
RUSTPROOF
UNDERCOAT
PROTECTION

The Titan offers infinite adjustability, maximum rigidity, maximum durability and performs like it came straight out of the arena!

The Titan's massive 6" square, 3/16" thick vertical post and extra heavy-duty dual-strut extension arm provide the toughest, most rigid standard in the industry. The post is set back 4 feet from the backboard to maximize safety. The bolt down anchor footing allows you to easily relocate the unit if you move.

Our EZ-Crank™ adjustment means players of any age, size or ability can change the rim height. To adjust, simply turn the crank handle. The Titan is infinitely adjustable from 10' down to 5'6". The rim height indicator shows the height of the rim.

Our "Double Spring-Assist" makes raising and lowering the goal easier even with our regulation size 42"x72" backboards.

First Team offers an array of backboards and rims with the Titan. Our Response™ tempered glass backboard offers the same look and authentic ball rebound enjoyed by college and professional players.

For added safety, pole padding and backboard padding are available for most Titan packages.

Every Titan package comes with a Lifetime Superior Warranty.

TITAN PACKAGE OPTIONS



- | | | | | | |
|-------------------------------------|--------------------------------------|-------------------------------------|-------------------------------------|-------------------------------------|--|
| • FT1600 Titan Pole System | • FT1600 Titan Pole System | • FT1600 Titan Pole System | • FT1600 Titan Pole System | • FT1600 Titan Pole System | • FT1600 Titan Pole System |
| • FT222 42"x72" Acrylic Backboard | • FT282 42"x72" Tempered Glass Bkbd. | • FT260 42"x60" Steel Backboard | • FT265 42"x72" Steel Backboard | • FT261 42"x60" Aluminum Bkbd. | • FT267 42"x72" Perforated Alum. Bkbd. |
| • FT186 Heavy Duty Flex Goal | • FT186 Heavy Duty Flex Goal | • FT172D Unbreakable Fixed Goal | • FT172D Unbreakable Fixed Goal | • FT172D Unbreakable Fixed Goal | • FT172D Unbreakable Fixed Goal |
| • Lifetime Superior Warranty | • Lifetime Superior Warranty ⬆ | • Lifetime Superior Warranty | • Lifetime Superior Warranty | • Lifetime Superior Warranty | • Lifetime Superior Warranty |
| • Approx. Shipping Weight: 380 lbs. | • Approx. Shipping Weight: 450 lbs. | • Approx. Shipping Weight: 400 lbs. | • Approx. Shipping Weight: 440 lbs. | • Approx. Shipping Weight: 320 lbs. | • Approx. Shipping Weight: 380 lbs. |

the STAINLESS OLYMPIAN™



ADJUSTABLE BASKETBALL SYSTEM

- All First Team goals are "direct mounted" to eliminate backboard breakage when players hang on the rim.
- Backboards are available in 42"x72" acrylic or tempered glass.
- Optional bolt-on TuffGuard™ backboard padding available in several colors

FREE!

LTR 80P Post Pad Lettering Upon Request With Purchase of Complete System

- Massive 6"x8" (1/4" wall) post gives incredible stability to unit
- Powder-coated STAINLESS STEEL post & extension arm construction

- Optional all-weather velcro wrap-around post padding for added safety (See padding section for available colors)

- EZ Crank™ adjustment allows infinite height adjust. from 10' - 5'6"

- Unique anchor system allows perfect pole leveling and easy pole removal if you move.



- Post to backboard extension distance is 48" with rim at 10' (Extension distance increases as rim height is lowered)

The Olympian is now STAINLESS! First Team is proud to offer the STAINLESS OLYMPIAN. First Team is the only company to offer adjustable basketball goals made from rust proof STAINLESS STEEL. The Stainless Olympian offers infinite height adjustment with unmatched durability and stability! First Team has designed the Stainless Olympian to outperform ANY basketball system on the planet! The Stainless Olympian's toughness and rigidity will amaze you and make your court the envy of the neighborhood! The Stainless Olympian's oversized 6"x8"x 1/4" thick post is a monster! Combine this with our LCG (Low Center of Gravity) pole structure design and welded dual strut extension arm and it makes for the most rigid pole structure available, hands down! The post is set back 4' from the backboard to maximize safety as well. The bolt down anchor footing allows you to easily relocate the unit if you move.

Our EZ-Crank adjustment and trademarked "Double Spring-Assist" make rim height adjustments a snap! To adjust, simply turn the crank handle. Any age player will be able to quickly and easily change rim heights anywhere from 10' down to 5'6". A clear and accurate rim height indicator is included.

First Team offers you a choice of clear acrylic or tempered glass backboards. Tempered glass backboards offer the same look and authentic ball response enjoyed by college and professional players. For additional safety, pole padding and backboard padding are available for all Stainless Olympian basketball systems. Every Stainless Olympian package comes with a Lifetime Superior Warranty. So if you are looking for a basketball system that is worthy of the "Basketball Gods" look no further than STAINLESS OLYMPIAN!

STAINLESS OLYMPIAN PACKAGES



- Our trademarked Spring Assist™ aids the crank, making goal adjustments effortless. The rim height indicator shows exact height of basket.

• Stainless steel EZ Crank™ Ensures lifelong performance!



STAINLESS OLYMPIAN SUPREME



STAINLESS OLYMPIAN ARENA

- FT1625ST Stainless Olympian Pole System
- FT222 42"x72" Acrylic Backboard
- FT186 Heavy Duty Flex Goal
- Lifetime Superior Warranty
- Approx. Shipping Weight: 480 lbs.

- FT1625ST Stainless Olympian Pole System
- FT232 42"x72" Tempered Glass Backboard
- FT186 Heavy Duty Flex Goal
- Lifetime Superior Warranty
- Approx. Shipping Weight: 550 lbs.

See Accessories Section for Backboard & Pole Padding Options.

www.firstteaminc.com

First Team, Inc. • Hutchinson, Kansas • Toll-Free 1-800-649-3688

the POWERHOUSE™ 5

ADJUSTABLE BASKETBALL SYSTEM

POWERHOUSE

- Unique CLEARSPAN™ backboard mount eliminates any visual obstructions behind glass

- Breakaway goal included

- Optional bolt-on TuffGuard™ backboard padding available in several colors

- Super Tough 5"x5" post gives stability to unit

- EZ Crank™ adjustment allows infinite height adjustment from 10' to 7'

- 16" clearance from back of post to crank handle

- Optional all-weather velcro wrap-around post padding for added safety (See padding section for available colors)

- Unique anchor system allows perfect pole leveling and easy pole removal if you move

- Baseplate to backboard extension is 36" with rim at 10' (Extension distance increases as rim height is lowered)

The PowerHouse 5 offers all of the great features you need at a price that will put you in the game!

The PowerHouse series of basketball systems was designed with performance, aesthetic appeal and economy in mind. The unit is built with a one-piece 5"x5" vertical post that incorporates our bolt-down anchor base for ease of assembly and relocation. The rim height is infinitely adjustable by simply turning the EZ Crank handle. The rim height indicator shows the height of the rim. Our Y-shaped extension arms and steel perimeter framed tempered glass backboard combine with First Team's exclusive CLEARSPAN™ backboard mounting making PowerHouse the most powerful and aesthetic units available in their price range!

For additional safety, pole padding and backboard padding can be added to any PowerHouse package.

When you're looking for a crank adjustable basketball system that looks as great as it performs, the CLEAR choice is POWERHOUSE!

PowerHouse 5 systems carry a Limited Lifetime Warranty.

POWERHOUSE 5 PACKAGE OPTION

See Accessories Section for Backboard & Pole Padding Options.

POWERHOUSE 560

- 5" Square Powerhouse Post
- 36" Offset Extension Arms
- PH4260 42"x60" Tempered Glass Backboard
- FT186 Heavy Duty Flex Goal
- Limited Lifetime Warranty
- Approx. Shipping Weight: 380 lbs.

the POWERHOUSE™ 6

ADJUSTABLE BASKETBALL SYSTEM



- Unique CLEARSPAN™ backboard mount eliminates any visual obstructions behind glass
- Breakaway goal included
- Optional bolt-on TuffGuard™ backboard padding available in several colors
- Super Tough 6"x6" post gives stability to unit

The PowerHouse 6 line offers all of the great features you need at a price that will put you in the game!

The PowerHouse series of basketball systems was designed with performance, aesthetic appeal and economy in mind. The unit is built with a one-piece 6"x6" vertical post that incorporates our bolt-down anchor base for ease of assembly and relocation. The rim height is infinitely adjustable by simply turning the EZ Crank handle. The rim height indicator shows the height of the rim. Our Y-shaped extension arms and steel perimeter framed tempered glass backboard combine with First Team's exclusive CLEARSPAN™ backboard mounting making PowerHouse the most powerful and aesthetic units available in their price range!

For additional safety, pole padding and backboard padding can be added to any PowerHouse package.

When you're looking for a crank adjustable basketball system that looks as great as it performs, the CLEAR choice is POWERHOUSE!

Each PowerHouse 6 basketball system is covered by a Limited Lifetime Warranty.

FREE!
LTR 78 Post Pad Lettering Upon Request With Purchase of Complete System

- Baseplate to backboard extension varies from 36" to 48" depending on package (see below for details).

POWERHOUSE 6 PACKAGE OPTIONS

- EZ Crank™ adjustment allows infinite height adjustment from 10' to 7'
- 16" clearance from back of post to crank handle
- Optional all-weather velcro wrap-around post padding for added safety (See padding section for available colors)
- Unique anchor system allows perfect pole leveling and easy pole removal if you move.

See Accessories Section for Backboard & Pole Padding Options.



POWERHOUSE 660

- 6" Square Powerhouse Post
- 36" Offset Extension Arms
- PH4260 42"x60" Tempered Glass Backboard
- FT186 Heavy Duty Flex Goal
- Limited Lifetime Warranty
- Approx. Shipping Weight: 390 lbs.



POWERHOUSE 672

- 6" Square Powerhouse Post
- 48" Offset Extension Arms
- PH4272 42"x72" Tempered Glass Backboard
- FT186 Heavy Duty Flex Goal
- Limited Lifetime Warranty
- Approx. Shipping Weight: 415 lbs.

the HYDROCHAMP™

ADJUSTABLE BASKETBALL SYSTEM



- Selection of various clear acrylic backboards in sizes ranging from 36"x48" to 36"x60"

- Special zinc undercoating protects against rust



- Welded top cap seals out moisture

- All components are powder coated black.

- Insta-Just™ height adjustment. No need for tools or a ladder. A simple broom handle allows you to adjust rim height in 6" increments.

- Post to backboard extension distance is 18" with rim at highest point (Extension distance increases as rim height is lowered)

- All First Team goals are "direct mounted" to eliminate backboard breakage when players hang on the rim.

First Team's making a splash with the HydroChamp! The HydroChamp makes a great unit for adjustable poolside basketball. The bolt down 4"x4" stainless steel post and adjustable adjustable arm system combine for a durable, economical and aesthetically pleasing poolside unit. All components are powder-coated black.

To adjust the backboard height, simply release the adjustment mechanism located behind the rim. Unit has a 30" rim adjustment range, adjustable in 6" increments.

Unit is secured to pool deck using anchor bolts supplied with unit. Anchor base cover is also included. Choose from three backboard sizes 48", 54" or 60". The HydroChamp is the perfect unit for anyone looking for a high quality, professional looking poolside basketball unit. Give your pool the home court advantage with First Team's HydroChamp! Each HydroChamp package is covered by our Lifetime Limited Warranty!

- Stainless Steel post & anchor bolts

- Protective cover hides anchor bolts

FT1350-SA

Order FT1350-SA special surface anchor for applications where standard anchor bolts present a hazard. Special surface anchors allow goal post to be secured to deck without vertical protrusion common with standard anchor bolts. Each kit includes (1) template, (4) surface anchor, (4) rebar & hardware. Approx. Shipping Weight: 20 lbs.



HYDROCHAMP PACKAGE OPTIONS



HYDROCHAMP II

- FT1103 Hydro Post
- FT1200ZC Champ Arm System
- FT210 36"x48" Acrylic Backboard
- FT186ZC Heavy Duty Flex Goal
- Lifetime Limited Warranty 
- Approx. Shipping Weight: 157 lbs.



HYDROCHAMP III

- FT1103 Hydro Post
- FT1200ZC Champ Arm System
- FT215 36"x54" Acrylic Backboard
- FT186ZC Heavy Duty Flex Goal
- Lifetime Limited Warranty 
- Approx. Shipping Weight: 167 lbs.



HYDROCHAMP SELECT

- FT1103 Hydro Post
- FT1200ZC Champ Arm System
- FT220 36"x60" Acrylic Backboard
- FT186ZC Heavy Duty Flex Goal
- Lifetime Limited Warranty 
- Approx. Shipping Weight: 177 lbs.

www.firstteaminc.com

First Team, Inc. • Hutchinson, Kansas • Toll-Free 1-800-649-3688

the HYDROSHOT™

ADJUSTABLE BASKETBALL SYSTEM



- All components are powder coated black.

- Selection of various clear acrylic backboards in sizes ranging from 36"x48" to 36"x60"

- Massive 4"x4" (3/16" wall) stainless steel post gives incredible stability to unit

- EZ Crank™ adjustment allows infinite height adjustment from 10' - 6'6"

- Special zinc undercoating protects rim against rust

- Optional bolt-on TuffGuard™ backboard padding available in several colors

- Tubular "H-Frame" design provides best backboard mounting available.

100%
stainless steel pole system construction!
Ensures lifelong performance!

- Direct rim mount design

- Post to backboard extension distance is 36" with rim at 10' (Extension distance increases as rim height is lowered)

- Rim height lowers to 25" above mounting surface.

The HydroShot brings premium grade basketball performance to your poolside!

For those who love to hoop it up while they splash around, First Team introduces the HydroShot STAINLESS STEEL adjustable poolside basketball system. The HydroShot's 4" square post and dual strut extension arm make a "tough as nails" poolside unit that will NEVER RUST!! No more flimsy, plastic models. The HydroShot will far exceed your expectations for a poolside basketball unit.

The HydroShot comes complete with your choice of three clear, professional looking acrylic backboards and breakaway rim. To adjust the unit, simply turn the crank handle positioned for easy access from the pool deck. The unit is infinitely adjustable from regulation 10' down to 6'6". An easy-to-read height indicator is provided as well.

Designed for commercial waterparks, the HydroShot also makes a first class residential poolside hoop. First Team's unique anchor bolt installation design allows you to easily relocate the unit if you ever need to. An anchor bolt cover is provided with each unit.

FT1350-SA

Order FT1350-SA special surface anchor for applications where standard anchor bolts present a hazard. Special surface anchors allow goal post to be secured to deck without vertical protrusion common with standard anchor bolts. Each kit includes (1) template, (4) surface anchor, (4) rebar & hardware. Approx. Shipping Weight: 20 lbs.



- Protective cover hides anchor bolts

HYDROSHOT PACKAGE OPTIONS



HYDROSHOT II

- FT1350 HydroShot Mount System
- FT210 36"x48" Acrylic Backboard
- FT186ZC Heavy Duty Flex Goal
- Lifetime Limited Warranty
- Approx. Shipping Weight: 245 lbs.



HYDROSHOT III

- FT1350 HydroShot Mount System
- FT215 36"x54" Acrylic Backboard
- FT186ZC Heavy Duty Flex Goal
- Lifetime Superior Warranty
- Approx. Shipping Weight: 255 lbs.



HYDROSHOT SELECT

- FT1350 HydroShot Mount System
- FT220 36"x60" Acrylic Backboard
- FT186ZC Heavy Duty Flex Goal
- Lifetime Superior Warranty
- Approx. Shipping Weight: 265 lbs.

the HYDROSPORT™

FIXED HEIGHT BASKETBALL SYSTEM



- Selection of various clear acrylic backboards in sizes ranging from 36"x48" to 36"x60"

- Welded top cap seals out moisture

- All First Team goals are "direct mounted" to eliminate backboard breakage when players hang on the rim.

- Special zinc undercoating protects against rust

- Optional bolt-on TuffGuard™ backboard padding available in several colors

- All components are powder coated black.

- Post to backboard extension distance is 24"

- 4"x4" post gives incredible stability to unit

- Stainless Steel post & anchor bolts

FT1350-SA

Order FT1350-SA special surface anchor for applications where standard anchor bolts present a hazard. Special surface anchors allow goal post to be secured to deck without vertical protrusion common with standard anchor bolts. Each kit includes (1) template, (4) surface anchor, (4) rebar & hardware. Approx. Shipping Weight: 20 lbs.



The HydroSport offers a professional look for your poolside at an affordable price!

The HydroSport's black powdercoated 4"x4" stainless steel post is designed with a bolt down anchor system similar to our upper end driveway basketball systems. The unit is secured to the pool deck using four stainless steel anchor bolts provided with unit. An ABS plastic anchor cover is also included. The HydroSport's extension arm is also powdercoated black and attaches to the post via U-bolts.

Though the HydroSport is considered a "Fixed Height" goal, the U-bolts can be loosened allowing the arm to be re-attached at any given height along the post.

A variety of backboards are available on the HydroSport. Pick the package that is right for your pool.

Each HydroSport basketball system is covered by First Team's Lifetime Limited Warranty.

HYDROSPORT PACKAGE OPTIONS

- Protective cover hides anchor bolts

HYDROSPORT II

- FT1103 Hydro Post
- FT1150ZC Sport Arm System
- FT210 36"x48" Acrylic Backboard
- FT186ZC Heavy Duty Flex Goal
- Lifetime Limited Warranty
- Approx. Shipping Weight: 142 lbs.

HYDROSPORT III

- FT1103 Hydro Post
- FT1150ZC Sport Arm System
- FT215 36"x54" Acrylic Backboard
- FT186ZC Heavy Duty Flex Goal
- Lifetime Limited Warranty
- Approx. Shipping Weight: 152 lbs.

HYDROSPORT SELECT

- FT1103 Hydro Post
- FT1150ZC Sport Arm System
- FT220 36"x60" Acrylic Backboard
- FT186ZC Heavy Duty Flex Goal
- Lifetime Limited Warranty
- Approx. Shipping Weight: 162 lbs.

www.firstteaminc.com

First Team, Inc. • Hutchinson, Kansas • Toll-Free 1-800-649-3688

the

SPORT™

FIXED HEIGHT BASKETBALL SYSTEM



- Selection of various clear acrylic backboards. Sizes range from 36"x48" to 36"x60"

- Super strength flex goals are "direct mounted" to eliminate any chance of backboard breakage

- Optional bolt-on TuffGuard™ backboard padding available in several colors

- Our one piece 4"x4" 11 ga. (1/8" wall) post is the heaviest of its kind in the industry

- Optional all-weather velcro wrap-around post padding for added safety (See padding section for available colors)

- Post is buried 36" below playing surface. (FT16 ground sleeve option can be purchased to make post removable.)

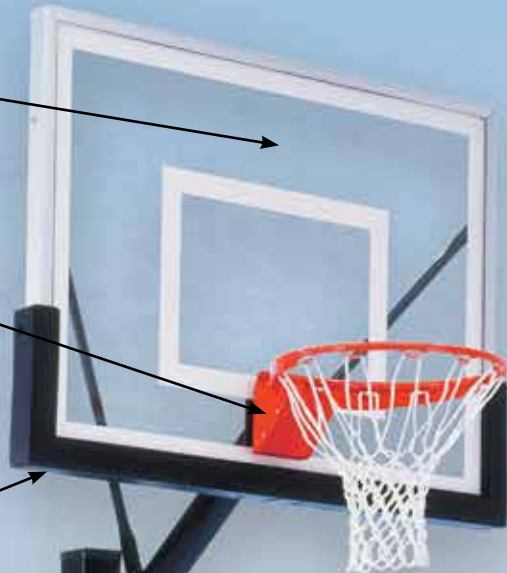

• Post to backboard extension distance is 24"

The Sport offers a professional look at an affordable price!

The Sport's 4"x4" 11 ga. steel post is 50% heavier than any goal of its kind. Our one piece post design eliminates the potential for joint deterioration common with sectional type posts.

The extension arm on the Sport is attached to the vertical post using two heavy duty U-bolts. Though the Sport is considered a "Fixed Height" goal, the U-bolts can be loosened allowing the arm to be re-attached at any given height along the post.

A variety of backboards and rims are offered with the Sport so you can choose the Sport package that's right for you.

For additional safety, pole padding and backboard padding can be added to any Sport package.

Every Sport package comes with a Lifetime Limited Warranty.

- Optional Bolt-down Baseplate

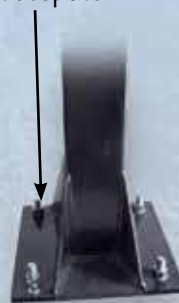

SPORT PACKAGE OPTIONS



SPORT II

- FT1100 4" Square Post
- FT1150 Sport Extension Arm
- FT210 36"x48" Acrylic Backboard
- FT184 Recreational Flex Goal
- Lifetime Limited Warranty 🏠
- Approx. Shipping Weight: 145 lbs.



SPORT III

- FT1100 4" Square Post
- FT1150 Sport Extension Arm
- FT215 36"x54" Acrylic Backboard
- FT186 Heavy Duty Flex Goal
- Lifetime Limited Warranty 🏠
- Approx. Shipping Weight: 155 lbs.



SPORT SELECT

- FT1100 4" Square Post
- FT1150 Sport Extension Arm
- FT220 36"x60" Acrylic Backboard
- FT186 Heavy Duty Flex Goal
- Lifetime Limited Warranty 🏠
- Approx. Shipping Weight: 165 lbs.

the

LEGACY™

FIXED HEIGHT BASKETBALL SYSTEM



First Team

- Selection of various clear acrylic, tempered glass & aluminum backboards. Sizes range from 36"x48" to 36"x60"
- H-Frame backboard brace for simple installation and excellent backboard rigidity
- Super strength flex goals are "direct mounted" to eliminate any chance of backboard breakage
- Optional bolt-on TuffGuard™ backboard padding available in several colors
- Optional all-weather velcro wrap-around post padding for added safety (See padding section for available colors)
- Post is buried 36" below playing surface. (FT16 ground sleeve option can be purchased to make post removable.)



• Our one piece 4"x4" 11 ga. (1/8" wall) post is the heaviest of its kind in the industry

• Post to backboard extension distance is 36"

The Legacy offers added durability and safety without exceeding your budget!

The Legacy's 4"x4" 11 ga. steel post is 50% heavier than any goal of its kind. Our one piece pole design eliminates joint deterioration common with sectional type posts.

The extension arm on the Legacy is constructed of tough 4"x4" square tubing and provides players with a 36" extension distance from post to backboard for added safety. The Legacy arm is attached to the vertical post using U-bolts and is considered a "Fixed Height" goal. However, the U-bolts can be loosened allowing the arm to be re-attached at any given height along the post.

A selection of backboards and rims are offered with the Legacy so you can pick the one that's right for you.

For additional safety, pole padding and backboard padding can be added to any Legacy package.

Every Legacy package comes with a Lifetime Superior Warranty.

- Optional Bolt-down Baseplate



LEGACY PACKAGE OPTIONS



LEGACY III



LEGACY SELECT



LEGACY TURBO



LEGACY NITRO



LEGACY ECLIPSE



LEGACY ENDURA

- | | | | | | |
|---------------------------------|---------------------------------|-----------------------------------|-----------------------------------|--|---------------------------------|
| • FT1100 4" Square Post | • FT1100 4" Square Post | • FT1100 4" Square Post | • FT1100 4" Square Post | • FT1100 4" Square Post | • FT1100 4" Square Post |
| • FT1700 Legacy Extension Arm | • FT1700 Legacy Extension Arm | • FT1700 Legacy Extension Arm | • FT1700 Legacy Extension Arm | • FT1700 Legacy Extension Arm | • FT1700 Legacy Extension Arm |
| • FT215 36"x54" Acrylic Bkbd. | • FT220 36"x60" Acrylic Bkbd. | • FT216 36"x54" Temp. Glass Bkbd. | • FT221 36"x60" Temp. Glass Bkbd. | • FT221SM 36"x60" Smoked Temp. Glass Bkbd. | • FT257 36"x60" Aluminum Bkbd. |
| • FT186 Heavy Duty Flex Goal | • FT186 Heavy Duty Flex Goal | • FT186 Heavy Duty Flex Goal | • FT186 Heavy Duty Flex Goal | • FT186 Heavy Duty Flex Goal | • FT1720 Unbreakable Fixed Goal |
| • Lifetime Superior Warranty | • Lifetime Superior Warranty | • Lifetime Superior Warranty | • Lifetime Superior Warranty | • Lifetime Superior Warranty | • Lifetime Superior Warranty |
| • Approx. Shipping Wt: 205 lbs. | • Approx. Shipping Wt: 215 lbs. | • Approx. Shipping Wt: 205 lbs. | • Approx. Shipping Wt: 215 lbs. | • Approx. Shipping Wt: 215 lbs. | • Approx. Shipping Wt: 215 lbs. |

www.firstteaminc.com

First Team, Inc. • Hutchinson, Kansas • Toll-Free 1-800-649-3688

the

LEGEND JR.™

FIXED HEIGHT BASKETBALL SYSTEM



• Extension arm is constructed of 5"x5" (3/16" wall) solid steel tubing

• Optional TuffGuard™ all-weather bolt-on backboard padding available in several colors

• Tough 5"x5" (3/16" wall) one piece steel post

• Optional all-weather velcro wrap-around post padding for added safety (See padding section for available colors)

• Post is buried 42" below playing surface. (FT17 ground sleeve option can be purchased to make post removable.)

• Post to backboard extension distance is 52"

• Extensive backboard selection is available

• All First Team goals are "direct mounted" to eliminate backboard breakage when players hang on the rim.

• Optional Bolt-down Baseplate

The Legend Jr. offers a combination of playground durability and professional performance!

The Legend Jr.'s vertical post and extension arm are both constructed of rugged 5" square 3/16" thick tubular steel. Combined they provide top-notch performance in both durability and rigidity. The post is set back 52" for added safety.

The extension arm on the Legend Jr. is attached to the vertical post using six high tensile 5/8" bolts. Though the Legend Jr. is considered a "Fixed Height" goal, the extension arm can be bolted at any height along the post.

First Team offers a large selection of backboards and rims with the Legend Jr. Choose a Legend Jr. package with one of our Response™ tempered glass backboards if you are wanting authentic gymnasium style ball reaction. Our popular Legend Jr. Dual packages add a second extension arm, backboard and rim to the opposite side of the post to maximize playing area on the playground.

For added safety, pole padding and backboard padding are available for most Legend Jr. packages.

Every Legend Jr. package comes with a Lifetime Superior Warranty.

LEGEND JR. PACKAGE OPTIONS



▶
**LEGEND JR.
III**

- FT1105 5" Square Post
- FT1750 Legend Jr. Ext. Arm
- FT215 36"x54" Acrylic Bkbd.
- FT186 Heavy Duty Flex Goal
- Lifetime Superior Warranty
- Approx. Shipping Wt: 345 lbs.

▶
**LEGEND JR.
SELECT**

▶
**LEGEND JR.
SELECT
DUAL**

- FT1105 5" Square Post
- FT1750 Legend Jr. Ext. Arm
- FT220 36"x60" Acrylic Bkbd.
- FT186 Heavy Duty Flex Goal
- Lifetime Superior Warranty
- Approx. Shipping Wt: 355 lbs.



▶
**LEGEND JR.
ULTRA**

- FT1105 5" Square Post
- FT1750 Legend Jr. Ext. Arm
- FT225 36"x54" Temp. Glass Bkbd.
- FT186 Heavy Duty Flex Goal
- Lifetime Superior Warranty
- Approx. Shipping Wt: 395 lbs.



▶
**LEGEND JR.
PRO**

- FT1105 5" Square Post
- FT1750 Legend Jr. Ext. Arm
- FT230 36"x60" Temp. Glass Bkbd.
- FT186 Heavy Duty Flex Goal
- Lifetime Superior Warranty
- Approx. Shipping Wt: 405 lbs.

▶
**LEGEND JR.
EXTREME**

▶
**LEGEND JR.
EXTREME
DUAL**

- FT1105 5" Square Post
- FT1750 Legend Jr. Ext. Arm
- FT256 36"x60" Steel Bkbd.
- FT172D Unbreakable Fixed Goal
- Lifetime Superior Warranty
- Approx. Shipping Wt: 400 lbs.



▶
**LEGEND JR.
ENDURA**

- FT1105 5" Square Post
- FT1750 Legend Jr. Ext. Arm
- FT257 36"x60" Aluminum Bkbd.
- FT172D Unbreakable Fixed Goal
- Lifetime Superior Warranty
- Approx. Shipping Wt: 350 lbs.

the

LEGEND™

FIXED HEIGHT BASKETBALL SYSTEM



• Extension arm is constructed of 6"x6" (3/16" wall) solid steel tubing

• Extensive backboard selection is available

• Optional TuffGuard™ all-weather bolt-on backboard padding available in several colors

• All First Team goals are "direct mounted" to eliminate backboard breakage when players hang on the rim.

• Massive 6"x6" (3/16" wall) one piece steel post

• Optional Bolt-down Baseplate

• Optional all-weather velcro wrap-around post padding for added safety (See padding section for available colors)

• Post to backboard extension distance is 66"

FREE!

LTR 78
Post Pad Lettering
Upon Request
With Purchase of
Complete System

• Post is buried 48" below playing surface. (FT18 ground sleeve option available to make post removable.)

The Legend offers exceptional rigidity, uncompromising durability and maximum safety even on the toughest courts!

Built from heavy 6" square, 3/16" thick steel tubing, the Legend provides unmatched stability and durability. Designed for the most rugged playgrounds, the Legend performs equally well on the home court. The post is positioned 66" behind the backboard for safety.

The extension arm on the Legend is attached to the vertical post via six 5/8" high tensile bolts. Though the Legend is considered a "Fixed Height" goal, the extension arm can be bolted at any height along the post.

First Team offers an array of backboards and rims with the Legend. Our Response™ tempered glass backboard offers the same look and authentic ball rebound enjoyed by college and professional players. Our popular Legend Dual packages add a second extension arm, backboard and rim to the opposite side of the post to maximize playing area on the playground.

For additional safety, pole padding and backboard padding are available for most Legend packages.

Every Legend package comes with a Lifetime Warranty.

LEGEND PACKAGE OPTIONS

LEGEND SUPREME

- FT1106 6" Square Post
- FT1850 Legend Extension Arm
- FT222 42"x72" Acrylic Bkbd.
- FT186 Heavy Duty Flex Goal
- Lifetime Superior Warranty
- Approx. Shipping Weight: 470 lbs.

LEGEND SUPREME DUAL



LEGEND ARENA

- FT1106 6" Square Post
- FT1850 Legend Extension Arm
- FT232 42"x72" Temp. Glass Bkbd.
- FT186 Heavy Duty Flex Goal
- Lifetime Superior Warranty
- Approx. Shipping Weight: 540 lbs.



LEGEND PLAYGROUND

- FT1106 6" Square Post
- FT1850 Legend Extension Arm
- FT260 42"x60" Steel Backboard
- FT172D Unbreakable Fixed Goal
- Lifetime Unconditional Warranty
- Approx. Shipping Weight: 490 lbs.

LEGEND PLAYGROUND DUAL



LEGEND EXCEL

- FT1106 6" Square Post
- FT1850 Legend Extension Arm
- FT265 42"x72" Steel Backboard
- FT172D Unbreakable Fixed Goal
- Lifetime Unconditional Warranty
- Approx. Shipping Weight: 530 lbs.

LEGEND EXCEL DUAL



LEGEND DYNASTY

- FT1106 6" Square Post
- FT1850 Legend Extension Arm
- FT280 42"x72" Fiberglass Bkbd.
- FT172D Unbreakable Fixed Goal
- Lifetime Unconditional Warranty
- Approx. Shipping Weight: 515 lbs.

(Shown with optional FT11 chain net)

LEGEND DYNASTY DUAL



LEGEND IMPERVIA

- FT1106 6" Square Post
- FT1850 Legend Extension Arm
- FT261 42"x60" Aluminum Bkbd.
- FT172D Unbreakable Fixed Goal
- Lifetime Unconditional Warranty
- Approx. Shipping Weight: 370 lbs.



LEGEND INTENSITY

- FT1106 6" Square Post
- FT1850 Legend Extension Arm
- FT267 42"x72" Perf. Alum. Bkbd.
- FT172D Unbreakable Fixed Goal
- Lifetime Unconditional Warranty
- Approx. Shipping Weight: 380 lbs.



the RENEGADE™

FIXED HEIGHT BASKETBALL SYSTEM



- Extensive backboard selection. Backboards are available in steel, aluminum, fiberglass or clear acrylic. Sizes vary from 36"x48" to 42"x72".

- Backboard braces for superior backboard rigidity

- Vinyl post cap seals out moisture

- Extension arm and braces are powdercoated

- Extension arm clamps to vertical post using U-bolts. Extension arm can be moved by loosening U-bolts

- Post to backboard extension distance is 48"

The Renegade offers commercial durability and the added flexibility sometimes needed on the playground. The Renegade post is constructed of 4 1/2" O.D. galvanized schedule 40 tubing. The post buries into the concrete a full 48" deep. A vinyl top cap seals out moisture.

The extension arm on the Renegade is attached to the vertical post using two heavy duty U-bolts. Though the Renegade is considered a "Fixed Height" goal, the U-bolts can be loosened, allowing the arm to be re-attached at any given height along the post.

An extensive selection of backboards and rims are available on the Renegade. Choose the package that fits your needs.

Every Renegade package comes with a 20-Year Limited Warranty.

- Super tuff flex or fixed goals are "direct mounted" to eliminate backboard stress.

RENEGADE PACKAGE OPTIONS

- Post is weather resistant galvanized

- Heavy-Duty 4 1/2" O.D. schedule 40 steel post

- Post is buried 48" below playing surface.

RENEGADE EXTREME

- FT1875 Renegade Post System
- FT1875EA Renegade Extension Arm
- FT256 36"x60" Steel Backboard
- FT172D Unbreakable Fixed Goal
- Lifetime Limited Warranty
- Approx. Shipping Weight: 295 lbs.

RENEGADE PLAYGROUND

- FT1875 Renegade Post System
- FT1875EA Renegade Extension Arm
- FT260 42"x60" Steel Backboard
- FT172D Unbreakable Fixed Goal
- Lifetime Limited Warranty
- Approx. Shipping Weight: 315 lbs.

RENEGADE MAX

- FT1875 Renegade Post System
- FT1875EA Renegade Extension Arm
- FT270 36"x64" Aluminum Backboard
- FT172D Unbreakable Fixed Goal
- Lifetime Limited Warranty
- Approx. Shipping Weight: 245 lbs.

RENEGADE ENDURA

- FT1875 Renegade Post System
- FT1875EA Renegade Extension Arm
- FT257 36"x60" Aluminum Backboard
- FT172D Unbreakable Fixed Goal
- Lifetime Limited Warranty
- Approx. Shipping Weight: 250 lbs.

RENEGADE IMPERVIA

- FT1875 Renegade Post System
- FT1875EA Renegade Extension Arm
- FT261 42"x 60" Aluminum Backboard
- FT172D Unbreakable Fixed Goal
- Lifetime Limited Warranty
- Approx. Shipping Weight: 260 lbs.

RENEGADE FLIGHT

- FT1875 Renegade Post System
- FT1875EA Renegade Extension Arm
- FT275 39"x54" Fiberglass Backboard
- FT172D Unbreakable Fixed Goal
- Lifetime Limited Warranty
- Approx. Shipping Weight: 245 lbs.

RENEGADE III

- FT1875 Renegade Post System
- FT1875EA Renegade Extension Arm
- FT215 36"x54" Acrylic Backboard
- FT186 Heavy Duty Flex Goal
- Lifetime Limited Warranty
- Approx. Shipping Weight: 240 lbs.

RENEGADE SELECT

- FT1875 Renegade Post System
- FT1875EA Renegade Extension Arm
- FT220 36"x60" Acrylic Backboard
- FT186 Heavy Duty Flex Goal
- Lifetime Limited Warranty
- Approx. Shipping Weight: 250 lbs.

RENEGADE SUPREME

- FT1875 Renegade Post System
- FT1875EA Renegade Extension Arm
- FT222 42"x72" Acrylic Backboard
- FT186 Heavy Duty Flex Goal
- Lifetime Limited Warranty
- Approx. Shipping Weight: 295 lbs.

the RUFFNECK™

FIXED HEIGHT BASKETBALL SYSTEM



- Extensive backboard selection
- Heavy-Duty 4 1/2" O.D. schedule 40 post
- Post is weather resistant galvanized
- "Nose-cone" backboard mounting design with through-bolt permanently locking "Nose-cone" to post

The RuffNeck offers exceptional durability at a price that meets any budget.

The RuffNeck is a "Fixed Height" pole system constructed of 4 1/2" O.D. galvanized schedule 40 tubing. The direct rim mount design allows the rim to be mounted through the backboard and into the post, eliminating backboard stress. The backboard is further supported by two tubular braces fixed to the neck of the post.

Our unique "nose-cone" backboard mounting design makes backboard installation simple.











First Team offers a wide variety of backboard & rim styles on the RuffNeck system, allowing you to select the perfect RuffNeck package for your application. Every RuffNeck package comes with a Lifetime Limited Warranty.

- First Team goals are "direct mounted" to eliminate backboard stress

• Post to backboard extension distance is 48"

- Post is buried 48" below playing surface.

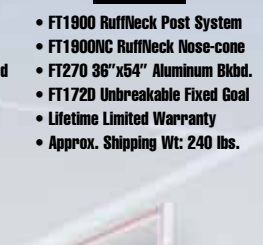
RUFFNECK PACKAGE OPTIONS

 <p>RUFFNECK EXTREME</p> <ul style="list-style-type: none"> • FT1900 RuffNeck Post System • FT1900NC RuffNeck Nose-cone • FT256 36"x60" Steel Backboard • FT172D Unbreakable Fixed Goal • Lifetime Limited Warranty • Approx. Shipping Wt: 290 lbs. 	 <p>RUFFNECK PLAYGROUND</p> <ul style="list-style-type: none"> • FT1900 RuffNeck Post System • FT1900NC RuffNeck Nose-cone • FT260 42"x60" Steel Backboard • FT172D Unbreakable Fixed Goal • Lifetime Limited Warranty • Approx. Shipping Wt: 310 lbs. 	 <p>RUFFNECK EXCEL</p> <ul style="list-style-type: none"> • FT1900 RuffNeck Post System • FT1900NC RuffNeck Nose-cone • FT265 42"x72" Steel Backboard • FT172D Unbreakable Fixed Goal • Lifetime Limited Warranty • Approx. Shipping Wt: 350 lbs. 	 <p>RUFFNECK MAX</p> <ul style="list-style-type: none"> • FT1900 RuffNeck Post System • FT1900NC RuffNeck Nose-cone • FT270 36"x54" Aluminum Bkbd. • FT172D Unbreakable Fixed Goal • Lifetime Limited Warranty • Approx. Shipping Wt: 240 lbs. 	 <p>RUFFNECK ENDURA</p> <ul style="list-style-type: none"> • FT1900 RuffNeck Post System • FT1900NC RuffNeck Nose-cone • FT257 36"x60" Aluminum Bkbd. • FT172D Unbreakable Fixed Goal • Lifetime Limited Warranty • Approx. Shipping Wt: 245 lbs. 	 <p>RUFFNECK IMPERVIA</p> <ul style="list-style-type: none"> • FT1900 RuffNeck Post System • FT1900NC RuffNeck Nose-cone • FT261 42"x60" Aluminum Bkbd. • FT172D Unbreakable Fixed Goal • Lifetime Limited Warranty • Approx. Shipping Wt: 250 lbs.
 <p>RUFFNECK INTENSITY</p> <ul style="list-style-type: none"> • FT1900 RuffNeck Post System • FT1900NC RuffNeck Nose-cone • FT267 42"x72" Perf. Alum. Bkbd. • FT172D Unbreakable Fixed Goal • Lifetime Limited Warranty • Approx. Shipping Wt: 260 lbs. 	 <p>RUFFNECK FLIGHT</p> <ul style="list-style-type: none"> • FT1900 RuffNeck Post System • FT1900NC RuffNeck Nose-cone • FT275 39"x54" Fiberglass Bkbd. • FT172D Unbreakable Fixed Goal • Lifetime Limited Warranty • Approx. Shipping Wt: 240 lbs. 	 <p>RUFFNECK DYNASTY</p> <ul style="list-style-type: none"> • FT1900 RuffNeck Post System • FT1900NC RuffNeck Nose-cone • FT280 42"x72" Fiberglass Backboard • FT172D Unbreakable Fixed Goal • Lifetime Limited Warranty • Approx. Shipping Wt: 335 lbs. 	 <p>RUFFNECK III</p> <ul style="list-style-type: none"> • FT1900 RuffNeck Post System • FT1900NC RuffNeck Nose-cone • FT215 36"x54" Acrylic Backboard • FT186 Heavy Duty Flex Goal • Lifetime Limited Warranty • Approx. Shipping Wt: 235 lbs. 	 <p>RUFFNECK SELECT</p> <ul style="list-style-type: none"> • FT1900 RuffNeck Post System • FT1900NC RuffNeck Nose-cone • FT220 36"x60" Acrylic Backboard • FT186 Heavy Duty Flex Goal • Lifetime Limited Warranty • Approx. Shipping Wt: 245 lbs. 	 <p>RUFFNECK SUPREME</p> <ul style="list-style-type: none"> • FT1900 RuffNeck Post System • FT1900NC RuffNeck Nose-cone • FT222 42"x72" Acrylic Backboard • FT186 Heavy Duty Flex Goal • Lifetime Limited Warranty • Approx. Shipping Wt: 290 lbs.

www.firstteaminc.com

First Team, Inc. • Hutchinson, Kansas • Toll-Free 1-800-649-3688

the BRUTE™



FIXED HEIGHT BASKETBALL SYSTEM

- Extensive backboard selection. Backboards are available in steel, aluminum, fiberglass or clear acrylic. Sizes vary from 36"x54" to 42"x72".

- Heavy-Duty 5 9/16" O.D. schedule 40 galvanized post.

- "Nose-cone" backboard mounting design with through-bolt permanently locking "Nose-cone" to post.

- First Team goals are "direct mounted" to eliminate backboard stress.

First Team's BRUTE fixed height basketball systems are a step ahead of the rest when it comes to playground rigidity, performance and durability!

The Brute series of basketball packages are built with a stable 5 9/16" diameter galvanized post. The post extension allows for 72"-78" of run-out room and is designed with First Team's unique nosecone style backboard mounting making backboard installation and setup a breeze.

The Brute is built to take whatever punishment comes its way and is fully covered by First Team's exclusive LIFETIME UNCONDITIONAL WARRANTY!

For added safety, pole padding and backboard padding are available for any Brute basketball package.

So don't get bullied into purchasing inferior units. Give your playground court added toughness and performance season after season with the BRUTE!

- Post is buried 48" below playing surface.

- Post to backboard extension distance is variable from 72"-78"

BRUTE EXTREME

- FT1905 Brute Post System
- FT1905NC Brute Nose-cone
- FT266 36"x60" Steel Backboard
- FT172D Unbreakable Fixed Goal
- Lifetime Unconditional Warranty
- Approx. Shipping Wt: 443 lbs.

BRUTE PLAYGROUND

- FT1905 Brute Post System
- FT1905NC Brute Nose-cone
- FT260 42"x60" Steel Backboard
- FT172D Unbreakable Fixed Goal
- Lifetime Unconditional Warranty
- Approx. Shipping Wt: 468 lbs.

BRUTE EXCEL

- FT1905 Brute Post System
- FT1905NC Brute Nose-cone
- FT265 42"x72" Steel Backboard
- FT172D Unbreakable Fixed Goal
- Lifetime Unconditional Warranty
- Approx. Shipping Wt: 490 lbs.

BRUTE MAX

- FT1905 Brute Post System
- FT1905NC Brute Nose-cone
- FT270 36"x54" Aluminum Backboard
- FT172D Unbreakable Fixed Goal
- Lifetime Unconditional Warranty
- Approx. Shipping Wt: 399 lbs.

BRUTE ENDURA

- FT1905 Brute Post System
- FT1905NC Brute Nose-cone
- FT257 36"x60" Aluminum Bkdb.
- FT172D Unbreakable Fixed Goal
- Lifetime Unconditional Warranty
- Approx. Shipping Wt: 405 lbs.

BRUTE IMPERVIA

- FT1905 Brute Post System
- FT1905NC Brute Nose-cone
- FT261 42"x60" Aluminum Bkdb.
- FT172D Unbreakable Fixed Goal
- Lifetime Unconditional Warranty
- Approx. Shipping Wt: 410 lbs.

BRUTE INTENSITY

- FT1905 Brute Post System
- FT1905NC Brute Nose-cone
- FT267 42"x72" Perf. Alum. Bkdb.
- FT172D Unbreakable Fixed Goal
- Lifetime Unconditional Warranty
- Approx. Shipping Wt: 410 lbs.

BRUTE FLIGHT

- FT1905 Brute Post System
- FT1905NC Brute Nose-cone
- FT275 38"x54" Fiberglass Backboard
- FT172D Unbreakable Fixed Goal
- Lifetime Unconditional Warranty
- Approx. Shipping Wt: 422 lbs.

BRUTE DYNASTY

- FT1905 Brute Post System
- FT1905NC Brute Nose-cone
- FT280 42"x72" Fiberglass Backboard
- FT172D Unbreakable Fixed Goal
- Lifetime Unconditional Warranty
- Approx. Shipping Wt: 480 lbs.

BRUTE III

- FT1905 Brute Post System
- FT1905NC Brute Nose-cone
- FT36 Silver Support Structure
- FT215 36"x54" Acrylic Backboard
- FT186 Heavy Duty Flex Goal
- Lifetime Unconditional Warranty
- Approx. Shipping Wt: 450 lbs.

BRUTE SELECT

- FT1905 Brute Post System
- FT1905NC Brute Nose-cone
- FT36 Silver Support Structure
- FT220 36"x60" Acrylic Backboard
- FT186 Heavy Duty Flex Goal
- Lifetime Unconditional Warranty
- Approx. Shipping Wt: 454 lbs.

BRUTE SUPREME

- FT1905 Brute Post System
- FT1905NC Brute Nose-cone
- FT42 Silver Support Structure
- FT222 42"x72" Acrylic Bkdb.
- FT186 Heavy Duty Flex Goal
- Lifetime Unconditional Warranty
- Approx. Shipping Wt: 495 lbs.

the

TYRANT™

FIXED HEIGHT BASKETBALL SYSTEM



• Extensive backboard selection. Backboards are available in steel, aluminum, fiberglass or clear acrylic. Sizes vary from 36"x54" to 42"x72".

• Heavy-Duty 6 5/8" O.D. schedule 40 galvanized post.

• "Nose-cone" backboard mounting design with through-bolt permanently locking "Nose-cone" to post.

• First Team goals are "direct mounted" to eliminate backboard stress.

When it comes to the playground, no other basketball system can stand up to the TYRANT!

First Team's Tyrant basketball system is our largest, most rigid basketball system yet! With its incredible 6 5/8" diameter galvanized post and outstanding 72"-78" overhang, the Tyrant stands alone as the country's leading playground basketball system.

First Team has incorporated its easy to install nosecone into the Tyrant pole structure design. This makes installing the backboard much easier, minimizing backboard lifting when installing the backboard. The Tyrant is INDESTRUCTIBLE and First Team backs it with our LIFETIME UNCONDITIONAL WARRANTY!

For added safety, pole padding and backboard padding are available for any Tyrant basketball package.

So why let your basketball court be run down by other systems that can't hold up? Let First Team show you the true meaning of reliability and toughness with the TYRANT!

• Post is buried 48" below playing surface.

• Post to backboard extension distance is variable from 72"-78"

TYRANT EXTREME

- FT1910 Tyrant Post System
- FT1910NC Tyrant Nose-cone
- FT256 36"x60" Steel Backboard
- FT172D Unbreakable Fixed Goal
- Lifetime Unconditional Warranty
- Approx. Shipping Wt: 440 lbs.

TYRANT PLAYGROUND

- FT1910 Tyrant Post System
- FT1910NC Tyrant Nose-cone
- FT260 42"x60" Steel Backboard
- FT172D Unbreakable Fixed Goal
- Lifetime Unconditional Warranty
- Approx. Shipping Wt: 460 lbs.

TYRANT EXCEL

- FT1910 Tyrant Post System
- FT1910NC Tyrant Nose-cone
- FT265 42"x72" Steel Backboard
- FT172D Unbreakable Fixed Goal
- Lifetime Unconditional Warranty
- Approx. Shipping Wt: 500 lbs.

TYRANT MAX

- FT1910 Tyrant Post System
- FT1910NC Tyrant Nose-cone
- FT270 36"x54" Aluminum Backboard
- FT172D Unbreakable Fixed Goal
- Lifetime Unconditional Warranty
- Approx. Shipping Wt: 410 lbs.

TYRANT ENDURA

- FT1910 Tyrant Post System
- FT1910NC Tyrant Nose-cone
- FT257 36"x60" Aluminum Bkbd.
- FT172D Unbreakable Fixed Goal
- Lifetime Unconditional Warranty
- Approx. Shipping Wt: 415 lbs.

TYRANT IMPERVIA

- FT1910 Tyrant Post System
- FT1910NC Tyrant Nose-cone
- FT261 42"x60" Aluminum Bkbd.
- FT172D Unbreakable Fixed Goal
- Lifetime Unconditional Warranty
- Approx. Shipping Wt: 420 lbs.

TYRANT INTENSITY

- FT1910 Tyrant Post System
- FT1910NC Tyrant Nose-cone
- FT267 42"x72" Perf. Alum. Bkbd.
- FT172D Unbreakable Fixed Goal
- Lifetime Unconditional Warranty
- Approx. Shipping Wt: 430 lbs.

TYRANT FLIGHT

- FT1910 Tyrant Post System
- FT1910NC Tyrant Nose-cone
- FT275 39"x54" Fiberglass Bkbd.
- FT172D Unbreakable Fixed Goal
- Lifetime Unconditional Warranty
- Approx. Shipping Wt: 410 lbs.

TYRANT DYNASTY

- FT1910 Tyrant Post System
- FT1910NC Tyrant Nose-cone
- FT280 42"x72" Fiberglass Backboard
- FT172D Unbreakable Fixed Goal
- Lifetime Unconditional Warranty
- Approx. Shipping Wt: 485 lbs.

TYRANT III

- FT1910 Tyrant Post System
- FT1910NC Tyrant Nose-cone
- FT38 Silver Support Structure
- FT215 36"x54" Acrylic Backboard
- FT186 Heavy Duty Flex Goal
- Lifetime Unconditional Warranty
- Approx. Shipping Wt: 385 lbs.

TYRANT SELECT

- FT1910 Tyrant Post System
- FT1910NC Tyrant Nose-cone
- FT38 Silver Support Structure
- FT220 36"x60" Acrylic Backboard
- FT186 Heavy Duty Flex Goal
- Lifetime Unconditional Warranty
- Approx. Shipping Wt: 395 lbs.

TYRANT SUPREME

- FT1910 Tyrant Post System
- FT1910NC Tyrant Nose-cone
- FT42 Silver Support Structure
- FT222 42"x72" Acrylic Backboard
- FT186 Heavy Duty Flex Goal
- Lifetime Unconditional Warranty
- Approx. Shipping Wt: 440 lbs.

www.firstteaminc.com

First Team, Inc. • Hutchinson, Kansas • Toll-Free 1-800-649-3688

the

RETROFIT36™

BASKETBALL REFURBISHING KIT



Turn this...



Into this...



• 5" slots on center | 5" |

• Vertical slots allow perfect 10' rim height

Pole Not Included

First Team RetroFit36 backboard packages are a perfect, hassle free choice for replacing old, worn out backboards on existing basketball posts.

Each RetroFit36 backboard package includes backboard, rim and easy-mount RetroFit36 h-frame bracket.

The RetroFit36 bracket is built with two vertical slots on the back side of the bracket. These slots are positioned 5" apart horizontally. Because the slots are 5" apart, it is recommended that the attachment plate at the end of the existing basketball post be at least 6"x6" in size. NOTE: Four holes may need to be drilled into the mounting plate on the neck of the post to match the 5" slot dimension. Once attached, the vertical slots in the

RetroFit36 bracket will allow the backboard and rim to be fine-tuned so perfect 10' rim height can be reached.

The RetroFit36 is available with a variety of backboard and rim options. Check below for package options. For additional safety, First Team offers backboard padding available in a variety of colors to fit any RetroFit36 package. First Team also offers a wide range of post pads to protect players from running into the basketball post.

Why tear out a perfectly good basketball post just because the backboard is worn out? Refurbish it with First Team RetroFit36 basketball backboard combos and get back in the game!

RETROFIT36 PACKAGE OPTIONS



RETROFIT36 III

- FT36RF RetroFit36 Bracket
- FT215 36"x54" Acrylic Bkbd.
- FT186 Heavy Duty Flex Goal
- Lifetime Limited Warranty
- Approx. Shipping Wt: 120 lbs.



RETROFIT36 SELECT

- FT36RF RetroFit36 Bracket
- FT220 36"x60" Acrylic Bkbd.
- FT186 Heavy Duty Flex Goal
- Lifetime Limited Warranty
- Approx. Shipping Wt: 130 lbs.



RETROFIT36 ULTRA

- FT36RF RetroFit36 Bracket
- FT225 36"x54" Temp. Glass Bkbd.
- FT186 Heavy Duty Flex Goal
- Lifetime Limited Warranty
- Approx. Shipping Wt: 170 lbs.



RETROFIT36 PRO

- FT36RF RetroFit36 Bracket
- FT230 36"x60" Temp. Glass Bkbd.
- FT186 Heavy Duty Flex Goal
- Lifetime Limited Warranty
- Approx. Shipping Wt: 180 lbs.



RETROFIT36 EXTREME

- FT36RF RetroFit36 Bracket
- FT256 36"x60" Steel Bkbd.
- FT172D Unbreakable Fixed Goal
- Lifetime Limited Warranty
- Approx. Shipping Wt: 180 lbs.



RETROFIT36 ENDURA

- FT36RF RetroFit36 Bracket
- FT257 36"x60" Aluminum Bkbd.
- FT172D Unbreakable Fixed Goal
- Lifetime Limited Warranty
- Approx. Shipping Wt: 130 lbs.

the **RETROFIT42**TM

BASKETBALL REFURBISHING KIT

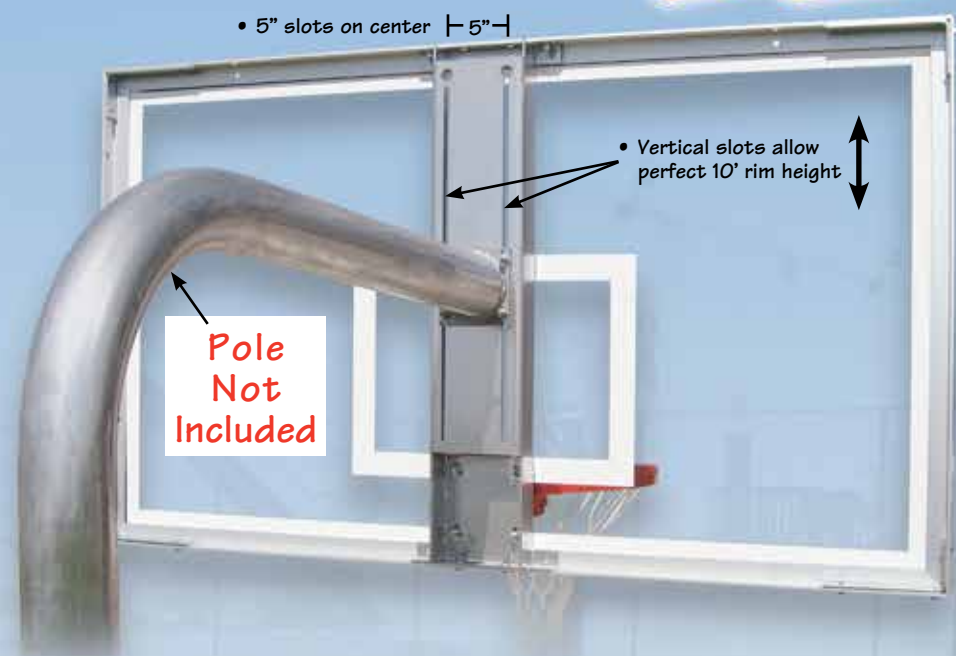

First Team RetroFit42 backboard packages are a perfect, hassle free choice for replacing old, worn out backboards on existing basketball posts.

Each RetroFit42 backboard package includes backboard, rim and easy-mount RetroFit42 h-frame bracket.

The RetroFit42 bracket is built with two vertical slots on the back side of the bracket. These slots are positioned 5" apart horizontally. Because the slots are 5" apart, it is recommended that the attachment plate at the end of the existing basketball post be at least 6"x 6" in size.

NOTE: Four holes may need to be drilled into the mounting plate on the neck of the post to match the 5" slot dimension. Once attached, the vertical slots in the

RetroFit42 bracket will allow the backboard and rim to be fine-tuned so perfect 10' rim height can be reached.

The RetroFit42 is available with a variety of backboard and rim options. Check below for package options. For additional safety, First Team offers backboard padding available in a variety of colors to fit any RetroFit42 package. First Team also offers a wide range of post pads to protect players from running into the basketball post.

Why tear out a perfectly good basketball post just because the backboard is worn out? Refurbish it with First Team RetroFit42 basketball backboard combos and get back in the game!

RETROFIT42 PACKAGE OPTIONS



RETROFIT42 SUPREME

- FT42RF RetroFit42 Bracket
- FT222 42"x72" Acrylic Backboard
- FT186 Heavy Duty Flex Goal
- Lifetime Limited Warranty
- Approx. Shipping Weight: 175 lbs.

RETROFIT42 ARENA

- FT42RF RetroFit42 Bracket
- FT232 42"x72" Temp. Glass Bkhd.
- FT186 Heavy Duty Flex Goal
- Lifetime Limited Warranty
- Approx. Shipping Weight: 255 lbs.

RETROFIT42 PLAYGROUND

- FT42RF RetroFit42 Bracket
- FT260 42"x60" Steel Backboard
- FT172D Unbreakable Fixed Goal
- Lifetime Limited Warranty
- Approx. Shipping Weight: 225 lbs.

RETROFIT42 EXCEL

- FT42RF RetroFit42 Bracket
- FT265 42"x72" Steel Backboard
- FT172D Unbreakable Fixed Goal
- Lifetime Limited Warranty
- Approx. Shipping Weight: 240 lbs.

RETROFIT42 IMPERVIA

- FT42RF RetroFit42 Bracket
- FT261 42"x60" Aluminum Bkhd.
- FT172D Unbreakable Fixed Goal
- Lifetime Limited Warranty
- Approx. Shipping Weight: 125 lbs.

RETROFIT42 INTENSITY

- FT42RF RetroFit42 Bracket
- FT267 42"x72" Perf. Alum. Bkhd.
- FT172D Unbreakable Fixed Goal
- Lifetime Limited Warranty
- Approx. Shipping Weight: 150 lbs.

www.firstteaminc.com

First Team, Inc. • Hutchinson, Kansas • Toll-Free 1-800-649-3688

FIXED GOALS



First Team

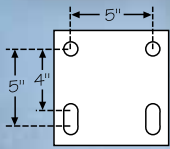
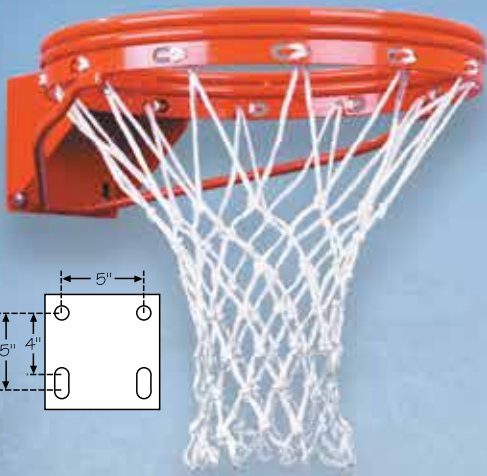

FT172D

- Most durable fixed goal in industry
- Double 5/8" solid rim design
- "Never-Fail" 3/16"x1" Continuous net-lock eliminates net-lock breakage
- Accepts nylon or chain nets
- Durable powdercoat finish
- Recommended where other goals have failed
- Net and mounting hardware included
- Lifetime Unconditional Warranty
- Approx. Shipping Weight: 27 lbs.

FT172D-GV

- Identical to FT172D except for finish
- Rustproof galvanized finish
- Net and mounting hardware included
- Lifetime Unconditional Warranty
- Approx. Shipping Weight: 27 lbs.

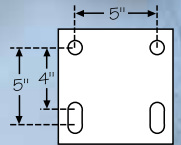
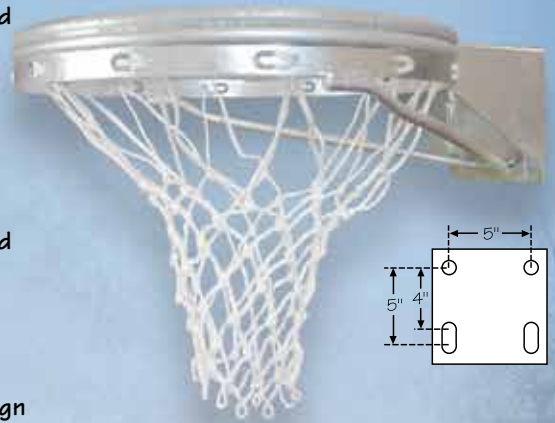

FT170D

- Heavy Duty 5/8" double ring design
- Never-Fail 3/16" x 1" continuous net-lock eliminates net-lock failure
- Fits most standard backboards
- Durable powdercoat finish
- Net and mounting hardware included
- 2-Year Superior Warranty
- Approx. Shipping Weight: 18 lbs.

FT170

- Standard 5/8" high tensile ring
- Never-Fail 3/16" x 1" continuous net-lock eliminates net-lock failure
- Fits most standard backboards
- Durable powdercoat finish
- Net and mounting hardware included
- 1-Year Limited Warranty
- Approx. Shipping Weight: 15 lbs.

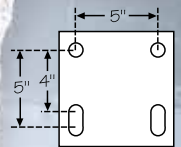
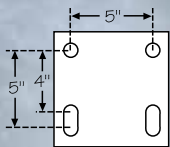
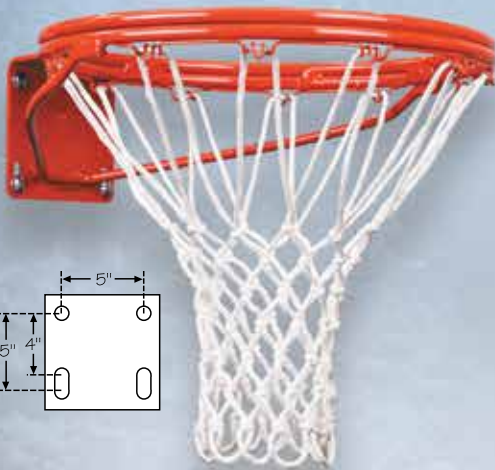

FT170DR

- Built to the same specifications as our FT170D goal
- Designed to be used with rear mount backboards only
- Durable powdercoat finish
- Net and mounting hardware included
- 2-Year Superior Warranty
- Approx. Shipping Weight: 23 lbs.

FT170R

- Built to the same specifications as our FT170 goal
- Designed to be used with rear mount backboards only
- Durable powdercoat finish
- Net and mounting hardware included
- 1-Year Limited Warranty
- Approx. Shipping Weight: 18 lbs.

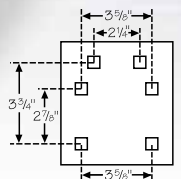
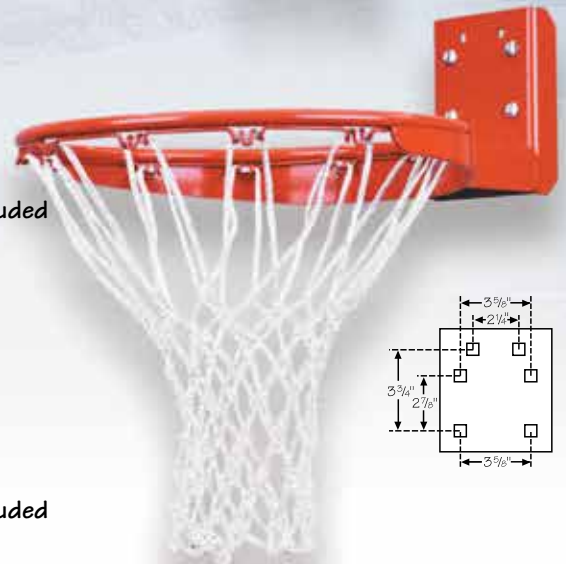
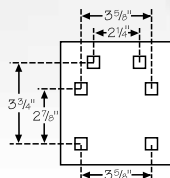
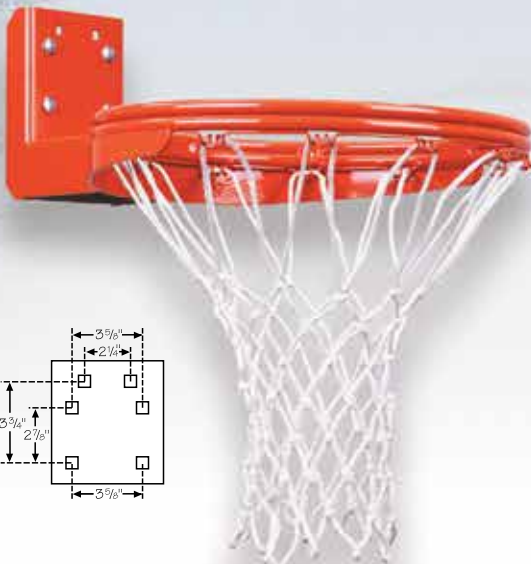

FLEX GOALS

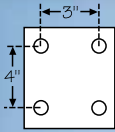

FT184

- Recreational flex goal for home use
- Totally enclosed mechanism
- Durable powdercoat finish
- Net and mounting hardware included
- 1-Year Limited Warranty
- Approx. Shipping Weight: 19 lbs.

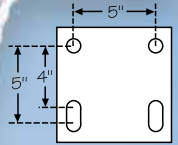
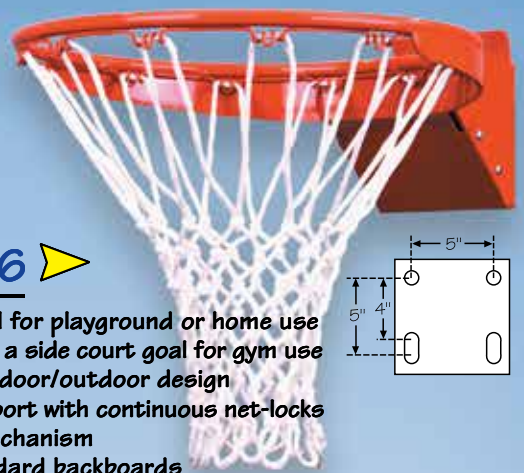

FT186

- Heavy duty flex goal for playground or home use
- Can also be used as a side court goal for gym use
- Low maintenance indoor/outdoor design
- 3/16" steel rim support with continuous net-locks
- Totally enclosed mechanism
- Mounts to all standard backboards
- Durable powdercoat finish
- Net and mounting hardware included
- 2-Yr Limited Warranty
- Approx. Shipping Weight: 21 lbs.

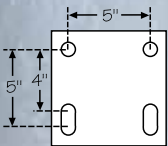

FT187D

- Super duty double rim flex goal
- Great for highly aggressive playground use
- Double 5/8" solid steel rings
- Never-Fail 3/16" x 1" net locks
- Dual return springs
- Totally enclosed mechanism
- Mounts to most standard backboards
- Durable powdercoat finish
- Net and mounting hardware included
- 3-Year Superior Warranty
- Approx. Shipping Weight: 29 lbs.

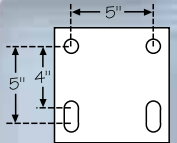
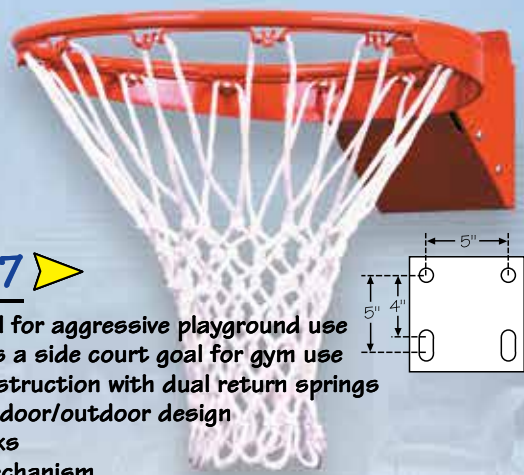

FT187

- Super duty flex goal for aggressive playground use
- Can also be used as a side court goal for gym use
- Extra strength construction with dual return springs
- Low maintenance indoor/outdoor design
- Continuous net-locks
- Totally enclosed mechanism
- Mounts to most standard backboards
- Durable powdercoat finish
- Net and mounting hardware included
- 2-Year Superior Warranty
- Approx. Shipping Weight: 24 lbs.



- Zinc undercoat for superior weather resistance

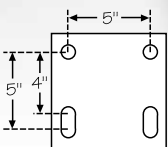

FT186-ZC

- Heavy duty flex goal for playground or home use
- Included on all First Team poolside units
- Great as an upgrade in difficult weather environments
- 3/16" steel rim support with Continuous net-locks
- Totally enclosed mechanism
- Mounts to all standard backboards
- Durable powdercoat finish
- Net and mounting hardware included
- 2-Year Limited Warranty
- Approx. Shipping Weight: 21 lbs.

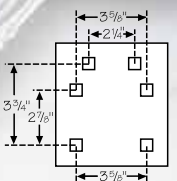
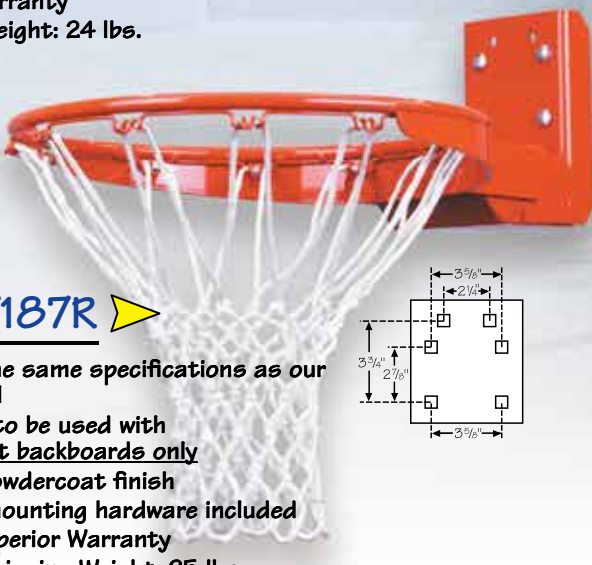

FT187R

- Built to the same specifications as our FT187 goal
- Designed to be used with rear mount backboards only
- Durable powdercoat finish
- Net and mounting hardware included
- 2-Year Superior Warranty
- Approx. Shipping Weight: 25 lbs.

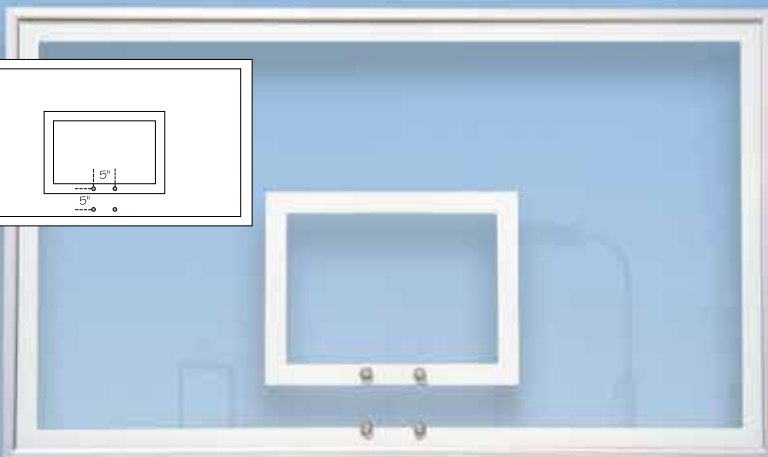
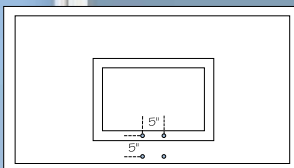
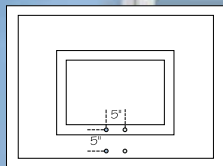

FT232

- 42"x72" Response™ tempered glass backboard
- All weather 1/2" thick tempered glass
- Competition grade aluminum framework
- Provides gymnasium quality ball reaction off of board
- Warranted on First Team systems only
- Approx. Shipping Weight: 170 lbs.

FT216

- 36"x54" cushioned 1/4" tempered glass
- Anodized aluminum framework
- Warranted on First Team systems only
- Approx. Shipping Weight: 45 lbs.

FT225

- 36"x54" Response™ tempered glass backboard
- All weather 3/8" thick tempered glass
- Competition grade aluminum framework
- Provides gymnasium quality ball reaction off board
- Warranted on First Team systems only
- Approx. Shipping Weight: 90 lbs.

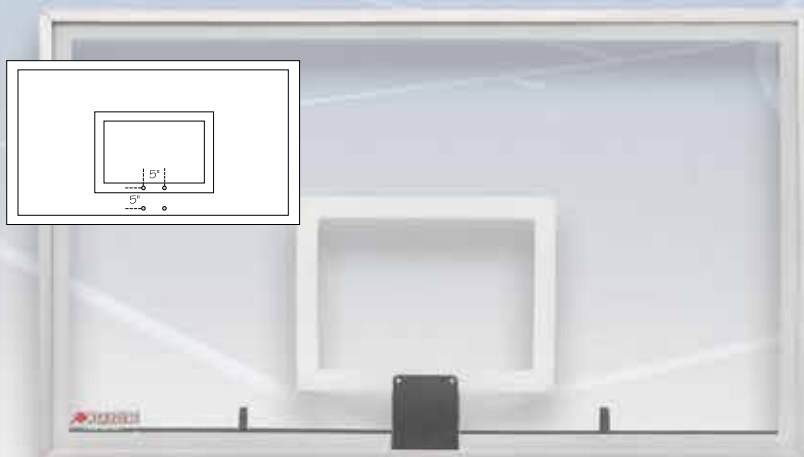
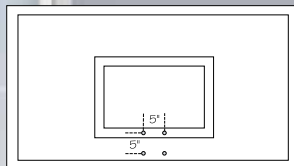
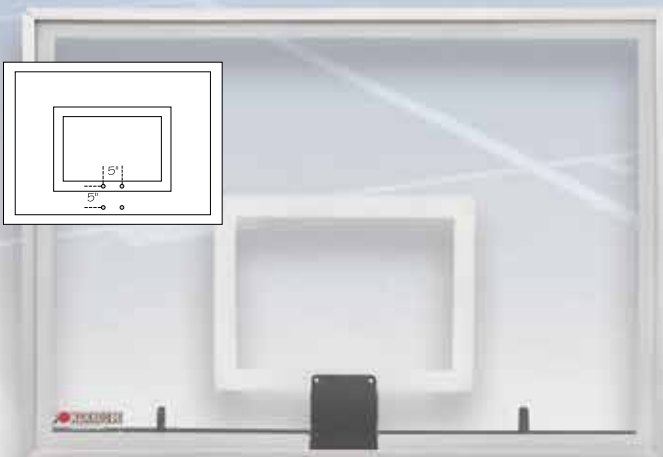
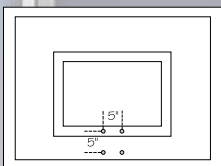
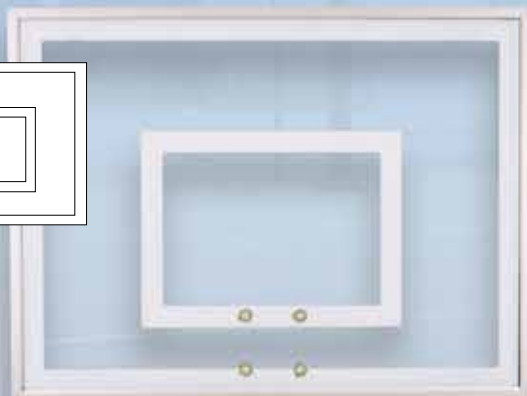
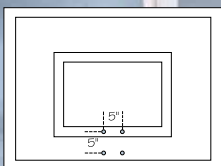

PH4260

- 42"x60"x 3/8" thick tempered glass backboard
- Steel perimeter frame support
- Glass notched for rim mounting
- Anodized aluminum frame
- Warranted on First Team systems only
- Approx. Shipping Weight: 197 lbs.

PH4272

- 42"x72"x 3/8" thick tempered glass backboard
- Steel perimeter frame support
- Glass notched for rim mounting
- Anodized aluminum frame
- Warranted on First Team systems only
- Approx. Shipping Weight: 222 lbs.

BACKBOARDS

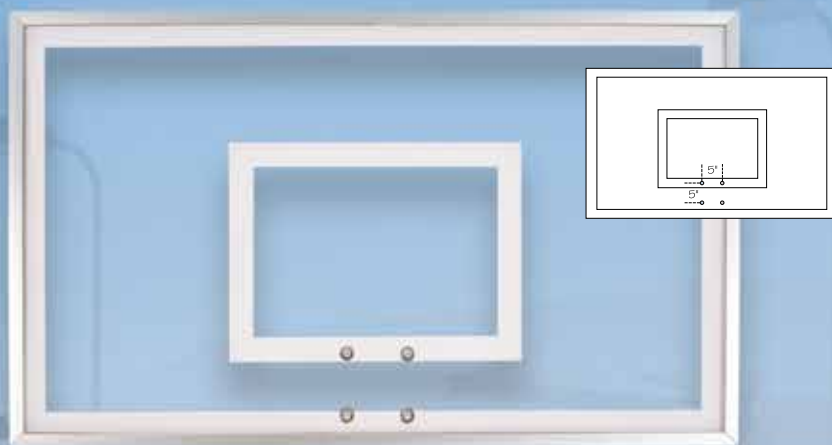

◀ FT221

- 36"x60" tempered glass backboard
- Cushioned 1/4" thick tempered glass
- Anodized aluminum framework
- Warranted on First Team systems only
- Approx. Shipping Weight: 55 lbs.

FT221SM ▶

- 36"x60" smoked tempered glass backboard
- Cushioned 1/4" thick smoked tempered glass
- Anodized aluminum framework
- Warranted on First Team systems only
- Approx. Shipping Weight: 55 lbs.

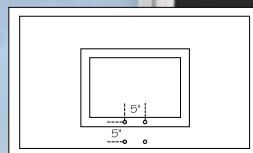

◀ FT230

- 36"x60" Response™ tempered glass backboard
- All weather 3/8" thick tempered glass
- Competition grade aluminum framework
- Provides gymnasium quality ball reaction off board
- Warranted on First Team systems only
- Approx. Shipping Weight: 100 lbs.

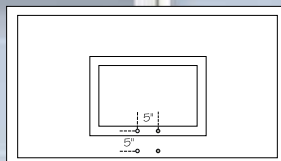

FT230H ▶

- 36"x60" Response™ tempered glass backboard
- All weather 3/8" thick tempered glass
- Competition grade aluminum framework
- Provides gymnasium quality ball reaction off board
- FT36HFM H-Frame provides rim support
- 10-Year Limited Warranty
- Approx. Shipping Weight: 145 lbs.

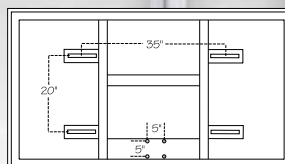

ACRYLIC BACKBOARDS

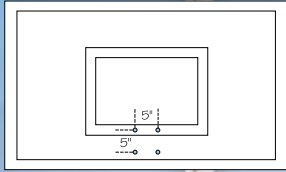

◀ FT222

- 42"x72" acrylic backboard
- All weather 1/2" thick clear acrylic
- Competition grade anodized alum. frame
- Warranted on First Team systems only
- Approx. Shipping Weight: 100 lbs.

FT220 ▶

- 36"x60" acrylic backboard
- All weather 1/2" thick clear acrylic
- Heavy anodized aluminum framework
- Warranted on First Team systems only
- Approx. Shipping Weight: 55 lbs.

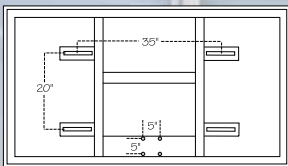
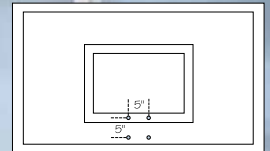

◀ FT222H

- 42"x72" acrylic backboard
- All weather 1/2" thick clear acrylic
- Competition grade anodized alum. frame
- FT42HFM H-Frame provides rim support
- 10-Year Limited Warranty
- Approx. Shipping Weight: 145 lbs.

FT220H ▶

- 36"x60" acrylic backboard
- All weather 1/2" thick clear acrylic
- Heavy anodized aluminum framework
- FT36HFM H-Frame provides rim support
- 10-Year Limited Warranty
- Approx. Shipping Weight: 100 lbs.

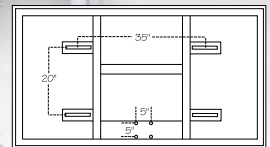



ACRYLIC BACKBOARDS

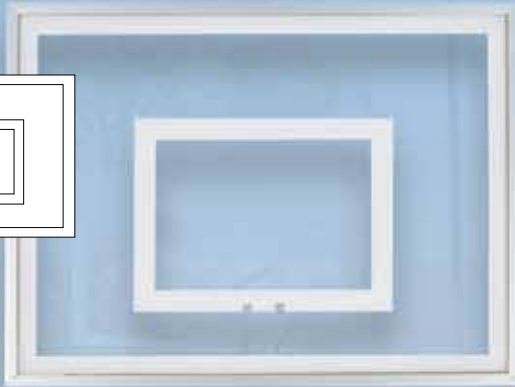
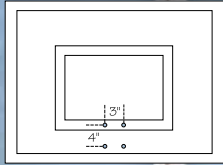

FT210

- 36"x48" acrylic backboard
- All weather 3/8" thick clear acrylic
- Heavy anodized aluminum framework
- Warranted on First Team systems only
- Approx. Shipping Weight: 36 lbs.

FT215

- 36"x54" all weather 1/2" thick clear acrylic
- Heavy anodized aluminum framework
- Warranted on First Team systems only
- Approx. Shipping Weight: 45 lbs.

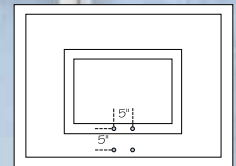

FIBERGLASS BACKBOARDS

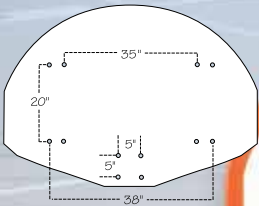

FT275

- Official fan-shaped 39"x54" fiberglass backboard
- Waterproof construction for indoor/outdoor use
- Orange markings are "molded-in"
- 10-Year Limited Warranty
- Approx. Shipping Weight: 39 lbs.

FT280

- Official 42"x72" rectangular fiberglass backboard
- Waterproof construction for indoor/outdoor use
- Orange markings are "molded-in"
- 10-Year Limited Warranty
- Approx. Shipping Weight: 66 lbs.

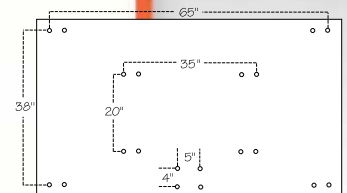

STEEL & ALUMINUM BACKBOARDS

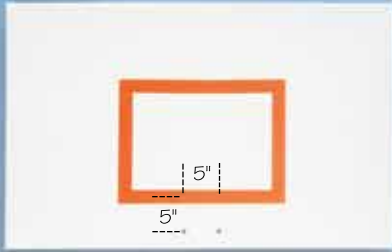

FT256

- 3'x5' Rectangular steel backboard
- 10 ga. construction
- White weather resistant powdercoat
- Official orange shooters square
- Warranted on First Team systems only
- Approx. Shipping Weight: 90 lbs.

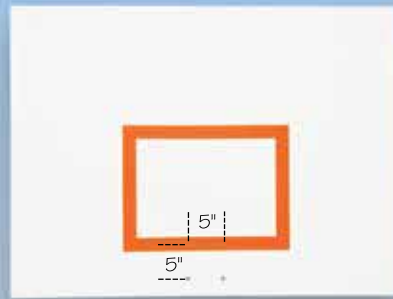

FT260

- 3 1/2'x5' Rectangular steel backboard
- 10 ga. construction
- White weather resistant powdercoat
- Official orange shooters square
- Warranted on First Team systems only
- Approx. Shipping Weight: 125 lbs.



FT260B

- 3 1/2'x5' Rectangular steel backboard
- 10 ga. skin & 1/4" steel support structure
- White weather resistant powdercoat
- Official orange shooters square
- 10-Year Superior Warranty
- Approx. Shipping Weight: 150 lbs.

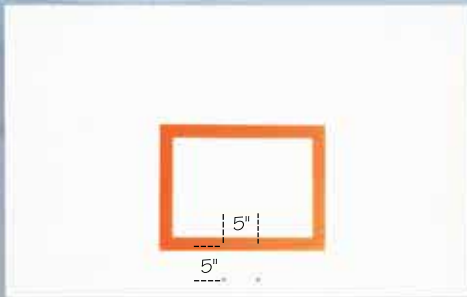
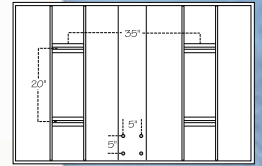

FT265

- 3 1/2'x6' Rectangular steel backboard
- 10 ga. construction
- White weather resistant powdercoat
- Official orange shooters square
- Warranted on First Team systems only
- Approx. Shipping Weight: 165 lbs.

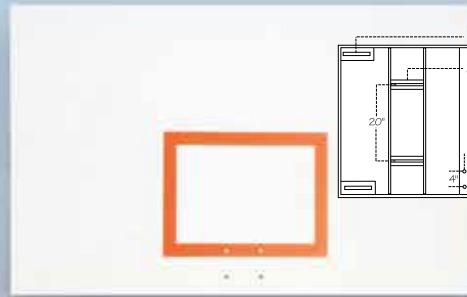

FT265B

- 3 1/2'x6' Rectangular steel backboard
- 10 ga. skin & 1/4" steel support structure
- White weather resistant powdercoat
- Official orange shooters square
- 10-Year Superior Warranty
- Approx. Shipping Weight: 190 lbs.

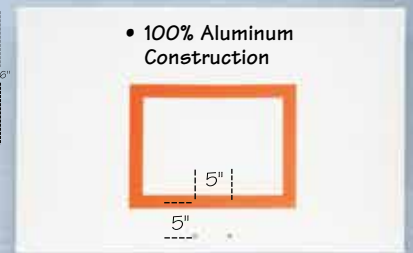
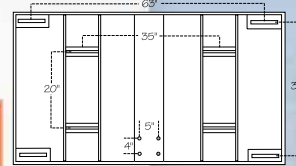

FT257

- 100% Aluminum Construction

- 3'x5' Rectangular aluminum backboard
- 10 ga. construction
- White weather resistant powdercoat
- Official orange shooters square
- Warranted on First Team systems only
- Approx. Shipping Weight: 35 lbs.

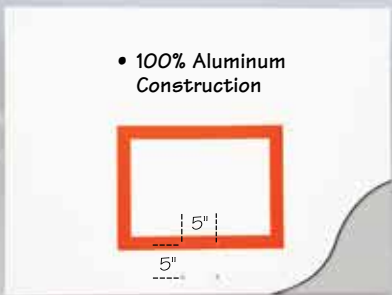

FT261

- 42"x60" Rect. aluminum backboard
- 10 ga. construction
- White weather resistant powdercoat
- Official orange shooters square
- Warranted on First Team systems only
- Approx. Shipping Weight: 39 lbs.

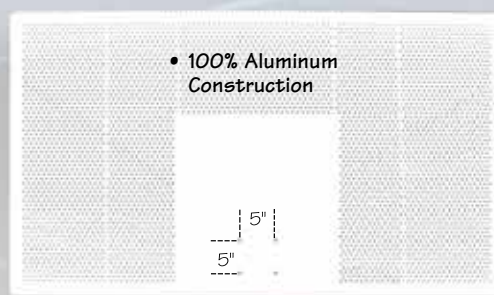

FT267

- 42"x72" Rect. aluminum backboard
- 10 ga. construction
- 3/8" perforations reduce wind resistance
- White weather resistant powdercoat
- Warranted on First Team systems only
- Approx. Shipping Weight: 55 lbs.

- 100% Aluminum Construction

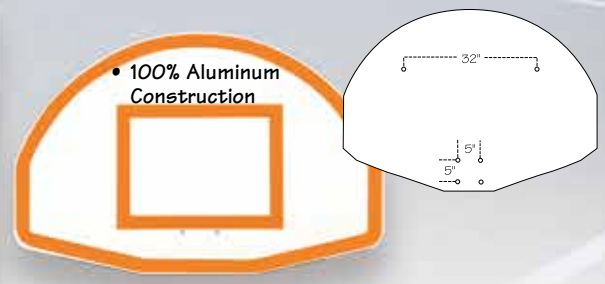

FT270

- 36"x54" Fan-shaped aluminum backboard
- Cast aluminum design
- White weather resistant powdercoat
- Official orange target and border
- 10-Year Limited Warranty
- Approx. Shipping Weight: 52 lbs.

- 100% Aluminum Construction

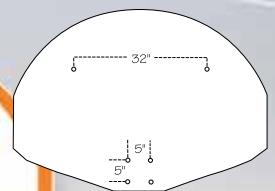

BACKBOARD PADDING



Backboard padding is available in these colors. Shades may vary slightly from color chart.

BK Black	RY Royal Blue
SC Scarlet	FG Forest Green
GR Grey	



FT48

- TuffGuard™ 48" backboard padding
- Molded urethane construction
- Secures to backboard via self-drilling screws
- All-weather
- Fits most 48" wide backboards
- 1-Year Limited Warranty
- Approx. Shipping Weight: 6 lbs.



FT54

- TuffGuard™ 54" backboard padding
- Molded urethane construction
- Secures to backboard via self-drilling screws
- All-weather
- Fits most 54" wide backboards
- 1-Year Limited Warranty
- Approx. Shipping Weight: 7 lbs.



FT60

- TuffGuard™ 60" backboard padding
- Molded urethane construction
- Secures to backboard via self-drilling screws
- All-weather
- Fits most 60" wide backboards
- 1-Year Limited Warranty
- Approx. Shipping Weight: 8 lbs.



FT72

- TuffGuard™ 72" backboard padding
- Molded urethane construction
- Secures to backboard via self-drilling screws
- All-weather
- Fits most 72" wide backboards
- 1-Year Limited Warranty
- Approx. Shipping Weight: 9 lbs.

www.firstteaminc.com

First Team, Inc. • Hutchinson, Kansas • Toll-Free 1-800-649-3688

SAFETY PADDING & CUSTOM LETTERING



FT75

- Premium pole pad for 4" or 5" posts
- Foam pad (1 1/2" thick) with sewn vinyl cover
- All-weather
- Velcro wrap attachment
- Pole pad is 66" tall
- 1-Year Limited Warranty
- App. Ship. Wt: 8 lbs.

FT74

- Pyramid shaped gusset pad
- 11 inches tall
- Fits bolt-down goals with 4" or 5" posts
- Also covers FT16 & FT17 ground sleeve options
- 1-Year Limited Warranty
- App. Ship. Wt: 2 lbs.

FT76 Pole Pad Combo

- Includes FT75 Pole Pad & FT74 Gusset Pad
- 1-Year Limited Warranty
- Approx. Shipping Weight: 10 lbs.



FT78

- Premium pole pad for 6" square posts
- Foam pad (2" thick) with sewn vinyl cover
- All-weather
- Contoured shape with velcro attachment
- Pole pad is 60" tall
- 1-Year Limited Warranty
- App. Ship. Wt: 8 lbs.

FT77

- Pyramid shaped gusset pad
- 14 1/2 inches tall
- Fits bolt-down goals with 6" posts
- Also covers FT18 ground sleeve option
- 1-Year Limited Warranty
- App. Ship. Wt: 2 lbs.

FT79 Pole Pad Combo

- Includes FT78 Pole Pad & FT77 Gusset Pad
- 1-Year Limited Warranty
- Approx. Shipping Weight: 10 lbs.



Pole Pads Now Available in 16 Colors

FT80P

- Same features as FT78 except:
- Deluxe pole pad for 6"x8" EZ-Crank pole systems
- 1-Year Limited Warranty
- App. Ship. Wt: 10 lbs.

FT80G

- Deluxe gusset pad for 6"x8" EZ-Crank pole systems
- 15 inches tall
- 1-Year Limited Warranty
- App. Ship. Wt: 2 lbs.

FT80 Pole Pad Combo

- Includes FT80P Pole Pad & FT80G Gusset Pad
- 1-Year Limited Warranty
- Approx. Shipping Weight: 10 lbs.

How to Order Custom Lettering for Padding:

First Team offers free custom lettering on most, but not all padding with the purchase of a complete system. Check catalog for lettering availability or call First Team for details.

Choose from 3 font styles, shown at right. Each font is available with or without a background color. Choose lettering color (foreground) from the colors shown below. If applicable, choose background color. Add the necessary elements to the padding model number to be lettered as shown in the examples:

To order lettering, photocopy this form and fax with padding order to: 620.663.6055.

Font Style ▼ Word(s) to Print (Max. 10 Letters)
 LTR 7 8 : 1 R Y H U T C H

▲ In this example, customer wants to letter on FT78 pole pad, using font style #1 with royal blue letters. Customer does not want a background color.

▼ Background Lettering Color
 LTR 7 8 : 2 R Y - W H H U T C H

▲ In this example, customer wants font style #2 with royal blue foreground letters and white background outline.

Maximum 10 letters per pad.
 First Team art department will space letters accordingly.

LTR □ □ □ □ : □ □ □ - □ □

FT81BC

- Protective padding for RollAbout ballast boxes (set of 2)



- Makes box corners much safer
- 2" thick foam vinyl covered pad
- All-weather pad slips on and off
- 1-Year Limited Warranty
- Approx. Shipping Weight: 10 lbs.

FT82BC

- Protective padding for Rampage ballast box



Font Style #1



ABCDEFGHIJ
 KLMNOPQR
 STUVWXYZ

Font Style #2



ABCDEFGHIJ
 KLMNOPQR
 STUVWXYZ

Font Style #3



ABCDEFGHIJ
 KLMNOPQR
 STUVWXYZ

Word(s) to Print (Max. 10 Letters)

Safety Padding and Custom Pad Lettering is available in these colors. Use color codes for ordering. Shades may vary slightly from color chart.

RY Royal Blue	SC Scarlet	GL Gold	PR Purple	KG Kelly Green	BK Black	CB Columbia Blue	MR Maroon	GR Grey	NY Navy Blue	OR Orange	FG Forest Green	BR Brick Red	SO Sienna Orange	DG Desert Gold	SB Saddle Brown	WH White (Lettering Only)
------------------	---------------	------------	--------------	-------------------	-------------	---------------------	--------------	------------	-----------------	--------------	--------------------	-----------------	---------------------	-------------------	--------------------	------------------------------



MISCELLANEOUS ACCESSORIES



▲ FT20

- Basketball Court Stencil Kit
- Provides an easy way to paint a regulation lane, free throw line and circle on any cement or blacktop surface
- Includes 3-point line
- Approx. Shipping Weight: 5 lbs.



FT16 ▲

- Ground sleeve for 4" direct bury posts
- Makes post removal easy
- Sleeves cements in place and post fits inside
- Post secures inside sleeve via eight tension bolts
- Sleeve buries 36" below playing surface
- Allows perfect post leveling
- 5-Year Superior Warranty
- Approx. Shipping Weight: 42 lbs.

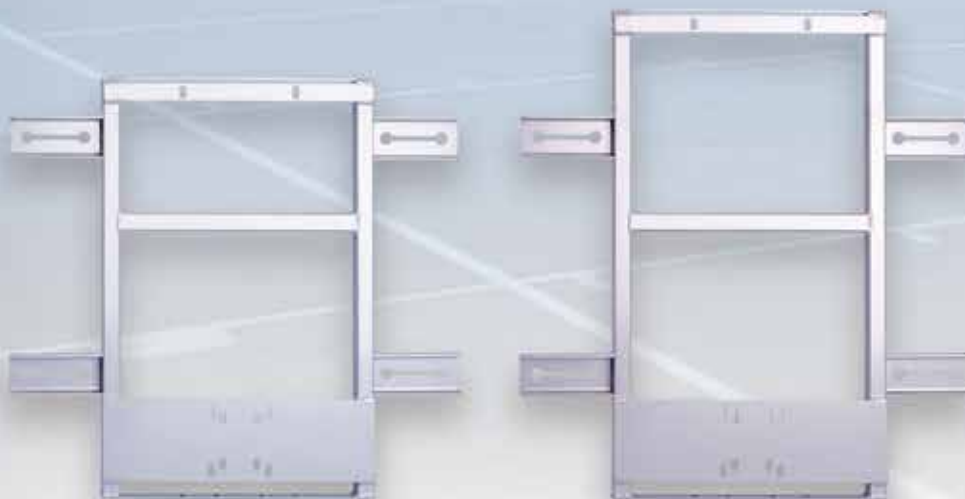

FT17 (Not shown)

- Same features as FT16 except:
- Ground sleeve for 5" direct bury posts
- Sleeve buries 42" below playing surface
- 10-Year Superior Warranty
- Approx. Shipping Weight: 57 lbs.

▲ FT36-HFM

- Recommended for use when certain First Team backboards are purchased separately (see list below)
- H-Frame provides mounting attachments and adequate rim support
- Provides 10-Year Limited Warranty on H-Frame and backboard
- FT36-HFM fits: FT210, FT215, FT220, FT225 & FT230
- FT42-HFM fits: FT222

▲ FT42-HFM

FT18 (Not shown)

- Same features as FT16 except:
- Ground sleeve for 6" direct bury posts
- Sleeve buries 48" below playing surface
- 10-Year Superior Warranty
- Approx. Shipping Weight: 72 lbs.

www.firstteaminc.com

First Team, Inc. • Hutchinson, Kansas • Toll-Free 1-800-649-3688

MISCELLANEOUS ACCESSORIES



FT22

- Original Airball Grabber
- 14' tall x 10' wide
- Maximize play/practice time by catching stray shots/passes
- Promote safety
- Reduce damage to neighbor's property/plants
- Fits all First Team pole mounted basketball goals
- Lightweight and easy to install
- Installs in less than 30 minutes
- Lifetime Limited Warranty
- Approx. Shipping Wt: 10 lbs.



FT225U

- Super Airball Grabber
- Larger size 16' high x 19' wide
- Maximize practice time without chasing stray balls
- Promote safety
- Reduce damage to neighbor's property
- Fits any basketball system with a square post
- Aluminum construction
- Folds for storage when needed
- Installs in 30 minutes, requires 2 people
- Lifetime Limited Warranty
- Approx. Shipping Wt: 50 lbs.



- Key operated handle lock
- Prevents unwanted adjustment on 4", 5" and 6" EZ-Crank adjustable goal systems
- Zinc plated
- 1-Year Limited Warranty
- Approx. Shipping Weight: 1 lb.

FT12

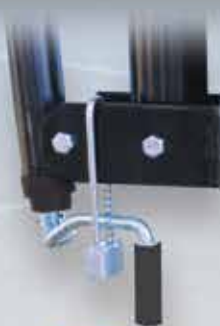

- Top Ring & Lid for floating basketball court floors
- Allows floating floors to move without damaging floor
- 5" I.D. Ring secures to floor
- Lid sits flush to finished floor
- Approx. Shipping Weight: 5 lbs.

FT52



- Threaded Socket
- Spring loaded core receives 1/2" bolt
- May be used for tile, concrete or sub surface below floating floors
- Approx. Shipping Weight: 1 lb.

FT50



FT1350-ACR FT1600-ACR

FT1400-ACR PH05/06-ACR

FT1500-ACR PH05CH-ACR

- Ground Anchor Kit
- Kit includes necessary hardware for relocating respective EZ-Crank adjustable basketball system
- Anchor kit includes J-bolts, template, rebar, hex nuts and instructions
- Approx. Shipping Weight: 15 lbs.

FT1350ST-ACR FT1625ST-ACR

- Ground Anchor Kit
- Kit includes necessary hardware for relocating respective EZ-Crank adjustable basketball system
- Anchor kit includes stainless steel J-bolts, template, rebar, hex nuts and instructions
- Approx. Shipping Weight: 15 lbs.

FT1350-SA

*FOR USE WITH POOLSIDE GOALS ONLY.

Order FT1350-SA special surface anchor for applications where standard anchor bolts present a hazard. Special surface anchors allow goal post to be secured to deck without vertical protrusion common with standard anchor bolts. Each kit includes (1) template, (4) surface anchor, (4) rebar & hardware. Approx. Shipping Weight: 20 lbs.

BASKETBALL NETS & BALLS



FT10

- Heavy competition braided nylon net
- Suitable as a competition net or as an upgrade for residential use
- Bright white
- 1-Year Limited Warranty
- Approx. Shipping Weight: 1 lb.



FT10AW

- Heavy duty anti-whip competition net
- Thick braided nylon reduces whip common with lighter nets
- Bright white
- 1-Year Limited Warranty
- Approx. Shipping Weight: 1 lb.



FT11

- Premium steel safety net
- Welded loops eliminate risk of player injury
- Attaches to any style goal via heavy duty "S" hooks
- Superior to normal style chain nets
- Zinc plated
- 2-Year Limited Warranty
- Approx. Shipping Weight: 3 lbs.



FT11E

- Economy chain net
- Outlasts nylon nets
- Attaches to any style goal via "S" hooks
- Zinc plated
- 1-Year Limited Warranty
- Approx. Shipping Weight: 1 lb.



BB2000M

- Official size & weight
- Indoor/Outdoor
- Composite Leather
- Player preferred soft feel
- High tack grip for better control
- Approx. Shipping Weight: 2 lbs.



BB2000W

- 28.5 size
- Indoor/Outdoor
- Composite Leather
- Player preferred soft feel
- High tack grip for better control
- Approx. Shipping Weight: 2 lbs.

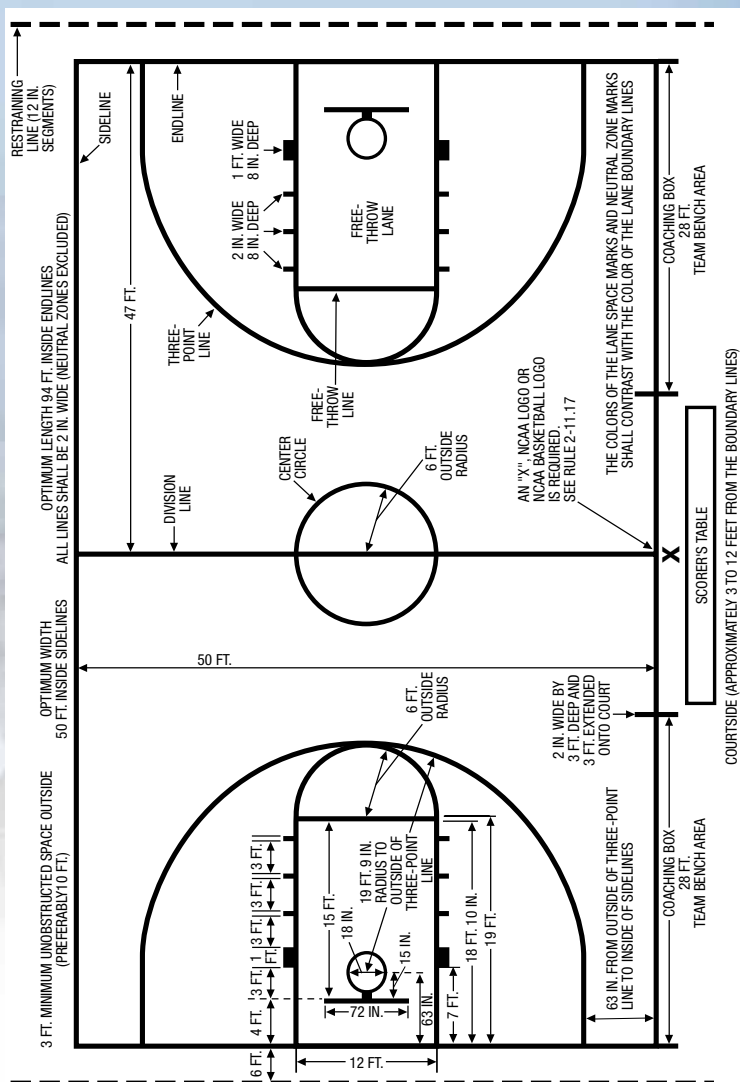

COURT VISION™

SOLAR POWERED COURT LIGHT

First Team



First Team's Court Vision solar powered court light is the first of its kind. No more cheap, flimsy, lightweight court lights attached to the basketball pole that shake when the ball hits the rim. This free-standing court light illuminates the playing surface without shaking due to vibration from gameplay. The post is made from 4" square aluminum for weather proof durability and has 3/4" radius corners for player safety. The components all have a black powder coat finish. The lamp sits approximately 16' above the playing court and provides 12,000 lumens to light up the night. The unit is designed to be installed without special lifting equipment. The hinged anchor base allows the post and lamp to be 100% assembled at ground level before standing upright. The anchor bolt installation allows easy post leveling making installation a breeze. Solar design saves money on your utility bill and saves you money on installation because there is no need to call an electrician out to wire power to the court. The commercial grade solar panel/battery on top of the lamp collects and stores enough power to stay lit for 16 hours without need for recharge so even a cloudy day won't shut down your game at night. Each unit includes a wireless remote for easy on/off control. First Team's Court Vision solar light has a shipping weight of 150 lbs. and is covered by a 5-year limited warranty.



Hinged Anchor For Easy Setup And Maintenance



Easy Installation



Bright, Long-Lasting LED Light Design



Weather Proof Solar Panel



Wireless Remote Control

the SUPERSTAR™

CUSTOM PRINTED FOLDING CHAIRS



the SUPERSTAR IMPRESSION

Optional Logo



- Unlimited Printed Design Possibilities
- 4-Color Print on Backrest, Seat Cushion Top & Front
- Choose From 10 Available Chair Frame Colors
- Orders under 10 Chairs subject to Art Charge
- Optional Name, Logo and/or Ball Decal on Backrest Frame

Order Superstar Impression using the color codes below.
The first color code indicates the color of the frame.
The second code indicates custom printed cushions.

Superstar Impression FT7500IMP-BK-GPH



the SUPERSTAR ATTITUDE

Optional Name with Ball Decal



- Seven Sports Options
- Great for Man Cave or Kids Room
- No Minimum
- Choose From 10 Available Chair Frame Colors
- Optional Name, Logo and/or Ball Decal on Backrest Frame

BB = Basketball
GF = Golf
TN = Tennis
BA = Baseball
SC = Soccer
FB = Football
VB = Volleyball



Order Superstar Attitude using the sample below.
The first color code indicates the color of the frame.
The second code indicates sport pattern of the cushions.

Superstar Attitude 7500ATT-WH-BB



the SUPERSTAR CLASSIC

Optional Name with Ball Decal



- 100 Color Combinations
- Choose Frame Color
- Choose Cushion Color
- Optional Name, Logo and/or Ball Decal on Backrest Frame
- No Minimum

Order Superstar Classic using the sample below.
The first color code indicates the color of the frame.
The second color code indicates the color of the cushions.

Superstar Classic 7500CLA-RY-SC

First Team introduces our Superstar lineup of custom folding chairs. Show your school or company spirit by choosing the Superstar line that fits your needs and budget. All chair frames are available in your choice of ten colors. We offer Superstar chairs at three levels. Our Superstar Impression line can be customized with digitally printed graphics to match whatever design your imagination can create. Our Superstar Attitude chairs are available with several pre-printed sport designs and can be customized with name or logo on backrest frame for an additional charge. For the even more budget conscious we offer Superstar Classic. With Superstar Classic, simply choose your frame color and cushion color. Add optional graphics on backrest frame if desired for a more personalized touch. Superstar Impression chairs are great for school sports teams or corporate group seating. Superstar Attitude and Superstar Classic chairs make great gifts for the sports lover or school athlete in your family. Don't settle for smaller chairs that use thinner foam and tiny backrest supports. Let First Team show you why Superstar chairs are quickly becoming America's number one choice for superior customized sports seating.

EACH SUPERSTAR CHAIR FEATURES:

- Extra Thick 3" Foam Seat Cushion for Comfort
- 1" Thick Foam Backrest Cushion
- 30 oz. Vinyl Cushion Covers, 10 Colors or Printed
- Powder Coated Chair Frame, 10 Colors Available
- Heavy Duty Chair Frame, Rated to 400 lbs.
- XL Backrest for Superior Comfort vs. Competition
- Rubber Cap Floor Protectors

When Ordering Lettering LTR7500:
LTR7500 1WH-BK-WILLIAMS

Indicates font style 1 in White, w/ Black outline

When Ordering Sport Ball Decal:

DC7500BB = Basketball DC7500SC = Soccer
DC7500FB = Football DC7500VB = Volleyball
DC7500GF = Golf Ball DC7500TN = Tennis Ball
DC7500BA = Baseball



BK Black	WH White	RY Royal Blue	SC Scarlet	NY Navy Blue	FG Forest Green	KG Kelly Green	OR Orange	PR Purple	GL Gold
-------------	-------------	------------------	---------------	-----------------	--------------------	-------------------	--------------	--------------	------------

Superstar™ Chairs are available in these frame and vinyl colors. Shades may vary slightly from color chart.

www.firstteaminc.com

First Team, Inc. • Hutchinson, Kansas • Toll-Free 1-800-649-3688

the SPORTZONE LUXURY STADIUM CHAIR

TM **First Team**

• Zippered Storage Pocket on Back

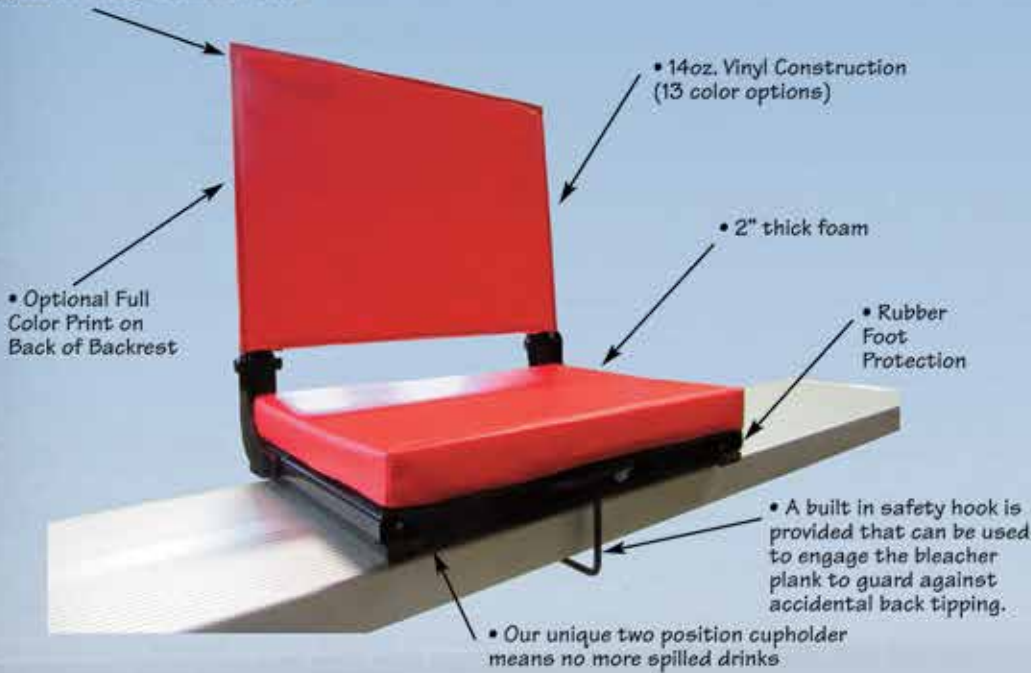

Stadium bleacher planks can be hard to sit on for extended periods of time and many stadium chairs don't provide the cushion or support needed to stay comfortable all the way to the end of the game.

Lasting comfort and convenience are what you get when you pick the SPORTZONE luxury stadium chair by First Team. Created for your viewing pleasure, Sportzone is unequaled in both design and function.

The 2" thick padded seat cushion ensures a comfortable seat all game long. Zippered storage pocket provides a convenient place to store a game program or other belongings. Our unique two position cupholder means no more kicking over your drink while it sits at your feet.

The Sportzone is manufactured from high tensile strength aluminum so it is strong, yet lightweight and easy to carry. A built in safety hook is provided that can be used to engage the bleacher plank to prevent accidental back tipping.

Full color graphics can be printed on the back of each backrest so you can customize to your favorite team, player or event.

When you are searching for the best in viewing comfort and performance, stay with a trusted name that's in everyone's comfort zone, Sportzone!



Model	Description	Shipping Weight	Warranty
SPORTZONE GPH	Chair with printed graphic padding	7#	Lifetime Limited
SPORTZONE LX	Chair and pads, no graphics	7#	Lifetime Limited

BK Black	WH White	RY Royal Blue	SC Scarlet	NY Navy Blue	FG Forest Green	KG Kelly Green	OR Orange	CB Columbia Blue	PR Purple	GL Gold	MR Maroon	GR Grey
-------------	-------------	------------------	---------------	-----------------	--------------------	-------------------	--------------	---------------------	--------------	------------	--------------	------------

Sportzone Chairs are available in these colors.

the TEAMMATE™

PORTABLE & FIXED PLAYER BENCHES

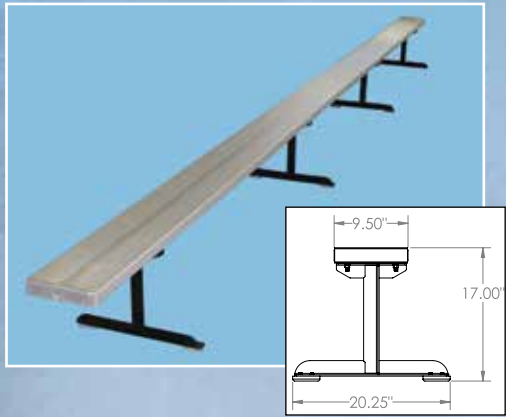

Part #	Description	Weight
TEM-PB-8	Portable Bench 8' Long - Seats 5 No Backrest	40 lbs.
TEM-PB-15	Portable Bench 15' Long - Seats 10 No Backrest	.65 lbs.
TEM-PB-21	Portable Bench 21' Long - Seats 14 No Backrest	90 lbs.



Part #	Description	Weight
TEM-PB-8-B	Portable Bench 8' Long - Seats 5 With Backrest	70 lbs.
TEM-PB-15-B	Portable Bench 15' Long - Seats 10 With Backrest	110 lbs.
TEM-PB-21-B	Portable Bench 21' Long - Seats 14 With Backrest	160 lbs.

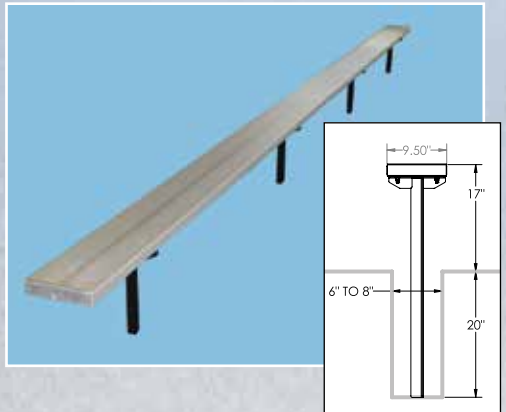

Part #	Description	Weight
TEM-FX-8	Fixed Bench 8' Long - Seats 5 No Backrest	40 lbs.
TEM-FX-15	Fixed Bench 15' Long - Seats 10 No Backrest	.65 lbs.
TEM-FX-21	Fixed Bench 21' Long - Seats 14 No Backrest	90 lbs.

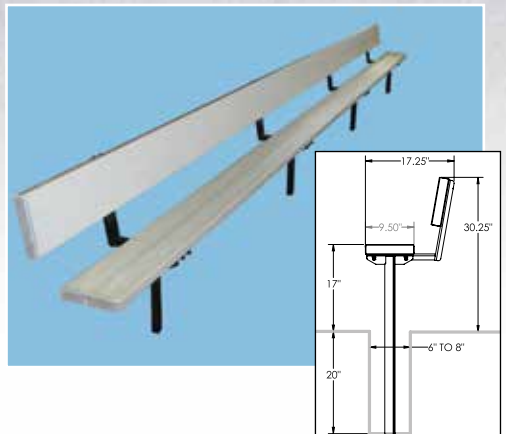

Part #	Description	Weight
TEM-FX-8-B	Fixed Bench 8' Long - Seats 5 With Backrest	70 lbs.
TEM-FX-15-B	Fixed Bench 15' Long - Seats 10 With Backrest	110 lbs.
TEM-FX-21-B	Fixed Bench 21' Long - Seats 14 With Backrest	160 lbs.

First Team introduces the Teammate line of portable and fixed player benches. All Teammate player benches use 9 5/8" x 1 3/4" anodized aluminum planking for seats and backrests. Support legs and backrest brackets are powdercoat painted black, steel construction. Legs are spaced on 6'0" centers. Portable player benches include rubber floor protectors to prevent floor damage.

Teammate player benches are available in 8', 15' and 21' lengths with and without backrests. "Fixed" benches are cemented in ground for a permanent installation, while "Portable" benches are freestanding allowing them to be easily moved. All planks include end caps for a finished look with no sharp edges.

For added school spirit, consider ordering benches in custom colors. First Team can powdercoat seat planks and backrests up to 15' lengths in a variety of colors for a minimal charge. See below for color availability.

Choose the Teammate player bench meets your seating needs. See chart for seating capacity. All Teammate player benches are covered by First Team's Lifetime Limited Warranty!

Seatplanks & backrests available in colors up to 21' lengths.

Available Colors:
Scarlet, Royal Blue, Navy Blue, Forest Green, Kelly Green, Gold, Orange, Purple, Black, White

the FANSTAND™

INDOOR TIP-N-ROLL BLEACHERS (2, 3 & 4 ROW)



First Team Tip-N-Roll Bleachers meet guidelines set by 2002 IBC recommendations for bleachers. Check with your building inspector for local & state code requirements.



Give your gym seating the versatility you need with First Team's new line of FanStand indoor tip-n-roll bleachers.

First Team's line of indoor tip-n-roll bleachers make providing added spectator seating a breeze. All seats use 9 5/8" x 1 3/4" anodized aluminum planking. Walk planks are 9 5/8" x 1 3/4" mill finished aluminum. FanStand bleachers are available with single or double wide walk planks. 4" tip n roll wheels are secured to back seat support to make bleachers portable. Simply tilt bleacher backwards onto wheels to roll.

First Team's FanStand bleachers are designed so the highest seat level is below 30" above ground level, eliminating the need for safety railing. Basic framing is all welded structural angle with bolted cross bracing to maximize bleacher strength for end shift loads. Framing is spaced on six foot centers. 2 1/2" rubber floor protectors are used on the bottom of frame to protect finished floors. Steel under structure is powder coat painted black.

Choose the FanStand bleacher that meets your seating needs. See chart for seating capacity. All FanStand bleachers are covered by First Team's Lifetime Limited Warranty!

Part #	Description	Seating Cap.	Wt.
FAN2-1FP-TNR-9	2-Row, Single Footplank, 9' long	12	115 lbs.
FAN2-2FP-TNR-9	2-Row, Double Footplank, 9' long	12	132 lbs.
FAN2-1FP-TNR-15	2-Row, Single Footplank, 15' long	20	187 lbs.
FAN2-2FP-TNR-15	2-Row, Double Footplank, 15' long	20	214 lbs.
FAN2-1FP-TNR-21	2-Row, Single Footplank, 21' long	28	259 lbs.
FAN2-2FP-TNR-21	2-Row, Double Footplank, 21' long	28	297 lbs.
FAN3-1FP-TNR-9	3-Row, Single Footplank, 9' long	18	177 lbs.
FAN3-2FP-TNR-9	3-Row, Double Footplank, 9' long	18	210 lbs.
FAN3-1FP-TNR-15	3-Row, Single Footplank, 15' long	30	272 lbs.
FAN3-2FP-TNR-15	3-Row, Double Footplank, 15' long	30	326 lbs.
FAN3-1FP-TNR-21	3-Row, Single Footplank, 21' long	42	384 lbs.
FAN3-2FP-TNR-21	3-Row, Double Footplank, 21' long	42	460 lbs.
FAN4-1FP-TNR-9	4-Row, Single Footplank, 9' long	24	230 lbs.
FAN4-2FP-TNR-9	4-Row, Double Footplank, 9' long	24	278 lbs.
FAN4-1FP-TNR-15	4-Row, Single Footplank, 15' long	40	356 lbs.
FAN4-2FP-TNR-15	4-Row, Double Footplank, 15' long	40	437 lbs.
FAN4-1FP-TNR-21	4-Row, Single Footplank, 21' long	56	500 lbs.
FAN4-2FP-TNR-21	4-Row, Double Footplank, 21' long	56	613 lbs.



Order Double Footplanks for Extra Comfort & Security

Seatplanks & footplanks available in colors up to 21' lengths.

Available Colors:
Scarlet, Royal Blue, Navy Blue, Forest Green, Kelly Green, Gold, Orange, Purple, Black, White

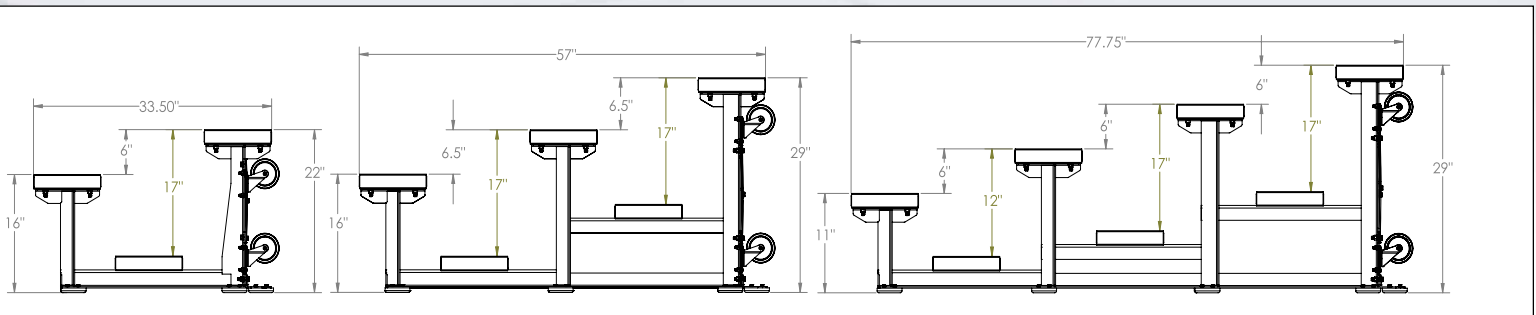

the FANSTAND™

OUTDOOR BLEACHERS (2, 3 & 4 ROW)



First Team FanStands™ meet 2002 IBC recommendations for bleachers. Check with your building inspector for local & state code requirements.

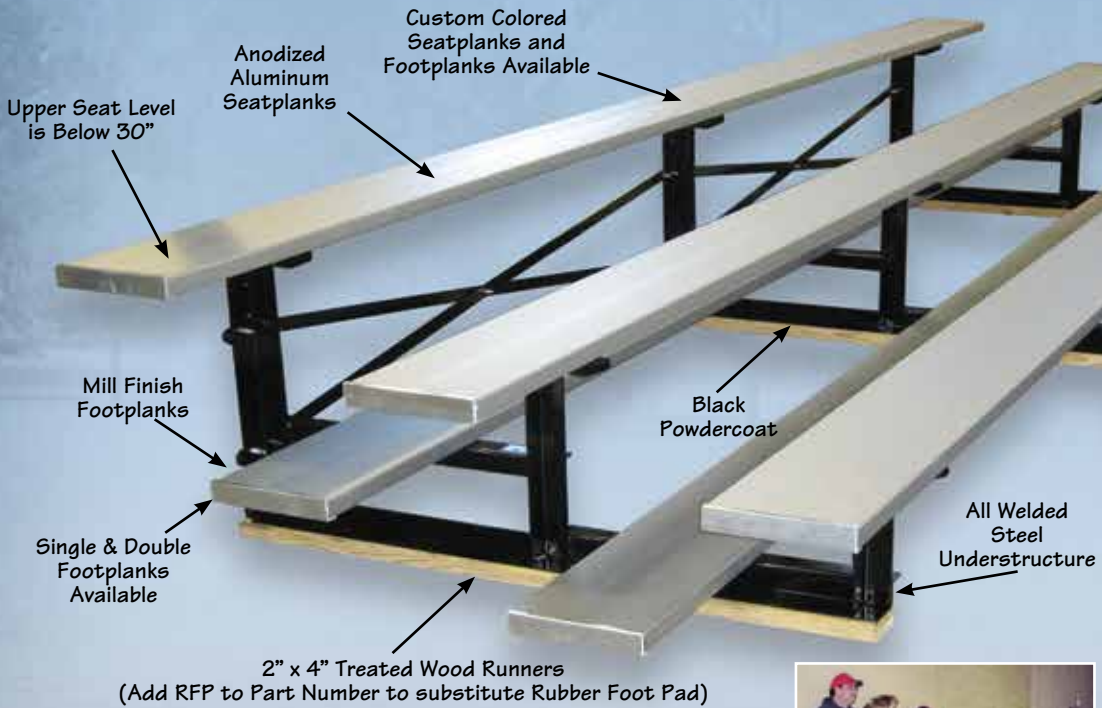

First Team's line of FanStand outdoor bleachers sets the standard for safety and affordability! First Team's line of outdoor bleachers makes providing added spectator seating safe and affordable. All seats use 9 5/8" x 1 3/4" anodized aluminum planking. Walk planks are 9 5/8" x 1 3/4" mill finished aluminum. FanStand bleachers are available with single or double wide walk planks. First Team's FanStand bleachers are designed so the highest seat level is below 30" above ground level, eliminating the need for safety railing. Basic framing is all welded structural angle with bolted cross bracing to maximize bleacher strength for end shift loads. Framing is spaced on six foot centers. Treated 2"x4" wood runners are bolted to the bottom of each frame to provide improved stability on soft surfaces. Rubber foot pads may be substituted upon request. Steel under structure is powder coat painted black.



Order Double Footplanks for Extra Comfort & Security

Choose the FanStand bleacher that meets your seating needs. See chart for seating capacity. All FanStand bleachers are covered by First Team's Lifetime Limited Warranty!

Seatplanks & footplanks available in colors up to 21' length.

Available Colors:
Scarlet, Royal Blue, Navy Blue, Forest Green, Kelly Green, Gold, Orange, Purple, Black, White

Part #	Description	Seating Cap.	Wt.
FAN2-1FP-9	2-Row, Sgl. Footplank, 9' long	12	115 lbs.
FAN2-2FP-9	2-Row, Dbl. Footplank, 9' long	12	132 lbs.
FAN2-1FP-15	2-Row, Sgl. Footplank, 15' long	20	187 lbs.
FAN2-2FP-15	2-Row, Dbl. Footplank, 15' long	20	214 lbs.
FAN2-1FP-21	2-Row, Sgl. Footplank, 21' long	28	259 lbs.
FAN2-2FP-21	2-Row, Dbl. Footplank, 21' long	28	297 lbs.
FAN3-1FP-9	3-Row, Sgl. Footplank, 9' long	18	177 lbs.
FAN3-2FP-9	3-Row, Dbl. Footplank, 9' long	18	210 lbs.
FAN3-1FP-15	3-Row, Sgl. Footplank, 15' long	30	272 lbs.
FAN3-2FP-15	3-Row, Dbl. Footplank, 15' long	30	326 lbs.
FAN3-1FP-21	3-Row, Sgl. Footplank, 21' long	42	384 lbs.
FAN3-2FP-21	3-Row, Dbl. Footplank, 21' long	42	460 lbs.
FAN4-1FP-9	4-Row, Sgl. Footplank, 9' long	24	230 lbs.
FAN4-2FP-9	4-Row, Dbl. Footplank, 9' long	24	278 lbs.
FAN4-1FP-15	4-Row, Sgl. Footplank, 15' long	40	356 lbs.
FAN4-2FP-15	4-Row, Dbl. Footplank, 15' long	40	437 lbs.
FAN4-1FP-21	4-Row, Sgl. Footplank, 21' long	56	500 lbs.
FAN4-2FP-21	4-Row, Dbl. Footplank, 21' long	56	613 lbs.

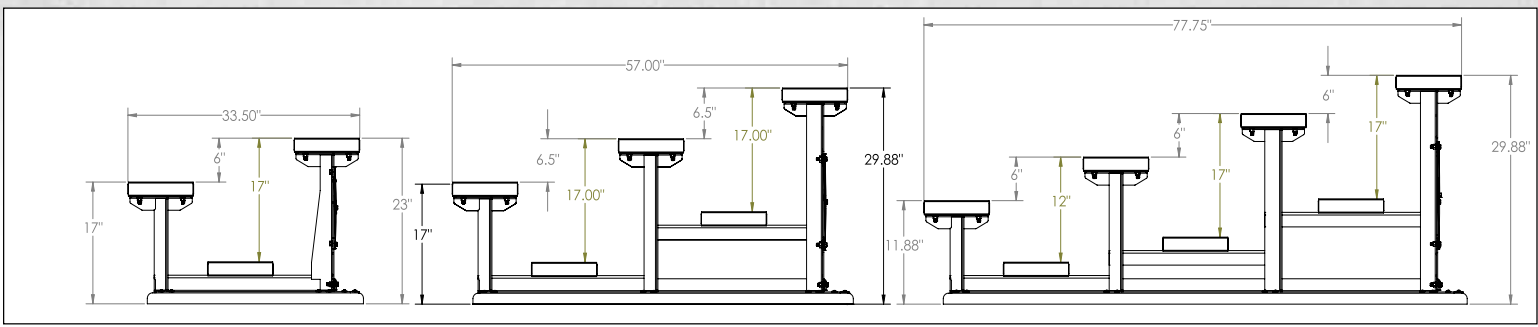

the **TOMAHAWK**TM
MEGADUTY TETHERBALL SET



First Team is proud to offer the TOMAHAWK mega duty tetherball set.

Our Tomahawk is the only tetherball pole you will ever need to buy. Constructed of one piece 2 3/8" diameter steel pipe with an exceptional 3/16" wall thickness, the Tomahawk will stand straight and true outperforming standard cheap thin wall, multi section posts.

The unit includes a high quality tetherball & rope with a recessed connection for player safety. Choose from standard in-ground installation with "TOMAHAWK PM" or choose "TOMAHAWK SP" to include our popular PVC sleeve option.

The bottom of the Tomahawk post has a built in anti-rotation notch which engages the sleeve to prevent post rotation inside the sleeve during play.

When you are comparing tetherball sets for your play-ground or backyard, there's no sense in going round and round about it, choose the one that runs circles around the competition, TOMAHAWK!

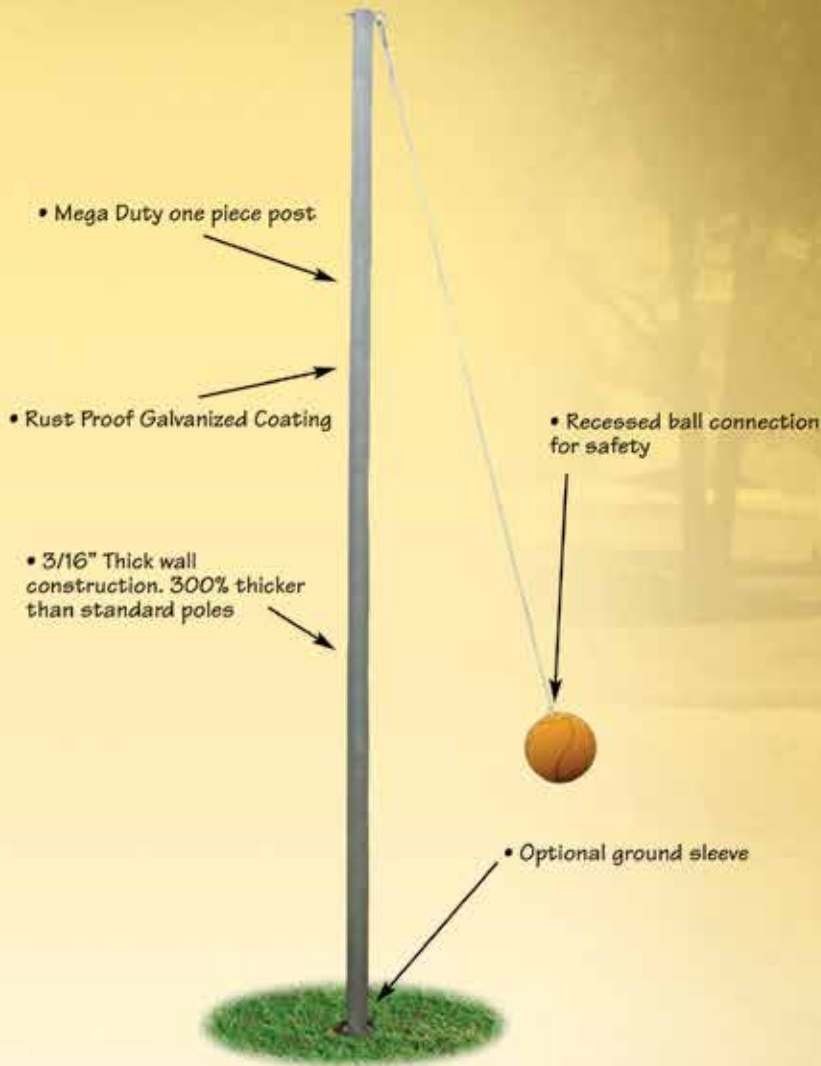

Optional Ground Sleeve & Cap



Heavy Duty One-Piece Post



Replacement FT510TB Tetherball/Rope Available

Model	Description	Shipping Weight	Warranty
TOMAHAWK PM	Inground Tetherball Set	50#	Lifetime Limited
TOMAHAWK SP	Inground Tetherball Set with Ground Sleeve	60#	Lifetime Limited

the FRONTIER™

STEEL COMPETITION VOLLEYBALL SET



FREE LETTERING
Upon Request

The Frontier steel competition volleyball system offers exceptional net and post rigidity at a price that will maximize your budget! Steel volleyball uprights have long been the popular standard when it comes to maintaining bowstring tight net tension. Though advances have been made with lightweight titanium standards, steel is still the most economical way to get competition quality net tensioning.

Typical steel standards from other manufacturers are heavy and difficult to set up and take down. This is not the case with First Team's Frontier system! Though Frontier's uprights are constructed of thick 1/4" wall steel tubing, the Frontier is the only volleyball system constructed with its own built in transport wheel on each post. The transport wheel makes moving and setup a snap. Simply roll each upright to its respective floor socket and drop post into place, no lifting required!

All Frontier packages come complete with a wormgear crank net tensioner that will not backdrive and is the safest in the industry. The telescoping pistons are spring loaded for simple, quick net height adjustments from 78" to 98" for all levels of play. The net height is shown on the built in net height indicator. Each system comes with a top quality knotless mesh competition net made with Kevlar. First Team competition antennae set comes standard. Upright padding is included in your choice of 12 colors, padded rope covers and chain net height gauge are also included.

The entire system meets all NCAA, National High School Federation and USVBA rules.

All Frontier systems are covered by First Team's Lifetime Limited Warranty.



Side-By-Side Systems Available

FREE LETTERING WITH PURCHASE OF VOLLEYBALL SYSTEM

Model	Description	Shipping Weight	Warranty
Frontier Complete	Complete System described above (Includes sockets)	220#	Lifetime Limited
Frontier Complete-SBS Side-by-Side	Complete side-by-side double court system (Includes sockets)	310#	Lifetime Limited
Frontier Express	Same system as Frontier Complete excluding floor sockets	200#	Lifetime Limited
Frontier Express-SBS Side-by-Side	Same side-by-side system as Frontier Complete-SBS excluding floor sockets	290#	Lifetime Limited



Frontier upright padding is available in these colors. Shades may vary slightly from color chart.

www.firstteaminc.com

First Team, Inc. • Hutchinson, Kansas • Toll-Free 1-800-649-3688

The ASTRO™

ALUMINUM COMPETITION VOLLEYBALL SET



First Team's Astro competition volleyball set makes lightweight, high performance volleyball affordable!

The Astro volleyball set is constructed of 3 1/2" x 1/4" wall high strength aluminum. Net is tensioned with our high grade precision wormgear crank with folding handle. First Team's wormgear net tensioning crank is exceptionally safe with no "backdrive" common with inferior net tensioners. Net height adjustments from 78" to 98" are quick and easy using our internal spring telescoping piston design. Slide the inner telescoping tube up or down and turn knob to secure. Net heights are displayed on the telescoping tube as shown in photo.

Each Astro volleyball system includes 3 1/2" uprights, net tensioner, our top of the line competition volleyball net made with KEVLAR, protective rope covers, antennae set, chain net height gauge and upright padding. Upright padding is available in 16 colors shown below. And don't forget, when you purchase an Astro volleyball system First Team will custom letter the upright padding at no extra charge!

The entire system meets all NCAA, National High School Federation and USYBA rules. All Astro volleyball systems are covered by First Team's Lifetime Limited Warranty.

FREE LETTERING
Upon Request



FREE LETTERING WITH PURCHASE OF VOLLEYBALL SYSTEM

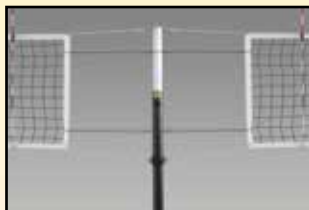

Side-By-Side Systems Available



Side Tape Tensioners



Bottom Rope Tensioner & Rope Covers

Model	Description	Shipping Weight	Warranty
Astro Complete	Complete System described above (Includes sockets)	160#	Lifetime Limited
Astro Complete-SBS Side-by-Side	Complete side-by-side double court system (Includes sockets)	245#	Lifetime Limited
Astro Express	Same system as Astro Complete excluding floor sockets	130#	Lifetime Limited
Astro Express-SBS Side-by-Side	Same side-by-side system as Astro Complete-SBS excluding floor sockets	215#	Lifetime Limited



Astro upright padding is available in these colors. Shades may vary slightly from color chart.

The GALAXY™

CARBON COMPETITION VOLLEYBALL SET



First Team introduces the GALAXY! The latest in innovative, high performance volleyball standards. The 3 1/2" diameter uprights are constructed of carbon fiber composite! Carbon fiber is the key, strong as steel and lighter than aluminum. Now volleyball programs can have it all, equipment that is lightweight and easy to setup without sacrificing upright rigidity or net tension. Carbon fiber has been used for many years in a variety of industries. Carbon fiber is used for such things as bicycle frames, golf clubs and aircraft. First Team's use of carbon fiber for volleyball sets provides space age, cutting edge performance to the sport. The Galaxy is truly as strong as steel, yet lighter than aluminum! The Galaxy comes complete with wormgear crank net tensioner that will not backdrive and is the safest in the industry. The telescoping pistons are spring loaded for simple, quick net height adjustments for Jr, Women's and Men's official heights and anywhere in between. The net height is shown on the built in net height indicator. Each system comes with a top quality knotless mesh competition net made with Kevlar. First Team competition antenna set comes standard. Upright padding is included and available in 16 colors. Padded rope covers and chain net height gauge are also included. The entire system meets all NCAA, National High School Federation and USVBA rules. All Galaxy volleyball systems are covered by First Team's Lifetime Superior Warranty. The Galaxy is simply the best volleyball system on the market today!

FREE LETTERING
Upon Request



Net Height Indicator



Wormgear Net Tensioning Crank

AS STRONG AS STEEL AND LIGHTER THAN ALUMINUM!



FREE LETTERING WITH PURCHASE OF VOLLEYBALL SYSTEM



Side-By-Side Systems Available



Side Tape Tensioners



Bottom Rope Tensioner & Rope Covers

Model	Description	Shipping Weight	Warranty
Galaxy Complete	Complete System described above (Includes sockets)	120#	Lifetime Superior
Galaxy Complete-SBS Side-by-Side	Complete side-by-side double court system (Includes sockets)	200#	Lifetime Superior
Galaxy Express	Same system as Galaxy Complete excluding floor sockets	100#	Lifetime Superior
Galaxy Express-SBS Side-by-Side	Same side-by-side system as Galaxy Complete-SBS excluding floor sockets	180#	Lifetime Superior



Galaxy upright padding is available in these colors. Shades may vary slightly from color chart.

www.firstteaminc.com

First Team, Inc. • Hutchinson, Kansas • Toll-Free 1-800-649-3688

the **STELLAR**™

ALUMINUM RECREATIONAL VOLLEYBALL SET



First Team's Stellar aluminum volleyball posts provide the flexibility and performance needed for today's demanding volleyball indoors or out! The Stellar is manufactured from heavy wall 3½" OD aluminum tubing yet is lightweight and easy to setup. The wormgear crank net tensioner will not backdrive and is the same tensioner used in on our elite level volleyball units. Net height is easily adjusted anywhere from 96" down to 42" for all levels of competition volleyball play as well as tennis, badminton, pickleball and other net games. An easy to read net height indicator label is located on each post. To adjust the net simply loosen the securing knob on each net collar and slide net up or down, twist knob tight to secure.

Stellar volleyball posts fit perfectly into any existing 3 ½" floor sockets. If your existing floor sockets are 4" diameter, First Team will provide floor socket adapters free of charge upon request. A variety of Stellar packages are available to suit your needs and budget. Select from complete packages including floor sockets, post pads, antennas, and net rope covers. Or pick the package that includes only those features you require. Post pads are available in 16 colors and lettering is included with the purchase of any Stellar package that includes padding!

Stellar units meet all NCAA, USVBA and National High School Federation rules. So, when you're searching for a volleyball post system that can meet your demands top to bottom, don't settle for performance that is less than Stellar!

FREE LETTERING
Upon Request



Rope Covers Included



Wormgear Net Tensioning Crank

FREE LETTERING WITH PURCHASE OF VOLLEYBALL SYSTEM

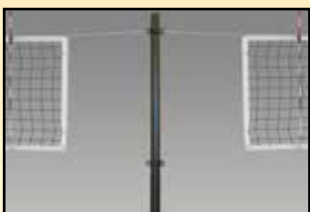

Bottom Rope Tensioner & Rope Covers



Side-By-Side Systems Available

Model	Description	Shipping Weight	Warranty
Stellar Complete	Complete System described above (Includes sockets)	170#	Lifetime Limited
Stellar Complete-SBS Side-by-Side	Complete side-by-side double court system (Includes sockets)	280#	Lifetime Limited
Stellar Express	Same system as Stellar Complete excluding floor sockets	155#	Lifetime Limited
Stellar Express-SBS Side-by-Side	Same side-by-side system as Stellar Complete-SBS excluding floor sockets	260#	Lifetime Limited
Stellar Basic	Same system as Stellar Complete excluding floor sockets, padding and antennas	110#	Lifetime Limited
Sand Stellar Complete	Same system as Stellar Complete including FT5035 Sand Sleeves instead of floor sockets	190#	Lifetime Limited
Sand Stellar Basic	Same system as Stellar Basic includes FT5035 Sand Sleeves	160#	Lifetime Limited



Stellar upright padding is available in these colors. Shades may vary slightly from color chart.

the

BLAST™

STEEL RECREATIONAL VOLLEYBALL SET



First Team introduces the Blast outdoor volleyball system. First Team's Blast volleyball systems are designed to offer high quality performance, durability, versatility and safety all in one affordable package.

The 4" square steel powdercoated uprights can be installed outdoors for either sand or grass volleyball courts. The infinitely adjustable net height from 7' 11 5/8" (men's competition height) down to 3' (tennis net height) makes the Blast a great unit for all ages and all types of net games. Our simple net tensioning device makes setting up the unit quick and easy providing competition level net tensioning.

Installation can be permanent by cementing posts in place, or post can be made removable when used with our FT16 sockets for sand.

First Team offers the Blast volleyball system in an array of configurations. Select from packages with or without padding, sleeves, etc. All Blast volleyball systems are covered by First Team's Lifetime Limited Warranty. When you are searching for the best in affordable volleyball systems, choose First Team and have a BLAST!

FREE LETTERING
Upon Request



Model	Description	Shipping Weight	Warranty
Blast Total	Complete system as described above	200#	Lifetime Limited
Blast Basic	Same system as Blast Total excluding padding and antennas	175#	Lifetime Limited
Sand Blast Complete	Same system as Blast Total plus includes FT16 sleeves for sand.	330#	Lifetime Limited



Blast upright padding is available in these colors. Shades may vary slightly from color chart.

www.firstteaminc.com

First Team, Inc. • Hutchinson, Kansas • Toll-Free 1-800-649-3688

the QUICKSET™

STEEL RECREATIONAL VOLLEYBALL SET



First Team's QuickSet provides quality net play and quick set-up without use of hazardous guy-wires! The QuickSet is the finest backyard volleyball set in its price range. The 2" square uprights are powdercoated black for competition styling. The galvanized upper sections telescope up and down to allow play at any height, men's, women's or junior. The QuickSet comes with the same high quality net and net tensioning device used on our higher end Blast systems.

Choose from two QuickSet configurations to meet your specific needs. The QuickSet-PM comes with our permanent ground stems that can be cemented in place providing a solid, permanent net installation. The QuickSet-SP is a great choice when post removal is desired. The QuickSet-SP includes our ground/floor sockets that can be installed in any indoor or outdoor location, allowing removal of the posts for storage. All systems include competition grade upright padding, available in an array of colors.

If your looking for an economical backyard volleyball system that out performs the rest, get ready, get set, QuickSet!

All QuickSet volleyball systems are covered by First Team's Lifetime Limited Warranty.

FREE LETTERING
Upon Request

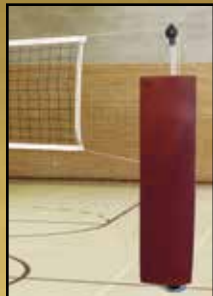

QuickSet-SP Includes Ground/Floor Sockets (Sockets not recommended for sand courts)



Model	Description	Shipping Weight	Warranty
QuickSet-SP	Complete System described above (Includes floor/ground sockets)	130 #	Lifetime Limited
QuickSet-PM	Same system as QuickSet-SP excluding floor sockets	100 #	Lifetime Limited
QuickSet-NP	Same system as QuickSet-PM excluding post pads	80 #	Lifetime Limited



QuickSet upright padding is available in these colors. Shades may vary slightly from color chart.

the APOLLO™

BACKYARD VOLLEYBALL SET



First Team's new Apollo™ backyard volleyball set is designed to provide exceptional net tension and easy setup without the need to imbed poles or sleeves in the ground. 2" diameter galvanized poles provide strong and stable net tension. Apollo's telescoping push button pole design allows quick and easy net height changes so all ages are able to play. Settings are available for official Men's, Women's and Jr. net heights. The net is made with heavy duty 3mm mesh construction surrounded by thick 14 oz. vinyl top, bottom and side bands. Uniquely designed guylines tensioners make for quick and easy guyline tensioning and the 18" guyline stakes included make sure they don't slip even when used on softer ground. Antennas, pole pads and boundary kit are included to give your backyard court that official touch. All components fit easily into the oversized storage bag which even allows extra room to store volleyballs with the set. So, when you next family gathering or weekend cookout calls for fun, reach for the stars with First Team's Apollo!

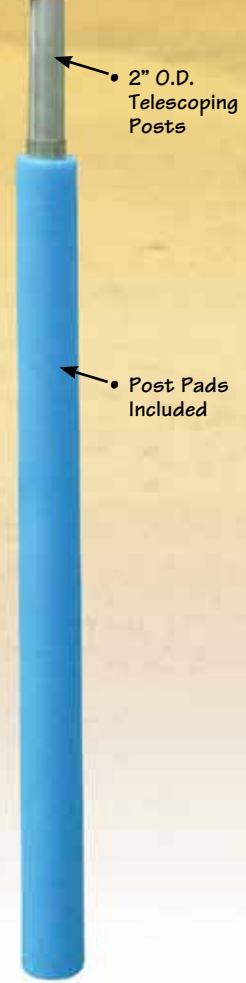
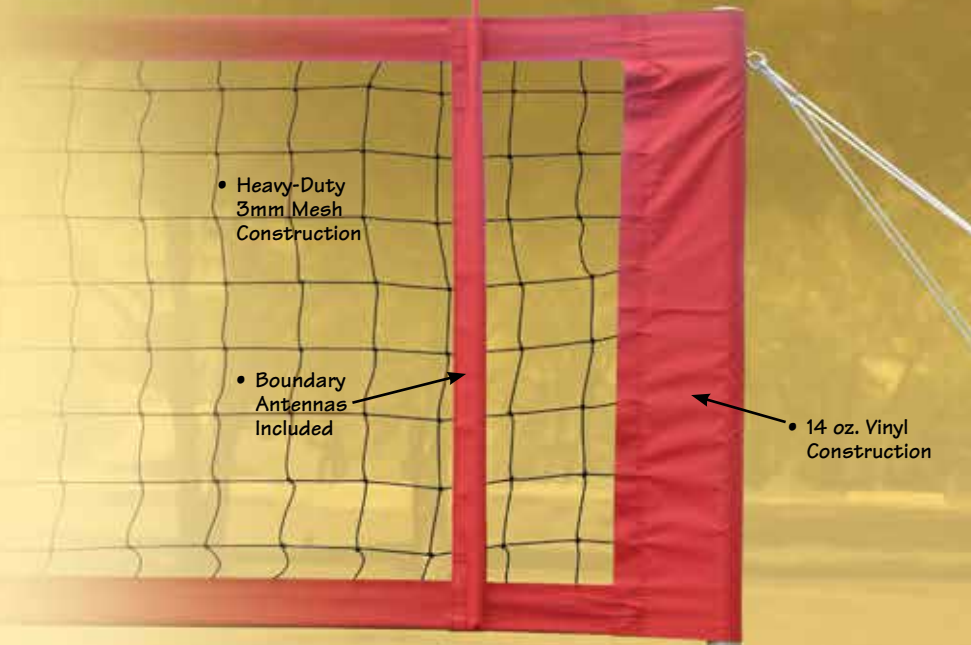

Model	Description	Shipping Weight	Warranty
Apollo USA	Complete System described above	45 #	10-Year Limited

www.firstteaminc.com

First Team, Inc. • Hutchinson, Kansas • Toll-Free 1-800-649-3688

the

HORIZON™

COMPETITION PORTABLE VOLLEYBALL SYSTEM



FREE LETTERING
Upon Request

First Team is proud to introduce the latest in portable volleyball technology with the Horizon! The Horizon competition portable volleyball system is perfect for facilities where volleyball floor socket installation is difficult or impossible.

The Horizon portable base units transport and set up in minutes. Base units can easily be rolled away into a storage room and folded flat for compact storage. Stand posts upright and secure with locking pin for play. The built in anti-skid floor protector engages the floor automatically when post is lifted.

The low profile base design allows for excellent visibility for spectators and line of sight for officials. Each self-contained base has 700# built in ballast to allow bow-string tight net tension requiring absolutely no floor anchors, guy wires or tools. The Horizon is designed for quick and easy net height adjustments including junior, official men's and women's heights with just the turn of a knob. Horizon units include First Team's top quality Kevlar net, antennas, rope covers, post and base padding which may be lettered at no charge. Order Horizon Complete ST package to include First Team's premium SturdiStand padded judges stand.

So, when you are exploring the possibilities for an elite level portable volleyball system, trust First Team and look to the Horizon!



Horizon Complete - ST Package

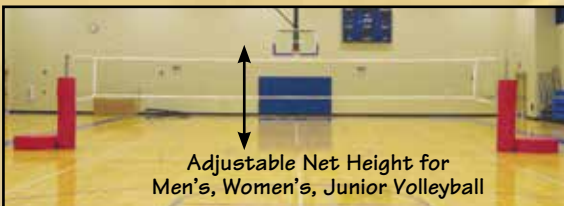

Adjustable Net Height for Men's, Women's, Junior Volleyball



Folds for Compact Storage & Transport



Easy One Person Setup



Bottom Rope Tensioner & Rope Covers



Net Height Indicator



Wormgear Net Tensioning Crank

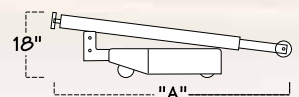
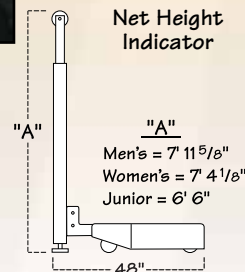

Model	Description	Shipping Weight	Warranty
Horizon Complete	Complete System described above	2500 #	Lifetime Superior
Horizon Complete-ST.	Same system as Horizon Complete including Padded Judges Stand	2800 #	Lifetime Superior

- RY Royal Blue
- SC Scarlet
- GL Gold
- PR Purple
- KG Kelly Green
- BK Black
- CB Columbia Blue
- MR Maroon
- GR Grey
- NY Navy Blue
- OR Orange
- FG Forest Green
- BR Brick Red
- SO Sienna Orange
- DG Desert Gold
- SB Saddle Brown

Horizon upright padding is available in these colors. Shades may vary slightly from color chart.

the PORTACOURT STELLAR™

PORTABLE RECREATIONAL VOLLEYBALL SYSTEM

FREE LETTERING
Upon Request

First Team proudly introduces the Portacourt Stellar portable recreational volleyball system. Portacourt sport bases provide the perfect combination of game quality net tension and ease of transport for budget conscious facilities that require higher level performance than common recreational tip n roll type sets. Portable volleyball sets are the answer for facilities where floor sockets are impossible or not desired. Each Portacourt sport base is designed to receive (19) 4"x8"x16" solid cement blocks (570 lbs.) commonly available at any builder's supply center. Simply slide the Stellar volleyball post into the post receiver sleeve welded to the front of the portable base. Then using a 3/4" socket wrench lower all three protective footpads to the floor. Set net height at men's, women's or junior height and your ready to play! Each unit includes safety padding to cover ballast box, neck and volleyball post. The base units can be moved by one adult with no need to remove ballast blocks. Each Portacourt Stellar package includes First Team's top quality Kevlar competition volleyball net, antennas, rope covers, post pads and base pads. Free post pad lettering is available upon request. Choose Portacourt Stellar ST package to include First Team's fully padded Sturdistand judges stand.

When your game calls for a recreational portable volleyball set that promises competition quality net tension and ease of transport. Call on First Team's Portacourt Stellar systems to get your game moving!



Rope Covers Included

Portacourt Stellar Complete Package Shown



Portacourt Stellar Complete - ST Package



User Supplied Concrete Block Ballast



Net Height Indicator



One Person Transport

Bottom Rope Tensioner & Rope Covers



Wormgear Net Tensioning Crank

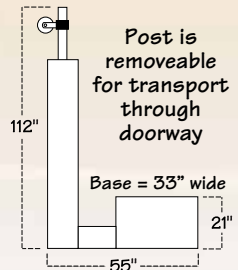

Model	Description	Shipping Weight	Warranty
Portacourt Stellar Complete	Complete System described above	500 lbs.	Lifetime Limited
Portacourt Stellar Complete ST	Same as Portacourt Stellar Complete Including Padded Judges Stand	600 lbs.	Lifetime Limited

- RY
Royal Blue
- SC
Scarlet
- GL
Gold
- PR
Purple
- KG
Kelly Green
- BK
Black
- CB
Columbia Blue
- MR
Maroon
- GR
Grey
- NY
Navy Blue
- OR
Orange
- FG
Forest Green
- BR
Brick Red
- SO
Sienna Orange
- DG
Desert Gold
- SB
Saddle Brown

Portacourt Stellar upright padding is available in these colors. Shades may vary slightly from color chart.

www.firstteaminc.com

First Team, Inc. • Hutchinson, Kansas • Toll-Free 1-800-649-3688

the **STELLAR AQUA**™ *First Team*

POOLSIDE ALUMINUM VOLLEYBALL SET

First Team is proud to introduce the Stellar Aqua poolside aluminum volleyball system! For those looking for a competition level quality volleyball set for the swimming pool, First Team's Stellar Aqua is unmatched!

The Stellar Aqua is manufactured using 3 1/2" diameter aluminum posts and a powder coat finish. The worm gear net tensioner is the same one used on our competition sets. No more sagging, drooping volleyball nets, the Stellar Aqua will remain bowstring tight. The Stellar Aqua-SP package includes our hinged ground sockets for easy installation and removal. When the posts are removed, the hinged lid covers the sleeve and provides a nice finished look. The net is manufactured from the same high quality materials our competition nets are made of. Because each pool set up is different, please specify the desired net length when ordering, allow 3 weeks for custom net production.

Allow
3 Weeks
For
Custom
Net Lengths

When choosing a volleyball system for your pool, don't settle for less than the best, First Team's Stellar Aqua!



Bottom Rope Tensioner



Wormgear
Net
Tensioning
Crank

Wormgear
Net
Tensioning
Crank



Model	Description	Shipping Weight	Warranty
Stellar Aqua - SP	Complete System described above	100#	Lifetime Limited

100

www.firstteaminc.com

First Team, Inc. • Hutchinson, Kansas • Toll-Free 1-800-649-3688

VOLLEYBALL ACCESSORIES

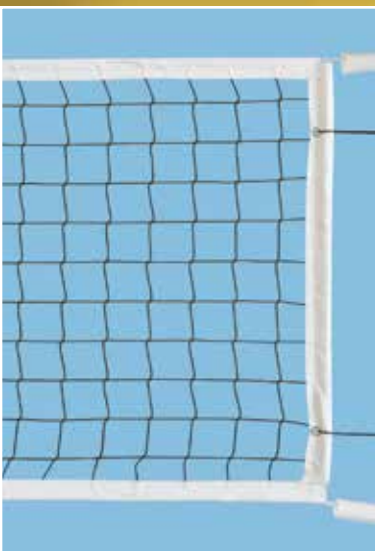

◀ FT5002

- Kevlar Competition Volleyball Net
- Designed specifically for First Team volleyball systems
- 1/4" No stretch Kevlar top rope
- Knotless woven webbing for tighter net tensioning and a more professional look
- Bright white top, bottom & side tapes
- 32' x 1 meter official size
- 2 Year Limited Warranty
- Shipping weight 15 lbs.

◀ FT5002-CL

- Custom Length Volleyball Net
- Same specifications as FT5002 except for custom length
- 2 Year Limited Warranty
- Shipping weight 15 lbs.



◀ FT5004

- Competition Volleyball Antennas
- Preferred by top programs
- Two-piece antenna
- Attaches to any 1 meter / 36" tall net with hook & loop fasteners
- Official 72" x 3/8" fiberglass rod
- Outfits one net
- 1 Year Limited Warranty
- Shipping weight 3 lbs.



◀ FT5300CH

- Blast Clamp Hardware Only
- Clamp set can be used with any 4"x4" square steel or wooden posts
- Perfect for budget conscious programs looking to save
- Includes net clamps, pulley wheel, clamp tensioning knobs and net tensioners
- Shipping weight 14 lbs. each



◀ FT5005

- Replacement Volleyball Winch
- Wormgear style crank net tensioner
- Safe, will not backdrive
- Secures to any 3" or 3 1/2" round diameter volleyball post
- 5 Year Limited Warranty
- Shipping weight 5 lbs.



◀ FT5010

- Competition Grade Volleyball Post Padding
- Meets NCAA, USVBA and National High School Federation rules
- Fits First Team as well as other manufacturers systems
- 1 1/2" thick high density foam with velcro closure
- Protects to 6' height
- Available in 12 colors
- Sold in pairs (outfits one complete volleyball system)
- LTR 5010 Pad Lettering available (10 letters max)
- 5 Year Limited Warranty
- Shipping weight 20 lbs.



◀ FT5001

- 3 1/2" Chrome Post Socket
- Designed for use with 3 1/2" diameter volleyball uprights
- Chrome painted hinged floor plate
- 10" deep
- For use on floating wooden floors, synthetic/tile floors or plain concrete floors
- Also works as a mower safe socket for outdoor grass or concrete courts
- Requires two sockets per system
- CAUTION! Floor sockets are difficult and often impossible to install on floors with basements or hollow cavities below. Consult an experienced installer for assistance.
- Shipping weight 10 lbs. each

FT5000RDC3 (Not shown)

- Volleyball Post Reducer
- Reduces First Team 3 1/2" round volleyball poles to fit into 3" floor sockets
- Factory installed Free with purchase of volleyball system

FT5000SPC3.5 (Not shown)

- Volleyball Floor Socket Spacer
- Reduces diameter of existing 4" floor sockets to fit 3 1/2" volleyball poles.
- Drops into place



◀ FT5010CP

- Center Post Padding for Side-By-Side volleyball systems
- Same as our FT5010 padding except has velcro closure on both sides allowing center post to accommodate nets on both sides of post.
- Provided standard with First Team side-by-side packages
- Sold individually
- LTR 5010CP Pad Lettering available (10 letters max)
- 5 Year Limited Warranty
- Shipping weight 10 lbs.

www.firstteaminc.com

First Team, Inc. • Hutchinson, Kansas • Toll-Free 1-800-649-3688

VOLLEYBALL ACCESSORIES



SturdiStand™

- Folding Padded Volleyball Judges Stand
- All-Aluminum Construction
- Meets all NCAA, National High School Federation and USVBA rules
- Easy pull-pin folding design
- Durable powdercoat finish
- Non-marking wheels and floor pads
- Heavy vinyl covered foam padding incl.
- Choose from 12 padding colors
- Lifetime Limited Warranty
- Shipping weight 60 lbs.



FT5012
Padding
Included



Ball Hog™

FT24

- Super Duty Volleyball Carrier
- Holds 30 volleyballs
- Large non-marking casters for "No-Tip" rolling
- Tote handle - easy transport
- Also a basketball carrier
- Approx. Shipping Wt. 92 lbs.



FT5050

- Economy Volleyball Judges Stand
- 1 1/4" diameter plated steel
- Non-marking wheels
- Artificial turf covered platform
- Padding Available in Black only
- Shipping weight 75 lbs.
- 1-Year Limited Warranty

FT5035

- Sand Volleyball Sleeve
- Allows easy removal of 3.5" diameter volleyball post
- Black powder coat finish
- Lifetime Limited Warranty
- Shipping weight: 31 lbs.

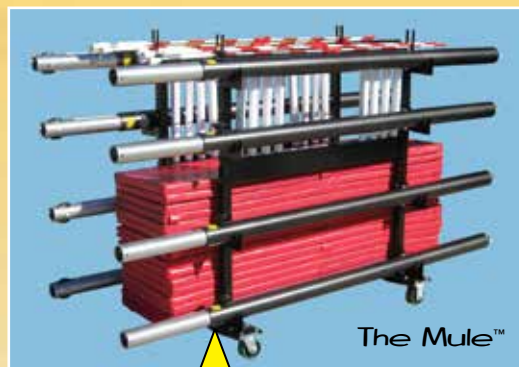

The Mule™

FT5025

- Volleyball Post Storage and Transport Cart
- Transports up to 4 complete courts
- Heavy Duty 2" tubular steel construction
- Easy one person transport
- Non-marking casters
- Cushioned post cradles protect post paint
- Black powder coat finish
- Lifetime Limited Warranty
- Shipping weight: 75 lbs.



FT5020

- Folding Volleyball Drill Cart
- Includes carrying case
- Measures 48"L x 22"W x 12"D x 40"H
- Holds approximately 30 balls
- Shipping weight 15 lbs.
- 1 Year Limited Warranty



FT15

- Economy Ball Carrier (also basketballs)
- 1" dia. chrome plated steel
- Includes four swivel casters
- Shipping weight 13 lbs.
- 1-Year Limited Warranty

VOLLEYBALL ACCESSORIES



FT5003

- Net Side Tensioners
- Included with all First Team Galaxy, Astro and Frontier volleyball systems
- Easy ratchet design pulls tight, with push button release
- Quick, easy and safe
- Set of four tensioners
- Shipping weight 1 lb.

FT5014

- Precise Height Net Height Gauge
- Best net height gauge available
- Preferred by top programs
- Telescoping aluminum
- Net height markings on pole for all common net heights
- Shipping weight 2 lbs.



FT5011

- Net Cable Covers
- Provided with Galaxy and Frontier
- Fits any manufacturers system
- 18" padding protects players from cables
- Set of four covers
- Shipping weight 1 lb.

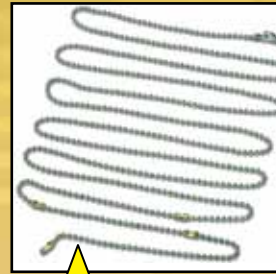

FT5013

- Net Setter Chain-Style Net Height Gauge
- Multiple indicators for all common net heights
- Shipping weight 1 lb.



FT5015

- Outdoor Volleyball Boundary Kit
- Bright Orange 1/4" polypropylene rope
- Corner ties and center court marking
- Heavy duty plastic corner stakes
- Measures 30'x60'
- Shipping weight 4 lbs.

THE VOLLEYBALL COURT

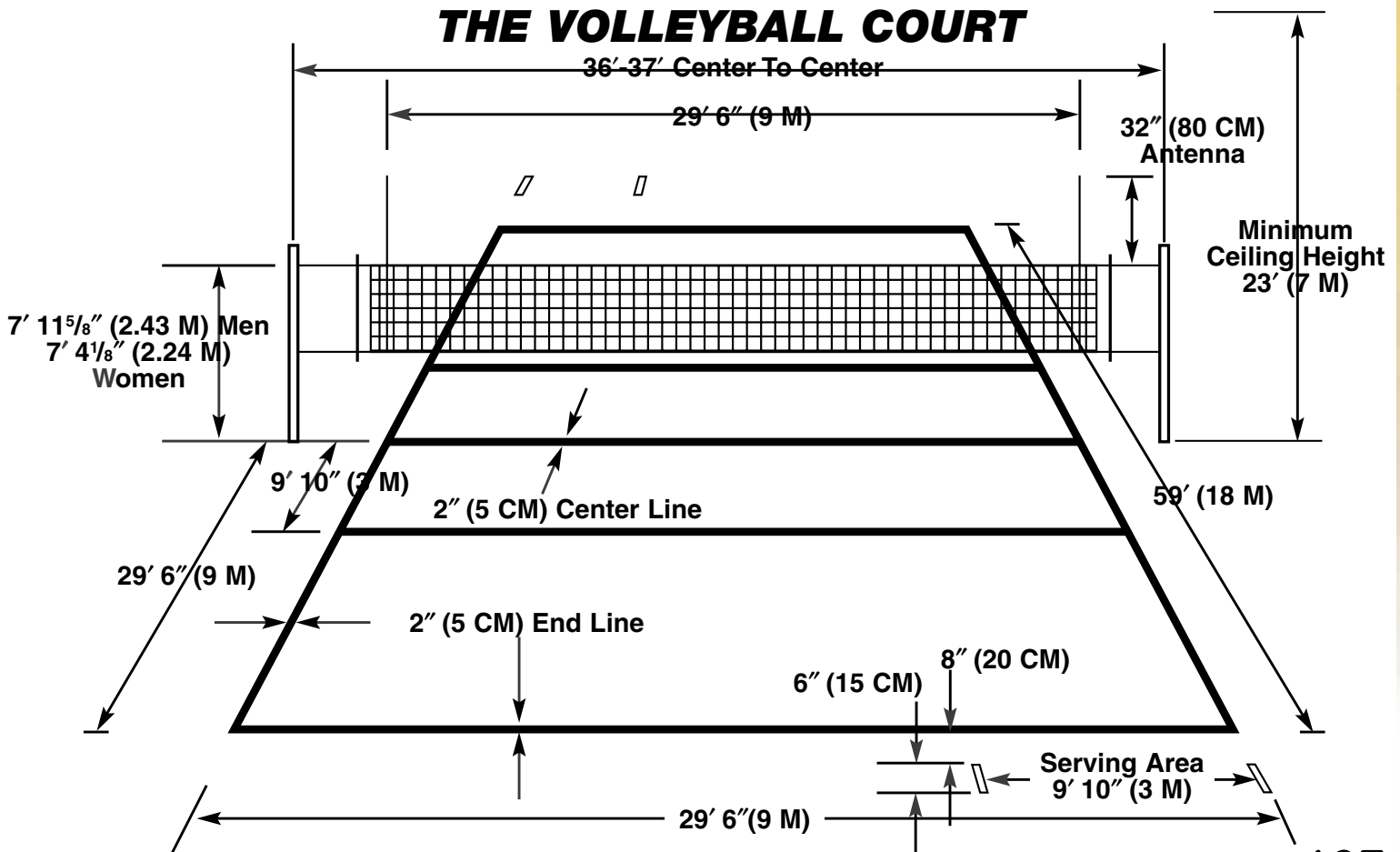

the WORLD CLASS™ 40

4" ROUND ALUMINUM PORTABLE SOCCER GOAL



First Team introduces the World Class 40 line of 4" round aluminum portable soccer goals! The World Class 40 line is designed to maximize functionality while keeping budget conscious programs in the game. No other line can claim to offer the value of World Class 40!

All World Class 40 soccer goals are manufactured to exacting standards for true, seamless fit throughout. The 4" round aluminum uprights and crossbar are powdercoated white for an aesthetic appeal. First Team's World Class net fastening system attaches net securely in place. Once in place, World Class net clips will not come loose or get lost. No more velcro straps, welded hooks or nylon ties. Unlike other manufacturers clips, World Class net fasteners will not become loose or cause misalignment of net.

World Class 40 backstays are manufactured of 100% galvanized 1 3/4" round tube and will not rust. Backstays are designed extra deep for added stability and security and include our built in portable wheel feature for ease of transport. All World Class 40 goals meet or exceed ASTM F2950-14 for tipover and failure requirements. All World Class soccer units meet NCAA, NHSF and FIFA rules.

First Team is also one of the only manufacturers to include a padding compensation feature with all soccer goals. All goals can be assembled at official opening width or extended to compensate for thickness of upright padding if applicable.

World Class 40 goals are sold complete and always include goal structure, backstays, ground bar, transport wheel kits, auger style ground anchors and professional style hexagonal net.

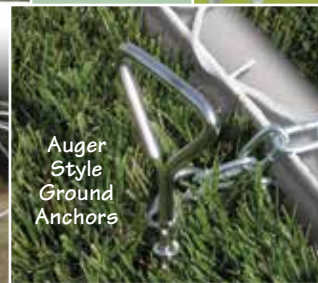

AVAILABLE IN 4 POPULAR SIZES:

- ELITE 24' x 8'
- SR. CLUB 21' x 7'
- JR. CLUB 18.5' x 6.5'
- ELEMENT 12' x 6.5'

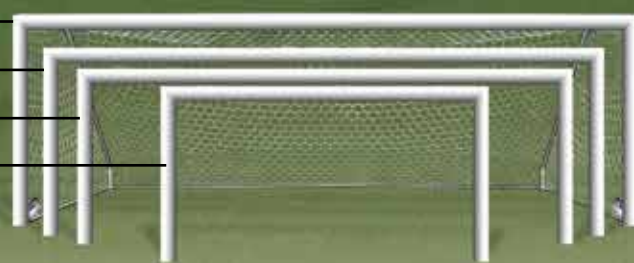

Model	Goal Size	Shipping Weight	Warranty
World Class 40 Elite-PB	24'(w) x 8'(h) x 4'(t) x 10'(b)	500#/pair	Lifetime Limited
World Class 40 Sr. Club-PB	21'(w) x 7'(h) x 4'(t) x 7'(b)	490#/pair	Lifetime Limited
World Class 40 Jr. Club-PB	18.5'(w) x 6.5'(h) x 4'(t) x 6.5'(b)	450#/pair	Lifetime Limited
World Class 40 Element-PB	12'(w) x 6.5'(h) x 4'(t) x 6.5'(b)	310#/pair	Lifetime Limited

the WORLD CLASS™ 40

4" ROUND ALUMINUM PERMANENT/SEMI-PERMANENT SOCCER GOAL



First Team introduces the World Class 40 line of 4" round aluminum permanent and semi-permanent soccer goals! The World Class 40 line is designed to maximize functionality while keeping budget conscious programs in the game. No other line can claim to offer the value of World Class 40!

All World Class 40 soccer goals are manufactured to exacting standards for true, seamless fit throughout. The 4" round aluminum uprights and crossbar are powdercoated white for an aesthetic appeal. First Team's World Class net fastening system attaches net securely in place. Once in place, World Class net clips

will not come loose or get lost. No more velcro straps, welded hooks or nylon ties. Unlike other manufacturers clips, World Class net fasteners will not become loose or cause misalignment of net.

All World Class 40 permanent and semi-permanent goals include free 4' European Style backstays giving depth to the goal and net. Semi-permanent packages include our exclusive ground sockets with chrome plated cover lids. And don't forget First Team always includes our heavy duty professional style hexagonal mesh net with every goal!

All World Class 40 goals meet or exceed ASTM F2950-14 guidelines. All World Class 40 soccer units meet NCAA, NHSF and FIFA rules.

First Team is also one of the only manufacturers to include a padding compensation feature with all soccer goals. All goals can be assembled at official opening width or extended to compensate for thickness of upright padding if applicable.



Net Stakes (8) Included



Net Attachment



Easy Semi-Permanent Installation



Mower Safe Sockets for Semi-Permanent Goals



Ground Stem extends to 36" for permanent in-ground footing or 10" for Semi-Permanent applications

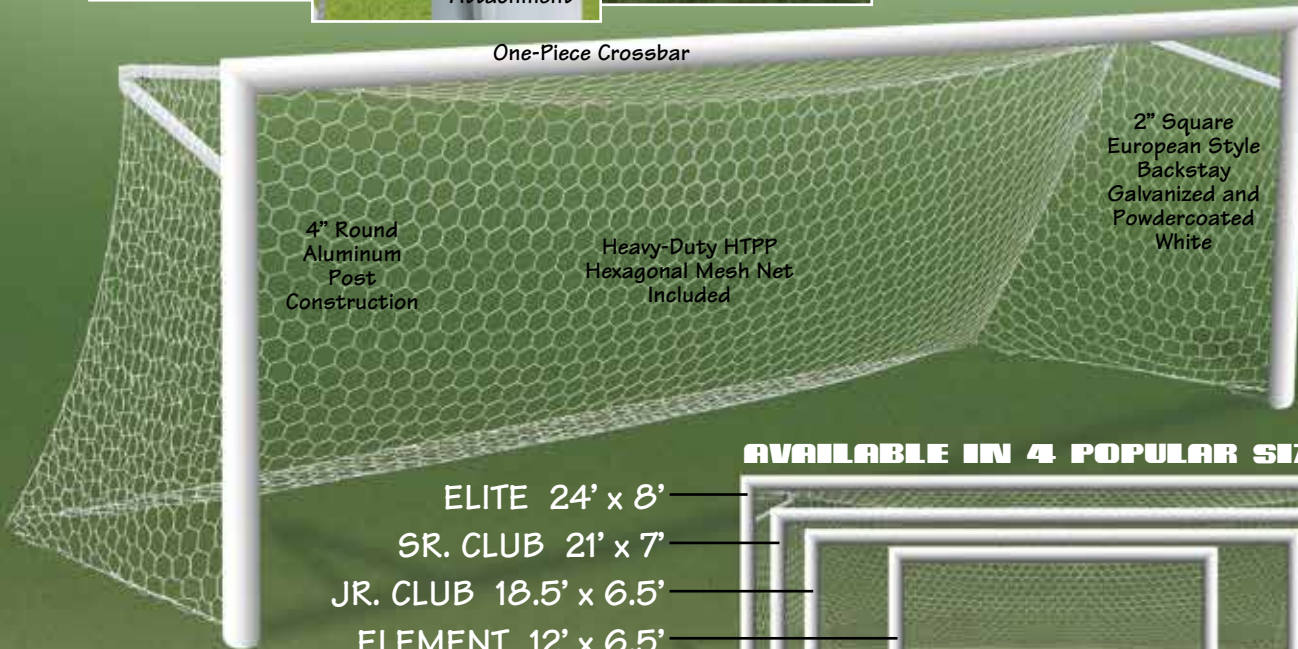

One-Piece Crossbar

4" Round Aluminum Post Construction

Heavy-Duty HTPP Hexagonal Mesh Net Included

2" Square European Style Backstay Galvanized and Powdercoated White

AVAILABLE IN 4 POPULAR SIZES:

- ELITE 24' x 8'
- SR. CLUB 21' x 7'
- JR. CLUB 18.5' x 6.5'
- ELEMENT 12' x 6.5'

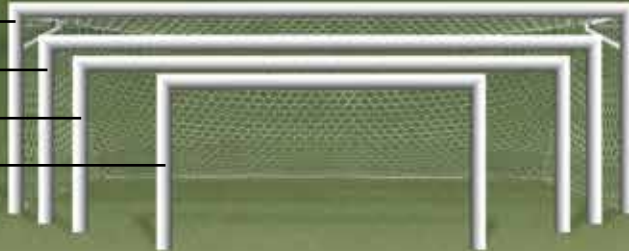

FREE! European Backstays Included

Model	Goal Type	Goal Size	Shipping Weight	Warranty
World Class 40 Elite-PM	Permanent	24'(w) x 8'(h) x 4'(t) x 10'(b)	500#/pair	Lifetime Limited
World Class 40 Sr. Club-PM	Permanent	21'(w) x 7'(h) x 4'(t) x 7'(b)	490#/pair	Lifetime Limited
World Class 40 Jr. Club-PM	Permanent	18.5'(w) x 6.5'(h) x 4'(t) x 6.5'(b)	450#/pair	Lifetime Limited
World Class 40 Element-PM	Permanent	12'(w) x 6.5'(h) x 4'(t) x 6.5'(b)	310#/pair	Lifetime Limited
World Class 40 Elite-SP	Semi-Permanent	24'(w) x 8'(h) x 4'(t) x 10'(b)	520#/pair	Lifetime Limited
World Class 40 Sr. Club-SP	Semi-Permanent	21'(w) x 7'(h) x 4'(t) x 7'(b)	510#/pair	Lifetime Limited
World Class 40 Jr. Club-SP	Semi-Permanent	18.5'(w) x 6.5'(h) x 4'(t) x 6.5'(b)	470#/pair	Lifetime Limited
World Class 40 Element-SP	Semi-Permanent	12'(w) x 6.5'(h) x 4'(t) x 6.5'(b)	330#/pair	Lifetime Limited

www.firstteaminc.com

First Team, Inc. • Hutchinson, Kansas • Toll-Free 1-800-649-3688

the GOLDEN GOAL™ 44

ALUMINUM PORTABLE SOCCER GOAL



First Team introduces the Golden Goal 44 line of portable aluminum soccer goals! The Golden Goal 44 line sets a new standard in the soccer industry for durability, dependability, portability and safety. No other line of soccer goals offers all of the built in features included with these units.



All Golden Goal 44 soccer goals are manufactured to exacting specifications for a true, seamless fit throughout. The 4"x4" square aluminum uprights and crossbar are extruded with a safe 3/4" rounded radius on the corners for safety. The uprights, crossbar and backstay are fully integrated with First Team exclusive "STAY-PUT" net attachment design. With "STAY-PUT" there are no velcro straps, welded hooks, screws, nylon ties or plastic clips. STAY-PUT is the first, fully integrated net

attachment system for soccer. Simply weave the attachment rope into the attachment notches located throughout the goal structure. The net will "STAY-PUT" until you are ready to remove it and there are no clips, etc. to lose or misplace. With STAY-PUT the net always remains tight and true because there are no clips to slide out of place common with other manufacturers lines.

Golden Goal 44 backstays are 100% manufactured of galvanized 2" square tubing that is powdercoated white, making the unit totally rust-proof for premium long-lasting aesthetic appeal. Backstays are reinforced at all corners to prevent weld fatigue common with other brands. All goals meet or exceed ASTM F2950-14 for tipover and failure requirements. All Golden

Goal 44 soccer units meet NCAA, National High School Federation and FIFA rules.

First Team is also one of the only manufacturers to include a padding compensation feature with all soccer goals. All goals can be assembled at official opening width or extended to compensate for thickness of upright padding if applicable.

Golden Goal 44's are sold complete and always include goal structure, backstays, ground bar, transport wheel kits, auger style ground anchors, and professional style hexagonal net. All Golden Goal 44 soccer goals are covered by First Teams' exclusive Lifetime Superior Warranty.

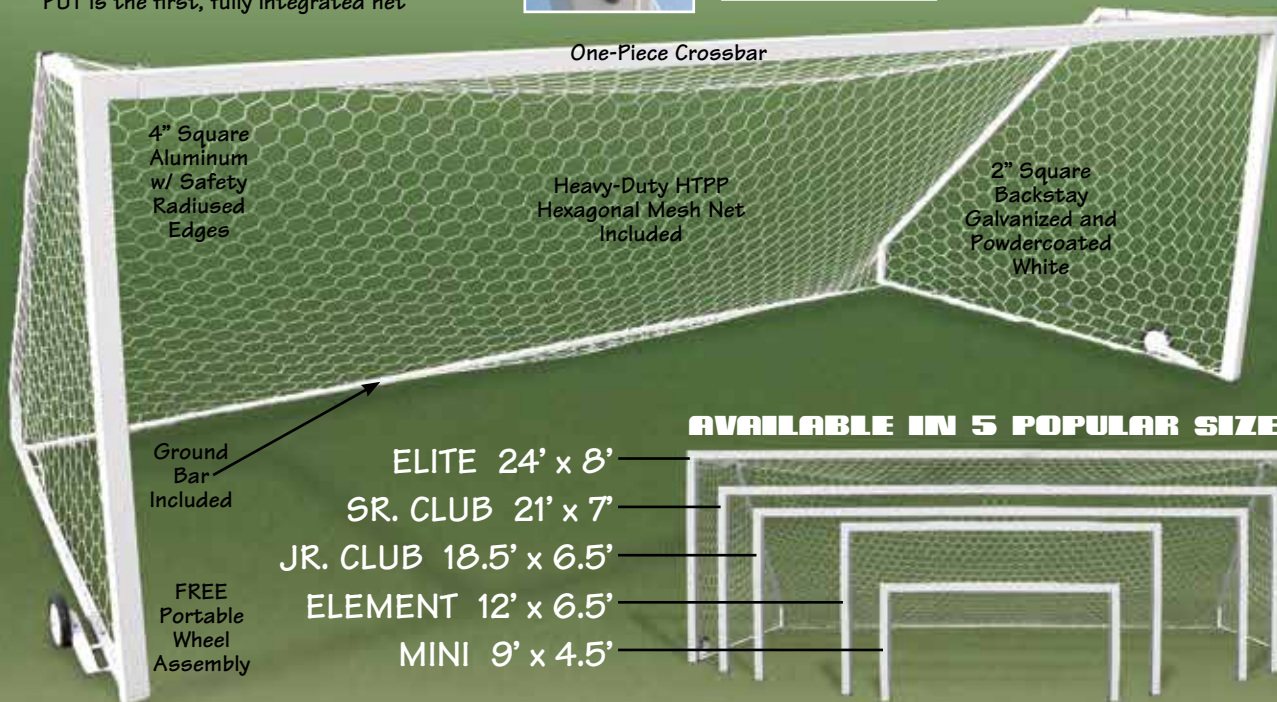

AVAILABLE IN 5 POPULAR SIZES:

- ELITE 24' x 8'
- SR. CLUB 21' x 7'
- JR. CLUB 18.5' x 6.5'
- ELEMENT 12' x 6.5'
- MINI 9' x 4.5'

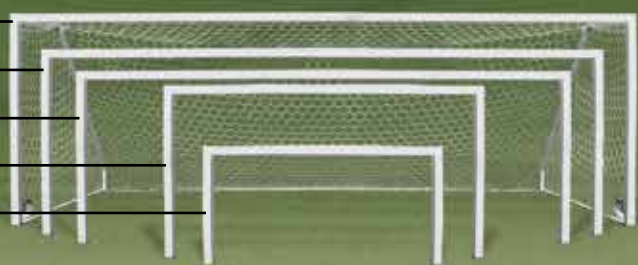

Model	Goal Size	Shipping Weight	Warranty
Golden Goal 44 Elite-PB	24'(w) x 8'(h) x 4'(t) x 10'(b)	500#/pair	Lifetime Superior
Golden Goal 44 Sr. Club-PB	21'(w) x 7'(h) x 4'(t) x 7'(b)	490#/pair	Lifetime Superior
Golden Goal 44 Jr. Club-PB	18.5'(w) x 6.5'(h) x 4'(t) x 6.5'(b)	450#/pair	Lifetime Superior
Golden Goal 44 Element-PB	12'(w) x 6.5'(h) x 4'(t) x 6.5'(b)	310#/pair	Lifetime Superior
Golden Goal 44 Mini-PB	9'(w) x 4.5'(h) x 2'(t) x 4.5'(b)	240#/pair	Lifetime Superior

the GOLDEN GOAL™ 44

ALUMINUM PERMANENT/SEMI-PERMANENT SOCCER GOAL



First Team introduces the Golden Goal 44 line of permanent and semi-permanent aluminum soccer goals! The Golden Goal 44 line sets a new standard in the soccer industry for durability, dependability, and safety. No other line of soccer goals offers all of the built in features included with these units.



All Golden Goal 44 soccer goals are manufactured to exacting specifications for a true, seamless fit throughout. The 4"x4" square aluminum uprights and crossbar are extruded with a safe 3/4" rounded radius on the corners for safety. The uprights and crossbar are fully integrated with First Team's exclusive "STAY-PUT" net attachment design. With "STAY-PUT" there are no velcro, welded hooks, screws, nylon ties or

plastic clips. STAY-PUT is the first, fully integrated net attachment system for soccer. Simply weave the attachment rope into the attachment notches located throughout the goal structure. The net will "STAY-PUT" until you are ready to remove it and there are no clips, etc. to lose or misplace. With STAY-PUT the net always remains tight and true because there are no clips to slide out of place common with other manufacturers lines.

All Golden Goal 44 permanent and semi-permanent units include free European Style backstays for added aesthetic appeal. Semi-permanent packages include our exclusive ground sockets with chrome plated cover lids. Don't forget First Team always includes our heavy duty professional style hexagonal mesh net with every goal!

All goals meet or exceed ASTM F2950-14 guidelines. All Golden Goal 44 soccer units meet NCAA, National High School Federation and FIFA rules.

First Team is also one of the only manufacturers to include a padding compensation feature with all soccer goals. All goals can be assembled at official opening width or extended to compensate for thickness of upright padding if applicable.

All Golden Goal 44 soccer goals are covered by First Team's exclusive Lifetime Superior Warranty.



AVAILABLE IN 5 POPULAR SIZES:

- ELITE 24' x 8'
- SR. CLUB 21' x 7'
- JR. CLUB 18.5' x 6.5'
- ELEMENT 12' x 6.5'
- MINI 9' x 4.5'

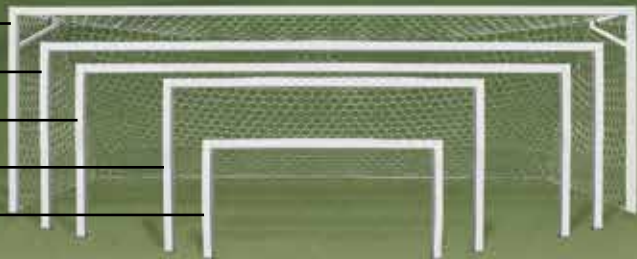

Model	Goal Type	Goal Size	Shipping Weight	Warranty
Golden Goal 44 Elite-PM	Permanent	24'(w) x 8'(h) x 4'(t) x 10'(b)	500#/pair	Lifetime Superior
Golden Goal 44 Sr. Club-PM	Permanent	21'(w) x 7'(h) x 4'(t) x 7'(b)	490#/pair	Lifetime Superior
Golden Goal 44 Jr. Club-PM	Permanent	18.5'(w) x 6.5'(h) x 4'(t) x 6.5'(b)	450#/pair	Lifetime Superior
Golden Goal 44 Element-PM	Permanent	12'(w) x 6.5'(h) x 4'(t) x 6.5'(b)	310#/pair	Lifetime Superior
Golden Goal 44 Mini-PM	Permanent	9'(w) x 4.5'(h) x 2'(t) x 4.5'(b)	240#/pair	Lifetime Superior
Golden Goal 44 Elite-SP	Semi-Permanent	24'(w) x 8'(h) x 4'(t) x 10'(b)	520#/pair	Lifetime Superior
Golden Goal 44 Sr. Club-SP	Semi-Permanent	21'(w) x 7'(h) x 4'(t) x 7'(b)	510#/pair	Lifetime Superior
Golden Goal 44 Jr. Club-SP	Semi-Permanent	18.5'(w) x 6.5'(h) x 4'(t) x 6.5'(b)	470#/pair	Lifetime Superior
Golden Goal 44 Element-SP	Semi-Permanent	12'(w) x 6.5'(h) x 4'(t) x 6.5'(b)	330#/pair	Lifetime Superior
Golden Goal 44 Mini-SP	Semi-Permanent	9'(w) x 4.5'(h) x 2'(t) x 4.5'(b)	260#/pair	Lifetime Superior

www.firstteaminc.com

First Team, Inc. • Hutchinson, Kansas • Toll-Free 1-800-649-3688

MISCELLANEOUS SOCCER ACCESSORIES

SOCCER NETS

Model #	Mesh Diameter	Width	Height	Top Depth	Bottom Depth	Shipping Weight
FT4024N	3MM	24'	8'	4'	10'	11 lbs. / each
FT4021N	3MM	21'	7'	4'	7'	7 lbs. / each
FT4018N	3MM	18.5'	6.5'	4'	6.5'	6 lbs. / each
FT4012N	3MM	12'	6.5'	4'	6.5'	5 lbs. / each
FT4009N	3MM	9'	4.5'	2'	4.5'	3 lbs. / each
FT4006FKN	3MM	6'	4'	0'	3'	3 lbs. / each



- Heavy duty high tenacity polypropylene (HTPP)
- Professional style hexagonal mesh
- Non-abrasive knotless netting
- White mesh with heavy perimeter attachment rope
- Usable with other brand soccer goals with similar dimensions
- **Notice! Soccer Nets are not returnable once opened unless defective**
- Two Year Limited Warranty

FT4025

- Official soccer corner flags
- One piece official corner flags
- 1" dia. white PVC with red flag
- Spring-loaded for player safety
- Push in ground anchor
- Set of 4
- App. shipping weight 20 lbs. UPS



FT4025TF

- Official soccer corner flags
- One piece official corner flags
- 1" dia. white PVC with red flag
- Made to use on artificial turf
- Weighted base for stability
- Set of 4
- App. shipping weight 7 lbs. UPS

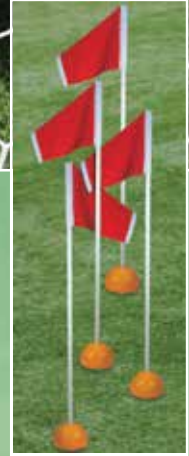

- Use when portable soccer goals sit underneath football goal posts
- Clamps to any 4 1/2", 5 9/16" or 6 5/8" round football goal post
- Prevents accidental tip over of portable soccer goals
- Quick attachment and removal using 3/4" hex wrench
- App. shipping weight 5 lbs.



FT4034

- 4' European Style Backstays
- Included FREE with every Golden Goal Permanent/Semi-Permanent Soccer Package
- Can use with other brands of soccer goals (requires drilling)
- Maintains 4' back depth for soccer nets
- Sold in pairs, order (1) pair per goal
- Approx. shipping weight 40 lbs./pair, Truck

FT4032 (Not shown)

- 2' European Style Backstays
- Same features as FT4034 except:
- Maintains 2' back depth for soccer nets
- Approx. shipping weight 20 lbs./pair, Truck



FT5001

- Post socket for semi-permanent goals
- Included with every Golden Goal Semi-Permanent Soccer Package
- Exclusively for Golden Goal & World Class soccer goals
- Chrome painted cover keeps out dirt and debris
- Mower safe
- Order two per goal
- App. shipping weight 18 lbs. UPS

FT4026

- Wheel kit for portable soccer goals
- Included with every First Team portable soccer goal
- Can be used with other brands (requires drilling)
- Reduces stress and breakage caused by dragging goals
- Flips forward for easy transport, flips back for play
- 10" transports wheels
- Sold as set of two (outfits one soccer goal)
- Approx. shipping weight 33 lbs. UPS



MISCELLANEOUS SOCCER ACCESSORIES



FT4048S

- Soccer post upright padding
- Protects players from contact with uprights
- 1" thick padding 48" tall section
- Fits 4"x4" square uprights
- Can be combined with our FT4030S padding to cover virtually any goal height
- Will not affect ball rebound off posts
- Sold in pairs
- Approx. shipping weight 10 lbs./pair UPS

FT4030S (Not shown)

- Soccer post upright padding
- Same features as FT4048S except 30" tall
- To be used in combination with FT4048S to pad virtually any goal height
- Sold in pairs
- Approx. shipping weight 10 lbs./pair UPS



FT4027

- Soccer goal ground anchors
- Auger type anchors
- Superior to ground stakes for goal anchoring
- Provided standard with all First Team portable soccer goals
- Set of (2) anchors, use (2) per goal
- Approx. shipping weight 5 lbs. UPS



FT4028

- Net stakes for permanent or semi-permanent soccer nets
- Set of (8) net stakes
- Hold net tightly and securely to ground
- Included with each First Team permanent or semi-permanent soccer goal
- Use 2 per side and 4 across back of net
- Approx. shipping weight 5 lbs. UPS

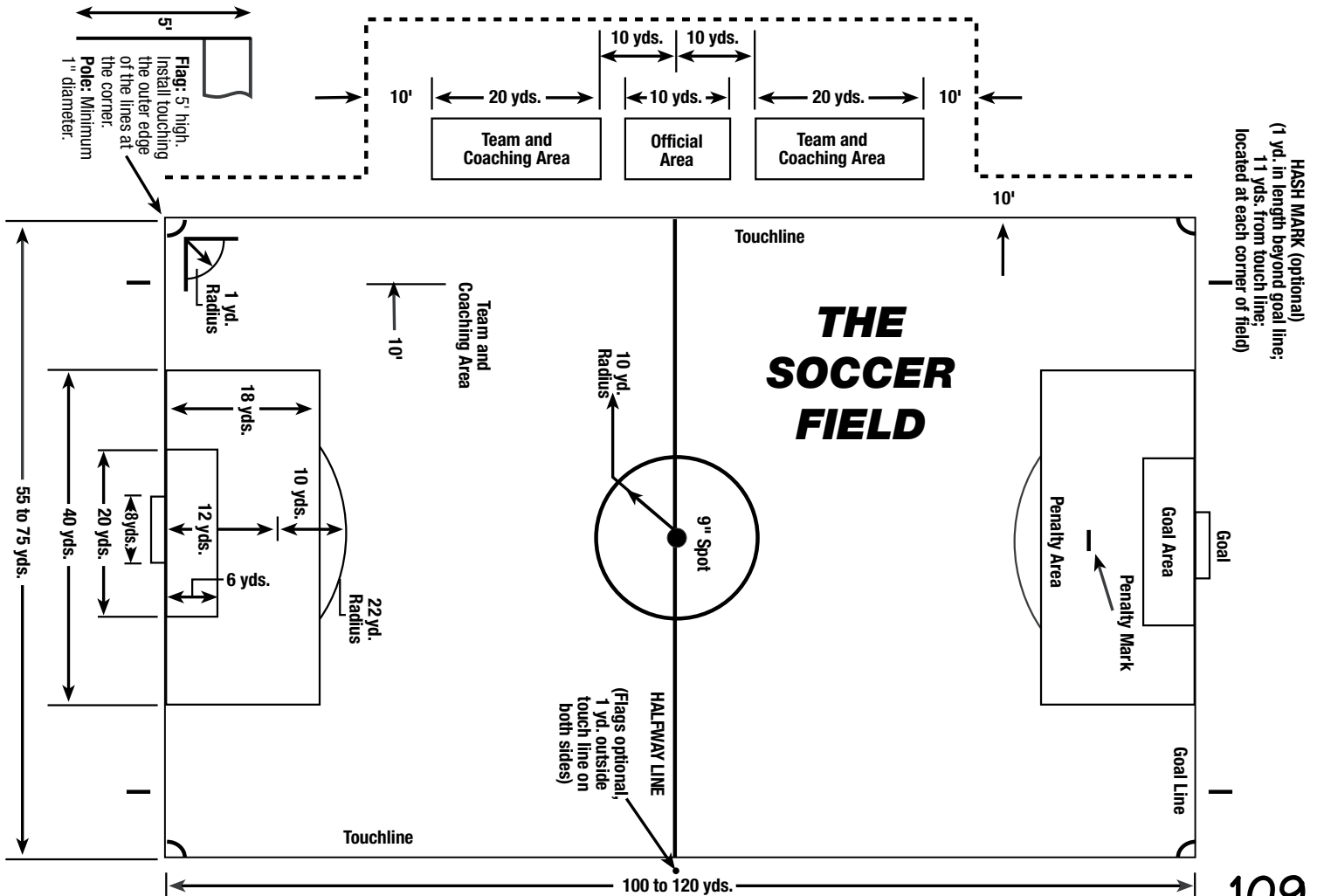

the **FREEKICK**™

BACKYARD PORTABLE SOCCER GOAL

First Team

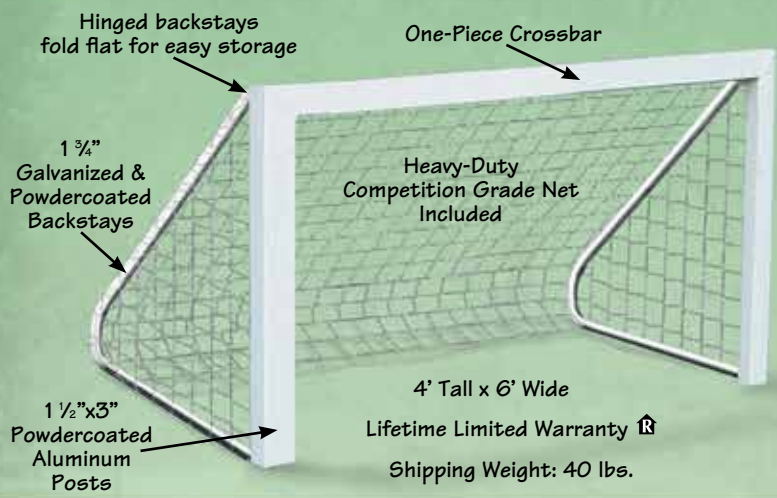

First Team introduces the FreeKick! The durable 1 1/2"x3" aluminum uprights and crossbar are powdercoated white for an official look and long term durability. The 1 3/4" galvanized backstays lock into place for rock solid play, yet quickly fold for convenient storage. The FreeKick comes complete with a competition grade net secured to the goal and backstays using our trademarked "Klip-It™" releasable clip design. No more chasing stray soccer balls because of sagging, out of place soccer nets. The FreeKick net will stay in place no matter what. Why settle for cheap, flimsy backyard goals that can't hold their ground? Finally, First Team offers a backyard soccer goal truly designed to perform up to the standards that your home team demands. The FreeKick is the perfect goal for tough backyard matches, spirited church play, daycare centers or anywhere soccer fans gather to play! When it comes time to choose a top quality soccer goal for your backyard, get your kicks with First Team's FreeKick!



LACROSSE GOALS



the **WARLORD**™
COMPETITION LACROSSE GOAL

First Team's WarLord competition lacrosse goal dominates the field! The unit's 6'x6' goal opening is constructed of 1.9" O.D. schedule 40 tubing making the WarLord as tough as it gets. The unit is supported by a flat-style ground bar for player safety. Net attachment is on the backside of goal opening. No wrap around string or velcro straps on the face of goal! Unit is designed to be disassembled for storage without removing net. All corners are mitered, welded construction. Entire goal structure is powder coated orange with black ground bar. Unit comes complete with our premium grade FT610N competition lacrosse net. The WarLord is covered by First Team's Lifetime Superior Warranty!

- FT610 WarLord Lacrosse Goal
- FT610N Heavy Duty Competition Lacrosse Net
- Lifetime Superior Warranty
- Approx. Shipping Weight: 75 lbs.



the **WARMONGER**™
ECONOMY LACROSSE GOAL

Great for practice or as a premium unit for backyard use, First Team's WarMonger is a great way to get into the game on budget. The WarMonger is constructed of formed heavy gauge 1 3/4" steel tubing with spring-pin assembly. Goal opening is 6'x6' with V-shaped bottom frame. The entire unit is powder coated orange and includes our FT605N standard lacrosse net. The WarMonger is covered by 5-Year Limited Warranty.

- FT605 WarMonger Lacrosse Goal
- FT605N Standard Duty Lacrosse Net
- 5-Year Limited Warranty
- Approx. Shipping Weight: 30 lbs.

FT605N ▶

- Official Size 6'x6'x7'
- 1 1/2" Square Mesh, 2.5 mm
- Bright White
- 1-Year Limited Warranty
- Approx. Shipping Weight: 3 lbs.



◀ **FT610N**

- Official Size 6'x6'x7'
- 1 1/2" Square Mesh, 4 mm
- Braided White Nylon
- 1-Year Limited Warranty
- Approx. Shipping Weight: 6 lbs.

the ALL PRO™ FOOTBALL GOALPOST

First Team™

FREE!
Wind
Direction
Streamers
Included!

20' Uprights
(10' extensions
avail. for 30'
uprights)

4" Diameter
Aluminum
Uprights

The ALL PRO line of football goalposts are First Team's biggest and best! The All Pro series boasts a massive 6 5/8" diameter steel post for maximum structural stability. For rust free performance the goalpost has a galvanized undercoating while the 6 5/8" diameter crossbar and 4" diameter uprights are made from rust free aluminum.

First Team's All Pro series has several installation features that make set up the easiest in the industry. First, the All Pro has a unique telescoping nosecone design that allows the overhang distance to be extended anywhere from 6'9" to 8'6". So no matter what, the crossbar comes out dead even with the back of the endzone every time. Second, the nosecone attachment not only allows the crossbar to be leveled at time of assembly, but you can also fine tune the crossbar elevation up to 2" up or down. So the crossbar is always at perfect 10' height every time. Third, each upright is attached to an adjustable corner elbow that is fully rotational allowing the uprights to be assembled perfectly straight every time.

Remember, because the All Pro can be set to a maximum overhang of 8'6" it works great when used in conjunction with portable soccer goals on multi-use fields. Post pads, ground sleeves and access frames are available for any All Pro package.

Wind direction streamers are included. All Pro football goalposts are covered by First Team's 10-Year Limited Warranty.

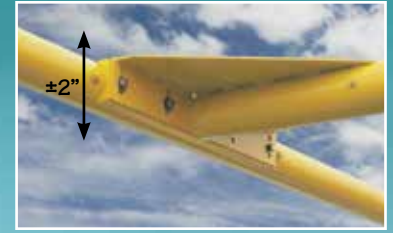

Crossbar Elevation Feature Ensures Perfect 10' Height



Crossbar & Upright Leveling Feature

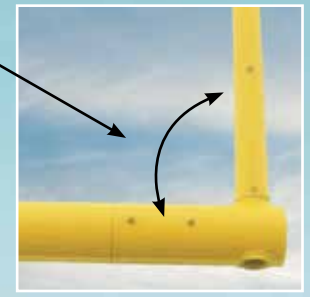

6 5/8" Rust-Free Aluminum Crossbar

6 5/8" Diameter Steel Post With Galvanized Undercoat For Rust-Free Protection

Adjustable Overhang From 6' 9" to 8' 6"

Optional Post Pad

Adjustable Uprights For Easy Leveling



Soccer Goal Friendly

FREE!
Post Pad Lettering
With Purchase of
Goalpost!

48" Bury
Order FT6006
Ground Sleeve for
Removeable Post

Model	Description	Ship. Wt. per Goal	Warranty
All Pro HSC-SY	All Pro 23' 4" Crossbar - Safety Yellow	900 lbs.	10-Yr. Limited
All Pro CLG-SY	All Pro 18' 6" Crossbar - Safety Yellow	900 lbs.	10-Yr. Limited

www.firstteaminc.com

First Team, Inc. • Hutchinson, Kansas • Toll-Free 1-800-649-3688

the ALL AMERICAN™ FOOTBALL GOALPOST

First Team

FREE!
Wind
Direction
Streamers
Included!

20' Uprights
(10' extensions
avail. for 30'
uprights)

4" Diameter
Aluminum
Uprights

When you are looking for exceptional football goalposts with industry leading features and warranty, trust First Team's ALL AMERICAN line! The All American series boasts a massive 5 9/16" diameter steel post for structural stability unmatched by competitor's lines. For rust free performance the goalpost has a galvanized undercoating while the 5 9/16" diameter crossbar and 4" diameter uprights are made from rust free aluminum. Don't be fooled by small diameter weak, sagging crossbars and flimsy uprights offered on many competitors systems.

First Team's All American series has several installation features that make set up the easiest in the industry. First, the All American has a unique telescoping nosecone design that allows the overhang distance to be extended anywhere from 6'9" to 8'6". So no matter what, the crossbar comes out dead even with the back of the endzone every time. Second, the nosecone attachment not only allows the crossbar to be leveled at time of assembly, but you can also fine tune the crossbar elevation up to 2" up or down. So the crossbar is always at perfect 10' height every time. Third, each upright is attached to an adjustable corner elbow that is fully rotational allowing the uprights to be assembled perfectly straight every time.

Remember, because the All American can be set to a maximum overhang of 8'6" it works great when used in conjunction with portable soccer goals on multi-use fields. Post pads, ground sleeves and access frames are available for any All American package.

Wind direction streamers are included. All American football goalposts are covered by First Team's 10-Year Limited Warranty.

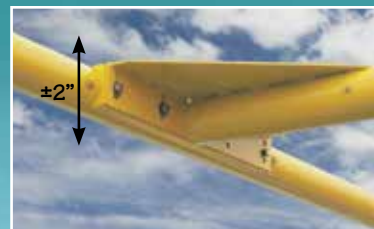

Crossbar Elevation Feature
Ensures Perfect 10' Height

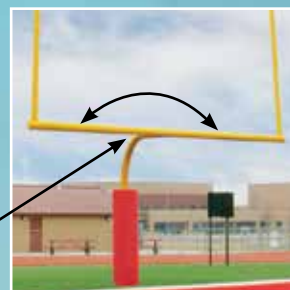

Crossbar
& Upright
Leveling
Feature

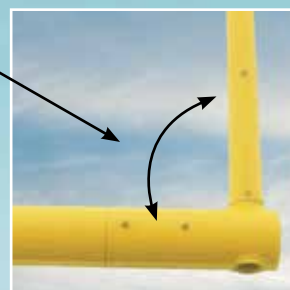

5 9/16" Rust-Free Aluminum Crossbar

5 9/16" Diameter
Steel Post With
Galvanized Undercoat
For Rust-Free
Protection

Adjustable Overhang
From 6' 9" to 8' 6"

Optional Post Pad

Adjustable
Uprights
For Easy
Leveling

FREE!
Post Pad Lettering
With Purchase of
Goalpost!

48" Bury
Order FT6005
Ground Sleeve for
Removeable Post



Soccer Goal
Friendly

Model	Description	Ship. Wt. per Goal	Warranty
All American HSC-SY	All American 23' 4" Crossbar - Safety Yellow	800 lbs.	10-Yr. Limited
All American CLG-SY	All American 18' 6" Crossbar - Safety Yellow	800 lbs.	10-Yr. Limited

the ALL STAR™ FOOTBALL GOALPOST

First Team

FREE!
Wind Direction
Streamers Included!

First Team's ALL Star football goalposts are perfect for any program on any budget! The All Star series sports a 4 1/2" diameter steel post that has a galvanized undercoating while the 4 1/2" diameter crossbar and 2 3/8" diameter uprights are made from rust free aluminum.

First Team's All Star series has built in crossbar and upright leveling features that make straight, professional installation a breeze. First, the All Star has a unique telescoping nosecone design that allows the overhang distance to be extended anywhere from 6' to 6' 6". So no matter what, the crossbar comes out dead even with the back of the endzone every time. Second, the nosecone attachment allows the crossbar to be leveled at time of assembly. Third, each upright is attached to an adjustable corner elbow that is fully rotational allowing the uprights to be assembled perfectly straight every time.

All Star packages are available with crossbar lengths of 23' 4" for high school or 18' 6" for college. See chart below for model numbers. Post pads with are available for any All Star goalpost package. Remember, post pad lettering is included free when you purchase a post pad with your All Star football goalpost.

Wind direction streamers are included. All Star football goalposts are covered by First Team's 10-Year Limited Warranty.

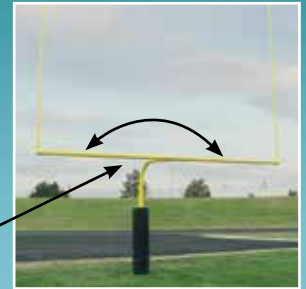

Crossbar & Upright Leveling Feature

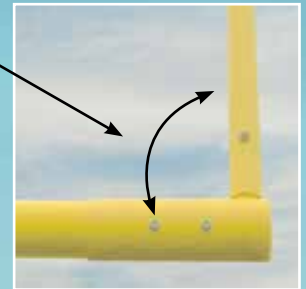

20' Uprights

2 3/8" Diameter Aluminum Uprights

Adjustable Uprights For Easy Leveling

4 1/2" Rust-Free Aluminum Crossbar

4 1/2" Diameter Steel Post With Galvanized Undercoat For Rust-Free Protection

Adjustable Overhang From 6' to 6' 6"

Optional Post Pad

FREE!
Post Pad Lettering With Purchase of Goalpost!

Crossbar Widths Available for High School or College

48" Post Bury

Model	Description	Ship. Wt. per Goal	Warranty
All Star HSC-SY	All Star 23' 4" Crossbar - Safety Yellow	500 lbs.	10-Yr. Limited
All Star CLG-SY	All Star 18' 6" Crossbar - Safety Yellow	500 lbs.	10-Yr. Limited

www.firstteaminc.com

First Team, Inc. • Hutchinson, Kansas • Toll-Free 1-800-649-3688

FOOTBALL ACCESSORIES



FT6060

- Post Pad for 6 5/8" Diameter Goalposts
- 72" Tall
- 6" Thick Foam
- Available in 16 Colors
- Weatherproof Vinyl
- Velcro Closure
- Available With Optional Lettering
- Meets all NCAA and NFHS rules
- Approx. Shipping Weight: 18 lbs.
- 1-Year Limited Warranty

FT6050 (Not shown)

Same as FT6060 except designed to fit 5 9/16" diameter football goalposts with 5" thick foam construction

FT6040 (Not shown)

Same as FT6060 except designed to fit 4 1/2" diameter football goalposts with 5" thick foam construction

FT6060-WP (Not shown)

Heavy duty vinyl wrap fits FT6060 football post pad. Lettering option available. Great for use where multiple teams utilize same field facility or for sprucing up old post pads. Available in 16 colors. Approx. Shipping Weight: 10 lbs. 1-Year Limited Warranty

FT6050-WP (Not shown)

Heavy duty vinyl wrap fits FT6050 football post pad. Lettering option available. Great for use where multiple teams utilize same field facility or for sprucing up old post pads. Available in 16 colors. Approx. Shipping Weight: 10 lbs. 1-Year Limited Warranty

See Custom Lettering Section For How To Order Padding Lettering, Or Call First Team



FT6000WDS

- Official Red 4"x42" Weather Resistant Streamers
- Rip Stop Nylon/Double Stitched
- Sold In Pairs
- Approx. Shipping Weight: 2 lbs.



FT6020-SY

- 10' Upright Extensions For 4" Diameter Uprights
- Increases Uprights to 30' Tall
- Sold In Sets Of Two (outfits one goal)
- Safety Yellow Powdercoating
- Approx. Shipping Weight: 60 lbs.



FT6000GLM

- Bright Orange End Zone Markers
- Self Standing, Bottom Weighted
- Safe Foam Filled
- Sold In Sets Of Four
- Approx. Shipping Weight: 11 lbs.
- 1-Year Limited Warranty



FT6000CMP

Securely clamps virtually any portable soccer goal to any football goal post. Eliminates need for sandbags or ground stakes. Sold individually. Order one kit per goal. Approx. Shipping Weight: 5 lbs.



FT6000SLM

- Football Sideline Markers
- Weighted Foam-Filled Nylon
- Black On Orange
- Folding Style
- 13" w x 13" h x 12" bottom
- Set of 11 Markers
- App. Shipping Wt.: 25 lbs.
- 1-Year Limited Warranty



FT6004 / FT6005 / FT6006

- Ground Sleeve For Football Goalpost
- Allows Goalpost Removal When Needed
- Rust-Proof Galvanized Steel Construction
- Order FT6004 for 4 1/2" Diameter Posts
- Order FT6005 for 5 9/16" Diameter Posts
- Order FT6006 for 6 5/8" Diameter Posts
- Sold Individually
- Approx. Shipping Weight: 200 lbs.



FT6002

- Access Frame For Football Ground Sleeves
- Wood Cover Top Included
- Approx. Shipping Weight: 25 lbs.

THE FOOTBALL FIELD

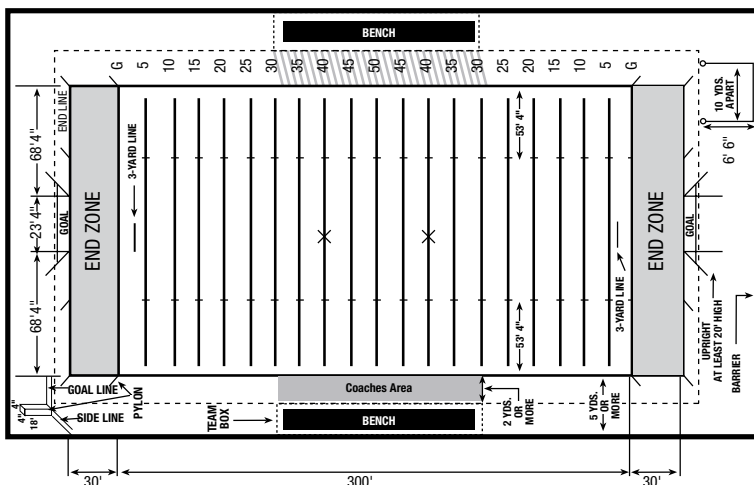

the **GRIDIRON**™

BACKYARD FOOTBALL GOALPOST

First Team



Easy One Person Setup



Store With the Uprights in Lower Position

First Team offers the revolutionary Gridiron backyard football goalpost. At last, a backyard football goalpost that is premium quality! Why settle for small, flimsy, plastic goalposts offered by other manufacturers? The Gridiron football goalpost is built solid from the ground up. The vertical post and crossbar are constructed from 3" aluminum. 1 1/2" diameter uprights are also made from aluminum construction. The crossbar stands 6'6" above the playing surface and measures 7' wide. The uprights are 74" tall above crossbar. All parts are coated with official safety yellow powder coat paint. Red wind streamers are included.

The Gridiron football goalpost is light weight and easy to carry due to aluminum construction. The unit folds for easy storage as shown. Several Gridiron combo packages are available so you can choose the kit that suits your backyard best. Choose Gridiron Complete package to receive post pad and removable ground socket. We will even print your name on the post pad FREE! All Gridiron package options are covered by First Team's Lifetime Limited Warranty.

Model	Description	Ship. Wt. per Goal	Warranty
Gridiron Complete	Includes Goalpost, Streamers, Post Pad & Ground Socket	90 lbs.	Lifetime Limited
Gridiron Express	Includes Goalpost, Streamers & Post Pad	70 lbs.	Lifetime Limited
Gridiron Basic	Includes Goalpost & Streamers Only	60 lbs.	Lifetime Limited

FT600OWDS-MINI

- Replacement mini wind streamers
- Wind streamers are included with every Gridiron package.
- Approx. Shipping Weight: 1 lb.

FT75

- Pole pad for Gridiron football goalpost
- 66" tall. Available in 16 colors
- Free LTR75 lettering when ordered with goalpost.
- Approx. Shipping Weight: 8 lbs.

FT5001

- Post socket
- Allows goalpost to be easily removed for storage
- Mower safe
- Lid flips open for installation, closes after removal.
- Approx. Shipping Weight: 10 lbs.



FREE!
Post Pad Lettering
With Purchase of
Goalpost!

www.firstteaminc.com

First Team, Inc. • Hutchinson, Kansas • Toll-Free 1-800-649-3688

the SENTRY™

TENNIS POST SYSTEM

First Team



First Team introduces the SENTRY™ tennis post system. The Sentry tennis post line is extremely durable and versatile, capable of meeting the needs of dedicated and multi-purpose courts. The Sentry post is manufactured from 3.5" OD heavy duty, 1/4" thick high tensile aluminum. Straight and true, the Sentry will stand up to high use courts and allows proper game tension on the net with no bowing on the posts. The worm gear net tensioner winch is safe, no chance of injury due to back drive common on competitor's winches. A heavy duty double top six net with coated top cable is included with each Sentry package. Center strap and anchor also included. Each Sentry package includes ground sleeves for easy installation and post removal. SENTRY TNPS includes standard PVC sleeves, while SENTRY TNSO includes our exclusive sockets with hinged cover lids. These sockets are particularly useful on multipurpose courts where a smooth flush surface is desired when tennis posts are removed. SENTRY TNSO also includes our exclusive Flush Mount strap anchor for flush surface when not in use.

Flush Surface Strap & Anchor



• Packages Include White Center Strap With Anchor

Standard Strap & Anchor



Model	Description	Shipping Weight	Warranty
SENTRY TNPS . . .	Complete tennis post system described above including PVC post sleeves, standard center strap & anchor	85 lbs.	Lifetime Limited
SENTRY TNSO . . .	Complete tennis post system described above including hinged lid sockets, flush mount center strap & anchor	115 lbs.	Lifetime Limited

the GUARDIAN™

TENNIS POST SYSTEM

First Team

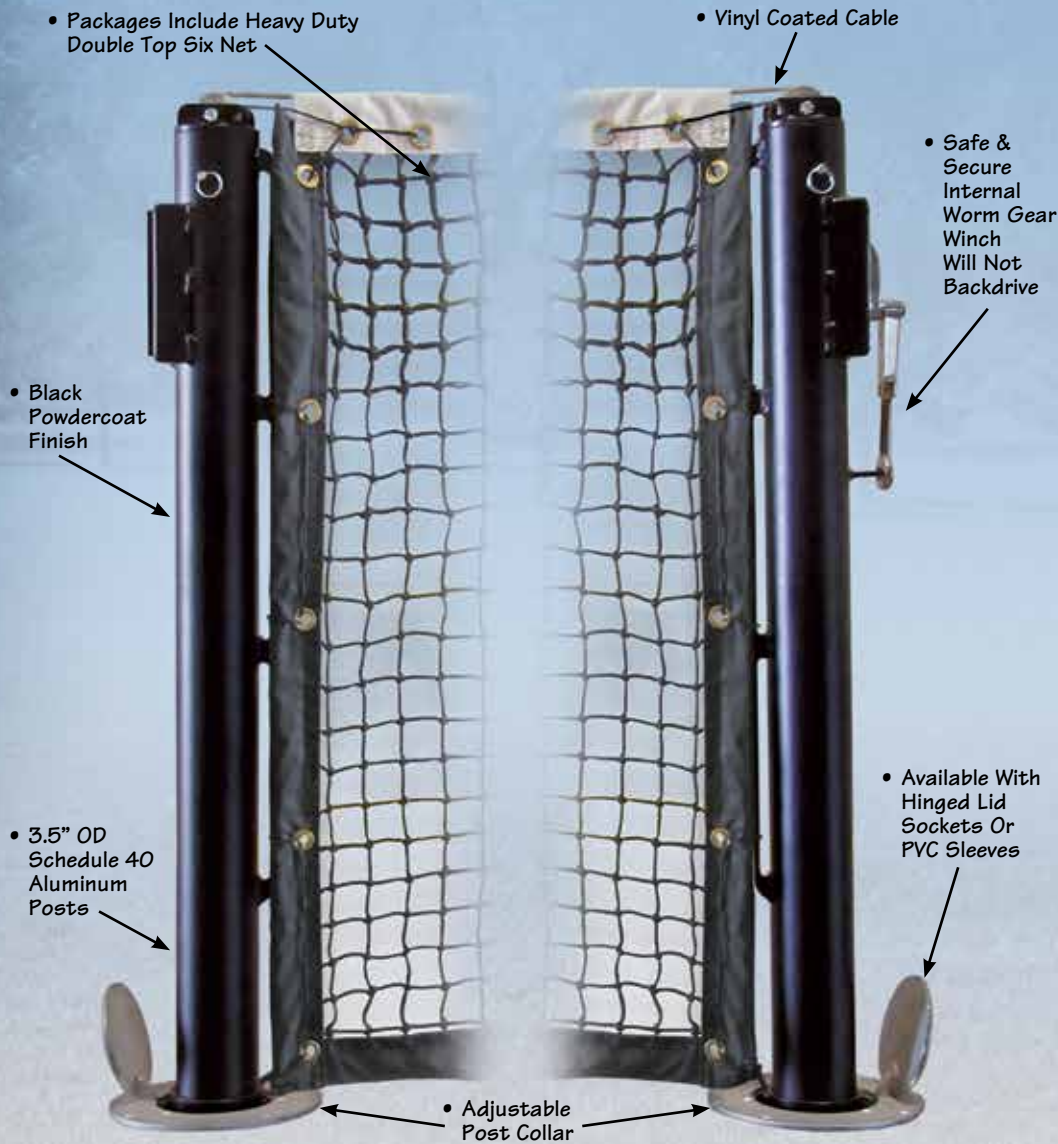

First Team introduces the Guardian tennis post system. The Guardian tennis post line is extremely durable and versatile, capable of meeting the needs of any top-notch court. The Guardian post is manufactured from 3.5" OD heavy duty, 1/4" thick high tensile aluminum. Straight and true, the Guardian will stand up to high use courts and allows proper game tension on the net with no bowing on the posts. The internal worm gear net tensioner winch has a clean look and is safe for users. Our exclusive internal winch is made from heavy duty stainless steel and is far stronger than competitor's common brass winch design. A heavy-duty double top six net with coated top cable is included with each Guardian package. Center strap and anchor also included. Each Guardian package includes ground sleeves for easy installation and post removal. Guardian TNPS includes standard PVC sleeves, while Guardian TNSO includes our exclusive hinged sockets. These sockets are particularly useful on multipurpose courts where a smooth flush surface is desired when tennis posts are removed. Guardian TNSO also includes our exclusive Flush Mount strap anchor for flush surface when not in use.

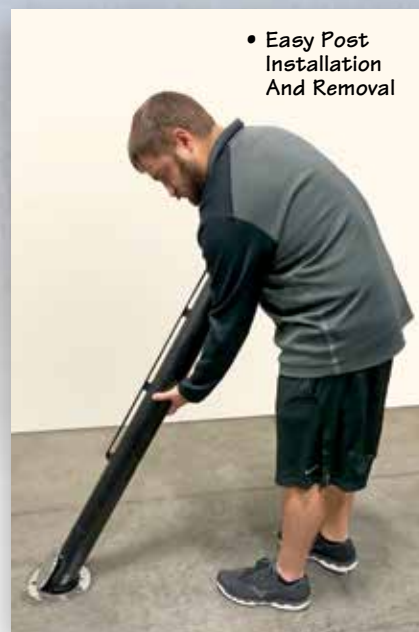

Model	Description	Shipping Weight	Warranty
GUARDIAN TNPS	Complete tennis post system described above including PVC post sleeves, standard center strap & anchor	85 lbs.	Lifetime Limited
GUARDIAN TNSO	Complete tennis post system described above including hinged lid sockets, flush mount center strap & anchor.	115 lbs.	Lifetime Limited

www.firstteaminc.com

First Team, Inc. • Hutchinson, Kansas • Toll-Free 1-800-649-3688

the SENTRY™

PICKLEBALL POST SYSTEM

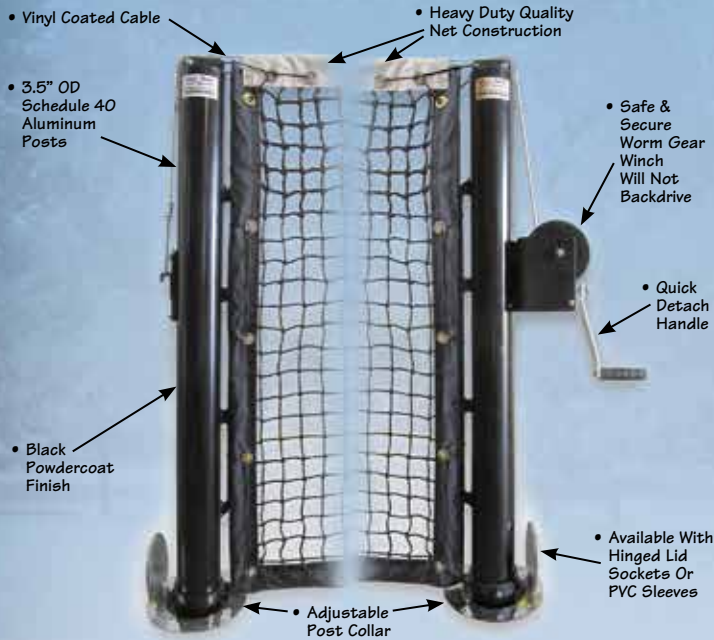

• Post Assembly Telescopes For Use As Tennis Post On Multi-Use Courts



First Team

First Team introduces the SENTRY™ pickleball post system. Sentry is the first pickleball set to feature the ability to quickly switch from pickleball to tennis on multi-use courts. The Sentry top cap telescopes up or down with just the pull of a pin to quickly change net height from 36" pickleball to 42" tennis. The unit is constructed of 3.5" OD heavy duty, 1/4" thick high tensile aluminum. Aluminum construction makes these posts easy to remove and store, or reset for tennis if desired. The heavy duty worm gear driven winch is easy and safe to operate and has a quick detach removable crank handle. Sentry package systems include a heavy duty pickleball net made from the same high quality components we use on our tennis nets. Choose from two Sentry system options: SENTRY PKPS includes standard PVC sleeves for post installation while SENTRY PKSO includes our exclusive sockets with hinged cover lids. These sockets are particularly useful on multipurpose courts where a smooth flush surface is desired when posts are removed.

Model	Description	Shipping Weight	Warranty
SENTRY PKPS	... Complete pickleball post system described above including PVC post sleeves	80 lbs.	Lifetime Limited
SENTRY PKSO	... Complete pickleball post system described above including hinged lid sockets	110 lbs.	Lifetime Limited

the GUARDIAN™

PICKLEBALL POST SYSTEM

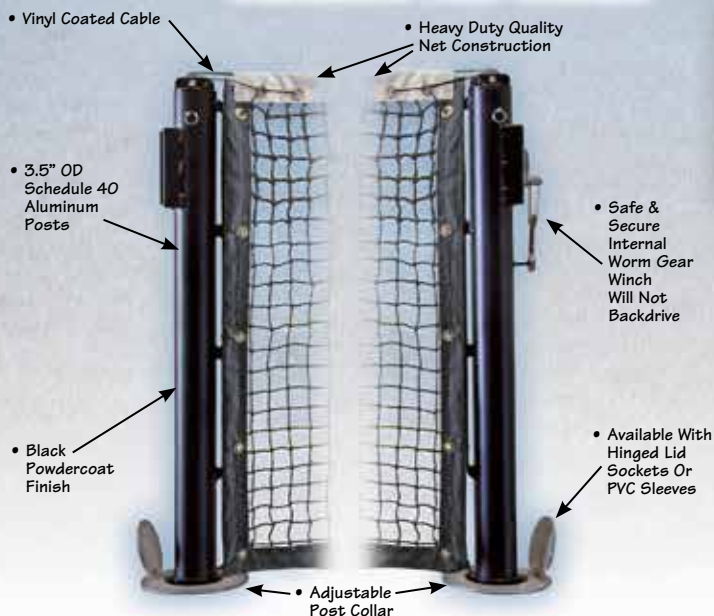

Internal Winch



Lockable Handle



First Team

First Team introduces the GUARDIAN™ pickleball post system. The unit is constructed of 3.5" OD heavy duty, 1/4" thick high tensile aluminum. Aluminum construction makes these posts easy to remove, store and setup. The heavy-duty steel internal worm gear driven winch is easy and safe to operate and has a lockable handle or handle may be removed. GUARDIAN package systems include a heavy duty, pickleball net made from the same high quality components we use on our tennis nets. Choose from GUARDIAN two system options: GUARDIAN PKPS includes standard PVC sleeves for post installation while GUARDIAN PKSO includes our exclusive sockets with hinged cover lids. These sockets are particularly useful on multipurpose courts where a smooth flush surface is desired when posts are removed.

Model	Description	Shipping Weight	Warranty
GUARDIAN PKPS	.. Complete pickleball post system described above including PVC post sleeves	80 lbs.	Lifetime Limited
GUARDIAN PKSO	.. Complete pickleball post system described above including hinged lid sockets	110 lbs.	Lifetime Limited

TENNIS/PICKLEBALL NETS & REPLACEMENT PARTS



FT8000T1 ▲

- Heavy Duty Tennis Net
- 42"H x 41' 6"L
- Tapered (38" middle)
- 3 mm Single Mesh
- 23 oz Headband
- 2.5" wide black vinyl side & bottom
- White vinyl coated cable with loop at both ends
- Side dowels included
- Shipping weight: 18 lbs.

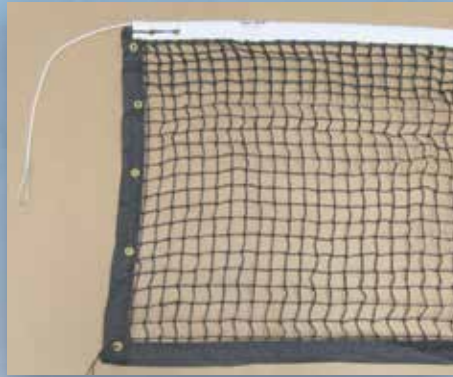

FT8000T2 ▲

- Heavy Duty Tennis Net
- 42"H x 41' 6"L,
- Tapered (38" middle)
- 3 mm Double Top Six Mesh
- 23 oz Headband
- 2.5" wide black vinyl side & bottom
- White vinyl coated cable with loop at both ends
- Side dowels included
- Shipping weight: 24 lbs.

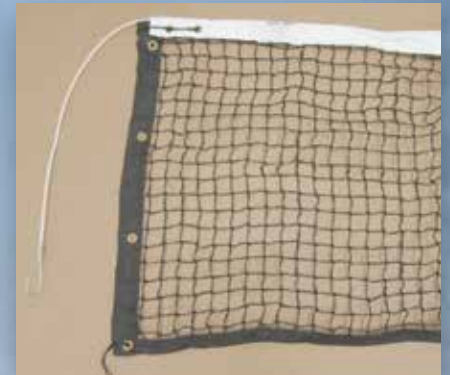

FT8000P1 ▲

- Heavy Duty Pickleball Net
- 36"H x 21' 6"L (2" Tapered)
- 3 mm Single Mesh
- 23 oz Headband, 2.5" wide
- Black vinyl side & bottom
- White vinyl coated cable with loop at both ends
- Side dowels included
- Shipping weight: 9 lbs.



FT8000STCS ▲

- Standard Tennis Net Strap
- 2" wide white webbing
- Adjustable buckle
- For use with FT8000A anchor
- Shipping weight: 1 lbs.



FT8000FMCS ▲

- Flush mount Tennis Net Strap
- 2" wide white webbing
- Non-Adjustable Design
- For use with FT50 anchor
- Great for multi-sport courts
- Shipping weight: 1 lbs.



FT5001 ▲

- Floor socket
- Hinged lid closes when post is removed
- Fits 3.5" diameter posts
- Great for multisport courts
- Shipping weight: 10 lbs.



FT8000PVC ▲

- PVC Post Sleeve
- 36" deep
- Fits 3.5" dia. round posts
- Shipping weight: 5 lbs.



FT8000A ▲

- Standard Tennis Net Anchor
- Galvanized steel
- For use with FT8000STCS strap
- Shipping weight 1 lbs.



FT50 ▲

- Flush mount anchor
- Spring loaded internal plunger
- For use with FT8000FMCS strap
- Great for multi-sport courts
- Shipping weight: 1 lbs.



▲ **FT8100W**

- Tennis Post Winch
- Worm Gear Tension Design
- Removable Crank Handle
- May require post drilling on other brand posts
- Shipping weight: 10 lbs.

WHAT'S NEW AT FIRST TEAM



The
Guardian™
Tennis Post
System
Page 117

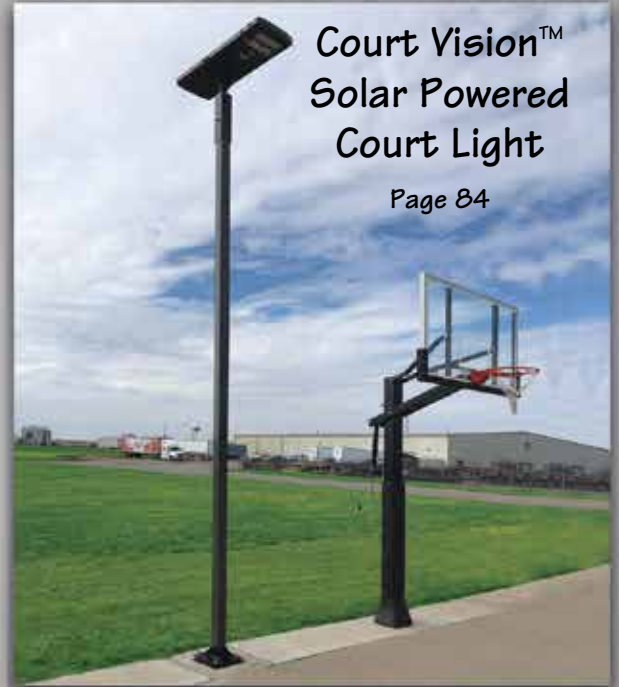

Court Vision™
Solar Powered
Court Light
Page 84

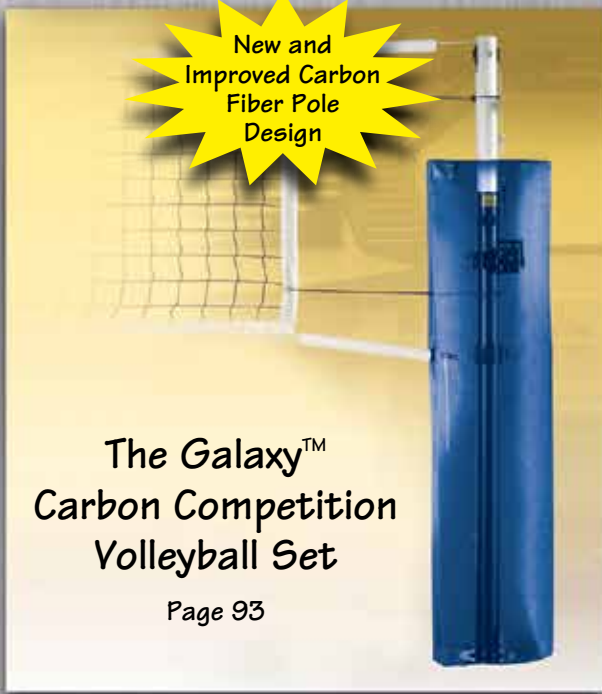

New and
Improved Carbon
Fiber Pole
Design

The Galaxy™
Carbon Competition
Volleyball Set
Page 93



The
Guardian™
Pickleball
Post System
Page 118



1-800-649-3688 • www.firstteaminc.com
902 Corey Road • Hutchinson, Kansas 67501
Sold Exclusively Through Authorized First Team Dealers

Proud Supplier To:

