

---

Open System for Earthquake Engineering Simulation (OpenSees)

# OpenSees Command Language Manual

Silvia Mazzoni, Frank McKenna, Michael H. Scott, Gregory L. Fenves,  
et al.



# Contents

<b>Introduction</b>	<b>11</b>
Notation .....	11
Copyright .....	13
Introduction to the Tcl command language .....	14
Tcl Commands Format.....	15
Example Tcl Commands .....	16
Additional Tcl Resources .....	17
OpenSees Interpreter.....	18
<b>OpenSees</b>	<b>19</b>
OpenSees Features .....	21
WHY OPENSEES? .....	21
+ The library of materials, elements and analysis commands makes OpenSees a powerful tool for numerical simulation of nonlinear structural and geotechnical systems .....	21
+ The OpenSees library of components is ever-growing and at the leading edge of numerical-simulation models .....	21
+ The OpenSees interface is based on a command-driven scripting language which enables the user to create more-versatile input files. ....	21
+ OpenSees is not a black box, making it a useful educational tool for numerical modeling	21
+ You can create your own material, element or analysis tools and incorporate them into OpenSees .....	21
+ NEES is supporting integration of OpenSees as the simulation component of laboratory testing.....	21
MODELS: .....	22
+ linear & nonlinear structural and geotechnical models .....	22
SIMULATIONS: .....	23
+ static push-over analyses .....	23
+ static reversed-cyclic analyses .....	23
+ dynamic time-series analyses.....	23
+ uniform-support excitation.....	23
+ multi-support excitation .....	23
MODELING FEATURES: .....	23
MODEL-BUILDING FEATURES: .....	24
ANALYSIS FEATURES:.....	26
ModelBuilder Object .....	29
Domain Object.....	30
Recorder Object .....	31
Analysis Object.....	31
<b>Model-Building Objects</b>	<b>33</b>
<b>model Command</b>	<b>34</b>
Basic Model Builder.....	34
build Command .....	35
<b>node Command</b>	<b>36</b>
<b>mass Command</b>	<b>37</b>

<b>constraints objects</b>	<b>38</b>
Single-Point Constraints.....	38
fix Command.....	38
fixX Command.....	39
fixY Command.....	39
fixZ Command.....	40
Multi-Point Constraints.....	41
equalDOF Command.....	41
rigidDiaphragm Command.....	41
rigidLink Command.....	42
<b>uniaxialMaterial Command</b>	<b>43</b>
<b>-- Contributed Uniaxial Materials</b>	<b>44</b>
BARSLIP Material.....	44
Concrete04 Material -- Popovics Concrete Material.....	57
<b>Concrete04 -- Material Behavior</b>	<b>61</b>
<b>FatigueMaterialExample.tcl</b>	<b>63</b>
<b>Limit State Material</b>	<b>73</b>
Shear Limit Curve.....	74
Axial Limit Curve.....	75
Shear Limit Curve.....	76
Example Files for Limit State Material.....	78
PINCHING4 Material.....	84
PINCHING4 Uniaxial Material Model Discussion.....	90
PyTzQz Uniaxial Materials.....	104
PySimple1 Material.....	104
TzSimple1 Material.....	105
QzSimple1 Material.....	106
PyLiq1 Material.....	107
TzLiq1 Material.....	108
PySimple1Gen Command.....	110
TzSimple1Gen Command.....	111
<b>ReinforcingSteel -- Material Behavior</b>	<b>125</b>
Elastic Material.....	125
Elastic-Perfectly Plastic Material.....	126
Elastic-Perfectly Plastic Gap Material.....	128
Elastic-No Tension Material.....	129
Parallel Material.....	130
Series Material.....	131
Hardening Material.....	133
Concrete01 Material -- Zero Tensile Strength.....	134
<b>Concrete01 -- Material Behavior</b>	<b>137</b>
Concrete02 Material -- Linear Tension Softening.....	137
<b>Concrete02 -- Material Behavior</b>	<b>143</b>
Concrete03 Material -- Nonlinear Tension Softening.....	143
<b>Concrete03 -- Material Behavior</b>	<b>147</b>

Steel01 Material .....	147
<b>Steel01 -- Material Behavior</b>	<b>152</b>
Steel02 Material -- Giuffré-Menegotto-Pinto Model with Isotropic Strain Hardening .....	153
<b>Steel02 -- Material Behavior</b>	<b>158</b>
Hysteretic Material.....	158
<b>Hysteretic -- Material Behavior</b>	<b>161</b>
Viscous Material .....	161
<b>nDMaterial Command</b>	<b>162</b>
Elastic Isotropic Material .....	162
J2 Plasticity Material.....	163
Plane Stress Material .....	163
Plate Fiber Material .....	164
UC Davis Soil Models.....	164
Template Elasto-Plastic Material.....	164
UCSD Soil Models.....	169
<b>section Command</b>	<b>191</b>
Elastic Section.....	192
Uniaxial Section.....	193
Fiber Section .....	194
Fiber Command.....	196
Quadrilateral Patch Command.....	197
Circular Patch Command .....	199
Straight Layer Command .....	201
Circular Layer Command .....	202
Section Aggregator.....	203
Elastic Membrane Plate Section .....	205
Plate Fiber Section .....	205
Bidirectional Section.....	206
Isolator2spring Section: Model to include buckling behavior of an elastomeric bearing .....	207
<b>element Command</b>	<b>215</b>

---

Truss Element .....	215
Corotational Truss Element.....	216
Elastic Beam Column Element.....	217
NonLinear Beam-Column Elements.....	218
Nonlinear Beam Column Element.....	218
Beam With Hinges Element .....	219
Displacement-Based Beam-Column Element.....	223
Zero-Length Elements.....	223
Zero-Length Element.....	224
Zero-Length ND Element .....	225
Zero-Length Section Element .....	226
Quadrilateral Elements.....	227
Quad Element .....	227
Shell Element .....	228
Bbar Plane Strain Quadrilateral Element .....	228
Enhanced Strain Quadrilateral Element.....	229
Brick Elements .....	230
Standard Brick Element.....	230
Bbar Brick Element.....	231
BeamColumnJoint Element.....	232
Beam-Column Joint Element Discussion .....	236
<b>Beam-Column Joint Element Discussion</b>	<b>236</b>
UC Davis Soil Elements .....	256
FourNodeQuadUP Element .....	256
u-p-U element.....	258
Eight Node Brick Element .....	259
Twenty Node Brick Element.....	261
<b>UC San Diego Soil Elements</b>	<b>263</b>
<b>block Command</b>	<b>273</b>
block2D Command.....	274
block3D Command.....	276
<b>region Command</b>	<b>278</b>
<b>Geometric Transformation Command</b>	<b>280</b>
Linear Transformation .....	280
P-Delta Transformation .....	286
Corotational Transformation.....	287
<b>Time Series</b>	<b>288</b>
Constant Time Series.....	289
Linear Time Series .....	289
Rectangular Time Series.....	290
Sine Time Series .....	291
Path Time Series.....	292
<b>pattern Command</b>	<b>294</b>

---

plain Pattern .....	294
load Command .....	295
sp Command .....	296
eleLoad Command .....	297
UniformExcitation Pattern .....	298
MultipleSupport Pattern .....	299
groundMotion Command .....	299
Plain GroundMotion .....	300
Interpolated GroundMotion .....	301
imposedMotion Command .....	301

---

**Recorder Objects 303**

Node Recorder .....	303
EnvelopeNode Recorder .....	305
Drift Recorder .....	306
Element Recorder .....	307
EnvelopeElement Recorder .....	309
Display Recorder .....	310
Plot Recorder .....	311
playback Command .....	311

---

**Analysis Objects 313**

---

**constraints Command 316**

Plain Constraints .....	318
Penalty Method .....	318
Lagrange Multipliers .....	319
Transformation Method .....	320

---

**numberer Command 321**

Plain Numberer .....	321
RCM Numberer .....	322

---

**system Command 323**

BandGeneral SOE .....	324
BandSPD SOE .....	324
ProfileSPD SOE .....	324
SparseGeneral SOE .....	324
UmfPack SOE .....	325
SparseSPD SOE .....	325

---

**test Command 326**

Norm Unbalance Test .....	326
Norm Displacement Increment Test .....	327
Energy Increment Test .....	328

---

**algorithm Command 329**

Linear Algorithm .....	329
Newton Algorithm .....	329
Newton with Line Search Algorithm .....	330
Modified Newton Algorithm .....	331
Krylov-Newton Algorithm .....	331
BFGS Algorithm .....	331
Broyden Algorithm .....	332

---

**integrator Command 333**

Load Control.....	334
Displacement Control.....	335
Minimum Unbalanced Displacement Norm.....	336
Arc-Length Control.....	336
Newmark Method.....	337
Hilbert-Hughes-Taylor Method.....	338
<b>analysis Command</b>	<b>339</b>
Static Analysis.....	339
Transient Analysis.....	340
VariableTransient Analysis.....	341
<b>rayleigh command</b>	<b>342</b>
<b>eigen Command</b>	<b>343</b>
<b>analyze Command</b>	<b>344</b>
<b>dataBase Commands</b>	<b>345</b>
FileDatastore Command.....	345
save Command.....	346
restore Command.....	346
<b>Miscellaneous Commands</b>	<b>347</b>
print Command.....	347
reset Command.....	348
wipe Command.....	348
wipeAnalysis Command.....	348
loadConst Command.....	349
getTime Command.....	349
nodeDisp Command.....	349
video Command.....	350
play Command.....	351
nodeBounds.....	351
display Command.....	352
<b>How To....</b>	<b>353</b>
Run OpenSees.....	354
...Define Units & Constants.....	356
...Generate Matlab Commands.....	357
...Define Tcl Procedure.....	357
...Read External files.....	359
Building The Model.....	360
...Define Variables and Parameters.....	360
...Build Model and Define Nodes.....	363
...Build Model and Define Nodes using Variables.....	364
...Define Materials.....	364
...Define Elements.....	365
Defining Output.....	366
...Define Analysis-Output Generation.....	366
...Define Data-Plot During Analysis.....	368
Gravity Loads.....	369
...Define Gravity Loads.....	369
...Run Gravity Analysis.....	370
Static Analysis.....	370
...Define Static Pushover Analysis.....	370



...Run Static Pushover Analysis.....	371
Dynamic Analysis .....	372
...Define Dynamic Ground-Motion Analysis .....	372
...Run Dynamic Ground-Motion Analysis .....	373
...Combine Input-File Components .....	373
...Run Parameter Study.....	374
...Run Moment-Curvature Analysis on Section .....	376
...Determine Natural Period & Frequency .....	377

---

**Getting Started with OpenSees 379**

Introduction.....	381
Download OpenSees .....	382
Run OpenSees.....	384
Problem Definition .....	386
Model Builder .....	387
Nodes .....	388
Elements .....	390
Recorders.....	391
Summary of Model-Building Input File .....	391
Loads and Analysis .....	394
1. Load definition .....	394
2. Analysis definition and features .....	395
3. Analysis execution.....	396
Gravity Loads .....	396
Summary of Gravity Loads.....	399
Lateral Loads -- Static Pushover.....	400
Lateral Loads -- Cyclic Lateral Load .....	401
Lateral Loads -- Dynamic ground motion.....	402

---

**Getting Going with OpenSees (under development) 406**

Problem Definition .....	407
Model Building.....	408
Variables and Units .....	408
Model Builder .....	410
Nodal Coordinates & Masses, Boundary Conditions .....	410
Materials.....	411
Element Cross Section.....	412
Elements and Element Connectivity .....	413
Gravity and other Constant Loads .....	414
Summary of Defining Structural Model .....	414
Error-Checking Tip for Model Building .....	419
Recorders for Output.....	425

---

**Analysis Components 426**

---

**Script Utilities Library 427**

---

matTest.tcl .....	427
RCcircSection.tcl .....	429
RCcircSectionFEDEAS.tcl .....	430
RCFrameDisplay.tcl .....	432
MomentCurvature.tcl .....	433
ReadSMDFile.tcl .....	434
RotSpring2D .....	436
StFramePZLdisplay.tcl .....	437
Wsection.tcl .....	437
RigidFrame3Ddisplay.tcl .....	438
Units&Constants.tcl .....	439
MatlabOutput.tcl .....	440
genPlaneFrame.tcl .....	440

---

**References** **443**

---

**Index** **447**

---

## CHAPTER 1

# Introduction

This document is intended to outline the basic commands currently available with the OpenSees interpreter. This interpreter is an extension of the Tcl/Tk language for use with OpenSees.

OpenSees is an object-oriented framework for finite element analysis. OpenSees' intended users are in the research community. A key feature of OpenSees is the interchangeability of components and the ability to integrate existing libraries and new components into the framework (not just new element classes) without the need to change the existing code. Core components, that is the abstract base classes, define the minimal interface (minimal to make adding new component classes easier but large enough to ensure all that is required can be accommodated).

## In This Chapter

Notation.....	11
Copyright.....	13
Introduction to the Tcl command language .....	14
OpenSees Interpreter.....	18

---

## Notation

The notation presented in this chapter is used throughout this document.

Input values are a string, unless the first character is a \$, in which case an integer, floating point number or variable is to be provided. In the Tcl language, variable references start with the \$ character. Tcl expressions can also be used as input to the commands where the input value is specified by the first character being a \$.

Optional values are identified in enclosing <> braces.

When specifying a variable quantity of values, the command line contains (**x \$values**). The number of values required, x, and the types of values, \$values, are specified in the description of the command.

An arbitrary number of input values is indicated with the dot-dot-dot notation, i.e. **\$value1 \$value2 ...**

The OpenSees interpreter constructs objects in the order they are specified by the user. New objects are often based on previously-defined objects. When specified as an object parameter, a previously-defined object must have already been added to the Domain. This requirement is specified in the description of the command arguments.

Also, and very important:

Do not use greek fonts ANYWHERE in your documentation, not only do they not come out in Html, they are not allowed in tcl, which is where this is important. I recommend spelling out the letters: alpha, beta, gamma, eps (short for epsilon), etc.

I recommend to not use them in your figures either, as you would be unable to refer to them. If you must use them you have to do it very carefully, as it may be okey for internal variables.

Example command:

```
node $nodeTag (ndm $coords) <-mass (ndf $MassValues)>
```

This line executes the *node command* (page 36) assigns coordinates and masses to a specified node. The **\$nodeTag** argument is an integer tag identifying the node. The coordinate arguments are specified with the parentheses (**()**) because the number of arguments is dependent on the definition of the model (*ndm* (page 34)): two arguments in 2D and three in 3D.

The mass specification at the node definition is optional. Therefore, it is enclosed in **<>** braces. The number of mass arguments is also dependent on the model definition, depending on the number of degrees of freedom assigned to a node (*ndf* (page 34)).

---

# Copyright

Copyright © 1999,2000 The Regents of the University of California. All Rights Reserved.

Permission to use, copy, modify, and distribute this software and its documentation for educational, research and non-profit purposes, without fee, and without a written agreement is hereby granted, provided that the above copyright notice, this paragraph and the following three paragraphs appear in all copies.

Permission to incorporate this software into commercial products may be obtained by contacting the University of California. [Bill Hoskins Office of Technology Licensing, 2150 Shattuck Avenue #150 Berkeley, CA 94720-1620, (510) 643-7201]

This software program and documentation are copyrighted by The Regents of the University of California. The software program and documentation are supplied "as is", without any accompanying services from The Regents. The Regents does not warrant that the operation of the program will be uninterrupted or error-free. The end-user understands that the program was developed for research purposes and is advised not to rely exclusively on the program for any reason.

IN NO EVENT SHALL THE UNIVERSITY OF CALIFORNIA BE LIABLE TO ANY PARTY FOR DIRECT, INDIRECT, SPECIAL, INCIDENTAL, OR CONSEQUENTIAL DAMAGES, INCLUDING LOST PROFITS, ARISING OUT OF THE USE OF THIS SOFTWARE AND ITS DOCUMENTATION, EVEN IF THE UNIVERSITY OF CALIFORNIA HAS BEEN ADVISED OF THE POSSIBILITY OF SUCH DAMAGE. THE UNIVERSITY OF CALIFORNIA SPECIFICALLY DISCLAIMS ANY WARRANTIES, INCLUDING, BUT NOT LIMITED TO, THE IMPLIED WARRANTIES OF MERCHANTABILITY AND FITNESS FOR A PARTICULAR PURPOSE. THE SOFTWARE PROVIDED HEREUNDER IS ON AN "AS IS" BASIS, AND THE UNIVERSITY OF CALIFORNIA HAS NO OBLIGATIONS TO PROVIDE MAINTENANCE, SUPPORT, UPDATES, ENHANCEMENTS, OR MODIFICATIONS.

---

# Introduction to the Tcl command language

The Tcl scripting language was chosen to support the OpenSees commands, which are used to define the problem geometry, loading, formulation and solution. These commands are one-line commands which have specific tasks, as described in this manual. The Tcl language provides useful programming tools, such as variables manipulation, mathematical-expression evaluation and control structures.

Tcl is a string-based scripting language which allows the following:

- Variables and variable substitution
- Mathematical-expression evaluation
- Basic control structures (if , while, for, foreach)
- Procedures
- File manipulation

More information on Tcl commands can be found at its web site: *Tcl/Tk Primer*  
(<http://dev.scriptics.com/scripting/primer.html>) (<http://dev.scriptics.com/scripting/primer.html>)

Handy Tcl commands:

**incr** - Increment the value of a variable:

```
set a 1  
incr a
```

a book reference:

Brent Welch <[welch@acm.org](mailto:welch@acm.org)>, Ken Jones, and Jeff Hobbs: **Practical Programming in Tcl and Tk**, (<http://www.beedub.com/book/>) 4th Edition ISBN: 0-13-038560-3, June, 2003  
(<http://www.beedub.com/book/>)

---

## Tcl Commands Format

Tcl scripts are made up of commands separated by new lines or semicolon (;).

The basic syntax for a Tcl command is:

```
command $arg1 $arg2 ...
```

**command**                    name of the Tcl command or user-defined procedure

**\$arg1 \$arg2 ...**            arguments for the command

Tcl allows any argument to be nested command:

```
command [nested-command1] [nested-command2]
```

where the [] are used to delimit the nested commands. The Tcl interpreter will first evaluate the nested commands and will then evaluate the outer command with the results to the nested commands.

The most basic command in Tcl is the set command:

```
set variable $value
```

for example:

```
set a 5
```

The Tcl interpreter regards a command starting with the pound sign (#) to be a comment statement, so it does not execute anything following the #. For example:

```
# this command assigns the value 5 to the variable a  
set a 5
```

The pound sign and the semicolon can be used together to put comments on the same line as the command. For example:

```
set a 5; # this command assigns the value 5 to the variable a
```

## Example Tcl Commands

arithmetic	procedure	for & foreach functions
<pre>&gt;set a 1 1 &gt;set b a a &gt;set b \$a 1 &gt;expr 2 + 3 5 &gt;expr 2 + \$a 3 &gt;set b [expr 2 + \$a] 3 &gt;</pre>	<pre>&gt;proc sum {a b} {     return [expr \$a + \$b] } &gt;sum 2 3 5 &gt;set c [sum 2 3] 5 &gt;</pre>	<pre>for {set i 1} {\$i &lt; 10} {incr i 1} {     puts "i equals \$i" }  set sum 0 foreach value {1 2 3 4} {     set sum [expr \$sum + \$value] } puts \$sum 10 &gt;</pre>
file manipulation	procedure & if statement	
<pre>&gt;set fileID [open tmp w] anumber &gt;puts \$fileID "hello" &gt;close \$fileID &gt;type tmp hello &gt; &gt;source Example1.tcl</pre>	<pre>&gt;proc guess {value} {     global sum     if {\$value &lt; \$sum} {         puts "too low"     } else {         if {\$value &gt; \$sum} {             puts "too high"         } else { puts "you got it!"}     } } &gt; guess 9 too low &gt;</pre>	



---

## Additional Tcl Resources

Here are additional resources for Tcl:

<http://www.freeprogrammingresources.com/tcl.html>  
(<http://www.freeprogrammingresources.com/tcl.html>)

(a large list of helpful resources)

<http://www.tcl.tk/man/> (<http://www.tcl.tk/man/>)

(Tcl/Tk manual pages)

<http://www.mit.edu/afs/sipb/user/golem/doc/tcltk-iap2000/TclTk1.html>  
(<http://www.mit.edu/afs/sipb/user/golem/doc/tcltk-iap2000/TclTk1.html>)

(a tutorial describing many commands by describing their implementation in a short program)

<http://www.beedub.com/book/> (<http://www.beedub.com/book/>)

(some sample chapters from Practical Programming in Tcl and Tk, by Welch and Jones)

<http://philip.greenspun.com/tcl/> (<http://philip.greenspun.com/tcl/>)

(not the most readable tutorial IMHO, but it does have Tickle-me-Elmo ;) It can be accessed from the link below as well.)

<http://www.tcl.tk/scripting/> (<http://www.tcl.tk/scripting/>)

<http://hegel.ittc.ukans.edu/topics/tcltk/tutorial-noplugin/index.html>  
(<http://hegel.ittc.ukans.edu/topics/tcltk/tutorial-noplugin/index.html>)

(a short tutorial on the essential Tcl commands, also includes a manual of Tcl/Tk commands at the website below)

<http://hegel.ittc.ukans.edu/topics/linux/man-pages/index/index-mann.html>  
(<http://hegel.ittc.ukans.edu/topics/linux/man-pages/index/index-mann.html>)

[http://pages.cpsc.ucalgary.ca/~saul/personal/archives/Tcl-Tk\\_stuff/tcl\\_examples/](http://pages.cpsc.ucalgary.ca/~saul/personal/archives/Tcl-Tk_stuff/tcl_examples/)  
([http://pages.cpsc.ucalgary.ca/~saul/personal/archives/Tcl-Tk\\_stuff/tcl\\_examples/](http://pages.cpsc.ucalgary.ca/~saul/personal/archives/Tcl-Tk_stuff/tcl_examples/))

(Tk widgets with screenshots)

---

## OpenSees Interpreter

The main abstractions of OpenSees will be explained using the OpenSees interpreter. The interpreter is an extension of the *Tcl* (page 15) scripting language. The OpenSees interpreter adds commands to Tcl for finite element analysis. Each of these commands is associated (bound) with a C++ procedure that is provided. It is this procedure that is called upon by the interpreter to parse the command. In this document we outline only those commands which have been added to Tcl by OpenSees.

For OpenSees we have added commands to Tcl for finite element analysis:

- Modeling – create nodes, elements, loads and constraints
- Analysis – specify the analysis procedure.
- Output specification – specify what it is you want to monitor during the analysis.

➤ **HELP**

*OpenSees Documentation Web Page* (<http://opensees.berkeley.edu/OpenSees/primer.html>)

<http://opensees.berkeley.edu/cgi-bin/OpenSeesCommands.pl>  
(<http://opensees.berkeley.edu/cgi-bin/OpenSeesCommands.pl>)

CHAPTER 2

# OpenSees

➤ **What is OpenSees?**

- An object-oriented software framework for simulation applications in earthquake engineering using finite element methods. OpenSees is not a code.
- A communication mechanism within PEER for exchanging and building upon research accomplishments.
- As open-source software, it has the potential for a community code for earthquake engineering.

my favorite:

- You can describe a structural/geotech. component at a number of levels:
  - element level - force-deformation model
  - section level - moment-curvature model
  - fiber level - material stress-strain model

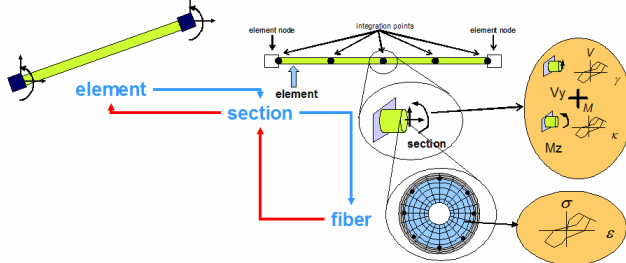

traditional code vs. OpenSEES

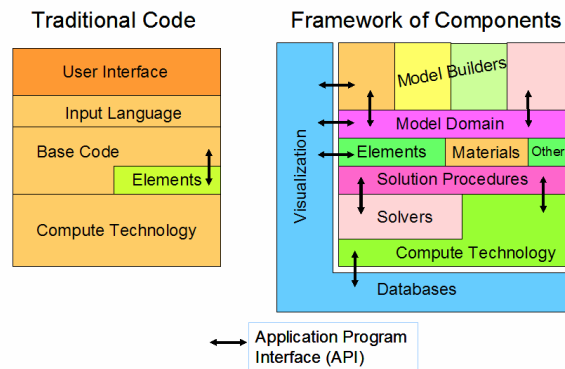

simulation-framework components

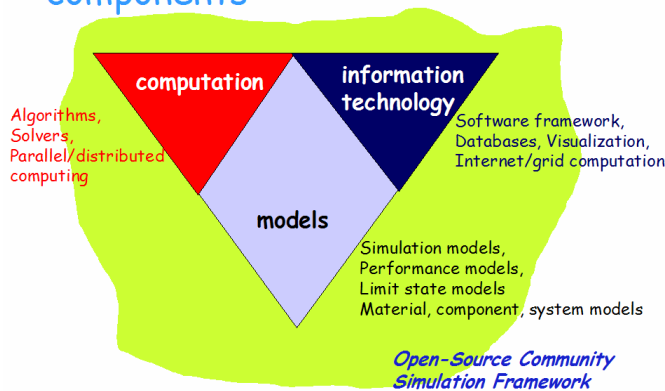

OpenSees is comprised of a set of modules to perform creation of the finite element model, specification of an analysis procedure, selection of quantities to be monitored during the analysis, and the output of results. In each finite element analysis, an analysis is used to construct 4 main types of objects, as shown

## main abstractions in OpenSEES

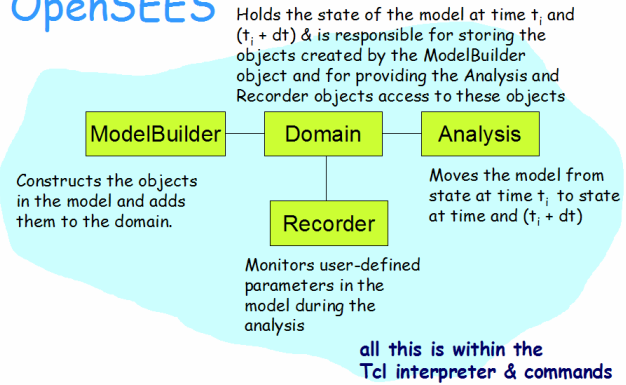

## domain & analysis objects

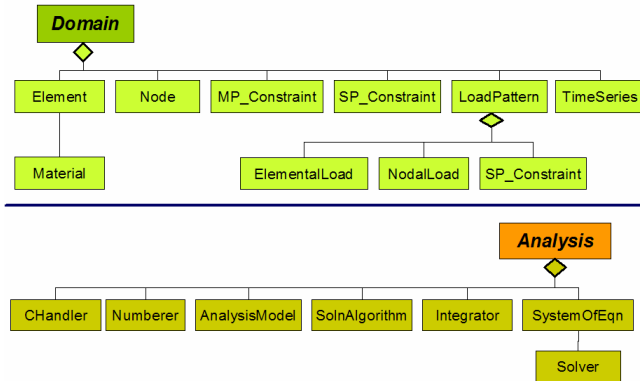

## In This Chapter

OpenSees Features .....	21
ModelBuilder Object .....	29
Domain Object .....	30
Recorder Object .....	31
Analysis Object .....	31

---

## OpenSees Features

- + The library of materials, elements and analysis is a powerful tool for numerical simulation of nonlinear systems**
- + The OpenSees library of components is ever-growing numerical-simulation models**
- + The OpenSees interface is based on a command-line interface that enables the user to create more-versatile input files**
- + OpenSees is not a black box, making it a useful tool for modeling**
- + You can create your own material, element or analysis into OpenSees**
- + NEES is supporting integration of OpenSees as a laboratory testing tool**

## WHY OPENSEES?

---

---

## **MODELS:**

**+ linear & nonlinear structural and  
geotechnical models**

---

## SIMULATIONS:

- + static push-over analyses**
- + static reversed-cyclic analyses**
- + dynamic time-series analyses**
- + uniform-support excitation**
- + multi-support excitation**

---

## MODELING FEATURES:

➤ **MODEL-BUILDING CAPABILITIES:**

- *model command* (page 34)
- *node command* (page 36)
- *mass command* (page 37)
- *constraints objects*
- *uniaxialMaterial command* (page 43)
- *nDMaterial command* (page 162)
- *section command* (page 191)
- *element command* (page 215)
- *block command* (page 273)
- *region command*
- *Geometric Transformation command* (page 280)

- *Time Series command* (page 288)
- *pattern command* (page 294)

➤ **ANALYSIS CAPABILITIES**

- *constraints command* (page 316)
- *numberer command* (page 321)
- *system command* (page 323)
- *test command* (page 326)
- *algorithm command* (page 329)
- *integrator command* (page 333)
- *analysis command* (page 339)
- *rayleigh command* (page 342)
- *eigen command* (page 343)
- *dataBase command*

➤ **RECORDER/OUTPUT CAPABILITIES**

- *Node Recorder* (page 303)
- *EnvelopeNode Recorder*
- *Drift Recorder*
- *Element Recorder* (page 307)
- *EnvelopeElement Recorder*
- *Display Recorder* (page 310)
- *Plot Recorder*
- *playback Command*

---

## MODEL-BUILDING FEATURES:

- **UNIAXIAL MATERIALS** (*page 43*):



- *Elastic Material* (page 125)
- *Elastic-Perfectly Plastic Material*
- *Elastic-Perfectly Plastic Gap Material*
- *Elastic-No Tension Material*
- *Parallel Material*
- *Series Material*
- *Hardening Material*
- *Concrete01 Material -- Zero Tensile Strength* (page 134)
- *Concrete02 Material -- Linear Tension Softening* (page 137)
- *Concrete03 Material -- Nonlinear Tension Softening* (page 143)
- *Steel01 Material* (page 147)
- *Steel02 Material -- Giuffré-Menegotto-Pinto Model with Isotropic Strain Hardening* (page 153)
- *Hysteretic Material* (page 158)
- *Viscous Material*
- *BARSLIP Material*
- *Bond\_SP01 - - Strain Penetration Model for Fully Anchored Steel Reinforcing Bars*
- *Concrete04 Material -- Popovics Concrete Material* (page 57)
- *Fatigue Material*
- *Limit State Material*
- *PINCHING4 Material* (page 84)
- *PyTzQz Uniaxial Materials*
- *Reinforcing Steel Material*

➤ **MULTIDIMENSIONAL/nD MATERIALS:**

- *Elastic Isotropic Material* (page 162)
- *J2 Plasticity Material*
- *Plane Stress Material*
- *Plate Fiber Material* (page 164)
- *Template Elasto-Plastic Material*
- *FluidSolidPorousMaterial Material*
- *PressureIndependMultiYield Material*
- *PressureDependMultiYield Material*

➤ **ELEMENTS:**

- *Truss Element*
- *Corotational Truss Element*

- *Elastic Beam Column Element* (page 217)
- *Nonlinear Beam Column Element* (page 218)
- *Beam With Hinges Element* (page 219)
- *Displacement-Based Beam-Column Element* (page 223)
- *Zero-Length Element*
- *Zero-Length ND Element*
- *Zero-Length Section Element* (page 226)
- *Quad Element*
- *Shell Element*
- *Bbar Plane Strain Quadrilateral Element* (page 228)
- *Enhanced Strain Quadrilateral Element*
- *Standard Brick Element*
- *Bbar Brick Element*
- *Eight Node Brick Element* (page 259)
- *Twenty Node Brick Element*
- *u-p-U element*
- *FourNodeQuadUP Element* (page 256)
- *BeamColumnJoint Element*

➤ **SECTIONS:**

- *Elastic Section* (page 192)
- *Uniaxial Section* (page 193)
- *Fiber Section* (page 194)
- *Section Aggregator*
- *Elastic Membrane Plate Section*
- *Plate Fiber Section* (page 205)
- *Bidirectional Section*
- *Isolator2spring Section: Model to include buckling behavior of an elastomeric bearing*

---

## ANALYSIS FEATURES:

- **Linear Equation Solvers** (page 323) -- provide the solution of the linear system of equations  $Ku = P$ . Each solver is tailored to a specific matrix topology.

- *Profile SPD* (page 324) -- Direct profile solver for symmetric positive definite matrices
  - *Band General* -- Direct solver for banded unsymmetric matrices
  - *Band SPD* -- Direct solver for banded symmetric positive definite matrices
  - *Sparse General* -- Direct solver for unsymmetric sparse matrices
  - *Sparse Symmetric* -- Direct solver for symmetric sparse matrices
  - *UmfPack General* -- Direct UmfPack solver for unsymmetric matrices
  - Full General -- Direct solver for unsymmetric dense matrices
  - Conjugate Gradient -- Iterative solver using the preconditioned conjugate gradient method
- ***Eigenvalue Solvers -- provide the solution of the generalized eigenvalue problem  $Kv = MvL$***
- Symmetric Arpack -- Arpack solver for symmetric matrices
  - Band Arpack -- Arpack solver for banded matrices
- ***DOF Numberers (page 321) -- number the degrees of freedom in the domain***
- *Plain* (page 321) -- Uses the numbering provided by the user
  - *RCM* (page 322) -- Renumbers the DOF to minimize the matrix band-width using the Reverse Cuthill-McKee algorithm
- ***Static Integrators (page 333) -- determine the next time step for an analysis***
- *Load Control* (page 334) -- Specifies the incremental load factor to be applied to the loads in the domain
  - *Displacement Control* (page 335) -- Specifies the incremental displacement at a specified DOF in the domain
  - *Minimum Unbalanced Displacement Norm* (page 336) -- Specifies the incremental load factor such that the residual displacement norm is minimized
  - *Arc Length* (page 336) -- Specifies the incremental arc-length of the load-displacement path
- ***Transient Integrators (page 333) -- determine the next time step for an analysis including inertial effects***
- *Newmark* (page 337) -- The two parameter time-stepping method developed by Newmark
  - *Hilbert-Hughes-Taylor* (page 338) -- The three parameter Hilbert-Hughes-Taylor time-stepping method
  - Central Difference -- Approximates velocity and acceleration by centered finite differences of displacement

➤ **Solution Algorithms (page 329) -- Iterate from the last time step to the current**

- *Linear Algorithm* -- Uses the solution at the first iteration and continues
- *Newton Algorithm* (page 329) -- Uses the tangent at the current iteration to iterate to convergence
- *Modified Newton Algorithm* -- Uses the tangent at the first iteration to iterate to convergence
- *Newton with Line Search Algorithm*
- *Krylov-Newton Algorithm*
- *BFGS Algorithm*
- *Broyden Algorithm*

➤ **Convergence Tests (page 326) -- Accept the current state of the domain as being on the converged solution path**

- *Norm Unbalance* -- Specifies a tolerance on the norm of the unbalanced load at the current iteration
- *Norm Displacement Increment* -- Specifies a tolerance on the norm of the displacement increments at the current iteration
- *Energy Increment* -- Specifies a tolerance on the inner product of the unbalanced load and displacement increments at the current iteration
- Relative Unbalance
- Relative Displacement Increment
- Relative Energy Increment

➤ **Constraint Handlers (page 316) -- Handle the constraints defined on the domain**

- *Plain Constraints* (page 318) -- Removes constrained degrees of freedom from the system of equations
- *Lagrange Multipliers* (page 319) -- Uses the method of Lagrange multipliers to enforce constraints
- *Penalty Method* (page 318) -- Uses penalty numbers to enforce constraints
- *Transformation Method* (page 320) -- Performs a condensation of constrained degrees of freedom

➤ **analysis Command (page 339) -- defines what type of analysis is to be performed**

- *Static Analysis* (page 339) -- solves the  $KU=R$  problem, without the mass or damping matrices.
- *Transient Analysis* (page 340) -- solves the time-dependent analysis. The time step in this type of analysis is constant. The time step in the output is also constant.
- *Variable Transient Analysis* (page 341) -- performs the same analysis type as the Transient Analysis object. The time step, however, is variable. This method is used when there are convergence problems with the Transient Analysis object at a peak or when the time step is too small. The time step in the output is also variable.

---

## ModelBuilder Object

The model builder constructs As in any finite element analysis, the analyst's first step is to subdivide the body being studied into elements and nodes, to define loads acting on the elements and nodes, and to define constraints acting on the nodes.

The ModelBuilder is the object in the program responsible for building the following objects in the model and adding them to the domain:

- **Node** (page 36)
- **Mass** (page 37)
- **Material** (page 162, page 43)
- **Section** (page 191)
- **Element** (page 215)
- **LoadPattern** (page 294)
- **TimeSeries** (page 288)
- **Transformation** (page 280)
- **Block** (page 273)
- **Constraint** (page 316)

---

# Domain Object

The Domain object is responsible for storing the objects created by the *ModelBuilder* (page 29) object and for providing the *Analysis* (page 313) and *Recorder* (page 31) objects access to these objects.

Figure 1: Domain Object

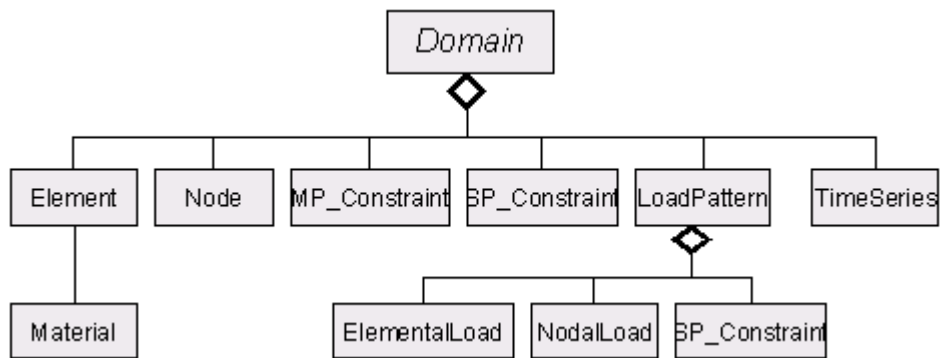

# Recorder Object

The recorder object monitors user-defined parameters in the model during the analysis. This, for example, could be the displacement history at a node in a transient analysis, or the entire state of the model at each step of the solution procedure. Several *Recorder* (page 303) objects are created by the analyst to monitor the analysis.

## ➤ What does a recorder do?

- Monitors the state of a domain component (node, element, etc.) during an analysis
- Writes this state to a file or to a database at selected intervals during the analysis
- There are also recorders for plotting and monitoring residuals

Once in a file, the information can be easily post-processed.

# Analysis Object

The Analysis objects are responsible for performing the analysis. The analysis moves the model along from state at time  $t$  to state at time  $t + dt$ . This may vary from a simple *static* (page 339) linear analysis to a *transient* (page 340, page 341) non-linear analysis. In OpenSees each Analysis object is composed of several component objects, which define the type of analysis how the analysis is performed.

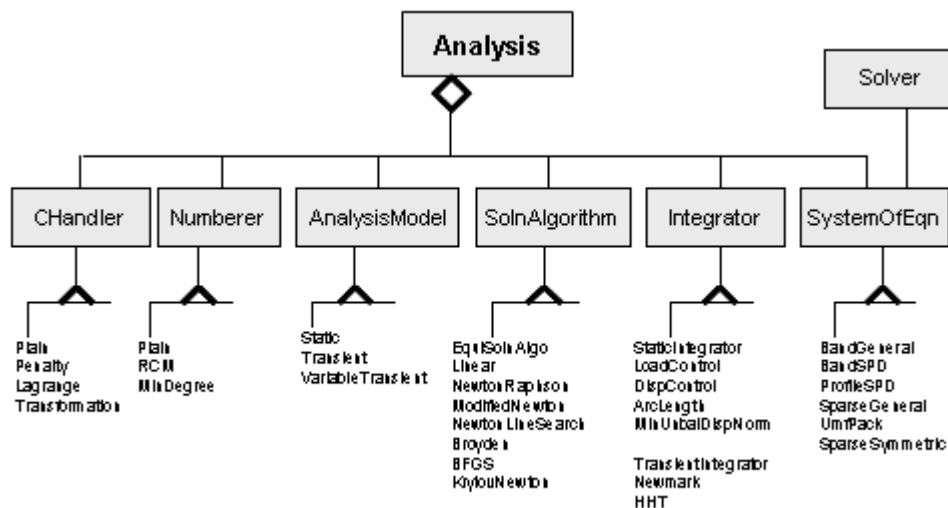

*Figure 2: Analysis Object*



## CHAPTER 3

# Model-Building Objects

These objects are used to create the physical model.

## In This Chapter

model Command.....	34
node Command.....	36
mass Command.....	37
constraints objects.....	38
uniaxialMaterial Command.....	43
nDMaterial Command.....	162
section Command.....	191
element Command.....	215
block Command.....	273
region Command.....	278
Geometric Transformation Command.....	280
Time Series.....	288
pattern Command.....	294

## CHAPTER 4

# model Command

This command is used to construct a ModelBuilder object.

Currently there is only one type of ModelBuilder accepted.

For an example of this command, refer to the *Model Building Example* (page 363)

## In This Chapter

Basic Model Builder.....	34
build Command.....	35

---

## Basic Model Builder

This command is used to construct the BasicBuilder object.

```
model BasicBuilder -ndm $ndm <-ndf $ndf>
```

<b>\$ndm</b>	dimension of problem (1,2 or 3)
<b>\$ndf</b>	number of degrees of freedom at node (optional)
	(default value depends on value of ndm:
	ndm=1 -> ndf=1
	ndm=2 -> ndf=3
	ndm=3 -> ndf=6)

These additional commands allow for the construction of *Nodes* (page 36), *Masses* (page 37), *Materials* (page 162, page 43), *Sections* (page 191), *Elements* (page 215), *LoadPatterns* (page 294), *TimeSeries* (page 288), *Transformations* (page 280), *Blocks* (page 273) and *Constraints* (page 316). These additional commands are described in the subsequent chapters.

EXAMPLE:

**model basic -ndm 3 -ndf 6;** # 3 spacial dimensions, 6 DOF's per node

For an example of this command, refer to the *Model Building Example* (page 363)

---

## build Command

This command is used to invoke build() (????) on the *ModelBuilder* (page 29) object.

**build**

This command has no effect a *BasicBuilder* (page 34) object, but will on other types of *ModelBuilder* (page 29) objects.

## CHAPTER 5

# node Command

This command is used to construct a Node object. It assigns coordinates and masses to the Node object.

```
node $nodeTag (ndm $coords) <-mass (ndf $MassValues)>
```

<b>\$nodeTag</b>	integer tag identifying node
<b>\$coords</b>	nodal coordinates ( <i>ndm</i> (page 34) arguments)
<b>\$MassValues</b>	nodal mass corresponding to each DOF ( <i>ndf</i> (page 34) arguments) (optional)

The optional **-mass** string allows analyst the option of associating nodal mass with the node

**EXAMPLE:**

```
node 1 0.0 0.0 0.0; # x,y,z coordinates (0,0,0) of node 1
```

```
node 2 0.0 120. 0.0; # x,y,z coordinates (0,120,0) of node 2
```

For an example of this command, refer to the *Model Building Example* (page 363)

## CHAPTER 6

# mass Command

This command is used to set the mass at a node.

```
mass $nodeTag (ndf $MassValues)
```

<b>\$nodeTag</b>	integer tag identifying the node associated with the mass
<b>\$MassValues</b>	mass values corresponding to each nodal degrees of freedom ( <i>ndf</i> (page 34) values)

EXAMPLE:

```
mass 2 2.5 0.0 2.5 0.0 0.0 0.0;    # define mass in x and z coordinates
```

For an example of this command, refer to the *Model Building Example* (page 363)

## CHAPTER 7

# constraints objects

From Cook: " A constraint either prescribes the value of a DOF (as in imposing a support condition) or prescribes a relationship among DOF. In common terminology, a single-point constraint sets a single DOF to a known value (often zero) and a multi-point constraint imposes a relationship between two or more DOF.... For example, support conditions on a three-bar truss invoke single-point constraints, while rigid links and rigid elements each invoke a multi-point constraint."

## In This Chapter

Single-Point Constraints .....	38
Multi-Point Constraints .....	41

---

## Single-Point Constraints

The following commands construct homogeneous single-point boundary constraints.

---

### fix Command

This command is used to construct homogeneous single-point boundary constraints.

**fix \$nodeTag (ndf \$ConstrValues)**

<b>\$nodeTag</b>	integer tag identifying the node to be constrained
<b>\$ConstrValues</b>	constraint type (0 or 1). <i>ndf</i> (page 29) values are specified, corresponding to the <i>ndf</i> degrees-of-freedom.
	The two constraint types are:
<b>0</b>	unconstrained
<b>1</b>	constrained

EXAMPLE:

```
fix 1 1 1 1 1 1 1;      # node 1: fully fixed
```

**fix 2 0 1 0 0 1 0 -mass 2.5 0.0 2.5 0.0 0.0 0.0;** # node 2: restrain axial elongation and torsion, translational masses in x-z plane only

For an example of this command, refer to the *Model Building Example* (page 363)

---

## fixX Command

This command is used to construct multiple homogeneous single-point boundary constraints for all nodes whose x-coordinate lies within a specified distance from a specified coordinate.

**fixX \$xCoordinate (ndf \$ConstrValues) <-tol \$tol>**

For example, this command is used when specifying boundary conditions for a series of nodes lying in a plane parallel to the y-z plane in global coordinates.

<b>\$xCoordinate</b>	x-coordinate of nodes to be constrained
<b>\$ConstrValues</b>	constraint type (0 or 1). <i>ndf</i> (page 29) values are specified, corresponding to the <i>ndf</i> degrees-of-freedom. The two constraint types are: <b>0</b> unconstrained <b>1</b> constrained
<b>\$tol</b>	user-defined tolerance (optional, default = 1e-10)

EXAMPLE:

**fixX 0.0 1 1 1 1 1 1 -tol 0.1;** # fully restrain all nodes in y-z plane at origin (x=0.0)

---

## fixY Command

This command is used to construct multiple homogeneous single-point boundary constraints for all nodes whose y-coordinate lies within a specified distance from a specified coordinate.

**fixY \$yCoordinate (ndf \$ConstrValues) <-tol \$tol>**

For example, this command is used when specifying boundary conditions for a series of nodes lying in a plane parallel to the x-z plane in global coordinates.

<b>\$yCoordinate</b>	y-coordinate of nodes to be constrained
<b>\$ConstrValues</b>	constraint type (0 or 1). <i>ndf</i> values are specified, corresponding to the <i>ndf</i> (page 34) degrees-of-freedom. The two constraint types are: <b>0</b> unconstrained <b>1</b> constrained
<b>\$tol</b>	user-defined tolerance (optional, default = 1e-10)

EXAMPLE:

```
fixY 0.0 1 1 1 1 1 1 -tol 0.1; # fully restrain all nodes in x-z plane at origin (y=0.0)
```

---

## fixZ Command

This command is used to construct multiple homogeneous single-point boundary constraints for all nodes whose z-coordinate lies within a specified distance from a specified coordinate.

**fixZ \$zCoordinate (ndf \$ConstrValues) <-tol \$tol>**

For example, this command is used when specifying boundary conditions for a series of nodes lying in a plane parallel to the x-y plane in global coordinates.

<b>\$zCoordinate</b>	z-coordinate of nodes to be constrained
<b>\$ConstrValues</b>	constraint type (0 or 1). <i>ndf</i> values are specified, corresponding to the <i>ndf</i> (page 34) degrees-of-freedom. The two constraint types are: <b>0</b> unconstrained <b>1</b> constrained
<b>\$tol</b>	user-defined tolerance (optional, default = 1e-10)

EXAMPLE:

```
fixZ 0.0 1 1 1 1 1 1 -tol 0.1; # fully restrain all nodes in x-y plane at origin (z=0.0)
```



---

## Multi-Point Constraints

The following commands construct multi-point boundary constraints.

---

### equalDOF Command

This command is used to construct a multi-point constraint between nodes.

```
equalDOF $rNodeTag $cNodeTag $dof1 $dof2 ...
```

<b>\$rNodeTag</b>	integer tag identifying the retained, or master node (rNode)
<b>\$cNodeTag</b>	integer tag identifying the constrained, or slave node (cNode)
<b>\$dof1 \$dof2 ...</b>	nodal degrees-of-freedom that are constrained at the cNode to be the same as those at the rNode  Valid range is from 1 through <i>ndf</i> (page 34), the number of nodal degrees-of-freedom.

EXAMPLE:

```
equalDOF 2 3 1 3 5; # impose the traslational displacements in x and z directions, and rotation about the y-axis of node 3 to be the same as those of node 2.
```

---

### rigidDiaphragm Command

This command is used to construct a number of Multi-Point Constraint (MP\_Constraint) objects. These objects will constraint certain degrees-of-freedom at the listed slave nodes to move as if in a rigid plane with the master node.

```
rigidDiaphragm $perpDirn $masterNodeTag $slaveNodeTag1 $slaveNodeTag2 ...
```

<b>\$perpDirn</b>	direction perpendicular to the rigid plane (i.e. direction 3 corresponds to the 1-2 plane) The rigid plane can be the 1-2, 1-3 or 2-3 plane
<b>\$masterNodeTag</b>	integer tag identifying the master node
<b>\$slaveNodeTag1</b> <b>\$slaveNodeTag2 ...</b>	nodes that are to be constrained to the master node

**NOTE:** The constraint object is constructed assuming small rotations.

**NOTE:** The rigidDiaphragm command works only for problems in three dimensions with six-degrees-of-freedom at the nodes (*ndf* (page 34) = 6).

EXAMPLE:

**rigidDiaphragm 2 2 4 5 6;** constrain nodes 4,5,6 to move as if in the same x-z plane as node 2.

---

## rigidLink Command

This command is used to construct a single MP\_Constraint object.

**rigidLink \$type \$masterNodeTag \$slaveNodeTag**

<b>\$type</b>	string-based argument for rigid-link type: <ul style="list-style-type: none"> <li><b>rod</b> only the translational degree-of-freedom will be constrained to be exactly the same as those at the master node</li> <li><b>beam</b> both the translational and rotational degrees of freedom are constrained.</li> </ul>
<b>\$masterNodeTag</b>	integer tag identifying the master node
<b>\$slaveNodeTag</b>	integer tag identifying the slave node to be constrained to master node

**NOTE:** The constraint object constructed for the beam option assumes small rotations

EXAMPLE:

**rigidLink beam 2 3;** # connect node 3 to node 2 via a rigid link-beam.

## CHAPTER 8

# uniaxialMaterial Command

This command is used to construct a `UniaxialMaterial` object which represents uniaxial stress-strain (or force-deformation) relationships.

The valid queries to any uniaxial material when creating an *ElementRecorder* (page 307) are 'strain,' 'stress,' and 'tangent.'

## In This Chapter

-- Contributed Uniaxial Materials .....	44
Elastic Material .....	125
Elastic-Perfectly Plastic Material .....	126
Elastic-Perfectly Plastic Gap Material .....	128
Elastic-No Tension Material .....	129
Parallel Material .....	130
Series Material .....	131
Hardening Material .....	133
Concrete01 Material -- Zero Tensile Strength .....	134
Concrete02 Material -- Linear Tension Softening .....	137
Concrete03 Material -- Nonlinear Tension Softening .....	143
Steel01 Material .....	147
Steel02 Material -- Giuffré-Menegotto-Pinto Model with Isotropic	
Strain Hardening .....	153
Hysteretic Material .....	158
Viscous Material .....	161

## CHAPTER 9

# -- Contributed Uniaxial Materials

These additional materials are contributions to OpenSees and should be available in the latest executable.

If you have questions about these objects, please do contact the individual authors directly.

## In This Chapter

BARSLIP Material .....	44
Bond_SP01 - - Strain Penetration Model for Fully Anchored Steel Reinforcing Bars.....	46
Concrete04 Material -- Popovics Concrete Material..	57
Fatigue Material.....	61
Limit State Material.....	73
PINCHING4 Material .....	84
PyTzQz Uniaxial Materials .....	104
Reinforcing Steel Material .....	112

## BARSLIP Material

Contact Author:

This command is used to construct a uniaxial material that simulates the bar force versus slip response of a reinforcing bar anchored in a beam-column joint. The model exhibits degradation under cyclic loading. Cyclic degradation of strength and stiffness occurs in three ways: unloading stiffness degradation, reloading stiffness degradation, strength degradation.

```
uniaxialMaterial BarSlip $matTag $fc $fy $Es $fu $Eh $db $ld $nb $depth  
$height <$anclratio> $bsFlag $type <$damage $unit>
```

<b>\$matTag</b>	unique material object integer tag
<b>\$fc</b>	positive floating point value defining the compressive strength of the concrete in which the reinforcing bar is anchored

<b>\$fy</b>	positive floating point value defining the yield strength of the reinforcing steel
<b>\$Es</b>	floating point value defining the modulus of elasticity of the reinforcing steel
<b>\$fu</b>	positive floating point value defining the ultimate strength of the reinforcing steel
<b>\$Eh</b>	floating point value defining the hardening modulus of the reinforcing steel
<b>\$ld</b>	floating point value defining the development length of the reinforcing steel
<b>\$db</b>	point value defining the diameter of reinforcing steel
<b>\$nb</b>	an integer defining the number of anchored bars
<b>\$depth</b>	floating point value defining the dimension of the member (beam or column) perpendicular to the dimension of the plane of the paper
<b>\$height</b>	floating point value defining the height of the flexural member, perpendicular to direction in which the reinforcing steel is placed, but in the plane of the paper
<b>\$ancLratio</b>	floating point value defining the ratio of anchorage length used for the reinforcing bar to the dimension of the joint in the direction of the reinforcing bar (optional, default: 1.0)
<b>\$bsFlag</b>	string indicating relative bond strength for the anchored reinforcing bar (options: "Strong" or "Weak")
<b>\$type</b>	string indicating where the reinforcing bar is placed. (options: "beamtopy", "beambot" or "column")
<b>\$damage</b>	string indicating whether there is full damage in the material or no damage (optional, options: "Damage", "NoDamage" ; default: Damage)
<b>\$unit</b>	string indicating the type of unit system used (optional, options: "psi", "MPa", "Pa", "psf", "ksi", "ksf") (default: "psi" / "MPa")*

**NOTE:**

Model Characteristics:

The uniaxial material model uses the *Pinching4 material* (page 84) model (Ref. Pinching4 material model). The response envelope for the bar-slip springs does not represent strength deterioration, but once the slip demand exceeds 3mm (0.12 in), strength deterioration due to cyclic loading initiates. As a result the bond-slip springs always exhibit positive stiffness, but strength deterioration upon reloading to a previously observed slip demand. Reloading and Unloading Stiffness deterioration are also simulated.

The damage index for unloading and reloading stiffness degradation is evaluated the same way as the Pinching4 material (ref. Pinching4 material doc.) but the index for strength degradation  $\mathcal{D}_i$  is specified as

$$\mathcal{D}_i = (gF1 \cdot (\tilde{d}_{\max}) + gF3) \leq gFLim$$

With degradation model parameters  $gF^*$ . It should be noted in here that the deterioration parameters for unloading, reloading stiffness and strength degradation cannot be modified by the user and are defined to represent observed behavior.

**\*NOTE:** The model includes predefined bond strengths, so there is the necessity to include in Units in this material model. For default one can specify units in psi (i.e. pounds/inch<sup>2</sup>) or in MPa (i.e. N/mm<sup>2</sup>). The code detects units in psi if the compressive strength of concrete is greater than 1000 otherwise it takes it as MPa system. The optional variable \$unit will help the user to specify other different types of unit systems according to one's choice, but currently it is limited to the unit systems as specified above. The user should also take care to specify the units of length in the corresponding matching units. (note: Pa = N/m<sup>2</sup>; ksf = kilo-pound/ft<sup>2</sup>)

## Bond\_SP01 - - Strain Penetration Model for Fully Anchored Steel Reinforcing Bars

URL: [http://www.uwm.edu/~jzhao/Bond\\_SP01\\_pages/Bond\\_index.html](http://www.uwm.edu/~jzhao/Bond_SP01_pages/Bond_index.html)  
[http://www.uwm.edu/~jzhao/Bond\\_SP01\\_pages/Bond\\_index.html](http://www.uwm.edu/~jzhao/Bond_SP01_pages/Bond_index.html)

Contact Authors: Jian Zhao, University of Wisconsin, Milwaukee [jzhao@uwm.edu]  
 Sri Sritharan, Iowa State University [sri@iastate.edu]

This command is used to construct a uniaxial material object for capturing strain penetration effects at the column-to-footing, column-to-bridge bent caps, and wall-to-footing intersections. In these cases, the bond slip associated with strain penetration typically occurs along a portion of the anchorage length. This model can also be applied to the beam end regions, where the strain penetration may include slippage of the bar along the entire anchorage length, but the model parameters should be chosen appropriately.

**uniaxialMaterial Bond\_SP01 \$matTag \$Fy \$Sy \$Fu \$Su \$b \$R**

This model is for fully anchored steel reinforcement bars that experience bond slip along a portion of the anchorage length due to strain penetration effects, which are usually the case for column and wall longitudinal bars anchored into footings or bridge joints

**\$matTag** Unique material object integer tag  
**\$Fy** Yield strength of the reinforcement steel  
**\$Sy** Rebar slip at member interface under yield stress and may be obtained from

$$S_y(in) = 0.1 \left( \frac{d_b(in) F_y(ksi)}{4000 \sqrt{f'_c(ksi)}} (2 * \alpha + 1) \right)^{1/\alpha} + 0.013(in)$$

or

$$S_y(mm) = 2.54 \left( \frac{d_b(mm) F_y(MPa)}{8437 \sqrt{f'_c(MPa)}} (2 * \alpha + 1) \right)^{1/\alpha} + 0.34(mm)$$

$d_b$ : rebar diameter

$F_y$ : yield strength of the reinforcement steel

$f'_c$ : concrete compressive strength of the adjoining connection member

$\alpha$ : parameter used in the local bond-slip relation and can be taken as 0.4 in accordance with CEB-FIP Model Code 90

**\$Fu** Ultimate strength of the reinforcement steel

**\$Su** Rebar slip at the loaded end at the bar fracture strength

$$S_u = (30 \sim 40) * S_y$$

**\$b** Initial hardening ratio in the monotonic slip vs. bar stress response (0.3~0.5)

**\$R** Pinching factor for the cyclic slip vs. bar response (0.5~1.0)

**NOTE:**

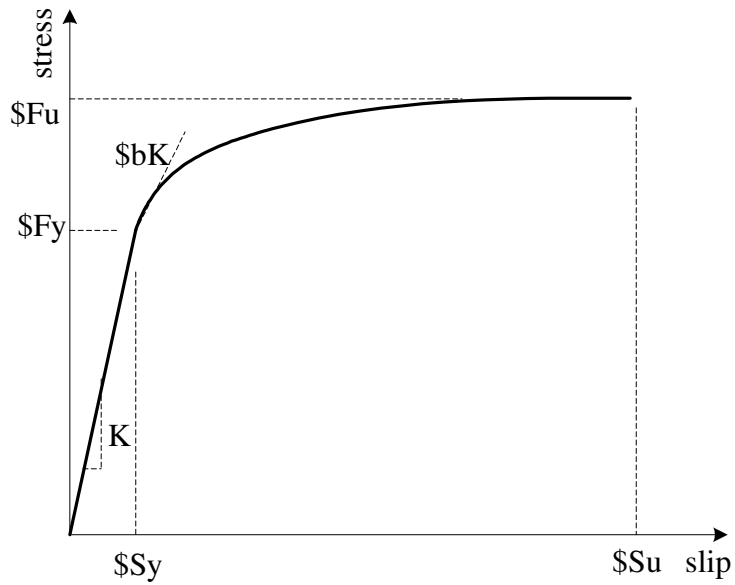



Figure 1: Monotonic bar stress vs. slip response as modelled in Bond\_SP01

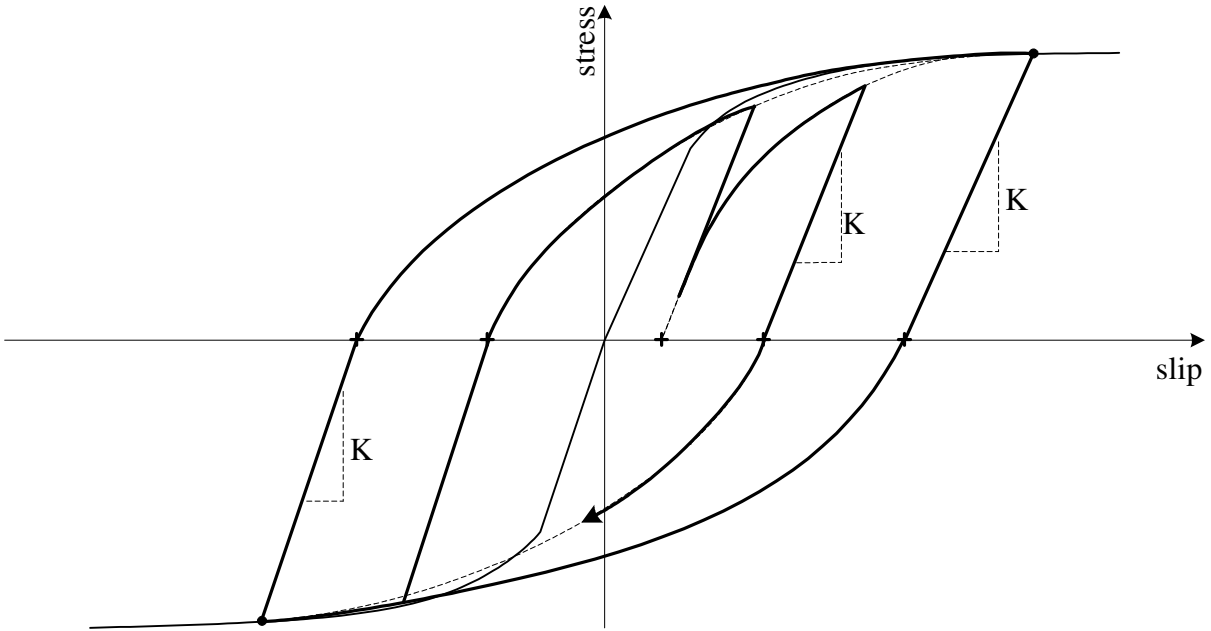

Figure 2: Cyclic bar stress vs. slip response as modelled in Bond\_SP01

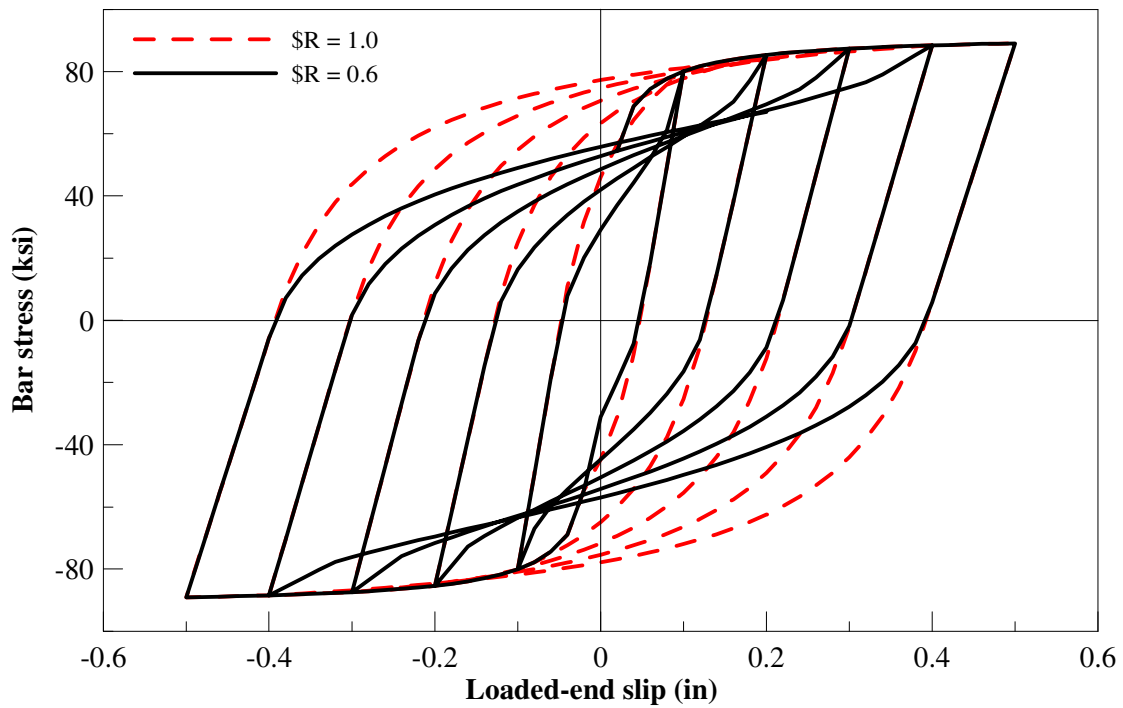

Figure 3: Pinching effect represented by  $\$R$  in Bond\_SP01**Model background:**

Capturing the structural response and associated damage require accurate modeling of localized inelastic deformations occurring at the member end regions as identified by shaded areas in Figure 4. These member end deformations consist of two components: 1) the flexural deformation that causes inelastic strains in the longitudinal bars and concrete, and 2) the member end rotation, as indicated by arrows in Figure 4, due to reinforcement slip. The slip considered here is the result of strain penetration along a portion of the fully anchored bars into the adjoining concrete members (e.g., footings and joints) during the elastic and inelastic response of a structure. Ignoring the strain penetration component may appear to produce satisfactory force-displacement response of the structural system by compromising strain penetration effects with greater contribution of the flexural action at a given lateral load. However, this approach will appreciably overestimate the strains and section curvatures in the critical inelastic regions of the member, and thereby overestimate the structural damage.

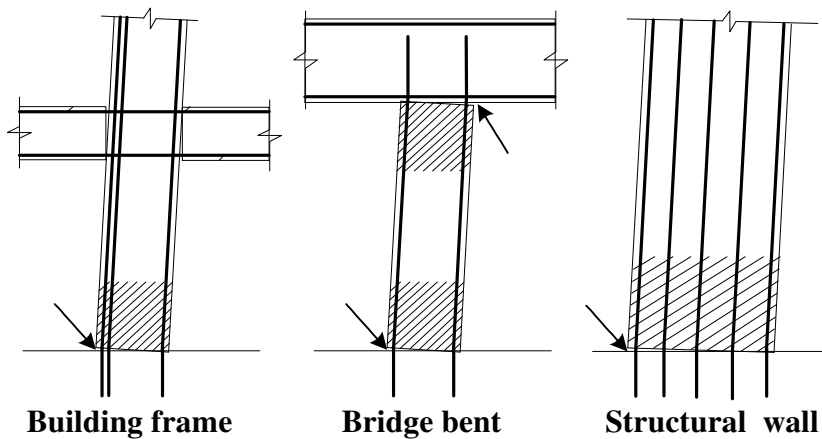

Figure 4: Expected inelastic regions at the column and wall ends

The zero-length section element available in OpenSees may be used to accurately model the strain penetration effects (or the fixed end rotations shown in Figure 4). Zero-length section elements have been generally used for section analyses to calculate the moment corresponding to a given curvature. To model the fixed-end rotation, the zero-length section element should be placed at the intersection between the flexural member and an adjoining member representing a footing or joint as shown in Figure 5. A duplicate node is also required between a fiber-based beam-column element and the adjoining concrete element as shown in Figure 5. The translational degree-of-freedom of this new node (i.e., node j in Figure 5) should be constrained to the other node (i.e., node i in Figure 5) to prevent sliding of the beam-column element under lateral loads because the shear resistance is not included in the zero-length section element.

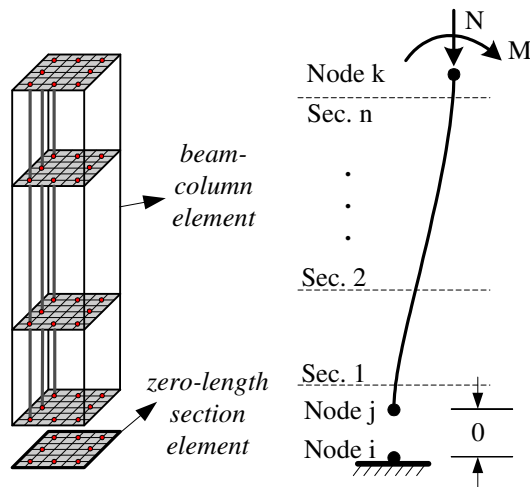

Figure 5: Adding a zero-length section element to a beam-column element

The zero-length section element in OpenSees is assumed to have a unit length such that the element deformations (i.e., elongation and rotation) are equal to the section deformations (i.e., axial strain and curvature). The material model for the steel fibers in the zero-length section element represents the bar slip instead of strain for a given bar stress. The uniaxial material model Bond\_SP01 is developed for steel fibers in the zero-length section elements.

### Note on Material Model for Concrete Fibers

Similar to the model proposed for the steel fibers, a material model describing the monotonic response and hysteretic rules is also required for the concrete fibers. The combination of using the zero-length section element and enforcing the plane section assumption at the end of a flexural member impose high deformations to the extreme concrete fibers in the zero-length element. These deformations would likely correspond to concrete compressive strains significantly greater than the strain capacity stipulated by typical confined concrete models. Such high compressive strains at the end of flexural members are possible because of additional confinement effects expected from the adjoining members and because of complex localized deformation at the member end. Without further proof, it is suggested that the concrete fibers in the zero-length section element follow a concrete model in OpenSees (e.g., Concrete02). To accommodate the large deformations expected to the extreme concrete fibers in the zero-length element, this concrete model may be assumed to follow a perfectly plastic behavior once the concrete strength reduces to 80% of the confined compressive strength. A parametric study has indicated that the simulation results would not be very sensitive to the compressive strain chosen to trigger the perfectly plastic behavior for the concrete fibers in the zero-length section element.

### Reference:

Zhao, J., and S. Sritharan. Modeling of strain penetration effects in fiber-based analysis of reinforced concrete structures. ACI Structural Journal. (Accepted for publication in 2006).

### example ss\_ic1.tcl

```
# bridge T-joint
# -----
# Units: kips, in.

# Pushover analysis multiple dispBeamColumn with strain penetration

# modeling the circular RC column in a bridge T-joint tested by
# Sri Sritharan
# "Seismic response of column/cap beam tee connections
# with cap beam prestressing" Ph.D. thesis, UCSD

# Create ModelBuilder (with two dimensions and 2 DOF/node)
model basic -ndm 2 -ndf 3

# Create nodes
# tag X Y
node 1 0.0 -48.0
node 2 0.0 -30.0
node 3 0.0 -12.0
node 4 0.0 0.0
node 5 0.0 12.0
node 6 0.0 30.0
node 7 0.0 48.0
node 8 12.0 0.0
node 9 19.0 0.0
node 10 40.0 0.0
node 11 61.5 0.0
node 12 84.0 0.0
node 13 12.0 0.0
# Fix supports at base of column
```

```

# Tag DX DY RZ
fix 1 1 1 0
fix 7 1 0 0
#equalDOF $rNodeTag $cNodeTag $dof1 $dof2
equalDOF 8 13 2

# Define materials for nonlinear columns
##column Core CONCRETE
uniaxialMaterial Concrete01 tag f'c ec0 f'cu ecu
1 -6.38 -0.004 -5.11 -0.014
uniaxialMaterial Concrete01 tag f'c ec0 f'cu ecu
200 -6.38 -0.004 -5.11 -0.014
##column Cover CONCRETE
uniaxialMaterial Concrete01 tag f'c ec0 f'cu ecu
2 -4.56 -0.002 0.0 -0.006
##column stub CONCRETE
uniaxialMaterial Elastic tag E
3 2280

##beam CONCRETE
uniaxialMaterial Concrete01 tag f'c ec0 f'cu
ecu
4 -5.76 -0.002 0.0 -0.006

## STEEL rebar
##STEEL02
uniaxialMaterial Steel02 tag $Fy $E $b $R0
$cR1 $cR2 $a1 $a2 $a3 $a4
0.041.0 0.04 1.0 5 65.0 29000 0.02 18.5 0.925 0.15
uniaxialMaterial Steel02 tag $Fy $E $b $R0
0.001.0 0.00 1.0 6 62.8 29000 0.02 18.5 0.925 0.15
uniaxialMaterial Elastic tag
7 29000

#uniaxialMaterial StrPen01
uniaxialMaterial StrPen01 $Tag $sy $fy $su $fu $Kz $R
$cD $db $fc $la
0.0 1.0 4.35 25.0 400 0.02 65 0.7 97.5 0.50 0.7

# Define cross-section for nonlinear column
set colDia 24; # bending in this direction (local and global y)
set cover 1.38;
set bcent 1.81; # [expr $cover+0.197+0.5]
set As 0.60; # Area of no. 7 bar
set R [expr $colDia/2.0]
set Rc [expr $colDia/2.0-$cover]
set Rb [expr $colDia/2.0-$bcent]

section Fiber 1 {
# core concrete fibers
patch circ 1 70 22 0.0 0.0 0.0 $Rc 0.0 360.0
# concrete cover fibers
patch circ 2 70 2 0.0 0.0 $Rc $R 0.0 360.0
# reinforcing fibers
layer circ 5 14 $As 0.0 0.0 $Rb -90.0 244.3
}
section Fiber 2 {
# core concrete fibers
patch circ 3 70 22 0.0 0.0 0.0 $Rc 0.0 360.0
# concrete cover fibers
patch circ 3 70 2 0.0 0.0 $Rc $R 0.0 360.0
# reinforcing fibers
layer circ 5 14 $As 0.0 0.0 $Rb -90.0 244.3
}
section Fiber 5 {

```

```

# core concrete fibers
patch circ          200   70   22   0.0   0.0   0.0   $Rc   0.0   360.0
# concrete cover fibers
patch circ          2     70    2   0.0   0.0   $Rc   $R    0.0   360.0
# reinforcing fibers
layer circ          400   14   $As  0.0   0.0   $Rb  -90.0  244.3
}

# Define cross-section for nonlinear cap beam
set bmw 27;          # bending in this direction (local and global y)
set bmh 24;          # bending in this direction (local and global y)
set cover 1.38;
set bcent 1.81;      # [expr $cover+0.197+0.5]

set aw [expr $bmw/2.0]
set ac [expr $bmw/2.0-$cover]
set ab [expr $bmw/2.0-$bcent]
set bw [expr $bmh/2.0]
set bc [expr $bmh/2.0-$cover]
set bb [expr $bmh/2.0-$bcent]

section Fiber 3 {
  # concrete fibers
  patch quad 4 48 1  -$bw  -$aw  $bw  -$aw  $bw  $aw  -$bw  $aw
  # reinforcing fibers
  layer straight 6 7 $As -$bb  $ab  -$bb  -$ab
  layer straight 6 7 $As  $bb  $ab  $bb  -$ab
}

# Define column elements
## Geometry of column elements
geomTransf Linear 1

# Number of integration points along length of element
set np 5

# Create the columns using displacement controlled beam-column elements
#
# tag      ndI      ndJ      nsecs  secID  transfTag
element dispBeamColumn 1 1 2 $np 3 1
element dispBeamColumn 2 2 3 $np 3 1
element dispBeamColumn 3 3 4 $np 3 1
element dispBeamColumn 4 4 5 $np 3 1
element dispBeamColumn 5 5 6 $np 3 1
element dispBeamColumn 6 6 7 $np 3 1
element dispBeamColumn 7 4 8 $np 2 1
element dispBeamColumn 8 13 9 $np 1 1
element dispBeamColumn 9 9 10 $np 1 1
element dispBeamColumn 10 10 11 $np 1 1
element dispBeamColumn 11 11 12 $np 1 1
# zeroLengthSection tag ndI ndJ secID
element zeroLengthSection 12 8 13 5

# Set up and perform analysis
## Create recorders
recorder Node -file topdispac.out -time -node 12 -dof 2 disp
recorder Node -file rot4ac.out -time -node 4 -dof 3 disp
recorder Node -file rot8ac.out -time -node 8 -dof 3 disp
recorder Drift drift84ac.out 4 8 2 1
recorder Drift curvatureac.out 8 9 3 1
recorder Drift curvatureac1.out 13 9 3 1

```

```
recorder Element -file secstrspac.out -time -ele 8 section 5 fiber -$Rb 0 5 stressStrain
recorder Element -file secstrsnac.out -time -ele 8 section 5 fiber $Rb 0 5 stressStrain
recorder Element -file secstrcac.out -time -ele 8 section 5 fiber $Rc 0 1 stressStrain
recorder plot topdispac.out Node12_Ydisp 10 10 300 300 -columns 2 1

set P -90.0
pattern Plain 1 "Constant" {
  load 12 $P 0.0 0.0
}

# Define analysis parameters
integrator LoadControl 0
system SparseGeneral -piv
test NormDisplncr 1.0e-4 2000
numberer Plain
constraints Plain
algorithm KrylovNewton
analysis Static

# Do one analysis for constant axial load
analyze 1

# Define reference force
pattern Plain 2 "Linear" {
  load 12 0.0 1.0 0.0
}

set dU1 -0.02
set dU2 0.02

# Perform the analysis
integrator DisplacementControl 12 2 $dU1
analyze 33
integrator DisplacementControl 12 2 $dU2
analyze 65
integrator DisplacementControl 12 2 $dU1
analyze 32

integrator DisplacementControl 12 2 $dU1
analyze 67
integrator DisplacementControl 12 2 $dU2
analyze 134
integrator DisplacementControl 12 2 $dU1
analyze 67

integrator DisplacementControl 12 2 $dU1
analyze 101
integrator DisplacementControl 12 2 $dU2
analyze 202
integrator DisplacementControl 12 2 $dU1
analyze 101

integrator DisplacementControl 12 2 $dU1
analyze 135
integrator DisplacementControl 12 2 $dU2
analyze 270
integrator DisplacementControl 12 2 $dU1
analyze 135

integrator DisplacementControl 12 2 $dU1
```

```

analyze 202
integrator DisplacementControl 12 2 $dU2
analyze 404
integrator DisplacementControl 12 2 $dU1
analyze 202

```

### materialmodels.tcl

```

# load pattern test
# -----
# Jian Zhao, Iowa State University
# June 20, 2004
# -----

#-----Create Model (2-D 3dof problem-plane truss)
model basic -ndm 2 -ndf 3

# Create nodes
# tag X Y
node 1 0.0 0.0
node 2 1.0 0.0
node 3 1.0 1.0

# Fix supports at node 1
# Tag DX DY RZ
fix 1 1 1 1
fix 2 0 1 1
fix 3 0 0 1

# Define faked material
# unconfined CONCRETE tag f'c ec0 f'cu ecu
uniaxialMaterial Concrete01 1 -4.5 -0.002 0.0 -0.006
# confined CONCRETE tag f'c ec0 f'cu ecu
uniaxialMaterial Concrete01 2 -6.0 -0.004 -5.0 -0.014
# unconfined CONCRETE tag f'c ec0 f'cu ecu
ratioft et0 ft0 beta etu
uniaxialMaterial Concrete03 3 -6.0 -0.004 -5.0 -0.014 0.5 0.45 0.0015
0.1 2.5 0.0025
# STEEL02 tag $Fy $E $b $R0 $cR1 $cR2
$a1 $a2 $a3 $a4
uniaxialMaterial Steel02 4 68.1 29000 0.010 22 0.925 0.15
0.041.0 0.04
#uniaxialMaterial StrPen01 tag $sy $fy $su $fu $Kz $R
$Cd$db $fc $la
uniaxialMaterial StrPen01 5 0.022 60 0.77 90 0.5 0.65
0.0 1.0 4.35 25.0

set mat 5
# Define truss element
# tag inode jnode A Mattag
element truss 1 1 2 1 $mat
element truss 2 1 3 1 $mat
element truss 3 2 3 1 $mat
#-----DONE Create Model

#-----Create Analysis
# Create displacement command recorders
recorder Node -file commanddisp.out-time -node 2 -dof 1
disp

```



```

# Create reaction force recorders (for checking material models)
recorder Element -file          reaction.out -time -ele 1 axialForce

pattern Plain 1 "Series -dt 0.01 -filePath cycload.txt" {
  sp 2 1 1
}

integrator LoadControl .01
system SparseGeneral -piv
test NormUnbalance 1.0e-6 100
numberer Plain
constraints Transformation
algorithm Newton
analysis Static

set numIncr 310
analyze $numIncr

wipe

```

## Concrete04 Material -- Popovics Concrete Material

Contact Authors:                    Laura Lowes: <http://www.ce.washington.edu/~lowes/>  
    Michael Berry: [mpberry@u.washington.edu](mailto:mpberry@u.washington.edu)

This command is used to construct a uniaxial Popovics concrete material object with degraded linear unloading/reloading stiffness according to the work of Karsan-Jirsa and tensile strength with exponential decay.

**uniaxialMaterial Concrete04 \$matTag \$fc \$ec \$ecu \$Ec <\$ft \$et> <\$beta>**

<b>\$matTag</b>	unique material object integer tag
<b>\$fc</b>	floating point values defining concrete compressive strength at 28 days (compression is negative)*
<b>\$ec</b>	floating point values defining concrete strain at maximum strength*
<b>\$ecu</b>	floating point values defining concrete strain at crushing strength*
<b>\$Ec</b>	floating point values defining initial stiffness**
<b>\$ft</b>	floating point value defining the maximum tensile strength of concrete
<b>\$et</b>	floating point value defining ultimate tensile strain of concrete

**\$beta** floating point value defining the exponential curve parameter to define the residual stress (as a factor of \$ft) at \$etu

**\*NOTE:** Compressive concrete parameters should be input as negative values.

**\*\*NOTE:** The envelope of the compressive stress-strain response is defined using the model

proposed by Popovics (1973). If the user defines  $E_c = 57000\sqrt{|f_c|}$  (in psi) then the envelope curve is identical to proposed by Mander et al. (1988).

### Model Characteristic:

**For loading in compression,** the envelope to the stress-strain curve follows the model proposed by Popovics (1973) until the concrete crushing strength is achieved and also for strains beyond that corresponding to the crushing strength.

$$f_{ci} = f_c' \left( \frac{\epsilon_{ci}}{\epsilon_c} \right)^n \frac{n}{n-1 + \left( \frac{\epsilon_{ci}}{\epsilon_c} \right)^n}$$

$$E_{sec} = \frac{f_{ci}}{\epsilon_{ci}} n = \frac{E_c}{E_c - E_{sec}}$$

where subscript i refer to the stress/strain at any load step. For unloading and reloading in compression, the Karsan-Jirsa model (1969) is used to determine the slope of the curve. For tensile loading, an exponential curve is used to define the envelope to the stress-strain curve:

$$\sigma_i = f_t \left( \frac{\beta f_t}{f_t} \right)^{\frac{\epsilon_i - \frac{f_t}{E_c}}{\frac{f_t}{E_c}}}$$

where  $\beta$  multiplier refers to the stress at ultimate tensile strain, generally the value considered is 0.1.

For unloading and reloading in tensile, the secant stiffness is used to define the path.

The following figures show example stress-strain histories generated using the model.

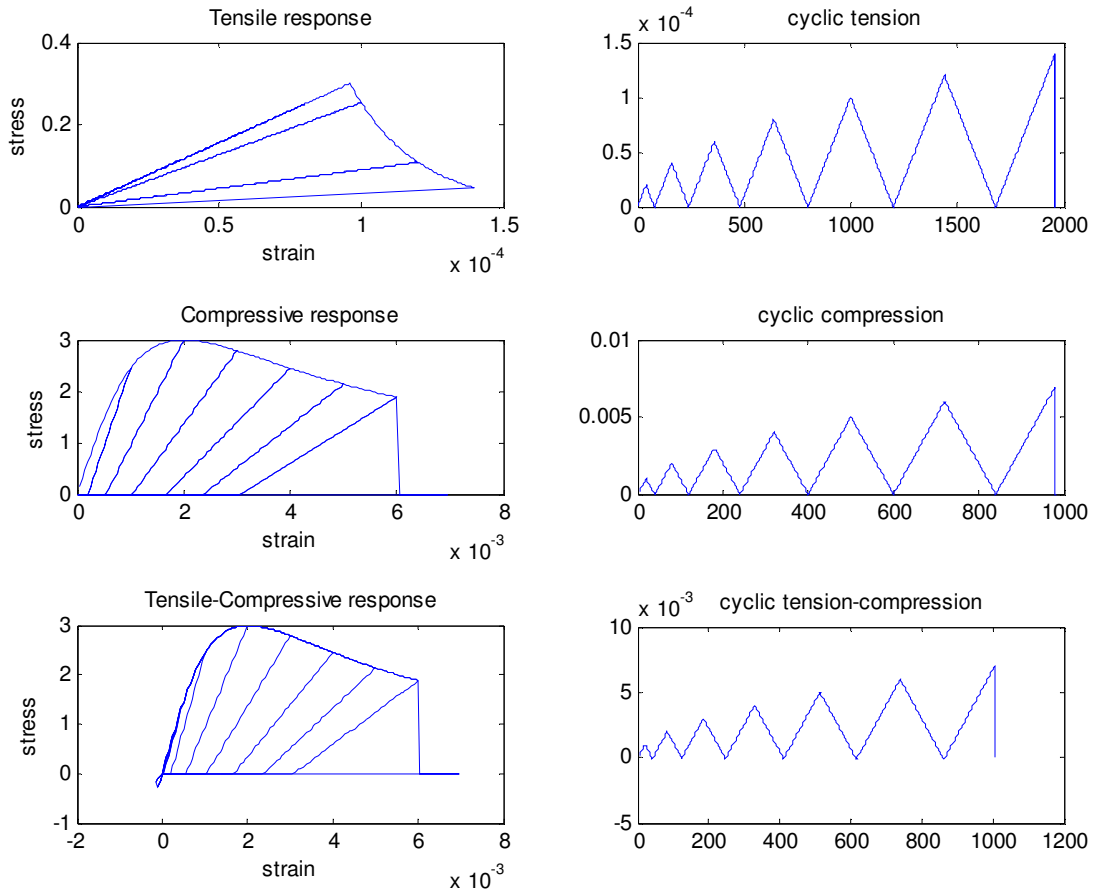

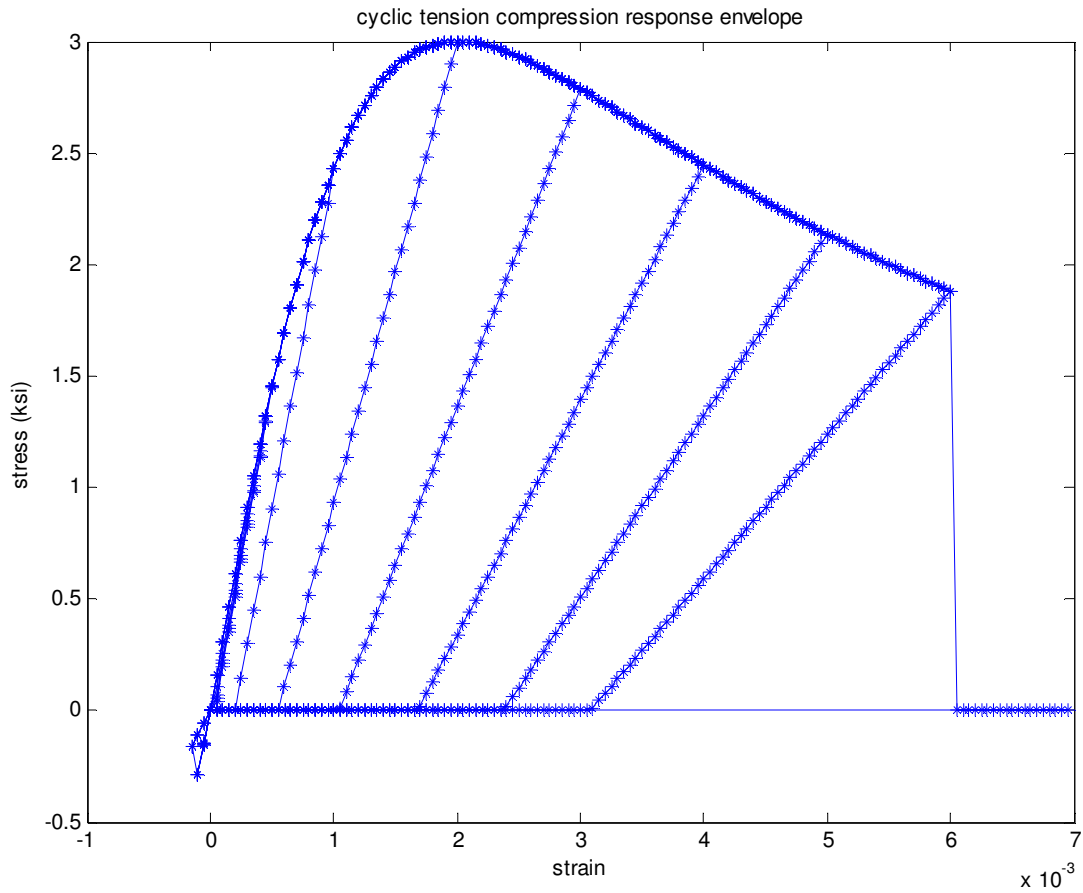
**Reference:**

Mander, J. B., Priestley, M. J. N., and Park, R. (1988). "Theoretical stress-strain model for confined concrete." *Journal of Structural Engineering ASCE*, 114(8), 1804-1825.

Popovics, S. (1973). "A numerical approach to the complete stress strain curve for concrete." *Cement and concrete research*, 3(5), 583-599.

Karsan, I. D., and Jirsa, J. O. (1969). "Behavior of concrete under compressive loading." *Journal of Structural Division ASCE*, 95(ST12).

## CHAPTER 10

# Concrete04 -- Material Behavior

Each material was subjected to a series of ten uniaxial tension and compression strain histories. The following is the response of this material to such strain excursions. The data shown are the normalized stresses versus strain. In the normalization, the steel stress was divided by the yield stress  $F_y$  and the concrete stress was divided by the absolute value of compressive strength  $f_c$  -- to maintain positive tension and negative compression. The first figure shows all 10 load patterns together, which are subsequently shown individually.

## Fatigue Material

Author:

[Patxi Uriz](#)

[Contact Information:](#)

[Exponent - Failure Analysis Associates](#)

[149 Commonwealth Drive Menlo Park, CA 94025](#)

[patxi@exponent.com](mailto:patxi@exponent.com)

The fatigue material uses a modified rainflow cycle counting algorithm to accumulate damage in a material using Miner's Rule. Element stress/strain relationships become zero when fatigue life is exhausted.

```
uniaxialMaterial Fatigue $matTag $tag <-E0 $E0> <-m $m>
<-min $min> <-max $max>
```

This material model accounts for the effects of low cycle fatigue. A modified rainflow cycle counter has been implemented to track strain amplitudes. This cycle counter is used in concert with a linear strain accumulation model (i.e. Miner's Rule), based on Coffin-Manson log-log relationships describing low cycle fatigue failure. This material "wraps" around another material and does not influence the stress-strain (or force-deformation) relationship of the parent material.

Once the Fatigue material model reaches a damage level of 1.0, the force (or stress) of the parent material becomes zero ( $1.0 \times 10^{-8}$  times the call to the material). If failure is triggered in compression, the material stress is dropped at the next zero-force crossing (i.e. compression force never "drops" to zero).

The Fatigue material assumes that each point is the last point of the history, and tracks damage with this assumption. If failure is not triggered, this pseudo-peak is discarded.

The material also has the ability to trigger failure based on a maximum or minimum strain (i.e. not related to fatigue). The default for these values is set to very large numbers.

The default values are calibrated parameters from low cycle fatigue tests of European steel sections Ballio and Castiglioni (1995), for more information about how material was calibrated, the user is directed to Uriz (2005).

<b>\$matTag</b>	unique material object integer tag
<b>\$tag</b>	Unique material object integer tag for the material that is being "wrapped"
<b>\$E0</b>	Value of strain at which one cycle will cause failure (default 0.191)
<b>\$m</b>	Slope of Coffin-Manson curve in log-log space (default -0.458)
<b>\$min</b>	Global minimum value for strain or deformation (default -1e16)
<b>\$max</b>	Global maximum value for strain or deformation (default 1e16)

Example Command:

[Example command: uniaxialMaterial Fatigue 2 1 -E0 0.191 -m -0.458](#)

[where 2 is the Fatigue material tag, and 1 is the material that is being wrapped, the -E0 and -m values I have listed here are the default values.](#)

Valid recorder objects for the material are 'stress', 'tangent', 'strain', 'stressStrain', and 'damage'. The stress, strain, and tangent recorder options must be available in the material that you are wrapping.

# FatigueMaterialExample.tcl

```
# Run an example script to test the fatigue material model

## Define model and loads
model BasicBuilder -ndm 2 -ndf 2
node 1 0.0 0.0
node 2 0.0 0.0
fix 1 1 1
fix 2 0 1
uniaxialMaterial Steel01 1 60.0 29800.0 0.003
uniaxialMaterial Fatigue 2 1
element zeroLength 1 1 2 -mat 2 -dir 1
pattern Plain 1 "Linear" {
  # nd FX
  load 2 1.0 0.0 0.0
}

## Recorders
recorder Element -file "Damage.out" -time -ele 1 material 1 damage
recorder Element -file "StressStrain.out" \
  -time -ele 1 material 1 stressANDstrain

## Set analysis parameters
test EnergyIncr 1.0e-8 200 0
algorithm Newton
system UmfPack
numberer RCM
constraints Plain
analysis Static

## Source the displacement history, and initialize analysis parameters
#source RandomStrainHstory1.tcl
source RandomStrainHstory2.tcl
set LoopLength [array size disp]
set h 1
set controlNode 2
set currentDisp [nodeDisp $controlNode 1 ]
puts [format "\n STARTING DISPLACEMENT = %5.3f \n" $currentDisp]
```



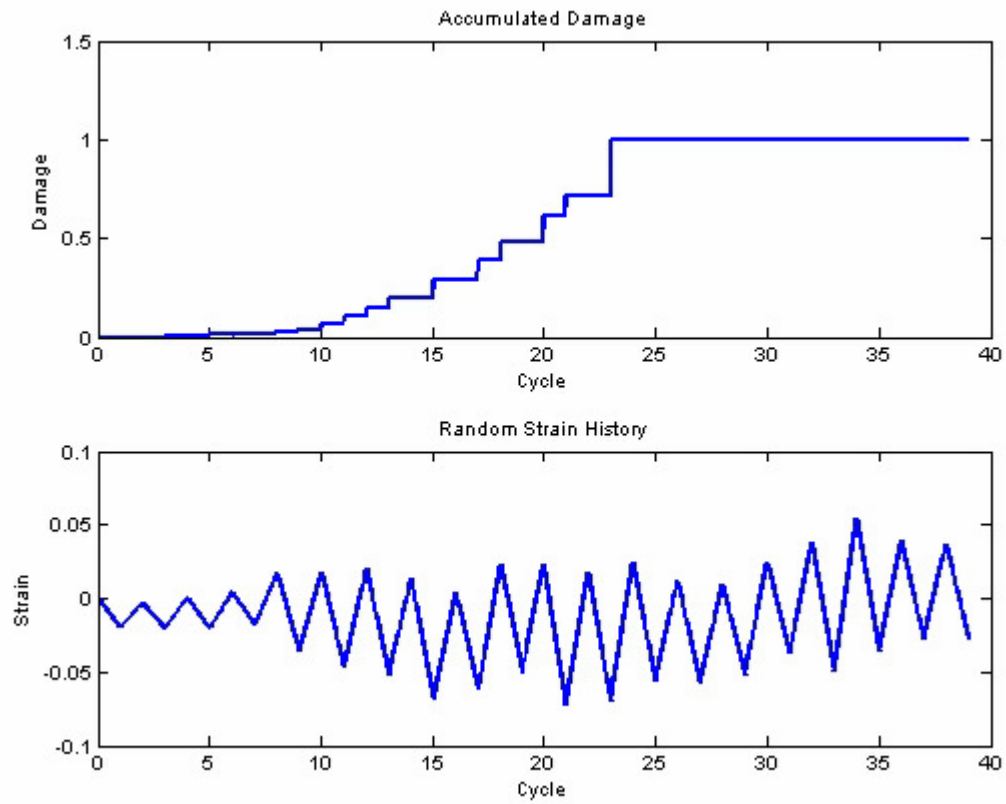

Figure 1. DamageExample1.jpg

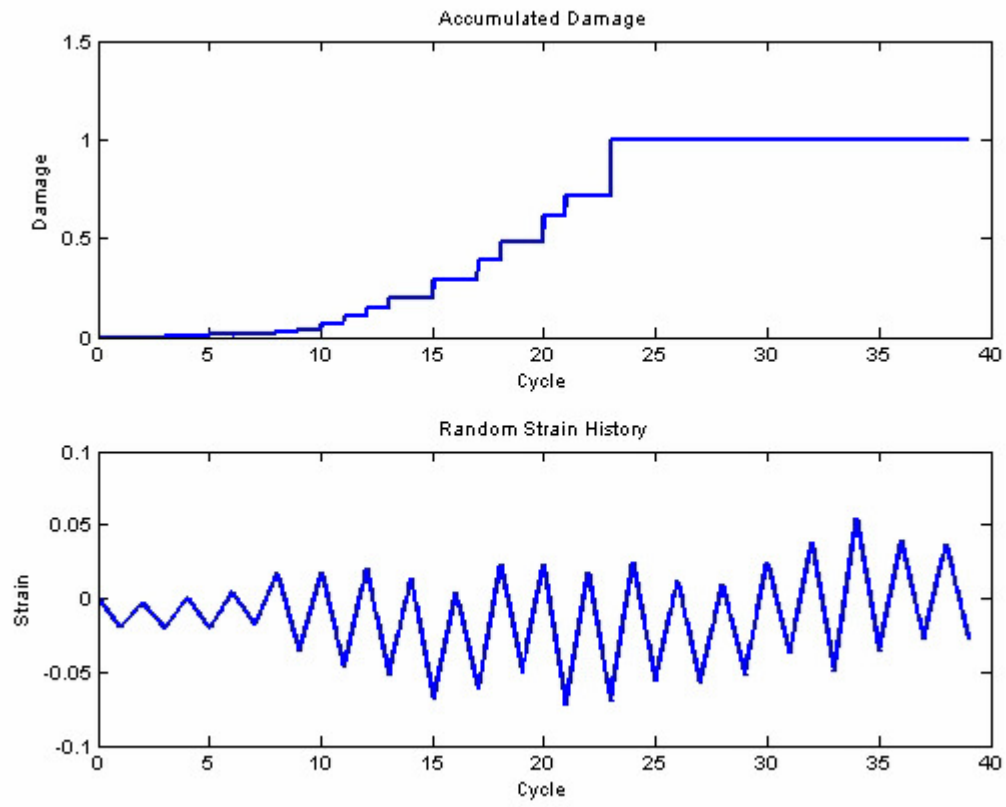

Figure 2. DamageExample2.jpg

**RandomStrainHistory1.tcl**

```
set disp(1) -0.0110
set disp(2) -0.0106
set disp(3) -0.0129
set disp(4) -0.0089
set disp(5) -0.0113
set disp(6) -0.0069
set disp(7) -0.0079
set disp(8) 0.0020
set disp(9) -0.0118
set disp(10) -0.0057
set disp(11) -0.0180
set disp(12) -0.0097
set disp(13) -0.0195
set disp(14) -0.0152
set disp(15) -0.0321
set disp(16) -0.0281
set disp(17) -0.0323
set disp(18) -0.0145
set disp(19) -0.0179
set disp(20) -0.0098
set disp(21) -0.0297
set disp(22) -0.0219
set disp(23) -0.0304
set disp(24) -0.0172
set disp(25) -0.0199
set disp(26) -0.0175
set disp(27) -0.0261
set disp(28) -0.0201
set disp(29) -0.0243
set disp(30) -0.0089
set disp(31) -0.0092
set disp(32) 0.0047
set disp(33) -0.0104
set disp(34) 0.0087
set disp(35) 0.0048
set disp(36) 0.0059
set disp(37) 0.0022
set disp(38) 0.0067
```



**RandomStrainHistory2.tcl**

```
set disp(1) -0.0058
set disp(2) 0.0028
set disp(3) -0.0043
set disp(4) -0.0040
set disp(5) -0.0088
set disp(6) -0.0048
set disp(7) -0.0057
set disp(8) 0.0120
set disp(9) 0.0077
set disp(10) 0.0138
set disp(11) 0.0056
set disp(12) 0.0125
set disp(13) 0.0019
set disp(14) 0.0036
set disp(15) -0.0053
set disp(16) 0.0028
set disp(17) -0.0011
set disp(18) 0.0084
set disp(19) 0.0024
set disp(20) 0.0154
set disp(21) 0.0078
set disp(22) 0.0123
set disp(23) -0.0006
set disp(24) 0.0022
set disp(25) -0.0022
set disp(26) 0.0027
set disp(27) 0.0012
set disp(28) 0.0033
set disp(29) -0.0059
set disp(30) 0.0058
set disp(31) -0.0081
set disp(32) 0.0005
set disp(33) -0.0092
set disp(34) -0.0024
set disp(35) -0.0066
set disp(36) -0.0042
set disp(37) -0.0094
```

## References

Uriz, Patxi (2005) "Towards Earthquake Resistant Design of Concentrically Braced Steel Structures," Doctoral Dissertation, Structural Engineering, Mechanics, and Materials, Department of Civil and Environmental Engineering, University of California, Berkeley, December 2005

Ballio, G., and Castiglioni, C. A. (1995). "A Unified Approach for the Design of Steel Structures under Low and/or High Cycle Fatigue." *Journal of Constructional Steel Research*, 34, 75-101.



## CHAPTER 11

# Limit State Material

Contact Author: Ken Elwood:  
<http://www.civil.ubc.ca/faculty/KElwood/KElwood.html>

This command is used to construct a uniaxial hysteretic material object with pinching of force and deformation, damage due to ductility and energy, and degraded unloading stiffness based on ductility. Failure of the material is defined by the associated limit curve.

**uniaxialMaterial LimitState \$matTag \$s1p \$e1p \$s2p \$e2p \$s3p \$e3p \$s1n \$e1n \$s2n \$e2n \$s3n \$e3n \$pinchX \$pinchY \$damage1 \$damage2 \$beta \$curveTag \$curveType.**

<b>\$matTag</b>		unique material object integer tag
<b>\$s1p</b>	<b>\$e1p</b>	stress and strain (or force & deformation) at first point of the envelope in the positive direction
<b>\$s2p</b>	<b>\$e2p</b>	stress and strain (or force & deformation) at second point of the envelope in the positive direction
<b>\$s3p</b>	<b>\$e3p</b>	stress and strain (or force & deformation) at third point of the envelope in the positive direction (optional)
<b>\$s1n</b>	<b>\$e1n</b>	stress and strain (or force & deformation) at first point of the envelope in the negative direction*
<b>\$s2n</b>	<b>\$e2n</b>	stress and strain (or force & deformation) at second point of the envelope in the negative direction*
<b>\$s3n</b>	<b>\$e3n</b>	stress and strain (or force & deformation) at third point of the envelope in the negative direction (optional)*
<b>\$pinchX</b>		pinching factor for strain (or deformation) during reloading
<b>\$pinchY</b>		pinching factor for stress (or force) during reloading
<b>\$damage1</b>		damage due to ductility: $D_1(\mu-1)$
<b>\$damage2</b>		damage due to energy: $D_2(E/E_{ult})$
<b>\$beta</b>		power used to determine the degraded unloading stiffness based on ductility, $\mu\beta$ (optional, default=0.0)
<b>\$curveTag</b>		an integer tag for the LimitCurve defining the limit surface
<b>\$curveType</b>		an integer defining the type of LimitCurve (0 = no curve, 1 = axial curve, all other curves can be any other integer)

\*NOTE: negative backbone points should be entered as negative numeric values

## In This Chapter

Shear Limit Curve.....	74
Axial Limit Curve .....	75
Shear Limit Curve.....	76
Example Files for Limit State Material .....	78

## Shear Limit Curve

This command is used to construct a shear limit curve object that is used to define the point of shear failure for a LimitStateMaterial object. Point of shear failure based on empirical drift capacity model from Chapter 2.

```
limitCurve Shear $curveTag $eleTag $rho $fc $b $h $d $Fsw $Kdeg $Fres  
$defType $forType <$ndI $ndJ $dof $perpDirn $delta>.
```

<b>\$curveTag</b>	unique limit curve object integer tag
<b>\$eleTag</b>	integer element tag for the associated beam-column element
<b>\$rho</b>	transverse reinforcement ratio ( $A_{sv}/bh$ )
<b>\$fc</b>	concrete compressive strength (psi)
<b>\$b</b>	column width (in.)
<b>\$h</b>	full column depth (in.)
<b>\$d</b>	effective column depth (in.)
<b>\$Fsw</b>	floating point value describing the amount of transverse reinforcement ( $F_{sw} = A_{sv}f_yd_c/s$ )
<b>\$Kdeg</b>	If positive: unloading stiffness of beam-column element ( $K_{unload}$ from Figure 4-8) if negative: slope of third branch of post-failure backbone (see Figure 4-6)
<b>\$Fres</b>	floating point value for the residual force capacity of the post-failure backbone (see Figure 4-6)

<b>\$defType</b>	integer flag for type of deformation defining the abscissa of the limit curve 1 = maximum beam-column chord rotations 2 = drift based on displacement of nodes ndI and ndJ
<b>\$forType</b>	integer flag for type of force defining the ordinate of the limit curve* 0 = force in associated limit state material 1 = shear in beam-column element
<b>\$ndI</b>	integer node tag for the first associated node (normally node I of \$eleTag beam-column element)
<b>\$ndJ</b>	integer node tag for the second associated node (normally node J of \$eleTag beam-column element)
<b>\$dof</b>	nodal degree of freedom to monitor for drift**
<b>\$perpDirn</b>	perpendicular global direction from which length is determined to compute drift**
<b>\$delta</b>	drift (floating point value) used to shift shear limit curve

**NOTE:** \* Option 1 assumes no member loads.

\*\* 1 = X, 2 = Y, 3 = Z

## Axial Limit Curve

This command is used to construct an axial limit curve object that is used to define the point of axial failure for a LimitStateMaterial object. Point of axial failure based on model from Chapter 3. After axial failure response of LimitStateMaterial is forced to follow axial limit curve.

**limitCurve Axial \$curveTag \$eleTag \$Fsw \$Kdeg \$Fres \$defType \$forType <\$ndI \$ndJ \$dof \$perpDirn \$delta>.**

<b>\$curveTag</b>	unique limit curve object integer tag
<b>\$eleTag</b>	integer element tag for the associated beam-column element
<b>\$Fsw</b>	floating point value describing the amount of transverse reinforcement ( $F_{sw} = A_{st}f_{yt}d_c/s$ )
<b>\$Kdeg</b>	floating point value for the slope of the third branch in the post-failure backbone, assumed to be negative (see Figure 4-6)
<b>\$Fres</b>	floating point value for the residual force capacity of the post-failure backbone (see Figure 4-6)

<b>\$defType</b>	integer flag for type of deformation defining the abscissa of the limit curve 1 = maximum beam-column chord rotations 2 = drift based on displacement of nodes ndI and ndJ
<b>\$forType</b>	integer flag for type of force defining the ordinate of the limit curve* 0 = force in associated limit state material 1 = shear in beam-column element 2 = axial load in beam-column element
<b>\$ndI</b>	integer node tag for the first associated node (normally node I of \$eleTag beam-column element)
<b>\$ndJ</b>	integer node tag for the second associated node (normally node J of \$eleTag beam-column element)
<b>\$dof</b>	nodal degree of freedom to monitor for drift**
<b>\$perpDirn</b>	perpendicular global direction from which length is determined to compute drift**
<b>\$delta</b>	drift (floating point value) used to shift axial limit curve

**NOTE:** \* Options 1 and 2 assume no member loads.

\*\* 1 = X, 2 = Y, 3 = Z

---

## Shear Limit Curve

This command is used to construct a shear limit curve object that is used to define the point of shear failure for a LimitStateMaterial object. Point of shear failure based on empirical drift capacity model from Chapter 2.

**limitCurve Shear \$curveTag \$eleTag \$rho \$fc \$b \$h \$d \$Fsw \$Kdeg \$Fres  
\$defType \$forType <\$ndI \$ndJ \$dof \$perpDirn \$delta>.**

<b>\$curveTag</b>	unique limit curve object integer tag
<b>\$eleTag</b>	integer element tag for the associated beam-column element
<b>\$rho</b>	transverse reinforcement ratio ( $A_{sv}/bh$ )
<b>\$fc</b>	concrete compressive strength (psi)
<b>\$b</b>	column width (in.)
<b>\$h</b>	full column depth (in.)
<b>\$d</b>	effective column depth (in.)

<b>\$Fsw</b>	floating point value describing the amount of transverse reinforcement ( $F_{sw} = A_{st}f_{yt}d_c/s$ )
<b>\$Kdeg</b>	If positive: unloading stiffness of beam-column element ( $K_{unload}$ from Figure 4-8) if negative: slope of third branch of post-failure backbone (see Figure 4-6)
<b>\$Fres</b>	floating point value for the residual force capacity of the post-failure backbone (see Figure 4-6)
<b>\$defType</b>	integer flag for type of deformation defining the abscissa of the limit curve 1 = maximum beam-column chord rotations 2 = drift based on displacement of nodes ndI and ndJ
<b>\$forType</b>	integer flag for type of force defining the ordinate of the limit curve* 0 = force in associated limit state material 1 = shear in beam-column element
<b>\$ndI</b>	integer node tag for the first associated node (normally node I of \$eleTag beam-column element)
<b>\$ndJ</b>	integer node tag for the second associated node (normally node J of \$eleTag beam-column element)
<b>\$dof</b>	nodal degree of freedom to monitor for drift**
<b>\$perpDirn</b>	perpendicular global direction from which length is determined to compute drift**
<b>\$delta</b>	drift (floating point value) used to shift shear limit curve

**NOTE:** \* Option 1 assumes no member loads.

\*\* 1 = X, 2 = Y, 3 = Z

---

## Example Files for Limit State Material

CenterCol\_basicModel.tcl

```

# Example analysis file for LimitStateMaterial
#
# Units: kip, in
# KJE, Feb 2003

source tags.tcl

# Number of analysis steps and step size
#set nSteps 35000
set nSteps 6000
set dlamda 0.1

# Loading option
set loading push
#set loading cyclic

# Analysis control option
set control load
#set control displ

#####
# Build model
#####

model BasicBuilder -ndm 2 -ndf 3

#####
# Define nodal mesh and B.C.s
#####
set L 58.0

# tag X Y
node 1 0.0 0.0
node 2 0.0 0.0
node 3 0.0 $L
node 4 0.0 $L
node 5 0.0 $L

# tag DX DY RZ
fix 1 1 1 1
fix 4 0 0 1
fix 5 1 1 1

#####
# Create column section
#####

source CenterColSecFiber.tcl

#####
# Define the beam-column element
#####
geomTransf PDelta 1
set nint 5
element nonlinearBeamColumn $bcTag 2 3 $nint $flexSec 1 -iter 5 1e-15

#####
# Define the zero-length end springs
#####
#rigid material
uniaxialMaterial Elastic $rigidMatTag 9.9e9

#bottom of column slip spring

```

**CenterColShearSpring.tcl**

```

# Defines Shear Spring
# Units: kip, in
# KJE, Feb 2003

# slopes of shear spring backbone
set rigidSlope 1700; #Values when using zero-length spring (G*Av/L)
set negSlope -8;

# residual shear capacity
set Vr 3.0;

# strengths for initial response
set Vi1 25.0;
set Vi2 30.0;
set Vi3 45.0;

# stiffness of unloading slope for flexural component
set kf 24.7 ;# measured off hysteresis plot from analysis

# define limit surface using shear drift model
#          tag      eleTag
# rho f'c b h d Fsw
# Kdeg Fres defType forType nodeI nodeJ dof perpDirn
limitCurve Shear $shearCurveTag $bcTag\
0.0018 3517.0 9.0 9.0 7.75 11.87\
$kf $Vr 2 0 1 4 1 2 0.0

# define HystereticMaterial
uniaxialMaterial LimitState $shearTag\
$Vi1 [expr $Vi1/$rigidSlope] $Vi2 [expr $Vi2/$rigidSlope] $Vi3 [expr $Vi3/$rigidSlope]\
[expr -$Vi1] [expr -$Vi1/$rigidSlope] [expr -$Vi2] [expr -$Vi2/$rigidSlope] [expr -$Vi3] [expr -$Vi3/$rigidSlope]\
$pinchX $pinchY $damage1 $damage2 $beta $shearCurveTag 2 0

```

**CenterColSecFiber.tcl**

```

# Defines Center Column Section
# Units: kip, in
# KJE, Feb 2003

set h 9.0
set b $h

set beta1 100.0
set beta2 100.0
set spall nospalling
set alphaS 0.015

# Set parameters for fiber section
set nfCore 28
set nfCover 4
set c 1.0
set z [expr $h/2.0-$c]
set y [expr $b/2.0-$c]
set nz [expr -$z]

```



```

set ny [expr -$y]
set zc [expr $z+$c]
set yc [expr $y+$c]
set nzc [expr -$zc]
set nyc [expr -$yc]
set fc -3.517
set fc [expr -3.517*$beta2/100.0]
set fcU [expr $fc*$beta1/100.0]

set fy 69.5
set Es 29000.0
set esy [expr $fy/$Es]
set esu 0.15
set fu [expr $fy+$alphaS*$Es*($esu-$esy)]

# Define parameters for elastic section
set Ec 3400
set A [expr $h*$b]
set Ig [expr $h*$h*$h*$b/12]

set Mcr 228.0
set Kcr 1.2e-4

set My 554.0 ;# for trilinear model (Mmax from UCFyber)
set Ky 6.3e-4 ;# based on UCFyber results

set Ry [expr $Ky*$L/6.0] ;# yield rotation
set EI [expr $My/$Ky]
set alpha 0.05

set Ku 0.05
set Mu [expr $My+$alpha*$EI*($Ku-$Ky)]
set Ru 0.5 ;# this assumes alpha is very small so diff between M-curv alpha and M-rot alpha is negligible

set pinchX 0.5
set pinchY 0.4
set damage1 0.0
set damage2 0.0

set beta 0.4 ;# only to be used with version 1.3

set lc [expr $EI/$Ec]

set slipStiff 91000 ;# see CenterColumnMomCurv.xls
set Rslip [expr $My/$slipStiff]
set alphaSlip [expr $alpha/(1.0+(1.0-$alpha)*($slipStiff*$L/6/$EI))]
set RslipU [expr $Rslip+($Mu-$My)/($alphaSlip*$slipStiff)]

# Create axial failure spring
source CenterColAxialSpring.tcl

# Create shear failure spring
source CenterColShearSpring.tcl

section Aggregator $shearAxialOnlySec $shearTag Vy $axialFailTag P

# Create fiber section

```

```

# Define uniaxialMaterials
#          tag      fc  epsc  f'cu  epscu
uniaxialMaterial Concrete01 $scoreTag $fc -0.002 $fcu -0.0052

if {$spall == "spalling"} {
uniaxialMaterial Concrete01 $coverTag $fc -0.002 0.0 -0.0060
} elseif {$spall == "nospalling"} {
uniaxialMaterial Concrete01 $coverTag $fc -0.002 $fcu -0.0052
} else {
    puts stderr "Invalid spalling option: $spall"
}

#          tag      fy  E  hardening ratio
#uniaxialMaterial Steel02 $steelTag 69.5 29000 $alphaS
uniaxialMaterial Hysteretic $steelTag $fy $esy $fu $esu\
    -$fy -$esy -$fu -$esu 1.0 1.0 0 0

# Define the fiber section
section Fiber $flexSec {

    # Define the concrete patch with fibers for unidirectional bending
    patch quadr $scoreTag 1 $nfCore $ny $z $ny $nz $y $nz $y $z
    # Define the four cover patches
    patch quadr $coverTag 1 $nfCover $nyc $zc $nyc $nzc $ny $nz $ny $z
    patch quadr $coverTag 1 $nfCover $y $z $y $nz $yc $nzc $yc $zc
    patch quadr $coverTag 1 $nfCore $ny $nz $nyc $nzc $yc $nzc $y $nz
    patch quadr $coverTag 1 $nfCore $nyc $zc $ny $z $y $z $yc $zc

    # Define the reinforcement explicitly using fiber command
    #  yloc zloc area matTag
    fiber -3.250 3.250 0.2 $steelTag 0
    fiber -3.250 -3.250 0.2 $steelTag 0
    fiber 3.250 -3.250 0.2 $steelTag 0
    fiber 3.250 3.250 0.2 $steelTag 0
    fiber -3.187 0.0 0.31 $steelTag 0
    fiber 3.187 0.0 0.31 $steelTag 0
    fiber 0.0 -3.187 0.31 $steelTag 0
    fiber 0.0 3.187 0.31 $steelTag 0 }

    # moment-rotation end springs for slip (assume elastic)
    uniaxialMaterial Elastic $centerSlipTag $slipStiff

set Acenter $A
set Eccenter $Ec
set lcenter $lc

```

### CenterColAxialSpring.tcl

```

# Defines Axial Spring
# Units: kip, in
# KJE, Feb 2003

```

```
set Fsw [expr 11.87/1.0]
```

```
# Axial elastic stiffness (only one axial spring used)
```

```

set axialElasticSlope [expr 99.0*$Ec*$A/$L]; #99 times more rigid than column
set axialNegSlope -90.0; #slope = axial load/axial displ)

# residual capacity
set Pr 5.0;

# axial loads used for setting initial elastic slope
set P1 65.0;
set P2 75.0;
set P3 85.0;

# define limit surface
#          tag      eleTag  Fsw  Kdeg      Fres defType forType nodel nodeJ dof  perpDir delta eleRemove
limitCurve Axial $axialCurveTag $bcTag $Fsw $axialNegSlope $Pr 2 2 1 4 1 2 0.0 0

# define LimitStateMaterial
uniaxialMaterial LimitState $axialFailTag\
    $P1 [expr $P1/$axialElasticSlope] $P2 [expr $P2/$axialElasticSlope] $P3 [expr $P3/$axialElasticSlope]\
    [expr -$P1] [expr -$P1/$axialElasticSlope] [expr -$P2] [expr -$P2/$axialElasticSlope] [expr -$P3] [expr
-$P3/$axialElasticSlope]\
    0.5 0.5 0.0 0.0 0.0 $axialCurveTag 1

```

### Tags.tcl

```

# UniaxialMaterial tags
set coreTag 1 ;# core concrete
set coverTag 2 ;# cover concrete
set steelTag 3 ;# steel

set shearTag 4 ;# shear limit state material
set momTag 5 ;# mom-curv hysteretic model
set axialTag 6 ;# elastic axial force-strain model
set momDegTag 7 ;# degrading moment-curv hysteretic model
set axialFailTag 8 ;# axial limit state material
set centerSlipTag 9 ;# elastic slip spring

set rigidMatTag 10
set softMatTag 11

# Section tags
set flexSec 1
set shearSec 2
set flexTopSec 3
set flexBotSec 4
set axialSec 5
set shearAxialSec 6
set axialOnlySec 7
set flexShearSec 8
set shearAxialOnlySec 9

# Limit Curve tags
set shearCurveTag 1
set axialCurveTag 2

# Element tags
set bcTag 99

```

**cyclic.txt**

```

1.2557524028480316e-003
1.2557524028480316e-003
3.0608252487525078e-003
1.5641001656305775e-003
1.1015791633965932e-003

-1.8313432524451514e+000

```

---

## PINCHING4 Material

Contact Author:

This command is used to construct a uniaxial material that represents a 'pinched' load-deformation response and exhibits degradation under cyclic loading. Cyclic degradation of strength and stiffness occurs in three ways: unloading stiffness degradation, reloading stiffness degradation, strength degradation.

```

uniaxialMaterial Pinching4 $matTag $ePf1 $ePd1 $ePf2 $ePd2 $ePf3 $ePd3
  $ePf4 $ePd4 <$eNf1 $eNd1 $eNf2 $eNd2 $eNf3 $eNd3 $eNf4 $eNd4>
  $rDispP $rForceP $uForceP <$rDispN $rForceN $uForceN > $gK1
  $gK2 $gK3 $gK4 $gKLim $gD1 $gD2 $gD3 $gD4 $gDLim $gF1 $gF2
  $gF3 $gF4 $gFLim $gE $dmgType

```

<b>\$matTag</b>	unique material object integer tag
<b>\$ePf1 \$ePf2 \$ePf3 \$ePf4</b>	floating point values defining force points on the positive response envelope
<b>\$ePd1 \$ePd2 \$ePd3 \$ePd4</b>	floating point values defining deformation points on the positive response envelope
<b>\$eNf1 \$eNf2 \$eNf3 \$eNf4</b>	floating point values defining force points on the negative response envelope (optional, default: negative of positive envelope values)
<b>\$eNd1 \$eNd2 \$eNd3 \$eNd4</b>	floating point values defining deformations points on the negative response envelope (optional, default: negative of positive envelope values)

---

<b>\$rDispP</b>	floating point value defining the ratio of the deformation at which reloading occurs to the maximum historic deformation demand
<b>\$rForceP</b>	floating point value defining the ratio of the force at which reloading begins to force corresponding to the maximum historic deformation demand
<b>\$uForceP</b>	floating point value defining the ratio of strength developed upon unloading from negative load to the maximum strength developed under monotonic loading
<b>\$rDispN</b>	floating point value defining the ratio of the deformation at which reloading occurs to the minimum historic deformation demand (optional, default: \$rDispP)
<b>\$rForceN</b>	floating point value defining the ratio of the force at which reloading begins to the force corresponding to the minimum historic deformation demand (optional, default: \$rForceP)
<b>\$uForceN</b>	floating point value defining the ratio of the strength developed upon unloading from a positive load to the minimum strength developed under monotonic loading (optional, default: \$rForceP)
<b>\$gK1 \$gK2 \$gK3 \$gK4 \$gKLim</b>	floating point values controlling cyclic degradation model for unloading stiffness degradation
<b>\$gD1 \$gD2 \$gD3 \$gD4 \$gDLim</b>	floating point values controlling cyclic degradation model for reloading stiffness degradation
<b>\$gF1 \$gF2 \$gF3 \$gF4 \$gFLim</b>	floating point values controlling cyclic degradation model for strength degradation
<b>\$gE</b>	floating point value used to define maximum energy dissipation under cyclic loading. Total energy dissipation capacity is defined as this factor multiplied by the energy dissipated under monotonic loading.
<b>\$dmgType</b>	string to indicate type of damage (option: "cycle", "energy")

NOTE:

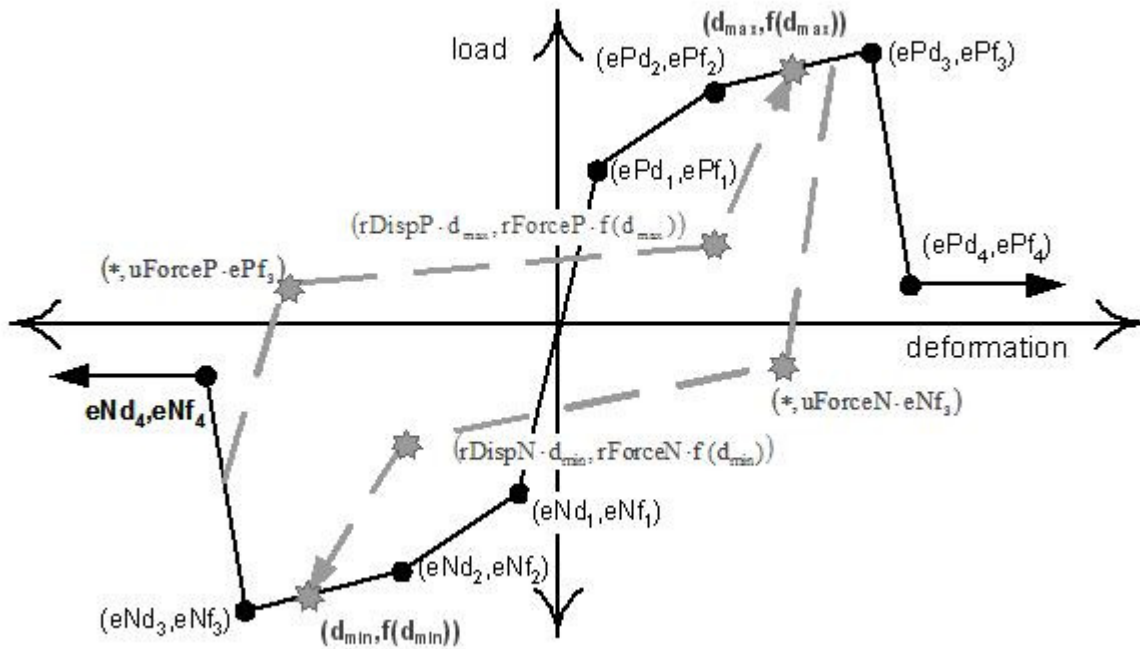

Figure 1: Definition of Pinching4 Uniaxial Material Model

Damage Models:

Stiffness and strength are assumed to deteriorate due to the imposed “load” history. The same basic equations are used to describe deterioration in strength, unloading stiffness and reloading stiffness:

$$k_i = k_0 \cdot (1 - \delta k_i)$$

where  $k_i$  is the unloading stiffness at time  $t_i$ ,  $k_0$  is the initial unloading stiffness (for the case of no damage), and  $\delta k_i$  (defined below) is the value of the stiffness damage index at time  $t_i$ .

$$d_{\max i} = d_{\max 0} \cdot (1 + \delta d_i)$$

where  $d_{\max i}$  is the deformation demand that defines the end of the reload cycle for increasing deformation demand,  $d_{\max 0}$  is the maximum historic deformation demand (which would be the deformation demand defining the end of the reload cycle if degradation of reloading stiffness is ignored), and  $\delta d_i$  (defined below) is the value of reloading stiffness damage index at time  $t_i$ .

$$(f_{\max})_i = (f_{\max})_0 \cdot (1 - \delta f_i)$$

where  $(f_{\max})_i$  is the current envelope maximum strength at time  $t_i$ ,  $(f_{\max})_0$  is the initial envelope maximum strength for the case of no damage, and  $\mathcal{F}_i$  (defined below) is the value of strength value index at time  $t_i$ .

The damage indices,  $\delta k_i$ ,  $\delta d_i$  and  $\mathcal{F}_i$ , may be defined to be a function of displacement history only (\$dmgType = "cycle") or displacement history and energy accumulation (\$dmgType = "energy"). For either case, all of the damage indices are computed using the same basic equation.

If the damage indices are assumed to be a function of displacement history and energy accumulation, the unloading stiffness damage index,  $\delta k_i$  is computed as follows:

$$\delta k_i = \left( gK1 \cdot (\tilde{d}_{\max})^{gK3} + gK2 \cdot \left( \frac{E_i}{E_{\text{monotonic}}} \right)^{gK4} \right) \leq gKLim$$

where

$$\tilde{d}_{\max} = \max \left[ \frac{d_{\max i}}{def_{\max}}, \frac{d_{\min i}}{def_{\min}} \right]$$

$$E_i = \int_{\text{load history}} dE$$

$$E_{\text{monotonic}} = gE \cdot \left( \int_{\text{monotonic load history}} dE \right)$$



with  $E_{\text{monotic}}$  equal to the energy required to achieve under monotonic loading the deformation that defines failure,  $\text{def}_{\text{max}}$  and  $\text{def}_{\text{min}}$  the positive and negative deformations that define failure. The other damage indices,  $\delta d_i$  and  $\delta f_i$ , are computed using the same equations with degradation model parameters  $gK^*$  replaced by  $gF^*$  and  $gD^*$ , as is appropriate.

The above expressions were meant for “Energy” type damage. The user specification of “Energy” type damage implements damage due to displacement as well as energy. Other type of damage can be activated: “Cycle” which implements damage due to displacement as well as damage accrued due to load cycle counting. The expressions for the “Cycle” damage are given below.

If the damage indices are assumed to be a function only of the displacement history, the unloading stiffness damage index,  $\delta k_i$  is computed as follows:

$$\delta k_i = \left( gK1 \cdot (\tilde{d}_{\text{max}})^{gK3} + gK2 \cdot (\text{Cycle})^{gK4} \right) \leq gKLim$$

where

$$\tilde{d}_{\text{max}} = \max \left[ \frac{d_{\text{max}i}}{\text{def}_{\text{max}}}, \frac{d_{\text{min}i}}{\text{def}_{\text{min}}} \right]$$

with Cycle equal to the number of cycles accrued in the loading history,  $\text{def}_{\text{max}}$  and  $\text{def}_{\text{min}}$  the positive and negative deformations that define failure. The other damage indices,  $\delta d_i$  and  $\delta f_i$ , are computed using the same equations with degradation model parameters  $gK^*$  replaced by  $gF^*$  and  $gD^*$ , as is appropriate.

➤ **EXAMPLE:**

main input file:

- *RCyclicPinch.tcl* (page 96)

supporting files:

- *procUniaxialPinching.tcl* (page 101)
- *procRCycDAns.tcl* (page 102)

# PINCHING4 Uniaxial Material Model Discussion

## PINCHING4 Uniaxial Material Model Discussion

The example files (*RCyclicPinch.tcl* (page 96), *procUniaxialPinching.tcl* (page 101), *procRCycDAns.tc* (page 102)) create a one-dimensional structural model consisting of a single truss element of length 1.0 and area 1.0 (Figure 1). The Pinching4 uniaxial material model is used to simulate the stress-strain response of the truss material. The truss is subjected to a pseudo-static cyclic loading. Several files are provided that include different input parameters for the Pinching4 material model and result in different load-displacement histories for the truss structure. Refer to the documentation about the Pinching4 uniaxial material model for additional information.

### Input for the Pinching4 Uniaxial Material Model

Refer to the documentation of the Pinching4 uniaxial material model for an explanation of the following notation.

### Response Envelopes:

In these examples the pinching material model is demonstrated with two different load-deformation response envelopes. Envelope 1 (Figure 2) defines a hardening-type response while Envelope 2 (Figure 2) defines a softening-type response.

### Envelope 1 (Figure 2):

$$\begin{bmatrix} ePd1 & ePf1 \\ ePd2 & ePf2 \\ ePd3 & ePf3 \\ ePd4 & ePf4 \end{bmatrix} = \begin{bmatrix} 0.0001 & 2 \\ 0.0055 & 6 \\ 0.0188 & 7 \\ 0.0189 & 7.2 \end{bmatrix} = \begin{bmatrix} -eNd1 & -eNf1 \\ -eNd2 & -eNf2 \\ -eNd3 & -eNf3 \\ -eNd4 & -eNf4 \end{bmatrix}$$

Envelope 2 (Figure 2):

$$\begin{bmatrix} ePd1 & ePf1 \\ ePd2 & ePf2 \\ ePd3 & ePf3 \\ ePd4 & ePf4 \end{bmatrix} = \begin{bmatrix} 0.0001 & 2 \\ 0.0055 & 6 \\ 0.0188 & 7 \\ 0.0189 & 0.2 \end{bmatrix} = \begin{bmatrix} -eNd1 & -eNf1 \\ -eNd2 & -eNf2 \\ -eNd3 & -eNf3 \\ -eNd4 & -eNf4 \end{bmatrix}$$

Load-Unload Response Parameters:

The form of the load-unload response, and the extent of pinching in the response history, is defined by the following six parameters. In each of the examples, the following values are used.

$$[rDispP \quad rForceP \quad uForceP] = [rDispN \quad rForceN \quad uForceN] = [0.5 \quad 0.25 \quad 0.05]$$

## Strength and Stiffness Degradation Parameters:

The Pinching4 uniaxial material model simulates degradation of stiffness and strength under cyclic loading. The example files demonstrate, individually and in combination, each of the two stiffness degradation options and the one strength degradation option. The following parameters are used to define strength and stiffness degradation, as needed, in the example files.

$$\begin{bmatrix} gK1 & gK2 & gK3 & gK4 & gKLim \\ gD1 & gD2 & gD3 & gD4 & gDLim \\ gF1 & gF2 & gF3 & gF4 & gFLim \\ gE \end{bmatrix} = \begin{bmatrix} 1.0 & 0.2 & 0.3 & 0.2 & 0.9 \\ 0.5 & 0.5 & 2.0 & 2.0 & 0.5 \\ 1.0 & 0.0 & 1.0 & 1.0 & 0.9 \\ 10.0 \end{bmatrix}$$

## Tcl Scripts:

The following tcl script files are used to run the examples:

*RCyclicPinch.tcl* (page 96)

*procUniaxialPinching.tcl* (page 101)

*procRCycDAns.tcl* (page 102)

Lines should be commented out as necessary within *RCyclicPinch.tcl* to exercise different degradation models of the Pinching4 uniaxial material model and different load histories.

If the structure is subjected to a monotonic load history, the load-displacement history is shown in Figure 2 results with the actual response history depending on the envelope chosen for the material model. If the structure is subjected to a cyclic load history (Figure 3), one of the load-displacement histories shown in Figure 4 results, with the exact response depending on the strength and stiffness degradation model employed. In this case the damage type activated was "Energy". The case in which the damage type activated was "Cycle" is shown in Figure 5.

## Figures:



Figure 3: Structural Model

Figure 1: Structural Model

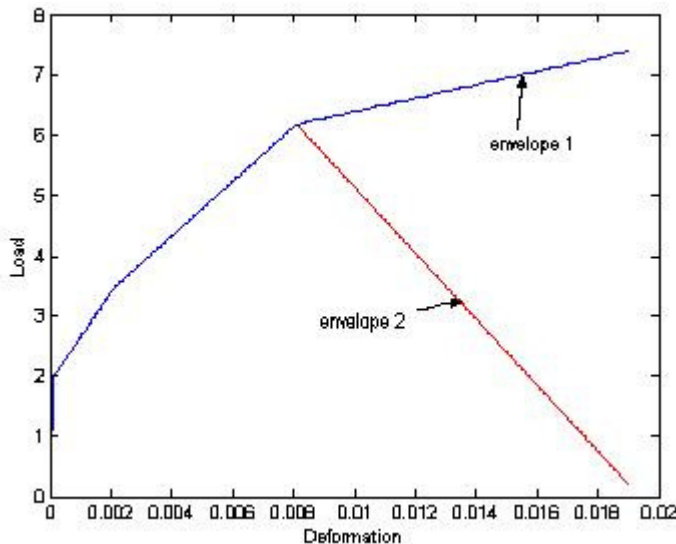

Figure 4: Response Envelopes

Figure 2: Response Envelopes

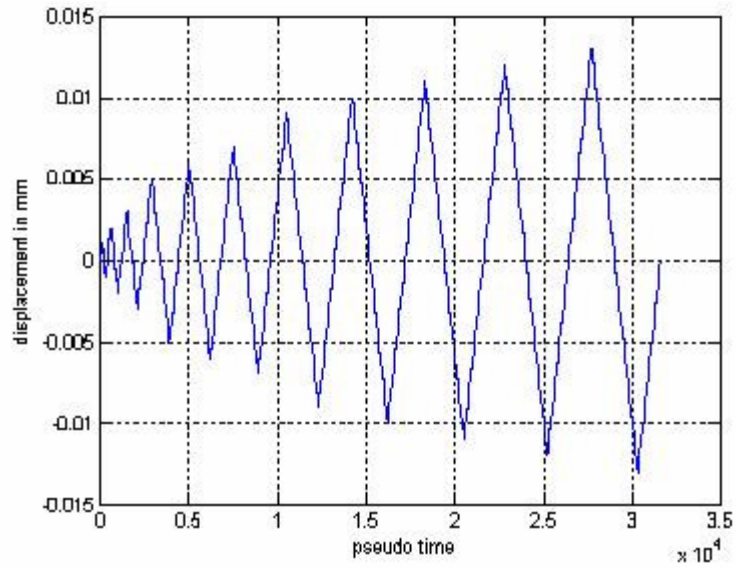
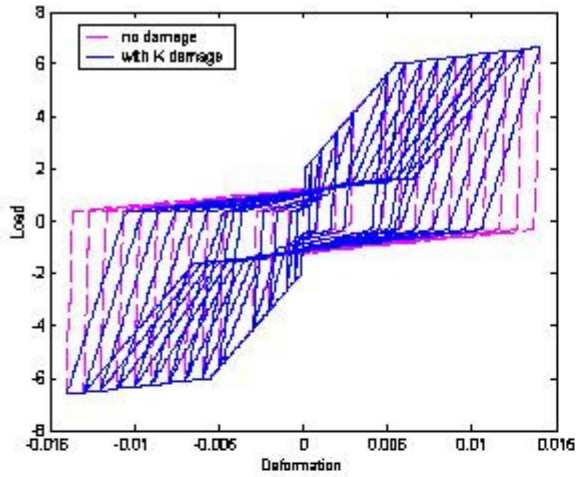
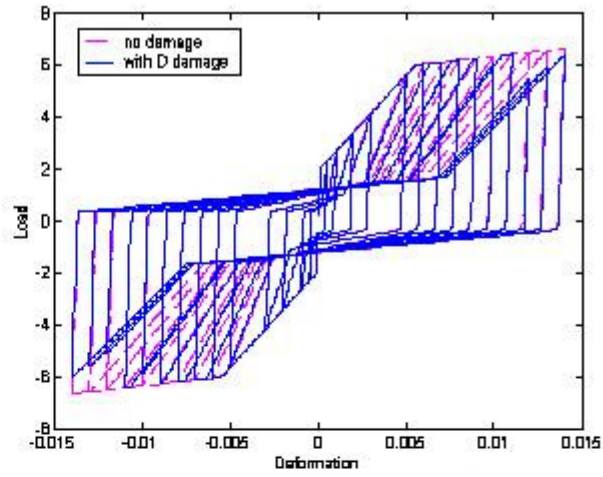

Figure 5: Cyclic Displacement History

Figure 3: Cyclic Displacement History



a) Only Unloading Stiffness Degradation



b) Only Re-Loading Stiffness Degradation

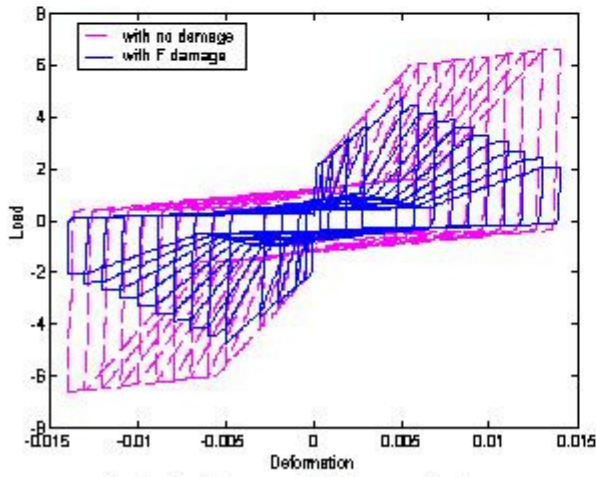

c) Only Strength Degradation

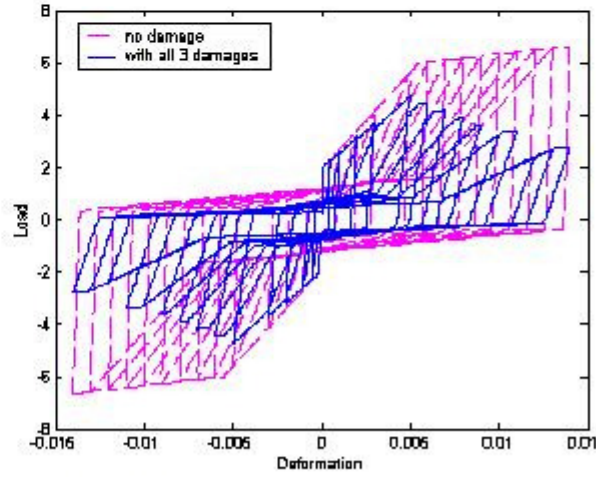

d) Both Stiffness and Strength Degradation

Figure 6: Load-Deformation Response Histories ("Energy type damage")

**Figure 4: Load-Deformation Response Histories ("Energy type damage")**

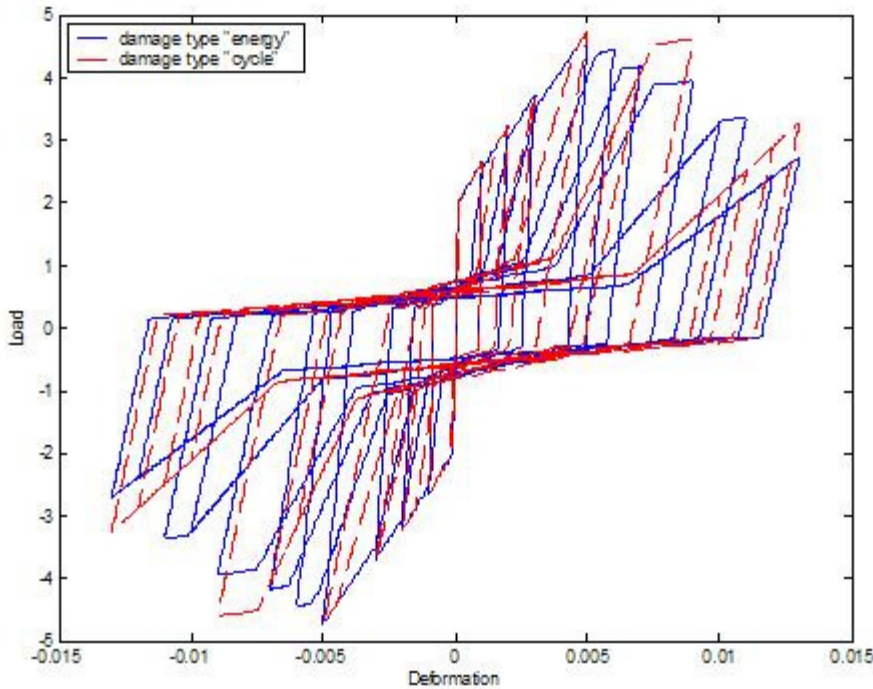

Figure 7: Plot showing Both Stiffness and Strength Degradation for Damage Type "Energy" and "Cycle"

**Figure 5. Plot showing Both Stiffness and Strength Degradation for Damage Type "Energy" and "Cycle"**

**RCyclicPinch.tcl**

```
#####
#####

# Test example for PINCHING MATERIAL #

# Written: N.Mitra #

# Description: uniaxial material with user defined envelope (softening type used here) and damage parameters #
```



```
# Date: May 04 2002 #

## Model subjected to reverse Cyclic Loading #

## File Name: RCyclicPinch.tcl #

# refer to Pinching-Type Material Model.doc for full explanation of the parameters #

#####
#####

wipe
#create the ModelBuilder object

model BasicBuilder -ndm 2 -ndf 2

# add nodes - command: node nodeId xCrd yCrd

node 1 0.0 0.0

node 2 1.0 0.0

## please keep the following procedures on the same path

source procUniaxialPinching.tcl

source procRCycDAns.tcl

##### Positive/Negative envelope Stress/Load

### stress1 stress2 stress3 stress4

set pEnvelopeStress [list 2.0 6.0 7.0 0.2]
```

```
set nEnvelopeStress [list -2.0 -6.0 -7.0 -0.2]

##### Positive/Negative envelope Strain/Deformation

### strain1 strain2 strain3 strain4

set pEnvelopeStrain [list 0.0001 0.0055 0.0188 0.0189]

set nEnvelopeStrain [list -0.0001 -0.0055 -0.0188 -0.0189]

##### Ratio of maximum deformation at which reloading begins

### Pos_env. Neg_env.

set rDisp [list 0.5 0.5]

##### Ratio of envelope force (corresponding to maximum deformation) at which reloading begins

### Pos_env. Neg_env.

set rForce [list 0.25 0.25]

##### Ratio of monotonic strength developed upon unloading

### Pos_env. Neg_env.

set uForce [list 0.05 0.05]

##### Coefficients for Unloading Stiffness degradation

### gammaK1 gammaK2 gammaK3 gammaK4 gammaKLimit

set gammaK [list 1.0 0.2 0.3 0.2 0.9]
```

```
#set gammaK [list 0.0 0.0 0.0 0.0 0.0]

##### Coefficients for Reloading Stiffness degradation

### gammaD1 gammaD2 gammaD3 gammaD4 gammaDLimit

set gammaD [list 0.5 0.5 2.0 2.0 0.5]

#set gammaD [list 0.0 0.0 0.0 0.0 0.0]

##### Coefficients for Strength degradation

### gammaF1 gammaF2 gammaF3 gammaF4 gammaFLimit

set gammaF [list 1.0 0.0 1.0 1.0 0.9]

#set gammaF [list 0.0 0.0 0.0 0.0 0.0]

set gammaE 10

# material ID

set matID 1

# damage type (option: "energy", "cycle")

set dam "energy"

# add the material to domain through the use of a procedure

procUniaxialPinching $matID $pEnvelopeStress $nEnvelopeStress $pEnvelopeStrain $nEnvelopeStrain $rDisp
```

```
$rForce $uForce $gammaK $gammaD $gammaF $gammaE $dam

# add truss elements - command: element truss trussID node1 node2 A matID

element truss 1 1 2 1.0 1

# set the boundary conditions - command: fix nodeID xResrnt? yRestrnt?

fix 1 1 1

fix 2 0 1

pattern Plain 1 Linear {

load 2 1 0

}

recorder Node -file RCyclicPinchR.out -node 2 -dof 1 disp

# build the components for the analysis object

system ProfileSPD

constraints Plain

test NormDisplncr 1.0e-8 20

algorithm Newton

numberer RCM
```

```

## analysis type used in the procedure is Static

set peakpts [list 0.0001 0.001 0.002 0.003 0.005 0.006 0.007 0.009 0.01 0.011 0.012 0.013 ]

set increments 10

set nodeTag 2

set dofTag 1

## start procedure for feeding in

## Reverse Cyclic loading to the model by Disp. control

procRCycDAns $increments $nodeTag $dofTag $peakpts

# print the results at nodes

print node

```

### procUniaxialPinching.tcl

```

#####
#####

# #

# procUniaxialPinching.tcl #

# procedure for activating the pinching material given its parameters in the form of list #

# created NM (nmitra@u.washington.edu) dated : Feb 2002 #

#####
#####

proc procUniaxialPinching { materialTag pEnvelopeStress nEnvelopeStress pEnvelopeStrain nEnvelopeStrain rDisp

```



```

# procedure for reverse cyclic displacement control analysis given the peak pts.          #
# analysis type used : STATIC                                                         #
# Written : N.Mitra                                                                    #
#####
proc procRCycDAns { incre nodeTag dofTag peakpts } {

set x [lindex $peakpts 0]
set fir [expr $x/$incre]

integrator DisplacementControl $nodeTag $dofTag 0.0 1 $fir $fir

# create the analysis object
analysis Static
# perform the analysis
analyze $incre
integrator DisplacementControl $nodeTag $dofTag 0.0 1 [expr -$fir] [expr -$fir]
analyze [expr 2*$incre]
integrator DisplacementControl $nodeTag $dofTag 0.0 1 $fir $fir
analyze $incre

for {set j 1} {$j < [llength $peakpts]} {incr j 1} {
  set tx [lindex $peakpts $j]
  set tinc [expr $tx/$fir]
  set rt [expr int($tinc)]

  integrator DisplacementControl $nodeTag $dofTag 0.0 1 $fir $fir
  analyze $rt
  integrator DisplacementControl $nodeTag $dofTag 0.0 1 [expr -$fir] [expr -$fir]
  analyze [expr 2*$rt]
  integrator DisplacementControl $nodeTag $dofTag 0.0 1 $fir $fir
  analyze $rt
}
##### end procRCycDAns.tcl #####
}

```

---

## PyTzQz Uniaxial Materials

This section describes commands that are used to construct uniaxial materials for p-y, t-z and q-z elements for modeling soil-structure interaction developed at UC Davis.

There is available documentation on UCD COmpGeomech work within OpenSees framework at:

[http://sokocalo.engr.ucdavis.edu/~jeremic/OpenSees/UCD\\_CG\\_OpenSees\\_Commands\\_2up.pdf](http://sokocalo.engr.ucdavis.edu/~jeremic/OpenSees/UCD_CG_OpenSees_Commands_2up.pdf)  
 (http://sokocalo.engr.ucdavis.edu/~jeremic/OpenSees/UCD\_CG\_OpenSees\_Commands\_2up.pdf)

Also, there is a more in depth writeup (lecture notes) at:

<http://sokocalo.engr.ucdavis.edu/~jeremic/CG/CompGeomechanicsLectureNotes.pdf>  
 (http://sokocalo.engr.ucdavis.edu/~jeremic/CG/CompGeomechanicsLectureNotes.pdf)

---

## PySimple1 Material

This command is used to construct a PySimple1 uniaxial material object.

```
uniaxialMaterial PySimple1 $matTag $soilType $pult $Y50 $Cd <$c>.
```

<b>\$matTag</b>	Unique material object integer tag.
<b>\$soilType</b>	soilType = 1 Backbone of p-y curve approximates Matlock (1970) soft clay relation.  soilType = 2 Backbone of p-y curve approximates API (1993) sand relation.
<b>\$pult</b>	Ultimate capacity of the p-y material. Note that “p” or “pult” are distributed loads [force per length of pile] in common design equations, but are both loads for this uniaxialMaterial [i.e., distributed load times the tributary length of the pile].



<b>\$Y50</b>	Displacement at which 50% of pult is mobilized in monotonic loading.
<b>\$Cd</b>	Variable that sets the drag resistance within a fully-mobilized gap as $Cd \cdot pult$ .
<b>\$c</b>	The viscous damping term (dashpot) on the far-field (elastic) component of the displacement rate (velocity). Default = 0.0. Nonzero c values are used to represent radiation damping effects.

**NOTE:** Full documentation of the PyLiq1 command is found in *PySimple1\_documentation.pdf* ([http://opensees.berkeley.edu/OpenSees/manuals/usermanual/documents/PySimple1\\_documentation.PDF](http://opensees.berkeley.edu/OpenSees/manuals/usermanual/documents/PySimple1_documentation.PDF))

---

## TzSimple1 Material

This command is used to construct a TzSimple1 uniaxial material object.

```
uniaxialMaterial TzSimple1 $matTag $tzType $tult $z50 <$c>.
```

<b>\$matTag</b>	Unique material object integer tag.
<b>\$tzType</b>	<p><math>tzType = 1</math> Backbone of t-z curve approximates Reese and O'Neill (1987) relation.</p> <p><math>tzType = 2</math> Backbone of t-z curve approximates Mosher (1984) relation.</p>
<b>\$tult</b>	Ultimate capacity of the t-z material. Note that "t" or "tult" are distributed loads [force per length of pile] in common design equations, but are both loads for this uniaxialMaterial [i.e., distributed load times the tributary length of the pile].
<b>\$z50</b>	Displacement at which 50% of tult is mobilized in monotonic loading.
<b>\$c</b>	The viscous damping term (dashpot) on the far-field (elastic) component of the displacement rate (velocity). Default = 0.0. Nonzero c values are used to represent radiation damping effects.

**NOTE:** Full documentation of the TzLiq1 command is included in: *TzSimple1\_documentation.PDF* ([http://opensees.berkeley.edu/OpenSees/manuals/usermanual/documents/TzSimple1\\_documentation.PDF](http://opensees.berkeley.edu/OpenSees/manuals/usermanual/documents/TzSimple1_documentation.PDF))

## QzSimple1 Material

This command is used to construct a QzSimple1 uniaxial material object.

```
uniaxialMaterial PySimple1 $matTag $qzType $qult $Y50 <$suction $c>.
```

<b>\$matTag</b>	Unique material object integer tag.
<b>\$soilType</b>	<p>qzType = 1 Backbone of q-z curve approximates Reese and O'Neill's (1987) relation for drilled shafts in clay.</p> <p>qzType = 2 Backbone of q-z curve approximates Vijayvergiya's (1977) relation for piles in sand.</p>
<b>\$qult</b>	Ultimate capacity of the q-z material. Note that "q" or "qult" are stresses [force per unit area of pile tip] in common design equations, but are both loads for this uniaxialMaterial [i.e., stress times tip area].
<b>\$z50</b>	Displacement at which 50% of pult is mobilized in monotonic loading. Note that Vijayvergiya's relation (qzType=2) refers to a "critical" displacement (zcrit) at which qult is fully mobilized, and that the corresponding z50 would be $0.125z_{crit}$ .
<b>\$suction</b>	Uplift resistance is equal to suction*qult. Default = 0.0. The value of suction must be 0.0 to 0.1.*
<b>\$c</b>	The viscous damping term (dashpot) on the far-field (elastic) component of the displacement rate (velocity). Default = 0.0. Nonzero c values are used to represent radiation damping effects.*

**NOTE:** Full documentation of the QzSimple1 command is found in:

*QzSimple1\_Documentation.pdf*

([http://opensees.berkeley.edu/OpenSees/manuals/usermanual/documents/QzSimple1\\_documentation.PDF](http://opensees.berkeley.edu/OpenSees/manuals/usermanual/documents/QzSimple1_documentation.PDF))

\***NOTE:** Optional variables suction and c must either both be omitted or both be included.

## PyLiq1 Material

This command is used to construct a PyLiq1 uniaxial material object.

**uniaxialMaterial PyLiq1 \$matTag \$soilType \$pult \$Y50 \$Cd \$c \$pRes  
\$solidElem1 \$solidElem2.**

<b>\$matTag</b>	Unique material object integer tag.
<b>\$soilType</b>	soilType = 1 Backbone of p-y curve approximates Matlock (1970) soft clay relation.  soilType = 2 Backbone of p-y curve approximates API (1993) sand relation.
<b>\$pult</b>	Ultimate capacity of the p-y material. Note that “p” or “pult” are distributed loads [force per length of pile] in common design equations, but are both loads for this uniaxialMaterial [i.e., distributed load times the tributary length of the pile].
<b>\$Y50</b>	Displacement at which 50% of pult is mobilized in monotonic loading.
<b>\$Cd</b>	Variable that sets the drag resistance within a fully-mobilized gap as $Cd \cdot pult$ .
<b>\$c</b>	The viscous damping term (dashpot) on the far-field (elastic) component of the displacement rate (velocity). Default = 0.0. Nonzero c values are used to represent radiation damping effects.
<b>\$pRes</b>	Minimum (or residual) p-y resistance that the material retains as the adjacent solid soil elements liquefy (i.e. at $r_u = 1.0$ ).
<b>\$solidElem1</b>	Element object integer tag for a solid element from which PyLiq1 will obtain mean effective stresses and pore pressures.
<b>\$solidElem2</b>	Element object integer tag for a solid element from which PyLiq1 will obtain mean effective stresses and pore pressures.

**NOTE:** Full documentation of the PyLiq1 command is found in: *PyLiq1\_Documentation.pdf* ([http://opensees.berkeley.edu/OpenSees/manuals/usermanual/documents/PyLiq1\\_documentation.pdf](http://opensees.berkeley.edu/OpenSees/manuals/usermanual/documents/PyLiq1_documentation.pdf))

**NOTE:** The implementation of PyLiq1 requires that the specified soil elements consist of FluidSolidPorousMaterials in FourNodeQuad elements. To model the effects of liquefaction with PyLiq1, it is necessary to use the material stage updating command:

**updateMaterialStage –material \$matNum –stage \$sNum**

where the argument matNum is the material number (for PyLiq1) and the argument sNum is the desired stage (valid values are 0 & 1). With sNum=0, the PyLiq1 behavior will be independent of any pore pressure in the specified solidElem's. When updateMaterialStage first sets sNum=1, PyLiq1 will obtain the average mean effective stress in the two solidElem's and treat it as the initial consolidation stress prior to undrained loading. Thereafter, the behavior of PyLiq1 will depend on the mean effective stresses (and hence excess pore pressures) in the solidElem's. The default value of sNum is 0 (i.e., sNum=0 if updateMaterialStage is not called). Note that the updateMaterialStage command is used with some soil material models, and that sNum=0 generally corresponds to the application of gravity loads (e.g., elastic behavior with no excess pore pressure development) and sNum=1 generally corresponds to undrained loading (e.g., plastic behavior with excess pore pressure development). The analysis for gravity loading cannot use the "algorithm Linear" command because the relevant soil materials do not currently work properly with this command. Instead, the "algorithm Newton" or some other option must be used.

---

## TzLiq1 Material

This command is used to construct a PyLiq1 uniaxial material object.

**uniaxialMaterial TzLiq1 \$matTag \$soilType \$tult \$z50 \$c \$solidElem1 \$solidElem2.**

**\$matTag**

Unique material object integer tag.

**\$tzType**

tzType = 1 Backbone of t-z curve approximates Reese and O'Neill (1987) relation.

tzType = 2 Backbone of t-z curve approximates Mosher (1984) relation.

<b>\$tult</b>	Ultimate capacity of the t-z material. Note that “t” or “tult” are distributed loads [force per length of pile] in common design equations, but are both loads for this uniaxialMaterial [i.e., distributed load times the tributary length of the pile].
<b>\$z50</b>	Displacement at which 50% of tult is mobilized in monotonic loading.
<b>\$c</b>	The viscous damping term (dashpot) on the far-field (elastic) component of the displacement rate (velocity). Default = 0.0. Nonzero c values are used to represent radiation damping effects.
<b>\$solidElem1</b>	Element object integer tag for a solid element from which TzLiq1 will obtain mean effective stresses and pore pressures.
<b>\$solidElem2</b>	Element object integer tag for a solid element from which TzLiq1 will obtain mean effective stresses and pore pressures.

**NOTE:** Full documentation of the TzLiq1 command is included in: *TzLiq1\_Documentation.pdf* ([http://opensees.berkeley.edu/OpenSees/manuals/usermanual/documents/TzLiq1\\_documentation.pdf](http://opensees.berkeley.edu/OpenSees/manuals/usermanual/documents/TzLiq1_documentation.pdf))

**NOTE:** The implementation of TzLiq1 requires that the specified soil elements consist of FluidSolidPorousMaterials in FourNodeQuad elements. To model the effects of liquefaction with TzLiq1, it is necessary to use the material stage updating command:

**updateMaterialStage –material \$matNum –stage \$sNum**

where the argument matNum is the material number (for TzLiq1) and the argument sNum is the desired stage (valid values are 0 & 1). With sNum=0, the TzLiq1 behavior will be independent of any pore pressure in the specified solidElem's. When updateMaterialStage first sets sNum=1, TzLiq1 will obtain the average mean effective stress in the two solidElem's and treat it as the initial consolidation stress prior to undrained loading. Thereafter, the behavior of TzLiq1 will depend on the mean effective stress (and hence excess pore pressures) in the solidElem's. The default value of sNum is 0 (i.e., sNum=0 if updateMaterialStage is not called). Note that the updateMaterialStage command is used with some soil material models, and that sNum=0 generally corresponds to the application of gravity loads (e.g., elastic behavior with no excess pore pressure development) and sNum=1 generally corresponds to undrained loading (e.g., plastic behavior with excess pore pressures development). The analysis for gravity loading cannot use the "algorithm Linear" command because the relevant soil materials do not currently work properly with this command. Instead, the "algorithm Newton" or some other option must be used.

## PySimple1Gen Command

This command is used to construct output files containing material properties for PySimple1 uniaxial materials. The PySimple1Gen command constructs PySimple1 materials (Boulanger, 2003) for pre-defined zeroLength elements.

```
PySimple1Gen $file1 $file2 $file3 $file4 $file5 <$file6>
```

<b>\$file1</b>	The name of an input file containing soil and pile properties required to define the PySimple1 materials.
<b>\$file2</b>	The name of an input file containing information about nodes that define the mesh in the domain.
<b>\$file3</b>	The name of an input file containing information about the zeroLength elements to be assigned PySimple1 materials (hereafter called p-y elements).
<b>\$file4</b>	The name of an input file containing information about the beam column elements that are attached to p-y elements.
<b>\$file5</b>	The name of the output file to which the PySimple1 materials are written.
<b>\$file6</b>	The name of the output file to which the applied patterns are written (optional).

The command has been structured such that \$File2, \$File3, \$File4, \$File5 and \$File6 can be sourced directly by OpenSees from within a master tcl file. Hence \$File2, \$File3 and \$File4 serve two purposes:

- 1 They provide information to PySimple1Gen to create the PySimple1 materials.
- 2 They can be sourced directly in a master tcl file to define the nodes, zeroLength elements for p-y materials, and pile elements, respectively.

Furthermore, \$File5 and \$File 6 serve the following purpose:

- 1 They can be sourced by OpenSees from within a master tcl file to define the PySimple1 materials and the applied patterns, respectively.

The intended use of the files is demonstrated in an example problem in the Appendix:

*PySimple1GenDocumentation.pdf*

(<http://opensees.berkeley.edu/OpenSees/manuals/usermanual/documents/PySimple1GenDocumentation.pdf>)

---

## TzSimple1Gen Command

The TzSimple1Gen command constructs TzSimple1 materials (Boulanger, 2003) for pre-defined zeroLength elements.

```
TzSimple1Gen $file1 $file2 $file3 $file4 $file5 <$file6>
```

<b>\$file1</b>	The name of an input file containing soil and pile properties required to define the TzSimple1 materials.
<b>\$file2</b>	The name of an input file containing information about the nodes that define the mesh in the domain.
<b>\$file3</b>	The name of an input file containing information about the zeroLength elements that are to be assigned TzSimple1 materials (hereafter called tz elements).
<b>\$file4</b>	The name of an input file containing information about the beam column elements that are attached to tz elements.
<b>\$file5</b>	The name of the output file to which the TzSimple1 materials are written.
<b>\$file6</b>	The name of the output file to which the applied patterns are written (optional).

The command has been structured such that \$File2, \$File3, \$File4, \$File5 and \$File6 can be sourced directly from within a master tcl file. Hence \$File2, \$File3 and \$File4 serve two purposes:

- 1 They provide information to TzSimple1Gen to create the TzSimple1 materials.
- 2 They can be sourced directly in a master tcl file to define the nodes, zeroLength elements for tz materials, and pile elements, respectively.

Furthermore, \$File5 and \$File6 serve the following purpose:

- 1 They can be sourced directly in a master tcl file to define the TzSimple1 materials and the applied patterns.

The dual use of the files is demonstrated in an example problem in the Appendix:

*TzSimple1GenDocumentation.pdf*

(<http://opensees.berkeley.edu/OpenSees/manuals/usermanual/documents/TzSimple1GenDocumentation.pdf>)

## Reinforcing Steel Material

Contact Authors: Jon Mohle M.S., P.E.

Sashi Kunnath:

<http://cee.engr.ucdavis.edu/faculty/kunnath/kunnath.htm>

This command is used to construct a ReinforcingSteel uniaxial material object. This object is intended to be used in a reinforced concrete fiber section as the steel reinforcing material.

```
uniaxialMaterial ReinforcingSteel $matTag $fy $fu $Es $Esh $esh $eult
< -GABuck $lsr $beta $r $gama > < -DMBuck $lsr < $alpha >>
< -CMFatigue $Cf $alpha $Cd > < -IsoHard <$a1 <$limit> > >
```

<b>\$matTag</b>	unique material object integer tag
<b>\$fy</b>	Yield stress in tension (see Figure 1)
<b>\$fu</b>	Ultimate stress in tension
<b>\$Es</b>	Initial elastic tangent
<b>\$Esh</b>	Tangent at initial strain hardening
<b>\$esh</b>	Strain corresponding to initial strain hardening
<b>\$eult</b>	Strain at peak stress
<b>-GABuck</b>	<b>Buckling Model Based on Gomes and Appleton (1997)</b>



	<b>\$lsr</b>	Slenderness Ratio (see Figure 2)
	<b>\$beta</b>	Amplification factor for the buckled stress strain curve. (see Figure 3)
	<b>\$r</b>	Buckling reduction factor r can be a real number between [0.0 and 1.0] r=1.0 full reduction (no buckling) r=0.0 no reduction 0.0<r<1.0 linear interpolation between buckled and unbuckled curves
	<b>\$gamma</b>	Buckling constant (see Figures 3 and 4)
<b>-DMBuck</b>		<b>Buckling model based on Dhakal and Maekawa (2002)</b>
	<b>\$lsr</b>	Slenderness Ratio (see Figure 2)
	<b>\$alpha</b>	Adjustment Constant usually between 0.75 and 1.0 Default: alpha=1.0, this parameter is optional.
<b>-CMFatigue</b>		<b>Coffin-Manson Fatigue and Strength Reduction</b>
	<b>\$Cf</b>	Coffin-Manson constant C (see Figure 5)
	<b>\$alpha</b>	Coffin-Manson constant $\alpha$ (see Figure 5)
	<b>\$Cd</b>	Cyclic strength reduction constant (see Figure 6 and Equation 3)
<b>-IsoHard</b>		<b>Isotropic Hardening / Diminishing Yield Plateau</b>
	<b>\$a1</b>	Hardening constant (default = 4.3)
	<b>\$limit</b>	Limit for the reduction of the yield plateau. % of original plateau length to remain (0.01 < limit < 1.0 ) Limit =1.0, then no reduction takes place (default =0.01)
<b>-MPCurveParams</b>		<b>Menegotto and Pinto Curve Parameters</b> $R = R_2 (1.0 - R_3 \varepsilon_t) (\varepsilon_y')^{R_1}$ see Fig 6b
	<b>\$R1</b>	(default = 0.333)
	<b>\$R2</b>	(default = 18)
	<b>\$R3</b>	(default = 4)

**NOTE:** This simulation is based on the Chang and Mander(1994) uniaxial steel model. The simulation has incorporated additional reversal memory locations to better control stress overshooting (default is 10 branches but this can be easily modified by changing the variable “LastRule\_RS” within the header file “ReinforcingSteel.h”). The cycle counting method implemented in the routine achieves the same result as rainflow counting. Fatigue parameters are based on the Coffin-Manson equation for plastic strain amplitude as indicated in Figure 6a. The buckling simulations incorporated consist of a variation on Gomes and Appleton(1997) and Dhakal and Maekawa(2002). The buckling and fatigue portions of this simulation are still being further enhanced and refined. Additional buckling and fatigue options should be available in the near future.

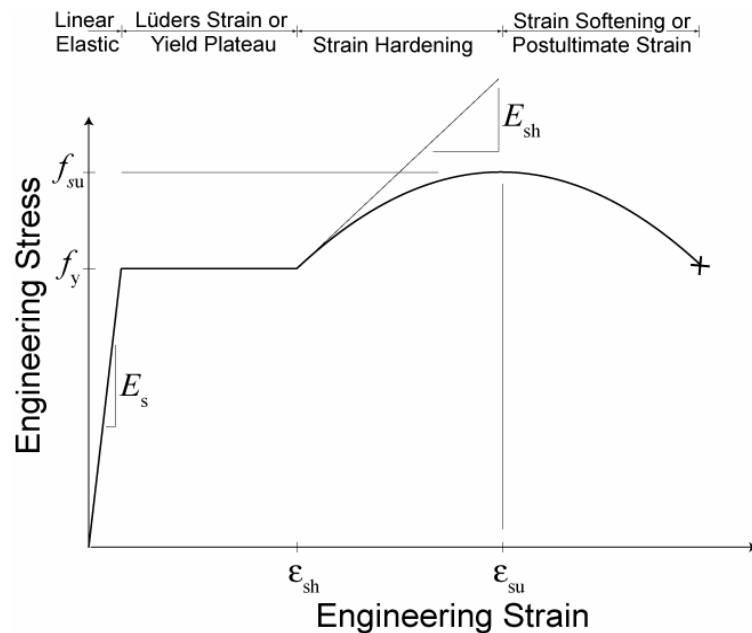

Figure 1: Material Constants

**BACKBONE CURVE:** The backbone curve shown in Figure 1 is used as a bounding surface for the reinforcing bar simulation. This backbone curve is shifted as described by Chang and Mander (1994) to account for Isotropic hardening. This backbone can be obtained by utilizing simple tension test data. Within the material class, the backbone curve is transformed from engineering stress space to natural stress space (accounting for change in area as the bar is stressed.) This allows the single backbone to represent both tensile and compressive stress-strain relations. The tension and compression backbone curves are not the same in engineering stress space for this model! This transformation assumes small strain relations described by Dodd and Restrepo-Posada (1995)

The softening region (strain greater than  $\epsilon_{ult}$ ), shown in Figure 1, is a localization effect due to necking and is a function of the gage length used during measurement. This geometric effect is ignored in this simulation. In this simulation, it is assumed that there is no softening in natural stress space. Because the simulation always converts back to engineering stress space, you will observe some softening in the tension response due to the reduction in area, however this will be much smaller than that shown in the original backbone curve proposed by Chang and Mander.

**DIMINISHING YIELD PLATEAU:** It has been observed that when a reinforcing bar is subjected to plastic strain reversals within the yield plateau, strain hardening will initiate at a lower strain than that of the same bar loaded monotonically. Additionally, isotropic hardening can result from repeated strain reversals and is commonly related to accumulated plastic strain. These two aspects of the stress-strain behavior of steel bars are somewhat related and that by shortening the yield plateau as a function of accumulated plastic strain, the model will have some capability to simulate both the diminishing yield plateau and isotropic hardening. The Chang and Mander model, on which this formulation is based, models only anisotropic hardening by shifting the backbone curves and by targeting previous reversal points on the backbone curves. By adding a component of isotropic hardening, the model has additional capabilities and is able to more accurately simulate test data.

Accumulated plastic strain is tracked within the material model for each branch, plateau adjustments are made only in the outer branches for simplicity. The plastic strain due to the backbone curve is ignored so that a monotonically loaded sample can be calibrated to a monotonic test sample more easily.

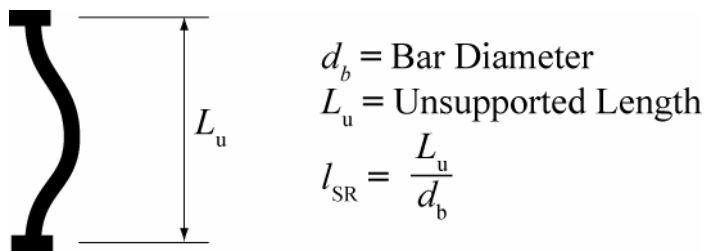

Figure 2: Slenderness Defined

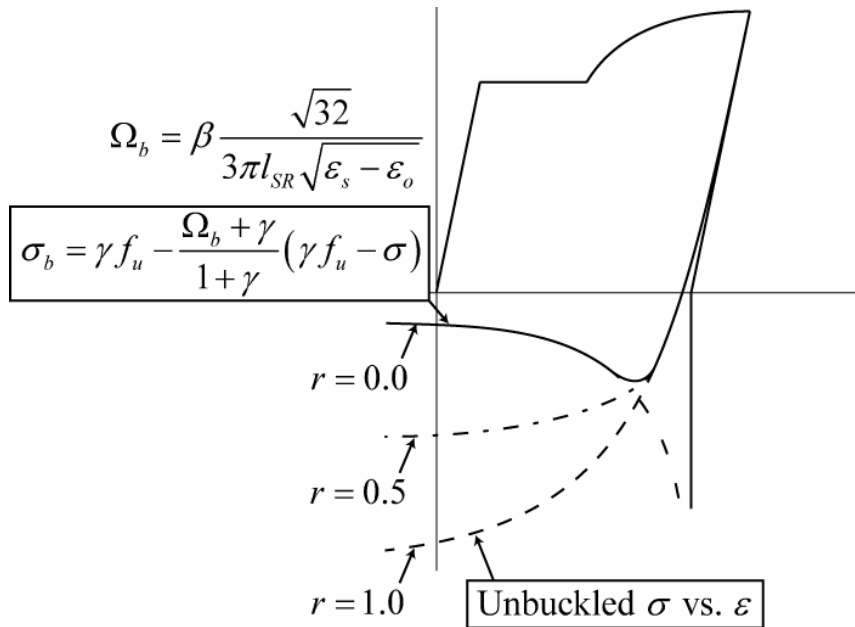

Figure 3: Buckling Parameters

**GOMES AND APPLETON BUCKLED CURVE:** Figure 3 describes the use of the buckling parameters modified from Gomes and Appleton(1997).  $\beta$  is an amplification factor that allows the user to scale the buckling curve. This is useful to adjust the location of the bifurcation point. The  $r$  factor is used to adjust the curve between the buckled curve and the unbuckled curve. The variable  $r$  can only be a real number between 0.0 and 1.0.

The  $\gamma$  factor is the positive stress location about which the buckling factor is initiated. This factor was introduced to avoid kinks in the reloading branch. The implementation of the  $\gamma$  factor is shown in Figure 3. The basic idea is that the stress strain curves are reduced toward the positive stress  $\gamma f_{su}$ .  $\gamma$  should be between 0.0 and 1.0. A  $\gamma$  of 0.0 will factor to the zero stress axis. This will usually produce a kink in the reloading curve at the zero stress location. Good results have been obtained using the following values for the buckling constants.

$\beta$	1.0		$\beta$	2.0
$r$	0.4		$r$	0.0
$\gamma$	0.5	or	$\gamma$	0.5

Figure 4 displays the buckling behavior due to the variation of the different constants. The response shown on the upper left is the unbuckled case. In each of the other cases, buckling behavior is defined by the constants shown.

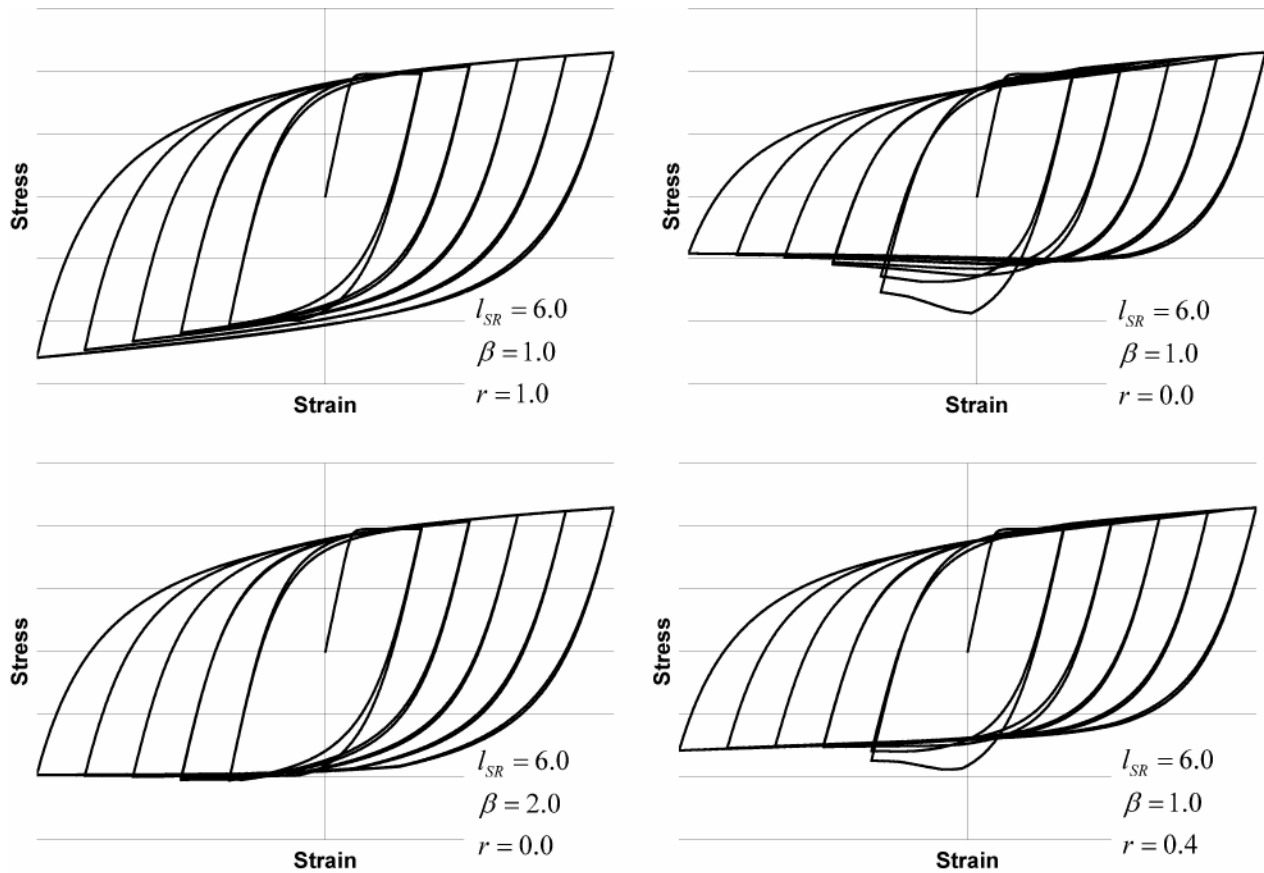

Figure 4: Effect of Sample Parameters in the Gomes and Appleton Buckling Model

**DHAKAL AND MAEKAWA BUCKLED CURVE:** The buckling model described in this section is based on Dhakal and Maekawa(2002). This model takes two terms,  $l_{sr}$  and  $\alpha$ .  $l_{sr}$  is the slenderness ratio as described in Figure 2 and  $\alpha$  is an amplification factor. Dhakal and Maekawa suggest a value of  $\alpha = 1.0$  for linear strain hardening and  $\alpha = 0.75$  for elastic perfectly plastic material behavior. The material model in this implementation is neither linear strain hardening nor elastic perfectly plastic. However, since the material model does include strain hardening  $\alpha = 1.0$  has been assumed as the default value. Figure 5 shows the unbuckled vs buckled stress strain response curves.

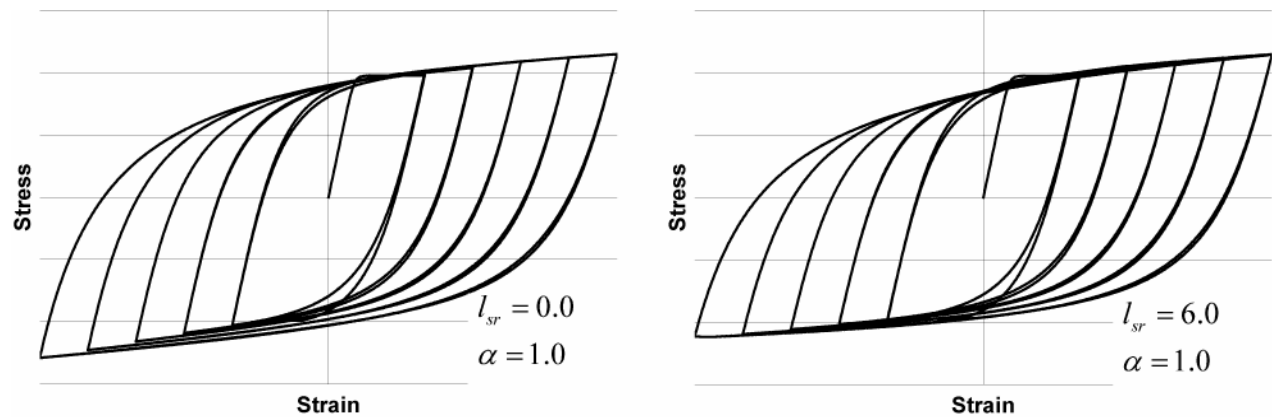

Figure 5: Effect of Suggested Parameters in the Dhakal and Maekawa Buckling Model

**CYCLIC DEGRADATION:**  $C_f$  and  $\alpha$  are factors used to relate the number of half cycles to fracture to the half cycle plastic strain amplitude (Figure 6a). Plastic strain half cycle amplitude is defined by Equation 1. The total half cycle strain amplitude,  $\epsilon_t$ , is shown in Figure 6b as the change in strain from reversal A to reversal B.  $C_f$  and  $\alpha$  are used to define a cumulative damage factor,  $D$ , as described in Equation 2.

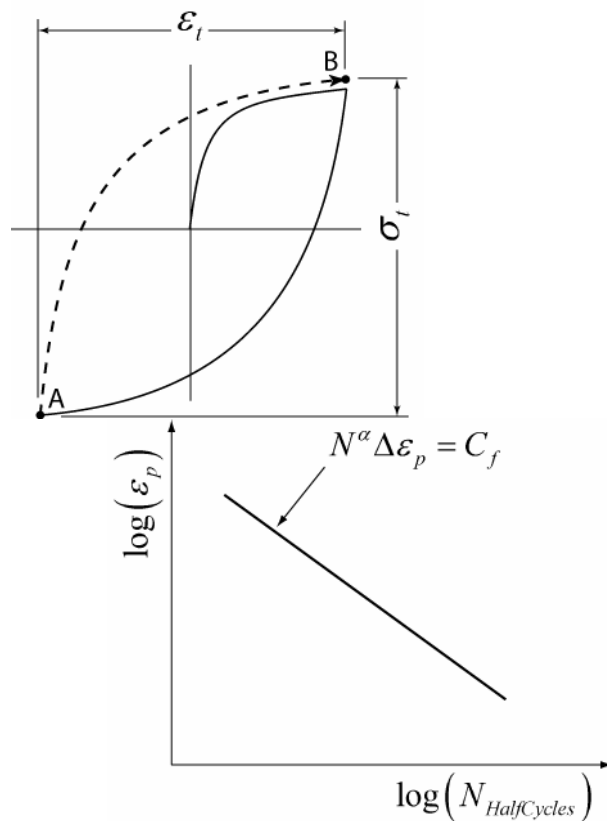

Figure 6a: Coffin-Manson Constants

$$\varepsilon_p = \varepsilon_t - \frac{\sigma_t}{E_s} \quad (1)$$

$$D = \sum \left( \frac{\Delta \varepsilon_p}{C_f} \right)^{\frac{1}{\alpha}} \quad (2)$$

Figure 6b: Half Cycle Terms Defined

The cumulative damage factor is zero at no damage and 1.0 at fracture. Once a bar has been determined to have fractured, the strength is rapidly degraded to zero.

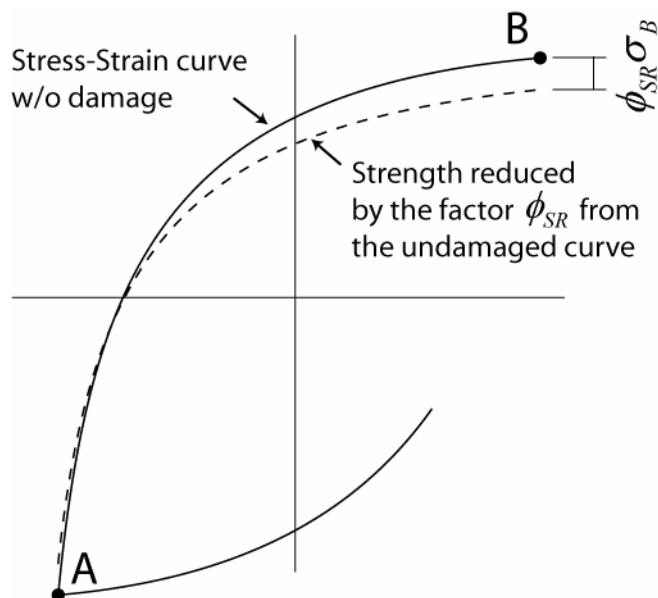



Figure 7: Strength Reduction

A degrade constant,  $K_1$ , is used to describe loss in strength due to damage or other phenomenon resulting in softening due to plastic reversals. The degradation is currently assumed to have a simple linear relationship with  $D$ . This is used to correlate strength degradation to the cumulative damage factor. This linear relationship is shown in Equation 3.

$$\phi_{SR} = K_1 D \quad (3)$$

Alternately this simple linear equation can be rewritten in a way that makes the strength degradation independent of the number of half cycles to failure. Keeping the failure and degradation terms independent is convenient for calibration. Equation 3 is rewritten below utilizing the strength degradation constant  $C_d$ .

$$\phi_{SR} = \sum \left( \frac{\Delta \epsilon_p}{C_d} \right)^{\frac{1}{\alpha}} \quad (4)$$

The constants  $K_1$  and  $C_d$  can be related as shown in Equation 5.

$$C_d = \frac{C_f}{K_1^\alpha} \quad (5)$$

Suggested starting values have been obtained from data reported by Brown and Kunnath (2000) for bars with a slenderness of 6. Keep in mind that this experimental data is limited and additional calibration may be necessary to capture realistic behavior in a reinforcing bar embedded in concrete and influenced by other factors such as confinement.

$\alpha$ :	0.506
$C_f$ :	0.26
$C_d$ :	0.389

### Sample Simulations of Degradation behavior

$\alpha$  is best obtained from calibration of test results.  $\alpha$  is used to relate damage from one strain range to an equivalent damage at another strain range. This is usually constant for a material type.

$C_f$  is the ductility constant used to adjust the number of cycles to failure. A higher value for  $C_f$  will result in a lower damage for each cycle. A higher value  $C_f$  translates to a larger number of cycles to failure.

$C_d$  is the strength reduction constant. A larger value for  $C_d$  will result in a lower reduction of strength for each cycle. The four charts shown in Figure 8 demonstrate the effect that some of the variables have on the cyclic response.

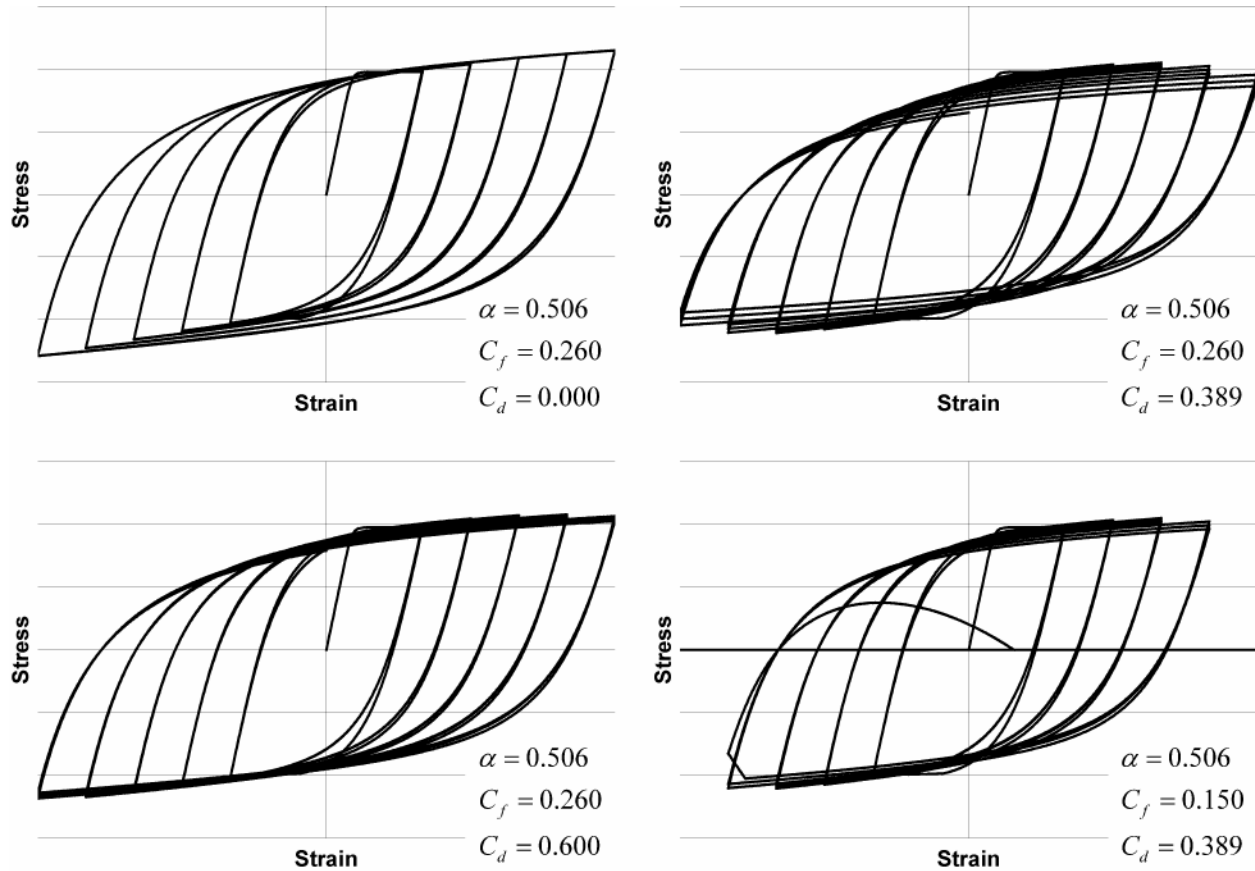

Figure 8: Fatigue and Degradation Parameter Examples

In Figure 8, the upper left response contains no strength degradation by setting the  $C_d$  variable to 0.0. The upper right response shows strength degradation due to the suggested values of  $C_i$ ,  $\alpha$ , and  $C_d$ . The response shown on the lower left demonstrates the change in the response when the suggested values of  $C_i$  and  $\alpha$  are used with  $C_d=0.6$ . Making the value of  $C_d$  larger results in less strength reduction due to damage. The response on the lower right once again returns to the suggested values but  $C_i$  is changed to 0.15. This results in a more rapid accumulation of damage causing the bar to fail sooner. Note however that the strength degradation is unaffected by the more rapid accumulation of damage. The strength reduction and failure are not interdependent making the model easier to calibrate.

## References

- 1 Chang, G. and Mander, J. (1994). "Seismic Energy Based Fatigue Damage Analysis of Bridge Columns: Part I – Evaluation of Seismic Capacity." NCEER Technical Report 94-0006.

- 2 Dodd, L. and Restrepo-Posada, J. (1995). "Model for Predicting Cyclic Behavior of Reinforcing Steel" J. Struct. Eng., 121(3), 433-445.
- 3 Gomes, A., and Appleton, J. (1997). "Nonlinear Cyclic Stress-Strain Relationship of Reinforcing Bars Including Buckling." Eng. Struct., 19(10), 822–826.
- 4 Brown, J. and Kunnath, S.K. (2000). "Low Cycle Fatigue Behavior of Longitudinal Reinforcement in Reinforced Concrete Bridge Columns." NCEER Technical Report 00-0007.
- 5 Dhakal, R. and Maekawa, K. (2002). "Modeling for Postyield Buckled of Reinforcement" J. Struct. Eng., 128(9), 1139-1147.

## CHAPTER 12

# ReinforcingSteel -- Material Behavior

Each material was subjected to a series of ten uniaxial tension and compression strain histories. The following is the response of this material to such strain excursions. The data shown are the normalized stresses versus strain. In the normalization, the steel stress was divided by the yield stress  $F_y$  and the concrete stress was divided by the absolute value of compressive strength  $f_c$  -- to maintain positive tension and negative compression. The first figure shows all 10 load patterns together, which are subsequently shown individually.

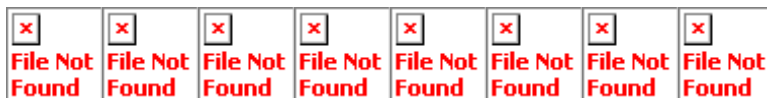

---

## Elastic Material

This command is used to construct an elastic uniaxial material object.

```
uniaxialMaterial Elastic $matTag $E <$eta>
```

<b>\$matTag</b>	unique material object integer tag
<b>\$E</b>	tangent
<b>\$eta</b>	damping tangent (optional, default=0.0)

Figure 8: Elastic Material

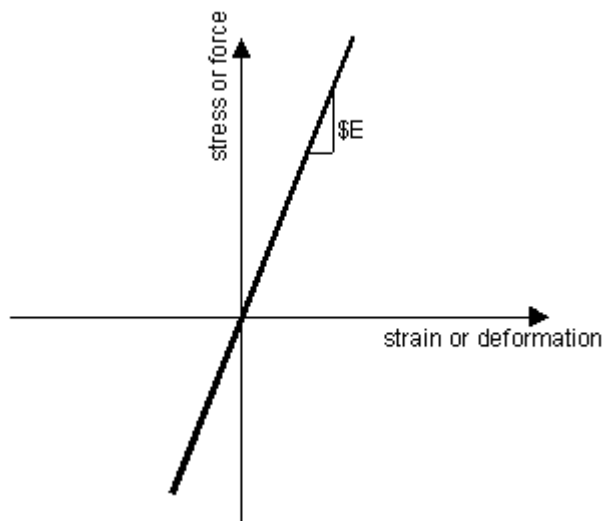

---

## Elastic-Perfectly Plastic Material

This command is used to construct an elastic perfectly-plastic uniaxial material object.

```
uniaxialMaterial ElasticPP $matTag $E $epsyP <$epsyN $eps0>
```

**\$matTag** unique material object integer tag

**\$E** tangent

<b><math>\epsilon_{syP}</math></b>	strain or deformation at which material reaches plastic state in tension
<b><math>\epsilon_{syN}</math></b>	strain at which material reaches plastic state in compression (optional, default: tension value)
<b><math>\epsilon_{s0}</math></b>	initial strain (optional, default: zero)

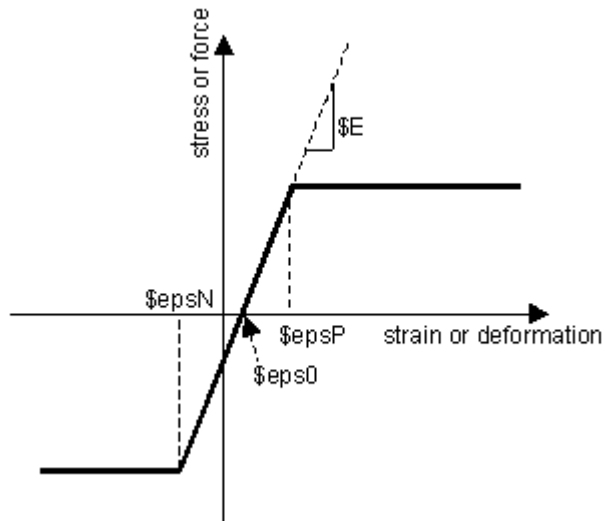

Figure 9: Elastic-Perfectly Plastic Material

## Elastic-Perfectly Plastic Gap Material

This command is used to construct an elastic perfectly-plastic gap uniaxial material object.

```
uniaxialMaterial ElasticPPGap $matTag $E $Fy $gap <$eta> <damage>
```

<b>\$matTag</b>	unique material object integer tag
<b>\$E</b>	tangent stiffness
<b>\$Fy</b>	stress or force at which material reaches plastic state
<b>\$gap</b>	initial gap (strain or deformation)
<b>\$eta</b>	hardening ratio ( $=E_h/E$ ), which can be negative
<b>damage</b>	a switch to accumulate damage in the material. If damage is omitted, default value, the gap material "re-centers" on load reversal.

**NOTE:** To create a compression-only gap element, NEGATIVE values need to be specified for \$Fy and \$gap.

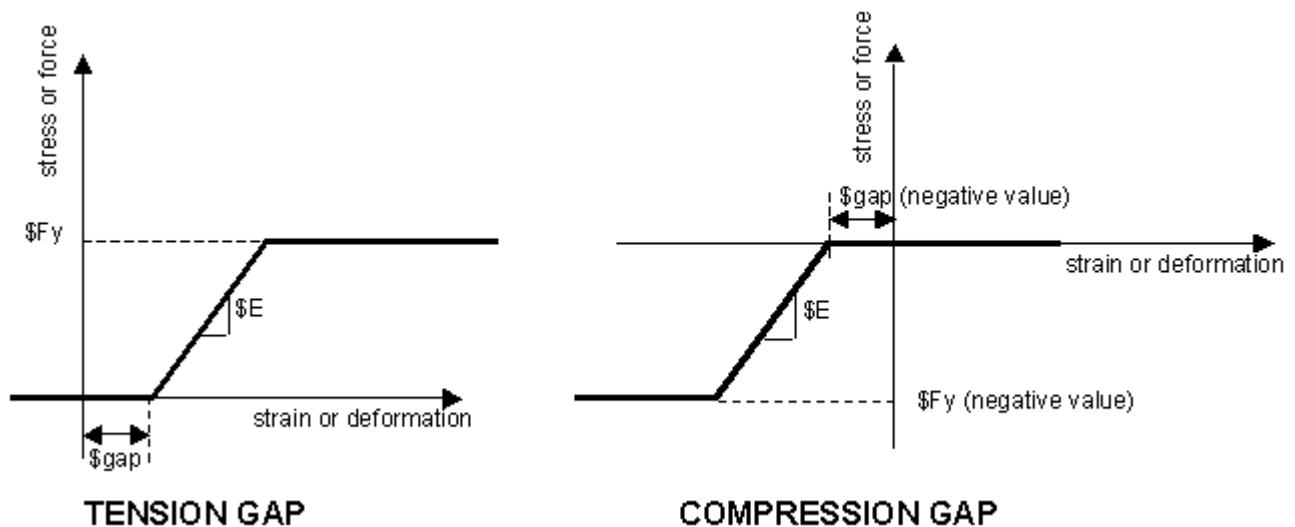

Figure 10: Elastic-Perfectly Plastic Gap Material



# Elastic-No Tension Material

This command is used to construct a uniaxial elastic-no tension material object.

```
uniaxialMaterial ENT $matTag $E
```

**\$matTag**                    unique material object integer tag

**\$E**                            elastic model in compression

In tension, there is zero stress.

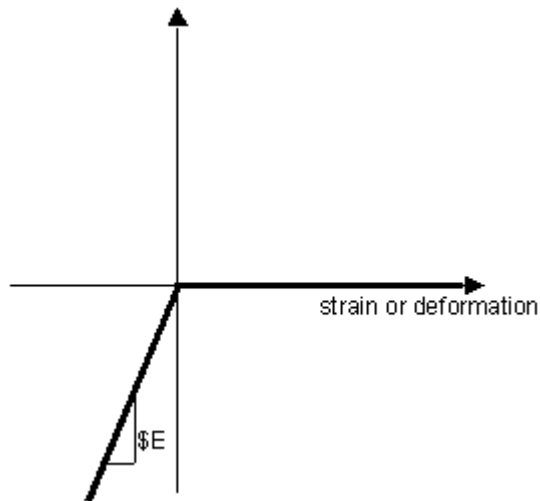

Figure 11: Elastic-No Tension Material

---

## Parallel Material

This command is used to construct a parallel material object made up of an arbitrary number of previously-constructed *UniaxialMaterial* (page 43) objects.

```
uniaxialMaterial Parallel $matTag $tag1 $tag2 ...
```

**\$matTag**                    unique material object integer tag  
**\$tag1 \$tag2 ...**            identification of materials making up the material model

The parallel material is represented graphically:

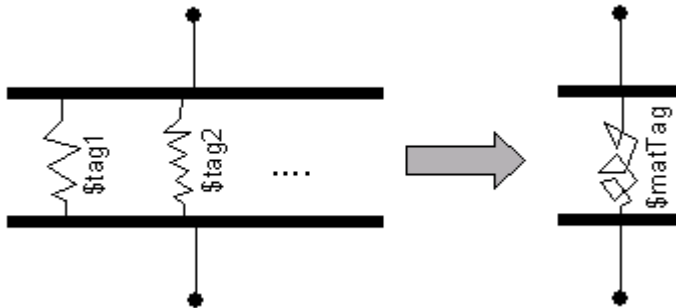
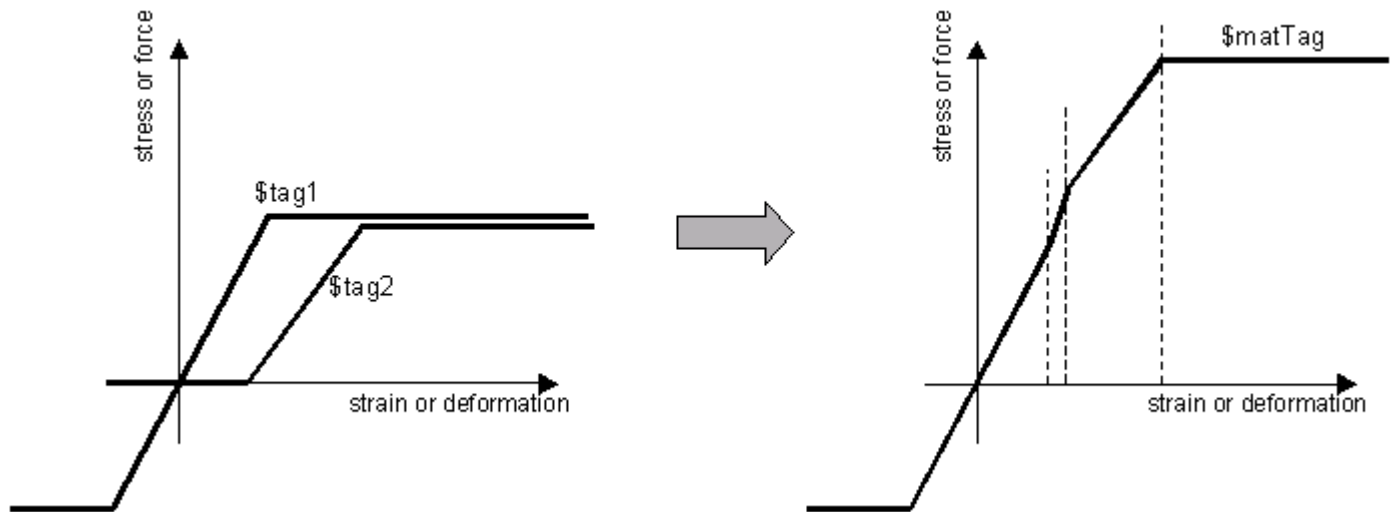

Figure 12: Parallel Material

In a parallel model, strains are equal and stresses and stiffnesses are additive:



## Series Material

This command is used to construct a series material object made up of an arbitrary number of previously-constructed *UniaxialMaterial* (page 43) objects.

```
uniaxialMaterial Series $matTag $tag1 $tag2 ...
```

**\$matTag**                    unique material object integer tag  
**\$tag1 \$tag2 ...**            identification of materials making up the material model

The series material is represented graphically:

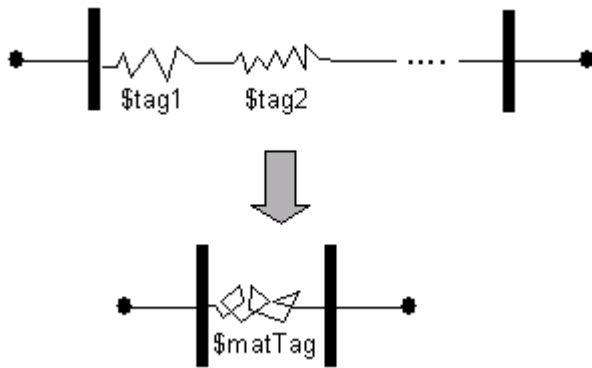

Figure 13: Series Material

In a series model, stresses are equal and strains and flexibilities are additive:

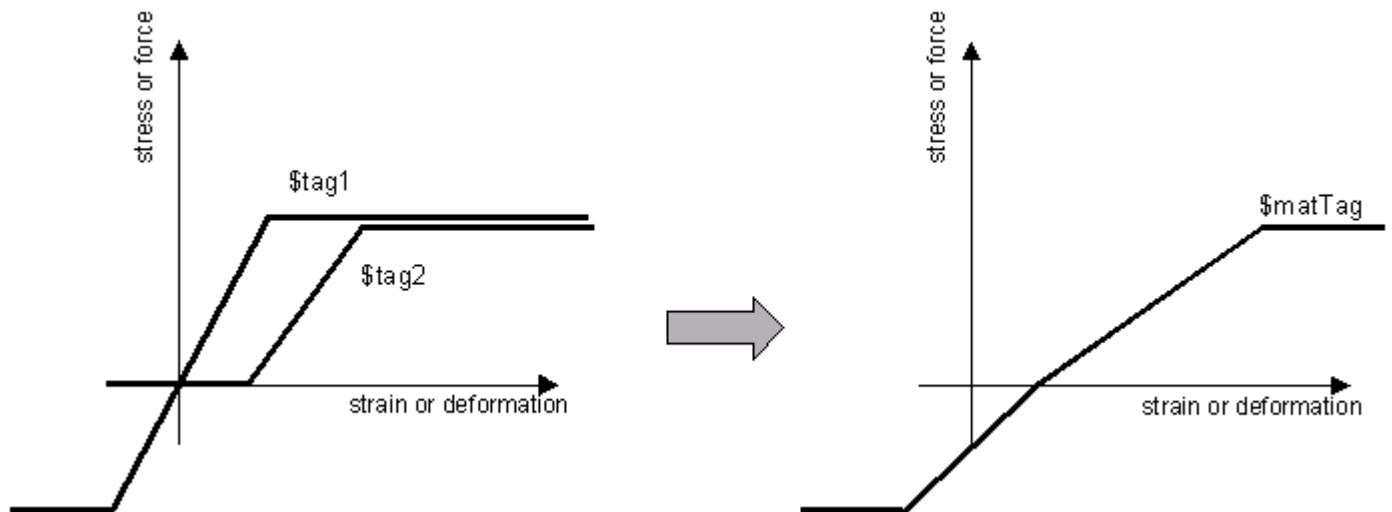

Figure 14: Series Material Relationship

## Hardening Material

This command is used to construct a uniaxial material object with combined linear kinematic and isotropic hardening. The model includes optional visco-plasticity using a Perzyna formulation (REF???)

**uniaxialMaterial Hardening \$matTag \$E \$sigmaY \$H\_iso \$H\_kin <\$eta>**

<b>\$matTag</b>	unique material object integer tag
<b>\$E</b>	tangent stiffness
<b>\$sigmaY</b>	yield stress or force
<b>\$H_iso</b>	isotropic hardening Modulus
<b>\$H_kin</b>	kinematic hardening Modulus
<b>\$eta</b>	visco-plastic coefficient (optional, default=0.0)

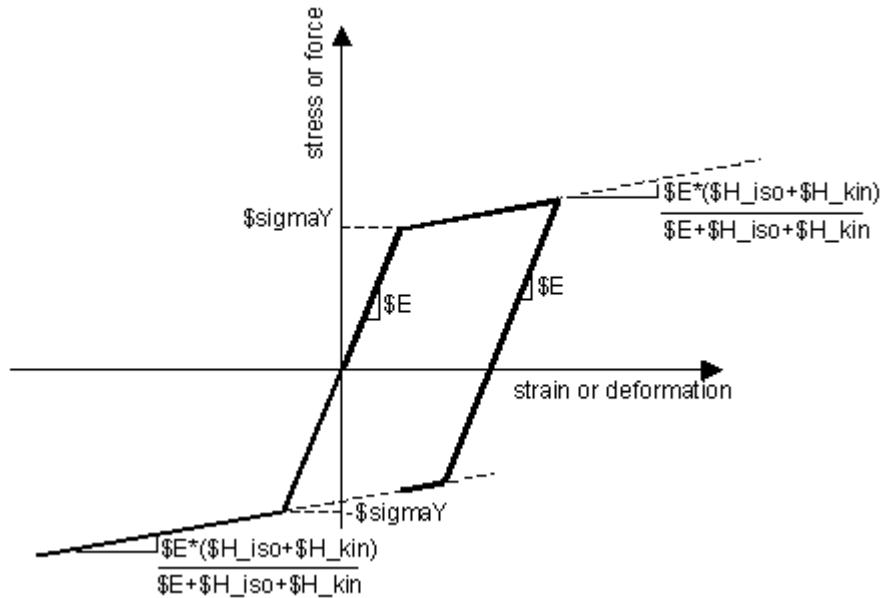

Figure 15: Hardening Material

---

## Concrete01 Material -- Zero Tensile Strength

This command is used to construct a uniaxial Kent-Scott-Park concrete material object with degraded linear unloading/reloading stiffness according to the work of Karsan-Jirsa and no tensile strength. (REF: Fedeas).

```
uniaxialMaterial Concrete01 $matTag $fpc $epsc0 $fpcu $epsU
```

<b>\$matTag</b>	unique material object integer tag
<b>\$fpc</b>	concrete compressive strength at 28 days (compression is negative)*
<b>\$epsc0</b>	concrete strain at maximum strength*
<b>\$fpcu</b>	concrete crushing strength *
<b>\$epsU</b>	concrete strain at crushing strength*

\***NOTE:** Compressive concrete parameters should be input as negative values.

The initial slope for this model is  $(2 * \text{\$fpc} / \text{\$epsc0})$

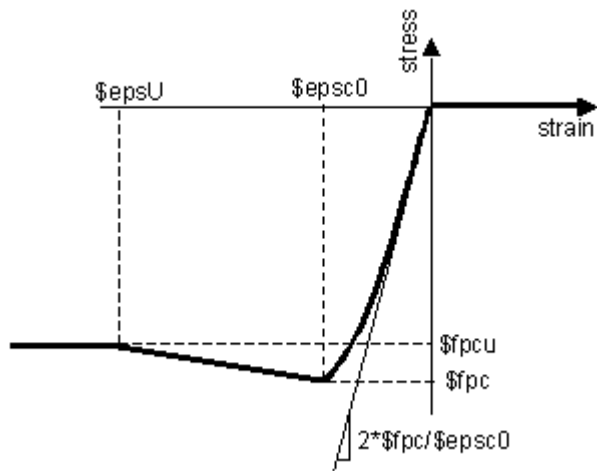
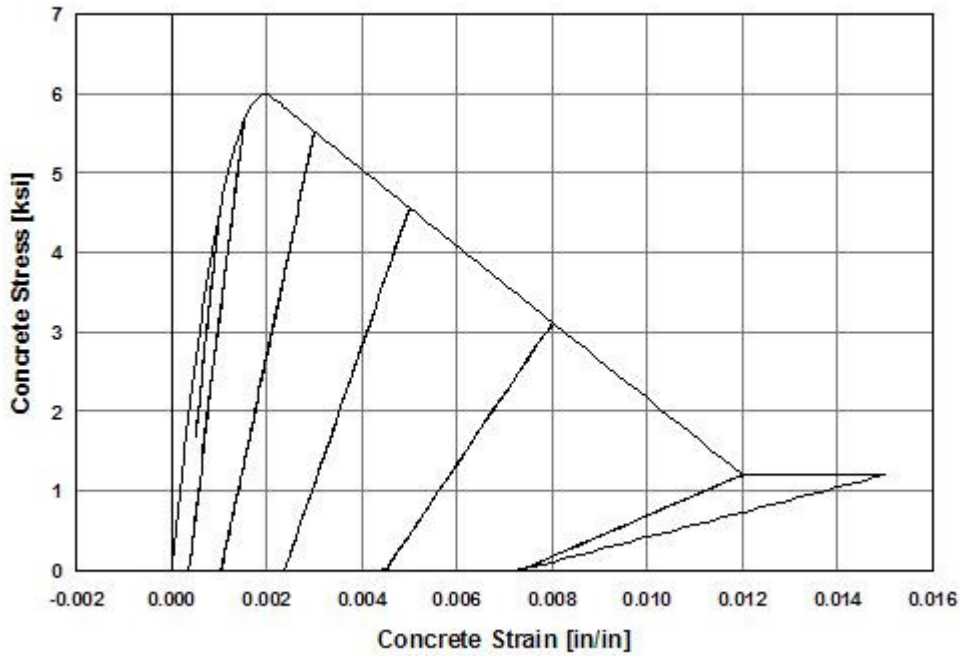

Figure 16: Concrete01 Material -- Material Parameters

Concrete01 Material -- Material Parameters



*Figure 17: Typical Hysteretic Stress-Strain Relation of Concrete\_1 Model*

Typical Hysteretic Stress-Strain Relation of Concrete\_1 Model



## CHAPTER 13

# Concrete01 -- Material Behavior

Each material was subjected to a series of ten uniaxial tension and compression strain histories. The following is the response of this material to such strain excursions. The data shown are the normalized stresses versus strain. In the normalization, the steel stress was divided by the yield stress  $F_y$  and the concrete stress was divided by the absolute value of compressive strength  $f_c$  -- to maintain positive tension and negative compression. The first figure shows all 10 load patterns together, which are subsequently shown individually.



---

## Concrete02 Material -- Linear Tension Softening

This command is used to construct a uniaxial concrete material object with tensile strength and linear tension softening. This is a Fedees Material and the source code may not be available, yet.

```
uniaxialMaterial Concrete02 $matTag $fpc $epsc0 $fpcu $epsU $lambda $ft $Ets
```

<b>\$matTag</b>	unique material object integer tag
<b>\$fpc</b>	compressive strength*
<b>\$epsc0</b>	strain at compressive strength*
<b>\$fpcu</b>	crushing strength*
<b>\$epsU</b>	strain at crushing strength*
<b>\$lambda</b>	ratio between unloading slope at \$epscu and initial slope
<b>\$ft</b>	tensile strength
<b>\$Ets</b>	tension softening stiffness (absolute value) (slope of the linear tension softening branch)

**\*NOTE:** Compressive concrete parameters should be input as negative values.

The initial slope for this model is  $(2 * f_{pc} / \epsilon_{psc0})$

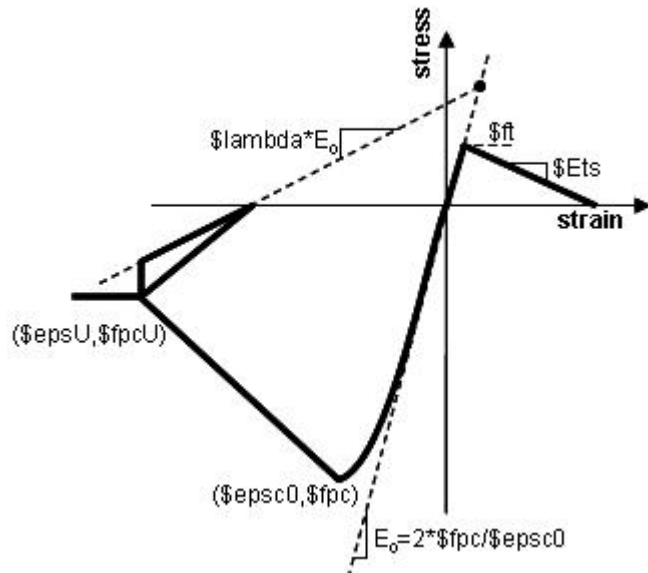

Figure 18: Concrete02 Material -- Material parameters

Concrete02 Material -- Material parameters

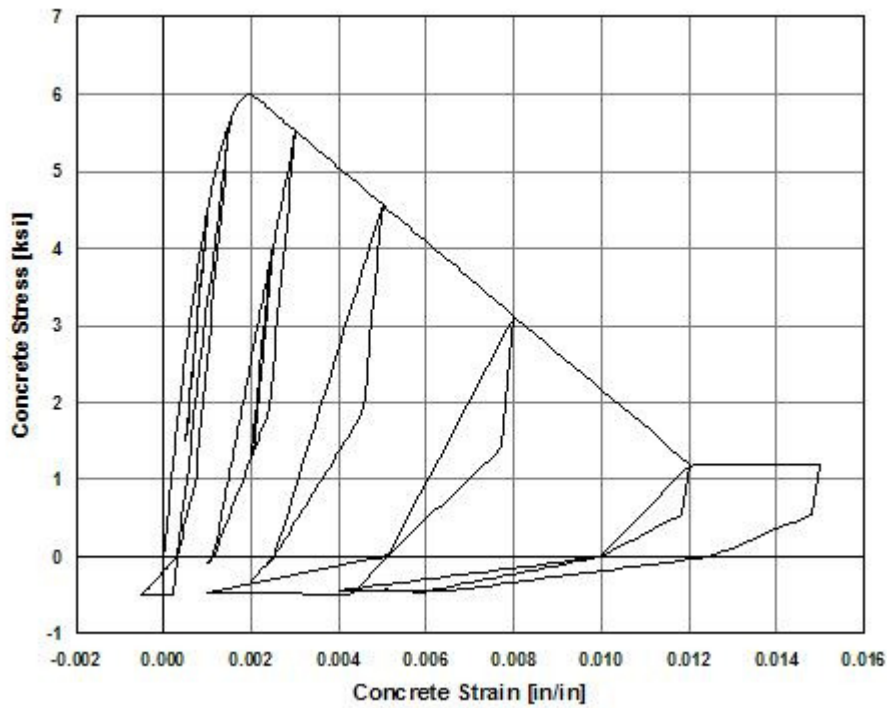

Figure 19: Typical Hysteretic Stress-Strain Relation of Concrete\_2 Model

Typical Hysteretic Stress-Strain Relation of Concrete\_2 Model

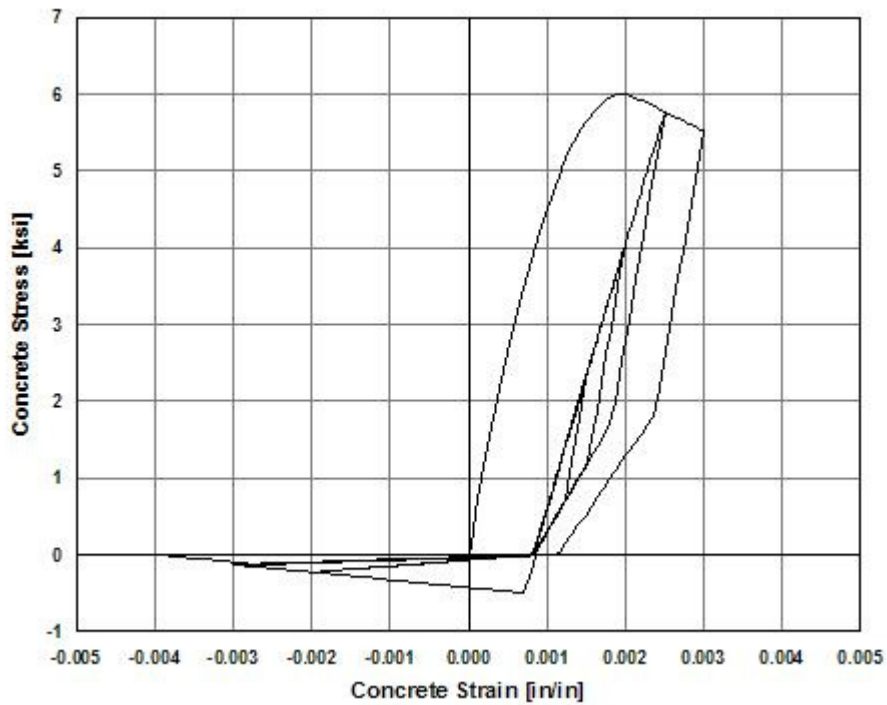

Figure 20: Hysteretic Stress-Strain Relation of Concrete\_2 Model in Tension-Compression

Hysteretic Stress-Strain Relation of Concrete\_2 Model in Tension-Compression

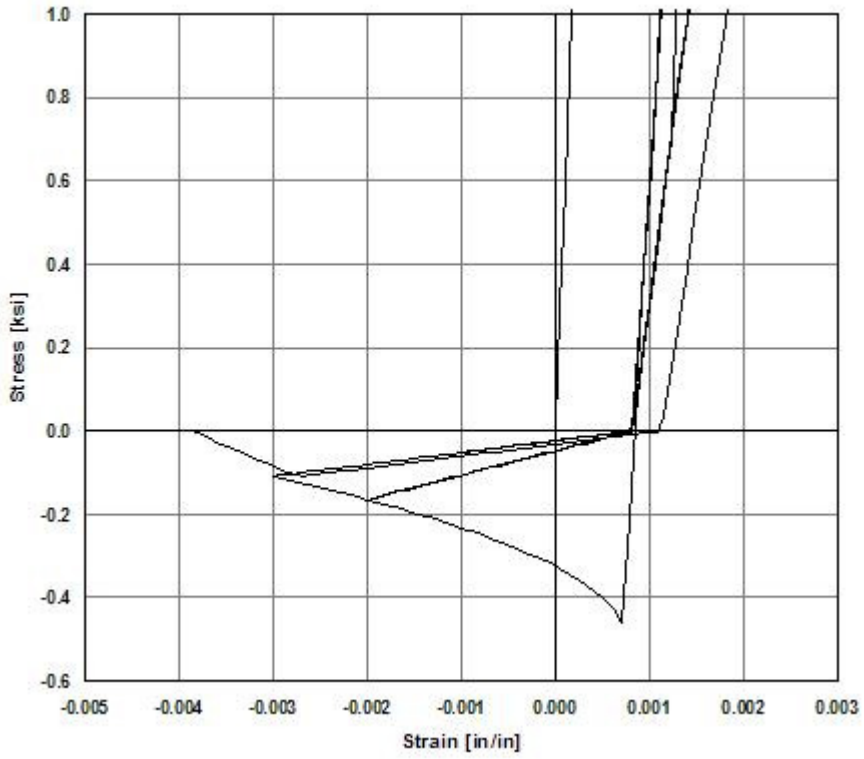

Figure 21: Hysteretic Stress-Strain Relation of Concrete\_2 Model in Tension-Compression (Detail)

Hysteretic Stress-Strain Relation of Concrete\_2 Model in Tension-Compression (Detail)

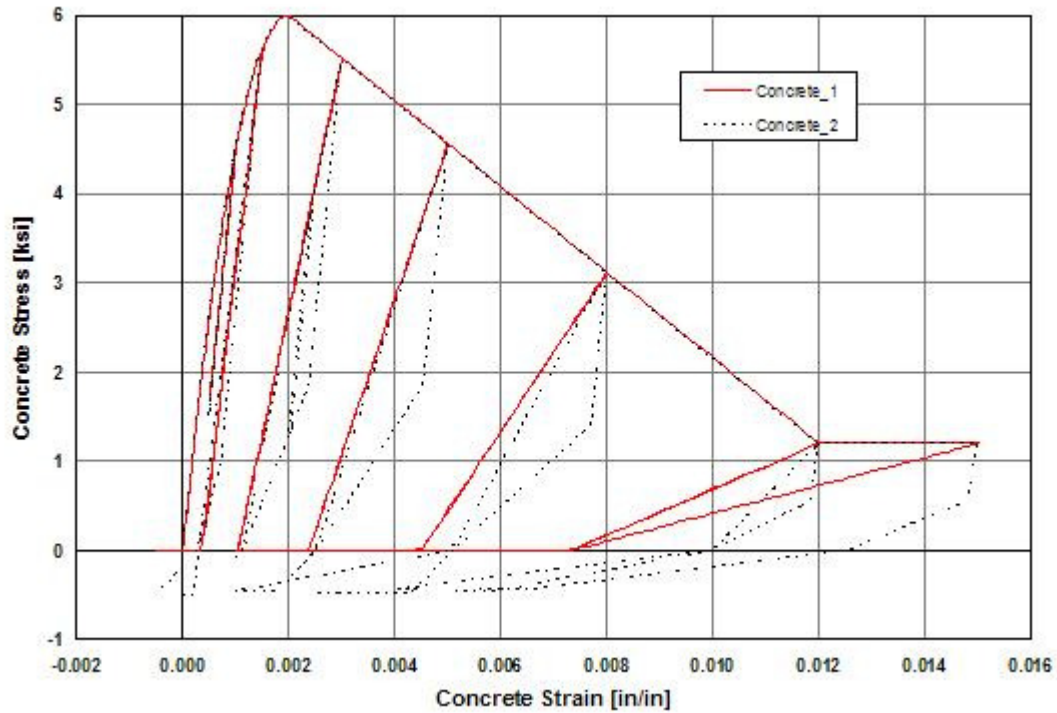

Figure 22: Comparison of Hysteretic Behavior of Concrete\_1 and Concrete\_2 model

Comparison of Hysteretic Behavior of Concrete\_1 and Concrete\_2 model

## CHAPTER 14

# Concrete02 -- Material Behavior

Each material was subjected to a series of ten uniaxial tension and compression strain histories. The following is the response of this material to such strain excursions. The data shown are the normalized stresses versus strain. In the normalization, the steel stress was divided by the yield stress  $F_y$  and the concrete stress was divided by the absolute value of compressive strength  $f_c$  -- to maintain positive tension and negative compression. The first figure shows all 10 load patterns together, which are subsequently shown individually.



---

## Concrete03 Material -- Nonlinear Tension Softening

This command is used to construct a uniaxial concrete material object with tensile strength and nonlinear tension softening. This is a Fedees Material and the source code may not be available, yet.

```
uniaxialMaterial Concrete03 $matTag $fpc $epsc0 $fpcu $epsU $lambda $ft
$epst0 $ft0 $beta $epstu
```

<b>\$matTag</b>	unique material object integer tag
<b>\$fpc</b>	compressive strength*
<b>\$epsc0</b>	strain at compressive strength*
<b>\$fpcu</b>	crushing strength*
<b>\$epsU</b>	strain at crushing strength*
<b>\$lambda</b>	ratio between unloading slope at \$epscu and initial slope (=2*\$fpc/\$epsc0)
<b>\$ft</b>	tensile strength
<b>\$epst0</b>	tensile strain at the transition from nonlinear to linear softening

<b><math>f_{t0}</math></b>	tensile stress at the transition from nonlinear to linear softening
<b><math>\beta</math></b>	exponent of the tension softening curve
<b><math>\epsilon_{pstu}</math></b>	ultimate tensile strain



**\*NOTE:** Compressive concrete parameters should be input as negative values.

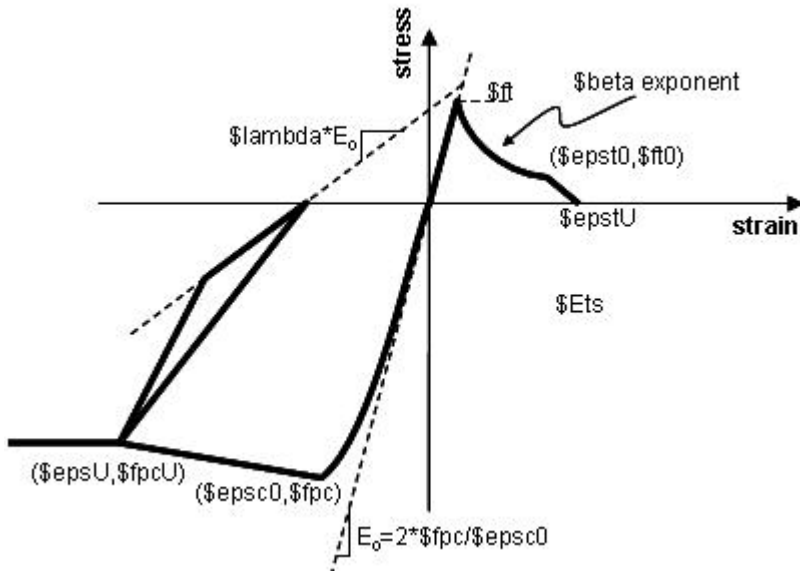

Figure 23: Concrete03 Material -- Material Parameters

Concrete03 Material -- Material Parameters

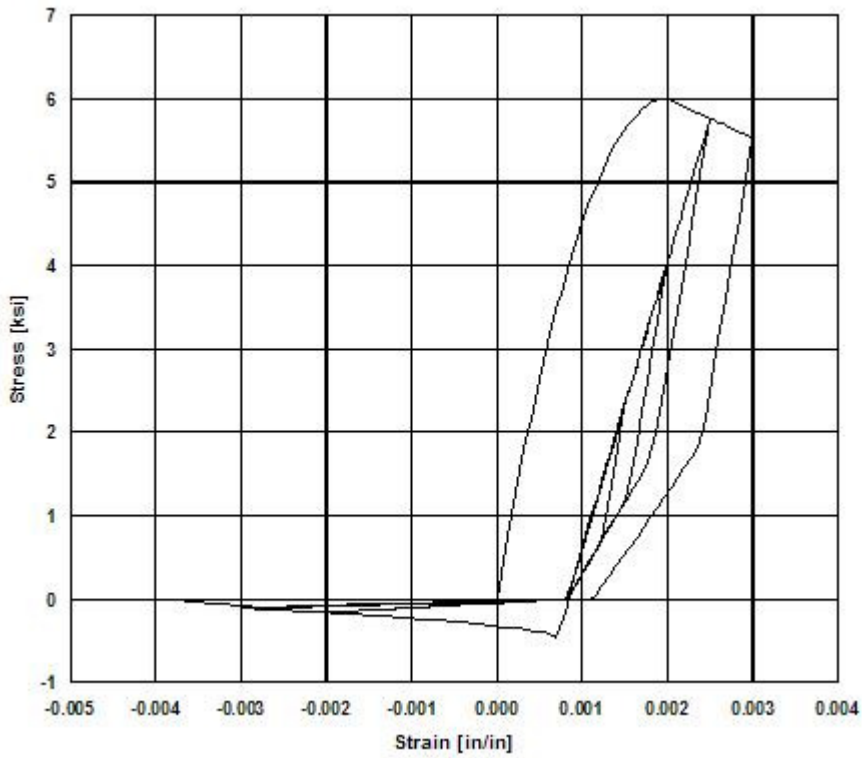

Figure 24: Hysteretic stress-strain relation of Concrete\_3 model in Tension-Compression

Hysteretic stress-strain relation of Concrete\_3 model in Tension-Compression

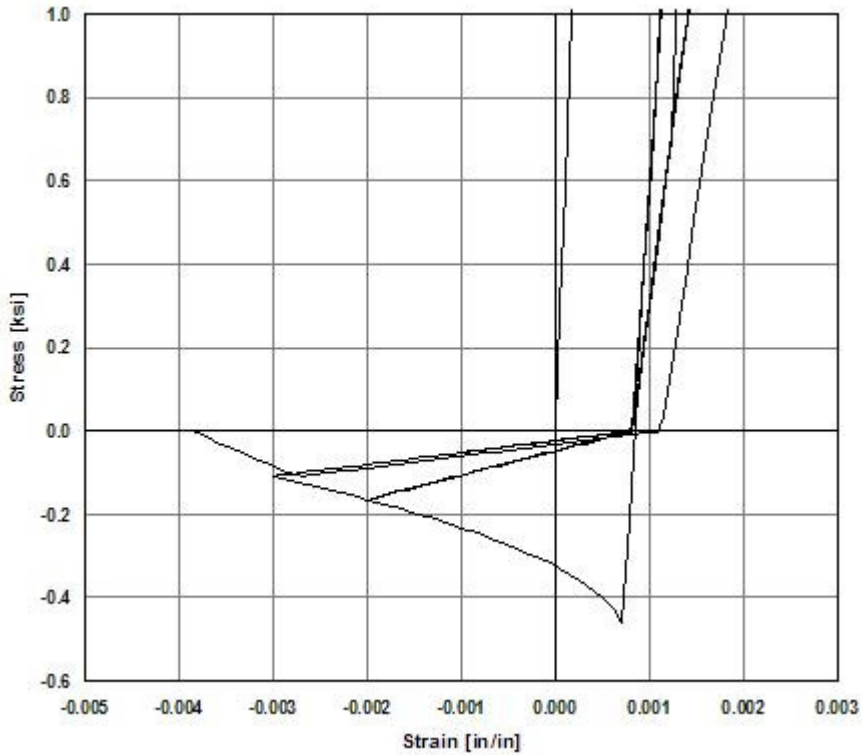

Figure 25: Hysteretic stress-strain relation of Concrete\_3 model in Tension-Compression (Detail)

Hysteretic stress-strain relation of Concrete\_3 model in Tension-Compression (Detail)

## CHAPTER 15

# Concrete03 -- Material Behavior

Each material was subjected to a series of ten uniaxial tension and compression strain histories. The following is the response of this material to such strain excursions. The data shown are the normalized stresses versus strain. In the normalization, the steel stress was divided by the yield stress  $F_y$  and the concrete stress was divided by the absolute value of compressive strength  $f_c$  -- to maintain positive tension and negative compression. The first figure shows all 10 load patterns together, which are subsequently shown individually.

---

## Steel01 Material

This command is used to construct a uniaxial bilinear steel material object with kinematic hardening and optional isotropic hardening described by a non-linear evolution equation (REF: Fedees).

```
uniaxialMaterial Steel01 $matTag $Fy $E0 $b <$a1 $a2 $a3 $a4>
```

<b>\$matTag</b>	unique material object integer tag
<b>\$Fy</b>	yield strength
<b>\$E0</b>	initial elastic tangent
<b>\$b</b>	strain-hardening ratio (ratio between post-yield tangent and initial elastic tangent)
<b>\$a1, \$a2, \$a3, \$a4</b>	isotropic hardening parameters: (optional, default: no isotropic hardening)
<b>\$a1</b>	isotropic hardening parameter, increase of compression yield envelope as proportion of yield strength after a plastic strain of $\$a2 * (\$Fy / E0)$ .
<b>\$a2</b>	isotropic hardening parameter (see explanation under \$a1)

- \$a3** isotropic hardening parameter, increase of tension yield envelope as proportion of yield strength after a plastic strain of  $\$a4 * (\$Fy/E0)$
- \$a4** isotropic hardening parameter (see explanation under \$a3)

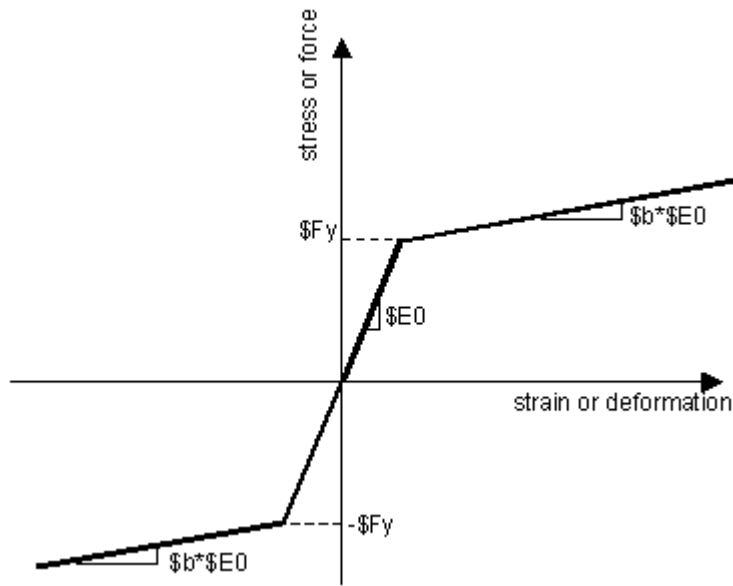

Figure 26: Steel01 Material -- Material Parameters of Monotonic Envelope

Steel01 Material -- Material Parameters of Monotonic Envelope

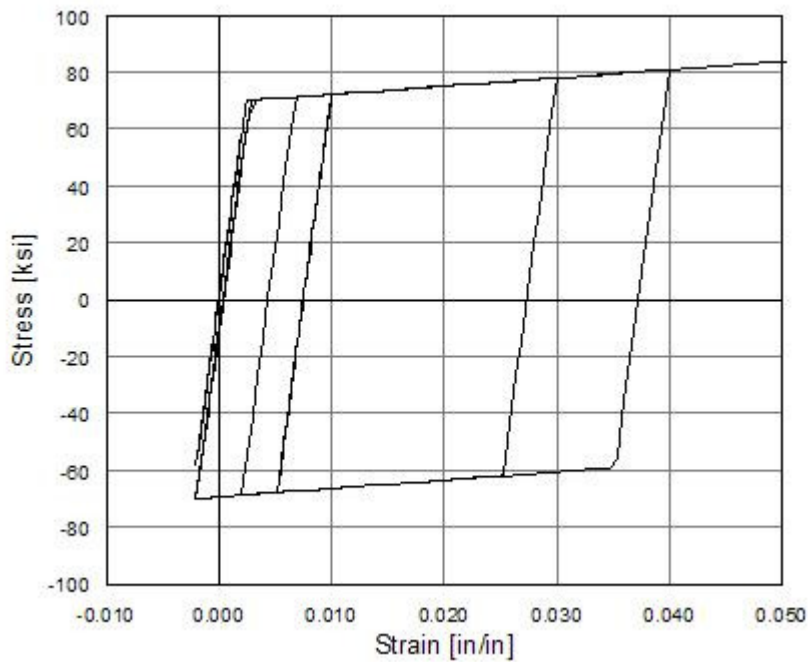

Figure 27: Steel01 Material -- Hysteretic Behavior of Model w/o Isotropic Hardening

Steel01 Material -- Hysteretic Behavior of Model w/o Isotropic Hardening

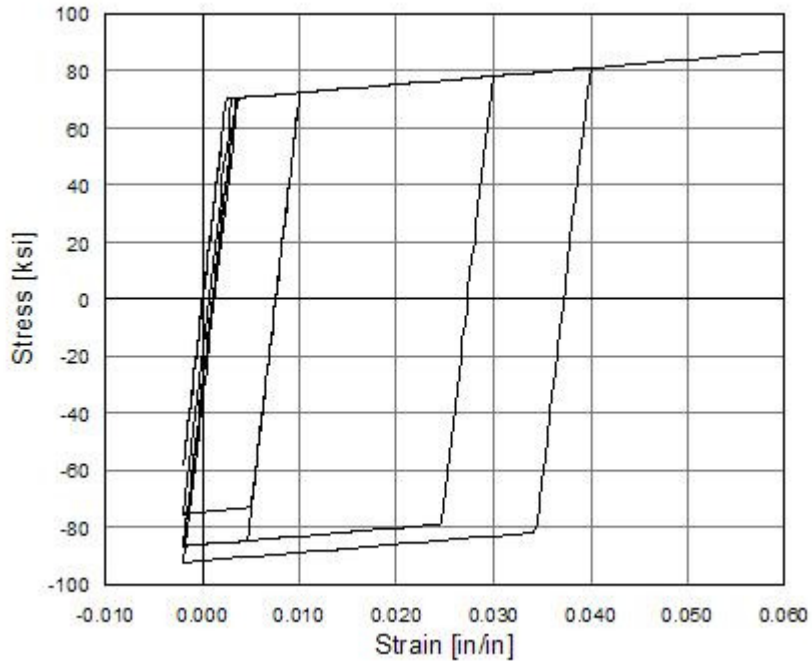
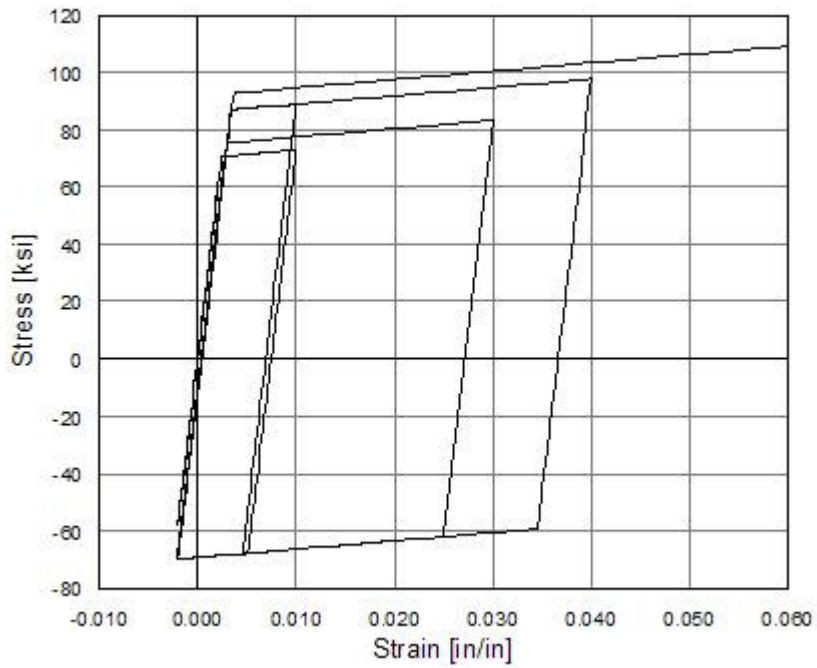

Figure 28: Hysteretic Behavior of Model with Isotropic Hardening in Compression

Steel01 Material -- Hysteretic Behavior of Model with Isotropic Hardening in Compression

Figure 29: Steel01 Material -- Hysteretic Behavior of Steel\_1 Model with Isotropic Hardening in Tension



Steel01 Material -- Hysteretic Behavior of Steel\_1 Model with Isotropic Hardening in Tension

## CHAPTER 16

# Steel01 -- Material Behavior

Each material was subjected to a series of ten uniaxial tension and compression strain histories. The following is the response of this material to such strain excursions. The data shown are the normalized stresses versus strain. In the normalization, the steel stress was divided by the yield stress  $F_y$  and the concrete stress was divided by the absolute value of compressive strength  $f_c$  -- to maintain positive tension and negative compression. The first figure shows all 10 load patterns together, which are subsequently shown individually.



## Steel02 Material -- Giuffré-Menegotto-Pinto Model with Isotropic Strain Hardening

This command is used to construct a uniaxial Giuffre-Menegotto-Pinto steel material object with isotropic strain hardening.

```
uniaxialMaterial Steel02 $matTag $Fy $E $b $R0 $cR1 $cR2 $a1 $a2 $a3 $a4
```

<b>\$matTag</b>	unique material object integer tag
<b>\$Fy</b>	yield strength
<b>\$E</b>	initial elastic tangent
<b>\$b</b>	strain-hardening ratio (ratio between post-yield tangent and initial elastic tangent)
<b>\$R0, \$cR1, \$cR2</b>	control the transition from elastic to plastic branches. Recommended values: <b>\$R0</b> =between 10 and 20, <b>\$cR1</b> =0.925, <b>\$cR2</b> =0.15
<b>\$a1, \$a2, \$a3, \$a4</b>	isotropic hardening parameters: (optional, default: no isotropic hardening)
<b>\$a1</b>	isotropic hardening parameter, increase of compression yield envelope as proportion of yield strength after a plastic strain of $a_2 * (F_y / E)$ .
<b>\$a2</b>	isotropic hardening parameter (see explanation under \$a1)
<b>\$a3</b>	isotropic hardening parameter, increase of tension yield envelope as proportion of yield strength after a plastic strain of $a_4 * (F_y / E)$
<b>\$a4</b>	isotropic hardening parameter (see explanation under \$a3)

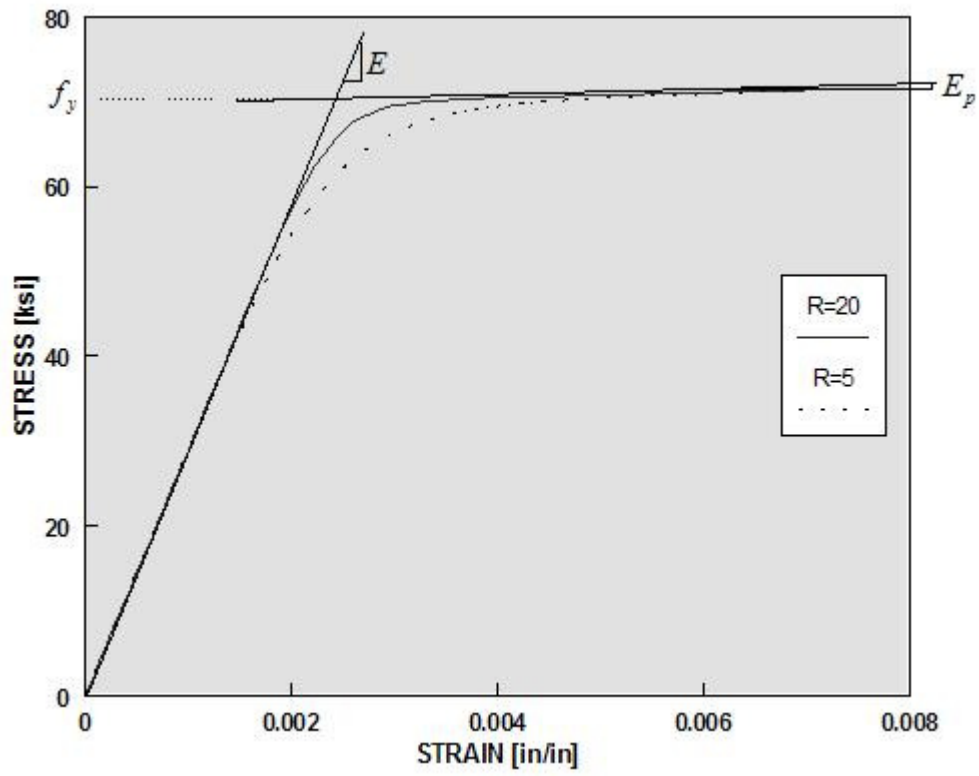

Figure 30: Steel02 Material -- Material Parameters of Monotonic Envelope

Steel02 Material -- Material Parameters of Monotonic Envelope

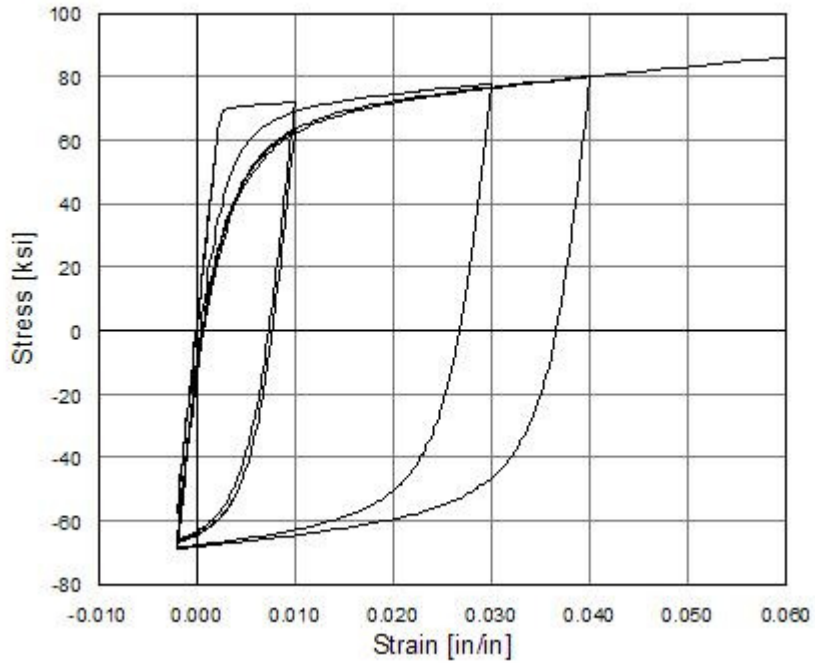

Figure 31: Steel02 Material -- Hysteretic Behavior of Model w/o Isotropic Hardening

Steel02 Material -- Hysteretic Behavior of Model w/o Isotropic Hardening

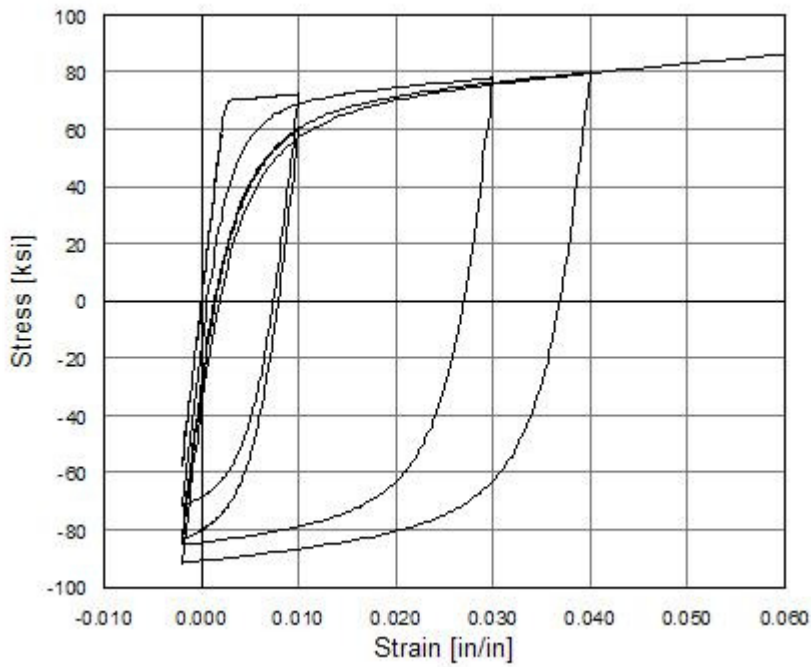
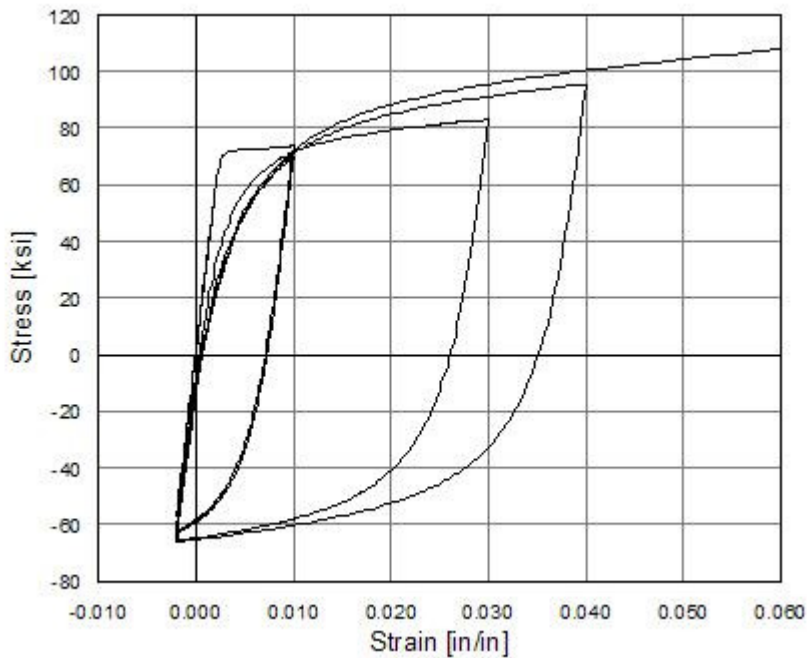

Figure 32: Steel02 Material -- Hysteretic Behavior of Model with Isotropic Hardening in Compression

Steel02 Material -- Hysteretic Behavior of Model with Isotropic Hardening in Compression



*Figure 33: Steel02 Material -- Hysteretic Behavior of Model with Isotropic Hardening in Tension*

Steel02 Material -- Hysteretic Behavior of Model with Isotropic Hardening in Tension

## CHAPTER 17

# Steel02 -- Material Behavior

Each material was subjected to a series of ten uniaxial tension and compression strain histories. The following is the response of this material to such strain excursions. The data shown are the normalized stresses versus strain. In the normalization, the steel stress was divided by the yield stress  $F_y$  and the concrete stress was divided by the absolute value of compressive strength  $f_c$  -- to maintain positive tension and negative compression. The first figure shows all 10 load patterns together, which are subsequently shown individually.

---

## Hysteretic Material

This command is used to construct a uniaxial bilinear hysteretic material object with pinching of force and deformation, damage due to ductility and energy, and degraded unloading stiffness based on ductility.

```
uniaxialMaterial Hysteretic $matTag $s1p $e1p $s2p $e2p <$s3p $e3p> $s1n  
$e1n $s2n $e2n <$s3n $e3n> $pinchX $pinchY $damage1 $damage2  
<$beta>
```

<b>\$matTag</b>		unique material object integer tag
<b>\$s1p</b>	<b>\$e1p</b>	stress and strain (or force & deformation) at first point of the envelope in the positive direction
<b>\$s2p</b>	<b>\$e2p</b>	stress and strain (or force & deformation) at second point of the envelope in the positive direction
<b>\$s3p</b>	<b>\$e3p</b>	stress and strain (or force & deformation) at third point of the envelope in the positive direction (optional)

<b>\$s1n</b>	<b>\$e1n</b>	stress and strain (or force & deformation) at first point of the envelope in the negative direction*
<b>\$s2n</b>	<b>\$e2n</b>	stress and strain (or force & deformation) at second point of the envelope in the negative direction*
<b>\$s3n</b>	<b>\$e3n</b>	stress and strain (or force & deformation) at third point of the envelope in the negative direction (optional)*
<b>\$pinchX</b>		pinching factor for strain (or deformation) during reloading
<b>\$pinchY</b>		pinching factor for stress (or force) during reloading
<b>\$damage1</b>		damage due to ductility: $D_1(\mu-1)$
<b>\$damage2</b>		damage due to energy: $D_2(E_i/E_{ult})$
<b>\$beta</b>		power used to determine the degraded unloading stiffness based on ductility, $\mu^{-\text{beta}}$ (optional, default=0.0)

\*NOTE: negative backbone points should be entered as negative numeric values

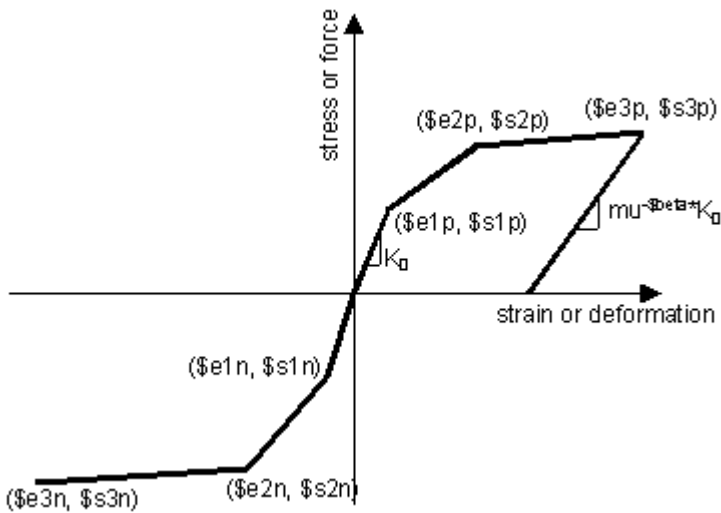

*Figure 34: Hysteretic Material*



## CHAPTER 18

# Hysteretic -- Material Behavior

Each material was subjected to a series of ten uniaxial tension and compression strain histories. The following is the response of this material to such strain excursions. The data shown are the normalized stresses versus strain. In the normalization, the steel stress was divided by the yield stress  $F_y$  and the concrete stress was divided by the absolute value of compressive strength  $f_c$  -- to maintain positive tension and negative compression. The first figure shows all 10 load patterns together, which are subsequently shown individually.

---

## Viscous Material

This command is used to construct a uniaxial material object with a non-linear elastic stress-strain-rate relation given by:

$$\text{stress} = C(\text{strain-rate})^{\alpha}$$

**uniaxialMaterial Viscous \$matTag \$C \$alpha**

**\$matTag**                      unique material object integer tag

**\$C**                                tangent

**\$alpha**                         damping tangent

## CHAPTER 19

# nDMaterial Command

This command is used to construct an NDMaterial object which represents stress-strain relationships at the integration points of continuum and force-deformation elements.

The valid queries to any ND material when creating an *ElementRecorder* (page 307) are 'strain,' 'stress,' and 'tangent.'

## In This Chapter

Elastic Isotropic Material.....	162
J2 Plasticity Material.....	163
Plane Stress Material .....	163
Plate Fiber Material .....	164
UC Davis Soil Models.....	164
UCSD Soil Models.....	169

---

## Elastic Isotropic Material

This command is used to construct an ElasticIsotropic material object.

**nDMaterial ElasticIsotropic \$matTag \$E \$v**

<b>\$matTag</b>	unique material object integer tag
<b>\$E</b>	elastic Modulus
<b>\$v</b>	Poisson's ratio

The material formulations for the ElasticIsotropic object are "ThreeDimensional," "PlaneStrain," "Plane Stress," "AxiSymmetric," and "PlateFiber." These are the valid strings that can be passed to the *continuum elements* (page 231, page 228, page 229, page 227, page 228, page 230) for the type parameter.

---

## J2 Plasticity Material

This command is used to construct a J2Plasticity material object.

```
nDmaterial J2Plasticity $matTag $K $G $sig0 $sigInf $delta $H
```

<b>\$matTag</b>	unique material object integer tag
<b>\$K</b>	bulk Modulus
<b>\$G</b>	shear Modulus
<b>\$sig0</b>	initial yield stress
<b>\$sigInf</b>	final saturation yield stress
<b>\$delta</b>	exponential hardening parameter
<b>\$H</b>	linear hardening parameter

---

## Plane Stress Material

This command is used to construct a plane-stress material wrapper which converts any three-dimensional material into a plane stress material via static condensation.

```
nDMaterial PlaneStress $matTag $threeDtag
```

<b>\$matTag</b>	unique material object integer tag
<b>\$threeDTag</b>	material tag for a previously-defined three-dimensional material

---

## Plate Fiber Material

This command is used to construct a plate-fiber material wrapper which converts any three-dimensional material into a plate fiber material (by static condensation) appropriate for shell analysis.

```
nDMaterial PlateFiber $matTag $threeDTag
```

**\$matTag**                    unique material object integer tag  
**\$threeDTag**                material tag for a previously-defined three-dimensional material

---

## UC Davis Soil Models

For further information or examples about the following models, please visit:

<http://sokocalo.engr.ucdavis.edu/~jeremic/> (<http://sokocalo.engr.ucdavis.edu/~jeremic/>)

---

## Template Elasto-Plastic Material

This command is used to construct the template elasto-plastic material object.

```
nDMaterial Template3Dep $matTag $ElmatTag -YS $ys -PS $ps -EPS $eps  

  <-ELS1 $el> <-ELT1 $et>
```

[\\$matTag](#)                    unique material object tag  
[\\$ElmatTag](#)                previously defined elastic nDMaterial (such as *ElasticIsotropic3D* (page 162), *PressureDependentElastic3D*) tag  
[\\$ys](#)                        yield surface variable, previously defined in [Yield Surface](#) (page 165) object  
[\\$ps](#)                        potential surface variable, previously defined in [Potential Surface](#) (page 166) object  
[\\$eps](#)                        elasto-plastic state variable, previously defined in [EPState](#) (page 168) object  
[\\$el](#)                        scalar (isotropic) evolution law variable, previously defined in [Evolution Law](#) (page 167) object

[\\$set](#) tensorial (kinematic) evolution law variable, previously defined in [Evolution Law](#) (page 167) object

### Yield Surface

This command sets the yield surface variable `ys` to be the specified type. Currently these include: Drucker-Prager yield surface, Rounded Mohr-Coulomb (Willam-Warnke) yield surface, von Mises yield surface, Cam-Clay yield surface and Leon yield surface.

```
set ys "-YieldSurfaceType <parameter list>"
```

Valid strings for `YieldSurfaceType` are DP, VM and CC.

➤ *For Drucker-Prager yield surface*

```
set ys "-DP"
```

➤ *For von Mises yield surface*

```
set ys "-VM"
```

➤ *For rounded Mohr-Coulomb (Willam-Warnke) yield surface*

```
set ys "-RMC01"
```

➤ *For Cam-Clay yield surface*

```
set ys "-CC $M"
```

[\\$M](#) Slope of the critical state line in p-q space

➤ *For Leon yield surface*

```
set ys "-Leon $fc $ft $e $c"
```

[\\$fc](#) compressive strength

<a href="#">\$ft</a>	tensile strength
<a href="#">\$e</a>	excentricity of yield surface (usually 0.6-0.7)
<a href="#">\$c</a>	cohesion

### Potential Surface

This command is used to set the potential surface variable [\\$ps](#) to the specific surface (or directly to the flow directions). Currently included are: Drucker-Prager potential surface, Rounded Mohr-Coulomb (Willam-Warnke) potential surface, von Mises potential surface, Cam-Clay potential surface and Leon potential surface.

```
set ps "-PotentialSurfaceType <parameter list>"
```

Valid strings for PotentialSurfaceType are DP, VM and CC.

➤ *For the Drucker-Prager potential surface*

```
set ps "-DP"
```

➤ *For the von Mises potential surface*

```
set ps "-VM"
```

➤ *For rounded Mohr-Coulomb (Willam-Warnke) potential surface*

```
set ps "-RMC01"
```

➤ *For the Cam-Clay potential surface*

```
set ps "-CC $M"
```

[\\$M](#) Slope of the critical state line in p-q space

➤ *For Leon potential surface*

```
set ps "-Leon $fc $ft $e $c"
```

<a href="#">\$fc</a>	compressive strength
<a href="#">\$ft</a>	tensile strength
<a href="#">\$e</a>	excentricity of yield surface (usually 0.6-0.7)
<a href="#">\$c</a>	cohesion

### Evolution Law

This command is used to set the evolution law variable [el](#) to the specified type. There are two types of evolutions laws implemented: scalar (isotropic) evolution and tensorial (kinematic) evolution. For scalar evolution law, there are linear scalar evolution law and nonlinear scalar evolution law. For tensorial evolution law, there are linear tensorial evolution law and nonlinear tensorial evolution law.

```
set el "-EvolutionLawType <parameter list>"
```

Valid strings for EvolutionLawType are Leq, NLp, LEij, and NLEij

➤ *For linear scalar evolution law*

```
set el "-Leq $a"
```

➤ *For Cam-Clay type nonlinear scalar evolution law*

```
set el "-NLp $e_o $lambda $k"
```

➤ *For linear tensorial evolution law*

```
set et "-LEij $a1"
```

➤ *For Armstrong-Frederick type nonlinear tensorial evolution law*

```
set et "-NLEij $h_a $C_r"
```

<a href="#">\$a</a>	linear hardening coefficient
<a href="#">\$e_o</a>	initial void ratio
<a href="#">\$lambda</a>	nonlinear evolution law constant (Cam-Clay type)
<a href="#">\$k</a>	nonlinear evolution law constant (Cam-Clay type)
<a href="#">\$a1</a>	linear tensorial evolution law constant
<a href="#">\$h_a</a>	nonlinear tensorial evolution law constant (Armstrong-Frederick type)
<a href="#">\$C_r</a>	nonlinear tensorial evolution law constant (Armstrong-Frederick type)

### EPState

This command is used to set the Elasto-Plastic State, which includes two states.

- *To set the initial stress tensor to variable [sts](#), if [-stressp \\$sts](#) is used in [eps](#):*

```
set sts "$sigma_xx $sigma_xy $sigma_xz $sigma_yx $sigma_yy $sigma_yz
        $sigma_zx $sigma_zy $sigma_zz"
```

- *To assign to the Elasto-Plastic state variable [eps](#) the specified state parameters*

```
set eps "<-NOD $nt> -NOS $ns $scalar1 $scalar2 ... <-stressp $sts>"
```

<a href="#">\$sigma_xx</a> <a href="#">\$sigma_xy</a> <a href="#">\$sigma_xz</a> <a href="#">\$sigma_yx</a> <a href="#">\$sigma_yy</a> <a href="#">\$sigma_yz</a> <a href="#">\$sigma_zx</a> <a href="#">\$sigma_zy</a> <a href="#">\$sigma_zz</a>	Initial stress tensor components (Default = 0.0),
<a href="#">\$nt</a>	number of tensorial internal variables
<a href="#">\$ns</a>	number of scalar internal variables
<a href="#">\$scalar1</a> <a href="#">\$scalar2</a> ...	corresponding initial values of scalar internal variables
<a href="#">\$sts</a>	initial stresses



---

## UCSD Soil Models

This chapter describes the user interfaces for: 1) a number of NDMaterial models developed for simulating nonlinear, drained/undrained soil response under general 3D cyclic loading conditions

**Please visit <http://cyclic.ucsd.edu/opensees> (<http://cyclic.ucsd.edu/opensees>) for examples.**

This documentation is last updated at 8/5/2005 by Zhaohui Yang ([zhyang@ucsd.edu](mailto:zhyang@ucsd.edu)) (<mailto:zhyang@ucsd.edu>) and Ahmed Elgamal ([elgamal@ucsd.edu](mailto:elgamal@ucsd.edu)) (<mailto:elgamal@ucsd.edu>).

### FluidSolidPorousMaterial

**FluidSolidPorousMaterial** couples the responses of two phases: fluid and solid. The fluid phase response is only volumetric and linear elastic. The solid phase can be any NDMaterial. This material is developed to simulate the response of saturated porous media under fully undrained condition. **Please visit <http://cyclic.ucsd.edu/opensees> (<http://cyclic.ucsd.edu/opensees>) for examples.**

#### OUTPUT INTERFACE:

The following information may be extracted for this material at given integration point, using the OpenSees Element Recorder facility (McKenna and Fenves 2001): "**stress**", "**strain**", "**tangent**", or "**pressure**". The "**pressure**" option records excess pore pressure and excess pore pressure ratio at a given material integration point.

<b>nDMaterial FluidSolidPorousMaterial \$tag \$nd \$soilMatTag \$combinedBulkModul</b>
--

<b>\$tag</b>	A positive integer uniquely identifying the material among all nDMaterials
<b>\$nd</b>	Number of dimensions, 2 for plane-strain, and 3 for general 3D analysis.
<b>\$soilMatTag</b>	The material number for the solid phase material (previously defined).

**\$combinBulkModul** Combined undrained bulk modulus  $B_c$  relating changes in pore pressure and volumetric strain, may be approximated by:

$$B_c \approx B_f / n$$

where  $B_f$  is the bulk modulus of fluid phase ( $2.2 \times 10^6$  kPa for water typically), and  $n$  the initial porosity.

1

**NOTE:**

- 1 Buoyant unit weight (total unit weight - fluid unit weight) should be used in definition of the finite elements composed of a **FluidSolidPorousMaterial**.
- 2 During the application of gravity (elastic) load, the fluid phase does not contribute to the material response.

## PressureDependMultiYield Material

**PressureDependMultiYield** material is an elastic-plastic material for simulating the essential response characteristics of pressure sensitive soil materials under general loading conditions. Such characteristics include dilatancy (shear-induced volume contraction or dilation) and non-flow liquefaction (cyclic mobility), typically exhibited in sands or silts during monotonic or cyclic loading. **Please visit <http://cyclic.ucsd.edu/opensees> (<http://cyclic.ucsd.edu/opensees>) for examples.**

When this material is employed in regular solid elements (e.g., FourNodeQuad, Brick), it simulates drained soil response. To simulate soil response under fully undrained condition, this material may be either embedded in a **FluidSolidPorousMaterial** (see below), or used with one of the solid-fluid fully coupled elements (see below) with very low permeability. To simulate partially drained soil response, this material should be used with a solid-fluid fully coupled element with proper permeability values.

During the application of gravity load (and static loads if any), material behavior is linear elastic. In the subsequent dynamic (fast) loading phase(s), the stress-strain response is elastic-plastic (see MATERIAL STAGE UPDATE below). Plasticity is formulated based on the multi-surface (nested surfaces) concept, with a non-associative flow rule to reproduce dilatancy effect. The yield surfaces are of the Drucker-Prager type.

### OUTPUT INTERFACE:

The following information may be extracted for this material at a given integration point, using the OpenSees Element Recorder facility (McKenna and Fenves 2001): "**stress**", "**strain**", "**backbone**", or "**tangent**".

For 2D problems, the stress output follows this order:  $\sigma_{xx}$ ,  $\sigma_{yy}$ ,  $\sigma_{zz}$ ,  $\sigma_{xy}$ ,  $\eta_r$ , where  $\eta_r$  is the ratio between the shear (deviatoric) stress and peak shear strength at the current confinement ( $0 \leq \eta_r \leq 1.0$ ). The strain output follows this order:  $\epsilon_{xx}$ ,  $\epsilon_{yy}$ ,  $\gamma_{xy}$ .

For 3D problems, the stress output follows this order:  $\sigma_{xx}$ ,  $\sigma_{yy}$ ,  $\sigma_{zz}$ ,  $\sigma_{xy}$ ,  $\sigma_{yz}$ ,  $\sigma_{zx}$ ,  $\eta_r$ , and the strain output follows this order:  $\epsilon_{xx}$ ,  $\epsilon_{yy}$ ,  $\epsilon_{zz}$ ,  $\gamma_{xy}$ ,  $\gamma_{yz}$ ,  $\gamma_{zx}$ .

The "**backbone**" option records (secant) shear modulus reduction curves at one or more given confinements. The specific recorder command is as follows:

```
recorder Element -ele $eleNum -file $fileName -dT $deltaT material $GaussNum backbone
  $p1 <$p2 ...>
```

where  $p_1, p_2, \dots$  are the confinements at which modulus reduction curves are recorded. In the output file, corresponding to each given confinement there are two columns: shear strain  $\gamma$  and secant modulus  $G_s$ . The number of rows equals the number of yield surfaces.

```
nDMaterial PressureDependMultiYield $tag $nd $rho $refShearModul
$refBulkModul $frictionAng $peakShearStra $refPress
$pressDependCoe $PTAng $contrac $dilat1 $dilat2 $liquefac1
$liquefac2 $liquefac3 <$noYieldSurf=20 <$r1 $Gs1 ...> $e=0.6
$cs1=0.9 $cs2=0.02 $cs3=0.7 $p_a=101>
```

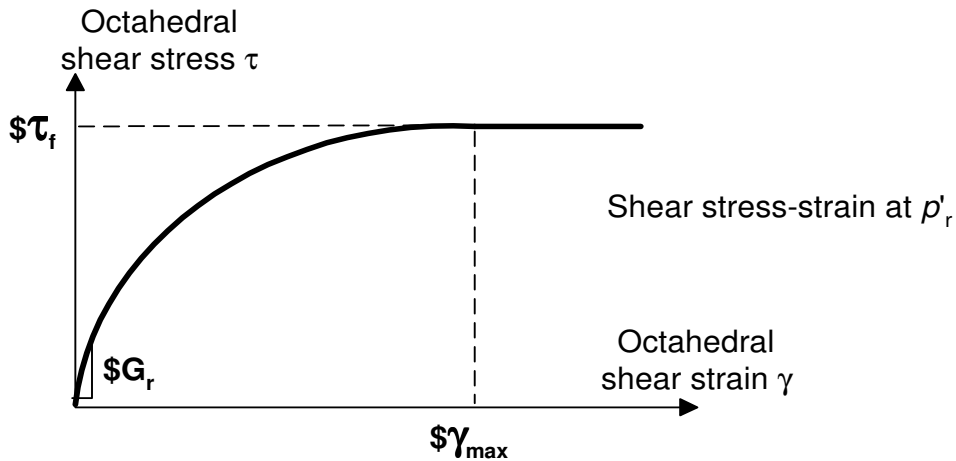

<b>\$tag</b>	A positive integer uniquely identifying the material among all nDMaterials.
<b>\$nd</b>	Number of dimensions, 2 for plane-strain, and 3 for 3D analysis.
<b>\$rho</b>	Saturated soil mass density.
<b>\$refShearModul (Gr)</b>	Reference low-strain shear modulus, specified at a reference mean effective confining pressure refPress of $p'_r$ (see below).
<b>\$refBulkModul (Br)</b>	Reference bulk modulus, specified at a reference mean effective confining pressure refPress of $p'_r$ (see below).
<b>\$frictionAng (f)</b>	Friction angle at peak shear strength, in degrees.

<b>\$peakShearStra (gmax)</b>	<p>An octahedral shear strain at which the maximum shear strength is reached, specified at a reference mean effective confining pressure refPress of <math>p'_r</math> (see below).</p> <p>Octahedral shear strain is defined as:</p> $\gamma = \frac{2}{3} \left[ (\varepsilon_{xx} - \varepsilon_{yy})^2 + (\varepsilon_{yy} - \varepsilon_{zz})^2 + (\varepsilon_{xx} - \varepsilon_{zz})^2 + 6\varepsilon_{xy}^2 + 6\varepsilon_{yz}^2 + 6\varepsilon_{xz}^2 \right]^{1/2}$
<b>\$refPress (<math>p'_r</math>)</b>	Reference mean effective confining pressure at which $G_r$ , $B_r$ , and $\gamma_{max}$ are defined.
<b>\$pressDependCoe (d)</b>	<p>A positive constant defining variations of <math>G</math> and <math>B</math> as a function of instantaneous effective confinement <math>p'</math>:</p> $G = G_r \left( \frac{p'}{p'_r} \right)^d \quad B = B_r \left( \frac{p'}{p'_r} \right)^d$
<b>\$PTAng (<math>\phi_{PT}</math>)</b>	Phase transformation angle, in degrees.
<b>\$contrac</b>	A non-negative constant defining the rate of shear-induced volume decrease (contraction) or pore pressure buildup. A larger value corresponds to faster contraction rate.
<b>\$dilat1, \$dilat2</b>	Non-negative constants defining the rate of shear-induced volume increase (dilation). Larger values correspond to stronger dilation rate.
<b>\$liquefac1, \$liquefac2, \$liquefac3</b>	<p>Parameters controlling the mechanism of liquefaction-induced perfectly plastic shear strain accumulation, i.e., cyclic mobility. <b>Set liquefac1 = 0 to deactivate this mechanism altogether.</b> liquefac1 defines the effective confining pressure (e.g., 10 kPa) below which the mechanism is in effect. Smaller values should be assigned to denser sands. liquefac2 defines the maximum amount of perfectly plastic shear strain developed at zero effective confinement during each loading phase. Smaller values should be assigned to denser sands. liquefac3 defines the maximum amount of biased perfectly plastic shear strain <math>\gamma_b</math> accumulated at each loading phase under biased shear loading conditions, as <math>\gamma_b = \text{liquefac2} \times \text{liquefac3}</math>. Typically, liquefac3 takes a value between 0.0 and 3.0. Smaller values should be assigned to denser sands. See the references listed at the end of this chapter for more information.</p>
<b>\$noYieldSurf</b>	Number of yield surfaces, optional (must be less than 40, default is 20). The surfaces are generated based on the hyperbolic relation defined in Note 2 below.

**\$r , \$Gs**

Instead of automatic surfaces generation (Note 2), **you can define yield surfaces directly based on desired shear modulus reduction curve.** To do so, add a minus sign in front of noYieldSurf, then provide noYieldSurf pairs of shear strain ( $\gamma$ ) and modulus ratio ( $G_s$ ) values. For example, to define 10 surfaces:

... -10  $\gamma_1$   $G_{s1}$  ...  $\gamma_{10}$   $G_{s10}$  ...

See Note 3 below for some important notes.

**\$e**

Initial void ratio, optional (default is 0.6).

**\$cs1, \$cs2, \$cs3, \$pa**

Parameters defining a straight critical-state line  $e_c$  in  $e$ - $p'$  space.

If  $cs3=0$ ,

$$e_c = cs1 - cs2 \log(p' / p_a)$$

else (Li and Wang, JGGE, 124(12)),

$$e_c = cs1 - cs2(p' / p_a)^{cs3}$$

where  $p_a$  is atmospheric pressure for normalization (typically 101 kPa in SI units). All four constants are optional (default values:  $cs1=0.9$ ,  $cs2=0.02$ ,  $cs3=0.7$ ,  $p_a=101$ ).

**NOTE:**

The friction angle  $\phi$  defines the variation of peak (octahedral) shear strength  $\tau_f$  as a function of current effective confinement  $p'$ :

$$\tau_f = \frac{2\sqrt{2} \sin \phi}{3 - \sin \phi} p'$$

Octahedral shear stress is defined as:

$$\tau = \frac{1}{3} \left[ (\sigma_{xx} - \sigma_{yy})^2 + (\sigma_{yy} - \sigma_{zz})^2 + (\sigma_{xx} - \sigma_{zz})^2 + 6\sigma_{xy}^2 + 6\sigma_{yz}^2 + 6\sigma_{xz}^2 \right]^{1/2}$$

- 1 (Automatic surface generation) At a constant confinement  $p'$ , the shear stress  $\tau$  (octahedral) - shear strain  $\gamma$  (octahedral) nonlinearity is defined by a hyperbolic curve (backbone curve):

$$\tau = \frac{G \gamma}{1 + \frac{\gamma}{\gamma_r} \left( \frac{p'_r}{p'} \right)^d}$$

where  $\gamma_r$  satisfies the following equation at  $p'_r$ :

$$\tau_f = \frac{2\sqrt{2} \sin \phi}{3 - \sin \phi} p'_r = \frac{G_r \gamma_{\max}}{1 + \gamma_{\max} / \gamma_r}$$

(User defined surfaces) The user specified friction angle  $f$  is ignored. Instead,  $f$  is defined as follows:

$$\sin \phi = \frac{3\sqrt{3} s_m / p'_r}{6 + \sqrt{3} s_m / p'_r}$$

where  $s_m$  is the product of the last modulus and strain pair in the modulus reduction curve. Therefore, it is important to adjust the backbone curve so as to render an appropriate  $f$ . If the resulting  $f$  is smaller than the phase transformation angle  $f_{PT}$ ,  $f_{PT}$  is set equal to  $f$ .

Also remember that improper modulus reduction curves can result in strain softening response (negative tangent shear modulus), which is not allowed in the current model formulation. Finally, note that the backbone curve varies with confinement, although the variations are small within commonly interested confinement ranges. Backbone curves at different confinements can be obtained using the OpenSees element recorder facility (see OUTPUT INTERFACE above).

- 1 The last five optional parameters are needed when critical-state response (flow liquefaction) is anticipated. Upon reaching the critical-state line, material dilatancy is set to zero.

## 1 SUGGESTED PARAMETER VALUES

For user convenience, a table is provided below as a quick reference for selecting parameter values. However, use of this table should be of great caution, and other information should be incorporated wherever possible.

	Loose Sand (15%-35%)	Medium Sand (35%-65%)	Medium-dense Sand (65%-85%)	Dense Sand (85%-100%)
--	-------------------------	--------------------------	--------------------------------	--------------------------



rho (ton/m <sup>3</sup> )	1.7	1.9	2.0	2.1
refShearModul (kPa, at p' <sub>v</sub> =80 kPa)	5.5x10 <sup>4</sup>	7.5x10 <sup>4</sup>	1.0x10 <sup>5</sup>	1.3x10 <sup>5</sup>
refBulkModu (kPa, at p' <sub>v</sub> =80 kPa)	1.5x10 <sup>5</sup>	2.0x10 <sup>5</sup>	3.0x10 <sup>5</sup>	3.9x10 <sup>5</sup>
frictionAng	29	33	37	40
peakShearStra (at p' <sub>v</sub> =80 kPa)	0.1	0.1	0.1	0.1
refPress (p' <sub>r</sub> , kPa)	80	80	80	80
pressDependCoe	0.5	0.5	0.5	0.5
PTAng	29	27	27	27
contrac	0.21	0.07	0.05	0.03
dilat1	0.	0.4	0.6	0.8
dilat2	0	2	3	5
liquefac1 (kPa)	10	10	5	0
liquefac2	0.02	0.01	0.003	0
liquefac3	1	1	1	0
e	0.85	0.7	0.55	0.45

## PressureDependMultiYield02 Material

**PressureDependMultiYield02** material is modified from **PressureDependMultiYield** material, with: 1) additional parameters ( $\$contrac3$  and  $\$dilat3$ ) to account for  $K\sigma$  effect, 2) a parameter to account for the influence of previous dilation history on subsequent contraction phase ( $\$contrac2$ ), and 3) modified logic related to permanent shear strain accumulation ( $\$liquefac1$  and  $\$liquefac2$ ). Please visit <http://cyclic.ucsd.edu/opensees> (<http://cyclic.ucsd.edu/opensees>) for examples.

```
nDMaterial PressureDependMultiYield02 $tag $nd $rho $refShearModul
$refBulkModul $frictionAng $peakShearStra $refPress
$pressDependCoe $PTAng $contrac1 $contrac3 $dilat1 $dilat3
<$noYieldSurf=20 <$r1 $Gs1 ...> $contrac2=5. $dilat2=3.
$liquefac1=1. $liquefac2=0. $e=0.6 $cs1=0.9 $cs2=0.02 $cs3=0.7
$pa=101>
```

- |                                  |   |
|----------------------------------|---|
| <b><math>\\$contrac3</math></b>  | A non-negative constant reflecting $K\sigma$ effect.  |
| <b><math>\\$dilat3</math></b>    | A non-negative constant reflecting $K\sigma$ effect.  |
| <b><math>\\$contrac2</math></b>  | A non-negative constant reflecting dilation history on contraction tendency.  |
| <b><math>\\$liquefac1</math></b> | Damage parameter to define accumulated permanent shear strain as a function of dilation history. <b>(Redefined and different from PressureDependMultiYield material).</b> |

<b>\$liquefac2</b>	Damage parameter to define biased accumulation of permanent shear strain as a function of load reversal history. ( <b>Redefined and different from PressureDependMultiYield material</b> ).
<b>Others</b>	See PressureDependMultiYield material above.



**NOTE:**

The following values are suggested for the model parameters.

	Dr=30%	Dr=40%	Dr=50%	Dr=60%	Dr=75%
--	--------	--------	--------	--------	--------

rho (ton/m3)	1.7	1.8	1.9	2.0	2.1
refShearModul (kPa, at $p'_v=80$ kPa)	$6 \times 10^4$	$9 \times 10^4$	$10 \times 10^4$	$11 \times 10^4$	$13 \times 10^4$
refBulkModu (kPa, at $p'_v=80$ kPa)	$16 \times 10^4$ ( $K_0=0.5$ )	$22 \times 10^4$ ( $K_0=0.47$ )	$23.3 \times 10^4$ ( $K_0=0.45$ )	$24 \times 10^4$ ( $K_0=0.43$ )	$26 \times 10^4$ ( $K_0=0.4$ )
frictionAng	31	32	33.5	35	36.5
PTAng	31	26	25.5	26	26
peakShearStra (at $p'_v=101$ kPa)	0.1				
refPress ( $p'_v$ , kPa)	101				
pressDependCoe	0.5				
Contrac1	0.087	0.067	0.045	0.028	0.013
Contrac3	0.18	0.23	0.15	0.05	0.0
dilat1	0.	0.06	0.06	0.1	0.3
dilat3	0.0	0.27	0.15	0.05	0.0
e	0.85	0.77	0.7	0.65	0.55

## PressureIndependentMultiYield Material

**PressureIndependentMultiYield** material is an elastic-plastic material in which plasticity exhibits only in the deviatoric stress-strain response. The volumetric stress-strain response is linear-elastic and is independent of the deviatoric response. This material is implemented to simulate monotonic or cyclic response of materials whose shear behavior is insensitive to the confinement change. Such materials include, for example, organic soils or clay under fast (undrained) loading conditions. **Please visit <http://cyclic.ucsd.edu/opensees> (<http://cyclic.ucsd.edu/opensees>) for examples.**

During the application of gravity load (and static loads if any), material behavior is linear elastic. In the subsequent dynamic (fast) loading phase(s), the stress-strain response is elastic-plastic (see MATERIAL STAGE UPDATE below). Plasticity is formulated based on the multi-surface (nested surfaces) concept, with an associative flow rule. The yield surfaces are of the Von Mises type.

### OUTPUT INTERFACE:

The following information may be extracted for this material at a given integration point, using the OpenSees Element Recorder facility (McKenna and Fenves 2001): "**stress**", "**strain**", "**backbone**", or "**tangent**".

For 2D problems, the stress output follows this order:  $\sigma_{xx}$ ,  $\sigma_{yy}$ ,  $\sigma_{zz}$ ,  $\sigma_{xy}$ ,  $\eta_r$ , where  $\eta_r$  is the ratio between the shear (deviatoric) stress and peak shear strength at the current confinement ( $0 \leq \eta_r \leq 1.0$ ). The strain output follows this order:  $\epsilon_{xx}$ ,  $\epsilon_{yy}$ ,  $\gamma_{xy}$ .

For 3D problems, the stress output follows this order:  $\sigma_{xx}$ ,  $\sigma_{yy}$ ,  $\sigma_{zz}$ ,  $\sigma_{xy}$ ,  $\sigma_{yz}$ ,  $\sigma_{zx}$ ,  $\eta_r$ , and the strain output follows this order:  $\epsilon_{xx}$ ,  $\epsilon_{yy}$ ,  $\epsilon_{zz}$ ,  $\gamma_{xy}$ ,  $\gamma_{yz}$ ,  $\gamma_{zx}$ .

The "**backbone**" option records (secant) shear modulus reduction curves at one or more given confinements. The specific recorder command is as follows:

```
recorder Element -ele $eleNum -file $fileName -dT $deltaT material $GaussNum backbone $p1 <$p2 ...>
```

where p1, p2, ... are the confinements at which modulus reduction curves are recorded. In the output file, corresponding to each given confinement there are two columns: shear strain  $\gamma$  and secant modulus  $G_s$ . The number of rows equals the number of yield surfaces.

```
nDmaterial PressureIndependMultiYield $tag $nd $rho $refShearModul
$refBulkModul $cohesi $peakShearStra <$frictionAng=0.
$refPress=100. $pressDependCoe=0. $noYieldSurf=20 <$r1 $Gs1 ...>
>
```

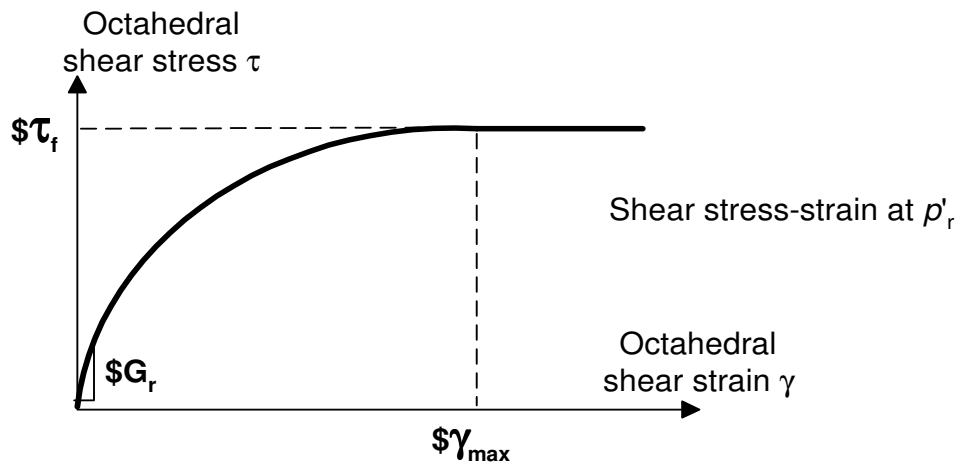

<b>\$tag</b>	A positive integer uniquely identifying the material among all nDMaterials.
<b>\$nd</b>	Number of dimensions, 2 for plane-strain, and 3 for 3D analysis
<b>\$rho</b>	Saturated soil mass density.
<b>\$refShearModul (Gr)</b>	Reference low-strain shear modulus, specified at a reference mean effective confining pressure refPress of $p'_r$ (see below).
<b>\$refBulkModul (Br)</b>	Reference bulk modulus, specified at a reference mean effective confining pressure refPress of $p'_r$ (see below).
<b>\$cohesi (c)</b>	Apparent cohesion at zero effective confinement.
<b>\$peakShearStra (gmax)</b>	An octahedral shear strain at which the maximum shear strength is reached, specified at a reference mean effective confining pressure refPress of $p'_r$ (see below).
<b>\$frictionAng (f)</b>	Friction angle at peak shear strength in degrees, optional (default is 0.0).
<b>\$refPress (<math>p'_r</math>)</b>	Reference mean effective confining pressure at which $G_r$ , $B_r$ , and $\gamma_{max}$ are defined, optional (default is 100.).



**\$pressDependCoe (d)** An optional non-negative constant defining variations of G and B as a function of initial effective confinement  $p'_i$  (default is 0.0):

$$G = G_r \left( \frac{p'_i}{p'_r} \right)^d \quad B = B_r \left( \frac{p'_i}{p'_r} \right)^d$$

If  $\phi=0$ , d is reset to 0.0.

**\$noYieldSurf** Number of yield surfaces, optional (must be less than 40, default is 20). The surfaces are generated based on the hyperbolic relation defined in Note 2 below.

**\$r , \$Gs** Instead of automatic surfaces generation (Note 2), **you can define yield surfaces directly based on desired shear modulus reduction curve.** To do so, add a minus sign in front of noYieldSurf, then provide noYieldSurf pairs of shear strain ( $\gamma$ ) and modulus ratio ( $G_s$ ) values. For example, to define 10 surfaces:

$$\dots -10 \gamma_1 G_{s1} \dots \gamma_{10} G_{s10} \dots$$

See Note 3 below for some important notes.

NOTE:

- 1 The friction angle  $\phi$  and cohesion  $c$  define the variation of peak (octahedral) shear strength  $\tau$  as a function of initial **effective** confinement  $p'_i$ :

$$\tau_f = \frac{2\sqrt{2} \sin \phi}{3 - \sin \phi} p'_i + \frac{2\sqrt{2}}{3} c$$

- 1 Automatic surface generation: at a constant confinement  $p'$ , the shear stress  $\tau$  (octahedral) - shear strain  $\gamma$  (octahedral) nonlinearity is defined by a hyperbolic curve (backbone curve):

$$\tau = \frac{G \gamma}{1 + \frac{\gamma}{\gamma_r} \left( \frac{p'_r}{p'} \right)^d}$$

where  $\gamma_r$  satisfies the following equation at  $p'_r$ :

$$\tau_f = \frac{2\sqrt{2} \sin \phi}{3 - \sin \phi} p'_r + \frac{2\sqrt{2}}{3} c = \frac{G_r \gamma_{\max}}{1 + \gamma_{\max} / \gamma_r}$$

(User defined surfaces) If the user specifies  $f=0$ , cohesion  $c$  will be ignored. Instead,  $c$  is defined by  $c=\sqrt{3}s_m/2$ , where  $s_m$  is the product of the last modulus and strain pair in the modulus reduction curve. Therefore, it is important to adjust the backbone curve so as to render an appropriate  $c$ .

If the user specifies  $f>0$ , this  $f$  will be ignored. Instead,  $f$  is defined as follows:

$$\sin \phi = \frac{3(\sqrt{3} \sigma_m - 2c) / p_r'}{6 + (\sqrt{3} \sigma_m - 2c) / p_r'}$$

If the resulting  $f<0$ , we set  $f=0$  and  $c=\sqrt{3}s_m/2$ .

Also remember that improper modulus reduction curves can result in strain softening response (negative tangent shear modulus), which is not allowed in the current model formulation. Finally, note that the backbone curve varies with confinement, although the variation is small within commonly interested confinement ranges. Backbone curves at different confinements can be obtained using the OpenSees element recorder facility (see OUTPUT INTERFACE above).

## 1 SUGGESTED PARAMETER VALUES

For user convenience, a table is provided below as a quick reference for selecting parameter values. However, use of this table should be of great caution, and other information should be incorporated wherever possible.

	Soft Clay	Medium Clay	Stiff Clay
--	-----------	-------------	------------

---

rho (ton/m <sup>3</sup> )	1.3	1.5	1.8
refShearModul (kPa)	1.3x10 <sup>4</sup>	6.0x10 <sup>4</sup>	1.5x10 <sup>5</sup>
refBulkModu (kPa)	6.5x10 <sup>4</sup>	3.0x10 <sup>5</sup>	7.5x10 <sup>5</sup>
cohesi (kPa)	18	37	75
peakShearStra	0.1	0.1	0.1
frictionAng	0	0	0
pressDependCoe	0	0	0



## updateMaterialStage

This command is used to update a **PressureDependMultiYield**, **PressureDependMultiYield02**, **PressureIndependMultiYield**, or **FluidSolidPorous** material. To conduct a seismic analysis, two stages should be followed. First, during the application of gravity load (and static loads if any), set material stage to 0, and material behavior is linear elastic (with  $G_r$  and  $B_r$  as elastic moduli). A **FluidSolidPorous** material does not contribute to the material response if its stage is set to 0. After the application of gravity load, set material stage to 1 or 2. In case of stage 2, all the elastic material properties are then internally determined at the current effective confinement, and remain constant thereafter. In the subsequent dynamic (fast) loading phase(s), the deviatoric stress-strain response is elastic-plastic (stage 1) or linear-elastic (stage 2), and the volumetric response remains linear-elastic. **Please visit <http://cyclic.ucsd.edu/opensees> (<http://cyclic.ucsd.edu/opensees>) for examples.**

**updateMaterialStage -material \$tag -stage \$sNum**

**\$tag** Material number.

**\$sNum** desired stage:

0 - linear elastic,

1 – plastic,

2 - Linear elastic, with elasticity constants (shear modulus and bulk modulus) as a function of initial effective confinement.

## updateParameter

This command is used to update:

1. Parameters of **PressureDependMultiYield** or **PressureIndependMultiYield** material. Currently, two material parameters, reference low-strain shear modulus  $G_r$  and reference bulk modulus  $B_r$ , can be modified during an analysis.
2. Permeability parameters of solid-fluid fully coupled elements including **FourNodeQuadUP**, **Nine\_Four\_Node\_QuadUP**, **BrickUP**, and **Twenty\_Eight\_Node\_BrickUP**.

Please visit <http://cyclic.ucsd.edu/opensees> (<http://cyclic.ucsd.edu/opensees>) for examples.

```
updateParameter -material $tag -refG $newVal
```

```
updateParameter -material $tag -refB $newVal
```

```
updateParameter -element $tag -hPerm $newVal
```

```
updateParameter -element $tag -vPerm $newVal
```

**\$tag**                      Material/element number.

**\$newVal**                  New parameter value.

## CHAPTER 20

# section Command

This command is used to construct a SectionForceDeformation object, hereto referred to as Section, which represents force-deformation (or resultant stress-strain) relationships at beam-column and plate sample points.

## ➤ What is a section?

- A section defines the stress resultant force-deformation response at a cross section of a beam-column or plate element
- Types of sections:
  - **Elastic** – defined by material and geometric constants
  - **Resultant** – general nonlinear description of force-deformation response, e.g. moment-curvature
  - **Fiber** – section is discretized into smaller regions for which the material stress-strain response is integrated to give resultant behavior, e.g. reinforced concrete

The valid queries to any section when creating an *ElementRecorder* (page 307) are 'force' and 'deformation.'

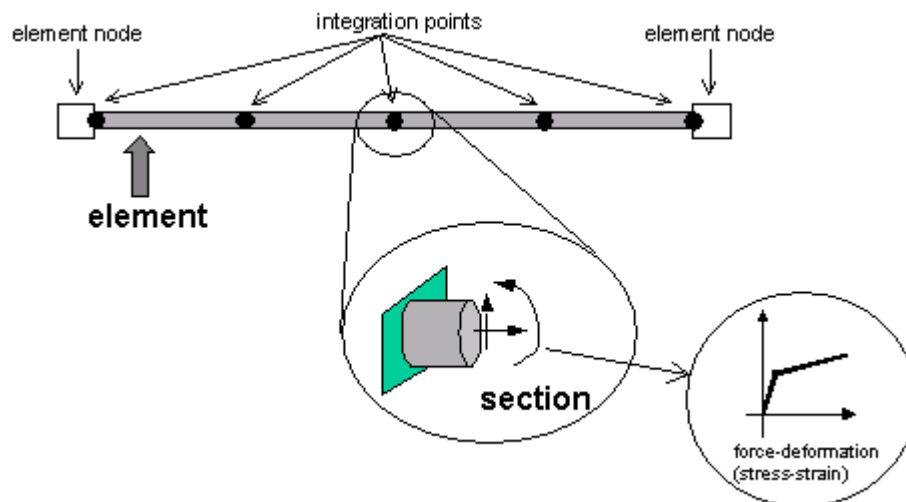

Figure 35: Section Representation

## In This Chapter

Elastic Section.....	192
Uniaxial Section.....	193
Fiber Section .....	194
Section Aggregator.....	203
Elastic Membrane Plate Section.....	205
Plate Fiber Section .....	205
Bidirectional Section.....	206
Isolator2spring Section: Model to include buckling behavior of an elastomeric bearing .....	207

---

## Elastic Section

This command is used to construct an ElasticSection object.

```
section Elastic $secTag $E $A $Iz <$Iy $G $J>
```

<b>\$secTag</b>	unique section object tag
<b>\$E</b>	Young's Modulus
<b>\$A</b>	cross-sectional area of section
<b>\$Iz</b>	second moment of area about the local z-axis
<b>\$Iy</b>	second moment of area about the local y-axis (optional, used for 3D analysis)
<b>\$G</b>	Shear Modulus (optional, used for 3D analysis)
<b>\$J</b>	torsional moment of inertia of section (optional, used for 3D analysis)

This command is useful for patch tests of the *nonlinear beam-column elements* (page 218). It also allows nonlinear beam-column elements to be used for elastic analysis.

EXAMPLE:

```
section Elastic 1 29000 100 100000 80000 20000 100000; # create elastic section with  
IDtag 1
```



---

## Uniaxial Section

This command is used to construct a `UniaxialSection` object which uses a previously-defined `UniaxialMaterial` (page 43) object to represent a single section force-deformation response quantity. (Formerly known as `Generic1d` section, which is still accepted by OpenSees)

**section Uniaxial \$secTag \$matTag \$string**

<b>\$secTag</b>	unique section object tag
<b>\$matTag</b>	previously-defined <code>UniaxialMaterial</code> (page 43) object
<b>\$string</b>	the force-deformation quantity to be modeled by this section object. One of the following strings is used:
<b>P</b>	Axial force-deformation
<b>Mz</b>	Moment-curvature about section local z-axis
<b>Vy</b>	Shear force-deformation along section local y-axis
<b>My</b>	Moment-curvature about section local y-axis
<b>Vz</b>	Shear force-deformation along section local z-axis
<b>T</b>	Torsion Force-Deformation

EXAMPLE:

```
section Uniaxial 1 1 Mz;    # create sectionID-tag 1 from UniaxialMaterialID-tag 1 for the
moment-curvature about section local z-axis.
```

---

## Fiber Section

The FiberSection object is composed of Fiber objects.

A fiber section has a general geometric configuration formed by subregions of simpler, regular shapes (e.g. quadrilateral, circular and triangular regions) called patches. In addition, layers of reinforcement bars can be specified. The subcommands *patch* (page 197) and *layer* (page 202, page 201) are used to define the discretization of the section into fibers. Individual fibers, however, can also be defined using the *fiber* (page 196) command (During generation, the Fiber objects are associated with *uniaxialMaterial* (page 43) objects, which enforce Bernoulli beam assumptions.

The geometric parameters are defined with respect to a planar local coordinate system (y,z). See figures.

```
section Fiber $secTag {  
    fiber <fiber arguments>  
    patch <patch arguments>  
    layer <layer arguments>  
}
```

An example fiber section is shown in the Figure.

Figure 36: Fiber Section

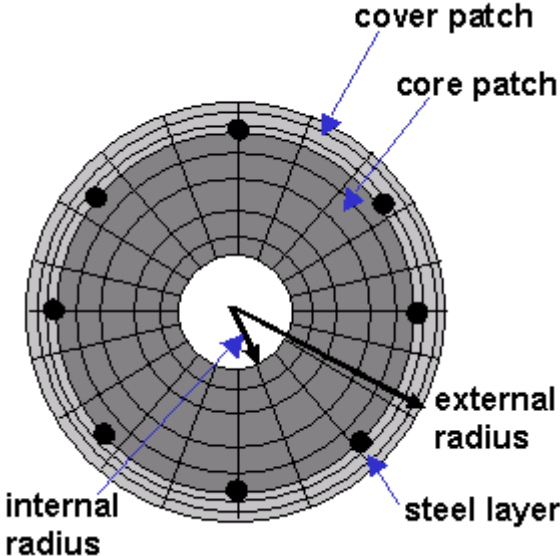

---

## Fiber Command

This command is used to construct a `UniaxialFiber` object and add it to the section.

```
fiber $yLoc $zLoc $A $matTag
```

<b>\$yLoc</b>	y coordinate of the fiber in the section (local coordinate system)
<b>\$zLoc</b>	z coordinate of the fiber in the section (local coordinate system)
<b>\$A</b>	area of fiber
<b>\$matTag</b>	material tag of the pre-defined <i>UniaxialMaterial</i> (page 43) object used to represent the stress-strain for the area of the fiber

**NOTE:** in 2D (page 34) bending is about the local z-axis

EXAMPLE:

```
fiber 0.0 0.0 1.0 1; # create a single fiber of area 1.0 at the origin (0,0) of the section, using materialIDtag 1
```

Figure 37: Fiber Command

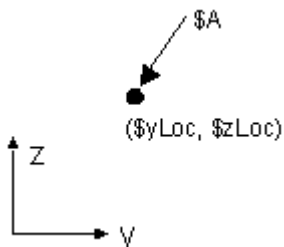

---

## Quadrilateral Patch Command

This command is used to construct a Patch object with a quadrilateral shape. The geometry of the patch is defined by four vertices: I J K L, as illustrated in the Figure. The coordinates of each of the four vertices is specified in sequence -- counter-clockwise.

```
patch quad $matTag $numSubdivIJ $numSubdivJK $yI $zI $yJ $zJ $yK $zK $yL $zL
```

<b>\$matTag</b>	material integer tag of the previously-defined <i>UniaxialMaterial</i> (page 43) object used to represent the stress-strain for the area of the fiber
<b>\$numSubdivIJ</b>	number of subdivisions (fibers) in the IJ direction.
<b>\$numSubdivJK</b>	number of subdivisions (fibers) in the JK direction.
<b>\$yI</b> <b>\$zI</b>	y & z-coordinates of vertex I (local coordinate system)
<b>\$yJ</b> <b>\$zJ</b>	y & z-coordinates of vertex J (local coordinate system)
<b>\$yK</b> <b>\$zK</b>	y & z-coordinates of vertex K (local coordinate system)
<b>\$yL</b> <b>\$zL</b>	y & z-coordinates of vertex L (local coordinate system)

**NOTE:** in 2D (page 34) bending is about the local z-axis

EXAMPLE:

**patch quad \$coreMatTag 8 8 -\$b -\$h \$b -\$h \$b \$h -\$b \$h;** # define core patch with 8 subdivisions within a rectangle of width 2b and depth 2h

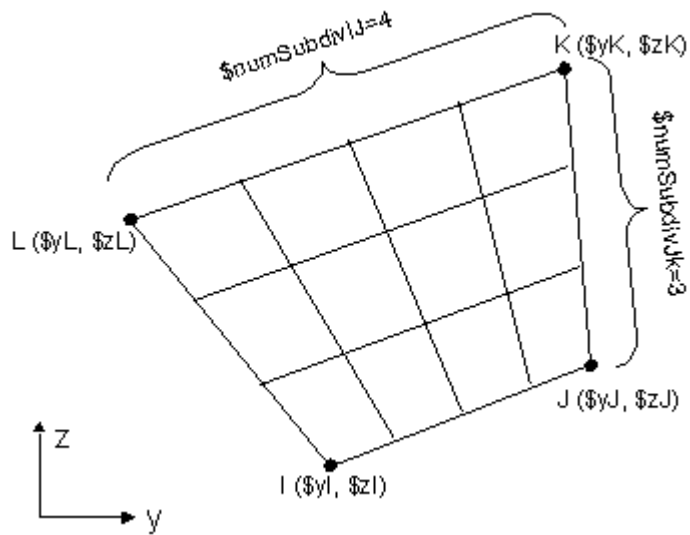

Figure 38: Quadrilateral Patch

---

## Circular Patch Command

This command is used to construct a Patch object with a circular shape.

```
patch circ $matTag $numSubdivCirc $numSubdivRad $yCenter $zCenter  
$intRad $extRad <$startAng $endAng>
```

<b>\$matTag</b>	material integer tag of the previously-defined <i>UniaxialMaterial</i> (page 43) object used to represent the stress-strain for the area of the fiber
<b>\$numSubdivCirc</b>	number of subdivisions (fibers) in the circumferential direction.
<b>\$numSubdivRad</b>	number of subdivisions (fibers) in the radial direction.
<b>\$yCenter</b> <b>\$zCenter</b>	y & z-coordinates of the center of the circle
<b>\$intRad</b>	internal radius
<b>\$extRad</b>	external radius
<b>\$startAng</b>	starting angle (optional. default=0.0)
<b>\$endAng</b>	ending angle (optional. default=360.0)

**NOTE:** in *2D* (page 34) bending is about the local z-axis

EXAMPLE:

**patch circ \$coreMatTag 8 8 0.0 0.0 0.0 \$h;** # define core patch with 8 subdivisions within a whole circle of diameter 2h

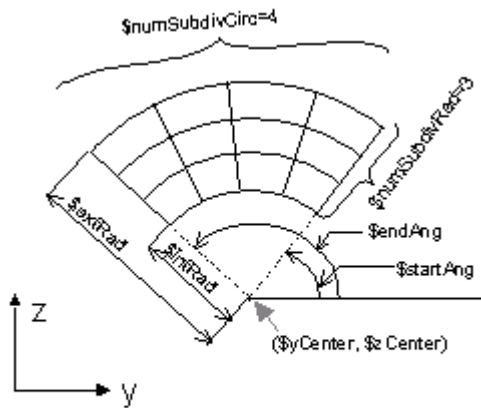



Figure 39: Circular Patch

## Straight Layer Command

This command is used to construct a straight layer of reinforcing bars.

**layer straight \$matTag \$numBars \$areaBar \$yStart \$zStart \$yEnd \$zEnd**

<b>\$matTag</b>	material integer tag of the previously-defined <i>UniaxialMaterial</i> (page 43) object used to represent the stress-strain for the area of the fiber
<b>\$numBars</b>	number of reinforcing bars along layer
<b>\$areaBar</b>	area of individual reinforcing bar
<b>\$yStart</b> <b>\$zStart</b>	y and z-coordinates of starting point of reinforcing layer (local coordinate system)
<b>\$yEnd</b> <b>\$zEnd</b>	y and z-coordinates of ending point of reinforcing layer (local coordinate system)

**NOTE:** in 2D (page 34) bending is about the local z-axis

EXAMPLE:

**layer straight \$steelMatTag 10 0.11 -b -h b -h;** # define steel layer of 10 bars with area 0.11 at bottom of section of width 2b by 2h

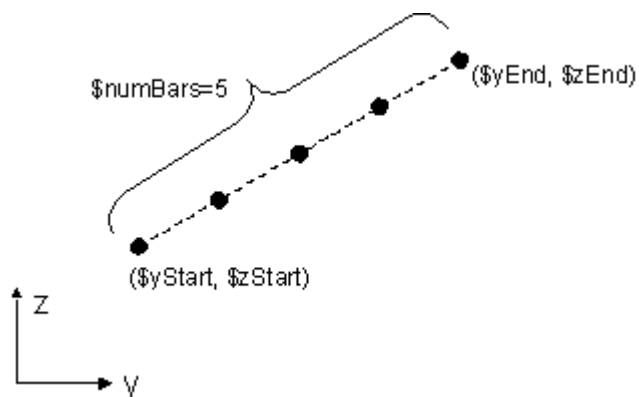

Figure 40: Straight Layer

# Circular Layer Command

This command is used to construct a circular layer of reinforcing bars.

```
layer circ $matTag $numBar $areaBar $yCenter $zCenter $radius <$startAng
$endAng>
```

<b>\$matTag</b>		material integer tag of the previously-defined <i>UniaxialMaterial</i> (page 43) object used to represent the stress-strain for the area of the fiber
<b>\$numBar</b>		number of reinforcing bars along layer
<b>\$areaBar</b>		area of individual reinforcing bar
<b>\$yCenter</b>	<b>\$zCenter</b>	y and z-coordinates of center of reinforcing layer (local coordinate system)
<b>\$radius</b>		radius of reinforcing layer
<b>\$startAng</b>	<b>\$endAng</b>	starting and ending angle of reinforcing layer, respectively. (Optional, Default: a full circle is assumed 0-360)

**NOTE:** in *2D* (page 34) bending is about the local z-axis

EXAMPLE:

```
layer circ $steelMatTag 10 0.11 0.0 0.0 $h 0 360; # define circular steel layer of 10 bars with
area 0.11 uniformly distributed along circumference of circle of diameter 2h
```

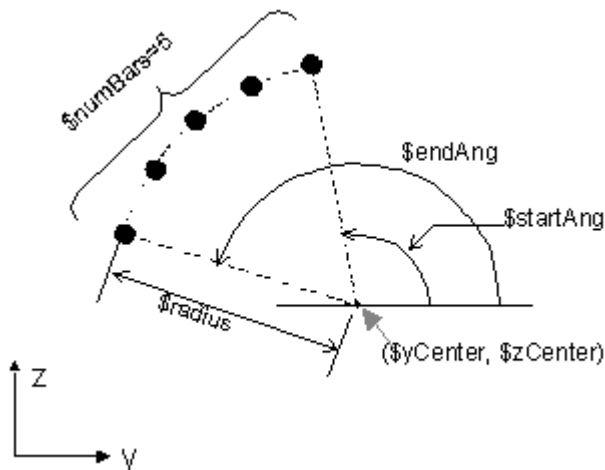

Figure 41: Circular Reinforcing Layer

---

## Section Aggregator

This command is used to construct a `SectionAggregator` object which groups previously-defined `UniaxialMaterial` (page 43) objects into a single section force-deformation model.

```
section Aggregator $secTag $matTag1 $string1 $matTag2 $string2 .....
<-section $sectionTag>
```

<b>\$secTag</b>	unique section object integer tag
<b>\$matTag1,</b> <b>\$matTag2 ...</b>	previously-defined <i>UniaxialMaterial</i> (page 43) objects
<b>\$string1, \$string2</b> ....	the force-deformation quantities corresponding to each section object. One of the following strings is used:
<b>P</b>	Axial force-deformation
<b>Mz</b>	Moment-curvature about section local z-axis
<b>Vy</b>	Shear force-deformation along section local y-axis
<b>My</b>	Moment-curvature about section local y-axis
<b>Vz</b>	Shear force-deformation along section local z-axis
<b>T</b>	Torsion Force-Deformation
<b>&lt;-section</b> <b>\$sectionTag&gt;</b>	specifies a previously-defined <i>Section</i> (page 191) object (identified by the argument <code>\$sectionTag</code> ) to which these <i>UniaxialMaterial</i> (page 43) objects may be added to recursively define a new <i>Section</i> (page 191) object

**NOTE:** The *UniaxialMaterial* (page 43) objects aggregated in this *Section* (page 191) object are uncoupled from each other as well as from the *Section* (page 191) object represented by `$sectionTag`, if present.

There are two main tasks that can be performed using the Section Aggregator:

- **1. Group previously defined uniaxial materials to describe stress resultant section behavior**

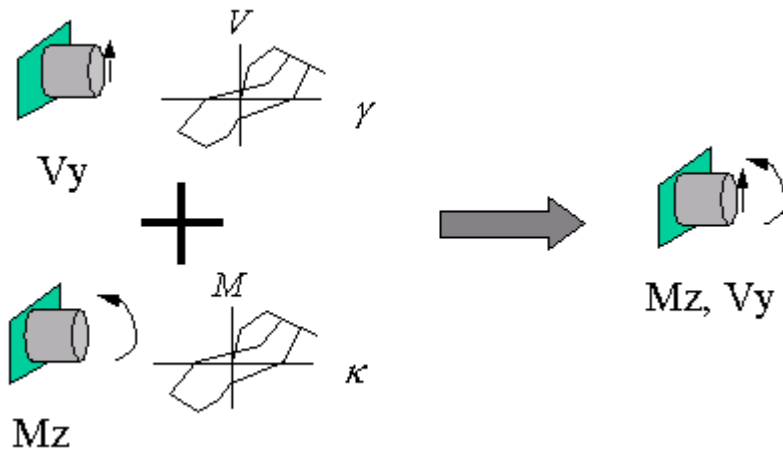

Figure 42: Section Aggregator 1

EXAMPLE:

**section Aggregator 1 2 Vy 5 Mz; #create new section with IDtag 1, taking the existing material tag 2 to represent the shear and the existing material tag 5 to represent the moment.**

- **2. Add to an existing section**

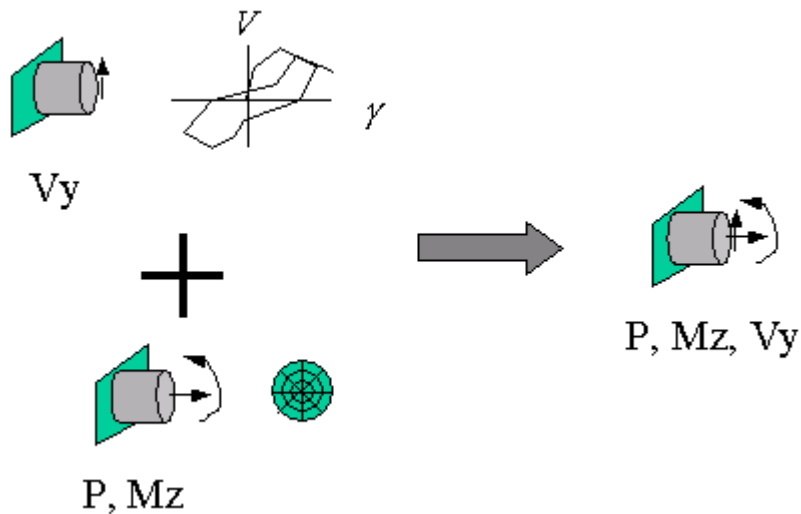

Figure 43: Section Aggregator 2

EXAMPLE:

**section Aggregator 2 2 Vy -section 4;** # create new section with IDtag 2, taking the existing material tag 2 to represent the shear and adding it to the existing section tag 4, which may be a fiber section where the interaction between axial force and flexure is already considered.

---

## Elastic Membrane Plate Section

This command is used to construct an ElasticMembranePlateSection object, which is an isotropic section appropriate for plate and shell analysis.

```
section ElasticMembranePlateSection $secTag $E $nu $h $rho
```

<b>\$secTag</b>	unique section object tag
<b>\$E</b>	Elastic Modulus
<b>\$nu</b>	Poisson's Ratio
<b>\$h</b>	thickness of the plate section
<b>\$rho</b>	mass density of the material (per unit volume)

---

## Plate Fiber Section

The plate fiber section takes any *plate fiber material* (page 164) and, by thickness integration, creates a plate section appropriate for shell analysis.

```
section PlateFiber $secTag $fiberTag $h
```

<b>\$secTag</b>	unique section object tag for section being constructed
<b>\$fiberTag</b>	material tag for a previously-defined <i>plate fiber material</i> (page 164)

**\$h** thickness of the plate section

---

## Bidirectional Section

This command is used to construct a Bidirectional section object which is the two-dimensional generalization of a one-dimensional elasto-plastic model with linear hardening.

**section Bidirectional \$matTag \$E \$sigY \$H\_iso \$H\_kin**

<b>\$matTag</b>	unique section object integer tag
<b>\$E</b>	Elastic Modulus
<b>\$sigY</b>	yield stress
<b>\$H_iso</b>	isotropic hardening Modulus
<b>\$H_kin</b>	kinematic hardening Modulus

then why do we have kinematic and isotripic hardening parameters?????\*\*\*\*\*

---

# Isolator2spring Section: Model to include buckling behavior of an elastomeric bearing

Author: Keri L. Ryan

Assistant Professor, Utah State University

Contact: <http://www.engineering.usu.edu/cee/faculty/kryan/>

This command is used to construct an Isolator2spring section object, which represents the buckling behavior of an elastomeric bearing for two-dimensional analysis in the lateral and vertical plane. An Isolator2spring section represents the resultant force-deformation behavior of the bearing, and should be used with a zeroLengthSection element. The bearing should be constrained against rotation.

**section Iso2spring \$matTag \$tol \$k1 \$Fyo \$k2o \$kvo \$hb \$PE <\$Po>**

<a href="#"><u>\$matTag</u></a>	unique section object integer tag
<a href="#"><u>\$tol</u></a>	tolerance for convergence of the element state. Suggested value: E-12 to E-10. OpenSees will warn if convergence is not achieved, however this usually does not prevent global convergence.
<a href="#"><u>\$k1</u></a>	initial stiffness for lateral force-deformation
<a href="#"><u>\$Fyo</u></a>	nominal yield strength for lateral force-deformation
<a href="#"><u>\$k2o</u></a>	nominal postyield stiffness for lateral force-deformation
<a href="#"><u>\$kvo</u></a>	nominal stiffness in the vertical direction
<a href="#"><u>\$hb</u></a>	total height of elastomeric bearing
<a href="#"><u>\$PE</u></a>	Euler Buckling load for the bearing
<a href="#"><u>\$Po</u></a>	axial load at which nominal yield strength is achieved (optional, default = 0.0, i.e. no strength degradation)

Model Characteristic:

This material model is based on a two-spring mechanical model of an elastomeric bearing, originally developed by Koh and Kelly [1987] (Figure 1). The model yields the approximate results as predicted by stability analysis of a multi-layer bearing. The axial flexibility of the bearing is modeled by an additional vertical spring in series (not shown in Figure 1). The original model

included only linear material behavior. The rotational stiffness is given by  $K_r = P_E h_b$  where

$$P_E = \frac{\pi^2 EI_S}{h_b^2}$$

is the Euler buckling load as a function of bending stiffness  $EI_S$  and bearing height

$$K_{bo} = \frac{GA}{t_r}$$

$$K_{vo} = \frac{E_c A}{t_r}$$

$h_b$ . The nominal shear stiffness  $K_{bo}$  and the vertical stiffness  $K_{vo}$ , where  $G$  is the shear modulus,  $E_c$  is the compression modulus,  $A$  is the cross-sectional area, and  $t_r$  is the total height of rubber.  $E_c$  and  $G$  can be related by the bearing shape factor  $S$  [Kelly 1997].

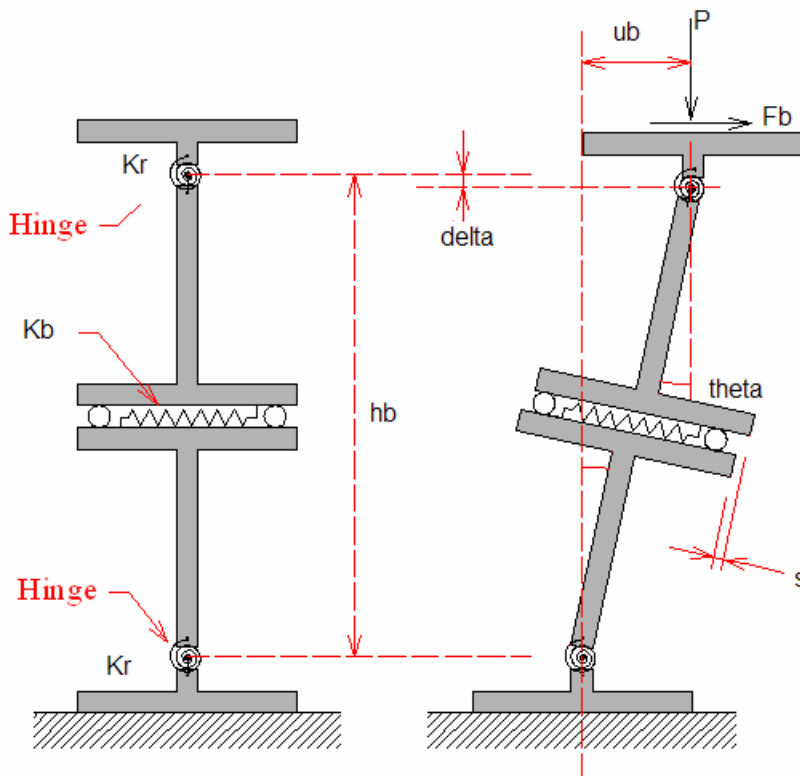



Figure 1: Two-spring model of an isolation bearing in the undeformed and deformed configuration.

[In this implementation, the linear shear spring has been replaced by a bilinear spring to represent the nonlinear behavior observed in elastomeric and lead-rubber bearings \[Ryan et. al 2005\] \(Figure 2\). The nonlinear behavior is implemented by rate-independent plasticity with kinematic hardening \[Simo and Hughes 1998\]. The behavior of the nonlinear spring is controlled by the initial stiffness  \$k\_1\$ , yield strength  \$F\_{y0}\$ , and postyield stiffness  \$k\_{20}\$ .](#)

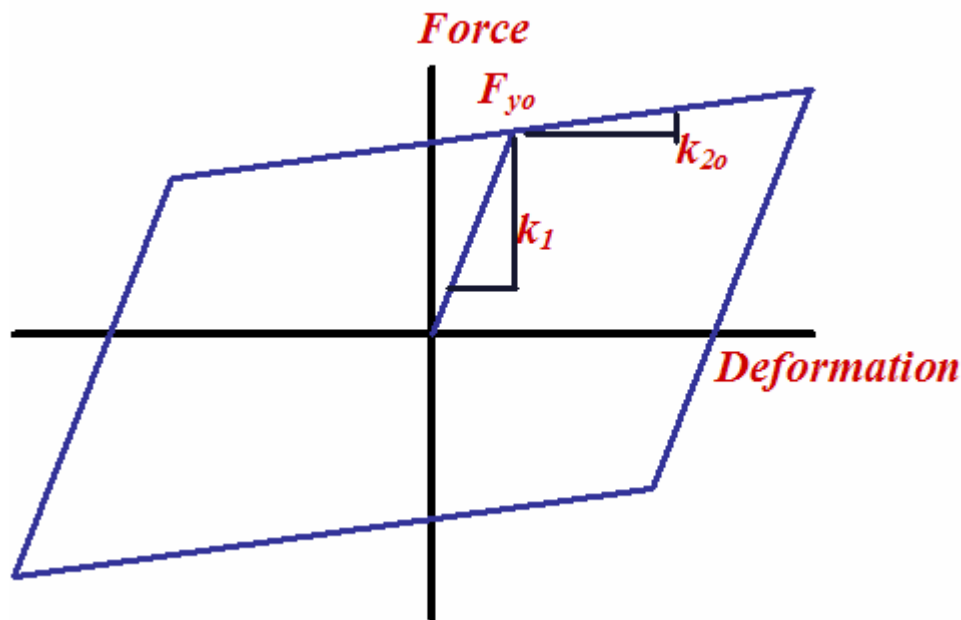

Figure 2: Bilinear shear spring and parameters.

Also included is an optional variation of strength with axial load, to represent the inability of lead-plug bearings to achieve their full strength when lightly loaded, as has been experimentally observed. An empirical equation for the yield strength as a function of compressive load has been developed from experimental data:

$$F_y(t) = F_y (1 - \exp(-P / P_o))$$

where  $P$  is the compressive load on the bearing and  $P_0$  is the axial load at which approximately 63% of the nominal strength is achieved (Figure 3). The bearing is assumed to have an acting yield strength of zero in tension. If not specified,  $P_0 = 0$ , which means that the strength equals the nominal yield strength and no strength degradation occurs.

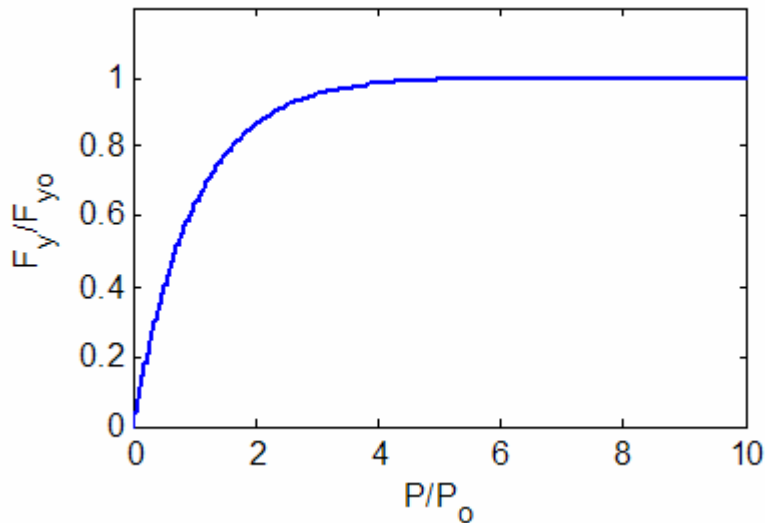

Figure 3: Empirical model for yield strength degradation.

The equilibrium equations and kinematic constraints for the two-spring model form a system of five nonlinear equations (below) which are solved by an internal iterative Newton algorithm (this is iteration within the material object). The stiffness matrix is formed by taking differentials of the equilibrium and kinematic equations. The return mapping algorithm is implemented at each iteration to determine the state of the shear spring.

$$F_b - f_s(s) + P\theta = 0$$

$$F_b h_b - P_E h_b \theta + P(s + h_b \theta) = 0$$

$$P - K_{v0} v = 0$$

$$u_b = s + h_b \theta$$

$$u_{bv} = v + s\theta + \frac{h_b \theta^2}{2}$$

Not defined previously,  $v$  is the deformation due to the vertical spring and  $u_{bv}$  is the total vertical deformation, including the geometric effect of tilting.

Analysis of the linear two-spring model leads to the following approximate coupled lateral force-deformation and vertical force-deformation equations:

$$F_b = K_b u_b = K_{bo} \left[ 1 - \left( \frac{P}{P_{cr}} \right) \right]^2 u_b \quad \text{where } P_{cr} = \sqrt{P_E K_{bo} h_b} \text{ is the critical buckling load for the bearing, and}$$

$$u_{bv} = \frac{P}{K_{vo}} + \frac{(K_{bo} h_b + P) u_b^2}{P_E h_b}$$

That is, lateral stiffness decreases as the axial load on the bearing approaches the critical load, and vertical flexibility increases in the laterally deformed configuration.

#### Example:

The following example demonstrates a simple cyclic lateral load test, and was used to produce the lateral force deformation behavior shown in Figure 4 by variation of the parameters  $P/P_{cr}$  and  $P/P_o$  in the *script file* (page 212).

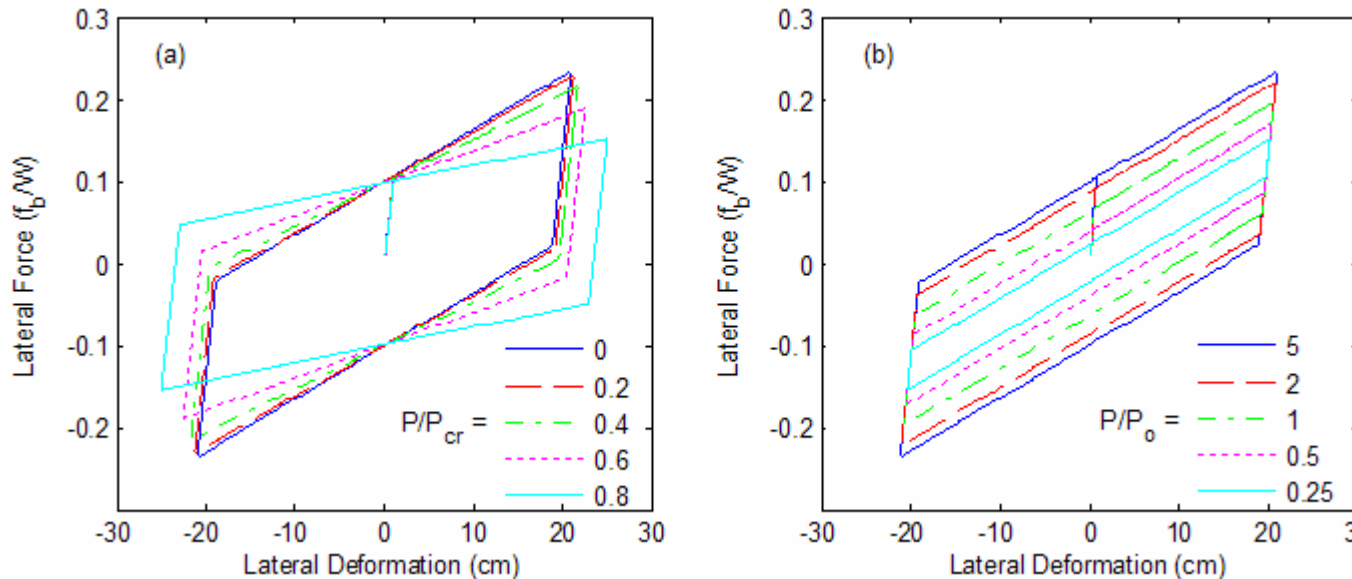

Figure 4: Cyclic lateral force deformation behavior of a bearing as a function of axial load: (a) postyield stiffness degrades as axial load  $P$  approaches the critical load  $P_{cr}$ , (b) yield strength degrades as axial load decreases relative to  $P_0$ .

### References:

- Ryan, Keri L., James M. Kelly and Anil K. Chopra (2005). "Nonlinear model for lead-rubber bearings including axial-load effects" [Journal of Engineering Mechanics, ASCE](#), 131(12).
- Kelly, James M. (1997). *Earthquake-Resistant Design with Rubber*. Springer-Verlag.
- Koh, C.-G. and Kelly, J. M. (1987). "Effects of axial load on elastomeric isolation bearings", Rep. No. UCB/EERC-86/12. Earthquake Engineering Research Center, University of California, Berkeley.
- Kelly, James M. (2003). "Tension buckling in multilayer elastomeric bearings", *Journal of Engineering Mechanics, ASCE*, 129(12):1363-1368.
- Simo, J. C and T. J. R. Hughes (1998). *Computational Inelasticity*. New York, NY, Springer.

## CyclicLoading\_Iso2spring.tcl

```
# Test Example for ISOLATOR2SPRING material
# Written: K. Ryan
# Date: November 22, 2005
#
# Description: A Single DOF isolator supporting a rigid mass. Generates lateral force deformation through
```

```

# application of a pseudo-static cyclic (sinusoidal) lateral force. Force deformation behavior varies
# as a function of the axial load P and normalized values of P/Pcr and P/Po
#
# Units: cm, dimensionless

set g 982.0
set PI [expr 2.0 * asin(1.0)]

# Define the model builder
model BasicBuilder -ndm 2 -ndf 3

# Assumed parameters which define system
# Period associated with second stiffness k2o
set Tb 2.5
# Normalized axial load parameter P/Pcr. Vary to produce data for Figure 4a
set PPcr 0.001
# Normalized axial load paramter P/Po. Vary to produce data for Figure 4b
set PPO 0.25
# Unit mass
set M 1.0
# Bearing shape factor
set S 20.0
# Yield displacement
set uy 1.0
# Strength coefficient (determines yield strength)
set mu 0.1
set tol 1.0e-10

# Parameters computed from the assumed ones
set wb [expr (2.0*$PI/$Tb)]
set k2o [expr $wb*$wb*$M]
set Fyo [expr $mu*$M*$g + $k2o*$uy]
set k1 [expr $Fyo/$uy]
set kvo [expr 6.0*$S*$S*$k2o]
set Pcr [expr $M*$g/$PPcr]
set Pe [expr 50.0*$Pcr]
set Ps [expr 1.0/50.0*$Pcr]
set hb [expr $Ps/$k2o]
set Po [expr $M*$g/$PPO]

# Define nodes
node 1 0.0 0.0
node 2 0.0 0.0

# Define single point constraints (Constrain the isolator against rotation)
fix 1 1 1 1
fix 2 0 0 1

# Create Iso2spring section
section Iso2spring 1 $tol $k1 $Fyo $k2o $kvo $hb $Pe $Po
#          id ndI ndJ mattag
element zeroLengthSection 1 1 2 1

# Apply gravity load on isolated mass
set P [expr $M*$g]
pattern Plain 1 "Linear" {
  load 2 0.0 -[expr $P] 0.0
}

system BandSPD

```

```
constraints Plain
numberer Plain
test EnergyIncr 1.0e-15 100
algorithm Newton
integrator LoadControl 0.1 1 0.1 0.1
analysis Static
initialize
analyze 10

loadConst -time 0.0

# Estimated postyield stiffness degradation
set k2oest [expr $k2o*(1.0-$PPcr*$PPcr)]
# Estimated yield strength degradation
set Fyoest [expr $Fyo*(1.0-exp(-$PPo))]

# Define amplitude of cyclic force to induce approx. 20 cm deformation
set Fu [expr $Fyoest + $k2oest*20.0]
# Apply sinusoidal lateral load
set SinePath "Trig 0.0 1.5 1.0"
pattern Plain 2 $SinePath {
  load 2 $Fu 0.0 0.0
}

wipeAnalysis
recorder Node -file Node2.out -node 2 -dof 1 disp
recorder Element 1 -file Elem1.out force

system BandGeneral
constraints Plain
numberer Plain
test EnergyIncr 1.0e-15 100
algorithm Newton
integrator LoadControl 0.01 1 0.001 0.1
analysis Static
analyze 1500

print ele 1
print node 2
```

## CHAPTER 21

# element Command

This command is used to construct an Element object.

## In This Chapter

Truss Element .....	215
Corotational Truss Element .....	216
Elastic Beam Column Element .....	217
NonLinear Beam-Column Elements .....	218
Zero-Length Elements .....	223
Quadrilateral Elements .....	227
Brick Elements .....	230
BeamColumnJoint Element .....	232
UC Davis Soil Elements .....	256
UC San Diego Soil Elements.....	263

---

## Truss Element

This command is used to construct a truss element object. There are two ways to construct a truss element object:

One way is to specify an area and a *UniaxialMaterial* (page 43) identifier:

```
element truss $eleTag $iNode $jNode $A $matTag
```

the other is to specify a *Section* (page 191) identifier:

```
element truss $eleTag $iNode $jNode $secTag
```

<b>\$eleTag</b>	unique element object tag
<b>\$iNode \$jNode</b>	end nodes
<b>\$A</b>	cross-sectional area of element
<b>\$matTag</b>	tag associated with previously-defined <i>UniaxialMaterial</i> (page 43)

**\$secTag** tag associated with previously-defined *Section* (page 191)

When constructed with a *UniaxialMaterial* (page 43) object, the truss element considers strain-rate effects, and is thus suitable for use as a damping element.

The valid queries to a truss element when creating an *ElementRecorder* (page 307) object are 'axialForce,' 'stiff,' 'deformations,' 'material matArg1 matArg2...,' 'section sectArg1 sectArg2...'. There will be more queries after the interface for the methods involved have been developed further.

---

## Corotational Truss Element

This command is used to construct a Corotational Truss (CorotTruss) element object. A corotational formulation adopts a set of corotational axes which rotate with the element, thus taking into account an exact geometric transformation between local and global frames of reference.

There are two ways to construct a Corotational Truss element object:

One way is to specify an area and a *UniaxialMaterial* (page 43) identifier:

```
element corotTruss $eleTag $iNode $jNode $A $matTag
```

the other is to specify a *Section* (page 191) identifier:

```
element corotTruss $eleTag $iNode $jNode $secTag
```

<b>\$eleTag</b>	unique element object tag
<b>\$iNode \$jNode</b>	end nodes
<b>\$A</b>	cross-sectional area of element
<b>\$matTag</b>	tag associated with previously-defined <i>UniaxialMaterial</i> (page 43) object
<b>\$secTag</b>	tag associated with previously-defined <i>Section</i> (page 191) object

**NOTE:** When constructed with a *UniaxialMaterial* (page 43) object, the truss element considers strain-rate effects, and is thus suitable for use as a damping element.

The valid queries to a corotational truss element when creating an *ElementRecorder* (page 307) object are 'axialForce,' 'stiff,' 'material \$matNum matArg1 matArg2...,' 'section \$secNum sectArg1 sectArg2...'



## Elastic Beam Column Element

This command is used to construct an `elasticBeamColumn` element object. The arguments for the construction of an elastic beam-column element depend on the dimension of the problem, *ndm* (page 29):

For a two-dimensional problem:

```
element elasticBeamColumn $eleTag $iNode $jNode $A $E $Iz $transfTag
```

For a three-dimensional problem:

```
element elasticBeamColumn $eleTag $iNode $jNode $A $E $G $J $Iy $Iz $transfTag
```

<b>\$eleTag</b>		unique element object tag
<b>\$iNode</b>	<b>\$jNode</b>	end nodes
<b>\$A</b>		cross-sectional area of element
<b>\$E</b>		Young's Modulus
<b>\$G</b>		Shear Modulus
<b>\$J</b>		torsional moment of inertia of cross section
<b>\$Iz</b>		second moment of area about the local z-axis
<b>\$Iy</b>		second moment of area about the local y-axis
<b>\$transfTag</b>		identifier for previously-defined <i>coordinate-transformation</i> (page 280) ( <code>CrdTransf</code> ) object

The valid queries to an elastic beam-column element when creating an *ElementRecorder* (page 307) object are 'stiffness' and 'force.'

---

## NonLinear Beam-Column Elements

There are basically two types of Nonlinear Beam-Column Elements

➤ **Force based elements**

- Distributed plasticity (*nonlinearBeamColumn* (page 218))
- Concentrated plasticity with elastic interior (*beamWithHinges* (page 219))

➤ **Displacement based element**

- Distributed plasticity with linear curvature distribution (*dispBeamColumn* (page 223))

---

## Nonlinear Beam Column Element

This command is used to construct a `nonlinearBeamColumn` element object, which is based on the non-iterative (or iterative) force formulation, and considers the spread of plasticity along the element.

```
element nonlinearBeamColumn $eleTag $iNode $jNode $numIntgrPts $secTag
$transfTag <-mass $massDens> <-iter $maxIters $tol>
```

<b>\$eleTag</b>	unique element object tag
<b>\$iNode</b> <b>\$jNode</b>	end nodes
<b>\$numIntgrPts</b>	number of integration points along the element.
<b>\$secTag</b>	identifier for previously-defined <i>section</i> (page 191) object
<b>\$transfTag</b>	identifier for previously-defined <i>coordinate-transformation</i> (page 280) ( <i>CrDTransf</i> ) object
<b>\$massDens</b>	element mass density (per unit length), from which a lumped-mass matrix is formed (optional, default=0.0)
<b>\$maxIters</b>	maximum number of iterations to undertake to satisfy element compatibility (optional, default=1)
<b>\$tol</b>	tolerance for satisfaction of element compatibility (optional, default= $10^{-16}$ )

The integration along the element is based on Gauss-Lobatto quadrature rule (two integration points at the element ends).

The element is prismatic, i.e. the beam is represented by the *section* (page 191) model identified by **\$secTag** at each integration point.

The **-iter** switch enables the iterative form of the flexibility formulation. Note that the iterative form can improve the rate of global convergence at the expense of more local element computation.

The valid queries to a nonlinear beam-column element when creating an *ElementRecorder* (page 307) object are 'force,' 'stiffness,' and 'section \$secNum secArg1 secArg2...' Where **\$secNum** refers to the integration point whose data is to be output.

Useful references for this element are found in the *References* (page 443, <http://www.>) chapter.

---

## Beam With Hinges Element

Contact Author:

Michael H. Scott

Oregon State University

<http://web.engr.oregonstate.edu/~mhscott/>

**Reference:**

Scott, M.H. and G.L. Fenves. "Plastic Hinge Integration Methods for Fo of Structural Engineering, ASCE, 132(2):244-252, February 2006.

This command is used to construct a beamWithHinges element object, which is based on the non-iterative (or iterative) flexibility formulation, and considers plasticity to be concentrated over specified hinge lengths at the element ends.

Note, the beamWithHinges element localize plastic hinging at the element ends only.

This type of element divides the element in three parts: two hinges at the ends, and a linear-elastic region in the middle. The hinges are defined by assigning to each a previously-defined section. The length of the each hinge is also specified by the user:

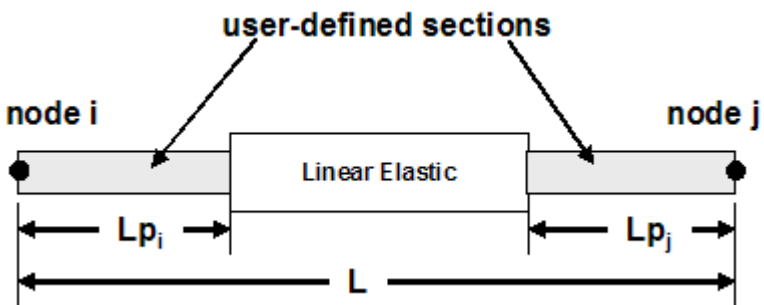

While the integration of distributed-plasticity force-base elements distributes the gauss points along the entire element length, the beamWithHinges element localizes the integration points in the hinge regions. Two integration points per hinge are used to be able represent the curvature distribution accurately -- Gauss-Radau Integration:

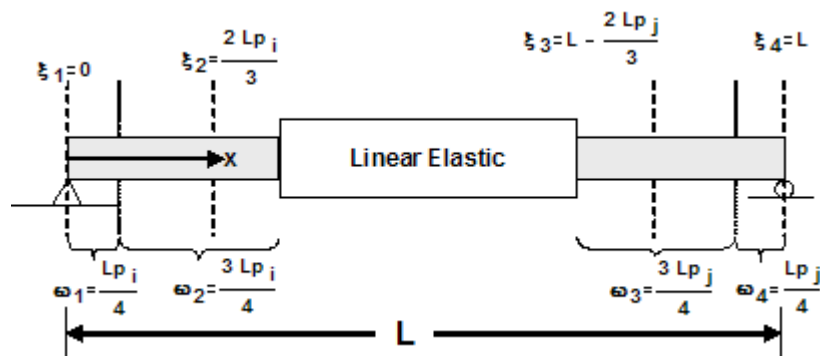

Two integration points per hinge, however, require too much computational overhead. A Modified Gauss-Radau Integration, developed by Scott et al., would apply the Gauss-Radau hinge integration over  $4L_p$  instead of  $L_p$ . Elastic properties are then applied to the interior integration points, where a closed-form solution is used:

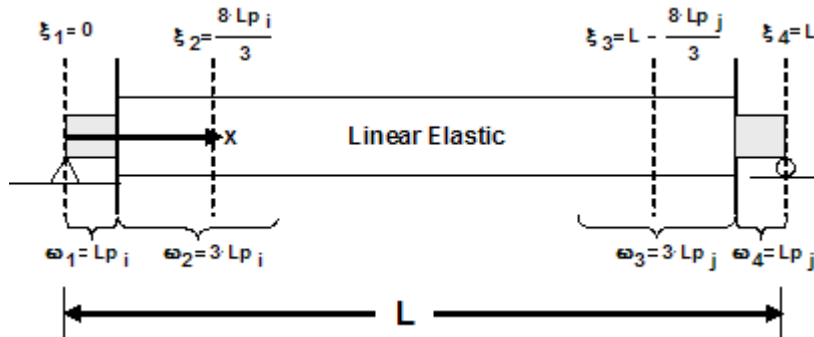

There are many advantages to this formulation over the other types of beamWithHinges:

- Nonlinear behavior is confined to the integration points at the element ends.
- The user only needs to specify the length of each hinge.
- Captures largest bending moment at the ends.
- Represents linear curvature distributions exactly.
- Characteristic length is equal to  $L_p$  when deformations localize.

The arguments for the construction of the element depend on the dimension of the problem,  $ndm$  (page 29).

For a two-dimensional problem:

```
element beamWithHinges $eleTag $iNode $jNode $secTagI $LpI $secTagJ $LpJ
  $E $A $Iz $transfTag <-mass $massDens> <-iter $maxIters $tol>
```

For a three-dimensional problem:

```
element beamWithHinges $eleTag $iNode $jNode $secTagI $LpI $secTagJ $LpJ
  $E $A $Iz $Iy $G $J $transfTag <-mass $massDens> <-iter $maxIters
  $tol>
```

**\$eleTag** unique element object tag

**\$iNode** **\$jNode** end nodes

<b>\$secTagI</b>	identifier for previously-defined <i>section</i> (page 191) object corresponding to node i
<b>\$Lpi</b>	hinge length at node i
<b>\$secTagJ</b>	identifier for previously-defined <i>section</i> (page 191) object corresponding to node j
<b>\$Lpj</b>	hinge length at node j
<b>\$E</b>	Young's Modulus
<b>\$A</b>	area of element cross-section
<b>\$Iz</b>	section moment of inertia about the section local z-axis
<b>\$Iy</b>	section moment of inertia about the section local y-axis
<b>\$G</b>	Shear Modulus
<b>\$J</b>	torsional moment of inertia of cross section
<b>\$transfTag</b>	identifier for previously-defined <i>coordinate-transformation</i> (page 280) (CrdTransf) object
<b>\$massDens</b>	element mass density (per unit length), from which a lumped-mass matrix is formed (optional, default=0.0)
<b>\$maxIters</b>	maximum number of iterations to undertake to satisfy element compatibility (optional, default=1)
<b>\$tol</b>	tolerance for satisfaction of element compatibility (optional, default= $10^{-16}$ )

The **-iter** switch enables the iterative form of the flexibility formulation. Note that the iterative form can improve the rate of global convergence at the expense of more local element computation.

**NOTE:** The elastic properties are integrated only over the beam interior, which is considered to be linear-elastic.

The valid queries to a beamWithHinges element when creating an *ElementRecorder* (page 307) object are 'force,' 'stiffness,' 'rotation' (hinge rotation), or 'section \$secNum secArg1 secArg2...'. Where **\$secNum** refers to the integration point whose data is to be output.

**NOTE:** The beamWithHinges element used here has four elastic sections and two fiber section at the end. Therefore for output in specifying \$secNum:

\$secNum=1: hinge at node i

\$secNum=6: hinge at node j

---

## Displacement-Based Beam-Column Element

This command is used to construct a `dispBeamColumn` element object, which is a distributed-plasticity, displacement-based beam-column element.

```
element dispBeamColumn $eleTag $iNode $jNode $numIntgrPts $secTag
    $transfTag <-mass $massDens>
```

<b>\$eleTag</b>	unique element object tag
<b>\$iNode</b> <b>\$jNode</b>	end nodes
<b>\$numIntgrPts</b>	number of integration points along the element.
<b>\$secTag</b>	identifier for previously-defined <i>section</i> (page 191) object
<b>\$transfTag</b>	identifier for previously-defined <i>coordinate-transformation</i> (page 280) ( <code>CrdTransf</code> ) object
<b>\$massDens</b>	element mass density (per unit length), from which a lumped-mass matrix is formed (optional, default=0.0)

The integration along the element is based on the Gauss-Legendre quadrature rule (REF???)

The element is prismatic, i.e. the beam is represented by the section model identified by `$secTag` at each integration point.

The valid queries to a displacement-based beam-column element when creating an *ElementRecorder* (page 307) object are 'force,' 'stiffness,' and 'section \$secNum secArg1 secArg2...' Where **\$secNum** refers to the integration point whose data is to be output.

---

## Zero-Length Elements

Zero-length elements connect two points at the same coordinate.

## Zero-Length Element

This command is used to construct a zeroLength element object, which is defined by two nodes at the same location. The nodes are connected by multiple *UniaxialMaterial* (page 43) objects to represent the force-deformation relationship for the element.

```
element zeroLength $eleTag $iNode $jNode -mat $matTag1 $matTag2 ... -dir
$dir1 $dir2 ... <-orient $x1 $x2 $x3 $yp1 $yp2 $yp3>
```

<b>\$eleTag</b>	unique element object tag
<b>\$iNode</b> <b>\$jNode</b>	end nodes
<b>\$matTag1</b> <b>\$matTag2 ...</b>	tags associated with previously-defined <i>UniaxialMaterials</i> (page 43)
<b>\$dir1 \$dir2 ...</b>	material directions:
	1,2,3      translation along local x,y,z axes, respectively
	4,5,6      rotation about local x,y,z axes, respectively

the orientation vectors can be specified for the element (optional):

<b>\$x1 \$x2 \$x3</b>	vector components in global coordinates defining local x-axis (vector x)
<b>\$yp1 \$yp2 \$yp3</b>	vector components in global coordinates defining vector yp which lies in the local x-y plane for the element:
	the local z-axis is defined by the cross product between the vectors x and yp

If the optional orientation vectors are not specified, the local element axes coincide with the global axes.

The valid queries to a zero-length element when creating an *ElementRecorder* (page 307) object are 'force,' 'deformation,' 'stiff,' and 'material \$matNum matArg1 matArg2 ...' Where **\$matNum** is the tag associated with the material whose data is to be output.



## Zero-Length ND Element

This command is used to construct a zeroLengthND element object, which is defined by two nodes at the same location. The nodes are connected by a single *NDMaterial* (page 162) object to represent the force-deformation relationship for the element.

```
element zeroLengthND $eleTag $iNode $jNode $matTag <$uniTag> <-orient $x1
  $x2 $x3 $yp1 $yp2 $yp3>
```

<b>\$eleTag</b>	unique element object tag
<b>\$iNode</b> <b>\$jNode</b>	end nodes
<b>\$matTag</b>	tag associated with previously-defined <i>NDMaterial</i> (page 162) object
<b>\$uniTag</b>	tag associated with previously-defined <i>UniaxialMaterial</i> (page 43) object which may be used to represent uncoupled behavior orthogonal to the plane of the NDmaterial response.  If the <i>NDMaterial</i> (page 162) object is of order two, the response lies in the element local x-y plane and the <i>UniaxialMaterial</i> object may be used to represent the uncoupled behavior orthogonal to this plane, i.e. along the local z-axis.  If the <i>NDMaterial</i> (page 162) object is of order three, the response is along each of the element local axes.
the orientation vectors can be specified for the element (optional):	
<b>\$x1 \$x2 \$x3</b>	vector components in global coordinates defining local x-axis (vector x)
<b>\$yp1 \$yp2 \$yp3</b>	vector components in global coordinates defining vector yp which lies in the local x-y plane for the element:  the local z-axis is defined by the cross product between the vectors x and yp

If the optional orientation vectors are not specified, the local element axes coincide with the global axes.

**NOTE:** The zeroLengthND element only represents translational response between its nodes

The valid queries to a zero-length element when creating an *ElementRecorder* (page 307) object are 'force,' 'deformation,' 'stiffness,' and 'material matArg1 matArg2 ...'

## Zero-Length Section Element

This command is used to construct a zeroLengthSection element object, which is defined by two nodes at the same location. The nodes are connected by a single *SectionForceDeformation* (page 191) object to represent the force-deformation relationship for the element.

```
element zeroLengthSection $eleTag $iNode $jNode $secTag <-orient $x1 $x2
    $x3 $yp1 $yp2 $yp3>
```

**\$eleTag** unique element object tag

**\$iNode \$jNode** end nodes

**\$secTag** tag associated with previously-defined *Section* (page 191) object

the orientation vectors can be specified for the element (optional):

**\$x1 \$x2 \$x3** vector components in global coordinates defining local x-axis (vector x)

**\$yp1 \$yp2 \$yp3** vector components in global coordinates defining vector yp which lies in the local x-y plane for the element:

the local z-axis is defined by the cross product between the vectors x and yp

If the optional orientation vectors are not specified, the local element axes coincide with the global axes.

The *section* (page 191) force-deformation response represented by section string P acts along the element local x-axis, and the response for code Vy along the local y-axis. The other modes of section response follow from this orientation.

The valid queries to a zero-length element when creating an *ElementRecorder* (page 307) object are 'force,' 'deformation,' 'stiffness,' and 'section secArg1 secArg2 ....'

**NOTE:** the ZeroLength section element only has 1 section therefore you do not need to identify the section in the recorder command .. Example:

```
recorder Element -file Element1.out -time -ele 1 section fiber 0.10 0.10 stressStrain
```

# Quadrilateral Elements

## Quad Element

This command is used to construct a FourNodeQuad element object which uses a bilinear isoparametric formulation.

```
element quad $eleTag $iNode $jNode $kNode $lNode $thick $type $matTag
<$pressure $rho $b1 $b2>
```

<b>\$eleTag</b>	unique element object tag
<b>\$iNode \$jNode \$kNode \$lNode</b>	four nodes defining element boundaries, input in counter-clockwise order around the element.
<b>\$thick</b>	element thickness (constant)
<b>\$type</b>	string representing material behavior.  Valid options depend on the <i>NDMaterial</i> (page 162) object and its available material formulations. The type parameter can be either "PlaneStrain" or "PlaneStress."
<b>\$matTag</b>	tag associated with previously-defined <i>NDMaterial</i> (page 162) object
<b>\$pressure</b>	surface pressure (???? sign convention????****)
<b>\$rho</b>	element mass density (per unit volume) from which a lumped element mass matrix is computed (optional, default=0.0)
<b>\$b1 \$b2</b>	constant body forces defined in the isoparametric domain (optional, default=0.0)

Consistent nodal loads are computed from the pressure and body forces.

The valid queries to a Quad element when creating an *ElementRecorder* (page 307) object are 'force,' 'stiffness,' and 'material \$matNum matArg1 matArg2 ...' Where **\$matNum** refers to the material object at the integration point corresponding to the node numbers in the isoparametric domain.

---

## Shell Element

This command is used to construct a ShellMITC4 element object, which uses a bilinear isoparametric formulation in combination with a modified shear interpolation to improve thin-plate bending performance.

```
element ShellMITC4 $eleTag $iNode $jNode $kNode $lNode $secTag
```

<b>\$eleTag</b>	unique element object tag
<b>\$iNode \$jNode \$kNode \$lNode</b>	four nodes defining element boundaries, input in counter-clockwise order around the element.
<b>\$secTag</b>	tag associated with previously-defined <i>SectionForceDeformation</i> (page 191) object.  Typically, corresponds to some <i>PlateFiberSection</i> (page 205), elastic or otherwise

Should the element be required to compute a mass matrix, a consistent translational element mass matrix is computed. Rotational-inertia terms are ignored.

The valid queries to a shell element when creating an *ElementRecorder* (page 307) object are 'force,' 'stiffness,' and 'material matArg1 matArg2 ...'

---

## Bbar Plane Strain Quadrilateral Element

This command is used to construct a four-node quadrilateral element object, which uses a bilinear isoparametric formulation along with a mixed volume/pressure B-bar assumption. This element is for plane strain problems only.

```
element bbarQuad $eleTag $iNode $jNode $kNode $lNode $matTag
```

<b>\$eleTag</b>	unique element object tag
<b>\$iNode \$jNode \$kNode \$lNode</b>	four nodes defining element boundaries, input in counter-clockwise order around the element
<b>\$matTag</b>	tag associated with previously-defined <i>NDMaterial</i> (page 162) object

Should the element be required to compute a mass matrix, a consistent translational element mass matrix is computed. Rotational-inertia terms are ignored.

---

## Enhanced Strain Quadrilateral Element

This command is used to construct a four-node quadrilateral element, which uses a bilinear isoparametric formulation with enhanced strain modes.

**element enhancedQuad \$eleTag \$iNode \$jNode \$kNode \$lNode type \$matTag**

<b>\$eleTag</b>	unique element object tag
<b>\$iNode \$jNode \$kNode \$lNode</b>	four nodes defining element boundaries, input in counter-clockwise order around the element.
<b>type</b>	string representing material behavior.  Valid options depend on the <i>NDMaterial</i> (page 162) object and its available material formulations. The type parameter can be either "PlaneStrain" or "PlaneStress."
<b>\$matTag</b>	tag associated with previously-defined <i>NDMaterial</i> (page 162) object

Should the element be required to compute a mass matrix, a consistent translational element mass matrix is computed. Rotational-inertia terms are ignored.

The valid queries to a zero-length element when creating an *ElementRecorder* (page 307) object are 'force,' 'stiffness,' and 'material matArg1 matArg2 ...'

# Brick Elements

## Standard Brick Element

This element is used to construct an eight-node brick element object, which uses a trilinear isoparametric formulation.

```
element stdBrick $eleTag $node1 $node2 $node3 $node4 $node5 $node6
      $node7 $node8 $matTag
```

<b>\$eleTag</b>	unique element object tag
<b>\$node1 \$node2 \$node3 \$node4 \$node5 \$node6 \$node7 \$node8</b>	eight nodes defining element boundaries, input order is shown in the figure
<b>\$matTag</b>	tag associated with previously-defined <i>NDMaterial</i> (page 162) object

Should the element be required to compute a mass matrix, a consistent translational element mass matrix is computed. Rotational-inertia terms are ignored.

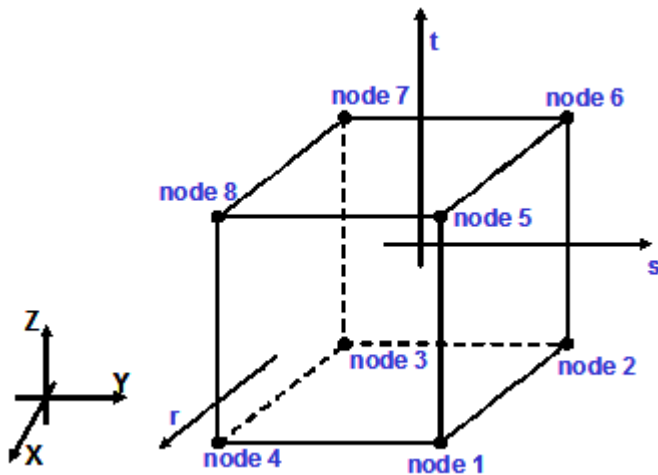

Figure 44: Node-Numbering for Standard Brick Element

Note: Node numbering for this element is different from that for the *eight-node brick* (page 259) (Brick8N) element.

## Bbar Brick Element

This command is used to construct an eight-node mixed volume/pressure brick element object, which uses a trilinear isoparametric formulation.

```
element bbarBrick $eleTag $node1 $node2 $node3 $node4 $node5 $node6
      $node7 $node8 $matTag
```

<b>\$eleTag</b>	unique element object tag
<b>\$node1 \$node2 \$node3 \$node4 \$node5 \$node6 \$node7 \$node8</b>	eight nodes defining element boundaries, input order is shown in the figure
<b>\$matTag</b>	tag associated with previously-defined <i>NMaterial</i> (page 162) object

Should the element be required to compute a mass matrix, a consistent translational element mass matrix is computed. Rotational-inertia terms are ignored

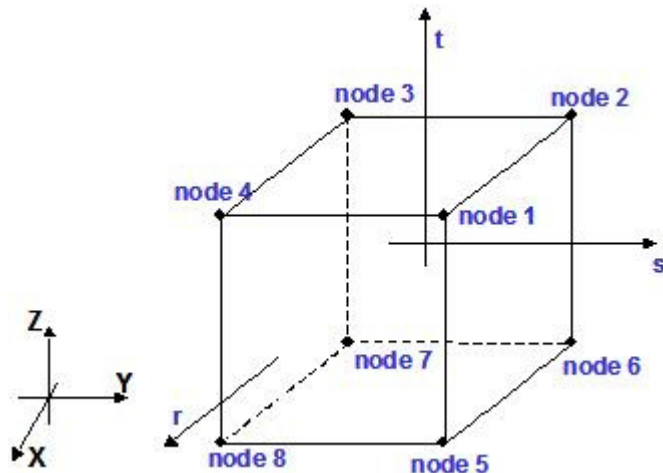

Figure 45: Node Numbering for Eight-Node Three-Dimensional Element

## BeamColumnJoint Element

This command is used to construct a two-dimensional beam-column-joint element object. The element may be used with both two-dimensional and three-dimensional structures; however, load is transferred only in the plane of the element.

```
element beamColumnJoint $eleTag $Nd1 $Nd2 $Nd3 $Nd4 $Mat1 $Mat2 $Mat3
$Mat4 $Mat5 $Mat6 $Mat7 $Mat8 $Mat9 $Mat10 $Mat11 $Mat12 $Mat13
<$eleHeightFac $eleWidthFac>
```

<b>\$eleTag</b>	an integer identifying the element tag in the domain
<b>\$Nd1,\$Nd2,\$Nd3,\$Nd4</b>	tag associated with previously defined nodes
<b>\$Mat1</b>	uniaxial material tag for left bar-slip spring at node 1
<b>\$Mat2</b>	uniaxial material tag for right bar-slip spring at node 1
<b>\$Mat3</b>	uniaxial material tag for interface-shear spring at node 1
<b>\$Mat4</b>	uniaxial material tag for lower bar-slip spring at node 2
<b>\$Mat5</b>	uniaxial material tag for upper bar-slip spring at node 2
<b>\$Mat6</b>	uniaxial material tag for interface-shear spring at node 2
<b>\$Mat7</b>	uniaxial material tag for left bar-slip spring at node 3
<b>\$Mat8</b>	uniaxial material tag for right bar-slip spring at node 3
<b>\$Mat9</b>	uniaxial material tag for interface-shear spring at node 3
<b>\$Mat10</b>	uniaxial material tag for lower bar-slip spring at node 4
<b>\$Mat11</b>	uniaxial material tag for upper bar-slip spring at node 4
<b>\$Mat12</b>	uniaxial material tag for interface-shear spring at node 4
<b>\$Mat13</b>	uniaxial material tag for shear-panel
<b>\$eleHeightFac</b>	floating point value (as a ratio to the total height of the element) to be considered for determination of the distance in between the tension-compression couples (optional, default: 1.0)
<b>\$eleWidthFac</b>	floating point value (as a ratio to the total width of the element) to be considered for determination of the distance in between the tension-compression couples (optional, default: 1.0)



NOTE:

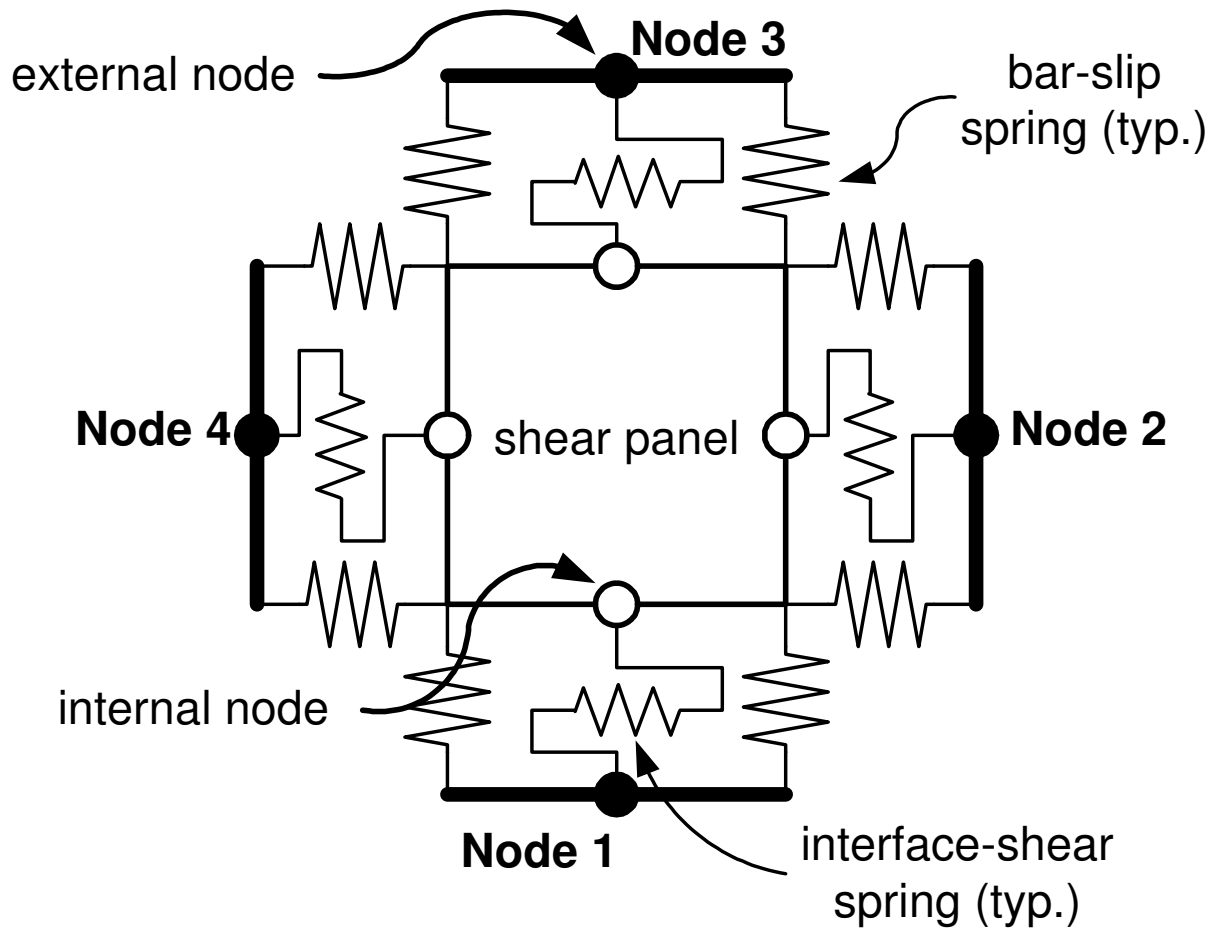

Figure 46: BeamColumnJoint Element

The valid queries to a BeamColumnJoint element when creating an *ElementRecorder* (page 307) are as follows:

'internalDisplacement' - returns the displacements of the internal joint nodes.

'externalDisplacement' - returns the displacement of the external joint nodes.

'deformation' - generates a four-column matrix in which the first column is the contribution to the total joint shear deformation of all of the bar-slip components of the joint, the second is the deformation contribution of the interface shear springs, the third is the deformation contribution of the shear-panel and the fourth is the total shear deformation of the joint.

'node1BarSlipL' - returns the load-deformation response history of the Bar-Slip spring on the Left at node 1.

'node1BarSlipR' - returns the load-deformation response history of the Bar-Slip spring on the Right at node 1.

'node1InterfaceShear' - returns the load-deformation response history of the Interface-Shear spring at node 1.

'node2BarSlipB' - returns the load-deformation response history of the Bar-Slip spring on the Bottom at node 2.

'node2BarSlipT' - returns the load-deformation response history of the Bar-Slip spring on the Top at node 2.

'node2InterfaceShear' - returns the load-deformation response history of the Interface Shear spring at node 1.

'node3BarSlipL' - returns the load-deformation response history of the Bar-Slip spring on the Left at node 3.

'node3BarSlipR' - returns the load-deformation response history of the Bar-Slip spring on the Right at node 3.

'node3InterfaceShear' - returns the load-deformation response history of the Interface-Shear spring at node 3.

'node4BarSlipB' - returns the load-deformation response history of the Bar-Slip spring on the Bottom at node 4.

'node4BarSlipT' - returns the load-deformation response history of the Bar-Slip spring on the Top at node 4.

'node4InterfaceShear' - returns the load-deformation response history of the Interface Shear spring at node 4.

'shearPanel' - returns the load-deformation response history of the Shear-Panel spring.

➤ **EXAMPLE:**

main input file:

- *PR1.tcl* (page 240)

supporting files:

- *procMKPC.tcl* (page 250)
- *procUniaxialPinching.tcl* (page 101)
- *procRC.tcl* (page 252)

References:

Lowes, Laura N.; Mitra, Nilanjan; Altoontash, Arash *A beam-column joint model for simulating the earthquake response of reinforced concrete frames PEER-2003/10* (<http://nisee.berkeley.edu/elibrary/getdoc?id=1288878>) Pacific Earthquake Engineering Research Center, University of California, Berkeley 2003 59 pages (400/P33/2003-10)

# Beam-Column Joint Element Discussion

## Beam-Column Joint Element Discussion

The example files (*PR1.tcl* (page 240), *procMKPC.tcl* (page 250), *procUniaxialPinching.tcl* (page 101), *procRC.tcl* (page 252)) create a model of a RC beam column sub-assembly (Figure 1). The cruciform is subjected to constant gravity load at nodes 4 and 7 and pseudo-static cyclic lateral load under displacement control at node 10. The beam-column-joint region (element number 7) is represented using a beamColumnJoint element (Figure 2), and the beams and columns (element numbers 1 through 6) are modeled using the nonlinearBeamColumn element. The beam-column joint consists of 13 components that may have different material constitutive models; in this example 9 of the 13 components utilize the nonlinear material model – Pinching4. Figure 3 shows the displacement history for node 10.

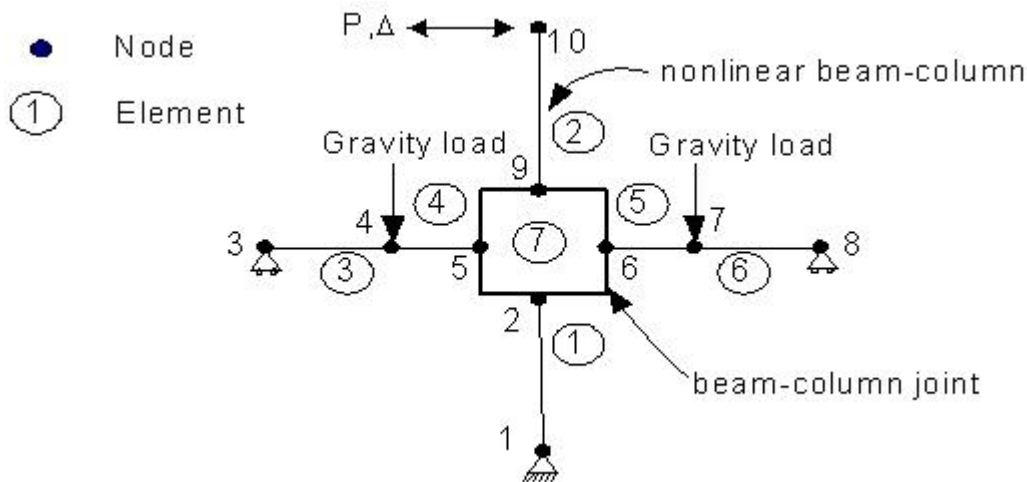

Figure 47: Cruciform model

Figure 1: Cruciform model

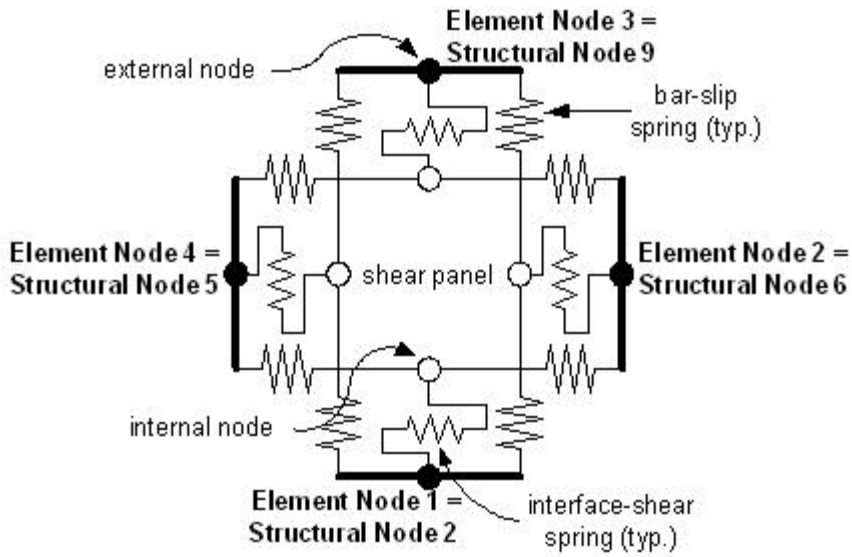
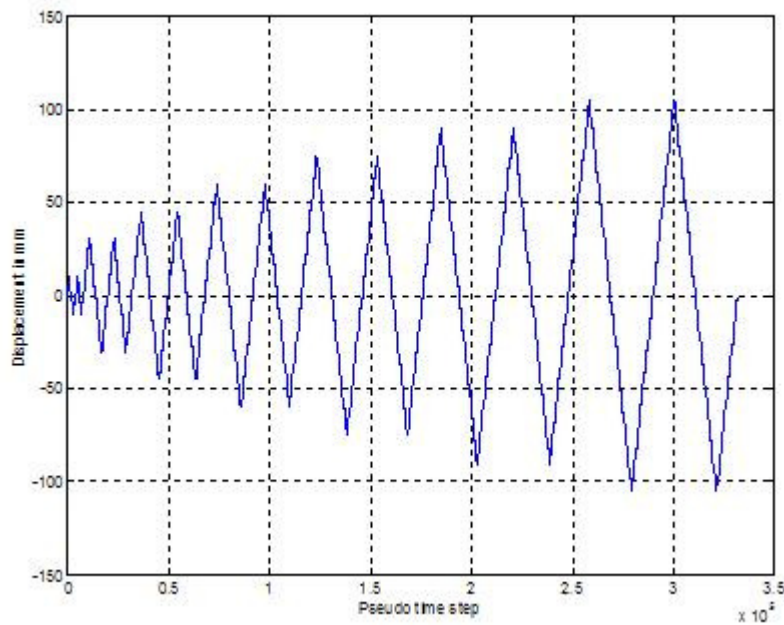

Figure 48: Beam Column Joint Element

Figure 2: Beam Column Joint Element



*Figure 49: Displacement history for Node 10*

Figure 3: Displacement history for Node 10

Tcl Scripts:

The following tcl script files are used to run the examples:

*PR1.tcl* (page 240)

*procMKPC.tcl* (page 250)

*procUniaxialPinching.tcl* (page 101)

*procRC.tcl* (page 252)

The p-delta response of cruciform, along with the response of each of the nonlinear joint components is shown below. The shear panel response shows the moment-curvature relationships whereas the bar slips at the beam top and bottom are represented by the force-slip plots (Figure 4).

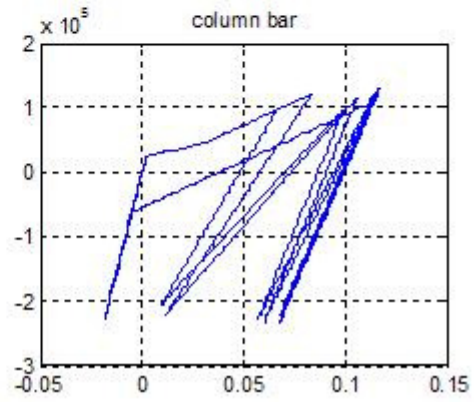
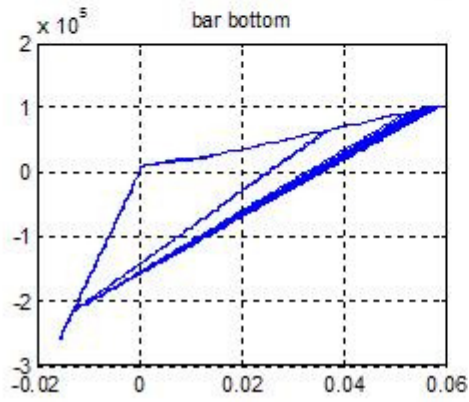
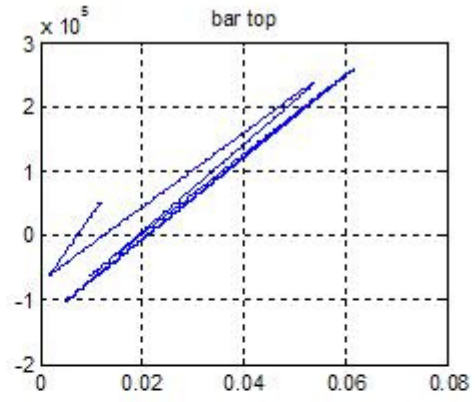
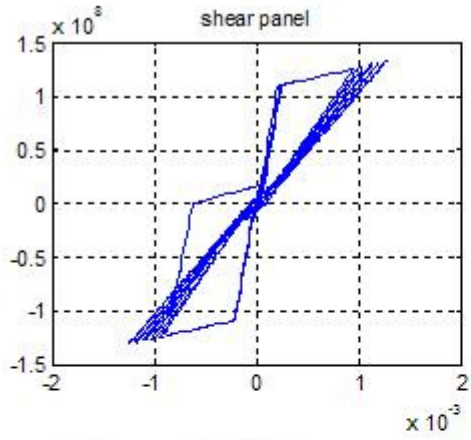

Figure 50: Nonlinear Joint component response

Figure 4: Nonlinear Joint component response

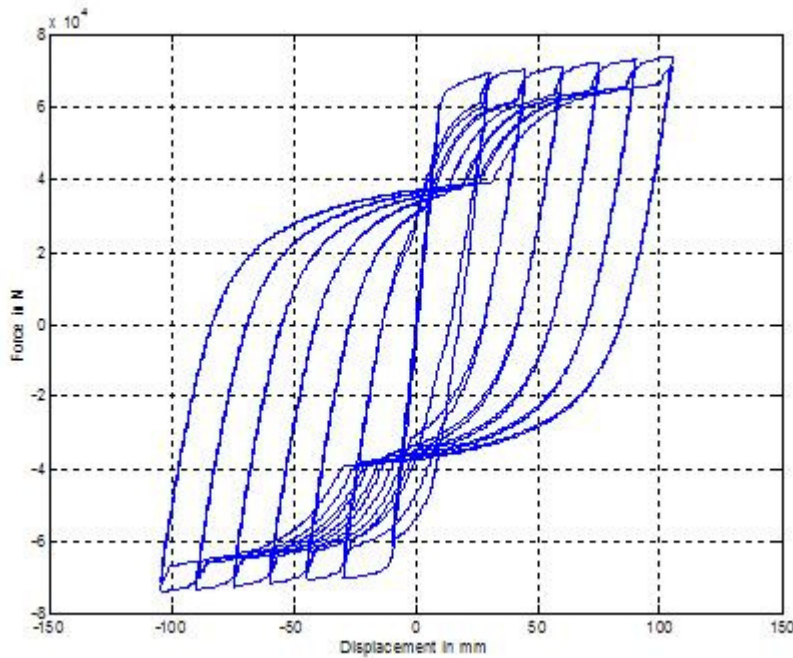

Figure 51: P-delta response of the cruciform

Figure 5. P-delta response of the cruciform

**PR1.tcl**

```
#####
# Test example for BEAM COLUMN ELEMENT JOINT ----- PARK RUITONG TEST SPECIMEN Unit 1
# Written: N.Mitra
# Description: 4 noded 12 dof element having 12 springs and a shear panel
# Date: Feb 16 2003
## Model consisting of a crucifix with beams and columns and a joint
## File Name: PR1.tcl
# refer to Beam-Column-Joint Element.doc for full explanation of the parameters
#####
```



```
#create the ModelBuilder object
model BasicBuilder -ndm 2 -ndf 3

## unit name ---- PR1
set fName "PR1";

source procMKPC.tcl
source procUniaxialPinching.tcl
source procRC.tcl

# all dimensions are in here as MPa (conversion factors are required in certain places)
set Strfactor 145; set Lenfactor [expr 1/25.4];

## Y taken as the inplane dim. against which the bending takes place
set colY 406; set colZ 305;
set bmY 457; set bmZ 229;

# covers
set colCov 43; set bmCov1 42; set bmCov2 33; set bmCov $bmCov1;

# y,z,x dimension of the joint respectively
set JointWidth [expr $colY]; set JointHeight [expr $bmY]; set JointDepth $colZ ;
set BeamLengthIn 645; set BeamLengthOut 1271; set ColumnLengthClear 1008;

set JointVolume [expr $JointWidth*$JointHeight*$JointDepth];

#####
##### material properties of column section
#####
set CUnconfFc -45.9; set CUnconfEc -0.002;
set CTSspace 60; set CTSlength 1853.53; set CTSFy 282; set CTSarea 28.3;
set CFy 498.0; set CEs 196600.0; set CsHratio 0.004216; set CAs 201.06;

procMKPC $CUnconfFc $CUnconfEc $colY $colZ $colCov $CTSspace $CTSlength $CTSFy $CTSarea $Strfactor
$Lenfactor

set CUnconfFcu [lindex $concreteProp 2]; set CUnconfEcu [lindex $concreteProp 3];
set CConfFc [lindex $concreteProp 4]; set CConfEc [lindex $concreteProp 5];
```

```

set CConfFcu [lindex $concreteProp 6]; set CConfEcu [lindex $concreteProp 7];

#####
##### material properties of beam section
#####
set BUnconfFc -45.9; set BUnconfEc -0.002;
set BTSspace 80; set BTSlength 1036; set BTSFy 282; set BTSarea 28.3;
set BFy 294.0; set BEs 210400.0; set BAs 201.06; set BsHratio 0.002322;

procMKPC $BUnconfFc $BUnconfEc $bmY $bmZ $bmCov $BTSspace $BTSlength $BTSFy $BTSarea $Strfactor
$Lenfactor

set BUnconfFcu [lindex $concreteProp 2]; set BUnconfEcu [lindex $concreteProp 3];
set BConfFc [lindex $concreteProp 4]; set BConfEc [lindex $concreteProp 5];
set BConfFcu [lindex $concreteProp 6]; set BConfEcu [lindex $concreteProp 7];

#####
##### details for the material models of bar slip of the beam
#####
set bs_fc [expr -$BUnconfFc]; set bs_fs $BFy; set bs_es $BEs; set bs_fsu 434; set bs_dbar 16; set bs_esh [expr
$BsHratio*$BEs];
set bs_wid $colZ; set bs_dep $bmY;
set bsT_nbars 5; set bsB_nbars 2;
set bs_ljoint $colY;

#####
##### details for the material models of bar slip of the column
#####
set cs_fc [expr -$CUnconfFc]; set cs_fs $CFy; set cs_es $CEs; set cs_fsu 660; set cs_dbar 16; set cs_esh [expr
$CsHratio*$CEs];
set cs_wid $colZ; set cs_dep $colY;
set cs_nbars 3;
set cs_ljoint $bmY;

#####
##### add nodes - command: node nodeId xCrd yCrd
#####
node 1 0.0 0.0
node 2 0.0 $ColumnLengthClear
node 3 [expr -$BeamLengthOut-$BeamLengthIn-$JointWidth/2] [expr $ColumnLengthClear+$JointHeight/2]

```

```

node 4 [expr -$BeamLengthIn-$JointWidth/2] [expr $ColumnLengthClear+$JointHeight/2]
node 5 [expr -$JointWidth/2] [expr $ColumnLengthClear+$JointHeight/2]
node 6 [expr $JointWidth/2] [expr $ColumnLengthClear+$JointHeight/2]
node 7 [expr $BeamLengthIn+$JointWidth/2] [expr $ColumnLengthClear+$JointHeight/2]
node 8 [expr $BeamLengthOut+$BeamLengthIn+$JointWidth/2] [expr $ColumnLengthClear+$JointHeight/2]
node 9 0.0 [expr $ColumnLengthClear+$JointHeight]
node 10 0.0 [expr 2*$ColumnLengthClear+$JointHeight]

# add material Properties - command: uniaxialMaterial matType matTag ...
#command: uniaxialMaterial Elastic tag? E?
uniaxialMaterial Elastic 1 10000000000.0

#####
##### inelastic beam column elements
#####
uniaxialMaterial Concrete01 10 $BUnconfFc $BUnconfEc $BUnconfFcu $BUnconfEcu

uniaxialMaterial Concrete01 20 $BConfFc $BConfEc $BConfFcu $BConfEcu

uniaxialMaterial Steel02 30 $BFy $BEs $BsHratio 18.5 0.925 0.15 0.0 0.4 0.0 0.5

uniaxialMaterial Concrete01 40 $CUnconfFc $CUnconfEc $CUnconfFcu $CUnconfEcu

uniaxialMaterial Concrete01 50 $CConfFc $CConfEc $CConfFcu $CConfEcu

uniaxialMaterial Steel02 60 $CFy $CEs $CsHratio 18.5 0.925 0.15 0.0 0.4 0.0 0.5

##### for columns ////////////////////////////////////////////////////////////////////
set z [expr $colZ/2.0]; set y [expr $colY/2.0];

section Fiber 1 {
patch rect 50 8 1 [expr $colCov-$y] [expr $colCov-$z] [expr $y-$colCov] [expr $z-$colCov]
patch rect 40 2 1 [expr -$y] [expr $colCov-$z] [expr $colCov-$y] [expr $z-$colCov]
patch rect 40 2 1 [expr $y-$colCov] [expr $colCov-$z] [expr $y] [expr $z-$colCov]

patch rect 40 8 1 [expr -$y] [expr -$z] [expr $y] [expr $colCov-$z]
patch rect 40 8 1 [expr -$y] [expr $z-$colCov] [expr $y] [expr $z]

```

```

layer straight 60 3 $CAs [expr $y-$colCov] [expr $colCov-$z] [expr $y-$colCov] [expr $z-$colCov]
layer straight 60 2 $CAs 0.0 [expr $colCov-$z] 0.0 [expr $z-$colCov]
layer straight 60 3 $CAs [expr $colCov-$y] [expr $colCov-$z] [expr $colCov-$y] [expr $z-$colCov]
}

##### for beams #####
set z [expr $bmZ/2.0]; set y [expr $bmY/2.0];

section Fiber 2 {
patch rect 20 8 1 [expr $bmCov1-$y] [expr $bmCov1-$z] [expr $y-$bmCov1] [expr $z-$bmCov1]
patch rect 10 2 1 [expr -$y] [expr $bmCov1-$z] [expr $bmCov1-$y] [expr $z-$bmCov1]

patch rect 10 2 1 [expr $y-$bmCov1] [expr $bmCov1-$z] [expr $y] [expr $z-$bmCov1]

patch rect 10 8 1 [expr -$y] [expr -$z] [expr $y] [expr $bmCov1-$z]
patch rect 10 8 1 [expr -$y] [expr $z-$bmCov1] [expr $y] [expr $z]

layer straight 30 3 $BAs [expr $y-$bmCov1] [expr $bmCov1-$z] [expr $y-$bmCov1] [expr $z-$bmCov1]
layer straight 30 2 $BAs [expr $y-$bmCov1-$bmCov2] [expr $bmCov1-$z] [expr $y-$bmCov1-$bmCov2] [expr $z-$bmCov1]
layer straight 30 2 $BAs [expr $bmCov1-$y] [expr $bmCov1-$z] [expr $bmCov1-$y] [expr $z-$bmCov1]
}

#####

## add geometric transformation -command: geomTransf transfType ...

## geomTransf Linear tag?
geomTransf Linear 1
geomTransf Linear 2

element nonlinearBeamColumn 1 1 2 5 1 2
element nonlinearBeamColumn 2 9 10 5 1 2
element nonlinearBeamColumn 3 3 4 3 2 1
element nonlinearBeamColumn 4 4 5 2 2 1
element nonlinearBeamColumn 5 6 7 2 2 1
element nonlinearBeamColumn 6 7 8 3 2 1

```

```
##### end element formation as well as material defination for beams and columns #####  
#####  
  
# for beam bottom  
set matID1 21  
set matID2 22  
  
uniaxialMaterial BarSlip $matID1 $bs_fc $bs_fs $bs_es $bs_fsu $bs_esh $bs_dbar $bs_ljoint $bsB_nbars $bs_wid  
$bs_dep strong beamBot  
uniaxialMaterial BarSlip $matID2 $bs_fc $bs_fs $bs_es $bs_fsu $bs_esh $bs_dbar $bs_ljoint $bsB_nbars $bs_wid  
$bs_dep strong beamBot  
  
## %%%%%%%%%%% equivalent statement can be made in other way  
#uniaxialMaterial BarSlip $matID1 $bs_fc $bs_fs $bs_es $bs_fsu $bs_esh $bs_dbar $bs_ljoint $bsB_nbars $bs_wid  
$bs_dep 1.0 strong beamBot damage  
#uniaxialMaterial BarSlip $matID2 $bs_fc $bs_fs $bs_es $bs_fsu $bs_esh $bs_dbar $bs_ljoint $bsB_nbars $bs_wid  
$bs_dep 1.0 strong beamBot damage  
  
# for beam top  
set matID3 31  
set matID4 32  
  
uniaxialMaterial BarSlip $matID3 $bs_fc $bs_fs $bs_es $bs_fsu $bs_esh $bs_dbar $bs_ljoint $bsT_nbars $bs_wid  
$bs_dep strong beamTop  
uniaxialMaterial BarSlip $matID4 $bs_fc $bs_fs $bs_es $bs_fsu $bs_esh $bs_dbar $bs_ljoint $bsT_nbars $bs_wid  
$bs_dep strong beamTop  
  
## %%%%%%%%%%% equivalent statement can be made in other way  
#uniaxialMaterial BarSlip $matID3 $bs_fc $bs_fs $bs_es $bs_fsu $bs_esh $bs_dbar $bs_ljoint $bsT_nbars $bs_wid  
$bs_dep 1.0 strong beamTop damage  
#uniaxialMaterial BarSlip $matID4 $bs_fc $bs_fs $bs_es $bs_fsu $bs_esh $bs_dbar $bs_ljoint $bsT_nbars $bs_wid  
$bs_dep 1.0 strong beamTop damage  
  
# for columns  
set matID5 41  
set matID6 42  
set matID7 43  
set matID8 44
```

```

uniaxialMaterial BarSlip $matID5 $cs_fc $cs_fs $cs_es $cs_fsu $cs_esh $cs_dbar $cs_ljoint $cs_nbars $cs_wid
$cs_dep strong column
uniaxialMaterial BarSlip $matID6 $cs_fc $cs_fs $cs_es $cs_fsu $cs_esh $cs_dbar $cs_ljoint $cs_nbars $cs_wid
$cs_dep strong column
uniaxialMaterial BarSlip $matID7 $cs_fc $cs_fs $cs_es $cs_fsu $cs_esh $cs_dbar $cs_ljoint $cs_nbars $cs_wid
$cs_dep strong column
uniaxialMaterial BarSlip $matID8 $cs_fc $cs_fs $cs_es $cs_fsu $cs_esh $cs_dbar $cs_ljoint $cs_nbars $cs_wid
$cs_dep strong column

## %%%%%%%%%%% equivalent statement can be made in other way
#uniaxialMaterial BarSlip $matID5 $cs_fc $cs_fs $cs_es $cs_fsu $cs_esh $cs_dbar $cs_ljoint $cs_nbars $cs_wid
$cs_dep 1.0 strong column damage
#uniaxialMaterial BarSlip $matID6 $cs_fc $cs_fs $cs_es $cs_fsu $cs_esh $cs_dbar $cs_ljoint $cs_nbars $cs_wid
$cs_dep 1.0 strong column damage
#uniaxialMaterial BarSlip $matID7 $cs_fc $cs_fs $cs_es $cs_fsu $cs_esh $cs_dbar $cs_ljoint $cs_nbars $cs_wid
$cs_dep 1.0 strong column damage
#uniaxialMaterial BarSlip $matID8 $cs_fc $cs_fs $cs_es $cs_fsu $cs_esh $cs_dbar $cs_ljoint $cs_nbars $cs_wid
$cs_dep 1.0 strong column damage

##### end material formation for bar slip
#####

##### material for shear panel
#####

## Positive/Negative envelope Stress
set p1 2.1932; set p2 4.0872; set p3 4.4862; set p4 [expr $p3*1e-3];

##          stress1      stress2      stress3      stress4
set pEnvStrsp [list [expr $p1*$JointVolume] [expr $p2*$JointVolume] [expr $p3*$JointVolume] [expr
$p4*$JointVolume]]
set nEnvStrsp [list [expr -$p1*$JointVolume] [expr -$p2*$JointVolume] [expr -$p3*$JointVolume] [expr
-$p4*$JointVolume]]

## Positive/Negative envelope Strain
##          strain1 strain2 strain3 strain4
set pEnvStnsp [list 0.0002 0.004465 0.0131 0.0269]
set nEnvStnsp [list -0.0002 -0.004465 -0.0131 -0.0269]

## Ratio of maximum deformation at which reloading begins
##          Pos_env. Neg_env.
set rDispsp [list 0.25 0.25]

```

```
## Ratio of envelope force (corresponding to maximum deformation) at which reloading begins
###      Pos_env.  Neg_env.
set rForcesp [list 0.15  0.15]

## Ratio of monotonic strength developed upon unloading
###      Pos_env.  Neg_env.
set uForcesp [list 0.0  0.0]

## Coefficients for Unloading Stiffness degradation
##      gammaK1  gammaK2  gammaK3  gammaK4  gammaKLimit
set gammaKsp [list 1.13364492409642  0.0  0.10111033064469  0.0  0.91652498468618]
#set gammaKsp [list 0.0  0.0  0.0  0.0  0.0]

#### Coefficients for Reloading Stiffness degradation
###      gammaD1  gammaD2  gammaD3  gammaD4  gammaDLimit
set gammaDsp [list 0.12  0.0  0.23  0.0  0.95]
#set gammaDsp [list 0.0  0.0  0.0  0.0  0.0]

#### Coefficients for Strength degradation
###      gammaF1  gammaF2  gammaF3  gammaF4  gammaFLimit
set gammaFsp [list 1.11  0.0  0.319  0.0  0.125]
#set gammaFsp [list 0.0  0.0  0.0  0.0  0.0]

set gammaEsp 10.0

uniaxialMaterial Pinching4 5 [lindex $pEnvStrsp 0] [lindex $pEnvStnsp 0] \
[lindex $pEnvStrsp 1] [lindex $pEnvStnsp 1] [lindex $pEnvStrsp 2] \
[lindex $pEnvStnsp 2] [lindex $pEnvStrsp 3] [lindex $pEnvStnsp 3] \
[lindex $nEnvStrsp 0] [lindex $nEnvStnsp 0] \
[lindex $nEnvStrsp 1] [lindex $nEnvStnsp 1] [lindex $nEnvStrsp 2] \
[lindex $nEnvStnsp 2] [lindex $nEnvStrsp 3] [lindex $nEnvStnsp 3] \
[lindex $rDisp 0] [lindex $rForcesp 0] [lindex $uForcesp 0] \
[lindex $rDisp 1] [lindex $rForcesp 1] [lindex $uForcesp 1] \
```

```

[index $gammaKsp 0] [index $gammaKsp 1] [index $gammaKsp 2] [index $gammaKsp 3] [index $gammaKsp 4] \
[index $gammaDsp 0] [index $gammaDsp 1] [index $gammaDsp 2] [index $gammaDsp 3] [index $gammaDsp 4] \
[index $gammaFsp 0] [index $gammaFsp 1] [index $gammaFsp 2] [index $gammaFsp 3] [index $gammaFsp 4] \
$gammaEsp energy

##### end material formation for shear panel #####

##element BeamColumnJoint tag? iNode? jNode? kNode? lNode? matTag1? matTag2? matTag3? matTag4?
##      matTag5? matTag6? matTag7? matTag8? matTag9? matTag10? matTag11? matTag12? matTag13?
##      <element Height factor?> <element Width factor?>
## please note: the four nodes are in anticlockwise direction around the element
##      requires material tags for all 13 different components within the element.

##      the first 12 being that of spring and the last of the shear panel

element beamColumnJoint 7 2 6 9 5 41 42 1 21 31 1 43 44 1 22 32 1 5
#element beamColumnJoint 7 2 6 9 5 1 1 1 1 1 1 1 1 1 1 1 1 1 1 1 1

## %%%%%%%%%%% equivalent statement can be made in other way
#element beamColumnJoint 7 2 6 9 5 41 42 1 21 31 1 43 44 1 22 32 1 5 1.0 1.0
#element beamColumnJoint 7 2 6 9 5 1 1 1 1 1 1 1 1 1 1 1 1 1 1 1.0 1.0

# set the boundary conditions - command: fix nodeID xResrnt? yRestrnt?
fix 1 1 1 0
fix 2 0 0 0
fix 3 0 1 0
fix 4 0 0 0
fix 5 0 0 0
fix 6 0 0 0
fix 7 0 0 0
fix 8 0 1 0
fix 9 0 0 0
fix 10 0 0 0

pattern Plain 2 Linear {
    load 4 0 -55000 0 -const
    load 7 0 -55000 0 -const

```



```
}

system ProfileSPD
constraints Plain
integrator LoadControl 0 1 0 0
test NormDisplncr 1e-8 150
algorithm Newton
numberer RCM
analysis Static
analyze 1
loadConst -time 0.0

pattern Plain 1 Linear {
    #load nd? Fx? Fy? Mz?
    load 10 1 0 0
}

set rbbt "_RBbt"; set rbtp "_RBtp"; set dlcbt "_DLCbr"; set sp "_Sp"; set jdf "_Jdf";
set lbbt "_LBbt"; set lbtp "_LBtp"; set drcbt "_DRCbr"; set ulcbt "_ULCbr"; set urcbt "_URCbr";
set RBbt [concat $fName$rbbt]; set RBtp [concat $fName$rbtp]; set Sp [concat $fName$sp];
set LBbt [concat $fName$lbbt]; set LBtp [concat $fName$lbtp]; set DLCbr [concat $fName$dlcbt];
set DRCbr [concat $fName$drcbt]; set URCbr [concat $fName$urcbt]; set ULCbr [concat $fName$ulcbt];
set Jdf [concat $fName$jdf];

recorder Node $fName.out disp -load -node 10 -dof 1
recorder Element 7 -file $RBbt.out node2BarSlipB stressStrain
recorder Element 7 -file $RBtp.out node2BarSlipT stressStrain
recorder Element 7 -file $LBbt.out node4BarSlipB stressStrain
recorder Element 7 -file $LBtp.out node4BarSlipT stressStrain
recorder Element 7 -file $DLCbr.out node1BarSlipL stressStrain
recorder Element 7 -file $DRCbr.out node1BarSlipR stressStrain
recorder Element 7 -file $ULCbr.out node3BarSlipL stressStrain
recorder Element 7 -file $URCbr.out node3BarSlipR stressStrain
recorder Element 7 -file $Sp.out shearpanel stressStrain
recorder Element 7 -file $Jdf.out deformation

set peakpts [list 0.1 10 10 30 30 45 45 60 60 75 75 90 90 105 105]
```

```

set increment 10
set nodeTag 10
set dofTag 1
procRC $increment $nodeTag $dofTag $peakpts

# print the results at node and at all elements
print node
#print element

```

### procMKPC.tcl

```

#####
#####
#
#           procMKPC.tcl
## procedure for evaluating the confined concrete material envelope points based upon the modified
## kent park procedure. The procedure takes in the unconfined concrete and confining steel properties.
## created : NM (nmitra@u.washington.edu) dated: Dec. 2002
#####
#####

proc procMKPC { CUnconfFc CUnconfEc Y Z Cov TSspace TSlength TSFy TSarea Strfactor Lenfactor } {

    set CUnconfEcu -0.004;
    set SecWid [expr $Lenfactor*$Z]; set SecDep [expr $Lenfactor*$Y]; set cover [expr $Lenfactor*$Cov];
    set UFc [expr -$Strfactor*$CUnconfFc]; set Ue0 [expr -$CUnconfEc]; set Uecu [expr -$CUnconfEcu];
    set hoopSpc [expr $Lenfactor*$TSspace]; set hoopLngth [expr $Lenfactor*$TSlength];
    set hoopFy [expr $Strfactor*$TSFy]; set hoopArea [expr $TSarea*$Lenfactor*$Lenfactor];

# ratio of volume of rectangular steel hoops to volumne of concrete core measured to outside of peripheral hoops
    set rhoS [expr ($hoopLngth*$hoopArea)/(($SecWid-2*$cover)*($SecDep-2*$cover)*$hoopSpc)];
# width of concrete core measured to outside of peripheral hoop
    set b [expr $SecWid - 2*$cover];

    set temp [expr $b/$hoopSpc]
    set e50u [expr (3+0.002*$UFc)/($UFc - 1000)]; set e50h [expr 3*$rhoS*pow($temp,0.5)/4];
    set Zm [expr 0.5*($UFc-1000)/(3+0.002*$UFc)]; set Z [expr 0.5/($e50u + $e50h - $Ue0)];
    set K [expr (1 + $rhoS*$hoopFy/$UFc)];

```

```

# unconfined ultimate compressive strength
    set UFcu [expr - $UFc*(1-Zm*(Uecu-Ue0))$ /$Strfactor];
#cracking strain in confined concrete
    set Ce0 [expr - $K*Ue0$ ];
# cracking stress in confined concrete
    set CFc [expr - $K*UFc$ /$Strfactor];
# ultimate stress in confined concrete
    set CFcu [expr 0.2* $CFc$ ];
# ultimate strain in confined concrete
    set Cecu [expr -(0.8/ $Z$  -  $Ce0$ )];

    global concreteProp;

    set concreteProp [list $CUnconfFc $CUnconfEc $UFcu $CUnconfEcu $CFc $Ce0 $CFcu $Cecu];

    #puts [lindex $concreteProp 0]

    return $concreteProp;
}

```

### procUniaxialPinching.tcl

```

#####
#####

# #

# procUniaxialPinching.tcl #

# procedure for activating the pinching material given its parameters in the form of list #

# created NM (nmitra@u.washington.edu) dated : Feb 2002 #

#####
#####

proc procUniaxialPinching { materialTag pEnvelopeStress nEnvelopeStress pEnvelopeStrain nEnvelopeStrain rDisp
rForce uForce gammaK gammaD gammaF gammaE damage} {

```

```

# add material - command: uniaxialMaterial ..... paramaters as shown

#uniaxialMaterial Pinching4 tag

#### stress1P strain1P stress2P strain2P stress3P strain3P stress4P strain4P

#### stress1N strain1N stress2N strain2N stress3N strain3N stress4N strain4N

#### rDispP rForceP uForceP rDispN rForceN uForceN

#### gammaK1 gammaK2 gammaK3 gammaK4 gammaKLimit

#### gammaD1 gammaD2 gammaD3 gammaD4 gammaDLimit

#### gammaF1 gammaF2 gammaF3 gammaF4 gammaFLimit gammaE $damage

uniaxialMaterial Pinching4 $materialTag [lindex $pEnvelopeStress 0] [lindex $pEnvelopeStrain 0] [lindex
$pEnvelopeStress 1] [lindex $pEnvelopeStrain 1] [lindex $pEnvelopeStress 2] [lindex $pEnvelopeStrain 2] [lindex
$pEnvelopeStress 3] [lindex $pEnvelopeStrain 3] [lindex $nEnvelopeStress 0] [lindex $nEnvelopeStrain 0] [lindex
$nEnvelopeStress 1] [lindex $nEnvelopeStrain 1] [lindex $nEnvelopeStress 2] [lindex $nEnvelopeStrain 2] [lindex
$nEnvelopeStress 3] [lindex $nEnvelopeStrain 3] [lindex $rDisp 0] [lindex $rForce 0] [lindex $uForce 0] [lindex $rDisp 1]
[lindex $rForce 1] [lindex $uForce 1] [lindex $gammaK 0] [lindex $gammaK 1] [lindex $gammaK 2] [lindex $gammaK 3]
[lindex $gammaK 4] [lindex $gammaD 0] [lindex $gammaD 1] [lindex $gammaD 2] [lindex $gammaD 3] [lindex
$gammaD 4] [lindex $gammaF 0] [lindex $gammaF 1] [lindex $gammaF 2] [lindex $gammaF 3] [lindex $gammaF 4]
$gammaE $damage

}

```

### procRC.tcl

```

#####
#####
#
#           procRC.tcl
## procedure for setting up a reversed cycle loading scheme. The input are mainly the
## peak points for the loading.
## The procedure primarily uses Displacement control for loading, if it fails uses ArcLength control
## created : NM (nmitra@u.washington.edu) dated: Sep 2002

```

```
#####  
#####  
  
proc procRC { incre nodeTag dofTag peakpts } {  
  
set displayTag 0;  
set numTimes 150;  
  
    set x [lindex $peakpts 0];  
    set dU [expr $x/$incre];  
    #set dU0 [expr $dU/1000];  
    set dU0 [expr $dU/10000];  
    integrator DisplacementControl $nodeTag $dofTag 0.0 1 $dU $dU  
    analysis Static  
    analyze $incre  
  
    integrator DisplacementControl $nodeTag $dofTag 0.0 1 [expr -$dU] [expr -$dU]  
    analyze [expr 2*$incre]  
  
    integrator DisplacementControl $nodeTag $dofTag 0.0 1 $dU $dU  
    analyze $incre  
  
    ## end the first peak pt start for others  
  
    for {set j 1} {$j} < [lindex $peakpts] {incr j 1} {  
  
        set y [lindex $peakpts $j]  
        set dSt [expr $y/$dU]  
        set dS [expr int($dSt)]  
  
        test NormDisplIncr 1e-8 $numTimes $displayTag  
        algorithm Newton  
  
##### start loading cycle #####  
        set t 0;  
  
        while {$t != $dS} {
```

```

integrator DisplacementControl $nodeTag $dofTag 0.0 1 $dU $dU
set ok [analyze 1]
incr t 1;

if {$ok != 0} {
#           if {$t == $dS} {break};
           puts "Displacement control failed ..... trying Arc-Length control"
           set currentDisp [nodeDisp $nodeTag $dofTag]
           puts "Current Displacement is $currentDisp"
#           algorithm Linear
           test NormDisplIncr 1e-6 $numTimes $displayTag
           #algorithm ModifiedNewton
#           integrator DisplacementControl $nodeTag $dofTag 0.0 1 $dU0 $dU0
#           integrator DisplacementControl $nodeTag $dofTag 0.0 10 $dU0 $dU0
           integrator ArcLength [expr $dU0] 1.0
#           set ok [analyze 1]
           analyze 1
        }
#           puts "that worked ..... back to regular Newton "
           test NormDisplIncr 1e-8 $numTimes $displayTag
#           algorithm Newton
    }

##### end of loading cycle, start unloading cycle #####

set t 0;

while {$t != [expr 2*$dS]} {
    integrator DisplacementControl $nodeTag $dofTag 0.0 1 [expr -$dU] [expr -$dU]
    set ok [analyze 1]
    incr t 1;

    if {$ok != 0} {
#           if {$t == [expr 2*$dS]} {break};
           puts "Displacement control failed ..... trying Arc-Length control"
           set currentDisp [nodeDisp $nodeTag $dofTag]
           puts "Current Displacement is $currentDisp"
#           algorithm Linear

```

```

        test NormDisplnCr 1e-6 $numTimes $displayTag
        #algorithm ModifiedNewton
#       integrator DisplacementControl $nodeTag $dofTag 0.0 1 [expr -$dU0] [expr -$dU0]
#       integrator DisplacementControl $nodeTag $dofTag 0.0 10 [expr -$dU0] [expr
-$dU0]

        integrator ArcLength [expr $dU0] 1.0
#       set ok [analyze 1]
        analyze 1
    }
#       puts "that worked .... back to regular Newton "
        test NormDisplnCr 1e-8 $numTimes $displayTag
#       algorithm Newton
    }

##### end of unloading cycle, start reloading cycle #####

    set t 0;

    while {$t != $dS} {
        integrator DisplacementControl $nodeTag $dofTag 0.0 1 $dU $dU
        set ok [analyze 1]
        incr t 1;

        if {$ok != 0} {
#           if {$t == $dS} {break};
            puts "Displacement control failed ..... trying Arc-Length control"
            set currentDisp [nodeDisp $nodeTag $dofTag]
            puts "Current Displacement is $currentDisp"
#           algorithm Linear
            test NormDisplnCr 1e-6 $numTimes $displayTag
            #algorithm ModifiedNewton
#           integrator DisplacementControl $nodeTag $dofTag 0.0 1 $dU0 $dU0
#           integrator DisplacementControl $nodeTag $dofTag 0.0 10 $dU0 $dU0
            integrator ArcLength [expr $dU0] 1.0
#           set ok [analyze 1]
            analyze 1
        }
    }

```

```

#           puts "that worked .... back to regular Newton "
           test NormDisplncr 1e-8 $numTimes $displayTag
#           algorithm Newton
           }

##### reloading cycle completed #####

           if {$ok == 0} {
               puts "analysis succesful at $y mm displacement";
           } else {
               puts "analysis could not proceed fine beyond $y mm displacement";
           }
       }
   }
}

```

---

## UC Davis Soil Elements

For further information or examples about the following elements, please visit:

<http://sokocalo.engr.ucdavis.edu/~jeremic/> (<http://sokocalo.engr.ucdavis.edu/~jeremic/>)

---

## FourNodeQuadUP Element

FourNodeQuadUP is a four-node plane-strain element using bilinear isoparametric formulation. This element is implemented for simulating dynamic response of solid-fluid fully coupled material, based on Biot's theory of porous medium. Each element node has 3 degrees-of-freedom (DOF): DOF 1 and 2 for solid displacement (u) and DOF 3 for fluid pressure (p).

```

element quadUP $eleTag $iNode $jNode $kNode $lNode $thick $type
    $matTag $bulk $fmass $hPerm $vPerm <$b1 $b2 $t>

```

**\$eleTag** unique element object tag

**\$iNode, \$jNode, \$kNode, \$lNode** Four element node (previously defined) numbers in counter-clockwise order around the element

**\$thick** Element thickness



<b>\$type</b>	The string "PlaneStrain"
<b>\$matTag</b>	Tag of an NDMaterial object (previously defined) of which the element is composed
<b>\$bulk</b>	<p>Combined undrained bulk modulus <math>B_c</math> relating changes in pore pressure and volumetric strain, may be approximated by:</p> $B_c \approx B_f / n$ <p>where <math>B_f</math> is the bulk modulus of fluid phase (<math>2.2 \times 10^6</math> kPa for water), and <math>n</math> the initial porosity.</p>
<b>\$fmass</b>	Fluid mass density
<b>\$hPerm</b>	Permeability coefficient in horizontal direction
<b>\$vPerm</b>	Permeability coefficient in vertical direction
<b>\$b1, \$b2</b>	Optional body forces in horizontal and vertical directions respectively (defaults are 0.0)
<b>\$t</b>	Optional uniform element normal traction, positive in tension (default is 0.0)

**TYPICAL RANGE OF PERMEABILITY COEFFICIENT (m/s)**

Gravel	Sand	Silty Sand	Silt	Clay
$>1.0 \times 10^{-3}$	$1.0 \times 10^{-5} \sim 1.0 \times 10^{-3}$	$1.0 \times 10^{-7} \sim 1.0 \times 10^{-5}$	$1.0 \times 10^{-9} \sim 1.0 \times 10^{-7}$	$<1.0 \times 10^{-9}$

**OUTPUT INTERFACE:**

Pore pressure can be recorded at an element node using OpenSees *Node Recorder* (page 303):

**recorder Node <-file \$fileName> <-time> <-node (\$node1 \$node2 ...)> -dof 3 vel**

Note: dof 3 is for pore pressure output.

The valid queries to a quadUP element when creating an *ElementRecorder* (page 307) are 'force', 'stiffness', or 'material matNum matArg1 matArg2 ...', where matNum represents the material object at the corresponding integration point.

## u-p-U element

This command is used to construct a u-p-U element object, which include two types: eight node element and twenty node element.

- For eight-node element:

```
element Brick8N_u_p_U $eleTag $node1 $node2 $node3 $node4 $node5
    $node6 $node7 $node8 $matTag $bf1 $bf2 $bf3 $n $alpha $soildDens
    $fluidDens $k1 $k2 $k3 $K_fluid $P
```

- For twenty-node element:

```
element Brick20N_u_p_U $eleTag $node1 $node2 $node3 $node4 $node5
    $node6 $node7 $node8 $node9 $node10 $node11 $node12 $node13
    $node14 $node15 $node16 $node17 $node18 $node19 $node20
    $matTag $bf1 $bf2 $bf3 $n $alpha $soildDens $fluidDens $k1 $k2 $k3
    $K_fluid $P
```

<b>\$eleTag</b>	unique element object tag
<b>\$node1 \$node2 \$node3 \$node4 \$node5 \$node6 \$node7 \$node8 ....</b>	node coordinate (either eight or twenty), input order is shown in the figure
<b>\$matTag</b>	material tag associated with previously-defined NDMaterial object
<b>\$bf1 \$bf2 \$bf3</b>	body force in the direction of global coordinates x, y and z
<b>\$n</b>	porosity
<b>\$alpha</b>	$1 - K_s / K_t$ (ratio of void space =1 for soils, =0.6 for concrete...)
<b>\$soildDens</b>	solid density
<b>\$fluidDens</b>	fluid density
<b>\$k1 \$k1 \$k3</b>	coefficient of permeability in the direction of x, y and z
<b>\$K_fluid</b>	fluid bulk modulus
<b>\$P</b>	pressure... not used currently (set to 0.0)

The valid queries to a Brick8N\_u\_p\_U and Brick20N\_u\_p\_U elements when creating an *ElementRecorder* (page 307) object are 'force,' 'stiffness,' 'stress', 'gausspoint' or 'plastic'. The output is given as follows:

'stress'	the six stress components from each Gauss points are output by the order: $\sigma_{xx}$ , $\sigma_{yy}$ , $\sigma_{zz}$ , $\sigma_{xy}$ , $\sigma_{xz}$ , $\sigma_{yz}$
'gausspoint'	the coordinates of all Gauss points are printed out
'plastic'	the equivalent deviatoric plastic strain from each Gauss point is output in the same order as the coordinates are printed

## Eight Node Brick Element

The command is used to construct an eight-node three dimensional brick element object, which is based on tensor operation.

**element Brick8N \$eletag \$node1 \$node2 \$node3 \$node4 \$node5 \$node6 \$node7 \$node8 \$matTag \$bf1 \$bf2 \$bf3 \$massDens**

<b>\$eletag</b>	unique element object tag
<b>\$node1 \$node2 \$node3 \$node4 \$node5 \$node6 \$node7 \$node8</b>	eight node coordinates, input order is shown in the figure
<b>\$matTag</b>	material tag associated with previously-defined NDMaterial object
<b>\$bf1 \$bf2 \$bf3</b>	body force in the direction of global coordinates x, y and z
<b>\$massDens</b>	mass density (mass/volume)

The valid queries to a Brick8N element when creating an *ElementRecorder* (page 307) object are 'force,' 'stiffness,' 'stress', 'gausspoint' or 'plastic'. The output is given as follows:

'stress'	the six stress components from each Gauss points are output by the order: $\sigma_{xx}$ , $\sigma_{yy}$ , $\sigma_{zz}$ , $\sigma_{xy}$ , $\sigma_{xz}$ , $\sigma_{yz}$
'gausspoint'	the coordinates of all Gauss points are printed out

'plastic'

the equivalent deviatoric plastic strain from each Gauss point is output in the same order as the coordinates are printed

Figure 52: Node Numbering for Eight-Node Three-Dimensional Element

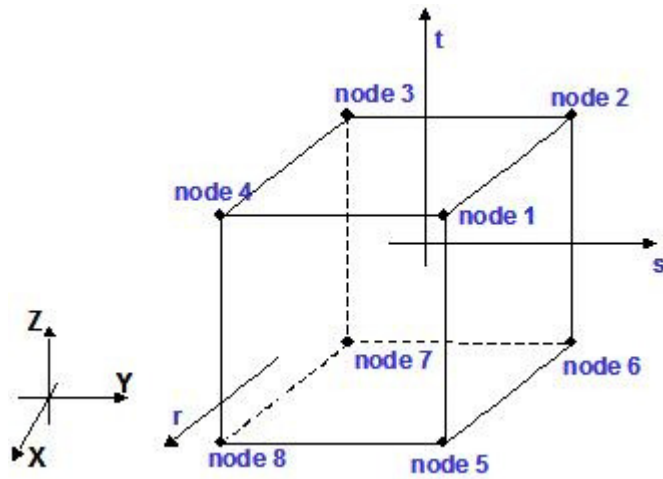

## Twenty Node Brick Element

The element is used to construct a twenty-node three dimensional element object

```
element Brick20N $eletag $node1 $node2 $node3 $node4 $node5 $node6
                $node7 $node8 $node9 $node10 $node11 $node12 $node13 $node14
                $node15 $node16 $node17 $node18 $node19 $node20 $matTag $bf1
                $bf2 $bf3 $massDen
```

<b>\$eletag</b>	unique element object tag
<b>\$node1 \$node2 \$node3 \$node4 \$node5 \$node6 \$node7 \$node8 \$node9 \$node10 \$node11 \$node12 \$node13 \$node14 \$node15 \$node16 \$node17 \$node18 \$node19 \$node20</b>	twenty node coordinates, input order is shown in the figure
<b>\$matTag</b>	material tag associated with previously-defined <i>NDMaterial</i> (page 162) object
<b>\$bf1 \$bf2 \$bf3</b>	body force in the direction of global coordinates x, y and z
<b>\$massDen</b>	mass density (mass/volume)

The valid queries to a Brick20N element when creating an *ElementRecorder* (page 307) object are 'force,' 'stiffness,' 'stress', 'gausspoint' or 'plastic'. The output is given as follows:

'stress'	the six stress components from each Gauss points are output by the order: sigma_xx, sigma_yy, sigma_zz, sigma_xy, sigma_xz, sigma_yz
'gausspoint'	the coordinates of all Gauss points are printed out
'plastic'	the equivalent deviatoric plastic strain from each Gauss point is output in the same order as the coordinates are printed

Figure 53: Node Numbering for Twenty-Node Three-Dimensional Element

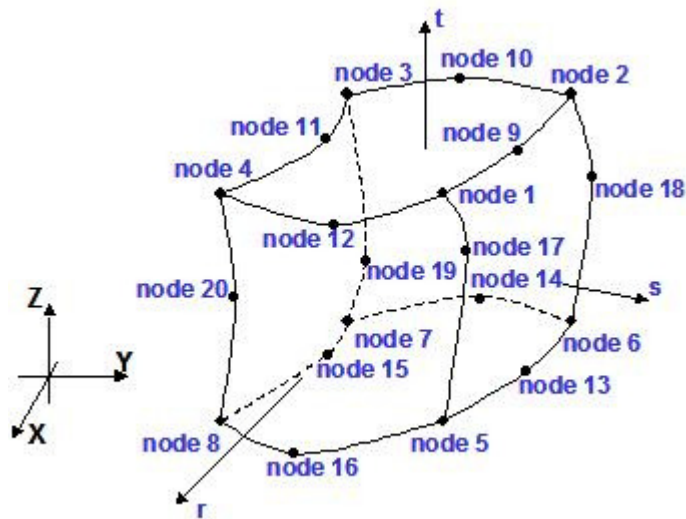

## CHAPTER 22

# UC San Diego Soil Elements

This chapter describes the user interfaces for: 1) a number of NDMaterial models developed for simulating nonlinear, drained/undrained soil response under general 3D cyclic loading conditions, and 2) a number of 2D and 3D solid-fluid fully coupled elements for simulating pore water pressure dissipation/redistribution.

**Please visit <http://cyclic.ucsd.edu/opensees> (<http://cyclic.ucsd.edu/opensees>) for examples.**

This documentation is last updated at 8/5/2005 by Zhaohui Yang ([zhyang@ucsd.edu](mailto:zhyang@ucsd.edu)) (<mailto:zhyang@ucsd.edu>) and Ahmed Elgamal ([elgamal@ucsd.edu](mailto:elgamal@ucsd.edu)) (<mailto:elgamal@ucsd.edu>).

## In This Chapter

FourNodeQuadUP.....	264
Nine_Four_Node_QuadUP .....	266
BrickUP .....	268
Twenty_Eight_Node_BrickUP .....	270

## FourNodeQuadUP

**FourNodeQuadUP** is a four-node plane-strain element using bilinear isoparametric formulation. This element is implemented for simulating dynamic response of solid-fluid fully coupled material, based on Biot's theory of porous medium. Each element node has 3 degrees-of-freedom (DOF): DOF 1 and 2 for solid displacement (u) and DOF 3 for fluid pressure (p). **Please visit <http://cyclic.ucsd.edu/opensees> (<http://cyclic.ucsd.edu/opensees>) for examples.**

### OUTPUT INTERFACE:

Pore pressure can be recorded at an element node using OpenSees Node Recorder:

```
recorder Node <-file $fileName> <-time> <-node ($nod1 $nod2 ...)> -dof 3 vel
```

See OpenSees command manual (McKenna and Fenves 2001) for nodal displacement, velocity, or acceleration recorders.

The valid queries to a quadUP element when creating an ElementRecorder are 'force', 'stiffness', or 'material matNum matArg1 matArg2 ...', where matNum represents the material object at the corresponding integration point.

```
element quadUP $eleTag $iNode $jNode $kNode $lNode $thick $matTag
    $bulk $fmass $hPerm $vPerm <$b1=0 $b2=0 $t=0>
```

<b>\$eleTag</b>	A positive integer uniquely identifying the element among all elements
<b>\$iNode, \$jNode, \$kNode, \$lNode</b>	Four element node (previously defined) numbers in counter-clockwise order around the element
<b>\$thick</b>	Element thickness
<b>\$matTag</b>	Tag of an NDMaterial object (previously defined) of which the element is composed



<b>\$bulk</b>	Combined undrained bulk modulus $B_c$ relating changes in pore pressure and volumetric strain, may be approximated by:  $B_c \approx B_f / n$ where $B_f$ is the bulk modulus of fluid phase ( $2.2 \times 10^6$ kPa for water), and $n$ the initial porosity.
<b>\$fmass</b>	Fluid mass density
<b>\$hPerm</b>	Permeability coefficient in horizontal direction
<b>\$vPerm</b>	Permeability coefficient in vertical direction
<b>\$b1, \$b2</b>	Optional gravity acceleration components in horizontal and vertical directions respectively (defaults are 0.0)
<b>\$t</b>	Optional uniform element normal traction, positive in tension (default is 0.0)

## TYPICAL RANGE OF PERMEABILITY COEFFICIENT (cm/s)

Gravel	Sand	Silty Sand	Silt	Clay
$>1.0 \times 10^{-1}$	$1.0 \times 10^{-3} \sim 1.0 \times 10^{-1}$	$1.0 \times 10^{-5} \sim 1.0 \times 10^{-3}$	$1.0 \times 10^{-7} \sim 1.0 \times 10^{-5}$	$<1.0 \times 10^{-7}$

## Nine\_Four\_Node\_QuadUP

**Nine\_Four\_Node\_QuadUP** is a 9-node quadrilateral plane-strain element. The four corner nodes have 3 degrees-of-freedom (DOF) each: DOF 1 and 2 for solid displacement (u) and DOF 3 for fluid pressure (p). The other five nodes have 2 DOFs each for solid displacement. This element is implemented for simulating dynamic response of solid-fluid fully coupled material, based on Biot's theory of porous medium. **Please visit <http://cyclic.ucsd.edu/opensees> (<http://cyclic.ucsd.edu/opensees>) for examples.**

### OUTPUT INTERFACE:

Pore pressure can be recorded at an element node using OpenSees Node Recorder:

```
recorder Node <-file $fileName> <-time> <-node ($nod1 $nod2 ...)> -dof 3 vel
```

See OpenSees command manual (McKenna and Fenves 2001) for nodal displacement, velocity, or acceleration recorders.

The valid queries to a Nine\_Four\_Node\_QuadUP element when creating an ElementRecorder are 'force', 'stiffness', or 'material matNum matArg1 matArg2 ...', where matNum represents the material object at the corresponding integration point.

```
element 9_4_QuadUP $eleTag $Node1 $Node2 $Node3 $Node4 $Node5
  $Node6 $Node7 $Node8 $Node9 $thick $matTag $bulk $fmass
  $hPerm $vPerm <$b1=0 $b2=0>
```

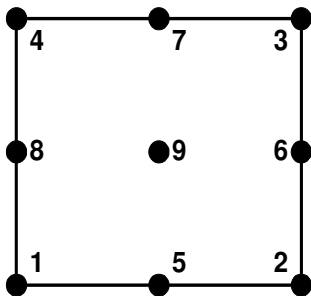

- \$eleTag**      A positive integer uniquely identifying the element among all elements
- \$Node1,...  
\$Node9**      Nine element node (previously defined) numbers (see figure above for order of numbering).
- \$thick**      Element thickness

<b>\$matTag</b>	Tag of an NDMaterial object (previously defined) of which the element is composed
<b>\$bulk</b>	Combined undrained bulk modulus $B_c$ relating changes in pore pressure and volumetric strain, may be approximated by:  $B_c \approx B_f / n$ where $B_f$ is the bulk modulus of fluid phase ( $2.2 \times 10^6$ kPa for water), and $n$ the initial porosity.
<b>\$fmass</b>	Fluid mass density
<b>\$hPerm, \$vPerm</b>	Permeability coefficient in horizontal and vertical directions respectively.
<b>\$b1, \$b2</b>	Optional gravity acceleration components in horizontal and vertical directions respectively (defaults are 0.0)

## BrickUP

**BrickUP** is an 8-node hexahedral linear isoparametric element. Each node has 4 degrees-of-freedom (DOF): DOFs 1 to 3 for solid displacement ( $u$ ) and DOF 4 for fluid pressure ( $p$ ). This element is implemented for simulating dynamic response of solid-fluid fully coupled material, based on Biot's theory of porous medium. **Please visit <http://cyclic.ucsd.edu/opensees> (<http://cyclic.ucsd.edu/opensees>) for examples.**

### OUTPUT INTERFACE:

Pore pressure can be recorded at an element node using OpenSees Node Recorder:

```
recorder Node <-file $fileName> <-time> <-node ($nod1 $nod2 ...)> -dof 3 vel
```

See OpenSees command manual (McKenna and Fenves 2001) for nodal displacement, velocity, or acceleration recorders.

The valid queries to a BrickUP element when creating an ElementRecorder are 'force', 'stiffness', or 'material matNum matArg1 matArg2 ...', where matNum represents the material object at the corresponding integration point.

```
element brickUP $eleTag $Node1 $Node2 $Node3 $Node4 $Node5 $Node6
  $Node7 $Node8 $matTag $bulk $fmass $PermX $PermY $PermZ
  <$bX=0 $bY=0 $bZ=0>
```

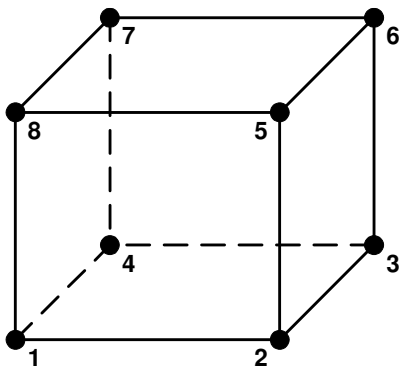

**\$eleTag** A positive integer uniquely identifying the element among all elements

**\$Node1,...  
\$Node8** Eight element node (previously defined) numbers (see figure above for order of numbering).

**\$matTag** Tag of an NDMaterial object (previously defined) of which the element is composed

**\$bulk** Combined undrained bulk modulus  $B_c$  relating changes in pore pressure and volumetric strain, may be approximated by:

$$B_c \approx B_f / n$$

where  $B_f$  is the bulk modulus of fluid phase ( $2.2 \times 10^6$  kPa for water), and  $n$  the initial porosity.

**\$fmass** Fluid mass density

**\$permX,**  
**\$permY,**  
**\$permZ** Permeability coefficients in x, y, and z directions respectively.

**\$bX, \$bY,**  
**\$bZ** Optional gravity acceleration components in x, y, and z directions directions respectively (defaults are 0.0)

## Twenty\_Eight\_Node\_BrickUP

**Twenty\_Eight\_Node\_BrickUP** is a 20-node hexahedral isoparametric element. The eight corner nodes have 4 degrees-of-freedom (DOF) each: DOFs 1 to 3 for solid displacement ( $u$ ) and DOF 4 for fluid pressure ( $p$ ). The other nodes have 3 DOFs each for solid displacement. This element is implemented for simulating dynamic response of solid-fluid fully coupled material, based on Biot's theory of porous medium. **Please visit <http://cyclic.ucsd.edu/opensees> (<http://cyclic.ucsd.edu/opensees>) for examples.**

### OUTPUT INTERFACE:

Pore pressure can be recorded at an element node using OpenSees Node Recorder:

```
recorder Node <-file $fileName> <-time> <-node ($nod1 $nod2 ...)> -dof 3 vel
```

See OpenSees command manual (McKenna and Fenves 2001) for nodal displacement, velocity, or acceleration recorders.

The valid queries to a **Twenty\_Eight\_Node\_BrickUP** element when creating an **ElementRecorder** are 'force', 'stiffness', or 'material matNum matArg1 matArg2 ...', where matNum represents the material object at the corresponding integration point.

```
element 20_8_BrickUP $eleTag $Node1 ... $Node20 $matTag $bulk $fmass
  $PermX $PermY $PermZ <$bX=0 $bY=0 $bZ=0>
```

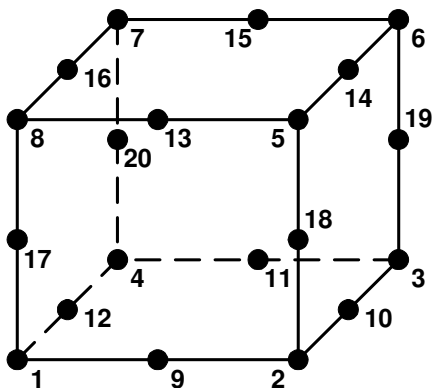

**\$eleTag** A positive integer uniquely identifying the element among all elements

---

<b>\$Node1,... \$Node20</b>	20 element node (previously defined) numbers (see figure above for order of numbering).
<b>\$matTag</b>	Tag of an NDMaterial object (previously defined) of which the element is composed
<b>\$bulk</b>	Combined undrained bulk modulus $B_c$ relating changes in pore pressure and volumetric strain, may be approximated by:  $B_c \approx B_f / n$ where $B_f$ is the bulk modulus of fluid phase ( $2.2 \times 10^6$ kPa for water), and $n$ the initial porosity.
<b>\$fmass</b>	Fluid mass density
<b>\$permX, \$permY, \$permZ</b>	Permeability coefficients in x, y, and z directions respectively.
<b>\$bX, \$bY, \$bZ</b>	Optional gravity acceleration components in x, y, and z directions directions respectively (defaults are 0.0)

## References

Elgamal, A., Lai, T., Yang, Z. and He, L. (2001). "Dynamic Soil Properties, Seismic Downhole Arrays and Applications in Practice," State-of-the-art paper, Proc., 4th Intl. Conf. on Recent Advances in Geote. E.Q. Engrg. Soil Dyn. March 26-31, San Diego, CA, S. Prakash (Ed.).

**Elgamal, A., Yang, Z. and Parra, E. (2002). "Computational Modeling of Cyclic Mobility and Post-Liquefaction Site Response," *Soil Dyn. Earthquake Engrg.*, 22(4), 259-271.**

Elgamal, A., Yang, Z., Parra, E. and Ragheb, A. (2003). "Modeling of Cyclic Mobility in Saturated Cohesionless Soils," *Int. J. Plasticity*, 19(6), 883-905.

McKenna, F. and Fenves, G. (2001). "The OpenSees Command Language Manual: version 1.2," Pacific Earthquake Engineering Center, Univ. of Calif., Berkeley. (<http://opensees.berkeley.edu>).

Parra, E. (1996). "Numerical Modeling of Liquefaction and Lateral Ground Deformation Including Cyclic Mobility and Dilation Response in Soil Systems," Ph.D. Thesis, Dept. of Civil Engineering, Rensselaer Polytechnic Institute, Troy, NY.

Yang, Z. (2000). "Numerical Modeling of Earthquake Site Response Including Dilation and Liquefaction," Ph.D. Thesis, Dept. of Civil Engineering and Engineering Mechanics, Columbia University, NY, New York.

**Yang, Z. and Elgamal, A. (2002). "Influence of Permeability on Liquefaction-Induced Shear Deformation," *J. Engrg. Mech., ASCE*, 128(7), 720-729.**

**Yang, Z., Elgamal, A. and Parra, E. (2003). "A Computational Model for Liquefaction and Associated Shear Deformation," *J. Geotechnical and Geoenvironmental Engineering, ASCE*, 129(12), 1119-1127.**



## CHAPTER 23

# block Command

The `block` command is used to generate meshes of quadrilateral or brick finite element.

The `block2D` (page 274) command generates meshes of quadrilateral elements in two or three dimensions. In three dimensions, a two-dimensional surface appropriate for shell analysis is generated.

The `block3D` (page 276) command generates three-dimensional meshes of eight-node brick solid element.

## In This Chapter

<code>block2D</code> Command.....	274
<code>block3D</code> Command.....	276

## block2D Command

The block2D command generates meshes of quadrilateral elements in two or three dimensions. In three dimensions, a two-dimensional surface appropriate for shell analysis is generated.

```

block2d $nx $ny $e1 $n1 element (element arguments) {
    1 $x1 $y1 <$z1>
    2 $x2 $y2 <$z2>
    3 $x3 $y3 <$z3>
    4 $x4 $y4 <$z4>
    <5> <$x5> <$y5> <$z5>
    <6> <$x6> <$y6> <$z6>
    <7> <$x7> <$y7> <$z7>
    <8> <$x8> <$y8> <$z8>
    <9> <$x9> <$y9> <$z9>
}

```

<b>\$nx</b>	<b>\$ny</b>	number of elements in the local x and y directions of the block, respectively
<b>\$e1</b>	<b>\$n1</b>	starting element and node number for generation, respectively
<b>element</b>		string defining which <i>quadrilateral element</i> (page 228, page 229, page 227, page 228) is being used
<b>(element arguments)</b>		list of data parameters for element being used. This list may include, but is not limited to, a \$matTag number
<b>{\$x1, .... \$x9} {\$y1, .... \$y9}</b>		coordinates of the block elements in two dimensions
<b>{\$z1, .... \$z9}</b>		coordinate of the block elements in third dimension (optional, default=0.0)

Only the first four nodes (1-4) are required. Nodes 5-9 are used to generate curved meshes. The user may specify any combination of nodes 5-9, omitting some of them if desired.

NOTE: this command only recognizes variable substitutions when the command arguments are placed in quotes rather than braces

EXAMPLE:

```

block2d $nx $ny $e1 $n1 element (element arguments) {
  1 $x1 $y1 <$z1>
  2 $x2 $y2 <$z2>
  3 $x3 $y3 <$z3>
  4 $x4 $y4 <$z4>
  <5> <$x5> <$y5> <$z5>
  <6> <$x6> <$y6> <$z6>
  <7> <$x7> <$y7> <$z7>
  <8> <$x8> <$y8> <$z8>
  <9> <$x9> <$y9> <$z9>
}

```

Figure 54: Node Numbering for Nine-Node block2D

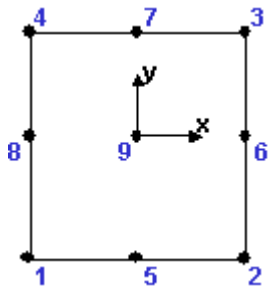

## block3D Command

The block3D command generates three-dimensional meshes of eight-node brick solid element.

```

block3d $nx $ny $nz $e1 $n1 element elementArgs {
    1 $x1 $y1 $z1
    2 $x2 $y2 $z2
    3 $x3 $y3 $z3
    4 $x4 $y4 $z4
    5 $x5 $y5 $z5
    6 $x6 $y6 $z6
    7 $x7 $y7 $z7
    8 $x8 $y8 $z8
    <9> <$x9> <$y9> <$z9>
    ...
    <27> <$x27> <$y27> <$z27>
}

```

<b>\$nx \$ny \$nz</b>	number of elements in the local x,y and z-direction of the block
<b>\$e1</b>	starting element number for generation
<b>\$n1</b>	starting node number for generation
<b>element</b>	define which <i>brick element</i> (page 231, page 230) is being used
<b>elementArgs</b>	list of data parameters for element being used. This list may include, but is not limited to, a \$matTag number
<b>{\$x1, ..., \$x27} {\$y1, ..., \$y27} {\$z1, ..., \$z27}</b>	coordinates of the block elements in three dimensions.

NOTE: this command only recognizes variable substitutions when the command arguments are placed in quotes rather than braces

Only the first eight nodes (1-8) are required. Nodes 9-27 are used to generate curved meshes. The user may specify any combination of nodes 9-27, omitting some of them if desired.

## CHAPTER 24

# region Command

The region command is used to label a group of nodes and elements. This command is also used to assign rayleigh damping parameters to the nodes and elements in this region.

```
region $regTag <-ele ($ele1 $ele2 ...)> <-eleRange $startEle $endEle> <-ele all>
      <-node ($node1 $node2 ...)> <-nodeRange $startNode $endNode>
      <-node all> <-rayleigh $alphaM $betaK $betaKinit $betaKcomm>
```

The region is specified by either elements or nodes, not both. If elements are defined, the region includes these elements and the all connected nodes. If nodes are specified, the region includes these nodes and all elements whose external nodes are prescribed.

<b>\$regTag</b>	unique integer tag
<b>\$ele1 \$ele2 ...</b>	tags of elements -- selected elements in domain (optional, default: omitted)
<b>\$startEle \$endEle</b>	tag for start and end elements -- range of selected elements in domain (optional, default: all)
<b>all</b>	all elements in domain (optional & default)
<b>\$alphaM \$betaK \$betaKinit \$betaKcomm</b>	Arguments to define Rayleigh damping matrix (optional, default: zero)

OR:

<b>\$regTag</b>	unique integer tag
<b>\$node1 \$node2 ...</b>	node tags -- select nodes in domain (optional, default: all)
<b>\$startNode \$endNode</b>	tag for start and end nodes -- range of nodes in domain (optional, default: all)
<b>all</b>	all nodes in domain (optional & default)
<b>\$alphaM \$betaK \$betaKinit \$betaKcomm</b>	Arguments to define Rayleigh damping matrix (optional, default: zero)

The damping matrix  $D$  is specified as a combination of stiffness and mass-proportional damping matrices:

$$D = \$alphaM * M + \$betaK * K_{current} + \$betaKinit * K_{init} + \$betaKcomm * K_{lastCommit}$$

The mass and stiffness matrices are defined as:

M	mass matrix used to calculate Rayleigh Damping
Kcurrent	stiffness matrix at current state determination used to calculate Rayleigh Damping
Kinit	stiffness matrix at initial state determination used to calculate Rayleigh Damping
KlastCommit	stiffness matrix at last-committed state determination used to calculate Rayleigh Damping

**NOTE:** a region is defined by either nodes or elements, not both.

**EXAMPLE:**

**region 1 -ele 1 5 -eleRange 10 15**

**region 2 -node 2 4 6 -nodeRange 9 12**

## CHAPTER 25

# Geometric Transformation Command

The geometric-transformation command (`geomTransf`) is used to construct a coordinate-transformation (`CrdTransf`) object, which transforms beam element stiffness and resisting force from the basic system to the global-coordinate system. The command has at least one argument, the transformation type. Each type is outlined below.

## In This Chapter

Linear Transformation .....	280
P-Delta Transformation .....	286
Corotational Transformation .....	287

---

## Linear Transformation

This command is used to construct a linear coordinate transformation (`LinearCrdTransf`) object, which performs a linear geometric transformation of beam stiffness and resisting force from the basic system to the global-coordinate system.

For a two-dimensional problem:

```
geomTransf Linear $transfTag <-jntOffset $dXi $dYi $dXj $dYj>
```

For a three-dimensional problem:

```
geomTransf Linear $transfTag $vecxzX $vecxzY $vecxzZ <-jntOffset $dXi $dYi $dZi $dXj $dYj $dZj>
```

**\$transfTag**                      unique identifier for `CrdTransf` object



**\$vecxzX \$vecxzY  
\$vecxzZ**

X, Y, and Z components of  $\text{vecxz}$ , the vector used to define the local x-z plane of the local-coordinate system. The local y-axis is defined by taking the cross product of the x-axis and the  $\text{vecxz}$  vector.

These components are specified in the global-coordinate system X,Y,Z and define a vector that is in a plane parallel to the x-z plane of the local-coordinate system.

These items need to be specified for the three-dimensional problem.

**\$dXi \$dYi \$dZi**

joint offset values -- absolute offsets specified with respect to the global coordinate system for element-end node i (the number of arguments depends on the dimensions of the current model) (optional)

**\$dXj \$dYj \$dZj**

joint offset values -- absolute offsets specified with respect to the global coordinate system for element-end node j (the number of arguments depends on the dimensions of the current model) (optional)

The element coordinate system is specified as follows:

The x-axis is the axis connecting the two element nodes; the y- and z-axes are then defined using a vector that lies on a plane parallel to the local x-z plane --  $\text{vecxz}$ . The y-axis is defined by taking the cross product of the x-axis and the  $\text{vecxz}$  vector. The section is attached to the element such that the y-z coordinate system used to specify the section corresponds to the y-z axes of the element.

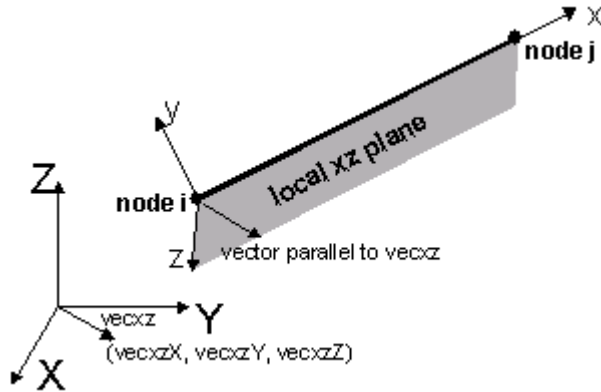
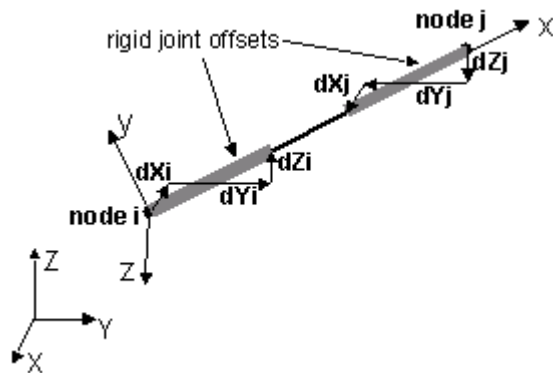

Figure 55: Definition of the Local Coordinate System



*Figure 56: Definition of Rigid Joint Offset (note: check sign of  $dX_i$ , etc components)*

The following figures should aid in understanding the vector  $\text{vecxz}$  definition:

### element cross-section:

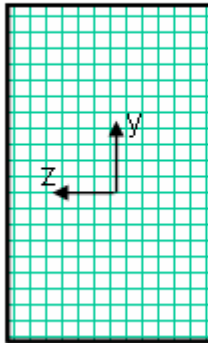

element 1

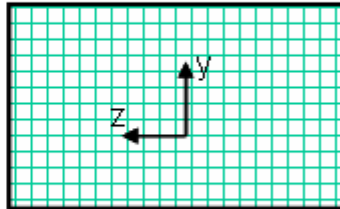

element 2

### element orientation:

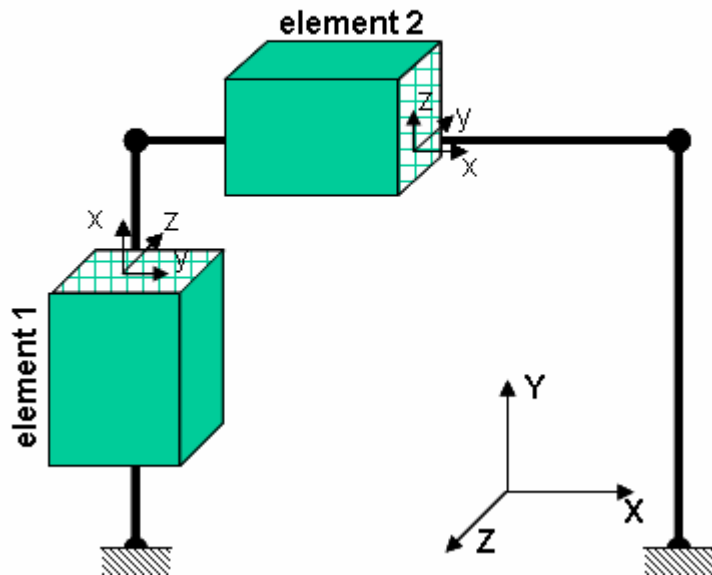

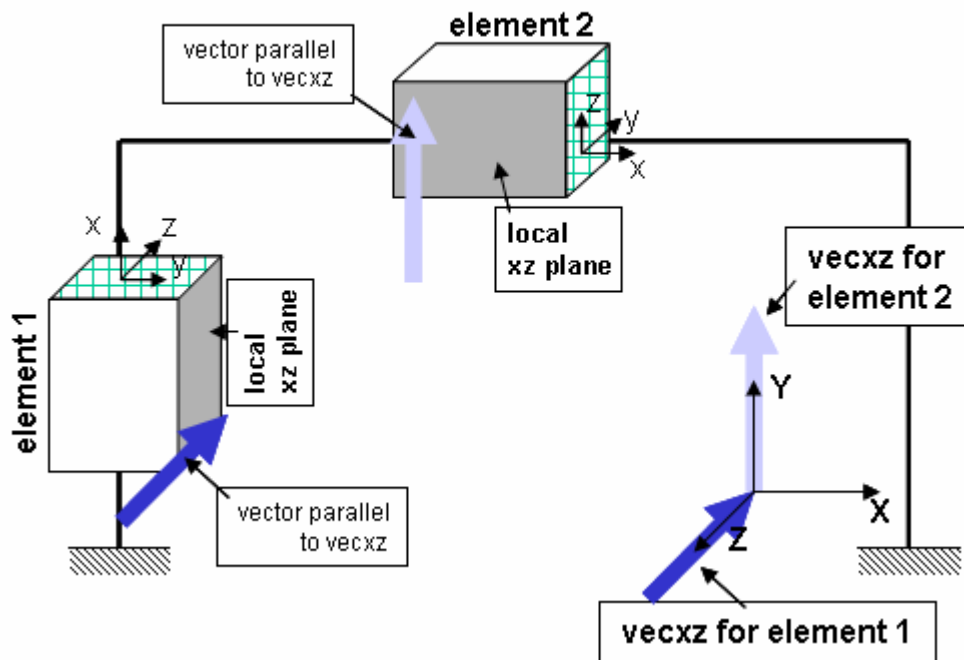
**element xz plane and vectors:****linear transformation command:**

element 1:

vecxz = z axis, coords: (0 0 -1)

**geomTransf Linear \$transfTag 0 0 -1**

element 2:

vecxz = y axis, coords: (0 1 0)

**geomTransf Linear \$transfTag 0 1 0**

## P-Delta Transformation

This command is used to construct the P-Delta Coordinate Transformation (PDeltaCrdTransf) object, which performs a linear geometric transformation of beam stiffness and resisting force from the basic system to the global coordinate system, considering second-order P-Delta effects.

For a two-dimensional problem:

```
geomTransf PDelta $transfTag <-jntOffset $dXi $dYi $dXj $dYj>
```

For a three-dimensional problem:

```
geomTransf PDelta $transfTag $vecxzX $vecxzY $vecxzZ <-jntOffset $dXi $dYi $dZi $dXj $dYj $dZj>
```

The element coordinate system and joint offset values are specified as in the *Linear transformation* (page 280).

<b>\$transfTag</b>	unique identifier for CrdTransf object
<b>\$vecxzX \$vecxzY \$vecxzZ</b>	X, Y, and Z components of vecxz, the vector used to define the local x-z plane of the local-coordinate system. (These items need to be specified for the three-dimensional problem.)  These components are specified in the global-coordinate system X,Y,Z and define a vector that is in a plane parallel to the x-z plane of the local-coordinate system.  These items need to be specified for the three-dimensional problem.
<b>\$dXi \$dYi \$dZi</b>	joint offset values -- absolute offsets specified with respect to the global coordinate system for element-end node i (the number of arguments depends on the dimensions of the current <i>model</i> (page 34)) (optional)
<b>\$dXj \$dYj \$dZj</b>	joint offset values -- absolute offsets specified with respect to the global coordinate system for element-end node j (the number of arguments depends on the dimensions of the current <i>model</i> (page 34)) (optional)

## Corotational Transformation

This command is used to construct the Corotational Coordinate Transformation (CorotCrdTransf) object, which performs an exact geometric transformation of beam stiffness and resisting force from the basic system to the global coordinate system.

For a two-dimensional problem:

```
geomTransf Corotational $transfTag <-jntOffset $dXi $dYi $dXj $dYj>
```

For a three-dimensional problem:

```
geomTransf Corotational $transfTag $vecxzX $vecxzY $vecxzZ <-jntOffset $dXi $dYi $dZi $dXj $dYj $dZj>
```

**NOTE:** The Corotational transformation is only available with the Win32 version of *OpenSees* (<http://opensees.berkeley.edu/OpenSees/binaries.html>).

The element coordinate system and joint offset values are specified as in the *Linear transformation* (page 280).

<b>\$transfTag</b>	unique identifier for CrdTransf object
<b>\$vecxzX \$vecxzY \$vecxzZ</b>	X, Y, and Z components of vecxz, the vector used to define the local x-z plane of the local-coordinate system. (These items need to be specified for the three-dimensional problem.)  These components are specified in the global-coordinate system X,Y,Z and define a vector that is in a plane parallel to the x-z plane of the local-coordinate system.
<b>\$dXi \$dYi \$dZi</b>	joint offset values -- absolute offsets specified with respect to the global coordinate system for element-end node i (the number of arguments depends on the dimensions of the current <i>model</i> (page 34)) (optional)
<b>\$dXj \$dYj \$dZj</b>	joint offset values -- absolute offsets specified with respect to the global coordinate system for element-end node j (the number of arguments depends on the dimensions of the current <i>model</i> (page 34)) (optional)

## CHAPTER 26

# Time Series

While there is no `timeSeries` command in the language, a number of commands take as the argument a list of items which defines the `TimeSeries` object to be constructed as part of the command, such as the *LoadPattern* (page 294) and *groundMotion* (page 299) objects.

Time series act differently depending on what type of object they are applied to:

**LoadPattern** (page 294) **object:**

Load factors are applied to the loads and constraints

**groundMotion** (page 299) **object:**

Load factors are applied at the DOF in a ground motion

The type of `TimeSeries` objects available are presented in this chapter.

**NOTE:** The `TimeSeries` objects are handled by the Tcl interpreter as lists. Therefore, they can be defined a-priori within quotes "" and given a variable name. EXAMPLE:

```
set Gaccel "Series -dt $dt -filePath $outFile -factor $GMfatt"; # time series information
pattern UniformExcitation 2 1 -accel $Gaccel;           # create uniform excitation
```

## In This Chapter

Constant Time Series .....	289
Linear Time Series .....	289
Rectangular Time Series .....	290
Sine Time Series .....	291
Path Time Series .....	292



---

## Constant Time Series

This command creates a `ConstantSeries` *TimeSeries* (page 288) object and associates it to the `LoadPattern` (page 294) object being constructed.

**Constant** <-factor \$cFactor>

**\$cFactor** load-factor coefficient. (optional. default = 1.0)

The load factor to be applied to the loads and constraints in the `LoadPattern` object is constant and equal to **\$cFactor**.

Figure 57: Constant Time Series

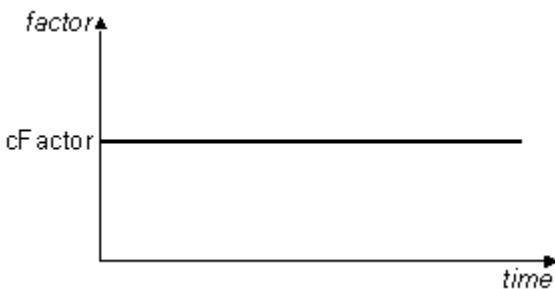

---

## Linear Time Series

This command creates a `LinearSeries` *TimeSeries* (page 288) object and associates it to the `LoadPattern` (page 294) or `groundMotion` (page 299) object being constructed.

**Linear** <-factor \$cFactor>

**\$cFactor** load-factor coefficient. (optional. default = 1.0)

The load factor to be applied to the loads and constraints in the LoadPattern or groundMotion object is equal to **\$cFactor\* time**

Figure 58: Linear Time Series

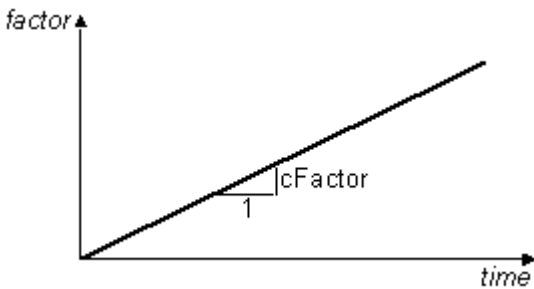

---

## Rectangular Time Series

This command creates a RectangularSeries *TimeSeries* (page 288) object and associates it to the *LoadPattern* (page 294) object being constructed.

**Rectangular \$tStart \$tFinish <-factor \$cFactor>**

**\$tStart** start time when the load factor is applied  
**\$tFinish** end time when the load factor is applied  
**\$cFactor** load-factor coefficient. (optional. default = 1.0)

The load factor to be applied to the loads and constraints in the LoadPattern object is constant and equal to **\$cFactor** during the domain time from **\$tStart** to **\$tFinish**

Figure 59: Rectangular Time Series

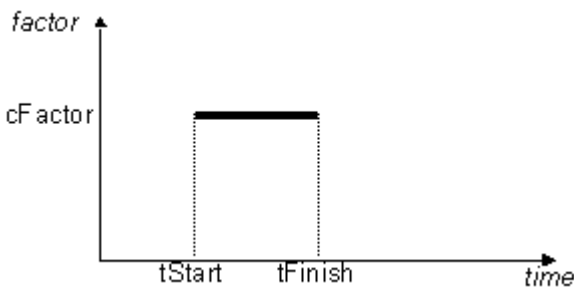

## Sine Time Series

This command creates a TrigSeries *TimeSeries* (page 288) object and associates it to the *LoadPattern* (page 294) object being constructed.

```
Sine $tStart $tFinish $period <-shift $shift> <-factor $cFactor>
```

<b>\$tStart</b>	start time when the load factor is applied
<b>\$tFinish</b>	end time when the load factor is applied
<b>\$period</b>	characteristic period of sine wave
<b>\$shift</b>	phase shift (radians) (optional. default = 0.0)
<b>\$cFactor</b>	load-factor coefficient. (optional. default = 1.0)

The load factor applied to the loads and constraints in the LoadPattern object is equal to:

$$cFactor \cdot \sin \left[ \frac{2 \cdot \pi \cdot (\text{time} - tStart)}{\text{period}} + \text{shift} \right]$$

Figure 60: Sine Time Series

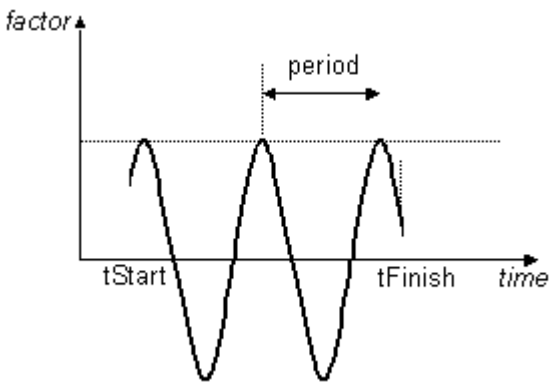

---

## Path Time Series

This command associates a *TimeSeries* (page 288) object of the type *PathSeries* or *PathTimeSeries* (if the increment is not constant) to a *LoadPattern* (page 294) object.

There are many ways to specify the load path.

For a load path where the values are specified at constant time intervals:

```
Series -dt $dt -values {list_of_values} <-factor $cFactor>
```

where the values are specified in a list included in the command

```
Series -dt $dt -filePath $fileName <-factor $cFactor>
```

where the values are taken from a file specified by **\$fileName**

For a load path where the values are specified at non-constant time intervals:

```
Series -time {list_of_times} -values {list_of_values} <-factor $cFactor>
```

where both time and values are specified in a list included in the command

```
Series -fileTime $fileName1 -filePath $fileName2 <-factor $cFactor>
```

where both time and values are taken from a file specified by **\$fileName1** (for the time data) and **\$fileName2** (for the values data)

**\$cFactor**                    load-factor coefficient. (optional. default = 1.0)

The load factor to be applied to the loads and constraints in the LoadPattern object is equal to **\$cFactor\*(user-defined series)**

## CHAPTER 27

# pattern Command

The pattern command is used to construct a `LoadPattern` object, its associated with the *TimeSeries* (page 288) object and the *Load* (page 295) and *Constraint* (page 316) objects for the pattern.

## In This Chapter

plain Pattern .....	294
UniformExcitation Pattern .....	298
MultipleSupport Pattern .....	299

---

## plain Pattern

This command is used to construct an ordinary *LoadPattern* (page 294) object in the *Domain* (page 30).

```

pattern Plain $patternTag (TimeSeriesType arguments) {
    load (load-command arguments)
    sp (sp-command arguments)
    eleLoad (eleLoad-command arguments)
}

```

<b>\$patternTag</b>	unique pattern object tag
<b>TimeSeriesType arguments</b>	list which is parsed to construct the <i>TimeSeries</i> (page 288) object associated with the <code>LoadPattern</code> object.
<b>load ...</b>	list of commands to construct nodal loads -- the <i>NodalLoad</i> (page 295) object
<b>sp ...</b>	list of commands to construct single-point constraints -- the <i>SP_Constraint</i> (page 296) object
<b>eleLoad ...</b>	list of commands to construct element loads -- the <i>eleLoad</i> (page 297) object

**NOTE:** The TimeSeries object is handled by the Tcl interpreter as a list and can be defined a-priori and given a variable name.

#### EXAMPLE

```
pattern Plain 1 Linear { ;           # define LoadPattern 1. impose load in a linear manner
    load 3 100 0. 0. 0. 0. 20.;      # apply force and moment at node 3
}
```

---

## load Command

This command is used to construct a NodalLoad object.

**load \$nodeTag (ndf \$LoadValues)**

The nodal load is added to the LoadPattern being defined in the enclosing scope of the pattern command.

<b>\$nodeTag</b>	node on which loads act
<b>\$LoadValues</b>	load values that are to be applied to the node. Valid range is from 1 through <i>ndf</i> (page 34), the number of nodal degrees-of-freedom.

#### EXAMPLE

```
load 3 100 0. 0. 0. 0. 20.; # apply force Fx=100 and moment Mz=20 at node 3
```

---

## sp Command

This command is used to construct a single-point non-homogeneous constraint (SP\_Constraint) object.

```
sp $nodeTag $DOFtag $DOFvalue
```

<b>\$nodeTag</b>	node on which the single-point constraint acts
<b>\$DOFtag</b>	degree-of-freedom at the node being constrained. Valid range is from 1 through <i>ndf</i> (page 34), the number of nodal degrees-of-freedom.
<b>\$DOFvalue</b>	reference value of the constraint to be applied to the DOF at the node.

### EXAMPLE

```
sp 3 1 0.1; # impose displacement Dx=0.1 at node 3
```



## eleLoad Command

The *elasticBeamColumn* (page 217), *forceBeamColumn* (*nonlinearBeamColumn* (page 218)) and *dispBeamColumn* (page 223) elements all handle ele loads.

➤ *The syntax for 2D is as follows:*

For uniformly-distributed load:

```
eleLoad -ele $eleTag1 <$eleTag2 ...> -type -beamUniform $Wz <$Wx>
```

For point load:

```
eleLoad -ele $eleTag1 $eleTag2 -type -beamPoint $Pz $xL <$Px>
```

➤ *The syntax for 3D is as follows:*

For uniformly-distributed load:

```
eleLoad -ele $eleTag1 <$eleTag2 ...> -type -beamUniform $Wy $Wz <$Wx>
```

For point load:

```
eleLoad -ele $eleTag1 $eleTag2 -type -beamPoint $Py $Pz $xL <$Px>
```

<b>\$eleTag1</b>	previously-defined-element tags
<b>&lt;\$eleTag2 .....</b>	additional previously-defined-element tags (optional)
<b>\$Wy</b>	3D: uniformly-distributed load in local y direction
<b>\$Wz</b>	2D: uniformly-distributed load in direction perpendicular to element longitudinal axis 3D: uniformly-distributed load in local z direction

<b>\$Wx</b>	uniformly-distributed load in direction parallel to element longitudinal axis
<b>\$Py</b>	3D: point load in local y direction
<b>\$Pz</b>	2D: point load in direction perpendicular to element longitudinal axis 3D: point load in local z direction
<b>\$xL</b>	location of point load, prescribed as fraction of element length
<b>\$Px</b>	point load in direction longitudinal to element longitudinal axis (applied at the same location as \$Pz)

were x axis is along the member.

**NOTE:** the forceBeamColumn (*nonlinearBeamColumn* (page 218)) element might have problems converging; the current code needs to be redone, 'MICHAEL' has promised to get around to it.

---

## UniformExcitation Pattern

This command is used to construct a UniformExcitation load pattern object.

```
pattern UniformExcitation $patternTag $dir -accel (TimeSeriesType arguments)
<-vel0 $ver0>
```

<b>\$patternTag</b>	unique pattern object tag
<b>\$dir</b>	direction of excitation (1, 2, or 3) used in formulating the inertial loads for the transient analysis.
<b>TimeSeriesType arguments</b>	<i>TimeSeries</i> (page 288) object associated with the acceleration record used in determining the inertial loads.
<b>\$vel0</b>	initial velocity to be assigned to each node (optional, default: zero)

**NOTE:** The TimeSeries object is handled by the Tcl interpreter as a list and can be defined a-priori and given a variable name.

EXAMPLE:

```
set Gaccel "Series -dt $dt -filePath $outFile -factor $GMfatt"; # time series information
pattern UniformExcitation 2 1 -accel $Gaccel; # create uniform excitation
with IDtag 2 in direction 1
```

---

## MultipleSupport Pattern

This command is used to construct a MultipleSupportExcitation load pattern object.

```
pattern MultipleSupport $patternTag {
    groundMotion (groundMotion-command arguments)
    imposedMotion (imposedMotion-command arguments)
}
```

<b>\$patternTag</b>	unique pattern object tag
<b>groundMotion ...</b>	list of commands to construct the <i>GroundMotions</i> (page 299) object that is then added to the object to define the multiple-support excitation that is being imposed on the model
<b>imposedMotion ...</b>	list of commands to construct the <i>ImposedSupportSP</i> (page 301) constraint object that is then added to the object to define the multiple-support excitation that is being imposed on the model

---

## groundMotion Command

The groundMotion command is used to construct a GroundMotion object used by the *ImposedMotionSP* (page 301) constraints in a *MultipleSupportExcitation* (page 299) object.

## Plain GroundMotion

This command is used to construct a plain GroundMotion object. Each GroundMotion object is associated with a number of *TimeSeries* (page 288) objects, which define the acceleration, velocity and displacement records.

```
groundMotion $gMotionTag Plain <-accel (accelSeriesType accelArgs)> <-vel  
(velSeriesType velArgs)> <-disp (dispSeriesType dispArgs)> <-int  
(IntegratorType intArgs)>
```

**\$gMotionTag** unique *GroundMotion* (page 299) object tag

**<-accel (accelSeriesType accelArgs)>**

*TimeSeries* (page 288) objects defining the acceleration record (optional).

**<-vel (velSeriesType velArgs)>**

*TimeSeries* (page 288) objects defining the velocity record (optional)

**<-disp (dispSeriesType dispArgs)>**

*TimeSeries* (page 288) objects defining the displacement record (optional)

**<-int (IntegratorType intArgs)>**

If only the acceleration record is specified, the user has the option of specifying the *TimeSeriesIntegrator* (page 333) that is to be used to integrate the acceleration record to determine the velocity and displacement record (optional, default: Trapezoidal)

**NOTE:** The *TimeSeries* object is handled by the Tcl interpreter as a list and can be defined a-priori and given a variable name.

**NOTE:** Any combination of the acceleration, velocity and displacement time-series can be specified.

---

## Interpolated GroundMotion

This command is used to construct an InterpolatedGroundMotion object.

```
groundMotion $gMotionTag Interpolated $gmTag1 $gmTag2 ... -fact $fact1
$fact2 ...
```

<b>\$gMotionTag</b>	unique <i>GroundMotion</i> (page 299) object tag
<b>\$gmTag1 \$gmTag2 ...</b>	ground motions which have already been added to the <i>MultipleSupportExcitation</i> (page 299) object.
<b>\$fact1 \$fact2 ...</b>	factors that are used in the interpolation of the ground motions to determine the ground motion for this InterpolatedGroundMotion object.

---

## imposedMotion Command

This command is used to construct an ImposedMotionSP constraint which is used to enforce the response of a dof at a node in the model. The response enforced at the node at any give time is obtained from the *GroundMotion* (page 299) object associated with the constraint.

```
imposedMotion $nodeTag $dirn $gMotionTag
```

<b>\$nodeTag</b>	node where response is enforced
<b>\$dirn</b>	dof of enforced response Valid range is from 1 through <i>ndf</i> (page 34), the number of nodal degrees-of-freedom.
<b>\$gMotionTag</b>	pre-defined <i>GroundMotion</i> (page 299) object tag

NOTE: The *GroundMotion* (page 299) object must be added to the *MultipleSupportExcitation* (page 299) pattern before the ImposedMotionSP constraint.

**FMK: ADD TIME-SERIES INTEGRATORS**

## CHAPTER 28

# Recorder Objects

The recorder commands are used to construct a Recorder object, which is used to monitor items of interest to the analyst at each commit().

## In This Chapter

Node Recorder .....	303
EnvelopeNode Recorder .....	305
Drift Recorder .....	306
Element Recorder .....	307
EnvelopeElement Recorder .....	309
Display Recorder .....	310
Plot Recorder .....	311
playback Command .....	311

---

## Node Recorder

The Node type records the displacement, velocity, acceleration and incremental displacement at the nodes (translational & rotational)

```
recorder Node <-file $fileName> <-xml $fileName> <-time> <-node ($node1  
$node2 ...)> <-nodeRange $startNode $endNode> <-region  
$RegionTag> <-node all> -dof ($dof1 $dof2 ...) $respType
```

<b>-file</b>	output recorder data to a file
<b>-xml</b>	output recorder data + xml metadata labelling each column of data (-file and -xml cannot be specified simultaneously)
<b>\$fileName</b>	file where results are stored. Each line of the file contains the result for a committed state of the domain (optional, default: screen output)
<b>-time</b>	this argument will place the pseudo time of the as the first entry in the line. (optional, default: omitted)
<b>\$node1 \$node2 ...</b>	tags nodes where response is being recorded -- select nodes in domain (optional, default: all)

<b>\$startNode</b> <b>\$endNode</b>	tag for start and end nodes where response is being recorded -- range of nodes in domain (optional, default: all)
<b>\$RegionTag</b>	tag for previously-defined selection of nodes defined using the Region command. (optional)
all	record all nodes in model. (Note: This option is recommended only for xml option as OpenSees rennumbers nodes)
<b>\$dof1 \$dof2 ...</b>	degrees of freedom of response being recorded.  Valid range is from 1 through <i>ndf</i> (page 34) , the number of nodal degrees-of-freedom.
<b>\$respType</b>	defines response type to be recorded. The following response types are available:
<b>disp</b>	displacement*
<b>vel</b>	velocity*
<b>accel</b>	acceleration*
<b>incrDisp</b>	incremental displacement
<b>"eigen i"</b>	eigenvector for mode i
<b>reaction</b>	nodal reaction

**NOTE:** **\$respType** must be the last argument in this command.

Do not forget the double quote in the eigen response type.

\*NOTE:

1. The all option has been removed from the documentation, as OpenSees rennumbers the nodes that are output.

2. For transient analysis, the response output recorded depends on the input:

*UniformExcitation* (page 298) Pattern(input acceleration record): Relative (wrt supports) disp, vel and accel

*MultipleSupport* (page 299)Pattern (input displacement record): Absolute disp, vel and accel

**Example:**



```

recorder Node -file nodeDisp.out -time -node 1 5 -nodeRange 10 25 -dof 2 disp
recorder Node -file node34.eig -time -node 3 4 -dof 1 2 3 "eigen 2"
recorder Node -file Rnode.out -time -node 1 3 5 -dof 1 2 reaction

```

---

## EnvelopeNode Recorder

The Node type records the envelope of displacement, velocity, acceleration and incremental displacement at the nodes (translational & rotational). The envelope consists of the following: minimum, maximum and maximum absolute value of specified response type.

```

recorder EnvelopeNode <-file $fileName> <-node ($node1 $node2 ...)>
  <-nodeRange $startNode $endNode> <-region $RegionTag> <-node
  all> -dof ($dof1 $dof2 ...) $respType

```

<b>\$fileName</b>	file where results are stored. Each line of the file contains the result for a committed state of the domain (optional, default: screen output)								
<b>\$node1 \$node2 ...</b>	where response is being recorded -- select nodes (optional, default: all)								
<b>\$startNode</b> <b>\$endNode</b>	tag for start and end where response is being recorded (optional, default: all)								
<b>\$RegionTag</b>	tag for previously-defined selection of nodes defined using the Region command. (optional)								
<b>all</b>	where response is being recorded -- all nodes in domain (optional & default)								
<b>\$dof1 \$dof2 ...</b>	degrees of freedom of response being recorded. Valid range is from 1 through <i>ndf</i> (page 34), the number of nodal degrees-of-freedom.								
<b>\$respType</b>	defines response type to be recorded. The following response types are available: <table style="margin-left: 20px;"> <tr> <td><b>disp</b></td> <td>displacement</td> </tr> <tr> <td><b>vel</b></td> <td>velocity</td> </tr> <tr> <td><b>accel</b></td> <td>acceleration</td> </tr> <tr> <td><b>incrDisp</b></td> <td>incremental displacement</td> </tr> </table>	<b>disp</b>	displacement	<b>vel</b>	velocity	<b>accel</b>	acceleration	<b>incrDisp</b>	incremental displacement
<b>disp</b>	displacement								
<b>vel</b>	velocity								
<b>accel</b>	acceleration								
<b>incrDisp</b>	incremental displacement								

NOTE: \$respType must be the last argument in this command.

Example:

```
recorder EnvelopeNode -file EnvelopeNode.out -time -node 1 5 -nodeRange 10 25 -dof 2 disp
```

---

## Drift Recorder

The Drift type records the displacement drift between two nodes. The drift is taken as the ratio between the prescribed relative displacement and the specified distance between the nodes.

```
recorder Drift -file $fileName <-time> -iNode ($inode1 $inode2 ...) -jNode
($jnode1 $jnode2 ...) -dof ($dof1 $dof2 ...) -perpDirn ($perpDirn1
$perpDirn2 ...)
```

<b>\$fileName</b>	file where results are stored. Each line of the file contains the result for a committed state of the domain
<b>-time</b>	this argument will place the pseudo time of the as the first entry in the line. (optional, default: omitted)
<b>(\$inode1 \$inode2 ...)</b>	set of i nodes for which drift is recorded
<b>(\$jnode1 \$jnode2 ...)</b>	set of j nodes for which drift is recorded
<b>(\$dof1 \$dof2 ...)</b>	set of nodal degrees of freedom to monitor for drift Valid range is from 1 through <i>ndm</i> (page 34), the number of nodal degrees-of-freedom.
<b>(\$perpDirn1 \$perpDirn2 ...)</b>	set of perpendicular global directions from which length is determined to compute drift (1 = X, 2 = Y, 3 = Z)

**Example:**

```
recorder Drift -file drift.out -time -iNode 1 2 -jNode 3 4 -dof 1 -perpDirn 2
```

## Element Recorder

The Element type records the response of a number of elements. The response recorded is element-dependent and depends on the arguments which are passed to the `setResponse()` element method.

```
recorder Element <-file $fileName> <-time> <-ele ($ele1 $ele2 ...)> <-eleRange
$startEle $endEle> <-region $regTag> <-ele all> ($arg1 $arg2 ...)
```

<code>-file</code>	output recorder data to a file
<code>-xml</code>	output recorder data + xml metadata labelling each column of data ( <code>-file</code> and <code>-xml</code> cannot be specified simultaneously)
<b>\$filename</b>	file where results are stored. Each line of the file contains the result for a committed state of the domain (optional, default: screen output)
<b>-time</b>	this argument will place the pseudo time of the as the first entry in the line. (optional, default: omitted)
<b>\$ele1 \$ele2 ...</b>	tags of elements whose response is being recorded -- selected elements in domain (optional, default: omitted)
<b>\$startEle \$endEle</b>	tag for start and end elements whose response is being recorded -- range of selected elements in domain (optional, default: all)
<b>\$regTag</b>	previously-defined tag of region of elements whose response is being recorded -- region of elements in domain (optional)
<b>all</b>	elements whose response is being recorded -- all elements in domain (optional & default)
<b>\$arg1 \$arg2 ...</b>	arguments which are passed to the <code>setResponse()</code> element method

The `setResponse()` element method is dependent on the element type, and is described with the *element Command* (page 215).

### ➤ **Beam-Column Elements (page 219, page 223, page 217, page 218) :**

Common to all beam-column elements:

**globalForce** – element resisting force in global coordinates (does not include inertial forces)

example:

```
recorder Element -file ele1global.out -time -ele 1 globalForce
```

**localForce** – element resisting force in local coordinates (does not include inertial forces)

example:

```
recorder Element -file ele1local.out -time -ele 1 localForce
```

### ➤ Sections: (page 191)

**section \$secNum** – request response quantities from a specific section along the element length,  
**\$secNum** refers to the integration point whose data is to be output

**force** – section forces

example: recorder Element -file ele1sec1Force.out –time -ele 1 section 1 force

**deformation** – section deformations

example: recorder Element -file ele1sec1Defo.out –time -ele 1 section 1 deformation

**stiffness** – section stiffness

example: recorder Element -file ele1sec1Stiff.out –time -ele 1 section 1 stiffness

**stressStrain** – record stress-strain response.

example: recorder Element -file ele1sec1StressStrain.out –time -ele 1 section 1 fiber \$y \$z  
 <\$matID> stressStrain

**\$y** local y coordinate of fiber to be monitored\*

**\$z** local z coordinate of fiber to be monitored\*

**\$matID** previously-defined material tag (optional)

**\*NOTE:** The recorder object will search for the fiber closest to the location (\$y,\$z) on the section and record its stress-strain response

**NOTE:** the *ZeroLength section element* (page 226) only has 1 section therefore you do not need to identify the section in the recorder command .. Example:

```
recorder Element -file Element1.out -time -ele 1 section 1 fiber 0.10 0.10 stressStrain
```

## OUTPUT FORMAT

The format of the output is typically dependent on the element and/or section type. In general, however, the output follows the order of the degrees of freedom.

Here are some cases:

element	<b>globalForce</b>	2D, 3dof: FX FY MZ
		3D, 6dof: FX FY FZ MX MY MZ
	<b>localForce</b>	2D, 3dof: Fx Fy Mz
		3D, 6dof: Fx Fy Fz Mx My Mz
section	<b>force</b>	Fx Mx

<b>deformation</b>	axial-strain curvature
<b>stressStrain</b>	stress strain

---

## EnvelopeElement Recorder

The Element type records the response of a number of elements. The response recorded is element-dependent and depends on the arguments which are passed to the setResponse() element method. The envelope consists of the following: **minimum**, **maximum** and **maximum absolute value** of specified response type.

```
recorder EnvelopeElement <-file $fileName> <-ele ($ele1 $ele2 ...)> <-eleRange $startele $endele> <-ele all> <-region $regTag> ($arg1 $arg2 ...)
```

<b>\$fileName</b>	file where results are stored. Each line of the file contains the result for a committed state of the domain (optional, default: screen output)
<b>\$eleID1 \$eleID2 ...</b>	tags of elements whose response is being recorded -- selected elements in <i>domain</i> (page 30) (optional, default: omitted)
<b>\$startele \$endele</b>	tag for start and end elements whose response is being recorded -- selected elements in <i>domain</i> (page 30) (optional, default: all)
<b>all</b>	elements whose response is being recorded -- all elements in <i>domain</i> (page 30) (optional & default)
<b>\$regTag</b>	tag of region of elements whose response is being recorded -- region of elements in <i>domain</i> (page 30) (optional)
<b>\$arg1 \$arg2 ...</b>	arguments which are passed to the setResponse() element method

The setResponse() element method is dependent on the element type, and is described with the *element Command* (page 215).

### ➤ **Beam-Column Elements (page 219, page 223, page 217, page 218) :**

Common to all beam-column elements:

**globalForce** – element resisting force in global coordinates (does not include inertial forces)

example:

```
recorder EnvelopeElement -file ele1global.out -time -ele 1 globalForce
```

**localForce** – element resisting force in local coordinates (does not include inertial forces)

example:

```
recorder EnvelopeElement -file ele1local.out -time -ele 1 localForce
```

➤ **Sections: (page 191)**

**section \$secNum** – request response quantities from a specific section along the element length,

**\$secNum** refers to the integration point whose data is to be output

**force** – section forces

example: recorder EnvelopeElement -file ele1sec1Force.out -time -ele 1 section 1 force

**deformation** – section deformations

example: recorder EnvelopeElement -file ele1sec1Force.out -time -ele 1 section 1 deformation

**stiffness** – section stiffness

example: recorder EnvelopeElement -file ele1sec1Force.out -time -ele 1 section 1 stiffness

**stressStrain** – record stress-strain response.

example: recorder EnvelopeElement -file ele1sec1Force.out -time -ele 1 section 1 fiber \$y \$z stressStrain

**\$y** local y coordinate of fiber to be monitored\*

**\$z** local z coordinate of fiber to be monitored\*

**\*NOTE:** The recorder object will search for the fiber closest to the location (\$y,\$z) on the section and record its stress-strain response

**NOTE:** the *ZeroLength section element* (page 226) only has 1 section therefore you do not need to identify the section in the recorder command .. Example:

```
recorder Element -file Element1.out -time -ele 1 section fiber 0.10 0.10 stressStrain
```

---

## Display Recorder

This recorder opens a graphical window for displaying of graphical information.

```
recorder display $windowTitle $xLoc $yLoc $xPixels $yPixels <-file $fileName>
```

**\$windowTitle** title of graphical window

**\$xLoc \$yLoc** horizontal and vertical location of graphical window (upper left-most corner)

<b>\$xPixels \$yPixels</b>	width and height of graphical window in pixels
<b>\$fileName</b>	in addition to the window display, information is sent to a file to redisplay images at a later time. (optional)

A TclFeViewer object is constructed. This constructor adds a number of additional commands to OpenSees, similar to the construction of the *BasicBuilder* (page 34). These additional commands are used to define the viewing system for the image that is place on the screen. These commands are currently under review and will be presented in a future version of this document.

---

## Plot Recorder

This recorder type opens a graphical window for the plotting of the contents of the prescribed file

```
recorder plot $fileName $windowTitle $xLoc $yLoc $xPixels $yPixels -columns  
$xCol0 $yCol0 <-columns $xCol1 $yCol1><-columns $xCol2 $yCol2> ...
```

<b>\$fileName</b>	source file of plotted data
<b>\$windowTitle</b>	title of graphical window
<b>\$xLoc \$yLoc</b>	horizontal and vertical location of graphical window in pixels (upper left-most corner)
<b>\$xPixels \$yPixels</b>	width and height of graphical window in pixels
<b>\$xCol0 \$yCol0</b>	Column number to be plotted in X-axis and Y-axis, respectively. One set of columns must be defined.
<b>\$xCol1 \$yCol1</b>	Additional lines may be plotted on the same graph by repeating the -columns command. These data come from the same source file. (optional)
<b>\$xCol2 \$yCol2</b>	

---

## playback Command

This command is used to invoke playback on all Recorder objects constructed with the *recorder command* (page 303).

```
playback $commitTag
```

<b>\$commitTag</b>	integer used to invoke the record() method (????)
--------------------	---





## CHAPTER 29

# Analysis Objects

The Analysis objects are responsible for performing the analysis. The analysis moves the model along from state at time  $t$  to state at time  $t + dt$ . This may vary from a simple *static* (page 339) linear analysis to a *transient* (page 340, page 341) non-linear analysis. In OpenSees each Analysis object is composed of several component objects, which define the type of analysis how the analysis is performed.

In general terms, the analysis objects are used to solve the following time-dependent equilibrium-equation problem for a transient analysis:

$$\mathbf{F}_I(\ddot{\mathbf{U}}) + \mathbf{F}_R(\mathbf{U}, \dot{\mathbf{U}}) = \mathbf{P}(t) \quad \text{-- transient equilibrium}$$

Where  $F_I$  is the acceleration-dependent inertial force vector,  $F_R$  is the velocity (damping) and displacement-dependent (stiffness) resisting-force vector.  $P(t)$  is the external applied-force vector. The acceleration, velocity and displacement vectors are all time-dependent.

The component classes consist of the following:

- **ConstraintHandler (page 316)** -- determines how the constraint equations are enforced in the analysis -- how it handles the boundary conditions/imposed displacements
- **DOF\_Numberer (page 321)** -- determines the mapping between equation numbers and degrees-of-freedom
- **AnalysisModel (page 339)** -- defines what time of analysis is to be performed
- **Integrator** -- determines the predictive step for time  $t+dt$
- **SolutionAlgorithm (page 329)** -- determines the sequence of steps taken to solve the non-linear equation at the current time step
- **SystemOfEqn/Solver** -- within the solution algorithm, it specifies how to store and solve the system of equations in the analysis

Figure 61: Analysis Object

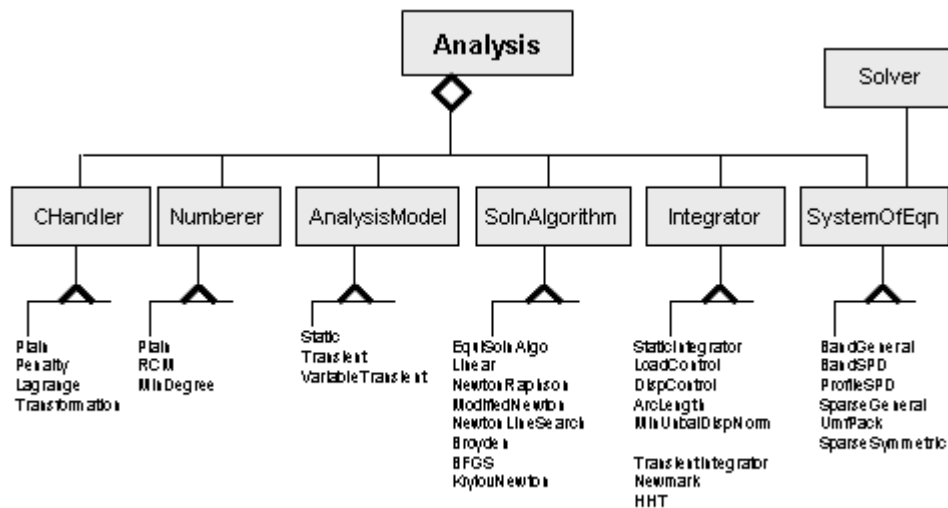

## In This Chapter

constraints Command .....	316
numberer Command .....	321
system Command .....	323
test Command .....	326
algorithm Command .....	329
integrator Command .....	333
analysis Command .....	339
rayleigh command .....	342
eigen Command .....	343
analyze Command .....	344
dataBase Commands .....	345



## CHAPTER 30

# constraints Command

This command is used to construct the ConstraintHandler object. The ConstraintHandler object determines how the constraint equations are enforced in the analysis. Constraint equations enforce a specified value for a DOF, or a relationship between DOFs. The degrees of freedom can be broken down into  $U_R$ , the retained DOF's, and  $U_C$ , the condensed DOF's:

$$U = \begin{pmatrix} U_R \\ U_C \end{pmatrix}$$

- The **Plain Constraints** (page 318) command is used to enforce homogeneous single-point constraints, such as the case of homogeneous boundary conditions, where all boundary conditions are fixity, using *single-point constraints* (page 38, <http://www.>). For this case:  $U_c=0.0$

The other constraints commands are used for ALL other cases, such as the case of non-homogeneous single-point constraints using the *sp command* (page 296), *multi-point constraints* (page 41), *imposed motions* (page 301) and *multi-support excitation* (page 299). For such cases, the relationship between DOF's can be written as:  $U_c=C_{RC}U_R$ . Where  $C_{RC}$  is a matrix of constants.

The following constraints handlers are currently available:

- **Penalty Method** (page 318) -- consists of adding large numbers to the stiffness matrix and the restoring-force vectors to impose a prescribed zero or nonzero DOF. This method applies very stiff elements (numerically) at the boundary conditions. These additional stiffnesses affect the eigenvalues/eigenvectors in a transient analysis. This is the recommended method for a static analysis.
- **Lagrange Multipliers** (page 319) -- apply the method of lagrange multipliers to the system of equations, thus enlarging the size of the matrices. Once Lagrange Multipliers have been applied, the resulting stiffness matrix is no longer positive definite. Therefore, this method should be used only if there are condition-number problems with the penalty method.
- **Transformation Method** (page 320) -- transforms the stiffness matrix by condensing out the constrained DOF's. This method reduces the size of the system for multi-point constraints. This is the recommended method for a transient analysis. However, this method should not be used when nodes are constrained in series. For example,  $U_3$  is constrained to  $U_2$ , which is then constrained to  $U_1$ .

Of the different methods, "the Lagrange multiplier method is more attractive than the transformation method if there are few constraint equations that couple many DOF. However, Lagrange multipliers are active at the structure level, but transformation equations can be applied at either the structure level or element by element. The latter has the appeal of disposing of constraints at an early stage, when the matrices are small and manageable". (Cook)

"In comparison with Lagrange multipliers, penalty functions have the advantage of introducing no new variables. However, the penalty matrix may significantly increase the bandwidth of the structural equations, depending on how DOF are numbered and what DOF are coupled by the constraint equations. Penalty functions have the disadvantage that penalty numbers must be chosen in an allowable range: large enough to be effective but not so large as to provoke numerical difficulties". (Cook)

More information and examples on these methods are discussed in detail in the Cook book.

## In This Chapter

Plain Constraints .....	318
Penalty Method .....	318
Lagrange Multipliers .....	319
Transformation Method .....	320

---

## Plain Constraints

This command creates a PlainHandler which is only capable of enforcing homogeneous single-point constraints. If other types of constraints exist in the domain, a different constraint handler must be specified.

**constraints Plain**

---

## Penalty Method

This command is used to construct a PenaltyConstraintHandler which will cause the constraints to be enforced using a penalty method. The penalty method consists of adding large numbers to the stiffness matrix and the restoring-force vectors to impose a prescribed zero or nonzero DOF.

**constraints Penalty \$alphaSP \$alphaMP**

<b>\$alphaSP</b>	factor used when adding the single-point constraint into the system of equations
<b>\$alphaMP</b>	factor used when adding the multi-point constraint into the system of equations

In this method the potential-energy equation which makes up the system of equations is augmented by a penalty function  $\frac{1}{2} \mathbf{t}^T [\alpha] \mathbf{t}$

where  $[\alpha]$  is a diagonal matrix of "penalty numbers". The resulting system of equations is of the form:

$$[K + C^T \alpha C] U = [R + C^T \alpha Q]$$

Where  $C^T\alpha C$  can be called the penalty matrix.  $C$  and  $Q$  are matrices containing constants,  $K$  is the stiffness matrix,  $U$  represents the DOF and  $R$  the restoring forces. If  $\alpha=0$  the constraints are ignored. As  $\alpha$  grows,  $U$  changes in such a way that the constraint equations are more nearly satisfied. In this case, however, the analysis becomes error prone, as the system represents a stiff region supported by a flexible region.

**NOTE:** The Penalty Method affects the maximum eigenvalues of the system and may cause problems in a Transient analysis.

The Penalty Method is discussed in detail in the Cook Book -- Concepts and Applications of Finite Element Analysis.

"Guideline for choice of  $\alpha$ : If computer words carry approximately  $p$  decimal digits, experience has shown that  $\alpha$  should not exceed  $10^{p/2}$ ". (Cook)

---

## Lagrange Multipliers

This command is used to construct a LagrangeConstraintHandler which will cause the constraints to be enforced using the method of Lagrange multipliers.

**constraints Lagrange** <\$alphaSP> <\$alphaMP>

**\$alphaSP** factor used when adding the single-point constraint into the system of equations (optional, default=1.0)

**\$alphaMP** factor used when adding the multi-point constraint into the system of equations (optional, default=1.0)

**NOTE:** Values for **\$alphaSP** and **\$alphaMP** other than 1.0 are permitted to offset numerical roundoff problems.

**NOTE:** The system of equations is not positive definite due to the introduction of zeroes on the diagonal by the constraint equations:

$$\begin{bmatrix} K & C^T \\ C & 0 \end{bmatrix} \begin{bmatrix} U \\ \lambda \end{bmatrix} = \begin{bmatrix} R \\ Q \end{bmatrix}$$

From Cook: "Lagrange's method of undetermined multipliers is used to find the maximum or minimum of a function whose variables are not independent but have some prescribed relation. In structural mechanics the function is the potential energy and the variables are the DOF".

---

## Transformation Method

This command is used to construct a TransformationConstraintHandler which will cause the constraints to be enforced using the transformation method.

### constraints Transformation

**NOTE:** With the current implementation, a retained node in an MP\_Constraint cannot also be specified as being a constrained node in another MP\_Constraint.

The constraint equations takes the following form:

$$(T^T K T) U_r = T^T R$$



## CHAPTER 31

# numberer Command

This command is used to construct the `DOF_Numberer` object. The `DOF_Numberer` object determines the mapping between equation numbers and degrees-of-freedom -- how degrees-of-freedom are numbered.

- **Plain** (page 321) -- nodes are assigned degrees-of-freedom arbitrarily, based on the input file. This method is recommended for small problems or when sparse solvers are used, as they do their own internal DOF numbering.
- **RCM** (page 322) -- nodes are assigned degrees-of-freedom using the Reverse Cuthill-McKee algorithm. This algorithm optimizes node numbering to reduce bandwidth using a numbering graph. This method will output a warning when the structure is disconnected.

As certain system of equation and solver objects do their own mapping, i.e. SuperLU, UmfPack, Kincho's, specifying a numberer other than plain may not be needed.

## In This Chapter

Plain Numberer .....	321
RCM Numberer .....	322

## Plain Numberer

This command is used to construct a `PlainNumberer` object.

**numberer Plain**

The Plain numberer assigns degrees-of-freedom to the nodes based on how the nodes are stored in the domain. Currently, the user has no control over how nodes are stored.

---

## RCM Numberer

This command is used to construct a RCMNumberer object.

**numberer RCM**

The RCM numberer uses the reverse Cuthill McKee (REF?) algorithm to number the degrees of freedom.

## CHAPTER 32

**system Command**

This command is used to construct the LinearSOE and LinearSolver objects to store and solve the system of equations in the analysis.

- Profile Symmetric Positive Definite (SPD)



*system ProfileSPD*

- Banded Symmetric Positive Definite



*system BandSPD*

- Sparse Symmetric Positive Definite



*system SparseSPD*

- Banded General



*system BandGeneral*

- Sparse Symmetric



*system Umfpack*

Figure 62: system command

**In This Chapter**

BandGeneral SOE.....	324
BandSPD SOE.....	324
ProfileSPD SOE.....	324
SparseGeneral SOE.....	324
UmfPack SOE.....	325
SparseSPD SOE.....	325

---

## BandGeneral SOE

This command is used to construct an un-symmetric banded system of equations object which will be factored and solved during the analysis using the Lapack band general solver.

```
system BandGeneral
```

---

## BandSPD SOE

This command is used to construct a symmetric positive definite banded system of equations object which will be factored and solved during the analysis using the Lapack band spd solver.

```
system BandSPD
```

---

## ProfileSPD SOE

This command is used to construct symmetric positive definite profile system of equations object which will be factored and solved during the analysis using a profile solver.

```
system ProfileSPD
```

---

## SparseGeneral SOE

This command is used to construct a general sparse system of equations object which will be factored and solved during the analysis using the SuperLU solver.

```
system SparseGeneral <-piv>
```

**-piv**                    perform partial-pivoting (optional, Default: no partial pivoting is performed)

---

## UmfPack SOE

This command is used to construct a general sparse system of equations object which will be factored and solved during the analysis using the UMFPACK solver. (REF?)

```
system UmfPack
```

---

## SparseSPD SOE

This command is used to construct a sparse symmetric positive definite system of equations object which will be factored and solved during the analysis using a sparse solver developed at Stanford University by Kincho Law. (REF?)

```
system SparseSPD
```

## CHAPTER 33

# test Command

This command is used to construct a `ConvergenceTest` object. Certain *SolutionAlgorithm* (page 329) objects require a `ConvergenceTest` object to determine if convergence has been achieved at the end of an iteration step. The convergence test is applied to the following equation:

$$K\Delta U = R$$

The test perform the following checks:

- **Norm Unbalance**  $\sqrt{R^T R} < \text{tol}$
- **Norm Displacement Increment**  $\sqrt{\Delta U^T \Delta U} < \text{tol}$
- **Energy Increment**  $\frac{1}{2} (\Delta U^T R) < \text{tol}$

## In This Chapter

Norm Unbalance Test .....	326
Norm Displacement Increment Test .....	327
Energy Increment Test .....	328

## Norm Unbalance Test

This command is used to construct a `CTestNormUnbalance` object which tests positive force convergence if the 2-norm of the `b` vector (the unbalance) in the *LinearSOE* (page 323) object is less than the specified tolerance.

```
test NormUnbalance $tol $maxNumIter <$printFlag>
```

<b>\$tol</b>	convergence tolerance
<b>\$maxNumIter</b>	maximum number of iterations that will be performed before "failure to converge" is returned
<b>\$printFlag</b>	flag used to print information on convergence (optional)

- 0 no print output (default)
- 1 print information on each step
- 2 print information when convergence has been achieved
- 4 print norm, dU and dR vectors
- 5 at convergence failure, carry on, print error message, but do not stop analysis

The test performs the following check:

$$\sqrt{R^T R} < \text{tol}$$

---

## Norm Displacement Increment Test

This command is used to construct a CTestNormDisplncr object which tests positive force convergence if the 2-norm of the x vector (the displacement increment) in the *LinearSOE* (page 323) object is less than the specified tolerance.

**test NormDisplncr \$tol \$maxNumIter <\$printFlag>**

<b>\$tol</b>	convergence tolerance
<b>\$maxNumIter</b>	maximum number of iterations that will be performed before "failure to converge" is returned
<b>\$printFlag</b>	flag used to print information on convergence (optional) <ul style="list-style-type: none"> <li>0 no print output (default)</li> <li>1 print information on each step</li> <li>2 print information when convergence has been achieved</li> <li>4 print norm, dU and dR vectors</li> <li>5 at convergence failure, carry on, print error message, but do not stop analysis</li> </ul>

The test performs the following check:

$$\sqrt{\Delta U^T \Delta U} < \text{tol}$$

## Energy Increment Test

This command is used to construct a CTestEnergyIncr object which tests positive force convergence if one half of the inner-product of the x and b vectors (displacement increment and unbalance) in the *LinearSOE* (page 323) object is less than the specified tolerance.

```
test EnergyIncr $tol $maxNumIter <$printFlag>
```

<b>\$tol</b>	convergence tolerance
<b>\$maxNumIter</b>	maximum number of iterations that will be performed before "failure to converge" is returned
<b>\$printFlag</b>	flag used to print information on convergence (optional)
	<ul style="list-style-type: none"> <li><b>0</b> no print output (default)</li> <li><b>1</b> print information on each step</li> <li><b>2</b> print information when convergence has been achieved</li> <li><b>4</b> print norm, dU and dR vectors</li> <li><b>5</b> at convergence failure, carry on, print error message, but do not stop analysis</li> </ul>

The test performs the following check:

$$\frac{1}{2} (\Delta U^T R) < \text{tol}$$



## CHAPTER 34

# algorithm Command

This command is used to construct a SolutionAlgorithm object, which determines the sequence of steps taken to solve the non-linear equation.

## In This Chapter

Linear Algorithm .....	329
Newton Algorithm .....	329
Newton with Line Search Algorithm .....	330
Modified Newton Algorithm .....	331
Krylov-Newton Algorithm .....	331
BFGS Algorithm .....	331
Broyden Algorithm .....	332

---

## Linear Algorithm

This command is used to construct a Linear algorithm object which takes one iteration to solve the system of equations.

**algorithm Linear**

---

## Newton Algorithm

This command is used to construct a NewtonRaphson algorithm object which uses the Newton-Raphson method to advance to the next time step.

**algorithm Newton**

**NOTE:** The tangent is updated at each iteration.

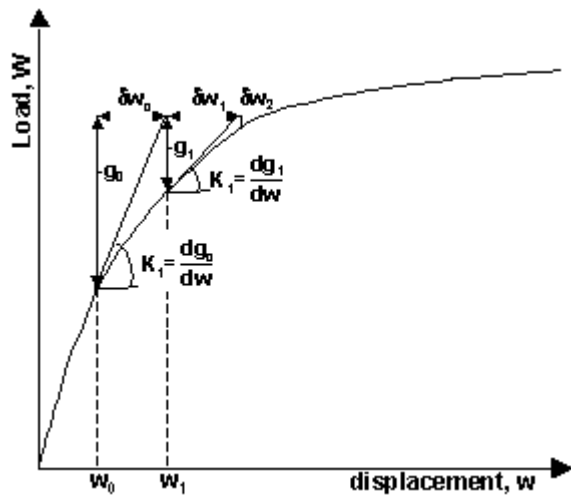

## Newton with Line Search Algorithm

This command is used to construct a NewtonLineSearch algorithm object which uses the Newton-Raphson method with line search to advance to the next time step.

### algorithm NewtonLineSearch \$ratio

#### \$ratio

limiting ratio between the residuals before and after the incremental update (between 0.5 and 0.8)

If the ratio between the residuals before and after the incremental update is greater than the specified limiting ratio the line search algorithm developed by Crissfield (REF?) is employed to try to improve the convergence.

---

## Modified Newton Algorithm

This command is used to construct a ModifiedNewton algorithm object which uses the Modified Newton-Raphson method to advance to the next time step. The difference between this method and the Newton-Raphson method is that the tangent stiffness is not updated at each step, thus avoiding expensive calculations needed in multi-DOF systems. However, more iterations may be needed to reach a prescribed accuracy.

**algorithm ModifiedNewton**

**NOTE:** The tangent at the first iteration of the current time step is used to iterate on the next time step.

---

## Krylov-Newton Algorithm

This command is used to construct a KrylovNewton algorithm object which uses a modified Newton method with Krylov subspace acceleration to advance to the next time step.

**algorithm KrylovNewton**

The accelerator is described by Carlson and Miller in "Design and Application of a 1D GWMFE Code" from *SIAM Journal of Scientific Computing* (<http://epubs.siam.org/sam-bin/dbq/toclist/SISC>) (Vol. 19, No. 3, pp. 728-765, May 1998).

---

## BFGS Algorithm

This command is used to construct a BFGS algorithm object for symmetric systems which performs successive rank-two updates of the tangent at the first iteration of the current time step.

**algorithm BFGS <\$count>**

**\$count**                      number of iterations within a time step until a new tangent is formed

---

## Broyden Algorithm

This command is used to construct a Broyden algorithm object for general unsymmetric systems which performs successive rank-one updates of the tangent at the first iteration of the current time step.

```
algorithm Broyden <$count>
```

**\$count**                    number of iterations within a time step until a new tangent is formed

## CHAPTER 35

# integrator Command

This command is used to construct the Integrator object. The Integrator object determines the meaning of the terms in the system of equation object  $Ax=B$ .

The Integrator object is used for the following:

- determine the predictive step for time  $t+dt$
- specify the tangent matrix and residual vector at any iteration
- determine the corrective step based on the displacement increment  $dU$

The system of nonlinear equations is of the form:

**Static analysis:**  $R(U, I) = \lambda P^* - F_R(U)$

**Transient analysis:**  $R(U, \dot{U}, \ddot{U}) = P(t) - F_I(\dot{U}) - F_R(U, \dot{U})$

The type of integrator used in the analysis is dependent on whether it is a **static analysis** (page 339) or **transient analysis** (page 340):

### STATIC ANALYSIS\*

- *LoadControl* (page 334)  $\lambda_n = \lambda_{n-1} + d\lambda$
- *DisplacementControl* (page 335)  $U_{j_n} = U_{j_{n-1}} + dU_j$
- *MinUnbalDispNorm* (page 336)  $d/d\lambda (dU_n^T dU_n) = 0$
- *ArcLength* (page 336)  $dU_n^T dU_n + \alpha^2 d\lambda_n = ds^2$

### TRANSIENT ANALYSIS

- *Newmark* (page 337)
- Hilbert-Hughes-Taylor Method (*HHT* (page 338))

\***NOTE:** static integrators should only be used with a *Linear TimeSeries* (page 289) object with a factor of 1.0.

## In This Chapter

Load Control.....	334
Displacement Control.....	335
Minimum Unbalanced Displacement Norm.....	336
Arc-Length Control.....	336
Newmark Method.....	337
Hilbert-Hughes-Taylor Method.....	338

---

## Load Control

This command is used to construct a StaticIntegrator object of type LoadControl

```
integrator LoadControl $dLambda1 <$Jd $minLambda $maxLambda>
```

<b>\$dLambda1</b>	first load increment (pseudo-time step) in the next invocation of the <i>analysis</i> (page 339) command.
<b>\$Jd</b>	factor relating load increment at subsequent time steps. (optional, default: 1.0)
<b>\$minLambda</b> <b>\$maxLambda</b>	arguments used to bound the load increment (optional, default: \$dLambda1 for both)

The load increment at iterations  $i$ ,  $d\text{Lambda}(i)$ , is related to the load increment at  $(i-1)$ ,  $d\text{Lambda}(i-1)$ , and the number of iterations at  $(i-1)$ ,  $J(i-1)$ , by the following:

$$d\text{Lambda}(i) = d\text{Lambda}(i-1) * Jd / J(i-1)$$

---

## Displacement Control

This command is used to construct a StaticIntegrator object of the type DisplacementControl.

```
integrator DisplacementControl $nodeTag $dofTag $dU1 <$Jd $minDu
$maxDu>
```

<b>\$nodeTag</b>	node whose response controls the solution
<b>\$dofTag</b>	degree-of-freedom whose response controls the solution.  Valid range is from 1 through <i>ndf</i> (page 34), the number of nodal degrees-of-freedom.
<b>\$dU1</b>	first displacement increment (pseudo-time step) in the next invocation of the <i>analysis</i> command
<b>\$Jd</b>	factor relating displacement increment at subsequent time steps. (optional, default: 1.0)
<b>\$minDu</b> <b>\$maxDu</b>	arguments used to bound the displacement increment (optional, default: \$dU1 for both)

The displacement increment at iterations  $i$ ,  $dU(i)$ , is related to the displacement increment at  $(i-1)$ ,  $dU(i-1)$ , and the number of iterations at  $(i-1)$ ,  $J(i-1)$ , by the following:

$$dU(i) = dU(i-1) * Jd / J(i-1)$$

$$U_{j_n} = U_{j_{n-1}} + dU_j$$

---

## Minimum Unbalanced Displacement Norm

This command is used to construct a StaticIntegrator object of type MinUnbalDispNorm.

**integrator MinUnbalDispNorm \$dLambda1 <\$Jd \$minLambda \$maxLambda>**

<b>\$dLambda1</b>	first load increment (pseudo-time step) at the first iteration in the next invocation of the <i>analysis</i> (page 339) command.
<b>\$Jd</b>	factor relating first load increment at subsequent time steps. (optional, default: 1.0)
<b>\$minLambda</b> <b>\$maxLambda</b>	arguments used to bound the load increment (optional, default: \$dLambda1 for both)

The load increment at iterations  $i$ ,  $d\Lambda_1(i)$ , is related to the load increment at  $(i-1)$ ,  $d\Lambda_1(i-1)$ , and the number of iterations at  $(i-1)$ ,  $J(i-1)$ , by the following:

$$d\Lambda_1(i) = d\Lambda_1(i-1) * Jd / J(i-1)$$

---

## Arc-Length Control

This command is used to construct a StaticIntegrator object of type ArcLength. Arc-length methods are used to enable the solution algorithm to pass limit points, such as maximum and minimum loads, and snap-through and snap-back responses. At these limit points, the stability of the numerical system is dependent on whether the analysis is performed under load or displacement control. In structural analysis, these limit points are characteristic of cracking of reinforced concrete and of buckling of shells.

**integrator ArcLength \$arclength \$alpha**

(??? is this the correct order, at the workshop Frank had it different)

<b>\$arclength</b>	arclength value
<b>\$alpha</b>	

SEE FMK

$$dU_n^T dU_n + \alpha^2 d\lambda_n = ds^2$$



The equilibrium equation can be written in the form:

$$g(p, \lambda) = q_i(p) - \lambda \cdot q_{ef} = 0$$

the arc-length method aims to find the intersection of the above equation with  $s = \text{constant}$ , where  $s$  is the arc-length, defined by:

$$s = \int 1 \, ds$$

and

$$ds = \sqrt{dp^T \cdot dp + d\lambda^2 \cdot \psi^2 \cdot q_{ef}^T \cdot q_{ef}}$$

the scaling parameter  $\psi$  is required because the load contribution depends on the adopted scaling between the load and displacement terms.

for the arc-length methods, one should replace the differential form of the equation for  $ds$  with an incremental form:

???

$$a = \left( \Delta p^T \cdot \Delta p + \Delta \lambda^2 \cdot \psi^2 \cdot q_{ef}^T \cdot q_{ef} \right) - \Delta l^2 = 0$$

$$a = \left( \Delta p^T \cdot \Delta p + \Delta \lambda^2 \cdot \psi^2 \cdot q_{ef}^T \cdot q_{ef} \right) - \Delta l^2 = 0$$

where  $\Delta l$  is the fixed 'radius of the desired intersection.

In the arc-length method the load parameter  $\lambda$  becomes a variable, adding one to the  $n$  displacement variables and equations.

## Newmark Method

This command is used to construct a TransientIntegrator object of type Newmark.

**integrator Newmark \$gamma \$beta**

**\$gamma** Newmark parameter  $\gamma$

**\$beta** Newmark parameter  $\beta$

The damping matrix  $D$  is specified as a combination of stiffness and mass-proportional damping matrices:

$$D = \$alphaM * M + \$betaK * Kcurrent + \$betaKinit * Kinit + \$betaKcomm * KlastCommit$$

The mass and stiffness matrices are defined as:

M	mass matrix used to calculate Rayleigh Damping
Kcurrent	stiffness matrix at current state determination used to calculate Rayleigh Damping
Kinit	stiffness matrix at initial state determination used to calculate Rayleigh Damping
KlastCommit	stiffness matrix at last-committed state determination used to calculate Rayleigh Damping

Note: Damping should be specified using the *Rayleigh* (page 342) command.

---

## Hilbert-Hughes-Taylor Method

This command is used to construct a TransientIntegrator object of type HHT or HHT1.

```
integrator HHT $gamma <$alphaM $betaK $betaKinit $betaKcomm>
```

<b>\$gamma</b>	Newmark parameter $\gamma$
<b>\$alphaM \$betaK \$betaKinit \$betaKcomm</b>	Arguments to define Rayleigh damping matrix (optional, default: zero)

The damping matrix  $D$  is specified as a combination of stiffness and mass-proportional damping matrices:

$$D = \$alphaM * M + \$betaK * Kcurrent + \$betaKinit * Kinit + \$betaKcomm * KlastCommit$$

The mass and stiffness matrices are defined as:

M	mass matrix
Kcurrent	stiffness matrix at current state determination
Kinit	stiffness matrix at initial state determination
KlastCommit	stiffness matrix at last-committed state determination

## CHAPTER 36

# analysis Command

This command is used to construct the *Analysis object* (page 313), which defines what type of analysis is to be performed. The following analysis types are available:

- *Static Analysis* (page 339) -- solves the  $KU=R$  problem, without the mass or damping matrices.
- *Transient Analysis* (page 340) -- solves the time-dependent analysis. The time step in this type of analysis is constant. The time step in the output is also constant.
- *Variable Transient Analysis* (page 341) -- performs the same analysis type as the Transient Analysis object. The time step, however, is variable. This method is used when there are convergence problems with the Transient Analysis object at a peak or when the time step is too small. The time step in the output is also variable.

All currently-available analysis objects employ incremental solution strategies.

## In This Chapter

Static Analysis .....	339
Transient Analysis .....	340
VariableTransient Analysis .....	341

---

## Static Analysis

This command is used to construct a StaticAnalysis object.

**analysis Static**

This analysis object is constructed with the component objects previously created by the analyst. If none has been created, default objects are constructed and used:

Component Object	Default object
------------------	----------------

<i>SolutionAlgorithm</i> (page 329), <i>StaticIntegrator</i> (page 335, page 333, page 334, page 336)	<i>NewtonRaphson</i> (page 329) <i>EquiSolnAlgo</i> with a <i>CTestNormUnbalance</i> (page 326) with a tolerance of 1e-6 and a maximum of 25 iterations
<i>ConstraintHandler</i> (page 316)	<i>PlainHandler</i> (page 318) <i>ConstraintHandler</i>
<i>DOF_Numberer</i> (page 321)	<i>RCM</i> (page 322) <i>DOF_Numberer</i>
<i>LinearSOE</i> (page 323), <i>LinearSolver</i> (page 323)	<i>profiled symmetric positive definite</i> (page 324) <i>LinearSOE</i> and <i>Linear Solver</i>
<i>Integrator</i>	<i>LoadControl StaticIntegrator</i> (page 334) with a constant load increment of 1.0

---

## Transient Analysis

This command is used to construct a *DirectIntegrationAnalysis* object.

### analysis Transient

This analysis object is constructed with the component objects previously created by the analyst. If none has been created, default objects are constructed and used:

Component Object	Default object
<i>SolutionAlgorithm</i> (page 329), <i>TransientIntegrator</i> (page 333)	<i>NewtonRaphson</i> (page 329) <i>EquiSolnAlgo</i> with a <i>CTestNormUnbalance</i> (page 326) with a tolerance of 1e-6 and a maximum of 25 iterations
<i>ConstraintHandler</i> (page 316)	<i>PlainHandler</i> (page 318) <i>ConstraintHandler</i>
<i>DOF_Numberer</i> (page 321)	<i>RCM</i> (page 322) <i>DOF_Numberer</i>
<i>LinearSOE</i> (page 323), <i>LinearSolver</i> (page 323)	<i>profiled symmetric positive definite</i> (page 324) <i>LinearSOE</i> and <i>Linear Solver</i>

Integrator	<i>Newmark TransientIntegrator</i> (page 337) with $\gamma=0.5$ and $\beta=0.25$
------------	--

## VariableTransient Analysis

This command is used to construct a `VariableTimeStepDirectIntegrationAnalysis` object.

### analysis VariableTransient

This analysis object is constructed with the component objects previously created by the analyst. If none has been created, default objects are constructed and used:

Component Object	Default object
<i>SolutionAlgorithm</i> (page 329), <i>TransientIntegrator</i> (page 333)	<i>NewtonRaphson</i> (page 329) <i>EquiSolnAlgo</i> with a <i>CTestNormUnbalance</i> (page 326) with a tolerance of 1e-6 and a maximum of 25 iterations
<i>ConstraintHandler</i> (page 316)	<i>PlainHandler</i> (page 318) <i>ConstraintHandler</i>
<i>DOF_Numberer</i> (page 321)	<i>RCM</i> (page 322) <i>DOF_Numberer</i>
<i>LinearSOE</i> (page 323), <i>LinearSolver</i> (page 323)	<i>profiled symmetric positive definite</i> (page 324) <i>LinearSOE</i> and <i>Linear Solver</i>
Integrator	<i>Newmark TransientIntegrator</i> (page 337) with $\gamma=0.5$ and $\beta=0.25$

## CHAPTER 37

# rayleigh command

This command is used to assign damping to all previously-defined elements and nodes:

```
rayleigh $alphaM $betaK $betaKinit $betaKcomm
```

The damping matrix  $D$  is specified as a combination of stiffness and mass-proportional damping matrices:

$$D = \alpha M + \beta K_{\text{current}} + \beta_{\text{init}} K_{\text{init}} + \beta_{\text{comm}} K_{\text{lastCommit}}$$

The mass and stiffness matrices are defined as:

M	mass matrix used to calculate Rayleigh Damping
Kcurrent	stiffness matrix at current state determination used to calculate Rayleigh Damping
Kinit	stiffness matrix at initial state determination used to calculate Rayleigh Damping
KlastCommit	stiffness matrix at last-committed state determination used to calculate Rayleigh Damping

## CHAPTER 38

# eigen Command

This command is used to perform a generalized eigenvalue problem to determine a specified number of eigenvalues and eigenvectors.

**eigen <\$type> \$numEigenvalues**

**\$type** eigen-value analysis type:

<b>frequency</b>	solve: $K - \lambda M$
<b>generalized</b>	solve: $K - \lambda M$ (default)
<b>standard</b>	solve: $K - \lambda I$

**\$numEigenvalues** number of first eigenvalues ( $\lambda$ ) to be determined

The eigenvectors are stored at the nodes and can be printed out using *Node Recorder* (page 303) or the *Print command* (page 347).

NOTE: The current eigensolver is able to solve only for  $N-1$  eigenvalues, where  $N$  is the number of internal DOFs. When running into this limitation, the user should add negligible masses to additional unrestrained degrees of freedom.

For example, for a 3-dof/node problem, instead of:

```
mass 1 100 0 0
```

the user should input:

```
mass 1 100 1e-9 0
```

where dof-2 at node 1 is unrestrained.

## CHAPTER 39

# analyze Command

This command is invoked on the Analysis object constructed with the *analysis command* (page 339).

```
analyze $numIncr <$dt> <$dtMin $dtMax $Jd>
```

<b>\$numIncr</b>	number of load steps
<b>\$dt</b>	time-step increment. Required if a transient analysis (page 340) or variable time step transient analysis (page 341) was specified.
<b>\$dtMin</b> <b>\$dtMax</b>	minimum and maximum time steps Required if a variable time step transient analysis (page 341) was specified.
<b>\$Jd</b>	number of iterations performed at each step Required if a variable time step transient analysis (page 341) was specified.

This command RETURNS:

- 0**    successful
- <0**    unsuccessful



## CHAPTER 40

# dataBase Commands

This command is used to construct a FE\_Datstore object.

Currently there is only one type of Datstore object available.

## In This Chapter

FileDatstore Command..... 345

## FileDatstore Command

This command is used to construct the FE\_Datstore object.

**database \$type \$dbName**

**\$type**

database type:

<b>File</b>	outputs database into a file
<b>MySQL</b>	creates a SQL database
<b>BerkeleyDB</b>	creates a BerkeleyDB database

**\$dbName**

database name.

If the database type is **File**, the command will save the data into a number of files, e.g. \$dbName.id11 for all ID objects of size 11 that sendSelf() is invoked upon.

The invocation of this command will add the additional commands save and restore to the OpenSees interpreter to allow users to save and restore model states.

---

## save Command

This command is used to save the state of the model in the database.

**save \$commitTag**

**\$commitTag**            unique identifier that can be used to *restore* (page 346) the state at a later time

---

## restore Command

This command is used to restore the state of the model from the information stored in the database.

**restore \$commitTag**

**\$commitTag**            unique identifier used to restore the state at the model when the *save* (page 346) command was invoked

## CHAPTER 41

# Miscellaneous Commands

These are a few additional miscellaneous command used in OpenSees

## In This Chapter

print Command.....	347
reset Command.....	348
wipe Command .....	348
wipeAnalysis Command .....	348
loadConst Command.....	349
getTime Command.....	349
nodeDisp Command.....	349
video Command .....	350
nodeBounds .....	351
display Command.....	352

---

## print Command

This command is used to print output.

To print all objects of the domain:

```
print <$fileName>
```

To print node information:

```
print <$fileName> -node <-flag $flag> <$node1 $node2 ...>
```

To print element information:

```
print <$fileName> -ele <-flag $flag> <$ele1 $ele2 ...>
```

**\$fileName**            fileName for printed output (optional, Default: stderr -- screen dump)

<b>\$flag</b>	integer flag to be sent to the print() method, depending on the node and element type (optional)
<b>\$node1 \$node2 ...</b>	node tag for selected-node output (optional) Default: all
<b>\$ele1 \$ele2 ...</b>	element tag for selected-element output (optional) Default: all

---

## reset Command

This command is used to set the state of the domain to its original state.

**reset**

The command invokes `revertToStart()` on the *Domain* (page 30) object.

---

## wipe Command

This command is used to destroy all constructed objects.

**wipe**

This command is used to start over without having to exist and restart the *interpreter* (page 18).

---

## wipeAnalysis Command

This command is used to destroy all objects constructed for the analysis.

**wipeAnalysis**

This command is used to start a new type of analysis. This command does not destroy the *elements* (page 215), *nodes* (page 36), *materials* (page 162, page 43), etc. It does destroy the solution strategies: the *algorithm* (page 329), *analysis* (page 339), *equation solver* (page 323), *constraint handler* (page 316), etc.

---

## loadConst Command

This command is used to invoke `setLoadConst()` on all *LoadPattern* (page 294) objects which have been created up to this point.

```
loadConst <-time $pseudoTime>
```

**-time \$pseudoTime** set pseudo time in the domain to \$pseudoTime (optional, default: zero)

---

## getTime Command

This command returns the time in the domain.

```
getTime
```

---

## nodeDisp Command

Returns the displacement or rotation at specified node.

```
nodeDisp $nodeTag $dof
```

**\$nodeTag** node tag

**\$dof** degree-of-freedom tag

Valid range is from 1 through *ndf* (page 34), the number of nodal degrees-of-freedom. (???)

---

## video Command

This command is used to construct a `TclVideoPlayer` object for displaying the images in a file created by the recorder *display* (page 310) command.

```
video -file $fileName -window $windowName
```

**\$fileName**                fileName of images file created by the recorder *display* (page 310) command

**\$windowName**            name of window to be created

The images are displayed by invoking the *play* (page 351) command.

---

## play Command

This command is used to play the TclVideoPlayer object created by the *video* (page 350) command.

**play**

---

## nodeBounds

This command returns a 5-element list of the max and min coordinates of the nodes defined in the domain:

**nodeBounds**

---

The command returns: "Xmin Ymin Zmin Xmax Ymax Zmax", independently of the domain dimensions, 1D, 2D or 3D, zeros are returned for the extra dimensions.

This command is useful when setting up a display.

### Example:

```
3D          set Xmin [lindex [nodeBounds] 0];
            set Ymin [lindex [nodeBounds] 1];
            set Zmin [lindex [nodeBounds] 2];
            set Xmax [lindex [nodeBounds] 3];
            set Ymax [lindex [nodeBounds] 4];
            set Zmax [lindex [nodeBounds] 5];

2D          set Xmin [lindex [nodeBounds] 0];
            set Ymin [lindex [nodeBounds] 1];
            set Xmax [lindex [nodeBounds] 3];
            set Ymax [lindex [nodeBounds] 4];

1D          set Xmin [lindex [nodeBounds] 0];
            set Xmax [lindex [nodeBounds] 3];
```

---

## display Command

This command is used to display the model defined in the domain, and is associated with the *display recorder* (page 310):

```
display $arg1 $arg2 $amplification
```

### Example usage:

```
set dAmp 10; # this amplification is dependent on the model size
```

```
if {$ShapeType == "ModeShape" } {  
    display -$nEigen 0 $dAmp; # display mode shape for mode $nEigen  
} elseif {$ShapeType == "NodeNumbers" } {  
    display 1 -1 0 ;          # display node numbers  
} elseif {$ShapeType == "DeformedShape" } {  
    display 1 5 $dAmp;       # display deformed shape  
}
```



## CHAPTER 42

# How To....

In this chapter, some examples on how to generate input for OpenSees for specific tasks will be presented.

## In This Chapter

Run OpenSees.....	354
...Define Units & Constants .....	356
...Generate Matlab Commands.....	357
...Define Tcl Procedure.....	357
...Read External files .....	359
Building The Model.....	360
Defining Output .....	366
Gravity Loads .....	369
Static Analysis.....	370
Dynamic Analysis .....	372
...Combine Input-File Components .....	373
...Run Parameter Study .....	374
...Run Moment-Curvature Analysis on Section .....	376
...Determine Natural Period & Frequency .....	377

---

# Run OpenSees

There are three ways that OpenSees/Tcl commands can be executed:

➤ **Interactive**

Commands can be input directly at the prompt, as shown in the figure (Win32 version):

Figure 63: Run OpenSees -- Interactive

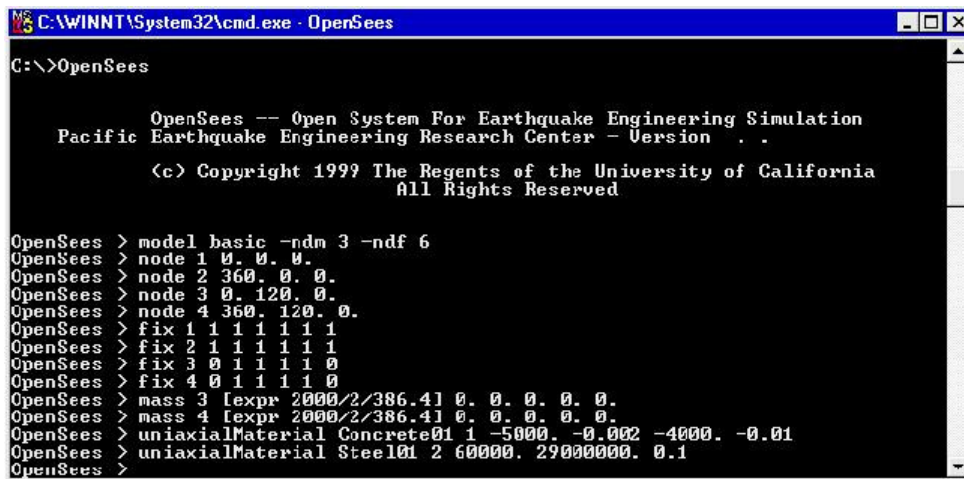

```
C:\WINNT\System32\cmd.exe - OpenSees
C:\>OpenSees

OpenSees -- Open System For Earthquake Engineering Simulation
Pacific Earthquake Engineering Research Center - Version . .

(c) Copyright 1999 The Regents of the University of California
All Rights Reserved

OpenSees > model basic -ndm 3 -ndf 6
OpenSees > node 1 0. 0. 0.
OpenSees > node 2 360. 0. 0.
OpenSees > node 3 0. 120. 0.
OpenSees > node 4 360. 120. 0.
OpenSees > fix 1 1 1 1 1 1
OpenSees > fix 2 1 1 1 1 1
OpenSees > fix 3 0 1 1 1 0
OpenSees > fix 4 0 1 1 1 0
OpenSees > mass 3 {expr 2000/2/386.41 0. 0. 0. 0. 0.
OpenSees > mass 4 {expr 2000/2/386.41 0. 0. 0. 0. 0.
OpenSees > uniaxialMaterial Concrete01 1 -5000. -0.002 -4000. -0.01
OpenSees > uniaxialMaterial Steel01 2 60000. 29000000. 0.1
OpenSees >
```

➤ **Execute Input File at OpenSees prompt**

This method is the most-commonly used one. An external file containing the input commands can be generated a-priori (inputFile.tcl) and be executed at the OpenSees prompt by using the source command. The generation of the input script files is presented in this chapter. The file execution is shown in the figure (Win32 version):



```

C:\openSees.exe

OpenSees -- Open System For Earthquake Engineering Simulation
Pacific Earthquake Engineering Research Center - Version . .
(c) Copyright 1999 The Regents of the University of California
All Rights Reserved

OpenSees > source inputFile.tcl
UmfpackGenLinS0E::setSize - n 4 nnz 16 lUal 160
UmfpackGenLinS0E::setSize - n 4 nnz 16 lUal 160
OpenSees > _
  
```

Figure 64: Run OpenSees -- Source File

➤ **Batch Mode**

The previously-created input file containing the Tcl script commands necessary to execute the analysis can also be executed at the MS-DOS/Unix prompt, as shown in the figure (Win32 version):

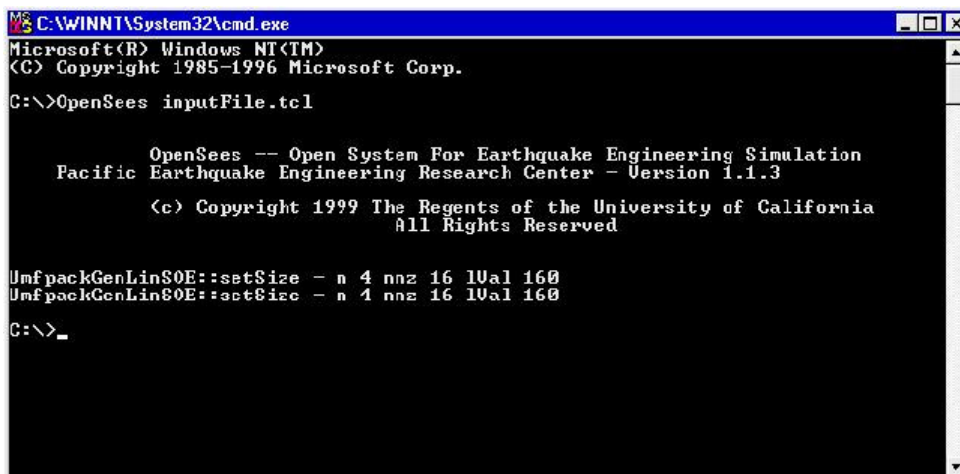

```

C:\WINNT\System32\cmd.exe
Microsoft(R) Windows NT(TM)
(C) Copyright 1985-1996 Microsoft Corp.
C:\>OpenSees inputFile.tcl

OpenSees -- Open System For Earthquake Engineering Simulation
Pacific Earthquake Engineering Research Center - Version 1.1.3
(c) Copyright 1999 The Regents of the University of California
All Rights Reserved

UmfpackGenLinS0E::setSize - n 4 nnz 16 lUal 160
UmfpackGenLinS0E::setSize - n 4 nnz 16 lUal 160
C:\>_
  
```

Figure 65: Run OpenSees -- Batch Mode

## ...Define Units & Constants

The OpenSees interpreter does not process units. Units, however, can be used when entering values if these units are defined previously. The unit definition consists of two parts: the basic units are defined first, all other units are subsequently defined. The basic units are assigned a value of one and all OpenSees output is in these units. It is very important that all basic units are independent of each other. The unit-definition file can contain both metric and Imperial units, as can the basic units. Hence, the input files may contain mixed units.

Constants, such as  $\pi$  and  $g$  can also be defined apriori.

An example of unit and constant definition is given in the following:

### ➤ Procedure to define units and constants

```
# ----Units&Constants.tcl-----
set in 1.;                # define basic units
set sec 1.;
set kip 1.;
set ksi [expr $kip/pow($in,2)];    # define dependent units
set psi [expr $ksi/1000.];
set ft [expr 12.*$in];
set lb [expr $kip/1000];
set pcf [expr $lb/pow($ft,3)];
set ksi [expr $kip/pow($in,2)];
set psi [expr $ksi/1000.];
set cm [expr $in/2.54];        # define metric units
set meter [expr 100.*$cm];
set MPa [expr 145*$psi];
set PI [expr 2*asin(1.0)];      # define constants
set g [expr 32.2*$ft/pow($sec,2)];
set U 1.e10;                  # a really large number
set u [expr 1/$U];           # a really small number
```

## CHAPTER

---

## ...Generate Matlab Commands

Matlab is a common tool for post-processing. Matlab command files can be generated using the Tcl scripting language. Using this technique ensures that the same analysis parameters are used.

Here is an example.

➤ *# script to generate .m file to be read by matlab*

```
# -----MatlabOutput.tcl-----
set Xframe 1;          # this parameter would be passed in
set fDir "Data/";
file mkdir $fDir;      # create directory
set outFileID [open $fDir/DataFrame$Xframe.m w]; # Open output file for writing
puts $outFileID "Xframe($Xframe) = $Xframe;"; # frame ID
puts $outFileID "Hcol($Xframe) = $Hcol;";      # column diameter
puts $outFileID "Lcol($Xframe) = $Lcol;";      # column length
puts $outFileID "Lbeam($Xframe) = $Lbeam;";    # beam length
puts $outFileID "Hbeam($Xframe) = $Hbeam;";    # beam depth
puts $outFileID "Bbeam($Xframe) = $Bbeam;";    # beam width
puts $outFileID "Weight($Xframe) = $Weight;";  ; # superstructure weight
close $outFileID
```

---

## ...Define Tcl Procedure

The procedure is a useful tool available from the Tcl language. A procedure is a generalized function/subroutine using arguments. Whenever the Tcl procedure is invoked, the contents of body will be executed by the Tcl interpreter.

An example of a Tcl procedure is found in RCcircSec.tcl. It defines a procedure which generates a circular reinforced concrete section with one layer of steel evenly distributed around the perimeter and a confined core:

```
# ----RCcircSec.tcl-----
#
# by Michael H. Scott
# Define a procedure which generates a circular reinforced concrete section
# with one layer of steel evenly distributed around the perimeter and a confined core.
```

```

# Formal arguments
# id - tag for the section that is generated by this procedure
# ri - inner radius of the section
# ro - overall (outer) radius of the section
# cover - cover thickness
# coreID - material tag for the core patch
# coverID - material tag for the cover patches
# steelID - material tag for the reinforcing steel
# numBars - number of reinforcing bars around the section perimeter
# barArea - cross-sectional area of each reinforcing bar
# nfCoreR - number of radial divisions in the core (number of "rings")
# nfCoreT - number of theta divisions in the core (number of "wedges")
# nfCoverR - number of radial divisions in the cover
# nfCoverT - number of theta divisions in the cover

# Notes
# The center of the reinforcing bars are placed at the inner radius
# The core concrete ends at the inner radius (same as reinforcing bars)
# The reinforcing bars are all the same size
# The center of the section is at (0,0) in the local axis system
# Zero degrees is along section y-axis

proc RCcircSection {id ri ro cover coreID coverID steelID numBars barArea nfCoreR nfCoreT nfCoverR
nfCoverT} {
    section fiberSec $id {
        set rc [expr $ro-$cover];          # Core radius
        patch circ $coreID $nfCoreT $nfCoreR 0 0 $ri $rc 0 360;    # Core patch
        patch circ $coverID $nfCoverT $nfCoverR 0 0 $rc $ro 0 360; # Cover patch
        if {$numBars <= 0} {
            return
        }
        set theta [expr 360.0/$numBars];    # Angle between bars
        layer circ $steelID $numBars $barArea 0 0 $rc $theta 360; # Reinforcing layer
    }
}

```

This procedure is invoked by the following commands, assuming that all arguments have been defined previously in the input generation:

```

source RCcircSection.tcl;
RCcircSection $IDcolFlex $riCol $roCol $cover $IDcore $IDcover $IDsteel $NbCol $AbCol $nfCoreR $nfCoreT
$nfCoverR $nfCoverT

```

**NOTE:** the file containing the definition of the procedure (RCcircSec.tcl) needs to be sourced before the procedure is invoked.

## ...Read External files

External files may either contain Tcl commands or data.

### ➤ *Common input file*

The external file may contain a series of commands that is common in most analyses. One set of Tcl commands that can be stored in a external file are ones which define units.

An example of an external file that may want to be read within the input commands is the unit-definition file presented earlier (*units&constants.tcl* (page 439)).

This file is invoked with the following command:

```
source units.tcl
```

### ➤ *Repeated Calculations*

An external file may contain a series of calculations that are repeated. An example of this is a parameter study:

```
set Hcolumn 66;
source analysis.tcl
set Hcolumn 78;
source analysis.tcl
```

The analysis.tcl file contains the commands that set up and execute the entire analysis.

### ➤ *External Data File*

The following commands open a data file (filename=inFilename), read the file row by row and assign the value of each row to the a single variable (Xvalues). If there are more than one value in the row, \$Xvalues is a list array, and the individual components may be extracted using the **lindex** command. The user may change the commands to be executed once the data-line has been read to whatever is needed in the analysis.

```
# ----ReadData.tcl-----
if [catch {open $inFilename r} inFileID] {; # Open the input file and check for error
    puts stderr "Cannot open $inFilename for reading"; # output error statement
} else {
    foreach line [split [read $inFileID] \n] {; # Look at each line in the file
        if {[length $line] == 0} {; # Blank line --> do nothing
            continue;
        } else {
```

```

        set Xvalues $line;      # execute operation on read data
    }
}
close $inFileID; ;          # Close the input file
}

```

## Building The Model

### ...Define Variables and Parameters

In the Tcl scripting language variables may be used to represent numbers. Once defined, these variables can be use instead of numbers in Tcl and OpenSees commands. When they are being recalled, the variables are preceded by the symbol \$. If this symbol is not used, the variable name is interpreted as a string command and an error may result.

A few examples are given:

MATERIAL PARAMETERS:

```

# -----MaterialParameters.tcl-----
set fc [expr -4.0*$ksi];          # nominal compressive strength of concrete
set Ec [expr 57*$ksi*sqrt(-$fc/$psi)];    # Concrete Elastic Modulus
set fc1C [expr 1.26394*$fc];      # CONFINED concrete (mander model), max stress
set eps1C [expr 2.*$fc1C/$Ec];    # strain at maximum stress
set fc2C $fc;                    # ultimate stress
set eps2C [expr 2.*$fc2C/$Ec];    # strain at ultimate stress
set fc1U $fc;                    # UNCONFINED concrete (parabolic model), max stress
set eps1U -0.003;                # strain at maximum stress
set fc2U [expr 0.1*$fc];         # ultimate stress
set eps2U -0.006;                # strain at ultimate stress
set Fy [expr 70.*$ksi];          # STEEL yield stress
set Es [expr 29000.*$ksi];       # elastic modulus of steel
set epsY [expr $Fy/$Es];         # steel yield strain
set Fy1 [expr 95.*$ksi];         # steel stress post-yield
set epsY1 0.03;                  # steel strain post-yield
set Fu [expr 112.*$ksi];         # ultimate stress of steel
set epsU 0.08;                   # ultimate strain of steel
set Bs [expr ($Fu-$Fy)/($epsU-$epsY)/$Es]; # post-yield stiffness ratio of steel

```



```

set pinchX 1.0; # pinching parameter for hysteretic model
set pinchY 1.0; # pinching parameter for hysteretic model
set damage1 0.0; # damage parameter for hysteretic model
set damage2 0.0; # damage parameter for hysteretic model
set betaMUsteel 0.0; # degraded unloading stiffness for hysteretic material based on MU(-beta)
set betaMUjoint 0.0; # degraded unloading stiffness for hysteretic material based on MU(-beta) --
timoshenko value of 0.5
set betaMUph 0.0; # degraded unloading stiffness for hysteretic material based on MU(-beta) --
timoshenko value of 0.5
set G $U; # Torsional stiffness Modulus
set J 1.; # Torsional stiffness of section, place here just to keep with G

```

**set GJ [expr \$G\*\$J]; # Torsional stiffness**

#### ELEMENT PARAMETERS:

```

# ----ElementParameters.tcl-----
set Hcol [expr 5*$ft]; # column diameter
set Lcol [expr 36*$ft]; # column length
set Hbeam [expr 8*$ft]; # beam depth
set Lbeam [expr 36*$ft]; # beam length
set GrhoCol 0.0125; # column longitudinal-steel ratio
set Weight [expr 2000.*$kip]; # superstructure weight
set Bbeam $Hcol; # beam width
set Rcol [expr $Hcol/2]; # COLUMN radius
set Acol [expr $PI*pow($Rcol,2)]; # column cross-sectional area
set cover [expr $Hcol/15]; # column cover width
set IgCol [expr $PI*pow($Rcol,4)/4]; # column gross moment of inertia, uncracked
set IyCol $IgCol; # elastic-column properties
set IzCol $IgCol; # elastic-column properties
set IzBeam [expr $Bbeam*pow($Hbeam,3)/12]; # beam gross moment of inertia, about horizontal Z-axis
set IyBeam [expr $Hbeam*pow($Bbeam,3)/12]; # beam gross moment of inertia, about the vertical Y-axis
set Abeam [expr $Hbeam*$Bbeam*10000]; # beam cross-sectional area, make it very very stiff
# define COLUMN section parameters
set NbCol 20; # number of column longitudinal-reinforcement bars
set AsCol [expr $GrhoCol*$Acol]; # total steel area in column section
set AbCol [expr $AsCol/$NbCol]; # bar area of column longitudinal reinforcement
set riCol 0.0; # inner radius of column section
set roCol $Rcol; # outer radius of column section
set IDcore 1; # ID tag for core concrete

```

```

set IDcover    2;      # ID tag for cover concrete
set IDsteel   3;      # ID tag for steel
set nfCoreR   8;      # number of radial fibers in core
set nfCoreT   16;     # number of tangential fibers in core
set nfCoverR  2;      # number of radial fibers in cover
set nfCoverT  16;     # number of tangential fibers in cover
set IDcolFlex 2;      # ID tag for column section in flexure, before aggregating torsion
set IDcolTors 10;    # ID tag for column section in torsion
set IDcolSec  1;      # ID tag for column section
set IDcolTrans 1;    # ID tag for column transformation, defining element normal
set IDbeamTrans 2;    # ID tag for beam transformation, defining element normal

```

```

set np 5;      # Number of integration points

```

#### GRAVITY PARAMETERS:

```

# ----GravityParameters.tcl-----
# define GRAVITY paramters
set Pdl [expr $Weight/2];          # gravity axial load per column
set Wbeam [expr $Weight/$Lbeam];  # gravity dead load distributed along beam length
set Mdl [expr $Wbeam*pow($Lbeam,2)/12]; # nodal moment due to distributed dl
set Mass [expr $Weight/$g];      # mass of superstructure

```

```

set Mnode [expr $Mass/2];        # nodal mass for each column joint

```

#### ANALYSIS PARAMETERS:

```

# ----AnalysisParameters.tcl-----
set DxPush [expr 0.1*$in]; # Displacement increment for pushover analysis
set DmaxPush [expr 0.05*$Lcol]; # maximum displacement for pushover analysis
set DtAnalysis [expr 0.005*$sec];# time-step Dt for lateral analysis
set DtGround [expr 0.02*$sec];# time-step Dt for input grond motion
set TmaxGround [expr 35*$sec]; # maximum duration of ground-motion analysis
set gamma 0.5; # gamma value for newmark integration

```

```

set beta 0.25 # beta value for newmark integration

```

## ...Build Model and Define Nodes

This example shows how to set up the geometry of the structure shown in the *Figure* (page 363).

These commands are typically placed at the beginning of the input file, after the header remarks.

```
# construct model builder using the model Command (page 34)
wipe;                # clear data from past analysis
model basic -ndm 3 -ndf 6;    # modelbuilder: basic (page 34), ndm= no. dimensions, ndf= no.
# Define nodes ----- frame is in X-Y plane (X-horizontal, Y-vertical) using the node Command (page 36)
node 1  0.    0.    0.; # base of left column
node 2  360.  0.    0.; # base of right columnn
node 3  0.    120.  0.; # top of left column
node 4  360.  120.  0.;  # top of right columnn
# Define Boundary Conditions and nodal mass using the fix Command (page 38) ! 1: restrained, 0: released
fix 1  1  1  1  1  1  1;
fix 2  1  1  1  1  1  1;
fix 3  0  1  1  1  1  0 -mass [expr 2000/2/386.4] 0. 0. 0. 0. 0.
fix 4  0  1  1  1  1  0
# define mass at node 4 using the mass Command (page 37):
```

```
mass 4 [expr 2000/2/32.2/12] 0. 0. 0. 0. 0.
```

# **NOTE:** The second command assigning the mass of a specific node will override any previous mass assignments to that node.

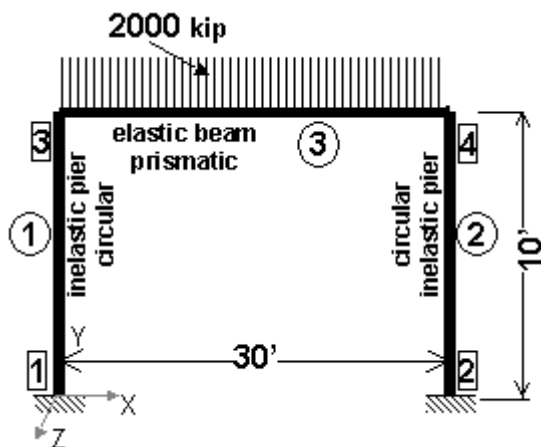

## ...Build Model and Define Nodes using Variables

This example sets up the geometry of the cantilever column shown in the *Figure* (page 363) -- using variables.

```
# -----Build&Nodes.tcl-----
wipe;                # clear data from past analysis
model basic -ndm 3 -ndf 6;
# define units and constants
# source units.tcl;    # if contained in external file
# Define nodes ----- frame is in X-Y plane (X-horizontal, Y-vertical) using the node Command (page 36)
node 1  0.          0.          0.;  # base of left column
node 2  $Lbeam      0.          0.;  # base of right columnn
node 3  0.          $Lcol      0.;  # top of left column
node 4  $Lbeam      $Lcol      0.;  # top of right columnn
# Define Boundary conditions using the fix Command (page 38) ! 1: restrained, 0: released
fix 1  1  1  1  1  1  1;  # fully-fixed support
fix 2  1  1  1  1  1  1;
fix 3  0  1  1  1  1  0  -mass $Mass 0.  0.  0.  0.  0.;
fix 4  0  1  1  1  1  0;
# define the mass at node 4 using the mass Command (page 37):
```

```
mass 4 $Mass 0.  0.  0.  0.  0.;
```

**# NOTE:** The second command assigning the mass of a specific node will override any previous mass assignments to that node.

## ...Define Materials

The following is an example on how to define materials for reinforced-concrete structures. The examples assume that the variables have been defined apriori. If these commands are placed into an external file they can be used in a number of analyses without significant modifications using the source command.

```
# -----MaterialsRC.tcl-----
set ConcreteMaterialType "inelastic";  # options: "elastic","inelastic"
set SteelMaterialType "hysteretic";    # options: "elastic","bilinear","hysteretic"
# CONCRETE
if {$ConcreteMaterialType == "elastic"} {
    uniaxialMaterial Elastic $IDcore $Ec
    uniaxialMaterial Elastic $IDcover $Ec
```

```

}
if {$ConcreteMaterialType == "inelastic"} {
    uniaxialMaterial Concrete01 $IDcore $fc1C $seps1C $fc2C $seps2C; # Core concrete
    uniaxialMaterial Concrete01 $IDcover $fc1U $seps1U $fc2U $seps2U; # Cover concrete
}
# STEEL
if {$SteelMaterialType == "elastic"} {
    uniaxialMaterial Elastic $IDsteel $Es
}
if {$SteelMaterialType == "bilinear"} {
    uniaxialMaterial Steel01 $IDsteel $Fy $Es $Bs
}
if {$SteelMaterialType == "hysteretic"} {
    uniaxialMaterial Hysteretic $IDsteel $Fy $sepsY $Fy1 $sepsY1 $Fu $sepsU -$Fy -$sepsY -$Fy1 -$sepsY1
    -$Fu -$sepsU $pinchX $pinchY $damage1 $damage2 $betaMUSTeel
}
}

```

## ...Define Elements

```

# -----ELEMENTS.tcl-----
# COLUMNS
set ColumnType "inelastic"; # options: "rigid" "elastic" "inelastic"
set np 5; # number of integration points
# source RCcircSection.tcl; # proc to define circular fiber section for flexural characteristics
RCcircSection $IDcolFlex $riCol $roCol $cover $IDcore $IDcover $IDsteel $NbCol $AbCol $nfCoreR $nfCoreT
$nfCoverR $nfCoverT
uniaxialMaterial Elastic $IDcolTors $GJ; # Define torsional stiffness
section Aggregator $IDcolSec $IDcolTors T -section $IDcolFlex; # attach torsion and flexure
geomTransf Linear $IDcolTrans 0 0 1; # Linear: no second-order effects
if {$ColumnType == "rigid"} {
    set $IyCol [expr $IyCol*$IyCol];
    set $IzCol [expr $IzCol*$IzCol];
    element elasticBeamColumn 1 1 3 $Acol $Ec $G $J $IyCol $IzCol $IDcolTrans
    element elasticBeamColumn 2 2 4 $Acol $Ec $G $J $IyCol $IzCol $IDcolTrans
}

```

```

if {$ColumnType == "elastic"} {
    element elasticBeamColumn 1 1 3 $Acol $Ec $G $J $IyCol $IzCol $IDcolTrans
    element elasticBeamColumn 2 2 4 $Acol $Ec $G $J $IyCol $IzCol $IDcolTrans
}
if {$ColumnType == "inelastic"} {
    element nonlinearBeamColumn 1 1 3 $np $IDcolSec $IDcolTrans
    element nonlinearBeamColumn 2 2 4 $np $IDcolSec $IDcolTrans
}
# BEAM
geomTransf Linear $IDbeamTrans 0 0 1; # define orientation of beam local axes

```

```

element elasticBeamColumn 3 3 4 $Abeam $Ec $G $J $IyBeam $IzBeam
$IDbeamTrans;

```

---

## Defining Output

### ...Define Analysis-Output Generation

Different output may be generated depending on whether the analysis is static or dynamic. Here is an example:

```

# -----Output.tcl-----
set fDir "Data/";
file mkdir $fDir; # create directory
set ANALYSIS "Static"; # this variable would be passed in
set IDctrlNode 3; # this variable would be passed in
if {$ANALYSIS == "Static"} {
    # Record nodal displacements -NODAL DISPLACEMENTS
    set fDstatFrame DStatFrame[expr $Xframe]
    set iNode "$IDctrlNode"; # can add node numbers to this list
    foreach xNode $iNode {
        set fNode Node$xNode
        set Filename $fDir$fDstatFrame$fNode
        recorder Node $Filename.out disp -time -node $xNode -dof 1 6;
    }; # end of xNode
    # Record element forces and deformations - COLUMNS
    set iEL "1 2"

```

```

set fFstatFrame FStatFrame[expr $Xframe]
set fDstatFrame DStatFrame[expr $Xframe]
foreach xEL $iEL {
    set fEI EI[expr $xEL]
    set iSEC "1 3 5"
    set Ffilename $Dir$fFstatFrame$fEI
    recorder Element $xEL -time -file $Ffilename.out localForce
    foreach xSEC $iSEC {
        set fSec Sec[expr $xSEC]
        set Dfilename $Dir$fDstatFrame$fEI$fSec
        recorder Element $xEL -file $Dfilename.out -time section $xSEC deformations
    }; # end of xSEC
}; # end of xEL
}; # end of static analysis

set ANALYSIS "Dynamic"; # this variable would be passed in
set GroundFile "ElCentro"; # this variable would be passed in
if {$ANALYSIS == "Dynamic"} {
    set fDDynaFrame DDynaFrame[expr $Xframe]
    set fGroundFile $GroundFile
    set Filename $Dir$fDDynaFrame$fGroundFile
    # Record nodal displacements
    recorder Node $Filename.out disp -time -node $iDctrlNode -dof 1
}; # end of dynamic analysis

```

## ...Define Data-Plot During Analysis

```
# -----RecorderPlot.tcl-----
```

```
set pfile "Data/node.out";
```

```
recorder Node $pfile disp -time -node $IDctrlNode -dof 1
```

```
set title PushFrame$Xframe;
```

```
recorder plot $pfile $title 0 0 350 350 -columns 2 1
```

```
set pfile "Data/Elem1.out";
```

```
set title PushElem1;
```

```
recorder Element 1 -time -file $pfile globalForce
```

```
recorder plot $pfile $title 400 0 350 350 -columns 2 1
```



---

# Gravity Loads

## ...Define Gravity Loads

```
# -----DefineGravity.tcl-----  
  
set GravSteps 10  
  
pattern Plain 1 Linear {  
    load 3 0. -$Pdl 0. 0. 0. -$Mdl ; # Fx Fy Fz Mx My Mz  
    load 4 0. -$Pdl 0. 0. 0. +$Mdl  
  
}  
  
system UmfPack; # solution procedure, how it solves system of equations  
  
constraints Plain; # how it handles boundary conditions, enforce constraints  
  
test NormDisplncr 1.0e-5 10 0;  
  
algorithm Newton;  
  
numberer RCM; # renumber dof's to minimize band-width  
  
integrator LoadControl [expr 1./$GravSteps] 1 [expr 1./$GravSteps] [expr 1./$GravSteps]  
  
analysis Static  
  
initialize; # this command will not be necessary in new versions of OpenSees
```

## ...Run Gravity Analysis

```
# -----RunGravity.tcl-----
analyze $GravSteps      # run gravity analysis
loadConst -time 0.0;   # keep gravity load and restart time -- lead to lateral-load analysis
```

---

## Static Analysis

### ...Define Static Pushover Analysis

The following commands are executed once the gravity loads have been defined and applied

```
# -----DefinePushover.tcl-----
set analysis "STATIC"; # this variable would be passed in
# the following settings do not need to be here if they have been defined in the gravity analysis
system UmfPack;
constraints Plain;
test NormDisplncr 1.0e-5 10 0;
algorithm Newton;
numberer RCM; analysis Static;
# -----
set PUSHOVER "DispControl"; # run displacement-controlled static pushover analysis
    pattern Plain 2 Linear {
        load $IDctrlNode      100.0 0.0 0.0 0.0 0.0 0.0
    }
if {$PUSHOVER == "LoadControl"} {
    integrator LoadControl 0.2 4 0.1 2.0
    set Nsteps 20
} elseif {$PUSHOVER == "DispControl"} {
    integrator DisplacementControl $IDctrlNode 1 $DxPush 1 $DxPush $DxPush
    set Nsteps [expr int($DmaxPush/$DxPush)]
} else {
```

```
puts stderr "Invalid PUSHOVER option"
```

```
}
```

## ...Run Static Pushover Analysis

While running a static pushover analysis may take a single command, convergence may not always be reached with a single analysis-parameter setting. A Tcl script which tries different solutions can be incorporated to improve the chances of convergence.

No convergence issues

The following command executes the static push-over analysis when convergence is not a problem.

```
# -----RunPushover.tcl-----
```

### analyze \$Nsteps

Convergence attempts

The following Tcl script should be incorporated in the input file to run a number of attempts at convergence:

```
# -----RunPushover2Converge.tcl-----
set ok [analyze $Nsteps]
# if analysis fails, try the following, performance is slowed inside this loop
if {$ok != 0} {
    set ok 0;
    set maxU $DmaxPush
    set controlDisp 0.0;
    test NormDisplnCr 1.0e-8 20 0
    while {$controlDisp < $maxU && $ok == 0} {
        set ok [analyze 1]
        set controlDisp [nodeDisp $IDctrlNode 1]
        if {$ok != 0} {
            puts "Trying Newton with Initial Tangent .."
            test NormDisplnCr 1.0e-8 1000 1
            algorithm Newton -initial
            set ok [analyze 1]
            test NormDisplnCr 1.0e-8 20 0
            algorithm Newton
        }
    }
}
```

```

    }
    if {$ok != 0} {
        puts "Trying Broyden .."
        algorithm Broyden 8
        set ok [analyze 1]
        algorithm Newton
    }
    if {$ok != 0} {
        puts "Trying NewtonWithLineSearch .."
        algorithm NewtonLineSearch .8
        set ok [analyze 1]
        algorithm Newton
    }
}; # end while loop
}; # end original if $ok!=0 loop
if {$ok != 0} {
    puts "DispControl Analysis FAILED"
    puts "Do you wish to continue y/n ?"; # include if want to pause at analysis failure
    gets stdin ans; # not recommended in parameter study
    if {$ans == "n"} done; # as it interrupts batch file
} else {
    puts "DispControl Analysis SUCCESSFUL"
}
}

```

---

## Dynamic Analysis

### ...Define Dynamic Ground-Motion Analysis

```

# -----DefineDynamic.tcl-----
wipeAnalysis
system UmfPack
constraints Plain

```

```

test NormDisplncr 1.0e-8 20 0;
algorithm Newton
numberer RCM
integrator Newmark $gamma $beta $alphaM $betaK $betaKcomm $betaKinit;
analysis Transient
set Nsteps [expr int($TmaxGround/$DtAnalysis)];
# read a PEER strong motion database file, extracts dt from the header and converts the file
# to the format OpenSees expects for uniform ground motions
source ReadSMDFile.tcl;
set dir "GMfiles/"
set outFile $dir$GroundFile.g3; # set variable holding new filename
set inFile $dir$GroundFile.th
ReadSMDFile $inFile $outFile dt; # convert the ground-motion file
set GMfatt [expr $g*$GMfact]; # data in input file is factor of g
set Gaccel "Series -dt $dt -filePath $outFile -factor $GMfatt"; # time series information

pattern UniformExcitation 2 1 -accel $Gaccel; # create uniform excitation

```

---

## ...Run Dynamic Ground-Motion Analysis

```
# -----RunDynamicGM.tcl-----
```

```
analyze $Nsteps $DtAnalysis;
```

---

## ...Combine Input-File Components

A series of Tcl-script input-file components have been presented in this section. These components can be combined to perform a static lateral-load analysis of the portal frame under consideration using the source command:

```
# ----FullStaticAnalysis.tcl-----
wipe
model basic -ndm 3 -ndf 6
source Units&Constants.tcl

```

```

source MaterialParameters.tcl
source ElementParameters.tcl
source GravityParameters.tcl
source AnalysisParameters.tcl
source MatlabOutput.tcl
source BuildModel&Nodesw/Variables--portal.tcl
source materialsRC.tcl
source RCcircSec.tcl
source Elements.tcl
source Output.tcl
source DefineGravity.tcl
source runGravity.tcl
source DefinePushover.tcl

```

```
source RunPushover2Converge.tcl
```

This method of breaking the input file into components is convenient when the size of the problem does not permit manageability of a single input file.

## ...Run Parameter Study

In a parameter study, the same analysis is performed on a number of models where only certain properties are varied, such as column height. There are two common types of parameter studies shown in this section: series and parallel parsing.

The following diagram illustrates the difference between series and parallel parsing for two parameter lists [1 2 3] and [A B C]:

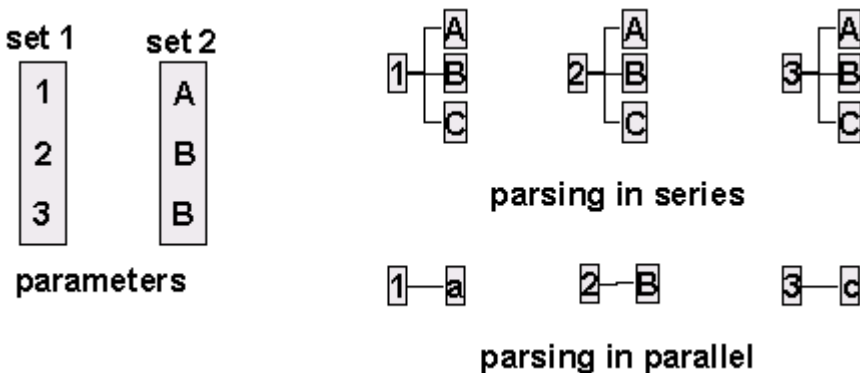

### Parsing in series

In this type of study, one parameter is held constant, while the others are parsed in sequence:

```
# -----ParameterStudySeries.tcl-----
source units.tcl
set iHcol "[expr 5.*$ft] [expr 6.5*$ft]";    # column diameter
set iLcol "[expr 36*$ft] [expr 42*$ft]";    # column length
set Xframe 0;          # initialize Frame Counter, used in output
foreach Hcol $iHcol {
    foreach Lcol $iLcol {
        set Xframe [expr $Xframe+1];
        set ANALYSIS "Static";
        source Analysis.tcl*
    }; # close iLcol loop
}; # close iHcol loop
```

**\*NOTE:** The file Analysis.tcl contains all the model and analysis commands.

### Parsing in parallel

In this study, the ith elements of each parameter list are considered together, resulting in fewer study models.

```
# -----ParameterStudyParallel.tcl-----
source units.tcl
set iHcol "[expr 5.*$ft] [expr 6.5*$ft]";    # column diameter
set iLcol "[expr 36*$ft] [expr 42*$ft]";    # column length
set Xframe 0;          # initialize Frame Counter, used in output
foreach Hcol $iHcol Lcol $iLcol{
    set Xframe [expr $Xframe+1];
    set ANALYSIS "Static";
    source Analysis.tcl*
}; # close iHcol & iLcol loop
```

**\*NOTE:** The file Analysis.tcl contains all the model and analysis commands.

## ...Run Moment-Curvature Analysis on Section

A procedure for performing section analysis (only does moment-curvature, but can be easily modified to do any mode of section response):

```
# -----MPhiProc.tcl-----
# Sets up a recorder which writes moment-curvature results to file
# make sure the node and element numbers are not used elsewhere in the model
# this procedure is set up for a 3-D problem: 3 dimensions/node, 6 dof/node
# Arguments
#   secTag -- tag identifying section to be analyzed
#   axialLoad -- axial load applied to section (negative is compression)
#   maxK -- maximum curvature reached during analysis
#   numIncr -- number of increments used to reach maxK (default 100)
proc MomentCurvature {secTag axialLoad maxK {numIncr 100} } {
    node 1001 0.0 0.0 0.0; # Define two nodes at (0,0)
    node 1002 0.0 0.0 0.0
    fix 1001 1 1 1 1 1; # Fix all degrees of freedom except axial and bending
    fix 1002 0 1 1 1 1 0
    element zeroLengthSection 2001 1001 1002 $secTag
    recorder Node Mphi.out disp -time -node 1002 -dof 6;# output moment & curvature

    integrator LoadControl 0 1 0 0; # Define analysis parameters
    system SparseGeneral -piv; # Overkill, but may need the pivoting!
    test NormUnbalance 1.0e-9 10
    numberer Plain;
    constraints Plain;
    algorithm Newton;
    analysis Static;

    pattern Plain 3001 "Constant" {
        load 1002 $axialLoad 0.0 0.0 0.0 0.0 0.0
    }; # Define constant axial load
    analyze 1; # Do one analysis for constant axial load
```



```

pattern Plain 3002 "Linear" {
    load 1002 0.0 0.0 0.0 0.0 0.0 1.0
}; # Define reference moment
set dK [expr $maxK/$numIncr]; # Compute curvature increment
# Use displacement control at node 1002 for section analysis, dof 6
integrator DisplacementControl 1002 6 $dK 1 $dK $dK
analyze $numIncr; # Do the section analysis

```

```

}
```

When including this procedure, ensure that the node and element numbers used by it are not used elsewhere in the OS model.

The above procedure may be incorporated into the static pushover analysis file:

```

# ----MomentCurvature.tcl-----
wipe
model basic -ndm 3 -ndf 6
source Units&Constants.tcl
source MaterialParameters.tcl
source ElementParameters.tcl
source GravityParameters.tcl
source materialsRC.tcl
source RCcircSec.tcl
RCcircSection $IDcolSec $riCol $roCol $cover $IDcore $IDcover $IDsteel $NbCol $AbCol $nfCoreR $nfCoreT
$nfCoverR $nfCoverT
source MPhiProc.tcl
set phiYest [expr $epsY/(0.7*$Hcol)]; # estimate yield curvature
set axialLoad -$Pdl; # define axial load -- +tension in Mom-curv analysis
set maxK [expr 20*$phiYest]; # maximum curvature reached during analysis

```

```

MomentCurvature $IDcolSec $axialLoad $maxK;

```

## ...Determine Natural Period & Frequency

The natural period and frequency of the structure can be determined at any point during the analysis using the *eigen* (page 343) command. In turn, these quantities can be stored as variables and used in defining analysis parameters, such as rayleigh-damping parameters:

```

# -----PeriodFreq&Damping.tcl-----

```

```
# determine Natural Period, Frequency & damping parameters for SDOF
set $xDamp 0.02;      # damping ratio (0.02-0.05-typical)
set lambda [eigen 1]
set omega [expr pow($lambda,0.5)]
set Tperiod [expr 2*$PI/$omega];    # period (sec.)
puts $Tperiod
set alphaM 0;        # stiffness-prop. RAYLEIGH damping parameter; D = alphaM*M
set betaK 0;        # stiffness proportional damping;          +beatK*KCurrent
set betaKcomm [expr 2*$xDamp/$omega];    # mass-prop. RAYLEIGH damping parameter;
    +betaKcomm*KlastCommitt
set betaKinit 0;    # initial-stiffness proportional damping          +beatKinit*Kini
```

## CHAPTER 43

# Getting Started with OpenSees

Under the NEESgrid support, a *Getting Started with OpenSees* (<http://peer.berkeley.edu/~silvia/OpenSees/gettingstarted/>) document has been produced.



Technical Report NEESgrid-TR  
2004-21

[www.neesgrid.org](http://www.neesgrid.org)

Getting Started with OpenSees

Silvia Mazzoni, Frank McKenna, Gregory L. Fenves

Pacific Earthquake Engineering Research Center

University of California, Berkeley

OpenSees version 1.6.0

please send questions and comments about the manual to [silvia@peer.berkeley.edu](mailto:silvia@peer.berkeley.edu)

The documentation and validation examples of the Getting Started with OpenSees Manual were supported by NEESgrid subcontract award 04-344 from the NEESgrid System Integrator (SI) under NSF grant CMS-0117853

## In This Chapter

Introduction .....	381
Download OpenSees .....	382
Run OpenSees.....	384
Problem Definition.....	386
Model Builder .....	387
Nodes.....	388
Elements .....	390
Recorders.....	391
Summary of Model-Building Input File .....	391
Loads and Analysis .....	394
Gravity Loads .....	396
Summary of Gravity Loads .....	399
Lateral Loads -- Static Pushover .....	400
Lateral Loads -- Cyclic Lateral Load .....	401
Lateral Loads -- Dynamic ground motion.....	402

---

## Introduction

Modern earthquake engineering utilizes modeling and simulation to understand the behavior and performance of systems during earthquakes. With the support of the National Science Foundation, the Pacific Earthquake Engineering Research Center (PEER) has developed the Open System for Earthquake Engineering Simulation, OpenSees for short, as a software platform for research and application of simulation for structural and geotechnical systems. The OpenSees software framework uses object-oriented methodologies to maximize modularity and extensibility for implementing models for behavior, solution methods, and data processing and communication procedures. The framework is a set of inter-related classes, such as domains (data structures), models, elements (which are hierarchical), solution algorithms, integrators, equation solvers, and databases. The classes are as independent as possible, which allows great flexibility in combining modules to solve simulation problems for buildings and bridges, including soil and soil-structure-foundation interaction, and most recently including reliability computational modules. The open source software is managed and made available to users and developers through the OpenSees website at <http://opensees.berkeley.edu> (<http://opensees.berkeley.edu>).

The software architecture and open-source approach for OpenSees provide many benefits to users interested in advanced simulation of structural and geotechnical systems with realistic models of nonlinear behavior. First, the modeling approach is very flexible in that allows selection and various combinations of a number of different element formulations and material formulations, along with different approximations of kinematics to account for large-displacements and P-D effects. As an open-source project, developers and researchers are using the extensible features of the software architecture to add additional capability. A second advantage is that there is a wide range of solution procedures and algorithms that the user can adapt to solve difficult nonlinear problems for static and dynamic loads. Another feature is that OpenSees has a fully programmable scripting language for defining models, solution procedures, and post-processing that can provide simple problem solving capability, as illustrated in this manual, or very sophisticated modeling and parameters studies of large, complex systems. Finally, OpenSees provides a flexible interface to computer resources, storage and databases, and network communication to take advantage of high-end computing systems. Structural and geotechnical models can be analyzed from desktop PC's to parallel computers within OpenSees.

As an advanced platform for computational simulation, OpenSees provides an important resource for the National Science Foundation-sponsored George E. Brown, Jr. Network for Earthquake Engineering Simulation (*NEES* (<http://www.nees.org>)), and it has been adopted by *NEESgrid* (<http://www.neesgrid.org>) System Integration project as the NEES simulation component. The NEESgrid decision to utilize OpenSees and adapt it to interface with other NEESgrid resources provides an important capability for NEES researchers and users. The modular design of OpenSees means that it can be customized for the integrating physical and computation simulation through data repositories, visualization, and hybrid control for advanced experimental methods, all of which meet important NEES objectives.

Open source software, such as OpenSees, requires community support and participation. The objective of this "Getting Started" manual is to provide an introduction so that users of OpenSees can obtain, install, and begin using the software to solve problems.

## Download OpenSees

To download and install OpenSees the user is required to download both the OpenSees and Tcl/Tk packages. The OpenSees and Tcl/Tk packages can both be downloaded from the OpenSees binaries webpage <http://opensees.berkeley.edu/binaries.html>. This page can be found using the quick links pull down menu from any of the OpenSees web pages. The binaries download page will be similar to that shown below.

The screenshot shows a web browser window displaying the 'OpenSees - Binaries Page - Mozilla'. The page title is 'Open System for Earthquake Engineering Simulation' and it is associated with the 'Pacific Earthquake Engineering Research Center'. A navigation menu on the left includes 'Quick Links', 'Main Page', 'About', 'Projects', 'User Pages', 'Developer Pages', 'FAQ', and 'Related Links'. The main content area is titled 'OpenSees Executable Distribution' and contains the following text:

OpenSees executables for Windows 98/2000/NTXP are available for download. The current version of OpenSees has been tested and is generally stable. However, users may encounter problems when running a new problem for the first time. For that reason we strongly encourage you to participate in the various message boards hosted by OpenSees. And please report any bugs you find! That, of course, is the whole reason we make these binaries available.

OpenSees uses Tcl/Tk, a general purpose scripting language that we have extended with commands for OpenSees. It is necessary to download a DLL for the Tcl/Tk interpreter.

The first step is download the two files below. The first file is a zip file containing the OpenSees executable. The second file is a self-installing executable for Tcl/Tk.

Note that for those of you who have downloaded before, YOU WILL HAVE TO INSTALL TCL/TK LIBRARIES AND HEADER FILES AGAIN. This is because we have upgraded to Tcl/Tk Version 8.4.4

**DOWNLOAD Windows Binaries**  
[Release\\_1.5.0](#) [OpenSees1.6.0.exe](#) [tcltk 8.4.4](#)

After downloading the Tcl/Tk executable you will need to run it to install the DLL's on your computer. During this step, you will be asked where to install the files. Currently the default is C:\. It is essential that you change this to "C:\Program Files\IEI" during the course of the installation. If you see an error message to the effect, "Cannot find tcl84.dll", you have skipped this step and must reinstall tcl. Note that you will probably have to uninstall the version you just installed first.

Finally, locate the opensees .exe in a convenient directory. It is advisable to execute OpenSees from a DOS shell and you are ready to go!

At this page the user is required to download two files OpenSees.X.X.X.exe and tcl/tk Y.Y.Y. This can be done by selecting (clicking) on the links located in the box labeled DOWNLOAD Windows Binaries.

The file downloaded by clicking on the OpenSees.X.X.X.exe link is a zip file, from which the OpenSees.X.X.X.exe file can be extracted using your favorite extractor. The user can place this executable anywhere they wish. It is recommended to place it in a directory near where all your scripts will be stored.

The file downloaded by clicking the tcl/tk Y.Y.Y link is an installer for Tcl/Tk. By clicking on the file the user is brought through a series of screens. The first screen shows the package information for Y.Y.Y, the second screen has the license agreement, you must accept the license to proceed with the installation. The third screen specifies the installation mode and location. Here the user must change the default installation location from C:/Tcl to C:/Program Files/Tcl (there is a space between Program and Files), as shown in the image below.

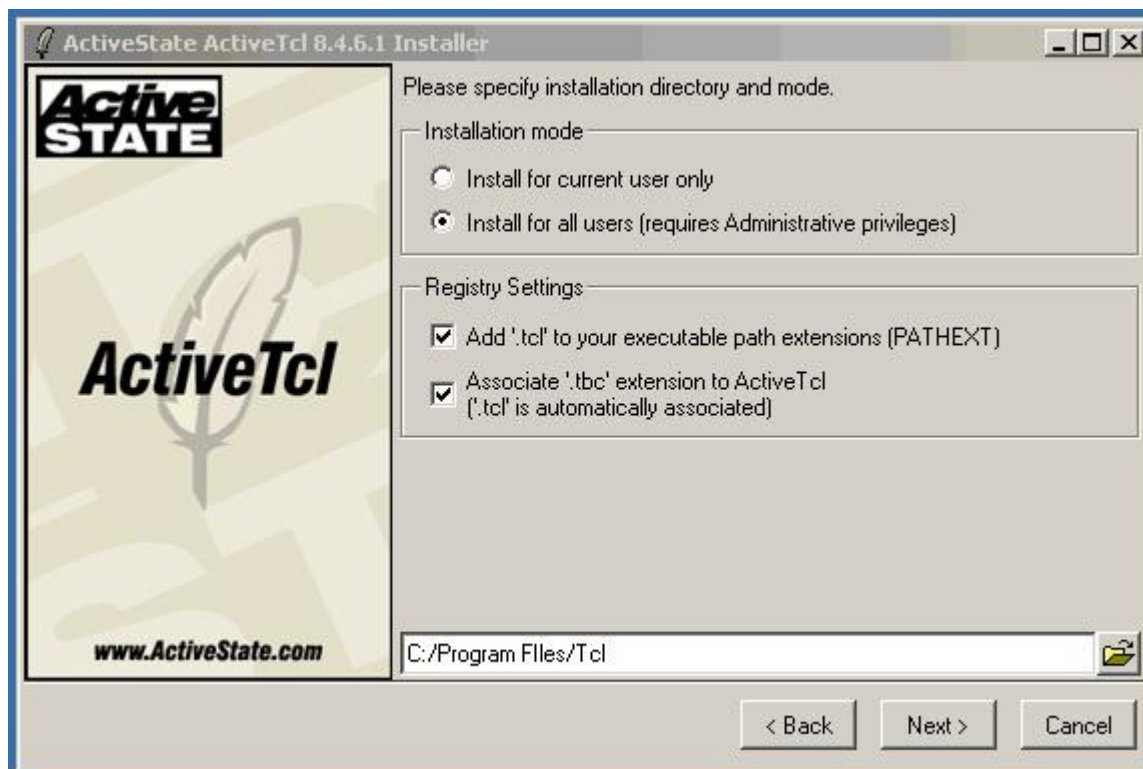

This is the only change the user must make. User now just keeps selecting Next until done.

---

## Run OpenSees

There are three ways that OpenSees/Tcl commands can be executed:

➤ **Interactive**

Commands can be input directly at the prompt, as shown in the figure (Win32 version):

Figure 66: Run OpenSees -- Interactive

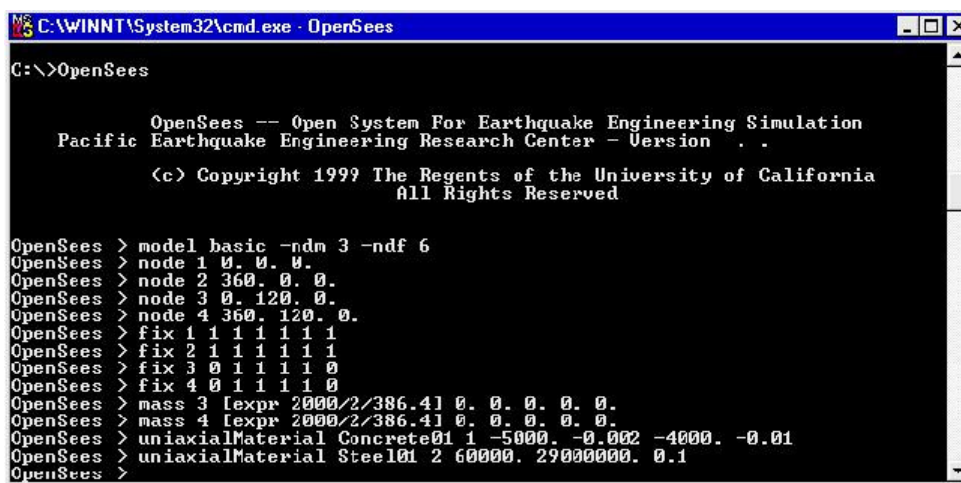

```
C:\WINNT\System32\cmd.exe - OpenSees
C:\>OpenSees

OpenSees -- Open System For Earthquake Engineering Simulation
Pacific Earthquake Engineering Research Center - Version . .
(c) Copyright 1999 The Regents of the University of California
All Rights Reserved

OpenSees > model basic -ndm 3 -ndf 6
OpenSees > node 1 0. 0. 0.
OpenSees > node 2 360. 0. 0.
OpenSees > node 3 0. 120. 0.
OpenSees > node 4 360. 120. 0.
OpenSees > fix 1 1 1 1 1 1
OpenSees > fix 2 1 1 1 1 1
OpenSees > fix 3 0 1 1 1 0
OpenSees > fix 4 0 1 1 1 0
OpenSees > mass 3 [expr 2000/2/386.41 0. 0. 0. 0.
OpenSees > mass 4 [expr 2000/2/386.41 0. 0. 0. 0.
OpenSees > uniaxialMaterial Concrete01 1 -5000. -0.002 -4000. -0.01
OpenSees > uniaxialMaterial Steel01 2 60000. 29000000. 0.1
OpenSees >
```



➤ **Execute Input File at OpenSees prompt**

This method is the most-commonly used one. An external file containing the input commands can be generated a-priori (inputFile.tcl) and be executed at the OpenSees prompt by using the source command. The generation of the input script files is presented in this chapter. The file execution is shown in the figure (Win32 version):



```

C:\openSees.exe

OpenSees -- Open System For Earthquake Engineering Simulation
Pacific Earthquake Engineering Research Center - Version . .
(c) Copyright 1999 The Regents of the University of California
All Rights Reserved

OpenSees > source inputFile.tcl
UmfpackGenLinS0E::setSize - n 4 nnz 16 lUal 160
UmfpackGenLinS0E::setSize - n 4 nnz 16 lUal 160
^
OpenSees > _

```

Figure 67: Run OpenSees -- Source File

➤ **Batch Mode**

The previously-created input file containing the Tcl script commands necessary to execute the analysis can also be executed at the MS-DOS/Unix prompt, as shown in the figure (Win32 version):

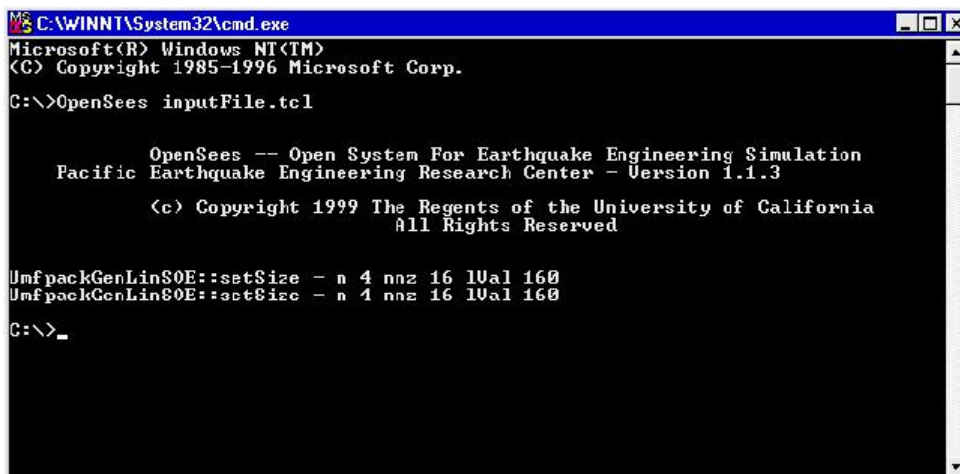

```

C:\WINNT\System32\cmd.exe
Microsoft(R) Windows NT(TM)
(C) Copyright 1985-1996 Microsoft Corp.
C:\>OpenSees inputFile.tcl

OpenSees -- Open System For Earthquake Engineering Simulation
Pacific Earthquake Engineering Research Center - Version 1.1.3
(c) Copyright 1999 The Regents of the University of California
All Rights Reserved

UmfpackGenLinS0E::setSize - n 4 nnz 16 lUal 160
UmfpackGenLinS0E::setSize - n 4 nnz 16 lUal 160
C:\>_

```

Figure 68: Run OpenSees -- Batch Mode

## Problem Definition

A portal frame will be used to demonstrate the OpenSees commands. A structural model will be defined first. Subsequently, a number of static and dynamic analyses will be defined and implemented.

The structural model consists of the planar portal frame shown in the figure below:

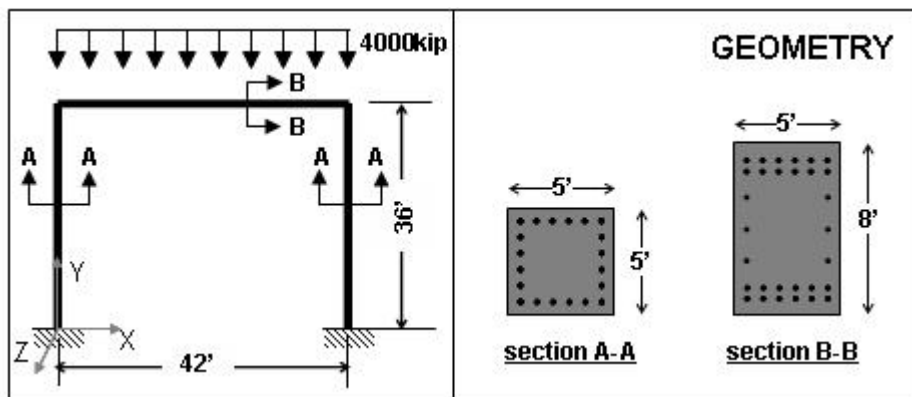

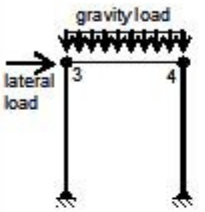

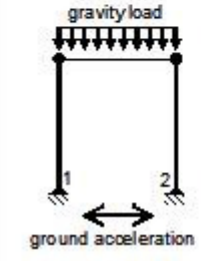

Figure 69: Getting Started -- Problem Definition, Geometry

The columns and beam will be modeled as elastic elements. At a more advanced level, these elements can be replaced by more refined element models.

In the analysis phase, the frame will be subjected to three different load cases:

- 1 DISPLACEMENT-CONTROLLED LATERAL PUSHOVER;
- 2 DISPLACEMENT-CONTROLLED REVERSED CYCLIC LATERAL LOADING;
- 3 DYNAMIC GROUND-MOTION-INPUT TRANSIENT ANALYSIS.

In all cases, however, the frame will be subjected to constant static gravity loads:

	<p><b>LOAD CASE 1: DISPLACEMENT-CONTROLLED LATERAL PUSHOVER</b> A lateral LOAD of increasing magnitude is imposed at nodes 3 and 4 until a desired maximum lateral displacement is reached at node 3. This is a static analysis.</p> <p><b>LOAD CASE 2: DISPLACEMENT-CONTROLLED REVERSED CYCLIC LATERAL LOADING</b> A lateral LOAD is applied at nodes 3 and 4 such that a predefined displacement history is achieved at node 3. This is a static analysis. The displacement history is shown in the figure:</p> 
	<p><b>LOAD CASE 3: DYNAMIC GROUND-MOTION-INPUT TRANSIENT ANALYSIS</b> A uniform acceleration history is imposed at all nodes constrained in the horizontal x-direction (nodes 1&amp; 2). The acceleration history is predefined. This is a transient (dynamic) analysis. A schematic of the acceleration history is shown in the figure:</p> 

## Model Builder

Defining the model builder expands the Tcl command library to include OpenSees-specific commands, such as node and element definition, etc. Currently, there is only one model builder available, *basic model builder* (page 34), this is the model builder that includes all the commands presented in this library.

The model builder also defines the number of dimensions (ndm) and degrees of freedom per node (ndf):

```
model BasicBuilder -ndm $ndm <-ndf $ndf>
```

For a 2-D problem, you really only need three degrees of freedom at each node, the two translations in the plane and the rotation about the plane's normal:

```
model basic -ndm 2 -ndf 3
```

## Nodes

At this point the user needs to decide which units will be used. In this demonstration, inches and kips will be used for length and force. Seconds will be used for time.

The assignment of node and element numbers is defined in the figure below:

Figure 70: Getting Started -- Nodes & Elements

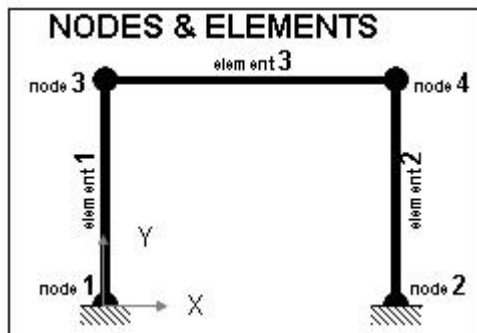

In a 2D problem only the x and y coordinates need to be defined, using the *node* (page 36) command:

```
node $nodeTag (ndm $coords) <-mass (ndf $MassValues)>
```

```
node 1 0 0
node 2 504 0
node 3 0 432
node 4 504 432
```

The boundary conditions are defined using the *fix* (page 38) command:

### **fix \$nodeTag (ndf \$ConstrValues)**

with three degrees of freedom per node are constrained:

```
fix 1 1 1 1
fix 2 1 1 1
fix 3 0 0 0
fix 4 0 0 0
```

where a fixed constraint is defined with a 1, a free constraint is defined with a 0.

Nodal masses are typically defined at the same time as the nodal coordinates. The nodal mass is used to calculate the eigenvalues and to perform the dynamic analysis. Only the nodal mass in the horizontal direction will be defined in this demonstration. Nodal masses can either be defined within the *node* (page 36) command, or they can be "appended" using the *mass* (page 37) command:

### **mass \$nodeTag (ndf \$MassValues)**

```
mass 3 5.180. 0.
mass 4 5.180. 0.
```

The mass value was calculated by dividing the nodal weight (1/2 of the total super-structure weight) by the gravitational constant  $g$  (32 ft/sec):

$$\text{mass} = \frac{4000 \cdot \text{kip}}{2 \cdot \left( 32.2 \cdot \frac{\text{ft}}{\text{sec}} \right) \cdot \left( \frac{12 \cdot \text{inch}}{1 \cdot \text{ft}} \right)}$$

## Elements

The elastic columns and beams are defined using the *elastic beam column element* (page 217). The characteristics of a 2-D elastic element depend on the material modulus and the section area and moment of inertia. Because the elements in this frame represent reinforced-concrete elements, the value of 4227 ksi for the elastic modulus of concrete will be used.

The following values represent the area and moment of inertia of the columns and beams:

	COLUMNS	BEAM
Area	$(5 \cdot 12) \cdot (5 \cdot 12) = 3600$	$(5 \cdot 12) \cdot (8 \cdot 12) = 5760$
Iz	$\frac{1}{12} \cdot (5 \cdot 12) \cdot (5 \cdot 12)^3 = 1080000$	$\frac{1}{12} \cdot (5 \cdot 12) \cdot (8 \cdot 12)^3 = 4423680$

The transformation command defines how the element coordinates correlate to the global model coordinates. In a 2D problem, element orientation does not need to be considered, and can be the same for all elements. The *linear transformation* (page 280) will be used in this demonstration:

```
geomTransf Linear $transfTag <-jntOffset $dXi $dYi $dXj $dYj>
```

```
geomTransf Linear 1
```

The following commands define the two columns (element 1 and 2) and the beam (element 3):

```
element elasticBeamColumn $eleTag $iNode $jNode $A $E $Iz $transfTag
```

```
element elasticBeamColumn 1 1 3 3600 4227 1080000 1
element elasticBeamColumn 2 2 4 3600 4227 1080000 1
element elasticBeamColumn 3 3 4 5760 4227 4423680 1
```

---

## Recorders

The recorder command is used to define the analysis output.

The node recorder will be used to output the horizontal and vertical displacements at node 3 into a file named Node3.out:

```
recorder Node <-file $fileName> <-time> <-node ($node1 $node2 ...)>  
<-nodeRange $startNode $endNode> <-region $RegionTag> <-node  
all> -dof ($dof1 $dof2 ...) $respType
```

```
recorder Node -file Node3.out -time -node 3 -dof 1 2 disp
```

The element recorder will be used to output the element forces. Element forces for element 1 will be output into file Element1.out:

```
recorder Element <-file $fileName> <-time> <-ele ($ele1 $ele2 ...)> <-eleRange  
$startEle $endEle> <-region $regTag> <-ele all> ($arg1 $arg2 ...)
```

```
recorder Element -file Element1.out -time -ele 1 force
```

---

## Summary of Model-Building Input File

The following is a compilation of all the commands necessary to build the model:

```
model basic -ndm 2 -ndf 3  
# nodal coordinates:  
node 1 0 0  
node 2 504 0  
node 3 0 432  
node 4 504 432  
# boundary conditions:  
fix 1 1 1 1  
fix 2 1 1 1  
fix 3 0 0 0  
fix 4 0 0 0  
# nodal masses:  
mass 3 5.18 0. 0.  
mass 4 5.18 0. 0.  
# transformation:
```

```
geomTransf Linear 1
# connectivity:
element elasticBeamColumn 1 1 3 3600 4227 1080000 1
element elasticBeamColumn 2 2 4 3600 4227 1080000 1
element elasticBeamColumn 3 3 4 5760 4227 4423680 1
# recorders
recorder Node -file Node3.out -time -node 3 -dof 1 2 disp
recorder Element -file Element1.out -time -ele 1 force
```

The above commands can be input line by line at the OpenSees command prompt:

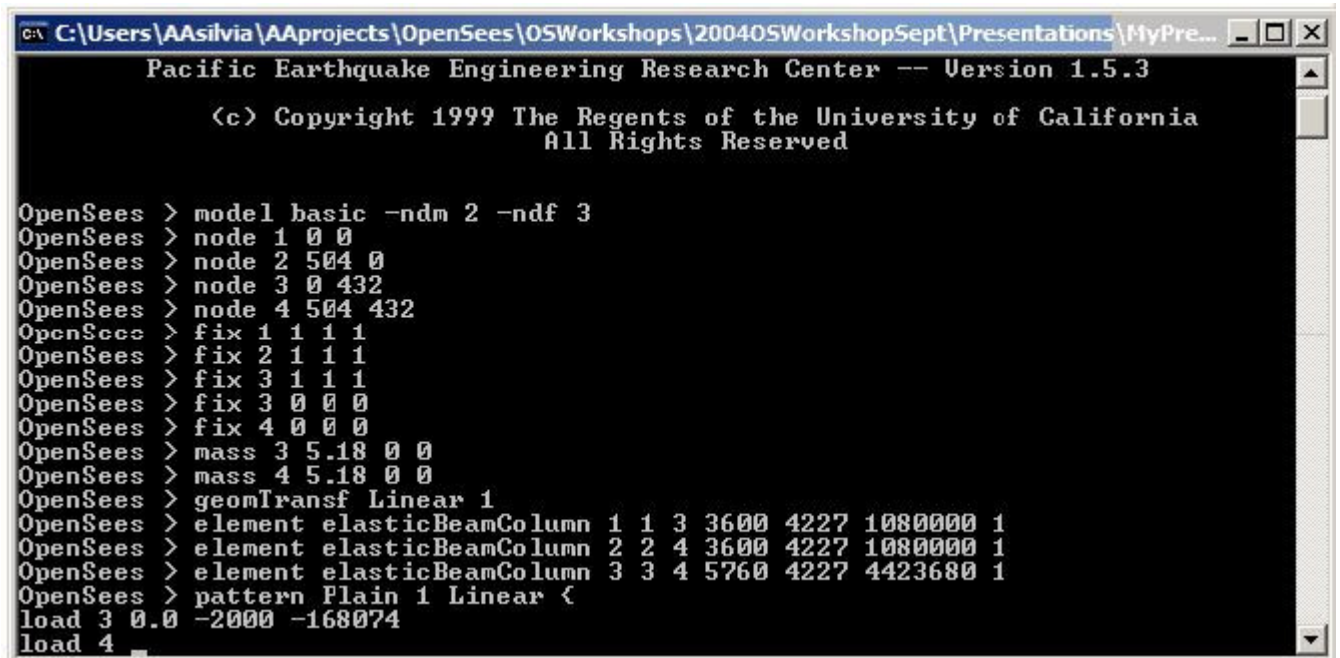

```
C:\Users\AAsilvia\AAsilvia\AAprojects\OpenSees\OSWorkshops\2004OSWorkshopSept\Ppresentations\MyPre...
Pacific Earthquake Engineering Research Center -- Version 1.5.3
(c) Copyright 1999 The Regents of the University of California
All Rights Reserved

OpenSees > model basic -ndm 2 -ndf 3
OpenSees > node 1 0 0
OpenSees > node 2 504 0
OpenSees > node 3 0 432
OpenSees > node 4 504 432
OpenSees > fix 1 1 1 1
OpenSees > fix 2 1 1 1
OpenSees > fix 3 1 1 1
OpenSees > fix 3 0 0 0
OpenSees > fix 4 0 0 0
OpenSees > mass 3 5.18 0 0
OpenSees > mass 4 5.18 0 0
OpenSees > geomTransf Linear 1
OpenSees > element elasticBeamColumn 1 1 3 3600 4227 1080000 1
OpenSees > element elasticBeamColumn 2 2 4 3600 4227 1080000 1
OpenSees > element elasticBeamColumn 3 3 4 5760 4227 4423680 1
OpenSees > pattern Plain 1 Linear <
load 3 0.0 -2000 -168074
load 4
```



Otherwise, they can be saved into an input file called **example.tcl**. This file can then be sourced in from the OpenSees command line:

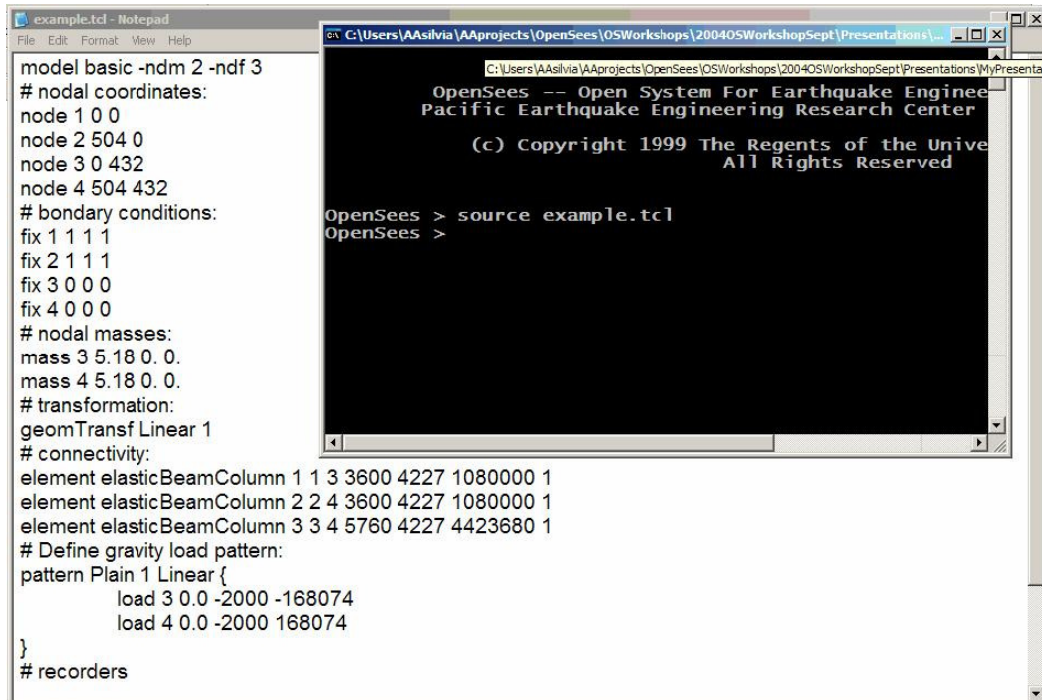

```
example.tcl - Notepad
File Edit Format View Help
model basic -ndm 2 -ndf 3
# nodal coordinates:
node 1 0 0
node 2 504 0
node 3 0 432
node 4 504 432
# boundary conditions:
fix 1 1 1 1
fix 2 1 1 1
fix 3 0 0 0
fix 4 0 0 0
# nodal masses:
mass 3 5.18 0. 0.
mass 4 5.18 0. 0.
# transformation:
geomTransf Linear 1
# connectivity:
element elasticBeamColumn 1 1 3 3600 4227 1080000 1
element elasticBeamColumn 2 2 4 3600 4227 1080000 1
element elasticBeamColumn 3 3 4 5760 4227 4423680 1
# Define gravity load pattern:
pattern Plain 1 Linear {
    load 3 0.0 -2000 -168074
    load 4 0.0 -2000 168074
}
# recorders
```

```
C:\Users\AAsilvia\AProjects\OpenSees\OSWorkshops\2004OSWorkshopSept\Presentation\MyPresentat...
OpenSees -- Open System For Earthquake Enginee
Pacific Earthquake Engineering Research Center
(c) Copyright 1999 The Regents of the Unive
All Rights Reserved
OpenSees > source example.tcl
OpenSees >
```

---

# Loads and Analysis

In OpenSees applying loads is a three-step process:

1. You must first define the loads in a load pattern
2. You must then define the analysis and its features
3. The loads are then applied when you execute the analysis

---

## 1. Load definition

Loads are defined using the pattern command. Three types of patterns are currently available:

**a. plain Pattern** -- this pattern is used to define the following:

- i. nodal loads, such as gravity loads and lateral loads (or load-controlled nodal displacements)
- ii. single-point constraints, such as displacement control at a node (typically used for a constant displacement at a node)
- iii. element loads, such as distributed gravity loads along the element (this is a new option, which still needs documentation).

**b. UniformExcitation Pattern** -- this type of pattern imposes a user-defined acceleration record to all fixed nodes, in a specified direction.

**c. MultipleSupport Pattern** -- this type of pattern imposes a user-defined displacement record at specified nodes, in a specified direction, or a ground-motion record.

## 2. Analysis definition and features

The analysis-definition part of OpenSees allows the user to define the different linear and nonlinear analysis tools available. For each analysis, the following items need to be defined, preferably in this order:

<b>constraints</b>	The constraints command is used to construct the ConstraintHandler object. Constraints enforce a relationship between degrees-of-freedom. The ConstraintHandler object determines how the constraint equations are enforced in the analysis.
<b>numberer</b>	The numberer command is used to construct the DOF_Numberer object. The DOF_Numberer object determines the mapping between equation numbers and degrees-of-freedom -- how degrees-of-freedom are numbered.
<b>system</b>	The system command is used to construct the LinearSOE and LinearSolver objects to store and solve the system of equations in the analysis.
<b>test</b>	The test command is used to construct a ConvergenceTest object. Certain SolutionAlgorithm objects require a ConvergenceTest object to determine if convergence has been achieved at the end of an iteration step.
<b>algorithm</b>	The algorithm command is used to construct a SolutionAlgorithm object, which determines the sequence of steps taken to solve the non-linear equation.
<b>integrator</b>	The <i>integrator</i> (page 333) command is used to construct the Integrator object. The Integrator object determines the meaning of the terms in the system of equation object. The Integrator object is used for the following: <ul style="list-style-type: none"> <li>▪ determine the predictive step for time <math>t+dt</math></li> <li>▪ specify the tangent matrix and residual vector at any iteration</li> <li>▪ determine the corrective step based on the displacement increment <math>dU</math></li> </ul>

<b>analysis</b>	<p>The <i>analysis</i> (page 339) command is used to construct the Analysis object. This analysis object is constructed with the component objects previously created by the analyst. All currently-available analysis objects employ incremental solution strategies. There are three types of analysis currently available:</p> <p><i>Static Analysis</i> (page 339)</p> <p><i>Transient Analysis</i> (page 340)</p> <p><i>VariableTransient Analysis</i> (page 341)</p>
-----------------	--

---

## 3. Analysis execution

The analysis is executed using the *analyze* (page 344) command. This command moves the analysis forward by the specified number of steps.

---

## Gravity Loads

Gravity loads are independent of the type of lateral loading and here they are considered part of the structural model.

### NODAL FORCES & MOMENTS

Because the beam is an elastic element, the vertical load distributed along the horizontal member can be represented by nodal forces and moments. The nodal forces are distributed equally to the two end nodes. The nodal bending moments are equal and opposite:

The nodal force is equal to one half of the superstructure weight:

$$\text{Force} = \frac{4000 \cdot \text{kip}}{2} = 2000 \cdot \text{kip}$$

the distributed load is calculated by dividing the total load by the beam length:

$$\text{DistributedLoad} = \frac{4000 \cdot \text{kip}}{(42 \cdot \text{ft}) \cdot \left(12 \cdot \frac{\text{inch}}{\text{ft}}\right)} = 7.94 \cdot \frac{\text{kip}}{\text{inch}}$$

distributed load:

The bending moment is then calculated from the

$$\text{Moment} = \frac{\text{DistributedLoad} \cdot \text{BeamLength}^2}{12} = \frac{\left(7.94 \frac{\text{kip}}{\text{inch}}\right) \cdot \left(42 \cdot \text{ft} \cdot 12 \cdot \frac{\text{inch}}{\text{ft}}\right)^2}{12} = 168074 \cdot \text{kip} \cdot \text{in}$$

## LOAD PATTERN DEFINITION

Like all loads in OpenSees, gravity loads require two steps. The first step defines the load into a load *pattern* (page 294), the second applies the load pattern and the associated gravity load. The *plain pattern* (page 294) command with a *linear time series* (page 289) is used in the load definition:

```
pattern Plain $patternTag (TimeSeriesType arguments) {

    load $nodeTag (ndf $LoadValues)

}
```

```
pattern Plain 1 Linear {
    load 3 0.0 -2000 -168074
    load 4 0.0 -2000 168074
}
```

## CREATE ANALYSIS

The *constraints* (page 316) command is used to construct the ConstraintHandler object. Constraints enforce a relationship between degrees-of-freedom. The ConstraintHandler object determines how the constraint equations are enforced in the analysis.

```
constraints Transformation
```

The *numberer* (page 321) command is used to construct the DOF\_Numberer object. The DOF\_Numberer object determines the mapping between equation numbers and degrees-of-freedom -- how degrees-of-freedom are numbered. With the RCM numberer nodes are assigned degrees-of-freedom using the Reverse Cuthill-McKee algorithm

```
numberer RCM
```

The *system* (page 323) command is used to construct the LinearSOE and LinearSolver objects to store and solve the system of equations in the analysis. The BandGeneral command is used to construct an un-symmetric banded system of equations object which will be factored and solved during the analysis using the Lapack band general solver

```
system BandGeneral
```

The *test* (page 326) command is used to construct a ConvergenceTest object. Certain SolutionAlgorithm objects require a ConvergenceTest object to determine if convergence has been achieved at the end of an iteration step. The convergence test is applied to the following equation:

$$K\Delta U = R$$

The NormDisplnCr test performs the following check:

Norm Displacement Increment  $\sqrt{\Delta U^T \Delta U} < \text{tol}$

```
test NormDisplnCr $tol $maxNumIter <$printFlag>
```

```
test NormDisplnCr 1.0e-6 6
```

The *algorithm* (page 329) command is used to construct a SolutionAlgorithm object, which determines the sequence of steps taken to solve the non-linear equation.

```
algorithm Newton
```

The *integrator* (page 333) command is used to construct the Integrator object. The Integrator object determines the meaning of the terms in the system of equation object. The Integrator object is used for the following:

- determine the predictive step for time t+dt
- specify the tangent matrix and residual vector at any iteration
- determine the corrective step based on the displacement increment dU

The system of nonlinear equations is of the form:

static analysis:  $R(U,I) = \lambda P^* - F_R(U)$

The type of integrator used in the analysis is dependent on whether it is a static analysis or transient analysis:

static analysis

LoadControl (page 334)	$\lambda_n = \lambda_{n-1} + d\lambda$
DisplacementControl (page 335)	$U_{j_n} = U_{j_{n-1}} + dU_j$
MinUnbalDispNorm (page 336)	$d/d\lambda (dU_n^T dU_n) = 0$
ArcLength (page 336)	$dU_n^T dU_n + \alpha^2 d\lambda_n = ds^2$

```
integrator LoadControl $dLambda1 <$Jd $minLambda $maxLambda>
```

```
integrator LoadControl 0.1
```

The *analysis* (page 339) command is used to construct the *Analysis object* (page 313). This analysis object is constructed with the component objects previously created by the analyst. All currently-available analysis objects employ incremental solution strategies.

```
analysis Static
```

The *analyze* (page 344) command is used to apply the gravity load (in 10 steps) and all loads that have been defined at this point, and the *loadConst* (page 349) command maintains the gravity load constant for the remainder of the the analyses and resets the current time to zero.

```
analyze $numIncr <$dt> <$dtMin $dtMax $Jd>
```

```
loadConst <-time $pseudoTime>
```

```
analyze 10
loadConst -time 0.0
```

## Summary of Gravity Loads

The gravity loads can be placed into a file, called GravityLoads.tcl with the following commands:

```
pattern Plain 1 Linear {
  load 3 0.0 -2000 -168074
```

```

load 4 0.0 -2000 168074
}
constraints Transformation
numberer RCM
system BandGeneral
test NormDisplnrcr 1.0e-6 6
algorithm Newton
integrator LoadControl 0.1
analysis Static
analyze 10
loadConst -time 0.0

```

This file can be sourced in after the example.tcl file:

```

source example.tcl
source GravityLoads.tcl

```

## Lateral Loads -- Static Pushover

The following commands assume that the example.tcl and the gravityloads.tcl files have been run. The wipe command should be used at the beginning of the input to clear any previous OpenSees-objects definition:

```

wipe
source example.tcl
source gravityloads.tcl

```

In this analysis, a lateral displacement of increasing amplitude is imposed at the free nodes (3 and 4). The imposed displacements are applied using a displacement-control integrator, where the load factors are scaled to reach the desired displacement (compared to an imposed-displacement analysis). This method is the most efficient when you have a non-strength-degrading system.

The first step is to define the load pattern. To do so, we create a new load pattern (ID tag 2) for the lateral loads

```

pattern Plain 2 Linear {
  load 3 100.0 0.0 0.0
  load 4 100.0 0.0 0.0
}

```

Most of the analysis features that were defined in the gravity analysis are still valid since this type of analysis is also static. The loads, however, are applied differently. While gravity was applied as a load, using the LoadControl integrator, the DisplacementControl integrator is used in this pushover:

```
integrator DisplacementControl $nodeTag $dofTag $dU1 <$Jd $minDu $maxDu>
```

The load is applied to node 3, in the direction of DOF 1, with a displacement increment of 0.1

```
integrator DisplacementControl 3 1 0.1
```



A total of a 1-inch displacement needs to be applied, hence 10 steps are needed:

```
analyze 10
```

## Lateral Loads -- Cyclic Lateral Load

The following commands assume that the `example.tcl` and the `gravityloads.tcl` files have been run. The `wipe` command should be used at the beginning of the input to clear any previous OpenSees-objects definition:

```
wipe
source example.tcl
source gravityloads.tcl
```

In this analysis, a lateral displacement cycle (positive and negative) of a prescribed amplitude is imposed at the free nodes (3 and 4). The imposed displacements are applied using a displacement-control integrator, where the load factors are scaled to reach the desired displacement (compared to an imposed-displacement analysis). This method is the most efficient when you have a non-strength-degrading system.

The first step is to define the load pattern. To do so, we create a new load pattern (ID tag 3) for the lateral loads

```
pattern Plain 3 Linear {
  load 3 100.0 0.0 0.0
  load 4 100.0 0.0 0.0
}
```

Most of the analysis features that were defined in the gravity analysis are still valid since this type of analysis is also static. The loads, however, are applied differently. While gravity was applied as a load, using the `LoadControl` integrator, the `DisplacementControl` integrator is used in this pushover. Similarly, while in the pushover analysis a single load increment was used, variable load increments are used to reverse the loading from positive to negative, and back to positive.

The load is applied to node 3, in the direction of DOF 1, with a displacement increment of 1 for the first rise to amplitude 1, -2 for the reversal to amplitude -1, and again positive 1 for the reversal back to amplitude zero:

```
integrator DisplacementControl 3 1 0.1
analyze 10
integrator DisplacementControl 3 1 -0.2
analyze 10
integrator DisplacementControl 3 1 0.1
analyze 10
```

this can be put into a `foreach` loop:

```
foreach Dincr {0.1 -0.2 0.1} {
  integrator DisplacementControl 3 1 $Dincr
  analyze 10
}
```

## Lateral Loads -- Dynamic ground motion

The following commands assume that the `example.tcl` and the `gravityloads.tcl` files have been run. The `wipe` command should be used at the beginning of the input to clear any previous OpenSees-objects definition:

```
wipe
source example.tcl
source gravityloads.tcl
```

The dynamic ground-motion analysis is a transient, rather than static, type of analysis. Therefore, most of the analysis components should be redefined.

First of all, the load pattern needs to be defined. The load pattern here consists of defining an acceleration time-history applied at the support nodes. The time-history is defined in a file named `BM68elc.th`, taken from the PEER strong-motion database. The first lines of this file are:

```
PACIFIC ENGINEERING AND ANALYSIS STRONG-MOTION DATA
BORREGO MOUNTAIN 04/09/68 0230, EL CENTRO ARRAY #9, 270
ACCELERATION TIME HISTORY IN UNITS OF G
NPTS= 4000, DT= .01000 SEC
-.1368849E-02 -.1659410E-02 -.1466880E-02 -.6865326E-03 -.6491235E-03
-.6172128E-03 -.5942289E-03 -.5720329E-03 -.5517003E-03 -.5367939E-03
-.5300330E-03 -.5315104E-03 -.5389920E-03 -.5492582E-03 -.5592027E-03
-.5659958E-03 -.5672101E-03 -.5617805E-03 -.5502959E-03 -.5347288E-03
-.5176619E-03 -.5013709E-03 -.4873454E-03 -.4763228E-03 -.4683559E-03
-.4626830E-03 -.4579708E-03 -.4512405E-03 -.4376077E-03 -.4130071E-03
-.3772566E-03 -.3363394E-03 -.3030926E-03 -.2926074E-03 -.3144186E-03
-.3668375E-03 -.4373818E-03 -.5104884E-03 -.5745380E-03 -.6248976E-03
-.6621411E-03 -.6878470E-03 -.7014600E-03 -.6985488E-03 -.6737667E-03
-.6258232E-03 -.5616336E-03 -.4955459E-03 -.4432164E-03 -.4144737E-03
-.4103149E-03 -.4251781E-03 -.4493034E-03 -.4742715E-03 -.4942019E-03
-.5021476E-03 -.4907415E-03 -.4549906E-03 -.4008473E-03 -.3457893E-03
-.3076823E-03 -.2975411E-03 -.3148410E-03 -.3469618E-03 -.3746677E-03
-.3814194E-03 -.3598713E-03 -.3127679E-03 -.2503611E-03 -.1870004E-03
-.1381307E-03 -.1166398E-03 -.1296596E-03 -.1730662E-03 -.2365307E-03
-.3092055E-03 -.3795541E-03 -.4410602E-03 -.4886626E-03 -.5170590E-03
-.5252823E-03 -.5139311E-03 -.4858098E-03 -.4459504E-03 -.3992677E-03
-.3528575E-03 -.3119584E-03 -.2767747E-03 -.2493392E-03 -.2343354E-03
-.2328132E-03 -.2443271E-03 -.2710242E-03 -.3142711E-03 -.3756243E-03
-.4585760E-03 -.5641321E-03 -.6901264E-03 -.8277058E-03 -.9398496E-03
-.9604577E-03 -.8289034E-03 -.5332316E-03 -.1380318E-03 .2342108E-03
.4651973E-03 .5026886E-03 .3746881E-03 .1623773E-03 -.5159882E-04
-.2224880E-03 -.3475301E-03 -.4529523E-03 -.5485990E-03 -.5963545E-03
-.5423656E-03 -.3657646E-03 -.1048402E-03 .1563278E-03 .3291475E-03
.3576328E-03 .2409380E-03 .2377646E-04 -.2316319E-03 -.4694656E-03
-.6625028E-03 -.8119362E-03 -.9298628E-03 -.1028468E-02 -.1108383E-02
-.1131224E-02 -.1020689E-02 -.7165112E-03 -.2327270E-03 .3181869E-03
.7732246E-03 .1012043E-02 .1013671E-02 .8560355E-03 .6690806E-03
.5646968E-03 .5919845E-03 .7377345E-03 .9490117E-03 .1157766E-02
.1288701E-02 .1282487E-02 .1122759E-02 .8318915E-03 .4619941E-03
.7578448E-04 -.2595554E-03 -.4939353E-03 -.6127490E-03 -.6275750E-03
```

```

-5752344E-03 -4995743E-03 -4264229E-03 -3601404E-03 -3004083E-03
-2406227E-03 -1628483E-03 -3998632E-04 .1649808E-03 .4539122E-03
.7517190E-03 .9316287E-03 .8846478E-03 .5857181E-03 .1074495E-03
-4397852E-03 -.9508948E-03 -.1343749E-02 -.1561289E-02 -.1537678E-02
-.1227062E-02 -.6359309E-03 .1519731E-03 .9751270E-03 .1659683E-02

```

A number of tcl scripts are available to the user at the openSees web site which have been written for specific tasks. The file ReadSMDFile.tcl is a script procedure which parses a ground motion record from the PEER strong motion database by finding dt in the record header, then echoing data values to the output file. This file should be saved in the same directory as the OpenSees executable:

```

# -----
# READSMDFILE.tcl
# Written: MHS
# Date: July 2000
# A procedure which parses a ground motion record from the PEER strong motion database by finding dt in the record
# header, then
# echoing data values to the output file. Formal arguments
#   inFilename -- file which contains PEER strong motion record
#   outFilename -- file to be written in format G3 can read
#   dt -- time step determined from file header
# Assumptions
#   The header in the PEER record is, e.g., formatted as follows:
#   PACIFIC ENGINEERING AND ANALYSIS STRONG-MOTION DATA
#   IMPERIAL VALLEY 10/15/79 2319, EL CENTRO ARRAY 6, 230
#   ACCELERATION TIME HISTORY IN UNITS OF G
#   NPTS= 3930, DT=.00500 SEC
proc ReadSMDFile {inFilename outFilename dt} {
    # Pass dt by reference
    upvar $dt DT
    # Open the input file and catch the error if it can't be read
    if [catch {open $inFilename r} inFileID] {
        puts stderr "Cannot open $inFilename for reading"
    } else {
        # Open output file for writing
        set outFileID [open $outFilename w]
        # Flag indicating dt is found and that ground motion
        # values should be read -- ASSUMES dt is on last line
        # of header!!!
        set flag 0
        # Look at each line in the file
        foreach line [split [read $inFileID] \n] {
            if {[length $line] == 0} {
                # Blank line --> do nothing
                continue
            } elseif {$flag == 1} {
                # Echo ground motion values to output file
                puts $outFileID $line
            } else {
                # Search header lines for dt
                foreach word [split $line] {
                    # Read in the time step
                    if {$flag == 1} {
                        set DT $word
                        break
                    }
                }
                # Find the desired token and set the flag
                if {[string match $word "DT="] == 1} {

```



In a transient analysis, the analyze command also requires a time step. This time step does not have to be the same as the input ground motion. The number of time steps is equal to the total duration of the analysis (10 seconds) divided by the time step (0.02):

```
analyze [expr 10/0.02] 0.02
```

## CHAPTER 44

# Getting Going with OpenSees (under development)

This document will walk you through the following:

- define gravity loads
- 1 Define the recorders for output
- 2 Define the analysis components. Three types of analyses will be set up:
  - a static displacement-controlled pushover analysis
  - a displacement-controlled reversed cyclic analysis
  - a dynamic ground-motion-input transient analysis

## In This Chapter

Problem Definition.....	407
Model Building .....	408
Recorders for Output .....	425
Analysis Components .....	426

# Problem Definition

The structural system that will be used in this document is the SDOF cantilever column shown in the figure below. The column cross section consist of a reinforced-concrete fiber section with different material properties for the confined core and the unconfined cover.

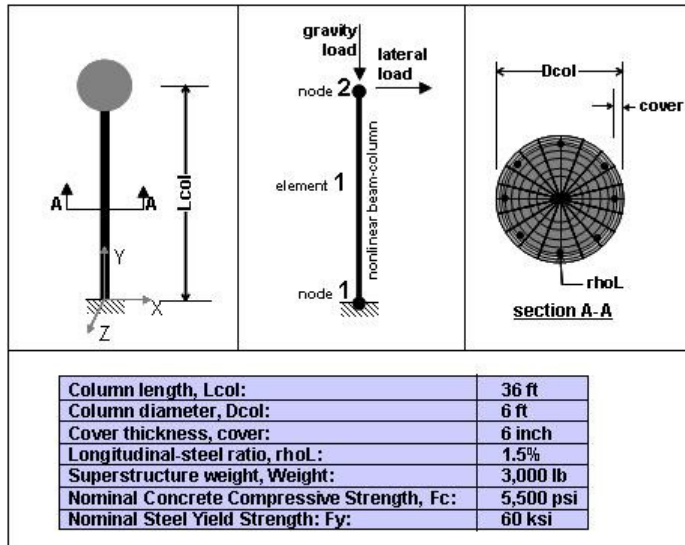

Figure 71: Problem Definition -- Geometry

This structure will be subjected to gravity loads, as well as three types of lateral load, applied in three different analyses. These loads are shown in the figure:

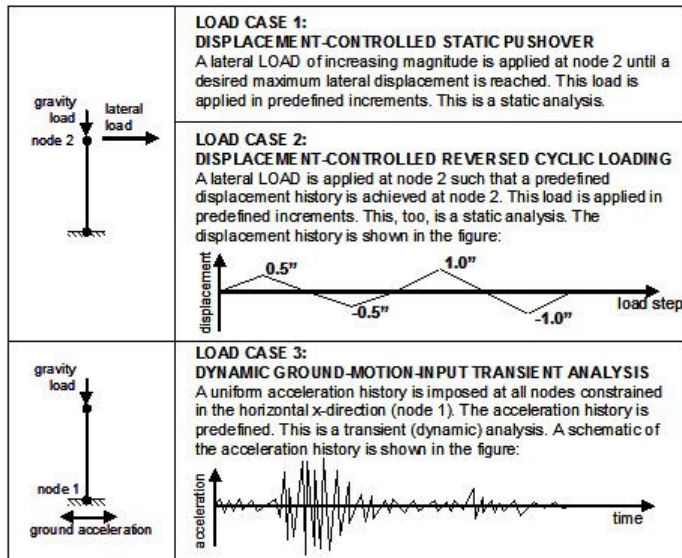

Figure 72: Problem Definition -- Loads

---

## Model Building

This chapter describes the main steps necessary to define the physical model of a structure.

---

## Variables and Units

The authors highly recommend that the user define variables and use these variables for the input commands. Variables can be defined using the Tcl "set" command:

```
set Radius 5;                # define radius of section
set Diameter [expr $Radius/2.]; # define section diameter
```

Therefore, it is recommended that the user define all material and geometric properties, as variables:

```
set fc -5000;
set fy 60000;
```

Because OpenSees does not use internal units, the user must keep track of the types of units being used. For example, the user must define all length units in either inches or meters, etc., consistently throughout.

The Tcl feature of being able to handle variables enables the user to define units as variables, and hence use them in building the model. Here is an example:

First of all, the basic units need to be defined. The OpenSees output will be in these units:

```
set in 1.;                # define basic unit -- length
set sec 1.;              # define basic unit -- time
set kip 1.;              # define basic unit -- weight (or define force, but not both)
```

The basic units must be independent of each other. Once they have been defined, additional units that are made up of these basic units can be defined:

```
set ksi [expr $kip/pow($in,2)]; # define engineering units
set psi [expr $ksi/1000.];
set ft [expr 12.*$in];
```

It is a good idea to define constants at the same time that units are defined:

```
set g [expr 32.2*$ft/pow($sec,2)]; # gravitational acceleration
set PI [expr 2*asin(1.0)];        # define constants
set U 1.e10;                      # a really large number
set u [expr 1/$U];                # a really small number
```



Once the units have been defined, model variables can be defined in terms of these units and, hence, they don't all have to be defined in the basic units:

```
set fc [expr -5500*$psi]; # CONCRETE Compressive Strength, ksi (+Tension, -Compression)
set Ec [expr 57000.*sqrt(-$fc/$psi)];# Concrete Elastic Modulus
set Fy [expr 68.*$ksi]; # STEEL yield stress
set Es [expr 29000.*$ksi]; # modulus of steel
set epsY [expr $Fy/$Es]; # steel yield strain
```

It is also a good idea to use variables for IDtags of materials, sections, elements, etc. This is done to ensure that the same ID tag is not used when defining the input. Also, it makes it easier in writing the input to use a variable name that makes sense. Here is an example:

```
# set up parameters for column section and element definition
set IDcore 1; # ID tag for core concrete
set IDcover 2; # ID tag for cover concrete
set IDsteel 3; # ID tag for steel
```

For the example structural model, the following variables need to be defined:

```
# define GEOMETRY variables
set Hcol [expr 6.*$ft]; # column diameter
set Lcol [expr 36*$ft]; # column length
set GrhoCol 0.015; # column longitudinal-steel ratio
set Weight [expr 3000.*$kip]; # superstructure weight
set Rcol [expr $Hcol/2]; # COLUMN radius
set Acol [expr $PI*pow($Rcol,2)]; # column cross-sectional area
set cover [expr 6*$in]; # column cover width
set G $U; # Torsional stiffness Modulus
set J 1.; # Torsional stiffness of section
set GJ [expr $G*$J]; # Torsional stiffness
# define COLUMN REINFORCEMENT variables
set NbCol 20; # number of column longitudinal-reinforcement bars
set AsCol [expr $GrhoCol*$Acol]; # total steel area in column section
set AbCol [expr $AsCol/$NbCol]; # bar area of column longitudinal reinforcement
# define GRAVITY variables
set Mass [expr $Weight/$g]; # mass of superstructure
set Mnode [expr $Mass]; # nodal mass for each column joint
# define DAMPING variables from $xDamp --SDOF system, use stiffness proportional damping only
set xDamp 0.02; # modal damping ratio
# ----- set analysis variables
set DxPush [expr 0.1*$in]; # Displacement increment for pushover analysis
set DmaxPush [expr 0.05*$Lcol]; # maximum displacement for pushover analysis
set gamma 0.5; # gamma value for newmark integration
set beta 0.25; # beta value for newmark integration
set DtAnalysis [expr 0.005*$sec]; # time-step Dt for lateral analysis
set DtGround [expr 0.02*$sec]; # time-step Dt for input ground motion
set TmaxGround [expr 50.*$sec]; # maximum duration of ground-motion analysis
```

---

## Model Builder

For a 2-D problem, you really only need three degrees of freedom at each node, the two translations in the plane and the rotation about the plane's normal:

```
model basic -ndm 2 -ndf 3
```

---

## Nodal Coordinates & Masses, Boundary Conditions

### NODAL COORDINATES AND NODAL MASSES

Once the dimensions of the problem is defined, it recommended that the user define the coordinates of the nodes, the mass associated with each node and DOF and the boundary conditions at the nodes.

The nodal coordinates are defined using the *node* (page 36) command. The number of parameters associated with this command are referenced to the model command. Nodal masses can be defined at the same time as the coordinates. In the two-dimensional problem considered here, only the x and y coordinates of each node need to be defined, and three mass parameters (two translation and one rotation of the plane) need to be defined:

```
node 1 0. 0.; # column base is located at the origin of the plane
node 2 0. $Lcol -mass $Mnode 0. 0.; # the column end has one translational mass in the x
direction, only
```

the nodal *mass* (page 37) can also be defined using the mass command:

```
mass 2 $Mnode 0. 0.; # this command supersedes any previous mass definition at this node.
```

### BOUNDARY CONDITIONS

The boundary conditions are defined using the *fix* (page 38) command. The tag 0 represents an unconstrained (free) degree of freedom, the tag 1 represents a constrained (fixed) DOF. For the structure under consideration, the column base is completely fixed (1-1-1) and the end is free (0-0-0). Three DOF's need to be defined here, the two translations and the rotation in the x-y plane:

```
fix 1 1 1 1; # fixed base
fix 2 0 0 0; # free end
```

## Materials

Once the nodes have been defined, the next step towards defining elements is the *material* (page 162, page 43) definition. This step may not be necessary when using elastic *element* (page 215) or *sections* (page 191), as the materials are defined with the element or section.

There are two types of materials currently available in OpenSees, *uniaxial materials* (page 43) and *nDmaterials* (page 162). The different types of concrete and steel materials are among the uniaxial materials. There are three types of concrete available:

- 1 *Concrete01* (page 134): uniaxial Kent-Scott-Park concrete material object with degraded linear unloading/reloading stiffness according to the work of Karsan-Jirsa and no tensile strength
- 2 *Concrete02* (page 137): uniaxial concrete material object with tensile strength and linear tension softening
- 3 *Concrete03* (page 143): uniaxial concrete material object with tensile strength and nonlinear tension softening.

Concrete02 will be used for the structure under consideration, as the tensile strength of the concrete is of interest in the elastic range, and modeling nonlinear tension softening is not considered necessary for the purpose of the example. The cover and core concrete will be modeled as different materials, using the same material type, but different stress and strain characteristics and different material tags. *Steel01* (page 147) will be used for the reinforcing steel.

Because some material characteristics are dependent on others, it is recommended that the user define the material properties using variables.

```
# Confined concrete:
set fc      [expr -5.5*$ksi];           # CONCRETE Compressive Strength, ksi (+Tension, -Compression)
set Ec      [expr 57*$ksi*sqrt(-$fc/$psi)]; # Concrete Elastic Modulus
set fc1C    [expr 1.26394*$fc];        # CONFINED concrete (mander model), maximum stress
set eps1C   [expr 2.*$fc1C/$Ec];       # strain at maximum stress
set fc2C    $fc;                       # ultimate stress
set eps2C   [expr 5*$eps1C];          # strain at ultimate stress
# Unconfined concrete:
set fc1U    $fc;                       # UNCONFINED concrete (todeschini parabolic model),
maximum stress
set eps1U   -0.003;                    # strain at maximum stress
set fc2U    [expr 0.1*$fc];            # ultimate stress
set eps2U   -0.006;                   # strain at ultimate stress
# Concrete02 variables:
set lambda  0.1;                       # ratio between unloading slope at $eps1C and initial slope
set ftC    [expr -$fc1C/10.];          # tensile strength +tension
set ftU    [expr -$fc1U/10.];          # tensile strength +tension
set Ets    [expr $Ec/10.];             # tension softening stiffness
# reinforcing steel
set Fy      [expr 68.*$ksi];           # STEEL yield stress
set Es      [expr 29000.*$ksi];        # modulus of steel
set epsY    [expr $Fy/$Es];           # steel yield strain
set Fu      [expr 95.2*$ksi];          # ultimate stress of steel
```

```
set epsU          0.1;          # ultimate strain of steel
set E2 [expr ($Fu-$Fy)/($epsU-$epsY)]; # post-yield tangent stiffness
set Bs          [expr $E2/$Es]; # post-yield stiffness ratio of steel
```

To facilitate referencing the different material types, the user should set up material tags as variables:

```
# set up parameters for column section and element definition
set IDcore  1;          # ID tag for core concrete
set IDcover 2;          # ID tag for cover concrete
set IDsteel 3;          # ID tag for steel
```

The materials are defined using the *uniaxialMaterial* (page 43) command:

```
uniaxialMaterial Concrete02 $IDcore    $fc1C  $eps1C  $fc2C  $eps2C  $lambda  $ftC  $Ets; # CORE
CONCRETE
uniaxialMaterial Concrete02 $IDcover    $fc1U  $eps1U  $fc2U  $eps2U  $lambda  $ftU  $Ets; #
COVER CONCRETE
uniaxialMaterial Steel01 $IDsteel $Fy $Es $Bs; # REINFORCING STEEL
```

## Element Cross Section

Some element types require that the element cross section be defined a-priori, this is done using the *section* (page 191) command. The section is used to represent force-deformation (or resultant stress-strain) relationships at beam-column and plate sample points.

While there are many types of sections available, the *fiber* (page 196) section will be used to define the cross section of the column in the structure under consideration. A fiber section has a general geometric configuration formed by subregions of simpler, regular shapes (e.g. quadrilateral, circular and triangular regions) called patches. In addition, individual or layers of reinforcement bars can be specified. The fiber section can be defined as a combination of the following:

*fiber* (page 196) -- a single fiber can be defined, such as a single reinforcing bar. The coordinates, associated area and material tag are prescribed with the fiber. (The coordinates are given with respect to the plane of the cross section, a coordinate transformation is later defined in the input using the transformation command)

*patch* (page 197) -- a patch defines an area that has a regular shape: *quadrilateral* (page 197) or *circular* (page 199). A different material can be associated with each patch.

*layer* (page 202, page 201) -- a layer defines a layer of reinforcement that has a regular shape: *straight* (page 201) or *circular*. (page 202) A different material can be associated with each layer.

The circular cross section of reinforced concrete will be defined using the patch and layer commands. First of all, it is important to define the variables:

```
# Notes
# The center of the reinforcing bars are placed at the inner radius
# The core concrete ends at the inner radius (same as reinforcing bars)
# The reinforcing bars are all the same size
# The center of the section is at (0,0) in the local axis system
```

```

# Zero degrees is along section y-axis
set IDcolFlex          2;          # ID tag for column section in flexure, before aggregating torsion
set riCol 0.0;        # inner radius of column section
set roCol $Rcol;      # outer radius of column section
set nfCoreR 8;        # number of radial fibers in core (number of "rings")
set nfCoreT 16;       # number of tangential fibers in core (number of "wedges")
set nfCoverR          2;          # number of radial fibers in cover
set nfCoverT          16;        # number of tangential fibers in cover
# cover - cover thickness, has been defined with the geometry
# IDcore - material tag for the core patch, has been defined with the materials
# IDcover - material tag for the cover patches, has been defined with the materials
# IDsteel - material tag for the reinforcing steel, has been defined with the materials
# NbCol               # number of column longitudinal-reinforcement bars, has been defined with the
geometry
# AbCol               # bar area of column longitudinal reinforcement, has been defined with the
geometry

```

The fiber cross section is defined as follows:

```

section fiberSec $IDcolFlex {
  set rc [expr $roCol-$cover];      # Core radius
  patch circ $IDcore $nfCoreT $nfCoreR 0 0 $riCol $rc 0 360;    # Define the core patch
  patch circ $IDcover $nfCoverT $nfCoverR 0 0 $rc $roCol 0 360; # Define the cover patch
  set theta [expr 360.0/$NbCol];    # Determine angle increment between bars
  layer circ $IDsteel $NbCol $AbCol 0 0 $rc $theta 360;        # Define the reinforcing layer
}

```

## Elements and Element Connectivity

Once the element cross section has been defined, additional mechanical properties must be associated (aggregated) to it. Elastic torsion needs to be added to the column under consideration, using an *elastic* (page 125) uniaxial material:

```

set IDcolTors          10;          # ID tag for column section in torsion
set IDcolSec 1;        # ID tag for column section
uniaxialMaterial Elastic $IDcolTors $GJ; # Define torsional stiffness
section Aggregator $IDcolSec $IDcolTors T -section $IDcolFlex; # attach torsion to flexure and create a new
section IDtag

```

The geometric *transformation* (page 280) is used to relate the local element, and section, coordinates to the global system coordinates (simple here for a 2-D problem):

```

set IDcolTrans          1;          # ID tag for column transformation, defining element normal
geomTransf Linear $IDcolTrans;    # Linear: no second-order effects

```

The element, a *nonlinearBeamColumn* (page 218) element, and its connectivity, are defined as follows:

```

set np          5;          # Number of integration points
element nonlinearBeamColumn 1 1 2 $np $IDcolSec $IDcolTrans

```

## Gravity and other Constant Loads

Gravity loads are independent of the type of lateral loading and are considered part of the structural model. These loads are first defined:

```
# apply constant gravity load (and other constant loads)
set Pdl      [expr $Weight];          # gravity axial load per column
pattern Plain 1 Linear {
  load 2    0.0 -$Pdl 0.0
}
```

The above defines the gravity load (ID=1) as a load in the negative y-direction at node 2 with a magnitude Pdl

And then applied:

```
# set up solution procedure
system UmfPack;          # solution procedure, Super-LU, how it solves system of equations
constraints Plain;      # how it handles boundary conditions, enforce constraints through the
transformation
# set up convergence criteria
test NormDisplncr 1.0e-5 10 0;    # tolerance, max no. of iterations, and print code , 1: every iteration
algorithm Newton;              # use Newton's solution algorithm: updates tangent
stiffness at every iteration
numberer RCM;                # renumber dof's to minimize band-width (optimization)
# set up load stepping
integrator LoadControl 0.1 1 0.1 0.1;    # variable load-stepping: Do initial incr., desired no. of iterations
to converge, Dmax, Dmin
# set up type of analysis, static for gravity
analysis Static
initialize
# RUN GRAVITY ANALYSIS
analyze 10
loadConst -time 0.0
```

## Summary of Defining Structural Model

```
# DEFINE UNITS
set in 1.;          # define basic unit -- length
set sec 1.;        # define basic unit -- time
set kip 1.;        # define basic unit -- weight (or define force, but not both)
set ksi [expr $kip/pow($in,2)];    # define engineering units
set psi [expr $ksi/1000.];
set ft [expr 12.*$in];
set g [expr 32.2*$ft/pow($sec,2)];    # gravitational acceleration
set PI [expr 2*asin(1.0)];            # define constants
set U 1.e10;          # a really large number
set u [expr 1/$U];    # a really small number
# define GEOMETRY variables
set Hcol [expr 6.*$ft];    # column diameter
```

```

set Lcol [expr 36*$ft]; # column length
set GrhoCol 0.015; # column longitudinal-steel ratio
set Weight [expr 3000.*$kip]; # superstructure weight
set Rcol [expr $Hcol/2]; # COLUMN radius
set Acol [expr $PI*pow($Rcol,2)]; # column cross-sectional area
set cover [expr $Hcol/15]; # column cover width
set G $U; # Torsional stiffness Modulus
set J 1.; # Torsional stiffness of section
set Gj [expr $G*$J]; # Torsional stiffness
# define COLUMN REINFORCEMENT variables
set NbCol 20; # number of column longitudinal-reinforcement bars
set AsCol [expr $GrhoCol*$Acol]; # total steel area in column section
set AbCol [expr $AsCol/$NbCol]; # bar area of column longitudinal reinforcement
# define GRAVITY variables
set Mass [expr $Weight/$g]; # mass of superstructure
set Mnode [expr $Mass]; # nodal mass for each column joint
# define DAMPING variables from $xDamp --SDOF system, use stiffness proportional damping only
set xDamp 0.02; # modal damping ratio
# ----- set analysis variables
set DxPush [expr 0.1*$in]; # Displacement increment for pushover analysis
set DmaxPush [expr 0.05*$Lcol]; # maximum displacement for pushover analysis
set gamma 0.5; # gamma value for newmark integration
set beta 0.25; # beta value for newmark integration
set DtAnalysis [expr 0.005*$sec]; # time-step Dt for lateral analysis
set DtGround [expr 0.02*$sec]; # time-step Dt for input ground motion
set TmaxGround [expr 50.*$sec]; # maximum duration of ground-motion analysis
# define ModelBuilder
model basic -ndm 2 -ndf 3; # basic: modelbuilder type, ndm= number of dimensions, ndf= #dof/node
# Nodal Coordinates and Nodal Masses
node 1 0. 0.; # column base is located at the origin of the plane
node 2 0. $Lcol -mass $Mnode 0. 0.; # the column end has one translational mass in the x
direction, only
# Boundary Conditions
fix 1 1 1 1; # fixed base
fix 2 0 0 0; # free end

# Confined concrete:
set fc [expr -5.5*$ksi]; # CONCRETE Compressive Strength, ksi (+Tension, -Compression)
set Ec [expr 57*$ksi*sqrt(-$fc/$psi)]; # Concrete Elastic Modulus
set fc1C [expr 1.26394*$fc]; # CONFINED concrete (mander model), maximum stress
set eps1C [expr 2.*$fc1C/$Ec]; # strain at maximum stress
set fc2C $fc; # ultimate stress
set eps2C [expr 5*$eps1C]; # strain at ultimate stress
# Unconfined concrete:
set fc1U $fc; # UNCONFINED concrete (todeschini parabolic model), maximum stress
set eps1U -0.003; # strain at maximum stress
set fc2U [expr 0.1*$fc]; # ultimate stress
set eps2U -0.006; # strain at ultimate stress
# Concrete02 variables:
set lambda 0.1; # ratio between unloading slope at $eps1C and initial slope
set ftC [expr -$fc1C/10.]; # tensile strength +tension
set ftU [expr -$fc1U/10.]; # tensile strength +tension
set Ets [expr $Ec/10.]; # tension softening stiffness
# reinforcing steel
set Fy [expr 68.*$ksi]; # STEEL yield stress
set Es [expr 29000.*$ksi]; # modulus of steel
set epsY [expr $Fy/$Es]; # steel yield strain
set Fu [expr 95.2*$ksi]; # ultimate stress of steel
set epsU 0.1; # ultimate strain of steel
set E2 [expr ($Fu-$Fy)/($epsU-$epsY)]; # post-yield tangent stiffness

```

```

set Bs [expr $E2/$Es]; # post-yield stiffness ratio of steel
# set up parameters for column section and element definition
set IDcore 1; # ID tag for core concrete
set IDcover 2; # ID tag for cover concrete
set IDsteel 3; # ID tag for steel
uniaxialMaterial Concrete02 $IDcore $fc1C $seps1C $fc2C $seps2C $lambda $ftC $Ets; # CORE CONCRETE
uniaxialMaterial Concrete02 $IDcover $fc1U $seps1U $fc2U $seps2U $lambda $ftU $Ets; # COVER CONCRETE
uniaxialMaterial Steel01 $IDsteel $Fy $Es $Bs; # REINFORCING STEEL

# element cross-section
# Notes
# The center of the reinforcing bars are placed at the inner radius
# The core concrete ends at the inner radius (same as reinforcing bars)
# The reinforcing bars are all the same size
# The center of the section is at (0,0) in the local axis system
# Zero degrees is along section y-axis
set IDcolFlex 2; # ID tag for column section in flexure, before aggregating torsion
set riCol 0.0; # inner radius of column section
set roCol $Rcol; # outer radius of column section
set nfCoreR 8; # number of radial fibers in core (number of "rings")
set nfCoreT 16; # number of tangential fibers in core (number of "wedges")
set nfCoverR 2; # number of radial fibers in cover
set nfCoverT 16; # number of tangential fibers in cover
# cover - cover thickness, has been defined with the geometry
# IDcore - material tag for the core patch, has been defined with the materials
# IDcover - material tag for the cover patches, has been defined with the materials
# IDsteel - material tag for the reinforcing steel, has been defined with the materials
# NbCol # number of column longitudinal-reinforcement bars, has been defined with the geometry
# AbCol # bar area of column longitudinal reinforcement, has been defined with the geometry
section fiberSec $IDcolFlex {
set rc [expr $roCol-$cover]; # Core radius
patch circ $IDcore $nfCoreT $nfCoreR 0 0 $riCol $rc 0 360; # Define the core patch
patch circ $IDcover $nfCoverT $nfCoverR 0 0 $rc $roCol 0 360; # Define the cover patch
set theta [expr 360.0/$NbCol]; # Determine angle increment between bars
layer circ $IDsteel $NbCol $AbCol 0 0 $rc $theta 360; # Define the reinforcing layer
}

# element connectivity
set IDcolTors 10; # ID tag for column section in torsion
set IDcolSec 1; # ID tag for column section
uniaxialMaterial Elastic $IDcolTors $GJ; # Define torsional stiffness
section Aggregator $IDcolSec $IDcolTors T -section $IDcolFlex; # attach torsion to flexure and create a new section
IDtag
set IDcolTrans 1; # ID tag for column transformation, defining element normal
geomTransf Linear $IDcolTrans; # Linear: no second-order effects
set np 5; # Number of integration points
element nonlinearBeamColumn 1 1 2 $np $IDcolSec $IDcolTrans

# apply constant gravity load (and other constant loads)
set Pdl [expr $Weight]; # gravity axial load per column
pattern Plain 1 Linear {
load 2 0.0 -$Pdl 0.0
}

# set up solution procedure
system UmfPack; # solution procedure, Super-LU, how it solves system of equations
constraints Plain; # how it handles boundary conditions, enforce constraints through the
transformation
# set up convergence criteria
test NormDisplncr 1.0e-5 10 0; # tolerance, max no. of iterations, and print code , 1: every iteration
algorithm Newton; # use Newton's solution algorithm: updates tangent

```



```
stiffness at every iteration
numberer RCM;                                # renumber dof's to minimize band-width (optimization)
# set up load stepping
integrator LoadControl 0.1 1 0.1 0.1;      # variable load-stepping
# set up type of analysis, static for gravity
analysis Static
initialize
# RUN GRAVITY ANALYSIS
analyze 10
loadConst -time 0.0

# print to screen that you are done with this step:
puts "Done with Structural Model Generation"
```

Please note the last command, it communicates to the user that all commands preceding it have been executed. The above commands can be submitted to OpenSees one-by-one, or they can be saved into a file, say `input1.tcl`.

Once the input file has been saved, it can be executed at the OpenSees command prompt:

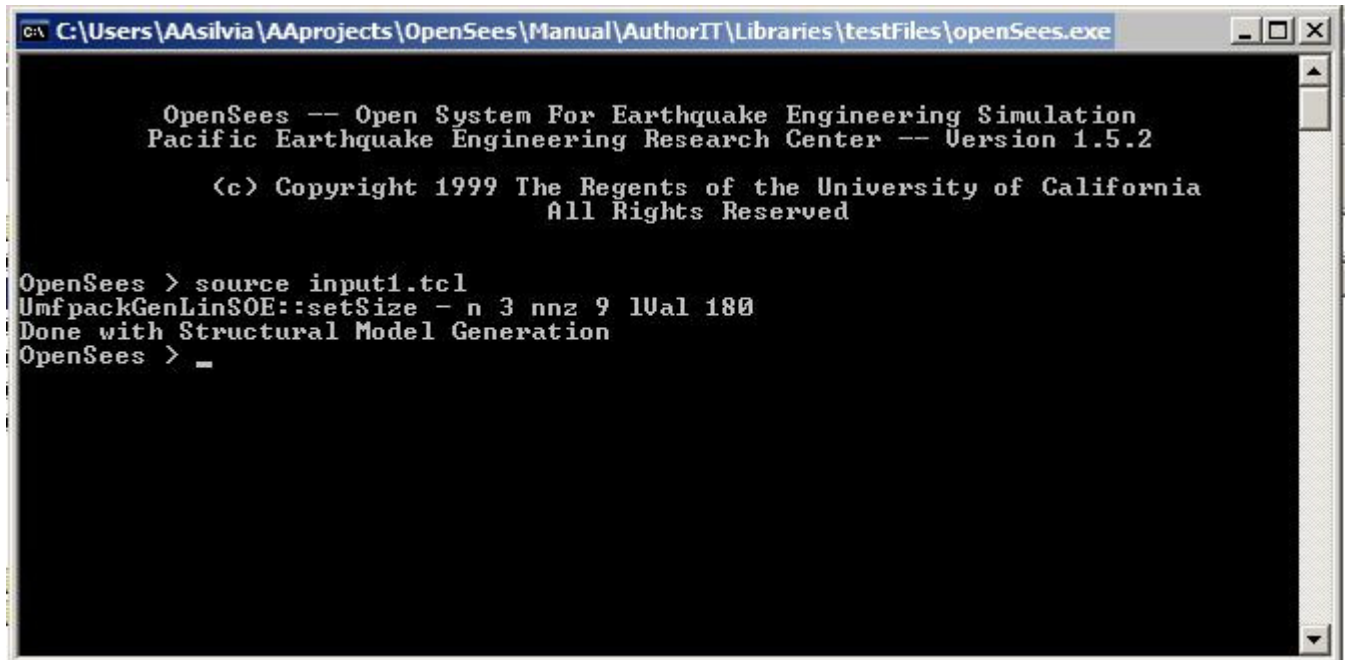

```
C:\Users\AAsilvia\AAsilvia\Projects\OpenSees\Manual\AuthorIT\Libraries\testFiles\openSees.exe
OpenSees -- Open System For Earthquake Engineering Simulation
Pacific Earthquake Engineering Research Center -- Version 1.5.2

(c) Copyright 1999 The Regents of the University of California
All Rights Reserved

OpenSees > source input1.tcl
UmfpackGenLinSOE::setSize - n 3 nnz 9 lUal 180
Done with Structural Model Generation
OpenSees > _
```

Of course, you will likely not get the clean response I got above.

Say you make a mistake. Likely it is a simple mistake it and you go and fix it (most errors that we ALL commit are simple typing errors). To check it, you need to source the input file once more:

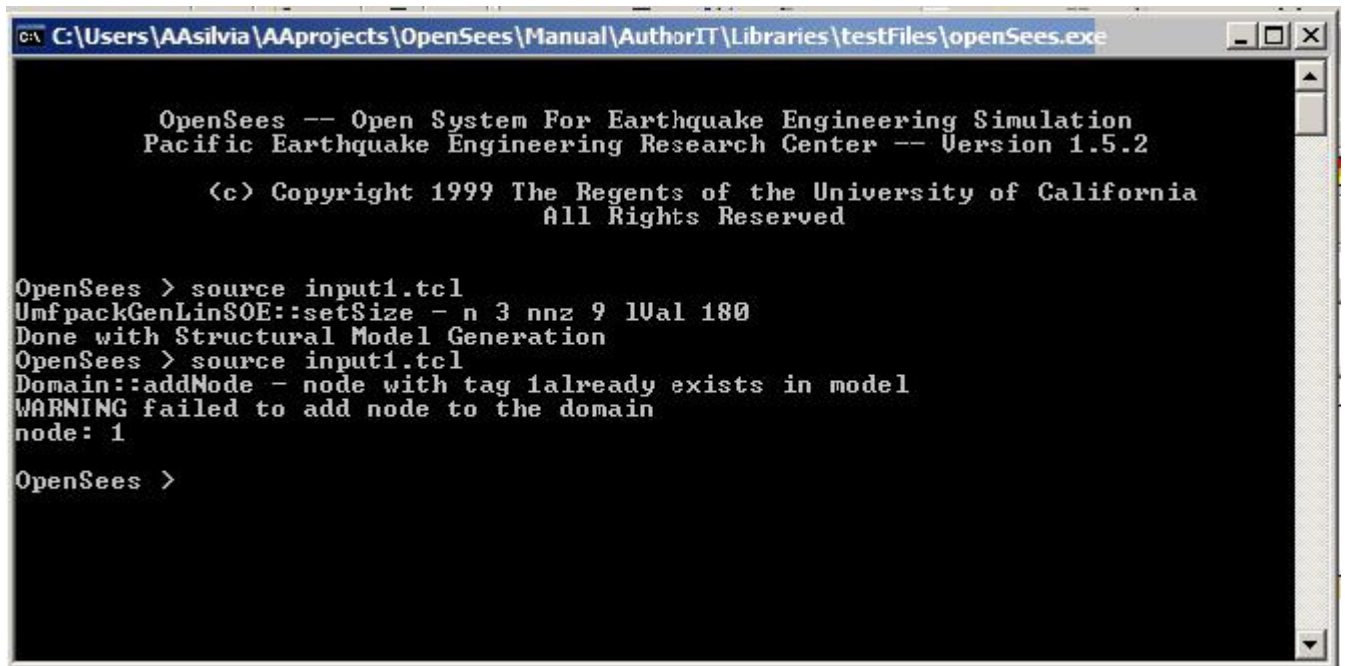
A screenshot of a Windows command prompt window titled "C:\Users\AAsilvia\AProjects\OpenSees\Manual\AuthorIT\Libraries\testFiles\openSees.exe". The window displays the OpenSees version information: "OpenSees -- Open System For Earthquake Engineering Simulation Pacific Earthquake Engineering Research Center -- Version 1.5.2" and copyright notice: "(c) Copyright 1999 The Regents of the University of California All Rights Reserved". The user enters the command "source input1.tcl". The output shows "UmfpackGenLinSOE::setSize - n 3 nnz 9 lUal 180 Done with Structural Model Generation". The user then enters "source input1.tcl" again. The output shows "Domain::addNode - node with tag 1already exists in model WARNING failed to add node to the domain node: 1". The prompt "OpenSees >" is shown at the end.

```
C:\Users\AAsilvia\AProjects\OpenSees\Manual\AuthorIT\Libraries\testFiles\openSees.exe

OpenSees -- Open System For Earthquake Engineering Simulation
Pacific Earthquake Engineering Research Center -- Version 1.5.2

(c) Copyright 1999 The Regents of the University of California
All Rights Reserved

OpenSees > source input1.tcl
UmfpackGenLinSOE::setSize - n 3 nnz 9 lUal 180
Done with Structural Model Generation
OpenSees > source input1.tcl
Domain::addNode - node with tag 1already exists in model
WARNING failed to add node to the domain
node: 1

OpenSees >
```

OpenSees does not allow you to define objects with the same IDtag more than once. To solve this problem, without exiting and re-entering OpenSees, you can use the *wipe* (page 348) command:

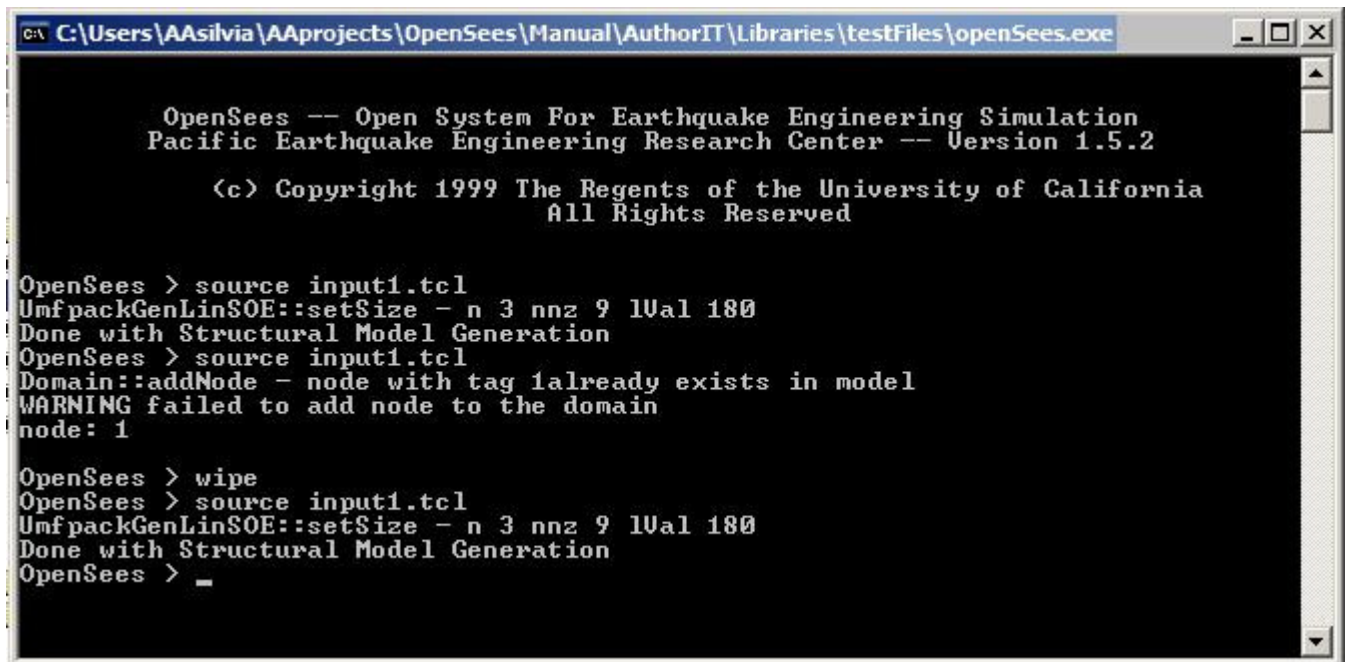
A screenshot of a Windows command prompt window titled "C:\Users\AAsilvia\AProjects\OpenSees\Manual\AuthorIT\Libraries\testFiles\openSees.exe". The window displays the OpenSees version information: "OpenSees -- Open System For Earthquake Engineering Simulation Pacific Earthquake Engineering Research Center -- Version 1.5.2" and copyright notice: "(c) Copyright 1999 The Regents of the University of California All Rights Reserved". The user enters the command "source input1.tcl". The output shows "UmfpackGenLinSOE::setSize - n 3 nnz 9 lUal 180 Done with Structural Model Generation". The user then enters "source input1.tcl" again. The output shows "Domain::addNode - node with tag 1already exists in model WARNING failed to add node to the domain node: 1". The user then enters "wipe". The output shows "Domain::addNode - node with tag 1already exists in model WARNING failed to add node to the domain node: 1". The user then enters "source input1.tcl". The output shows "UmfpackGenLinSOE::setSize - n 3 nnz 9 lUal 180 Done with Structural Model Generation". The prompt "OpenSees >" is shown at the end.

```
C:\Users\AAsilvia\AProjects\OpenSees\Manual\AuthorIT\Libraries\testFiles\openSees.exe

OpenSees -- Open System For Earthquake Engineering Simulation
Pacific Earthquake Engineering Research Center -- Version 1.5.2

(c) Copyright 1999 The Regents of the University of California
All Rights Reserved

OpenSees > source input1.tcl
UmfpackGenLinSOE::setSize - n 3 nnz 9 lUal 180
Done with Structural Model Generation
OpenSees > source input1.tcl
Domain::addNode - node with tag 1already exists in model
WARNING failed to add node to the domain
node: 1

OpenSees > wipe
Domain::addNode - node with tag 1already exists in model
WARNING failed to add node to the domain
node: 1

OpenSees > source input1.tcl
UmfpackGenLinSOE::setSize - n 3 nnz 9 lUal 180
Done with Structural Model Generation
OpenSees > _
```

Once you get confirmation that all the input commands have been executed correctly, you are ready to move on to the next step. Type `exit`, press `enter` and go on.

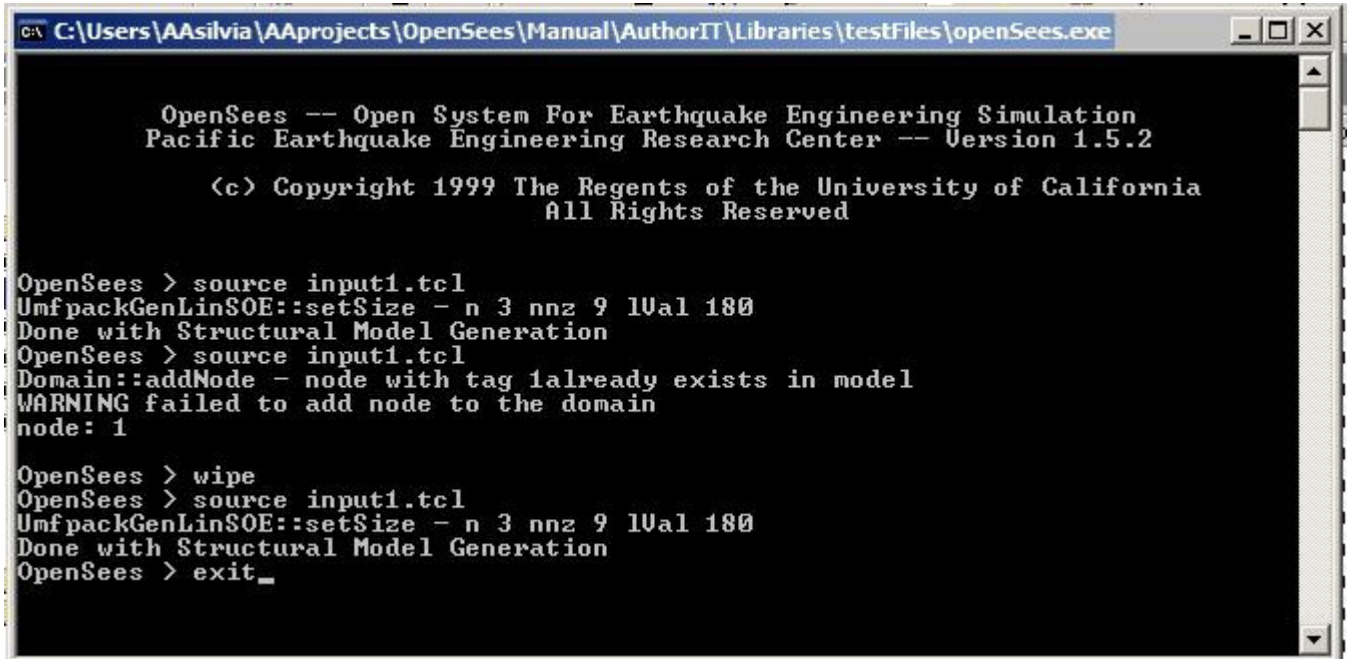

```

C:\Users\AAsilvia\AAsilvia\AAprojects\OpenSees\Manual\AuthorIT\Libraries\testFiles\openSees.exe

OpenSees -- Open System For Earthquake Engineering Simulation
Pacific Earthquake Engineering Research Center -- Version 1.5.2

(c) Copyright 1999 The Regents of the University of California
All Rights Reserved

OpenSees > source input1.tcl
UmfpackGenLinSOE::setSize - n 3 nnz 9 lUal 180
Done with Structural Model Generation
OpenSees > source input1.tcl
Domain::addNode - node with tag 1already exists in model
WARNING failed to add node to the domain
node: 1

OpenSees > wipe
OpenSees > source input1.tcl
UmfpackGenLinSOE::setSize - n 3 nnz 9 lUal 180
Done with Structural Model Generation
OpenSees > exit_

```

## Error-Checking Tip for Model Building

To enable error-checking, it is good practice to place markers within the input file. Markers are simple statements to be output to the screen using the `puts` (<http://docsrv.sco.com:507/en/man/html.TCL/puts.TCL.html>) tcl command. These markers tell the user what commands have been completed. This way, if an error occurs, the user is able to find the location of the error. Here is an example, where `puts` commands are placed here and there in the `input1.tcl` file:

```

puts "Begin units defintion"
# DEFINE UNITS
set in 1.; # define basic unit -- length
set sec 1.; # define basic unit -- time
set kip 1.; # define basic unit -- weight (or define force, but not both)
set ksi [expr $kip/pow($in,2)]; # define engineering units
set psi [expr $ksi/1000.];
set ft [expr 12.*$in];
set g [expr 32.2*$ft/pow($sec,2)]; # gravitational acceleration
set PI [expr 2*asin(1.0)]; # define constants
set U 1.e10; # a really large number
set u [expr 1/$U]; # a really small number
puts "Units have been defined"
# define GEOMETRY variables
set Hcol [expr 6.*$ft]; # column diameter
set Lcol [expr 36*$ft]; # column length
set GrhoCol 0.015; # column longitudinal-steel ratio

```

```

set Weight [expr 3000.*$kip]; # superstructure weight
set Rcol [expr $Hcol/2]; # COLUMN radius
set Acol [expr $PI*pow($Rcol,2)]; # column cross-sectional area
set cover [expr $Hcol/15]; # column cover width
set G $U; # Torsional stiffness Modulus
set J 1.; # Torsional stiffness of section
set GJ [expr $G*$J]; # Torsional stiffness
# define COLUMN REINFORCEMENT variables
set NbCol 20; # number of column longitudinal-reinforcement bars
set AsCol [expr $GrhoCol*$Acol]; # total steel area in column section
set AbCol [expr $AsCol/$NbCol]; # bar area of column longitudinal reinforcement
# define GRAVITY variables
set Mass [expr $Weight/$g]; # mass of superstructure
set Mnode [expr $Mass]; # nodal mass for each column joint
# define DAMPING variables from $xDamp --SDOF system, use stiffness proportional damping only
set xDamp 0.02; # modal damping ratio
# ----- set analysis variables
set DxPush [expr 0.1*$in]; # Displacement increment for pushover analysis
set DmaxPush [expr 0.05*$Lcol]; # maximum displacement for pushover analysis
set gamma 0.5; # gamma value for newmark integration
set beta 0.25; # beta value for newmark integration
set DtAnalysis [expr 0.005*$sec]; # time-step Dt for lateral analysis
set DtGround [expr 0.02*$sec]; # time-step Dt for input ground motion
set TmaxGround [expr 50.*$sec]; # maximum duration of ground-motion analysis
puts "All initial variables have been defined"
# define ModelBuilder
model basic -ndm 2 -ndf 3; # basic: modelbuilder type, ndm= number of dimensions, ndf= #dof/node
puts "the Model has been built"
# Nodal Coordinates and Nodal Masses
node 1 0. 0.; # column base is located at the origin of the plane
node 2 0. $Lcol -mass $Mnode 0. 0.; # the column end has one translational mass in the x
direction, only
# Boundary Conditions
fix 1 1 1 1; # fixed base
fix 2 0 0 0; # free end
puts "Nodal Coordinates, Nodal Masses, and Boundary Conditions have been defined"
puts "Begin material definition"
# Confined concrete:
set fc [expr -5.5*$ksi]; # CONCRETE Compressive Strength, ksi (+Tension, -Compression)
set Ec [expr 57*$ksi*sqrt(-$fc/$psi)]; # Concrete Elastic Modulus
set fc1C [expr 1.26394*$fc]; # CONFINED concrete (mander model), maximum stress
set eps1C [expr 2.*$fc1C/$Ec]; # strain at maximum stress
set fc2C $fc; # ultimate stress
set eps2C [expr 5*$eps1C]; # strain at ultimate stress
# Unconfined concrete:
set fc1U $fc; # UNCONFINED concrete (todeschini parabolic model), maximum stress
set eps1U -0.003; # strain at maximum stress
set fc2U [expr 0.1*$fc]; # ultimate stress
set eps2U -0.006; # strain at ultimate stress
# Concrete02 variables:
set lambda 0.1 ; # ratio between unloading slope at $eps1C and initial slope
set ftC [expr -$fc1C/10.]; # tensile strength +tension
set ftU [expr -$fc1U/10.]; # tensile strength +tension
set Ets [expr $Ec/10.]; # tension softening stiffness
# reinforcing steel
set Fy [expr 68.*$ksi]; # STEEL yield stress
set Es [expr 29000.*$ksi]; # modulus of steel
set epsY [expr $Fy/$Es]; # steel yield strain
set Fu [expr 95.2*$ksi]; # ultimate stress of steel
set epsU 0.1; # ultimate strain of steel

```

```

set E2 [expr ($Fu-$Fy)/($epsU-$epsY)]; # post-yield tangent stiffness
set Bs [expr $E2/$Es]; # post-yield stiffness ratio of steel
# set up parameters for column section and element definition
set IDcore 1; # ID tag for core concrete
set IDcover 2; # ID tag for cover concrete
set IDsteel 3; # ID tag for steel
puts "All material variables have been defined"
uniaxialMaterial Concrete02 $IDcore $fc1C $eps1C $fc2C $eps2C $lambda $ftC $Ets; # CORE CONCRETE
uniaxialMaterial Concrete02 $IDcover $fc1U $eps1U $fc2U $eps2U $lambda $ftU $Ets; # COVER CONCRETE
uniaxialMaterial Steel01 $IDsteel $Fy $Es $Bs; # REINFORCING STEEL
puts "All materials have been defined"
puts "Being element cross-section definition"
# element cross-section
# Notes
# The center of the reinforcing bars are placed at the inner radius
# The core concrete ends at the inner radius (same as reinforcing bars)
# The reinforcing bars are all the same size
# The center of the section is at (0,0) in the local axis system
# Zero degrees is along section y-axis
set IDcolFlex 2; # ID tag for column section in flexure, before aggregating torsion
set riCol 0.0; # inner radius of column section
set roCol $Rcol; # outer radius of column section
set nfCoreR 8; # number of radial fibers in core (number of "rings")
set nfCoreT 16; # number of tangential fibers in core (number of "wedges")
set nfCoverR 2; # number of radial fibers in cover
set nfCoverT 16; # number of tangential fibers in cover
# cover - cover thickness, has been defined with the geometry
# IDcore - material tag for the core patch, has been defined with the materials
# IDcover - material tag for the cover patches, has been defined with the materials
# IDsteel - material tag for the reinforcing steel, has been defined with the materials
# NbCol # number of column longitudinal-reinforcement bars, has been defined with the geometry
# AbCol # bar area of column longitudinal reinforcement, has been defined with the geometry
puts "All element-cross-section variables have been defined"
puts "Begin section definition"
section fiberSec $IDcolFlex {
set rc [expr $roCol-$cover]; # Core radius
patch circ $IDcore $nfCoreT $nfCoreR 0 0 $riCol $rc 0 360; # Define the core patch
patch circ $IDcover $nfCoverT $nfCoverR 0 0 $rc $roCol 0 360; # Define the cover patch
puts "All patches have been defined"
set theta [expr 360.0/$NbCol]; # Determine angle increment between bars
layer circ $IDsteel $NbCol $AbCol 0 0 $rc $theta 360; # Define the reinforcing layer
puts "All layers have been defined"
}
puts "End of element-cross-section definition"
puts "Begin Element Connectivity"
# element connectivity
set IDcolTors 10; # ID tag for column section in torsion
set IDcolSec 1; # ID tag for column section
uniaxialMaterial Elastic $IDcolTors $GJ; # Define torsional stiffness
section Aggregator $IDcolSec $IDcolTors T -section $IDcolFlex; # attach torsion to flexure and create a new section
IDtag
puts "All has been aggregated"
set IDcolTrans 1; # ID tag for column transformation, defining element normal
geomTransf Linear $IDcolTrans; # Linear: no second-order effects
set np 5; # Number of integration points
element nonlinearBeamColumn 1 1 2 $np $IDcolSec $IDcolTrans
puts "End Element definition"
puts "Begin Gravity loads"
# apply constant gravity load (and other constant loads)
set Pdl [expr $Weight]; # gravity axial load per column

```

```
pattern Plain 1 Linear {
  load 2 0.0 -$PdI 0.0
}
puts "Gravity Load Pattern has been defined"
# set up solution procedure
system UmfPack;                # solution procedure, Super-LU, how it solves system of equations
constraints Plain;             # how it handles boundary conditions, enforce constraints through the
transformation
# set up convergence criteria
test NormDisplncr 1.0e-5 10 0; # tolerance, max no. of iterations, and print code , 1: every iteration
algorithm Newton;              # use Newton's solution algorithm: updates tangent
stiffness at every iteration
numberer RCM;                  # renumber dof's to minimize band-width (optimization)
# set up load stepping
integrator LoadControl 0.1 1 0.1 0.1; # variable load-stepping
# set up type of analysis, static for gravity
analysis Static
puts "Static Analysis for Gravity and Constant loads has been defined"
initialize
# RUN GRAVITY ANALYSIS
analyze 10
loadConst -time 0.0
puts "End of Gravity Analysis"
# print to screen that you are done with this step:
puts "Done with Structural Model Generation"
```

The OpenSees control window will look like this:

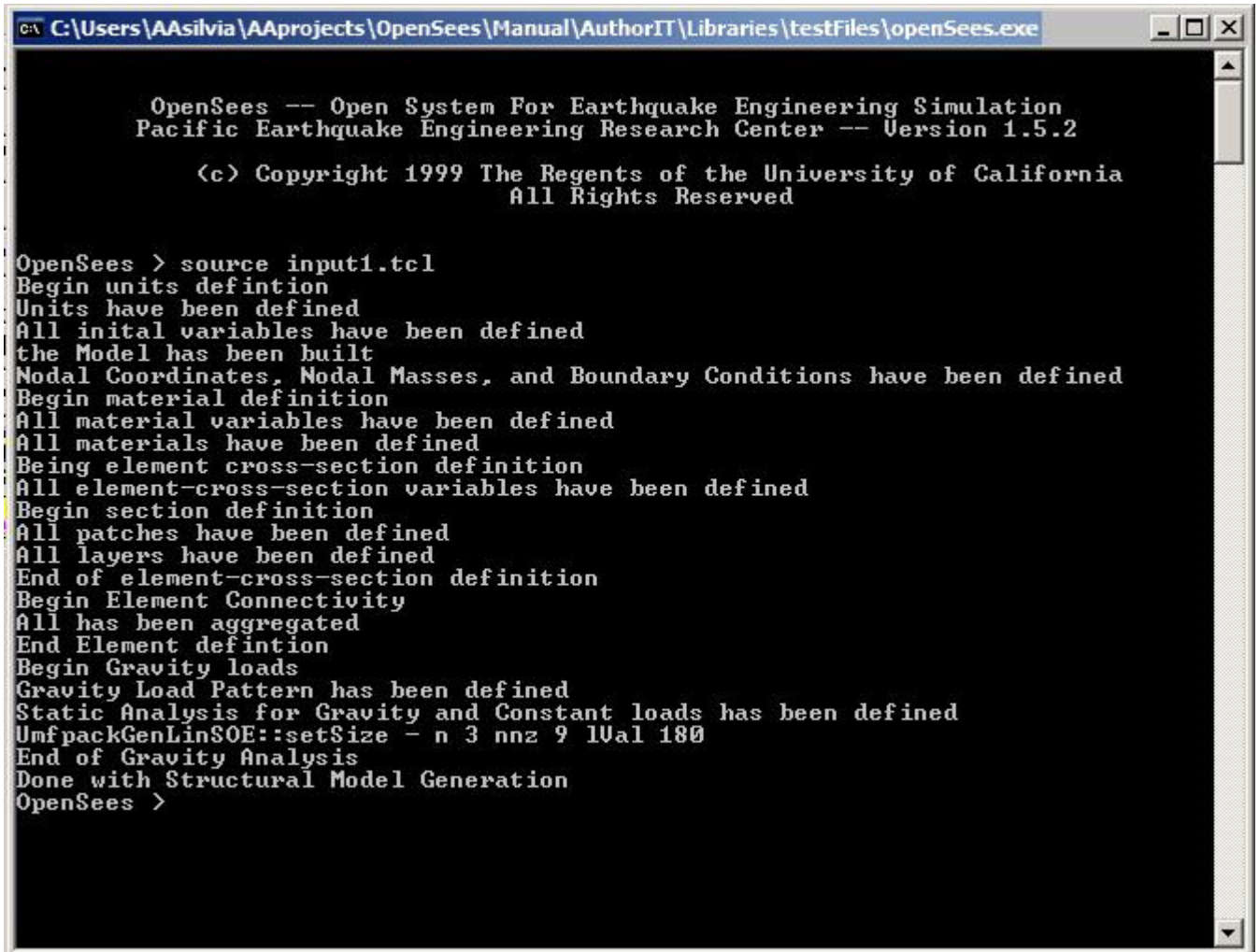
A screenshot of a Windows command prompt window titled "C:\Users\AAsilvia\AAsilvia\Projects\OpenSees\Manual\AuthorIT\Libraries\testFiles\openSees.exe". The window has a black background with white text. The text shows the OpenSees version information and a series of status messages from a Tcl script execution. The messages indicate that units, initial variables, the model, nodal coordinates, material definitions, element cross-sections, section definitions, patches, layers, element connectivity, and gravity loads have all been successfully defined. The script concludes with "Done with Structural Model Generation" and returns the prompt "OpenSees >".

```
C:\Users\AAsilvia\AAsilvia\Projects\OpenSees\Manual\AuthorIT\Libraries\testFiles\openSees.exe

OpenSees -- Open System For Earthquake Engineering Simulation
Pacific Earthquake Engineering Research Center -- Version 1.5.2

(c) Copyright 1999 The Regents of the University of California
All Rights Reserved

OpenSees > source input1.tcl
Begin units definition
Units have been defined
All initial variables have been defined
the Model has been built
Nodal Coordinates, Nodal Masses, and Boundary Conditions have been defined
Begin material definition
All material variables have been defined
All materials have been defined
Begin element cross-section definition
All element-cross-section variables have been defined
Begin section definition
All patches have been defined
All layers have been defined
End of element-cross-section definition
Begin Element Connectivity
All has been aggregated
End Element definition
Begin Gravity loads
Gravity Load Pattern has been defined
Static Analysis for Gravity and Constant loads has been defined
UmfpackGenLinSOE::setSize - n 3 nnz 9 lUal 180
End of Gravity Analysis
Done with Structural Model Generation
OpenSees >
```



When there is an error, it can be localized:

The screenshot shows a Windows command prompt window titled "C:\Users\AAsilvia\AAsilvia\Projects\OpenSees\Manual\AuthorIT\Libraries\testFiles\openSees.exe". The window displays the following text:

```

OpenSees -- Open System For Earthquake Engineering Simulation
Pacific Earthquake Engineering Research Center -- Version 1.5.2

(c) Copyright 1999 The Regents of the University of California
All Rights Reserved

OpenSees > source input1.tcl
Begin units definition
Units have been defined
All initial variables have been defined
the Model has been built
Nodal Coordinates, Nodal Masses, and Boundary Conditions have been defined
Begin material definition
All material variables have been defined
All materials have been defined
Begin element cross-section definition
All element-cross-section variables have been defined
Begin section definition
WARNING - error reading information in < >
invalid command name "HELLO"
OpenSees > _

```

Based on the markers, the erroneous command is located within the section definition, between the two puts commands.

```

puts "Begin section definition"
section fiberSec $IDcolFlex {
set rc [expr $roCol-$cover]; # Core radius
patch circ $IDcore $nfCoreT $nfCoreR 0 0 $riCol $rc 0 360; # Define the core patch
HELLO
patch circ $IDcover $nfCoverT $nfCoverR 0 0 $rc $roCol 0 360; # Define the cover patch
puts "All patches have been defined"
set theta [expr 360.0/$NbCol]; # Determine angle increment between bars
layer circ $IDsteel $NbCol $AbCol 0 0 $rc $theta 360; # Define the reinforcing layer
puts "All layers have been defined"
}

```



## Recorders for Output

The recorder commands are currently being modified and the documentation will be updated accordingly. So stay tuned..... The following, therefore, may not yet work well.....

Recorders are used to monitor the state of the model at each analysis step. They can be placed at nodes, elements, sections, fibers....

First of all, it is convenient to place all output data in a subdirectory:

```
file mkdir data
set FileName0 "data/"
```

The name \$FileName0 will be appended to each filename so that the output be placed in the data subdirectory.

The first recorder of interest on the cantilever column is a recorder to measure the horizontal and vertical displacements of the column end, node 2, as well as the rotation. The *node* (page 303) recorder is used:

```
set FileName1 Node2DxDyQz; # it is very good practice to give the output file a descriptive name
set $FileName $FileName0$FileName1
recorder Node $FileName.out disp -node 2 -dof 1 2 3;
```

The next items of interest are the element forces and deformations, using the *elemen* (page 307)t recorder. For the *nonlinearBeamColumn* (page 218) element, you really only need the forces at the element ends:

```
set FileName1 Fel1
set $FileName $FileName0$FileName1
recorder Element 1 -time -file $FileName.out localForce; # output local element forces for element 1
```

The element deformations at the cross-section level can be recorded at any integration point. For this example, the deformation at the first integration point (the base of the column) will be recorded:

```
set FileName1 Del1sec1
set $FileName $FileName0$FileName1
recorder Element -file $FileName.out -ele 1 section 1 deformations
```

Recorders can also be placed anywhere on a fiber section to measure fiber stresses and strains. When more than one material may occupy the location specified (such as a steel bar at the edge of the confined-concrete core), a preferred material can be specified. The location of the recorder is specified using the local coordinate system. If no fiber is located at that coordinate, a blank file will be output (very common error).

```
set FileName1 SSEL1sec1
set $FileName $FileName0$FileName1
recorder Element -file $FileName.out -ele 1 section 1 fiber $Rcol 0. $IDcore stressStrain;
```

## CHAPTER 45

**Analysis Components**

## CHAPTER 46

# Script Utilities Library

A library of Tcl Procedures is included in this chapter. The user could modify the procedures to meet the needs of the analysis.

## In This Chapter

matTest.tcl.....	427
RCcircSection.tcl.....	429
RCcircSectionFEDEAS.tcl.....	430
RCFrameDisplay.tcl.....	432
MomentCurvature.tcl.....	433
ReadSMDFile.tcl.....	434
RotSpring2D.....	436
StFramePZLdisplay.tcl.....	437
Wsection.tcl.....	437
RigidFrame3Ddisplay.tcl.....	438
Units&Constants.tcl.....	439
MatlabOutput.tcl.....	440
genPlaneFrame.tcl.....	440

---

## matTest.tcl

➤ ***A script for testing uniaxial materials with a single DOF truss.***

- This script requires an additional *file*  
(<http://opensees.berkeley.edu/OpenSees/examples/pattern1.txt>).

```
# matTest.tcl: SDOF truss to test uniaxial material models
# Units: kip, in
# MHS, Sept 1999
# email: mhscott@ce.berkeley.edu
model BasicBuilder -ndm 1 -ndf 1
# Define nodes
node 1 0.0
node 2 1.0
# Fix node 1
fix 1 1
# Define uniaxialMaterial
```

```
#          tag f'c epsc f'cu epscu
uniaxialMaterial Concrete01 1 -5.0 -0.002 -1.0 -0.004
# Define truss element with unit area
#          tag ndI ndJ A matTag
element truss 1 1 2 1.0 1
set dt 1.0 ;# Increment between data points
set filename pattern1.txt ;# Filename containing data points
set factor 0.006 ;# Factor applied to data values
# Read displacement pattern from file
# Note, any pattern type can be used here: Linear, Path, Sine, etc.
pattern Plain 1 "Series -dt $dt -filePath $filename -factor $factor" {
    # Set reference displacement value
    # node dof value
    sp 2 1 1.0
}
# Impose monotonic displacements
#pattern Plain 2 "Linear -factor $factor" {
#    sp 2 1 1.0
#}
# Record nodal displacements (same as strains since truss length is 1.0)
recorder Node truss.out disp -load -node 2 -dof 1
# Record truss force (same as stress since truss area is 1.0)
recorder Element 1 -time -file force.out force
system UmfPack
constraints Penalty 1.0e12 1.0e12
# Set increment in load factor used for integration
# Does not have to be the same as dt used to read in displacement pattern
set dl $dt
integrator LoadControl $dl 1 $dl $dl
test NormDisplnCr 1.0e-6 10
algorithm Newton
numberer RCM
analysis Static
analyze 10000
```

## RCcircSection.tcl

- ***# Define a procedure which generates a circular reinforced concrete section # with one layer of steel evenly distributed around the perimeter and a confined core.***

```

# Formal arguments
# id - tag for the section that is generated by this procedure
# ri - inner radius of the section
# ro - overall (outer) radius of the section
# cover - cover thickness
# coreID - material tag for the core patch
# coverID - material tag for the cover patches
# steelID - material tag for the reinforcing steel
# numBars - number of reinforcing bars around the section perimeter
# barArea - cross-sectional area of each reinforcing bar
# nfCoreR - number of radial divisions in the core (number of "rings")
# nfCoreT - number of theta divisions in the core (number of "wedges")
# nfCoverR - number of radial divisions in the cover
# nfCoverT - number of theta divisions in the cover
#
# Notes
# The center of the reinforcing bars are placed at the inner radius
# The core concrete ends at the inner radius (same as reinforcing bars)
# The reinforcing bars are all the same size
# The center of the section is at (0,0) in the local axis system
# Zero degrees is along section y-axis
#
proc RCcircSection {id ri ro cover coreID coverID steelID numBars barArea nfCoreR nfCoreT nfCoverR nfCoverT} {

# Define the fiber section
section fiberSec $id {
    # Core radius
    set rc [expr $ro-$cover]
    # Define the core patch
    patch circ $coreID $nfCoreT $nfCoreR 0 0 $ri $rc 0 360
    # Define the cover patch

```

```

    patch circ $coverID $nfCoverT $nfCoverR 0 0 $rc $ro 0 360
    if {$numBars <= 0} {
        return
    }
    # Determine angle increment between bars
    set theta [expr 360.0/$numBars]
    # Define the reinforcing layer
    layer circ $steelID $numBars $barArea 0 0 $rc $theta 360
}
}

```

---

## RCcircSectionFEDEAS.tcl

- ***# Define a procedure which generates a circular reinforced concrete section # with one layer of steel evenly distributed around the perimeter and a confined core.***

```

# Writes section information in FEDEAS format to the TCL file stream fedeas
#
# Formal arguments
# id - tag for the section that is generated by this procedure
# ri - inner radius of the section
# ro - overall (outer) radius of the section
# cover - cover thickness
# coreID - material tag for the core patch
# coverID - material tag for the cover patches
# steelID - material tag for the reinforcing steel
# numBars - number of reinforcing bars around the section perimeter
# barArea - cross-sectional area of each reinforcing bar
# nfCoreR - number of radial divisions in the core (number of "rings")
# nfCoreT - number of theta divisions in the core (number of "wedges")
# nfCoverR - number of radial divisions in the cover
# nfCoverT - number of theta divisions in the cover
# fedeas - file stream to which FEDEAS information is written
#
#           Calling procedure should define a TCL file stream, e.g.
#           set fedeas [open fedeas.out w]
#
# Notes

```

```

# The center of the reinforcing bars are placed at the inner radius
# The core concrete ends at the inner radius (same as reinforcing bars)
# The reinforcing bars are all the same size
# The center of the section is at (0,0) in the local axis system
# Zero degrees is along section y-axis
# Assumes G3 material tags and FEDEAS material tags are consistent
#
proc RCcircSectionFEDEAS {id ri ro cover coreID coverID steelID numBars barArea nfCoreR nfCoreT nfCoverR
nfCoverT fedeas} {

# Define the fiber section
section fiberSec $id {

    puts $fedeas fsection;    # FEDEAS fsection command
    puts $fedeas $id;        # fsection id
    puts $fedeas 2,0;        # 2 patches, reference axis is geometric centroid
    # Core radius
    set rc [expr $ro-$cover]
    # Define the core patch
    patch circ $coreID $nfCoreT $nfCoreR 0 0 $ri $rc 0 360
    puts $fedeas $coreID,2,$nfCoreR,$nfCoreT,1,1;    # matID,circular,nfRad,nfAng,propIJ,propJK
    puts $fedeas 0,0;                # (y,z) center of patch
    puts $fedeas $ri,$rc;            # R1,R2
    puts $fedeas 0,360;              # theta1,theta2
    puts $fedeas 0,0;                # NOT USED
    # Define the cover patch
    patch circ $coverID $nfCoverT $nfCoverR 0 0 $rc $ro 0 360
    puts $fedeas $coverID,2,$nfCoverR,$nfCoverT,1,1
    puts $fedeas 0,0
    puts $fedeas $rc,$ro
    puts $fedeas 0,360
    puts $fedeas 0,0
    if {$numBars <= 0} {
        puts $fedeas 0
        puts $fedeas ""
        return
    }
}

# Determine angle increment between bars

```

```

set theta [expr 360.0/$numBars]
puts $feideas 1;          # Number of layers
# Define the reinforcing layer
layer circ $steelID $numBars $barArea 0 0 $rc $theta 360
puts $feideas $steelID,2,$numBars,,$barArea;      # matID,circular,numBars,<barSize>,barArea
puts $feideas 0,0;          # (y,z) center of arc
puts $feideas $rc;          # RL
puts $feideas $theta,360;   # theta1,theta2
puts $feideas ""
}
}

```

---

## RCFrameDisplay.tcl

### ➤ # a window showing the displaced shape

```

recorder display DispShape 10 10 300 300 -wipe

# next three commands define viewing system, all values in global coords
vvp 288.0 150.0 0 # point on the view plane in global coord, center of local viewing system
vup 0 1 0 # dirn defining up direction of view plane
vpn 0 0 1 # direction of outward normal to view plane

# next three commands define view, all values in local coord system
prp 0 0 100 # eye location in local coord sys defined by viewing system
viewWindow -400 400 -400 400 # view bounds uMin, uMax, vMin, vMax in local coords
plane 0 150 # distance to front and back clipping planes from eye
projection 0 # projection mode

port -1 1 -1 1 # area of window that will be drawn into
fill 1 # fill mode
display 1 0 10

```



## MomentCurvature.tcl

- *# A procedure for performing section analysis (only does moment-curvature, but can be easily modified to do any mode of section reponse.*

```

# MHS
# October 2000
#
# Arguments
#   secTag -- tag identifying section to be analyzed
#   axialLoad -- axial load applied to section (negative is compression)
#   maxK -- maximum curvature reached during analysis
#   numIncr -- number of increments used to reach maxK (default 100)
#
# Sets up a recorder which writes moment-curvature results to file
# section$secTag.out ... the moment is in column 1, and curvature in column 2
proc MomentCurvature {secTag axialLoad maxK {numIncr 100}} {
    # Define two nodes at (0,0)
    node 1 0.0 0.0
    node 2 0.0 0.0

    # Fix all degrees of freedom except axial and bending
    fix 1 1 1 1
    fix 2 0 1 0

    # Define element
    #           tag ndI ndJ secTag
    element zeroLengthSection 1 1 2 $secTag

    # Create recorder
    recorder Node section$secTag.out disp -time -node 2 -dof 3

    # Define constant axial load
    pattern Plain 1 "Constant" {
        load 2 $axialLoad 0.0 0.0
    }
}

```

```

# Define analysis parameters
integrator LoadControl 0 1 0 0
system SparseGeneral -piv; # Overkill, but may need the pivoting!
test NormUnbalance 1.0e-9 10
numberer Plain
constraints Plain
algorithm Newton
analysis Static

# Do one analysis for constant axial load
analyze 1

# Define reference moment
pattern Plain 2 "Linear" {
    load 2 0.0 0.0 1.0
}

# Compute curvature increment
set dK [expr $maxK/$numIncr]

# Use displacement control at node 2 for section analysis
integrator DisplacementControl 2 3 $dK 1 $dK $dK

# Do the section analysis
analyze $numIncr
}

```

---

## ReadSMDFile.tcl

- ***A procedure which converts a PEER strong motion database (<http://peer.berkeley.edu/smcat/>) file to OpenSees format***

```

#
# -----READSDMFILE.TCL-----read gm input format
#
# Written: MHS
# Date: July 2000
#

```

```
# A procedure which parses a ground motion record from the PEER
# strong motion database by finding dt in the record header, then
# echoing data values to the output file.
#
# Formal arguments
#   inFilename -- file which contains PEER strong motion record
#   outFilename -- file to be written in format G3 can read
#   dt -- time step determined from file header
#
# Assumptions
#   The header in the PEER record is, e.g., formatted as follows:
#   PACIFIC ENGINEERING AND ANALYSIS STRONG-MOTION DATA
#   IMPERIAL VALLEY 10/15/79 2319, EL CENTRO ARRAY 6, 230
#   ACCELERATION TIME HISTORY IN UNITS OF G
#   NPTS= 3930, DT= .00500 SEC
proc ReadSMDFile {inFilename outFilename dt} {
    # Pass dt by reference
    upvar $dt DT

    # Open the input file and catch the error if it can't be read
    if [catch {open $inFilename r} inFileID] {
        puts stderr "Cannot open $inFilename for reading"
    } else {
        # Open output file for writing
        set outFileID [open $outFilename w]

        # Flag indicating dt is found and that ground motion
        # values should be read -- ASSUMES dt is on last line
        # of header!!!
        set flag 0

        # Look at each line in the file
        foreach line [split [read $inFileID] \n] {

            if {[length $line] == 0} {
                # Blank line --> do nothing
                continue
            } elseif {$flag == 1} {
```

```

        # Echo ground motion values to output file
        puts $outFileID $line
    } else {
        # Search header lines for dt
        foreach word [split $line] {
            # Read in the time step
            if {$flag == 1} {
                set DT $word
                break
            }
            # Find the desired token and set the flag
            if {[string match $word "DT="] == 1} {
                set flag 1
            }
        }
    }
}
# Close the output file
close $outFileID
# Close the input file
close $inFileID
}
}

```

---

## RotSpring2D

➤ ***# Procedure which creates a rotational spring for a planar problem***

```

# rotSpring2D.tcl
# SETS A MULTIPOINT CONSTRAINT ON THE TRANSLATIONAL DEGREES OF FREEDOM,
# SO DO NOT USE THIS PROCEDURE IF THERE ARE TRANSLATIONAL ZEROLENGTH
# ELEMENTS ALSO BEING USED BETWEEN THESE TWO NODES
#
# Written: MHS
# Date: Jan 2000
#
# Formal arguments
#     eleID - unique element ID for this zero length rotational spring

```

```

# nodeR - node ID which will be retained by the multi-point constraint
# nodeC - node ID which will be constrained by the multi-point constraint
# matID - material ID which represents the moment-rotation relationship
#           for the spring
proc rotSpring2D {eleID nodeR nodeC matID} {
    # Create the zero length element
    element zeroLength $eleID $nodeR $nodeC -mat $matID -dir 6

    # Constrain the translational DOF with a multi-point constraint
    # retained constrained DOF_1 DOF_2 ... DOF_n
    equalDOF $nodeR $nodeC 1 2
}

```

---

## StFramePZLdisplay.tcl

➤ *# a window to plot the nodal displacements versus load*

```

if {$displayMode == "displayON"} {
    recorder plot StFramePZL1.out Node4Xdisp 10 400 300 300 -columns 3 1

    # a window showing the displaced shape
    recorder display g3 10 10 300 300 -wipe
    prp 288.0 150.0 100.0
    vrp 288.0 150.0 0
    vup 0 1 0
    vpn 0 0 1
    viewWindow -400 400 -400 400
    plane 0 150
    port -1 1 -1 1
    projection 0
    fill 1
    display 2 0 10
}

```

---

## Wsection.tcl

➤ *Procedure for creating a wide flange steel fiber section*

```

# Wsection.tcl: tcl procedure for creating a wide flange steel fiber section
# written: Remo M. de Souza
# date: 06/99
# modified: 08/99 (according to the new general modelbuilder)

```

```

# input parameters
# secID - section ID number
# matID - material ID number
# d = nominal depth
# tw = web thickness
# bf = flange width
# tf = flange thickness
# nfdw = number of fibers along web depth
# nftw = number of fibers along web thickness
# nfbf = number of fibers along flange width
# nftf = number of fibers along flange thickness
proc Wsection { secID matID d tw bf tf nfdw nftw nfbf nftf } {
    set dw [expr $d - 2 * $tf]
    set y1 [expr -$d/2]
    set y2 [expr -$dw/2]
    set y3 [expr $dw/2]
    set y4 [expr $d/2]
    set z1 [expr -$bf/2]
    set z2 [expr -$tw/2]
    set z3 [expr $tw/2]
    set z4 [expr $bf/2]
    #
    section fiberSec $secID {
        #          nflJ nfJK  yI zI  yJ zJ  yK zK  yL zL
        patch quadr $matID $nfbf $nftf $y1 $z4 $y1 $z1 $y2 $z1 $y2 $z4
        patch quadr $matID $nftw $nfdw $y2 $z3 $y2 $z2 $y3 $z2 $y3 $z3
        patch quadr $matID $nfbf $nftf $y3 $z4 $y3 $z1 $y4 $z1 $y4 $z4
    }
}

```

## RigidFrame3Ddisplay.tcl

➤ *# a window showing the displaced shape*

```

set displayType "PLAN"
#set displayType "PERSPECTIVE"

# a window showing the displaced shape

```

```

recorder display g3 10 10 300 300 -wipe

if {$displayType == "PERSPECTIVE"} {
    prp -7500 -5000 50000
    vrp 0 -500 250
    vup 0 0 1
    vpn 0 -1 0
    viewWindow -200 400 -300 300
}

if {$displayType == "PLAN"} {
    prp 0 0 1000
    vrp 0 0 0
    vup 0 -1 0
    vpn 0 0 -1
    viewWindow -200 200 -200 200
}

plane 0 1e12
port -1 1 -1 1
projection 1
fill 0
display 1 0 10

```

---

## Units&Constants.tcl

### ➤ *Procedure to define units and constants*

```

# ----Units&Constants.tcl-----
set in 1.;                # define basic units
set sec 1.;
set kip 1.;
set ksi [expr $kip/pow($in,2)];        # define dependent units
set psi [expr $ksi/1000.];
set ft [expr 12.*$in];
set lb [expr $kip/1000];
set pcf [expr $lb/pow($ft,3)];
set ksi [expr $kip/pow($in,2)];

```

```

set psi [expr $ksi/1000.];
set cm [expr $in/2.54];          # define metric units
set meter [expr 100.*$cm];
set MPa [expr 145*$psi];
set PI [expr 2*asin(1.0)];      # define constants
set g [expr 32.2*$ft/pow($sec,2)];
set U 1.e10;                    # a really large number
set u [expr 1/$U];             # a really small number

```

---

## MatlabOutput.tcl

➤ *# script to generate .m file to be read by matlab*

```

# -----MatlabOutput.tcl-----
set Xframe 1;                   # this parameter would be passed in
set fDir "Data/";
file mkdir $fDir;              # create directory
set outFileID [open $fDir/DataFrame$Xframe.m w]; # Open output file for writing
puts $outFileID "Xframe($Xframe) = $Xframe;"; # frame ID
puts $outFileID "Hcol($Xframe) = $Hcol;";      # column diameter
puts $outFileID "Lcol($Xframe) = $Lcol;";      # column length
puts $outFileID "Lbeam($Xframe) = $Lbeam;";    # beam length
puts $outFileID "Hbeam($Xframe) = $Hbeam;";    # beam depth
puts $outFileID "Bbeam($Xframe) = $Bbeam;";    # beam width
puts $outFileID "Weight($Xframe) = $Weight;";  ; # superstructure weight
close $outFileID

```

---

## genPlaneFrame.tcl

➤ *# Define a procedure which will generate nodes and elements for a plane frame having absolute column line locations in the list*

```

# 'columnLine', absolute girder line locations in the list 'girderLine',
# section IDs for the columns and girders, 'columnID' and 'girderID', and
# 'nIntPt' integration points along every member.
#
# Notes: automatically fixes the base nodes
#       only generate nonlinearBeamColumn elements

```



```

# allows columns and girders to be spaced arbitrarily
# does not add nodal masses or loads, but can be extended to do so
# starts node numbering at 1
#
# Formal arguments
# columnLine - a list of column line locations
# The actual argument would be defined as so, set columns {0 120 240 360}
# girderLine - a list of girder line locations
# The actual argument would be defined as so, set girders {180 300 420}
# columnID - an integer representing the section ID (tag) for the columns in the frame
# girderID - an integer representing the section ID (tag) for the girders in the frame
# nIntPt - an integer representing the number of integration points along each member in the frame
proc genPlaneFrame {columnLine girderLine columnID girderID nIntPt} {
  set n 1; # Node number counter
  geomTransf Linear 1; # Geometric transformation for all elements
  # For each column line
  foreach xLoc $columnLine {

```

```

node $n $xLoc 0
# Fix the base node
fix $n 1 1 1
incr n 1
# For each girder line
foreach yLoc $girderLine {

```

```

  node $n $xLoc $yLoc
  incr n 1

```

```

}

```

```

}

# Useful variables
set numCol [llength $columnLine]
set numGir [llength $girderLine]
set e 1; # Element number counter
# For each column line
for {set i 1} {$i <= $numCol} {incr i 1} {

```

```

# Node number at the base of this column line
set bottom [expr ($i-1)*$numGir + $j]
# Node number at the top of this column line
set top [expr $i*$numGir + $j]
# Travel up this column line creating elements
for {set j $bottom} {$j <= [expr $top-1]} {incr j 1} {

```

```

    element nonlinearBeamColumn $e $j [expr $j+1] $nIntPt $columnID 1
    incr e 1

```

```

}

```

```

}

# Difference in node numbers I and J for any girder in the frame
set delta [expr $numGir+1]

# For each girder line
for {set j 1} {$j <= $numGir} {incr j 1} {

```

```

    # Node number at the left end of this girder line
    set left [expr $j+1]
    # Node number at the right end of this girder line
    set right [expr ($numCol-1)*$numGir + $numCol + $j]
    # Travel across this girder line creating elements
    for {set k $left} {$k < $right} {incr k $delta} {

```

```

        element nonlinearBeamColumn $e $k [expr $k+$delta] $nIntPt $columnID 1
        incr e 1

```

```

    }

```

```

}

}; #end proc

```

## CHAPTER 47

# References

API(1993). Recommended Practice for Planning, Design, and Constructing Fixed Offshore Platforms. API RP 2A - WSD, 20th ed., American Petroleum Institute.

Boulanger, R. W. (2003). The PySimple1 Material. <http://opensees.berkeley.edu> (<http://opensees.berkeley.edu/>).

Cook, R. D., D. S. Malkus, M. E. Plesha. "Concepts and Applications of Finite Element Analysis." John Wiley & Sons, 1989.

Crisfield, M. A. "Non-linear Finite Element Analysis of Solids and Structures." John Wiley & Sons, vol. 1, 1991

Elgamal, A., Lai, T., Yang, Z. and He, L. (2001). "Dynamic Soil Properties, Seismic Downhole Arrays and Applications in Practice," State-of-the-art paper, Proc., 4th Intl. Conf. on Recent Advances in Geote. E.Q. Engrg. Soil Dyn. March 26-31, San Diego, CA, S. Prakash (Ed.).

Elgamal, A., Yang, Z. and Parra, E. (2002). "Computational Modeling of Cyclic Mobility and Post-Liquefaction Site Response," Soil Dyn. Earthquake Engrg., 22(4), 259-271.

Elgamal, A., Yang, Z., Parra, E. and Ragheb, A. (2003). "Modeling of Cyclic Mobility in Saturated Cohesionless Soils," Int. J. Plasticity, 19(6), 883-905.

Georgiadis, M. (1983). "Development of p-y curves for layered soils." Proc., Geotechnical Practice in Offshore Engineering, ASCE, pp. 536-545.

Lowes, Laura N.; Mitra, Nilanjan; Altoontash, Arash *A beam-column joint model for simulating the earthquake response of reinforced concrete frames PEER-2003/10* (<http://nisee.berkeley.edu/elibrary/getdoc?id=1288878>) Pacific Earthquake Engineering Research Center, University of California, Berkeley 2003 59 pages (400/P33/2003-10)

Matlock, H. (1970). "Correlations of design of laterally loaded piles in soft clay."Proc. Offshore Technology Conference, Houston, TX, Vol 1, No.1204, pp. 577-594.

McKenna, F. and Fenves, G. (2001). "The OpenSees Command Language Manual: version 1.2," Pacific Earthquake Engineering Center, Univ. of Calif., Berkeley. (<http://opensees.berkeley.edu> (<http://opensees.berkeley.edu/>)).

Mosher, R. L., (1984) "Load Transfer Criteria for Numerical Analysis of Axially Loaded Piles in Sand," US Army Engineering Waterways Experimental Station, Automatic Data Processing Center, Vicksburg, Mississippi, January.

Parra, E. (1996). "Numerical Modeling of Liquefaction and Lateral Ground Deformation Including Cyclic Mobility and Dilation Response in Soil Systems," Ph.D. Thesis, Dept. of Civil Engineering, Rensselaer Polytechnic Institute, Troy, NY.

Reese, L.C., and O'Neill, M. W., (1987) "Drilled Shafts: Construction Procedures and Design Methods," Report No. FHWA-HI-88-042, U.S. Department of Transportation, Federal Highway Administration, Office of Implementation, McLean, Virginia.

Vijayvergiya, V.N. (1977) "Load-Movement Characteristics of Piles," Proceedings, Ports 77 Conference, American Society of Civil Engineers, Long Beach, CA, March.

Yang, Z. (2000). "Numerical Modeling of Earthquake Site Response Including Dilation and Liquefaction," Ph.D. Thesis, Dept. of Civil Engineering and Engineering Mechanics, Columbia University, NY, New York.

Yang, Z. and Elgamal, A. (2002). "Influence of Permeability on Liquefaction-Induced Shear Deformation," J. Engrg. Mech., ASCE, 128(7), 720-729.

Yang, Z., Elgamal, A. and Parra, E. (2003). "A Computational Model for Liquefaction and Associated Shear Deformation," J. Geotechnical and Geoenvironmental Engineering, ASCE, December (in press).

#### **For the Force-Based Beam-Column Element:**

Neuenhofer, Ansgar, FC Filippou. *Geometrically Nonlinear Flexibility-Based Frame Finite Element* ([Neuenhofer, Ansgar, FC Filippou. \*Evaluation of Nonlinear Frame Finite-Element Models\* \(](http://ascelibrary.aip.org/vsearch/servlet/VerityServlet?KEY=JSENDH&smode=strresults&sort=rel&maxdisp=25&origquery=%28flexibility%29+&threshold=0&pjournals=IJGNAI%2CJAEIEEZ%2CJAEIED%2CJBENF%2CJCRGEI%2CJCCOF%2CJCCEE5%2CJCCEMD4%2CJLEED9%2CJENMDT%2CJOEEDU%2CJGGFEFK%2CJHEND8%2CJHYEFF%2CJITSE4%2CJIDEDH%2CJMEAEA%2CJMCEE7%2CJPCFEV%2CJPEPE3%2CJSENDH%2CJSUED2%2CJTPEDI%2CJUPDDM%2CJWRMD5%2CJWPED5%2CLMEEAZ%2CNHREFO%2CPPHMF8%2CPPSCFX%2C&pyears=&possible1=flexibility&possible1zone=article&possible3=Neuenhofer&possible3zone=author&bool3=and&OUTLOG=NO&viewabs=JSENDH&key=DISPLAY&docID=1&page=1&chapter=0&aqs=). ASCE Journal of Structural Engineering, Vol. 124, No. 6, June, 1998. ISSN 0733-9445/98/0006-0704-0711. Paper 16537. pp. 704-711.</p>
</div>
<div data-bbox=)

Neuenhofer, Ansgar, FC Filippou. ERRATA -- Geometrically Nonlinear Flexibility-Based Frame Finite Element. *ASCE Journal of Structural Engineering*, Vol. 124, No. 6, June, 1998. ISSN 0733-9445/98/0006-0704-0711. Paper 16537. pp. 704-711.

Taucer, Fabio F, E Spacone, FC Filippou. *A Fiber Beam-Column Element for Seismic Response Analysis of Reinforced Concrete Structures. Report No. UCB/EERC-91/17* (<http://nisee.berkeley.edu/elibrary/getdoc?id=237794>). Earthquake Engineering Research Center, College of Engineering, University of California, Berkeley. December 1991.

Spacone, Enrico, V Ciampi, FC Filippou. *A Beam Element for Seismic Damage Analysis. Report No. UCB/EERC-92/07*. (<http://nisee.berkeley.edu/elibrary/getdoc?id=241936>) Earthquake Engineering Research Center, College of Engineering, University of California, Berkeley. August 1992.

#### **BeamWithHinges Element:**

Scott, M.H. and G.L. Fenves. "Plastic Hinge Integration Methods for Force-Based Beam-Column Elements", *Journal of Structural Engineering*, ASCE, 132(2):244-252, February 2006.

#### **ReinforcingSteel Material:**

Chang, G. and Mander, J. (1994). "Seismic Energy Based Fatigue Damage Analysis of Bridge Columns: Part I – Evaluation of Seismic Capacity." NCEER Technical Report 94-0006.

Dodd, L. and Restrepo-Posada, J. (1995). "Model for Predicting Cyclic Behavior of Reinforcing Steel" *J. Struct. Eng.*, 121(3), 433-445.

Gomes, A., and Appleton, J. (1997). "Nonlinear Cyclic Stress-Strain Relationship of Reinforcing Bars Including Buckling." *Eng. Struct.*, 19(10), 822–826.

Brown, J. and Kunnath, S.K. (2000). "Low Cycle Fatigue Behavior of Longitudinal Reinforcement in Reinforced Concrete Bridge Columns." NCEER Technical Report 00-0007.

Dhokal, R. and Maekawa, K. (2002). "Modeling for Postyield Buckled of Reinforcement" *J. Struct. Eng.*, 128(9), 1139-1147.

#### **Concrete04 Element:**

Mander, J. B., Priestley, M. J. N., and Park, R. (1988). "Theoretical stress-strain model for confined concrete." *Journal of Structural Engineering ASCE*, 114(8), 1804-1825.

Popovics, S. (1973). "A numerical approach to the complete stress strain curve for concrete." *Cement and concrete research*, 3(5), 583-599.

Karsan, I. D., and Jirsa, J. O. (1969). "Behavior of concrete under compressive loading." *Journal of Structural Division ASCE*, 95(ST12).

**Useful Resources:**

National Information Service for Earthquake Engineering -- *NISEE. The Earthquake Engineering Online Archive* (<http://nisee.berkeley.edu/elibrary/>) (full text reports, images and data).  
<http://nisee.berkeley.edu/elibrary/>

National Information Service for Earthquake Engineering -- *NISEE. Earthquake Engineering Abstracts Database* (<http://nisee.berkeley.edu/eea.html>): <http://nisee.berkeley.edu/eea.html>

American Society of Civil Engineer -- *ASCE. Online Journals Program*  
(<http://www.pubs.asce.org/journals/jrns.html>). <http://www.pubs.asce.org/journals/jrns.html>

# Index

-- Contributed Uniaxial Materials • 44

.

...Build Model and Define Nodes • 34, 35, 36, 37, 39, 364

...Build Model and Define Nodes using Variables • 365

...Combine Input-File Components • 374

...Define Analysis-Output Generation • 367

...Define Data-Plot During Analysis • 369

...Define Dynamic Ground-Motion Analysis • 373

...Define Elements • 366

...Define Gravity Loads • 370

...Define Materials • 365

...Define Static Pushover Analysis • 371

...Define Tcl Procedure • 358

...Define Units & Constants • 357

...Define Variables and Parameters • 361

...Determine Natural Period & Frequency • 378

...Generate Matlab Commands • 358

...Read External files • 360

...Run Dynamic Ground-Motion Analysis • 374

...Run Gravity Analysis • 371

...Run Moment-Curvature Analysis on Section • 377

...Run Parameter Study • 375

...Run Static Pushover Analysis • 372

## A

Additional Tcl Resources • 17

algorithm Command • 24, 28, 314, 327, 330, 341, 342, 350, 399

analysis Command • 24, 28, 314, 336, 337, 340, 345, 350, 397, 400

Analysis Components • 427

Analysis Object • 31

Analysis Objects • 30, 314, 340, 400

analyze Command • 345, 397, 400

Arc-Length Control • 27, 335, 337, 400

Axial Limit Curve • 75

## B

BandGeneral SOE • 27, 325

BandSPD SOE • 27, 325

BARSLIP Material • 25, 44

Basic Model Builder • 12, 34, 35, 36, 37, 197, 199, 200, 202, 203, 305, 306, 312, 364, 388

Bbar Brick Element • 26, 163, 232, 277

Bbar Plane Strain Quadrilateral Element • 26, 163, 229, 275

Beam With Hinges Element • 26, 219, 220, 308, 310

Beam-Column Joint Element Discussion • 237

BeamColumnJoint Element • 26, 233

BFGS Algorithm • 28, 332

Bidirectional Section • 26, 207

block Command • 23, 29, 34, 274

block2D Command • 274, 275

block3D Command • 274, 277

Bond\_SP01 - - Strain Penetration Model for Fully Anchored Steel Reinforcing Bars • 25, 46

Brick Elements • 231

BrickUP • 269

Broyden Algorithm • 28, 333

build Command • 35

Building The Model • 361

## C

CenterCol\_basicModel.tcl • 78

CenterColAxialSpring.tcl • 82

CenterColSecFiber.tcl • 80

CenterColShearSpring.tcl • 80

Circular Layer Command • 195, 203, 413

Circular Patch Command • 200, 413

Concrete01 -- Material Behavior • 138

Concrete01 Material -- Zero Tensile Strength • 25, 135, 412

Concrete02 -- Material Behavior • 144

Concrete02 Material -- Linear Tension Softening • 25, 138, 412  
Concrete03 -- Material Behavior • 148  
Concrete03 Material -- Nonlinear Tension Softening • 25, 144, 412  
Concrete04 -- Material Behavior • 61  
Concrete04 Material -- Popovics Concrete Material • 25, 57  
Constant Time Series • 290  
constraints Command • 24, 28, 29, 34, 295, 314, 317, 341, 342, 350, 398  
constraints objects • 23, 38  
Copyright • 13  
Corotational Transformation • 288  
Corotational Truss Element • 25, 217  
cyclic.txt • 84  
CyclicLoading\_Iso2spring.tcl • 212, 213

## D

dataBase Commands • 24, 346  
Defining Output • 367  
Displacement Control • 27, 335, 336, 341, 400  
Displacement-Based Beam-Column Element • 26, 219, 224, 298, 308, 310  
display Command • 353  
Display Recorder • 24, 311, 351, 353  
Domain Object • 30, 295, 310, 349  
Download OpenSees • 383  
Drift Recorder • 24, 307  
Dynamic Analysis • 373

## E

eigen Command • 24, 344, 378  
Eight Node Brick Element • 26, 232, 260  
Elastic Beam Column Element • 26, 218, 298, 308, 310, 391  
Elastic Isotropic Material • 25, 163, 165  
Elastic Material • 25, 126, 414  
Elastic Membrane Plate Section • 26, 206  
Elastic Section • 26, 193  
Elastic-No Tension Material • 25, 130  
Elastic-Perfectly Plastic Gap Material • 25, 129  
Elastic-Perfectly Plastic Material • 25, 127  
eleLoad Command • 295, 298  
element Command • 23, 29, 34, 216, 308, 310, 350, 412  
Element Cross Section • 413

Element Recorder • 24, 43, 163, 192, 217, 218, 220, 223, 224, 225, 226, 227, 228, 229, 230, 235, 258, 260, 262, 308, 426  
Elements • 391  
Elements and Element Connectivity • 414  
Energy Increment Test • 28, 329  
Enhanced Strain Quadrilateral Element • 26, 163, 230, 275  
EnvelopeElement Recorder • 24, 310  
EnvelopeNode Recorder • 24, 306  
EPState • 165, 169  
equalDOF Command • 41  
Error-Checking Tip for Model Building • 420  
Evolution Law • 165, 166, 168  
Example Files for Limit State Material • 78  
example ss\_ic1.tcl • 52  
Example Tcl Commands • 16

## F

Fatigue Material • 25, 61  
FatigueMaterialExample.tcl • 63  
Fiber Command • 195, 197, 413  
Fiber Section • 26, 195  
FileDatastore Command • 346  
fix Command • 38, 364, 365, 390, 411  
fixX Command • 39  
fixY Command • 39  
fixZ Command • 40  
FluidSolidPorousMaterial • 170  
FourNodeQuadUP • 265  
FourNodeQuadUP Element • 26, 257

## G

genPlaneFrame.tcl • 441  
Geometric Transformation Command • 23, 29, 34, 218, 219, 223, 224, 281, 414  
getTime Command • 350  
Getting Going with OpenSees (under development) • 407  
Getting Started with OpenSees • 380  
Gravity and other Constant Loads • 415  
Gravity Loads • 370, 397  
groundMotion Command • 289, 290, 300, 301, 302

## H

Hardening Material • 25, 134  
Hilbert-Hughes-Taylor Method • 27, 335, 339  
How To.... • 354  
Hysteretic -- Material Behavior • 162



Hysteretic Material • 25, 159

## I

imposedMotion Command • 300, 302, 318  
 integrator Command • 24, 27, 301, 334, 341, 342, 396, 399  
 Interpolated GroundMotion • 302  
 Introduction • 11, 382  
 Introduction to the Tcl command language • 14  
 Isolator2spring Section  
   Model to include buckling behavior of an elastomeric bearing • 26, 208

## J

J2 Plasticity Material • 25, 164

## K

Krylov-Newton Algorithm • 28, 332

## L

Lagrange Multipliers • 28, 318, 320  
 Lateral Loads -- Cyclic Lateral Load • 402  
 Lateral Loads -- Dynamic ground motion • 403  
 Lateral Loads -- Static Pushover • 401  
 Limit State Material • 25, 73  
 Linear Algorithm • 28, 330  
 Linear Time Series • 290, 335, 398  
 Linear Transformation • 281, 287, 288, 391  
 load Command • 295, 296  
 Load Control • 27, 335, 341, 400  
 loadConst Command • 350, 400  
 Loads and Analysis • 395

## M

mass Command • 23, 29, 34, 37, 364, 365, 390, 411  
 materialmodels.tcl • 56  
 Materials • 412  
 MatlabOutput.tcl • 441  
 matTest.tcl • 428  
 Minimum Unbalanced Displacement Norm • 27, 335, 337, 341, 400  
 Miscellaneous Commands • 348  
 Model Builder • 388, 411  
 Model Building • 409  
 model Command • 23, 34, 40, 41, 42, 287, 288, 296, 297, 302, 307, 336, 350, 364

ModelBuilder Object • 29, 30, 35, 38, 39, 218, 222  
 Model-Building Objects • 33  
 Modified Newton Algorithm • 28, 332  
 MomentCurvature.tcl • 434  
 MultipleSupport Pattern • 300, 302, 305, 318  
 Multi-Point Constraints • 41, 318

## N

nDMaterial Command • 23, 29, 34, 163, 226, 228, 229, 230, 231, 232, 262, 350, 412  
 Newmark Method • 27, 335, 338, 342  
 Newton Algorithm • 28, 330, 341, 342  
 Newton with Line Search Algorithm • 28, 331  
 Nine\_Four\_Node\_QuadUP • 267  
 Nodal Coordinates & Masses, Boundary Conditions • 411  
 node Command • 12, 23, 29, 34, 36, 350, 364, 365, 389, 390, 411  
 Node Recorder • 24, 258, 304, 344, 426  
 nodeBounds • 352  
 nodeDisp Command • 350  
 Nodes • 389  
 Nonlinear Beam Column Element • 26, 219, 298, 299, 308, 310, 414, 426  
 NonLinear Beam-Column Elements • 193, 219  
 Norm Displacement Increment Test • 28, 328  
 Norm Unbalance Test • 28, 327, 341, 342  
 Notation • 11  
 numberer Command • 24, 27, 314, 322, 341, 342, 399

## O

OpenSees • 19  
 OpenSees Features • 21  
 OpenSees Interpreter • 18, 349

## P

Parallel Material • 25, 131  
 Path Time Series • 293  
 pattern Command • 24, 29, 34, 289, 290, 291, 292, 293, 295, 350, 398  
 P-Delta Transformation • 287  
 Penalty Method • 28, 318, 319  
 PINCHING4 Material • 25, 46, 84  
 PINCHING4 Uniaxial Material Model  
   Discussion • 91  
 Plain Constraints • 28, 318, 319, 341, 342  
 Plain GroundMotion • 301

Plain Numberer • 27, 322  
plain Pattern • 295, 398  
Plane Stress Material • 25, 164  
Plate Fiber Material • 25, 165, 206  
Plate Fiber Section • 26, 206, 229  
play Command • 351, 352  
playback Command • 24, 312  
Plot Recorder • 24, 312  
Potential Surface • 165, 167  
PR1.tcl • 236, 237, 239, 241  
PressureDependMultiYield Material • 172  
PressureDependMultiYield02 Material • 179  
PressureIndependMultiYield Material • 184  
print Command • 344, 348  
Problem Definition • 387, 408  
procMKPC.tcl • 236, 237, 239, 251  
procRC.tcl • 236, 237, 239, 253  
procRCycDAns.tcl • 90, 91, 93, 103  
procUniaxialPinching.tcl • 90, 91, 93, 102,  
236, 237, 239, 252  
ProfileSPD SOE • 27, 325, 341, 342  
PyLiq1 Material • 108  
PySimple1 Material • 105  
PySimple1Gen Command • 111  
PyTzQz Uniaxial Materials • 25, 105

## Q

Quad Element • 26, 163, 228, 275  
Quadrilateral Elements • 228  
Quadrilateral Patch Command • 195, 198,  
413  
QzSimple1 Material • 107

## R

RandomStrainHistory1.tcl • 67  
RandomStrainHistory2.tcl • 70  
rayleigh command • 24, 339, 343, 405  
RCcircSection.tcl • 430  
RCcircSectionFEDEAS.tcl • 431  
RCFrameDisplay.tcl • 433  
RCM Numberer • 27, 322, 323, 341, 342  
RCyclicPinch.tcl • 90, 91, 93, 97  
ReadSMDFile.tcl • 435  
Recorder Object • 30, 31  
Recorder Objects • 31, 304, 312  
Recorders • 392  
Recorders for Output • 426  
Rectangular Time Series • 291  
References • 72, 220, 444  
region Command • 23, 279

Reinforcing Steel Material • 25, 113  
ReinforcingSteel -- Material Behavior • 126  
reset Command • 349  
restore Command • 347  
rigidDiaphragm Command • 41  
RigidFrame3Ddisplay.tcl • 439  
rigidLink Command • 42  
RotSpring2D • 437  
Run OpenSees • 355, 385

## S

save Command • 347  
Script Utilities Library • 428  
Section Aggregator • 26, 204  
section Command • 23, 29, 34, 192, 204,  
216, 217, 219, 220, 223, 224, 227, 229,  
309, 311, 412, 413  
Series Material • 25, 132  
Shear Limit Curve • 74, 76  
Shell Element • 26, 163, 229, 275  
Sine Time Series • 292  
Single-Point Constraints • 38, 318  
sp Command • 295, 297, 318  
SparseGeneral SOE • 27, 325  
SparseSPD SOE • 27, 326  
Standard Brick Element • 26, 163, 231, 277  
Static Analysis • 29, 31, 314, 335, 340, 371,  
397  
Steel01 -- Material Behavior • 153  
Steel01 Material • 25, 148, 412  
Steel02 -- Material Behavior • 159  
Steel02 Material -- Giuffré-Menegotto-Pinto  
Model with Isotropic Strain Hardening • 25,  
154  
StFramePZLdisplay.tcl • 438  
Straight Layer Command • 195, 202, 413  
Summary of Defining Structural Model • 415  
Summary of Gravity Loads • 400  
Summary of Model-Building Input File • 392  
system Command • 24, 26, 324, 327, 328,  
329, 341, 342, 350, 399

## T

Tags.tcl • 83  
Tcl Commands Format • 15, 18  
Template Elasto-Plastic Material • 25, 165  
test Command • 24, 28, 327, 399  
Time Series • 24, 29, 34, 289, 290, 291, 292,  
293, 295, 299, 301, 405  
Transformation Method • 28, 318, 321

Transient Analysis • 29, 31, 314, 335, 340,  
341, 345, 397  
Truss Element • 25, 216  
Twenty Node Brick Element • 26, 262  
Twenty\_Eight\_Node\_BrickUP • 271  
TzLiq1 Material • 109  
TzSimple1 Material • 106  
TzSimple1Gen Command • 112

## U

UC Davis Soil Elements • 257  
UC Davis Soil Models • 165  
UC San Diego Soil Elements • 264  
UCSD Soil Models • 170  
UmfPack SOE • 27, 326  
Uniaxial Section • 26, 194  
uniaxialMaterial Command • 23, 24, 29, 34,  
43, 131, 132, 194, 195, 197, 198, 200, 202,  
203, 204, 216, 217, 225, 226, 350, 412,  
413  
UniformExcitation Pattern • 299, 305, 405  
Units&Constants.tcl • 360, 440  
updateMaterialStage • 190  
updateParameter • 191  
u-p-U element • 26, 259

## V

Variables and Units • 409  
VariableTransient Analysis • 29, 31, 314,  
340, 342, 345, 397  
video Command • 351, 352  
Viscous Material • 25, 162

## W

wipe Command • 349, 419  
wipeAnalysis Command • 349  
Wsection.tcl • 438

## Y

Yield Surface • 165, 166

## Z

Zero-Length Element • 26, 225  
Zero-Length Elements • 224  
Zero-Length ND Element • 26, 226  
Zero-Length Section Element • 26, 227, 309,  
311