



# Vodafone One Net

Cisco SPA 525G2 IP phone user guide



# Content

Chapter 1 – Getting started .....	4
Important information.....	4
Supported features .....	4
Safety instructions.....	4
Installing your phone.....	4
Throwing your phone away .....	4
Welcome to Vodafone One Net .....	5
Introduction to the Cisco 525G2 IP phone.....	5
Looking after your phone.....	6
Understanding your phone’s lines and buttons.....	6
Your phone features explained .....	6
Soft key buttons.....	8
Using the keypad and menu buttons.....	9
Entering numbers and text in fields.....	10
Deleting characters.....	10
Using phone hardware and accessories.....	10
Using the speakerphone .....	10
Using wired and wireless headsets .....	10
Switching between the handset, headset and speakerphone during a call.....	13
Chapter 2 – Installing your Cisco SPA 525G IP phone .....	14
Installing your phone.....	14
Before you start.....	14
Connecting the handset.....	14
IP phone connections .....	14
Attaching the desk stand.....	15
Mounting the phone to the wall .....	16
MB100 wall mount kit.....	16
Chapter 3 – Using basic phone functions.....	18
Making and answering calls .....	18
Adjusting call volume and muting.....	19
Adjusting the call volume.....	19
Using mute .....	19
Putting a call on hold.....	19
Resuming a call.....	19
Ending a call.....	19
Transferring calls.....	20
Making an assisted call transfer .....	20
Making an unassisted (blind) transfer .....	20
Redialling.....	20
Viewing and returning missed calls .....	20
Returning a missed call.....	20
Viewing a list of missed calls .....	21
Turning the missed calls shortcut on and off .....	22
Call forwarding .....	22
Forwarding all calls to a single number .....	22
Forwarding calls when your phone’s busy .....	22
Forwarding calls when you don’t answer .....	23
Delaying Call forwarding when you don’t answer .....	23
Ending Call forwarding options .....	23
Setting Do not disturb.....	23

Using Call pickup.....	24
Group call pickup functions in two ways:.....	24
Making an Ad-hoc conference call.....	24
Using the phone directories.....	24
Using your personal address book.....	25
Using the Vodafone One Net directory.....	26
Using the call history lists.....	27
Viewing call history lists.....	27
Deleting a call history list.....	27
Calling from the call history lists.....	27
Deleting an entry from the call history lists.....	27
Saving a call history list number to your personal directory.....	27
Accessing voicemail.....	28
Chapter 4 – Using advanced phone features.....	29
Setting up privacy and security features.....	29
Blocking anonymous calls.....	29
Locking your phone.....	29
Creating and using speed dials.....	30
Creating speed dials on unused line buttons.....	30
Creating numerical speed dials.....	30
Using your IP phone with your Bluetooth-enabled mobile.....	31
Enabling Bluetooth.....	31
Pairing your Cisco SPA 525G2 with a Bluetooth-enabled mobile.....	32
Importing your mobile phone address book into the Cisco SPA 525G2.....	35
Making a mobile call from your Cisco SPA 525G2.....	36
Receiving mobile calls using the Cisco SPA 525G2.....	37
Switching audio from Your Cisco SPA 525G2 to your mobile.....	38
Viewing mobile phone battery and signal information on your Cisco SPA 525G2.....	38
Charging Your Mobile Phone Using Your Cisco SPA 525G2.....	39
Playing MP3 files on your phone.....	40
Creating the playlist.....	40
Playing songs.....	40
Changing the Left and Right Channel for Stereo Headsets.....	41
Customising your LCD screen.....	41
Changing the LCD screen contrast.....	41
Setting the screen backlight timer.....	42
Configuring the phone screen saver.....	42
Using ringtones.....	43
Changing the date and time.....	43
Restarting your phone.....	43
Viewing phone, network and call information.....	43
Viewing phone information.....	43
Viewing network information.....	44
Viewing phone line and extension information.....	44
Viewing peripheral status.....	44
Using FAC codes.....	45
Breakout Code.....	45
Call forwarding.....	45
Do not disturb.....	46
Caller ID.....	46
Call pickup.....	47

# Chapter 1 – Getting started

## Important information

Before using the Cisco SPA 525G2 for the first time, please make sure you read the instructions on phone safety and disposal, as well as the setup information in this guide.

## Supported features

There are a number of features on the 525 which are not supported with Vodafone One Net but appear on the user menu.

Only features contained in the user guide are supported on Vodafone One Net. The USB call recording feature found in the menu is not supported on Vodafone One Net.

## Safety instructions

You should try to keep your phone away from damp conditions - don't install the phone in a room with high humidity (for example, in bathrooms, laundry rooms or damp basements). Also, don't immerse your phone in water - and be careful not to spill or pour liquids on it.

## Installing your phone

Don't install your phone in surroundings that are at risk of explosions (in paint shops, for example) and don't use the phone in any environment if you smell gas or other potentially explosive fumes.

Don't use your phone during thunderstorms: lightning striking the power grid may cause electric shocks.

Your Cisco 525G2 phone is CE and FCC-certified and meets European and US health, safety and environmental standards. Unauthorised opening, changing or modifying of your phone will invalidate the warranty and CE and FCC certifications. If the phone malfunctions, please call Vodafone Customer Services on 191 from a Vodafone One Net phone.

This device is for indoor use only.

## Throwing your phone away

This phone is subject to European Directive 2002/96/EC and shouldn't be disposed of with general household rubbish.

The separate collection and proper disposal of electrical and electronic devices is to protect human health and the environment, as well as helping to ensure recycling of re-usable elements.

If you don't know where or how to dispose of your phone at the end of its life span, contact your local town or city council, your local waste management provider or Vodafone Customer Services on 191 from a Vodafone phone.

## Welcome to Vodafone One Net

Vodafone One Net is an innovative, fully-hosted telephony solution that helps you manage your business calls effectively. It integrates your fixed and mobile phones – and gives you landline numbers on your mobile - so you'll never miss a business call.

This guide is designed to introduce you to the Cisco 525G2 and the features associated with Vodafone One Net.

Further help and support can be found by calling customer services on 191 from a Vodafone One Net phone or by logging in to your My account area on [vodafone.co.uk](http://vodafone.co.uk).

You can also contact your company administrator who will be able to access and amend certain Vodafone One Net service settings through the online portal.

## Introduction to the Cisco 525G2 IP phone



The Cisco 525G2 IP Phone is a full-featured VoIP (Voice over Internet Protocol) phone that provides voice communication over an IP network. It provides traditional features, such as call forwarding, redialing, speed dialing, transferring calls, conference calling and accessing voice mail. Calls can be made or received with a handset, headset or speaker.

The Cisco 525G2 phone is connected to the network through its Ethernet connection. The Cisco 525G2 provides an additional Ethernet port that allows a computer to be connected to the network through the IP phone.

The Cisco 525G2 has a 3.2-inch LCD screen, provides up to five telephone extensions and includes the following features:

- 2 Ethernet 10/100 Mbps ports
- 802.3af power over Ethernet support
- USB 2.0 host port for connecting a USB memory stick or mobile phone charger
- AUX port (to attach a Cisco SPA attendant console)
- Bluetooth capability for headset support
- Bluetooth capability for mobile phone pairing
- 2.5mm stereo headphone jack
- Kensington security slot support

## Looking after your phone

To keep your Cisco IP phone as good as new, avoid exposure to excessive heat, sun, cold temperatures and water. To clean it, use a slightly moistened paper or cloth towel – don't spray or pour cleaning solution directly on to the unit.

## Understanding your phone's lines and buttons

### Your phone features explained



## IP phone features

#	Phone feature	Description
1	Handset	Pick up to answer or make calls
2	Speaker	Use this when you put a call on loudspeaker
3	Message waiting indicator	When this is: Red: you've got a new voicemail message Flashing red: you've got an incoming call
4	LCD screen	Your phone may vary, but the screen typically displays: Date and time Line extensions Soft key options Startup logo, screensaver, background photo and photo album
5	Line keys	This shows the status of your phone line. Your phone may vary but typically, when this is: Green: the line's idle Red: the line's active or in use Flashing red (slow): the line's on hold Flashing red (fast): the line's ringing Orange: the line's unregistered and can't be used Flashing orange: the phone isn't connected to the network
6	Soft key buttons	Press a soft key button to perform the action on the label on the LCD screen
7	Navigation button	Press in each direction to scroll through items on the LCD screen
8	Centre select button	Press to choose an option or menu highlighted on the LCD screen
9	Messages button	Press to access voicemail (this must be set up by your Vodafone One Net administrator first)
10	Hold button	Press to place a call on hold
11	Setup button	Press to access the phone's menu to set your preferences (e.g. your directory and speed-dials), access your call history and set up features like Call forwarding
12	Mute button	Press to turn mute on and off. When the phone's muted, the button glows red.
13	Volume button	You can increase and decrease the volume of the handset, headset, speaker (when the handset is off the hook) or ringer (when the handset is on the hook)
14	Headset button	Turn the headset on or off. When the headset's on, the button will glow green
15	Speaker button	Turn the speaker on or off. When the speaker's on, the button will glow green
16	Keypad	Dial phone numbers, enter letters and choose menu items

## Soft key buttons

The phone displays four soft key buttons at a time on the LCD screen. Different soft key buttons will be displayed depending on the phone screen or menu that's shown. You can see more soft key buttons by pressing the 'More' soft key when available.

The following table shows some of the typical soft key buttons available on the Cisco 525G2 (in alphabetical order). You might not have all of them on your phone, and you may have more buttons that aren't listed here. Your phone administrator could also add custom soft key buttons to your phone - such as speed dials to specific company numbers. Ask your Vodafone One Net administrator for more details.

### Soft key button functions

Button	Function
Add	Add a new item (e.g. a new directory entry)
Add list	Create a new list (e.g. an MP3 playlist)
Alpha	You can enter alphabetic characters in a data entry field
Answer	Answer an incoming call
Back	Go to the previous screen
BlindXfer	Perform an unassisted call transfer. See 'Making an unassisted (Blind) transfer'
Call Rtn	If you miss a call, choose Call Rtn to dial the number that called you. See 'Viewing and returning missed calls'
Clear	Delete an entire text/number field
Clr DND	Clear your Do not disturb settings
Clr Fwd	Clear your Call forwarding settings
Conf	Start a conference call. See 'Organising a three-way conference call'
ConfLine	Bring two active calls on your phone into a single conference call
Connect	Connect to the selected item (e.g. a wireless network or Bluetooth device)
Copy	Copy the selected item (e.g. a contact in your address book)
DelChar	Delete the last number or letter entered
Delete	Delete an entire item (e.g. a number from your call history list)
Dial	Call a list of numbers or a number you highlight in a list
Directory	Access your personal address book. See 'Using your personal address book'
DND	Do Not Disturb - stops incoming calls from ringing through to your phone. See 'Turning Do not disturb on'
Edit	Open an item so that you can edit numbers or letters, or enable and disable features
EditDial	Edit a number before dialling
End Call	Disconnect a call
Forward	Forward calls when they come through to your phone. See 'Forwarding calls'
Handset	Switch audio from the Cisco SPA 525G2 to your Bluetooth-enabled mobile phone. See 'Using the Cisco SPA 525G2 with a Bluetooth-enabled mobile phone'
Handsfree	Switch audio from a Bluetooth-enabled mobile phone to the Cisco SPA 525G2. See 'Using the Cisco SPA 525G2 with a Bluetooth-enabled mobile phone'



Hold	Place a call on hold. See 'Putting a call on hold'
Ignore	Ignore an incoming call
List	In some menus, pressing 'List' will show a list of pre-set items
Miss	See all your missed calls
Next	Move to the next item in a list (e.g. a song in an MP3 playlist)
Option	Enter a sub-menu
Paste	Paste the item you copied into a list or field
Play	Play a selected item (e.g. a song or ringtone)
Previous	Move to a previous item in a list (e.g. a song in an MP3 playlist)
Redial	See a list of recently dialled numbers. See 'Redialling'
Refresh	Refresh the screen when you've changed your settings, or when you want to update information
Resume	Resume a call that's on hold
Save	Save any changes you make
Scan	Scan for Bluetooth devices
Select	Select a highlighted item on the LCD screen
Transfer	Transfer a call to another number. See 'Transferring calls'
View	See more information about a selected item
XferLine	Transfer active calls to each other

## Using the keypad and menu buttons

### Using keypad shortcuts

Get to the menu or sub-menu you want more quickly using keypad shortcuts. For example, to reach the Call History menu, press the Setup button followed by 2.

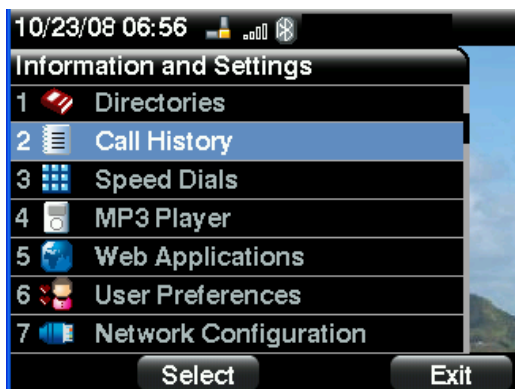

*Note: Menu layouts and options can change depending on the software release you're using.*

### Using the navigation button

Use the navigation buttons to scroll up and down the menu items, then choose 'Select' or press the Select button to choose the highlighted item.

## Entering numbers and text in fields

When you enter numbers and letters on an IP phone, you can use the keypad and/or soft key buttons. In general, the following guidelines apply:

- Use the keypad to enter numbers and characters – press the keys multiple times to choose the number or letter you need. You can use the following characters:

Key	Characters
1	1 / : \ , ! ; \$ ^
2	abc2ABC
3	def3DEF
4	ghi4GHI
5	jkl5JKL
6	mno6MNO
7	pqr7PQRS
8	tuv8TUV
9	wxyz9WXYZ
0	Space 0 ~ ? > ' < "
*	. @ * & % [ ] _
#/P	# + - = ( ) { }

### Deleting characters

Use the delChar soft key button to delete the last character entered, or Option > Clear to remove the whole entry.

## Using phone hardware and accessories

### Using the speakerphone

With SPA IP Phones you can use a speakerphone during calls – just press the Speaker button when the handset's on or off the hook to start.

### Using wired and wireless headsets

The SPA IP phones support headsets from different manufacturers. For the latest supported models, please call 191 from your Vodafone One Net phone to speak to customer services.

### Connecting the headset

Each headset may vary – please read the following instructions, or see the manufacturer's user guide for more details.

- For Bluetooth headsets, see 'Connecting a Bluetooth headset'
- For wired headsets, connect the 2.5mm connector from the headset into the headset port on the right side of the IP phone as shown:



### Connecting a Bluetooth headset

Before you connect a Bluetooth headset, you'll need to enable Bluetooth on your phone:

1. Press the Setup button.
2. Choose 'User preferences'.
3. Choose 'Bluetooth configuration'.
4. With Bluetooth selected, press the right arrow key to turn Bluetooth on.



5. Press Set.

Once Bluetooth's enabled on your phone, you'll need to create a profile for your headset:

1. Press the Setup button
2. Scroll to 'User preferences' and press Select
3. Scroll to 'Bluetooth configuration' and press Select
4. Scroll to 'Bluetooth mode' and press the right arrow key to choose one of the following:
  - a. Phone - choose this option if you want your Cisco SPA 525G2 IP phone to be paired with a Bluetooth headset only (i.e. you don't want to pair it with a Bluetooth-enabled phone as well)
  - b. Both - choose this option if you want your Cisco SPA 525G2 to pair with a Bluetooth headset and Bluetooth-enabled mobile phone (see 'Using the Cisco SPA 525G2 with a Bluetooth-enabled mobile phone' for more information)
5. Press 'Set'

*Note: Your Cisco SPA 525G2 IP phone will only connect to one device at a time.*

6. If multiple Bluetooth devices are in range of the Cisco SPA 525G2, the first device to be connected will be the one prioritised in your Bluetooth profiles list (Bluetooth Configuration > Bluetooth profiles).
7. Scroll to 'Bluetooth profiles' and press the right arrow key to see the profile screen
8. Press 'Scan' to search for your headset

*Note: Your Bluetooth headset might not be found if there are lots of Bluetooth-enabled devices near you. If this happens, check the headset is on and has Bluetooth activated, then try again.*

9. Choose your headset in the list of devices found, then press the select key or 'Connect' soft key to edit the profile
10. Scroll to 'PIN' and enter the PIN code for your Bluetooth headset
11. Scroll to 'Connect automatically' and press the right arrow key to activate
12. Press 'Connect' – a tick will appear next to the headset when the connection's successful

### Using a headset with an IP phone

*Note: Steps to use your headset with the SPA IP Phone may vary. Consult the user documentation for your headset for more information.*

- To use a wired headset, press the Headset button on your phone and dial the number to place a call. Press the Headset button again to answer an incoming call
- To use a non-Bluetooth wireless headset (such as Jabra or Plantronics), you might need to take the receiver off the hook before making a call through the headset
- To use a Bluetooth headset, first make sure your headset's turned on. Then press the Headset button on your phone (or, if supported, press the Answer button on your Bluetooth headset twice) and dial the number to place a call. To answer an incoming call, press the Answer button on your headset

For more information, see the manufacturer's user guide.

## Switching between the handset, headset and speakerphone during a call

You can choose to use your handset, headset or speakerphone during a call, but only one can be used during each call. You can keep the handset on the hook when you use the speakerphone or headset.

Here's how to switch between audio options:

**Handset to speakerphone** – press the Speakerphone button and place the handset back on the hook.

**Speakerphone to headset** – press the Headset button

**Speakerphone to handset** – pick up the handset

**Headset to speakerphone** – press the Speakerphone button

## Chapter 2 – Installing your Cisco SPA 525G IP phone

### Installing your phone

Your Cisco 525G2 phone will have been set up by a Vodafone One Net engineer, so it should already be correctly installed and working. However, the information within this section of the guide will help you move a phone to another location or swap it with another device.

### Before you start

Before you install your phone, check with your Vodafone One Net administrator (if you have one) that the network's ready, read the safety information and make sure you have all the phone parts and user guides available.

*Note:* The RJ-11 port marked 'AUX' is reserved for connection with the Cisco SPA 500S Attendant Console that works with the Cisco 525G2. It can't be used as a telephone line port.

*Important:* Don't plug a telephone line cord into the port marked 'AUX'

### Connecting the handset

1. Insert the longest end of the coiled phone cord into the back of the phone base in the slot marked with a phone symbol. This port is labelled #5 on the Cisco 525G2 IP phone connections image.
2. Insert the short end of the phone cord into the jack at the bottom of the handset (not shown).

### IP phone connections





Number	Feature
1	Auxiliary port - only for use with the Cisco SPA attendant console
2	Power port - insert the power adapter plug here
3	Additional Ethernet port - connect an Ethernet cable to this port to provide network connectivity to a PC.
4	Switch (Ethernet) port - connect the network cable to this port
5	Phone cord port - Insert one end of the phone cord here and the other into the jack at the bottom of the handset
6	USB port – you can insert an external USB memory stick here, or use it to charge a device (e.g. a Bluetooth-enabled mobile phone) if your phone has a mini-USB port

## Attaching the desk stand

*Note: If you want to mount the phone to a wall, you don't need to attach the desk stand. If you're also attaching a Cisco SPA attendant console, you should attach the console before attaching the desk stand.*

1. Match the tabs on the desk stand with the slots on the back of the phone.
2. Slide the bottom tabs into the slots.
3. Lightly press down on the top of the desk stand - it should easily slide into the top slots (don't force it).

## Mounting the phone to the wall

To mount your IP phone to a wall, you'll need the MB100 wall mount bracket kit (you'll need to buy this separately).

### MB100 wall mount kit



1. Align the bracket with the holes in the phone's base.

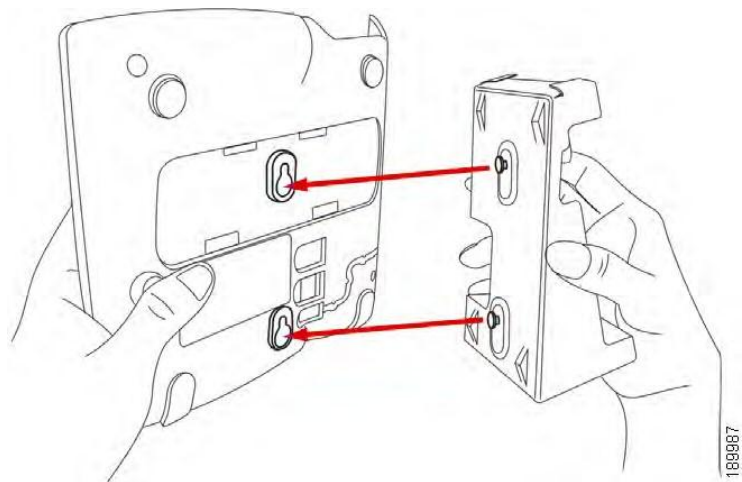

2. Move the bracket so the phone's Ethernet and handset ports are still accessible when it's connected.
3. Push the bracket onto the phone's base and slide it upwards to lock it in place.



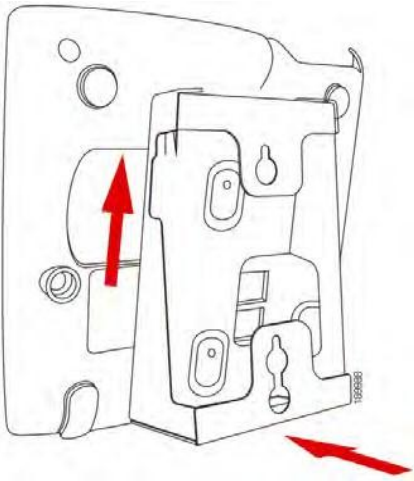

4. Plug in the Ethernet and power cables.

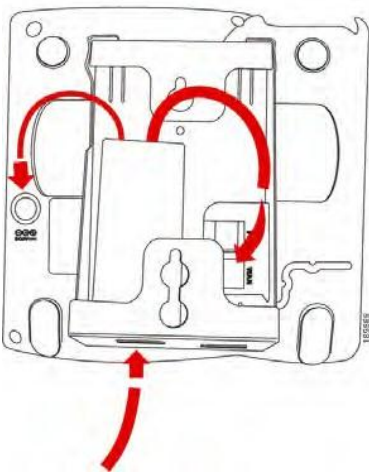

5. Mount the phone on the wall using screws

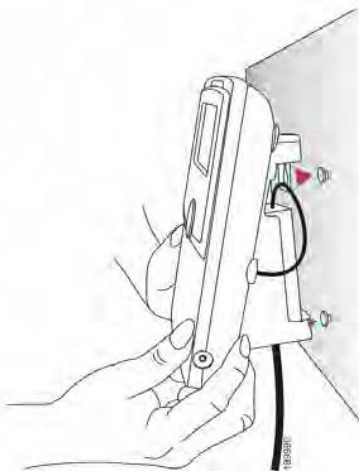

## Chapter 3 – Using basic phone functions

This chapter will show you how to use the basic functions of your Cisco SPA 525G2 IP phone, and includes the following sections:

- Making and answering calls
- Adjusting the call volume and muting
- Putting a call on hold
- Resuming a call
- Ending a call
- Transferring calls
- Redialling
- Viewing and returning missed calls
- Turning the missed calls shortcut on and off
- Call forwarding
- Setting Do not disturb
- Answering a call
- Making a three-way conference call
- Using the phone directories
- Using the call history lists
- Setting or changing a phone password
- Accessing voicemail

### Making and answering calls

*Note: You might need to include a pre-fix number when you dial an external number - ask your Vodafone One Net administrator for more details.*

*Note: Your IP phone will be configured with two lines that represent the same outgoing number, indicated by the first two green line keys. Each line can hold up to two calls, but only one call may be connected across both lines at any one time; the other calls will be kept on hold. You can use the up and down arrow keys to scroll through all calls on the two lines. The maximum number of calls that can be held on the phone at one time is four, with two held on each line.*

To make a call when you are not on a call or holding a call, you can:

- Pick up the receiver
- Press the Speaker button
- Press the Headset button
- Press one of the green line keys

To make a new call when you have one or more calls on hold, you can:

- Press the 'New Call' soft key. If only one call is on hold for the current line this will place the new call on the same line, otherwise the other line will be used (provided there are less than two calls already held on it).
- Press an empty green line key to place the call on another line.

To answer a call you can:

- Press the flashing red (fast) line key
- Press the answer soft key

If you're on a call and another call comes in, you can choose one of the following options:

- Press the Answer soft key (or the Ignore soft key if you want to ignore the incoming call)
- Press the flashing red (fast) line key

If you answer an incoming call when one is already in progress, the call in progress will be put on hold and the incoming call will come through to you. Regardless of which line the new call comes in on, the line key for the call placed on hold will slowly flash red.

To return to the first call, press the flashing red line key or choose the call on your phone's screen using the up and down arrow keys, then press the Resume soft key.

## Adjusting call volume and muting

### Adjusting the call volume

To adjust the volume while you're on a call, use the + and – keys.

If you press the Volume buttons when you're not on a call, it'll change how loud the phone rings when a call comes through.

### Using mute

To mute the phone microphone, speaker or headset microphone, press the Mute button on the phone - the light will turn red when it's muted. Press the Mute button again to turn them back on.

### Putting a call on hold

To put a call on hold, press the Hold button or the 'Hold' soft key – the line key will slowly flash red.

### Resuming a call

To resume a call once you've put it on hold, press the flashing red line key or choose the call on your phone's screen using the up and down arrow keys, then press the Resume soft key to be connected again. For multiple calls, all calls will be put on hold except the active call.

### Ending a call

- Handset – hang up
- Speakerphone – press the Speaker button
- Headset – either press the Headset button (wired) or put the receiver on the hook (wireless)
- Press the 'End Call' soft key

## Transferring calls

You can make two types of call transfers:

**Assisted** – Dial the person you're transferring to – and speak to them before transferring the call

**Unassisted (blind)** – Transfer the call without speaking to the person you're transferring it to

### Making an assisted call transfer

1. During a call press 'Transfer.' and then either:
2. Enter the number you want to transfer the call to, or:
  - a. Press 'Directory' and choose a number from your personal or One Net directory.
  - b. Press 'Dial' – the call will be put on hold and a new line will be opened to dial the number.
3. Do one of the following:
  - c. To transfer the call without waiting for the other person to answer, press 'Transfer' – and hang up when it starts to ring. If you hang up before it rings, the transfer will fail. If you dial the wrong number, press the 'new call' button and dial again.
  - d. To transfer after speaking to the person you're transferring to, press 'Transfer' at any time during the conversation.

To transfer a call to another party who is already on hold, press "Xfer Line". If you have more than one call on hold, you will be presented with a list on screen to select which call to transfer to.

### Making an unassisted (blind) transfer

1. Press 'BlindXfer' during a call.
2. Enter the number of the person you want to transfer the call to and press 'Dial' – the call will then be transferred.

## Redialling

To redial a number:

1. Press 'Redial' and choose the number you want to call
2. (Optional) Press 'EditDial' to change the details of a particular number (e.g. to add an area code)
3. Lift the handset or press 'Dial' to choose a number you want to dial automatically

## Viewing and returning missed calls

When you miss a call, a notification will be displayed on your IP phone's LCD screen. You can also turn off this feature - see 'Turning the missed calls shortcut on and off'.

### Returning a missed call

- When the LCD screen shows a missed call, press the Call Rtn button to call back
- When the LCD screen doesn't show a missed call, you can return a call from the missed call list (see 'Viewing a list of missed calls'). Choose the call you want to return and press 'Dial'.

*Note: If the missed call came from an international or external number, you might have to edit the number before returning it (e.g. to add an area code). Press 'EditDial' and use the soft key buttons and keypad to amend the number.*

## Viewing a list of missed calls

- When the LCD screen shows a missed call, press the 'Miss' soft key to view a list of missed calls
- When the LCD screen doesn't show a missed call:
  1. Press the Setup button.
  2. Scroll to 'Call History' and press 'Select'.
  3. Scroll to 'Missed Calls' and press 'Select'.

You can then do one of the following:

- Press 'Dial' to return the call
- Press 'EditDial' to edit the number before calling, then press 'Dial'
- Press the 'Option' soft key and choose one of the following:
  - a. Delete entry - this will remove the entry from the missed calls list.
  - b. Delete list – all entries will be deleted from the missed calls list.
  - c. Add to address book – it'll then appear in your personal address book.

## Turning the missed calls shortcut on and off

Choose how missed call notifications appear on your LCD screen - just follow these steps:

1. Press 'Setup'.
2. Scroll to 'User Preferences' and press 'Select'.
3. Choose 'Call preferences'.
4. Scroll to 'Miss call shortcut'.
5. Press the right arrow key to turn the feature on or off and press the 'Set' soft key.
6. Scroll to 'Miss call banner'.
7. Press the right arrow key to turn the feature on or off and press the 'Set' soft key

## Call forwarding

You can forward all calls, forward calls when the phone is busy, or forward unanswered calls.

To forward calls:

1. Press 'Setup'.
2. Scroll to 'User preferences' and press 'Select'.
3. Choose 'Call preferences'.
4. Under Call forwarding, press the right arrow key to turn Call forwarding on – then press the 'Save' soft key.

There are different types of Call forwarding – see the following section for more details.

### Forwarding all calls to a single number

1. In the 'Call preferences' screen, scroll to 'Forward all number'.
2. Enter the number you want to forward all calls to - for example, another extension number or an external number – or enter '121' to forward calls to voicemail. If you want to forward calls to an external number, make sure you enter any access or area codes (if applicable).

*Note: If you need to enter a URL, press 'Option' and choose 'Input IP' before you enter the Call forwarding information.*

3. Press 'Set'.

Or.

1. Press 'Forward' on the home screen and enter the number you want to forward calls to and press 'Dial'.
2. To clear the 'all calls forwarded' setting, press 'Clr Fwd' from the home screen.

### Forwarding calls when your phone's busy

1. In the 'Call Preferences' screen, scroll to 'Forward busy number'.
2. Enter the number you want to forward all calls to - for example, another extension number or an external number – or enter '121' to forward calls to voicemail. If you want to forward calls to an external number, make sure you enter any access or area codes (if applicable).
3. Press 'Set'.

## Forwarding calls when you don't answer

1. In the 'Call preferences' screen, scroll to 'Forward no ans number'.
2. Enter the number you want to forward all calls to - for example, another extension number or an external number – or enter '121' to forward calls to voicemail. If you want to forward calls to an external number, make sure you enter any access or area codes (if applicable).
3. Press 'Set'.

## Delaying Call forwarding when you don't answer

1. This setting is set by the One Net Application server and cannot be configured on the phone.

## Ending Call forwarding options

1. Under 'Call Preferences', scroll to the relevant call forwarding feature you want to change or remove.
2. Press 'Option' and scroll to 'clear'.
3. Press 'Select' and then 'Set'.

## Setting Do not disturb

.Use the Do Not Disturb feature to stop incoming calls coming through to your phone. If voicemail's set up, incoming calls will be sent straight to voicemail. If voicemail isn't set up, callers will hear a busy tone or pre-recorded message.

You can also set Do not disturb from your PC - see 'Setting Do not disturb'.

Choose one of the following options:

- Press the Do not disturb soft key button – you'll see a notification on your LCD screen to show it's turned on
- Press the Setup button and choose 'User preferences'

Then:

1. Choose 'Call preferences'.
2. Scroll to 'Do not disturb'.
3. Press the 'Right Arrow' key to turn Do not disturb 'On'.
4. Press 'Set'.

To turn Do not disturb off, choose one of the following options:

- Press the 'Clr DND' soft key on your phone
- Press the 'Setup' button and choose 'User preferences'

Then:

1. Choose 'Call preferences'.
2. Scroll to 'Do not disturb'.
3. Press the right arrow key to turn Do not disturb 'Off'.
4. Press 'Set'.

## Using Call pickup

The Call pickup feature lets you answer calls made to one phone, on another. There are two scenarios for this:

**Personal call pickup:** answer a call ringing on one of your phones, from another of your phones (for example, answer a call to your landline phone on your mobile, when you're out of the office). This feature is activated by dialling a Feature Access Code (FAC) on the mobile or landline phone. To pick up a call which is ringing on another device in your personal group, the FAC code is #154\*.

**Group call pickup:** this lets you answer a call to another user's phone within your Call pickup group (for example, when they're in a meeting), from your phone.

Group call pickup functions in two ways:

**Any call pickup:** Enter the corresponding Feature Access code to pick up the longest ringing call in your Call pickup group.

**Specific call pickup:** Enter the same Feature Access Code followed by the ringing extension number of the phone that's ringing, so you can pick it up.

*Note: A speed-dial for Group call pickup will be assigned to the bottom line key when your phone is installed. This can be changed if not required, see 'Creating and using speed dials'.*

## Making an Ad-hoc conference call

Follow these steps to start an Ad-hoc conference call:

1. Press the Conf button during a call - the first call will be placed on hold and a second call will be opened (you'll hear a dial tone) on the same line
2. Dial the second person's number
3. Press the Conf button again – all parties will be added to the conference call. When you hang up, the other two parties will be disconnected.

To bring two active calls into one conference call:

1. Press 'ConfLine' during one of the active calls. If you have two active calls, they'll be conferenced automatically. If you have more than two active lines, you'll need to scroll to choose the call you want to bring into the conference.
2. Press 'Select'

## Using the phone directories

On the Cisco 525G2 IP phone, you'll get several different types of phone directories, depending on the model you have and what your Vodafone One Net administrator has set up for your company account.

In general, you'll have the following directories:

**Personal address book** – This is where you can store and view the numbers you call a lot. You can also dial numbers from your company directory.

**Corporate directory** – This is where you'll find a list of all your company's numbers



## Using your personal address book

To access the phone directory, press the Directory button or Setup button, choose 'Directories' then 'personal address book'. You'll find the following options in the address book:

- Options - press this and choose one of the following:
  - Search - find the name of the person you want to contact
  - Delete - if you want to remove a contact
  - Copy - if you want to copy a contact
  - Paste - once you've copied a contact
  - Edit dial - you can edit a contact's number before dialling
- Dial - choose this when you want to dial a highlighted contact
- Add - if you want to add a new contact

Use the down arrow key to scroll through entries in the address book. Use the right arrow key to scroll through the phone numbers available for a contact. Press the tick button to edit a contact

### Adding a new contact

1. In the personal address book screen, press 'Add'.
2. Enter the name of the person you want to add using the keypad - then use the down arrow key to navigate to the next fields.

*Note:* To enter numbers and letters, press 'Option' and choose 'Input all'. To enter numbers only, press 'Option' and choose 'Input Num'. To clear all characters from an entry, press 'Option' then 'Clear'.

3. Enter the number you want to add, including any prefixes you need to call an external number and any area codes (if necessary). You need to enter at least one phone number for every contact.

*Note:* To enter numbers and letters, press 'Option' and choose 'Input all'. To enter numbers only, press 'Option' and choose 'Input Num'. To enter an IP address, press 'Option' and choose 'Input IP'. To enter a FAC code, press 'Option' and choose 'Input FAC code (see 'Using FAC codes')'. To clear all characters from an entry, press 'Option' then 'Clear'.

4. (Optional) To change the ringtone for a caller:
  - a. Press the right arrow key – you'll be taken to the 'Select ringtone' screen.
  - b. Scroll through the available ringtones.
  - c. Press 'Play' to hear the ringtone or 'Select' to assign it to the person whose number you're adding to the directory.
5. Press 'Save'.

### Copying a contact

You can copy a contact to create a new contact, changing information as necessary on the second contact. To copy a contact:

1. In the personal address book screen, scroll to find a contact and highlight it.
2. Press 'Option', then 'Copy'.
3. Press 'Option' again and choose 'Paste'.
4. Edit any necessary details and press 'Save'.

### Searching for a contact

1. In the personal address book screen, press 'Option' and choose 'Search'.
2. Enter the person's name – as you type, a list of names will appear. Scroll to highlight the entry you want.
3. Press 'Dial' to call the contact or 'Option' to delete, copy or edit their details.

### Deleting a contact

1. In the personal address book screen, highlight the contact you want to delete.
2. Press 'Option' and choose 'Delete'.
3. Press 'OK' to delete the contact.

### Editing a contact

1. In the personal address book screen, highlight the contact you want to edit.
2. Choose one of the following:
  - a. Edit numbers in an entry – press the 'Select' button to choose the contact.
  - b. Delete numbers individually - press the 'DelChar' soft key.
  - c. Delete all numbers - press 'Option' and choose 'Clear'.
3. Press 'Save' when you've finished.

### Using the Vodafone One Net directory

To use the Vodafone One Net directory:

1. Press the 'Directory' key on the phone.
2. Press the 'Select' key on the phone to enter the Vodafone One Net directory menu.
3. Enter the search keywords in the text box using the numeric or alphanumeric keys on the phone.
4. Enter the search criteria and press 'Submit' to start the search - the results will be displayed on the screen.
5. To choose a contact, scroll up and down using the navigation keys on your phone or use the numeric keys on the phone.

*Note: When more than 10 entries match the search criteria, the user can press the 'Get more' button on the phone to view more entries.*

6. Highlight a contact to view their details.
7. To call a contact:
  - a. Press 'Call' – a new screen will be opened, displaying the contact information.
  - b. Press 'Dial'.

To perform an optional directory search:

1. Press the 'Menu' button - the 'Information and settings' screen will appear
2. Scroll to 'Vodafone One Net directory' and press 'Select' - the 'Directories' screen will appear
3. Press 'Select' to enter the 'Directory search' screen
4. Enter the search details and press 'Submit' to start a search

## Using the call history lists

### Viewing call history lists

1. Press the Setup button.
2. Scroll to 'Call history' and choose 'Select'.
3. Choose the call history list you want to view:
  - a. All calls – shows all the calls that have been made, received and missed on your phone.
  - b. Missed calls - shows the last 60 missed calls.
  - c. Received calls – shows the caller ID of the last 60 answered calls.
  - d. Placed calls - shows all calls made from the phone.
1. Press 'Select' to see the list in full.

You can also view the call history lists from your PC - see 'Viewing call history lists'.

### Deleting a call history list

1. Press the Setup button.
2. Scroll to 'Call history' and press 'Select'.
3. Scroll to the call history list you want to delete.
4. Press 'Option' and choose 'Delete list'.
5. Press 'OK' to delete the list.

### Calling from the call history lists

To dial a number from one of the call history lists:

1. Choose the call.
2. Press 'Dial'.

*Note: If the call came from an international or external number, you might have to edit the number before dialling it (e.g. to add an area code). Press the EditDial button to edit the call and use the soft key buttons and keypad to amend the number.*

### Deleting an entry from the call history lists

1. Choose the call in the call history list.
2. Press 'Option' and choose 'Delete entry'.
3. Press 'OK'.

### Saving a call history list number to your personal directory

1. Choose the call in the call history list.
2. Press 'Option' and choose 'Add to address book'.
3. Press 'Select' – the address book entry screen will appear.
4. Edit the information (if necessary) and press 'Save' again – the entry will then be added to your directory.

## Accessing voicemail

To access your voicemail, press the Messages button on your phone. Your Vodafone One Net administrator should set your phone up with the correct voicemail number so Messages button automatically dials your voicemail inbox.

## Chapter 4 – Using advanced phone features

This chapter shows you how to set up and use advanced features on your Cisco SPA 525G2 IP phone, and contains the following sections:

- Setting up privacy and security features
- Creating and using speed dials
- Using your IP phone with your Bluetooth-enabled mobile
- Playing MP3 files on your phone
- Customising your LCD screen
- Using ringtones
- Changing the date and time
- Restarting your phone
- Viewing phone, network and call information
- Using FAC codes

### Setting up privacy and security features

#### Blocking anonymous calls

You can choose to block calls from unknown numbers coming through to your phone. Anyone who calls you from an unknown number will hear a busy signal or pre-recorded message.

To block anonymous calls:

1. Press the Setup button.
2. Scroll to 'User preferences' and press 'Select'.
3. Choose 'Call preferences'.
4. Scroll to 'Block anonym call' and press the right arrow key to turn it on.
5. Press 'Set'.

#### Locking your phone

You can lock access to the sensitive features of your phone such as the directory and call lists when you are not close to your phone. If this feature is setup, a padlock icon will appear in the top right corner of the screen to indicate whether your phone is locked or unlocked.

To change the password for unlocking your phone and switch this feature on:

1. Press the Setup button.
2. Scroll to 'Device Administration' and press 'Select'.
3. Choose 'Set Password' and press 'Select'.
4. Enter the current password (leave blank for default) and enter the new password using the keypad.
5. Press 'Save'. The password will be updated and the phone placed in the unlocked state.

*Note: To later remove the phone lock feature after it has been set up, simply change the password back to the default value (blank).*

To lock your phone:

1. Press the Setup button.
2. Scroll to 'Device Administration' and press 'Select'.
3. Choose 'Logout' and press 'Select'.
4. Press 'OK'.

To unlock your phone:

1. Press the Setup button.
2. Scroll to 'Device Administration' and press 'Select'.
3. Choose 'Login' and press 'Select'.
4. Enter the configured password and press 'Login'.

If you wish to access a sensitive feature when the device is locked, you will be prompted for the password. Enter the password and press 'Login'. The device will remain unlocked until you lock it again.

The phone unlock feature can be disabled if you have forgotten your password. Please call Vodafone customer services on 191 from your Vodafone One Net phone.

## Creating and using speed dials

You can assign unused line buttons on your phone to act as a speed dial. Depending on how your extensions are set up, you can have up to three speed dials in place.

When a speed dial's assigned to a number, that, when pressed on the keypad, dials the number assigned to it. You can have up to 8 of these speed dials. Each speed dial can be a phone number, IP address or URL.

### Creating speed dials on unused line buttons

1. Press the unused line button and hold down for three seconds - the 'Define speed dial' window will be displayed.
2. Enter a name for the speed dial.
3. Press the down arrow key to reach the phone number field, then enter the phone number and press 'Save'.
4. Once a speed dial has been created, it will be displayed next to the line button – then just press the line button when you want to use the speed dial.

### Creating numerical speed dials

1. Press the Setup button
2. Scroll to 'Speed dials' and press 'Select'
3. To add a new speed dial, scroll to 'Select an unused speed dial location' (2 through 9).

## Using your IP phone with your Bluetooth-enabled mobile

The Cisco SPA 525G2 supports Bluetooth so you can use your phone with a wireless Bluetooth-enabled headset. You can also use your IP phone with a Bluetooth-enabled mobile.

You can do the following:

- Pair your Bluetooth-enabled mobile phone and Cisco SPA 525G2. Your mobile is assigned a line button on your Cisco SPA 525G2. You can make and receive mobile calls using the Cisco SPA 525G2
- Switch audio for in-progress calls between your mobile phone and the Cisco SPA 525G2
- Import your mobile phone address book to your Cisco SPA 525G2 personal address book
- Use your Cisco SPA 525G2 as a “handsfree device” for your mobile phone

*Note: Not all mobile phones support this function. See the list of Bluetooth-enabled mobile phones supported with the Cisco SPA 525G2 that is posted at the Cisco support community at <http://www.cisco.com/go/smallbizsupport>, and also consult the latest Cisco SPA 525G2 release notes available at [cisco.com](http://www.cisco.com).*

### Enabling Bluetooth

To enable Bluetooth:

1. Press the Setup button.
2. Scroll to User Preferences and press Select.
3. With Bluetooth selected, press the right arrow key until a blue check mark appears.

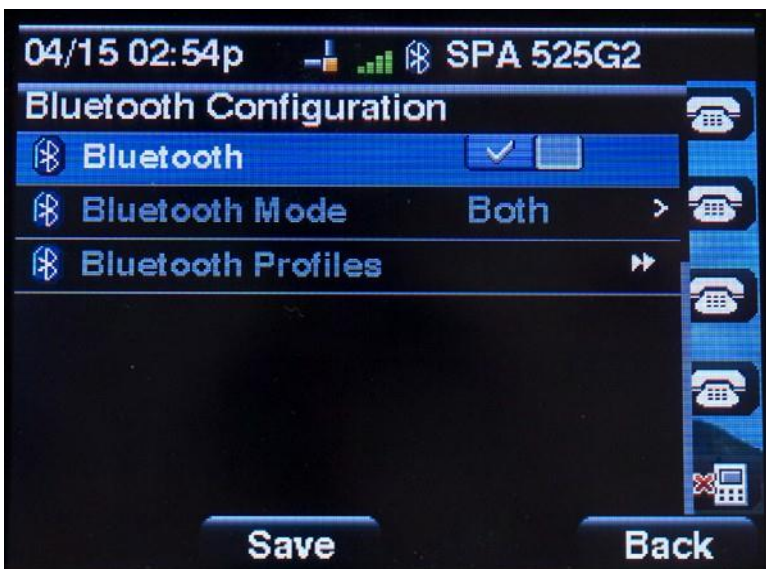

4. Press Set.

## Pairing your Cisco SPA 525G2 with a Bluetooth-enabled mobile

This feature is based on the following standard Bluetooth profiles:

- Phone Book Access Profile 1.0
- Handsfree Profile 1.5
- Handset Profile 1.1

*Note:* Not all mobile phones support this function. See the list of Bluetooth-enabled mobile phones supported with the Cisco SPA 525G2 that is posted at the Cisco support community at <http://www.cisco.com/go/smallbizsupport>, and also consult the latest Cisco SPA 525G2 release notes available at [cisco.com](http://www.cisco.com).

To pair your Cisco SPA 525G2 with your Bluetooth-enabled mobile phone, you can either initiate pairing from the Cisco SPA 525G2, or from your mobile phone.

### Initiating pairing from the Cisco SPA 525G2

1. Enable Bluetooth as described in the "Enabling Bluetooth section.
2. Press the 'Setup' button.
3. Scroll to User Preferences and press 'Select'.
4. Scroll to 'Bluetooth Configuration' and press 'Select'.
5. Scroll to 'Bluetooth Mode' and press the 'Right Arrow' key to choose one of the following:

**Handsfree** – Your Cisco SPA 525G2 will operate as a handsfree device with a Bluetooth-enabled mobile phone.

**Both** – Your Cisco SPA 525G2 will operate with your Bluetooth-enabled mobile phone or operate with a Bluetooth headset. (See "Connecting Bluetooth Headsets" section on page 18 for more information on Bluetooth headsets.)

*Note:* Your Cisco SPA 525G2 will connect to only one device at a time (either the Bluetooth headset or the Bluetooth-enabled mobile phone.). If multiple Bluetooth devices are in range of the Cisco SPA 525G2, the order of devices in the 'Bluetooth Configuration > Bluetooth Profiles' list is used, and the device with a higher priority is activated first.

6. Scroll to 'Bluetooth Profiles' and press the 'Right Arrow' key to enter the profile screen.
7. Press 'Scan' to scan for your mobile phone.

*Note:* Depending on the network environment (for example, the number of Bluetooth devices and noise level), your Bluetooth headset may not appear on the found devices list. Ensure the headset is powered on and has Bluetooth activated, and retry the scan.

8. In the Select a 'Bluetooth Device to Pair' list, select the mobile phone to which you want to pair and press 'Connect'.



## Initiating pairing from Your Bluetooth-enabled mobile

*Note: The procedure varies depending on your phone model. You must turn Bluetooth on, and you may need to configure a separate setting to make your mobile phone discoverable by other devices. The following example uses an Apple iPhone. Before starting, it's helpful to find the MAC address of your Cisco SPA 525G2 IP phone. From your IP phone, go to the 'Setup' menu and select 'Status'. Select 'Product Information'. The MAC address is displayed.*

1. On your iPhone, click 'Settings'.
2. Under 'General', choose 'Bluetooth'. Ensure Bluetooth is turned on.



3. In the Bluetooth Window, under Devices, find the MAC address on the back of your Cisco SPA 525G2 IP phone.
4. Select the MAC address of the Cisco SPA 525G2.
5. Enter the PIN (the default is 0000) and press Connect.



When paired with your mobile phone, the Cisco SPA 525G2 display screen assigns one of your line buttons to the mobile phone. A mobile phone icon with a flashing lightning bolt icon is displayed next to the mobile phone name, number, or other identifier (such as the phone model) for your phone.



*Note: The name, number, or other identifier shown depends on what is configured on your mobile phone. If you have not configured a name on your phone, the phone may display your phone number or some other identifier (such as the phone model). The display name can vary depending on your phone model and configuration.*

The Bluetooth phone icon colours show the status of your mobile phone and/or the Cisco SPA 525G2:

**No icon** – Bluetooth is disabled

**Gray icon** – Bluetooth is enabled, but the phones are not connected.

**Blue icon** – Bluetooth is enabled and the Cisco SPA 525G2 is connected to a headset.

**Green icon** – Bluetooth is enabled and the Cisco SPA 525G2 is connected to a mobile phone.

To verify the mobile phone configuration:

1. On the Cisco SPA 525G2, press the Setup Button.
2. Scroll to User Preferences and press Select.
3. Scroll to Bluetooth Configuration and press Select.
4. Scroll to Bluetooth Profiles and press the Right Arrow key.

The mobile phone appears in the list of Bluetooth devices.

## Importing your mobile phone address book into the Cisco SPA 525G2

*Note:* Not all mobile phones support this function. See the list of Bluetooth-enabled mobile phones supported with the Cisco SPA 525G2 that is posted at the Cisco support community at <http://www.cisco.com/go/smallbizsupport>, and also consult the latest Cisco SPA 525G2 release notes available at [cisco.com](http://www.cisco.com).

To import your mobile phone book into the personal address book on the Cisco SPA 525G2:

1. Press the 'Directory' softkey, or press the 'Setup' button and select 'Directories'.
2. Select 'Personal Address Book'.

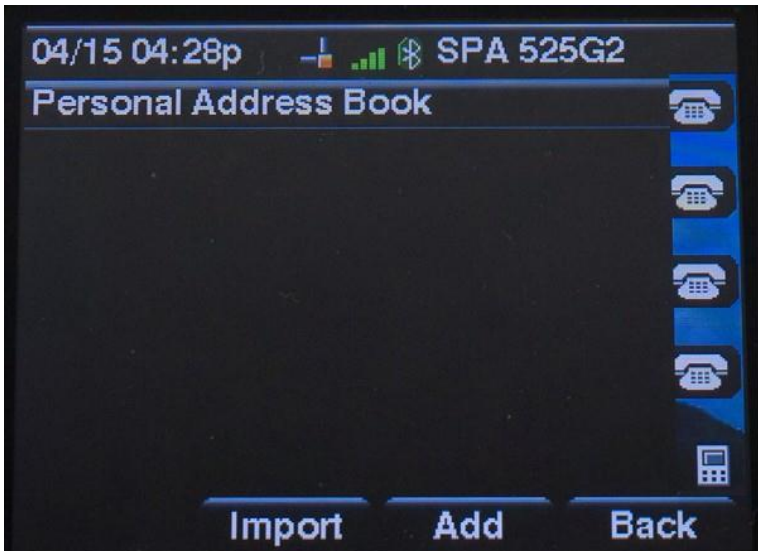

3. Press the 'Option' softkey and select 'Import'

*Note:* Depending on your mobile phone, you may need to authorize the Bluetooth connection, even if the phone is already paired with the Cisco SPA 525G.

4. The phone displays a status message about the import.

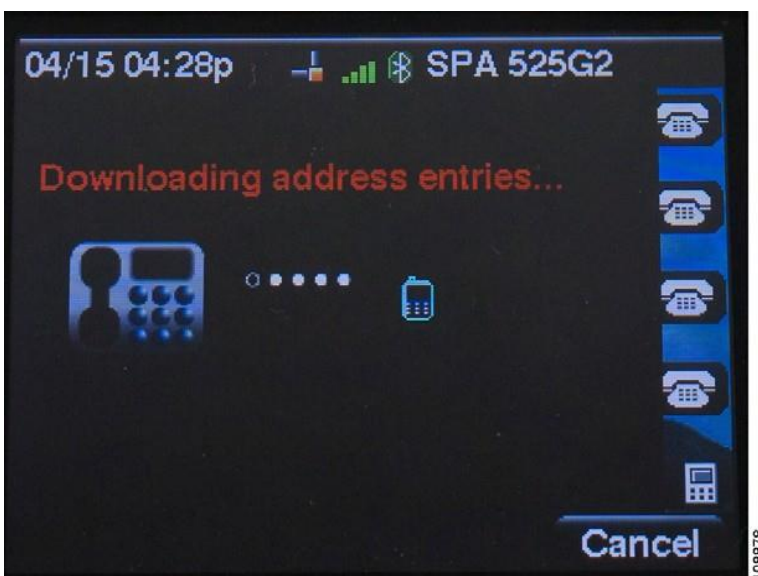

5. If the import is successful, your imported contacts are shown in the Directory.

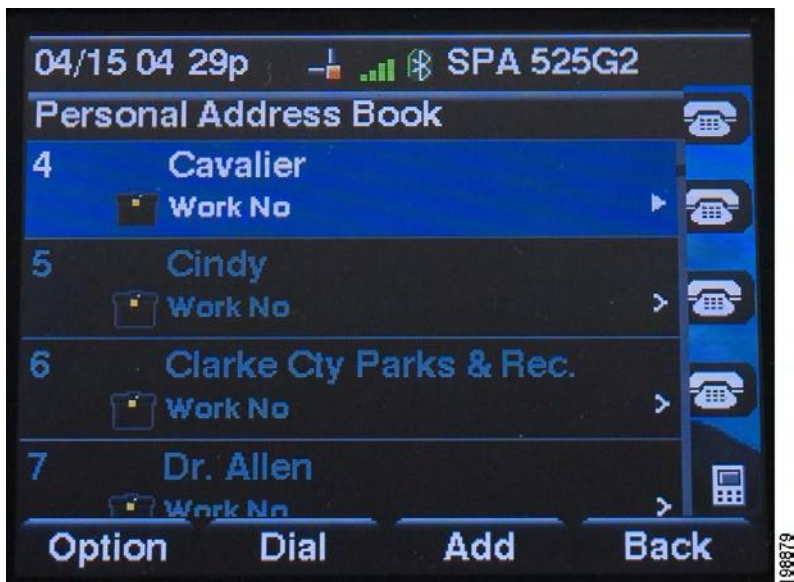

## Making a mobile call from your Cisco SPA 525G2

When you make a mobile phone call using your Cisco SPA 525G2, your Cisco SPA 525G2 acts as a handsfree device for your phone. The call is made through your mobile phone, but the audio is present on the Cisco SPA 525G2 and the call control is done using the Cisco SPA 525G2, unless you switch back to your mobile phone.

*Note:* Not all mobile phones support this function. See the list of Bluetooth-enabled mobile phones supported with the Cisco SPA 525G2 that is posted at the Cisco support community at <http://www.cisco.com/go/smallbizsupport>, and also consult the latest Cisco SPA 525G2 release notes available at [cisco.com](http://www.cisco.com).

1. Press the line button associated with your mobile phone (the line button is marked with a mobile phone icon with a flashing lightning bolt).
2. Do one of the following:
  - o Enter a number to dial and press the 'Dial' softkey
  - o Press the 'Directory' softkey and select 'Personal Address Book'. Choose a number and press the 'Dial' softkey
  - o Select 'Redial', then scroll to select a recently-called number and press the 'Select' button

*Note:* If you usually enter a digit before dialing (such as 9 to reach an outside line), remember that this call is made through your mobile phone. You should follow the usual practice for making calls on your mobile phone (for example, you probably do not dial a digit to reach an outside line on your mobile phone).

The outgoing call appears on both your Cisco SPA 525G2 and your mobile phone display. The Cisco SPA 525G2 displays an off-hook icon next to the mobile phone display name.



After the call is connected, the icon next to the mobile phone display shows that the call is established. The audio goes through the Cisco SPA 525G2, although the mobile phone display also shows a connected call.



### Receiving mobile calls using the Cisco SPA 525G2

If your mobile phone is paired with the Cisco SPA 525G2, an incoming call to your mobile phone is also shown on the Cisco SPA 525G2.



Do one of the following:

- Press the 'Answer' softkey to connect to the call
- Press the red flashing line button associated with your mobile phone
- Pick up the Cisco SPA 525G2 handset
- Press Ignore to ignore the call

### Switching audio from Your Cisco SPA 525G2 to your mobile

*Note:* You can only switch audio back and forth between the Cisco SPA 525G2 and your mobile phone if the call is connected using the Cisco SPA 525G2-to-mobile phone feature. (For example, you cannot switch a call on your Cisco SPA 525G2 that is not associated with your mobile phone.)

*Note:* Not all mobile phones support this function. See the list of Bluetooth-enabled mobile phones supported with the Cisco SPA 525G2 that is posted at the Cisco support community at <http://www.cisco.com/go/smallbizsupport>, and also consult the latest Cisco SPA 525G2 release notes available at [cisco.com](http://www.cisco.com).

- To switch audio from your Cisco SPA 525G2 to your mobile phone, on a connected call, press the soft key depicting the two devices with an arrow from the phone to the mobile.
- To switch audio back to the Cisco SPA 525G2 from your mobile phone, on a connected call, press the soft key depicting the two devices with an arrow from the mobile to the phone.

### Viewing mobile phone battery and signal information on your Cisco SPA 525G2

When a mobile phone call is incoming, outgoing, or connected on your Cisco SPA 525G2, the Cisco SPA 525G2 display shows information about your mobile phone.

*Note:* Not all mobile phones support this function. See the list of Bluetooth-enabled mobile phones supported with the Cisco SPA 525G2 that is posted at the Cisco support community at <http://www.cisco.com/go/smallbizsupport>, and also consult the latest Cisco SPA 525G2 release notes available at [cisco.com](http://www.cisco.com).



The display bubble shows the following information:

- Battery indicator—Shows the battery life left on your mobile phone.
- Signal strength—Shows the signal strength for your mobile phone.
- Network (optional)—May show the phone network for your mobile phone.

### Charging Your Mobile Phone Using Your Cisco SPA 525G2

You can use the USB port on the Cisco SPA 525G2 model to charge your Bluetooth-enabled mobile phone if your phone has a mini-USB port.



## Playing MP3 files on your phone

Your phone contains an audio player that can play .mp3 files. To play music on your phone, you must load the audio files onto a USB memory device (not sold with the phone). The phone reads the files from the device, so the device must remain inserted while playing the files.

*Note: Only MP3 music with no Digital Media Rights protection can be played on the Cisco SPA 525G2 IP Phone.*

## Creating the playlist

*Note: The MP3 playlist on the Cisco SPA 525G2 is limited to 48 songs.*

1. Connect a USB storage device to your PC.
2. Create a directory named 'mp3' on the USB device and copy the audio files into that directory.
3. Remove the USB device from your PC and insert it into the USB slot on the Cisco SPA 525G2.
4. Press the 'Setup' button.
5. Scroll to MP3 Player and press 'Select'.
6. Press 'Add List' to create a playlist from the songs on the USB device.
7. Choose songs by choosing one of the following methods:
  - o Choose individual songs by scrolling to the song you want and pressing the 'Right Arrow' key or the 'Select' button.
  - o Choose all songs on the USB device by pressing 'SelectAll'.
  - o You can clear all selected songs by pressing 'ClearAll'.
8. After choosing songs, the songs will be marked with a check in the box next to the song. Press 'Add' to add the selected songs to the playlist.

## Playing songs

In the Playlist, scroll to the song you want to begin playing and press 'Play'. You have the following controls:

**Stop** – Stop the song. Pressing play will restart song play.

**Previous** – Move to the previous song in the playlist.

**Next** – Move to the next song in the playlist.

**Back** – Move back one screen to the playlist.

## Controlling the Audio

Use the 'Volume' button on the phone to turn the music up or down.

To switch the audio destination between the speaker, headset, and handset, press the 'Up Arrow' or 'Down Arrow' key. The icon on the left above the song length display shows the audio destination of speaker, handset, or headset (see the following graphic).





## Changing the Left and Right Channel for Stereo Headsets

When using a stereo headset inserted into the Cisco SPA 525G2, you may need to switch the audio left and right channels to hear the correct audio channel in the right or left ear. To change the audio:

1. Press the 'Setup' button.
2. Scroll to 'User Preferences' and press 'Select'.
3. Scroll to 'Audio Preferences' and press 'Select'.
4. Press the 'Right Arrow' key to set Swap L/R Channel to 'On'.
5. Press 'Set'.

## Customising your LCD screen

You can customize your LCD screen in the ways described below.

### Changing the LCD screen contrast

To adjust the contrast of the LCD screen:

1. Press the 'Setup' button.
2. Scroll to 'User Preferences' and press 'Select'.
3. Scroll to 'Screen Preferences' and press 'Select'.
4. Scroll to 'Display Brightness'. The default contrast is 15. Enter a number between 1 (lowest) and 15 (greatest) to change the contrast.
5. Press 'Set'.

## Setting the screen backlight timer

You can set a timer for your screen so that your LCD screen becomes dark after a specified time when the phone is idle:

1. Press the 'Setup' button.
2. Scroll to 'User Preferences' and press 'Select'.
3. Scroll to 'Screen Preferences' and press 'Select'.
4. Scroll to 'Backlight'. Press the 'Right Arrow' key to choose 'On', which means that the darkening feature is enabled.
5. Scroll to 'Backlight Timer'. Enter the number of seconds before the display should shut off after the phone is idle.
6. Press 'Set'.

## Configuring the phone screen saver

You can enable your phone's screen saver and specify its appearance and the amount of time for the phone to be idle before it begins.

To configure your screen saver:

1. Press the 'Setup' button.
2. Scroll to 'User Preferences' and press 'Select'.
3. Scroll to 'Screen Preferences' and press 'Select'.
4. With 'Screen Saver' highlighted, press the 'Right Arrow' key to choose 'On'.
5. Scroll to 'Screen Saver Settings' and press the 'Right Arrow' key to choose the settings:
  - o Screen Saver Type, choose from:
    - Black Background** – Displays a black screen.
    - Gray Background** – Displays a gray screen.
    - Black/Gray Rotation** – The screen incrementally cycles from black to gray.
    - Picture Rotation** – The screen rotates through available pictures that your phone administrator has made available on the phone.
    - Digital Frame** – Shows the background picture.
  - o Trigger Interval – Enter the number of seconds that the phone remains idle before the screen saver turns on.
  - o Refresh Interval – Enter the number of seconds before the screen saver should refresh (if, for example, you chose a rotation of pictures).
6. Press 'Set'.

## Using ringtones

Each extension of your phone can have a different ring tone. To change a ring tone:

1. Press the 'Setup' button.
2. Scroll to 'User Preferences' and press 'Select'.
3. Scroll to 'Audio Preferences' and press 'Select'.
4. Scroll to the extension for which you want to select a ring tone and press the 'Right Arrow' key.
5. Scroll through the ring tones and press 'Play' to play the highlighted ring tone. Press 'Select' to choose the highlighted ringtone for that extension.
6. Press 'Set'.

## Changing the date and time

The date and time for your phone will be set by Vodafone One Net.

## Restarting your phone

Occasionally you may need to restart your phone if the screen locks up. To restart your phone:

1. Press the Setup button
2. Scroll to 'Device administration' and press 'Select'
3. Scroll to 'Restart' and press 'Select'

## Viewing phone, network and call information

### Viewing phone information

1. Press the Setup button.
2. Scroll to 'Status' and press 'Select'.
3. Choose 'Product information' – you'll then see the following information:
  - Product name
  - Serial number
  - MAC (hardware) address
  - Software version
  - Hardware version
  - Certificate
  - Customisation

## Viewing network information

1. Press the Setup button.
2. Scroll to 'Status' and press 'Select'.
3. Scroll to 'Network status' and press 'Select' - you'll then be able to see the following information:
  - o Network type
  - o Network status
  - o Addressing type
  - o IP address
  - o Subnet mask
  - o Default router
  - o Primary DNS
  - o Secondary DNS
  - o MAC (hardware) address

## Viewing phone line and extension information

1. Press the Setup button
2. Scroll to 'Status' and press 'Select'
3. Scroll to 'Phone status' and press 'Select' - you'll then be able to see the following information:
  - o Phone status – up time and packets sent/received
  - o Extension status – this will tell you if an extension's been registered and when, plus lots more
  - o Line status – active calls and call information
  - o Provisioning status – If a profile rule was used, and the status
  - o Call statistics history – this details information about individual calls

## Viewing peripheral status

To see information about phone peripherals, like a USB memory stick or Cisco SPA attendant console:

1. Press the Setup button
2. Scroll to 'Status' and press 'Select'
3. Scroll to 'Peripheral status' and press 'Select' – you'll then be able to see the following information:
  - o USB status
  - o Attendant console (Attn Cons) status

## Using FAC codes

As well as using your phone's menu, many of the Vodafone One Net features can be accessed and activated or deactivated by dialling short Feature Access Codes (also known as FAC codes).

*Note: After each code entry, press 'Confirm' to activate.*

### Breakout Code

The following Feature Access Code is available and can be initiated from your Cisco SPA 514G2.

Feature Access Code	Behaviour
983 (+number)	The Breakout code is used where there is a conflict with an extension number within the company with an advertised Short Dial Code not within the company. For example, to dial 2222 Vodafone road watch service when there is a valid internal extension of 2222 within the company you would need to dial 9832222.

### Call forwarding

The following Feature Access Codes are available and can be initiated from your Cisco SPA 514G2.

Feature Access Code	Behaviour
1200	Removes all active call diverts, including those to voicemail.
1212	Activates Forward all calls to voicemail, so now all incoming calls to your number will be put through to voicemail.
1212 + Number (121201635555555)	Activates Forward all calls to the number specified, so now all incoming calls to your number will divert to the one entered. Useful if you are out of the office and want calls to come to your mobile.
1213	Removes Forward all calls, incoming calls will now come back to your phone.
1224	Activates Call forward unanswered to voicemail, after 30 seconds if the call is not answered it will go to voicemail.
1224 + Number (122401635555555)	Activates Call forward unanswered to Number specified, after 30 seconds if the call is not answered it will go to the number entered.
1225	Removes Call forward unanswered, calls will ring for 60 seconds before being disconnected. Note: The call will go nowhere just drop.
1226	Activates Call forward busy to voicemail, if you are on a call, unless call waiting is turned on, the next incoming call will be sent to voicemail.
1226 + Number (122601635555555)	Activates Call forward busy to number specified, if you are on a call, unless call waiting is turned on, the next incoming call will be sent to the number entered.
1227	Removes Call forward busy, if you are on a call, unless call waiting is turned on, the next incoming call will receive an engaged tone. Note: Call waiting will only wait one incoming call, any others will follow divert rules.
1228	Activates Call forward unavailable to voicemail, if your phone is turned off is then all incoming calls will go to voicemail.

1228 + Number (122801635555555)	Activates Call forward unavailable to the Number specified, if your phone is turned off all incoming calls will go to the number entered.
1229	Removes Call forward unavailable to Voicemail, if your phone is turned off then ALL incoming calls will get a number not in use tone and drop, they will not go to voicemail.

## Do not disturb

The following Feature Access Codes are available and can be initiated from your Cisco SPA 514G2

Feature Access Code	Behaviour
126	Activates Do not disturb for the phone you're calling from.
127	De-activates Do not disturb for the phone you're calling from.
124	Activate Do not disturb for both your mobile and fixed line phones.
125	De-activates Do not disturb for both your mobile and fixed line phones.

## Caller ID

The following Feature Access Codes are available and can be initiated from your Cisco SPA 514G2.

Feature Access Code	Behaviour
1470 (+number)	Present my Caller ID on a per call basis (used when you number is normally withheld).
141 (+number)	Withhold my Caller ID on a per call basis (used when you number is normally presented).
#21 (+number)*	Per call dial out with Multi-user hunt group number (user's terminal belongs to unique Multi-user hunt group).
#22#yy (+number)*	Per call dial out with Multi-user hunt group number where a user belongs to more than one Multi-user hunt group – yy is the two-digit number associated with the Multi-user hunt group.
#23 (+number)	Per call dial out with Company Number.

In the cases where a subscriber has subscribed to always display the Caller ID by default, it is possible to restrict Caller ID on a per-call basis, by dialling 141 followed by the target number.

Users activate this feature by dialling a Feature Access Code (FAC) to initiate an outbound call from the Company number, the FAC for this is #23#01234567890\*, where 01234567890 is the target number to be dialled.

**Example:** Sam wishes to call an existing business contact, he simply dials 01202445566. This will present his own Caller ID to the target caller.

**Example:** Olivia wishes to call a new customer from the company main number. She dials #23#01202445566, the call receiver will see the Generic main number as the Caller ID in this case.

It is also possible to force a company number to be presented for selected list of users so that all their outgoing off-net calls will only present the Main company number.

In the cases where a subscriber has subscribed to always restrict the Caller ID by default, it is possible to allow Caller ID on a per call basis, by dialling 1470 followed by the target number.

## Call pickup

The following Feature Access Codes are available and can be initiated from your Cisco SPA 514G2.

Feature Access Code	Behaviour
#154*	Personal call pickup is used to pick up a ring call that belongs to the same user and can be used to answer a call ringing on the user's mobile on their desk phone
#155*	Any call pickup is used to pick up the longest ringing call from a Pickup group.
#155* (+extension)	Specific call pickup is used to pickup a specific call from a Pickup group.

*Note: It is possible to setup a line button or soft key to access Group call pickup. If you would like this configured on your phones, please contact customer services on 191 from a Vodafone phone.*