

(formerly H-Series™)

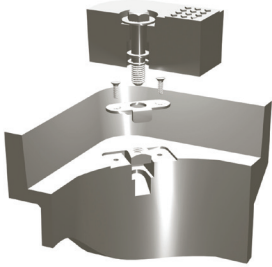

Bolt Down Detail

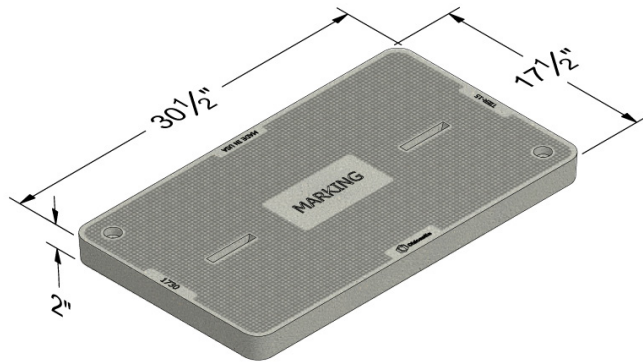

COVER

Style: Flush Solid
Material: Polymer Concrete
Model: 17" x 30"
Weight: Tier 15: 62 lbs.
Tier 22: 85 lbs.

Std. Fasteners: 1/2-13 Stainless Steel Hex Head Bolt, Washer and Floating Nut

Options: Logos and Special Markings
Surface: Slip Resistant
Performance: ANSI/SCTE-77, Tier 15 or Tier 22*

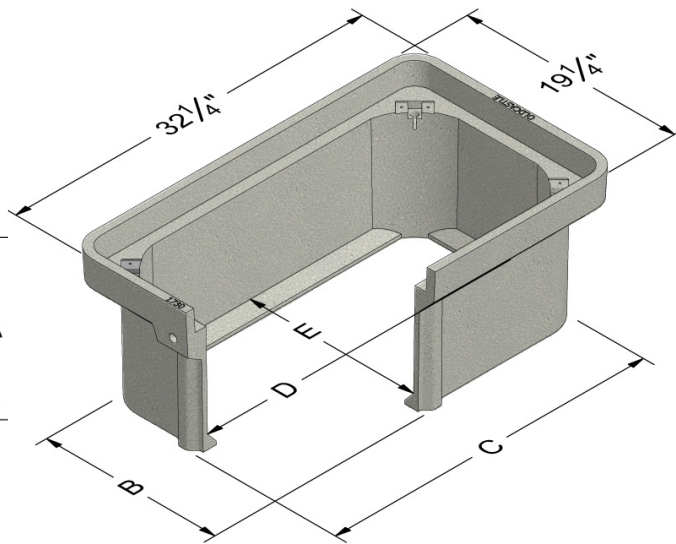



BODY

Material: Polymer Concrete
Model: 17" x 30"
Weight: 12" Depth: 65 lbs.
18" Depth: 88 lbs.
24" Depth: 114 lbs.

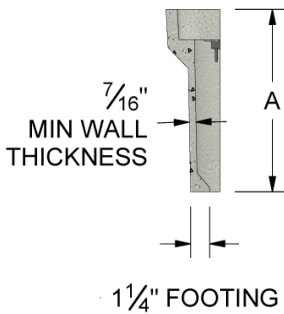
Wall Type: Straight
Performance: ANSI/SCTE-77 Tier 22



-  Medium Duty: Incidental, Non-deliberate Traffic
-  Heavy Duty: Incidental, Non-deliberate Traffic

	A	B	C	D	E
1730-12	12	17-1/4	30-1/4	28-3/16	15-3/16
1730-18	18	17-1/8	30-1/8	28	15
1730-24	24	17	30	27-3/4	14-3/4

For use in non-vehicular traffic situations only.

Actual load rating is determined by the box and cover combination.

Weights and dimensions may vary slightly.

Based upon lid and body combination, this unit can be Tier 15 or Tier 22.

* T22 rating when paired with T22 polymer concrete lid.

Cover comes standard with permanent markings for manufacturer, load rating, model size and manufacturing location.

OPTIONS

AVAILABLE POLYMER COVER:

- Flush Solid
- Flush 2-Piece (Uni-Half)
- Flush Pedestal Provision

AVAILABLE STEEL COVER:

- One Piece

FASTENER OPTIONS FOR COVERS:

- Penta Head Bolt
- Oldcastle Enclosures Vandal Resistant Bolt
- Penta Coil Thread Bolt
- Captive Bolt Retainer

ADD ON OPTIONS:

- EMS Marker (E)
- Mouseholes/Knockouts
- Rack Mount (A)
- Cable Racks/Cable Arms (B)
- Unistrut (C)
- Pulling Eye - 1,000 lb and 3,000 lb (D)
- Ground Buss (F)
- Dividers
- Racking Provision
- Lid Gaskets*
- Solid Bottom
- Custom Marking Plate (Polymer)

*Lid Gaskets inhibit water flow into the box, they do not make enclosure fully waterproof.

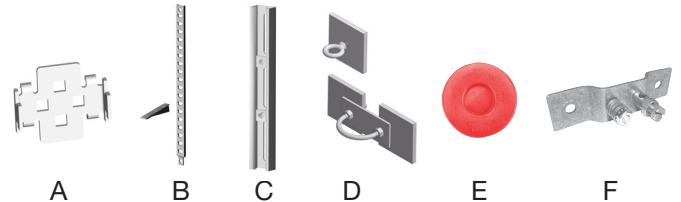
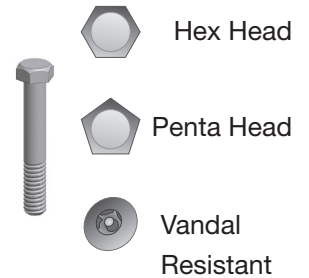
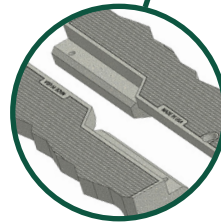
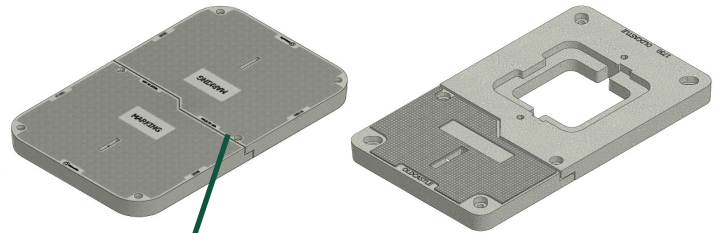
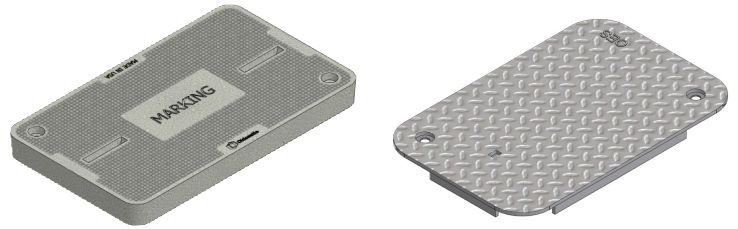

PRODUCT LOAD RATING



Medium Duty: Incidental, Non-deliberate traffic
For use in non-vehicular traffic situations only. Actual load rating is determined by the box and cover combination.



Heavy Duty: Incidental, Non-deliberate traffic
For use in non-vehicular traffic situations only. Actual load rating is determined by the box and cover combination.

NOTES

Actual load rating is determined by the box and cover combination. Weights and dimensions may vary slightly