

FINAL REPORT
PROJECT NO. A-2132

NASA CR-160032

**94/183 GHz MULTICHANNEL RADIOMETER
FOR CONVAIR FLIGHTS**

By

J. A. Gagliano,
J. A. Stratigos
R. E. Forsythe
J. M. Schuchardt

Prepared For

GODDARD SPACE FLIGHT CENTER
Greenbelt, Maryland 20771
Contract NAS5-24480

January, 1979

N80-33047

GEORGIA INSTITUTE OF TECHNOLOGY

Engineering Experiment Station
Atlanta, Georgia 30332



1979



94/183 GHz MULTICHANNEL RADIOMETER
FOR CONVAIR FLIGHTS

J. A. Gagliano, J. A. Stratigos
R. E. Forsythe and J. M. Schuchardt.
Georgia Institute of Technology
Engineering Experiment Station
Atlanta, Georgia 30332

January, 1979
Final Report (A-2132)

Prepared For
GODDARD SPACE FLIGHT CENTER
Greenbelt, Maryland 20771
Contract NAS5-24480

Page Intentionally Left Blank

1. Report No.	2. Government Accession No.	3. Recipient's Catalog No.	
4. Title and Subtitle 94/183 GHz Multichannel Radiometer for Convair Flights		5. Report Date	6. Performing Organization Code
7. Author(s) J. A. Gagliano and others	8. Performing Organization Report No.		
9. Performing Organization Name and Address Engineering Experiment Station Georgia Institute of Technology Atlanta, Georgia 30332		10. Work Unit No.	11. Contract or Grant No. NAS5-24480
12. Sponsoring Agency Name and Address NASA Goddard Space Flight Center Greenbelt, Maryland 20771 Project Manager, J. L. King		13. Type of Report and Period Covered Final Technical Report 4/6/78 to 2/2/79	
		14. Sponsoring Agency Code 946	
15. Supplementary Notes			
16. Abstract <p>A multichannel 94/183 GHz radiometer was designed, built, and installed on the NASA Convair 990 research aircraft to take data for hurricane penetration flights, SEASAT-A underflights for measuring rain and water vapor, and Nimbus-G underflights for new sea ice signatures and sea surface temperature data (94 GHz only). The radiometer utilized IF frequencies of 1, 5, and 8.75 GHz about the peak of the atmospheric water vapor absorption line, centered at 183.3 GHz, to gather data needed to determine the shape of the water molecule line. Another portion of the radiometer operated at 94 GHz and obtained data on the sea brightness temperature, sea ice signatures, and on areas of rain near the ocean surface.</p> <p>The radiometer used a multiple lens antenna/temperature calibration technique using 3 lenses and corrugated feed horns at 94 GHz and 183 GHz. Alignment of the feed beams at 94 GHz and 183 GHz was accomplished using a 45° oriented reflecting surface which permitted simultaneous viewing of the feeds on alternate cycles of the chopping intervals. This technique is referred to as the "super chopper" concept. A microstrip multiplexer was used in the 183.3 GHz portion of the radiometer. A split block mixer at 183 GHz was designed to allow wider IF bandwidths.</p>			
17. Key Words (Selected by Author(s)) Radiometer multichannel, Milli-meter waves, 94 GHz, 184 GHz, Mixer, Triplexer, Microprocessor control.		18. Distribution Statement	
19. Security Classif. (of this report) UNCLASSIFIED	20. Security Classif. (of this page) UNCLASSIFIED	21. No. of Pages	22. Price*

* For sale by the National Technical Information Service, Springfield, Virginia 22151.

FOREWORD

This final report was prepared by the Electromagnetics Laboratory of the Engineering Experiment Station, Georgia Institute of Technology under Contract NAS5-24480. The contract was initiated by the Applications Directorate of NASA Goddard Space Flight Center, Greenbelt, Maryland. The contract was administered by J. L. King of the Earth Observations Systems Division.

The period of performance was 6 April 1978 to 31 December, 1978.

Report authors are J. A. Gagliano, J. A. Stratigos, R. E. Forsythe and J. M. Schuchardt.

The views and conclusions contained in this document are those of the authors and should not be interpreted as necessarily representing the official policies, either expressed or implied, of NASA GSFC or the U. S. Government.

We would like to acknowledge the valuable contribution to the successful completion of this project made by E. Peterson, NASA Ames Research Center; G. T. Wrixon, Electrical Engineering Department, University College at Cork, Ireland and the following Georgia Tech Personnel: D. O. Gallentine, J. M. Newton, V. T. Brady, R. W. Bird, J. J. McSheehy, J. A. Cook, L. C. Solomon and C. P. Hayth.

PREFACE

The primary objective of this program was to design, build, and flight test a multichannel 94/183 GHz radiometer on the NASA Convair 990 aircraft. The flight data taken by the radiometer was in support of Project Storm Fury (hurricane flights), SEASAT-A satellite underflight program over the Gulf of Alaska, and Nimbus-G satellite underflight program over the Greenland Sea, the Norwegian Sea, and the Pacific Ocean. Components from the 183 GHz radiometer used on NASA Contract NAS5-23603 (refer to Georgia Tech Final Technical Report A-1866) were augmented by adding a nominal 8.75 GHz IF channel. The new 94 GHz RF portion of the radiometer used a nominal 2.3 GHz IF channel. Both the 94 GHz and 183 GHz lens feeds used corrugated conical horns designed to provide low sidelobe antenna patterns. Alignment of the feed beams at 94 GHz and 183 GHz was accomplished using a 45° oriented reflecting surface which permitted simultaneous viewing of the feeds on alternate cycles of the chopping intervals. This concept is referred to as the "super chopper" concept. The lens focal lengths were modified to accommodate the super chopper blade.

Major new components of the radiometer include: a mixer at 183 GHz designed to allow wider IF bandwidths and constructed using a split block technique, a mixer at 94 GHz utilizing a GaAs Schottky barrier diode mounted in a Sharpless-type mount, a four-port microstrip triplexer with the capability of allowing dc bias to be applied to the 183 GHz mixer diode, a tuned LO injection cavity at 94 GHz, low-noise, high gain amplifiers at 2 GHz and 8.75 GHz, super chopper blade for simultaneous chopping at 94 GHz and 183 GHz, and expanded microprocessor control and display of the data collected.

The purpose for constructing the multichannel 94/183 GHz radiometer was to measure the atmospheric attenuation due to water vapor absorption near the water vapor absorption line centered at 183.35 GHz. The 8.75 GHz IF channel provides additional data to aid in determining the shape of the water vapor absorption line. The 94 GHz RF portion of the

radiometer yields data on the brightness temperature of the sea and the atmosphere in those cases where the radiometer can see to ground level, and in the areas of precipitation where the radiometer sees the cold cosmic background scattered by the raindrops.

Installation of the radiometer onboard the NASA Convair 990 was completed on 26 June 1978 at the NASA Ames Research Center at Moffett Field, California. Engineering test checkout flights were completed on 30 June 1978. Artic flights in the vicinity of Fairbanks, Alaska took place from 11 July to 13 July 1978, for a total of 16 flight hours. Hurricane flight support was provided on Hurricane Cora with deployment of the Convair out of Puerto Rico and on Hurricane Rosa with deployment from San Diego, California.

SEASAT-A underflights were performed out of Seattle, Washington, during the time span of 10 September to 21 September. The measurements for water vapor and rain cell detection were performed over the Gulf of Alaska.

Nimbus-G underflight program was initiated on 25 October and ended on 19 November. Test sites for performing sea surface temperature, new sea ice and snow signature measurements, and near-surface winds include the Arctic Ocean, Greenland Sea, Greenland Test Sites, Norwegian Sea/Ocean Polar Front, Pacific Ocean, and Gulf of Alaska. Only the 94 GHz radiometer was used for the Nimbus-G underflight program.

The radiometer system was removed from the Convair 990 the week of 20 November and returned to Georgia Tech.

TABLE OF CONTENTS

	<u>PAGE</u>
FOREWORD.....	v
PREFACE.....	vii
TABLE OF CONTENTS.....	ix
LIST OF ILLUSTRATIONS.....	xi
LIST OF TABLES.....	xiii
1.0 INTRODUCTION.....	1
2.0 RADIOMETER COMPONENTS.....	11
2.1 Front-End System.....	11
2.2 Interface System.....	18
2.3 Data Processing System.....	24
2.4 Packaging Concept.....	28
3.0 OPERATION OF THE RADIOMETER.....	31
4.0 FLIGHT EXPERIMENTS.....	35
4.1 Hurricane Cora Penetration Flight.....	35
4.2 SEASAT-A Satellite Underflights (Gulf of Alaska)....	42
4.3 NIMBUS-G Satellite Underflights (Arctic Ocean, Greenland Sea, Norwegian Sea, Gulf of Alaska, Pacific Ocean).....	46
APPENDIX A - OPERATING SYSTEM SOFTWARE.....	49
APPENDIX B - ELECTRONIC SCHEMATICS.....	147
APPENDIX C - MECHANICAL DRAWINGS.....	157
APPENDIX D - SEASAT GULF OF ALASKA EXPERIMENT PLAN.....	179
APPENDIX E - THE FALL 1978 CV-990 NIMBUS-G/SMMR MISSION.....	191
APPENDIX F - CALIBRATION ERROR CORRECTION.....	203
APPENDIX G - CARTRIDGE TAPE DATA FORMAT.....	209
APPENDIX H - LOG OF CONVAIR 990 94/183 GHz RADIOMETER.....	221

LIST OF ILLUSTRATIONS

<u>FIGURE</u>	<u>PAGE</u>
1 CV 990 Aircraft - Radiometer Flight Geometry.....	2
2 Super-Chopper Concept - Shown Reflecting To Antenna At 94 GHz and Reflecting Into Reference Load at 183 GHz.....	3
3 Super-Chopper - Shown Transmitting To Reference Loat At 94 GHz and Transmitting To Antenna At 183 GHz.....	4
4 94/183 GHz CV 990 Radiometer Block Diagram.....	5
5 94/183 GHz CV 990 Radiometer Channel Allocation.....	6
6 94/183 GHz Radiometer (Window Mounted Components).....	8
7 94/183 GHz Radiometer (Rack Mounted Components).....	9
8 Measured and Calculated 180 GHz Feed Horn Antenna Pattern.....	12
9 Corrugated Horn Pattern, E-Plane (94.5 GHz).....	13
10 Corrugated Horn Pattern, H-Plane (94.5 GHz).....	14
11 94/183 GHz Radiometer (Showing Major Components).....	15
12 Insertion Loss Measured From LO to Mixer (Dotted Line) and Mixer to Antenna (Solid Line) of 91.65 GHz Directional Filter.....	16
13 Microstrip Triplexer (With dc Port).....	17
14 Measured Gain Versus Frequency of 1 GHz IF Amplifier....	19
15 Measured Frequency Response of 5 GHz IF Amplifier.....	20
16 Measured Gain Versus Frequency of 10 GHz IF Amplifier (183 GHz Channel).....	21
17 Measured Gain Versus Frequency of 2.3 GHz IF Amplifier (94 GHz Channel).....	22
18 Video Amplifier Frequency Response.....	23
19 94/183 GHz Radiometer Interface Electronics Package.....	25
20 Command Sequence for Setting Time of Day and Manual Calibration.....	32
21 Radiometer System Status Printout.....	33

LIST OF ILLUSTRATIONS (continued)

<u>FIGURE</u>	<u>PAGE</u>
22 Time UT SMHP '78 Flight 7 - Cora: Convair Over Raincell Area and 94/183 GHz Radiometer Looking Down.....	36
23 Time UT SMHP '78 Flight 7 - Cora: Raincell detected at 18:27 UT.....	37
24 Time UT SMHP '78 Flight 7 - Cora: Raincell detected at 18:38 UT.....	38
25 Time UT SMHP '78 Flight - Cora: Multiple Raincells Measured as Convair Flies Through Overcast Region.....	39
26 Time UT SMHP '78 Flight - Cora: Temperature Drop In All Four Radiometer Channels at 17:01 UT.....	40
27 Time UT SMHP '78 Flight 8 (Day 225): Spiral Descent With 30° Left Roll Angle. Note Radar Interference at GT RAD 2 (10 GHz IF Channel).....	41
28 Time UT SMHP '78 Flight 13 (Plot 2): Convair Under Raincell Area and 94/183 GHz Radiometer is Looking Up...	43
29 Time UT SMHP '78 Flight 13 (Plot 2): Multiple Raincells By GT RAD 3 (94 GHz).....	44
30 Time UT SMHP '78 Flight 12A (Plot 2): Radiometer Looking Up As Convair Performs Descent. Note Increase In Temperature On All Three 183 GHz Channels (Upper Three Traces).....	45
31 Time UT Day 301 Flight 99 Nimbus G: Convair Flying 500 Feet Above Sea Level Over Ice Cap Regions. Note Negative Peaks Over Open Water Seen By 94 GHz (Bottom Trace).....	47
32 Time UT Day 307 Flight 9 Nimbus G: Convair Performs 90° Left Bank Wingover. 94 GHz Radiometer Measures 30°K Looking Up.....	48

LIST OF TABLES

<u>Number</u>		<u>PAGE</u>
1	94/183 GHz CONVAIR 990 RADIOMETER DATA SOURCES.....	26
2	COMPUTER TERMINAL COMMANDS.....	29

1.0 INTRODUCTION

The flight geometry of the 94/183 GHz radiometer is illustrated in Figure 1. Two beam angles for viewing the scene are shown. The sky view is at 15° upwards from a level flight position of the aircraft. The earth view is a downward view of 45° achieved using an external deflector. The beamwidth of the scene being viewed is 2.5° at 183 GHz and 5.0° at 94 GHz. Figures 2 and 3 show the chopping scheme used to view the scene alternately between the 94 GHz feed and the 183 GHz feed using a dielectric lens and a rotating chopper. Figure 2 shows the scene viewed by the 94 GHz feed horn while the 183 GHz feed views the reference load. Rotating the chopper blade one slot position as shown in Figure 3 results in the 183 GHz feed horn viewing the scene and the 94 GHz feed horn viewing the reference.

A block diagram of the 94/183 GHz multichannel radiometer is shown in Figure 4. The scene is chopped at a 200 Hz rate using the super chopper concept described above. In the 94 GHz case, the signal is mixed with a klystron local oscillator and down-converted to a 2.32 GHz IF. In the 183 GHz case, the signal is mixed with a solid state doubler driven by the klystron LO and then down-converted to IF's at 1, 5, and 8.75 GHz. These three IF channels are triplexed, amplified, and then filtered. Following amplification, the signals are video detected and then routed to video amplifiers. The video amplifiers are low noise, high gain devices having bandpass responses tailored for each channel. The video outputs are synchronously detected using phase sensitive detectors. The microcomputer digitizes the outputs of the phase sensitive detectors, controls the storage of data from all four channels onto the cartridge tape recorder, performs periodic automatic calibration and converts voltage readings to temperature data. The data recorded are proportional to the apparent brightness temperature for each channel.

Figure 5 shows the radiometer channel allocation along the water vapor absorption line centered at 183.35 GHz. Simultaneous measurements

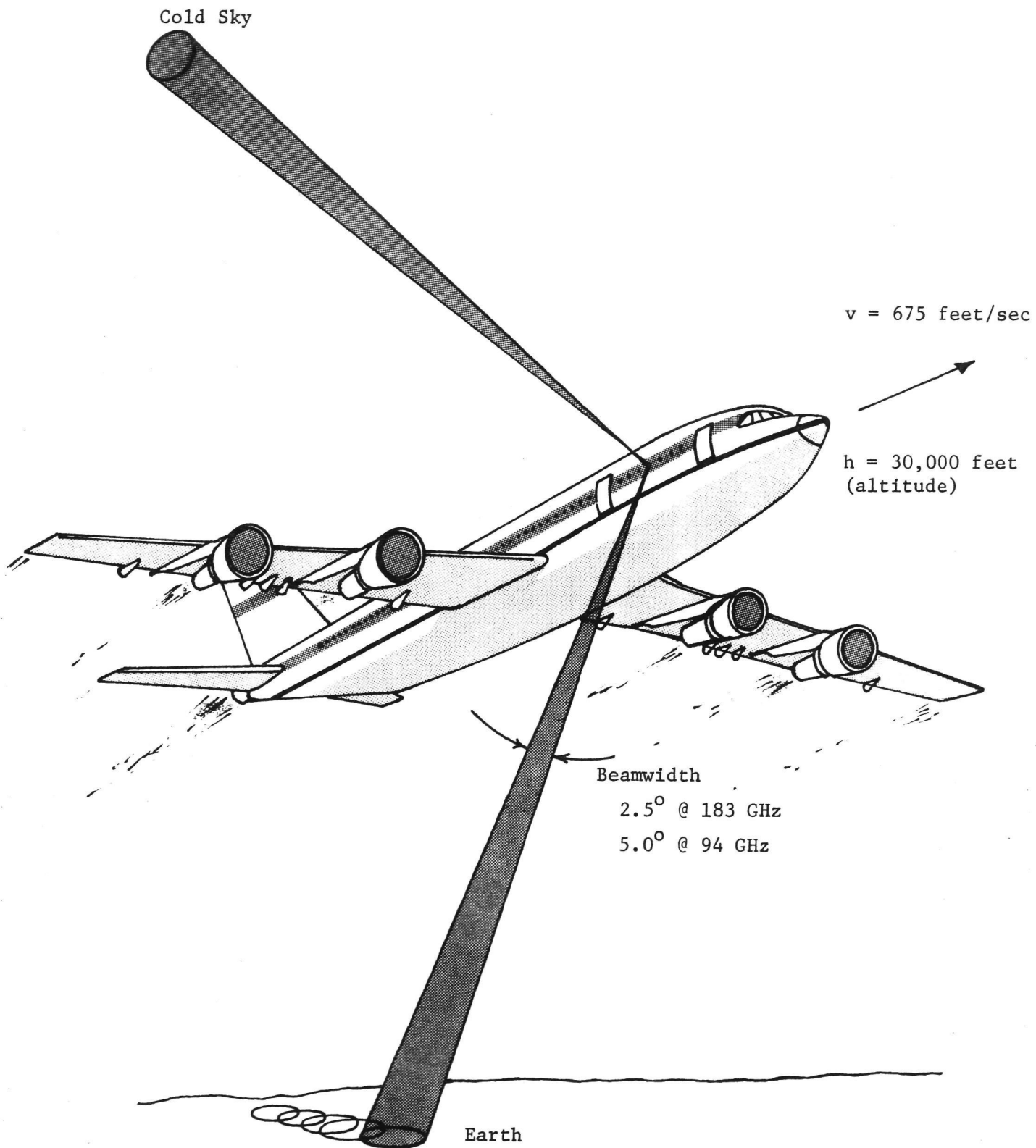

Figure 1. CV 990 Aircraft - Radiometer Flight Geometry.

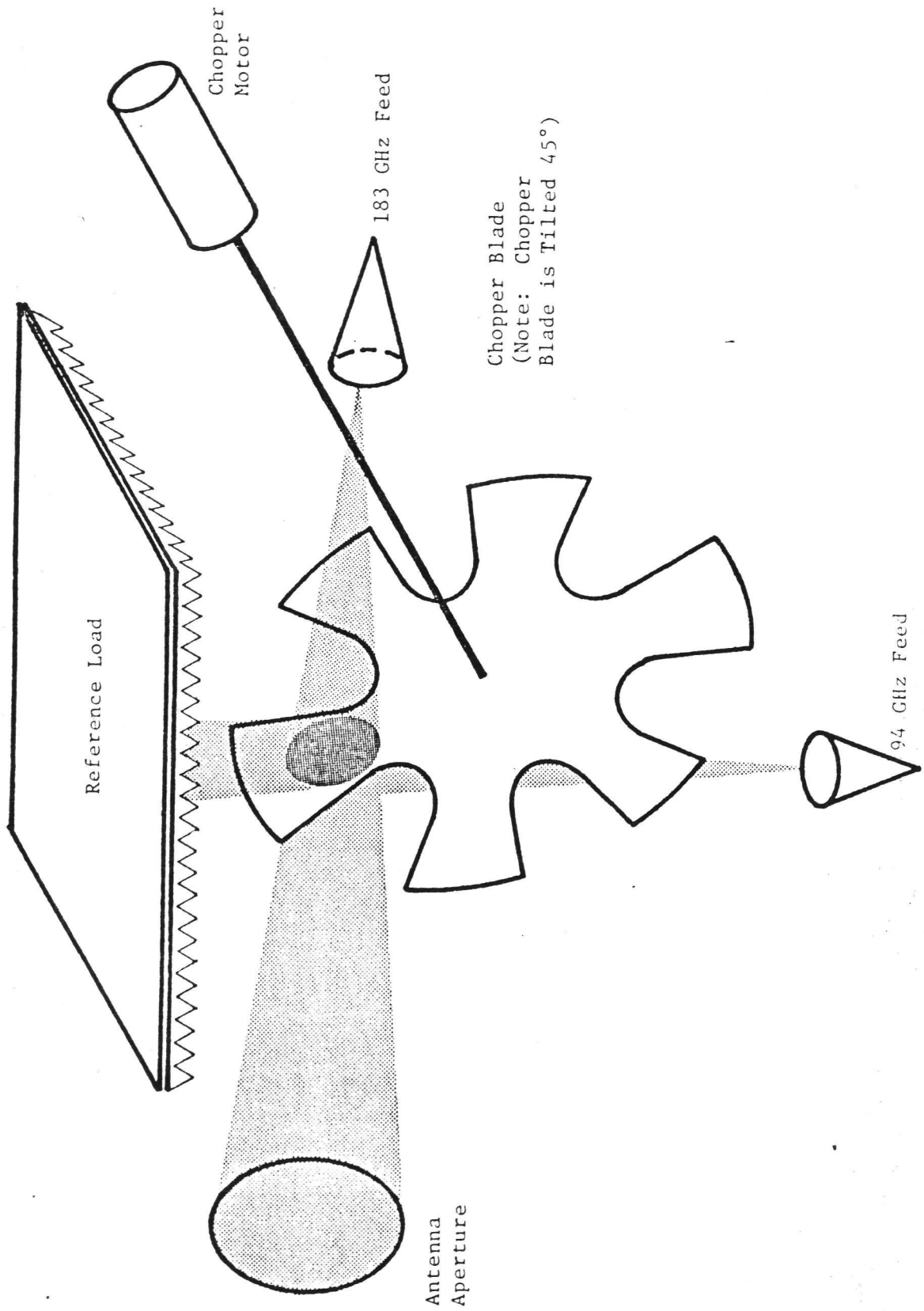

Figure 2. Super-Chopper Concept - Shown Reflecting To Antenna At 94 GHz and Reflecting Into Reference Load at 183 GHz.

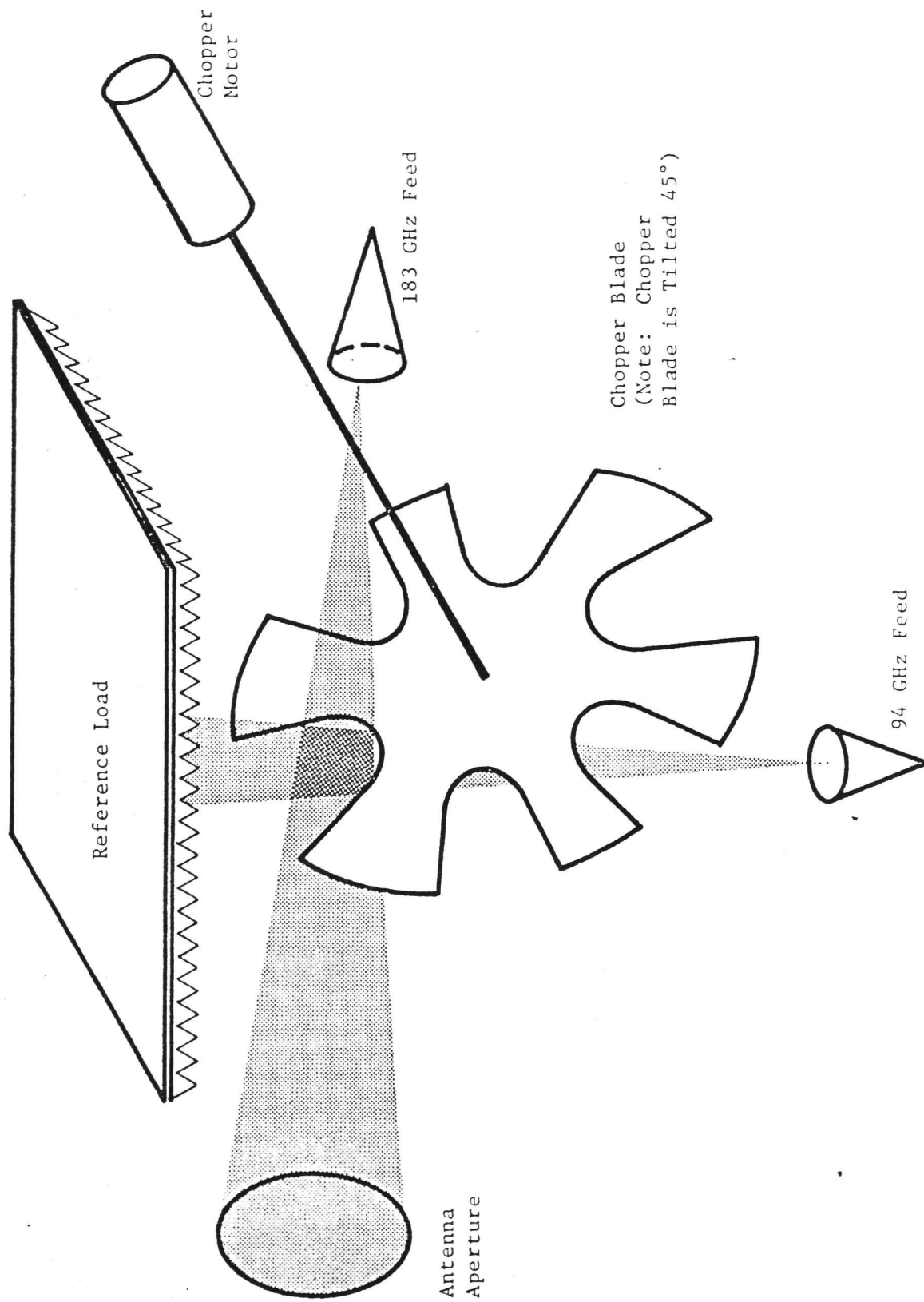

Figure 3. Super-Chopper - Shown Transmitting To Reference Load at 94 GHz and Transmitting to Antenna at 183 GHz.

Page Intentionally Left Blank

Page Intentionally Left Blank

at three channels provide a more accurate estimate of water vapor concentration by determining the shape of the absorption line over a ± 10.5 GHz portion of the spectrum. Figure 5 also illustrates the low atmospheric attenuation at 91.675 GHz. The 94 GHz portion of the radiometer yields data on the brightness temperature of the sea and on areas of precipitation near the ocean surface.

The 94/183 GHz radiometer consists of a front-end assembly designed to mount in a Convair 990 passenger window and a console of rack mountable electronics assembled in a Convair 990 equipment rack. The power supplies and associated interface electronics between the front-end and the console are packaged in a separate chassis mounted in an aircraft low-boy rack. Figure 6 is a view of the front-end showing the "super chopper" blade housing with the hot reference load mounted directly above. Figure 7 shows the control console which contains the data processing equipment used to process and display the data measured by the radiometer. On the rear of the microcomputer system panel are the connections required to send analog data to the ADDAS computer and serial link data to the Goddard computer. All connections between the various modules were made with multi-conductor shielded cables using "MS" type connectors. This was done to insure reliable connections and also to facilitate the installation and removal of equipment.

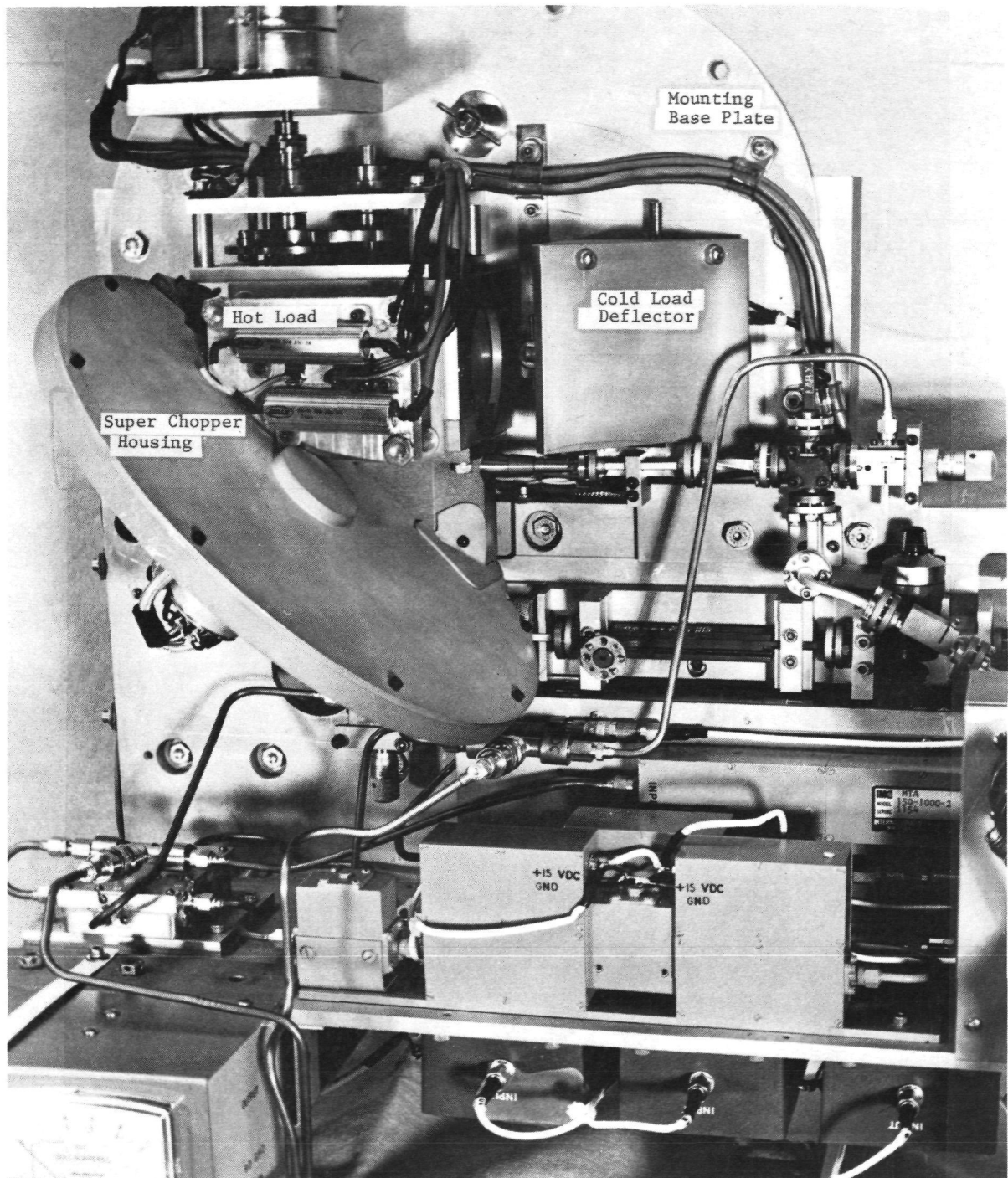

Figure 6. 94/183 GHz Radiometer (Window Mounted Components).

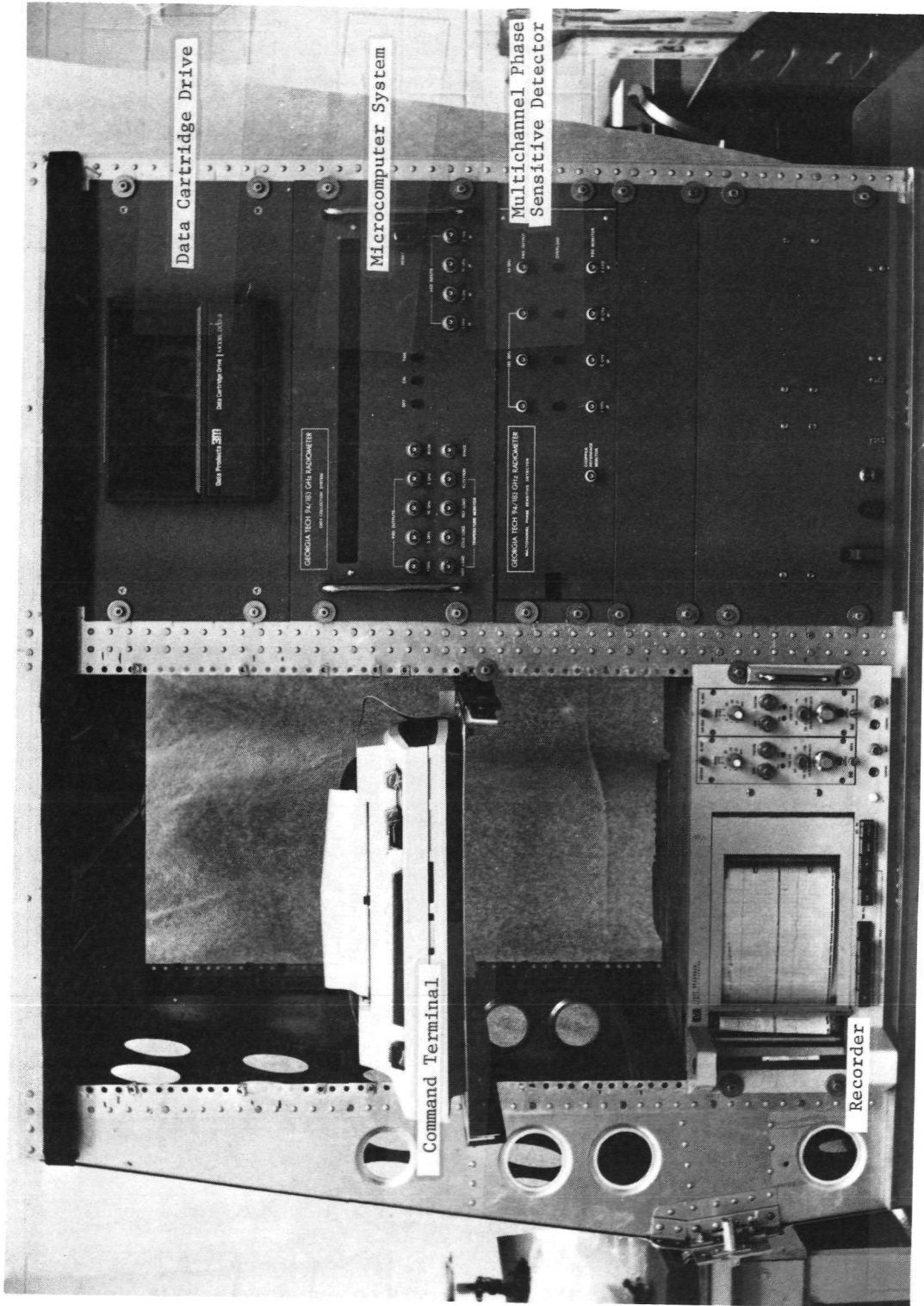

Figure 7. 94/183 GHz Radiometer (Rack Mounted Components).

2.0 RADIOMETER COMPONENTS

2.1 Front-End System

The radiometer front-end uses three 2.0 inch diameter lenses as follows: one for viewing the scene, one for viewing the hot load, and one for viewing the cold load. These lenses are of a $f/1.767$ design using a single refracting structure having a grooved anti-reflection flat surface toward the scene and a spherically curved surface toward the focus. Further details are contained in the Georgia Tech Final Technical Report A-1866, Section 2.1.

The 94 GHz and 183 GHz feed horns are corrugated conical horns having symmetric far-field patterns, small sidelobes and backlobes. Figures 8, 9, and 10 are antenna patterns for the 183 GHz feed horn and 94 GHz feed horn, respectively. The feed horns and lenses are mounted in a housing illustrated in Section 2.1 of the Final Technical Report A-1866. This housing contains the Geneva mechanism reflector used to select the scene, hot load, or cold load. The hot and cold loads are manufactured from cast lossy dielectric materials having machined grooves at the Brewster angle of the dielectric. As reported in Report A-1866, the cold load is heat sunk to the aircraft skin producing a temperature of 260°K in flight. The hot load is heated to a temperature of 340°K using two power resistors as heating elements.

Figure 11 shows the antenna mechanism with attached hot load mounted above the super chopper housing. The 183 GHz mixer shown is of split block construction with a low-pass filter structure having a roll-off near 14 GHz. A tuneable cavity provides LO injection at 183 GHz. The 94 GHz mixer shown in Figure 11 is a single-ended mixer design using a GaAs Schottky barrier diode. The LO injection diplexer is a directional filter providing low RF losses in the signal path and in the local oscillator path. Figure 12 is measured data on the insertion loss of the 94 GHz directional filter.

The microstrip triplexer is a three port device with IF outputs at 1, 5, and 8.75 GHz. It was designed to pass dc bias current through the 1 GHz port to the 183 GHz mixer diode. Figure 13 depicts the layout concept for the triplexer. The package is mounted on the front-end as shown in Figure 11.

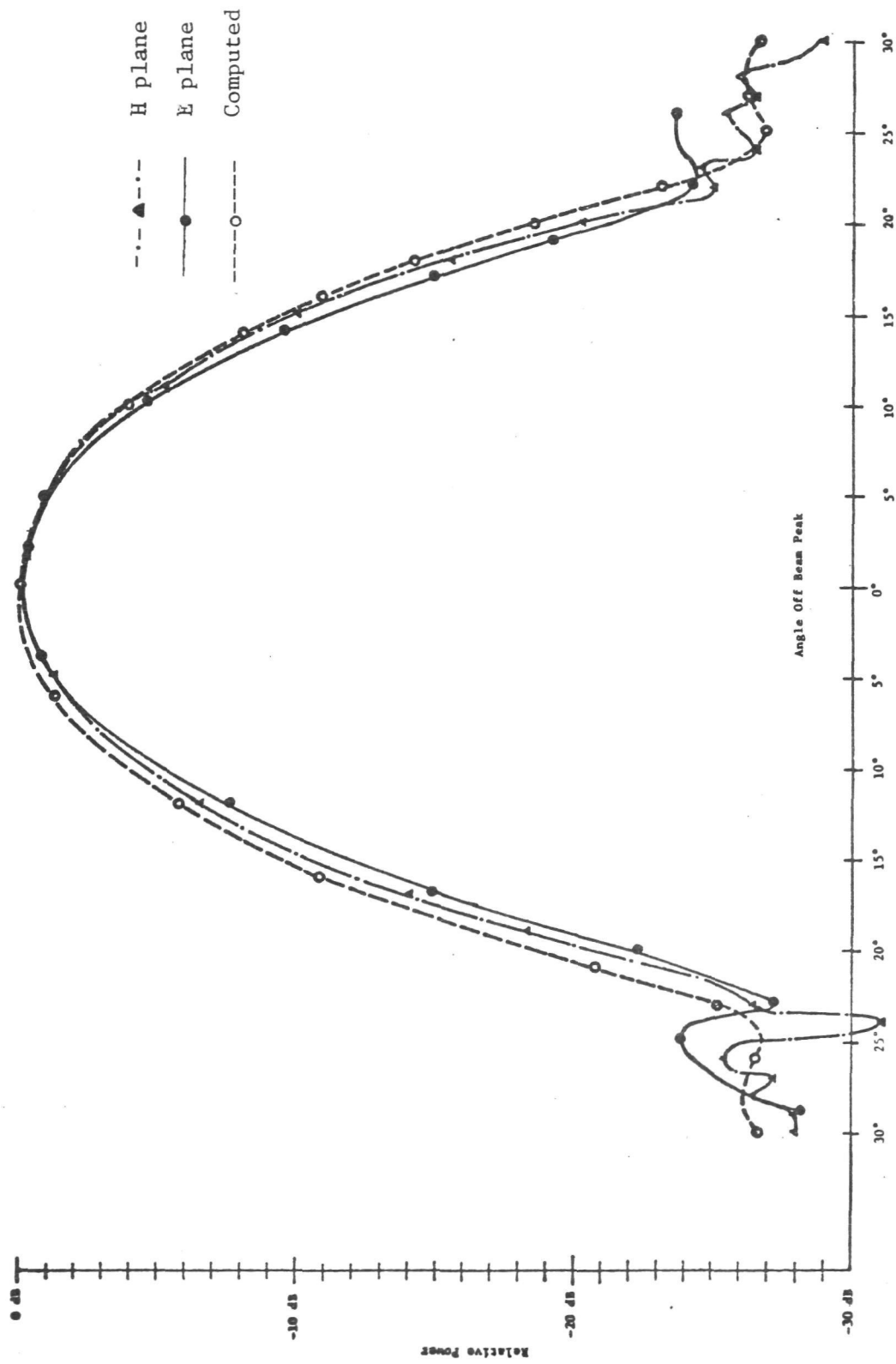

Figure 8. Measured and Calculated 180 GHz. Feed Horn Antenna Pattern.

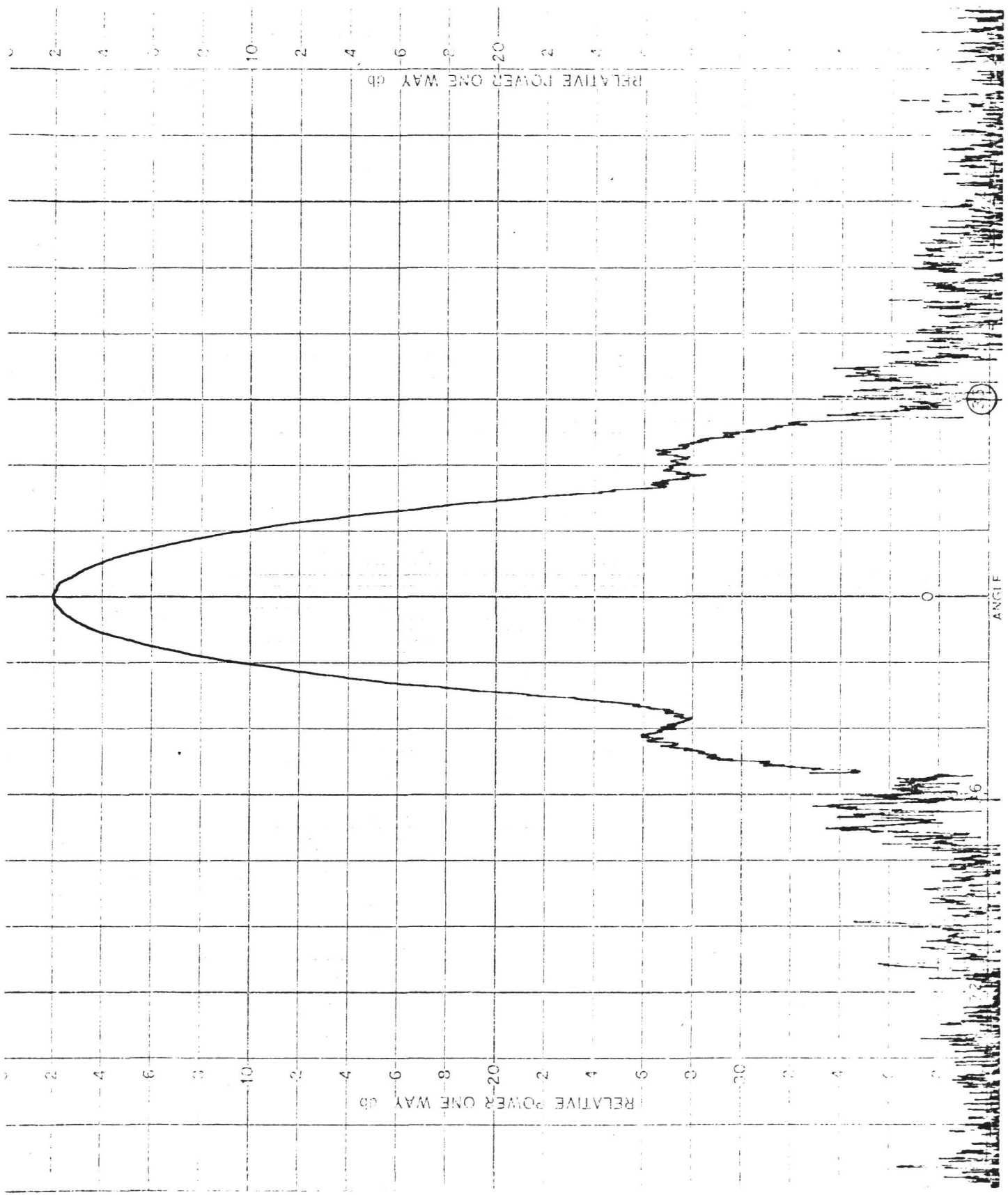

Figure 9. Corrugated Horn Pattern, E-Plane (94.5 GHz).

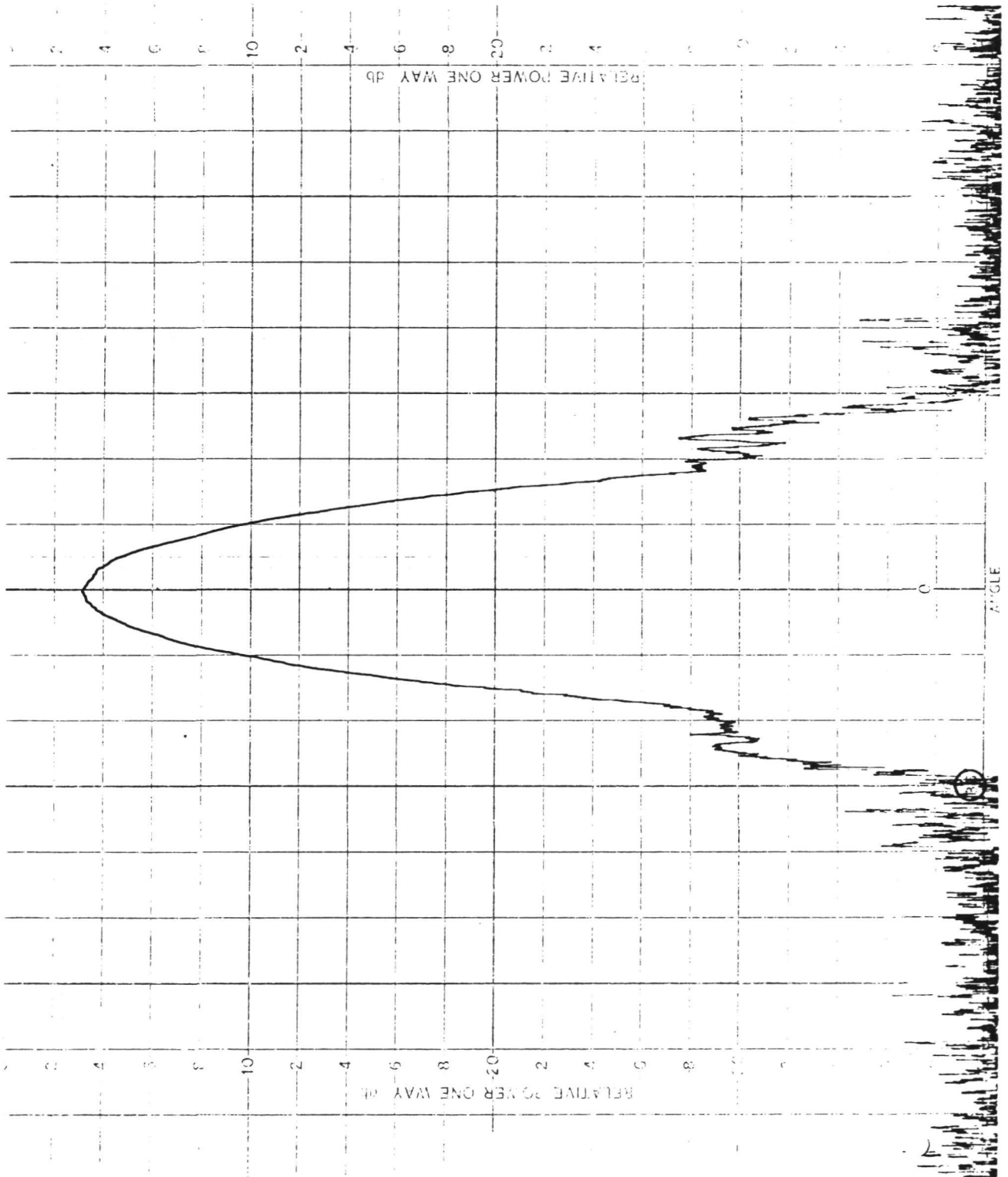

Figure 10. Corrugated Horn Pattern, H-Plane (94.5 GHz).

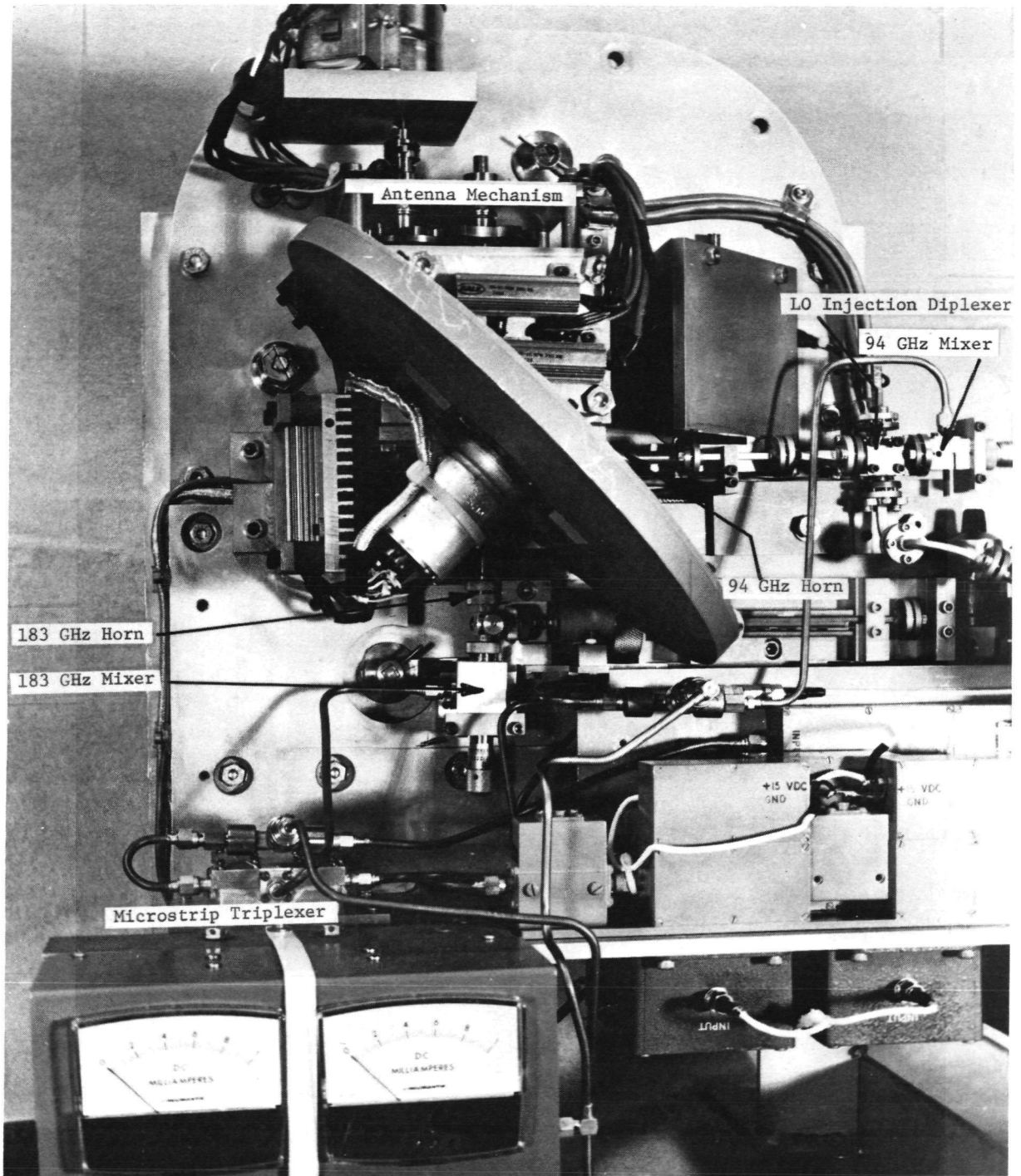

Figure 11. 94/183 GHz Radiometer (Showing Major Components).

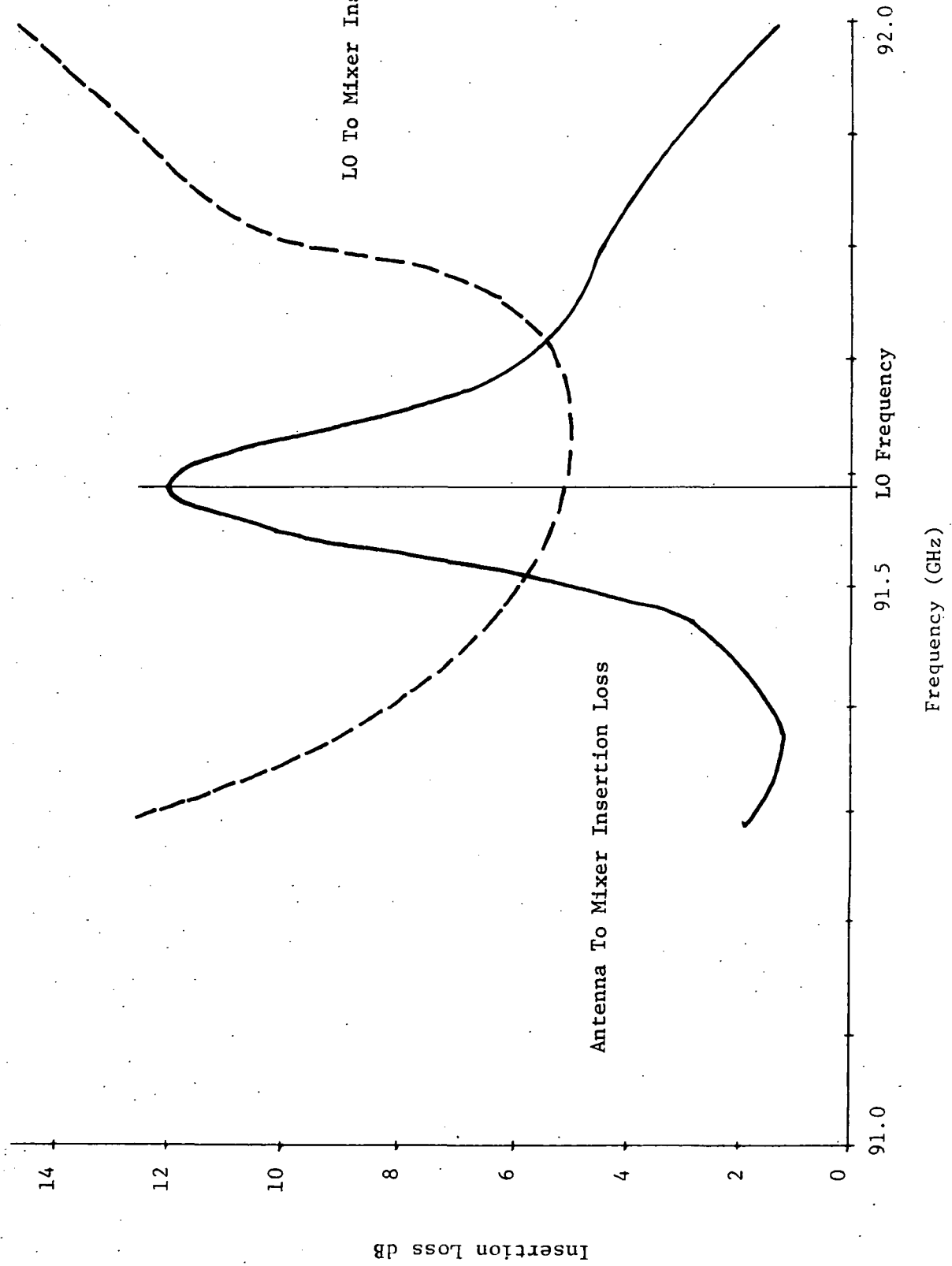

Figure 12. Insertion Loss Measured From LO to Mixer (Dotted Line) and Mixer to Antenna (Solid Line) of 91.65 GHz Directional Filter. Less than 0.5 dB loss at signal sidebands of 88.8 to 89.8 GHz and 93.5 to 94.5 GHz.

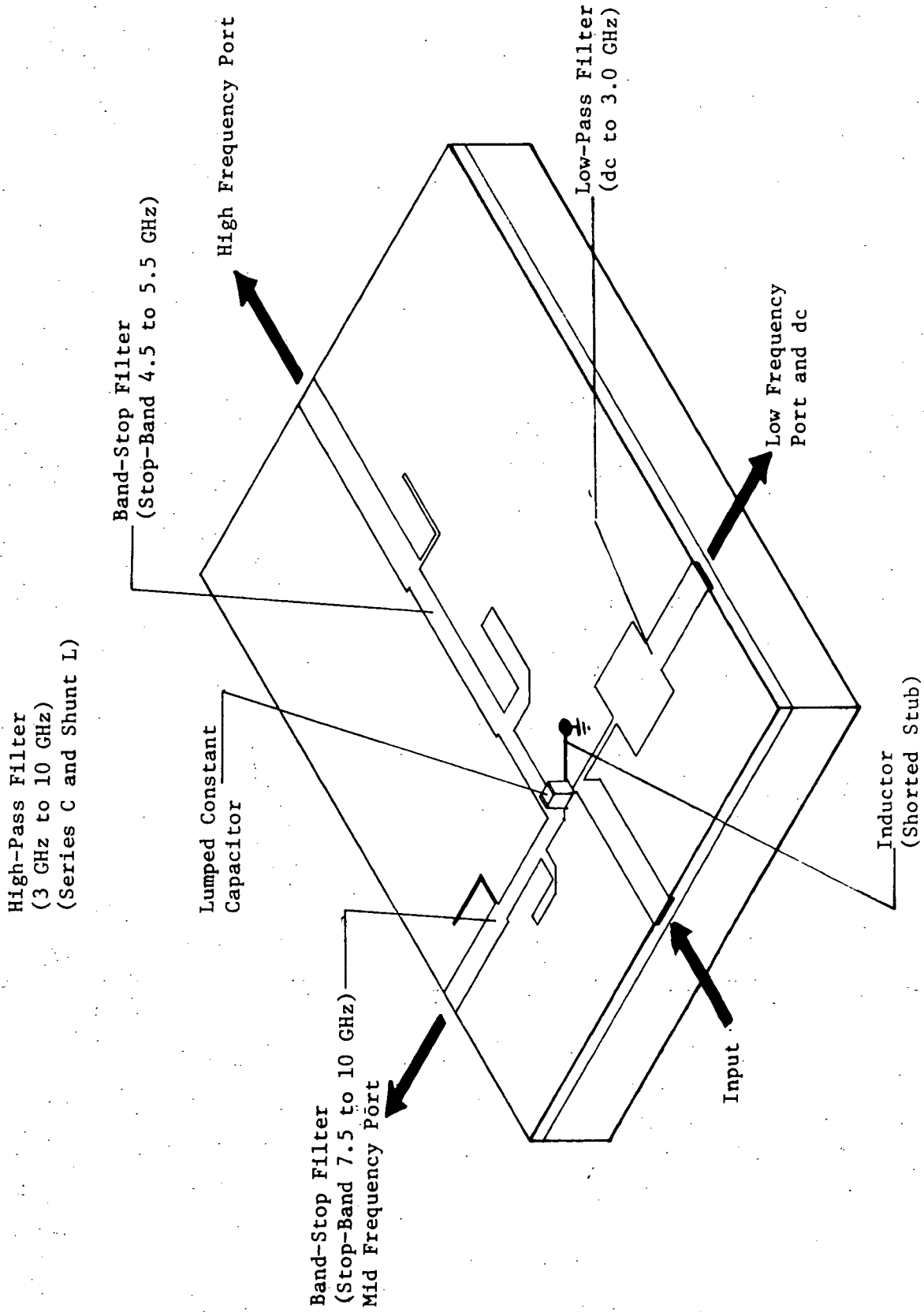

Figure 13. Microstrip Triplexer (With dc Port).

Four IF amplifiers were used to produce channels at 1, 5, and 8.75 GHz removed from the RF frequency of 183 GHz and at 2 GHz removed from the RF frequency of 94 GHz. The microstrip triplexer couples the 183 GHz mixer to the 1, 5, and 8.75 GHz IF amplifiers. Bandpass filters follow the outputs of the 1 and 5 GHz amplifiers. A cavity filter follows the 8.75 GHz IF amplifier's output. The 2 GHz IF amplifier is preceded and followed by separate bandpass filters. The purpose of the filters is to provide the desired frequency response for each channel. Figures 14 through 17 are measured gain versus frequency plots for all four IF channels.

A tunnel diode detector at each filtered IF amplifier's output is used to detect the chopped noise signal from the scene. Since the maximum change in the detector's output is in the order of millivolts, a video amplifier with high gain and low noise characteristics is required prior to synchronous detection. The video amplifier will boost the signal to the nominal 0 to 10 volt range. Figure 18 is a plot of the video amplifier's gain versus frequency.

2.2 Interface System

The front-end of the radiometer is interconnected to the rack-mounted data processor with the interface system. The interface system consists of the following: linear thermistor amplifiers, chopper reference signal generator, Geneva mechanism logic circuit, and ac/dc power supplies.

The thermistor amplifiers convert the resistance of thermo-linear thermistors mounted on the hot load, cold load, reference load, and klystron into a dc voltage proportional to the temperature of the load being measured. The chopper reference is a TTL signal output operating at approximately 200 Hz frequency. The chopper itself has an upper limit of 600 Hz. This signal is an input to the phase sensitive detectors to be described later. The Geneva mechanism circuit accepts a start command from the data processor and sends the 115 Vac signal used to energize the motor driving the calibration reflector.

--- Without Filter
— With Filter

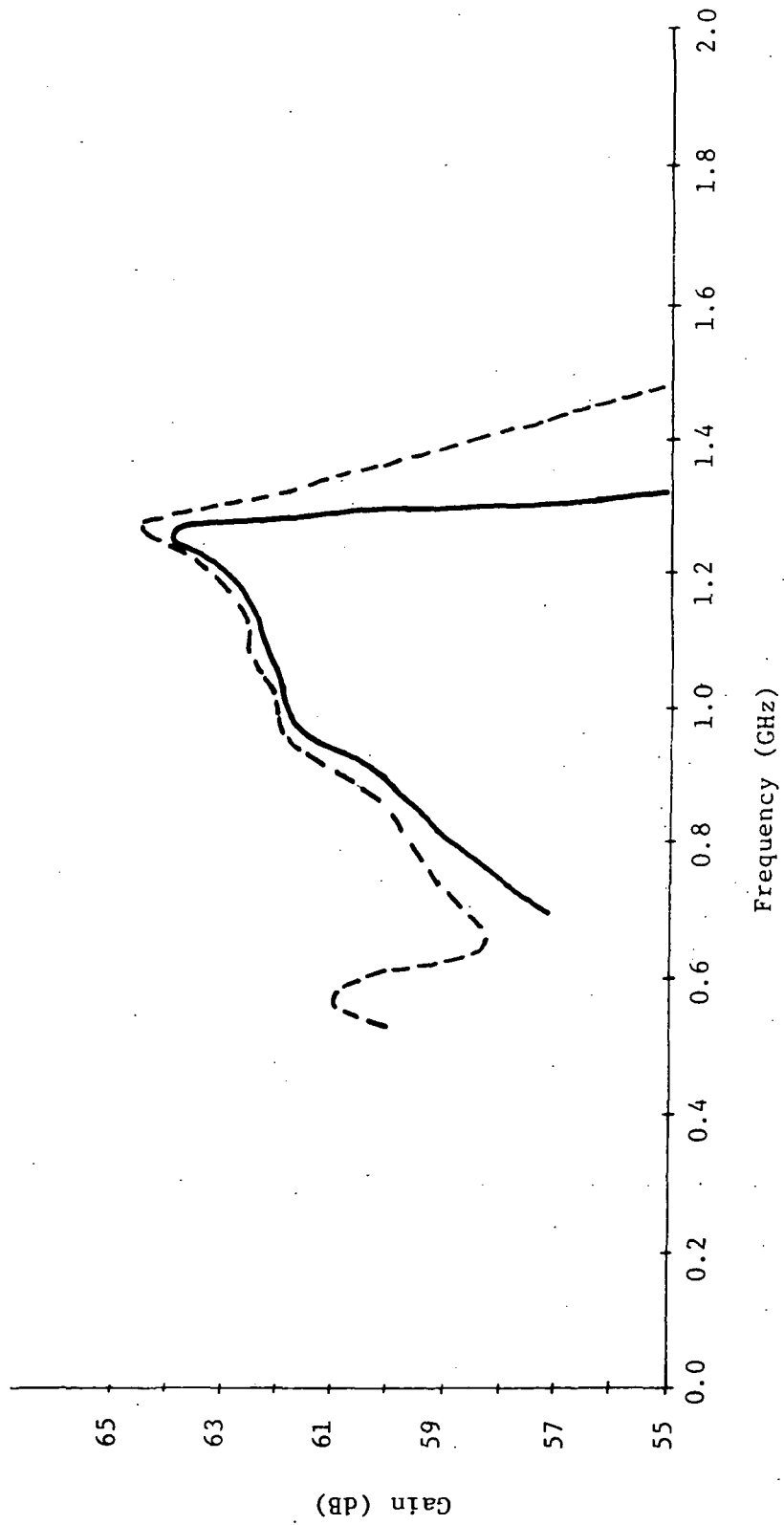

Figure 14. Measured Gain Versus Frequency of 1 GHz IF Amplifier.

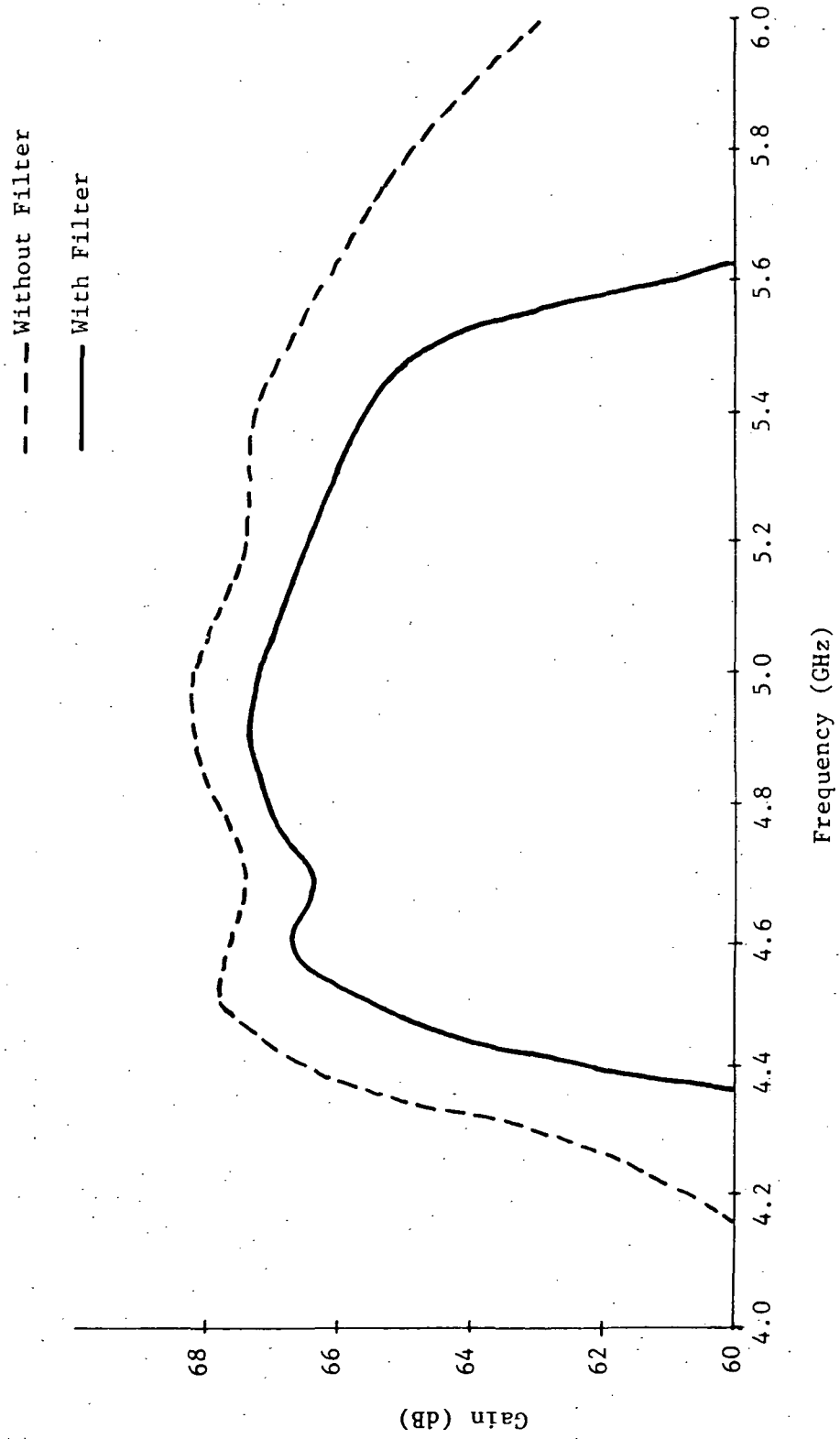

Figure 15. Measured Frequency Response of 5 GHz IF Amplifier.

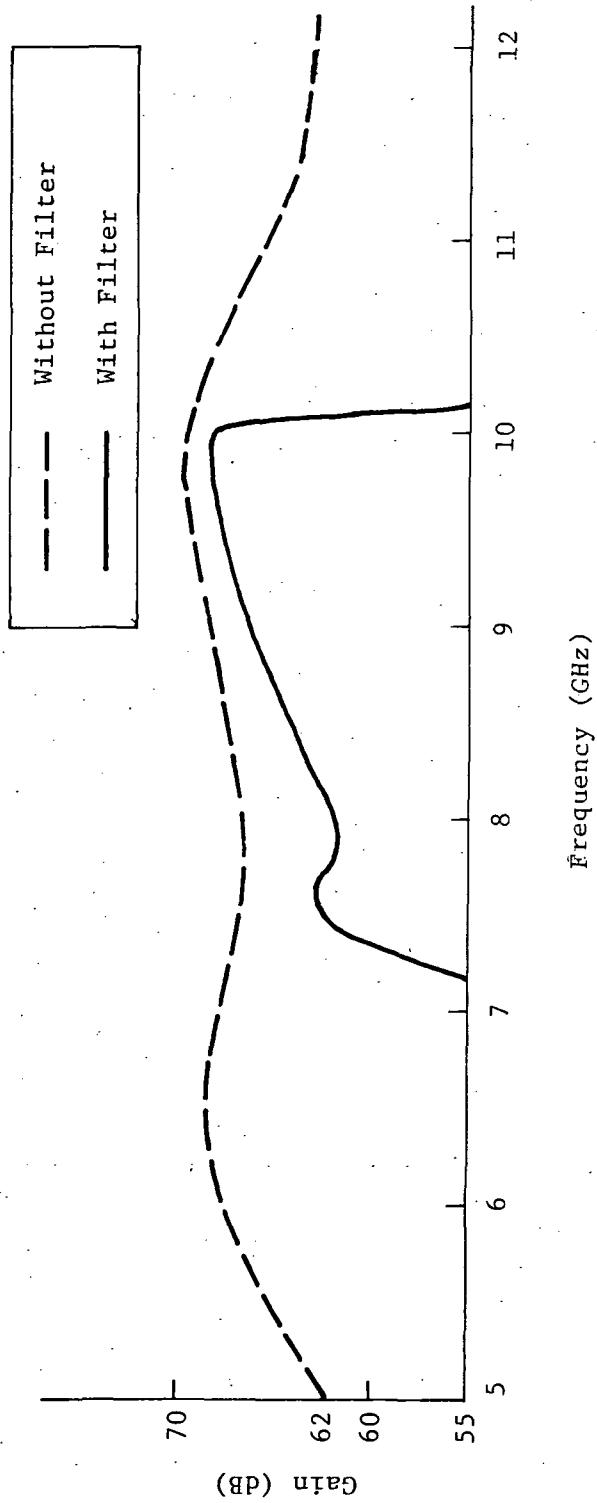

Figure 16. Measured Gain versus Frequency of 10 GHz IF Amplifier (183 GHz Channel).

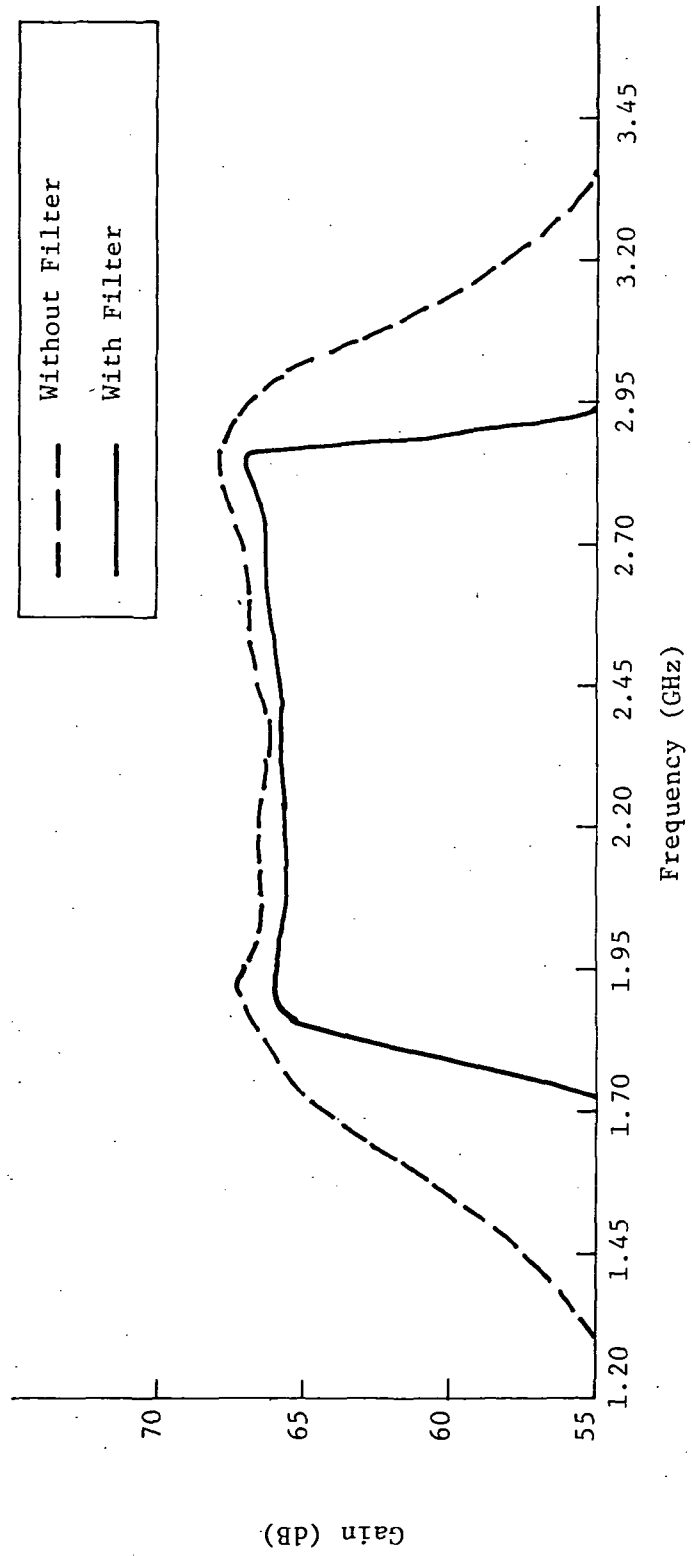

Figure 17. Measured Gain versus Frequency of 2.3 GHz IF Amplifier (94 GHz Channel).

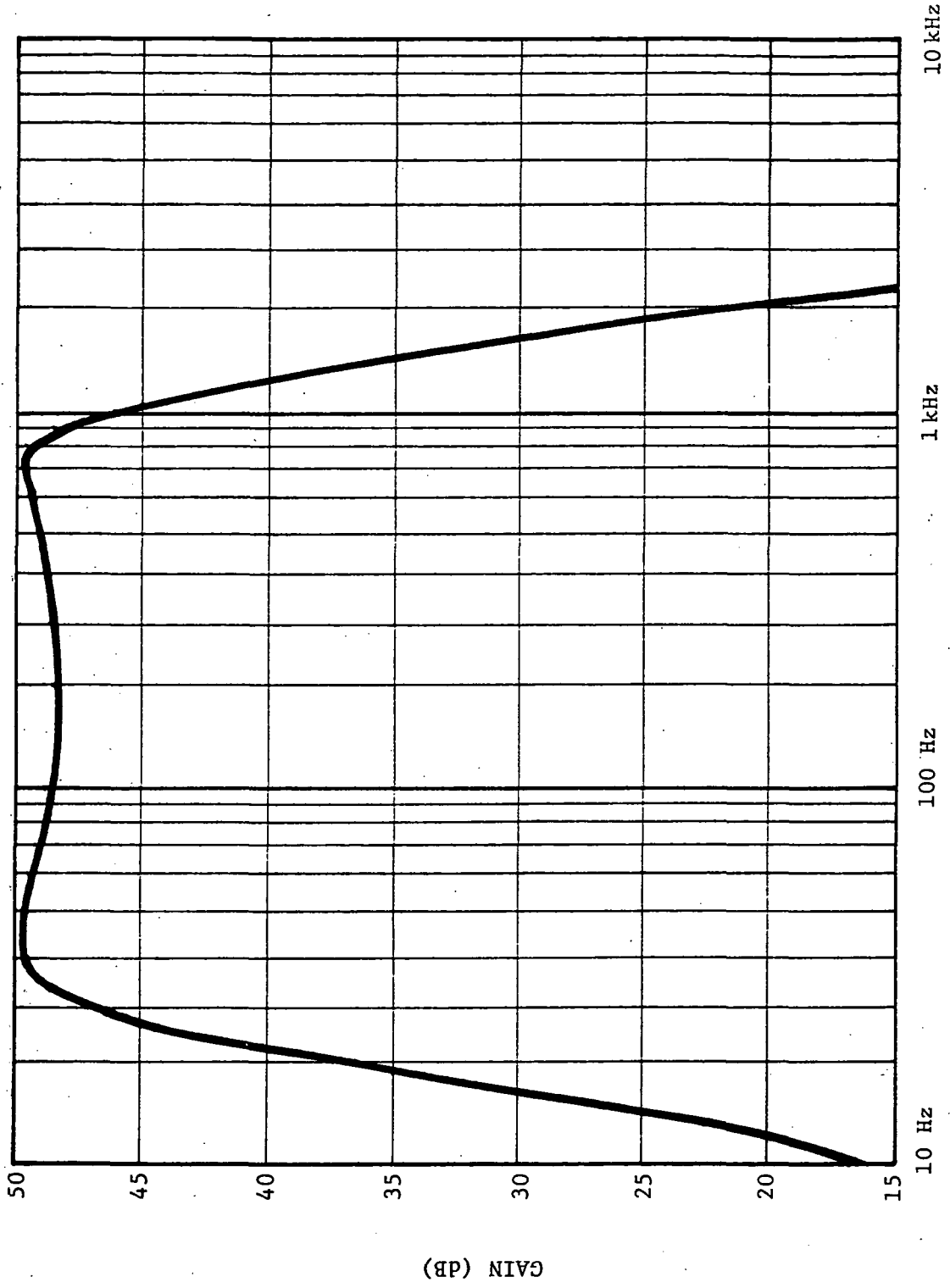

Figure 18. Video Amplifier Frequency Response.

Power supplies generate the necessary dc voltages required by the IF amplifiers (+ 15, and + 12 Vdc), the video amplifiers (+ 15 Vdc), and the super chopper motor (+ 24 Vdc). Figure 19 is a photograph of the interconnect box containing the interface electronics and power supplies. This system was installed in the low-boy rack beneath the window mounted radiometer front-end.

2.3 Data Processing System

The data processing system (see Section 1.0, Figure 7) collects data during flight and stores data for future analysis if desired. The outputs from the video amplifiers described in Section 2.1 are fed to the four channel phase sensitive detector panel. Each phase sensitive channel consists of Evans Instruments Models 4110 and 4114 phase sensitive detector and phase control unit, respectively. The Model 4110 consists of a variable gain ac amplifier, bandpass filter, multiplier, integrator, and low gain dc amplifier stage. The bandpass filter center frequency is 200 Hz, i.e. chopping frequency. The integration time constant is 250 msec as derived later on in this section. The chopper reference from the interconnect box drives the Model 4114 phase control unit. The Model 4114 output is a square wave shifted in phase up to 180°. This reference signal is multiplied with the radiometer signal in the Model 4110 phase sensitive detector. The output of the Model 4110 is a dc voltage which is proportional to the scene temperature.

A multichannel A/D converter is used to sample the sources of data, such as the outputs of the phase sensitive detectors. The microcomputer is used to record the data from the A/D converter. There are nine primary sources of data that are recorded from the radiometer. These are the four phase sensitive detector outputs which correspond to brightness temperatures in the three 183 GHz and one 94 GHz channels and five temperature sensor outputs. In addition, several housekeeping parameters such as time, date and flight number are recorded periodically for identification of data. Table 1 summarizes all data sources, their size in bits and how often they are recorded.

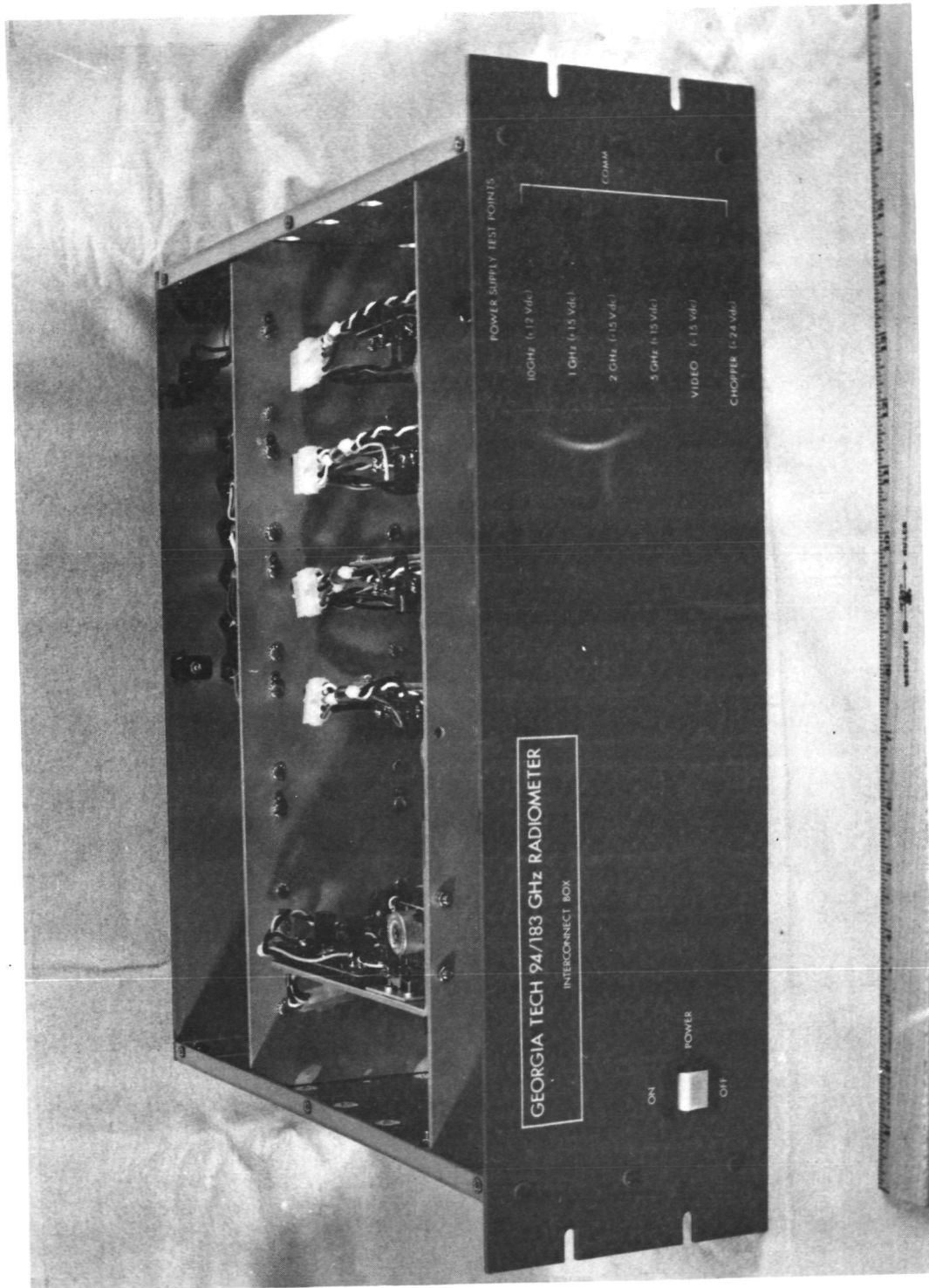

Figure 19. 94/183 GHz Radiometer Interface Electronics Package.

TABLE I

94/183 GHz CONVAIR 990 RADIOMETER DATA SOURCES

DATA SOURCE	DESIGNATION	SIZE (BITS)	RECORDING INTERVAL
<u>PSD OUTPUTS:</u>			
183 GHz Channel 1	PSD1	12	$\tau/2$
183 GHz Channel 2	PSD2	12	$\tau/2$
183 GHz Channel 3	PSD3	12	$\tau/2$
94 GHz	PSD4	12	$\tau/2$
<u>TEMPERATURES:</u>			
Hot Load	HTLD	12	1 per Frame
Cold Load	COLD	12	1 per Frame
Reference Load	RFLD	12	1 per Frame
Klystron	KLYS	12	1 per Frame
Spare	SPRE	12	1 per Frame
<u>HOUSEKEEPING DATA:</u>			
Radiometer Input Source	FTYP	8	1 per Frame
(Hot Load, Sky, etc)	TIME	24	1 per Frame
Time (GMT)	DATE	24	1 per Frame
Date (GMT)	FLNO	8	1 per Frame
Flight No.			

The four primary data sources are obviously the four radiometer outputs, PSD1-PSD4, which are outputs from the four phase sensitive detectors (PSD) and correspond directly to brightness temperatures. In order to satisfy the Nyquist-rate sampling, these outputs should be sampled at least once every $\tau/2$ seconds where τ is the integration time of the phase sensitive detector. τ is chosen to yield an acceptable ΔT_{\min} within the constraints of the relative "speed" of the observed phenomenon. Even if τ is shorter than the integration time required for the desired ΔT_{\min} , post flight integration with a longer τ is possible if the data are sampled and recorded at $\leq \tau/2$. There are some transient phenomenon associated with cloud layers close to the aircraft that produce radiometer signatures at 183 GHz of less than one second. In addition, the 94 GHz channel was viewing the ground where relatively rapid temperature variations were observed from altitudes up to 30,000 feet. Some ground temperature variations were also noted at 183 GHz.

It is desirable to use as short an integration time as possible consistent with a practical recording capacity from the cartridge tape recorder. The load temperature and housekeeping data are relatively slow changing data and were not recorded as often as the radiometer data. Since the ASCII cartridge tape standard specifies a maximum record length of 2048 bytes*, it was convenient to record the load temperature and housekeeping data once per record. Thus, each tape record has 108 bits or roughly 14 bytes of "overhead" leaving 2030 bytes for data. Each tape cartridge has a capacity of 2.8 megabytes. After allowing for starting and stopping delays and inter-record gaps (IRG) 1200 blocks were recorded on a cartridge. Thus approximately 2.436 megabytes were available for recording the four radiometer channels on each cartridge. Since each radiometer data word is 12 bits (see Table 1) 48 bits or 6 bytes are required for all four channels. Since it was

*It is desirable to use the longest record possible since this makes more efficient use of tape by minimizing the number of the starts and stops required.

desired to limit the data recorded to one flight per cartridge and the longest flight did not exceed 7 hours, a recording (data collecting) rate of 16 samples per second suffices. This corresponds to sampling all four channels every 62 ms. Therefore, per Nyquist-rate criteria, $\tau \geq 124$ ms for the integration time. For all Convair Flights the phase sensitive detector integration time (τ) was 250 ms.

Operation of the microcomputer is controlled from the computer terminal mounted in the aircraft rack. Table 2 is a summary of the operating system commands to the terminal. Appendix A is a listing of the microcomputer operating system software. Appendix B includes electronic schematics of the Data Processing System.

2.4 Packaging Concept

Refer to Final Report A-1866, Section 2.7, in regard to the packaging and mounting of the front-end radiometer to the aircraft window. Drawing No. 1 of Final Report A-1866 shows the heavy aluminum window plate with the radiometer components mounted. Appendix C includes the mechanical drawings of all new parts fabricated at Georgia Tech for the radiometer.

Refer to Appendix C of Final Report A-1866 for the radiometer sub-assemblies carried over to the 94/183 GHz radiometer.

TABLE 2

COMPUTER TERMINAL COMMANDS

<u>TYPED COMMAND</u>	<u>OPERATION</u>
Load	Sets new tape at load point prior to data run
Unload	Resets old tape to load point prior to tape removal
Stop	Stops tape immediately
Forward	Tape advances at normal rate
Fastfor	Tape advances at faster rate
Reverse	Tape reverses at normal rate
Rewind	Tape reverses at faster rate
Read	Reads tape contents onto system memory
Write	Writes system memory contents onto tape
Track	Sets the track number (four per tape)
Data On	Starts data collection on tape
Data Off	Stops data collection on tape
Out	Switches radiometer to viewing outside (scene)
Hot	Switches radiometer to viewing hot load
Cold	Switches radiometer to viewing cold load
Calibrate	Perform manual calibration between hot and cold load
Status	Terminal prints out status of radiometer system
Set Cal	Select calibration interval in minutes (01 to 99)
Print Cal	Terminal prints out gain and offset for each channel
Disp Hot	Display hot load temperature(°K) on computer display
Disp Cold	" cold " " " " "
Disp Ref	" reference " " " " "
Disp Klys	" Klystron " " " "
Disp 183	" 1,5, & 10 GHz " " " "
Disp 94	" 2 GHz " " " "
Avg 183	Display averaged (10 samples/sec) 1,5 & 10 GHz temperatures(°)
Avg 94	Display averaged (10 samples/sec) 2 GHz temperatures(°)
Print Volts	Terminal prints out analog-to-digital converter inputs i.e., 1 GHz, 5 GHz, 10 GHz, 2 GHz, Hot Load, Cold Load, Ref Load, Klystron, Spare Thermister
Time	Display time of day, last date block stored, time remaining to next calibration, and data collection status
Set Time	Sets time of day, flight number, and day of year
View	Terminal prints out radiometer viewing port i.e., outside, cold load, or hot load
Init	Display "Ga Tech Radiometer"
Tape	Display tape drive status i.e., track and block number
Print L	Terminal prints out in °K the hot load, cold load, Ref load, klystron, and spare thermistor load
Print R	Terminal prints out in °K the 1 GHz, 5 GHz, 10 GHz, and 2 GHz radiometer temperatures.

3.0 OPERATION OF THE RADIOMETER

Initial warm-up and system check-out occurred prior to takeoff before each Convair flight. This included turning on the klystron power supply and the chopper motor power supply for stabilization. A tape cartridge was installed in the recorder in preparation for data collection. After takeoff, the operator used the computer terminal to start the data collection process. Figure 20 shows a typical terminal command and response operation for setting the time of day. The terminal responds with: Ga. Tech Millimeter Radiometer, link to GSFC status, flight number (00), day (0000), and time (00:00:00). In order to set the flight number, day, and time, the operator types "set time" as shown. The terminal responds by asking the question "flight number?". The operator responded with "01" for that particular flight. Similarly "0179" was entered for the day and 210225 for the time in hours, minutes, and seconds. By typing "Time" the data display panel verifies that the time of day was entered as shown. The radiometer can be calibrated either manually or automatically. By typing "Calibrate", the computer terminal responds as shown. Calibration data includes the gain and offset for each radiometer channel. In order to calibrate automatically, the operator selects a calibration interval (in one minute increments). Usually the calibration cycle was set for two minutes minimum to five minutes maximum. In addition the radiometer stores data on the tape cartridge recorder if the command "Data On" is entered.

Figure 21 demonstrates the "System Status" feature of the data collection system. Features include Data Collection (Ga. Tech tape recorder) On or Off, link to GSFC (Goddard Interdata Computer) On or Off, and Ga. Tech recorder tape drive status. Load temperatures ($^{\circ}$ K) and radiometer temperatures ($^{\circ}$ K) are provided. For this status printout the radiometer is viewing the ground, i.e. 45° downward from a level flight position of the aircraft. By typing "Data ON", the system responds as shown providing the time (22:02:28) at which the radiometer begins storing flight data. One block of data is stored every 25

GA. TECH MILLIMETER RADIOMETER
CONVAIR 990 VER. 2.0

?LINK TO GSFC ON

FLIGHT NO. 00 DAY 0 0000 TIME 00:00:00

SET TIME

FLIGHT NO. ?

?01

DAY ?

?0179

TIME ?

?210225

?TIME

?CALIBRATE

FLIGHT NO. 01 DAY 0179 TIME 21:03:14

HOT LOAD - COLD LOAD =037.96

CALIBRATION DATA

	GAIN (DEG/VOLT)	OFFSET (DEG)
183/1 GHZ	040.83	-010.22
183/5 GHZ	043.86	-041.99
183/10 GHZ	060.29	-176.02
94 GHZ	063.06	-196.44

Figure 20. Command Sequence for Setting Time of Day and Manual Calibration.

?

GA. TECH MILLIMETER RADIOMETER
SYSTEM STATUS

FLIGHT NO. 01 DAY 0179 TIME 22:02:00
DATA COLLECTION OFF
LINK TO GSFC OFF
TAPE DRIVE STATUS: TRACK 00 BLOCK 0036

HOT LOAD TEMP	COLD LOAD TEMP	REF. LOAD TEMP	KLYSTRON TEMP
337.55	271.94	300.66	309.95

RADIOMETER TEMPERATURES

183/1 GHZ	183/5 GHZ	183/10 GHZ	94 GHZ
269.37	273.71	277.37	200.23

RADIOMETER IS VIEWING GROUND

DATA ON

DATA COLLECTION ON

FLIGHT NO. 01 DAY 0179 TIME 22:02:28

?DISP 94

Figure 21. Radiometer System Status Printout.

seconds and immediately transferred to Goddard's Interdata Computer. For the hurricane and SEASAT-A underflight programs, three IF channels at 183 GHz and one IF channel at 94 GHz were transferred to Goddard every 25 seconds. For the Nimbus-G underflight program, only the 94 GHz channel was transferred to Goddard every 100 seconds.

In addition to the radiometer's own data storage system, NASA Ames and NASA Goddard recorded data from the Georgia Tech Radiometer. The NASA Ames Airborne Digital Data Acquisition System (ADDAS) continuously monitored the following analog voltages from the radiometer and recorded them on magnetic tape at 0.1 second intervals:

GT0: Output voltage from PSD which is proportional to scene temperature at 1 GHz IF channel

GT1: Same as GT0 for 5 GHz IF channel

GT2: Same as GT0 for 10 GHz IF channel

GT3: Same as GT0 for 2 GHz IF channel

and at 1.0 second intervals:

HL: Output voltage from linear thermistor amplifier which is proportional to hot load temperature

CL: Same as HL for cold load temperature

RL: Same as HL for reference load temperature

KL: Same as HL for klystron tube temperature

SL: Same as HL for spare

GT0-GT3 were displayed, in degrees Kelvin, on the CRT located above the instrument rack. ADDAS also monitored an "automatic calibrate" digital signal used to update the gain (deg/volt) and offset (deg) constants shown in Figure 20. This provided accurate data required for the plots shown in Section 4.2 and 4.3, SEASAT-A and Nimbus-G satellites underflight programs.

4.0 FLIGHT EXPERIMENTS

4.1 Hurricane Cora Penetration Flight

The attached plots were made by the NASA-Ames Airborne Digital Data Acquisition System (ADDAS) from data taken with the Georgia Tech 94/183 GHz radiometer onboard the NASA Convair 990 aircraft while deployed to Hurricane Cora. Preliminary data from the first hurricane penetration have indicated that the 94 GHz channel is capable of detecting rainfall. Figure 22 is representative of the phenomenon detected when the Convair flew over an area of heavy rainfall and is due to the colder cosmic background sky temperature scattered by the rain drops.

The data plotted in this figure are from top to bottom: 183 GHz (1 GHz IF), 183 GHz (5 GHz IF), 183 GHz (8.75 GHz IF), 94 GHz, pressure altitude, and IR surface temperature. The triangular peaks at 3 minute intervals are portions of the radiometer's automatic calibration cycle. The scales for the brightness temperatures are in degrees Kelvin but are not absolute.

The event at 16:51 UT shows the passage of the plane over a rain cell that was also detected by weather radar and Goddard's Electronically Scanned Microwave Radiometer (ESMR). The temperature drop was the greatest at 94 GHz and slightly less in the 183 GHz channels as would be expected due to the differing atmospheric attenuations. Similar events are shown in Figure 23 at 18:27 UT and at 18:38 UT in Figure 24. Figures 25 and 26 show effects from multiple rain cells and passage from overcast to clear areas.

A spiral descent profile is shown in Figure 27. RFI from ground radar caused the noise in the 10 GHz data. This plot was sampled at a 2 second rate and thus shows the calibration cycles better.

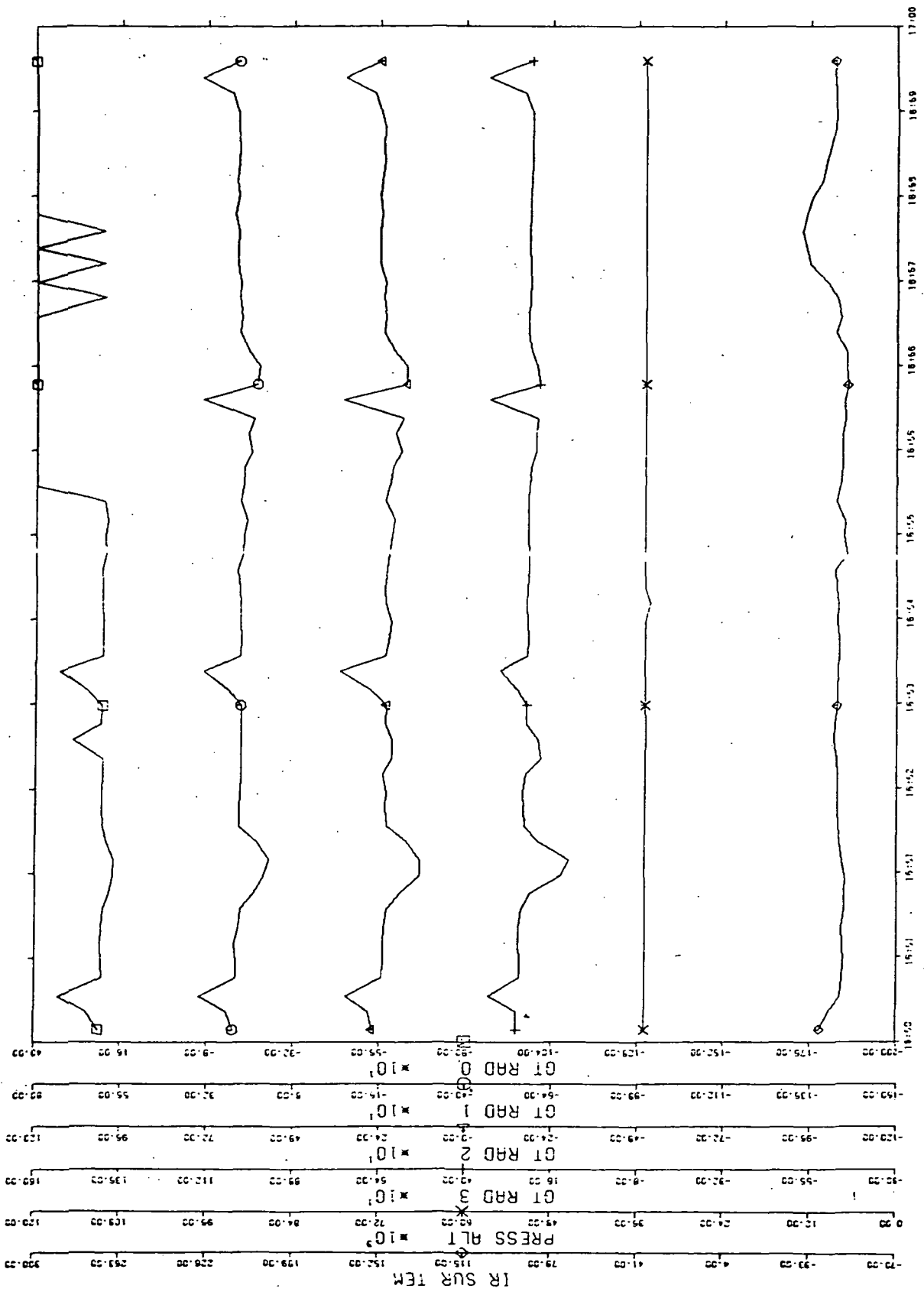

Figure 22. Time UT SMHP '78 Flight 7 - Cora: Convair Over Raincell Area and 94/183 GHz Radiometer Looking Down.

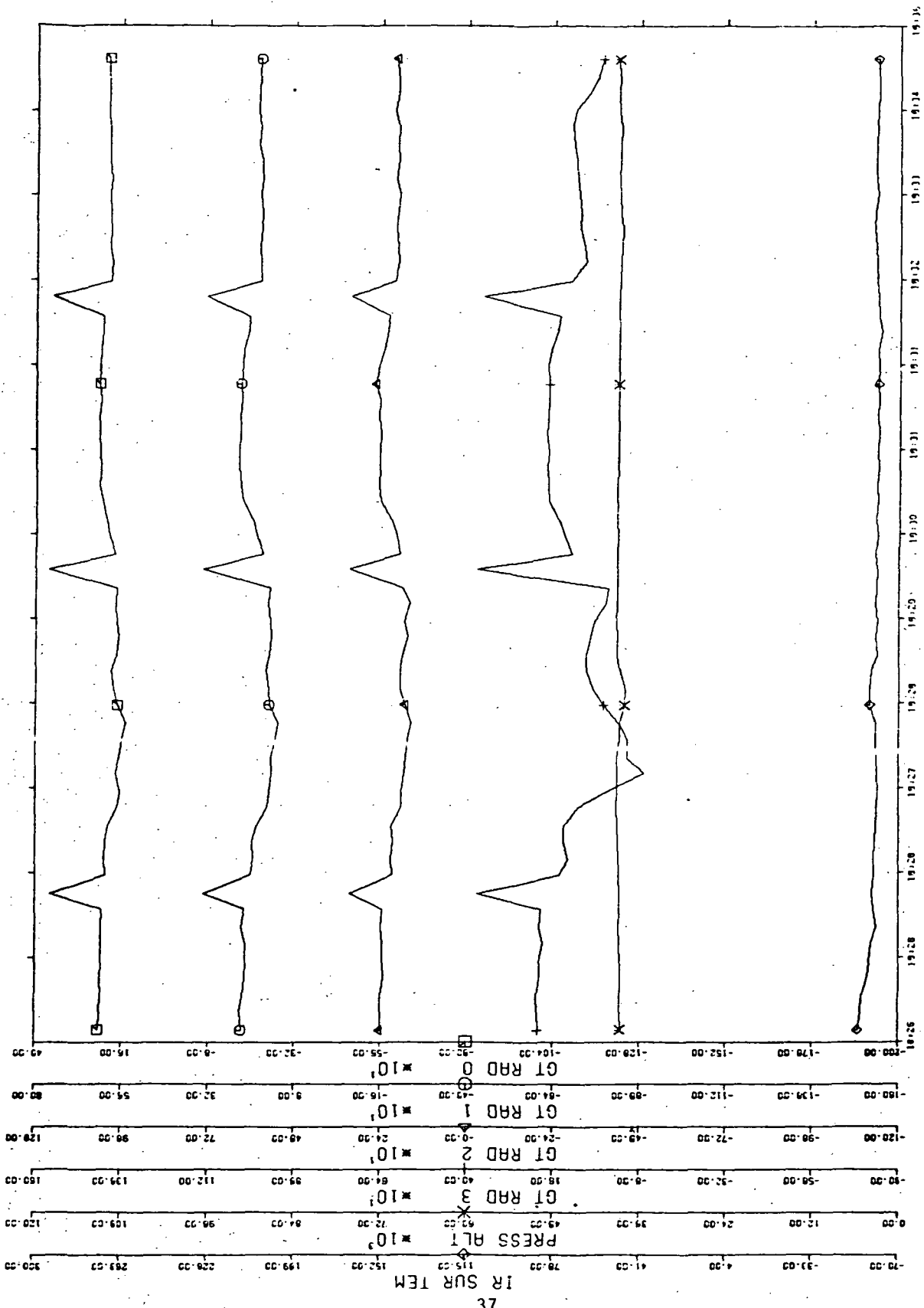

Figure 23. Time UT SMHP '78 Flight 7 - Cora: Raincell detected at 18:27 UT.

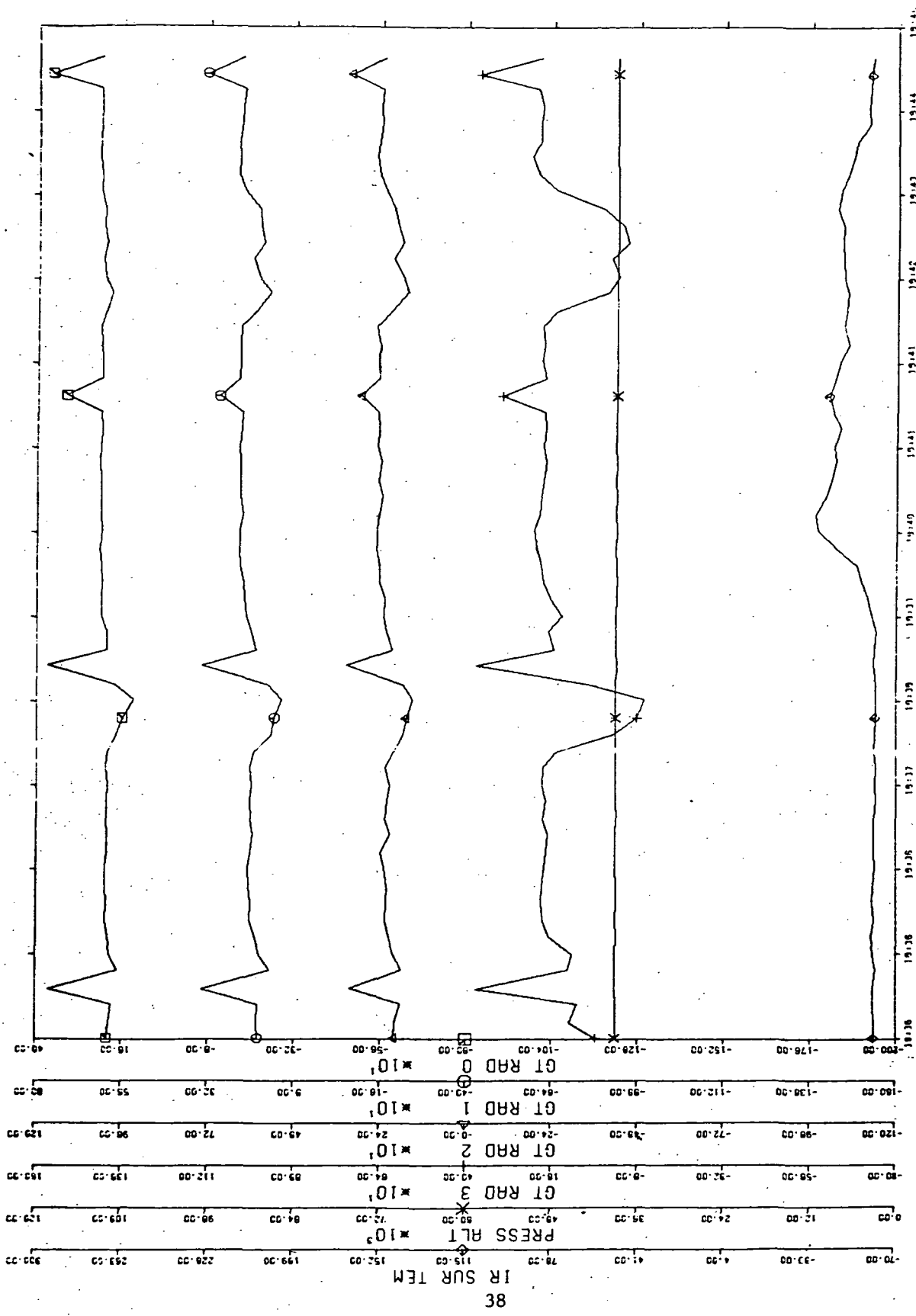

Figure 24. Time UT SMHP '78 Flight 7 - Cora: Raincell detected at 18:38 UT.

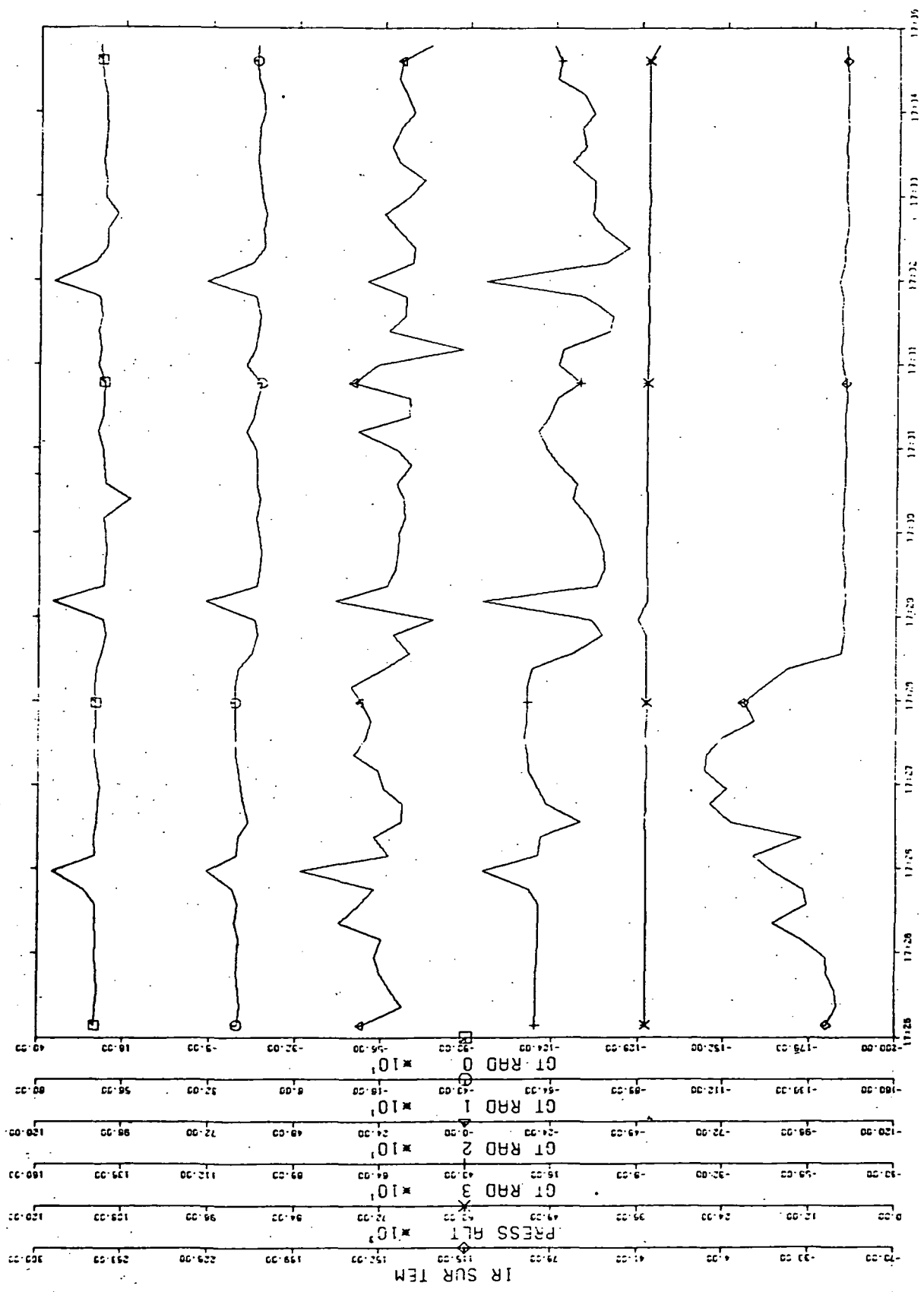

Figure 25. Time UT SMHP '78 Flight - Cora: Multiple Raincells measured as Convair Flies Through Overcast Region.

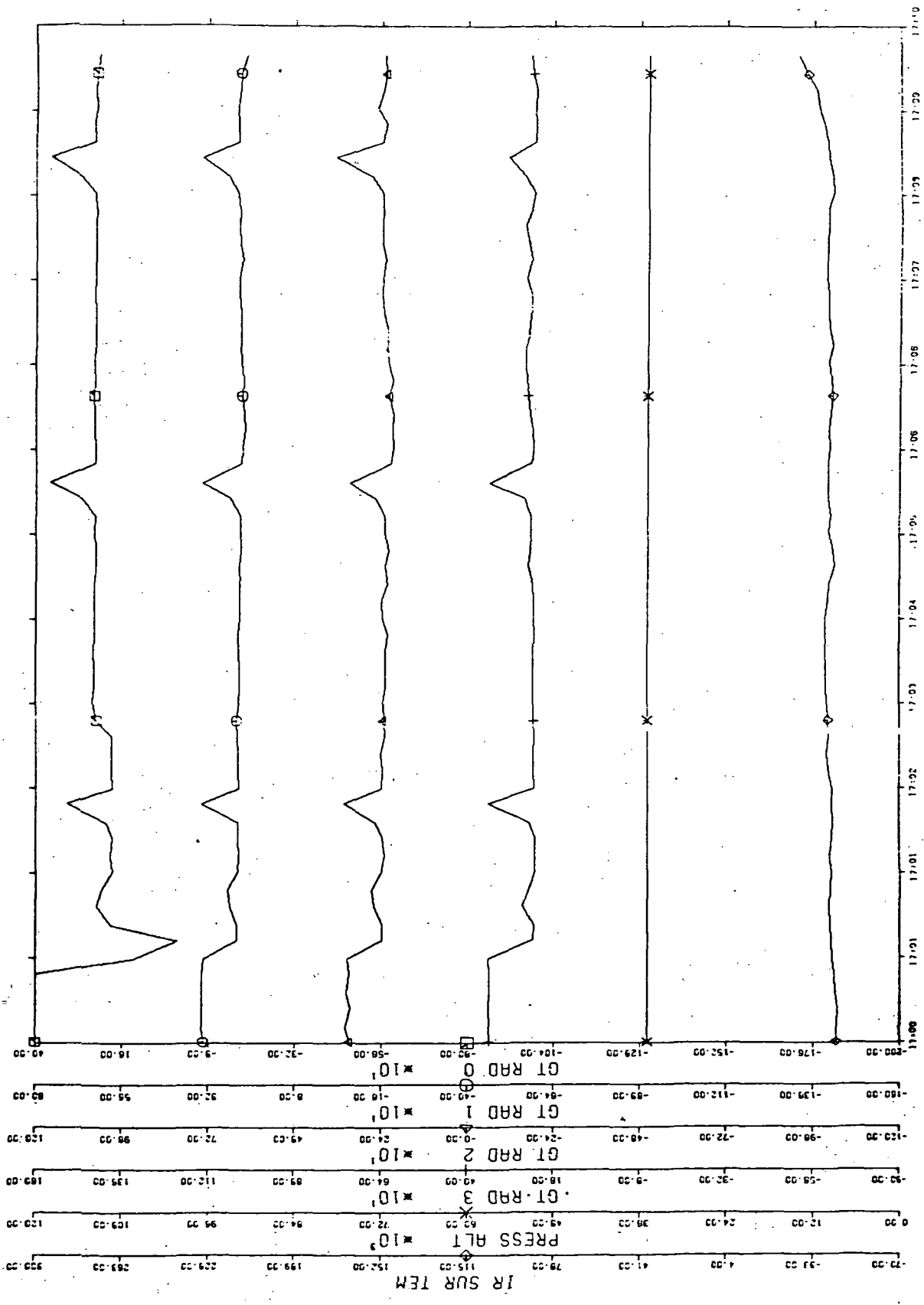

Figure 26. Time UT SMHP '78 Flight - Cora: Temperature Drop In All Four Radiometer Channels at 17:01 UT.

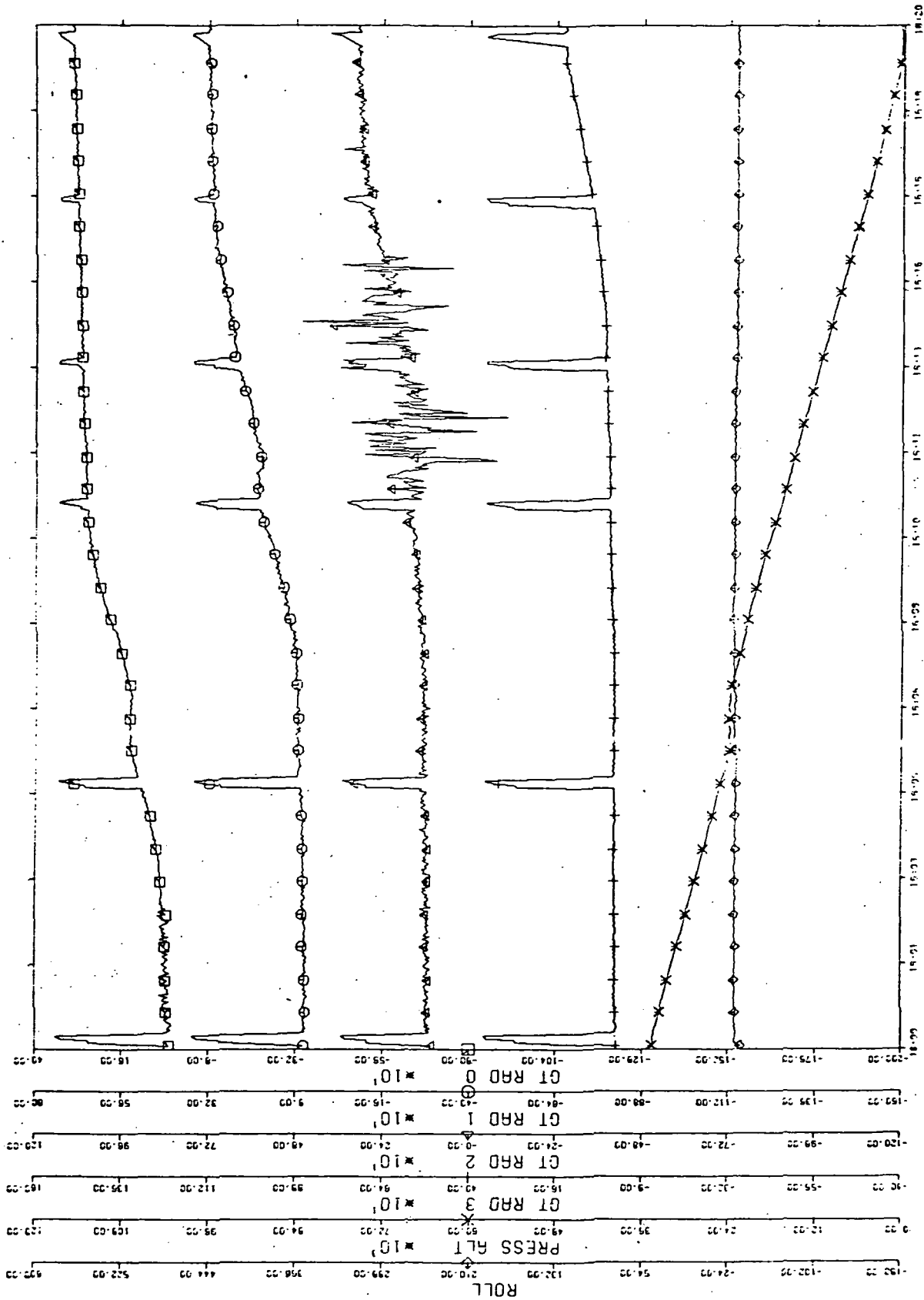

Figure 27. Time UT SMHP '78 Flight 8 (Day 225): Spiral Descent With 30° Left Roll Angle.
 Note Radar Interference At GT RAD 2 (10 GHz IF Channel).

4.2 SEASAT-A Satellite Underflights (Gulf of Alaska)

Appendix D describes the SEASAT-A Gulf of Alaska Experiment Plan including the CV-990 underflights (Phase III).

ADDAS plots are included for data taken during SEASAT-A underflights. The scales for the brightness temperatures, GT RAD 0 (1 GHz IF), GT RAD 1 (5 GHz IF), GT RAD 2 (10 GHz IF), and GT RAD 3 (2 GHz IF) are in degrees Kelvin and are absolute because ADDAS was provided an auto-calibrate signal with each calibration cycle. This signal was used by ADDAS to update the gain and offset constants discussed in Section 3.0, operation of the radiometer.

Figure 28 is a plot of data taken with the radiometer looking up (15° above the horizon), where the aircraft was flying at an altitude of 1,000 feet over the Gulf of Alaska. Weather radar detected clusters of rain cells above the aircraft during the time duration of this data plot. The top three tracks are 183 GHz (1 GHz IF), 183 GHz (5 GHz IF), and 183 GHz (10 GHz IF). The absolute temperature for these channels was 280°K up to and including time 7:10. This represents an upper limit imposed by the temperature of the lower atmosphere. However, the 94 GHz, represented by the fourth track down from the top, shows an increase in temperature with a jump of 100°K at the event time 7:10. This event coincided with the aircraft flying under a rain cell as detected by Goddard's electronically scanned microwave radiometer. This sudden jump in temperature is possibly due to the overlying rain cell absorbing radiation and re-radiating at its internal temperature, thus causing an increase in the brightness temperature desired.

Figure 29 is a data plot beginning fifteen minutes later where once again multiple rain cells were detected by weather radar. The 94 GHz channel verifies this with numerous peaks over the time span shown. A calibration cycle occurred at approximately 7:35 UT as indicated by peaks on all four radiometer channels.

Figure 30 is a spiral descent profile plotted from another SEASAT-A underflight. A manual calibration was performed at 22:52 UT with automatic calibration cycles following at 22:54 UT and 22:59 UT. Notice the increase in brightness temperatures on all three 183 GHz channels as the aircraft descends. The radiometer was looking up during the left spiral descent with the aircraft banked at a roll angle of about -30 degrees.

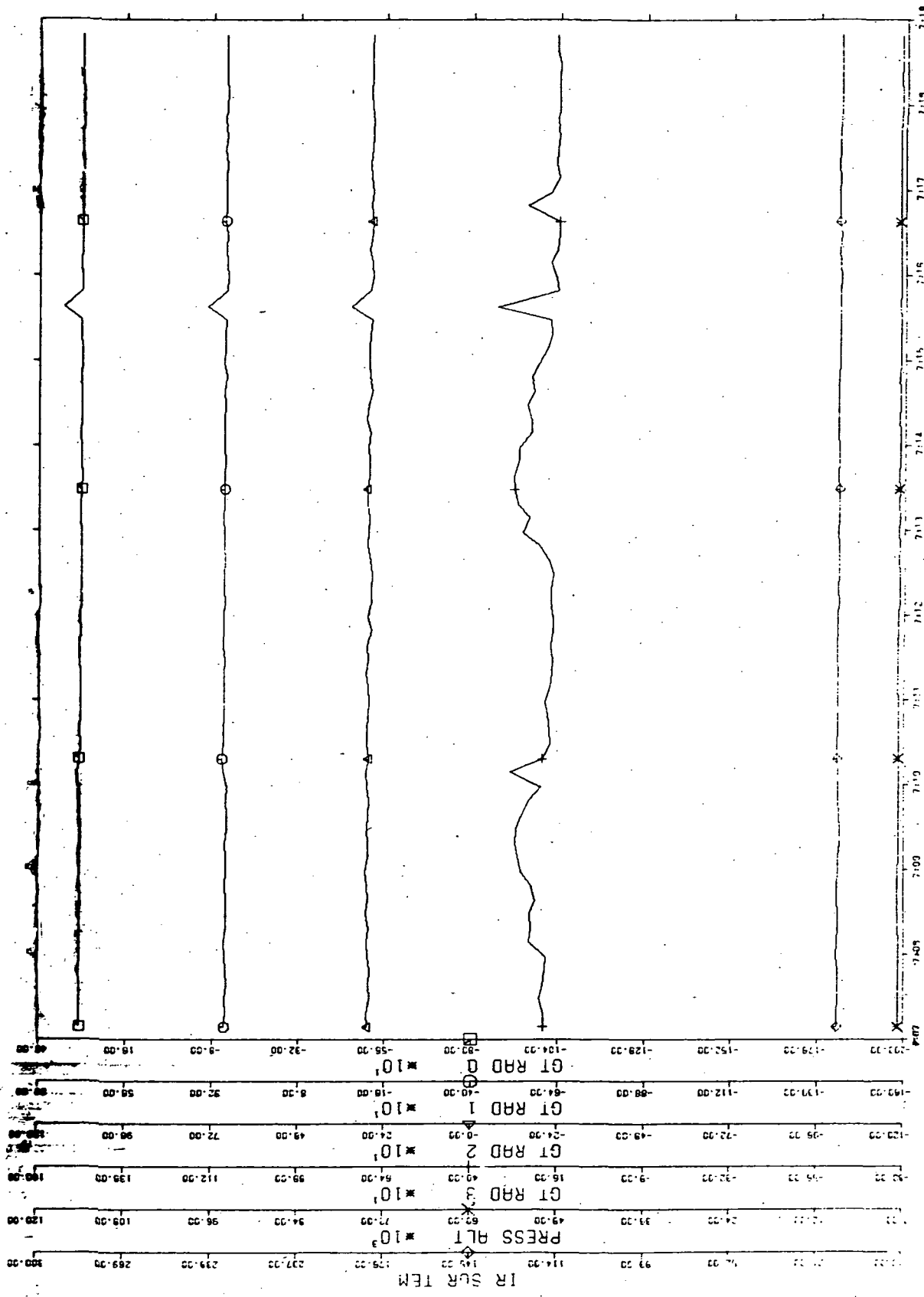

Figure 28. Time UT SMHP '78 Flight 13 (Plot 2): Convair Under Raincell Area and 94/183 GHz Radiometer is Looking Up.

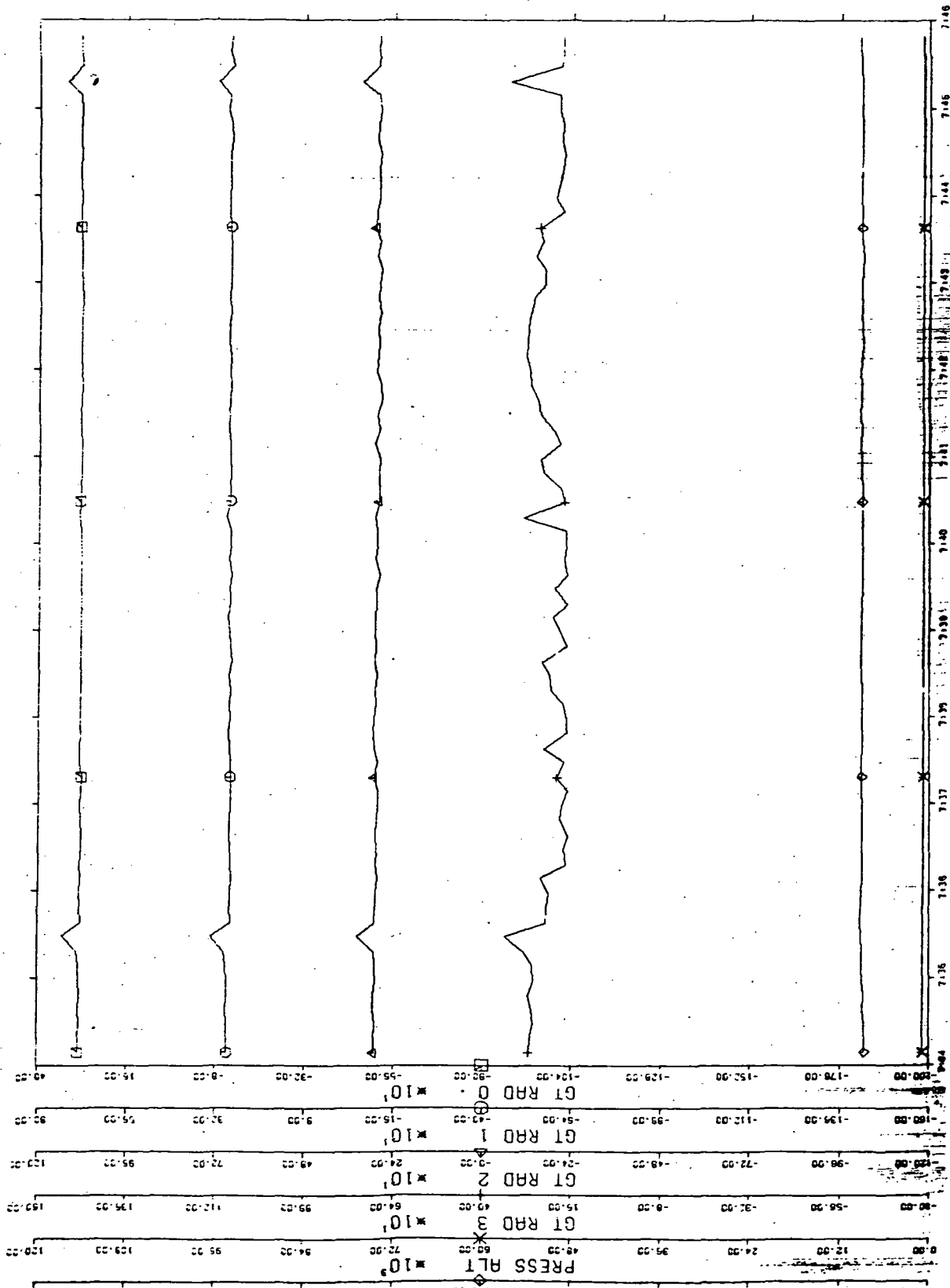

Figure 29. Time UT SMHP '78 Flight 13 (Plot 2): Multiple Raincells Detected By GT RAD 3 (94 GHz).

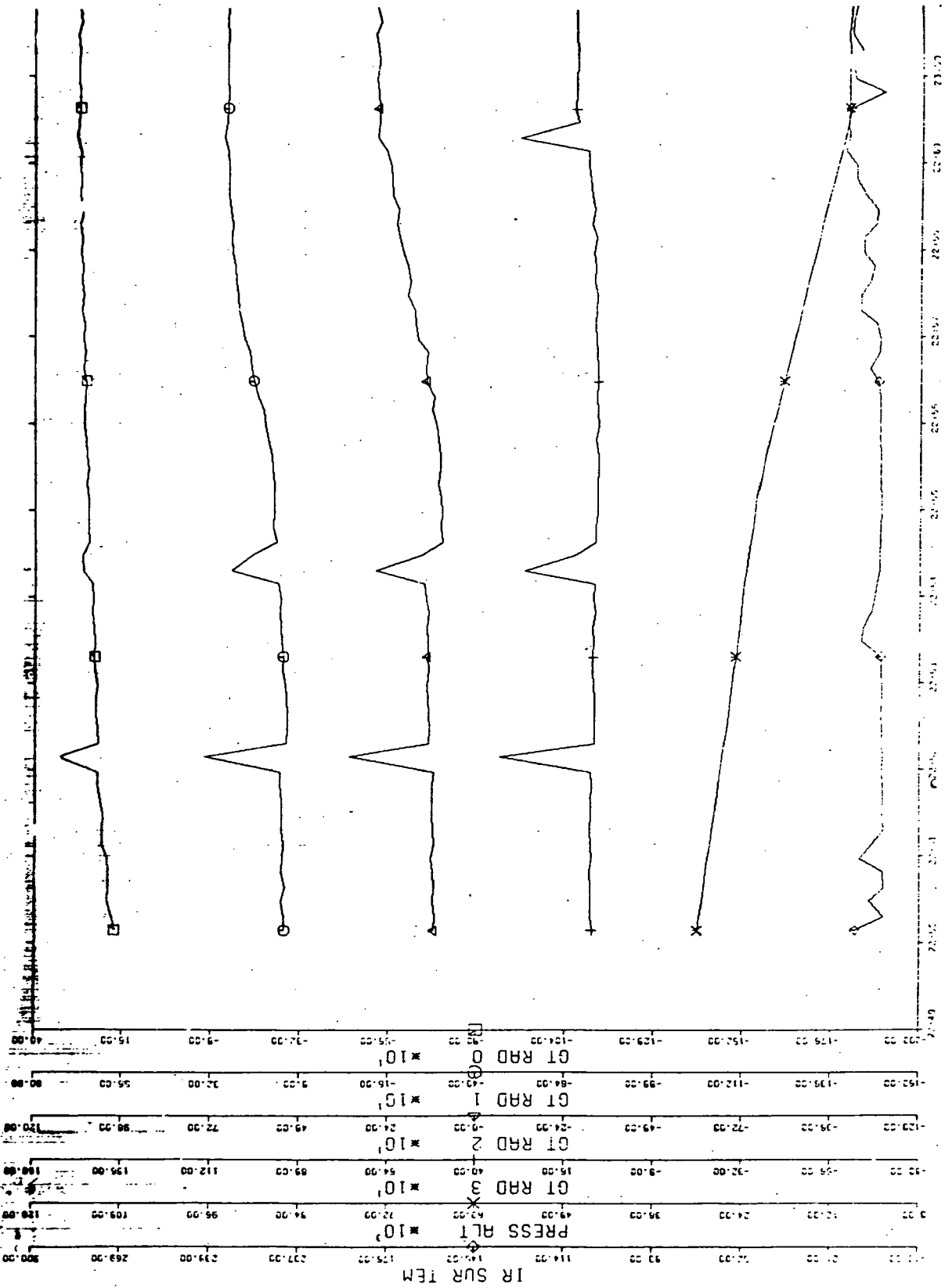

Figure 30. Time UT SMHP '78 Flight 12A (Plot 2): Radiometer Looking Up As Convair Performs Descent. Note Increase In Temperature On All Three 183 GHz Channels (Upper Three Traces).

4.3 NIMBUS-G Satellite Underflights (Arctic Ocean, Greenland Sea, Norwegian Sea, Gulf of Alaska, Pacific Ocean)

Only the 94 GHz portion of the radiometer was used during the Nimbus-G satellite underflight program. Measurements of interest include first-year thin ice, multiyear ice, sheet ice, sea surface temperature (SST), and near-surface winds (NSW). A detailed description of each data set performed is included in Appendix E, Fall 1978 Nimbus-G Mission.

ADDAS plots illustrate the type data measured under varying flight conditions. Figure 31 is a plot provided by ADDAS for Flight 5 (Day 301) which was a Thule, Greenland local flight over northern Greenland ice cap regions. Visual observations onboard the Convair reported a large region of broken ice in the sea during the time span of 17:00 to 18:30. The ADDAS plot is of twelve minutes duration beginning at time UT 18:24. During these peaks the 94 GHz radiometer was looking down at sea water which is reflecting the cold sky. The warmer temperature of approximately 220°K was measured over ice which has a lower reflectivity than water, thus less reflection of cold sky off the sea ice.

The peaks occurring at time UT 18:29 and 18:34 are calibration cycle times for the 94 GHz radiometer. Figure 32 is another plot taken during a wing-over maneuver where the 94 GHz is looking up at 15° above the horizon. During this time the Convair is maintaining a roll angle of approximately -30°. A negative roll angle signifies a left roll angle. Observe that after the calibration cycle at time 10:07:59, the 94 GHz measures a cold sky temperature of approximately 30°K. However, as the Convair comes out of the left roll angle, the 94 GHz temperature increases as the radiometer upward viewing angle decreases. Toward the end of the plot, the Convair goes back into a left roll angle and the radiometer temperature drops accordingly.

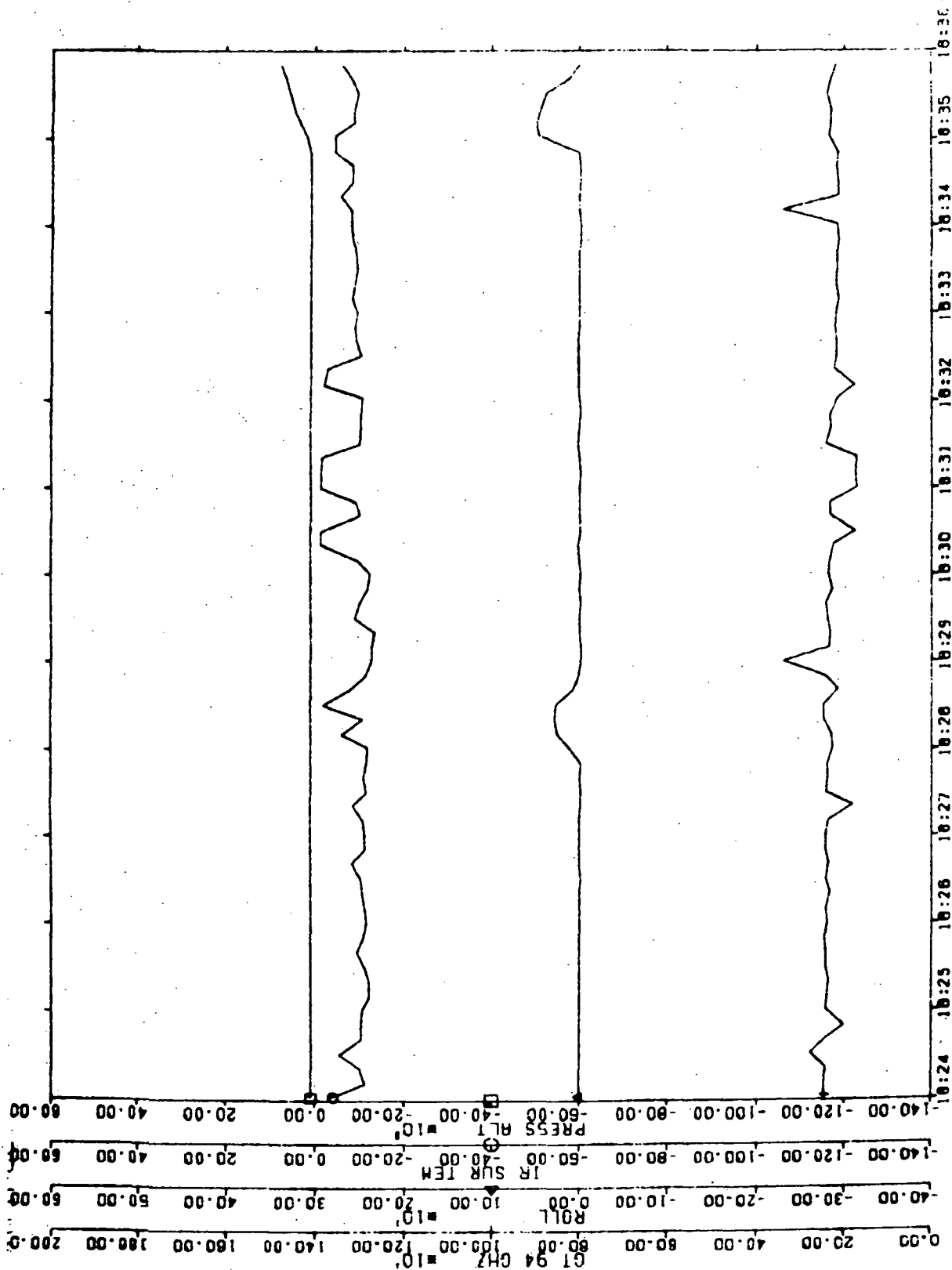

Figure 31. Time UT Day 301 Flight 99 Nimbus G: Convair Flying 500 Feet Above Sea Level Over Ice Cap Regions. Note Negative Peaks Over Open Water Seen By 94 GHz (Bottom Trace).

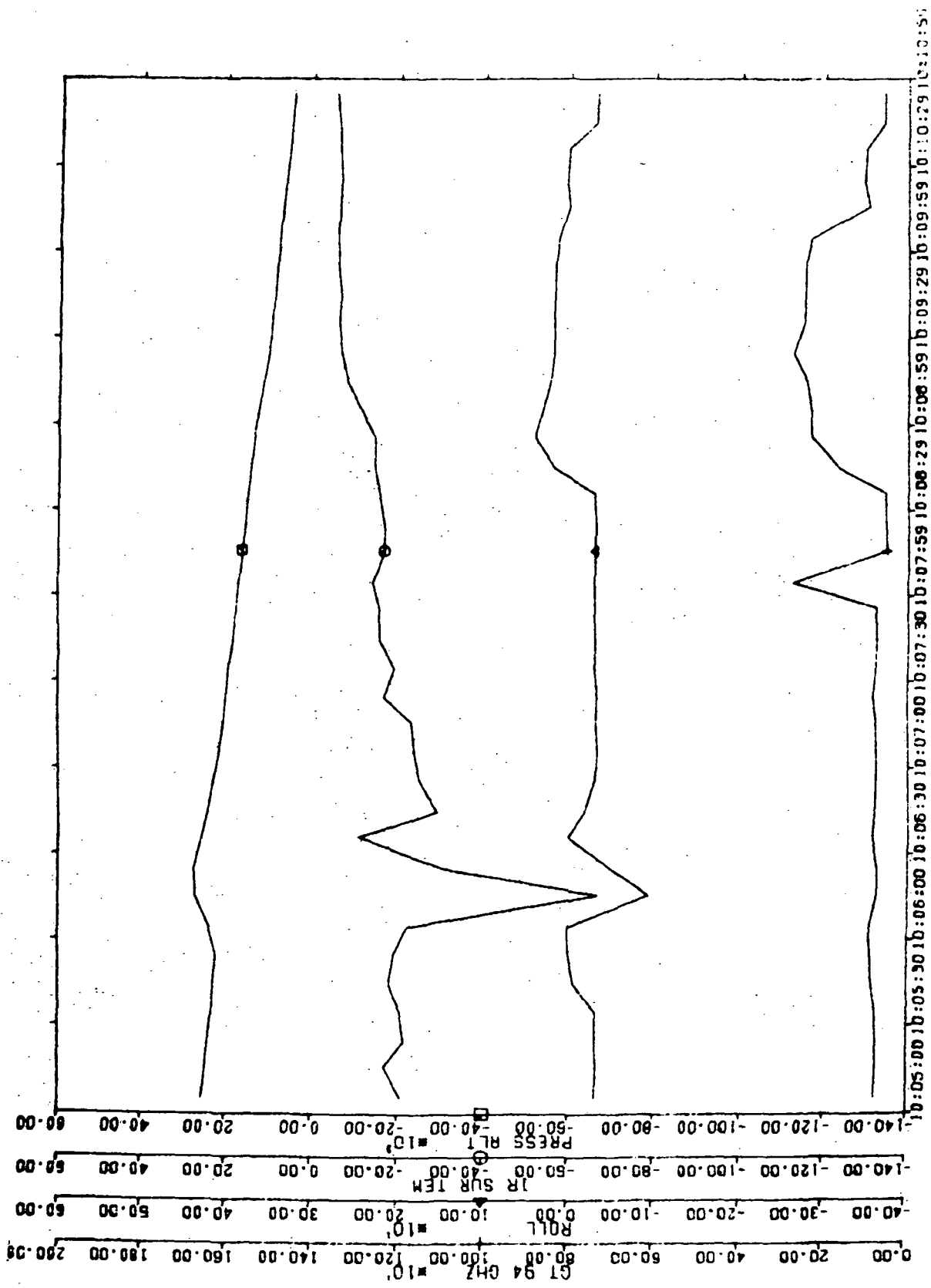

Figure 32. Time UT Day 307 Flight 9 Nimbus G: Convair Performs 90° Left Bank Wingover.
94 GHz Radiometer measures 30°K Looking Up.

APPENDIX A
OPERATING SYSTEM SOFTWARE

```

00002                SECTION, BOOTSTRAP, ABSOLUTE
00003                ; PERIPHERAL ASSIGNMENTS
00004                ;
00005                8404    PIA2AD    EQU    8404H    ; TAPE DRIVE STATUS
00006                8405    PIA2AC    EQU    8405H    ; TR0 (TRACK SET BIT)
00007                8406    PIA2BD    EQU    8406H    ; TAPE CONTROL
00008                8407    PIA2BC    EQU    8407H    ; TR1 ON CB2
00009                ;
00010                ;
00011                ; ACIAs, SSDA AND APU
00012                ;
00013                8408    ACIA1C    EQU    8408H    ; CONTROL CONSOLE
00014                8409    ACIA1D    EQU    8409H    ; XMIT AND RCV INTERRUPTS
00015                8808    ACIA2C    EQU    8808H    ; AUX SERIAL INTERFACE
00016                8809    ACIA2D    EQU    8809H    ; XMIT AND RCV INTERRUPTS
00017                8804    SSDAC    EQU    8804H    ; SSDA STATUS/CONTROL1 REGISTERS
00018                8805    SSDAD    EQU    8805H    ; SSDA DATA/CONTROL2, CONTROL3, SYNC CODE REGS.
00019                FE07    WINTEK    EQU    0FE07H    ; WINTEK START ADDRESS
00020                FD36    INCH      EQU    0FD36H    ; WINTEK INPUT ROUTINE
00021                FD80    OUTCH     EQU    0FD80H    ; WINTEK OUTPUT
00022                FDA6    CRLF      EQU    0FDA6H
00023                FD7A    OUT4HS    EQU    0FD7AH
00024                FD7C    OUT2HS    EQU    0FD7CH    ; OUTPUT 2 HEX FROM X
00025                FD92    OUTHEX    EQU    0FD92H    ; OUTPUT HEX FROM A
00026                FD45    INHEX     EQU    0FD45H    ; GET SINGLE HEX IN A
00027                FC64    IN2HEX    EQU    0FC64H    ; GET HEX ANIN A AND B
00028                ; CONSTANTS
00029                0080    CRCPH     EQU    80H      ; CRC POLY MS BYTE
00030                0041    CRCPL     EQU    41H      ; CRC POLY LS BYTE
00031                0004    LOADCODE  EQU    04H      ; TAPE CONTROL CODES
00032                0006    STOPCODE  EQU    06H
00033                0008    FORCODE   EQU    08H
00034                000A    FFCODE    EQU    0AH
00035                000C    REVCODE    EQU    0CH
00036                000E    RENCODE   EQU    0EH
00037                ;
00038                0000    ORG        0
00039                ; TEMPORARY VARIABLES AND POINTERS FOR TAPE ROUTINES
00040                ;
00041                0000    0002    BYCOUNT  BLOCK  2    ; TEMP BYTE COUNTER FOR TREAD/TWRITE
00042                0002    0002    XTEMP1   BLOCK  2    ; TEMPORARY X REGISTER STORAGE
00043                0004    0002    XTEMP2   BLOCK  2    ; "
00044                0006    0002    XTEMP3   BLOCK  2    ; "
00045                0008    0002    XTEMP4   BLOCK  2    ; "
00046                000A    0001    CRCH     BLOCK  1
00047                000B    0001    CRCL     BLOCK  1    ; CRC CODE FOR TAPE
00048                000C    0002    BUFNT    BLOCK  2    ; TEMP FOR DECODE
00049                000E    0001    TRACKN   BLOCK  1
00050                000F    0002    BLKNUM   BLOCK  2
00051                0011    0001    BLOCKS   BLOCK  1    ; BLOCK COUNTER FOR TREAD AND TWRITE
00052                0012    0001    F_RDWR   BLOCK  1    ; READ/WRITE FLAG
00053                ;
00054                F800    ORG        0F800H

```

```

00053          ;
00054          ;SET UP PIA2--TAPE DRIVE STATUS/CONTROL
00055          ;
00056          ;
00057          ;
00058          SET     #03E9H
00059          LDS     #8400H
00060          LDX     #8400H
00061          CLR     5,X
00062          CLR     7,X
00063          CLR     4,X
00064          LDA     #3FH
00065          STA     6,X
00066          LDA     #3CH
00067          STA     5,X
00068          LDA     7,X
00069          STA     #36H
00070          LDA     6,X
00071          ;
00072          ;PROGRAM SDDA FOR TAPE DRIVE I/O
00073          ;
00074          LDA     #3
00075          STA     SDDAC
00076          LDA     #0BH
00077          STA     SDDAC
00078          LDA     #5DH
00079          STA     SDDAD
00080          LDA     #4BH
00081          STA     SDDAC
00082          LDA     #0EH
00083          STA     SDDAD
00084          LDA     #8BH
00085          STA     SDDAC
00086          LDA     #1
00087          STA     SDDAD
00088          LDA     #0C8H
00089          STA     SDDAC
00090          ;
00091          ;MAIN COMMAND LOOP
00092          ;
00093          START   JSR     LOAD
00094          JSR     CRLF
00095          START1  LDX     #RDYMSG
00096          JSR     STRNGOUT
00097          JSR     CRLF
00098          JSR     INCH
00099          CMP     A,"B"
00100          BNE     NOTB
00101          CLR     A
00102          JSR     TRACK
00103          LDA     #4
00104          LDX     #1000H
00105          JSR     TREAD
00106          JMP     1000H
00107          ;
00058          ;CLEAR CONTROL REGISTERS
00059          ;
00060          ;A-SIDE FOR ALL INPUTS
00061          ;B-SIDE FOR 2 INXS (PB7,PB6) AND 6 OUTS (PB0-PB5)
00062          ;ENABLE CA2 AND CB2 FOR TRACK CONTROL OUTPUTS
00063          ;
00064          ;ISSUE STOP COMMAND TO TAPE AND SET
00065          ;SET WRN=WDR=1
00066          ;
00067          ;RESET XMTR AND RCVR
00068          ;STORE IN CONTROL 1
00069          ;DISABLE RCVR SYNC
00070          ;ACCESS CONTROL 2
00071          ;8 BIT WORD, 1 BYTE XFER AND TX SYNC ON UNDERFLOW
00072          ;STORE IN CONTROL 2
00073          ;ACCESS CONTROL 3
00074          ;
00075          ;SET CTUF=CTS=1 AND 1 SYNC MODE
00076          ;ACCESS SSYNC CODE REGISTER
00077          ;SET SYNC CODE REGISTER TO 01
00078          ;
00079          ;ACCESS XMIT FIFO AND CLR RESET BITS
00080          ;
00081          ;LOAD CART
00082          ;PRINT PROMPT
00083          ;
00084          ;GET COMMAND
00085          ;
00086          ;ASSUME NORMAL BOOT HERE
00087          ;START ADDRESS
00088          ;READ IN PROGRAM
00089          ;GO TO IT

```

```

00108
00109 F868 8152      NOTB   CMP A  #"R"      ;R FOR READ
00110 F86A 2605      BNE   NOTR
00111 F86C BDF881      JSR   READ
00112 F86F 20D8      BRA   START1
00113 F871 8157      NOTR   CMP A  #"W"      ;W FOR WRITE
00114 F873 2605      BNE   NOTW
00115 F875 BDF886      JSR   WRITE      ;GO WRITE
00116 F878 20CF      BRA   START1
00117 F87A 8120      NOTW   CMP A  #20H     ;IS IT A SPACE?
00118 F87C 26C5      BNE   START
00119 F87E 7EFE07     JMP   WINTEK
00120
00121
00122 F881 7F0012     READ   CLR   F. RDWR    ;CLEAR READ/WRITE FLAG
00123 F884 2004      BRA   TRACKSET
00124 F886 86FF      WRITE  LDA A  #0FFH     ;SET READ/WRITE FLAG
00125 F888 9712      STA A  F. RDWR
00126
00127 F88A BDFDA6     TRACKSET JSR   CRLF
00128 F88D CEFB21     LDX   #TRKMSG      ;ASK FOR TRACK
00129 F890 8D39      BSR   STRNGOUT
00130 F892 BDFD45     JSR   INHEX        ;WAIT FOR TRACK ENTRY
00131 F895 C103      CMP B  #3          ;VALID TRACK?
00132 F897 22F1      BHI   TRACKSET
00133 F899 17       TBA
00134 F89A BDF954     JSR   TRACK        ;SET TRACK
00135 F89D BDFDA6     JSR   CRLF
00136 F8A0 CEFB47     RDWR   LDX   #STRMSG   ;ASK FOR START ADDRESS
00137 F8A3 BDF8CB     JSR   STRNGOUT
00138 F8A6 BDFD45     JSR   INHEX
00139 F8A9 D702      STA B  XTEMP1
00140 F8AB BDFD45     JSR   INHEX
00141 F8AE D703      STA B  XTEMP1+1
00142 F8B0 BDFDA6     JSR   CRLF
00143 F8B3 CEFB29     RDWR1  LDX   #BLKMSG     ;ASK FOR BLOCKS
00144 F8B6 BDF8CB     JSR   STRNGOUT
00145 F8B9 BDFD45     JSR   INHEX
00146 F8BC 17       TBA
00147 F8BD DE02      LDX   XTEMP1
00148 F8BF D612      LDA B  F. RDWR
00149 F8C1 2604      BNE   RDWR2
00150 F8C3 BDF83B     JSR   TREAD
00151 F8C6 39       RTS
00152 F8C7 BDF973     RDWR2  JSR   TWRITE
00153 F8CA 39       RTS
00154
00155
00156 F8CB A600     STRNGOUT LDA A  0,X
00157 F8CD 08      INX
00158 F8CE BDFD80     JSR   OUTCH
00159 F8D1 8104     CMP A  #4
00160 F8D3 26F6     BNE   STRNGOUT

```

```

00161 F8D5 39          RTS
00162
00163          ; TAPE DRIVE CONTROL SUBROUTINES
00164          ;
00165          ;
00166          ; TAPE MOTION COMMANDS. USE BY DATA COLLECTION SOFTWARE
00167          ; AND UTILITY COMMANDS.
00168          ;
00169          ; LOAD CART
00170          ;
00171 F8D6 B68404      LOAD      LDA A   PIA2AD      ; GET STATUS
00172 F8D9 8430          AND A   #30H        ; CHECK IF ALREADY LOADED
00173 F8DB 2712          BEQ     LOAD2
00174 F8DD 8110          CMP A   #10H        ; CHECK IF STAUTS=0
00175 F8DF 2708          BEQ     LOAD1      ; YES, STAUTUS OK, LOAD CART
00176 F8E1 CEFB5A       LDX    #MESSNR     ; TURN ON NOT READY MESSAGE
00177 F8E4 BDF8CB       JSR    STRNGOUT
00178 F8E7 2006          BRA    LOAD2
00179 F8E9 8D0D          LOAD1   BSR    STOP      ; STOP TAPE IF MOVING
00180 F8EB 8604          LDA A   #LOADCODE  ; GET LOAD CODE
00181 F8ED 8D23          BSR    TCMND       ; ISSUE COMMAND
00182 F8EF 4F           LOAD2   CLR A
00183 F8F0 970F          STA A   BLKNUM     ; CLEAR BLOCK NUMBER
00184 F8F2 9710          STA A   BLKNUM+1
00185 F8F4 BDF908       JSR    REWIND
00186 F8F7 39          RTS
00187          ;
00188          ; STOP TAPE
00189 F8F8 8606          STOP   LDA A   #STOPCODE ; GET STOP CODE
00190 F8FA 2016          BRA    TCMND
00191          ;
00192          ; MOVE TAPE FORWARD
00193 F8FC 8608          FORWD  LDA A   #FORCODE
00194 F8FE 2012          BRA    TCMND
00195          ;
00196          ; FAST FORWARD
00197 F900 860A          FFORWD LDA A   #FFOWCODE
00198 F902 200E          BRA    TCMND
00199          ;
00200          ; REVERSE
00201 F904 860C          REVERSE LDA A   #REVCODE
00202 F906 200A          BRA    TCMND
00203          ;
00204          ; REWIND
00205 F908 860E          REWIND LDA A   #REWCODE
00206 F90A 7F000F       CLR    BLKNUM
00207 F90D 7F0010       CLR    BLKNUM+1
00208 F910 2000          BRA    TCMND
00209          ;
00210          ; PULSE PROPER TAPE CONTROL LINE
00211          ;
00212 F912 F68406       TCMND  LDA B   PIA2BD      ; GET OLD CONTROL WORD
00213 F915 C4F0          AND B   #0F0H        ; MASK OF LS HALF

```

```

00214 F917 1B          ABA          ;ADD IN NEW COMMAND
00215 F918 878406     STA A   PIA2BD   ;PUT OUT NEW COMMAND
00216 F91B 84F0       AND A   #0F0H   ;CLEAR COMMAND
00217 F91D 878406     STA A   PIA2BD
00218 F920 39         RTS
00219
00220
00221                 ;UNLOAD CART FOR REMOVAL
00222
00223 F921 8DD5     UNLOAD   BSR   STOP          ; STOP TAPE IF MOVING
00224 F923 8604     LDA A   #LOADCODE
00225 F925 8DEB     BSR   TCMND
00226 F927 8604     LDA A   #LOADCODE   ;ISSUE TWO LOAD PULSES
00227 F929 8DE7     BSR   TCMND
00228 F92B 39         RTS
00229
00230
00231
00232                 ;TAPE STATUS MONITOR. CHECKS TAPE STATUS BITS ON PIA2A
00233                 ;TO DETERMINE APPROPRIATE STATUS.
00234
00235 F92C 868404     CKRDY   LDA A   PIA2AD   ;GET STATUS
00236 F92F 8430     AND A   #30H          ;CHECK RDY AND ST BITS
00237 F931 2709     BEQ   CKRDY1
00238 F933 CEFB5A     LDX   #MESSNR        ;TURN ON NOT READY MSG
00239 F936 8DF8CB     JSR   STRNGOUT
00240 F939 7EF843     JMP   START          ;RETURN TO MAIN PROGRAM
00241 F93C 39         CKRDY1  RTS
00242
00243
00244 F93D 868404     CKLOAD  LDA A   PIA2AD   ;GET STATUS
00245 F940 8402     AND A   #02H          ;SEE IF TAPE AT LOAD POINT
00246 F942 39         RTS
00247
00248                 ;CHECK IF WRITE PROTECT IS ON
00249 F943 868406     CKFP   LDA A   PIA2BD   ;GET FP AND TM BITS
00250 F946 8440     AND A   #40H          ;CHECK BIT 6
00251 F948 2609     BNE   CKFP1          ;NOT PROTECTED
00252 F94A CEFB32     LDX   #FPMSG         ;TURN ON FILE PROTECT MESSAGE
00253 F94D 8DF8CB     JSR   STRNGOUT
00254 F950 7EF843     JMP   START
00255 F953 39         CKFP1  RTS
00256
00257
00258                 ;SET TRACK NO. FROM CONTENTS OF A
00259                 ;A MAY BE =0,1,2,3
00260 F954 8103     TRACK  CMP A   #3          ;SEE IF ALLOWABLE VALUE
00261 F956 221A     BHI   TRACK3        ;NOPE, RETURN
00262 F958 970E     STA A   TRACKN      ;UPDATE TRACK NO.
00263 F95A F68405     LDA B   PIA2AC      ;GET TR0 CONTROL WORD
00264 F95D 8D0C     BSR   TRACK2        ;SET OR CLEAR TRACK BIT AS REQUIRED
00265 F95F F78405     STA B   PIA2AC      ;REPLACE TR0
00266 F962 F68407     LDA B   PIA2BC      ;GET TR1 BIT

```

```

00267 F965 8004          BSR   TRACK2      ; DO SAME FOR TR1
00268 F967 F78407       STA B  PIA2BC
00269 F96A 39           RTS
00270 F96B CA38         TRACK2 ORA B  #38H    ; CLEAR TRACK BIT
00271 F96D 44           LSR A              ; CHECK DESIRED TRACK NO.
00272 F96E 2402        BCC   TRACK3
00273 F970 C4F7        AND B  #0F7H
00274 F972 39         TRACK3 RTS
00275
00276
00277
00278 ; TAPE WRITE ROUTINE
00279 ; WRITES 2048 BYTES TO TAPE.  STARTING ADDRESS OF BLOCK IN X.
00280
00281 F973 9711         TWRITE STA A  BLOCKS    ; SAVE NO. OF BLOCKS TO WRITE
00282 F975 BDF92C       JSR   CKRDY        ; SEE IF DRIVE READY FOR WRITE
00283 F978 BDF943       JSR   CKFP         ; SEE IF FP SET
00284 F97B 8620         TWRITES LDA A  #20H
00285 F97D B78406       STA A  PIA2BD     ; SET WRN=0
00286 F980 8680        LDA A  #80H       ; ACCESS SYNC CODE REGISTER
00287 F982 B78804       STA A  SSDAC
00288 F985 4F          CLR A
00289 F986 B78805       STA A  SSDAD     ; SET SYNC CODE TO 00
00290 F989 C6C0        LDA B  #0C0H     ; ACCESS XMIT FIFO
00291 F98B F78804       STA B  SSDAC
00292 F98E B78805       STA A  SSDAD     ; ZERO OUT FIFO
00293 F991 B78805       STA A  SSDAD
00294 F994 B78805       STA A  SSDAD
00295 F997 BDFAC0       JSR   CRC         ; COMPUTE CRC FOR BLOCK
00296 F99A BDF93D       JSR   CKLOAD     ; SEE IF AT LOAD POINT (A=FF IF TRUE)
00297 F99D 36          PSH A            ; SAVE LOAD STATUS
00298 F99E BDF8FC       JSR   FORWD     ; START DRIVE
00299 F9A1 32          PUL A            ; GET LOAD STATUS BACK
00300 F9A2 4D          TST A            ; TEST LOAD FLAG
00301 F9A3 2605        BNE   TWRITE1    ; BYPASS 1 SEC DELAY
00302 F9A5 8601        LDA A  #1
00303 F9A7 BDFB0D       JSR   SECDLY     ; DELAY 1 SEC
00304 F9AA 862F        TWRITE1 LDA A  #47    ; 47 MS IRG DELAY
00305 F9AC BDFB04       JSR   MSDLY
00306 F9AF DF02        STX  XTEMP1     ; SAVE BLOCK POINTER
00307 F9B1 CE0800       LDX  #0800H    ; 2048 BYTE COUNT
00308 F9B4 DF00        STX  BYCOUNT
00309 F9B6 DE02        LDX  XTEMP1     ; RETREIVE POINTER
00310 F9B8 4F          CLR A
00311 F9B9 B78406       STA A  PIA2BD     ; SET WDR=0
00312 F9BC 8D68        BSR   WRTBYT     ; PAD WITH A FEW ZEROS
00313 F9BE 8D66        BSR   WRTBYT     ; WRITE A FEW ZEROS FOR SPACING
00314 F9C0 8D64        BSR   WRTBYT
00315 F9C2 8D62        BSR   WRTBYT
00316 F9C4 8655        LDA A  #55H     ; SYNC BYTE
00317 F9C6 8D5E        BSR   WRTBYT
00318 F9C8 4F          CLR A            ; WRITE PREAMBLE
00319 F9C9 8D5B        BSR   WRTBYT

```

```

00320 F9CB 8601          LDA A  #1
00321 F9CD 8D57          BSR  WRTBYT
00322 F9CF A600          TWRITE2 LDA A  0,X          ; GET BYTE FROM BLOCK
00323 F9D1 8D53          BSR  WRTBYT          ; SEND BYTE TO SSDA
00324 F9D3 08           INX          ; INCREMENT BYTE POINTER
00325 F9D4 DF02          STX  XTEMP1         ; SAVE BYTE POINTER
00326 F9D6 DE00          LDX  BYCOUNT       ; GET BYTE COUNTER
00327 F9D8 09           DEX          ; DECREMENT BYTE COUNTER
00328 F9D9 2706          BEQ  TWRITE3        ; DONE
00329 F9DB DF00          STX  BYCOUNT       ; SAVE COUNT
00330 F9DD DE02          LDX  XTEMP1         ; RETREIVE POINTER
00331 F9DF 20EE          BRA  TWRITE2        ; DO NEXT BYTE
00332 F9E1 960A          TWRITE3 LDA A  CRCH          ; WRITE CRC ON TAPE
00333 F9E3 8D41          BSR  WRTBYT          ; BYPASS CRC
00334 F9E5 960B          LDA A  CRCL
00335 F9E7 8D3D          BSR  WRTBYT
00336 F9E9 8680          LDA A  #80H          ; WIRTE POSTAMBLE
00337 F9EB 8D39          BSR  WRTBYT
00338 F9ED 4F           CLR A
00339 F9EE 8D36          BSR  WRTBYT
00340 F9F0 B68804        TWRITE4 LDA A  SSDAC          ; CHECK TUF FLAG
00341 F9F3 8510          BIT A  #10H          ; MASK OF TUF BIT
00342 F9F5 27F9          BEQ  TWRITE4        ; WAIT UNTILL XMIT FIFO IS EMPTY
00343 F9F7 8640          LDA A  #40H          ; RESET TUF FLAG
00344 F9F9 B78804        STA A  SSDAC          ; ACCESS CONTROL 3
00345 F9FC 860E          LDA A  #0EH
00346 F9FE B78805        STA A  SSDAD
00347 FA01 8620          LDA A  #20H          ; SET WDR=1
00348 FA03 B78406        STA A  PIA2BD
00349 FA06 861A          LDA A  #26           ; WAIT 26 MS FOR IRG
00350 FA08 BDFB04        JSR  MSDLY
00351 FA0B BDF8F8        TWRITES JSR  STOP          ; STOP TAPE
00352 FA0E 8619          LDA A  #25           ; WAIT FOR TAPE TO STOP
00353 FA10 BDFB04        JSR  MSDLY
00354 FA13 BDFAF31       JSR  INCBLK          ; INC BLOCK NUMBER
00355 FA16 DE02          LDX  XTEMP1         ; GET DATA POINTER BACK
00356 FA18 7A0011       DEC  BLOCKS          ; DEC BLOCK COUNT
00357 FA1B 2703          BEQ  TWRITE6        ; DONE
00358 FA1D 7EF97B       JMP  TWRITES        ; GO WRITE ANOTHER BLOCK
00359 FA20 8630          TWRITE6 LDA A  #30H          ; SET WRN=WDR=1
00360 FA22 B78406        STA A  PIA2BD
00361 FA25 39           RTS
00362
00363
00364          ; SEND A BYTE TO SSDA
00365
00366 FA26 F68804        WRTBYT LDA B  SSDAC          ; CHECK TDRA BIT
00367 FA29 54           LSR B
00368 FA2A 54           LSR B
00369 FA2B 24F9          BCC  WRTBYT          ; XMTR STILL BUSY
00370 FA2D B78805        STA A  SSDAD          ; STORE BYTE IN XMIT FIFO
00371 FA30 39           RTS
00372

```

```

00373 ; INCREMENT 16 BIT BLOCK NUMBER
00374 INCBLK STX XTEMP2 ; SAVE X
00375 FA31 DF04 LDX BLKNUM
00376 FA33 DE0F INX
00377 FA35 08 STX BLKNUM
00378 FA36 DF0F LDX XTEMP2
00379 FA38 DE04 RTS
00380 FA3A 39
00381
00382
00383
00384
00385
00386 ; TREAD. READS 2048 BYTES FROM NEXT BLOCK ON TAPE
00387 ; TO MEMORY STARTING AT LOCATION IN X. COMPARES CRCS
00388 ; AND RETURNS A=0 IF THEY MATCH
00389
00390 TREAD STA A BLOCKS ; SAVE BLOCK COUNT
00391 FA3B 9711 TREAD11 STX XTEMP2 ; SAVE FILE POINTER
00392 FA3D DF04 JSR CKRDY ; SEE IF DRIVE READY
00393 FA42 BDF8FC JSR FORAD ; START TAPE FORWARD
00394 FA45 8619 LDA A #25 ; WAIT 25 MS FOR TAPE TO SPEED UP
00395 FA47 BDFB04 JSR NSDLY ; RESET SSDA RCVR
00396 FA4A 8601 LDA A #1
00397 FA4C B78804 STA A SSDAC ; DISABLE SYNC, ACCESS SYNC CODE REG
00398 FA4F 8688 LDA A #88H
00399 FA51 B78804 STA A SSDAC
00400 FA54 8655 LDA A #55H
00401 FA56 B78805 STA A SSDAD ; SET SYNC CODE=55
00402 FA59 B68404 LDA A PIRZAD ; CHECK GAP BIT
00403 FASC 48 ASL A ; WAIT FOR GAP BEFORE TRYING TO READ
00404 FA5D 2AFA BPL TREAD12
00405 FASF 4F CLR A
00406 FA60 B78804 STA A SSDAC ; ENABLE RCVR SYNC
00407 FA63 8D51 BSR RDBYTE ; WAIT FOR FIRST BYTE FOLLOWING FIRST SYNC
00408 FA65 8101 CMP A #1 ; CHECK FOR SECOND PREAMBLE BYTE
00409 FA67 26FA BNE TREAD1 ; NOT THERE, TRY AGAIN
00410 FA69 DF02 STX XTEMP1 ; SAVE POINTER
00411 FA6B CE0800 LDX #0800H ; BYTE COUNT
00412 FA6E DF00 STX BYCOUNT
00413 FA70 DE02 LDX XTEMP1 ; GET POINTER
00414 FA72 8D42 BSR RDBYTE ; GET A BYTE
00415 FA74 A700 STA A 0. X ; PUT IT IN MEMORY
00416 FA76 08 INX ; INCREMENT MEMORY POINTER
00417 FA77 DF02 STX XTEMP1 ; SAVE POINTER
00418 FA79 DE00 LDX BYCOUNT
00419 FA7B 09 DEX ; DECREMENT BYTE COUNT
00420 FA7C 2706 BEQ TREAD3 ; DONE, GET CRC
00421 FA7E DF00 STX BYCOUNT ; SAVE COUNT
00422 FA80 DE02 LDX XTEMP1 ; GET POINTER BACK
00423 FA82 20EE BRA TREAD2 ; GET ANOTHER BYTE
00424 FA84 8D30 BSR RDBYTE ; GET FIRST CRC BYTE
00425 FA86 36 PSH A ; SAVE IT

```



```

00426 FAB7 8D2D          BSR    RDBYTE      ; GET NEXT CRC BYTE
00427 FAB9 36           PSH A              ; SAVE IT
00428 FAB8 862B          LDA A    #43
00429 FABC BDFB04        JSR    MSDLY       ; WAIT 43 MS FOR IRG
00430 FABF BDF8F8        JSR    STOP        ; STOP TAPE
00431 FA92 DE04          LDX    XTEMP2     ; RETREIVE POINTER
00432 FA94 BDFAC0        JSR    CRC         ; COMPUTE CRC ON NEW DATA
00433 FA97 32           PUL A              ; GET CRC BACK
00434 FA98 33           PUL B
00435 FA99 900B          SUB A    CRCL      ; COMPARE LS BYTE
00436 FA9B 2604          BNE    TREAD4
00437 FA9D D00A          SUB B    CRCH
00438 FA9F 2708          BEQ    TREAD45
00439 FAA1 CEFB71        TREAD4  LDX    #CRCMSG ; CRC ERROR MESSAGE
00440 FAA4 BDF8CB        JSR    STRNGOUT
00441 FAA7 200C          BRA    TREAD5
00442 FAA9 BDFAF31      TREAD45 JSR    INCBLK    ; I?NCREMENT BLOCK NUMBER
00443 FAAC 7A0011        DEC    BLOCKS     ; DECREMENT BLOCK COUNTER
00444 FAAF 2704          BEQ    TREAD5     ; DONE
00445 FAB1 DE02          LDX    XTEMP1     ; GET DATA POINTER
00446 FAB3 2088          BRA    TREAD011   ; GO READ ANOTHER BLOCK
00447 FAB5 39           TREAD5  RTS
00448
00449
00450 ; READ A BYTE FROM SSDA FIFO AND COMPUTE CRC
00451 FAB6 B68804        RDBYTE  LDA A    SSDAC ; CHECK RDA FLAG
00452 FAB9 44           LSR A
00453 FAB8 24FA          BCC    RDBYTE     ; WAIT FOR RDA=1
00454 FABC B68805        LDA A    SSDAD    ; GET A BYTE FROM FIFO
00455 FABF 39           RTS
00456
00457 ; COMPUTE A 16 BIT CRC CHECK CODE FROM A 2048 BYTE BUFFER
00458 ; POINTED TO BY X. RETURNS CRC IN CRCH AND CRCL
00459 FAC0 7F000A        CRC     CLR    CRCH  ; CLEAR CRC IN NEEDED
00460 FAC3 7F000B        CLR    CRCL
00461 FAC6 DF06          CRC1   STX    XTEMP3 ; SAVE POINTER
00462 FAC8 DF04          STX    XTEMP2     ; SAVE X THRU SUBROUTINE
00463 FAC9 CE0800        LDX    #0800H    ; BYTE COUNT
00464 FACD DF00          CRC2   STX    BYCOUNT ; SAVE I
00465 FACF DE06          LDX    XTEMP3
00466 FAD1 A600          LDA A    0,X      ; GET CHARACTER
00467 FAD3 8D0B          BSR    CRCC       ; COMPUTE CRC
00468 FAD5 08           INX
00469 FAD6 DF06          STX    XTEMP3
00470 FAD8 DE00          LDX    BYCOUNT  ; GET COUNT
00471 FADA 09           DEX
00472 FADB 26F0          BNE    CRC2
00473 FADD DE04          LDX    XTEMP2     ; RETREIVE POINTER
00474
00475 FADF 39           RTS
00476
00477 ; DO CRC ONE BYTE AT A TIME
00478 FAE0 970C          CRCC   STA A    BUFPNT

```

```

00479 FAE2 8680          LDA A  #80H          ; MASK
00480 FAE4 78000B      CRCC1  ASL   CRCL
00481 FAE7 79000A      ROL   CRCH
00482 FAEA 950C          BIT A  BUFPNT
00483 FAEC 2704          BEQ   CRCC2
00484 FAE5 2510          BCS  NOCHANGE
00485 FAF0 2002          BRA  CHANGE
00486 FAF2 240C      CRCC2  BCC  NOCHANGE
00487 FAF4 C641      CHANGE LDA B  #CRCPL
00488 FAF6 D80B      EOR B  CRCL
00489 FAF8 D70B      STA B  CRCL
00490 FAF4 C630      LDA B  #CRCPH
00491 FAF4 D80A      EOR B  CRCH
00492 FAFE D70A      STA B  CRCH
00493 FB00 44          NOCHANGE LSR A
00494 FB01 26E1      BNE   CRCC1
00495 FB03 39          RTS
00496
00497
00498          ; DELAY ROUTINES
00499 FB04 C6A5      MSDLY  LDA B  #0A5H
00500 FB06 5A      MSDLY1 DEC B
00501 FB07 26FD      BNE   MSDLY1
00502 FB09 4A      DEC A
00503 FB0A 26F8      BNE   MSDLY
00504 FB0C 39          RTS
00505
00506          ; DELAY A SECONDS
00507 FB0D 36      SECDLY PSH A          ; SAVE A
00508 FB0E 86FF      LDA A  #0FFH
00509 FB10 8DF2      BSR  MSDLY
00510 FB12 86FF      LDA A  #0FFH
00511 FB14 8DEE      BSR  MSDLY
00512 FB16 86FF      LDA A  #0FFH
00513          BSR  MSDLY
00514 FB18 86FF      LDA A  #0FFH
00515 FB1A 8DE8      BSR  MSDLY
00516 FB1C 32          PUL A
00517 FB1D 4A          DEC A
00518 FB1E 26ED      BNE   SECDLY
00519 FB20 39          RTS
00520
00521          ; ASCII MESSAGES
00522 FB21 54524143    TRKMSG ASCII  "TRACK? "
00522 FB25 483F20
00523 FB28 04          BYTE  4
00524 FB29 424C4F43    BLKMSG ASCII  "BLOCKS? "
00524 FB2D 48533F20
00525 FB31 04          BYTE  4
00526 FB32 54415045    FPMSG  ASCII  "TAPE WRITE PROTECTED"
00526 FB36 20575249
00526 FB3A 54452050
00526 FB3E 524F5445

```

00526	FB42	43544544			
00527	FB46	04		BYTE	4
00528	FB47	53544152	STRMSG	ASCII	"STARTING ADDRESS? "
00528	FB4B	54494E47			
00528	FB4F	20414444			
00528	FB53	52455353			
00528	FB57	3F20			
00529	FB59	04		BYTE	4
00530	FB5A	44524956	MESSNR	ASCII	"DRIVE NOT READY!"
00530	FB5E	45204E4F			
00530	FB62	54205245			
00530	FB66	41445921			
00531	FB6A	04		BYTE	4
00532	FB6B	52454144	RDVMSG	ASCII	"READY"
00532	FB6F	59			
00533	FB70	04		BYTE	4
00534	FB71	43524320	CRCMSG	ASCII	"CRC ERROR!!!"
00534	FB75	4552524F			
00534	FB79	52212121			
00535	FB7D	04		BYTE	4
00536					

Scalars

ACIAR1C - 8408
 CRCPL - 0041
 INCH - FD36
 OUTCH - FD80
 PIA2BD - 8406
 STOPCODE 0006

ACIAR1D - 8409
 CRLF - FDA6
 INHEX - FD45
 OUTHEX - FD92
 REVCODE 000C
 WINTEK - FE07

ACIAR2C - 8808
 FFLOWCODE 000A
 LOADCODE 0004
 PIA2AC - 8405
 REVCODE 000E

ACIAR2D - 8809
 FORCODE 0008
 OUT2HS - FD7C
 PIA2AD - 8404
 SSDAC - 8804

CRCPH - 0000
 IN2HEX - FC64
 OUT4HS - FD7A
 PIA2BC - 8407
 SSDAD - 8805

BOOTSTR Section Absolute (FB7E)

BLKMSG - FB29
 CHANGE - FAF4
 CKRDY1 - F93C
 CRCC1 - FAE4
 F. RDWR - 0012
 INIT2 - F807
 MESSNR - FB5A
 NUTR - F871
 RDWR2 - F8C7
 SECPLY - FB0D
 STRMSG - FB47
 TRACKN - 000E
 TREAD12 - FA59
 TREAD5 - FAB5
 TWRITE3 - F9E1
 UNLOAD - F921
 XTEMP3 - 0006

BLOCKS - 0011
 CKFP1 - F953
 CRC1 - FAC6
 CRCH - 000A
 FORMD - F8FC
 LOAD - F8D6
 MSDLY1 - FB06
 RDBYTE - FAB6
 READ - F881
 START1 - F849
 TRACK - F954
 TREAD - FA3B
 TREAD3 - FA84
 TWRITE - F973
 TWRITE5 - FA0B
 WRTBYT - FA26

BUFPNT - 000C
 CKLOAD - F93D
 CRC2 - FACD
 CRCL - 000B
 FPMMSG - FB32
 LOAD1 - F8E9
 NOCHANGE - FB00
 RDWR - F8A0
 REVERSE - F904
 STOP - F8F8
 TRACK2 - F96B
 TREAD1 - FA63
 TREAD4 - FAA1
 TWRITE1 - F9AA
 TWRITE6 - FA20
 XTEMP1 - 0002

BYCOUNT 0000
 CKRDY - F92C
 CRCC - FAE0
 CRCMSG - FB71
 INCBLK - FA31
 LOAD2 - F9EF
 NOTB - F868
 RDWR1 - F8B3
 REWIND - F908
 STRNGOUT - F8C8
 TRACK3 - F972
 TREAD11 - FA3D
 TREAD45 - FAA9
 TWRITE2 - F9CF
 TWRITES - F97B
 XTEMP2 - 0004

536 Source Line 536 Assembled Lines 13221 Bytes available

>>> No assembly errors detected <<<

```

00004 SECTION CONVAIR, ABSOLUTE
00005 *****RADIATION*****
00006 *****RADIATION*****
00007 ;DATA COLLECTION, CONTROL AND ANALYSIS SYSTEM FOR
00008 ;A MULTI-CHANNEL MILLIMETER RADIOMETER FOR THE NASA
00009 ;CONVAIR 990 RESEARCH AIRCRAFT THIS EFFORT WAS
00010 ;SUPPORTED BY GEORGIA TECH CONTRACTS A-1902 AND A-2132
00011 *****
00012 ;Written by Jim Stratigos, Rob Bird and John Cook
00013 *****
00014 *****
00015 ;PERIPHERAL ASSIGNMENTS
00016 ;
00017 ;
00018 ;A/D MS 8 BITS
00019 ;A/D START CONVERSION (SC) AND END CONV (EOC)
00020 ;A/D LS 4 BITS (PB0-PB3) AND MUX ADR (PB4-PB7)
00021 ;NO HANDSHAKES
00022 ;TAPE DRIVE STATUS
00023 ;TR0 (TRACK SET BIT)
00024 ;TAPE CONTROL
00025 ;TR1 ON CB2
00026 ;DISPLAY DATA AND CONTROL
00027 ;DISPLAY RESET AND UPDATE (CA1, CA2)
00028 ;IRIGB IN, CLUTCH CNTRL , AND REFLECTOR SENSE
00029 ;100 MS (CB1) AND 1 SEC (CB2) INTERRUPTS
00030 ;
00031 ;
00032 ;ACIAS, SSDA AND APU
00033 ;
00034 ;
00035 ;ACIA1C EQU 8408H ;CONTROL CONSOLE
00036 ;ACIA1D EQU 8409H ;XMIT AND RCY INTERRUPTS
00037 ;ACIA2C EQU 8808H ;AUX SERIAL INTERFACE
00038 ;ACIA2D EQU 8809H ;XMIT AND RCY INTERRUPTS
00039 ;SSDAC EQU 8804H ;SSDA STATUS/CONTROL1 REGISTERS
00040 ;SSDAD EQU 8805H ;SSDA DATA/CONTROL2, CONTROL3, SYNC CODE REGS.
00041 ;APUDATA EQU 880CH ;FLOATING PT PROC DATA
00042 ;APUSTAT EQU 880DH ; " " STATUS/COMMAND
00043 ;
00044 ;EXTERNAL EQUATES
00045 ;IRQV EQU 03F7H ;WINTEK IRQ VECTOR
00046 ;NMIV EQU 03FDH ;WINTEK NMI VECTOR
00047 ;
00048 ;CONSTANTS
00049 ;CRCPL EQU 80H ;CRC POLY MS BYTE
00050 ;LOADCODE EQU 41H ;CRC POLY LS BYTE
00051 ;STOPCODE EQU 04H ;TAPE CONTROL CODES
00052 ;FORCODE EQU 06H
00053 ;FFQWCODE EQU 08H
00054 ;REVCODE EQU 09H
00055 ;REWCODE EQU 0CH
00056 ;REWCODE EQU 0EH

```

00056, ;
00057, ;
00058, ; RAM VARIABLES ON PAGE 0
00059, ;
00060, 0000, ;
00061, ;
00062, ;
00063, ;
00064, ;
00065, ;
00066, ;
00067, ;
00068, ;
00069, 0000, 0001, ; CURRENT TRACK NUMBER
00070, 0001, 0002, ; CURRENT BLOCK NUMBER
00071, 0003, 0002, ; FRAME TYPE IDENTIFIER, INDICATES POSITION OF REFLECTORS
00072, 0005, 0001, ; REFLECTOR POSITION INDICATOR
00073, ;
00074, ; REAL TIME CLOCK DATA FROM 100 MS INTERNAL CLOCK
00075, ;
00076, 0006, 0001, ; FLIGHT BLOCK 1
00077, 0007, 0001, ; DAYS.HI BLOCK 1
00078, 0008, 0001, ; DAYS.LO BLOCK 1
00079, 0009, 0001, ; HOURS BLOCK 1
00080, 000A, 0001, ; MINUTES BLOCK 1
00081, 000B, 0001, ; SECONDS BLOCK 1
00082, ;
00083, ;
00084, 000C, 0001, ; IRIGFLT BLOCK 1
00085, 000D, 0001, ; IRIGDAYH BLOCK 1
00086, 000E, 0001, ; IRIGDAYL BLOCK 1
00087, 000F, 0001, ; IRIGHOUR BLOCK 1
00089, 0010, 0001, ; IRIGMIN BLOCK 1
00089, 0011, 0001, ; IRIGSEC BLOCK 1
00090, ;
00091, ;
00092, ;
00093, 0012, 0005, ; CH0TEMP BLOCK 5
00094, 0017, 0005, ; CH1TEMP BLOCK 5
00095, 001C, 0005, ; CH2TEMP BLOCK 5
00096, 0021, 0005, ; CH3TEMP BLOCK 5
00097, ;
00098, ;
00099, ;
00100, 0026, 0005, ; HTLDTEMP BLOCK 5
00101, 002B, 0005, ; COLDTEMP BLOCK 5
00102, 0030, 0005, ; RELDTEMP BLOCK 5
00103, 0035, 0005, ; KLYSTEMP BLOCK 5
00104, 003A, 0005, ; SPRETEMP BLOCK 5
00105, ;
00106, ;
00107, 003F, 0004, ; 32 BIT HOT AND COLD LOAD TEMPS
HTTEMP32 BLOCK 4

```

00108 0043 0004 CDTEMP32 BLOCK 4
00109 0047 0004 HTCD32 BLOCK 4 ; HOT-COLD TEMP
00110
00111 004B 0004 CH0VAVG BLOCK 4 ; AVERAGE OF LAST 10 CH0 SAMPLES (32 BIT9 VOLTS
00112 004F 0004 CH1VAVG BLOCK 4 ; AVERAGE OF LAST 10 CH1 SAMPLES
00113 0053 0004 CH2VAVG BLOCK 4 ; AVERAGE OF LAST 10 CH2 SAMPLES
00114 0057 0004 CH3VAVG BLOCK 4 ; AVERAGE OF LAST 10 CH3 SAMPLES
00115
00116 005B 0005 CH0TAVG BLOCK 5 ; CH0 AVERAGE TEMP IN BCD
00117 0060 0005 CH1TAVG BLOCK 5
00118 0065 0005 CH2TAVG BLOCK 5
00119 006A 0005 CH3TAVG BLOCK 5
00120
;
; 12-BIT DATA FROM RADIOMETER ADC CHANNELS 0-8 (UPDATED EVERY SECOND).
00121 ADC0 BLOCK 2 ; RADIOMETER CHANNEL 0
00122 006F 0002 ADC1 BLOCK 2 ; RADIOMETER CHANNEL 1
00123 0071 0002 ADC2 BLOCK 2 ; RADIOMETER CHANNEL 2
00124 0073 0002 ADC3 BLOCK 2 ; RADIOMETER CHANNEL 3
00125 0075 0002 ADC4 BLOCK 2 ; CHANNEL 4 DATA (HOT LOAD)
00126 0077 0002 ADC5 BLOCK 2 ; CHANNEL 5 DATA (COLD LOAD)
00127 0079 0002 ADC6 BLOCK 2 ; CHANNEL 6 DATA (REFERENCE LOAD)
00128 007B 0002 ADC7 BLOCK 2 ; CHANNEL 7 DATA (KLYSTRON)
00129 007D 0002 ADC8 BLOCK 2 ; CHANNEL 8 DATA (SPARE)
00130 007F 0002 ;
00131 ; TEMPORARY VARIABLES FOR FLOATING POINT CALCULATIONS
00132 ;
;
; TEMPORARY VARIABLE STORAGE.
00133 SAM10AVG BLOCK 2 ; HOLDS RUNNING TOTAL OF TEN SAMPLE AVERAGE
00134 0081 0002 TEMP32 BLOCK 4 ; TEMPORARY SPACE FOR FLT-PT. TEMPERATURES
00135 0083 0004 SAVER BLOCK 1 ; ACCUMULATOR A
00136 0087 0001 SAVERB BLOCK 1 ; ACCUMULATOR B
00137 0088 0001 TEMPA BLOCK 1 ; ACCUMULATOR A
00138 0089 0001 TEMPB BLOCK 1 ; ACCUMULATOR B
00139 008A 0001 TEMPX BLOCK 2 ; REGISTER X
00140 008B 0002 SAVEX1 BLOCK 2 ; REGISTER X
00141 008D 0002 SAVEX2 BLOCK 2 ; REGISTER X
00142 008F 0002 SAVEX3 BLOCK 2 ; REGISTER X
00143 0091 0002 SAVEX4 BLOCK 2 ; REGISTER X
00144 0093 0002 APUSTS BLOCK 1 ; STATUS OF LAST APU CALCULATION
00145 0095 0002 ENTRYA BLOCK 1 ; HOLDS PARTIALLY PACKED BCD NUMBER
00146 0097 0001 ENTRYB BLOCK 1 ; HOLDS PARTIALLY PACKED BCD NUMBER
00147 0098 0001 INTREG BLOCK 2 ; HOLDS INTEGER PART OF FLOATING-PT NUMBER
00148 0099 0001 FPT32 BLOCK 4 ; HOLDS CURRENT FLOATING-POINT NUMBER
00149 009A 0002
00150 009C 0004
00151
00152 ;
00153 ; FLAGS: FF=SET AND 00=CLEAR
00154
00155 00A0 0001 F. CMND BLOCK 1 ; COMMAND PRESENT FLAG FOR INBUFF
00156 00A1 0001 F. NUMBR BLOCK 1 ; NUMBER PRESENT FLAG
00157 00A2 0001 F. SMIN BLOCK 1 ; 5 MINUTE FLAG FOR IRIGB READ
00158 00A3 0001 F. BADTIM BLOCK 1 ; BAD TIME FLAG FOR IRIGB
00159 00A4 0001 F. CALTIM BLOCK 1 ; CALIBRATE TIME FLAG

```

```

00100 00A5 0001      F. NUBLOC BLOCK 1      ; TAPE DATA BLOCK READY FLAG
00101 00A6 0001      F. DATA BLOCK 1      ; DATA COLLECTION ON/OFF FLAG WHILE WRITING ON TAPE
00102 00A7 0001      F. XMIT BLOCK 1      ; TRANSMIT BUFFER FLAG
00103 00A8 0001      F. FULBLK BLOCK 1     ; INDICATES DATA BUFFER IS FULL
00104 00A9 0001      F. STATUS BLOCK 1    ; INDICATES WHEN TO PRINT OUT AUTOMATIC STATUS DATA
00105 00AA 0001      F. COLLEC BLOCK 1    ; DATA COLLECTION ENABLE FLAG
00106 00AB 0001      F. GSFC BLOCK 1      ; GODDARD UP/DOWN FLAG
00107
00108      ; TEMPORARY VARIABLES AND POINTERS FOR TAPE ROUTINES
00109
00170 00AC 0002      BYCOUNT BLOCK 2     ; TEMP BYTE COUNTER FOR TREAD/TWRITE
00171 00AD 0002      XTEMP1 BLOCK 2      ; TEMPORARY X REGISTER STORAGE
00172 00AE 0002      XTEMP2 BLOCK 2      ; "
00173 00AF 0002      XTEMP3 BLOCK 2      ; "
00174 00B0 0002      XTEMP4 BLOCK 2      ; "
00175 00B1 0001      CRCH BLOCK 1       ; CRC CODE FOR TAPE
00176 00B2 0001      CRCL BLOCK 1       ; TEMP FOR DECODE
00177 00B3 0002      BUFPNT BLOCK 2     ; "
00178 00B4 0002      TABPNT BLOCK 2     ; "
00179 00B5 0002      BTEMP BLOCK 2     ; "
00180 00B6 0002      CBUFF BLOCK 2     ; TEMPORARY POINTER FOR INBUFF
00181 00B7 0001      BLOCKS BLOCK 1     ; BLOCK COUNTER FOR TREAD AND TWRITE
00182 00B8 0002      NEXSTATE BLOCK 2   ; STATE POINTER FOR NUMBER INPUT
00183 00B9 0002      NEXTDISP BLOCK 2   ; DISPLAY BUFFER POINTER
00184 00BA 0002      DISPADR BLOCK 2   ; DISPLAY DRIVER ROUTINE POINTER
00185 00BB 0002      HEXPTR BLOCK 2    ; POINTER TO HEX DATA FOR DEBUGGING
00186 00BC 0001      CTSCNTR BLOCK 1   ; COUNTER FOR TIMEOUT ON CTS FROM GODDARD
00187 00BD 0001      TCNT BLOCK 1      ; "
00188 00BE 0001      FCNT BLOCK 1      ; "
00189 00BF 0001      SKIPSGN BLOCK 1   ; "
00190 00C0 0002      BLKCNT BLOCK 2    ; "
00191 00C1 0001      GSFCIO BLOCK 1   ; GODDARD TIME OUT INTERVAL IN MS
00192
00193      ; IRQ AND NMI SERVICE ROUTINE VARIABLE STORAGE
00194
00195 00D0 0002      IRQT1 BLOCK 2     ; "
00196 00D1 0002      IRQT2 BLOCK 2     ; "
00197
00198 00D4 0001      NMI_F0 BLOCK 1   ; IRIGB FLAG
00199 00D5 0002      NMI_F1 BLOCK 2   ; "
00200 00D6 0001      RTC_CNTR BLOCK 1  ; 100 MS COUNTER FOR IRIGB READ
00201 00D7 0001      RTC_STAT BLOCK 1  ; RTC STATUS
00202 00D8 0001      MSCNTR BLOCK 1   ; RTC MS COUNTER
00203 00D9 0001      STATCNTN BLOCK 1  ; TIMER FOR STATUS PRINTOUT
00204 00DA 0001      STATTIME BLOCK 1  ; TIME INTERVAL FOR STATUS
00205 00DB 0001      CAL_CNTR BLOCK 1  ; CALIBRATION INTERVAL IN MINUTES
00206 00DC 0001      CAL_TIME BLOCK 1  ; "
00207 00DD 0002      DATAFNTR BLOCK 2 ; POINTER TO NEXT AVAILABLE TAPE BUFFER LOCATION
00208 00DE 0001      NMI_TMP1 BLOCK 1  ; "
00209 00DF 0001      NEWCHAR BLOCK 1  ; OUTPUT CHARACTER BUFFER PNTR.
00210 00E0 0002      NEXTCHAR BLOCK 2  ; BUFFER POINTER FOR OUTCH
00211 00E1 0002      LASTCHAR BLOCK 2  ; "

```



```

Tektronix M6600 ASH V3.1 CONVAIR 990 RADIOMETER Page 5
ADDRESS AND VARIABLE ASSIGNMENTS
00212 00E7 0002 BLOCKEND BLOCK 2 ; "
00213 00E9 0002 AVGPTR BLOCK 2 ; POINTER TO AVERAGE BUFFER
00214
00215 00E8 0050 AVGBUFF BLOCK 80 ; BUFFER FOR AVERAGING
00216
00217
00218 ;
00219 ; RADIOMETER CALIBRATION CONSTANTS (32 BIT FLOATING POINT)
00220 ; SET TO NOMINAL VALUES OF 40 DEG/VOLT AND -10 DEG OFFSET FOR TESTING
00221 0138 0680 CH0GAIN WORD 0680H ; 183 GHZ GAIN IN DEG. K/VOLT
00222 013D 0000 WORD 0000H
00223 013F 0000 CH0OFST WORD 0000H ; " " OFFSET IN DEG. K
00224 0141 0000 WORD 0000H
00225 0143 0680 CH1GAIN WORD 0680H ; 188 GHZ GAIN
00226 0145 0000 WORD 0000H
00227 0147 0000 CH1OFST WORD 0000H ; " " OFFSET
00228 0149 0000 WORD 0000H
00229 014B 0680 CH2GAIN WORD 0680H ; 193 GHZ GAIN
00230 014D 0000 WORD 0000H
00231 014F 0000 CH2OFST WORD 0000H ; " " OFFSET
00232 0151 0000 WORD 0000H
00233 0153 0680 CH3GAIN WORD 0680H ; 94 GHZ GAIN
00234 0155 0000 WORD 0000H
00235 0157 0000 CH3OFST WORD 0000H ; " " OFFSET
00236 0159 0000 WORD 0000H
00237
00238 015B 0054 XMITBUF BLOCK 100 ; TRANSMITT BUFFER

```

```

00241          ; PERIPHERAL INITIALIZATION
00242          ORG      1000H
00243 1000 01      INIT1  NOP          ; FIX FOR SEI INSTRUCTION
00244 1001 0F          SEI
00245 1002 8E4000    LDS      #4000H
00246 1005 CE0000    LDX      #0          ; POINT TO START OF RAM
00247 1008 6F00      INIT11 CLR      0,X        ; CLEAR IT
00248 100A 08          INX
00249 100B 8C0200    CPX      #0200H    ; DONE?
00250 100E 26F8      BNE      INIT11
00251
00252 1010 CE2903    LDX      #CBUFFER    ; INIT BUFFER POINTER
00253 1013 DFBE      STX      CBUFF
00254 1015 CE015B    LDX      #XMITBUF    ; INITIALIZE OUTCHAR POINTER
00255 1018 DFE3      STX      NEXTCHAR
00256 101A CE28EF    LDX      #DISPLY     ; INIT DISP BUFFER POINTER
00257 101D DFC3      STX      NEXTDISP
00258 101F DFD0      STX      IRQT1       ; INIT DISPLAY ISR POINTER
00259 1021 BD15AE    JSR      CLRDISP    ; BLANK DISPLAY
00260 1024 CE1C0B    LDX      #INITMS     ; INITIALIZE DISPLAY DRIVER
00261 1027 DFC5      STX      DISPADR
00262 1029 CE00EB    LDX      #AVGBUFF    ; INIT AVERAGE BUFFER
00263 102C DFE9      STX      AVGPTR
00264 102E 8605      LDA      A #5
00265 1030 97DD      STA      A CAL.TIME  ; INIT CAL TIMER TO 5 MINUTES
00266 1032 97DC      STA      A CAL.CNTR  ; INIT CAL COUNTER
00267 1034 860A      LDA      A #10
00268 1036 97DA      STA      A STATCNTR ; INIT STATUS TIMER
00269 1038 97DB      STA      A STATTIME ; STORAGE FOR STATUS TIME
00270 103A 8619      LDA      A #25      ; SET GODDARD CTS TIME OUT TIMER
00271 103C 97C9      STA      A CTSCNTR
00272 103E 97CF      STA      A GSFCTO   ; SET TIME OUT TIMER
00273 1040 CE06A0    LDX      #06A0H     ; INIT RADIOMETER GAINS TO 40 DEG/VOLT
00274 1043 FF0138    STX      CH0GAIN
00275 1046 FF0143    STX      CH1GAIN
00276 1049 FF014B    STX      CH2GAIN
00277 104C FF0153    STX      CH3GAIN
00278 104F CE84A0    LDX      #84A0H     ; INIT OFFSETS TO -10 DEGREES
00279 1052 FF013F    STX      CH0OFST
00280 1055 FF0147    STX      CH1OFST
00281 1058 FF014F    STX      CH2OFST
00282 105B FF0157    STX      CH3OFST
00283
00284          ; SET UP PIA1--A/D CONTROL
00285
00286 105E CE8400    INIT2  LDX      #8400H    ; PIA BASI ADDRESS
00287 1061 6F01      CLR      1,X        ; CLEAR CONTROL REGISTERS
00288 1063 6F03      CLR      3,X        ; " " "
00289 1065 6F00      CLR      0,X        ; A-SIDE FOR ALL INPUTS
00290 1067 86F0      LDA      A #0F0H    ; B-SIDE FOR 4 INS (PB0-PB3) AND
00291 1069 A702      STA      A 2,X      ; 4 OUTS (PB4-PB7)
00292 106B 863C      LDA      A #3CH     ; HANDSHAKE WIT EOC AND CA1 AND SC ON CA2

```

```

00293 106D A701          STA A 1,X
00294 106F 8604         LDA A #4
00295 1071 A703          STA A 3,X
00296
00297 ; SET UP PIA2--TAPE DRIVE STATUS/CONTROL
00298 ;
00299 INIT3 CLR 5,X ; CLEAR CONTROL REGISTERS
00300 CLR 7,X ;
00301 CLR 4,X ; A-SIDE FOR ALL INPUTS
00302 1079 863F         LDA A #3FH ; B-SIDE FOR 2 INXS (PB7,PB6) AND 6 OUTS (PB0-PB5)
00303 107B A700          STA A 6,X ; ENABLE CA2 AND CB2 FOR TRACK CONTROL OUTPUTS
00304 107D 863C         LDA A #3CH
00305 107F A705          STA A 5,X
00306 1081 A707          STA A 7,X
00307 1083 8636         LDA A #36H ; ISSUE STOP COMMAND TO TAPE AND SET
00308 1085 A706          STA A 6,X ; WRN=WDR=1
00309
00310 ; SET UP IRQ AND NMI POINTERS
00311 INIT31 LDA A #7EH ; STORE JUMP CODE
00312 STA A IRQV
00313 108C CE20D4        LDX #IRQ. ISR
00314 108F FF03F8        STX IRQV+1
00315 1092 8703FD        STA A NMIV
00316 1095 CE1E77        LDX #NMI. ISR
00317 1098 FF03FE        STX NMIV+1
00318
00319 ;
00320 ; SET UP PIA3--DISPLAY/REFLECTOR CONTROL/TIME CODE
00321 ;
00322 INIT4 LDX #800H ; BASE ADDRESS
00323 CLR 1,X ; CLEAR CONTROL REGISTERS
00324 10A0 6F03           CLR " ;
00325 10A2 86FF          LDA A #0FFH ; A-SIDE FOR ALL OUTPUTS
00326 10A4 A700          STA A 0,X ;
00327 10A6 8630          LDA A #30H ; B-SIDE FOR 2 OUTS (PB4,PB5) AND 6 INS
00328 10A8 A702          STA A 2,X ;
00329 10AA 863D          LDA A #3DH ; ENABLE IRQ ON CA1 NEG EDGE AND SET CA2 HIGH
00330 10AC A701          STA A 1,X ;
00331 10AE 860D          LDA A #0DH ; SET CB1 AND CB2 FOR INTRPTS ON NEG EDGE FOR RTCs
00332 10B0 A703          STA A 3,X ;
00333 10B2 86FF          LDA A #0FFH ; BLANK DISPLAY
00334 10B4 A700          STA A 0,X ;
00335 10B6 A702          STA A 2,X ; DISABLE CLUTCH
00336
00337 ; SET UP ACIA1--CONSOLE RSS232--PORT 0
00338 ;
00339 INIT5 LDA A #3 ; RESET CODE
00340 10BA B78408        STA A ACIA1C ; RESET ACIA
00341 10BD 8685          LDA A #085H ; SET UP ACIA FOR 7 DATA BITS, EVEN PARITY, 2 STOP BITS
00342 10BF B78408        STA A ACIA1C ; ENABLE RCVR INTERRUPTS ONLY INITIALLY
00343
00344 ; SET UP ACIA2--REMOTE RS232--PORT 1

```

```

00345.
00346 10C2 8603          ; RESET ACIA
00347 10C4 B78808      STA A ACIA2C
00348 10C7 8611          ; SET UP ACIA FOR 8 DATA BITS, 2 STOP BITS, NO INTRPTS
00349 10C9 B78808      STA A ACIA2C
00350
00351
00352
00353 ; PROGRAM SSDA FOR TAPE DRIVE I/O
00354 10CC 8603          ; RESET XMTR AND RCVR
00355 10CE B78804      ; STORE IN CONTROL 1
00356 10D1 8608          ; DISABLE RCVR SYNC
00357 10D3 B78804      ; ACCESS CONTROL 2
00358 10D6 865D          ; 8 BIT WORD, 1 BYTE XFER AND TX SYNC ON UNDERFLOW
00359 10D8 B78805      ; STORE IN CONTROL 2
00360 10DB 864B          ; ACCESS CONTROL 3
00361 10DD B78804
00362 10E0 860E          ; SET CTUF=CTS=1 AND 1 SYNC MODE
00363 10E2 B78805
00364 10E5 868B          ; ACCESS SSYNC CODE REGISTER
00365 10E7 B78804      ; SET SYNC CODE REGISTER TO 01
00366 10EA 8601
00367 10EC B78805
00368 10EF 86C8          ; ACCESS XMIT FIFO AND CLR RESET BITS
00369 10F1 B78804
00370
00371 10F4 86C8          ; WAIT FOR THINGS TO WARM UP
00372 10F6 BD1666      JSR MSDLY
00373 10F9 BD1A18      JSR CRLF
00374 10FC CE253F      LDX #RADMSG
00375 10FF BD1DF4      JSR STRNGOUT
00376 1102 CE26D7      LDX #CONMSG
00377 1105 BD1DF4      JSR STRNGOUT
00378 1108 01          ; SOFT RESTART ENTRY
00379 1109 0E          RESTART NOP
00380 110A 7E1683      CLI
00381                  JMP MAINLOOP

```

```

00384 ;
00385 ; INTERRUPT DRIVEN ACIA INPUT ROUTINE FOR CONSOLE.
00386 ; FILLS CBUFFER WITH DATA FROM CONSOLE UNTILL CARRIAGE
00387 ; RETURN IS RCVD. THEN SENDS OUT LINE FEED AND SETS F. CMND
00388 ; FLAG.
00389 1100 DEBE INBUFF LDX CBUFF ; NEXT BUFFER LOCATION
00390 110F B68409 LDA A ACIA1D ; GET CHARACTER
00391 1112 B78409 STA A ACIA1D ; ECHO
00392 1115 4D TST A
00393 1116 273C BEQ INBUFF6 ; IGNORE NULLS
00394 1118 810A CMP A #0AH ; WAS IT A LINE FEED?
00395 111A 2738 BEQ INBUFF6 ; IGNORE IT
00396 111C 811B CMP A #1BH ; ESCAPE CHARACTER?
00397 111E 260E BNE INBUFF1 ; NO
00398 1120 CE2508 LDX #DELMSC ; PRINT "DEL"
00399 1123 BD1DF4 JSR STRNGOUT ; PRINT MESSAGE
00400 1126 7F00A0 CLR F. CMND
00401 1129 7F00A1 CLR F. NUMBR
00402 112C 2021 BRA INBUFF4 ; RETURN
00403 112E 810D INBUFF1 CMP A #0DH ; CARRIAGE RETURN
00404 1130 2716 BEQ INBUFF3 ; YES
00405 1132 8108 CMP A #8 ; BACKSPACE?
00406 1134 2608 BNE INBUFF2 ; PROCESS CHARACTER
00407 1136 8C2903 CPX #CBUFFER ; WAS IT FIRST CHARACTER?
00408 1139 2719 BEQ INBUFF6 ; YES, DONT BACKSPACE
00409 113B 09 DEX ; BACH UP POINTER
00410 113C 2014 BRA INBUFF5 ; RETURN
00411 113E 8C2913 INBUFF2 CPX #CBUFFER+16 ; END OF BUFFER
00412 1141 2705 BEQ INBUFF3 ; BUFFER FULL, TERMINATE
00413 1143 A700 STA A 0,X ; PUT CHARACTER IN BUFFER
00414 1145 08 INX ; BUMP POINTER
00415 1146 200A BRA INBUFF5
00416 1148 8604 INBUFF3 LDA A #4 ; BUFFER TERMINATOR
00417 114A A700 STA A 0,X
00418 114C 7A00A0 DEC F. CMND ; SET COMMAND READY FLAG
00419 114F CE2903 INBUFF4 LDX #CBUFFER ; INIT BUFFER POINTER
00420 1152 DFBE INBUFF5 STX CBUFF ; SAVE POINTER
00421 1154 39 INBUFF6 RTS
00422 ;
00423 ;
00424 ;
00425 ; DECODES COMMAND IN CBUFFER VIA COMMAND TABLE WHEN F. CMND FLAG
00426 ; IS SET BY INBUFF. JUMPS TO APPROPRIATE ROUTINE IF COMMAND FOUND
00427 ; PRINTS ERROR MESSAGE IF COMMAND NOT FOUND
00428 ;
00429 1155 BD1A1F DECODE JSR LFEED ; SEND OFUT LINE FEED
00430 1158 CE2903 LDX #CBUFFER ; POINTER TO BUFFER
00431 115B A600 DECODE1 LDA A 0,X ; GET CHARACTER FROM BUFFER
00432 115D 8120 CMP A #20H ; IS IT A SPACE?
00433 115F 2603 BNE DECODE11 ; NO
00434 1161 08 INX ; SKIP SPACE
00435 1162 20F7 BRA DECODE1
    
```

```

00436 1164 DFBC      DECODE11 STX  BTEMP      ;SAVE POINTER TO FIRST COMMAND CHAR.
00437 1166 DF88      STX  BUFPT     ;COMMAND PARSING POINTER
00438 1168 CE2727    LDX  #CMDTABLE ;POINTER TO COMMAND TABLE
00439 116B DFBA      DECODE2  STX  TABPNT     ;SAVE POINTER
00440 116D 6D00      TST  0,X       ;IS IT A NULL?
00441 116F 2723      BEQ  DECODE4    ;COMMAD FOU?ND?
00442 1171 A100      CMP  A 0,X     ;COMPARE CHARACTERS
00443 1173 260C      BNE  DECODE3    ;ARE THEY EQUAL?
00444 1175 DEB8      LDX  BUFPT     ;RESTORE POINTER
00445 1177 08        INX             ;BUMP IT
00446 1178 A600      DECODE21 LDA  A 0,X     ;GET NEXT CHAR
00447 117A DF88      STX  BUFPT     ;SAVE POINTER
00448 117C DEBA      LDX  TABPNT     ;GET TABLE POINTER
00449 117E 08        INX             ;BUMP IT
00450 117F 20EA      BRA  DECODE2
00451 1181 08        DECODE3 INX             ;BUMP POINTER
00452 1182 6D00      TST  0,X       ;IS IT A NULL
00453 1184 26FB      BNE  DECODE3    ;MOVE TO NEXT COMMAND
00454 1186 08        INX             ;BUMP TABLE POINTER 3 TIMES
00455 1187 08        INX
00456 1188 08        INX
00457 1189 6D00      TST  0,X       ;TABLE END?
00458 118B 270E      BEQ  DECERR     ;RETURN WITH ERROR
00459 118D 09        DEX
00460 118E DFBA      STX  TABPNT
00461 1190 DEBC      LDX  BTEMP     ;GET POINTER TO FIRST BUFFER CHAR.
00462 1192 20E4      BRA  DECODE21  ;REPEAT
00463 1194 08        DECODE4 INX             ;POINT TO COMMAND ADDRESS
00464 1195 EE00      LDX  0,X       ;GET ADDRESS
00465 1197 AD00      JSR  0,X       ;GO DO COMMAND
00466 1199 2006      BRA  DECODE5
00467 119B CE2457    DECERR LDX  #SYNMSG ;PRINT ERROR MESSAGE
00468 119E BD1DF4    JSR  STRNGOUT
00469 11A1 7F00A0    DECODE5 CLR  F.CMND  ;CLEAR FLAG
00470 11A4 39        RTS
00471
00472
00473 ; CONVERT TWO CHARACTERS IN CBUFFER INTO A SINGLE HEX BYTE IN A
00474 ; SETS CARRY AS ERROR CONDITION IF NON-HEX CHARACTER FOUND OR IF MORE
00475 ; THAN TWO CHARACTERS IN BUFFER.
00476
00477 11A5 CE2903    INBYTE LDX  #CBUFFER ;POINTER TO INPUT BUFFER
00478 11A8 A600    INBYTE1 LDA  A 0,X   ;GET A CHARACTER
00479 11AA 08      INX
00480 11AB 8120    CMP  A #20H      ;SKIP SPACES
00481 11AD 27F9    BEQ  INBYTE1
00482 11AF 8D14    BSR  TESTHEX    ;CONVERT TO HEX DIGIT AND TEST IF GOOD
00483 11B1 2510    BCS  INBYTE2    ;ERROR EXIT
00484 11B3 48      ASL  A          ;SHIFT TO MS NIBBLE
00485 11B4 48      ASL  A
00486 11B5 48      ASL  A
00487 11B6 48      ASL  A
    
```

```

00488 11B7 16          TAB
00489 11B8 A600       LDA A 0,X           ; GET NEXT CHARACTER
00490 11BA 08          INX
00491 11BB 8D08       BSR TESTHEX
00492 11BD 2504       BCS INBYTE2        ; ERROR EXIT
00493 11BF 1B          ABA           ; FORM COMPLETE BYTE
00494 11C0 0C          CLC
00495 11C1 2001       BRA INBYTE3
00496 11C3 0D          INBYTE2 SEC           ; ERROR CONDITION
00497 11C4 39          INBYTE3 RTS
00498
00499                ; CONVERT ASCII CHARACTER IN A TO HEX NIBBLE. SET CARRY IF NOT HEX.
00500
00501 11C5 8030       TESTHEX SUB A #30H     ; REMOVE ASCII BIAS
00502 11C7 2B10       BMI NOTHEX        ; CHARACTER LESS THAN 30H?
00503 11C9 8109       CMP A #09H        ; GREATER THAN 9?
00504 11CB 2F0A       BLE YESHEX        ; ALREADY PROPER HEX
00505 11CD 8111       CMP A #11H        ; WAS IT LESS THAN AN "A"?
00506 11CF 2B08       BMI NOTHEX
00507 11D1 8116       CMP A #16H        ; GREATER THAN F?
00508 11D3 2E04       BGT NOTHEX
00509 11D5 8007       SUB A #07H        ; SUBTRACT LETTER BIAS FOR A-F
00510 11D7 0C          YESHEX CLC
00511 11D8 39          RTS
00512 11D9 0D          NOTHEX SEC
00513 11DA 39          RTS
00514
00515
00516
00517                ; GET 2 BYTE NUMBER FROM CBUFFER AND PLACE RESULT IN X.
00518                ; CARRY SET IF A NON-HEX DIGIT FOUND OR IF THERE ARE NOT EXACTLY
00519                ; FOUR CHARACTERS IN BUFFER.
00520
00521 11DB CE2903       IN2BYTES LDX #CBUFFER ; POINTER TO INPUT BUFFER
00522 11DE 8DC8       BSR INBYTE1        ; CONVERT FIRST TWO CHARS TO HEX
00523 11E0 2511       BCS IN2BYTE2      ; ERROR EXIT
00524 11E2 97AE       STA A XTEMP1      ; SAVE RESULT
00525 11E4 8DC2       BSR INBYTE1        ; GET NEXT BYTE
00526 11E6 25DB       BCS INBYTE2
00527 11E8 97AF       STA A XTEMP1+1
00528 11EA A600       LDA A 0,X         ; LOOK FOR 04
00529 11EC 8104       CMP A #4
00530 11EE 2603       BNE IN2BYTE2      ; ERROR EXIT IF NOT FOUND
00531 11F0 0C          CLC
00532 11F1 2001       BRA IN2BYTE3
00533 11F3 0D          IN2BYTE2 SEC
00534 11F4 DEAE       IN2BYTE3 LDX XTEMP1 ; GET 2 BYTES IN X
00535 11F6 39          RTS
00536
00537

```

```

00540
00541 ; TAPE DRIVE CONTROL SUBROUTINES
00542
00543
00544 ; TAPE MOTION COMMANDS. USE BY DATA COLLECTION SOFTWARE
00545 ; AND UTILITY COMMANDS.
00546
00547 ; LOAD CART
00548
00549 LOAD LDA A PIA2AD ; GET STATUS
00550 AND A #30H ; CHECK IF ALREADY LOADED
00551 BEQ LOAD2
00552 CMP A #10H ; CHECK IF STAUTS=0
00553 BEQ LOAD1 ; YES, STAYTUS OK, LOAD CART
00554 LDX #MESSNR ; TURN ON NOT READY MESSAGE
00555 JSR STRNGOUT
00556 BRA LOAD2
00557 LOAD1 BSR STOP ; STOP TAPE IF MOVING
00558 LDA A #LOADCODE ; GET LOAD CODE
00559 BSR TCMND ; ISSUE COMMAND
00560 CLR A
00561 STA A BLKNUM ; CLEAR BLOCK NUMBER
00562 STA A BLKNUM+1
00563 LOAD2 RTS
00564
00565 ; STOP TAPE
00566 STOP LDA A #STOPCODE ; GET STOP CODE
00567 BRA TCMND
00568
00569 ; MOVE TAPE FORWARD
00570 FORWD LDA A #FORCODE
00571 BRA TCMND
00572
00573 ; FAST FORWARD
00574 FFORWD LDA A #FFOWCODE
00575 BRA TCMND
00576
00577 ; REVERSE
00578 REVERSE LDA A #REVCODE
00579 BRA TCMND
00580
00581 ; REWIND
00582 REWIND LDA A #REWCODE
00583 CLR BLKNUM
00584 CLR BLKNUM+1
00585 BRA TCMND
00586
00587 ; PULSE PROPER TAPE CONTROL LINE
00588
00589 TCMND LDA B PIA2BD ; GET OLD CONTROL WORD
00590 AND B #0F0H ; MASK OF LS HALF
00591 ABA ; ADD IN NEW COMMAND
    
```



```

00592 1236 B78406      STA A  PIA2BD      ; PUT OUT NEW COMMAND
00593 1239 84F0       AND A  #0F0H      ; CLEAR COMMAND
00594 123B B78406      STA A  PIA2BD
00595 123E 39         RTS
00596
00597
00598                ; UNLOAD CART FOR REMOVAL
00599
00600 123F 8DD5       UNLOAD  BSR      STOP      ; STOP TAPE IF MOVING
00601 1241 8604       LDA A  #LOADCODE
00602 1243 8DEB       BSR      TCMND
00603 1245 8604       LDA A  #LOADCODE      ; ISSUE TWO LOAD PULSES
00604 1247 8DE7       BSR      TCMND
00605 1249 39         RTS
00606
00607
00608
00609                ; TAPE STATUS MONITOR. CHECKS TAPE STATUS BITS ON PIA2A
00610                ; TO DETERMINE APPROPRIATE STATUS.
00611                ; RETURNS TO ROUTINE ONE LEVEL LOWER ON STACK IF ERROR
00612
00613 124A B68404      CKRDY  LDA A  PIA2AD      ; GET STATUS
00614 124D 8430       AND A  #30H        ; CHECK RDY AND ST BITS
00615 124F 2605       BNE   CKRDY1
00616 1251 B68406      LDA A  PIA2BD      ; CHECK TAPE MOTION BIT
00617 1254 2B08       BMI   CKRDY2      ; NOT MOVING
00618 1256 CE242C     CKRDY1 LDX  #MESSNR    ; TURN ON NOT READY MSG
00619 1259 BD1DF4     JSR   STRNGOUT
00620 125C 31         INS
00621 125D 31         INS
00622 125E 39         CKRDY2 RTS
00623
00624
00625 125F B68404      CKLOAD LDA A  PIA2AD      ; GET STATUS
00626 1262 8402       AND A  #02H        ; SEE IF TAPE AT LOAD POINT
00627 1264 39         RTS
00628
00629                ; CHECK IF WRITE PROTECT IS ON
00630 1265 B68406      CKFP  LDA A  PIA2BD      ; GET FP AND TM BITS
00631 1268 8440       AND A  #40H        ; CHECK BIT 6
00632 126A 2606       BNE   CKFP1      ; NOT PROTECTED
00633 126C CE2518     LDX  #FPMSG       ; TURN ON FILE PROTECT MESSAGE
00634 126F BD1DF4     JSR   STRNGOUT
00635 1272 39         CKFP1 RTS
00636
00637
00638                ; SET TRACK NO. FROM CONTENTS OF A
00639                ; A MAY BE =0,1,2,3
00640 1273 8103       TRACK  CMP A  #3         ; SEE IF ALLOWABLE VALUE
00641 1275 221A       BHI   TRACK3      ; NOPE, RETURN
00642 1277 9700       STA A  TRACKN     ; UPDATE TRACK NO.
00643 1279 F68405     LDA B  PIA2AC     ; GET TR0 CONTROL WORD
    
```

```

00644 127C 800C          ;SET OR CLEAR TRACK BIT AS REQUIRED
00645 127E F78405      ;REPLACE TR0
00646 1281 F68407      ;GET TR1 BIT
00647 1284 8004          ;DO SAME FOR TR1
00648 1286 F78407
00649 1289 39
00650 129A CA38
00651 128C 44
00652 128D 2402
00653 128F C4F7
00654 1291 39
00655
00656
00657
00658
00659
00660 1292 CE248:
00661 1295 BD1DF1
00662 1298 7A00A1
00663 1298 CE12A:
00664 129E DFC1
00665 12A0 2031
00666 12A2 BD11D:
00667 12A5 2408
00668 12A7 CE247:
00669 12AA BD1DF
00670 12AD 20E3
00671 12AF DFB4
00672 12B1 CE248:
00673 12B4 BD1DF:
00674 12B7 7A00A
00675 12BA CE12C
00676 12BD DFC1
00677 12BF 2012
00678 12C1 BD11A
00679 12C4 2408
00680 12C6 CE247:
00681 12C9 BD1DF:
00682 12CC 20E3
00683 12CE DEB4
00684 12D0 BD141C
00685 12D3 39
00686
00687
00688
00689 12D4 CE24B:
00690 12D7 BD1DF1
00691 12DA 7A00A
00692 12DD CE12E:
00693 12E0 DFC1
00694 12E2 2031
00695 12E4 BD11D:

BSR TRACK2
STA B PIR2AC          ;SET OR CLEAR TRACK BIT AS REQUIRED
LDA B PIR2BC          ;REPLACE TR0
BSR PIR2BC           ;GET TR1 BIT
STA B PIR2BC           ;DO SAME FOR TR1

RTS
ORA B #38H           ;CLEAR TRACK BIT
LSR A                ;CHECK DESIRED TRACK NO.
BCC TRACK3          ;SET TRACK BIT
AND B #0F7H         ;DONE
RTS

TRACK2
TRACK3

; WRITE MEMORY TO TAPE . ASKS FOR STARTING ADDRESS AND
; NUMBER OF 2K BYTE BLOCKS. USES STATE POINTER "NEXSTATE"
; TO FETCH NUMBER VIA INBUFF AND JUMP FROM MAINPROGRAM
WRITE LDX #STRMSG
JSR STRGNOC
DEC F. NUMBR
LDX #WRITE1
STX NEXSTATE
BRA WRITES
JSR IN2BYTES
BCC WRITE2
LDX #NUMERR
JSR STRNGOUT
BRA WRITE
STX XTEMP4
WRITE2 LDX #BLKMSG
JSR STRGNOC
DEC F. NUMBR
LDX #WRITE3
STX NEXSTATE
BRA WRITES
JSR INBYTE
BCC WRITE4
LDX #NUMERR
JSR STRNGOUT
BRA WRITE2
LDX XTEMP4
JSR TWRITE
RTS

; READ BLOCKS FROM TAPE TO MEMORY STARTING AT CURRENT BLOCK
;
READ LDX #STRMSG
JSR STRGNOC
DEC F. NUMBR
LDX #READ1
STX NEXSTATE
BRA READS
JSR IN2BYTES
READ1 JSR IN2BYTES
; CONVERT TO HEX

```

```

00696 12E7 2408      BCC      READ2      ;SKIP IF NO ERROR
00697 12E9 CE247D   LDX      #NUMERR   ;
00698 12EC 8D1DF4   JSR      STRNGOUT  ;
00699 12EF 20E3     BRA      READ      ;TRY AGAIN
00700 12F1 DF84     STX      XTEMP4    ;SAVE ADDRESS
00701 12F3 CE248C   LDX      #BLKMSG   ;ASK FOR NUMBER OF BLOCKS
00702 12F6 8D1DFF   JSR      STRNGNOC  ;
00703 12F9 7A00A1  DEC      F.NUMBR   ;SET NUMBER FLAG
00704 12FC CE1303  LDX      #READ3    ;
00705 12FF DFC1    STX      NEXSTATE  ;
00706 1301 2012    BRA      READ5     ;
00707 1303 8D11A5  JSR      INBYTE    ;CONVERT TO HEX
00708 1306 2408    BCC      READ4     ;
00709 1308 CE247D   LDX      #NUMERR   ;
00710 130B 8D1DF4   JSR      STRNGOUT  ;
00711 130E 20E3    BRA      READ2     ;
00712 1310 DE84    LDX      XTEMP4    ;
00713 1312 8D14E4  JSR      TREAD     ;
00714 1315 39      RTS
00715
00716
00717
00718
00719
00720 1316 8D124A   ;MOVE CART TO DESIRED BLOCK AND TRACK
00721 1319 CE24FB   ;CHECKS FOR CART READY FIRST
00722 131C 8D1DFF   ;ALSO CHECKS FOR VALID BLOCK
00723 131F 7A00A1  SEEK     CKRDY     ;SEE IF CART IS READY
00724 1322 CE1329  LDX      #TRACKMSG ;ASK FOR TRACK NUMBER
00725 1325 DFC1    DEC      F.NUMBR   ;PRINT WITH NO CR
00726 1327 2014    LDX      #SEEK1    ;SET NUMBER FLAG
00727 1329 8D11A5  STX      NEXSTATE  ;SET STATE POINTER
00728 132C 2408    BRA      SEEK5     ;GET BYTE FROM CBUFFER
00729 132E CE247D   JSR      INBYTE    ;SKIP IF NO ERROR
00730 1331 8D1DF4  BCC      SEEK2     ;PRINT ERROR MESSAGE
00731 1334 20E0    LDX      #NUMERR   ;TRY AGAIN
00732 1336 8103    JSR      STRNGOUT  ;CHECK FOR VALID TRACK NO
00733 1338 22F4    BRA      SEEK1    ;TRY AGAIN IF INVALID NUMBER
00734 133A 8D1273  CMP     A          ;GO SET TRACK NUMBER
00735 133D 39      BHI     SEEK11    ;STOP HERE TILL NEXT ROUTINE IS WRITTEN!
00736
00737 ;THIS ROUTINE MOVES TAPE TO DESIRED BLOCK NUMBER STARTING AT PRESENT
00738 ;BLOCK. ASSUMES PRESENT BLOCK NUMBER IS IN BLKNUM AND THAT MAX BLOCK
00739 ;NUMBER IS 0130
00740 ;WILL STOP TAPE IF GAP LONGER THAN 47 MS IS FOUND
00741 133E 8D124A   JSR      CKRDY     ;SEE IF DRIVE IS READY
00742 1341 7F00CC  CLR     SKIPSGN   ;
00743 1344 7F00CA  CLR     TCNT      ;
00744 1347 7F00CB  CLR     FCNT      ;
00745 134A CE24C6  LDX      #BLOCKMSG ;
00746 134D 8D1DFF   JSR      STRNGNOC  ;
00747 1350 7A00A1  DEC     F.NUMBR   ;

```

```

00748 1353 CE1350          LDX    #BLOCK1
00749 1356 DFC1           STX    NEXSTATE
00750 1358 39            RTS
00751 1359 BD11D0        BLOCK1 JSR    IN2BYTES    ; GET BLOCK NUMBER IN X
00752 135C 2408          BCC    BLOCK2        ; SKIP IF NO ERROR
00753 135E CE2460        BLOCK11 LDX    #BKERMSG     ; PRINT ERROR MSG
00754 1361 BD1DF4        JSR    STRNGOUT
00755 1364 20D8          BRA    FBLOCK
00756 1366 96AE          BLOCK2 LDA A  XTEMP1      ; GET MS BYTE OF DESIRED BLOCK
00757 1368 8102          CMP A  #2
00758 136A 2CF2          BGE    BLOCK11
00759 136C DFC0          STX    BLKCNT        ; SAVE X
00760 136E 96CE          LDA A  BLKCNT+1     ; SUBTRACT DESIRED FROM PRESENT BLOCK
00761 1370 9002          SUB A  BLKNUM+1
00762 1372 D6CD          LDA B  BLKCNT
00763 1374 D201          SBC B  BLKNUM
00764 1376 2409          BCC    SKIPPOS      ; POSITIVE SKIP
00765 1378 43           SKIPNEG COM A      ; CONVERT BACK TO SIGN. MAG
00766 1379 53           COM B
00767 137A 0B01          ADD A  #1
00768 137C C900          ADC B  #0
00769 137E 7A00C0        DEC    SKIPSGN      ; SET FOR NEG SKIP
00770 1381 D7CD          SKIPPOS STA B  BLKCNT
00771 1383 97CE          STA A  BLKCNT+1
00772 1385 DECD          SKIP1  LDX    BLKCNT
00773 1387 09           DEX
00774 1388 DFC0          STX    BLKCNT
00775 138A 8CFFFF        CPX    #0FFFFH     ; MINUS?
00776 138D 276A          BEQ    SKIP53
00777 138F 8C0000        CPX    #0
00778 1392 273A          BEQ    SKIPS        ; SKIP SLOW
00779 1394 96CC          LDA A  SKIPSGN
00780 1396 2B05          BMI    SKIP1B
00781 1398 BD14D0        JSR    INCBLK
00782 139B 2003          BRA    SKIPF        ; SKIP FAST
00783 139D BD1410        SKIP1B JSR    DECBLK
00784 13A0 8D58          SKIPF  BSR    FAST
00785 13A2 B68400        LDA A  PIA2AD      ; CHECK GAP BIT
00786 13A5 48           ASL A
00787 13A6 2A16          BPL    SKIPG        ; IN GAP
00788 13A8 96CB          LDA A  FCNT        ; BLOCK TIMER
00789 13AA 22F4          BHI    SKIPF        ; ALREADY CHECKED TIMER
00790 13AC 8106          CMP A  #6
00791 13AE 2309          BLS    SKIPF1
00792 13B0 7F00C0        CLR    TCNT
00793 13B3 86FF          LDA A  #0FFH
00794 13B5 97CB          STA A  FCNT
00795 13B7 20CC          BRA    SKIP1
00796 13B9 7C00C0        SKIPF1 INC    FCNT
00797 13BC 20E2          BRA    SKIPF
00798 13BE 96CA          SKIPG  LDA A  TCNT
00799 13C0 81C8          CMP A  #200

```

```

00800 13C2 2305          BLS    SKIPG1
00801 13C4 7F00CB       CLR    FCNT
00802 13C7 20D7         BRA    SKIPF
00803 13C9 7C00CA       SKIPG1 INC    TCNT
00804 13CC 20D2         BRA    SKIPF
00805 13CE 96CC         SKIPS  LDA  A  SKIPSGN    ; WHICH WAY?
00806 13D0 2A05         BPL    SKIPSPL
00807 13D2 BD1412       JSR    DECBLK
00808 13D5 2003         BRA    SKIPS11
00809 13D7 BD14DA       SKIPSPL JSR    INCBLK
00810 13DA BD1216       SKIPS11 JSR    STOP
00811 13DD 8628         LDA  A  #40
00812 13DF BD1666       JSR    MSDLY
00813 13E2 BD1406       JSR    SLOW
00814 13E5 B68404       SKIPS1  LDA  A  PIA2AD
00815 13E8 48           ASL  A
00816 13E9 2AFA         BPL    SKIPS1
00817 13EB B68404       SKIPS2  LDA  A  PIA2AD
00818 13EE 48           ASL  A
00819 13EF 2BFA         BMI    SKIPS2
00820 13F1 861A         LDA  A  #26
00821 13F3 BD1666       JSR    MSDLY
00822 13F6 BD1216       JSR    STOP
00823 13F9 39          SKIPS3  RTS
00824
00825
00826 ; SET FASTFORWARD IF SKIPSGN IS POS OR REWIND IF NEG
00827 13FA 96CC         FAST   LDA  A  SKIPSGN
00828 13FC 2A04         BPL    GOFORWD
00829 13FE BD1226       JSR    REWIND
00830 1401 39          RTS
00831 1402 BD121E       GOFORWD JSR    FFORWD
00832 1405 39          RTS
00833
00834 ; SET FORWARD IF SKIPSGN IS POS OR REVERSE IF NEG
00835 1406 96CC         SLOW  LDA  A  SKIPSGN
00836 1408 2A04         BPL    GOFOR
00837 140A BD1222       JSR    REVERSE
00838 140D 39          RTS
00839 140E BD121A       GOFOR  JSR    FORWD
00840 1411 39          RTS
00841
00842
00843 ; DECREMENT BLOCK COUNTER
00844 1412 DF00         DECBLK STX    XTEMP2
00845 1414 DE01         LDX    BLKNUM
00846 1416 09         DEX
00847 1417 DF01         STX    BLKNUM
00848 1419 DE00         LDX    XTEMP2
00849 141B 39          RTS
00850
00851
    
```

```

00052      ; TAPE WRITE ROUTINE
00053      ; WRITES 2048 BYTES TO TAPE.  STARTING ADDRESS OF BLOCK IN X.
00054
00055 141C 97C0      TWRITE  STA A  BLOCKS      ; SAVE NO. OF BLOCKS TO WRITE
00056 141E BD124F    JSR    CKRDY      ; SEE IF DRIVE READY FOR WRITE
00057 1421 BD1265    JSR    CKFP       ; SEE IF FP SET
00058 1424 8620      TWRITES LDA A  #20H
00059 1426 B78406    STA A  PIA2BD    ; SET WRN=0
00060 1429 8680      LDA A  #80H      ; ACCESS SYNC CODE REGISTER
00061 142B B78804    STA A  SSDAC
00062 142E 4F       CLR A
00063 142F B78805    STA A  SSDAD     ; SET SYNC CODE TO 00
00064 1432 C6C0      LDA B  #0C0H     ; ACCESS XMIT FIFO
00065 1434 F78804    STA B  SSDAC
00066 1437 B78805    STA A  SSDAD     ; ZERO OUT FIFO
00067 143A B78805    STA A  SSDAD
00068 143D B78805    STA A  SSDAD
00069 1440 BD156A    JSR    CRC       ; COMPUTE CRC FOR BLOCK
00070 1443 BD125F    JSR    CKLOAD    ; SEE IF AT LOAD POINT (A=FF IF TRUE)
00071 1446 36       PSH A           ; SAVE LOAD STATUS
00072 1447 BD121F    JSR    FORWD     ; START DRIVE
00073 144A 32       PUL A           ; GET LOAD STATUS BACK
00074 144B 4D       TST A           ; TEST LOAD FLAG
00075 144C 2605     BNE    TWRITE1   ; BYPASS 1 SEC DELAY
00076 144E 8601     LDA A  #1
00077 1450 BD166F    JSR    SECDLY    ; DELAY 1 SEC
00078 1453 862F     TWRITE1 LDA A  #47      ; 47 MS IRG DELAY
00079 1455 BD166E    JSR    MSDLY
00080 1458 DFAE     STX    XTEMP1    ; SAVE BLOCK POINTER
00081 145A CE0800    LDX    #0800H    ; 2048 BYTE COUNT
00082 145D DFAC     STX    BYCOUNT
00083 145F DEAE     LDX    XTEMP1    ; RETREIVE POINTER
00084 1461 4F       CLR A
00085 1462 B78406    STA A  PIA2BD    ; SET WDR=0
00086 1465 8D68     BSR    WRBVT     ; PAD WITH A FEW ZEROS
00087 1467 8D66     BSR    WRBVT     ; WRITE A FEW ZEROS FOR SPACING
00088 1469 8D64     BSR    WRBVT
00089 146B 8D62     BSR    WRBVT
00090 146D 8655     LDA A  #55H     ; WRITE SYNC BYTE
00091 146F 8D5E     BSR    WRBVT
00092 1471 4F       CLR A           ; WRITE PREAMBLE (0001)
00093 1472 8D5B     BSR    WRBVT
00094 1474 8601     LDA A  #1       ; SECOND BYTE OF PREAMBLE
00095 1476 8D57     BSR    WRBVT
00096 1478 A600     TWRITE2 LDA A  0,X      ; GET BYTE FROM BLOCK
00097 147A 8D53     BSR    WRBVT    ; SEND BYTE TO SSDA
00098 147C 08       INX            ; INCREMENT BYTE POINTER
00099 147D DFAE     STX    XTEMP1    ; SAVE BYTE POINTER
00090 147F DEAC     LDX    BYCOUNT ; GET BYTE COUNTER
00001 1481 09       DEX            ; DECREMENT BYTE COUNTER
00002 1482 2706     BEQ    TWRITE3   ; DONE
00003 1484 DFAC     STX    BYCOUNT ; SAVE COUNT

```

```

00904 1486 DEAE          LDX  XTEMP1      ; RETREIVE POINTER
00905 1488 20EE          BRA  TWRITE2     ; DO NEXT BYTE
00906 148A 96B6          TWRITE3 LDA A  CRCH      ; WRITE CRC ON TAPE
00907 148C 8D41          BSR  WRTBYT     ; BYPASS CRC
00908 148E 96B7          LDA A  CRCL
00909 1490 8D3D          BSR  WRTBYT
00910 1492 868D          LDA A  #80H      ; WIRTE POSTAMBLE
00911 1494 8D39          BSR  WRTBYT
00912 1496 4F           CLR A
00913 1497 8D36          BSR  WRTBYT
00914 1499 B68804        TWRITE4 LDA A  SSDAC   ; CHECK TUF FLAG
00915 149C 8510          BIT A  #10H      ; MASK OF TUF BIT
00916 149E 27F9          BEQ  TWRITE4     ; WAIT UNTILL XMIT FIFO IS EMPTY
00917 14A0 8640          LDA A  #40H      ; RESET TUF FLAG
00918 14A2 B78804        STA A  SSDAC     ; ACCESS CONTROL 3
00919 14A5 860E          LDA A  #0EH
00920 14A7 B78805        STA A  SSDAD
00921 14AA 8620          LDA A  #20H      ; SET WDR=1
00922 14AC B78406        STA A  PIA2BD
00923 14AF 861A          LDA A  #26
00924 14B1 8D1666        JSR  MSDLY       ; WAIT 26 MS FOR IRG
00925 14B4 8D1216        TWRITES JSR  STOP        ; STOP TAPE
00926 14B7 8619          LDA A  #25       ; WAIT FOR TAPE TO STOP
00927 14B9 8D1666        JSR  MSDLY
00928 14BC 8D14DA        JSR  INCBLK      ; INC BLOCK NUMBER
00929 14BF DEAE          LDX  XTEMP1      ; GET DATA POINTER BACK
00930 14C1 7A00C0        DEC  BLOCKS      ; DEC BLOCK COUNT
00931 14C4 2703          BEQ  TWRITES6    ; DONE
00932 14C6 7E1424        JMP  TWRITES     ; GO WRITE ANOTHER BLOCK
00933 14C9 8630          TWRITE6 LDA A  #30H   ; SET WRN=WDR=1
00934 14CB B78406        STA A  PIA2BD
00935 14CE 39           RTS
00936
00937
00938          ; SEND A BYTE TO SSDA
00939
00940 14CF F68804        WRTBYT LDA B  SSDAC ; CHECK TDRA BIT
00941 14D2 54           LSR B
00942 14D3 54           LSR B
00943 14D4 24F9          BCC  WRTBYT      ; XMTR STILL BUSY
00944 14D6 B78805        STA A  SSDAD     ; STORE BYTE IN XMIT FIFO
00945 14D9 39           RTS
00946
00947          ; INCREMENT 16 BIT BLOCK NUMBER
00948
00949 14DA DF80          INCBLK STX  XTEMP2 ; SAVE X
00950 14DC DE01          LDX  BLKNUM
00951 14DE 08           INX
00952 14DF DF01          STX  BLKNUM
00953 14E1 DEB0          LDX  XTEMP2
00954 14E3 39           RTS
00955

```

TAPE CONTROL ROUTINES

```

00956
00957
00958
00959
00960
00961
00962
00963
00964 14E4 97C0
00965 14E6 DF80
00966 14E8 8D124A
00967 14EB 8D121A
00968 14EE 8619
00969 14F0 8D1666
00970 14F3 8601
00971 14F5 878804
00972 14F8 8688
00973 14FA 878804
00974 14FD 8655
00975 14FF 878805
00976 1502 868404
00977 1505 48
00978 1506 2AFA
00979 1508 4F
00980 1509 878804
00981 150C 8D52
00982 150E 8101
00983 1510 26FA
00984 1512 DF4E
00985 1514 CE0800
00986 1517 DF4C
00987 1519 DE4E
00988 151B 8D43
00989 151D A700
00990 151F 08
00991 1520 DF4E
00992 1522 DE4C
00993 1524 09
00994 1525 2706
00995 1527 DF4C
00996 1529 DE4E
00997 152D 20EE
00998 152D 8D31
00999 152F 36
01000 1530 8D2E
01001 1532 36
01002 1533 862B
01003 1535 8D1666
01004 1538 8D1216
01005 153B DE80
01006 153D 8D156A
01007 1540 32

; TREAD. READS 2048 BYTES FROM NEXT BLOCK ON TAPE
; TO MEMORY STARTING AT LOCATION IN X. COMPARES CRCs
; AND RETURNS A=0 IF THEY MATCH
TREAD STA A BLOCKS
TREAD11 STX XTEMP2
JSR CKRDY
JSR FORWD
LDA A #25
JSR MSDLY
LDA A #1
STA A SSDAC
LDA A #88H
STA A SSDAC
LDA A #55H
STA A SSDAD
LDA A PIR2AD
ASL A
TREAD12 BPL A
CLR A
STA A SSDAC
BSR RDBYTE
CMP A #1
BNE TREAD1
STX XTEMP1
LDX #0800H
STX BYCOUNT
LDX XTEMP1
RDBYTE
STA A 0.X
INX
STX XTEMP1
DEX
BEQ TREAD3
STX BYCOUNT
LDX XTEMP1
BRA TREAD2
BSR RDBYTE
PSH A
PSH A #43
LDA A MSDLY
JSR STOP
LDX XTEMP2
JSR CRC
PUL A

; SAVE BLOCK COUNT
; SAVE FILE POINTER
; SEE IF DRIVE READY
; START TAPE FORWARD
; WAIT 25 MS FOR TAPE TO SPEED UP
; RESET SSDA RCVR
; DISABLE SYNC, ACCESS SYNC CODE REG
; SET SYNC CODE=55
; CHECK GAP BIT
; WAIT FOR GAP BEFORE TRYING TO READ
; ENABLE RCVR SYNC
; WAIT FOR FIRST BYTE FOLLOWING FIRST SYNC
; CHECK FOR SECOND PREAMBLE BYTE
; NOT THERE, TRY AGAIN
; SAVE POINTER
; BYTE COUNT
; GET POINTER
; GET A BYTE
; PUT IT IN MEMORY
; INCREMENT MEMORY POINTER
; SAVE POINTER
; DECREMENT BYTE COUNT
; DONE, GET CRC
; SAVE COUNT
; GET POINTER BACK
; GET ANOTHER BYTE
; GET FIRST CRC BYTE
; SAVE IT
; GET NEXT CRC BYTE
; SAVE IT
; WAIT 43 MS FOR IRG
; STOP TAPE
; RETRIEVE POINTER
; COMPUTE CRC STARTING WITH OLD CRC
; COMPARE NEW CRC WITH ONE FROM TAPE

```



```

01008 1541 33          PUL B
01009 1542 90B7       SUB A CRCL          ; COMPARE LS BYTE
01010 1544 2604       BNE TREAD4
01011 1546 D0B6       SUB B CRCH          ; COMPARE MS BYTE
01012 1548 2709       BEQ TREAD45
01013 154A CE249A     TREAD4 LDX #CRCMSG      ; PRINT ERROR MESSAGE
01014 154D BD1DFF     JSR STRNGNOC
01015 1550 7E1C31     JMP TAPE1          ; REPORT BLOCK AND TRACK NO.
01016 1553 BD14DA     TREAD45 JSR INCBLK     ; INCREMENT BLOCK NUMBER
01017 1556 7A00C6     DEC BLOCKS        ; DECREMENT BLOCK COUNTER
01018 1559 2704       BEQ TREAD5        ; DONE
01019 155B DEAE       LDX XTEMP1        ; GET DATA POINTER
01020 155D 2027       BRA TREAD11       ; GO READ ANOTHER BLOCK
01021 155F 39        TREAD5 RTS
01022                ;
01023                ;
01024                ; READ A BYTE FROM SSDA FIFO AND COMPUTE CRC
01025 1560 B68804     RDBYTE LDA A SSDAC  ; CHECK RDA FLAG
01026 1563 44        LSR A
01027 1564 24FA       BCC RDBYTE        ; WAIT FOR RDA=1
01028 1566 B68805     LDA A SSDAD       ; GET A BYTE FROM FIFO
01029 1569 39        RTS
01030                ;
01031                ; COMPUTE A 16 BIT CRC CHECK CODE FROM A 2048 BYTE BUFFER
01032                ; POINTED TO BY X. RETURNS CRC IN CRCH AND CRCL
01033 156A 7F00B6     CRC CLR CRCH        ; CLEAR CRC IN NEEDED
01034 156D 7F00B7     CLR CRCL
01035 1570 DFB2       CRC1 STX XTEMP3      ; SAVE POINTER
01036 1572 DFB0       STX XTEMP2      ; SAVE X THRU SUBROUTINE
01037 1574 CE0800     LDX #0800H       ; BYTE COUNT
01038 1577 DFAC       CRC2 STX BYCOUNT    ; SAVE I
01039 1579 DEB2       LDX XTEMP3
01040 157B A600       LDA A 0,X         ; GET CHARACTER
01041 157D 8D0B       BSR CRCC         ; COMPUTE CRC
01042 157F 08        INX
01043 1580 DFB2       STX XTEMP3
01044 1582 DEAC       LDX BYCOUNT    ; GET COUNT
01045 1584 09        DEX
01046 1585 26F0       BNE CRC2
01047 1587 DEB0       LDX XTEMP2      ; RETREIVE POINTER
01048 1589 39        RTS
01049                ;
01050                ; DO CRC ONE BYTE AT A TIME
01051 158A 9789       CRCC STA A TEMPA
01052 158C 8680       LDA A #80H        ; MASK
01053 158E 7800B7     CRCC1 ASL CRCL
01054 1591 7900B6     ROL CRCH
01055 1594 9589       BIT A TEMPA
01056 1596 2704       BEQ CRCC2
01057 1598 2510       BCS NOCHANGE
01058 159A 2002       BRA CHANGE
01059 159C 240C       CRCC2 BCC NOCHANGE

```

01060	159E	C641	CHANGE	LDA	B	#CRCPL
01061	15A0	D8B7		EOR	B	CRCL
01062	15A2	D7B7		STA	B	CRCL
01063	15A4	C680		LDA	B	#CRCPH
01064	15A6	D8B6		EOR	B	CRCH
01065	15A8	D7B6		STA	B	CRCH
01066	15AA	44	NOCHANGE	LSR	A	
01067	15AB	26E1		BNE		CRCC1
01068	15AD	39		RTS		

```

01071
01072          ; FILL DISPLAY WITH BLANKS
01073 15AE CE28EF  CLRDISP LDX  #DISPLY
01074 15B1 DFC3    STX  NEXTDISP  ; INIT DISP O POINTER
01075 15B3 8620    LDA  A  #20H    ; BLANK CODE
01076 15B5 A700    CLRDISP1 STA A  0.X
01077 15B7 08      INX
01078 15B8 8C2903  CPX  #DISPLY+20 ; DONE?
01079 15B8 26F8    BNE  CLRDISP1
01080 15BD 39      RTS
01081          ; PUT BCD TEMPERATURE POINTED TO BY X IN NEXT 5 DISPLAY LOCATIONS
01082          ; ONLY PUTS 3 DIGITS TO LEFT AND 1 TO RIGHT OF DECIMAL. ASSUMES
01083          ; 4 BYTE PLUS SIGN PACKED BCD FORMAT
01084 15BE A601    DISPTEMP LDA A  1.X  ; GET MS DIGITS
01085 15C0 8C1612  JSR  DISPHR   ; PUT LS DIGIT IN DISPLAY
01086 15C3 A602    LDA  A  2.X
01087 15C5 8C1605  JSR  DISPHEX
01088 15C8 862E    LDA  A  #". "
01089 15CA 8D15F1  JSR  DISPCHAR
01090 15CD A603    LDA  A  3.X
01091 15CF 8D160C  JSR  DISPHL
01092 15D2 39      RTS
01093
01094          ; PUT STRING IN DISPLAY BUFFER BEGINNING AT FIRST DISPLAY POSITION.
01095          ; LOOKS FOR 04 AS TERMINATOR
01096 15D3 DFB0    DISPSTNG STX  XTEMP2  ; SAVE MESSAGE POINTER
01097 15D5 CE28EF  LDX  #DISPLY  ; INIT DISP POINTER
01098 15D8 DFC3    STX  NEXTDISP
01099 15DA DEB0    LDX  XTEMP2   ; GET MESSAGE POINTER BACK
01100
01101          ; PUT STRING IN DISPLAY BUFFER BEGINNING AT NEXT DISPLAY LOCATION
01102          ; STORED IN NEXTDISP
01103 15DC DFB0    DISPNEXT STX  XTEMP2  ; SAVE MESSAGE POINTER
01104 15DE A600    LDA  A  0.X  ; GET CHAR
01105 15E0 8104    CMP  A  #04H  ; DONE?
01106 15E2 2707    BEQ  DISP2
01107 15E4 8D0B    BSR  DISPCHAR ; PUT CHAR IN BUFFER
01108 15E6 DEB0    LDX  XTEMP2  ; GET MESSAGE POINTER BACK
01109 15E8 03      INX
01110 15E9 28F1    BRA  DISPNEXT
01111 15EB 39      DISP2  RTS
01112          ; PUT A SPACE IN DISPLAY BUFFER
01113 15EC 8620    DISPSPC LDA A  #20H
01114 15EE 8D01    BSR  DISPCHAR
01115 15F0 39      RTS
01116
01117
01118
01119          ; PUT SINGLE CHARACTER IN DISPLAY BUFFER AT CURRENT BUFFER
01120          ; POSITION AS INDICATED BY DISPNEXT. RESETS POINTER WHEN FULL.
01121 15F1 DFAE    DISPCHAR STX  XTEMP1
01122 15F3 DEC3    LDX  NEXTDISP ; GET BUFFER POINTER

```

```

01123 15F5 A700          STA A 0,X          ; PUT CHAR IN BUFFER
01124 15F7 08           INX
01125 15F8 8C2903       CPX      #DISPLY+20
01126 15FB 2603       BNE     DISPCH1
01127 15FD CE28EF       LDX     #DISPLY
01128 1600 DFC3       DISPCH1 STX     NEXTDISP
01129 1602 DEAE       LDX     XTEMP1
01130 1604 39           RTS
01131
01132
01133          ; CONVERT NUMBER IN A INTO 2 HEX DIGITS AND PUT IN DISBUFF
01134 1605 36       DISPHEX PSH A          ; SAVE CHARACTER
01135 1606 8D04       BSR     DISPHL          ; OUTPUT LEFT DIGIT
01136 1608 32       PUL A
01137 1609 8D07       BSR     DISPHR          ; OUTPUT RIGHT DIGIT
01138 160B 39       RTS
01139
01140 160C 44       DISPHL LSR A
01141 160D 44       LSR A
01142 160E 44       LSR A
01143 160F 44       LSR A
01144 1610 2002       BRA     DISPHL
01145 1612 840F       DISPHR AND A #0FH
01146 1614 810A       DISPHEX CMP A #0AH
01147 1616 2502       BCS     DISPHEX
01148 1618 8B07       ADD A #07H
01149 161A 8B30       DISPHEX ADD A #30H
01150 161C 20D3       BRA     DISPCHAR
01151
01152
01153
01154          ; PUT A/D CHANNELS IN DISPLAY IN HEX FOR TESTING
01155          ; CHANNELS 0-3:
01156 161E CE006F       TESTADR LDX     #ADC0          ; POINTER TO CHANEL 0 DATA
01157 1621 C604       LDA B #4
01158 1623 2005       BRA     TESTAD
01159
01160          ; CHANNELS 4-8
01161 1625 CE0077       TESTADL LDX     #ADC4
01162 1628 C605       LDA B #5
01163
01164 162A DF80       TESTAD STX     XTEMP2          ; SAVE X
01165 162C CE28EF       LDX     #DISPLY
01166 162F DFC3       STX     NEXTDISP
01167 1631 DEB0       LDX     XTEMP2
01168 1633 A600       NEXTCH LDA A 0,X          ; GET BYTE
01169 1635 8DDB       BSR     DISPHR          ; PUT OUT LS DIGIT
01170 1637 A601       LDA A 1,X
01171 1639 8DCA       BSR     DISPHEX        ; PUT OUT NEXT 2 DIGITS
01172 163B 8D15EC      JSR     DISPSPC        ; PUT OUT A SPACE
01173 163E 08       INX
01174 163F 08       INX

```

```

01175 1640 5A          DEC B
01176 1641 26F0       BNE  NEXTCH
01177 1643 39         RTS
01178
01179                ; PUT HEX DATA FROM MEMORY IN DISPLAY FOR DEBUGGING
01180                ; MEMORY POINTER "HEXPTR" IS SET BY "SETHEX"
PUTHEX  LDX  #DISPLY          ; INIT DISP PTR
        STX  NEXTDISP
        LDA  A  HEXPTR        ; DISPLAY POINTER
        JSR  DISPHEX
        LDA  A  HEXPTR+1
        JSR  DISPHEX
        LDA  A  #"="          ; DISPLAY EQUALS
        JSR  DISPCHAR
        LDX  HEXPTR          ; GET PTR
        LDA  B  #7           ; COUNTER FOR 7 BYTES
PUTHEX1 LDA  A  0,X
        INX
        JSR  DISPHEX
        DEC  B
        BNE  PUTHEX1
        RTS
01187
01188
01189
01190                ; DELAY ROUTINES
01201 1666 C6A5       MSDLY  LDA  B  #0A5H
01202 1668 5A        MSDLY1  DEC  B
01203 1669 26FD       BNE   MSDLY1
01204 166B 4A        DEC  A
01205 166C 26F8       BNE   MSDLY
01206 166E 39        RTS
01207
01208                ; DELAY A SECONDS
01209 166F 36        SECDLY  PSH  A          ; SAVE A
01210 1670 86FF       LDA  A  #0FFH
01211 1672 8DF2       BSR   MSDLY
01212 1674 86FF       LDA  A  #0FFH
01213 1676 8DEE       BSR   MSDLY
01214 1678 86FF       LDA  A  #0FFH
01215                BSR   MSDLY
01216 167A 86FF       LDA  A  #0FFH
01217 167C 8DE8       BSR   MSDLY
01218 167E 32        PUL  A
01219 167F 4A        DEC  A
01220 1680 26ED       BNE   SECDLY
01221 1682 39        RTS
01222
    
```

```

01224                ; MAINLOOP
01225 1683 BD1A18    MAINLOOP JSR   CRLF           ; SEND CRLF
01226 1686 863F          LDA A  #3FH           ; PROMPT
01227 1688 BD1DED          JSR   OUTCH
01228 168B BD19EA    MAIN1   JSR   TESTGSFC        ; TEST SERIAL PORT 1 CTS
01229 168E 96A9          LDA A  F. STATUS       ; CHECK STATUS PRINTOUT FLAG
01230 1690 2A06          BPL   MAIN2
01231 1692 BD1D60          JSR   STATUS
01232 1695 7F00A9        CLR   F. STATUS
01233 1698 96A0    MAIN2   LDA A  F. CNND        ; CHECK FOR PENDING COMMAND
01234 169A 2A18          BPL   NOCMND
01235 169C 96A1          LDA A  F. NUMBR       ; IS IT A NUMBER?
01236 169E 2A0F          BPL   NONUMBR
01237 16A0 BD1A18          JSR   CRLF           ; NUMBER ACKNOWLEDGED
01238 16A3 7F00A1        CLR   F. NUMBR       ; CLEAR FLAGS
01239 16A6 7F00A0        CLR   F. CNND
01240 16A9 DEC1          LDX   NEXSTATE       ; GET ADDRESS OF WHERE NUMBER IS WANTED
01241 16AB AD00          JSR   0,X            ; GO THERE
01242 16AD 20D4          BRA   MAINLOOP
01243 16AF BD1155    NONUMBR JSR   DECODE         ; DECODE COMMAND
01244 16B2 20CF          BRA   MAINLOOP       ; GO BACK AND CHECK FLAGS
01245 16B4 96A8    NOCMND  LDA A  F. FULBLK      ; BLOCK READY TO BE WRITTEN?
01246 16B6 2A27          BPL   NOCAL
01247 16B8 8601          LDA A  #1            ; WRITE 1 BLOCK
01248 16BA CE3000        LDX   #DATABUFF
01249 16BD BD141C          JSR   TWRITE
01250 16C0 96B6          LDA A  CRCH          ; SEND CRC OF LAST BLOCK TO GODDARD
01251 16C2 BD1E42          JSR   OUTGSFC
01252 16C5 96B7          LDA A  CRCL
01253 16C7 BD1E42          JSR   OUTGSFC
01254 16CA BD171A          JSR   FTYPE         ; CALCULATE FRAME TYPE OF NEXT FRAME
01255 16CD 7F00A8        CLR   F. FULBLK      ; CLEAR BLOCK FULL FLAG
01256 16D0 7A00A6        DEC   F. DATA       ; TURN DATA COLLECTION BACK ON
01257 16D3 8D19          BSR   CKEW          ; CHECK FOR TAPE EARLY WARNING BIT
01258 16D5 96A4    NOTFULL LDA A  F. CALTIM      ; TIME TO CALIBRATE?
01259 16D7 2A06          BPL   NOCAL
01260 16D9 BD172A          JSR   CALIBRTE      ; RUN CAL AND CALC GAINS
01261 16DC 7F00A4        CLR   F. CALTIM      ; CLEAR CAL FLAG
01262 16DF DEC5          LDX   DISPADR       ; FILL DISPLAY BUFFER WITH COMMANDED DATA
01263 16E1 AD00          JSR   0,X
01264 16E3 BD221A          JSR   LOADTEMP      ; CALCULATE LOAD TEMPS
01265 16E6 BD21A9          JSR   RADTEMP       ; CALCULATE RAD TEMPS
01266 16E9 BD21DD          JSR   RADAVG0       ; CALC AVERAGE TEMPS
01267 16EC 209D          BRA   MAIN1
01268
01269                ; CHECK TAP EARLY WARNING BIT TO SEE IF END OF TRACK NEAR
01270 16EE 868404        CKEW   LDA A  PIR2AD      ; GET EW BIT
01271 16F1 44          LSR A
01272 16F2 2519          BCS   NOTEW        ; NOT EW YET
01273 16F4 9600          LDA A  TRACKN       ; GET TRACK NO.
01274 16F6 8103          CMP A  #3           ; LAST RTRACK?
01275 16F8 2714          BEQ   TAPEDONE

```

```

01276 16FA 4C          INC A          ; NEXT TRACK
01277 16FB BD1273     JSR TRACK
01278 16FE BD1226     JSR REWIND
01279 1701 CE271C     LDX #NEWMSG    ; PRINT NEW TRACK MESSAGE
01280 1704 BD1DF4     JSR STRNGOUT
01281 1707 BD1C2B     JSR TAPE
01282 170A BD1CFF     JSR WHERE      ; PRINT OUT TIME OF NEW TRACK START
01283 170D 39        NOTEW RTS
01284 170E BD123F     TAFEDONE JSR UNLOAD ; UNLOAD TAPE
01285 1711 CE1C12     LDX #TAPEWARN
01286 1714 DFC5       STX DISPADR   ; PRINT TAPE WARNING MESSAGE
01287 1716 BD191C     JSR HALT     ; STOP DATA COLLECTION
01288 1719 39        RTS
01289
01290
01291                ; CREATE FRAME TYPE BYTE
01292                ; BITS 0,1 ARE INTERNAL LOAD POS
01293                ; BIT 5 IS HIGH FOR SKY, LOW FOR GROUND
01294                ; BIT 7 IS HIGH FOR CAL FRAME
01295 171A 9605        FTYPE LDA A RFLPOS ; GET LOAD STATUS
01296 171C F68802     LDA B PIA3BD  ; CHECK SKY/GROUND BIT
01297 171F C440       AND B #40H   ; MASK OFF BIT
01298 1721 1B        ABA
01299 1722 D6A4       LDA B F.CALTIME
01300 1724 C480       AND B #80H
01301 1726 1B        ABA
01302 1727 9703     STA A FRANTYPE
01303 1729 39        RTS
01304

```



```

01359 1786 BD1DED JSR OUTCH
01360 1789 BD10CD JSR OUTSPACE
01361 178C CE25F0 LDX #COLDMSG1
01362 178F BD10FF JSR STRNGNOC
01363 1792 863D LDA R # "="
01364 1794 BD1DED JSR OUTCH
01365 1797 CE0047 LDX #HTCD32
01366 179A BD1813 JSR PRINT32
01367 179D BD1A18 JSR CRLF
01368 17A0 CE2688 LDX #CALMSG1
01369 17A3 BD1DF4 JSR STRNGOUT
01370 17A6 CE263E LDX #MSG183
01371 17A9 BD10FF JSR STRNGNOC
01372 17AC BD1DBC JSR OUT2SPC
01373 17AF CE0136 LDX #CH0GAIN
01374 17B2 BD1813 JSR PRINT32 ; PRINT 32 BIT NUMBER IN BCD
01375 17B5 BD1DB4 JSR OUT10SPC
01376 17B8 CE013F LDX #CH00FST
01377 17BB BD1813 JSR PRINT32
01378 17BE BD1A18 JSR CRLF
01379 17C1 CE2649 LDX #MSG188
01380 17C4 BD10FF JSR STRNGNOC
01381 17C7 BD1DBC JSR OUT2SPC
01382 17CA CE0143 LDX #CH1GAIN
01383 17CD BD1813 JSR PRINT32
01384 17D0 BD1DB4 JSR OUT10SPC
01385 17D3 CE0147 LDX #CH10FST
01386 17D6 BD1813 JSR PRINT32
01387 17D9 BD1A18 JSR CRLF
01388 17DC CE2654 LDX #MSG193
01389 17DF BD10FF JSR STRNGNOC
01390 17E2 BD10CD JSR OUTSPACE
01391 17E5 CE0148 LDX #CH2GAIN
01392 17E8 BD1813 JSR PRINT32
01393 17EB BD1DB4 JSR OUT10SPC
01394 17EE CE014F LDX #CH20FST
01395 17F1 BD1813 JSR PRINT32
01396 17F4 BD1A18 JSR CRLF
01397 17F7 CE2660 LDX #MSG94
01398 17FA BD10FF JSR STRNGNOC
01399 17FD BD10CD JSR OUTSPACE
01400 1800 CE0153 LDX #CH3GAIN
01401 1803 BD1813 JSR PRINT32
01402 1806 BD1DB4 JSR OUT10SPC
01403 1809 CE0157 LDX #CH30FST
01404 180C BD1813 JSR PRINT32
01405 180F BD1A18 JSR CRLF
01406 1812 39 RTS
01407
01408
01409 ; PRINT 32 BIT NUMBER AT X IN BCD
01410 1813 DF8D PRINT32 STX SAVEX
    
```

```

01411 1815 EE00
01412 1817 DF9C
01413 1819 DE0D
01414 181B EE02
01415 181D DF9E
01416 181F CE003A
01417 1822 B0228C
01418 1825 CE003A
01419 1828 B01D42
01420 182B 39
01421
01422
01423
01424
01425
01426
01427 182C DF8F
01428 182E B044
01429 1830 DE8F
01430 1832 C604
01431 1834 B02393
01432 1837 B023C2
01433 183A CE0047
01434 183D C604
01435 183F B02393
01436 1842 B023E9
01437 1845 B023D2
01438 1848 B023F1
01439 184B DE8D
01440 184D C604
01441 184F B023A7
01442 1852 DF8D
01443 1854 DE8F
01444 1856 C604
01445 1858 B02393
01446 185B B023CA
01447 185E CE0043
01448 1861 C604
01449 1863 B02393
01450 1866 B023E9
01451 1869 B023C2
01452 186C DE8D
01453 186E C604
01454 1870 B023A7
01455 1873 39
01456
01457
01458
01459 1874 9677
01460 1876 D678
01461 1878 B02277
01462 187B CE28C7

LDX #X
STX FPT32
LDX SAVEX
LDX 2,X
STX FPT32+2
LDX #SPRETEMP
JSR FTBCD
LDX #SPRETEMP
JSR OUTTEMP
RTS

; MOVE DAT A TO FPT32
; TEMP BCD STORAGE

; CALCULATE RADIOMETER GAIN AND OFFSET
; CALL WITH X AT AVERAGE OF COLD LOAD SAMPLES (32 BIT VOLTS)
; SAVE X WITH POINTER TO WHERE GAIN AND OFFSET SHOULD GO AND
; AVERAGE HOT LOAD VOLTAGE AT TOS IN APU
CALCGAIN STX SAVEX1
BSR DIFHC
LDX LDA B #4
JSR PUSH
JSR FSUB
LDX #HTCD32
LDA B #4
JSR PUSH
JSR XCHF
JSR FDIV
JSR PTOF
LDX SAVEX
LDA B #4
JSR PULL
STX SAVEX
LDX LDA B #4
LDA B #4
JSR PUSH
JSR XCHF
JSR FSUB
LDX LDA B #4
LDA B #4
JSR PULL
RTS

; PTR TO COLD AVG
; PUT COLD AVG ON STACK
; <COLD AVG> <GAIN>
; COLD LOAD TEMP 32 BIT
; PUSH COLD LOAD TEMP
; COLD TEMP-<GAIN> <COLD AVG>
; POINTER TO OFFSET

; CALCULATE HOT LOAD AND COLD LOAD TEMP AND THEIR DIFFERENCE
DIFHC
LDA A ADC4
LDA B ADC4+1
JSR BINVOLTS
LDX #HTLDGAIN
; CONVERT TO VOLTS

```

```

01463 187E BD2266      JSR    VOLTTEMP
01464 1881 CE003F      LDX    #HTTEMP32      ; PTR TO RESULT
01465 1884 C604        LDA    B    #4
01466 1886 BD23A7      JSR    PULL
01467 1889 9679        LDA    A    ADC5      ; COLD LOAD BINARY
01468 188B D67A        LDA    B    ADC5+1
01469 188D BD2277      JSR    BINVOLTS
01470 1890 CE28CF      LDX    #COLDGAIN
01471 1893 BD2266      JSR    VOLTTEMP
01472 1896 BD23F1      JSR    PTOF          ; COPY TOS TO NOS
01473 1899 CE0043      LDX    #CDTEMP32
01474 189C C604        LDA    B    #4
01475 189E BD23A7      JSR    PULL
01476 18A1 CE003F      LDX    #HTTEMP32
01477 18A4 C604        LDA    B    #4
01478 18A6 BD2393      JSR    PUSH
01479 18A9 BD23E9      JSR    XCHF
01480 18AC BD23C2      JSR    FSUB          ; HOT TEMP-COLD TEMP
01481 18AF CE0047      LDX    #HTCD32
01482 18B2 C604        LDA    B    #4
01483 18B4 BD23A7      JSR    PULL
01484 18B7 39          RTS
01485
01486
01487      ; AVERAGE 10 SAMPLES FROM CH0-CH3 STORED IN AVGBUFF BY INTERRUPT
01488      ; SERVICE ROUTINE EVERY 100 MS
01489      ; PUT RESULT IN CH0VAVG-CH3VAVG
01490 18B8 8D27      AVERAGE BSR    AVERAGE0      ; AVERAGE CH0 SAMPLES
01491 18BA CE004B      LDX    #CH0VAVG      ; PTR TO RESULT
01492 18BD C604        LDA    B    #4
01493 18BF BD23A7      JSR    PULL
01494 18C2 8D24      BSR    AVERAGE1
01495 18C4 CE004F      LDX    #CH1VAVG
01496 18C7 C604        LDA    B    #4
01497 18C9 BD23A7      JSR    PULL
01498 18CC 8D21      BSR    AVERAGE2
01499 18CE CE0053      LDX    #CH2VAVG
01500 18D1 C604        LDA    B    #4
01501 18D3 BD23A7      JSR    PULL
01502 18D6 8D1E      BSR    AVERAGE3
01503 18D8 C604        LDA    B    #4
01504 18DA CE0057      LDX    #CH3VAVG
01505 18DD BD23A7      JSR    PULL
01506 18E0 39          RTS
01507
01508
01509 18E1 CE00EB      AVERAGE0 LDX    #AVGBUFF      ; PTR TO SAMPLES
01510 18E4 BD216E      JSR    AVG10          ; TAKE AVERAGE
01511 18E7 39          RTS
01512 18E8 CE00FF      AVERAGE1 LDX    #AVGBUFF+20
01513 18EB BD216E      JSR    AVG10
01514 18EE 39          RTS

```

```

01515 18EF CE0113    AVERAGE2 LDX    #AVGBUFF+40
01516 18F2 BD216E    JSR      AVG10
01517 18F5 39       RTS
01518 18F6 CE0127    AVERAGE3 LDX    #AVGBUFF+60
01519 18F9 BD216E    JSR      AVG10
01520 18FC 39       RTS
01521
01522
01523
01524
01525
01526                ; TURN DATA COLLECTION ON AND OFF
01527 18FD CE2584    START    LDX    #DATAMSG
01528 1900 BD1DFF    JSR      STRNGNOC
01529 1903 BD1DA8    JSR      PRTON
01530 1906 BD1CFF    JSR      WHERE
01531 1909 BD171A    JSR      FTYPE        ; CALC FRAME TYPE OF FIRST FRAME
01532 190C BD1A25    JSR      OUTSIDE     ; HOME REFLECTOR
01533 190F 86FF     LDA A    #OFFH
01534 1911 97AA     STA A    F. COLLECT
01535 1913 97A6     STA A    F. DATA
01536 1915 97A5     STA A    F. NUBLOC   ; FLAG A NEW BLOCK
01537 1917 39       RTS
01538
01539 1918 CE2584    HALT    LDX    #DATAMSG
01540 191B BD1DFF    JSR      STRNGNOC
01541 191E BD1DAD    JSR      PRTOFF
01542 1921 BD1CFF    JSR      WHERE
01543 1924 7F00AA    CLR     F. COLLECT
01544 1927 7F00A6    CLR     F. DATA
01545 192A 39       RTS
01546
01547                ; SET CALIBRATION TIME INTERVAL FROM CONSOLE.
01548                ; INITIAL VALUE IS 5 MINUTES
01549 192B CE260B    SETCAL  LDX    #CALMSG        ; ASK FOR CAL INTERVAL
01550 192E BD1DFF    JSR      STRNGNOC
01551 1931 7A00A1    DEC     F. NUMBR       ; SET NUMBER REQUEST FLAG
01552 1934 CE193B    LDX    #SETCAL1
01553 1937 DFC1     STX    NEXSTATE
01554 1939 2014    BRA    SETCAL3
01555 193B BD11A5    SETCAL1 JSR      INBYTE       ; CONVERT ASCII TO HEX
01556 193E 2408    BCC    SETCAL2       ; ERROR?
01557 1940 CE247D    SETCAL11 LDX    #NUMERR       ; PRINT ERROR MSG
01558 1943 BD1DF4    JSR      STRNGOUT
01559 1946 20E3    BRA    SETCAL        ; LOOP IF ERROR
01560 1948 4D       SETCAL2 TST A           ; CHECK FOR ZERO ENTRY
01561 1949 27F5    BEQ    SETCAL11
01562 194B 97DD    STA A  CAL. TIME
01563 194D 97DC    STA A  CAL. CNTR    ; RESET COUNTER
01564 194F 39       SETCAL3 RTS
01565
01566                ; SET HEX DEBUG POINTER

```

```

01567 1950 CE24B2      SETHEX  LDX  #STRMSG
01568 1953 BD1DFF          JSR  STRNGNOC
01569 1956 BD19E5          JSR  OUTQUES
01570 1959 7A00A1          DEC  F. NUMBR
01571 195C CE1962          LDX  #SETHEX1
01572 195F DFC1           STX  NEXSTATE
01573 1961 39             RTS
01574 1962 BD11DB      SETHEX1 JSR  IN2BYTES
01575 1965 25E9          BCS  SETHEX
01576 1967 DFC7          STX  HEXPTR
01577 1969 39             RTS
01578
01579
; PRINT FIRST 9 A/D CHANELS IN VOLTS ON CONSOLE
01580
; ASSUMES DATA IS IN ADC0-ADC8
01581 196A BD1A18      PRINVOLT JSR  CRLF
01582 196D CE006F          LDX  #ADC0      ; FIRST DATA
01583 1970 DF95          PRINTV1 STX  SAVEX4
01584 1972 A600          LDA  A  0. X
01585 1974 E601          LDA  B  1. X
01586 1976 CE003A          LDX  #SPRETEMP; ; TEMP FOR BCD
01587 1979 BD22AB          JSR  VOLTSBCD
01588 197C CE003A          LDX  #SPRETEMP
01589 197F BD1D42          JSR  OUTTEMP
01590 1982 BD1DBC          JSR  OUT2SPC
01591 1985 DE95          LDX  SAVEX4      ; GET POINTER TO DATA BACK
01592 1987 08            INX
01593 1988 08            INX
01594 1989 8C0081          CPX  #ADC8+2
01595 198C 26E2          BNE  PRINTV1
01596 198E BD1A18          JSR  CRLF
01597 1991 39             RTS
01598
;
01599
;
01600
; SET TIME, DAY AND FLIGHT NUMBER MANUALLY
01601
SETTIME  LDX  #FLTMSG
01602 1992 CE256C          JSR  STRNGNOC
01603 1995 BD1DFF          JSR  OUTQUES      ; PRINT QUESTION MARK
01604 1998 BD19E5          DEC  F. NUMBR
01605 199B 7A00A1          LDX  #SETT1
01606 199E CE19A5          STX  NEXSTATE
01607 19A1 DFC1           BRA  SETT4
01608 19A3 203F          SETT1  JSR  INBYTE
01609 19A5 BD11A5          BCS  SETT2      ; ERROR ?, IGNORE IT
01610 19A8 2502          STA  A  FLIGHT
01611 19AA 9706          SETT2  LDX  #DAYMSG
01612 19AC CE2579          JSR  STRNGNOC
01613 19AF BD1DFF          BSR  OUTQUES
01614 19B2 8D31          DEC  F. NUMBR
01615 19B4 7A00A1          LDX  #SETT2
01616 19B7 CE19BE          STX  NEXSTATE
01617 19BA DFC1           BRA  SETT4
01618 19BC 2026
    
```

```

01619 198E BD110B      SETT22 JSR   IN2BYTES
01620 19C1 2502        BCS   SETT3
01621 19C3 DF07        STX   DAYS HI
01622 19C5 CE257E      SETT3 LDX   #TIMEMSG
01623 19C8 BD1DFF      JSR   STRNGNOC
01624 19CB 8018        BSR   OUTQUES
01625 19CD 7A00A1      DEC   F. NUMBR
01626 19D0 CE19D7      LDX   #SETT33
01627 19D3 DFC1        STX   NEXSTATE
01628 19D5 200D        BRA   SETT4
01629 19D7 BD110B      SETT33 JSR  IN2BYTES
01630 19DA DF09        STX   HOURS
01631 19DC CE2907      LDX   #CBUFFER+4
01632 19DF BD11A3      JSR   INBYTE1
01633 19E2 970B        STA A SECONDS
01634 19E4 39          SETT4  RTS
01635
01636                  ;PRINT A QUESTION MARK
01637 19E5 863F      OUTQUES LDA A #3FH
01638 19E7 7E1DED      JMP   OUTCH
01639
01640
01641                  ;CHECK STATUS OF CTS FLAG SET BY SERIAL PORT 1.
01642                  ;PRINT MESSAGE IF IT CHANGES STATES FROM 00 TO FF
01643 19EA 96AB      TESTGSFC LDA A F. GSFC      ;WAS IT LOW BEFORE?
01644 19EC 2A14      BPL   GSFCOK      ;YES, DO NOTHING
01645 19EE CE2595      LDX   #LINKMSG    ;PRINT ON MESSAGE
01646 19F1 BD1DFF      JSR   STRNGNOC
01647 19F4 BD1DAD      JSR   PRTOFF
01648 19F7 BD1CFF      JSR   WHERE
01649 19FA 860F      LDA A #0FH        ;MAKE NON ZERO AND POSITIVE
01650 19FC 97AB      STA A F. GSFC
01651 19FE 7F00A3      CLR   F. BADTIM
01652 1A01 39          RTS
01653 1A02 2613      GSFCOK BNE   GSFCOK1    ;DO NOTHING IF FLAG IS ZERO
01654 1A04 96A3      LDA A F. BADTIM    ;CHECK PRINT FLAG
01655 1A06 260F      BNE   GSFCOK1
01656 1A08 CE2595      LDX   #LINKMSG
01657 1A0B BD1DFF      JSR   STRNGNOC
01658 1A0E BD1DAB      JSR   PRTON
01659 1A11 BD1CFF      JSR   WHERE
01660 1A14 7A00A3      DEC   F. BADTIM    ;SET PRINT FLAG
01661 1A17 39          GSFCOK1 RTS
01662
01663
01664
01665 1A18 CE2515      CRLF  LDX   #CRLFSTR
01666 1A1B BD1DFF      JSR   STRNGNOC
01667 1A1E 39          RTS
01668
01669 1A1F 860A      LFEED LDA A #0AH
01670 1A21 BD1DED      JSR   OUTCH

```

Tektronix N6800 ASM v3.1 CONVAIR 990 RADIOMETER
CALIBRATION ROUTINES

Page 35

01671 1A24.39
01672

RTS

```

01675
01676 ; INTERNAL REFLECTOR MOTION CONTROL ROUTINES
01677
01678 ; HOME REFLECTOR TO "OUTSIDE" POSITION
01679
01680 1A25 B68802 OUTSIDE LDA A PIA3BD ; TEST SENSE SWITCH
01681 1A28 2A04 BPL POSOK ; ALREADY HOME
01682 1A2A 8D16 BSR CLTCHON ; TURN CLUTCH ON
01683 1A2C 20F7 BRA OUTSIDE ; LOOP TILL DONE
01684 1A2E 8D09 POSOK BSR CLTCHOFF ; TURN CLUTCH OFF
01685 1A30 7F0005 CLR RFLPOS ; CLEAR REFLECTOR POSITION FLAG
01686 1A33 86FF LDA A #0FFH ; WAIT FOR CLUTCH TO DISENGAGE
01687 1A35 BD1666 JSR MSDLY
01688 1A38 39 RTS
01689
01690
01691 ; TURN CLUTCH OFF
01692 1A39 8620 CLTCHOFF LDA A #20H ; SET PB5=1
01693 1A3B BA8802 ORA A PIA3BD
01694 1A3E B78802 STA A PIA3BD
01695 1A41 39 RTS
01696
01697 ; TURN CLUTCH ON
01698 1A42 86DF CLTCHON LDA A #0DFH ; SET PB5=0
01699 1A44 B48802 AND A PIA3BD
01700 1A47 B78802 STA A PIA3BD
01701 1A4A 39 RTS
01702
01703
01704 ; PULSE CLUTCH ON FOR 1/4 SEC
01705 1A4B 8DF5 PULSE BSR CLTCHON ; TURN CLUTCH ON
01706 1A4D 8619 LDA A #25 ; DELAY 25 MS
01707 1A4F BD1666 JSR MSDLY
01708 1A52 8DE5 BSR CLTCHOFF ; TURN CLUTCH OFF
01709 1A54 8632 LDA A #50
01710 1A56 BD1666 JSR MSDLY
01711 1A59 39 RTS
01712
01713
01714 ; MOVE REFLECTOR TO COLD LOAD
01715 1A5A 9605 COLD LDA A RFLPOS ; CHECK CURRENT POSITION
01716 1A5C 2604 BNE COLD1 ; AT OUTSIDE?
01717 1A5E 8DEB BSR PULSE ; MOVE TO COLD LOAD
01718 1A60 2008 BRA COLD2
01719 1A62 8101 COLD1 CMP A #1 ; ALREADY AT COLD POS?
01720 1A64 2704 BEQ COLD2 ; YES
01721 1A66 8DBD BSR OUTSIDE
01722 1A68 8DE1 BSR PULSE
01723 1A6A 8601 COLD2 LDA A #1
01724 1A6C 9705 STA A RFLPOS ; UPDATE REFLECTOR POSITION FLAG
01725 1A6E 39 RTS
01726

```



```

01727          ; MOVE TO HOT LOAD
01728 1A6F 9605      HOT      LDA A  RFLPOS
01729 1A71 2608          BNE      HOT1          ; IS IT HOME?
01730 1A73 8DD6          BSR      PULSE          ; MOVE IT TO COLD LOAD
01731 1A75 8601          LDA A  #1          ; WAIT 1 SEC FOR IT TO GET THERE
01732 1A77 BD166F          JSR      SECDLY
01733 1A7A 8DCF          BSR      PULSE          ; MOVE TO HOT LOAD
01734 1A7C 2006          BRA      HOT2
01735 1A7E 8102      HOT1    CMP A  #2          ; IS IT ALREADY THERE?
01736 1A80 2702          BEQ      HOT2
01737 1A82 8DC7          BSR      PULSE          ; MOVE IT TO HOT LOAD
01738 1A84 8602      HOT2    LDA A  #2          ; UPDATE FLAG
01739 1A86 9705          STA A  RFLPOS
01740 1A88 39          RTS
01741
01742          ; DETERMINES WHAT THE RADIOMETER IS VIEWING FROM THE EXTERNAL
01743          ; REFLECTOR POSITION SWITCH AND RFLPOS STATUS BYTE FOR THE CALIBRATION
01744          ; REFLECTOR
01745 1A89 CE261C      VIEW    LDX      #RADMSG2
01746 1A8C BD1DFF          JSR      STRNGNOC
01747 1A8F 9605          LDA A  RFLPOS          ; CHECK INT. REFL POS
01748 1A91 2720          BEQ      VIEW1          ; LOOKING OUT?
01749 1A93 8101          CMP A  #1          ; COLD LOAD?
01750 1A95 2608          BNE      NOTCOLD
01751 1A97 CE25F0          LDX      #COLDMSG1
01752 1A9A BD1DF4          JSR      STRNGOUT
01753 1A9D 2029          BRA      VIEW3
01754 1A9F 8102      NOTCOLD  CMP A  #2
01755 1AA1 2608          BNE      NOTHOT
01756 1AA3 CE25E6          LDX      #HOTMSG1
01757 1AA6 BD1DF4          JSR      STRNGOUT
01758 1AA9 201D          BRA      VIEW3
01759 1AAB CE2701      NOTHOT  LDX      #RFLERR
01760 1AAE BD1DF4          JSR      STRNGOUT
01761 1AB1 2015          BRA      VIEW3
01762 1AB3 B68802      VIEW1   LDA A  PIA3BD          ; CHECK SKY/GROUND SWITCH
01763 1AB6 8540          BIT A  #40H
01764 1AB8 2708          BEQ      VIEW2          ; IS IT GROUND?
01765 1ABA CE2633          LDX      #SKYMSG
01766 1ABD BD1DF4          JSR      STRNGOUT          ; PRINT "SKY"
01767 1AC0 2006          BRA      VIEW3
01768 1AC2 CE2637      VIEW2   LDX      #GNDSMSG
01769 1AC5 BD1DF4          JSR      STRNGOUT
01770 1AC8 39          VIEW3   RTS
01771
01772

```

```

01775
01776 ; PUT ADDRESS OF DISPLAY ROUTINE IN DISPADR
01777 1AC9 CE1C0B INIT LDX #INITMS
01778 1ACC 203A BRA SETADR
01779 1ACE CE1B0E SETCOLD LDX #DISPCOLD
01780 1AD1 2035 BRA SETADR
01781 1AD3 CE1B1B SETHOT LDX #DISPHOT
01782 1AD6 2030 BRA SETADR
01783 1AD8 CE1B35 SETREF LDX #DISPREF
01784 1ADB 202B BRA SETADR
01785 1ADD CE1B28 SETKLYS LDX #DISPKLYS
01786 1AE0 2026 BRA SETADR
01787 1AE2 CE1B42 SET183 LDX #DISP183
01788 1AE5 2021 BRA SETADR
01789 1AE7 CE1B63 SET94 LDX #DISP94
01790 1AEA 201C BRA SETADR
01791 1AEC CE1B81 SET183A LDX #DISP183A
01792 1AEF 2017 BRA SETADR
01793 1AF1 CE1BA2 SET94A LDX #DISP94A
01794 1AF4 2012 BRA SETADR
01795 1AF6 CE1BC0 DISTIME LDX #TESTIME
01796 1AF9 200D BRA SETADR
01797 1AFB CE161E TEST1 LDX #TESTADR
01798 1AFE 2008 BRA SETADR
01799 1B00 CE1625 TEST2 LDX #TESTADL
01800 1B03 2003 BRA SETADR
01801 1B05 CE1644 TEST3 LDX #PUTHEX
01802 ;
01803 1B08 DFC5 SETADR STX DISPADR
01804 1B0A BD15AE JSR CLRDISP ; CLEAR OUT OLD DISPLAY MESSAGE
01805 1B0D 39 RTS
01806 ;
01807 ; PUT TEMPERATURES IN DISPLAY
01808 ;
01809 1B0E CE25C6 DISPCOLD LDX #COLDMSG
01810 1B11 BD15D3 JSR DISPSTNG
01811 1B14 CE0028 LDX #COLDTEMP
01812 1B17 BD15BE JSR DISPTEMP
01813 1B1A 39 RTS
01814 ;
01815 1B1B CE25B7 DISPHOT LDX #HOTMSG
01816 1B1E BD15D3 JSR DISPSTNG
01817 1B21 CE0026 LDX #HTLDTEMP
01818 1B24 BD15BE JSR DISPTEMP
01819 1B27 39 RTS
01820 ;
01821 1B28 CE25FB DISPKLYS LDX #KLYMSG
01822 1B2B BD15D3 JSR DISPSTNG
01823 1B2E CE0035 LDX #KLYSTEMP
01824 1B31 BD15BE JSR DISPTEMP
01825 1B34 39 RTS
01826 ;

```

```

01827 1835 CE25D6      DISPREF LDX      #REFMSG
01828 1838 BD15D3      JSR      DISPSTNG
01829 1838 CE0030      LDX      #RELDTEMP
01830 183E BD15BE      JSR      DISPTEMP
01831 1841 39          RTS
01832
01833 1842 CE28EF      DISP183 LDX      #DISPLY      ;INTI DISPLAY BUFF
01834 1845 DFC3        STX      NEXTDISP
01835 1847 CE0012      LDX      #CH0TEMP    ;DISPLAY ALL 183 GHZ TEMPS
01836 184A BD15BE      JSR      DISPTEMP
01837 184D BD15EC      JSR      DISPSPC
01838 1850 CE0017      LDX      #CH1TEMP
01839 1853 BD15BE      JSR      DISPTEMP
01840 1856 BD15EC      JSR      DISPSPC
01841 1859 CE001C      LDX      #CH2TEMP
01842 185C BD15BE      JSR      DISPTEMP
01843 185F BD15EC      JSR      DISPSPC
01844 1862 39          RTS
01845
01846 1863 CE2660      DISP94  LDX      #MSG94
01847 1866 BD15D3      JSR      DISPSTNG
01848 1869 DEC3        LDX      NEXTDISP    ;BACKUP POINTER
01849 186B 09          DEX
01850 186C 09          DEX
01851 186D 09          DEX
01852 186E 09          DEX
01853 186F DFC3        STX      NEXTDISP
01854 1871 CE25BF      LDX      #TEMPMSG
01855 1874 BD15DC      JSR      DISPNEXT
01856 1877 BD15EC      JSR      DISPSPC
01857 187A CE0021      LDX      #CH3TEMP
01858 187D BD15BE      JSR      DISPTEMP
01859 1880 39          RTS
01860
; DISPLAY AVERAGE RAD TEMPS
01861
DISP183A LDX      #DISPLY
01862 1881 CE28EF      DISP183A LDX      #DISPLY
01863 1884 DFC3        STX      NEXTDISP
01864 1886 CE005B      LDX      #CH0TAVG
01865 1889 BD15BE      JSR      DISPTEMP
01866 188C BD15EC      JSR      DISPSPC
01867 188F CE0060      LDX      #CH1TAVG
01868 1892 BD15BE      JSR      DISPTEMP
01869 1895 BD15EC      JSR      DISPSPC
01870 1898 CE0065      LDX      #CH2TAVG
01871 189B BD15BE      JSR      DISPTEMP
01872 189E BD15EC      JSR      DISPSPC
01873 18A1 39          RTS
01874
;
01875
DISP94A  LDX      #MSG94
01876 18A2 CE2660      DISP94A  LDX      #MSG94
01877 18A5 BD15D3      JSR      DISPSTNG
01878 18A8 DEC3        LDX      NEXTDISP
  
```

```

01879 18AA 09          DEX
01880 18AB 09          DEX
01881 18AC 09          DEX
01882 18AD 09          DEX
01883 18AE 0FC3      NEXTDISP
01884 18B0 CE25BF     #TEMPMSG
01885 18B3 ED15DC     DISPNEXT
01886 18B6 8D15EC     JSR
01887 18B9 CE006A     LDX #CH3TAVG
01888 18BC ED15BE     JSR
01889 18BF 39        RTS
01890
01891
01892
01893 18C0 CE28EF     ;PUT TIME IN DISPLAY #DISPLY
01894 18C3 DFC3      TESTIME LDX NEXTDISP
01895 18C5 9601     LDA A BLKNUM
01896 18C7 ED1605     JSR DISPHEX
01897 18CA 9602     LDA A BLKNUM+1
01898 18CC ED1605     JSR DISPHEX
01899 18CF ED15EC     JSR DISPSPC
01900 18D2 9609     LDA A HOURS
01901 18D4 ED1605     JSR DISPHEX
01902 18D7 C63A     LDA B #": "
01903 18D9 17        TBA
01904 18DA ED15F1     JSR DISPCCHAR
01905 18DD 960A     LDA A MINUTES
01906 18DF ED1605     JSR DISPHEX
01907 18E2 17        TBA
01908 18E3 ED15F1     JSR DISPCCHAR
01909 18E6 960B     LDA A SECONDS
01910 18E8 ED1605     JSR DISPHEX
01911 18EB ED15EC     JSR DISPSPC
01912 18EE 96DC     LDA A CAL CNTR
01913 18F0 ED1605     JSR DISPHEX
01914 18F3 ED15EC     JSR DISPSPC
01915 18F6 96AA     LDA A F. COLLECT
01916 18F8 270A     BEQ NOTONN
01917 18FA CE2684     LDX #ONMSG
01918 18FD ED15DC     JSR DISPHEX
01919 1C00 ED15EC     JSR DISPSPC
01920 1C03 39        RTS
01921 1C04 CE2687     NOTONN LDX #OFFMSG
01922 1C07 ED15DC     JSR DISPHEX
01923 1C0A 39        RTS
01924
01925
01926 1C0B CE243C     ;PUT SIGN ON MESSAGE IN DISPLAY
01927 1C0E ED1503     INITMS LDX #INITMSG
01928 1C11 39        JSR DISPSTNG
01929
01930
; FLUSH END OF TAPE WARNING MESSAGE IN DISPLAY AND RING BELL ON CONSOLE

```

tronix M8800 ASM V.3.1 CONVAIR 990 RADIOMETER
PAGE DISPLAY COMMANDS

```

31 1C12 CE26EC      TAPEWARN LDX #WNGMSG
32 1C15 BD15D3      JSR DISPSTNG
33 1C18 8607        LDA A #7 ; BELL
34 1C1A BD1DED      JSR OUTCH ; WAIT
35 1C1D 86C8        LDA A #200
36 1C1F BD1666      JSR MSDLY
37 1C22 BD15AE      JSR CLRDISP
38 1C25 86C8        LDA A #200
39 1C27 BD1666      JSR MSDLY
40 1C2A 39          RTS
41
42
43
44
45
46
47
48 1C2B CE25A3      ; PRINT CURRENT TRACK AND BLOCK NUMBER
49 1C2E BD1DFF      TAPE LDX #TAPMSG
50 1C31 CE26C9      TAPE1 JSR STRGNOC ; PRINT MSG WITH NO CR LF
51 1C34 BD1DFF      LDX #TRKMSG
52 1C37 9600        LDA A TRACKN ; GET TRACK NUMBER
53 1C39 BD1DD4      JSR OUTHEX
54 1C3C BD1DC0      LDX #BLKMSG ; PRINT A SPACE
55 1C3F CE26D0      JSR STRGNOC ; PRINT "BLOCK"
56 1C42 BD1DFF      LDX #BLKNUM
57 1C45 CE0001      JSR OUT2HEX
58 1C48 BD1DC9      JSR CRLF
59 1C4B BD1A18      JSR CRLF
60 1C4E 33          RTS
61
62
63
64 1C4F BD1A18      ; PRINT LOAD TEMPS ON CONSOLE
65 1C52 CE25B7      TEMPL JSR CRLF
66 1C55 BD1DFF      LDX #HOTMSG
67 1C58 BD1DC0      JSR STRGNOC
68 1C5B BD1DC0      JSR OUTSPACE
69 1C5E CE25C6      LDX #COLDMSG
70 1C61 BD1DFF      JSR STRGNOC
71 1C64 BD1DC0      JSR OUTSPACE
72 1C67 BD1DC0      JSR OUTSPACE
73 1C6A CE25D6      LDX #REFMSG
74 1C6D BD1DFF      JSR STRGNOC
75 1C70 BD1DC0      JSR OUTSPACE
76 1C73 BD1DC0      JSR OUTSPACE
77 1C76 CE25F8      LDX #KLYMSG
78 1C79 BD1DFF      JSR STRGNOC
79 1C7C BD1A18      JSR CRLF
80 1C7F CE0026      LDX #HTLDTEMP
81 1C82 BD1D42      JSR OUTTEMP
82 1C85 BD1D84      JSR OUT10SPC

```

```

1983 1C88 CE002B      LDX    #COLDTEMP
1984 1C88 BD1D42      JSR    OUTTEMP
1985 1C8E BD1DB4      JSR    OUT10SPC
1986 1C91 CE0030      LDX    #RELDTEMP
1987 1C94 BD1D42      JSR    OUTTEMP
1988 1C97 BD1DB4      JSR    OUT10SPC
1989 1C9A CE0035      LDX    #KLYSTEMP
1990 1C9D BD1D42      JSR    OUTTEMP
1991 1CA0 BD1DB4      JSR    OUT10SPC
1992 1CA3 BD1A18      JSR    CRLF
1993 1CA6 39          RTS
1994
1995
1996      ; PRINT OUT ALL FOUR RADIOMETER CHANNEL TEMPERATURES
1997 TEMPR JSR CRLF
1998      LDX    #RADMSG3      ; PRINT RADIOMETER MESSAGE
1999      JSR    STRNGOUT
2000      LDX    #MSG183      ; PRINT "183 GHZ"
2001      JSR    STRNGNOC
2002      JSR    OUTSPACE
2003      LDX    #MSG188
2004      JSR    STRNGNOC
2005      JSR    OUTSPACE
2006      LDX    #MSG193
2007      JSR    STRNGNOC
2008      JSR    OUTSPACE
2009      LDX    #MSG94      ; PRINT 94 GHZ TEMP
2010      JSR    STRNGNOC
2011      JSR    OUTSPACE
2012      JSR    CRLF
2013      LDX    #CH0TEMP
2014      JSR    OUTTEMP
2015      JSR    OUT6SPC
2016      LDX    #CH1TEMP
2017      JSR    OUTTEMP
2018      JSR    OUT6SPC
2019      LDX    #CH2TEMP
2020      JSR    OUTTEMP
2021      JSR    OUT6SPC
2022      LDX    #CH3TEMP
2023      JSR    OUTTEMP
2024      JSR    OUTSPACE
2025      JSR    CRLF
2026      JSR    CRLF
2027
2028
2029
2030      ; PRINT CURRENT FLIGHT NUMBER, DAY AND TIME
2031 WHERE JSR CRLF      ; PRINT CR AND LF
2032      LDX    #FLTMSG      ; PRINT "FLIGHT"
2033      JSR    STRNGNOC
2034      LDA    A FLIGHT
    
```

```

02035 1D0A BD1DD4      JSR   OUTHEX
02036 1D0D BD1DCD      JSR   OUTSPACE
02037 1D10 CE2579      LDX   #DAYMSG          ; PRINT "DAY"
02038 1D13 BD1DFF      JSR   STRNGNOC
02039 1D16 CE0007      LDX   #DAYS.HI        ; PRINT DAY
02040 1D19 BD1DC9      JSR   OUT2HEX
02041 1D1C BD1DCD      JSR   OUTSPACE
02042 1D1F CE257E      TIME  LOX   #TIMEMSG   ; PRINT "TIME"
02043 1D22 BD1DFF      JSR   STRNGNOC
02044 1D25 9609        LDA   A   HOURS
02045 1D27 BD1DD4      JSR   OUTHEX
02046 1D2A 863A        LDA   A   #": "
02047 1D2C BD1DED      JSR   OUTCH           ; PRINT ": "
02048 1D2F 960A        LDA   A   MINUTES
02049 1D31 BD1DD4      JSR   OUTHEX
02050 1D34 863A        LDA   A   #": "
02051 1D36 BD1DED      JSR   OUTCH
02052 1D39 960B        LDA   A   SECONDS
02053 1D3B BD1DD4      JSR   OUTHEX
02054 1D3E BD1A18      JSR   CRLF
02055 1D41 39          RTS
02056
02057
02058 ; PRINT PACKED BCD NUMBER ON CONSOLE. ASSUMES FIXED POINT
02059 ; FORMAT WITH 4 DIGITS TO LEFT AND RIGHT OF DECIMAL POINT.
02060 ; FIRST BYTE IS SIGN. CALL WITH X POINTING TO SIGN BYTE.
02061 1D42 A600      OUTTEMP LDA A 0,X          ; GET SIGN BYTE
02062 1D44 2705      BEQ   OUTPOS          ; BRANCH IF POS
02063 1D46 862D      LDA   A   #"- "
02064 1D48 BD1DED      JSR   OUTCH           ; PRINT A MINUS SIGN
02065 1D4B A601      OUTPOS  LDA A 1,X          ; GET MS BYTE
02066 1D4D BD1DE1      JSR   OUTHEXR        ; PRINT IT
02067 1D50 A602      LDA   A   2,X
02068 1D52 BD1DD4      JSR   OUTHEX
02069 1D55 862E      LDA   A   #". "
02070 1D57 BD1DED      JSR   OUTCH           ; PRINT DECIMAL PT
02071 1D5A A603      LDA   A   3,X
02072 1D5C BD1DD4      JSR   OUTHEX
02073 1D5F 39          RTS
02074
02075
02076 ; PRINT ENTIRE SYSTEM STATUS MESSAGES ON CONSOLE.
02077 ; NORMALLY CALLED AFTER CAL CYCLE
02078 1D60 BD1A18      STATUS JSR   CRLF
02079 1D63 CE253F      LDX   #RADMSG        ; PRINT RAD. MSG
02080 1D66 BD1DF4      JSR   STRNGOUT
02081 1D69 CE255E      LDX   #RADMSG1
02082 1D6C BD1DF4      JSR   STRNGOUT
02083 1D6F BD1A18      JSR   CRLF
02084 1D72 BD1CFF      JSR   WHERE          ; PRING FLIGHT, DAY AND TIME
02085 1D75 CE2584      LDX   #DATAMSG
02086 1D78 BD1DFF      JSR   STRNGNOC

```

```

02087 1D78 96A6          LDA A  F. DATA      ;TEST DATA COLLECTION FLAG
02088 1D7D 2604          BNE  STATUS1       ;IS DATA COLLECTION ON?
02089 1D7F 8D2C          BSR  PRTOFF        ;PRINT "OFF"
02090 1D81 2002          BRA  STATUS2
02091 1D83 8D23          STATUS1 BSR  PRTON   ;PRINT "ON"
02092 1D85 BD1A18        STATUS2 JSR  CRLF
02093 1D88 CE2595        LDX  #LINKMSG      ;PRINT "LINK TO GSFC"
02094 1D8B BD1DFF        JSR  STRNGNOC
02095 1D8E 96AB          LDA A  F. GSFC
02096 1D90 2604          BNE  STATUS3       ;BRANCH IF FLAG=FF
02097 1D92 8D14          BSR  PRTON         ;PRINT "ON"
02098 1D94 2002          BRA  STATUS4
02099 1D96 8D15          STATUS3 BSR  PRTOFF  ;PRINT "OFF"
02100 1D98 BD1A18        STATUS4 JSR  CRLF
02101 1D9B BD1C2B        JSR  TAPE           ;PRINT TAPE STATUS
02102 1D9E BD1C4F        JSR  TEMPL         ;PRINT LOAD TEMPS
02103 1DA1 BD1CA7        JSR  TEMPR         ;PRINT RADIOMETER TEMPS
02104 1DA4 BD1A89        JSR  VIEW          ;PRINT WHAT RADIOMETER IS VIEWING
02105 1DA7 39           RTS
02106                   ;
02107                   ;
02108 1DAB CE2684        PRTON  LDX  #ONMSG
02109 1DAB 2003          BRA  PRT1
02110 1DAD CE2687        PRTOFF LDX  #OFFMSG
02111 1DB0 BD1DFF        PRT1  JSR  STRNGNOC
02112 1DB3 39           RTS
02113                   ;
02114                   ;

```



```

117
118
119
120
121
122 10B4 060A      OUT10SPC LDA B  #10
123 10B6 2008      BRA      OUTSPC
124 10B8 0606      OUT6SPC  LDA B  #6
125 10BA 2004      BRA      OUTSPC
126 10BC 0602      OUT2SPC  LDA B  #2
127 10BE 2000      BRA      OUTSPC
128 10C0 37        OUTSPC   PSH B
129 10C1 8D1DCD    JSR      OUTSPACE
130 10C4 33        PUL B
131 10C5 5A        DEC B
132 10C6 26F8     BNE      OUTSPC
133 10C8 39        RTS
134
135
136
137
138 10C9 8D06     OUT2HEX  BSR   THB
139
140
141 10CB 8D04     OUT1HEX  BSR   THB
142 10CD 8620     OUTSPACE LDA A #20H
143 10CF 281C     BRA      OUTCH
144
145
146
147 10D1 A600     THB      LDA A 0,X
148 10D3 08      INX
149
150 10D4 36      OUTHEX   PSH A
151 10D5 8D04     BSR      OUTHEXL
152 10D7 32      PUL A
153 10D8 8D07     BSR      OUTHEXR
154 10DA 39      RTS
155
156 10DB 44      OUTHEXL  LSR A
157 10DC 44      LSR A
158 10DD 44      LSR A
159 10DE 44      LSR A
160 10DF 2002     BRA      THB1
161 10E1 840F     OUTHEXR  AND A #0FH ; MASK OFF LS PART
162 10E3 810A     THB1     CMP A #0AH
163 10E5 2502     BCS     THB2
164 10E7 8B07     ADD A #07
165 10E9 8B30     THB2     ADD A #30H ; MAKE ASCII
166 10EB 2000     BRA      OUTCH
167
168

```

```

02169                                ;
02170                                ;
02171                                ;
02172                                ;
02173                                ;
02174                                ;
02175                                ;
02176                                ;
02177                                ;
02178                                ;
02179                                ;
02180 1DED 8D1B                      ;PUT. CHARACTER ONTO BUFFER
02181 1DEF 8604                      ;AND SEND AN ETX TO START TRANSMISSION
02182 1DF1 8D17                      ;BY WRITING AN ETX TO BUFFER
02183 1DF3 39                          ;
02184                                ;
02185                                ;
02186                                ;
02187                                ;
02188                                ;
02189                                ;
02190                                ;
02191                                ;
02192                                ;
02193                                ;
02194                                ;
02195 1DF4 8D09                      ;SEND STRING
02196 1DF6 860D                      ;SEND CARRIAGE RETURN
02197 1DF8 8DF3                      ;SEND LINE FEED
02198 1DFA 860A                      ;
02199 1DFC 8DEF                      ;
02200 1DFE 39                          ;
02201                                ;
02202                                ;
02203                                ;
02204                                ;
02205                                ;
02206 1DFE A600                      ;GET THE CHARACTER POINTED TO BY RX
02207 1E01 8D1E0A                    ;PUT IT INTO TRANSMIT BUFFER < EVEN IF ETX >
02208 1E04 08                          ;BUMP THE POINTER
02209 1E05 8104                      ;SEE IF AN ETX
02210 1E07 26F6                      ;IF NOT THEN GET NEXT CHAR
02211 1E09 39                          ;
02212                                ;
02213                                ;
02214                                ;
02215                                ;
02216                                ;
02217                                ;
02218                                ;
02219                                ;
02220                                ;

```

***** TRANSMIT SINGLE CHARACTER IMMEDIATELY
***** INPUT ASCII IN RA

***** OUTCH *****

***** STRNGOUT *****

***** PUT STRING POINTED TO BY RX ONTO TRANSMIT BUFFER
***** STRING MUST END WITH AN 04H (ETX)
***** SENDS OUT CR AND LF FOLLOWING STRING

STRNGOUT BSR STRNGNOC
LDA A #0DH
BSR OUTCH
LDA A #0AH
BSR OUTCH
RTS

STRNGNOC LDA A 0,X
JSR CHAR. INS
INX
CMP A #04
BNE STRNGNOC
RTS

***** CHAR. INS *****

***** PUTS THE INPUT ASCII CODE INTO TRANSMIT BUFFER
***** INPUT CODE IS IN RA
***** STARTS TRANSMISSION WHEN CODE IS 04H < ETX >
***** ETX IS NOT PUT INTO BUFFER

```

02221
02222
02223
02224
02225
02226 1E0A DFAE          ;SAVE THE X REGISTER
02227 1E0C D6A7          ;SEE IF WE ARE ALREADY SENDING A BLOCK FROM THE BUFFER
02228 1E0E 2A0E          ;IF WE ARE NOT THEN SKIP
02229
02230
02231
02232 1E10 8104          ;SEE IF ETX
02233 1E12 2707          ;IF SO THEN GO ON AND EXIT
02234 1E14 DEE5          ;IF NO THEN PUT ON AS LAST CHAR IN BUFFER
02235 1E16 08
02236 1E17 A700
02237 1E19 DFE5
02238 1E1B DEAE
02239 1E1D 39
02240
02241
02242
02243 1E1E 8104          ;SEE IF ETX
02244 1E20 2709          ;IF SO THEN SKIP TO SET TRANSMIT FLAG
02245 1E22 DEE3          ;IF NOT ETX THEN PUT ONTO CURRENT BLOCK
02246 1E24 A700
02247 1E26 08
02248 1E27 DFE3
02249 1E29 20F0
02250
02251
02252
02253 1E2B DEE3          ;GET THE ADDRESS OF NEXT FREE CHAR ON BLOCK
02254 1E2D 09           ;POINT IT TO LAST INPUT CHAR
02255 1E2E DFE7          ;RESET THE OTHER TWO POINTERS
02256 1E30 DFE5
02257 1E32 CE015B       ;NOW RESET THE BLOCK POINTER (CHARS TO BE SENT)
02258 1E35 DFE3
02259 1E37 C6FF
02260 1E39 D7A7
02261 1E3B C6A1
02262 1E3D F78408
02263 1E40 20D9
02264
02265
02266
02267 1E42 37           ;SET FLAG THAT SAYS WE RARE XMITTING
02268 1E43 F68808       ;CAUSE THE ACIA TO BE INTERRUPTING
02269 1E46 C508
02270 1E48 260F
02271 1E4A 7F00A8
02272 1E4D 7F00C9

```

```

02273 1E50 F68808          LDA B  ACIA2C          ; GET ACIA STATUS AGAIN
02274 1E53 54              LSR B
02275 1E54 54              LSR B
02276 1E55 24EC           BCC   OUTGS1          ; LOOP TILL IT IS
02277 1E57 2019           BRA   OUTGS3          ;
02278 1E59 7D00AB         OU. AS2  TST   F. GSFC      ; CHECK FLAG
02279 1E5C 2617           BNE   OUTGS4          ; DONT WAIT IF FLAG IS SET
02280 1E5E 36              PSH A                ; SAVE A
02281 1E5F 8601           LDA A  #1             ; DELAY 1 MS
02282 1E61 8D1666         JSR   MSDLY
02283 1E64 32              PUL A
02284 1E65 7A00C9         DEC   CTSCNTR        ; BUMP COUNTER
02285 1E68 26D9           BNE   OUTGS1          ; TRY TILL COUNTER OVERFLOWS
02286 1E6A C6FF           LDA B  #0FFH         ; SET FLAG NEG AND NON ZERO
02287 1E6C D7AB           STA B  F. GSFC
02288 1E6E D6CF           LDA B  GSFCFO        ; RESET TIME OUT TIMER
02289 1E70 D7C9           STA B  CTSCNTR
02290 1E72 B78809         OU. AS3  STA A  ACIA2D      ; SEND DATA
02291 1E75 33             OU. AS4  PUL B          ; GET B BACK
02292 1E76 39              RTS
02293                      ;
02294                      ;

```

```

02297 .....
02298 .....
02299 .....
02300 .....
02301 .....
02302 .....
02303 .....
02304 .....
02305 .....
02306 .....
02307 .....
02308 .....
02309 .....
02310 .....
02311 .....
02312 .....
02313 .....
02314 .....
02315 .....
02316 .....
02317 .....
02318 .....
02319 .....
02320 .....
02321 .....
02322 .....
02323 .....
02324 .....
02325 .....
02326 .....
02327 .....
02328 .....
02329 .....
02330 .....
02331 .....
02332 .....
02333 .....
02334 .....
02335 .....
02336 1E77 B68 03 .....
02337 1E7A 2B6 .....
02338 1E7C 48 .....
02339 1E7D 2A0 .....
02340 1E7F 200 .....
02341 .....
02342 .....
02343 .....
02344 .....
02345 .....
02346 .....
02347 .....
02348 .....

NMI_ISR

**** NON MASKABLE INTERRUPT SERVICE ROUTINE ****
**** DATA COLLECTION, REAL TIME CLOCK, IRIGB ****

MACRO COUNT ;**** COUNT CHECKER USED IN "NMI_ISR" ****
;*****
;****
LDA A '2'
ADD A #1
DAA
STA A '2'
CMP A #'1'H
BEQ '3'
JMP NMI_DATA ;**** ELSE END COUNT SEQ. ****
;*****
;**** GET THE COUNT VARIABLE ****
;**** INCREMENT IT ****
;**** MAKE IT BCD ****
;**** REPLACE THE VARIABLE ****
;**** SEE IF AT RESET VALUE ****
;**** IF SO THEN SKIP TO NEXT ****
;**** ELSE END COUNT SEQ. ****
;*****

ENDM
****
DEFINE SYMBOLS FOR A READABLE PROGRAM ****
IR EQU PIA3BD ;DEFINE THE DATA REGISTER FOR IRIGB INPUTS
NMI IR EQU PIA3BC ;ADDRESS OF THE PIA FOR BOTH IRIGB AND RTC
;
;**** VECTOR TO THE INTERRUPTING CLOCK DRIVER ****
NMI BR LDA R NMI_PIA ;READ THE PIA TO SEE WHO GAVE NMI
BMI NMI_RTC ;IF CB1 THEN IT WAS RTC 100 MS
ASL A ;ELSE TEST FOR CB2 (<100-MS RTC PULSE)
BPL NMI_EX0 ;IF CB2 NOT SET THEN WE HAD A FALSE INTERRUPT
BRA NMI_IRIG ;IF CB2 THEN IT WAS IRIGB
;
;**** IRIGS INTERRUPT DRIVER ****

```

```

02349          NMI IRIG LDA A F, SMIN          ; SEE IF 5 MINUTES ARE UP < THAT IS PERIOD OF RTC SYNCH CHECK >
02350 1E81 96A2          BMI IRIGB. 1          ; IF SO THEN PROCESS IRIGB IRQ
02351 1E83 2B08          LDA A NMI.F0          ; TEST IF WE ARE INITIAL ENTRY INTO PROGRAM
02352 1E85 96D4          BEQ IRIGB. 1          ; IF SO THEN PROCESS IRIGB IRQ < GET INITIAL VALUES >
02353 1E87 2704          LDA A IRIGB. IN        ; NEITHER CASE VALID, SO RESET IRQ AND EXIT
02354 1E89 B68002          NMI.EX0 RTI          ; HERE IS AN EXIT POINT
02355 1ESC 7B          ;
02356          ;
02357          ;          ***** INPUT THE IRIGB TIME CODE < TAKES 1 SEC > *****
02358          ;
02359 1E8D B02061          IRIGB. 1 JSR          ; GO READ THE CODE
02360          ;
02361          ;          ***** SEE IF INITIAL ISR ENTRY *****
02362          ;
02363 1E90 96D4          LDA A NMI.F0          ; INITIAL ENTRY?
02364 1E92 2609          BNE IRIGB. 3          ; IF NOT THEN SKIP
02365 1E94 96D5          LDA A NMI.F1          ; SEE IF IRIGSET GOT HUNG < IRIGB NONFUNCTIONAL >
02366 1E96 28F4          BMI NMI.EX0          ; IF WE ARE HUNG THEN EXIT WITHOUT TRYING TO INIT THE VALUES
02367 1E98 7300D4          IRIGB. 2 COM          ; WE DID NOT GET HUNG, SO RESET FLAG AND UPDATE
02368 1E9B 2029          BRA          ;
02369          ;
02370          ;          ***** TEST IF IRIGB WAS HUNG UP *****
02371          ;
02372 1E9D 96D5          IRIGB. 3 LDA A NMI.F1          ; READ THE "HUNG-UP" FLAG
02373 1E9F 28E8          BMI NMI.EX0          ; IF WE ARE HUNG THEN EXIT < FLAG IS ALREADY SET >
02374          ;
02375          ;          ***** CHECK THE IRIGB AGAINST THE SYSTEM CLOCK *****
02376          ;
02377          ;
02378          ;
02379          ;
02380          ;
02381          ;
02382          ;          ***** FIRST TEST THE SECONDS CLOCK *****
02383          ;
02384 1EA1 9611          IRI LDA A IRIGSEC          ; READ THE SECONDS VALUE RETURNED FROM IRIGSET
02385 1EA3 960B          SUB A SECONDS          ; FIND THE DIFFERENCE BETWEEN IT AND THE SYS TIME
02386 1EA5 40          TST A          ; TAKE THE ABSOLUTE VALUE
02387 1EA6 2A01          BPL IRIGB. 5          ; IF POS THEN SKIP
02388 1EA8 43          COM A          ;
02389 1EA9 8101          CMP A #1          ; SEE IF WITHIN ERROR
02390 1EAB 2E32          BGT IRIG. BAD          ; IF NOT THEN GGOTO FAIL SECTION
02391          ;
02392          ;          ***** TEST THE MINUTES *****
02393          ;
02394 1EAD 9610          IRI LDA A IRIGMIN          ; READ THE MINUTES
02395 1EAF 910A          CMP A MINUTES          ; COMPARE TO SYSTEM MINUTES.
02396 1EB1 262C          BNE IRIG. BAD          ;
02397          ;
02398          ;          ***** TEST THE HOURS *****
02399          ;
02400 1EB3 960F          IRI LDA A IRIGHOUR          ;
  
```

```

02401 1EB5 9109      CMP A  HOURS
02402 1EB7 2626      BNE  IRIG.BAD
02403
02404
02405      ;      **** TEST THE LSB OF DAYS      ****
02406 1EB9 960E      LDA A  IRIGDAYL
02407 1EBB 9109      CMP A  DAYS.LO
02408 1EBD 2620      BNE  IRIG.BAD
02409
02410      ;      **** TEST DAYS MSB      ****
02411
02412 1EBF 960D      LDA A  IRIGDAYH
02413 1EC1 9107      CMP A  DAYS.HI
02414 1EC3 261A      BNE  IRIG.BAD
02415 1EC5 3B      NMI.EX1
02416      RTI
02417
02418
02419
02420
02421
02422
02423 1EC6 9611      IRIG.UPD LDA A  IRIGSEC
02424 1EC8 970B      STA A  SECONDS
02425
02426 1ECA 9610      LDA A  IRIGMIN
02427 1ECC 970A      STA A  MINUTES
02428
02429 1ECE 960F      LDA A  IRIGHOUR
02430 1ED0 9709      STA A  HOURS
02431
02432 1ED2 960E      LDA A  IRIGDAYL
02433 1ED4 9708      STA A  DAYS.LO
02434
02435 1ED6 960D      LDA A  IRIGDAYH
02436 1ED8 9707      STA A  DAYS.HI
02437
02438 1EDA 960C      LDA A  IRIGFLT
02439 1EDC 9706      STA A  FLIGHT
02440
02441 1EDE 3B      NMI.EX2
02442      RTI
02443
02444
02445
02446
02447
02448
02449 1EDF 8680      IFIG.BAD LDA A  #20H
02450 1EE1 97A3      STA A  F.BADTIM
02451 1EE3 3B      NMI.EX3
02452      RTI

```

```

02453 ;
02454 ;
02455 ;
02456 ;
02457 ;
02458 ;
02459 ;
02460 ;
02461 1EE4 B68902 NMI RTC LDA A IRIGB.IN ;CLEAR NMI FLAGS
02462 1EE7 01 NOP
02463 1EE8 0E CLI ;ENABLE IRQ FOR DISPALY
02464 1EE9 96D8 LDA A RTC.STAT ;SEE IF WE SHOULD CHECK FOR A HUNG IRIGB
02465 1EEB 260B BNE RTC.SEC1 ;IF NOT THEN SKIP
02466 ;
02467 ;
02468 ;
02469 1EED 96D7 LDA A RTC.CNTR ;COUNT UP A TEMPORARY COUNTER
02470 1EEF 4C INC A
02471 1EF0 97D7 STA A RTC.CNTR ;SAVE THE NEW VALUE
02472 1EF2 8103 CMP A #3 ;SEE IF 300 MS
02473 1EF4 2602 BNE RTC.SEC1 ;IF NOT THEN GOTO NEXT SECTION
02474 1EF6 9708 STA A RTC.STAT ;IF SO THEN MAKE THE STATE VAR NONZERO <IRIGB IS HUNG>
02475 ;
02476 ;
02477 ;
02478 ;
02479 ;
02480 1EF8 96C0 RTC.SEC1 LDA A BLOCKS ;SEE IF TAPE IS READING OR WRITING
02481 1EFA 2631 BNE RTC.SEC2 ;
02482 1EFC DEE9 FILLBUFF LDX AVGPTR ;GET PTR TO NEXT LOCATIONS
02483 1EFE 4F CLR A
02484 1EFF BD2035 JSR GETDATA ;GET CH0 DATA
02485 1F02 A700 STA A 0,X ;PUT IN BUFFER
02486 1F04 E701 STA B 1,X
02487 1F06 8601 LDA A #1 ;CH1
02488 1F08 BD2035 JSR GETDATA
02489 1F0B A714 STA A 20,X
02490 1F0D E715 STA B 21,X
02491 1F0F 8602 LDA A #2
02492 1F11 BD2035 JSR GETDATA
02493 1F14 A728 STA A 40,X
02494 1F16 E729 STA B 41,X
02495 1F18 8603 LDA A #3
02496 1F1A BD2035 JSR GETDATA
02497 1F1D A73C STA A 60,X
02498 1F1F E73D STA B 61,X
02499 1F21 08 INX
02500 1F23 08 INX
02501 1F23 9C00FF CPX #AVGBUFF+20 ;DONE YET?
02502 1F26 2603 BNE FILBUF1
02503 1F28 CE00EB LDX #AVGBUFF
02504 1F2B DFE9 STX AVGPTR
  
```



```

02505 + ;COUNT SECONDS
02506 + RTC.SECS COUNT 10, I, MSCNTR J, I, RTC. SEC. J ;*** GET THE COUNT VARIABLE ***
02507 + LDA A MSCNTR ;*** INCREMENT IT ***
02508 + ADD A #1 ;*** MAKE IT BCD ***
02509 + DAA ;*** REPLACE THE VARIABLE ***
02510 + STA A MSCNTR ;*** SEE IF AT RESET VALUE ***
02511 + CMP A #10H ;*** IF SO THEN SKIP TO NEXT ***
02512 + BEQ RTC. SEC ;*** ELSE END COUNT SEQ. ***
02513 + JMP NMI. DATA ;*** ELSE END COUNT SEQ. ***
02514 +
02515 +
02516 +
02517 +
02518 +
02519 +
02520 +
02521 +
02522 +
02523 +
02524 +
02525 +
02526 +
02527 +
02528 +
02529 +
02530 +
02531 +
02532 +
02533 +
02534 +
02535 +
02536 +
02537 +
02538 +
02539 +
02540 +
02541 +
02542 +

```

```

02543 1F77 86FF LDA A #0FFH
02544 1F79 97A9 STA A F. STATUS
RTC.MINS
02545 1F7B 96DC LDA A CAL.CNTR
02546 1F7D 8899 ADD A #99H
02547 1F7F 19 DAA
02548 1F80 970C STA A CAL.CNTR
02549 1F82 2608 BNE RTC.MIN2
02550 1F84 96D0 LDA A CAL.TIME
02551 1F86 970C STA A CAL.CNTR
02552 1F88 8680 LDA A #80H
02553 1F8A 97A4 STA A F.CALTIM
02554 RTC.MIN2 COUNT 60, [ MINUTES J, [ RTC.HOUR ]
+ LDA A MINUTES ;*** GET THE COUNT VARIABLE ***
+ ADD A #1 ;*** INCREMENT IT ***
+ DAA ;*** MAKE IT BCD ***
+ STA A MINUTES ;*** REPLACE THE VARIABLE ***
+ CMP A #60H ;*** SEE IF AT RESET VALUE ***
+ BEQ RTC.HOUR ;***IF SO THEN SKIP TO NEXT ***
+ JMP NMI.DATA ;*** ELSE END COUNT SEQ. ****

```

```

02555 ***** HOURS TIMING *****
02556
02557
02558 1F9A 7F000A RTC.HOUR CLR MINUTES ;WE GOT ANOTHER HOUR SO RESET MINUTES
02559 1F9D 9609 24, [ HOURS J, [ RTC.DAYL ]
+ LDA A HOURS ;*** GET THE COUNT VARIABLE ***
+ DAA ;*** INCREMENT IT ***
+ STA A HOURS ;*** MAKE IT BCD ***
+ CMP A #24H ;*** REPLACE THE VARIABLE ***
+ BEQ RTC.DAYL ;*** SEE IF AT RESET VALUE ***
+ JMP NMI.DATA ;***IF SO THEN SKIP TO NEXT ***

```

```

02560 ***** DAYS TIMING *****
02561
02562
02563 1FAB 7F0009 RTC.DAYL CLR HOURS
02564 1FAE 9608 LDA A DAYS.LO
02565 1F80 8601 ADD A #1
02566 1F82 19 DAA
02567 1F83 9708 STA A DAYS.LO
02568 1FB5 2407 BCC NMI.DATA
02569 1FB7 9607 LDA A DAYS.HI
02570 1FB9 8601 ADD A #1
02571 1F8B 19 DAA
02572 1FBC 9707 STA A DAYS.HI

```

```

02573
02574
02575
02576
02577 ***** REAL TIME CLOCK DATA COLLECTION *****
02578
02579
02580

```

```

02581 NMI.DAT1 LDA A F. COLLECT ;OK TO TAKE DATA?
02582 1FB8 96A8 BPL NMI.EX4 ;NO, RETURN
02583 1FC0 2A57 LDA A F. DATA ;SEE IF WE SHOULD COLLECT ANY DATA
02584 1FC2 96A6 BPL NMI.EX4 ;IF NOT THEN EXIT FROM THE ISR
02585 1FC4 2A53 ;
02586 ;
02587 ; ***** SEE IF A NEW DATA BLOCK *****
02588 ;
02589 NMI.DAT1 LDA A F. NUBLOC ;SEE IF WE HAVE A NEW DATA BLOCK
02590 1FC6 96A5 BPL NMI.DAT2 ;IF NOT THEN SKIP TO NEXT SECTION
02591 1FC8 2A38 CLR F. NUBLOC ;RESET THE FLAG (IT WILL SOON NOT BE NEW)
02592 1FCA 7F00A5 LDX #DATABUFF ;SET POINTER TO BEGINNING OF DATA BUFFER
02593 ;SEND HEADER TO GODDARD
02594 1FD0 8647 LDA A #"G"
02595 1FD2 8D1E40 JSR OUTCSFC
02596 1FD5 8654 LDA A #"T"
02597 1FD7 8D1E40 JSR OUTCSFC
02598 1FDA 9601 LDA A BLKNUM
02599 1FDC D602 LDA B BLKNUM+1
02600 1FDE 8D3A BSR PUTDATA
02601 ;
02602 1FE0 9607 LDA A DAYS.HI ;PUT THE DATE ON THE TAPE
02603 1FE2 D608 LDA B DAYS.LO ; DATE IS 2 BYTES LONG
02604 1FE4 8D34 BSR PUTDATA ;PUT THE DATA INTO THE BUFFER
02605 ;
02606 1FE6 9606 LDA A FLIGHT ;NOW SET THE FLIGHT ONTO THE BUFFER
02607 1FE8 D609 LDA B HOURS ;AND THE TIME (MS BYTE FIRST)
02608 1FEA 8D2E BSR PUTDATA
02609 ;
02610 1FEC 960A LDA A MINUTES
02611 1FEE D60B LDA B SECONDS
02612 1FF0 8D28 BSR PUTDATA
02613 ;
02614 1FF2 9603 LDA A FRAMTYPE ;GET THE TYPE OF FRAME THAT THIS ONE IS
02615 1FF4 8D1E42 JSR OUTCSFC ;SEND DATA TO SERIAL PORT 1
02616 1FF7 A700 STA A 0,X ;PUT IT INTO BUFFER
02617 1FF9 08 INX ;NEXT FREE ADDRESS
02618 ;
02619 1FFA 8604 LDA A #4 ;READ A/D CHANNELS 4 TO 8
02620 1FFC C608 LDA B #8
02621 1FFE 8D28 BSR GETSOME ;READ THESE DATA CHANNELS AND PUT THEM ON THE BUFFER
02622 2000 DFDE STX DATAPNTR ;SAVE THE VALUE OF BYTE POINTER
02623 ;
02624 ; ***** READ THE NORMAL 4 A/D CHANNELS *****
02625 ;
02626 2002 DEDE NMI.DAT2 LDX DATAPNTR ;GET POINTER TO THE NEXT FREE BYTES
02627 2004 4F CLR A ;READ FROM CHANNELS 0 TO 3
02628 2005 C603 LDA B #3
02629 2007 8D1F BSR GETSOME ;SAVE THE POINTER
02630 2009 DFDE STX DATAPNTR ;SEE IF WE HAVE A FULL BUFFER
02631 200B 8C3803 CPX #DATABUFF+803H
02632 200E 2609 BNE NMI.EX4 ;IF NOT THEN EXIT

```

```

02633 2010 7F00AC CLR F, DATA ; IF FULL THEN CLEAR THE DATA COLLECTION FLAG
02634 2013 8680 LDA A #80H ; AND SET THE FULL BUFFER FLAG
02635 2015 97A8 STA A F, FULBLK
02636 2017 97A8 STA A F, NUBLOC ; SET NEW BLOCK FLAG
02637 2019 38 ; EXIT OUT OF ISR
02638
02639 ;
02640 ; ***** PUTDATA: WRITE TWO BYTES TO BUFFER *****
02641 201A A700 STA A 0,X
02642 201C BD1E42 JSR OUTGSFC ; SEND DATA TO SERIAL PORT 1
02643 201F E701 STA B 1,X ; WRITE THE TWO BYTES
02644 2021 17 TBR
02645 2022 BD1E42 JSR OUTGSFC ; SEND TO SERIAL PORT 1
02646 2025 08 INX
02647 2026 08 INX
02648 2027 39 RTS
02649
02650 ;
02651 ; ***** GETSOME: READ CHANNELS FROM A/D *****
02652 2028 37 GETSOME PSH B ; SAVE END CHANNEL
02653 2029 36 PSH A ; AND SAVE THE START CHANNEL
02654 202A 8D09 GETSOME1 BSR ; GET A SINGLE CHANNEL FROM A/D (CHAN. # IN RA)
02655 202C 8DEC BSR PUTDATA ; WRITE THE DATA TO THE BUFFER
02656 202E 32 PUL A ; NEXT CHANNEL
02657 202F 33 PUL B
02658 2030 4C INC A
02659 2031 11 CBR
02660 2032 23F4 BLS GETSOME ; SEE IF THAT IS ALL OF THE CHANNELS
02661 2034 39 RTS ; LOOP IF NOT
02662
02663 ;
02664 ; ***** GETDATA: READ SINGLE DATA CHANNEL FROM A/D *****
02665 ;
02666 ; ***** 12 BIT WORD FROM A/D *****
02667 ; ***** CHANNEL NUMBER IN RA *****
02668 ; ***** RESULT IN RA (MS BYTE) AND RB (LS BYTE) *****
02669 ;
02670 ;
02671 2035 48 GETDATA ASL A ; LEFT JUSTIFY THE CHANNEL NUMBER
02672 2036 48 ASL A
02673 2037 48 ASL A
02674 2038 48 ASL A
02675 2039 B78400 STA A PIA1BD
02676 203C 8634 LDA A #34H ; WRITE THE CHANNEL NUMBER TO THE PIA
02677 203E B78401 STA A PIA1AC ; SET START CONVERSION (SC) TO 0
02678 2041 863C LDA A #3CH ; BY SETTING CA1 TO A 0
02679 2043 B78401 STA A PIA1AC ; NOW SET SC TO A 1
02680 ; BY WRITING TO CA1
02681 2046 B68401 GETDATA1 LDA A PIA1AC ; READ THE PIA CONTROL REGISTER FOR END OF CONVERSION
02682 2049 2AFB BPL GETDATA1 ; LOOP UNTIL IT IS SET
02683
02684 204B B68401 LDA A PIA1AD ; NOW READ THE MS 8 BITS

```



```
02737          ;
02738          ;     **** READ THE DATA (HIGH BYTE)  ****
02739 207F 9D0F     BSR  IRIGBYTE
02740 2081 0700     STA B IRIGDAYH
02741          ;
02742          ;     **** READ THE FLIGHT NUMBER  ****
02743          ;
02744 2083 8D0B     BSR  IRIGBYTE
02745 2005 070C     STA B IRIGFLT
02746          ;
02747          ;     **** RESET THE PIA CONTROL  ****
02748          ;
02749 2087 868003    LDA A NMI.PIA        ; LOAD THE PIA CONTROL REGISTER
02750 208A 8A0C     ORA A #0CH          ; DIS-ENABLE THE INTERRUPTS
02751 208C 878803    STA A NMI.PIA
02752 208F 39      RTS                    ; GO BACK TO NMI ROUTINE
02753          ;
02754          ;
02755          ;
02756          ;
02757          ;     **** IRIGBYTE  ****
02758          ;
02759          ;
02760          ;     **** READ 8 BITS FROM IRIGB INTO B REGISTER  ****
02761          ;
02762          ;     **** SKIP THE LEADING SPACER PULSE IF CALLED AT "IRIGBYTE"  ****
02763          ;
02764          ;
02765          ;
02766 2090 8D12     IRIGBYTE BSR        ; SKIP THE SPACE BIT
02767 2092 CE0009   IRIGBYT1 LDX #09H         ; USE X AS A BIT COUNTER
02768 2095 8D0D     IRIGBYT2 BSR        ; READ THE 1/ST DATA BIT (LSB FIRST)
02769 2097 09     DEX                    ; COUNT DOWN NUMBER OF BITS
02770 2098 8C0004   CPX #04           ; 15/TH BIT IS NIBBLE SEPARATOR
02771 209B 27F8   BEQ IRIGBYT2        ; IF WE ARE THERE THEN SKIP THAT BIT
02772 209C 56     ROR B                 ; ELSE MOVE CARRY INTO B (CARRY WAS THE DATA BIT)
02773 209E 8C0000   CPX #0             ; SEE IF ALL DONE
02774 20A1 26F2   BNE IRIGBYT2        ; IF NOT THEN LOOP FOR NEXT BIT
02775 20A3 39     RTS
02776          ;
02777          ;
02778          ;
02779          ;
02780          ;
02781          ;     **** IRIGBIT  ****
02782          ;
02783          ;
02784          ;     **** READS A DATA BIT FROM CODE (SPACER OR NORMAL)  ****
02785          ;
02786          ;     **** EXITS TO CALLING ROUTINE IF HUNG UP  ****
02787          ;
02788          ;

```

```

02789 20A4 7D00D5      IRIGBIT      NMI.F1      ;SEE IF WE ARE HUNG UP
02790 20A7 2A01      BPL          IRIGBIT1     ;IF NOT THEN CONTINUE
02791 20A9 39        RTS
02792 20AA 7F00D8      CLR          RTC.STAT     ;RESET COUNTER TO SEE IF ARE HUNG <TIMING LOOP>
02793 20AD 868802      LDA A       IRIGB.IN     ;READ THE PIA DATA REGISTER
02794 20B0 44        LSR A       ;LOOK AT LSB <THE CLOCK INPUT>
02795 20B1 2507      BCS         IRIGBIT3     ;IF WE HAVE IT THEN GO TO NEXT SECTION
02796 20B3 7D00D8      TST         RTC.STAT     ;ELSE SEE IF WE ARE HUNG <200 MS WAIT>
02797 20B6 2617      BNE         IRICHUNG     ;IF IT GETS COUNTED UP THEN WE ARE HERE TOO LONG
02798 20B8 20F3      BRA         IRIGBIT2     ;IF NOT SET THEN LOOP AND LOOK FOR CLOCK
02799
02800 20BA 7F00D8      CLR          RTC.STAT     ;START PROCESS OVER TO FIND FALLING CLOCK
02801 20BD 168802      LDA A       IRIGB.IN     ;READ IN THE PIA AGAIN
02802 20C0 44        LSR A       ;LOOK AT CLOCK BIT <LSB>
02803 20C1 2407      BCC         IRIGBIT5     ;IF CLOCK HAS FALLEN THEN GOTO NEXT SECTION
02804 20C3 7D00D8      TST         RTC.STAT     ;ELSE LOOK FOR HANG-UP
02805 20C6 2607      BNE         IRICHUNG     ;LOOP AND LOOK FOR CLOCK FALLING
02806 20C8 20F3      BRA
02807
02808 20CA 44        LSR A       ;WE GOT RISING AND FALLING EDGE, SO GET DATA <BIT 1>
02809 20CB 7C00D8      INC         RTC.STAT     ;MAKE RTC.STAT NONZERO SO THAT RTC ISR WILL NOT THINK WE ARE HUNG
02810 20CE 39        RTS          ;EXIT WITH DATA BIT IN THE CARRY BIT
02811
02812 20CF 8680      LDA A       #80H        ;SET THE HUNG FLAG
02813 20D1 7D05      STA A       NMI.F1
02814 20D3 39        RTS

```



```

02869 .....
02870 .....
02871 .....
02872 .....
02873 .....
02874 .....
02875 .....
02876 20EF 96A7      ;SEE IF WE ARE TRANSMITTING ANY CHARS
02877 20F1 2806      ;IF WE ARE THEN SKIP TO HANDLER
02878 20F3 8685      ;IF WE ARENT TRANSMITTING, RESET ACIA NOT TO GET ANY MORE IRQS.
02879 20F5 B79409    ;BY STORING THE ABOVE VALUE INTO THE ACIA CONTROL REG.
02880 20F8 39        ;AND EXIT
02881 .....
02882 20F9 DEE3      XMIT1
02883 20FB A600      LDA A #85H
02884 20FD B78409    STA A ACIA1.C
02885 2100 9CE7      CPX BLOCKEND
02886 2102 2704      BEQ XMIT2
02887 2104 08        INX
02888 2105 DFE3      STX NEXTCHAR
02889 2107 39        RTS
02890 .....
02891 .....
02892 .....
02893 2108 8685      XMIT2
02894 210A B78408    STA A ACIA1.C
02895 210D 9CE5      CPX LASTCHAR
02896 210F 2728      BEQ XMIT4
02897 .....
02898 2111 CE0150     XMIT3
02899 2114 DFE3      STX NEXTCHAR
02900 2116 DEE7      LDX BLOCKEND
02901 2118 08        INX
02902 2119 DFE7      STX BLOCKEND
02903 211B A600      LDA A #85H
02904 211D DEE3      LDX NEXTCHAR
02905 211F A700      STA A #01H
02906 2121 08        INX
02907 2122 DFE3      STX NEXTCHAR
02908 2124 DEE7      LDX BLOCKEND
02909 2126 9CE5      CPX LASTCHAR
02910 2128 26EE      BNE XMIT3
02911 .....
02912 212A DEE3      XMIT3
02913 212C 09        DEX
02914 212D DFE7      STX BLOCKEND
02915 212F DFE5      LASTCHAR
02916 2131 CE0150     #XMITBUF
02917 2134 DFE3      STX NEXTCHAR
02918 2126 86A1      LDA A #0A1H
02919 2138 B78408    STA A ACIA1.C
02920 213B 39        RTS
  
```

```

02921
02922 213C 7F00A7      XMIT+   CLR    F.XMIT      ;WE SEND A WHOLE BUFFER SO EXIT
02923 213F CE015B      LD      #XMITBUF   ;RESET THE NEWCHAR POINTER
02924 2142 DFE3        ST      NEXTCHAR
02925 2144 39         RTS
02926                ;SEND CHARACTER TO DISPLAY WHEN IT INTERRUPTS
02927                ;RESET AFTER SENDING 20 CHARACTERS
02928 2145 B68800      DISPLAY LDA A 8800H      ;CLR FLAG
02929 2148 DED0        LD      IRQT1      ;TEMP
02930 214A 8C2903      CPX    #DISPLY+20
02931 214D 2709        BEQ    STARTUP
02932 214F A600        LDA A 0,X
02933 2151 B78800      STA A 8800H
02934 2154 08         INX
02935 2155 DFD0        STX    IRQT1
02936 2157 39         RTS
02937 2158 CE28EF      STARTUP LD      #DISPLY
02938 215B A600        LDA A 0,X
02939 215D B78800      STA A 8800H
02940 2160 08         INX
02941 2161 DFD0        STX    IRQT1
02942 2163 8635        RESET  LDA A #35H
02943 2165 B78801      STA A 8801H
02944 2168 863D        LDA A #3DH
02945 216A B78801      STA A 8801H
02946 216D 39         RTS
02947

```

```

02950 ;
02951 ;   FLOATING POINT SUBROUTINES
02952 ;
02953 ;
02954 ;
02955 ;
02956 ;
02957 ;
02958 ;   "AVERAGE" SUBROUTINE.
02959 ;   COMPUTATION OF RUNNING AVERAGE OF 10 SUCCESSFUL SAMPLES FROM ADC
02960 ;   ENTRY: X REGISTER POINTS TO 1ST ADDRESS OF SAMPLES BUFFER.
02961 ;   EXIT: AVERAGE OF 10 SAMPLES IS LEFT AT TOS IN APU.
02962 ;   SAVE DATA POINTER
02963 ;   INITIALIZE RUNNING TOTAL VARIABLE
02964 ;   SAMPLE COUNT
02965 ;   GET THE FIRST SAMPLE
02966 ;   ADD SAMPLE TO RUNNING TOTAL
02967 ;   UPDATE RUNNING TOTAL
02968 ;   INCREMENT POINTER TO NEXT SAMPLE
02969 ;
02970 ;   BRANCHES UNTIL ALL TEN SAMPLES WERE COMPUTED
02971 ;
02972 ;   PUTS 12-BIT WORD ONTO TOS IN APU
02973 ;   PUSH 2 ZEROS FOR 32 BIT FIXED FORMAT
02974 ;   CONVERTS 32-BIT FIXED-PT TO 32-BIT FLT-PT FORMAT
02975 ;   GET 32-BIT VALUE OF 4095
02976 ;   PUTS 32-BIT FLT-PT NUMBER ONTO TOS IN APU
02977 ;   COMPUTES AVERAGE... (SUMMED SAMPLES)/10.0
02978 ;
02979 ;   "RADTEMP" SUBROUTINE.
02980 ;   CONVERSION OF ADC CHANNELS 0-3 TO TEMPERATURE (BCD).
02981 ;   ENTRY: FOUR 12-BIT NUMBER = "ADC0" THRU "ADC3" (2 BYTE BLOCKS).
02982 ;   EXIT: BCD RESULTS = "CH0TEMP" THRU "CH3TEMP" (5 BYTE BLOCKS).
02983 ;
02984 ;   RADTEMP: LDX #CH0TEMP
02985 ;   STX SAVEX1
02986 ;   LDX #CH0GAIN
02987 ;   STX SAVEX2
02988 ;   LDX #ADC0
02989 ;   LDA A 0,X
02990 ;   LDA B 1,X
02991 ;   INX
02992 ;   INX
02993 ;   STX SAVEX3
02994 ;   SAVE THIS POINTER
02995 ;
02996 ;   RADTEMP1 LDA A 0,X
02997 ;   LDA B 1,X
02998 ;   INX
02999 ;   INX
03000 ;   STX SAVEX3
03001 ;   SAVE THIS POINTER

```



```

03054 2220 DF93      ;SAVE INCREMENTED POINTER
03055 222F DE91      ;SET DATA POINTER AT APPROPRIATE CAL CONST
03056 2231 8D1D      ;CONVERT 12-BIT NUMBER TO TEMPERATURE (BCD)
03057 2233 DE91      ;INCREMENTS X REGISTER 8 TIMES TO NEXT CAL CONST
03058 2235 C608      ;SAVES INCREMENTED POINTER
03059 2237 8D12      ;INCREMENTS X REG 5 TIMES TO NEXT RESULT LOCATION
03060 2239 DF91      ;SAVE INCREMENTED POINTER
03061 223B DE8F      ;TESTS TO SEE IF CHANNEL 8 HAS BEEN SAMPLED
03062 223D C605      ;BRANCH UNTIL CHANNEL 8 HAS BEEN CONVERTED
03063 223F 8D0A      ;INCRMNXTX SUBROUTINE.
03064 2241 DF8F      INCREMENTS X REGISTER "B" TIME.
03065 2243 DE93      ENTRY: X REGISTER CONTAINS POINTER TO BE INCREMENTED.
03066 2245 8C0081    ACCB CONTAINS THE VALUE "B".
03067 2248 26DD      EXIT: X REGISTER CONTAINS NEW UPDATED VALUE.
03068 224A 39        ACCB = ZERO, ACCA DOES NOT CHANGE.
03069                ;INCREMENTS X REGISTER BY ONE
03070                ;DECREMENTS INCREMENTAL COUNTER
03071                ;BRANCH UNTIL ACCB = 0
03072                INCRMNXTX INX
03073                DEC B
03074                BNE INCRMNXTX
03075                RTS
03076 224B 08        "TEMPBCD" SUBROUTINE.
03077 224C 5A        CONVERSION OF 12-BIT ADC WORD TO TEMPERATURE (BCD).
03078 224D 26FC      ENTRY: ACCA,ACCB CONTAINS 12-BIT NUMBER.
03079 224F 39        X REGISTER POINTS TO CALIBRATION CONSTANTS.
03080                "SAVEX1" POINTS TO LOCATION OF BCD RESULT.
03081                BCD RESULT IN LOCATION SPECIFIED BY X REGISTER.
03082                ACCA,ACCB ARE DESTROYED.
03083                TEMPBCD STX
03084                JSR BINVOLTS
03085                LDX SAVEX1
03086                BSR VOLTTEMP
03087                LDX #FPT32
03088                LDA B #04H
03089                JSR PULL
03090                LDX SAVEX1
03091                BSR FPTBCD
03092                LDX #04H
03093                JSR PULL
03094                LDX SAVEX1
03095                BSR FPTBCD
03096                LDX #04H
03097                JSR PULL
03098                LDX #04H
03099                JSR PULL
03100                LDX #04H
03101                JSR PULL
03102                LDX #04H
03103                JSR PULL
03104                LDX #04H
03105                JSR PULL
    
```

```

03106 226B BD23CA JSR FMUL ; MULT GAIN BY A/D VOLTS
03107 226E C604 LDA B #04H
03108 2270 BD2393 JSR PUSH ; PUSH 4-BYTE FLOATING-POINT NUMBER ON APU STACK
03109 2273 BD238A JSR FADD ; ( GAIN X VOLTAGE ) + OFFSET
03110 2276 39 RTS
03111
;
; "BINVOLTS" SUBROUTINE
03112 ; CONVERSION OF 12-BIT A/D WORD TO A VOLTAGE RANGING FROM 0-10V.
03113 ; ENTRY: ACCA,ACCB CONTAINS 12-BIT NUMBER.
03114 ; EXIT: 32-BIT FLT-PT. VOLTAGE LEFT AT TOS IN APU.
03115 ; BINVOLTS PSH B ; SAVES 12-BIT WORD ON STACK
03116 2277 37 PSH A
03117 2278 36 LDA B #VOLTS10 ; X REG. POINTS TO FULL SCALE VOLTAGE...10V
03118 2279 CE2424 LDA B #04H ; PUSH 4-BYTE FLOATING-POINT NUMBER ON STACK
03119 227C C604 JSR PUSH ; X REG. POINTS TO 12-BIT WORD
03120 227E BD2393 JSR TSX
03121 2281 30 LDA B #02H ; PUSH 2-BYTE FIXED-POINT NUMBER ON SAPU STACK
03122 2282 C602 JSR PUSH ; CONVERT FIXED-POINT TO FLOATING-POINT BINARY
03123 2284 BD2393 JSR FLTS ; X REG. POINTS TO FULL SCALE 12-BIT WORD (4095)
03124 2287 BD23DA JSR #FSADCMD ; PUSH 4-BYTE FLOATING-POINT NUMBER ON APU STACK
03125 228A CE2428 LDA B #04H ; ADCWORD/4095<1.0
03126 228D C604 JSR FDIV ; (ADCWORD/4095)*X10VOLTS
03127 228F BD2393 JSR FMUL ; CLEAN UP STACK
03128 2292 BD23D2 JSR
03129 2295 BD23CA JSR
03130 2298 31 INS
03131 2299 31 INS
03132 229A 39 RTS
03133
;
; TOSBCD
03134 ; CONVERT NUMBER ON TOS TO BCD AT X
03135 TOSBCD STX SAVEX1
03136 229B DF8F LDX #FPT32
03137 229D CE009C LDA B #4
03138 22A0 C604 JSR PULL
03139 22A2 BD23A7 JSR SAVEX1
03140 22A5 DE8F LDX FPTBCD
03141 22A7 BD22E6 JSR
03142 22AA 39 RTS
03143
;
; "VOLTSBCD" SUBROUTINE.
03144 ; CONVERSION OF 12-BIT ADC WORD TO VOLTAGE (BCD).
03145 ; ENTRY: ACCA,ACCB CONTAINS 12-BIT NUMBER.
03146 ; X REGISTER POINTS TO LOCATION OF RESULT.
03147 ; EXIT: BCD RESULT IN LOCATION SPECIFIED BY X REGISTER.
03148 ; ACCA,ACCB ARE DESTROYED.
03149 ; VOLTSBCD STX SAVEX1 ; SAVES DATA POINTER
03150 22AB DF8F BSR BINVOLTS ; CONVERTS 12-BIT NUMBER TO 32-BIT VOLTAGE
03151 22AD 8DC8 LDX #FPT32
03152 22AF CE009C LDA B #04H
03153 22B2 C604 JSR PULL
03154 22B4 BD23A7 JSR SAVEX1 ; REMOVES 32-BIT NUMBER FROM TOS
03155 22B7 DE8F LDX FPTBCD ; SETS DATA POINTER
03156 22B9 8D01 BSR ; CONVERTS 32-BIT NUMBER TO BCD
03157 22BB 39 RTS

```

```

03158 ;
03159 ;
03160 ;
03161 ;
03162 ;
03163 ;
03164 ;
03165 STX DF8F ; "FPTBCD" SUBROUTINE
03166 CLR 7F009A ; CONVERSION OF 32-BIT FLOATING-POINT NUMBER TO 32-BIT PACKED BCD.
03167 CLR 7F009B ; ROUTINE ASSUMES 32-BIT FLT-PT. NUMBER = "FPT32"
03168 CLR 6F00 ; X REGISTER POINTS TO LOCATION OF BCD RESULT.
03169 CLR 22C6 CE009C ; ENTRY: BCD RESULT SPECIFIED BY X REGISTER.
03170 CLR 22C9 A600 ; EXIT: ACCA,ACCB ARE DESTROYED.
03171 CLR 22CB 2733 ;
03172 CLR 22CD 2A07 ;
03173 CLR 22CF DE8F ;
03174 CLR 22D1 6A00 ;
03175 CLR 22D3 CE009C ;
03176 CLR 22D5 48 ;
03177 CLR 22D7 47 ;
03178 CLR 22D8 2A0F ;
03179 CLR 22DA C609 ;
03180 CLR 22DC 6401 ;
03181 CLR 22DE 5A ;
03182 CLR 22DF 2603 ;
03183 CLR 22E1 08 ;
03184 CLR 22E2 2030 ;
03185 CLR 22E4 4C ;
03186 CLR 22E5 26F5 ;
03187 CLR 22E7 2017 ;
03188 CLR 22E9 C611 ;
03189 CLR 22EB 6803 ;
03190 CLR 22ED 6901 ;
03191 CLR 22EF 6901 ;
03192 CLR 22F1 79009B ;
03193 CLR 22F4 79009A ;
03194 CLR 22F5 5A ;
03195 CLR 22F8 2603 ;
03196 CLR 22FA 08 ;
03197 CLR 22FB 2017 ;
03198 CLR 22FD 4A ;
03199 CLR 22FE 26EB ;
03200 CLR 2300 A601 ;
03201 CLR 2302 36 ;
03202 CLR 2303 DE8F ;
03203 CLR 2305 08 ;
03204 CLR 2306 969A ;
03205 CLR 2308 D69B ;
03206 CLR 230A 8D09 ;
03207 CLR 230C DE8F ;
03208 CLR 230E 08 ;
03209 CLR 230F 08 ;

FPTBCD STX DF8F ; SAVES RESULT POINTER
        CLR 7F009A ; INITIALIZE INTEGER REGISTERS
        CLR 7F009B ;
        CLR 6F00 ;
        CLR 22C6 CE009C ; INITIALIZE BCD SIGN VALUE
        CLR 22C9 A600 ; SET POINTER TO 32-BIT NUMBER
        CLR 22CB 2733 ; GET EXPONENT PART OF 32-BIT NUMBER
        CLR 22CD 2A07 ; DON'T SHIFT IF ZERO EXPONENT
        CLR 22CF DE8F ; BRANCHES IF 32-BIT NUMBER IS POSITIVE
        CLR 22D1 6A00 ; IT IS NEG. FIX BCD SIGN BYTE TO BE NEGATIVE
        CLR 22D3 CE009C ; SIGN BYTE IS NEGATIVE
        CLR 22D5 48 ; RESETS DATA POINTER
        CLR 22D7 47 ; CONVERTS 7-BIT 2S COMP. TO 8-BIT 2S COMP
        CLR 22D8 2A0F ; BRANCHES TO POS. SHIFTING ROUTINE IF 32-BIT=POS
        CLR 22DA C609 ; INITIALIZES BIT COUNTER
        CLR 22DC 6401 ; MOVES BINARY POINT OVER TO THE LEFT
        CLR 22DE 5A ; DECREMENT BIT COUNTER
        CLR 22DF 2603 ; BRANCHES IF UNDERFLOW DOES NOT OCCUR
        CLR 22E1 08 ; SETS OVERFLOW BIT TO DENOTE AN ERROR
        CLR 22E2 2030 ; BRANCHES TO END OF ROUTINE
        CLR 22E4 4C ; ADJUSTS THE EXPONENT
        CLR 22E5 26F5 ; BRANCHES THRU LOOP UNLESS BINARY PT IS ADJUSTED
        CLR 22E7 2017 ; BRANCHES TO CONVERSION PART OF THIS ROUTINE
        CLR 22E9 C611 ; INITIALIZES BIT COUNTER
        CLR 22EB 6803 ; BEGIN POSITIVE SHIFTING ROUTINE
        CLR 22ED 6901 ; ROTATES 3RD BYTE OF 32-BIT NUMBER
        CLR 22EF 6901 ; ROTATES 2ND BYTE OF 32-BIT NUMBER
        CLR 22F1 79009B ; ROTATES 32-BIT NUMBER INTO INTEGER REGISTER
        CLR 22F4 79009A ;
        CLR 22F5 5A ; DECREMENT BIT COUNTER
        CLR 22F8 2603 ; BRANCHES IF OVERFLOW HAS NOT OCCURED
        CLR 22FA 08 ; SETS OVERFLOW BIT TO DENOTE AN ERROR
        CLR 22FB 2017 ; BRANCHES TO END OF ROUTINE
        CLR 22FD 4A ; ADJUSTS THE EXPONENT
        CLR 22FE 26EB ; BRANCHES THRU LOOP UNLESS BINARY PT IS ADJUSTED
        CLR 2300 A601 ; GETS BINARY FRACTION IN ACCA
        CLR 2302 36 ; SAVE A
        CLR 2303 DE8F ; SETS DATA POINTER
        CLR 2305 08 ;
        CLR 2306 969A ; RETRIEVES THE BINARY INTEGER
        CLR 2308 D69B ;
        CLR 230A 8D09 ; CONVERT INTEGER PART
        CLR 230C DE8F ; SETS DATA POINTER
        CLR 230E 08 ;
        CLR 230F 08 ;
    
```

1 Electronix N6800 ASM V3.1 CONVAIR 990 RADIOMETER
 OPERATING POINT ROUTINES

```

01210 2310 08      INX
01211 2311 32      PUL A
01212 2312 8D53      BSR
01213 2314 39      RTS
01214
01215
01216
01217
01218
01219
01220
01221
01222
01223
01224
01225 2315 DF8D      BINBCD
01226 2317 CE241A      STX SAVEX
01227 231A 7F0098      LDX #K10K
01228 231D 7F0099      CLR ENTRYA
01229 2320 7F0087      CLR SAVED
01230 2323 E001      SUB B 1,X
01231 2325 A200      SBC A 0,X
01232 2327 2505      BCS CVDEC5
01233 2329 7C0087      INC SAVED
01234 232C 20F5      BRA CVDEC2
01235 232E EB01      ADD B 1,X
01236 2330 A900      ADC A 0,X
01237 2332 36      PSH A
01238 2333 9687      LDA A SAVED
01239 2335 8D13      BSR PACK
01240 2337 32      PUL A
01241 2338 08      INX
01242 2339 08      INX
01243 233A 9C2424      CPX #K10K+10
01244 233D 26E1      BNE CVDEC1
01245 233F 9698      LDA A ENTRYA
01246 2341 D699      LDA B ENTRYB
01247 2343 DE8D      LDX SAVEX
01248 2345 A700      STA A 0,X
01249 2347 E701      STA B 1,X
01250 2349 39      RTS
01251
01252
01253
01254
01255
01256 234A 780099      "PACK" SUBROUTINE
01257 234D 790098      PACKS BINARY NUMBERS INTO BCD FORM
01258 2350 780099      ACCA SHOULD CONTAIN THE UNPACKED BCD FORM
01259 2353 790098      ROUTINE DESTROYS CONTENTS OF ACCA.
01260 2356 780099      ASL ENTRYB
01261 2359 790098      ROL ENTRYA
    
```



```
03262 235C 780099          ASL   ENTRYB           ; SHIFTS 16-BIT BINARY INFORMATION OVER ONE CHAR.
03263 235F 790098          ROL   ENTRYA           ; ENTRYB LOOKS LIKE "X0"
03264 2362 9899           ADD  A  ENTRYB           ; PACKS IN ANOTHER UNPACKED BCD FORM
03265 2364 9799           STA  A  ENTRYB
03266 2366 39             RTS

;
; "BINFPT" SUBROUTINE
;
; CONVERSION OF FRACTIONAL PART OF BINARY NUMBER TO PACKED BCD.
; LOAD FRACTIONAL PART IN ACCA BEFORE EXECUTION.
; ACCB IS USED IN CALCULATION.
; ROUTINE EXITS WITH BCD ANSWER (<4 DECIMAL PLACES> IN ACCA, ACCB.
;
; BINFPT
;   STX  A  SAVED
;   LDA  B  #06H
;   STA  B  SAVED
;   LDX  A  #CONST
;   CLR  A
;   CLR  B
;   STA  A  TEMPB
;   ASL  SAVED
;   BCC  BINB
;   TBA
;   ADD  A  1, X
;   DAA
;   TAB
;   LDA  A  TEMPB
;   ADC  A  0, X
;
; BIN2
;   INX
;   INX
;   DEC  SAVED
;   BNE  BIN1
;   LDX  SAVED
;   STA  A  0, X
;   STA  B  1, X
;   RTS

;
; "PUSH" SUBROUTINE
;
; MOVES B BYTES OF DATA ONTO APU STACK
; LOAD ACCB WITH NUMBER OF BYTES TO BE PLACED ONTO APU STACK
; LOAD ACCX WITH ADDRESS OF MS BYTE OF DATA TO BE PLACED ONTO STACK.
; ROUTINE WILL PLACE BYTES ON APU STACK IN SUCH A MANNER AS TO HAVE
; THE MS BYTE OF DATA AT TOP OF STACK (TOS).
; ROUTINE EXITS WITH ACCX POINTING AT NEXT B BYTES OF DATA.
; SAVES THE NUMBER OF BYTES
; INCREMENTS ACCX TO POINT AT LAST BYTE OF DATA
; DECREMENT BIT COUNTER
; BRANCHES THRU LOOP UNTIL 8 BITS ARE SHIFTED
; RETRIEVE DATA POINTER
; SAVES 16-BIT PACKED BCD CHARACTER
;
; PUSH
;   PSH  B
;   INX
;   DEC  B
;   BNE  PUSH1
;   STX  TEMPX
;   PUL  B
;   DEX
;   LDA  A  0, X
;
; PUSH1
;   PSH  B
;   INX
;   DEC  B
;   BNE  PUSH1
;   STX  TEMPX
;   PUL  B
;   DEX
;   LDA  A  0, X
```

Tektronix M6800 ASM V3.1 CONVAIR 990 RADIOMETER Page 70
 FLOATING POINT ROUTINES

```

03314 239E B78 0C STA A APUDATA ; ENTER THE CURRENT BYTE OF DATA ONTO THE APU STACK
03315 23A1 5A BNE ; DECREMENTS THE BYTE COUNTER
03316 23A2 26F BNE PUSH2 ; BRANCHES THRU UNTIL LS BYTE OF DATA IS ENTERED
03317 23A4 DE8 LDX TEMPX ; RETRIEVES THE ADDRESS OF NEXT BATCH OF DATA
03318 23A6 39 RTS
03319
;
;
;
03320 "PULL" SUBROUTINE
03321 REMOVES B BYTES OF DATA FROM STACK.
03322 LOAD ACCB WITH NUMBER OF BYTES TO BE REMOVED FROM APU STACK.
03323 LOAD ACCX WITH ADDRESS OF WHERE TOS IS TO BE PLACED.
03324 ROUTINE WILL PULL BYTES FROM APU STACK AND PLACE THEM INTO
03325 MEMORY SPECIFIED BY THE ADDRESS IN ACCX.
03326 23A7 B680C PULL LDA A APUDATA ; PLACES REMOVED DATA INTO MEMORY AT ACCX
03327 23A8 A700 STA A 0,X ; INCREMENTS ACCX TO NEXT MEMORY LOCATION
03328 23AC 08 INX ; DECREMENTS BYTE COUNTER
03329 23AD 5A DEC B ; BRANCHES THRU UNTIL B BYTES OF DATA ARE REMOVED
03330 23AE 26F7 BNE PULL
03331 23B0 39 RTS
03332
;
;
;
03333 "TSTEND" SUBROUTINE
03334 LOOPS UNTIL END LFLAG FROM APU GOES LOW (ON PA7 OF PIR2)
03335 23B1 B68104 TSTEND LDA A PIR2AD ; CHECK END FLAG
03336 23B4 28FB BMI TSTEND ; LOOP TILL LOW
03337 23B6 B6880D LDA A APUSTAT ; CLEAR FLAG
03338 23B9 39 RTS
03339
;
;
;
03340 "FADD" SUBROUTINE
03341 ADDS TWO 32-BIT FLOATING POINT NUMBERS (B+A).
03342 BOTH NUMBERS MUST BE ON APU STACK BEFORE EXECUTION OF COMMAND.
03343 ROUTINE EXITS WHEN APU IS FINISHED.
03344 23BA C610 LDA B #10H ; LOADS IN ADD OP CODE
03345 23BC F7600D STA B APUSTAT ; ISSUES COMMAND TO APU
03346 23BF 8DF0 BSR TSTEND ; WAITS UNTIL APU IS FINISHED
03347 23C1 39 RTS
03348
;
;
;
03349 "FSUB" SUBROUTINE
03350 SUBTRACTS TWO 32-BIT FLOATING POINT NUMBERS (B-A).
03351 BOTH NUMBERS MUST BE ON APU STACK BEFORE EXECUTION OF COMMAND.
03352 ROUTINE EXITS WHEN APU IS FINISHED.
03353 23C2 C611 LDA B #11H ; LOADS IN SUBTRACT OP CODE
03354 23C4 F7600D STA B APUSTAT ; ISSUES COMMAND TO APU
03355 23C7 8DE BSR TSTEND ; WAITS UNTIL APU IS FINISHED
03356 23C9 39 RTS
03357
;
;
;
03358 "FMUL" SUBROUTINE
03359 MULTIPLIES TWO 32-BIT FLOATING POINT NUMBERS (A*B).
03360 BOTH NUMBERS MUST BE ON APU STACK BEFORE EXECUTION OF COMMAND.
03361 ROUTINE EXITS WHEN APU IS FINISHED.
03362 23CA C612 LDA B #12H ; LOADS IN MULTIPLY OP CODE
03363 23CC F7600D STA B APUSTAT ; ISSUES MULTIPLY COMMAND TO APU
03364 23CF 8DE BSR TSTEND ; WAITS UNTIL APU IS FINISHED
03365 23D1 39 RTS

```

```

03366      ;
03367      ;      "FDIV" SUBROUTINE
03368      ;      DIVIDES TWO 32-BIT FLOATING POINT NUMBERS (B/A).
03369      ;      BOTH NUMBERS MUST BE ON APU STACK BEFORE EXECUTION OF COMMAND.
03370      ;      ROUTINE EXITS WHEN APU IS FINISHED.
03371 23D2 C613      FDIV      LDA B #13H      ; LOADS IN DIVIDE OPCODE
03372 23D4 F7880D      STA B APUSTAT      ; ISSUES DIVIDE COMMAND TO APU
03373 23D7 8DD8      BSR      TSTEND      ; WAITS UNTIL APU IS FINISHED
03374 23D9 39      RTS
03375      ;
03376      ;      "FLTS" SUBROUTINE
03377      ;      CONVERSION OF 16-BIT FIXED PT # TO A 32-BIT FLOATING PT #
03378      ;      16-BIT FIXED POINT # MUST BE ON APU STACK BEFORE EXECUTION.
03379      ;      ROUTINE EXITS WHEN APU IS FINISHED.
03380 23DA C61D      FLTS      LDA B #1DH      ; LOADS IN FLOAT OPCODE
03381 23DC F7880D      STA B APUSTAT      ; ISSUES COMMAND TO APU
03382 23DF 8DD0      BSR      TSTEND      ; WAITS UNTIL APU IS FINISHED
03383 23E1 39      RTS
03384      ;
03385      ;      FLOAT A 32 BIT FIXED POINT NUMBER
03386 23E2 C61C      FLTD      LDA B #1CH      ;
03387 23E4 F7880D      STA B APUSTAT      ;
03388 23E7 20C8      BRA      TSTEND
03389      ;
03390      ;      "XCHF" SUBROUTINE
03391      ;      EXCHANGES 32-BIT STACK OPERANDS (TOS AND NOS)
03392      ;      BOTH NUMBERS MUST ON APU STACK BEFORE EXECUTION BEGINS.
03393      ;      ROUTINE EXITS WHEN APU IS FINISHED.
03394 23E9 C619      XCHF      LDA B #19H      ; LOADS IN EXCHANGE COMMAND
03395 23EB F7880D      STA B APUSTAT      ; ISSUES COMMAND TO APU
03396 23EE 8DC1      BSR      TSTEND      ; WAITS UNTIL APU IS FINISHED
03397 23F0 39      RTS
03398      ;
03399 23F1 C617      PTOF      LDA B #17H      ;
03400 23F3 F7880D      STA B APUSTAT      ;
03401 23F6 20B9      BRA      TSTEND
03402      ;
03403      ;      POP NOS INTO TOS
03404 23F8 C618      POPF      LDA B #18H      ;
03405 23FA F7880D      STA B APUSTAT      ;
03406 23FD 20B2      BRA      TSTEND
03407      ;
03408 23FF CE1108      PATCH      LDX #RESTART      ;
03409 2402 FF03C3      STX      03C3H      ; PUT IN WINTEK PROG CNTR
03410 2405 31      INS      ;
03411 2406 31      INS      ; FIX STACK
03412 2407 7EFE07      JMP      0FE07H      ; GO TO WINTEK
03413      ;
03414      ;      TABLE OF BCD CONSTANTS FOR "BINFPT" SUBROUTINE.
03415 240A 5000      CONST      WORD      5000H      ; BIT=-1
03416 240C 2500      WORD      2500H      ; BIT=-2
03417 240E 1250      WORD      1250H      ; BIT=-3
    
```

```
03418 2410 0625      WORD  0625H  ;BIT=-4
03419 2412 0312      WORD  0312H  ;BIT=-5
03420 2414 0156      WORD  0156H  ;BIT=-6
03421 2416 0078      WORD  0078H  ;BIT=-7
03422 2418 0039      WORD  0039H  ;BIT=-8
03423
03424 ;
; TABLE OF DECIMAL CONSTANTS FOR "BINBCD" SUBROUTINE.
K10K  WORD  10000  ;FIFTH DECIMAL CHARACTER
      WORD  1000   ;FORTH DECIMAL CHARACTER
      WORD  100    ;THIRD DECIMAL CHARACTER
      WORD  10     ;SECOND DECIMAL CHARACTER
      WORD  1      ;FIRST DECIMAL CHARACTER
VOLTS10 WORD  04A0H  ;FULL SCALE A/D VOLTAGE (10.000)
      WORD  0000H
FSADCND WORD  0CFFH  ;FULL SCALL A/D WORD (0FFF)
      WORD  0000H
```

```

03436          ; ASCII MESSAGES FOR CONVAIR SOFTWARE AND COMMAND JUMP TABLE.
03437          ;
03438          ;
03439 242C 44524056 MESSNR  ASCII  "DRIVE NOT READY"
03439 2430 4520404F
03439 2434 54205045
03439 2438 414450
03440 243B 04
03441 243C 2047402E INITMSG  ASCII  " GA. TECH RADIOMETER"
03441 2440 20544043
03441 2444 48205041
03441 2448 4449404D
03441 244C 45544052
03442 2450 04
03443 2451 52454044 RDYMSG  ASCII  "READY"
03443 2455 59
03444 2456 04
03445 2457 494E5041 SYNMSG  ASCII  "INVALID COMMAND"
03445 245B 4C494020
03445 245F 434F404D
03445 2463 414E40
03446 2466 04
03447 2467 494C4045 BKERMSG  ASCII  "ILLEGAL BLOCK NUMBER!"
03447 246B 47414020
03447 246F 424C4043
03447 2473 4B204055
03447 2477 4D424052
03447 247B 21
03448 247C 04
03449 247D 494E5041 NUMERR  ASCII  "INVALID NUMBER"
03449 2481 4C494020
03449 2485 4E554042
03449 2489 4552
03450 248B 04
03451 248C 4E4F2020 BLKSMMSG ASCII  "NO. OF BLOCKS"
03451 2490 4F462042
03451 2494 4C4F404B
03451 2498 53
03452 2499 04
03453 249A 43524020 CRCMSG  ASCII  "CRC ERROR AT BLOCK : "
03453 249E 4552004F
03453 24A2 52204054
03453 24A6 2042404F
03453 24AA 434B2020
03453 24AE 202030
03454 24B1 04
03455 24B2 20535041 STRTMSG  ASCII  " STARTING ADDRESS? "
03455 24B6 5254404E
03455 24BA 47204044
03455 24BE 44524053
03455 24C2 533F20
03456 24C5 04
          BYTE  4
  
```

```

03457 24C6 2042404F BLOCKMSG ASCII " BLOCK NUMBER? "
03457 24CA 434B204E
03457 24CE 554D4045
03457 24D2 523F2044
03458 24D5 04 BYTE 4
03459 24D6 4741404E GAINMSG ASCII "GAIN IN DEG/VOLT "
03459 24DA 20494020
03459 24DE 4445402F
03459 24E2 564F4054
03459 24E6 20
03460 24E7 04 BYTE 4
03461 24E8 4F464053 OFSTMSG ASCII "OFFSET IN DEGREES "
03461 24EC 45542049
03461 24F0 4E204045
03461 24F4 47524045
03461 24F8 5320
03462 24FA 04 BYTE 4
03463 24FB 20545041 TRACKMSG ASCII " TRACK NUMBER? "
03463 24FF 434B204E
03463 2503 554D4045
03463 2507 523F2044
03464 250A 04 BYTE 4
03465 250B 2A2A2044 DELMSG ASCII "****DEL***"
03465 250F 454C202A
03465 2513 2A
03466 2514 04 BYTE 4
03467 2515 0D0A CRLFSTR WORD 0D0AH
03468 2517 04 BYTE 4
03469 2518 54415045 FPMMSG ASCII "TAPE IS WRITE PROTECTED"
03469 251C 20495020
03469 2520 57524054
03469 2524 45205052
03469 2528 4F544043
03469 252C 54454044
03470 252F 04
03471 2530 41505020 APUERMSG ASCII "APU ERROR!!!!!"
03471 2534 4552504F
03471 2538 52212021
03471 253C 2121
03472 253E 04 BYTE 4
03473
03474 253F 47412020 RADMSG ASCII "GA. TECH MILLIMETER RADIOMETER"
03474 2543 54454048
03474 2547 204D404C
03474 254B 4C494045
03474 254F 54455020
03474 2553 52414049
03474 2557 4F4D4054
03474 255B 4552
03475 255D 04
03476 255E 53595054 RADMSG1 ASCII "SYSTEM STATUS"
03476 2562 454D2053
  
```

03476	2566	54415455			
03476	256A	53			
03477	256B	04		BYTE	4
03478	256C	464C4947	FLTMSG	ASCII	"FLIGHT NO. "
03478	2570	4854204E			
03478	2574	4F2E2020			
03479	2578	04		BYTE	4
03480	2579	44415920	DAYMSG	ASCII	"DAY "
03481	257D	04		BYTE	4
03482	257E	54494D45	TIMEMSG	ASCII	"TIME "
03482	2582	20			
03483	2583	04		BYTE	4
03484	2584	44415441	DATAMSG	ASCII	"DATA COLLECTION "
03484	2588	20434F4C			
03484	258C	4C454354			
03484	2590	494F4E20			
03485	2594	04		BYTE	4
03486	2595	4C494E4B	LINKMSG	ASCII	"LINK TO GSFC "
03486	2599	20544F20			
03486	259D	47534643			
03486	25A1	20			
03487	25A2	04		BYTE	4
03488	25A3	54415045	TAPEMSG	ASCII	"TAPE DRIVE STATUS: "
03488	25A7	20445249			
03488	25AB	56452053			
03488	25AF	54415455			
03488	25B3	533A20			
03489	25B6	04		BYTE	4
03490	25B7	484F5420	HOTMSG	ASCII	"HOT LOAD"
03490	25BB	4C4F4144			
03491	25BF	2054454D	TEMPMSG	ASCII	" TEMP "
03491	25C3	5020			
03492	25C5	04		BYTE	4
03493	25C6	434F4C44	COLDMSG	ASCII	"COLD LOAD TEMP "
03493	25CA	204C4F41			
03493	25CE	44205445			
03493	25D2	4D5020			
03494	25D5	04		BYTE	4
03495	25D6	5245462E	REFMSG	ASCII	"REF. LOAD TEMP "
03495	25DA	204C4F41			
03495	25DE	44205445			
03495	25E2	4D5020			
03496	25E5	04		BYTE	4
03497	25E6	484F5420	HOTMSG1	ASCII	"HOT LOAD "
03497	25EA	4C4F4144			
03497	25EE	20			
03498	25EF	04		BYTE	4
03499	25F0	434F4C44	COLDMSG1	ASCII	"COLD LOAD "
03499	25F4	204C4F41			
03499	25F8	4420			
03500	25FA	04		BYTE	4
03501	25FB	4B4C5953	KLYSMG	ASCII	"KLYSTRON TEMP "

03501	25FF	54524F4E			
03501	2603	20544540			
03501	2607	502020			
03502	260A	04		BYTE	4
03503	260B	4341402E	CALMSG	ASCII	"CAL. INTERVAL ? "
03503	260F	20494E54			
03503	2613	45525041			
03503	2617	4C203F20			
03504	261B	04		BYTE	4
03505	261C	52414449	RADMSG2	ASCII	"RADIOMETER IS VIEWING "
03505	2620	4F4D4554			
03505	2624	45522019			
03505	2628	53205649			
03505	262C	4557494E			
03505	2630	4720			
03506	2632	04		BYTE	4
03507	2633	534B59	SKYMSG	ASCII	"SKY"
03508	2636	04		BYTE	4
03509	2637	47524F55	GNDMSG	ASCII	"GROUND"
03509	263B	4E44			
03510	263D	04		BYTE	4
03511	263E	3138332F	MSG183	ASCII	"183/1 GHZ "
03511	2642	31204748			
03511	2646	5A20			
03512	2648	04		BYTE	4
03513	2649	3138332F	MSG188	ASCII	"183/5 GHZ "
03513	264D	35204748			
03513	2651	5A20			
03514	2653	04		BYTE	4
03515	2654	3138332F	MSG193	ASCII	"183/10 GHZ "
03515	2658	31302047			
03515	265C	485A20			
03516	265F	04		BYTE	4
03517	2660	39342047	MSG94	ASCII	"94 GHZ "
03517	2664	485A2020			
03517	2668	202020			
03518	266B	04		BYTE	4
03519	266C	52414449	RADMSG3	ASCII	"RADIOMETER TEMPERATURES"
03519	2670	4F4D4554			
03519	2674	45522054			
03519	2678	454D5045			
03519	267C	52415455			
03519	2680	524553			
03520	2683	04		BYTE	4
03521	2684	4F4E	ONMSG	ASCII	"ON"
03522	2686	04		BYTE	4
03523	2687	4F4646	OFFMSG	ASCII	"OFF"
03524	268A	04		BYTE	4
03525	268B	43414C49	CALMSG1	ASCII	"CALIBRATION DATA"
03525	268F	42524154			
03525	2693	494F4E20			
03525	2697	44415441			

03526	269B	0D0A	WORD	0D0AH		
03527	269D	20202020	ASCII	"	GAIN (DEG/VOLT)	OFFSET (DEG) "
03527	26A1	20202020				
03527	26A5	20204741				
03527	26A9	494E2028				
03527	26AD	4445472F				
03527	26B1	564F4C54				
03527	26B5	29202020				
03527	26B9	204F4646				
03527	26BD	53455420				
03527	26C1	28444547				
03527	26C5	292020				
03528	26C8	04	BYTE	4		
03529						
03530	26C9	54524143	TRKMSG	ASCII	"TRACK "	
03530	26CD	4B20				
03531	26CF	04		BYTE	4	
03532	26D0	424C4F43	BLKMSG	ASCII	"BLOCK "	
03532	26D4	4B20				
03533	26D6	04		BYTE	4	
03534	26D7	434F4E56	CONMSG	ASCII	"CONVAIR 990 VER. 2.0"	
03534	26DB	41495220				
03534	26DF	39393020				
03534	26E3	5645522E				
03534	26E7	20322E30				
03535	26EB	04		BYTE	4	
03536	26EC	21212121	WNGMSG	ASCII	"!!!!TAPE WARNING!!!!"	
03536	26F0	54415045				
03536	26F4	20574152				
03536	26F8	4E494E47				
03536	26FC	21212121				
03537	2700	04		BYTE	4	
03538	2701	5245464C	RFLERR	ASCII	"REFLECTOR POSITION ERROR!!"	
03538	2705	4543544F				
03538	2709	5220504F				
03538	270D	53495449				
03538	2711	4F4E2045				
03538	2715	52524F52				
03538	2719	2121				
03539	271B	04		BYTE	4	
03540	271C	4E455720	NEWMSG	ASCII	"NEW TRACK "	
03540	2720	54524143				
03540	2724	4B20				
03541	2726	04		BYTE	4	
03542						
03543						
03544						
03545						

```

03548
03549          ; COMMAND TABLE
03550          ;
03551 2727 4C4F4144  CNDTABLE ASCII "LOAD"
03552 272B 00          BYTE 0
03553 272C 11F7        WORD LOAD
03554 272E 554E4C4F    ASCII "UNLOAD"
03554 2732 4144
03555 2734 00          BYTE 0
03556 2735 123F        WORD UNLOAD
03557 2737 53544F50    ASCII "STOP"
03558 273B 00          BYTE 0
03559 273C 1216        WORD STOP
03560 273E 464F5257    ASCII "FORWARD"
03560 2742 415244
03561 2745 00          BYTE 0
03562 2746 121A        WORD FORWD
03563 2748 46415354    ASCII "FASTFOR"
03563 274C 464F52
03564 274F 00          BYTE 0
03565 2750 121E        WORD FFORWD
03566 2752 52455645    ASCII "REVERSE"
03566 2756 525345
03567 2759 00          BYTE 0
03568 275A 1222        WORD REVERSE
03569 275C 52455749    ASCII "REWIND"
03569 2760 4E44
03570 2762 00          BYTE 0
03571 2763 1226        WORD REWIND
03572 2765 52454144    ASCII "READ"
03573 2769 00          BYTE 0
03574 276A 12D4        WORD READ
03575 276C 57524954    ASCII "WRITE"
03575 2770 45
03576 2771 00          BYTE 0
03577 2772 1292        WORD WRITE
03578 2774 54524143    ASCII "TRACK"
03578 2778 4B
03579 2779 00          BYTE 0
03580 277A 1316        WORD SEEK
03581 277C 424C4F43    ASCII "BLOCK"
03581 2780 4B
03582 2781 00          BYTE 0
03583 2782 133E        WORD FBLOCK
03584 2784 44415441    ASCII "DATA ON"
03584 2788 204F4E
03585 278B 00          BYTE 0
03586 278C 18FD        WORD START
03587 278E 44415441    ASCII "DATA OFF"
03587 2792 204F4646
03588 2796 00          BYTE 0
03589 2797 1918        WORD HALT
  
```

03590 2799 4F5554	ASCII	"OUT"
03591 279C 00	BYTE	0
03592 279D 1A25	WORD	OUTSIDE
03593 279F 484F54	ASCII	"HOT"
03594 27A2 00	BYTE	0
03595 27A3 1A6F	WORD	HOT
03596 27A5 434F4C44	ASCII	"COLD"
03597 27A9 00	BYTE	0
03598 27AA 1A5A	WORD	COLD
03599 27AC 43414C49	ASCII	"CALIBRATE"
03599 27B0 42524154		
03599 27B4 45		
03600 27B5 00	BYTE	0
03601 27B6 172A	WORD	CALIBRATE
03602 27B8 53544154	ASCII	"STATUS"
03602 27BC 5553		
03603 27BE 00	BYTE	0
03604 27BF 1D60	WORD	STATUS
03605 27C1 53455420	ASCII	"SET CAL"
03605 27C5 43414C		
03606 27C8 00	BYTE	0
03607 27C9 192B	WORD	SETCAL
03608 27CB 5052494E	ASCII	"PRINT CAL"
03608 27CF 54204341		
03608 27D3 4C		
03609 27D4 00	BYTE	0
03610 27D5 1778	WORD	PRINTCAL
03611 27D7 44495350	ASCII	"DISP HOT"
03611 27DB 20484F54		
03612 27DF 00	BYTE	0
03613 27E0 1AD3	WORD	SETHOT
03614 27E2 44495350	ASCII	"DISP COLD"
03614 27E6 20434F4C		
03614 27EA 44		
03615 27EB 00	BYTE	0
03616 27EC 1ACE	WORD	SETCOLD
03617 27EE 44495350	ASCII	"DISP REF"
03617 27F2 20524546		
03618 27F6 00	BYTE	0
03619 27F7 1AD8	WORD	SETREF
03620 27F9 44495350	ASCII	"DISP KLYS"
03620 27FD 204B4C59		
03620 2801 53		
03621 2802 00	BYTE	0
03622 2803 1ADD	WORD	SETKLYS
03623 2805 44495350	ASCII	"DISP 183"
03623 2809 20313833		
03624 280D 00	BYTE	0
03625 280E 1AE2	WORD	SET183
03626 2810 44495350	ASCII	"DISP 94"
03626 2814 203934		
03627 2817 00	BYTE	0

03628	2818	1AE7	WORD	SET94
03629	281A	41564720	ASCII	"AVG 183"
03629	281E	313833		
03630	2821	00	BYTE	0
03631	2822	1AEC	WORD	SET183A
03632	2824	41564720	ASCII	"AVG 94"
03632	2828	3934		
03633	282A	00	BYTE	0
03634	282B	1AF1	WORD	SET94A
03635	282D	5052494E	ASCII	"PRINT VOLTS"
03635	2831	5420564F		
03635	2835	4C5453		
03636	2838	00	BYTE	0
03637	2839	196A	WORD	PRINVOLT
03638	283B	54494D45	ASCII	"TIME"
03639	283F	00	BYTE	0
03640	2840	1AF6	WORD	DISTIME
03641	2842	53455420	ASCII	"SET TIME"
03641	2846	54494D45		
03642	284A	00	BYTE	0
03643	284B	1992	WORD	SETTIME
03644	284D	56494557	ASCII	"VIEW"
03645	2851	00	BYTE	0
03646	2852	1A89	WORD	VIEW
03647	2854	494E4954	ASCII	"INIT"
03648	2858	00	BYTE	0
03649	2859	1AC9	WORD	INIT
03650	285B	54415045	ASCII	"TAPE"
03651	285F	00	BYTE	0
03652	2860	1C2B	WORD	TAPE
03653	2862	5052494E	ASCII	"PRINT L"
03653	2866	54204C		
03654	2869	00	BYTE	0
03655	286A	1C4F	WORD	TEMPL
03656	286C	5052494E	ASCII	"PRINT R"
03656	2870	542052		
03657	2873	00	BYTE	0
03658	2874	1CA7	WORD	TEMPR
03659	2876	57484552	ASCII	"WHERE"
03659	287A	45		
03660	287B	00	BYTE	0
03661	287C	1CFF	WORD	WHERE
03662	287E	54455354	ASCII	"TEST1"
03662	2882	31		
03663	2883	00	BYTE	0
03664	2884	1AFB	WORD	TEST1
03665	2886	54455354	ASCII	"TEST2"
03665	288A	32		
03666	288B	00	BYTE	0
03667	288C	1B00	WORD	TEST2
03668	288E	54455354	ASCII	"TEST3"
03668	2892	33		

```

03669 2893 00      BYTE 0
03670 2894 1805    WORD TEST3
03671 2896 53455420 ASCII "SET HEX"
03672 289D 00      BYTE 0
03673 289E 1950    WORD SETHex
03674 28A0 50415443 ASCII "PATCH"
03675 28A5 00      BYTE 0
03676 28A6 23FF    WORD PATCH
03677 28A8 00      BYTE 0
03678 28A9 001E   BLOCK 30
03679
03680 ; THERMISTOR CALIBRATION CONSTANTS FOR LOAD TEMPERATURES
03681 28C7 84A0    WORD HTLDGAIN
03682 28C9 0000    WORD 0
03683 28CB 09BA    WORD HTLD0FST
03684 28CD 0000    WORD 0
03685 28CF 84A0    WORD COLDGAIn
03686 28D1 0000    WORD 0
03687 28D3 09A1    WORD COLD0FST
03688 28D5 0000    WORD 0
03689 28D7 84A0    WORD RELDGAIn
03690 28D9 0000    WORD 0
03691 28DB 09BA    WORD RELD0FST
03692 28DD 0000    WORD 0
03693 28DF 84A0    WORD KLYSGAIn
03694 28E1 0000    WORD 0
03695 28E3 09BA    WORD KLY0FST
03696 28E5 0000    WORD 0
03697 28E7 84A0    WORD SPREGAIn
03698 28E9 0000    WORD 0
03699 28EB 09BA    WORD SPREFST
03700 28ED 0000    WORD 0
03701
03702 ;
03703 28EF 0014    DISPLAY BLOCK 20
03704 2903 0014    CBUFFER BLOCK 20
03705 ;
03706 ;
03707 ;
03708 ;
03709 ;
03710 3000 0800    ORG 3000H
03711 ; DATA COLLECTION INPUT BUFFER STARTS HERE
; ORG 3000H
; PLASMA DISPLAY BUFFER
; CHARACTER INPUT BUFFER FROM CONSOLE DEVICE
; SPARE CHANNEL GAIN =-10 DEG/VOLT
; KLYSTRON OFFSET=373 DEGREES
; KYSTRON GAIN =-10 DEG/VOLT
; REF OFFSET =373 DEGREES
; REF LOAD GAIN =-10 DEG/VOLT
; OFFSET = 323 DEGREES
; COLD GAIN =-10 DEG/VOLT
; OFFSET IS 373 DEGREES
; AMP GAIN=-10 DEG/VOLT
; SPACE FOR MORE COMMANDS
;

```

Strings and Macros

COUNT -- 01E4 M

Scalars

ACIAR1.C 8408
 ACIAR2D - 8809
 FFWCODE 000A
 INI.PIR 8803
 PIA1BD - 8402
 PIA3AC - 8801
 REWCODE 000E

ACIARIC - 8408
 APUSTAT 880D
 IRIGB.IN 8802
 PIA1AC - 8401
 PIA2AD - 8404
 PIA3BC - 8803
 SSDAD -- 8805

ACIAR1D - 8409
 CRCPH -- 0080
 IRQV --- 03F7
 PIA1AD - 8400
 PIA2BC - 8407
 PIA3BD - 8802
 STOPCODE 0006

ACIAR2C - 8808
 CRCPL -- 0041
 LOADCODE 0004
 PIA1BC - 8403
 PIA2BD - 8406
 REVCODE 000C

CONVAIR Section Absolute (<3600>)

ADC0 --- 006F
 ADC5 --- 0079
 APUERMSG 2530
 AVERAGE2 18EF
 AVGPTR - 00E9
 BINVOLTS 2277
 BLKMSG 248C
 BLOCKMSG 24C6
 CAL_CNTR 00DC
 CAL3 --- 1767
 CBUFF --- 008E
 CH0TAVG 005B
 CH1TAVG 0060
 CH2TAVG 0065
 CH3TAVG 006A
 CHARINS1 1E1B
 CKFF1 -- 1272
 CLRDISP 158E
 COLD --- 1A5A
 COLDMSC1 25F0
 CRC --- 156A
 CRC2 --- 159C
 CRLFSTR 2515
 DATABUFF 3000
 DAYS_LO 0008
 DECODE11 1164
 DECODE5 11A1
 DISP2 -- 15EB
 DISPCHAR 15F1
 DISPHL - 160C
 DISPLY - 28EF
 DISPTIME 15BE
 DISPTEMP 15BE
 F_BADTIM 00A3
 F_FULBLK 00A8
 F_XMIT -- 00A7
 FDIY --- 2302

ADC1 --- 0071
 ADC6 --- 007B
 APUSTS - 0097
 AVERAGE3 18F6
 BIN1 --- 2374
 BKERMSG 2467
 BLOCK1 - 1359
 BLOCKS - 00C0
 CAL_TIME 00DD
 CALCGAIN 182C
 CBUFFER 2903
 CH0TEMP 0012
 CH1TEMP 0017
 CH2TEMP 001C
 CH3TEMP 0021
 CHARINS2 1E1E
 CKLOAD - 125F
 CLRDISP1 1585
 COLD1 -- 1A62
 COLDOFST 28D3
 CRC1 --- 1570
 CRCH --- 00B6
 CTSNTR 00C9
 DATMSG 258A
 DECBLK - 1412
 DECODE2 1168
 DELMSG - 250B
 DISP94 - 1863
 DISPCOLD 1E0E
 DISPHOT 1B1B
 DISPNEXT 15DC
 DISTIME 1AF6
 F_CALTIM 00A4
 F_GSFC - 00A8
 FADD --- 23BA
 FFORMD - 121E

ADC2 --- 0073
 ADC7 --- 007D
 AVERAGE 1888
 AVG10 -- 216E
 BIN2 --- 2385
 BLKCNT - 00CD
 BLOCK11 135E
 BTEMP -- 00BC
 CAL0 --- 173D
 CALIBRTE 172A
 CDTEMP32 0043
 CH0VAVG 004B
 CH1VAVG 004F
 CH2VAVG 0053
 CH3VAVG 0057
 CHARINS3 1E2B
 CKRDY -- 124A
 CLTCHOFF 1A39
 COLD2 -- 1A6A
 COLDTEMP 002B
 CRC2 --- 1577
 CRCL --- 00B7
 CYDEC1 - 2320
 DATAPNTR 00DE
 DECERR - 119B
 DECODE21 1178
 DIFHC -- 1874
 DISP94A 1BA2
 DISPH1 - 1614
 DISPHR - 1612
 DISPREF 1B35
 ENTRYA - 0098
 F_CMND - 00A0
 F_NUMLOC 00A5
 FAST --- 13FA
 FILBUF1 1F2B

ADC3 --- 0075
 ADC8 --- 007F
 AVERAGE0 18E1
 AVG11 -- 2178
 BINBCD - 2315
 BLKMSG - 26D0
 BLOCK2 - 1366
 BPOINT - 00B8
 CAL1 --- 174B
 CALMSG - 260B
 CH0GAIN 013B
 CH1GAIN 0143
 CH2GAIN 014B
 CH3GAIN 0153
 CHANGE - 159E
 CKEN --- 16EE
 CKRDY1 - 1256
 CLTCHON 1A42
 COLDGAIN 28CF
 CONMSG - 26D7
 CRCC --- 158A
 CRCMSG - 249A
 CYDEC2 - 2323
 DAYMSG - 2579
 DECODE - 1155
 DECODE3 1181
 DISP183 0045
 DISPADR 1842
 DISPH2 - 161A
 DISPKLYS 1B28
 DISPSPC 15EC
 ENTRYB - 0099
 F_COLLEC 00AA
 F_NUMBR 00A1
 F6LOCK - 133E
 FILLBUFF 1EFC

FLTD --- 23E2	FLTMSG -- 256C	FLTS --- 23DA	FMUL --- 23CA	FORMD --- 121A
FPMSC --- 2518	FPT1 --- 22D6	FPT2 --- 22DC	FPT3 --- 22E4	FPT32 --- 009C
FPT4 --- 22E9	FPT5 --- 22EB	FPT6 --- 22FD	FPT7 --- 2300	FPT8 --- 2314
FPTBCD - 22BC	FRAMTYPE 0003	FSADCMD 2428	FSUB --- 23C2	FTYPE --- 171A
GAINMSG 24D6	GETDATA 2035	GETDATA1 2046	GETONE - 1F48	GETSOME 2028
GETSOME1 202A	GNDMSG - 2637	GJFOR - 140E	GOFORWD 1402	GSFCOK - 1A02
GSFCOK1 1A17	GSFCTO - 00CF	HALT --- 1918	HEXPR - 00C7	HOT --- 1A6F
HOT1 --- 1A7E	HOT2 --- 1A84	HOTMSG - 2567	HOTMSG1 25E6	HOURS --- 0009
HTC032 - 0047	HTLDGAIN 28C7	HTLDOFST 28C8	HTLTEMP 0026	HTTEMP32 003F
IN2BYTE2 11F3	IN2BYTE3 11F4	IN2BYTES 11DB	INBUFF - 110D	INBUFF1 112E
INBUFF2 113E	INBUFF3 1148	INBUFF4 114F	INBUFF5 1152	INBUFF6 1154
INBYTE - 11A5	INBYTE1 11A8	INBYTE2 11C3	INBYTE3 11C4	INCBLK - 14DA
INCRMTX 224B	INIT --- 1AC9	INIT1 --- 1000	INIT11 - 1008	INIT2 --- 105E
INIT3 --- 1073	INIT31 - 1087	INIT4 --- 1098	INIT5 --- 10B8	INIT6 --- 10C2
INIT7 --- 10CC	INITMS - 1C08	INITMSG 243C	INTREG - 009A	IRIG.8AD 1EDF
IRIC.UPD 1EC6	IRIGB.1 1E8D	IRIGB.2 1E98	IRIGB.3 1E9D	IRIGB.4 1EA1
IRIGB.5 1EA9	IRIGBIT 20A4	IRIGBIT1 20AA	IRIGBIT2 20AD	IRIGBIT3 20BA
IRIGBIT4 20BD	IRIGBITS 20CA	IRIGSET 2061	IRIGBYT1 2092	IRIGBYT2 2095
IRIGBYTE 209D	IRIGDAYH 000D	IRIGDAYL 000E	IRIGFLT 000C	IRIGHOUR 000F
IRICHUNG 20CF	IRIGMIN 0010	IRIGSEC 0011	IRQ.ISR 20D4	IRQ.ISR0 20E1
IRQ.ISR1 20E6	IRQ.ISR2 20EE	IRQT1 --- 00D0	IRQT2 --- 00D2	K10K --- 241A
KLYDFST 28E3	KLYSGAIN 28DF	KLYSMSG 25FB	KLYSTEMP 0035	LASTCHAR 00E5
LFEED --- 1A1F	LINKMSG 2595	LOAD --- 11F7	LOAD1 --- 120A	LOAD2 --- 1215
LOADTEMP 221A	MAIN1 --- 168B	MAIN2 --- 1698	MAINLOOP 1683	MESSNR - 242C
MINUTES 000A	MSCNTR - 00D9	MSDLY --- 1666	MSDLY1 - 1668	MSG183 - 263E
MSG188 - 2649	MSG193 - 2654	MSG94 --- 2660	NEWCHAR 00E1	NEWMSG - 271C
NEXSTATE 00C1	NEXTCH - 1633	NEXTCHAR 00E3	NEXTDISP 00C3	NMI.DAT1 1FC6
NMI.DAT2 2002	NMI.DATA 1FBE	NMI.EX0 1E8C	NMI.EX1 1E55	NMI.EX2 1EDE
NMI.EX3 1EE3	NMI.EX4 2019	NMI.F0 --- 00D4	NMI.F1 - 0005	NMI.IRIG 1E81
NMI.ISR 1E77	NMI.RTC 1EE4	NMI.TMP1 00E0	NOCAL --- 16DF	NOCHANGE 15AA
NOCMD - 16B4	NUMBER 16AF	NOTCOLD 1A9F	NOTEM --- 170D	NOTFULL 16D5
NOTHEX - 11D9	NOTHOT - 1AAB	NOTORN - 1C04	NUMERR - 247D	OFFMSG - 2687
OFSTMSG 24E8	ONMSG --- 2684	OUT10SPC 1D84	OUT1HEX 1DCB	OUTHEX 1DC9
OUT2SPC 1DBC	OUT6SPC 1DB8	OUTCH --- 1DED	OUTGS1 - 1E43	OUTGS2 - 1E59
OUTGS3 - 1E72	OUTGS4 - 1E75	OUTGSFC 1E42	OUTHEX - 1DD4	OUTHEXL 1DD8
OUTHEXR 1DE1	OUTPOS - 1D4B	OUTQUES 19E5	OUTSIDE 1A25	OUTSPACE 1DDC
OUTSPC - 1DC0	PRINT32 1813	PACK --- 234A	PATCH --- 23FF	POFF --- 23F8
POSOK --- 1A2E	PRTOFF - 1DAD	PRINTCAL 1778	PRINTV1 1970	PRINVOLT 196A
PRT1 --- 1DB0	PULSE --- 1A4B	PUSH --- 2393	PUSH2 --- 2398	PULL --- 23A7
PULSE --- 1A48	PUTHEX1 165C	RADAVG0 21DD	RADAVG1 21EC	PUTDATA 201A
PUTHEX - 1644	RADMSG - 253F	RADMSG1 255E	RADMSG2 261C	RADAVG2 21FB
RADAVG3 220A	RADTEMP 21A9	RDYTE - 1560	RDYMSG - 2451	RADMSG3 266C
RADTEMP 21A9	READ1 --- 12E4	READ2 - 12F1	READ3 --- 1303	READ --- 12D4
READ5 --- 1315	RECEIVER 110D	REFMSG - 25D6	RELDGAIN 28D7	READ4 --- 1310
RELDTEMP 0030	RESET --- 2163	RESTART 1108	REVERSE 1222	RELDQFST 28D8
RFLERR - 2701	RTC.MIN 1F59	RTC.CNTR 00D7	RTC.DAYL 1FAB	RELDQFST 28D8
RTC.MIN 1F59	RTC.SEC1 1EF8	RTC.MIN1 1F67	RTC.MINS 1F7B	RTC.HOUR 1F9A
RTC.SEC1 1EF8	SAVEB --- 0088	SAVEX - 008D	SAVEX1 - 008F	RTC.SEC 1F3B
SAVEB --- 0088	SAVEX4 - 0095	SECDLY - 166F	SEEK --- 1316	SAVER --- 0087
SAVEX4 - 0095	SEEK11 - 132E	SET94 - 1AF1	SET183 - 1AE2	SAVEX3 - 0093
SET94 --- 1AE7	SET94A - 1AF1	SET94B - 1B08	SET183A 1AEC	SEEK1 --- 1329
				SETCAL 193B

Tektronix M6800 ASM V3.1 Symbol Table

Page 84

SETCAL11 1940	SETCAL2 1948	SETCAL3 194F	SETCOLD 18CE	SETHEX -- 1950
SETHEX1 1962	SETHOT - 1AD3	SETKLYS 1ADD	SETREF - 1AD8	SETT1 -- 19A5
SETT2 -- 19AC	SETT22 - 19BE	SETT3 -- 19C5	SETT33 - 19D7	SETT4 -- 19E4
SETTIME 1992	SKIPI1 -- 1385	SKIPIB - 139D	SKIPF -- 13A0	SKIPF1 - 13B9
SKIPC -- 13BE	SKIPC1 - 13C9	SKIPNEG 1378	SKIPPOS 1381	SKIPS -- 13CE
SKIPS1 - 13E5	SKIPSI1 13DA	SKIPSE - 13EB	SKIPS3 - 13F9	SKIPSGN 00CC
SKIPSPL 13D7	SKYMSG - 2633	SLOW --- 1406	SPREGAIN 23E7	SPROFST 28EB
SPRETEMP 003A	START -- 18FD	STARTUP 2158	STATCNR 00DA	STATIME 00DB
STATUS - 1D60	STATUS1 1D83	STATUS2 1D85	STATUS3 1D96	STATUS4 1D98
STOP --- 1216	STRNGNOC 1DFF	STRNGOUT 1DF4	STRMSG 2482	SYNMSG - 2457
TABPNT - 00BA	TAPE --- 1C2B	TAPE1 -- 1C31	TAPEDONE 170E	TAPMSG 25A3
TAPEWARN 1C12	TCMND -- 1230	TCNT --- 00CA	TEMP32 - 0083	TEMPA -- 0089
TEMPB -- 008A	TEMPBCD 2250	TEML -- 1C4F	TEMPMSG 25BF	TEMPR -- 1CA7
TEMPX -- 008B	TEST1 -- 1AFB	TEST2 -- 1B00	TEST3 -- 1B05	TESTAD - 162A
TESTADL 1625	TESTADR 161E	TESTSFC 19EA	TESTHEX 11C5	TESTIME 1BC0
THB --- 1DD1	THB1 --- 1DE3	THB2 --- 1DE9	TIME --- 1D1F	TIMMSG 257E
TOSBCD - 2298	TRACK -- 1273	TRACK2 - 128A	TRACK3 - 1291	TRACKMSG 24FB
TRACKN - 0000	TRANSMIT 20EF	TREAD -- 14E4	TREAD1 - 150C	TREAD11 14E6
TREAD12 1502	TREAD2 - 151B	TREAD3 - 152D	TREAD4 - 154A	TREAD45 1553
TREAD5 - 155F	TRKMSG - 26C9	TSTEND - 23B1	TWRITE - 141C	TWRITE1 1453
TWRITES 1478	TWRITES3 148A	TWRITE4 1499	TWRITES 14B4	TWRITE6 14C9
TWRITES 1424	UNLOAD - 123F	VIEW --- 1A89	VIEW1 -- 1AB3	VIEW2 -- 1AC2
VIEW3 -- 1AC8	VOLTS10 2424	VOLTSBCD 22AB	VOLTEMP 2266	WHERE -- 1CFF
WNGMSG - 26EC	WRITE -- 1292	WRITE1 - 12A2	WRITE2 - 12AF	WRITE22 12B1
WRITE3 - 12C1	WRITE4 - 12CE	WRITE5 - 12D3	WRBYT - 14CF	XCHF --- 23E9
XMIT1 -- 20F9	XMIT2 -- 2108	XMIT3 -- 2118	XMIT4 -- 213C	XMITBUF 015B
XTEMP1 - 00AE	XTEMP2 - 00B0	XTEMP3 - 00B2	XTEMP4 - 00B4	YESHEX - 11D7

3711 Source Lines 3743 Assembled Lines 5782 Bytes available

>>> No assembly errors detected <<<

APPENDIX B
ELECTRONIC SCHEMATICS

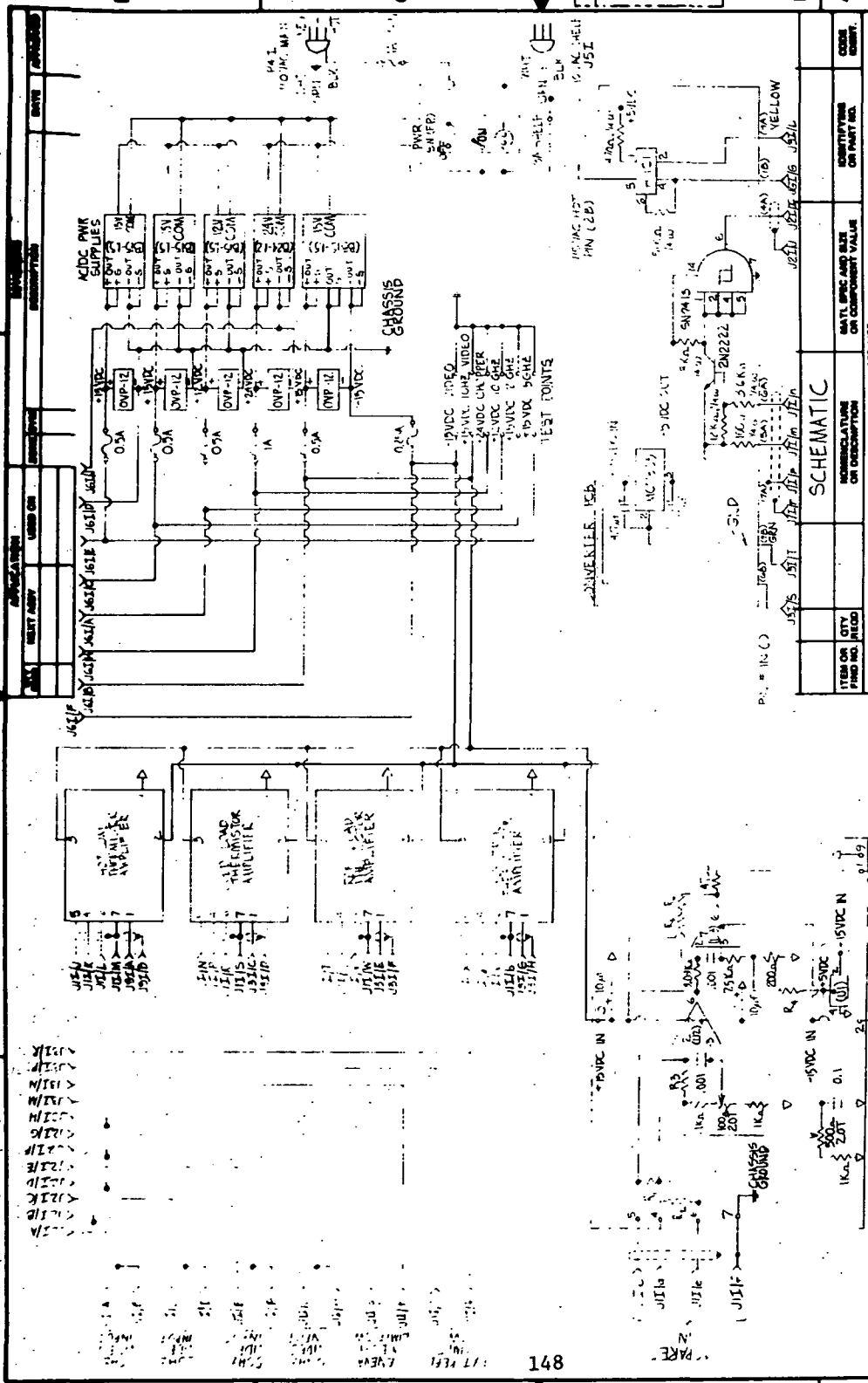

ITEM OR QTY		PHD NO.	FIELD	DESCRIPTION	MATL. SPEC AND QTY	COMPT. VALUE	IDENTIFYING OR PART NO.	CODE	QTY.								
SCHEMATIC																	
PART LIST																	
CONTINUED NO.		<table border="1" style="width: 100%;"> <tr> <td>DATE</td> <td>REV.</td> <td>BY</td> <td>DESCRIPTION</td> </tr> <tr> <td>5/12/78</td> <td></td> <td></td> <td></td> </tr> </table>								DATE	REV.	BY	DESCRIPTION	5/12/78			
DATE	REV.	BY	DESCRIPTION														
5/12/78																	
ALL DIMENSIONS ARE IN INCHES UNLESS OTHERWISE SPECIFIED TOLERANCES: 3 PLACE DECIMALS 2 PLACE DECIMALS 1 PLACE DECIMAL		GEORGIA TECH 941183 GHz RADIOMETER INTERCONNECT BOX															
DIMENSIONS IN INCHES UNLESS OTHERWISE SPECIFIED TOLERANCES: 3 PLACE DECIMALS 2 PLACE DECIMALS 1 PLACE DECIMAL UNLESS OTHERWISE SPECIFIED		GEORGIA INSTITUTE OF TECHNOLOGY SCHOOL OF ELECTRICAL ENGINEERING 705 LEE STREET ATLANTA, GEORGIA 30332															
DIMENSIONS IN MILLIMETERS UNLESS OTHERWISE SPECIFIED TOLERANCES: 0.25 MILLIMETERS 0.10 MILLIMETERS 0.05 MILLIMETERS UNLESS OTHERWISE SPECIFIED		PART NO. A2132-010															
DIMENSIONS IN MILLIMETERS UNLESS OTHERWISE SPECIFIED TOLERANCES: 0.25 MILLIMETERS 0.10 MILLIMETERS 0.05 MILLIMETERS UNLESS OTHERWISE SPECIFIED		PROJECT NO.															

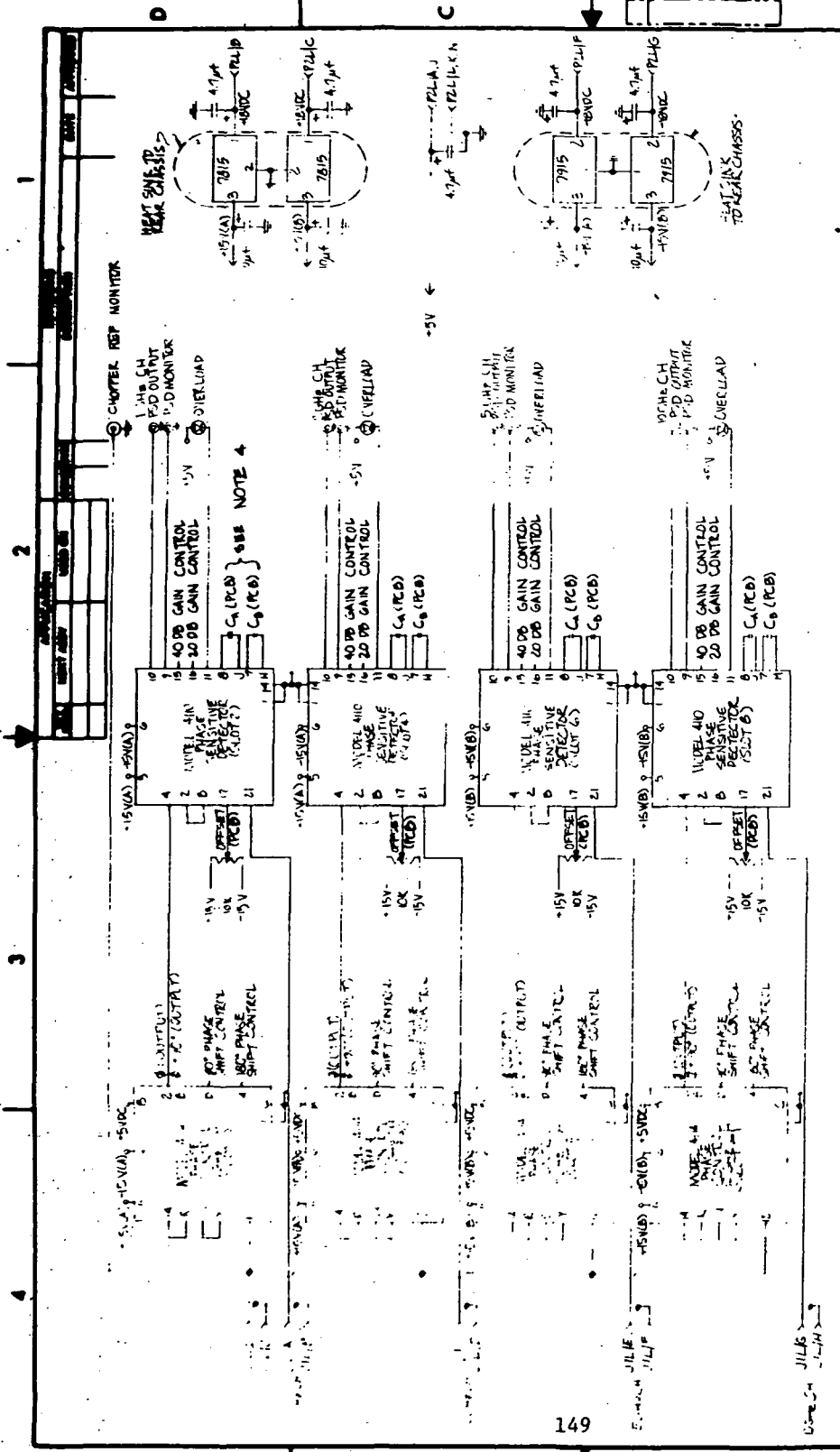

ITEM OR QTY	DESCRIPTION	DATE SPEC AND REV	MANUFACTURER OR PART NO.	OTHER
1	MODEL 410 PHASE SENSITIVE DETECTOR			
2	40 DB GAIN CONTROL			
3	20 DB GAIN CONTROL			
4	PHASE SHIFT CONTROL			
5	CHANNEL REPETITION MONITOR			
6	CAPACITORS			

PARTS LIST		CONTRACT NO.
DATE	5/10/78	
BY	RLR	
CHKD		
PRCD		
APPR		
DATE		

SCHEMATIC		CONTRACT NO.
DATE	5/10/78	
BY	RLR	
CHKD		
PRCD		
APPR		
DATE		

GEORGIA TECH 94/183 GHZ RADIOMETER MULTICHANNEL PHASE SENSITIVE DETECTOR	
DATE	5/10/78
BY	RLR
CHKD	
PRCD	
APPR	
DATE	

ALL DIMENSIONS ARE IN INCHES UNLESS OTHERWISE SPECIFIED
 TOLERANCES
 1 PLACE DECIMALS
 2 PLACE DECIMALS
 3 PLACE DECIMALS
 FRACTIONS 1/8 INCHES & UP
 1/16 INCHES & UP
 ALL DIMENSIONS UNLESS OTHERWISE SPECIFIED
 SHALL BE TO UNLESS OTHERWISE SPECIFIED
 DIMENSIONS SHALL BE TO UNLESS OTHERWISE SPECIFIED

1) MODEL 410 CAPACITORS C₁ ARE DETERMINED BY: C₁(µF) = f_c
 2) PSD MODEL 410 (REVISION 52) CAPACITORS C₅ AND C₆ ARE DETERMINED BY: C₅(µF) = f_c
 3) PSD MODEL 410 (REVISION 56) CAPACITORS C₅ AND C₆ ARE DETERMINED BY: C₅(µF) = f_c
 4) PSD MODEL 410 (REVISION 52 AND 56) CAPACITORS C₅ AND C₆ ARE DETERMINED BY: C₅(µF) = f_c - TIME CONSTANT (500) - (0.01 500)

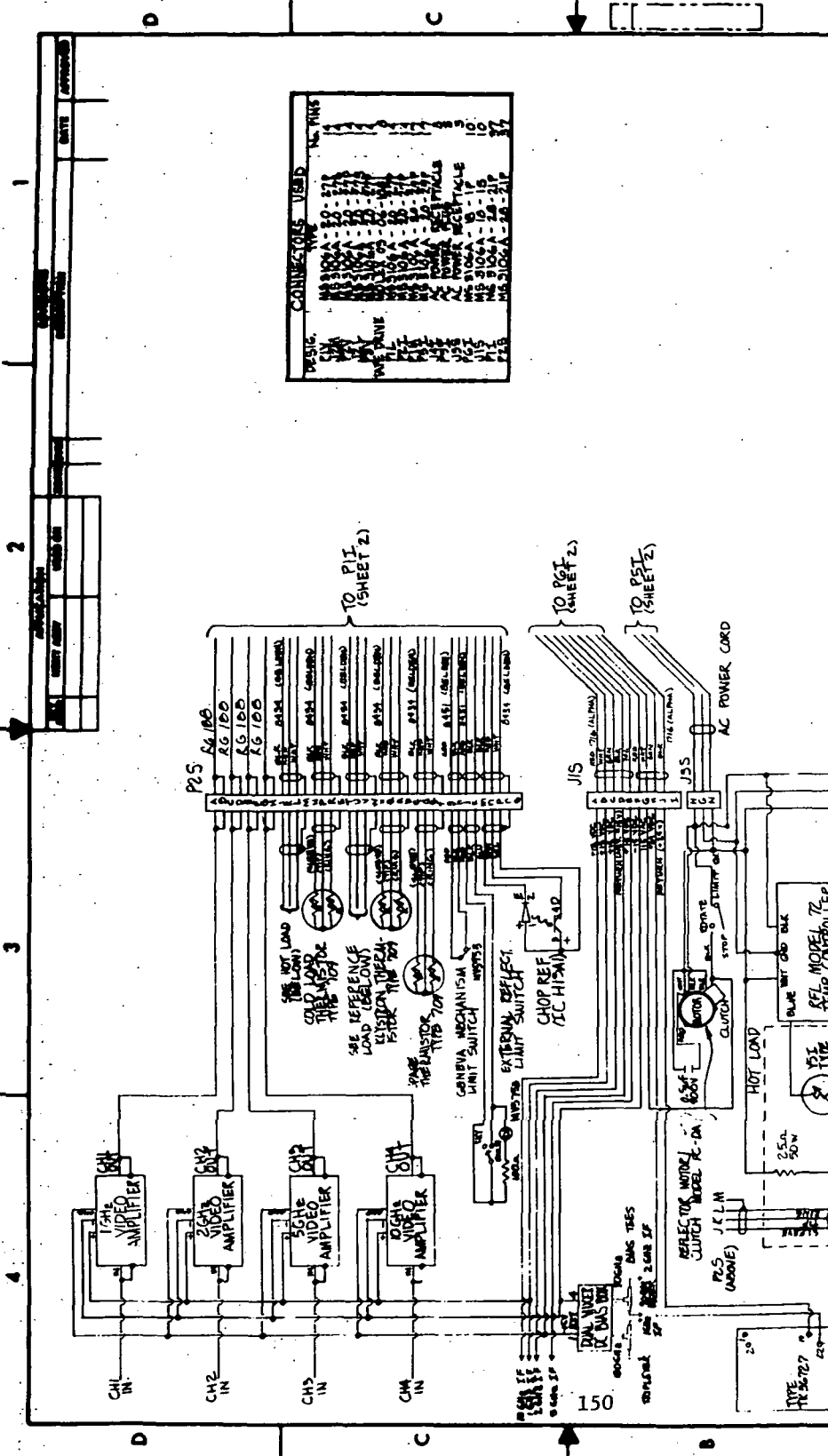

ITEM OR QTY. PART NO. (REQD.)		CONTRACT NO.	
DATE	21.4	DATE	9/7/76
TIME	ZLC	TIME	
CHK		CHK	
PRD		PRD	
APP		APP	
TIME		TIME	

ALL DIMENSIONS ARE IN INCHES UNLESS OTHERWISE SPECIFIED

3 PLACE DECIMALS
2 PLACE DECIMALS
1 PLACE DECIMAL

FRANCHISE 2

MAX SURFACE PLACEMENT 100
ALL SURFACE PLACEMENTS
SMALL SURFACE PLACEMENT
AND SURFACE PLACEMENT

ITEM OR QTY. PART NO. (REQD.)

DATE

TIME

CHK

PRD

APP

TIME

WIRING DIAGRAM SHELF TO RACKMOUNT ELECTRONICS (LEFT)

REV. 1001

REV. 1002

REV. 1003

REV. 1004

REV. 1005

REV. 1006

REV. 1007

REV. 1008

REV. 1009

REV. 1010

REV. 1011

REV. 1012

REV. 1013

REV. 1014

REV. 1015

REV. 1016

REV. 1017

REV. 1018

REV. 1019

REV. 1020

REV. 1021

REV. 1022

REV. 1023

REV. 1024

REV. 1025

REV. 1026

REV. 1027

REV. 1028

REV. 1029

REV. 1030

REV. 1031

REV. 1032

REV. 1033

REV. 1034

REV. 1035

REV. 1036

REV. 1037

REV. 1038

REV. 1039

REV. 1040

REV. 1041

REV. 1042

REV. 1043

REV. 1044

REV. 1045

REV. 1046

REV. 1047

REV. 1048

REV. 1049

REV. 1050

REV. 1051

REV. 1052

REV. 1053

REV. 1054

REV. 1055

REV. 1056

REV. 1057

REV. 1058

REV. 1059

REV. 1060

REV. 1061

REV. 1062

REV. 1063

REV. 1064

REV. 1065

REV. 1066

REV. 1067

REV. 1068

REV. 1069

REV. 1070

REV. 1071

REV. 1072

REV. 1073

REV. 1074

REV. 1075

REV. 1076

REV. 1077

REV. 1078

REV. 1079

REV. 1080

REV. 1081

REV. 1082

REV. 1083

REV. 1084

REV. 1085

REV. 1086

REV. 1087

REV. 1088

REV. 1089

REV. 1090

REV. 1091

REV. 1092

REV. 1093

REV. 1094

REV. 1095

REV. 1096

REV. 1097

REV. 1098

REV. 1099

REV. 1100

4 3 2 1

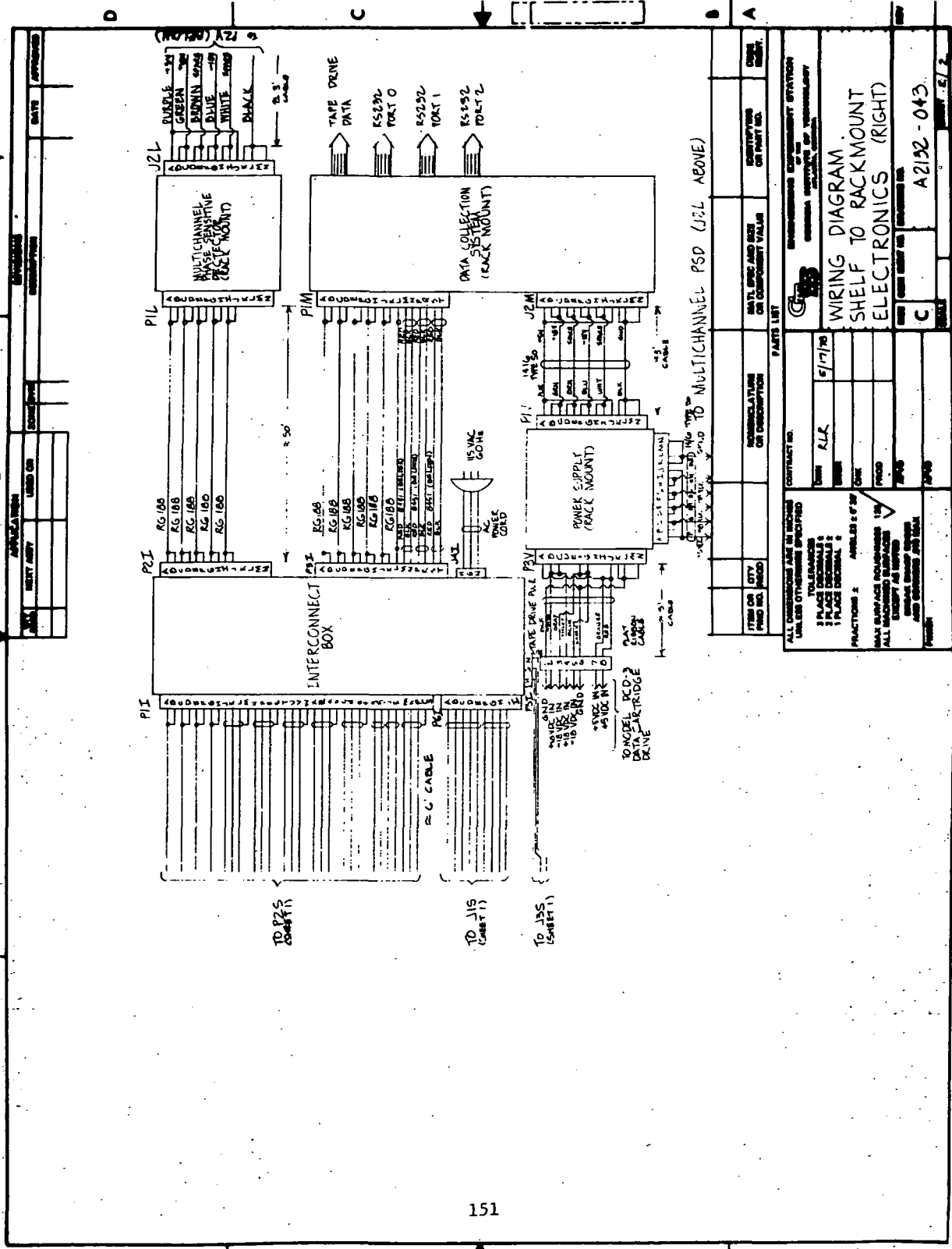

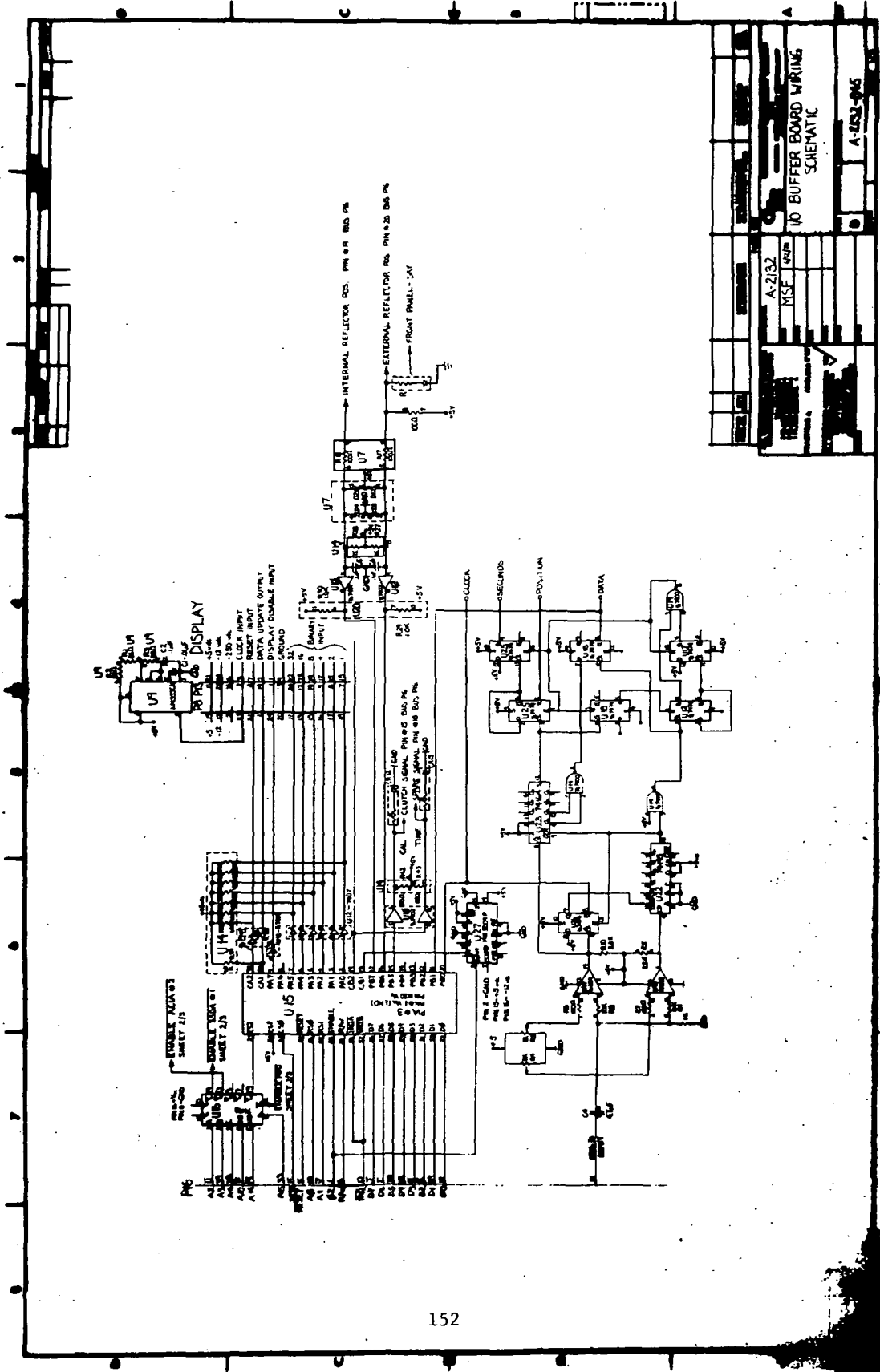

A-2132
MSE 1000
IO BUFFER BOARD WIRING
SCHEMATIC
A-2132-005

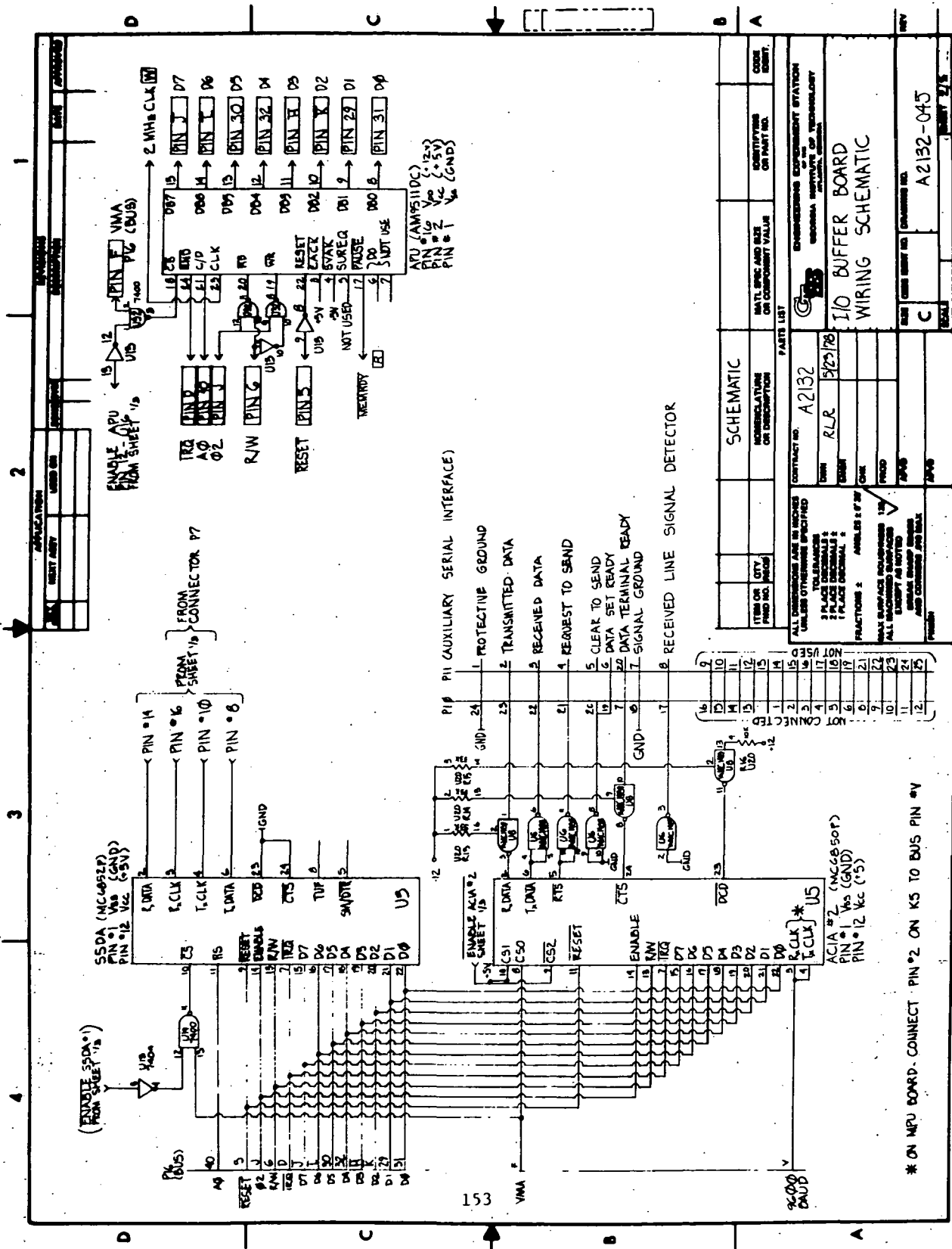

SCHEDULING		SCHEDULING	
REST AREA	USED ON	REST AREA	USED ON
SCHEDULE		SCHEDULE	

ITEM OR QTY. REQ'D	DESCRIPTION	MATERIAL AND QTY. OR COMPONENT VALUE	IDENTIFYING OR PART NO.	CODE
PARTS LIST				
	A2132			
1	RLR	9/29/78		
<small>ALL DIMENSIONS ARE IN INCHES UNLESS OTHERWISE SPECIFIED</small> <small>TOLERANCES:</small> 3 PLACE DECIMALS : ±0.001 2 PLACE DECIMALS : ±0.005 1 PLACE DECIMALS : ±0.050				
<small>FUNCTIONS:</small> 1. ANNOTATED PARTS 2. MAXIMUM SURFACE MOUNTING 3. ALL SURFACE MOUNTING 4. ALL SURFACE MOUNTING 5. ALL SURFACE MOUNTING				
<small>PREPARED BY:</small> DATE: 9/29/78 DRAWING NO.: A2132-045				

* ON MPU BOARD. CONNECT PIN #2 ON K5 TO BUS PIN #V

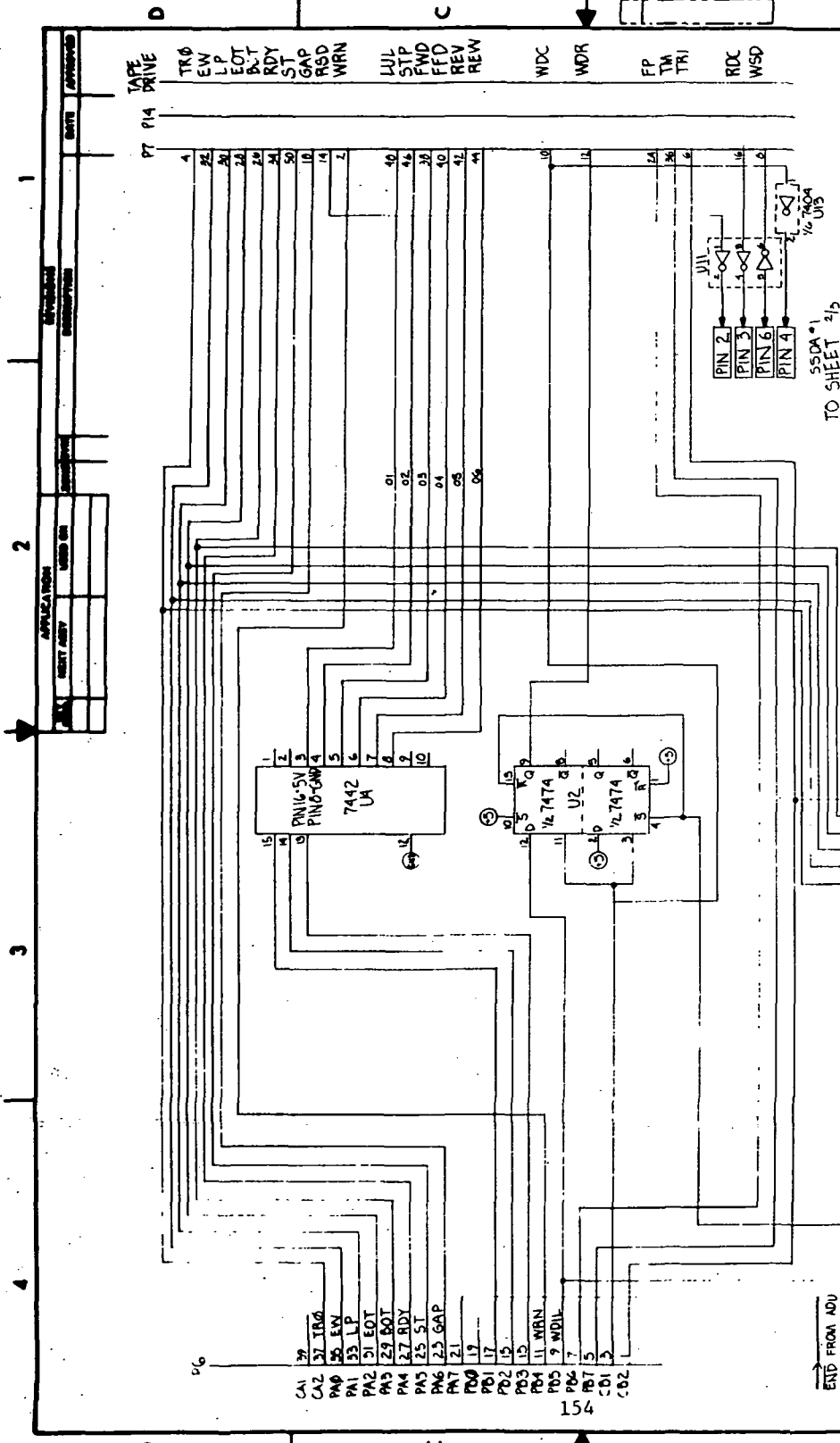

APPLICATIONS		REVISIONS	
DATE	DESCRIPTION	DATE	DESCRIPTION

ITEM OR CITY	QTY	UNIT	DESCRIPTION

CONTRACT NO.	DATE	TIME	BY	CHKD	APP'D
A2132	4/27/78				

SCHEMATIC		PARTS LIST	
ITEM OR CITY	QTY	MAT'L SPEC AND SIZE OR COMPONENT VALUE	IDENTIFYING OR PART NO.

ENGINEERING EXPERIMENT STATION			
GEORGIA INSTITUTE OF TECHNOLOGY			
I/O BUFFER BOARD			
WIRING SCHEMATICS			
SCALE	C	WORK SHEET NO.	A2132-045
DATE		DESIGNED BY	
		CHECKED BY	
		APPROVED BY	

TO SHEET 2/5

END FROM ADU

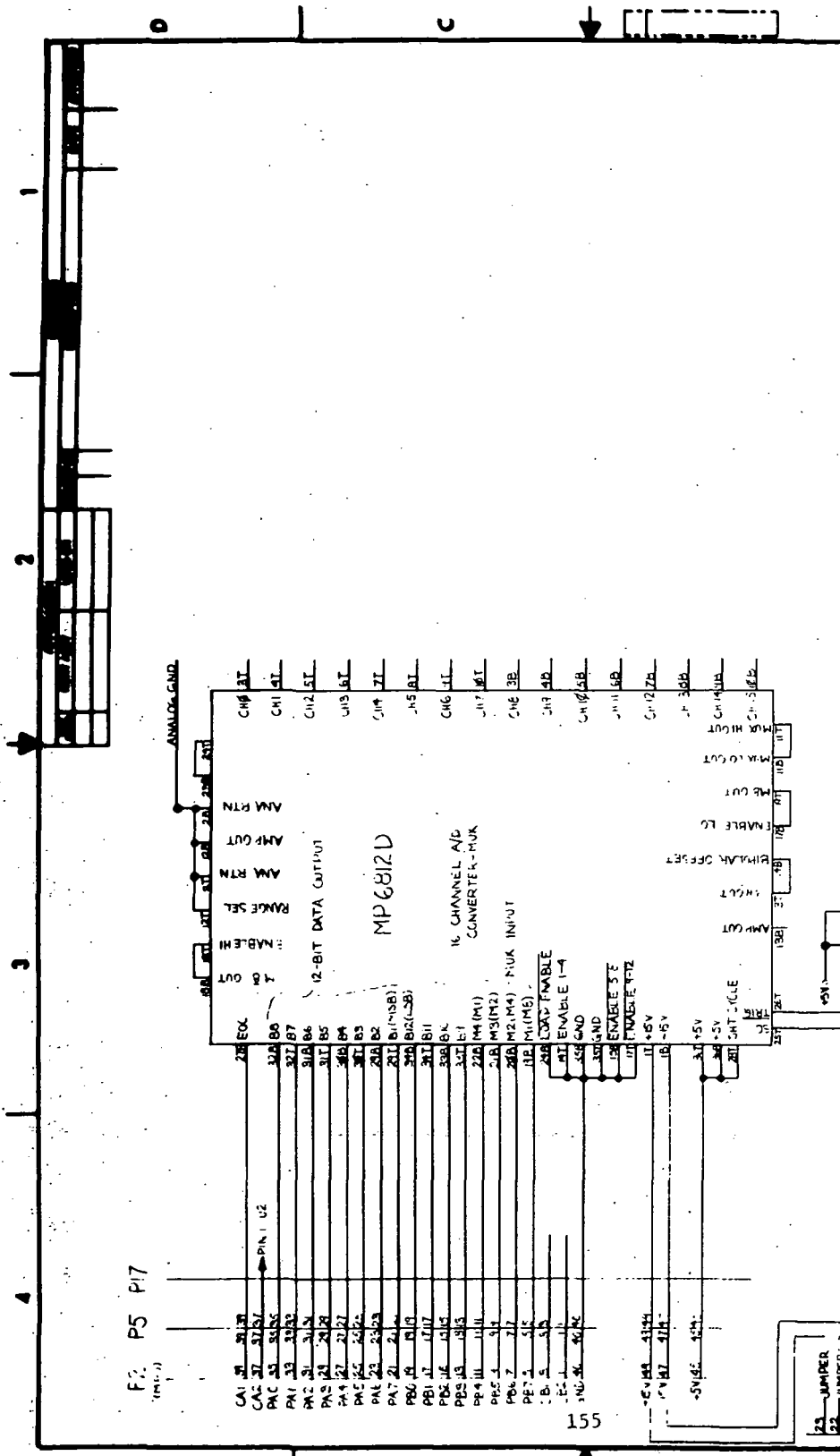

PARTS LIST		CONTINUED ON REVERSE	
ITEM OR QTY (PART NO. FIRST)	DESCRIPTION	MATERIAL AND SIZE OR COMPONENT VALUE	IDENTIFYING OR PART NO.
PARTS LIST			
	CONTINUED NO. A-2132		
	MSF	6/2176	
	MSF		
	MSF		
	MSF		
	MSF		
	MSF		
	MSF		
	MSF		

**DATA ACQUISITION BOARD
WIRING SCHEMATIC**

ALL DIMENSIONS ARE IN INCHES
UNLESS OTHERWISE SPECIFIED

VOLUNTARILY
I PLACE DIMENSIONS
I PLACE DIMENSIONS
I PLACE DIMENSIONS

FUNCTIONS:
1. ANALOG INPUT
2. ANALOG OUTPUT
3. ANALOG OUTPUT
4. ANALOG OUTPUT
5. ANALOG OUTPUT
6. ANALOG OUTPUT
7. ANALOG OUTPUT
8. ANALOG OUTPUT
9. ANALOG OUTPUT
10. ANALOG OUTPUT
11. ANALOG OUTPUT
12. ANALOG OUTPUT
13. ANALOG OUTPUT
14. ANALOG OUTPUT
15. ANALOG OUTPUT
16. ANALOG OUTPUT
17. ANALOG OUTPUT
18. ANALOG OUTPUT
19. ANALOG OUTPUT
20. ANALOG OUTPUT
21. ANALOG OUTPUT
22. ANALOG OUTPUT
23. ANALOG OUTPUT
24. ANALOG OUTPUT
25. ANALOG OUTPUT
26. ANALOG OUTPUT
27. ANALOG OUTPUT
28. ANALOG OUTPUT
29. ANALOG OUTPUT
30. ANALOG OUTPUT
31. ANALOG OUTPUT
32. ANALOG OUTPUT
33. ANALOG OUTPUT
34. ANALOG OUTPUT
35. ANALOG OUTPUT
36. ANALOG OUTPUT
37. ANALOG OUTPUT
38. ANALOG OUTPUT
39. ANALOG OUTPUT
40. ANALOG OUTPUT
41. ANALOG OUTPUT
42. ANALOG OUTPUT
43. ANALOG OUTPUT
44. ANALOG OUTPUT
45. ANALOG OUTPUT
46. ANALOG OUTPUT
47. ANALOG OUTPUT
48. ANALOG OUTPUT
49. ANALOG OUTPUT
50. ANALOG OUTPUT
51. ANALOG OUTPUT
52. ANALOG OUTPUT
53. ANALOG OUTPUT
54. ANALOG OUTPUT
55. ANALOG OUTPUT
56. ANALOG OUTPUT
57. ANALOG OUTPUT
58. ANALOG OUTPUT
59. ANALOG OUTPUT
60. ANALOG OUTPUT
61. ANALOG OUTPUT
62. ANALOG OUTPUT
63. ANALOG OUTPUT
64. ANALOG OUTPUT
65. ANALOG OUTPUT
66. ANALOG OUTPUT
67. ANALOG OUTPUT
68. ANALOG OUTPUT
69. ANALOG OUTPUT
70. ANALOG OUTPUT
71. ANALOG OUTPUT
72. ANALOG OUTPUT
73. ANALOG OUTPUT
74. ANALOG OUTPUT
75. ANALOG OUTPUT
76. ANALOG OUTPUT
77. ANALOG OUTPUT
78. ANALOG OUTPUT
79. ANALOG OUTPUT
80. ANALOG OUTPUT
81. ANALOG OUTPUT
82. ANALOG OUTPUT
83. ANALOG OUTPUT
84. ANALOG OUTPUT
85. ANALOG OUTPUT
86. ANALOG OUTPUT
87. ANALOG OUTPUT
88. ANALOG OUTPUT
89. ANALOG OUTPUT
90. ANALOG OUTPUT
91. ANALOG OUTPUT
92. ANALOG OUTPUT
93. ANALOG OUTPUT
94. ANALOG OUTPUT
95. ANALOG OUTPUT
96. ANALOG OUTPUT
97. ANALOG OUTPUT
98. ANALOG OUTPUT
99. ANALOG OUTPUT
100. ANALOG OUTPUT

DATE: **A-2132-017**

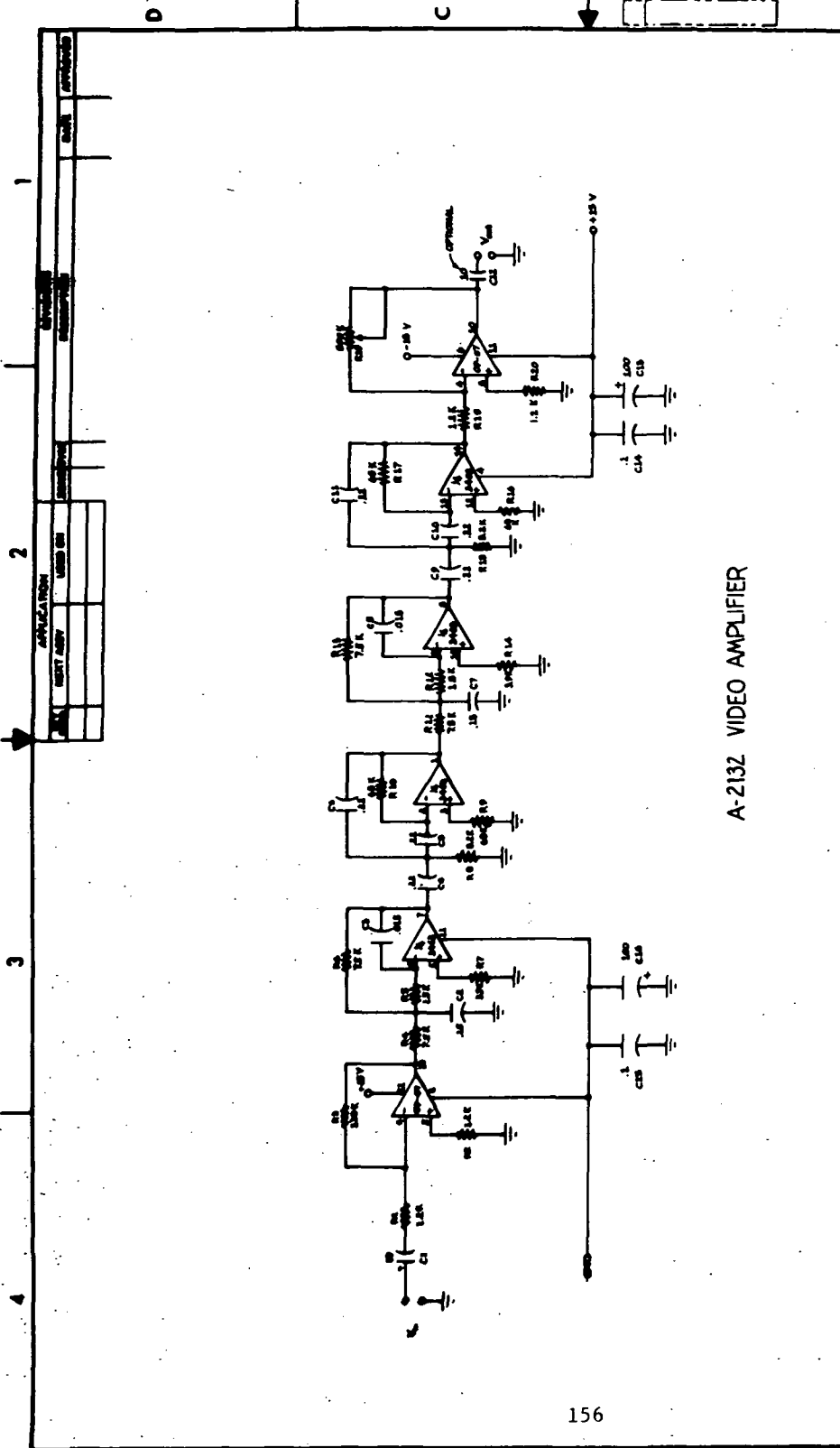

A-2132 VIDEO AMPLIFIER

APPLICATOR		REVISION		DATE APPROVED	
ITEM OR QTY (NEED)	DESCRIPTION	MATERIAL SPEC AND SIZE OR COMPONENT VALUE	IDENTIFICATION OR PART NO.	QTY	REMARKS
PARTS LIST					
CONTRACT NO.					
NOMENCLATURE OR DESCRIPTION					
MATERIAL SPEC AND SIZE OR COMPONENT VALUE					
IDENTIFICATION OR PART NO.					
QTY					
REMARKS					
A-2132-016					

APPENDIX C
MECHANICAL DRAWINGS

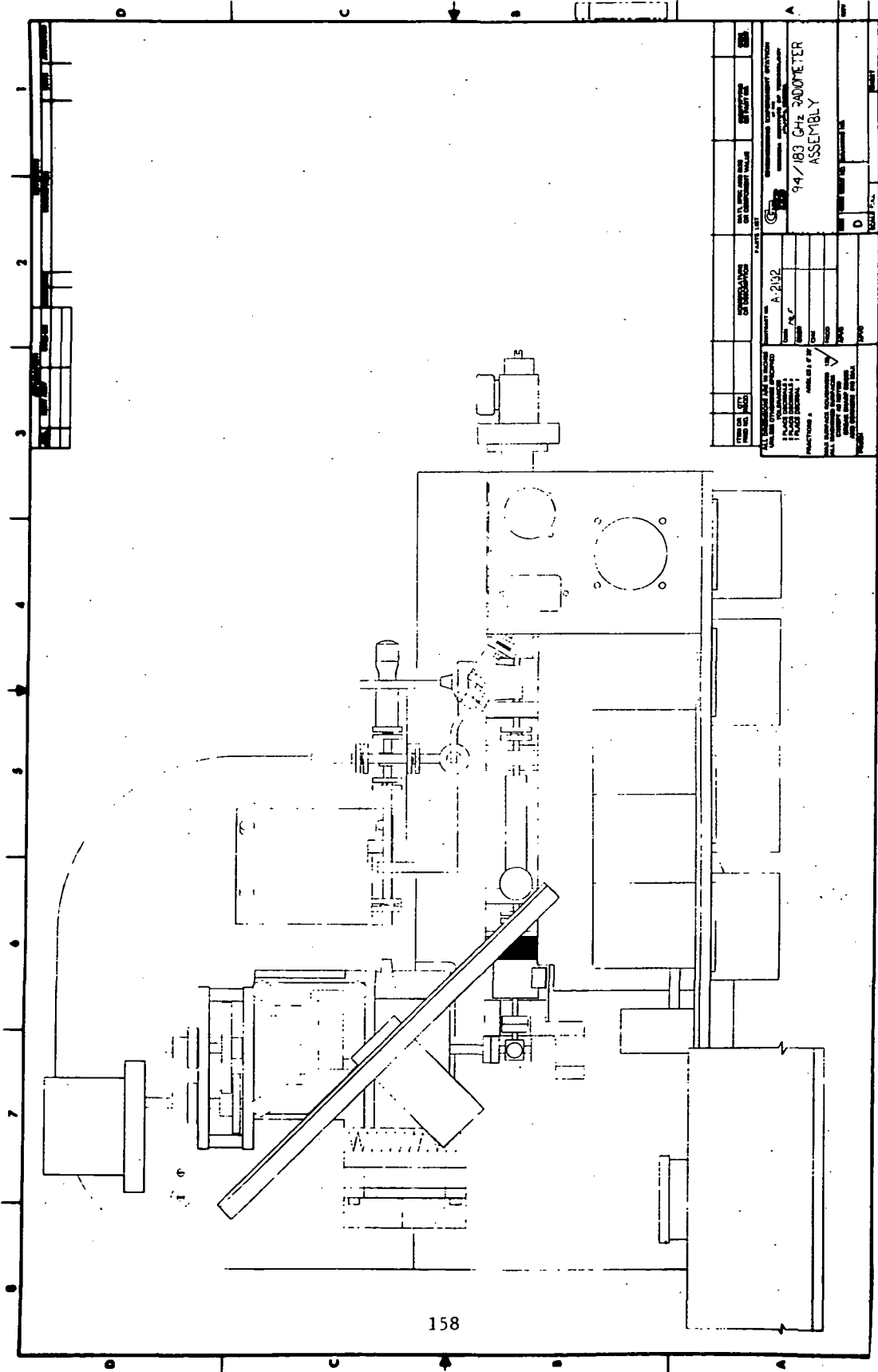

PROJECT TITLE 94/83 CHR. RADOMETER ASSEMBLY	
DRAWING NO. A-2192	
DATE	SCALE
DESIGNED BY	CHECKED BY
DRAWN BY	APPROVED BY
PROJECT NO.	
SHEET NO.	
TOTAL SHEETS	
DATE	
DRAWN BY	
DATE	
CHECKED BY	
DATE	
APPROVED BY	
DATE	

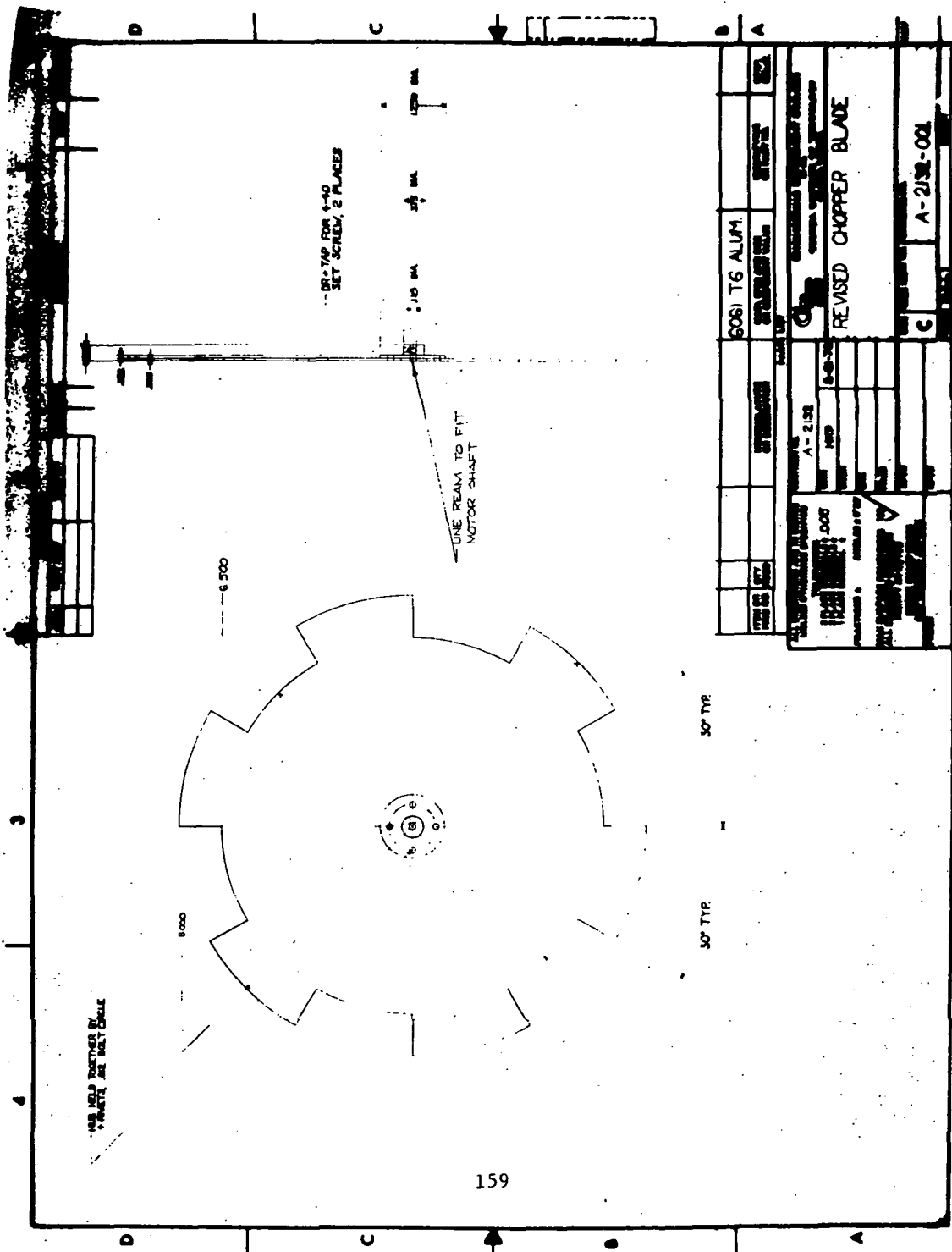

DESIGN NO.	REVISED CHOPPER BLADE
DATE	1958
BY	A-2132-001
CHECKED	
APPROVED	
MATERIAL	6061 T6 ALUM.
FINISH	STANDARD
QUANTITY	1000
SCALE	AS SHOWN
PROJECT	
WORK CENTER	
OPERATOR	
INSPECTOR	
DATE	
TIME	
REVISIONS	
NO.	DESCRIPTION
1	REVISED CHOPPER BLADE

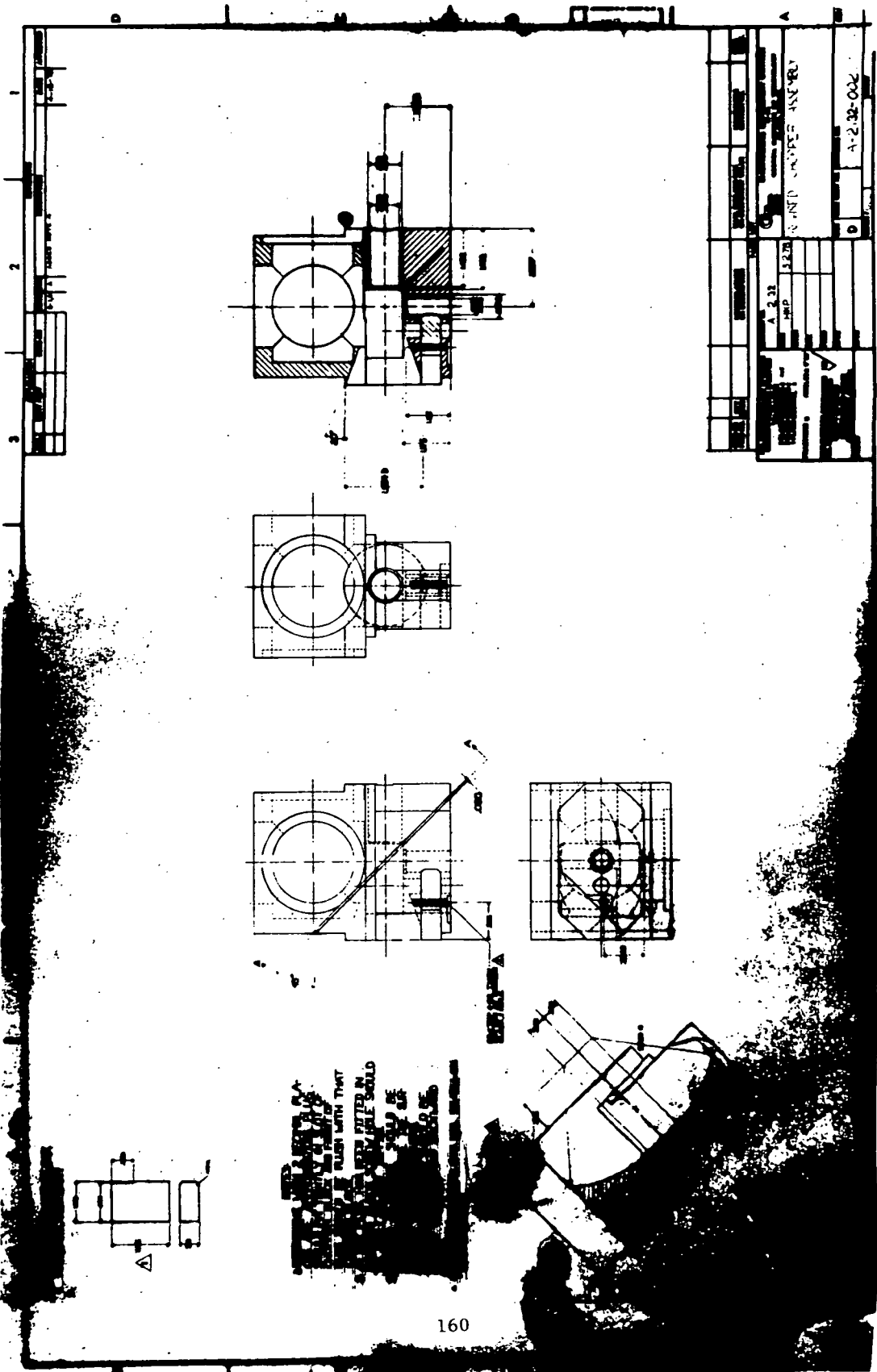

THIS DRAWING IS THE PROPERTY OF
 THE UNITED STATES GOVERNMENT
 AND IS TO BE USED ONLY FOR THE
 PURPOSES SPECIFIED IN THE
 CONTRACT. IT IS TO BE RETURNED
 TO THE OFFICE OF ORIGIN UPON
 COMPLETION OF THE PROJECT.
 ALL RIGHTS ARE RESERVED.

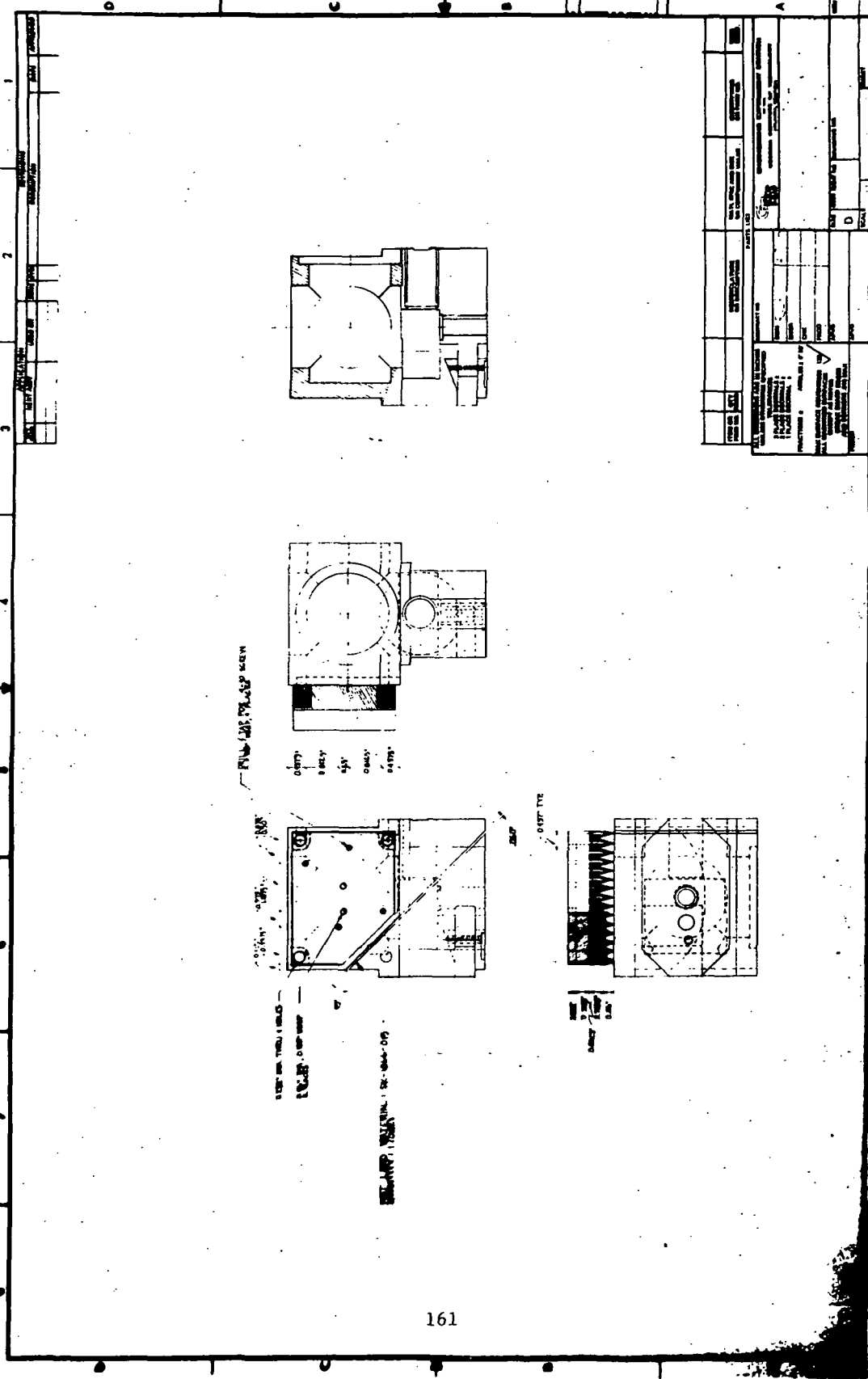

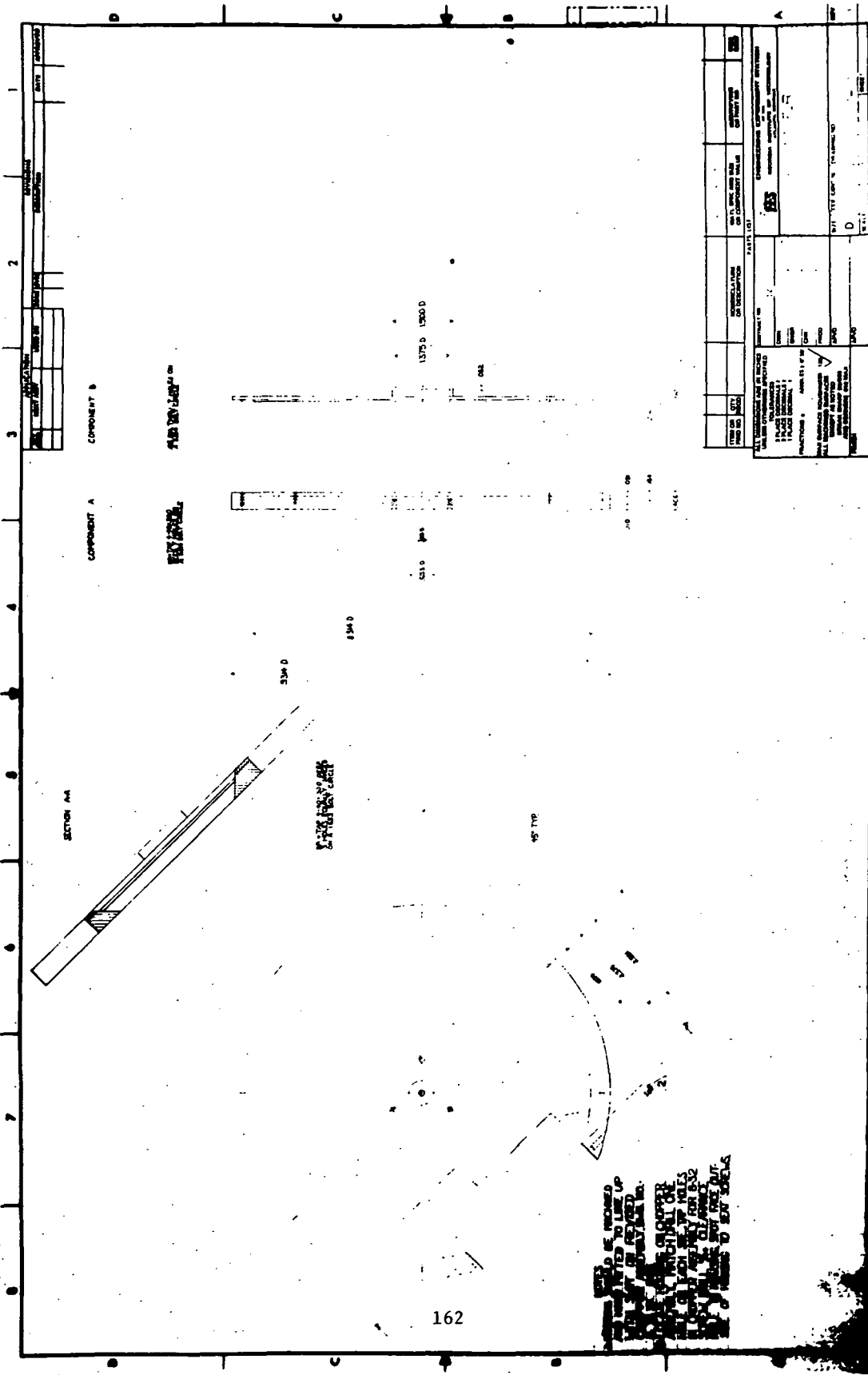

GENERAL INFORMATION		PART I (C)	
DESIGN NO.	162	DATE	1/1/68
PROJECT NO.		DRAWN BY	
CHECKED BY		DATE	
SCALE		NO.	0
NOT TO SCALE		DATE	
SHEET NO.		OF SHEETS	
SHEET NO.		OF SHEETS	

DO NOT BE MISLED
 THIS PLAN IS FOR INFORMATION ONLY
 AND IS NOT TO BE USED FOR CONSTRUCTION
 WITHOUT THE PERMISSION OF THE
 DESIGNER. THE DESIGNER'S OFFICE
 IS NOT RESPONSIBLE FOR ANY
 ERRORS OR OMISSIONS THAT MAY
 OCCUR IN THE USE OF THIS PLAN.
 THE USER SHOULD VERIFY ALL
 DIMENSIONS AND CONDITIONS
 BEFORE CONSTRUCTION.

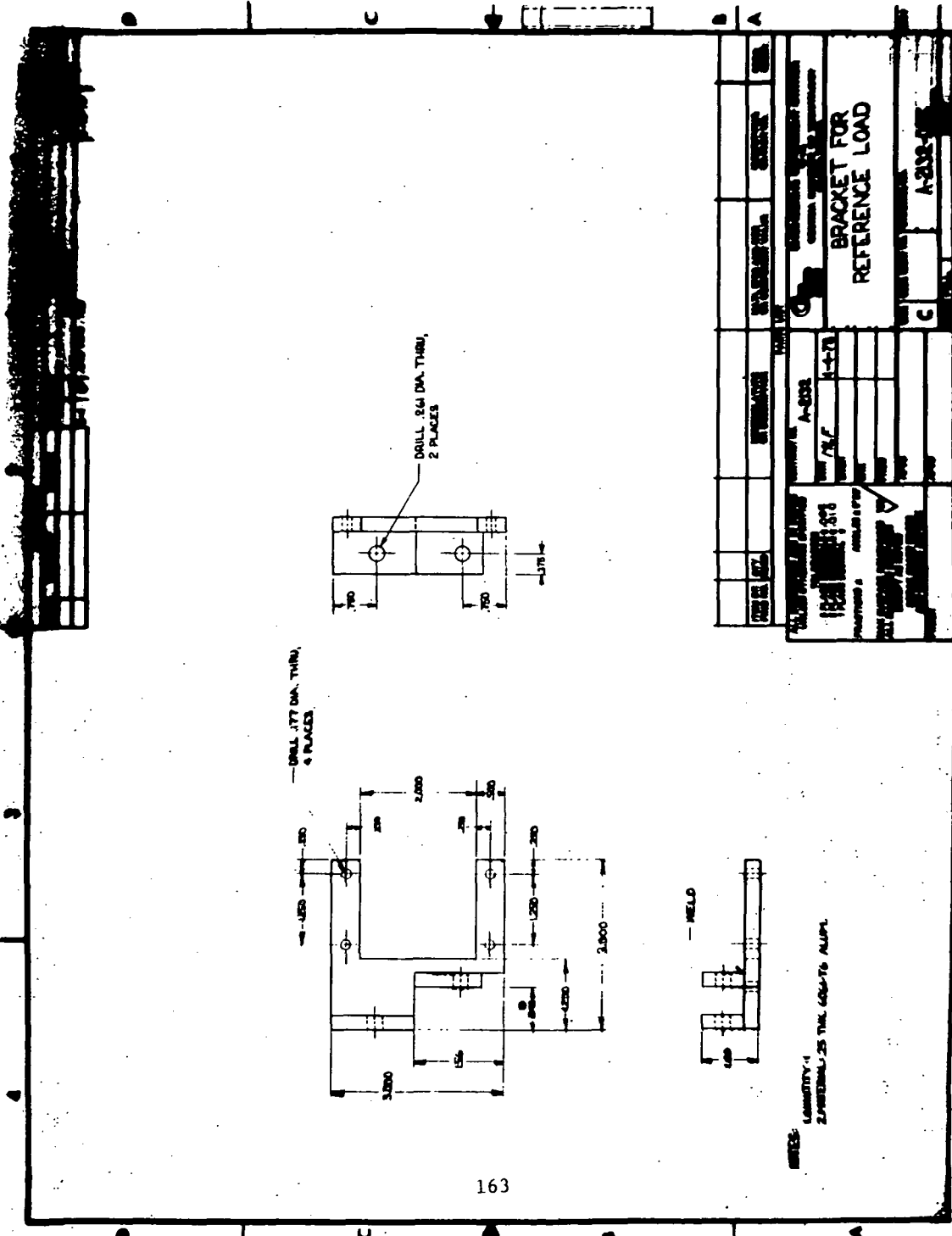

DRILL 177 DIA. THRU,
4 PLACES

DRILL 261 DIA. THRU,
2 PLACES

WELD

NOTE: MATERIAL: 25 THK. 6061-T6 ALUM.

REV.	DATE	DESCRIPTION	BY	CHKD.
PARTIAL LIST OF MATERIALS				
QTY.	DESCRIPTION	UNIT	PART NUMBER	
BRACKET FOR REFERENCE LOAD				
A-202				

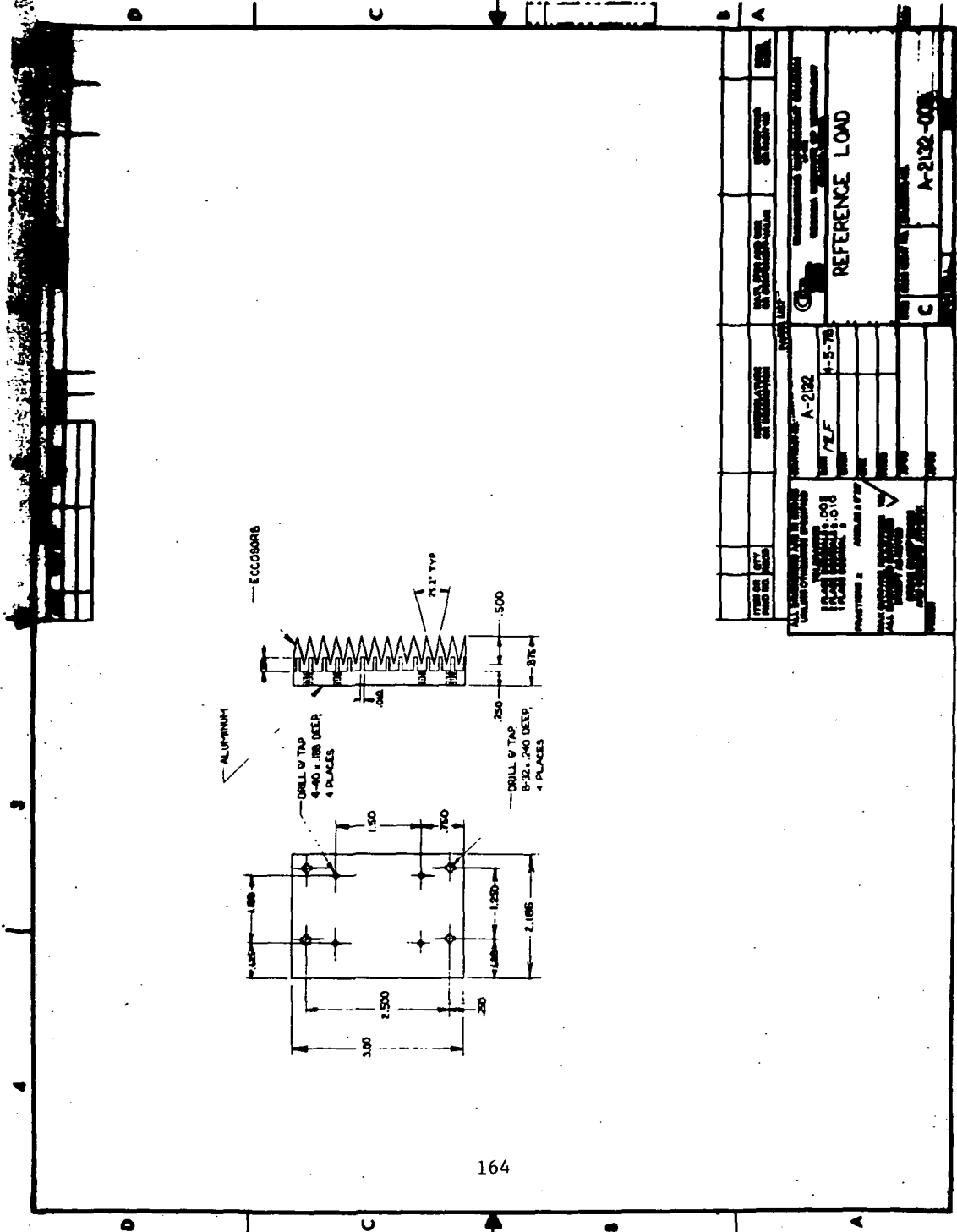

ITEM NO.	REV.	DESCRIPTION	DATE
ALL DIMENSIONS UNLESS OTHERWISE SPECIFIED UNLESS OTHERWISE SPECIFIED FINISHES: A-2132 SURFACE: 7ZLF MATERIAL: A-5-78 ALL DIMENSIONS UNLESS OTHERWISE SPECIFIED ALL DIMENSIONS UNLESS OTHERWISE SPECIFIED ALL DIMENSIONS UNLESS OTHERWISE SPECIFIED ALL DIMENSIONS UNLESS OTHERWISE SPECIFIED			
REFERENCE LOAD A-2132-00			

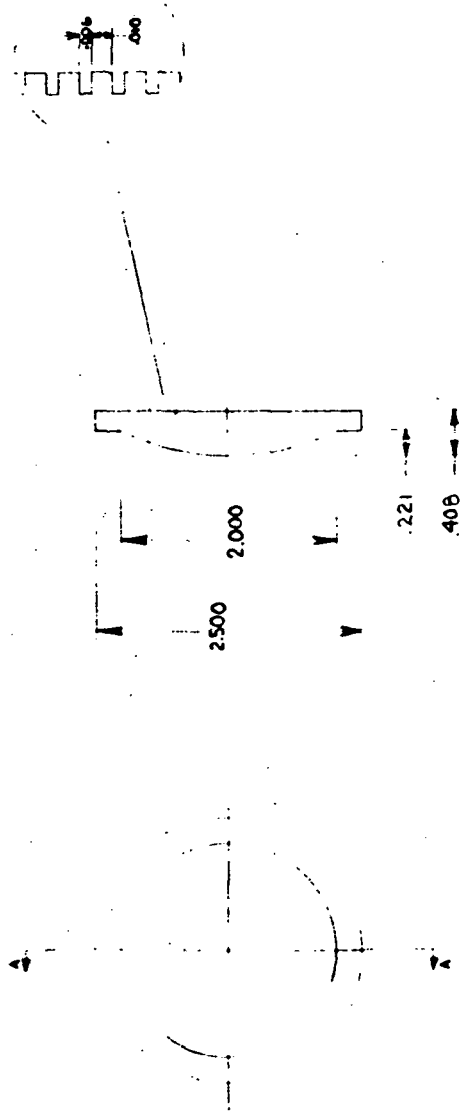

SECTION A-A

- NOTES:
1. MATERIAL-REXOLITE
 2. QUANTITY-4
 3. TOLERANCES-OVERALL DIM. - ±.005
GROOVE DIM. - ±.002
 4. CUT CURVED SURFACE USING TEM-PLATE PROVIDED

ENGINEERING EXPERIMENT STATION
OF THE
GEORGIA INSTITUTE OF TECHNOLOGY
ATLANTA, GEORGIA

LENS

NO.	DESCRIPTION OF CHANGE	CH.	DATE

SCALE: FULL DATE: 4-14-78
CONTRACT NO. A-2132
PROJECT NO.

DR. MLF
ENGR.
CH.
APP.

DRAWING NO. A-2132-018

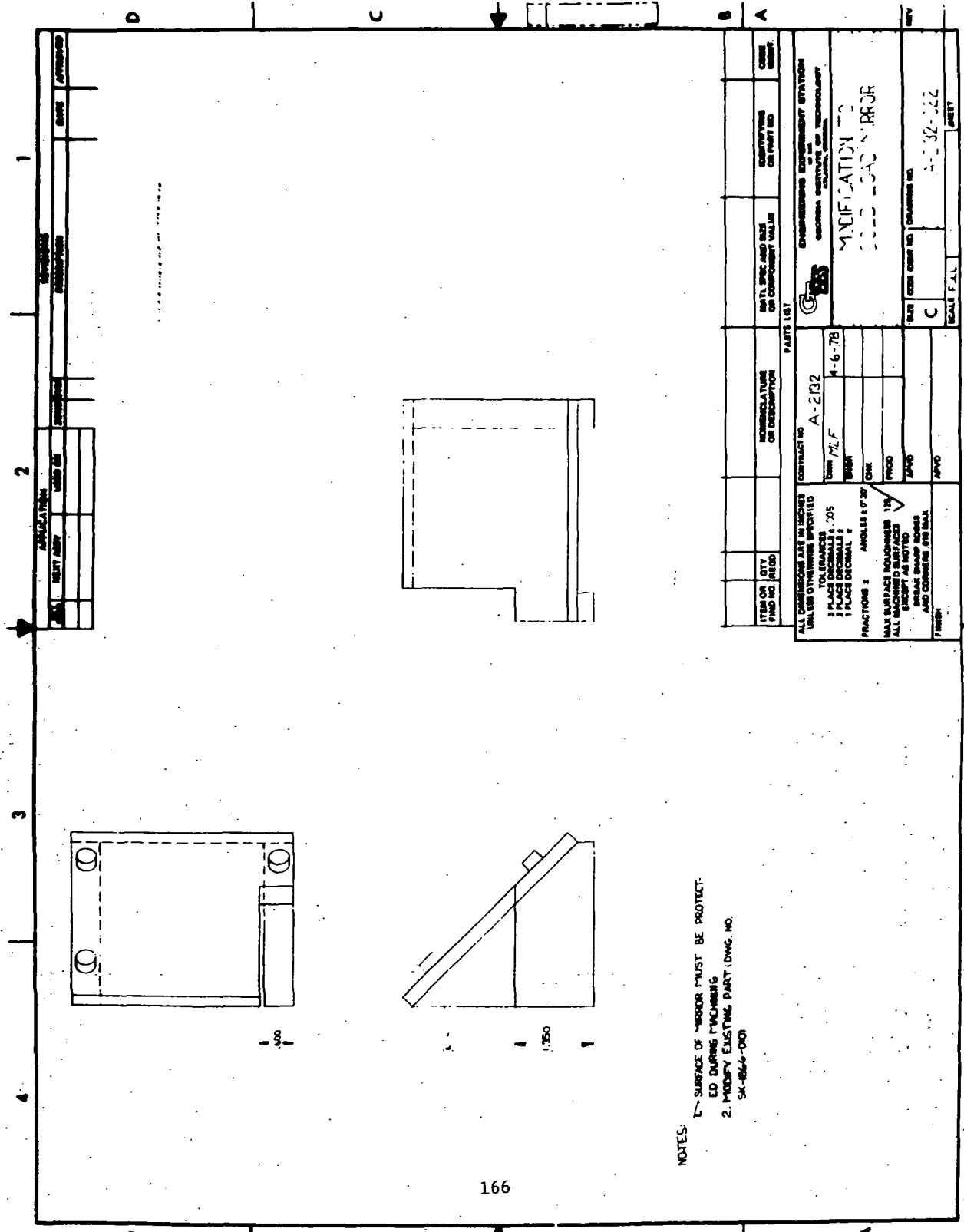

APPLICATOR	DATE	APPROVED
TEST AREA	USE OF	

ITEM OR CITY PART NO. / QTY	DESCRIPTION	QUANTITY	DATE
PARTS LIST			
CONTRACT NO. A-2132		ENGINEERING DEPARTMENT STATION	
DRAWN M.L.F.		GENERAL INSTITUTE OF TECHNOLOGY	
DATE 4-6-78		MODIFICATION NO.	
CHECK		CROSS-CHECK NUMBER	
PROOF			
APPROVED			
FINISH			
TOLERANCES UNLESS OTHERWISE SPECIFIED			
3 PLACE DECIMALS : .005			
1 PLACE DECIMALS :			
FRACTIONS : ANGLES : 0/32			
MAX SURFACE FINISHES UNLESS OTHERWISE SPECIFIED			
ALL MACHINED SURFACES UNLESS OTHERWISE SPECIFIED			
SHARP CORNERS AND EDGES UNLESS OTHERWISE SPECIFIED			
AND CHAMFER PER Dwg. NO.			
SCALE 1:1		PARTY	

NOTES:
 1. SURFACE OF HOLE MUST BE PROTECTED DURING FINISHING.
 2. MODIFY EXISTING PART DWG. NO. SK-866-001

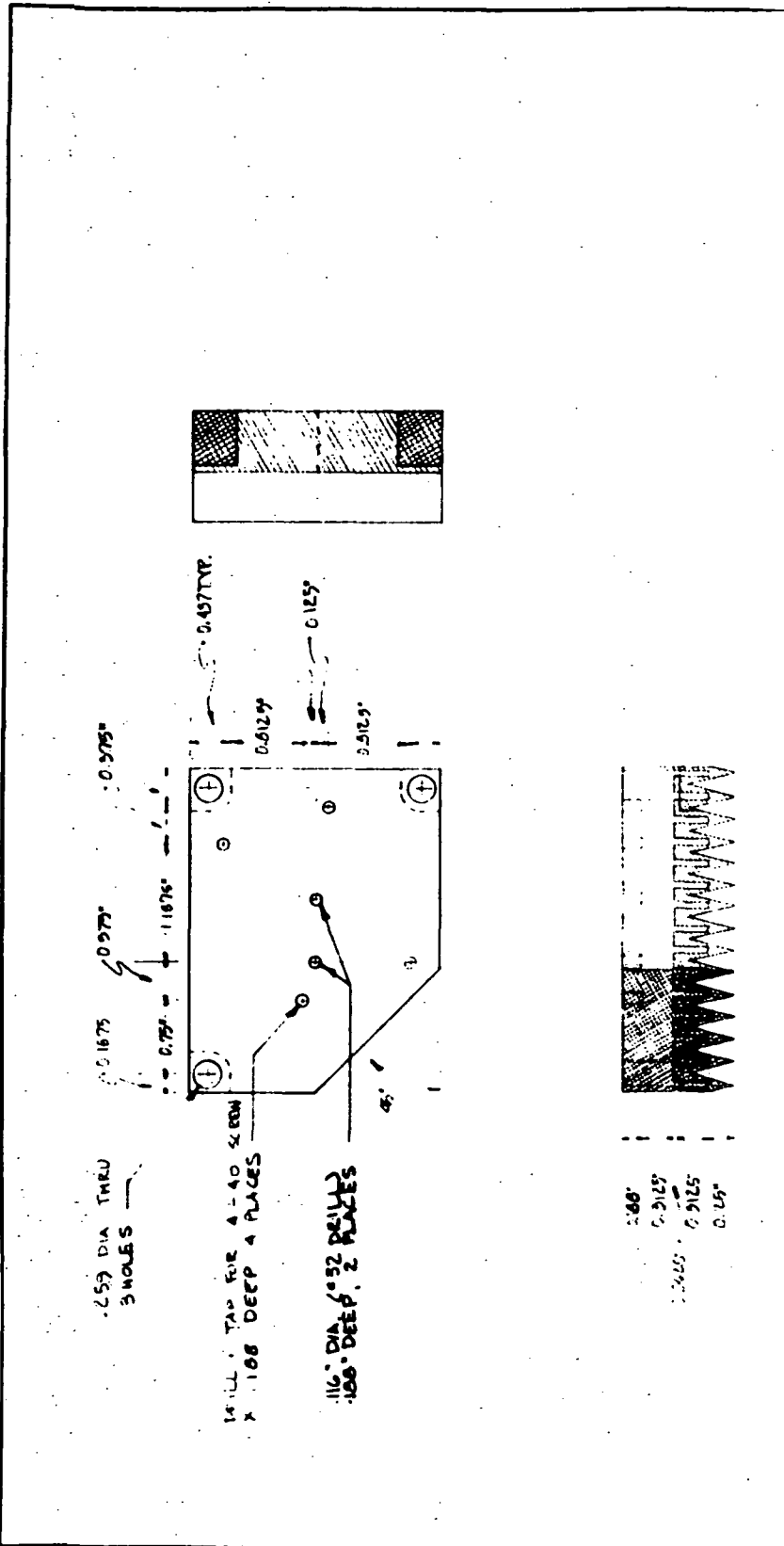

NOTES:
 1. MODIFY EXISTING PART(DWG. NO. SK-1866-016)

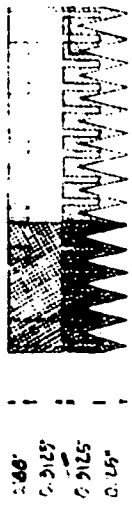

ENGINEERING EXPERIMENT STATION OF THE GEORGIA INSTITUTE OF TECHNOLOGY ATLANTA, GEORGIA		HOT LOAD MODIFICATION	
DR. RLR	DRAWING NO.	A2132-023	
ENGR.	ENGR.		
CHK.	CHK.		
APP.	APP.		
A	HOLE RELOCATIONS	DATE	
B	45° CUT TO CORNER	CHK.	
NO.	DESCRIPTION OF CHANGE	DATE	4/10/70
SCALE:	1" = 1"		
CONTRACT NO.			
PROJECT NO.			

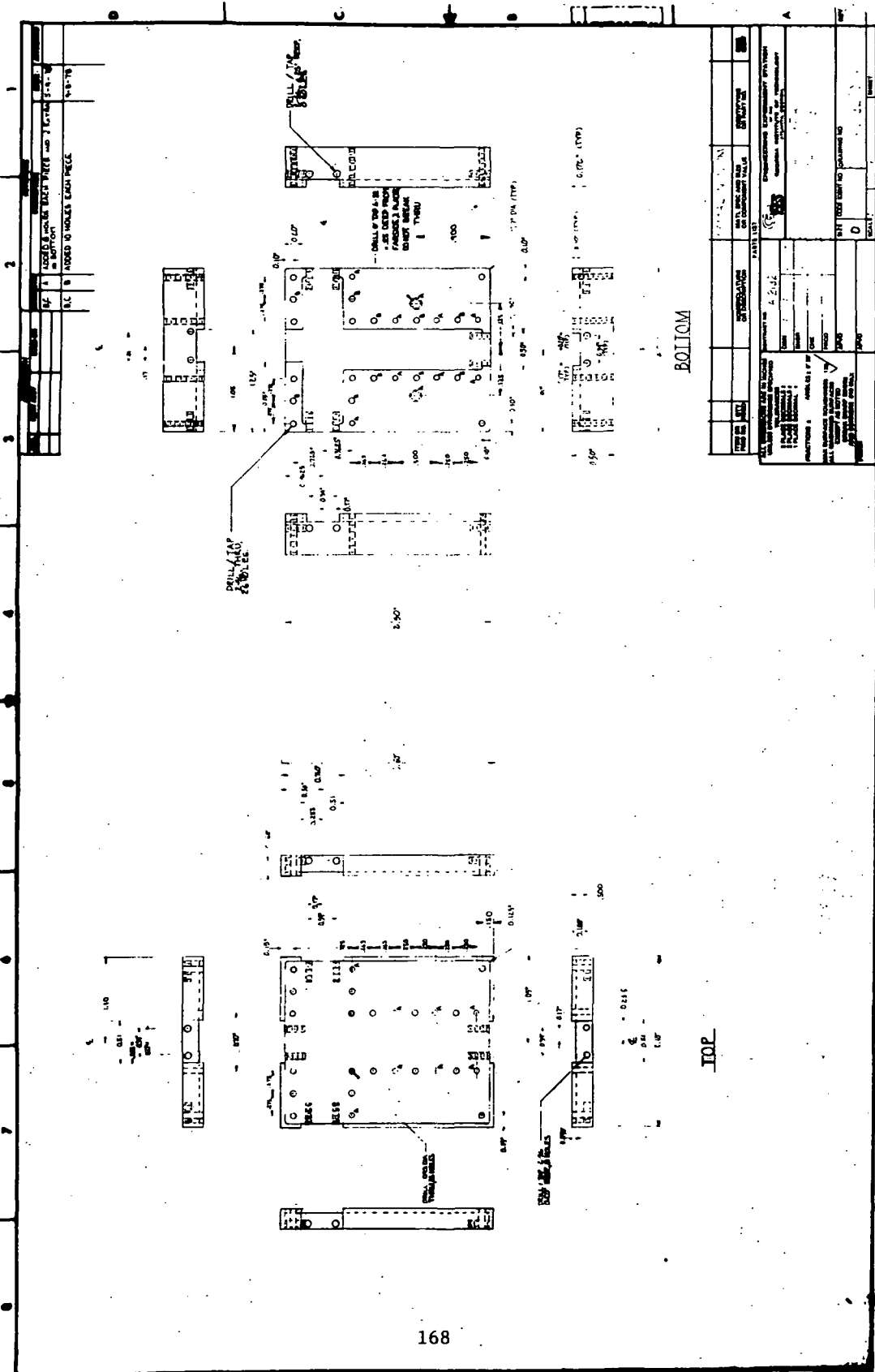

SECTION	1	2	3	4	5	6	7
NO. 1	NO. 2	NO. 3	NO. 4	NO. 5	NO. 6	NO. 7	NO. 8
<p>NO. 1 - 100% COMPLETE - BRICK WALL AND 1 FLOOR SLAB - 1953-78</p> <p>NO. 2 - 100% COMPLETE - BRICK WALL AND 1 FLOOR SLAB - 1953-78</p> <p>NO. 3 - 100% COMPLETE - BRICK WALL AND 1 FLOOR SLAB - 1953-78</p> <p>NO. 4 - 100% COMPLETE - BRICK WALL AND 1 FLOOR SLAB - 1953-78</p> <p>NO. 5 - 100% COMPLETE - BRICK WALL AND 1 FLOOR SLAB - 1953-78</p> <p>NO. 6 - 100% COMPLETE - BRICK WALL AND 1 FLOOR SLAB - 1953-78</p> <p>NO. 7 - 100% COMPLETE - BRICK WALL AND 1 FLOOR SLAB - 1953-78</p> <p>NO. 8 - 100% COMPLETE - BRICK WALL AND 1 FLOOR SLAB - 1953-78</p>							

BOTTOM

TOP

PROJECT NO.	4-214
DATE	10/1/51
DESIGNED BY	W. H. HARRIS
CHECKED BY	H. B. HARRIS
APPROVED BY	H. B. HARRIS
SCALE	AS SHOWN
SHEET NO.	10
TOTAL SHEETS	12
DATE PLOTTED	10/1/51
BY	H. B. HARRIS

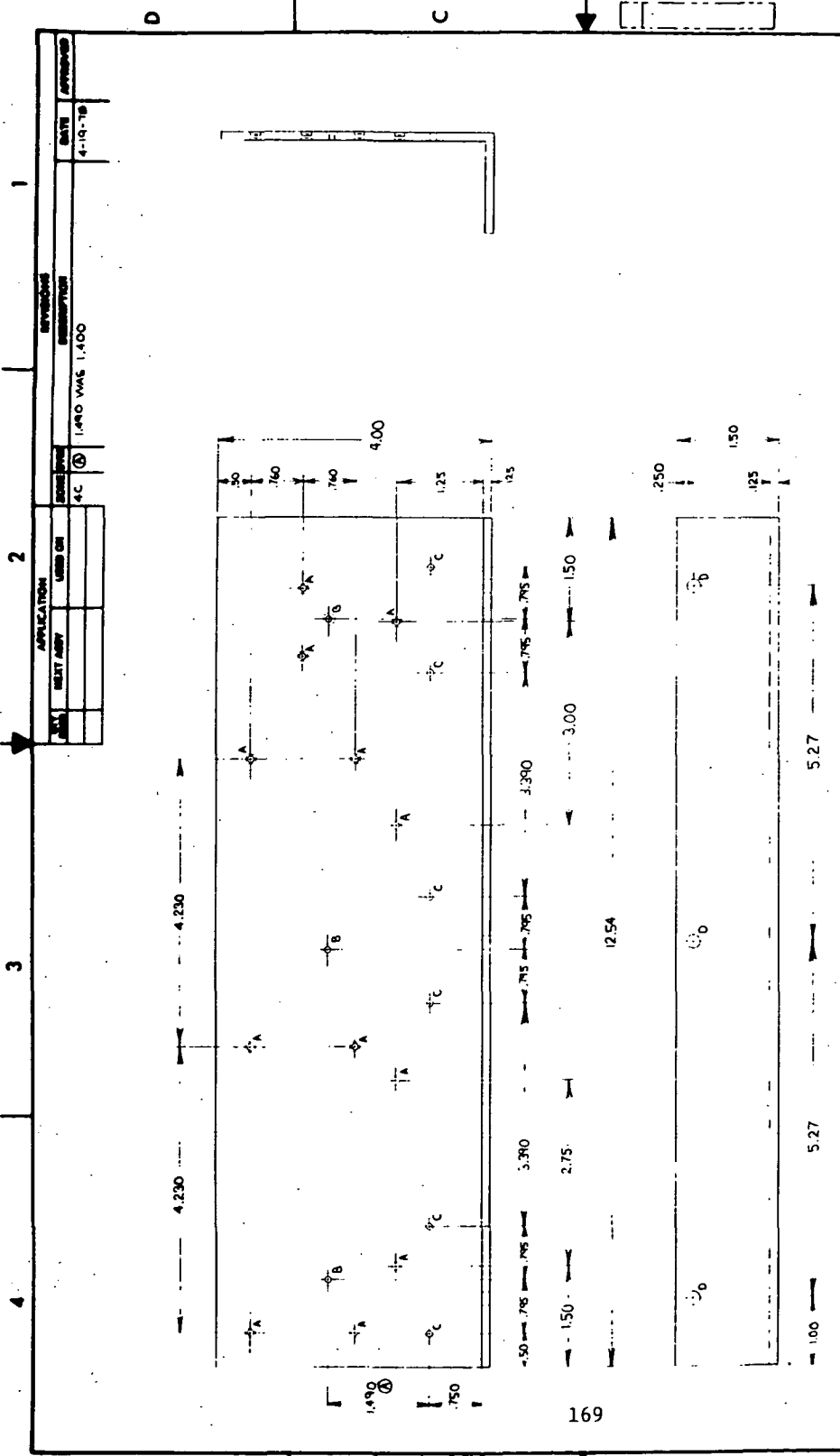

- NOTES:
1. QUANTITY: 1 (ONE)
 2. MATERIAL: ALUMINUM
 3. HOLES MARKED "A" - DRILL & TAP 6-32 THRU, 12 PLACES
 4. HOLES MARKED "B" - DRILL .104 DIA. THRU, CSINK .055 DEEP
 5. HOLES MARKED "C" - DRILL .104 DIA. THRU
 6. HOLES MARKED "D" - DRILL .221 DIA. THRU

APPLICATOR	APPROVED
DATE	DATE
REVISED	REVISED
DESCRIPTION	DESCRIPTION
1.490 WAS 1.400	4-14-78

ITEM OR PART NO.	QUANTITY	DESCRIPTION	UNIT	PRICE	TOTAL
PARTS LIST					
CONTRACT NO.	A-2132				
DRG. NO.	MZF 417-78				
ALL DIMENSIONS ARE IN INCHES UNLESS OTHERWISE SPECIFIED 1 PLACE DECIMALS ± .005 2 PLACE DECIMALS ± .010 3 PLACE DECIMALS ± .030 FRACTIONS ± ANGLES ± .010					
MAX SURFACE ROUGHNESS 125 ALL SURFACES TO BE FINISHED EXCEPT AS NOTED DRILL SHARP EDGES AND CORNERS ARE RADIUS FINISH					
MATERIAL SPEC AND QTY ON COMPONENT VALUE		IDENTIFYING ON PART NO.		CODE IDENT.	
GENERAL INFORMATION OF TECHNOLOGY		ENGINEERING EXPERIMENT STATION		GEORGIA INSTITUTE OF TECHNOLOGY	
ATLANTA, GEORGIA		IF AMPLIFIER & FILTER BRACKET		DRAWING NO. A-2132-025	
SIZE	C	CORE COPY NO.	C	DRAWING NO.	A-2132-025
SCALE	FULL				

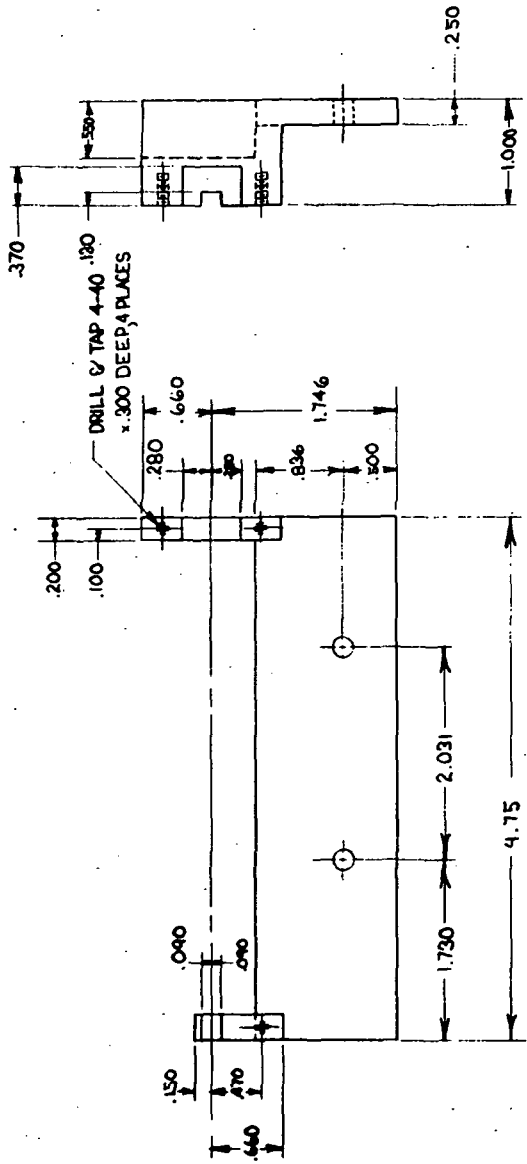

DRILL .120 DIA. THRU,
2 PLACES

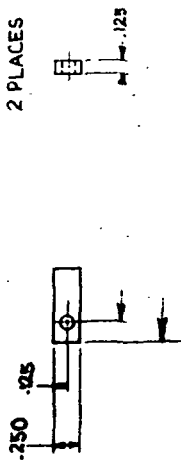

ENGINEERING DEPARTMENT STATION GEORGIA INSTITUTE OF TECHNOLOGY ATLANTA, GEORGIA		DRAWING NO. A-2132-027	
WAVEGUIDE BRACKET		DATE 5-9-76	
NO. / DFN		DATE	
A REDBANN		5-9-76	
NO. / DESCRIPTION OF CHANGE		DATE	
SCALE FULL		DATE 5-9-76	
CONTRACT NO. A-2132		DRAWING NO. A-2132-027	
PROJECT NO.		APP.	

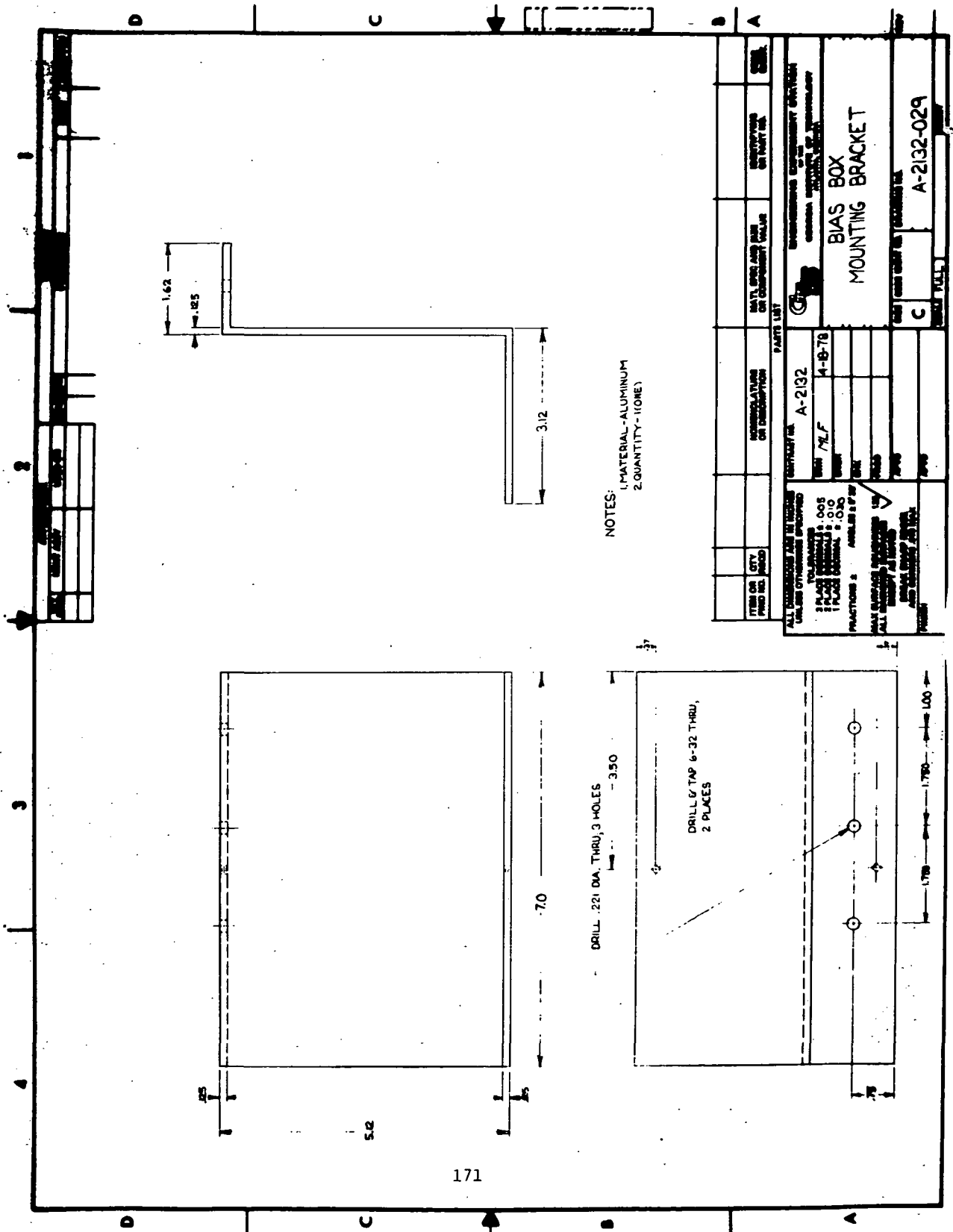

NOTES:
 1. MATERIAL - ALUMINUM
 2. QUANTITY - 1109E

ITEM OR CITY PART NO.	QUANTITY	DESCRIPTION	MATERIAL OR EQUIV. VALUE	REVISION OR PART NO.	DATE
		A-2132			
		74F			
		4-8-78			

PARTS LIST	
ITEM OR CITY PART NO.	DESCRIPTION
	A-2132
	74F
	4-8-78

BIAIS BOX MOUNTING BRACKET	
MATERIAL - ALUMINUM	
QUANTITY - 1109E	
DATE - 4-8-78	
DRAWN BY - [Signature]	
CHECKED BY - [Signature]	
APPROVED BY - [Signature]	
PART NO. A-2132-029	

REV	DATE	BY	CHKD	DESCRIPTION
1	11-18-76			ADDED TAPPED HOLES
2	11-18-76			ADDED TAPPED HOLES
3	11-18-76			ADDED TAPPED HOLES
4	11-18-76			ADDED TAPPED HOLES

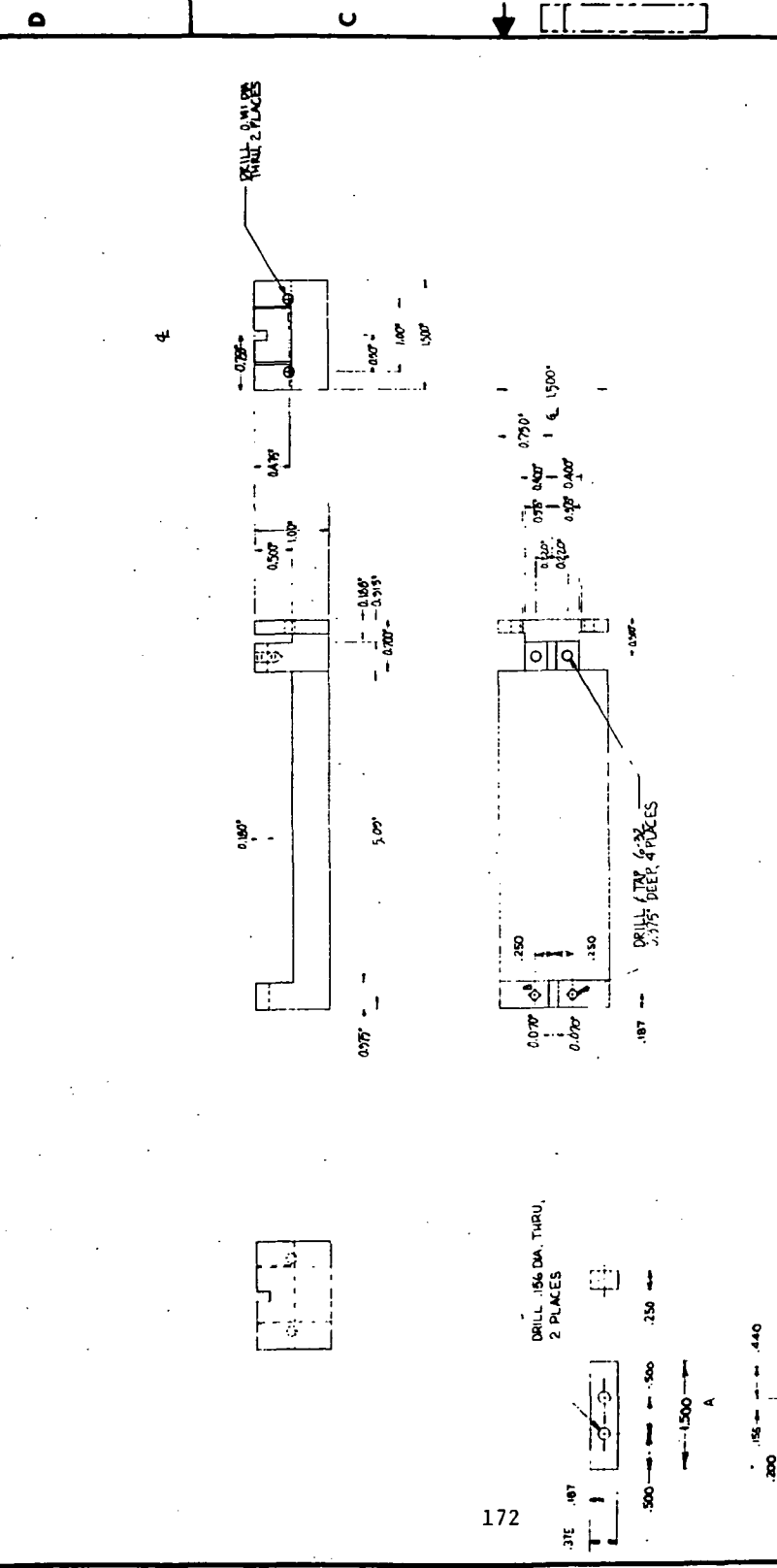

ITEM OR QTY. PART NO. FIELD	DESCRIPTION	CONTRACT NO.	DATE	BY	CHKD	FRCD	APPR
	1.00" ALUMINUM		4/18/76	RLR			
ALL DIMENSIONS ARE IN INCHES UNLESS OTHERWISE SPECIFIED TOLERANCES: 1 PLACE DECIMALS ± .010 2 PLACE DECIMALS ± .005 3 PLACE DECIMALS ± .001 FRACTIONS ± ANGLES ± .030 MAX SURFACE ROUGHNESS 125 ALL MACHINED SURFACES UNLESS OTHERWISE SPECIFIED TO BE FINISHED TO AS-BUILT DIMENSIONS AND CONFORM TO ALL REQUIREMENTS							
WAVEGUIDE BRACKET EXTENSION CONTRACT NO. A2132-030 DATE 4/18/76 BY RLR CHKD FRCD APPR							

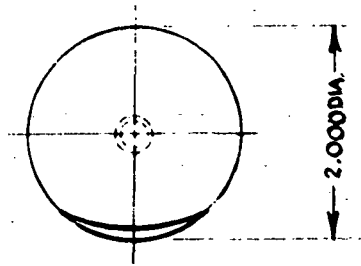
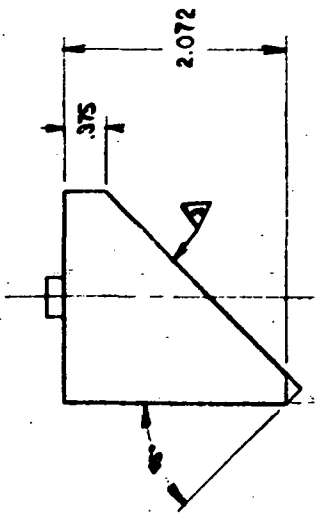

NOTES:

1. TOLERANCES - $\pm .008$
 2. MODIFY EXISTING PART (DWG. NO. SK-1866-006)
- MIRROR SURFACE MUST BE PROTECTED

ENGINEERING DEPARTMENT STATION		DRAWING NO.	
GEORGIA INSTITUTE OF TECHNOLOGY		A-2132-033	
ATLANTA, GEORGIA			
MODIFICATION OF ROTATING MIRROR			
DR. M.L.F.	DR. M.L.F.		
CHK.	CHK.		
APP.	APP.		
NO. DESCRIPTION OF CHANGE		DATE	
SCALE: FULL		REV. 5-3-78	
CONTRACT NO. A-2132			
PROJECT NO.			

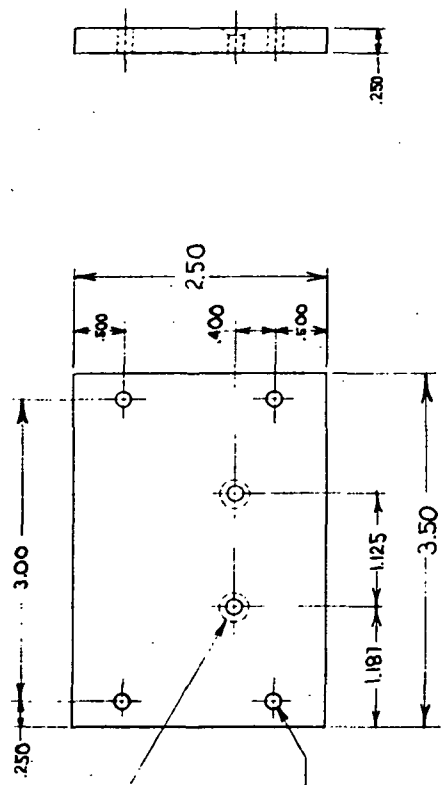

DRILL .161 DIA. THRU/SINK
.128 DEEP, 2 PLACES

DRILL .161 DIA. THRU,
4 PLACES

ENGINEERING EXPERIMENT STATION OF THE GEORGIA INSTITUTE OF TECHNOLOGY ATLANTA, GEORGIA		DRAWING NO. A-2132-034	
TRIPLEXER MOUNTING PLATE		DR. /Z/F	DATE
NO.	DESCRIPTION OF CHANGE	BY	DATE
SCALE: FULL	DATE: 5-8-78		
CONTRACT NO. A-2132		DR. /Z/F	DATE
PROJECT NO.		BY	DATE

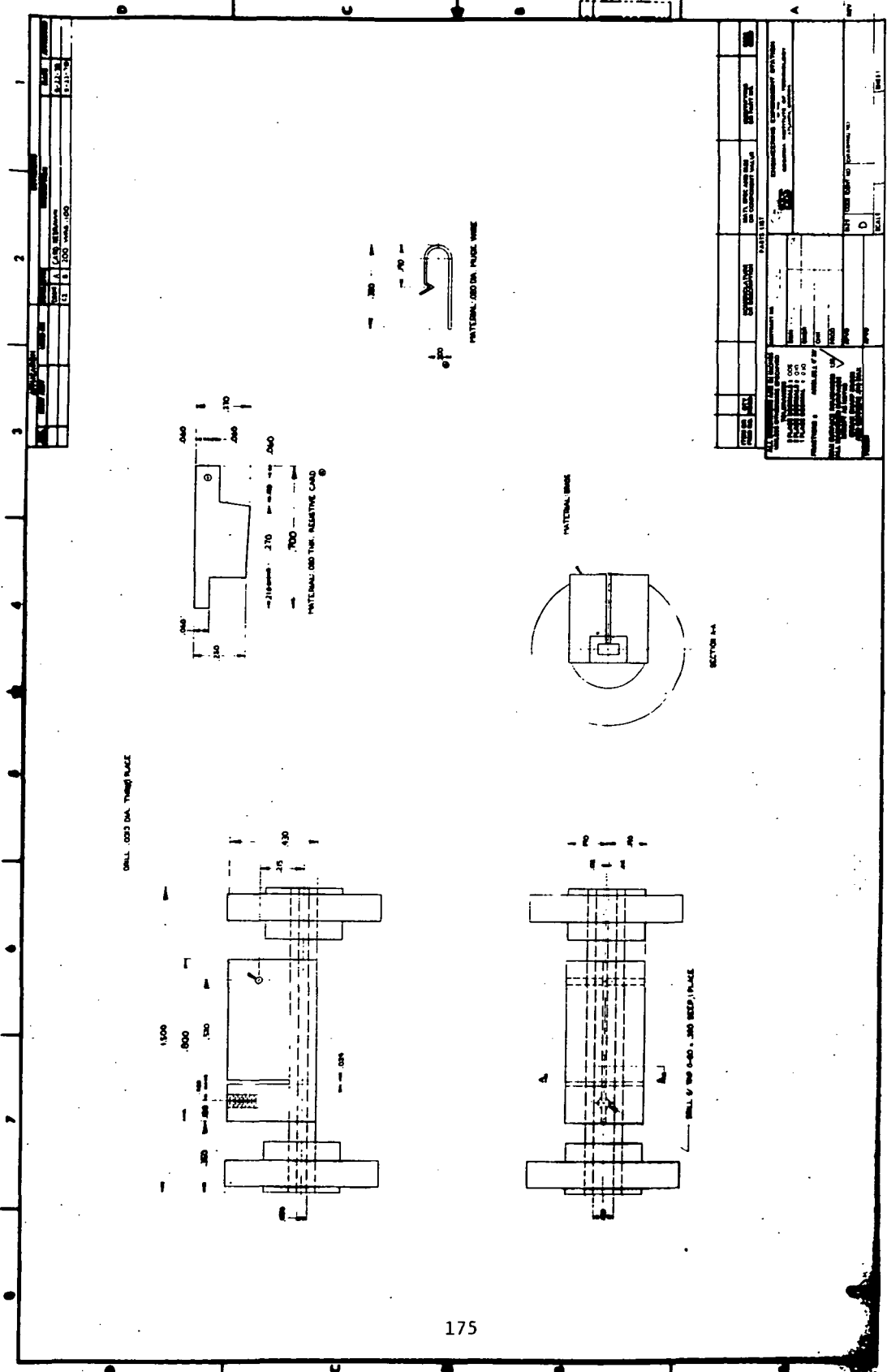

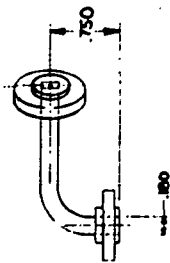
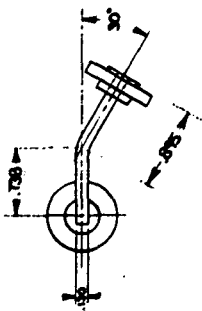
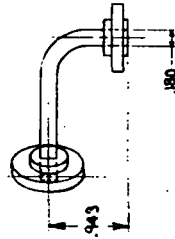
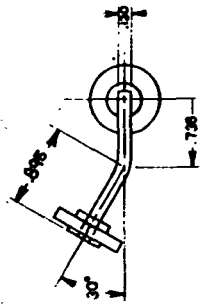

ENGINEERING EXPERIMENT STATION OF THE GEORGIA INSTITUTE OF TECHNOLOGY ATLANTA, GEORGIA		SPECIAL WAVEGUIDE BENDS	
DATE	DESIGNED BY	NO. / REV.	ISSUED FOR
			A-2132-036
NO. OF COPIES	DATE	BY	APP.
	5-11-78		
FULL TITLE		A-2132	
PROJECT NO.		A-2132-036	

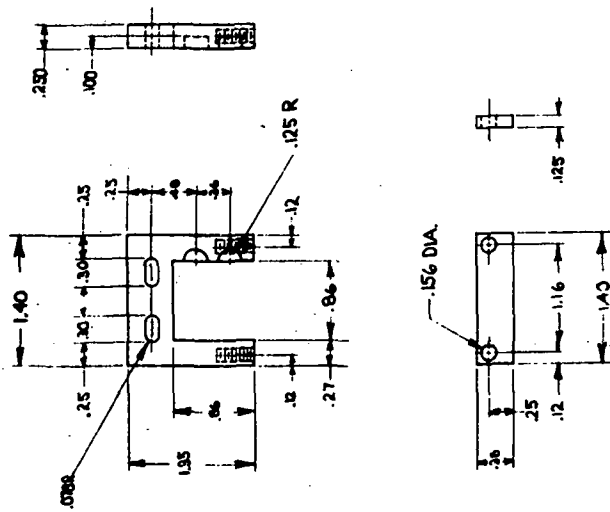

ENGINEERING DEPARTMENT STATION		GEORGIA INSTITUTE OF TECHNOLOGY	
MIXER BRACKET		DRAWING NO. A-2132-044	
NO. OF SHEETS	DATE	SCALE	PROJECT NO.
1	5-30-78	1/2" = 1"	A-2132
DESCRIPTION OF CHANGE		CONTRACT NO.	
		A-2132	

APPENDIX D

SEASAT GULF OF ALASKA EXPERIMENT PLAN

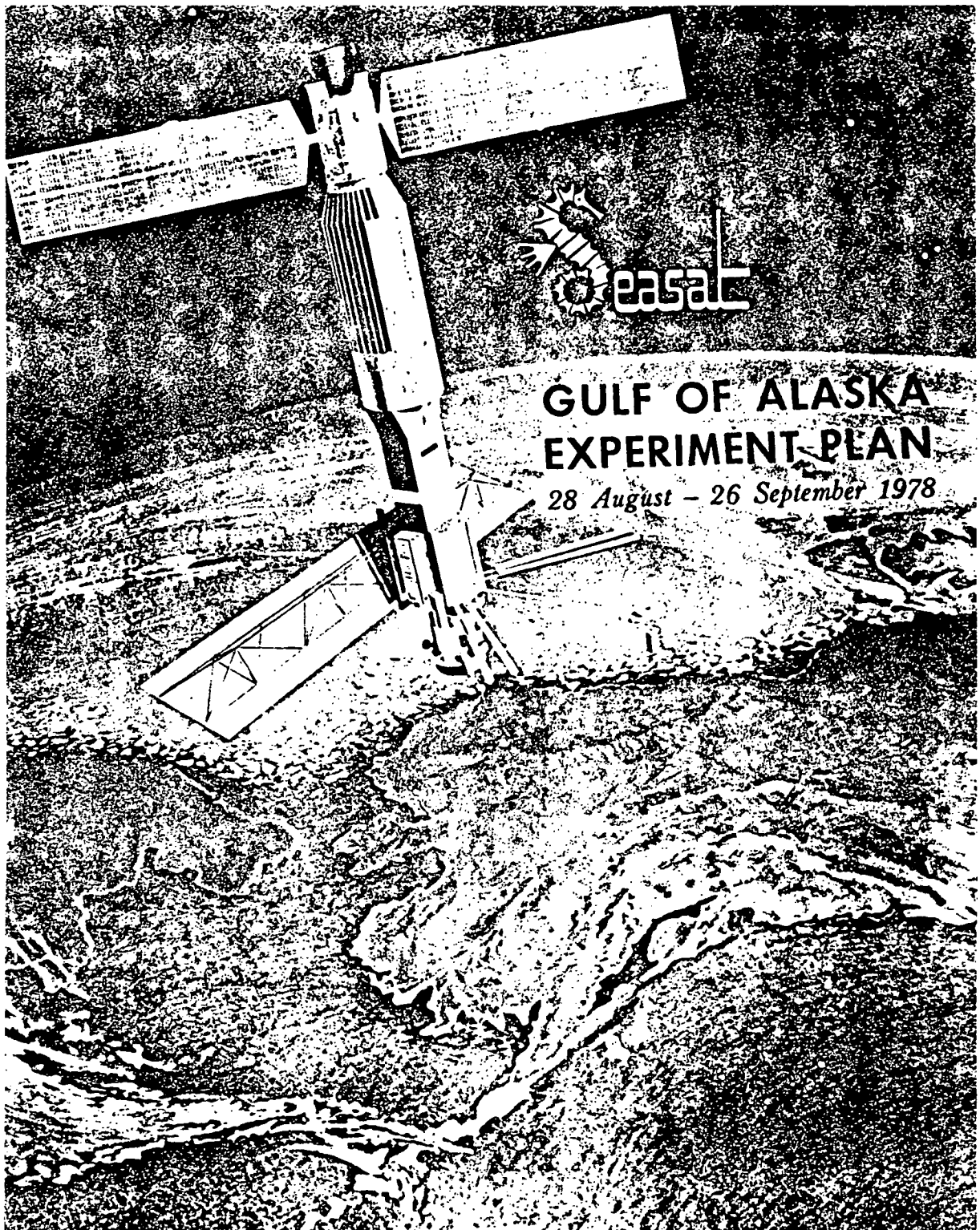

SECTION III

PLAN OF OPERATION (SPECIFIC)

A. PHASE I

The Oceanographer (Figure 3-1) will depart Seattle on August 28 and proceed directly to Ocean Station PAPA, 50°N 145°W. There the Oceanographer will inspect the mooring of a previously deployed Waverider buoy, which will be monitored by the Canadian Coast Guard Cutters, Quadra and Vancouver, during the

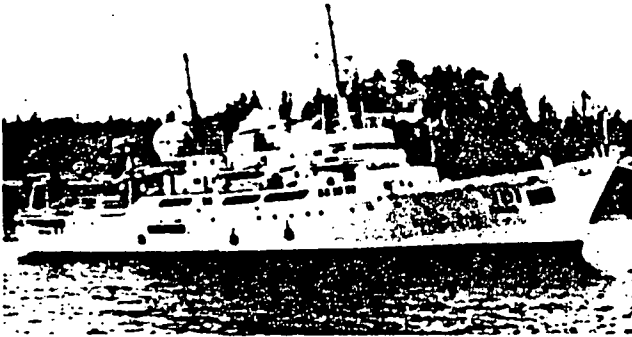

Figure 3-1. The OSS Oceanographer

experiment. The mooring for the Waverider buoy is as shown in Figure 3-2. The 200-m section of 3/8-in. nylon rope between the rubber shock cord and the buoyant tether will be replaced with a section of 3/8-in. nylon with shielded cover to protect the line against chafing if it becomes entangled with the main mooring during a storm. The light and radar reflector on the surface float will enable the Ocean Station vessels to keep position on the buoy at all times while on station.

Also while at Ocean Station PAPA, the Oceanographer will conduct a performance comparison of shipboard oceanographic and meteorological instruments with the Vancouver. This intership calibration of instruments will provide the necessary information for relating the analyses of data from both platforms. During

this performance test, both ships will take continuous one-half hour anemometer wind records, sea surface temperature, and appropriate simultaneous surface and upper air measurements of temperature and pressure. A 30-min wave record will also be taken with the pitch and roll buoy from the Oceanographer while the Vancouver takes equal records with the Waverider and Tucker meter. Following the performance tests, the Oceanographer will proceed to the starting point of the first CTD section.

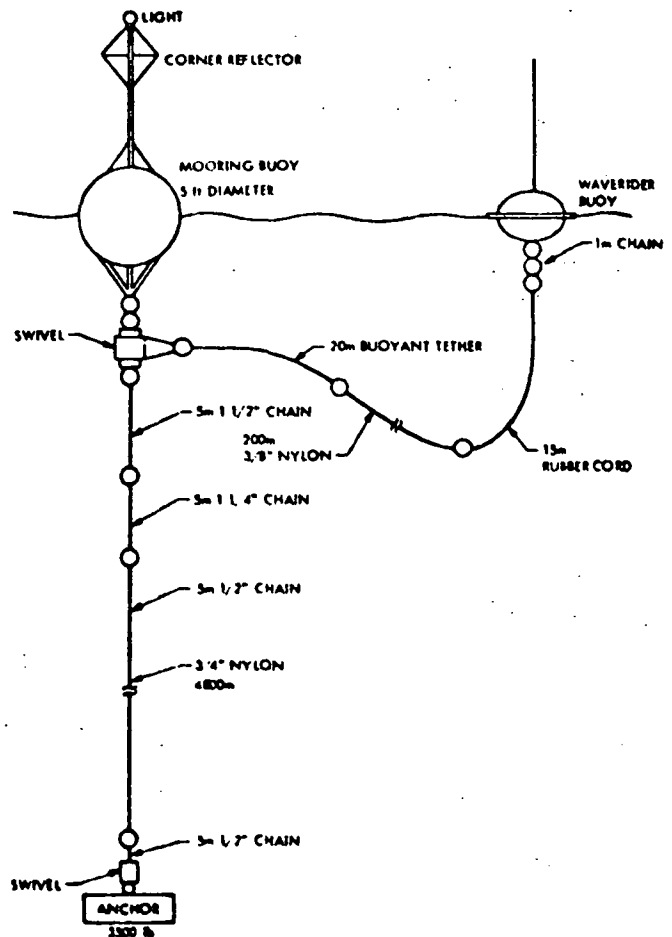

Figure 3-2. Waverider Buoy Mooring Configuration

B. PHASE II

Upon completion of the performance tests, the Oceanographer will proceed to the starting point of the first CTD section. A total of 18 stations will be taken at locations shown in Figure 3-3 and tabulated in Table 3-1. The station spacing is closest together (5 nm) along the section line normal to the continental slope off Kodiak Island, where the westward flow is generally most intense. Three geostationary satellite-tracked buoys will be set adrift near station 15 to track the flow during the period of the experiment. After completing the 18 stations of Section 1, the Oceanographer will proceed to Section 2, where an additional 19 CTD stations will be taken. See Figure 3-4 and Table 3-2 for station locations. The two CTD sections and the satellite-tracked drift buoys

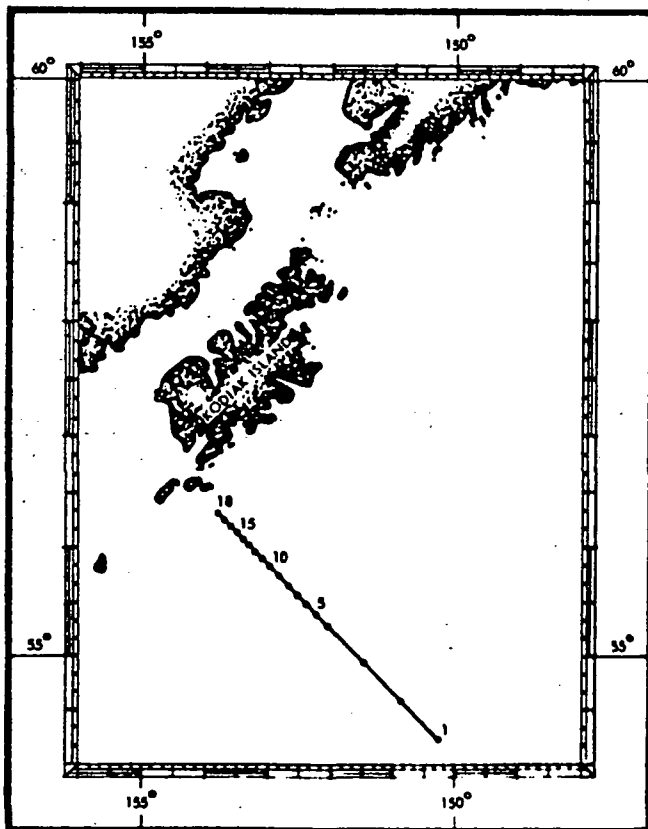

Figure 3-3. CTD Stations - Section 1

Table 3-1. CTD Locations - Section 1

Station	Latitude (°N)	Longitude (°W)
1	54°-12'	150°-18'
2	54°-32'	150°-53'
3	54°-54'	151°-28'
4	55°-12'	152°-00'
5	55°-18'	152°-13'
6	55°-25'	152°-24'
7	55°-32'	152°-25'
8	55°-38'	152°-46'
9	55°-42'	152°-52'
10	55°-45'	152°-58'
11	55°-48'	152°-04'
12	55°-52'	153°-10'
13	55°-55'	153°-15'
14	56°-00'	153°-22'
15	56°-04'	153°-28'
16	56°-08'	153°-35'
17	56°-11'	153°-42'
18	56°-18'	153°-48'

should provide sufficient information to describe the large-scale field of motion and the sea level slope in the region.

During this phase, underway data will be taken between all stations. Also, at relevant satellite overpass times, the Oceanographer will make the appropriate *in situ* oceanographic and meteorological observations for satellite sensor validation.

C. PHASE III

Upon completion of Section 2, the Oceanographer will proceed to Site B, arriving there September 7 in time to make observations for the first satellite pass for that day. The Oceanographer will remain on station at Site B until completing observations for the second

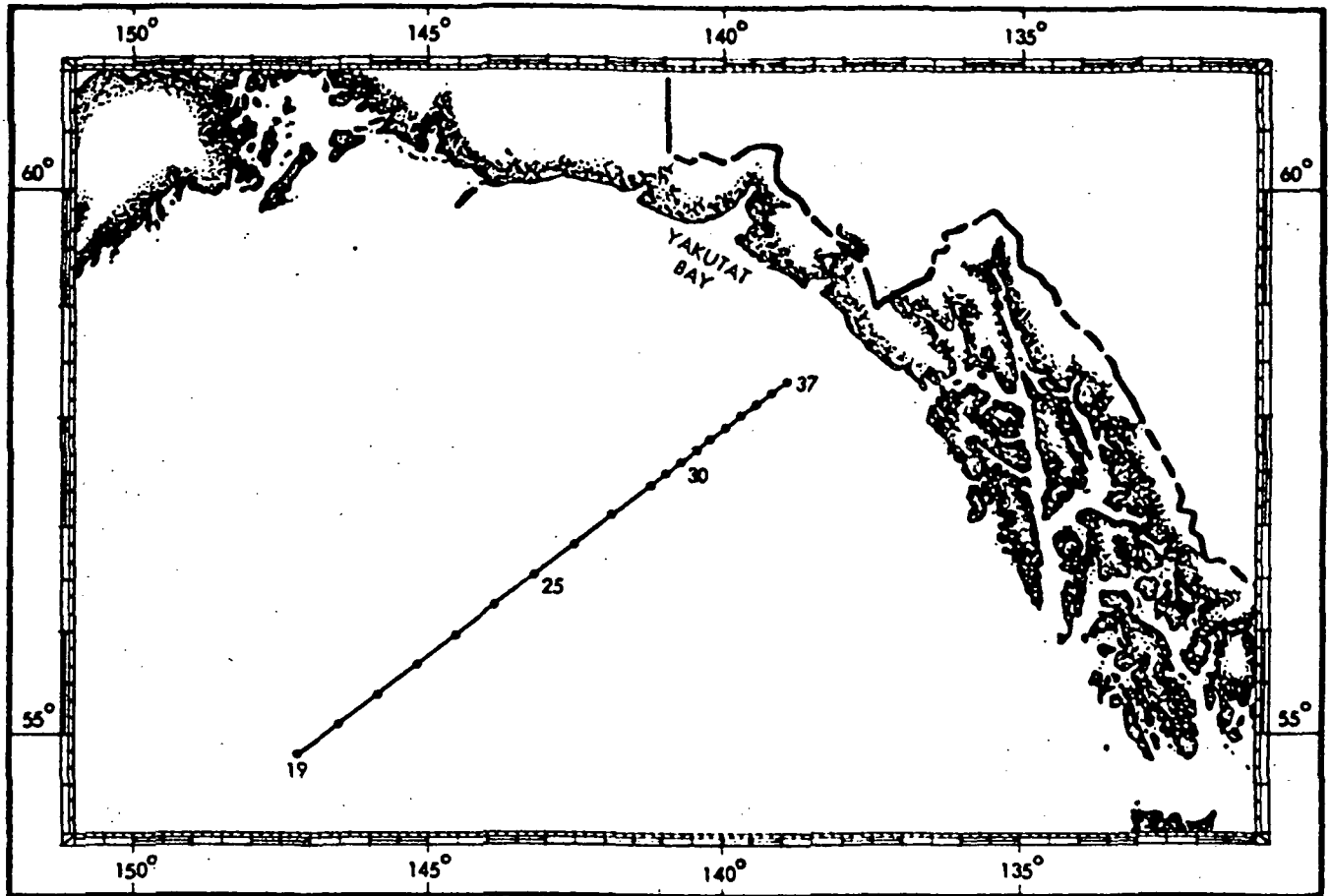

Figure 3-4. CTD Stations – Section 2

satellite overpass for September 9, and then proceed to Site A arriving there on September 10. Because of time constraints west to east, the Oceanographer will not arrive at Site A in time for the first orbit for that day. Data will be taken underway for this pass thus eliminating the pitch and roll buoy observation. At Site A, the Oceanographer will make observations for the remaining satellite overpass for September 10. It will then return to Site B on September 12, where this observational procedure will again be repeated. This alternate occupation of Sites A and B will continue through September 25.

During each overpass at Sites A and B, the ship will obtain 30-min wind and wave records, standard surface and upper air meteorological

observations, and a CTD station. Between sites, the Oceanographer will make underway observations including the expendable bathythermograph (XBT). On the westward leg, XBT casts will be taken every 60 nm. On the eastward leg, because of the lack of time, no CTD stations will be taken.

Part of Phase III operations may also include the Synthetic Aperture Radar (SAR) coastal wave experiment. In the event of a well-developed swell, the ship may be directed to break off the above-described operations and proceed to a coastal site off Vancouver Island to await the satellite overpass. For details of this experiment see Section IV-B, "Measurement Procedures, Coastal Wave Measurements."

Table 3-2. CTD Locations – Section 2

Station	Latitude (°N)	Longitude (°W)
19	54°-48'	147°-11'
20	55°-07'	146°-28'
21	55°-27'	145°-46'
22	55°-44'	145°-04'
23	55°-57'	144°-34'
24	56°-13'	143°-59'
25	56°-32'	143°-15'
26	56°-51'	142°-32'
27	57°-07'	141°-46'
28	57°-28'	141°-00'
29	57°-34'	140°-45'
30	57°-40'	140°-30'
31	57°-45'	140°-15'
32	57°-53'	140°-00'
33	58°-00'	139°-44'
34	58°-05'	139°-28'
35	58°-11'	139°-12'
36	58°-14'	139°-06'
37	58°-20'	138°-55'

A major element of the Phase III operation will be the aircraft overflights of the Oceanographer at Sites A and B coincident with the satellite's passage. The four aircraft will periodically rendezvous over the ship on days when orbits pass over regions selected for aircraft underflights (Figure 3-5). Selection of aircraft operating areas was based on the following considerations: (1) sensor experiment involved, (2) range capabilities of individual aircraft, and (3) on-station time requirements for data collection.

Because the mission requirements differ for each of the four aircraft, the flight schedules are largely independent of one another.

The four aircraft participating in the Gulf of Alaska Experiment are:

- | | | |
|-----|----------|---------|
| (1) | NASA | NC-130B |
| (2) | NASA | CV-990A |
| (3) | Navy | RP-3A |
| (4) | Canadian | CV-580 |

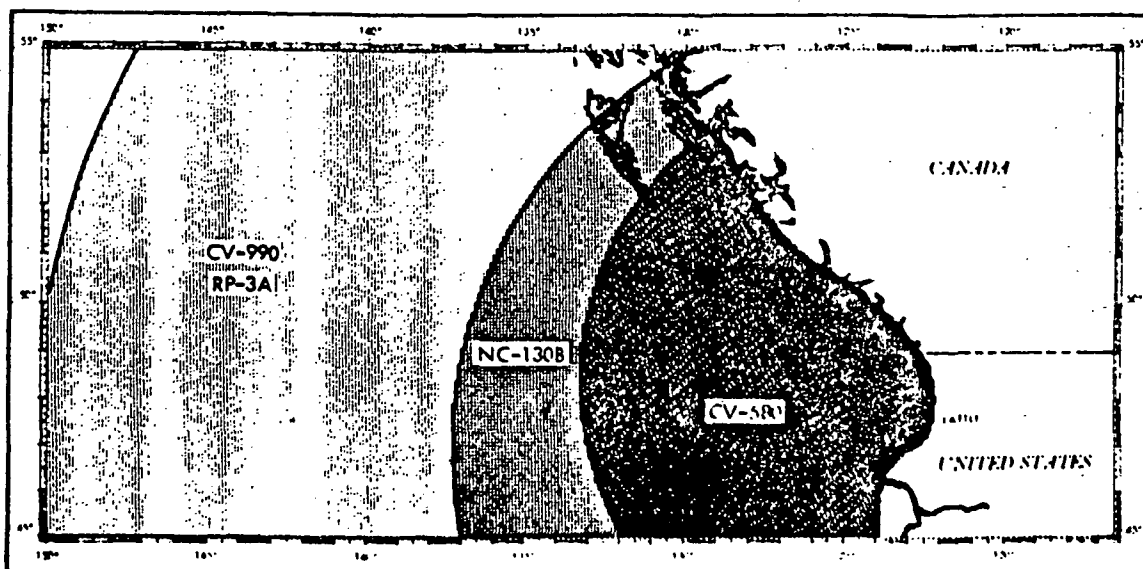

Figure 3-5. Aircraft Operating Regions

Table 4-7. Observation Plan for NC-130B

Data Type	Recording Method	Recorded Output	Processing Schedule	Responsible Individual
Radar Backscattering Cross Section	Digital 9-track tape recorder	Backscatter power as a function of incidence angle and azimuth-1/2 s integration	2 weeks	L. Schroeder LRC
Surface Wave Profiles	Analog FM	Surface wave profiles	2 months	L. Schroeder LRC
Sea Surface Temperature	Digital 9-track tape recorder	1-s samples	2 weeks	L. Schroeder LRC
Air Temperature	Digital 9-track tape recorder	1-s samples	2 weeks	L. Schroeder LRC
Photography	Photographic film	Photo prints	2 months	L. Schroeder LRC
Wind Speed, Direction	LTN-51 digital tape	Wind speed and direction listings	2 weeks	L. Schroeder LRC

3. NASA CV-990A

a. General Flight Plans. The CV-990A (Figure 4-12) is equipped with an airborne version of the Seasat Scanning Multifrequency



Figure 4-12. NASA CV-990A

Microwave Radiometer (SMMR). Table 4-8 lists remote sensing instrumentation aboard this aircraft. The CV-990A will measure emitted radiation from the ocean surface at five frequencies while flying within the 659-km-wide swath of the satellite's SMMR. The CV-990A is scheduled to make four flights during the period of September 11 to 16, 1978. The details of the data collection flights are shown in Figures 4-13 through 4-16.

The data collection schemes for all CV-990A flights call for the recording of continuous airborne SMMR observations at 35,000-ft altitude through the Seasat SMMR swath, with arrival times over either the Oceanographer or the Ocean Station PAPA weather ship at Satellite overpass times.

CV-990A data collection will continue through the swath until the aircraft reaches the swath's outer edge. A descent to 500 ft will be made, and data collection will continue at this altitude on the return leg. During return, the aircraft will measure surface winds using its Inertial Navigation System (INS), conducting INS calibration maneuvers each half hour. These maneuvers consist of a 5 deg right-bank 90 deg turn and a return to track at 5 deg left bank (Figure 4-17). Also during the return leg at 500-ft altitude, the aircraft will collect radiation data from airborne upward-looking radiometers.

b. Schedule. Because of Faraday rotation effects on the polarization of surface-emitted radiation, all but one flight of the CV-990A will be conducted during night-time hours when the ionospheric density is lowest, and rotational effects are at a minimum. These flights are shown in Figures 4-13 through 4-15. The single daylight flight will be conducted in the region of Ocean Station PAPA. The track for this flight is shown in Figure 4-16.

Table 4-8. Remote Sensing Instrumentation for CV-990A

Sensor	Measurement
Synthetic Aperture Radar L-Band	Wave directional spectra
Scanning Multichannel Microwave Radiometer Simulator 6.6, 10.6, 18, 21, 37 GHz	Sea surface temperature Surface winds Atmospheric water vapor and liquid water
Electronic Scanning Microwave Radiometer (ESMR) 19.35 GHz	Rain mapping
Microwave Radiometers, 21, 37 GHz upward looking	Atmospheric water vapor and liquid water
1.4 GHz Nadir Viewing	Exploratory
94, 183 GHz 45° to right side	Rain, water vapor
118 GHz 45° to right side	Atmospheric temperature profiles
PRT-5 Infrared Radiometer	Sea surface temperature
RC-9 Camera	Cloud cover, foam

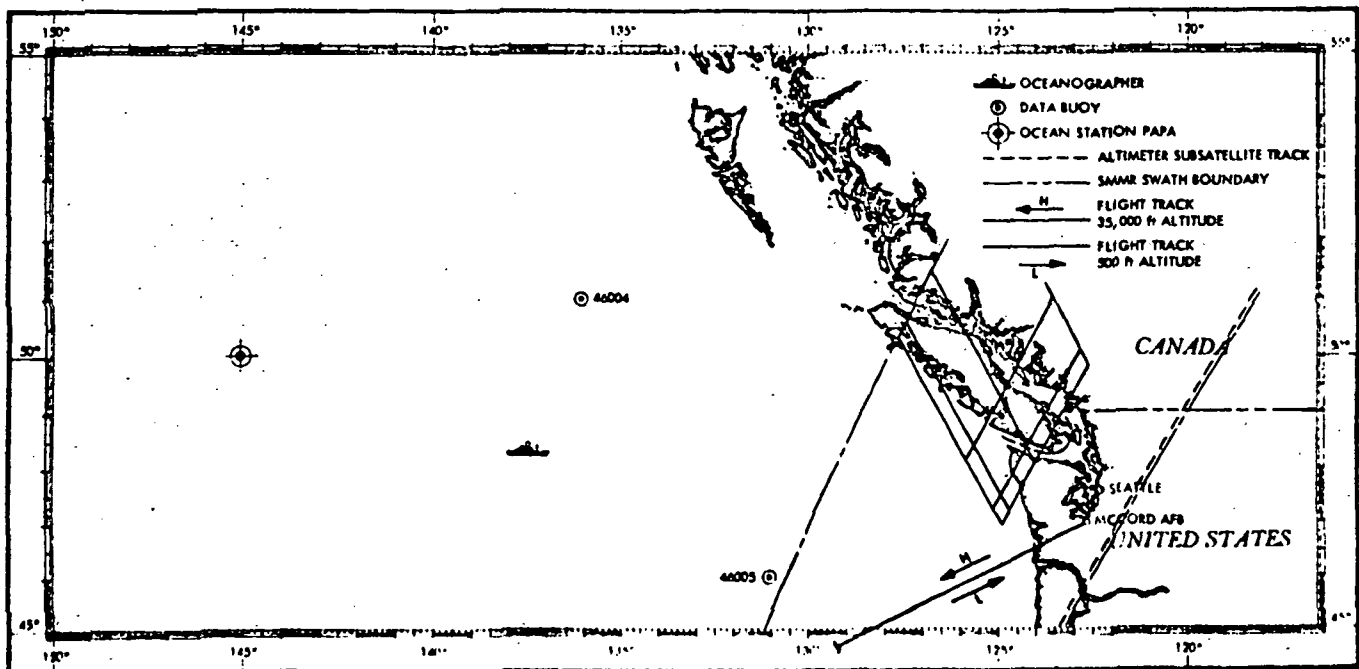

Figure 4-13. Flight Plan for CV-990A, Option 1

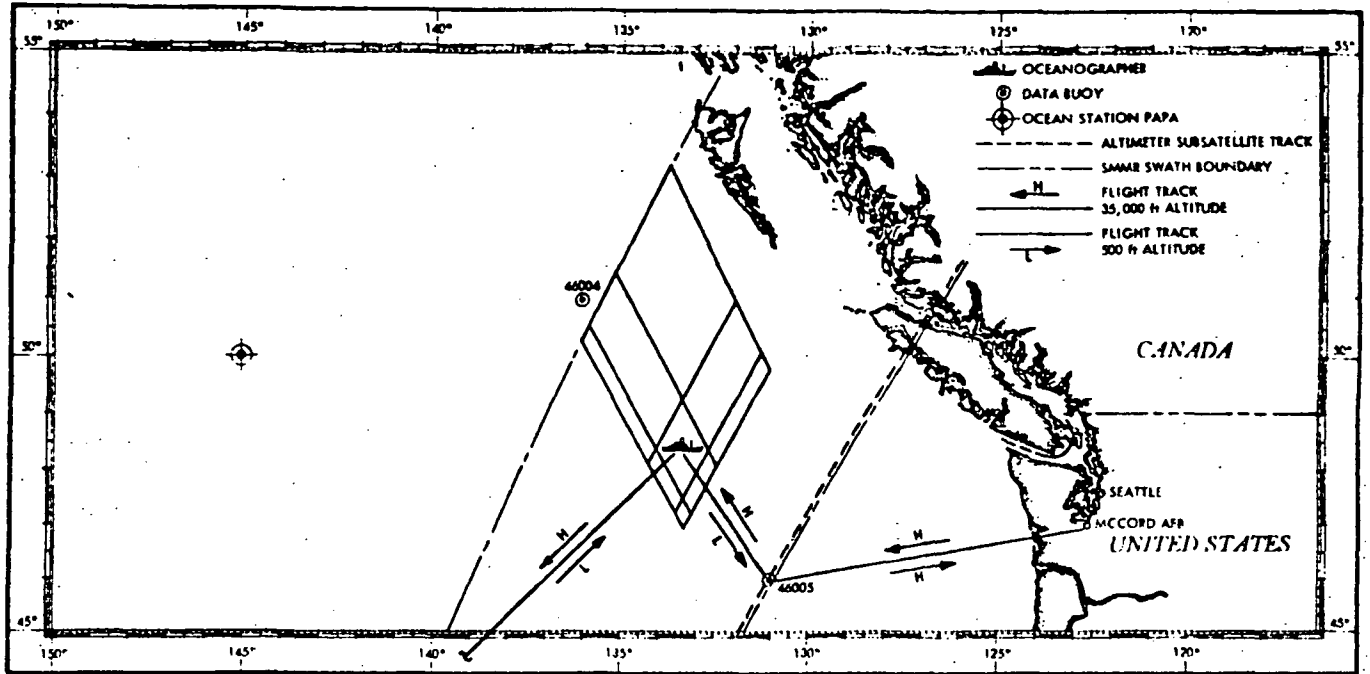

Figure 4-14. Flight Plan for CV-990A, Option 2

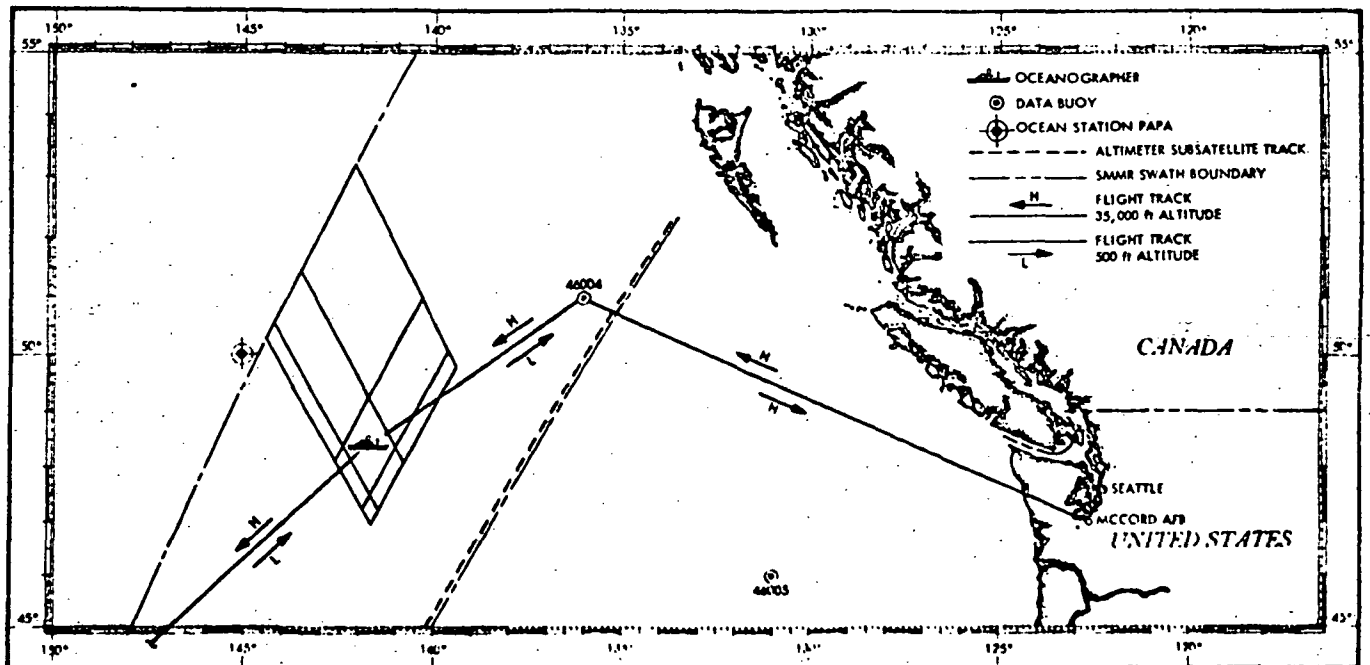

Figure 4-15. Flight Plan for CV-990A, Option 3

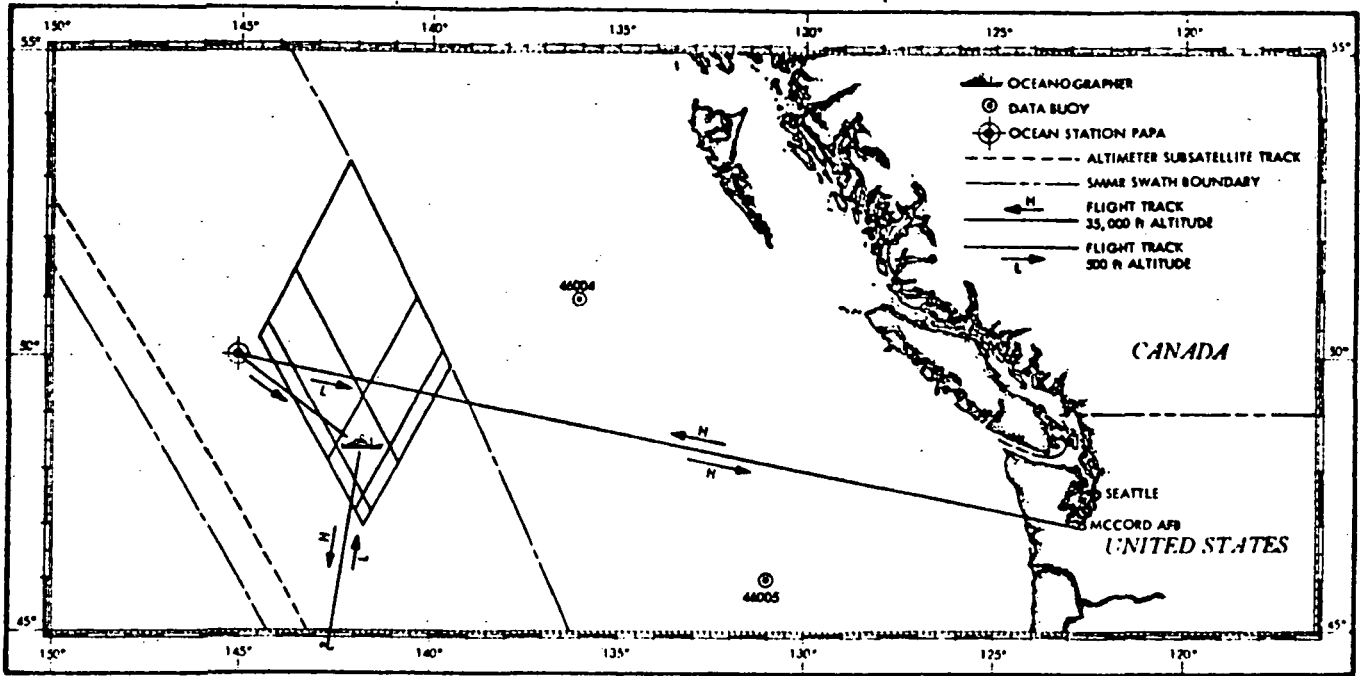

Figure 4-16. Flight Plan for CV-990A, Option 4

The flight dates and times possible under these restrictions are listed in Table 4-9, which identifies the night-time orbits (descending) covering the regions depicted in Figures 4-13 through 4-15, and the daytime orbits (ascending) required for coverage of Ocean Station PAPA.

the instruments' recorded output, the processing schedule, and the responsible individuals. The Chief Scientist aboard the CV-990A will be responsible for providing copies of all processed data to the Seasat Support Center, JPL, Pasadena, California.

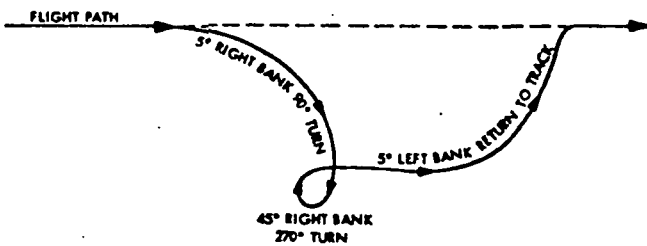

Figure 4-17. Inertial Navigation System Calibration Manuever

c. Data Observation Responsibilities. The observation plan for each type of data to be taken aboard the CV-990A is outlined in Table 4-10. This table specifies the recording method,

4. Navy RP-3A

a. General Flight Plans. The RP-3A (Figure 4-18) is instrumented with a five-frequency airborne radiometer system comparable to, but not identical with, the airborne system being flown by the NASA CV-990A. Table 4-11 lists remote sensing instrumentation aboard this aircraft. The RP-3A is scheduled to make eight flights during the period September 18 to 28, 1978. Four of these flights will be in the area of Ocean Station PAPA. The remaining four flights will be carried out in the region between Ocean Station PAPA and the U.S.—Canadian Coast. Details of these flight plans are shown in Figures 4-19 through 4-22.

Table 4-9. Flight Day Opportunities for CV-990A

Day	Orbit	Time (GMT) at 50°N
11 Sept	none	
12 Sept	1106 1112	0828 1814
13 Sept	1120	0759
14 Sept	1134	0730
15 Sept	1149 1155	0840 1825
16 Sept	1163	0811

Table 4-10. Observation Plan for CV-990A

Data Type	Recording Method	Recorded Output	Processing Schedule	Responsible Individual
Microwave Radiation, Scanning 6.6, 10.6, 18, 22.2, 37 GHz	Digital 9-track tape recorder	Brightness temperature 20 samples/s	6 months	T. Wilheit GSC
Microwave Radiation, Upward 21, 37 GHz	Digital 9-track tape recorder	Brightness temperature 20 samples/s	6 months	T. Wilheit GSC
Microwave Radiation Upward 21, 37 GHz	Digital 9-track tape recorder	Brightness temperature 20 samples/s	6 months	T. Wilheit GSC
Microwave Radiation, Fixed Angle 94, 183 GHz	Digital tape cassette, digital 9-track tape recorder	Brightness temperature 20 samples/s	6 months	T. Wilheit GSC
Microwave Radiation, Fixed Angle 118 GHz	Digital tape cassette, digital 9-track tape recorder	Brightness temperature 20 samples/s	6 months	T. Wilheit GSC
Microwave Radiation (ESMR) Scanning, 19.35 GHz	Digital 9-track tape recorder	Brightness temperature 20 samples/s	6 months	T. Wilheit GSC
Infrared Radiation 9.5 - 10.5 μ	Airborne digital data acquisition system	Instantaneous value every 10-s	List-immediately digital tape - 2 month	E. Peterson ARC
Radar Imagery, L-Band Synthetic Aperture	Optical recorder	Film	1 month	R. Jordan JPL
Photography	Photographic film	Photo prints	1 month	T. Wilheit GSC

APPENDIX E

FALL 1978 CV-990 NIMBUS G/SMMR MISSION

Ames Research Center
Moffett Field, California
94035

Reply to Attn of:

SEM:211-12

October 6, 1978

TO: Distribution

FROM: Earl V. Petersen, CV-990 Project Manager

SUBJECT: The Fall 1978 -- CV-990 NIMBUS-G/SMMR Mission
Bulletin No. 1 - Flight Requests, Schedule, Bases of
Operation, Passports, Coordinators, Arctic Clothing,
and Hotel Reservations

This bulletin announces the Fall 1978 -- CV-990 NIMBUS-G/SMMR Mission
(NIMBUS-G Mission).

1.0 FLIGHT REQUESTS

The CV-990 NIMBUS-G Mission is an integrated program supporting several flight requests which have a common set of sensors and flight requirements. The CV-990 NIMBUS-G Mission FY 1979 OSTA Flight Requests are as follows:

#0311 Multipurpose Short Pulse Radar;
P.I. - D. M. LeVine, NASA/GSFC
(No flight hours assigned)

The objectives are as follows:

1. To demonstrate the feasibility and practicality of a real aperture, non-imaging microwave technique for routine measurements of ocean wave directional spectra and surface wind speed from high-altitude aircraft and satellites.
2. To acquire sea ice, snow, and ice sheet signatures in vertical soundings and side-looking imagery. This cryospheric data will be used (1) to assess potential of remote active microwave sensing of ice physical parameters, and (2) to support the CV-990 Fall Microwave Experiment (FR #0714), principally with side-looking imagery.

This experiment will concentrate on the development, operation, and data analysis of the Short Pulse Radar (13.9 GHz).

The flight areas required by Flight Request #0714 are adequate to meet the flight objectives of #0311; thus, no dedicated flights for this request are planned.

#0655 Multispectral Studies of the Freeze-Thaw
 Line, Surface Water, and Lake Ice;
 P.I. - D. K. Hall, NASA/GSFC
 (One flight; 6 flight hours)

The objective is to study the hydrology of the North Slope of Alaska and to provide more information so that the volume of surface water contained on the North Slope can be estimated. Active and passive microwave data will be used to attempt ice thickness determinations on some of the larger thaw lakes on the North Slope. Signatures of frozen and unfrozen tundra will be determined using passive microwave data. Overflow river ice, or augeis, will be overflowed and its extent and volume determined by analysis of stereo air photos. The extent and volume will be compared with results obtained in 1978 utilizing aircraft and satellite data.

The sensors required are common to those listed under Flight Request #0714.

This request requires one dedicated data flight over several rivers and lake test sites on the North Slope of Alaska. This flight can be easily integrated into the overall flight schedule of Flight Request #0714.

#0714 SMMR Underflights for Ocean/Atmosphere Parameters
 and New Sea Ice Signatures;
 P.I. - P. Gloersen, NASA/GSFC
 (18 flights; 104 flight hours)

The objectives are as follows:

1. Obtain multispectral microwave radiometric and other supporting data to be used in calculating offsets, retrieval algorithms and constants for spacecraft (S/C) SMMR open ocean, atmosphere, and sea ice (particularly new sea ice) parameters. Aircraft (A/C) underflights using the A/C simulator and other support instruments are essential for proper S/C SMMR radiometric calibration and adjustment of geographical parameter retrieval algorithm constants.
2. Obtain sufficiently large and varied data set to permit an initial assessment of the accuracy of the sea ice retrieval algorithm. The present A/C data set is not sufficient for verifying the functional form of the sea ice parameter retrieval algorithm.

3. Obtain a sufficiently large and varied data set to permit an initial assessment of the accuracy of the sea surface, temperature retrieval algorithm, including comparison with Airborne Expandable Bathy Thermograph (AXBT) data. Aircraft SMMR data in areas known to be free of Radio Frequency Interference (RFI) for the S/C SMMR are required, along with detailed ocean surface truth (e.g., AXBT's) in order to establish the accuracy of the SST retrieval algorithm.
4. Obtain data to determine retrievable continental ice sheet parameters. Based on the existing A/C SMMR data set for the Greenland ice sheet, present concepts of the retrievable parameters developed from analysis of NIMBUS-5 ESMR and P-3 Multifrequency Microwave Radiometer (MFMR) data do not appear entirely appropriate. Additional A/C SMMR data obtained in different locations on the ice sheet and with different temperature profiles are required to establish the ice sheet parameters that may be retrieved.
5. Obtain a sufficiently large and varied data set to permit an initial assessment of the accuracy of the algorithm to obtain near-surface wind (NSW) speeds over oceans (cold ocean case). Aircraft underflights for NSW speed data sets are required, over and above those acquired during the 1978 CV-990 hurricane expedition. These are needed to obtain additional data from sufficiently large samplings and variations of sea/atmosphere conditions for proper evaluation of NSW retrieval accuracies.
6. Obtain additional data for radiometric calibration of the S/C SMMR.

To meet the objectives, the P.I. (P. Gloersen) will make the necessary arrangements to provide sensor systems as follows:

- (1) Aircraft SMMR (Scanning Multichannel Microwave Radiometer) Simulator (6.6, 10.7, 18, 21, and 37 GHz); NASA/GSFC.
- (2) Microwave Radiometers (1.4 and 94 GHz); NASA/GSFC.
- (3) Short Pulse Radar (13.9 GHz); NASA/GSFC (supported by Flight Request #0311).
- (4) Ocean Temperature Scanner; NASA/GSFC.
- (5) Downward Viewing Infrared (10-micron) PRT-5 Radiometer; NASA/ARC.
- (6) Aerial Cameras; NASA/ARC.

This request required sufficient flights to acquire a satisfactory data set for first-year thin ice, multiyear ice, ice concentration under initial annual ice canopy growth conditions, sheet ice, sea surface temperature (SST), and near-surface winds (NSW). To acquire the data set, several flight areas and test sites have been requested as follows:

1. Canadian Archipelago Test Sites (sea ice).
2. Arctic Ocean (multiyear ice).
3. Greenland Sea (sea ice and SST).
4. Greenland Test Sites (ice sheet).
5. Beaufort and Chuckchi Seas, and Baffin Bay (sea ice).
6. Norwegian Sea/Ocean Polar Front (SST).
7. Pacific Ocean and Gulf of Alaska (SST and NSW).

2.0 SCHEDULE

The CV-990 flights will be planned and coordinated primarily to underfly NIMBUS-G and, to the extent possible, SEASAT-A. Also, the flights will be coordinated with several ground-truth sites in Canada and Greenland, and with two aircraft -- a NOAA/RFC P-3 out off the Seattle area and a Norwegian P-3.

The general schedule that follows is based on the contingency of a successful NIMBUS-G (to be designated NIMBUS-7 in orbit) launch on October 23, 1978.

October

10 - 16 (Tue - Mon)	Experimenters' Equipment Installation and Ground Calibration
17 - 18 (Tue - Wed)	Aircraft Preflight
19 (Thur)	Pilot Proficiency
Oct 20 - Nov 19	Experimenters' Flight Period

The tentative flight schedule for the NIMBUS-G/SMMR underflights is as follows (specific flight dates may change because of NIMBUS-G and SEASAT-A orbital updates or weather conditions):

<u>Flight #</u>	<u>October</u>	
1	20 (Fri)	Experimenters' Check-out and Data Flight/Pacific Ocean. Moffett to Moffett.
2	24 (Tue)	Transit and Data Flight/Fresh and Salt Water Lakes, and Desert Calibration Test Sites. Moffett to Andrews AFB, Maryland.
3A, B	25 (Wed)	Transit, Sea Surface Temperature (SST) (Gulf Stream), and Sea Ice Data Flight/Atlantic Ocean and Baffin Bay. Andrews to Gander, Canada to Thule AB, Greenland.
4	27 (Fri)	Multiyear Sea Ice and Ice Sheet Data Flight/Arctic Ocean and Greenland. Thule to Thule.
5	28 (Sat)	Transit and Ice Sheet Data Flight/Greenland Test Sites. Thule to Sondrestrom, Greenland.
6	30 (Mon)	Transit, Ice Sheet, Sea Ice, and SST (Polar Ocean Front) Data Flight/Greenland Test Sites; Greenland and Norwegian Seas. Sondrestrom to Bodo, Norway.
	<u>November</u>	
7	1 (Wed)	SST (Polar Ocean Front) and Sea Ice Data Flight/Greenland and Norwegian Seas. (Flight to be coordinated with AXBT drops from Norwegian P-3 aircraft.) Bodo to Bodo.
8A, B	2 (Thur)	Transit Flight (a.m.)/Bodo to Bergen, Norway. Aircraft on Display. Transit Flight (p.m.)/Bergen to Bodo.

<u>Flight #</u>	<u>November</u>	
9	3 (Fri)	Same as Flight #7 Above. Bodo to Bodo.
10	6 (Mon)	Transit, SST (Polar Ocean Front), Sea Ice and Ice Sheet Data Flight/ Norwegian and Greenland Seas, and Greenland Test Sites. Bodo to Thule.
11	7 (Tue)	Sea Ice Data Flight/Baffin Bay, and Canadian Eastern Shore and Inlet Test Sites. Thule to Thule.
12	8 (Wed)	Transit and Sea Ice Types Data Flight/ Canadian Archipelago and Beaufort Sea Test Sites. Thule to Fairbanks, Alaska (Port of Entry).
13	10 (Fri)	Sea Ice Types and Concentrations Data Flight/Chuckchi and Beaufort Seas, and Mackenzie Bay Test Sites. Fairbanks to Fairbanks.
14	11 (Sat)	Multispectral Studies of Freeze-Thaw Line, Surface Water, and Lake Ice (FR #0655)/North Slope of Alaska and Frozen Lakes Near Barrow. Fairbanks to Fairbanks.
15	12 (Sun)	Transit and SST Data Flight/Gulf of Alaska and Pacific Ocean. Fairbanks to Hickam AFB, Hawaii.
16	13 (Mon)	Nighttime SST Data Flight/Pacific Ocean. Hickam to Hickam.
17	16 (Thur)	Transit, SST, RFI (Aircraft and NIMBUS-G Intercomparison Test), and NOAA P-3 Coordination Data Flight/ North Pacific Ocean Buoy Test Site. (Flight to be coordinated with NOAA/RFC P-3 aircraft based at Seattle-Tacoma International.) Hickam to McChord AFB, Washington.

<u>Flight #</u>	<u>November</u>	
18	17 (Fri)	Near-Surface Winds (NSW) and P-3 Coordination Data Flight/North Pacific Ocean Buoy Test Site. McChord to McChord.
19	19 (Sun)	Transit, SST, NSW, Ocean, Atmosphere, and P-3 Coordination Data Flight/ North Pacific Ocean Buoy Test Site. McChord to Moffett.
	20 (Mon)	Ground Calibration of Microwave Systems and Start of Removal of Equipment.
	21 & 22 (Tue & Wed)	Unloading of Experimenters' Equipment.

3.0 BASES OF OPERATION

The bases of operation for the CV-990 NIMBUS-G Mission are as follows:

October 20 - 23	Moffett Field, California
October 24	Andrews AFB, Maryland
October 25 - 27	Thule AB, Greenland, Denmark
October 28 - 29	Sondrestrom AB, Greenland
October 30 - November 5	Bodo, Norway
November 6 - 7	Thule AB, Greenland
November 8 - 11	Fairbanks International, Alaska
November 12 - 15	Hickam AFB, Hawaii
November 16 - 18	McChord AFB, near Tacoma, Washington
November 19	Moffett Field, California

4.0 PASSPORTS

All participants traveling to Thule and Sondrestrom, Greenland, and Bodo, Norway with the CV-990 are required to have a passport.

5.0 COORDINATORS

5.1 The personnel who will coordinate the NASA-ARC support of this CV-990 program are as follows:

1. Earl V. Petersen - NASA/ARC CV-990 NIMBUS-G/SMMR Mission Manager and Mission Director.
(Commercial 415 965-5342*; FTS 448-5342*)
2. John O. Reller, Jr. - NASA/ARC CV-990 Assistant Mission Manager and Mission Director.
(Commercial 415 965-5392*; FTS 448-5392*)

5.2 Support personnel for this mission are as follows:

1. Curtis L. Muehl - NASA/ARC CV-990 Facility Manager who is responsible for the Airborne Digital Data Acquisition System (ADDAS), housekeeping system, aircraft system-experiment interfaces, and aircraft systems calibrations.
(Commercial 415 965-6431*; FTS 448-6431*)
2. Donald L. Wilson (Informatics) - CV-990 ADDAS Programming/Contract Supervisor.
(Commercial 415 965-6493; FTS 448-6493)
3. Seth S. Kurasaki - NASA/ARC CV-990 Program Engineer who is responsible for certification of the experiment equipment installation design and construction, and the installation of the equipment aboard the CV-990.
(Commercial 415 965-6320; FTS 448-6320)

6.0 ARCTIC CLOTHING

For the mission to Alaska, Greenland, and Norway, all flight personnel will be furnished parka and gloves. (Our supply of gloves has dwindled over the years; therefore, please try to furnish your own.) This clothing will be for general use in the cold climates; however, it will also be part of your aircraft arctic survival equipment. Thus, on all flights in Alaska, Greenland, and Norway, this clothing must be aboard the CV-990.

To facilitate issuance of this clothing, everyone who will participate in these flights will be contacted by John Reller to get his/her parka size. Remember, this clothing is U.S. Government property and must be returned to the Ames Research Center/Medium Altitude Missions branch at the completion of the mission.

*If no answer at this number, call 415 965-5336 or FTS 448-5336 and leave a message with the secretary.

7.0 HOTEL RESERVATIONS

Hotel reservations will be made for all personnel who will travel with the CV-990. The hotels and rates will be announced in an Experimenters' Notice.

Earl V. Petersen

Earl V. Petersen

Distribution:
Attached

DISTRIBUTION LIST

Medium Altitude Missions Branch

C. A. Syvertson	200-1
M. Bader	202-11
V. D. Reed	200-16
S. A. Miller	204-12
D. H. Dennis	200-4
M. A. Knutson	240-3
E. W. Gomersall	240-5
J. P. Miller	240-5

L. Roberts	200-3
D. E. Reese	211-17
F. J. Drinkwater	211-17
R. M. Reynolds	211-17
H. L. Turner	211-17
J. J. McLaughlin	211-17
R. H. Davidson	211-17
R. C. Innis	211-3
G. W. Stinnett	211-3
W. G. Stahl	211-3
F. P. Kosik	211-3
R. P. Gallant	211-3
C. J. Sewell	211-9
E. G. Mundwyler	211-5

L. G. Bright	200-5
R. E. Eddy	200-5
L. S. Stollar	204-6
E. R. Vernon	246-1

A. Giovannetti	213-1
R. P. Michaelis	203-6
J. A. March	203-6
B. G. Pongeggi (2)	203-6

S. Doiguchi	213-4
D. F. Engelbert	213-4
J. A. Hallam	213-4
S. S. Kurasaki	213-8
R. W. Morris	213-2
F. F. DeMuth	244-5

Air Force Systems Command Liaison Office

Lt. Col. M. S. Tavenner	206-3
-------------------------	-------

NASA Headquarters

S. W. Keller	ES-5
L. R. Greenwood	EB-8
B. T. Nolan	ESF-5
P. G. Thome	ER-2
S. W. McCandless, Jr.	EBC-8
B. G. Garner	LIC-17

Northrop Services, Inc./ARC

R. W. Legg	211-4A
E. C. Mitz	211-4A
G. H. Harner	211-4A
V. Nespolo	211-4A
C. H. Berg	211-4A
C. T. Schultz	211-4A
G. E. Frenzel	211-4A
B. B. Gray	211-4A
G. E. Gibson	211-4A
D. J. McKinnon	211-4A
J. Dyson	211-4A
A. A. Hill	211-4A
M. Svihovec	211-4A
R. Montour	211-4A
J. S. Edwards	211-4A
J. A. Goularte	211-4A

Systems Consultants, Inc./ARC

W. A. Cleveland	244-2A
-----------------	--------

Informatics, Inc./ARC

D. L. Wilson	248-1
J. C. Peck	248-1
S. M. Young	248-1
S. Lathrop	248-1
M. S. Kuo	248-1

Jet Propulsion Laboratory

J. A. Dunne	264-420
-------------	---------

NASA - Lewis Research Center

I. A. Lezberg	77-2
P. J. Perkins	77-2
D. C. Briehl	77-2

Distribution List

2

NASA - Goddard Space Flight Center

D. Atlas 910.0
P. Gloersen 910.0
J. Eckerman 946.0
T. T. Wilheit 946.0
D. M. LeVine 946.0
W. T. Walton 946.0
R. L. Kutz 946.0
C. D. Calhoon 946.0
J. L. King 946.0
F. C. Jackson 946.0
D. S. Smith 944.0
H. Z. Reed 944.0
J. Semyan 944.0
F. G. Huegel 944.0
A. T. C. Chang 913.0
D. K. Hall 913.0
H. J. Zwally 913.0
J. L. Mueller 913.0
P. S. Schopf 913.0
J. Crawford 913.0
W. L. Barnes 941.0
C. D. Mason 863.0
B. C. Diesen, Jr. 601.0

NOAA - Environmental Research Lab

W. N. Hess

NOAA - Research Facilities Center

C. E. Emmanuel
J. McFadden

NOAA - Sea-Air Interaction Lab

D. Ross

NOAA - Pacific Marine Environmental
Laboratory

N. Mognard

United Airlines

U. R. C. Gustafsson

Georgia Institute
of Technology

J. A. Stratigos
J. Schuchardt

Sense Systems, Inc.

J. J. Kirwan

U.S. Geological Survey

W. J. Campbell
J. A. Wayenberg

Department of Environment
Ottawa, Canada

R. O. Ramseier

University of Denmark
Lyngby, Denmark

P. Gudmandsen

University of Bergen
Bergen, Norway

O. Johonnesen

APPENDIX F

CALIBRATION ERROR CORRECTION

PROBLEM

Warmer temperatures ($\sim 30^\circ\text{K}$) were observed when looking at the scene with the 94 GHz channel of the radiometer system than were expected during the flight tests. The radiometer was reassembled upon return from the test flights. This same characteristic was present when viewing the liquid nitrogen load used in the lab. This load has been investigated both theoretically and experimentally to determine its brightness temperature which is $\sim 100^\circ\text{K}$.

POST FLIGHT LAB TEST

First the 94 GHz channel was calibrated with the liquid nitrogen load in front of the scene lens with and without the 183 GHz channel turned on. No significant change was seen in the apparent temperature of the liquid nitrogen load under these two conditions. This test was performed several times with the same results. Then the 94 GHz channel was loosened from its bracket. The 94 GHz antenna was moved to a slightly different angle and set firmly into the RF head. Calibration tests were again made with and without the 183 GHz channel turned on. It was found that by moving the antenna a brightness temperature of 100°K was observed both with and without the 183 GHz system turned on. These tests firmly indicate a slight misalignment of the antenna was the reason for the observation of the warmer than expected scene temperatures during the flight on the 94 GHz radiometer channel. It is thought that adjustments of the feed to obtain the proper polarization alignment for the 94 GHz channel produced the angular misalignment that may have contributed to this problem.

SOLUTION

During the tests no error was found when viewing a room temperature load through the scene lens. This should be expected considering the source of the error. If the antenna is partially viewing room temperature loads and a colder scene, then the scene would look warmer due to the partial contribution of the room temperature load. However,

if the antenna is viewing a room temperature load through the scene lens then partially viewing another room temperature load would have no effect on the apparent scene temperature. An error curve can be made which shows actual and observed temperatures if a linear error contribution is assumed. An example is shown in Figure F1.

An observed gain of 63.33°K per volt and an observed offset of -198.5°K were recorded following a typical calibration cycle. For this cycle the radiometer output voltage was +8.44 volts looking at the hot load (336°K) and the voltage was +7.24 volts looking at the cold load (260°K).

Using Equation [A] on Figure F1,

$$\begin{aligned} \text{Observed Gain} &= \frac{336^{\circ}\text{K} - 260^{\circ}\text{K}}{8.44\text{v} - 7.24\text{v}} \\ &= 63.33^{\circ}\text{K per volt} . \end{aligned}$$

Using Equation [B] on Figure F1,

$$\begin{aligned} \text{Observed Output} &= 336^{\circ}\text{K} - (8.44\text{v})(63.33^{\circ}\text{K per volt}) \\ &= -198.5^{\circ}\text{K} \end{aligned}$$

Using Equation [C] on Figure F1,

$$\text{Observed Output} = \frac{\text{Observed Temperature} + 198.5^{\circ}\text{K}}{63.33^{\circ}\text{K per volt}}$$

For an observed temperature of 130°K, Equation [C] yields an output of +5.19 volts ($V_{130/100}$) and for a temperature of 250°K the output is +7.08 volts (V_{250}).

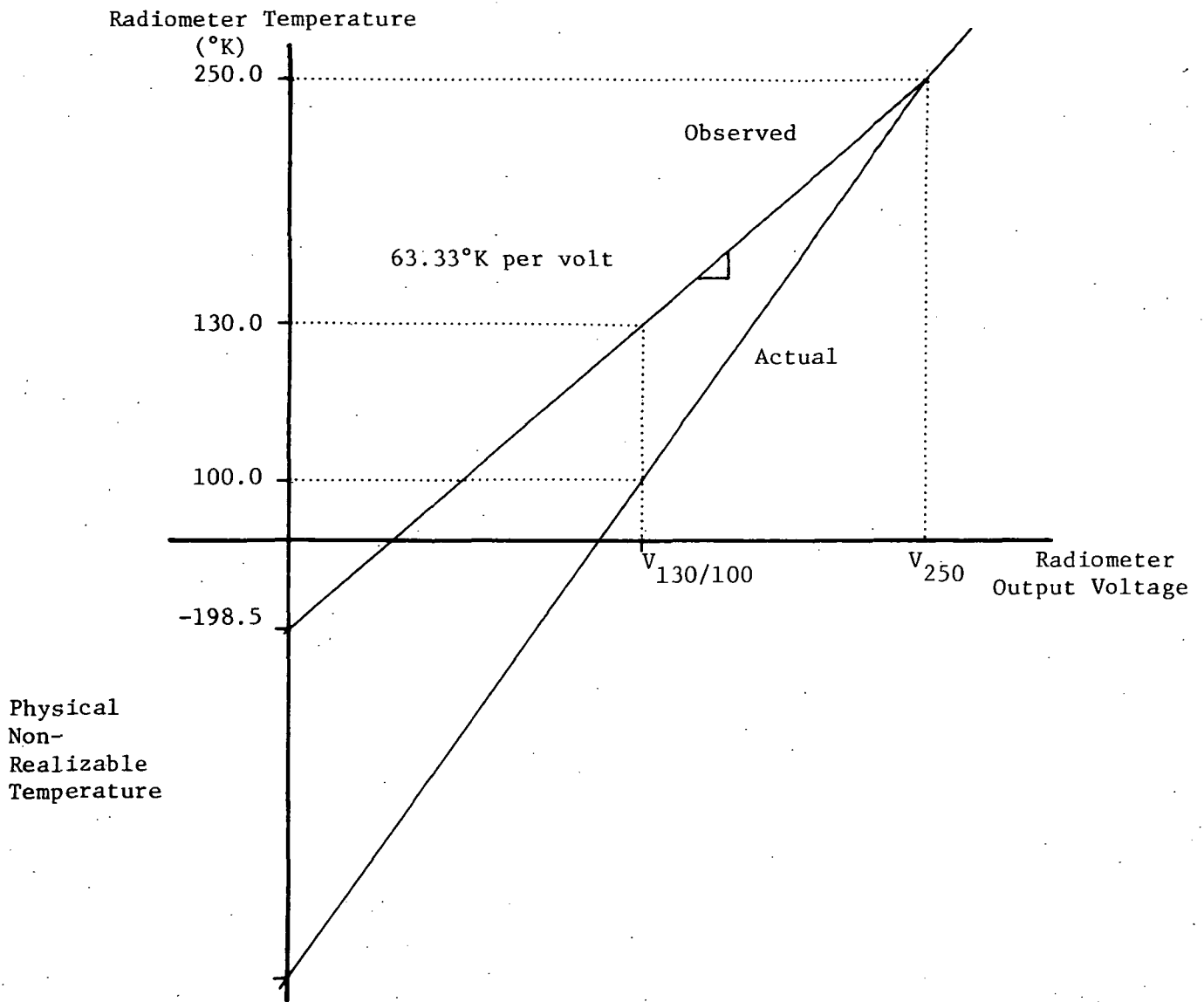

$$\text{Gain (}^\circ\text{K per volt)} = \frac{T_2 - T_1}{V_2 - V_1} \quad [A]$$

$$\text{Offset (}^\circ\text{K)} = T_2 - (V_2)(\text{Gain}) \quad [B]$$

$$\text{Output (volts)} = \frac{\text{Temperature} - \text{Offset}}{\text{Gain}} \quad [C]$$

Figure F1. Observed Radiometer Temperature Curve versus Actual Radiometer Temperature Curve for the 94 GHz Channel Only.

From Figure F1 the gain and offset for the actual radiometer temperature can now be computed.

Using Equation [A] on Figure F1,

$$\begin{aligned}\text{Actual Gain} &= \frac{250^{\circ}\text{K} - 100^{\circ}\text{K}}{7.08\text{v} - 5.19\text{v}} \\ &= 79.37^{\circ}\text{K per volt}\end{aligned}$$

Using Equation [B] on Figure F1,

$$\begin{aligned}\text{Actual Offset} &= 250^{\circ}\text{K} - (7.08\text{v})(79.37^{\circ}\text{K per volt}) \\ &= -311.9^{\circ}\text{K}\end{aligned}$$

The actual temperature as a function of the observed voltage output is given by:

Using Equation [D],

$$\text{Actual Temperature} = (79.37^{\circ}\text{K per volt})(\text{Observed Output Voltage}) - 311.9^{\circ}\text{K}$$

Typical temperatures are tabulated below for output voltages observed.

<u>Observed Output (volts)</u>	<u>Actual Radiometer Temperature (°K)</u>
+7.08	250
+5.57	130
+5.19	100
+4.31	30
+3.93	0

Equation [D] above should be updated with each calibration cycle as new Gain and Offset constants are calculated.

APPENDIX G

CARTRIDGE TAPE DATA FORMAT

CARTRIDGE TAPE DATA FORMAT

Data from the four radiometer channels along with various housekeeping parameters were recorded in fixed length blocks using a modified ANSI standard recording format*. Each block of data contains 2048 bytes of information which results from approximately 25 seconds of radiometer operation. The Nimbus-G flight data (94 GHz only) were recorded every 100 seconds. Each block of data is preceded by a preamble and followed by a 16 bit CRC (Cyclic Redundancy Check) character and a postamble. The preamble consists of 4 bytes of 00_{16} followed by a 55_{16} and then the ANSI standard preamble of 00_{16} , 01_{16} (15 zero bits followed by a 1). The 2048 bytes of data are then followed by a 16 bit CRC character computed with the CRC polynomial:

$$X^{16} + X^{12} + X^5 + X^1 + 1$$

Following the CRC character is the postamble consisting of a 1 followed by 15 zeros (80_{16}). Figure G1 illustrates the data block format. Blocks are separated by the ANSI standard inter-record gap.

DATA BLOCK FORMAT

The first 19 bytes of each data block contain housekeeping data that is recorded only once per block. The remainder of the block contains samples of the outputs of the four phase sensitive detectors on the four radiometer channels. These data repeat every 16 bytes. Table G1 lists the various parameters in the data block. Note that all voltages (load temperatures and radiometer temperatures) are 12 bit values in 2 bytes with the most significant 4 bits always zero. All temperatures are represented as 0-10 Vdc values with 0000_{16} corresponding to 0 volts and $0FFF_{16}$ corresponding to 10.0 volts. The section of this appendix on calibration explains how to convert these voltages to temperatures.

* American National Standards Committees, X3, X4, "Recorded Magnetic Tape Cartridge for Information Interchange," April 1975.

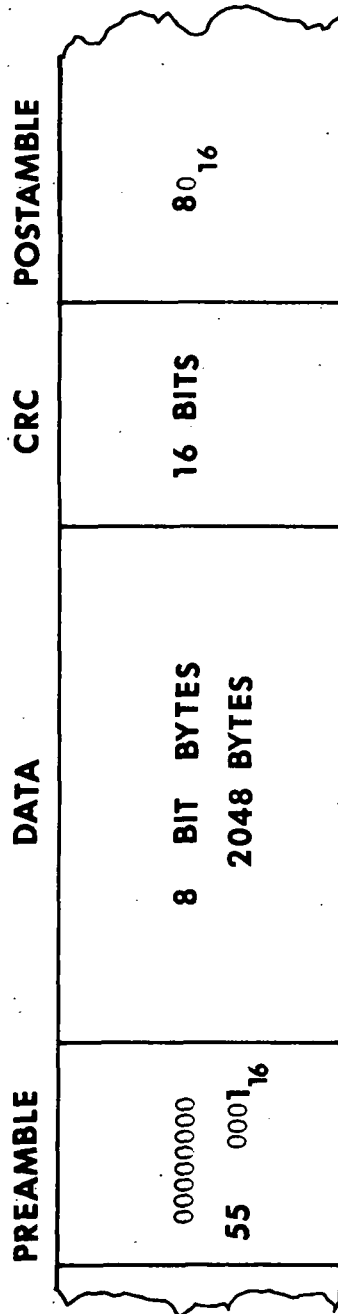

Figure G1. Magnetic Cartridge Tape Format.

TABLE G1

CONVAIR 990 183/94 GHZ RADIOMETER DATA BLOCK FORMAT

<u>BYTE NO.</u>	<u>CONTENTS</u>	<u>COMMENT</u>
0	Block Number (High)	Most Significant Byte
1	Block Number (Low)	Least Significant Byte
2	Day (High)	Julian Date
3	Day (Low)	Julian Date
4	Flight Num.	
5	Hours	Time of Start of Block
6	Minutes	Time of Start of Block
7	Seconds	Time of Start of Block
8	Block ID	
9	Hot Load Temp. (High)	
10	Hot Load Temp. (Low)	
11	Cold Load Temp. (High)	
12	Cold Load Temp. (Low)	
13	Reference Load Temp. (High)	
14	Reference Load Temp. (Low)	
15	Klystron Temp. (High)	
16	Klystron Temp. (Low)	
17	Spare Temp. (High)	
18	Spare Temp. (Low)	
19	Channel 0 (High)	183 GHz, 1 GHz IF
20	Channel 0 (Low)	
21	Channel 1 (High)	183 GHz, 5 GHz IF
22	Channel 1 (Low)	
23	Channel 2 (High)	183 GHz, 10 GHz IF
24	Channel 2 (Low)	
25	Channel 3 (High)	94 GHz
26	Channel 3 (Low)	

TABLE G1 (CONT'D.)

CONVAIR 990 183/94 GHz RADIOMETER DATA BLOCK FORMAT

<u>BYTE NO.</u>	<u>CONTENTS</u>	<u>COMMENT</u>
27	Channel 0 (High)	
28	Channel 0 (Low)	
29	Channel 1 (High)	
30	Channel 1 (Low)	
31	Channel 2	
32	Channel 2	
33	Channel 3	
34	Channel 3	
2047	Sequence Repeats	

HOUSEKEEPING DATA

Bytes 0-1: Block Number (Binary)

This number represents the block count of the total number of data blocks recorded since the data collection system was initialized. In the event of a power failure or system failure during a flight this number will be reset to zero. It will also be reset at the start of a new track.

Bytes 2-3: Julian Date (BCD)

This number is entered manually into the system during initialization. Due to equipment problems this data may be incorrect (i.e. 0000) on some tapes. It should be always verified against the flight number.

Byte 4: Flight Number (BCD)

The flight number was also entered manually and is correct on all tapes.

Bytes 5-7: Time (BCD)

These bytes contain the GMT time (hours, minutes, seconds) of the start of the data block. In order to determine the time of a particular radiometer output sample, add 100 ms for each four channel cycle.

Byte 8: Block ID

This byte indicates where the radiometer was looking during a particular block. Table G2 illustrates possible values of block ID and their meaning. Note that during normal operation a block ID of 80_{16} indicates a calibration block containing hot load, cold load and "outside" temperature data.

Bytes 9-18: Load Temperatures

The temperature of the hot load, cold load, reference load, klystron and a spare thermistor channel are recorded as 12 bit values corresponding to the voltage developed by a linear thermistor sensor.

TABLE G2
BLOCK ID CODE

BIT MAP

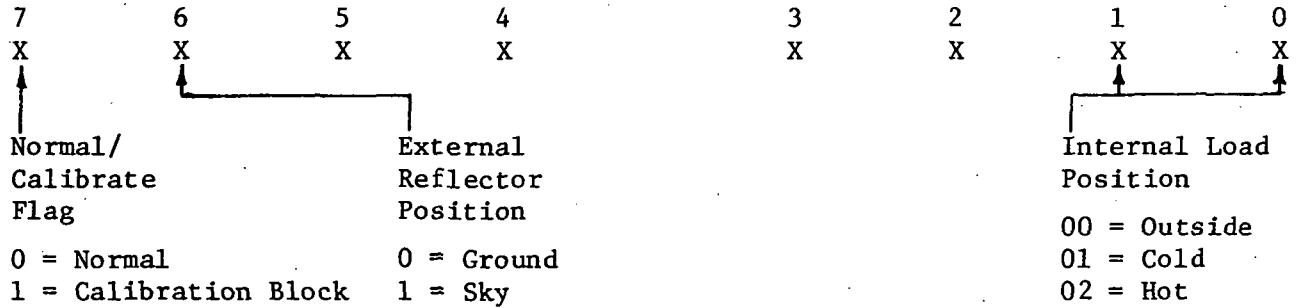

Normal ID Codes

BLOCK ID (HEX)	MEANING
00	Normal Operation Viewing Ground
40	Normal Operation Viewing Sky
80	Calibration Frame Viewing Ground
C0	Calibration Frame Viewing Sky

NOTE: Other codes indicate abnormal operation such as interruption of calibration sequence.

CALIBRATION

In order to convert the radiometer output voltages from the cartridge tape data, GSFC Interdata tapes or the ADDAS tapes into brightness temperatures they must be scaled by the appropriate calibration data. This is accomplished by examining the data blocks for a block ID of 80₁₆ which denotes a block containing both hot and cold load calibration cycle at intervals of either 3 or 5 minutes. The calibration interval was variable in 1 minute intervals by the operator but was usually set at 3 or 5 minutes depending on a particular flight plan. Under normal operation the radiometer collected data for 25 seconds and wrote the data on tape for 2 seconds. An internal timer set a calibration flag on the whole minute when the calibration interval had elapsed. Since it was desirable to start the calibration at the beginning of a 25 second data collection cycle, the calibration cycle was not initiated until the start of the next cycle. Thus, the actual calibration interval could vary up to approximately 3 minutes, 27 seconds. Once a calibration cycle was initiated, the cold and hot loads were each viewed for six seconds to allow time for the PSD outputs to settle. The radiometer integration time was 0.2 seconds. Switching time was one second for outside to cold and for cold to hot and 2 seconds for hot to outside. The entire cycle thus took 16 seconds. In order to extract calibration data from a data block it is necessary to examine the first 16 seconds (160 samples) of data in order to pick out the peak of the cold and hot calibration cycles.

CONVERSION CONSTANTS

To convert the load temperature voltages into degrees Kelvin, the constants in Table G3 should be used. The binary number from the data block must first be converted to volts by multiplying by 1/4096 volts/bit or 2.44 mV/bit then use the constants in Table G3 to convert to temperature. Figure G2 shows a printout of a typical data block and its interpretation. Once the load temperatures are known, it is then necessary to extract the peak PSD output voltage for each channel when the radiometer was viewing the cold and hot loads, convert these data to voltage and then use this information to obtain the point-scope calibration formula for each channel. Table G4 shows a sample calibration example.

TABLE G3
THERMISTOR CALIBRATION CONSTANTS

	Gain (°K/Volt)	Offset (°K)
Cold Load	-10	323
Hot Load	-10	373
Reference Load	-10	373
Klystron	-10	373

Example: Hot Load Data = $05D8_{16} = 1496$

$1496 \times 2.44 \text{ mV/BIT} = 3.65 \text{ Volts}$

$(3.65 \text{ Volts} \times -10 \text{ °K/Volt}) + 373\text{°K} = 336.5\text{°K}$

```

00 05 02 78 17 23 28 57 00 05 08 07 51 0B 72 09
BD 08 4A 0A E5 0B 8B 0B 05 09 3D 0A EC 0B 84 0A
FE 09 39 0A E4 0B 85 0A F9 09 3B 0A E3 0B 85 0A
F9 09 3A 0A EB 0B 8A 0A F3 09 3D 0A F0 0B 83 0A
FB 09 3B 0A F1 0B 89 0B 05 09 3B 0A EF 0B 8A 0B
11 09 39 0A E5 0B 88 0B 1B 09 36 0A DA 0B 85 0B
1F 09 37 0A D6 0B 86 0B 16 09 3B 0A C5 0B 86 0B
15 09 3B 0A BE 0B 86 0B 10 09 38 0A B5 0B 8E 0B
07 09 3C 0A B2 0B 8A 0B 05 09 38 0A AB 0B 87 0B
05 09 3B 0A B1 0B 85 0B 04 09 39 0A B2 0B 89 0B
02 09 3A 0A AE 0B 84 0A FE 09 39 0A B1 0B 85 0A
FE 09 39 0A AF 0B 84 0A FE 09 3A 0A B2 0B 85 0B
03 09 3B 0A C1 0B 80 0A FF 09 3A 0A CE 0B 83 0B
09 09 3B 0A DA 0B 81 0B 0C 09 35 0A E5 0B 86 0B
0D 09 37 0A F4 0B 85 0B 09 09 38 0A F7 0B 83 0B
09 09 38 0A FB 0B 85 0B 01 09 3B 0A F8 0B 88 0A
FF 09 36 0A EE 0B 86 0B 04 09 36 0A E2 0B 8A 0B
0A 09 39 0A D0 0B 87 0B 0A 09 3B 0A B8 0B 86 0B
05 09 3C 0A B6 0B 84 0B 0B 09 3D 0A B6 0B 83 0B
0D 09 3D 0A BC 0B 86 0B 05 09 3C 0A B6 0B 83 0B
01 09 3C 0A BA 0B 83 0B 02 09 3E 0A C0 0B 81 0B
06 09 3D 0A D0 0B 81 0B 0C 09 3E 0A DE 0B 82 0B
0E 09 3C 0A DC 0B 82 0B 0C 09 3F 0A DE 0B 83 0B
04 09 3B 0A E4 0B 85 0A FC 09 3B 0A E7 0B 81 0A
F9 09 39 0A E7 0B 86 0A F9 09 3A 0A DF 0B 85 0A
FE 09 3A 0A DF 0B 84 0B 03 09 3A 0A E1 0B 85 0B

```

BLOCK NUMBER: 0005
JULIAN DATE: 278
FLIGHT NUMBER: 17
TIME (GMT): 23:28:57
BLOCK ID: 00

Hot Load Voltage: $05D8_{16} = 1496 \times 2.44 \text{ mV/BIT} = 3.65 \text{ Volts}$
Cold Load Voltage: $0751_{16} = 1873 \times 2.44 \text{ mV/BIT} = 4.57 \text{ Volts}$
Reference Load Voltage: $0B72_{16} = 2930 \times 2.44 \text{ mV/BIT} = 7.15 \text{ Volts}$
Klystron Voltage: $09BD_{16} = 2493 \times 2.44 \text{ mV/BIT} = 6.08 \text{ Volts}$
Spare Voltage: $084A_{16} = \text{Not Used}$

Figure G2. Data Block Decoding

TABLE G4
RADIOMETER CALIBRATION EXAMPLE

Hot Load Temperature = 336.5°K (T_{HOT})

Cold Load Temperature = 250.0°K (T_{COLD})

PSD Voltage When Viewing Hot Load = 7.54 Volts (V_{HOT})

PSD Voltage When Viewing Cold Load = 6.23 Volts (V_{COLD})

$$\text{Gain} = G = \frac{T_{\text{HOT}} - T_{\text{COLD}}}{V_{\text{HOT}} - V_{\text{COLD}}} = 66.03^{\circ}\text{K/Volt}$$

$$\text{Offset} = 0 = T_{\text{HOT}} - G V_{\text{HOT}} = 336.5 - 497.9 = -161.4^{\circ}\text{K}$$

$$T_{\text{RAD}} = V_{\text{RAD}} G + 0 = V_{\text{RAD}} (66.03^{\circ}\text{K/Volt}) - 161.4^{\circ}\text{K}$$

APPENDIX H

LOG OF CONVAIR 990 94/183 GHz RADIOMETER

APPENDIX H

FLIGHT LOG OF CONVAIR 990 94/183 GHz RADIOMETER

FLIGHT	DAY	LOCATION	TIME	COMMENTS
07	8/11/78	San Juan, PR Hurricane Cora	16:08:59	Take Off
			16:12:21	Data on, looking up
			16:16	Power failure
			16:39	Adjusted offsets, looking up
			16:43	Entered clouds at fringes of Cora
			16:45	Some TACAN at 1,2 GHz
			16:52	Severe turbulence and drop in temperature on all channels
			16:56	1 GHz stuck at 10 volts.
			17:00	Back on, bad connection on offset pot
			17:19	TACAN, 1,2 GHz
			17:25	RFI at 1 GHz
			17:28	Turbulence and drop of 100° on 94 GHz
			17:34	Rain
			16:54	16:54 16:55 ADDAS plots
				17:25 17:35 ADDAS plots
			18:00	Track 02
			18:14	Until 18:17 rain
			18:19	Until 18:22 rain
			18:27	135° at 94 GHz. Coldest yet
			18:34	Rain
			18:43	Rain
			18:52	TACAN at 1 GHz
			19:04	Switched up for wingover (WO)
			19:11:07	WO at 25,000 feet
				Last block 02-00AE

APPENDIX H

FLIGHT LOG OF CONVAIR 990 94/183 GHZ RADIOMETER (continued)

FLIGHT	DAY	LOCATION	TIME	COMMENTS
08	8/13/78	San Juan-Homestad	14:11:41	Take off, start data on track 02 Block 00AF
			14:31:20	Data on
			14:32:21	Restarted, looking up during climb
			14:41:12	System restart
			14:35	Switched down
			14:47	TACAN 1 GHz
			15:17	Adjust 10 GHz to match ADDAS
			15:21	Bad RFI on 10 GHz
			15:55	Data started
			15:56	Tuned 94 GHz
			16:00	30° left spiral from 35,000 feet started descent with left turns, clear air, begin plot
			16:06	Holding at 24,000 feet
			16:10	Altitude 18,000 feet
			16:12	RFI at 10 GHz
			16:18:58	500 feet altitude
09	9/10/78	Moffett-Moffett	04:34:40	Data on, Tape #4, Track 00
			04:36:40	Data off
			04:38:51	Data on
			04:46:12	Data off
			04:52:54	Data on
			04:53:16	Begin satellite underflight data run. Radiometer viewing sky
				183 GHz okay, 94 GHz has problems
				Checked 94 GHz attenuator and bias - OK

APPENDIX H

FLIGHT LOG OF CONVAIR 990 94/183 GHZ RADIOMETER (continued)

FLIGHT DAY	LOCATION	TIME	COMMENTS
09	9/10/78 Moffett-Moffett	06:16:44 06:16:45	Altitude 20,000 feet Begin 90° WO looking at sky Saw temperature rise on 183 GHz, left spiral
		6:39:30	Fly at low altitude (1,000 feet)
		7:11:00	Switch Radiometer to viewing ground System bombs, * reboot and start data collection. System bombed when switched to track 01
		8:11:22	Data on
		8:30:30	Start altitude climb, radiometer temperature rise
		8:59:30	Data collection off. Tape status: Track 01, Block 00
12 A,B	9/14/78 Moffett-McCord	21:27:26 22:52:00 05:04:37	Begin flight Ascent begins, data on, looking at sky Data collection on Interference at 1 GHz, repetitive
		05:18:40	94 GHz drops temperature over water
		05:48:35	Altitude 32,000 feet
		06:49:00	Data collection off
		07:45:39	Data collection on, terminal problems
		08:06:44	Terminal is back on, problem appears to be intermittent
		08:13:00	Switch to sky Data off

*Software conflict between system status printout and calibration. Radiometer continues to collect data and send to ADDAS.

APPENDIX H

FLIGHT LOG OF CONVAIR 990 94/183 GHZ RADIOMETER (continued)

FLIGHT	DAY	LOCATION	TIME	COMMENTS
18	11/17/78	McCord-McCord	19:14:00	Take off, tape #9, block 03.
			22:11:00	Looking up. Saw change of 250° to 200°. May be rain overhead.
			22:30:00	Down looking
			22:40:00	Passing through rain. Saw 50°
			22:48:00	Change in down looking 94 GHz temperature
			22:49:00	Big temperature increase, 210° - 280°
			22:58:00	Uplooking
			23:02:00	Rain
			23:11:00	Climbing out of rain
			23:34:00	Down looking
			23:38:00	94 GHz temperature display is indicating in hex. Also showing low temperature.
			00:43:05	Rebooted system
				W0. 33° coolest temperature
19	11/19/78	McCord to Moffett	19:24:00	Take off. Uplooking
			20:07:00	Restart system
			21:37:00	30° spiral to right, switched up then back down
			21:48:00	500 feet
			21:50:00	Alternating between up and down at 60 second intervals
			22:00:00	Switching to 5 minute up/down intervals
			23:58:00	W0. 23° on display

APPENDIX H

FLIGHT LOG OF CONVAIR 990 94/183 GHZ RADIOMETER (continued)

FLIGHT	DAY	LOCATION	TIME	COMMENTS
17	10/5/78	Hurricane Rosa	22:50:00	Adjusted gains and offsets, gain at 5 GHz and 2 GHz is now a little low
			23:26:00	Start data looking down
			23:30:00	Some TACAN at 1 GHz
			00:00:00	Adjusting frequency of klystron
			00:51:00	Passing 90 miles west of eye of Hurricane Rosa
			01:04:00	System bombed
			01:10:00	Restarted
			01:46:00	Rain on 94 GHz
			02:00:00	Tape on track 01, wrong track
			02:30:00	Switched to track 03
04:13:12	WO at 25,000 feet			
18	10/6/78	Miramar-Moffett	19:29:37	94 GHz $\frac{183/1 \text{ GHz}}{30^\circ}$ 183/5 GHz $\frac{183/10 \text{ GHz}}{50^\circ}$ 183/10 GHz $\frac{100^\circ}{100^\circ}$
			19:47:00	Take off, tape #6, track 04, bad TACAN on 2 GHz
			19:49:00	Right WO
			19:52:00	Right WO
			19:55:00	Left WO
			19:56:00	Left WO
			20:45:00	Get plot until 19:56
			21:02:00	Looking up during descent into Moffett
				Touch down

APPENDIX H

FLIGHT LOG OF CONVAIR 990 94/183 GHZ RADIOMETER (continued)

FLIGHT	DAY	LOCATION	TIME	COMMENTS
2	10/24/78	Moffett-Andrews AFB	15:05:59	Terminal on line, viewing fresh and salt water lakes during flight
	15:18:10			Saw a 90°K drop in temperature over a small body of water
	15:34:40			Begin data collection
	15:51:55			Data off
	16:15:00			Start run over Salt Lake, Utah
	16:19:30			Temperature down to 186.5°K
	16:27:00			Data off
	16:31:00			Data on
	17:26:14			Data off
	17:37:05			Data collection on
	17:41:10			Switch to looking up at sky, 94 GHz shows 42.6°K
	17:50:00			System bombs
	17:58:20			Data collection on, 94 GHz looks up at sky at 36,000 feet and sees 35°K
	18:12:26			Switch to radiometer looking down, data on
	18:13:20			System bombs
	18:15:17			System on, data on, altitude 37,000 feet
	18:30:30			Over Lake Michigan, temperature reads 263°K prior to lake run
	18:34:09			198°K over water
	18:35:20			Calibrate
	18:37:20			194°K over water
	18:38:50			191°K over water
	18:40:32			Calibration
	18:42:25			Shoreline, temperature 265°K
	18:45:20			Data off
	19:23:00			System off

NIMBUS-G FLIGHTS

APPENDIX H

FLIGHT LOG OF CONVAIR 990 94/183 GHZ RADIOMETER (continued)

FLIGHT	DAY	LOCATION	TIME	COMMENTS
3,A,B	10/25/78	Andrews-Gander- Thule	12:11:35	Terminal on, data collection off, 90 GHz front-end OK
			12:38:00	Aircraft power is interrupted, reset system, problem with terminal after power surge
			12:44:45	System on line, over Nova Scotia, Gulf of St. Lawrence, Newfoundland
			13:21:00	Set calibration interval 3 minutes
			13:23:00	Terminal problems
			13:31:56	Passing over weight point 7, land: 94 GHz goes to 256°K
			13:35:00	Start plot, plot taken from Nova Scotia to Newfoundland
			13:47:00	Stop plot, over land: 256°K, water: 180°K
			13:50:00	Data collection off, terminal problems
			14:01:34	Terminal back on
			16:22:09	Data collection on, calibrate internal 5 min
			16:51:30	System bombs, terminal stops responding while in local mode
			19:32:00	Switch to sky
			19:35:50	Start left bank W0
			19:33:00	Data Plot till 19:39
20:09:00	500 feet over sea ice and icebergs			
20:11:50	Turn system off			

APPENDIX H

FLIGHT LOG OF CONVAIR 990 94/183 GHZ RADIOMETER (continued)

FLIGHT	DAY	LOCATION	TIME	COMMENTS
4	10/26/78	Thule-Thule	15:20:24	Terminal on
			15:21:00	Data collection on, track 01, block 0000
			15:46:10	94 GHz approximately 155°K
			16:22:00	45° right bank, 94 GHz = 175°K
			16:50:00	System bombs
			16:55:30	System back on
			17:18:55	Data collection on
			18:09:00	WO at 88°, look at sky, 94 GHz = 29° low temperature
			18:15:00	Switch radiometer to look at ground altitude 500 feet
			19:48:00	Shut off front-end, last data block track 02, block 004A
			05	10/29/78
14:23:34	45° right bank for 360° turn			
15:18:00	94 GHz, cold temperature = 164°K snow covering ice at 9,000 feet elevation			
15:24:00	System bombs			
15:31:00	Terminal back on			
15:44:31	Data collection back on			
16:56:00	Switch to sky in preparation for left bank WO			
17:04:00	Calibrate			
17:05:00	Start left WO, 30°K temperature			
17:06:00	Start right WO, 200°K temperature			

APPENDIX H

FLIGHT LOG OF CONVAIR 990 94/183 GHZ RADIOMETER (continued)

FLIGHT	DAY	LOCATION	TIME	COMMENTS
05	10/29/78	Thule-Thule	17:16:33	Data on, Looking at ground
			17:39:13	Flying over sea ice, Temperature = 213°K
			17:43:00	More sea ice. Temperature = 225°K (1725 feet radar altitude)
			17:49:00	Temperature down to 200°K over snow covered ice.
			17:54:00	Open water. (188°K)
06	10/30/78	Thule-Bodo	17:58:00	Shore fast ice. (230°K)
			18:22:00	Uniform ice. (240°K)
			18:37:47	Data collection off
			14:32:20	Data collection on. Do manual calibration
			15:33:15	Data off.
07	11/01/78	Bodo-Bodo	16:14:00	Left bank WO, 45°, Temperature drops to 90°
			16:53:45	System bombs, back on, block 48
			17:42:00	Switch to sky to prepare for WO
			17:56:00	System bombs, block 0004
			18:32:32	Turn data off, block 000F
			07:53:45	Terminal on. Sea surface Temperature flight. Tape #7, track 03.
			08:00:19	Data collection on
08:05:16	Data collection off. 2 GHz channel appears noisy (no RFI)			
			08:43:31	Data collection on, 2 minutes to WP3. Software bombs on track 03, block 001E.

APPENDIX H

FLIGHT LOG OF CONVAIR 990 94/183 GHZ RADIOMETER (continued)

FLIGHT	DAY	LOCATION	TIME	COMMENTS
07	11/01/78	Bodo-Bodo	09:39:40	Data collection back on
			10:00:00	Problem with 94 GHz display, sometimes displays in Hex. Software bomb.
			11:10:00	Data collection on
			11:37:25	Switch radiometer to sky for WO, begin WO.
			11:55:00	Begin 500 feet run over ocean, data collection on, start plot.
			12:03:00	Start plot
			12:16:00	Start plot
			12:19:00	Start plot
			12:41:01	Data collection off (Block 0004)
			08:01:05	Tape #7, track 03, block 77 ₁₆
09	11/03/78	Bodo-Bodo over sea	08:40:49	Data collection on, software bomb
			09:47:20	Data on
			10:06:14	90° left WO
			10:08:00	Calibration, right 90° WO
			10:11:00	90° left WO
			10:11:35	Calibration
			11:06:27	Data collection off
			11:28:56	Data collection on

APPENDIX H

FLIGHT LOG OF CONVAIR 990 94/183 GHZ RADIOMETER (continued)

FLIGHT	DAY	LOCATION	TIME	COMMENTS
10	11/06/78	Bodo--Sondrestrom	09:16:48	Data collection on
			09:49:28	Data collection on, problem with PCU* board, replace with spare.
			10:00:38	Data collection on
			10:20:00	Software bomb
			10:22:53	Data collection on, hot temperature = 335.35°K, Volt _{hot} = 5.220 volts, cold temperature = 262.89°K, Volt _{cold} = 7.48 volts
11	11/07/78	Sondrestrom-Thule	11:27:00	Software bomb, block 0021
			11:29:17	Data on
			12:47:30	Start plot
			13:48:00	Start data plot
			13:58:00	Power "Glitch", turn system off in preparation for descent
			13:30:35	Data on
			13:50:00	Software bomb, block 0003
			13:53:06	Data back on
			14:10:00	Power is interrupted
			14:14:44	Data link on
12	11/08/78	Thule-Thule	14:23:00	Calibrate
			14:26:00	Calibrate, terminal problems, will repair terminal at end of flight.
			15:00:00	GSFC has spare terminal (TI 735)
			15:30:43	Data collection on
			15:48:00	Software bombs, block 009
			15:50:55	Data on

*Phase Control Unit

APPENDIX H

FLIGHT LOG OF CONVAIR 990 94/183 GHZ RADIONETER (continued)

FLIGHT	DAY	LOCATION	TIME	COMMENTS			
12	11/08/78	Thule-Thule	16:26:44	Switch to sky			
			16:34:13	Data off			
			16:40:42	Data on			
			16:42:44	Switch to ground			
			16:55:41	Data off			
			17:44:44	System bombs. Problem with initial startup. PCB loose. Refit PCB. System OK.			
			18:32:14	Data on			
			18:39:44	Data off			
			13	11/09/78	Thule to Fairbanks	16:03:44	Data on. Tape # 8, track 03
						16:50:44	Software bombs, block 0013
16:52:25	Data on						
17:04:44	Change offset to decrease PSD voltage.						
17:12:34	Temperature Hot = 336° V Hot = 1 volt						
19:16:31	Temperature Cold = 267° V Cold = 3 volts						
19:19:37	Turn off front end						
21:44:44	Front end back on.						
21:47:45	Data Collection on						
14	11/11/78	Fairbanks to Fairbanks				21:11:44	Switch to sky. Preparation for WO
			19:34:44	WO Temperature = 24°C			
			19:46:00	Voltage = 8 volts			
			20:06:00	Gain = -51.75			
				Offset = 396.85°K			
				System down for landing			
				Take off. Looking up			
				Switched down			
				Missed cold load in calibration cycle. Manual cycle commanded on TTY.			

APPENDIX H

FLIGHT LOG OF CONVAIR 990 94/183 GHZ RADIOMETER (continued)

FLIGHT	DAY	LOCATION	TIME	COMMENTS
14	11/11/78	Fairbanks-Fairbanks	20:24:00	Crash.
			20:46:00	10° drop as plane flew over patch of thin ice.
			20:53:00	Crash. Status/Calibration conflict.
			21:23:00	Back up.
			21:31:00	Switch up for 30° spiral sky = 23° at 30600 ft.
			21:33:00	Crash. Patch of 2A00. Will not allow status print out.
			21:45:00	Level at 2300 feet. Looking down.
			21:31:00	Begin plot.
			21:45:00	End plot.
			23:36:00	Climb out for WO. Switch to looking up.
			23:40:46	WO. Saw 23°
15	11/12/78	Fairbanks-Fairbanks	20:04:22	Tape #9, track 01. Recycle system with patches. Take off.
			22:48:00	Software crash.
			00:04:00	Noted that tape was on track 04 instead of 01.
			00:58:14	WO (Up looking).
16	11/13/78	Fairbanks to Hilo	19:50:00	Take off.
			02:17:00	Tape #9. Start on track 01. Data off.
17	11/16/78	Hilo to McCord	19:58:00	Data on. All OK. Moisture problems on ground caused all PSD*channels to overload but OK in air. Started on track 02, tape 9. Finished on track 02.
			01:43:00	Touchdown.

*Phase Sensitive Detector