



NASA CR-135190
ITI P-1250

(NASA-CR-135190) PERFORMANCE TESTS WITH A N77-28492
4.75 INCH BORE TAPERED-ROLLER BEARINGS AT
HIGH SPEEDS Final Report (Industrial
Tectonics, Inc., Compton, Calif.) 100 p Unclas
HC A05/MF A01 CSCI 131 G3/37 39227

FINAL REPORT
ON

Performance Tests With 4.75 Inch Bore Tapered-Roller Bearings At High Speeds

by
Hans R. Signer
and
Stanley I. Pinel

INDUSTRIAL TECTONICS, INCORPORATED
COMPTON, CALIFORNIA 90221

prepared for

NATIONAL AERONAUTICS AND SPACE ADMINISTRATION
NASA Lewis Research Center
Contract NAS 3-18017
Richard J. Parker, Project Manager



۱۰

۱۱

1. Report No. NASA CR-135190	2. Government Accession No	3 Recipient's Catalog No.	
4. Title and Subtitle PERFORMANCE TESTS WITH 4.75 INCH BORE TAPERED-ROLLER BEARINGS AT HIGH SPEEDS		5 Report Date May 1977	6 Performing Organization Code
		8 Performing Organization Report No. ITI P-1250	
7. Author(s) Hans R. Signer and Stanley I. Pinel		10. Work Unit No.	
9. Performing Organization Name and Address Industrial Tectonics, Inc. 18301 South Santa Fe Ave. Compton, California 90221		11. Contract or Grant No NAS 3-18017	
		13. Type of Report and Period Covered Contractor Report	
12. Sponsoring Agency Name and Address National Aeronautics and Space Administration Washington, D.C. 20546		14. Sponsoring Agency Code	
		15. Supplementary Notes Final Report. Project Manager, Richard J. Parker, Fluid System Components Division, NASA-Lewis Research Center, Cleveland, Ohio 44135	
16. Abstract The performance of 120.65 mm (4.75 inch) tapered-roller bearings was investigated in a series of high speed parametric tests. Prior to performing these tests, additional instrumentation was installed on the test machine for measuring shaft, bearing cone and cone-rib temperatures, separator and spindle rotative speeds, and radial spindle excursion. Two additional test machines, built in an earlier program, were operated for a total of 50 hours each, and their reliable performance was demonstrated. The tapered-roller bearings were tested at speeds to 15,000 rpm which results in a cone-rib tangential velocity of 130 m/sec. (25,500 ft/min). Lubrication was applied either by jets or directly to the cone-rib, augmented with jets. Additional test parameters included thrust loads to 53,400 N (12,000 lbs), radial loads to 26,700 N (6,000 lbs), lubricant flow rates from 1.9×10^{-3} to 15.1×10^{-3} m ³ /min. (0.5 to 4.0 gpm), and lubricant inlet temperatures of 350°K and 364°K (170°F and 195°F). Temperature distribution, separator speed, and drive-motor power demand were determined as functions of these test parameters. The limitations of jet lubrication and the advantages of cone-rib lubrication were demonstrated. "Balanced" bearing operating temperatures were achieved by combining cone-rib lubrication with external cup cooling.			
17. Key Words (Suggested by Author(s)) Tapered-roller bearings High speed bearing testing Bearing performance Bearing lubrication		18. Distribution Statement Unclassified-unlimited Subject category 37	
19 Security Classif. (of this report) Unclassified	20. Security Classif. (of this page) Unclassified	21. No. of Pages 96	22. Price*

TABLE OF CONTENTS

	<u>Page</u>
1. Summary	1
2. Introduction	3
3. Test Facility Preparation	5
3.1 Test Rig	5
3.1.1 Mechanical Arrangement	5
3.1.2 Lubrication System	5
3.1.3 Load System	6
3.1.4 Instrumentation	6
3.2 Provisions for Additional Instrumentation	7
3.2.1 Measurement of Separator and Spindle Speeds	7
3.2.2 Measurement of Spindle Excursion	7
3.2.3 Additional Temperature Measurements	7
3.3 Demonstration of Test Rigs	8
3.3.1 Load System, Instrumentation, Safety Equipment	8
3.3.2 Operation at High Loads and Low Speeds	9
3.3.3 Operation at High Speeds with Low Loads	9
3.3.4 Post-Test Inspection	10
4. Parametric Study	11
4.1 Test Facilities	11
4.2 Test Bearings	11
4.3 Lubricant	12
4.4 Test Procedure	12
4.5 Discussion of Results	14
4.5.1 Effect of Lubricant Flow	14
4.5.2 Effects of Radial and Thrust Loads	16
4.5.3 Effect of Shaft Speed and Lubrication Method	16
4.5.4 Controlled Bearing Temperature Tests	17
4.5.5 Power Measurements	18
4.5.6 Separator Speed	19
4.6 Conclusions	19
5. References	21

TABLE OF CONTENTS (Con't)

	<u>Page</u>
<u>Tables</u>	
Table I - Machine S/N 2 - Performance at High Loads and Low Speed.	22
Table II - Machine S/N 3 - Performance at High Loads and Low Speed.	25
Table III - Machine S/N 2 - Performance at Low Loads and High Speeds:	28
Table IV - Machine S/N 3 - Performance at Low Loads and High Speeds.	30
Table V - Test Bearing Specification.	32
Table VI - Properties of Tetraester Lubricant.	33
Table VII - Matrix of Test Conditions - Test Phase A	34
Table VIII- Test Results - Parametric Study - Phase A	36
Table IX - Test Results - Parametric Study - Phase B	74

TABLE OF CONTENTS (Con't)

	<u>Page</u>
<u>Illustrations</u>	
Figure 1 - High Speed Tapered-Roller Bearing Test Machine.	75
Figure 2 - Photograph of High Speed Tapered-Roller Bearing Test Machine.	76
Figure 3 - Control Console	77
Figure 4 - Test Machines S/N 2 and S/N 3.	78
Figure 5 - Tapered-Roller Bearing Test Facility.	79
Figure 6 - Thrust Load Calibration, Test Machine S/N 2.	80
Figure 7 - Radial Load Calibration, Test Machine S/N 2.	81
Figure 8 - Thrust Load Calibration, Test Machine S/N 3.	82
Figure 9 - Radial Load Calibration, Test Machine S/N 3.	83
Figure 10 - Test Bearing Lubrication and Thermocouple Locations.	84
Figure 11 - Test Bearing.	85
Figure 12 - Bearing Temperature as a Function of Lubricant Flow at 6,000 rpm.	86
Figure 13 - Bearing Temperature as a Function of Lubricant Flow at 10,000 rpm.	87
Figure 14 - Bearing Temperature as a Function of Lubricant Flow at 15,000 rpm.	88
Figure 15 - Cone-Face Temperature as a Function of Radial Load.	89
Figure 16 - Cone-Face Temperature as a Function of Thrust Load.	89
Figure 17 - Cone-Face Temperature as a Function of Speed, 350°K (170°F) Oil Inlet Temperature.	90
Figure 18 - Cone-Face Temperature as a Function of Speed, 364°K (195°F) Oil Inlet Temperature.	90
Figure 19 - Cone-Face Temperatures With Jet and Cone-Rib Lubrication as a Function of Shaft Speed.	91
Figure 20 - Bearing Temperatures as a Function of Shaft Speed	92
Figure 21 - Effect of Cup Cooling on Bearing and Oil-Out Temperatures.	92
Figure 22 - Power Demand as a Function of Lubricant Flow at 10,000 rpm.	93
Figure 23 - Power Demand as a Function of Shaft Speed.	94
Figure 24 - Power Demand as a Function of Load.	95

1. SUMMARY

The program reported herein was a multi-task effort with the primary objective to investigate the performance of 120.65 mm (4.75 inch) bore tapered-roller bearings at high speeds.

Before initiating the tapered-roller bearing tests, the instrumentation of the test machine was complemented with features to measure shaft, bearing cone and cone-rib temperatures, as well as separator and spindle rotative speeds, and radial spindle excursion.

Two additional tapered-roller bearing test machines, built in an earlier program, were operated for a total of 50 hours each. In a series of tests, these machines were run with 53,400 N (12,000 lbs) thrust and 26,700 N (6,000 lbs) radial load, using commercial tapered-roller bearings. To demonstrate the machine performance at high speeds, the tapered-roller bearings were replaced by high performance split-inner ring ball bearings, and the machines were run at speeds to 20,000 rpm. The qualification tests demonstrated satisfactory and stable operation of both machines, including their subsystems and instrumentation.

The operating characteristics of 120.65 mm (4.75 inch) bore tapered-roller bearings were measured at shaft speeds to 15,000 rpm. The cone-rib tangential velocity at this speed was 130 m/sec. (25,500 ft/min). Lubrication was applied either by jets or directly to the cone-rib through holes from a manifold at the cone bore, augmented with jets at the roller small end side. The test conditions included thrust loads to 53,400 N (12,000 lbs), radial loads to 26,700 N (6,000 lbs), lubricant flow rates from 1.9×10^{-3} to $15.1 \times 10^{-3} \text{ m}^3/\text{min}$. (0.5 to 4.0 gpm), and lubricant inlet temperatures of 350°K and 364°K (170°F and 195°F). Temperature distribution, separator speed, and drive motor power demand

were determined as functions of shaft speed, thrust and radial loads, lubricant flow rate, lubricant introduction method and inlet temperatures.

During the course of testing the limitations of jet lubrication became clearly visible. By combining cone-rib lubrication with external cup cooling, it was possible to temperature "tune" the individual bearing components, and reliable, low temperature operation could be achieved at high speeds.

2. INTRODUCTION

Tapered-roller bearings combine the radial load capacity of cylindrical roller bearings with the ability of ball bearings to carry heavy thrust loads. They offer advantages such as smaller envelope dimensions and lower weight in applications where heavy combined radial and thrust loads must be transmitted. However, reliable operation has been limited mostly to low or moderate speed applications.

Research efforts conducted under contracts by the U.S. Armed Forces and NASA have advanced the high-speed tapered-roller bearing technology. Laboratory tests reported in references [1] and [2] have shown that tapered-roller bearings can be operated at very high speeds if special attention is given to designing and lubricating these bearings. The method of supplying lubricant to the critical cone-rib contact is of particular importance. From research references [1] and [3] it was concluded that highly loaded tapered-roller bearings operate most successfully at high speeds when lubricant is supplied directly to the cone-rib contact through holes from a manifold at the cone bore.

Computer programs have been developed and are now available to aid in the design of high speed tapered-roller bearings. These programs, described in references [4] and [5], consider the lubrication requirements in the analysis of the kinematic and thermal bearing performance. Experimental data of bearing performance at high speeds and under combined loading, as presented in this report, are now needed to evaluate and verify the predictions of these analytical programs.

The research reported herein was conducted in the test facilities of Industrial Tectonics, Inc., Bearing Division, on an ITI developed tapered-roller bearing test machine described in reference [6]. As part of this program, additional features

were added to the instrumentation of this machine, increasing its versatility during bearing performance testing.

Two tapered-roller bearing test machines of the same type, which are intended for future life testing, were built by ITI under a previous NASA contract, NAS 3-17355. These machines were operated and their reliable performance was successfully demonstrated.

The primary objective of this program was to investigate the performance of 120.65 mm (4.75 inch) bore tapered-roller bearings at speeds up to 15,000 rpm (1.81×10^6 DN*). The maximum cone-rib tangential velocity at this speed was 130 m/sec. (25,500 ft/min) Lubrication was applied either by jets or directly to the cone-rib through holes from a manifold at the cone-bore, augmented with jets at the roller small end side. These tests resulted in a clear definition of the operating characteristics and temperature distribution of the bearing for various shaft speeds, thrust and radial loads, lubricant flow rates, lubricant introduction methods and oil inlet temperatures.

*DN, a bearing speed parameter, is equal to the product of the bearing bore in millimeters and the shaft speed in rpm.

3. TEST FACILITY PREPARATION

3.1 Test Rig

3.1.1 Mechanical Arrangement

In the tapered-roller bearing test machine, L-197, each of the two (2) test bearings is mounted in its own test head as shown in Figure 1. The right (rear) test head assembly is mounted rigidly to the machine frame, while the left (front) one is axially movable on linear rolling contact bearings. Thrust load is applied to the test bearings by hydraulic jacks acting to separate the two test head assemblies. The hydraulic radial load actuator is centered between the test bearings and transmits its force to the machine spindle through a pair of radial roller bearings. One end of the tubular test spindle accepts a drive pulley for the high speed flat belt. Oil is supplied through the other end by a stationary lubrication probe. Annular grooves or channels at the spindle bore direct the lubricant through radial holes to the test bearings and load bearings for inner ring lubrication and cooling. For jet lubrication of the test bearings, two jet probes are located 180° apart at the roller small end of each test bearing.

The test spindle is driven by flat belts. A 3,600 rpm, 75 kw (100 hp), 460 volt, 3 phase electric motor is controlled by a reduced voltage starter to select the desired acceleration rate during start-up. Test spindle speeds from 6,000 to 20,000 rpm are chosen by exchanging drive pulleys at the motor. The pair of flat belts are guided by an idler pulley arrangement which maintains a controlled pre-load on the slack side of the belts. Some of these drive system components are visible in Figure 2.

3.1.2 Lubrication System

The oil flow from a $45.4 \times 10^{-3} \text{ m}^3/\text{min}$. (12 gpm), $690 \times 10^3 \text{ N/m}^2$ (100 psi) gear pump passes through a 10 micron filter and an oil to water heat exchanger before branching off into five (5) lubricant circuits. These circuits supply oil to the test

bearings for cone-rib lubrication, jet lubrication and outer ring cooling and to the cylindrical roller bearings for lubrication and ring cooling. The flow through each circuit is infinitely adjustable with flow control valves and can be measured with a flow rate indicator. The oil inlet temperature is adjustable by controlling the rate of flow passing through or by-passing the heat exchanger. Scavenging of oil from the test bearing and cylindrical roller bearing housings is by large capacity gravity drain lines. Flow and level switches, relief valves, and pressure gages protect the hydraulic circuits.

3.1.3 Load System

The hydraulic system pressure for both the thrust and the radial load actuators are controlled by air pressure regulators and air to oil pressure boosters. Accumulators which are part of each oil pressure loop assure easy control and stable loads throughout the adjustment range.

3.1.4 Instrumentation

Thermocouples are installed for temperature measurements of each test bearing cup, both load bearing outer rings, and the oil inlets and outlets of the load and test bearing housings. A strip chart recorder connected to the thermocouples provides a permanent temperature log for all test stations. An adjustable relay terminates a test if bearing ring temperature limits are exceeded. Provisions exist to measure test bearing cone-face temperatures with an infrared pyrometer aimed through an air purged sight tube assembly. Additional temperature measuring capabilities, described in paragraph 3.2.3, were added to the machine as part of this contract.

The machine vibration level is measured with piezoelectric accelerometers which automatically shut-down the test when the machine vibration exceeds a pre-determined level as may be due to a bearing failure. Flow switches and oil level switches protect the test machine in the event of lubrication system malfunction. Meters indicate line current and voltage to the drive spindle motor.

3.2 Provisions for Additional Instrumentation

The first program objective was to complement the existing instrumentation of the test machine. The following features were added:

3.2.1 Measurement of Separator and Spindle Speeds

Proximity probes were installed to measure the test bearing inner ring and separator rotational speeds. The measured values are displayed on digital tachometers at the control console, Figure 3.

3.2.2 Measurement of Spindle Excursion

The radial excursion of the test spindle from its rotational centerline is measured with proximity probes located in the test housings near the spindle ends. The output from these probes is displayed on an oscilloscope showing the amplitude of the shaft excursion in the two (2) planes represented by the axes of the probes (X-Y display) for each of the two (2) test spindle locations.

3.2.3 Additional Temperature Measurements

The test machine was further upgraded by adding thermocouples to record temperatures of the rear test bearing housing at either side of the test bearing, as well as at the inside diameter of the test bearing cone, the cone-rib, and at the test spindle on either side of the test bearing. The output from the shaft thermocouples was wired through a slip ring system which, later on in the program, was replaced with a FM multiplex wireless data system. The transmitter was

mounted with an adaptor to the belt pulley at the test spindle. A special FM receiver indicates the measured temperatures on a digital display.

3.3 Demonstration of Test Rigs

Under contract NAS 3-17355, Industrial Tectonics, Inc. built two (2) additional test machines of the type L-197. These machines, serial numbers 2 and 3, are shown in Figure 4. They are of identical design as the initial test rig, serial number 1, which was fabricated under contract NAS 3-16812 and was described earlier in this report and in reference [6]. All three machines, shown in Figure 5, are connected to the same services and share the central control console shown in Figure 3. In a future program this entire facility will be used to perform a series of high speed tapered-roller bearing fatigue tests. For consistent results in such a program the operational characteristics of all machines must be identical.

To check out their performance, the machines serial number 2 and serial number 3 were subjected to a series of tests. The contractual test conditions for these check-out runs duplicated those used to demonstrate the initial rig.

The qualification tests demonstrated satisfactory and stable operation of both machines, serial number 2 and serial number 3, including their subsystems and instrumentation. Based on the test results, which are further detailed below, it was concluded that both machines meet all specified requirements. They exhibited the same operational characteristics as machine serial number 1.

3.3.1 Load System, Instrumentation, Safety Equipment

During this initial check-out phase, the load systems and the output from all thermocouples were calibrated against known standards. The safety equipment and shut-down devices were checked by functional tests.

All components operated in accordance with the equipment specifications. The safety and shut-down systems operated satisfactorily and within tolerance.

The load calibration curves are given in Figures 6 through 9.

3.3.2 Operation at High Loads and Low Speeds

Using commercial tapered-roller bearings (Timken, type TS, Cone: 795 Class 3; Cup: 792 Class 2) in the test chambers, each machine was operated for 24 hours at 3,000 rpm, with a thrust load of 35,600 N (8,000 lbs) and a radial load of 13,350 N (3,000 lbs) per bearing. The cup and cone-rib temperatures were held below 436°K (325°F).

Without changing the speed or bearing temperatures the machines were then operated for one (1) additional hour with 53,400 N (12,000 lbs) thrust and 26,700 N (6,000 lbs) radial load per bearing, which represent maximum machine design loads.

The machine and bearings operated smoothly without sign of distress to any component. The loads and all operating parameters remained stable and all subsystems and instruments performed reliably. The lab data sheets of this test sequence are given in Table I for machine serial number 2 and in Table II for machine serial number 3.

3.3.3 Operation at High Speed with Low Loads

The tapered-roller bearings were replaced with high precision split-inner ring ball bearings. The performance data of these bearings was known from earlier investigations, reported in reference [7].

A fifteen (15) hour test run was then conducted with each machine at 15,000 rpm under 26,700 N (6,000 lbs) thrust load and 4,450 N (1,000 lbs) radial load. Test bearing inner and outer ring temperatures were held below 489°K (420°F).

In a final test, the machines were run for ten (10) hours at a speed of 20,000 rpm with no radial load and 26,700 N (6,000 lbs) thrust load. The inner and outer rings of the test ball bearings were maintained at a temperature of $489^{\circ}\text{K} \pm 8^{\circ}$ ($420^{\circ}\text{F} \pm 15^{\circ}\text{F}$).

During the tests both machines operated without a sign of distress to any of their components. The loads and all operating parameters remained stable. All subsystems and instruments operated reliably. The lab data sheets from these tests are shown in Table III for machine serial number 2 and in Table IV for machine serial number 3.

3.3.4 Post-Test Inspection

Upon conclusion of the tests described in paragraph 3.3.2 and 3.3.3, which represent a total of fifty (50) hours of operation, the machines were dismantled and thoroughly inspected.

No visible or measurable damage or distress was observed in any of the machines, their components, or the test bearings.

4. PARAMETRIC STUDY

4.1 Test Facilities

The high speed tapered-roller bearing test machine L-197, serial number 1, described in the preceding section of this report was used for these studies. Measurements were made of bearing inner ring speed, bearing separator speed, test spindle excursion, oil flow, and machine vibration level. Thermocouples recorded the operating temperatures at the test bearing cup, cone bore and cone-rib, the test bearing housing and spindle, as well as of the oil at the inlets and outlets to the test bearing housing. The thermocouple locations are illustrated in Figure 10.

For jet lubrication of the test bearings, two jet probes as shown in Figure 10 were located 180° apart at the roller small end. Each jet probe contained two holes directed at the test bearing. Two-thirds of the jet flow was directed toward the inside diameter of the separator and one-third was directed toward its outside diameter. The orifice diameters were varied to maintain jet velocities in the range between 15 and 33 m/sec. (45 and 100 feet per second). Cone-rib lubrication was accomplished through radial oil holes at the machine spindle.

Drive spindle power loss was determined by measuring line-to-line voltage and line current to the test rig drive motor. Motor drive power was then calculated as a function of line current, reflecting bearing power usage at the various operating conditions.

4.2 Test Bearings

The test bearings were class 2 tapered-roller bearings with 120.65 mm (4.75 inch) bore and 206.38 mm (8.125 inch) outside diameter. The cup angle was 34°, and the roller included angle

was $3^{\circ} 10'$. The bearing contained 25 rollers with a large end diameter of 18.288 mm (0.720 inch) and overall length of 34.618 mm (1.3452 inch). The rollers were fully crowned with a crown radius of 25.4 mm (1,000 inch) and had a spherical end radius equal to 80% of the apex length.

The material of the cup, cone and rollers was case-carburized consumable electrode vacuum melted AISI 4320 steel. The one piece, roller riding separator was silver plated AISI 1010 steel. The hardnesses, case depth and surface finish specifications are shown in Table V.

The cone contained forty (40) oil holes, 1.016 mm (0.040 inch) diameter, drilled through from a manifold on the cone-bore to the undercut at the large end of the cone, as shown in Figure 11.

The basic dynamic load ratings for this bearing are 74,700 N (16,800 lbs) radial load and 58,700 N (13,200 lbs) thrust load. The rating is defined as the thrust or radial load which gives a 10% life of 90 million cone revolutions. The AFBMA basic dynamic capacity is 288,000 N (64,800 lbs).

4.3 Lubricant

The oil used for the demonstration runs of the test rigs and for the parametric studies was a 5 centistoke neopentylpolyol (tetra) ester. This type II oil is qualified to MIL-L-23699 as well as to the internal oil specification of most major aircraft engine manufacturers. Properties of the oil are presented in Table VI.

4.4 Test Procedure

The test procedure was adjusted according to the test conditions to be evaluated. Generally, a program cycle was defined which would allow the evaluation of a number of conditions without a

major interruption. With the exception of speed, all test parameters such as load, lubricant flow rate and oil temperature could be adjusted while the test was in operation. During a test, the machine and test bearings were allowed to reach an equilibrium condition before data were recorded and before proceeding to another test condition.

Two (2) test series were performed. These were as follows:

Phase A - Objective and Test Conditions

The objective was to record bearing performance for a matrix of loads and speeds shown in Table VII. Oil inlet temperatures of 350°K and 364°K (170°F and 195°F) were chosen and oil flow rates were varied using both, jet and cone-rib lubrication. When cone-rib lubrication was used, a constant jet flow of $3.8 \times 10^{-3} \text{ m}^3/\text{min}$. (1.0 gpm) was also used to assure lubrication of the roller small ends.

When in the course of testing it became apparent that a particular combination of test conditions would result in distress to the test bearing or would generate a bearing temperature above 436°K (325°F), the test was aborted or omitted. In Table VII such tests have been indicated.

The lab data sheets from Phase A tests are shown in Table VIII.

Phase B - Objective and Test Conditions

Tests were run at shaft speeds of 12,500 rpm, a thrust load of 53,400 N (12,000 lbs), radial load of 26,700 N (6,000 lbs) and an oil inlet temperature of 350°K (170°F). A constant jet lube oil flow rate of $3.8 \times 10^{-3} \text{ m}^3/\text{min}$. (1.0 gpm) was maintained. The objective was to establish the cone-rib lube oil flow and outer ring cooling oil flow rates which produce a cup and cone operating temperature of $416^\circ\text{K} \pm 3^\circ$ ($290^\circ\text{F} \pm 5^\circ\text{F}$). The oil flow rates achieved were intended to

be used during a tapered-roller bearing fatigue test investigation in a subsequent contract.

The data from the Phase B tests are documented in Table IX.

4.5 Discussion of Results

The test results presented in Tables VIII and IX were reviewed for consistency and reasonableness. In this process the effects of lubricant flow, shaft speed and method of lubrication became apparent. The results have been further examined and can be illustrated in several ways.

4.5.1 Effect of Lubricant Flow

Figures 12 through 14 show test bearing and oil outlet temperatures as function of lubricant oil flow rates. Figure 12 illustrates these results at 6,000 rpm, Figure 13 at 10,000 rpm, and Figure 14 at 15,000 rpm. The graphs represent test runs with 53,400 N (12,000 lbs) thrust load and 26,700 N (6,000 lbs) radial load. The trends for lower loads were identical, though in some cases the temperatures were insignificantly lower.

At 6,000 rpm the bearing temperatures decreased by an average of 28°K (50°F) as flows were increased from 1.9×10^{-3} to $7.6 \times 10^{-3} \text{ m}^3/\text{min}$. (0.5 to 2.0 gpm) with jet lubrication. At higher flow rates, the rate of temperature decrease diminished.

Similar effects are seen for cone-rib lubrication, where the total flow rate includes $3.8 \times 10^{-3} \text{ m}^3/\text{min}$. (1.0 gpm) of lubricant through jets at the roller small end of the bearing. Thus, the data points at $3.8 \times 10^{-3} \text{ m}^3/\text{min}$. (1.0 gpm) are for zero cone-rib flow rate.

The first test at 10,000 rpm with a jet flow rate of $3.8 \times 10^{-3} \text{ m}^3/\text{min}$. (1.0 gpm) at an oil inlet temperature of 350°K (170°F) resulted in surface distress of the cone-rib on one of the test bearings. The test bearing on which cone-face and cone-bore temperatures were measured was not damaged. Further tests at this flow rate and below were not run. By examination of Figure 13(a) we find that a temperature greater than 433°K (320°F) would be expected by extrapolation of the cone-face temperature curve. When the temperature limitations of the AISI 4320 material of the cone and rollers are considered along with the severity of the rolling/sliding contact, the occurrence of surface damage under these conditions is not unexpected.

Information for the cone-rib flow rates as low as $1.9 \times 10^{-3} \text{ m}^3/\text{min}$. (0.5 gpm), i.e. a total flow rate of $5.7 \times 10^{-3} \text{ m}^3/\text{min}$. (1.5 gpm) was obtained for 10,000 rpm for both oil-in temperatures. At the higher oil-in temperature, the maximum cone face temperatures at this flow rate was only 404°K (267°F).

Only one (1) test was run at 15,000 rpm with jet flow, the lower flow conditions were eliminated due to predictable bearing distress. Readings were obtained for all desired flow rates with cone-rib flow at 350°K (170°F) oil-in temperature. Tests with 364°K (195°F) oil-in temperature and total flow rates less than $7.6 \times 10^{-3} \text{ m}^3/\text{min}$. (2.0 gpm) were not run due to temperature limitations.

An increased effect of flow rate on the oil-out temperature is seen at a shaft speed of 15,000 rpm, whereas the flow rate effect on bearing temperatures is not significantly different from that at the lower speeds.

It is generally observed that, as flow rates increase, the reductions in bearing temperature diminishes. Bearing temperatures are affected only little by flow rates above $11.4 \times 10^{-3} \text{ m}^3/\text{min}$. (3.0 gpm). Therefore, greater flow rates do not seem to be warranted for bearings at these conditions, especially where cone-rib lubrication is used.

4.5.2 Effects of Radial and Thrust Loads

Figures 15 and 16 show that radial and thrust loads have little influence on the cone face temperature. This observation is typical throughout the range of data taken. Hence, regardless of speed, oil-in temperature, or flow rates, changes in load had little effect on bearing or oil-out temperatures.

4.5.3 Effect of Shaft Speed and Lubrication Method

Figures 17 and 18 show the effect of shaft speed on cone face temperatures for oil inlet temperatures of 350°K (170°F) and 364°K (195°F), respectively. Cone face temperatures increased nearly 50°K (90°F) by increasing shaft speed from 6,000 rpm to 15,000 rpm when $15.2 \times 10^{-3} \text{ m}^3/\text{min}$. (4.0 gpm) jet lubrication was used. If the curves of Figure 17(a) for jet lubrication with 350°K (170°F) oil-in are projected to 15,000 rpm, we find an oil flow of at least $7.6 \times 10^{-3} \text{ m}^3/\text{min}$. (2.0 gpm) will be required to keep the cone face temperature below 436°K (325°F). It becomes further apparent that, even with the maximum jet flow of $15.1 \times 10^{-3} \text{ m}^3/\text{min}$. (4.0 gpm), the temperature limit of 436°K (325°F) would be reached at approximately 16,500 rpm. Similarly, all curves of Figure 18(a) for 364°K (195°F) oil-in extrapolate to unacceptably high cone face temperatures for speeds above 13,000 rpm.

Shaft speed has less effect on the cone face temperature when cone-rib lubrication is used. Satisfactory cone-race temperatures were measured at 15,000 rpm with a total flow rate as low as $5.7 \times 10^{-3} \text{ m}^3/\text{min}$. (1.5 gpm) for 350°K (170°F) and with $7.6 \times 10^{-3} \text{ m}^3/\text{min}$. (2.0 gpm) for 364°K (195°F) oil inlet temperatures. Extension of the curves in Figures 17(b) and 18(b) indicate satisfactory operating temperatures may be expected at speeds to 20,000 rpm.

The advantage of cone-rib lubrication is further illustrated in Figure 19, which shows the difference of cone-face temperatures with jet lubrication and with cone-rib lubrication. Cone-rib lubrication lowers cone face temperature as much as 34°K (62°F) at 15,000 rpm. A temperature improvement is even found at 6,000 rpm, where the benefit is approximately 13°K (23°F).

It can be observed from Figures 12 through 14, that when cone-rib lubrication is used, the highest bearing temperatures are measured at the cup outside diameter. When jet lubrication alone is used, the highest temperatures were on the cone face. This is further demonstrated in Figure 20 where the temperatures are plotted against shaft speed for an oil-in temperature of 364°K (195°F) and a total oil flow of $11.4 \times 10^{-3} \text{ m}^3/\text{min}$. (3.0 gpm). Cone bore and oil-out temperatures for jet lubrication and for cone-rib lubrication are not significantly different.

4.5.4 Controlled Bearing Temperature Tests

It was the primary objective of this program phase to find a "safe" lubricant flow condition which would produce a uniform bearing temperature of $416^\circ\text{K} \pm 3^\circ$ ($290^\circ\text{F} \pm 5^\circ\text{F}$) at 12,500 rpm.

Balanced bearing temperatures were achieved by combining the previously described method of cone-rib lubrication with cup cooling. The latter was accomplished by flowing oil in the cup housing in contact with the outside diameter of the cup. The influence of this outer ring cooling is illustrated in Figure 21. The data shown was obtained with $5.7 \times 10^{-3} \text{ m}^3/\text{min}$. (1.5 gpm) total lubricant flow at 364°K (195°F) inlet temperature. The addition of $2.6 \times 10^{-3} \text{ m}^3/\text{min}$. (0.7 gpm) cup cooling flow is represented by solid symbols in Figure 21. The cup outside temperature decreased by 14°K (25°F) without significantly changing the cone face and cone bore temperatures. The oil outlet temperature was 6°K (11°F) lower because of the heat removed by the cup cooling oil.

Some additional tests, shown in Table IX, were run to explore other operating conditions that would meet the test objective. From the data available it can be extrapolated that a balanced bearing temperature of 416°K (290°F) is achieved by raising the oil inlet temperature to 366°K (200°F) and otherwise maintaining all operating parameters of the previously described test. When the oil inlet temperature is further raised to 379°K (222°F) and the cup cooling oil flow is increased to $3.4 \times 10^{-3} \text{ m}^3/\text{min}$. (0.9 gpm), the balanced bearing operating temperature is 422°K (300°F).

4.5.5 Power Measurements

Voltage and current measurements for the electric motor driving the test machine were recorded in all tests. While small individual irregularities have been noticed in relation to this data, the trends appear to be valid.

The range of machine power demand was compared for jet lubrication and cone-rib lubrication. While a substantial overlap exists, the power demand is generally greater for jet lubrication. This is shown in Figure 22 where power demand was plotted for both jet and cone-rib total lubricant flow at 10,000 rpm.

The increasing power demand with increasing speed is shown in Figure 23.

The machine power varied only little due to variations in thrust or radial loads as shown in Figure 24.

4.5.6 Separator Speed

Separator speed was measured at each test condition except at 15,000 rpm. The ratio of the separator speed to the shaft speed remained constant at about 0.44987 for all the tests measured.

No significant rolling element slip was discovered.

4.6 Conclusions

The results from the parametric performance tests described in the previous paragraphs lead to the following conclusions:

1. There are definite limitations in using jets for the lubrication of tapered-roller bearings at high speeds. A $15.1 \times 10^{-3} \text{ m}^3/\text{min}$. (4.0 gpm) flow with 350°K (170°F) oil was required to operate at 15,000 rpm. Lowering the flow or increasing the oil inlet temperature produced cone face temperatures above 436°K (325°F). At speeds greater than 16,500 rpm, unacceptably high cone-face temperatures can be expected.
2. Tapered-roller bearing operation at high speeds was most successful with cone-rib lubrication, augmented with jets at the roller small end side. At 15,000 rpm, lubrication was

adequate with $5.7 \times 10^{-3} \text{ m}^3/\text{min}$ (1.5 gpm) flow of 350°K (170°F) oil, or with $7.6 \times 10^{-3} \text{ m}^3/\text{min}$. (2.0 gpm) flow of 364°K (195°F) oil. No benefits were observed by increasing the total oil flow above $11.4 \times 10^{-3} \text{ m}^3/\text{min}$. (3.0 gpm). Satisfactory operating temperatures can be expected to at least 20,000 rpm.

3. The highest temperatures in a jet lubricated high speed tapered-roller bearing was measured at the cone-rib. When applying cone-rib lubrication, this component temperature drops, but the cup temperature is increased. By combining cone-rib lubrication with external cup cooling, the individual bearing components can be temperature tuned, and reliable, low temperature bearing operation can be achieved at high speeds.
4. Bearing temperatures and test rig power requirements increased with increasing shaft speed, but changed very little due to changes in either radial or thrust loads.
5. As the lubricant flow rate increased, bearing temperatures decreased and the required drive power increased. Power required was less with cone-rib lubrication than with jet lubrication.
6. At 6,000 rpm, flow rates as low as $1.9 \times 10^{-3} \text{ m}^3/\text{min}$. (0.5 gpm) provided stable bearing operation for all conditions tested.

5. REFERENCES

1. Conners, T.F.; Morrison, F.R.: Feasibility of Tapered-Roller Bearings for Main-Shaft Engine Applications. USAAMRDL-Technical Report 73-46, 1973.
2. Cornish, R.F.; Orvos, P.S.; Dressler, G.J.: Design, Development and Testing of High Speed Tapered-Roller Bearings for Turbine Engines. AFAPL-TR-75-26, 1975.
3. Lemanski, A.J.; Lenski, J.W.; Drago, R.J.: Design, Fabrication, Test, and Evaluation of Spiral Bevel Support Bearings (Tapered-Roller). USAAMRDL, Technical Report 73-16, 1973.
4. Cornish, R.F.; Orvos, P.S.; Gupta, S.R.: Development of High Speed Tapered-Roller Bearing. AFAPL-TR-73-85, 1973.
5. Crecelius, W.J.; Milke, D.R.: Dynamic and Thermal Analysis of High Speed Tapered-Roller Bearings Under Combined Loading. SKF AL73P010, NASA CR-121207, 1973.
6. Signer, H.R.: Design, Fabrication, and Operation of a Test Rig for High Speed Tapered-Roller Bearings. ITI P-1248, NASA CR-134595, 1974.
7. Signer, H.R.; Bamberger, E.N.; Zaretsky, E.V.: Parametric Study of the Lubrication of Thrust Loaded 120 mm Bore Ball Bearings to 3 Million DN. ASME Transactions, Journal of Lubrication Technology, Vol. 96, Series F No. 3, July, 1974.

TABLE I

LAB DATA SHEETS - MACHINE S/N 2 - PERFORMANCE TESTS AT HIGH LOADS AND LOW SPEED

INDUSTRIAL TECTONICS, INC.		TAPERED ROLLER BEARING TEST MACHINE L-197 CHECKOUT PERFORMANCE TESTS TRB#2		DATE 7-16-75 PAGE 1 of 3			
REP. BY V. MILLER		CUSTOMER NASA					
CHKD BY		TIME (HRS)		2.3	6.3	10.3	14.3
TEST NO. IIIa		Load lbs.		8000	8000	8000	8000
TEST OBJECTIVES		Thrust PER /		3000	3000	3000	3000
Test Brgs. Speed RPM		Radial / BRG.		3130	3130	3130	3130
TAPERED R/B 3,000		SPINDLE SPEED (RPM)					
LOADS		1. Front #1		200	213	192	191
Thrust 8000 Radial 3000		2. Front #2		197	211	189	189
LUBRICATION		3. Rear #1		188	199	179	180
Type MIL-L-23699A		4. Rear #2		188	201	178	180
DRIVE SYSTEM		5. Slave Front		162	174	134	135
Time to Reach Full Speed		6. Slave Rear		158'	171	129	129
Cold 3.6 SEC Hot 3 SEC		7. Lube Oil Out Front		201	210	190	191
SETTINGS		8. Lube Oil Out Rear		184	191	178	177
Start-Up		9. Cooling Oil Out Front		182	208	166	167
Voltage 65 Time Delay 31 SEC		10. Cooling Oil Out Rear		180	192	163	164
Lube Flow Switches		11. Oil Test Brg.		177	190	154	156
Test Brg. 2.0 GPM Slave Brg. 1.5 GPM		12. Oil In Slave Brg.		150	159	115	115
Time Delay Pump 70 SEC Bearing Temp. <325 °F		INFRA- RED I.R.		-	-	-	-
Vibration 20		Inner JETS Ring ONLY Test Brg.		4.3	4.8	2.5	2.5
NOTES:		Slave Brg.		3.2	3.5	2.0	2.0
COLD VALVE CLOSED. HOT VALVE FULL OPEN. METERED WATER THRU Hx TO SET TEST TEMP.		Cooling Oil Test Brg.		1.3	φ	1.0	1.0
		Slave Brg.		1.1	φ	1.3	1.3
		MOTOR VOLTAGE (VOLTS)		-	-	-	-
		CURRENT (AMPS)		-	-	-	-
		H.P. (CALCULATED)		-	-	-	-
		VIBRATION %		φ	φ	<10	<10
		Shaft Excursion (inch-T.I.R.) Front		-	-	.0016	.0016
		Rear		-	-	.0017	.0017
						①	①

TABLE I (Continued)



INDUSTRIAL TECTONICS, INC.

REP.

BY V. Miller

CHECKED BY

TAPERED ROLLER BEARING
TEST MACHINE L-197
CHECKOUT PERFORMANCE
TESTS TRB#2

DATE 7-18-75 PAGE 2 OF 3

CUSTOMER

NASA

TEST NO. IIIa		TIME (HRS.)	20.1	22.9	24.0		
TEST OBJECTIVES		Load lbs.	Thrust PER/	8000	8000	8000	
Test Brgs.	Speed RPM		Radial /BRG.	3000	3000	3000	
TAPERED R/B 3000		SPINDLE SPEED (RPM)		3130	3130	3130	
LOADS		1.	Front	#1	190	192	163
Thrust	Radial			#2	188	190	160
8000	3000	2.	Rear	#1	179	181	153
LUBRICATION				#2	178	180	152
Type MIL-L-23699A		3.	Slave Front		134	134	132
DRIVE SYSTEM				Slave Rear		128	128
Time to Reach Full Speed		4.	Lube Oil Out		Front	190	191
Cold	Hot			Rear	176	178	150
3.6 SEC	3.0 SEC	5.	Cooling Oil Out	Front	166	167	132
SETTINGS				Rear	162	164	128
Start-Up		6.	Oil	Test Brg.	154	156	114
Voltage	Time Delay			In	Slave Brg.	114	113
65 %	31 SEC	INFRA- RED I.R.		-	-	-	
Lube Flow Switches		7.	Inner JETS Ring ONLY	Test Brg.	2.5	2.5	2.5
Test Brg.	Slave Brg.			Slave Brg.	2.0	2.0	2.0
2.0 GPM	1.5 GPM	8.	Cooling Oil	Test Brg.	1.0	1.0	1.0
Time Delay Pump	Bearing Temp.			Slave Brg.	1.3	1.3	1.3
70 SEC	<325 °F	MOTOR		VOLTAGE (VOLTS)	-	-	-
Vibration		VIBRATION, %		CURRENT (AMPS)	-	-	-
20 %		Shaft Excursion (inch-T.I.R.)		H.P. (CALCULATED)	-	-	-
NOTES:		Front		VIBRATION, %	<10	<10	<10
① COLD OIL VALVE CLOSED. HOT OIL VALVE FULL OPEN. METERED WATER THRU Hx TO SET TEST TEMP.		Rear		Shaft Excursion (inch-T.I.R.)	.0016	.0016	.0016
② HOT OIL VALVE CLOSED. COLD OIL VALVE FULL OPEN. Hx WATER FULL OPEN.					①	①	②

7803

TABLE I (Continued)

INDUSTRIAL TECTONICS, INC.
 REF. BY **V. MILLER**
 CNKD BY

TAPERED ROLLER BEARING
 TEST MACHINE L-197
 CHECKOUT PERFORMANCE
 TESTS TRB#2

DATE **7-22-75** PAGE **3** OF **3**
 CUSTOMER
NASA

TEST NO. III b		TIME (HRS.)		0.4	1.0		
TEST OBJECTIVES		Load lbs.	Thrust	PER/	12,000	12,000	
Test Brgs.	Speed RPM		Radial	/BRG.	6,000	6,000	
TAPERED RIB		SPINDLE SPEED (RPM)		3130	3130		
LOADS		1.	Brg. Outer Ring Test	Front #1	168	197	
Thrust	Radial			Front #2	165	193	
12,000	6000	3.	Rear	#1	155	182	
LUBRICATION		4.		#2	153	181	
Type	DRIVE SYSTEM		5.	Slave Front	136	135	
MIL-L-23699A	Time to Reach Full Speed				6.	Rear	130
Cold	Hot	7.	Lube Oil Out	Front		170	195
3.5 SEC	2.2 SEC			8.	Rear	150	180
SETTINGS		9.	Cooling Oil Out	Front	134	170	
Start-Up				10.	Rear	132	165
Voltage	Time Delay	11.	Oil	Test Brg.	115	156	
65	30 SEC			12.	In	Slave Brg.	114
Lube Flow Switches		INFRA-RED I.R.		-	-		
Test Brg.	Slave Brg.	Inner JETS Ring ONLY	Oil	Test Brg.	2.5	2.5	
2.0 GPM	1.5 GPM			Slave Brg.	2.0	2.0	
Time Delay Pump	Bearing Temp.	Cooling Oil	Oil	Test Brg.	1.0	1.0	
70 SEC	< 325 °F			Slave Brg.	1.3	1.3	
Vibration		MOTOR		VOLTAGE (VOLTS)	-	-	
20				CURRENT (AMPS)	-	-	
NOTES:				H.P. (CALCULATED)	-	-	
① HOT OIL VALVE CLOSED. COLD OIL VALVE FULL OPEN. ② HOT OIL VALVE FULL OPEN. COLD OIL VALVE CLOSED. FULL Hx FLOW (WATER).		VIBRATION		< 10	< 10		
		Shaft Excursion (inch-T.I.R.)		Front	.0016	.0016	
				Rear	.0017	.0017	
					①	②	

TABLE II

LAB DATA SHEETS - MACHINE S/N 3 - PERFORMANCE TESTS AT HIGH LOADS AND LOW SPEED

ITI INDUSTRIAL TECTONICS, INC.
 REF. BY V. MILLER
 CHKD BY

TAPERED ROLLER BEARING
 TEST MACHINE L-197
 CHECKOUT PERFORMANCE TESTS
 TRB#3

DATE 8-12-75 PAGE 1 OF 3
 CUSTOMER NASA

TEST NO. III a		TIME (HRS)	1.0	6.0	10.6	13.3		
TEST OBJECTIVES		Load lbs.	Thrust PER	8000	8000	8000	8000	
Test Brgs.	Speed RPM		Radial BRG	3000	3000	3000	3000	
TAPERED R/B 3000		SPINDLE SPEED (RPM)		3130	3130	3130	3130	
LOADS		TEMPERATURES °F	1. Thrust	Front #1	200	200	193	191
Thrust 8000	Radial 3000			2. Test #2	198	196	190	189
LUBRICATION		3. Test #1	4. Test #2	Front #1	193	193	184	183
Type MIL-L-23699A				Rear #2	190	190	181	180
DRIVE SYSTEM		5. Slave Front	6. Slave Rear	7. Lube Oil Out Front	203	205	195	195
Time to Reach Full Speed Cold 3.5 SEC Hot 2.2 SEC				8. Lube Oil Out Rear	194	195	178	179
SETTINGS		9. Cooling Oil Out Front	10. Cooling Oil Out Rear	11. Oil Test Brg.	180	184	154	155
Start-Up Voltage 65 % Time Delay 30 SEC				12. Oil In Slave Brg.	167	155	113	115
Lube Flow Switches		INFRA-RED I.R.		-	-	-	-	
Test Brg. GPM 1.8	Slave Brg. GPM 1.8	FLOW GPM	Inner JETS Ring ONLY Test Brg.	4.0	4.0	2.5	2.5	
Time Delay Pump 60 SEC	Bearing Temp. <325 °F		Oil Slave Brg.	2.2	2.2	2.0	2.0	
Vibration 20 %		MOTOR	Cooling Test Brg.	0	0	1.0	1.0	
			Oil Slave Brg.	1.3	1.3	1.3	1.3	
NOTES:		VOLTAGE (VOLTS)		-	-	-	-	
① COLD OIL VALVE SLIGHTLY OPEN. HOT OIL VALVE FULL OPEN. FULL H _x WATER FLOW. ② COLD OIL VALVE CLOSED. HOT OIL VALVE FULL OPEN. METERED WATER THRU H _x TO SET TEST TEMP.		CURRENT (AMPS)		-	-	-	-	
		H.P. (CALCULATED)		-	-	-	-	
		VIBRATION %		-	-	-	-	
		Shaft Excursion (inch-T.I.R.)	Front	-	-	.0014	.0012	
			Rear	-	-	.0005	.0007	
						①	②	

TABLE II (Continued)



INDUSTRIAL TECTONICS, INC.

REF.

BY V. Miller

CHKD BY

TAPERED ROLLER BEARING
TEST MACHINE L-197
CHECKOUT PERFORMANCE
TESTS TRB#3

DATE 8-15-75 PAGE 2 OF 3

CUSTOMER

NASA

TEST NO. III a		TIME (HRS)		18.8	21.2	22.8	24.0
TEST OBJECTIVES		Load lbs.	Thrust PER	8000	8000	8000	8000
Test Brgs.	Speed RPM		Radial BRG.	3000	3000	3000	3000
TAPERED R/B		SPINDLE SPEED (RPM)		3130	3130	3130	3130
LOADS		1.	Exg. Outer Ring	Test	Front	#1	191
Thrust	Radial						190
8000	3000	2.	Slave	Rear	#1	184	
		182					
LUBRICATION		3.	Slave	Rear	#2	180	
Type	MIL-L-23699A	4.				179	
DRIVE SYSTEM		5.	Front			136	
Time to Reach Full Speed		6.	Rear			130	
Cold	Hot	7.	Lube Oil Out	Front		193	
3.5 SEC	2.2 SEC	8.	Lube Oil Out	Rear		178	
SETTINGS		9.	Cooling Oil Out	Front		167	
Start-Up		10.	Cooling Oil Out	Rear		163	
Voltage	Time Delay	11.	Oil In	Test Brg.		155	
65	30 SEC	12.	Oil In	Slave Brg.		118	
Lube Flow Switches		INFRA-RED I.R.		-	-	-	-
Test Brg.	Slave Brg.	Inner JETS Ring ONLY		Test Brg.	2.5	2.5	2.5
GPM	1.8 GPM	Oil		Slave Brg.	2.0	2.0	2.0
Time Delay Pump	Bearing Temp.	Cooling Oil		Test Brg.	1.0	1.0	1.0
60 SEC	< 325 °F	Oil		Slave Brg.	1.3	1.3	1.3
Vibration		MOTOR		VOLTAGE (VOLTS)	-	-	-
20				CURRENT (AMPS)	-	-	-
NOTES:				H.P. (CALCULATED)	-	-	-
① COLD OIL VALVE SLIGHTLY OPEN, HOT OIL VALVE FULL OPEN. METERED WATER THRU Hx. TO SET TEST TEMP.		VIBRATION %		-	-	-	-
② HOT OIL VALVE CLOSED. COLD OIL VALVE FULL OPEN. FULL Hx. FLOW (WATER).		Shaft Excursion (inch-T.I.R.)		Front	.0012	.0012	.0012
				Rear	.0007	.0007	.0007
					①	①	②

TABLE II (Continued)

IT INDUSTRIAL TECTONICS, INC.
 REF. BY V. MILLER
 CHKD BY

TAPERED ROLLER BEARING
 TEST MACHINE L-197
 CHECKOUT PERFORMANCE
 TESTS TRB#3

DATE 8-15-75 PAGE 3 OF 3
 CUSTOMER NASA

TEST NO. IIIb		TIME (HRS)		0.4	1.0				
TEST OBJECTIVES		Load lbs.	Thrust PER/	12000	12000				
Test Brgs.	Speed RPM		Radial /BRG.	6000	6000				
TAPERED R/B 3000		SPINDLE SPEED (RPM)		3130	3130				
LOADS		1.	Front	#1	168	198			
Thrust	Radial			#2	166	195			
12000	6000	2.	Rear	#1	159	187			
LUBRICATION				#2	156	185			
Type MIL-L-23699A		3.	Front						
DRIVE SYSTEM									
Time to Reach Full Speed		4.	Rear						
Cold	Hot								
3.5 SEC	2.2 SEC	5.	Front						
SETTINGS									
Start-Up		6.	Rear						
Voltage	Time Delay								
65 %	30 SEC	7.	Lube Oil Out	Front	171	199			
Lube Flow Switches				Rear	150	182			
Test Brg. GPM	Slave Brg. GPM	8.	Cooling Oil Out	Front	135	174			
	1.8 GPM			Rear	129	167			
Time Delay Pump	Bearing Temp.	9.	Oil	Test Brg.	115	157			
60 SEC	<325 °F			Slave Brg.	115	114			
Vibration		10.	In						
20 %									
NOTES:		INFRA- RED I.R.		-	-				
① HOT OIL VALVE CLOSED. COLD OIL VALVE FULL OPEN. FULL Hx WATER FLOW. ② HOT OIL VALVE FULL OPEN. COLD OIL VALVE CLOSED. FULL Hx WATER FLOW.		11.	Inner Ring ONLY	Test Brg.	2.5	2.5			
				Slave Brg.	2.0	2.0			
		12.	Cooling Oil	Test Brg.	1.0	1.0			
				Slave Brg.	1.3	1.3			
		MOTOR		VOLTAGE (VOLTS)		-	-		
				CURRENT (AMPS)		-	-		
		H.P. (CALCULATED)		-	-				
		VIBRATION %		-	-				
		Shaft Excursion (inch-T.I.R.)	Front	.0012	.0012				
			Rear	.0007	.0007				
				①	②				

780

TABLE III

LAB DATA SHEETS - MACHINE S/N 2 - PERFORMANCE TESTS AT
LOW LOADS AND HIGH SPEEDS

IT INDUSTRIAL TECTONICS, INC.
REP. BY S. DAMITTO
CHKD BY

TAPERED ROLLER BEARING
TEST MACHINE L-197
CHECKOUT PERFORMANCE
TESTS TRB#2

DATE 11-19-75 PAGE 1 OF 2
CUSTOMER
NASA

TEST NO. <u>IV d</u>		TIME (HRS)		3.9	7.0	10.1	14.4	
TEST OBJECTIVES		Load lbs.	Thrust <u>PER/</u>	6000	6000	6000	6000	
Test Brgs. <u>BALL BEARINGS #13116 MODIFIED</u>	Speed RPM <u>15,000</u>		Radial <u>BRG.</u>	1250	1250	1250	1250	
LOADS		SPINDLE SPEED (RPM)		15145	15145	15145	15145	
Thrust <u>6000</u>	Radial <u>1250</u>	TEMPERATURES °F	1. Outer Ring Test	Front #1	366	369	369	347
LUBRICATION				2. Front #2	-	-	-	-
Type <u>MIL-L-23699A</u>				3. Rear #1	369	372	371	350
DRIVE SYSTEM				4. Rear #2	-	-	-	-
Time to Reach Full Speed				5. Slave Front	307	309	316	280
Cold <u>30</u> SEC	Hot - SEC			6. Slave Rear	290	292	299	266
SETTINGS				7. Lube Oil Out Front	345	347	350	326
Start-Up				8. Lube Oil Out Rear	331	335	336	313
Voltage <u>80</u> %	Time Delay <u>30</u> SEC			9. Cooling Oil Out Front	325	329	327	304
Lube Flow Switches				10. Cooling Oil Out Rear	337	339	339	304
Test Brg. <u>2.0</u> GPM	Slave Brg. <u>1.5</u> GPM			11. Oil Test Brg.	297	299	304	275
Time Delay Pump <u>70</u> SEC	Bearing Temp. <u>HIGHEST ATTAINABLE_{sp}</u>			12. Oil In Slave Brg.	199	199	212	150
Vibration <u>20</u> %		INFRA-RED I.R.		-	-	-	-	
NOTES:		MOTOR FLOW GPM	Inner Ring Oil Test Brg.	3.5	3.5	3.5	3.5	
			Inner Ring Oil Slave Brg.	1.8	1.8	1.8	1.8	
		MOTOR VOLTAGE (VOLTS)	Cooling Oil Test Brg.	.35	.35	.50	.50	
			Cooling Oil Slave Brg.	.55	.55	.55	.55	
		MOTOR CURRENT (AMPS)		-	-	-	-	
		MOTOR H.P. (CALCULATED)		-	-	-	-	
		VIBRATION %		11	12	14	12	
		Shaft Excursion (inch-T.I.R.)	Front	.0019	.0019	.0019	.0019	
			Rear	.0014	.0014	.0014	.0014	

TABLE III (Continued)

IT INDUSTRIAL TECTONICS, INC.
 REF. **SYS. DAMITIO**
 CHKD BY

TAPERED ROLLER BEARING
 TEST MACHINE L-197
 CHECKOUT PERFORMANCE
 TESTS **TRB#2**

DATE **11-26-75** PAGE **2** OF **2**
 CUSTOMER
 NASA

TEST NO. IV e		TIME (HRS)	5.0	8.1	9.8	
TEST OBJECTIVES		Load lbs.	Thrust PER/	6000	6000	6000
Test Brgs. BALL BEARINGS #13116 MODIFIED	Speed RPM 20,000		Radial /BRG.	0	0	0
LOADS		SPINDLE SPEED (RPM)				
Thrust 6000	Radial 0		20,375	20,375	20,375	
LUBRICATION		TEMPERATURES °F	1. Front #1	410	416	416
Type MIL-1-23699A			2. Front #2	-	-	-
DRIVE SYSTEM			3. Rear #1	410	419	418
Time to Reach Full Speed			4. Rear #2	-	-	-
Cold	Hot		5. Front	-	-	-
30 SEC	25 SEC		6. Rear	-	-	-
SETTINGS			7. Lube Oil Out Front	388	390	391
Start-Up			8. Lube Oil Out Rear	368	371	373
Voltage	Time Delay		9. Cooling Oil Front	346	345	345
80	30 SEC		10. Cooling Oil Rear	347	348	348
Lube Flow Switches			11. Oil Test Brg.	312	310	310
Test Brg. 1.8 GPM	Slave Brg. 0 GPM		12. In Slave Brg.	-	-	-
Time Delay Pump 70 SEC	Bearing Temp. 420 ± 15 °F	INFRA-RED I.R.				
Vibration 20		Inner Ring Oil Test Brg.	2.5	2.5	2.5	
NOTES: * THIS FIGURE REPRESENTS FLOW TO STUB-SHAFT SUPPORT BRG.		Inner Ring Oil Slave Brg.*	.4	.4	.4	
		Cooling Oil Test Brg.	1.1	1.1	1.1	
		Cooling Oil Slave Brg.	-	-	-	
		MOTOR				
		VOLTAGE (VOLTS)				
		CURRENT (AMPS)				
		H.P. (CALCULATED)				
		VIBRATION g				
		Shaft Excursion (inch-T.I.R.) Front	-	-	-	
		Shaft Excursion (inch-T.I.R.) Rear	.0021	.0021	.0021	

TABLE IV

LAB DATA SHEETS - MACHINE S/N 3 - PERFORMANCE TESTS AT
LOW LOADS AND HIGH SPEEDS

INDUSTRIAL TECTONICS, INC.
REF. BY V. MILLER
CHKD BY

TAPERED ROLLER BEARING
TEST MACHINE L-197
CHECKOUT PERFORMANCE
TESTS TRB#3

DATE 8-29-75 PAGE 1 OF 2
CUSTOMER
NASA

TEST NO. <u>IV d</u>		TIME (HRS)	4.7	8.5	11.1	14.7			
TEST OBJECTIVES		Load lbs.	Thrust	PER/	6000	6000	6000	6000	
Test Brgs. BALL BEARING #13116 MODIFIED	Speed RPM <u>15000</u>		Radial.	/BRG.	1250	1250	1250	1250	
LOADS		SPINDLE SPEED (RPM)			15120	15120	15120	15120	
Thrust <u>6000</u>	Radial <u>1250</u>	1.	Front	#1	349	353	352	354	
LUBRICATION		2.	Test	#2	-	-	-	-	
Type <u>MIL-L-23699A</u>		3.		Rear	#1	339	341	340	349
DRIVE SYSTEM		4.	#2		-	-	-	-	
Time to Reach Full Speed		5.		Brg. Slave	Front	276	283	281	285
Cold <u>30 SEC</u>	Hot - SEC	6.			Rear	265	293	289	290
SETTINGS		7.		Lube Oil Out	Front	343	342	343	345
Start-Up		8.			Rear	330	329	327	336
Voltage <u>80</u>	Time Delay <u>30 SEC</u>	9.		Cooling Oil Out	Front	310	311	311	315
Lube Flow Switches		10.			Rear	306	306	306	320
Test Brg. <u>2.0 GPM</u>	Slave Brg. <u>2.0 GPM</u>	11.		Oil In	Test Brg.	285	287	285	291
Time Delay Pump <u>70 SEC</u>	Bearing Temp. <u>HIGHEST ATTAINABLE °F</u>	12.			Slave Brg.	186	192	190	195
Vibration <u>20</u>		INFRARED I.R.			-	-	-	-	
NOTES:		Inner Ring Oil		Test Brg.	3.75	3.75	3.75	3.75	
① COLD OIL VALVE CLOSED. HOT OIL VALVE FULL OPEN.		Cooling Oil		Slave Brg.	2.55	2.55	2.55	2.55	
		Cooling Oil		Test Brg.	0.5	0.5	0.5	0.5	
		Slave Brg.			0.65	0.65	0.65	0.65	
		VOLTAGE (VOLTS)			-	-	-	-	
		CURRENT (AMPS)			-	-	-	-	
		H.P. (CALCULATED)			-	-	-	-	
		VIBRATION %			<10	<10	<10	<10	
		Shaft Excursion (inch-T.I.R.)		Front	.0013	.0015	.0014	.0015	
				Rear	.0012	.0012	.0014	.0016	
		WATER OUT TEMP @ Hr. °F			209	213	214	222	
					①	①	①	①	

TABLE IV. (Continued)



INDUSTRIAL TECTONICS, INC.

TAPERED ROLLER BEARING
TEST MACHINE L-197
CHECKOUT PERFORMANCE
TESTS TRB#3

DATE 10-6-75 PAGE 2 OF 2

CUSTOMER

NASA

REP. BY V. MILLER
CHKD BY

TEST NO. <u>IV.e</u>		TIME (HRS)	4.5	8.9	10.0				
TEST OBJECTIVES		Load lbs.	Thrust	PERI	6000	6000	6000		
Test Brgs	Speed RPM		Radial	IBRG	⊖	⊖	⊖		
BALL BEARINGS #1316 MODIFIED	20,000								
LOADS		SPINDLE SPEED (RPM)		20365	20365	20365			
Thrust	Radial	TEMPERATURES OF	1. Brg. Outer Ring Test	Front #1	423	410	412		
6000	⊖			2. #2	-	-	-		
LUBRICATION				3. Brg. Outer Ring Test	Rear	#1	417	410	412
Type	MIL-L-23699A					#2	-	-	-
DRIVE SYSTEM				4. Brg. Slave	Front		-	-	-
Time to Reach Full Speed	Cold					Hot		-	-
	30 SEC			25 SEC					
SETTINGS				7. Lube Oil Out	Front		390	382	386
Start-Up	Voltage					Time Delay		365	365
	80 %			30 SEC					
Lube Flow Switches				9. Cooling Oil Out	Front		354	344	347
Test Brg.	Slave Brg.						350	341	345
1.8 GPM	- GPM								
Time Delay Pump	Bearing Temp.	11. Oil In	Test Brg.		310	305	308		
70 SEC	420 ± 15 °F				Slave Brg.	-	-	-	
Vibration									
20 %		INFRA-RED I.R.			-	415	419		
NOTES:		MOTOR FLOW GPM	Inner Ring Oil	Test Brg.	2.5	2.5	2.5		
* THIS FIGURE REPRESENTS FLOW TO SUB-SHAFT SUPPORT BRG.				Slave Brg.*	.4	.4	.4		
		Cooling Oil	Test Brg.		1.1	1.1	1.1		
				Slave Brg.	-	-	-		
		MOTOR		VOLTAGE (VOLTS)	-	-	-		
				CURRENT (AMPS)	-	-	-		
				H.P. (CALCULATED)	-	-	-		
		VIBRATION %			<10	<10	<10		
		Shaft Excursion (inch-T.I.R.)	Front	.0018	.001	.001			
			Rear	.0012	.0021	.0022			
		WATER OUT TEMP @ 1/2" °F			94	94	96		

TABLE V - TEST BEARING SPECIFICATIONS

Case hardness, Rockwell C	58 to 64
Core hardness, Rockwell C	25 to 48
Case depth (to 0.5% carbon level after final grind), cm(in.):	
Cup and cone	0.086 to 0.185 cm (0.034 to 0.073 in.)
Roller	0.091 to 0.201 cm (0.036 to 0.079 in.)
Surface finish ¹ μm (μin.) rms:	
Cone raceway	0.15 (6)
Cup raceway	0.20 (8)
Cone-rib	0.18 (7)
Roller taper	0.13 (5)
Roller spherical	0.15 (6)

¹measured values.

TABLE VI
PROPERTIES OF TETRAESTER LUBRICANT

Additives	Antiwear Oxidation Inhibitor Antifoam
Kinematic viscosity, cS, at -	
311 K (100°F)	28.5
372 K (210°F)	5.22
477 K (400°F)	1.31
Flash point, K (°F)	533 (500)
Fire point, K (°F)	Unknown
Autoignition temperature, K (°F)	694 (800)
Pour point, K (°F)	214 (-75)
Volatility (6.5 hr at 477 K (400°F)), wt.%	3.2
Specific heat at 477 K (400°F), J/(kg) (K), (Btu/(lb) (°F))	2340 (0.54)
Thermal conductivity at 477 K (400°F), J/(m) (sec) (K), (Btu/(hr) (ft) (°F))	0.13 (0.075)
Specific gravity at 477 K (400°F)	0.850

TABLE VII

Matrix of Test Conditions

Test Phase A
(S.I. Units)

Shaft Speed, Rpm	Thrust Load, N	Radial Load, N	350°K		364°K		Total Lube Flow Rate, m ³ /min. X 10 ⁻³															Test Sheet No.			
			Front Erg.S/N	Rear Erg.S/N	Front Erg.S/N	Rear Erg. S/N	350°K Oil In					364°K Oil In					350°K	364°K							
							Jet		▽ Cone-Rib			Jet		▽ Cone-Rib											
			1.9	3.8	7.6	11.4	15.1	5.7	7.6	11.4	13.3	15.1	1.9	3.8	7.6	11.4	15.1	5.7	7.6	11.4	13.3	15.1			
6000	26,700	13,350	5	1	5	1	✓	✓	✓	✓	✓	✓	✓	✓	✓	✓	✓	✓	✓	✓	✓	✓	1	7	
		20,000	5	1	5	1																	1	7	
	40,000	26,700	5	1	5	1	✓	✓	✓	✓	✓	✓	✓	✓	✓	✓	✓	✓	✓	✓	✓	✓	2	8	
		13,350	5	1	5	1	✓	✓	✓	✓	✓	✓	✓	✓	✓	✓	✓	✓	✓	✓	✓	✓	3	9	
	53,400	20,000	5	1	5	1																	3	9	
		26,700	5	1	5	1	✓	✓	✓	✓	✓	✓	✓	✓	✓	✓	✓	✓	✓	✓	✓	✓	4	10	
	10000	26,700	13,350	5	1	5	1	✓	✓	✓	✓	✓	✓	✓	✓	✓	✓	✓	✓	✓	✓	✓	5	11	
			20,000	5	1	5	1																5	11	
		40,000	26,700	5	1	5	1	✓	✓	✓	✓	✓	✓	✓	✓	✓	✓	✓	✓	✓	✓	✓	6	12	
			13,350	4	1	5	1		*	✓	✓	✓	✓	✓	✓	✓	✓	✓	✓	✓	✓	✓	✓	13	21
		53,400	20,000	4	1	5	1		✓	✓	✓	✓	✓	✓	✓	✓	✓	✓	✓	✓	✓	✓	✓	14	22
			26,700	4	1	5	1		✓	✓	✓	✓	✓	✓	✓	✓	✓	✓	✓	✓	✓	✓	✓	15	23
15000	40,000	13,350	4	1	5	1		✓	✓	✓	✓	✓	✓	✓	✓	✓	✓	✓	✓	✓	✓	16	24		
		20,000	4	1	5	1		✓	✓	✓	✓	✓	✓	✓	✓	✓	✓	✓	✓	✓	✓	17	25		
	53,400	26,700	4	1	5	1		✓	✓	✓	✓	✓	✓	✓	✓	✓	✓	✓	✓	✓	✓	18	26		
		13,350	4	1	5	1		✓	✓	✓	✓	✓	✓	✓	✓	✓	✓	✓	✓	✓	✓	19	27		
	9,000	20,000	4	1	5	1		✓	✓	✓	✓	✓	✓	✓	✓	✓	✓	✓	✓	✓	✓	✓	20	28	
		26,700	4	1	5	1		✓	✓	✓	✓	✓	✓	✓	✓	✓	✓	✓	✓	✓	✓	✓	20	28	
53,400	40,000	4,450	6	1	6	1																#	29	34	
		9,000	6	1	6	1																	30	35	
	20,000	13,350	6	1	6	1																		31	36
		26,700	6	1	6	1																		32	37
		26,700	6	1	6	1																#	33	38	

✓ Successful test with temperature data.
 * Cone-rib failure.
 # Shut-down, temperature limit reached.

▽ Cone-rib flow includes 3.8 X 10⁻³ m³/min. jet flow.
 □ Unsafe area; did not run.

TABLE VII (Con't)

Matrix of Test Conditions

Test Phase A (English Units)			170°F		195°F		Total Lube Flow Rate, gal/min.																				Test Sheet No.				
			Front Brg.S/N	Rear Brg.S/N	Front Brg.S/N	Rear Brg.S/N	170°F Oil In					195°F Oil In					170 °F	195 °F													
							Jet		V Cone-Rib			Jet		V Cone-Rib																	
			Shaft Speed, Rpm	Thrust Load, Lbs.	Radial Load, Lbs.																										
0.5	1.0	2.0				3.0	4.0	1.5	2.0	3.0	3.5	4.0	0.5	1.0	2.0	3.0	4.0	1.5	2.0	3.0	3.5	4.0									
6000	6000	3000	5	1	5	1	✓	✓	✓	✓	✓	✓	✓	✓	✓	✓	✓	✓	✓	✓	✓	✓	✓	✓	1	7					
		4500	5	1	5	1																			✓	1	7				
↓	↓	6000	5	1	5	1	✓	✓	✓	✓	✓	✓	✓	✓	✓	✓	✓	✓	✓	✓	✓	✓	✓	✓	✓	2	8				
		9000	5	1	5	1	✓	✓	✓	✓	✓	✓	✓	✓	✓	✓	✓	✓	✓	✓	✓	✓	✓	✓	✓	✓	3	9			
↓	↓	4500	5	1	5	1																			✓	3	9				
		6000	5	1	5	1	✓	✓	✓	✓	✓	✓	✓	✓	✓	✓	✓	✓	✓	✓	✓	✓	✓	✓	✓	✓	4	10			
↓	12000	3000	5	1	5	1	✓	✓	✓	✓	✓	✓	✓	✓	✓	✓	✓	✓	✓	✓	✓	✓	✓	✓	✓	5	11				
		4500	5	1	5	1																			✓	5	11				
↓	6000	6000	5	1	5	1	✓	✓	✓	✓	✓	✓	✓	✓	✓	✓	✓	✓	✓	✓	✓	✓	✓	✓	✓	6	12				
		3000	4	1	5	1																					13	21			
↓	↓	4500	4	1	5	1																					14	22			
		9000	4	1	5	1																						15	23		
↓	↓	4500	4	1	5	1																						16	24		
		6000	4	1	5	1																							17	25	
↓	12000	3000	4	1	5	1																						18	26		
		4500	4	1	5	1																							19	27	
↓	6000	6000	4	1	5	1																							20	28	
		1000	6	1	6	1																							29	34	
↓	9000	2000	6	1	6	1																							30	35	
		3000	6	1	6	1																								31	36
↓	12000	4500	6	1	6	1																								32	37
		6000	6	1	6	1																								33	38

✓ Successful test with temperature data.
 * Cone-rib failure.
 # Shut-down, temperature limit reached.

∇ Cone-rib flow includes 1.0 gpm jet flow.
 □ Unsafe area; did not run.

INDUSTRIAL TECTONICS, INC. 

Table VIII

Test Results - Parametric Study - Phase A

PERFORMANCE TESTS WITH HIGH SPEED TAPERED ROLLER BEARINGS

W. O. 7000-4 - IV a

FRONT BEARING S/N 5

REAR BEARING S/N 1

Notes: (Unless Otherwise Specified)

1. Cone face T/C at ~3.14 inch radius.

CONSTANT TEST SETTINGS: shaft speed 6000 rpm
 Thrust Load 6000 lbs
 Oil Inlet Temp 170 °F

SYMBOLS: Δ Test Condition (4-tims)
 ← Reference Data Only
 * Calculated Values

TEST NO.	SPEED (RPM)		CONE RIB	OIL FLOW (GPM)			OIL PRES.		RNG. LOADS		TEMPERATURE OF										SHAFT & CURS-HAN		VIB. LEVEL	MOTOR			TEST LAB (°F)	REMARKS	D.C.B. NO.										
	SHAFT	SEPARATOR		SUPPORT		JETS	SUPP. INCL.	1ST BEG.	THIRST	RADIAL	REAR BEARING										1000	1000		I	V	HP													
				I.R.	O.R.						1	2	3	4	5	6	7	8	9	10										11	12	13	14	15	16	17	18	19	20
AG6I4.0	6070	2730	⊕	1.5	0.2	4.0	92	98	6000	3020	200	201	202	199	181	195	203	201	178	-	195	201	201	203	190	197	171	204	198	172	.9	1.25	<10	40.0	458	27.5	82	#5 JETS	2-10-75 AD
AG6I3.0	6100	2745	⊕	1.5	0.2	3.0	91	90	6000	3000	205	204	206	202	179	199	209	206	161	-	197	206	205	206	190	202	171	203	196	173	.9	1.25	<10	38.5	451	25	59	#5 JETS	2-10-75 AD
2.0	6105		⊕	1.5	0.2	2.0	109	113	6000	3000	220	216	217	213	187	208	223	215	185	-	210	217	216	217	187	212	170	203	195	169	.9	1.25	<10	37.0	452	23	73	#5 JETS	2-10-75 AD
1.0	6090	2740	⊕	1.5	0.2	1.0	106	112	6000	3000	241	237	240	235	202	222	241	232	197	-	232	239	239	241	189	238	171	202	196	171	.9	1.25	<10	35.5	465	22.3	74	#1 JETS	2-10-75 AD
RENEW 1.0	6085	2740	⊕	1.5	0.2	1.0	100	105	5963	2990	241	236	239	234	198	214	241	232	198	-	221	239	239	240	190	236	171	205	197	172	.9	1.25	<10	34.0	457	19.5	69	#1 JETS	2-10-75 AD
0.5	6095	2740	⊕	1.5	0.2	0.5	105	110	6000	2990	268	268	272	265	220	244	269	259	214	-	248	270	270	272	195	267	170	209	202	177	.9	1.25	<10	31.9	458	16.3	76	#1 JETS	2-10-75 AD
AG6I3.0	6080	2735	2.9	1.5	0.2	1.0	105	110	5963	2980	195	212	215	212	194	180	185	202	188	-	193	211	214	214	190	205	169	200	196	173	.9	1.25	<10	37.5	454	24	73	#1 JETS	2-10-75 AD
2.5																																							
2.0	6080	2735	2.0	1.5	0.2	1.0	94	100	6000	3000	195	212	217	212	189	180	189	204	184	-	195	214	214	215	190	202	169	204	197	174	.9	1.25	<10	36.5	458	23	67	#1 JETS	2-10-75 AD
1.0	6085	2740	1.0	1.5	0.2	1.0	93	98	5970	3000	209	219	222	217	194	186	195	208	189	-	203	220	220	221	189	210	169	202	196	171	.9	1.25	<10	35.3	458	21.5	76	#1 JETS	2-10-75 AD
0.5	6085	2740	0.5	1.5	0.2	1.0	100	106	6000	2970	222	225	228	223	196	195	204	212	190	-	214	226	226	228	188	218	169	202	195	170	.9	1.25	<10	35.8	459	22.2	75	#1 JETS	2-10-75 AD
AG6I3.0	6070	2730	2.9	1.5	0.2	1.0	105	110	6000	4520	195	211	214	211	191	180	185	200	183	-	192	210	211	212	-	190	205	169	197	175	.9	1.25	<10	36.7	457	23	72	#1 JETS	2-10-75 AD

Table VIII - Continued

REPRODUCIBILITY OF THE ORIGINAL PAGE IS POOR

Notes: (Unless Otherwise Specified)

1. Cone face T/C at ~3.14 inch radius.

CONSTANT TEST SETTINGS: Shaft Speed 6000 rpm
Thrust Load 6000 lbs
Oil Inlet Temp 170 °F

SYMBOLS: Δ Test Condition (Setting)
← Reference Data Only
* Calculated Values

PERFORMANCE TESTS WITH HIGH SPEED TAPERED ROLLER BEARINGS

N. O. 7000-4 - IV a

FRONT BEARING S/N 5

REAR BEARING S/N 1

TEST NO.	SPEED (RPM)		OIL FLOW (GPM)				OIL PRES.		BKG. LOADS		TEMPERATURE OF																				SHAFT EXCURSION		VIB LEVEL	MOTOR			TEST LAB (°F)	NOTES	DATE
	SHAFT Δ	SEPARATOR	OIL RIB Δ	SUPPORT		JLTS Δ	OUTP ING.	TEST ING.	TANGENTIAL		FRONT BEARING										REAR BEARING		FRONT In x 10 ⁻³	REAR In x 10 ⁻³	I	V	HP *												
				I.R.	O.R.				REG.	OUTER RING	REG.	FACE	IN	OUT	IN	OUT	IN	OUT	IN	OUT	IN	OUT						IN	OUT										
				1	2				3	4	1	2	3	4	5	6	7	8	9	10	11	12						13	14	15	16	17		18	19	20			
A6FJ240	6075	2130	⊖	1.5	0.2	4.0	92	98	6000	6030	199	199	200	197	179	193	201	200	177	-	193	199	199	201	190	195	169	206	199	170	.9	1.25	<10	40.5	457	28.2	82	#1JTB	2-26-75 AD
3.0	6105	2745	⊖	1.5	0.2	3.0	91	91	6000	5970	205	204	206	202	180	200	208	206	183	-	198	206	205	207	191	201	171	207	200	173	.9	1.25	<10	39.0	451	25.7	62	#5JTB	2-24-75 AD
2.0	6105	2745	⊖	1.5	0.2	2.0	110	113	5963	5980	220	216	217	213	188	220	223	215	186	-	210	216	216	217	190	211	171	206	199	171	.9	1.25	<10	37.2	452	23.2	74	#1JTB	2-24-75 AD
1.0	6090	2735	⊖	1.5	0.2	1.0	100	106	6087	6000	242	236	239	235	201	224	242	233	200	-	231	239	239	241	190	236	170	208	200	171	.9	1.25	<10	34.9	456	20.5	70	#1JTB	2-14-75 AD
0.5	6095	2740	⊖	1.5	0.2	0.5	105	112	6000	6000	268	266	270	264	221	245	266	257	214	-	248	267	268	271	193	266	170	210	203	173	.9	1.25	<10	33	459	18.0	76	#1JTB	2-25-75 AD
A6FJ240	6075	2735	2.9	1.5	0.2	1.0	104	110	6000	6040	195	210	213	211	191	179	185	200	184	-	195	214	214	216	192	201	169	204	198	174	.9	1.25	<10	40.0	459	27.8	72	#1JTB	2-23-75 AD
2.5	6085	2735	2.0	1.5	0.2	1.0	94	100	6000	5970	195	211	216	211	189	179	189	204	186	-	196	214	214	215	192	202	169	206	199	174	.9	1.25	<10	36.5	459	23.0	68	#1JTB	2-23-75 AD
1.0	6085	2740	1.0	1.5	0.2	1.0	93	98	6000	5970	206	218	220	217	192	185	195	208	189	-	204	219	219	221	190	209	169	205	198	170	.9	1.25	<10	36.2	458	22.7	75	#1JTB	2-13-75 AD
0.5	6085	2735	0.5	1.5	0.2	1.0	101	106	6037	6000	222	225	228	224	197	196	205	214	193	-	215	226	226	228	190	219	170	206	199	170	.9	1.25	<10	35.6	460	22.2	74	#1JTB	2-13-75 AD

Table VIII - Continued

Notes: (Unless Otherwise Specified)

1. Cone face T/C at 3.14 inch radius.

CONSTANT TEST SETTINGS: Shaft Speed 6000 rpm
 Thrust Load 2000 lbs
 Oil Inlet Temp 170 °F

PERFORMANCE TESTS WITH HIGH SPEED TAPERED ROLLER BEARINGS

W. O. 7000-4 - IV a

SYMBOLS: Δ Test Condition (Setting)
 ← Reference Data Only
 * Calculated Values

FRONT BEARING S/N 5 REAR BEARING S/N 1

TEST NO.	SPLD (RPM)		TYPE RIB	OIL FLOW (GPM)		OIL PRES.		BKG. LOADS		TEMPERATURE OF										SHAFT DEFLECTION		VIB LEVEL	MOTOR			TEST LAB (°F)	NOTES	DATE												
	SWAFT	SEPARATOR		I.R.	O.P.	SUPP. INRG.	TEST INRG.	TANG.	RADIAL	FRONT BEARING										FRONT	REAR		I	V	HP															
										I.B.G. O.B.	OUTER RING	INNER RING	SHAF. I.D.	SHAF. O.D.	SHAF. I.D.	SHAF. O.D.	SHAF. I.D.	SHAF. O.D.	SHAF. I.D.										SHAF. O.D.	SHAF. I.D.	SHAF. O.D.	SHAF. I.D.	SHAF. O.D.	SHAF. I.D.	SHAF. O.D.					
49dJ14.0	6075	2735	⊕	1.5	0.2	4.0	92	97	8963	1970	203	204	206	202	181	188	208	205	179	-	197	204	204	206	190	203	171	204	198	172	.9	1.25	<10	40.6	458	28.5	81	#1 JETS	2-8-75 100	
3.0	6100	2740	⊕	1.5	0.2	3.0	92	92	9037	3000	207	209	210	206	182	200	212	209	181	-	201	210	208	210	189	204	171	203	197	171	.9	1.25	<10	40.0	457	27.5	64	#5 JETS	2-11-75 100	
2.0	6105	2745	⊕	1.5	0.2	2.0	110	113	9000	3010	225	221	223	218	191	222	229	221	189	-	215	222	221	222	199	218	171	204	197	170	.9	1.25	<10	37.5	452	28.8	76	#5 JETS	2-11-75 100	
1.0	6080	2740	⊕	1.5	0.2	1.0	100	105	9000	3010	247	242	245	240	204	227	247	237	200	-	237	246	245	247	188	243	170	204	197	170	.9	1.25	<10	35.5	455	21.4	72	#1 JETS	2-11-75 100	
0.5	6090	2740	⊕	1.5	0.2	0.5	105	110	9000	3000	274	273	277	271	224	249	274	264	216	-	257	276	275	278	192	272	170	207	199	174	.9	1.25	<10	32.3	458	17.0	76	#1 JETS	2-11-75 100	
49dRI3.0	6070	2730	2.9	1.5	0.2	1.0	104	110	8963	2980	199	216	220	216	196	184	187	203	186	-	194	219	219	220	187	204	169	200	195	169	.9	1.25	<10	38.8	459	26.3	72	#1 JETS	2-11-75 100	
2.5																																								
2.0	6080	2735	2.0	1.5	0.2	1.0	95	100	9037	3000	197	217	221	217	193	181	191	208	187	-	197	218	218	219	189	204	169	202	196	173	.9	1.25	<10	37.6	460	25.0	70	#1 JETS	2-11-75 100	
1.0	6080	2735	1.0	1.5	0.2	1.0	94	99	8963	3000	212	224	227	222	196	188	198	212	191	-	208	225	225	227	189	215	170	201	196	170	.9	1.25	<10	36.2	459	22.6	75	#1 JETS	2-11-75 100	
0.5	6085	2740	1.0	1.5	0.2	1.0	101	106	8963	2970	227	230	233	229	199	199	209	218	194	-	219	231	231	233	189	224	170	202	196	170	.9	1.25	<10	36.2	460	22.2	74	#1 JETS	2-11-75 100	
49eRI3.0	6075	2735	2.9	1.5	0.2	1.0	105	111	8963	4500	196	214	218	215	193	181	188	204	185	-	195	209	208	210	191	204	169	203	198	173	.9	1.25	<10	38.3	461	25.5	75	#1 JETS	2-11-75 100	

Table VIII - Continued

PERFORMANCE TESTS WITH HIGH SPEED TAPERED ROLLER BEARINGS

W. O. 7880-4 - IV a

FRONT BEARING S/N 5 REAR BEARING S/N 1

Notes: (Unless Otherwise Specified)

1. Cone face T/C at ~3.14 inch radius.

CONSTANT TEST SETTINGS: Shaft Speed 6000 rpm
Thrust Load 2000 lbs
Oil Inlet Temp 170 °F

SYMBOLS: Δ Test Condition (Settime)
← Reference Data Only
* Calculated Values

TEST NO.	SPEED (RPM)		COND RIB	OIL FLOW (GPM)			OIL PRES.		BKG. LOADS		TEMPERATURE OF										SHAFT EXCURSION		VIB LEVEL	ATCR			TEST LAB (°F)	NOTES	DWC										
	SHAFT	SEPARATOR		SUPPORT I.R.	JETTS O.P.	SUPP BRG.	TEST BRG.	INSTRADIAL	REAR BEARING										FRONT	REAR	I	V		HP															
									HSG. OUTER RING		HSG. INNER RING		CONC. PIN		SHAFT		LUBR. OUTER RING								SLAVE BLADE					FRONTAL		IN							
199J24.0	6070	2735	⊕	1.5	0.2	4.0	92	107	9000	6020	204	204	205	201	182	198	206	204	179	-	197	204	204	206	191	204	171	207	200	171	.9	1.25	<10	42.9	458	31.0	81	#5 JETTS	2-11-75 10
3.0	6100	2735	⊕	1.5	0.2	3.0	92	92	9000	6000	208	208	210	206	183	201	212	208	183	-	201	209	207	209	189	208	171	206	199	170	.9	1.25	<10	40.5	451	27.4	66	#5 JETTS	2-11-75 10
2.0	6105	2745	⊕	1.5	0.2	2.0	111	114	9037	6000	224	220	222	221	191	213	229	220	189	-	216	222	221	223	190	217	171	206	199	170	.9	1.25	<10	38	458	25.2	79	#5 JETTS	2-11-75 10
1.0	6080	2735	⊕	1.5	0.2	1.0	100	105	9000	4500	249	243	246	242	206	219	248	239	202	-	238	248	247	249	192	244	171	208	201	172	.9	1.25	<10	35.3	456	21.2	73	#1 JETTS	2-11-75 10
0.5	6090	2740	⊕	1.5	0.2	0.5	105	111	9000	4460	275	275	280	274	226	250	276	266	218	-	256	269	269	272	193	276	170	210	202	173	.9	1.25	<10	33.8	457	19.1	76	#1 JETTS	2-11-75 10
199R13.0	6075	2730	2.9	1.5	0.2	1.0	105	110	9000	6000	198	214	218	215	194	183	189	205	187	-	196	219	219	220	192	205	170	205	199	175	.9	1.25	<10	39.6	460	22.3	76	#1 JETTS	2-11-75 10
2.5	6080	2735	2.0	1.5	0.2	1.0	95	100	9000	5970	196	217	221	217	194	181	192	208	188	-	197	218	218	219	191	206	169	206	200	173	.9	1.25	<10	37.9	461	25.4	71	#1 JETTS	2-11-75 10
1.0	6085	2735	1.0	1.5	0.2	1.0	93	99	9037	5970	211	222	226	221	196	187	198	211	191	-	207	225	225	227	190	214	170	205	199	171	.9	1.25	<10	37.3	457	24.5	75	#1 JETTS	2-11-75 10
0.5	6085	2735	0.5	1.5	0.2	1.0	101	106	8863	6000	227	230	233	228	228	199	209	219	195	-	207	231	231	233	190	224	170	205	199	170	.9	1.25	<10	37.1	461	24.1	72	#1 JETTS	2-11-75 10

Table VIII - Continued

Notes: (Unless Otherwise Specified)

1. Cone face T/C at 3.14 inch radius.

CONSTANT TEST SETTINGS: Shaft Speed 6,000 rpm
 Thrust Load 12,000 lbs
 Oil Inlet Temp 170 °F

SYMBOLS: Δ Test Condition (Retain)
 ← Reference Data Only
 * Calculated Values

PERFORMANCE TESTS WITH HIGH SPEED TAPERED ROLLER BEARINGS

N. O. 7000-4 - IV a

FRONT BEARING S/N 5

REAR BEARING S/N 1

TEST NO.	SPEED (RPM)		OIL FLOW (GPM)			OIL PRES.		BRG. LOADS		TEMPERATURE OF														SLANT FRICTION		VID LEVEL	MTRP			TEST LAB (°F)	NOTES	OVL BL						
	SHAFT Δ	SEPARATOR	ONE RIB Δ	SUPPORT		JETTS Δ	SUPP BRG. Δ	TEST INLET Δ	RADIAL Δ	REAR BEARING										FRONT BEARING				IN	OUT		I	V	HP									
				I.R.	O.R.					O.B. OUTER RING				I.N. INNER RING						OIL IN		OIL OUT																
				1	2					1	2	3	4	1	2	3	4	5	6	7	8	9	10										11	12	13	14	15	16
2dRI4.0	6070	2735	⊕	1.5	0.2	4.0	92	107	119633000	205	206	207	204	183	198	209	206	179	-	201	207	207	208	188	202	171	203	196	169	.9	1.25	<10	428	458	30.9	80	#BEFS	2-12-75 AD
3.0	6095	2740	⊕	15	0.2	3.0	93	93	120373000	209	210	212	208	185	204	215	211	183	-	203	213	211	213	187	205	170	202	195	170	.9	1.25	<10	409	451	28.0	68	#JETTS	2-24-75 AD
2.0	6105	2745	⊕	15	0.2	2.0	111	114	119803000	226	223	225	220	192	206	231	221	189	-	217	225	223	225	188	218	171	203	196	170	.9	1.25	<10	364	455	25.9	82	#JETTS	2-24-75 AD
1.0	6085	2740	⊕	1.5	0.2	1.0	100	106	119633000	251	246	249	245	208	221	251	240	202	-	201	251	250	252	190	247	170	204	197	171	.9	1.25	<10	354	455	21.9	74	#JETTS	2-14-75 AD
0.5	6090	2740	⊕	1.5	0.2	0.5	105	111	119633000	280	281	286	279	229	255	283	271	221	-	261	286	285	286	193	284	171	207	200	174	.9	1.25	<10	324	457	17.2	76	#JETTS	2-14-75 AD
2dRI3.0	6075	2730	2.9	1.5	0.2	1.0	106	112	119633000	199	217	221	218	196	184	189	206	188	-	195	220	220	221	187	204	169	200	195	168	.9	1.25	<10	406	461	28.7	76	#JETTS	2-12-75 AD
2.5	6075	2735	2.0	1.5	0.2	1.0	95	101	120002970	201	221	225	221	196	184	195	211	189	-	201	222	221	223	191	209	170	204	197	173	.9	1.25	<10	367	459	26.2	73	#JETTS	2-12-75 AD
1.0	6080	2735	1.0	1.5	0.2	1.0	94	99	120002970	214	226	229	225	198	189	200	215	192	-	209	227	228	229	188	216	169	201	195	170	.9	1.25	<10	361	457	25.2	75	#JETTS	2-12-75 AD
0.5	6085	2740	0.5	1.5	0.2	1.0	101	106	119633000	230	234	237	232	202	201	213	221	196	-	223	235	235	237	189	227	170	202	196	171	.9	1.25	<10	375	462	24.8	73	#JETTS	2-12-75 AD
AI2eRI3.0	6070	2730	2.9	1.5	0.2	1.0	105	111	119634480	197	216	220	216	194	182	189	207	186	-	197	219	219	220	190	206	170	201	196	174	.9	1.25	<10	404	462	28.8	76	#JETTS	2-12-75 AD

Table VIII - Continued

PERFORMANCE TESTS WITH HIGH SPEED TAPERED ROLLER BEARINGS

N. O. 7000-4 - IV a

Notes: (Unless Otherwise Specified)

1. Cone face T/C at ~3.14 inch radius.

CONSTANT TEST SETTINGS: Shaft Speed 6000 rpm
 Thrust Load 12000 lbf
 Oil Inlet Temp 170 °F

SYMBOLS: Δ Test Condition (Setting)
 ← Reference Data Only
 * Calculated Values

FRONT BEARING S/N 5

REAR BEARING S/N 1

TEST NO.	SPEED (RPM)		OIL FLOW (GPM)				OIL PRES.		DRG. LOADS		TEMPERATURE OF										SHAFT EXCURSION		VIB LEVEL	MOTOR			TEST LAB (°F)	NOTES	DATE											
	SHAFT Δ	SEPARATOR	CORE RLB Δ	SUPPORT		JETS Δ	SUPP DRG. Δ	INSTR DRG. Δ	INFLSTR/RADIAL		REAR BEARING										FRONT	REAR		I	V	HP *														
				J.R.	O.R.				INFL	RADIAL	BEARING O.D.	OUTER RING	BEARING I.D.	FACE	I.R.	I.D.	TEMP (°F)	TEMP (°F)	TEMP (°F)	TEMP (°F)										TEMP (°F)	TEMP (°F)	TEMP (°F)	TEMP (°F)	TEMP (°F)	TEMP (°F)	TEMP (°F)	TEMP (°F)	TEMP (°F)	TEMP (°F)	TEMP (°F)
11221240	6070	2730	⊖	1.5	0.2	4.0	92	97	12000	5980	204	204	206	202	182	197	206	205	177	-	197	205	204	206	189	200	170	205	198	170	.9	1.25	<10	430	459	313	81	#6 JTB	2-18-75 170	
3.0	6095	2740	⊖	1.5	0.2	3.0	93	93	12000	5970	210	210	212	208	185	203	215	211	184	-	203	212	210	213	189	205	170	205	198	169	.9	1.25	<10	406	451	275	70	#5 JTB	2-20-75 170	
2.0	6105	2745	⊖	1.5	0.2	2.0	112	115	12000	6030	216	222	225	220	192	214	230	221	189	-	216	225	223	225	189	219	170	206	198	169	.9	1.25	<10	394	453	265	85	#5 JTB	2-24-75 170	
1.0	6080	2735	⊖	1.5	0.2	1.0	100	105	11963	5970	252	246	250	246	210	232	252	241	202	-	242	252	251	253	191	248	170	207	200	171	.9	1.25	<10	358	456	219	76	#15 JTB	2-24-75 170	
0.5	6090	2735	⊖	1.5	0.2	0.5	105	111	11963	5980	281	281	286	280	230	256	282	271	220	-	212	287	286	288	194	283	170	210	202	174	.9	1.25	<10	329	458	178	76	#1 JTB	2-24-75 170	
11221230	6070	2730	2.9	1.5	0.2	1.0	105	110	12000	5980	199	216	220	217	195	183	191	207	187	-	197	220	220	221	195	205	169	202	198	173	.9	1.25	<10	412	461	295	76	#17 JTB	2-18-75 170	
2.5																																								
2.0	6080	2735	2.0	1.5	0.2	1.0	95	101	12014	5978	200	220	225	221	197	193	194	210	190	-	202	222	221	223	192	208	170	206	200	173	.9	1.3	<10	38	460	255	75	#17 JTB	2-20-75 170	
1.0	6080	2735	1.0	1.5	0.2	1.0	94	99	12000	6030	214	225	229	225	197	189	199	215	192	-	210	228	228	230	190	217	170	205	198	170	.9	1.25	<10	375	459	245	74	#7 JTB	2-14-75 170	
0.5	6085	2740	0.5	1.5	0.2	1.0	101	106	11963	6030	230	233	236	232	202	202	212	221	197	-	212	235	235	237	190	226	170	205	199	170	.9	1.25	<10	371	463	245	74	#1 JTB	2-15-75 170	

TABLE VIII - CONTINUED

PERFORMANCE TESTS WITH HIGH SPEED TAPERED ROLLER BEARINGS

N. O. 7000-4 - IV a

Notes: (Unless Otherwise Specified)

1. Cone face $\frac{1}{8}$ " at $\frac{1}{4}$ " radius.

CONSTANT TEST SETTINGS: Shaft Speed 6000 rpm
Thrust Load 6000 lb.
Oil Inlet Temp 195 °F

SYMBOLS: Δ Test Condition (Setting)
→ Reference Data Only
* Calculated Values

FRONT BEARING S/N 5

REAR BEARING S/N 1

TEST NO.	SPEED (RPM)		OIL RIB	OIL FLOW (GPM)			OIL PRESS.		BKG. LOADS		TEMPERATURE OF																			SHAFT DEVIATION		VIB LEVEL	AXIAL			TEST LAB (°F)	NOTES	DATE
	INMPT	SEPARATOR		SUPPORT		JETS	SUPP. BRG.	TEST BRG.	THIRST/RADIAL		REAR BEARING										FRONT BEARING									FRONT	REAR		I	V	HP			
				I.R.	O.R.				I.R.	O.B.	1	2	3	4	5	6	7	8	9	10	11	12	13	14	15	16	17	18	19									
AG61140	6080	2735	\emptyset	1.5	0.2	4.0	90	86	6037	3020	219	219	220	217	199	215	222	221	200	213	220	220	221	211	216	194	224	218	197	1.9	1.25	<10	31.9	453	24.5	73	#1 JETS	2-10-75 AD
3.0	6105	2745	\emptyset	1.5	0.2	3.0	94	94	5963	2980	226	226	228	224	205	220	219	227	205	220	227	226	228	214	223	195	226	219	198	.9	1.25	<10	36.2	453	22.0	82	#5 JETS	2-10-75 AD
2.0	6110	2745	\emptyset	1.5	0.2	2.0	103	106	6000	2980	237	234	235	231	206	225	240	235	206	229	234	234	235	215	231	196	227	219	200	.9	1.25	<10	34.8	452	20.2	82	#5 JETS	2-10-75 AD
1.0	6090	2745	\emptyset	1.5	0.2	1.0	98	103	5940	3010	256	252	255	250	218	237	256	250	219	247	256	255	257	217	254	195	229	222	202	.9	1.25	<10	34.0	461	20.0	77	#1 JETS	2-10-75 AD
0.5	6100	2745	\emptyset	1.5	0.2	0.5	102	108	6000	3000	261	279	263	278	238	259	282	275	236	213	283	283	284	221	281	196	234	228	206	.9	1.25	<10	31.7	460	16.0	81	#1 JETS	2-10-75 AD
AG61230	6085	2735	2.9	1.5	0.2	1.0	103	108	6000	2978	218	231	234	231	210	206	210	224	206	216	234	234	235	217	227	195	222	218	201	.9	1.25	<10	37	452	23.0	75	#1 JETS	2-10-75 AD
AG61230	6085	2735	2.9	1.5	0.2	1.0	104	109	6000	3000	218	232	235	232	214	205	210	223	210	216	235	235	236	215	226	195	225	220	200	.9	1.25	<10	31.7	463	26.5	78	#1 JETS	2-10-75 AD
2.5																																						
2.0	6085	2740	2.0	1.5	0.2	1.0	84	89	6000	3000	218	231	234	230	204	204	212	225	206	217	233	233	234	215	227	195	227	219	201	.9	1.25	<10	36.8	458	23.5	67	#1 JETS	2-10-75 AD
1.0	6090	2740	1.0	1.5	0.2	1.0	87	92	6000	3000	230	239	242	238	215	210	219	230	214	227	240	240	242	216	232	195	228	221	202	.9	1.25	<10	34.1	461	20.1	75	#1 JETS	2-10-75 AD
0.5	6090	2740	0.5	1.5	0.2	1.0	104	110	6000	3000	240	241	244	240	207	216	225	233	211	231	242	243	244	215	238	195	227	221	201	.9	1.25	<10	32.9	452	17.5	70	#1 JETS	2-10-75 AD
AG61230	6080	2735	2.9	1.5	0.2	1.0	102	108	6037	4478	218	231	235	232	210	206	210	224	208	216	235	235	236	215	225	194	224	219	200	.9	1.25	<10	36.0	456	21.8	78	#1 JETS	2-10-75 AD

REPRODUCIBILITY OF THE ORIGINAL PAGE IS POOR

Table VIII - Continued

Notes: (Unless Otherwise Specified)

1. Cone face 7/8 at ~3.14 inch radius.

CONSTANT TEST SETTINGS: Shift Speed 6000 rpm
 Thrust Load 6000 lbs
 Oil Inlet Temp 125 °F

PERFORMANCE TESTS WITH HIGH SPEED TAPERED ROLLER BEARINGS

W. O. 7000-4 - IV a

SYMBOLS: Δ Test Condition (Setting)
 \leftarrow Reference Data Only
 * Calculated Values

FRONT BEARING S/N 5 NEAR BEARING S/N 1

TEST NO.	SPEED (RPM)		OIL FLOW (GPM)				OIL PRES.		BKG. LOADS		TEMPERATURE OF														SHAFT EXCURSION		VID LEVEL	MOTOR			TEST LAB (°F)	NOTES	DATE						
	SHAFT Δ	SEPARATION	ONE RIB Δ	SUPPORT		JETS Δ	CUMP ENG.	TEST ENG.	TANGENTIAL Δ	RADIAL Δ	BEARING														FRONT Δ	REAR Δ		I	V	IP *									
				I.R.	O.R.						REG. O.B.	OUTER RING	INNER RING	FACE	I.D.	I.O.	SHAVE	L.B. OUT	OUTER RING	INNER RING	FACE	I.D.	I.O.	SHAVE			IN				OUT	IN	OUT	IN	OUT	IN	OUT		
ALF124.0	6080	2735	\oplus	15	0.2	40	91	87	6037	6000	221	220	221	219	200	215	223	222	201	-	216	220	221	222	215	221	196	228	221	199	.9	1.25	<10	385	457	25.5	76	#1 JTG	2-17-70
3.0	6110	2745	\oplus	15	0.2	30	94	94	6000	6030	214	224	226	222	204	218	227	226	206	-	218	223	223	226	214	225	195	218	221	198	.9	1.25	<10	384	486	24.0	82	#5 JTG	2-17-70
2.0	6110	2745	\oplus	15	0.2	20	104	106	6037	6000	237	234	225	231	207	224	239	234	211	-	229	234	234	236	216	231	195	229	222	199	.9	1.25	<10	384	452	21.2	82	#5 JTG	2-17-70
1.0	6090	2740	\oplus	15	0.2	10	98	103	6037	6020	258	253	256	252	210	241	258	250	221	-	248	256	256	258	218	256	196	232	226	202	.9	1.25	<10	383	461	20.1	78	#1 JTG	2-17-70
0.5	6095	2740	\oplus	15	0.2	0.5	102	108	6000	5970	290	276	261	277	238	258	280	273	236	-	263	281	281	284	221	281	195	236	229	206	.9	1.25	<10	389	461	16.8	81	#1 JTG	2-17-70
ALF123.0	6085	2540	2.9	15	0.2	1.0	102	108	5963	6030	217	229	233	230	210	204	221	223	207	-	215	232	233	234	216	228	195	225	220	200	.9	1.25	<10	387	453	21.7	79	#1 JTG	2-17-70
2.5																																							
2.0	6085	2740	2.0	15	0.2	1.0	85	90	6037	5960	219	232	236	232	208	205	213	225	209	-	218	232	233	233	217	229	195	230	223	201	.9	1.25	<10	383	458	23.1	69	#1 JTG	2-17-70
1.0	6085	2740	1.0	15	0.2	1.0	88	92	6000	6000	229	237	241	237	212	209	219	229	212	-	225	239	238	240	217	231	195	230	224	201	.9	1.25	<10	385	461	20.7	75	#1 JTG	2-17-70
0.5	6085	2740	0.5	15	0.2	1.0	93	98	6074	5980	241	243	246	242	217	217	226	234	216	-	234	245	245	247	215	241	195	228	221	201	.9	1.25	<10	389	458	19.4	76	#1 JTG	2-17-70

Table VIII - Continued

Notes: (Unless Otherwise Specified)

CONSTANT TEST SETTINGS: shaft speed 6000 rpm
 Thrust load 9000 lb
 Oil Inlet Temp 125 °F

PERFORMANCE TESTS WITH HIGH SPEED TAPERED ROLLER BEARINGS

N. O. 7800-4 - IV a

SYMBOLS: Δ Test Condition (Setting)
 ← Reference Data Only
 * Calculated Values

TEST NO.	FRONT BEARING S/N			REAR BEARING S/N										TEMPERATURES OF										OIL PRESSURE		VIB		ECCENTRICITY (%)	LUBES	O.C.									
	SHAFT	SEALS	OR	1	2	3	4	5	6	7	8	9	10	11	12	13	14	15	16	17	18	19	20	FRONT	REAR	HVLL	AVG												
99A/124.0	6075	2737	Δ	1.5	0.2	4.0	92	98	9000	2178	223	224	225	222	204	218	227	226	203	-	216	226	226	227	214	225	196	226	219	199	.9	1.25	<10	37.5	46.0	27.3	79	#6 Jets	2.175
3.0	6105	2745	⊕	1.5	0.2	3.0	94	94	8963	3000	219	230	232	228	208	206	233	231	208	-	223	231	230	232	215	230	196	227	221	199	.9	1.25	<10	31.8	45.8	24.8	82	#5 Jets	2.175
2.0	6115	2745	⊕	1.5	0.2	2.0	104	111	8963	2970	240	238	239	235	209	209	244	238	209	-	231	239	238	239	214	235	195	226	220	199	.9	1.25	<10	36.0	45.3	24.1	82	#5 Jets	2.175
1.0	6093	2740	⊕	1.5	0.2	1.0	98	103	8182	3000	262	259	261	257	225	245	264	256	224	-	254	262	262	264	217	260	196	230	223	202	.9	1.25	<10	34.0	46.1	19.9	78	#1 Jets	2.175
0.5	00	2740	⊕	1.5	0.2	0.5	102	108	9000	3030	286	285	289	284	241	263	289	280	238	-	269	289	289	291	220	285	195	233	226	206	.9	1.25	<10	31.0	46.0	16.5	82	#1 Jets	2.175
99B/R13.0	6060	2735	2.9	1.5	0.2	1.0	102	108	9000	3000	220	235	238	235	212	207	212	226	209	-	219	236	237	238	215	229	195	225	219	202	.9	1.25	<10	36.0	45.3	22.7	78	#1 Jets	2.175
2.5																																							
2.0	6085	2740	2.0	1.5	0.2	1.0	85	90	9000	3000	221	236	241	236	211	206	216	229	209	-	221	237	238	239	216	231	196	228	221	202	.9	1.25	<10	36.4	45.9	21.7	71	#1 Jets	2.175
1.0	6085	2740	1.0	1.5	0.2	1.0	88	93	8963	2970	233	242	246	242	215	210	221	233	215	-	229	244	244	245	217	236	195	228	222	202	.9	1.25	<10	35.9	46.1	22.6	74	#1 Jets	2.175
0.5	6085	2735	0.5	1.5	0.2	1.0	93	98	9037	2980	244	247	250	246	217	218	229	238	216	-	237	249	249	251	246	243	195	228	221	201	.9	1.25	<10	34.7	45.8	20.4	75	#1 Jets	2.175
99C/R13.0	6080	2730	2.9	1.5	0.2	1.0	103	108	9000	4520	222	235	239	236	214	208	213	227	211	-	219	236	237	238	218	229	195	225	220	201	.9	1.25	<10	37.8	45.2	24.2	80	#1 Jets	2.175

Table VIII - Continued

PERFORMANCE TESTS WITH HIGH SPEED TAPERED ROLLER BEARINGS

W. O. 7000-4 - IV a

Notes: (Unless Otherwise Specified)

1. Cone face T/C at ~3.14 inch radius.

CONSTANT TEST SETTINGS: Shaft Speed 6000 rpm
 Thrust Load 9000 lbs
 Oil Inlet Temp 125 °F

SYMBOLS: Δ Test Condition (Setting)
 ← Reference Data (only)
 * Calculated Values

FRONT BEARING S/N 5

REAR BEARING S/N 1

TRT NO.	SPEED (RPM)		OIL FLOW (GPM)			OIL PRES.		ING. LOADS		TEMPERATURE OF										SHAFT EXCURSION		VIB LEVEL	AXTOR			TEST LAB (°F)	NOTES	DATE BY										
	SHAFT	SEPARATOR	ONE RIB	SUPPORT		JLTS	SUPP INGT.	TST INGT.	TANGENTIAL	RADIAL	REAR BUN L.G.					FRONT BEARING					IN		OUT	I	V				HP									
				I.R.	O.R.						INGT.	OUTER RING	IN	OUT	IN	OUT	IN	OUT	IN	OUT										IN	OUT	IN	OUT					
APR 40	6080	2735	Δ	1.5	0.2	4.0	93	98	9000	5970	221	222	223	220	202	216	225	223	202	218	223	224	225	215	223	195	228	221	198	.9	1.25	<10	398	458	27.3	80	*6 JTB	2-18-75 AD
3.0	6105	2745	⊖	1.5	0.2	3.0	95	95	8900	5970	227	218	230	226	206	226	233	231	206	221	230	229	231	215	229	195	229	222	199	.9	1.25	<10	389	460	27.8	81	*5 JTB	2-18-75 AD
2.0	6110	2745	⊖	1.5	0.2	2.0	104	107	9000	5970	241	239	241	236	210	235	247	239	212	233	239	240	215	236	195	229	222	199	.9	1.25	<10	359	453	21.8	82	*5 JTB	2-22-75 AD	
1.0	6090	2740	⊖	1.5	0.2	1.0	98	103	9037	6060	262	262	257	224	245	244	256	225	253	262	262	263	218	261	196	231	225	202	.9	1.25	<10	355	461	22.0	78	*1 JTB	2-24-75 UM	
0.5	6095	2745	⊖	1.5	0.2	0.5	102	108	9000	5970	289	286	291	285	243	244	290	282	240	270	291	290	292	223	287	196	236	230	207	.9	1.25	<10	331	460	18.5	81	*1 JTB	2-27-75 AD
APR 30	6080	2735	2.9	1.5	0.2	1.0	103	109	9000	6030	219	234	237	234	212	205	211	228	211	217	234	236	237	215	226	194	226	221	201	.9	1.25	<10	375	453	24.0	75	*1 JTB	2-12-75 AD
2.5	6085	2735	2.0	1.5	0.2	1.0	85	90	9074	5970	222	236	241	237	212	206	215	228	211	22	238	238	239	217	231	195	230	223	201	.9	1.25	<10	372	460	24.5	73	*1 JTB	2-22-75 AD
1.0	6085	2735	1.0	1.5	0.2	1.0	88	93	9000	6030	232	241	245	240	215	210	220	233	216	227	243	242	244	217	235	194	230	224	201	.9	1.25	<10	355	463	22.0	74	*1 JTB	2-22-75 AD
0.5	6090	2740	0.5	1.5	0.2	1.0	96	99	8963	5960	245	247	251	246	218	218	230	237	218	238	249	249	251	217	244	195	231	224	201	.9	1.25	<10	345	459	20.4	75	*1 JTB	2-27-75 AD

Table VIII - Continued

Notes: (Unless Otherwise Specified)

1. Cone face T/C at ~3.14 inch radius.

CONSTANT TEST SETTINGS: Shaft Speed 6000 rpm
Thrust Load 2000 lbf
Oil Inlet Temp 125 °F

SYMBOLS: Δ Test Continuation (Setting)
← Reference Data Only
* Calculated Values

PERFORMANCE TESTS WITH HIGH SPEED TAPERED ROLLER BEARINGS

W. O. 7000-4 - IV a

FRONT BEARING S/N 5

REAR BEARING S/N 1

TEST NO.	SHAFT (RPM)		OIL FILM (CM)	OIL PRESS.		INFL. LOADS		TEMPERATURE OF																				SHAFT EXPANSION		VIB. LEVEL	AVG. TORQUE (HP)	TEST LAB (°F)	NOTES	DIN. (IN)					
	UNIT	SHAFT/SHAFT		INLET	OUTLET	INLET	OUTLET	INLET	OUTLET	LOC. 1	LOC. 2	LOC. 3	LOC. 4	LOC. 5	LOC. 6	LOC. 7	LOC. 8	LOC. 9	LOC. 10	LOC. 11	LOC. 12	LOC. 13	LOC. 14	LOC. 15	LOC. 16	LOC. 17	LOC. 18	LOC. 19	LOC. 20						IN x 10 ⁻³	OUT x 10 ⁻³			
A12dUA4.0	6075	2735	1.5	0.2	4.0	92	87	11963	3000	224	225	226	223	204	219	228	226	203	-	216	226	226	227	214	221	196	225	219	199	.9	1.25	<10	40.8	457	28.6	81	#1 JTB	2-10-75	
3.0	6105	2735	1.5	0.2	3.0	95	95	11963	2970	229	230	232	228	207	236	234	231	207	-	223	233	231	233	213	230	195	225	218	198	.9	1.25	<10	39.5	459	27.2	80	#5 JTB	2-10-75	
2.0	6105	2745	1.5	0.2	2.0	104	107	11963	3000	243	241	243	238	211	233	248	239	210	-	234	242	241	242	214	238	195	226	220	198	.9	1.25	<10	36.2	455	22.2	82	#5 JTB	2-10-75	
1.0	6090	2740	1.5	0.2	1.0	98	103	12087	3040	265	261	264	260	226	247	267	257	225	-	256	266	265	267	217	264	196	229	222	202	.9	1.25	<10	35.2	460	21.5	78	#1 JTB	2-10-75	
0.5	6095	2745	1.5	0.2	1.0	103	108	11963	3030	271	270	274	269	245	266	283	262	240	-	274	285	274	276	220	270	195	233	226	206	.9	1.25	<10	32.3	461	17.3	80	#1 JTB	2-10-75	
A12dUA3.0	6075	2730	2.9	1.5	0.2	1.0	103	108	11963	3000	221	236	237	236	214	206	211	228	208	-	229	240	240	210	215	233	195	222	218	201	.9	1.25	<10	37.7	453	24.0	75	#1 JTB	2-10-75
2.5																																							
2.0	6085	2740	2.0	1.5	0.2	1.0	86	90	12074	3000	223	238	243	239	215	206	217	230	213	-	223	238	240	240	220	235	195	224	220	202	.9	1.25	<10	38.9	460	26.4	72		
1.0	6085	2735	1.0	1.5	0.2	1.0	88	93	11963	3000	235	244	248	244	216	211	224	236	217	-	220	246	246	248	216	239	194	227	221	201	.9	1.25	<10	36.0	462	21.6	74	#1 JTB	2-10-75
0.5	6085	2740	0.5	1.5	0.2	1.0	94	99	11963	3020	247	250	253	249	219	221	232	240	219	-	240	253	252	254	216	247	195	228	221	201	.9	1.25	<10	35.2	459	21.5	75	#1 JTB	2-10-75
A12dUA3.0	6080	2735	2.9	1.5	0.2	1.0	102	108	11963	4540	221	236	240	236	214	209	211	227	209	-	219	236	238	239	214	234	195	225	220	201	.9	1.25	<10	38.4	455	25.5	75	#1 JTB	2-10-75

Table VIII - Continued

Notes: (Unless Otherwise Specified)

1. Cone face T/C at ≈ 3.14 inch radius.

CONSTANT TEST SETTINGS: Shaft Speed 6000 rpm
Thrust Load 1000 lbs.
Oil Inlet Temp 125 °F

SYMBOLS: Δ Test Condition (Setting)
← Reference Data Only
* Calculated Values

PERFORMANCE TESTS WITH HIGH SPEED TAPERED ROLLER BEARINGS

W. O., 7000-4 - IV a

FRONT BEARING S/N 5

REAR BEARING S/N 1

TEST NO.	SIZES (INCH)		CONE RND	OIL FLOW (GPM)		OIL PRES.		PRG. LOADS		TEMPERATURE OF																	SHFT EXTENSION		VIB LEVEL	A70P			TEST LAB (°F)	NOTES	D.O.L.				
	SHAFT	SEPARATOR		I.R.	O.R.	SUPP BRG.	TEST BRG.	THRUST	WADLAR	FRONT BEARING				REAR BEARING				OIL				FRONT	REAR	I	V	HP													
										INSG. O.B.	OUTER RING	INSG. I.B.	OUTER RING	INSG. O.B.	OUTER RING	INSG. I.B.	OUTER RING	IN	OUT	IN	OUT						IN	OUT		IN	OUT								
91251240	6075	2735	\emptyset	1.5	0.2	4.0	92	98	11963	6000	223	224	225	222	202	218	227	225	201	-	219	224	225	226	214	225	195	228	221	199	.9	1.25	<10	40.7	45.7	28.6	81	#1 JTB	2-11-75
3.0	6100	2745	\emptyset	1.5	0.2	3.0	96	96	11963	6030	229	230	233	229	207	225	234	232	207	-	223	231	231	233	215	231	195	229	222	198	.9	1.25	<10	39.0	46.0	26.8	80	#5 JTB	2-11-75
2.0	6105	2745	\emptyset	1.5	0.2	2.0	105	108	11963	5970	243	241	243	238	211	232	249	239	211	-	231	242	241	242	216	238	195	229	222	198	.9	1.25	<10	36.6	45.4	22.8	82	#5 JTB	2-11-75
1.0	6090	2740	\emptyset	1.5	0.2	1.0	98	103	11963	5970	245	261	264	260	226	246	267	257	222	-	256	265	265	267	217	264	195	231	225	201	.9	1.25	<10	35.2	46.1	21.5	79	#1 JTB	2-11-75
0.5	6095	2745	\emptyset	1.5	0.2	0.5	103	108	11963	6000	243	241	245	240	246	267	243	264	242	-	275	246	245	247	223	242	196	236	230	206	.9	1.25	<10	33.5	44.0	19.0	78	#1 JTB	2-11-75
91251230	6080	2735	2.9	1.5	0.2	1.0	102	108	11963	5970	222	236	240	237	214	267	212	228	209	-	220	241	240	241	218	233	195	227	221	202	.9	1.25	<10	38.2	45.2	24.7	75	#1 JTB	2-11-75
3.0	6085	2740	2.9	1.5	0.2	1.0	105	110	11963	5970	222	237	240	237	215	208	214	228	211	-	220	239	240	241	217	231	195	227	221	202	.9	1.25	<10	39.8	46.3	27.8	78	#1 JTB	2-11-75
2.0	6080	2735	2.0	1.5	0.2	1.0	86	101	12000	5970	223	238	243	239	215	206	216	230	212	-	222	240	239	240	217	233	195	230	223	201	.9	1.25	<10	38.7	46.0	26.2	75	#1 JTB	2-11-75
1.0	6085	2735	1.0	1.5	0.2	1.0	88	93	12000	5970	225	244	249	244	216	211	214	237	217	-	231	246	246	248	218	239	196	231	224	202	.9	1.25	<10	37.2	46.2	24.5	74	#1 JTB	2-11-75
0.5	6085	2735	0.5	1.5	0.2	1.0	94	99	12000	6000	248	250	251	249	240	221	233	241	220	-	244	253	252	255	217	248	195	231	224	201	.9	1.25	<10	35.7	46.0	22.3	75	#1 JTB	2-11-75

Table VIII - Continued

-48-

Notes: (Unless Otherwise Specified)

CONSTANT TEST SETTINGS: Load 10,000 lbf
 Thrust Load 6000 lbf
 Oil Inlet Temp 170 °F

13

PERFORMANCE TESTS WITH HIGH SLEDGED TAPERED ROLLER BEARINGS. Cone face T/C at ~3.14 inch radius.

W. O. 7000-4 - IV a

SYMBOLS: Δ Test Condition (Existing)
 ← Reference Data Only
 • Calculated Value

FRONT BEARING S/N 4

REAR BEARING S/N 1

TEST NO.	OIL FILM (MIL)		OIL DRIP (MIL)	OIL FILM (MIL)		TEMPERATURE OF										OIL FILM		VIBRATION			F.L.S. TAB (°F)	REMARKS	D.S.															
	SUBJECT	SEPARATION		I.R.	O.B.	JETS	INLET					OUTLET					INLET	REAR	I	V				IP														
							1	2	3	4	5	6	7	8	9	10									11	12	13	14	15	16								
86dJI 40	10055	4525	0	1.5	0.2	40	111	107	5963	3020	130	225	225	220	187	221	241	225	187	217	227	230	229	204	219	170	241	226	172	.75	1.3	135	450	52.5	78	#6 JETS	112.75	
30	10065	4530	0	1.5	0.2	3.0	94	93	5985	3000	151	132	239	228	194	229	246	230	195	226	238	240	241	206	243	171	245	229	174	.75	1.3	105	453	50.0	69	#5 JETS	112.75	
2.0	10080	4535	0	1.5	0.2	2.0	102	105	6000	3040	262	251	253	247	201	246	269	246	201	234	255	257	256	205	263	170	245	229	174	.75	1.25	555	452	44.5	62	#5 JETS	112.75	
1.0																																						
.5																																						
86dRI 30	10075	4530	2.9	1.5	0.2	1.0	103	109	5963	2990	212	242	247	240	208	190	200	214	200	210	242	243	245	206	228	170	242	229	175	.8	1.4	514	452	43.4	76	#1 JETS	112.75	
25	10080	4530	2.5	1.5	0.2	1.0	87	92	5963	2970	215	245	251	244	210	191	205	227	202	212	246	250	250	211	231	171	241	226	173	.75	1.35	51	450	43.0	71	#1 JETS	112.75	
20	10065	4535	2.0	1.5	0.2	1.0	101	106	6037	2990	220	246	251	245	213	195	205	226	204	217	250	251	253	207	237	170	243	228	173	.75	1.35	515	451	43.5	77	#1 JETS	112.75	
10	10080	4535	1.0	1.5	0.2	1.0	103	108	6000	3000	239	251	257	251	211	210	220	233	206	232	260	265	264	209	256	169	242	226	173	.75	1.35	<10	517	451	40.8	69	#1 JETS	112.75
10	10200	4570	1.0	1.5	0.2	1.0	103	108	6075	2970	240	252	257	251	211	211	217	231	201	232	263	268	267	210	263	170	249	232	175	.95	1.15	<10	530	458	42.5	78	#1 JETS	112.75
.5	10090	4535	0.5	1.5	0.2	1.0	104	109	6000	3000	259	263	267	262	221	227	239	242	210	243	273	274	277	211	276	170	245	230	175	.75	1.35	495	455	38.5	72	#1 JETS	112.75	

Table VIII - Continued

Notes: (Unless Otherwise Specified)

1. Cone face T/C at ~ 3.14 inch radius.

CONSTANT TEST SETTINGS: Shaft Speed 10,000 rpm
Thrust Load 6,000 lbs
Oil Inlet Temp 170 °F

PERFORMANCE TESTS WITH HIGH SPEED TAPERED ROLLER BEARINGS

W. O. 7000-4 - IV a

FRONT BEARING S/N 4

REAR BEARING S/N 1

SYMBOLS: Δ Test Condition (Setting)
← Reference Data Only
* Calculated Value

14

TEST NO.	SPEED (RPM)		OIL FLOW (GPM)			OIL PRES.		BKG. LOADS		TEMPERATURE OF																				SHAFT EXCURSION		VIB LEVEL	MOTOR			TEST LAB (°F)	NOTES	INVT. BY	
	Δ	SEPARATOR	CONE RIB Δ	SUPPORT		SUPP BKG.	T1ST ING.	TANGENTIAL	RADIAL	REAR BEARING										FRONT BEARING										FRONT In x 10 ⁻³	REAR In x 10 ⁻³		I	V	HP				
				I.R.	O.R.					JETS Δ	I.S.G. OUTER RING				REV. RING		CONE FACE		BKG. FACE		SHAFT		LUB.		OUTER RING				INNER RING			OIL IN				SLAVE BEARING			
				←	→					Δ	1	2	3	4	5	6	7	8	9	10	11	12	13	14	15	16	17	18	19			20				21	22	23	24
B6eJI 40	10060	4525	\ominus	1.5	0.2	4.0	111	107	6000	4500	230	225	275	222	188	224	243	226	189	-	218	228	230	230	205	222	170	245	230	172	.75	1.3	64.0	451	53.2	78	#6 JETs	1-25-75 AD	
30	10065	4530	\ominus	1.5	0.2	3.0	94	94	6000	4500	239	232	232	229	194	228	246	230	194	-	224	238	239	241	208	242	170	247	232	173	.75	1.3	59.5	453	48.7	68	#5 JETs	1-29-75 AD	
20	10080	4535	\ominus	1.5	0.2	2.0	103	106	6000	4500	262	251	252	247	202	245	268	245	202	-	238	254	257	257	208	262	170	249	234	175	.75	1.25	56.3	452	45.5	64	#5 JETs	1-30-75 AD	
10																																							
.5																																							
B6eRI 30	10070	4535	2.9	1.5	0.2	1.0	104	110	6037	4500	214	242	247	241	210	190	200	223	201	-	210	243	246	247	214	228	170	244	231	176	.75	1.35	55.0	453	44.0	77	#1 JETs	1-25-75 AD	
25	10080	4535	2.5	1.5	0.2	1.0	87	92	6000	4500	215	244	249	243	210	188	202	225	203	-	212	245	249	249	207	232	170	246	231	173	.75	1.35	55.0	452	43.9	74	#1 JETs	1-25-75 AD	
20	10080	4530	2.0	1.5	0.2	1.0	101	106	6037	4480	225	245	250	245	212	194	205	225	205	-	216	249	251	253	208	226	170	246	231	173	.75	1.35	54.6	452	43.6	78	#1 JETs	1-24-75 AD	
10	10080	4530	1.0	1.5	0.2	1.0	103	108	6037	4480	240	254	259	254	215	211	222	234	210	-	233	262	266	267	209	259	170	247	232	175	.75	1.35	<10	536	455	42.2	70	#1 JETs	1-25-75 AD
5	10090	4535	0.5	1.5	0.2	1.0	104	110	5980	4490	240	244	268	263	223	216	238	243	213	-	242	273	275	278	209	276	170	252	235	176	.75	1.35	50.0	455	39.0	72	#1 JETs	1-25-75 AD	

Table VIII - Continued

Notes: (Unless Otherwise Specified)

1. Cone face T/C at ~3.14 inch radius.

CONSTANT TEST SETTINGS: Shaft Speed 10,000 rpm
Thrust Load 9000 lbs
Oil Inlet Temp 170 °F

15

PERFORMANCE TESTS WITH HIGH SPEED TAPERED ROLLER BEARINGS

W. O. 7000-4 - IV a

SYMBOLS: Δ Test Condition (Series)
← Reference Data Only
* Calculated Values

FRONT BEARING S/N 4 REAR BEARING S/N 1

TEST NO.	SPEED (RPM)		OIL FLOW (GPM)			OIL PRES.		WGT. LOSS		TEMPERATURE OF										SHAFT EXCITATION		VIB LEVEL	ATM.			TEST LAB (°F)	NOTES	T.M.											
	SHAFT Δ	SEPARATOR	CORE RIB Δ	SUPPORT		JETTS Δ	SUPP. INQ. Δ	TEST DRG. Δ	THINSTRADIAL Δ	REAR BEARING										PEAK	RMS		I	V	HP														
				I.R.	O.R.					1	2	3	4	5	6	7	8	9	10										11	12	13	14	15	16	17	18	19	20	
89JRI 40	10055	4525	0	1.5	0.2	4.0	111	106	9037	2970	234	230	231	226	190	226	247	230	190	224	232	233	233	204	232	169	241	227	171	.75	1.3	66.5	451	55.6	79	#6 JETS	2375 80		
30	10065	4525	0	1.5	0.2	3.0	94	94	8963	4470	244	238	240	234	198	235	255	238	198	235	244	244	246	206	248	170	244	229	173	.75	1.3	61.5	453	50.9	71	#5 JETS	2375 80		
20	10060	4535	0	1.5	0.2	2.0	102	105	9020	2980	213	257	259	252	205	250	275	252	204	243	260	263	262	206	267	170	246	230	174	.75	1.25	57.3	453	46.3	65	#5 JETS	2375 80		
10																																							
.5																																							
89JRI 30	10070	4530	2.9	1.5	0.2	1.0	101	106	9000	3010	217	250	256	250	216	193	204	231	205	215	250	251	253	211	234	171	245	230	176	.75	1.4	56.7	453	46.6	81	#1 JETS	2375 80		
25	10075	4530	2.5	1.5	0.2	1.0	85	91	9000	3022	218	252	259	251	216	192	206	232	206	216	251	255	255	211	235	169	242	228	173	.75	1.35	<10	59	485	48.7	76	#1 JETS	2375 80	
20	10075	4530	2.0	1.5	0.2	1.0	101	107	9000	3020	215	254	258	252	217	199	211	234	209	211	255	259	259	211	242	169	243	229	173	.75	1.35	56.3	454	45.7	77	#2 JETS	2375 80		
10	10080	4535	1.0	1.5	0.2	1.0	103	108	8963	3000	245	261	266	261	220	215	227	242	211	223	269	273	273	208	264	171	248	230	175	.75	1.35	<10	53.4	452	42.3	70	#1 JETS	2375 80	
.5	10085	4540	0.5	1.5	0.2	1.0	104	110	8963	3040	262	272	277	271	227	231	247	251	216	256	282	283	286	210	284	171	250	232	177	.75	1.35	53.0	455	42.3	73	#1 JETS	2375 80		

REPRODUCIBILITY OF THE ORIGINAL PAGE IS POOR

Table VIII - Continued

Notes: (Unless Otherwise Specified)

1. Cone face T/C at ~3.14 inch radius.

CONSTANT TEST SETTINGS: Shaft speed 10,000 rpm
Thrust Load 9,000 lbf
Oil Inlet Temp 170 °F

16

PERFORMANCE TESTS WITH HIGH SPEED TAPERED ROLLER BEARINGS

W. O. 7000-4 - IV a

SYMBOLS: Δ Test Oxidation (Setting)

◊ Reference Data Only

* Calculated Values

FRONT BEARING S/N 4 REAR BEARING S/N 1

TEST NO.	SPEED (RPM)		OIL FLOW (GPM)			OIL PRES.		PRG. LONG.		TEMPERATURE OF										SHAFT EXCURSION		VIB LEVEL	MOTOR			TEST LAB (°F)	NOTES	O.V. H												
	SHAFT Δ	SEPARATOR	OIL RIB Δ	IMPORT		JETTS Δ	SUPT PRG. Δ	TEST PRG. Δ	THICK Δ	RADIAL Δ	REAR ROLLER										FRONT		REAR	I	V				HP *											
				I.R.	O.R.						REG. O.D.	OUTER RING	REG. I.D.	OUTER RING	REG. I.D.	OUTER RING	REG. I.D.	OUTER RING	REG. I.D.	OUTER RING										REG. I.D.	OUTER RING	REG. I.D.	OUTER RING	REG. I.D.	OUTER RING	REG. I.D.				
				1	2						3	4	5	6	7	8	9	10	11	12										13	14	15	16	17	18	19	20			
89eRZ 40	10055	4525	0	1.5	0.2	4.0	110	106	8963	4480	233	219	230	225	190	227	247	230	190	-	216	232	233	233	204	233	170	245	236	172	.75	1.3	660	452	552	80	#6 JTB	1-28-75 AD		
30	10060	4525	0	1.5	0.2	3.0	95	94	9000	4480	244	237	239	224	198	225	255	238	198	-	235	244	244	246	206	247	169	246	232	172	.75	1.3	640	455	537	73	#5 JTB	1-28-75 AD		
20	10075	4530	0	1.5	0.2	2.0	102	105	9037	4480	268	257	260	253	246	249	275	252	202	-	244	261	263	263	208	268	170	249	234	174	.75	1.25	582	452	478	66	#5 JTB	1-30-75 AD		
10																																								
.5																																								
89eRZ 30	10065	4530	2.9	1.5	0.2	1.0	104	109	9000	4460	217	250	255	249	216	191	204	232	205	-	214	249	250	252	214	232	170	245	232	175	.75	1.4	565	452	986	80	#1 JTB	1-28-75 AD		
25	10065	4525	2.5	1.5	0.2	1.0	86	91	9000	4520	218	252	257	251	216	190	204	231	206	-	215	251	255	255	207	235	170	247	232	174	.75	1.35	582	452	474	77	#1 JTB	1-24-75 AD		
20	10080	4525	2.0	1.5	0.2	1.0	102	106	8983	4500	224	253	257	251	216	197	207	232	207	-	221	255	258	259	211	242	170	245	231	174	.75	1.35	573	457	472	77	#1 JTB	1-27-75 AD		
10	10080	4535	1.0	1.5	0.2	1.0	102	107	9000	4500	245	260	265	260	210	215	227	242	214	-	228	269	272	272	210	244	169	250	232	175	.75	1.3	<10	542	452	438	70	#1 JTB	1-27-75 AD	
.5	10086	4535	0.5	1.5	0.2	1.0	104	110	9000	4520	267	271	276	271	227	229	246	250	216	-	256	280	280	284	210	233	170	252	236	176	.75	1.35	524	458	420	73	#1 JTB	1-27-75 AD		

Table VIII - Continued

Notes: (Unless Otherwise Specified)

1. Cone face T/C at ~3.14 inch radius.

CONSTANT TEST SETTINGS: Shaft Speed 10,000 rpm
Thrust Load 3000 lb
Oil Inlet Temp 170 °F

SYMBOLS: Δ Test Condition (Setting)
← Reference Data Only
* Calculated Values

PERFORMANCE TESTS WITH HIGH SPEED TAPERED ROLLER BEARINGS

W. O. 7000-4 - IV a

FRONT BEARING S/N 4

REAR BEARING S/N 1

TEST NO.	SPEED (RPM)		OIL FLOW (GPM)			OIL PRESS.		DRG. LOADS		TEMPERATURE OF														SHAFT EXTENSION		VID (MM)	MOTOR			TEST LAB (°F)	NOTES	OVRT. (°F)						
	INLET Δ	SEPARATION	ONE RIB Δ	SUPPORT		JMS Δ	SUPP ING. Δ	TEST INGT. Δ	TANG. Δ	RADIAL Δ	FRONT BEARING														FRONT IN x 10 ⁻³		REAR IN x 10 ⁻³	I	V				HP					
				I.R.	O.R.						E.G. OUTER RING				E.G. INNER RING				E.G. ROLLER				E.G. CAGE															
				1	2						3	4	5	6	7	8	9	10	11	12	13	14	15	16										17	18	19	20	
39421	40	10050	4525	⊖	1.5	0.2	40	110	106	8963	5970	234	229	230	225	190	226	249	231	190	222	233	234	234	206	232	170	247	232	171	.75	1.3	655	453	549	80	#6 JETS	127.5
	30	10060	4525	⊖	1.5	0.2	30	106	105	9000	6000	244	238	240	235	198	235	256	239	199	232	244	244	246	207	248	170	249	234	171	.75	1.3	610	453	535	73	#5 JETS	129.5
	20	10075	4530	⊖	1.5	0.2	20	102	105	9000	6000	267	256	257	252	205	249	276	252	203	244	260	262	262	209	268	170	251	236	174	.75	1.25	580	452	580	66	#5 JETS	136.5
	10																																					
	5																																					
19491	30	10065	4530	2.95	1.5	0.2	1.0	103	109	9000	6030	216	219	254	248	215	190	204	231	207	213	249	252	252	211	231	170	245	232	174	.75	1.35	580	452	472	80	#1 JETS	123.5
20004	25	10070	4530	2.9	1.5	0.2	1.0	106	111	9037	6000	216	218	254	247	214	192	204	233	205	214	249	250	251	215	232	171	242	231	175	.75	1.3	519	461	483	79	#1 JETS	120.5
	20	10065	4535	2.5	1.5	0.2	1.0	86	91	9037	6030	219	252	257	251	216	191	206	233	209	215	251	255	255	215	235	170	245	232	174	.75	1.3	580	452	472	77	#1 JETS	120.5
	10	10080	4530	1.0	1.5	0.2	1.0	102	107	9037	6030	215	210	266	260	220	215	217	242	214	228	269	272	272	212	263	170	252	236	175	.75	1.3	410	550	453	70	#1 JETS	127.5
	5	10085	4540	0.5	1.5	0.2	1.0	104	110	8963	6000	267	272	276	271	236	230	246	250	218	256	281	282	285	210	263	170	253	237	176	.75	1.35	532	458	430	73	#1 JETS	123.5

Table VIII - Continued

Notes: (Unless Otherwise Specified)

1. Cone face T/C at 3.14 inch radius.

CONSTANT TEST SETTINGS: Shaft Speed 10,000 rpm
Thrust Load 12,000 lbs
Oil Inlet Temp 170 °F

PERFORMANCE TESTS WITH HIGH SPEED TAPERED ROLLER BEARINGS

M. O. 7000-4 - IV a

FRONT BEARING S/N 4

REAR BEARING S/N 1

SYMBOLS: Δ Test Condition (Setting)
Reference Data Only
* Calculated Values

TEST NO.	SPEED (RPM)		OIL FLOW (GPM)				OIL PRES.		BKG. LOADS		TEMPERATURE OF														SHAFT ENCOURSION		VIB LEVEL	MOTOR			TEST LAB (°F)	NOTES	DATE BY						
	SHAFT Δ	SEPARATOR	CORE RLE Δ	SUPPORT		JETS Δ	SUPP BKG.	TEST BKG.	THERM	RADIAL	REAR BEARING										FRONT BEARING		FRONT In x 10 ⁻³	REAR In x 10 ⁻³	I	V		HP *											
				I.R.	O.R.						OUTER RING				SHAFT		CONE		BKG. SHAFT		L.O. OUT	OUTER RING					LARGE OUT		OIL IN Δ	SLAVE BEARING									
	1	2	3	4	1	2	3	4	5	6	7	8	9	10	11	12	13	14	15	16		17(1)	18(2)	19(3)	20(4)														
B12001 40	10055	4520	\ominus	1.5	0.2	4.0	110	106	17000	2990	226	232	234	228	191	230	250	234	190	-	222	235	226	226	205	224	169	241	227	170	.75	1.3	460	455	56.0	80	#6 JETS	1-2-75 MD	
30	10060	4525	\oplus	1.5	0.2	3.0	97	97	11863	3000	246	241	243	237	200	238	258	241	200	-	220	247	247	249	204	250	169	243	229	171	.75	1.3	621	455	53.1	72	#5 JETS	1-2-75 MD	
20	10070	4530	\ominus	1.5	0.2	2.0	102	105	12051	3030	272	261	264	257	208	254	279	256	204	-	246	265	265	266	206	271	170	247	231	174	.75	1.25	592	452	55.0	68	#5 JETS	1-2-75 MD	
10																																							
5																																							
B12002 30	10060	4525	2.9	1.5	0.2	1.0	103	108	11863	3040	279	259	260	253	218	207	226	206	-	217	253	255	256	206	235	170	240	228	174	.8	1.35	620	452	51.4	80	#1 JETS	1-2-75 MD		
25	10065	4530	2.5	1.5	0.2	1.0	86	91	2000	3020	221	257	263	256	219	194	209	236	209	-	219	256	259	259	211	240	170	244	230	175	.8	1.35	582	450	47.4	78	#1 JETS	1-2-75 MD	
20	10070	4530	2.0	1.5	0.2	1.0	101	106	11863	3000	279	259	264	258	221	199	215	240	211	-	226	261	263	264	207	246	170	241	228	175	.75	1.35	<10	598	460	50.2	76	#1 JETS	1-2-75 MD
10	10075	4535	1.0	1.5	0.2	1.0	102	108	12000	3040	250	266	271	266	225	218	232	248	215	-	243	275	278	278	209	269	171	248	231	176	.75	1.3	<10	862	453	45.6	71	#1 JETS	1-2-75 MD
5	10080	4535	0.5	1.5	0.2	1.0	104	110	12037	3000	272	278	282	278	231	235	251	256	219	-	260	288	289	291	214	290	171	250	232	177	.75	1.35	535	460	43.5	73	#1 JETS	1-2-75 MD	

Table VIII - Continued

-54-

Notes: (Unless Otherwise Specified)

1. Cone face T/C at ≈ 3.16 inch radius.

CONSTANT TEST SETTINGS: Shaft Speed 10,000 rpm
 Thrust Load 12,000 lbs
 Oil Inlet Temp 170 °F

SYMBOLS: Δ Test Condition (Setting)
 \leftarrow Reference Data Only
 * Calculated Values

PERFORMANCE TESTS WITH HIGH SPEED TAPERED ROLLER BEARINGS

W. O. 7000-A - IV a

FRONT BEARING S/N 4

REAR BEARING S/N 1

19

TEST NO.	SPEED (RPM)		OIL FLOW (GPM)				OIL PRES.		DRG. LOADS		TEMPERATURE OF																				SHAFT EXCURSION		VIB LEVEL	MOTOR			TEST LAB (°F)	NOTES	D.C.T.
	SHAFT	SEPARATOR	CONE RIB	SUPPORT		JETS	SUPT ING.	TEST ENG.	THRUST	RADIAL	REAR BEARING										FRONT BEARING										FRONT	REAR		X	V	IP			
				I.R.	O.R.						REG. O.B.	OUTER RING	REG. I.B.	INNER RING	SHAFT	DRUM	OUTER RING	REG. I.B.	INNER RING	SHAFT	DRUM	OUTER RING	REG. I.B.	INNER RING	SHAFT	DRUM	OUTER RING	REG. I.B.	INNER RING	SHAFT			DRUM				OUTER RING	REG. I.B.	INNER RING
	Δ	Δ	Δ	Δ	Δ	Δ	Δ	Δ	Δ	Δ	1	2	3	4	5	6	7	8	9	10	11	12	13	14	15	16	17(1)	18(2)	19(3)	20(4)	In x 10 ⁻³	In x 10 ⁻³	a	°	°	°			
B12eT140	10055	4520	\emptyset	1.5	0.2	4.0	110	106	11963	4480	236	232	234	229	192	230	251	235	191	-	222	235	236	236	205	235	169	244	230	170	.75	1.3	66.2	458	56.4	79	#6 JETS	123-75 80	
30	10060	4525	\emptyset	1.5	0.2	3.0	98	98	11963	4500	246	240	243	236	199	237	259	242	201	-	224	247	247	249	209	251	170	245	231	173	.75	1.3	64.2	457	59.3	72	#5 JETS	124-75 80	
20	10070	4530	\emptyset	1.5	0.2	2.0	102	105	12000	4500	273	262	265	258	209	255	281	258	205	-	216	245	262	267	210	272	169	249	234	173	.75	1.25	59.1	455	48.7	68	#5 JETS	125-75 80	
10																																							
5																																							
B12eT130	10065	4530	2.9	1.5	0.2	1.0	103	108	12000	4520	219	253	260	253	218	194	206	236	206	-	216	251	251	255	214	235	170	243	231	174	.75	1.35	62.0	452	51.4	79	#1 JETS	123-75 80	
25	10050	4525	2.5	1.5	0.2	1.0	89	95	12000	4520	220	255	261	254	218	193	208	236	209	-	218	255	257	258	214	240	170	242	230	175	.75	1.35	61.3	450	50.2	77	#1 JETS	124-75 80	
20	10055	4530	2.0	1.5	0.2	1.0	101	106	12000	4520	219	258	263	257	220	199	212	239	212	-	225	260	262	263	214	245	170	242	232	175	.75	1.3	59.3	460	49.7	77	#1 JETS	125-75 80	
10	10060	4530	1.0	1.5	0.2	1.0	102	107	11963	4540	250	266	272	267	225	217	231	249	216	-	213	275	278	278	210	269	170	250	234	176	.75	1.3	55.8	453	45.0	72	#1 JETS	127-75 80	
5	10070	4535	0.5	1.5	0.2	1.0	104	110	12000	4500	225	271	285	277	224	237	253	259	221	-	212	289	287	292	213	290	171	253	236	177	.75	1.35	54.2	458	44.1	74	#1 JETS	127-75 80	

Table VIII - Continued

PERFORMANCE TESTS WITH HIGH SPEED TAPERED ROLLER BEARINGS

N. O. 7000-4 - IV a

Notes: (Unless Otherwise Specified)

1. Cone face T/C at ≈ 3.14 inch radius.

CONSTANT TEST SETTINGS: Shaft Speed 10,000 rpm
Thrust Load 12,000 lbs
Oil Inlet Temp. 170 °F

SYMBOLS: Δ Test Condition (Setting)
← Reference Data Only
* Calculated Values

FRONT BEARING S/N 4

REAR BEARING S/N 1

TEST NO.	SPEED (RPM)		OIL FLOW (GPM)				OIL PRESS.		BKG. LOADS		TEMPERATURE OF														SHAFT EXCURSION		MOTOR			TEST LAB (°F)	NOTES	INSTR BY									
	SHAFT Δ	SEPARATOR	DRB RIG Δ	SUPPORT		JETTS Δ	SUPP BKG. Δ	TEST BKG. Δ	PRELUS Δ	RADIAN Δ	REAR BEARING										FRONT BEARING				OIL IN Δ	SLAVE BEARING		FRONT In x 10 ⁻³	REAR In x 10 ⁻³				VIB LEVEL	I	V	IP					
				I.R.	O.R.						INSG. O.B.	OUTER RING				INSG. I.R.	SHAFT FACE	I.R.	I.N.	SHAFT I.N.	LUB. OUT	FRONT BEARING				IN	FRONT										REAR				
				1	2						3	4	5	6	7	8	9	10	11	12	13	14	15	16		17	18										19	20	21	22	23
B12FRT 40	10050	4520	Δ			1.5	0.2	4.0	110	106	11863	5780	226	232	234	229	193	229	251	234	192	-	224	235	236	236	245	235	169	247	233	171	.75	1.3	66.7	458	510	78	#6 JETs	1-25-70	
30	10060	4525	Δ			1.5	0.2	3.0	109	108	12000	6000	246	240	243	226	199	226	258	241	200	-	235	237	237	239	207	250	170	248	234	171	.75	1.3	65.0	458	552	72	#5 JETs	1-25-70	
20	10070	4530	Δ			1.5	0.2	2.0	102	105	12037	6000	273	262	265	259	209	259	280	258	207	-	249	265	267	267	211	274	171	257	237	175	.75	1.25	59.0	457	488	68	#5 JETs	1-25-70	
10																																									
5																																									
B12FRT 30	10065	4530	Δ			1.5	0.2	1.0	103	108	11863	6000	279	253	259	258	218	193	205	225	206	-	216	253	256	256	210	238	171	250	235	175	.75	1.35	61.5	459	51.7	77	#1 JETs	1-25-70	
25	10060	4525	Δ			1.5	0.2	1.0	90	95	12057	6000	221	255	261	255	219	193	207	226	211	-	219	255	259	259	208	240	170	246	232	175	.75	1.35	61.8	451	51.0	78	#1 JETs	1-25-70	
20	10065	4530	Δ			1.5	0.2	1.0	100	106	11863	6030	229	258	263	257	220	200	214	240	212	-	225	260	263	264	212	247	170	247	233	175	.8	1.3	58.5	461	48.8	78	#1 JETs	1-25-70	
10	10075	4535	Δ			1.5	0.2	1.0	102	107	11000	5780	250	266	271	266	226	200	233	248	217	-	223	275	279	278	272	269	170	259	236	176	.75	1.3	50.3	455	45.7	74	#1 JETs	1-25-70	
5	10080	4535	Δ			1.5	0.2	1.0	104	110	12057	6020	274	279	281	278	223	235	252	258	222	-	241	278	279	281	273	289	169	259	236	176	.75	1.3	58.4	460	43.9	74	#1 JETs	1-25-70	

Table VIII - Continued

PERFORMANCE TESTS WITH HIGH SPEED TAPERED ROLLER BEARINGS

W. O. 7000-4 - IV a.

FRONT BEARING S/N 5

REAR BEARING S/N 1

Notes: (Unless Otherwise Specified)

1. Cone face T/C at ≈ 3.14 inch radius.

CONSTANT TEST SETTINGS: Shaft Speed 10,000 rpm
 Thrust Load 6,000 lbs
 Oil Inlet Temp. 195 °F

SYMBOLS: Δ Test Condition (Setting)
 \rightarrow Reference Data Only
 * Calculated Values

TEST NO.	SPEED (RPM)		OIL FLOW (GPM)				OIL PRES.		BRG. LOADS		TEMPERATURE (°F)																		SHAFT EXCURSION		VIB LEVEL			MOTOR			TEST LAG (°F)	NOTES	DNB BY	
	Δ	SEPARATOR	CONE RIB Δ	SUPP. FRONT		JETS Δ	SUPP. BRG.	TEST BRG.	THRUST	RADIAL	REAR BEARING										FRONT BEARING								FRONT	REAR	I	V	HP							
				I.R.	O.R.						HSG. O.B.	1	2	3	4	HSG. I.B.	5	6	C.B. FACE	7	8	I.R.	I.B.	9	10	LUBR. OUT	11	OUTER RING						12	13	14				15
BGRJII 4.0	10070	4525	0	1.5	0.2	4.0	98	94	6087	3030	245	241	242	238	206	239	255	241	208	-	236	243	246	245	221	245	194	256	241	191	.9	1.25	<10	52.1	450	470	66	*6 JETS	2-7-75	
3.0	10070	4530	0	1.5	0.2	3.0	99	99	5963	3030	255	249	251	246	208	246	261	247	212	-	241	253	255	255	222	257	194	257	242	191	.9	1.25	<10	56.9	458	464	75	*5 JETS	2-7-75	
2.0	10095	4540	0	1.5	0.2	2.0	91	94	6000	3000	275	265	268	261	219	258	279	260	217	-	251	265	267	267	223	275	194	258	242	192	.9	1.25	<10	57.8	452	40.6	65	*5 JETS	2-7-75	
1.0																																								
.5																																								
BGRJII 3.0	10080	4535	2.9	1.5	0.2	1.0	101	107	5963	3000	219	258	263	256	226	206	217	238	216	-	226	256	258	259	225	246	195	257	243	194	.9	1.3	<10	53.7	458	435	70	*1 JETS	2-5-75	
2.5	10085	4535	2.5	1.5	0.2	1.0	104	109	6037	2970	231	260	265	259	229	206	218	240	218	-	229	258	261	261	230	248	195	257	243	195	.85	1.25	<10	51.7	459	412	76	*1 JETS	2-5-75	
2.0	10080	4535	2.5	1.5	0.2	1.0	108	113	6037	3000	238	261	265	259	226	211	222	242	219	-	223	262	265	265	222	253	195	255	241	193	.85	1.25	<10	51.5	452	40.1	66	*1 JETS	2-5-75	
1.0	10085	4540	1.0	1.5	0.2	1.0	94	109	1000	3030	255	269	273	268	231	228	238	250	224	-	218	283	286	286	229	282	195	259	244	195	.75	1.3		61.5	452	40.1	69	*1 JETS (10000)	2-7-75	
REAR UN 1.0	10085	4535	1.0	1.5	0.2	1.0	94	100	5963	3010	255	269	273	268	233	228	237	249	225	-	249	275	278	278	225	271	195	256	243	195	.85	1.25	<10	49.7	455	38.5	78	*1 JETS	2-7-75	
.5	10095	4545	0.5	1.5	0.2	1.0	101	106	6037	3000	274	279	282	277	239	241	255	256	229	-	263	284	285	289	276	288	196	261	255	195	.85	1.25	<10	47.5	455	36.2	79	*1 JETS	2-7-75	

*NOTE: TEST BGRJII 1.0 - FRONT BRG SLIGHTLY DAMAGED AT CONE RIB. USE REAR BRG DATA ONLY - FR BRG SHL & REAR SHL FOR THIS TEST.

Table VIII - Continued

Notes: (Unless Otherwise Specified)

CONSTANT TEST SETTINGS: Shaft Speed 10,000 rpm
 Thrust Load 6000 lbs
 Oil Inlet Temp 195 °F

PERFORMANCE TESTS WITH HIGH SPEED TAPERED ROLLER BEARINGS

1. Cone face T/C at ≈ 3.14 inch radius.

W. O. 7000-4 - IV a

SYMBOLS: Δ Test Condition (Setting)
 \leftarrow Reference Data Only
 * Calculated Values

FRONT BEARING S/N 5

REAR BEARING S/N 1

TEST NO.	SPEED (RPM)		CONE RIB	OIL FLOW (GPM)			OIL PRES.		BKG. LOADS		TEMPERATURE OF																				SHAFT EXCURSION		VIB LEVEL	MOTOR			TEST LAB (°F)	NOTES	DATE BY		
	SHAFT	SEPARATOR		I.R.	O.R.	JETS	SLIP ING.	TEST BKG.	INDUST.	RADIAL	REAR BEARING										FRONT BEARING					LUBE IN	SLAVE BEARING	FRONT	REAR	I	V	IP									
											INLET	OUT	1	2	3	4	5	6	7	8	9	10	11	12	13									14	15	16				17	18
366JII 40	10070	4530	Δ	1.5	0.2	4.0	98	94	6037	4540	247	242	249	240	208	242	258	242	211	-	236	244	246	246	223	245	195	258	244	191	.9	1.25	<10	58.1	453	47.2	67	#6 JETS	2-27-75		
3.0	10015	4530	Δ	1.5	0.2	3.0	98	98	5963	4500	256	250	251	247	215	248	264	249	215	-	244	254	255	257	226	259	195	261	246	192	.9	1.25	<10	57.0	457	46.2	76	#5 JETS	2-27-75		
2.0	10090	4540	Δ	1.5	0.2	2.0	91	94	6037	4500	276	266	269	263	221	257	280	261	219	-	253	266	268	268	225	275	195	261	246	193	.9	1.2	<10	52.9	454	41.0	67	#5 JETS	2-11-75		
1.0																																									
.5																																									
366RII 30	10085	4535	Δ	2.9	1.5	1.0	102	108	6037	4480	230	259	263	257	228	207	216	238	217	-	226	256	259	260	224	245	195	260	246	193	.9	1.3	<10	54.0	459	43.7	70	#1 JETS	2-27-75		
2.5	10085	4540	Δ	2.5	1.5	1.0	103	09	6037	4500	231	260	265	259	230	209	220	241	220	-	229	259	262	262	223	248	195	256	244	193	.85	1.25	<10	53.3	458	42.9	76	#1 JETS	2-27-75		
2.0	10085	4535	Δ	2.0	1.5	1.0	108	114	6037	4480	238	261	266	260	228	212	222	241	221	-	223	262	266	266	223	253	195	261	245	192	.9	1.25	<10	53.2	452	41.8	67	#1 JETS	2-27-75		
1.0	10085	4535	Δ	1.0	1.5	1.0	95	100	6037	4480	251	270	275	270	235	219	240	252	228	-	250	265	289	289	232	284	195	265	249	196	.75	1.3		(52.3)	453	41.2	70	#1 JETS	2-11-75		
REAR 1.0	10085	4540	Δ	1.0	1.5	1.0	101	106	6000	4530	255	268	273	267	231	228	232	248	223	-	249	275	279	279	226	273	195	260	246	194	.9	1.25		50.2	455	39.2	76	#1 JETS	2-27-75		
.5	10095	4540	Δ	0.5	1.5	1.0	101	107	6037	4540	274	279	283	278	240	243	254	256	230	-	263	285	285	289	277	288	194	264	248	194	.85	1.25	<10	45.2	459	44.0	79	#1 JETS	2-27-75		

*Note: TEST 366RII 1.0 FRONT BEG. IS SIGNIF. DAMAGED AT CONG. RING USE REAR BEG DATA ONLY. - FR BEG S/N 4 - REAR S/N 1 FOR THIS TEST.

Table VIII - Continued

PERFORMANCE TESTS WITH HIGH SPEED TAPERED ROLLER BEARINGS

W. O. 7000-4 - IV a

Notes: (Unless Otherwise Specified)

1. Cone face T/C at ~3.14 inch radius.

CONSTANT TEST SETTINGS: Shaft Speed 10,000 rpm
 Thrust Load 9,000 lbs
 Oil Inlet Temp 195 °F

SYMBOLS: Δ Test Condition (Setting)
 ← Reference Data Only
 * Calculated Values

FRONT BEARING S/N 5

REAR BEARING S/N 1

TEST NO.	SPEED (RPM)		OIL FLOW (GPM)				OIL PRES.		BKG. LOADS		TEMPERATURE OF																				SHAFT EXCURSION		VIB LEVEL			MOTOR			TEST LAB (°F)	NOTES	DATE BY	
	SHAFT Δ	SEPARATOR	CONC RIB Δ	SUPPORT		JETS Δ	SUPT BKG. ←	TEST BKG. →	TANGENTIAL Δ	RADIAL Δ	REAR BEARING										FRONT BEARING										FRONT In x 10 ⁻³	REAR In x 10 ⁻³	V	I	HP							
				I.R.	O.H.						INSG. O.B.	OUTER RING #1 #2 #3 #4	HOG I.A.B.	SUPT. F.D.	CONC. FACE	DRG. I.R.	SHAFT I.B.	LUBR. OUT	OUTER RING #1 #2 #3 #4	LUBR. IN	SHAFT IN	SLAGT. BEARING FRONT REAR IN																				
B9dJII 4.0	10065	4525	0	1.5	0.2	4.0	98	95	9037	3000	251	248	249	244	211	246	264	248	211	-	241	250	251	251	223	250	195	256	241	191	.9	1.25	<10	60.7	452	500	70	#6 JETS	2-10-58	MD		
3.0	10065	4525	0	1.5	0.2	3.0	98	98	9000	3030	261	255	258	252	218	250	269	254	217	-	251	260	261	262	225	264	195	258	243	192	.9	1.25	<10	58.6	456	484	76	#5 JETS	2-10-58	MD		
2.0	10065	4540	0	1.5	0.2	2.0	91	94	9037	3030	282	272	275	269	224	263	288	267	221	-	256	273	272	274	224	281	194	258	244	192	.9	1.25	<10	54.8	452	486	70	#5 JETS	2-10-58	MD		
1.0																																										
.5																																										
B9dRI 3.0	10075	4530	2.9	1.5	0.2	1.0	102	108	9000	3000	234	265	270	264	233	211	221	246	220	-	231	263	265	266	225	251	196	256	243	194	.8	1.3	<10	51.5	461	446	71	#1 JETS	2-10-58	MD		
2.5	10080	4535	2.5	1.5	0.2	1.0	104	109	9037	2980	262	268	271	266	234	210	223	248	223	-	223	264	266	267	223	253	195	253	241	193	.85	1.25	<10	54.0	459	436	76	#1 JETS	2-10-58	MD		
2.0	10085	4535	2.0	1.5	0.2	1.0	109	114	9000	3000	242	269	274	268	234	215	226	250	223	-	239	269	272	271	223	260	195	258	243	193	.85	1.25	<10	53.8	455	433	74	#1 JETS	2-10-58	MD		
1.0	10080	4530	1.0	1.5	0.2	1.0	95	100	9000	3000	262	277	281	276	239	231	244	259	231	-	255	283	287	286	233	280	197	261	246	196	.9	1.25	<10	55.0	457	445	71	#1 JETS	2-10-58	MD		
Recon 1.0	10080	4535	1.0	1.5	0.2	1.0	101	106	8963	2980	262	277	282	276	239	233	245	259	230	-	255	283	287	286	233	280	197	261	246	196	.9	1.25	<10	52.3	456	416	76	#1 JETS	2-10-58	MD		
.5	10095	4540	0.5	1.5	0.2	1.0	102	107	9000	3030	280	286	290	285	243	244	258	263	230	-	261	290	290	291	226	285	194	260	245	194	.85	1.25	<10	49.0	460	385	78	#1 JETS	2-10-58	MD		

*NOTE: FRONT BEG. SLIGHTLY DAMAGED AT CONC RIB. USE REAR BEG. DATA ONLY. TEST B.9dR 3.0 - FR BEG S/N 4 - REAR S/N 1 FOR THIS TEST.

REPRODUCIBILITY OF THE ORIGINAL PAGE IS POOR

Table VIII - Continued

PERFORMANCE TESTS WITH HIGH SPEED TAPERED ROLLER BEARINGS

W. O. 7000-4 - IV a

Notes: (Unless Otherwise Specified)

1. Cone face T/C at ~3.14 inch radius.

CONSTANT TEST SETTINGS: Shaft Speed 10,000 rpm
Thrust Load 9,000 lbs
Oil Inlet Temp 195 °F

SYMBOLS: Δ Test Condition (Setting)
← Reference Data Only
* Calculated Values

FRONT BEARING S/N 5

REAR BEARING S/N 1

TEST NO.	SPEED (RPM)		OIL FLOW (GPM)				OIL PRS.		TRG. LOADG		TEMPERATURE OF																SHAFT EXCURSION		VIB LEVEL	METUR			TEST LAB (°F)	NOTES	OVL BY						
	SHAFT Δ	SEPARATOR Δ	CONE RIB Δ	SUPPORT		JETTS Δ	SUPP REG. Δ	TEST REG. Δ	TRG. Δ	RADIAL Δ	REAR BEARING										FRONT BEARING						FRONT	REAR		I	V	IP									
				I.R.	O.R.						ISG. O.B.	OUTL. RING	ISG. I.D.	OUT. B.F. FACE	B.F. I.P.	SHAFT I.D.	LOUT. (OUT)	OUTER RING	ISG. I.D.	OUT. B.F. FACE	B.F. I.P.	SHAFT I.D.	LOUT. (OUT)	OUTER RING	ISG. I.D.	OUT. B.F. FACE										B.F. I.P.	SHAFT I.D.				
B9eJII.4.0	10060	4525	⊖	1.5	0.2	4.0	98	95	8963	4540	250	247	248	244	210	244	262	247	210	-	239	249	250	250	223	249	195	259	244	192	.9	1.25	<10	61.3	454	51.0	71	#6 JETS	2-75 AD		
3.0	10065	4525	⊖	1.5	0.2	3.0	98	98	9000	4480	261	255	258	253	218	252	269	255	217	-	250	260	261	262	226	264	195	260	246	192	.9	1.25	<10	59.7	457	49.8	76	#5 JETS	2-75 AD		
2.0	10085	4535	⊖	1.5	0.2	2.0	91	94	9037	4520	282	272	275	269	225	244	287	266	220	-	258	272	274	275	225	281	194	260	246	193	.9	1.2	<10	55.2	452	44.2	71	#5 JETS	2-11-75 AD		
1.0																																									
.5																																									
B9eRII.3.0	10075	4530	2.9	1.5	0.2	1.0	103	108	8963	4530	274	265	270	263	232	210	221	246	221	-	230	261	263	264	230	250	195	252	242	192	.9	1.3	<10	57.3	459	47.3	72	#1 JETS	2-5-75 AD		
2.5	10080	4535	2.5	1.5	0.2	1.0	104	109	8963	4480	235	267	272	266	234	210	224	249	225	-	233	264	267	268	225	254	196	260	246	194	.85	1.25	<10	56.2	460	46.2	75	#1 JETS	2-5-75 AD		
2.0	10075	4530	2.0	1.5	0.2	1.0	108	114	9037	4520	242	269	274	268	235	213	227	250	225	-	239	269	272	272	230	250	195	259	244	193	.85	1.25	<10	55.2	454	44.5	76	#1 JETS	2-6-75 AD		
1.0	10080	4535	1.0	1.5	0.2	1.0	95	100	8963	4500	261	277	281	276	239	232	244	258	230	-	256	243	247	226	227	195	264	249	195	.75	1.3		(55.8	459	45.5)	72	#1 JETS (2.5)	2-5-75 AD			
RERUN 1.0	10075	4535	1.0	1.5	0.2	1.0	101	106	9000	4440	261	276	282	276	238	231	241	256	230	-	255	283	276	276	233	280	195	262	246	194	.9	1.25		52.8	457	42.3	75		2-11-75 AD		
.5	10095	4540	0.5	1.5	0.2	1.0	102	107	8963	4540	280	286	290	285	244	245	261	265	233	-	270	290	290	292	231	282	194	262	248	195	.85	1.25	<10	47.6	440	32.7	76	#1 JETS	2-6-75 AD		

* NOTE: TEST B9eRII.1.0 - FRONT BEG SLIGHTLY DAMAGED AT CONE RIB. USE REAR BEARING DATA ONLY. FR BEG S/N 4. REAR S/N 1 FOR THIS TEST.

Table VIII - Continued

Notes: (Unless Otherwise Specified)

1. Cone Inch T/C at r=3.14 inch radius.

CONSTANT TEST SETTINGS: Shaft Speed 10,000 rpm
 Thrust Load 9,000 lbs
 Oil Inlet Temp 195 °F

259

PERFORMANCE TESTS WITH HIGH SPEED TAPERED ROLLER BEARINGS

W.O. 7000-4 - IV a

SYMBOLS: Δ Test Condition (Setting)

← Reference Data Only

* Calculated Values

FRONT BEARING S/N 5

REAR BEARING S/N 1

TEST NO.	SPEED (RPM)		OIL FLOW (GPM)			OIL PRES.		BRG. LOADS		TEMPERATURE OF															SHAFT EXCURSION		VIB LEVEL			MOTOR			TEST LAB (°F)	NOTES	DATE BY							
	SHAFT Δ	SEPARATOR Δ	CORE RIB Δ	SUPPORT		JETTS Δ	SUPP BRG. Δ	TEST BRG. Δ	THRUST Δ	RADIAL Δ	REAR BEARING										FRONT BEARING					FRONT In x 10 ⁻³	REAR In x 10 ⁻³	I	V	IP												
				I.R.	O.R.						ISG O.B.	OUTER RING	ISG I.B.	SHAFT	INNER RING	BRG. FACE	SHAFT I.R.	SHAFT I.B.	LUBR OUT	OUTER RING	INNER RING	LUBE IN	SLAVE BEARING	FRONT IN	REAR IN																	
B9FJK40	10065	4525	⊖	1.5	0.2	4.0	98	95	9037	6080	250	247	249	244	210	213	263	249	211	-	239	249	250	251	-	250	195	261	247	192	.9	1.25	<10	510	455	510	72	#6 JTB	2-75	MD		
3.0	10065	4530	⊖	1.5	0.2	3.0	98	98	9000	6030	261	255	258	253	218	251	270	255	217	-	250	259	260	262	-	264	195	263	248	192	.9	1.25	<10	510	524	458	410	76	#5 JTB	2-75	MD	
2.0	10090	4535	⊖	1.5	0.2	2.0	91	94	9037	5970	252	272	275	270	225	265	289	267	220	-	258	275	273	275	226	280	195	264	249	193	.9	1.25	<10	516	452	434	73	#5 JTB	2-75	MD		
1.0																																										
.5																																										
B9FRK30	10075	4530	2.9	1.5	0.2	1.0	103	108	9037	6020	234	265	270	263	232	210	220	246	222	-	230	262	264	275	250	195	261	246	193	.9	1.25	<10	515	458	472	73	#1 JTB	2-75	MD			
2.5	10085	4535	2.5	1.5	0.2	1.0	105	110	8863	6030	235	266	271	266	234	211	223	248	225	-	232	264	266	267	230	195	260	246	192	.85	1.25	<10	553	461	455	75	#1 JTB	2-75	MD			
2.0	10080	4530	2.0	1.5	0.2	1.0	110	115	9037	6040	242	269	274	268	235	215	227	249	226	-	238	269	272	272	278	260	195	260	246	193	.85	1.25	<10	516	452	441	79	#1 JTB	2-75	MD		
1.0	10080	4535	1.0	1.5	0.2	1.0	95	100	9000	6000	262	276	281	276	239	233	245	259	232	-	255	272	285	291	273	272	195	265	250	196	.75	1.3		550	460	450	72	#1 JTB	2-75	MD		
REAR 1.0	10080	4530	1.0	1.5	0.2	1.0	101	106	9037	6000	261	276	281	276	239	232	244	257	229	-	255	282	285	286	228	280	195	266	250	195	.9	1.25		530	458	426	75		2-75	MD		
.5	10090	4540	0.5	1.5	0.2	1.0	102	107	9000	3032	260	285	290	285	244	245	261	265	236	-	269	290	289	291	229	284	194	265	249	194	.85	1.2	<10	479	461	374	76	#1 JTB	2-75	MD		

* Note: Test B9FRK10 - Front Brg Severely Damaged at Conc. Exp. Use Rear Brg Data ONLY. Fr Brg S/N 4 - Rear S/N 1. FOR THIS TEST.

REPRODUCIBILITY OF THE ORIGINAL PAGE IS POOR

Table VIII - Continued

PERFORMANCE TESTS WITH HIGH SPEED TAPERED ROLLER BEARINGS

N. O. 7000-4 - IV a

Notes: (Unless Otherwise Specified)

1. Cone face 7/8 at ~3.14 inch radius.

CONSTANT TEST SETTINGS: Shaft Speed 10,000 rpm
Thrust Load 12,000 lbs
Oil Inlet Temp 195 °F

SYMBOLS: Δ Test Condition (Setting)
← Reference Data Only
* Calculated Values

FRONT BEARING S/N 5

REAR BEARING S/N 1

TEST NO.	SPEED (RPM)		OIL FLOW (GPM)			OIL PRS.		BEG. LOADS		TEMPERATURE OF																				SHAFT EXCURSION		VIB LEVEL	MOTOR			TEST LAB (°F)	NOTES	DATE BY			
	SHAFT Δ	SEPARATOR	CONE RIB Δ	SUPPORT		JETS Δ	SUPP BEG.	TEST BEG.	TANGENTIAL	RADIAL	R/L/R BEARING										FRONT BEARING				SLAVE BEARING		FRONT In x 10 ⁻³	REAR In x 10 ⁻³	I	V	IP *										
				I.R.	O.R.						INSG. O.B.	OUTER RING	INSG. I.B.	SWAMP. FACE	COND. PING.	SWAMP. I.R.	SWAMP. I.B.	LUBE OUT	FRONT PING	LUBE IN	OIL IN Δ	FRONT	REAR																		
B12dJII 4.0	10060	4525	⊖	1.5	0.2	4.0	98	95	12000	3000	291	251	253	248	213	248	267	251	212	-	242	254	255	254	223	253	196	256	242	193	.9	1.25	<10	608	457	608	74	#6 JETS	2-7-75	AD	
3.0	10075	4535	⊖	1.5	0.2	3.0	100	100	11963	3020	262	258	261	255	218	254	274	257	216	-	253	263	263	264	223	266	195	258	243	192	.9	1.25	<10	600	460	603	76	#5 JETS	2-7-75	AD	
2.0	10075	4535	⊖	1.5	0.2	2.0	91	94	12037	2990	287	271	280	274	228	268	292	270	222	-	261	277	278	277	225	286	195	259	245	193	.9	1.25	<10	550	453	440	78	#5 JETS	2-11-75	AD	
1.0																																									
.5																																									
B12dRII 3.0	10075	4535	2.9	1.5	0.2	1.0	102	108	12000	3030	236	269	274	268	235	211	221	249	222	-	232	265	265	267	226	252	195	252	241	193	.85	1.3	<10	578	458	477	73	#1 JETS	2-5-75	AD	
2.5	10075	4535	2.5	1.5	0.2	1.0	105	110	11963	3020	239	271	277	271	237	213	226	251	226	-	226	268	270	271	230	257	196	255	243	194	.85	1.25	<10	560	461	463	76	#1 JETS	2-5-75	AD	
2.0	10075	4530	2.0	1.5	0.2	1.0	111	116	12037	3000	246	275	279	273	239	218	231	255	228	-	241	274	275	276	227	264	195	258	243	193	.85	1.25	<10	559	458	455	78	#1 JETS	2-6-75	AD	
1.0	10080	4535	1.0	1.5	0.2	1.0	95	100	12000	3020	262	283	288	282	243	236	250	264	233	-	260	303	306	306	230	303	196	263	247	198	.75	1.3	<10	566	459	455	73	#1 JETS (REAR)	1-20-75	AD	
FRUN 1.0	10070	4530	1.0	1.5	0.2	1.0	101	106	12000	3000	266	282	287	281	242	235	248	262	230	-	257	288	291	291	227	264	195	263	246	195	.9	1.25	<10	539	459	437	73	#1 JETS	1-21-75	AD	
.5	10090	4540	0.5	1.5	0.2	1.0	102	107	12000	2970	285	291	296	290	247	250	266	270	234	-	272	296	296	297	226	290	195	261	246	195	.85	1.25	<10	490	460	383	75	#1 JETS	2-11-75	AD	

* NOTE: TEST B12dRII 1.0 - FRONT BEG SLIGHTLY DAMAGED. AT CONE RIB. USE REAR BEG DATA ONLY. FR BEG S/N 4 - REAR S/N 1. FOR THIS TEST.

Table VIII - Continued

-62-

PERFORMANCE TESTS WITH HIGH SPEED TAPERED ROLLER BEARINGS
 W. O. 7000-4 - IV a
 Notes: (Unless Otherwise Specified)
 1. Cone face T/C at ~3.14 inch radius.
 FRONT BEARING S/N 5 REAR BEARING S/N 1

CONSTANT TEST SETTINGS: Shaft Speed 10,000 rpm
 Thrust Load 12,000 lbs
 Oil Inlet Temp 195 °F
 SYMBOLS: Δ Test Condition (Setting)
 ← Reference Data Only
 * Calculated Values

TEST NO.	SPEED (RPM)		OIL FLOW (GPM)			OIL PRES.		BRG. LOADS		TEMPERATURE OF																SHAFT EXCURSION		VIB LEVEL	MOTOR			TEST LAB (°F)	NOTES	DATE BY						
	SHAFT Δ	SEPARATOR	ONE RIB Δ	SUPPORT I.R. O.R.	JETS Δ	SUPP BRG. Δ	TEST BRG. Δ	TANGENTIAL Δ	RADIAL Δ	REAR BEARING										FRONT BEARING						FRONT	REAR		I	V	HP *									
	1	2	3	4	5	6	7	8	9	10	11	12	13	14	15	16	17	18	19	20	21	22	23	24	25	26	27	28	29	30	31	32	33	34	35	36				
12eJII4.0	10050	4520	⊖	1.5	0.2	4.0	98	95	12000	4530	255	251	254	248	214	217	267	250	212	-	245	254	255	254	226	253	196	260	246	193	.9	1.2	<10	62.8	458	630	76	#6 Jets	2-11-75 AO	
3.0	10070	4530	⊖	1.5	0.2	3.0	100	100	12000	4520	264	258	261	256	220	255	214	258	217	-	255	262	263	265	225	265	195	261	246	192	.9	1.25	<10	61.2	460	516	76	#5 Jets	2-11-75 AO	
2.0	10075	4535	⊖	1.5	0.2	2.0	91	94	12000	4510	288	278	281	275	229	270	292	270	224	-	262	278	280	280	227	288	196	263	248	195	.9	1.2	<10	55.2	453	443	80	#5 Jets	2-11-75 AO	
1.0																																								
.5																																								
12eR13.0	10070	4530	2.9	1.5	0.2	1.0	103	109	12000	4480	236	269	274	268	235	213	223	250	224	-	233	265	267	268	224	253	194	260	245	192	.85	1.25	<10	57.9	458	475	74	#1 Jets	2-11-75 AO	
2.5	10080	4535	2.5	1.5	0.2	1.0	105	110	1163	4510	239	271	277	270	237	211	226	253	226	-	236	268	269	271	229	257	195	257	244	193	.85	1.25	<10	56.7	461	469	76	#1 Jets	2-11-75 AO	
2.0	10075	4530	2.0	1.5	0.2	1.0	102	107	12000	4522	247	276	280	274	239	217	232	256	230	-	242	274	278	278	228	264	195	257	245	195	.85	1.25	<10	57.0	460	472	78	#1 Jets	2-11-75 AO	
1.0	10070	4530	1.0	1.5	0.2	1.0	95	100	12037	4500	267	282	286	282	244	237	250	244	234	-	240	302	304	305	234	302	195	261	249	196	.75	1.3	(57.5	460	477)	73	#1 Jets	2-11-75 AO		
1.0	10070	4530	1.0	1.5	0.2	1.0	101	106	12000	4530	266	282	288	281	242	233	246	261	231	-	259	288	291	291	229	286	195	265	249	196	.9	1.25	54.3	460	441	72	#1 Jets	2-11-75 AO		
.5	10090	4535	0.5	1.5	0.2	1.0	101	107	12000	4520	285	291	296	291	246	250	265	270	257	-	275	294	295	297	230	290	196	263	248	196	.9	1.25	<10	52.7	463	430	74	#1 Jets	2-11-75 AO	

* Note: Test 8.12eR2.10 Front Brg slightly damaged at cone rib Use Rear Brg Data Only. Fr Brg S/N 4 - Rear S/N 1 FOR THIS TEST.

Table VIII - Continued

PERFORMANCE TESTS WITH HIGH SPEED TAPERED ROLLER BEARINGS

W. O. 7000-4 - IV a

Notes: (Unless Otherwise Specified)
1. Cone face T/C at ≈ 3.14 inch radius.

CONSTANT TEST SETTINGS: Shaft Speed 10,000 rpm
Thrust Load 12,000 lbs
Oil Inlet Temp 195 °F

SYMBOLS: Δ Test Condition (Setting)
← Reference Data Only
* Calculated Values

FRONT BEARING S/N 5

REAR BEARING S/N 1

TEST NO.	SPEED (RPM)		OIL FLOW (GPM)				OIL PRES.		BRG. LOADS		TEMPERATURE OF																				SHAFT ENCOURSION		MOTOR			TEST LAB (°F)	NOTES	DATE BY		
	SHAFT Δ	SEPARATOR	CONE RIB Δ	SUPPORT		JETS Δ	SUPP. BRG.	TEST BRG.	TANG.	RADIAL	REAR BEARING										FRONT BEARING					OIL IN Δ	SLAVE BEARING		FRONT	REAR	LEVEL	I	V	HP						
				I.R.	O.R.						HSG. O.B.	OUTER RING	HSG. I.B.	FACE	CONC.	PRF.	SHAFT	LUB. OIL	OUTER RING	INLET	OUTLET	INLET	OUTLET	INLET	OUTLET		INLET	OUTLET							INLET				OUTLET	INLET
B12FJII 4.0	10055	4525	\emptyset	1.5	0.2	4.0	98	94	19635970	254	251	253	248	213	247	267	251	213	-	241	253	255	255	226	252	195	262	248	192	.9	1.2	<10	638	456	537	76	#6 JTB	1-7-75	AD	
3.0	10070	4530	\emptyset	1.5	0.2	3.0	100	100	19636000	264	258	261	256	220	254	274	258	218	-	252	263	263	265	226	267	195	263	248	192	.9	1.25	<10	612	460	516	76	#5 JTB	1-7-75	AD	
2.0	10075	4530	\emptyset	1.5	0.2	2.0	91	94	100376000	288	277	281	274	278	269	292	271	224	-	264	278	279	280	226	287	195	265	249	194	.9	1.2	<10	553	455	492	80	#5 JTB	1-7-75	AD	
1.0																																								
5																																								
B12FRII 3.0	10075	4530	2.9	1.5	0.2	1.0	102	108	19635970	235	238	274	267	235	212	222	249	224	-	251	264	265	267	226	253	194	261	247	192	.85	1.25	<10	583	459	485	75	#1 JTB	1-7-75	AD	
2.5	10075	4530	2.5	1.5	0.2	1.0	104	110	10006020	238	231	226	220	237	212	226	252	226	-	226	268	270	271	231	257	195	259	247	194	.85	1.25	<10	573	461	475	76	#1 JTB	1-7-75	AD	
2.0	10075	4530	2.0	1.5	0.2	1.0	103	108	100376000	246	274	279	272	238	216	230	256	229	-	241	273	277	276	227	264	195	263	248	195	.85	1.25	<10	583	454	461	78	#1 JTB	1-7-75	AD	
1.0	10075	4530	1.0	1.5	0.2	1.0	95	100	10006030	266	282	287	281	243	235	249	263	224	-	210	303	306	306	235	303	195	264	250	196	.75	1.3	618	460	483	73	#1 JTB (RHS)	1-7-75	AD		
RE-RUN 1.0	10065	4530	1.0	1.5	0.2	1.0	101	106	10006000	266	282	287	281	242	235	246	263	232	-	259	286	290	291	235	285	195	264	251	196	.9	1.2	547	460	448	72	#1 JTB	1-7-75	AD		
.5	10085	4540	0.5	1.5	0.2	1.0	102	107	19636030	286	291	296	290	248	250	267	271	240	-	273	296	296	298	229	221	195	266	250	195	.9	1.2	<10	504	462	401	73	#1 JTB	1-7-75	AD	

*NOTE: TEST B12 FRII 1.0 - FRONT BRG. SLIGHTLY DAMAGED BY CONE RIB. USE REAR BRG. DATA ONLY. EC BRG. S/N 4 - REAR S/N 1 - FOR THIS TEST.

Table VIII - Continued

-64-

29

PERFORMANCE TESTS WITH HIGH SPEED TAPERED ROLLER BEARINGS
W. O. 7000-4 - IV a

Notes: (Unless Otherwise Specified)

1. Cone face T/C at ~3.14 inch radius.
2. Shaft I.D seal at front end of shaft.
3. 5 psig seal pressure at belt end shaft seal.
4. T/C's 6,7,8,9 measured with Acurex telemetry system.

CONSTANT TEST SETTINGS: Shaft Speed 15,000 rpm
Thrust Load 9,000 lbs
Oil Inlet Temp 170 °F

SYMBOLS: Δ Test Condition (Setting)
← Reference Data Only
* Calculated Values.

FRONT BEARING S/N 6

REAR BEARING S/N 1

TEST NO.	SPEED (RPM)		OIL FLOW (GPH)				OIL PRES.		DRG. LOADS		TEMPERATURE OF																	SHAFT EXCURSION		VID LEVEL	MOTOR			TEST LAB (°F)	NOTES	DATE					
	SHAFT Δ	SEPARATOR	CONE RIB Δ	SUPPORT		JETS Δ	SUPP DRG. ←	TEST DRG. →	INDUS. Δ	RADIAL Δ	REAR BEARING											FRONT BEARING				FRONT $\text{In} \times 10^{-3}$	REAR $\text{In} \times 10^{-3}$	I	V		HP *										
				I.R.	O.R.						HSC. OUTER RING				HSC. I.D.			DRG. SHAFT				CL. LUBE			OIL IN Δ							SLAVE BEARING									
				1	2						3	4	5	6	7	8	9	10	11	12	13	14	15	16	17							18	19				20				
C96JI 4.0	15080		Δ	1.5	0.2	4.0	104	98	9000	1094	266	255	254	250	198	200	299	236	189	—	257	259	262	259	223	262	71	273	252	170	1.1	1.7	—	92	452	80.5	78	#6 Jets	7/28		
3.0																																									
2.0																																									
1.0																																									
.5																																									
C96RI 3.0	15190	—	2.9	1.5	0.2	1.0	109	113	9037	1066	241	280	283	274	228	230	250	230	175	244	244	229	207	230	260	169	275	253	172	.8	1.8	—	84	458	73.8	81	#1 Jets	7/28			
2.5	15190		2.5	1.5	0.2	1.0	108	112	910	1045	250	282	284	282	231	230	235	253	233	175	252	269	233	272	228	266	170	277	255	174	.75	1.8	—	83	457	72.9	82	#6 Jets	7/28		
2.0	15175	—	2.0	1.5	0.2	1.0	111	116	8900	1110	257	285	287	285	234	235	259	256	235	175	260	293	278	297	230	274	170	277	256	174	1.0	1.8	—	81	460	71.4	80	#6 Jets	7/28		
1.0	15180	—	1.0	1.5	0.2	1.0	106	110	8937	1000	285	295	297	294	243	238	260	264	241	171	287	299	304	307	226	303	170	279	247	170	1.4	1.8	—	78	458	68.0	86	#1 Jets	7/28		
.5	15230	—	0.5	1.5	0.2	1.0	110	114	9000	1022	316	316	316	314	258	261	284	270	247	174	319	312	317	319	223	324	170	281	255	175	1.3	1.8	—	72	457	62.1	82	#1 Jets	7/28		

REPRODUCIBILITY OF THE ORIGINAL PAGE IS POOR

Table VIII - Continued

PERFORMANCE TESTS WITH HIGH SPEED TAPERED ROLLER BEARINGS

W. O. 7000-4 - IV a

NOTES: (UNLESS OTHERWISE SPECIFIED)

1. Cone face T/C at ~ 3.14 inch radius.
2. Shaft I.D. seal at front end of shaft.
3. 5 psig seal pressure at belt end shaft seal.
4. T/C's 6,7,8,9 measured with Acurex telemetry system.

CONSTANT TEST SETTINGS: Shaft Speed 15,000 rpm
 Thrust Load 9,000 lbs
 Oil Inlet Temp 170 °F

SYMBOLS: Δ Test Condition (Setting)
 \leftarrow Reference Data Only
 * Calculated Value

FRONT BEARING S/N 6

REAR BEARING S/N 1

TEST NO.	SPEED (RPM)		OIL FLOW (GPM)				OIL PRES.		BRG. LOADS		TEMPERATURE OF																				SHAFT EXCURSION		VIB LEVEL	MOTOR			TEST LAB (°F)	NOTES	DATE BY	
	SHAFT Δ	SEPARATOR	CONE RIB Δ	SUPPORT		JLTS Δ	SUPP DRG. Δ	TEST BRG. Δ	THRUST Δ	RADIAL Δ	REAR BEARING										FRONT BEARING										FRONT Δ	REAR Δ		I	V	IP				
				I.R.	O.R.						ESG. D.B.	1	2	3	4	5	6	7	8	9	10	11	12	13	14	15	16	17	18	19										20
96JI 4.0 RERUN 4.0 3.0 2.0 1.0 .5	15140		\emptyset	1.4	0.2	3.9	108	104	9000	2011	267	255	254	250	196	300	238	191	253	258	261	259	225	269	169	277	264	169	1.1	1.7		95	151	83.0	76	#6 Jets	8-15-75 J.M.			
	15100		\emptyset	1.5	0.2	4.0	104	98	9110	2000	265	255	259	250	197	291	236	191	255	259	261	259	226	261	170	278	264	170	1.1	1.7		95	157	83.0	76	#6 Jets	8-15-75 J.M.			
96RI 3.0 2.5 2.0 1.0 .5	15105		2.9	1.5	0.2	1.0	114	118	9074	1978	240	280	283	280	227	225	250	226	174	242	283	288	287	231	260	169	282	261	171	1.1	1.6		88	153	76.6	80	#1 Jets	8-15-75 J.M.		
	15165		2.5	1.5	0.2	1.0	112	116	8960	1985	248	282	285	283	232	232	254	232	175	252	289	293	292	235	267	170	283	267	174	1.0	1.8		84	155	73.5	84	#1 Jets	8-15-75 J.M.		
	15170		2.0	1.5	0.2	1.0	110	115	8960	1900	288	285	287	285	235	241	255	235	175	256	293	298	297	232	276	171	285	269	175	1.1	1.8		82	160	72.4	81	#1 Jets	8-15-75 J.M.		
	15180		1.0	1.5	0.2	1.0	106	111	9000	2000	285	296	297	295	247	260	269	244	174	288	300	306	309	289	265	172	285	261	172	1.4	1.8		80	159	70.3	85	#1 Jets	8-15-75 J.M.		
	15225		0.5	1.5	0.2	1.0	110	114	8998	2020	316	315	316	314	258	286	273	252	174	319	312	317	319	232	323	170	287	266	175	1.3	1.8		73	155	62.7	82	#1 Jets	8-15-75 J.M.		

Table VIII - Continued

PERFORMANCE TESTS WITH HIGH SPEED TAPERED ROLLER BEARINGS
W. O. 7000-4 - IV a'

NOTES: (UNLESS OTHERWISE SPECIFIED)

1. Cone face T/C at 3.14 inch radius.
2. Shaft I.D. seal at front end of shaft.
3. 5 psig seal pressure at belt end shaft seal.
4. T/C's 6,7,8,9 measured with Acurex telemetry system.

CONSTANT TEST SETTINGS: Shaft speed 15,000 rpm
Thrust Load 12,000 lbs
Oil Inlet Temp 170 °F

SYMBOLS: Δ Test Condition (Setting)
← Reference Data Only
* Calculated Values

FRONT BEARING S/N 6

REAR BEARING S/N 1

TEST NO.	SPEED (RPM)		OIL FLOW (GPM)				OIL PRES.		BRG. LOADS		TEMPERATURE OF											SHAFT EXCURSION		MOTOR			TEST LAB (°F)	MATER	DATE BY											
	SHAFT Δ	SEPARATOR	CONE RIB Δ	SUPPORT		JETS Δ	SUPP BRG.	TEST BRG.	TIR	RADIAL	REAR BEARING				FRONT BEARING				OIL IN Δ	SHAFT BEARING		FRONT	REAR	VIB LEVEL	I	V				HP *										
				I.N.	O.R.						NSG. O.B.	OUTER RING	NSG. I.B.	SHAFT C.B.	CON. R. FACE	CON. R. I.R.	SHAFT I.B.	CON. R. I.B.		TEMP. IN	TEMP. OUT										TEMP. IN	TEMP. OUT	IN	OUT	IN	OUT				
C12A11A0	14960		Δ	1.5	0.2	4.0	103	97	1200	2456	270	258	258	254	199	297	234	187	257	263	265	264	227	264	170	280	268	170	1.0	1.7	—	97	453	85.0	80	*6 Jets	8-22-79			
3.0																																								
2.0																																								
1.0																																								
.5																																								
C12A1130	16150		2.9	1.5	.2	1.0	115	119	1200	3100	246	286	270	286	232	265	233	260	235	175	249	270	295	234	270	287	270	174	1.0	1.6	—	92	452	80.2	85	*6 Jets	8-22-79			
2.5	15155		2.5	1.5	.2	1.0	112	116	1190	2700	253	287	271	258	235	262	235	263	235	175	256	275	300	277	237	273	170	286	271	174	1.0	1.8	—	88	453	77.3	84	*6 Jets	8-22-79	
2.0	15170		2.0	1.5	0.2	1.0	112	116	1207	3011	264	289	291	290	236	242	226	234	176	266	277	302	302	234	280	171	288	271	176	1.0	1.8	—	86	453	74.8	79	*1 Jets	8-22-79		
1.0	15195		1.0	1.5	0.2	1.0	111	115	1200	2967	274	305	306	305	254	266	266	273	252	174	278	307	314	317	235	311	170	287	274	174	1.1	1.8	—	82	458	71.7	80	*1 Jets	8-22-79	
.5	15220		0.5	1.5	0.2	1.0	110	114	1195	2978	323	322	323	321	262	291	278	252	175	325	319	324	326	234	330	171	290	275	176	1.3	1.7	—	75	497	65.1	82	*1 Jets	8-22-79		

Table VIII - Continued

NOTES: (UNLESS OTHERWISE SPECIFIED)

PERFORMANCE TESTS WITH HIGH SPEED TAPERED ROLLER BEARINGS

W. O. 7000-4 - IV a

1. Cone face T/C at ~3.14 inch radius.
2. Shaft I.D. seal at front end of shaft.
3. 5 psig seal pressure at bolt end shaft seal.
4. T/C's 6,7,8,9 measured with Acurex telemetry system.

CONSTANT TEST SETTINGS: Shaft Speed 15,000 rpm
 Thrust Load 12,000 lbs
 Oil Inlet Temp 170 °F

SYMBOLS: Δ Test Condition (Setting)
 \leftarrow Reference Data Only
 * Calculated Values

FRONT BEARING S/N 6

REAR BEARING S/N 1

TEST NO.	SPEED (RPM)		OIL FLOW (GPM)				OIL PRES.		DRG. LOADS		TEMPERATURE OF																	SHAFT EXCURSION		VIB LEVEL	MOTOR			TEST LAB (°F)	NOTES	DATE BY					
	SHAFT Δ	SEPARATOR	CONE RIB Δ	SUPPORT		JETS Δ	SUPP BRG. \leftarrow	TEST BRG. \leftarrow	TANGENTIAL Δ	RADIAL Δ	REAR BEARING																	FRONT	REAR		I	V	HP								
				I.R.	O.R.						FRONT BEARING																														
				1	2						3	4	5	6	7	8	9	10	11	12	13	14	15	16	17	18	19										20				
C12eJI40	14890		0	1.5	0.2	4.0	109	105	12110	4500	219	257	256	253	198	117	293	231	185	-	256	260	263	262	277	265	170	278	270	169	1.0	1.7	-	101	450	88.3	81	*C Jets	8-27-75		
	3.0																																								
	2.0																																								
	1.0																																								
	.5																																								
C12eRI50	15130		2.9	1.5	0.2	1.0	114	118	12000	4610	246	285	289	287	233	167	233	260	234	175	248	291	295	295	294	267	170	290	275	174	-	-	-	90	455	87.1	85	*1 Jet	8-27-75		
	2.5	15155	2.5	1.5	0.2	1.0	112	116	11205	4505	252	289	270	287	235	166	238	263	237	175	255	295	300	297	236	272	170	290	276	174	.9	1.8	-	87	460	77.2	83	*1 Jet	8-27-75		
	2.0	15170	2.0	1.5	0.2	1.0	108	113	11205	4500	243	291	293	291	238	165	242	267	235	175	265	299	303	303	234	277	170	292	276	174	1.0	1.8	-	88	459	86.6	81	*1 Jet	8-27-75		
	1.0	15190	2.0	1.5	0.2	1.0	111	115	12000	4566	293	304	306	305	254	167	267	274	251	175	297	308	314	317	235	312	170	292	278	174	1.1	1.8	-	82	457	71.9	80	*1 Jet	8-27-75		
	.5	15215	0.5	1.5	0.2	1.0	110	114	11603	4478	323	322	323	321	263	161	290	277	255	175	324	319	324	326	236	331	170	295	281	175	1.4	1.8	-	97	459	68.3	82	*1 Jet	8-27-75		

Table VIII - Continued

NOTES: (UNLESS OTHERWISE SPECIFIED)

CONSTANT TEST SETTINGS: Shaft Speed 15,000 rpm
 Thrust Load 12,000 lbs
 Oil Inlet Temp 170 °F

PERFORMANCE TESTS WITH HIGH SPEED TAPERED ROLLER BEARINGS

W. O. 7000-4 - IV a

1. Cone face T/C at ~3.14 inch radius.
2. Shaft I.D. seal at front end of shaft.
3. 5 psig seal pressure at belt end shaft seal.
4. T/C's 6,7,8,9 measured with Acurex telemetry system

SYMBOLS: Δ Test Condition (Setting)
 ←→ Reference Data Only
 * Calculated Values

FRONT BEARING S/N 6 R BEARING S/N 1

TEST NO.	SPEED (RPM)		OIL FLOW (GPM)				OIL PRESS.		BRG. LOADS		TEMPERATURE OF														SHAFT EXCURSION		VIB LEVEL	MOTOR			TEST LAB (°F)	NOTES	DATE BY							
	SHAFT Δ	SEPARATOR Δ	CONE RIB Δ	SUPPORT		JETS Δ	SUPP BRG. Δ	TEST BRG. Δ	THRUST Δ	RADIAL Δ	REAR BEARING											FRONT BEARING			FRONT In x 10 ⁻³	REAR In x 10 ⁻³		I	V	HP *										
				I.R.	O.R.						NSG. O.B.	OUTER RING.	HSG. I.D.	SUPPORT C.N.	CONE FACE	BRG. I.R.	SHAFT I.D.	SHAFT OUT	LOC. OUT	FRONT OLDER RING	SLAVE BEARING IN	SLAVE BEARING OUT	IN	OUT																
				1	2						3	4	5	6	7	8	9	10	11	12	13	14	15	16			17(1)				18(2)	19(3)	20(4)							
C124TIA.0	14940		0	1.5	0.2	4.0	108	104	119	25	60	270	258	258	254	199	297	297	190	259	261	269	264	229	265	170	284	274	169	1.0	1.7	100	449	87.1	81	#6 Jets	8-22-71			
30																																								
2.0																																								
1.0																																								
.5																																								
C124TIB.0	15130		2.9	1.5	0.2	1.0	114	118	120	125	6000	246	285	287	285	265	235	263	251	175	249	292	297	296	237	267	170	292	277	113	—	—	—	72	454	80.9	85	#1 Jet	8-22-71	
2.5	15150		2.5	1.5	0.2	1.0	112	116	119	125	6035	251	288	291	289	236	239	237	244	238	175	255	295	300	300	234	272	170	293	278	173	7.5	1.8	—	89	460	79.0	82	#1 Jet	8-22-71
2.0	15175		2.0	1.5	0.2	1.0	110	114	121	125	5975	263	290	293	292	239	241	241	267	236	175	266	299	304	304	239	280	170	295	279	174	.9	1.8	—	88	455	77.9	80	#1 Jet	8-22-71
1.0	15190		1.0	1.5	0.2	1.0	110	114	120	125	6000	293	305	304	305	254	261	267	277	252	176	297	309	315	317	237	312	170	296	281	175	1.2	1.8	—	83	456	72.4	80	#1 Jets	8-22-71
.5	15210		0.5	1.5	0.2	1.0	110	114	119	125	6033	323	322	322	321	313	290	280	254	175	324	320	324	327	237	331	170	300	285	175	1.2	1.8	—	76	460	66.6	81	#1 Jets	8-22-71	

Table VIII - Continued

PERFORMANCE TESTS WITH HIGH SPEED TAPERED ROLLER BEARINGS

W. O. 7000-4 - IV a

NOTES: (UNLESS OTHERWISE SPECIFIED)

1. Cone face T/C at ~3.14 inch radius.
2. Shaft I.D. seal at front end of shaft.
3. 5 psig seal pressure at bolt end shaft seal.
4. T/C's 6,7,8,9 measured with Acurex telemetry system.

CONSTANT TEST SETTINGS: Shaft Speed 15,000 rpm
 Thrust Load 9,000 lbs
 Oil Inlet Temp. 195 °F

SYMBOLS: Δ Test Condition (Setting)
 ←→ Reference Data Only
 * Calculated Values

FRONT BEARING S/N 6 REAR BEARING S/N 1

TEST NO.	SPEED (RPM)		OIL FLOW (GPM)			OIL PRES.		ORG. LOADS		TEMPERATURE OF											SHAFT EXCURSION		MOTOR			TEST LAB (°F)	NOTES	DATE BY										
	SHAFT	SEPARATOR	CORE RLB	SUPPORT		JETS	SUPP BRG.	TEST BRG.	INSTR.	RADIAL	REAR BEARING				FRONT BEARING				OIL IN Δ	SLAVE BEARING		FRONT	REAR	I	V				HP									
				I.R.	O.R.						INSG. D.B.	OUTER RING	INSG. I.B.	SHAFT C.R.	FACE	BRG. I.R.	BRG. I.B.	SHAFT I.R.		SHAFT I.B.	LOW IN									LOW OUT	IN	OUT	FRONT	REAR				
C96JI40																																						
	3.0																																					
	2.0																																					
	1.0																																					
	.5																																					
C96R130	15210		2.9	1.5	0.2	1.0	105	110	9075	1022	258	294	297	295	244	245	265	337	195	261	301	305	303	245	278	199	292	271	191	.8	2.0	-	82	455	71.4	72	#1 Jets	8/15/71
	25 15230		2.5	1.5	0.2	1.0	101	105	9057	1022	163	295	298	296	246	250	268	245	196	268	303	308	306	244	283	195	292	272	195	.9	1.9	-	81	456	70.4	74	#1 Jets	8/23/71
	2.0 15235		2.0	1.5	0.2	1.0	105	110	9037	1044	279	298	301	299	251	256	269	249	196	279	308	313	311	245	292	194	295	272	194	.7	1.8	-	78	457	78.0	77	#1 Jets	8/25/71
	1.0 15250		1.0	1.5	0.2	1.0	110	115	9075	1044	300	310	311	310	269	271	272	257	196	305	315	321	322	249	319	194	297	276	197	1.2	1.8	-	74	462	64.8	79	#2 Jets	8/25/71
	.5																																					

Table VIII - Continued

NOTES: (UNLESS OTHERWISE SPECIFIED)

1. Cone face T/C at ~3.14 inch radius.
2. Shaft I.D. seal at front end of shaft.
3. 5 psig seal pressure at belt and shaft seal.
4. T/C's 6,7,8,9 measured with Acurex telemetry system.

COMPIST TEST SETTINGS: Shaft Speed 15,000 rpm
 Thrust Load 9000 lbs
 Oil Inlet Temp 195 °F

SYMBOLS: Δ Test Condition (Setting)
 \longleftrightarrow Reference Data Only
 * Calculated Values

PERFORMANCE TESTS WITH HIGH SPEED TAPERED ROLLER BEARINGS

N. O. 7000-4 - IV a

FRONT BEARING S/N 6

REAR BEARING S/N 1

TEST NO.	SPEED (RPM)		OIL FLOW (GPM)				OIL PRES.		BRG. LOADS		TEMPERATURE OF											SHAFT EXCURSION		VIB LEVEL	MOTOR			TEST LAB (°F)	NOTES	DATE BY										
	SHAFT	SEPARATOR	CONG. RIB	SUPPORT		JETS	SLIP BRG.	TEST BRG.	INDUST.	RADIAL	REAR BEARING						FRONT BEARING					FRONT	REAR		I	V	HP *													
				I.R.	O.R.						IN	OUT	IND.	RAD.	TEMP.	OIL	OUTER RING			SHAFT	LUB.										TEMP.	SLAVE BEARING								
																	1	2	3													4	5	6	7	8	9	10	11	12
9C9JII40																																								
3.0																																								
2.0																																								
1.0																																								
.5																																								
9C9RTI30	15210		2.9	1.5	0.2	1.0	105	110	9037	1878	258	294	296	295	244	243	264	237	196	262	301	305	304	286	279	195	297	281	193	.7	1.9	—	83	454	72.3	73	#1 Jets	9/20		
2.5	15225		2.5	1.5	0.2	1.0	102	106	9037	2000	264	296	299	297	297	250	265	247	196	269	304	309	307	249	284	195	299	289	199	.8	1.9	—	81	460	71.3	73	#1 Jets	9/22		
2.0	15235		2.0	1.5	0.2	1.0	105	110	9087	2044	274	299	301	300	251	257	268	250	196	279	308	313	312	249	292	194	301	287	195	1.1	1.8	—	81	454	70.2	79	#1 Jets	9/23		
1.0	15250		1.0	1.5	0.2	1.0	110	114	9112	2000	300	310	311	311	264	271	272	259	197	306	316	321	322	251	319	195	304	289	198	1.2	1.8	—	74	461	64.6	80	#1 Jets	9/23		
.5																																								

REPRODUCIBILITY OF THE ORIGINAL PAGE IS POOR

Table VIII - Continued

NOTES: (UNLESS OTHERWISE SPECIFIED)

1. Cone face T/C at ~3.14 inch radius.
2. Shaft I.D. seal at front end of shaft.
3. 5 psig seal pressure at belt end shaft seal.
4. T/C's 6,7,8,9 measured with Acurox telemetry system.

CONSTANT TEST SETTINGS: Shaft Speed 15,000 rpm
 Thrust Load 12,000 lbs
 Oil Inlet Temp 135 °F

SYMBOLS: Δ Test Condition (Setting)
 \leftarrow Reference Data Only
 * Calculated Value

PERFORMANCE TESTS WITH HIGH SPEED TAPERED ROLLER BEARINGS

W. O. 7000-4 - IV a

FRONT BEARING S/N 6

REAR BEARING S/N 1

TEST NO.	SPEED (RPM)		OIL FLOW (GPM)				OIL PRES.		BKG. LOADS		TEMPERATURE OF											SHAFT EXCURSION		VIB LEVEL	MOTOR			TEST LAB (°F)	NOTES	DATE BY								
	SHAFT	SEPARATOR	LINE RID	SUPPORT		JETTS	SUPP. BKG.	TEST BKG.	THERM	RADIAL	REAR BEARING						FRONT BEARING					FRONT	REAR		I	V	HP											
				I.R.	O.R.						HSC I.D.	OUTER RING	HSC I.D.	IN	OUTER RING	IN	OUTER RING	IN	OUTER RING	IN	OUTER RING										IN	OUTER RING	IN					
C12dJ140																																						
30																																						
20																																						
10																																						
.5																																						
C12dJ130	15200		2.9	1.5	0.2	1.0	105	110	1200	3011	263	300	304	302	249	249	274	246	197	237	307	311	310	247	284	196	302	288	195	.7	1.9	—	85	487	74.7	73	*1 Jets	8-21-75 J.M.
25	15210		2.5	1.5	0.2	1.0	101	105	1197	3033	269	302	305	303	252	254	273	249	197	274	310	315	313	250	289	195	301	289	195	.8	1.9	—	85	455	74.3	74	*1 Jets	8-21-75 J.M.
20	15225		2.0	1.5	0.2	1.0	105	110	1203	2956	280	305	307	306	255	260	275	254	197	235	315	319	318	252	298	195	305	291	197	1.1	1.8	—	83	457	72.7	87	*1 Jets	8-21-75 J.M.
10	15240		1.0	1.5	0.2	1.0	110	115	1125	2978	307	317	319	318	268	278	282	267	199	313	322	328	330	252	325	195	307	294	200	1.1	1.8	—	78	460	68.5	79	*1 Jets	8-21-75 J.M.
.5																																						

Table VIII - Continued

PERFORMANCE TESTS WITH HIGH SPEED TAPERED ROLLER BEARINGS

W. O. 7000-4 - IV a

FRONT BEARING S/N 6

REAR BEARING S/N 1

NOTES: (UNLESS OTHERWISE SPECIFIED)

1. Cone face T/C at ≈ 3.14 inch radius.
2. Shaft I.D. seal at front end of shaft.
3. 5 psig seal pressure at belt end shaft seal.
4. T/C's 6,7,8,9 measured with Acurex telemetry system.

CONSTANT TEST SETTINGS: Shaft Speed 15,000 rpm

Thrust Load 12,000 lbs

Oil Inlet Temp 195 °F

SYMBOLS: Δ Test Condition (Setting)

\leftarrow Reference Data Only

* Calculated Values

30

TEST NO.	SPEED (RPM)		OIL FLOW (GPM)				OIL PRES.		BRG. LOADS		TEMPERATURE OF										SHAFT EXCURSION		VIB LEVEL			MOTOR	TEST LAB (°F)	NOTES	DATE	BY									
	SHAFT	SEPARATOR	LINE RIB	SUPPORT		JETS	SUPP BRG.	TEST BRG.	THURST RADIAL	THRUST	FRONT BEARING	SHAFT I.D.	SHAFT I.D.	SHAFT I.D.	SHAFT I.D.	SHAFT I.D.	SHAFT I.D.	SHAFT I.D.	SHAFT I.D.	SHAFT I.D.	SHAFT I.D.	SHAFT I.D.	SHAFT I.D.	SHAFT I.D.	SHAFT I.D.	SHAFT I.D.					SHAFT I.D.	SHAFT I.D.	SHAFT I.D.	SHAFT I.D.	SHAFT I.D.	SHAFT I.D.	SHAFT I.D.	SHAFT I.D.	SHAFT I.D.
C12FJ14.0																																							
3.0																																							
2.0																																							
1.0																																							
.5																																							
C12FRT3.0	15200		2.9	1.5	0.2	1.0	104	108	12000	5978	263	300	304	302	250	250	274	250	197	216	307	312	311	259	285	196	309	296	195	.9	1.9	87	459	76.8	73	#1 Jets	8-22-77		
2.5	15210		2.5	1.5	0.2	1.0	102	106	12110	5956	270	302	305	303	251	255	276	254	197	215	310	315	314	252	290	195	309	296	196	.7	1.8	86	455	75.3	77	#1 Jets	8-22-77		
2.0	15220		2.0	1.5	0.2	1.0	105	110	12057	5978	280	305	308	307	255	260	277	255	198	205	316	320	319	256	298	195	311	298	197	1.0	1.8	83	458	73.1	80	#1 Jets	8-22-77		
1.0																																							
.5																																							

Table IX

Test Results - Parametric Study - Phase B

PERFORMANCE TESTS WITH HIGH SPEED TAPERED ROLLER BEARINGS

M. O. 7000-4 - IV b

FRONT BEARING S/N 6

NOTES: (UNLESS OTHERWISE SPECIFIED)

1. Cone face T/C at 3.14 inch radius.
2. Shaft I.D. seal at front end of shaft.
3. 5 psig seal pressure at belt end shaft seal.
4. T/C's 6,7,8,9 measured with Acurex telemetry system.

CONSTANT TEST SETTINGS: Shaft Speed 12,500 rpm

Thrust Load 12,000 lbs

Oil Inlet Temp 125 °F, 110 °F

SYMBOLS: Δ Test Condition (Setting)

\leftarrow Reference Data Only

* Calculated Values

TEST NO.	SPEED (RPM)		OIL FLOW (GPM) @ 125°F						OIL PRES.		BKG. LOADS		TEMPERATURES OF																	SHAFT EXCURSION		VIB LEVEL	MOTOR			TEST LAB (°F)	Sump OUT (°F)	NOTES	DWD BY
	SHAFT	SEPARATOR	CONC RIB	Taper	SUPPORT		JETS	SUPP BRG.	TEST BRG.	TANGENTIAL	RADIAL	FRONT BEARING																	FRONT	REAR	I		V	HP					
					IN	OUT						IN	OUT	IN	OUT	IN	OUT	IN	OUT	IN	OUT	IN	OUT	IN	OUT	IN	OUT	IN							OUT				
IVb1a	12535		.65	.8	1.5	0.2	1.0	108	110	1200	6033	290	281	281	284	241	251	281	285	252	220	288	281	277	286	222	296	194	287	272	197	1.4	1.7	62	461	52.6	89	245	7/71
IVb2a	12535		.65	.7	1.5	0.2	1.0	109	112	1203	6022	291	284	284	287	244	251	282	285	252	224	287	285	282	287	226	299	195	287	274	199	1.4	1.7	61	451	50.0	92	247	7/71
IVb1b	12530		.5	.7	1.5	0.2	1.0	113	116	11963	6000	298	287	287	289	245	251	287	284	257	225	293	287	284	292	226	304	195	287	273	199	1.4	1.7	61	457	50.0	218	7/71	
IVb1c	12530		.5	.7	1.5	0.2	1.0	114	117	11963	5970	301	291	291	294	249	251	290	288	255	232	297	292	289	286	233	308	205	293	279	204	1.4	1.7	61	449	49.7	88	256	7/71
IVb2	12535		.5	.7	1.5	0.2	1.0	111	115	11966	5722	307	310	316	312	255	251	290	286	255	230	304	313	313	317	310	175	289	275	197	1.4	1.7	61	450	49.9	86	253	7/71	
IVb3b	12535		1.0	1.0	1.5	0.2	1.0	103	106	11963	5756	286	288	287	290	253	251	296	289	258	235	288	287	284	291	236	297	214	297	283	210	1.4	1.7	62	451	51.1	85	262	7/71
IVb1d	12549		.5	.9	1.5	0.2	1.0	104	106	12037	6023	300	301	300	303	262	251	300	300	269	246	308	301	297	306	247	319	222	306	291	220	1.4	1.7	58	453	51.6	83	270	7/71
IVb1e	12545		1.0	.95	1.5	0.2	1.0	92	94	12056	6000	298	300	300	302	265	251	289	301	272	250	277	299	296	303	251	309	229	312	296	228	1.4	1.7	60	461	50.5	89	278	7/71
IVb4a	12535		0.5	.7	1.5	0.2	1.0	103	108	11963	6083	290	297	303	297	237	241	271	270	229	285	297	299	301	294	170	289	256	171	1.4	1.7	63	451	52.0	77	225	7/71		
IVb4b	12525		1.0	.7	1.5	0.2	1.0	87	91	12037	6000	269	284	290	285	231	245	248	265	227	284	284	286	281	275	170	266	255	169	1.4	1.7	66	449	55.0	77	227	7/71		

REPRODUCIBILITY OF THE ORIGINAL PAGE IS POOR

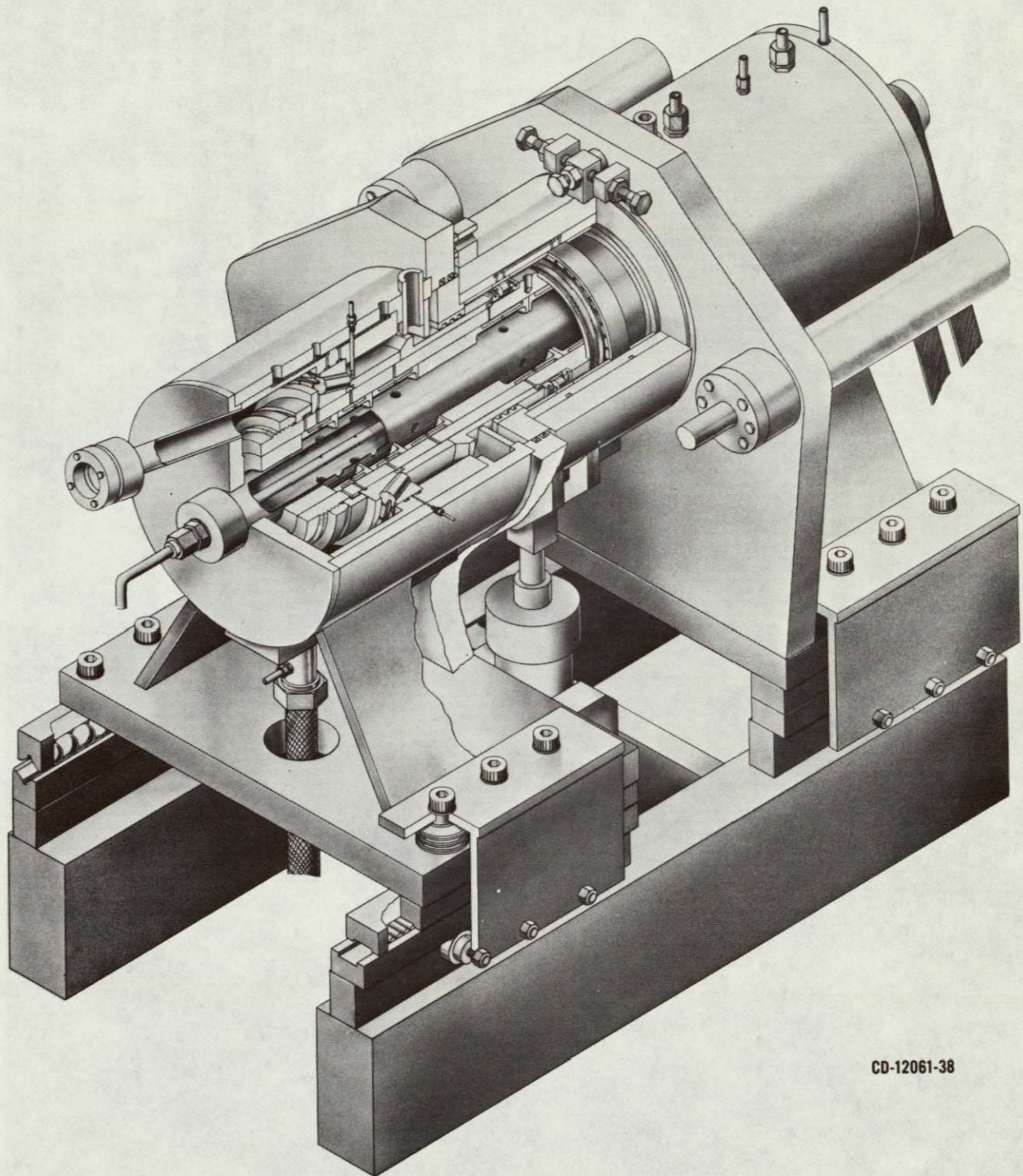

CD-12061-38

High-Speed Tapered-Roller Bearing Test Machine

Figure 1

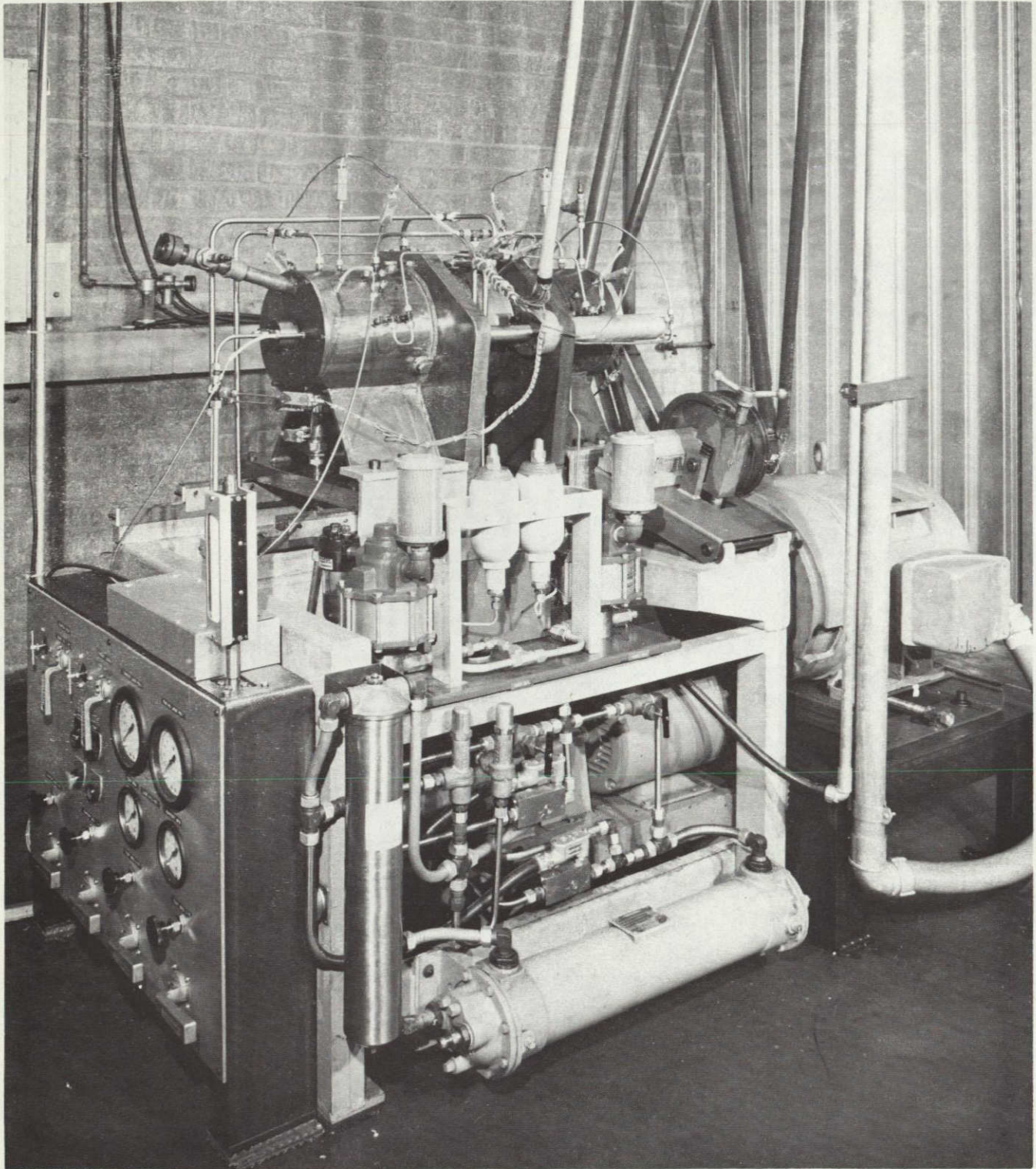

Tapered-Roller Bearing
Test Machine

Figure 2

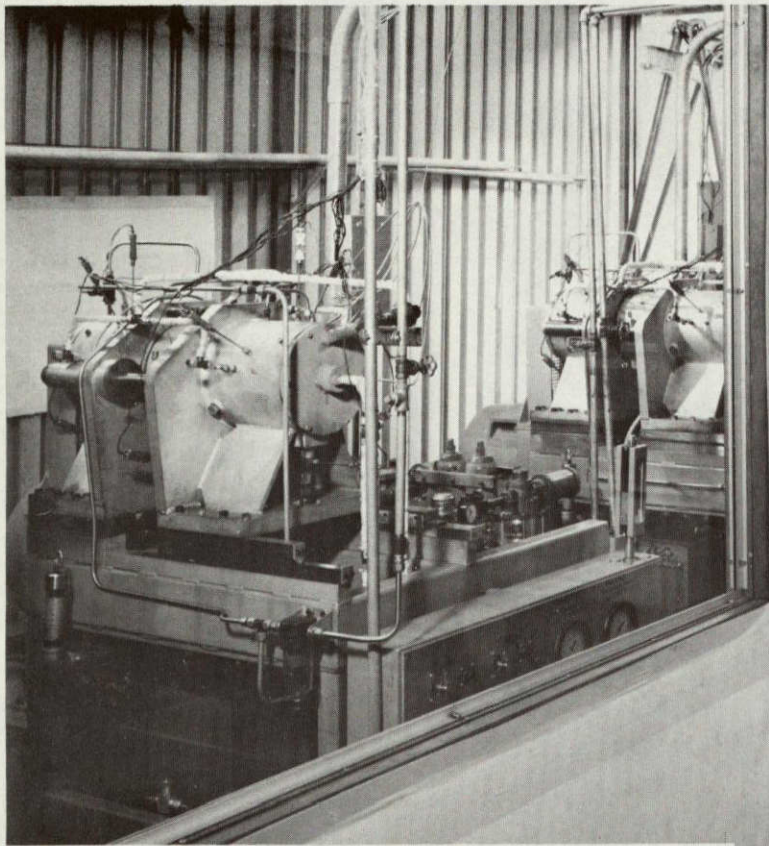

Tapered-Roller Bearing
Test Facility
- Control Console -

Figure 3

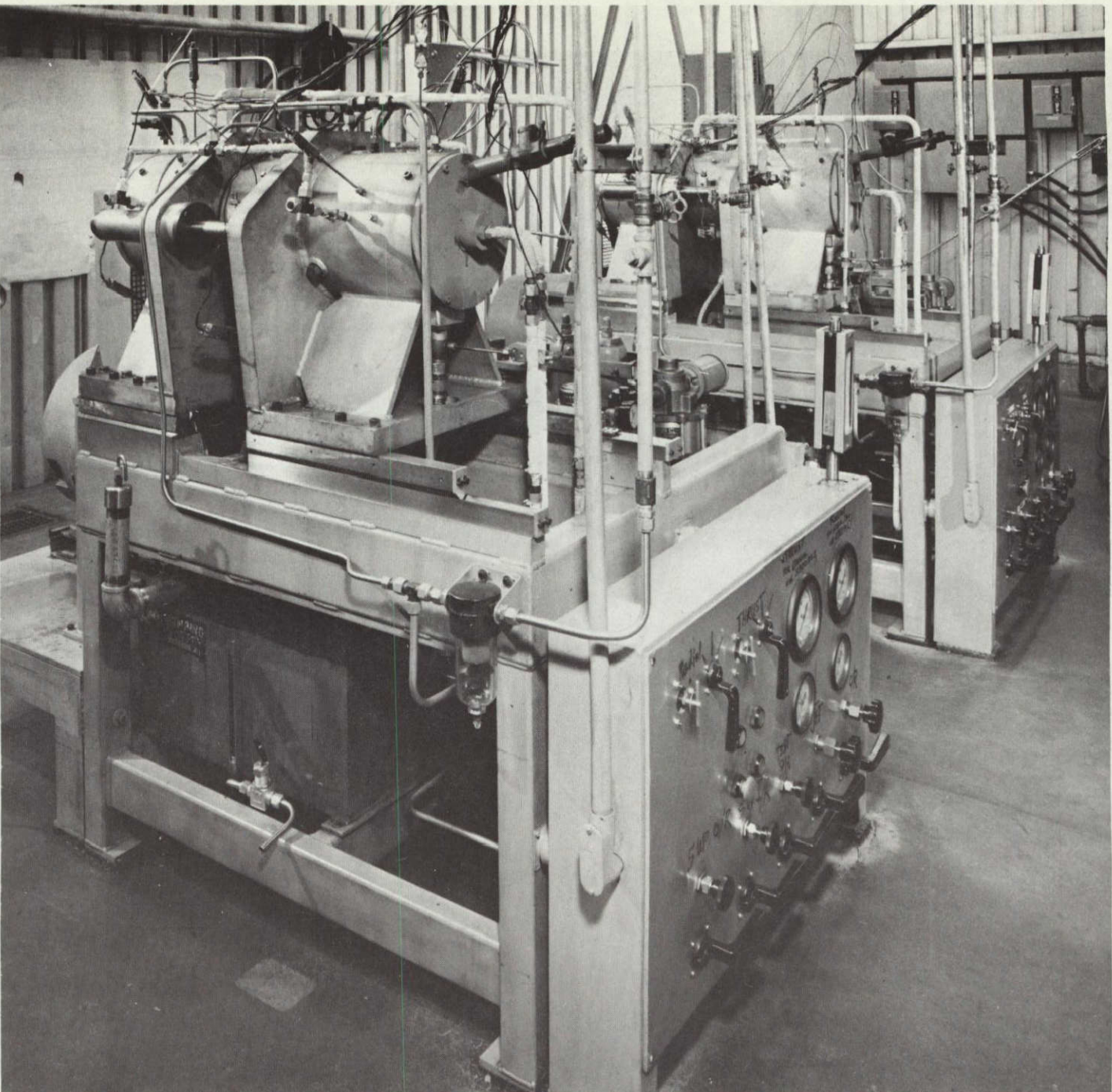

Tapered-Roller Bearing
Test Machines S/N 2 and S/N 3

Figure 4

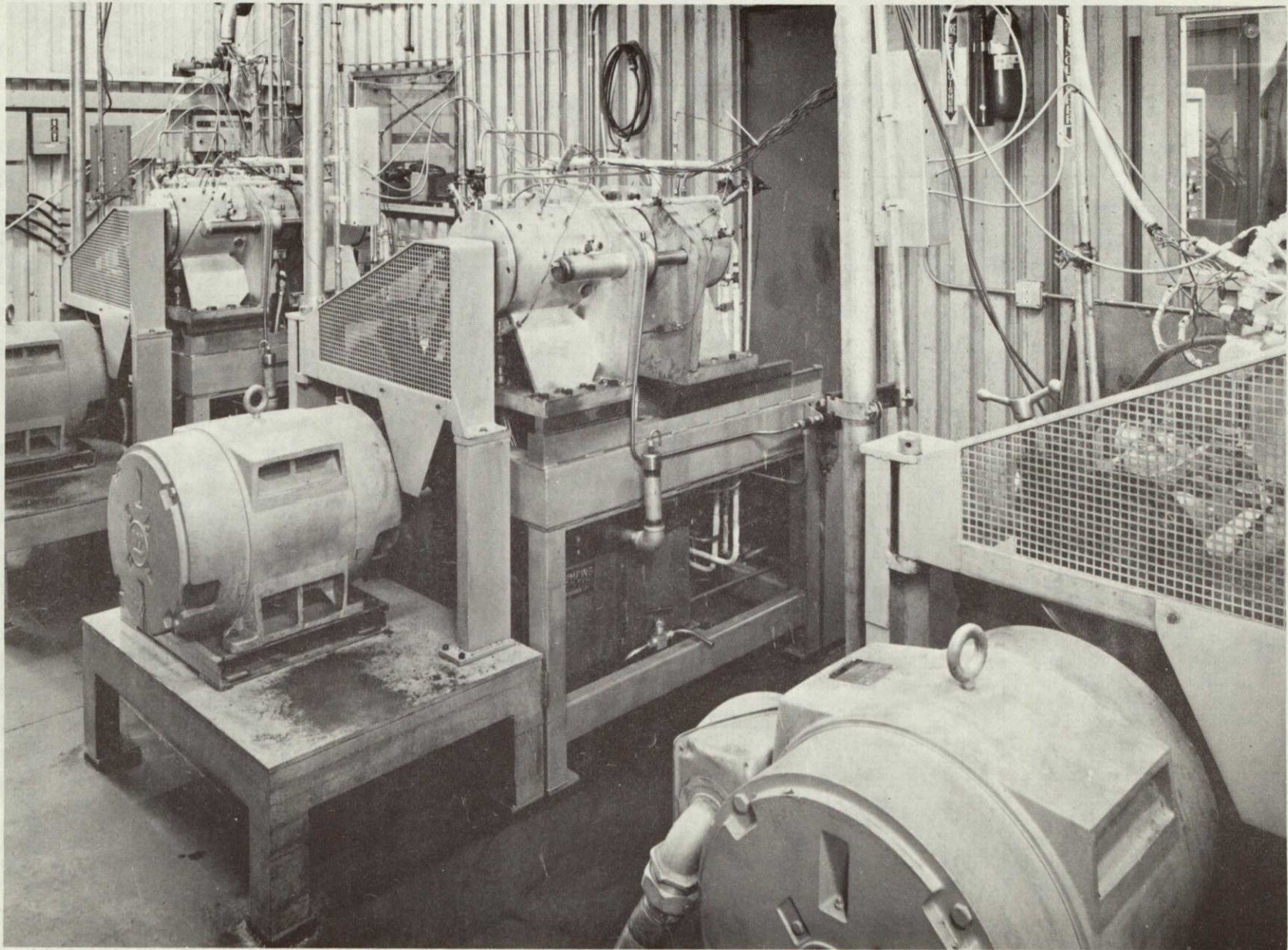

Tapered-Roller Bearing
Test Facility
Figure 5

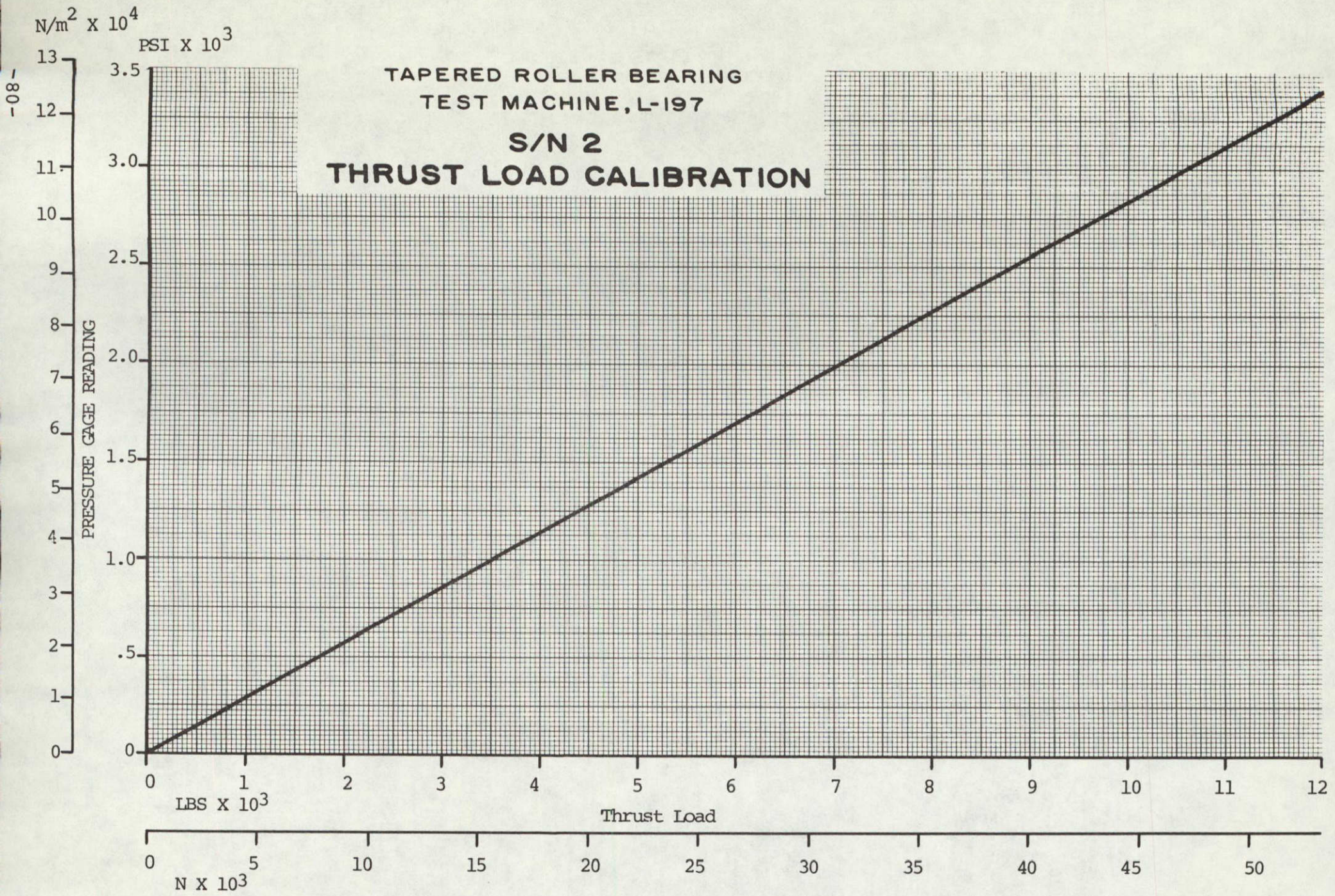

Figure 6

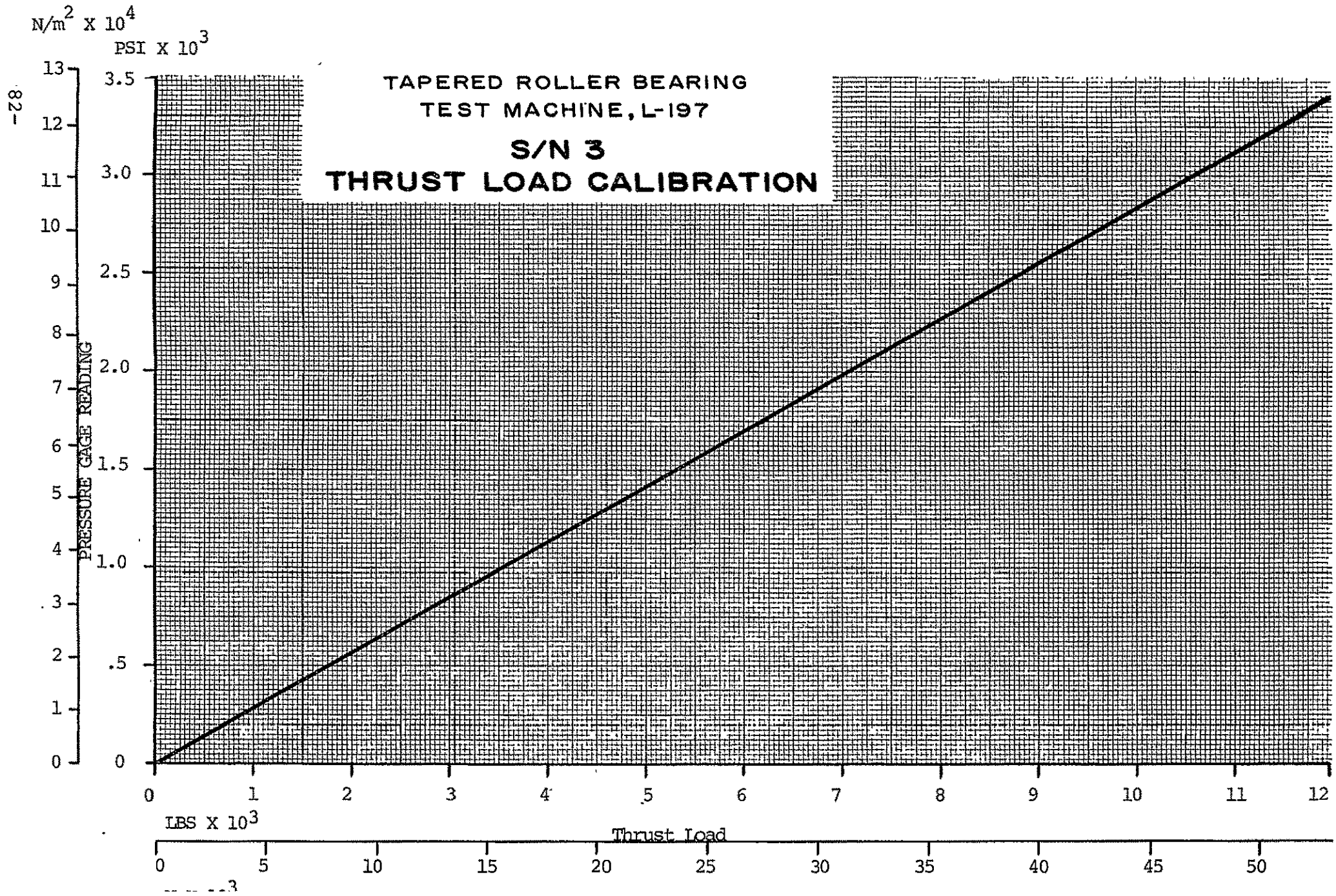
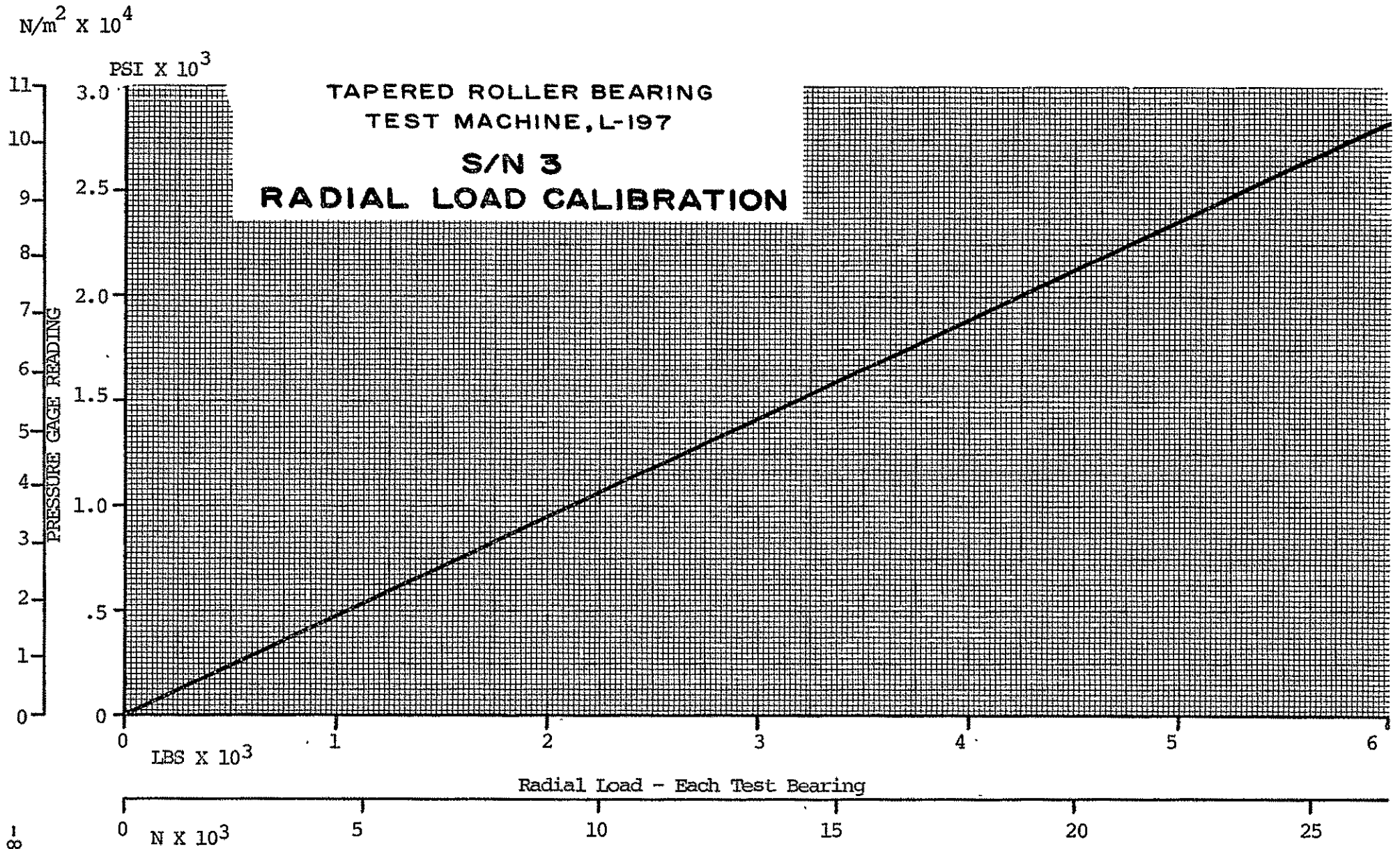

Figure 8



-83-

Figure 9

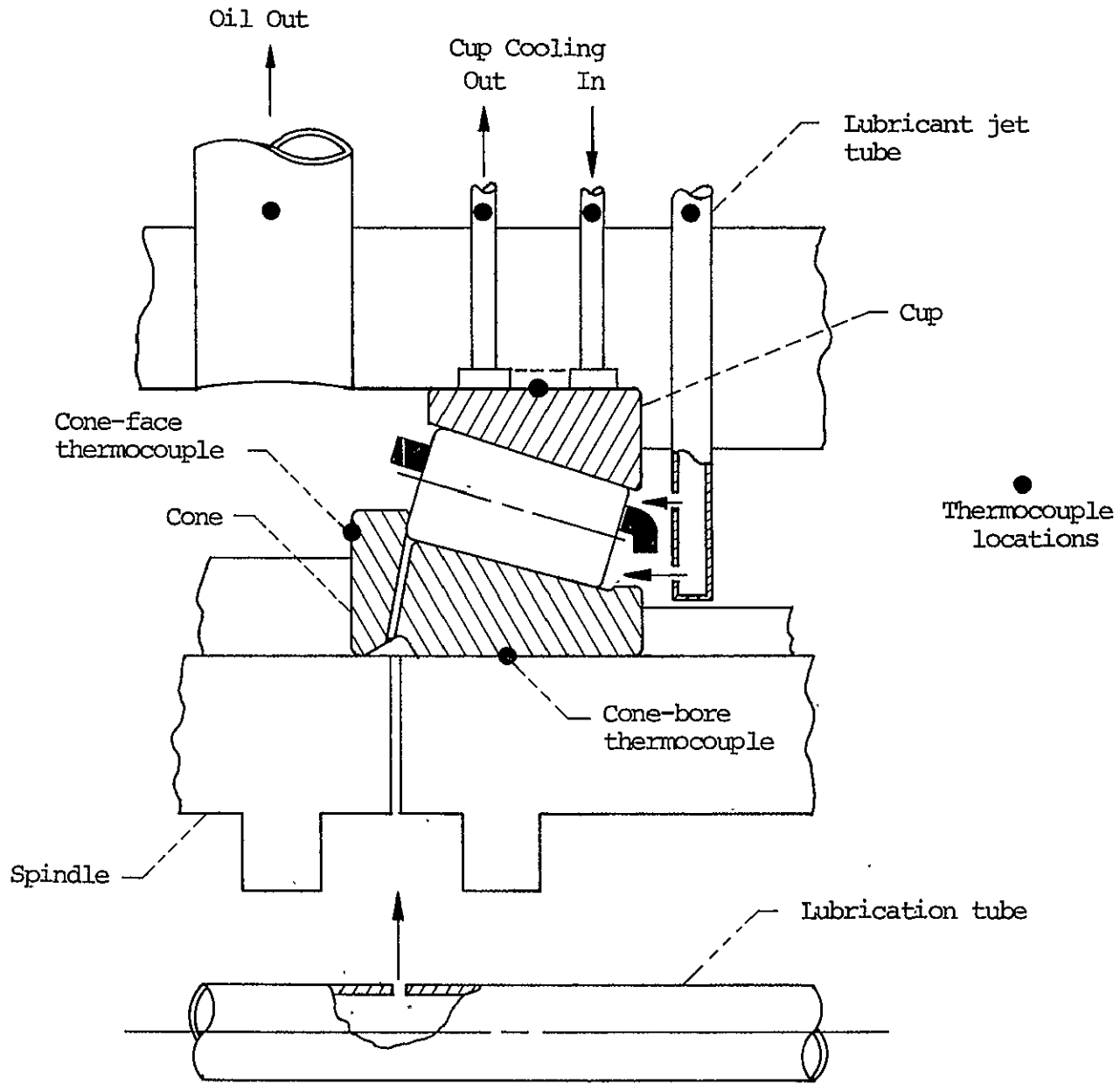
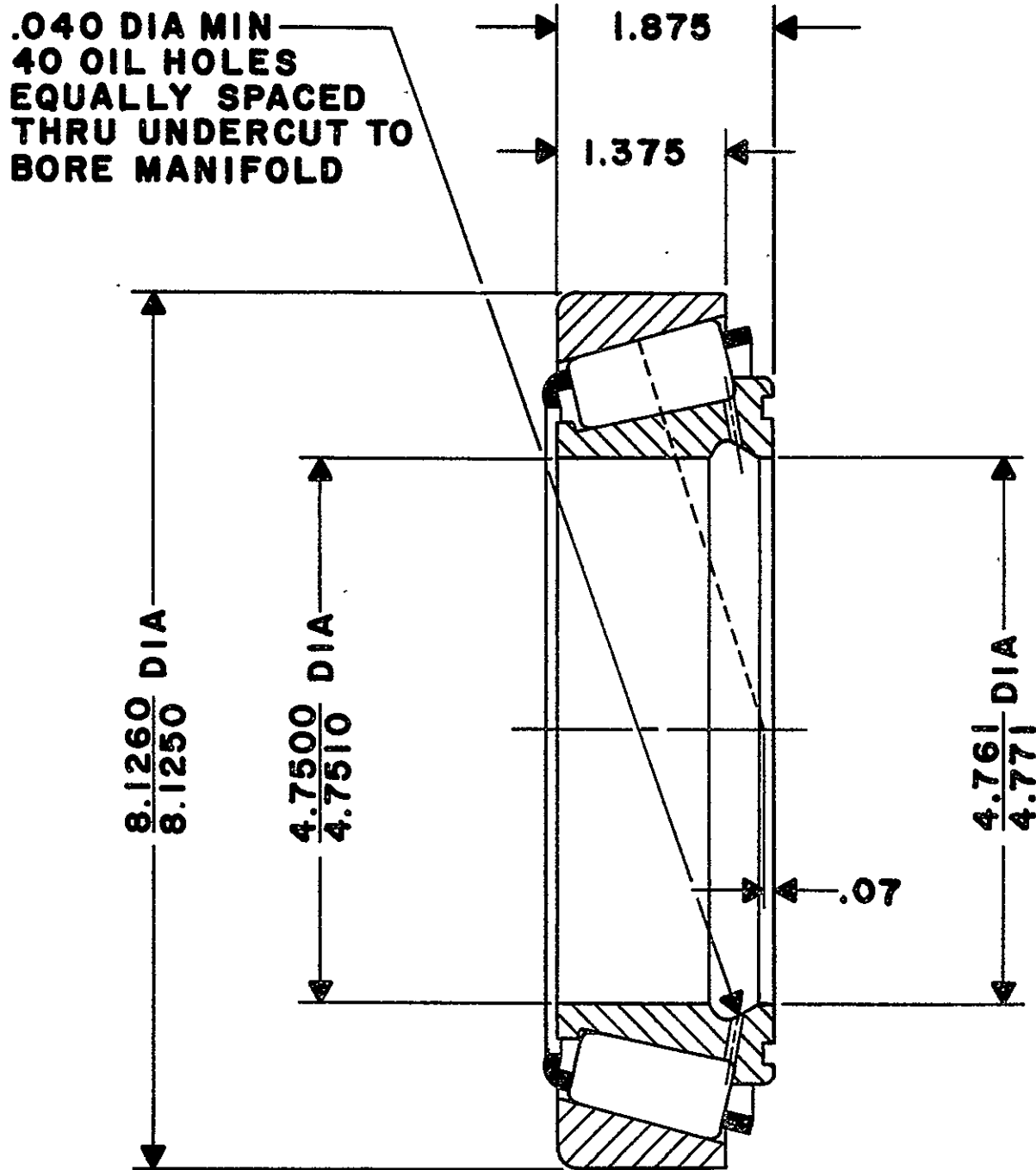
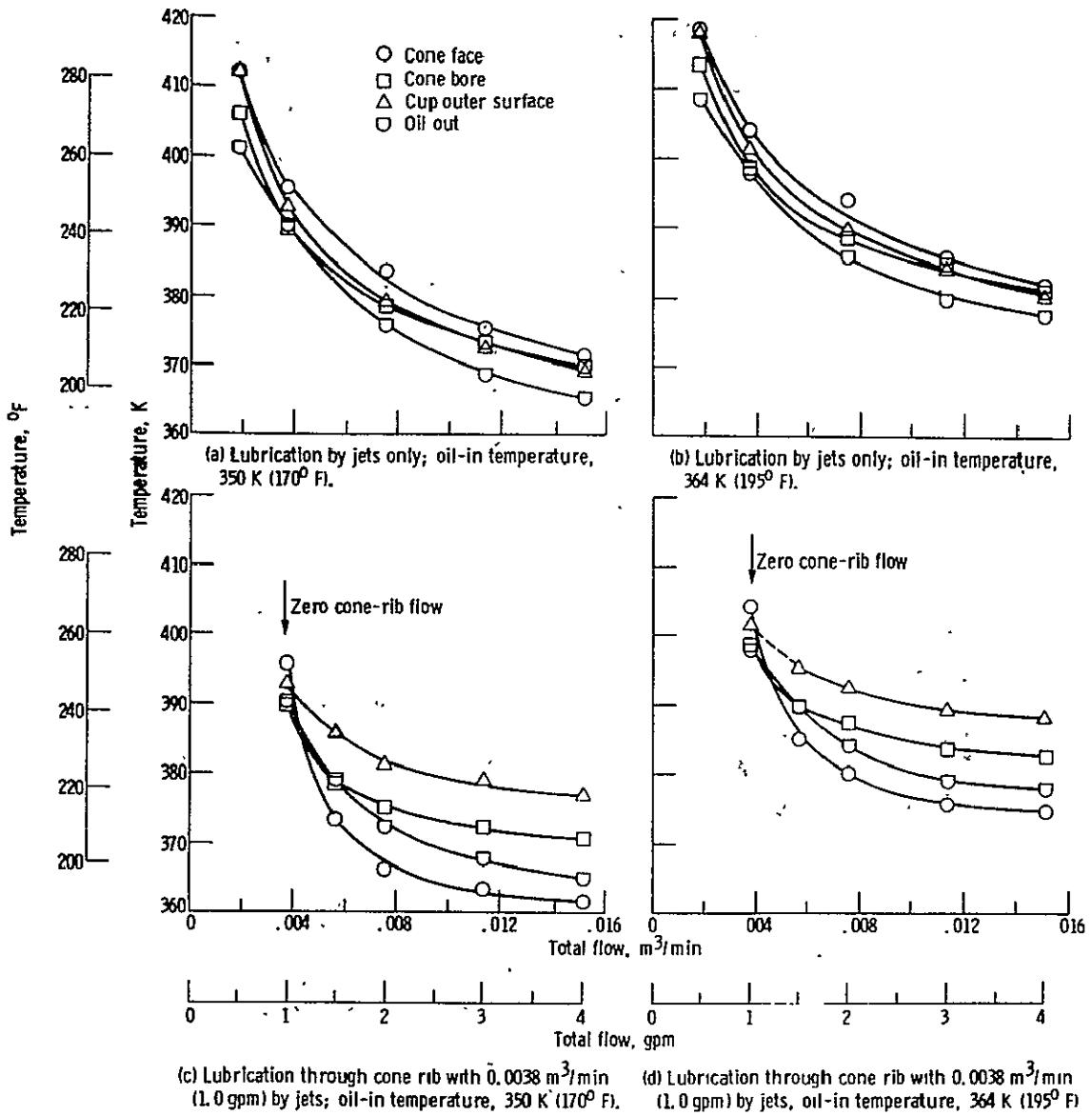

Figure 10 - Test Bearing lubrication and thermocouple locations.



Test Bearing
Tapered-Roller Bearing Test Program

Figure 11



- Temperature as a function of flow rate at shaft speed of 6000 rpm. Thrust load, 53 400 N (12 000 lb); radial load, 26 700 N (6000 lb).

Figure 12

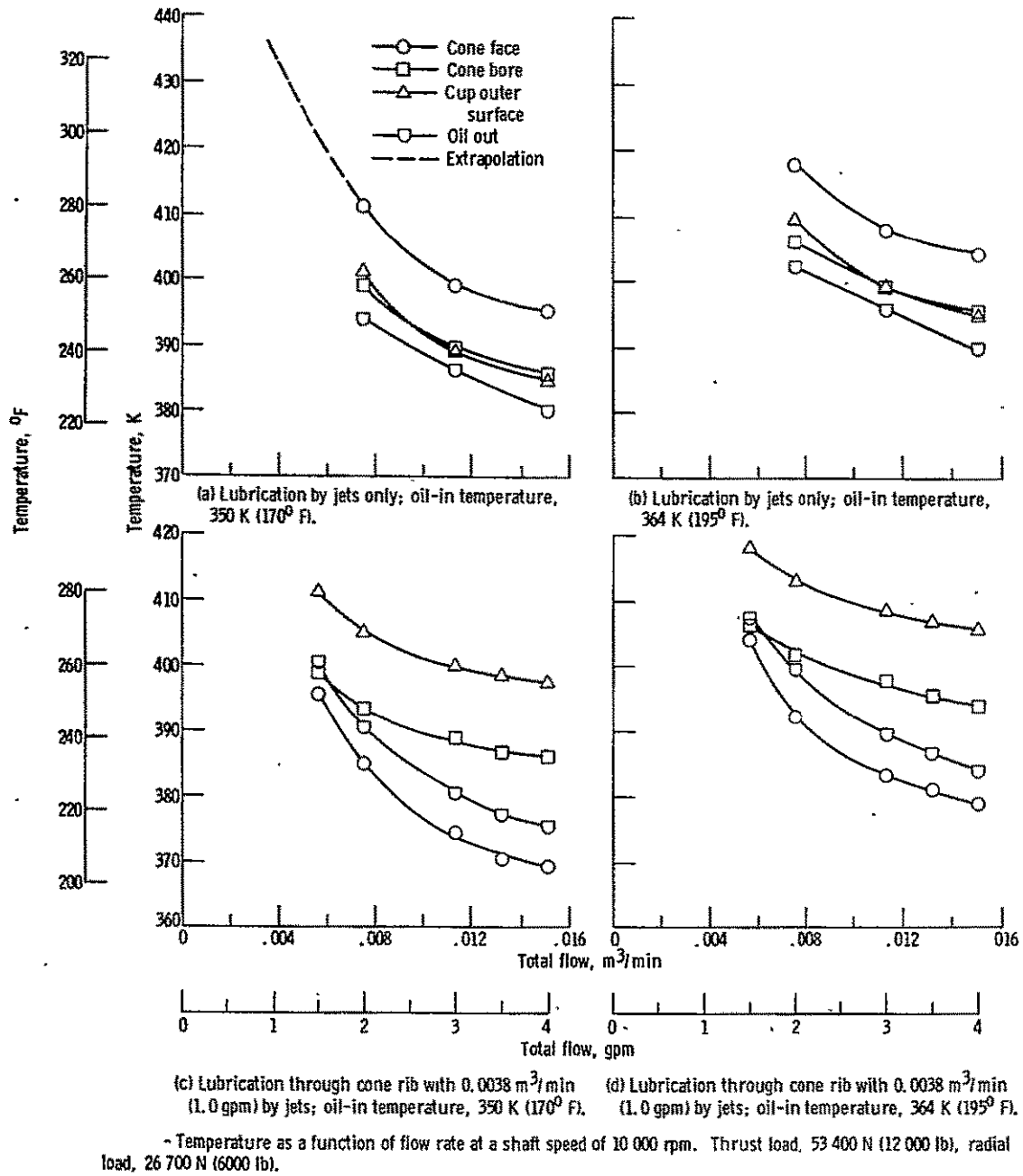
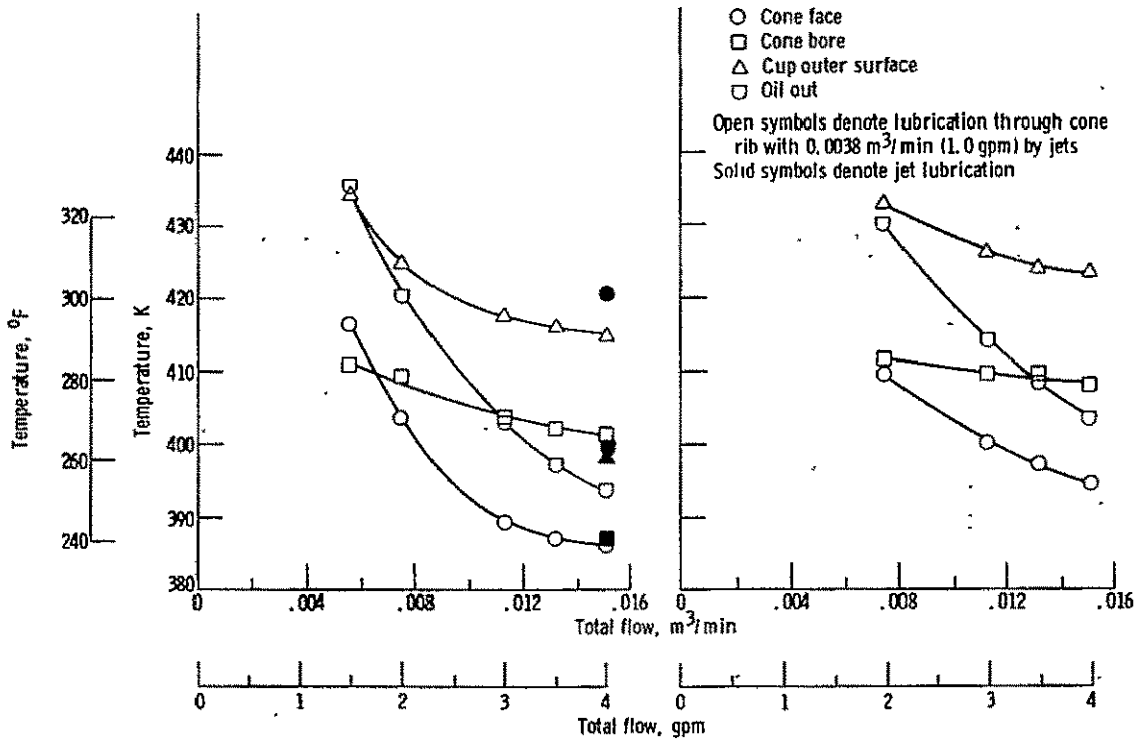
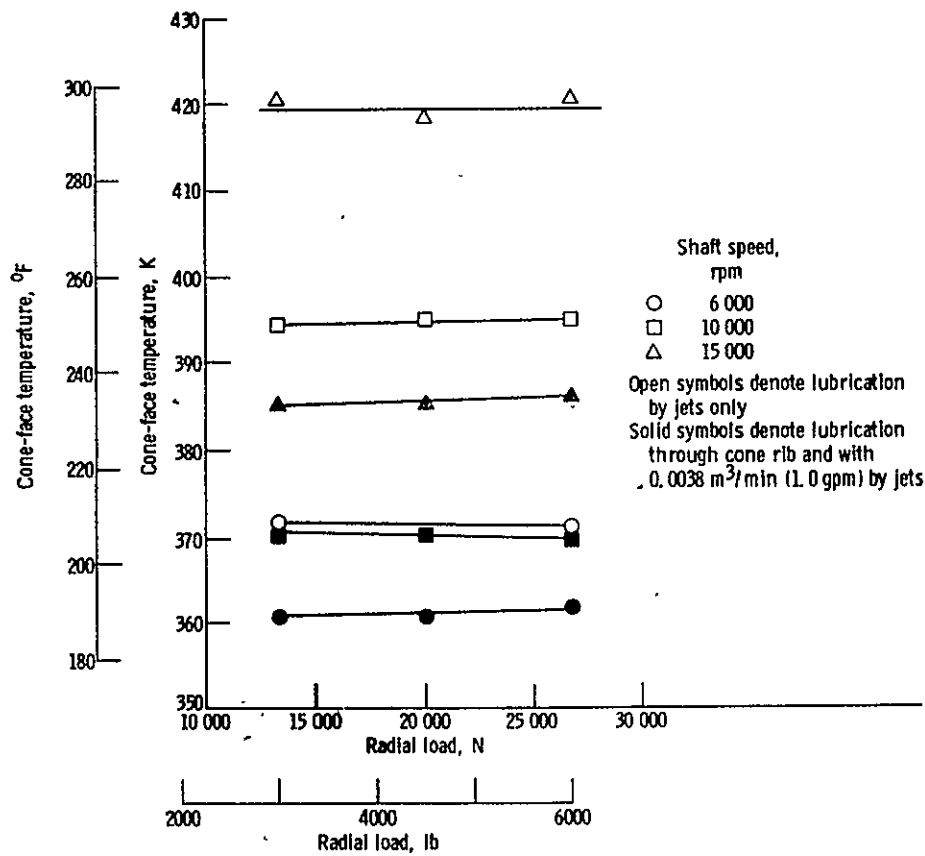

Figure 13



- Temperature as function of flow rate at shaft speed of 15 000 rpm. Thrust load, 53 400 N (12 000 lb); radial load, 26 700 N (6000 lb).

Figure 14



- Effect of radial load on cone-face temperature. Thrust load, 53 400 N (12 000 lb); oil-in temperature, 350 K (170° F); total oil flow, 0.0151 m³/min (4.0 gpm).

Figure 15

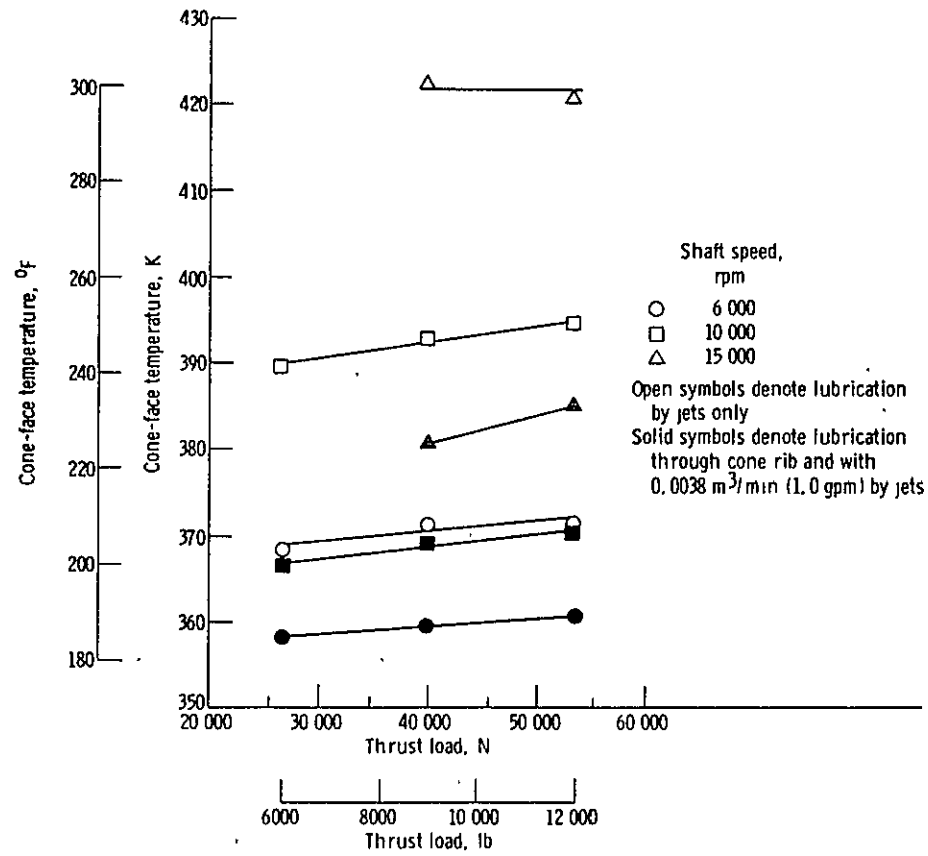

- Effect of thrust load on cone-face temperature. Radial load, 13 400 N (3000 lb); oil-in temperature, 350 K (170° F); total oil flow, 0.0151 m³/min (4.0 gpm).

Figure 16

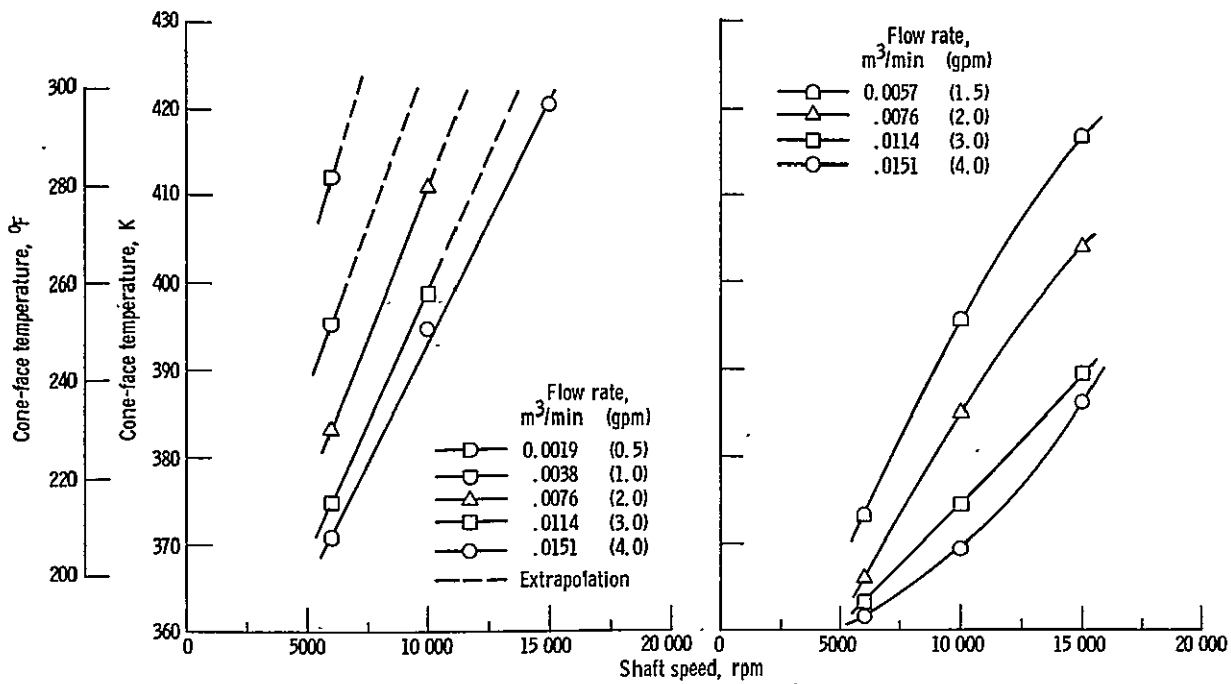

(a) Lubrication by jets only.

(b) Lubrication through cone rib with 0.0038 m³/min (1.0 gpm) by jets.

- Effect of shaft speed and flow rate on cone-face temperature for oil-in temperature of 350 K (170° F). Thrust load, 53 400 N (12 000 lb); radial load, 26 700 N (6000 lb).

Figure 17

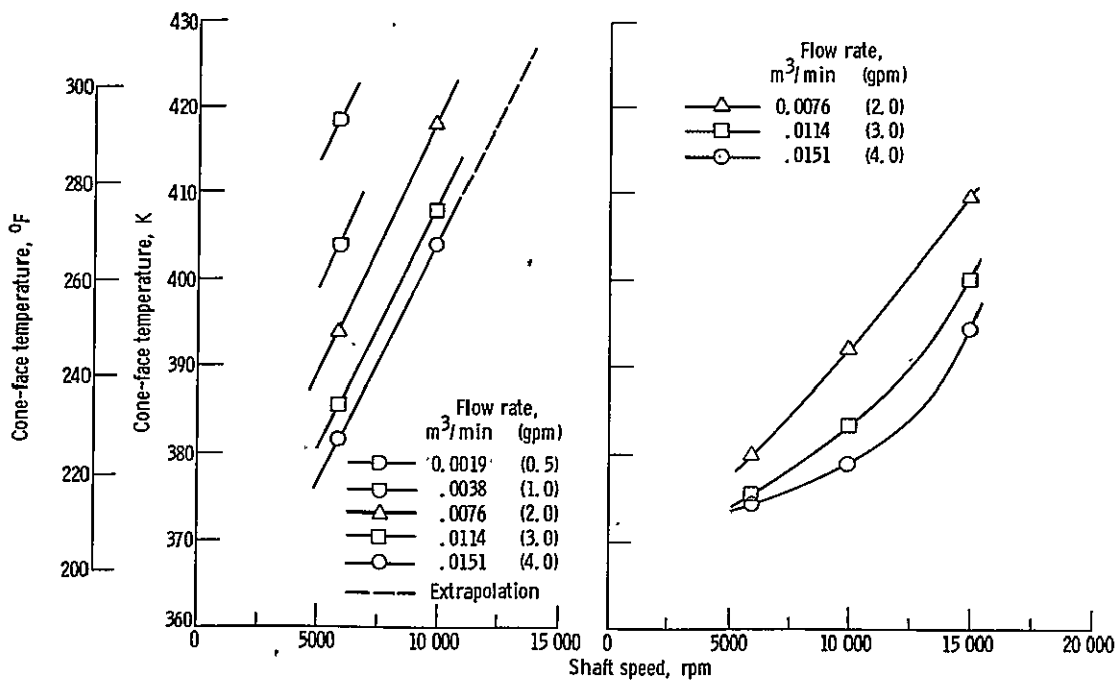

(a) Lubrication by jets only.

(b) Lubrication through cone rib with 0.0038 m³/min (1.0 gpm) by jets.

- Effect of shaft speed and flow rate on cone-face temperature for oil-in temperature of 364 K (195° F). Thrust load, 53 400 N (12 000 lb); radial load, 26 700 N (6000 lb).

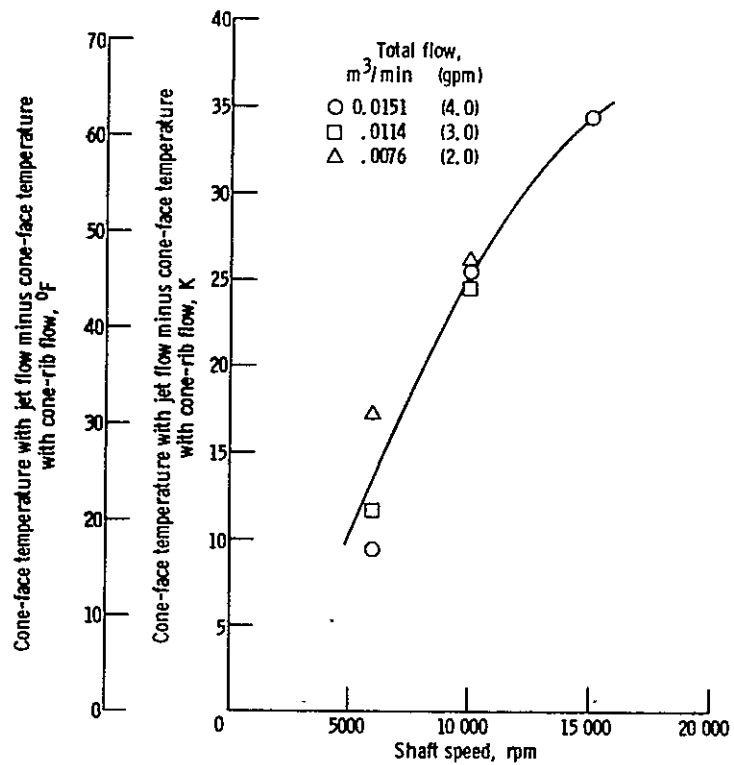

- Effect of shaft speed on cone-face temperature with jet lubrication minus that with cone-rib lubrication. Oil-in temperature, 350 K (170^o F); thrust load, 53 400 N (12 000 lb); radial load, 26 700 N (6000 lb).

Figure 19

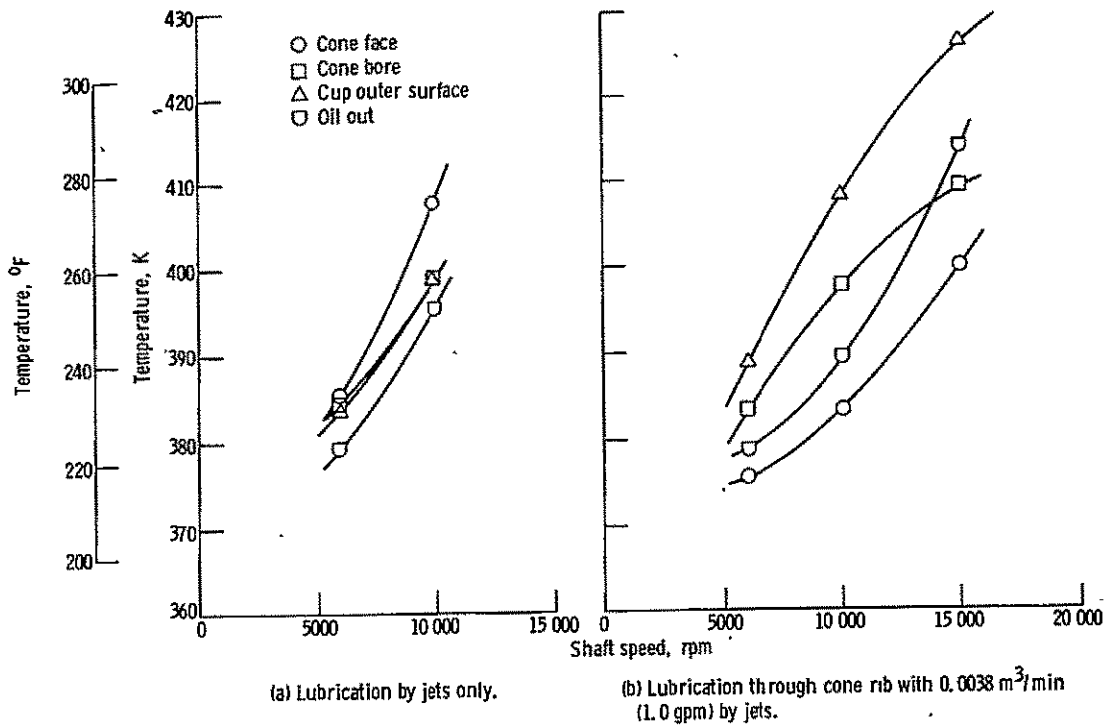

- Effect of jet lubrication and cone-rib lubrication on bearing and oil-out temperatures. Thrust load, $53\,400 \text{ N}$ ($12\,000 \text{ lb}$); radial load, $26\,700 \text{ N}$ (6000 lb); oil-in temperature, 364 K (195° F); total oil flow rate, $0.0114 \text{ m}^3/\text{min}$ (3.0 gpm).

Figure 20

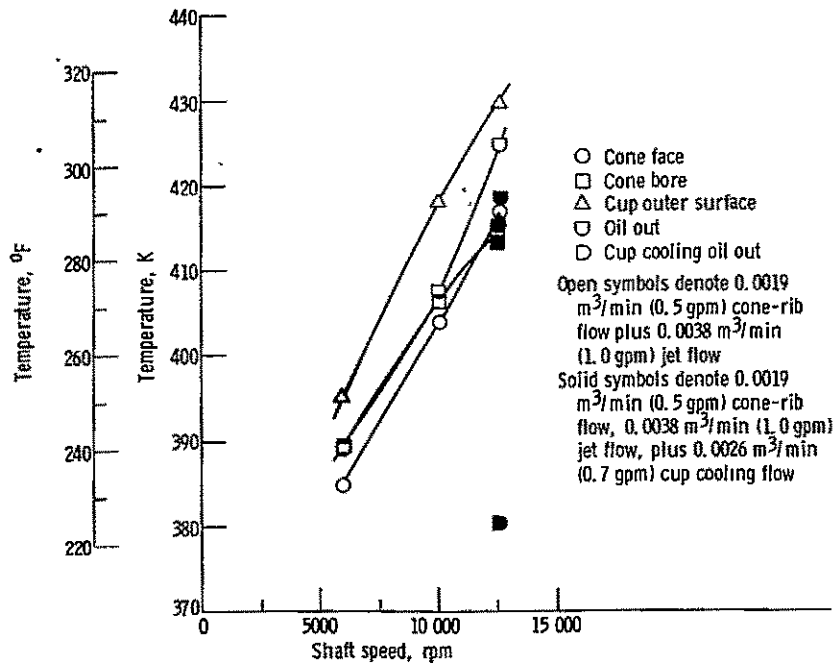

- Effect of cup cooling on bearing and oil-out temperatures. Thrust load, $53\,400 \text{ N}$ ($12\,000 \text{ lb}$); radial load, $26\,700 \text{ N}$ (6000 lb); oil-in temperature, 364 K (195° F).

Figure 21

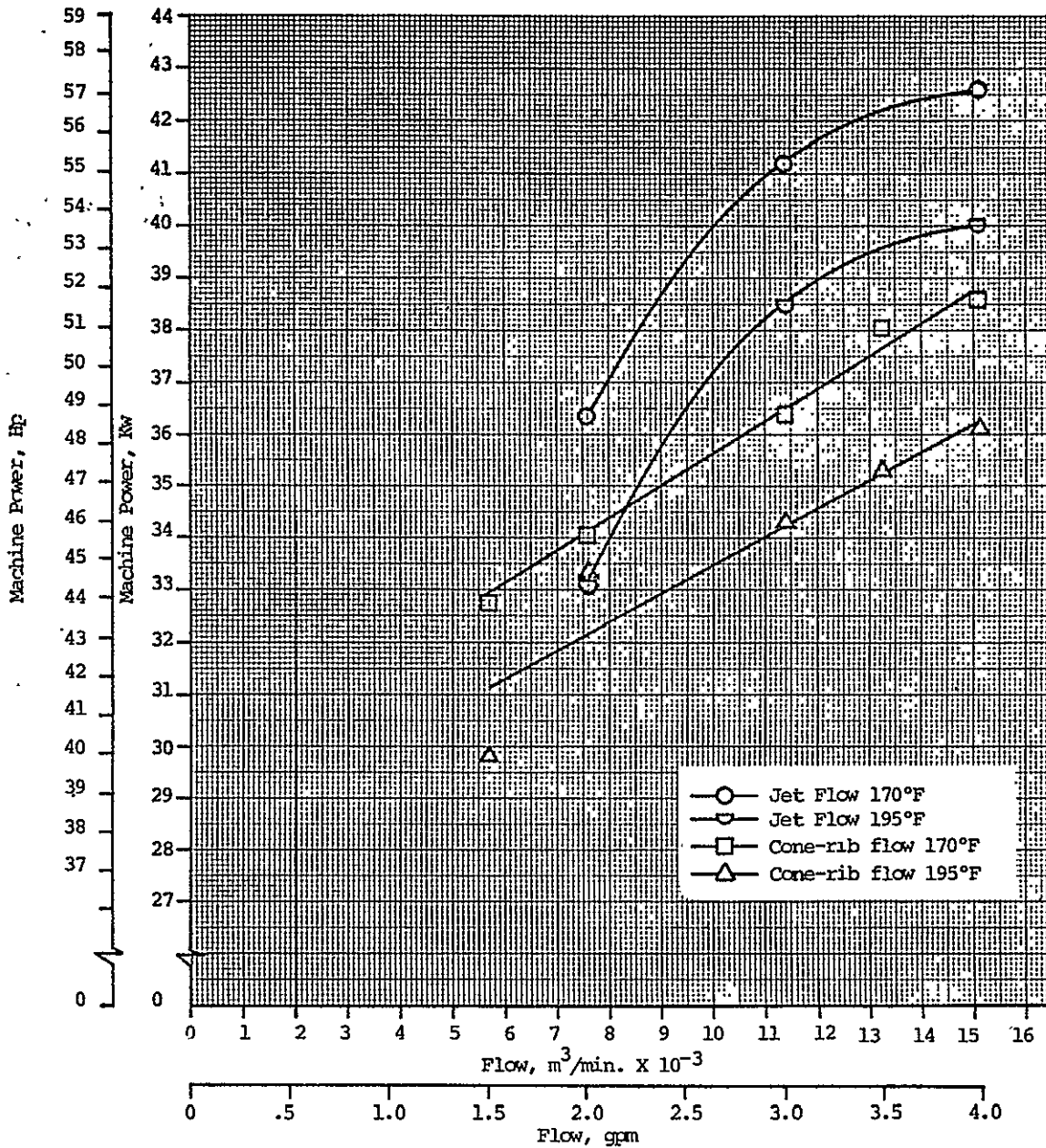

Test machine power demand as a function of flow rate at 10,000 rpm shaft speed, 53,400 N (12,000 lbs) thrust load, 26,700 N (6,000 lbs) radial load.

Figure 22

7-2

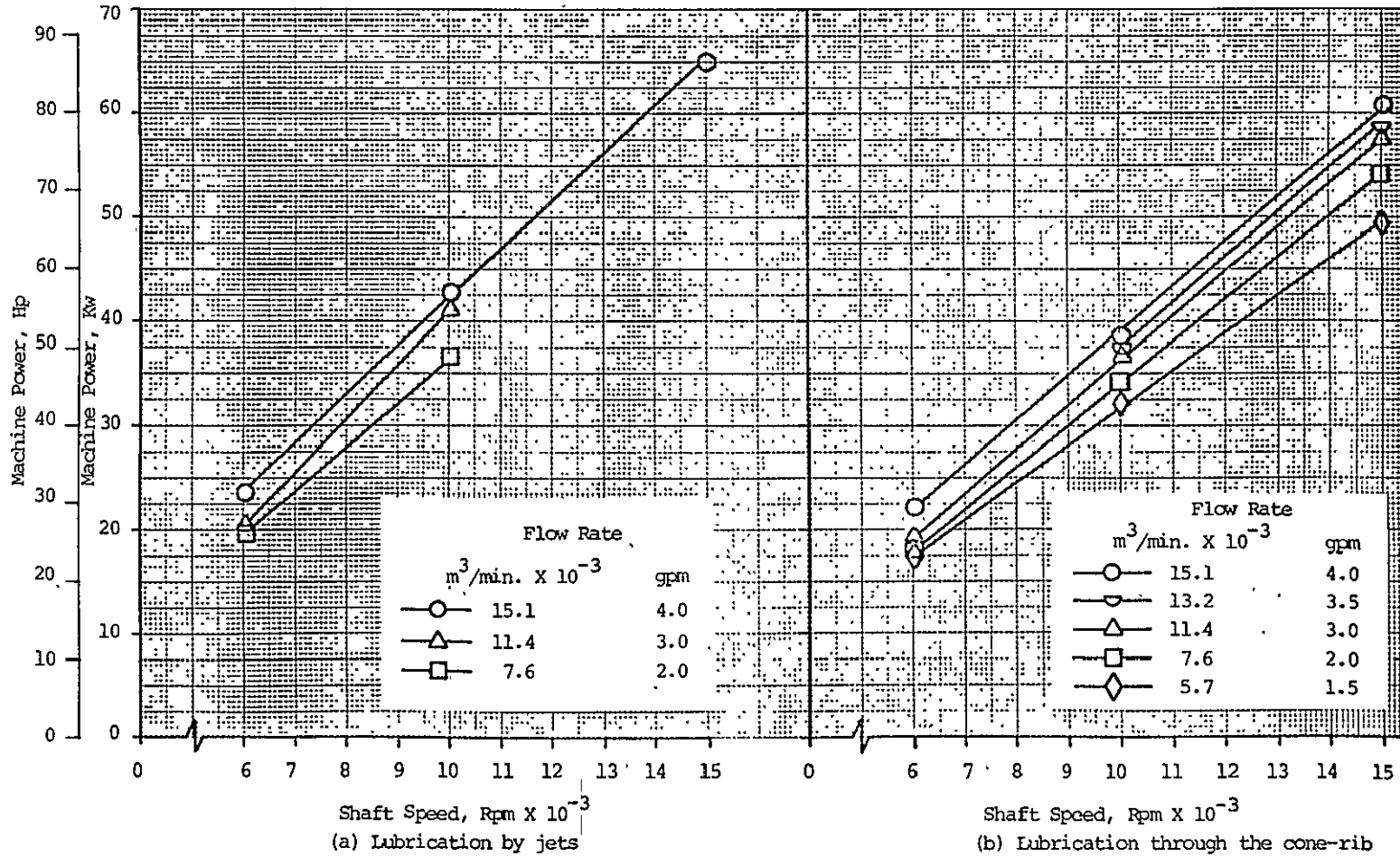

Effect of shaft speed and flow rate on test machine power demand for an oil-in temperature of 350°K (170°F). Thrust load 53,400 N (12,000 lb), radial load 28,700 N (6,000 lb).

Figure 23

○ 6,000 rpm
 □ 10,000 rpm
 △ 15,000 rpm

Open symbols: $15.1 \times 10^{-3} \text{ m}^3/\text{min}$. (4.0 gpm) jet flow.
 Solid symbols: $15.1 \times 10^{-3} \text{ m}^3/\text{min}$. (4.0 gpm) total cone-rib flow.

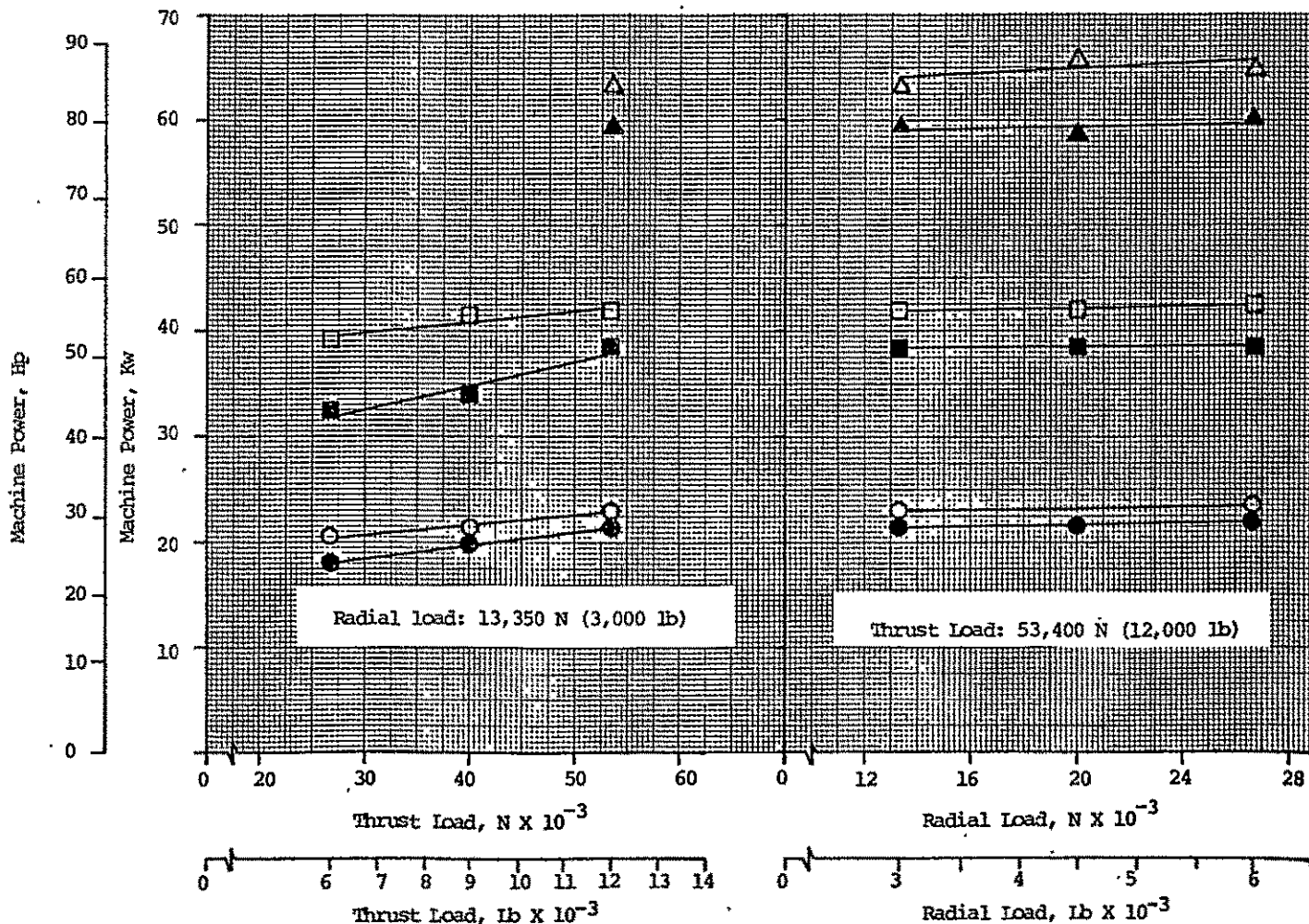

Effect of thrust and radial load on test machine power demand. Oil-in temperature 350°K (170°F), total oil flow $15.1 \times 10^{-3} \text{ m}^3/\text{min}$. (4.0 gpm).

Figure 24

Report Distribution List
for CR-135190

<u>Recipient</u>	<u>No. of Copies</u>
NASA/Lewis Research Center 21000 Brookpark Road Cleveland, OH. 44135	
Attn: R. J. Parker, M/S 6-1	25
L. W. Schopen, M/S 500-305	1
Library, M/S 60-3	2
Management Services Division, M/S 5-5	1
NASA Scientific and Technical Information Facility Attn: Accessioning Department P.O. Box 8757 Balt/Wash International Airport Maryland 21240	20
U.S. Army Air Mobility R & D Laboratory Lewis Directorate, M/S 77-5 21000 Brookpark Road Cleveland, OH 44135	2
U. S. Army Air Mobility R & D Laboratory Ames Research Center Attn: SAVDL-AS Moffett Field, CA 94035	1
U. S. Army Air Mobility R & D Laboratory Eustis Directorate Fort Eustis, VA 23604	2
The Timken Company 1835 Dueber Ave., SW Canton, OH 44706 Attn: R. Cornish	2