

FINAL REPORT OF BASIC CONTRACT

GENERAL PURPOSE SIMULATION SYSTEM OF THE DATA MANAGEMENT SYSTEM FOR SPACE SHUTTLE MISSION 18

CONTRACT NAS8-31458

July 15, 1975

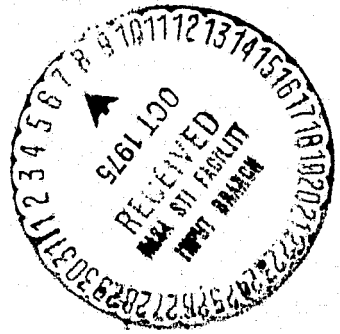

PREPARED FOR:

**DATA SYSTEMS LABORATORY
National Aeronautics and Space Administration
George C. Marshall Space Flight Center, Alabama 35812**

(NASA-CR-143942) GENERAL PURPOSE SIMULATION SYSTEM OF THE DATA MANAGEMENT SYSTEM FOR SPACE SHUTTLE MISSION 18 Final Report (D P Associates, Inc., Huntsville, Ala.) 103 p HC \$5.25

N75-31946
Unclas
35827
CSCL 05B G3/82

FOREWORD

This document presents results of work performed by D P Associates, Inc., Huntsville, Alabama, under Contract NAS8-31458 (SB420-8(a)-75-C-122) for the George C. Marshall Space Flight Center, Data Systems Laboratory. Technical coordination was through Mr. Frank Crumbley, Mr. Douglas Thomas and Mr. James Mabry.

ABSTRACT

This report presents the simulation program of the science and engineering data management system for Space Shuttle. The programming language used was General Purpose Simulation System V (OS). The data flow was modeled from its origin at the experiments or subsystems to transmission from Space Shuttle. Mission 18 was the particular flight chosen for simulation. First, the general structure of the program is presented and the trade studies which were performed are identified. Inputs required to make runs are discussed followed by identification of the output statistics. Some areas for model modifications are pointed out. The appendices contain a detailed model configuration, program listing and results.

TABLE OF CONTENTS

SPACE SHUTTLE DATA MANAGEMENT SYSTEM SIMULATION

	<u>Page</u>
Introduction	1
Research Methodology	
Assumptions	3
Experiment Schedules	3
Downlink Schedule	4
Data Flow Modules	4
Trade Studies	4
User Notes	
Input Requirements	5
Output Characteristics	5
Model Modification	21
Appendices	22-98

SPACE SHUTTLE DATA MANAGEMENT SYSTEM SIMULATION

Introduction

The data management system for Space Shuttle is a complicated arrangement of interconnected devices which carry several types of data simultaneously. Understanding the interrelationships of data flowing through this system and how actions of one set or burst of data effect the progress of other data by analytical study is a prohibitively complicated task. When it is realized that over four hundred Space Shuttle flights are planned, each with a similarly complicated data management system, the need for simulation becomes apparent.

The objective of this task was to write a simulation of the data management system using GPSS (General Purpose Simulation System) in such a way as to determine possible bottlenecks, losses of information, and other changing effects on data under alternative conditions. As a basis from which future expansion can be made the program developed handles science and engineering data from its' origin at the mission experiments and subsystems to transmission from one of three signal processors onboard shuttle. Mission 18 was chosen as a representation case for simulation. The data generated by detached payloads and the GPC (General Purpose Computer) were not considered.

GPSS is a discrete event simulation language which allows the programmer to set up a model of a system with the relationships between the parts or blocks of the model defined. Units, called transactions, are then generated and sent through the program. They proceed in a way defined by the model.

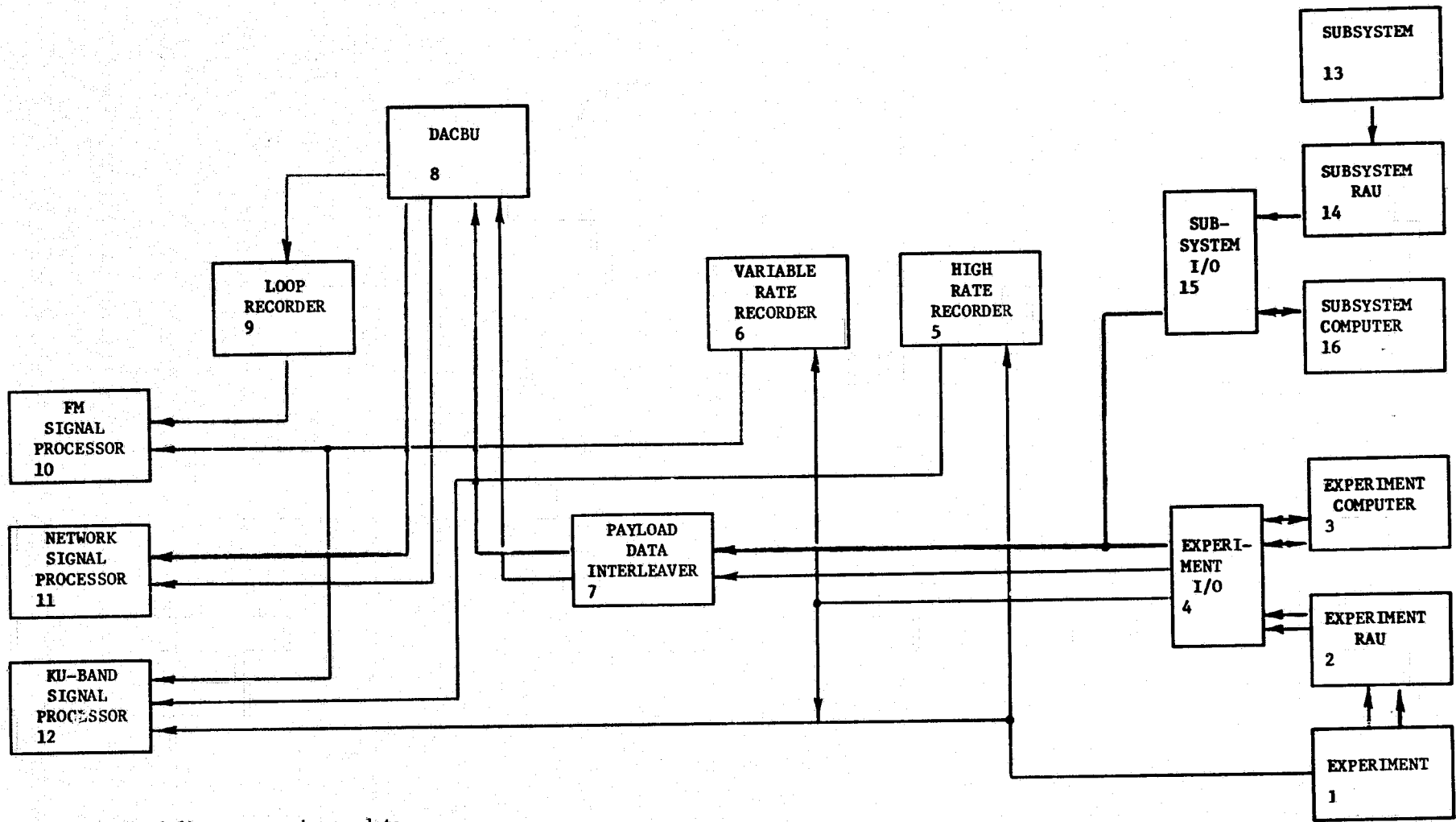

Black lines are science data
 Red lines are engineering data

Data Flow Model
 Fig. 1

Research Methodology

Assumption

All data which flows through the simulation is in bits. One unit of simulation clock time is .01 hours or 36 seconds. This unit was chosen to achieve simulation of the entire seven day (16800 time units) mission with reasonable computer run times and still allow sufficient resolution in the generation of data. Thus, if an experiment has an output rate of 30 thousand bits per second there would be 30 x 36 or 1080 thousand bits generated in one time unit. In each time unit that data is generated a transaction is created and the data flow associated with that time unit is assigned to the transaction as a parameter. The transaction then enters the model. Each block in the model (shown in figure 1) has a transfer rate associated with it which represents the handling capacity of the block in bits. This is the amount of data the block can handle in one time unit and is defined as a storage capacity in the program. Appendix A gives a more detailed description of the model configuration. (The module numbers in Appendix A correspond to the numbers in the blocks of Figures 1, 3, 4 and 5).

Experiment Schedules

A schedule of experiments from Mission 18 was used to create a tape for input to the GPSS model. A data flow rate is associated with each experiment so that each time unit an experiment is scheduled to be running that experiment's flow rate is put on a transaction. This data represents scientific information. Engineering data from the experiments is generated at a constant rate. This constant rate simulates monitoring and control of experiments. All data from subsystems are classified as engineering data. These bit rates are the sum of a

constant rate and a rate keyed to, and calculated as, a percent of the experiment data flow rate.

Downlink Schedule

The schedule for sending signals from the shuttle is part of the simulation program rather than on a separate device which has to be read in, as is the experiment schedule. This inclusion is possible because the downlink availability is considered to be cyclic on a per day basis. Therefore, only one day's schedule need be initialized and the following days are programmed to be derived from the first day.

Data Flow Modules

The simulation was modularized for ease in programming and documentation. These modules are outlined in Figure 2. The first module is the creation of the input tape and is separate from the main program. Modules 2, 3 and 4 run consecutively on the program listing with the exception that Part 3 of modules 3 and 4 are combined. The graphical output section is considered part of the downlink schedule, module 5.

Figures 3-5 illustrate the parts of the model used in each module.

Trade Studies

Four modifications to the basic system configuration were run to obtain insight into the behavior of the model. These modifications are listed in Figure 6. The results are shown in Appendix C.

User Notes

Input Requirements

The simulation program was written for the IBM 360 at MSFC. The job cards necessary to access this machine and to make the experiment tape available are shown below.

```
JOB CARD
// EXEC GPSSV, PARM=B
//GPSS.DJBTAP1 DD UNIT=TAPE9, VOLUME=SER=AO614, LABEL=(, BLP),
// DISP=(OLD, KEEP)
//GPSS, DINPUT1 DD *
```

The experiment tape contains a fullword matrix shown in Appendix D. Each column represents the start of an experiment. The rows are the start times (in hundredths of hours), the experiment numbers (107 is XCN-007, 44 is XEQ-044, the rest are XOP experiments) and the duration of the experiment respectively. A FORTRAN program was also written to convert the experiment schedule cards given to cards suitable for input to the tape program.

If changes in block capacities are required they can be implemented by changing the storage definitions. Changes in the percent of data allocated to branches in the data flow are made in the variable definition statements. In order to investigate the effects of changes in data rates associated with each experiment the function definitions would be altered. The first number of each pair of numbers in the function represents the experiment and the second number is the corresponding data flow rate in K bits per time period.

Output Characteristics

The most informative parts of output are the storage statistics. This section lists each block that was used. The outputs are shown in Appendix B.

For the experiment and subsystem computers the average contents, entities and average time/unit are contained in the section titled "User Chains." User Chain 4 is the experiment computers and User Chain 16 is the subsystem computer. In both sections "Entities" is in thousands of bits. Under the "Facilities" section facility 50 represents the downlink availability "Average Utilization During Total Time" is the percent of time the downlink is available during the missions.

The amount of data lost is given under "Fullword Savevalues." Numbers 2 thru 16 correspond to the block numbers shown in Figure 1. If a block number is not present no data was lost at that point. The contents are in thousands of bits.

The block counts at the beginning of the output section are keyed to the program listing and give the number of transactions which have entered a program block (a line of code in GPSS is called a block, these blocks are not the same as blocks in the model).

The graphical output gives a representation of the status of various model blocks at 6 hour intervals. The graphs for experiment and subsystem RAU and I/O blocks as well as the KU Band signal processor block represent maximum contents. The other graphs represent current contents. These current contents blocks will not show any data unless it is being delayed at the block no matter how much data has gone through. This is because any data that goes into a block and is not delayed will immediately leave that block and since the graphs are made at the end of the time unit, nothing will appear as current contents (See Figures 7 thru 15).

SPACE SHUTTLE DATA SYSTEM SIMULATION
PROGRAM MODULES

<u>Module</u>	<u>Description</u>
1	Experiment Data Input (Experiment Science Data and Subsystem Engineering Data).
2	Experiment Science Data Part 1. Experiment to I/O Part 2. I/O to Computer. Computer to I/O to Payload Data Interleaver to transmit. Part 3. I/O to KU-Band or V. R. Rec. Part 4. Experiment to KU-Band or H. R. Rec.
3	Experiment Engineering Data Part 1. Experiment to I/O Part 2. I/O to Computer. Computer to I/O to Payload Data Interleaver. Part 3. Payload Data Interleaver to transmit.
4	Subsystem Engineering Data Part 1. Subsystem to I/O Part 2. I/O to Computer. Computer to I/O to Payload Data Interleaver. Part 3. Payload Data Interleaver to transmit.
5	Downlink Schedule

Figure 2

PRECEDING PAGE BLANK NOT FILMED

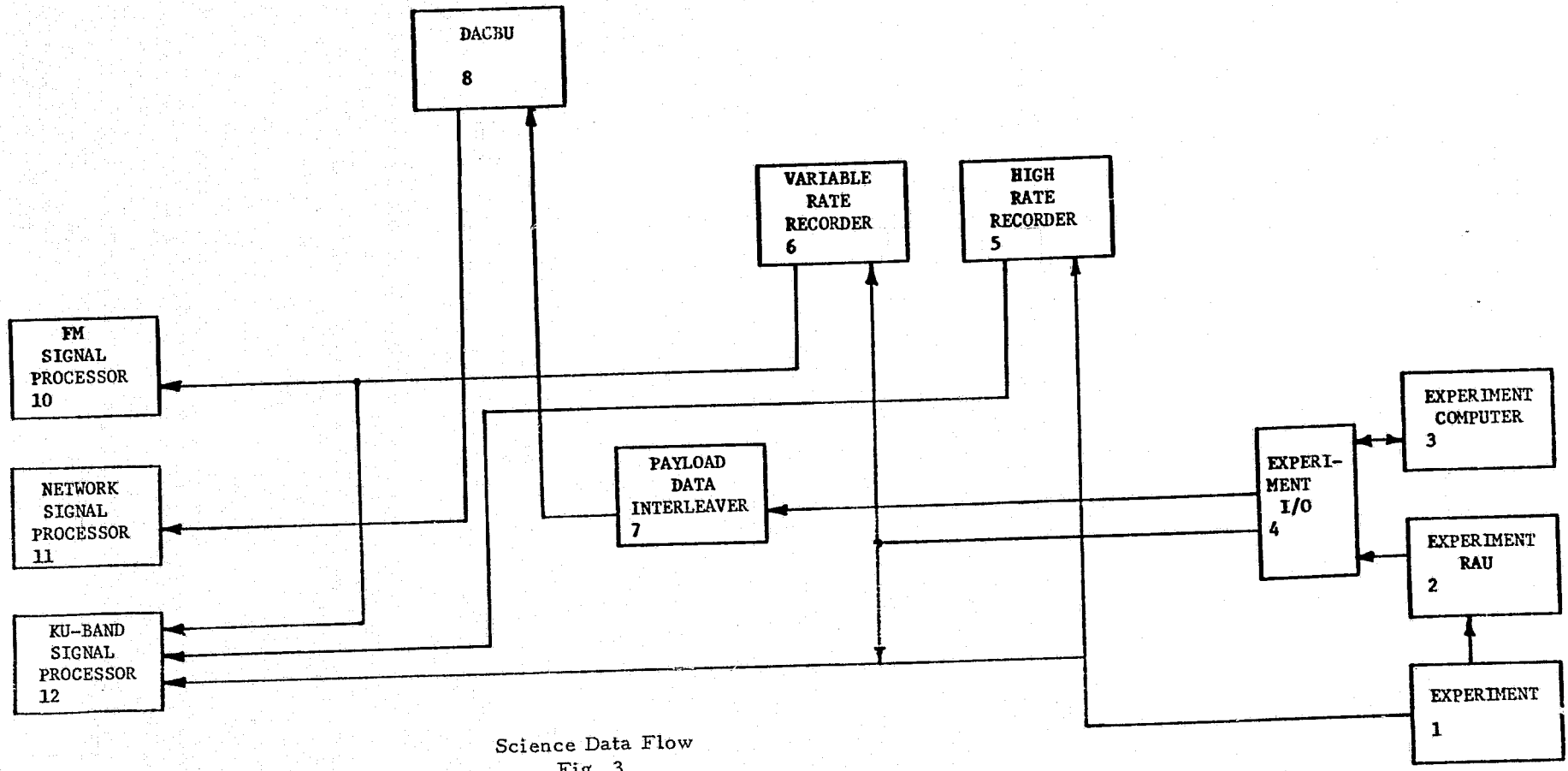

Science Data Flow
Fig. 3

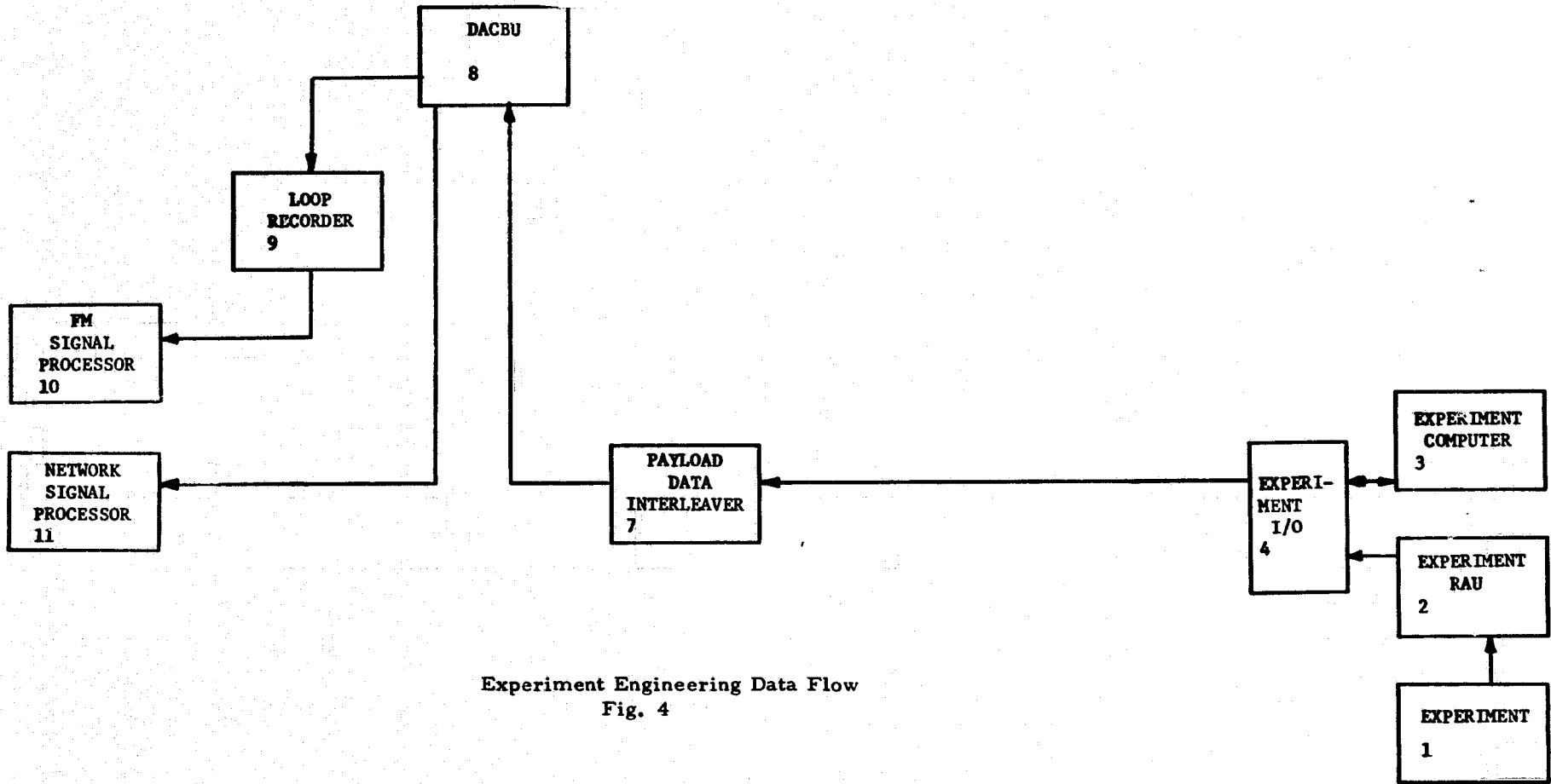

Experiment Engineering Data Flow
Fig. 4

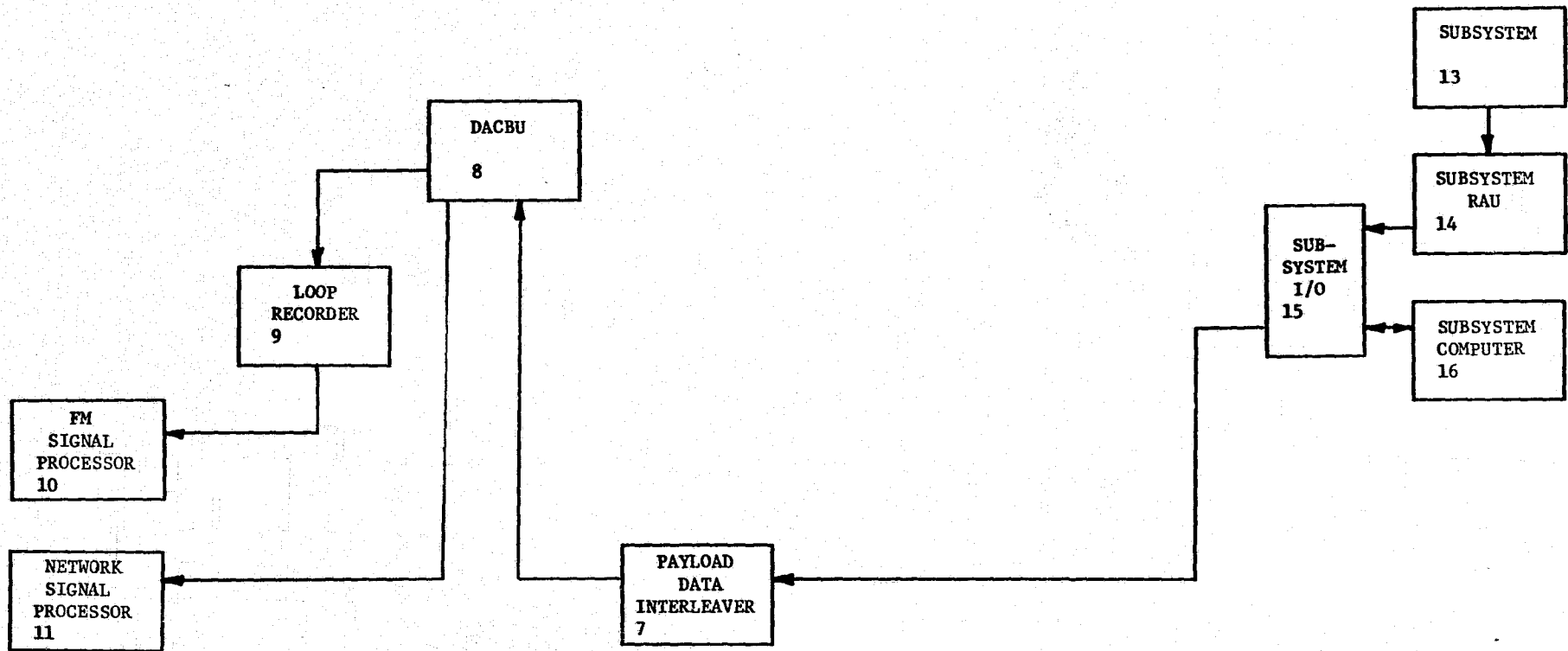

Subsystem Engineering Data Flow
Fig 5

MODIFICATIONS TO BASIC DATA SYSTEM CONFIGURATION

Modification 1: Capacity of high rate recorder increased by 25%.

Modification 2: Capacities of experiment and subsystem computers increased by 50%.

Modification 3: KU-Band Signal Processer failure 50 hours into mission.

Modification 4: Competing requirement for Downlink resulting in 10% decrease in Downlink availability.

Figure 6

2400

ORIGINAL PAGE IS
OF POOR QUALITY

2200

2000

1800

1600

EXPERIMENT 1400

8AU

CONTENTS 1200

(K-3115)

1000

800

600

400

200

0

6 12 18 24 30 36 42 48 54 60 66 72 78 84 90 96 102 108 114 120 126 132 138 144 150 156 162

TIME (HOURS)

PRECEDING PAGE BLANK NOT FILMED

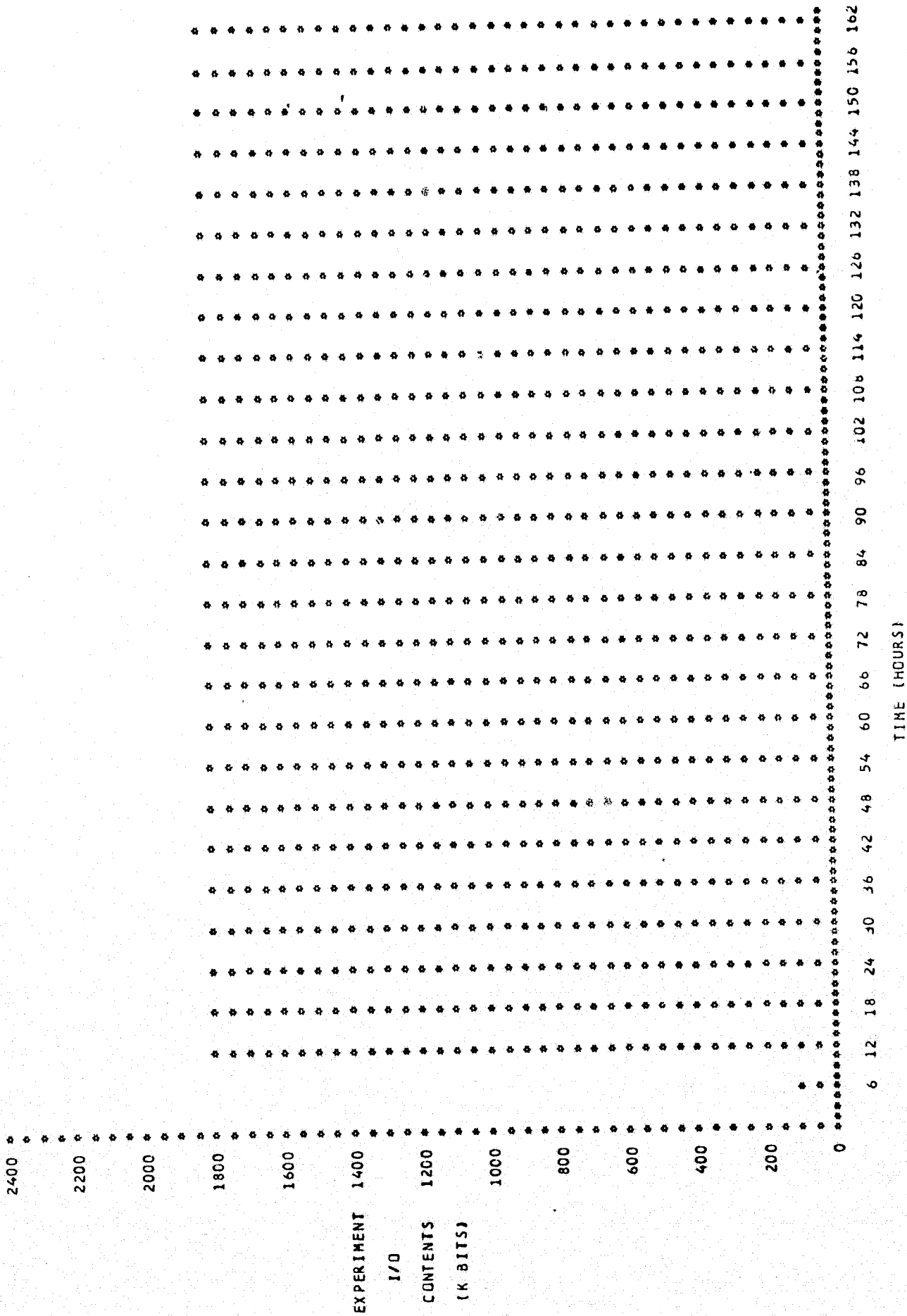

FIGURE 3: CONTENTS OF EXPERIMENT I/O AS A FUNCTION OF TIME.

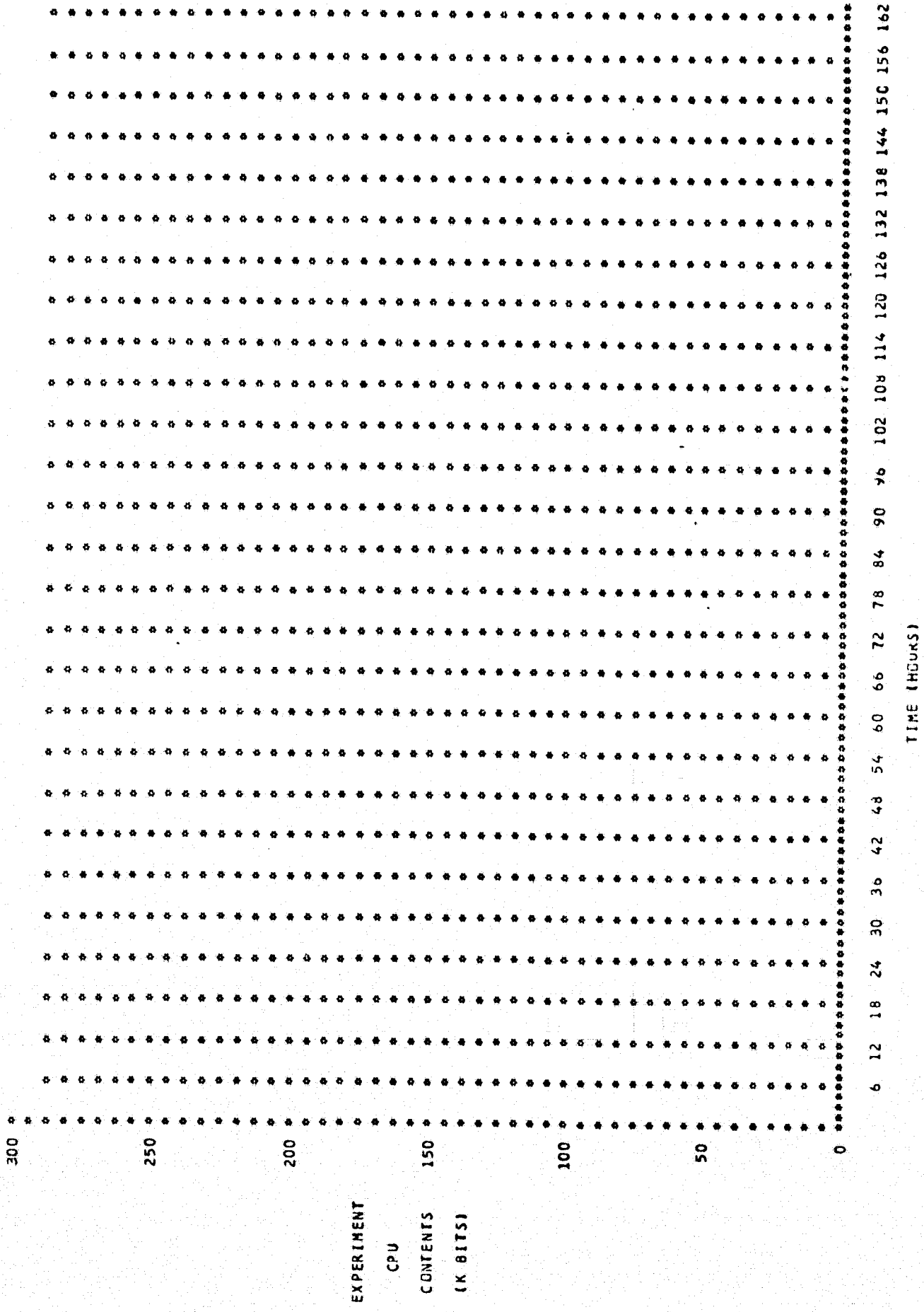

FIGURE 9: CONTENTS OF EXPERIMENT CPU AS A FUNCTION OF TIME.

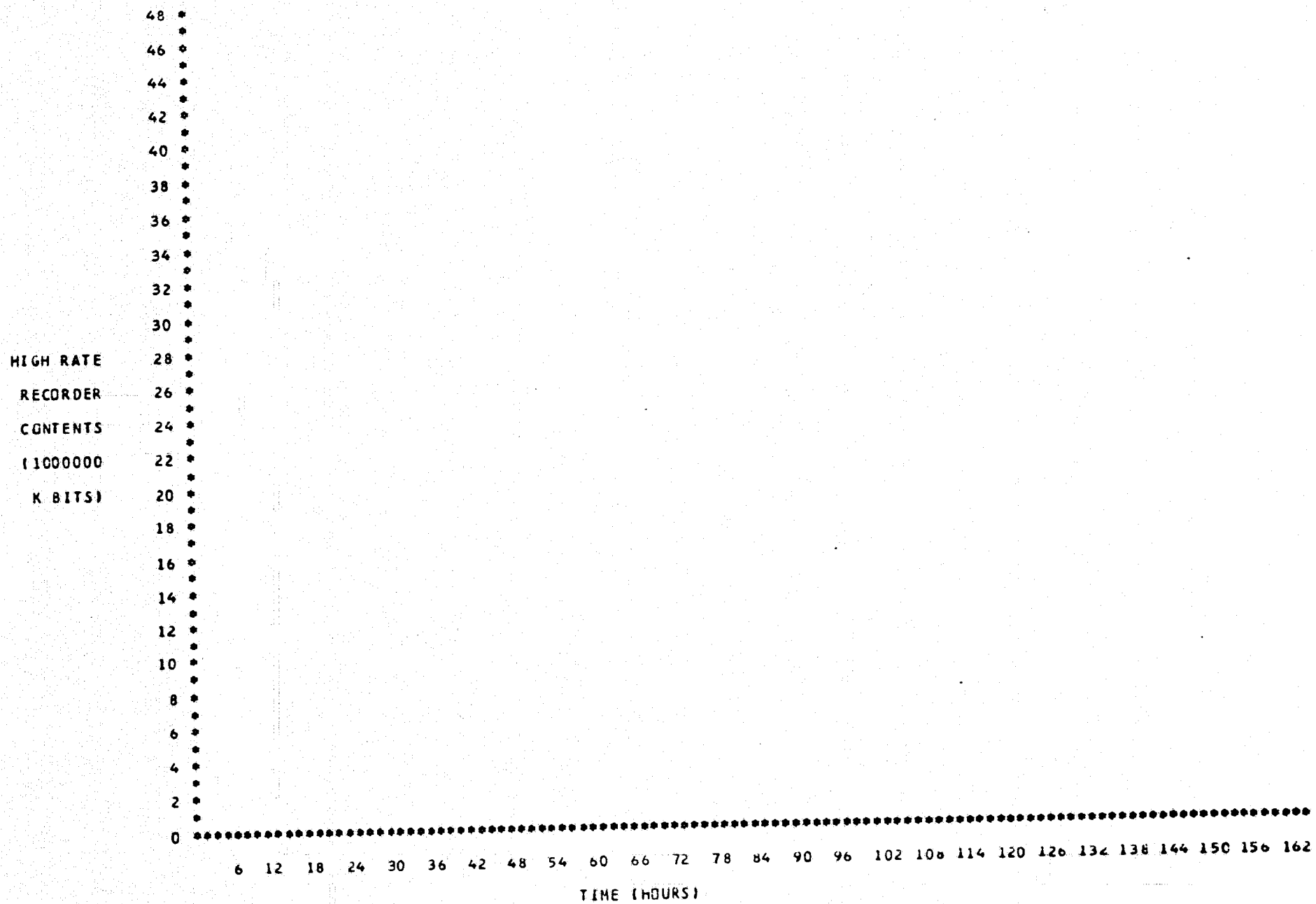

FIGURE 10: CONTENTS OF HIGH RATE RECORDER AS A FUNCTION OF TIME.

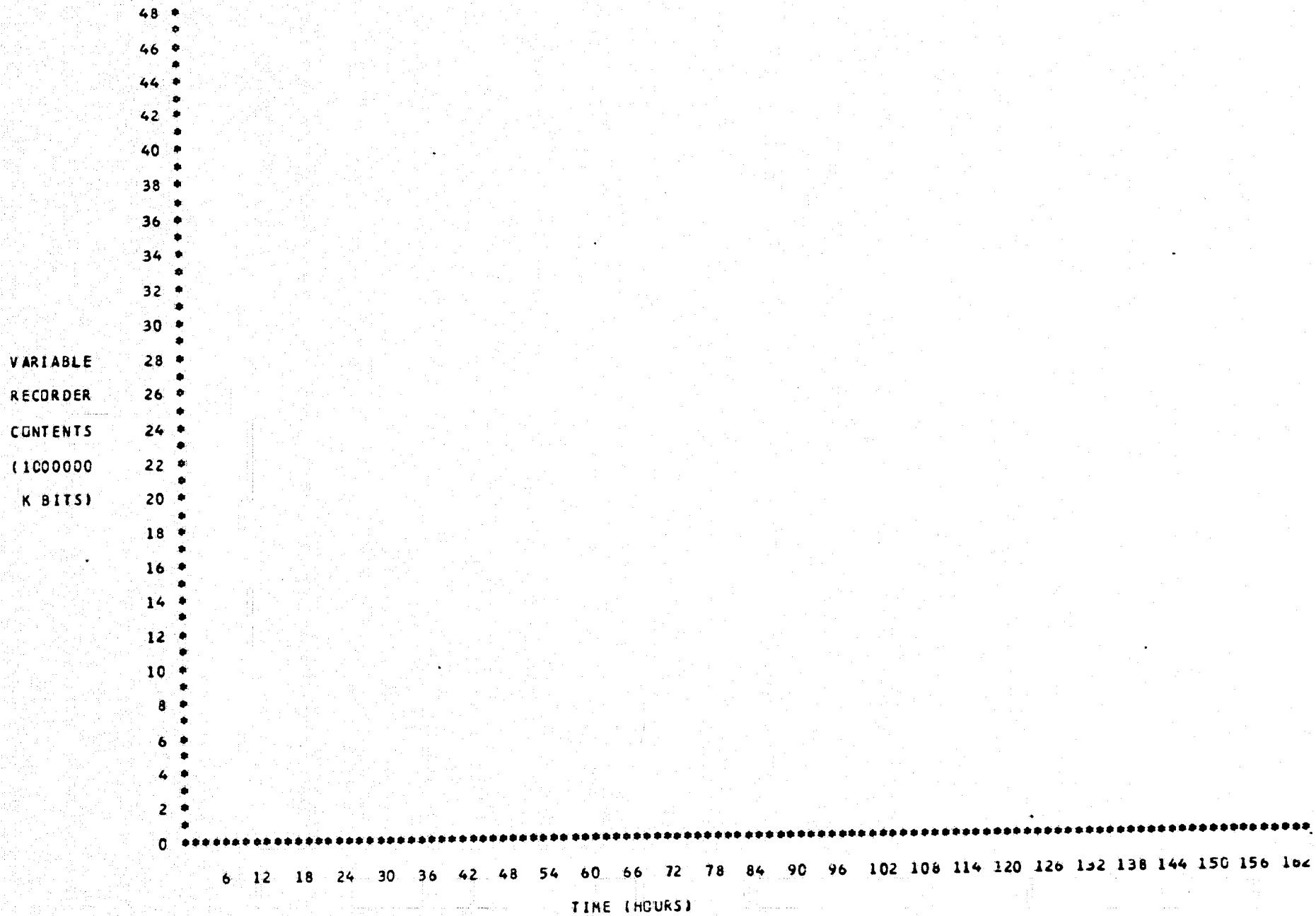

FIGURE 11: CONTENTS OF VARIABLE RATE RECORDER AS A FUNCTION OF TIME.

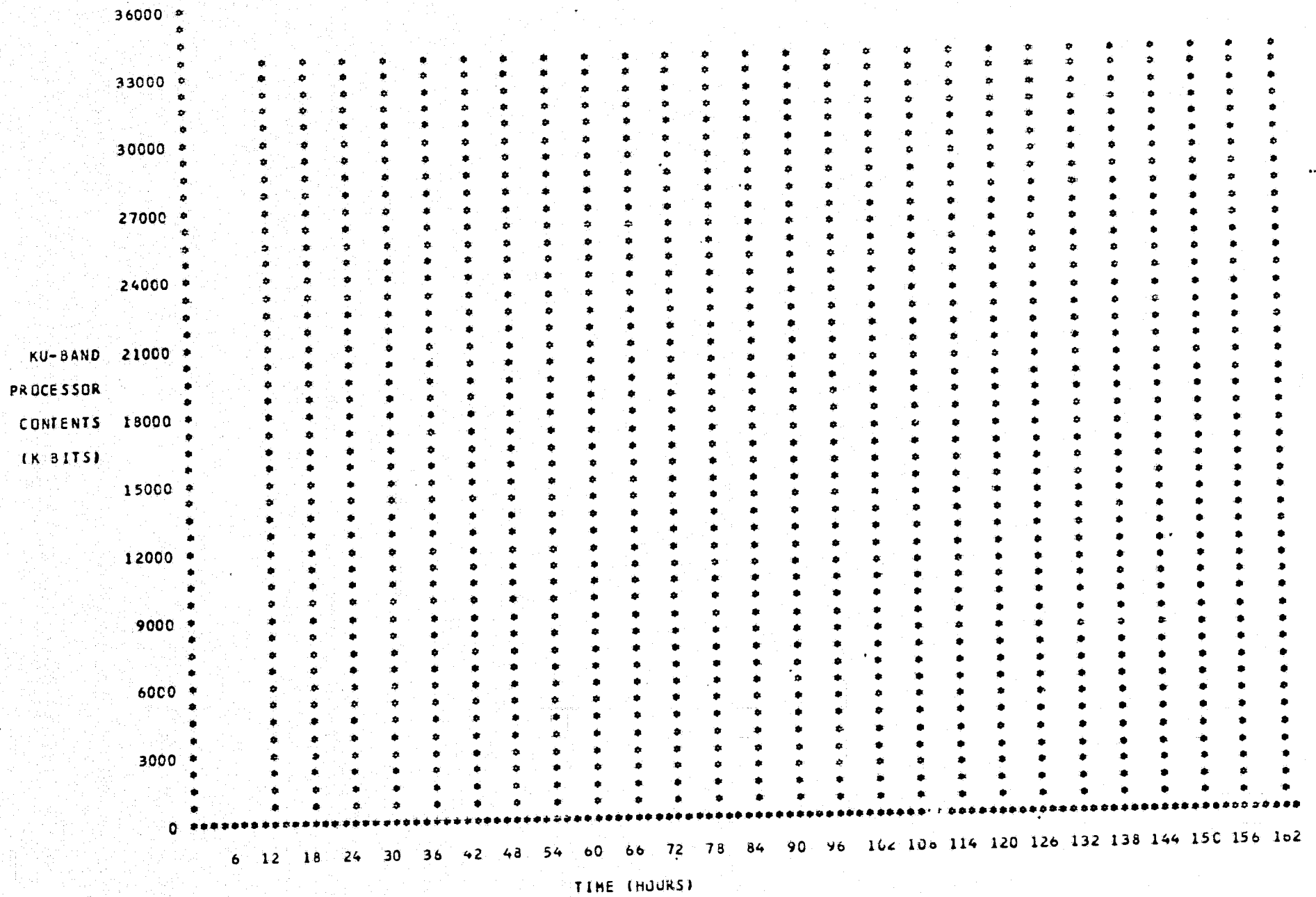

FIGURE 12: CONTENTS OF KU-BAND PROCESSOR AS A FUNCTION OF TIME.

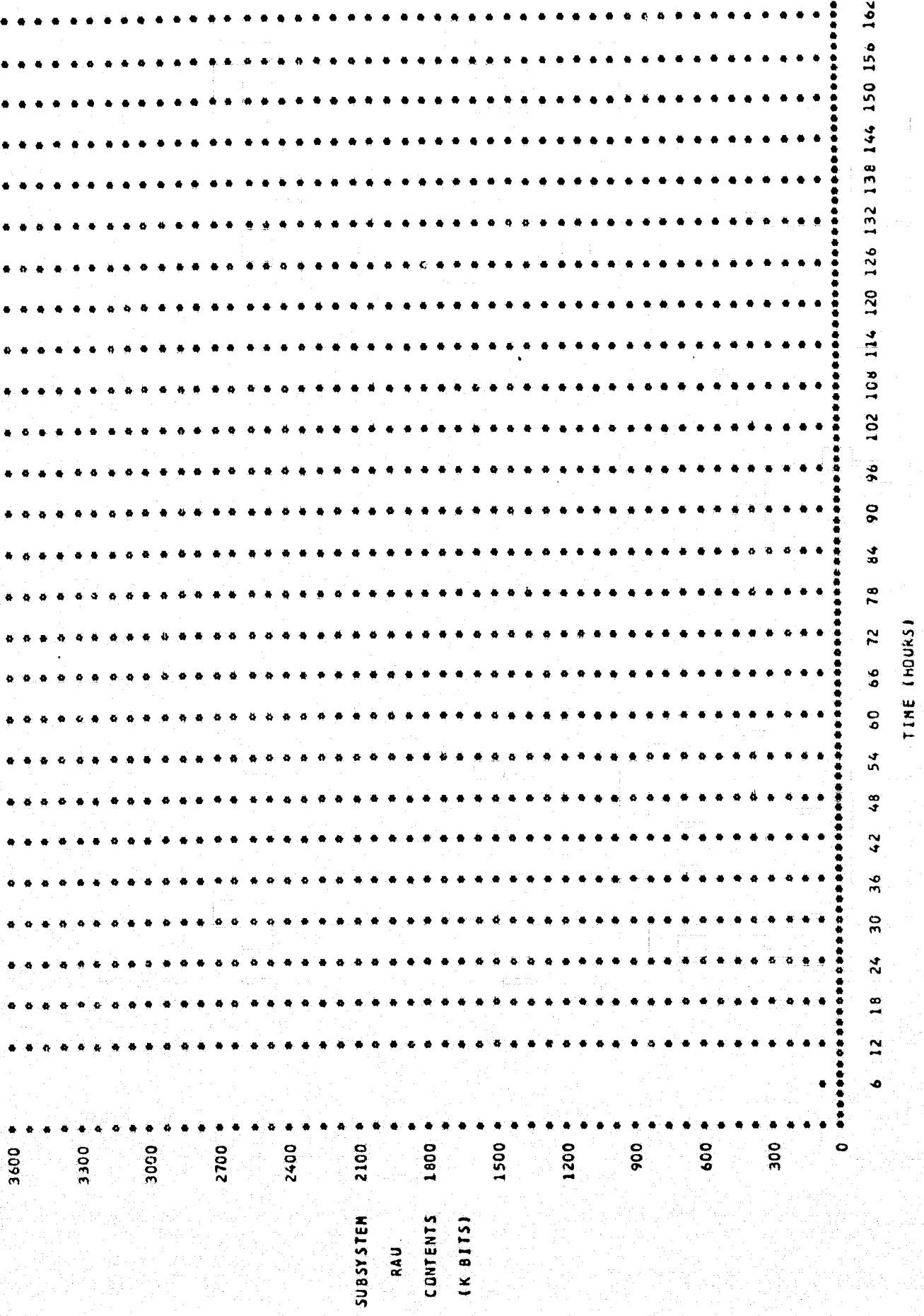

FIGURE 13: CONTENTS OF SUBSYSTEM RAU AS A FUNCTION OF TIME.

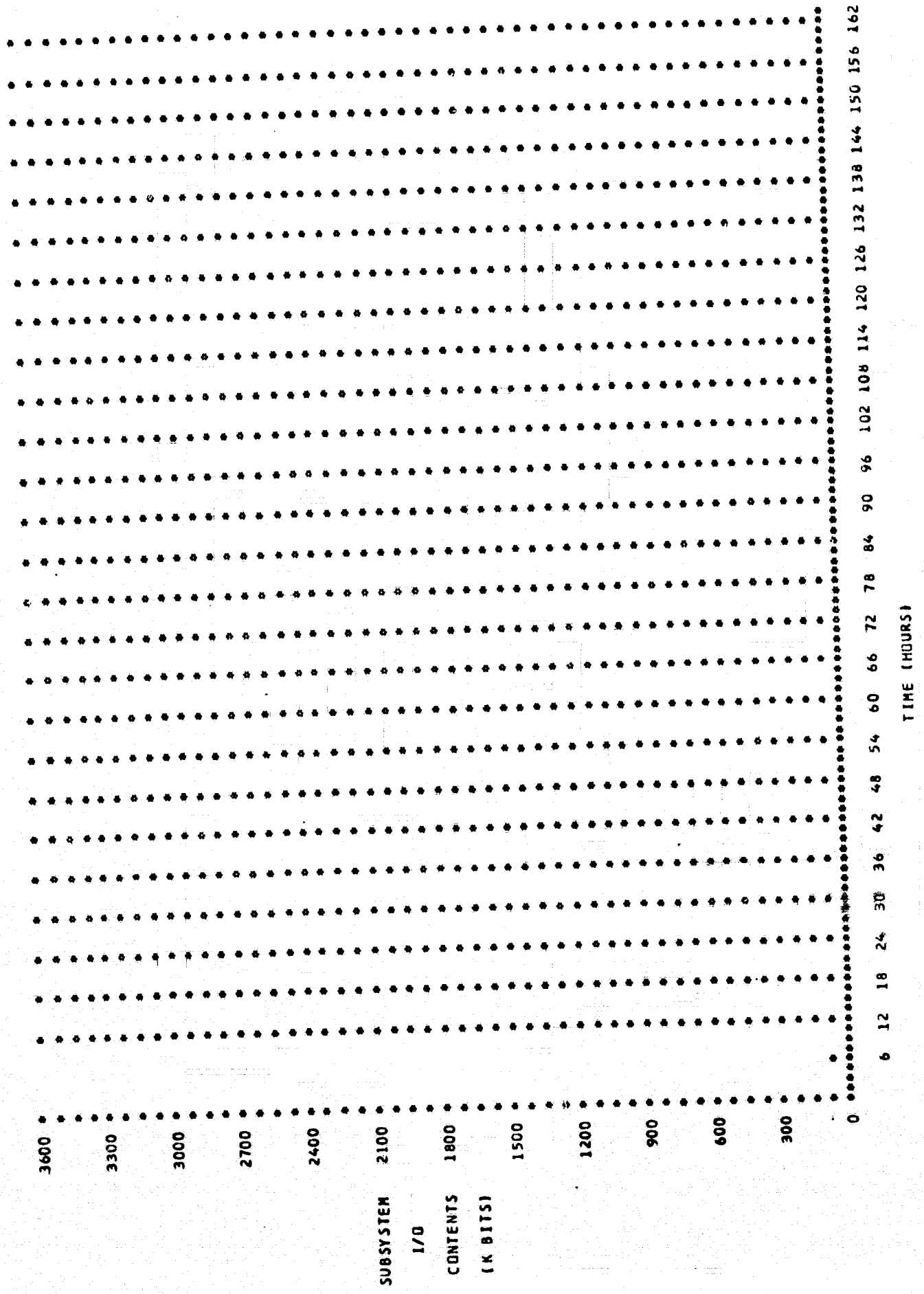

FIGURE 14: CONTENTS OF SUBSYSTEM I/O AS A FUNCTION OF TIME.

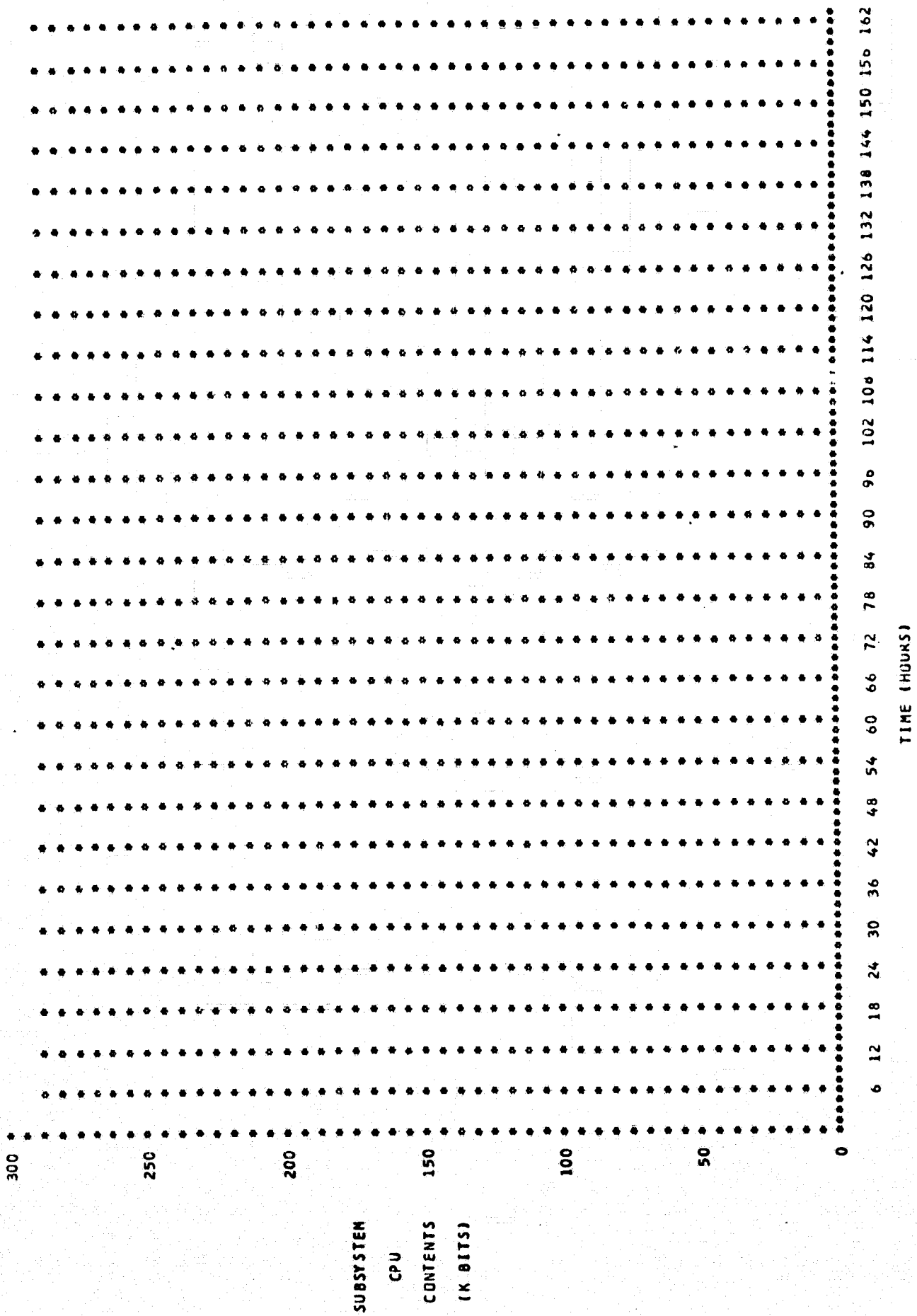

FIGURE 15: CONTENTS OF SUBSYSTEM CPU AS A FUNCTION OF TIME.

Model Modification

In order to make sensitivity runs it is necessary to change certain program statements. This can be done in many cases in the same compilation since GPSS allows certain changes to be made and the program to be then run again.

For modification one (Figure 2) the storage capacity of the high rate recorder was changed in the storage definition card, statement 229. For modification two, storage definitions for 4 and 16 were increased 50% to represent a corresponding increase in computer capacity. In order to fail the KU Band signal processor in modification three, it was necessary to add a section that would generate a transaction when failure occurred and fill the KU Band thus preventing any actual data from entering. Modification four required changing the initial cards in module 5. The time span for each acquisition was reduced 10%.

APPENDICES

	<u>Page</u>
Appendix A - System Module I/O Configuration	23-27
Appendix B - Program Listing	28-53
Appendix C - Program Output	
1. Original Model	54-62
2. Modifications	63-94
3. Sample DMS Statistics	95-96
Appendix D - Tape Creation Program	97-98

Appendix A

SYSTEM MODULE I/O CONFIGURATION

<u>Module</u>	<u>Configuration</u>
1	<p>Experiment</p> <ul style="list-style-type: none">● Science Data<ul style="list-style-type: none">● Inputs: None● Outputs: Compiled from mission schedule.<ul style="list-style-type: none">● 95 percent direct transmission.● 5 percent transmitted to RAU.● Engineering Data<ul style="list-style-type: none">● Inputs: None● Outputs: Transmitted to RAU. Rate 3KBPS.
2	<p>Experiment RAU</p> <ul style="list-style-type: none">● Science Data<ul style="list-style-type: none">● Inputs: From Experiment at rate compiled from mission schedule.● Outputs: Transmitted to Experiment I/O at 1MBPS.● Engineering Data<ul style="list-style-type: none">● Inputs: From Experiment at 3KBPS.● Outputs: Transmitted to Experiment I/O at 1MBPS.
3	<p>Experiment I/O</p> <ul style="list-style-type: none">● Science Data<ul style="list-style-type: none">● Inputs:<ul style="list-style-type: none">● Experiment RAU at 1MBPS.● Experiment Computer at 8KBPS.● Outputs:<ul style="list-style-type: none">● Experiment Computer at 8KBPS; thru Experiment I/O to Payload Data Interleaver at 8KBPS.● To Variable Rate Recorders (Downlink not available) or to FM Signal Processor (Downlink available, KU BAND Signal Processor not available) or KU BAND Signal Processor (Downlink available) at 1MBPS.

Module

Configuration

- Engineering Data
 - Inputs:
 - Experiment RAU at 1MBPS.
 - Experiment Computer at 1MBPS.
 - Outputs: Payload Data Interleaver at 1MBPS.

- 4 Experiment Computer
 - Science Data
 - Inputs: Experiment I/O at 8KBPS.
 - Outputs: Experiment I/O at 8KBPS.

 - Engineering Data
 - Inputs: Experiment I/O at 8KBPS.
 - Outputs: Experiment I/O at 8KBPS.

- 5 High Rate Recorders
 - Science Data
 - Inputs: Experiment at rate compiled from mission schedule.
 - Capacity: 30MBPS input; 36,000 M bits total.
 - Outputs: KU BAND Signal Processor at 30MBPS.

 - Engineering Data
N/A

- 6 Variable Rate Recorders
 - Science Data
 - Inputs: Experiment I/O.
 - Capacity: 30MBPS input; 36,000 M bits total.
 - Outputs: KU BAND Signal Processor at 30MBPS or FM Signal Processor at 5MBPS.

 - Engineering Data
N/A

Module

Configuration

7

Payload Data Interleaver

- Science Data
 - Inputs:
 - Experiment I/O at 8KBPS.
 - Payload Signal Processor (omit).
 - Outputs: DACBU at 16KBPS.

- Engineering Data
 - Inputs:
 - Experiment I/O, Subsystem I/O at 64KBPS.
 - Payload Signal Processor (omit).
 - Outputs: DACBU at 64KBPS.

8

DACBU

- Science Data
 - Inputs: Payload Data Interleaver at 64KBPS.
 - Outputs: Network Signal Processor at 64KBPS.

- Engineering Data
 - Inputs:
 - Payload Data Interleaver at 64KBPS.
 - GPC IOB (omit).
 - Outputs:
 - Loop Recorder at 128KBPS.
 - Network Signal Processor at 128KBPS.

9

Loop Recorder

- Science Data
 - N/A

- Engineering Data
 - Inputs: DACB at 128KBPS.
 - Outputs: FM Signal Processor at 128KBPS.

10

FM Signal Processor

- Science Data
 - Inputs: Variable Rate Recorder at 5MBPS.
 - Outputs: Ground at 1MBPS.

- Engineering
 - Inputs: Loop Recorder at 128KBPS.
 - Outputs: Ground at 1MBPS.

<u>Module</u>	<u>Configuration</u>
11	<p>Network Signal Processor</p> <ul style="list-style-type: none"> ● Science <ul style="list-style-type: none"> ● Inputs: DACBU at 64KBPS. ● Outputs: Ground at 96 or 192 KBPS or KU-BAND Signal Processor at 192KBPS. ● Engineering <ul style="list-style-type: none"> ● Inputs: DACBU at 192KBPS. ● Outputs: Ground at 96 or 192 KBPS or KU-BAND Signal Processor at 192KBPS.
12	<p>KU-BAND Signal Processor</p> <ul style="list-style-type: none"> ● Science Data <ul style="list-style-type: none"> ● Inputs: <ul style="list-style-type: none"> ● Experiment at rate determined by mission schedule. ● High Rate Recorders at 30MBPS. ● Variable Rate Recorders at 30MBPS. ● Network Signal Processor at 192KBPS. ● Outputs: Ground at 30MBPS. ● Engineering Data <ul style="list-style-type: none"> ● Inputs: Network Signal Processor at 192KBPS. ● Outputs: Ground at 30MBPS.
13	<p>Subsystem</p> <ul style="list-style-type: none"> ● Science Data N/A ● Engineering Data <ul style="list-style-type: none"> ● Inputs: None ● Outputs: RAU at 3KBPS plus 10 percent of experiment data rate compiled from mission schedule.
14	<p>Subsystem RAU</p> <ul style="list-style-type: none"> ● Science Data N/A ● Engineering Data <ul style="list-style-type: none"> ● Inputs: Subsystem a 3KBPS plus 10 percent of experiment data rate compiled from mission schedule. ● Outputs: Subsystem I/O at 1MBPS.

Module

Configuration

15

Subsystem I/O

- Science Data
N/A

- Engineering Data

- Inputs:

- Subsystem RAU at 1MBPS.
- Experiment Computer at 8KBPS.

- Outputs:

- Experiment Computer at 8KBPS.
- Payload Data Interleaver at 1MBPS.

16

Experiment Computer

- Science Data
N/A

- Engineering Data

- Inputs: Subsystem I/O at 8KBPS.
- Outputs: Subsystem I/O at 8KBPS.

Appendix B

*** GPSS V - OS VERSION ***
*** IBM PROGRAM PRODUCT 5734-XS2 (VIM3) ***

REALLOCATE COM,59500
REALLOCATE BLO,750,VAR,51
REALLOCATE FAC,50,STD,25,LOG,1,FSV,500,BVR,1,CHA,20,TAB,1

STATEMENT
NUMBER

1
2
3

BLOCK
NUMBER

```
*LOC OPERATION A,B,C,D,E,F,G,H,I COMMENTS
SIMULATE 25
*****
*****
**
**
** D. P. ASSOCIATES, INC.
**
** SPACE SHUTTLE DATA SYSTEM SIMULATION
**
**
*****
*****
* MACRO DEFINITION FOR TRANSMISSION OF ALL DATA TO NEXT UNIT
*
TRNSA STARTMACRO
#A GATE SNF #B,#C
TEST GE #D,PF3,#E
#F ENTER #B,PF3
BUFFER
LEAVE #B,PF3
TRANSFER #G
ENDMACRO
*
* MACRO DEFINITION FOR TRANSMISSION OF PART DATA TO NEXT UNIT
*
#A (TRNSP MACRO) = #E (TRNSA MACRO)
#F (TRNSP MACRO) = #A (TRNSA MACRO)
#H (TRNSP MACRO) = #F (TRNSA MACRO)
TRNSP STARTMACRO
#A ASSIGN #B,#C,PF
SPLIT 1,#D
PRIORITY #E
ASSIGN 3,#I,PF
ADVANCE 1
TRANSFER #F
#D ASSIGN 3,#G,PF
TRANSFER #H
ENDMACRO
*
* MACRO DEFINITION FOR DELAY TRANSMISSION TO NEXT UNIT
*
#A (WAITA MACRO) = #C (TRNSA MACRO)
#D (WAITA MACRO) = #A (TRNSA MACRO)
*
WAITA STARTMACRO
#A PRIORITY #B
QUEUE #C,PF3
ADVANCE 1
DEPAKT #C,PF3
TRANSFER #D
ENDMACRO
*
* MACRO DEFINITION FOR TRANSMISSION OF ALL DATA TO SIGNAL PROCESSOR
*
TMITA STARTMACRO
```

STATEMENT
NUMBER
4
5
6
7
8
9
10
11
12
13
14
15
16
17
18
19
20
21
22
23
24
25
26
27
28
29
30
31
32
33
34
35
36
37
38
39
40
41
42
43
44
45
46
47
48
49
50
51
52
53
54
55
56
57
58

#A	GATE SNF	#B,#C	59
	TEST GE	#D,PF3,#E	60
	ENTER	#B,PF3	61
	BUFFER		62
	LEAVE	#B,PF3	63
	TERMINATE		64
	ENDMACRO		65
•			66
•	MACRO DEFINITION FOR TRANSMISSION OF PART DATA TO SIGNAL PROCESSOR		67
•	#A (TMITP MACRO) = #E (TMITA MACRO)		68
•			69
	TMITP STARTMACRO		70
#A	ASSIGN	#B,#C,PF	71
	SPLIT	1,#D	72
	ASSIGN	3,#F,PF	73
	TRANSFER	,#E	74
	ENDMACRO		75
•			76
•	MACRO DEFINITION FOR TRANSMISSION OF ALL DATA TO V. R. RECORDER		77
•			78
	RECDA STARTMACRO		79
#A	ASSIGN	5,PF3,PF	80
	GATE SNF	#B,#C	81
	TEST GE	#D,#E,#F	82
	ENTER	#B,#E	83
	TRANSFER	,#G	84
	ENDMACRO		85
•			86
•	MACRO DEFINITION FOR TRANSMISSION OF PART DATA TO RECORDER		87
•			88
	RECDP STARTMACRO		89
#A	ASSIGN	#B,#C,PF	90
	ENTER	#D,#C	91
	ASSIGN	#E,#J,PF	92
	SAVEVALUE	#I,#G	93
	ASSIGN	3,#F	94
	TRANSFER	,#H	95
	ENDMACRO		96
•			97
•	MACRO DEFINITION OF RECORDER DUMP, ALL DATA		98
•			99
	DUMPA STARTMACRO		100
#A	GATE U	50,#B	101
	GATE SNF	#C,#D	102
	TEST GE	#E,PF3,#F	103
	LEAVE	#G,PF5	104
	TRANSFER	,#H	105
	ENDMACRO		106
•			107
•	MACRO DEFINITION OF RECORDER DUMP, PART DATA		108
•			109
	DUMPP STARTMACRO		110
#A	ASSIGN	#B,#C,PF	111
	SPLIT	1,#J	112
	PRIORITY	#D	113
	ADVANCE	#E	114
	ASSIGN	3,#I,PF	115

	TRANSFER	,#F	116
#J	ASSIGN	3,#G	117
	LEAVE	#H,PF5	118
	ENDMACRO		119
JUMP1	STARTMACRO		120
	TRANSFER	,#A	121
	ENDMACRO		122
*			123
*	MACRO DEFINITION FOR DELAY TO NEXT DOWNLINK		124
*			125
DLAY1	STARTMACRO		126
#A	PRIORITY	#B	127
	ADVANCE	V5	128
	TRANSFER	,#C	129
	ENDMACRO		130
*			131
*	MACRO DEFINITION FOR DELAY ONE TIME UNIT IN RECORDER DUMP		132
*			133
DLAY2	STARTMACRO		134
#A	PRIORITY	#B	135
	ADVANCE	1	136
	TRANSFER	,#C	137
	ENDMACRO		138
*			139
*	MACRO DEFINITION FOR RECORDING DATA LOST AT RECORDERS		140
*			141
LOSED	STARTMACRO		142
#A	SAVEVALUE	#B+,PF3	143
	TERMINATE		144
	ENDMACRO		145
*			146
*	MACRO DEFINITION FOR COMPUTER LOAD ROUTINE, PART 1		147
*			148
COMPA	STARTMACRO		149
#A	TEST GE	#B,PF3,#C	150
	ENTER	#D,PF3	151
#E	LINK	#D,FIFO	152
	ENDMACRO		153
*			154
*	MACRO DEFINITION FOR COMPUTER LOAD ROUTINE, PART 2		155
*			156
COMPB	STARTMACRO		157
#A	TEST G	#B,0,#C	158
	ASSIGN	4,#B,PF	159
	SPLIT	1,#D	160
	ENTER	#E,#B	161
	TRANSFER	,#F	162
#D	ASSIGN	3,#G,PF	163
	ENDMACRO		164
*			165
*	MACRO DEFINITION FOR COMPUTER LOAD ROUTINE, PART 3		166
*			167
COMPC	STARTMACRO		168
#A	SPLIT	1,#B	169
	QUEUE	#C	170
	SEIZF	#C	171
	DEPART	#C	172

#D	UNLINK	#C,#E,1	173
	SPLIT	1,#F	174
	RELEASE	#C	175
	TERMINATE		176
	ENDMACRO		177
* MACRO DEFINITION FOR COMPUTER LOAD ROUTINE, PART 4			178
* COMPD STARTMACRO			179
#A	SEIZE	#B	180
	BUFFER		181
	TEST E	PF3,#C,#D	182
	RELEASE	#B	183
	TERMINATE		184
#D	TEST L	#C,PF3,#E	185
	ASSIGN	3,#F,PF	186
	TRANSFER	#G	187
#E	ASSIGN	3,#H,PF	188
	ASSIGN	2,#I,PF	189
	RELEASE	#B	190
	SAVEVALUE	#J,PF3	191
	LINK	#b,LIFO	192
	ENDMACRO		193
* MACRO DEFINITION FOR COMPUTER LOAD ROUTINE, PART 5			194
* COMPE STARTMACRO			195
#A	SAVEVALUE	#B,PF3	196
	SAVEVALUE	#C,PF2	197
	SAVEVALUE	#D,PF3	198
	TERMINATE		199
	ENDMACRO		200
* EQUATE STATEMENTS			201
RAUEX	EQU	2,S	202
IDEXP	EQU	3,S	203
CPUEX	EQU	4,S	204
HRREC	EQU	5,S	205
VRREC	EQU	6,S	206
PDINT	EQU	7,S	207
DACBU	EQU	8,S	208
LMREC	EQU	9,S	209
FMSIG	EQU	10,S	210
NWSIG	EQU	11,S	211
KUSIG	EQU	12,S	212
RAUSU	EQU	14,S	213
IDSUB	EQU	15,S	214
CPUSU	EQU	16,S	215
* STORAGE DEFINITIONS			216
2	STORAGE	36000	217
3	STORAGE	36000	218
4	STORAGE	288	219
5	STORAGE	36000000	220
			221
			222
			223
			224
			225
			226
			227
			228
			229

6	STORAGE	36000000	230
7	STORAGE	2304	231
8	STORAGE	4608	232
9	STORAGE	4608	233
10	STORAGE	36000	234
11	STORAGE	6912	235
12	STORAGE	1C90000	236
14	STORAGE	36000	237
15	STORAGE	36000	238
16	STORAGE	288	239
			240
			241
			242
			243
			244
			245
			246
			247
			248
			249
			250
			251
			252
			253
			254
			255
			256
			257
			258
			259
			260
			261
			262
			263
			264
			265
			266
			267
			268
			269
			270
			271
			272
			273
			274
			275
			276
			277
			278
			279
			280
			281
			282
			283
			284
			285
			286
			287
			288
			289
			290
			291
			292
			293
			294
			295
			296
			297
			298
			299
			300
			301
			302
			303
			304
			305
			306
			307
			308
			309
			310
			311
			312
			313
			314
			315
			316
			317
			318
			319
			320
			321
			322
			323
			324
			325
			326
			327
			328
			329
			330
			331
			332
			333
			334
			335
			336
			337
			338
			339
			340
			341
			342
			343
			344
			345
			346
			347
			348
			349
			350
			351
			352
			353
			354
			355
			356
			357
			358
			359
			360
			361
			362
			363
			364
			365
			366
			367
			368
			369
			370
			371
			372
			373
			374
			375
			376
			377
			378
			379
			380
			381
			382
			383
			384
			385
			386
			387
			388
			389
			390
			391
			392
			393
			394
			395
			396
			397
			398
			399
			400

```

*
* FUNCTION DEFINITIONS
*
*   DATA FLOW RATES FOR EXPERIMENTS
FLOW FUNCTION PF2,D9
1,8640/4,1080/5,1080/6,8640/7,8640/8,360/12,309/44,36000/107,18000
*   DATA FLOW RATES FOR SUBSYSTEMS
FLOW1 FUNCTION PF2,D9
1,0/4,1080/5,0/6,0/7,8640/8,0/12,0/44,36000/107,18000
*
*****
**
** MODULE 2. EXPERIMENT SCIENCE DATA
**
**
*****
*
* PART 1. EXPERIMENT TO I/O
*
*   INPUT EXPERIMENT DATA FROM JOBTAPE
*
JOBTAPE JOBTA1,SEQ1,730
1
2 SEQ1 ASSIGN 4,PF3,PF 310
3 TEST LE PF4,0,BLITZ 311
4 TERMINATE 312
5 BLITZ ASSIGN 3,FN$FLOW,PF 313
6 TRANSFER ,LOOP1 314
7 UNITS ADVANCE 1 315
8 LOOP1 SPLIT 1,BLK1 316
9 LOOP LOGP 4PF,UNITS 317
10 TERMINATE 318
* INPUT FOR EXPERIMENT SCIENCE DATA, PART 4
11 BLK1 SPLIT 1,SECT4 320
* INPUT FOR SUBSYSTEM ENGINEERING DATA
12 SPLIT 1,MODL4 322
*
* EXPERIMENT RAU
*
13 RAU ASSIGN 3,V13,PF 326
* TRANSMIT ALL DATA TO EXPERIMENT RAU
14 TRNSA MACRO RAUSG,2,WAIT2,R2,PART2,RAUEN,IOSEG 328
RAUSG GATE SNF 2,WAIT2 328
15 TEST GE R2,PF3,PART2 328
16 RAUEN ENTER 2,PF3 328
17 BUFFER 328
18 LEAVE 2,PF3 328
19 TRANSFER ,IOSEG 328
* TRANSMIT PART DATA TO EXPERIMENT RAU
TRNSP MACRO PART2,10,R2,MOV2,12,RAUSG,PF10,RAUEN,V22 329
20 PART2 ASSIGN 1C,R2,PF 330
21 SPLIT 1,MOV2 330
22 PRIORITY 12 330
23 ASSIGN 3,V22,PF 330
24 ADVANCE 1 330
25 TRANSFER ,RAUSG 330
26 MOV2 ASSIGN 3,PF10,PF 330

```

287
288
289
290
291
292
293
294
295
296
297
298
299
300
301
302
303
304
305
306
307
308
309
310
311
312
313
314
315
316
317
318
319
320
321
322
323
324
325
326
327
328
328
328
328
328
328
328
329
330
330
330
330
330
330
330

27	TRANSFER ,RAUEN	330
	* DELAY TRANSMISSION ONE TIME UNIT	331
	WAITA MACRO WAIT2,11,2,RAUSG	332
28	WAIT2 PRIORITY 11	332
29	QUEUE 2,PF3	332
30	ADVANCE 1	332
31	DEPART 2,PF3	332
32	TRANSFER ,RAUSG	332
	•	333
	* EXPERIMENT I/O	334
	•	335
	* TRANSMIT ALL DATA TO EXPERIMENT I/O	336
	TRNSA MACRO IOSEG,3,WAIT3,R3,PART3,IOENT,SPLT3	337
33	IOSEG GATE SNF 3,WAIT3	337
34	TEST GE R3,PF3,PART3	337
35	IOENT ENTEK 3,PF3	337
36	BUFFER	337
37	LEAVE 3,PF3	337
38	TRANSFER ,SPLT3	337
	* TRANSMIT PART DATA TO EXPERIMENT I/O	338
	TRNSP MACRO PART3,10,R3,MOV3,16,IOSEG,PF10,IOENT,V23	339
39	PART3 ASSIGN 10,R3,PF	339
40	SPLIT 1,MOV3	339
41	PRIORITY 16	339
42	ASSIGN 3,V23,PF	339
43	ADVANCE 1	339
44	TRANSFER ,IOSEG	339
45	MOV3 ASSIGN 3,PF10,PF	339
46	TRANSFER ,IOENT	339
	* DELAY TRANSMISSION ONE TIME UNIT	340
	WAITA MACRO WAIT3,15,3,IOSEG	341
47	WAIT3 PRIORITY 15	341
48	QUEUE 3,PF3	341
49	ADVANCE 1	341
50	DEPART 3,PF3	341
51	TRANSFER ,IOSEG	341
52	SPLT3 SPLIT 1,EXCPU	342
	* PERCENT OF DATA TRANSMITTED VIA KU OR FM PROCESSOR	343
53	ASSIGN 3,V14,PF	344
54	TRANSFER ,DOWN4	345
	•	346
	* PART 2. I/O TO COMPUTER. COMPUTER TO PAYLOAD DATA INTERLEAVER TO	347
	• TRANSMIT	348
	•	349
	* EXPERIMENT COMPUTER	350
	•	351
	* PERCENT OF DATA TRANSMITTED THRU COMPUTER	352
55	EXCPU ASSIGN 3,V15,PF	353
56	TEST L PF3,1,SCCPU	354
57	ASSIGN 3,1,PF	355
	•	356
	* TRANSMIT DATA TO EXPERIMENT COMPUTER	357
	COMPA MACRO SCCPU,R4,FOURB,4,FOURA	358
58	SCCPU TEST GE R4,PF3,FOURB	358
59	ENTER 4,PF3	358
60	FOURA LINK 4,FIFO	358
	COMPB MACRO FOURB,R4,FOURC,FOURD,4,FOURA,V9	359

61	FOURB	TEST G	R4,0,FOURC	359
62		ASSIGN	4,R4,PF	359
63		SPLIT	1,FOURD	359
64		ENTER	4,R4	359
65		TRANSFER	,FOURA	359
66	FOURD	ASSIGN	3,V9,PF	360
	COMPC	MACRO	FCUKC,FOURA,4,FOURE,FOURF,BUFF4	360
67	FOURC	SPLIT	1,FOURA	360
68		QUEUE	4	360
69		SEIZE	4	360
70		DEPART	4	360
71	FOURE	UNLINK	4,FOURF,1	360
72		SPLIT	1,BUFF4	360
73		RELEASE	4	360
74		TERMINATE		361
	COMPD	MACRO	BUFF4,4,X21,FOURG,FOURH,V8,FOURE,V7,X20,4-	361
75	BUFF4	SEIZE	4	361
76		BUFFER		361
77		TEST E	PF3,X21,FOURG	361
78		RELEASE	4	361
79		TERMINATE		361
80	FOURG	TEST L	X21,PF3,FOURH	361
81		ASSIGN	3,V8,PF	361
82		TRANSFER	,FOURE	361
83	FOURH	ASSIGN	3,V7,PF	361
84		ASSIGN	2,X20,PF	361
85		RELEASE	4	361
86		SAVEVALUE	4-,PF3	361
87		LINK	4,LIFO	362
	COMPE	MACRO	FOURF,21,20,4+	362
88	FOURF	SAVEVALUE	21,PF3	362
89		SAVEVALUE	20,PF2	362
90		SAVEVALUE	4+,PF3	362
91		TERMINATE		363
	*			364
	*	PAYLOAD DATA INTERLEAVER		365
	*			366
	*	TRANSMIT ALL DATA TO PAYLOAD DATA INTERLEAVER		367
	TRNSA	MACRO	PDPRT,7,WATE7,R7,PIEC7,PAYEN,DACSG	367
92	PDPRT	GATE SNF	7,WATE7	367
93		TEST GE	R7,PF3,PIEC7	367
94	PAYEN	ENTER	7,PF3	367
95		BUFFER		367
96		LEAVE	7,PF3	367
97		TRANSFER	,DACSG	368
	*	TRANSMIT PART DATA TO PAYLOAD DATA INTERLEAVER		369
	TRNSP	MACRO	PIEC7,10,R7,TRVL7,16,PDPRT,PF10,PAYEN,V27	369
98	PIEC7	ASSIGN	10,R7,PF	369
99		SPLIT	1,TRVL7	369
100		PRIORITY	16	369
101		ASSIGN	3,V27,PF	369
102		ADVANCE	1	369
103		TRANSFER	,PDPRT	369
104	TRVL7	ASSIGN	3,PF10,PF	369
105		TRANSFER	,PAYEN	370
	*	DELAY TRANSMISSION ONE TIME UNIT		371
	WAITA	MACRO	WATE7,15,7,PDPRT	

106	WATE7 PRIORITY	15	371
107	QUEUE	7,PF3	371
108	ADVANCE	1	371
109	DEPART	7,PF3	371
110	TRANSFER	,PDPRT	372
	•		373
	•	DATA ACQUISITION CONTROL AND BUFFER UNIT	374
	•		375
	•	TRANSMIT ALL DATA TO DACBU	376
	TRNSA MACRO	DACSG,8,WATE8,R8,PIEC8,DACEN,KUSND	376
111	DACSG GATE SNF	8,WATE8	376
112	TEST GE	R8,PF3,PIEC8	376
113	DACEN ENTER	8,PF3	376
114	BUFFER		376
115	LEAVE	8,PF3	376
116	TRANSFER	,KUSND	377
	•	TRANSMIT PART DATA TO DACBU	378
	TRNSP MACRO	PIEC8,10,R8,TRVL8,16,DACSG,PF10,DACEN,V28	378
117	PIEC8 ASSIGN	1C,R8,PF	378
118	SPLIT	1,TRVL8	378
119	PRIORITY	16	378
120	ASSIGN	3,V28,PF	378
121	ADVANCE	1	378
122	TRANSFER	,DACSG	378
123	TRVL8 ASSIGN	3,PF10,PF	378
124	TRANSFER	,DACEN	379
	•	DELAY TRANSMISSION ONE TIME UNIT	380
	WAITA MACRO	WATE8,15,8,DACSG	380
125	WATE8 PRIORITY	15	380
126	QUEUE	8,PF3	380
127	ADVANCE	1	380
128	DEPART	8,PF3	380
129	TRANSFER	,DACSG	381
	•		382
	•	DOWNLINK AVAILABLE?	383
	•		384
130	GATE U	50,SPIL8	385
	•		386
	•	KU-BAND	387
	•		388
	•	TRANSMIT ALL DATA TO KU-BAND	389
	TMITA MACRO	KUSND,12,NSSND,R12,SUM12	389
131	KUSND GATE SNF	12,NSSND	389
132	TEST GE	R12,PF3,SUM12	389
133	ENTER	12,PF3	389
134	BUFFER		389
135	LEAVE	12,PF3	389
136	TERMINATE		390
	•	TRANSMIT PART DATA TO KU-BAND	391
	TMITP MACRO	SUM12,10,R12,NSSND,KUSND,V32	391
137	SUM12 ASSIGN	1C,R12,PF	391
138	SPLIT	1,NSSND	391
139	ASSIGN	3,V32,PF	391
140	TRANSFER	,KUSND	392
	•		393
	•	NETWORK SIGNAL PROCESSOR	394
	•		

	* TRANSMIT ALL DATA TO NETWORK SIGNAL PROCESSOR	395
	TMITA MACRO NSSND,11,SPIL8,R11,SUM11	396
141	NSSND GATE SNF 11,SPIL8	396
142	TEST GE R11,PF3,SUM11	396
143	ENTER 11,PF3	396
144	BUFFER	396
145	LEAVE 11,PF3	396
146	TERMINATE	397
	* TRANSMIT PART DATA TO NETWORK SIGNAL PROCESSOR	398
	TMITP MACRO SUM11,10,R11,SPIL8,NSSND,V31	398
147	SUM11 ASSIGN 1C,R11,PF	398
148	SPLIT 1,SPIL8	398
149	ASSIGN 3,V31,PF	398
150	TRANSFER ,NSSND	399
151	SPIL8 SAVEVALUE 8+,PF3	400
	* PART 3. I/O TO KU-BAND OR V.R. RECORDER	401
	* DOWNLINK AVAILABLE?	402
	* DOWN4 GATE U 5C,VRREC	403
152	* KU-BAND	404
	* TRANSMIT ALL DATA TO KU-BAND	405
	TMITA MACRO KUSEG,12,VRREC,R12,PRT12	406
153	KUSEG GATE SNF 12,VRREC	407
154	TEST GE R12,PF3,PRT12	408
155	ENTER 12,PF3	409
156	BUFFER	410
157	LEAVE 12,PF3	410
158	TERMINATE	410
	* TRANSMIT PART DATA TO KU-BAND	411
	TMITP MACRO PRT12,10,R12,VRREC,KUSEG,V32	412
159	PRT12 ASSIGN 1C,R12,PF	412
160	SPLIT 1,VRREC	412
161	ASSIGN 3,V32,PF	412
162	TRANSFER ,KUSEG	412
	* V.R. RECORDER	413
	* TRANSMIT ALL DATA TO V.R. RECORDER	414
	RECDA MACRO VRREC,6,LOSE6,R6,PF3,PART6,DUMP6	415
163	VRREC ASSIGN 5,PF3,PF	416
164	GATE SNF 6,LOSE6	417
165	TEST GE R6,PF3,PART6	417
166	ENTER 6,PF3	417
167	TRANSFER ,DUMP6	417
	* TRANSMIT PART DATA TO V.R. RECORDER, LOSE PART DATA	418
	RECDP MACRO PART6,10,R6,6,11,PF10,PF11,DUMP6,6+,V26	419
168	PART6 ASSIGN 1C,R6,PF	419
169	ENTER 6,R6	419
170	ASSIGN 11,V26,PF	419
171	SAVEVALUE 6+,PF11	419
172	ASSIGN 3,PF10	419
173	TRANSFER ,DUMP6	420

	* DUMP V.R. RECORDER TO (1) KL-BAND, (2) FM SIGNAL PROCESSOR	421
	*	422
	* DUMP ALL DATA TO KU-BAND	423
	DUMPA MACRO DUMP6,DLAY6,12,DMP6A,R12,PTA12,6,KUSEG	424
174	DUMP6 GATE U 5C,DLAY6	424
175	GATE SNF 12,DMP6A	424
176	TEST GE R12,PF3,PTA12	424
177	LEAVE 6,PF5	424
178	TRANSFER ,KUSEG	425
	* DUMP PART DATA TO KU-BAND	426
	DUMPP MACRO PTA12,10,R12,4,0,DMP6A,PF10,6,V32,MOV12	426
179	PTA12 ASSIGN 1C,R12,PF	426
180	SPLIT 1,MOV12	426
181	PRIORITY 4	426
182	ADVANCE 0	426
183	ASSIGN 3,V32,PF	426
184	TRANSFER ,DMP6A	426
185	MOV12 ASSIGN 3,PF10	426
186	LEAVE 6,PF5	427
	JUMP1 MACRO KUSEG	427
187	TRANSFER ,KUSEG	428
	* DUMP ALL DATA TO FM-BAND	429
	DUMPA MACRO DMP6A,DLAY6,10,DLA6A,R10,PTA12,6,FMSEG	429
188	DMP6A GATE U 5C,DLAY6	429
189	GATE SNF 1C,DLA6A	429
190	TEST GE R10,PF3,PTA12	429
191	LEAVE 6,PF5	429
192	TRANSFER ,FMSEG	430
	* DUMP PART DATA TO FM BAND	431
	DUMPP MACRO PTA10,10,R10,4,1,DUMP6,PF10,6,V34,MOV06	431
193	PTA10 ASSIGN 10,R10,PF	431
194	SPLIT 1,MOV06	431
195	PRIORITY 4	431
196	ADVANCE 1	431
197	ASSIGN 3,V34,PF	431
198	TRANSFER ,DUMP6	431
199	MOV06 ASSIGN 3,PF10	431
200	LEAVE 6,PF5	432
	JUMP1 MACRO FMSEG	432
201	TRANSFER ,FMSEG	433
	* DELAY UNTIL DOWNLINK AVAILABLE	434
	DLAY1 MACRO DLAY6,3,DUMP6	434
202	DLAY6 PRIORITY 3	434
203	ADVANCE V5	434
204	TRANSFER ,DUMP6	435
	* DELAY ONE TIME UNIT	436
	DLAY2 MACRO DLA6A,1,DUMP6	436
205	DLA6A PRIORITY 1	436
206	ADVANCE 1	436
207	TRANSFER ,DUMP6	437
	* F.M. SIGNAL PROCESSOR	438
	*	439
	* TRANSMIT ALL DATA TO F.M. SIGNAL PROCESSOR	440
	*	441
	TNITA MACRO FMSEG,10,DUMP6,R10,PT10	442
208	FMSEG GATE SNF 1C,DUMP6	442

209	TEST GE	R10,PF3,PRT10	442
210	ENTER	10,PF3	442
211	BUFFER		442
212	LEAVE	10,PF3	442
213	TERMINATE		443
	* TRANSMIT PART DATA TO F.M. SIGNAL PROCESSOR		444
	TMITP MACRO	PKT10,10,R10,DUMP6,FMSEG,V30	444
214	PRT10 ASSIGN	10,R10,PF	444
215	SPLIT	1,DUMP6	444
216	ASSIGN	3,V30,PF	444
217	TRANSFER	,FMSEG	444
	* RECORDER FILLED, DATA LOST (IN SAVEVALUE 6)		445
218	LDSE6 SAVEVALUE	6+,PF3	445
219	TERMINATE		447
	* PART 4. EXPERIMENT TO KU-BAND OR H.R. RECORDER		448
	* DOWNLINK AVAILABLE?		450
	* SECT4 ASSIGN 3,V2,PF		451
220	GATE U	50,HRREC	452
221	* KU-BAND SIGNAL PROCESSOR		453
	* TRANSMIT ALL DATA TO KU-BAND		454
	TMITA MACRO	KUSIG,12,HRREC,R12,SEC12	455
222	KUSIG GATE SNF	12,HRREC	456
223	TEST GE	R12,PF3,SEC12	457
224	ENTER	12,PF3	458
225	BUFFER		459
226	LEAVE	12,PF3	460
227	TERMINATE		460
	* TRANSMIT PART DATA TO KU-BAND		461
	TMITP MACRO	SEC12,10,R12,HRREC,KUSIG,V32	462
228	SEC12 ASSIGN	10,R12,PF	462
229	SPLIT	1,HRREC	462
230	ASSIGN	3,V32,PF	462
231	TRANSFER	,KUSIG	462
	* H.R. RECORDER		463
	* TRANSMIT ALL DATA TO H.R. RECORDER		464
	RECDA MACRO	HRREC,5,LOSE5,R5,PF3,PART5,DUMPS	465
232	HRREC ASSIGN	5,PF3,PF	466
233	GATE SNF	5,LOSE5	467
234	TEST GE	R5,PF3,PART5	467
235	ENTER	5,PF3	467
236	TRANSFER	,DUMPS	467
	* TRANSMIT PART DATA TO H.R. RECORDER		468
	RECDP MACRO	PART5,10,R5,5,11,PF10,PF11,DUMPS,5+,V41	469
237	PART5 ASSIGN	10,R5,PF	469
238	ENTER	5,R5	469
239	ASSIGN	11,V41,PF	469
240	SAVEVALUE	5+,PF11	469
241	ASSIGN	3,PF10	469
242	TRANSFER	,DUMPS	469

```

*
*   RECORD DATA LOST
*
243 LOSES SAVEVALUE 5+,PF3
244   TERMINATE

*
*   DUMP H.R. RECORDER TO KU-BAND
*
*   DUMP ALL DATA TO KU-BAND
DUMPA MACRO   DUMP5,DLAY5,12,DLASA,R12,SEA12,5,KUSIG
245 DUMPS GATE U   SC,DLAY5
246     GATE SNF  12,DLASA
247     TEST GE   R12,PF3,SEA12
248     LEAVE     5,PF5
249     TRANSFER  ,KUSIG

*   DUMP PART DATA TO KU-BAND
DUMPP MACRO   SEA12,10,R12,4,0,DLASA,PF10,5,V32,MOVES
250 SEA12 ASSIGN  1C,R12,PF
251     SPLIT     1,MOVES
252     PRIORITY  4
253     ADVANCE   0
254     ASSIGN    3,V32,PF
255     TRANSFER  ,DLASA
256 MOVES ASSIGN  3,PF10
257     LEAVE     5,PF5
JUMP1 MACRO   KUSIG
258     TRANSFER ,KUSIG

*   DELAY UNTIL DC=NLINK AVAILABLE
DLAY1 MACRO   DLAY5,3,DUMP5
259 DLAY5 PRIORITY 3
260     ADVANCE   V5
261     TRANSFER  ,DUMP5

*   DELAY ONE TIME UNIT
DLAY2 MACRO   DLASA,1,DUMP5
262 DLASA PRIORITY 1
263     ADVANCE   1
264     TRANSFER  ,DUMP5

*****
**
**   MODULE 3.  EXPERIMENT ENGINEERING DATA
**
*****

*
*   INPUT EXPERIMENT DATA
*

265     GENERATE  1,,200,14775,10,25PF
266     ASSIGN    3,108,PF

*
*   PART 1.  EXPERIMENT TO I/O
*
*   EXPERIMENT RAU
*
*   TRANSMIT ALL DATA TO EXPERIMENT RAU
TRNSA MACRO   RAUPT,2,HOLD2,R2,SOME2,RAUGO,10PRT
267 RAUPT GATE SNF  2,HOLD2
268     TEST GE   R2,PF3,SOME2

```

```

470
471
472
473
474
475
476
477
478
479
479
479
479
480
481
481
481
481
481
481
481
481
481
481
481
482
482
483
484
484
484
484
485
486
486
486
487
488
489
490
491
492
493
494
495
496
497
498
499
500
501
502
503
504
504
504

```

269	RAUGO ENTER	2,PF3	504
270	BUFFER		504
271	LEAVE	2,PF3	504
272	TRANSFER	,IOPRT	505
	* TRANSMIT PART DATA TO EXPERIMENT RAU		506
	TRNSP MACRO	SOME2,10,R2,TRVL2,12,RAUPT,PF10,RAUGO,V22	506
273	SOME2 ASSIGN	10,R2,PF	506
274	SPLIT	1,TRVL2	506
275	PRIORITY	12	506
276	ASSIGN	3,V22,PF	506
277	ADVANCE	1	506
278	TRANSFER	,KAUPT	506
279	TRVL2 ASSIGN	3,PF10,PF	506
280	TRANSFER	,RAUGO	507
	* DELAY TRANSMISSION ONE TIME UNIT		508
	WAITA MACRO	HOLD2,11,2,RAUGO	508
281	HOLD2 PRIORITY	11	508
282	QUEUE	2,PF3	508
283	ADVANCE	1	508
284	DEPAKT	2,PF3	508
285	TRANSFER	,KAUGO	509
	* EXPERIMENT I/O		510
	* TRANSMIT ALL DATA TO EXPERIMENT I/O		511
	TRNSA MACRO	IOPRT,3,HOLD3,R3,SOME3,IOGOS,SPLZ3	512
286	IOPRT GATE SNF	3,HOLD3	513
287	TEST GE	R3,PF3,SOME3	513
288	IOGOS ENTER	3,PF3	513
289	BUFFER		513
290	LEAVE	3,PF3	513
291	TRANSFER	,SPLZ3	513
	* TRANSMIT PART DATA TO EXPERIMENT I/O		514
	TRNSP MACRO	SOME3,10,R3,TRVL3,16,IOPRT,PF10,IOGOS,V30	515
292	SOME3 ASSIGN	10,R3,PF	515
293	SPLIT	1,TRVL3	515
294	PRIORITY	16	515
295	ASSIGN	3,V30,PF	515
296	ADVANCE	1	515
297	TRANSFER	,IOPRT	515
298	TRVL3 ASSIGN	3,PF10,PF	515
299	TRANSFER	,IOGOS	515
	* DELAY TRANSMISSION ONE TIME UNIT		516
	WAITA MACRO	HOLD3,15,3,IOPRT	517
300	HOLD3 PRIORITY	15	517
301	QUEUE	3,PF3	517
302	ADVANCE	1	517
303	DEPAKT	3,PF3	517
304	TRANSFER	,IOPRT	517
	* EXTRM COULD BE CHANGED TO AN ASSIGN BEFORE PDSEG IF SOME DATA		518
	* BYPASSES THE COMPUTER.		519
305	SPLZ3 SPLIT	1,EXTRM	520
306	ASSIGN	3,V15,PF	521
307	TEST L	PF3,1,EDCPU	522
308	ASSIGN	3,1,PF	523
	* PART 2. I/O TO COMPUTER TO I/O TO PAYLOAD DATA INTERLEAVE		524
			525

			526
			527
			528
			529
			530
			530
			530
309	COMPA MACRO	EDCPU,R4,FOREB,4,FOREA	531
310	EDCPU TEST GE	R4,PF3,FOREB	531
311	ENTER	4,PF3	531
	FOREA LINK	4,FIFO	531
	COMPB MACRO	FOREB,R4,FUREC,FORED,4,FOREA,V9	531
312	FOREB TEST G	R4,O,FGREC	531
313	ASSIGN	4,R4,PF	531
314	SPLIT	1,FORED	531
315	ENTER	4,R4	531
316	TRANSFER	,FOREA	531
317	FORED ASSIGN	3,V9,PF	532
	COMPC MACRO	FOREC,FOREA,4,FOREE,FOREF,BUFE4	532
	FOREC SPLIT	1,FOREA	532
318	FOREC	4	532
319	QUEUE	4	532
320	SEIZE	4	532
321	DEPART	4	532
322	FOREE UNLINK	4,FOREF,1	532
323	SPLIT	1,BUFE4	532
324	RELEASE	4	532
325	TERMINATE		533
	COMPD MACRO	BUFE4,4,X23,FOREG,FOREH,V4,FOREE,V3,X22,4-	533
326	BUFE4 SEIZE	4	533
327	BUFFER		533
328	TEST E	PF3,X23,FOREG	533
329	RELEASE	4	533
330	TERMINATE		533
331	FOREG TEST L	X23,PF3,FOREH	533
332	ASSIGN	3,V4,PF	533
333	TRANSFER	,FOKEE	533
334	FOREH ASSIGN	3,V3,PF	533
335	ASSIGN	2,X22,PF	533
336	RELEASE	4	533
337	SAVEVALUE	4-,PF3	533
338	LINK	4,LIFO	534
	COMPE MACRO	FOREF,23,22,4+	534
339	FOREF SAVEVALUE	23,PF3	534
340	SAVEVALUE	22,PF2	534
341	SAVEVALUE	4+,PF3	534
342	TERMINATE		535
	*****		536
	EXPERIMENT ENGINEERING DATA STOPS HERE SINCE IT IS NOT CALLED		537
	FROM THE COMPUTER		538
	*****		539
	TRANSMIT ALL DATA BACK THRU EXPERIMENT I/O		540
	TRNSA MACRO	IOEXP,3,STP3,R3,HAF3,IOETR,SEGPD	540
343	IOEXP GATE SNF	3,STP3	540
344	TEST GE	R3,PF3,HAF3	540
345	IOETR ENTER	3,PF3	540
346	BUFFER		540
347	LEAVE	3,PF3	541
348	TRANSFER	,SEGPD	541
	*****		542
	TRANSMIT PART DATA BACK THRU EXPERIMENT I/O		
	TRNSP MACRO	HAF3,10,R3,ZIP3,16,IOEXP,PF10,IOETR,V23	

349	HAF3	ASSIGN	10,R3,PF	542
350		SPLIT	1,ZIP3	542
351		PRIORITY	16	542
352		ASSIGN	3,V23,PF	542
353		ADVANCE	1	542
354		TRANSFER	,IOEXP	542
355	ZIP3	ASSIGN	3,PF10,PF	542
356		TRANSFER	,IOETR	542
	*	DELAY TRANSMISSION ONE TIME UNIT		543
	WAITA	MACRO	STP3,15,3,IOEXP	544
357	STP3	PRIORITY	15	544
358		QUEUE	3,PF3	544
359		ADVANCE	1	544
360		DEPART	3,PF3	544
361		TRANSFER	,IOEXP	544
	*			545
	*	PART 3. PAYLOAD DATA INTERLEAVER TO TRANSMIT		546
	*			547
362	SEGPD	TRANSFER	,PDSEG	548
	*****			549
	**			550
	**	MODULE 4. SUBSYSTEM ENGINEERING DATA		551
	**			552
	*****			553
	*			554
	*	PART 1. SUBSYSTEM TO I/O		555
	*			556
	*	SUBSYSTEM ENGINEERING DATA INPUT		557
	*			558
363		GENERATE	1,,200,14775,,25PF	559
364		ASSIGN	3,108,PF	560
365		TRANSFER	,SKIP	561
366	MODL4	ASSIGN	4,PF3,PF	562
367		ASSIGN	3,FNSFLOW1,PF	563
368		ASSIGN	3,V15,PF	564
369	SKIP	PRIORITY	10	565
370		TEST E	PF3,0,ERAUS	566
371		TERMINATE		567
	*			568
	*	SUBSYSTEM RAU		569
	*			570
	*	TRANSMIT ALL DATA TO SUBSYSTEM RAU		571
	TRNSA	MACRO	ERAUS,14,WAT14,R14,PRT14,ERAUN,EIOSG	572
372	ERAUS	GATE SNF	14,WAT14	573
373		TEST GE	R14,PF3,PRT14	573
374	ERAUN	ENTER	14,PF3	573
375		BUFFER		573
376		LEAVE	14,PF3	573
377		TRANSFER	,EIOSG	573
	*	TRANSMIT PART DATA TO SUBSYSTEM RAU		574
	TRNSP	MACRO	PRT14,10,R14,MVP14,12,ERAUS,PF10,ERAUN,V34	575
378	PRT14	ASSIGN	10,R14,PF	575
379		SPLIT	1,MVP14	575
380		PRIORITY	12	575
381		ASSIGN	3,V34,PF	575
382		ADVANCE	1	575

383	TRANSFER	,ERAUS	575
384	MVP14 ASSIGN	3,PF10,PF	575
385	TRANSFER	,ERAUN	575
	* DELAY TRANSMISSION ONE TIME UNIT		576
	WAITA MACRO	WAIT4,11,14,ERAUS	577
386	WAIT4 PRIORITY	11	577
387	QUEUE	14,PF3	577
388	ADVANCE	1	577
389	DEPART	14,PF3	577
390	TRANSFER	,ERAUS	577
	* SUBSYSTEM I/O		578
	* TRANSMIT ALL DATA TO SUBSYSTEM I/O		579
	TRNSA MACRO	EIOSG,15,WAT15,R15,PRT15,EIOEN,SPL15	580
391	EIOSG GATE SNF	15,WAT15	581
392	TEST GE	R15,PF3,PRT15	582
393	EIOEN ENTEK	15,PF3	582
394	BUFFER		582
395	LEAVE	15,PF3	582
396	TRANSFER	,SPL15	582
	* TRANSMIT PART DATA TO SUBSYSTEM I/O		583
	TRNSP MACRO	PRT15,10,R15,MVP15,16,EIOSG,PF10,EIOEN,V35	584
397	PRT15 ASSIGN	10,R15,PF	584
398	SPLIT	1,MVP15	584
399	PRIORITY	16	584
400	ASSIGN	3,V35,PF	584
401	ADVANCE	1	584
402	TRANSFER	,EIOSG	584
403	MVP15 ASSIGN	3,PF10,PF	584
404	TRANSFER	,EIOEN	584
	* DELAY TRANSMISSION ONE TIME UNIT		585
	WAITA MACRO	WAIT5,15,15,EIOSG	586
405	WAIT5 PRIORITY	15	586
406	QUEUE	15,PF3	586
407	ADVANCE	1	586
408	DEPART	15,PF3	586
409	TRANSFER	,EIOSG	586
	* ENGINEERING SUBSYSTEM DATA IN I/O; 90 PERCENT TERMINATED 10 PERCENT TO SUBSYSTEM COMPUTER.		587
	* SBTRM COULD BE CHANGED TO AN ASSIGN BEFORE PDSEG IF SOME DATA BYPASSES THE COMPUTER.		588
410	SPL15 SPLIT	1,SBTRM	589
411	ASSIGN	3,V15,PF	590
412	TEST L	PF3,1,SBCPU	591
413	ASSIGN	3,1,PF	592
	* PART 2. I/O TO COMPUTER TO I/O TO PAYLOAD DATA INTERLEAVER		593
	* SUBSYSTEM COMPUTER		594
	* TRANSMIT DATA TO SUBSYSTEM COMPUTER		595
	COMPA MACRO	SBCPU,R16,TEENB,16,TEENA	596
414	SBCPU TEST GE	R16,PF3,TEENB	597
415	ENTEK	16,PF3	598

416	TEENA LINK	16, FIFO	603
	COMPB MACRO	TEEN8, R16, TEENC, TEEND, 16, TEENA, V9	604
417	TEENB TEST G	R16, 0, TEENC	604
418	ASSIGN	4, R16, PF	604
419	SPLIT	1, TEEND	604
420	ENTER	16, R16	604
421	TRANSFER	, TEENA	604
422	TEEND ASSIGN	3, V9, PF	604
	COMPC MACRO	TEENC, TEENA, 16, TEENE, TEENF, BUF16	605
423	TEENC SPLIT	1, TEENA	605
424	QUEUE	16	605
425	SEIZE	16	605
426	DEPART	16	605
427	TEENE UNLINK	16, TEENF, 1	605
428	SPLIT	1, BUF16	605
429	RELEASE	16	605
430	TERMINATE		606
	COMPD MACRO	BUF16, 16, X25, TEENG, TEENH, V12, TEENE, V11, X24, 16-	606
431	BUF16 SEIZE	16	606
432	BUFFER		606
433	TEST E	PF3, X25, TEENG	606
434	RELEASE	16	606
435	TERMINATE		606
436	TEENG TEST L	X25, PF3, TEENH	606
437	ASSIGN	3, V12, PF	606
438	TRANSFER	, TEENE	606
439	TEENH ASSIGN	3, V11, PF	606
440	ASSIGN	2, X24, PF	606
441	RELEASE	16	606
442	SAVEVALUE	16-, PF3	606
443	LINK	16, LIFO	607
	COMPE MACRO	TEENF, 25, 24, 16+	607
444	TEENF SAVEVALUE	25, PF3	607
445	SAVEVALUE	24, PF2	607
446	SAVEVALUE	16+, PF3	607
447	TERMINATE		608
	*****		609
	• SUBSYSTEM ENGINEERING DATA STOPS HERE SINCE IT IS NOT CALLED		610
	• FROM THE COMPUTER		611
	*****		612
	• TRANSMIT ALL DATA BACK THRU SUBSYSTEM I/O		613
	TRNSA MACRO	IOSUB, 15, STP15, R15, HAF15, IOSTR, PDSEG	613
448	IOSUB GATE SNF	15, STP15	613
449	TEST GE	R15, PF3, HAF15	613
450	IOSTR ENTER	15, PF3	613
451	BUFFER		613
452	LEAVE	15, PF3	613
453	TRANSFER	, PDSEG	614
	• TRANSMIT PART DATA BACK THRU SUBSYSTEM I/O		615
	TRNSP MACRO	HAF15, 10, R15, ZIP15, 16, IOSUB, PF10, IOSTR, V35	615
454	HAF15 ASSIGN	10, R15, PF	615
455	SPLIT	1, ZIP15	615
456	PRIORITY	16	615
457	ASSIGN	3, V35, PF	615
458	ADVANCE	1	615
459	TRANSFER	, IOSUB	615
460	ZIP15 ASSIGN	3, PF10, PF	615

```

461     TRANSFER      ,IOSTR
      * DELAY TRANSMISSION ONE TIME UNIT
      WAITA MACRO    STP15,15,15,IOSUB
462     STP15 PRIORITY 15
463     QUEUE        15,PF3
464     ADVANCE      1
465     DEPART       15,PF3
466     TRANSFER     ,IOSUB
      * TRANSMIT TO PAYLOAD DATA INTERLEAVER
467     TRANSFER     ,PDSEG
      *
      * PART 3. PAYLOAD DATA INTERLEAVER TO TRANSMIT
      *
      * PAYLOAD DATA INTERLEAVER
      *
      * TRANSMIT ALL DATA TO PAYLOAD DATA INTERLEAVER
      TRNSA MACRO    PDSEG,7,WAIT7,R7,PAK7,PDENT,DCSEG
468     PDSEG GATE SNF 7,WAIT7
469     TEST GE      R7,PF3,PAK7
470     PDENT ENTER   7,PF3
471     BUFFER
472     LEAVE        7,PF3
473     TRANSFER     ,DCSEG
      * TRANSMIT PART DATA TO PAYLOAD DATA INTERLEAVER
      TRNSP MACRO    PART7,10,R7,MOVP7,16,PDSEG,PF10,PDENT,V27
474     PART7 ASSIGN 10,R7,PF
475     SPLIT        1,MOVP7
476     PRIORITY     16
477     ASSIGN       3,V27,PF
478     ADVANCE      1
479     TRANSFER     ,PDSEG
480     MOVP7 ASSIGN  3,PF10,PF
481     TRANSFER     ,PDENT
      * DELAY TRANSMISSION ONE TIME UNIT
      WAITA MACRO    WAIT7,15,7,PDSEG
482     WAIT7 PRIORITY 15
483     QUEUE        7,PF3
484     ADVANCE      1
485     DEPART       7,PF3
486     TRANSFER     ,PDSEG
      *
      * DATA ACQUISITION CONTROL AND BUFFER UNIT
      *
      * TRANSMIT ALL DATA TO DACBU
      TRNSA MACRO    DCSEG,8,WAIT8,R8,PART8,DCENT,DLSEG
487     DCSEG GATE SNF 8,WAIT8
488     TEST GE      R8,PF3,PART8
489     DCENT ENTER   8,PF3
490     BUFFER
491     LEAVE        8,PF3
492     TRANSFER     ,DLSEG
      * TRANSMIT PART DATA TO DACBU
      TRNSP MACRO    PART8,10,R8,MOVP8,16,DCSEG,PF10,DCENT,V28
493     PART8 ASSIGN 10,R8,PF
494     SPLIT        1,MOVP8
495     PRIORITY     16
496     ASSIGN       3,V28,PF

```

```

615
616
617
617
617
617
617
617
617
618
619
620
620
621
622
623
624
625
626
626
626
626
626
626
627
628
628
628
628
628
628
628
628
628
628
629
630
630
630
630
630
630
630
630
631
632
633
634
635
635
635
635
635
635
635
635
636
637
637
637
637
637

```

497	ADVANCE	1	637
498	TRANSFER	,DCSEG	637
499	MOVPB ASSIGN	3,PF10,PF	637
500	TRANSFER	,DCENT	637
	* DELAY TRANSMISSION ONE TIME UNIT		638
	WAITA MACRO	WAIT8,15,8,DCSEG	639
501	WAITB PRIORITY	15	639
502	QUEUE	8,PF3	639
503	ADVANCE	1	639
504	DEPART	8,PF3	639
505	TRANSFER	,DCSEG	640
	* DOWNLINK AVAILABLE?		641
	* DLSEG GATE U 50,LMREC		642
506	* KU-BAND		643
	* TRANSMIT ALL DATA TO KU-BAND		644
	TMITA MACRO	KUPRT,12,NSPRT,R12,PTL12	645
	KUPRT GATE SNF	12,NSPRT	646
507	TEST GE	R12,PF3,PTL12	647
508	ENTER	12,PF3	648
509	BUFFER		648
510	LEAVE	12,PF3	648
511	TERMINATE		648
512	* TRANSMIT PART DATA TO KU-BAND		649
	TMITP MACRO	PTL12,10,R12,NSPRT,KUPRT,V32	650
513	PTL12 ASSIGN	10,R12,PF	650
514	SPLIT	1,NSPRT	650
515	ASSIGN	3,V32,PF	650
516	TRANSFER	,KUPRT	651
	* NETWORK SIGNAL PROCESSOR		652
	* TRANSMIT ALL DATA TO NETWORK SIGNAL PROCESSOR		653
	TMITA MACRO	NSPRT,11,LMREC,R11,PRT11	654
517	NSPRT GATE SNF	11,LMREC	655
518	TEST GE	R11,PF3,PRT11	655
519	ENTER	11,PF3	655
520	BUFFER		655
521	LEAVE	11,PF3	655
522	TERMINATE		655
	* TRANSMIT PART DATA TO NETWORK SIGNAL PROCESSOR		656
	TMITP MACRO	PRT11,10,R11,LMREC,NSPRT,V31	657
523	PRT11 ASSIGN	10,R11,PF	657
524	SPLIT	1,LMREC	657
525	ASSIGN	3,V31,PF	657
526	TRANSFER	,NSPRT	657
	* LOOP MAINTENANCE RECORDER		658
	* TRANSMIT ALL DATA TO L.M. RECORDER		659
	RECDA MACRO	LMREC,9,LOSE9,R9,PART9,4608,DUMP9,LMRC1,4608	660
527	LMREC ASSIGN	5,PF3,PF	661
528	GATE SNF	9,LOSE9	662
529	TEST GE	R9,PART9,4608	662

530	ENTER	9,PART9	062
531	TRANSFER	,DUMP9	062
	* TRANSMIT PART DATA TO L.M. RECORDER		063
	RECDP MACRO	PART9,10,R9,9,11,PF10,PF11,DUMP9,9+,V29	064
532	PART9 ASSIGN	10,R9,PF	064
533	ENTER	9,R9	064
534	ASSIGN	11,V29,PF	064
535	SAVEVALUE	9+,PF11	064
536	ASSIGN	3,PF10	064
537	TRANSFER	,DUMP9	065
	* DUMP L.M. RECORDER TO F.M. SIGNAL PROCESSOR		066
	* DUMP ALL DATA TO F.M. SIGNAL PROCESSOR		068
	DUMPA MACRO	DUMP9,DLAY9,10,DLA9A,R10,PRA10,9,FMPRT	069
538	DUMP9 GATE U	50,DLAY9	069
539	GATE SNF	10,DLA9A	069
540	TEST GE	R10,PF3,PRA10	069
541	LEAVE	9,PF5	069
542	TRANSFER	,FMPRT	070
	* DUMP PART DATA TO F.M. SIGNAL PROCESSOR		071
	DUMPP MACRO	PRA10,10,R10,4,1,DUMP9,PF10,9,V30,MVA10	071
543	PRA10 ASSIGN	10,R10,PF	071
544	SPLIT	1,MVA10	071
545	PRIORITY	4	071
546	ADVANCE	1	071
547	ASSIGN	3,V30,PF	071
548	TRANSFER	,DUMP9	071
549	MVA10 ASSIGN	3,PF10	071
550	LEAVE	9,PF5	072
	JUMPI MACRO	FMPRT	072
551	TRANSFER	,FMPRT	073
	* DELAY UNTIL DOWNLINK AVAILABLE		074
	DLAY1 MACRO	DLAY9,3,DUMP9	074
552	DLAY9 PRIORITY	3	074
553	ADVANCE	V5	074
554	TRANSFER	,DUMP9	075
	* DELAY ONE TIME UNIT		076
	DLAY2 MACRO	DLA9A,1,DUMP9	076
555	DLA9A PRIORITY	1	076
556	ADVANCE	1	076
557	TRANSFER	,DUMP9	077
	* F.M. SIGNAL PROCESSOR		078
	* TRANSMIT ALL DATA TO F.M. SIGNAL PROCESSOR		081
	TMITA MACRO	FMPRT,10,DUMP9,R10,SEG10	082
558	FMPRT GATE SNF	10,DUMP9	082
559	TEST GE	R10,PF3,SEG10	082
560	ENTER	10,PF3	082
561	BUFFER		082
562	LEAVE	10,PF3	082
563	TERMINATE		083
	* TRANSMIT PART DATA TO F.M. SIGNAL PROCESSOR		084
	TMITP MACRO	SEG10,10,R10,DUMP9,FMPRT,V30	084
564	SEG10 ASSIGN	10,R10,PF	084

```

565      SPLIT      1,DUMP9
566      ASSIGN     3,V30,PF
567      TRANSFER  ,FNPRT
568      EXTRM TERMINATE
569      SBTRM TERMINATE
570      LOSE9 SAVEVALUE 3+,PF3
571      TERMINATE

*****
**
**  MODULE 5. DOWNLINK SCHEDULE
**
**
*****

2      MATRIX      X,1,60
      INITIAL     MX2(1,1),417/MX2(1,2),422/MX2(1,3),425/MX2(1,4),500
      INITIAL     MX2(1,5),503/MX2(1,6),561/MX2(1,7),583/MX2(1,8),594
      INITIAL     MX2(1,9),600/MX2(1,10),728/MX2(1,11),742
      INITIAL     MX2(1,12),761/MX2(1,13),772/MX2(1,14),900
      INITIAL     MX2(1,15),906/MX2(1,16),928/MX2(1,17),950
      INITIAL     MX2(1,18),1106/MX2(1,19),1117/MX2(1,20),1283
      INITIAL     MX2(1,21),1286/MX2(1,22),1339/MX2(1,23),1344
      INITIAL     MX2(1,24),1411/MX2(1,25),1425/MX2(1,26),1439
      INITIAL     MX2(1,27),1444/MX2(1,28),1500/MX2(1,29),1511
      INITIAL     MX2(1,30),1572/MX2(1,31),1592/MX2(1,32),1606
      INITIAL     MX2(1,33),1608/MX2(1,34),1672/MX2(1,35),1675
      INITIAL     MX2(1,36),1731/MX2(1,37),1758/MX2(1,38),1897
      INITIAL     MX2(1,39),1914/MX2(1,40),1928/MX2(1,41),1939
      INITIAL     MX2(1,42),2069/MX2(1,43),2072/MX2(1,44),2094
      INITIAL     MX2(1,45),2117/MX2(1,46),2272/MX2(1,47),2289
      INITIAL     MX2(1,48),2447/MX2(1,49),2453/MX2(1,50),2511
      INITIAL     MX2(1,51),2517/MX2(1,52),2586/MX2(1,53),2594
      INITIAL     MX2(1,54),2611/MX2(1,55),2617/MX2(1,56),2672
      INITIAL     MX2(1,57),2683/MX2(1,58),2728/MX2(1,59),2739
      INITIAL     MX2(1,60),2797
722      GENERATE  ,400,1,50,25PF      CREATE CONTRL TRANS.
723      LOOP2 ASSIGN 1+,1,PF          SET INDEX
724      TEST E    PF1,1,MOVE1        FIRST TIME THROUGH?
725      SAVEVALUE 50,V18
726      ASSIGN   2,V19,PF          SET FIRST CHANGE TIME
727      TRANSFER ,DLINK            GO TO DOWN LINK SECTION
728      MOVE1 ASSIGN 2,V20,PF        FIND NEXT STATUS CHANGE
729      DLINK ADVANCE PF2
730      ASSIGN   1+,1,PF          INCREMENT EVENT COUNT
731      ASSIGN   2,V20,PF        FIND NEXT CHANGE
732      SEIZE    50
733      ADVANCE  PF2              TIES UP FACILITY 50
734      RELEASE  50              DOWN LINK AVAILABLE
735      TEST E    PF1,60,GOMED      RELEASES FACILITY 50
736      ASSIGN   1,0,PF          DETERMINE TIME NEXT DOWNLNK
737      ASSIGN   3+,1,PF
738      ASSIGN   4,1,PF
739      SAVEVALUE 50,V6
740      ADVANCE  3              TO END OF CYCLE
741      TRANSFER ,LOOP2
742      GOMED ASSIGN 4,V17,PF
743      CKDLK SAVEVALUE 50,V6
744      TRANSFER ,LOOP2
745      PLUTA GENERATE 600,.,.,.2,25PF

```

```

084
084
084
085
086
087
088
089
090
091
092
093
094
095
096
097
098
099
100
101
102
103
104
105
106
107
108
109
110
111
112
113
114
115
116
117
118
119
120
121
122
123
124
125
126
127
128
129
130
131
132
133
134
135
136
137
138

```

596	SAVEVALUE	V42,S12	747
597	SAVEVALUE	V43,S13	748
598	SAVEVALUE	V44,S14	749
599	SAVEVALUE	V45,V36	750
600	SAVEVALUE	V46,V37	751
601	SAVEVALUE	V47,S12	752
602	SAVEVALUE	V48,S14	753
603	SAVEVALUE	V49,S15	754
604	SAVEVALUE	V50,S16	755
605	TERMINATE		756
606	GENERATE	16300	757
607	TERMINATE	1	758
	START	1	759
	REPORT		760
	OUTPUT		761
	GRAPH	X,101,127	762
	ORIGIN	50,22	763
	X	1,3,5,7,9,11	764
	Y	0,200,12,4	765
5	STATEMENT	22,10,EXPERIMENT	766
8	STATEMENT	24,3,RAW	767
6	STATEMENT	26,9,CONTENTS	768
6	STATEMENT	28,8,(K BITS)	769
26	STATEMENT	52,10,6 12 18 24 30 36 42 48 54 60 66 72 1	770
78 84 90 96	STATEMENT	102 108 114 120 126 132 138 144 150 156 162	771
50	STATEMENT	54,12,TIME (HOURS)	772
8	STATEMENT	58,59,FIGURE 7: CONTENTS OF EXPERIMENT RAW AS A FUNCTI	773
	IGN OF TIME:		774
	ENDGRAPH		775
	EJECT		776
	GRAPH	X,131,157	777
	ORIGIN	50,22	778
	X	1,3,5,7,9,11	779
	Y	0,250,12,4	780
5	STATEMENT	22,10,EXPERIMENT	781
8	STATEMENT	24,3,RAW	782
6	STATEMENT	26,9,CONTENTS	783
6	STATEMENT	28,8,(K BITS)	784
26	STATEMENT	52,10,6 12 18 24 30 36 42 48 54 60 66 72 1	785
78 84 90 96	STATEMENT	102 108 114 120 126 132 138 144 150 156 162	786
50	STATEMENT	54,12,TIME (HOURS)	787
8	STATEMENT	58,59,FIGURE 8: CONTENTS OF EXPERIMENT RAW AS A FUNCTI	788
	IGN OF TIME:		789
	ENDGRAPH		790
	EJECT		791
	GRAPH	X,151,171	792
	ORIGIN	50,22	793
	X	1,3,5,7,9,11	794
	Y	0,50,6,8	795
5	STATEMENT	22,10,EXPERIMENT	796
8	STATEMENT	24,3,CPU	797
6	STATEMENT	26,9,CONTENTS	798
6	STATEMENT	28,8,(K BITS)	799
26	STATEMENT	52,10,6 12 18 24 30 36 42 48 54 60 66 72 1	800
78 84 90 96	STATEMENT	102 108 114 120 126 132 138 144 150 156 162	801
50	STATEMENT	54,12,TIME (HOURS)	802
8	STATEMENT	58,59,FIGURE 9: CONTENTS OF EXPERIMENT CPU AS A FUNCTI	803

-51-

ION OF TIME.

ENDGRAPH
 EJECT
 GRAPH X,191,217
 ORIGIN 50,22
 X ,1,3,,,NO
 Y 0,2,24,2
 5 STATEMENT 22,9,HIGH RATE
 6 STATEMENT 24,8,RECORDER
 6 STATEMENT 26,8,CONTENTS
 6 STATEMENT 28,8,(100000
 7 STATEMENT 30,7,K BITS)
 26 STATEMENT 52,106,6 12 18 24 30 36 42 48 54 60 66 72 1
 78 84 90 96 102 108 114 120 126 132 138 144 150 156 162
 60 STATEMENT 54,12,TIME (HOURS)
 8 STATEMENT 58,64,FIGURE 10: CONTENTS OF HIGH RATE RECORDER AS A 1

FUNCTION OF TIME.

ENDGRAPH
 EJECT
 GRAPH X,221,247
 ORIGIN 50,22
 X ,1,3,,,NO
 Y 0,2,24,2
 6 STATEMENT 22,8,VARIABLE
 6 STATEMENT 24,8,RECORDER
 6 STATEMENT 26,8,CONTENTS
 6 STATEMENT 28,8,(100000
 7 STATEMENT 30,7,K BITS)
 26 STATEMENT 52,106,6 12 18 24 30 36 42 48 54 60 66 72 1
 78 84 90 96 102 108 114 120 126 132 138 144 150 156 162
 60 STATEMENT 54,12,TIME (HOURS)
 8 STATEMENT 58,63,FIGURE 11: CONTENTS OF VARIABLE RATE RECORDER A1

S A FUNCTION OF TIME.

ENDGRAPH
 EJECT
 GRAPH X,251,277
 ORIGIN 50,22
 X ,1,3,,,NO
 Y 0,300,12,4
 7 STATEMENT 22,7,KU-BAND
 5 STATEMENT 24,9,PROCESSOR
 5 STATEMENT 26,8,CONTENTS
 6 STATEMENT 28,8,(K BITS)
 26 STATEMENT 52,106,6 12 18 24 30 36 42 48 54 60 66 72 1
 78 84 90 96 102 108 114 120 126 132 138 144 150 156 162
 60 STATEMENT 54,12,TIME (HOURS)
 8 STATEMENT 58,63,FIGURE 12: CONTENTS OF KU-BAND PROCESSOR AS A F1

UNCTION OF TIME.

ENDGRAPH
 EJECT
 GRAPH X,281,307
 ORIGIN 50,22
 X ,1,3,,,NO
 Y 0,300,12,4
 5 STATEMENT 22,9,SUBSYSTEM
 9 STATEMENT 24,3,RAU
 6 STATEMENT 26,8,CONTENTS

796
 797
 798
 799
 800
 801
 802
 803
 804
 805
 806
 807
 808
 809
 810
 811
 812
 813
 814
 815
 816
 817
 818
 819
 820
 821
 822
 823
 824
 825
 826
 827
 828
 829
 830
 831
 832
 833
 834
 835
 836
 837
 838
 839
 840
 841
 842
 843
 844
 845
 846
 847
 848
 849
 850
 851
 852

6	STATEMENT	28,8,(K BITS)																		853
26	STATEMENT	52,106,6	12	18	24	30	36	42	48	54	60	66	72	1						854
78	84	90	96	102	108	114	120	126	132	138	144	150	156	162						855
60	STATEMENT	54,12,TIME (HOURS)																		856
8	STATEMENT	58,58,FIGURE 13:CONTENTS OF SUBSYSTEM RAU AS A FUNCTI1																		857
	ON OF TIME.																			858
	ENDGRAPH																			859
	EJECT																			860
	GRAPH	X,311,337																		861
	ORIGIN	50,22																		862
	X	,1,3,,,,NO																		863
	Y	0,300,12,4																		864
5	STATEMENT	22,9,SUBSYSTEM																		865
8	STATEMENT	24,3,I/O																		866
6	STATEMENT	26,8,CONTENTS																		867
6	STATEMENT	28,8,(K BITS)																		868
26	STATEMENT	52,106,6	12	18	24	30	36	42	48	54	60	66	72	1						869
78	84	90	96	102	108	114	120	126	132	138	144	150	156	162						870
60	STATEMENT	54,12,TIME (HOURS)																		871
8	STATEMENT	58,58,FIGURE 14:CONTENTS OF SUBSYSTEM I/O AS A FUNCTI1																		872
	ON OF TIME.																			873
	ENDGRAPH																			874
	EJECT																			875
	GRAPH	X,341,367																		876
	ORIGIN	50,22																		877
	X	,1,3,,,,NO																		878
	Y	0,50,6,8																		879
5	STATEMENT	22,9,SUBSYSTEM																		880
8	STATEMENT	24,3,CPU																		881
6	STATEMENT	26,8,CONTENTS																		882
6	STATEMENT	28,8,(K BITS)																		883
26	STATEMENT	52,106,6	12	18	24	30	36	42	48	54	60	66	72	1						884
78	84	90	96	102	108	114	120	126	132	138	144	150	156	162						885
60	STATEMENT	54,12,TIME (HOURS)																		886
8	STATEMENT	58,58,FIGURE 15:CONTENTS OF SUBSYSTEM CPU AS A FUNCTI1																		887
	ON OF TIME.																			888
	ENDGRAPH																			889
	END																			890

RELATIVE CLOCK

16800 ABSOLUTE CLOCK

16800

BLOCK COUNTS

BLOCK CURRENT	TOTAL	BLOCK CURRENT	TOTAL	BLOCK CURRENT	TOTAL	BLOCK CURRENT	TOTAL	BLOCK CURRENT	TOTAL
1 0	0	11 0	51476	21 0	0	31 0	0	41 0	0
2 0	929	12 0	51476	22 0	0	32 0	0	42 0	0
3 0	929	13 0	25738	23 0	0	33 0	25738	43 0	0
4 0	3	14 0	25738	24 0	0	34 0	25738	44 0	0
5 0	926	15 0	25738	25 0	0	35 0	25738	45 0	0
6 0	926	16 0	25738	26 0	0	36 0	25738	46 0	0
7 0	24812	17 0	25738	27 0	0	37 0	25738	47 0	0
8 0	51476	18 0	25738	28 0	0	38 0	25738	48 0	0
9 0	25738	19 0	25738	29 0	0	39 0	0	49 0	0
10 0	926	20 0	0	30 0	0	40 0	0	50 0	0

BLOCK CURRENT	TOTAL	BLOCK CURRENT	TOTAL	BLOCK CURRENT	TOTAL	BLOCK CURRENT	TOTAL	BLOCK CURRENT	TOTAL
51 0	0	61 0	25738	71 0	43247	81 0	17509	91 0	32500
52 0	51476	62 0	0	72 0	86494	82 0	17509	92 0	0
53 0	25738	63 0	0	73 0	43247	83 0	24276	93 0	0
54 0	25738	64 0	0	74 0	43247	84 0	24276	94 0	0
55 0	25738	65 0	0	75 0	43247	85 0	24276	95 0	0
56 0	25738	66 0	0	76 0	43247	86 0	24276	96 0	0
57 0	0	67 0	51476	77 0	43247	87 0	24276	97 0	0
58 0	25738	68 0	25738	78 0	1462	88 0	32586	98 0	0
59 0	0	69 0	25738	79 0	1462	89 0	32586	99 0	0
60 0	25738	70 0	25738	80 0	41785	90 0	32586	100 0	0

BLOCK CURRENT	TOTAL	BLOCK CURRENT	TOTAL	BLOCK CURRENT	TOTAL	BLOCK CURRENT	TOTAL	BLOCK CURRENT	TOTAL
101 0	0	111 0	0	121 0	0	131 0	0	141 0	0
102 0	0	112 0	0	122 0	0	132 0	0	142 0	0
103 0	0	113 0	0	123 0	0	133 0	0	143 0	0
104 0	0	114 0	0	124 0	0	134 0	0	144 0	0
105 0	0	115 0	0	125 0	0	135 0	0	145 0	0
106 0	0	116 0	0	126 0	0	136 0	0	146 0	0
107 0	0	117 0	0	127 0	0	137 0	0	147 0	0
108 0	0	118 0	0	128 0	0	138 0	0	148 0	0
109 0	0	119 0	0	129 0	0	139 0	0	149 0	0
110 0	0	120 0	0	130 0	0	140 0	0	150 0	0

BLOCK CURRENT	TOTAL	BLOCK CURRENT	TOTAL	BLOCK CURRENT	TOTAL	BLOCK CURRENT	TOTAL	BLOCK CURRENT	TOTAL
151 0	0	161 0	0	171 0	0	181 0	0	191 0	0
152 0	25738	162 0	0	172 0	0	182 0	0	192 0	0
153 0	25738	163 0	3494	173 0	0	183 0	0	193 0	0
154 0	25738	164 0	3494	174 0	6988	184 0	0	194 0	0
155 0	25738	165 0	3494	175 0	3494	185 0	0	195 0	0
156 0	25738	166 0	3494	176 0	3494	186 0	0	196 0	0
157 0	25738	167 0	3494	177 0	3494	187 0	0	197 0	0
158 0	25738	168 0	0	178 0	3494	188 0	0	198 0	0
159 0	0	169 0	0	179 0	0	189 0	0	199 0	0
160 0	0	170 0	0	180 0	0	190 0	0	200 0	0

BLOCK CURRENT	TOTAL	BLOCK CURRENT	TOTAL	BLOCK CURRENT	TOTAL	BLOCK CURRENT	TOTAL	BLOCK CURRENT	TOTAL
201 0	0	211 0	0	221 0	25738	231 0	0	241 0	0
202 0	3494	212 0	0	222 0	25738	232 0	3494	242 0	0
203 0	3494	213 0	0	223 0	25738	233 0	3494	243 0	0
204 0	3494	214 0	0	224 0	25738	234 0	3494	244 0	0
205 0	0	215 0	0	225 0	25738	235 0	3494	245 0	0960
206 0	0	216 0	0	226 0	25738	236 0	3494	246 0	3494
207 0	0	217 0	0	227 0	25738	237 0	0	247 0	3494
208 0	0	218 0	0	228 0	0	238 0	0	248 0	3494
209 0	0	219 0	0	229 0	0	239 0	0	249 0	3494

210	0	0	220	0	25738	230	0	0	240	0	0	250	0	0	
BLOCK CURRENT	TOTAL	BLOCK CURRENT	TOTAL	BLOCK CURRENT	TOTAL	BLOCK CURRENT	TOTAL	BLOCK CURRENT	TOTAL	BLOCK CURRENT	TOTAL	BLOCK CURRENT	TOTAL	BLOCK CURRENT	TOTAL
251	0	0	261	0	3494	271	0	14775	281	0	0	291	0	14775	
252	0	0	262	0	0	272	0	14775	282	0	0	292	0	0	
253	0	0	263	0	0	273	0	0	283	0	0	293	0	0	
254	0	0	264	0	0	274	0	0	284	0	0	294	0	0	
255	0	0	265	0	14775	275	0	0	285	0	0	295	0	0	
256	0	0	266	0	14775	276	0	0	286	0	14775	296	0	0	
257	0	0	267	0	14775	277	0	0	287	0	14775	297	0	0	
258	0	0	268	0	14775	278	0	0	288	0	14775	298	0	0	
259	0	3494	269	0	14775	279	0	0	289	0	14775	299	0	0	
260	0	3494	270	0	14775	280	0	0	290	0	14775	300	0	0	

BLOCK CURRENT	TOTAL	BLOCK CURRENT	TOTAL	BLOCK CURRENT	TOTAL	BLOCK CURRENT	TOTAL	BLOCK CURRENT	TOTAL	BLOCK CURRENT	TOTAL	BLOCK CURRENT	TOTAL	BLOCK CURRENT	TOTAL
301	0	0	311	0	14776	321	0	14749	331	0	42748	341	0	44848	
302	0	0	312	0	14749	322	0	44848	332	0	30099	342	0	44848	
303	0	0	313	0	1	323	0	89696	333	0	30099	343	0	0	
304	0	0	314	0	2	324	0	44848	334	0	12649	344	0	0	
305	0	29550	315	0	1	325	0	44848	335	0	12649	345	0	0	
306	0	14775	316	0	1	326	0	44848	336	0	12649	346	0	0	
307	0	14775	317	0	1	327	0	44848	337	0	12649	347	0	0	
308	0	0	318	0	29498	328	0	44848	338	0	12649	348	0	0	
309	0	14775	319	0	14749	329	0	2100	339	0	44848	349	0	0	
310	0	26	320	0	14749	330	0	2100	340	0	44848	350	0	0	

BLOCK CURRENT	TOTAL	BLOCK CURRENT	TOTAL	BLOCK CURRENT	TOTAL	BLOCK CURRENT	TOTAL	BLOCK CURRENT	TOTAL	BLOCK CURRENT	TOTAL	BLOCK CURRENT	TOTAL	BLOCK CURRENT	TOTAL
351	0	0	361	0	0	371	0	14148	381	0	0	391	0	26365	
352	0	0	362	0	0	372	0	26365	382	0	0	392	0	26365	
353	0	0	363	0	14775	373	0	26365	383	0	0	393	0	26365	
354	0	0	364	0	14775	374	0	26365	384	0	0	394	0	26365	
355	0	0	365	0	14775	375	0	26365	385	0	0	395	0	26365	
356	0	0	366	0	25738	376	0	26365	386	0	0	396	0	26365	
357	0	0	367	0	25738	377	0	26365	387	0	0	397	0	0	
358	0	0	368	0	25738	378	0	0	388	0	0	398	0	0	
359	0	0	369	0	40513	379	0	0	389	0	0	399	0	0	
360	0	0	370	0	40513	380	0	0	390	0	0	400	0	0	

BLOCK CURRENT	TOTAL	BLOCK CURRENT	TOTAL	BLOCK CURRENT	TOTAL	BLOCK CURRENT	TOTAL	BLOCK CURRENT	TOTAL	BLOCK CURRENT	TOTAL	BLOCK CURRENT	TOTAL	BLOCK CURRENT	TOTAL
401	0	0	411	0	26365	421	0	1	431	0	50530	441	0	24166	
402	0	0	412	0	26365	422	0	1	432	0	50530	442	0	24166	
403	0	0	413	0	0	423	0	52678	433	0	50530	443	0	24166	
404	0	0	414	0	26365	424	0	26339	434	0	2173	444	0	50530	
405	0	0	415	0	26	425	0	26339	435	0	2173	445	0	50530	
406	0	0	416	0	26366	426	0	26339	436	0	48357	446	0	50530	
407	0	0	417	0	26339	427	0	50530	437	0	24191	447	0	50530	
408	0	0	418	0	1	428	0	101060	438	0	24191	448	0	0	
409	0	0	419	0	2	429	0	50530	439	0	24166	449	0	0	
410	0	52730	420	0	1	430	0	50530	440	0	24166	450	0	0	

BLOCK CURRENT	TOTAL	BLOCK CURRENT	TOTAL	BLOCK CURRENT	TOTAL	BLOCK CURRENT	TOTAL	BLOCK CURRENT	TOTAL	BLOCK CURRENT	TOTAL	BLOCK CURRENT	TOTAL	BLOCK CURRENT	TOTAL
451	0	0	461	0	0	471	0	0	481	0	0	491	0	0	
452	0	0	462	0	0	472	0	0	482	0	0	492	0	0	
453	0	0	463	0	0	473	0	0	483	0	0	493	0	0	
454	0	0	464	0	0	474	0	0	484	0	0	494	0	0	
455	0	0	465	0	0	475	0	0	485	0	0	495	0	0	
456	0	0	466	0	0	476	0	0	486	0	0	496	0	0	
457	0	0	467	0	0	477	0	0	487	0	0	497	0	0	
458	0	0	468	0	0	478	0	0	488	0	0	498	0	0	
459	0	0	469	0	0	479	0	0	489	0	0	499	0	0	
460	0	0	470	0	0	480	0	0	490	0	0	500	0	0	

BLOCK CURRENT	TOTAL	BLOCK CURRENT	TOTAL	BLOCK CURRENT	TOTAL	BLOCK CURRENT	TOTAL	BLOCK CURRENT	TOTAL
501	0	511	0	521	0	531	0	541	0
502	0	512	0	522	0	532	0	542	0
503	0	513	0	523	0	533	0	543	0
504	0	514	0	524	0	534	0	544	0
505	0	515	0	525	0	535	0	545	0
506	0	516	0	526	0	536	0	546	0
507	0	517	0	527	0	537	0	547	0
508	0	518	0	528	0	538	0	548	0
509	0	519	0	529	0	539	0	549	0
510	0	520	0	530	0	540	0	550	0

BLOCK CURRENT	TOTAL	BLOCK CURRENT	TOTAL	BLOCK CURRENT	TOTAL	BLOCK CURRENT	TOTAL	BLOCK CURRENT	TOTAL
551	0	561	0	571	0	581	0	591	0
552	0	562	0	572	1	582	0	592	197
553	0	563	0	573	204	583	1	593	197
554	0	564	0	574	204	584	0	594	197
555	0	565	0	575	7	585	0	595	28
556	0	566	0	576	7	586	6	596	28
557	0	567	0	577	7	587	6	597	28
558	0	568	14775	578	197	588	6	598	28
559	0	569	26365	579	204	589	6	599	28
560	0	570	0	580	204	590	6	600	28

BLOCK CURRENT	TOTAL	BLOCK CURRENT	TOTAL	BLOCK CURRENT	TOTAL	BLOCK CURRENT	TOTAL	BLOCK CURRENT	TOTAL
601	0		28						
602	0		28						
603	0		28						
604	0		28						
605	0		28						
606	0		1						
607	0		1						

 * FACILITIES *

FACILITY	NUMBER ENTRIES	AVERAGE TIME/TRAN	-AVERAGE UTILIZATION DURING-		CURRENT STATUS	PERCENT AVAILABILITY	TRANSACTION NUMBER	
			TOTAL TIME	AVAIL. UNAVAIL. TIME TIME			SEIZING	PREEMPTING
4	128582	.000	.000			100.0		
16	76869	.000	.000			100.0		
50	204	69.422	.842			100.0		6

 *
 * STORAGE *
 *

STORAGE	CAPACITY	AVERAGE CONTENTS	ENTRIES	-AVERAGE UTILIZATION DURING-		CURRENT STATUS	PERCENT AVAILABILITY	CURRENT CONTENTS	MAXIMUM CONTENTS
				AVERAGE TIME/UNIT	TOTAL TIME				
RAUEX	36000	.000	8674698	.000	.000		100.0		1800
IDEXP	36000	.000	8674698	.000	.000		100.0		1800
CPUEX	288	284.355	288	16587.406	.987		100.0	288	288
HRREC	36000000	9877.769	20397390	8.136	.000		100.0		772206
VKREC	36000000	467.540	965472	8.136	.000		100.0		38586
KUSIG	1080000	.000	140960572	.000	.000		100.0		34200
RAUSU	36000	.000	14987124	.000	.000		100.0		3600
IDSUB	36000	.000	14987124	.000	.000		100.0		3600
CPUSU	288	284.355	288	16587.406	.987		100.0	288	288

 * QUEUES *

QUEUE	MAXIMUM CONTENTS	AVERAGE CONTENTS	TOTAL ENTRIES	ZERO ENTRIES	PERCENT ZEROS	AVERAGE TIME/TRANS	AVERAGE TIME/TRANS	TABLE NUMBER	CURRENT CONTENTS
4	1	.000	40487	40487	100.0	.000	.000		
16	1	.000	26339	26339	100.0	.000	.000		

AVERAGE TIME/TRANS = AVERAGE TIME/TRANS EXCLUDING ZERO ENTRIES

 * USER CHAINS *

USER CHAIN	TOTAL ENTRIES	AVERAGE TIME/TRANS	CURRENT CONTENTS	AVERAGE CONTENTS	MAXIMUM CONTENTS
4	77439	.892	5	4.114	54
16	50532	3.210	2	9.655	28

 *
 * FULLWORD SAVEVALUES *
 *

NUMBER - CONTENTS	NUMBER - CONTENTS	NUMBER - CONTENTS	NUMBER - CONTENTS	NUMBER - CONTENTS	NUMBER - CONTENTS
4 861932	16 1497871	20 5	21 5	22 44	23 22
24 44	25 297	50 16689	101 108	102 1800	103 1800
104 1800	105 1800	106 1800	107 1800	108 1800	109 1800
110 1800	111 1800	112 1800	113 1800	114 1800	115 1800
116 1800	117 1800	118 1800	119 1800	120 1800	121 1800
122 1800	123 1800	124 1800	125 1800	126 1800	127 1800
128 1800	131 108	132 1800	133 1800	134 1800	135 1800
136 1800	137 1800	138 1800	139 1800	140 1800	141 1800
142 1800	143 1800	144 1800	145 1800	146 1800	147 1800
148 1800	149 1800	150 1800	151 1800	152 1800	153 1800
154 1800	155 1800	156 1800	157 1800	158 1800	161 288
162 288	163 288	164 288	165 288	166 288	167 288
168 288	169 288	170 288	171 288	172 288	173 288
174 288	175 288	176 288	177 288	178 288	179 288
180 288	181 288	182 288	183 288	184 288	185 288
186 288	187 288	188 288	252 34200	253 34200	254 34200
255 34200	256 34200	257 34200	258 34200	259 34200	260 34200
261 34200	262 34200	263 34200	264 34200	265 34200	266 34200
267 34200	268 34200	269 34200	270 34200	271 34200	272 34200
273 34200	274 34200	275 34200	276 34200	277 34200	278 34200
281 108	282 3600	283 3600	284 3600	285 3600	286 3600
287 3600	288 3600	289 3600	290 3600	291 3600	292 3600
293 3600	294 3600	295 3600	296 3600	297 3600	298 3600
299 3600	300 3600	301 3600	302 3600	303 3600	304 3600
305 3600	306 3600	307 3600	308 3600	311 108	312 3600
313 3600	314 3600	315 3600	316 3600	317 3600	318 3600
319 3600	320 3600	321 3600	322 3600	323 3600	324 3600
325 3600	326 3600	327 3600	328 3600	329 3600	330 3600
331 3600	332 3600	333 3600	334 3600	335 3600	336 3600
337 3600	338 3600	341 288	342 288	343 288	344 288
345 288	346 288	347 288	348 288	349 288	350 288
351 288	352 288	353 288	354 288	355 288	356 288
357 288	358 288	359 288	360 288	361 288	362 288
363 288	364 288	365 288	366 288	367 288	368 288

 * FULLWORD MATRICES *
 * *****

FULLWORD MATRIX

ROW/COLUMN	2	3	4	5	6	7	8	9	10	
1	417	422	425	500	503	561	583	594	600	728
ROW/COLUMN	11	12	13	14	15	16	17	18	19	20
1	742	761	772	900	906	928	950	1106	1117	1283
ROW/COLUMN	21	22	23	24	25	26	27	28	29	30
1	1286	1339	1344	1411	1425	1439	1444	1500	1511	1572
ROW/COLUMN	31	32	33	34	35	36	37	38	39	40
1	1592	1606	1608	1672	1675	1731	1758	1897	1914	1928
ROW/COLUMN	41	42	43	44	45	46	47	48	49	50
1	1939	2039	2072	2094	2117	2272	2289	2447	2453	2511
ROW/COLUMN	51	52	53	54	55	56	57	58	59	60
1	2517	2586	2594	2611	2617	2672	2683	2728	2739	2797

RELATIVE CLOCK 16800 ABSOLUTE CLOCK 16800

BLOCK COUNTS		16800		ABSOLUTE CLOCK		16800		BLOCK CURRENT		TOTAL		BLOCK CURRENT		TOTAL	
BLOCK CURRENT	TOTAL	BLOCK CURRENT	TOTAL	BLOCK CURRENT	TOTAL	BLOCK CURRENT	TOTAL	BLOCK CURRENT	TOTAL	BLOCK CURRENT	TOTAL	BLOCK CURRENT	TOTAL	BLOCK CURRENT	TOTAL
1	0	929	11	0	51476	21	0	0	31	0	0	41	0	0	0
2	0	929	12	0	25738	22	0	0	32	0	25738	42	0	0	0
3	0	3	13	0	25738	23	0	0	33	0	25738	43	0	0	0
4	0	926	14	0	25738	24	0	0	34	0	25738	44	0	0	0
5	0	926	15	0	25738	25	0	0	35	0	25738	45	0	0	0
6	0	24812	16	0	25738	26	0	0	36	0	25738	46	0	0	0
7	0	51476	17	0	25738	27	0	0	37	0	25738	47	0	0	0
8	0	25738	18	0	25738	28	0	0	38	0	0	48	0	0	0
9	0	926	19	0	0	29	0	0	39	0	0	49	0	0	0
10	0	51476	20	0	0	30	0	0	40	0	0	50	0	0	0

BLOCK CURRENT	TOTAL	BLOCK CURRENT	TOTAL	BLOCK CURRENT	TOTAL	BLOCK CURRENT	TOTAL	BLOCK CURRENT	TOTAL	BLOCK CURRENT	TOTAL	BLOCK CURRENT	TOTAL	BLOCK CURRENT	TOTAL
51	0	51476	61	0	0	71	0	86494	81	0	17509	91	0	0	0
52	0	25738	62	0	0	72	0	43247	82	0	24276	92	0	0	0
53	0	25738	63	0	0	73	0	43247	83	0	24276	93	0	0	0
54	0	25738	64	0	0	74	0	43247	84	0	24276	94	0	0	0
55	0	25738	65	0	0	75	0	43247	85	0	24276	95	0	0	0
56	0	0	66	0	51476	76	0	43247	86	0	24276	96	0	0	0
57	0	25738	67	0	25738	77	0	1462	87	0	32586	97	0	0	0
58	0	0	68	0	25738	78	0	1462	88	0	32586	98	0	0	0
59	0	25738	69	0	25738	79	0	41785	89	0	32586	99	0	0	0
60	0	25738	70	0	43247	80	0	17509	90	0	32586	100	0	0	0

BLOCK CURRENT	TOTAL	BLOCK CURRENT	TOTAL	BLOCK CURRENT	TOTAL	BLOCK CURRENT	TOTAL	BLOCK CURRENT	TOTAL	BLOCK CURRENT	TOTAL	BLOCK CURRENT	TOTAL	BLOCK CURRENT	TOTAL
101	0	0	111	0	0	121	0	0	131	0	0	141	0	0	0
102	0	0	112	0	0	122	0	0	132	0	0	142	0	0	0
103	0	0	113	0	0	123	0	0	133	0	0	143	0	0	0
104	0	0	114	0	0	124	0	0	134	0	0	144	0	0	0
105	0	0	115	0	0	125	0	0	135	0	0	145	0	0	0
106	0	0	116	0	0	126	0	0	136	0	0	146	0	0	0
107	0	0	117	0	0	127	0	0	137	0	0	147	0	0	0
108	0	0	118	0	0	128	0	0	138	0	0	148	0	0	0
109	0	0	119	0	0	129	0	0	139	0	0	149	0	0	0
110	0	0	120	0	0	130	0	0	140	0	0	150	0	0	0

BLOCK CURRENT	TOTAL	BLOCK CURRENT	TOTAL	BLOCK CURRENT	TOTAL	BLOCK CURRENT	TOTAL	BLOCK CURRENT	TOTAL	BLOCK CURRENT	TOTAL	BLOCK CURRENT	TOTAL	BLOCK CURRENT	TOTAL
151	0	25738	161	0	0	171	0	0	181	0	0	191	0	0	0
152	0	25738	162	0	3494	172	0	6988	182	0	0	192	0	0	0
153	0	25738	163	0	3494	173	0	3494	183	0	0	193	0	0	0
154	0	25738	164	0	3494	174	0	3494	184	0	0	194	0	0	0
155	0	25738	165	0	3494	175	0	3494	185	0	0	195	0	0	0
156	0	25738	166	0	0	176	0	3494	186	0	0	196	0	0	0
157	0	25738	167	0	0	177	0	0	187	0	0	197	0	0	0
158	0	0	168	0	0	178	0	0	188	0	0	198	0	0	0
159	0	0	169	0	0	179	0	0	189	0	0	199	0	0	0
160	0	0	170	0	0	180	0	0	190	0	0	200	0	0	3494

BLOCK CURRENT	TOTAL	BLOCK CURRENT	TOTAL	BLOCK CURRENT	TOTAL	BLOCK CURRENT	TOTAL	BLOCK CURRENT	TOTAL	BLOCK CURRENT	TOTAL	BLOCK CURRENT	TOTAL	BLOCK CURRENT	TOTAL
201	0	3494	211	0	0	221	0	25738	231	0	3494	241	0	0	0
202	0	3494	212	0	0	222	0	25738	232	0	3494	242	0	6988	0
203	0	0	213	0	0	223	0	25738	233	0	3494	243	0	3494	0
204	0	0	214	0	0	224	0	25738	234	0	0	244	0	3494	0
205	0	0	215	0	0	225	0	25738	235	0	0	245	0	3494	0
206	0	0	216	0	0	226	0	0	236	0	0	246	0	3494	0
207	0	0	217	0	0	227	0	0	237	0	0	247	0	0	0
208	0	0	218	0	25738	228	0	0	238	0	0	248	0	0	0
209	0	0	219	0	25738	229	0	0	239	0	0	249	0	0	0

-63-

210	0	0	220	0	25738	230	0	3494	240	0	0	250	0	0	
BLOCK CURRENT	TOTAL	BLOCK CURRENT	TOTAL	BLOCK CURRENT	TOTAL	BLOCK CURRENT	TOTAL	BLOCK CURRENT	TOTAL	BLOCK CURRENT	TOTAL	BLOCK CURRENT	TOTAL	BLOCK CURRENT	TOTAL
251	0	0	251	0	0	271	0	0	281	0	0	291	0	0	
252	0	0	262	0	14775	272	0	0	282	0	0	292	0	0	
253	0	0	263	0	14775	273	0	0	283	0	14775	293	0	0	
254	0	0	264	0	14775	274	0	0	284	0	14775	294	0	0	
255	0	0	265	0	14775	275	0	0	285	0	14775	295	0	0	
256	0	3494	266	0	14775	276	0	0	286	0	14775	296	0	0	
257	0	3494	267	0	14775	277	0	0	287	0	14775	297	0	0	
258	0	3494	268	0	14775	278	0	0	288	0	14775	298	0	0	
259	0	0	269	0	14775	279	0	0	289	0	0	299	0	0	
260	0	0	270	0	0	280	0	0	290	0	0	300	0	0	

BLOCK CURRENT	TOTAL	BLOCK CURRENT	TOTAL	BLOCK CURRENT	TOTAL	BLOCK CURRENT	TOTAL	BLOCK CURRENT	TOTAL	BLOCK CURRENT	TOTAL	BLOCK CURRENT	TOTAL	BLOCK CURRENT	TOTAL
301	0	0	311	0	2	321	0	44848	331	0	12049	341	0	0	
302	0	29550	312	0	1	322	0	44848	332	0	12049	342	0	0	
303	0	14775	313	0	1	323	0	44848	333	0	12049	343	0	0	
304	0	14775	314	0	1	324	0	44848	334	0	12049	344	0	0	
305	0	0	315	0	29498	325	0	44848	335	0	12049	345	0	0	
306	0	14775	316	0	14749	326	0	2100	336	0	44848	346	0	0	
307	0	26	317	0	14749	327	0	2100	337	0	44848	347	0	0	
308	0	14776	318	0	14749	328	0	42748	338	0	44848	348	0	0	
309	0	14749	319	0	44848	329	0	30099	339	0	44848	349	0	0	
310	0	1	320	0	89696	330	0	30099	340	0	0	350	0	0	

BLOCK CURRENT	TOTAL	BLOCK CURRENT	TOTAL	BLOCK CURRENT	TOTAL	BLOCK CURRENT	TOTAL	BLOCK CURRENT	TOTAL	BLOCK CURRENT	TOTAL	BLOCK CURRENT	TOTAL	BLOCK CURRENT	TOTAL
351	0	0	361	0	14775	371	0	26365	381	0	0	391	0	26365	
352	0	0	362	0	14775	372	0	26365	382	0	0	392	0	26365	
353	0	0	363	0	25738	373	0	26365	383	0	0	393	0	26365	
354	0	0	364	0	25738	374	0	26365	384	0	0	394	0	0	
355	0	0	365	0	25738	375	0	0	385	0	0	395	0	0	
356	0	0	366	0	40513	376	0	0	386	0	0	396	0	0	
357	0	0	367	0	40513	377	0	0	387	0	0	397	0	0	
358	0	0	368	0	14148	378	0	0	388	0	26365	398	0	0	
359	0	0	369	0	26365	379	0	0	389	0	26365	399	0	0	
360	0	14775	370	0	26365	380	0	0	390	0	26365	400	0	0	

BLOCK CURRENT	TOTAL	BLOCK CURRENT	TOTAL	BLOCK CURRENT	TOTAL	BLOCK CURRENT	TOTAL	BLOCK CURRENT	TOTAL	BLOCK CURRENT	TOTAL	BLOCK CURRENT	TOTAL	BLOCK CURRENT	TOTAL
401	0	0	411	0	26365	421	0	26339	431	0	2173	441	0	50530	
402	0	0	412	0	26	422	0	26339	432	0	2173	442	0	50530	
403	0	0	413	0	26366	423	0	26339	433	0	48357	443	0	50530	
404	0	0	414	0	26339	424	0	50530	434	0	24191	444	0	50530	
405	0	0	415	0	1	425	0	101060	435	0	24191	445	0	0	
406	0	0	416	0	2	426	0	50530	436	0	24166	446	0	0	
407	0	52730	417	0	1	427	0	50530	437	0	24166	447	0	0	
408	0	26365	418	0	1	428	0	50530	438	0	24166	448	0	0	
409	0	26365	419	0	1	429	0	50530	439	0	24166	449	0	0	
410	0	0	420	0	52678	430	0	50530	440	0	24166	450	0	0	

BLOCK CURRENT	TOTAL	BLOCK CURRENT	TOTAL	BLOCK CURRENT	TOTAL	BLOCK CURRENT	TOTAL	BLOCK CURRENT	TOTAL	BLOCK CURRENT	TOTAL	BLOCK CURRENT	TOTAL	BLOCK CURRENT	TOTAL
451	0	0	461	0	0	471	0	0	481	0	0	491	0	0	
452	0	0	462	0	0	472	0	0	482	0	0	492	0	0	
453	0	0	463	0	0	473	0	0	483	0	0	493	0	0	
454	0	0	464	0	0	474	0	0	484	0	0	494	0	0	
455	0	0	465	0	0	475	0	0	485	0	0	495	0	0	
456	0	0	466	0	0	476	0	0	486	0	0	496	0	0	
457	0	0	467	0	0	477	0	0	487	0	0	497	0	0	
458	0	0	468	0	0	478	0	0	488	0	0	498	0	0	
459	0	0	469	0	0	479	0	0	489	0	0	499	0	0	
460	0	0	470	0	0	480	0	0	490	0	0	500	0	0	

 * FACILITIES *

FACILITY	NUMBER ENTRIES	AVERAGE TIME/TRAN	AVERAGE UTILIZATION DURING		CURRENT STATUS	PERCENT AVAILABILITY	TRANSACTION NUMBER	
			TOTAL TIME	AVAIL. UNAVAIL. TIME			SEIZING	PREEMPTING
4	128582	.000	.000			100.0		
10	76869	.000	.000			100.0		
50	204	69.422	.842			100.0		6

 *
 * STORAGES *
 *

STORAGE	CAPACITY	AVERAGE CONTENTS	ENTRIES	AVERAGE TIME/UNIT	AVERAGE UTILIZATION DURING			CURRENT STATUS	PERCENT AVAILABILITY	CURRENT CONTENTS	MAXIMUM CONTENTS
					TOTAL TIME	AVAIL. TIME	UNAVAIL. TIME				
RAUEX	36000	.000	8674698	.000	.000			100.0		1000	
IEEXP	36000	.000	8674698	.000	.000			100.0	288	288	
CPUEX	288	284.355	288	16587.406	.987			100.0		77200	
HAREC	45000000	9877.769	20397390	8.136	.000			100.0		36566	
VAREC	36000000	467.540	965472	8.136	.000			100.0		34200	
KUSIG	1080000	.000	140960572	.000	.000			100.0		3000	
RAUSU	36000	.000	14987124	.000	.000			100.0		3600	
IESUB	36000	.000	14987124	.000	.000			100.0	288	288	
CPUSU	288	284.355	288	16587.406	.987						

 * QUEUES *

QUEUE	MAXIMUM CONTENTS	AVERAGE CONTENTS	TOTAL ENTRIES	ZERO ENTRIES	PERCENT ZERUS	AVERAGE TIME/TRANS	AVERAGE TIME/TRANS	TABLE NUMBER	CURRENT CONTENTS
4	1	.000	40487	40487	100.0	.000	.000		
16	1	.000	26339	26339	100.0	.000	.000		

AVERAGE TIME/TRANS = AVERAGE TIME/TRANS EXCLUDING ZERO ENTRIES

 * USER CHAINS *

USER CHAIN	TOTAL ENTRIES	AVERAGE TIME/TKANS	CURRENT CONTENTS	AVERAGE CONTENTS	MAXIMUM CONTENTS
4	77439	.892	5	4.114	54
16	50532	3.210	2	9.055	28

 * FULLWORD SAVEVALUES *

NUMBER	CONTENTS	NUMBER	CONTENTS	NUMBER	CONTENTS	NUMBER	CONTENTS	NUMBER	CONTENTS	NUMBER	CONTENTS	NUMBER	CONTENTS
4	861932	16	1497871	20	5	21	5	22	44	23	22		
24	44	25	297	50	16689	101	108	102	1800	103	1600		
104	1800	105	1800	106	1800	107	1800	108	1800	109	1800		
110	1800	111	1800	112	1800	113	1800	114	1800	115	1800		
116	1800	117	1800	118	1800	119	1800	120	1800	121	1800		
122	1800	123	1800	124	1800	125	1800	126	1800	127	1800		
128	1800	131	108	132	1800	133	1800	134	1800	135	1800		
136	1800	137	1800	138	1800	139	1800	140	1800	141	1800		
142	1800	143	1800	144	1800	145	1800	146	1800	147	1800		
148	1800	149	1800	150	1800	151	1800	152	1800	153	1800		
154	1800	155	1800	156	1800	157	1800	158	1800	161	288		
162	288	163	288	164	288	165	288	166	288	167	288		
168	288	169	288	170	288	171	288	172	288	173	288		
174	288	175	288	176	288	177	288	178	288	179	288		
190	288	181	288	182	288	183	288	184	288	185	288		
186	288	187	288	188	288	252	34200	253	34200	254	34200		
255	34200	256	34200	257	34200	258	34200	259	34200	260	34200		
261	34200	262	34200	263	34200	264	34200	265	34200	266	34200		
267	34200	268	34200	269	34200	270	34200	271	34200	272	34200		
273	34200	274	34200	275	34200	276	34200	277	34200	278	34200		
281	3600	282	3600	283	3600	284	3600	285	3600	286	3600		
287	3600	288	3600	289	3600	296	3600	291	3600	292	3600		
293	3600	294	3600	295	3600	296	3600	297	3600	298	3600		
299	3600	300	3600	301	3600	302	3600	303	3600	304	3600		
305	3600	306	3600	307	3600	308	3600	311	108	312	3600		
313	3600	314	3600	315	3600	316	3600	317	3600	318	3600		
319	3600	320	3600	321	3600	322	3600	323	3600	324	3600		
325	3600	326	3600	327	3600	328	3600	329	3600	330	3600		
331	3600	332	3600	333	3600	334	3600	335	3600	336	3600		
337	3600	338	3600	341	288	342	288	343	288	344	288		
345	288	346	288	347	288	348	288	349	288	350	288		
351	288	352	288	353	288	354	288	355	288	356	288		
357	288	358	288	359	288	360	288	361	288	362	288		
363	288	364	288	365	288	366	288	367	288	368	288		

RELATIVE CLOCK

16800 ABSOLUTE CLOCK

16800

BLOCK COUNTS

BLOCK CURRENT	TOTAL	BLOCK CURRENT	TOTAL	BLOCK CURRENT	TOTAL	BLOCK CURRENT	TOTAL	BLOCK CURRENT	TOTAL
1	929	11	51476	21	0	31	0	41	0
2	929	12	25738	22	0	32	25738	42	0
3	0	13	25738	23	0	33	25738	43	0
4	926	14	25738	24	0	34	25738	44	0
5	926	15	25738	25	0	35	25738	45	0
6	24812	16	25738	26	0	36	25738	46	0
7	51476	17	25738	27	0	37	25738	47	0
8	25738	18	25738	28	0	38	0	48	0
9	0	19	0	29	0	39	0	49	0
10	51476	20	0	30	0	40	0	50	0

BLOCK CURRENT	TOTAL	BLOCK CURRENT	TOTAL	BLOCK CURRENT	TOTAL	BLOCK CURRENT	TOTAL	BLOCK CURRENT	TOTAL
51	51476	61	0	71	0	81	17496	91	0
52	25738	62	0	72	0	82	24206	92	0
53	25738	63	0	73	0	83	24206	93	0
54	25738	64	0	74	0	84	24206	94	0
55	25738	65	0	75	0	85	24206	95	0
56	0	66	51476	76	0	86	24206	96	0
57	25738	67	25738	77	0	87	32573	97	0
58	0	68	25738	78	0	88	32573	98	0
59	25738	69	25738	79	0	89	32573	99	0
60	25738	70	43234	80	0	90	32573	100	0

BLOCK CURRENT	TOTAL	BLOCK CURRENT	TOTAL	BLOCK CURRENT	TOTAL	BLOCK CURRENT	TOTAL	BLOCK CURRENT	TOTAL
101	0	111	0	121	0	131	0	141	0
102	0	112	0	122	0	132	0	142	0
103	0	113	0	123	0	133	0	143	0
104	0	114	0	124	0	134	0	144	0
105	0	115	0	125	0	135	0	145	0
106	0	116	0	126	0	136	0	146	0
107	0	117	0	127	0	137	0	147	0
108	0	118	0	128	0	138	0	148	0
109	0	119	0	129	0	139	0	149	0
110	0	120	0	130	0	140	0	150	0

BLOCK CURRENT	TOTAL	BLOCK CURRENT	TOTAL	BLOCK CURRENT	TOTAL	BLOCK CURRENT	TOTAL	BLOCK CURRENT	TOTAL
151	25738	161	0	171	0	181	0	191	0
152	25738	162	3494	172	6988	182	0	192	0
153	25738	163	3494	173	3494	183	0	193	0
154	25738	164	3494	174	3494	184	0	194	0
155	25738	165	3494	175	3494	185	0	195	0
156	25738	166	0	176	0	186	0	196	0
157	25738	167	0	177	0	187	0	197	0
158	0	168	0	178	0	188	0	198	0
159	0	169	0	179	0	189	0	199	0
160	0	170	0	180	0	190	0	200	3494

BLOCK CURRENT	TOTAL	BLOCK CURRENT	TOTAL	BLOCK CURRENT	TOTAL	BLOCK CURRENT	TOTAL	BLOCK CURRENT	TOTAL
201	3494	211	0	221	25738	231	3494	241	0
202	3494	212	0	222	25738	232	3494	242	6988
203	0	213	0	223	25738	233	3494	243	3494
204	0	214	0	224	25738	234	0	244	3494
205	0	215	0	225	25738	235	0	245	3494
206	0	216	0	226	0	236	0	246	3494
207	0	217	0	227	0	237	0	247	0
208	0	218	25738	228	0	238	0	248	0
209	0	219	25738	229	0	239	0	249	0

BLOCK CURRENT	TOTAL	BLOCK CURRENT	TOTAL	BLOCK CURRENT	TOTAL	BLOCK CURRENT	TOTAL	BLOCK CURRENT	TOTAL
251	0	201	0	271	0	281	0	291	0
252	0	202	0	14775	0	202	0	292	0
253	0	203	0	14775	0	283	14775	293	0
254	0	204	0	14775	0	204	14775	294	0
255	0	205	0	14775	0	205	4775	295	0
256	0	206	0	14775	0	256	14775	296	0
257	3494	207	0	14775	0	287	14775	297	0
258	3494	208	0	14775	0	288	14775	298	0
259	0	209	0	14775	0	289	0	299	0
260	0	270	0	0	0	290	0	300	0

BLOCK CURRENT	TOTAL	BLOCK CURRENT	TOTAL	BLOCK CURRENT	TOTAL	BLOCK CURRENT	TOTAL	BLOCK CURRENT	TOTAL	
301	0	311	2	321	0	44848	331	12040	341	0
302	0	312	1	322	0	44848	332	12040	342	0
303	14775	313	1	323	0	44040	333	12040	343	0
304	14775	314	1	324	0	44040	334	12040	344	0
305	0	315	29472	325	0	44040	335	12040	345	0
306	14775	316	14736	326	2990	336	44040	346	0	
307	0	317	14736	327	2090	337	44040	347	0	
308	14776	318	14736	328	42750	338	44040	348	0	
309	14736	319	44048	329	30112	339	44048	349	0	
310	0	320	89070	330	0	30112	340	0	350	0

BLOCK CURRENT	TOTAL	BLOCK CURRENT	TOTAL	BLOCK CURRENT	TOTAL	BLOCK CURRENT	TOTAL	BLOCK CURRENT	TOTAL	
351	0	361	0	371	0	26305	381	0	391	0
352	0	362	0	372	0	26305	382	0	392	0
353	0	363	25738	373	0	26305	383	0	393	0
354	0	364	25738	374	0	26305	384	0	394	0
355	0	365	25738	375	0	0	385	0	395	0
356	0	366	40513	376	0	0	386	0	396	0
357	0	367	40513	377	0	0	387	0	397	0
358	0	368	14148	378	0	0	388	26355	398	0
359	0	369	26305	379	0	0	389	26305	399	0
360	14775	370	26365	380	0	0	390	26355	400	0

BLOCK CURRENT	TOTAL	BLOCK CURRENT	TOTAL	BLOCK CURRENT	TOTAL	BLOCK CURRENT	TOTAL	BLOCK CURRENT	TOTAL	
401	0	411	26305	421	0	26326	431	1549	441	0
402	0	412	39	422	0	26326	432	1549	442	0
403	0	413	26366	423	0	26326	433	49590	443	0
404	0	414	26326	424	0	51139	434	24813	444	0
405	0	415	1	425	0	102278	435	24513	445	0
406	0	416	2	426	0	51139	436	24777	446	0
407	52730	417	1	427	0	51139	437	24777	447	0
408	26305	418	1	428	0	51139	438	24777	448	0
409	26305	419	1	429	0	51139	439	24777	449	0
410	0	420	52652	430	0	51139	440	24777	450	0

BLOCK CURRENT	TOTAL	BLOCK CURRENT	TOTAL	BLOCK CURRENT	TOTAL	BLOCK CURRENT	TOTAL	BLOCK CURRENT	TOTAL	
451	0	461	0	471	0	0	481	0	491	0
452	0	462	0	472	0	0	482	0	492	0
453	0	463	0	473	0	0	483	0	493	0
454	0	464	0	474	0	0	484	0	494	0
455	0	465	0	475	0	0	485	0	495	0
456	0	466	0	476	0	0	486	0	496	0
457	0	467	0	477	0	0	487	0	497	0
458	0	468	0	478	0	0	488	0	498	0
459	0	469	0	479	0	0	489	0	499	0
460	0	470	0	480	0	0	490	0	500	0

-72-

BLOCK CURRENT	TOTAL	BLOCK CURRENT	TOTAL	BLOCK CURRENT	TOTAL	BLOCK CURRENT	TOTAL	BLOCK CURRENT	TOTAL
501	C	511	0	521	0	531	0	541	0
502	C	512	0	522	0	532	0	542	0
503	C	513	0	523	0	533	0	543	0
504	C	514	0	524	0	534	0	544	0
505	C	515	0	525	0	535	0	545	0
506	C	516	0	526	0	536	0	546	0
507	C	517	0	527	0	537	0	547	0
508	C	518	0	528	0	538	0	548	0
509	C	519	0	529	0	539	0	549	0
510	C	520	0	530	0	540	0	550	0

BLOCK CURRENT	TOTAL	BLOCK CURRENT	TOTAL	BLOCK CURRENT	TOTAL	BLOCK CURRENT	TOTAL	BLOCK CURRENT	TOTAL
551	C	561	0	571	7	581	6	591	20
552	C	562	0	572	7	582	6	592	20
553	C	563	0	573	7	583	6	593	20
554	C	564	14775	574	177	584	6	594	20
555	C	565	26365	575	204	585	6	595	20
556	C	566	0	576	204	586	6	596	20
557	C	567	0	577	204	587	6	597	20
558	C	568	1	578	204	588	177	598	20
559	C	569	204	579	204	589	177	599	20
560	C	570	204	580	203	590	177	600	28

BLOCK CURRENT	TOTAL	BLOCK CURRENT	TOTAL	BLOCK CURRENT	TOTAL	BLOCK CURRENT	TOTAL	BLOCK CURRENT	TOTAL
601	C		28						
602	C		28						
603	C		28						

-78-

 * FACILITIES *

FACILITY	NUMBER ENTRIES	AVERAGE UTILIZATION DURING		CURRENT STATUS	PERCENT AVAILABILITY	TRANSACTION NUMBER SEIZING PREEMPTING
		AVAIL. TIME	UNAVAIL. TIME			
4	128556	.000	.000	100.0		
52	77409	.000	.000	100.0		
	204	67.422	.842			6

 2 STORAGES

STORAGE	CAPACITY	AVERAGE CONTENTS	ENTRIES	AVERAGE TIME/UNIT	AVERAGE UTILIZATION DURING			PERCENT AVAILABILITY	CURRENT CONTENTS	MAXIMUM CONTENTS
					TOTAL TIME	UNAVAIL. TIME	LUKRENT STATUS			
1AUEX	36000	.000	8074098	.000	.000		100.0		1000	
1AUEX	36000	420.365	432	10590.859	.000		100.0	432	432	
1AUEX	36000	407.540	432	10590.859	.000		100.0		772200	
1AUEX	36000	407.540	432	10590.859	.000		100.0		30560	
1AUEX	36000	407.540	432	10590.859	.000		100.0		4200	
1AUEX	36000	407.540	432	10590.859	.000		100.0		3000	
1AUEX	36000	407.540	432	10590.859	.000		100.0		3000	
1AUEX	36000	407.540	432	10590.859	.000		100.0		432	

 * QUEUES *

QUEUE	MAXIMUM CONTENTS	AVERAGE CONTENTS	TOTAL ENTRIES	ZERO ENTRIES	PERCENT ZEROS	AVERAGE TIME/TRANS	SAVERAGE TIME/TRANS	TABLE NUMBER	CURRENT CONTENTS
4	1	.000	40474	40474	100.0	.000	.000		
10	1	.000	20326	20326	100.0	.000	.000		

▶ AVERAGE TIME/TRANS = AVERAGE TIME/TRANS EXCLUDING ZERO ENTRIES

 * * * * * USER CHAINS * * * * *

USER CHAIN	TOTAL ENTRIES	AVERAGE TIME/TURNS	CURRENT CONTENTS	AVERAGE CONTENTS	MAXIMUM CONTENTS
4	77429	0.777	5	4.503	34
10	51143	4.232	4	13.637	41

 * FULLWORD SAVEVALUES *

NUMBER	CONTENTS	NUMBER	CONTENTS	NUMBER	CONTENTS	NUMBER	CONTENTS	NUMBER	CONTENTS	NUMBER	CONTENTS
4	861931	16	1497727	20	5	21	5	22	44	23	24
24	44	25	69	50	10039	101	100	102	1800	103	1800
104	1800	105	1800	106	1800	107	1800	108	1800	109	1800
110	1800	111	1800	112	1800	113	1800	114	1800	115	1800
116	1800	117	1800	118	1800	119	1800	120	1800	121	1800
122	1800	123	1800	124	1800	125	1800	126	1800	127	1800
128	1800	131	108	132	1800	133	1800	134	1800	135	1800
136	1800	137	1800	138	1800	139	1800	140	1800	141	1800
142	1800	143	1800	144	1800	145	1800	146	1800	147	1800
149	1800	149	1800	150	1800	151	1800	152	1800	153	1800
154	1800	155	1800	156	1800	157	1800	158	1800	159	432
162	432	163	432	164	432	165	432	166	432	167	432
168	432	169	432	170	432	171	432	172	432	173	432
174	432	175	432	176	432	177	432	178	432	179	432
180	432	181	432	182	432	183	432	184	432	185	432
186	432	187	432	188	432	252	34200	253	34200	254	34200
255	34200	256	34200	257	34200	258	34200	259	34200	260	34200
261	34200	262	34200	263	34200	264	34200	265	34200	266	34200
267	34200	268	34200	269	34200	270	34200	271	34200	272	34200
273	34200	274	34200	275	34200	276	34200	277	34200	278	34200
281	3600	282	3600	283	3600	284	3600	285	3600	286	3600
287	3600	288	3600	289	3600	290	3600	291	3600	292	3600
293	3600	294	3600	295	3600	296	3600	297	3600	298	3600
299	3600	300	3600	301	3600	302	3600	303	3600	304	3600
305	3600	306	3600	307	3600	308	3600	309	108	310	3600
313	3600	314	3600	315	3600	316	3600	317	3600	318	3600
319	3600	320	3600	321	3600	322	3600	323	3600	324	3600
325	3600	326	3600	327	3600	328	3600	329	3600	330	3600
331	3600	332	3600	333	3600	334	3600	335	3600	336	3600
337	3600	338	3600	341	432	342	432	343	432	344	432
345	432	346	432	347	432	348	432	349	432	350	432
351	432	352	432	353	432	354	432	355	432	356	432
357	432	358	432	359	432	360	432	361	432	362	432
363	432	364	432	365	432	366	432	367	432	368	432

RELATIVE CLOCK		16800		ABSOLUTE CLOCK		16800									
BLOCK COUNTS															
BLOCK CURRENT	TOTAL	BLOCK CURRENT	TOTAL	BLOCK CURRENT	TOTAL	BLOCK CURRENT	TOTAL	BLOCK CURRENT	TOTAL	BLOCK CURRENT	TOTAL	BLOCK CURRENT	TOTAL	BLOCK CURRENT	TOTAL
1	0	429	0	51470	0	21	0	31	0	41	0	0	0	0	0
2	0	429	0	25738	0	22	0	32	0	42	0	0	0	0	0
3	0	3	0	25738	0	23	0	33	0	43	0	0	0	0	0
4	0	426	0	25738	0	24	0	34	0	44	0	0	0	0	0
5	0	426	0	25738	0	25	0	35	0	45	0	0	0	0	0
6	0	24812	0	25738	0	26	0	36	0	46	0	0	0	0	0
7	0	51470	0	25738	0	27	0	37	0	47	0	0	0	0	0
8	0	25738	0	25738	0	28	0	38	0	48	0	0	0	0	0
9	0	426	0	0	0	29	0	39	0	49	0	0	0	0	0
10	0	51470	0	0	0	30	0	40	0	50	0	0	0	0	0
51	0	51470	0	0	0	71	0	66494	0	91	0	0	0	0	0
52	0	25738	0	0	0	72	0	43247	0	92	0	0	0	0	0
53	0	25738	0	0	0	73	0	43247	0	93	0	0	0	0	0
54	0	25738	0	0	0	74	0	43247	0	94	0	0	0	0	0
55	0	25738	0	0	0	75	0	43247	0	95	0	0	0	0	0
56	0	0	0	51470	0	76	0	43247	0	96	0	0	0	0	0
57	0	25738	0	25738	0	77	0	1462	0	97	0	0	0	0	0
58	0	0	0	25738	0	78	0	1462	0	98	0	0	0	0	0
59	0	25738	0	25738	0	79	0	41705	0	99	0	0	0	0	0
60	0	25738	0	43247	0	80	0	17509	0	100	0	0	0	0	0
101	0	0	0	111	0	121	0	131	0	141	0	0	0	0	0
102	0	0	0	112	0	122	0	132	0	142	0	0	0	0	0
103	0	0	0	113	0	123	0	133	0	143	0	0	0	0	0
104	0	0	0	114	0	124	0	134	0	144	0	0	0	0	0
105	0	0	0	115	0	125	0	135	0	145	0	0	0	0	0
106	0	0	0	116	0	126	0	136	0	146	0	0	0	0	0
107	0	0	0	117	0	127	0	137	0	147	0	0	0	0	0
108	0	0	0	118	0	128	0	138	0	148	0	0	0	0	0
109	0	0	0	119	0	129	0	139	0	149	0	0	0	0	0
110	0	0	0	120	0	130	0	140	0	150	0	0	0	0	0
151	0	25738	0	101	0	171	0	181	0	191	0	19345	0	0	0
152	0	20193	0	102	0	20193	0	182	0	192	0	19345	0	0	0
153	0	6393	0	153	0	20193	0	183	0	193	0	0	0	0	0
154	0	6393	0	104	0	20193	0	184	0	194	0	0	0	0	0
155	0	6393	0	155	0	20193	0	185	0	195	0	0	0	0	0
156	0	6393	0	156	0	0	0	186	0	196	0	0	0	0	0
157	0	6393	0	157	0	0	0	187	0	197	0	0	0	0	0
158	0	0	0	158	0	0	0	188	0	198	0	0	0	0	0
159	0	0	0	159	0	0	0	189	0	199	0	0	0	0	0
160	0	0	0	170	0	0	0	190	0	200	0	0	0	0	0
201	0	0	0	211	0	19345	0	231	0	241	0	0	0	0	0
202	0	3474	0	212	0	19345	0	232	0	242	0	12366	0	0	0
203	0	3474	0	213	0	19345	0	233	0	243	0	12366	0	0	0
204	0	3474	0	214	0	0	0	234	0	244	0	8075	0	0	0
205	0	0	0	215	0	0	0	235	0	245	0	6979	0	0	0
206	0	0	0	216	0	0	0	236	0	246	0	6979	0	0	0
207	0	0	0	217	0	0	0	237	0	247	0	1695	0	0	0
208	0	19345	0	218	0	0	0	238	0	248	0	840	0	0	0
209	0	19345	0	219	0	0	0	239	0	249	0	340	0	0	0

210	0	19345	220	0	25738	230	0	0	240	0	1	250	0	848
BLOCK CURRENT	TOTAL	BLOCK CURRENT	TOTAL	BLOCK CURRENT	TOTAL	BLOCK CURRENT	TOTAL	BLOCK CURRENT	TOTAL	BLOCK CURRENT	TOTAL	BLOCK CURRENT	TOTAL	
251	0	848	261	0	848	271	0	14775	281	0	0	291	0	14775
252	0	0	262	0	848	272	0	14775	282	0	0	292	0	14775
253	0	0	263	0	848	273	0	14775	283	0	0	293	0	14775
254	0	0	264	0	0	274	0	14775	284	0	0	294	0	0
255	0	0	265	0	0	275	0	0	285	0	0	295	0	0
256	0	0	266	0	0	276	0	0	286	0	0	296	0	0
257	0	0	267	0	14775	277	0	0	287	0	0	297	0	0
258	0	0	268	0	14775	278	0	0	288	0	14775	298	0	0
259	0	0	269	0	14775	279	0	0	289	0	14775	299	0	0
260	0	0	270	0	14775	280	0	0	290	0	14775	300	0	0
BLOCK CURRENT	TOTAL	BLOCK CURRENT	TOTAL	BLOCK CURRENT	TOTAL	BLOCK CURRENT	TOTAL	BLOCK CURRENT	TOTAL	BLOCK CURRENT	TOTAL	BLOCK CURRENT	TOTAL	
301	0	0	311	0	14775	321	0	14749	331	0	2100	341	0	44848
302	0	0	312	0	26	322	0	14749	332	0	2100	342	0	44848
303	0	0	313	0	14776	323	0	14749	333	0	42748	343	0	44848
304	0	0	314	0	14749	324	0	44848	334	0	30099	344	0	44848
305	0	0	315	0	1	325	0	89696	335	0	30099	345	0	0
306	0	0	316	0	2	326	0	44848	336	0	12649	346	0	0
307	0	29550	317	0	1	327	0	44848	337	0	12649	347	0	0
308	0	14775	318	0	1	328	0	44848	338	0	12649	348	0	0
309	0	14775	319	0	1	329	0	44848	339	0	12649	349	0	0
310	0	0	320	0	29498	330	0	44848	340	0	12649	350	0	0
BLOCK CURRENT	TOTAL	BLOCK CURRENT	TOTAL	BLOCK CURRENT	TOTAL	BLOCK CURRENT	TOTAL	BLOCK CURRENT	TOTAL	BLOCK CURRENT	TOTAL	BLOCK CURRENT	TOTAL	
351	0	0	361	0	0	371	0	40513	381	0	0	391	0	0
352	0	0	362	0	0	372	0	40513	382	0	0	392	0	0
353	0	0	363	0	0	373	0	14148	383	0	0	393	0	26365
354	0	0	364	0	0	374	0	26365	384	0	0	394	0	26365
355	0	0	365	0	14775	375	0	26365	385	0	0	395	0	26365
356	0	0	366	0	14775	376	0	26365	386	0	0	396	0	26365
357	0	0	367	0	14775	377	0	26365	387	0	0	397	0	26365
358	0	0	368	0	25738	378	0	26365	388	0	0	398	0	26365
359	0	0	369	0	25738	379	0	26365	389	0	0	399	0	0
360	0	0	370	0	25738	380	0	0	390	0	0	400	0	0
BLOCK CURRENT	TOTAL	BLOCK CURRENT	TOTAL	BLOCK CURRENT	TOTAL	BLOCK CURRENT	TOTAL	BLOCK CURRENT	TOTAL	BLOCK CURRENT	TOTAL	BLOCK CURRENT	TOTAL	
401	0	0	411	0	0	421	0	2	431	0	50530	441	0	24166
402	0	0	412	0	52730	422	0	1	432	0	50530	442	0	24166
403	0	0	413	0	26365	423	0	1	433	0	50530	443	0	24166
404	0	0	414	0	26365	424	0	1	434	0	50530	444	0	24166
405	0	0	415	0	0	425	0	52678	435	0	50530	445	0	24166
406	0	0	416	0	26365	426	0	26339	436	0	2173	446	0	50530
407	0	0	417	0	26	427	0	26339	437	0	2173	447	0	50530
408	0	0	418	0	26365	428	0	26339	438	0	48357	448	0	50530
409	0	0	419	0	26339	429	0	50530	439	0	24191	449	0	50530
410	0	0	420	0	1	430	0	101060	440	0	24191	450	0	0
BLOCK CURRENT	TOTAL	BLOCK CURRENT	TOTAL	BLOCK CURRENT	TOTAL	BLOCK CURRENT	TOTAL	BLOCK CURRENT	TOTAL	BLOCK CURRENT	TOTAL	BLOCK CURRENT	TOTAL	
451	0	0	461	0	0	471	0	0	481	0	0	491	0	0
452	0	0	462	0	0	472	0	0	482	0	0	492	0	0
453	0	0	463	0	0	473	0	0	483	0	0	493	0	0
454	0	0	464	0	0	474	0	0	484	0	0	494	0	0
455	0	0	465	0	0	475	0	0	485	0	0	495	0	0
456	0	0	466	0	0	476	0	0	486	0	0	496	0	0
457	0	0	467	0	0	477	0	0	487	0	0	497	0	0
458	0	0	468	0	0	478	0	0	488	0	0	498	0	0
459	0	0	469	0	0	479	0	0	489	0	0	499	0	0
460	0	0	470	0	0	480	0	0	490	0	0	500	0	0

-08-

BLOCK CURRENT	TOTAL	BLOCK CURRENT	TOTAL	BLOCK CURRENT	TOTAL	BLOCK CURRENT	TOTAL	BLOCK CURRENT	TOTAL
501	0	511	0	521	0	531	0	541	0
502	0	512	0	522	0	532	0	542	0
503	0	513	0	523	0	533	0	543	0
504	0	514	0	524	0	534	0	544	0
505	0	515	0	525	0	535	0	545	0
506	0	516	0	526	0	536	0	546	0
507	0	517	0	527	0	537	0	547	0
508	0	518	0	528	0	538	0	548	0
509	0	519	0	529	0	539	0	549	0
510	0	520	0	530	0	540	0	550	0

BLOCK CURRENT	TOTAL	BLOCK CURRENT	TOTAL	BLOCK CURRENT	TOTAL	BLOCK CURRENT	TOTAL	BLOCK CURRENT	TOTAL
551	0	561	0	571	0	581	0	591	0
552	0	562	0	572	0	582	0	592	0
553	0	563	0	573	0	583	0	593	0
554	0	564	0	574	0	584	0	594	0
555	0	565	0	575	0	585	0	595	0
556	0	566	0	576	0	586	1	596	0
557	0	567	0	577	0	587	0	597	0
558	0	568	0	578	0	588	0	598	0
559	0	569	0	579	0	589	0	599	0
560	0	570	0	580	0	590	0	600	0

BLOCK CURRENT	TOTAL	BLOCK CURRENT	TOTAL	BLOCK CURRENT	TOTAL	BLOCK CURRENT	TOTAL	BLOCK CURRENT	TOTAL
601	0	611	0	621	0	631	0	641	0
602	0	612	0	622	0	632	0	642	0
603	0	613	0	623	0	633	0	643	0
604	0								
605	0								
606	0								
607	0								
608	0								
609	0								
610	0								

-81-

 * FACILITIES *

FACILITY	NUMBER ENTRIES	AVERAGE TIME/TRAN	AVERAGE UTILIZATION DURING-		CURRENT STATUS	PERCENT AVAILABILITY	TRANSACTION NUMBER SEIZING-PREEMPTING
			TOTAL TIME	UNAVAIL. TIME			
4	128582	.000	.000			100.0	
13	70359	.000	.000			100.0	
50	234	69.422	.842				6

 * STORAGES *

STORAGE	CAPACITY	AVERAGE CONTENTS	ENTRIES	-AVERAGE UTILIZATION DURING-		CURRENT STATUS	PERCENT AVAILABILITY	CURRENT CONTENTS	MAXIMUM CONTENTS
				AVERAGE TIME/UNIT	TOTAL TIME				
RAUEX	36000	.000	8674698	.000	.000		100.0		1800
IGEXP	36000	.000	8674698	.000	.000		100.0		1800
CPUEX	288	284.355	288	16587.406	.987		100.0	288	288
HRSEC	36000000	1521904.000	41121762	8792.621	.597		100.0	36000000	36566
VNREC	36000000	467.540	5055595	1.554	.000		100.0		1620
FM SIG	36000	.000	4813153	.000	.000		100.0	1080000	1080000
KUSIG	1080000	753571.375	35524348	358.740	.702		100.0		3600
KUSU	36000	.000	14987124	.000	.000		100.0		3600
IUSUB	36000	.000	14987124	.000	.000		100.0		3600
CPUSU	288	284.355	288	16587.406	.987		100.0	288	288

 * QUEUES *

QUEUE	MAXIMUM CONTENTS	AVERAGE CONTENTS	TOTAL ENTRIES	ZERO ENTRIES	PERCENT ZEROS	AVERAGE TIME/TRANS	AVERAGE TIME/TRANS	TABLE NUMBER	CURRENT CONTENTS
4	1	.000	47487	47487	100.0	.000	.000		
16	1	.000	26339	26339	100.0	.000	.000		

\$ AVERAGE TIME/TRANS = AVERAGE TIME/TRANS EXCLUDING ZERU ENTRIES

 * USER CHAINS *

USER CHAIN	TOTAL ENTRIES	AVERAGE TIME/TRANS	CURRENT CONTENTS	AVERAGE CONTENTS	MAXIMUM CONTENTS
4	77439	.892	5	4.114	54
16	57532	3.217	2	9.655	23

FULLWORD SAVEVALUES

NUMBER	CONTENTS	NUMBER	CONTENTS	NUMBER	CONTENTS	NUMBER	CONTENTS	NUMBER	CONTENTS	NUMBER	CONTENTS
4	861932	5	65703066	12	36000000	16	1497871	20	5	21	5
22	46	23	22	24	44	25	297	26	16689	101	108
102	1800	103	1800	104	1800	105	1800	106	1800	107	1800
108	1800	109	1800	110	1800	111	1800	112	1800	113	1800
114	1800	115	1800	116	1800	117	1800	118	1800	119	1800
120	1800	121	1800	122	1800	123	1800	124	1800	125	1800
126	1800	127	1800	128	1800	131	1800	132	1800	133	1800
134	1800	135	1800	136	1800	137	1800	138	1800	139	1800
140	1800	141	1800	142	1800	143	1800	144	1800	145	1800
146	1800	147	1800	148	1800	149	1800	150	1800	151	1800
152	1800	153	1800	154	1800	155	1800	156	1800	157	1800
158	1800	159	1800	160	1800	161	1800	162	1800	163	1800
164	288	165	288	166	288	167	288	168	288	169	288
170	288	171	288	172	288	173	288	174	288	175	288
176	288	177	288	178	288	179	288	180	288	181	288
182	288	183	288	184	288	185	288	186	288	187	288
188	288	189	288	190	288	191	288	192	288	193	288
194	288	195	288	196	288	197	288	198	288	199	288
200	13	201	16	202	20	203	28	204	35	205	36
206	36	207	36	208	36	209	36	210	36	211	36
212	36	213	36	214	36	215	36	216	36	217	36
218	36	219	36	220	36	221	36	222	36	223	36
224	3600	225	3600	226	3600	227	3600	228	3600	229	3600
230	3600	231	3600	232	3600	233	3600	234	3600	235	3600
236	3600	237	3600	238	3600	239	3600	240	3600	241	3600
242	3600	243	3600	244	3600	245	3600	246	3600	247	3600
248	3600	249	3600	250	3600	251	3600	252	3600	253	3600
254	3600	255	3600	256	3600	257	3600	258	3600	259	3600
260	3600	261	3600	262	3600	263	3600	264	3600	265	3600
266	3600	267	3600	268	3600	269	3600	270	3600	271	3600
272	3600	273	3600	274	3600	275	3600	276	3600	277	3600
278	3600	279	3600	280	3600	281	3600	282	3600	283	3600
284	3600	285	3600	286	3600	287	3600	288	3600	289	3600
290	3600	291	3600	292	3600	293	3600	294	3600	295	3600
296	3600	297	3600	298	3600	299	3600	300	3600	301	3600
302	3600	303	3600	304	3600	305	3600	306	3600	307	3600
308	3600	309	3600	310	3600	311	3600	312	3600	313	3600
314	3600	315	3600	316	3600	317	3600	318	3600	319	3600
320	3600	321	3600	322	3600	323	3600	324	3600	325	3600
326	3600	327	3600	328	3600	329	3600	330	3600	331	3600
332	3600	333	3600	334	3600	335	3600	336	3600	337	3600
338	3600	339	3600	340	3600	341	3600	342	3600	343	3600
344	288	345	288	346	288	347	288	348	288	349	288
350	288	351	288	352	288	353	288	354	288	355	288
356	288	357	288	358	288	359	288	360	288	361	288
362	288	363	288	364	288	365	288	366	288	367	288
368	288										

86

RELATIVE CLOCK

16800 ABSOLUTE CLOCK

16800

BLOCK COUNTS

BLOCK CURRENT	TOTAL	BLOCK CURRENT	TOTAL	BLOCK CURRENT	TOTAL	BLOCK CURRENT	TOTAL	BLOCK CURRENT	TOTAL
1	929	11	51476	21	0	31	0	41	0
2	929	12	25738	22	0	32	0	42	0
3	0	13	25738	23	0	33	0	43	0
4	926	14	25738	24	0	34	0	44	0
5	0	15	25738	25	0	35	0	45	0
6	24812	16	25738	26	0	36	0	46	0
7	51476	17	25738	27	0	37	0	47	0
8	25738	18	25738	28	0	38	0	48	0
9	926	19	0	29	0	39	0	49	0
10	51476	20	0	30	0	40	0	50	0

BLOCK CURRENT	TOTAL	BLOCK CURRENT	TOTAL	BLOCK CURRENT	TOTAL	BLOCK CURRENT	TOTAL	BLOCK CURRENT	TOTAL
51	51476	61	0	71	85494	81	17509	91	0
52	25738	62	0	72	43247	82	24276	92	0
53	25738	63	0	73	43247	83	24276	93	0
54	25738	64	0	74	43247	84	24276	94	0
55	25738	65	0	75	43247	85	24276	95	0
56	0	66	51476	76	43247	86	24276	96	0
57	25738	67	25738	77	1402	87	32536	97	0
58	0	68	25738	78	1402	88	32536	98	0
59	25738	69	25738	79	41785	89	32536	99	0
60	25738	70	43247	80	17509	90	32536	100	0

BLOCK CURRENT	TOTAL	BLOCK CURRENT	TOTAL	BLOCK CURRENT	TOTAL	BLOCK CURRENT	TOTAL	BLOCK CURRENT	TOTAL
101	0	111	0	121	0	131	0	141	0
102	0	112	0	122	0	132	0	142	0
103	0	113	0	123	0	133	0	143	0
104	0	114	0	124	0	134	0	144	0
105	0	115	0	125	0	135	0	145	0
106	0	116	0	126	0	136	0	146	0
107	0	117	0	127	0	137	0	147	0
108	0	118	0	128	0	138	0	148	0
109	0	119	0	129	0	139	0	149	0
110	0	120	0	130	0	140	0	150	0

BLOCK CURRENT	TOTAL	BLOCK CURRENT	TOTAL	BLOCK CURRENT	TOTAL	BLOCK CURRENT	TOTAL	BLOCK CURRENT	TOTAL
151	0	161	0	171	0	181	0	191	0
152	0	162	5572	172	11144	182	0	192	0
153	0	163	5572	173	5572	183	0	193	0
154	0	164	5572	174	5572	184	0	194	0
155	0	165	5572	175	5572	185	0	195	0
156	0	166	0	176	5572	186	0	196	0
157	0	167	0	177	0	187	0	197	0
158	0	168	0	178	0	188	0	198	0
159	0	169	0	179	0	189	0	199	0
160	0	170	0	180	0	190	0	200	5572

BLOCK CURRENT	TOTAL	BLOCK CURRENT	TOTAL	BLOCK CURRENT	TOTAL	BLOCK CURRENT	TOTAL	BLOCK CURRENT	TOTAL
201	0	211	0	221	25738	231	5572	241	0
202	0	212	0	222	25738	232	5572	242	11144
203	0	213	0	223	25738	233	5572	243	5572
204	0	214	0	224	25738	234	0	244	5572
205	0	215	0	225	25738	235	0	245	5572
206	0	216	0	226	0	236	0	246	5572
207	0	217	0	227	0	237	0	247	0
208	0	218	25738	228	0	238	0	248	0
		219	25738	229	0	239	0	249	0

-87-

219	0	0	220	0	25738	230	0	5572	240	0	0	250	0	0
BLCK CURRENT	TOTAL	BLCK CURRENT	TOTAL	BLCK CURRENT	TOTAL	BLCK CURRENT	TOTAL	BLCK CURRENT	TOTAL	BLCK CURRENT	TOTAL	BLCK CURRENT	TOTAL	
251	0	0	261	0	0	271	0	0	281	0	0	291	0	0
252	0	0	262	0	14775	272	0	0	282	0	0	292	0	0
253	0	0	263	0	14775	273	0	0	283	0	14775	293	0	0
254	0	0	264	0	14775	274	0	0	284	0	14775	294	0	0
255	0	0	265	0	14775	275	0	0	285	0	14775	295	0	0
256	0	5572	266	0	14775	276	0	0	286	0	14775	296	0	0
257	0	5572	267	0	14775	277	0	0	287	0	14775	297	0	0
258	0	5572	268	0	14775	278	0	0	288	0	14775	298	0	0
259	0	0	269	0	14775	279	0	0	289	0	0	299	0	0
260	0	0	270	0	0	280	0	0	290	0	0	300	0	0

BLCK CURRENT	TOTAL	BLCK CURRENT	TOTAL	BLCK CURRENT	TOTAL	BLCK CURRENT	TOTAL	BLCK CURRENT	TOTAL	BLCK CURRENT	TOTAL			
301	0	311	0	2	321	0	44848	331	0	12049	341	0	0	
302	0	29550	312	0	1	322	0	44848	332	0	12049	342	0	0
303	0	14775	313	0	1	323	0	44848	333	0	12049	343	0	0
304	0	14775	314	0	1	324	0	44848	334	0	12049	344	0	0
305	0	0	315	0	29498	325	0	44848	335	0	12049	345	0	0
306	0	14775	316	0	14749	326	0	2100	336	0	44848	346	0	0
307	0	26	317	0	14749	327	0	2100	337	0	44848	347	0	0
308	0	14775	318	0	14749	328	0	42748	338	0	44848	348	0	0
309	0	14749	319	0	44848	329	0	30099	339	0	44848	349	0	0
310	0	1	320	0	89698	330	0	30099	340	0	350	0	0	

BLCK CURRENT	TOTAL	BLCK CURRENT	TOTAL	BLCK CURRENT	TOTAL	BLCK CURRENT	TOTAL	BLCK CURRENT	TOTAL	BLCK CURRENT	TOTAL			
351	0	0	361	0	14775	371	0	26365	381	0	0	391	0	26365
352	0	0	362	0	14775	372	0	26365	382	0	0	392	0	26365
353	0	0	363	0	25738	373	0	26365	383	0	0	393	0	26365
354	0	0	364	0	25738	374	0	26365	384	0	0	394	0	0
355	0	0	365	0	25738	375	0	0	385	0	0	395	0	0
356	0	0	366	0	42513	376	0	0	386	0	0	396	0	0
357	0	0	367	0	42513	377	0	0	387	0	0	397	0	0
358	0	0	368	0	14143	378	0	0	388	0	26365	398	0	0
359	0	0	369	0	26365	379	0	0	389	0	26365	399	0	0
360	0	14775	370	0	26365	380	0	0	390	0	26365	400	0	0

BLCK CURRENT	TOTAL	BLCK CURRENT	TOTAL	BLCK CURRENT	TOTAL	BLCK CURRENT	TOTAL	BLCK CURRENT	TOTAL	BLCK CURRENT	TOTAL			
401	0	0	411	0	26365	421	0	26339	431	0	2173	441	0	50530
402	0	0	412	0	26	422	0	26339	432	0	2173	442	0	50530
403	0	0	413	0	26366	423	0	26339	433	0	48357	443	0	50530
404	0	0	414	0	26339	424	0	50530	434	0	24191	444	0	50530
405	0	0	415	0	1	425	0	101367	435	0	24191	445	0	0
406	0	0	416	0	2	426	0	50530	436	0	24166	446	0	0
407	0	52750	417	0	1	427	0	50530	437	0	24166	447	0	0
408	0	26365	418	0	1	428	0	50530	438	0	24166	448	0	0
409	0	26365	419	0	1	429	0	50530	439	0	24166	449	0	0
410	0	0	420	0	52678	430	0	50530	440	0	24166	450	0	0

BLCK CURRENT	TOTAL	BLCK CURRENT	TOTAL	BLCK CURRENT	TOTAL	BLCK CURRENT	TOTAL	BLCK CURRENT	TOTAL	BLCK CURRENT	TOTAL			
451	0	0	461	0	0	471	0	0	481	0	0	491	0	0
452	0	0	462	0	0	472	0	0	482	0	0	492	0	0
453	0	0	463	0	0	473	0	0	483	0	0	493	0	0
454	0	0	464	0	0	474	0	0	484	0	0	494	0	0
455	0	0	465	0	0	475	0	0	485	0	0	495	0	0
456	0	0	466	0	0	476	0	0	486	0	0	496	0	0
457	0	0	467	0	0	477	0	0	487	0	0	497	0	0
458	0	0	468	0	0	478	0	0	488	0	0	498	0	0

BLOCK CURRENT	TOTAL	BLOCK CURRENT	TOTAL	BLOCK CURRENT	TOTAL	BLOCK CURRENT	TOTAL	BLOCK CURRENT	TOTAL
501	0	511	0	521	0	531	0	541	0
502	0	512	0	522	0	532	0	542	0
503	0	513	0	523	0	533	0	543	0
504	0	514	0	524	0	534	0	544	0
505	0	515	0	525	0	535	0	545	0
506	0	516	0	526	0	536	0	546	0
507	0	517	0	527	0	537	0	547	0
508	0	518	0	528	0	538	0	548	0
509	0	519	0	529	0	539	0	549	0
510	0	520	0	530	0	540	0	550	0

BLOCK CURRENT	TOTAL	BLOCK CURRENT	TOTAL	BLOCK CURRENT	TOTAL	BLOCK CURRENT	TOTAL	BLOCK CURRENT	TOTAL
551	0	561	0	571	7	581	0	591	0
552	0	562	0	572	7	582	0	592	0
553	0	563	0	573	7	583	0	593	0
554	0	564	14775	574	197	584	0	594	0
555	0	565	26365	575	204	585	0	595	0
556	0	566	0	576	0	586	0	596	0
557	0	567	0	577	0	587	0	597	0
558	0	568	1	578	0	588	0	598	0
559	0	569	0	579	1	589	0	599	0
560	0	570	204	580	0	590	0	600	0

BLOCK CURRENT	TOTAL	BLOCK CURRENT	TOTAL	BLOCK CURRENT	TOTAL	BLOCK CURRENT	TOTAL	BLOCK CURRENT	TOTAL
601	0		28						
602	0		28						
603	0		28						

 * FACILITIES *

FACILITY	NUMBER ENTRIES	AVERAGE TIME/ENTRY	UTILIZATION DURING		CURRENT STATUS	PERCENT AVAILABILITY	TRANSACTION NUMBER SETTING-PREEMPTING
			TOTAL AVAIL. TIME	UNAVAIL. TIME			
4	128582	.077	.000			100.0	
18	78807	.056	.000			100.0	
20	274	63.137	.766			100.0	6

STORAGES

STORAGE	CAPACITY	AVERAGE CONTENTS	ENTRIES	AVERAGE TIME/UNIT	-AVERAGE UTILIZATION DURING-		CURRENT STATUS	PERCENT AVAILABILITY	CURRENT CONTENTS	MAXIMUM CONTENTS
					TOTAL TIME	UNAVAIL. TIME				
KAUEA	30000	.000	0074090	.000	.000		100.0		1000	
LDLXP	30000	.00	0074093	.000	.000		100.0		1000	
CPJEX	288	204.355	288	10587.400	.987		100.0	288	288	
MAKEC	3000000	19251.332	30672732	10.544	.000		100.0		865918	
MAKEC	3000000	911.131	1451753	10.544	.000		100.0		40999	
KUSIG	1000000	.000	147900372	.000	.000		100.0		34200	
RAUSU	30000	.000	14987124	.000	.000		100.0		3600	
LDJUS	30000	.00	14987124	.000	.000		100.0	288	3600	
CPJUS	288	204.355	288	10587.400	.987		100.0	288	288	

 * QUEUES *

QUEUE	MAXIMUM CONTENTS	AVERAGE CONTENTS	TOTAL ENTRIES	ZERO ENTRIES	PERCENT ZEROS	AVERAGE TIME/TRANS	\$ AVERAGE TIME/TRANS	TABLE NUMBER	CURRENT CONTENTS
4	1	.000	40487	40487	100.0	.000	.000		
10	1	.000	20339	20339	100.0	.000	.000		

\$ AVERAGE TIME/TRANS = AVERAGE TIME/TRANS EXCLUDING ZERO ENTRIES

* USER CHAINS *

USER CHAIN	TOTAL ENTRIES	AVERAGE TIME/TRANS	CURRENT CONTENTS	AVERAGE CONTENTS	MAXIMUM CONTENTS
4	77439	.892	5	4.114	54
16	55532	3.210	2	9.635	28

FULL WORD SAVEVALUES

NUMBER - CONTENTS	NUMBER - CONTENTS	NUMBER - CONTENTS	NUMBER - CONTENTS	NUMBER - CONTENTS	NUMBER - CONTENTS	NUMBER - CONTENTS	NUMBER - CONTENTS	NUMBER - CONTENTS	NUMBER - CONTENTS
24 351932	16 1497371	23 5	21 5	22 44	23 23	24 22	25 1800	26 1500	27 1500
25 54	27 297	50 16689	171 108	102 1800	103 103	104 1500	105 1500	106 1400	107 1400
104 1400	105 1800	106 1800	107 1800	108 1800	109 109	110 1500	111 1500	112 1800	113 1500
111 1500	112 1500	113 1800	114 1800	115 1800	116 116	117 1800	118 1800	119 1800	120 1800
117 1500	118 1800	119 1800	120 1800	121 1800	121 121	122 1800	123 1800	124 1800	125 1300
122 1300	123 1800	124 1800	125 1800	126 1800	127 127	128 1800	129 1800	130 1800	131 1800
129 1800	130 1800	131 1800	132 1800	133 1800	132 132	133 1800	134 1800	135 1800	136 1800
132 1800	133 1800	134 1800	135 1800	136 1800	135 135	136 1800	137 1800	138 1800	139 1800
137 1800	138 1800	139 1800	140 1800	141 1800	141 141	142 1800	143 1800	144 1800	145 1800
143 1800	144 1800	145 1800	146 1800	147 1800	147 147	148 1800	149 1800	150 1800	151 1800
150 1800	151 1800	152 1800	153 1800	154 1800	153 153	155 1800	156 1800	157 1800	158 1800
154 1800	155 1800	156 1800	157 1800	158 1800	158 158	159 1800	160 1800	161 1800	162 1800
162 288	163 288	164 288	165 288	166 288	167 167	168 288	169 288	170 288	171 288
169 288	170 288	171 288	172 288	173 288	172 172	173 288	174 288	175 288	176 288
174 288	175 288	176 288	177 288	178 288	177 177	178 288	179 288	180 288	181 288
180 288	181 288	182 288	183 288	184 288	184 184	185 288	186 288	187 288	188 288
187 288	188 288	189 288	190 288	191 288	189 189	192 288	193 288	194 288	195 288
194 288	195 288	196 288	197 288	198 288	196 196	199 288	200 288	201 288	202 288
201 288	202 288	203 288	204 288	205 288	204 204	206 288	207 288	208 288	209 288
207 288	208 288	209 288	210 288	211 288	209 209	212 288	213 288	214 288	215 288
214 288	215 288	216 288	217 288	218 288	217 217	219 288	220 288	221 288	222 288
222 288	223 288	224 288	225 288	226 288	225 225	227 288	228 288	229 288	230 288
229 288	230 288	231 288	232 288	233 288	230 230	234 288	235 288	236 288	237 288
234 288	235 288	236 288	237 288	238 288	237 237	239 288	240 288	241 288	242 288
241 288	242 288	243 288	244 288	245 288	242 242	246 288	247 288	248 288	249 288
249 288	250 288	251 288	252 288	253 288	251 251	254 288	255 288	256 288	257 288
254 288	255 288	256 288	257 288	258 288	257 257	259 288	260 288	261 288	262 288
261 288	262 288	263 288	264 288	265 288	264 264	266 288	267 288	268 288	269 288
267 288	268 288	269 288	270 288	271 288	269 269	272 288	273 288	274 288	275 288
274 288	275 288	276 288	277 288	278 288	276 276	279 288	280 288	281 288	282 288
281 288	282 288	283 288	284 288	285 288	284 284	286 288	287 288	288 288	289 288
287 288	288 288	289 288	290 288	291 288	289 289	292 288	293 288	294 288	295 288
294 288	295 288	296 288	297 288	298 288	296 296	299 288	300 288	301 288	302 288
299 288	300 288	301 288	302 288	303 288	302 302	304 288	305 288	306 288	307 288
304 288	305 288	306 288	307 288	308 288	307 307	309 288	310 288	311 288	312 288
307 288	308 288	309 288	310 288	311 288	310 310	312 288	313 288	314 288	315 288
312 288	313 288	314 288	315 288	316 288	315 315	317 288	318 288	319 288	320 288
314 288	315 288	316 288	317 288	318 288	317 317	319 288	320 288	321 288	322 288
317 288	318 288	319 288	320 288	321 288	318 318	322 288	323 288	324 288	325 288
322 288	323 288	324 288	325 288	326 288	323 323	327 288	328 288	329 288	330 288
325 288	326 288	327 288	328 288	329 288	327 327	330 288	331 288	332 288	333 288
329 288	330 288	331 288	332 288	333 288	330 330	334 288	335 288	336 288	337 288
332 288	333 288	334 288	335 288	336 288	333 333	337 288	338 288	339 288	340 288
337 288	338 288	339 288	340 288	341 288	337 337	342 288	343 288	344 288	345 288
340 288	341 288	342 288	343 288	344 288	341 341	345 288	346 288	347 288	348 288
343 288	344 288	345 288	346 288	347 288	345 345	348 288	349 288	350 288	351 288
347 288	348 288	349 288	350 288	351 288	348 348	352 288	353 288	354 288	355 288
351 288	352 288	353 288	354 288	355 288	352 352	356 288	357 288	358 288	359 288
354 288	355 288	356 288	357 288	358 288	356 356	359 288	360 288	361 288	362 288
357 288	358 288	359 288	360 288	361 288	359 359	362 288	363 288	364 288	365 288
362 288	363 288	364 288	365 288	366 288	364 364	367 288	368 288	369 288	370 288
365 288	366 288	367 288	368 288	369 288	367 367	370 288	371 288	372 288	373 288

SAMPLE DMS STATISTICS

EQPT NO.	STATISTIC	BASE	1	2	3	4
2	Experiment RAU					
	MAX. CONTENTS (K BITS)	1800	1800	1800	1800	1800
	AVG. TIME/TRANS.	0	0	0	0	0
	TOTAL ENTRIES	8,674,698	8,674,698	8,674,698	8,674,698	8,674,698
3	Experiment I/O					
	MAX. CONTENTS (K BITS)	1800	1800	1800	1800	1800
	AVG. TIME/TRANS.	0	0	0	0	0
	TOTAL ENTRIES	8,674,698	8,674,698	8,674,698	8,674,698	8,674,698
4	Experiment Computer					
	MAX. CONTENTS (K BITS)	288	288	432*	288	288
	AVG. TIME/TRANS.	.892	.892	.977*	.892	.892
	TOTAL ENTRIES	77,439	77,439	77,426*	77,439	77,439
	DATA LOST (K BITS)	861,932	861,932	861,931*	861,932	861,932
14	Subsystem RAU					
	MAX. CONTENTS (K BITS)	3600	3600	3600	3600	3600
	AVG. TIME/TRANS.	0	0	0	0	0
	TOTAL ENTRIES	14,987,124	14,987,124	14,987,124	14,987,124	14,987,124
15	Subsystem I/O					
	MAX. CONTENTS (K BITS)	3600	3600	3600	3600	3600
	AVG. TIME/TRANS.	0	0	0	0	0
	TOTAL ENTRIES	14,987,124	14,987,124	14,987,124	14,987,124	14,987,124
16	Subsystem Computer					
	MAX. CONTENTS (K BITS)	288	288	432*	288	288
	AVG. TIME/TRANS.	3.21	3.21	4.282*	3.21	3.21
	TOTAL ENTRIES	50,532	50,532	51,143*	50,532	50,532
	DATA LOST (K BITS)	1,497,871	1,497,871	1,497,727*	1,497,871	1,497,871
5	High Rate Recorder					
	MAX. CONTENTS (K BITS)	772,206	772,206	772,206	36,000,000*	865,818*
	AVG. TIME/TRANS.	8.136	8.136	8.136	8792.621*	10.544*
	TOTAL ENTRIES	20,397,390	20,397,390	20,397,390	41,121,762*	30,672,732*
	DATA LOST (K BITS)	0	0	0	65,703,066*	0
	DUMPS (TRANSACTIONS)	3,494	3,494	3,494	848*	5572*
6	Variable Rate Recorder					
	MAX. CONTENTS (K BITS)	36,566	36,566	36,566	36,566	40,999*
	AVG. TIME/TRANS.	8.136	8.136	8.136	1.554*	10.544*
	TOTAL ENTRIES	965,472	965,472	965,472	5,055,595*	1,451,753*
	DATA LOST (K BITS)	0	0	0	0	0
	DUMPS (TRANSACTIONS)	3,494	3,494	3,494	848*	5572*

EQPT NO.	STATISTIC	BASE	1	2	3	4
10	FM Signal Processor					
	MAX. CONTENTS	0	0	0	1,620*	0
	AVG. TIME/TRANS.	0	0	0	0	0
	TOTAL ENTRIES	0	0	0	4,813,158*	0
	DATA LOST (K BITS)	0	0	0	0	0
12	KU-Band Signal Processor					
	MAX. CONTENTS	34,200	34,200	34,200	34,200	34,200
	AVG. TIME/TRANS.	0	0	0	0	0
	TOTAL ENTRIES	140,960,572	140,960,572	140,960,572	35,524,348*	140,960,572
	DATA LOST (K BITS)	0	0	0	36,000,000*	0

* DATA DIFFERENT FROM BASE DATA

Program To Create Experiment Schedule Tape

BLOCK NUMBER	LOC	OPERATION	A,B,C,D,E,F,G,H,I	COMMENTS	STATEMENT NUMBER
				*****	1
				**	2
				**	3
				** D. P. ASSOCIATES, INC.	4
				**	5
				** SHUTTLE MISSION 18 DATA SYSTEM	6
				**	7
				** MODULE 1: CREATION OF DATA ENTRIES	8
				**	9
				*****	10
				*	11
				SIMULATE	12
				* AN INITIAL CARD IS REQUIRED FOR EACH DATA ENTRY. MATRIX MX1 WILL	13
				* CONTAIN THE FOLLOWING DATA ELEMENTS:	14
				* MX1(1,J) THE TIME FROM LAUNCH OF DATA ENTRY J.	15
				* MX1(2,J) EXPERIMENT NUMBER I.D. OF DATA ENTRY J.	16
				1 MATRIX X,3,929	17
				* MX1(3,J) DURATION OF DATA ENTRY J.	18
				INITIAL MX1(1,1),731/MX1(2,1),107/MX1(3,1),12	19
				INITIAL MX1(1,2),769/MX1(2,2),107/MX1(3,2),14	20
				INITIAL MX1(1,3),786/MX1(2,3),44/MX1(3,3),14	21
				INITIAL MX1(1,4),800/MX1(2,4),107/MX1(3,4),7	22
				INITIAL MX1(1,5),861/MX1(2,5),107/MX1(3,5),10	23
				INITIAL MX1(1,6),899/MX1(2,6),107/MX1(3,6),13	24
				INITIAL MX1(1,7),940/MX1(2,7),44/MX1(3,7),20	25
				INITIAL MX1(1,8),960/MX1(2,8),107/MX1(3,8),4	26
				INITIAL MX1(1,9),967/MX1(2,9),107/MX1(3,9),13	27
				INITIAL MX1(1,10),1015/MX1(2,10),107/MX1(3,10),17	28
				INITIAL MX1(1,11),1100/MX1(2,11),107/MX1(3,11),12	29
				INITIAL MX1(1,12),1101/MX1(2,12),44/MX1(3,12),11	30
				INITIAL MX1(1,13),1166/MX1(2,13),107/MX1(3,13),13	31
				INITIAL MX1(1,14),1181/MX1(2,14),107/MX1(3,14),13	32
				INITIAL MX1(1,15),1195/MX1(2,15),107/MX1(3,15),13	33
				INITIAL MX1(1,16),1298/MX1(2,16),107/MX1(3,16),13	34
				INITIAL MX1(1,17),1342/MX1(2,17),107/MX1(3,17),8	35
				INITIAL MX1(1,18),1600/MX1(2,18),7/MX1(3,18),22	36
				INITIAL MX1(1,19),1800/MX1(2,19),12/MX1(3,19),27	37
				INITIAL MX1(1,20),1873/MX1(2,20),5/MX1(3,20),13	38
				INITIAL MX1(1,21),1877/MX1(2,21),12/MX1(3,21),88	39
				INITIAL MX1(1,22),1879/MX1(2,22),7/MX1(3,22),84	40
				INITIAL MX1(1,23),1956/MX1(2,23),5/MX1(3,23),12	41
				INITIAL MX1(1,24),1970/MX1(2,24),12/MX1(3,24),30	42
				INITIAL MX1(1,25),1972/MX1(2,25),7/MX1(3,25),16	43
				INITIAL MX1(1,26),1990/MX1(2,26),7/MX1(3,26),7	44
				INITIAL MX1(1,27),1993/MX1(2,27),5/MX1(3,27),20	45
				INITIAL MX1(1,28),2034/MX1(2,28),5/MX1(3,28),12	46
				INITIAL MX1(1,29),2039/MX1(2,29),4/MX1(3,29),3	47
				INITIAL MX1(1,30),2047/MX1(2,30),12/MX1(3,30),7	48
				INITIAL MX1(1,31),2056/MX1(2,31),12/MX1(3,31),105	49
				INITIAL MX1(1,32),2056/MX1(2,32),5/MX1(3,32),13	50
				INITIAL MX1(1,33),2059/MX1(2,33),7/MX1(3,33),57	51
				INITIAL MX1(1,34),2116/MX1(2,34),5/MX1(3,34),13	52
				INITIAL MX1(1,35),2120/MX1(2,35),7/MX1(3,35),9	53
				INITIAL MX1(1,36),2134/MX1(2,36),7/MX1(3,36),9	54
				INITIAL MX1(1,37),2145/MX1(2,37),7/MX1(3,37),14	55
				INITIAL MX1(1,38),2153/MX1(2,38),5/MX1(3,38),19	

-97-

INITIAL	MX1(1,894),14667/MX1(2,894),5/MX1(3,894),13	911
INITIAL	MX1(1,895),14671/MX1(2,895),107/MX1(3,895),12	912
INITIAL	MX1(1,896),14675/MX1(2,896),4/MX1(3,896),2	913
INITIAL	MX1(1,897),14677/MX1(2,897),7/MX1(3,897),2	914
INITIAL	MX1(1,898),14690/MX1(2,898),7/MX1(3,898),11	915
INITIAL	MX1(1,899),14702/MX1(2,899),7/MX1(3,899),1	916
INITIAL	MX1(1,900),14705/MX1(2,900),107/MX1(3,900),12	917
INITIAL	MX1(1,901),14711/MX1(2,901),7/MX1(3,901),39	918
INITIAL	MX1(1,902),14744/MX1(2,902),107/MX1(3,902),12	919
INITIAL	MX1(1,903),14744/MX1(2,903),5/MX1(3,903),13	920
INITIAL	MX1(1,904),14756/MX1(2,904),7/MX1(3,904),45	921
INITIAL	MX1(1,905),14779/MX1(2,905),107/MX1(3,905),13	922
INITIAL	MX1(1,906),14779/MX1(2,906),5/MX1(3,906),13	923
INITIAL	MX1(1,907),14800/MX1(2,907),5/MX1(3,907),23	924
INITIAL	MX1(1,908),14809/MX1(2,908),107/MX1(3,908),13	925
INITIAL	MX1(1,909),14816/MX1(2,909),44/MX1(3,909),5	926
INITIAL	MX1(1,910),14830/MX1(2,910),5/MX1(3,910),13	927
INITIAL	MX1(1,911),14831/MX1(2,911),107/MX1(3,911),13	928
INITIAL	MX1(1,912),14847/MX1(2,912),107/MX1(3,912),13	929
INITIAL	MX1(1,913),14847/MX1(2,913),5/MX1(3,913),13	930
INITIAL	MX1(1,914),14861/MX1(2,914),107/MX1(3,914),13	931
INITIAL	MX1(1,915),14890/MX1(2,915),5/MX1(3,915),13	932
INITIAL	MX1(1,916),14911/MX1(2,916),5/MX1(3,916),13	933
INITIAL	MX1(1,917),14911/MX1(2,917),107/MX1(3,917),15	934
INITIAL	MX1(1,918),14952/MX1(2,918),107/MX1(3,918),13	935
INITIAL	MX1(1,919),14952/MX1(2,919),5/MX1(3,919),13	936
INITIAL	MX1(1,920),14968/MX1(2,920),44/MX1(3,920),7	937
INITIAL	MX1(1,921),14971/MX1(2,921),5/MX1(3,921),21	938
INITIAL	MX1(1,922),15047/MX1(2,922),5/MX1(3,922),13	939
INITIAL	MX1(1,923),15117/MX1(2,923),5/MX1(3,923),13	940
INITIAL	MX1(1,924),15132/MX1(2,924),5/MX1(3,924),12	941
INITIAL	MX1(1,925),15194/MX1(2,925),5/MX1(3,925),13	942
INITIAL	MX1(1,926),15207/MX1(2,926),5/MX1(3,926),16	943
INITIAL	MX1(1,927),15229/MX1(2,927),5/MX1(3,927),12	944
INITIAL	MX1(1,928),15245/MX1(2,928),5/MX1(3,928),13	945
INITIAL	MX1(1,929),15269/MX1(2,929),5/MX1(3,929),13	946

947
948
949
950
951
952
953
954
955
956
957
958
959
960
961
962
963

-96-

1	GENERATE	C,,1,,25PF	CREATE WORKER TRANSACTION	948
2	ASSIGN	12,1,PF	NUMBER FIRST DATA ENTRY	949
3	TRANSFER	,EXP1		950
4	EXP ASSIGN	12+,1,PF	NUMBER DATA ENTRIES	951
5	ADVANCE	V1	DELAY INTERARRIVAL TIME	952
6	EXP1 ASSIGN	1,MX1(1,P12),PF	RECORD TIME FROM LAUNCH	953
7	ASSIGN	2,MX1(2,P12),PF	RECORD EXPERIMENT NUMBER	954
8	ASSIGN	3,MX1(3,P12),PF	RECORD DATA ENTRY DURATION	955
9	WRITE	JOBTAP1	CREATE JOBTAPE RECORD	956
10	TEST E	P12,929,EXP		957
11	TERMINATE	1		958
	CLEAR	MX1		959
1	VARIABLE	MX1(1,P12)-MX1(1,V2)	COMPUTE INTERARRIVAL TIME	960
2	VARIABLE	P12-1		961
	START	1		962
	END			963