

MSC-07161

MSC-D159618

March 1973

N74-73793

DESIGN DATA HANDBOOK  
FOR  
FLEXIBLE SOLAR ARRAY SYSTEMS

Space Station Solar Array  
Technology Evaluation Program  
Contract NAS9-11039

Prepared for  
Manned Spacecraft Center  
Houston, Texas

APPROVED BY:

  
L. G. Chidester  
Program Manager

PREPARED BY:

  
D. J. Parquet

REPRODUCED BY  
NATIONAL TECHNICAL  
INFORMATION SERVICE  
U. S. DEPARTMENT OF COMMERCE  
SPRINGFIELD, VA. 22161

LOCKHEED MISSILES & SPACE COMPANY

## CONTENTS

<u>Section</u>		<u>Page</u>
1.0	INTRODUCTION	1-1
2.0	SOLAR ARRAY COMPONENT DESIGN DATA	2-1
	2.1 Solar Array Structure	2-5
	2.1.1 Solar Array Structure Design Approach	2-7
	2.1.2 Packaging Techniques of Flexible Solar Arrays	2-11
	2.1.3 Candidate Structural Materials	2-13
	2.1.4 Deployment/Retraction Structures	2-15
	2.2 Solar Array Substrate Assembly	2-27
	2.2.1 Solar Cells	2-31
	2.2.2 Coverglasses	2-41
	2.2.3 Coverglass Adhesives	2-49
	2.2.4 Solar Cell Interconnectors	2-53
	2.2.5 Flexible Substrate Materials	2-63
	2.2.6 Substrate Module Joint	2-75
	2.2.7 Substrate Wiring Harness	2-81
	2.3 Solar Array Drive Systems	2-93
	2.3.1 Gears	2-95
	2.3.2 Bearings	2-99
	2.3.3 Motors	2-103
	2.4 Power and Signal Transfer Devices	2-107
	2.4.1 Slip Rings and Brushes	2-111
	2.4.2 Power Clutch	2-121
	2.4.3 Flexible Cables	2-125
	2.4.4 Rotary Transformers	2-127
	2.4.5 Rolling Contacts	2-129
	2.5 Lubrication	2-133
	2.5.1 Oils	2-137
	2.5.2 Greases	2-145
	2.5.3 Solids	2-149
3.0	SOLAR ARRAY SYSTEM DESIGN AND SIZING CRITERIA	3-1
	3.1 Weight and Cost Analysis	3-3
	3.2 Solar Cell Performance and Loss Analysis	3-31
	3.3 Thermodynamics of Flexible Solar Arrays	3-53
	3.4 Causes and Effects of Hot Spots	3-61
	3.5 On-Array Electronics	3-75
	3.6 Dynamics of Flexible Solar Arrays	3-79
4.0	PHYSICAL CONSTANTS AND CONVERSION FACTORS	4-1

**Preceding page blank**

## ILLUSTRATIONS

	<u>Page</u>	
2-1	Initial Deployment Sequence	2-1
2-2	Basic Structural Elements	2-2
2-3	Array Wing	2-3
2.2-1	Substrate Assembly Exploded View	2-28
2.2-2	Electrical Module Assembly Sequence	2-29
2.2.1-1	Typical Solar Cell	2-31
2.2.1-2	2 x 4 cm Wraparound Solar Cell	2-37
2.2.1-3	Relative Cost Comparison of Wraparound vs Conventional Cells	2-38
2.2.2-1	Typical Coverglass	2-41
2.2.2-2	Weight of Coverglasses for Conventional Cells	2-43
2.2.2-3	Weight of Coverglasses for Wraparound Cells	2-43
2.2.2-4	Cost vs Area for 2,000,000 Equivalent 2 x 2 cm Coverglasses	2-44
2.2.2-5	Relative Cost vs Thickness for 8 cm <sup>2</sup> Coverglasses	2-45
2.2.2-6	Specific Cost vs Area for 2,000,000 .012 in. Coverglasses	2-45
2.2.2-7	Summation of Normalized Solar Cell Output Current	2-46
2.2.5-1	Stress vs Strain - Basic Substrate	2-71
2.2.5-2	Stress vs Strain - Kapton - Fiberglass	2-72
2.2.5-3	Stress vs Strain - Substrate with Circuit	2-72
2.2.5-4	Modulus of Elasticity vs Temperature	2-73
2.2.5-5	Tensile Strength vs Temperature	2-73
2.2.6-1	LSSSA Module Joint	2-75
2.2.7-1	LSSSA Flexible Harness	2-81
2.3.1-1	Basic Gear Types	2-96
2.4.2-1	Power Clutch Reset During an All-Sunlit Orbit	2-122
2.4.2-2	Low Current Housekeeping Clutch	2-122
2.4.4-1	Rotary Transformer	2-128
2.4.5-1	Movement Pin Rotation	2-129
2.4.5-2	Contact Ring/Drive Gear Pair	2-130
2.5.1-1	Weight Loss Flux Rate Comparisons	2-140
3.2-1	NRL Solar Energy Distribution Curve	3-32

## ILLUSTRATIONS (Cont.)

		<u>Page</u>
3.2-2	Relative N/P Solar Cell Spectral Response - $2\ \Omega\text{cm}$ @ $25^{\circ}\text{C}$	3-32
3.2-3	Relative N/P Solar Spectral Response - $10\ \Omega\text{cm}$ @ $25^{\circ}\text{C}$	3-33
3.2-4	Solar Cell Spectral Response vs Temperature	3-33
3.2-5	Degradation of Spectral Response of N/P Solar Cells under 1 MeV Electron Bombardment	3-34
3.2-6	Variation of Solar Cell Parameters as a Function of Solar Intensity	3-34
3.2-7	Typical 2 x 4 cm Wraparound Solar Cell I-V Curves	3-36
3.2-8	$2\ \Omega\text{cm}$ Degradation Data - % loss $I_{sc}$	3-40
3.2-9	$2\ \Omega\text{cm}$ Degradation Data - % loss $V_{oc}$	3-40
3.2-10	$2\ \Omega\text{cm}$ Degradation Data - % loss $P_{max}$	3-41
3.2-11	$2\ \Omega\text{cm}$ Degradation Data - % loss $V @ P_{max}$	3-41
3.2-12	$10\ \Omega\text{cm}$ Degradation Data - % loss $I_{sc}$	3-42
3.2-13	$10\ \Omega\text{cm}$ Degradation Data - % loss $V_{oc}$	3-42
3.2-14	$10\ \Omega\text{cm}$ Degradation Data - % loss $P_{max}$	3-43
3.2-15	$10\ \Omega\text{cm}$ Degradation Data - % loss $V @ P_{max}$	3-43
3.2-16	Maximum Power vs Irradiation of N/P Solar Cells at $27^{\circ}\text{C}$	3-44
3.2-17	Relative Power vs Orbital Life	3-44
3.2-18	Variation of Solar Cell Parameters as a Function of Temperature	3-48
3.3-1	Total Hemispherical Emittance of FEP Compared with Fused Silica	3-55
3.3-2	Backside Thermal Property Magnitudes to Minimize Cell Temperature	3-58
3.3-3	Space Station Solar Array Substrate Design (Wraparound Cells)	3-59
3.3-4	Lockheed Communications Satellite Substrate Design (Conventional Cells)	3-59
3.4-1	Shadowing Effects	3-65
3.4-2	Effect of Shaded or Open Circuit Solar Cells on Cell Module Performance	3-70
3.4-3	Temperature Effect on Power Dissipation Where One Cell is Faulty Out of Seven	3-71
3.4-4	Shading Effects on a Typical LMSC Solar Panel	3-72

## ILLUSTRATIONS (Cont.)

		<u>Page</u>
3.6-1	Schematic for Dynamic Analysis	3-82
3.6-2	Pre-tension Required to Prevent Array Buckle Under Spinning Loads, $b = 3$ ft	3-83
3.6-3	Pre-tension Required to Prevent Array Buckle Under Spinning Loads, $b = 6$ ft	3-83
3.6-4	Pre-tension Required to Prevent Array Buckle Under Spinning Loads, $b = 12$ ft	3-84
3.6-5	Pre-tension Required to Prevent Array Buckle Under Spinning Loads, $b = 24$ ft	3-84
3.6-6	Transverse Load Factor on Array Substrate Under Spinning Loads	3-85
3.6-7	System Distorted in Torsion	3-87

## TABLES

	<u>Page</u>	
2.1.1-1	Solar Array Structure Design Considerations	2-7
2.1.2-1	Flexible Solar Array Packaging Methods	2-12
2.1.3-1	Aerospace Materials	2-14
2.1.4-1	Basic Beam Cross Section Forms	2-16
2.1.4-2	Beam and Beam Member Cross Section Variations	2-17
2.1.4-3	Truss Configuration Variations	2-17
2.1.4-4	Basic Stowage Methods and Variations	2-19
2.1.4-5	Extension/Retraction Methods	2-20
2.1.4-6	Deployable Structures Survey (2 sheets)	2-23
2.1.4-7	Characteristics of SPAR Aerospace Stem-type Boom	2-25
2.1.4-8	Characteristics of Existing Astromasts	2-26
2.2.1-1	Comparison of Solar Cells	2-33
2.2.1-2	Solar Cell Configuration Selection Considerations	2-35
2.2.2-1	Coverglass Design Considerations	2-42
2.2.3-1	Coverglass Adhesives	2-49
2.2.4-1	Solar Cell Interconnect Design Considerations	2-54
2.2.4-2	Physical and Mechanical Properties of Metals Used in Interconnects	2-56
2.2.4-3	Advantages and Disadvantages of Different Methods of Soldering	2-57
2.2.4-4	Types of Joining Processes	2-58
2.2.4-5	Survey of Interconnect Metals vs Joining Process	2-59
2.2.5-1	Properties of Flexible Substrate Materials	2-65
2.2.5-2	Tensile, Tear, and Creep Properties of Flexible Substrate Materials (2 sheets)	2-67
2.2.6-1	Flexible Substrate Joining Techniques	2-77
2.2.6-2	Lockheed Kapton Joining Techniques Investigation (Pre-LSSSA)	2-78
2.2.6-3	LSSSA Module Joints	2-79
2.3.1-1	Gear System Tradeoffs	2-97
2.3.2-1	Bearing Design Considerations	2-100
2.3.2-2	Bearing System Tradeoff	2-101

## TABLES (Cont.)

	<u>Page</u>	
2.3.3-1	Characteristics of Drive Systems Relative to Driver Motor Characteristics	2-103
2.3.3-2	Motor Tradeoff Table	2-105
2.4-1	Power Transfer Device Selection Considerations	2-109
2.4.1-1	Slip Ring Design Considerations	2-112
2.4.1-2	Brush Design Considerations	2-114
2.4.1-3	Operating Temperatures of ODAPT Candidate Brushes	2-116
2.4.1-4	Voltage Drop for ODAPT Candidate Brushes	2-117
2.4.1-5	Wear Rate of Brushes Under a Variety of Operating Conditions	2-118
2.4.1-6	Brush Types	2-119
2.5-1	General Lubricant Design Considerations	2-134
2.5-2	Advantageous Lubricant Types for Various Mechanical and Electrical Components	2-135
2.5.1-1	Friction and Wear Properties of Oils	2-138
2.5.1-2	Vapor Pressures of ODAPT Candidate Oils	2-139
2.5.1-3	Lubrication Tradeoff - Oils	2-141
2.5.1-4	Proposed ODAPT Oils	2-143
2.5.2-1	Friction and Wear Properties of Greases	2-146
2.5.2-2	Lubrication Tradeoff - Greases	2-147
2.5.2-3	Proposed ODAPT Greases	2-148
2.5.3-1	Lubrication Tradeoff - Solids	2-150
2.5.3-2	Proposed ODAPT Solid Lubricants	2-151
3.1-1	SSSA Baseline Design Requirements	3-4
3.1-2	SSSA Baseline Design Component and Weight Breakdown	3-5
3.1-3	Percentage Weight and Cost Savings Associated with Changes in the SSA Baseline Design Requirements	3-28
3.2-1	Equivalent 1 MeV Electron Fluences	3-38
3.2-2	Equivalent 1 MeV Electron Fluence Summary of Cell Degradations	3-39
3.3-1	Thermal Conductivities of Flexible Array Components	3-53
3.3-2	Thermal Properties of LMSC Flexible Substrates	3-54

## TABLES (Cont.)

		<u>Page</u>
3.3-3	Comparison of Calculated Steady-State Temperatures of Flexible Arrays in Orbit	3-57
3.4-1	Hot Spot Design Considerations	3-67
3.5-1	On-Array Electronics Design Considerations	3-76
3.6-1	Dynamic Analysis Considerations of a Flexible Solar Array	3-79



## 1.0 INTRODUCTION

This report is a design handbook of consolidated data collected or generated during the Space Station Solar Array Technology Evaluation Program. It presents the parametric information needed for the design of a complete flexible solar array and its associated structure, orientation drive and power transfer equipment. In no sense of the word, however, should it be considered a "procedure" on how to achieve the required design--only the combined effort of a number of experienced people can accomplish that. The sole purpose of this report, therefore, is not to provide a textbook, but to provide a handbook of guidelines, considerations, data, figures and suggestions that will be a useable tool to experienced solar array system designers. As much as possible, the information is presented in as general a form as possible in order that designers of both large and small solar arrays could use the information. In some cases, however, the scope of the Space Station Solar Array contract precluded investigations into certain designs, materials, sizes, etc. It will be obvious in these instances that the information presented is applicable to only one particular design or class of designs and should not be generalized without careful attention to the logical governing constraints.

Throughout this report, numerous references are made to the information presented in the First Topical Report and the First Topical Report Update of this contract. Each of these reports contain a categorized bibliography with a combined total of over 700 documents that are specifically applicable to the flexible solar array subject. These two reports must be consulted and used in conjunction with this Design Handbook for they provide a history of design approaches--an always valuable source of information.

The format of this report was prepared so that use may be made of each section with as little reliance as possible on other sections. Nearly every section has a table of design considerations and its own set of supporting data and figures. In addition, references specific to the text of that section are provided at the end of the section so that page shuffling is minimized. The philosophy of this report and/or the limited space availability did not allow a detailed design guide for some components, e. g. ,

bearings, gears, and motors. The design of these components (and others) have been very adequately covered in numerous other books. In these sections, therefore, referral is made to the appropriate vendors and the text references at the end of the section.

The three-ring notebook binder has again been utilized to provide an easily accessible and updatable source of information. Section 2.0 discusses all of the major components of a solar array and drive system with emphasis on information that is of a design data nature. (Ball Brothers Research Corporation did not prepare any part of this report. However, the source of the information in Sections 2.3, 2.4 and 2.5 is their work performed under contract to LMSC). Section 3.0 contains design and sizing information necessary to fully optimize the solar array's weight, cost, performance, etc. Section 4.0 contains a conversion table for the user's convenience because of the recent requirement that all NASA contracts be reported in metric units. The included document, The International System of Units: Physical Constants and Conversion Factors, was written by E. A. Mechtly and is approved and updated periodically by the General Conference on Weights and Measures.

## 2.0 SOLAR ARRAY COMPONENT DESIGN DATA

Although the Space Station Solar Array (SSSA) is nearly two orders of magnitude larger than any array ever flown, the components used for this application are very basic to the design of any solar array. The following excerpt from the Second Topical Report of this contract should provide an introduction to the operations and relationships of the major components.

"The initial deployment sequence of the solar array is shown in Figure 2-1 starting with the position of the stowed quadrants which are packaged within the 14 ft. maximum envelope, a basic requirement of the design. Initial deployment of the quadrants outward is accomplished by a Jackscrew mechanism as shown. Once this phase of the deployment has been accomplished, the upper portion of the structure (the OSA-outboard support assembly) begins major array deployment."

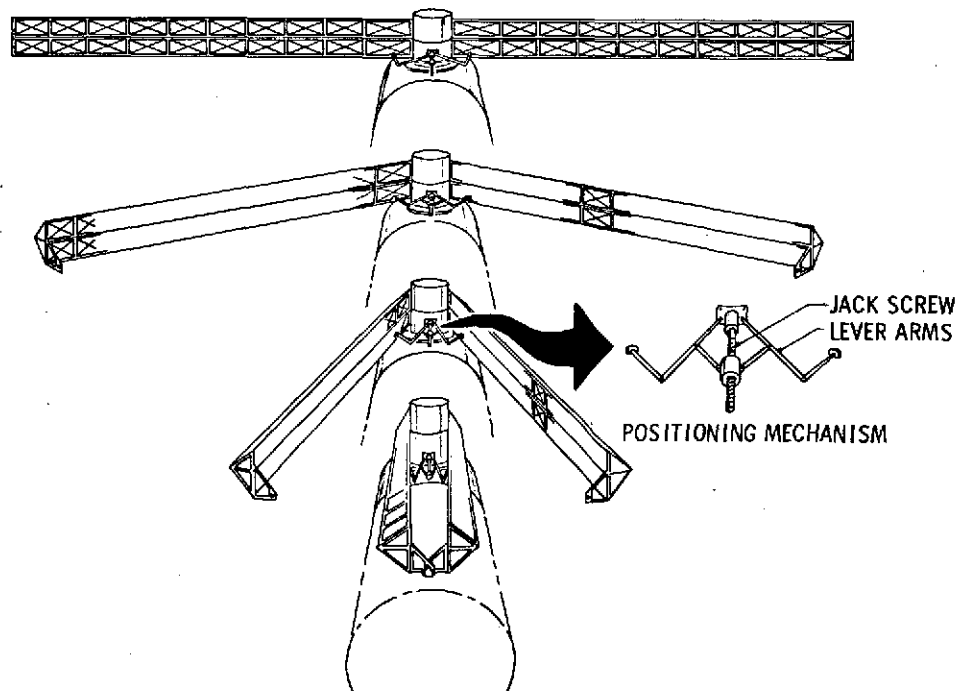

Figure 2-1 Initial Deployment Sequence

"The major structural elements of the solar array are shown in Figure 2-2 which also depicts the next step in the deployment sequence. Two inboard solar array strips, on either side of the boom, deploy in this initial sequence to provide power for the artificial "g" mode which is the initial mode assumed to be employed in the operational station. The inboard and outboard supports, which also form the upper and lower supports for the packaged array during launch, contain the tensioning mechanisms required for proper support of the arrays. These support assemblies also provide housings for the guide wire assembly which is used for solar array strip alignment and assures retraction capability. Once all ten solar array strips have been deployed, subsequent retractions are accomplished with the structure and all solar array strips being retracted together. An attachment point is provided for support of the inboard support assembly during ascent and artificial "g" as shown."

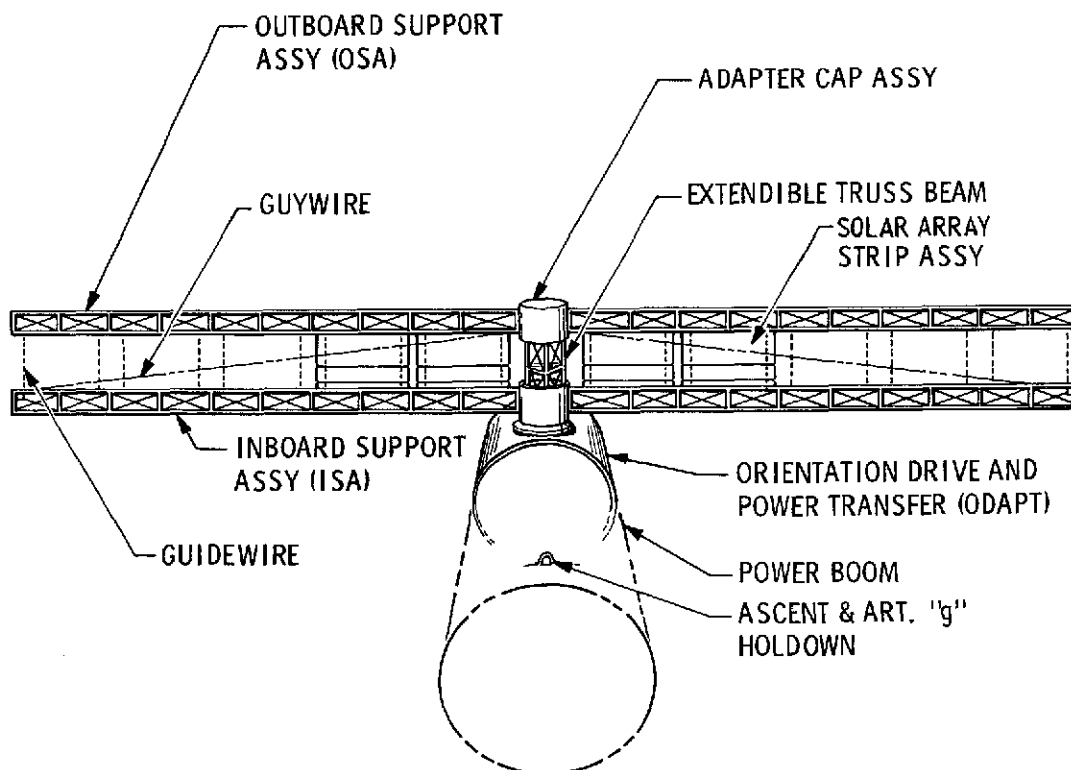

Figure 2-2 Basic Structural Elements

Figure 2-3 shows the deployed arrays with guy wires in place and the inset shows further details of the packaged array prior to deployment. As shown, the solar modules are folded accordion style into the structural package. In areas where the solar cells are face to face in the package, protection is provided (not shown) by means of embossed Kapton pads. The wiring harness, whose purpose is to collect power from the solar cells, runs along each side of the entire length of each strip. The substrate module joint not only provides the mechanical connection between the array modules, but also provides a hinge line which becomes the refold memory for array retraction.

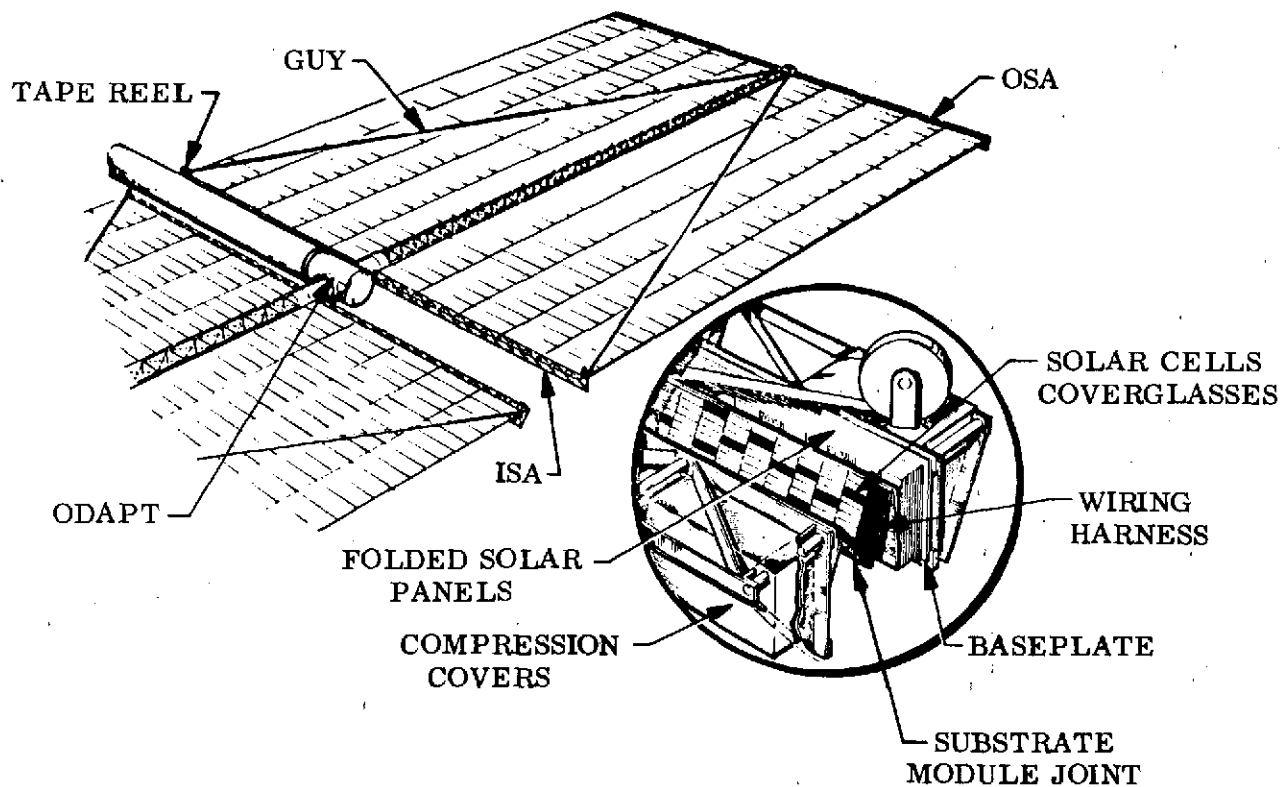

Figure 2-3 Array Wing

Section 2.0, then, will discuss each of the major components of a solar array system and present data not only generated during this program but also data that has been selected from other sources. As indicated on the facing page to this section, the discussions on the following pages will be divided into five major areas: Solar Array Structure, Solar Array Substrate Assembly, Solar Array Drive Systems, Power and Signal Transfer Devices, and Lubrication.

## 2.1 SOLAR ARRAY STRUCTURE

Perhaps the most difficult design task in the total flexible solar array system is the design of the structural mechanisms. This hardware must package, release, deploy, tension, and (in some cases) retract the solar panels. In addition, interface must be made with a tracking system (where applicable) so that maximum power can be obtained from the array. The inability to perform any one of these tasks can result, at best, in greatly reduced solar array output or, at worst, total failure of the mission. It is imperative, therefore, that good design practices be used in all phases of the structural design. In addition, as a check on the final design, a qualification test program should be executed under simulated mission conditions so that operation in space will be assured.

Of all the structural devices mentioned previously in Section 2.0, only the deployment/retraction structure will be given an appreciable amount of space in the following subsections. This is because it is the most basic component of the entire structural assembly. In addition, whereas the other designs are usually very mission specific in nature, the design of a deployment/retraction structure can in some cases be a choice among existing designs, e. g., the Spar Bi-Stem boom, the Fairchild Hiller Hingelock TEE, the Astromast extendible truss, etc. Therefore, the major purpose of Section 2.1 is to familiarize the designer with the types of deployment/retraction devices available (see Section 2.1.4) so that the selection and interface of the device to the application can be simplified. The design of the other structural mechanisms will be briefly covered in the section on Solar Array Structure Design Approach (see Section 2.1.1). In addition, a short section covering three techniques of packaging flexible solar arrays will be presented to familiarize the designer with the basic tradeoffs involved in each (see Section 2.1.2). Finally, the section on Candidate Structural Materials will survey the materials most frequently used in space applications (see Section 2.1.3).

Preceding page blank

2.1.1 Solar Array Structure Design Approach

The objective of the solar array structural design is to provide hardware that will meet all of the specific array design requirements. Table 2.1.1-1 presents a design approach that is suggested as a starting point. The major considerations given should be suitable for most applications. The details of each mission, however, will always be the final guide and obvious changes in approach will be self-evident.

TABLE 2.1.1-1  
SOLAR ARRAY STRUCTURE DESIGN CONSIDERATIONS

<u>REQUIREMENT</u>	<u>METHOD OF RESOLUTION</u>	<u>DATA REQUIRED</u>
Determine the most satisfactory configuration compatible with other spacecraft, components and environments	Prepare layout of solar array configurations and perform tradeoffs on the systems including function, weight, reliability and cost. The configuration tradeoffs include the results of the major component tradeoffs	<ol style="list-style-type: none"> <li>1. Power requirements expressed in area for ascent and orbit.</li> <li>2. Electrical module size options.</li> <li>3. Array orbital position requirements relative to vehicle axes.</li> <li>4. Fixed or tracking arrays.</li> <li>5. Retraction requirements.</li> <li>6. Panel flatness and alignment requirements.</li> <li>7. Space allocation and spacecraft interfaces.</li> <li>8. Panel tension realignment.</li> <li>9. Hold-down requirements.</li> <li>10. Articulation requirements.</li> </ol>
(a) Select Boom Type	Review available types of booms and select or develop those which will meet the configuration and environment requirements. Evaluate the booms and integrate the results into the configuration tradeoffs and layouts.	<ol style="list-style-type: none"> <li>1. Major external orbital loads developed from altitude and spacecraft operation.</li> <li>2. Substrate tension requirements to satisfy dynamic natural frequency requirements.</li> </ol>

Preceding page blank

Table 2.1.1-1 Solar Array Structure Design Considerations (Cont.)

<u>REQUIREMENT</u>	<u>METHOD OF RESOLUTION</u>	<u>DATA REQUIRED</u>
		<ol style="list-style-type: none"> <li>3. Boom stiffness requirements.</li> <li>4. Orbital temperature variations of the boom which may cause thermal bending.</li> <li>5. Retraction requirements.</li> <li>6. Space allocation and solar array mechanical and electrical interfaces.</li> <li>7. Reliability redundancy requirements.</li> </ol>
(b) Select Substrate Packaging System	Review the available systems considering the function, space allocation, reliability, weight, and configuration positioning requirements. Integrate results into configuration tradeoffs and layouts.	<ol style="list-style-type: none"> <li>1. Access to existing solar array systems definition.</li> <li>2. Space allocation and interface requirements.</li> <li>3. Ascent and orbital environments.</li> </ol>
(c) Select Tensioning System Type	Review available systems of substrate tensioning and perform tradeoffs to develop a system which accommodates the tension, travel and configuration requirements. Integrate results into configuration tradeoffs and layouts.	<ol style="list-style-type: none"> <li>1. Tension magnitude.</li> <li>2. Required travel to accommodate substrate stretch and thermal expansion and contraction.</li> <li>3. Substrate alignment and planarity requirements. (This is generally related to orbital altitude.)</li> </ol>
(d) Select Tracking System	Review available types of tracking systems and perform tradeoff evaluations to develop a system which will meet the tracking rates and loads, the orbital environment and the mission duration. Integrate results into configuration tradeoffs and layouts.	<ol style="list-style-type: none"> <li>1. Tracking rates.</li> <li>2. Tracking torques.</li> <li>3. Ascent and orbital environments.</li> <li>4. Mission duration.</li> <li>5. Space allocation and solar array mechanical and electrical interfaces.</li> <li>6. Reliability redundancy.</li> </ol>



Table 2.1.1-1 Solar Array Structure Design Considerations (Cont.)



<u>REQUIREMENT</u>	<u>METHOD OF RESOLUTION</u>	<u>DATA REQUIRED</u>
(e) Select Release System	Review available systems and components and perform tradeoffs with developed systems concerning function, weight, reliability, contamination and shock. Integrate results into configuration tradeoffs and layouts.	<ol style="list-style-type: none"> <li>1. Access to pyrotechnic and release system data.</li> <li>2. Reliability redundancy requirements.</li> <li>3. Predicted temperatures.</li> <li>4. Sensitivity of surrounding components to pyro shock.</li> </ol>

### 2.1.2 Packaging Techniques of Flexible Solar Arrays

Historically, three basic methods have been used to package flexible solar arrays-- the drum roller, the flat spindle, and the flat fold. Table 2.1.2-1 lists these three methods and discusses each in the major categories of packaging characteristics, ground handling capabilities, ascent capabilities, tie-down and release, tensioning method, stowage volume and reliability. In addition, overall general comments are given. This chart should provide a summary source of information adequate for use in initial tradeoff analyses. Reference 1 should be consulted if a more complete discussion of each method is desired.

**Preceding page blank**

TABLE 2.1.2-1  
FLEXIBLE SOLAR ARRAY PACKAGING METHODS

ILLUSTRATIONS	STOWAGE METHOD	DRUM ROLLER 1	FLAT SPINDLE 2	FLAT PACK 3
				
PACKAGING	PROTECTIVE PADDING FOR SOLAR CELLS DURING FLIGHT AND GROUND HANDLING	PRESENT STATE-OF-THE-ART METHODS ARE APPLICABLE; BECAUSE OF LARGE DEPLOYED AREA, MANUFACTURING PROBLEMS, COST, ETC. ARE INCREASED, CONSIDER OTHER POSSIBILITIES. BOND SHEET OF ENHANCED KAPTON TO ENTIRE REAR SURFACE. FEP COVER SHEET, BESIDES RADIATION PROTECTOR, COULD REPLACE EXISTING CUSHIONING MATERIAL. TESTS IN PROGRESS SHOULD INCLUDE VIBRATION, DRUM CURVATURE MAY REQUIRE USE OF CUSHIONING MATERIAL.	SAME AS DRUM ROLLER EXCEPT FEP COVERS AND THE SPINDLE FLAT SURFACE COULD ELIMINATE USING CUSHIONING MATERIAL.	SAME AS DRUM ROLLER EXCEPT CUSHION MATERIAL MUST BE ON CELL SIDE OF EVERY OTHER PANEL. CELL AREA IS DECREASED IF CUSHIONING BUTTONS, STRIPS, OR WINDOW FRAME SECTIONS ARE USED. REMOVABLE CUSHIONING SHEET BETWEEN CELL-TO-CELL FOLD FOR HANDLING AND ASCENT PROTECTION ONLY.
	DEPLOYMENT/RETRACTION	VERY GOOD FOR ROLLING UP LARGE SURFACE AREAS. IF PARTIALLY DEPLOYED DURING ARTIFICIAL "G", 1.) DRUM MUST BE RESTRAINED TO PREVENT ROTATION, AND 2.) INCREASED PANEL TENSION RESULT IN INCREASED BENDING OF STOWED CELLS AND DAMAGE MAY OCCUR.	SAME AS 1 EXCEPT INCREASED TENSION DOES NOT AFFECT STOWED CELLS. INDEXING OF PANEL BEND AREA TO SPINDLE IS CRITICAL PROBLEM DURING RETRACTION. UNEVEN (JERKY) RATE OF DEPLOYMENT DUE TO CHANGING MOMENT ARM.	IF PARTIALLY DEPLOYED DURING ARTIFICIAL "G", A HOLD-DOWN FRAMEWORK DEVICE KEEP STOWED PANELS IN PLACE. INCREASED TENSION DOES NOT AFFECT STOWED CELLS. AS PROVEN BY TRW, RETRACTION IS FEASIBLE.
	DRUM/SPINDLE END SUPPORT	END SUPPORTED USING PRESENT STATE-OF-THE-ART METHODS. SUPPORTS ARE CRITICAL STRESS AND THERMAL AREA. ADVERSE CONDITIONS WILL NOT INTERFERE WITH POSITIVE DEPLOYMENT/RETRACTION.	SAME AS ABOVE EXCEPT SUPPORT HEIGHT FROM THE BASE TO THE $\epsilon$ IS GREATER.	NONE REQUIRED.
	ATTACHMENT TO STRUCTURE	ATTACHMENT IS IN THE AREA OF END SUPPORT RESULTS IN CONCENTRATED SYSTEM LOADING. REMOVAL OF UNDESIRABLE RESONANT FREQUENCIES BY STRUCTURAL CHANGES DIFFICULT TO ACHIEVE.	SAME AS 1.	MOUNTING HOLES DISTRIBUTED AS REQUIRED. EASY TO REMOVE UNDESIRABLE RESONANT FREQUENCIES. (ADD MORE ATTACHMENTS)
	POWER TRANSFER	PRESENT STATE-OF-THE-ART METHODS ARE APPLICABLE. POWER TRANSFER EQUIPMENT CAN BE ELIMINATED BY DEPLOYING DRUM, BUT ALSO RESULTS IN HIGH TIP LOAD.	SAME AS 1.	NONE REQUIRED.
GROUND HANDLING CAPABILITIES	MANUFACTURING HANDLING	EASY TO STORE SOLAR PANEL WITH MINIMUM NUMBER OF PERSONNEL. TENSION FOR TIGHT PANEL WRAP IS NOT ADJUSTABLE AND ANY CHANGE REQUIRES RE-EXTENSION. VULNERABLE TO DAMAGE, SO A PROTECTIVE CONTAINER MUST BE PROVIDED.	EASY TO STORE SOLAR PANEL WITH MINIMUM NO. OF PERSONNEL. ADJUSTABLE PANEL RESTRAINING FORCE. PANELS CONTAINED IN BOX, ALWAYS PROTECTED.	ADDITIONAL PERSONNEL REQUIRED TO FOLD PANELS. ADJUSTABLE PANEL RESTRAINING FORCE. PANELS CONTAINED IN A BOX. ALWAYS PROTECTED. PANELS CAN BE CHECKED AND/OR REPLACED WITHOUT EXTENDING.
	GROUND TEST HANDLING	VULNERABLE TO DAMAGE ONCE OUT OF CONTAINER. DIFFICULT TO INSTALL INSTRUMENTATION ON DRUM. DURING AND AFTER VIBRATION TEST: 1.) EXTENSION OF PANELS REQUIRED TO CHANGE TIGHTNESS OF WRAP OR CHECK FOR DAMAGE TO CELLS, INTERCONNECTS, ETC. 2.) DIFFICULT TO VERIFY SMALL ROTATIONAL MOVEMENT BETWEEN PANEL WRAPS.	PANELS ARE CONTAINED-PROTECTED DURING TEST. DIFFICULT TO INSTALL INSTRUMENTATION ON SPINDLE IF NEEDED. PANEL RESTRAINING FORCE EASILY ADJUSTED DURING TEST. REQUIRE EXTENSION TO VISUALLY CHECK FOR DAMAGE TO CELLS, INTERCONNECTS, ETC.	SAME AS 2 EXCEPT NO DIFFICULTY TO INSTALL INSTRUMENTATION. EASY TO VISUALLY CHECK FOR DAMAGE TO CELLS, INTERCONNECTS, ETC. WITHOUT EXTENDING PANELS.
	EFFECT OF LONG TERM STORAGE	SLIGHT EFFECT ON INTERCONNECTS AND CELLS DUE TO CURVATURE. TIGHT WRAP MAY: 1.) RESULT IN A "SET" OF CUSHIONING PAD CAUSING A CHANGE IN THE RESTRAINING FORCE, 2.) CAUSE UNLIE BENDING STRESSES ON THE SOLAR CELLS, OR 3.) CAUSE SUBSTRATE EDGE CURL FOR LARGE ASPECT RATIOS.	NO EFFECT ON INTERCONNECTS OR CELLS STOWED ON FLAT SURFACE. PANEL RESTRAINING FORCE EASILY REMOVED, REAPPLIED, AND READJUSTED.	SAME AS 2. IN ADDITION SHARP BENDS IN FEEDER HARNES WILL RESULT IN "KINKS" WHEN EXTENDED, DISAPPEARING IN TIME.
	PROTECTION FROM CONTAMINATION AND DAMAGE	PROTECTIVE BLANKET CAN BE ADDED TO THE PANEL FOR THE FINAL WRAP ON THE DRUM. ADDS LENGTH TO THE EXTENDED ARRAY. EXPOSED DURING TEST. NO PROTECTION FROM FALLING OBJECTS.	PANELS ARE CONTAINED IN A BOX. ALWAYS PROTECTED.	SAME AS 2.
	LOADS AND DYNAMIC EFFECTS	POSSIBLE DRUM PRE-ROTATION IF NOT LOCKED. IF LAUNCH AXIS IS PARALLEL TO DRUM $\epsilon$ , WRAPPED PANELS COULD "FUNNEL" DURING ASCENT.	PANELS ARE CONTAINED IN A BOX WITH SPINDLE HELD IN PLACE. EASY TO READJUST RESTRAINING FORCE (ASCENT PRE-LOAD).	PANELS ARE CONTAINED IN A BOX. EASY TO READJUST RESTRAINING FORCE (ASCENT PRE-LOAD). MINIMUM NUMBER MOVING PARTS.
ASCENT CAPABILITIES	THERMAL	UNLESS THERMALLY PROTECTED, TEMPERATURE GRADIENT BETWEEN THE INNERMOST TO THE OUTERMOST PANEL WRAPS, OUTGASSING OF LUB, SEALS, ETC., OR THERMAL DISTORTION OF MOVING PARTS MAY OCCUR.	PANELS CONTAINED IN BOX. UNLESS THERMALLY PROTECTED, OUTGASSING OF LUB, SEALS, ETC. OR THERMAL DISTORTION OF MOVING PARTS MAY OCCUR.	PANELS ARE CONTAINED IN A BOX. ALWAYS PROTECTED.
	TIE-DOWN AND RELEASE	DRUM PRE-ROTATION MAY OCCUR DURING LAUNCH AND ASCENT-SHOULD HAVE A RELEASABLE LOCK. EXISTING STATE-OF-THE-ART METHODS ARE APPLICABLE.	PRIOR TO PANEL DEPLOYMENT, CONTAINER BASE ROTATE 180°. EXISTING STATE-OF-THE-ART METHODS APPLY.	SAME AS 2 EXCEPT CONTAINER BASE IS STATIONARY.
	TENSION METHOD	IF PARTIALLY DEPLOYED DURING ARTIFICIAL "G", RELEASABLE LOCK (DRUM BRAKE) REDUCES PANEL TENSION. RESULT IN HIGHEST RESTRAINING TORQUE (FUNCTION OF THE WRAPPED DRUM RADIUS-LARGEST MOMENT ARM).	IF PARTIALLY DEPLOYED DURING ARTIFICIAL "G" AND SPINDLE PARALLEL TO PARTIALLY EXTENDED PANELS (SMALLEST MOMENT ARM), RELEASABLE LOCK (SPINDLE BRAKE) REACT PANEL TENSION. RESULT IN LOWEST RESTRAINING TORQUE.	PANEL TENSIONS ARE NOT PRESENT DURING DEPLOYMENT. IF PARTIALLY DEPLOYED DURING ARTIFICIAL "G", A CUSHION BACKED FRAMEWORK HOLDSDOWN THE REMAINING STOWED PANELS. NO MOVING PARTS AND ITS PRESET PRIOR TO LAUNCH.
	STOWAGE VOLUME	MOST RELATIVE STOWAGE VOLUME	INTERMEDIATE RELATIVE STOWAGE VOLUME	LEAST RELATIVE STOWAGE VOLUME
	GENERAL DESIGN COMMENTS	UNCERTAINTIES OF ACTUAL FRICTION COEFFICIENTS BETWEEN ADJACENT WRAPS MAKE IT VERY DIFFICULT TO RELIABLY ESTIMATE THE AMOUNT OF TENSION REQUIRED ON THE PANELS TO PREVENT DAMAGE DUE TO ASCENT VIBRATION. THE TENSION REQUIRED TO RESTRAIN THE PANEL IS NOT ADJUSTABLE AND IS VERY DIFFICULT TO CHANGE. UNDESIRABLE RESONANT FREQUENCIES ARE DIFFICULT TO REMOVE. THE END SUPPORTS ARE CONSIDERED TO A CRITICAL AREA AND IT MUST WITHSTAND ADVERSE CONDITIONS (ASCENT LOADING AND THERMAL DISTORTION) TO ASSURE POSITIVE DEPLOYMENT. LOADING ON THE DRUM IS SMALL AND IT CAN BE LIGHT. THE MINIMUM DRUM THICKNESS IS DETERMINED BY STIFFNESS REQUIREMENT.	UNDESIRABLE RESONANT FREQUENCIES ARE DIFFICULT TO REMOVE. END SUPPORTS ARE CONSIDERED TO BE A CRITICAL AREA AND IT MUST WITHSTAND ADVERSE CONDITIONS (ASCENT LOADING AND THERMAL DISTORTION) TO ASSURE POSITIVE DEPLOYMENT. CREEP OF SUBSTRATE MATERIAL AND CHANGING WIDTHS OF THE BEND AREA MUST BE KEPT WITHIN A TOLERABLE RANGE TO MINIMIZE INDEXING PROBLEM. HOWEVER, THERMAL EXPANSION/CONTRACTION AND HIGH TENSIONS DURING ARTIFICIAL "G" INCREASE THE PROBLEM.	UNDESIRABLE RESONANT FREQUENCIES CAN BE ELIMINATED BY SIMPLE STRUCTURAL CHANGES SUCH AS ADDING MORE MOUNTING BOLTS. CONTAINERS BY ITSELF IS VERY FLIMSY, HOWEVER WHEN THE PANEL SUPPORT (CONTAINER BOTTOM), PANELS, AND COVER ARE ASSEMBLED, IT BECOMES VERY RIGID. SIDE AND END MEMBERS ARE THIN SECTIONS AND ARE CONSIDERED TO BE NON-STRUCTURAL AND ONLY SERVE AS ENVIRONMENTAL PROTECTORS. FOLD LINES CAN BE HINGED SO THAT EACH FOLDED PANEL IS AN INDIVIDUAL RECTANGULAR SECTION. REPAIR AND REPLACEMENT OF PANELS CAN BE DONE WITHOUT EXTENSION.

### 2.1.3 Candidate Structural Materials

Material selection for solar array applications involves consideration of many environmental and fabrication factors. The materials used in these applications must be capable of withstanding the environments of the ground handling phase as components during fabrication and assembly and as systems during various test phases; of the boost phase when the materials will experience compression, tension, shear, bending, and fast changes in pressure; and of the orbital phase which will subject the materials to additional factors such as fatigue, large temperature extremes, temperature cycling and exposure to high vacuum and radiation. In addition to the environmental factors, the material costs, development status, and producibility must be considered to assure that a cost and time-effective design is produced.

These considerations leading toward a low cost, easily producible, lightweight, high strength and high modulus material demand a constant search for new materials and the development of their fabrication techniques. Table 2.1.3-1 lists the most commonly used materials and includes some new materials being considered for spacecraft applications. The chart reviews the ambient physical properties and includes present costs, predicted costs, and a producibility rating. In general, composites look very promising as structural materials, especially graphite/epoxy. It is lighter than aluminum, 2-1/3 times as strong and 5 times as stiff. In addition, it can be fabricated with the techniques presently developed for the epoxy/fiberglass materials. It is the most cost-effective, advanced composite and is presently being applied to many structural components in the aircraft industry. Unfortunately, the physical characteristics data of this and several of the other materials in the space environment are limited. Therefore, a choice for a space application might require additional qualification tests to insure mission success.

TABLE 2.1.3-1  
AEROSPACE MATERIALS

	$\rho$ DENSITY (lb/in <sup>3</sup> )	$F_{tu}$ (ksi)	$F_{cu}$ (ksi)	$E_t$ (x 10 <sup>6</sup> psi)	$E_c$ (x 10 <sup>6</sup> psi)	$F_t/\rho$ (x 10 <sup>6</sup> $\frac{\text{psi}}{\text{lb/in}^3}$ )	COEF OF THERMAL EXPANSION 10 <sup>-6</sup> IN/IN/°F		VAPOR PRESS AT 10 <sup>-8</sup> MILL. OF Hg, KELVIN	MATERIAL COST/LB		COST/IN <sup>3</sup>		PRODUCIBILITY RATING COMPARISON MATRIX (1) GOOD, (10) POOR
							LONG	TRANSV		1970	1972	1970	1972	
ALUMINUM 7178-T6 2024-T3	.102 .100	88 64	78 64	10.4 10.5	10.5 10.7	102 105	13.0 13.0	13.0 13.0	950 (LIQUID) 950 (LIQUID)	1 1	1 1	1.02 1.00	1.02 1.00	1 1
MAGNESIUM AS31B-H24	.064	42	26	6.3	6.5	102	14.0	11.0	460	1	1	.64	.64	3-4
CRES 301	.286	141	141	26	26	91	9.0	9.0	1150	1.5	1.5	4.3	4.3	1
TITANIUM Ti 13V-11Cr-3Al Pure	.175 .163	125 50	120 42	14.5 15.5	* 16	83 95	4.8 5.3	4.8 5.3	* 1330	14 14	14 14	24.5 22.8	24.5 22.8	5 5
LOCKALLOY 62-38 AL	.076	57	42	28	28	370	8	8	950	200	200	152.0	152.0	7-8
BERYLLIUM	.067	78	53	42	42	627	6.4	6.4	970	200	200	134.0	134.0	10
EPOXY-FIBERGLASS**	.065	45	45	3.5	3.5	54	5.5	6.7	*	2	2	1.3	1.3	2
GRAPHITE/EPOXY**	.058	166	144	40	40	800	-5	16	*	98	50	57	29	2.5
BORON/EPOXY**	.070	200	200	30	30	430	2.75	16.0	1650	250-425	150	236.0	150.0	5
BORON/ALUMINUM	.096	165	165	33	33	344	2.0	13.0	950	1000	125	960	120	7
PRD-49 DUPONT FIBER -EPOXY	.050	210	45	12	12	240	-2.8	2.0	*		50		2.5	3.5

\* RELIABLE NUMBERS NOT AVAILABLE  
\*\* 60% FIBER VALUES

#### 2.1.4 Deployment/Retraction Structures

This section summarizes the evaluation of current extensible structures technology and is presented in a fashion to facilitate trade-off and systems selections. Eight Tables have been prepared for this purpose:

Table 2.1.4-1	Basic Beam Cross-Section Forms
Table 2.1.4-2	Beam and Beam Member Cross Section Variations
Table 2.1.4-3	Truss Configuration Variations
Table 2.1.4-4	Basic Stowage Methods and Variations
Table 2.1.4-5	Extension/Retraction Methods
Table 2.1.4-6	Deployable Structures Survey
Table 2.1.4-7	Characteristics of Spar Aerospace Stem-type Booms
Table 2.1.4-8	Characteristics of Astro Research Astromasts

These should provide sufficient information to perform a preliminary analysis of the applicability of a deployment/retraction structure to specific mission requirements. To facilitate this analysis, the tables have been functionally grouped and are presented in the pages that follow.

2.1.4.1 Basic Structure Forms

Table 2.1.4-1, Basic Beam Cross Section Forms, shows the common forms of beam members. Each member has advantages, as indicated, and the selection of one over the other should involve trade-offs of weight, strength, cost, availability, and manufacturability. Table 2.1.4-2, Beam and Beam Member Cross-section Variations, presents some of the possible variations in beam form. It should be noted that these variations are generally the result of functional considerations and not purely structural ones, i.e., the tubular variations result from the requirement that the member be flattened for stowage and/or extension and/or retraction, and the solid variations result from efficiency considerations. The structural characteristics of the members vary considerably from those of their basic form. The last table to be presented in this section is Table 2.1.4-3, Truss Configuration Variations. Trusses are defined as a combination of members so arranged and joined as to form a rigid framework. They

TABLE 2.1.4-1  
BASIC BEAM CROSS SECTION FORMS











STRUCTURE	FORM	STRUCTURAL CHARACTERISTICS	COMMENTS
SOLID		GOOD TENSION MEMBER, MOMENT OF INERTIA CHANGES IN ORTHOGONAL DIRECTIONS	ECONOMICAL MATERIAL SECTION, FLAT SURFACES FACILITATE FABRICATION OF TRUSS STRUCTURES
		FAT SECTION SUITABLE FOR HIGH SHEAR LOADS	PRIMARILY USED IN MECHANISMS; HOWEVER USEFUL FOR SHORT BEAMS OR STRUTS
		FAT SECTION SUITABLE FOR HIGH SHEAR LOADS, CONSTANT MOMENT OF INERTIA	ECONOMICAL MAT'L SECTION, BEAM END FITTINGS FABRICATED WITH SIMPLE DRILLED HOLES
		MOMENT OF INERTIA CHANGES IN ORTHOGONAL DIRECTIONS	USUALLY A FORGED SHAPE;USED EXTENSIVELY AS A SIMPLE BEAM
TUBES		TORSIONALLY GOOD, PROVIDES DIFFERENT MOMENT OF INERTIA IN ORTHOGONAL AXIS	WIDELY USED IN ANTENNA STRUCTURES WHEREIN WAVEGUIDE SERVES ITS NORMAL MICROWAVE FUNCTION AS WELL AS STRUCTURAL SUPPORT
		TORSIONALLY GOOD, PROVIDES EQUAL MOMENT OF INERTIA IN ORTHOGONAL AXIS	USED IN STRUCTURES WHERE FLAT SURFACES FOR MOUNTING OR FABRICATION ARE DESIRED
		TORSIONALLY STIFFEST TO WEIGHT FORM AVAILABLE, CONSTANT MOMENT OF INERTIA	ECONOMICAL, WIDELY USED FORM COMMERCIALY AVAILABE IN A BROAD SELECTION OF MATERIALS AND ALLOYS
		TORSIONALLY GOOD, PROVIDES DIFFERENT MOMENT OF INERTIA IN ORTHOGONAL AXIS	USUALLY PRODUCED IN FABRICATION SHOP BY FLATTENING A ROUND TUBE
TRUSS BEAMS		TORSIONALLY GOOD, PROVIDES DIFFERENT MOMENT OF INERTIA IN ORTHOGONAL AXIS	COMMONLY USED IN BRIDGE TRUSSES OR ANY TRUSS WITH UNSYMMETRICAL LOADING
		TORSIONALLY GOOD, PROVIDES EQUAL MOMENT OF INERTIA IN ORTHOGONAL AXIS	COMMONLY USED WHERE LOADS ARE SYMMETRICAL SUCH AS RADIO TOWERS
		TORSIONALLY GOOD, MOMENT OF INERTIA MAY BE VARIED IN ANY OF THREE DIRECTIONS	GENERALLY USED FOR SYMMETRICAL LOADS, HOWEVER CAN BE MADE ASYMMETRICAL FOR SPECIAL CONDITIONS

TABLE 2.1.4-2  
BEAM AND BEAM MEMBER CROSS SECTION VARIATIONS



















BEAM FORM	VARIATION	COMMENTS
 OPEN SECTIONS		LOW OUT OF PLANE STIFFNESS LIMIT THIS TO LOW BENDING AND TORSIONAL LOAD APPLICATIONS.
		LOW TORSIONAL STIFFNESS, HIGH DYNAMIC DAMPING, EVEN WHEN MADE TO OVERLAP. WIDELY USED AS SMALL DIAMETER, LONG MEMBERS FOR ELECTROMAGNETIC ANTENNA. SEVERE THERMAL BENDING PROBLEMS.
		BROAD RANGE OF SIZES AND MATERIALS AVAILABLE. SUITABLE FOR STIFFENERS OR COMPONENT PARTS OF A BUILT-UP BEAM OR COLUMN.
		SIMILAR TO ABOVE WITH SLIGHTLY IMPROVED BENDING STRENGTH.
		WIDELY USED AS STRUCTURAL BEAMS. IDEAL FOR HIGH BENDING LOADS ABOUT THE MAJOR PRINCIPAL AXIS
		AS ABOVE EXCEPT HIGHER FLANGE BUCKLING HAZARD. SHEAR CENTER NOT COINCIDENT WITH C.G.
 ROUND TUBE	 	APPROACHES THE STRUCTURAL CHARACTERISTICS OF A THIN WALLED TUBE. EXACT MECHANICAL PROPERTIES DEPEND UPON INDIVIDUAL DESIGN. USUALLY <6 IN DIA AND WITH APPROX 250:1 DIAMETER TO THICKNESS RATIO. CRITICAL REVIEW OR APPLICATIONS ARE REQUIRED TO MINIMIZE THERMAL BENDING PROBLEMS.
 FLATTENED TUBE	 	USUALLY IN THIN WALLED SECTIONS. BENDING LOAD CAPACITY VARIES WITH LATERAL CURVATURES. TEST DATA LIMITED, ANALYSIS METHOD NOT DEVELOP FOR BEAM WITH SEALED EDGES. CENTER PIECE HELPS STABILIZE SHAPE, HENCE INCREASES STRENGTH AND STIFFNESS. HOWEVER INCREASED DRUM WEIGHT SHOULD BE STUDIED IN A TRADE-OFF.
 TUBULAR DELTA		USUALLY IN THIN WALLED SECTIONS AND LIMITED IN SIZE TO 6 INCHES PER SIDE.

TABLE 2.1.4-3  
TRUSS CONFIGURATION VARIATIONS

CONFIGURATION	COMMENTS
1 	DIAGONALS AND BATTENS BOTH SUBJECTED TO COMPRESSION AND TENSION LOADS.
2 	SAME AS ABOVE.
3 	DIAGONAL MEMBERS SUBJECTED TO BOTH COMPRESSION AND TENSION. CONSEQUENTLY MEMBERS MUST BE HEAVY ENOUGH TO RESIST COLUMN BUCKLING.
4 	REDUNDANT DIAGONALS SUBJECTED TO BOTH COMPRESSION AND TENSION. OFTEN USED WHEN TRUSS IS TO BE FOLDED.
5 	LIGHTWEIGHT DESIGN, SHORT BATTENS SUBJECTED TO COMPRESSION LOADS LONG DIAGONALS SUBJECTED TO TENSION LOADS.
FIGURES 1, 2, AND 3 HAVE APPROXIMATELY THE SAME STRENGTH AND WEIGHT. THE COMBINATION OF FIGURES 4 AND 5 TRUSS FORMS MAKES A FEASIBLE STRUCTURE.	

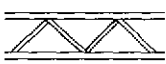
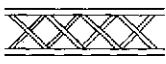

are the most efficient structures in terms of stiffness, weight, and material economy. Trusses also have the geometry required to allow the beam to be folded, and yet be strong, stiff and lightweight when extended.

#### 2.1.4.2 Basic Structures Stowage and Deployment Methods

The three basic methods of stowing beams--folding, rolling, and telescoping--are presented in Table 2.1.4-4. Folding is mechanically the simplest and most versatile stowage method and, as a result, is the method most frequently used for general extensible structure applications. Rolling beams on or in drums is a possible low volume solution to some stowage problems and is a method that can be used for stowing beams of a variety of cross-sectional shapes. The thickness and therefore strength of the beams, however, is limited by the coiling stresses. Telescoping of beams, the last method, is a relatively common method of stowage and has been used for a variety of applications. Although the stowage efficiency ratio of stowed-to-extended height is low, it may be increased by either increasing the number of telescoping sections or combining the telescoping method with the folding method. Both alternatives are at the expense of weight and/or beam stiffness.

In Table 2.1.4-5 are presented several basic methods of extending or retracting the above beams. The prime movers can be changed in accordance with design constraints. For example, it is conceivable that pneumatic or hydraulic motors could be interchanged with electric motors to produce rotary motion but they cannot be reversed. Whatever the case, the most effective or available energy source and the motion required determine the method or energy/motion transducer used.

TABLE 2.1.4-4  
BASIC STOWAGE METHODS AND VARIATIONS











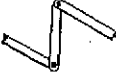

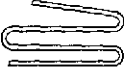
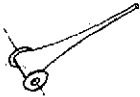
METHOD	VARIATIONS	CHARACTERISTICS	COMMENTS
FOLDED		STOWS BY DISPLACEMENT ONLY, STOW VOLUME IS APPROX. EQUAL TO EXTENDED VOLUME.	SIMPLE, EFFECTIVE, AND WIDELY USED, LIGHT WEIGHT FOR MORE HEAVILY LOADED SYSTEMS.
		STOWS VERY COMPACT, REQUIRES LATCHES TO DEVELOP RIGIDITY. EXCELLENT DEPLOYMENT DEVICE	MULTIPLE HINGE JOINTS REQUIRE PRUDENT DESIGN TO MINIMIZE LOOSENESS. USUALLY SPRING LOADED AGAINST A DAMPER MECHANISM.
		STOWAGE CAPABILITY DEPENDS UPON THE MATERIAL ALLOWABLE STRESS AND THICKNESS. INFLATIBLES USING METAL FOILS STOW VERY COMPACTLY	NO JOINTS OR LATCHES REQUIRED TO PROVIDE A RIGID STRUCTURE. COLUMN STRENGTH IS LIMITED BY MATERIAL THICKNESS, STOWED CONFIGURATION, AND ALLOWABLE STRESS. NO REMOTE RETRACTION.
ROLLED		BEAM IS WRAPPED AROUND A REEL AND ITSELF. REQUIRES A SECTION OF THE BEAM REMAIN EXTENDED BUT STOWS COMPACTLY. CAN BE SELF EXTENDING BUT USUALLY MOTOR DRIVEN	USUALLY CAPABLE OF MANY EXTENSIONS AND RETRACTIONS WITHOUT DEGRADING PERFORMANCE, DEVELOPS FULL STRENGTH AT PARTIAL EXTENSION. COLUMN STRENGTH IS LIMITED BY MAT'L THICKNESS STOW CONFIG. & STRESS
		USUALLY SELF EXTENDING BY STORED-SPRING ENERGY, ALTHOUGH SOME MOTOR DRIVEN MODELS HAVE BEEN USED	CAPABLE OF MANY EXTENSIONS OR RETRACTIONS WITHOUT DEGRADING PERFORMANCE. COLUMN STRENGTH IS VERY LIMITED.
TELESCOPED		STOWED VOLUME FROM 20 TO 50 PERCENT OF EXTENDED VOLUME. DESIGNS READILY ADAPT TO DEVELOP ALL USABLE STRENGTH OR INDIVIDUAL MEMBERS	SIMPLE, FEW PARTS, MAKE DESIGN VERY RELIABLE. MAY BE TRUSSES, TUBES OR COMBINATIONS OF THE TWO

TABLE 2.1.4-5  
EXTENSION/RETRACTION METHODS

PRIME MOVER	STOWAGE METHOD	BEAM SECTION FORM	CHARACTERISTICS
ELECTRIC MOTOR	REEL STORED		REMOTE ACTUATION, CAPABLE OF MULTIPLE EXTENSIONS AND RETRACTIONS. SOME MODELS INCORPORATE TWO STORAGE REELS THAT ARE INTERCONNECTED AND DRIVEN BY A COMMON MOTOR.
			REMOTE ACTUATION, CAPABLE OF MULTIPLE EXTENSIONS AND RETRACTIONS. USES THREE STORAGE REELS INTERCONNECTED AND DRIVEN BY A COMMON MOTOR.
			REMOTE ACTUATION, CAPABLE OF MULTIPLE EXTENSIONS AND RETRACTIONS. A SINGLE STORAGE REEL IS DRIVEN BY THE MOTOR.
			WIRE TRUSS IS FOLDED AND ROLLED UP ON A SINGLE, MOTOR DRIVEN REEL.
	TELESCOPING		REMOTE EXTENSION MAY BE ACCOMPLISHED BY MOTOR DRIVEN WINCH ACTION OR A MOTOR DRIVEN HYDRAULIC SYSTEM. BEAM SECTIONS MAY BE SOLID OR TRUSS.
FOLDING		VARIOUS	REMOTE EXTENSION MAY BE ACCOMPLISHED BY MOTOR DRIVEN WINCH ACTION OR BY A MOTOR DRIVEN SCREW JACK (USUALLY IN CONJUNCTION WITH MECHANICAL SPRINGS).
MECHANICAL SPRINGS	REEL STORED	SAME BEAM SECTION USED AS ELECT. MOTOR CONFIG.	SPRING MOTOR POWERS EXTENSION ONLY, MANUAL RETRACTION REWINDS MOTOR.
	TELESCOPING		SPRINGS OR SPRING MOTOR POWERS EXTENSION ONLY, REQUIRES MANUAL RETRACTION. GENERALLY USED WITH A DAMPER TO CONTROL EXTENSION DYNAMICS.
	FOLDING	VARIOUS	SPRINGS AT EACH JOINT EXTEND STRUCTURE, MANUAL RETRACTION REQD. MAY BE USED IN CONJUNCTION WITH AN ELECTRICAL MOTOR THAT WILL ASSIST IN EXTENSION AND CONTROL EXTENSION DYNAMICS.
PNEUMATIC (STORED GAS)	TELESCOPING		SLIDING SEALS MAKE TELESCOPIC MAST GAS TIGHT, GAS PRESSURE EXTENDS CYLINDERS. MANUAL RETRACTION REQD.
	FOLDING	VARIOUS	SEALED TUBES INFLATED WITH GAS PRESSURE, MANUAL RETRACTION REQD. PNEUMATIC ACTUATORS MAY BE EMPLOYED TO ERECT HINGED JOINTS, AGAIN MUST BE RETRACTED MANUALLY.

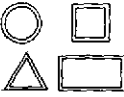
#### 2.1.4.3 Deployment/Retraction Structures Reviewed

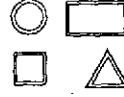
The purpose of this section is to inform the designer of the state of the art in extension/retraction structures so that efficient utilization of design time can be obtained by drawing on the experience of other designers. The survey presented in Table 2.1.4-6 considers twenty unique extensible structures, most of which are available from several sources. The structures are separated in the chart by stowage method (telescoping, folding, or rolling). Further, they are separated by structural differences, i. e., truss vs solid, interlocking vs overlapping, etc. The chart displays general characteristics, uses and experiences, and known fabricators. It will be noted that many of the designs have fundamental similarities; each system has features that exhibit dominance of one or more primary considerations such as stiffness, strength, weight, economy, stowage, deployment, or retraction. Additional information as well as photographs of each structure can be obtained from Reference 1.

#### 2.1.4.4 Deployment/Retraction Structures for Flexible Arrays

The total field of current extendible structure technology that was reviewed in References 1 and 2 indicated that all deployment booms used on flexible solar arrays could be grouped into two categories: the extendible stored reel and the articulated lattice. Of the two, the extendible stored reel has received by far the most usage. It must be stated, though, that the boom strength relative to the length requirements have been very minimal for nearly all of these applications. However, in low load applications, the stored reel is the ideal choice of deployment/retraction device. Table 2.1.4-7 exemplifies the many possible parametric variations of this type of boom. Although it was prepared by Spar Aerospace, it should be remembered that other companies also fabricate this type of boom (see References 1 and 2). The relative characteristics of each must be traded off to match the application. Table 2.1.4-8 presents parametric characteristics of existing Astro Research Astromasts. This articulated lattice type of boom has the best potential when strength or stiffness governs a design. In any case, because either of these two basic boom types can be used for most applications, the applicable vendor must be consulted for the most recent and applicable design information so that a decision for a specific mission has a firm qualitative and quantitative basis.

REFERENCES

(Section 2.1)

1. First Topical Report, Evaluation of Space Station Solar Array Technology,  
Report No. LMSC-A981486, December 1970.
2. First Topical Report Update, Evaluation of Space Station Solar Array Technology,  
Report No. LMSC D159124, July 1972.
3. Second Topical Report, Design and Analysis, Space Station Solar Array Technology  
Evaluation Program, Report No. LMSC-A995719, November 1971.



TABLE 2.1.4-6  
(Sheet 2 of 2)

LMSC-D159618

NO. & NAME OF DETACHABLE STRUCTURE	ILLUSTRATION	DESCRIPTION & CHARACTERISTICS OF STRUCTURE & MECHANISM OF DETACHMENT CAPABILITY	FLIGHT EXPERIENCE	SOURCE	DEVELOPMENT WORK	GENERAL DESIGN COMMENTS	RELIABILITY	DESIGN & MANUFACTURING DEVELOPMENT STAGE	INSTALLATION ON AIRCRAFT
11 TRIANGULAR WIRE		SOLID SPRING WIRE CONSTRUCTION. TRIANGULAR SECTION. FOLDS UP TO CONCENTRATE. ONE END OF THE TRIANGULAR SECTION IS WELDED TO A BEAM SO THAT THE REMAINING 2 SIDES CAN BE WELDED TOGETHER. THE FOLDED BEAM CAN THEN BE ROLLED UP ON A BEEL. BEEL KEYS WILL HOLD MOTOR & GEAR TRAIN. DETACHMENT ACCOMPLISHED BY REVERING MOTOR. IF RETRACTION IS NOT DESIRED, SPRING FORCE FOR MOTOR MUST BE USED FOR EXTENSION.	FLIGHT EXPERIENCE UNKNOWN	MATHAMITTA DEFENSE CORP.	SOME DEVELOPMENT MODELING, TESTS UNKNOWN	FOLDS INTO TRIANGULAR TO ACHIEVE REASONABLE TORSIONAL STIFFNESS. BEING USED IN REDUCING LINE BURST. FORMERLY USED IN AIR AND COAST GUARDIAN. MANY TRIANGULAR CONCEPTS. BEEL KEYS WILL HOLD MOTOR & GEAR TRAIN. DETACHMENT ACCOMPLISHED BY REVERING MOTOR. IF RETRACTION IS NOT DESIRED, SPRING FORCE FOR MOTOR MUST BE USED FOR EXTENSION.	A LARGE NUMBER OF WIRE PARTS. MINIMAL TOOLING AND REQUIRED CONSTRUCTION. FABRICATING METHODS.	CONSTRUCTION ALLOWS REPAIRED DETACHMENT/RETRACTION WITH MINOR PERFORMANCE DEGRADATION.	STORES ON A BEEL WITH THE OUTBOARD END DOWN. THE OUTBOARD SECTION SHOULD BE PROTECTED FROM UNDESIRABLE PRESENTATION.
12 TENSILE WIRE BEAM		TWO PAGES OF WIRING TAPE ARE ATTACHED TO APPROXIMATELY 1/2 IN. OF THE BEAM. THE SECTION IS REINFORCED AND BOLDED UP ON A BEEL FOR STORAGE. THE BEAM IS FLATTENED AND THE BEEL KEYS WILL HOLD MOTOR & GEAR TRAIN. DETACHMENT ACCOMPLISHED BY REVERING MOTOR. IF RETRACTION IS NOT DESIRED, SPRING FORCE FOR MOTOR MUST BE USED FOR EXTENSION.	FLIGHT EXPERIENCE UNKNOWN	BOEING CO., ASTRO DESIGN CORP., SANTA BARBARA, CALIFORNIA	TRADE NAME MODEL DEVELOPMENT MODEL 20-11 LONG. PARTS AND TESTS. TRADE NAME MODEL 20-11 LONG. PARTS AND TESTS. TRADE NAME MODEL 20-11 LONG. PARTS AND TESTS.	LINEAR DYNAMIC SYSTEM. VERY COMPACT STORAGE. ROOM DEVELOPMENTAL STIFFNESS AS IN STRUCTURE. THE BEAM IS GOOD FOR MEDIUM LENGTH APPLICATIONS. BEEL KEYS WILL HOLD MOTOR & GEAR TRAIN. DETACHMENT ACCOMPLISHED BY REVERING MOTOR. IF RETRACTION IS NOT DESIRED, SPRING FORCE FOR MOTOR MUST BE USED FOR EXTENSION.	FABRICATION AND ASSEMBLY TECHNIQUES WILL BE USED. CONVENTIONAL ASSEMBLY TECHNIQUES.	SAME AS NO. 11 (MOVIE)	SAME AS NO. 11 (MOVIE)
13 TENSILE (WIRE)		BEAM CONSISTS OF 2 PAGES OF WIRING TAPE WITH EDGE FRINGS CONTAINING WIRE AND GEAR TRAINS. PARTS AND TESTS. TRADE NAME MODEL 20-11 LONG. PARTS AND TESTS. TRADE NAME MODEL 20-11 LONG. PARTS AND TESTS.	NO FLIGHT EXPERIENCE	LOCKHEED MISSILES & SPACE COMPANY, SUPERVALLEY, CALIFORNIA	PROPORTIONS OF THE WIRING TAPE HAVE BEEN TESTED AND APPROVED. TRADE NAME MODEL 20-11 LONG. PARTS AND TESTS. TRADE NAME MODEL 20-11 LONG. PARTS AND TESTS.	HIGH DYNAMIC STIFFNESS. FAIRLY COMPACT STORAGE. AGAIN A MEDIUM LENGTH APPLICATION. BEEL KEYS WILL HOLD MOTOR & GEAR TRAIN. DETACHMENT ACCOMPLISHED BY REVERING MOTOR. IF RETRACTION IS NOT DESIRED, SPRING FORCE FOR MOTOR MUST BE USED FOR EXTENSION.	FABRICATION AND ASSEMBLY TECHNIQUES WILL BE USED. CONVENTIONAL ASSEMBLY TECHNIQUES.	SAME AS NO. 11 (MOVIE)	SAME AS NO. 11 (MOVIE)
14 INDICATED (WIRE)		3 PAGES BEAM, TWO OUTER PRE-COMPACTION SPRING TAPE ARE FLATTENED & BOLDED UP ON THE BEEL. THE BEEL KEYS WILL HOLD MOTOR & GEAR TRAIN. DETACHMENT ACCOMPLISHED BY REVERING MOTOR. IF RETRACTION IS NOT DESIRED, SPRING FORCE FOR MOTOR MUST BE USED FOR EXTENSION.	FLIGHT EXPERIENCE UNKNOWN	SANDERS ASSOCIATES INC., INDIANAPOLIS, IND.	TWO DEVELOPMENTAL ENGINEERING MODELS HAVE BEEN TESTED AND APPROVED. TRADE NAME MODEL 20-11 LONG. PARTS AND TESTS. TRADE NAME MODEL 20-11 LONG. PARTS AND TESTS.	LINEAR DYNAMIC SYSTEM. FAIRLY COMPACT STORAGE. AGAIN A MEDIUM LENGTH APPLICATION. BEEL KEYS WILL HOLD MOTOR & GEAR TRAIN. DETACHMENT ACCOMPLISHED BY REVERING MOTOR. IF RETRACTION IS NOT DESIRED, SPRING FORCE FOR MOTOR MUST BE USED FOR EXTENSION.	FABRICATION AND ASSEMBLY TECHNIQUES WILL BE USED. CONVENTIONAL ASSEMBLY TECHNIQUES.	CONSTRUCTION ALLOWS REPAIRED DETACHMENT/RETRACTION WITH MINOR PERFORMANCE DEGRADATION. MINIMAL TOOLING AND REQUIRED CONSTRUCTION.	STORES ON A BEEL WITH THE OUTBOARD END DOWN. THE OUTBOARD SECTION SHOULD BE PROTECTED FROM UNDESIRABLE PRESENTATION.
15 INTERLOCKING RETRACTION BEEL STORE		2 PAGES OF PRE-COMPACTION SPRING TAPE ARE FLATTENED & BOLDED UP ON THE BEEL. THE BEEL KEYS WILL HOLD MOTOR & GEAR TRAIN. DETACHMENT ACCOMPLISHED BY REVERING MOTOR. IF RETRACTION IS NOT DESIRED, SPRING FORCE FOR MOTOR MUST BE USED FOR EXTENSION.	SEE UNITS GO TO 130 FT LONG WERE FLOWN ON THE ORADIAN DEPLOYMENT SATELLITES.	SPAN AIRSPACE PRODUCTS LTD., ONTARIO, CANADA	TRADE NAME DEVELOPMENT MODEL 20-11 LONG. PARTS AND TESTS. TRADE NAME DEVELOPMENT MODEL 20-11 LONG. PARTS AND TESTS.	LINEAR DYNAMIC SYSTEM. VERY COMPACT STORAGE. THE BEAM IS GOOD FOR MEDIUM LENGTH APPLICATIONS. BEEL KEYS WILL HOLD MOTOR & GEAR TRAIN. DETACHMENT ACCOMPLISHED BY REVERING MOTOR. IF RETRACTION IS NOT DESIRED, SPRING FORCE FOR MOTOR MUST BE USED FOR EXTENSION.	FABRICATION AND ASSEMBLY TECHNIQUES WILL BE USED. CONVENTIONAL ASSEMBLY TECHNIQUES.	SAME AS NO. 14 (MOVIE)	SAME AS NO. 14 (MOVIE)
16 EXTENSIBLE AIR STORE		WELDED SPRING TAPE FOR TAPERED BEEL FLATTENED AND BOLDED UP ON A BEEL FOR STORAGE. THE BEEL KEYS WILL HOLD MOTOR & GEAR TRAIN. DETACHMENT ACCOMPLISHED BY REVERING MOTOR. IF RETRACTION IS NOT DESIRED, SPRING FORCE FOR MOTOR MUST BE USED FOR EXTENSION.	USED AS ANTENNA. DENSITY GRADIENT BEAM. ALUMINUM TUBE. AIR STORE. WINDING AND MANY MORE. TRADE NAME MODEL 20-11 LONG. PARTS AND TESTS. TRADE NAME MODEL 20-11 LONG. PARTS AND TESTS.	SPAN AIRSPACE PRODUCTS LTD., ONTARIO, CANADA	TRADE NAME MODEL 20-11 LONG. PARTS AND TESTS. TRADE NAME MODEL 20-11 LONG. PARTS AND TESTS.	LINEAR DYNAMIC SYSTEM. VERY COMPACT STORAGE. THE BEAM IS GOOD FOR MEDIUM LENGTH APPLICATIONS. BEEL KEYS WILL HOLD MOTOR & GEAR TRAIN. DETACHMENT ACCOMPLISHED BY REVERING MOTOR. IF RETRACTION IS NOT DESIRED, SPRING FORCE FOR MOTOR MUST BE USED FOR EXTENSION.	FABRICATION AND ASSEMBLY TECHNIQUES WILL BE USED. CONVENTIONAL ASSEMBLY TECHNIQUES.	CONSTRUCTION ALLOWS REPAIRED DETACHMENT/RETRACTION WITH MINOR PERFORMANCE DEGRADATION.	STORES ON A BEEL WITH THE OUTBOARD END DOWN. THE OUTBOARD SECTION SHOULD BE PROTECTED FROM UNDESIRABLE PRESENTATION.
17 SPRING WIRE		WIRE IS FORMED BY A MECHANICALLY PRESTRESSED SPRING. THE BEEL KEYS WILL HOLD MOTOR & GEAR TRAIN. DETACHMENT ACCOMPLISHED BY REVERING MOTOR. IF RETRACTION IS NOT DESIRED, SPRING FORCE FOR MOTOR MUST BE USED FOR EXTENSION.	USED TO PROTECT POIL. USED FOR CENTRAL CONTROL STATION ON ANDERSON. TRADE NAME MODEL 20-11 LONG. PARTS AND TESTS. TRADE NAME MODEL 20-11 LONG. PARTS AND TESTS.	AMERICAN SPRING CO., HARTFORD, CT.	TRADE NAME MODEL 20-11 LONG. PARTS AND TESTS. TRADE NAME MODEL 20-11 LONG. PARTS AND TESTS.	VERY COMPACT STORAGE. VERY LOW AREA AND TORSIONAL STIFFNESS. BEEL KEYS WILL HOLD MOTOR & GEAR TRAIN. DETACHMENT ACCOMPLISHED BY REVERING MOTOR. IF RETRACTION IS NOT DESIRED, SPRING FORCE FOR MOTOR MUST BE USED FOR EXTENSION.	MINIMUM SPECIAL TOOLING AND REQUIRED CONSTRUCTION. FABRICATING METHODS.	SAME AS NO. 14 (MOVIE)	SAME AS NO. 14 (MOVIE)
18 INFLATABLE		HAS THREE TUBES. MOTOR, MOTOR ARE FLATTENED AND BOLDED UP ON A BEEL FOR STORAGE. THE BEEL KEYS WILL HOLD MOTOR & GEAR TRAIN. DETACHMENT ACCOMPLISHED BY REVERING MOTOR. IF RETRACTION IS NOT DESIRED, SPRING FORCE FOR MOTOR MUST BE USED FOR EXTENSION.	SEVERAL LOOP ANTENNAS, 4 TO 8 FT DIA. WERE FLOWN ON THE ORADIAN DEPLOYMENT SATELLITES. TRADE NAME MODEL 20-11 LONG. PARTS AND TESTS. TRADE NAME MODEL 20-11 LONG. PARTS AND TESTS.	LOCKHEED S.C., SUPERVALLEY, CALIFORNIA	TRADE NAME MODEL 20-11 LONG. PARTS AND TESTS. TRADE NAME MODEL 20-11 LONG. PARTS AND TESTS.	HIGH DYNAMIC STIFFNESS. FAIRLY COMPACT STORAGE. AGAIN A MEDIUM LENGTH APPLICATION. BEEL KEYS WILL HOLD MOTOR & GEAR TRAIN. DETACHMENT ACCOMPLISHED BY REVERING MOTOR. IF RETRACTION IS NOT DESIRED, SPRING FORCE FOR MOTOR MUST BE USED FOR EXTENSION.	MINIMUM TOOLING AND REQUIRED CONSTRUCTION. FABRICATING METHODS.	PERFORMANCE DEGRADATION NOTICABLE WITH BEEL KEYS WILL HOLD MOTOR & GEAR TRAIN. DETACHMENT ACCOMPLISHED BY REVERING MOTOR. IF RETRACTION IS NOT DESIRED, SPRING FORCE FOR MOTOR MUST BE USED FOR EXTENSION.	STORES WILL MUST HAVE A GAS SUPPLY. VERY DELICATE. MUST BE PROTECTED FROM UNDESIRABLE PRESENTATION.
19 BOLDED INFLATABLE		TWO SYSTEMS ARE SHOWN. IN A SOLID CORE OF WIRE. THE BEEL KEYS WILL HOLD MOTOR & GEAR TRAIN. DETACHMENT ACCOMPLISHED BY REVERING MOTOR. IF RETRACTION IS NOT DESIRED, SPRING FORCE FOR MOTOR MUST BE USED FOR EXTENSION.	FLIGHT EXPERIENCE UNKNOWN	GOODRICH AIRCRAFT CORP., WASHINGTON, OHIO	DEVELOPED A SERIES OF INFLATABLE BOLDED STRUCTURES FOR USE IN THE ORADIAN DEPLOYMENT SATELLITES. TRADE NAME MODEL 20-11 LONG. PARTS AND TESTS. TRADE NAME MODEL 20-11 LONG. PARTS AND TESTS.	HIGH DYNAMIC STIFFNESS. FAIRLY COMPACT STORAGE. AGAIN A MEDIUM LENGTH APPLICATION. BEEL KEYS WILL HOLD MOTOR & GEAR TRAIN. DETACHMENT ACCOMPLISHED BY REVERING MOTOR. IF RETRACTION IS NOT DESIRED, SPRING FORCE FOR MOTOR MUST BE USED FOR EXTENSION.	MINIMUM TOOLING AND REQUIRED CONSTRUCTION. FABRICATING METHODS.	NOT RECOMMENDED DEVELOPMENT TESTS CAN NOT BE MADE ON FLIGHT. DEVELOPMENT TESTS AND OTHER QUALITY ASSURANCE TESTING MUST BE USED.	STORES WILL, BUT DOES REQUIRE ATTENDING PRODUCTION CONTAINER.
20 FIBER WIRE		CYLINDRICAL SECTION WITH SPHERICAL SEATS ON EACH END. THE BEEL KEYS WILL HOLD MOTOR & GEAR TRAIN. DETACHMENT ACCOMPLISHED BY REVERING MOTOR. IF RETRACTION IS NOT DESIRED, SPRING FORCE FOR MOTOR MUST BE USED FOR EXTENSION.	FLIGHT EXPERIENCE UNKNOWN	GENERAL ELECTRIC CO., WASHINGTON, OHIO	DEVELOPED FOR NASA AN ORADIAN DEPLOYMENT SATELLITE. TRADE NAME MODEL 20-11 LONG. PARTS AND TESTS. TRADE NAME MODEL 20-11 LONG. PARTS AND TESTS.	HIGH DYNAMIC STIFFNESS. FAIRLY COMPACT STORAGE. AGAIN A MEDIUM LENGTH APPLICATION. BEEL KEYS WILL HOLD MOTOR & GEAR TRAIN. DETACHMENT ACCOMPLISHED BY REVERING MOTOR. IF RETRACTION IS NOT DESIRED, SPRING FORCE FOR MOTOR MUST BE USED FOR EXTENSION.	MINIMUM TOOLING AND REQUIRED CONSTRUCTION. FABRICATING METHODS.	REPAIRED DEVELOPMENT TESTS CAN NOT BE MADE. MUST BE PROTECTED FROM UNDESIRABLE PRESENTATION.	REPAIRED DEVELOPMENT TESTS CAN NOT BE MADE. MUST BE PROTECTED FROM UNDESIRABLE PRESENTATION.

TABLE 2.1.4-7  
CHARACTERISTICS OF EXISTING SPAR AEROSPACE STEM-TYPE BOOMS

Program	FRUSA	Apollo 15/16 Mass Spectrometer	15/16 Gamma Ray	Apollo 17 Lunar Sounder	AEG- Telefunken	NASA- Langley
Type	Bi-Stem	Bi-Stem	Bi-Stem	Bi-Stem	Bi-Stem	MTS Boom
Diameter	.86 in	2.0	2.0	1.34	.86	.86
Element Length	16.0 ft	25.0 ft	27.0 ft	34.0 ft <sup>2</sup>	16.0 ft	11.0 ft
Mechanism Size	4.0x11.0D	10.0Dx73.5L	10.0Dx18.0L	7.5"x8.0"x14.5"	16.0x6.0x4.0	5.0x16.0x4.0
Mechanism Weight	17.0 Lb	57.0 Lb	45.0 Lb	22.5 Lb	16.0 Lb	12.0 Lb
Element Material	301 S. S.	455 S. S.	455 S. S.	455 S. S.	301 S. S.	301 S. S.
Thermal Coating	Silver Plate	Silver Plate	Silver Plate		No Coating	No Coating
Motor Type	DC Motor	2 Motors DC	2 Motors DC	DC Motor	DC Motor	DC Motor
Extension Rate	1/2"/sec	1.8"/sec	1.8"/sec	6.0"/sec	1.6"/sec	7.3"/sec
Number of Boom(s)/ Mech.	2	1	1	2	2	4
Element Thickness	.005	.012	.012	.007	.005	.005
Number of Units (Production)	2	3	3	4	1	1

LOCKHEED MISSILES & SPACE COMPANY

2-25

LMSC-D159618



TABLE 2.1.4-8  
CHARACTERISTICS OF EXISTING ASTROMASTS

Application	Antenna Support Jeep Mounted (Prototype)	Erector/Support for S/C Helical Antennae	Central Support for Parabolic Mesh Antenna (Subscale Model)	Antenna Support for use on Lunar Surface (Eng. Model)	Support for Space Station Solar Cell Array (Eng. Model)	Support Boom for Antennae of Orbiting Interferometer (Test Segment)
Mast type	Articulated longeron	Continuous longeron	Continuous longeron	Continuous longeron	Articulated longeron	Continuous longeron
Mast diam (in.)	13.4	4	6	10	20	8
Mast length (ft)	40	15	8	100	84	10 <sup>(1)</sup>
Approx weight Mast (lb)	46	0.30	2.0	20	214	1.3
Canister <sup>(2)</sup> (lb)	128	(3)	20	30	186	(3)
Package size <sup>(4)</sup>	25 x 43	4.25 x 6 <sup>(5)</sup>	7 x 20	11 x 42	24 x 52	8.5 x 4 <sup>(5)</sup>
Motors	1-1/4 hp 28 V DC	None	1-Globe 28 V DC	2-Globe 28 V DC	3-12 amp 28 V DC	None
Extension rate	1 ft/sec	--	4 in./sec	2 in./sec	2.5 in./sec	--
Bending stiffness (lb-in. <sup>2</sup> ) x 10 <sup>-6</sup>	77	0.12	0.70	5.5	280	2.04
Bending strength (in.-lb)	7800	25	80	460	36,000	200

- (1) 10 ft test segment of 125 ft required length  
(2) No significant effort made to minimize canister weight  
(3) No canister supplied  
(4) Cylindrical volume - cyl. diam (in.) x cyl. height (in.)  
(5) Size of retracted boom alone - no canister supplied

## 2.2 SOLAR ARRAY SUBSTRATE ASSEMBLY

The purpose of this section, 2.2, is to provide design information applicable to one of the more recent developments in solar array technology--the flexible substrate. Some of the advantages of this assembly approach are: 1) less weight per square foot which means less vehicle launching cost, 2) greatly increased solar array area capability over conventional rigid honeycomb panels due to reduced stowage volume, 3) less cost due to full ability to combine wraparound solar cell technology with integrated printed circuit technology production techniques, and 4) ability to fully automate solar panel production.

A typical flexible substrate assembly with the components in their related layers is shown in Figure 2.2-1. The basic laminate is composed of coverglasses, coverglass adhesive, wraparound solar cells, a Kapton/FEP dielectric and structural plastic film, and an integral printed circuit interconnect. In order to present a clearer picture of this method of preparation of the array substrate, the electrical module assembly sequence of the SSSA (Space Station Solar Array) substrate is shown in Figure 2.2-2. Although the method is neither universal throughout the industry nor applicable to all flexible array applications (e.g., hardened flexible solar arrays would use neither copper interconnects nor solder but would use, for example, aluminum interconnects and ultrasonic bonding) it is typical and therefore provides a sound introduction to the individual components of the assembly. They will be more fully discussed in the subsections that follow.

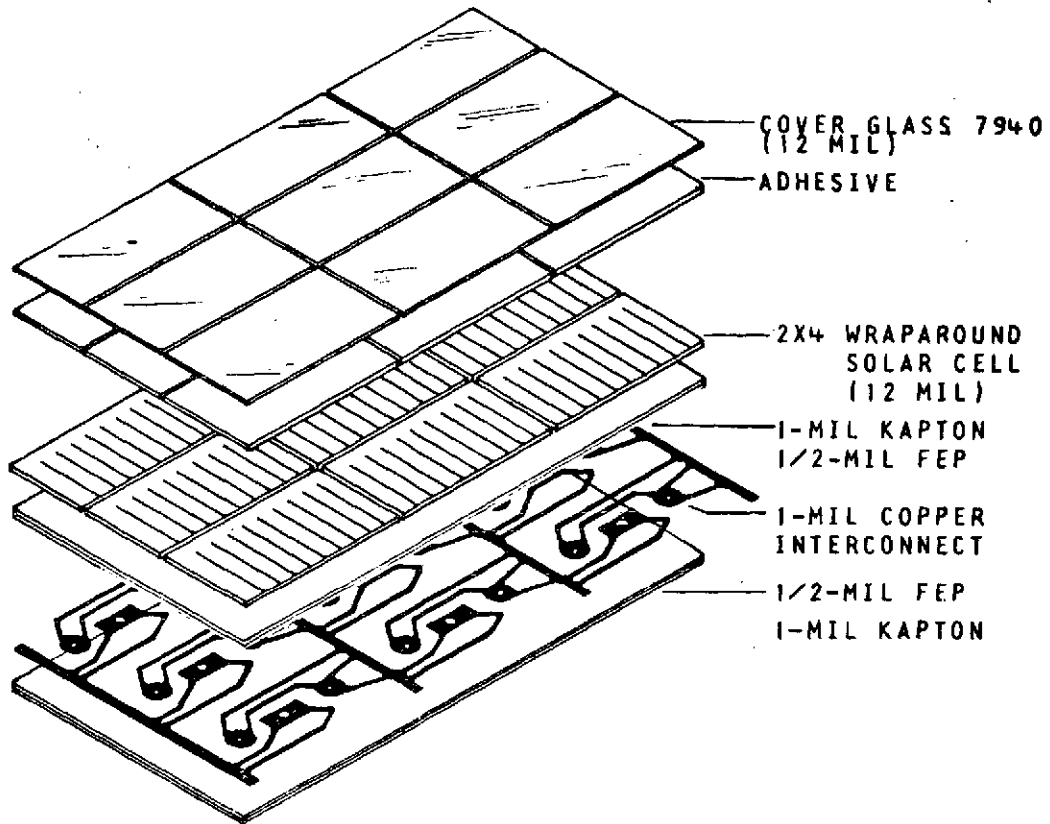

Figure 2.2-1 Substrate Assembly Exploded View

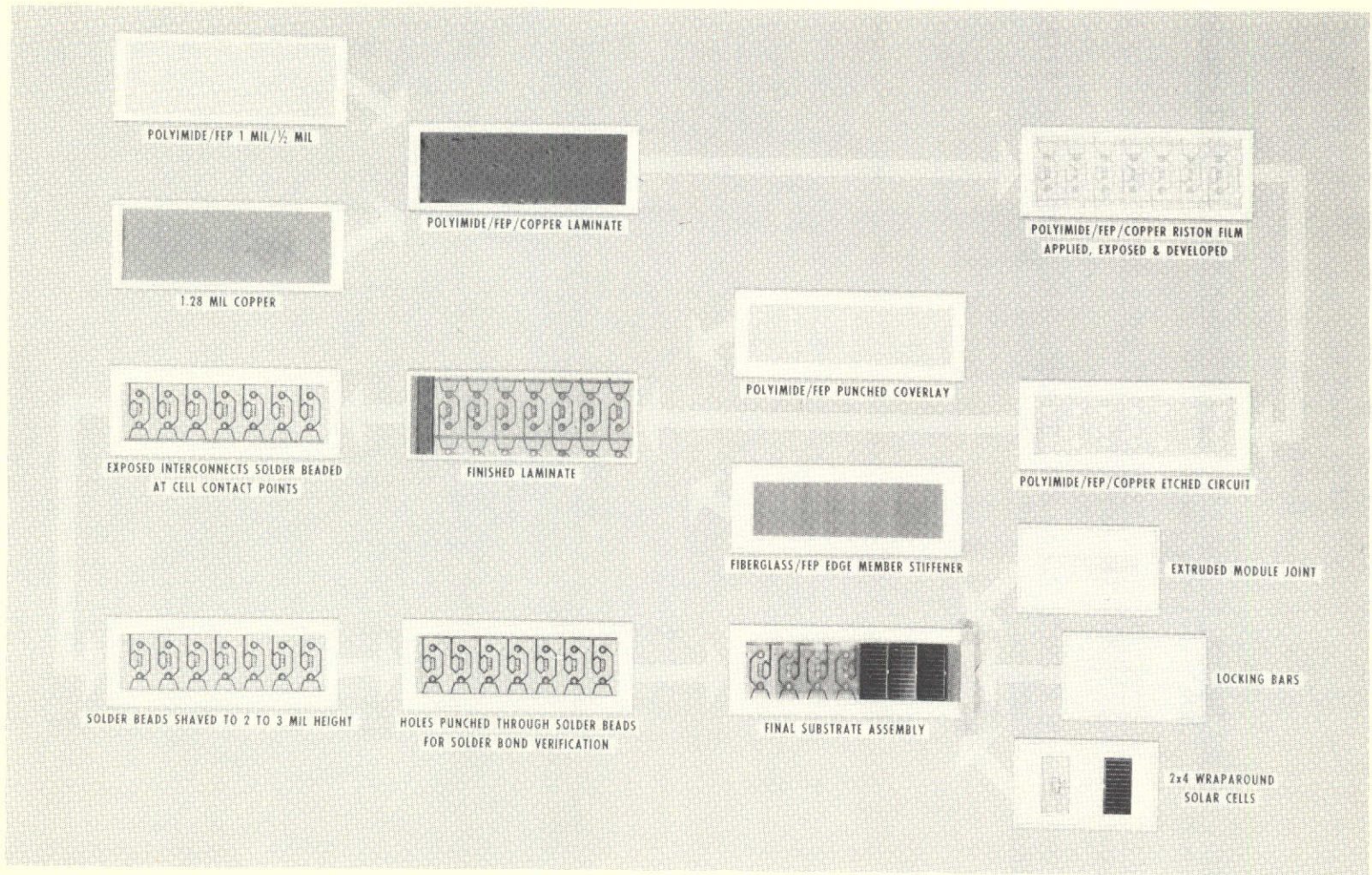

Figure 2.2-2 Electrical Module Assembly Sequence

REFERENCES

(Section 2.2)

1. First Topical Report, Evaluation of Space Station Solar Array Technology,  
Report No. LMSC-A981486, December 1970.
2. First Topical Report Update, Evaluation of Space Station Solar Array Technology,  
Report No. LMSC D159124, July 1972.
3. Second Topical Report, Design and Analysis, Space Station Solar Array Technology  
Evaluation Program, Report No. LMSC-A995719, November 1971.



## 2.2.1 Solar Cells

### 2.2.1.1 Function in System

The key element of every array system is the solar cell which converts sunlight into electrical energy for the vehicle power system. A typical solar cell is shown below in Figure 2.2.1-1.

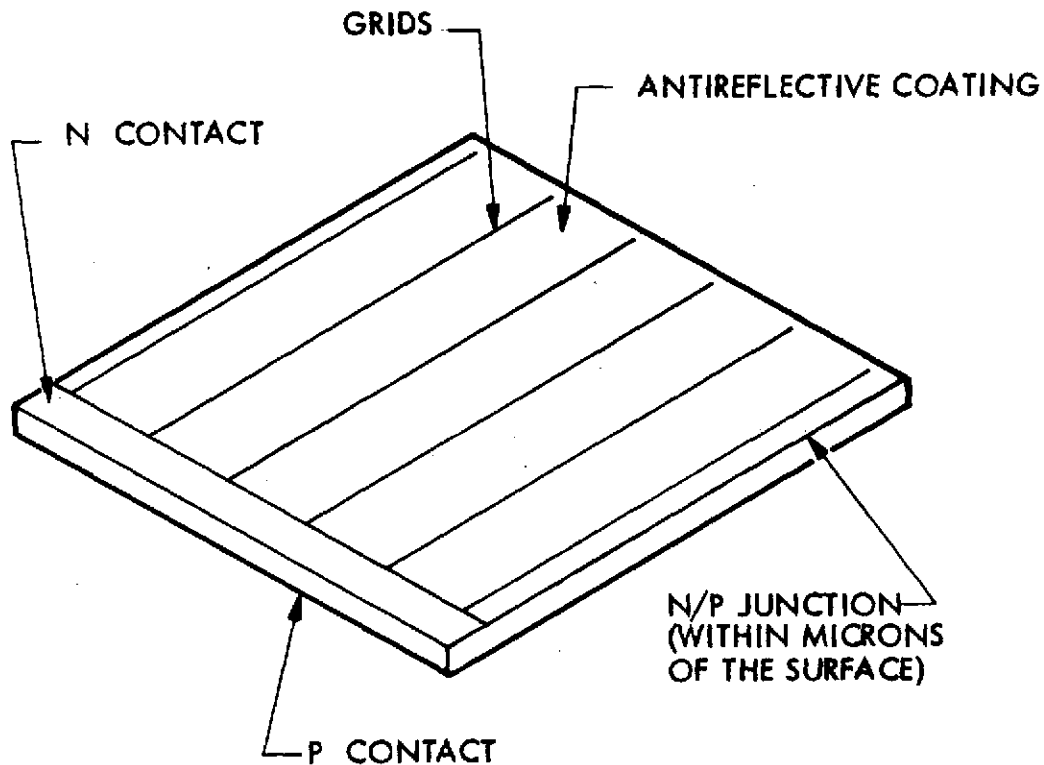

Figure 2.2.1-1 Typical Solar Cell

### 2.2.1.2 Design Parameters

Table 2.2.1-1 presents the major types of solar cells currently available in the industry. Some general features of each are also presented. The cell that has received by far the most usage is the conventional N/P silicon solar cell. Its technology is well established and currently it is the most efficient cell produced on a regular basis outside of the laboratory. The typical N-on-P Si solar cell is manufactured from P-type single crystal silicon having a resistivity of 2 or 10  $\Omega$ -cm. The illuminated surface of the cell contains a shallow diffused, 0.3  $\mu$ m deep N-type layer

doped with phosphorus. Electrical contact to the cell is accomplished by an evaporated Ti/Ag contact. An antireflective coating composed of an SiO<sub>2</sub>-layer causes the blue surface appearance. The wraparound cell (identical to the conventional except that the negative electrode is wrapped around to the back of the cell) is, however, gaining in use because it allows much more efficient panel fabrication techniques. Table 2.2.1-2 presents some of the detailed considerations used in selecting a conventional or a wraparound silicon solar cell for a solar array.

TABLE 2.2.1-1  
COMPARISON OF SOLAR CELLS

	CONVENTIONAL SILICON	WRAPAROUND ELECTRODE	LITHIUM-DOPED	ION-IMPLANTATION	LARGE AREA	ALUMINUM CONTACT CELLS	NOTES ON SILICON CELLS	CdS	CdTe
Manufacturing Methods	Boron-doped substrate with phosphorus diffusion. N on P is standard.	Same as conventional cell with additional masking and dielectric gap on back.	P on N junction cell with small quantities of lithium diffused into the cell.	Accelerated ions used to control accurate doping of cell.	Same as conventional cell.	Simple runs fabricated successfully on several cell sizes.		Vacuum deposited onto plastic-film substrate. Junction formed by chemical dip. Grills cemented with metallized epoxy. Mylar or Kapton plastic encapsulation.	Co-evaporation of Cd and Te onto thin Mo substrate. Copper telluride vacuum flash evaporated to form junction. Evaporated gold grid. Krylon sealing and AR coating, or $Al_2O_3$ AR coating.
Size	Standard size of 2 x 2 cm, 6 to 14 mils thick.	2 x 2 and 2 x 4 cm, 10 to 14 mils thick.	Standard size of 2 x 2 cm, 6 to 14 mils thick.	Standard size of 2 x 2 cm, 6 to 14 mils thick.	Width: 2 cm to 1.5 in. Length: 2 cm to 6 in. Usually in 2 x 3, 2 x 4, 2 x 5, and 2 x 6 cm sizes.	Standard size of 2 x 2 cm, 6 to 14 mils thick.		Standard size of 3 in. x 3 in. area and 2-5 mils thick. Areas up to 1 sq ft possible.	No standard. 2 x 3 cm cells up to 320 cm <sup>2</sup> cells have been made.
Efficiency	10-11% AMO average.	Apparent power increase. Output increased 3% due to increased active area.	11% AMO average.	11% AMO average.	Same as conventional cell.	Same as conventional cell.		AMO, Kapton covered 3.3% average in pilot production, 6% maximum.	AMI, Krylon covered, 4.8% average, 6% maximum.
Temperature Performance	Power change of -0.6% of original per °C.	Power change same as conventional cell.	Unirradiated cell power change same as conventional cell.	Power change same as conventional cell.	Power change same as conventional cell.	Power change same as conventional cell.	Temperature cycling affects: (1) annealing of radiation damage and recovery of power, and (2) contacts, bonding, and material fatigue.	Power change of -0.46% of original per °C increase.	Power change of -0.57% of original per °C increase.
Cost	\$3 to \$6 each in large orders.	\$10 to \$50 each in small quantities. 5 to 20% more expensive than conventional cells in production.	Approximately 10% more expensive than conventional cells in production.	\$6 to \$10 each. Production is limited at this time.	\$6 to \$12 each in large orders.	\$11 each in small quantities, \$3 to \$6 in large orders.	Higher average efficiency specs and thinner cells decrease yield, increase cost, and reduce lb/watt.	\$25 each in small quantities. Expect to reach \$5 each in production.	Unknown.
Weight	2.3 gm/cm <sup>2</sup> silicon, 0.015 g/cm <sup>2</sup> of solder area. 10-mil soldered cell weighs 0.2932 gm each, average.	10-mil cell weighs 0.2932 gm.	10-mil cell weighs 0.2932 gm.	10-mil cell weighs 0.2932 gm.	2 x 4 cm cell is 10 mils longer than two 2 x 2 cm cells. 10-mil cell weighs 0.5901 gm.	10-mil cell weighs 0.2932 gm.		3 in. x 3 in. standard weighs 1.6 gm with plastic encapsulation. A low-weight design is 1.25 gm/cell.	A 3 in. x 3 in. cell with plastic cover would weigh 2 gm.
Cost of Cells/m <sup>2</sup> of Array Module	(200 cells/m <sup>2</sup> , \$5/cell, 10 mil) \$1000.	(200 cells/m <sup>2</sup> , \$5.50/cell, 10 mil) \$1100.	(200 cells/m <sup>2</sup> , \$5.50/cell, 10 mil) \$1100.	(200 cells/m <sup>2</sup> , \$8 cell, 10 mil) \$1000.	(100 cells/m <sup>2</sup> , \$10/cell, 2 x 4 cm, 10 mil) \$1000.	(200 cells/m <sup>2</sup> , \$5/cell, 10 mil) \$1000.	Cost savings in larger cell are expected to appear in reduced handling/watt of assembled array.	(14.2 cells/m <sup>2</sup> , \$5 cell) \$71.	Unknown.
Watts/m <sup>2</sup> of Array Module at 0° Angle of Incidence	(61.1 mW average at 25°C AMO 20-cm, 10 mils nominal) 14.2.	(62.0 mW average at 25°C AMO 20-cm, 5 mils nominal) 14.6.	(10 mils at 25°C AMO 20-cm) 14.2.	(10 mils 25°C AMO 20-cm) 14.2.	(121.2 mW average at 25°C AMO 20-cm 10 mils, 2 x 4 cm) 14.2.	61.1 mW average at 25°C AMO 20-cm, 10 mils nominal) 14.2.	B.O.L. Power. Spacing between modules and effects of covers not included.	(0.259 W average at 25°C AMO) 3.63.	(0.279 W average for 3 in. x 3 in. cell AMI) 3.96.
Radiation Damage	At 1500 nautical miles, 40% degradation in one year.	Same as conventional.	At 1500 nautical miles, 40% degradation in five to ten years. Testing and development continuing.	Same as conventional.	Same as conventional.	Same as conventional cell. Low Z Al reduces energy deposition in contacts due to nuclear weapons effects.		Low-energy protons cause significant damage. 1-mil Kapton covers drop initial power but limits power degradation to 10% for 10 <sup>14</sup> p/cm <sup>2</sup> , 1 to 5 Mev.	Limited data, electron-degradation insignificant. 15% degradation with 7 x 10 <sup>13</sup> p/cm <sup>2</sup> (2.4 Mev). Krylon covers darken under UV radiation and a polysilane cover has been proposed by the French.
Availability	Available now.	Available now.	Can be obtained in small quantities.	Available now. Production rate capability is low.	Usual sizes. Available now.	Available now.		Can be obtained at a rate of 50 cells/day now.	U.S. efforts nil at this time. A French government laboratory (Laboratoire E.R.G.) indicates pilot production but effort is mainly developmental.



TABLE 2.2.1-2  
SOLAR CELL CONFIGURATION SELECTION CONSIDERATIONS

PARAMETER	CHOICES	COMMON SELECTION*	CRITERIA
Materials	See Text	Silicon	See Above
Type	N/P or P/N	N/P	Much more radiation resistant than P/N
Size	2 cm by 2 up to 10 cm 3 cm by 3 cm	2 by 2 or 2 by 4	Tooling is developed and cost has been optimized. Tendency to use larger cell to facilitate panel fabrication
Thickness	4 to 18 mil	Variable	Based on performance and radiation requirements (see Section 3.2)
Base Material Resistivity	2 or 10 $\Omega$ cm	Variable	"
Contacts	Conventional or Wraparound	Conventional	Technology is well developed. Tendency is to use wraparound (see Figure 2.2.1-2) to eliminate series tab and facilitate panel fabrication
Contact Material	AgTi, Ag-Pd-Ti, Al, Ni-Cu-Au	AgTi	May degrade in presence of humidity, therefore is used when contact is solder coated.
		Ag-Pd-Ti	Does not degrade in humidity, therefore normally used when contact is solderless.
		Al	Low Z material, used with hardened array or when welding is the joining method

\*Based on general industry trends

Preceding page blank

TABLE 2.2.1-2 (Cont.)  
 SOLAR CELL CONFIGURATION SELECTION CONSIDERATIONS

PARAMETER	CHOICES	COMMON SELECTION*	CRITERIA
Soldered or Solderless Contacts	Soldered, Solderless	Soldered	Facilitates soldering of interconnects, used where weight is not a problem
		Solderless	Used where weight is a problem or welding is required
Antireflective Coating	SiO, TiO <sub>x</sub> , CeO <sub>x</sub>	SiO	Conventional cell coating that is easy to control but is optimized for air/silicon interface
		TiO <sub>x</sub> or CeO <sub>x</sub>	Used with integral cover-glasses (TiO <sub>x</sub> perhaps easier to control)
Power	--	Variable	See paragraph below
Weight	--	Variable	
Cost	--	Variable	

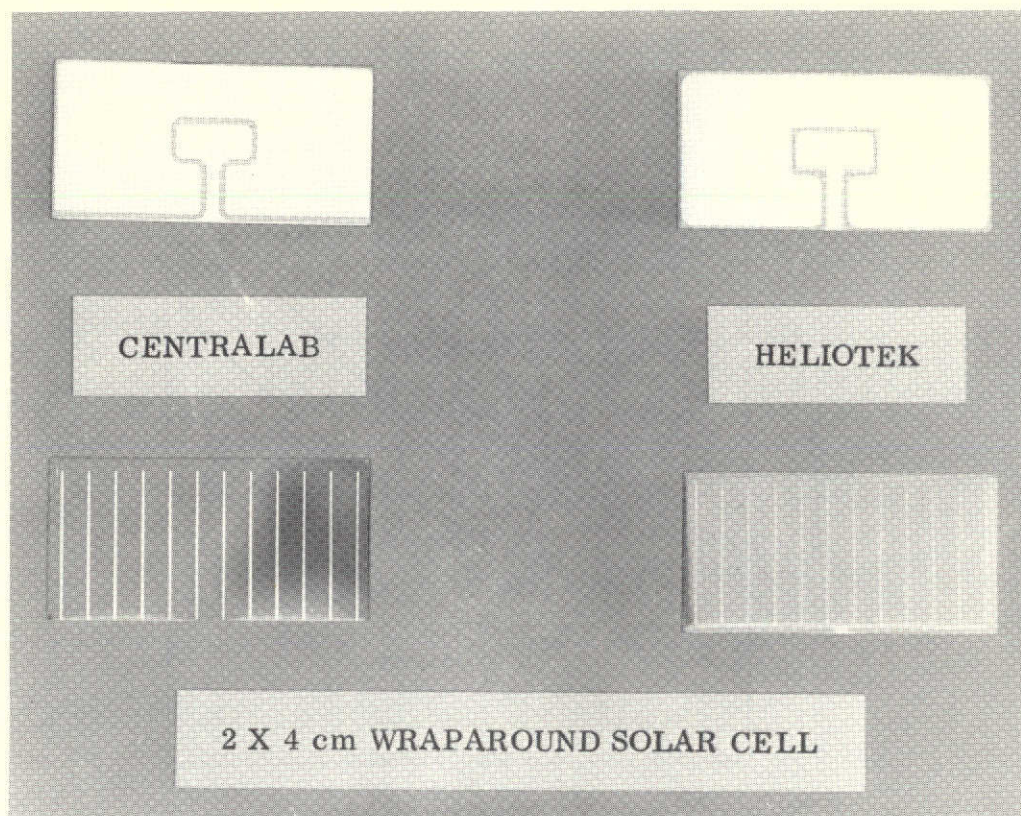

Figure 2.2.1-2 2 x 4 cm Wraparound Solar Cell

In reference to Table 2.2.1-2, the relationships between solar cell power, weight and cost are time and "situation" dependent. Therefore, the cell manufacturer must be involved and consulted for finalizing these tradeoffs. However, for estimation purposes, the following data is presented:

AVERAGE SILICON SOLAR CELL POWER (at 1.0 a. u.) -  $P \approx 15 \text{ mw/cm}^2$

AVERAGE SILICON SOLAR CELL WEIGHT -

$$W_{\text{SOLDERLESS CELL}} \approx (.024 \text{ gm/mil}) \times (\text{Thickness} + 1 \text{ mil}) / 4 \text{ cm}^2$$

$$\text{ADDED WEIGHT FOR SOLDER DIPPED CELL} \approx .14 \text{ gm}/4 \text{ cm}^2$$

$$\text{ADDED WEIGHT FOR SOLDER DIPPED AND PRESSED CELL} \approx .07 \text{ gm}/4 \text{ cm}^2$$

AVERAGE SILICON SOLAR CELL COST - See Figure 2.2.1-3

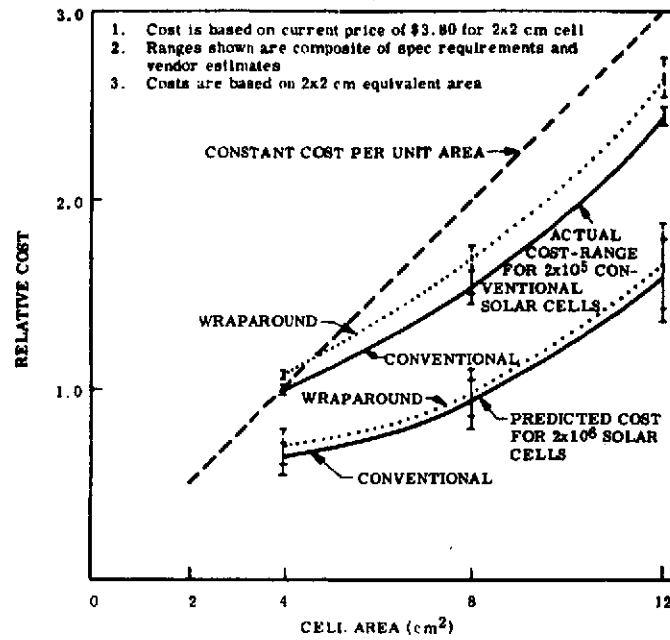

Figure 2.2.1-3 Relative Cost Comparison of Wraparound vs Conventional Cells

## REFERENCES

(Section 2.2.1)

1. First Topical Report, Evaluation of Space Station Solar Array Technology, Section 4.1.3.3, Report No. LMSC-A981486, December 1970.
2. First Topical Report Update, Evaluation of Space Station Solar Array Technology, Section 4.1.3.3, Report No. LMSC-D159124, July 1972.
3. Second Topical Report, Design and Analysis, Space Station Solar Array Program, Section 3.2.3, Report No. LMSC-A995719, November 1971.
4. Communication, K. S. Ling of Centralab to J. A. Mann of LMSC, 5 August 1969.
5. Centralab Solar Cell Space Manual, 1968.
6. J. A. Mann and K. S. Ling, "Large Area Wraparound Contact Silicon Solar Cell Application and Development", Proceedings of the 7th IECEC, September 1972.

## 2.2.2 Coverglasses

### 2.2.2.1 Function in the System

The solar cell cover slide is required in the array assembly to:

- Reduce cell operating temperature by providing a surface with a high thermal emittance.
- Provide cell protection from radiation degradation.
- Provide cell protection from micrometeorite erosion.
- Reduce handling and mechanical stresses on the cell.

A typical coverglass is shown below in Figure 2.2.2-1.

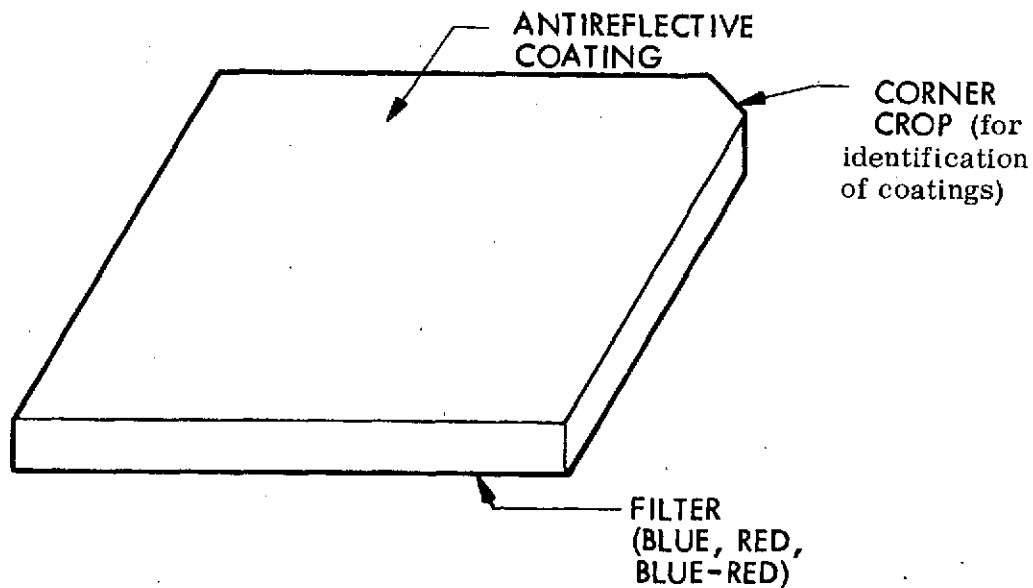

Figure 2.2.2-1 Typical Coverglass

### 2.2.2.2 Design Parameters

Discussed in Table 2.2.2-1 are the various parameters that must be considered when selecting a solar cell coverglass. To date, fused silica (in high radiation environments) and microsheet (in low radiation environments) have been the common material selections. Figures 2.2.2-2 through 2.2.2-6 show various cost and weight tradeoffs for these two materials. Section 2.2.3 will discuss some of the adhesives used in attaching conventional coverglasses to the solar cell.

Preceding page blank

TABLE 2.2.2-1  
COVERGLASS DESIGN CONSIDERATIONS

PARAMETER	CHOICES	COMMON SELECTION*	CRITERIA
Material	Fused silica, microsheet, doped glass, FEP (heat sealed)	Fused silica	Used when best transmission and radiation resistance required
		Microsheet	Inexpensive, however will degrade from UV and radiation
Type	Conventional, Integral Heat Sealed	Conventional	Traditional approach.
		Integral and Heat Seal	Possible future use for greater area coverage at less cost
Size	--	Adequate to cover solar cell	Because of tolerances, conventional method does not provide full coverage near N contact unless costly manufacturing care is exercised.
Thickness	2 mil and above	Dependent on radiation, weight, cost tradeoffs	See Section 3.2 and Figures 2.2.2-2 through 2.2.2-6.
Coatings	AR, Blue, Red, Blue-Red	AR + Blue	AR reduces reflections, blue protects adhesive from UV (see Section 2.2.3).
Weight	--	Variable	See Figures 2.2.2-2 through 2.2.2-6
Cost	--	Variable	

\*Based on general industry trends

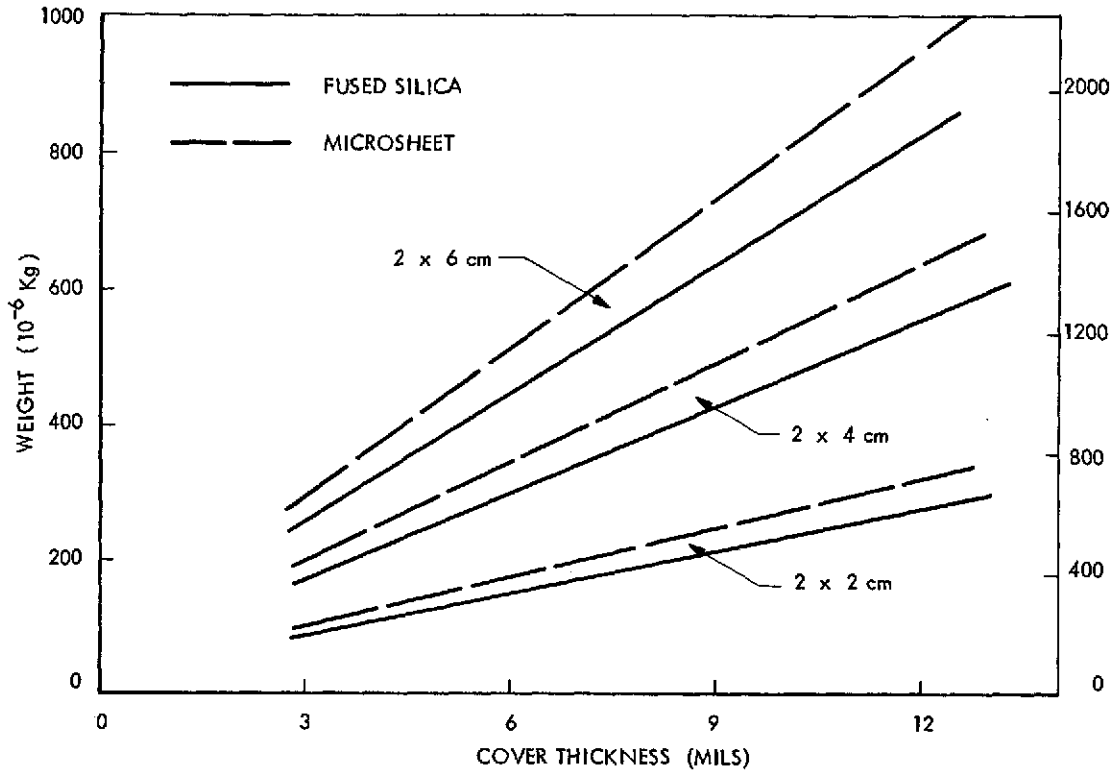

Figure 2.2.2-2 Weight of Coverglasses for Conventional Cells

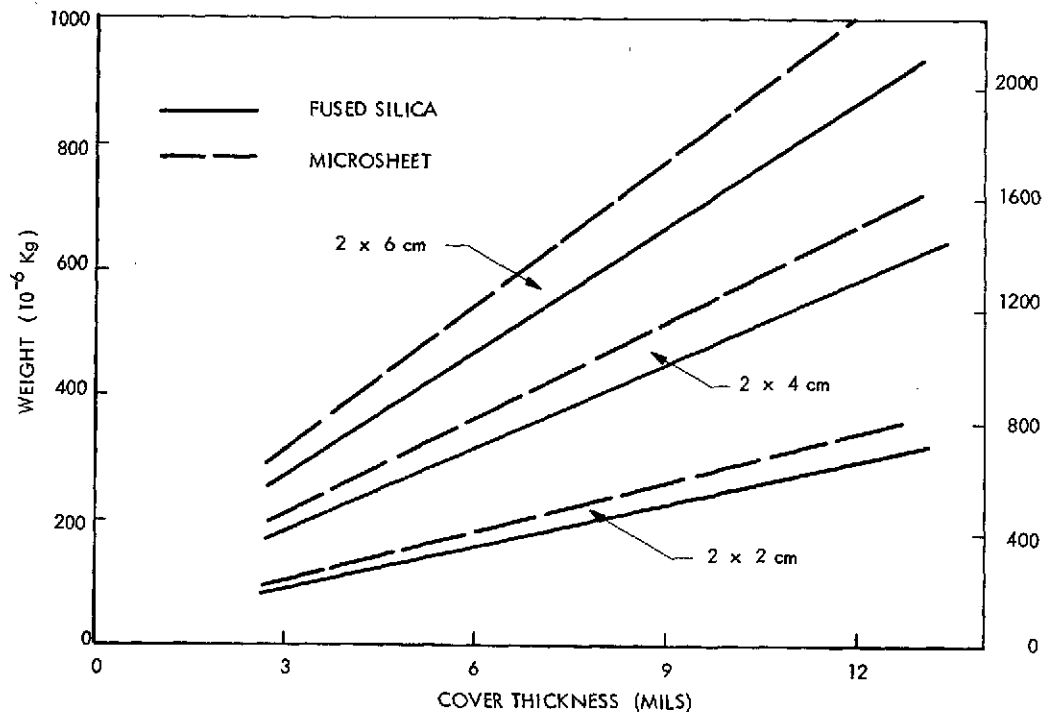

Figure 2.2.2-3 Weight of Coverglasses for Wraparound Cells



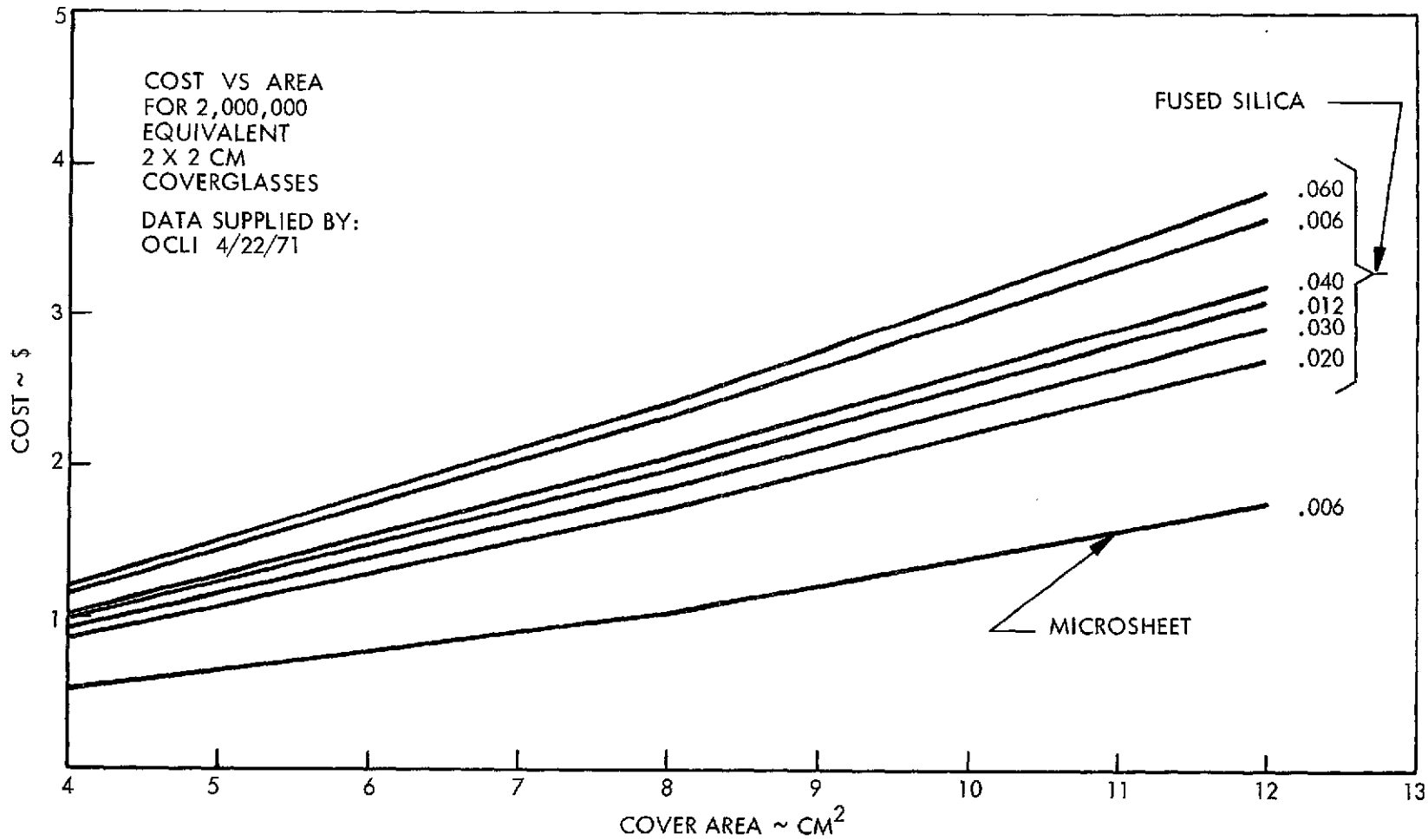

Figure 2.2.2-4 Cost vs Area for 2,000,000 Equivalent 2 x 2 cm Coverglasses

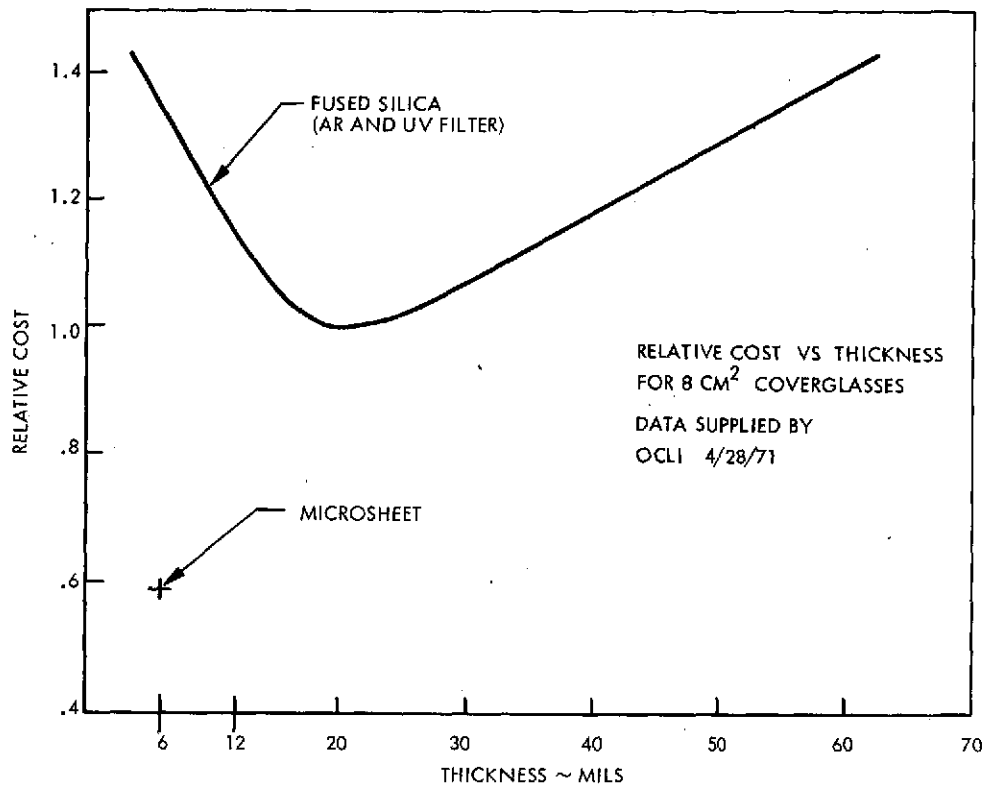

Figure 2.2.2-5 Relative Cost vs Thickness for 8 cm<sup>2</sup> Coverglasses

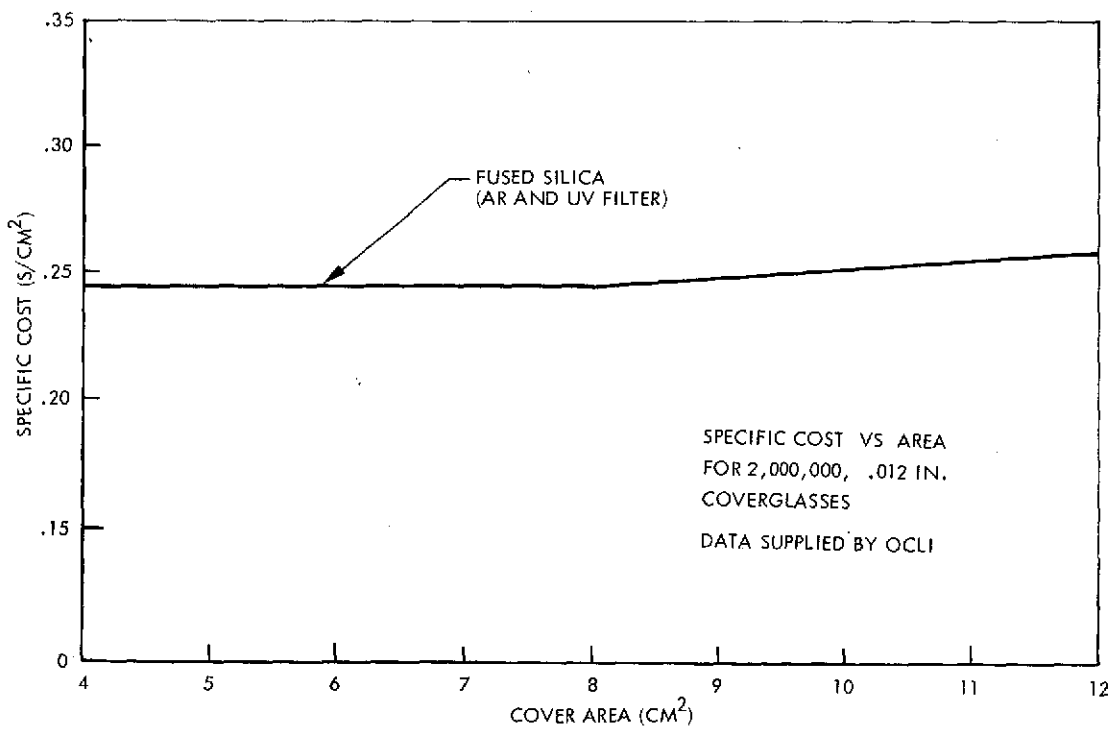

Figure 2.2.2-6 Specific Cost vs Area for 2,000,000 0.012-inch Coverglasses

To give the designer an idea of how much solar energy is cut off by various coverglass filters, a figure such as Figure 2.2.2-7 should be constructed. The "solar energy curve" is the integrated Johnson's curve of the solar spectrum. The ordinate shows what percent of the total energy available has occurred up to a given wavelength. The other curve is a normalized summation of solar cell output current versus wavelength. (This curve is prepared by multiplying the solar cell response (see Figure 3.2-4) by the available solar energy at each wavelength (see Figure 3.2-1). It will, of course, shift as a function of temperature, irradiation and resistivity. It should be redrawn for each specific design case in question). With curves such as these, tradeoffs of filter-caused power losses versus filter-caused temperature reductions (due to heat energy cut off and better thermal emittance) may be made.

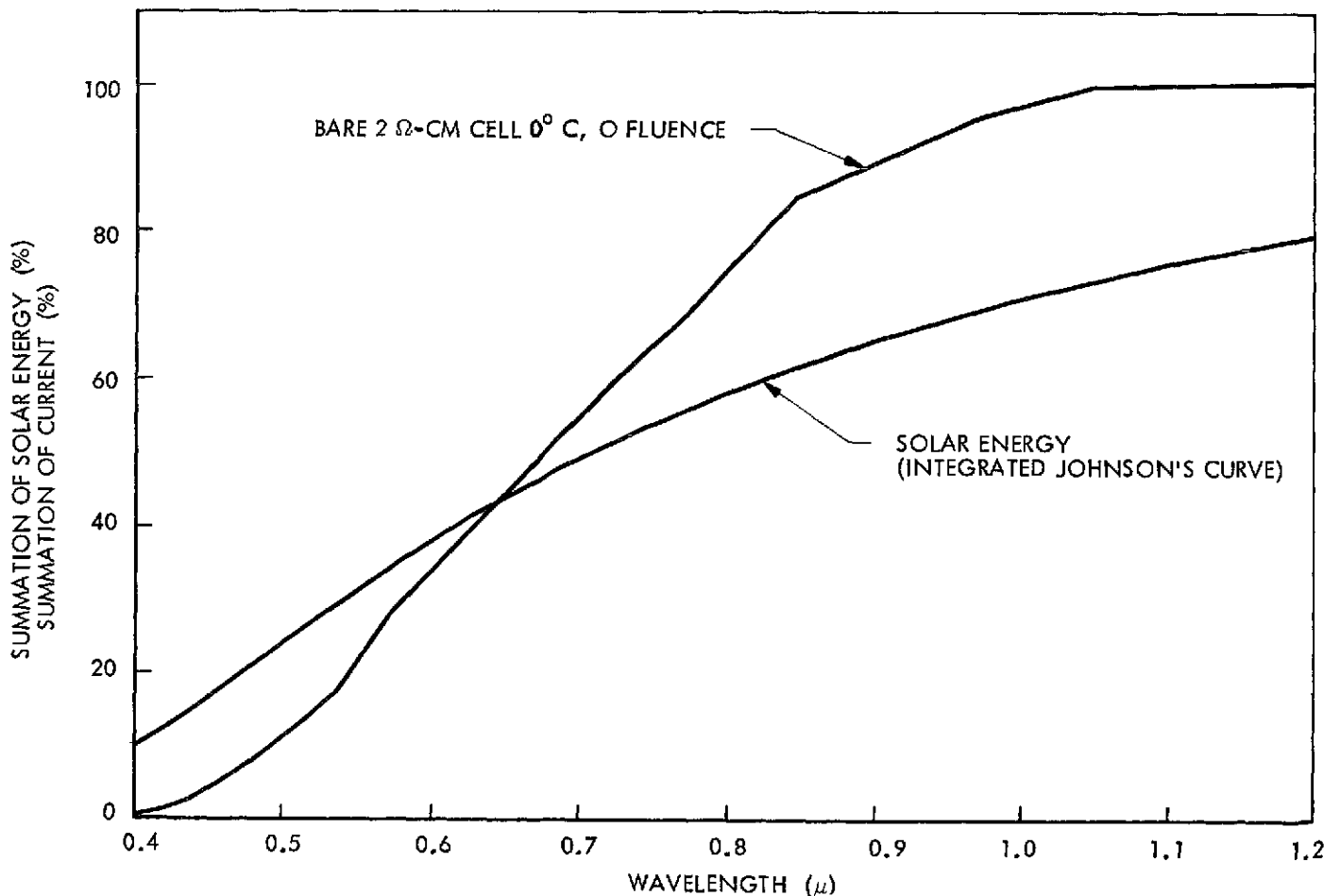

Figure 2.2.2-7 Summation of Normalized Solar Cell Output Current

## REFERENCES

(Section 2.2.2)

1. First Topical Report, Evaluation of Space Station Solar Array Technology, Section 4.1.3.4, Report No. LMSC-A981486, December 1970.
2. First Topical Report Update, Evaluation of Space Station Solar Array Technology, Report no. LMSC D159124, July 1972.
3. Second Topical Report, Design and Analysis, Space Station Solar Array Technology Evaluation Program, Section 3.2.4, Report No. LMSC-A995719, November 1971.
4. Private Communication, T. A. Richter of Optical Coating Laboratory, Inc. to D. J. Parquet of LMSC, April 22, 1971.
5. F. S. Johnson, NRL Solar Energy Distribution Curve, Journal of Meteorology, December 1954.

## 2.2.3 Coverglass Adhesives

2.2.3.1 Function in the System

The coverglass adhesive is provided in the array system to adhere conventional coverglasses to the solar cell.

2.2.3.2 Design Parameters

Two fundamental properties that this adhesive must have are: (1) high optical transmittance in the solar cell response region, and (2) resistance to space environmental degradation (charged particle, UV, thermal and mechanical stress, and vacuum). The two adhesives used almost exclusively in the industry are both silicones: General Electric RTV-602 and Dow Corning XR-63-489 (same as Sylgard 182). Their properties are given in Table 2.2.3-1.

TABLE 2.2.3-1  
COVERGLASS ADHESIVES

PROPERTIES	UNITS	GE RTV-602	Dow Corning XR-63-489
Density	(g/cm <sup>3</sup> )	.99	1.02
Light Trans.	(%)	--	85
Haze	(%/mil)	--	.01
Hardness	(Shore A)	15	40
Tensile Str.	(PSI)	100	900
Refractive Index		1.406	1.43
Coefficient of Linear Thermal Exp.	(in/in/°C)	29.2 x 10 <sup>-5</sup>	30 x 10 <sup>-5</sup>
Volume Resistivity	(ohm-cm)	10 <sup>14</sup>	10 <sup>14</sup>
Thermal Cond.	(cal/cm <sup>2</sup> C sec)	4.1 x 10 <sup>-4</sup>	3.5 x 10 <sup>-4</sup>

The major difference between these adhesives is their relative manufacturability and radiation resistance. The RTV has a lower bond strength making rework easier. In addition, it is more compatible with other solar panel silicone adhesives. (Because Dow Corning XR-63-489 will not cure in the presence of other silicones, rework of a

Preceding page blank

completed XR-63-489 panel is usually done with RTV-602). The major advantage of Sylgard 182 (refined, unprimed) is its resistance to darkening in UV. There is much conflicting data as to degree of darkening (some indicate that 182 does not degrade in UV(reference 1), others indicate that there is a measurable amount (reference 3) of degradation) but there is a consensus that the RTV is not as good in UV as the Sylgard. Therefore, the "Blue" filter is definitely required for RTV-602 but very probably is not with the Sylgard 182.

## REFERENCES

(Section 2. 2. 3)

1. Handbook of Space Environmental Effects on Solar Cell Power Systems, Contract No. NASW-01345, Exotech, Inc., January 1968.
2. Centralab Solar Cell Space Manual, 1968.
3. J. Haynos, Investigation of Resinous Materials for Use as Solar Cell Coverglass Adhesives, Report No. X-716-65-369, September 1965.
4. D. L. Reynard, Irradiation of Solar Cell Coverslides and Adhesives with 1.5 MeV Electrons, Contract No. AF04(657)-787, Report No. LMSC 3-56-64-5, August 1964.
5. R. E. Mauri, Evaluation of Optical Properties and Environmental Stability of Solar Cell Adhesives, Report No. LMSC-AO-34229, April 1964.

## 2.2.4 Solar Cell Interconnectors

### 2.2.4.1 Function in the System

The function of the interconnect in any solar cell array is to:

- Provide an electrical conductor that interconnects the solar cells in parallel and in series
- Provide the mechanical attachment of the cells to the substrate (for the adhesiveless, printed circuit substrate approach (see Figure 2.2-1)).

### 2.2.4.2 Design Parameters

Each solar panel interconnect must be designed to match specific requirements that are obtained by knowing the series/parallel arrangement, packing factor requirements, torque effects, joining technique, stress effects, etc. The following tables and charts provide the data necessary for selecting the interconnect material and the associated joining technique.

**Preceding page blank**



TABLE 2. 2. 4-1  
SOLAR CELL INTERCONNECT DESIGN CONSIDERATIONS

REQUIREMENT	METHOD OF RESOLUTION	DATA REQUIRED
1. Solar Cell Parameters	Obtain from solar cell specification	Mechanical - Cell type, dimensions and tolerances Cell contacts - size and location Electrical - cell minimum output current at optimum voltage and constant temperature
2. Panel/Cell Configuration	Obtain from array sizing	- Array series/parallel requirements - Number of panels - Number of cells/panel
3. Environmental Conditions of Array	Derive from mission analysis and spacecraft design	- Temperature extremes - Number of thermal cycles - Spacecraft system constraints, eg., EMI, shadowing effects, etc.
4. Develop Panel Packing Factor	Packing Factor = $\frac{\text{Total Cell Area}}{\text{Total Panel Area}}$	- Cell orientation - Intercell spacing (series and parallel) - Expansion/contraction of panel components
5. Submodule Current Capacity	Obtain maximum current load on any submodule from consideration of 1 and 2 above	None
6. Panel Circuitry Layout	Consider array series/parallel requirements to determine panel series/parallel arrangement being careful to eliminate or minimize magnetic effects	None
7. Interconnect/Cell Joining Technique	- Consider solar cell constraints - Consider and evaluate various joining techniques (soldering, ultrasonic bonding, parallel gap, etc.)	- See solar cell specification - See Tables 2. 2. 4-3, -4, and -5.

TABLE 2.2.4-1 (Cont.)  
SOLAR CELL INTERCONNECT DESIGN CONSIDERATIONS

REQUIREMENT	METHOD OF RESOLUTION	DATA REQUIRED
7. (Cont.)	<ul style="list-style-type: none"> <li>- Consider manufacturing and process constraints and limitations</li> <li>- Thermal cycling</li> </ul>	
8. Interconnect Material Selection	<ul style="list-style-type: none"> <li>- Select metal from Table 2.2.4-2</li> <li>- Consider:               <ul style="list-style-type: none"> <li>Compatibility with bonding method</li> <li>Ductility of metal</li> <li>Equipment Limitations</li> <li>Thermal Conductivity</li> <li>Density-Weight Constrictions</li> <li>Tensile/Yield Strength</li> <li>Plating Requirements</li> <li>Environmental Constraints (e.g., hardening requirements)</li> <li>Thermal Cycling</li> </ul> </li> </ul>	- See Tables 2.2.4-2, -3, -4, -5 and Steps 1-7
9. Interconnect Pattern Design	<ul style="list-style-type: none"> <li>- Configure pattern considering the following:               <ul style="list-style-type: none"> <li>Current Loads</li> <li>Redundancy (for reliability)</li> <li>Series/parallel requirements</li> <li>Minimal loads-temp cycling</li> <li>Sufficient flexibility and mechanical strength</li> <li>Accurate cell placement</li> <li>Easy repair and service</li> <li>High cell temperature prevention</li> </ul> </li> </ul>	See Steps 1-8

TABLE 2.2.4-2  
PHYSICAL AND MECHANICAL PROPERTIES OF METALS USED IN INTERCONNECTS

PROPERTY	METAL											
	Al	Ti	Ni	Cu	Mo	Pb	Ag	Sn	Au	Kovar <sup>a</sup>	Si	Sn 62 Solder
Density (lb/in <sup>3</sup> )	0.098	0.163	0.322	0.324	0.369	0.41	0.379	0.208	0.698	0.302	0.084	0.303
Coef. thermal expansion ( $\mu$ -in/in <sup>o</sup> C)	23.0	4.67	13.3	16.5	4.90	29.0	17.0	23.0	14.2	5.0	3.0	24.0
Thermal conductivity (cal/sq cm/cm/ <sup>o</sup> C/sec)	0.57	.04	0.22	0.941	0.34	0.083	1.0	0.15	0.71	0.40	0.20	.12
Electrical conductivity (% IACS) <sup>b</sup>	64.9	3.1	25	103	34	8.3	106	15.6	73.4	3.5		11.9
Electrical resistivity ( $\mu$ -ohm-cm)	2.65	42	6.84	1.73	5.2	20.6	1.59	11.5	2.19	49	10x10 <sup>6</sup>	14.5
Magnetic susceptibility (10 <sup>-6</sup> cgs)	0.6	1.25		-0.08	0.04	-0.1	-0.2	0.03	-0.15		-0.13	
Modulus of elasticity (10 <sup>6</sup> psi)	10	16.8	30	16	47	2.6	11	6	12	19	10	6
Specific stiffness (E/ $\rho$ x 10 <sup>6</sup> in.)	92.0	103	93	49.4	127	4.9	29	28.9	15.8	99.3	119.0	.20
Tensile strength (10 <sup>3</sup> psi)	6.8	34	46	37	115	1.9	18.2	2.2	19	77.5	30	10
Yield strength (10 <sup>3</sup> psi)	1.7	20	8.5	6.5	100	0.8	7.9	1.3	40	59.5	24	7.5
Elongation (%)	60	54	30	40	4	30	50	40	45	16.8		32
Solderability*	2	3	1	1	2	1	1	1	1	2	3	--
Melting Temperatures ( <sup>o</sup> F)	1220.4	3300	2651	1981.4	4760	621.3	1760.9	449.4	1945.4	2642	2605	364

<sup>a</sup>Kovar is not a pure metal, but rather an alloy of the following composition: 29 Ni, 17 Co, 53 Fe

<sup>b</sup>International Annealed Copper Standards

\* 1. Solders under normal conditions, 2. Solders under special conditions, 3. Not normally soldered

TABLE 2.2.4-3  
ADVANTAGES AND DISADVANTAGES OF DIFFERENT METHODS OF SOLDERING

METHOD	ADVANTAGES	DISADVANTAGES
<ul style="list-style-type: none"> <li>● Hand Held               <ul style="list-style-type: none"> <li>. Iron-Gun</li> </ul> </li> </ul>		Not conducive to automation or process control
<ul style="list-style-type: none"> <li>● Reflow               <ul style="list-style-type: none"> <li>. Single Point Resist.</li> <li>. Parallel Gap</li> <li>. Iron</li> <li>. Infrared Heating</li> </ul> </li> </ul>	Currently most generally used process.	
<ul style="list-style-type: none"> <li>● Induction</li> </ul>	Demonstrated use by LMSC and Hughes	
<ul style="list-style-type: none"> <li>● Tunnel Oven</li> </ul>		Difficult process control. Cells subjected to long dwell at temp/restricted to small specimens.
<ul style="list-style-type: none"> <li>● Hot Gas</li> </ul>	Does not touch work.	Fixturing to maintain contact. Only evaluated by British. Expensive tooling.

TABLE 2.2.4-4  
 TYPES OF JOINING PROCESSES

METHOD	ADVANTAGES	DISADVANTAGES
● Ultrasonic Bonding	Feasibility investigated and demonstrated. Compatible with many material combinations.	Must hold cells very steady. Throat limitations on unit. Relatively expensive tooling and fixturing. High stresses on cell. Organic contaminants must be removed.
● Thermo Compression	Low Temp - good bond. Needs simple heated probe.	Gold to gold
● Conductive Epoxy	Extensively used in microelectronics - least process impact on cells - inexpensive. Relatively good repair.	May have temp cycle limitations - upper temps limit 275°C - possible rad degradation
● Mechanical Fastening	Might be feasible in combination with separate tabs	Not cost effective
● Welding	Strong bond - work from one side/several metal systems	May thermal shock cells
. Parallel Gap Resist	Preliminary evals. and feas. demonstrated - in house support program	Oxides of metals must be removed
. Electron Beam	Strong bond - small (.001") spotwelds	Requires vacuum - difficult to control depth/not currently feasible for cells
. Laser	May be a promising system	Still highly experimental
● Brazing (In combination with parallel gap)	Strong bonds - may not have to use flux - Rapid technique	May thermal shock cells
● Thermal-Diffusion		Requires proper fixturing

Table 2.2.4-5

SURVEY OF INTERCONNECT METALS VS. JOINING PROCESS

Interconnect Metal (1)	Compatibility With Solar Array	Cell Contact Material (2)	Joining Process							
			Soldering	Ultrasonic Bonding	Parallel Gap Welding/Bracing	Thermal Diffusion	Thermal Compression	Conductive Epoxy	Laser Welding	Mechanical
Copper	Most commonly used metal - stamped, etched, expanded mesh.	Ti - Ag (3)	Broad use	Feasible	Feasible	Not demonstrated	Copper oxide and thermal cond. problem	Feasible	Feasible	Not demonstrated
	Good thermal conduction	Al	No	Feasible	Not feasible	Not demonstrated	(Same)			
		Ag	Feasible	Feasible	Feasible	Not demonstrated	(Same)			
Kovar	Suitability largely function of plated material and thickness	Ti - Ag	Broad use	Feasible	Demonstrated	Plating dependent	Non ductile			
	Magnetic	Al	No	Plating may give better bond.	Feasible	Not known	(Same)			(6)
	Good thermal coefficient	Ag	Ag plated to Ag	Possibly plating thickness dependent	Feasible	Feasible if Ag plated	(Same)			
Silver	Prominently used in form of expanded metal mesh	Ti - Ag	Broad use	Demonstrated	Demonstrated	Demonstrated	Oxides and thermal cond. problem			
	Good thermal conduction	Al	No	Feasible	Brazing preform required	Oxides and thermal cond. problems	(Same)	(4)	(5)	
		Ag	Feasible	Feasible	Feasible	Should be optimum	(Same)			Not demonstrated
Aluminum	Favored for radiation hardened systems	Ti - Ag	No	Feasible	Brazing preform required	Oxides and thermal cond. problems	Feasible but difficult			Forestieri with FEP encapsulation
	Weight advantages	Al	Highly specialized	Optimum	Not feasible	Possible oxide problem	(Same)			Not demonstrated
	Good thermal conduction	Ag	No	Feasible	Brazing preform required	Oxides and thermal cond. problem	(Same)			
Moly	Limited, proprietary technology on plating	Ti - Ag	Demonstrated	Plating dependent	Feasible	Function of plating	Non ductile			(6)
	Good thermal coefficient	Al	No	Plating dependent	Not feasible	Not feasible	(Same)			
		Ag	Feasible	Plating dependent	Plating dependent	Function of plating	(Same)	Feasible	Feasible	Not demonstrated

259

NOTES: (1) Other metals, Au, Be-Cu, Ni and Pt have also been used but in small quantities and not on production systems.  
 (2) Ni-Cu-Au contacts are no longer in general use.  
 (3) Passivated contacts, Ti-Pd-Ag would interface the same as Ti-Ag, but with improved humidity resistance.

(4) Early investigations by JPL using silk screening, some problems with temp range limits, resistance, dispersion of solvents. New matr. now available.  
 (5) Question on depth control, dissimilar metals, cost and production implementation.  
 (6) Probably requires preattached cell tabs. Electrical integrity function of cleanliness, electrolytics, interface pressure.

2-59

## REFERENCES

(Section 2.2.4)

1. First Topical Report, Evaluation of Space Station Solar Array Technology, Section 4.1.3.2, Report No. LMSC-A981486, December 1970.
2. First Topical Report Update, Evaluation of Space Station Solar Array Technology, Report No. LMSC D159124, July 1972.
3. Second Topical Report, Design and Analysis, Space Station Solar Array Technology Evaluation Program, Section 3.2.2, Report No. LMSC-A995719, November 1971.
4. Survey and Study for an Improved Solar Cell Module, NASA-JPL STOD Task No. 43, August 8, 1969.

**Preceding page blank**

## 2.2.5 Flexible Substrate Materials

### 2.2.5.1 Function in the System

The function of the substrate is to provide a basis of support for the solar cells and interconnects.

### 2.2.5.2 Design Parameters

The feasibility of flexible, lightweight solar arrays became practical with the development of high-strength, thin-film plastic materials. A candidate material for a flexible substrate must not only meet the mechanical and electrical requirements but must also withstand the rigors of the space environment. Such thin-film requirements can be listed as follows:

- It must be highly flexible, experience minimum elongation under load, and have a high tensile strength.
- It must be an electrical insulator.
- It must be stable in space environment (hard vacuum, radiation, and temperature extremes).
- Ideally, it should be highly transmissive to infrared wavelengths to transfer heat directly from the cell back surface to space or be compatible with thermal coatings that may have to be applied.
- It must be compatible with the manufacturing method of substrate assembly.

The common properties needed in the selection of a candidate substrate material are outlined in Table 2.2.5-1 with corresponding values given for Kapton, FEP-Teflon, Mylar, and FEP impregnated fiberglass. To date, the common selection for substrate material has been Kapton H-film if the solar cells are to be glued down. However, LMSC with its integral printed circuit, adhesiveless approach to solar cell assembly has been using Kapton F-film which is a laminate of Kapton H-film and FEP-Teflon film. Mylar has been used by some foreign companies but its resistance to UV is not quite as good as Kapton or FEP. The FEP impregnated glass cloth has been found by

**Preceding page blank**



LMSC to be an excellent tensile and tear strengthener of the substrate. (The material in the table is Dodge 368-5, a special tear resistant glass).

Tables 2.2.5-2A and 2.2.5-2B and Figures 2.2.5-1 through 2.2.5-5 show the results of tensile, tear and creep tests performed on many materials, laminations and joints considered for the Space Station Solar Array substrate.

TABLE 2.2.5-1  
 PROPERTIES OF FLEXIBLE SUBSTRATE MATERIALS

PARAMETER	MATERIAL			
	KAPTON H-FILM (POLYIMIDE) (1 MIL)	TEFLON FEP (FLUOROPLASTIC) (1 MIL)	MYLAR (TYPE T) (POLYESTER) (1 MIL)	FEP IMPREGNATED FIBERGLASS (DODGE 368-S) (5 MIL)
RELATIVE COST	1.0	0.62	0.08	6.0
PROPERTY TEMPERATURE UNLESS OTHERWISE NOTED	25°C	25°C	25°C	25°C
ULTIMATE TENSILE STRENGTH (PSI)	25,000	3,000	45,000	125 LB/IN. WIDTH
YIELD POINT AT 3% (PSI)	10,000	1,700	NOT REPORTED	-
STRESS TO PRODUCE 5% ELONGATION (PSI)	13,000	1,800	23,000	-
ULTIMATE ELONGATION (%)	70	300	40	5%
TENSILE MODULUS (PSI)	430,000	70,000	800,000	-
FOLDING ENDURANCE (CYCLES)	10,000	4,000	100,000	-
INITIAL TEAR STRENGTH (GRAVES) (GM/MIL)	510	270	450	10,000
PROPAGATING TEAR STRENGTH (EMELDORF) (GM/MIL)	8	125	20	-
SPECIFIC GRAVITY	1.42	2.15	1.377	2.20
CREEP RESISTANCE	GOOD	POOR	GOOD	EXCELLENT
MELTING POINT (°C)	NONE	260-280	250	260-280 (FEP MELT)
ZERO STRENGTH TEMPERATURE (°C)	815	255	248	-
COEFFICIENT OF THERMAL EXPANSION (IN./IN./°C)	$2.0 \times 10^{-5}$ (14° TO 38°C)	$2.35 \times 10^{-5}$ AT -77°C $5.0 \times 10^{-5}$ AT 100°C	$1.7 \times 10^{-5}$ (30° TO 50°C)	-
COEFFICIENT OF THERMAL CONDUCTIVITY (CAL) (CM) (CM <sup>2</sup> ) (SEC) (°C)	$3.72 \times 10^{-4}$	$4.65 \times 10^{-4}$	$3.7 \times 10^{-4}$ (25° TO 75°C)	-
SPECIFIC HEAT (CAL/GM/°C)	0.261 AT 40°C	0.28	0.28	-
HEAT SEALABLE	NO	YES (280° TO 370°C)	NO (UNLESS COATED OR TREATED)	YES (SAME AS FEP-TEFLON)
SHRINKAGE	0.3% AT 250°C, 0.5% AT 300°C, 3% AT 400°C (FOR 30 MIN)	0.7% STRETCH (IN M.D.), 2.2% SHRINK (IN T.D.), 150°C, 30 MIN	-	-
USABLE TEMPERATURE LIMITS (°C)	-269 TO 400	-240 TO +200	-70 TO 150	-
EMISSIVITY	.80	.85	NOT REPORTED	-
ABSORPTIVITY	NOT REPORTED	3% FROM 0.5 TO 3.8 μM	NOT REPORTED	-
TRANSMISSIVITY	0.66	96% FROM 0.5 TO 3.8 μM	.86 AT 0.8 μM	-
REFLECTIVITY	~0.13	1%	NOT REPORTED	-
DIELECTRIC STRENGTH (1 MIL, 60 CYCLES (VOLTS)	7,000	6,500	7,500	-
MOISTURE ABSORPTANCE	2.9% IN H <sub>2</sub> O FOR 24 HR AT 23.5°C	<0.01% IN H <sub>2</sub> O FOR 24 HR AT 23.5°C	<0.8% IN H <sub>2</sub> O FOR 24 HR AT 23.5°C	<0.01 IN H <sub>2</sub> O FOR 24 HR
OUTGASSING WEIGHT LOSS	0.25% IN HELIUM FOR 2 HR AT 400°C	-	NOT REPORTED	-
RADIATION RESISTANCE	NO LOSS IN TRANSMISSION AFTER 10 <sup>14</sup> , 800 KEV PROTONS/CM <sup>2</sup> , 2.6 X 10 <sup>17</sup> , 1 MEV ELECTRONS/CM <sup>2</sup> OR UV UP TO 9600 ESH	NO LOSS IN TRANSMISSION AFTER 10 <sup>14</sup> , 800 KEV PROTONS/CM <sup>2</sup> OR 2.6 X 10 <sup>17</sup> , 1 MEV ELECTRONS/CM <sup>2</sup> , 4.5% LOSS IN TRANSMISSION AFTER 2 EQUIVALENT SOLAR YEARS OF UV.	NO LOSS IN TRANSMISSION AFTER 10 <sup>14</sup> , 800 KEV PROTONS/CM <sup>2</sup> , 5% LOSS AFTER 2.6 X 10 <sup>17</sup> , 1 MEV ELECTRONS, 20% LOSS AFTER 3510 ESH	EXCELLENT
AVAILABILITY	0.25 TO 5 MILS, 60 IN. MAX. WIDTH	0.5 TO 20 MILS, 48 IN. MAX. WIDTH	0.5 TO 1.5 MILS	39 IN. MAX. WIDTH

TABLE 2.2.5-2A  
TENSILE, TEAR AND CREEP PROPERTIES OF FLEXIBLE SUBSTRATE MATERIALS

SAMPLE NUMBER	SAMPLE NAME	SCHEMATIC	MATERIALS	THICKNESS (MILS)	GAGE SIZE (IN.)	TEST TEMP (°F)	NO. OF SPECIMENS TESTED	TENSILE STRENGTH (LB/IN.)			INITIAL TEAR STRENGTH			CREEP STRENGTH									
								MEAN	STANDARD DEVIATION	ULTIMATE MPAN	ELONGATION (%)	STANDARD DEVIATION	GAGE SIZE (IN.)	TEST TEMP (°F)	NO. OF SPECIMENS TESTED	INITIAL TEAR STRENGTH			GAGE SIZE (IN.)	NO. OF SPECIMENS TESTED	CREEP RATE (LN. IN./DAY) 14 LB./IN. LOADING 80°C. 30 DAYS		
																MEAN (LB)	MEAN (GM/MIL)	STANDARD DEVIATION (GM/MIL)					
21	BASIC SUBSTRATE		A - CIRCUIT MATERIALS CO., 1 MIL KAPTON-1/2 MIL FEP LAMINATE B - NONE C - CIRCUIT MATERIALS CO., 1 MIL KAPTON-1/2 MIL FEP LAMINATE	2.0	2 x 0.5	-80 75 170	3 5 5	70.8 89.16 49.85	4.44 1.84 3.08	30.3 47.3 41.9	8.8 1.8 5.1	ATSM 1000 -66	15	5		17.14	985	91.1	2	2	30 - 1		
23	KAPTON-FIBERGLASS		A - CIRCUIT MATERIALS CO., 1 MIL KAPTON-1/2 MIL FEP LAMINATE B - DODGE INDUSTRIES, 100% FEP IMPREGNATED 368-5 GLASS CLOTH C - CIRCUIT MATERIALS CO., 1 MIL KAPTON-1/2 MIL FEP LAMINATE	8.0	2 x 0.5	-80 75 170	5 5 3	285.8 207.20 212.00	7.38 8.96 3.46	1.0 3.0 8.8	0.7 0.2 0.2		15	5	17.14	985	91.1	2	2				
24	FIBERGLASS		A - NONE B - DODGE INDUSTRIES, 100% FEP IMPREGNATED 368-5 GLASS CLOTH C - NONE	5.0	2 x 0.5	-80 75 170	5 5 5	217.68 219.00 183.00	18.84 3.02 11.20	6.7 3.8 4.7	0.8 0.2 0.4		15	5	8.74	805	35.9	103.0	2	2			
22	KAPTON-100% COPPER		A - CIRCUIT MATERIALS CO., 1 MIL KAPTON-1/2 MIL FEP LAMINATE B - CHRY BRASS CO., 1.28 MIL KAPTON-1/2 MIL FEP LAMINATE C - CIRCUIT MATERIALS CO., 1 MIL KAPTON-1/2 MIL FEP LAMINATE	4.28									15	5	8.40	808	78.4						
25	BASELINE DESIGN		HEAT SEALED LAMINATION (2 LAYERS, EACH 1 MIL KAPTON AND 1/2 MIL FEP-CIRCUIT MATERIALS CO.), INTEGRAL PRINTED CIRCUIT (1.28 MIL COPPER-CLIP BRASS CO.), HEAT SEALED LOOPS (5 MILS, 368-5 FIBERGLASS - DODGE IND.), ALUMINUM EXTRUDED JOINT AND LOCKING BARS, 2 x 4 CN SOLAR CELLS	6 x 1.8		75	3	31.94	0.60	6.0	1.3									2 x 20.8	2	2	34.6
23	LAMINATION JOINT		HEAT SEALED LAMINATION (2 LAYERS, EACH 1 MIL KAPTON AND 1/2 MIL FEP-CIRCUIT MATERIALS CO.), 0.25-IN. LAMINATION AREA OF 368-5 FIBERGLASS (DODGE IND.)	2 x 0.5		-80 75 170	3 3 3	78.6 67.32 44.86	3.32 4.76 1.00											3 x 15	3	3	38.3
23	BASELINE JOINT		SAME AS 23 BUT NO CIRCUIT AND NO SOLAR CELLS	6 x 1.8		-80 75 170	3 3 3	44.67 36.67 33.33	0.58 1.15 1.27											3 x 21	2	2	31.5
24	ALTERNATE JOINT		TWO SAMPLES IDENTICAL TO 23 JOINED WITH EXTRUDED JOINT AND LOCKING BARS. "FLAPS" ARE NOT BONDED - FRICTION HOLDS JOINT TOGETHER	6 x 1.8		-80 75 170	3 4 3	42.77 35.00 39.67	1.66 1.41 2.31											3 x 22	1	1	55.0
21	C.M.C. SUBSTRATE - WIDE		BASIC SUBSTRATE FABRICATED FROM CIRCUIT MATERIAL CO. 1 MIL KAPTON/1/2 MIL FEP	6 x 1.6		-80 75 170	2 2 2	71.09 88.12 48.97	0.32 2.10 0	34.0 48.5 0	0 7.8 0.1												
21	DUPONT SUBSTRATE - WIDE		BASIC SUBSTRATE FABRICATED FROM DUPONT 185F015 P-FILM (1-MIL KAPTON/1/2 MIL FEP LAMINATE)	6 x 1.6		-80 75 170	2 3 2	73.12 88.15 47.75	3.53 2.22 0.35	37.4 23.6 34.3	3.6 5.1 1.4												
21	SUBSTRATE WITH CIRCUIT		CIRCUIT MATERIAL CO. SUBSTRATE MATERIALS WITH 1.28 MIL CLIP BRASS CO. ROLLED AND ANNEALED COPPER CIRCUIT	6 x 1.8		-80 75 170	3 3 4	65.85 49.70 43.30	1.81 1.44 1.38	15.6 16.4 23.3	1.8 2.2 6.9												
22	SUBSTRATE WITH CIRCUIT (SPECIAL)		1 x 7 CIRCUIT WITH PUNCHED COVERLAY CUT INTO 1.5 IN. WIDE STRIPS, THREE SOLDERLESS CELLS SOLDERED TO EACH OF THREE STRIPS (DUPONT KAPTON/FEP, 1.28 MIL CLIP BRASS CO. ROLLED AND ANNEALED COPPER CIRCUIT)	1 x 1.8		75	4	48.20	2.38	13.3	2.8												
22	SUBSTRATE WITH CIRCUIT AND CELLS (SPECIAL)			7 x 1.8		75	3	40.11	5.78	8.6	3.8												

TABLE 2.2.5-2B

TENSILE, TEAR AND CREEP PROPERTIES OF FLEXIBLE SUBSTRATE MATERIALS

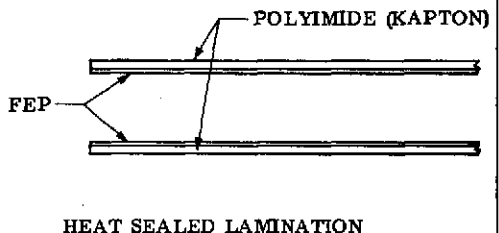
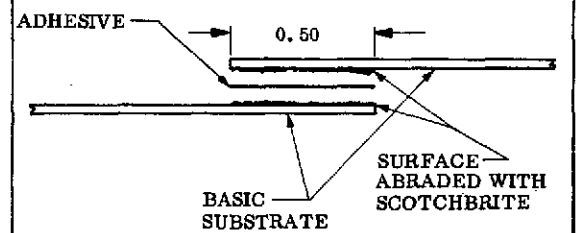
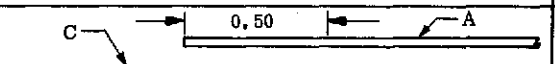
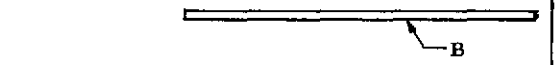
SAMPLE NUMBER	SAMPLE NAME	SCHEMATIC	MATERIALS	THICKNESS (MILS)	GAGE SIZE (IN.)	TEST TEMP. (°F)	NO. OF SPECIMENS TESTED	TENSILE STRENGTH				GAGE SIZE	TEST TEMP. (°F)	NO. OF SPECIMENS TESTED	INITIAL TEAR STRENGTH			GAGE SIZE (IN.)	NO. OF SPECIMENS TESTED	CREEP STRENGTH	
								TENSILE STRENGTH (LB/IN.)		ULTIMATE ELONGATION (%)					MEAN (LB)	MEAN (GM/MIL)	STANDARD DEVIATION (GM/MIL)			CREEP RATE (μIN./IN./DAY)	
								MEAN	STANDARD DEVIATION	MEAN	STANDARD DEVIATION									0.89 LB @ 0.45 LB/IN. LOADING 60°C 2 WK, 77°C 1 WK	8.39 LB @ 4.19 LB/IN. LOADING 77°C 30 DAYS
Y4	MATERIALS		DODGE INDUSTRIES #381-4FF TFE IMPREGNATED GLASS, 1/2 MIL COAT FEP BOTH SIDES	4.0	2 × 1/2	75	6	66.00	8.48	6.83	0.65	ASTM 1004 - 66	75	3	4.03	457	32.8				
Y5			T. F. E. INC. #502-3 FEP IMPREGNATED GLASS CLOTH	3.0			6	76.60	11.32	7.65	0.60		4	3.47	525	21.8					
Y6			T. F. E. INC. #502AA-3 TFE IMPREGNATED GLASS CLOTH	3.0			6	67.82	9.56	7.46	0.37		3	3.67	552	10.1					
Y7			DODGE INDUSTRIES #391-4 FEP IMPREGNATED GLASS CLOTH	4.0			6	90.00	4.38	9.00	0.42		3	4.05	459	11.9					
Y8			DODGE INDUSTRIES FLUROPEEL #45 FEP IMPREGNATED GLASS CLOTH	1.5			6	28.46	3.20	7.90	1.13		3	1.54	465	16.0					
Y9			DODGE INDUSTRIES #381-2 TFE IMPREGNATED GLASS CLOTH	2.0			6	30.26	4.00	6.83	0.72		3	1.38	313	9.1					
Y10			DODGE INDUSTRIES #368-5 TFE IMPREGNATED GLASS CLOTH SPECIAL WEAVE	5.0			6	126.56	5.02	9.33	0.89		3	8.38	760	70.2	2 × 20	1	0	0	
Z1	BASIC SUBSTRATE		3.5 MIL THICK, HEAT SEALED LAMINATION OF 2 LAYERS KAPTON/FEP (200F011 AND 150F019 DUPONT F-FILM)	3.5			9	57.63	2.33	53.38	7.59		3	3.66	475	38.4	2 × 20	2	0	3.3 IN./IN./DAY	
B1	LAP JOINTS		1 MIL FEP FILM (HEAT SEAL)				5	37.94	17.94												
B2			PRODUCT RESEARCH COMPANY #1535 POLYURETHANE (CLEAR)				7	53.42	1.52												
B3			CREST PRODUCTS COMPANY NARMCO RESIN #3135 WITH CURING AGENT #7111 (RECOMMENDED BY DUPONT)				8	51.12	5.16												
B4			MODIFIED EPOXY				7	42.12	3.40												
B6			DODGE INDUSTRIES #381-4FF FEP COATED GLASS CLOTH (HEAT SEAL)				6	49.30	7.54												
B7			T. F. E. INCORPORATED #502-3 FEP IMPREGNATED GLASS CLOTH (HEAT SEAL)				6	44.56	4.94												
B8			DODGE INDUSTRIES #391-4 FEP IMPREGNATED GLASS CLOTH (HEAT SEAL)			2 × 1/2	3	14.54	7.34												
				1-IN. LAP JOINT WITH KAPTON DOUBLE BACK TAPE (PERMACEL)													2 × 20	2	1 WK TO LEVEL OUT TO 0 CREEP RATE	FAILED WITHIN 1 DAY	
C1	LAMINATION JOINTS		A - 200F011 F-FILM B - 150F019 F-FILM C - BASIC SUBSTRATE		2 × 2-1/2		5	54.00	3.24				75								
C2			A - 200F011 F-FILM B - 150F019 F-FILM C - DODGE INDUSTRIES #381-4FF		2 × 2-1/2	75	5	59.84	1.98												

2-69 A

2-69 B

Preceding page blank

C

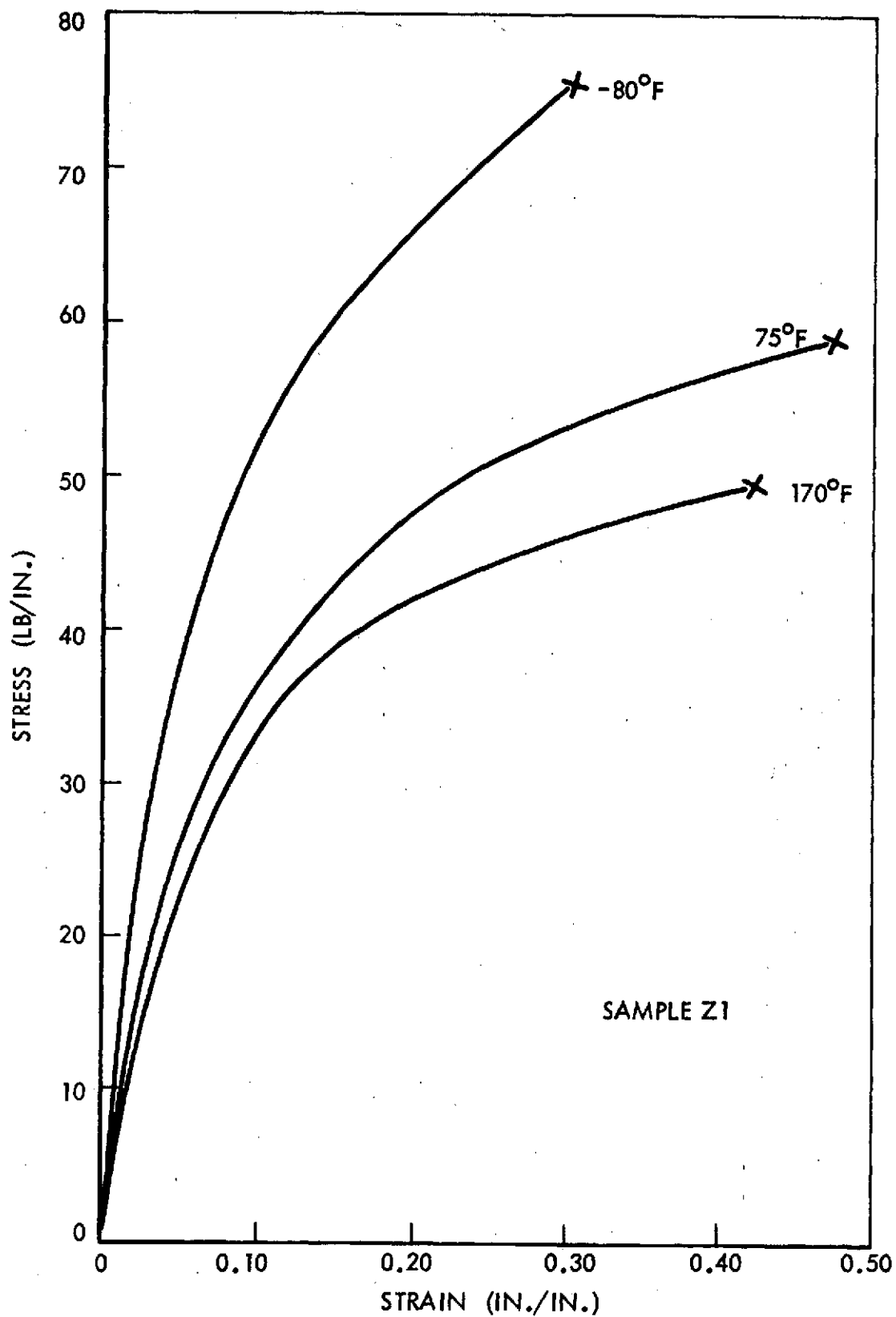

Figure 2.2.5-1 Stress vs Strain Curve - Basic Substrate

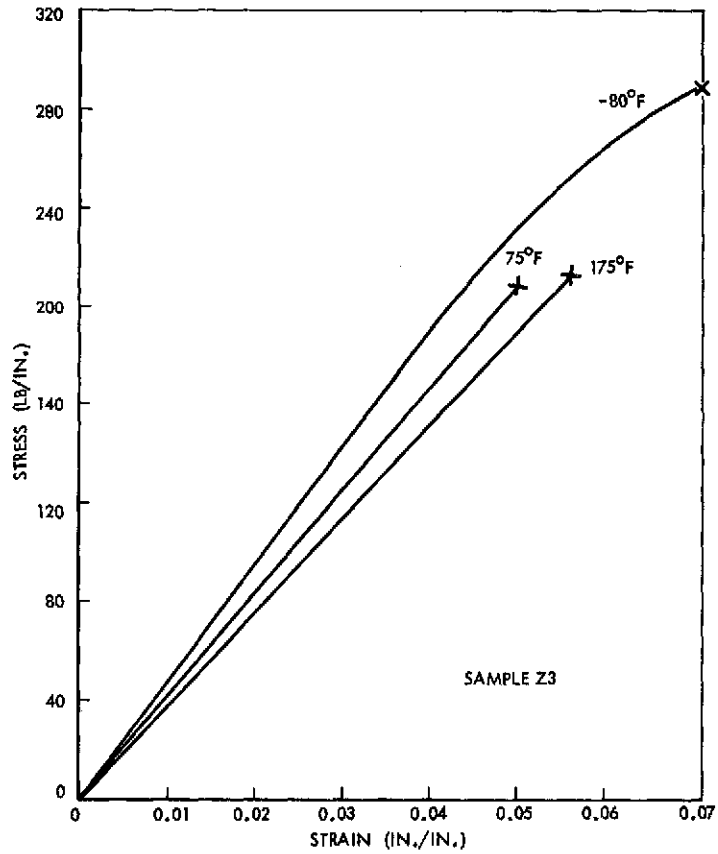

Figure 2.2.5-2 Stress vs Strain Curve - Kapton-Fiberglass

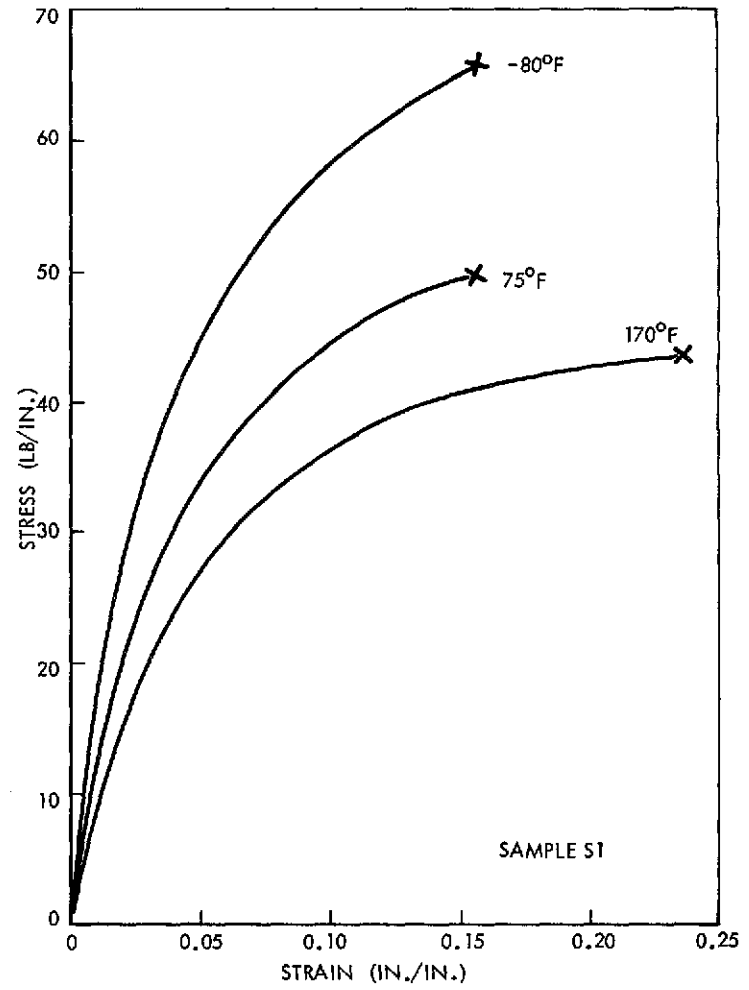

Figure 2.2.5-3 Stress vs Strain Curve - Substrate with Circuit

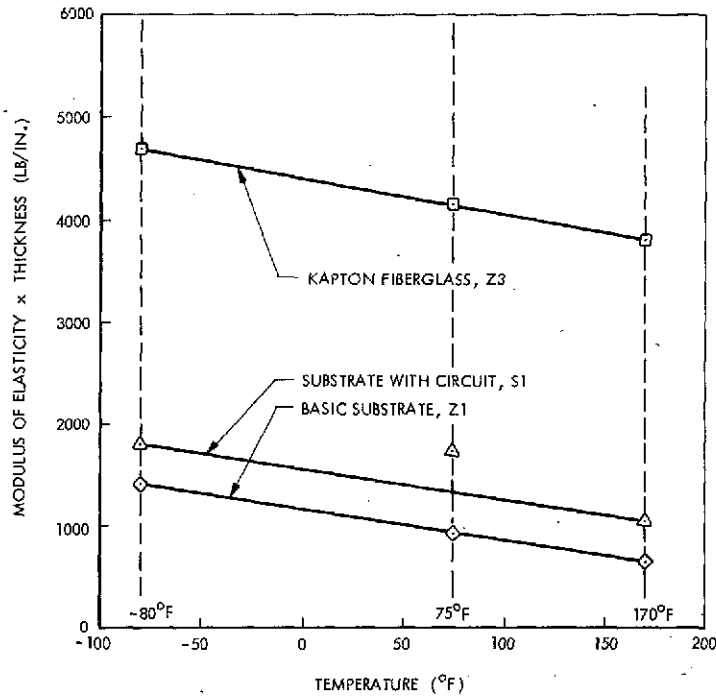

Figure 2.2.5-4 Modulus of Elasticity vs Temperature

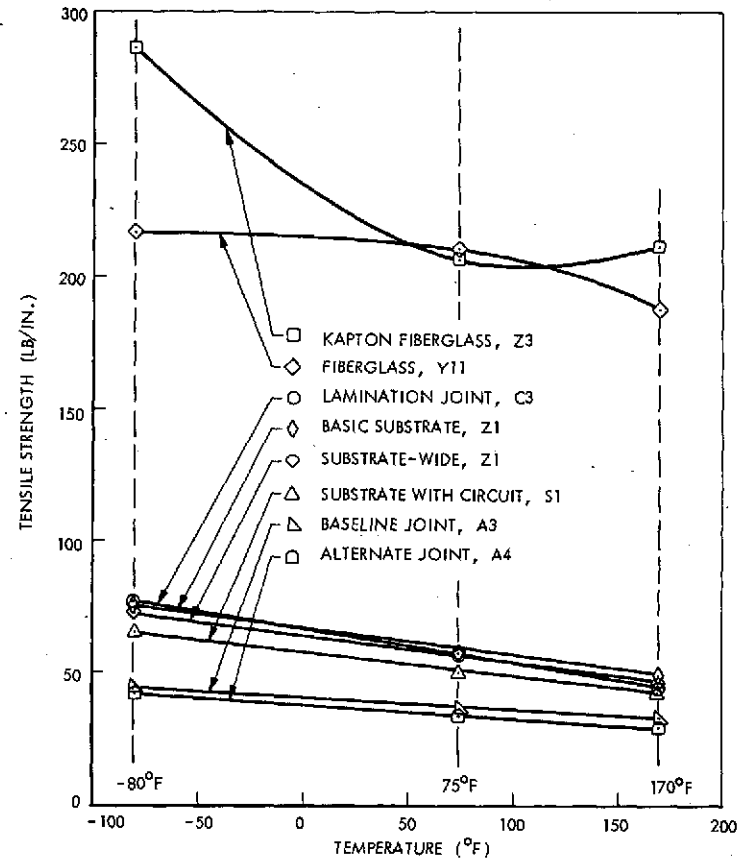

Figure 2.2.5-5 Tensile Strength vs Temperature

## REFERENCES

(Section 2.2.5)

1. First Topical Report, Evaluation of Space Station Solar Array Technology,  
Report No. LMSC-A981486, December 1970.
2. First Topical Report Update, Evaluation of Space Station Solar Array Technology,  
Report No. LMSC D159124, July 1972.
3. Second Topical Report, Design and Analysis, Space Station Solar Array Technology  
Evaluation Program, Report No. LMSC-A995719, November 1971.
4. D. J. Parquet, Tensile and Tear Tests, Solar Cell Substrate, Space Station  
Solar Array Technology Evaluation Program, Report No. LMSC-A999457,  
December 1971.
5. D. J. Parquet, Creep Tests, Solar Cell Substrate, Space Station Solar Array  
Technology Evaluation Program, Report No. LMSC-D152986, April 1972.



## 2.2.6 Substrate Module Joint

### 2.2.6.1 Function in the System

The function of the module joint is to provide a mechanical connection between the array modules. It also provides a hinge line which becomes the refold memory (where applicable) for array retraction and supplies the lateral stiffness to keep the array strip flat. The module joint used on the Space Station Solar Array is shown in Figure 2.2.6-1.

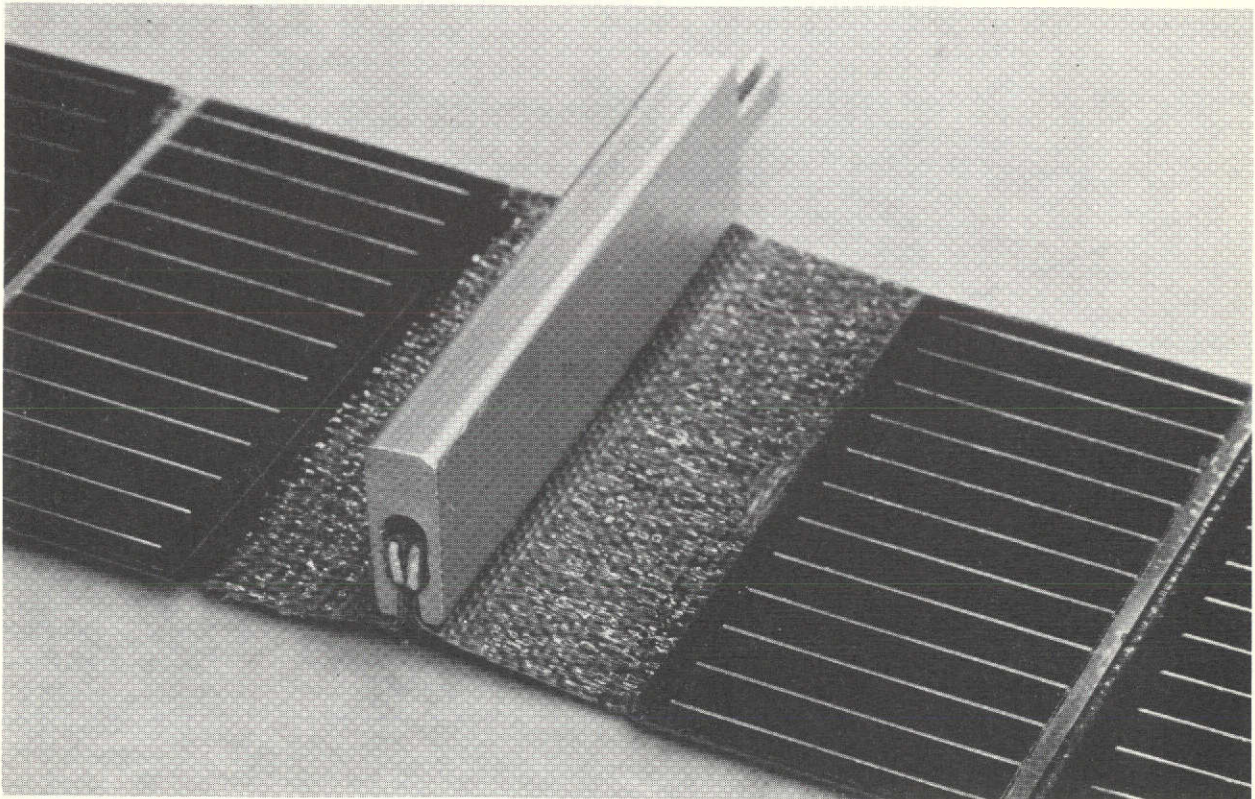

Figure 2.2.6-1 LSSSA Module Joint

#### 2.2.6.2 Design Parameters

A proper module joint is easy to manufacture, apply, remove and repair. In addition, its strength must provide an adequate safety margin over design requirements.

Several types of joints considered not only by LMSC but also by other companies are shown in Tables 2.2.6-1, -2 and -3. (Tables 2.2.5-2A and 2.2.5-2B give the tensile and creep strengths of various lap joints. These considerations and configurations should provide a basis from which to design a module joint to the requirements of a specific flexible array.

TABLE 2.2.6-1  
FLEXIBLE SUBSTRATE JOINING TECHNIQUES









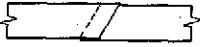

NO.	APPLICATIONS	METHOD	DESCRIPTION	TEST	EASE OF REMOVAL	BIBLIO. NO.
1	LMSC 50 FT <sup>2</sup> ID FLAT PACK	 LAP BOND	ADHESIVE 80 FLUORO PLASTICS, INC. PHILADELPHIA, PA.	LAP SHEAR TESTS	FAIR	L.4-3
2	LMSC 80 FT <sup>2</sup> ID ARRAY	 SHEAR BOND (DOUBLE SIDED TAPE)  LAP BOND (TAPED)	KAPTON TAPE PERMACEL EE-6761	LAP SHEAR TESTS	FAIR	L.4-19
3	LMSC ID MODULE JOINING EVALUATION 1968	SEE FOLLOWING CHART	SEE FOLLOWING CHART	PRODUCIBILITY EVALUATION		L.4-19
4	GENERAL ELECTRIC 30 W/LB ROLLUP SOLAR ARRAY	 LAP BOND	KAPTON-TO-KAPTON WITH G.E. SMRD 745 COMPOUND	LAP SHEAR TEST KAPTON TO GOLD PLATED COPPER ~>98 LB/IN	FAIR	G.2-1 THRU G.2-4
5	HUGHES FLEXIBLE ROLLUP SOLAR ARRAY	 LAP BOND	0.25 IN. LAP BOND KAPTON TO KAPTON (0.003) BONDED WITH HUGHES FORMULATED ADHESIVE	SOLAR PANEL (CELLS BONDED TO FIBER- GLASS SUBSTRATE) WAS TEMP. CYCLED +80 TO -300°F SUCCESSFULLY. TENSILE LAP SHEAR ~73 LB/IN.	FAIR	H.6-7 THRU H.6-13
6	FAIRCHILD-HILLER 30 W/LB ROLLUP SOLAR ARRAY	 LAPPED AND LACED  LAP BOND	0.002 KAPTON WITH HOLE PATTERN ALONG EDGE OF 2 x 3 FT. SUBSTRATE SECTIONS. TWO SUCH SECTIONS ARE LACED TOGETHER BY LAPPING THE HOLES. FIX WAS TO BOND END OF LACE WITH ADHESIVE.  H-FILM TO HFO FILM THERMAL SET; DOW A-1000 SILICONE ADHESIVE; AND PERMACEL 18	LAP SHEAR TEST ~9 LB/IN. FAILED BY UNLACING. ADEQUATE SINCE DESIGN LOAD EXPECTED WAS 0.1 LB/IN	GOOD  FAIR	F.1-1 THRU F.1-4
7	RYAN 30 W/LB ROLLUP SOLAR ARRAY	 LAP BOND	KAPTON-TO-KAPTON WITH FM 1044R ADHESIVE	PEEL STRENGTH ~2.3 PSI; SHEAR STRENGTH >109 PSI	FAIR	R.4-5 THRU R.4-8
8	TACONIC PLASTICS, INC. TEE GLASS CATALOG	 PIN SLICE  SEWN SEAM	ALLIGATOR LACING THROUGH WHICH A PIN IS PLACED TO COMPLETE THE SPLICE.  SUBSTRATE IS OVERLAPPED AND SEWN (MORE APPLICABLE TO IMPREGNATED FIBERGLASS CLOTH)		GOOD  POOR	

TABLE 2. 2. 6-2  
 LOCKHEED KAPTON JOINING TECHNIQUES INVESTIGATION (PRE-LSSSA)



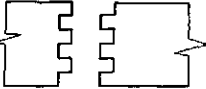

NO.	DESCRIPTION	METHOD	BOND PEEL STRENGTH LB/IN	EASE OF APPLICATION	ROOM TEMP CURE	NUMBER OF OPERATIONS	METHOD OF APPLICATION	CATALYST	EASE OF REMOVAL	REPAIR-ABILITY	BIBLIO. NO.	
1	ADHESIVE 80, FLUOROPLASTICS, INC.	 LAP JOINT	4+	GOOD	YES	2	BRUSH OR SPRAY	NOT REQUIRED	FAIR	GOOD	L. 4-19	
2	DUPONT ADHESIVE 46970		3	GOOD	NO	3	BRUSH OR SPRAY	RC-805	FAIR	GOOD		
3	DUPONT ADHESIVE 46960		3	GOOD	NO	3	BRUSH OR SPRAY	RC-805	FAIR	GOOD		
4	DUPONT ADHESIVE 46950		3	GOOD	NO	3	BRUSH OR SPRAY	RC-805	FAIR	GOOD		
5	ALUMINUM REINFORCED - 5 MIL AL. BONDED WITH ADHESIVE 80 TO MYLAR. LAP BONDED AND STAPLED	 KAPTON ALUMINUM MYLAR STAPLE KAPTON	4	GOOD	-	4	BRUSH OR SPRAY AND STAPLER	N/A	GOOD	GOOD	L. 4-19	
6	VELCRO PAD BONDED TO KAPTON WITH ADHESIVE 80	 VELCRO KAPTON	4	FAIR	-	3	PRESSURE	N/A	GOOD	GOOD		
7	20 MESH AL. SCREEN SANDWICHED BETWEEN 2 LAYERS OF 5 MIL MYLAR, BONDED TO KAPTON WITH ADHESIVE 80, WIRE THRU HOOKS		4	FAIR	-	4	-	N/A	GOOD	GOOD		
8	20 MESH AL. SCREEN SANDWICHED AND BONDED BETWEEN AL. FOIL AND KAPTON WIRE THRU HOOKS	SIMILAR TO ABOVE	4	FAIR	-	4	-	N/A	GOOD	FAIR		
9	DOUBLE BACK TAPE, 1-IN. WIDE MYSTIC TAPE, BORDEN CHEMICAL CO.	 LAP JOINT	1	GOOD	-	2	PRESSURE	N/A	GOOD	GOOD		
10	LOOPED MYLAR BONDED TO KAPTON AND FORMED INTO "PIANO HINGE"	 MYLAR WIRE KAPTON	4	FAIR	-	4	LACE	N/A	GOOD	POOR		
11	KAPTON IS LAPPED, HOLE PUNCHED, AND LACED WITH KAPTON STRIP		-	POOR	-	3	LACE	N/A	GOOD	POOR		L. 4-19

TABLE 2.2.6-3  
LSSSA MODULE JOINTS

Method	Description	Strength		Manufacturability	Ease of Assy	Ease of Repair
		Tensile (lb/in.)	Creep Rate 60°C, 14 lb/in			
 <p>2 in. Wide x 20.5 in. Gage Length</p>	<p>Baseline Design: Heat Sealed Lamination (2 layers, each 1 mil Kapton and 1/2 mil FEP - Circuit Materials Co.), Integral Printed Circuit (1.28 mil copper - Olin Brass Co.), Heat Sealed Loops (5 mils, 368-5 Fiberglass - Dodge Ind.), Aluminum Extruded Joint and Locking Bars 2 x 4 cm Solar Cells</p>	<p>-80°F 45 -75°F 37 170°F 33</p>	0	Fair	Good	Poor
 <p>2 in. Wide x 22 in. Gage Length</p>	<p>Alternate Joint: Two samples identical to above but loops are not completed. "Flaps" are not bonded - friction holds joint together</p>	<p>-80°F 43 75°F 33 170°F 30</p>	0	Good	Good	Poor

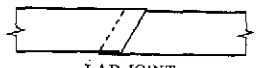
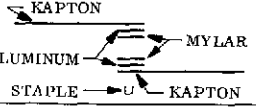
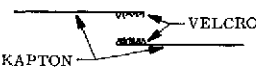
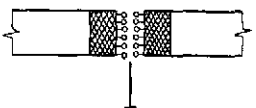
NOTE: Optimum configuration of above two joints would be a laminated-in, "hard edge" that would slide into retainer. This would eliminate possible fiberglass wear problems if the modules had to be removed very often. In addition, if the edge were very accurately controlled (the process for which would have to be developed) the panel-to-panel dimensional control would be much simplified.

## REFERENCES

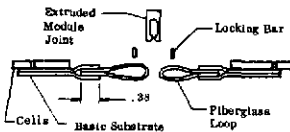
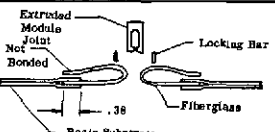
(Section 2.2.6)

1. First Topical Report, Evaluation of Space Station Solar Array Technology, Report No. LMSC-A981486, December 1970.
2. First Topical Report Update, Evaluation of Space Station Solar Array Technology, Report No. LMSC D159124, July 1972.
3. Second Topical Report, Design and Analysis, Space Station Solar Array Technology Evaluation Program, Report No. LMSC-A995719, November 1971.
4. D. J. Parquet, Tensile and Tear Tests, Solar Cell Substrate, Space Station Solar Array Technology Evaluation Program, Report No. LMSC-A999457, December 1971.
5. D. J. Parquet, Creep Tests, Solar Cell Substrate, Space Station Solar Array Technology Evaluation Program, Report No. LMSC-D152986, April 1972.

## 2.2.7 Substrate Wiring Harness

### 2.2.7.1 Function in the System

The array power distribution system will:

- Provide the feeder harness on the array to collect power and route it inboard.
- Provide instrumentation, signal and power wiring distribution from the array to the vehicle.

A figure of the multilayer flex harness developed for the Space Station Solar Array is shown in Figure 2.2.7-1.

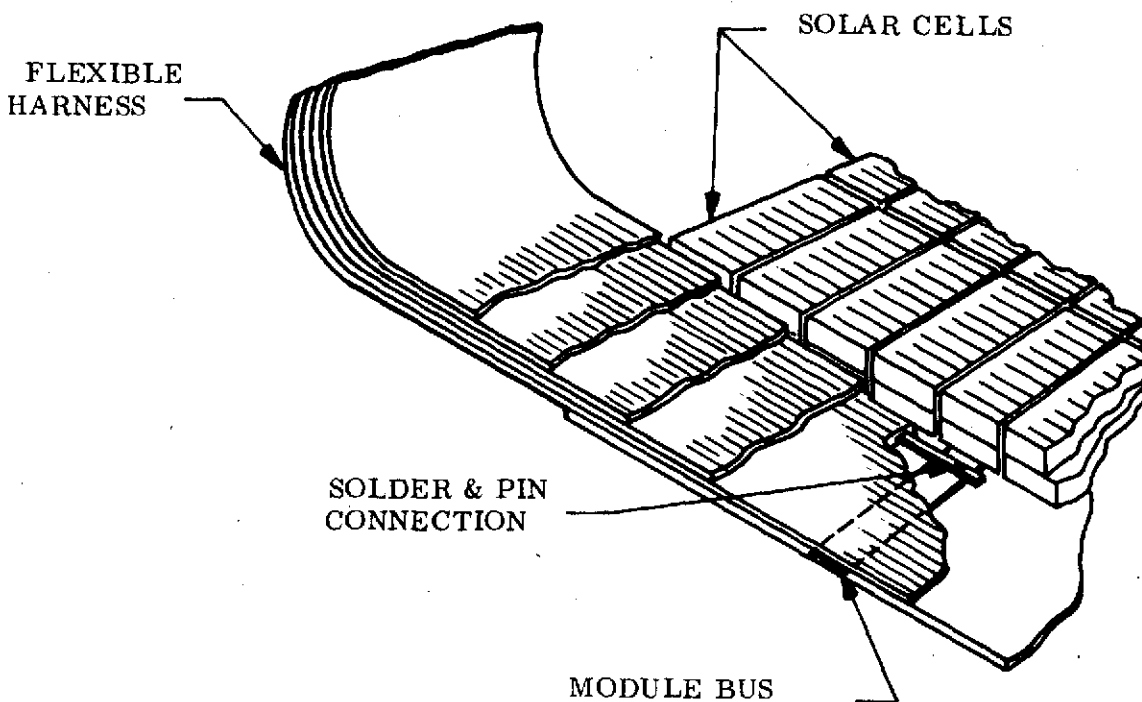

Figure 2.2.7-1 LSSSA Flexible Harness

### 2.2.7.2 Design Parameters

In making the design, the following factors must be considered:

1. Round wire cable vs flat conductor cable
2. Copper conductors vs aluminum conductors
3. Maximum permissible cable voltage drop from input to output
4. Current carrying capacity and conductor widths, thicknesses and separations
5. Conductor and cable temperature rise
6. Type of insulation material based on electrical, mechanical, chemical and environmental applications
7. Thermal characteristics of the bundle
8. Dielectric requirements between layers
9. Dielectric requirements between conductors
10. EMI considerations: isolation or shielding
11. Number of conductors per cable
12. Type of connector (termination method) applicable to requirements
13. Qualification tests
14. Reliability of the proposed wiring system

References 1, 2, and 3 at the end of this section give excellent discussions of each of the above factors. Four of these factors, however, give designers some very special problems. These are discussed below.

2.2.7.2.1 Round Wire Cable vs Flat Conductor Cable. Solar arrays, from the very fashion in which they are stowed, usually require that flat conductor cable be used. However, the advantages and disadvantages of FCC vs RWC are presented here in order that a good selection for a special circumstance may be made.

#### FCC ADVANTAGES

The general attributes of FCC, as compared with RWC, are significant in many applications:

- Lighter weight due to collective strength of the conductors and by electrically and mechanically stronger insulation.



- More flexible and stronger than RWC (much greater resistance to bending handling).
- Space savings due to its flatness (lower volume).
- Higher current capacity and more efficient heat dissipation due to larger surface area and smaller insulation volume.
- Controlled and reproducible electrical characteristics: flat conductors are in fixed position, assuring a repeatable, more uniform wiring system from vehicle-to-vehicle with identical electrical characteristics.
- Time saving due to FCC geometry and tooling for termination, testing, and installation (shorter harness manufacturing time).
- Cost savings: easier assembly of FCC harness results in greater reliability and lower cost. Reduction in inspection and termination costs.
- Simpler to route and support in a vehicle.
- Eliminates many RWC shielding requirements by the controlled location of all conductors and by the separation of sensitive circuits.
- Cleaning and sterilization is much easier.
- Visual inspection is very simple.
- Excellent quality control potentials.
- Fewer installation errors due to position of conductor in cable.
- Termination by layer reduces assembly cost and increases reliability.
- No identification is required for individual conductors.
- Greater system flexibility with use of distributors.
- Better reliability due to reduction in number of junctions, more flexibility, higher cut-through (cold-flow) strength by using Mylar or Kapton.
- Less chance of damage during installation when pulled over sharp edges.

#### SPECIAL FCC ADVANTAGES

The unique characteristics and geometry of FCC provide many special design advantages not available with round wiring:

- Adhesive bonding.
- Has a plastic memory which facilitates its use as retractable cable for drawer pull-out applications.
- It can be reinforced in discrete areas for single and double read-out plug-in terminations.

- It can be used for component mounting to eliminate terminal boards, printed circuit boards, or other component mounting means.
- Conductor surfaces can be gold plated in discrete areas for card read-out devices, plug-in terminations, or sliding contacts.
- Conductive coatings can be baked on the surface of the cable to provide a lightweight electrostatic shield.
- Shields can be designed to give specific capacitance values to the conductor directly beneath the shield within  $\pm 10$  percent to eliminate use of capacitors in some applications.
- Layers of cables can be interconnected with eyelets or pins which are soldered to pad areas on various layers.
- Special electrical characteristics can be designed into the cable.
- Continuous self-retracting cable made up has been flexed from 500,000 to 700,000 cycles without failure. The cable is capable of being bent around a 0.010 radius without failure of the conductor. Low temperature flexibility is excellent.
- Flexible printed circuits employed in rotary joints have undergone  $10^7$  flexing cycles without failure at room temperature and  $10^6$  cycles at 400°F. FCC connectors increase the reliability of harness systems by reducing the number of contacts per termination.
- Exceptional designs employing adhesive-backed cable placed in ducts and channels utilize the structural metal as a heat sink, thereby reducing conductor temperature rise and reducing conductor sizes. Adhesive-backed cable can also eliminate the cost and weight of cable clamps.
- The use of high temperature insulating materials allows conductor temperatures to rise within the limits of design without cable deterioration and provides additional opportunities for weight savings.
- Shielding thin flexible shields can be applied to both surfaces of the cable which will not add more than 0.002-inch thickness to the total cable thickness.

## FCC DISADVANTAGES

In general, the past lack of a great variety of qualified connector sizes and styles, the difficulty of making circuit changes, and the need for an RWC-FCC transition for current vehicle configurations have hindered the use of FCC. The following is a list of the major disadvantages:

- New system with fewer developed and qualified hardware items and less experience.
- New engineering, manufacturing and quality control technology development required.
- Requires the use of distributors for more complicated systems.
- More difficult to bend in three planes simultaneously.
- Difficulty in making circuit changes (Advantage and Disadvantage). Must include many distribution units per vehicle in order to make circuit changes.
- Repair of FCC is more difficult (if not impossible) than RWC.
- Cable layouts require a coordinated conductor (pin) function.
- Only a limited number of connector sizes and styles are presently available. Need qualified connectors.
- Cost of FCC cables and connectors are high due to small production quantities.
- Tooling for FCC termination is not yet on the market, and the initial cost will be more expensive than a soldering iron or hand crimp tool used in round wiring, but the piece cost of FCC termination will be many times less than that of round wire termination.
- Need qualified personnel to handle FCC.
- Need for hermetically sealed connectors.
- Need to isolate sensitive circuits which requires additional wires.
- More vulnerable to puncture damage.
- Existing installation configuration of black-boxes is not always compatible with FCC (clearance for bends).
- Existing qualified black-boxes with cylindrical connectors require transition of FCC to RWC which increases manufacturing complexity and cost, vehicle weight, wiring errors and reduces the reliability as compared with an all-FCC system.

- Installation of hybrid configuration of FCC and RWC harnesses is cumbersome because of the differences in cable geometry.
- Transition boxes or connectors would be required in a multitude of instances to satisfy routing of signals from one connector to two or more connectors.
- Re-evaluation of vehicle systems relative to EMI is required when changing to FCC.
- Development of high current FCC harness compatible with installation on existing vehicle designs.
- Need development of high current FCC connectors for high current (large size) FCC.
- Must provide for vehicle growth or rapid response modification capability.
- Lack of automatic fabrication equipment.
- Higher material costs.

2.2.7.2.2 Copper vs Aluminum Conductors. The second major problem that meets the conductor cable designer is whether to use aluminum or copper conductors. Aluminum presents a significant weight savings over copper even though larger AWG size of aluminum must be used to obtain the same conduction as copper. A comparison of copper and aluminum wire characteristics appears in the following tabulation (the comparison is for RWC but the same comparison may be made for FCC).

	<u>For 20 AWG Wire at 20°C</u>	
	<u>Copper (annealed)</u>	<u>Aluminum (hard drawn)</u>
Diameter in mils	31.96	32
Resistance (ohms/1000 ft)	10.15	16.7
Weight (lb/1000 ft)	3.092	.939
Tensile strength (lb/in. <sup>2</sup> )	60,000 - 70,000	30,000 - 40,000
Hardness	2.5 - 3.0	2.0 - 2.9
Coefficient of thermal expansion	$14 \times 10^{-6}$	$24 \times 10^{-6}$
Cost	--	Least
Termination	Best	--

Comparisons of other properties and characteristics are summarized in the following list:

- Aluminum conductivity is 67% that of copper
  - . Must use larger AWG size of aluminum to obtain same resistance as copper
  - . Even with the increased AWG size, aluminum weighs significantly less than copper (aluminum's major advantage)
- Aluminum occupies greater volume than copper
- Aluminum is subject to corrosion
- Main problem with the use of aluminum wire is termination -
  - . Cannot solder directly to aluminum - must be plated (silver plate for solder requirements. If silver plate is scratched, aluminum will corrode)
  - . Best termination is crimp type. Note that most aerospace connectors are gold-plated; aluminum and gold occupy extreme positions with regard to EMF (aluminum acts as an anode, gold as a cathode - great potential difference between the two)
- Cost of aluminum less than cost of copper
- Aluminum is stiffer than copper (less tensile strength). In flexibility tests at LMSC, flexing wire 45 deg through orifice, produced the following results;
  - . 17-18 oscillations for copper before it work-hardened and broke
  - . 3-8 oscillations for aluminum before it broke (less predictable)
- Aluminum and copper exhibit approximately the same workability

2.2.7.2.3 Type of Insulation Material. The third major area of consideration is the type of insulation material to be used to protect the conductors. The following is directed to FCC insulation as it is the only viable choice for arrays that require a good packaging efficiency.

The three types of insulation best suited for aerospace application are: polyesters (Mylar), polyimides (Kapton), and fluoroethylenes (Teflon). Comparison of their primary electrical and mechanical characteristics have been presented in Table 2.2.5-1. A comparison of the major properties of each insulation type is as follows:

- a. Polyester (Mylar, Celanar, Scotch par) to +150°C
  - Thermoset
  - Good radiation resistance
  - Good flexural fatigue life
  - Excellent dimensional stability
  - High dielectric strength retained in high humidity environments
  - Absorbs water rapidly
  - Relatively stiff film
  - Extremely flammable
  - Available with polyolefin, polyester and epoxy adhesives
  - Low loss factor
  - Accurately gaged
  - Easily chemically milled
  - The only thermoset compatible with weld-through technique
  - Inexpensive
  
- b. Polyimides (Kapton) to +400°C
  - Thermoset
  - Use is temperature limited by adhesive
  - Excellent dimensional stability
  - Relatively stiff
  - Good flexural fatigue
  - Absorbs water rapidly, thus requires extensive pre-drying in some assembly operations
  - Expensive
  - Easily bonded with adhesives
  - At high temperatures, contact with certain metal must be watched to prevent deterioration of circuit
  - Retains dielectric strength in high moisture environments

- Low loss factor
  - Best radiation resistance
  - Easily chemically milled
- c. Fluoroethylenes (Teflon) to +250°C
- TFE (thermoset material in limited use with adhesive bonding)
  - FEP (Thermoplastic film)
    - Excellent humidity resistance
    - Low loss factor
    - Good radiation resistance
    - Low dielectric constant
    - Excellent flexibility
    - Unpredictable and poor dimensional stability when thermoplastically bonded
    - Available with activated surfaces for use with adhesives (FEP Type "C")
    - Unsurpassed solvent resistance

2.2.7.2.4 Criteria for Selection of Termination Procedure or Connector. The last major problem facing the FCC designer is the type of connector or termination method to be used. FCC connectors are usually very high in cost due to their small production quantities and limited tooling availability. However, if the following electrical, mechanical and environmental considerations are well made with enough lead time, costs should be minimized and the full advantages of the flat conductor cable method can be obtained. The following tabularizes these considerations:

Electrical Considerations:

1. Current carrying capacity
2. Voltage drop
3. Dielectric Strength
4. Shielding
5. Insulation Resistance
6. Discontinuity interruptions

**Mechanical Considerations:**

1. Environment caused tolerance changes
2. Cable retention under load
3. Mating and unmating forces
4. Durability
5. Flexing

**Environmental Considerations:**

1. Temperature extremes
2. Thermal shock
3. Chemical exposure
4. Moisture
5. Arc resistance
6. Ozone atmosphere during storage
7. Sand and dust
8. Air leakage
9. Storage life
10. Outgassing



## REFERENCES

(Section 2.2.7)

1. E. R. Hnatek, Survey of Flat Conductor Cable Technology, Report No. LMSC-A951795B, December 1969.
2. W. Angele, et al, Flat Conductor Cable Design, Manufacture, and Installation, Report No. NASA TMX-53975, NASA-MSFC, January 1970.
3. W. Angele, et al, Flat Conductor Cable Connector Survey of 1970, Report No. NASA TMX-64613, NASA-MSFC, July 1971.
4. General Specification for Connectors, Electrical, Environment Resistant, For Use with Flexible, Flat Conductor Cable, and Round Wire, MIL-C-55544A, June 1971.
5. First Topical Report, Evaluation of Space Station Solar Array Technology, Section 4.1.3.5, Report No. LMSC-A981486, December 1970.
6. Second Topical Report, Design and Analysis, Space Station Solar Array Technology Evaluation Program, Section 3.2.6, Report No. LMSC-A995719, November 1971.

### 2.3 SOLAR ARRAY DRIVE SYSTEM

A drive system is defined as a unit having a motor to supply rotational power, a power transfer device to take electrical power across the rotating joint, and its own bearings to maintain alignment. A review of drive system technology in Reference 1 showed that drive systems come in all shapes and sizes, substantiating the premise that there has been no standardization. Drive systems are designed specifically for each application and its associated requirements. As such, only the basic components can be used from system to system. It is these components, not their packaging, therefore, that will be discussed in the following sections. (Due to the great extent of design information available in other sources on gears, bearings and motors, their coverage in these sections will be confined to qualitative considerations only. References at the end of the section as well as pertinent vendor data should provide adequate information for the design of these components).

Preceding page blank

### 2.3.1 Gears

The choice of types and sizes of gears is due largely to the gear ratio required, the volume available to accommodate the drive system, the availability of the gears, and the technology status of the various types of gears. These basic types include spur gears, helical gears, worm gears, harmonic drive gears, and bevel gears. (See Figure 2.3.1-1). Obviously, the only real choice in gear system design is the shape of the teeth. Once the gear ratio is determined from considerations of the system drag, the moments of inertia, the motor, and the control system, the gear assembly must be analyzed for tooth stress, wear rate, and gear-induced bearing loads.

The analytical techniques of the many types of gears are detailed in the references at the end of this section. In addition, for more complete specifications and cost information, vendors should be consulted. Table 2.3.1-1 presents a summary trade-off of the basic gear systems versus technology status, efficiency, friction and wear, and bearing loads. Some general remarks are also included.

**Preceding page blank**

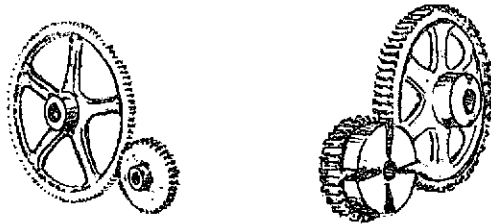

SPUR GEARS

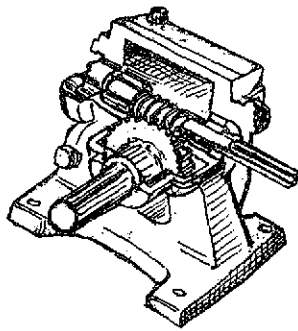
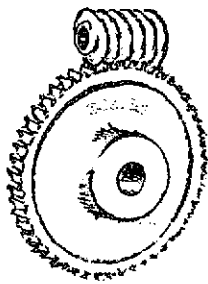

WORMS AND WORM GEARS

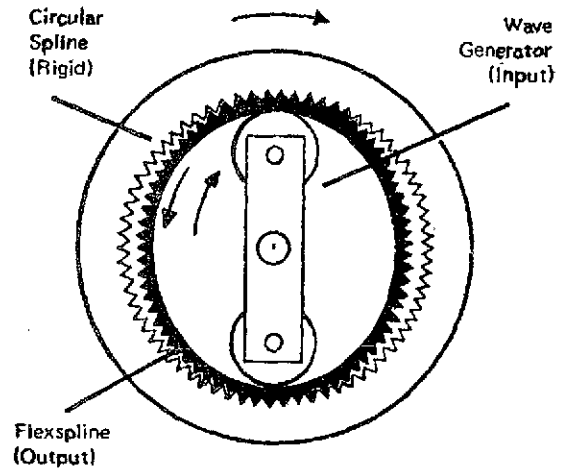

HARMONIC DRIVE GEARS

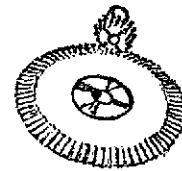
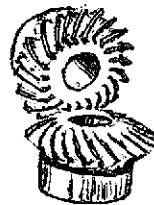

HELICAL GEARS

Figure 2.3.1-1 Basic Gear Types

TABLE 2.3.1-1  
GEAR SYSTEM TRADEOFFS

CONSIDERATIONS GEAR TYPE	TECHNOLOGY STATUS	EFFICIENCY PERCENT	FRICTION AND WEAR	BEARING LOADS	REMARKS
SPUR	<ul style="list-style-type: none"> <li>• Available in many sizes</li> <li>• Available in many mat'ls</li> <li>• Large sizes</li> <li>• Manufacturing techniques</li> </ul>	95 to 98	Minimum (rolling contact)	Minimum	<ul style="list-style-type: none"> <li>• Large annular gear can be part of large bearing</li> <li>• Lower cost</li> </ul>
HELICAL	<ul style="list-style-type: none"> <li>• Off the shelf sizes up to 6" dia.</li> <li>• Large sizes available</li> </ul>	95 to 98	Minimum (rolling contact)	Same as Spur, except axial load applied to shaft	Large load/tooth capability
WORM	<ul style="list-style-type: none"> <li>• Available up to 10" dia.</li> <li>• Available in sealed housing</li> </ul>	60 to 80	High (rubbing contact)	High	<ul style="list-style-type: none"> <li>• High ratio (100:1) available</li> <li>• Cannot be driven backwards</li> <li>• Alignment is difficult</li> </ul>
HARMONIC	<ul style="list-style-type: none"> <li>• Well developed and available in small sizes</li> </ul>	60 to 90	Low (rolling contact)	No drive shaft-wave generator has small loads	<ul style="list-style-type: none"> <li>• No backlash</li> <li>• Ratios from 100:1 to 200:1 available</li> <li>• No life test data available</li> </ul>
BEVEL	<ul style="list-style-type: none"> <li>• Well developed</li> <li>• Available in relatively small sizes</li> </ul>	95-98	Minimum (rolling contact)	Same as Spur, except axial load applied to shaft	Angle of shafts usually 90°

### 2.3.2 Bearings

As with the other drive system components, the technology of bearings is well advanced. The basic design considerations for both on-the-ground and in-space bearings are almost identical. See Table 2.3.2-1. (The only notable difference is the lubrication method for the space vacuum environment which will be covered in Section 2.5).

In the selection of a bearing for a specific application, the first decision that must be made is the type of bearing that will be used. The choice between the two basic categories (plain or rolling element) is generally obvious. However, a further choice must be made between the many different subcategories. For example, the large bearings on the ODAPT (Orientation Drive and Power Transfer System) certainly had to be rolling-element bearings to allow as low a friction as possible. However, a choice between ball bearings, roller bearings or individual rollers also had to be made. Thus, the generalized tradeoff shown in Table 2.3.2-2 had to be completed. Because of this table and its associated considerations, ball bearings were selected for providing the rotary motion transfer. This general procedure must be followed for any bearing-associated problem. After the specific type of bearing has been selected, detailed analytical calculations must be made to determine each of the parameters listed in Table 2.3.2-1. The geometry of the individual bearing components, e. g., ball diameter, ball contact angle, thickness of the races, number of balls, etc., will be determined as the analysis progresses.

The equations applicable to the above calculations have been so thoroughly covered in the literature that they were not incorporated in this report. However, several sources have been included in the references at the end of this section. They should be consulted not only for their detailed analyses, but also for more specific discussions of the various bearing types. In addition, bearing vendor data should also be consulted for specific information, analytical techniques, and cost data.

**Preceding page blank**

TABLE 2.3.2-1  
BEARING DESIGN CONSIDERATIONS

PARAMETER	REMARKS
Static Load Capacity	Limiting load that can be endured while bearing is at rest without suffering excessive permanent deformation.
Dynamic Load Capacity	The load at which 90% of a group of bearings can survive one-million inner-race revolutions. (Load may be reduced to increase life.)
Fatigue Life	Length of time the bearing will survive under dynamic loading before fatigue failure occurs.
Stiffness	Resistance to deformation under load.
Friction	Resistance to motion of the inner-race relative to the outer race due to lubricant viscosity, tolerances, etc.
Tolerance to Thermal Gradients	Ability of the bearing to maintain operation under increasing thermal gradients.
Lubrication	Most bearings fail due to lubricant starvation or improper lubricant selection.
Materials	Materials should be selected from trade-offs of maximum temperature, load, life requirements, cost, etc.
Weight	Function of size and materials.
Maintainability or Replaceability	Ease of replacement if bearing fails.
Cost Delivery	Exotic requirements will cause long lead times and high costs.

TABLE 2.3.2-2  
BEARING SYSTEM TRADEOFF

CONSIDERATIONS	BALL BEARINGS	ROLLER BEARINGS	INDIVIDUAL ROLLERS
Radial load	Advantage	Advantage	Advantage
Thrust load	Advantage	Advantage	Advantage
Combined load	Advantage	Advantage	Advantage
Spring rate, axial	Advantage	Advantage	Advantage
Spring rate, radial	Advantage	Advantage	Advantage
Friction	Advantage	Disadvantage	Disadvantage
Tol to thermal gradients	Disadvantage	Disadvantage	Disadvantage
Fatigue life	Advantage	Disadvantage	Disadvantage
Weight	Advantage	Disadvantage	Disadvantage
Maintainability or Replaceability	Disadvantage	Disadvantage	Advantage*
Delivery	Disadvantage	Disadvantage	Advantage

\*Preloaded roller is questionable and preload must be removed.



2.3.3 Motors

With some modifications, motors capable of use on the ground can also be used in space. As opposed to the other drive system components, however, the design of a motor is less a problem of analysis and more one of selection. For this reason, there is much vendor interface before a decision on a motor is reached. Very often, the motors for space application turn out to be one of a kind configurations of common types. As a result, vendor advice usually proves invaluable.

The design approach taken in motor selection should be one of trading off the various drive system characteristics with the characteristics of the various motor types. Some of these parameters are listed below in Table 2.3.3-1.

TABLE 2.3.3-1  
 CHARACTERISTICS OF DRIVE SYSTEMS  
 RELATIVE TO DRIVER MOTOR CHARACTERISTICS

DRIVER SYSTEM CHARACTERISTICS	VS	MOTOR CHARACTERISTICS
<ul style="list-style-type: none"> <li>● Operation mode of system (On-Off, Continuous, etc.)</li> <li>● Frequency of starting or stopping</li> <li>● Load characteristics                             <ul style="list-style-type: none"> <li>system inertias</li> <li>system friction torque</li> <li>system lubrication torque</li> </ul> </li> <li>● Environment (vacuum, temperature)</li> <li>● System voltage characteristics (AC, DC)</li> <li>● Volume restrictions</li> <li>● Weight restrictions</li> </ul>		<ul style="list-style-type: none"> <li>● Torque (peak, continuous)</li> <li>● Horsepower</li> <li>● Speed</li> <li>● Gearing adaptability</li> <li>● Brush wear</li> <li>● Insulation</li> <li>● Lubrication</li> <li>● Starting characteristics</li> <li>● Complexity of motor control circuitry</li> <li>● Past performance</li> <li>● Weight</li> <li>● Volume</li> <li>● Cost</li> </ul>

**Preceding page blank**

As an example, the motor trade-off prepared for the Space Station Solar Array ODAPT is shown in Table 2.3.3-2. Each of eight different motor types was considered in relation to its more important characteristics. The DC thrust-type torque motor was finally selected for this application because of its history of successful space application, simplicity of design, simplicity of the control system to drive it, and its operational compatibility with large inertial loads.

Reference 10 at the end of this section presents both basic and more recent information on the subject of electric motors. Perhaps of more importance is the Manufacturer's Index which will lead to more detailed information on the many motors available to the industry.

TABLE 2.3.3-2  
MOTOR TRADE OFF TABLE

MOTOR TYPE	WEIGHT (LBS.)	SIZE	TORQUE EFFICIENCY #- FT/WATT	GEARING ADAPTABILITY	CONTROL SYSTEM COMPATIBILITY	LIFE (Does Not Include Bearings)	REMARKS
DC Brush Type Torque	7.5	8" dia x 1-3/4"	0.027	Pancake mounting, no problem with gearing	Excellent	Brushes are only wear elements. However, 10 yrs is feasible	Can handle large inertia loads. Impressive history of successful space applications
DC Brushless Type Torque	4	4-3/4" dia x 2-1/4"	0.022	Pancake mounting, no problem with gearing	Electronic Complexity Otherwise Excellent	10 yrs feasible	Can handle large inertia loads. Very complex electronics
Servo Motor	2# motor 5# gear-head.	No unit mfr with torque reqmts except with extra gearhead	0.00025 at motor	Gear size matching problem - 140:1 needed	More complex electronics to control AC	10 yrs feasible	Poor torque per watt ratio. Inverter losses must be charged against drive
DC Stepper	4	4-3/4" dia x 2-1/4"	0.022	Pancake mounting - gearing must absorb repeated mech. shock	Complicated electronics	10 yrs questionable due to repeated mech shock	High surge currents, does not drive inertia loads well. Detent torque could be useful.
AC Stepper	3 motor 7# gear-head	No unit mfr with torque reqmts except with gearhead	0.00002	Gear size mounting problem	Complicated electronics	10 yrs questionable due to repeated mech shock	Poor torque efficiency, high surge currents does not drive inertia loads well
Induction	20	10" dia 11" long	0.0007	No problem	More complex Electronics to control AC	10 yrs feasible	Low starting torque, high starting surge current. Inverter inefficiency must be charged to drive
AC Synchronous	25	10" dia 14" long	Poor - depends on starting method	No problem	More complex electronics to control AC	10 yrs feasible	Poor starting torque without aux. means. Inverter losses must be charged to drive.
AC Torque	40	15" dia x 4	0.002	No problem	More complex electronics to control AC	10 yrs feasible	Poor torque per watt ratio. Poor torque per pound ratio. Inverter losses charged to drive.

## REFERENCES

(Section 2.3)

1. First Topical Report, Evaluation of Space Station Solar Array Technology, Report No. LMSC-A981486, December 1970.
2. Second Topical Report, Design and Analysis, Space Station Solar Array Technology Evaluation Program, Report No. LMSC-A995719, November 1971.
3. 1971-72 Mechanical Drives Reference Issue, Machine Design, Penton Publication, June 17, 1971.
4. Vallance and Doughtie, Design of Machine Members, McGraw-Hill.
5. C. A. Underwood, "Operating Life of Gears", Product Engineering, May 14, 1962.
6. J. E. Shigley, Mechanical Engineering Design, McGraw-Hill Book Company.
7. J. E. Shigley, Theory of Machines, McGraw-Hill Book Company, 1961.
8. 1972-73 Bearings Reference Issue, Machine Design, June 22, 1972, Penton Publication.
9. T. A. Harris, Rolling Bearing Analysis, John Wiley and Sons, 1966
10. 1972-73 Electric Motors Reference Issue, Machine Design, April 13, 1972, Penton Publication.

## 2.4 POWER AND SIGNAL TRANSFER DEVICES

Presented in Table 2.4-1 is a summary of selection considerations for the five major power transfer devices. Slip rings, power clutches, flex cables, rotary transformers, and rolling contacts are traded off versus some comparative design parameters. It can be seen that for signal transfer across oscillating gimbals, flex cables and slip rings are first and second choices, respectively. In addition, for continuously rotating gimbals there is nothing really second to slip rings for the transfer of signals. Power slip rings, however, have alternatives because high current levels can cause problems that might possibly be better handled by another device (if the technology existed). But for low level operation, nothing compares to a slip ring. The reliability is extremely high and problems are almost nonexistent.

As a result, detailed design parameters will be given below only for slip rings and flex cables. The other three devices will be discussed mainly from a descriptive standpoint as presented by an expert on each device.

TABLE 2.4-1

## POWER TRANSFER DEVICE SELECTION CONSIDERATIONS

## OSCILLATORY/STATIONARY GIMBAL

DEVICE	SIZE & WEIGHT	LIFE & MAINT.	POWER CONSUMPTION	COST & SCHEDULE	TECHNOLOGY STATUS	LUBRICATION
Slip Ring	Intermediate	10 years possible	Intermediate I <sup>2</sup> R. Overcome brush friction	Second	State-of-the-art	Dry lube incorporated in brushes.
Power Clutch	Intermediate	10 years possible. Components replaceable.	Intermediate I <sup>2</sup> R. Have to reset.	Third	Concept Stage	No lube on contacts. Motor parts need miscellaneous lubrication
Flex Cable	Lowest	10 years possible.	Lowest I <sup>2</sup> R.	First (lowest)	State-of-the-art	Individual strands lubricated within sheath.
Rotary Transformer	Highest	10 years possible.	Highest losses (due to inverter)	Dependent on size and efficiency.	Industrial units off the shelf. Space units need dev.	None
Rolling Contact	Intermediate	Fatigue problems.	Intermediate I <sup>2</sup> R. Overcome bearing friction.	Fourth	Working models but need development.	Conductive dry lube.

## ROTATING GIMBAL

DEVICE	SIZE & WEIGHT	LIFE & MAINT.	POWER CONSUMPTION	COST & SCHEDULE	TECHNOLOGY STATUS	LUBRICATION
Slip Ring	Lowest	10 years possible.	Low I <sup>2</sup> R. Overcome brush friction.	First (lowest)	State-of-the-art	Dry lube incorporated in brushes.
Power Clutch	Lowest	10 years possible. Components replaceable.	Low I <sup>2</sup> R. Have to reset.	Second	Concept Stage	No lube on contacts. Motor parts need miscellaneous lubrication.
Flex Cable	-	-	-	-	-	-
Rotary Transformer	Highest	10 years possible.	Highest losses (due to inverter)	Dependent on size and efficiency.	Industrial units off the shelf. Space units need dev.	None
Rolling Contact	Intermediate	Fatigue problems.	Low I <sup>2</sup> R. Overcome bearing friction.	Third	Working models but need development.	Conductive dry lube.

Preceding page blank

#### 2.4.1 Slip Rings and Brushes

Tables 2.4.1-1 and -2, respectively, contain the parameters that should be considered in the design of slip rings and brushes for a power or signal transfer device. Note the very close relationship between slip ring material and brush material. They must be selected in conjunction with each other because it is the combination that will determine sliding friction, electrical contact resistance, weld tendency, operating temperature, and wear rates. Because the operation of slip rings and brushes, both in test chambers and in space, has become quite common, a large amount of data is now available. Tables 2.4.1-3 through 2.4.1-5 present wear rates, operation temperatures, and voltage drops of several slip ring/brush combinations versus pressure, current density, sliding speed, and time. Table 2.4.1-6 provides some additional information pertaining to the types of brushes available. Using proper materials, lubrication and handling, slip rings and brushes are almost perfect devices. The following tabulation shows some of their major advantages and disadvantages:

##### ADVANTAGES

- Well developed technology
- Unlimited rotation in either direction
- Performance not degraded by stopping, starting or reversing
- High reliability over long operating periods
- Brushes replaceable
- No ring wear
- Excellent flight history

##### DISADVANTAGES

- Relatively heavy
- Large size results in production problems
- Relatively high cost
- Produces fairly high thermal inputs due to losses at brush-ring interface

The references included at the end of this section will not only provide additional data but will also give some discussion on specific designs for flight applications. Vendors should also be contacted for information concerning cost, geometries, and specific design questions.

**Preceding page blank**

TABLE 2.4.1-1  
SLIP RING DESIGN CONSIDERATIONS

PARAMETER	REMARKS
Max Current	One of the major sizing factors in determining slip ring cross section.
Thermal & Electrical Conductivity	The two most important considerations. For good electrical efficiency and good heat dissipation properties, it is imperative that these two properties be as high as possible (at the possible expense of weight).
Material	Generally chosen in conjunction with a brush material that produces low sliding friction, low electrical contact resistance, and no tendency to weld while the brushes are stopped. Possible choices are Ag, coin Ag (90% Ag, 10% Cu), Cu, Au, or laminate of coin Ag and Cu.
Geometry	Determined from vehicle, brush, and current constraints.
Weight	A function of material and geometry.
Cost	A function of material and geometry (difficulty of fabrication).
Brush Material	In conjunction with ring material, determines sliding friction, electrical contact resistance, weld tendency when brushes are stopped, and voltage drop between brush and slip ring.
Sliding Friction	Relative resistance to motion between brush and slip ring (function of speed, materials and pressure).
Electrical Contact Resistance	Ease at which current may pass from brush to slip ring. Measured in terms of voltage drop which is a function of pressure, current density, materials, and relative motion between brush and slip ring. (See Table 2.4.1-2)
Weld Tendency When Brushes Stopped	A function of materials, lubrications, pressure, and temperature



TABLE 2.4.1-1 (Cont.)  
SLIP RING DESIGN CONSIDERATIONS

PARAMETER	REMARKS
Brush Speed	A factor in determining wear rates and operating temperatures.
Brush Pressure	A factor in determining wear rates, operating temperatures, contact resistance, and weld tendency.
Brush Travel	A factor in determining wear rates.
Operating Temperatures	A factor in determining wear rates and lubricant life.
Lubricant	Usually contained in the brushes to prevent excessive wear rates, sliding friction or operating temperatures and to eliminate any welding tendency of the brush to the ring.
Wear Rate	A function of material, speed, pressure, travel, temperature, and lubricant.

TABLE 2.4.1-2  
BRUSH DESIGN CONSIDERATIONS

PARAMETER	REMARKS
Brush Hardness	Quality Control parameter that indicates shock absorbing characteristics and ability to ride smoothly on rapidly revolving surface. Brush hardness inversely proportional to wear.
Contact Drop	Resistance of one cubic inch of brush material and used to determine ohmic resistance. Specific resistance should be low to minimize heating for high current, low voltage applications.
Coefficient of Friction	Increased friction causes increased wear and heat. Should be low to reduce required motor torque.
Current Density	Current density capabilities inversely proportional to brush temperature
Brush Porosity	A function of required amount of lubrication which in turn is a function of temperature, vapor pressure, and life
Shunt Type	Tamped connections used where brushes too small to rivet or where high strength is not required.  Rivet shunt is stronger, less susceptible to vibration failure, and provides greater heat transfer area
Brush Pressure	Pressure should be equal on all brushes to eliminate unequal current distribution  Limited range of pressures where best performance is obtained (electrical wear is inversely proportional and mechanical wear is directly proportional to brush pressure).  High current or high speed requires high pressure.  Optimum pressure obtained by testing as was done on ODAPT candidate brushes (see Tables 2.4.1-3 through 2.4.1-5).

TABLE 2.4.1-2 (Cont.)

## BRUSH DESIGN CONSIDERATIONS

PARAMETER	REMARKS
Brush Holders	<p>Must allow accurate contact under all conditions.</p> <p>Must carry away about half of the generated heat to minimize brush temperature rise.</p> <p>Should be as many separate brushes in parallel as possible to increase number of electrical contact points, to provide greatest chance of at least one brush being in contact during vibration, and to allow for maximum heat dissipation.</p> <p>Spring mechanism should add as little mass as possible to allow brush to follow collector eccentricities.</p>
Brush Fabrication	<p>Appropriate brush lubricant exhibits high thermal and/or oxidation stability and low evaporation rate. (Special lubricant additives available to provide other needed properties). See Sections 2.5.1, 2.5.2 and 2.5.3 for oil, grease and solid lubricant discussion. See Tables 2.4.1-3 and -4 for operating temperature and voltage drop vs several lubricant/brush material combinations.</p>

TABLE 2.4.1-3  
OPERATING TEMPERATURES ( $^{\circ}\text{C}$ ) OF ODAPT CANDIDATE BRUSHES

	<u>Vac Kote Lubed Silver/Graphite</u>		<u>MoS<sub>2</sub> Lubed Silver/Copper</u>	<u>NbSe<sub>2</sub> Lubed Silver</u>
	<u>50 A/in<sup>2</sup></u>	<u>100 A/in<sup>2</sup></u>	<u>50 A/in<sup>2</sup></u>	<u>50 A/in<sup>2</sup></u>
<u>Copper Slip Rings</u>				
Sliding				
4 psi	88; 73-74	---		
8 psi	63; 60-63	---		
10-12 psi	80-81	---		
13-16 psi	50-60			
Static				
4 psi	76	---		
8 psi	54	---		
10-12 psi	75-78	---		
13-16 psi	50-61	---		
<u>Silver Slip Rings</u>				
Sliding				
4 psi	72-76	100-102	49-56	61-63
8 psi	35-58	38-51	---	---
Static				
4 psi	58-62	82-88	44-49	50-51
8 psi	32-46	39-47	---	---

TABLE 2.4.1-4  
 VOLTAGE DROP FOR ODAPT CANDIDATE BRUSHES  
 (For Single Contacts)

Brushes:	<u>Vac Kote Lubed Silver/Graphite</u>		<u>MoS<sub>2</sub> Lubed Silver/Copper</u>	<u>NbSe<sub>2</sub> Lubed Silver</u>
	<u>50 A/in<sup>2</sup></u>	<u>100 A/in<sup>2</sup></u>	<u>50 A/in<sup>2</sup></u>	<u>50 A/in<sup>2</sup></u>
<u>Copper Slip Rings</u>				
Sliding for:	<u>~200 hrs</u>	<u>~650 hrs</u>		
4 psi	0.25	0.18		
8 psi	0.18	0.17		
10-16 psi	0.22	----		
Static for:	<u>~375 hrs</u>			
4 psi	0.14			
8 psi	0.14			
10-16 psi	0.17			
<u>Silver Slip Rings</u>				
Sliding for:	<u>~200 hrs</u>	<u>~200 hrs</u>	<u>~200 hrs</u>	<u>~200 hrs</u>
4 psi	0.25	0.34	0.09	0.08
8 psi	0.20	0.23	----	
Static for:	<u>~375 hrs</u>	<u>~375 hrs</u>	<u>~1200 hrs</u>	<u>~375 hrs</u>
4 psi	0.20	0.27	0.25	0.073
8 psi	0.19	0.21	0.20	0.066

TABLE 2.4.1-5

## WEAR RATES OF BRUSHES UNDER A VARIETY OF OPERATING CONDITIONS (IN VACUUM)

	<u>Brush Composition</u>	<u>Slip Ring</u>	<u>Brush Press., psi</u>	<u>Curr. Den. A/in<sup>2</sup></u>	<u>Sliding Speed, in/min</u>	<u>Wear Rate in/in</u>	<u>Test Location</u>
(1)	85% Ag	a) Ag	10	229	318	$1.5 \times 10^{-9}$	AEDC
	2.5% Cu	b) Ag	6-10	300	424	$1.3 \times 10^{-9}$	LMSC
	12.5% MoS <sub>2</sub>	c) Coin Ag	19.5	147	409	$1.1 \times 10^{-9}$	BBRC (non-ODAPT)
(2)	85% Ag 15% NbSe <sub>2</sub>	Coin Ag	3.6	80	0.056	$1.7 \times 10^{-8}$	Westinghouse
(3)	88% Ag 12% NbSe <sub>2</sub>	Coin Ag	10	147	409	$1.4 \times 10^{-11}$	BBRC (non-ODAPT)
(4)	85% Ag 15% MoS <sub>2</sub>	Coin Ag	4.8	80	0.056	$1.4 \times 10^{-8}$	Westinghouse
(5)	90% Ag 10% Graphite	Au	10	229	318	$1.5 \times 10^{-8}$	AEDC
(6)	75% Ag	Ag	6-10	300	424	$1.7 \times 10^{-9}$	LMSC
	15% Mo 10% MoS <sub>2</sub>						
(7)	75% MoS <sub>2</sub> 25% Mo + Ta	Coin Ag	10	147	409	$1.7 \times 10^{-11}$	BBRC (non-ODAPT)
(8)	75% Ag	Coin Ag	18	2000	82	$7 \times 10^{-10}$	BBRC
	20% Graphite 5% MoS <sub>2</sub> plus Vac Kote Oil						(non-ODAPT)

Data Sources - 1. LMSC-A981486, Dec. 1970, matrix chart GG. 2. BBRC TN67-12 and other unpublished BBRC Data. 3. Moberly and Johnson, "Electrical Sliding Contacts for Applications in Space Environments", Supp. to IEEE Trans on Aerospace, June 1965, 252-7.

TABLE 2.4.1-6  
BRUSH TYPES

TYPE	REMARKS
Carbon-Graphite	<p>Composed of Mixtures of Amorphous Carbons and Graphites</p> <p>Characteristics - High Harness, High Mechanical Strength, Pronounced Abrasive (Cleaning) Action, Depend on Presence of Absorbed Moisture for Lubricating Properties - Unsatisfactory for Space</p> <p>Application - Low Current Densities, Use Where a Brush with Low Friction Properties not Required</p>
Electrographitic	<p>Amorphous Carbon Changed to Graphitic Structure with High Temperature (2400<sup>o</sup>C)</p> <p>Characteristics - Higher Density, Lower Strengths, Lower Hardness, Lower Specific Resistance than Carbon-Graphite, Pure and Free From Abrasive Ash, Low Friction, Medium to High Contact Drop, Depend on Presence of Absorbed Moisture for Lubricating Properties - Unsatisfactory for Space</p> <p>Application - Medium Surface Speeds (5000 to 6000 fpm), Medium Current Densities (60 to 80 amps per square inch)</p>
Metal-Graphite	<p>Powered Metal and Graphite Bonded Together or Pores of Graphite Impregnated with Molten Metal</p> <p>Characteristics - Low Contact Drop, High Current Carrying Capability, Good Frictional and Surface Speed Properties, Silver-Graphite Brushes have Higher Current Ratings and Lower Specific Resistance</p> <p>Applications - Slip Rings and Low Voltage Commutating Devices, Silver-Graphite used in Applications Requiring Low and Stable Contact Drop</p>

TABLE 2.4.1-6 (Cont.)  
BRUSH TYPES

TYPE	REMARKS
Dichalcogen (MoS <sub>2</sub> , NbSe <sub>2</sub> )	Developed for Use in Space and Inert Atmospheres Characteristics - Lower Friction Properties in Vacuum, Not an Electrical Conductor, High Specific Resistance Applications - Used in Low Concentrations in Presence of Large Proportions of Silver and/or Copper, NbSe <sub>2</sub> Used for Long-Life Applications



#### 2.4.2 Power Clutch

The power clutch is a unique device which, in theory at least, has the good qualities of a slip ring without the bad. In essence, it is a set of high quality electrical contacts, one of which is fixed to one side of the gimbal axis and the other, while attached electrically to the other side, is free to rotate via a flexible cable. In operation, the contacts are clamped together and the whole device rotates, winding up the flexible cable. When the cable is wound up to the allowed extent, the "clutch" is disengaged and the cable end is spun backwards until the cable is unwound, then the contacts are reengaged. Of course the electrical circuit is interrupted, but this can be taken care of by having two units in parallel and resetting them at different times. This is an extremely promising idea but very little work has been done other than the initial laboratory studies. With proper development it could be a good power transfer device.

The following is in great part an excerpt from a paper entitled, "Rotary Relay for Space Power Transfer". (See Reference 1). The author, H. Theron Haynie of the Boeing Company, explains the basic design of his concept of the power clutch:

"It is made up of three pairs of rotors and stators; each pair is a complete circuit. Cable pairs are used to reduce the connector size. Adjacent rotors and stators are insulated by a Teflon washer. Figure 2.4.2-1 shows a typical wiring circuit that can be quickly reset during an all-sunlight orbit. Figure 2.4.2-2 is a low-current house-keeping clutch with several circuits. Adjacent conductors are insulated by a Teflon washer.

A central tube of nylon, the structural backbone of the system, serves as the rotor pivot; it also houses the recycle actuator and guides the clamping piston. An extension handle protruding from the center enables manual actuation.

The stator assemblies are made up of circular plates with a metal-matrix, solid-lubricant composite attached with silver foil diffusion bonding. The stators are held concentric by the nylon backbone tube and are prevented from rotating by the cabling connection. The composite lubricant is Boeing Compact 046-46, which prevents vacuum welding to the rotor.

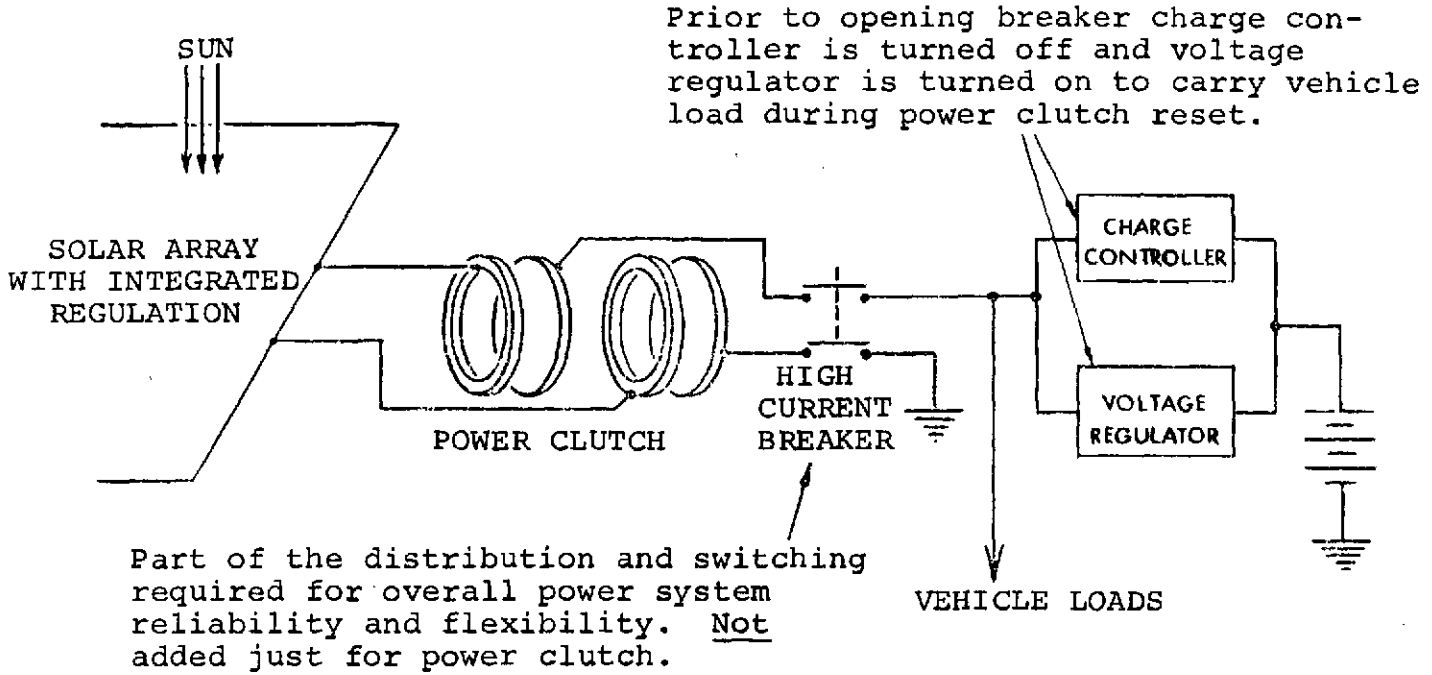

Fig. 2.4.2-1 Power Clutch Reset During an All-Sunlit Orbit

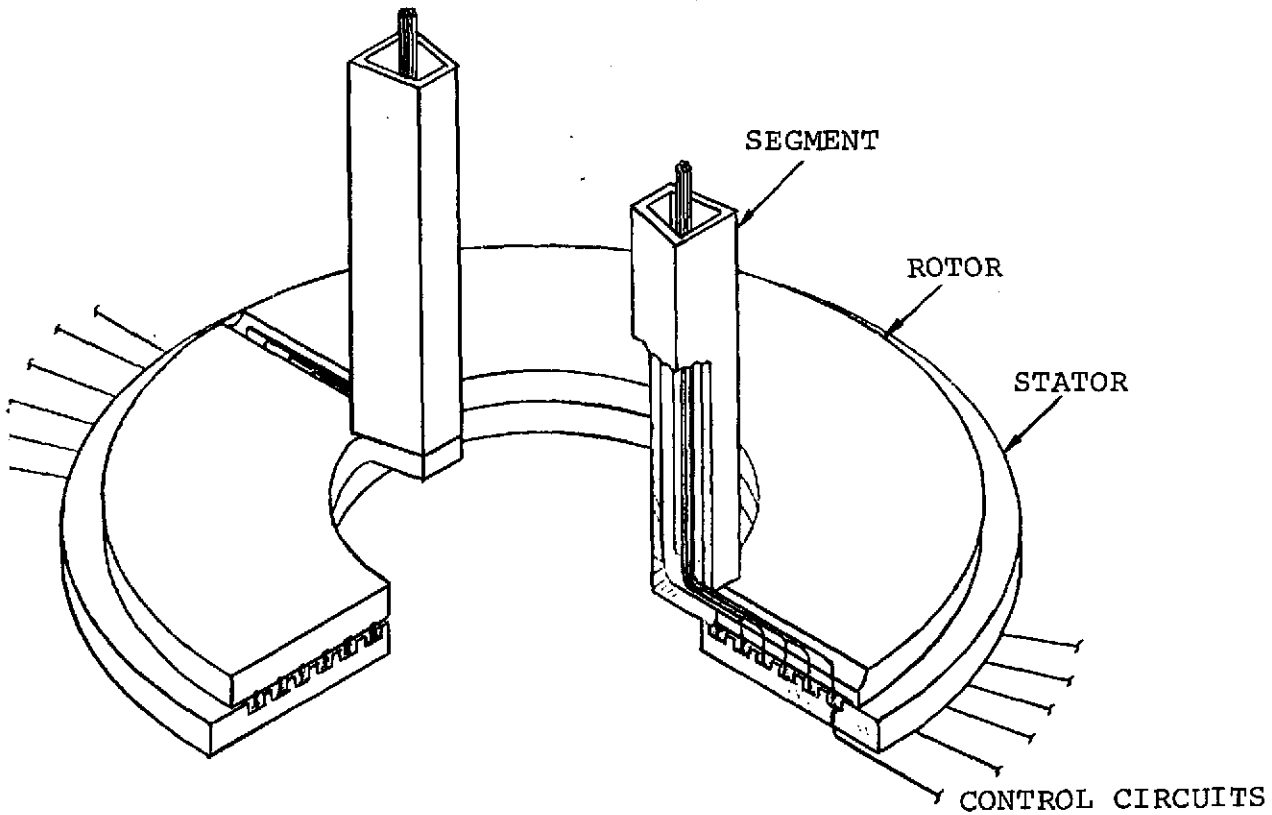

Fig. 2.4.2-2 Low-Current Housekeeping Clutch

The rotor assemblies are circular plates assembled to the conducting segment. The segments pivot around the nylon tube and are separated from each other by Teflon insulating bars. Flexible, straightlay multi-strand No. 30 wire (0.010 in. diameter) constitutes the cables bolted to the segments. The umbilical is made of two cables for each rotor assembly.

The operating piston and springs supply the clamping action to maintain the rotors and stators in contact for good electrical conducting properties. Recycle driving torque is supplied by a clock spring. A stepper motor or a gear train can also be used.

Earth satellites and space stations that are required to be earth or stellar-oriented during orbit will ordinarily be designed to have symmetrical solar panels mounted at the end of the boom. In service, the boom rotates one revolution per orbit to keep the panel pointed toward the sun. The cabling is routed inside and along the axis of the boom. The electrical connections to the spacecraft power bus have sealed pass-through connections in the pressure barrier. A manual override release can be mounted in the pressurized compartment."

Note in the above discussion that flex cables are an integral part of a power clutch. The entire discussion on flex cables of Section 2.4.3, therefore, applies to this device. Mr. Haynie has fabricated and demonstrated a small working model of his concept. In addition, a few other companies have expended a limited amount of effort on similar devices. Thorough development, however, has been slow.

### 2.4.3 Flex Cables

A review of the literature conducted in Reference 1 determined that every spacecraft on which information had been received used flex cables for power and signal transfer across limited rotation gimbals. They are the best choice possible in these situations. Properly installed, the fatigue life of a flex cable is essentially infinite. The design problems of a flex cable are little more than the determination of wire size, configuration (solid or multi strand conductors, flat or round wire), and insulation material. Special attention must be paid to the flexibility of the cable to allow for the rotation. In addition, the torque required to flex the cables is an important consideration. The entire section on wiring harnesses presented in Section 2.2.7 is applicable to this discussion. Finally, there are a great many general and company-issued handbooks, vendor catalogs, and text books that may be consulted for additional or more specific information.

**Preceding page blank**

#### 2.4.4 Rotary Transformers

A common tendency in ground applications is to turn to rotary transformers when transferring power across rotary joints for very long periods of time. The reason for this is the absence of any mechanical contact. For almost every space application, however, rotary transformers have lost in the final tradeoffs because of high weight or low efficiency. (Efficiencies up to 96-97 percent are possible, given enough core material, which means enough weight.) In addition, if the electrical energy on both sides of the rotary joint is DC, the conversion losses (DC to AC, AC to DC) must be charged to the power transfer system.

Notwithstanding the above, several comprehensive analyses and design studies have been conducted to define equations and parameters necessary for rotary transformer design. (See References 1 and 3). Presented below is an extract from literature supplied by S. Himmelstein and Company, Elk Grove Village, Illinois, one of the leading rotary transformer manufacturers.

"Figure 2.4.4-1 illustrates an elementary rotary transformer. One winding (the rotor) is mounted on a rotating shaft while the other winding (the stator) is fixed to an outer housing. An air gap is provided between the rotor and stator sections to allow rotation without physical contact. The magnetic circuit is designed so that there is no intentional change of flux linkages when relative motion between the rotor and stator occurs. This is exactly opposite from motors and resolvers where a change of the flux linkages with rotation is desired.

With this arrangement, electrical signals and power can be coupled between the rotating and stationary member without any contact--brushes, fluid couplings, etc. The energy transfer is independent of shaft speed or direction--from shaft stopped through maximum rated speed.

**Preceding page blank**

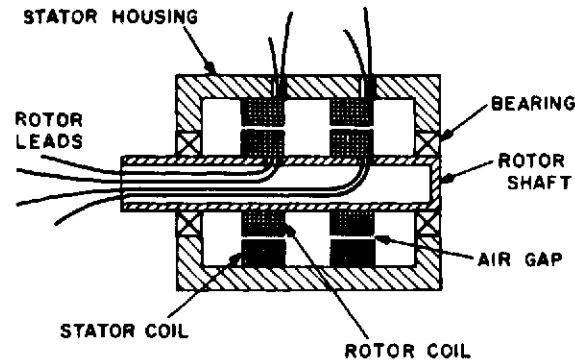

Figure 2.4.4-1 Rotary Transformer

A rotary transformer has the following inherent advantages:

1. No wear or wear products
2. No arcing
3. No friction or heating effects
4. No viscous drag from liquid contact
5. Energy transfer is unaffected by the presence of oil, water, vacuum and other environment-borne contaminants

The rotary transformer can be designed with extremely high electrical performance even when compared to fixed transformers."

Almost all of the technology available for transformer design for atmospheric application is usable for space applications. Rotary transformer design has been reduced to practice and is quite straightforward. However, the problems involved with getting several parallel circuits (some power and some low level signal) across a rotary joint are not all obvious. Getting one large power circuit across the joint seems to be no problem, but the complication of many circuits might prove to be difficult or impossible. The basic concept, however, is very attractive and should be further investigated.

#### 2.4.5 Rolling Contacts

Several types of rolling contact devices have been attempted for electrical power transfer, but they all may be categorized into two general types--headed bearings and gears. The bearing types are either sleeve or ball bearings which simply transfer electrical power through the device while it is rotating. The gear types use different gear shapes and arrangements but the basic idea is the same. The concept is described below as written by W. P. Fleming of MIT in a paper entitled "A Non-Sliding Rotary Electrical Connector". (See Reference 1).

"The way this device achieves continuous non-sliding contact may be illustrated by the action of a ring rolling inside a slightly larger ring (Figure 2.4.5-1). If both rings are rigid, then rolling point contact exists. If, however, the rings have some depth and one or both rings possess a small amount of flexibility, then a contact area exists. It is apparent that if the rings are nearly the same size, then very large contact areas will be formed with very little deformation of either ring.

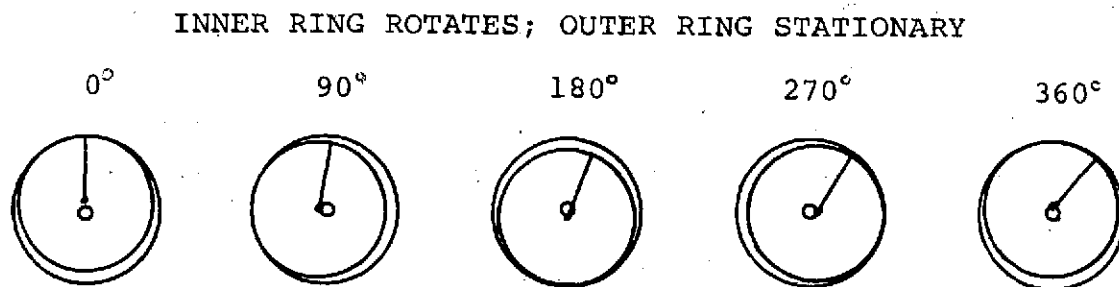

Figure 2.4.5-1 Movement Pin Rotation

If the inner ring is constrained so that it cannot rotate about its own center, the outer ring is caused to rotate about its center. The final result, then, is an orbital motion of the inner ring and a rotary motion of the outer ring. Because the "orbit" is quite small, it is practical to attach leads to it, and allow them to flex slightly as the device operates. They will not twist or wind up, because the inner ring does not revolve, it

only orbits. It is equally apparent that leads connected to the outer ring will revolve continuously. In this way, continuous physical contact is maintained between a ring which rotates and a ring which does not rotate.

Referring to the orbiting movement of the inner ring and the rotary movement of the outer ring implies, of course, that a friction driving force exists between them. If the contact surfaces of the two rings (neglecting any ring flexibility) were not smooth but had teeth, then a positive gear drive would result. Figure 2.4.5-2 shows the similarity between the contact ring motion and the gear engagement. This internal/external gear pair is the classic wobble gear, a well-known and effective differential type of speed reducer.

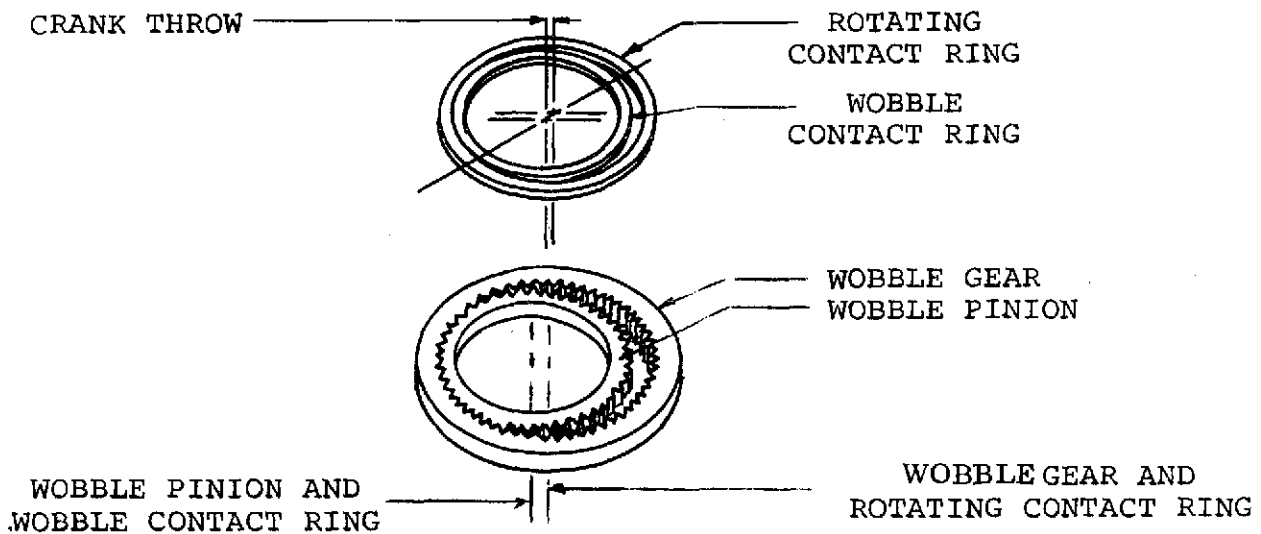

Figure 2.4.5-2 Contact Ring/Drive Gear Pair  
(Separated for easy viewing)

By attaching the wobble pinion and wobble contact ring of Figure 2.4.5-2 to a common cylindrical support up through the center of each, and likewise attaching the wobble gear and rotating contact ring to a common cylindrical member around the outside of each, then both will operate together exactly as previously described. In this way, the gear mesh will carry the torque load required for the inner cylinder to drive the outer cylinder, and the contact rings will contact just as before. By stacking up



several contact ring pairs on these cylinders, with each pair insulated from its adjoining pairs, then a contact assembly of several circuits can be assembled.

The application of a gear set fixes the speed ratio between the rings. Because of this, careful ring sizing is required to achieve zero contact slippage, while by the same token, deliberate forward or reverse slippage may be built-in by sizing the contact diameters or gears accordingly."

Mr. Fleming has made working models for both current transfer tests and driving torque tests. Another approach to pure rolling contact current transfer was developed and tested by Mr. Edward J. Devine of Goddard Space Flight Center. (See Reference 1). His extensive tests, including tests in vacuum, have produced some satisfactory results.

As seen above, electrical energy transfer through rolling contact (either gears or bearings) is an attractive idea. More work would have to be done, however, before it could be considered for space flight.

## REFERENCES

(Section 2.4)

1. First Topical Report, Evaluation of Space Station Solar Array Technology, Report No. LMSC-A981486, December 1970.
2. Second Topical Report, Design and Analysis, Space Station Solar Array Technology Evaluation Program, Report No. LMSC-A995719, November 1971.
3. Clauss, F. J., Electrical Transmission Components for a Large Aerospace Environmental Chamber, Report No. AEDC-TR-65-40 and LMSC-2-68-64-1, February 1965.
4. Brown, R. E., A Review of Considerations for Brush Selection and Application, BBRC Report No. SS-R-1-006, August 1970.

## 2.5 LUBRICATION

The most important objective of lubrication is the elimination of potential failures induced by wear and adhesion of adjacent surfaces. This problem of selecting a proper material for the lubrication of advanced spacecraft systems is complicated by the unique environmental conditions surrounding the performance of a complete mission. Three sets of conditions influence the requirements for lubrication: (1) ground activities, (2) short-time operation during launch, ascent and reentry, and (3) operation in space. The optimum lubrication system should be compatible with all of these sets of environments and should result from the proper selection of materials, good engineering design, and careful application of test and checkout procedures. Table 2.5-1 presents the design factors that should be considered in selecting a lubricant for a particular application.

Table 2.5-2 presents advantageous lubricant types (oil, grease, or solid) for various mechanical and electrical components as a function of life, maintainability, contamination, technology status, lubricating properties, and cost.

These two tables provide a good introduction for the remainder of this section. Oil, grease, and solid lubricants will be further discussed as they pertain to the lubrication of solar array ODAPT (Orientation Drive and Power Transfer) components. The design factors, as well as the advantageous lubricant for a specific situation, should be kept in mind as the individual lubricants are discussed.

TABLE 2. 5-1  
GENERAL LUBRICANT DESIGN CONSIDERATIONS

PARAMETER	REMARKS
Definition of Lifetime	Based on Torque (some equipment requires a constant lubricant viscosity for proper operation) Based on Wear (accumulation of wear debris or consumption of the material (e. g. , brushes, thin film lubricants, etc.) may limit life) Based on Noise (Life of electrical contacts is limited by electrical noise generated)
Environment	Vacuum Radiation Reactive Materials
Operating Conditions	Speed Load Temperature Duty Cycle (continuous or intermittent) Type of Motion (sliding, rotating, oscillating, rolling, etc.) Current Density (electrical contacts) Brush Force (electrical contacts)
Parts	Geometry and Type of Part Materials and Material Combinations Hardness Surface Finish Tolerances Effect on Other Parts (e. g. , combination of oil on other parts)
Installation and Handling Variables	Alignment Balancing Mounting Rigidity Run-In Cleanliness Sealing and Protection Against Corrosion and Contamination
Lubrication (other than type of lubricant)	Amount of Lubricant Manner of Application Replenishment.

TABLE 2.5-2  
ADVANTAGEOUS LUBRICANT-TYPES FOR VARIOUS MECHANICAL AND ELECTRICAL COMPONENTS

	Slip Ring Brushes	Flex Cables	Drive Motor Brushes	Drive Gears	Gear Box Brgs.	Pinion & Ring Gears	Large Ball Brgs.	Roller System Brgs.	Slip due to Diff. Expan.	Remarks
Lubricant Life	Solid Oil	Grease	Oil	Oil	Oil Grease	Grease Solid	Oil	Oil	Solid	Lube life is dependent upon volatility, thermal exposure, and load, speed, rolling, sliding conditions as well as seal effectiveness
Maintainability	Solid	Grease	Oil Solid	Oil	Oil	Grease	Oil	Oil	Grease	Lube replenishment considerations include possibility of reservoirs, feed lines, seals, and accessibility
Contamination	Solid	Solid	Solid	Solid	Solid	Solid	Solid	Solid	Solid	Solids have lowest volatility, hence give less contamination. Greases are rated next, and oils, depending on seals, give most
Technology Status	Oil Solid	Grease Oil	Oil Solid	Grease Oil Solid	Oil Grease	Grease Solid Oil	Oil Grease	Oil Grease	Solid Grease	All three types have been used in vacuum for bearings, gears, and brushes
Lubricating Properties	Solid Oil	Grease Solid	Oil Solid	Oil Grease Solid	Oil Grease	Grease Solid	Oil Grease	Oil Grease	Solid Grease	Oils, greases give viscous drag; more subject to temp variation. Loads and speeds are large influence on best choice.
Cost and Schedule	Oil	Oil	Oil	Oil	Oil	Oil	Oil	Oil	Oil	Oils generally least costly, greases add compounding cost, and solids generally highest. The order varies.

### 2.5.1 Oils

The two main classes of liquid lubricants are petroleum oils and synthetic oils. Petroleum oils are derived from natural mineral deposits in the earth of which the two most widely used types for a spacecraft are the paraffinic and the highly refined distillates of mineral oil. Oxygen inhibitors and load-carrying additives are usually added to these oils to make up for natural deficiencies in properties. Synthetic oils are formulated from chemicals and can have properties that are unobtainable from the petroleum oils. The various types can be formulated for use over an extremely wide temperature range with high thermal and oxidative stability, and with resistance to chemicals and radiation. Properties can be improved by chemical modification.

Some of the more important properties that should be considered for any liquid lubricant include: 1) volatility, 2) radiation stability, 3) thermal stability, 4) compatibility with contacting materials, 5) viscosity, 6) flammability, and, especially in the atmospheric environment, 7) oxidation and 8) hydrolytic stability. Each of these properties has been characterized by standard tests and are documented in the specification of each particular oil. Reference 3 is an excellent source of specs and test data on most of the oils used in the industry today. In addition, under contract to LMSC, Ball Brothers Research Corporation filled some of the gaps in the existing test data by determining friction and wear properties, vapor pressures, and weight loss flux rates of several oils suitable for use on the space station drive system. Test descriptions and results are presented in Reference 6. They are also presented in Tables 2.5.1-1, -2 and Figure 2.5.1-1, on the following pages, for completeness.

From the general standpoint of using oils to lubricate the various components of a drive system, Table 2.5.1-3 will provide insight into some of the tradeoffs that must be made in selecting a liquid lubricant for a given application. Lubricant life, maintainability, contamination, technology status, lubricating properties, and cost and schedule are presented with comments on the ability of an oil, per se, to meet the requirement of lubricating specific drive system components.

**Preceding page blank**

TABLE 2.5.1-1  
 FRICTION AND WEAR PROPERTIES OF OILS  
 (4-BALL TEST)

Test Conditions:

Load 10 kg (initial Hertz stress = 210,000 psi)  
 Speed 600 rpm (45 ft/min sliding)  
 Duration 90 minutes  
 Balls 52100 steel

<u>Candidate Oil</u>	Min. Coef. of Friction			Wear Scar Dia., mm.		
	38°C	70°C	100°C	38°C	70°C	100°C
Vac Kote Petroleum	0.099 <u>0.094</u>	0.098	0.096	0.401 <u>0.432</u>	0.479	0.483
Vac Kote Ester	0.085	0.088	0.093	0.280	0.276	0.273
Vac Kote Ether	0.122	0.118	0.114 0.113	0.241	0.220	0.224 0.207
Krytox 143 AB	<u>0.113*</u>	<u>0.105*</u>	<u>0.098*</u>	<u>0.381</u>	<u>0.308</u>	<u>0.363</u>
XRM 217D	<u>0.080</u>	<u>0.073</u>	<u>0.073</u>	<u>0.211</u>	<u>0.195</u>	<u>0.198</u>
Versilube F-50	<u>0.096*</u>	erratic*	<u>0.080*</u>	<u>0.491</u>	0.445	<u>0.488</u>
FS-1265	<u>0.085</u>	0.083	<u>0.072</u>	<u>0.194</u>	0.207	<u>0.381</u>

\*Noisy sliding

NOTE: Underlined data were obtained under the ODAPT test program

TABLE 2.5.1-2  
VAPOR PRESSURES OF ODAPT CANDIDATE OILS

Candidate Oil	Vapor Pressure, Torr, at 25°C	Percent Stripped	Data Source
Vac Kote Petroleum	$2.5 \times 10^{-9}$	5	BBRC
Vac Kote Ester	$9.1 \times 10^{-11}$	3.8	BBRC
Vac Kote Ether	$2.0 \times 10^{-11}$	5	BBRC
Krytox 143 AB	$6.8 \times 10^{-13}$	10	BBRC (ODAPT)
XRM 217D	$1.9 \times 10^{-9}$	0.2	BBRC (ODAPT)
Versilube F-50	$2.6 \times 10^{-9}$	--	BBRC
FS-1265	$9.2 \times 10^{-9}$	Vacuum Stripped	Dow-Corning



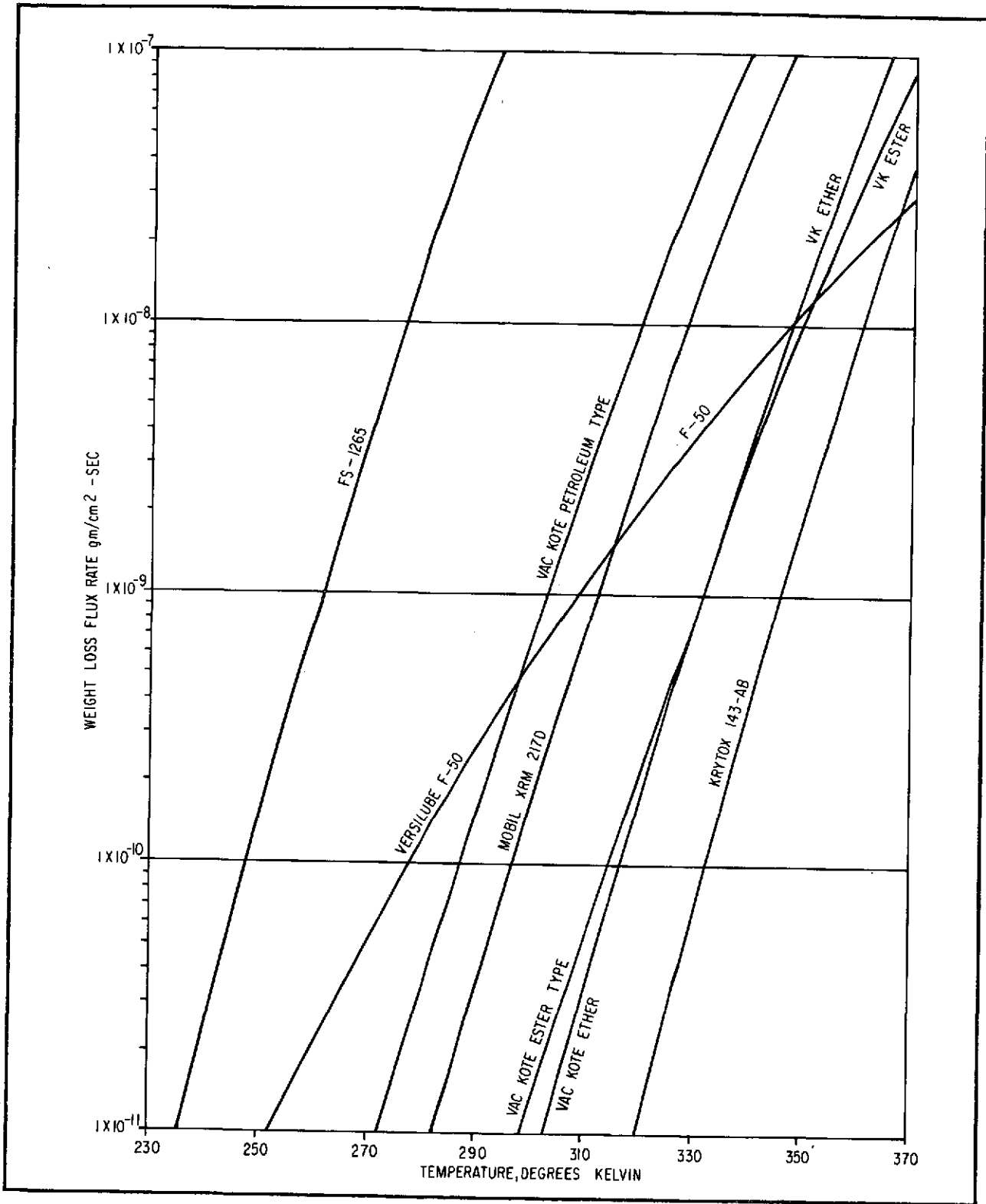

Figure 2.5.1-1 Weight-Loss Flux Rate Comparisons

TABLE 2.5.1-3  
LUBRICATION TRADEOFF- OILS

	Slip Ring Brushes	Flex Cables	Drive Motor Brushes	Drive Gears	Gear Box Brgs.	Pinion and Ring Gears	Large Ball Bearings	Roller System Bearings	Slip Due to Diff. Expan.	Remarks
Lubricant Life	Capable of 10 yr. life with oil atmos. maintained by sintered reservoir	Probable 10 yr. life from initial fill if cable covering is properly sealed at ends.	Capable of 10 yr. life using sintered reservoirs in brush vicinity	Capable of 10 yr. life from initial fill plus sintered reservoirs.	Same	10 yr. life would require periodic replenishment. Sealing would be difficult	Capable of 10 yr. life with labyrinth seals and sintered reservoirs with provision for oil replenishment	Capable of 10 yr. life with labyrinth seals and sintered reservoirs in each roller	10 yr. life unlikely without provisions for press. distribution periodically	Lube oil life in space is highly dependent on vapor press. Adequate seals and reservoirs req'd for 10 yr.
Maintainability	Probably will be necessary to add oil, but oil loss rate to space would be high without careful labyrinth sealing	Oil addition would be difficult but would probably be unnecessary	With reservoir system, oil addition would be unnecessary. Wear of brushes adequate for 10 yr. life	Additional oil could be added easily if required	Same	Oil additions could be easily made but would probably req. frequently	Oil lines to replenish reservoirs with oil would permit easy servicing	With adequate seals and reservoirs, no additional oil need be req'd.	Lube not easily maintained in place. Would require frequent additions	If necessary, oil lines could be designed in to each lube area for adding oil periodically
Contamination	Oil loss would contaminate spacecraft environment externally	Low rate of oil loss and hence low contamination rate	Same	Same	Same	Sealing would probably be only moderately effective giving high oil loss rate and contamination	Labyrinth seals could be made effective enough to keep space contam. at low rate	Same	Most of oil added would be soon lost to spacecraft environment and add to contamination	Oil vapors escaping from ODAPT would constitute a contaminate for solar cells and optics
Technology Status	Vackote lubricated brushes have proven to be highly reliable in OSO and other spacecraft	Testing program required.	Vackote lubricated motor brushes are space-proven in OSO and other spacecraft	One reference to space use for oil in reduction gear drive in TN 70-71	Extensive use in space Vackoted bearings are space proven	One reference to space use for oil in gear drive (TN 70-71)	Extensive use in space for much smaller ball bearings. No reason to doubt use in longer	Same as for gear box bearings	No references to use of oil for this type application	Oil compositions for space use have been successfully used for up to 3-1/2 yrs. in space
Lubricating Properties	Vackote in brushes is excellent; others would require test program	Adequate for the low loads and speeds experienced during flexing	Vackote in brushes is excellent; others would require test program	Oils with EP additives can handle gear loads. Temp. range -65 to (+) 165 contin. (+200° part time)	Ideal for ball brgs. Temp range -65 to +165°F. continuous. Part time to +200°F.	Oil can adequately handle the gear tooth loading and speeds	Ideal for ball bearings. Temp. range -65 to 165°F. contin. (to 200°F. part time)	Same as for gear box bearings	Difficult to maintain oil film capable of handling high loads involved	Oils compounded with suitable additives make possible boundary lubr. conditions. Thick film lubr. not usually possible in space
Cost and Schedule	Low relative cost and readily available 6 wk. delivery for most space oil	Same	Same	Same	Same	Same	Same	Same	Same	Same

2-141

This tradeoff was completed for the Space Station ODAPT and, where an oil was selected as the lubricating medium, the specific oil proposed for each component is presented in Table 2.5.1-4. Note that in some cases, a number of different oils were found that would serve the purpose equally well. In these cases, boundary considerations must be made, e.g., what is the effect of a number of different oils sharing the same "spacecraft atmosphere"--is it more cost effective to use the most general purpose oil, etc? The last row of Table 2.5.3-2 gives the recommended lubricant considering all factors combined.

As is the case for many of the ODAPT components, the analysis and considerations that have only been mentioned above are well documented in the literature. The cited references, in addition to the others at the end of this section, should aid the designer in the analysis of an oil lubricant system. (The reader is specifically directed to Part A, Appendix C.5 of Reference 2 for problems concerning lubricant oil loss from components through openings in component enclosures. For a 10 year space station life, it will be extremely critical that contaminants, e.g., vaporized oils, be reduced to essentially zero. This appendix details the analysis of molecular oil loss).

TABLE 2.5.1-4  
PROPOSED ODAPT OILS

	Slip Ring Brushes	Flex Cables	Drive Motor Brushes	Drive Gears	Gear Box Brgs	Pinion & Ring Gears	Large Ball Brg.	Roller System Brgs.	Slip Due to Diff. Expan.	Remarks
Oils:										
1. Krytox 143AB				X	X		X	X		Fluoropolyether: inert, stable, high cost
2. FS-1265							X	X		Fluorosilicone: excellent brg. lub'n. in LMSC vac tests
3. GE F-50				X	X		X	X		Extensive vac test and space experience
4. Vac Kote Ester				X	X		X	X		Unpublished BBRC test data show these to be very promising multi-purpose space lubes
5. Vac Kote Ether	X Impreg. into brushes		X Impreg. into brushes	X	X		X	X		
6. Vac Kote Petroleum	X Impreg. into brushes		X Impreg. into brushes	X	X		X	X		Extensive vac test and space experience (OSO)
7. DC-7024							X	X		Excellent brg. lub'n. in LMSC vac tests
8. XRM-141C							X	X		Excellent brg. lub'n in LMSC vac tests

### 2.5.2 Greases

For all practical purposes, greases are classified as liquids since they are oils with an appropriate thickening agent added. For this reason, the important properties of greases can be assumed to be essentially the same as the base oil. Greases are generally used only where leakage is too high to retain an oil. Wear rate data related specifically to grease is presented in Table 2.5.2-1. In addition, general tradeoff considerations of lubricating various drive and power transfer system components with grease are presented in Table 2.5.2-2 as a function of life, maintainability, contamination, properties, and cost and schedule. The types of greases suggested as being acceptable for lubing the different components of the space station ODAPT are presented in Table 2.5.2-3. The last row in Table 2.5.3-3 gives the recommended lubricant considering all factors combined.

**Preceding page blank**

TABLE 2.5.2-1  
 FRICTION AND WEAR PROPERTIES OF GREASES (FOUR-BALL TEST)

Test Conditions:

Load            10 kg (initial Hertz stress = 210,000 psi)  
 Speed          600 rpm (45 ft/min sliding)  
 Duration       90 minutes  
 Balls          52100 steel

Candidate Grease	Min. Coef. of Friction			Wear Scar Dia., mm.		
	38°C	70°C	100°C	38°C	70°C	100°C
Vac Kote ester base	0.071	0.083	0.098	0.379	0.389	0.384
Vac Kote petro. base	0.080	0.073	0.071	0.416	0.494	0.525
DuPont PL-631	0.120**	0.105	0.100	0.413	0.298	0.256
Krytox 240 AC	0.106**	0.110**	0.120	0.517	0.424	0.368
Supermil M125	0.089**	0.083**	0.077** (60 min)	0.384	0.445	0.328* (60 min)
Versilube G-300	0.174** (13 min)	0.093** (15 min)	>0.22** (zero min)	0.504* (13 min)	0.456 (15 min)	0.560* (zero min)

Note: All data in this table were obtained under the ODAPT test program except for tests at 100°C on Krytox 240AC and Versilube G-300

\*Failed at time indicated due to high friction ( $\mu > 0.22$ ).

\*\*Noisy sliding

TABLE 2.5.2-2  
LUBRICATION TRADEOFF - GREASES

	Slip Ring Brushes	Flex Cables	Drive Motor Brushes	Drive Gears	Gear Box Bearings	Pinion and Ring Gears	Large Ball Bearings	Roller System Bearings	Slip Due to Diff. Expan.	Remarks
Lubricant Life	Same as for oil-lubed brushes. (10 yr. life capability with reservoirs)	Capable of 10 yr. life from initial fill if cable covering is properly sealed at ends	Capable of 10 yr. life using sintered reservoirs in brush vicinity with oil impregnation	Capable of 10 yr. life with periodic additions to gears	Capable of 10 yr. life with oil reser. to maintain grease consistency	Capable of 10 yr. using periodic grease additions. Effective sealing would be difficult	Same as for Gear Box Brgs.	Same	Capable of 10 yr. life using grease with solid lube	Grease life in space extends life of oil through evaporation retarding effect of thickener
Maintainability	Probably will be necessary to add oil to reservoirs. Labyrinth sealing required	Addition of grease would be unnecessary	Addition of more grease would not be possible, but oil vapor environment from reservoir would maintain brush lub'n.	Addition of grease must be directly to gears. Feed line system would be required	Addition of more grease not practical. Oil reser. would maintain grease consistency	Grease feed lines must be provided so that periodic grease additions could be made	Same	Same	Feed line with distribution ring may be required	Grease consistency maintained through periodic additions where feasible or by oiled sintered reservoirs and seals
Contamination	Oil loss (from grease and oil reservoirs) would contaminate external spacecraft environment	With proper sealing, oil vapor loss from grease would be negligible	Close-coupled motor housing with drive-gear box would minimize oil vapor escape to contaminate environment.	Oil vapor loss from well sealed gear box (labyrinth) would be minimal	Same	Oil vapor would escape slowly from grease to contaminate external space station environment	Same	Same	Same as for Pinion and Ring Gears	Only the oil vapors from a grease would contaminate external space station environment. Rate slower than for exposed oil.
Technology Status	Greases in brushes not as common as oils, but same principles are involved	Testing program required	Same as for slip ring brushes	Drive gears referenced in TN 70-71 used grease in almost every case	Some references to space use. Several effective space-type greases are available.	See drive gears, Pinion and ring gears more exposed. This favors use of adherent grease	Same as for Gear Box Brgs.	Same	No references to this type application, but would be same as for heavy load sliding	Effective space greases have been developed and used successfully in vacuum environments
Lubricating Properties	Similar to oils. Oil from grease in brushes would actually be the lube medium	Grease lub'n would be ideal for slip of conductors during flexing	Same as for slip ring brushes	Greases with EP additives could easily handle ODAPT gear loads. Temp ranges: -65 to +350°F.	Space-type greases available for effective ball bearing lubrication. Ranges: -65° to +350°F.	Same as for Drive Gears	Same as for Gear Box Brgs.	Same	Grease compounded with solid lube or EP additive would be adequate	Space-type greases available for ball bearing and heavy load duty. Temps from -100° to +350°F
Cost and Schedule	Moderate relative cost and readily available. 6 weeks delivery for most space greases	Same	Same	Same	Same	Same	Same	Same	Same	Same

2-147

LMSC-D159618

TABLE 2.5.2-3  
PROPOSED ODAPT GREASES

	Slip Ring Brushes	Flex Cables	Drive Motor Brushes	Drive Gears	Gear Box Brgs.	Pinion & Ring Gears	Large Ball Brg.	Roller System Brgs.	Slip Due to Diff. Expan.	Remarks
GREASES:										
1. duPont PL-631					X		X	X		Fluoropolyether thickened with ammeline. AFML vac. brg. tests
2. GE G-300				X	X	X	X	X		Extensive space lub'n experience in brgs. and gears
3. Krytox 240AC					X		X	X		Fluoropolyether thickened with TFE. Costly, inert, stable
4. Supermil M150							X	X		Fluorosilicone with ammeline thickener. Good brg. lub'n in LMSC tests
5. Vac Kote Ester Base		X		X	X	X	X	X		Unpublished BBRC test data show these to be promising bearing and gear space lubes
6. Vac Kote Petrol. Base		X		X	X	X	X	X with MoS <sub>2</sub> added		



### 2.5.3 Solids

A solid lubricant is a laminar solid capable of decreasing the amount of wear between moving surfaces by sliding under boundary conditions. The properties of a laminar solid that determine its value as a lubricant are: (1) crystal structure, (2) thermal (and oxidative) stability, (3) melting point, (4) thermal conductivity, (5) mechanical properties, (6) chemical stability, and (7) purity.

Because of the laminar crystal structure of solid lubricants, they are highly anisotropic with very pronounced isodimensional mechanical properties. These properties are usually associated with a low shear strength and a low coefficient of friction. In the laminar structure, the atoms within a plane are held together by strong chemical bonds whereas the distance between planes is relatively high and the bonding is weak. In graphite, for example, the interatomic distance is 1.42 Å within the plane and 3.35 Å between planes. These materials lubricate due to the ease with which they can be sheared. Not all laminar solids are effective lubricants, however. Moreover, their lubricating effectiveness may vary with such service conditions as temperature or the presence of gases such as O<sub>2</sub>, CO<sub>2</sub>, and H<sub>2</sub>O.

Table 2.5.3-1 will provide some insight into the tradeoffs of using a solid lubricant to lubricate the various components of an orientation drive and power transfer system. From the standpoints of life, maintainability, technology status, properties and cost and schedule, it can be seen that solid lubricants would be excellent choices for some components and very poor choices for others. Table 2.5.3-2 shows the results of the space station ODAPT tradeoff with several candidate solid lubricants recommended as being feasible for lubing some of the ODAPT components. Note the last row in the table gives the recommended selection when considering all factors combined. Solid lubes were chosen only for brushes and for slip due to differential expansion. It will be noted that these are generally the only two areas of selection for solid lubricants because, unless there is some critical factor that must be considered, e.g., contamination, solid lubricants do not do as good a job as oils or greases.

TABLE 2.5.3-1  
LUBRICATION TRADEOFF - SOLIDS

	Slip Ring Brushes	Flex Cables	Drive Motor Brushes	Drive Gears	Gear Box Bearings	Pinion and Ring Gears	Large Ball Bearings	Roller System Bearings	Slip Due to Diff. Expan.	Remarks
Lubricant Life	Capable of 10 yr. life with possible total brush wear of less than 0.2 inch	10 yr. life doubtful - tests required	10 yr. life probable - test required	10 yr. life with bonded solid film doubtful - tests req'd. Sacrificial idler gear technique possible 10 yr tests req'd	10 yr life uncertain: requires testing. Solid on balls, races with sacrificial solid retainer	Same as for Drive Gears	Same as for Gear Box Bearings	Same	Capable of 10 yr. life. Solids ideal for slow speed heavy loads with short sliding dist.	Solid film life is highly dependent on load, speed, geometry. Sacrificial idler and ball retainer give contin. lube supply.
Maintainability	None required, ordinarily. Replace whole brush if necessary	Difficult to replenish dry solid. Probably require replacing whole flex cable if it needed relubing with solid	No maintenance required except to replace whole brush or motor if life is not adequate	Not possible to renew bonded film. Req. change-out gear box. Sacrificial idler in box not readily accessible	Not possible to replenish. Requires replacement of gear box.	Not possible to replenish solid film. Sacrificial idler easily replaced.	Not possible to replenish solid lube in ball bearing.	Same. Would require replacement of roller cluster assembly.	Not possible to replenish except by pressure delivery of solid suspended in liquid or grease.	Solid films not usually replenishable to parts in place. Sacrificial idlers replaceable but not ball retainers.
Contamination	Nil	Nil	Nil	Nil	Nil	Nil	Nil	Nil	Nil	Low volatility of solids would make their contribution to contamination negligible.
Technology Status	Extensively tested in vacuum chambers and used in space programs	No references to use of solid lube on flex cable in space. Would require test program	Solid lubed motor brushes have been vacuum tested and used in spacecraft	Bonded and unbonded solids used in spacecraft and in vacuum chamber tests. No ref. to idler use in space	Dry lubed brgs. used in spacecraft and in vacuum chambers. Dry Vac Kote very effective	Same as for Drive Gears	Same as for Gear Box Bearings	Same	No reference to space use in this particular applications. Many ref. to solids on sliding parts at heavy loads	Solid lubes have been used extensively in spacecraft on gears, bearings, cams, and other sliding parts.
Lubricating Properties	Better in vacuum than in normal air atmospheres. Lube properties little affected by temp variation	Solids could easily handle flexing loads, be little affected by temp. variation. Wear life in this application is unknown	Same as for Slip Ring Brushes. Some solid combine good electrical conductivity with good lubrication	Bonded and unbonded films take high loads, slow speeds. Solids not affected much by temp. variation	Same	Same	Same	Same	Same	Solids are ideal for slow speed, heavy load applications for short total sliding distance. Temp range -250° to +1000°F in vacuum.
Cost and Schedule	Low to high relative cost, depending on solid lube. Brushes with solid lube available in about 8 wks delivery	Processing costs relatively high	Same as for Slip Ring Brushes	Processing solid films rel. high cost. Idler gear relatively high cost due to fabrication	Relatively high cost. Processed at BBRC	Same as for Drive Gears	Same as for Gear Box Bearings	Same	Solid film cost rel. high. Solid in oil or grease would be relatively moderate cost	Relatively high cost of solid films is due to careful processing req'd. Sacrificial idlers and ball retainers require care in fabrication.

TABLE 2.5.3-2  
PROPOSED ODAPT SOLID LUBRICANTS

	Slip Ring Brushes	Flex Cables	Drive Motor Brushes	Drive Gears	Gear Box Brgs.	Pinion & Ring Gears	Large Ball Brg.	Roller System Brgs.	Slip Due to Diff. Expan.	Remarks
<b>SOLIDS:</b>										
<b>A. Solid Film Lubri- cants</b>										
1. MoS <sub>2</sub> plus Binder				X						Electrofilm 4396 & Everlube 811
2. MoS <sub>2</sub> applied mechanically (e.g. Vac Kote dry)								X		Unbonded MoS <sub>2</sub> includes burnished films
<b>B. Self-lubricating Solids</b>										
1. Westinghouse Ag/PTFE/WSe <sub>2</sub>				X	X	X	X	X		Used as sacrifi- cial idler gears & brg. retainers. Vaccum test experience at high loads & slow speeds
2. Westinghouse Cu/PTFE/WSe <sub>2</sub>				X	X	X	X	X		Bartemp and Rulon A plus MoS <sub>2</sub>
3. PTFE/MoS <sub>2</sub> / Filler					X		X	X		
<b>C. Brushes</b>										
1. Ag/Cu plus 12% MoS <sub>2</sub>	X		X							Extensive vac test & space experience
2. Ag/Graphite plus 12% MoS <sub>2</sub>	X		X							Promising brush material
3. Ag/Gra. plus 5% MoS <sub>2</sub> + Vac Kote	X									Extensive vac test and space experience (OSO)

TABLE 2.5.3-2 (Cont.)

	Slip Ring Brushes	Flex Cables	Drive Motor Brushes	Drive Gears	Gear Box Brgs.	Pinion & Ring Gears	Large Ball Brg.	Roller System Brgs.	Slip Due to Diff. Expan.	Remarks
C. Brushes (Cont.)										
4. Silver plus 15% NbSe <sub>2</sub>	X		X							Promising mtl. based on Westinghouse & BBRC test data
5. Silver/Graphite plus Vac Kote			X							Extensive vac test & space experience (OSO)
Tentative Selections	Silver plus NbSe <sub>2</sub>	Vac Kote Petrol. base grease	Vac Kote Petrol. Oil in Silver/ graphite brushes	Vac Kote Oil	VacKote Oil	VacKote Grease	VacKote Ester Oil	VacKote Ester Oil		Bar- nished MoS <sub>2</sub> film

LOCKHEED MISSILES & SPACE COMPANY

2-152

LMSC-D159618

REFERENCES  
(Section 2.5)

1. First Topical Report, Evaluation of Space Station Solar Array Technology, Report No. LMSC-A981486, December 1970.
2. Second Topical Report, Design and Analysis, Space Station Solar Array Technology Evaluation Program, Report No. LMSC-A995719, March 1971.
3. Campbell, M. E. and Thompson, M. B., Lubrication Handbook for Use in the Space Industry, Contract No. NAS8-27662, MRI Project No. 3535-E, March 1972.
4. Silversher, H. I., "Materials for Lubrication Application", Space Materials Handbook - Third Edition, Report No. AD 692 353, July 1968.
5. Campbell, M. E., Solid Lubricants - A Survey, Report No. NASA SP-5059(01), 1972.
6. Third Topical Report - Design Support, Major Hardware, and System Level Testing, Report No. MSC-07160, LMSC-D153526, September 1972.

### 3.0 SOLAR ARRAY SYSTEM DESIGN AND SIZING CRITERIA

The amount of engineering, material, manufacturing and test required for the production of a fully operational solar array qualified for flight runs into thousands of dollars per square foot. Therefore, careful consideration must be given to such parameters as solar cell efficiencies, radiation effects, cell packing factors, circuit voltage drops, coverglass losses, operating temperature effects, weight, shadowing and open circuit problems, losses associated with fabrication, and finally, the cost of manufacturing and test. The purpose of this section, 3.0, therefore, is to discuss those considerations necessary to assure the design of a low cost, low weight, efficient, and reliable solar array.

### 3.1 WEIGHT AND COST ANALYSIS

The final configuration of any solar array is the result of many requirements, considerations, tradeoffs, and compromises. Given a new set of circumstances, the new design might range anywhere from completely different to very similar. It would depend on how similar the new circumstances were to the original ones and then on the relative importance given to each new requirement or parameter of the design. For the Space Station, a solar array system design was developed around the given and assumed requirements listed in Table 3.1-1. These requirements were by no means clearly stated at the initiation of the contract--they were derived in an iterative process by NASA-MSC, NASA-MSFC, Lockheed, McDonnell Douglas, and North American Rockwell. Where there were multiple requirements or where no clear requirement was given, the baseline SSSA design always assumed the anticipated, worst-case condition or most logical operational case. With stringent constraints such as these, however, it follows that the solar array configuration is a worst-case design. It would be useful to determine the impact on the design of certain changes in requirements.

The purpose of this section, then, is to define this impact and assess the magnitude of the change in terms of its effect on system weight and cost. In Table 3.1-2 are outlined the weights of the major components of the Space Station Solar Array. Beginning with a total system weight and cost of, respectively, 4043 kg and 100%, the savings associated with several possible changes in requirements were developed. The parameters studied included:  $\pm 20\%$  variation in power requirement; 2.5, 5 and 10 year orbital life, cell and coverglass thicknesses of 8-12 mils and 6-12 mils respectively, a weight optimized system, elimination of the artificial gravity experiment, and elimination of the array and structure retraction requirement. Each of these were associated with relatively minor changes in the basic SSSA design, with such items as advanced beryllium structures and elimination of the astronaut access tunnel within the ODAPT considered beyond the scope of this effort. Even with these restrictions, the range in watts per kilogram BOL in this study was from a baseline of 24.6 (11.2 watts/lb) to a maximum of 37.4 (17 watts/lb) for the parameters considered. It is interesting to note that if 8 mil cells and 3 mil covers are used in conjunction with optimum use of beryllium and composites in the system, power densities of 59 watts/kg (27 watts/lb) BOL are predicted. This number converts to 73 watts/kg (33 watts/lb) when the

Preceding page blank

TABLE 3.1-1  
SSSA DESIGN BASELINE REQUIREMENTS

	ITEM	REQUIREMENT
FIRST LEVEL REQUIREMENTS	Power Module Size	14' x 38'
	Art. "g" Mode	Art "g" at Start of Flight Only
	Power Level	25 KW Avg, 100 KW max.
	Power Module Weight	20,000 lb
	Launch Mode	Shuttle
	Resupply Level	Complete Power Module - No EVA Replace Strip - EVA Required
	Life	10 Years
	Inclination	55°
	Altitude	240 - 270 nm
	Station Orientation	Y-Axis Perpendicular to Orbit Plane, Z-Axis Down
SECOND LEVEL REQUIREMENTS	Resupply Accommodation	Main Structure Retractable - (Array Strips Retractable)
	Art. "g" Mode	Main Structure Fully Deployable to 84' with 4 Strips Per Wing
	Art. "g" Loads	Maximum Art. "g" Radius of Rotation Displacement 44'
	Array Orientation	2-Axes Tracking $\pm 12^\circ$ Point Accuracy
	Lowest Possible Level of Resupply	Array Strip (6' x 80') EVA Required
	Maintainability	Shirtsleeve Maintenance (Astronaut Access Passage to Drive System)
	Array Voltage Interface	112 Volts



TABLE 3.1-2  
SSSA BASELINE DESIGN COMPONENT AND WEIGHT BREAKDOWN

COMPONENT	DESCRIPTION	SYSTEM WEIGHT (kg)	
Array			1695
Solar Cells	12 mil x 2 x 4 cm Wraparound	587.54	
Coverglasses	12 mil x 2 x 4 cm Fused Silica	508.67	
Adhesive	App. 1-1/2 mil, XR-63-489	30.10	
Solder	SN 62, 4 Pads/Cell	17.15	
Substrate	2 mil Kapton, 1 mil FEP	134.50	
Copper Int.	33% Area, 1 mil Thick	39.63	
Hinge	Aluminum Extrusion	79.25	
Stiffeners	5 Mil Fiberglass	20.96	
Leader	Kapton/FEP/Fiberglass	1.65	
Feeder Harness	Kapton/FEP Insulated Copper	131.63	
Misc.	Contingency, Diodes, Wiring, etc.	144.24	
Astromast	Astro Research Extendible Beam		218
Beam		127.0	
Canister		91.0	
Other Structure			770
Adapter Canister	Canister, T Ring	24.94	
Mtg. Assy.			
Adapter Cap Assy.	Cap, J Ring	27.94	
ISA	Truss, Support	106.69	
OSA	Truss, Support	98.34	
Compression Cover	Cover, Stiffener, Honeycomb, Foam	87.09	
Base Plate Assy	Honeycomb, Foam	41.73	
Positioning Mech.	Jackscrew, Links, Motor, Bracket	3.76	
Guy Wire Assy.	Tape, Reel, Turnbuckle, Motor	16.87	
O "g" Tens. Mech.	Spring, Motor, Reel, Gears, Tape	32.11	
Art "g" Tens. Mech.	Bellows, Cable, Housing, Valves, Gas	11.70	
Guide Wire Sys.	Cables, Pulleys, Negator	114.31	
Hold Down Device	Pyro Explosive Nuts	17.42	
Padding	Embossed Kapton	79.83	
Release & Tie Down	Bracket, Solenoid	7.53	
Misc.	Fasteners, Wiring, Etc.	100.00	
ODAPT			1360
Structure	Inner & Outer Cylinder, Supports	605.10	
Bearings	Inner and Outer Bearing	202.58	
Slip Ring	Inner and Outer, Power & Signal Slip Rings	252.20	
Motor/Driver/Gear	Inner and Outer	119.75	
Misc.		181.44	
SYSTEM TOTAL			4043

generally accepted method of quoting power density excluding tracking hardware weight is employed.

The method used in the following analyses is very basic in nature--it simply requires the correct assessment of a component for its relationship to the other components and parameters of the system. Then, based on a working experience with the system, several assumptions are made which are then logically carried through to a conclusion. In this way, diverse relationships such as the variation in extendible truss beam weight as a function of array output power or the variation in drive system weight as a function of cell and coverglass thickness were relatively easy to develop. The analysis is presented in full in the subsections that follow so that the reader may not only fully understand the final results, but also so that he can become familiar with this estimation method and perhaps use similar techniques on his own designs.

The following five subsections, then, analyze the effect on weight and cost of each of the previously listed requirement changes. Each section is organized identically. First, the effect of the requirement change on the weight of the Array, the Extendible Truss Beam, the Other Structure, and finally of the ODAPT is determined. Then, the effect that these weight changes have on the cost of the components is determined. The last subsection, 3.1.6, summarizes and combines all of the results into Table 3.1-3. The following cost relationships were assumed in the analysis:

<u>SYSTEM</u>		
Array	-	50%
Beam and Other Structure	-	30%
ODAPT	-	20%
<u>Array</u>		
Materials	-	50%
Mfg., Test, Qual, etc.	-	40%
Other	-	10%
<u>Beam and Other Structure</u>		
Beam	-	30%
Other Structure	-	70%

3.1.1 Effect of Power Requirements on System Weight and Cost

WEIGHT

Array - From Table 3.1-2, the weight of the baseline array is 1695 kg. (Mass will be considered synonymous with weight in this analysis). The end-of-life (EOL) power of the array (after 10 years) operating at 70°C is 67.2 KW. Using this power as  $P_M$ , the array weight can be ratioed as:

$$W = 1695 \left( \frac{P_M}{67.2} \right)$$

Extendable Truss Beam (ETB) - Astro Research in reference (4) gives the weight of an articulating truss in compression as:

$$W = K \left( \frac{P}{L^2} \right)^{2/3} \quad \text{where, } P = \text{compression load}$$

$$L = \text{ETB length}$$

and,  $K \propto L^3$ .

Then,

$$W \propto L^3 \left( \frac{P}{L^2} \right)^{2/3}$$

and,  $W \propto L^{5/3} P^{2/3}$ .

If  $L \propto \sqrt{A_{\text{Array}}} \propto \sqrt{P_M}$   $A_{\text{Array}} = \text{Array Area}$

(assuming the area density is constant),

then:

$$W \propto P^{2/3} (P_M)^{5/6}$$

P, load, is due primarily to array pretension (necessary in artificial "g") which varies with array strip length and therefore ETB length. Thus,

$$P \propto L \propto \sqrt{P_M}$$

$$W \propto P_M^{2/3} P_M^{5/6}$$

$$W \propto P_M^{7/6}$$

Finally, if the weight of the ETB is 218 kg and if the 91 kg canister weight is assumed relatively constant, then:

$$W = 91 + 127 \left( \frac{P_M}{67.2} \right)^{1.17}$$

Other Structure - The total weight of this structure is 770 kg. About 362 kg of this is array tensioning mechanisms, guy wires, etc. that remain relatively constant with small variations of power system size. The balance is made up primarily of the inboard support assembly and outboard support assembly, ISA and OSA, which vary a great deal with array size.

Astro Research gives the weight of an articulating truss in bending as:

$$W \propto M^{2/3} \frac{L_{OSA}}{ISA} \quad \text{where } M \text{ is the bending moment.}$$

Assume the ISA and OSA are similar enough to the ETB to have the same weight relationship. Then, for a cantilever beam with a uniform loading  $w$ :

$$M \propto w \frac{L_{OSA}^2}{ISA}$$

and

$$\begin{aligned} W &\propto L w^{2/3} (L)^{2,2/3} \\ &= L^{7/3} w^{2/3}. \end{aligned}$$

But

$$L \propto \sqrt{P_M},$$

so

$$W \propto P_M^{7/6} w^{2/3}.$$

Including effects of variation of loading:

$$w \propto L.$$

$$\begin{aligned} \text{Then, } W &\propto P_M^{7/6} L^{2/3} \\ &= P_M^{7/6} P_M^{2/6}. \\ W &\propto P_M^{9/6} = P_M^{1.5}. \end{aligned}$$

Therefore, the weight of the other structure can be estimated as:

$$W = 362 + 408 \left( \frac{P_M}{67.2} \right)^{1.5}$$

ODAPT - Total drive system weight for the LSSA baseline design is 1360 kg. Most of the weight (908 kg) is assumed to be structural tie-in with the boom. This can vary directly with the bending moment at the base of the boom due to artificial "g" operation. The rest of the weight may be considered relatively constant.

$$M \propto L_{ETB}^2$$

$$\text{and } L \propto \sqrt{A_{Array}} \propto \sqrt{P_M}$$

so

$$M \propto P_M$$

Since

$$W \propto M,$$

then

$$W_D = 452 + 908 \left( \frac{P_M}{67.2} \right)$$

#### System Weight Summary

From the above equations--

$$W_{Array} = 1695 \left( \frac{P_M}{67.2} \right)$$

$$W_{ETB} = 91 + 127 \left( \frac{P_M}{67.2} \right)^{1.17}$$

$$W_{Other Structure} = 362 + 408 \left( \frac{P_M}{67.2} \right)^{1.5}$$

$$W_{ODAPT} = 452 + 908 \left( \frac{P_M}{67.2} \right)$$

The following weight table can be generated:

$P_M$	$\frac{P_M}{67.2}$	Array (kg)	Beam (kg)	Other Structure (kg)	ODAPT (kg)	System (kg)
53.7	.8	1356	189	654	1178	3377
67.2	1.0	1695	218	770	1360	4043
80.64	1.2	2034	248	898	1542	4722

Note that only  $\pm 20\%$  changes in EOL power have been considered. Any larger changes are assumed to be bordering on the requirement that there be at least a partial redesign of the beam and/or structure. The above weights have been translated into percentage weight savings over the baseline design and are presented in Table 3.1-3.

## COST

### Array, Extendible Truss Beam, Other Structure, ODAPT

Because the power changes probably will occur by addition or deletion of strips up to a maximum of  $\pm 40\%$  or as indicated above, a more accurate  $\pm 20\%$  change, the cost change (conservatively) can be estimated by the cost of the added or deleted strips alone (i.e., neglect the cost effect of slight changes in beam, structure, or ODAPT).

$\frac{P_M}{67.2}$	New Array Cost	New System Cost*
.8	.8	.9
1.0	1.0	1.0
1.2	1.2	1.1

\*Based on cost ratio of: array - 50%, beam and other structure - 30%,  
ODAPT - 20%

The above has also been translated into percentage cost savings and is presented in Table 3.1-3.

### 3.1.2 Effect of Orbital Life and Cell/Coverglass Thickness on System Weight and Cost

#### WEIGHT

##### Array

##### Assumptions:

1. Constant EOL Power of 67.2 KW must be supplied
2. 70°C array operating temperature
3. Identical orbit (55° inclination, 300 nm altitude)

Figure 3.2-17 presents the radiation-caused degradation in power supplied by various cell/cover combinations when subjected to the space station orbit for up to 10 years. The following table can be prepared from this data:

LIFE	Combination cell/cover thickness (mils)	Fraction of Power remaining due to radiation	Fraction of area needed for 67.2 KW EOL Power	Cell/Cover Weight (kg)**	New Array Weight (kg)	$\rho$ *** (array area density) (kg/m <sup>2</sup> )
2.5 YEARS	12/12	.915	.96	1052	1651	1.97
	12/6	.883	.99	833	1432	1.65
	8/12	.88	.99	907	1506	1.74
	8/6	.85	1.03	681	1280	1.42
5.0 YEARS	12/12	.9	.97	1063	1662	1.96
	12/6	.864	1.01	850	1449	1.64
	8/12	.862	1.01	925	1524	1.73
	8/6	.836	1.04	688	1287	1.41
10 YEARS	12/12	.874	1.00	1096	1695	1.94
	12/6	.84	1.04	876	1474	1.62
	8/12	.84	1.04	952	1551	1.71
	8/6	.81	1.08	714	1313	1.39

\*Baseline

\*\*Assumes 6 mil cover weighs 1/2 of a 12 mil cover. Assumes from Centralab data that the weight of 4 cm<sup>2</sup> of solderless solar cell is (.024 gm/mil) (Thickness + 1 mil). Weight does not include the adhesive weight.

\*\*\*Kg per square meter of power producing area of 874 m<sup>2</sup>.

It should be mentioned at this point that the solar cells considered in this analysis are 2  $\Omega$ -cm cells. For the space station orbit (55° inclination, 300 nm altitude) the total radiation dose reaching the cell junction does not warrant the switch to the initially lower power, 10  $\Omega$ -cm cells. This may be verified by consulting Table 3.2-1. Even if 8 mil cells and 3 mil covers were considered, the worst case Bailey data at 10 years predicts a damage equivalent, 1 MeV electron fluence of only  $7.3 \times 10^{14}$  electrons/cm<sup>2</sup>. (That is,  $59 \times 10^{13}$  e/cm<sup>2</sup> through the 3 mil cover thickness from the front and  $14 \times 10^{13}$  e/cm<sup>2</sup> through the 12 mil cell and substrate thickness from the back - see table note d). From Figure 3.2-16, it can be seen that for this fluence, the 2  $\Omega$ -cm cells are still producing approximately 5% more relative power than the 10  $\Omega$ -cm cells.

Ultra thin cells and covers also were not considered in this analysis due to their extreme fragility and high cost. For an array as large and as difficult to assemble as the Space Station Solar Array, even the 8/6 combination is thought very marginal by some experts, especially if the shuttle payload launch cost/pound comes out as low as expected.

Extendible Truss Beam - From section 3.1.1, the weight of the ETB is:

$$W \propto L^{5/3} P^{2/3}.$$

Since  $L \propto \sqrt{A_{\text{Array}}}$ ,

$$W \propto A^{5/6} P^{2/3}.$$

P, the compression load in the beam, varies as the product of the length and the square root of the now varying area density  $\rho$ . (See equation (1), section 3.6).

Thus,  $P \propto L\sqrt{\rho} = \sqrt{A} \sqrt{\rho}$ .

Combining,

$$W \propto A^{7/6} \rho^{1/3}.$$

Finally, if the 91 kg canister weight is assumed constant and the remaining 127 kg changes with array area and array area density, then:



$$W = 91 + 127 \left( \frac{A}{874} \right)^{1.17} \left( \frac{\rho}{1.94} \right)^{.33}$$

Other Structure - From section 3.1.1, the weight of the ISA and OSA is,

$$W \propto L^{7/3} w^{2/3}$$

Because the ISA and OSA are acted upon by the same strip pretension that causes the compression in the extendible beam, the uniform load,  $w$ , will also be proportional to  $L\sqrt{\rho}$ .

Thus

$$W \propto L^{7/3} L^{2/3} \rho^{2/6},$$

$$W \propto L^3 \rho^{1/3}$$

But,  $L \propto \sqrt{A_{\text{Array}}}$ . Thus:

$$W \propto A^{3/2} \rho^{1/3}$$

Finally, because 362 kg out of 770 kg is relatively constant,

$$W = 362 + 408 \left( \frac{A}{874} \right)^{1.5} \left( \frac{\rho}{1.94} \right)^{.33}$$

ODAPT - As before, most of the drive system weight varies with the bending moment at the base of the extendible beam during artificial "g". Thus, for a cantilever beam under uniform loading (approximate):

$$M \propto wL^2 \text{ ETB}$$

But,  $w \propto L\sqrt{\rho}$ . Therefore,

$$M \propto L^3 \sqrt{\rho}$$

Since  $L \propto \sqrt{A_{\text{Array}}}$ ,

$$M \propto A^{3/2} \rho^{1/2},$$

and  $M \propto W$ , so

$$W \propto A^{3/2} \rho^{1/2}$$

Finally,

$$W = 452 + 908 \left( \frac{A}{874} \right)^{1.5} \left( \frac{\rho}{1.94} \right)^{.5}$$

System Weight Summary - From the preceding tables and equations, then, the following weight table can be generated. It has also been converted into percentage weight savings over the baseline design and is presented in Table 3.1-3.

LIFE	Combination Cell/Cover Thickness (mils)	Array (kg)	Extendible Beam (kg)	Other Structure (kg)	ODAPT (kg)	System (kg)
2.5 YEARS	12/12	1651	212	748	1313	3924
	12/6	1432	210	743	1277	3662
	8/12	1506	212	750	1299	3767
	8/6	1280	210	747	1264	3501
5.0 YEARS	12/12	1662	214	753	1323	3952
	12/6	1449	212	754	1299	3714
	8/12	1524	215	761	1322	3822
	8/6	1287	211	751	1273	3522
* 10.0 YEARS	12/12	1695	218	770	1360	4043
	12/6	1474	216	770	1332	3792
	8/12	1551	218	777	1356	3902
	8/6	1331	215	772	1314	3632

\*Baseline

**COST**

Array - Assume the cost of 874 m<sup>2</sup> of the 12/12 combination that will supply 67.2 KW of power at 70<sup>o</sup>C at the end of 10 years as the baseline (100%). In addition, assume the following cell thickness relationships from data supplied by Centralab:

- o relative cost of 2 x 4 conventional Ag Pd Ti solderless cell compared to a 18 mil, 2 x 2 conventional Ag Pd Ti solderless cell:
  - 12 mil - 1.586
  - 8 mil - 1.892

Although actual costs are difficult to predict, the ratios should be approximately correct. Assuming the ratio of cost of wraparound cells is the same as the ratio of conventional cells,

$$r (8/12)_{\text{Cell}} = \frac{1.892}{1.586} = 1.19$$

From Figure 2.2.2-5, the following coverglass cost relationships can be assumed:

- o relative cost of  $10^6$ , 2 x 4 cm fused silica coverglasses compared to  $10^6$ , 2 x 4 cm, 20 mil fused silica coverglasses:

12 mil - 1.14

6 mil - 1.34

$$r (6/12)_{\text{Cover}} = \frac{1.34}{1.14} = 1.17$$

In addition to these two cell and cover ratios, it is necessary to know the relationship of the cell cost to the coverglass cost so that the true effect of changing the cell and/or cover thickness can be assessed.

Based on recent LMSC program experience, the ratio of cost between a 2 x 4, conventional, 12 mil solar cell and a 2 x 4, 12 mil fused silica cover is approximately 1.60. In discussions with the cell vendors, it has been determined that for large orders, a wraparound cell would cost approximately 15% more than a conventional cell. Therefore, the true ratio that must be used for the baseline 12/12 combination is:

$$r (\text{Cell/Cover}) = (1.6) (1.15) = 1.84$$

Extendible Truss Beam, Other Structure, ODAPT - Because the changes in weight of the beam, structure and ODAPT are usually less than 5%, their effects on system cost can be neglected. This is a valid assumption if it is assumed that the weight savings of the other than array components are taken in reduced material section, not in reduced parts count. This small material cost savings would be insignificant in comparison to engineering, test, labor, etc.

System Cost Summary - The change in area of the solar array caused by the changes in cell and cover thicknesses and orbital life requirements would cause the changes in cost indicated in the following table. These figures have also been converted to cost savings and are summarized in Table 3.1.3.

* Life	Combination Cell/Cover	Req'd Array Area	Req'd Array Material Cost****	Req'd Array Mfg. Cost	Req'd** Array Cost	Req'd*** System Cost
10 Years	12/12	1.00	1.00	1.00	1.00	1.00
	12/6	1.04	1.09	1.04	1.06	1.03
	8/12	1.04	1.18	1.04	1.11	1.06
	8/6	1.08	1.28	1.08	1.17	1.09
5 Years	12/12	.97	.97	.97	.97	.99
	12/6	1.01	1.06	1.01	1.03	1.02
	8/12	1.01	1.15	1.01	1.08	1.04
	8/6	1.04	1.23	1.04	1.13	1.07
2.5 Years	12/12	.96	.96	.96	.96	.98
	12/6	.99	1.04	.99	1.02	1.01
	8/12	.99	1.12	.99	1.06	1.03
	8/6	1.03	1.22	1.03	1.12	1.06

\* Baseline

\*\* Assuming cell/cover cost - 50%, total mfg. cost including test, qual, etc. - 40%, other - 10%.

\*\*\* Cost savings of ETB, Other Structure, and ODAPT have been neglected. See Text. To arrive at the figures in this column, it was assumed that the relationship between system component costs are as follows: array - 50%, ODAPT - 20%, beam and other structure - 30%. Thus, a 10% increase in array cost would cause a 5% increase in system cost.

\*\*\*\* Sample calculation for 8/6 combination for 10 year life compared to 12/12 combination for 10 year life:

$$\begin{aligned}
 \text{Cost ratio} &= \frac{[r (\text{Cell/Cover}) C_{\text{Cell}} + C_{\text{Cover}}]_{\text{New}}}{[r (\text{Cell/Cover}) C_{\text{Cell}} + C_{\text{Cover}}]_{12/12}} \times \frac{A_{\text{New}}}{A_{12/12}} \\
 &= \left[ \frac{(1.84) (1.892) + (1.34)}{(1.84) (1.586) + (1.14)} \right] \times 1.08 \\
 &= 1.28
 \end{aligned}$$

### 3.1.3 Effect of Weight Optimization on System Weight and Cost

#### WEIGHT

The weight savings presented below are not "exotic" weight savings that would add inordinately to the cost. They are the relatively "easy" weight savings that could be obtained if low weight were deemed more critical.

Array - There are several substrate areas that could be weight optimized (in addition to the thinner cells and covers already discussed):

1. Welding instead of soldering the solar cell would essentially eliminate the solder weight at a savings of 17.15 kg.
2. Aluminum instead of copper interconnects would result in a savings of 27.6 kg for equivalent metal thickness and area coverage.
3. Integral covers (either glass or FEP) would eliminate the coverglass adhesive at a savings of 30.1 kg.
4. Aluminum instead of copper conductors in the feeder harness would result in a weight savings of 52.7 kg if the baseline 112 volt system still allowed only a maximum 1.5 volt drop. If aluminum was used in the wire harness that runs from each strip to the diode J-box there would be an additional savings of 33.4 kg.

Taken separately, these savings are insignificant. However, taken together they represent a savings of 157 kg or 9% over baseline array weight.

Extendible Truss Beam - The given weight of 218 kg is already the totally optimized weight expected by Astro Research to be representative of the flight configuration. Therefore, no savings.

Other Structure - If FEP covers were used instead of glass covers, it has been shown that the protective embossed Kapton padding could be eliminated at a savings of 79.8 kg or approximately 10%. Although an additional 10% could probably be eliminated from the other structural members, only a single 10% will be recorded because of the present uncertainties in using an FEP system.

ODAPT - With the constraint that there be a tunnel for astronaut access through the ODAPT, it is difficult to design a very compact and lightweight system. However, it would not be too difficult to reduce the ODAPT system weight by up to 20% using composites and less rigid designs. The savings would be 272 kg.

## COST

Array - The cost savings associated with each area of weight saving are as follows:

1. Weld instead of solder - the LSSSA substrate cost should approach \$2000/ft<sup>2</sup>. If cell laydown manufacturing costs .15 manhours/cell:

$$\text{mfg cost/ft}^2 = \$375/\text{ft}^2$$

Assume this cost breaks down as 1/3 filtering, 1/3 soldering and 1/3 cleanup. Because welding requires no fluxing, solder beading or cleanup, perhaps 1/3 of the soldering cost and 1/3 of the cleanup cost could be saved or 2/9 of the entire cell laydown manufacturing cost. This is a

$$\frac{\left(\frac{2}{9}\right) (375)}{2000} \times 100\% = 4\%$$

savings of the array cost.

2. Aluminum instead of copper interconnects - no savings.
3. Integral covers instead of conventional covers - from OCLI data in Figure 2.2.2-4, 10<sup>6</sup>, 2 x 4, 12 mil, fused silica covers would cost \$2/covers. From Reference 5, 10<sup>6</sup>, 2 x 4 cells covered with 12 mils of 7070 glass would cost approximately \$ .90/covers.

Because there would be slightly more radiation degradation in the 7070 glass and therefore would require more active area, assume that the integral covers save nothing over the conventional covers except the filtering operation. Thus, from 1 above, this saves

$$\frac{\left(\frac{1}{3}\right) (375)}{2000} \times 100\% = 6\%$$

of the array cost.

If FEP were used, assume that the material cost that is saved is exactly the cost of the conventional coverglass but that the FEP laydown cost is exactly the same as the cost of the conventional filtering operation. This would therefore save the material cost of \$2/cover or

$$\frac{(\$2/\text{cover}) (100 \text{ covers}/\text{ft}^2)}{\$2000/\text{ft}^2} \times 100\% = 10\%$$

Assume average cost of the two approaches would allow savings of 8%.

4. Aluminum instead of copper conductors in the feeder harness and wiring harness - Although the aluminum would probably cost more because of its difficult connection processes, it would be insignificant when compared to the rest of the array cost.

Extendible Truss Beam - No cost impact.

Other Structure - The elimination of the packaging material would probably save no more than 5% of the structure cost.

ODAPT - The 20% change in weight would be the result of smaller section thicknesses out of perhaps more expensive materials in combination with smaller and therefore cheaper parts (e. g. , it has been suggested that the outer cylinder structure does not have to be corrugated as it is now). Therefore, the cost impact is assumed to be negligible.

### 3.1.4 Effect of Artificial Gravity Experiment Elimination on System Weight and Cost

#### WEIGHT

Array - The reduced load situation caused by the artificial "g" elimination would warrant a change to thinner substrate materials at a savings of 67.25 kg.

Extendible Truss Beam - The baseline beam weight of 218 kg is a totally weight optimized beam that will sustain the art "g" loads. However, if only zero "g" loads are required, the weight change could be estimated by the same methods used previously.

From 3.1.1, the weight of an articulating truss in compression is

$$W \propto L^{5/3} P^{2/3}$$

For present considerations, L is constant. Therefore,

$$W \propto P^{2/3}$$

From reference 1, pg 3.1-15, Figure 3.1-10, the resultant compression on the beam load during artificial "g" is 1590 lbs. Thus, assuming a relatively constant canister weight of 91 kg:

$$W = 91 + 127 \left( \frac{P}{1590} \right)^{.67}$$

From the same figure, it can be seen that if only zero "g" operation was required,  $P_3 \times 4 = 276 \times 4 = 1104$  lbs would be eliminated;  $P_5 = -132$  lbs would be eliminated; and probably at least  $1/2$  of  $P_6 = 0.5 \times 528 \times .933 = 246$  lbs would be eliminated. Therefore  $P = 1590 - 1104 - (-132) - 246 = 372$  lbs. Thus, an estimated beam weight would be

$$W = 91 + 127 \left( \frac{372}{1590} \right)^{.67} = 139 \text{ kg as opposed to the art "g" weight of 218 kg}$$

This is a savings of 79 kg.

**Preceding page blank**



Other Structure - If only the zero "g" operation was required, all of the strips could be pulled up at once. Out of the entire baseline tensioning mechanism, only the tension springs would be needed at a weight of 10 kg for all 20 strips. This would be a savings of 33.8 kg.

ODAPT - From 3.1.1, the drive system weight can be assumed to vary with the bending moment at the base of the beam. This moment, because of the complicated loading and support system, can be assumed to vary with the magnitude of the axial beam column load. Thus,

$$M \propto P.$$

As before, 908 kg out of 1360 kg is assumed to be structural tie in with the beam. Also, it was previously determined in this subsection that during artificial "g" there is a 1590 lb compression load. Thus,

$$W \propto M \propto P$$

$$\text{and } W = 452 + 908 \left( \frac{P}{1590} \right)$$

From reference 1, pg. 3.1-17, the zero "g" tip load is 280 lbs.

Therefore, the zero "g" drive system weight is estimated at:

$$W = 452 + 908 \left( \frac{280}{1590} \right) = 612 \text{ kg}$$

This is an indicated savings of 748 kg or 55%. Obviously, this result must be tempered slightly. Assuming all of the structure and bearings were reduced in weight by 1/2 because of the greatly reduced load, the savings would be approximately 500 kg or 35%. This is a more reasonable figure.

## COST

Array - Thinner substrate materials would have an insignificant effect on cost.

Extendible Truss Beam - A beam that weighs 79 kg or  $\frac{79}{218} \times 100\% = 36\%$  less because of a strength requirement reduction probably could be fabricated in a less strong fashion, i. e., a simpler design. Therefore, because there is a weight

and strength reduction it would probably be safe to estimate a cost reduction that reflects not only rather insignificant cost changes caused by reduced cross section and cheaper materials, but also by simpler fabrication techniques due to the simplified design. Therefore, assume that the cost savings for the beam is half the weight savings or 18%.

Other Structure - The reduced cost of the tensioning mechanism is insignificant.

ODAPT - Although there is a large change in weight, there has been no assumed change in function or basic drive system size. Therefore, the weight change is in part the result of changes in section and in part the result of changes in load, e. g., less load requires lower powered (lighter, cheaper) drive motors. However, the weight savings attributed to the 500 kg or 35% should probably be no more than 15-20% because of the remaining electronics and mechanisms.

### 3.1.5 Effect of Retraction Requirement Elimination on System Weight and Cost

#### WEIGHT

Array - If there were no requirement for retraction, the largest weight change in the substrate would be the elimination of the hinge and stiffeners. Because of the fact that the stiffeners are also edge tear reinforcements, they would have to be replaced with, perhaps, a very open weave scrim-type cloth at a weight savings of probably 15.72 kg or 75%. The aluminum hinge could be completely eliminated. If the fiberglass at the joint were folded over and punched, a simple piano hinge would be formed. A .040" diameter magnesium rod would still allow for easy module replacement. The weight savings for the hinge would be approximately .2 lb/module or 75.29 kg/array.

Extendible Truss Beam - If there were no retraction requirement, the Extendible Structure Number 6 in Matrix J on page 4-79 of Reference 6 could be used. It has been estimated that this beam would weigh approximately 68 kg. Although two of them would still be needed, there would be a net savings of 82 kg.

Other Structure - No change.

ODAPT - No change.

#### COST

Array - The net effect of the elimination of the baseline hinge and stiffeners would be insignificant.

Extendible Truss Beam - Replacement of a retractable beam with a non retractable one would probably result in a cost savings of 25% because of the lesser degree of complexity required.

Other Structure - No change.

ODAPT - No change.

Preceding page blank

3.1.6 Summary of Effects on System Weight and Cost

As indicated previously, all of the weight and cost savings associated with the various possible parameter or requirement changes over the baseline have been converted into percentages and are presented in Table 3.1-3. (Note that minus signs indicate increases in cost or weight and that dash lines indicate insignificant changes in cost or weight). As with any estimation, however, a certain degree of constraint must be exercised in using the results. Arbitrary additions of individual cost or weight savings cannot be made without careful consideration of the associated assumptions. In addition, although many of the estimates are on the conservative side, there are some that might be considered optimistic due to their taking for granted some processes not yet space qualified (e.g., welding of solar cells to interconnects on a large scale, connection procedures for aluminum flat conductor cable, etc.). At this printing, however, the needed technology areas associated with the various uncertainties are developing well ahead of their expected need date.

Notwithstanding the above, and considering the fact that the five basic parameter changes do not have an independent effect on the weight or cost of a new design, the table may best be used if the savings are considered fractional reductions of the weight or cost of the baseline design instead of discrete, totally independent reductions. For example, if the new requirements were:

- 2-1/2 year life (instead of 10 year)
- Total weight optimization,

the table indicates a possible savings over the baseline design of:

PARAMETER	SYSTEM WEIGHT SAVINGS (%)	SYSTEM COST SAVINGS (%)
2.5 yr, 8/6	14	-6
Weight Optimize	13	7

(The 8/6 combination was used because light weight is now desired).

Preceding page blank

TABLE 3.1-3  
 PERCENTAGE WEIGHT AND COST SAVINGS ASSOCIATED WITH CHANGES  
 IN THE SSSA BASELINE DESIGN REQUIREMENTS \*\*\*\*  
 (minus sign indicates higher cost or weight)

Ref. Sec.	Parameter Changed	Array		Beam		Other Structure		ODAPT		System			
		Weight	Cost	Weight	Cost	Weight	Cost	Weight	Cost	Weight	Cost		
*	2.3.1.1 Power .8 P <sub>max</sub> = 53.8 KW EOL 1.0 P <sub>max</sub> = 67.2 KW EOL 1.2 P <sub>max</sub> = 80.7 KW EOL	20	20	13	--	15	--	13	--	16	10		
		0	0	0	0	0	0	0	0	0	0		
		-20	-20	-14	--	-17	--	-13	--	-17	-10		
**	2.3.1.2 Orbital Cell/Cover <u>Life (Yrs) Thickness (Mils)</u>	3	4	3	--	3	--	3	--	3	2		
2.5		12/12	16	-2	4	--	4	--	6	--	9	-1	
		12/6	11	-6	3	--	3	--	4	--	7	-3	
		8/12	24	-12	4	--	3	--	7	--	14	-6	
		8/6	2	3	2	--	2	--	3	--	2	1	
5.0		12/12	15	-3	3	--	2	--	4	--	8	-2	
		12/6	10	-8	1	--	1	--	3	--	6	-4	
		8/12	24	-13	3	--	2	--	6	--	13	-7	
		8/6	0	0	0	0	0	0	0	0	0	0	
*		10.0	12/12	13	-6	1	--	0	--	2	--	6	-3
			12/6	8	-11	0	--	-1	--	0	--	4	-6
			8/12	21	-17	1	--	0	--	3	--	10	-9
***	2.3.1.3 Weight Optimize	9	12	--	--	10	5	20	--	13	7		
	2.3.1.4 No Artificial "g" Experiment	4	--	36	18	4	--	35	20	17	6		
	2.3.1.5 No Retraction Requirement	5	--	38	25	--	--	--	--	4	2		

\* Indicates Baseline Design

\*\* Assumes Identical EOL Power of 67.2 KW

\*\*\* Includes welded solar cells, aluminum interconnects and feeder harness, integral or FEP coverglasses, and a weight optimized ODAPT. Does not include thinner substrate materials as this is considered if artificial "g" experiment is eliminated. Does not include thinner cells and covers.

\*\*\*\* See text for instructions on using the figures in this table.

An estimation of the new system weight and cost would be:

$$\begin{aligned} \text{WEIGHT} &= (.86) (.87) = .75 \\ \text{COST} &= (1.06) (.93) = .99 \end{aligned}$$

In examining the analysis, however, it will be seen that although the weight and cost estimates for the orbital life and cell/cover thicknesses are probable close, the cost of the weight optimization depends largely on the application of FEP or integral cover-glasses and the welding of the solar cells instead of soldering. If these processes were determined infeasible, the new system weight could very well be 75% of the former weight as indicated above, but the new system cost would be 6% higher--entirely caused by the more expensive array substrate. For a space station solar array system that will cost in the tens of millions of dollars, 6% is a rather substantial sum.

However, accepting the table as an estimation only, the following interesting and perhaps probable requirement changes with their associated savings can be noted:

		<u>SYSTEM SAVINGS</u>	
1. 2.5 year life	total weight optimization	WEIGHT	- 38%
	no art. "g" experiment	COST	- 7%
2. 5.0 yr life	light weight system	WEIGHT	- 39%
	high loads approaching art "g" loads	COST	- 12%
	no retraction requirement		
	80% power required		
3. 10.0 yr life	light weight system	WEIGHT	- 35%
	no art "g" experiment	COST	- 5%

REFERENCES  
(Section 3.1)

1. Second Topical Report - Design and Analysis - Space Station Solar Array Technology Evaluation Program, Report No. LMSC-A995715, November 1971.
2. Third Topical Report - Design Support, Major Hardware, and System Level Testing - Space Station Solar Array Technology Evaluation Program, Report No. LMSC D153526, MSC No. 07160, September 1972.
3. Gandel, M. G., Design Data Handbook for Regenerative Fuel Cell Study, Report No. LMSC-D159786, November 1972.
4. Crawford, R. F., "Strength and Efficiency of Deployable Booms for Space Applications", paper presented at AAS/AIAA Variable Geometry and Expandable Structures Conference, Anaheim, California, April 1971.
5. Private communication, A. Kirkpatrick of Ion Physics to D. Parquet of LMSC, May 5, 1971.
6. First Topical Report - Evaluation of Space Station Solar Array Technology, Report No. LMSC-A981486, December 1970.

### 3.2 SOLAR CELL PERFORMANCE AND LOSS ANALYSIS

The purpose of this section is to outline the basic considerations used in determining the internal losses in performance of a solar cell. Those parameters that influence beginning of life (BOL) and end of life (EOL) performance of the solar cells are explained with specific examples of the Space Station analysis included for a clearer understanding of the techniques involved. It will be noted that most of the working curves in this section were taken from two technical reports written by Centralab and Heliotek (see references 1 and 2 at back of section). These reports should most definitely be consulted if a detailed discussion of the curves is desired.

Basically, there are five factors that will influence the per-unit-area performance of a silicon solar cell. These are: cell base resistivity, cell thickness, cell operating temperature, amount of particle irradiation that has reached the cell junction, and UV degradation. The sun energy incident on a cell in earth orbit has been determined by many investigators to be approximately  $135 \text{ mw/cm}^2$  and in the form of a spectrum of intensities at various wavelengths. Figure 3.2-1 shows this spectrum as measured by Johnson (Reference 4). Figures 3.2-2, -3, -4 and -5 illustrate how the cell responds to these energy wavelengths as a function of cell resistivity, thickness, temperature and radiation. Note that it is most sensitive to wavelengths around 0.8 microns while the solar spectrum peak is at 0.33 microns. In general, however, solar cells have a conversion efficiency of approximately 11% and are able to provide a useable power level of at least 15 milliwatts per square centimeter when under illumination of 1.0 suns. Figure 3.2-6 shows the variation in solar cell parameters as a function of increasing or decreasing solar intensity.



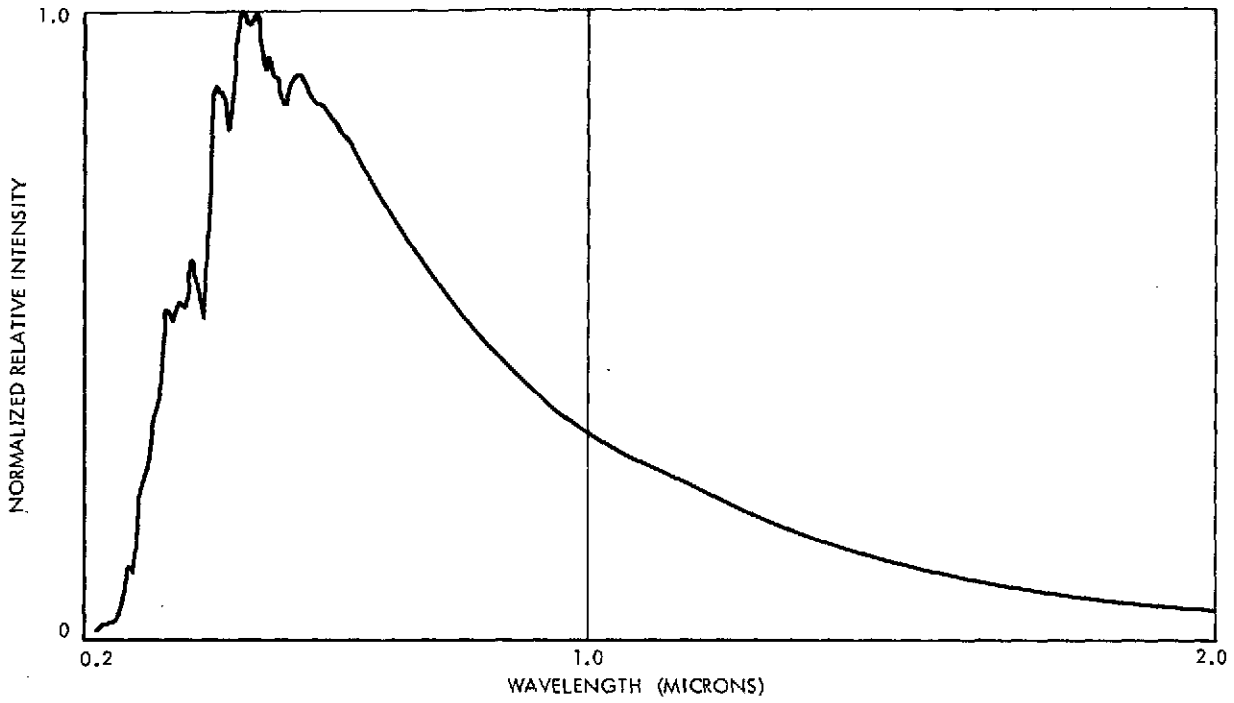

Figure 3.2-1 NRL Solar Energy Distribution Curve

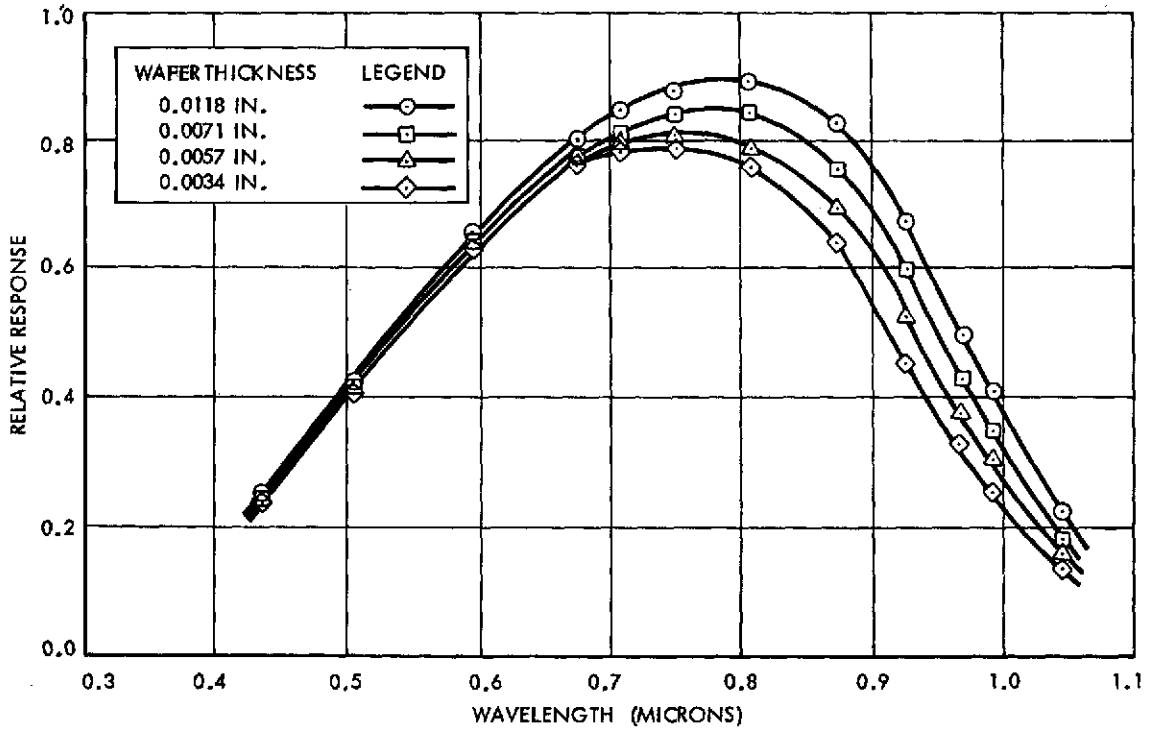

Figure 3.2-2 Relative N/P Solar Cell Spectral Response -  $2 \Omega\text{-cm}$  at  $25^{\circ}\text{C}$

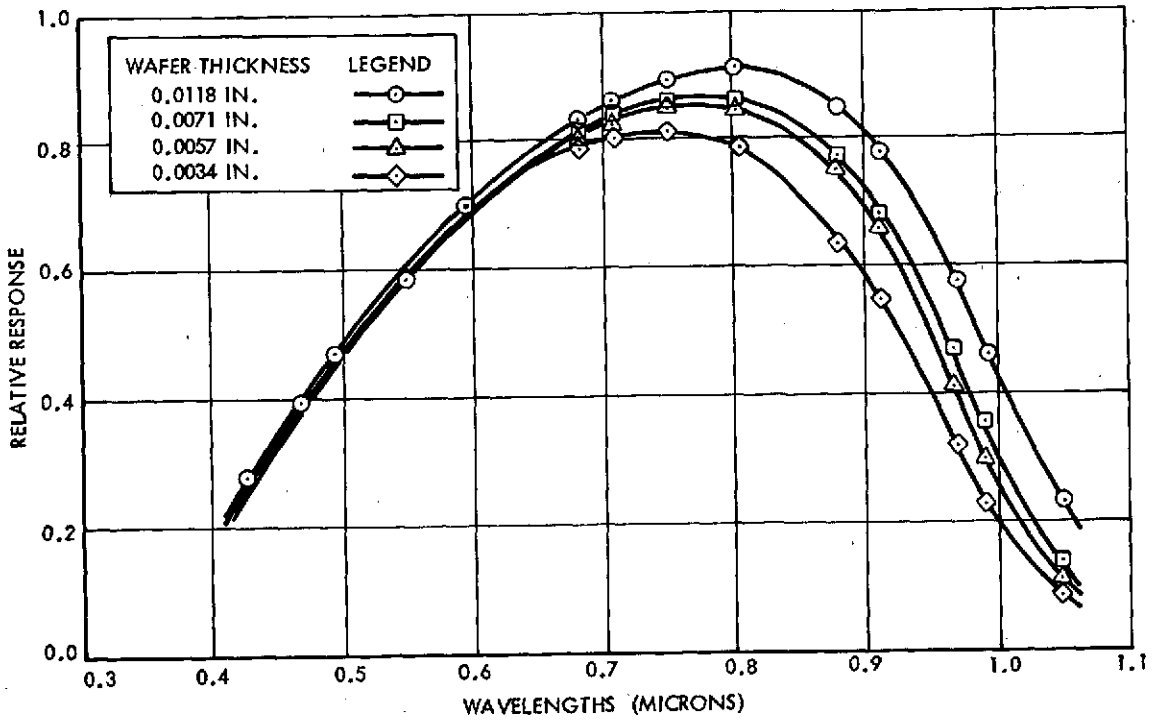

Figure 3.2-3 Relative N/P Solar Cell Spectral Response - 10 Ω-cm at 25°C

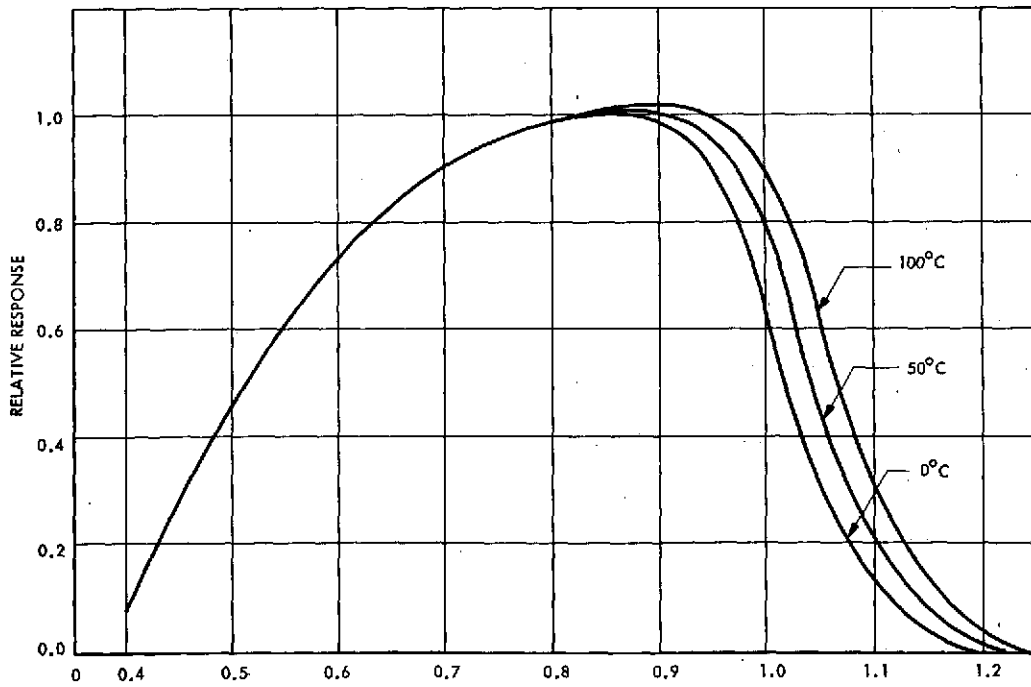

Figure 3.2-4 Solar Cell Spectral Response vs Temperature

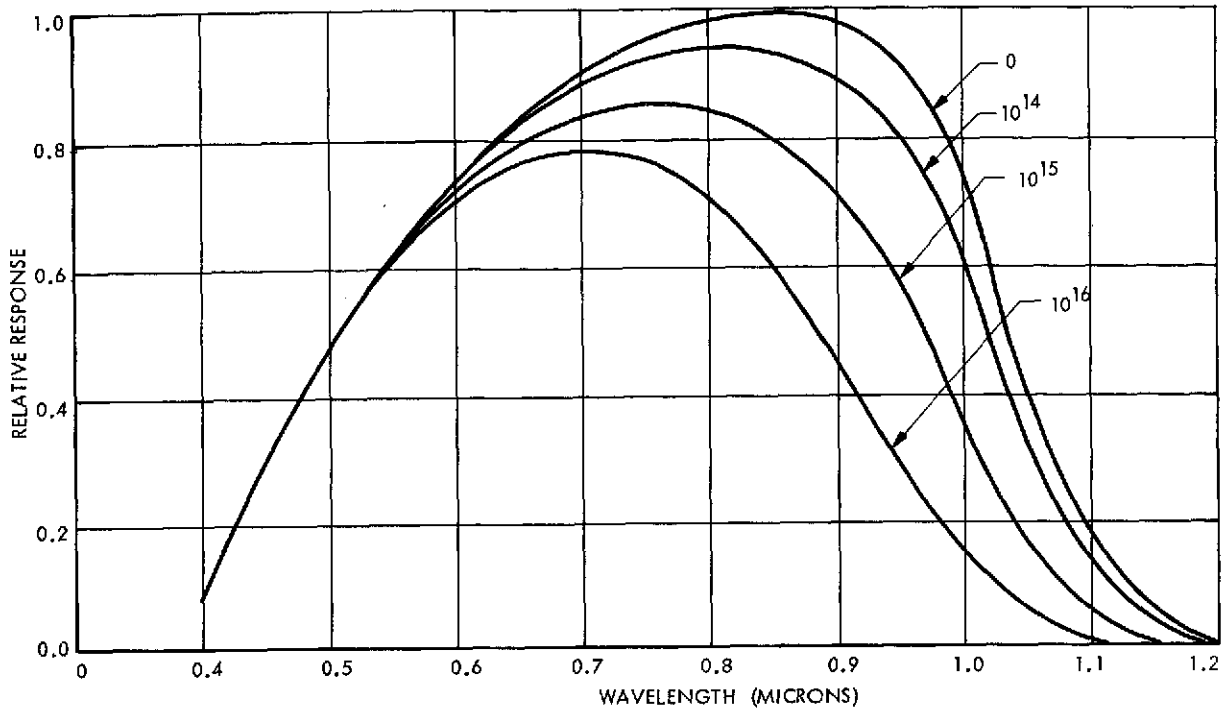

Figure 3.2-5 Degradation of Spectral Response of N/P Solar Cells Under 1-MeV Electron Bombardment

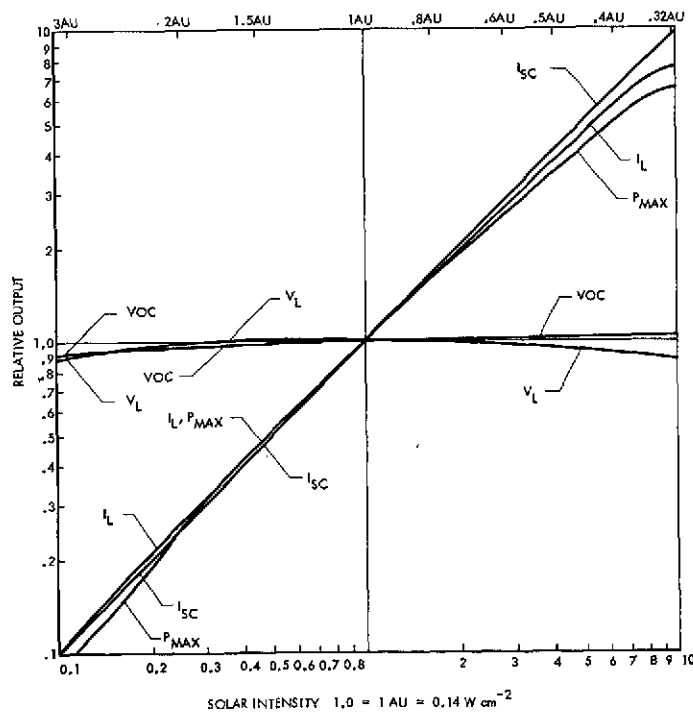

Figure 3.2-6 Variation of Solar Cell Parameters as a Function of Solar Intensity

In order to determine how much solar cell power should be supplied at BOL to provide enough power at EOL, the cell resistivity and thickness (and protecting coverglass thickness), have to be traded-off against the expected irradiation, cell operating temperature and other loss effects. There are various approaches used in the industry but basically they involve solving for the F factors in the following formula:

$$P_{\text{BOL}} = \frac{P_{\text{EOL}}}{\prod_{i=1}^n (F_i)} \quad (1)$$

where

- $P_{\text{BOL}}$  = Beginning of life power
- $P_{\text{EOL}}$  = End of life power (maximum required vehicle power)
- $\prod_{i=1}^n (F_i)$  = Product of all of the loss factors (loss factors usually less than 1.0) where:
- $F_1$  = Radiation loss factor
  - $F_2$  = Temperature loss factor
  - $F_3$  = Effectivity loss factor
  - $F_4$  to  $F_n$  = Other loss factors

Some typical solar cell curves are shown in Figure 3.2-7 for 8 mil and 12 mil, 2 x 4 cm wraparound solar cells. These two cells will be used for determining loss factors in the following example.

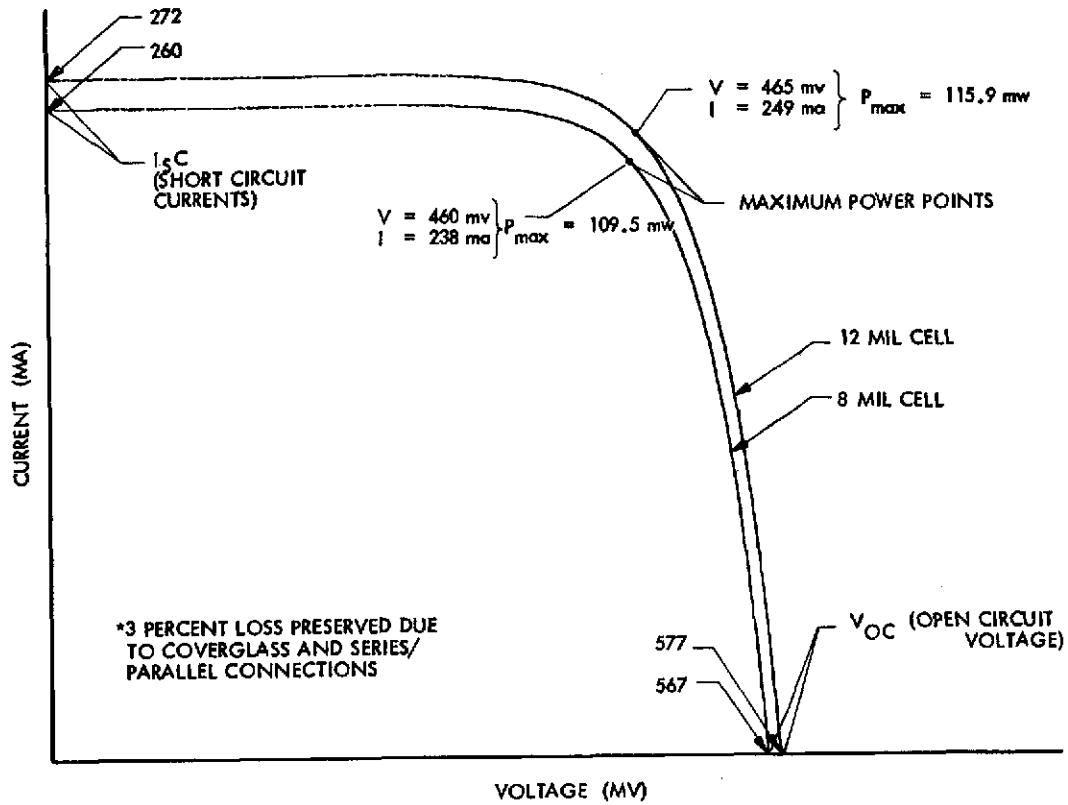

Figure 3.2-7 Typical 2 x 4 Wraparound Solar Cell I-V Curves

### 3.2.1 Radiation Loss Factor

The number of damage equivalent, 1 MeV electrons per square centimeter that reach the cell junction is the basis upon which all solar cell degradation due to radiation is determined. Equivalence implies the combining of the effects of electrons and protons of differing energies through the use of a relative damage coefficient yielding the same effect as does a unit fluence of 1 MeV electrons. The method of determination was initially developed for the DASA-funded Trapped Radiation Handbook (Reference 5) and is detailed for Space Station parameters in Reference 3, Appendix B.6. The results of this study are shown in Table 3.2-1 and are similar to what should be developed for any specific mission in question. The equivalent  $\text{SiO}_2$  shield thickness in the table is the equivalent material thickness protecting the solar cell junction whether it is from the front by the coverglass or from the back by the substrate and bulk cell material. The silicon p material offers some protection from the back to the junction because the junction is within a few microns of the front of the cell. ( $10 \Omega\text{-cm}$  cells were not considered in this tradeoff because, as seen in Figure 3.2-16,  $2 \Omega\text{-cm}$  cells always have more power output than  $10 \Omega\text{-cm}$  cells until a fluence of  $5 \times 10^{15}$  electrons has been reached. It was known by experience that the space station array would not exhibit this "crossover" fluence. If it had, additional fluence tables would have to have been calculated).

The next step in the determination of the radiation factor is the calculation of Table 3.2-2 by using the data of Table 3.2-1 to determine total front and back side fluences for the various cell and cover thicknesses under consideration. (If the substrate is honeycomb, there will be essentially zero backside fluences). The 300 nautical mile,  $55^\circ$  inclination Space Station orbit was used in conjunction with the worst case Bailey data. Only four cell/cover thicknesses combinations were considered in this example because of weight, cost, and breakage considerations. Every array has its own specific requirements that make such exclusions possible.

TABLE 3.2-1

EQUIVALENT 1 MeV ELECTRON FLUENCES,  $\phi_{eq}$  ( $e/cm^2$ ), FOR N/P TYPE SILICON SOLAR CELLS IN LOW ALTITUDE CIRCULAR ORBITS IN THE TIME PERIOD 1977-1990

Mission Duration			2.5 years <sup>b</sup>			5 years <sup>b</sup>			10 years			
			Trapped Only	Trapped + Solar Flare		Trapped Only	Trapped + Solar Flare		Trapped Only	Trapped + Solar Flare		
Inclination	Altitude	Eqvt. SiO <sub>2</sub> Shield Thick. (mils)	$\phi_{eq}^a$	$\phi_{eq}^a$	$\phi_{eq}^a$	$\phi_{eq}^a$	$\phi_{eq}^a$	$\phi_{eq}^a$	$\phi_{eq}^a$	$\phi_{eq}^a$	$\phi_{eq}^a$	
			( $e/cm^2$ )	( $e/cm^2$ )	( $e/cm^2$ )	( $e/cm^2$ )	( $e/cm^2$ )	( $e/cm^2$ )	( $e/cm^2$ )	( $e/cm^2$ )	( $e/cm^2$ )	
90	200	3	2.1	25	8.3	4.3	27	11	8.6	31	15	
		6	.96	12	5.2	1.9 <sup>a</sup>	13	6.2	3.8	15	8.1	
		12 <sup>d</sup>	.43	5.3	3.1	.86	5.7	3.5	1.7	6.6	4.4	
		15.7 <sup>c</sup>	.32	3.8	2.4	.64	4.1	2.7	1.3	4.7	3.4	
	300	3	7.1	30	13	14	37	20	28	51	34	
		6	3.4	15	7.6	6.8	18	11	14	25	18	
		12	1.6	6.5	4.3	3.3	8.2	5.9	6.6	11	9.2	
		15.7	1.2	4.7	3.3	2.4	5.9	4.5	4.8	8.3	6.9	
	55 <sup>e</sup>	200	3	2.6	25	8.8	5.2	28	11	10	33	17
			6	1.3	13	5.5	2.6	14	6.8	5.2	17	9.4
			12	.60	5.5	3.2	1.2	6.1	3.8	2.4	7.3	5
			15.7	.43	3.9	2.5	.87	4.3	3.0	1.7	5.2	3.8
300		3	9.1	32	15	18	41	24	36	59	42	
		6	4.6	16	8.8	9.1	21	13	18	39	22	
		12	2.2	7.1	4.8	4.4	9.3	7.0	8.8	14	11	
		15.7	1.6	5.1	3.7	3.3	6.7	5.4	6.6	10	8.7	
28.5		200	3	.69	.69	.69	1.4	1.4	1.4	2.8	2.8	2.8
			6	.33	.33	.33	.66	.66	.66	1.3	1.3	1.3
			12	.18	.18	.18	.36	.36	.36	.72	.72	.72
			15.7	.15	.15	.15	.30	.30	.30	.60	.60	.60
	300	3	6.3	6.3	6.3	13	13	13	25	25	25	
		6	3.5	3.5	3.5	7.1	7.1	7.1	14	14	14	
		12	2.0	2.0	2.0	4.0	4.0	4.0	8.1	8.1	8.1	
		15.7	1.6	1.6	1.6	3.3	3.3	3.3	6.6	6.6	6.6	

<sup>a</sup>Note that the values for  $\phi_{eq}$  are in units of  $10^{13}$  1 MeV electrons/cm<sup>2</sup>.

<sup>b</sup>Solar Flare contribution for worst case 2.5 and 5 year mission beginning in 1977.

<sup>c</sup>This value is for a 12 mil cell thickness and a 3 mil equiv. thickness for the cell Substrate.

<sup>d</sup>This value is slightly greater than the actual (11.57) thickness for an 8 mil cell thickness & A 3 Mil Equivalent Thickness For the Cell Substrate.

<sup>e</sup>For this inclination orbit the solar flare contribution may be small. Values quoted are for 65° or greater inclination and are upper limits.

TABLE 3.2-2  
EQUIVALENT 1 MeV ELECTRON FLUENCE SUMMARY OF CELL DEGRADATION  
BAILEY DATA - 300 NM - 55° INCLINATION - FRONT  
AND BACK SIDE

Cell/Cover Thickness (Mils)	Exposed Surface	2.5 Yr.	5.0 Yr.	10.0 Yr.
12/12	Front	$7.09 \times 10^{13}$	$9.30 \times 10^{13}$	$13.7 \times 10^{13}$
	Back	<u>5.11</u>	<u>6.75</u>	<u>10.0</u>
	Total	$1.220 \times 10^{14}$	$1.605 \times 10^{14}$	$2.37 \times 10^{14}$
12/6	Front	$16.0 \times 10^{13}$	$20.5 \times 10^{13}$	$29.6 \times 10^{13}$
	Back	<u>5.11</u>	<u>6.75</u>	<u>10.0</u>
	Total	$2.111 \times 10^{14}$	$2.725 \times 10^{14}$	$3.96 \times 10^{14}$
8/12	Front	$7.09 \times 10^{13}$	$9.3 \times 10^{13}$	$13.7 \times 10^{13}$
	Back	<u>7.09</u>	<u>9.3</u>	<u>13.7</u>
	Total	$1.418 \times 10^{14}$	$1.86 \times 10^{14}$	$2.74 \times 10^{14}$
8/6	Front	$16.0 \times 10^{13}$	$20.5 \times 10^{13}$	$29.6 \times 10^{13}$
	Back	<u>7.09</u>	<u>9.3</u>	<u>13.7</u>
	Total	$2.309 \times 10^{14}$	$2.98 \times 10^{14}$	$4.33 \times 10^{14}$

After the total equivalent 1 MeV electron fluences have been determined for the candidate cell/cover combinations, cell degradation curves are consulted to determine the losses in  $I_{sc}$ ,  $V_{oc}$ ,  $P_{max}$  and  $V$  at  $P_{max}$ . (See Figures 3.2-8 through -15 which are plotted from data in Reference 2. Figure 3.2-16 presents the degradation in maximum power for 2 and 10  $\Omega$  cm cells of various thicknesses versus fluences of 1 MeV electrons. Although it was seen in the other curves that the thicker cells degrade at a faster rate, Figure 3.2-16 shows the true relationship between the cell thicknesses when actual power output of the thicker cells is considered). A final tradeoff of the thickness of the cell and cover can usually be made by plotting relative maximum power vs orbital life. This has been done in Figure 3.2-17 for the given example.



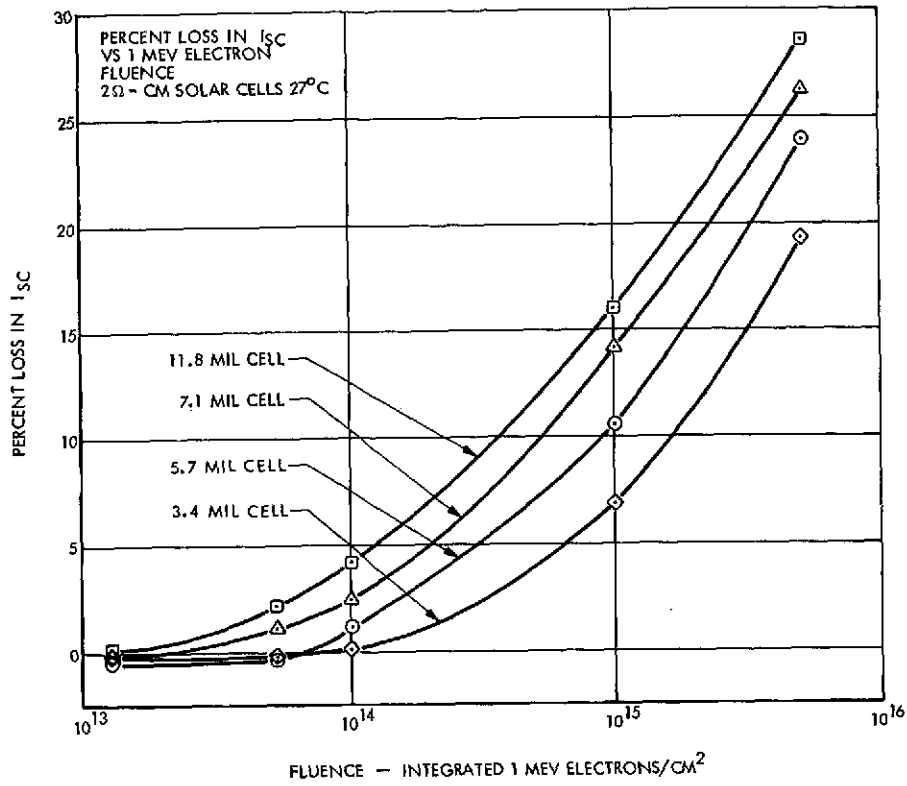

Figure 3.2-8  $2\Omega$ -cm Degradation Data - % Loss  $I_{sc}$

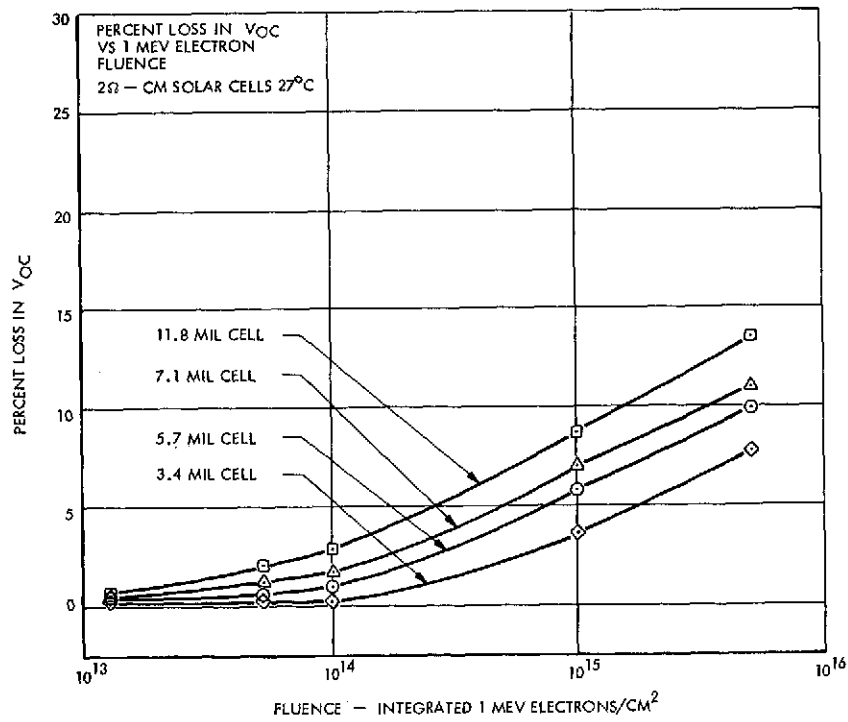

Figure 3.2-9  $2\Omega$ -cm Degradation Data - % Loss  $V_{oc}$

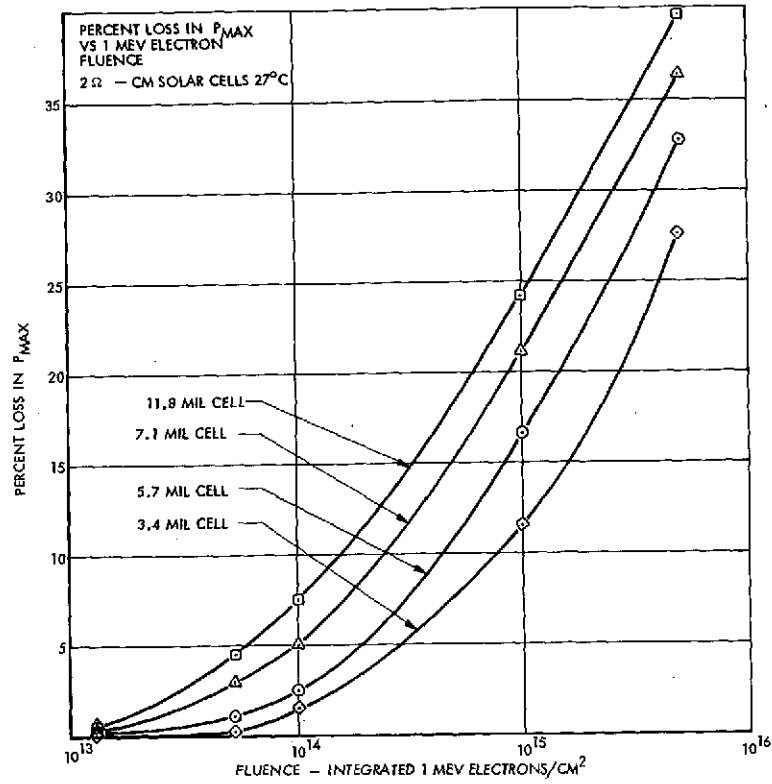

Figure 3.2-10 2 Ω-cm Degradation Data - % Loss P<sub>max</sub>

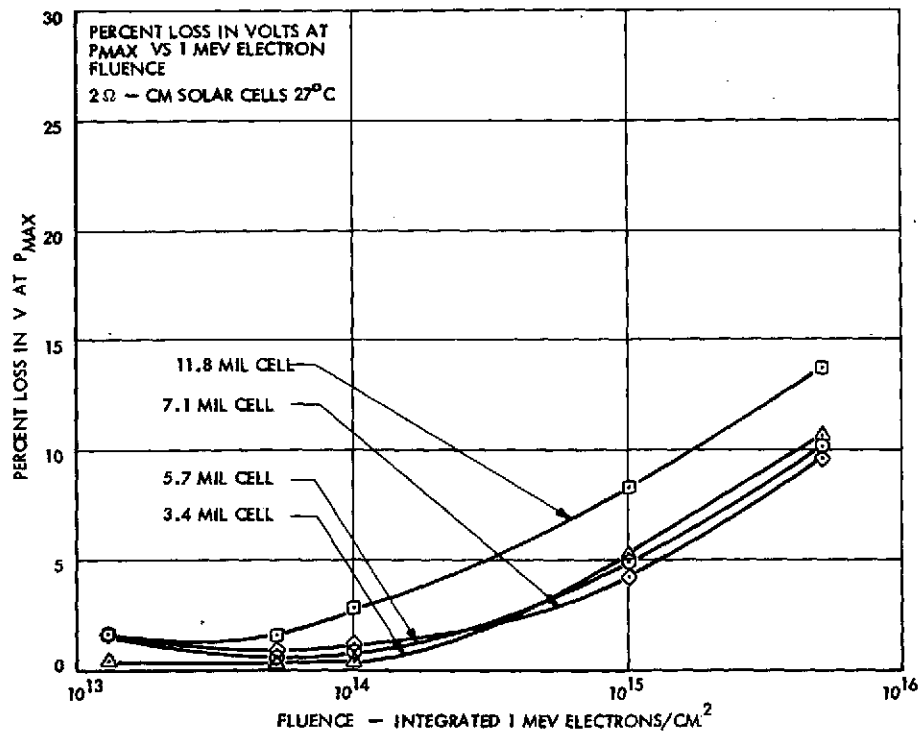

Figure 3.2-11 2 Ω-cm Degradation Data - % Loss V @ P<sub>max</sub>

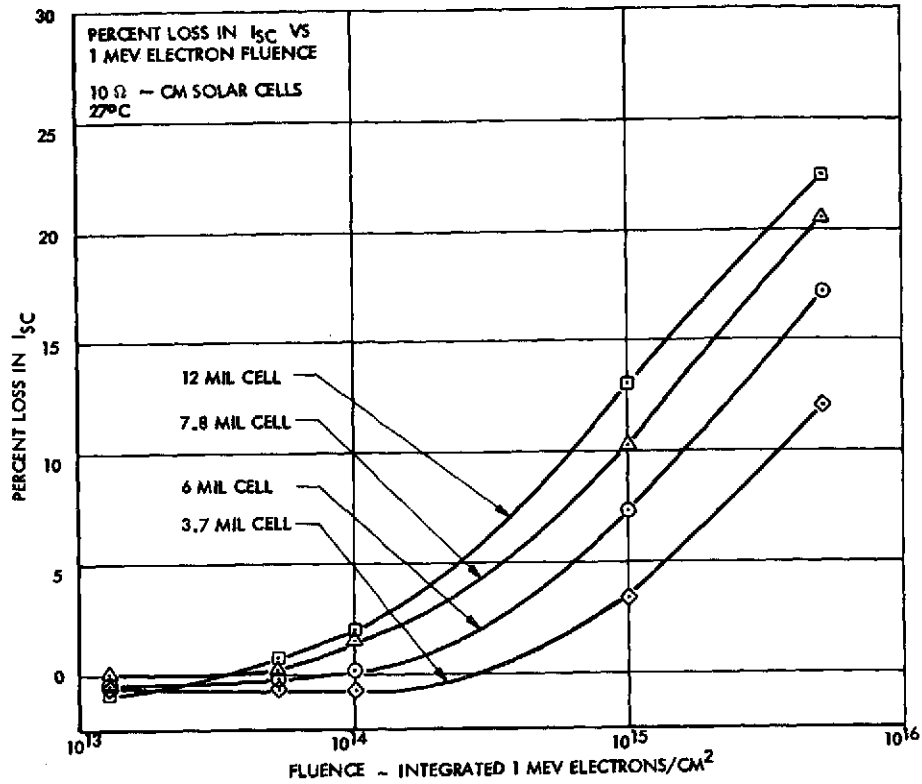

Figure 3.2-12 10  $\Omega$ -cm Degradation Data - % Loss  $I_{sc}$

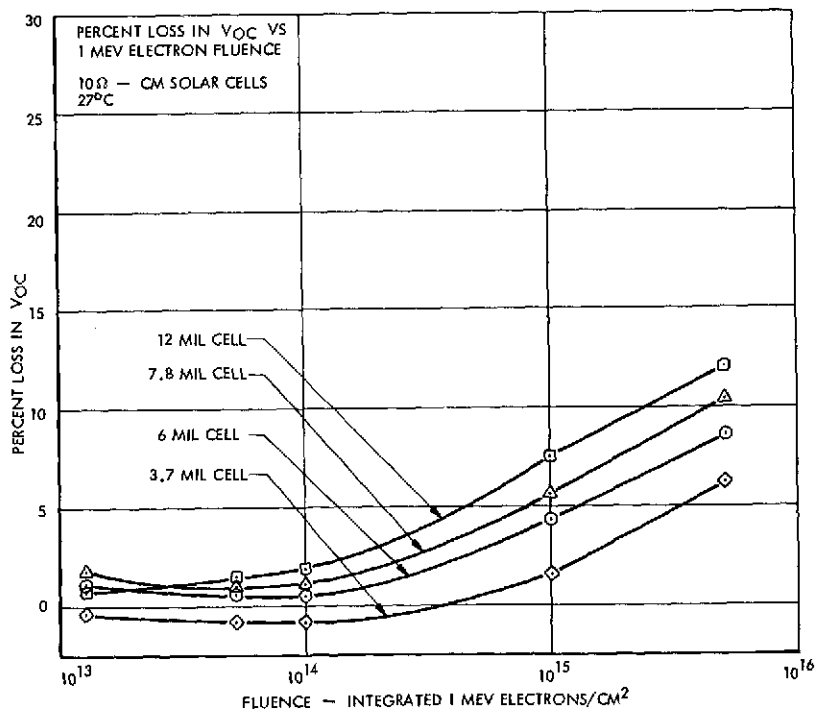

Figure 3.2-13 10  $\Omega$ -cm Degradation Data - % Loss  $V_{oc}$

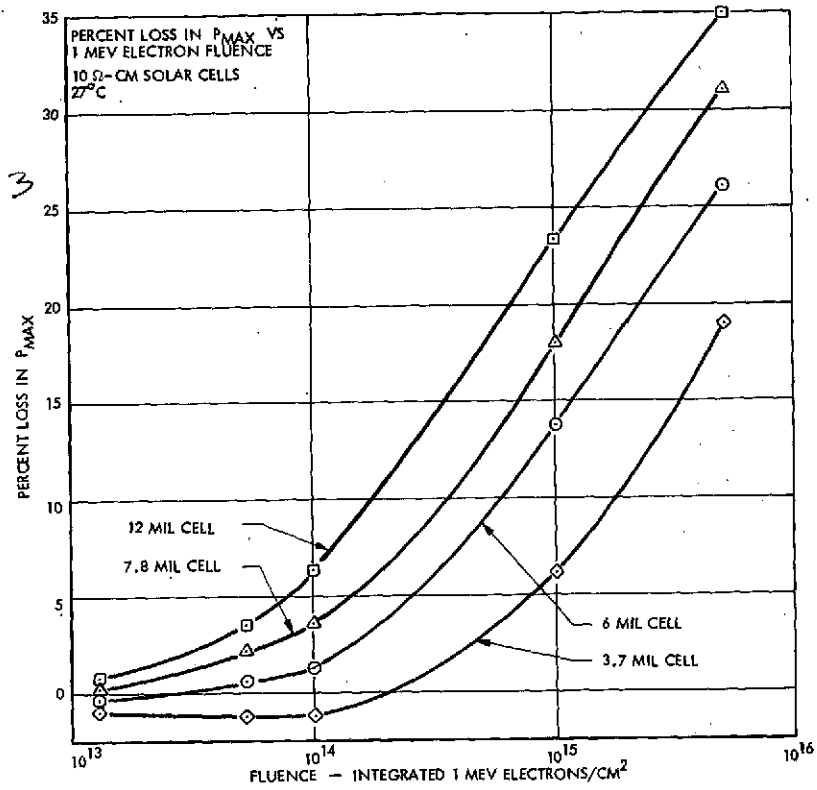

Figure 3.2-14 10  $\Omega$ -cm Degradation Data - % Loss  $P_{max}$

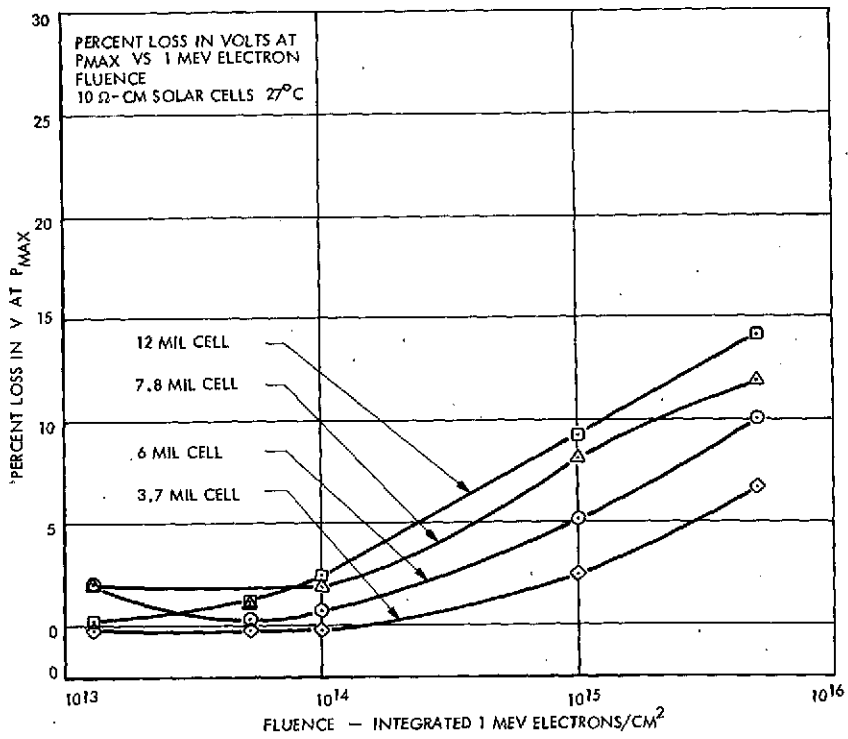

Figure 3.2-15 10  $\Omega$ -cm Degradation Data - % Loss V @  $P_{max}$

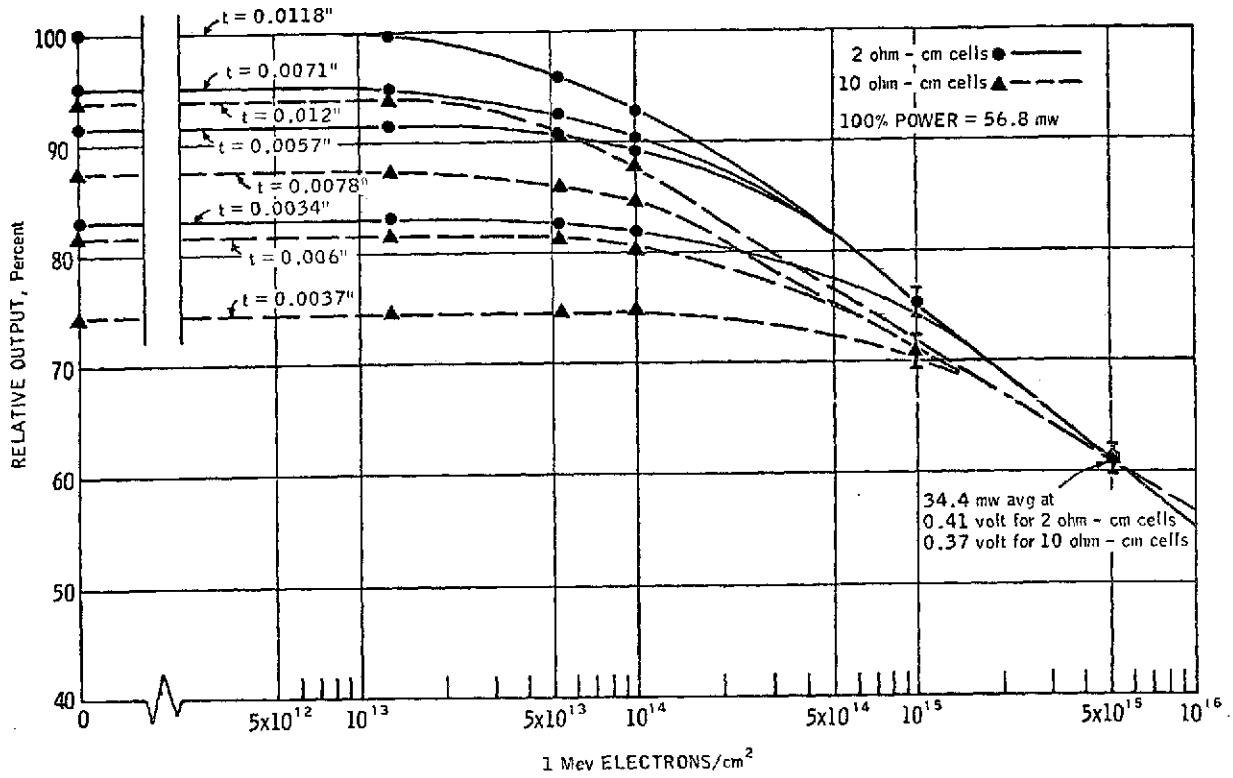

Figure 3.2-16 Maximum Power vs Irradiation of N/P Solar Cells at 27°C

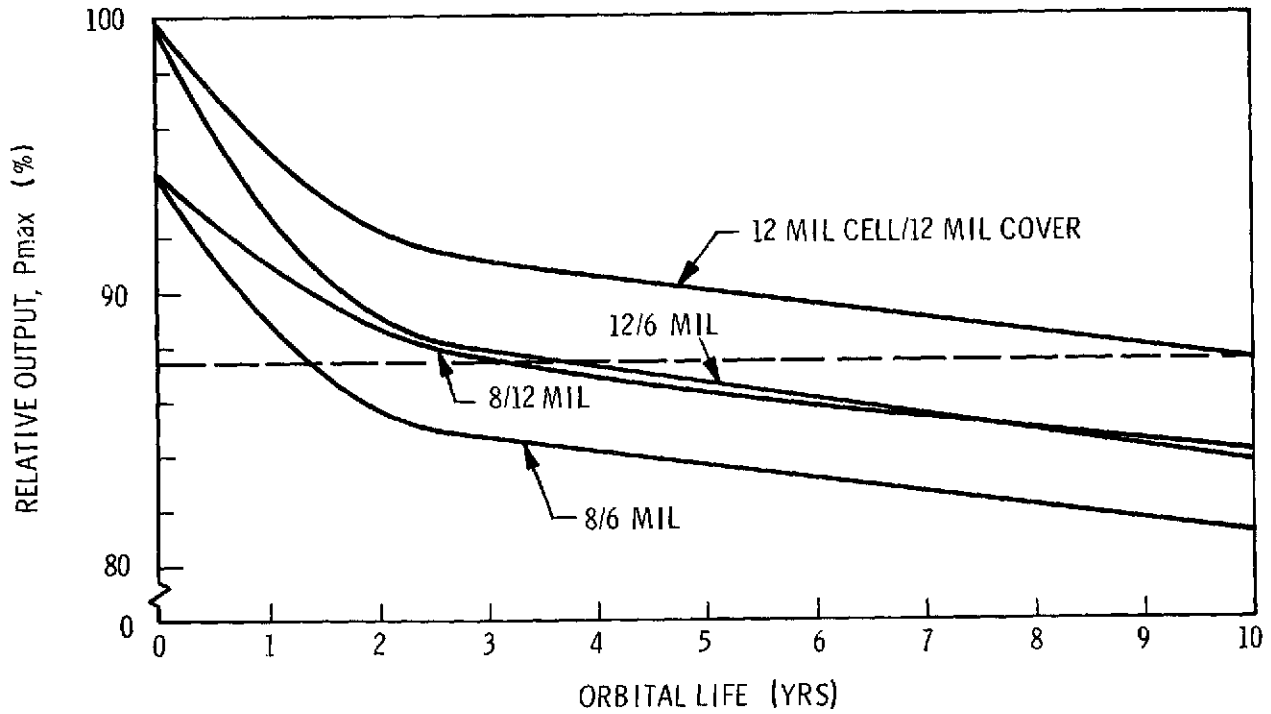

Figure 3.2-17 Relative Power vs Orbital Life

From a curve such as Figure 3.2-17, a final cell/cover combination can be selected by considering the cost, weight, area, breakage requirements, etc. (See specific sections in this report that relate to the basic array components). At the end of the array's 10 year life, then, the percent of power remaining for the selected configuration is the radiation loss factor for Equation (1). For the Space Station, the tradeoffs led to the selection of a 12 mil cell and a 12 mil coverglass. (See Section 3.1 for the effect that the other cell/cover combinations would have on the array system weight and cost). Therefore, the radiation loss factor ( $F_1$ ) is 0.874 after 10 years.

### 3.2.2 Temperature Loss Factor

The variation in the various solar cell parameters as a function of temperature is plotted in Figure 3.2-18 with 30°C as a basis. After a thermal analysis and/or test has been conducted on the solar cell substrate to determine the cell operating temperature, Figure 3.2-18 is consulted to determine the reduction (or increase) in cell parameters. The relative power output corresponding to the determined temperature is the temperature loss factor for Equation (1). Because the maximum cell operating temperature for the space station array is expected to be 80°C, the temperature loss factor ( $F_2$ ) is therefore approximately 0.7. (For certain requirements, it may be desired to use the average cell operating temperature, which would change this loss factor).

Preceding page blank

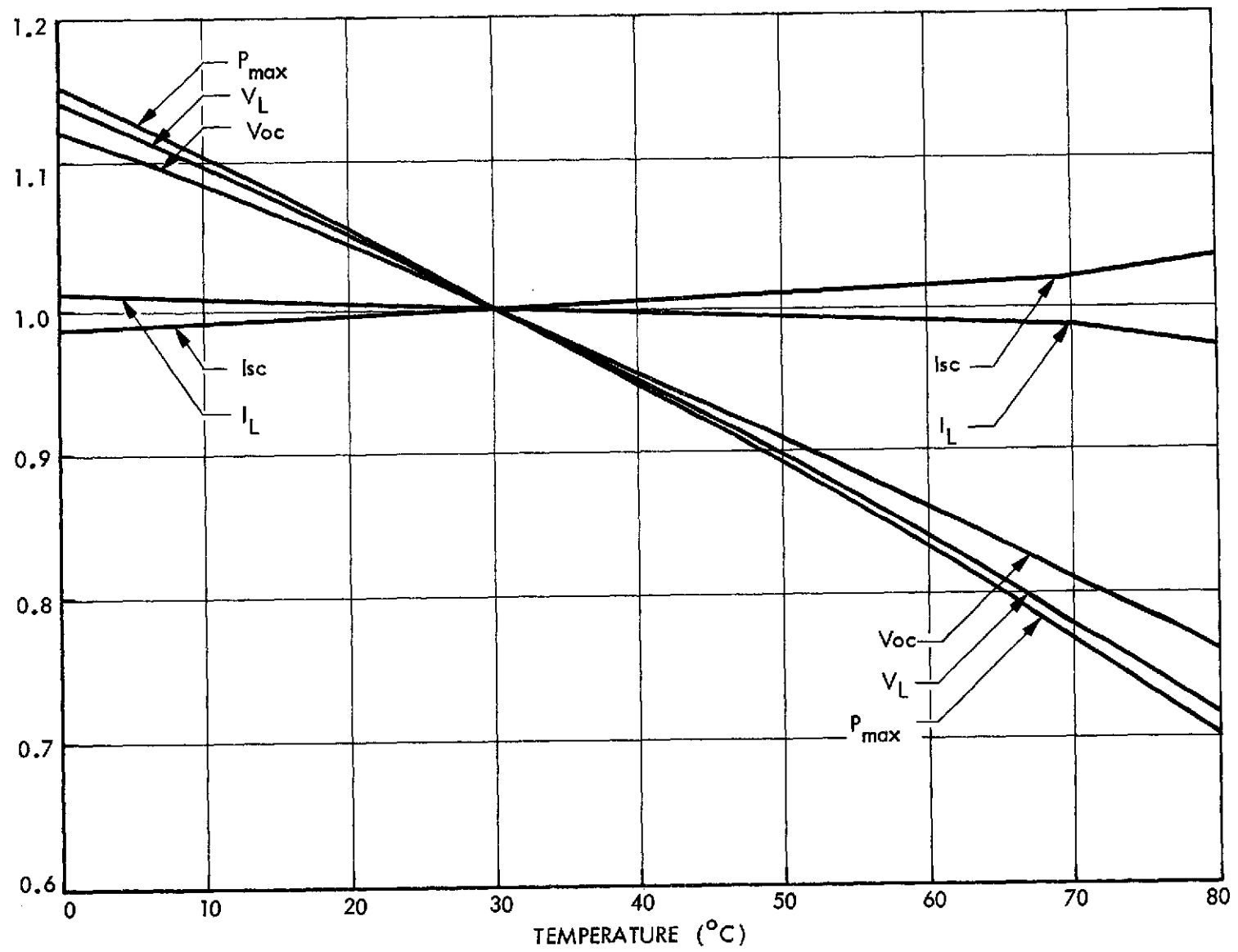

Figure 3.2-18 Variation of Solar Cell Parameters as a Function of Temperature



### 3.2.3 Other Loss Factors

Listed below are the other factors that may contribute to power losses in the array.

<u>Parameter</u>	<u>Loss Expected*</u>	<u>Loss Factor</u>
● Assembly	3%	.97
coverglass transmission		
cell mismatch		
series/parallel		
● Micrometeoroid erosion	Not determined	1.0
● Thermal property degradation	2%	.98
● Aging, UV (SiO <sub>2</sub> , Blue Filter, Coverglass Adhesive)	2%	.98
● Seasonal variation in solar flux energy (from solstice to equinox)	3%	.97

\*These factors are average losses based on LMSC experience

### 3.2.4 Beginning of Life Power

After all of the loss factors have been determined, they are multiplied together and divided into the required end of life power to obtain the needed beginning of life power. For the above example,

$$\prod_{i=1}^n (F_i) = .553$$

$$\text{Therefore, } P_{\text{BOL}} = \frac{P_{\text{EOL}}}{.553} = 1.8 P_{\text{EOL}}$$

Thus, approximately 1.8 times as many cells are needed at beginning of life to cover the degradation that occurs by end of life of the Space Station Solar Array.

With the above determined value, the solar array designer knows what ratio of power must be supplied to cover the internal solar cell losses. The geometric factors and the physical configuration of the array (series/parallel arrangement, number and size of panels, etc.), however, must be determined from considerations of the entire power system.

Preceding page blank

REFERENCES  
(Section 3.2)

1. Centralab Solar Cell Space Manual, 1968.
2. J. H. Martin and E. L. Ralph, "Radiation Damage to Thin Silicon Solar Cells", Proceedings of the 1967 IECEC, August 1967.
3. Second Topical Report, Design and Analysis, Space Station Solar Array Technology Evaluation Program, Appendix B-6, Report No. LMSC-A995715, November 1971.
4. F. S. Johnson, NRL Solar Energy Distribution Curve, Journal of Meteorology, December 1954.
5. D. L. Crowther and W. H. Harless, "Effects of Trapped Radiation on Spacecraft Systems", The Trapped Radiation Handbook, Contract No. DA-49-146-X2-570 to General Electric, Report No. DNA 2524H, December 1971.

### 3.3 THERMODYNAMICS OF FLEXIBLE SOLAR ARRAYS

As seen in Figure 3.2-18 the operating temperature of a solar cell has a pronounced effect on its output. It is therefore critical that a good thermal analysis and/or test be performed on the solar panel in order that worst case temperatures and therefore worst case power levels can be predicted. Tables 3.3-1 and -2 below present some thermal conductivities and optical properties of flexible substrates so that this analysis can be made. Figure 3.3-1 shows the effect of temperature on the total hemispherical emittance of FEP Teflon and fused silica coverglass materials.

TABLE 3.3-1  
THERMAL CONDUCTIVITIES OF FLEXIBLE ARRAY COMPONENTS

COMPONENT	THERMAL CONDUCTIVITY (Btu/Hr-Ft-°F)
Solar Cell/Coverglass	50.
Kapton	.097
FEP	.11
Copper	226.
Aluminum	135.
Silver	242.

TABLE 3.3-2  
 THERMAL PROPERTIES OF LMSC FLEXIBLE SUBSTRATES  
 (Tolerances -  $\alpha \pm .03$ ,  $\epsilon \pm .05$ )

	Front		Back		Back (w/Kapton)*		Other	
	$\epsilon_{IR}$	$\alpha_s$	$\epsilon_{IR}$	$\alpha_s$	$\epsilon_{IR}$	$\alpha_s$	$\epsilon_{IR}$	$\alpha_s$
Centralab 12 mil solar cell, 12 mil fused silica cover, blue filter & AR coating, silicone adhesive diffuse Ag-Ti solderless cell back	.81	.70	.03	.10	.84	.33		
Same as above but no blue filter on coverglass	.81	.80						
Centralab 12 mil solar cell, 5 mil type C FEP cover, thermally bonded	.88	.83						
Heliotek 12 mil solar cell, 12 mil fused silica cover, blue filter & AR coating, silicone adhesive, shiny "orange peeled" appearing Ag-Ti solderless cell back	.81	.74	.03	.10	.84	.33		
Same as above but no blue filter on coverglass	.81	.83						
Heliotek 12 mil solar cell, 6 mil microsheet cover, blue filter & AR coating, silicone adhesive	.82	.78						
SAT (French Mfg.) solar cell with TiO <sub>2</sub> AR cell coating, 12 mil fused silica cover, blue filter & AR coating, RTV 602 cover adhesive, diffuse soldered cell back	.84	.77	.10	.35	.85	.51		
1 mil Kapton, 1/2 mil FEP thermally bonded to opaque copper foil							.80	.45
1 mil Kapton, 1/2 mil FEP thermally bonded to opaque 5 mil Dodge Ind. 368-5 FEP impregnated fiberglass							.88	.70

\*Laminate of 1 mil Kapton, 1 mil FEP, 1 mil Kapton placed over cell back

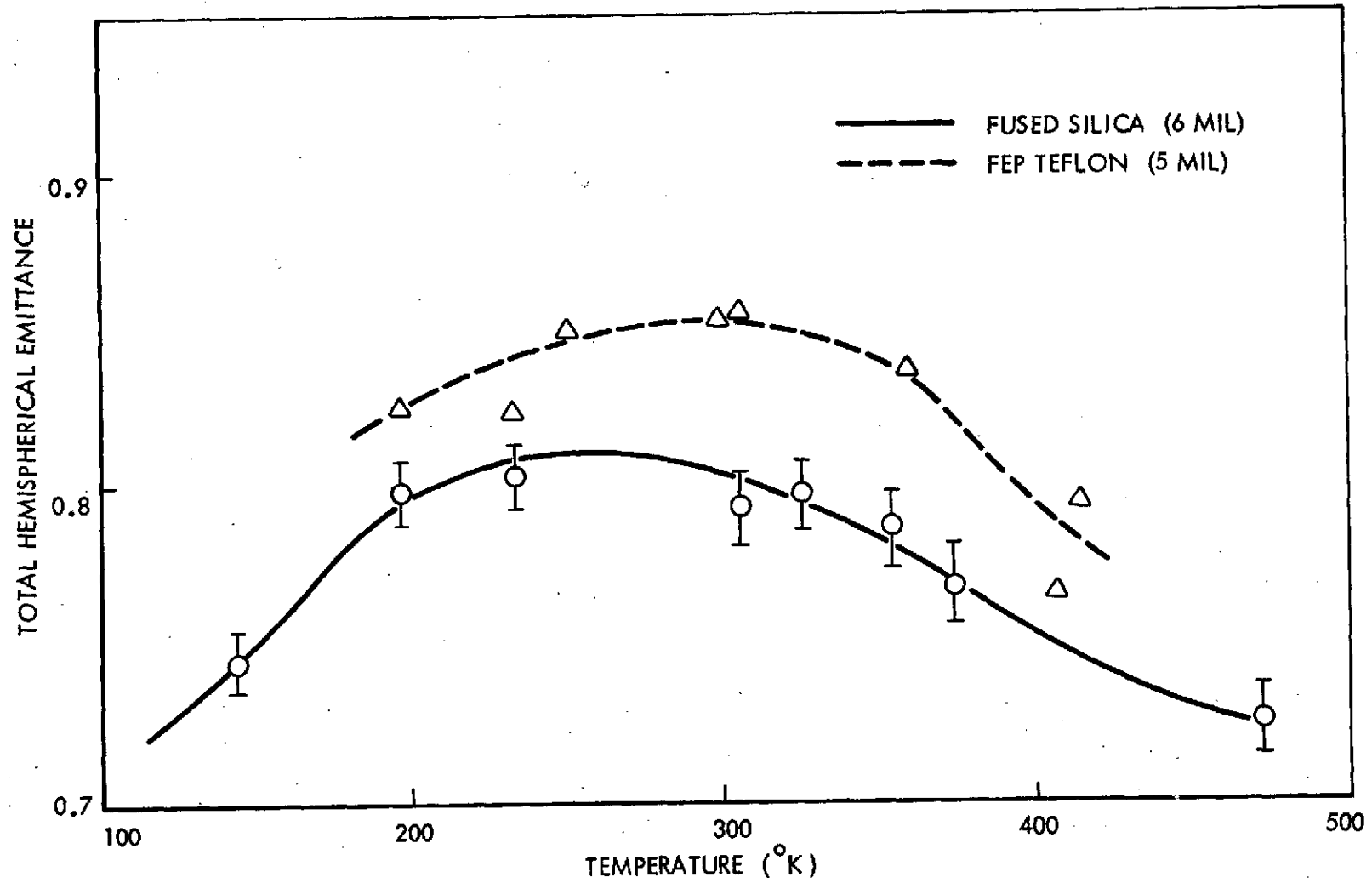

Figure 3.3-1 Total Hemispherical Emittance of FEP Compared with Fused Silica

Although it is beyond the scope of this report to explain how to perform a thermal analysis of a solar array (see Reference 1), Table 3.3-3 was prepared in order to give the designer a feel for what solar cell temperatures to expect on a flexible solar array. Two designs using the printed circuit substrate approach are presented--one with wraparound cells in low earth orbit (Figure 3.3-3), the other with conventional cells in synchronous orbit (Figure 3.3-4). Several design suggestions obtained as a result of the two analyses are as follows:

1. The heat from the solar cell travels through the solder spots and spreads throughout the substrate via the circuit. The heat is then conducted through the thin layer of Kapton directly over the circuit and then is radiated to space. Therefore, it is advantageous to make the circuit as large as possible.
2. If the area of the electrical connection is made very small, e.g., if ultrasonic bonding is used instead of soldering, there will be very little, if any, effect on the cell operating temperature. (In the thermal analysis of Reference 1, typical thermal resistances of the substrate were of the order of 100,000. Resistances of the solder spots were of the order of 50 - magnitudes less. Therefore, these resistances could be essentially neglected and the assumption could be made that the electrical contact nodes were heat sources at constant temperature. Thus, even if this spot were decreased in size by a factor of 100, the resistance would be raised to the order of only 5000--still orders of magnitude less than that of the substrate. As a result, it would still be a good approximation to assume the smaller contacts as heat sources at constant temperature and little if any effect would be seen in the cell operating temperature. In addition, if considerations of actual conduction area reduction, actual conduction length reduction, and actual increases in thermal conductivities of interconnect metals over solder, it will be found that the small area welding situation is as good as, if not better than, the large area soldering situation.

3. The amount of heat that can be radiated from the backside of the array is proportional to the average temperature of the substrate. Therefore, the circuit pattern should be spread out as uniformly as possible, leaving no relatively large (cold) areas of Kapton.
4. To prevent the absorptance at albedo and earthshine and also allow maximum radiation of heat from the cell back to space, the optical property magnitudes shown in Figure 3.3-2 of the substrate and cell back are suggested. A low  $\alpha$  cell back and a high  $\tau$  substrate have the most effect on the elimination of the "greenhouse effect" in flexible solar arrays.

TABLE 3.3-3  
COMPARISON OF CALCULATED STEADY STATE  
TEMPERATURES OF FLEXIBLE ARRAYS IN ORBIT

LOW EARTH ORBIT (270 nm, $\beta = 0^\circ$ )		SYNCHRONOUS ORBIT (22,000 nm)	
DESIGN	MAX CELL TEMP	DESIGN	MAX CELL TEMP
LSSSA Design (33% copper by area) (See Figure 3.3-3)	175 <sup>o</sup> F	LCS Design (30% copper by area) (See Figure 3.3-4)	135 <sup>o</sup> F
LSSSA Design but 100% copper by area	160 <sup>o</sup> F	LCS Design but 100% copper by area	121 <sup>o</sup> F
Flat Plate Conduction Model - $0^\circ$ $\Delta T$ through substrate, LSSSA Thermal Properties	154 <sup>o</sup> F	Flat Plate Conduction Model - $0^\circ$ $\Delta T$ through substrate, LCS Thermal Properties	117 <sup>o</sup> F
Radiation Model - LSSSA Design but no conduction through solder spots (substrate separated from cells)	211 <sup>o</sup> F	Radiation Model - LCS Design but no conduction through solder spots or tabs (substrate separated from cells)	200 <sup>o</sup> F



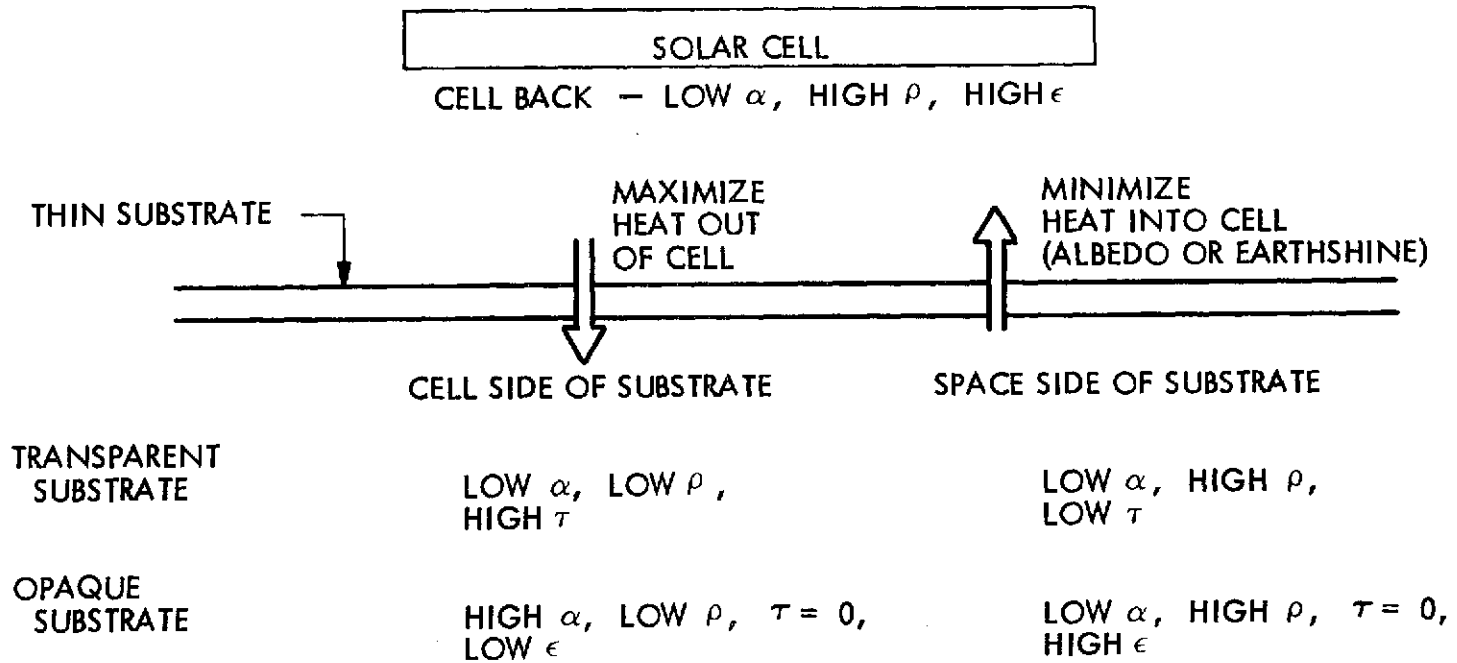

Figure 3.3-2 Backside Thermal Property Magnitudes to Minimize Cell Temperature

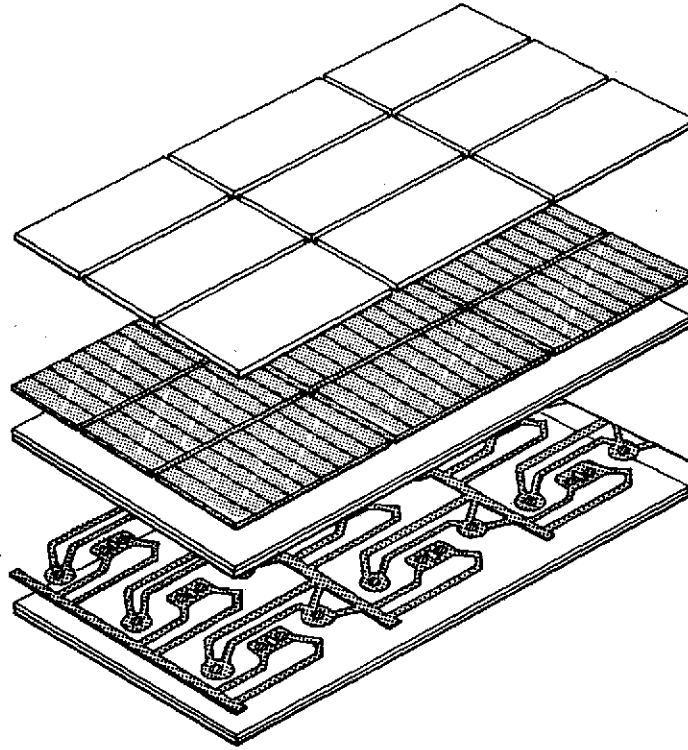

Figure 3.3-3 Space Station Solar Array Substrate Design (Wraparound Cells)

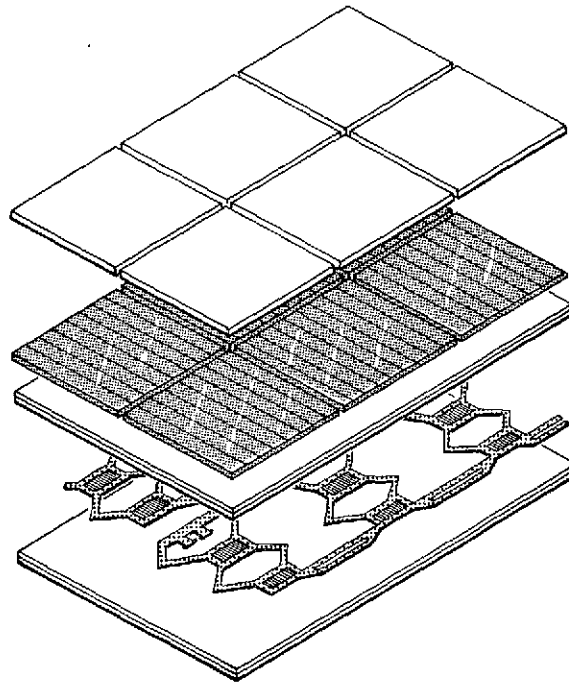

Figure 3.3-4 Lockheed Communications Satellite Substrate Design (Conventional Cells)

REFERENCES  
(Section 3.3)

1. Second Topical Report, Design and Analysis, Space Station Solar Array Technology Evaluation Program, Appendix B1, Report No. LMSC-A995719, November 1971.
2. S. A. Greenberg, et al, Investigation of FEP Teflon as a Cover for Silicon Solar Cells, Report No. NASA CR-72970, LMSC-D243070, August 1971.

### 3.4 CAUSES AND EFFECTS OF HOT SPOTS

In the 1969 IECEC (Intersociety Energy Conversion Engineering Conference), F. A. Blake and K. L. Hansen of General Electric reported a phenomenon that they "discovered" while studying the problems associated with high voltage solar cell systems. (See Reference 1). In general, the phenomenon, labeled as the "Hot Spot" failure mode, causes very localized heating in solar cell arrays and produces, among other things, high temperatures in the affected area. In contrast to the historic study of gross shadowing effects which should ideally cause power losses nearly proportional to the area of the shadow, the Hansen/Blake paper pointed out that solar array designers should also study the effects that "small" shadows, edges of large shadows, or open circuits have on the remaining unaffected cells, i. e., determine the magnitude of the "Hot Spot" effect on these remaining cells. As stated in the paper,

"The sequence of events in the occurrence of a "Hot Spot" is:

1. An anomaly which affects the current output of one or more cells occurs in a series element in a solar array string. The anomaly can be the result of cell failure, interconnect failure, or partial shadowing. Note that not all of the cells in the series element are affected.
2. The operating point on the I-V characteristic curve shifts for all of the series elements in the string, with the troubled element being driven into the negative voltage region and the normal elements moving to higher positive voltage operating points. The summation of the higher voltages compensates for the reversed voltage across the troubled element and allows the total voltage across the string to remain essentially constant.
3. The anomalous element dissipates part of the power produced by the remaining normal elements with which it is in series. The dissipation is proportional to the current transmitted and the voltage drop.

4. The temperature of the current carrying cells in the dissipating element rises. Under some conditions of cell layout, array temperature, and array construction, the temperature may reach or exceed the solder melt point.

5. If the solder melt temperature is reached, the opening of additional cell interconnections increases the power dissipation per cell and the failure progresses until the entire circuit is failed open."

Since this paper was presented, the "Hot Spot" failure mode has been the subject of much conversation and consideration by solar array designers. The most comprehensive, subsequent study of the phenomenon to date was performed on the Skylab-Orbital Workshop solar panels under the presence of shadows from the ATM solar panels. Preliminarily studied by Jim Miller of NASA-MSFC (see Reference 2) and then fully analyzed by TRW (see Reference 3), this mission analysis has produced an example of methods and techniques that should be used in the determination of solar panel design from considerations of failures induced by shadows and open circuits. However, as is the case with most mission-specific analyses, the problem at hand took precedence over the generalized problem. The purpose of this section, then, is to summarize in one place the causes and effects of, and the design considerations related to, the "Hot Spot" phenomenon so that the problem can be addressed for other missions with different boundary conditions.

### 3.4.1 Causes of Hot Spots

There are three main causes of "Hot Spots":

1. Shadows - The most immediate and direct cause of "Hot Spots" if the vehicle shades the solar panels. The shadows can be either hard (umbra) or soft (penumbra) shadows depending on the size of the obstacle as well as the solar panel-to-obstacle distance.
2. Open Circuits - In a well-designed array, these should not occur in appreciable numbers even for very long missions.
3. Cell Mismatch - A general term denoting anything that causes non-uniform I-V output between cells, especially between cells within a parallel sub-module. (This cause can be virtually eliminated through good design and manufacturing practices). It can result from: a) Selecting poorly matched cells to begin with, b) Non-uniform cell temperatures, c) Non-uniform degradation, d) Non-uniform contamination causing Isc losses and non-uniform temperatures, e) Broken or cracked cells, f) Non-uniform circuit impedance resulting from cold solder joints, relatively small conductance area through joint (thermal cycling damage), etc.

### 3.4.2 Effects of Hot Spots

The three causes of "Hot Spots" all result in a reverse voltage bias being imposed on the remaining operational cells. This is because of the failure of one or more cells to pass as much current as the remaining operational cells in the same paralleled submodule. The non-failed portion of the array is forced to operate at the maximum current capability of the operative cells of the failed submodule. See Figure 3.4-1.

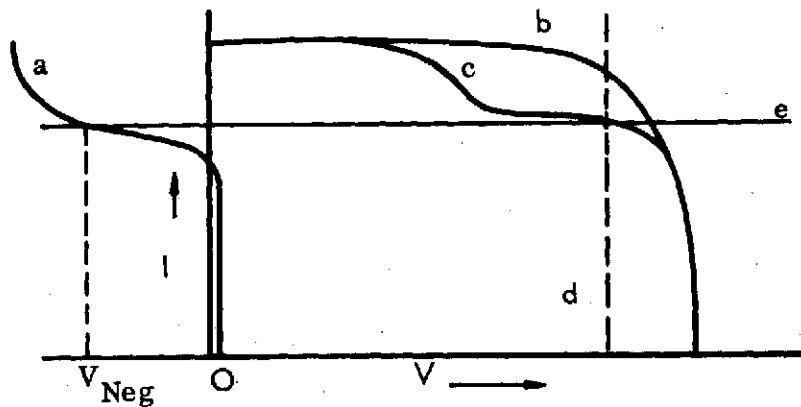

- a. Represents the I-V characteristics of the affected submodule
- b. Represents the I-V characteristics of the non-failed portion of the solar array
- c. Represents the summary of solar arrays a and b and the I-V characteristics of the composite system
- d. The dashed line represents the system operating voltage
- e. The solid line represents the level of current limiting by the failed portion of the array

Figure 3.4-1 Shadowing Effects

Preceding page blank

The operational cells in the failed submodule must dissipate power equal to the product of the current passed (line e) and the impressed negative voltage ( $V_{NEG}$ ) as determined by the system operating voltage (line d). The sum effect of a shadow, open circuit or cell mismatch is, therefore, any one or all of the following:

1. Loss in array power
2. Cell breakdown causing shorts (because of too high a reverse voltage being imposed on the cells)
3. Local heating severe enough to cause:
  - a) Solder melting (open circuits)
  - b) High thermal stress
  - c) Limited thermal cycling fatigue life
  - d) Other high temperature-induced damage to the solar panel

It should be stressed that the magnitude of the "Hot Spot" effect is directly related to the reverse voltage characteristics of the panel solar cells. These characteristics received no control at the vendors. Obviously, this makes the problem that much harder. If shadowing and open circuits are expected to be a serious problem, the cells received for production use must be thoroughly characterized in the reverse region.



### 3.4.3 Design Considerations of "Hot Spots"

The design variables that are significant and that must be considered when designing solar panels to reduce or eliminate "Hot Spot" failures are presented in Table 3.4-1. With the increasing complexity and longer life requirements of present day space vehicles, it is a very real problem that shadows and/or open circuits could exist or develop. The following design considerations should be carefully weighed in conjunction with the other system tradeoffs.

TABLE 3.4-1  
"HOT SPOT" DESIGN CONSIDERATIONS

PARAMETER	REMARKS
I-V Characteristics of Array Solar Cells in the Reverse Voltage Region	Ideally, cells should break down where the impressed cell voltage becomes negative, causing a system I-V characteristic that is simply one series element less than the no-fault I-V characteristic and a power to be dissipated of zero. However, because this is not in actuality possible, a tradeoff must be made between the existing breakdown voltage and the effect that this breakdown voltage has on the magnitude of the power that must be dissipated. See Figure 3.4-1.
Magnitude of Results That Shadows and Open Circuits Have on System I-V Characteristics	The theoretical open circuit or shadow is much worse than actual case. Thus, non faulted cells can be driven to a higher current than they can generate, allowing higher current plateaus, resulting in lower reverse voltage as given in Figure 3.4-1. In addition, Figure 3.4-2 shows the relative differences in effect of a shadow as opposed to an open circuit on the system I-V characteristics.

TABLE 3.4-1 (Cont.)

PARAMETER	REMARKS
Magnitude and Range of Power System Operating Voltage	Power dissipation is directly related to the reverse voltage experienced by the module and the circuit operational voltage of the power system. Thus, not only the magnitude but also the range of the power system voltage should be minimized.
Operating Temperature of Solar Cells	See Figure 3.4-3. Power to be dissipated is reduced as the cell operating temperature is increased.
BOL/EOL Characteristics of Solar Panel	Similar to cell operating temperature effect. Power to be dissipated is reduced as the integrated radiation damage increases, i. e., as EOL is approached.
Dynamics of Shadow Travel	Solar cells require from a few seconds to several minutes to develop shorts if operating under reverse bias conditions. Both an increase in electrical stress duration and repetitive application of stress can cause cell failures.
Number of Cells in Parallel	The greater the number of cells in parallel (except for one) the less is the power that has to be dissipated per cell, i. e., in Figure 3.4-1, plateau e would relatively move up and thus effectively reduce $V_{NEG}$ . If there is only one cell in parallel, a shadow or open circuit "shuts off" the series string and thus reduces the power to be dissipated to zero.
Number of Cells Experiencing a Fault	"Hot Spot" effect is most severe when the fault is confined to a single series element. Additional faults in other elements in the same series circuit reduces the heating per cell.
Circuit Design	The "Hot Spot"-related purpose of idealized circuit design is to eliminate open circuits by providing redundancy in, and eliminating all stresses in, all electrical contact joints. Good circuit design should approach this ideal.

TABLE 3.4-1 (Cont.)

PARAMETER	REMARKS
Fabrication Techniques	Good fabrication techniques will minimize cell mismatch and unbonded cell contact joints.
On Array Electronics	For the penalty of weight, cost and voltage drops, diodes may be used to protect the solar panel from shadows, open circuits and gross cell mismatches. (See Section 3.5).
Reliability	Probabilistic magnitudes of open circuits, cell breakdown voltages, etc. must be made to fully determine the number of cells failed, their positions and the consequences thereof (See Reference 3).
Shadows	<p>1) If possible, shadows should be eliminated or minimized by eliminating or reducing the cause, moving the solar panels, and/or investigating the probability of a single cell or several cells in parallel being shaded.</p> <p>2) Angle of incidence and penumbra width do not have a significant effect on the highest single cell reverse voltage. However, the highest single cell power dissipation does significantly decrease with an increase in these parameters.</p> <p>3) Figure 3.4-4 shows a parametric shadowing test on a production solar panel.</p>

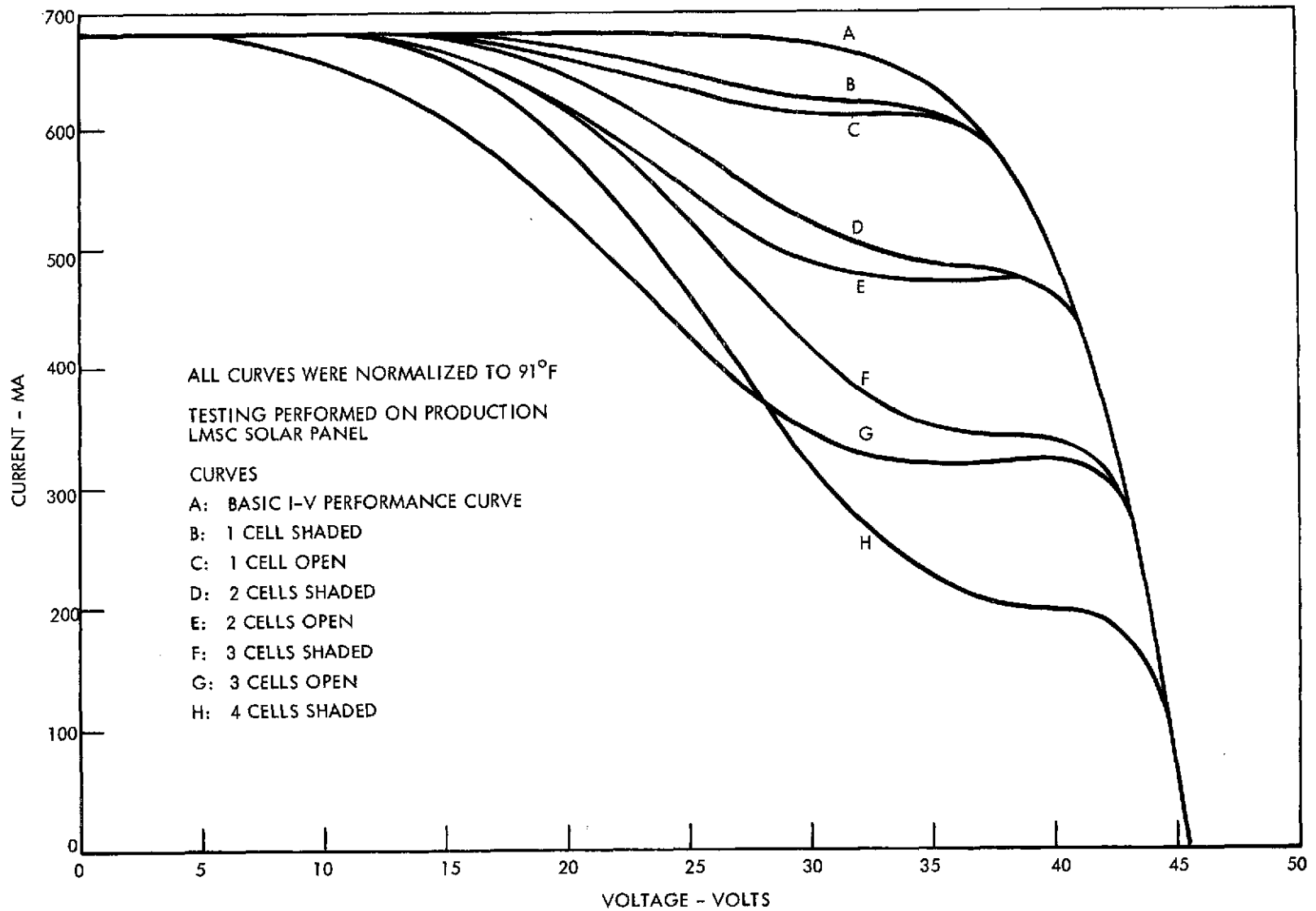

Figure 3.4-2 Effect of Shaded or Open Circuit Solar Cells on Cell Module Performance

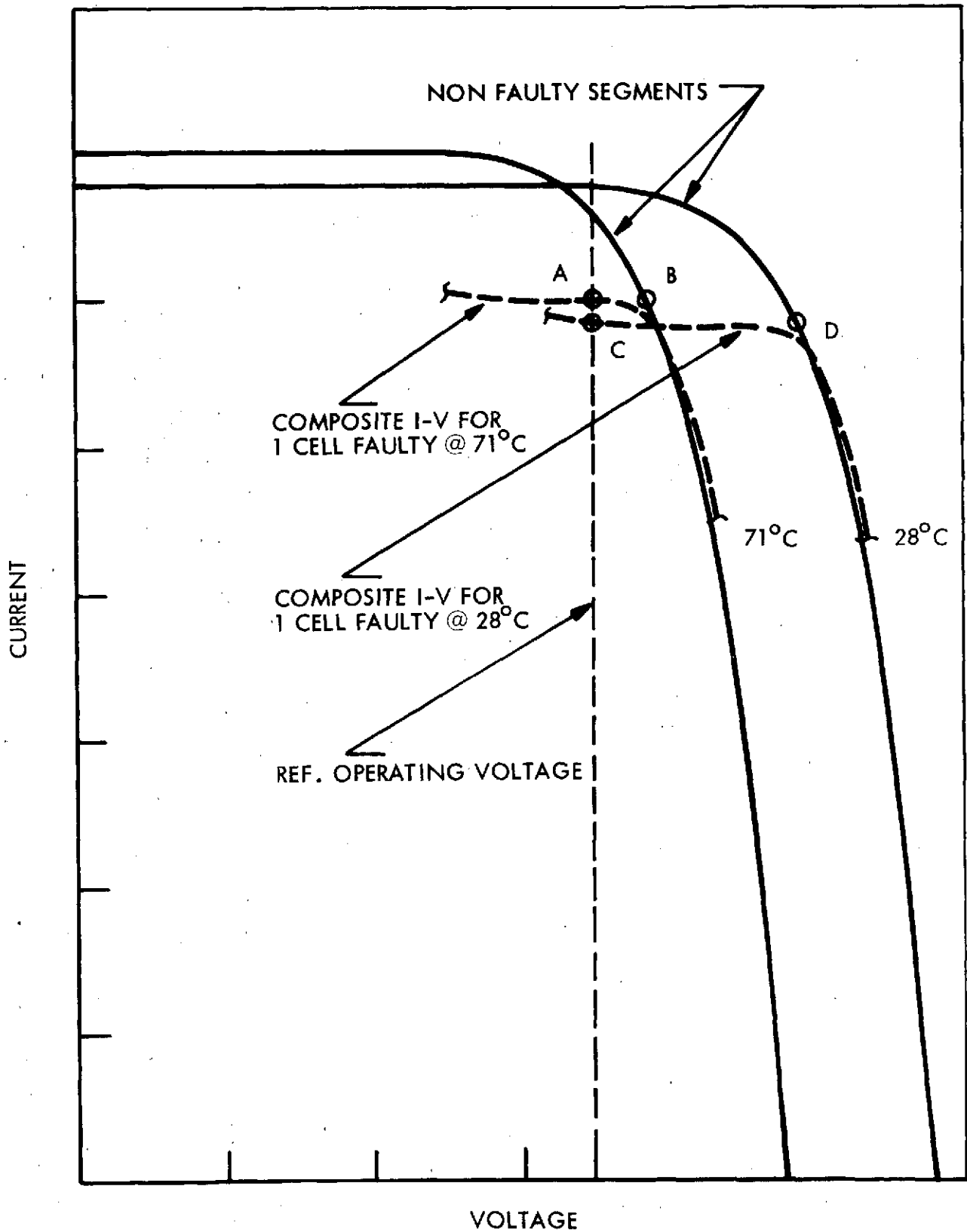

Figure 3.4-3 Temperature Effect on Power Dissipation Where One Cell is Faulty Out of Seven

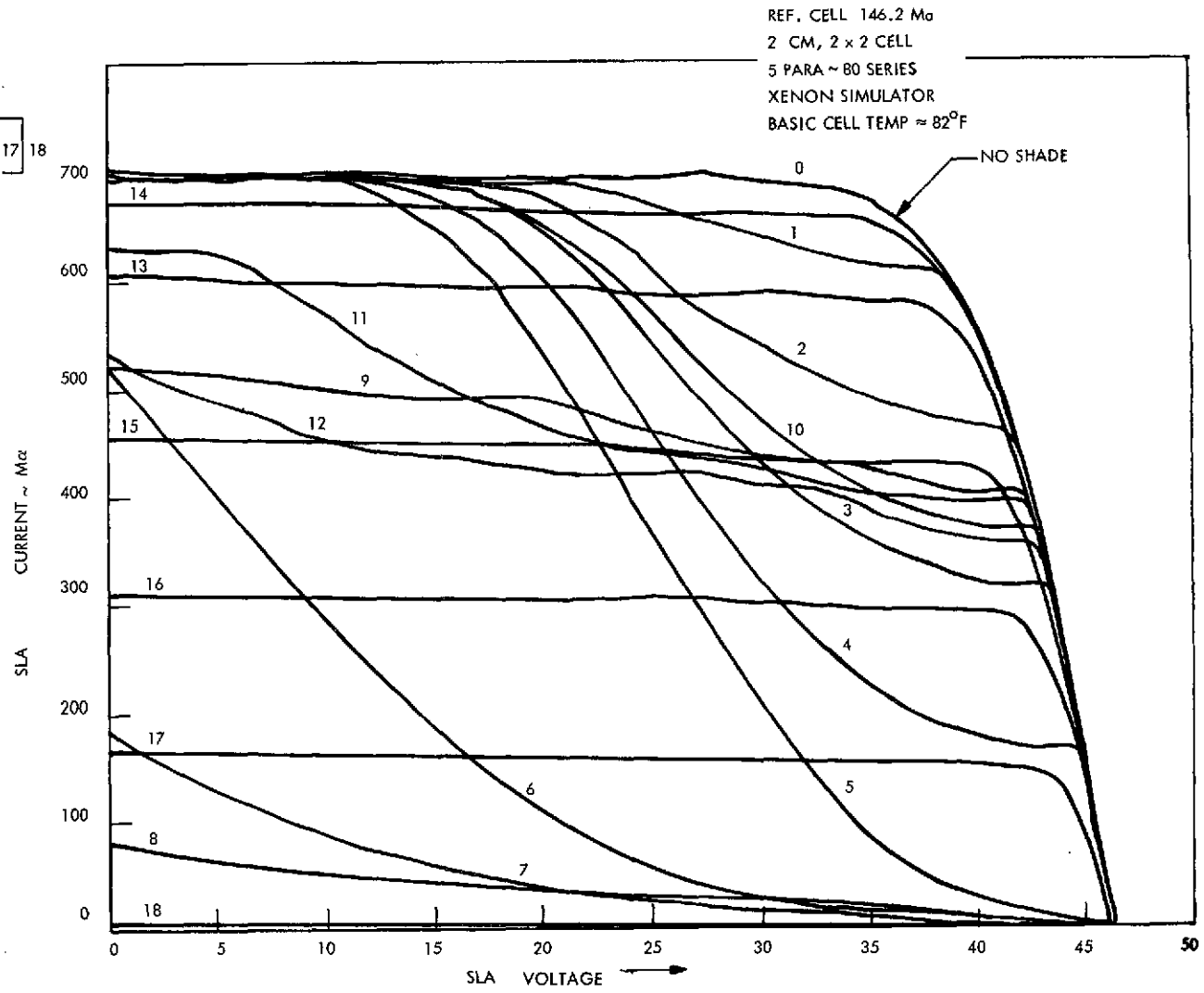
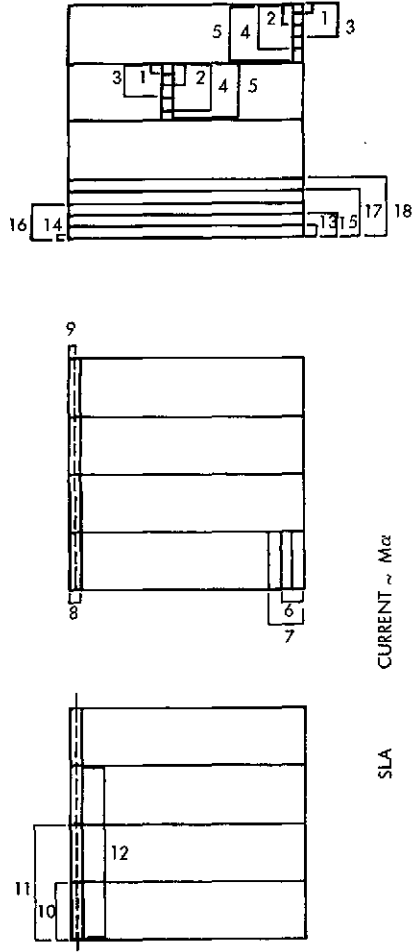

Figure 3.4-4 Shading Effects on a Typical LMSC Solar Panel

REFERENCES  
(Section 3.4)

1. F. A. Blake and K. L. Hansen, "The "Hot Spot" Failure Mode for Solar Arrays", 1969 IECEC Proceedings, Paper Number 699070
2. J. L. Miller, "Analysis of Effects of Shadowed and Open Solar Cells on OWS Solar Cell Array Performance", Research Achievements Review, Vol IV, Report No. 4 NASA TMX-64642, February 1972
3. H. Riess and H. S. Rauschenbach, Skylab-Orbital Workshop SAS Z-Local Vertical Study, Volumes I and II, report no. SAS 4-3117, November 1971.
4. J. W. Fairbanks et al, "Solar Array Shadowing Analysis and Design Accommodation", 1968 IEEE Photovoltaic Specialist Conference (Seventh) Proceedings
5. Second Topical Report, Design and Analysis, Space Station Solar Array Technology Program, Appendix B7, Report No. LMSC-A995719, November 1971.
6. H. S. Rauschenbach, "Electrical Output of Shadowed Solar Arrays", Proceedings of the Photovoltaic Specialist Conference (7th), November 1968.
7. W. R. Baron and P. F. Virobik, "Solar Array Shading and a Method of Reducing the Associated Power Loss, " Proceedings of the Photovoltaic Specialists Conference (4th), August 1964.

### 3.5 ON-ARRAY ELECTRONICS

On-array electronics are defined as electronic devices mounted on or near the solar array substrate for the purpose of conditioning solar cell power at the source. This definition is as opposed to the conventional approach in which all power conditioning/battery control electronics are located on the vehicle. There are several advantages of controlling the solar cells at the array level: (1) voltage and current control can become more versatile by switching in or out specified electronic sections depending on system demand, (2) there is increased reliability of modular power conditioning as opposed to large, centrally located power conditioning units, (3) failed portions of the array can be by-passed without their causing damage to other portions of the array, (see Section 3.4), and (4) excessive heat generation can be dissipated at the source by direct radiation rather than by adding to the vehicle heat load.

Basically, there are three devices, all diodes, that are used in conjunction with on-array controls: blocking/isolation diodes, bypass diodes, and zener diodes. The first, the blocking/isolation diode, prevents batteries from feeding solar panels during the eclipse and panels from feeding panels if a difference in output exists between the panels due to some deficiency (shadowing, open circuits, shorts, etc.). Although these diodes have received extensive use in the industry, there is the potential that they can be eliminated if the reverse bias characteristics of the solar cells themselves are relied upon to prevent reverse flow of current. The second type of diode, the bypass diode, is used most frequently (if only recently) for the protection against shadowing failures (see Section 3.4). These diodes may be either conventional (discrete) diodes or integral (monolithic) diodes. Although lacking in flight experience, integral diodes, because they are an integral part of each solar cell, could provide the ultimate in protection against shadowing if power dissipation capabilities could be brought up. The commonly used conventional diodes are capable of providing the same protection but, because of their size and associated assembly problems, are at best placed across individual submodules but usually placed across entire modules or panels. The third type of diode, the zener diode, is generally needed only in the early portion of a mission to limit what would be higher than desired voltages (caused by the design of the panel to EOL I-V characteristics). They also have received only limited flight experience.

Preceding page blank



Although the use of on-array electronics has to date been limited, it will most definitely increase in the future. For very long missions, serious consideration should be given to bypass diodes to protect against open circuit-caused "Hot Spot" failures. In addition, as vehicle requirements become more complex, the solar array size must increase to provide the power. Further thought, then, should be given to zener diodes for voltage limiting functions- they could be advantageous from a reliability standpoint in that they are a light weight, passive system at an ideal location to dissipate heat. As an aid in these diode selection decisions, Table 3.5-1 should be consulted. In it are presented all of the important on-array electronics design considerations that should be traded off in order that maximum levels of confidence may be assured for the final solar array design.

TABLE 3.5-1  
ON-ARRAY ELECTRONICS DESIGN CONSIDERATIONS

PARAMETER	REMARKS
Device Temperature	No operation data below $-55^{\circ}\text{C}$ for conventional diodes nor below $-20^{\circ}\text{C}$ for integral diodes. Thus, design problems of voltage control at eclipse exit. Also, zeners exhibit voltage variations with changing temperatures.
Radiation Environment	Diodes, like solar cells, must be protected from damaging radiation to prevent permanent damage.
Power Conditioning Requirements	Definition must be made as to the desired function, e. g. , voltage regulation, current regulation, or allocation of separately regulated sections of array to specific loads.
Power Handling Capability	There is a limit to power handling capability of all diodes, especially integral diodes.
Failure Protection of Solar Cells	Tradeoffs of "Hot Spot"-caused losses of mission performance vs cost, weight, reliability, etc. , should be made for an array both with and without diodes.

TABLE 3.5-1 (Cont.)

PARAMETER	REMARKS
Reliability Effects of On-Array Electronics	More complexity (e. g., addition of on-array electronics) will reduce system reliability.
Thermal Cycling	Most basic flaw in using diodes is their high failure rate when thermal cycled. Problem may be alleviated by use of integral diodes which impose a limit of complexity equivalent to the solar cells themselves.
Heat Dissipation	<p>Select microelectronic devices for minimum heat dissipation.</p> <p>Provide heat sink radiation areas.</p> <p>Use shielding materials (mirrors) against the sun</p>
Size Limitations	Thickness of diodes may be as much as .25" because of base and radiation protection requirements. Determine effect on packaging of array.
Manufacture and Assembly	For conventional diodes, consider selection of materials—radiation shield, semiconductor substrate, heat sink material, overlay mirror—and their effect on manufacture and assembly
Cost	<p>Development of electronic packages</p> <p>Selection and evaluation of load switches</p> <p>Preparation of software</p> <p>Development of control linkage</p>
Results of Analyses and Tests	<p>The following are based on conclusions of references at end of this section</p> <p>Power conditioning should be limited to pure voltage regulation</p> <p>Voltage transients pose an important voltage regulation problem</p> <p>Voltage references should be located on board the vehicle</p> <p>Protective circuits and device requirements can be satisfied with present technology</p> <p>Performance loss of solar array using on-array electronics is of a magnitude of 5%</p>

REFERENCES  
(Section 3.5)

1. T. Ebersole, et al, Study of High Voltage Solar Array Configurations with Integrated Power Control Electronics, General Electric, NASA CR 72725, GE No. 70504256, June 1970.
2. B. G. Herron, et al, High Voltage Solar Array Configuration Study, Hughes Aircraft Co., NASA CR 72724, July 1970.
3. W. F. Springgate, et al, High Voltage Solar Array Electrical Configuration Study, The Boeing Company, NASA CR 72723, Boeing No. D180-10037-1, April 1970.
4. R. M. Diamond and E. D. Steele, "Solar Array with Integral Diodes", Proceedings of the International Colloquium on Solar Cells, Toulouse, France, July 1970.
5. R. M. Diamond, "Advanced Developments of Integral Diodes", Proceedings of the 9th Photovoltaic Specialists Conference, May 1972.
6. First Topical Report, Space Station Solar Array Technology Evaluation Program, Section 4.1.3.9, Report No. LMSC-A981486, December 1970.

## 3.6 DYNAMICS OF FLEXIBLE SOLAR ARRAYS

Table 3.6-1 below lists all of the significant steps that should be followed for a dynamic analysis of a flexible solar array. For each specific requirement, there is given a method of resolution. Any data that may be needed is indicated. Note that requirements for both a preliminary as well as a final design dynamic analysis are presented.

TABLE 3.6-1  
DYNAMIC ANALYSIS CONSIDERATIONS OF A FLEXIBLE SOLAR ARRAY

REQUIREMENT	METHOD OF RESOLUTION	DATA REQUIRED
<u>Preliminary Design</u>		
- Determine most efficient structure which does not violate other non-structural constraints	- Review previous designs, their analysis, tests, and test results	none
- Satisfy natural fundamental frequency constraints	- Perform parametric studies to determine variations in system weight, bending and torsional frequencies, array pretension requirements, boom loads, boom tip deflections, etc., with variations in boom properties, blanket configuration, blanket aspect ratio, and array length	none
- Investigate response of array to inner and outer gimbal torques	- Determine system response, in functional mode, to various actuating torque time histories	none
- Investigate external loads such as docking, attitude control, spinup, etc.	- Determine maximum permissible acceleration and array structure static capability	- Fundamental natural frequency and generalized mass

TABLE 3.6-1 (Cont.)

REQUIREMENT	METHOD OF RESOLUTION	DATA REQUIRED
<u>Final Design</u>		
- Ascent loads (array stowed)		
- Response to low frequency transients due to ignition, burn-out, staging, aerodynamics, etc.	Dynamic model of array  Modal Properties  Response to base transient acceleration or incorporation in dynamic model of complete vehicle and calculation of response to specific engine or aerodynamic excitation	Array mass, stiffness and geometric properties  Time history of transient accelerations at location of array in vehicle,  or  Dynamic model of vehicle & transient excitation forces.
- Acoustic environment	Acoustic test to specified acoustic spectrum	Acoustic spectrum at array location in vehicle
- Pyrotechnic shock environment	Review design for possible areas sensitive to pyro-shock and specify suitable tests based on past experience and pyro shock data	none
- Orbit Condition (Array deployed)		
- Array deployment loads	Straightforward rigid body dynamic analysis of deployment event	Mass and geometric and kinematic properties
- Blanket pretensions, boom loads, boom deflections during artificial g	Use data derived in preliminary analysis	Boom stiffness properties, and "slop" if any.
- Assurance that array will not be subject to aerodynamic flutter or divergence	Derive valid method for flutter analysis when mean free molecular path is several feet	Array mass & stiffness properties. Orbital altitude. Orbital velocity.

TABLE 3.6-1 (Cont.)

REQUIREMENT	METHOD OF RESOLUTION	DATA REQUIRED
- Aerodynamic drag loads on array	$1/2 \cdot \rho V^2 \cdot S C_d$ ( $C_d = 2$ )	Air density Velocity Area of Array
- Docking loads in array (if present)	Dynamic model of deployed array Modal properties Response to base transient acceleration or incorporation in dynamic model of complete vehicle, and calculation of response to specific docking transient	Mass, stiffness and geometric properties of array. Acceleration time history at base of array, or load-displacement-velocity relationship for docking system, & relevant docking data
- Control System Response analysis (non-spinning)	Dynamic model of array Modal properties Dynamic representation of array in other than modal terms	For a linear system  For a non-linear system
- Control Systems Response analysis (spinning)	As for non spinning array above	

A problem unique to flexible solar arrays is that they must be tensioned to impart them with structural rigidity. It is very important if the spacecraft is spinning (as shown in Figure 3.6-1) that this tension be maintained to the proper degree to prevent buckling or wrinkling of the substrate. Figures 3.6-2 through -5 express this required tension (P) for the varying parameters of array length (L), load factor (n), blanket tensile modulus (E), thickness (t), blanket density ( $\rho$ ), and blanket width (b). Load factor (n) is obtained from Figure 3.6-6. Values of the combined parameter (Et) may be obtained from Figure 2.2.5-2. The equation for Figures 3.6-2 through -5 was derived in reference 1 and is presented below:

$$P = \frac{-1 + \sqrt{1 + \frac{36 \rho n L^4}{\pi^2 E t b^3}}}{\frac{24 L^2}{\pi E t b^3}} \quad (1)$$

Note in the curves of this equation that the longitudinal component of centrifugal force at midspan of the array blanket must be subtracted from the determined tension. This value is given below in Equation 2 where g is the acceleration of gravity and r is shown in Figure 3.6-1.

$$F = \frac{\omega^2 \rho b L}{2 g} \left( \frac{3L}{4} + r \right) \quad (2)$$

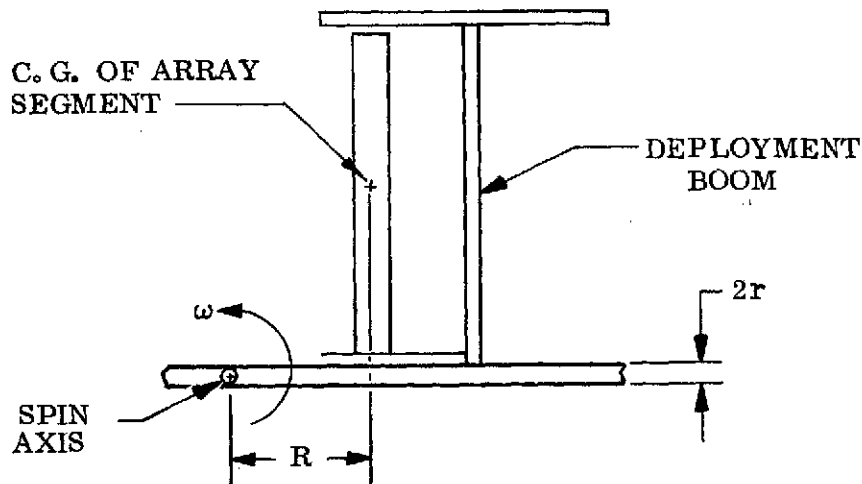

Figure 3.6-1 Schematic for Dynamics Analysis

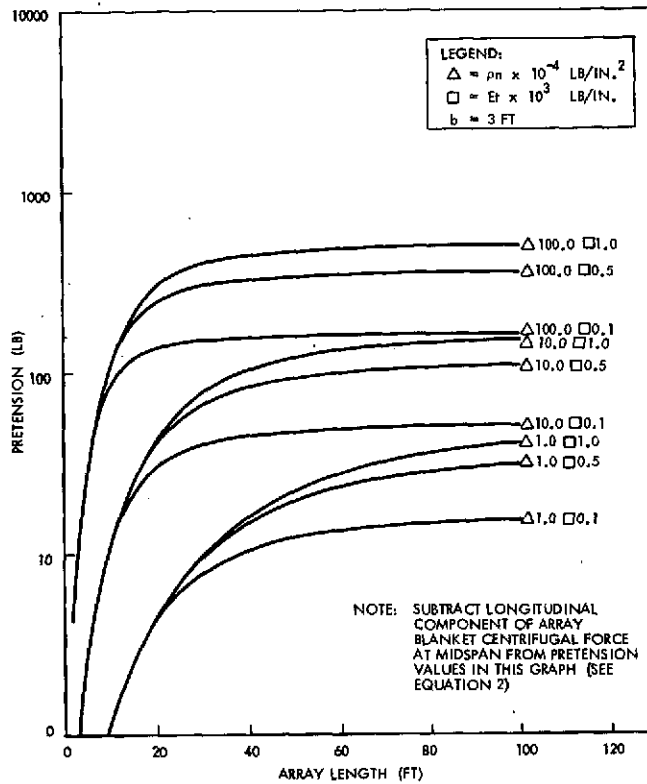

Figure 3.6-2 Pre-tension Required to Prevent Array Buckle Under Spinning Loads,  $b = 3$  ft

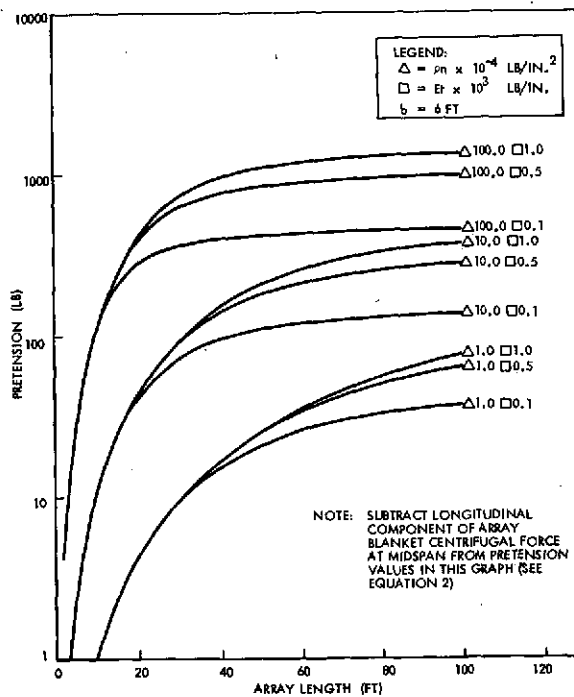

Figure 3.6-3 Pre-tension Required to Prevent Array Buckle Under Spinning Loads,  $b = 6$  ft



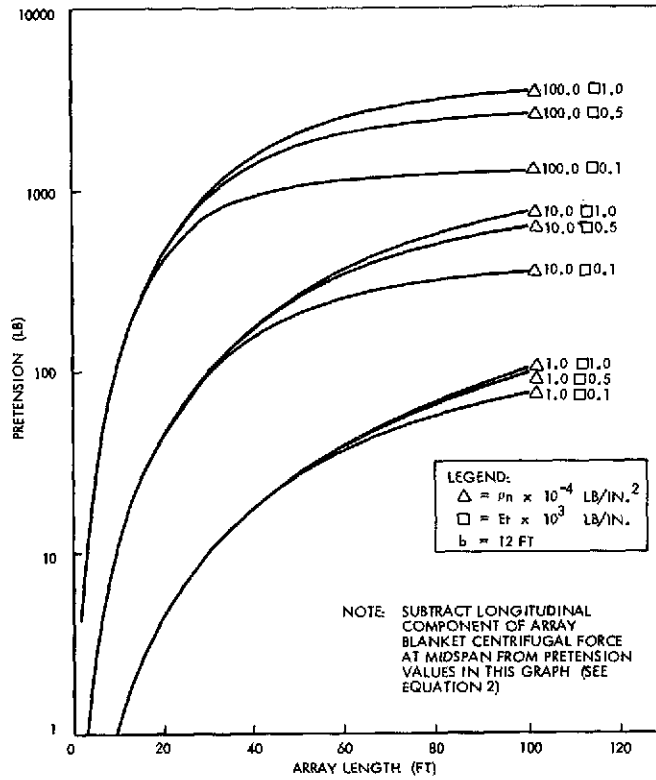

Figure 3.6-4 Pre-tension Required to Prevent Array Buckle Under Spinning Loads,  $b = 12$  ft

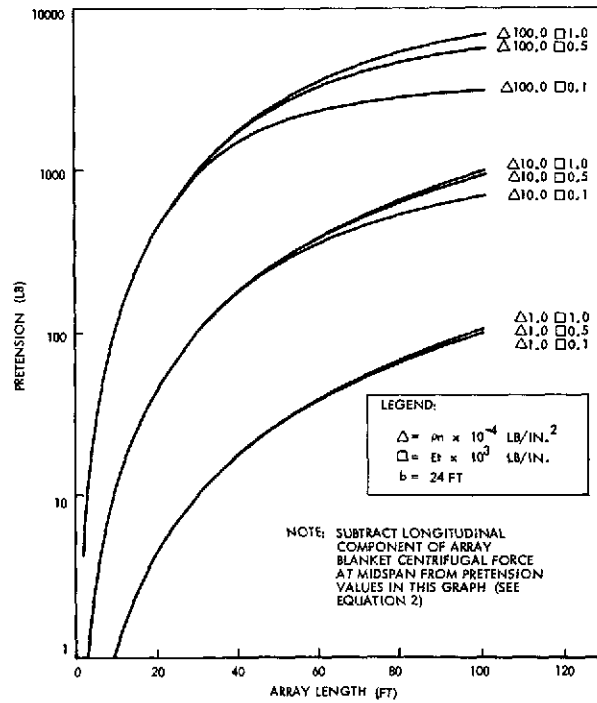

Figure 3.6-5 Pre-tension Required to Prevent Array Buckle Under Spinning Loads,  $b = 24$  ft

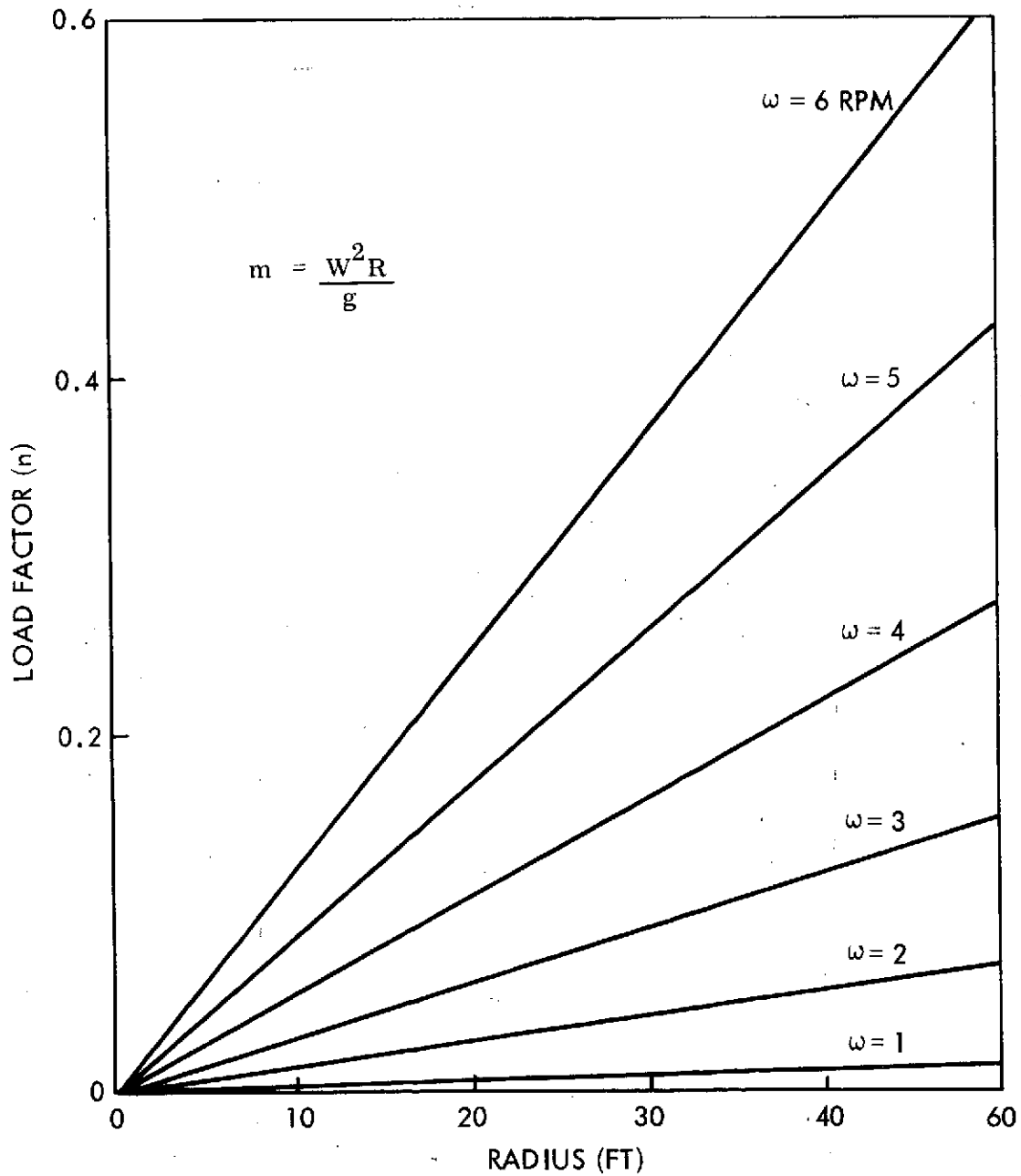

Figure 3.6-6 Transverse Load Factor on Array Substrate Under Spinning Loads

Besides the increase in rigidity that is given to the array with an increase in tension, the natural frequency of vibration of the blanket also is increased. Equation 3 presents the first mode natural catenary frequency of vibration in Hz for a flexible solar array in terms of length (L), tension (P), acceleration of gravity (g), and blanket density ( $\rho$ ).

$$f = \frac{1}{2L} \sqrt{\frac{Tg}{\rho}} \quad (3)$$

This equation is good for any tensioned blanket whether or not the spacecraft is spinning. Equation 4 presents the first mode torsional frequency of the complete array as a function of blanket tension (P), length (L), torsional rigidity of the deployment boom (GJ), blanket density ( $\rho$ ), width of complete array blanket (2S), and moment of inertial of the outboard support member of the array about the boom's longitudinal axis (I).

$$f^2 = \frac{\frac{1}{4\pi^2} \left( \frac{PS^3}{3L} + \frac{GJ}{2L} \right)}{\left( \frac{\rho LS^3}{9} + \frac{I}{2} \right)} \quad (4)$$

Figure 3.6-7 depicts schematically the torsional distortion of the complete array. If the torsional frequency of one individual strip is desired, GJ and I may be set at zero. Equation 4 will then reduce as follows:

$$f = \frac{1}{2\pi L} \sqrt{\frac{3Pg}{\rho}} \quad (5)$$

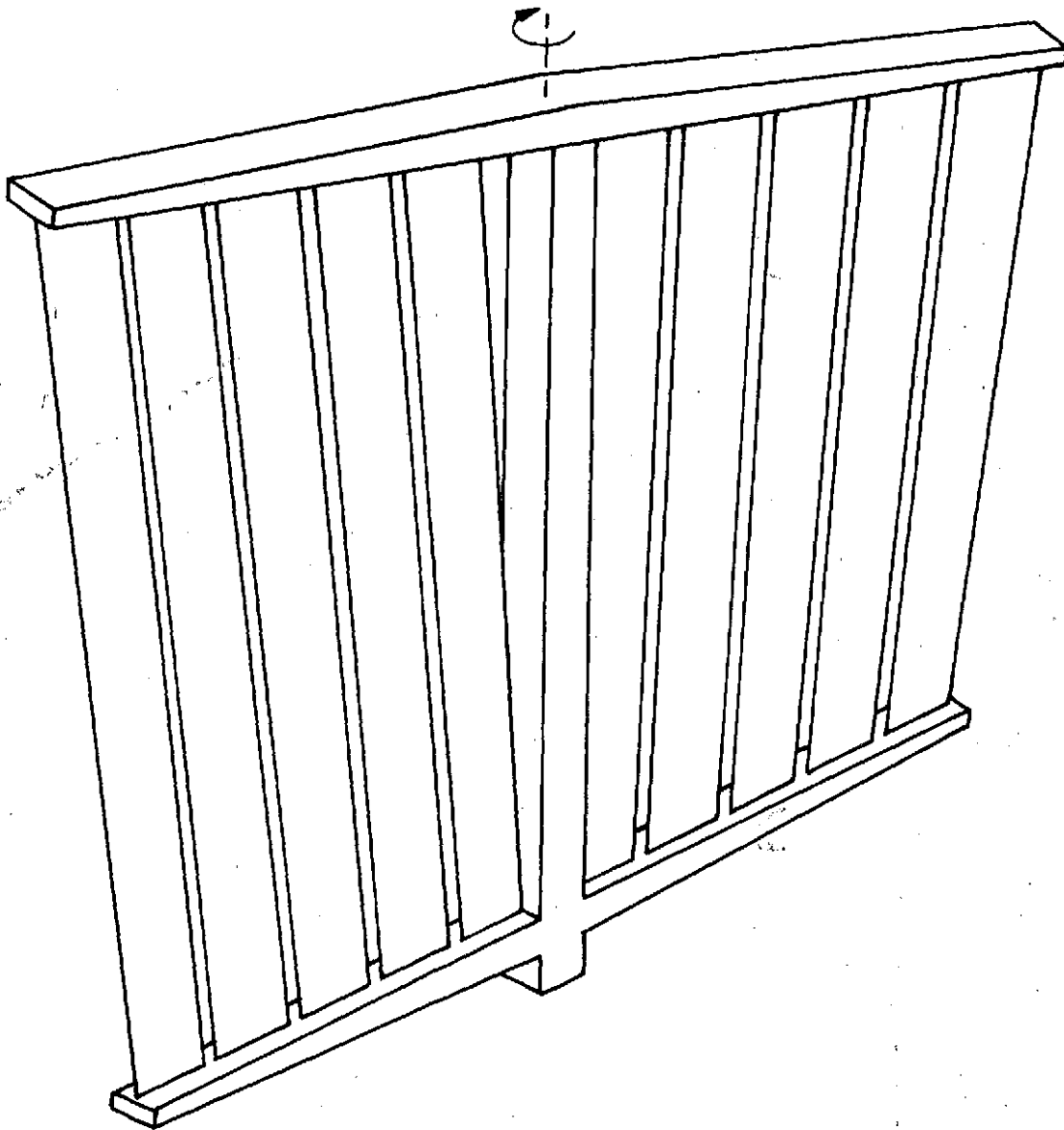

Figure 3.6-7 System Distorted in Torsion

REFERENCES  
(Section 3.6)

1. Second Topical Report, Design and Analysis, Space Station Solar Array Technology Evaluation Program, Appendix B. 2, Report No. LMSC-A995719, November 1971.