

N 7 3 2 7 5 6 7

R - 746

SIRU DEVELOPMENT — FINAL REPORT

VOLUME III

SOFTWARE DESCRIPTION AND  
PROGRAM DOCUMENTATION

by

John Oehrle

March 1973

CASE FILE  
COPY

CHARLES STARK DRAPER  
LABORATORY

MASSACHUSETTS INSTITUTE OF TECHNOLOGY

CAMBRIDGE, MASSACHUSETTS, 02139

R- 746

SIRU DEVELOPMENT — FINAL REPORT

VOLUME III

SOFTWARE DESCRIPTION AND  
PROGRAM DOCUMENTATION

by

John Oehrle

March 1973

Charles Stark Draper Laboratory  
Massachusetts Institute of Technology  
Cambridge, Massachusetts  
02139

APPROVED: J. P. Gilmore  
J. P. GILMORE, DEPUTY ASSOCIATE DIRECTOR

APPROVED: N. E. Sears  
N. E. SEARS, ASSOCIATE DIRECTOR

APPROVED: D. G. Hoag 11 Apr 73  
D. G. HOAG, DEPUTY DIRECTOR

## ACKNOWLEDGEMENT

This report was prepared under our Project No. 55-32600, sponsored by the Lyndon B. Johnson Space Center of the National Aeronautics and Space Administration through Contract No. NAS 9-8242.

The SIRU System's success in its present state of hardware, software and analytical maturity represents the dedicated efforts of many people from the NASA L. B. Johnson Space Center and The Draper Laboratory to synthesize, design, fabricate and test a redundant, body mounted inertial system employing state-of-the-art redundancy management techniques.

Singular acknowledgement for contributions to the Software developed and documented in the volume is made to :

Richard McKern for his guidance and directions,

James Keenan for the development of the calibrations and data handling programs and for the implementation of the DOS operating system,

Stephan Helfant for his aid in compiling and preparing this document for printing.

The publication of this report does not constitute approval by the National Aeronautics and Space Administration of the findings or the conclusions contained therein. It is published only for the exchange and stimulation of ideas.

SIRU DEVELOPMENT FINAL REPORT

ABSTRACT

This report presents a complete description of the development and initial evaluation of the Strapdown Inertial Reference Unit (SIRU) system sponsored by the NASA Johnson Space Center under Contract NAS9-8242.

The SIRU configuration is a modular inertial subsystem with hardware and software features that achieve fault tolerant operational capabilities. The SIRU redundant hardware design is formulated about a six gyro and six accelerometer instrument module package. The modules are mounted in this package so that their measurement input axes form a unique symmetrical pattern that corresponds to the array of perpendiculars to the faces of a regular dodecahedron. This six axes array provides redundant independent sensing and the symmetry enables the formulation of an optimal software redundant data processing structure with self-contained fault detection and isolation (FDI) capabilities.

This report consists of four volumes.

Volume I, System Development, documents the system mechanization with the analytic formulation of the FDI and processing structure; the hardware redundancy design and the individual modularity features; the computational structure and facilities; and the initial subsystem evaluation results.

Volume II, Gyro Module, is devoted specifically to the Gyro Module, the inertial instrument and its digital strapdown torque-to-balance loop, the mechanical, thermal, and electronic design and function, test procedures and test equipment and performance results and analysis.

Volume III, Software, documents the basic SIRU software coding system used in the DDP-516 computer. The documentation covers the instrument compensation software, reorganizational and FDI processing, and the inertial attitude and velocity algorithm routines as well as servicing, input/output, etc. software.

Volume IV, Accelerometer Module, is devoted specifically to the Accelerometer Module, the inertial instrument and its digital strapdown torque-to-balance loop, the mechanical, thermal and electronic design and function and performance results and analysis, as it differs from the Gyro Module.

In addition to this report, SIRU Utilization Report R-747, has been issued documenting analyses, software and evaluation activities in the application of advanced statistical FDI algorithms, calibration and alignment techniques to the SIRU system.

April 1973

SIRU SOFTWARE DESCRIPTION  
and  
PROGRAM DOCUMENTATION

TABLE OF CONTENTS

INTRODUCTION . . . . .	.1
SYSTEM ORGANIZATION . . . . .	.4
MAIN PROGRAM . . . . .	.7
Subroutines . . . . .	20

## INTRODUCTION:

The purpose of creating the SIRU operating system was to implement and verify operation of the algorithms shown in Figure 1 on an available laboratory computer (Honeywell DDP-516) at an update rate of 100 times/sec. These algorithms can be divided into two sets, an accelerometer data processor and a gyro data processor. In the strapdown implementation it is important to process the accelerometer information into the inertial frame using the average attitude information over the  $\Delta V$  accumulation period.

The system begins to accumulate  $\Delta V$  pulses from the torque to balance instrument loops after initialization. After 5 ms the system begins to accumulate  $\Delta\theta$  pulses. Five ms later or 10 ms from initialization the accelerometer pulse counters give an interrupt and the accelerometer data processors perform the proper algorithms on the 10 ms of  $\Delta V$  accumulation. Five ms later the 10 ms of  $\Delta\theta$  accumulation is processed to update attitude. The accelerometer and gyro algorithm processing loops are performed alternately every 5 ms thereafter resulting in the required staggering of these tasks. (This software has also been run at an update rate of 50 times/second. Ref. SIRU Utilization Report R-747).

Figure 1 shows what is done during either the accelerometer or gyro 5 ms updates. On the accelerometer side we require the system to do the following tasks.

### TASKS

- A1) Read the 6 accelerometer counters.
- A2) Compensate accelerometers for average scale factor, bias and the misalignments of each accelerometer's input axis around their input and pendulous reference axes.
- A3) Compensate accelerometers for errors due to  $R\omega^2$  and  $R\dot{\omega}$  as a function of the accelerometers' positions relative to one another.
- A4) Accumulate corrected accelerometer body output for failure detection and isolation.
- A5) Perform failure detection and isolation resulting in a current failure status.

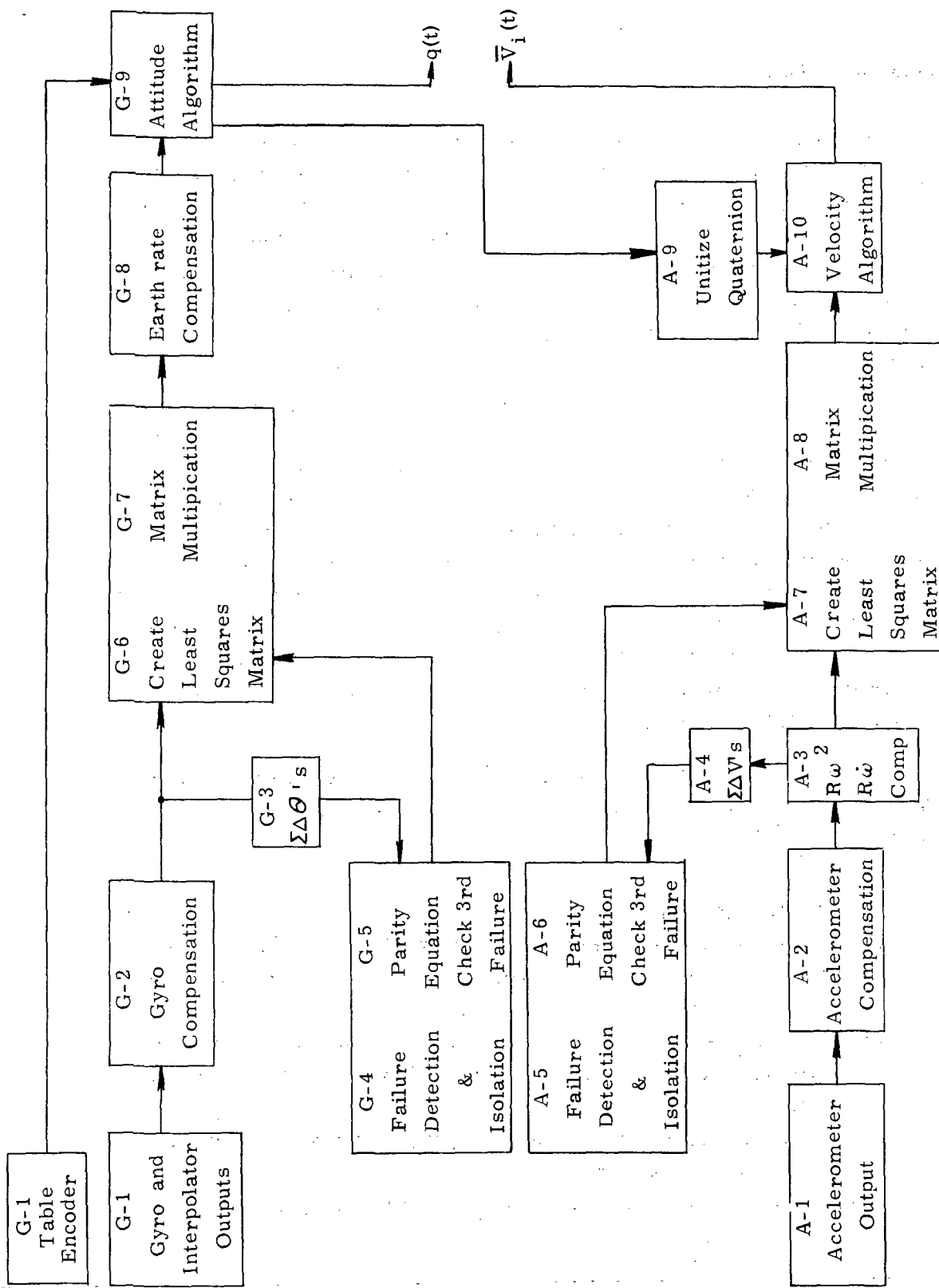

FIGURE 1 SIRU DATA PROCESSING



- A6) Check parity equation for third fail.
- A7) Create least squares matrix (as a function of fail status) to transform the 6 compensated  $\Delta V$ 's into the X, Y, Z body frame.
- A8) Do the 6 to 3 matrix multiplication.
- A9) Unitize attitude quaternion prior to velocity algorithm processing.
- A10) Do the velocity algorithm, i.e., use the current attitude quaternion to generate the velocity transformation matrix and transform the incremental body velocity into the inertial frame.
- A11) Accumulate  $\Delta \bar{V}$  inertial for output processing.

On the gyro side we presently require the system to do the following tasks:

- G1) Read the table angle encoder, the six gyros & interpolators.
- G2) Compensate the gyros for  $\pm\Delta SF$ , NBD, ADIA, ADOA, ADSRA, anisoelasticity, misalignments, aniso inertia, SRA cross-coupling and OA coupling.
- G3) Accumulate the corrected gyro body output for failure detection and isolation.
- G4) Perform the failure detection and isolation processing resulting in a current failure status.
- G5) Check the parity equation for third fail.
- G6) Create the least squares matrix (as a function of failure status) to transform the six compensated  $\Delta \theta$ 's into the X, Y, Z body frame.
- G7) Do the 6 to 3 matrix multiplication.
- G8) Compensate for earth rate.
- G9) Update the quaternion attitude.

In the time remaining, output of the system's status is performed either on the teletype, the CRT display or on an incremental digistor tape for further analysis. The format is shown in the documentation of the output programs. The information outputted includes the quaternion of attitude,  $\Delta \bar{V}_I$  accumulated over some interval, a squared error monitor and fail status for gyros and accelerometers, test-table angle encoder and time since initialization.

SYSTEM ORGANIZATION:

The main program (MPRO) in turn calls all the subroutines to accomplish the tasks described in the introduction. These programs are documented in the following sections in the order listed below:

<u>Program</u>	<u>Task</u>	<u>Page</u>
MPRO	main program	7
ALPO	Output	20
SFPOUT		31
SXOU		36
SDGS		39
(FTLIBY)		Fortran library
READ	A1,G1	43
ACOM	A2	47
GCOM	G2	52
DCMT		61
DCOA		65
ROMS	A3	69
PREX	A4	78
GARC	G3	81
GFIS	G4	87
ERDE		93
CFSE		99
PFIS		112
GPRT	G5	115
PRTY	A6	118
PPEX		123
GMIN		G6
GPMA	A7	128
EMIN		138
MG63	G7	140
MV63	A8	146
SPUN	A9	149
VESP	A10	158
VACU	A11	169
ERC6	G8	171
AA6S	G9	174

Preceding the documentation of these programs is a load map showing the core location of each subroutine.

SYSTEM LOAD MAP

LDRX 23665 1000 64  
 GO  
 MN  
 I BMRU  
 MR  
 C BREAD  
 MR  
 C BGFIS  
 MR  
 C BGC0M  
 MR  
 C BERC6  
 MR  
 C BEMIN  
 MR  
 C BGMIN  
 MR  
 C BDC0A  
 MR  
 C BAC0M  
 MR  
 C BDCMT  
 MR  
 C BMV63  
 MR  
 C BMG63  
 MR  
 C BVESP  
 MR  
 C BPFIS  
 MR  
 C BAA6S  
 MR  
 C BVACU  
 MR  
 C BSPUN  
 MR  
 C BPREX  
 MR  
 C BERDE  
 MR  
 C BCFSE  
 MR  
 C BGARC  
 MR  
 C BALPO  
 MR  
 C BFOUT  
 MR  
 C BXOU  
 MR  
 C FTLIBY

MR  
 C BGPMA  
 MR  
 C BPPEX  
 MR  
 C BGPRT  
 MR  
 C BPRTY  
 MR  
 C BDGS  
 MR  
 C BRIMS  
 LC  
 M  
 \*START 01000  
 \*HIGH 14370  
 \*NAMES 17132  
 \*COMM 23777  
 \*BASE 00244  
 LIST 00001  
 RUPT 01450  
 ASCT 01506  
 ICINIT 01656  
 INPIP 01731  
 INGYRO 01764  
 GFIS 02070  
 KEYG 02225  
 GCOM 02242  
 ERCO 02726  
 EMIN 03034  
 GMIN 03100  
 DC0A 03144  
 AOAP 03252  
 ROAP 03254  
 COAP 03256  
 DOAP 03260  
 EOAP 03262  
 FOAP 03264  
 ACOM 03274  
 DCMI 03476  
 DCMT 03551  
 MP63 03664  
 MG63 04012  
 VELA 04206  
 FXX 04654  
 FXY 04656  
 FXZ 04660  
 FYX 04662  
 FYY 04664  
 FYZ 04666  
 FZX 04670  
 FZY 04672  
 FZZ 04674

PFIS 04726  
 KEYP 05050  
 ATTA 05060  
 VACU 05506  
 SPUN 05560  
 PARC 06040  
 PACC 06166  
 ERDE 06172  
 SECA 06524  
 GARC 07344  
 GACC 07524  
 OUTPUT 07530  
 DODSP 07600  
 FPOUTC 10340  
 OUT100 10552  
 IOMODE 10604  
 X1OU 10636  
 XNOU 10642  
 XNOUA 10646  
 XOOCT 10652  
 CNOU 10670  
 CNOUA 10675  
 COOCT 10750  
 C1OU 11004  
 DOPAGE 11176  
 CRTOUT 11476  
 CRT0UA 11504  
 SORTX 11614  
 F\$AT 11614  
 ARG\$ 11676  
 T1OU 11747  
 TNOUA 11772  
 TNOU 11777  
 TOOCT 12047  
 MATR 12102  
 GMAT 12136  
 PPRT 12630  
 GPRT 12712  
 PRTY 12774  
 DGSWRT 13250  
 DGSRI 13311  
 ROMS 14000  
 WXPR 14333  
 WYPR 14334  
 WZPR 14335  
 23777  
 LC  
 OK  
 SAVE RMPRU 64 14370 1000  
 OK

PROGRAM NAME  
SOURCE: MPRO  
BINARY: BMPRO  
STARTING LOCATION: '1000  
GENERAL DESCRIPTION:

This is the main executive of the system operating program which calls the appropriate subroutines to accomplish the algorithms defined in the introduction and the definition of system tasks. It is divided into three sections of code. First is initialization and the enabling of interrupt. Next is a waiting loop (location LOOP) which checks to see if it is time for output and if so, calls the proper output routines. When this waiting loop is interrupted (every 5 milliseconds), the program sequence goes to the last section (location RUPT) which in turn decides whether its time to update the PIPA or gyro algorithms, goes to either PDO or GDO, saves the processing registers as they were at time of interrupt, calls the appropriate algorithms following PDO or GDO, restores the processing registers and returns to whatever was being processed at time of interrupt.

The initialization section first calls DCMI (see documentation for program source name DCMT) to enable the gyro OA misalignment parameters to be taken from the base sector and saved elsewhere in core. It then zeroes out all locations in the base sector that don't contain compensation parameters (namely locations '260-'421, '430-'477, '574-'677 and '744-'777). It zeroes out the gyro and PIPA error accumulator residuals accessible through the indexed external addresses CCAG and CCAP (see programs with source names GARC and PREX). It zeroes out the 6 previous OA coupling offsets (AOAP-FOAP accessible in the program DCOA through the external address PAOA-PAOF). It zeroes the four erroneous interrupt counters (disk, ASR-33 teletype, miscellaneous and clock). It zeroes out the gyro and PIPA fail keys (KEYG and KEYP) in programs GFIS and PFIS). It zeroes WXPR, WYPR and WZPR (see program ROMS) and sets GACC and PACC to equal -6001 (used to wait 60 seconds in the error accumulator programs GARC and PREX). TCNT (the time counter for the output loop) is set to its maximum of '77777 so that an output will be done at t=0. It puts a round of '40000 in the low order residuals of the gyro pulse counts,

PIPA pulse counts, gyro x, y and z delta thetas, PIPA x, y and z delta Vs, the quaternion and the delta V inertial accumulators. The '40000 it stores in '460 is to set lamda of the quaternion equal to 1. It then generates the gyro and PIPA 6 x 3 matrices by calling GMIN and EMIN. It stores the address to go to when interrupted in '63 and calls ICINIT, which sets up the interrupt cycle (see documentation for program source name READ). Finally it does a JST (internal call) to GETM in order to set up the timing and MODE for whichever of three output modes is desired.

The output waiting loop simply checks the time counter (TCNT) to see if it is greater than or equal to the time at which to output (CRIT).<sup>\*</sup> If TCNT is less than CRIT (i.e., it is not time to output) and if sense switches three and four are not reset and set respectively<sup>\*\*</sup>, the waiting loop will just continue to loop. The waiting loop continues to get interrupted so that the PIPA and gyro processing can be updated every five milliseconds.

When enough updates have occurred and TCNT becomes greater than CRIT, the program jumps to OUT, where output is started. If sense switches three and four are set, the program will first initialize the quaternion to 1,0,0,0 (see documentation for AA6S). The program then continues at NOQZ where all the data to be output is saved in a 52 word buffer called QTMP as follows:

---

\* Note that TCNT is incremented by 1 after every gyro algorithm loop so it counts in hundredths of a second. CRIT is set up by GETM and depends on the output mode.

\*\* To stop this program and return to DOS (the disk operating system) sense switch four is set while sense switch three is left reset. By setting sense switch three and then setting sense switch four, the quaternion will be initialized at the time the next output starts.

<u>Location</u>	<u>Contents</u>
QTMP-QTMP+7	quaternion
QTMP+8-QTMP+13	Sum of delta V inertial since the last output
QTMP+14-QTMP+15	First and second gyro fail status
QTMP+16-QTMP+17	First and second PIPA fail status
QTMP+18-QTMP+19	Time elapsed since start of program
QTMP+20-QTMP+21	Encoder angle of test table
QTMP+22-QTMP+23	gyro and PIPA third fail indicators
QTMP+24-QTMP+37	gyro squared errors
QTMP+38-QTMP+51	PIPA squared errors

The delta V accumulators and the time counter are then zeroed after which the proper output mode is gotten. Parts of QTMP are then rescaled so that the output routine can handle them. Finally, a call to OUTPUT is made with the addresses of QTMP and MODE. Upon return from output a jump back to LOOP is made.

The last section of this main program, starting at RUPT, handles the PIPA and gyro interrupts as they come along every five milliseconds. The first interrupt, by the PIPA's, and every other one thereafter, will cause program control to "jump store" to RUPT where the SKS '507 instruction will not skip and the jump to PDO is executed. Here the processing registers (A register, keys, B register and index register) are saved and calls to the subroutines necessary to update the PIPA algorithms are made (see the introduction and description of implementation methods). The PIPA squared errors are then saved in the buffer PISE for future output, then the processing registers are restored and a JMP\* RUPT causes program control to go back to where it was when last interrupted.

The second interrupt, by the gyros, and every other one thereafter, will cause control to "jump store" to RUPT where the SKS '507 instruction

---

\* See previous page

will skip and the SKS '407 instruction will not, and the jump to GDO is executed. Here the processing registers are saved. The table angle encoder is read after which calls to the subroutines necessary to update the gyro algorithms are made (see the introduction and description of implementation methods). The output timer, TCNT, and the overall timer, TIME are incremented before a jump to COMN restores the processing registers and returns to where the program control was when the gyro interrupt occurred.



MICROCOMP TELECOMMUNICATED DATA  
DDP-516 ASSEMBLY LISTING

0001				REL	
0002	00000	0 10	00000	CALL	DCMI
0003	00001	00000	7	DBL	
0004	00002	0 02	00342	DLD	DZRO
0005	00003	0 35	00654	LDX	=-98
0006	00004	1 04	00422	DST	'422,1
0007	00005	0 12	00000	IRS	0
0008	00006	0 12	00000	IRS	0
0009	00007	0 01	00004	JMP	*-3
0010	00010	0 35	00653	LDX	=-40
0011	00011	1 04	00500	DST	'500,1
0012	00012	0 12	00000	IRS	0
0013	00013	0 12	00000	IRS	0
0014	00014	0 01	00011	JMP	*-3
0015	00015	0 35	00652	LDX	=-68
0016	00016	1 04	00700	DST	'700,1
0017	00017	0 12	00000	IRS	0
0018	00020	0 12	00000	IRS	0
0019	00021	0 01	00016	JMP	*-3
0020	00022	0 35	00651	LDX	=-28
0021	00023	1 04	01000	DST	'1000,1
0022	00024	-0 04	00337	DST*	CCAG
0023	00025	-0 04	00340	DST*	CCAP
0024	00026	0 12	00000	IRS	0
0025	00027	0 12	00000	IRS	0
0026	00030	0 01	00023	JMP	*-5
0027	00031	-0 04	00324	DST*	PAOA
0028	00032	-0 04	00325	DST*	PAOB
0029	00033	-0 04	00326	DST*	PAOC
0030	00034	-0 04	00327	DST*	PAOD
0031	00035	-0 04	00330	DST*	PAOE
0032	00036	-0 04	00331	DST*	PAOF
0033	00037	00000	5	SGL	
0034	00040	0 04	00507	STA	DSCT
0035	00041	0 04	00506	STA	ASCT
0036	00042	0 04	00510	STA	MSCT
0037	00043	0 04	00511	STA	ICNT
0038	00044	-0 04	00332	STA*	GYEK
0039	00045	-0 04	00333	STA*	PYEK
0040	00046	-0 04	00334	STA*	RPXW
0041	00047	-0 04	00335	STA*	RPYW
0042	00050	-0 04	00336	STA*	RPZW
0043	00051	0 02	00650	LDA	=-6001
0044	00052	-0 04	00337	STA*	CCAG
0045	00053	-0 04	00340	STA*	CCAP
0046	00054	0 02	00647	LDA	= '77777
0047	00055	0 04	00637	STA	TCNT
0048	00056	0 02	00646	LDA	= '40000
0049	00057	0 04	00401	STA	'401
0050	00060	0 04	00403	STA	'403
0051	00061	0 04	00405	STA	'405
0052	00062	0 04	00407	STA	'407
0053	00063	0 04	00411	STA	'411
0054	00064	0 04	00413	STA	'413
0055	00065	0 04	00601	STA	'601
0056	00066	0 04	00603	STA	'603
0057	00067	0 04	00605	STA	'605

MICROCOMP TELECOMMUNICATED DATA  
DDP-516 ASSEMBLY LISTING

```

0058 00070 0 04 00607 STA '607
0059 00071 0 04 00611 STA '611
0060 00072 0 04 00613 STA '613
0061 00073 0 04 00415 STA '415
0062 00074 0 04 00417 STA '417
0063 00075 0 04 00421 STA '421
0064 00076 0 04 00615 STA '615
0065 00077 0 04 00617 STA '617
0066 00100 0 04 00621 STA '621
0067 00101 0 04 00460 STA '460
0068 00102 0 04 00463 STA '463
0069 00103 0 04 00467 STA '467
0070 00104 0 04 00473 STA '473
0071 00105 0 04 00477 STA '477
0072 00106 0 04 00447 STA '447
0073 00107 0 04 00453 STA '453
0074 00110 0 04 00457 STA '457
0075 00111 0 10 00000 CALL GMIN
0076 00112 0 10 00000 CALL EMIN
0077 00113 0 02 00323 LDA RDAD
0078 00114 0 04 00063 STA '63
0079 00115 0 10 00000 CALL ICINIT
0080 00116 0 02 00645 LDA =6
0081 00117 74 0020 SMK '20
0082 00120 0 10 00310 JST GETM TO SET UP TIME
0083 *
0084 *
0085 00121 000401 LOOP FNB
0086 00122 0 02 00637 LDA TCNT
0087 00123 0 11 00635 CAS CRIT
0088 00124 101000 NOP
0089 00125 0 01 00141 JMP OUT
0090 00126 000201 IAB
0091 00127 101002 SS4
0092 00130 0 01 00121 JMP LOOP
0093 00131 100004 SR3
0094 00132 0 01 00121 JMP LOOP
0095 *
0096 * EXIT CODING
0097 *
0098 00133 14 0047 OCP '47
0099 00134 14 0057 OCP '57
0100 00135 140040 CRA
0101 00136 74 0020 SMK '20
0102 00137 001001 INH
0103 00140 -0 01 00631 JMP* DOS
0104 *
0105 *
0106 00141 100004 OUT SR3
0107 00142 101002 SS4
0108 00143 0 01 00165 JMP NOOZ
0109 00144 000007 DBL
0110 00145 0 02 00342 DLD DZRO
0111 00146 0 04 00460 DST '460
0112 00147 0 04 00462 DST '462
0113 00150 0 04 00464 DST '464
0114 00151 0 04 00466 DST '466

```

MICROCOMP TELECOMMUNICATED DATA  
DDP-516 ASSEMBLY LISTING

0115	00152	0 04 00470	DST	'470
0116	00153	0 04 00472	DST	'472
0117	00154	0 04 00474	DST	'474
0118	00155	0 04 00476	DST	'476
0119	00156	000005	SGL	
0120	00157	0 02 00646	LDA	= '40000
0121	00160	0 04 00460	STA	'460
0122	00161	0 04 00463	STA	'463
0123	00162	0 04 00467	STA	'467
0124	00163	0 04 00473	STA	'473
0125	00164	0 04 00477	STA	'477
0126	00165	000007	NOQZ DBL	
0127	00166	0 02 00460	DLD	'460
0128	00167	0 04 00346	DST	QTMP
0129	00170	0 02 00464	DLD	'464
0130	00171	0 04 00350	DST	QTMP+2
0131	00172	0 02 00470	DLD	'470
0132	00173	0 04 00352	DST	QTMP+4
0133	00174	0 02 00474	DLD	'474
0134	00175	0 04 00354	DST	QTMP+6
0135	00176	0 02 00444	DLD	'444
0136	00177	0 04 00356	DST	QTMP+8
0137	00200	0 02 00450	DLD	'450
0138	00201	0 04 00360	DST	QTMP+10
0139	00202	0 02 00454	DLD	'454
0140	00203	0 04 00362	DST	QTMP+12
0141	00204	0 02 00316	DLD	'316
0142	00205	0 04 00364	DST	QTMP+14
0143	00206	0 02 00320	DLD	'320
0144	00207	0 04 00366	DST	QTMP+16
0145	00210	0 02 00776	DLD	TIME
0146	00211	0 04 00370	DST	QTMP+18
0147	00212	0 02 00322	DLD	'322
0148	00213	0 04 00374	DST	QTMP+22
0149	00214	0 02 00324	DLD	'324
0150	00215	0 04 00372	DST	QTMP+20
0151	00216	0 02 00326	DLD	'326
0152	00217	0 04 00376	DST	QTMP+24
0153	00220	0 02 00330	DLD	'330
0154	00221	0 04 00400	DST	QTMP+26
0155	00222	0 02 00332	DLD	'332
0156	00223	0 04 00402	DST	QTMP+28
0157	00224	0 02 00436	DLD	'436
0158	00225	0 04 00404	DST	QTMP+30
0159	00226	0 02 00440	DLD	'440
0160	00227	0 04 00406	DST	QTMP+32
0161	00230	0 02 00442	DLD	'442
0162	00231	0 04 00410	DST	QTMP+34
0163	00232	0 02 00574	DLD	'574
0164	00233	0 04 00412	DST	QTMP+36
0165	00234	0 02 00432	DLD	PISE
0166	00235	0 04 00414	DST	QTMP+38
0167	00236	0 02 00434	DLD	PISE+2
0168	00237	0 04 00416	DST	QTMP+40
0169	00240	0 02 00436	DLD	PISE+4
0170	00241	0 04 00420	DST	QTMP+42
0171	00242	0 02 00440	DLD	PISE+6

MICROCOMP TELECOMMUNICATED DATA

DDP-516 ASSEMBLY LISTING

0172	00243	0 04 00422	DST	QTMP+44
0173	00244	0 02 00442	DLD	PISE+8
0174	00245	0 04 00424	DST	QTMP+46
0175	00246	0 02 00444	DID	PISE+10
0176	00247	0 04 00426	DST	QTMP+48
0177	00250	0 02 00446	DID	PISE+12
0178	00251	0 04 00430	DST	QTMP+50
0179	00252	0 02 00342	DLD	DZFO
0180	00253	0 04 00444	DST	'444
0181	00254	0 04 00450	DST	'450
0182	00255	0 04 00454	DST	'454
0183	00256	000005	SGL	
0184	00257	0 04 00637	STA	TCNT
0185	00260	0 10 00310	JST	GETM
0186	00261	000007	DBL	
0187	00262	0 02 00356	DLD	QTMP+8
0188	00263	0411 71	LLS	7
0189	00264	0 04 00356	DST	QTMP+8
0190	00265	0 02 00360	DLD	QTMP+10
0191	00266	0411 71	LLS	7
0192	00267	0 04 00360	DST	QTMP+10
0193	00270	0 02 00362	DLD	QTMP+12
0194	00271	0411 71	LLS	7
0195	00272	0 04 00362	DST	QTMP+12
0196	00273	0 35 00651	LDX	=-28
0197	00274	1 02 00432	DLD	QTMP+52,1
0198	00275	0411 67	LLS	9
0199	00276	1 04 00432	DST	QTMP+52,1
0200	00277	0 12 00000	IRS	0
0201	00300	0 12 00000	IRS	0
0202	00301	0 01 00274	JMP	*-5
0203	00302	000005	SGL	
0204	00303	0 10 00000	CALL	OUTPUT
0205	00304	0 000346	DAC	QTMP
0206	00305	0 000636	DAC	MODE
0207	00306	000000	OCT	0
0208	00307	0 01 00121	JMP	LOOP
0209				
0210	00310	0 000000	GETM DAC	**
0211	00311	140040	CRA	
0212	00312	100020	SR1	
0213	00313	141206	AOA	
0214	00314	100010	SR2	
0215	00315	0 02 00644	LDA	=2
0216	00316	0 04 00636	STA	MODE
0217				
0218	00317	0 04 00000	STA	0
0219	00320	1 02 00632	LDA	TCON,1
0220	00321	0 04 00635	STA	CRIT
0221	00322	-0 01 00310	JMP*	GETM
0222				
0223	00323	0 000000	RDAD XAC	RUPT
0224	00324	0 000000	PAOA XAC	AOAP
0225	00325	0 000000	PAOB XAC	BOAP
0226	00326	0 000000	PAOC XAC	COAP
0227	00327	0 000000	PAOD XAC	DOAP
0228	00330	0 000000	PAOE XAC	EOAP

MICROCOMP TELECOMMUNICATED DATA  
DDP-516 ASSEMBLY LISTING

0229	00331	0	000000	PAOP XAC	FOAP
0230	00332	0	000000	GYEK XAC	KEYG
0231	00333	0	000000	PYEK XAC	KEYP
0232	00334	0	000000	RPXW XAC	WXPR
0233	00335	0	000000	RPYW XAC	WYPR
0234	00336	0	000000	RPZW XAC	WZPR
0235	00337	1	000000	CCAG XAC	GACC,1
0236	00340	1	000000	CCAP XAC	PACC,1
0237	00342	000000		DZRO DBP	0
	00343	000000			
0238	00344	000000		DONE OCT	0,1
	00345	000001			
0239	00346	000000		QTMP BSZ	52
	00347	000000			
	00350	000000			
	00351	000000			
	00352	000000			
	00353	000000			
	00354	000000			
	00355	000000			
	00356	000000			
	00357	000000			
	00360	000000			
	00361	000000			
	00362	000000			
	00363	000000			
	00364	000000			
	00365	000000			
	00366	000000			
	00367	000000			
	00370	000000			
	00371	000000			
	00372	000000			
	00373	000000			
	00374	000000			
	00375	000000			
	00376	000000			
	00377	000000			
	00400	000000			
	00401	000000			
	00402	000000			
	00403	000000			
	00404	000000			
	00405	000000			
	00406	000000			
	00407	000000			
	00410	000000			
	00411	000000			
	00412	000000			
	00413	000000			
	00414	000000			
	00415	000000			
	00416	000000			
	00417	000000			
	00420	000000			
	00421	000000			
	00422	000000			

MICROCOMP TELECOMMUNICATED DATA  
DDP-516 ASSEMBLY LISTING

00423	000000			
00424	000000			
00425	000000			
00426	000000			
00427	000000			
00430	000000			
00431	000000			
0240	00432	000000	PISE BSZ	14
	00433	000000		
	00434	000000		
	00435	000000		
	00436	000000		
	00437	000000		
	00440	000000		
	00441	000000		
	00442	000000		
	00443	000000		
	00444	000000		
	00445	000000		
	00446	000000		
	00447	000000		
0241			*	
0242			*	
0243				SUBR RUPT
0244				SUBR ASCT
0245				REL
0246	00450	0 000000	RUPT DAC	**
0247	00451	14 0102	OCF	'102 SHUT OFF DGS
0248	00452	34 0507	SKS	'507
0249	00453	0 01 00512	JMP	PDO
0250	00454	34 0407	SKS	'407
0251	00455	0 01 00565	JMP	GDO
0252	00456	34 0607	SKS	'607
0253	00457	0 01 00501	JMP	ICLK
0254	00460	34 0425	SKS	'425
0255	00461	0 01 00475	JMP	DISK DISK RUPT
0256	00462	34 0404	SKS	'404
0257	00463	0 01 00467	JMP	ASR ASR RUPT
0258	00464	0 12 00510	IRS	MSCT MISCELLANEOUS
0259	00465	000401	PSM ENB	
0260	00466	-0 01 00450	JMP*	RUPT
0261			*	
0262	00467	14 0004	ASR OCF	4
0263	00470	54 0004	INA	4 DUMMPY
0264	00471	101000	NOP	
0265	00472	0 12 00506	IRS	ASCT
0266	00473	101000	NOP	IN CASE OF SKIP
0267	00474	0 01 00465	JMP	RSM
0268			*	
0269	00475	14 1425	DISK OCF	'1425
0270	00476	0 12 00507	IRS	DSCT
0271	00477	101000	NOP	IN CASE OF SKIP
0272	00500	0 01 00465	JMP	RSM
0273			*	
0274	00501	0 12 00511	ICLK IRS	ICNT
0275	00502	101000	NOP	
0276	00503	14 0027	OCF	'27

MICROCOMP TELECOMMUNICATED DATA  
DDP-516 ASSEMBLY LISTING

0277	00504	14 0067	OCP	'67
0278	00505	0 01 00465	JMP	RSM
0279	00506	000000	ASCT BSZ	1
0280	00507	000000	DSCT BSZ	1
0281	00510	000000	MSCT BSZ	1
0282	00511	000000	ICNT BSZ	1
0283			*	
0284			*	
0285	00512	0 13 00640	PDO IMA	AREG
0286	00513	000043	INR	
0287	00514	000005	SGL	
0288	00515	0 04 00641	STA	KEYS
0289	00516	000201	IAB	
0290	00517	0 04 00642	STA	BREG
0291	00520	0 15 00643	STX	XREG
0292			*	
0293			*	
0294			*	
0295			*	
0296	00521	0 10 00000	CALL INPIP	
0297	00522	000401	ENB	
0298	00523	0 10 00000	CALL ACOM	
0299	00524	0 10 00000	CALL ROMS	
0300	00525	0 10 00000	CALL PABC	
0301	00526	0 10 00000	CALL PFIS	
0302	00527	0 10 00000	CALL PPRT	
0303	00530	0 10 00000	CALL EMIN	
0304	00531	0 10 00000	CALL MP63	
0305	00532	0 10 00000	CALL SPUN	
0306	00533	0 10 00000	CALL VELA	
0307	00534	0 10 00000	CALL VACU	
0308	00535	000007	DBL	
0309	00536	0 02 00326	DID	'326
0310	00537	0 04 00432	DST	PISE
0311	00540	0 02 00330	DID	'330
0312	00541	0 04 00434	DST	PISE+2
0313	00542	0 02 00332	DLD	'332
0314	00543	0 04 00436	DST	PISE+4
0315	00544	0 02 00436	DLD	'436
0316	00545	0 04 00440	DST	PISE+6
0317	00546	0 02 00440	DLD	'440
0318	00547	0 04 00442	DST	PISE+8
0319	00550	0 02 00442	DLD	'442
0320	00551	0 04 00444	DST	PISE+10
0321	00552	0 02 00574	DLD	'574
0322	00553	0 04 00446	DST	PISE+12
0323	00554	000005	SGL	
0324			*	
0325			*	
0326	00555	0 35 00643	COMN LDX	XREG
0327	00556	0 02 00642	LDA	BREG
0328	00557	000201	IAB	
0329	00560	0 02 00641	LDA	KEYS
0330	00561	171020	OTK	
0331	00562	0 13 00640	IMA	AREG
0332	00563	000401	ENB	
0333	00564	-0 01 00450	JMP*	RUPT

MICROCOMP TELECOMMUNICATED DATA  
DDP-516 ASSEMBLY LISTING

```

0334 *
0335 *
0336 00565 0 13 00640 GDO IMA AREG
0337 00566 000043 INK
0338 00567 000005 SGL
0339 00570 0 04 00641 STA KEYS
0340 00571 000201 IAB
0341 00572 0 04 00642 STA BREG
0342 00573 0 15 00643 STX XREG
0343 *
0344 *
0345 00574 34 0007 SKS '007 WAIT FOR DIGISEC
0346 00575 0 01 00574 JMP *-1
0347 00576 14 0406 OCP '406 HOLD
0348 00577 0401 62 LRS 14 WAIT 8 MCT'S
0349 00600 54 1016 INA '1016 HIGH HALF
0350 00601 101000 NOP
0351 00602 0 04 00324 STA '324
0352 00603 54 1006 INA '1006 LOW HALF
0353 00604 101000 NOP
0354 00605 0 04 00325 STA '325
0355 00606 14 0006 OCP '006 END HOLD
0356 00607 0 10 00000 CALL INGYRO
0357 00610 000401 ENB
0358 00611 0 10 00000 CALL DCMT
0359 00612 0 10 00000 CALL GCOM
0360 00613 0 10 00000 CALL GARC
0361 00614 0 10 00000 CALL GFIS
0362 00615 0 10 00000 CALL GPRT
0363 00616 0 10 00000 CALL GMIN
0364 00617 0 10 00000 CALL MG63
0365 00620 0 10 00000 CALL FRCO
0366 00621 0 10 00000 CALL ATTA
0367 00622 0 12 00637 IRS TCNT
0368 00623 000007 DEL
0369 00624 0 02 00776 DLD TIME
0370 00625 0 06 00344 DAD DONE
0371 00626 0 04 00776 DST TIME
0372 00627 000005 SGL
0373 *
0374 *
0375 00630 0 01 00555 JMP COMN
0376 *
0377 *
0378 *
0379 00631 030000 DOS OCT 30000
0380 00632 013560 TCON DEC 6000 30 SEC FOR TTY
0381 00633 000620 DEC 400 4 SEC FOR CRT
0382 00634 000144 DEC 100 .4 SEC FOR DGS
0383 *
0384 00635 000000 CRIT BSZ 1
0385 00636 000000 MODE BSZ 1
0386 00637 077777 TCNT OCT 77777
0387 00640 000000 AREG BSZ 1
0388 00641 000000 KEYS BSZ 1
0389 00642 000000 BREG BSZ 1
0390 00643 000000 XREG BSZ 1

```



MICROCOMP TELECOMMUNICATED DATA  
DDP-516 ASSEMBLY LISTING

0391		000776	TIME EQU	'776
0392	00644	000002	END	
	00645	000006		
	00646	040000		
	00647	077777		
	00650	164217		
	00651	177744		
	00652	177674		
	00653	177730		
	00654	177636		

PROGRAM NAME (Note: this is a FORTRAN program)  
 SOURCE: ALPO  
 BINARY: BALPO  
 ENTRY POINTS (location): OUTPUT ('07530), DODSP ('07600)  
 GENERAL DESCRIPTION:

When called, this subroutine will output the information about the system status either on the teletype or the CRT screen in the format shown in Figure 2 or as a block of 104 bytes (6 single precision numbers giving gyro and PIPA fail status and third fail indication and 23 double precision numbers; 4 for the quaternion, 3 for  $\Delta V_I$ , 14 for gyro and PIPA squared errors, 1 for time and 1 for the encoder) on digistor tape. See the documentation for MPRO (the main program which calls OUTPUT) and for the output subroutines SDGS, SXOU and SFPOUT.

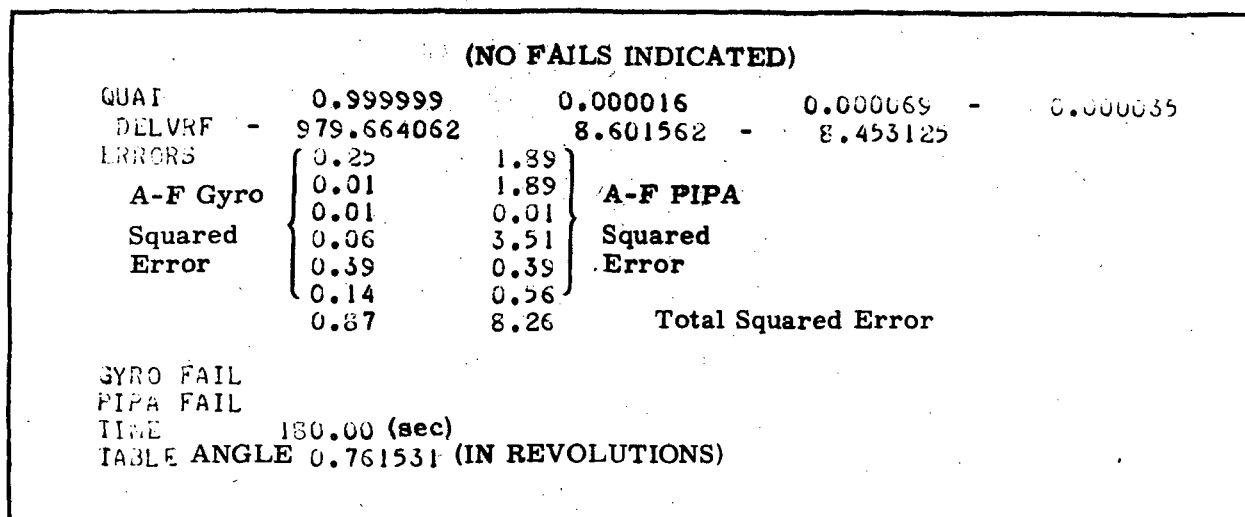

Fig. 2 CRT System Status Display

MICROCOMP TELECOMMUNICATED DATA  
 DDP-516 ASSEMBLY LISTING  
 SUBROUTINE OUTPUT (ARG, MODE)

```

000000   DAC   000000
000001   CALL  F$AT
000002   OCT   000002
000003   DAC   000000
000004   DAC   000000
      INTEGER ARG (52) , MODE, MODSAV
      DATA MODSAV /-1/
000005   JMP   000000
000006   OCT   177777
      IF (MODE.EQ.2) GOTO 100
      STG   000005
000007   LDA*  MODE
000010   SUB   ='000002
000011   SZE   000000
000012   JMP   000000
000013   JMP   _100
      STG   000012
      IF (MODE.EQ.MODSAV) GOTO 50
000014   LDA*  MODE
000015   SUB   MODSAV
000016   SZE   000000
000017   JMP   000000
000020   JMP   _50
      STG   000017
      CALL  IOMODE (MODE)
000021   CALL  IOMODE
000022   DAC*  MODE
      MODSAV=MODE
000023   LDA*  MODE
000024   STA   MODSAV
50   CALL  DODSP (ARG)
      STG   _50
000025   CALL  DODSP
000026   DAC*  ARG
      IF (MODSAV.EQ.1) CALL C10U (2H -)
000027   LDA   MODSAV
000030   SUB   ='000001
000031   SZE   000000
000032   JMP   000000
000033   CALL  C10U
000034   DAC   ='120336
      STG   000032
      RETURN
C
C DIGTSTOP OUTPUT
C
000035   JMP*  000000
100   CALL  DGSWRT (ARG,52)
      STG   _100
000036   CALL  DGSWRT
000037   DAC*  ARG
000040   DAC   ='000064
000041   OCT   000000
      RETURN
000042   JMP*  000000
      END

```

MICROCOMP TELECOMMUNICATED DATA  
DDP-516 ASSEMBLY LISTING

C  
C  
C

```

000043   STG   ='000001
         OCT   000001
         STG   ='000002
000044   OCT   000002
000003   DAC   ARG
000004   DAC   MODE
         STG   ='000064
000045   OCT   000064
000006   DAC   MODSAV
000036   DAC   _100
000025   DAC   _50
000000   DAC   IOMODE
000000   DAC   DODSP
000000   DAC   C10U
         STG   ='120336
000046   OCT   120336
000000   DAC   DGSWRT
        SUBROUTINE DODSP(ARG)
000000   DAC   000000
000001   CALL  F$AT
000002   OCT   000001
000003   DAC   000000
        COMMON/LIST/ LIST(1)
        LOGICAL LIST
        INTEGER ARG(24)
        CALL XNOUA(8HQAT ,8)
000004   JMP   000000
         STG   000004
000005   JMP   000000
000006   OCT   150725
000007   OCT   140724
000010   OCT   120240
000011   OCT   120240
         STG   000005
000012   CALL  XNOUA
000013   DAC   000006
000014   DAC   ='000010
000015   OCT   000000
        DO 10 I=1,7,2
000016   LDA   ='000001
000017   STA   I
        CALL FPOUTC(ARG(I),1,6)
000020   LDA   I
000021   ADD   ARG
000022   ADD   000024
000023   JMP   000025
000024   OCT   177777
000025   STA   T$1000
000026   CALL  FPOUTC
000027   DAC*  T$1000
000030   DAC   ='000001
000031   DAC   ='000006
000032   OCT   000000
10      CALL XNOUA(2H ,2)

```

MICROCOMP TELECOMMUNICATED DATA  
DDP-516 ASSEMBLY LISTING

```

000033 CALL XNOUA
000034 DAC = '120240
000035 DAC = '000002
000036 OCT 000000
000037 LDA I
000040 ADD = '000002
000041 CAS = '000007
000042 JMP 000045
000043 JMP 000017
000044 JMP 000017
CALL X10U (138)
000045 CALL X10U
000046 DAC = '000212
CALL XNOUA (8HDELVRP , 8)
000047 JMP 000000
000050 OCT 142305
000051 OCT 146326
000052 OCT 151306
000053 OCT 120240
STG 000047
000054 CALL XNOUA
000055 DAC 000050
000056 DAC = '000010
000057 OCT 000000
DO 20 I=9,13,2
000060 LDA = '000011
000061 STA I
CALL FPOUTC (ARG (I) , 15, 6)
000062 LDA I
000063 ADD ARG
000064 ADD 000066
000065 JMP 000067
000066 OCT 177777
000067 STA T$1000
000070 CALL FPOUTC
000071 DAC* T$1000
000072 DAC = '000017
000073 DAC = '000006
000074 OCT 000000
20 CALL XNOUA (2H , 2)
000075 CALL XNOUA
000076 DAC = '120240
000077 DAC = '000002
000100 OCT 000000
000101 LDA I
000102 ADD = '000002
000103 CAS = '000015
000104 JMP 000107
000105 JMP 000061
000106 JMP 000061
CALL X10U (138)
000107 CALL X10U
000110 DAC = '000212
CALL XNOUA (8HERRORS , 8)
000111 JMP 000000
000112 OCT 142722
000113 OCT 151317

```

MICROCOMP TELECOMMUNICATED DATA  
DDP-516 ASSEMBLY LISTING

```

000114 OCT 151323
000115 OCT 120240
          STG 000111
000116 CALL XNOUA
000117 DAC 000112
000120 DAC ='000010
000121 OCT 000000
          DO 25 I=1,13,2
000122 LDA ='000001
000123 STA I
          CALL FPOUTC (ARG (I+24), 15, 2)
000124 LDA I
000125 ADD ARG
000126 ADD 000130
000127 JMP 000131
000130 OCT 000027
000131 STA T$1000
000132 CALL FPOUTC
000133 DAC* T$1000
000134 DAC ='000017
000135 DAC ='000002
000136 OCT 000000
          CALL XNOUA (2H , 2)
000137 CALL XNOUA
000140 DAC ='120240
000141 DAC ='000002
000142 OCT 000000
          CALL FPOUTC (ARG (I+38), 15, 2)
000143 LDA I
000144 ADD ARG
000145 ADD 000147
000146 JMP 000150
000147 OCT 000045
000150 STA T$1000
000151 CALL FPOUTC
000152 DAC* T$1000
000153 DAC ='000017
000154 DAC ='000002
000155 OCT 000000
          CALL X10U (138)
000156 CALL X10U
000157 DAC ='000212
25      CALL XNOUA (8H , 8)
000160 JMP 000000
000161 OCT 120240
000162 OCT 120240
000163 OCT 120240
000164 OCT 120240
          STG 000160
000165 CALL XNOUA
000166 DAC 000161
000167 DAC ='000010
000170 OCT 000000
000171 LDA I
000172 ADD ='000002
000173 CAS ='000015
000174 JMP 000177

```

MICROCOMP TELECOMMUNICATED DATA  
DDP-516 ASSEMBLY LISTING

```

000175    JMP    000123
000176    JMP    000123
        CALL X10H(138)
000177    CALL  X10H
000200    DAC    ='000212
        CALL XNOVA(10HGYRO FAIL ,10)
000201    JMP    000000
000202    OCT    143731
000203    OCT    151317
000204    OCT    120306
000205    OCT    140711
000206    OCT    146240
        STG    000201
000207    CALL  XNOVA
000210    DAC    000202
000211    DAC    ='000012
000212    OCT    000000
        IF(ARG(15).EQ.0) GO TO 35
000213    LDA    ARG
000214    ADD    000216
000215    JMP    000217
000216    OCT    000016
000217    STA    T$1000
000220    LDA*   T$1000
000221    SZE    000000
000222    JMP    000000
000223    JMP    _35
        STG    000222
        CALL XNOVA(4H ,4)
000224    JMP    000000
000225    OCT    120240
000226    OCT    120240
        STG    000224
000227    CALL  XNOVA
000230    DAC    000225
000231    DAC    ='000004
000232    OCT    000000
        CALL X10H(ARG(15)+192)
000233    LDA    ARG
000234    ADD    000236
000235    JMP    000237
000236    OCT    000016
000237    STA    T$1000
000240    LDA*   T$1000
000241    ADD    ='000300
000242    STA    T$1001
000243    CALL  X10H
000244    DAC    T$1001
        IF(ARG(16).EQ.0) GO TO 35
000245    LDA    ARG
000246    ADD    000250
000247    JMP    000251
000250    OCT    000017
000251    STA    T$1000
000252    LDA*   T$1000
000253    SZE    000000
000254    JMP    000000

```

MICROCOMP TELECOMMUNICATED DATA  
DDP-516 ASSEMBLY LISTING

```

000255    JMP    _35
          STG    000254
          CALL XNOUA(4H ,4)
000256    JMP    000000
000257    OCT    120240
000260    OCT    120240
          STG    000256
000261    CALL XNOUA
000262    DAC    000257
000263    DAC    =1000004
000264    OCT    000000
          CALL X10U(ARG(16)+192)
000265    LDA    ARG
000266    ADD    000270
000267    JMP    000271
000270    OCT    000017
000271    STA    T$1000
000272    LDA*   T$1000
000273    ADD    =1000300
000274    STA    T$1001
000275    CALL X10U
000276    DAC    T$1001
          IF(ARG(23).NE.0) CALL XNOUA(10H THIRD ,10)
000277    LDA    ARG
000300    ADD    000302
000301    JMP    000303
000302    OCT    000026
000303    STA    T$1000
000304    LDA*   T$1000
000305    SNZ    000000
000306    JMP    000000
000307    JMP    000000
000310    OCT    120240
000311    OCT    120240
000312    OCT    152310
000313    OCT    144722
000314    OCT    142240
          STG    000307
000315    CALL XNOUA
000316    DAC    000310
000317    DAC    =1000012
000320    OCT    000000
          STG    000306
35      CALL X10U(138)
          STG    _35
000321    CALL X10U
000322    DAC    =1000212
          CALL XNOUA(10HPIPA FAIL ,10)
000323    JMP    000000
000324    OCT    150311
000325    OCT    150301
000326    OCT    120306
000327    OCT    140711
000330    OCT    146240
          STG    000323
000331    CALL XNOUA
000332    DAC    000324

```



MICROCOMP TELECOMMUNICATED DATA  
DDP-516 ASSEMBLY LISTING

```

000333   DAC   ='000012
000334   OCT   000000
          IF(ARG(17).EQ.?) GO TO 40
000335   LDA   ARG
000336   ADD   000340
000337   JMP   000341
000340   OCT   000020
000341   STA   T$1000
000342   LDA*  T$1000
000343   SZE   000000
000344   JMP   000000
000345   JMP   _40
          STG   000344
          CALL XNOUA(4H ,4)
000346   JMP   000000
000347   OCT   120240
000350   OCT   120240
          STG   000346
000351   CALL  XNOUA
000352   DAC   000347
000353   DAC   ='000004
000354   OCT   000000
          CALL X10U(ARG(17)+192)
000355   LDA   ARG
000356   ADD   000360
000357   JMP   000361
000360   OCT   000020
000361   STA   T$1000
000362   LDA*  T$1000
000363   ADD   ='000300
000364   STA   T$1001
000365   CALL  X10U
000366   DAC   T$1001
          IF(ARG(18).EQ.0) GO TO 40
000367   LDA   ARG
000370   ADD   000372
000371   JMP   000373
000372   OCT   000021
000373   STA   T$1000
000374   LDA*  T$1000
000375   SZE   000000
000376   JMP   000000
000377   JMP   _40
          STG   000376
          CALL XNOUA(4H ,4)
000400   JMP   000000
000401   OCT   120240
000402   OCT   120240
          STG   000400
000403   CALL  XNOUA
000404   DAC   000401
000405   DAC   ='000004
000406   OCT   000000
          CALL X10U(ARG(18)+192)
000407   LDA   ARG
000410   ADD   000412
000411   JMP   000413

```

MICROCOMP TELECOMMUNICATED DATA  
DDP-516 ASSEMBLY LISTING

```

000412 OCT 000021
000413 STA T$1000
000414 LDA* T$1000
000415 ADD ='000300
000416 STA T$1001
000417 CALL X10H
000420 DAC T$1001
      IF(ARG(24).NE.0) CALL XNOVA(10H THIRD ,10)
000421 LDA ARG
000422 ADD 000424
000423 JMP 000425
000424 OCT 000027
000425 STA T$1000
000426 LDA* T$1000
000427 SNZ 000000
000430 JMP 000000
000431 JMP 000000
000432 OCT 120240
000433 OCT 120240
000434 OCT 152310
000435 OCT 144722
000436 OCT 142240
      STG 000431
000437 CALL XNOVA
000440 DAC 000432
000441 DAC ='000012
000442 OCT 000000
      STG 000430
40 CALL Y10U(138)
      STG _40
000443 CALL X10U
000444 DAC ='000212
      CALL XNOVA(8HTIME ,8)
000445 JMP 000000
000446 OCT 152311
000447 OCT 146705
000450 OCT 120240
000451 OCT 120240
      STG 000445
000452 CALL XNOVA
000453 DAC 000446
000454 DAC ='000010
000455 OCT 000000
      CALL OUT100(ARG(19))
000456 LDA ARG
000457 ADD 000461
000460 JMP 000462
000461 OCT 000022
000462 STA T$1000
000463 CALL OUT100
000464 DAC* T$1000
      CALL X10U(138)
000465 CALL X10U
000466 DAC ='000212
      CALL XNOVA(8HTABLE ,8)
000467 JMP 000000
000470 OCT 152301

```

MICROCOMP TELECOMMUNICATED DATA  
DDP-516 ASSEMBLY LISTING

```

000471 OCT 141314
000472 OCT 142640
000473 OCT 120240
      STG 000467
000474 CALL XNOVA
000475 DAC 000470
000476 DAC ='000010
000477 OCT 000000
      CALL FPOUTC (ARG (21), 0, 6)
000500 LDA ARG
000501 ADD 000503
000502 JMP 000504
000503 OCT 000024
000504 STA T$1000
000505 CALL FPOUTC
000506 DAC* T$1000
000507 DAC ='000000
000510 DAC ='000006
000511 OCT 000000
      CALL X10U (138)
000512 CALL X10U
000513 DAC ='000212
      CALL X10U (138)
000514 CALL X10U
000515 DAC ='000212
      RETURN
000516 JMP* 000000
      END
000517 STG ='000001
      OCT 000001
      STG ='000002
000520 OCT 000002
      STG ='000004
000521 OCT 000004
      STG ='000006
000522 OCT 000006
000003 DAC ARG
000000 DAC LIST
000000 DAC XNOVA
      STG ='000010
000523 OCT 000010
000033 DAC _10
      STG I
000524 OCT 004640
      STG ='000007
000525 OCT 000007
000000 DAC FPOUTC
      STG T$1000
000526 OCT 012244
      STG ='120240
000527 OCT 120240
000000 DAC X10U
      STG ='000212
000530 OCT 000212
000075 DAC _20
      STG ='000011
000531 OCT 000011

```

MICROCOMP TELECOMMUNICATED DATA  
DDP-516 ASSEMBLY LISTING

	STG	= '000015
000532	OCT	000015
	STG	= '000017
000533	OCT	000017
000160	DAC	- 25
	STG	= '000012
000534	OCT	000012
	STG	= '000000
000535	OCT	000000
000321	DAC	- 35
	STG	= '000300
000536	OCT	000300
	STG	T\$1001
000537	OCT	012244
000443	DAC	- 40
000000	DAC	OUT100

\$0

PROGRAM NAME:

SOURCE: SFPOUT

BINARY: BFPOUT

ENTRY POINT (location): FPOUTC ('10340), OUT100 ('10552)

GENERAL DESCRIPTION:

FPOUTC is called by the output subroutine ALPO and prints on the teletype or displays on the CRT (See documentation for subroutine SXOU) a decimal number representation of the binary number designated by the call. The call in FORTRAN is

CALL FPOUTC (ARG, S, P)

or in DAP

CALL	FPOUTC
DAC	ARG
DAC	S
DAC	P
OCT	0

where ARG is the number to be printed, S is the number of bits after the sign bit before the binary point, and P is how many decimal digits to print after the decimal point.

OUT100 is also called by ALPO and is used to print on the teletype or display on the CRT 1/100 of a double precision integer. It is only used to print out the variable TIME, which is really a count of updates and needs to be divided by 100 to scale it to seconds. The call in FORTRAN is CALL OUT100 (TIME), or in DAP

CALL	OUT100
DAC	TIME

MICROCOMP TELECOMMUNICATED DATA  
DDP-516 ASSEMBLY LISTING

0001				SUBR	FPOUTC	
0002				FEL		
0003	00000	0 000000	FPOU	DAC	**	
0004	00001	0 10 00000	CALL	FSAT		
0005	00002	000003	DEC3	OCT	3	
0006	00003	0 00 00000	ARG	PZE		
0007	00004	0 00 00000	SCAL	PZE		
0008	00005	0 00 00000	PREC	PZE		
0009	00006	140040	CRA			
0010	00007	0 04 00166	STA	SGFL		SIGN FLAG
0011	00010	0 04 00173	STA	INT		
0012	00011	0 02 00202	LDA	BLBL		
0013	00012	0 04 00170	STA	STR		
0014	00013	0 04 00171	STA	STR+1		
0015	00014	0 04 00172	STA	STR+2		OVERLAYS CNTR
0016	00015	0 02 00206	LDA	SIX		
0017	00016	0 04 00167	STA	PPTR		
0018			*			
0019	00017	0 35 00003	LDX	ARG		
0020	00020	1 02 00001	LDA	1,1		
0021	00021	000201	IAB			
0022	00022	1 02 00000	LDA	0,1		
0023	00023	000007	DBL			
0024	00024	0 04 00174	DST	FRAC		
0025	00025	101400	SMI			
0026	00026	0 01 00033	JMP	ARGP		
0027	00027	0 12 00166	IRS	SGFL		
0028	00030	0 07 00174	DSB	FRAC		
0029	00031	0 07 00174	DSB	FRAC		
0030	00032	0 04 00174	DST	FRAC		
0031			*			
0032	00033	000005	ARGP	SGL		
0033	00034	-0 02 00004	LDA*	SCAL		
0034	00035	101040	SNZ			
0035	00036	0 01 00051	JMP	SDON		
0036	00037	101400	SMI			
0037	00040	0 01 00144	JMP	TPLS		
0038	00041	0 03 00210	ANA	OC77		
0039	00042	0 05 00201	ERA	RSI		
0040	00043	0 04 00046	STA	INS2		
0041	00044	000007	DBL			
0042	00045	0 02 00174	DLD	FRAC		
0043	00046	0 00 00000	INS2	***		
0044	00047	0 04 00174	DST	FRAC		
0045	00050	000005	SGL			
0046			*			
0047	00051	0 02 00173	SDON	LDA	INT	
0048	00052	0400 60	NEXT	LRL	16	
0049	00053	0 17 00207	DIV	TEN		
0050	00054	0 04 00173	STA	INT		
0051	00055	000201	IAB			
0052	00056	0 06 00176	ADD	FRMT		
0053			*			
0054	00057	000201	IAB			
0055	00060	0 02 00167	LDA	PPTR		
0056	00061	0 07 00205	SUB	ONE		
0057	00062	0 04 00167	STA	PPTR		

MICROCOMP TELECOMMUNICATED DATA  
DDP-516 ASSEMBLY LISTING

0058	00063	0404 77	LGR	1
0059	00064	0 04 00000	STA	0
0060	00065	1 02 00170	LDA	STR, 1
0061	00066	100001	SRC	
0062	00067	000201	IAB	
0063	00070	0414 70	LGL	8
0064	00071	0402 70	LRR	8
0065	00072	1 04 00170	STA	STR, 1
0066				
0067	00073	0 02 00173	LDA	INT
0068	00074	100040	SZE	
0069	00075	0 01 00052	JMP	NEXT
0070	00076	0 02 00166	LDA	SGPL
0071	00077	101040	SNZ	
0072	00100	0 01 00104	JMP	SOUT
0073	00101	0 02 00170	LDA	STR
0074	00102	0 05 00204	ERA	NEGS
0075	00103	0 04 00170	STA	STR
0076	00104	0 10 00000	SOUT CALL	XNOUA
0077	00105	0 000170	DAC	STR
0078	00106	0 000206	DAC	SIX
0079	00107	000000	OCT	0
0080				
0081	00110	-0 02 00005	LDA*	PREC
0082	00111	140407	TCA	
0083	00112	101400	SMI	
0084	00113	-0 01 00000	JMP*	FPOU
0085	00114	0 04 00172	STA	CNTR
0086	00115	0 10 00000	CALL	X10U
0087	00116	0 000203	DAC	DOTC
0088				
0089	00117	0 02 00175	FLP LDA	LOW
0090	00120	0 16 00207	MPY	TEN
0091	00121	000007	DBL	
0092	00122	0 04 00166	DST	TEMP
0093	00123	0 02 00174	DLI	HIGH
0094	00124	0 16 00207	MPY	TEN
0095	00125	0 06 00176	DAD	FRMT
0096	00126	0 13 00173	IMA	DGT
0097	00127	140040	CRA	
0098	00130	000201	IAB	
0099	00131	0 06 00166	DAD	TEMP
0100	00132	100001	SRC	
0101	00133	0 12 00173	IRS	DGT
0102	00134	140100	SSP	
0103	00135	0 04 00174	DST	FRAC
0104	00136	000005	SGL	
0105	00137	0 10 00000	CALL	X10U
0106	00140	0 000173	DAC	DGT
0107	00141	0 12 00172	IRS	CNTR
0108	00142	0 01 00117	JMP	FLP
0109	00143	-0 01 00000	JMP*	FPOU
0110				
0111	00144	0 05 00200	TPLS ERA	LSI
0112	00145	141206	AOA	
0113	00146	0 04 00153	STA	INS1
0114	00147	0 35 00002	LDX	DEC3

MICROCOMP TELECOMMUNICATED DATA  
DDP-516 ASSEMBLY LISTING

0115	00150	140040		CRA	
0116	00151	000201		IAB	
0117	00152	1 02 00172	TPLP	LDA	INT-1,1
0118	00153	0 00 00000	INS1	***	
0119	00154	140100		SSP	
0120	00155	1 13 00172		IHA	INT-1,1
0121	00156	000201		IAB	
0122	00157	0 02 00000		LDA	0
0123	00160	0 07 00205		SUB	ONE
0124	00161	0 04 00000		STA	0
0125	00162	100040		SZE	
0126	00163	0 01 00152		JMP	TPLP
0127	00164	0 01 00051		JMP	SDON
0128			*		
0129			*		
0130			*		
0131	00166	000000		TEMP	DBP 0
	00167	000000			
0132	00170	000000		STR	DBP 0
	00171	000000			
0133	00172	000000		CNTR	BSZ 1
0134	00173	000000		INT	BSZ 1
0135	00174	000000		FRAC	DBP 0
	00175	000000			
0136		000173		DGT	EQU INT
0137		000174		HIGH	EQU FRAC
0138		000175		LOW	EQU FRAC+1
0139		000166		SGFL	EQU TEMP
0140		000167		PPTR	EQU TEMP+1
0141			*		
0142	00176	000260		FRMT	OCT 260,0
	00177	000000			
0143	00200	0411 77		LSI	LLS 1
0144	00201	0401 00		PSI	LRS 0
0145	00202	120240		BIBL	OCT 120240
0146	00203	000256		DOTC	OCT 256
0147	00204	006400		NEGS	OCT 6400
0148			*		
0149	00205	000001		ONE	DEC 1
0150	00206	000006		SIX	DEC 6
0151	00207	000012		TEN	OCT 12
0152	00210	000077		OC77	DEC 63
0153	00211	000000		ZERE	OCT 0
0154				FIN	
0155			*		
0156			*		
0157				SUBR	OUT100
0158				REL	
0159	00212	0 000000	OUT1	DAC	**
0160	00213	0 10 00000		CALL	ARG\$
0161	00214	-0 000212		DAC*	OUT1
0162	00215	1 02 00001		LDA	1,1
0163	00216	000201		IAB	
0164	00217	1 02 00000		LDA	0,1
0165	00220	0 17 00240		DIV	D100
0166	00221	0 04 00236		STA	OTMP
0167	00222	140040		CRA	



MICROCOMP TELECOMMUNICATED DATA  
DDP-516 ASSEMBLY LISTING

0168	00223	000201	IAB		
0169	00224	0 17 00240	DIV	D100	
0170	00225	141206	AOA		
0171	00226	0 04 00237	STA	OTMP+1	
0172	00227	0 10 00000	CALL	FPOUTC	
0173	00230	0 000236	DAC	OTMP	
0174	00231	0 000242	DAC	=15	
0175	00232	0 000241	DAC	=2	
0176	00233	000000	OCT	0	
0177	00234	0 12 00212	IPS	OUT1	
0178	00235	-0 01 00212	JMP*	OUT1	
0179			*		
0180	00236	000000	OTMP BSZ	2	
	00237	000000			
0181	00240	000144	D100 DEC	100	
0182	00241	000002	END		
	00242	000017			

PROGRAM NAME

SOURCE: SXOU

BINARY: BXOU

ENTRY POINTS (location): IOMODE ('10604), X1OU ('10636),  
XNOU ('10642), XNOUA ('10646), XOOCT ('10652)

GENERAL DESCRIPTION:

This subroutine is really an intermediary to the output calls to either the FORTRAN teletype output routines (T1OU, TNOU, TNOUA and TOOCT), or the CRT output routines (C1OU, CNOU, CNOUA and COOCT). The subroutine ALPO (see documentation) first calls IOMODE with the argument 0 if it wants to output on the teletype or 1 if it wants to output on the CRT. From then on, every call to X1OU, XNOU or XOOCT will be rerouted to look like the proper call to either the teletype or CRT routines.

MICROCOMP TELECOMMUNICATED DATA  
DDP-516 ASSEMBLY LISTING

```

0001                                SUBR  IOMODE
0002                                SUBR  X10U
0003                                SUBR  XNOU,XNO
0004                                SUBR  XNOUA,XNOA
0005                                SUBR  XOOCT
0006                                REL
0007                                *
0008 00000  0 000000  IOMO DAC  **
0009 00001  0 35 00000  LDX  IOMO
0010 00002 -1 02 00000  LDA*  0,1
0011 00003  0 35 00063  LDX  =0
0012 00004  100040      SZF
0013 00005  0 35 00062  LDX  =4
0014 00006  000007      DBI
0015 00007  1 02 00022  DLD  ADL,1
0016 00010  0 04 00016  DST  LST
0017 00011  1 02 00024  DLD  ADL+2,1
0018 00012  0 04 00020  DST  LST+2
0019 00013  000005      SGL
0020 00014  0 12 00000  IRS  IOMO
0021 00015 -0 01 00000  JMP* IOMO
0022                                *
0023 00016  000000  LST  DEP  0
0024 00020  000000      DEP  0
0025 00022  0 000000  ADL  XAC  T10U
0026 00023  0 000000      XAC  TNOU
0027 00024  0 000000      XAC  TNOUA
0028 00025  0 000000      XAC  TOOCT
0029 00026  0 000000      XAC  C10U
0030 00027  0 000000      XAC  CNOU
0031 00030  0 000000      XAC  CNOUA
0032 00031  0 000000      XAC  COOCT
0033                                *
0034                                *
0035 00032  0 000000  X10U DAC  **
0036 00033  0 35 00063  LDX  =0
0037 00034  0 02 00032  LDA  X10U
0038 00035  0 01 00051  JMP  COMN
0039                                *
0040 00036  0 000000  XNO  DAC  **
0041 00037  0 35 00061  LDX  =1
0042 00040  0 02 00036  LDA  XNO
0043 00041  0 01 00051  JMP  COMN
0044                                *
0045 00042  0 000000  XNOA DAC  **
0046 00043  0 35 00060  LDX  =2
0047 00044  0 02 00042  LDA  XNOA
0048 00045  0 01 00051  JMP  COMN
0049                                *
0050 00046  0 000000  XOOC DAC  **
0051 00047  0 35 00057  LDX  =3
0052 00050  0 02 00046  LDA  XOOC
0053                                *
0054 00051 -1 04 00016  COMN STA* LST,1
0055 00052  1 02 00016  LDA  LST,1

```

MICROCOMP TELECOMMUNICATED DATA  
DDP-516 ASSEMBLY LISTING

0056	00053	141206	AOA		
0057	00054	0 04 00056	STA	TEMP	
0058	00055	-0 01 00056	JMP*	TEMP	
0059			*		
0060	00056	000000	TEMP	BSZ	1
0061			*		
0062	00057	000003	END		
	00060	000002			
	00061	000001			
	00062	000004			
	00063	000000			

PROGRAM NAME

SOURCE: SDGS

BINARY: BDGS

ENTRY POINTS (location): DGSRD ('13311), DGSWRT ('13250)

GENERAL DESCRIPTION:

These two subroutines are for reading and writing words on the digistor tape. The SIRU system only writes on the digistor tape. A fortran statement; CALL DGSWRT (ARG, 52), or the DAP instructions,

CALL	DGSWRT
DAC	ARG
DAC	= '64
OCT	0

when executed, will cause this subroutine to write a heading, 52 words of information starting with ARG, and one word of parity on the digistor tape. It will then return.

MICROCOMP TELECOMMUNICATED DATA  
DDP-516 ASSEMBLY LISTING

0001				REL	
0002				SUBR	DGSRD
0003				SUBR	DGSWRT
0004			*		
0005	00000	0 000000	DGSW	DAC	**
0006	00001	0 10 00000		CALL	P\$AT
0007	00002	000002		OCT	2
0008	00003	0 00 00000	WARY	PZE	
0009	00004	0 00 00000	WCNT	PZE	
0010	00005	-0 02 00004		LDA*	WCNT
0011	00006	140407		TCA	
0012	00007	101400		SMI	
0013	00010	-0 01 00000		JMP*	DGSW
0014	00011	0 04 00004		STA	WCNT
0015	00012	140040		CRA	
0016	00013	0 04 00143		STA	ACC
0017	00014	0 02 00145		LDA	= ' 201
0018	00015	0 10 00127		JST	WRT
0019	00016	0 10 00127		JST	WRT
0020	00017	0 02 00144		LDA	= ' 177777
0021	00020	0 10 00127		JST	WRT
0022	00021	0 10 00127		JST	WRT
0023			*		
0024	00022	-0 02 00003	WLUP	LDA*	WAPY
0025	00023	141340		ICA	
0026	00024	0 10 00127		JST	WRT
0027	00025	141340		ICA	
0028	00026	0 10 00127		JST	WRT
0029	00027	0 10 00122		JST	PRTY
0030	00030	0 12 00003		IRS	WARY
0031	00031	0 12 00004		IRS	WCNT
0032	00032	0 01 00022		JMP	WLUP
0033			*		
0034	00033	0 02 00143		LDA	ACC
0035	00034	141340		ICA	
0036	00035	0 10 00127		JST	WRT
0037	00036	141340		ICA	
0038	00037	0 10 00127		JST	WRT
0039	00040	-0 01 00000		JMP*	DGSW
0040			*		
0041			*		
0042			*		
0043	00041	0 000000	DGSR	DAC	**
0044	00042	0 10 00000		CALL	P\$AT
0045	00043	000002		OCT	2
0046	00044	0 00 00000	RARY	PZE	
0047	00045	0 00 00000	RCNT	PZE	
0048	00046	-0 02 00045		LDA*	RCNT
0049	00047	140407		TCA	
0050	00050	101400		SMI	
0051	00051	-0 01 00041		JMP*	DGSR
0052	00052	0 04 00045		STA	RCNT
0053	00053	140040		CRA	
0054	00054	0 04 00143		STA	ACC
0055	00055	140040	RLOK	CRA	
0056	00056	0 10 00135		JST	RD
0057	00057	0 05 00145		ERA	= ' 201

MICROCOMP TELECOMMUNICATED DATA  
DDP-516 ASSEMBLY LISTING

0058	00060	100040		SZE	
0059	00061	0 01 00055		JMP	RLOK
0060	00062	140040		CRA	
0061	00063	0 10 00135		JST	RD
0062	00064	0 05 00145		ERA	= '201
0063	00065	100040		SZE	
0064	00066	0 01 00055		JMP	RLOK
0065	00067	140040		CRA	
0066	00070	0 10 00135		JST	RD
0067	00071	141340		ICA	
0068	00072	0 10 00135		JST	RD
0069	00073	0 05 00144		ERA	= '177777
0070	00074	100040		SZE	
0071	00075	0 01 00055		JMP	RLOK
0072			*		
0073	00076	140040	RLUP	CRA	
0074	00077	0 10 00135		JST	RD
0075	00100	141340		ICA	
0076	00101	0 10 00135		JST	RD
0077	00102	-0 04 00044		STA*	RARY
0078	00103	0 10 00122		JST	PRTY
0079	00104	0 12 00044		IRS	RARY
0080	00105	0 12 00045		IRS	RCNT
0081	00106	0 01 00076		JMP	RLUP
0082			*		
0083	00107	140040		CRA	
0084	00110	0 10 00135		JST	RD
0085	00111	141340		ICA	
0086	00112	0 10 00135		JST	RD
0087	00113	0 05 00143		ERA	ACC
0088	00114	101040		SNZ	
0089	00115	0 01 00120		JMP	**+3
0090	00116	140040		CRA	
0091	00117	100000		SKP	
0092	00120	141206		AOA	
0093	00121	-0 01 00041		JMP*	DGSR
0094			*		
0095			*		
0096			*		
0097	00122	0 000000	PRTY	DAC	**
0098	00123	0 05 00143		ERA	ACC
0099	00124	0416 77		ALR	1
0100	00125	0 04 00143		STA	ACC
0101	00126	-0 01 00122		JMP*	PPTY
0102			*		
0103	00127	0 000000	WRT	DAC	**
0104	00130	14 0002		OCP	'2
0105	00131	74 0002		OTA	'2
0106	00132	0 01 00130		JMP	*-2
0107	00133	14 0102		OCP	'102
0108			*		
0109	00134	-0 01 00127		JMP*	WRT
0110			*		
0111	00135	0 000000	RD	DAC	**
0112	00136	14 0001		OCP	'1
0113	00137	54 0001		INA	'1
0114	00140	0 01 00137		JMP	*-1

MICROCOMP TELECOMMUNICATED DATA  
DDP-516 ASSEMBLY LISTING

```
0115 00141 14 0101 OCP '101
0116 00142 -0 01 00135 JMP* RD
0117 *
0118 00143 000000 ACC BSZ 1
0119 *
0120 00144 177777 END
00145 000201
```



PROGRAM NAME

SOURCE: READ

BINARY: BREAD

ENTRY POINTS (location): ICINIT ('01656), INPIP ('01731),  
INGYRO ('01764)

GENERAL DESCRIPTION:

The subroutine ICINIT will set up the gyro and PIPA interface to interrupt the main program every 5 milliseconds. The first interrupt will be a PIPA interrupt and will occur when the PIPA counters have 10 milliseconds of data in them. The next interrupt will be a gyro interrupt 5 milliseconds later and will occur when the gyro counters have 10 milliseconds of data in them. From then on every 5 milliseconds the interrupts will occur alternately. ICINIT will also read the initial interpolator values of the gyros.

The subroutine INPIP will read the 6 PIPA pulse counters and store them in the locations indicated by the listing with a scaling of  $2^{-6}$  pulses. For example, an octal 000400 represents one pulse or 4 cm/sec of  $\Delta V$ .

The subroutine INGYRO will read the 6 gyro pulse counters, subtract the old interpolator values, add the new interpolator values and store them in the locations indicated by the listing. These are also scaled at  $2^{-6}$  pulses. For example, an octal 000400 represents one pulse or  $7 \times 2^{-15}$  radians.

MICROCOMP TELECOMMUNICATED DATA  
DDP-516 ASSEMBLY LISTING

0001			SUBR	ICINIT	
0002			REL		
0003	00000	0 000000	ICIN DAC	**	
0004	00001	14 0047	OCP	'47	DISABLE GYRO
0005	00002	14 0057	OCP	'57	DISABLE PIP
0006	00003	14 0077	OCP	'77	RESET PRESET
0007	00004	0 02 00210	LDA	=47	
0008	00005	74 0077	OTA	'77	SET PRESET
0009	00006	0 01 00005	JMP	*-1	
0010	00007	14 0027	OCP	'27	CLR & ENB CLOCK
0011	00010	34 0207	SKS	'207	WAIT FOR PULSE
0012	00011	0 01 00010	JMP	*-1	
0013	00012	0400 56	LRL	18	WAIT 10 MICSEC.
0014	00013	14 0017	OCP	'17	CLR AND ENABLE PIPA
0015	00014	0 35 00207	LDX	=-24	
0016	00015	14 0027	WLUP OCP	'27	CLR & ENB CLOCK
0017	00016	34 0207	SKS	'207	WAIT FOR PULSE
0018	00017	0 01 00016	JMP	*-1	
0019	00020	0 12 00000	IRS	0	
0020	00021	0 01 00015	JMP	WLUP	WAIT FOR 22
0021	00022	14 0027	OCP	'27	
0022	00023	14 0067	OCP	'67	DISABLE CLOCK
0023	00024	0400 56	LRL	18	WAIT 18 MICSEC.
0024	00025	14 0007	OCP	'7	ENABLE GYRO
0025	00026	34 0307	SKS	'307	SKIP IF INTRPLTR REDY
0026	00027	0 01 00026	JMP	*-1	
0027					* READ INITIAL INTERPOLATOR DATA
0028	00030	54 1307	INA	'1307	
0029	00031	0 01 00030	JMP	*-1	
0030	00032	0 04 00430	STA	'430	OLD INTRPPLTR DATA
0031	00033	54 1317	INA	'1317	
0032	00034	0 01 00033	JMP	*-1	
0033	00035	0 04 00431	STA	'431	
0034	00036	54 1327	INA	'1327	
0035	00037	0 01 00036	JMP	*-1	
0036	00040	0 04 00432	STA	'432	
0037	00041	54 1337	INA	'1337	
0038	00042	0 01 00041	JMP	*-1	
0039	00043	0 04 00433	STA	'433	
0040	00044	54 1347	INA	'1347	
0041	00045	0 01 00044	JMP	*-1	
0042	00046	0 04 00434	STA	'434	
0043	00047	54 1357	INA	'1357	
0044	00050	0 01 00047	JMP	*-1	
0045	00051	0 04 00435	STA	'435	
0046	00052	-0 01 00000	JMP*	ICIN	
0047			*		
0048			*		
0049			*		
0050			SUBR	INPIP	
0051			REL		
0052	00053	0 000000	INPI DAC	**	
0053	00054	54 1107	INA	'1107	
0054	00055	0 01 00054	JMP	*-1	
0055	00056	141240	ICR		
0056	00057	0 04 00600	STA	PIPA	
0057	00060	54 1117	INA	'1117	

MICROCOMP TELECOMMUNICATED DATA  
DDP-516 ASSEMBLY LISTING

0058	00061	0 01 00060	JMP	*-1	
0059	00062	141240	ICR		
0060	00063	0 04 00602	STA	PIPB	
0061	00064	54 1127	INA	'1127	
0062	00065	0 01 00064	JMP	*-1	
0063	00066	141240	ICR		
0064	00067	0 04 00604	STA	PIPC	
0065	00070	54 1137	INA	'1137	
0066	00071	0 01 00070	JMP	*-1	
0067	00072	141240	ICR		
0068	00073	0 04 00606	STA	PIPD	
0069	00074	54 1147	INA	'1147	
0070	00075	0 01 00074	JMP	*-1	
0071	00076	141240	ICR		
0072	00077	0 04 00610	STA	PIPE	
0073	00100	54 1157	INA	'1157	
0074	00101	0 01 00100	JMP	*-1	
0075	00102	141240	ICR		
0076	00103	0 04 00612	STA	PIPF	
0077	00104	14 1017	QCP	'17	CLEAR AND ENABLE
0078	00105	-0 01 00053	JMP*	INPI	
0079		*			
0080		*			
0081		000600	PIPA EQU	'600	
0082		000602	PIPB EQU	PIPA+2	
0083		000604	PIPC EQU	PIPB+2	
0084		000606	PIPD EQU	PIPC+2	
0085		000610	PIPE EQU	PIPD+2	
0086		000612	PIPF EQU	PIPE+2	
0087		*			
0088		*			
0089			SUBR	INGYRO	
0090			REL		
0091		*			
0092	00106	0 000000	INGY DAC	**	
0093	00107	54 1007	INA	'1007	
0094	00110	0 01 00107	JMP	*-1	
0095	00111	141240	ICR		
0096	00112	0 07 00430	SUB	'430	
0097	00113	0 04 00400	STA	GYRA	
0098	00114	54 1017	INA	'1017	
0099	00115	0 01 00114	JMP	*-1	
0100	00116	141240	ICR		
0101	00117	0 07 00431	SUB	'431	
0102	00120	0 04 00402	STA	GYRB	
0103	00121	54 1027	INA	'1027	
0104	00122	0 01 00121	JMP	*-1	
0105	00123	141240	ICR		
0106	00124	0 07 00432	SUB	'432	
0107	00125	0 04 00404	STA	GYRC	
0108	00126	54 1037	INA	'1037	
0109	00127	0 01 00126	JMP	*-1	
0110	00130	141240	ICR		
0111	00131	0 07 00433	SUB	'433	
0112	00132	0 04 00406	STA	GYRD	
0113	00133	54 1047	INA	'1047	
0114	00134	0 01 00133	JMP	*-1	

MICROCOMP TELECOMMUNICATED DATA  
DDP-516 ASSEMBLY LISTING

```

0115 00135 141240 ICR
0116 00136 0 07 00434 SUB '434
0117 00137 0 04 00410 STA GYRE
0118 00140 54 1057 INA '1057
0119 00141 0 01 00140 JMP *-1
0120 00142 141240 ICR
0121 00143 0 07 00435 SUB '435
0122 00144 0 04 00412 STA GYRF
0123 00145 14 0007 OCP '7
0124 * READ INTERPOLATORS
0125 00146 34 0307 SKS '307
0126 00147 0 01 00146 JMP *-1
0127 00150 54 1307 INA '1307
0128 00151 0 01 00150 JMP *-1
0129 00152 0 04 00430 STA '430
0130 00153 0 06 00400 ADD GYRA
0131 00154 0 04 00400 STA GYRA
0132 00155 54 1317 INA '1317
0133 00156 0 01 00155 JMP *-1
0134 00157 0 04 00431 STA '431
0135 00160 0 06 00402 ADD GYRB
0136 00161 0 04 00402 STA GYRB
0137 00162 54 1327 INA '1327
0138 00163 0 01 00162 JMP *-1
0139 00164 0 04 00432 STA '432
0140 00165 0 06 00404 ADD GYRC
0141 00166 0 04 00404 STA GYRC
0142 00167 54 1337 INA '1337
0143 00170 0 01 00167 JMP *-1
0144 00171 0 04 00433 STA '433
0145 00172 0 06 00406 ADD GYRD
0146 00173 0 04 00406 STA GYRD
0147 00174 54 1347 INA '1347
0148 00175 0 01 00174 JMP *-1
0149 00176 0 04 00434 STA '434
0150 00177 0 06 00410 ADD GYRE
0151 00200 0 04 00410 STA GYRE
0152 00201 54 1357 INA '1357
0153 00202 0 01 00201 JMP *-1
0154 00203 0 04 00435 STA '435
0155 00204 0 06 00412 ADD GYRF
0156 00205 0 04 00412 STA GYRF
0157 00206 -0 01 00106 JMP* INGY
0158 *
0159 *
0160 000400 GYRA EQU '400
0161 000402 GYRB EQU GYRA+2
0162 000404 GYRC EQU GYRB+2
0163 000406 GYRD EQU GYRC+2
0164 000410 GYRE EQU GYRD+2
0165 000412 GYRF EQU GYRE+2
0166 *
0167 00207 177750 END
00210 000057

```

CLFAR AND ENABLE

PROGRAM NAME  
SOURCE: ACOM  
BINARY: BACOM  
ENTRY POINTS (location): ACOM ('03274)  
GENERAL DESCRIPTION:

This subroutine compensates the accelerometers for scale factor, bias and two misalignments, SO and SP, expressed as misalignments toward the negative X, Y and Z axes. Considering just the A accelerometer, the following equations are programmed.

$$AAPC = AAPC + AABD + \frac{1}{2^6} AASF AAPC$$

where

AAPC is accelerometer A's pulse count

AABD is accelerometer A's bias

and

AASF is  $2^6$ X accelerometer A's  $\Delta$  scale factor

then

$$AAPC = \frac{1}{2^9} (DVXB AAMX + DVYB AAMY + DVZB AAMZ)$$

DVXB, DVYB, DVZB are the  $\Delta V_{x,y,z}$  outputs in the body frame and AAMX, Y, Z are  $2^9$ X accelerometer A's misalignments in the negative X, Y, Z directions. See listing for coding.

MICROCOMP TELECOMMUNICATED DATA  
DDP-516 ASSEMBLY LISTING

0001				REL	
0002				SUBR	ACOM
0003	00000	0 000000	ACOM	DAC	**
0004	00001	0 02 00600		LDA	AAPC
0005	00002	0 16 00700		MPY	AASF
0006	00003	000007		DBL	
0007	00004	0401 72		LRS	6
0008	00005	0 06 00706		DAD	AABD
0009	00006	0 06 00600		DAD	AAPC
0010	00007	0 04 00600		DST	AAPC
0011	00008	0 02 00602		DLD	ABPC
0012	00011	0 16 00701		MPY	ABSF
0013	00012	0401 72		LRS	6
0014	00013	0 06 00710		DAD	ABBD
0015	00014	0 06 00602		DAD	ABPC
0016	00015	0 04 00602		DST	ABPC
0017	00016	0 02 00604		DLD	ACPC
0018	00017	0 16 00702		MPY	ACSF
0019	00020	0401 72		LRS	6
0020	00021	0 06 00712		DAD	ACBD
0021	00022	0 06 00604		DAD	ACPC
0022	00023	0 04 00604		DST	ACPC
0023	00024	0 02 00606		DLD	ADPC
0024	00025	0 16 00703		MPY	ADSF
0025	00026	0401 72		LRS	6
0026	00027	0 06 00714		DAD	ADBD
0027	00030	0 06 00606		DAD	ADPC
0028	00031	0 04 00606		DST	ADPC
0029	00032	0 02 00610		DLD	AEPF
0030	00033	0 16 00704		MPY	AESF
0031	00034	0401 72		LRS	6
0032	00035	0 06 00716		DAD	AEBD
0033	00036	0 06 00610		DAD	AEPF
0034	00037	0 04 00610		DST	AEPF
0035	00040	0 02 00612		DLD	AFPC
0036	00041	0 16 00705		MPY	AFSF
0037	00042	0401 72		LRS	6
0038	00043	0 06 00720		DAD	AFBD
0039	00044	0 06 00612		DAD	AFPC
0040	00045	0 04 00612		DST	AFPC
0041	00046	0 02 00614		DLD	DVXB
0042	00047	0 16 00722		MPY	AAMX
0043	00050	0 04 00166		DST	TACM
0044	00051	0 02 00614		DLD	DVXB
0045	00052	0 16 00723		MPY	ARMX
0046	00053	0 04 00170		DST	TBCM
0047	00054	0 02 00614		DLD	DVXB
0048	00055	0 16 00724		MPY	ACMX
0049	00056	0 04 00172		DST	TCCM
0050	00057	0 02 00614		DLD	DVXB
0051	00060	0 16 00725		MPY	ADMX
0052	00061	0 04 00174		DST	TDCM
0053	00062	0 02 00614		DLD	DVXB
0054	00063	0 16 00726		MPY	AEMX
0055	00064	0 04 00176		DST	TECM
0056	00065	0 02 00614		DLD	DVXB
0057	00066	0 16 00727		MPY	AFMX

MICROCOMP TELECOMMUNICATED DATA  
DDP-516 ASSEMBLY LISTING

0058	00067	0 04	00200	DST	TPCM
0059	00070	0 02	00616	DLD	DVYB
0060	00071	0 16	00730	MPY	AAMY
0061	00072	0 06	00166	DAD	TACH
0062	00073	0 04	00166	DST	TACH
0063	00074	0 02	00616	DLD	DVYB
0064	00075	0 16	00731	MPY	ABMY
0065	00076	0 06	00170	DAD	TBCM
0066	00077	0 04	00170	DST	TBCM
0067	00100	0 02	00616	DLD	DVYB
0068	00101	0 16	00732	MPY	ACHY
0069	00102	0 06	00172	DAD	TCCM
0070	00103	0 04	00172	DST	TCCM
0071	00104	0 02	00616	DLD	DVYB
0072	00105	0 16	00733	MPY	ADMY
0073	00106	0 06	00174	DAD	TDCM
0074	00107	0 04	00174	DST	TDCM
0075	00110	0 02	00616	DLD	DVYB
0076	00111	0 16	00734	MPY	AEMY
0077	00112	0 06	00176	DAD	TECH
0078	00113	0 04	00176	DST	TECH
0079	00114	0 02	00616	DLD	DVYB
0080	00115	0 16	00735	MPY	AFMY
0081	00116	0 06	00200	DAD	TPCM
0082	00117	0 04	00200	DST	TPCM
0083	00120	0 02	00620	DLD	DVZB
0084	00121	0 16	00736	MPY	AAHZ
0085	00122	0 06	00166	DAD	TACH
0086	00123	0401	67	LRS	9
0087	00124	0 06	00600	DAD	AAPC
0088	00125	0 04	00600	DST	AAPC
0089	00126	0 02	00620	DLD	DVZB
0090	00127	0 16	00737	MPY	ABMZ
0091	00130	0 06	00170	DAD	TBCM
0092	00131	0401	67	LRS	9
0093	00132	0 06	00602	DAD	ABPC
0094	00133	0 04	00602	DST	ABPC
0095	00134	0 02	00620	DLD	DVZB
0096	00135	0 16	00740	MPY	ACMZ
0097	00136	0 06	00172	DAD	TCCM
0098	00137	0401	67	LRS	9
0099	00140	0 06	00604	DAD	ACPC
0100	00141	0 04	00604	DST	ACPC
0101	00142	0 02	00620	DLD	DVZB
0102	00143	0 16	00741	MPY	ADMZ
0103	00144	0 06	00174	DAD	TDCM
0104	00145	0401	67	LRS	9
0105	00146	0 06	00606	DAD	ADPC
0106	00147	0 04	00606	DST	ADPC
0107	00150	0 02	00620	DLD	DVZB
0108	00151	0 16	00742	MPY	AEMZ
0109	00152	0 06	00176	DAD	TECH
0110	00153	0401	67	LRS	9
0111	00154	0 06	00610	DAD	AEPC
0112	00155	0 04	00610	DST	AEPC
0113	00156	0 02	00620	DLD	DVZB
0114	00157	0 16	00743	MPY	AFMZ

MICROCOMP TELECOMMUNICATED DATA  
DDP-516 ASSEMBLY LISTING

0115	00160	0 06 00200	DAD	TFCM
0116	00161	0401 67	LRS	9
0117	00162	0 06 00612	DAD	AFPC
0118	00163	0 04 00612	DST	AFPC
0119	00164	000005	SGL	
0120	00165	-0 01 00000	JMP*	ACOM
0121		000600	AAPC EQU	'600
0122		000602	ABPC EQU	AAPC+2
0123		000604	ACPC EQU	AAPC+4
0124		000606	ADPC EQU	AAPC+6
0125		000610	AAPC EQU	AAPC+8
0126		000612	AFPC EQU	AAPC+10
0127		000700	AASF EQU	'700
0128		000701	ABSP EQU	AASF+1
0129		000702	ACSP EQU	AASF+2
0130		000703	ADSP EQU	AASF+3
0131		000704	AESP EQU	AASF+4
0132		000705	AFSP EQU	AASF+5
0133		000706	AABD EQU	'706
0134		000710	ABBD EQU	AABD+2
0135		000712	ACBD EQU	AABD+4
0136		000714	ADBD EQU	AABD+6
0137		000716	AESD EQU	AABD+8
0138		000720	AFBD EQU	AABD+10
0139		000722	AAMX EQU	'722
0140		000723	ARMX EQU	AAMX+1
0141		000724	ACMX EQU	AAMX+2
0142		000725	ADMX EQU	AAMX+3
0143		000726	AEMX EQU	AAMX+4
0144		000727	AFMX EQU	AAMX+5
0145		000730	AAMY EQU	AAMX+6
0146		000731	ABMY EQU	AAMX+7
0147		000732	ACMY EQU	AAMX+8
0148		000733	ADMY EQU	AAMX+9
0149		000734	AEMY EQU	AAMX+10
0150		000735	AFMY EQU	AAMX+11
0151		000736	AAMZ EQU	AAMX+12
0152		000737	ABMZ EQU	AAMX+13
0153		000740	ACMZ EQU	AAMX+14
0154		000741	ADMZ EQU	AAMX+15
0155		000742	AEMZ EQU	AAMX+16
0156		000743	AFMZ EQU	AAMX+17
0157		000614	DVXB EQU	'614
0158		000616	DVYB EQU	DVXB+2
0159		000620	DVZB EQU	DVXB+4
0160	00166	000000	TACM DBP	0
	00167	000000		
0161	00170	000000	TBCM DBP	0
	00171	000000		
0162	00172	000000	TCCM DBP	0
	00173	000000		
0163	00174	000000	TDCM DBP	0
	00175	000000		
0164	00176	000000	TECM DBP	0
	00177	000000		
0165	00200	000000	TFCM DBP	0
	00201	000000		



MICROCOMP TELECOMMUNICATED DATA  
DDP-516 ASSEMBLY LISTING  
0166 END

PROGRAM NAME  
 SOURCE: GCOM  
 BINARY: BGCOM  
 ENTRY POINT (location): GCOM ('02242)  
 GENERAL DESCRIPTION:

This subroutine compensates the gyros for  $\pm\Delta SF$ , NBD, ADIA, ADOA, ADSRA, major compliance, GO, GS and OA coupling (by calling the OA coupling compensation subroutine, DCOA). Considering just the A gyro its compensation parameters are:

GANS =  $2^6$  X gyro A negative  $\Delta SF$   
 GAPS =  $2^6$  X gyro A positive  $\Delta SF$   
 GABD = gyro A's NBD  
 ADAX, Y, Z =  $2^{12}$  x Acceleration dependent  
 drifts of gyro A for  
 accelerations on the  
 X, Y and Z axes  
 (a function of ADIA, OA, SRA)  
 AASD =  $2^6$  x A gyro acceleration  
 squared drift or major  
 compliance  
 GAMX, Y, Z =  $2^{10}$  x gyro A's misalignment  
 along the negative X, Y  
 and Z axes (functions  
 of GO and GS).

For the A gyro the following equations are implemented.

$$GAPC = GAPC + GABD + \frac{1}{2^6} GAPC \begin{matrix} \text{GAPS} \\ \text{or} \\ \text{GANS} \end{matrix}$$

where GAPC is Gyro A's pulse count

$$GAPC = \frac{1}{2^{12}} (ADAX DVXB + ADAY DVYB + ADAZ DVZB)$$

where DVXB, DVYB and DVZB are the accelerations (in units of  $\Delta V_{x,y,z}$  per update).

$$GAPC = GAPC + \frac{1}{2^6}(DVZB DVZB - DVXB DVXB - DVXB DVZB) AASD$$

where the parenthesized expression is proportional to DVAIA DVASRA, the product of the accelerations on A gyros IA and SRA.

CALL DCOA (see documentation for subroutine DCOA)

$$GAPC = GAPC + \frac{1}{2^{10}}(GAMX DTXB + GAMY DTYB + GAMZ DTZB)$$

where DTXB, DTYB and DTZB are  $\Delta\theta_x$ ,  $\Delta\theta_y$  and  $\Delta\theta_z$  during the last update.

(Note, since ACOM is the subroutine which compensates the accelerometers and is a little simpler, it might be better to read its documentation first).

MICROCOMP TELECOMMUNICATED DATA  
DDP-516 ASSEMBLY LISTING

0001			REL	
0002			SUBR	GCOM
0003	00000	0 000000	GCOM DAC	**
0004	00001	0 02 00400	LDA	GAPC
0005	00002	000007	DBL	
0006	00003	101400	SMI	
0007	00004	0 01 00007	JMP	**3
0008	00005	0 16 00506	MPY	GANS
0009	00006	100000	SKP	
0010	00007	0 16 00500	MPY	GAPS
0011	00010	0401 72	LRS	6
0012	00011	0 06 00514	DAD	GABD
0013	00012	0 06 00400	DAD	GAPC
0014	00013	0 04 00400	DST	GAPC
0015	00014	0 02 00402	DLD	GBPC
0016	00015	101400	SMI	
0017	00016	0 01 00021	JMP	**3
0018	00017	0 16 00507	MPY	GBNS
0019	00020	100000	SKP	
0020	00021	0 16 00501	MPY	GBPS
0021	00022	0401 72	LRS	6
0022	00023	0 06 00516	DAD	GBBD
0023	00024	0 06 00402	DAD	GBPC
0024	00025	0 04 00402	DST	GBPC
0025	00026	0 02 00404	DLD	GCPC
0026	00027	101400	SMI	
0027	00030	0 01 00033	JMP	**3
0028	00031	0 16 00510	MPY	GCNS
0029	00032	100000	SKP	
0030	00033	0 16 00502	MPY	GCPS
0031	00034	0401 72	LRS	6
0032	00035	0 06 00520	DAD	G CBD
0033	00036	0 06 00404	DAD	GCPC
0034	00037	0 04 00404	DST	GCPC
0035	00040	0 02 00406	DLD	GDPC
0036	00041	101400	SMI	
0037	00042	0 01 00045	JMP	**3
0038	00043	0 16 00511	MPY	GDNS
0039	00044	100000	SKP	
0040	00045	0 16 00503	MPY	GDPS
0041	00046	0401 72	LRS	6
0042	00047	0 06 00522	DAD	GDBD
0043	00050	0 06 00406	DAD	GDPC
0044	00051	0 04 00406	DST	GDPC
0045	00052	0 02 00410	DLD	GEPC
0046	00053	101400	SMI	
0047	00054	0 01 00057	JMP	**3
0048	00055	0 16 00512	MPY	GENS
0049	00056	100000	SKP	
0050	00057	0 16 00504	MPY	GEPS
0051	00060	0401 72	LRS	6
0052	00061	0 06 00524	DAD	GEBD
0053	00062	0 06 00410	DAD	GEPC
0054	00063	0 04 00410	DST	GEPC
0055	00064	0 02 00412	DLD	GFPC
0056	00065	101400	SMI	
0057	00066	0 01 00071	JMP	**3

MICROCOMP TELECOMMUNICATED DATA  
DDP-516 ASSEMBLY LISTING

0058	00067	0 16	00513	MPY	GFNS
0059	00070	100000		SKP	
0060	00071	0 16	00505	MPY	GFPS
0061	00072	0401	72	LRS	6
0062	00073	0 06	00526	DAD	GFBD
0063	00074	0 06	00412	DAD	GFPC
0064	00075	0 04	00412	DST	GFPC
0065	00076	0 02	00614	DLD	DVXB
0066	00077	0 16	00530	MPY	ADAX
0067	00100	0 04	00450	DST	TACM
0068	00101	0 02	00614	DLD	DVXB
0069	00102	0 16	00531	MPY	ADBX
0070	00103	0 04	00452	DST	TBCM
0071	00104	0 02	00614	DLD	DVXB
0072	00105	0 16	00532	MPY	ADCX
0073	00106	0 04	00454	DST	TCCM
0074	00107	0 02	00614	DLD	DVXB
0075	00110	0 16	00533	MPY	ADDX
0076	00111	0 04	00456	DST	TDCM
0077	00112	0 02	00614	DLD	DVXB
0078	00113	0 16	00534	MPY	ADEX
0079	00114	0 04	00460	DST	TECM
0080	00115	0 02	00614	DLD	DVXB
0081	00116	0 16	00535	MPY	ADFX
0082	00117	0 04	00462	DST	TFCM
0083	00120	0 02	00616	DLD	DVYB
0084	00121	0 16	00536	MPY	ADAY
0085	00122	0 06	00450	DAD	TACM
0086	00123	0 04	00450	DST	TACM
0087	00124	0 02	00616	DLD	DVYB
0088	00125	0 16	00537	MPY	ADEY
0089	00126	0 06	00452	DAD	TBCM
0090	00127	0 04	00452	DST	TBCM
0091	00130	0 02	00616	DLD	DVYB
0092	00131	0 16	00540	MPY	ADCY
0093	00132	0 06	00454	DAD	TCCM
0094	00133	0 04	00454	DST	TCCM
0095	00134	0 02	00616	DLD	DVYB
0096	00135	0 16	00541	MPY	ADDY
0097	00136	0 06	00456	DAD	TDCM
0098	00137	0 04	00456	DST	TDCM
0099	00140	0 02	00616	DLD	DVYB
0100	00141	0 16	00542	MPY	ADEY
0101	00142	0 06	00460	DAD	TECM
0102	00143	0 04	00460	DST	TECM
0103	00144	0 02	00616	DLD	DVYB
0104	00145	0 16	00543	MPY	ADFY
0105	00146	0 06	00462	DAD	TFCM
0106	00147	0 04	00462	DST	TFCM
0107	00150	0 02	00620	DLD	DVZB
0108	00151	0 16	00544	MPY	ADAZ
0109	00152	0 06	00450	DAD	TACM
0110	00153	0401	64	IRS	12
0111	00154	0 06	00400	DAD	GAPC
0112	00155	0 04	00400	DST	GAPC
0113	00156	0 02	00620	DLD	DVZB
0114	00157	0 16	00545	MPY	ADBZ

MICROCOMP TELECOMMUNICATED DATA  
DDP-516 ASSEMBLY LISTING

0115	00160	0 06 00452	DAD	TBCM
0116	00161	0401 64	LRS	12
0117	00162	0 06 00402	DAD	GBPC
0118	00163	0 04 00402	DST	GBPC
0119	00164	0 02 00620	DLD	DVZB
0120	00165	0 16 00546	MPY	ADCZ
0121	00166	0 06 00454	DAD	TCCM
0122	00167	0401 64	LRS	12
0123	00170	0 06 00404	DAD	GCPC
0124	00171	0 04 00404	DST	GCPC
0125	00172	0 02 00620	DLD	DVZB
0126	00173	0 16 00547	MPY	ADDZ
0127	00174	0 06 00456	DAD	TDCM
0128	00175	0401 64	LRS	12
0129	00176	0 06 00406	DAD	GDPC
0130	00177	0 04 00406	DST	GDPC
0131	00200	0 02 00620	DLD	DVZB
0132	00201	0 16 00550	MPY	ADEZ
0133	00202	0 06 00460	DAD	TECM
0134	00203	0401 64	LRS	12
0135	00204	0 06 00410	DAD	GEPC
0136	00205	0 04 00410	DST	GEPC
0137	00206	0 02 00620	DLD	DVZB
0138	00207	0 16 00551	MPY	ADFZ
0139	00210	0 06 00462	DAD	TFCM
0140	00211	0401 64	LRS	12
0141	00212	0 06 00412	DAD	GFPC
0142	00213	0 04 00412	DST	GFPC
0143	00214	0 02 00614	DLD	DVXB
0144	00215	0 16 00614	MPY	DVXB
0145	00216	0 04 00434	DST	XSQU
0146	00217	0 02 00616	DLD	DVYB
0147	00220	0 16 00616	MPY	DVYB
0148	00221	0 04 00436	DST	YSQU
0149	00222	0 02 00620	DLD	DVZB
0150	00223	0 16 00620	MPY	DVZB
0151	00224	0 04 00440	DST	ZSQU
0152	00225	0 02 00614	DLD	DVXB
0153	00226	0 16 00616	MPY	DVYB
0154	00227	0 04 00442	DST	XWHY
0155	00230	0 02 00614	DLD	DVXB
0156	00231	0 16 00620	MPY	DVZB
0157	00232	0 04 00444	DST	XZEE
0158	00233	0 02 00616	DLD	DVYB
0159	00234	0 16 00620	MPY	DVZB
0160	00235	0 04 00446	DST	YZEE
0161	00236	0 02 00440	DLD	ZSQU
0162	00237	0 07 00434	DSB	XSQU
0163	00240	0 07 00444	DSB	XZEE
0164	00241	0 16 00422	MPY	AASD
0165	00242	0401 72	LRS	6
0166	00243	0 06 00400	DAD	GAPC
0167	00244	0 04 00400	DST	GAPC
0168	00245	0 02 00440	DLD	ZSQU
0169	00246	0 07 00434	DSB	XSQU
0170	00247	0 06 00444	DAD	XZEE
0171	00250	0 16 00423	MPY	BASD

MICROCOMP TELECOMMUNICATED DATA  
DDP-516 ASSEMBLY LISTING

0172	00251	0401 72	LRS	6
0173	00252	0 06 00402	DAD	GBPC
0174	00253	0 04 00402	DST	GBPC
0175	00254	0 02 00434	DLD	XSQU
0176	00255	0 07 00436	DSR	YSQU
0177	00256	0 07 00442	DSB	XWHY
0178	00257	0 16 00424	MPY	CASD
0179	00260	0401 72	LRS	6
0180	00261	0 06 00404	DAD	GCPC
0181	00262	0 04 00404	DST	GCPC
0182	00263	0 02 00434	DLD	XSQU
0183	00264	0 07 00436	DSB	YSQU
0184	00265	0 06 00442	ADD	XWHY
0185	00266	0 16 00425	MPY	DASD
0186	00267	0401 72	LRS	6
0187	00270	0 06 00406	DAD	GDPC
0188	00271	0 04 00406	DST	GDPC
0189	00272	0 02 00436	DLD	YSQU
0190	00273	0 07 00440	DSB	ZSQU
0191	00274	0 07 00446	DSB	YZEE
0192	00275	0 16 00426	MPY	EASD
0193	00276	0401 72	LRS	6
0194	00277	0 06 00410	DAD	GEPC
0195	00300	0 04 00410	DST	GEPC
0196	00301	0 02 00436	DLD	YSQU
0197	00302	0 07 00440	DSB	ZSQU
0198	00303	0 06 00446	ADD	YZEE
0199	00304	0 16 00427	MPY	FASD
0200	00305	0401 72	LRS	6
0201	00306	0 06 00412	DAD	GFPC
0202	00307	0 04 00412	DST	GFPC
0203	00310	000005	SGL	
0204	00311	0 10 00000	CALL	DCOA
0205	00312	000007	DBL	
0206	00313	0 02 00414	DLD	DTXB
0207	00314	0 16 00552	MPY	GAMX
0208	00315	0 04 00450	DST	TACM
0209	00316	0 02 00414	DLD	DTXB
0210	00317	0 16 00553	MPY	GEMX
0211	00320	0 04 00452	DST	TFCM
0212	00321	0 02 00414	DLD	DTXB
0213	00322	0 16 00554	MPY	GCMX
0214	00323	0 04 00454	DST	TCCM
0215	00324	0 02 00414	DLD	DTXB
0216	00325	0 16 00555	MPY	GDMX
0217	00326	0 04 00456	DST	TDCM
0218	00327	0 02 00414	DLD	DTXB
0219	00330	0 16 00556	MPY	GEMX
0220	00331	0 04 00460	DST	TECM
0221	00332	0 02 00414	DLD	DTXB
0222	00333	0 16 00557	MPY	GFMX
0223	00334	0 04 00462	DST	TFCM
0224	00335	0 02 00416	DLD	DTYB
0225	00336	0 16 00560	MPY	GAMY
0226	00337	0 06 00450	DAD	TACM
0227	00340	0 04 00450	DST	TACM
0228	00341	0 02 00416	DLD	DTYB

MICROCOMP TELECOMMUNICATED DATA  
DDP-516 ASSEMBLY LISTING

0229	00342	0 16	00561	MPY	GBMY
0230	00343	0 06	00452	DAD	TBCM
0231	00344	0 04	00452	DST	TBCM
0232	00345	0 02	00416	DLD	DTYB
0233	00346	0 16	00562	MPY	GCMY
0234	00347	0 06	00454	DAD	TCCM
0235	00350	0 04	00454	DST	TCCM
0236	00351	0 02	00416	DLD	DTYB
0237	00352	0 16	00563	MPY	GDMY
0238	00353	0 06	00456	DAD	TDCM
0239	00354	0 04	00456	DST	TDCM
0240	00355	0 02	00416	DLD	DTYB
0241	00356	0 16	00564	MPY	GEMY
0242	00357	0 06	00460	DAD	TECM
0243	00360	0 04	00460	DST	TECM
0244	00361	0 02	00416	DLD	DTYB
0245	00362	0 16	00565	MPY	GFMY
0246	00363	0 06	00462	DAD	TFCM
0247	00364	0 04	00462	DST	TFCM
0248	00365	0 02	00420	DLD	DTZB
0249	00366	0 16	00566	MPY	GAMZ
0250	00367	0 06	00450	DAD	TACM
0251	00370	0401	66	LRS	10
0252	00371	0 06	00400	DAD	GAPC
0253	00372	0 04	00400	DST	GAPC
0254	00373	0 02	00420	DLD	DTZB
0255	00374	0 16	00567	MPY	GBMZ
0256	00375	0 06	00452	DAD	TBCM
0257	00376	0401	66	LRS	10
0258	00377	0 06	00402	DAD	GBPC
0259	00400	0 04	00402	DST	GBPC
0260	00401	0 02	00420	DLD	DTZB
0261	00402	0 16	00570	MPY	GCMZ
0262	00403	0 06	00454	DAD	TCCM
0263	00404	0401	66	LRS	10
0264	00405	0 06	00404	DAD	GCPC
0265	00406	0 04	00404	DST	GCPC
0266	00407	0 02	00420	DLD	DTZB
0267	00410	0 16	00571	MPY	GDMZ
0268	00411	0 06	00456	DAD	TDCM
0269	00412	0401	66	LRS	10
0270	00413	0 06	00406	DAD	GDPC
0271	00414	0 04	00406	DST	GDPC
0272	00415	0 02	00420	DLD	DTZB
0273	00416	0 16	00572	MPY	GEMZ
0274	00417	0 06	00460	DAD	TECM
0275	00420	0401	66	LRS	10
0276	00421	0 06	00410	DAD	GEPC
0277	00422	0 04	00410	DST	GEPC
0278	00423	0 02	00420	DLD	DTZB
0279	00424	0 16	00573	MPY	GFMZ
0280	00425	0 06	00462	DAD	TFCM
0281	00426	0401	66	LRS	10
0282	00427	0 06	00412	DAD	GFPC
0283	00430	0 04	00412	DST	GFPC
0284	00431	000005		SGL	
0285	00432	-0 01	00000	JMP*	GCOM



MICROCOMP TELECOMMUNICATED DATA  
DDP-516 ASSEMBLY LISTING

0286	000400	GAPC EQU	'400
0287	000402	GBPC EQU	GAPC+2
0288	000404	GCPC EQU	GAPC+4
0289	000406	GDPC EQU	GAPC+6
0290	000410	GEPC EQU	GAPC+8
0291	000412	GFPC EQU	GAPC+10
0292	000500	GAPS EQU	'500
0293	000501	GBPS EQU	GAPS+1
0294	000502	GCPS EQU	GAPS+2
0295	000503	GDPS EQU	GAPS+3
0296	000504	GFPS EQU	GAPS+4
0297	000505	GFPS EQU	GAPS+5
0298	000506	GANS EQU	GAPS+6
0299	000507	GBNS EQU	GAPS+7
0300	000510	GCNS EQU	GAPS+8
0301	000511	GDNS EQU	GAPS+9
0302	000512	GENS EQU	GAPS+10
0303	000513	GFNS EQU	GAPS+11
0304	000514	GABD EQU	'514
0305	000516	GBRD EQU	GABD+2
0306	000520	GCRD EQU	GABD+4
0307	000522	GDBD EQU	GABD+6
0308	000524	GERD EQU	GABD+8
0309	000526	GFBD EQU	GABD+10
0310	000530	ADAX EQU	'530
0311	000531	ADBX EQU	ADAX+1
0312	000532	ADCX EQU	ADAX+2
0313	000533	ADDX EQU	ADAX+3
0314	000534	ADEX EQU	ADAX+4
0315	000535	ADFX EQU	ADAX+5
0316	000536	ADAY EQU	ADAX+6
0317	000537	ADRY EQU	ADAX+7
0318	000540	ADCY EQU	ADAX+8
0319	000541	ADY EQU	ADAX+9
0320	000542	ADEY EQU	ADAX+10
0321	000543	ADFY EQU	ADAX+11
0322	000544	ADAZ EQU	ADAX+12
0323	000545	ADBZ EQU	ADAX+13
0324	000546	ADCZ EQU	ADAX+14
0325	000547	ADDZ EQU	ADAX+15
0326	000550	ADEZ EQU	ADAX+16
0327	000551	ADFZ EQU	ADAX+17
0328	000552	GAMX EQU	'552
0329	000553	GBMX EQU	GAMX+1
0330	000554	GCMX EQU	GAMX+2
0331	000555	GDMX EQU	GAMX+3
0332	000556	GEMX EQU	GAMX+4
0333	000557	GPMX EQU	GAMX+5
0334	000560	GAMY EQU	GAMX+6
0335	000561	GBMY EQU	GAMX+7
0336	000562	GCMY EQU	GAMX+8
0337	000563	GDMY EQU	GAMX+9
0338	000564	GEMY EQU	GAMX+10
0339	000565	GPMY EQU	GAMX+11
0340	000566	GAMZ EQU	GAMX+12
0341	000567	GBMZ EQU	GAMX+13
0342	000570	GCMZ EQU	GAMX+14

MICROCOMP TELECOMMUNICATED DATA  
DDP-516 ASSEMBLY LISTING

0343	000571	GDMZ EQU	GAMX+15
0344	000572	GEMZ EQU	GAMX+16
0345	000573	GFMZ EQU	GAMX+17
0346	000422	AASD EQU	'422
0347	000423	BASD EQU	AASD+1
0348	000424	CASD EQU	AASD+2
0349	000425	DASD EQU	AASD+3
0350	000426	EASD EQU	AASD+4
0351	000427	FASD EQU	AASD+5
0352	000614	DVXB EQU	'614
0353	000616	DVYB EQU	DVXB+2
0354	000620	DVZB EQU	DVXB+4
0355	000414	DTXB EQU	'414
0356	000416	DTYB EQU	DTXB+2
0357	000420	DTZB EQU	DTXB+4
0358	00434	XSQU DBP	0
	00435		
0359	00436	YSQU DBP	0
	00437		
0360	00440	ZSQU DBP	0
	00441		
0361	00442	XWHY DBP	0
	00443		
0362	00444	XZEE DBP	0
	00445		
0363	00446	YZEE DBP	0
	00447		
0364	00450	TACM DBP	0
	00451		
0365	00452	TBCM DBP	0
	00453		
0366	00454	TCCM DBP	0
	00455		
0367	00456	TDCM DBP	0
	00457		
0368	00460	TECH DBP	0
	00461		
0369	00462	TFCM DBP	0
	00463		
0370		END	

PROGRAM NAME

SOURCE: DCMT

BINARY: BDCMT

ENTRY POINTS (location): DCMI ('03476), DCMT ('03551)

GENERAL DESCRIPTION:

The subroutine DCMT modifies the misalignments of the SIRU gyros about their output axes as a function of  $W_{IA}$ , their input axis rate which is proportional to the number of pulses each gyro got in one update ( $\Delta t = .01$  sec.). The subroutine DCMI is called by the initialization section of the main program and gets these misalignments from the base sector and stores them in the buffer section between the subroutines DCMI and DCMT. It does this only once and sets the word ONLO to 1 so that if the main program is restarted, it won't get misalignments from the base sector that are already modified.

Subroutine DCMT, which is called every update, takes these OA misalignments stored in the buffer, modifies them according to the gyro's IA rate and stores them back in the base sector to be used by the gyro compensation program GCOM.

MICROCOMP TELECOMMUNICATED DATA  
DDP-516 ASSEMBLY LISTING

0001				REL	
0002				SUBR	DCMI
0003				SUBR	DCMT
0004	00000	0 000000	DCMI	DAC	**
0005	00001	0 02 00036		LDA	ONLO
0006	00002	100040		SZE	
0007	00003	-0 01 00000		JMP*	DCMI
0008	00004	0 02 00552		LDA	GAMX
0009	00005	0 04 00037		STA	AMXB
0010	00006	0 02 00566		LDA	GAMZ
0011	00007	0 04 00040		STA	AMZB
0012	00010	0 02 00553		LDA	GBMX
0013	00011	0 04 00041		STA	BMXB
0014	00012	0 02 00567		LDA	GBMZ
0015	00013	0 04 00042		STA	BMZB
0016	00014	0 02 00554		LDA	GCMX
0017	00015	0 04 00043		STA	CMXB
0018	00016	0 02 00562		LDA	GCMY
0019	00017	0 04 00044		STA	CMYB
0020	00020	0 02 00555		LDA	GDMX
0021	00021	0 04 00045		STA	DMXB
0022	00022	0 02 00563		LDA	GDMY
0023	00023	0 04 00046		STA	DMYB
0024	00024	0 02 00564		LDA	GEMY
0025	00025	0 04 00047		STA	EMYB
0026	00026	0 02 00572		LDA	GEMZ
0027	00027	0 04 00050		STA	EMZB
0028	00030	0 02 00565		LDA	GFMY
0029	00031	0 04 00051		STA	FMYB
0030	00032	0 02 00573		LDA	GFMZ
0031	00033	0 04 00052		STA	FMZB
0032	00034	0 12 00036		IRS	ONLO
0033	00035	-0 01 00000		JMP*	DCMI
0034	00036	000000	ONLO	OCT	0
0035		000552	GAMX	EQU	'552
0036		000566	GAMZ	EQU	GAMX+12
0037		000553	GBMX	EQU	GAMX+1
0038		000567	GBMZ	EQU	GAMX+13
0039		000554	GCMX	EQU	GAMX+2
0040		000562	GCMY	EQU	GAMX+8
0041		000555	GDMX	EQU	GAMX+3
0042		000563	GDMY	EQU	GAMX+9
0043		000564	GEMY	EQU	GAMX+10
0044		000572	GEMZ	EQU	GAMX+16
0045		000565	GFMY	EQU	GAMX+11
0046		000573	GFMZ	EQU	GAMX+17
0047	00037	000000	AMXB	OCT	0
0048	00040	000000	AMZB	OCT	0
0049	00041	000000	BMXB	OCT	0
0050	00042	000000	BMZB	OCT	0
0051	00043	000000	CMXB	OCT	0
0052	00044	000000	CMYB	OCT	0
0053	00045	000000	DMXB	OCT	0
0054	00046	000000	DMYB	OCT	0
0055	00047	000000	EMYB	OCT	0
0056	00050	000000	EMZB	OCT	0
0057	00051	000000	FMYB	OCT	0

MICROCOMP TELECOMMUNICATED DATA  
DDP-516 ASSEMBLY LISTING

0058	00052	000000	FMZB	OCT	0
0059	00053	0 000000	DCMT	DAC	**
0060	00054	0 02 00400		LDA	GAPC
0061	00055	0 16 00151		MPY	APRX
0062	00056	0401 00		LRS	0
0063	00057	0 06 00037		ADD	AMXB
0064	00060	0 04 00552		STA	GAMX
0065	00061	0 02 00400		LDA	GAPC
0066	00062	0 16 00152		MPY	APRZ
0067	00063	0401 00		LRS	0
0068	00064	0 06 00040		ADD	AMZB
0069	00065	0 04 00566		STA	GAMZ
0070	00066	0 02 00402		LDA	GBPC
0071	00067	0 16 00153		MPY	BPRX
0072	00070	0401 00		LRS	0
0073	00071	0 06 00041		ADD	BMXB
0074	00072	0 04 00553		STA	GBMX
0075	00073	0 02 00402		LDA	GBPC
0076	00074	0 16 00154		MPY	BPRZ
0077	00075	0401 00		LRS	0
0078	00076	0 06 00042		ADD	BMZB
0079	00077	0 04 00567		STA	GBMZ
0080	00100	0 02 00404		LDA	GCPC
0081	00101	0 16 00155		MPY	CPRX
0082	00102	0401 00		LRS	0
0083	00103	0 06 00043		ADD	CMXB
0084	00104	0 04 00554		STA	GCMX
0085	00105	0 02 00404		LDA	GCPC
0086	00106	0 16 00156		MPY	CPRY
0087	00107	0401 00		LRS	0
0088	00110	0 06 00044		ADD	CMYB
0089	00111	0 04 00562		STA	GCMY
0090	00112	0 02 00406		LDA	GDPC
0091	00113	0 16 00157		MPY	DPRX
0092	00114	0401 00		LRS	0
0093	00115	0 06 00045		ADD	DMXB
0094	00116	0 04 00555		STA	GDMX
0095	00117	0 02 00406		LDA	GDPC
0096	00120	0 16 00160		MPY	DPRY
0097	00121	0401 00		LRS	0
0098	00122	0 06 00046		ADD	DMYB
0099	00123	0 04 00563		STA	GDMY
0100	00124	0 02 00410		LDA	GEPC
0101	00125	0 16 00161		MPY	EPRY
0102	00126	0401 00		LRS	0
0103	00127	0 06 00047		ADD	EMYB
0104	00130	0 04 00564		STA	GEMY
0105	00131	0 02 00410		LDA	GEPC
0106	00132	0 16 00162		MPY	EPRZ
0107	00133	0401 00		LRS	0
0108	00134	0 06 00050		ADD	EMZB
0109	00135	0 04 00572		STA	GEMZ
0110	00136	0 02 00412		LDA	GFPC
0111	00137	0 16 00163		MPY	FPRY
0112	00140	0401 00		LRS	0
0113	00141	0 06 00051		ADD	FMYB
0114	00142	0 04 00565		STA	GFMY

MICROCOMP TELECOMMUNICATED DATA  
DDP-516 ASSEMBLY LISTING

0115	00143	0 02 00412	LDA	GFPC
0116	00144	0 16 00164	MPY	FPRZ
0117	00145	0401 00	LRS	0
0118	00146	0 06 00052	ADD	PMZB
0119	00147	0 04 00573	STA	GFMZ
0120	00150	-0 01 00053	JMP*	DCMT
0121		000400	GAPC EQU	'400
0122		000402	GBPC EQU	GAPC+2
0123		000404	GCPC EQU	GAPC+4
0124		000406	GDPC EQU	GAPC+6
0125		000410	GEPC EQU	GAPC+8
0126		000412	GFPC EQU	GAPC+10
0127	00151	000000	APRX OCT	0
0128	00152	000000	APRZ OCT	0
0129	00153	000000	BPRX OCT	0
0130	00154	000000	BPRZ OCT	0
0131	00155	000000	CPRX OCT	0
0132	00156	000000	CPRY OCT	0
0133	00157	000000	DPRX OCT	0
0134	00160	000000	DPRY OCT	0
0135	00161	000000	EPRY OCT	0
0136	00162	000000	FPRZ OCT	0
0137	00163	000000	FPRY OCT	0
0138	00164	000000	FPRZ OCT	0
0139			END	

PROGRAM NAME

SOURCE: DCOA

BINARY: BDCOA

ENTRY POINT (location): DCOA ('03144)

ACCESSIBLE VARIABLES (location): AOAP ('03252)

BOAP ('03254), COAP ('03256), DOAP ('03260), EOAP ('03262),

FOAP ('03264)

GENERAL DESCRIPTION:

The SIRU gyros sense not only a rotational input about their input axes, i.e., the  $\Delta\theta$  pulses over some interval would equal the integral of  $W_{IRA}$  over that interval, but also they sense a change in the rotational input about their output axes, i.e., the  $\Delta\theta$  pulses over some interval would equal  $(-I)/H$  times the integral of  $W_{ORA}$  over that interval. The latter can essentially be considered an error source since the gyro output is supposed to represent only the former input axis rotation.

The integral of  $W_{ORA}$  from  $t_1$  to  $t_2$  is simply  $W_{ORA}(t_2) - W_{ORA}(t_1)$ . The  $\Delta\theta$  error during that interval is simply  $(-I)/H W_{ORA}(t_2) - (-I)/H W_{ORA}(t_1)$ . To compensate this error, one simply has to add  $((I)/H)(W_{ORA}(t_2))$  and subtract  $((I)/H)(W_{ORA}(t_1))$  at time  $t_2$ . Over one update interval the rate  $W_{ORA}$  (for say the E gyro) equals

$$\frac{\Delta\theta_x}{\Delta t}$$

Since  $\Delta t$  is constant, we can express  $W_{ORA}$  as  $K\Delta\theta_x$  and rewrite the compensation quantity as

$$+(\frac{I}{H} K) \Delta\theta_x(t_2) - (\frac{I}{H} K) \Delta\theta_x(t_1) .$$

This subroutine is called once per update and calculates the first of the two compensation terms above. The second term is saved from the previous update. DTXB, DTYB and DTZB are  $\Delta\theta_x$ ,  $\Delta\theta_y$  and  $\Delta\theta_z$  respectively.

GAIH, GBIH . . . . . GFH are the scaled constants equal to

$$(\frac{I}{H} K)$$

(Note that since the E gyro has its ORA along the plus x axis, GEIH will be positive whereas the F gyro, whose ORA is along the minus X axis will have a negative GFH.) The method for compensating the E gyro is as follows: (the others are analogous)

$$EOAO = DTXB GEIH = \Delta\theta_x(t_2)\left(\frac{1}{H}K\right)$$

and

$$GEPC = EOAO + GEPC - EOAP$$

$$\text{where } EOAP = \Delta\theta_x(t_1)\left(\frac{1}{H}K\right)$$

(Note, EOAP (previous EOAO) must be set to zero at  $t = 0$  and is therefore an accessible variable to the main program).



MICROCOMP TELECOMMUNICATED DATA  
DDP-516 ASSEMBLY LISTING

0001				REL	
0002				SUBR	DCOA
0003				SUBR	AOAP
0004				SUBR	BOAP
0005				SUBR	COAP
0006				SUBR	DOAP
0007				SUBR	EOAP
0008				SUBR	FOAP
0009	00000	0	000000	DCOA DAC	**
0010	00001	0	02 00414	LDA	DTXB
0011	00002		000007	DBI	
0012	00003	0	16 00126	MPY	GEIH
0013	00004	0	04 00102	DST	EOAO
0014	00005	0	02 00414	DLD	DTXB
0015	00006	0	16 00127	MPY	GFIH
0016	00007	0	04 00104	DST	FOAO
0017	00010	0	02 00416	DLD	DTYB
0018	00011	0	16 00122	MPY	GAIH
0019	00012	0	04 00072	DST	AOAO
0020	00013	0	02 00416	DLD	DTYB
0021	00014	0	16 00123	MPY	GBIH
0022	00015	0	04 00074	DST	BOAO
0023	00016	0	02 00420	DLD	DTZB
0024	00017	0	16 00124	MPY	GCIH
0025	00020	0	04 00076	DST	COAO
0026	00021	0	02 00420	DLD	DTZB
0027	00022	0	16 00125	MPY	GDIH
0028	00023	0	04 00100	DST	DOAO
0029	00024	0	06 00406	DAD	GDPC
0030	00025	0	07 00114	DSB	DOAP
0031	00026	0	04 00406	DST	GDPC
0032	00027	0	02 00072	DLD	AOAO
0033	00030	0	06 00400	DAD	GAPC
0034	00031	0	07 00106	DSB	AOAP
0035	00032	0	04 00400	DST	GAPC
0036	00033	0	02 00074	DLD	BOAO
0037	00034	0	06 00402	DAD	GBPC
0038	00035	0	07 00110	DSB	BOAP
0039	00036	0	04 00402	DST	GBPC
0040	00037	0	02 00076	DLD	COAO
0041	00040	0	06 00404	DAD	GCPC
0042	00041	0	07 00112	DSB	COAP
0043	00042	0	04 00404	DST	GCPC
0044	00043	0	02 00102	DLD	EOAO
0045	00044	0	06 00410	DAD	GEPC
0046	00045	0	07 00116	DSB	EOAP
0047	00046	0	04 00410	DST	GEPC
0048	00047	0	02 00104	DLD	FOAO
0049	00050	0	06 00412	DAD	GFPC
0050	00051	0	07 00120	DSB	FOAP
0051	00052	0	04 00412	DST	GFPC
0052	00053	0	02 00072	DLD	AOAO
0053	00054	0	04 00106	DST	AOAP
0054	00055	0	02 00074	DLD	BOAO
0055	00056	0	04 00110	DST	BOAP
0056	00057	0	02 00076	DLD	COAO
0057	00060	0	04 00112	DST	COAP

MICROCOMP TELECOMMUNICATED DATA  
DDP-516 ASSEMBLY LISTING

0058	00061	0 02 00100	DLD	DOAO
0059	00062	0 04 00114	DST	DOAP
0060	00063	0 02 00102	DLD	EOAO
0061	00064	0 04 00116	DST	EOAP
0062	00065	0 02 00104	DLD	FOAO
0063	00066	0 04 00120	DST	FOAP
0064	00067	000005	SGL	
0065	00070	-0 01 00000	JMP*	DCOA
0066	00072	000000	AOAO DBP	0
	00073	000000		
0067	00074	000000	BOAO DBP	0
	00075	000000		
0068	00076	000000	COAO DBP	0
	00077	000000		
0069	00100	000000	DOAO DBP	0
	00101	000000		
0070	00102	000000	EOAO DBP	0
	00103	000000		
0071	00104	000000	FOAO DBP	0
	00105	000000		
0072	00106	000000	AOAP DBP	0
	00107	000000		
0073	00110	000000	ROAP DBP	0
	00111	000000		
0074	00112	000000	COAP DBP	0
	00113	000000		
0075	00114	000000	DOAP DBP	0
	00115	000000		
0076	00116	000000	EOAP DBP	0
	00117	000000		
0077	00120	000000	FOAP DBP	0
	00121	000000		
0078	00122	000000	GAIH OCT	0
0079	00123	000000	GBIH OCT	0
0080	00124	000000	GCIH OCT	0
0081	00125	000000	GDIH OCT	0
0082	00126	000000	GEIH OCT	0
0083	00127	000000	GFIH OCT	0
0084		000400	GAPC EQU	'400
0085		000402	GBPC EQU	GAPC+2
0086		000404	GCPC EQU	GAPC+4
0087		000406	GDPC EQU	GAPC+6
0088		000410	GEPC EQU	GAPC+8
0089		000412	GFPC EQU	GAPC+10
0090		000414	DTXB EQU	'414
0091		000416	DTYB EQU	DTXB+2
0092		000420	DTZB EQU	DTXB+4
0093			END	

PROGRAM NAME  
 SOURCE: ROMS  
 BINARY: BROMS  
 ENTRY POINTS (location): ROMS ('14000)  
 ACCESSIBLE VARIABLES: WXPR ('14333),  
 WYPR ('14334), WZPR ('14335)  
 GENERAL DESCRIPTION:

When the SIRU strapdown system is subjected to a rotational environment its accelerometers will sense acceleration due to  $\omega^2 R$  and  $\dot{\omega} R$ . Since the accelerometers do not all sense acceleration at the same point, these rotation-induced accelerations will make the accelerometers appear to be in disagreement. This subroutine compensates the accelerometers to make them look as if they are all sensing acceleration at the same point (since the location of this point is not critical we pick the center of the A accelerometer so that at least the A accelerometer need not be compensated).

Consider some point which has an R vector from the center of the A accelerometer of (RX, RY, RZ). The acceleration sensed at this point different from the acceleration sensed at the center of the A accelerometer is:

$$\begin{aligned}
 & \bar{i}(\omega_x \omega_y RY + \omega_x \omega_z RZ - \omega_y^2 R_x - \omega_z^2 RX + \dot{\omega}_y RZ - \dot{\omega}_z RY) \\
 & + \bar{j}(\omega_y \omega_z RZ + \omega_y \omega_x RX - \omega_x^2 RY - \omega_z^2 RY + \dot{\omega}_z RX - \dot{\omega}_x RZ) \\
 & + \bar{k}(\omega_z \omega_x RX + \omega_z \omega_y RY - \omega_x^2 RZ - \omega_y^2 RZ + \dot{\omega}_x RY - \dot{\omega}_y RX)
 \end{aligned}$$

B, C, D, E and F accelerometers can be corrected by adding the negative of the acceleration each one senses due to rotation. For the F accelerometer this would be

$$-S (Z \text{ axis acceleration}) + C (Y \text{ axis acceleration})$$

where

$$C = \text{cosine}, S = \text{sine}$$

or

$$\begin{aligned}
 & -S(\omega_z \omega_x \text{RFX} + \omega_z \omega_y \text{RFY} - \omega_x^2 \text{RFZ} - \omega_y^2 \text{RFZ} + \dot{\omega}_x \text{RFY} - \dot{\omega}_y \text{RFX}) \\
 & + C(\omega_y \omega_z \text{RFZ} + \omega_y \omega_x \text{RFX} - \omega_x^2 \text{RFY} - \omega_z^2 \text{RFY} + \dot{\omega}_z \text{RFX} - \dot{\omega}_x \text{RFZ})
 \end{aligned}$$

these terms can be combined to give:

$$\begin{aligned}
 & C \text{ RFX}(\omega_y \omega_x + \dot{\omega}_z) \\
 & + C \text{ RFY}(-\omega_x^2 - \omega_z^2) \\
 & + C \text{ RFZ}(\omega_y \omega_z - \dot{\omega}_x) \\
 & + S \text{ RFX}(-\omega_z \omega_x + \dot{\omega}_y) \\
 & + S \text{ RFY}(-\omega_z \omega_y - \dot{\omega}_x) \\
 & + S \text{ RFZ}(\omega_x^2 + \omega_y^2)
 \end{aligned}$$

a similar set of corrections can be derived for accelerometers B, C, D and E.

This subroutine first calculates  $\omega_x \omega_y$ ,  $\omega_x \omega_z$ ,  $\omega_y \omega_z$ ,  $\omega_x^2$ ,  $\omega_y^2$ ,  $\omega_z^2$ ,  $\dot{\omega}_x$ ,  $\dot{\omega}_y$  and  $\dot{\omega}_z$  using  $\Delta \theta_x$ ,  $\Delta \theta_y$  and  $\Delta \theta_z$  over one update interval as an indication of  $\omega_x$ ,  $\omega_y$  and  $\omega_z$ . It then calculates

$$\text{PAR1} = \omega_y \omega_x + \dot{\omega}_z$$

$$\text{PAR2} = \omega_x^2 + \omega_z^2$$

$$\text{PAR3} = \omega_y \omega_z - \dot{\omega}_x$$

$$\text{PAR4} = \omega_z \omega_x - \dot{\omega}_y$$

$$\text{PAR5} = \omega_z \omega_y - \dot{\omega}_x$$

$$\text{PAR6} = \omega_x^2 + \omega_y^2$$

$$\text{PAR7} = \omega_y^2 + \omega_z^2$$

$$\text{PAR8} = \omega_x \omega_y - \dot{\omega}_z$$

$$\text{PAR9} = \omega_x \omega_z + \dot{\omega}_y$$

F's correction can now be defined as:

```

C RFX PAR1
-C RFY PAR2
+C RFZ PAR3
-S RFX PAR4
-S RFY PAR5
+S RFZ PAR6

```

Without doing the whole derivation B's correction can be defined as:

```

-C RBX PAR4
-C RBY PAR5
+C RBZ PAR6
-S RBX PAR7
+S RBY PAR8
+S RBZ PAR9

```

C, D and E have similar corrections.

The terms in the above equations such as -C RBX are constants and are stored as such in this subroutine. They are functions of the following table of distances which was made from detailed drawings of the SIRU PI-frame and SIRU accelerometers.

AXIS R(cm)	A	B	C	D	E	F
X	0	-8.603	13.937	13.937	2.718	0.902
Y	0	-1.816	-24.021	-15.418	-27.081	11.130
Z	0	0	2.482	0.665	1.085	1.085

MICROCOMP TELECOMMUNICATED DATA  
DDP-516 ASSEMBLY LISTING

0001				ABS	
0002				ORG	*14000
0003				SUBR	WXPR
0004				SUBR	WYPR
0005				SUBR	WZPR
0006				SUBR	ROMS
0007	14000	0	000000	ROMS DAC	**
0008	14001	0	02 00414	LDA	WX
0009	14002	0	16 00416	MPY	WY
0010	14003	0	04 14322	STA	WXWY
0011	14004	0	02 00414	LDA	WX
0012	14005	0	16 00420	MPY	WZ
0013	14006	0	04 14323	STA	WXWZ
0014	14007	0	02 00416	LDA	WY
0015	14010	0	16 00420	MPY	WZ
0016	14011	0	04 14324	STA	WYWZ
0017	14012	0	02 00414	LDA	WX
0018	14013	0	16 00414	MPY	WX
0019	14014	0	04 14325	STA	WXSQ
0020	14015	0	02 00416	LDA	WY
0021	14016	0	16 00416	MPY	WY
0022	14017	0	04 14326	STA	WYSQ
0023	14020	0	02 00420	LDA	WZ
0024	14021	0	16 00420	MPY	WZ
0025	14022	0	04 14327	STA	WZSQ
0026	14023	0	02 00414	LDA	WX
0027	14024	0	07 14333	SUB	WXPR
0028	14025	0	415 72	ALS	6
0029	14026	0	04 14330	STA	WXDT
0030	14027	0	02 00416	LDA	WY
0031	14030	0	07 14334	SUB	WYPR
0032	14031	0	415 72	ALS	6
0033	14032	0	04 14331	STA	WYDT
0034	14033	0	02 00420	LDA	WZ
0035	14034	0	07 14335	SUB	WZPR
0036	14035	0	415 72	ALS	6
0037	14036	0	04 14332	STA	WZDT
0038	14037	0	06 14322	ADD	WXWY
0039	14040	0	04 14262	STA	PAR1
0040	14041	0	16 14336	MPY	CRFX
0041	14042	0	000007	DBL	
0042	14043	0	04 14304	DST	CORP
0043	14044	0	000005	SGL	
0044	14045	0	02 14325	LDA	WXSQ
0045	14046	0	06 14327	ADD	WZSQ
0046	14047	0	04 14264	STA	PAR2
0047	14050	0	16 14337	MPY	CRFY
0048	14051	0	000007	DBL	
0049	14052	0	06 14304	DAD	CORP
0050	14053	0	04 14304	DST	CORP
0051	14054	0	000005	SGL	
0052	14055	0	02 14324	LDA	WYWZ
0053	14056	0	07 14330	SUB	WXDT
0054	14057	0	04 14266	STA	PAR3
0055	14060	0	16 14340	MPY	CRFZ
0056	14061	0	000007	DBL	
0057	14062	0	04 14316	DST	TEM1

MICROCOMP TELECOMMUNICATED DATA  
DDP-516 ASSEMBLY LISTING

0058	14063	0 06	14304	DAD	CORF
0059	14064	0 04	14304	DST	CORF
0060	14065	000005		SGL	
0061	14066	0 02	14323	LDA	WXWZ
0062	14067	0 07	14331	SUB	WYDT
0063	14070	0 04	14270	STA	PAR4
0064	14071	0 16	14341	MPY	SRFX
0065	14072	000007		DBL	
0066	14073	0 06	14304	DAD	CORF
0067	14074	0 04	14304	DST	CORF
0068	14075	000005		SGL	
0069	14076	0 02	14324	LDA	WYWZ
0070	14077	0 07	14330	SUB	WXDT
0071	14100	0 04	14272	STA	PAR5
0072	14101	0 16	14342	MPY	SRFY
0073	14102	000007		DBL	
0074	14103	0 06	14304	DAD	CORF
0075	14104	0 04	14304	DST	CORF
0076	14105	000005		SGL	
0077	14106	0 02	14325	LDA	WXSQ
0078	14107	0 06	14326	ADD	WYSQ
0079	14110	0 04	14274	STA	PAR6
0080	14111	0 16	14343	MPY	SRFZ
0081	14112	000007		DBL	
0082	14113	0 04	14306	DST	CORE
0083	14114	0 06	14304	DAD	CORF
0084	14115	0401	67	LRS	9
0085	14116	0 06	00612	DAD	'612
0086	14117	0 04	00612	DST	'612
0087	14120	000005		SGL	
0088	14121	0 02	14326	LDA	WYSQ
0089	14122	0 06	14327	ADD	WZSQ
0090	14123	0 04	14276	STA	PAR7
0091	14124	0 16	14351	MPY	CRDX
0092	14125	000007		DBL	
0093	14126	0 04	14310	DST	CORD
0094	14127	0 04	14312	DST	CORC
0095	14130	000005		SGL	
0096	14131	0 02	14322	LDA	WXWY
0097	14132	0 07	14332	SUB	WZDT
0098	14133	0 04	14300	STA	PAR8
0099	14134	0 16	14352	MPY	CRDY
0100	14135	000007		DBL	
0101	14136	0 06	14310	DAD	CORD
0102	14137	0 04	14310	DST	CORD
0103	14140	000005		SGL	
0104	14141	0 02	14323	LDA	WXWZ
0105	14142	0 06	14331	ADD	WYDT
0106	14143	0 04	14302	STA	PAR9
0107	14144	0 16	14353	MPY	CRDZ
0108	14145	000007		DBL	
0109	14146	0 06	14310	DAD	CORD
0110	14147	0 04	14310	DST	CORD
0111	14150	0 02	14264	DLA	PAR2
0112	14151	0 16	14345	MPY	CREY
0113	14152	0 06	14306	DAD	CORE
0114	14153	0 07	14316	DSB	TEM1

MICROCOMP TELECOMMUNICATED DATA  
DDP-516 ASSEMBLY LISTING

0115	14154	0 04	14306	DST	CORE
0116	14155	0 02	14270	DLD	PAR4
0117	14156	0 16	14346	MPY	SREX
0118	14157	0 06	14306	DAD	CORE
0119	14160	0 04	14306	DST	CORE
0120	14161	0 02	14272	DLD	PAR5
0121	14162	0 16	14350	MPY	SREY
0122	14163	0 06	14306	DAD	CORE
0123	14164	0401	67	LRS	9
0124	14165	0 06	00610	DAD	'610
0125	14166	0 04	00610	DST	'610
0126	14167	0 02	14262	DLD	PAR1
0127	14170	0 16	14354	MPY	SRDX
0128	14171	0 04	14320	DST	TEM2
0129	14172	0 06	14310	DAD	CORD
0130	14173	0 04	14310	DST	CORD
0131	14174	0 02	14264	DLD	PAR2
0132	14175	0 16	14355	MPY	SRDY
0133	14176	0 06	14310	DAD	CORD
0134	14177	0 04	14310	DST	CORD
0135	14200	0 02	14266	DLD	PAR3
0136	14201	0 16	14356	MPY	SRDZ
0137	14202	0 06	14310	DAD	CORD
0138	14203	0401	67	LRS	9
0139	14204	0 06	00606	DAD	'606
0140	14205	0 04	00606	DST	'606
0141	14206	0 02	14300	DLD	PAR8
0142	14207	0 16	14357	MPY	CRCY
0143	14210	0 06	14312	DAD	CORC
0144	14211	0 07	14320	DSB	TEM2
0145	14212	0 04	14312	DST	CORC
0146	14213	0 02	14302	DLD	PAR9
0147	14214	0 16	14360	MPY	CRCZ
0148	14215	0 06	14312	DAD	CORC
0149	14216	0 04	14312	DST	CORC
0150	14217	0 02	14264	DLD	PAR2
0151	14220	0 16	14361	MPY	SRCY
0152	14221	0 06	14312	DAD	CORC
0153	14222	0 04	14312	DST	CORC
0154	14223	0 02	14266	DLD	PAR3
0155	14224	0 16	14362	MPY	SRCZ
0156	14225	0 06	14312	DAD	CORC
0157	14226	0401	67	LRS	9
0158	14227	0 06	00604	DAD	'604
0159	14230	0 04	00604	DST	'604
0160	14231	0 02	14270	DLD	PAR4
0161	14232	0 16	14363	MPY	CRBX
0162	14233	0 04	14314	DST	CORB
0163	14234	0 02	14272	DLD	PAR5
0164	14235	0 16	14364	MPY	CRBY
0165	14236	0 06	14314	DAD	CORB
0166	14237	0 04	14314	DST	CORB
0167	14240	0 02	14276	DLD	PAR7
0168	14241	0 16	14365	MPY	SRBX
0169	14242	0 06	14314	DAD	CORB
0170	14243	0 04	14314	DST	CORB
0171	14244	0 02	14300	DLD	PAR8



MICROCOMP TELECOMMUNICATED DATA

DDP-516 ASSEMBLY LISTING

0172	14245	0 16	14366	MPY	SRBY
0173	14246	0 06	14314	DAD	CORB
0174	14247	0401	67	LRS	9
0175	14250	0 06	00602	DAD	'602
0176	14251	0 04	00602	DST	'602
0177	14252	000005		SGL	
0178	14253	0 02	00414	LDA	WX
0179	14254	0 04	14333	STA	WXPR
0180	14255	0 02	00416	LDA	WY
0181	14256	0 04	14334	STA	WYPR
0182	14257	0 02	00420	LDA	WZ
0183	14260	0 04	14335	STA	WZPR
0184	14261	-0 01	14000	JMP*	ROMS
0185	14262	000000	PAR1	DBP	0
	14263	000000			
0186	14264	000000	PAR2	DBP	0
	14265	000000			
0187	14266	000000	PAR3	DBP	0
	14267	000000			
0188	14270	000000	PAR4	DBP	0
	14271	000000			
0189	14272	000000	PAR5	DBP	0
	14273	000000			
0190	14274	000000	PAR6	DBP	0
	14275	000000			
0191	14276	000000	PAR7	DBP	0
	14277	000000			
0192	14300	000000	PAR8	DBP	0
	14301	000000			
0193	14302	000000	PAR9	DBP	0
	14303	000000			
0194	14304	000000	CORF	DBP	0
	14305	000000			
0195	14306	000000	CORE	DBP	0
	14307	000000			
0196	14310	000000	CORD	DBP	0
	14311	000000			
0197	14312	000000	CORC	DBP	0
	14313	000000			
0198	14314	000000	CORB	DBP	0
	14315	000000			
0199	14316	000000	TEM1	DBP	0
	14317	000000			
0200	14320	000000	TEM2	DBP	0
	14321	000000			
0201	14322	000000	WXWY	OCT	0
0202	14323	000000	WXWZ	OCT	0
0203	14324	000000	WYWZ	OCT	0
0204	14325	000000	WXSQ	OCT	0
0205	14326	000000	WYSQ	OCT	0
0206	14327	000000	WZSQ	OCT	0
0207	14330	000000	WXDT	OCT	0
0208	14331	000000	WYDT	OCT	0
0209	14332	000000	WZDT	OCT	0
0210	14333	000000	WXPR	OCT	0
0211	14334	000000	WYPR	OCT	0
0212	14335	000000	WZPR	OCT	0

MICROCOMP TELECOMMUNICATED DATA  
DDP-516 ASSEMBLY LISTING

0213	14336	001145	CRFX	DEC	76.703B12
0214	14337	161152	CRFY	DEC	-946.8B12
0215	14340	001342	CRFZ	DEC	92.26B12
0216	14341	177205	SRFX	DEC	-47.405B12
0217	14342	166667	SRFY	DEC	-585.15B12
0218	14343	000710	SRFZ	DEC	57.02B12
0219	14344	174307	CREX	DEC	-231.19B12
0220	14345	134003	CREY	DEC	-2303.69B12
0221	14346	135670	SREX	DEC	-142.88
	14347	107535			
0222	14350	026176	SREY	DEC	1423.76B12
0223	14351	155364	CRDX	DEC	-1185.55B12
0224	14352	153404	CRDY	DEC	-1311.52B12
0225	14353	000704	CRDZ	DEC	56.609B12
0226	14354	164433	SRDX	DEC	-732.71B12
0227	14355	163254	SRDY	DEC	-810.56B12
0228	14356	177351	SRDZ	DEC	-34.986B12
0229	14357	140046	CRCY	DEC	-2043.33B12
0230	14360	003230	CRCZ	DEC	211.096B12
0231	14361	023566	SRCY	DEC	1262.85B12
0232	14362	002023	SRCZ	DEC	130.464B12
0233	14363	013336	CRBY	DEC	731.813B12
0234	14364	002323	CRBY	DEC	154.49B12
0235	14365	007042	SRBY	DEC	452.29B12
0236	14366	176405	SRBY	DEC	-95.48B12
0237		000414	WX	EQU	'414
0238		000416	WY	EQU	'416
0239		000420	WZ	EQU	'420
0240					END

PROGRAM NAME:

SOURCE: PREX

BINARY: BPREX

ENTRY POINTS (location): PARC ('06040)

ACCESSABLE VARIABLES (location): PACC ('06166)

GENERAL DESCRIPTION:

This subroutine is essentially equivalent to GARC, the gyro error accumulator, except it only accumulates compensated pulses from the six PIPAs. The only other difference is that when it is time to purge the PIPA accumulators, it puts a 1 in location '765 (note the instruction IRS '765) which clues the PIPA parity equation solver (program source name PPEX, subroutine entry point PPRT) not to do its calculation. This feature is solely for timing considerations.

MICROCOMP TELECOMMUNICATED DATA  
DDP-516 ASSEMBLY LISTING

0001				REL	
0002				SUBR	PARC
0003				SUBR	PACC
0004	00000	0 000000	PARC	DAC	**
0005	00001	0 12 00126		IRS	PACC
0006	00002	0 01 00023		JMP	NPCC
0007	00003	0 12 00765		IRS	*765
0008	00004	0 02 00131		LDA	=-6000
0009	00005	0 04 00126		STA	PACC
0010	00006	0 35 00130		LDX	=-12
0011	00007	000007		DBL	
0012	00010	1 02 00316	LUPE	DLD	PAPA+12,1
0013	00011	1 07 00106		DSB	ARES+12,1
0014	00012	1 04 00316		DST	PAPA+12,1
0015	00013	1 02 00124		DLD	ARES+12,1
0016	00014	1 07 00106		DSB	ARES+12,1
0017	00015	1 04 00106		DST	ARES+12,1
0018	00016	1 02 00316		DLD	PAPA+12,1
0019	00017	1 04 00124		DST	ARES+12,1
0020	00020	0 12 00000		IRS	0
0021	00021	0 12 00000		IRS	0
0022	00022	0 01 00010		JMP	LUPE
0023	00023	0 02 00600	NPCC	LDA	PAPC
0024	00024	000007		DBL	
0025	00025	0401 61		LRS	15
0026	00026	0 06 00302		DAD	PAPA
0027	00027	0 04 00302		DST	PAPA
0028	00030	0401 73		LRS	5
0029	00031	0 04 00744		DST	AARP
0030	00032	0 02 00602		DLD	PBPC
0031	00033	0401 61		LRS	15
0032	00034	0 06 00304		DAD	PBPA
0033	00035	0 04 00304		DST	PBPA
0034	00036	0401 73		LRS	5
0035	00037	0 04 00746		DST	BARP
0036	00040	0 02 00604		DLD	PCPC
0037	00041	0401 61		LRS	15
0038	00042	0 06 00306		DAD	PCPA
0039	00043	0 04 00306		DST	PCPA
0040	00044	0401 73		LRS	5
0041	00045	0 04 00750		DST	CARP
0042	00046	0 02 00606		DLD	PDPC
0043	00047	0401 61		LRS	15
0044	00050	0 06 00310		DAD	PDPA
0045	00051	0 04 00310		DST	PDPA
0046	00052	0401 73		LRS	5
0047	00053	0 04 00752		DST	DARP
0048	00054	0 02 00610		DLD	PEPC
0049	00055	0401 61		LRS	15
0050	00056	0 06 00312		DAD	PEPA
0051	00057	0 04 00312		DST	PEPA
0052	00060	0401 73		LRS	5
0053	00061	0 04 00754		DST	EARP
0054	00062	0 02 00612		DLD	PFPC
0055	00063	0401 61		LRS	15
0056	00064	0 06 00314		DAD	PFFA
0057	00065	0 04 00314		DST	PFFA

MICROCOMP TELECOMMUNICATED DATA  
DDP-516 ASSEMBLY LISTING

0058	00066	0401 73	LRS	5
0059	00067	0 04 00756	DST	FARP
0060	00070	000005	SGL	
0061	00071	-0 01 00000	JMF*	PARC
0062		000600	PAPC EQU	'600
0063		000602	PBPC EQU	PAPC+2
0064		000604	PCPC EQU	PAPC+4
0065		000606	PDPC EQU	PAPC+6
0066		000610	PEPC EQU	PAPC+8
0067		000612	PFPC EQU	PAPC+10
0068		000302	PAPA EQU	'302
0069		000304	PBPA EQU	PAPA+2
0070		000306	PCPA EQU	PAPA+4
0071		000310	PDPA EQU	PAPA+6
0072		000312	PEPA EQU	PAPA+8
0073		000314	PFPA EQU	PAPA+10
0074		000744	AARP EQU	'744
0075		000746	BARP EQU	AARP+2
0076		000750	CARP EQU	AARP+4
0077		000752	DARP EQU	AARP+6
0078		000754	EARP EQU	AARP+8
0079		000756	FARP EQU	AARP+10
0080	00072	000000	ARES DBP	0
	00073	000000		
0081	00074	000000	BRES DBP	0
	00075	000000		
0082	00076	000000	CRES DBP	0
	00077	000000		
0083	00100	000000	DRES DBP	0
	00101	000000		
0084	00102	000000	ERES DBP	0
	00103	000000		
0085	00104	000000	FRES DBP	0
	00105	000000		
0086	00106	000000	SRES DBP	0
	00107	000000		
0087	00110	000000	ARRS DBP	0
	00111	000000		
0088	00112	000000	BRRS DBP	0
	00113	000000		
0089	00114	000000	CRRS DBP	0
	00115	000000		
0090	00116	000000	DRRS DBP	0
	00117	000000		
0091	00120	000000	ERRS DBP	0
	00121	000000		
0092	00122	000000	FRRS DBP	0
	00123	000000		
0093	00124	000000	SRRS DBP	0
	00125	000000		
0094	00126	164217	PACC DEC	-6001
0095	00127	000000	STSE OCT	0
0096	00130	177764	END	
	00131	164220		

PROGRAM NAME:  
SOURCE: GARC  
BINARY: BGARC  
ENTRY POINTS (location): GARC ('07344)  
ACCESSABLE VARIABLES (location): GACC ('07524)  
GENERAL DESCRIPTION:

This subroutine accumulates the 6 compensated gyro pulse counts (GAPC, GBPC, GCPC, GDPC, GEPC and GFPC) in the six gyro pulse accumulators (GAPA, GBPA, GCPA, GDPA, GEPA and GFPA) and then stores the accumulations in the six arguments (AARG, BARG, CARG, DARG, EARG, and FARG) for the squared error calculator (see documentation for program source name CFSE, subroutine entry point SECA). It also accumulates

$$\sum |\Delta\theta X| + |\Delta\theta Y| + |\Delta\theta Z|$$

to be used to increase the maximum allowable total squared error to allow for dynamic scale factor and misalignment errors (see documentation for GFIS).

The 6 compensated gyro pulse counts are double precision numbers with the high order word being of significance and the low order word being carried along as a residual. Thus, every time an LRS 15 instruction operates on a gyro pulse count in the accumulator, it is simply to shift the residual out. Scaling can best be expressed by giving the representation of one gyro pulse for GAPC, GAPA and AARG.

GAPC oct 00400, 00000

GAPA oct 00000, 00400

AARG oct 00000, 00010

Therefore, the bit granularity of the arguments used by the squared error calculator is  $\pm 1/8$  pulse.

In order that the gyro pulse accumulators don't overflow, they are periodically purged of old accumulation. Define A ( $t_1, t_2$ ) to be the accumulation of gyro pulses between times  $t_1$  and  $t_2$ . Every minute starting at  $t = 60$ , the following purge is performed (let us look just at the A gyro accumulator).

$$GAPA = GAPA - ARES$$

$$ARES = ARRS - ARES$$

$$ARRS = GAPA$$

ARES = A gyro residual.

ARRS = A gyro residual residual.

following this procedure we get:

at time = 60

$$GAPA = GAPA - ARES$$

$$GAPA = A(0, 60) - 0 = A(0, 60)$$

$$ARES = ARRS - ARES = 0 - 0 = 0$$

$$ARRS = GAPA = A(0, 60)$$

at time = 120

$$GAPA = GAPA - ARES$$

$$GAPA = A(0, 120) - 0 = A(0, 120)$$

$$ARES = ARRS - ARES = A(0, 60) - 0 = A(0, 60)$$

$$ARRS = GAPA = A(0, 120)$$

at time = 180

$$GAPA = GAPA - ARES$$

$$GAPA = A(0, 180) - A(0, 60) = A(60, 180)$$

$$ARES = ARRS - ARES = A(0, 120) - A(0, 60) = A(60, 120)$$

$$ARRS = GAPA = A(60, 180)$$

at time = 240

$$GAPA = GAPA - ARES$$

$$GAPA = A(60, 240) - A(60, 120) = A(120, 240)$$

$$ARES = ARRS - ARES = A(60, 180) - A(60, 120) = A(120, 180)$$

$$ARRS = GAPA = A(120, 240) \text{ etc.}$$

the flow chart follows.

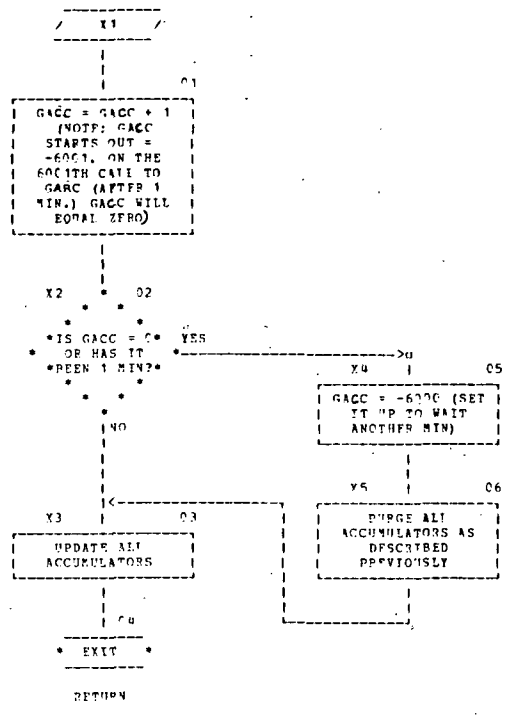

FLOWCHART - GARC



MICROCOMP TELECOMMUNICATED DATA  
DDP-516 ASSEMBLY LISTING

0001				REL	
0002				SUBR	GARC
0003				SUBR	GACC
0004	00000	0 000000	GARC	DAC	**
0005	00001	0 12 00160		IRS	GACC
0006	00002	0 01 00032		JMP	NGCC
0007	00003	0 02 00163		LDA	==6000
0008	00004	0 04 00160		STA	GACC
0009	00005	0 35 00162		LDX	--12
0010	00006	000007		DBL	
0011	00007	1 02 00302	LUPE	DLD	GAPA+12,1
0012	00010	1 07 00140		DSB	APES+12,1
0013	00011	1 04 00302		DST	GAPA+12,1
0014	00012	1 02 00156		DLD	AFRS+12,1
0015	00013	1 07 00140		DSB	APES+12,1
0016	00014	1 04 00140		DST	APES+12,1
0017	00015	1 02 00302		DLD	GAPA+12,1
0018	00016	1 04 00156		DST	ARRS+12,1
0019	00017	0 12 00000		IRS	0
0020	00020	0 12 00000		IRS	0
0021	00021	0 01 00007		JMP	LUPE
0022	00022	0 02 00774		DLD	SUDT
0023	00023	0 07 00140		DSB	SPES
0024	00024	0 04 00774		DST	SUDT
0025	00025	0 02 00156		DLD	SPRS
0026	00026	0 07 00140		DSB	SPES
0027	00027	0 04 00140		DST	SRES
0028	00030	0 02 00774		DLD	SUDT
0029	00031	0 04 00156		DST	SRRS
0030	00032	0 02 00400	NGCC	LDA	GAPC
0031	00033	000007		DBL	
0032	00034	0401 61		LRS	15
0033	00035	0 06 00266		DAD	GAPA
0034	00036	0 04 00266		DST	GAPA
0035	00037	0401 73		LRS	5
0036	00040	0 04 00744		DST	AARG
0037	00041	0 02 00402		DLD	GBPC
0038	00042	0401 61		LRS	15
0039	00043	0 06 00270		DAD	GBPA
0040	00044	0 04 00270		DST	GBPA
0041	00045	0401 73		LRS	5
0042	00046	0 04 00746		DST	BARG
0043	00047	0 02 00404		DLD	GCPC
0044	00050	0401 61		LRS	15
0045	00051	0 06 00272		DAD	GCPA
0046	00052	0 04 00272		DST	GCPA
0047	00053	0401 73		LRS	5
0048	00054	0 04 00750		DST	CARG
0049	00055	0 02 00406		DLD	GDPC
0050	00056	0401 61		LRS	15
0051	00057	0 06 00274		DAD	GDPA
0052	00060	0 04 00274		DST	GDPA
0053	00061	0401 73		LRS	5
0054	00062	0 04 00752		DST	DARG
0055	00063	0 02 00410		DLD	GFPC
0056	00064	0401 61		LRS	15
0057	00065	0 06 00276		DAD	GEPA

MICROCOMP TELECOMMUNICATED DATA  
DDP-516 ASSEMBLY LISTING

0058	00066	0 04 00276	DST	GEPA
0059	00067	0401 73	LRS	5
0060	00070	0 04 00754	DST	FARG
0061	00071	0 02 00412	DLA	GFPC
0062	00072	0401 61	LRS	15
0063	00073	0 06 00300	DAD	GFPA
0064	00074	0 04 00300	DST	GFPA
0065	00075	0401 73	LRS	5
0066	00076	0 04 00756	DST	FARG
0067	00077	000005	SGL	
0068	00100	0 02 00414	LDA	DTXB
0069	00101	100400	SPL	
0070	00102	140407	TCA	
0071	00103	0 04 00161	STA	STSE
0072	00104	0 02 00416	LDA	DTYB
0073	00105	100400	SPL	
0074	00106	140407	TCA	
0075	00107	0 06 00161	ADD	STSE
0076	00110	0 04 00161	STA	STSE
0077	00111	0 02 00420	LDA	DTZB
0078	00112	100400	SPL	
0079	00113	140407	TCA	
0080	00114	0 06 00161	ADD	STSE
0081	00115	000007	DBL	
0082	00116	0401 61	LRS	15
0083	00117	0 06 00774	DAD	SUDT
0084	00120	0 04 00774	DST	SUDT
0085	00121	000005	SGL	
0086	00122	-0 01 00000	JMP*	GARC
0087		000400	GAPC EQU	'400
0088		000402	GBPC EQU	GAPC+2
0089		000404	GCPC EQU	GAPC+4
0090		000406	GDPC EQU	GAPC+6
0091		000410	GEPC EQU	GAPC+8
0092		000412	GFPC EQU	GAPC+10
0093		000266	GAPA EQU	'266
0094		000270	GPBA EQU	GAPA+2
0095		000272	GCPA EQU	GAPA+4
0096		000274	GDPA EQU	GAPA+6
0097		000276	GEPA EQU	GAPA+8
0098		000300	GFPA EQU	GAPA+10
0099		000744	AARG EQU	'744
0100		000746	BARG EQU	AARG+2
0101		000750	CARG EQU	AARG+4
0102		000752	DARG EQU	AARG+6
0103		000754	EARG EQU	AARG+8
0104		000756	FARG EQU	AARG+10
0105		000414	DTXB EQU	'414
0106		000416	DTYB EQU	DTXB+2
0107		000420	DTZB EQU	DTXB+4
0108		000774	SUDT EQU	'774
0109	00124	000000	ARES DBP	0
	00125	000000		
0110	00126	000000	BRES DBP	0
	00127	000000		
0111	00130	000000	CRES DBP	0
	00131	000000		

MICROCOMP TELECOMMUNICATED DATA  
DDP-516 ASSEMBLY LISTING

0112	00132	000000	DRES DBP	0
	00133	000000		
0113	00134	000000	ERES DBP	0
	00135	000000		
0114	00136	000000	FRS DBP	0
	00137	000000		
0115	00140	000000	SRES DBP	0
	00141	000000		
0116	00142	000000	ARRS DBP	0
	00143	000000		
0117	00144	000000	BRRS DBP	0
	00145	000000		
0118	00146	000000	CRRS DBP	0
	00147	000000		
0119	00150	000000	DRRS DBP	0
	00151	000000		
0120	00152	000000	ERRS DEP	0
	00153	000000		
0121	00154	000000	FRRS DBP	0
	00155	000000		
0122	00156	000000	SRRS DBP	0
	00157	000000		
0123	00160	164217	GACC DEC	-6001
0124	00161	000000	STSE OCT	0
0125	00162	177764	END	
	00163	164220		

PROGRAM NAME

SOURCE: GFIS

BINARY: BGFIS

ENTRY POINTS (location): GFIS ('2070)

ACCESSABLE VARIABLES (location): KEYG ('2225)

GENERAL DESCRIPTION:

This subroutine controls the logic for the gyro failure detection and isolation. When called (once every gyro update) it decides which failure (first or second) should be searched for using such considerations as gyro fail status and which search it made the previous time. It will then store in locations '760 and '761 the maximum allowable total squared error (MASE) for either the first (FMSE) or second (SMSE) failure search. (FMSE and SMSE are modified at the beginning of this subroutine to allow for dynamic errors. Location '774 contains a proportion of the sum of the absolute values of the total rotations about axes X, Y and Z. Adding the square of this sum to FFAD and SFAD gives the modified maximum allowable total squared errors FMSE and SMSE).

It will store in location '762 the squared error ratio for either the first fail (FFRT) or second fail (SFRT) isolation criteria (see documentation for SECA, program source name CFSE). In location '763 it will store the number of the instrument to be considered failed (see documentation for ERDE). It will then call ERDE which, in turn, calls the squared error calculator SECA (program source name CFSE). Since the gyro error accumulator (GARC) has been called prior to GFIS, SECA has the proper arguments for the instrument accumulated measurements. GFIS gives SECA the proper total allowable squared error and the proper squared error ratio. After the squared errors have been calculated and a decision of detection and/or isolation has been made, ERDE will store the decision code in location '764 and return to GFIS. GFIS will then decide what the gyro fail status should be and store the number of the gyro first and second failures in location '316 and '317 respectively. The logic of this program is shown in the following flow chart. Note that sense switch 3, if set, will prevent any failure from healing.

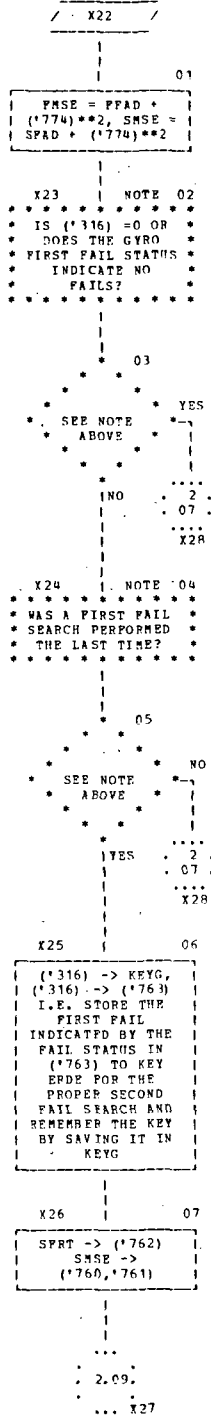

FLOWCHART - GFIS

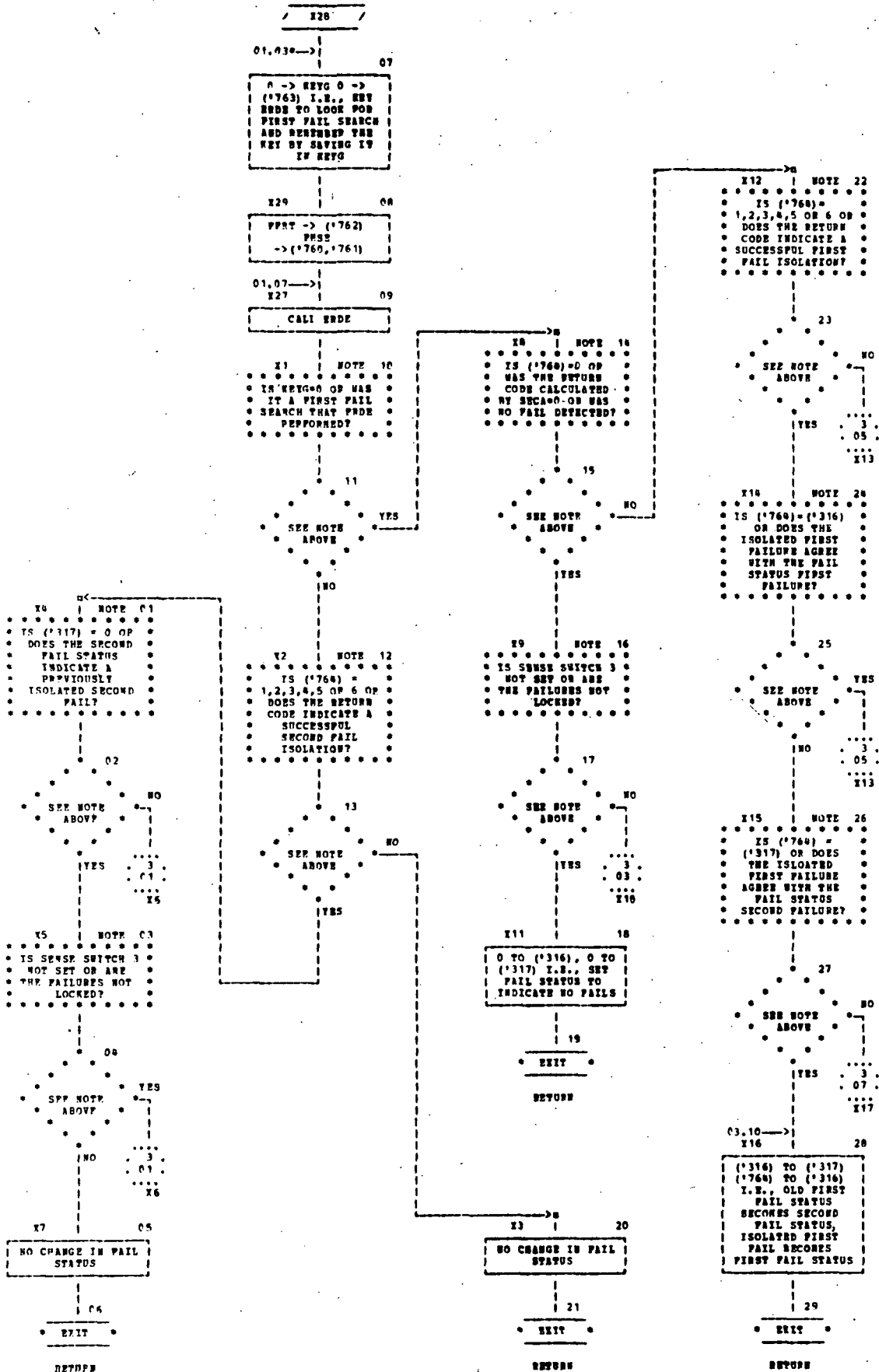

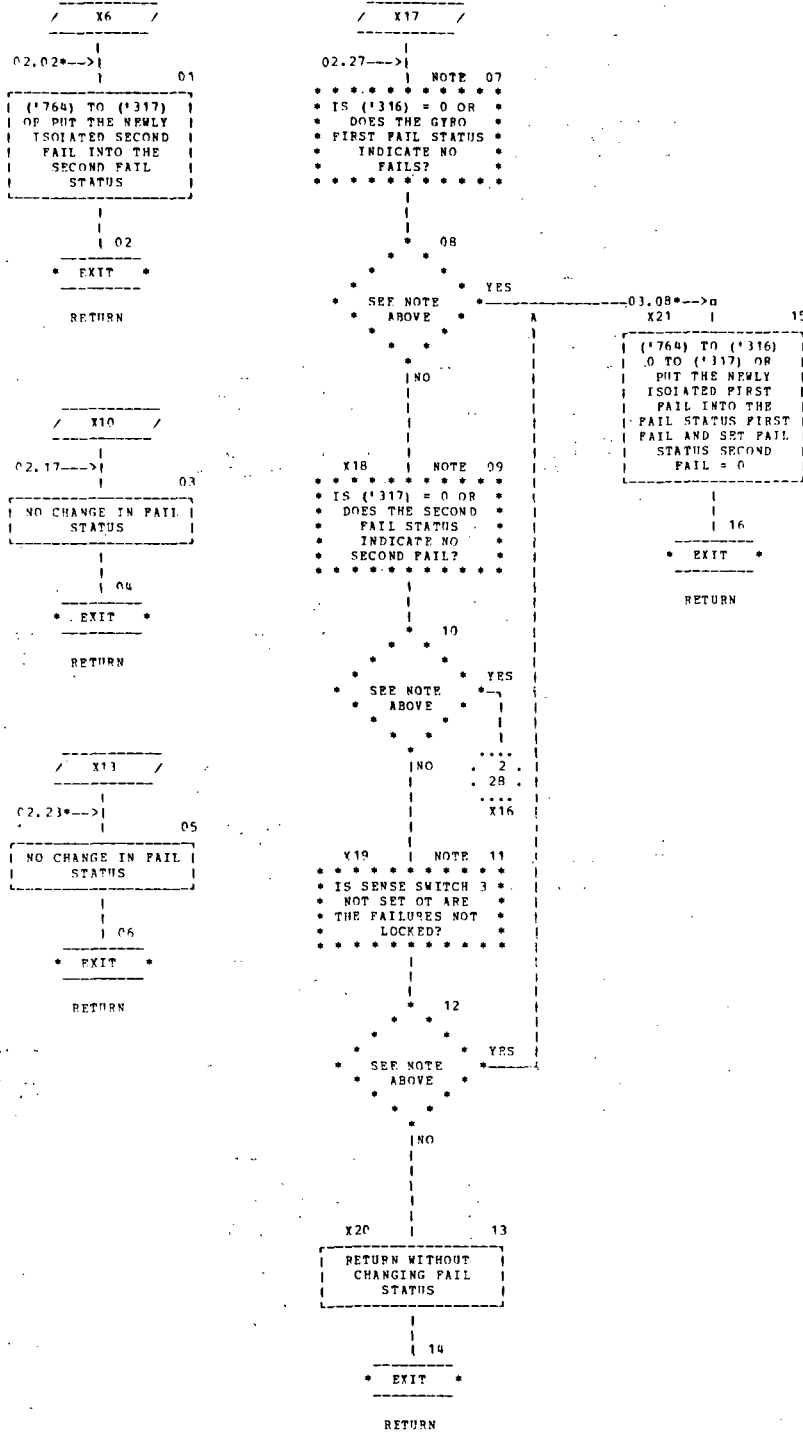

MICROCOMP TELECOMMUNICATED DATA  
DDP-516 ASSEMBLY LISTING

0001				REL	
0002				SUBR	GFIS
0003				SUBR	KEYG
0004	00000	0 000000	GFIS	DAC	**
0005	00001	0 02 00774		LDA	'774
0006	00002	0405 75		ARS	3
0007	00003	0 04 00142		STA	ALOP
0008	00004	0 16 00142		MPY	ALOP
0009	00005	000007		DRL	
0010	00006	0 04 00142		DST	ALOP
0011	00007	0 06 00144		DAD	FFAD
0012	00010	0 04 00136		DST	FMSE
0013	00011	0 02 00142		DLD	ALOP
0014	00012	0 06 00146		DAD	SFAD
0015	00013	0 04 00140		DST	SMSE
0016	00014	000005		SGL	
0017	00015	0 02 00316		LDA	'316
0018	00016	100040		SZE	
0019	00017	0 01 00032		JMP	ALOP
0020	00020	140040	FFTR	CRA	
0021	00021	0 04 00135		STA	KEYG
0022	00022	0 04 00763		STA	'763
0023	00023	0 02 00133		LDA	FFRT
0024	00024	0 04 00762		STA	'762
0025	00025	000007		DBL	
0026	00026	0 02 00136		DLD	FMSE
0027	00027	0 04 00760		DST	'760
0028	00030	000005		SGL	
0029	00031	0 01 00046		JMP	COCA
0030	00032	0 02 00135	ALOP	LDA	KEYG
0031	00033	100040		SZE	
0032	00034	0 01 00020		JMP	FFTR
0033	00035	0 02 00316		LDA	'316
0034	00036	0 04 00135		STA	KEYG
0035	00037	0 04 00763		STA	'763
0036	00040	0 02 00134		LDA	SFRT
0037	00041	0 04 00762		STA	'762
0038	00042	000007		DBI	
0039	00043	0 02 00140		DLD	SMSE
0040	00044	0 04 00760		DST	'760
0041	00045	000005		SGL	
0042	00046	0 10 00000	COCA	CALL	ERDE
0043	00047	0 02 00135		LDA	KEYG
0044	00050	100040		SZE	
0045	00051	0 01 00117		JMP	SFSR
0046	00052	0 02 00764		LDA	'764
0047	00053	100040		SZE	
0048	00054	0 01 00063		JMP	NOZE
0049	00055	100004		SR3	
0050	00056	-0 01 00000		JMP*	GFIS
0051	00057	140040		CRA	
0052	00060	0 04 00316		STA	'316
0053	00061	0 04 00317		STA	'317
0054	00062	-0 01 00000		JMP*	GFIS
0055	00063	0 07 00150	NOZE	SUB	=7
0056	00064	101400		SMI	
0057	00065	-0 01 00000		JMP*	GFIS



MICROCOMP TELECOMMUNICATED DATA  
DDP-516 ASSEMBLY LISTING

0058	00066	0 02 00764	LDA	'764
0059	00067	0 11 00316	CAS	'316
0060	00070	0 01 00072	JMP	**2
0061	00071	-0 01 00000	JMP*	GFIS
0062	00072	0 11 00317	CAS	'317
0063	00073	0 01 00075	JMP	**2
0064	00074	0 01 00112	JMP	SPCA
0065	00075	0 02 00316	LDA	'316
0066	00076	101040	SNZ	
0067	00077	0 01 00105	JMP	**6
0068	00100	0 02 00317	LDA	'317
0069	00101	101040	SNZ	
0070	00102	0 01 00112	JMP	SPCA
0071	00103	100004	SR3	
0072	00104	-0 01 00000	JMP*	GFIS
0073	00105	0 02 00764	LDA	'764
0074	00106	0 04 00316	STA	'316
0075	00107	140040	CRA	
0076	00110	0 04 00317	STA	'317
0077	00111	-0 01 00000	JMP*	GFIS
0078	00112	0 02 00316	SPCA LDA	'316
0079	00113	0 04 00317	STA	'317
0080	00114	0 02 00764	LDA	'764
0081	00115	0 04 00316	STA	'316
0082	00116	-0 01 00000	JMP*	GFIS
0083	00117	0 02 00764	SFSR LDA	'764
0084	00120	0 07 00150	SUB	=7
0085	00121	101400	SMI	
0086	00122	-0 01 00000	JMP*	GFIS
0087	00123	0 02 00317	LDA	'317
0088	00124	101040	SNZ	
0089	00125	0 01 00130	JMP	**3
0090	00126	100004	SR3	
0091	00127	-0 01 00000	JMP*	GFIS
0092	00130	0 02 00764	LDA	'764
0093	00131	0 04 00317	STA	'317
0094	00132	-0 01 00000	JMP*	GFIS
0095	00133	034343	FFRT OCT	34343
0096	00134	030600	SFRT OCT	30600
0097	00135	000000	KEYG OCT	0
0098	00136	000000	FMSE DBP	0
	00137	000000		
0099	00140	000000	SMSE DBP	0
	00141	000000		
0100	00142	000000	ALOP DBP	0
	00143	000000		
0101	00144	000000	FFAD OCT	0,2200
	00145	002200		
0102	00146	000000	SFAD OCT	0,1632
	00147	001632		
0103	00150	000007	END	

PROGRAM NAME  
SOURCE: ERDE  
BINARY: BERDE  
ENTRY POINTS (location: ERDE ('06172)  
GENERAL DESCRIPTION:

This subroutine is called by either the gyro failure detection and isolation logic subroutine (GFIS) or the PIPA failure detection and isolation logic subroutine (PFIS) and in turn calls the squared error calculator (SECA, program source name CFSE). Core location '763 tells this subroutine which instrument is to be considered failed. If location '763 is zero, it means that no instrument is to be considered failed and when it calls SECA, it must indicate this with a -7 in the index register. SECA will then calculate the no fail squared error equations and return with a code in the A register which ERDE will store in core location '764 so that its calling program (either GFIS or PFIS) can use the result.

If the failure key (location '763) is a 1, 2, 3, 4, 5 or 6, it indicates that the second fail squared error equations are to be calculated considering A, B, C, D, E or F as the failed instrument. Again, ERDE will store the return from SECA in location '764 for use by GFIS or PFIS. If '763 is a 1 and instrument A is to be considered failed, MA (see description of SECA, program source name CFSE), the accumulated measurement of instrument A, must be replaced by

$$\sqrt{0.2} (MB - MC - MD + ME + MF)$$

the calculation of MA using MB, MC, MD, ME and MF. Then when SECA calculates the first fail squared error equations using the new MA and the old MB, MC, MD, ME and MF, it gets the same results it would have gotten had it used the second fail squared error equations considering A failed. Similarly, if the fail key ('763) is a 2, B is considered failed and MB must be replaced by

$$\sqrt{0.2} (MA + MC + MD + ME + MF)$$

Also, with instrument B failed, the index register must contain a -2 when SECA is called. Similar steps are taken when instruments C, D, E or F are to be considered failed. The flow chart for the subroutine ERDE follows:

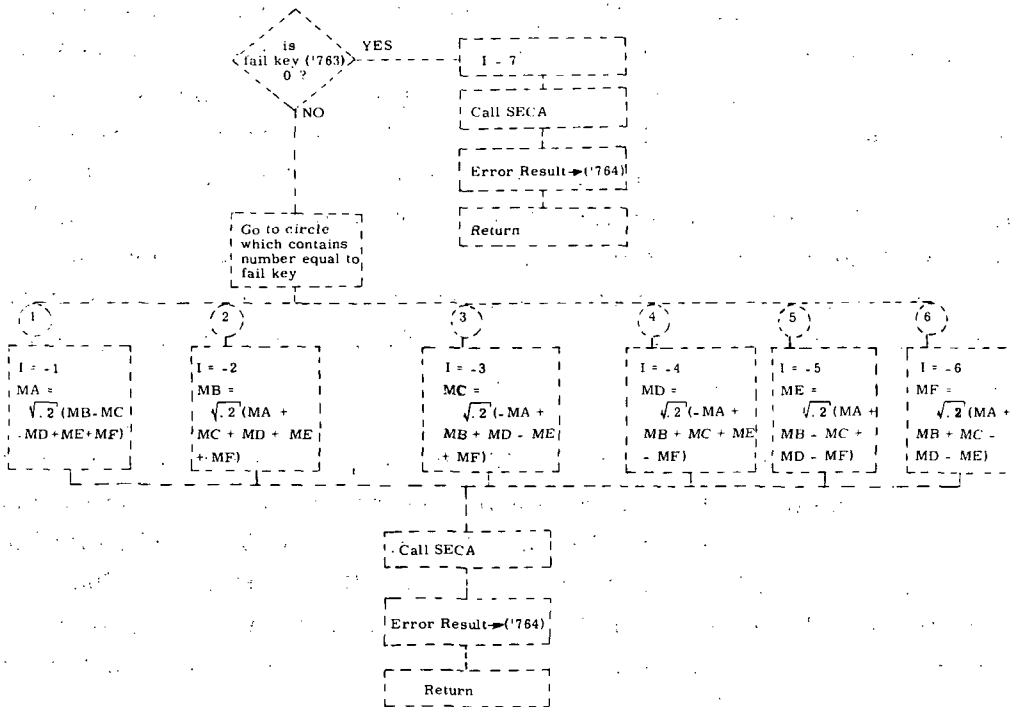

**FLOWCHART - ERDE**

MICROCOMP TELECOMMUNICATED DATA  
DDP-516 ASSEMBLY LISTING

0001				REL	
0002				SUBR	ERDE
0003	00000	0 000000	ERDE	DAC	**
0004	00001	0 02 00763		LDA	'763
0005	00002	100040		SZE	
0006	00003	0 01 00010		JMP	AROF
0007	00004	0 35 00331		LDX	=-7
0008	00005	0 10 00000		CALL	SECA
0009	00006	0 04 00764		STA	'764
0010	00007	-0 01 00000		JMP*	ERDE
0011	00010	0 04 00000	AROF	STA	0
0012	00011	-1 01 00011	EASE	JMP*	EASE,1
0013	00012	0 000020		DAC	AFAL
0014	00013	0 000057		DAC	BFAL
0015	00014	0 000116		DAC	CFAL
0016	00015	0 000166		DAC	DFAL
0017	00016	0 000225		DAC	EFAL
0018	00017	0 000264		DAC	FFAL
0019	00020	000007	AFAL	DBL	
0020	00021	0 02 00746		LDA	MB
0021	00022	0 06 00754		ADD	ME
0022	00023	0 06 00756		ADD	MF
0023	00024	0 07 00750		SUB	MC
0024	00025	0 07 00752		SUB	MD
0025	00026	0 04 00160		STA	TEM1
0026	00027	0 16 00155		MPY	RPTT
0027	00030	0 04 00162		STA	TEM2
0028	00031	0 02 00160		LDA	TEM1
0029	00032	000201		IAB	
0030	00033	0 16 00155		MPY	RPTT
0031	00034	0 06 00164		ADD	HALF
0032	00035	000201		IAB	
0033	00036	140040		CRA	
0034	00037	0 06 00162		ADD	TEM2
0035	00040	0 04 00162		STA	TEM2
0036	00041	0 02 00160		LDA	TEM1
0037	00042	0 16 00156		MPY	RPTT+1
0038	00043	0 06 00164		ADD	HALF
0039	00044	140320		CSA	
0040	00045	000201		IAB	
0041	00046	140040		CRA	
0042	00047	100001		SRC	
0043	00050	140401		CMA	
0044	00051	0 06 00162		ADD	TEM2
0045	00052	0 04 00744		STA	MA
0046	00053	0 35 00327		LDX	=-1
0047	00054	0 10 00000		CALL	SECA
0048	00055	0 04 00764		STA	'764
0049	00056	-0 01 00000		JMP*	ERDE
0050	00057	000007	BFAL	DBL	
0051	00060	0 02 00744		LDA	MA
0052	00061	0 06 00750		ADD	MC
0053	00062	0 06 00752		ADD	MD
0054	00063	0 06 00754		ADD	ME
0055	00064	0 06 00756		ADD	MF
0056	00065	0 04 00160		STA	TEM1
0057	00066	0 16 00155		MPY	RPTT

MICROCOMP TELECOMMUNICATED DATA  
DDP-516 ASSEMBLY LISTING

0058	00067	0 04 00162	STA	TEM2
0059	00070	0 02 00160	LDA	TEM1
0060	00071	000201	IAB	
0061	00072	0 16 00155	MPY	RPTT
0062	00073	0 06 00164	ADD	HALF
0063	00074	000201	IAB	
0064	00075	140040	CRA	
0065	00076	0 06 00162	ADD	TEM2
0066	00077	0 04 00162	STA	TEM2
0067	00100	0 02 00160	LDA	TEM1
0068	00101	0 16 00156	MPY	RPTT+1
0069	00102	0 06 00164	ADD	HALF
0070	00103	140320	CSA	
0071	00104	000201	IAB	
0072	00105	140040	CRA	
0073	00106	100001	SPC	
0074	00107	140401	CMA	
0075	00110	0 06 00162	ADD	TEM2
0076	00111	0 04 00746	STA	MB
0077	00112	0 35 00326	LDX	=-2
0078	00113	0 10 00000	CALL	SECA
0079	00114	0 04 00764	STA	'764
0080	00115	-0 01 00000	JMP*	ERDE
0081	00116	000007	CPAL DBL	
0082	00117	0 02 00746	LDA	MB
0083	00120	0 06 00752	ADD	MD
0084	00121	0 06 00756	ADD	MF
0085	00122	0 07 00744	SUB	MA
0086	00123	0 07 00754	SUB	ME
0087	00124	0 04 00160	STA	TEM1
0088	00125	0 16 00155	MPY	RPTT
0089	00126	0 04 00162	STA	TEM2
0090	00127	0 02 00160	LDA	TFM1
0091	00130	000201	IAB	
0092	00131	0 16 00155	MPY	RPTT
0093	00132	0 06 00164	ADD	HALF
0094	00133	000201	IAB	
0095	00134	140040	CRA	
0096	00135	0 06 00162	ADD	TEM2
0097	00136	0 04 00162	STA	TEM2
0098	00137	0 02 00160	LDA	TEM1
0099	00140	0 16 00156	MPY	RPTT+1
0100	00141	0 06 00164	ADD	HALF
0101	00142	140320	CSA	
0102	00143	000201	IAB	
0103	00144	140040	CRA	
0104	00145	100001	SPC	
0105	00146	140401	CMA	
0106	00147	0 06 00162	ADD	TEM2
0107	00150	0 04 00750	STA	MC
0108	00151	0 35 00325	LDX	=-3
0109	00152	0 10 00000	CALL	SECA
0110	00153	0 04 00764	STA	'764
0111	00154	-0 01 00000	JMP*	ERDE
0112	00155	034476	RPTT DEC	.4472135955BB0
	00156	022705		
0113	00160	000000	TEM1 DBP	0

MICROCOMP TELECOMMUNICATED DATA  
DDP-516 ASSEMBLY LISTING

00161	000000			
0114 00162	000000	TEM2 DBP	0	
00163	000000			
0115 00164	000000	HALF OCT	0,40000	
00165	040000			
0116 00166	000007	DPAL DBL		
0117 00167	0 02 00746	LDA	MB	
0118 00170	0 06 00750	ADD	MC	
0119 00171	0 06 00754	ADD	MF	
0120 00172	0 07 00744	SUB	MA	
0121 00173	0 07 00756	SUB	MF	
0122 00174	0 04 00160	STA	TEM1	
0123 00175	0 16 00155	MPY	RPTT	
0124 00176	0 04 00162	STA	TEM2	
0125 00177	0 02 00160	LDA	TEM1	
0126 00200	000201	IAB		
0127 00201	0 16 00155	MPY	RPTT	
0128 00202	0 06 00164	ADD	HALF	
0129 00203	000201	IAB		
0130 00204	140040	CRA		
0131 00205	0 06 00162	ADD	TEM2	
0132 00206	0 04 00162	STA	TEM2	
0133 00207	0 02 00160	LDA	TEM1	
0134 00210	0 16 00156	MPY	RPTT+1	
0135 00211	0 06 00164	ADD	HALF	
0136 00212	140320	CSA		
0137 00213	000201	IAB		
0138 00214	140040	CRA		
0139 00215	100001	SRC		
0140 00216	140401	CMA		
0141 00217	0 06 00162	ADD	TEM2	
0142 00220	0 04 00752	STA	MD	
0143 00221	0 35 00330	LDX	--4	
0144 00222	0 10 00000	CALL	SECA	
0145 00223	0 04 00764	STA	'764	
0146 00224	-0 01 00000	JMP*	ERDE	
0147 00225	000007	EPAL DBL		
0148 00226	0 02 00744	LDA	MA	
0149 00227	0 06 00746	ADD	MB	
0150 00230	0 06 00752	ADD	MD	
0151 00231	0 07 00750	SUB	MC	
0152 00232	0 07 00756	SUB	MF	
0153 00233	0 04 00160	STA	TEM1	
0154 00234	0 16 00155	MPY	RPTT	
0155 00235	0 04 00162	STA	TEM2	
0156 00236	0 02 00160	LDA	TEM1	
0157 00237	000201	IAB		
0158 00240	0 16 00155	MPY	RPTT	
0159 00241	0 06 00164	ADD	HALF	
0160 00242	000201	IAB		
0161 00243	140040	CRA		
0162 00244	0 06 00162	ADD	TEM2	
0163 00245	0 04 00162	STA	TEM2	
0164 00246	0 02 00160	LDA	TEM1	
0165 00247	0 16 00156	MPY	RPTT+1	
0166 00250	0 06 00164	ADD	HALF	
0167 00251	140320	CSA		

MICROCOMP TELECOMMUNICATED DATA  
DDP-516 ASSEMBLY LISTING

0168	00252	000201		IAB	
0169	00253	140040		CRA	
0170	00254	100001		SRC	
0171	00255	140401		CMA	
0172	00256	0 06 00162		ADD	TEM2
0173	00257	0 04 00754		STA	ME
0174	00260	0 35 00324		LDX	=-5
0175	00261	0 10 00000		CALL	SECA
0176	00262	0 04 00764		STA	*764
0177	00263	-0 01 00000		JMP*	ERDE
0178	00264	000007	FFAL	DRL	
0179	00265	0 02 00744		LDA	MA
0180	00266	0 06 00746		ADD	MB
0181	00267	0 06 00750		ADD	MC
0182	00270	0 07 00752		SUB	MD
0183	00271	0 07 00754		SUB	ME
0184	00272	0 04 00160		STA	TEM1
0185	00273	0 16 00155		MPY	RPTT
0186	00274	0 04 00162		STA	TEM2
0187	00275	0 02 00160		LDA	TEM1
0188	00276	000201		IAB	
0189	00277	0 16 00155		MPY	RPTT
0190	00300	0 06 00164		ADD	HALF
0191	00301	000201		IAB	
0192	00302	140040		CRA	
0193	00303	0 06 00162		ADD	TEM2
0194	00304	0 04 00162		STA	TEM2
0195	00305	0 02 00160		LDA	TEM1
0196	00306	0 16 00156		MPY	RPTT+1
0197	00307	0 06 00164		ADD	HALF
0198	00310	140320		CSA	
0199	00311	000201		IAB	
0200	00312	140040		CRA	
0201	00313	100001		SRC	
0202	00314	140401		CMA	
0203	00315	0 06 00162		ADD	TEM2
0204	00316	0 04 00756		STA	MF
0205	00317	0 35 00323		LDX	=-6
0206	00320	0 10 00000		CALL	SECA
0207	00321	0 04 00764		STA	*764
0208	00322	-0 01 00000		JMP*	ERDE
0209		000744	MA	EQU	*744
0210		000746	MB	EQU	MA+2
0211		000750	MC	EQU	MA+4
0212		000752	MD	EQU	MA+6
0213		000754	ME	EQU	MD+2
0214		000756	MF	EQU	MD+4
0215	00323	177772		END	
	00324	177773			
	00325	177775			
	00326	177776			
	00327	177777			
	00330	177774			
	00331	177771			

PROGRAM NAME

SOURCE: CFSE

BINARY: BCFSE

RELATED MEMOS: FAILURE ISOLATION IN SIRU (OEHRLE)

ENTRY POINTS (location): SECA ('06524)

GENERAL DESCRIPTION:

This subroutine, when called, will calculate either the first or second squared errors of instruments A-F from a set of accumulated measurements (MA - MF) stored in the base sector of the DDP 516, decide whether the total squared error is greater than some limit (also stored in the base sector) and if it is, decide if any instruments squared error exceeds a certain fraction (also stored in the base sector) of the total squared error. Then it will return with a code in the A register indicating the result of the above decisions. If during the calculations the error in any instrument exceeds or equals  $2^{12}$  pulses (an overflow condition), or if the total squared error exceeds or equals  $2^{24}$  pulses squared, the return code in the A register will indicate that the calculations could not be completed due to huge errors in one or more instruments.

The arguments MA - MF (see documentation for subroutines GARC + PREX) are stored in locations '744 - '757 and are six double precision numbers. If the calling program (see documentation for subroutine ERDE) wishes the squared errors calculated for the second fail detection with say instrument A failed, it will replace MA with what MB - MF calculate for MA (substituting this new MA and the old MB - MF into the first fail equations calculates the second fail squared errors for instruments B - F and therefore, eliminates writing 6 sets of second fail equations) and put a -1 in the index register. If instrument B is failed it will calculate MB from the other 5 measurements and put a -2 in the index register, etc.

The following are the return codes:



code	meaning
0	TSE (total squared error) did not exceed MASE (maximum allowable squared error stored in the base sector in location '760).
1-6	TSE0 did exceed MASE and the squared error of instrument A (for code 1) B (for code 2) etc. exceeded FONT TSE0 (FONT is the squared error ratio criteria to isolate a failure. It is .44 for a first fail isolation and .38 for a second fail isolation and is put in the base sector in location '762 by the calling program (see documentation for subroutines GFIS & PFIS).
7	TSE0 exceeded MASE but no instrument's squared error exceeded FONT TSE0
8-13	There was a huge error $\geq 2^{12}$ pulses when calculating the error of instrument A (for code of 8) B (for code of 9) etc.

14

In summing ASE0  
through FSE0 (A squared error  
through F squared error)  
to get TSE0, an  
overflow occurred  
(the sum was  $\geq 2^{24}$   
pulses squared)

The subroutine flow chart follows:

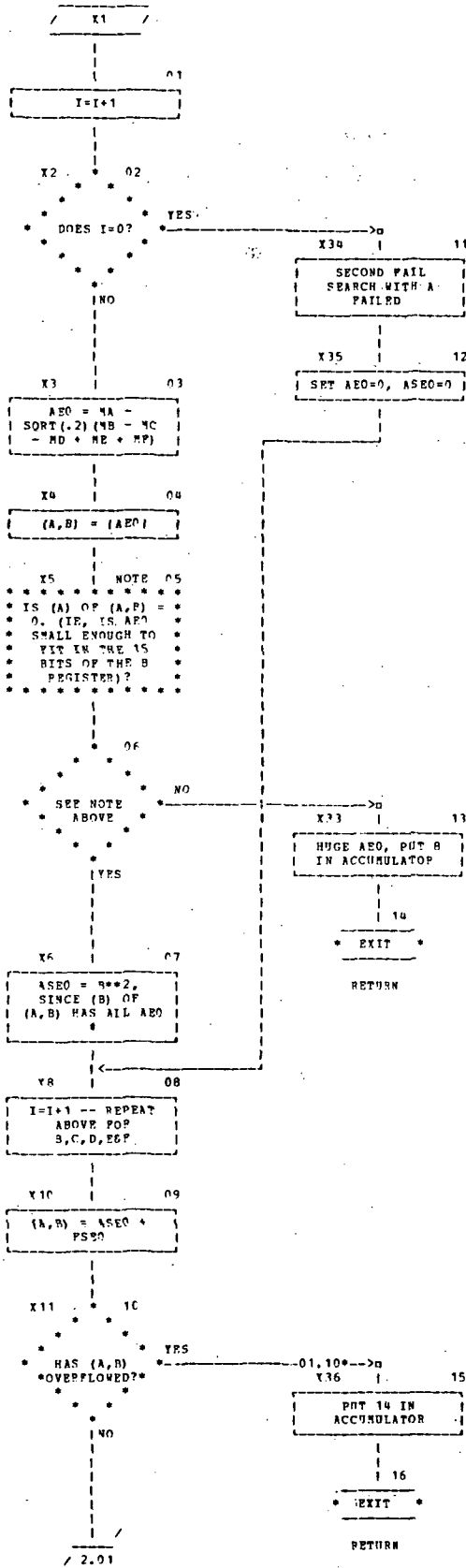

FLOWCHART - SECA

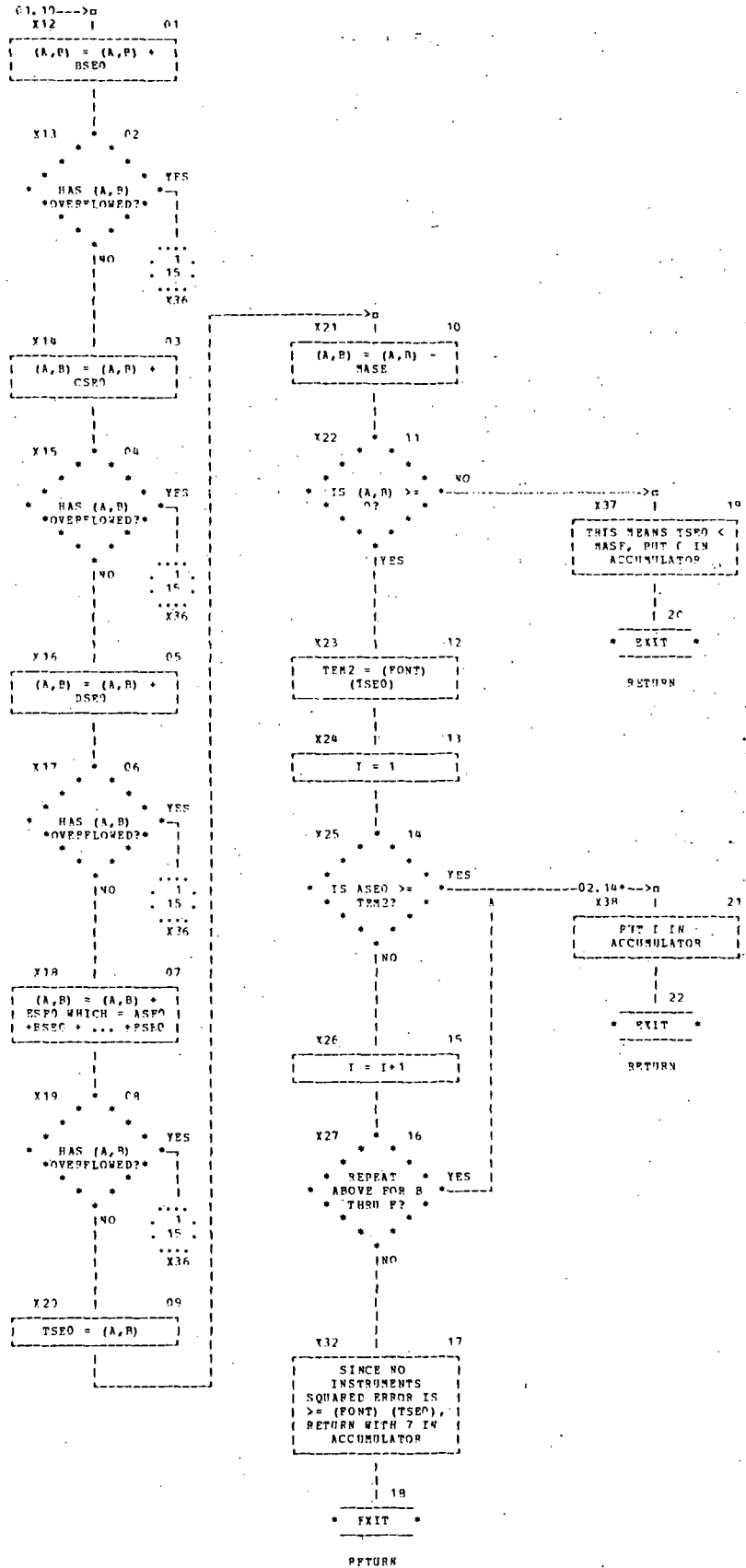

MICROCOMP TELECOMMUNICATED DATA  
DDP-516 ASSEMBLY LISTING

0001				SUBR	SECA
0002				REL	
0003	00000	0 000000	SECA	DAC	**
0004	00001	000007		DBL	
0005	00002	0 12 00000		IRS	0
0006	00003	0 01 00012		JMP	ACAL
0007	00004	140040		CRA	
0008	00005	000201		IAB	
0009	00006	140040		CRA	
0010	00007	0 04 00224		STA	AEO
0011	00010	0 04 00326		STA	ASEO
0012	00011	0 01 00060		JMP	BTFC
0013	00012	0 02 00750	ACAL	LDA	MC
0014	00013	0 06 00752		ADD	MD
0015	00014	0 07 00746		SUB	MB
0016	00015	0 07 00754		SUB	ME
0017	00016	0 07 00756		SUB	MF
0018	00017	0 04 00216		STA	TEM1
0019	00020	0 16 00213		MPY	RPPT
0020	00021	0 04 00220		STA	TEM2
0021	00022	0 02 00216		LDA	TEM1
0022	00023	000201		IAB	
0023	00024	0 16 00213		MPY	RPPT
0024	00025	0 06 00222		ADD	HALF
0025	00026	000201		IAB	
0026	00027	140040		CRA	
0027	00030	0 06 00220		ADD	TEM2
0028	00031	0 04 00220		STA	TEM2
0029	00032	0 02 00216		LDA	TEM1
0030	00033	0 16 00214		MPY	RPPT+1
0031	00034	0 06 00222		ADD	HALF
0032	00035	140320		CSA	
0033	00036	000201		IAB	
0034	00037	140040		CRA	
0035	00040	100001		SRC	
0036	00041	140401		CMA	
0037	00042	0 06 00220		ADD	TEM2
0038	00043	0 06 00744		ADD	MA
0039	00044	0 04 00224		STA	AEO
0040	00045	101400		SMI	
0041	00046	0 01 00051		JMP	AEPO
0042	00047	0 07 00224		SUB	AEO
0043	00050	0 07 00224		SUB	AEO
0044	00051	101040	AEPO	SNZ	
0045	00052	0 01 00054		JMP	SESE
0046	00053	0 01 00565		JMP	HUAE
0047	00054	000201	SESE	IAB	
0048	00055	0 04 00326		STA	ASEO
0049	00056	0 16 00326		MPY	ASEO
0050	00057	0 04 00326		STA	ASEO
0051	00060	0 12 00000	BTFC	IRS	0
0052	00061	0 01 00070		JMP	BCAL
0053	00062	140040		CRA	
0054	00063	000201		IAB	
0055	00064	140040		CRA	
0056	00065	0 04 00226		STA	BEO
0057	00066	0 04 00330		STA	BSEO

MICROCOMP TELECOMMUNICATED DATA  
DDP-516 ASSEMBLY LISTING

0058	00067	0 01 00141	JMP	CTFC
0059	00070	140040	BCAL CRA	
0060	00071	000201	IAB	
0061	00072	140040	CRA	
0062	00073	0 07 00744	SUB	MA
0063	00074	0 07 00750	SUB	MC
0064	00075	0 07 00752	SUB	MD
0065	00076	0 07 00754	SUB	ME
0066	00077	0 07 00756	SUB	MF
0067	00100	0 04 00216	STA	TEM1
0068	00101	0 16 00213	MPY	RPTT
0069	00102	0 04 00220	STA	TEM2
0070	00103	0 02 00216	LDA	TEM1
0071	00104	000201	IAB	
0072	00105	0 16 00213	MPY	RPTT
0073	00106	0 06 00222	ADD	HALF
0074	00107	000201	IAB	
0075	00110	140040	CRA	
0076	00111	0 06 00220	ADD	TEM2
0077	00112	0 04 00220	STA	TEM2
0078	00113	0 02 00216	LDA	TEM1
0079	00114	0 16 00214	MPY	RPTT+1
0080	00115	0 06 00222	ADD	HALF
0081	00116	140320	CSA	
0082	00117	000201	IAB	
0083	00120	140040	CRA	
0084	00121	100001	SPC	
0085	00122	140401	CMA	
0086	00123	0 06 00220	ADD	TEM2
0087	00124	0 06 00746	ADD	ME
0088	00125	0 04 00226	STA	BEO
0089	00126	101400	SMI	
0090	00127	0 01 00132	JMP	BEPO
0091	00130	0 07 00226	SUB	BEO
0092	00131	0 07 00226	SUB	BEO
0093	00132	101040	BEPO SNZ	
0094	00133	0 01 00135	JMP	LTSE
0095	00134	0 01 00570	JMP	HUBE
0096	00135	000201	LTSE IAB	
0097	00136	0 04 00330	STA	BSEO
0098	00137	0 16 00330	MPY	BSEO
0099	00140	0 04 00330	STA	BSEO
0100	00141	0 12 00000	CTFC IRS	0
0101	00142	0 01 00151	JMP	CCAL
0102	00143	140040	CPA	
0103	00144	000201	IAB	
0104	00145	140040	CRA	
0105	00146	0 04 00230	STA	CFO
0106	00147	0 04 00332	STA	CSEO
0107	00150	0 01 00244	JMP	DTEC
0108	00151	0 02 00744	CCAL LDA	MA
0109	00152	0 06 00754	ADD	ME
0110	00153	0 07 00746	SUB	MB
0111	00154	0 07 00752	SUB	MD
0112	00155	0 07 00756	SUB	MF
0113	00156	0 04 00216	STA	TEM1
0114	00157	0 16 00213	MPY	RPTT

MICROCOMP TELECOMMUNICATED DATA  
DDP-516 ASSEMBLY LISTING

0115	00160	0 04 00220	STA	TEM2
0116	00161	0 02 00216	LDA	TEM1
0117	00162	000201	IAB	
0118	00163	0 16 00213	MPY	RPTT
0119	00164	0 06 00222	ADD	HALF
0120	00165	000201	IAB	
0121	00166	140040	CRA	
0122	00167	0 06 00220	ADD	TEM2
0123	00170	0 04 00220	STA	TEM2
0124	00171	0 02 00216	LDA	TEM1
0125	00172	0 16 00214	MPY	RPTT+1
0126	00173	0 06 00222	ADD	HALF
0127	00174	140320	CSA	
0128	00175	000201	IAB	
0129	00176	140040	CRA	
0130	00177	100001	SRC	
0131	00200	140401	CMA	
0132	00201	0 06 00220	ADD	TEM2
0133	00202	0 06 00750	ADD	MC
0134	00203	0 04 00230	STA	CEO
0135	00204	101400	SMI	
0136	00205	0 01 00210	JMP	CEPO
0137	00206	0 07 00230	SUB	CEO
0138	00207	0 07 00230	SUB	CEO
0139	00210	101040	CEPO SNZ	
0140	00211	0 01 00240	JMP	NBSE
0141	00212	0 01 00573	JMP	HUCE
0142	00213	034476	RPTT DEC	.4472135955BB0
	00214	022705		
0143	00216	000000	TEM1 DBP	0
	00217	000000		
0144	00220	000000	TEM2 DBP	0
	00221	000000		
0145	00222	000000	HALF OCT	0,40000
	00223	040000		
0146	00224	000000	AEO DBP	0
	00225	000000		
0147	00226	000000	BEO DBP	0
	00227	000000		
0148	00230	000000	CEO DBP	0
	00231	000000		
0149	00232	000000	DEO DBP	0
	00233	000000		
0150	00234	000000	EEO DBP	0
	00235	000000		
0151	00236	000000	FEO DBP	0
	00237	000000		
0152		000326	ASEO EQU	'326
0153		000330	BSEO EQU	'330
0154		000332	CSEO EQU	'332
0155		000436	DSEO EQU	'436
0156		000440	ESEO EQU	'440
0157		000442	FSEO EQU	'442
0158		000574	TSEO EQU	'574
0159	00240	000201	NBSE IAB	
0160	00241	0 04 00332	STA	CSEO
0161	00242	0 16 00332	MPY	CSEO

MICROCOMP TELECOMMUNICATED DATA

DDP-516 ASSEMBLY LISTING

0162	00243	0 04 00332	STA	CSE0
0163	00244	0 12 00000	DTFC IRS	0
0164	00245	0 01 00254	JMP	DCAL
0165	00246	140040	CRA	
0166	00247	000201	IAB	
0167	00250	140040	CRA	
0168	00251	0 04 00232	STA	DE0
0169	00252	0 04 00436	STA	DSE0
0170	00253	0 01 00322	JMP	ETFC
0171	00254	0 02 00744	DCAL LDA	MA
0172	00255	0 06 00756	ADD	MF
0173	00256	0 07 00746	SUB	MB
0174	00257	0 07 00750	SUB	MC
0175	00260	0 07 00754	SUB	ME
0176	00261	0 04 00216	STA	TEM1
0177	00262	0 16 00213	MPY	RPTT
0178	00263	0 04 00220	STA	TEM2
0179	00264	0 02 00216	LDA	TEM1
0180	00265	000201	IAB	
0181	00266	0 16 00213	MPY	RPTT
0182	00267	0 06 00222	ADD	HALF
0183	00270	000201	IAB	
0184	00271	140040	CRA	
0185	00272	0 06 00220	ADD	TEM2
0186	00273	0 04 00220	STA	TEM2
0187	00274	0 02 00216	LDA	TEM1
0188	00275	0 16 00214	MPY	RPTT+1
0189	00276	0 06 00222	ADD	HALF
0190	00277	140320	CSA	
0191	00300	000201	IAB	
0192	00301	140040	CRA	
0193	00302	100001	SFC	
0194	00303	140401	CMA	
0195	00304	0 06 00220	ADD	TFM2
0196	00305	0 06 00752	ADD	MD
0197	00306	0 04 00232	STA	DE0
0198	00307	101400	SMI	
0199	00310	0 01 00313	JMP	DEPO
0200	00311	0 07 00232	SUB	DE0
0201	00312	0 07 00232	SUB	DE0
0202	00313	101040	DEPO SNZ	
0203	00314	0 01 00316	JMP	RSSE
0204	00315	0 01 00576	JMP	HUDE
0205	00316	000201	RSSE IAB	
0206	00317	0 04 00436	STA	DSE0
0207	00320	0 16 00436	MPY	DSE0
0208	00321	0 04 00436	STA	DSE0
0209	00322	0 12 00000	ETFC IRS	0
0210	00323	0 01 00332	JMP	ECAL
0211	00324	140040	CRA	
0212	00325	000201	IAB	
0213	00326	140040	CRA	
0214	00327	0 04 00234	STA	EEO
0215	00330	0 04 00440	STA	ESE0
0216	00331	0 01 00400	JMP	FTFC
0217	00332	0 02 00750	ECAL LDA	MC
0218	00333	0 06 00756	ADD	MF



MICROCOMP TELECOMMUNICATED DATA  
DDP-516 ASSEMBLY LISTING

0219	00334	0 07 00744	SUB	MA
0220	00335	0 07 00746	SUB	MB
0221	00336	0 07 00752	SUB	MD
0222	00337	0 04 00216	STA	TEM1
0223	00340	0 16 00213	MPY	RPTT
0224	00341	0 04 00220	STA	TEM2
0225	00342	0 02 00216	LDA	TEM1
0226	00343	000201	IAB	
0227	00344	0 16 00213	MPY	RPTT
0228	00345	0 06 00222	ADD	HALF
0229	00346	000201	IAB	
0230	00347	140040	CRA	
0231	00350	0 06 00220	ADD	TEM2
0232	00351	0 04 00220	STA	TEM2
0233	00352	0 02 00216	LDA	TEM1
0234	00353	0 16 00214	MPY	RPTT+1
0235	00354	0 06 00222	ADD	HALF
0236	00355	140320	CSA	
0237	00356	000201	IAB	
0238	00357	140040	CRA	
0239	00360	100001	SRC	
0240	00361	140401	CMA	
0241	00362	0 06 00220	ADD	TEM2
0242	00363	0 06 00754	ADD	ME
0243	00364	0 04 00234	STA	EEO
0244	00365	101400	SMI	
0245	00366	0 01 00371	JMP	EEPO
0246	00367	0 07 00234	SUB	EEO
0247	00370	0 07 00234	SUB	EEO
0248	00371	101040	EEPO SNZ	
0249	00372	0 01 00374	JMP	LESE
0250	00373	0 01 00601	JMP	HUEE
0251	00374	000201	LESE IAB	
0252	00375	0 04 00440	STA	ESEO
0253	00376	0 16 00440	MPY	ESEO
0254	00377	0 04 00440	STA	ESEO
0255	00400	0 12 00000	FTFC IRS	0
0256	00401	0 01 00410	JMP	FCAL
0257	00402	140040	CRA	
0258	00403	000201	IAB	
0259	00404	140040	CRA	
0260	00405	0 04 00236	STA	FEO
0261	00406	0 04 00442	STA	FSEO
0262	00407	0 01 00456	JMP	NTFC
0263	00410	0 02 00752	FCAL LDA	MD
0264	00411	0 06 00754	ADD	ME
0265	00412	0 07 00744	SUB	MA
0266	00413	0 07 00746	SUB	MB
0267	00414	0 07 00750	SUB	MC
0268	00415	0 04 00216	STA	TEM1
0269	00416	0 16 00213	MPY	RPTT
0270	00417	0 04 00220	STA	TEM2
0271	00420	0 02 00216	LDA	TEM1
0272	00421	000201	IAB	
0273	00422	0 16 00213	MPY	RPTT
0274	00423	0 06 00222	ADD	HALF
0275	00424	000201	IAB	

MICROCOMP TELECOMMUNICATED DATA  
DDP-516 ASSEMBLY LISTING

0276	00425	140040	CRA	
0277	00426	0 06 00220	ADD	TEM2
0278	00427	0 04 00220	STA	TEM2
0279	00430	0 02 00216	LDA	TEM1
0280	00431	0 16 00214	MPY	RPTT+1
0281	00432	0 06 00222	ADD	HALF
0282	00433	140320	CSA	
0283	00434	000201	IAB	
0284	00435	140040	CRA	
0285	00436	100001	SRC	
0286	00437	140401	CMA	
0287	00440	0 06 00220	ADD	TEM2
0288	00441	0 06 00756	ADD	MF
0289	00442	0 04 00236	STA	FEO
0290	00443	101400	SMI	
0291	00444	0 01 00447	JMP	FEP0
0292	00445	0 07 00236	SUB	FEO
0293	00446	0 07 00236	SUR	FEO
0294	00447	101040	FEP0 SNZ	
0295	00450	0 01 00452	JMP	VMSE
0296	00451	0 01 00604	JMP	HUFE
0297	00452	000201	VMSE IAB	
0298	00453	0 04 00442	STA	FSE0
0299	00454	0 16 00442	MPY	FSE0
0300	00455	0 04 00442	STA	FSE0
0301	00456	0 06 00326	NTFC ADD	ASE0
0302	00457	100001	SRC	
0303	00460	0 01 00562	JMP	OVFL
0304	00461	0 06 00330	ADD	BSE0
0305	00462	100001	SRC	
0306	00463	0 01 00562	JMP	OVFL
0307	00464	0 06 00332	ADD	CSE0
0308	00465	100001	SRC	
0309	00466	0 01 00562	JMP	OVFL
0310	00467	0 06 00436	ADD	DSF0
0311	00470	100001	SRC	
0312	00471	0 01 00562	JMP	OVFL
0313	00472	0 06 00440	ADD	ESE0
0314	00473	100001	SRC	
0315	00474	0 01 00562	JMP	OVFL
0316	00475	0 04 00574	STA	TSE0
0317	00476	0 07 00760	SUB	MASE
0318	00477	100400	SPL	
0319	00500	0 01 00557	JMP	ZRTU
0320	00501	0 02 00574	LDA	TSE0
0321	00502	0 16 00762	MPY	PONT
0322	00503	0 04 00220	STA	TEM2
0323	00504	0 02 00574	LDA	TSE0
0324	00505	000201	IAB	
0325	00506	0 16 00762	MPY	PONT
0326	00507	000201	IAB	
0327	00510	140040	CRA	
0328	00511	0 06 00220	ADD	TEM2
0329	00512	0 04 00220	STA	TEM2
0330	00513	0 35 00617	IDX	=1
0331	00514	0 02 00326	LDA	ASE0
0332	00515	0 07 00220	SUB	TEM2

MICROCOMP TELRCOMMUNICATED DATA  
DDP-516 ASSEMBLY LISTING

0333	00516	101400		SMI	
0334	00517	0 01 00554		JMP	FOND
0335	00520	0 12 00000		IRS	0
0336	00521	0 02 00330		LDA	BSE0
0337	00522	0 07 00220		SUB	TEM2
0338	00523	101400		SMI	
0339	00524	0 01 00554		JMP	FOND
0340	00525	0 12 00000		IRS	0
0341	00526	0 02 00332		LDA	CSE0
0342	00527	0 07 00220		SUB	TEM2
0343	00530	101400		SMI	
0344	00531	0 01 00554		JMP	FOND
0345	00532	0 12 00000		IRS	0
0346	00533	0 02 00436		LDA	DSE0
0347	00534	0 07 00220		SUB	TEM2
0348	00535	101400		SMI	
0349	00536	0 01 00554		JMP	FOND
0350	00537	0 12 00000		IRS	0
0351	00540	0 02 00440		LDA	ESE0
0352	00541	0 07 00220		SUB	TEM2
0353	00542	101400		SMI	
0354	00543	0 01 00554		JMP	FOND
0355	00544	0 12 00000		IRS	0
0356	00545	0 02 00442		LDA	PSE0
0357	00546	0 07 00220		SUB	TEM2
0358	00547	101400		SMI	
0359	00550	0 01 00554		JMP	FOND
0360	00551	000005		SGL	
0361	00552	0 02 00616		LDA	=7
0362	00553	-0 01 00000		JMP*	SECA
0363	00554	000005	FOND	SGL	
0364	00555	0 02 00000		LDA	0
0365	00556	-0 01 00000		JMP*	SECA
0366	00557	000005	ZPTU	SGL	
0367	00560	140040		CRA	
0368	00561	-0 01 00000		JMP*	SECA
0369	00562	000005	OVFL	SGL	
0370	00563	0 02 00615		LDA	=14
0371	00564	-0 01 00000		JMP*	SECA
0372	00565	000005	HUAE	SGL	
0373	00566	0 02 00614		LDA	=8
0374	00567	-0 01 00000		JMP*	SECA
0375	00570	000005	HUBE	SGL	
0376	00571	0 02 00613		LDA	=9
0377	00572	-0 01 00000		JMP*	SECA
0378	00573	000005	HUCE	SGL	
0379	00574	0 02 00612		LDA	=10
0380	00575	-0 01 00000		JMP*	SECA
0381	00576	000005	HUDE	SGL	
0382	00577	0 02 00611		LDA	=11
0383	00600	-0 01 00000		JMP*	SECA
0384	00601	000005	HUEE	SGL	
0385	00602	0 02 00610		LDA	=12
0386	00603	-0 01 00000		JMP*	SECA
0387	00604	000005	HUFE	SGL	
0388	00605	0 02 00607		LDA	=13
0389	00606	-0 01 00000		JMP*	SECA

MICROCOMP TELECOMMUNICATED DATA  
DDP-516 ASSEMBLY LISTING

0390	000762	FONT	EQU	'762
0391	000744	MA	EQU	'744
0392	000746	ME	EQU	MA+2
0393	000750	MC	EQU	MA+4
0394	000752	MD	EQU	MA+6
0395	000754	ME	EQU	MD+2
0396	000756	MF	EQU	MD+4
0397	000760	MASE	EQU	'760
0398	00607		END	
	00610			
	00611			
	00612			
	00613			
	00614			
	00615			
	00616			
	00617			

PROGRAM NAME

SOURCE: PFIS

BINARY: BPFIS

ENTRY POINTS (location): PFIS ('04725)

ACCESSIBLE VARIABLES (location): KEYP ('05050)

GENERAL DESCRIPTION:

This subroutine controls the logic for the PIPA failure detection and isolation. It is identical to the subroutine GFIS, which controls the gyro failure detection and isolation, except that the PIPA fail status is contained in location '320 and '321 instead of '316 and '317 and that the PIPA maximum allowable squared errors (FMSE and SMSE) are not modified at the beginning of this subroutine as are the gyro's at the beginning of GFIS. So see documentation for the subroutine GFIS.

MICROCOMP TELECOMMUNICATED DATA  
DDP-516 ASSEMBLY LISTING

0001				REL	
0002				SUBR	PFIS
0003				SUBR	KEYP
0004	00000	0 000000	PFIS	DAC	**
0005	00001	0 02 00320		LDA	'320
0006	00002	100040		SZE	
0007	00003	0 01 00016		JMP	ALOF
0008	00004	140040	FFTR	CRA	
0009	00005	0 04 00122		STA	KEYP
0010	00006	0 04 00763		STA	'763
0011	00007	0 02 00117		LDA	FFRT
0012	00010	0 04 00762		STA	'762
0013	00011	000007		DBL	
0014	00012	0 02 00124		DLD	FMSE
0015	00013	0 04 00760		DST	'760
0016	00014	000005		SGL	
0017	00015	0 01 00032		JMP	COCA
0018	00016	0 02 00122	ALOF	LDA	KEYP
0019	00017	100040		SZE	
0020	00020	0 01 00004		JMP	FFTR
0021	00021	0 02 00320		LDA	'320
0022	00022	0 04 00122		STA	KEYP
0023	00023	0 04 00763		STA	'763
0024	00024	0 02 00120		LDA	SPRT
0025	00025	0 04 00762		STA	'762
0026	00026	000007		DBL	
0027	00027	0 02 00126		DLD	SMSE
0028	00030	0 04 00760		DST	'760
0029	00031	000005		SGL	
0030	00032	0 10 00000	COCA	CALL	ERDE
0031	00033	0 02 00122		LDA	KEYP
0032	00034	100040		SZE	
0033	00035	0 01 00103		JMP	SFSR
0034	00036	0 02 00764		LDA	'764
0035	00037	100040		SZE	
0036	00040	0 01 00047		JMP	NOZE
0037	00041	100004		SR3	
0038	00042	-0 01 00000		JMP*	PFIS
0039	00043	140040		CRA	
0040	00044	0 04 00320		STA	'320
0041	00045	0 04 00321		STA	'321
0042	00046	-0 01 00000		JMP*	PFIS
0043	00047	0 07 00130	NOZE	SUB	=7
0044	00050	101400		SMI	
0045	00051	-0 01 00000		JMP*	PFIS
0046	00052	0 02 00764		LDA	'764
0047	00053	0 11 00320		CAS	'320
0048	00054	0 01 00056		JMP	**2
0049	00055	-0 01 00000		JMP*	PFIS
0050	00056	0 11 00321		CAS	'321
0051	00057	0 01 00061		JMP	**2
0052	00060	0 01 00076		JMP	SPCA
0053	00061	0 02 00320		LDA	'320
0054	00062	101040		SNZ	
0055	00063	0 01 00071		JMP	**6
0056	00064	0 02 00321		LDA	'321
0057	00065	101040		SNZ	

MICROCOMP TELECOMMUNICATED DATA

DDP-516 ASSEMBLY LISTING

0058	00066	0 01 00076	JMP	SPCA
0059	00067	100004	SR3	
0060	00070	-0 01 00000	JMP*	PFIS
0061	00071	0 02 00764	LDA	'764
0062	00072	0 04 00320	STA	'320
0063	00073	140040	CRA	
0064	00074	0 04 00321	STA	'321
0065	00075	-0 01 00000	JMP*	PFIS
0066	00076	0 02 00320	SPCA LDA	'320
0067	00077	0 04 00321	STA	'321
0068	00100	0 02 00764	LDA	'764
0069	00101	0 04 00320	STA	'320
0070	00102	-0 01 00000	JMP*	PFIS
0071	00103	0 02 00764	SFSR LDA	'764
0072	00104	0 07 00130	SUB	=7
0073	00105	101400	SMI	
0074	00106	-0 01 00000	JMP*	PFIS
0075	00107	0 02 00321	LDA	'321
0076	00110	101040	SNZ	
0077	00111	0 01 00114	JMP	++3
0078	00112	100004	SR3	
0079	00113	-0 01 00000	JMP*	PFIS
0080	00114	0 02 00764	LDA	'764
0081	00115	0 04 00321	STA	'321
0082	00116	-0 01 00000	JMP*	PFIS
0083	00117	034343	FFRT OCT	34343
0084	00120	030600	SFRT OCT	30600
0085	00122	000000	KEYP DBP	0
	00123	000000		
0086	00124	000000	FMSE OCT	0,20000
	00125	020000		
0087	00126	000000	SMSE OCT	0,14632
	00127	014632		
0088	00130	000007	END	

PROGRAM NAME  
SOURCE: GPRT  
BINARY: BGPRT  
ENTRY POINT (location): GPRT ('12712)  
GENERAL DESCRIPTION:

This subroutine, when called, will in turn call PRTY to solve for the gyro parity equation if there are already 2 gyro failures. If the appropriate parity equation indicates an overflow or exceeds a certain limit it will store a 1 in octal location 322. Otherwise, octal location 322 will stay zero. The limit the equation must exceed (GMSE) is three pulses (GBSE = OCT 0, 30) plus some appropriate fraction of the

$$\sum \left| \Delta \theta_x \right| + \left| \Delta \theta_y \right| + \left| \Delta \theta_z \right|$$

which is stored in '774 by the gyro error accumulator GARC and allows for dynamic errors. This limit is calculated by the first four instructions of this subroutine.

GPRT will then set ('322) to zero and determine if there are 2 gyro failures (the gyro first and second fails are stored in octal locations 316 and 317). If there are not 2 failures, it will return. Otherwise, it calculates in the A register the code necessary to tell PRTY which parity equation to calculate. The codes are:

<u>Parity Equation</u>	<u>2 failures</u>	<u>code</u>
CDEF	A, B	0
BDEF	A, C	7
BCEF	A, D	14
BCDF	A, E	21
BCDE	A, F	28
ADEF	B, C	35
ACEF	B, D	42
ACDF	B, E	49
ACDE	B, F	56
ABEF	C, D	63
ABDF	C, E	70
ABDE	C, F	77
ABCF	D, E	84
ABCE	D, F	91
ABCD	E, F	98



The general method for calculating the code is the same as that used by GMIN for the gyro matrix generator. When PRTY returns, GPRT determines if the parity equation either exceeds its limit or has overflowed. In either case, it will indicate so by changing octal location 322 to a 1 before returning.

MICROCOMP TELECOMMUNICATED DATA  
DDP-516 ASSEMBLY LISTING

0001				SUBR	GPRT
0002				REL	
0003	00000	0 000000	GPRT	DAC	**
0004	00001	0 02 00774		LDA	'774
0005	00002	0405 75		ARS	3
0006	00003	0 06 00053		ADD	GBSE+1
0007	00004	0 04 00051		STA	GMSE+1
0008	00005	140040		CRA	
0009	00006	0 04 00322		STA	'322
0010	00007	0 02 00317		LDA	'317
0011	00010	101040		SNZ	
0012	00011	-0 01 00000		JMP*	GPRT
0013	00012	0 11 00316		CAS	'316
0014	00013	0 01 00024		JMP	SFLA
0015	00014	101000		NOP	
0016	00015	0 06 00045		ADD	ADST
0017	00016	0 04 00046		STA	IDPT
0018	00017	0 02 00316		LDA	'316
0019	00020	0415 75		ALS	3
0020	00021	0 07 00316		SUB	'316
0021	00022	-0 06 00046		ADD*	IDPT
0022	00023	0 01 00033		JMP	PRCL
0023	00024	0 02 00316	SFLA	LDA	'316
0024	00025	0 06 00045		ADD	ADST
0025	00026	0 04 00046		STA	IDPT
0026	00027	0 02 00317		LDA	'317
0027	00030	0415 75		ALS	3
0028	00031	0 07 00317		SUB	'317
0029	00032	-0 06 00046		ADD*	IDPT
0030	00033	0 10 00000	PRCL	CALL	PRTY
0031	00034	101000		NOP	
0032	00035	100400		SPL	
0033	00036	0 01 00042		JMP	OVRF
0034	00037	000007		DBL	
0035	00040	0 07 00050		DSB	GMSE
0036	00041	101400		SMI	
0037	00042	0 12 00322	OVRF	IRS	'322
0038	00043	000005		SGL	
0039	00044	-0 01 00000		JMP*	GPRT
0040	00045	0 000054	ADST	DAC	CRPS
0041	00046	000000		IDPT	DBP 0
	00047	000000			
0042	00050	000000	GMSE	OCT	0,30
	00051	000030			
0043	00052	000000	GBSE	OCT	0,30
	00053	000030			
0044	00054	000000	CRPS	OCT	0,177762,16,43,61,70
	00055	177762			
	00056	000016			
	00057	000043			
	00060	000061			
	00061	000070			
0045				END	

PROGRAM NAME:  
 SOURCE: PRTY  
 BINARY: BPRTY  
 ENTRY POINTS (location): PRTY ('12774)  
 GENERAL DESCRIPTION:

This subroutine calculates the parity equation used to detect third failures from the arguments stored in locations '744 - '757 by the gyro or PIPA error accumulators. It is called by GPRT if and when the gyro fail status indicates 2 failures and by PPRT (program source name PPEX) if and when the PIPA fail status indicates 2 failures. When called the A register contains a code to tell which of the fifteen parity equations to calculate (see documentation for GPRT). For example, if instruments C and F were failed, the code would be 77 (octal 115) and the JMP\* PONT, the fifth instruction in PRTY would effect a jump to the block of code: (note, at this point the (A, B) register contains a double precision zero).

DSB	MB
DSB	ME
DST	SINT
DLD	MA
DAD	MD
DST	COST
JMP	CALC

SINT is the sine term of the parity equation = - MB - ME. COST is the cosine term of the parity equation = MA + MD. Each of the 15 parity equations has a block of code (7 instructions each) similar to the block above. The jump to CALC will start a sequence of instructions which will multiply SINT by SINE = sine  $\alpha$  and COST by COSN = cosine  $\alpha$  and then add the two results and take the absolute value. If the high order word of this double precision result is zero (which indicates that the absolute value of the parity equation is less than  $2^{15}$  or  $2^{12}$  instrument pulses), this subroutine will return with the parity equation result in the (A, B) register. If the high order word is not zero, (A, B) will contain a double precision -1 at the return.



MICROCOMP TELECOMMUNICATED DATA

DDP-516 ASSEMBLY LISTING

0058	00067	0 02 00744	DLD	MA
0059	00070	0 07 00752	DSB	MD
0060	00071	0 04 00234	DST	SINT
0061	00072	0 02 00750	DLD	MC
0062	00073	0 07 00756	DSB	MF
0063	00074	0 04 00236	DST	COST
0064	00075	0 01 00156	JMP	CALC
0065	00076	0 02 00744	DLD	MA
0066	00077	0 07 00750	DSB	MC
0067	00100	0 04 00234	DST	SINT
0068	00101	0 02 00752	DLD	MD
0069	00102	0 07 00754	DSB	ME
0070	00103	0 04 00236	DST	COST
0071	00104	0 01 00156	JMP	CALC
0072	00105	0 07 00744	DSB	MA
0073	00106	0 07 00746	DSB	MB
0074	00107	0 04 00234	DST	SINT
0075	00110	0 02 00754	DLD	ME
0076	00111	0 06 00756	DAD	MF
0077	00112	0 04 00236	DST	COST
0078	00113	0 01 00156	JMP	CALC
0079	00114	0 02 00744	DLD	MA
0080	00115	0 06 00756	DAD	MF
0081	00116	0 04 00234	DST	SINT
0082	00117	0 02 00752	DLD	MD
0083	00120	0 07 00746	DSB	MB
0084	00121	0 04 00236	DST	COST
0085	00122	0 01 00156	JMP	CALC
0086	00123	0 07 00746	DSB	MB
0087	00124	0 07 00754	DSB	ME
0088	00125	0 04 00234	DST	SINT
0089	00126	0 02 00744	DLD	MA
0090	00127	0 06 00752	DAD	MD
0091	00130	0 04 00236	DST	COST
0092	00131	0 01 00156	JMP	CALC
0093	00132	0 07 00746	DSB	MR
0094	00133	0 07 00756	DSB	MF
0095	00134	0 04 00234	DST	SINT
0096	00135	0 02 00744	DLD	MA
0097	00136	0 06 00750	DAD	MC
0098	00137	0 04 00236	DST	COST
0099	00140	0 01 00156	JMP	CALC
0100	00141	0 02 00744	DLD	MA
0101	00142	0 06 00754	DAD	ME
0102	00143	0 04 00234	DST	SINT
0103	00144	0 02 00750	DLD	MC
0104	00145	0 07 00746	DSB	MB
0105	00146	0 04 00236	DST	COST
0106	00147	0 01 00156	JMP	CALC
0107	00150	0 02 00744	DLD	MA
0108	00151	0 07 00746	DSB	MB
0109	00152	0 04 00236	DST	COST
0110	00153	0 02 00750	DLD	MC
0111	00154	0 06 00752	DAD	MD
0112	00155	0 04 00234	DST	SINT
0113	00156	0 02 00234	CALC DLD	SINT
0114	00157	0 16 00245	MPY	SINE+1

MICROCOMP TELECOMMUNICATED DATA  
DDP-516 ASSEMBLY LISTING

0115	00160	0401 77	LRS	1
0116	00161	0 04 00240	DST	TEM1
0117	00162	0 02 00244	DLD	SINE
0118	00163	0 16 00235	MPY	SINT+1
0119	00164	0401 77	LRS	1
0120	00165	0 06 00240	DAD	TEM1
0121	00166	0 06 00250	DAD	HALF
0122	00167	0401 62	LRS	14
0123	00170	0 04 00240	DST	TEM1
0124	00171	0 02 00234	DLD	SINT
0125	00172	0 16 00244	MPY	SINE
0126	00173	0 06 00240	DAD	TEM1
0127	00174	0 04 00234	DST	SINT
0128	00175	0 02 00236	DLD	COST
0129	00176	0 16 00247	MPY	COSN+1
0130	00177	0401 77	LRS	1
0131	00200	0 04 00240	DST	TEM1
0132	00201	0 02 00246	DLD	COSN
0133	00202	0 16 00237	MPY	COST+1
0134	00203	0401 77	LRS	1
0135	00204	0 06 00240	DAD	TEM1
0136	00205	0 06 00250	DAD	HALF
0137	00206	0401 62	LRS	14
0138	00207	0 04 00240	DST	TEM1
0139	00210	0 02 00236	DLD	COST
0140	00211	0 16 00246	MPY	COSN
0141	00212	0 06 00240	DAD	TEM1
0142	00213	0 06 00234	DAD	SINT
0143	00214	0 04 00236	DST	COST
0144	00215	101400	SMI	
0145	00216	0 01 00222	JMP	**4
0146	00217	0 07 00236	DSB	COST
0147	00220	0 07 00236	DSB	COST
0148	00221	0 04 00236	DST	COST
0149	00222	100040	SZE	
0150	00223	0 01 00226	JMP	HUER
0151	00224	000005	SGL	
0152	00225	-0 01 00000	JMP*	PRTY
0153	00226	0 02 00242	HUER DLD	NEG1
0154	00227	000005	SGL	
0155	00230	-0 01 00000	JMP*	PRTY
0156		000744	MA EQU	'744
0157		000746	MB EQU	MA+2
0158		000750	MC EQU	MA+4
0159		000752	MD EQU	MA+6
0160		000754	ME EQU	MA+8
0161		000756	MF EQU	MA+10
0162	00232	000000	DZRO DBP	0
	00233	000000		
0163	00234	000000	SINT DBP	0
	00235	000000		
0164	00236	000000	COST DBP	0
	00237	000000		
0165	00240	000000	TEM1 DBP	0
	00241	000000		
0166	00242	177777	NEG1 OCT	177777,77777
	00243	077777		

MICROCOMP TELECOMMUNICATED DATA  
DDP-516 ASSEMBLY LISTING

0167	00244	041513	SINE OCT	41513,12033
	00245	012033		
0168	00246	066342	COSN OCT	66342,10027
	00247	010027		
0169	00250	000000	HALF OCT	0,20000
	00251	020000		
0170	00252	0 000006	ADAB DAC	ABFA
0171	00253	000000	PONT OCT	0
0172			END	

PROGRAM NAME

SOURCE: PPEX

BINARY: BPPEX

ENTRY POINT (location): PPRT ('12360)

GENERAL DESCRIPTION:

This subroutine determines PIPA third failures in a similar way to the way GPRT determines gyro third failures. However, it does not allow for dynamic errors as does GPRT and will not do its parity equation calculation if octal location 765 is set to 1. This would indicate that on this update the PIPA error accumulator (program source name PREX, subroutine entry point PARC) is purging its accumulation. The timing considerations are so stringent that at times, doing both jobs would be impossible. Other than the above considerations, look to GPRT for documentation of the methods used.



MICROCOMP TELECOMMUNICATED DATA  
DDP-516 ASSEMBLY LISTING

0001				SUBR	PPRT
0002				REL	
0003	00000	0 000000	PPRT	DAC	**
0004	00001	0 02 00765		LDA	'765
0005	00002	101040		SNZ	
0006	00003	0 01 00007		JMP	GOAH
0007	00004	140040		CRA	
0008	00005	0 04 00765		STA	'765
0009	00006	-0 01 00000		JMP*	PPRT
0010	00007	140040	GOAH	CRA	
0011	00010	0 04 00323		STA	'323
0012	00011	0 02 00321		LDA	'321
0013	00012	101040		SNZ	
0014	00013	-0 01 00000		JMP*	PPRT
0015	00014	0 11 00320		CAS	'320
0016	00015	0 01 00026		JMP	SFLA
0017	00016	101000		NOP	
0018	00017	0 06 00047		ADD	ADST
0019	00020	0 04 00050		STA	IDPT
0020	00021	0 02 00320		LDA	'320
0021	00022	0415 75		ALS	3
0022	00023	0 07 00320		SUB	'320
0023	00024	-0 06 00050		ADD*	IDPT
0024	00025	0 01 00035		JMP	PRCL
0025	00026	0 02 00320	SFLA	LDA	'320
0026	00027	0 06 00047		ADD	ADST
0027	00030	0 04 00050		STA	IDPT
0028	00031	0 02 00321		LDA	'321
0029	00032	0415 75		ALS	3
0030	00033	0 07 00321		SUB	'321
0031	00034	-0 06 00050		ADD*	IDPT
0032	00035	0 10 00000	PRCL	CALL	PRTY
0033	00036	101000		NOP	
0034	00037	100400		SPL	
0035	00040	0 01 00044		JMP	OVRF
0036	00041	000007		DBL	
0037	00042	0 07 00052		DSB	PMSE
0038	00043	101400		SMI	
0039	00044	0 12 00323	OVRF	IRS	'323
0040	00045	000005		SGI	
0041	00046	-0 01 00000		JMP*	PPRT
0042	00047	0 000054	ADST	DAC	CRPS
0043	00050	000000	IDPT	DBP	0
	00051	000000			
0044	00052	000000	PMSE	OCT	0,40
	00053	000040			
0045	00054	000000	CRPS	OCT	0,177762,16,43,61,70
	00055	177762			
	00056	000016			
	00057	000043			
	00060	000061			
	00061	000070			
0046				END	

PROGRAM NAME  
 SOURCE: GMIN  
 BINARY: BGMIN  
 ENTRY POINTS (location): GMIN ('03100)  
 GENERAL DESCRIPTION:

This subroutine, when called, will calculate, using the gyro fail status from locations '316 and '317, the code which tells the gyro least squares matrix generator (see documentation for program source name GPMA, subroutine entry point GMAT) which of the 22 matrices to generate. Prior to the call to GMAT, this code is put in the A register. The codes are:

<u>fail status</u>	<u>code</u>
no fail	0
A fail	9
B fail	18
C fail	27
D fail	36
E fail	45
F fail	54
AB fail	63
AC fail	72
AD fail	81
AE fail	90
AF fail	99
BC fail	108
BD fail	117
BE fail	126
BF fail	135
CD fail	144
CE fail	153
CF fail	162
DE fail	171
DF fail	180
EF fail	189

If there is no second fail, i.e., ('317) = 0, then the code is simply 9 x ('316), or the number of the first fail (0 - 6) times 9. If there is a second fail, first a decision is made as to which of the two fails is larger, i.e., F fail (6) is larger than B fail (2). The code is then generated by taking 9 x the larger fail plus 45 if the smaller fail is A (1), 81 if the smaller fail is B (2), 108 if the smaller fail is C (3), 126 if the smaller fail is D (4), or 135 if the smaller fail is E (5). 45, 81, 108, 126 and 135 have the octal equivalents 55, 121, 154, 176 and 207 respectively. The program flow chart follows.

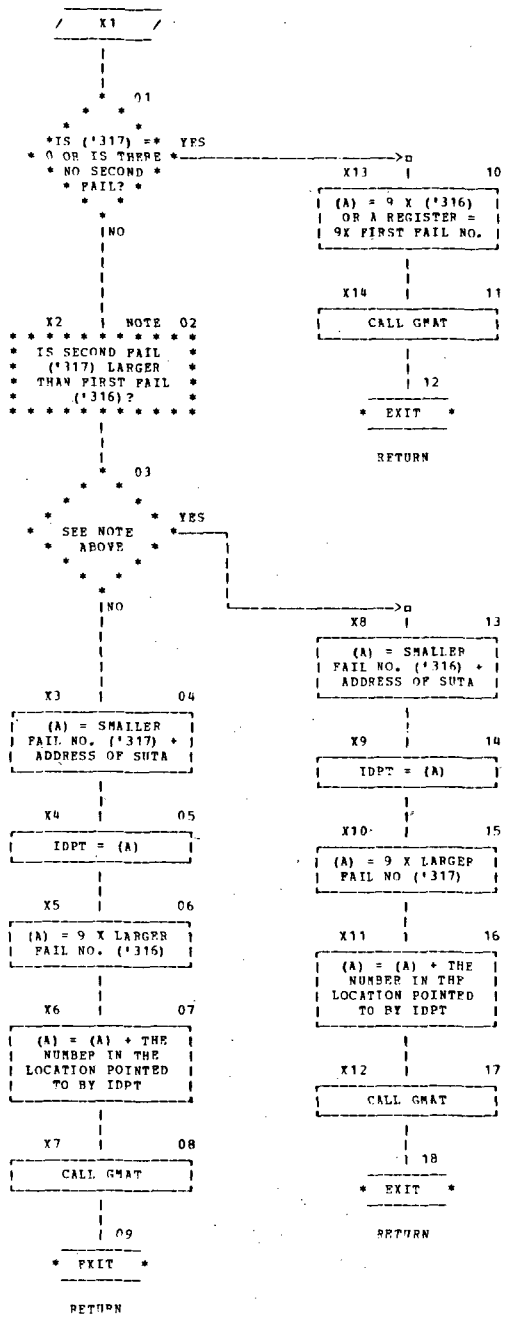

FLOWCHART - GMIN

MICROCOMP TELECOMMUNICATED DATA  
DDP-516 ASSEMBLY LISTING

```

0001                                REL
0002                                SUBR  GMIN
0003 00000 0 000000  GMIN DAC  **
0004 00001 0 02 00317 LDA  '317
0005 00002 101040     SNZ
0006 00003 0 01 00026 JMP  OOFA
0007 00004 0 11 00316 CAS  '316
0008 00005 0 01 00016 JMP  SFLA
0009 00006 0 01 00026 JMP  OOFA
0010 00007 0 06 00033 ADD  ADST
0011 00010 0 04 00034 STA  IDPT
0012 00011 0 02 00316 LDA  '316
0013 00012 0415 75     ALS  3
0014 00013 0 06 00316 ADD  '316
0015 00014 -0 06 00034 ADD* IDPT
0016 00015 0 01 00031 JMP  PMCL
0017 00016 0 02 00316 SFLA LDA  '316
0018 00017 0 06 00033 ADD  ADST
0019 00020 0 04 00034 STA  IDPT
0020 00021 0 02 00317 LDA  '317
0021 00022 0415 75     ALS  3
0022 00023 0 06 00317 ADD  '317
0023 00024 -0 06 00034 ADD* IDPT
0024 00025 0 01 00031 JMP  PMCL
0025 00026 0 02 00316 OOFA LDA  '316
0026 00027 0415 75     ALS  3
0027 00030 0 06 00316 ADD  '316
0028 00031 0 10 00000 PMCL CALL GMAT
0029 00032 -0 01 00000 JMP* GMTN
0030 00033 0 000035  ADST DAC  SUTA
0031 00034 000000     IDPT BSZ  1
0032 00035 000000     SUTA OCT  0, 55, 121, 154, 176, 207
      00036 000055
      00037 000121
      00040 000154
      00041 000176
      00042 000207

0033                                END

```

PROGRAM NAME

SOURCE: GPMA

BINARY: BGPMA

ENTRY POINTS (location): MATR ('12102), GMAT ('12136)

GENERAL DESCRIPTION:

This program contains the two subroutines GMAT and MATR which generate the appropriate gyro or PIPA 6 x 3 least square matrix when called (with the proper code in the A register) by GMIN or EMIN (see documentation for GMIN and EMIN). These subroutines make use of two tables. The first, the double precision data table (DPDT), contains all the double precision fractions used in any of the 22 (1 no fail, 6 single fail and 15 double fail) least square matrices. For example, the first fraction in the table is a double precision 0(DBP 0), the second is

$$\frac{\text{sine } \alpha}{2} = 0.26865556403$$

(OCT 20645, 45016), the third is

$$-\frac{\text{sine } \alpha}{2}, \text{ the fourth is } \frac{\text{cos } \alpha}{2}$$

The second table (TABL) contains 22 sets of pointers, each set of which indicates which constants from the first table belong to a particular matrix. Each set is made of 9 16 bit words, or 18 bytes. Since there are 18 elements to each 6 x 3 matrix, each byte points to one element. For example, the first nine words (octal 1000, 3004, 6, 4004, 10, 1000, 6, 1000, 4002) point to the constants for the no fail matrix. The next nine point to the constants for the A fail matrix. The code that GMIN or EMIN generates before calling GMAT or MATR tells where in the TABL to get the first of the nine words that point to the matrix corresponding to the gyro or PIPA fail status. Consider again the first nine words in TABL pointing to the no fail matrix constants. The first of the nine words is octal 1000 or binary 00000010 00000000, which when broken into bytes becomes octal 2, 0. All nine broken in to bytes become 2, 0, 6, 4, 0, 6, 10, 4, 0, 10, 2, 0, 0, 6, 2, 0, 10, 2. Calling sine  $\alpha$  S and cos  $\alpha$  C, these 18 bytes point respectively to

$$\frac{S}{2}, 0, \frac{C}{2}, -\frac{S}{2}, 0, \frac{C}{2}, -\frac{C}{2}, -\frac{S}{2}, 0, -\frac{C}{2}, \frac{S}{2}, 0, 0, \frac{C}{2}, \frac{S}{2}, 0, -\frac{C}{2} \text{ and } \frac{S}{2},$$

which are the 18 elements of the no fail matrix. The flow chart for GMAT (MATR is analogous) follows:

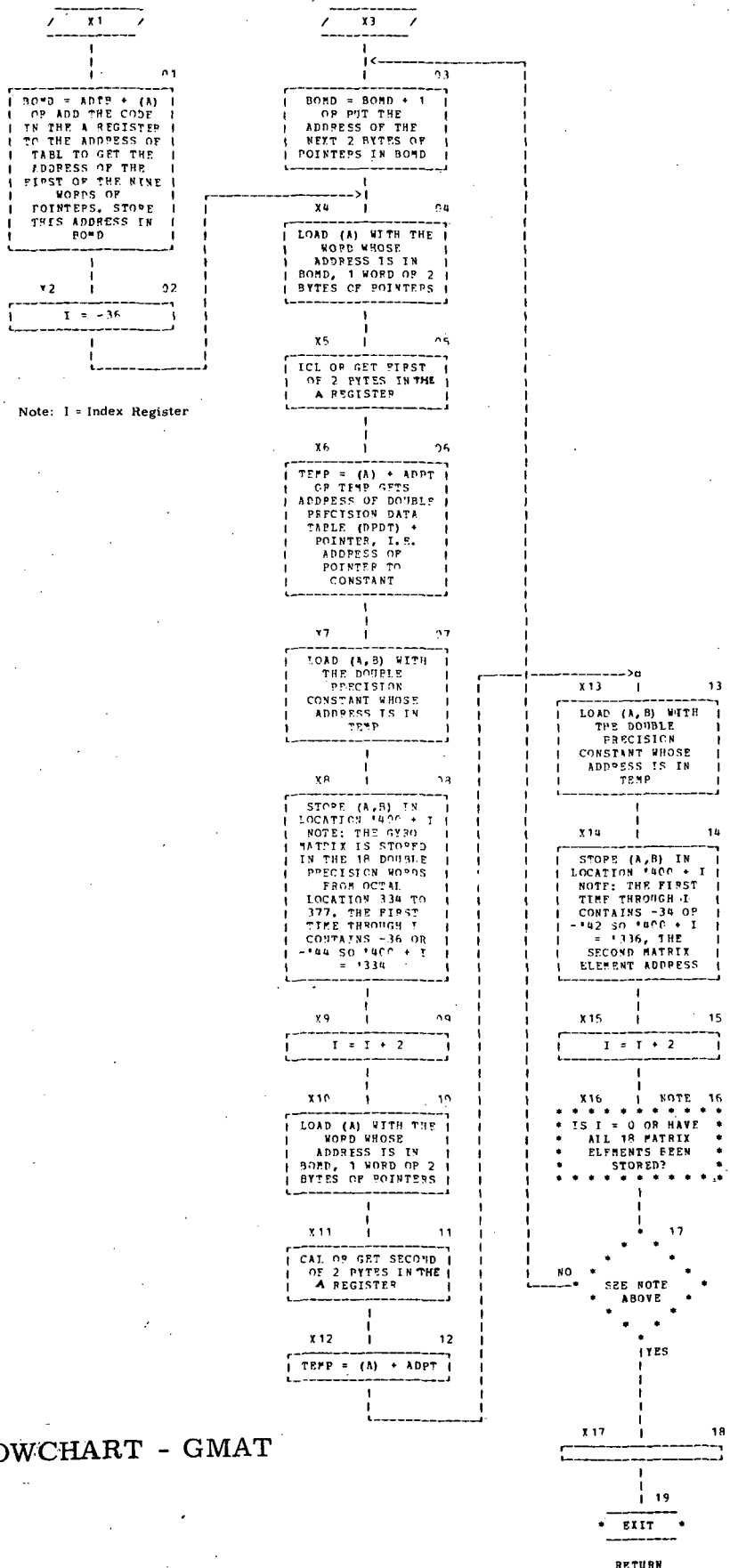

FLOWCHART - GMAT

MICROCOMP TELECOMMUNICATED DATA  
DDP-516 ASSEMBLY LISTING

0001				SUBR	MATR
0002				SUBR	GMAT
0003				REL	
0004	00000	0	000000	MATR DAC	**
0005	00001	0	06 00070	ADD	ADTB
0006	00002	0	04 00071	STA	BOMD
0007	00003	0	35 00524	LDX	= '177734
0008	00004	0	01 00006	JMP	BEGN
0009	00005	0	12 00071	FULL IRS	BOMD
0010	00006	-0	02 00071	BEGN LDA*	BOMD
0011	00007		141140	ICL	
0012	00010	0	06 00073	ADD	ADPT
0013	00011	0	04 00072	STA	TEMP
0014	00012		000007	DBL	
0015	00013	-0	02 00072	DLD*	TEMP
0016	00014	1	04 00666	DST	'666,1
0017	00015		000005	SGL	
0018	00016	0	12 00000	IRS	0
0019	00017	0	12 00000	IRS	0
0020	00020	-0	02 00071	LDA*	BOMD
0021	00021		141050	CAL	
0022	00022	0	06 00073	ADD	ADPT
0023	00023	0	04 00072	STA	TEMP
0024	00024		000007	DBL	
0025	00025	-0	02 00072	DLD*	TEMP
0026	00026	1	04 00666	DST	'666,1
0027	00027		000005	SGL	
0028	00030	0	12 00000	IRS	0
0029	00031	0	12 00000	IRS	0
0030	00032	0	01 00005	JMP	FULL
0031	00033	-0	01 00000	JMP*	MATR
0032	00034	0	000000	GMAT DAC	**
0033	00035	0	06 00070	ADD	ADTB
0034	00036	0	04 00071	STA	BOMD
0035	00037	0	35 00524	LDY	= '177734
0036	00040	0	01 00042	JMP	GEGN
0037	00041	0	12 00071	GUIL IRS	BOMD
0038	00042	-0	02 00071	GEGN LDA*	BOMD
0039	00043		141140	ICL	
0040	00044	0	06 00073	ADD	ADPT
0041	00045	0	04 00072	STA	TEMP
0042	00046		000007	DBL	
0043	00047	-0	02 00072	DLD*	TEMP
0044	00050	1	04 00400	DST	'400,1
0045	00051		000005	SGL	
0046	00052	0	12 00000	IRS	0
0047	00053	0	12 00000	IRS	0
0048	00054	-0	02 00071	LDA*	BOMD
0049	00055		141050	CAL	
0050	00056	0	06 00073	ADD	ADPT
0051	00057	0	04 00072	STA	TEMP
0052	00060		000007	DBL	
0053	00061	-0	02 00072	DLD*	TEMP
0054	00062	1	04 00400	DST	'400,1
0055	00063		000005	SGL	
0056	00064	0	12 00000	IRS	0
0057	00065	0	12 00000	IRS	0



MICROCOMP TELECOMMUNICATED DATA

DDP-516 ASSEMBLY LISTING

0058	00066	0 01 00041	JMP	GULL
0059	00067	-0 01 00034	JMP*	GMAT
0060	00070	0 000216	ADTB DAC	TABL
0061	00071	000000	BOMB BSZ	1
0062	00072	000000	TEMP BSZ	1
0063	00073	0 000074	ADPT DAC	DPDT
0064	00074	000000	DPDT DBP	0
	00075	000000		
0065	00076	020645	OCT	20645,45016
	00077	045016		
0066	00100	157132	OCT	157132,32762
	00101	032762		
0067	00102	033161	OCT	33161,04013
	00103	004013		
0068	00104	144616	OCT	144616,73765
	00105	073765		
0069	00106	011231	OCT	11231,36014
	00107	036014		
0070	00110	166546	OCT	166546,41764
	00111	041764		
0071	00112	047311	OCT	47311,72023
	00113	072023		
0072	00114	130466	OCT	130466,5755
	00115	005755		
0073	00116	034776	OCT	34776,33025
	00117	033025		
0074	00120	143001	OCT	143001,44753
	00121	044753		
0075	00122	042575	OCT	42575,13015
	00123	013015		
0076	00124	135202	OCT	135202,64763
	00125	064763		
0077	00126	007414	OCT	7414,7002
	00127	007002		
0078	00130	170363	OCT	170363,70776
	00131	070776		
0079	00132	014130	OCT	14130,66010
	00133	066010		
0080	00134	163647	OCT	163647,11770
	00135	011770		
0081	00136	045474	OCT	45474,43011
	00137	043011		
0082	00140	132303	OCT	132303,34767
	00141	034767		
0083	00142	074674	OCT	74674,16047
	00143	016047		
0084	00144	103103	OCT	103103,61731
	00145	061731		
0085	00146	003155	OCT	03155,03010
	00147	003010		
0086	00150	174622	OCT	174622,74770
	00151	074770		
0087	00152	043503	OCT	43503,66422
	00153	066422		
0088	00154	134274	OCT	134274,11356
	00155	011356		
0089	00156	040326	OCT	40326,63412

MICROCOMP TELECOMMUNICATED DATA  
DDP-516 ASSEMBLY LISTING

	00157	063412		
0090	00160	137451	OCT	137451,14366
	00161	014366		
0091	00162	050651	OCT	50651,46021
	00163	046021		
0092	00164	127126	OCT	127126,31757
	00165	031757		
0093	00166	031170	OCT	31170,27424
	00167	027424		
0094	00170	146607	OCT	146607,50354
	00171	050354		
0095	00172	046660	OCT	46660,71432
	00173	071432		
0096	00174	131117	OCT	131117,6346
	00175	006346		
0097	00176	076664	OCT	76664,72435
	00177	072435		
0098	00200	101113	OCT	101113,5343
	00201	005343		
0099	00202	024022	OCT	24022,50026
	00203	050026		
0100	00204	153755	OCT	153755,27752
	00205	027752		
0101	00206	005145	OCT	05145,57377
	00207	057377		
0102	00210	172632	OCT	172632,20401
	00211	020401		
0103	00212	026013	OCT	26013,24414
	00213	024414		
0104	00214	151764	OCT	151764,53364
	00215	053364		
0105	00216	001000	TABL OCT	1000,3004,6
	00217	003004		
	00220	000006		
0106	00221	004004	OCT	4004,10,1000
	00222	000010		
	00223	001000		
0107	00224	000006	OCT	6,1000,4002
	00225	001000		
	00226	004002		
0108	00227	000000	OCT	0,14,16
	00230	000014		
	00231	000016		
0109	00232	014004	OCT	14004,20030,1040
	00233	020030		
	00234	001040		
0110	00235	015006	OCT	15006,11032,4022
	00236	011032		
	00237	004022		
0111	00240	005000	OCT	5000,7000,0
	00241	007000		
	00242	000000		
0112	00243	014004	OCT	14004,17030,1036
	00244	017030		
	00245	001036		
0113	00246	016006	OCT	16006,11034,4022
	00247	011034		

MICROCOMP TELECOMMUNICATED DATA  
DDP-516 ASSEMBLY LISTING

	00250	004022		
0114	00251	011032	OCT	11032,3024,16006
	00252	003024		
	00253	016006		
0115	00254	000000	OCT	0,20,5000
	00255	000020		
	00256	005000		
0116	00257	017026	OCT	17026,1040,14002
	00260	001040		
	00261	014002		
0117	00262	011034	OCT	11034,3024,15006
	00263	003024		
	00264	015006		
0118	00265	010014	OCT	10014,0,0
	00266	000000		
	00267	000000		
0119	00270	020026	OCT	20026,1036,14002
	00271	001036		
	00272	014002		
0120	00273	001036	OCT	1036,13004,17026
	00274	013004		
	00275	017026		
0121	00276	004024	OCT	4024,16010,11032
	00277	016010		
	00300	011032		
0122	00301	000000	OCT	0,0,10012
	00302	000000		
	00303	010012		
0123	00304	001040	OCT	1040,13004,20026
	00305	013004		
	00306	020026		
0124	00307	004024	OCT	4024,15010,11034
	00310	015010		
	00311	011034		
0125	00312	000016	OCT	16,5000,0
	00313	005000		
	00314	000000		
0126	00315	000000	OCT	0,0,0
	00316	000000		
	00317	000000		
0127	00320	022004	OCT	22004,44,1000
	00321	000044		
	00322	001000		
0128	00323	000006	OCT	6,23000,4046
	00324	023000		
	00325	004046		
0129	00326	000000	OCT	0,110,46056
	00327	000110		
	00330	046056		
0130	00331	000000	OCT	0,104,25120
	00332	000104		
	00333	025120		
0131	00334	027066	OCT	27066,37054,32072
	00335	037054		
	00336	032072		
0132	00337	000000	OCT	0,110,45056
	00340	000110		

MICROCOMP TELECOMMUNICATED DATA  
DDP-516 ASSEMBLY LISTING

	00341	045056		
0133	00342	042054	OCT	42054,50000,0
	00343	050000		
	00344	000000		
0134	00345	026062	OCT	26062,35056,34076
	00346	035056		
	00347	034076		
0135	00350	000000	OCT	0,54,47102
	00351	000054		
	00352	047102		
0136	00353	034100	OCT	34100,30064,35054
	00354	030064		
	00355	035054		
0137	00356	000000	OCT	0,112,30106
	00357	000112		
	00360	030106		
0138	00361	000000	OCT	0,54,50102
	00362	000054		
	00363	050102		
0139	00364	032074	OCT	32074,26070,37060
	00365	026070		
	00366	037060		
0140	00367	045056	OCT	45056,43000,0
	00370	043000		
	00371	000000		
0141	00372	043112	OCT	43112,27000,0
	00373	027000		
	00374	000000		
0142	00375	000000	OCT	0,104,25116
	00376	000104		
	00377	025116		
0143	00400	025062	OCT	25062,35060,34076
	00401	035060		
	00402	034076		
0144	00403	043114	OCT	43114,27000,0
	00404	027000		
	00405	000000		
0145	00406	042054	OCT	42054,47000,0
	00407	047000		
	00410	000000		
0146	00411	030066	OCT	30066,37052,32072
	00412	037052		
	00413	032072		
0147	00414	025116	OCT	25116,41000,0
	00415	041000		
	00416	000000		
0148	00417	032074	OCT	32074,25070,37056
	00420	025070		
	00421	037056		
0149	00422	000000	OCT	0,114,30106
	00423	000114		
	00424	030106		
0150	00425	025120	OCT	25120,41000,0
	00426	041000		
	00427	000000		
0151	00430	034100	OCT	34100,27064,35052
	00431	027064		

MICROCOMP TELECOMMUNICATED DATA  
DDP-516 ASSEMBLY LISTING

	00432	035052		
0152	00433	046056	OCT	46056,43000,0
	00434	043000		
	00435	000000		
0153	00436	023000	OCT	23000,3050,6
	00437	003050		
	00440	000006		
0154	00441	000000	OCT	0,0,0
	00442	000000		
	00443	000000		
0155	00444	000042	OCT	42,1000,22002
	00445	001000		
	00446	022002		
0156	00447	037056	OCT	37056,33074,25062
	00450	033074		
	00451	025062		
0157	00452	000000	OCT	0,60,43112
	00453	000060		
	00454	043112		
0158	00455	000000	OCT	0,120,42052
	00456	000120		
	00457	042052		
0159	00460	035054	OCT	35054,31100,30066
	00461	031100		
	00462	030066		
0160	00463	000000	OCT	0,60,43114
	00464	000060		
	00465	043114		
0161	00466	047102	OCT	47102,25000,0
	00467	025000		
	00470	000000		
0162	00471	035052	OCT	35052,31100,27066
	00472	031100		
	00473	027066		
0163	00474	030110	OCT	30110,46000,0
	00475	046000		
	00476	000000		
0164	00477	000000	OCT	0,116,42052
	00500	000116		
	00501	042052		
0165	00502	037060	OCT	37060,33074,26062
	00503	033074		
	00504	026062		
0166	00505	030110	OCT	30110,45000,0
	00506	045000		
	00507	000000		
0167	00510	050102	OCT	50102,25000,0
	00511	025000		
	00512	000000		
0168	00513	001000	OCT	1000,21004,42
	00514	021004		
	00515	000042		
0169	00516	004050	OCT	4050,10,23000
	00517	000010		
	00520	023000		
0170	00521	000000	OCT	0,0,0
	00522	000000		

MICROCOMP TELECOMMUNICATED DATA

DDP-516 ASSEMBLY LISTING

00523 000000

0171 00524 177734 END

PROGRAM NAME

SOURCE: EMIN

BINARY: BEMIN

ENTRY POINTS (location): EMIN ('03034)

GENERAL DESCRIPTION:

This subroutine, when called, will calculate, using the PIPA fail status from locations '320 and '321, the code which tells the PIPA least squares matrix generator (see documentation for program source name GPMA, subroutine entry point MATR) which of the 22 matrices to generate. Prior to the call to MATR, this code is put in the A register. For an explanation of the codes and a flow chart of this subroutine, see documentation for program source name GMIN.

MICROCOMP TELECOMMUNICATED DATA  
DDP-516 ASSEMBLY LISTING

```

0001                                REL
0002                                SUBR  EMIN
0003 00000      0 000000  EMIN  DAC  **
0004 00001      0 02 00321  LDA   '321
0005 00002      101040      SNZ
0006 00003      0 01 00026  JMP   OOFA
0007 00004      0 11 00320  CAS   '320
0008 00005      0 01 00016  JMP   SFLA
0009 00006      0 01 00026  JMP   OOFA
0010 00007      0 06 00033  ADD   ADST
0011 00010      0 04 00034  STA   IDPT
0012 00011      0 02 00320  LDA   '320
0013 00012      0415 75      ALS   3
0014 00013      0 06 00320  ADD   '320
0015 00014      -0 06 00034  ADD*  IDPT
0016 00015      0 01 00031  JMP   PMCL
0017 00016      0 02 00320  SFLA  LDA   '320
0018 00017      0 06 00033  ADD   ADST
0019 00020      0 04 00034  STA   IDPT
0020 00021      0 02 00321  LDA   '321
0021 00022      0415 75      ALS   3
0022 00023      0 06 00321  ADD   '321
0023 00024      -0 06 00034  ADD*  IDPT
0024 00025      0 01 00031  JMP   PMCL
0025 00026      0 02 00320  OOFA  LDA   '320
0026 00027      0415 75      ALS   3
0027 00030      0 06 00320  ADD   '320
0028 00031      0 10 00000  PMCL  CALL  MATR
0029 00032      -0 01 00000  JMP*  EMIN
0030 00033      0 000035  ADST  DAC   SUTA
0031 00034      000000      IDPT  BSZ   1
0032 00035      000000      SUTA  OCT   0,55,121,154,176,207
      00036      000055
      00037      000121
      00040      000154
      00041      000176
      00042      000207
0033                                END

```



PROGRAM NAME

SOURCE: MG63

BINARY: BMG63

ENTRY POINTS (location): MG63 ('04012)

GENERAL DESCRIPTION:

This subroutine performs the 6 x 3 matrix multiplication which transforms the six gyro  $\Delta\theta$  outputs into the x, y, z frame. The 6 x 3 matrix is stored as double precision fractions in locations '334 — '377 and it is the least squares matrix corresponding to the gyro fail status. The six gyro pulse counts are single precision fractions scaled at  $7 \cdot 2^{-8}$  radians (for example, 1 gyro pulse would be represented as an octal 000400 =  $7 \cdot 2^{15}$  radians) and are stored in locations '400, '402, '404, '406, '410, and '412 respectively.

$\Delta\theta X$ ,  $\Delta\theta Y$  and  $\Delta\theta Z$  are first formed in temporary double precision accumulators DTXU, DTYU and DTZU, double precision fractions scaled at  $7 \cdot 2^{-8}$  radians. These are then multiplied by 7/4 and added into DTXB, DTYB and DTZB (locations) '414-'415, '416-'417 and '420-'421), which are double precision fractions now scaled at  $2^{-6}$  radians. Since the attitude algorithm (see documentation for ATTA, program name AA6S) only uses the high order of DTXB, DTYB and DTZB, the low order is saved as a residual and at the beginning of MG63 only the high order is zeroed.

The internal subroutine MUPY will do three single by double multiplies and adds, performing the functions expressed by the following equations:

$$DTXU = DTXU + (GMAT + I) PTMP$$

$$DTYU = DTYU + (GMAT + 2 + I) PTMP$$

$$DTZU = DTZU + (GMAT + 4 + I) PTMP$$

where  $(GMAT + 2 + I)$  is the double precision fractional matrix element stored in locations '334 + 2 + I and '334 + 3 + I, where I is the contents of the index register. If, for example, I = 6 and PTMP = GBPC (gyro B

pulse count), the above equations can be written:

$$DTXU = DTXU + ('342, '343) GBPC$$

$$DTYU = DTYU + ('344, '345) GBPC$$

$$DTZU = DTZU + ('346, '347) GBPC$$

The 6 x 3 matrix is shown below and it can be seen that the above example shows how all of gyro B's contribution to the X, Y and Z axes can be gotten by setting I = 6, PTMP = GBPC and doing the internal subroutine MUPY.

('334, '335) ('342, '343) ('350, '351) ('356, '357) ('364, '365) ('372, '373)  
('336, '337) ('344, '345) ('352, '353) ('360, '361) ('366, '367) ('374, '375)  
('340, '341) ('346, '347) ('354, '355) ('362, '363) ('370, '371) ('376, '377)

6 x 3 matrix storage locations.

The flow chart for MG63 follows:

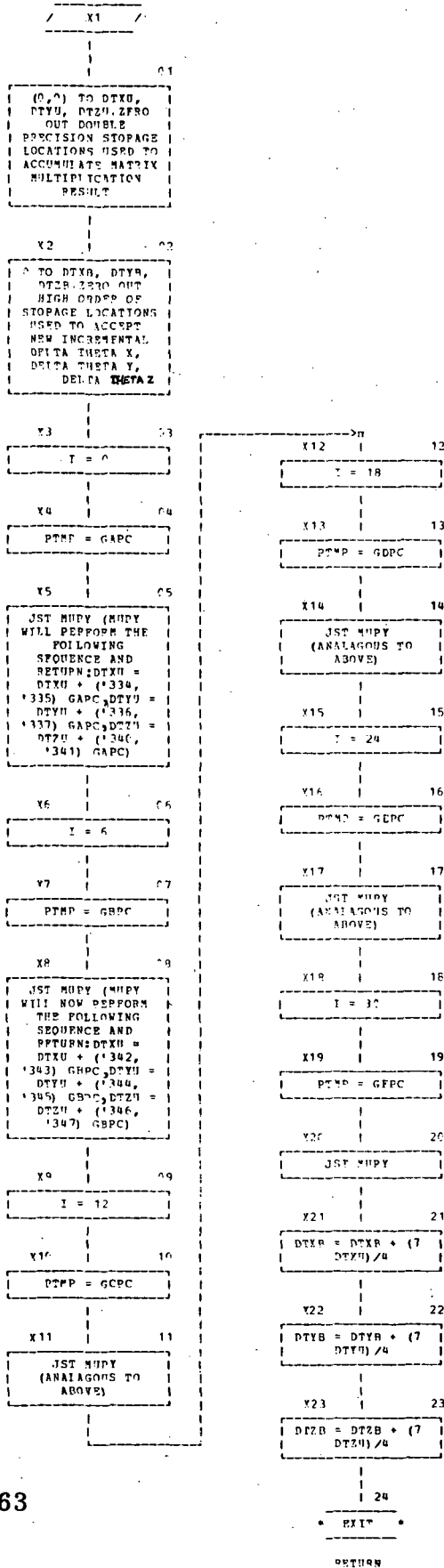

FLOWCHART - MG63

MICROCOMP TELECOMMUNICATED DATA  
DDP-516 ASSEMBLY LISTING

0001				REL	
0002				SUBR	MG63
0003	00000	0 000000	MG63	DAC	**
0004	00001	140040		CRA	
0005	00002	0 04 00102		STA	DTXU
0006	00003	0 04 00103		STA	DTXU+1
0007	00004	0 04 00104		STA	DTYU
0008	00005	0 04 00105		STA	DTYU+1
0009	00006	0 04 00106		STA	DTZU
0010	00007	0 04 00107		STA	DTZU+1
0011	00010	0 04 00414		STA	DTXB
0012	00011	0 04 00416		STA	DTYB
0013	00012	0 04 00420		STA	DTZB
0014	00013	0 04 00000		STA	0
0015	00014	0 02 00400		LDA	GAPC
0016	00015	0 04 00100		STA	PTMP
0017	00016	0 10 00112		JST	MUPY
0018	00017	0 35 00173		LDX	=6
0019	00020	0 02 00402		LDA	GBPC
0020	00021	0 04 00100		STA	PTMP
0021	00022	0 10 00112		JST	MUPY
0022	00023	0 35 00172		IDX	=12
0023	00024	0 02 00404		LDA	GCPC
0024	00025	0 04 00100		STA	PTMP
0025	00026	0 10 00112		JST	MUPY
0026	00027	0 35 00171		LDX	=18
0027	00030	0 02 00406		LDA	GDPC
0028	00031	0 04 00100		STA	PTMP
0029	00032	0 10 00112		JST	MUPY
0030	00033	0 35 00170		LDX	=24
0031	00034	0 02 00410		LDA	GEPC
0032	00035	0 04 00100		STA	PTMP
0033	00036	0 10 00112		JST	MUPY
0034	00037	0 35 00167		LDX	=30
0035	00040	0 02 00412		LDA	GFPC
0036	00041	0 04 00100		STA	PTMP
0037	00042	0 10 00112		JST	MUPY
0038	00043	000007		DRL	
0039	00044	0 02 00074		DLD	DBPO
0040	00045	0 07 00102		DSB	DTXU
0041	00046	0401 76		LRS	2
0042	00047	0 06 00102		DAD	DTXU
0043	00050	0 06 00102		DAD	DTXU
0044	00051	0 06 00414		DAD	DTXB
0045	00052	0 04 00414		DST	DTXB
0046	00053	0 02 00074		DLD	DBPO
0047	00054	0 07 00104		DSB	DTYU
0048	00055	0401 76		LRS	2
0049	00056	0 06 00104		DAD	DTYU
0050	00057	0 06 00104		DAD	DTYU
0051	00060	0 06 00416		DAD	DTYB
0052	00061	0 04 00416		DST	DTYB
0053	00062	0 02 00074		DLD	DBPO
0054	00063	0 07 00106		DSB	DTZU
0055	00064	0401 76		LRS	2
0056	00065	0 06 00106		DAD	DTZU
0057	00066	0 06 00106		DAD	DTZU

MICROCOMP TELECOMMUNICATED DATA  
DDP-516 ASSEMBLY LISTING

0058	00067	0 06 00420	DAD	DTZB
0059	00070	0 04 00420	DST	DTZB
0060	00071	000005	SGL	
0061	00072	-0 01 00000	JMP*	MG63
0062	00074	000000	DBPO DBP	0
	00075	000000		
0063	00076	000000	TEMP DBP	0
	00077	000000		
0064	00100	000000	PTMP DBP	0
	00101	000000		
0065	00102	000000	DTXU DBP	0
	00103	000000		
0066	00104	000000	DTYU DBP	0
	00105	000000		
0067	00106	000000	DTZU DBP	0
	00107	000000		
0068	00110	000000	HALF OCT	0,40000
	00111	040000		
0069		000414	DTXB EQU	'414
0070		000416	DTYB EQU	DTXB+2
0071		000420	DTZB EQU	DTXB+4
0072		000400	GAPC EQU	'400
0073		000402	GBPC EQU	GAPC+2
0074		000404	GCPC EQU	GAPC+4
0075		000406	GDPC EQU	GAPC+6
0076		000410	GEPC EQU	GAPC+8
0077		000412	GFPC EQU	GAPC+10
0078		000334	GMAT EQU	'334
0079	00112	0 000000	MUPY DAC	**
0080	00113	000007	DBL	
0081	00114	1 16 00334	MPY	GMAT,1
0082	00115	0 04 00076	DST	TEMP
0083	00116	0 02 00100	DLD	PTMP
0084	00117	1 16 00335	MPY	GMAT+1,1
0085	00120	0 06 00110	DAD	HALF
0086	00121	140320	CSA	
0087	00122	000201	IAB	
0088	00123	140040	CRA	
0089	00124	100001	SRC	
0090	00125	140401	CMA	
0091	00126	0 06 00076	DAD	TEMP
0092	00127	0 06 00102	DAD	DTXU
0093	00130	0 04 00102	DST	DTXU
0094	00131	0 02 00100	DLD	PTMP
0095	00132	1 16 00336	MPY	GMAT+2,1
0096	00133	0 04 00076	DST	TEMP
0097	00134	0 02 00100	DLD	PTMP
0098	00135	1 16 00337	MPY	GMAT+3,1
0099	00136	0 06 00110	DAD	HALF
0100	00137	140320	CSA	
0101	00140	000201	IAB	
0102	00141	140040	CRA	
0103	00142	100001	SRC	
0104	00143	140401	CMA	
0105	00144	0 06 00076	DAD	TEMP
0106	00145	0 06 00104	DAD	DTYU
0107	00146	0 04 00104	DST	DTYU

MICROCOMP TELECOMMUNICATED DATA

DDP-516 ASSEMBLY LISTING

0108	00147	0 02 00100	DLD	PTMP
0109	00150	1 16 00340	MPY	GMAT+4,1
0110	00151	0 04 00076	DST	TEMP
0111	00152	0 02 00100	DLD	PTMP
0112	00153	1 16 00341	MPY	GMAT+5,1
0113	00154	0 06 00110	DAD	HALF
0114	00155	140320	CSA	
0115	00156	000201	IAB	
0116	00157	140040	CRA	
0117	00160	100001	SRC	
0118	00161	140401	CMA	
0119	00162	0 06 00076	DAD	TEMP
0120	00163	0 06 00106	DAD	DTZU
0121	00164	0 04 00106	DST	DTZU
0122	00165	000005	SGL	
0123	00166	-0 01 00112	JMP*	MUPY
0124	00167	000036	END	
		00170	000030	
		00171	000022	
		00172	000014	
		00173	000006	

PROGRAM NAME

SOURCE: MV63

BINARY BMV63

ENTRY POINTS (location): MP63 ('03664)

GENERAL DESCRIPTION:

This subroutine performs the 6 x 3 matrix multiplication which transforms the 6 PIPA  $\Delta V$  outputs into the X, Y, Z frame. It is an almost identical program to MG63 (see documentation for MG63) except that  $\Delta VX$ ,  $\Delta VY$  and  $\Delta VZ$  do not have to be scaled by 7/4 as in the gyro 6 x 3 multiplication.

MICROCOMP TELECOMMUNICATED DATA  
DDP-516 ASSEMBLY LISTING

0001			REL	
0002			SUBR	MP63
0003	00000	0 000000	MP63 DAC	**
0004	00001	140040	CRA	
0005	00002	0 04 00614	STA	DVXB
0006	00003	0 04 00616	STA	DVYB
0007	00004	0 04 00620	STA	DVZB
0008	00005	0 04 00000	STA	0
0009	00006	0 02 00600	LDA	AAPC
0010	00007	0 04 00040	STA	PTMP
0011	00010	0 10 00044	JST	MUPY
0012	00011	0 35 00125	LDX	=6
0013	00012	0 02 00602	LDA	ABPC
0014	00013	0 04 00040	STA	PTMP
0015	00014	0 10 00044	JST	MUPY
0016	00015	0 35 00124	LDX	=12
0017	00016	0 02 00604	LDA	ACPC
0018	00017	0 04 00040	STA	PTMP
0019	00020	0 10 00044	JST	MUPY
0020	00021	0 35 00123	LDX	=18
0021	00022	0 02 00606	LDA	ADPC
0022	00023	0 04 00040	STA	PTMP
0023	00024	0 10 00044	JST	MUPY
0024	00025	0 35 00122	LDX	=24
0025	00026	0 02 00610	LDA	AEPC
0026	00027	0 04 00040	STA	PTMP
0027	00030	0 10 00044	JST	MUPY
0028	00031	0 35 00121	LDX	=30
0029	00032	0 02 00612	LDA	AFPC
0030	00033	0 04 00040	STA	PTMP
0031	00034	0 10 00044	JST	MUPY
0032	00035	-0 01 00000	JMP*	MP63
0033	00036	000000	TEMP DBP	0
	00037	000000		
0034	00040	000000	PTMP DBP	0
	00041	000000		
0035	00042	000000	HALF OCT	0,40000
	00043	040000		
0036		000614	DVXB EQU	'614
0037		000616	DVYB EQU	DVXB+2
0038		000620	DVZB EQU	DVXB+4
0039		000600	AAPC EQU	'600
0040		000602	ABPC EQU	AAPC+2
0041		000604	ACPC EQU	AAPC+4
0042		000606	ADPC EQU	AAPC+6
0043		000610	AEPC EQU	AAPC+8
0044		000612	AFPC EQU	AAPC+10
0045		000622	PMAT EQU	'622
0046	00044	0 000000	MUPY DAC	**
0047	00045	000007	DBL	
0048	00046	1 16 00622	MPY	PMAT,1
0049	00047	0 04 00036	DST	TEMP
0050	00050	0 02 00040	DLD	PTMP
0051	00051	1 16 00623	MPY	PMAT+1,1
0052	00052	0 06 00042	DAD	HALF
0053	00053	140320	CSA	
0054	00054	000201	IAB	



MICROCOMP TELECOMMUNICATED DATA  
DDP-516 ASSEMBLY LISTING

0055	00055	140040	CRA	
0056	00056	100001	SRC	
0057	00057	140401	CMA	
0058	00060	0 06 00036	DAD	TEMP
0059	00061	0 06 00614	DAD	DVXB
0060	00062	0 04 00614	DST	DVXB
0061	00063	0 02 00040	DL D	PTMP
0062	00064	1 16 00624	MPY	PMAT+2,1
0063	00065	0 04 00036	DST	TEMP
0064	00066	0 02 00040	DL D	PTMP
0065	00067	1 16 00625	MPY	PMAT+3,1
0066	00070	0 06 00042	DAD	HALF
0067	00071	140320	CSA	
0068	00072	000201	IAB	
0069	00073	140040	CRA	
0070	00074	100001	SRC	
0071	00075	140401	CMA	
0072	00076	0 06 00036	DAD	TEMP
0073	00077	0 06 00616	DAD	DVYB
0074	00100	0 04 00616	DST	DVYB
0075	00101	0 02 00040	DL D	PTMP
0076	00102	1 16 00626	MPY	PMAT+4,1
0077	00103	0 04 00036	DST	TEMP
0078	00104	0 02 00040	DL D	PTMP
0079	00105	1 16 00627	MPY	PMAT+5,1
0080	00106	0 06 00042	DAD	HALF
0081	00107	140320	CSA	
0082	00110	000201	IAB	
0083	00111	140040	CRA	
0084	00112	100001	SRC	
0085	00113	140401	CMA	
0086	00114	0 06 00036	DAD	TEMP
0087	00115	0 06 00620	DAD	DVZB
0088	00116	0 04 00620	DST	DVZB
0089	00117	000005	SGL	
0090	00120	-0 01 00044	JMP*	MOPY
0091	00121	000036	END	
	00122	000030		
	00123	000022		
	00124	000014		
	00125	000006		

PROGRAM NAME

SOURCE: SPUN

BINARY: BSPUN

ENTRY POINTS (location): SPUN ('05560)

GENERAL DESCRIPTION:

This subroutine when called will correct the quaternion in order to maintain it as a unit quaternion. It imposes the constraint that

$$\lambda^2 + \rho_x^2 + \rho_y^2 + \rho_z^2 = 1.$$

Ideally the equations to be implemented would be

$$\begin{aligned}\lambda' &= \lambda d \\ \rho_x' &= \rho_x d \\ \rho_y' &= \rho_y d \\ \rho_z' &= \rho_z d\end{aligned}$$

where

$$d = \frac{1}{\sqrt{\lambda^2 + \rho_x^2 + \rho_y^2 + \rho_z^2}}$$

However, since the sum of the squares of the elements of the quaternion never deviates significantly from 1, we can simplify as follows:

$$\epsilon = \lambda^2 + \rho_x^2 + \rho_y^2 + \rho_z^2 - 1$$

or

$$\lambda^2 + \rho_x^2 + \rho_y^2 + \rho_z^2 = 1 + \epsilon$$

$$\sqrt{\lambda^2 + \rho_x^2 + \rho_y^2 + \rho_z^2} = \sqrt{1 + \epsilon} \approx 1 + \frac{\epsilon}{2}$$

$$d \approx \frac{1}{1 + \frac{\epsilon}{2}} \approx 1 - \frac{\epsilon}{2}$$

so

$$\lambda' \approx \lambda(1 - \frac{\epsilon}{2})$$

$$\rho_x' \approx \rho_x(1 - \frac{\epsilon}{2})$$

$$\rho_y' \approx \rho_y(1 - \frac{\epsilon}{2})$$

$$\rho_z' \approx \rho_z(1 - \frac{\epsilon}{2})$$

Using the scaling and terminology for the quaternion described in the program AA6S

$$(i. e., L = \frac{\lambda}{2}, RX = \frac{\rho_x}{2}, RY = \frac{\rho_y}{2} \text{ and } RZ = \frac{\rho_z}{2})$$

we derive the new constraint that

$$L^2 + RX^2 + RY^2 + RZ^2 \text{ equal } 1/4$$

$$L' = L D$$

$$RX' = RX D$$

$$RY' = RY D$$

$$RZ' = RZ D$$

where

$$D = \frac{1}{2\sqrt{L^2 + RX^2 + RY^2 + RZ^2}}$$

$$E = L^2 + RX^2 + RY^2 + RZ^2 - \frac{1}{4}$$

$$L^2 + RX^2 + RY^2 + RZ^2 = \frac{1}{4} + E$$

$$\sqrt{L^2 + RY^2 + RY^2 + RZ^2} = \sqrt{\frac{1}{4} + E} \approx \frac{1}{2} + E$$

$$D \approx \frac{1}{1 + 2E} \approx 1 - 2E$$

so

$$L' = L (1 - 2E)$$

$$RX' = RX (1 - 2E)$$

$$RY' = RY (1 - 2E)$$

$$RZ' = RZ (1 - 2E)$$

or

$$\begin{aligned}\Delta L &= -2E L \\ \Delta RX &= -2E RX \\ \Delta RY &= -2E RY \\ \Delta RZ &= -2E RZ\end{aligned}$$

Now expand the  $\Delta L$  term (the  $\Delta RX$ ,  $\Delta RY$  and  $\Delta RZ$  terms are analogous).  
Since  $\Delta L$  is very small we shall really calculate

$$2^{24} \Delta L = -2^{25} E L.$$

define  $FACT = -2^{25} E$ . Then

$$\Delta L = \frac{FACT L}{2^{24}}$$

since

$$L = L_1 + \frac{L_2}{2^{15}} + \frac{L_3}{2^{30}}$$

then

$$\Delta L = \frac{FACT L_1}{2^{24}} + \frac{FACT L_2}{2^{39}} + \frac{FACT L_3}{2^{54}}$$

and we need only calculate

$$\Delta L = \frac{FACT L_1}{2^{24}}$$

repeating we have

$$E = L^2 + RX^2 + RY^2 + RZ^2 - 1/4$$

and

$$L^2 = L_1^2 + \frac{L_2^2}{2^{30}} + \frac{L_3^2}{2^{60}} + \frac{L_1 L_2}{2^{14}} + \frac{L_1 L_3}{2^{29}} + \frac{L_2 L_3}{2^{44}}$$

$$RX^2 = RX_1^2 + \frac{RX_2^2}{2^{30}} + \frac{RX_3^2}{2^{60}} + \frac{RX_1 RX_2}{2^{14}} + \frac{RX_1 RX_3}{2^{29}} + \frac{RX_2 RX_3}{2^{44}}$$

$$RY^2 = \dots$$

$$RZ^2 = \dots$$

substituting and gathering terms we get

$$\begin{aligned}
 E = & L1^2 + RX1^2 + RY1^2 + RZ1^2 \\
 & + \frac{L2^2 + RX2^2 + RY2^2 + RZ2^2}{2^{30}} + \frac{L3^2 + RX3^2 + RY3^2 + RZ3^2}{2^{60}} \\
 & + \frac{L1 L2 + RX1 RX2 + RY1 RY2 + RZ1 RZ2}{2^{14}} \\
 & + \frac{L1 L3 + RX1 RX3 + RY1 RY3 + RZ1 RZ3}{2^{29}} \\
 & + \frac{L2 L3 + RX2 RX3 + RY2 RY3 + RZ2 RZ3}{2^{44}} - \frac{1}{4}
 \end{aligned}$$

We now want to calculate

$$FACT = -2^{25}E$$

Since FACT has only 15 bits of significance, all terms contributing to E with denominators greater than  $2^{40}$  can be ignored. This eliminates the terms

$$\frac{L3^2 \dots}{2^{60}} \text{ and } \frac{L2 L3 \dots}{2^{44}}$$

The flow chart for the implementation on the DDP516 of the above derivation follows.

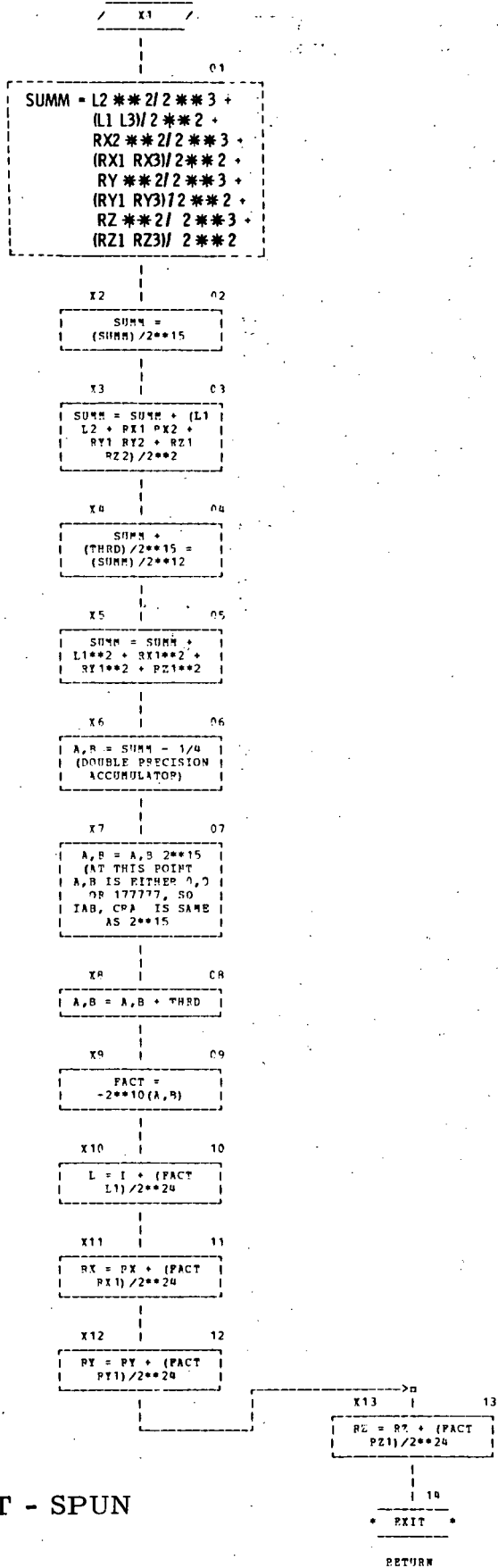

FLOWCHART - SPUN

MICROCOMP TELECOMMUNICATED DATA  
DDP-516 ASSEMBLY LISTING

0001			REL	
0002			SUBR	SPUN
0003	00000	0 000000	SPUN DAC	**
0004	00001	0 02 00461	LDA	L2
0005	00002	000007	DBL	
0006	00003	0 16 00461	MPY	L2
0007	00004	0401 77	LRS	1
0008	00005	0 04 00244	DST	OVFP
0009	00006	0 02 00462	DLD	L3
0010	00007	000201	IAB	
0011	00010	0 07 00254	DSB	FUDG
0012	00011	0 16 00460	MPY	L1
0013	00012	0 06 00244	DAD	OVFP
0014	00013	0401 76	LRS	2
0015	00014	0 04 00242	DST	SUMH
0016	00015	0 02 00464	DLD	RX1
0017	00016	000201	IAB	
0018	00017	0 16 00465	MPY	RX2
0019	00020	0401 77	LRS	1
0020	00021	0 04 00244	DST	OVFP
0021	00022	0 02 00466	DLD	RX3
0022	00023	000201	IAB	
0023	00024	0 07 00254	DSB	FUDG
0024	00025	0 16 00464	MPY	RX1
0025	00026	0 06 00244	DAD	OVFP
0026	00027	0401 76	LRS	2
0027	00030	0 06 00242	DAD	SUMH
0028	00031	0 04 00242	DST	SUMH
0029	00032	0 02 00470	DLD	RY1
0030	00033	000201	IAB	
0031	00034	0 16 00471	MPY	RY2
0032	00035	0401 77	LRS	1
0033	00036	0 04 00244	DST	OVFP
0034	00037	0 02 00472	DLD	RY3
0035	00040	000201	IAB	
0036	00041	0 07 00254	DSB	FUDG
0037	00042	0 16 00470	MPY	RY1
0038	00043	0 06 00244	DAD	OVFP
0039	00044	0401 76	LRS	2
0040	00045	0 06 00242	DAD	SUMH
0041	00046	0 04 00242	DST	SUMH
0042	00047	0 02 00474	DLD	RZ1
0043	00050	000201	IAB	
0044	00051	0 16 00475	MPY	RZ2
0045	00052	0401 77	LRS	1
0046	00053	0 04 00244	DST	OVFP
0047	00054	0 02 00476	DLD	RZ3
0048	00055	000201	IAB	
0049	00056	0 07 00254	DSB	FUDG
0050	00057	0 16 00474	MPY	RZ1
0051	00060	0 06 00244	DAD	OVFP
0052	00061	0401 76	LRS	2
0053	00062	0 06 00242	DAD	SUMH
0054	00063	0401 61	LRS	15
0055	00064	0 04 00242	DST	SUMH
0056	00065	0 02 00460	DLD	L1
0057	00066	0 16 00461	MPY	L2

MICROCOMP TELECOMMUNICATED DATA  
DDP-516 ASSEMBLY LISTING

0058	00067	0 04 00244	DST	OVFP
0059	00070	0 02 00464	DLD	RX1
0060	00071	0 16 00465	MPY	RX2
0061	00072	0 06 00244	DAD	OVFP
0062	00073	0 04 00244	DST	OVFP
0063	00074	0 02 00470	DLD	RY1
0064	00075	0 16 00471	MPY	RY2
0065	00076	0 06 00244	DAD	OVFP
0066	00077	0 04 00244	DST	OVFP
0067	00100	0 02 00474	DLD	RZ1
0068	00101	0 16 00475	MPY	RZ2
0069	00102	0 06 00244	DAD	OVFP
0070	00103	0401 76	LRS	2
0071	00104	0 06 00242	DAD	SUMM
0072	00105	0 04 00242	DST	SUMM
0073	00106	0411 75	LLS	3
0074	00107	140040	CRA	
0075	00110	0 04 00252	DST	THRD
0076	00111	0 02 00242	DLD	SUMM
0077	00112	0401 64	LRS	12
0078	00113	0 04 00242	DST	SUMM
0079	00114	0 02 00460	DLD	L1
0080	00115	0 16 00460	MPY	L1
0081	00116	0 06 00242	DAD	SUMM
0082	00117	0 04 00242	DST	SUMM
0083	00120	0 02 00464	DLD	RX1
0084	00121	0 16 00464	MPY	RX1
0085	00122	0 06 00242	DAD	SUMM
0086	00123	0 04 00242	DST	SUMM
0087	00124	0 02 00470	DLD	RY1
0088	00125	0 16 00470	MPY	RY1
0089	00126	0 06 00242	DAD	SUMM
0090	00127	0 04 00242	DST	SUMM
0091	00130	0 02 00474	DLD	RZ1
0092	00131	0 16 00474	MPY	RZ1
0093	00132	0 06 00242	DAD	SUMM
0094	00133	0 07 00250	DSB	TWNZ
0095	00134	000201	IAB	
0096	00135	140040	CRA	
0097	00136	000201	IAB	
0098	00137	0 06 00252	DAD	THRD
0099	00140	0411 66	LLS	10
0100	00141	0 06 00256	DAD	HALF
0101	00142	140407	TCA	
0102	00143	0 04 00246	DST	FACT
0103	00144	0 16 00460	MPY	L1
0104	00145	0 06 00256	DAD	HALF
0105	00146	000201	IAB	
0106	00147	140040	CRA	
0107	00150	000201	IAB	
0108	00151	0401 67	LRS	9
0109	00152	0 06 00462	DAD	L3
0110	00153	0 04 00244	DST	OVFP
0111	00154	140040	CRA	
0112	00155	0 04 00462	DST	L3
0113	00156	0 02 00244	DLD	OVFP
0114	00157	0401 61	LRS	15



MICROCOMP TELECOMMUNICATED DATA  
DDP-516 ASSEMBLY LISTING

0115	00160	0 06 00460	DAD	L1
0116	00161	0 04 00460	DST	L1
0117	00162	0 02 00464	DLD	RX1
0118	00163	0 16 00246	MPY	FACT
0119	00164	0 06 00256	DAD	HALF
0120	00165	000201	IAB	
0121	00166	140040	CRA	
0122	00167	000201	IAB	
0123	00170	0401 67	LRS	9
0124	00171	0 06 00466	DAD	RX3
0125	00172	0 04 00244	DST	OVFP
0126	00173	140040	CRA	
0127	00174	0 04 00466	DST	RX3
0128	00175	0 02 00244	DLD	OVFP
0129	00176	0401 61	LRS	15
0130	00177	0 06 00464	DAD	RX1
0131	00200	0 04 00464	DST	RX1
0132	00201	0 02 00470	DLD	RY1
0133	00202	0 16 00246	MPY	FACT
0134	00203	0 06 00256	DAD	HALF
0135	00204	000201	IAB	
0136	00205	140040	CRA	
0137	00206	000201	IAB	
0138	00207	0401 67	LRS	9
0139	00210	0 06 00472	DAD	RY3
0140	00211	0 04 00244	DST	OVFP
0141	00212	140040	CRA	
0142	00213	0 04 00472	DST	RY3
0143	00214	0 02 00244	DLD	OVFP
0144	00215	0401 61	LRS	15
0145	00216	0 06 00470	DAD	RY1
0146	00217	0 04 00470	DST	RY1
0147	00220	0 02 00474	DLD	RZ1
0148	00221	0 16 00246	MPY	FACT
0149	00222	0 06 00256	DAD	HALF
0150	00223	000201	IAB	
0151	00224	140040	CRA	
0152	00225	000201	IAB	
0153	00226	0401 67	LRS	9
0154	00227	0 06 00476	DAD	RZ3
0155	00230	0 04 00244	DST	OVFP
0156	00231	140040	CRA	
0157	00232	0 04 00476	DST	RZ3
0158	00233	0 02 00244	DLD	OVFP
0159	00234	0401 61	LRS	15
0160	00235	0 06 00474	DAD	RZ1
0161	00236	0 04 00474	DST	RZ1
0162	00237	000005	SGL	
0163	00240	-0 01 00000	JMP*	SPUN
0164	00242	000000	SUMM	DBP 0
	00243	000000		
0165	00244	000000	OVFP	DBP 0
	00245	000000		
0166	00246	000000	FACT	DBP 0
	00247	000000		
0167	00250	020000	TWNZ	OCT 20000,0
	00251	000000		

MICROCOMP TELECOMMUNICATED DATA  
DDP-516 ASSEMBLY LISTING

0168	00252	000000	THRD DBP	0
	00253	000000		
0169	00254	040000	FUDG OCT	40000,0
	00255	000000		
0170	00256	000000	HALF OCT	0,40000
	00257	040000		
0171		000460	L1 EQU	*460
0172		000461	L2 EQU	L1+1
0173		000462	L3 EQU	L1+2
0174		000464	PX1 EQU	L1+4
0175		000465	RX2 EQU	L1+5
0176		000466	PX3 EQU	L1+6
0177		000470	RY1 EQU	L1+8
0178		000471	RY2 EQU	L1+9
0179		000472	RY3 EQU	L1+10
0180		000474	PZ1 EQU	L1+12
0181		000475	PZ2 EQU	L1+13
0182		000476	PZ3 EQU	L1+14
0183			END	

PROGRAM NAME

SOURCE: VESP

BINARY: BVESP

RELATED MEMOS: T-493

ENTRY POINTS (location): VELA ('04206)

ACCESSABLE VARIABLES (location): FXX ('04654),

FXY ('04656), FXZ ('04660), FYX ('04662), FYY ('04664),

FYZ ('04666), FZX ('04670), FZY ('04672),

PZZ ('04674)

GENERAL DESCRIPTION:

This subroutine, when called, will construct a cosine matrix from the quaternion which transforms a vector in the body frame to the inertial frame. It will then multiply the  $\Delta V$  in the body frame by this matrix to get  $\Delta V$  in the inertial frame. The cosine matrix can be expressed in terms of the quaternion elements as:

$$C(Q) = \begin{bmatrix} 1 - 2(\rho_y^2 + \rho_z^2) & 2(\rho_x\rho_y - \lambda\rho_z) & 2(\rho_x\rho_z + \lambda\rho_y) \\ 2(\rho_x\rho_y + \lambda\rho_z) & 1 - 2(\rho_x^2 + \rho_z^2) & 2(\rho_y\rho_z - \lambda\rho_x) \\ 2(\rho_x\rho_z - \lambda\rho_y) & 2(\rho_y\rho_z + \lambda\rho_x) & 1 - 2(\rho_x^2 + \rho_y^2) \end{bmatrix}$$

This can be written as:

$$\begin{bmatrix} f_{xx} & f_{xy} & f_{xz} \\ f_{yx} & f_{yy} & f_{yz} \\ f_{zx} & f_{zy} & f_{zz} \end{bmatrix}$$

where

$$f_{xx} = 1 - 2(\rho_y^2 + \rho_z^2)$$

$$f_{xy} = 2(\rho_x\rho_y - \lambda\rho_z)$$

$$f_{xz} = 2(\rho_x\rho_z + \lambda\rho_y)$$

.

.

.

$$f_{zz} = 1 - 2(\rho_x^2 + \rho_y^2)$$

Observe that all elements of the matrix consist of various combinations of the nine quaternion products:  $\rho_x^2, \rho_y^2, \rho_z^2, \rho_x\rho_y, \rho_x\rho_z, \rho_y\rho_z, \lambda\rho_x, \lambda\rho_y$  and  $\lambda\rho_z$ . Therefore, in the subroutine implementation the nine quaternion products are first calculated. Only 30 bits of each quaternion element is used and the cosine matrix elements are calculated to have a word size of 30 bits also. Scaling is as follows:

$$\lambda = 2L1 + \frac{L2}{2^{14}}$$

$$\rho_x = 2RX1 + \frac{RX2}{2^{14}}$$

$$\rho_y = 2RY1 + \frac{RY2}{2^{14}}$$

$$\rho_z = 2RZ1 + \frac{RZ2}{2^{14}}$$

$$\rho_x^2 = 4RX1^2 + \frac{RX1 RX2}{2^{12}} + \frac{RX2^2}{2^{28}}$$

or

$$RXSQ = \frac{\rho_x^2}{2} = 2RX1^2 + \frac{RX1 RX2}{2^{13}} + \frac{RX2^2}{2^{29}}$$

the other 8 quaternion products are scaled the same as  $\rho_x^2$ .

We also define:

$$FXX = \frac{f_{xx}}{4} = \frac{1}{4} - \left( \frac{\rho_y^2}{2} + \frac{\rho_z^2}{2} \right)$$

⋮

$$FZZ = \frac{f_{zz}}{4} = \frac{1}{4} - \left( \frac{\rho_x^2}{2} + \frac{\rho_y^2}{2} \right)$$

or

$$F_{XX} = \frac{1}{4} - R_{YSQ} - R_{ZSQ}$$

•  
•  
•

$$F_{ZZ} = \frac{1}{4} - R_{XSQ} - R_{YSQ}$$

Now we can write the equations to be implemented as:

$$DVIX = 4 (F_{XX} DVXB + F_{XY} DVYB + F_{XZ} DVZB)$$

$$DVII = 4 (F_{YX} DVXB + F_{YY} DVYB + F_{YZ} DVZB)$$

$$DVIZ = 4 (F_{ZX} DVXB + F_{ZY} DVYB + F_{ZZ} DVZB)$$

where DVIX is  $\Delta V$  in the inertial frame scaled the same as DVBX,  $\Delta V$  in the body frame. The flow chart for the implementation on the DDP-516 of the above derivation follows:

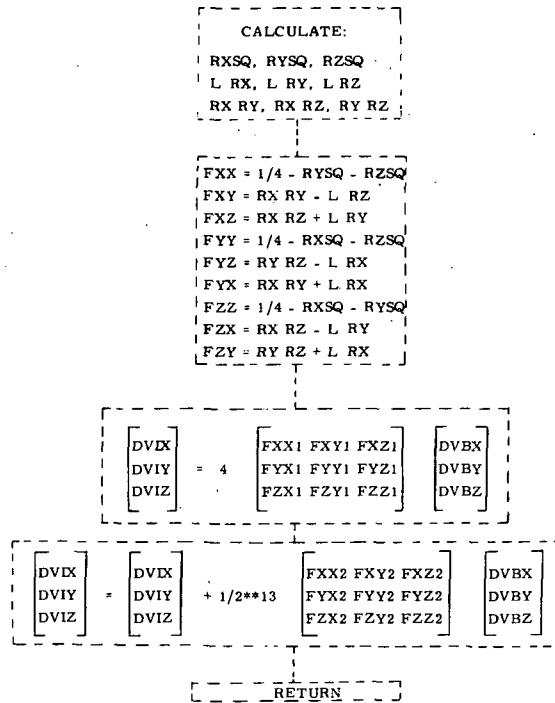

FLOWCHART - VELA

MICROCOMP TELECOMMUNICATED DATA  
DDP-516 ASSEMBLY LISTING

0001			REL	
0002			SUBR	FXX
0003			SUBR	FXY
0004			SUBR	FXZ
0005			SUBR	FYX
0006			SUBR	FYY
0007			SUBR	FYZ
0008			SUBR	FZX
0009			SUBR	FZY
0010			SUBR	FZZ
0011			SUBR	VELA
0012	00000	0 000000	VELA DAC	**
0013	00001	0 02 00465	LDA	RX2
0014	00002	000007	DBL	
0015	00003	0 16 00465	MPY	RX2
0016	00004	000201	IAB	
0017	00005	140040	CRA	
0018	00006	0401 77	LRS	1
0019	00007	0 04 00444	DST	T1
0020	00010	0 02 00464	DLD	RX1
0021	00011	0 16 00465	MPY	RX2
0022	00012	0 06 00444	DAD	T1
0023	00013	0 06 00512	DAD	SQRD
0024	00014	0401 63	LRS	13
0025	00015	0 04 00444	DST	T1
0026	00016	0 02 00464	DLD	RX1
0027	00017	0 16 00464	MPY	RX1
0028	00020	0411 77	LLS	1
0029	00021	0 06 00444	DAD	T1
0030	00022	0 04 00470	DST	RXSQ
0031	00023	0 02 00470	DLD	RY1
0032	00024	000201	IAB	
0033	00025	0 16 00471	MPY	RY2
0034	00026	000201	IAB	
0035	00027	140040	CRA	
0036	00030	0401 77	LRS	1
0037	00031	0 04 00444	DST	T1
0038	00032	0 02 00470	DLD	RY1
0039	00033	0 16 00471	MPY	RY2
0040	00034	0 06 00444	DAD	T1
0041	00035	0 06 00512	DAD	SQRD
0042	00036	0401 63	LRS	13
0043	00037	0 04 00444	DST	T1
0044	00040	0 02 00470	DLD	RY1
0045	00041	0 16 00470	MPY	RY1
0046	00042	0411 77	LLS	1
0047	00043	0 06 00444	DAD	T1
0048	00044	0 04 00472	DST	RYSQ
0049	00045	0 02 00474	DLD	RZ1
0050	00046	000201	IAB	
0051	00047	0 16 00475	MPY	RZ2
0052	00050	000201	IAB	
0053	00051	140040	CRA	
0054	00052	0401 77	LRS	1
0055	00053	0 04 00444	DST	T1
0056	00054	0 02 00474	DLD	RZ1
0057	00055	0 16 00475	MPY	RZ2

MICROCOMP TELECOMMUNICATED DATA  
DDP-516 ASSEMBLY LISTING

0058	00056	0 06 00444	DAD	T1
0059	00057	0 06 00512	DAD	SORD
0060	00060	0401 63	LRS	13
0061	00061	0 04 00444	DST	T1
0062	00062	0 02 00474	DLD	RZ1
0063	00063	0 16 00474	MPY	RZ1
0064	00064	0411 77	LLS	1
0065	00065	0 06 00444	DAD	T1
0066	00066	0 04 00474	DST	RZSQ
0067	00067	0 02 00460	DLD	L1
0068	00070	000201	IAB	
0069	00071	0 16 00465	MPY	RX2
0070	00072	000201	IAB	
0071	00073	140040	CRA	
0072	00074	0 04 00444	DST	T1
0073	00075	0 02 00460	DLD	L1
0074	00076	0 16 00465	MPY	RX2
0075	00077	0 06 00444	DAD	T1
0076	00100	0 04 00444	DST	T1
0077	00101	0 02 00464	DID	RX1
0078	00102	0 16 00461	MPY	L2
0079	00103	0 06 00444	DAD	T1
0080	00104	0 06 00514	DAD	CPRD
0081	00105	0401 62	LRS	14
0082	00106	0 04 00444	DST	T1
0083	00107	0 02 00460	DID	L1
0084	00110	0 16 00464	MPY	RX1
0085	00111	0411 77	LLS	1
0086	00112	0 06 00444	DAD	T1
0087	00113	0 04 00476	DST	LRX
0088	00114	0 02 00460	DID	L1
0089	00115	000201	IAB	
0090	00116	0 16 00471	MPY	RY2
0091	00117	000201	IAB	
0092	00120	140040	CRA	
0093	00121	0 04 00444	DST	T1
0094	00122	0 02 00460	DID	L1
0095	00123	0 16 00471	MPY	RY2
0096	00124	0 06 00444	DAD	T1
0097	00125	0 04 00444	DST	T1
0098	00126	0 02 00470	DID	RY1
0099	00127	0 16 00461	MPY	L2
0100	00130	0 06 00444	DAD	T1
0101	00131	0 06 00514	DAD	CPRD
0102	00132	0401 62	LRS	14
0103	00133	0 04 00444	DST	T1
0104	00134	0 02 00460	DID	L1
0105	00135	0 16 00470	MPY	RY1
0106	00136	0411 77	LLS	1
0107	00137	0 06 00444	DAD	T1
0108	00140	0 04 00500	DST	LRV
0109	00141	0 02 00460	DLD	L1
0110	00142	000201	IAB	
0111	00143	0 16 00475	MPY	RZ2
0112	00144	000201	IAB	
0113	00145	140040	CRA	
0114	00146	0 04 00444	DST	T1



MICROCOMP TELECOMMUNICATED DATA  
DDP-516 ASSEMBLY LISTING

0115	00147	0 02 00460	DLD	L1
0116	00150	0 16 00475	MPY	RZ2
0117	00151	0 06 00444	DAD	T1
0118	00152	0 04 00444	DST	T1
0119	00153	0 02 00474	DLD	RZ1
0120	00154	0 16 00461	MPY	L2
0121	00155	0 06 00444	DAD	T1
0122	00156	0 06 00514	DAD	CPRD
0123	00157	0401 62	LRS	14
0124	00160	0 04 00444	DST	T1
0125	00161	0 02 00460	DLD	L1
0126	00162	0 16 00474	MPY	RZ1
0127	00163	0411 77	LLS	1
0128	00164	0 06 00444	DAD	T1
0129	00165	0 04 00502	DST	LRZ
0130	00166	0 02 00464	DLD	RX1
0131	00167	000201	IAB	
0132	00170	0 16 00471	MPY	RY2
0133	00171	000201	IAB	
0134	00172	140040	CRA	
0135	00173	0 04 00444	DST	T1
0136	00174	0 02 00464	DLD	RX1
0137	00175	0 16 00471	MPY	RY2
0138	00176	0 06 00444	DAD	T1
0139	00177	0 04 00444	DST	T1
0140	00200	0 02 00470	DLD	RY1
0141	00201	0 16 00465	MPY	RX2
0142	00202	0 06 00444	DAD	T1
0143	00203	0 06 00514	DAD	CPRD
0144	00204	0401 62	LRS	14
0145	00205	0 04 00444	DST	T1
0146	00206	0 02 00464	DLD	RX1
0147	00207	0 16 00470	MPY	RY1
0148	00210	0411 77	LLS	1
0149	00211	0 06 00444	DAD	T1
0150	00212	0 04 00504	DST	RXRY
0151	00213	0 02 00464	DLD	RX1
0152	00214	000201	IAB	
0153	00215	0 16 00475	MPY	RZ2
0154	00216	000201	IAB	
0155	00217	140040	CRA	
0156	00220	0 04 00444	DST	T1
0157	00221	0 02 00464	DLD	RX1
0158	00222	0 16 00475	MPY	RZ2
0159	00223	0 06 00444	DAD	T1
0160	00224	0 04 00444	DST	T1
0161	00225	0 02 00474	DLD	RZ1
0162	00226	0 16 00465	MPY	RX2
0163	00227	0 06 00444	DAD	T1
0164	00230	0 06 00514	DAD	CPRD
0165	00231	0401 62	LRS	14
0166	00232	0 04 00444	DST	T1
0167	00233	0 02 00464	DLD	RX1
0168	00234	0 16 00474	MPY	RZ1
0169	00235	0411 77	LLS	1
0170	00236	0 06 00444	DAD	T1
0171	00237	0 04 00506	DST	RXRZ

MICROCOMP TELECOMMUNICATED DATA  
DDP-516 ASSEMBLY LISTING

0172	00240	0 02 00470	DLD	RY1
0173	00241	000201	IAB	
0174	00242	0 16 00475	MPY	RZ2
0175	00243	000201	IAB	
0176	00244	140040	CRA	
0177	00245	0 04 00444	DST	T1
0178	00246	0 02 00470	DLD	RY1
0179	00247	0 16 00475	MPY	RZ2
0180	00250	0 06 00444	DAD	T1
0181	00251	0 04 00444	DST	T1
0182	00252	0 02 00474	DLD	RZ1
0183	00253	0 16 00471	MPY	RY2
0184	00254	0 06 00444	DAD	T1
0185	00255	0 06 00514	DAD	CPRD
0186	00256	0401 62	LRS	14
0187	00257	0 04 00444	DST	T1
0188	00260	0 02 00470	DLD	RY1
0189	00261	0 16 00474	MPY	RZ1
0190	00262	0411 77	LLS	1
0191	00263	0 06 00444	DAD	T1
0192	00264	0 04 00510	DST	RYRZ
0193	00265	0 02 00516	DLD	ONQT
0194	00266	0 07 00472	DSB	RYSQ
0195	00267	0 07 00474	DSB	RZSQ
0196	00270	0 04 00446	DST	FXX
0197	00271	0 02 00504	DLD	RXRY
0198	00272	0 07 00502	DSB	LRZ
0199	00273	0 04 00450	DST	FXX
0200	00274	0 02 00506	DLD	RXRZ
0201	00275	0 06 00500	DAD	LRX
0202	00276	0 04 00452	DST	FXZ
0203	00277	0 02 00516	DLD	ONQT
0204	00300	0 07 00470	DSB	RXSQ
0205	00301	0 07 00474	DSB	RZSQ
0206	00302	0 04 00456	DST	FYY
0207	00303	0 02 00510	DLD	RYRZ
0208	00304	0 07 00476	DSB	LRX
0209	00305	0 04 00460	DST	FYZ
0210	00306	0 02 00504	DLD	RXRY
0211	00307	0 06 00502	DAD	LRZ
0212	00310	0 04 00454	DST	FXX
0213	00311	0 02 00516	DLD	ONQT
0214	00312	0 07 00470	DSB	RXSQ
0215	00313	0 07 00472	DSB	RYSQ
0216	00314	0 04 00466	DST	FZZ
0217	00315	0 02 00506	DLD	RXRZ
0218	00316	0 07 00500	DSB	LRX
0219	00317	0 04 00462	DST	FZX
0220	00320	0 02 00510	DLD	RYRZ
0221	00321	0 06 00476	DAD	LRX
0222	00322	0 04 00464	DST	FZY
0223	00323	0 02 00446	DLD	FXX
0224	00324	0 16 00614	MPY	DVBX
0225	00325	0 04 00666	DST	DVIX
0226	00326	0 02 00450	DLD	FXX
0227	00327	0 16 00616	MPY	DVBY
0228	00330	0 06 00666	DAD	DVIX

MICROCOMP TELECOMMUNICATED DATA  
DDP-516 ASSEMBLY LISTING

0229	00331	0 04	00666	DST	DVIX
0230	00332	0 02	00452	DLD	FXZ
0231	00333	0 16	00620	MPY	DVBZ
0232	00334	0 06	00666	DAD	DVIX
0233	00335	0411	76	LLS	2
0234	00336	0 04	00666	DST	DVIX
0235	00337	0 02	00454	DLD	FYX
0236	00340	0 16	00614	MPY	DVBX
0237	00341	0 04	00670	DST	DVIY
0238	00342	0 02	00456	DLD	FYY
0239	00343	0 16	00616	MPY	DVBY
0240	00344	0 06	00670	DAD	DVIY
0241	00345	0 04	00670	DST	DVIY
0242	00346	0 02	00460	DLD	FYZ
0243	00347	0 16	00620	MPY	DVBZ
0244	00350	0 06	00670	DAD	DVIY
0245	00351	0411	76	LLS	2
0246	00352	0 04	00670	DST	DVIY
0247	00353	0 02	00462	DLD	FZX
0248	00354	0 16	00614	MPY	DVBX
0249	00355	0 04	00672	DST	DVIZ
0250	00356	0 02	00464	DLD	FZY
0251	00357	0 16	00616	MPY	DVBY
0252	00360	0 06	00672	DAD	DVIZ
0253	00361	0 04	00672	DST	DVIZ
0254	00362	0 02	00466	DLD	FZZ
0255	00363	0 16	00620	MPY	DVBZ
0256	00364	0 06	00672	DAD	DVIZ
0257	00365	0411	76	LLS	2
0258	00366	0 04	00672	DST	DVIZ
0259	00367	0 02	00614	DLD	DVBX
0260	00370	0 16	00447	MPY	FXX+1
0261	00371	0 04	00444	DST	T1
0262	00372	0 02	00616	DLD	DVBY
0263	00373	0 16	00451	MPY	FXY+1
0264	00374	0 06	00444	DAD	T1
0265	00375	0 04	00444	DST	T1
0266	00376	0 02	00620	DLD	DVBZ
0267	00377	0 16	00453	MPY	FXZ+1
0268	00400	0 06	00444	DAD	T1
0269	00401	0 06	00512	DAD	SQRD
0270	00402	0401	63	LRS	13
0271	00403	0 06	00666	DAD	DVIX
0272	00404	0 04	00666	DST	DVIX
0273	00405	0 02	00614	DLD	DVBX
0274	00406	0 16	00455	MPY	FYX+1
0275	00407	0 04	00444	DST	T1
0276	00410	0 02	00616	DLD	DVBY
0277	00411	0 16	00457	MPY	FYY+1
0278	00412	0 06	00444	DAD	T1
0279	00413	0 04	00444	DST	T1
0280	00414	0 02	00620	DLD	DVBZ
0281	00415	0 16	00461	MPY	FYZ+1
0282	00416	0 06	00444	DAD	T1
0283	00417	0 06	00512	DAD	SQRD
0284	00420	0401	63	LRS	13
0285	00421	0 06	00670	DAD	DVIY

MICROCOMP TELECOMMUNICATED DATA

DDP-516 ASSEMBLY LISTING

0286	00422	0 04 00670	DST	DVIY	
0287	00423	0 02 00614	DLD	DVBX	
0288	00424	0 16 00463	MPY	FZX+1	
0289	00425	0 04 00444	DST	T1	
0290	00426	0 02 00616	DLD	DVBY	
0291	00427	0 16 00465	MPY	FZY+1	
0292	00430	0 06 00444	DAD	T1	
0293	00431	0 04 00444	DST	T1	
0294	00432	0 02 00620	DLD	DVBZ	
0295	00433	0 16 00467	MPY	FZZ+1	
0296	00434	0 06 00444	DAD	T1	
0297	00435	0 06 00512	DAD	SQRD	
0298	00436	0401 63	LRB	13	
0299	00437	0 06 00672	DAD	DVIZ	
0300	00440	0 04 00672	DST	DVIZ	
0301	00441	000005	SGL		
0302	00442	-0 01 00000	JMP*	VELA	
0303	00444	000000	T1	DBP	0
	00445	000000			
0304	00446	000000	FXX	DBP	0
	00447	000000			
0305	00450	000000	FXY	DBP	0
	00451	000000			
0306	00452	000000	FXZ	DBP	0
	00453	000000			
0307	00454	000000	FYX	DBP	0
	00455	000000			
0308	00456	000000	FYY	DBP	0
	00457	000000			
0309	00460	000000	FYZ	DBP	0
	00461	000000			
0310	00462	000000	FZY	DBP	0
	00463	000000			
0311	00464	000000	FZY	DBP	0
	00465	000000			
0312	00466	000000	FZZ	DBP	0
	00467	000000			
0313	00470	000000	RXSQ	DBP	0
	00471	000000			
0314	00472	000000	RYSQ	DBP	0
	00473	000000			
0315	00474	000000	RZSQ	DBP	0
	00475	000000			
0316	00476	000000	LRX	DBP	0
	00477	000000			
0317	00500	000000	LRV	DBP	0
	00501	000000			
0318	00502	000000	LRZ	DBP	0
	00503	000000			
0319	00504	000000	RXRY	DBP	0
	00505	000000			
0320	00506	000000	RXRZ	DBP	0
	00507	000000			
0321	00510	000000	RYZR	DBP	0
	00511	000000			
0322	00512	000000	SQRD	OCT	0,10000
	00513	010000			

MICROCOMP TELECOMMUNICATED DATA  
DDP-516 ASSEMBLY LISTING

0323	00514	000000	CPRD	OCT	0,20000
	00515	020000			
0324	00516	020000	ONQT	OCT	20000,0
	00517	000000			
0325		000460	L1	EQU	'460
0326		000461	L2	EQU	L1+1
0327		000464	RX1	EQU	L1+4
0328		000465	RX2	EQU	L1+5
0329		000470	RY1	EQU	L1+8
0330		000471	RY2	EQU	L1+9
0331		000474	RZ1	EQU	L1+12
0332		000475	RZ2	EQU	L1+13
0333		000614	DVBX	EQU	'614
0334		000616	DVBY	EQU	DVBX+2
0335		000620	DVBZ	EQU	DVBX+4
0336		000666	DVIX	EQU	'666
0337		000670	DVIY	EQU	DVIX+2
0338		000672	DVIZ	EQU	DVIX+4
0339				END	

PROGRAM NAME:  
SOURCE: VACU  
BINARY: BVACU  
ENTRY POINTS (location): VACU ('05506)  
GENERAL DESCRIPTION:

This subroutine, when called, accumulates delta velocity in the inertial frame (DVIX, DVIY and DVIZ calculated by the velocity algorithm, program source name VESP subroutine entry point VELA). The three accumulators (XAV1-XAV3, YAV1-YAV3 and ZAV1-ZAV3) are triple precision accumulators and a brief examination of this subroutine will show that it performs the following three tasks:

$$XAV = XAV + \frac{DVIX}{2^{15}}$$

$$YAV = YAV + \frac{DVIY}{2^{15}}$$

$$ZAV = ZAV + \frac{DVIZ}{2^{15}}$$

MICROCOMP TELECOMMUNICATED DATA  
DDP-516 ASSEMBLY LISTING

0001			REL	
0002			SUBR	VACU
0003	00000	0 000000	VACU DAC	**
0004	00001	000007	DBL	
0005	00002	0 02 00666	DLN	DVIX
0006	00003	140040	CRA	
0007	00004	0 06 00446	DAD	XAV3
0008	00005	0 04 00446	DST	XAV3
0009	00006	000201	IAB	
0010	00007	140040	CRA	
0011	00010	000201	IAB	
0012	00011	0 06 00666	DAD	DVIX
0013	00012	0401 61	LRS	15
0014	00013	0 06 00444	DAD	XAV1
0015	00014	0 04 00444	DST	XAV1
0016	00015	0 02 00670	DLN	DVIY
0017	00016	140040	CRA	
0018	00017	0 06 00452	DAD	YAV3
0019	00020	0 04 00452	DST	YAV3
0020	00021	000201	IAB	
0021	00022	140040	CRA	
0022	00023	000201	IAB	
0023	00024	0 06 00670	DAD	DVIY
0024	00025	0401 61	LRS	15
0025	00026	0 06 00450	DAD	YAV1
0026	00027	0 04 00450	DST	YAV1
0027	00030	0 02 00672	DLN	DVIZ
0028	00031	140040	CRA	
0029	00032	0 06 00456	DAD	ZAV3
0030	00033	0 04 00456	DST	ZAV3
0031	00034	000201	IAB	
0032	00035	140040	CRA	
0033	00036	000201	IAB	
0034	00037	0 06 00672	DAD	DVIZ
0035	00040	0401 61	LRS	15
0036	00041	0 06 00454	DAD	ZAV1
0037	00042	0 04 00454	DST	ZAV1
0038	00043	000005	SGL	
0039	00044	140040	CRA	
0040	00045	0 04 00446	STA	XAV3
0041	00046	0 04 00452	STA	YAV3
0042	00047	0 04 00456	STA	ZAV3
0043	00050	-0 01 00000	JMP*	VACU
0044		000666	DVIX EQU	'666
0045		000670	DVIY EQU	DVIX+2
0046		000672	DVIZ EQU	DVIX+4
0047		000444	XAV1 EQU	'444
0048		000446	XAV3 EQU	XAV1+2
0049		000450	YAV1 EQU	XAV1+4
0050		000452	YAV3 EQU	XAV1+6
0051		000454	ZAV1 EQU	XAV1+8
0052		000456	ZAV3 EQU	XAV1+10
0053			END	

PROGRAM NAME  
SOURCE: ERC6  
BINARY: BERC6  
ENTRY POINTS (location): ERCO ('2726)  
GENERAL DESCRIPTION:

This subroutine will do the equivalent of torquing a gyro in a gimbal IMU. It essentially compensates the gyros for a drift in the inertial frame and is used to take out WIE, earth rate, thus the acronym ERCO or earth rate compensation. It does this by transforming the negative of the drift in the inertial frame into the body frame and adding it to the gyros as an equivalent NBD. It makes use of the cosine matrix ( $C_B^I$ ) developed from the quaternion by the subroutine VELA which transforms the  $\Delta V_B$  into  $\Delta V_I$ . The gyro drift in the body frame due to earth rate is:

$$\begin{bmatrix} \omega_{IEXB} \\ \omega_{IEYB} \\ \omega_{IEZB} \end{bmatrix} = C_B^{IT} \begin{bmatrix} \omega_{IEXI} \\ \omega_{IEYI} \\ \omega_{IEZI} \end{bmatrix}$$

$C_B^I$  is created by VELA and its elements are FXX, FXY, FXZ, FZX, FYY, FYZ, FZY and FZZ. This subroutine gains access to the constants by using the pseudo-op XAC or external address constant. For example, the pseudo-op XFXX XAC FXX puts the address of FXX in the location called XFXX. Of course, the transpose of the above matrix ( $C_B^{IT}$ ) is FXX, FZX, FXY, FYY, FZY, FXZ, FYZ and FZZ.

The X, Y and Z inertial rates to be compensated for are stored in octal locations 250, 251 and 252 respectively. These are specially scaled constants that are the negative of the earth rate sensed on these inertial axes. If, for example, the X, Y and Z inertial axes were north, east and down at this latitude ( $42^\circ, 21', 51''$ ), locations 250, 251 and 252 would contain the octal constants -44121, 0 and 40763. The  $\Delta\theta_X$ ,  $\Delta\theta_Y$  and  $\Delta\theta_Z$  to be compensated are contained in octal locations 414, 416 and 420. The subroutine itself is so straight-forward that no flow chart is necessary.



MICROCOMP TELECOMMUNICATED DATA  
DDP-516 ASSEMBLY LISTING

0001				REL	
0002				SUBR	ERCO
0003	00000	0 000000	ERCO	DAC	**
0004	00001	000007		DBL	
0005	00002	-0 02 00074		DLD*	XFXK
0006	00003	0 06 00072		DAD	MRRD
0007	00004	0 16 00250		MPY	'250
0008	00005	0 04 00064		DST	XERC
0009	00006	-0 02 00077		DLD*	XFYK
0010	00007	0 06 00072		DAD	MRRD
0011	00010	0 16 00251		MPY	'251
0012	00011	0 06 00064		DAD	XERC
0013	00012	0 04 00064		DST	XERC
0014	00013	-0 02 00102		DLD*	XFZX
0015	00014	0 06 00072		DAD	MRRD
0016	00015	0 16 00252		MPY	'252
0017	00016	0 06 00064		DAD	XERC
0018	00017	0401 64		LRS	12
0019	00020	0 06 00414		DAD	'414
0020	00021	0 04 00414		DST	'414
0021	00022	-0 02 00075		DLD*	XFXK
0022	00023	0 06 00072		DAD	MRRD
0023	00024	0 16 00250		MPY	'250
0024	00025	0 04 00066		DST	YERC
0025	00026	-0 02 00100		DLD*	XFYK
0026	00027	0 06 00072		DAD	MRRD
0027	00030	0 16 00251		MPY	'251
0028	00031	0 06 00066		DAD	YERC
0029	00032	0 04 00066		DST	YERC
0030	00033	-0 02 00103		DLD*	XFZY
0031	00034	0 06 00072		DAD	MRRD
0032	00035	0 16 00252		MPY	'252
0033	00036	0 06 00066		DAD	YERC
0034	00037	0401 64		LRS	12
0035	00040	0 06 00416		DAD	'416
0036	00041	0 04 00416		DST	'416
0037	00042	-0 02 00076		DLD*	XFXZ
0038	00043	0 06 00072		DAD	MRRD
0039	00044	0 16 00250		MPY	'250
0040	00045	0 04 00070		DST	ZERC
0041	00046	-0 02 00101		DLD*	XFYZ
0042	00047	0 06 00072		DAD	MRRD
0043	00050	0 16 00251		MPY	'251
0044	00051	0 06 00070		DAD	ZERC
0045	00052	0 04 00070		DST	ZERC
0046	00053	-0 02 00104		DLD*	XFZZ
0047	00054	0 06 00072		DAD	MRRD
0048	00055	0 16 00252		MPY	'252
0049	00056	0 06 00070		DAD	ZERC
0050	00057	0401 64		LRS	12
0051	00060	0 06 00420		DAD	'420
0052	00061	0 04 00420		DST	'420
0053	00062	000005		SGL	
0054	00063	-0 01 00000		JMP*	ERCO
0055	00064	000000	XERC	DBP	0
	00065	000000			
0056	00066	000000	YERC	DBP	0

MICROCOMP TELECOMMUNICATED DATA  
DDP-516 ASSEMBLY LISTING

00067	000000			
0057	00070	000000	ZFRC DEP	0
	00071	000000		
0058	00072	000000	MRRD OCT	0,40000
	00073	040000		
0059	00074	0 000000	XFXX XAC	FXX
0060	00075	0 000000	XFXY XAC	FXY
0061	00076	0 000000	XFXZ XAC	FXZ
0062	00077	0 000000	XPYX XAC	PYX
0063	00100	0 000000	XPYY XAC	PYY
0064	00101	0 000000	XPYZ XAC	PYZ
0065	00102	0 000000	XPZX XAC	PZX
0066	00103	0 000000	XPZY XAC	PZY
0067	00104	0 000000	XPZZ XAC	PZZ
0068			END	

PROGRAM NAME  
SOURCE: AA6S  
BINARY: BAA6S  
RELATED MEMOS: T-493  
ENTRY POINTS (location): ATTA ('05060)  
GENERAL DESCRIPTION:

This subroutine when called will perform a third order attitude algorithm to update the quaternion of rotation. The equation representing the algorithm can be expressed as:

$$\begin{aligned}\rho_x' &= \lambda S \alpha_x + R \rho_x + S(\rho_y \alpha_z - \rho_z \alpha_y) \\ \rho_y' &= \lambda S \alpha_y + R \rho_y + S(\rho_z \alpha_x - \rho_x \alpha_z) \\ \rho_z' &= \lambda S \alpha_z + R \rho_z + S(\rho_x \alpha_y - \rho_y \alpha_x) \\ \lambda' &= -S(\bar{\rho} \cdot \bar{\alpha}) + R \lambda\end{aligned}$$

where

$$\begin{aligned}\bar{\alpha} &= \frac{\Delta \theta}{2} \\ M &= \bar{\alpha} \cdot \bar{\alpha} \\ R &= (1 - \frac{1}{2} M) \\ S &= (1 - \frac{1}{6} M)\end{aligned}$$

expanding this equation, if we define  $\Delta = \Delta \theta_x \Delta \theta_x + \Delta \theta_y \Delta \theta_y + \Delta \theta_z \Delta \theta_z$

$$\rho_x' = \lambda \left(1 - \frac{\Delta}{24}\right) \frac{\Delta \theta_x}{2} + \left(1 - \frac{\Delta}{8}\right) \rho_x + \left(1 - \frac{\Delta}{24}\right) \left(\frac{\rho_y \Delta \theta_z - \rho_z \Delta \theta_y}{2}\right)$$

therefore:

$$\rho_x' = \rho_x + \frac{\lambda \Delta \theta_x}{2} - \frac{\lambda \Delta \Delta \theta_x}{48} - \frac{\Delta \rho_x}{8} + \frac{\rho_y \Delta \theta_z - \rho_z \Delta \theta_y}{2} - \Delta \frac{(\rho_y \Delta \theta_z - \rho_z \Delta \theta_y)}{48}$$

to determine  $\rho_y'$ , replace x, y, z subscripts by y, z, x in the equation for  $\rho_x'$ . To determine  $\rho_z'$ , replace x, y, z subscripts by z, x, y in the equation

for  $\rho_x'$ . Then,

$$\lambda' = -S(\bar{\rho} \cdot \bar{\alpha}) + R\lambda$$

therefore:

$$\lambda' = \lambda - \frac{\Delta}{8}\lambda - \frac{(\rho_x \Delta\theta_x + \rho_y \Delta\theta_y + \rho_z \Delta\theta_z)}{2} + \frac{\Delta}{48}(\rho_x \Delta\theta_x + \rho_y \Delta\theta_y + \rho_z \Delta\theta_z)$$

In the present DDP516 implementation the actual numbers in the computer are scaled as follows:

$$DX = 2^6 \Delta\theta_x \text{ or } \Delta\theta_x = DX 2^{-6}$$

$$DY = 2^6 \Delta\theta_y \text{ or } \Delta\theta_y = DY 2^{-6}$$

$$DZ = 2^6 \Delta\theta_z \text{ or } \Delta\theta_z = DZ 2^{-6}$$

$$RX = \frac{\rho_x}{2} \text{ or } \rho_x = 2RX$$

$$RY = \frac{\rho_y}{2} \text{ or } \rho_y = 2RY$$

$$RZ = \frac{\rho_z}{2} \text{ or } \rho_z = 2RZ$$

$$L = \frac{\lambda}{2} \text{ or } \lambda = 2L$$

$$D^2 = 2^{12} \Delta \text{ or } \Delta = D^2 2^{-12} = (DX^2 + DY^2 + DZ^2) 2^{-12}$$

now substituting this scaling into the equation given above we find:

$$\begin{aligned} 2RX' = 2RX + \frac{L DX}{2^6} - \frac{L D^2 DX}{3 2^{21}} - \frac{D^2 RX}{2^{14}} \\ + \frac{RY DZ - RZ DY}{2^6} - \frac{D^2 (RY DZ - RZ DY)}{3 2^{21}} \end{aligned}$$

if we define

$$\Delta RX = RX' - RX$$

then,

$$\Delta RX = \frac{L DX}{2^7} - \frac{L D^2 DX}{3 \cdot 2^{22}} - \frac{D^2 RX}{2^{15}} + \frac{RY DZ - RZ DY}{2^7} - \frac{D^2 (RY DZ - RZ DY)}{3 \cdot 2^{22}}$$

also,

$$2L' = 2L - \frac{D^2 L}{2^{14}} - \frac{RX DX + RY DY + RZ DZ}{2^6} + \frac{D^2 (RX DX + RY DY + RZ DZ)}{3 \cdot 2^{21}}$$

and if

$$\Delta L = L' - L,$$

$$\Delta L = -\frac{D^2 L}{2^{15}} - \frac{RX DX + RY DY + RZ DZ}{2^7} + \frac{D^2 (RX DX + RY DY + RZ DZ)}{3 \cdot 2^{22}}$$

The equations for  $\Delta RY$  and  $\Delta RZ$  are obtained in a similar manner.

A 16 bit word in the DDP516 is made up of a sign bit and 15 bits of fraction. For example, 0110 000 000 000 000 represents +.75 decimal. Each quaternion component is made up of three of these numbers. For example, L will be represented by

$$L1 + \frac{L2}{2^{15}} + \frac{L3}{2^{30}},$$

which is equivalent to a 45 bit signed fraction where the sign bits of L2 and L3 are ignored. In core L1 is in location '460, L2 in '461 and L3 + '40000\* is in '463. Location '462 is normally zero except when '463 overflows into '462 which is then added to '461. RX, RY and RZ follow L in core in locations '464, '470 and '474 respectively. A unit quaternion in core

$$(\lambda = 1, \rho_x = 0, \rho_y = 0, \rho_z = 0)$$

or

$$L = 1/2, RX = 0, RY = 0, RZ = 0)$$

would look like the following (in octal):

---

\* Since only L1 and L2 are used in the velocity algorithm, the '40000 (1/2) added to L3 is for rounding.

loc.	'460	'461	'462	'463
L	040000	000000	000000	040000
	L1	L2		L3+'40000
loc.	'464	'465	'466	'467
RX	000000	000000	000000	040000
	RX1	RX2		RX3+'40000
loc.	'470	'471	'472	'473
RY	000000	000000	000000	040000
	RY1	RY2		RY3+'40000
loc.	'474	'475	'476	'477
RZ	000000	000000	000000	040000
	RZ1	RZ2		RZ3+'40000

DX, DY and DZ are single precision fractions. However,  $D^2$  will be 30 bits and will be represented by

$$D^2_1 + \frac{D^2_2}{2^{15}}$$

With these considerations in mind the quaternion update equations can be expanded as:

$$\begin{aligned}
\Delta RX = & \frac{L1 DX}{2^7} + \frac{L2 DX}{2^{22}} + \frac{L3 DX}{2^{37}} \\
& - \frac{DX D^2_1 L1}{3 \times 2^{22}} - \frac{DX D^2_1 L2}{3 \times 2^{37}} - \frac{DX D^2_1 L3}{3 \times 2^{52}} \\
& - \frac{DX D^2_2 L1}{3 \times 2^{37}} - \frac{DX D^2_2 L2}{3 \times 2^{52}} - \frac{DX D^2_2 L3}{3 \times 2^{67}} \\
& - \frac{D^2_1 RX1}{2^{15}} - \frac{D^2_1 RX2}{2^{30}} - \frac{D^2_1 RX3}{2^{45}} \\
& - \frac{D^2_2 RX1}{2^{30}} - \frac{D^2_2 RX2}{2^{45}} - \frac{D^2_2 RX3}{2^{60}} \\
& + \frac{RY1 DZ}{2^7} + \frac{RY2 DZ}{2^{22}} + \frac{RY3 DZ}{2^{37}} \\
& - \frac{RZ1 DY}{2^7} - \frac{RZ2 DY}{2^{22}} - \frac{RZ3 DY}{2^{37}}
\end{aligned}$$

$$\begin{aligned}
& - \frac{D^2_1 RY1 DZ}{3 \times 2^{22}} - \frac{D^2_1 RY^2 DZ}{3 \times 2^{37}} - \frac{D^2_1 RY3 DZ}{3 \times 2^{52}} \\
& + \frac{D^2_1 RZ1 DY}{3 \times 2^{22}} + \frac{D^2_1 RZ2 DY}{3 \times 2^{37}} + \frac{D^2_1 RZ3 DY}{3 \times 2^{52}} \\
& - \frac{D^2_2 RY1 DZ}{3 \times 2^{37}} - \frac{D^2_2 RY2 DZ}{3 \times 2^{52}} - \frac{D^2_2 RY3 DZ}{3 \times 2^{67}} \\
& + \frac{D^2_2 RZ1 DY}{3 \times 2^{37}} + \frac{D^2_2 RZ2 DY}{3 \times 2^{52}} + \frac{D^2_2 RZ3 DY}{3 \times 2^{67}} \\
\Delta L = & - \frac{D^2_1 L1}{2^{15}} - \frac{D^2_1 L2}{2^{30}} - \frac{D^2_1 L3}{2^{45}} - \frac{D^2_2 L1}{2^{30}} - \frac{D^2_2 L2}{2^{45}} - \frac{D^2_2 L3}{2^{60}} \\
& - \frac{RX1 DX}{2^7} - \frac{RX2 DX}{2^{22}} - \frac{RX3 DX}{2^{37}} - \frac{RY1 DY}{2^7} - \frac{RY2 DY}{2^{22}} - \frac{RY3 DY}{2^{37}} \\
& - \frac{RZ1 DZ}{2^7} - \frac{RZ2 DZ}{2^{22}} - \frac{RZ3 DZ}{2^{37}} \\
& + \frac{D^2_1 RX1 DX}{3 \times 2^{22}} + \frac{D^2_1 RX2 DX}{3 \times 2^{37}} + \frac{D^2_1 RX3 DX}{3 \times 2^{52}} \\
& + \frac{D^2_1 RY1 DY}{3 \times 2^{22}} + \frac{D^2_1 RY2 DY}{3 \times 2^{37}} + \frac{D^2_1 RY3 DY}{3 \times 2^{52}} \\
& + \frac{D^2_1 RZ1 DZ}{3 \times 2^{22}} + \frac{D^2_1 RZ2 DZ}{3 \times 2^{37}} + \frac{D^2_1 RZ3 DZ}{3 \times 2^{52}} \\
& + \frac{D^2_2 RX1 DX}{3 \times 2^{37}} + \frac{D^2_2 RX2 DX}{3 \times 2^{52}} + \frac{D^2_2 RX3 DX}{3 \times 2^{67}} \\
& + \frac{D^2_2 RY1 DY}{3 \times 2^{37}} + \frac{D^2_2 RY2 DY}{3 \times 2^{52}} + \frac{D^2_2 RY3 DY}{3 \times 2^{67}} \\
& + \frac{D^2_2 RZ1 DZ}{3 \times 2^{37}} + \frac{D^2_2 RZ2 DZ}{3 \times 2^{52}} + \frac{D^2_2 RZ3 DZ}{3 \times 2^{67}}
\end{aligned}$$

With  $\Delta RY$  and  $\Delta RZ$  defined in a similar manner.

The algorithm that is written considers L, RX, RY and RZ to have only 37 bits of significance. Therefore, all terms in the final equations with denominators greater than  $2^{37}$  can be ignored. This simplifies the final equations to be programmed to:

$$\begin{aligned} \Delta RX = & \frac{L1 DX}{2^7} + \frac{L2 DX}{2^{22}} - \frac{DX D^2_1 L1}{3 \times 2^{22}} \\ & - \frac{D^2_1 RX1}{2^{15}} - \frac{D^2_1 RX2}{2^{30}} - \frac{D^2_2 RX1}{2^{30}} \\ & + \frac{RY1 DZ}{2^7} + \frac{RY2 DZ}{2^{22}} - \frac{RZ1 DY}{2^7} - \frac{RZ2 DY}{2^{22}} \\ & - \frac{D^2_1 RY1 DZ}{3 \times 2^{22}} + \frac{D^2_1 RZ1 DY}{3 \times 2^{22}} \end{aligned}$$

and,

$$\begin{aligned} \Delta L = & - \frac{D^2_1 L1}{2^{15}} - \frac{D^2_1 L2}{2^{30}} - \frac{D^2_2 L1}{2^{30}} \\ & - \frac{RX1 DX}{2^7} - \frac{RX2 DX}{2^{22}} - \frac{RY1 DY}{2^7} - \frac{RY2 DY}{2^{22}} - \frac{RZ1 DZ}{2^7} - \frac{RZ2 DZ}{2^{22}} \\ & + \frac{D^2_1 RX1 DX}{3 \times 2^{22}} + \frac{D^2_1 RY1 DY}{3 \times 2^{22}} + \frac{D^2_1 RZ1 DZ}{3 \times 2^{22}} \end{aligned}$$

The final simplification is to replace

$$(-2D^2_1)/3$$

with a variable called D3 and to calculate  $2^7 \Delta RX$ ,  $2^7 \Delta RY$ ,  $2^7 \Delta RZ$  and  $2^7 \Delta L$  before deriving  $\Delta RX$ ,  $\Delta RY$ ,  $\Delta RZ$  and  $\Delta L$ . The program equations then are:

$$\begin{aligned} 2^7 \Delta RX = & L1 DX + \frac{L2 DX}{2^{15}} + \frac{DX D3 L1}{2^{16}} \\ & - \frac{D^2_1 RX1}{2^8} - \frac{D^2_1 RX2}{2^{23}} - \frac{D^2_2 RX1}{2^{23}} \\ & + RY1 DZ + \frac{RY2 DZ}{2^{15}} - RZ1 DY - \frac{RZ2 DY}{2^{15}} \\ & + \frac{D3 RY1 DZ}{2^{16}} - \frac{D3 RZ1 DY}{2^{16}} \end{aligned}$$



and,

$$\begin{aligned} 2^7 \Delta L = & \frac{D^2_1 L1}{2^8} - \frac{D^2_1 L2}{2^{23}} - \frac{D^2_2 L1}{2^{23}} \\ & - \frac{RX1 DX}{2^{15}} - \frac{RX2 DX}{2^{15}} - \frac{RY1 DY}{2^{15}} - \frac{RY2 DY}{2^{15}} - \frac{RZ1 DZ}{2^{15}} - \frac{RZ2 DZ}{2^{15}} \\ & - \frac{D3 RX1 DX}{2^{16}} - \frac{D3 RY1 DY}{2^{16}} - \frac{D3 RZ1 DZ}{2^{16}} \end{aligned}$$

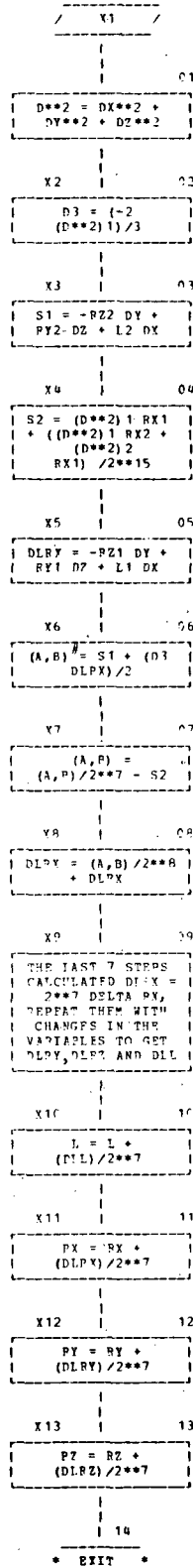

FLOWCHART - ATTA

RETURN

# The Double Precision Accumulator

MICROCOMP TELECOMMUNICATED DATA  
DDP-516 ASSEMBLY LISTING

REL	ADDR	OPER	DATA	REL	DATA
0001				REL	
0002				SUBR	ATTA
0003	00000	0	000000	ATTA DAC	**
0004	00001	0	02 00414	LDA	DX
0005	00002	000007		DBL	
0006	00003	0	16 00414	MPY	DX
0007	00004	0	04 00410	DST	D1
0008	00005	0	02 00416	DLD	DY
0009	00006	0	16 00416	MPY	DY
0010	00007	0	06 00410	DAD	D1
0011	00010	0	04 00410	DST	D1
0012	00011	0	02 00420	DLD	DZ
0013	00012	0	16 00420	MPY	DZ
0014	00013	0	06 00410	DAD	D1
0015	00014	0	04 00410	DST	D1
0016	00015	0	16 00424	MPY	= '125253
0017	00016	0	06 00420	DAD	TRND
0018	00017	0	04 00412	DST	D3
0019	00020	0	02 00416	DLD	DY
0020	00021	0	16 00475	MPY	RZ2
0021	00022	0	04 00414	DST	S1
0022	00023	0	02 00420	DLD	DZ
0023	00024	0	16 00471	MPY	RY2
0024	00025	0	07 00414	DSB	S1
0025	00026	0	04 00414	DST	S1
0026	00027	0	02 00414	DLD	DX
0027	00030	0	16 00461	MPY	L2
0028	00031	0	06 00414	DAD	S1
0029	00032	0	04 00414	DST	S1
0030	00033	0	02 00464	DLD	RX1
0031	00034	0	16 00411	MPY	D2
0032	00035	0	04 00416	DST	S2
0033	00036	0	02 00410	DLD	D1
0034	00037	0	16 00465	MPY	RX2
0035	00040	0	06 00416	DAD	S2
0036	00041	0401 61		LRS	15
0037	00042	0	04 00416	DST	S2
0038	00043	0	02 00410	DLD	D1
0039	00044	0	16 00464	MPY	RX1
0040	00045	0	06 00416	DAD	S2
0041	00046	0	04 00416	DST	S2
0042	00047	0	02 00416	DLD	DY
0043	00050	0	16 00474	MPY	RZ1
0044	00051	0	04 00402	DST	DLRX
0045	00052	0	02 00420	DLD	DZ
0046	00053	0	16 00470	MPY	RY1
0047	00054	0	07 00402	DSB	DLRX
0048	00055	0	04 00402	DST	DLRX
0049	00056	0	02 00414	DLD	DX
0050	00057	0	16 00460	MPY	L1
0051	00060	0	06 00402	DAD	DLRX
0052	00061	0	04 00402	DST	DLRX
0053	00062	0	16 00412	MPY	D3
0054	00063	0401 77		LRS	1
0055	00064	0	06 00414	DAD	S1
0056	00065	0401 71		LRS	7
0057	00066	0	07 00416	DSB	S2

MICROCOMP TELECOMMUNICATED DATA  
DDP-516 ASSEMBLY LISTING

0058	00067	0 06	00422	DAD	SRND
0059	00070	0401	70	LRS	8
0060	00071	0 06	00402	DAD	DLRX
0061	00072	0 04	00402	DST	DLRX
0062	00073	0 02	00420	DLD	DZ
0063	00074	0 16	00465	MPY	RX2
0064	00075	0 04	00414	DST	S1
0065	00076	0 02	00414	DLD	DX
0066	00077	0 16	00475	MPY	RZ2
0067	00100	0 07	00414	DSB	S1
0068	00101	0 04	00414	DST	S1
0069	00102	0 02	00416	DLD	DY
0070	00103	0 16	00461	MPY	L2
0071	00104	0 06	00414	DAD	S1
0072	00105	0 04	00414	DST	S1
0073	00106	0 02	00470	DID	RY1
0074	00107	0 16	00411	MPY	D2
0075	00110	0 04	00416	DST	S2
0076	00111	0 02	00410	DLD	D1
0077	00112	0 16	00471	MPY	RY2
0078	00113	0 06	00416	DAD	S2
0079	00114	0401	61	LRS	15
0080	00115	0 04	00416	DST	S2
0081	00116	0 02	00410	DID	D1
0082	00117	0 16	00470	MPY	RY1
0083	00120	0 06	00416	DAD	S2
0084	00121	0 04	00416	DST	S2
0085	00122	0 02	00420	DLD	DZ
0086	00123	0 16	00464	MPY	RX1
0087	00124	0 04	00404	DST	DLRY
0088	00125	0 02	00414	DLD	DX
0089	00126	0 16	00474	MPY	RZ1
0090	00127	0 07	00404	DSB	DLRY
0091	00130	0 04	00404	DST	DLRY
0092	00131	0 02	00416	DLD	DY
0093	00132	0 16	00460	MPY	L1
0094	00133	0 06	00404	DAD	DLRY
0095	00134	0 04	00404	DST	DLRY
0096	00135	0 16	00412	MPY	D3
0097	00136	0401	77	LRS	1
0098	00137	0 06	00414	DAD	S1
0099	00140	0401	71	LRS	7
0100	00141	0 07	00416	DSB	S2
0101	00142	0 06	00422	DAD	SRND
0102	00143	0401	70	LRS	8
0103	00144	0 06	00404	DAD	DLRY
0104	00145	0 04	00404	DST	DLRY
0105	00146	0 02	00414	DID	DX
0106	00147	0 16	00471	MPY	RY2
0107	00150	0 04	00414	DST	S1
0108	00151	0 02	00416	DLD	DY
0109	00152	0 16	00465	MPY	RX2
0110	00153	0 07	00414	DSB	S1
0111	00154	0 04	00414	DST	S1
0112	00155	0 02	00420	DLD	DZ
0113	00156	0 16	00461	MPY	L2
0114	00157	0 06	00414	DAD	S1

MICROCOMP TELECOMMUNICATED DATA  
DDP-516 ASSEMBLY LISTING

0115	00160	0 04 00414	DST	S1
0116	00161	0 02 00474	DLD	RZ1
0117	00162	0 16 00411	MPY	D2
0118	00163	0 04 00416	DST	S2
0119	00164	0 02 00410	DLD	D1
0120	00165	0 16 00475	MPY	RZ2
0121	00166	0 06 00416	DAD	S2
0122	00167	0401 61	LRS	15
0123	00170	0 04 00416	DST	S2
0124	00171	0 02 00410	DLD	D1
0125	00172	0 16 00474	MPY	RZ1
0126	00173	0 06 00416	DAD	S2
0127	00174	0 04 00416	DST	S2
0128	00175	0 02 00414	DLD	DX
0129	00176	0 16 00470	MPY	RY1
0130	00177	0 04 00406	DST	DLRZ
0131	00200	0 02 00416	DLD	DY
0132	00201	0 16 00464	MPY	RX1
0133	00202	0 07 00406	DSB	DLRZ
0134	00203	0 04 00406	DST	DLRZ
0135	00204	0 02 00420	DLD	DZ
0136	00205	0 16 00460	MPY	L1
0137	00206	0 06 00406	DAD	DLRZ
0138	00207	0 04 00406	DST	DLRZ
0139	00210	0 16 00412	MPY	D3
0140	00211	0401 77	LRS	1
0141	00212	0 06 00414	DAD	S1
0142	00213	0401 71	LRS	7
0143	00214	0 07 00416	DSB	S2
0144	00215	0 06 00422	DAD	SRND
0145	00216	0401 70	LRS	8
0146	00217	0 06 00406	DAD	DLRZ
0147	00220	0 04 00406	DST	DLRZ
0148	00221	0 02 00414	DLD	DX
0149	00222	0 16 00465	MPY	RX2
0150	00223	0 04 00414	DST	S1
0151	00224	0 02 00416	DLD	DY
0152	00225	0 16 00471	MPY	RY2
0153	00226	0 06 00414	DAD	S1
0154	00227	0 04 00414	DST	S1
0155	00230	0 02 00420	DLD	DZ
0156	00231	0 16 00475	MPY	RZ2
0157	00232	0 06 00414	DAD	S1
0158	00233	0 04 00414	DST	S1
0159	00234	0 02 00460	DLD	L1
0160	00235	0 16 00411	MPY	D2
0161	00236	0 04 00416	DST	S2
0162	00237	0 02 00410	DLD	D1
0163	00240	0 16 00461	MPY	L2
0164	00241	0 06 00416	DAD	S2
0165	00242	0401 61	LRS	15
0166	00243	0 04 00416	DST	S2
0167	00244	0 02 00410	DLD	D1
0168	00245	0 16 00460	MPY	L1
0169	00246	0 06 00416	DAD	S2
0170	00247	0 04 00416	DST	S2
0171	00250	0 02 00414	DLD	DX

MICROCOMP TELECOMMUNICATED DATA

DDP-516 ASSEMBLY LISTING

0172	00251	0 16 00464	MPY	RX1
0173	00252	0 04 00400	DST	DLL
0174	00253	0 02 00416	DLD	DY
0175	00254	0 16 00470	MPY	RY1
0176	00255	0 06 00400	DAD	DLL
0177	00256	0 04 00400	DST	DLL
0178	00257	0 02 00420	DLD	DZ
0179	00260	140407	TCA	
0180	00261	0 16 00474	MPY	RZ1
0181	00262	0 07 00400	DSB	DLL
0182	00263	0 04 00400	DST	DLL
0183	00264	0 16 00412	MPY	D3
0184	00265	0401 77	LRS	1
0185	00266	0 07 00414	DSB	S1
0186	00267	0401 71	LRS	7
0187	00270	0 07 00416	DSB	S2
0188	00271	0 06 00422	DAD	SRND
0189	00272	0401 70	LRS	8
0190	00273	0 06 00400	DAD	DLL
0191	00274	0 04 00400	DST	DLI
0192	00275	140040	CRA	
0193	00276	000201	IAB	
0194	00277	0401 71	LRS	7
0195	00300	140040	CRA	
0196	00301	0 06 00462	DAD	L3
0197	00302	0 04 00462	DST	L3
0198	00303	000201	IAB	
0199	00304	140040	CRA	
0200	00305	0 06 00460	DAD	L1
0201	00306	0 04 00460	DST	L1
0202	00307	0 02 00400	DLD	DLL
0203	00310	0401 71	LRS	7
0204	00311	0 06 00460	DAD	L1
0205	00312	0 04 00460	DST	L1
0206	00313	0 02 00402	DLD	DLRX
0207	00314	140040	CRA	
0208	00315	000201	IAB	
0209	00316	0401 71	LRS	7
0210	00317	140040	CRA	
0211	00320	0 06 00466	DAD	RX3
0212	00321	0 04 00466	DST	RX3
0213	00322	000201	IAB	
0214	00323	140040	CRA	
0215	00324	0 06 00464	DAD	RX1
0216	00325	0 04 00464	DST	RX1
0217	00326	0 02 00402	DLD	DLRX
0218	00327	0401 71	LRS	7
0219	00330	0 06 00464	DAD	RX1
0220	00331	0 04 00464	DST	RX1
0221	00332	0 02 00404	DLD	DLRY
0222	00333	140040	CRA	
0223	00334	000201	IAB	
0224	00335	0401 71	LRS	7
0225	00336	140040	CRA	
0226	00337	0 06 00472	DAD	RY3
0227	00340	0 04 00472	DST	RY3
0228	00341	000201	IAB	

MICROCOMP TELECOMMUNICATED DATA  
DDP-516 ASSEMBLY LISTING

0229	00342	140040	CRA		
0230	00343	0 06 00470	DAD	RY1	
0231	00344	0 04 00470	DST	RY1	
0232	00345	0 02 00404	DLD	DLRY	
0233	00346	0401 71	LRS	7	
0234	00347	0 06 00470	DAD	RY1	
0235	00350	0 04 00470	DST	RY1	
0236	00351	0 02 00406	DLD	DLRZ	
0237	00352	140040	CRA		
0238	00353	000201	IAB		
0239	00354	0401 71	LRS	7	
0240	00355	140040	CRA		
0241	00356	0 06 00476	DAD	RZ3	
0242	00357	0 04 00476	DST	RZ3	
0243	00360	000201	IAB		
0244	00361	140040	CRA		
0245	00362	0 06 00474	DAD	RZ1	
0246	00363	0 04 00474	DST	RZ1	
0247	00364	0 02 00406	DLD	DLRZ	
0248	00365	0401 71	LRS	7	
0249	00366	0 06 00474	DAD	RZ1	
0250	00367	0 04 00474	DST	RZ1	
0251	00370	000005	SGL		
0252	00371	140040	CRA		
0253	00372	0 04 00462	STA	L3	
0254	00373	0 04 00466	STA	RX3	
0255	00374	0 04 00472	STA	RY3	
0256	00375	0 04 00476	STA	RZ3	
0257	00376	-0 01 00000	JMP*	ATTA	
0258	00400	000000	DLL	DBP	0
	00401	000000			
0259	00402	000000	DLRX	DBP	0
	00403	000000			
0260	00404	000000	DLRY	DBP	0
	00405	000000			
0261	00406	000000	DLRZ	DBP	0
	00407	000000			
0262	00410	000000	D1	OCT	0
0263	00411	000000	D2	OCT	0
0264	00412	000000	D3	DBP	0
	00413	000000			
0265	00414	000000	S1	DBP	0
	00415	000000			
0266	00416	000000	S2	DBP	0
	00417	000000			
0267	00420	000000	TRND	OCT	0,40000
	00421	040000			
0268	00422	000000	SRND	OCT	0,200
	00423	000200			
0269		000414	DX	EQU	*414
0270		000416	DY	EQU	DX+2
0271		000420	DZ	EQU	DX+4
0272		000460	L1	EQU	*460
0273		000461	L2	EQU	L1+1
0274		000462	L3	EQU	L1+2
0275		000464	RX1	EQU	L1+4
0276		000465	RX2	EQU	L1+5

MICROCOMP TELECOMMUNICATED DATA  
DDP-516 ASSEMBLY LISTING

0277	000466	RX3	EQU	L1+6
0278	000470	RY1	EQU	L1+8
0279	000471	RY2	EQU	L1+9
0280	000472	RY3	EQU	L1+10
0281	000474	RZ1	EQU	L1+12
0282	000475	RZ2	EQU	L1+13
0283	000476	RZ3	EQU	L1+14
0284	00424	125253	END	



## DISTRIBUTION LIST

### Internal:

R. Ragan	W. Woolsey
D. Hoag	G. Ogletree
N. Sears	R. McKern (10)
R. Battin	R. Trueblood
L. Larson	M. Hamilton
J. Harper	S. Copps
G. Silver (JSC)	J. Kernan
T. Lawton (JSC)	R. Cushing
E. Olsson (JSC)	T. Shuck
R. Cooper	D. Brown
D. Dove	J. StAmand
G. Edmonds	R. White
J. Feldman	L. Willy
P. Felleman	W. Trosky
J. Gilmore (25)	R. Sheridan
S. Helfant	J. Sinkiewicz
R. Hutchinson	C. Lory
G. Bukow	B. Katz
R Booth (50)	D. Sprague
R. Blaha	T. Schamp
K. Vincent	R. White
H. Musoff	E. Salamin
J. Oehrle	M. Johnston
G. McWeeney	R. Millard
D. Swanson	W. Tanner
A. Laats	H. McOuat
E. Jones	Apollo Library (2)
	MIT/DL Doc. Center (10)

External:

NASA/MSC National Aeronautics and Space Administration (36 + 1R)  
Lyndon B. Johnson Space Center  
APOLLO Document Control Group (BM86) (18 + 1R)  
Houston, Texas 77058

Attn: T. Lins, EG2  
K. Cox, EG2  
W. Swingle, EG5  
M. Jones, EG5  
T. Barry, EG5  
J. Hanaway, EG7  
W. Bradford, EA2  
H. Tindall, EA  
R. Chilton, EG  
R. Nobles, FM7  
D. Cheatham, EG  
S. Mann, FM7  
P. Pixley, FM4  
R. Savely, FM4  
A. Weatherstroem, EG5  
S. Kamin, FM7  
B. Cochrell, FM4  
R. Eckelkamp, FM4  
T. Lapko, BC7

NASA/MSFC National Aeronautics and Space Administration (20)  
George C. Marshall Space Flight Center  
Huntsville, Alabama 35812

Attn: M. Brooks, S&E-ASTR-SG  
H. Brown, S&E-ASTR-SGA  
G. Doane, S&E-ASTR-SGA  
B. Doran, S&E-ASTR-SGA  
B. Gaines, R-ASTR-GCC  
B. Moore, S&E-ASTR-DIR  
F. Wojtalik, S&E-ASTR-G  
B. Wiesenmaier, S&E-CSE-F

Codes: A&TS-PR-RS (1)  
A&TS-PR-M (1)  
A&TS-MS-IL (1)  
A&TS-MS-IP (2)  
A&TS-MS-IP (2)  
S&E-ASTR-GD (2)  
S&E-ASTR-S (2)

NASA/HDQ National Aeronautics and Space Administration (3)  
600 Independence Ave., SW  
Washington 25, DC 20546

Attn: R. Murad, MHE  
L. Goolsby, ROA  
E. Hall, MTG

NASA/AMES National Aeronautics and Space Administration (2)  
Ames Research Center  
Moffet Field, California 94035

Attn: R. Hruby  
H. Lessing