

NASA TECHNICAL NOTE

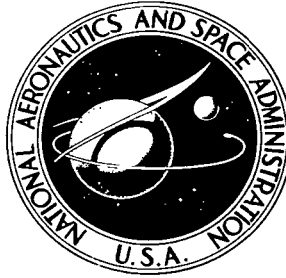

NASA TN D-6215

C.1

NASA TN D-6215



LOAN COPY: RE  
AFWL (DOC  
KIRTLAND AFB, N. M.

LOW-SPEED STATIC WIND-TUNNEL  
INVESTIGATION OF A HALF-SPAN FUSELAGE  
AND VARIABLE-SWEEP PRESSURE WING MODEL

*by John E. Lamar and L. Wayne McKinney*

*Langley Research Center*

*Hampton, Va. 23365*



0132922

1. Report No. NASA TN D-6215	2. Government Accession No.	3. Recipient's Catalog No.	
4. Title and Subtitle LOW-SPEED STATIC WIND-TUNNEL INVESTIGATION OF A HALF-SPAN FUSELAGE AND VARIABLE-SWEEP PRESSURE WING MODEL		5. Report Date August 1971	6. Performing Organization Code
		8. Performing Organization Report No. L-7548	
7. Author(s) John E. Lamar and L. Wayne McKinney		10. Work Unit No. 136-13-01-04	11. Contract or Grant No.
9. Performing Organization Name and Address NASA Langley Research Center Hampton, Va. 23365		13. Type of Report and Period Covered Technical Note	
		14. Sponsoring Agency Code	
12. Sponsoring Agency Name and Address National Aeronautics and Space Administration Washington, D.C. 20546		15. Supplementary Notes	
16. Abstract  <p>The experimental balance and pressure data obtained from tests of an untwisted variable-sweep wing with an outboard pivot exhibited nonlinearities in both total normal-force-coefficient and pitching-moment-coefficient curves for all sweep angles and fuselage conditions. These total effects have been traced back through the section data and pressure distributions to find the causes. The causes of these nonlinearities were found to be (1) separation of flow on the outer panel and (2) a leading-edge vortex flow on the inner panel. A fuselage added to the wing had little effect on the aerodynamic characteristics. Predictions of wing loadings and performance characteristics were made by using the modified Multhopp method and a comparison with experimental results indicated reasonable agreement. The changes in span loading as a result of leading-edge shed-vortex formation and flow separation at the higher angles of attack caused an increase in the induced-drag parameter.</p>			
17. Key Words (Suggested by Author(s)) Variable-sweep wing Pressure distributions Flow separation Comparisons with theory		18. Distribution Statement  Unclassified - Unlimited	
19. Security Classif. (of this report) Unclassified	20. Security Classif. (of this page) Unclassified	21. No. of Pages 322	22. Price* \$6.00



## CONTENTS

	Page
<u>SUMMARY</u> . . . . .	1
<u>INTRODUCTION</u> . . . . .	1
<u>SYMBOLS</u> . . . . .	2
<u>MODEL DESCRIPTION</u> . . . . .	4
<u>TEST CONDITIONS AND PROCEDURE</u> . . . . .	5
<u>RESULTS AND DISCUSSION</u> . . . . .	6
GENERAL COMMENTS . . . . .	6
PRESENTATION OF RESULTS . . . . .	6
FLOW SEPARATION . . . . .	7
Near the Leading Edge . . . . .	7
Inboard of leading-edge break . . . . .	7
Outboard of leading-edge break . . . . .	8
At the Trailing Edge . . . . .	9
SECTION AND TOTAL NORMAL-FORCE AND PITCHING-MOMENT COEFFICIENTS . . . . .	10
<u>COMPARISONS BETWEEN THEORY AND EXPERIMENT</u> . . . . .	11
<u>SUMMARY OF RESULTS</u> . . . . .	14
<u>APPENDIX A – VARIABLE-SWEEP-WING PRESSURE DATA FOR                     FUSELAGE OFF</u> . . . . .	15
<u>APPENDIX B – VARIABLE-SWEEP-WING PRESSURE DATA FOR                     FUSELAGE ON</u> . . . . .	137
<u>APPENDIX C – FORWARD-FACING CUBIC-CURVE-FIT METHOD WITH                     ARBITRARY SPACING AND FLOATING ORIGIN</u> . . . . .	253
<u>REFERENCES</u> . . . . .	264
<u>FIGURES</u> . . . . .	265

# LOW-SPEED STATIC WIND-TUNNEL INVESTIGATION OF A HALF-SPAN FUSELAGE AND VARIABLE-SWEEP PRESSURE WING MODEL

By John E. Lamar and L. Wayne McKinney  
Langley Research Center

## SUMMARY

The experimental balance and pressure data obtained from wind-tunnel tests of an untwisted variable-sweep wing with an outboard pivot exhibited nonlinearities in both total normal-force-coefficient and pitching-moment-coefficient curves for all sweep angles and fuselage conditions. These total effects have been traced back through the section data and pressure distributions to find the causes. The causes of these nonlinearities were found to be (1) separation of flow on the wing outer panel and (2) a leading-edge vortex flow on the inner panel. A fuselage added to the wing had little effect on the aerodynamic characteristics.

Predictions of wing loadings and performance characteristics were made by using the modified Multhopp method and a comparison with experimental results indicated reasonable agreement. The changes in span loading as a result of leading-edge shed-vortex formation and flow separation at the higher angles of attack caused an increase in the induced-drag parameter.

## INTRODUCTION

For many years, the National Aeronautics and Space Administration has been studying both experimentally and analytically the aerodynamic characteristics of vehicles utilizing variable-sweep wings to provide multimission capability or to minimize the aerodynamic-center movement and the resulting trim drag penalties over a wide speed range. Results of these studies are contained in a large number of technical reports, many of which are summarized conveniently in reference 1 for supersonic-transport-type aircraft and in reference 2 for military fighter-type airplanes.

The referenced studies have usually been concerned with the overall aerodynamic characteristics of variable-sweep wings and, therefore, there is insufficient detailed information to explain the unusual variations sometimes obtained with these configurations. Tuft and other flow visualization studies are useful in establishing that changes in the flow over the wing have occurred. These studies can be used to explain the cause of the data variation insofar as relative values are concerned. However, in order to provide

the detailed information required to quantitatively establish local flow characteristics, it is necessary to obtain the pressure distributions over the wing. Therefore, a model of a variable-sweep pressure wing was built and tested at three different sweep positions to provide this information, and the results are reported herein. The data obtained are discussed initially from the standpoint of where and when flow breakdown occurs and how the integrated pressures influence the section and total aerodynamic characteristics. Also presented are (1) a correlation of the integrated pressure data with respect to the force-balance data, (2) fuselage and sweep effects, and (3) appropriate comparisons with results predicted by using the modified Multhopp method of reference 3. Tables and plots of the pressure data are presented in appendixes A and B and the method used to compute the section normal-force and pitching-moment coefficients is developed in appendix C.

### SYMBOLS

Values are given in both SI and U.S. Customary Units. The measurements and calculations were made in U.S. Customary Units.

A	aspect ratio,	$b^2/S_{ref}$
b	span, meters (inches); listed as B in appendixes A and B	
$C_{D,i}$	total vortex drag coefficient,	$A \int_{-1}^1 \frac{c_l^c}{2b} \alpha_i d\frac{y}{b/2}$
$\Delta C_D$	increment in total drag coefficient associated with zero thrust (drag due to lift)	
$C_L$	total lift coefficient,	$\frac{\text{Lift}}{q_\infty S_{ref}}$
$C_{L\alpha}$	total lift-curve slope,	$\left. \frac{\partial C_L}{\partial \alpha} \right _{C_L=0}$ , per radian
$C_m$	total pitching-moment coefficient about	$\frac{c_{ref}}{4}$ , $\frac{\text{Pitching moment}}{q_\infty S_{ref} c_{ref}}$
$C_{m\alpha}$	total pitching-moment-coefficient-curve slope,	$\left. \frac{\partial C_m}{\partial \alpha} \right _{C_m=0}$ , per degree
$C_N$	total normal-force coefficient,	$\frac{\text{Normal force}}{q_\infty S_{ref}}$

$C_{N\alpha}$	total normal-force-coefficient-curve slope, $\left. \frac{\partial C_N}{\partial \alpha} \right _{C_N=0}$ , per degree
$C_p$	pressure coefficient, $\frac{p - p_\infty}{q_\infty}$ ; listed as CP in appendixes A and B
$C_{p,u}$	pressure coefficient on wing upper surface, $\frac{p_u - p_\infty}{q_\infty}$ ; listed as CPU in appendixes A and B
$C_{p,l}$	pressure coefficient on wing lower surface, $\frac{p_l - p_\infty}{q_\infty}$ ; listed as CPL in appendixes A and B
$\Delta C_p$	incremental pressure coefficient, $C_{p,l} - C_{p,u}$
$c$	local chord, meters (inches); listed as C in appendixes A and B
$c_{av}$	average chord, meters (inches), $\frac{2 \int_0^{b/2} c \, dy}{b}$
$c_l$	section lift coefficient
$c_m$	section pitching-moment coefficient about local leading edge, $\int_0^1 (x/c) \Delta C_p \, d(x/c)$
$c_{m\alpha}$	section pitching-moment-coefficient-curve slope, $\left. \frac{\partial c_m}{\partial \alpha} \right _{c_m=0}$ , per degree
$c_n$	section normal-force coefficient, $\int_0^1 \Delta C_p \, d\frac{x}{c}$
$c_{n\alpha}$	section normal-force-coefficient-curve slope, $\left. \frac{\partial c_n}{\partial \alpha} \right _{c_n=0}$ , per degree
$c_{ref}$	reference chord (mean geometric chord of the $\Lambda = 30^\circ$ outer panel when extended to plane of symmetry), 30.968 centimeters (12.192 inches)

m	number of span stations where pressure modes are defined in modified Multhopp method
N	number of chordal control points at each span station employed in modified Multhopp method
p	local static pressure, newtons/meter <sup>2</sup> (pounds/foot <sup>2</sup> )
p <sub>u</sub>	local static pressure on wing upper surface, newtons/meter <sup>2</sup> (pounds/foot <sup>2</sup> )
p <sub>l</sub>	local static pressure on wing lower surface, newtons/meter <sup>2</sup> (pounds/foot <sup>2</sup> )
p <sub>∞</sub>	free-stream static pressure, newtons/meter <sup>2</sup> (pounds/foot <sup>2</sup> )
q <sub>∞</sub>	free-stream dynamic pressure, newtons/meter <sup>2</sup> (pounds/foot <sup>2</sup> )
S <sub>ref</sub>	reference area, 0.326 meter <sup>2</sup> (3.503 feet <sup>2</sup> )
x,y	chordwise and spanwise distances, respectively, centimeters (inches); listed as X and Y in appendixes A and B
x <sub>ac</sub>	distance from leading edge of reference chord to aerodynamic center (positive aft), $-\frac{\partial C_m}{\partial C_L} \Big _{C_L=0} + \frac{1}{4}$ , in fractions of c <sub>ref</sub>
α	wing angle of attack, degrees
α <sub>i</sub>	induced angle of attack, degrees
Λ	leading-edge sweepback angle of wing outer panel, degrees

### MODEL DESCRIPTION

The untwisted, semispan, variable-sweep pressure wing model tested was composed of three different outer wing panels having leading-edge sweepback angles of 15°, 30°, and 40° and a common inner panel. Three outer panels were used so that the pressure ports on the outer panel would be in streamwise rows. These assembled components can be seen in figures 1, 2, and 3. In order to accommodate the changes in



spanwise position of the break (between the inner and outer panels) with changes in sweep, fairing blocks were used as indicated in figure 2.

The wings were composed of basic NACA 64AOXX airfoil sections. In order to account for change in streamwise thickness with sweep, the thickness ratio varied at the different sweep angles as indicated in figure 2. It should be pointed out that the thicknesses of the  $\Lambda = 15^\circ$  and  $40^\circ$  outer panels are not exactly those that would be obtained by sweeping the reference wing ( $\Lambda = 30^\circ$ ). These values are, however, the closest even percentages of thickness and were chosen to facilitate comparisons with two-dimensional data.

The effects of a fuselage were simulated by mounting a common semicircular half-span fuselage model with a maximum radius of 8.89 cm (3.5 in.) over the inner panel for each different wing outer panel tested. A drawing of the fuselage-wing combination is shown in figure 1 and photographs of most of the combinations are presented as figure 3.

The spanwise distances to the pressure ports are given in figure 2(a); the chordwise locations  $x/c$  are the same for the three panels and are at 0, 0.025, 0.050, 0.075, 0.10, 0.20, 0.30, 0.40, 0.60, 0.80, and 1.00. The geometric data for the  $\Lambda = 30^\circ$ , or reference, wing (fig. 2(b)) were used to reduce the force and moment data to coefficient form.

### TEST CONDITIONS AND PROCEDURE

The models were tested from the sidewall of the Langley high-speed 7- by 10-foot tunnel at a Mach number of 0.23 with an average dynamic pressure of  $3734.7 \text{ N/m}^2$  ( $78 \text{ lb/ft}^2$ ) and temperature of  $7.2^\circ \text{ C}$  ( $45^\circ \text{ F}$ ). These conditions result in a Reynolds number of  $5.58 \times 10^6$  per meter or  $1.7 \times 10^6$  per foot. The models were tested without fixed transition. All tests were conducted through an angle-of-attack range from approximately  $-4^\circ$  to  $31^\circ$  with the fuselage off and from about  $-4^\circ$  to  $25^\circ$  with the fuselage on. The angles of attack were corrected for jet-boundary effects by the method of reference 4.

The models were mounted on a sidewall turntable and balance system through a reflection plane as shown in figure 1. The reflection plane was used not only to provide the effects induced by the other half wing and fuselage but also to move the model out from the influence of the tunnel-wall boundary layer. No attempt was made to account for the effects of the reflection-plane boundary layer.

The pressures were measured by five pressure transducers which have a maximum error of not more than 1/2 of 1 percent full-scale which would result in a maximum error in pressure coefficient of  $\pm 0.022$ . The dynamic pressures used to compute the pressure coefficients were taken to be the average of the dynamic pressures measured by these five gages.

## RESULTS AND DISCUSSION

### GENERAL COMMENTS

The measured pressure data on the variable-sweep-wing models are presented in tabular and graphical form in appendixes A and B for the fuselage off and fuselage on, respectively. Most of these data are not discussed in detail, but some of the data which illustrate points of flow separation, formation of vortex near the leading edge, or other interesting phenomena are singled out for the reader's inspection. These data not only are used to determine the aforementioned interesting occurrences but also are integrated chordwise by the method described in appendix C to arrive at section characteristics that are then integrated spanwise for certain test conditions to obtain the total longitudinal aerodynamic characteristics. The chordwise integrations are performed for all sweep angles with the fuselage off and on, and these data are compared with theoretical results.

### PRESENTATION OF RESULTS

The results obtained in this investigation are presented in the following figures:

	Figure
Effect of spanwise location on the flow separation near the leading edge of a variable-sweep wing at $\Lambda = 15^\circ$ with fuselage on . . . . .	4
Tuft patterns on a variable-sweep wing at $\Lambda = 15^\circ$ with fuselage on . . . . .	5
Effect of angles of attack and sweepback on the trailing-edge flow separation at $x/c = 1.00$ of a variable-sweep wing with fuselage off . . . . .	6
Effect of spanwise location on the section normal-force coefficients . . . . .	7
Effect of spanwise location on the section pitching-moment coefficients . . . . .	8
Effect of sweep on total normal-force and pitching-moment coefficients as determined from force balance data . . . . .	9
Correlation of integrated pressure data with force balance data for $\Lambda = 30^\circ$ and fuselage off . . . . .	10
Effect of angle of attack and fuselage on span load distribution . . . . .	11
Effect of fuselage on $C_{N_\alpha}$ and $C_{m_\alpha}$ . . . . .	12
Experimental and theoretical wing-alone span load distribution at $\Lambda = 30^\circ$ and $\alpha = 5.76^\circ$ . . . . .	13
Effect of spanwise location on the experimental and theoretical wing-alone chordwise pressure distributions at $\Lambda = 30^\circ$ and $\alpha = 5.76^\circ$ . . . . .	14
Experimental and theoretical section normal-force-coefficient-curve slopes . . . . .	15

	Figure
Experimental and theoretical section pitching-moment-coefficient-curve slopes . . . . .	16
Effect of sweepback angle on wing-alone longitudinal aerodynamic characteristics . . . . .	17
Experimental and theoretical drag-due-to-lift variations as effected by span loading and loss of leading-edge suction for $\Lambda = 30^\circ$ and fuselage off . . . . .	18

## FLOW SEPARATION

Because of the high sweep angle of the inner panel and the relatively thin outer panel, a leading-edge type of flow separation and a shed vortex are to be expected. Most of the discussion deals with this kind of flow.

### Near the Leading Edge

The  $\Lambda = 15^\circ$   $C_{p,u}$  data selected for presentation in figure 4 are taken from appendix B and are plotted as a function of  $\alpha$ . The  $C_{p,u}$  data were obtained from pressure ports at several different spanwise stations near the leading edge. From the replotted data, it is possible to determine where flow separation begins, how it progresses, and at what angles of attack the effect of the vortex becomes important. The data for the  $\Lambda = 15^\circ$  fuselage-on test configuration were selected because (1) they are typical for these test and model conditions and (2) tuft flow patterns on this configuration had been photographed (fig. 5) and should prove useful in interpreting the pressure data.

Before detail studies of the data in figure 4 are made, the conditions of flow separation and leading-edge shed vortex are described in terms of the pressure variations. The initiation of flow separation is indicated when the  $C_{p,u}-\alpha$  curve exhibits its first inflection point which is followed by a reduction in the rate of change of suction pressure. The separation could, of course, be followed by a reattachment. The flow is assumed to be fully separated when both (1) the  $C_{p,u}-\alpha$  curve reaches a local minimum suction after the first inflection point and (2) the  $C_{p,u}-\alpha$  curve remains essentially constant with increasing  $\alpha$ . The leading-edge shed vortex shows up in the pressure graphs either as a sudden increase in  $C_{p,u}$  after which the  $C_{p,u}$  level remains about constant or as a local maximum suction followed by an essentially constant value of  $C_{p,u}$ .

Inboard of leading-edge break.- An analysis of the data in figure 4 indicates that the flow separates and, hence, a leading-edge vortex forms at the juncture between the inner and outer panels ( $2y/b \approx 0.334$ ) at approximately  $4.5^\circ$  angle of attack. The  $C_{p,u}$  data also show that at  $2y/b = 0.334$  (just slightly outboard of the juncture),  $x/c = 0$ , and  $\alpha = 0$  almost full stagnation pressure is developed (which is to be expected due to the low leading-edge sweep on the outer panel).

Since the wing does not have a sharp leading edge, the flow begins to separate a short distance aft of the leading edge at a point where the separation burble would be formed. However, before the flow can become fully separated at this spanwise station, the point at which the leading-edge vortex forms moves from the leading-edge break forward and inboard in the region of the fairing blocks. Thus, the station near the leading-edge break becomes influenced by the vortex, and the suction pressures increase as seen at about  $6^\circ$  angle of attack. Notice that between  $\alpha = 6^\circ$  and  $9.6^\circ$  the pressures at  $x/c = 0.025, 0.050, \text{ and } 0.200$  first increase and then decrease rather than continue to increase as would be expected for pressure ports underneath a vortex shed from the leading edge. The reasons for this behavior are (1) in this angle-of-attack range, the vortex origination point has not moved forward along the leading edge beyond the inboard edge of the fairing blocks, which may be due in part to the increase in leading-edge radius and actual thickness levels that are found moving inboard in a spanwise direction from the leading-edge break, and (2) with increasing angle of attack, the vortex tends to move up and away from the upper surface.

Above  $\alpha = 9.6^\circ$ , the vortex begins to form successively more inboard along the leading edge with each increase in angle of attack which adds more circulation to the vortex near the leading edge. In general, this increased circulation causes the suction pressure to rise at  $2y/b = 0.334$  and  $x/c = 0.025, 0.050, \text{ and } 0.200$  until the vertical displacement of the shed vortex is sufficient to reduce the effects of the increase in circulation. Afterwards, the suction pressures are reduced and take on nearly constant values which is indicative of a separated flow condition. However, at  $x/c = 0$  the suction pressures are, for the most part, continually increasing because the shed-vortex feeding sheet must pass either over the pressure port or very close by it.

From figure 4 it can be seen that, at  $2y/b = 0.217$ , the flow around the leading edge separates near  $\alpha = 15^\circ$ ; this is, in general, a higher angle of attack than that required for separation aft of the leading edge. The effects of the shed vortex on  $C_{p,u}$  become noticeable at  $x/c = 0.200$  as early as  $\alpha = 10.5^\circ$ , whereas the vortex effects are not noticeable at  $x/c = 0.025$  and  $0.050$  until  $\alpha \approx 16^\circ$ .

At the most inboard station ( $2y/b = 0.130$ ) at which data were taken during the tests with the fuselage on, the results showed attached flow at the leading edge for all angles of attack and the effects of some separation and shed vortex at the other pressure ports. However, the separation and vortex effects occur at a higher angle of attack at  $2y/b = 0.130$  than at  $2y/b = 0.217$ , because of the more inboard location on the wing.

Outboard of leading-edge break.- The tuft patterns in figure 5 show that the flow outboard of the leading-edge break is attached and basically streamwise up until about  $\alpha \approx 6^\circ$  where some spanwise flow occurs. The pressure data in appendix B (pp. 156-159) also indicate that attached flow is to be expected up to  $\alpha \approx 6^\circ$ . Above  $\alpha \approx 6^\circ$  or  $7^\circ$  the

flow near the leading edge begins to separate as indicated by the pressure measurements, and the erratic flow behavior associated with separation is seen in the tuft patterns. For further increase in angle of attack, more and more of the leading edge becomes completely stalled. It should be recognized that the data presented are for a flat wing; however, appropriate twist and camber of the outer panel of the wing should delay leading-edge flow separation, and consequently stall, until higher angles of attack are reached.

#### At the Trailing Edge

Fuselage-off trailing-edge pressures (appendix A) for  $\Lambda = 15^\circ$ ,  $30^\circ$ , and  $40^\circ$  are presented in figure 6 at several nominal angles of attack. From the figure it can be seen that the trailing-edge flow does not separate inboard of the leading-edge break at least up to  $\alpha \approx 10.4^\circ$ . However, below  $\alpha \approx 10.4^\circ$  the flow has begun to separate along the trailing edge on the outer panel at the following spanwise stations either slightly before or at the indicated angles of attack:

$\Lambda$ , deg	$\alpha$ , deg	$2y/b$
15 . . . . .	$\approx 6.3$	0.33
30 . . . . .	$\approx 7.3$	0.90
40 . . . . .	$\approx 5.8$	0.70

Once trailing-edge type of flow separation has occurred at any spanwise station, increasing the angle of attack generally leads to more flow separation along the trailing edge. Further increases in angle of attack finally lead to complete flow separation or detachment all along the trailing edge of the outer panel. The angles of attack at which this complete separation occurs are as follows:

$\Lambda$ , deg	$\alpha$ , deg
15	$\approx 8.4$
30	$\approx 9.4$
40	<sup>a</sup> $\approx 9.4$

The angles of attack at which the flow begins to separate on the outer panel and those at which the flow becomes fully separated differ for the fuselage-on and fuselage-off models only for  $\Lambda = 40^\circ$ . The differences are the beginning of separation at

---

<sup>a</sup>From the data at  $2y/b = 0.6$  for  $\Lambda = 40^\circ$ , it appears that the flow has reattached at this time; however, it is thought that once trailing-edge type of flow separation has occurred at a station the further increases in the angle of attack can only exaggerate the separation and, hence, these data are subject to question.

$\alpha \leq 5.31^\circ$  or about  $0.5^\circ$  sooner (even though at the same spanwise station) and fully separated flow at  $\alpha \leq 8.4^\circ$  or about  $1^\circ$  sooner for the fuselage-on model.

As a note of interest, the two-dimensional trailing-edge stall has occurred for the NACA 64A006 airfoil at  $\alpha = 8^\circ$  as shown in reference 5.

Although complete flow separation has occurred along the trailing edge of the outer panel at  $\alpha > 10.4^\circ$ , it isn't until  $\alpha \approx 16^\circ$  that trailing-edge flow separation can be seen from the pressure data for the inner panel (appendix B;  $\Lambda = 15^\circ$ , fuselage on,  $\alpha = 15.6^\circ$ ). The tuft patterns also indicate that the trailing-edge flow separates at  $2y/b = 0.217$  for  $\alpha \leq 16^\circ$ . Once separation begins on the inner panel, increasing the angle of attack causes more flow separation.

### SECTION AND TOTAL NORMAL-FORCE AND PITCHING-MOMENT COEFFICIENTS

The section normal-force coefficient, section pitching-moment coefficient, and total normal-force and pitching-moment coefficients are presented in figures 7, 8, and 9, respectively. Correlation of these data is made not only to explain total effects in terms of section characteristics but also to substantiate that the integrated pressure data give overall results not much different from those obtained from force balance measurements. The effects of the fuselage on these section and total data are seen in figures 9, 11, 12, 15, and 16 to be small.

The balance data indicate (fig. 9) that for  $\Lambda = 15^\circ, 30^\circ$ , and  $40^\circ$  the wing developed a nonlinearity in both the normal-force-coefficient and the pitching-moment-coefficient curves between angles of attack of  $9^\circ$  and  $16^\circ$ . This nonlinearity was also found in the surface pressure integrations at  $\Lambda = 30^\circ$  as shown in figure 10. Therefore, in an attempt to correlate the pressure measurement data and the resulting integrated section normal-force-coefficient and pitching-moment-coefficient data with the nonlinearities of the wing normal-force-coefficient and pitching-moment-coefficient curves, it is necessary to examine figures 4, 5, 7, and 8 and appendixes A and B. From these figures, it is apparent that there are two phenomena which occur in this angle-of-attack range ( $\alpha = 9^\circ$  to  $16^\circ$ ). The first phenomenon is flow separation on the outer-panel trailing edge above  $\alpha \approx 9^\circ$  for all test sweep angles, as already discussed and shown in figure 6. The second phenomenon is the change in flow around the wing leading edge. For example, on the outboard 55 percent of the wing outer panel the pressure data (appendix A, pp. 76 to 85) show that flow separation occurs on the leading edge. Because of the low to moderate values of  $\Lambda$  and because of the outer-panel aspect ratio, the separated flow does not form into a tightly rolled up vortex sheet and produce an increase in normal force (vortex lift); instead, a loss in normal force like that usually found for wings having

separated flow regions occurs on this section of the outer panel. However, on the inner panel flow near the leading edge forms a separation burble and, because of the high sweepback angle, the air inside this burble forms into a spanwise vortex which results in an increase in normal force. (See fig. 7(c) for typical results of both types of changes in  $c_{n\alpha}$ .) These two phenomena, loss in section normal force outboard and increase in section normal force near the leading edge inboard (which can be seen in fig. 11), produce the nonlinearities in the normal-force-coefficient curves in this  $\alpha$  range. These phenomena also produce the changes in the  $c_m$  curves (fig. 8) which show up as a nonlinearity in the total pitching-moment-coefficient curves. The nonlinearity in the  $C_m-\alpha$  curve also does not appear outside this  $\alpha$  range because for the most part the separation has not begun or become significant or the flow has fully separated so that once again a pseudostabilized flow exists. In either of these  $\alpha$  ranges if the  $c_n$  or  $c_m$  curves are quasi-linear, then the  $C_N$  and  $C_m$  curves will also be basically linear.

In order to substantiate that the pressure data behave as presented in appendixes A and B, the integrations of the pressure data over the wing are compared with balance data in figure 10. The agreement between the two sets of data is good; this indicates that the tabulated pressure data are correct within tolerances and that the methods of fairing used for the chordwise and spanwise pressure data produced curves which were reasonable. Note that an extrapolation of the data to the plane of symmetry had to be made at each angle of attack.

## COMPARISONS BETWEEN THEORY AND EXPERIMENT

To illustrate the degree to which a potential-flow theoretical method, such as the one described in reference 3, predicts the measured span and chord loadings, comparisons between theory and experiment are made in figures 13 and 14 for  $\Lambda = 30^\circ$  at an angle of attack where flow separation is not severe. The angle of attack selected is  $5.76^\circ$  and for this value of  $\alpha$  the modified Multhopp method (ref. 3) predicts well the distribution of the experimental span-loading parameter  $c_{nc}/C_{Nc_{av}}$ . (See fig. 13.) For the same angle of attack, the chordwise distribution of lifting pressure is also generally well predicted by the theory (fig. 14) at several spanwise stations.

Comparisons between theory and experiment for  $\Lambda = 15^\circ, 30^\circ$ , and  $40^\circ$  are presented in terms of the slopes of the section normal-force coefficient and pitching-moment-coefficient curves in figures 15 and 16. The  $c_{n\alpha}$  trends shown in figure 15 indicate reasonable agreement between experiment (fuselage-on and fuselage-off data) and theory. The values of  $c_{n\alpha}$  are closely predicted inboard of  $2y/b = 0.40$  for  $\Lambda = 15^\circ$  and  $30^\circ$ . Outboard of  $2y/b = 0.40$ , however, the theoretical values of  $c_{n\alpha}$  are larger than the experimental values for all test sweep angles. This overprediction results in a higher

theoretical value of  $C_{N\alpha}$ . For  $\Lambda = 15^\circ$  and  $40^\circ$ , the wing outer panel has a skewed tip (zero taper) which results in large values of  $c_{n\alpha}$  (figs. 15(a) and 15(c)); this phenomenon is the same as that found for delta wings.

The trends and values of  $c_{m\alpha}$  shown in figure 16 are predicted reasonably well by the theory except that inboard of  $2y/b = 0.20$  and around  $2y/b = 0.45$  some differences are noted for  $\Lambda = 40^\circ$ . In general, when differences between theory and experiment exist, they occur on the outer panel and result in the prediction of a more stable section pitching-moment coefficient than is found experimentally. When this increase in local stability is translated into the total pitching-moment-coefficient-curve slope, the theoretical value is more stable than the experimental value.

The total longitudinal aerodynamic characteristics were also predicted by theory for  $\Lambda = 15^\circ, 30^\circ$ , and  $40^\circ$  and are presented with the experimental fuselage-off data in figure 17. In general, the trends are well predicted but the absolute levels differ by a maximum of about 10 percent for  $C_{N\alpha}$ , 27 percent for  $C_{m\alpha}$ , 4.5 percent (ahead) of  $c_{ref}$  for  $x_{ac}$ , and 20 percent for  $C_{D,i}/C_L^2$ .

Because of the insensitivity of the axial-force gage of the balance used, no satisfactory drag measurements could be made. However, an analysis of the drag due to lift based on the theoretical span loadings, the experimental span loadings, and the normal-force characteristics may be of some interest. The induced drag is one part of the drag due to lift that is examined. Calculations for the induced-drag parameter  $C_{D,i}/C_L^2$  are based on equation (143) of reference 6 and the results are presented in figure 17 (for  $\alpha = 5.5^\circ \pm 0.3^\circ$ ) and in figure 18 (for various angles of attack). The equation used for the calculations is as follows:

$$\frac{C_{D,i}}{C_L^2} = \frac{b^2}{S_{ref}C_L^2} \int_{-1}^1 \frac{c_l c}{2b} \alpha_i d\left(\frac{2y}{b}\right)$$

and only applies rigorously to spanwise lift distributions, as can be seen. It can be approximately applied to the experimental spanwise normal-force distributions provided the following two assumptions are made:

(1) The experimental  $c_{nc}/2b-2y/b$  curve has the same shape as the  $c_l c/2b-2y/b$  curve.

(2) When the experimental  $c_{nc}/2b-2y/b$  curve is integrated with  $\alpha_i$  across the span and multiplied by  $b^2/S_{ref}C_N^2$ , it is in the same proportion as the usual definition for  $C_{D,i}/C_L^2$  given previously (that is,  $\frac{C_{D,i}}{C_L^2} \approx \frac{C_{D,i}}{C_N^2} = \frac{b^2}{S_{ref}C_N^2} \int_{-1}^1 \frac{c_{nc}}{2b} \alpha_i d\left(\frac{2y}{b}\right)$ ).



It must be kept in mind that the preceding method deals only with the induced drag and, of course, gives no indication of the profile drag due to lift that would have been included in any force measurements.

The induced-drag results presented in figure 18 represent the assumptions of (1) an elliptical span loading, (2) the theoretical span loading for the wing in question, and (3) the experimentally determined span loading. Also presented are total drag-due-to-lift results based on the assumption that no leading-edge suction is developed and that the friction drag is independent of the lift coefficient. With these assumptions, the resultant force is essentially normal to the chord plane and the drag-due-to-lift parameter is given by

$$\frac{\Delta C_D}{C_L^2} = \frac{C_N \sin \alpha}{C_N^2 \cos^2 \alpha} = \frac{\sin \alpha}{C_N \cos^2 \alpha}$$

This expression uses the experimental normal-force results. For the potential-flow calculation assuming no suction, the expression  $\Delta C_D/C_L^2 = 1/C_{L\alpha}$  was used.

From the results presented in figure 18, the following observations can be made:

(1) The deviation of the theoretical span loading from an elliptical shape results in only a minor penalty in induced drag as seen by the fact that the induced-drag parameter is within 4 percent of  $1/\pi A$ . The same is true for the effect of the experimental span loading in the low angle-of-attack range.

(2) As the angle of attack increases, substantial increases in induced drag occur due to the increased proportion of the actual loading carried inboard of the leading-edge break (attributed to vortex lift effects on the highly swept inner panel as illustrated in fig. 11(b)).

(3) The experimentally determined zero-percent leading-edge-suction results are higher than those predicted by theory because the actual angle of attack required for a given lift is greater than the angle predicted by theory.

With regard to the change in span loading with increasing  $\alpha$  and its effect on the induced-drag parameter, in the range of  $\alpha$  where the span loading is increasing inboard of the leading-edge break the pressures on the wing upper surface near the leading edge show that the suction peaks are beginning to be no longer developed (appendix A,  $\Lambda = 30$ ,  $\alpha = 18.56^\circ$ ). Thus, the loss in leading-edge suction is showing up as an increase in the section normal force in the same manner as was predicted for sharp-edge delta wings by the leading-edge suction method of reference 7.

## SUMMARY OF RESULTS

From a study of the results obtained from tests of an untwisted variable-sweep pressure wing, the following summary is presented:

1. Most of the wing outer panel experienced leading-edge flow separation at moderate angles of attack because the wing was thin and untwisted. The flow near the leading edge of the wing inner panel began to separate at the leading-edge break at an angle of attack of about  $5^{\circ}$ . With increasing angle of attack the separation point moved inboard and forward to the leading edge. However, at any given inboard spanwise location, flow separation occurred only after parts of the section aft of the wing leading edge, and nearby, had already experienced it. The nonlinearity in the curves of total normal-force coefficient and pitching-moment coefficient can be explained in terms of the nonlinear section normal-force development on the wing inner panel due to the leading-edge shed vortex and the loss in section normal force on the wing outer panel due to flow separation. Both effects depend on angle of attack.

2. The modified Multhopp theory (presented in NASA TN D-4427) predicts well the trends of the experimental pressure and the section and total longitudinal aerodynamic characteristics prior to flow separation but the absolute levels predicted disagree slightly.

3. The fuselage was found to have little effect on the section or total longitudinal aerodynamic characteristics.

4. The pressure integration technique used to obtain the section aerodynamic characteristics was adequate as was verified by integrating these results across the span and then comparing these data with balance data.

5. At angles of attack larger than  $10^{\circ}$  to  $12^{\circ}$ , significant increases in the induced-drag parameter occur because of the changes in the span loading associated with leading-edge shed vortex inboard of the leading-edge break and separated flow outboard of the break.

6. The induced-drag parameter at zero-percent leading-edge suction is underpredicted by the theory because the theoretical lift-curve slope is too high.

Langley Research Center,  
National Aeronautics and Space Administration,  
Hampton, Va., May 7, 1971.

## APPENDIX A

### VARIABLE-SWEEP-WING PRESSURE DATA FOR FUSELAGE OFF

The pressure measurements made on the variable-sweep wings with fuselage off (fig. 2 and top photographs of figs. 3(b) and 3(c)) are presented in this appendix in coefficient form in tables and graphs on facing pages. The data for the three sweepback angles are arranged in order of increasing angle of attack. These data begin on page 16 for  $\Lambda = 15^\circ$ , page 56 for  $\Lambda = 30^\circ$ , and page 96 for  $\Lambda = 40^\circ$ .

# APPENDIX A

## P R E S S U R E M E A S U R E M E N T S

OUTER PANEL SWEEP= 15.0000 DEGREES

FUSELAGE OFF

ANGLE OF ATTACK= -4.38751 DEGREES

### S P A N W I S E L O C A T I O N

	2Y/B .04333	2Y/B .12996	2Y/B .21661	2Y/B .33426	2Y/B .43233	2Y/B .48036	2Y/B .57641	2Y/B .67250	2Y/B .86465
X/C	-CPU	-CPU	-CPU	-CPU	-CPU	-CPU	-CPU	-CPU	-CPU
0.000	-.02024	.08273	.30931	1.80093	.09338	.03994	.36339	-.18368	-.48418
.025	-.05297	-.03928	-.02793	-.57960	-.45820	-.47470	-.46488	-.46166	-.44055
.050	-.02381	-.02678	-.01810	-.31750	-.29571	-.29529	-.27303	-.28010	-.30191
.075	-.02500	0.00000	-.00983	-.22661	-.20233	-.22851	-.20232	-.21183	-.21465
.100	-.01190	.00893	-.00259	-.14070	-.13945	-.15649	-.14077	-.14990	-.13160
.200	.01666	.03333	.01759	.00436	0.00000	-.00327	-.00524	-.01408	-.02322
.300	.03690	.07320	.03517	.07035	.08715	.07923	.08053	.06615	.04715
.400	.03869	.05654	.03827	.12264	.13696	.12506	.11262	.10275	.07530
.600	.05654	.04702	.03982	.09463	.11144	.10869	.09690	.09782	.07460
.800	.03095	.02262	.02121	.02864	.01681	.02815	.01964	.03026	.00985
1.000	-.05654	-.07201	-.07086	-.06350	-.11642	-.07268	-.10149	-.03026	-.01408
X/C	-CPL	-CPL	-CPL	-CPL	-CPL	-CPL	-CPL	-CPL	-CPL
0.000	-.02024	.08273	.30981	1.80093	.09338	.03994	.36339	-.18368	-.48418
.025	.11844	.24521	.39204	1.55549	1.19481	1.19845	1.11196	1.14870	1.16137
.050	.12320	.23092	.33722	1.11569	1.04904	1.05102	.98091	.98248	.76416
.075	.14819	.22676	.34374	.83648	.79998	.79088	.78826	.77049	.65499
.100	.15117	.20474	.31860	.76885	.73648	.72208	.71422	.68175	.56555
.200	.16903	.20057	.27931	.56466	.59952	.60479	.57465	.54583	.44934
.300	.16188	.21604	.27567	.48123	.53228	.51595	.49434	.48244	.43878
.400	.19045	.24104	.27567	.42956	.48123	.46488	.45309	.44723	.36764
.600	.17617	.19640	.23740	.26708	.30879	.30446	.29726	.28221	.23928
.800	.11903	.12260	.09827	.11330	.09587	.09690	.09690	.10838	.09290
1.000	-.05654	-.07201	-.07036	-.06350	-.11642	-.07268	-.10149	-.03026	-.01408

## P R E S S U R E M E A S U R E M E N T S

OUTER PANEL SWEEP= 15.0000 DEGREES

FUSELAGE OFF

ANGLE OF ATTACK= -3.79080 DEGREES

### S P A N W I S E L O C A T I O N

	2Y/B .04333	2Y/B .12996	2Y/B .21661	2Y/B .33426	2Y/B .43233	2Y/B .48036	2Y/B .57641	2Y/B .67250	2Y/B .86465
X/C	-CPU	-CPU	-CPU	-CPU	-CPU	-CPU	-CPU	-CPU	-CPU
0.000	-.02560	.05729	.21626	1.21145	-.25468	-.16490	.16894	-.43994	-.62431
.025	-.04876	-.02621	-.03832	-.49912	-.37050	-.40989	-.37153	-.39296	-.39723
.050	-.01928	-.01524	-.01260	-.26236	-.22781	-.24297	-.18576	-.21926	-.24773
.075	-.01341	.03169	-.00157	-.14782	-.14014	-.15082	-.13394	-.16160	-.15021
.100	.00244	.02316	.01312	-.08063	-.09279	-.09086	-.08617	-.11675	-.10109
.200	.03596	.04310	.02729	.04799	.04159	.04577	.04308	.02705	.01068
.300	.05607	.07253	.05459	.10622	.11514	.11846	.10365	.09183	.06478
.400	.07070	.06948	.06981	.16893	.17021	.17230	.14201	.13241	.08258
.600	.06704	.05181	.04567	.10686	.12670	.12855	.11173	.10236	.07688
.800	.04815	.02743	.03097	.04479	.02432	.03231	.02827	.03702	.02064
1.000	-.05912	-.07680	-.07716	-.06399	-.12030	-.07807	-.10971	-.05054	-.01566
X/C	-CPL	-CPL	-CPL	-CPL	-CPL	-CPL	-CPL	-CPL	-CPL
0.000	-.02560	.05729	.21626	1.21145	-.25468	-.16490	.16894	-.43994	-.62431
.025	.10422	.21027	.33226	1.37935	1.08339	1.10060	1.00495	1.02873	.98242
.050	.11580	.19504	.24552	1.02128	.95858	.96858	.90190	.88554	.66113
.075	.12982	.20662	.24919	.82740	.74947	.73553	.73216	.69461	.56638
.100	.14872	.20113	.28765	.68534	.60358	.65874	.63314	.60485	.49941
.200	.16456	.19077	.25353	.53496	.57015	.57252	.52700	.49300	.39682
.300	.17188	.19930	.26770	.47793	.48377	.00681	.44960	.44669	.38115
.400	.19443	.22003	.26827	.43577	.44601	.46643	.42266	.43031	.33128
.600	.17553	.16285	.22571	.27132	.29244	.30287	.27864	.26767	.21143
.800	.13713	.11458	.10288	.11774	.09771	.09994	.09557	.09753	.07973
1.000	-.05412	-.07680	-.07716	-.06399	-.12030	-.07807	-.10971	-.05054	-.01566

# APPENDIX A

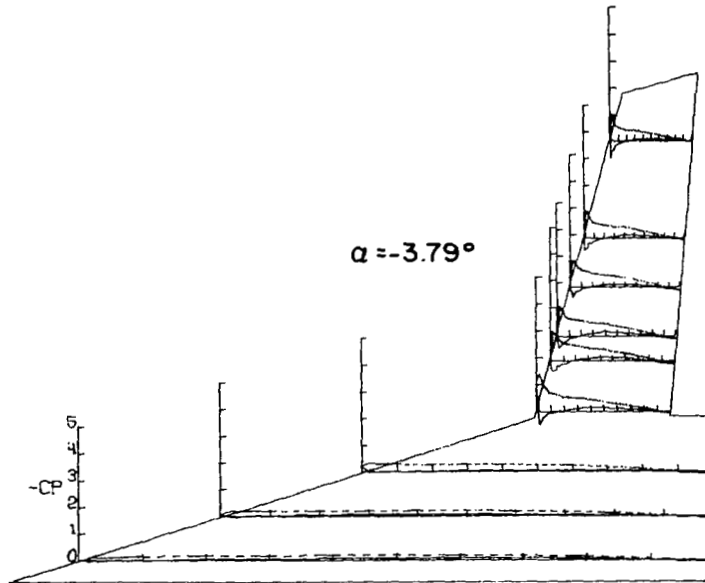
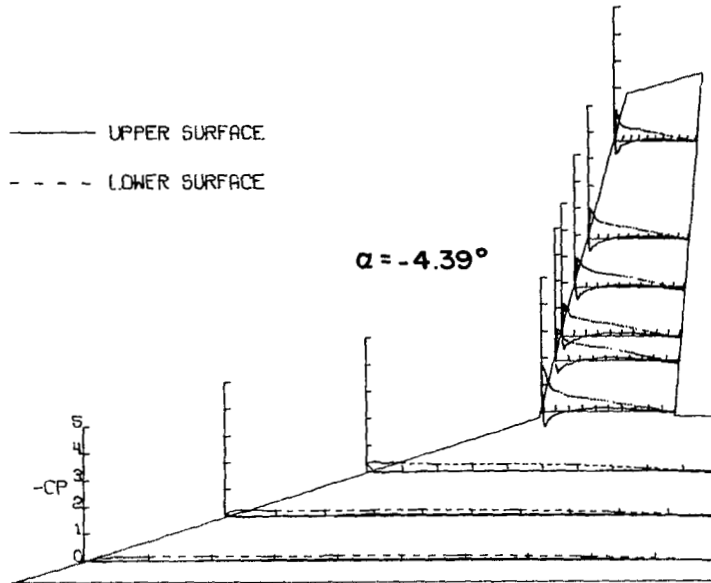

# APPENDIX A

## P R E S S U R E M E A S U R E M E N T S

OUTER PANEL SWEEP= 15.0000 DEGREES

FUSELAGE OFF

ANGLE OF ATTACK= -3.22189 DEGREES

### S P A N W I S E L O C A T I O N

	2Y/B	2Y/B	2Y/B	2Y/B	2Y/B	2Y/B	2Y/B	2Y/B	2Y/B
	.04333	.12996	.21661	.33426	.43233	.48036	.57641	.67250	.86465
X/C	-CPU	-CPU	-CPU	-CPU	-CPU	-CPU	-CPU	-CPU	-CPU
0.000	-.03434	.03312	.14022	.75592	-.48215	-.36512	-.17210	-.77332	-.72720
.025	-.03005	-.01533	-.01746	-.40841	-.29301	-.30708	-.30708	-.31135	-.32288
.050	-.00429	-.00552	-.00159	-.20517	-.15772	-.16737	-.14308	-.16576	-.18450
.075	.00491	.03312	.01640	-.10194	-.10258	-.10731	-.10528	-.12252	-.12540
.100	.01227	.03557	.02804	-.02308	-.03911	-.05129	-.04117	-.06054	-.05766
.200	.03373	.06501	.03968	.07245	.07566	.07356	.07154	.05405	.05117
.400	.05519	.09015	.06237	.12759	.14939	.14713	.13768	.12468	.09730
.600	.06010	.08647	.06720	.17632	.19106	.18492	.17007	.14126	.11531
.800	.07005	.07114	.05873	.11925	.14105	.13835	.12418	.12324	.09081
1.000	-.04784	-.03189	-.02804	-.04296	-.02565	-.02362	-.02295	-.02162	-.00865
	-.05887	-.07666	-.07619	-.07437	-.12567	-.08774	-.11203	-.06054	-.04829

	CPL	CPL	CPL	CPL	CPL	CPL	CPL	CPL	CPL
X/C	-CPL	-CPL	-CPL	-CPL	-CPL	-CPL	-CPL	-CPL	-CPL
0.000	-.03434	.03312	.14022	.75592	-.48215	-.36512	-.17210	-.77332	-.72720
.025	-.09935	.17346	.28943	1.13170	.92197	.92327	.89221	.91744	.91239
.050	.10732	.18828	.26932	.92710	.85273	.84155	.80170	.79627	.60442
.075	.12879	.19195	.27197	.73091	.66551	.67000	.65311	.62678	.61498
.100	.14657	.18460	.26562	.64436	.59563	.61394	.58355	.56114	.45295
.200	.16497	.17294	.24445	.49946	.50907	.52979	.47513	.46882	.35703
.300	.15025	.19502	.23863	.44047	.46035	.46635	.41978	.42410	.37145
.400	.13398	.20506	.24763	.39367	.41034	.42181	.38671	.39742	.32457
.600	.17294	.17417	.22117	.25261	.28403	.28683	.27333	.25297	.21189
.800	.11959	.12379	.08625	.10258	.09681	.08099	.09381	.08360	.08072
1.000	-.05887	-.07666	-.07619	-.07437	-.12567	-.08774	-.11203	-.06054	-.04829

## P R E S S U R E M E A S U R E M E N T S

OUTER PANEL SWEEP= 15.0000 DEGREES

FUSELAGE OFF

ANGLE OF ATTACK= -2.68753 DEGREES

### S P A N W I S E L O C A T I O N

	2Y/B	2Y/B	2Y/B	2Y/B	2Y/B	2Y/B	2Y/B	2Y/B	2Y/B
	.04333	.12996	.21661	.33426	.43233	.48036	.57641	.67250	.86465
X/C	-CPU	-CPU	-CPU	-CPU	-CPU	-CPU	-CPU	-CPU	-CPU
0.000	-.04655	.00306	.08918	.25399	-.05655	-.59001	-.42086	-.88291	-.79920
.025	-.02450	-.00756	-.01161	-.33796	-.17779	-.22083	-.20472	-.22109	-.25257
.050	.01531	.00796	.01847	-.10731	-.09207	-.09263	-.05974	-.08157	-.14524
.075	.00740	.04410	.02546	-.03810	-.03111	-.05705	-.04497	-.06797	-.07656
.100	.02266	.04594	.04222	.07349	.00693	.00604	.00873	-.00501	-.01359
.200	.05451	.06676	.06345	.11175	.10540	.10404	.10270	.08872	.05295
.300	.07289	.11148	.07652	.15557	.18160	.18257	.16579	.15455	.09802
.400	.07779	.09861	.09129	.19684	.20509	.20137	.17989	.16456	.11734
.600	.09494	.08636	.07757	.13842	.15303	.15707	.14297	.13523	.09802
.800	.05319	.04716	.03905	.05715	.03305	.02752	.02282	.01646	.02003
1.000	-.05696	-.07595	-.07705	-.08001	-.13040	-.10337	-.12015	-.06511	-.04579

	CPL	CPL	CPL	CPL	CPL	CPL	CPL	CPL	CPL
X/C	-CPL	-CPL	-CPL	-CPL	-CPL	-CPL	-CPL	-CPL	-CPL
0.000	-.04655	.00306	.08918	.25399	-.05655	-.59001	-.42086	-.88291	-.79920
.025	-.08124	.15797	.25013	1.06296	.79752	.84705	.75637	.79122	.75470
.050	.01247	.16536	.23377	.32863	.74735	.73257	.71674	.73608	.52056
.075	.12005	.16783	.24855	.65655	.59647	.60523	.56828	.56997	.45755
.100	.12924	.17702	.22002	.55940	.54798	.55242	.53765	.49264	.40815
.200	.14700	.16170	.21161	.44702	.48575	.48060	.45442	.43106	.33439
.300	.14063	.19907	.21319	.39431	.44882	.40945	.41213	.37807	.36662
.400	.17540	.20519	.23377	.38225	.40066	.40609	.37991	.37950	.30074
.600	.15435	.17855	.19420	.23430	.27558	.26580	.26580	.23325	.20320
.800	.11633	.11046	.06127	.09175	.08191	.08256	.08055	.08443	.06582
1.000	-.05846	-.07595	-.07705	-.09001	-.13040	-.10337	-.12015	-.06511	-.04579

# APPENDIX A

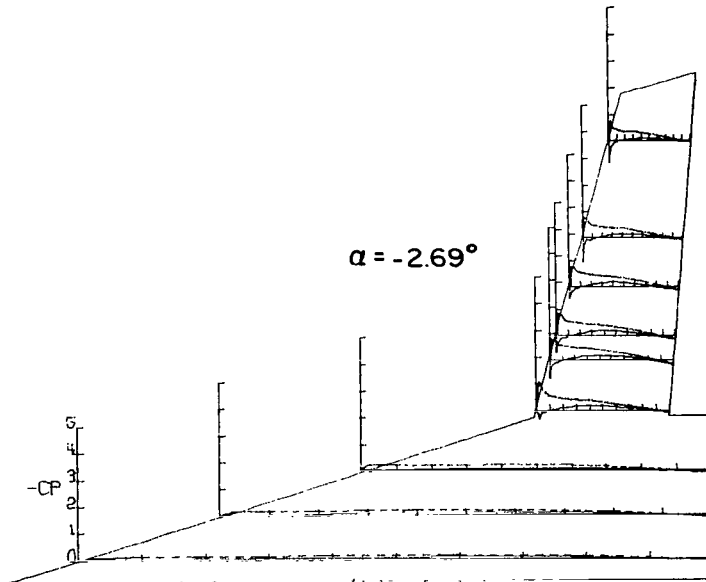
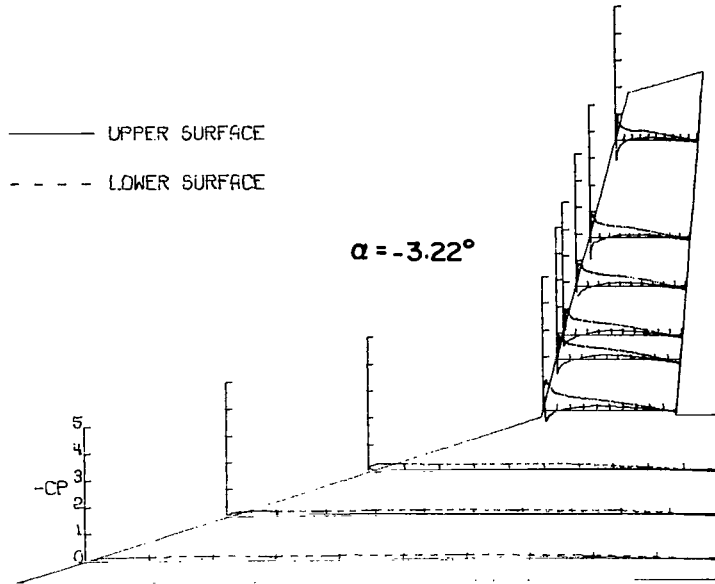

# APPENDIX A

## P R E S S U R E M E A S U R E M E N T S

OUTER PANEL SWEEP= 15.00000 DEGREES

FUSELAGE OFF

ANGLE OF ATTACK= -1.63748 DEGREES

### S P A N W I S E L O C A T I O N

	2Y/B .04333	2Y/B .12996	2Y/B .21661	2Y/B .33426	2Y/B .43233	2Y/B .48036	2Y/B .57641	2Y/B .67250	2Y/B .86465
X/C	-CPU	-CPU	-CPU	-CPU	-CPU	-CPU	-CPU	-CPU	-CPU
0.000	-.07138	-.04520	.00466	-.46152	-.87558	-.81985	-.75482	-.99442	-.94508
.025	-.00952	.00773	.02071	-.06557	.04122	-.01577	-.01577	-.02960	-.07470
.050	.00952	.03331	.03106	.04871	.06932	.09650	.10905	.03594	-.00846
.075	.02558	.06781	.06731	.09618	.09118	.07752	.08080	.06202	.02819
.100	.03033	.06307	.06420	.12678	.12740	.12022	.11496	.09867	.06484
.200	.06781	.09279	.09423	.17799	.19298	.18394	.18920	.16562	.13813
.300	.07792	.11420	.11339	.20859	.22982	.23518	.21482	.20720	.16139
.400	.09100	.10885	.12167	.23794	.24794	.25029	.22467	.21143	.15928
.600	.08684	.09457	.08388	.13989	.17424	.16686	.16555	.15011	.12333
.800	.06364	.05056	.04712	.05683	.05240	.04073	.04139	.03524	.02326
1.000	-.05710	-.07019	-.07197	-.08244	-.12116	-.10642	-.11168	-.06977	-.04440
X/C	-CPL	-CPL	-CPL	-CPL	-CPL	-CPL	-CPL	-CPL	-CPL
0.000	-.07138	-.04520	.00466	-.46152	-.87558	-.81985	-.75482	-.99442	-.94508
.025	.04996	.09338	.15947	.62078	.47901	.50781	.45723	.46620	.48384
.050	.07197	.11182	.16620	.54146	.50836	.52489	.47693	.51628	.34066
.075	.08625	.11658	.17811	.46465	.43404	.40730	.42175	.39426	.31316
.100	.11182	.13859	.18794	.42280	.40469	.40336	.39613	.37663	.31104
.200	.12431	.14513	.17862	.36035	.39282	.38759	.36657	.33784	.27345
.300	.13561	.16952	.19674	.35161	.37909	.36066	.34358	.33855	.31880
.400	.15703	.19272	.20140	.32975	.36285	.35146	.33701	.33220	.27838
.600	.12848	.14454	.16827	.20172	.24794	.23190	.24044	.21213	.19381
.800	.09933	.09755	.07507	.08244	.07307	.06832	.07489	.07400	.06272
1.000	-.05710	-.07019	-.07197	-.03244	-.12116	-.10642	-.11168	-.06977	-.04440

## P R E S S U R E M E A S U R E M E N T S

OUTER PANEL SWEEP= 15.00000 DEGREES

FUSELAGE OFF

ANGLE OF ATTACK= -1.05488 DEGREES

### S P A N W I S E L O C A T I O N

	2Y/B .04333	2Y/B .12996	2Y/B .21661	2Y/B .33426	2Y/B .43233	2Y/B .48036	2Y/B .57641	2Y/B .67250	2Y/B .86465
X/C	-CPU	-CPU	-CPU	-CPU	-CPU	-CPU	-CPU	-CPU	-CPU
0.000	-.07660	-.05685	-.03003	-.64902	-.91127	-.88184	-.86139	-.98454	-.96401
.025	.00419	.01376	.03676	.06037	.16288	.08640	.10817	.08423	-.01274
.050	.03351	.04428	.06161	.15031	.15219	.12664	.19457	.11962	.04318
.075	.04129	.08557	.09475	.19490	.16351	.14708	.14576	.13731	.09626
.100	.04787	.07061	.08336	.20188	.18678	.18138	.17347	.14297	.12457
.200	.07241	.09934	.10200	.21697	.22766	.22491	.22293	.21800	.16492
.300	.08617	.12567	.12219	.23835	.26099	.26383	.24206	.23357	.18049
.400	.08976	.11549	.12012	.25282	.28489	.26844	.25789	.23003	.17341
.600	.08476	.09814	.09371	.15848	.19307	.19391	.17676	.17412	.13307
.800	.06822	.05805	.05022	.06666	.06415	.05342	.05145	.04813	.02831
1.000	-.04787	-.07061	-.06627	-.07673	-.12578	-.09696	-.10685	-.06016	-.04318
X/C	-CPL	-CPL	-CPL	-CPL	-CPL	-CPL	-CPL	-CPL	-CPL
0.000	-.07660	-.05685	-.03003	-.64902	-.91127	-.88184	-.86139	-.98454	-.96401
.025	.03590	.07301	.11701	.44840	.39659	.37443	.29812	.36407	.38250
.050	.05805	.09934	.13410	.45098	.42451	.42872	.39640	.40942	.29963
.075	.07899	.10771	.16132	.41130	.36659	.35221	.35023	.33504	.24136
.100	.09694	.11190	.15895	.37231	.34904	.35485	.32517	.32654	.24207
.200	.12207	.11799	.16050	.33017	.34904	.35287	.32451	.31238	.23357
.300	.11789	.14541	.17241	.32514	.33709	.32649	.30472	.30813	.28736
.400	.16157	.17114	.18691	.31885	.33017	.33176	.30868	.31734	.24844
.600	.12746	.13404	.15843	.19747	.23143	.22425	.21700	.20663	.17907
.800	.09694	.08438	.06308	.08239	.06163	.06398	.05804	.07432	.05238
1.000	-.04787	-.07061	-.06627	-.07673	-.12578	-.09696	-.10685	-.06016	-.04318



# APPENDIX A

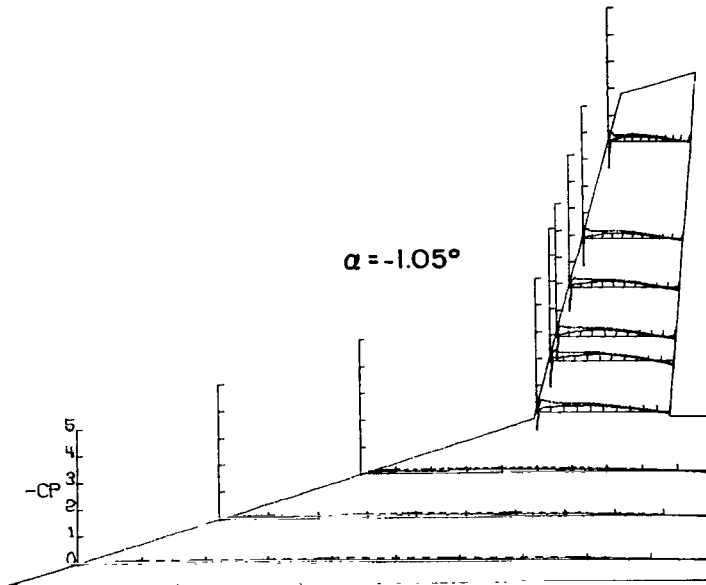
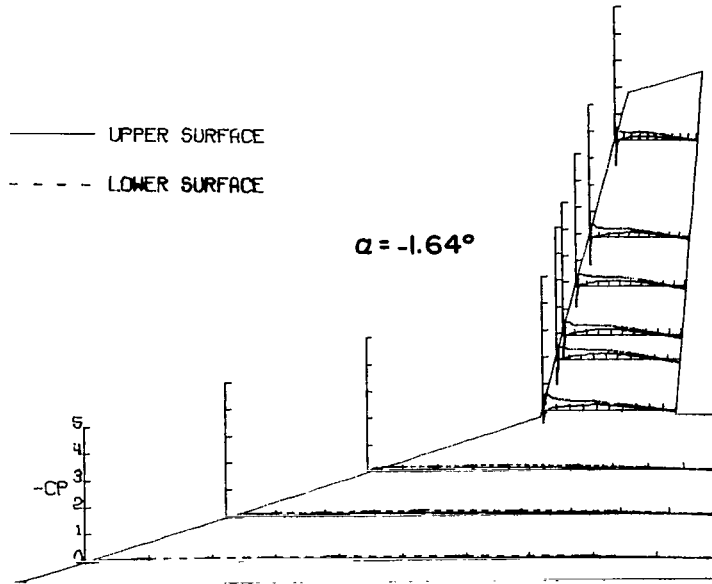

# APPENDIX A

## P R E S S U R E M E A S U R E M E N T S

OUTER PANEL SWEEP= 15.0000 DEGREES

FUSELAGE OFF

ANGLE OF ATTACK= -1.11398 DEGREES

### S P A N W I S E L O C A T I O N

	2Y/B .04333	2Y/B .12996	2Y/B .21651	2Y/B .33426	2Y/B .43233	2Y/B .48036	2Y/B .57641	2Y/B .67250	2Y/B .86465
X/C	-CPU	-CPU	-CPU	-CPU	-CPU	-CPU	-CPU	-CPU	-CPU
0.000	-.06112	-.05113	-.01834	-.66112	-.90119	-.85065	-.87257	-.95457	-.95389
.025	.01469	.02233	.04076	.08864	.15882	.10835	.12318	.07106	.04031
.050	.04290	.05642	.07744	.15451	.15205	.14253	.17671	.12504	.06355
.075	.03350	.08463	.07234	.15759	.16805	.13414	.13737	.10386	.09020
.100	.05407	.09169	.10088	.20437	.17482	.17477	.15394	.14896	.12436
.200	.07474	.09286	.09986	.21730	.22160	.21347	.20186	.19064	.13393
.300	.03698	.12518	.11565	.22961	.26100	.25152	.23540	.20704	.17151
.400	.09110	.11461	.12839	.25915	.26469	.26571	.23797	.22207	.15579
.600	.09991	.10520	.11412	.17051	.18898	.19412	.16832	.17629	.11958
.800	.06112	.05407	.06470	.06463	.05909	.04708	.04837	.03758	.01982
1.000	-.05642	-.06876	-.04280	-.08187	-.12250	-.11028	-.11157	-.08131	-.04783
X/C	-CPL	-CPL	-CPL	-CPL	-CPL	-CPL	-CPL	-CPL	-CPL
0.000	-.06112	-.05113	-.01834	-.66112	-.90119	-.85065	-.87257	-.95457	-.95389
.025	.03350	.07523	.12941	.45737	.35457	.36244	.34052	.33166	.35012
.050	.05466	.09991	.13858	.44690	.41058	.44177	.39533	.39320	.27901
.075	.08169	.12460	.15182	.38473	.33795	.33858	.32955	.32893	.23642
.100	.09932	.11637	.16507	.36503	.35949	.32955	.33084	.29542	.22891
.200	.12460	.12166	.16048	.32502	.34718	.35148	.31472	.29474	.21729
.300	.11402	.14987	.17118	.31394	.34472	.31537	.30569	.28995	.27469
.400	.15104	.16574	.17984	.31086	.32071	.31537	.29215	.28311	.23574
.600	.11754	.13811	.15233	.13713	.22961	.20766	.21089	.20157	.16263
.800	.09639	.09345	.07184	.08864	.07079	.06836	.05998	.06901	.05056
1.000	-.05642	-.06876	-.04280	-.08187	-.12250	-.11028	-.11157	-.08131	-.04783

## P R E S S U R E M E A S U R E M E N T S

OUTER PANEL SWEEP= 15.0000 DEGREES

FUSELAGE OFF

ANGLE OF ATTACK= -.51798 DEGREES

### S P A N W I S E L O C A T I O N

	2Y/B .04333	2Y/B .12996	2Y/B .21651	2Y/B .33426	2Y/B .43233	2Y/B .48036	2Y/B .57641	2Y/B .67250	2Y/B .86465
X/C	-CPU	-CPU	-CPU	-CPU	-CPU	-CPU	-CPU	-CPU	-CPU
0.000	-.06687	-.06265	-.04590	-.82207	-.91734	-.90244	-.90907	-.89327	-.97684
.025	.02138	.06205	.08762	.24643	.23217	.25261	.21433	.21770	.24228
.050	.04519	.07892	.10536	.37034	.33690	.35434	.29993	.31345	.21770
.075	.03012	.09940	.13170	.32429	.27767	.28865	.28267	.26896	.19031
.100	.04675	.10603	.13392	.23842	.26814	.27538	.25945	.24368	.18259
.200	.11550	.12591	.14500	.29716	.32113	.31943	.29595	.26124	.20646
.300	.17109	.14699	.15804	.30599	.32176	.30256	.29329	.26896	.26264
.400	.13735	.16145	.15647	.29653	.30234	.30590	.28865	.28231	.22191
.600	.12109	.13555	.14604	.18612	.22334	.20968	.20902	.18048	.15941
.800	.04333	.09498	.05737	.07886	.06435	.05972	.05972	.05688	.04705
1.000	-.05642	-.07470	-.06397	-.08770	-.13565	-.10949	-.11214	-.08419	-.05478
X/C	-CPL	-CPL	-CPL	-CPL	-CPL	-CPL	-CPL	-CPL	-CPL
0.000	-.06687	-.06265	-.04590	-.82207	-.91734	-.90244	-.90907	-.89327	-.97684
.025	.02138	.06205	.08762	.24643	.23217	.25261	.21433	.21770	.24228
.050	.04519	.07892	.10536	.37034	.33690	.35434	.29993	.31345	.21770
.075	.03012	.09940	.13170	.32429	.27767	.28865	.28267	.26896	.19031
.100	.04675	.10603	.13392	.23842	.26814	.27538	.25945	.24368	.18259
.200	.11550	.12591	.14500	.29716	.32113	.31943	.29595	.26124	.20646
.300	.17109	.14699	.15804	.30599	.32176	.30256	.29329	.26896	.26264
.400	.13735	.16145	.15647	.29653	.30234	.30590	.28865	.28231	.22191
.600	.12109	.13555	.14604	.18612	.22334	.20968	.20902	.18048	.15941
.800	.04333	.09498	.05737	.07886	.06435	.05972	.05972	.05688	.04705
1.000	-.05642	-.07470	-.06397	-.08770	-.13565	-.10949	-.11214	-.08419	-.05478

# APPENDIX A

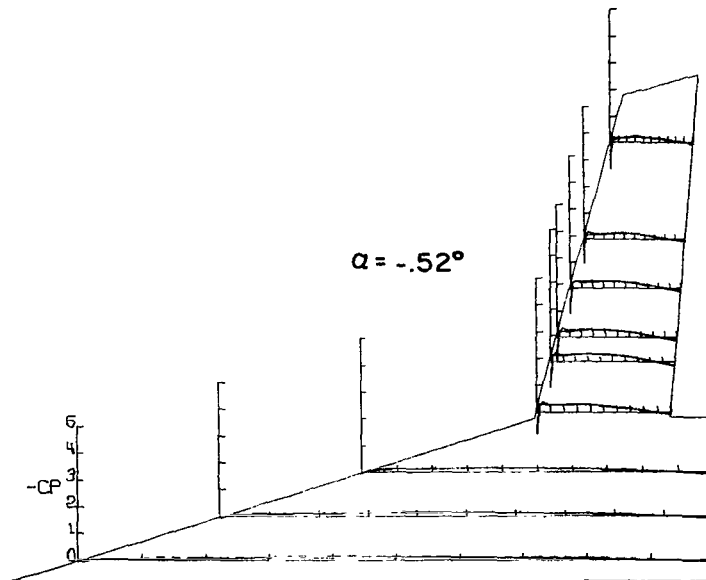
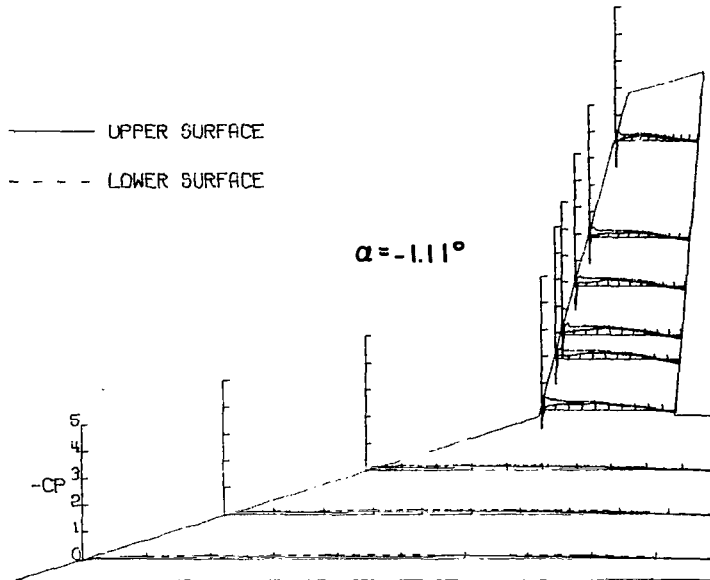

# APPENDIX A

## P R E S S U R E M E A S U R E M E N T S

OUTER PANEL SWEEP= 15.0000 DEGREES

FUSELAGE OFF

ANGL OF ATTACK= -.01653 DEGREES

### S P A N W I S E L O C A T I O N

	2Y/B .04333	2Y/B .12996	2Y/B .21661	2Y/B .33426	2Y/B .43233	2Y/B .48036	2Y/B .57641	2Y/B .67250	2Y/B .86465
X/C	-CPU	-CPU	-CPU	-CPU	-CPU	-CPU	-CPU	-CPU	-CPU
0.000	-.07650	-.05260	-.03066	-.90823	-.91828	-.90712	-.91041	-.95072	-.96834
.025	.02929	.05977	.09250	.34816	.42145	.35061	.34272	.32091	.20861
.050	.07112	.08547	.11744	.36053	.35048	.31641	.35651	.29905	.18888
.075	.05678	.10459	.11848	.30965	.29835	.28088	.27694	.25865	.19240
.100	.06814	.10639	.12212	.32473	.32159	.29404	.28878	.26992	.22270
.200	.08965	.11715	.13407	.30714	.30274	.30325	.28549	.27486	.22341
.300	.10818	.14285	.15070	.29395	.31531	.32956	.29338	.29341	.22200
.400	.11595	.13328	.16057	.31342	.31907	.32364	.28615	.28261	.20861
.600	.12071	.11954	.13199	.19911	.21355	.22037	.19800	.20579	.15998
.800	.07351	.07411	.07535	.06469	.07726	.05197	.06249	.05568	.04863
1.000	-.05200	-.06814	-.06444	-.08856	-.13316	-.11577	-.11512	-.08739	-.04863

	-CPL	-CPL	-CPL	-CPL	-CPL	-CPL	-CPL	-CPL	-CPL
0.000	-.07650	-.05260	-.03066	-.90823	-.91828	-.90712	-.91041	-.95072	-.96834
.025	.00657	.04303	.07275	.12813	.09296	.39867	.07631	.10360	.12051
.050	.02809	.06754	.08159	.23428	.21104	.24207	.20458	.22130	.15505
.075	.06515	.08905	.10757	.24684	.20225	.20655	.21576	.20156	.14095
.100	.07949	.10041	.10757	.22172	.21104	.21313	.20787	.20156	.15505
.200	.10459	.09563	.11952	.23993	.26945	.25766	.24470	.22764	.16421
.300	.10699	.12551	.13667	.26569	.27448	.25720	.23615	.23962	.23116
.400	.13269	.14882	.14239	.27008	.28516	.27825	.25720	.26006	.21354
.600	.10699	.12432	.13355	.17147	.20853	.19866	.18813	.17619	.15011
.800	.07830	.07411	.07535	.06218	.05527	.03947	.04736	.05215	.04440
1.000	-.05200	-.06814	-.06444	-.08856	-.13316	-.11577	-.11512	-.08739	-.04863

## P R E S S U R E M E A S U R E M E N T S

OUTER PANEL SWEEP= 15.0000 DEGREES

FUSELAGE OFF

ANGLE OF ATTACK= .49809 DEGREES

### S P A N W I S E L O C A T I O N

	2Y/B .04333	2Y/B .12996	2Y/B .21661	2Y/B .33426	2Y/B .43233	2Y/B .48036	2Y/B .57641	2Y/B .67250	2Y/B .86465
X/C	-CPU	-CPU	-CPU	-CPU	-CPU	-CPU	-CPU	-CPU	-CPU
0.000	-.06733	-.05005	-.01820	-.90375	-.87525	-.87650	-.89281	-.90927	-.94762
.025	.04409	.08759	.09302	.51475	.57977	.43956	.47412	.40056	.32449
.050	.07329	.10011	.11931	.46705	.44413	.39977	.43303	.37055	.25103
.075	.06853	.12990	.12437	.39953	.39210	.35738	.35673	.32659	.22941
.100	.07746	.12037	.12588	.38962	.36360	.36064	.34238	.31612	.27822
.200	.08759	.12216	.12791	.31653	.34131	.32999	.32869	.31193	.24336
.300	.12633	.15791	.14398	.32024	.34502	.35412	.33456	.31124	.24684
.400	.12037	.14003	.15318	.31839	.34379	.34043	.32869	.29868	.21546
.600	.12990	.12752	.12032	.20008	.22485	.22826	.21195	.20361	.15619
.800	.08347	.07329	.04904	.08053	.07557	.07369	.06261	.06276	.03556
1.000	-.05125	-.07746	-.07280	-.03238	-.13256	-.10891	-.11348	-.08368	-.05439

	-CPL	-CPL	-CPL	-CPL	-CPL	-CPL	-CPL	-CPL	-CPL
0.000	-.06733	-.05005	-.01820	-.90375	-.87525	-.87650	-.89281	-.90927	-.94762
.025	.01137	.02622	.02482	-.00743	-.02478	.00717	-.01304	-.01743	.03347
.050	.03158	.04171	.04601	.15548	.12389	.16565	.11674	.14016	.08437
.075	.05899	.06614	.06370	.10415	.11831	.13026	.12261	.13306	.09065
.100	.06555	.08342	.07272	.15257	.15672	.15552	.13826	.13388	.10181
.200	.09534	.08461	.08443	.20441	.23105	.21978	.20347	.18199	.13318
.300	.09474	.13348	.10465	.24158	.25357	.23673	.22173	.21337	.21058
.400	.12573	.13169	.10764	.24777	.24963	.24978	.22695	.23290	.18409
.600	.13666	.10726	.10712	.16135	.18493	.18260	.17021	.15759	.13597
.800	.08263	.07031	.04196	.05070	.04336	.04304	.04239	.04951	.03765
1.000	-.05125	-.07746	-.07280	-.08238	-.13256	-.10891	-.11348	-.08368	-.05439

# APPENDIX A

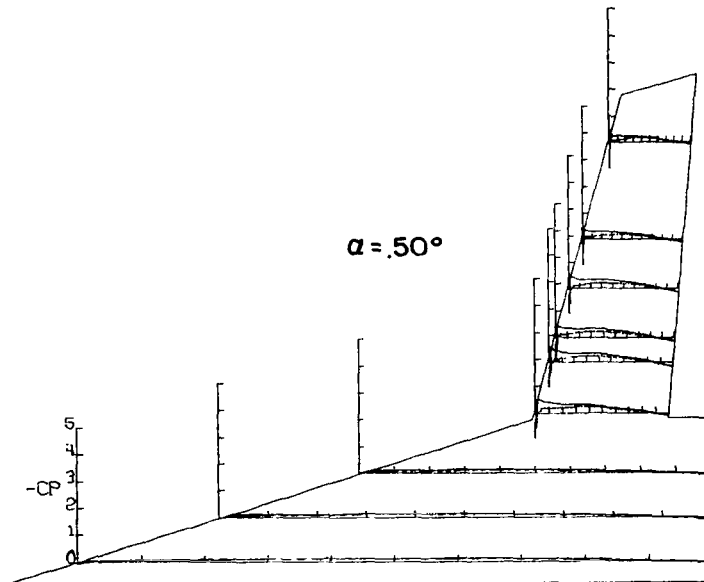
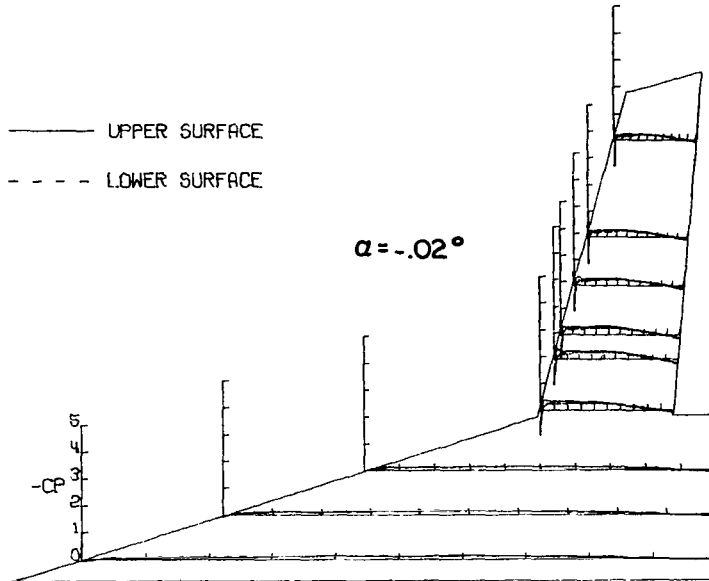

# APPENDIX A

## P R E S S U R E M E A S U R E M E N T S

OUTER PANEL SWEEP= 15.0000 DEGREES

FUSELAGE OFF

ANGLE OF ATTACK= 1.54757 DEGREES

### S P A N W I S E L O C A T I O N

	2Y/B .04333	2Y/B .12996	2Y/B .21661	2Y/B .33426	2Y/B .43233	2Y/B .48036	2Y/B .57641	2Y/B .67250	2Y/B .86465
X/C	-CPU	-CPU	-CPU	-CPU	-CPU	-CPU	-CPU	-CPU	-CPU
0.000	-.06073	-.01022	.02445	-.04713	-.08550	-.82270	-.86106	-.82469	-.95638
.025	.00675	.12447	.16231	.92700	.85593	.74721	.75449	.68155	.48209
.050	.00419	.13650	.16761	.67481	.62575	.57911	.62809	.52438	.36791
.075	.00539	.16176	.17067	.54840	.54085	.49600	.48013	.44262	.33761
.100	.00238	.13650	.16609	.53375	.49369	.46426	.45764	.41091	.36369
.200	.11245	.15935	.16257	.40312	.42073	.40209	.39548	.36791	.32069
.300	.12507	.17490	.16965	.36853	.40501	.40143	.38225	.35664	.30166
.400	.14492	.17198	.17831	.36605	.39672	.38754	.36439	.33479	.25424
.600	.14131	.14793	.14061	.22326	.25345	.23874	.22948	.21691	.16691
.800	.04700	.08419	.06368	.09119	.09119	.07407	.07010	.06479	.03944
1.000	-.00592	-.07216	-.08436	-.08239	-.12892	-.12565	-.11772	-.09930	-.06127

	-CPL	-CPL	-CPL	-CPL	-CPL	-CPL	-CPL	-CPL	-CPL
0.000	-.06073	-.01022	.02445	-.04713	-.08550	-.82270	-.86106	-.82469	-.95638
.025	-.07405	-.01143	.00051	-.23018	-.20502	-.19179	-.21361	-.22395	-.16057
.050	.00541	.01924	.02089	-.01698	-.02767	-.00661	-.04299	-.02676	-.07465
.075	.03488	.04371	.04025	.01950	-.00440	-.00992	-.00265	-.01127	-.01690
.100	.05592	.05352	.04891	.05597	.04339	.03571	.03108	.02183	.00634
.200	.08118	.06855	.06063	.13458	.14528	.13822	.11243	.09578	.05634
.300	.09402	.09802	.07336	.19747	.19119	.19046	.15012	.15353	.13029
.400	.11124	.11726	.07693	.20691	.20879	.19443	.17790	.17395	.13874
.600	.10042	.09501	.07846	.14213	.16163	.15475	.14086	.12818	.11057
.800	.07697	.06735	.04025	.05660	.03585	.02381	.02447	.03169	.02747
1.000	-.05592	-.07216	-.08406	-.08239	-.12892	-.12565	-.11772	-.09930	-.06127

## P R E S S U R E M E A S U R E M E N T S

OUTER PANEL SWEEP= 15.0000 DEGREES

FUSELAGE OFF

ANGLE OF ATTACK= 1.60661 DEGREES

### S P A N W I S E L O C A T I O N

	2Y/B .04333	2Y/B .12996	2Y/B .21661	2Y/B .33426	2Y/B .43233	2Y/B .48036	2Y/B .57641	2Y/B .67250	2Y/B .86465
X/C	-CPU	-CPU	-CPU	-CPU	-CPU	-CPU	-CPU	-CPU	-CPU
0.000	-.05921	-.01974	.02733	-.05555	-.08859	-.81087	-.86130	-.83411	-.94217
.025	.06797	.12978	.17727	.94657	.87627	.76300	.77030	.67288	.51880
.050	.09030	.13157	.18139	.68859	.62582	.60849	.64749	.57605	.39158
.075	.06612	.15370	.17727	.55740	.53982	.52155	.50563	.47922	.34846
.100	.08432	.14891	.18088	.51660	.49902	.48771	.48970	.42974	.39370
.200	.11243	.15549	.15902	.40800	.43502	.42998	.42799	.38734	.32372
.300	.12200	.18350	.17984	.36658	.41554	.40309	.41738	.36967	.29757
.400	.13934	.16925	.18397	.35779	.40236	.39546	.37823	.34563	.26556
.600	.13944	.14652	.14480	.22472	.25861	.26011	.25016	.23236	.18363
.800	.09509	.06313	.06536	.08537	.09415	.08693	.08693	.07981	.05650
1.000	-.06279	-.04492	-.08503	-.08474	-.12993	-.11015	-.11015	-.08758	-.05509

	-CPL	-CPL	-CPL	-CPL	-CPL	-CPL	-CPL	-CPL	-CPL
0.000	-.05921	-.01974	.02783	-.05555	-.08859	-.81087	-.86130	-.83411	-.94217
.025	-.01734	-.00299	.00876	-.23238	-.22735	-.19774	-.21765	-.19352	-.10806
.050	.06791	.00437	.02164	-.07487	-.33955	.00265	-.06171	-.02048	-.04308
.075	.02033	.04485	.04535	.02699	-.00063	-.00730	.01856	.00428	-.04238
.100	-.02751	.04485	.05256	.05649	.04236	.04910	.05508	.02543	.02472
.200	-.07452	.06797	.06454	.13972	.13307	.12561	.12209	.11512	.08617
.300	-.03170	.09468	.07781	.13705	.19708	.13911	.15992	.15891	.15256
.400	-.07099	.12380	.08745	.20149	.20905	.20637	.19442	.18716	.15679
.600	-.07199	.08351	.03348	.14437	.16195	.16389	.15262	.13843	.11442
.800	-.12691	.06397	.03805	.04771	.03515	.02787	.03650	.03661	.03661
1.000	-.06279	-.04492	-.08503	-.08474	-.12993	-.11015	-.11015	-.08758	-.05509

# APPENDIX A

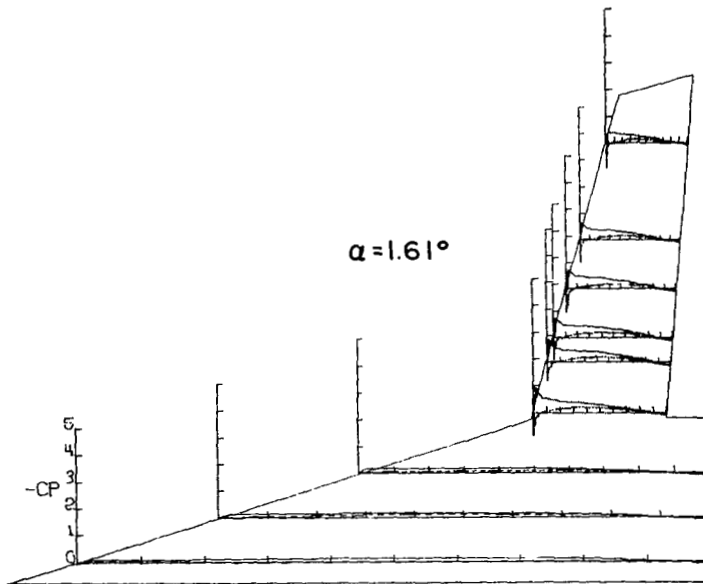
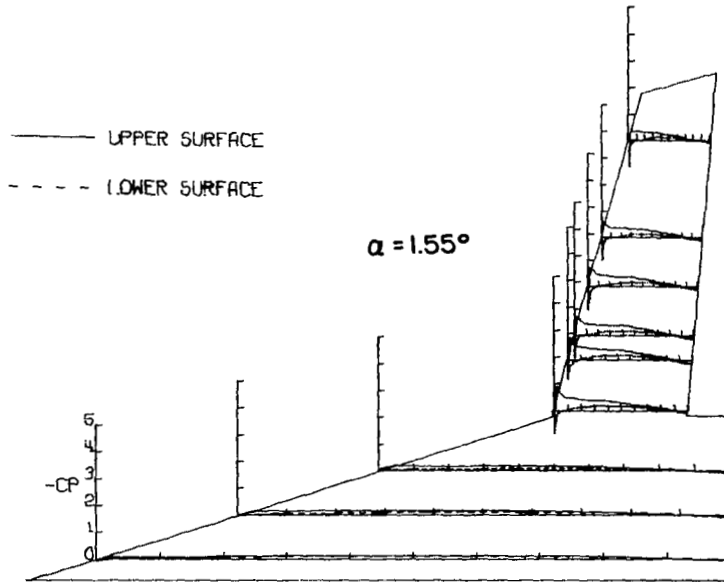

# APPENDIX A

## P R E S S U R E M E A S U R E M E N T S

OUTER PANEL SWEEP= 15.00000 DEGREES

FUSELAGE OFF

ANGLE OF ATTACK= 2.05893 DEGREES

### S P A N W I S E L O C A T I O N

	2Y/B	2Y/B	2Y/B	2Y/B	2Y/B	2Y/B	2Y/B	2Y/B	2Y/B
	.04333	.12996	.21661	.33426	.43233	.48036	.57641	.67250	.86465
X/C	-CPU	-CPU	-CPU	-CPU	-CPU	-CPU	-CPU	-CPU	-CPU
0.000	-.05111	-.00241	-.06610	-.72664	-.53220	-.70696	-.76686	-.69476	-.93224
.025	.08298	.15454	.20290	1.11559	1.00378	.91039	.89655	.81483	.62103
.050	.10343	.16296	.21110	.78951	.73800	.68642	.71013	.65871	.46117
.075	.09320	.17619	.20597	.64836	.60858	.56455	.55203	.52342	.38974
.100	.09681	.15695	.19470	.55808	.56881	.51409	.53186	.48522	.41237
.200	.12387	.16837	.18036	.44002	.46591	.43510	.43510	.41591	.34871
.300	.13349	.19242	.18907	.39331	.44507	.42786	.40877	.38974	.31971
.400	.14071	.18761	.19521	.37879	.42108	.39561	.38178	.36003	.27352
.600	.14372	.16176	.15576	.23359	.27462	.24943	.25013	.23606	.19224
.800	.11305	.08900	.07585	.11237	.09217	.09190	.08096	.09188	.05866
1.000	-.05232	-.07156	-.07737	-.07576	-.12626	-.11914	-.11514	-.08552	-.05372

	2Y/B	2Y/B	2Y/B	2Y/B	2Y/B	2Y/B	2Y/B	2Y/B	2Y/B
	.04333	.12996	.21661	.33426	.43233	.48036	.57641	.67250	.86465
X/C	-CPL	-CPL	-CPL	-CPL	-CPL	-CPL	-CPL	-CPL	-CPL
0.000	-.05111	-.00241	-.06610	-.72664	-.53220	-.70696	-.76686	-.69476	-.93224
.025	-.02345	-.01744	-.01076	-.33901	-.30555	-.28041	-.31333	-.26504	-.24172
.050	0.00000	.01263	.00564	-.11869	-.09154	-.08228	-.11585	-.08199	-.11298
.075	.03007	.03668	.03587	-.02588	-.06566	-.07438	-.05266	-.03181	-.05372
.100	.05232	.05773	.04253	.00758	-.01326	-.00592	-.01382	-.00989	-.01444
.200	.07817	.06013	.05636	.10417	.12311	.10137	.08491	.08128	.04877
.300	.07276	.08779	.06866	.15846	.16667	.14330	.12441	.12934	.12793
.400	.11185	.11545	.07429	.19508	.19255	.18431	.15995	.17882	.14136
.600	.08118	.09020	.07481	.13258	.15151	.14481	.13099	.12793	.11521
.800	.07096	.06855	.03997	.04609	.03093	.01540	.02041	.03181	.03110
1.000	-.05232	-.07156	-.07737	-.07576	-.12626	-.11914	-.11519	-.08552	-.05372

## P R E S S U R E M E A S U R E M E N T S

OUTER PANEL SWEEP= 15.00000 DEGREES

FUSELAGE OFF

ANGLE OF ATTACK= 2.62119 DEGREES

### S P A N W I S E L O C A T I O N

	2Y/B	2Y/B	2Y/B	2Y/B	2Y/B	2Y/B	2Y/B	2Y/B	2Y/B
	.04333	.12996	.21661	.33426	.43233	.48036	.57641	.67250	.86465
X/C	-CPU	-CPU	-CPU	-CPU	-CPU	-CPU	-CPU	-CPU	-CPU
0.000	-.05263	.04545	.10663	-.54136	-.31490	-.56987	-.67012	-.56391	-.87150
.025	.10466	.16240	.24197	1.34703	1.17253	1.08184	1.07854	.95368	.76955
.050	.11722	.18480	.24658	.89641	.81424	.79207	.82772	.73723	.54396
.075	.10286	.20872	.23325	.70948	.70258	.63630	.63630	.58894	.48422
.100	.10286	.16865	.21633	.63106	.62228	.58877	.59669	.53342	.46595
.200	.12380	.17343	.20147	.47738	.46734	.49467	.48676	.45681	.37810
.300	.15160	.20094	.21172	.43033	.47487	.47555	.44982	.43081	.34296
.400	.15669	.19735	.21736	.41778	.44287	.45114	.41553	.39708	.30361
.600	.16327	.17164	.17378	.25155	.28417	.28032	.27174	.25562	.20365
.800	.10944	.10825	.07485	.10790	.10225	.09036	.09959	.08708	.06812
1.000	-.05442	-.06397	-.07074	-.08029	-.10915	-.11015	-.09498	-.08497	-.04665

	2Y/B	2Y/B	2Y/B	2Y/B	2Y/B	2Y/B	2Y/B	2Y/B	2Y/B
	.04333	.12996	.21661	.33426	.43233	.48036	.57641	.67250	.86465
X/C	-CPL	-CPL	-CPL	-CPL	-CPL	-CPL	-CPL	-CPL	-CPL
0.000	-.05263	.04545	.10663	-.54136	-.31490	-.56987	-.67012	-.56391	-.87150
.025	-.02990	-.03110	-.01743	-.43786	-.36579	-.37002	-.40431	-.36658	-.32234
.050	-.01495	.00060	-.00513	-.18129	-.18631	-.14313	-.16687	-.16292	-.18610
.075	.01495	.01794	.01179	-.10476	-.12860	-.12860	-.10751	-.09621	-.09621
.100	.03528	.03349	.01692	-.05018	-.06022	-.04881	-.06134	-.06320	-.06812
.200	.06399	.05562	.02973	.07574	.08155	.08772	.08134	.04354	.02177
.300	.05921	.07715	.04460	.12609	.13926	.11872	.10355	.09251	.10674
.400	.08971	.10286	.05485	.16686	.17627	.16753	.14906	.15028	.12149
.600	.01253	.07775	.05434	.11229	.13734	.12862	.12927	.10674	.10112
.800	.05133	.04725	.01948	.03701	.03169	.01913	.02308	.02739	.01896
1.000	-.05442	-.06397	-.07074	-.08029	-.10915	-.11015	-.09498	-.08497	-.04665



# APPENDIX A

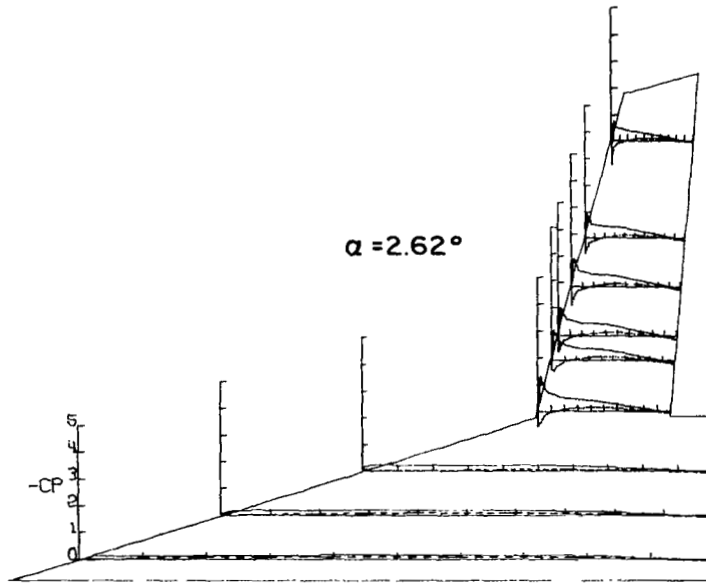
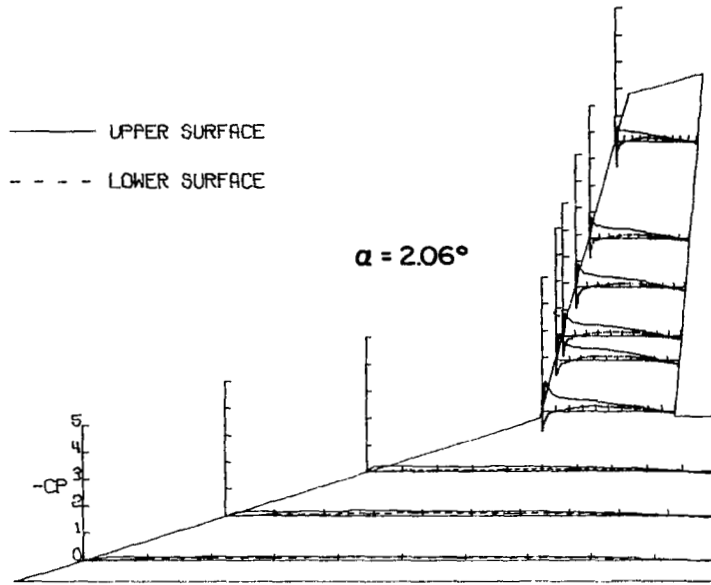

# APPENDIX A

## P R E S S U R E M E A S U R E M E N T S

OUTER PANEL SWEEP= 15.0000 DEGREES

FUSELAGE OFF

ANGLE OF ATTACK= 3.1710 DEGREES

### S P A N W I S E L O C A T I O N

	2Y/3	2Y/3	2Y/3	2Y/3	2Y/B	2Y/3	2Y/B	2Y/B	2Y/B
	.04333	.12996	.21661	.33426	.43233	.48036	.57641	.67250	.86465
X/C	-CPU	-CPU	-CPU	-CPU	-CPU	-CPU	-CPU	-CPU	-CPU
0.000	-.13325	.08728	.20066	-.29143	-.08575	-.41092	-.53231	-.39565	-.80106
.025	.12171	.21552	.33546	1.52514	1.35794	1.26311	1.20380	1.13756	.80446
.050	.12646	.20306	.31385	1.04395	.93264	.90431	.90951	.85125	.60823
.075	.11696	.20127	.27835	.87333	.75932	.72761	.68148	.68295	.50628
.100	.11512	.18521	.25726	.72018	.68662	.67628	.64315	.60404	.51815
.200	.13545	.17396	.23359	.51326	.51823	.52777	.49206	.50628	.39734
.300	.14724	.20721	.23410	.44615	.48219	.49076	.46090	.44623	.35405
.400	.15496	.19296	.24491	.41073	.44677	.44467	.41611	.40223	.31285
.500	.15912	.16803	.18214	.25104	.28459	.27914	.26680	.25888	.20794
.600	.09656	.10034	.07358	.10066	.09756	.08764	.09478	.08513	.07187
1.000	-.04275	-.08075	-.06586	-.06214	-.11558	-.09802	-.10322	-.07397	-.05443

	2Y/3	2Y/3	2Y/3	2Y/3	2Y/B	2Y/3	2Y/B	2Y/B	2Y/B
	.04333	.12996	.21661	.33426	.43233	.48036	.57641	.67250	.86465
X/C	-CPL	-CPL	-CPL	-CPL	-CPL	-CPL	-CPL	-CPL	-CPL
0.000	-.03325	.08728	.20066	-.29143	-.08575	-.41092	-.53231	-.39565	-.80106
.025	-.04057	-.03562	-.02161	-.49897	-.44491	-.42195	-.45246	-.42774	-.43542
.050	-.03950	-.01247	-.01852	-.23861	-.25352	-.20968	-.24603	-.21771	-.22818
.075	.01157	.00653	-.00051	-.15845	-.18144	-.17527	-.16229	-.15421	-.15607
.100	.02791	.02672	.01029	-.10315	-.11123	-.11166	-.10646	-.11374	-.10397
.200	.05478	.03740	.02521	.03418	.03666	.03700	.02142	.01116	-.00768
.300	.05937	.07303	.03859	.11309	.11185	.09672	.07530	.08862	.08862
.400	.08947	.09322	.04116	.14416	.15162	.14022	.13438	.12770	.11165
.600	.07243	.07659	.05145	.11061	.12625	.12659	.11750	.10885	.09071
.800	.05225	.04037	.02470	.03604	.01802	.01428	.01947	.02582	.01814
1.000	-.04275	-.08075	-.06586	-.06214	-.11558	-.09802	-.10322	-.07397	-.05443

## P R E S S U R E M E A S U R E M E N T S

OUTER PANEL SWEEP= 15.0000 DEGREES

FUSELAGE OFF

ANGLE OF ATTACK= 3.69147 DEGREES

### S P A N W I S E L O C A T I O N

	2Y/3	2Y/3	2Y/3	2Y/3	2Y/B	2Y/3	2Y/B	2Y/B	2Y/B
	.04333	.12996	.21661	.33426	.43233	.48036	.57641	.67250	.86465
X/C	-CPU	-CPU	-CPU	-CPU	-CPU	-CPU	-CPU	-CPU	-CPU
0.000	-.01433	.12619	.27186	.00125	-.15241	-.13891	-.35869	-.16038	-.70218
.025	.13037	.23075	.37245	1.69969	1.52820	1.36535	1.40516	1.28051	.93439
.050	.13635	.23204	.36058	1.13912	1.04545	.98420	1.00443	.91624	.69573
.075	.12918	.23982	.33324	.92246	.86217	.83017	.81059	.75644	.58548
.100	.12670	.21290	.30737	.78890	.78266	.74533	.71596	.67899	.58687
.200	.14371	.20393	.27495	.57295	.60416	.59130	.56716	.54152	.45289
.300	.16565	.23084	.27186	.43308	.54611	.53216	.51455	.48988	.39009
.400	.16446	.20633	.27134	.43065	.48183	.47151	.45521	.42289	.33566
.600	.17463	.18001	.22440	.29762	.29708	.29739	.27978	.27613	.21198
.800	.12320	.10645	.11555	.11454	.10111	.10043	.09913	.09483	.07182
1.000	-.04459	-.07117	-.07841	-.07739	-.11359	-.11739	-.09913	-.09902	-.05021

	2Y/3	2Y/3	2Y/3	2Y/3	2Y/B	2Y/3	2Y/B	2Y/B	2Y/B
	.04333	.12996	.21661	.33426	.43233	.48036	.57641	.67250	.86465
X/C	-CPL	-CPL	-CPL	-CPL	-CPL	-CPL	-CPL	-CPL	-CPL
0.000	-.01433	.12619	.27186	.00125	-.15241	-.13891	-.35869	-.16038	-.70218
.025	-.05761	-.03887	-.02476	-.51749	-.52364	-.53477	-.53999	-.52297	-.47207
.050	-.03648	-.02392	-.02578	-.32704	-.32455	-.31565	-.29608	-.30090	-.27613
.075	.01136	.01076	.01135	-.29721	-.23904	-.21782	-.22043	-.21407	-.19455
.100	.01435	.01296	.00464	-.16789	-.16602	-.16602	-.16604	-.16526	-.15898
.200	.02741	.03827	.02940	.00437	.00437	-.00326	-.00717	-.02092	-.04184
.300	.04246	.06040	.05157	.07739	.07427	.06778	.04435	.05160	.04602
.400	.08014	.08442	.05335	.12545	.11671	.12140	.10174	.10459	.07740
.600	.06457	.04844	.06500	.07675	.09906	.13043	.08504	.08319	.07043
.800	.04426	.04485	.03372	.02938	.01311	.00196	.00130	.01883	.01952
1.000	-.04459	-.07117	-.07841	-.07739	-.11359	-.11739	-.09913	-.09902	-.05021

# APPENDIX A

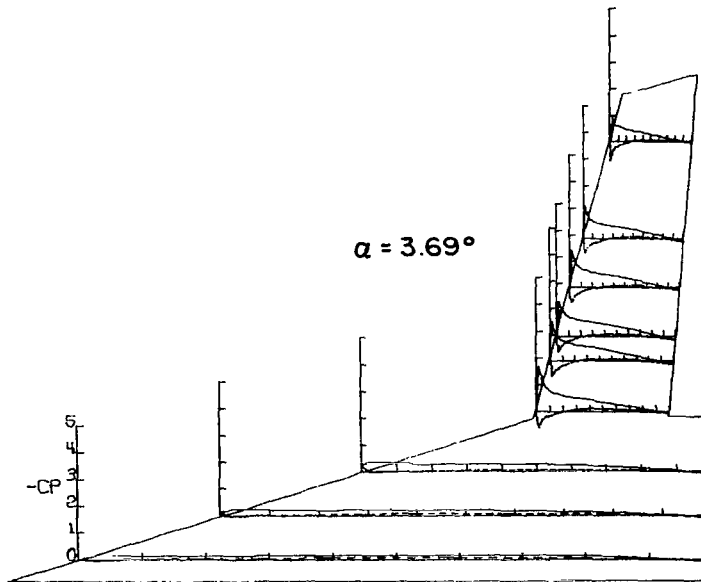
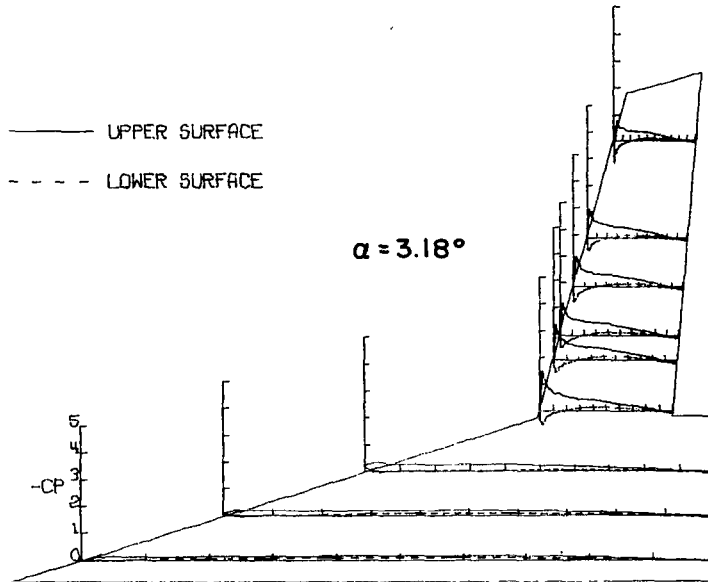

# APPENDIX A

## P R E S S U R E M E A S U R E M E N T S

OUTER PANEL SWEEP= 15.0000 DEGREES

FUSELAGE OFF

ANGLE OF ATTACK= 4.21706 DEGREES

### S P A N W I S E L O C A T I O N

	2Y/A	2Y/B	2Y/B	2Y/D	2Y/D	2Y/B	2Y/B	2Y/D	2Y/B
	.04333	.12996	.21661	.33426	.43233	.48036	.57641	.67250	.86465
X/C	- CPU	- CPU	- CPU	- CPU	- CPU	- CPU	- CPU	- CPU	- CPU
0.000	-.01386	-.16868	-.37172	-.18235	-.46509	-.08421	-.09482	-.11349	-.60930
.025	-.15000	-.27049	-.41672	2.12665	1.78524	1.57806	1.54952	1.45165	1.06620
.050	-.15061	-.25784	-.37883	1.40696	1.21051	1.12017	1.19980	1.03781	-.78226
.075	-.13193	-.24760	-.33644	1.07254	-.96640	-.91047	-.88791	-.82556	-.68643
.100	-.13073	-.22290	-.30832	-.88635	-.85394	-.80562	-.80031	-.75032	-.67152
.200	-.14940	-.20543	-.27918	-.62394	-.64490	-.63773	-.61116	-.59770	-.48980
.300	-.16968	-.23675	-.27969	-.52609	-.58772	-.57468	-.55370	-.52813	-.42378
.400	-.16988	-.21868	-.27406	-.46573	-.52228	-.50993	-.48871	-.45999	-.36203
.600	-.18494	-.19217	-.22344	-.29291	-.32086	-.31763	-.30370	-.29485	-.23478
.800	-.11923	-.10783	-.08846	-.12560	-.11119	-.10941	-.11140	-.10782	-.08441
1.000	-.05723	-.07591	-.08131	-.05909	-.10420	-.09748	-.09284	-.08228	-.04894
X/C	- CPL	- CPL	- CPL	- CPL	- CPL	- CPL	- CPL	- CPL	- CPL
0.000	-.01386	-.16868	-.37172	-.18235	-.46509	-.08421	-.09482	-.11349	-.60930
.025	-.06566	-.04578	-.02863	-.65698	-.61631	-.58088	-.62531	-.58306	-.52844
.050	-.04398	-.03856	-.05062	-.38440	-.39647	-.35874	-.38659	-.35324	-.37026
.075	-.01024	-.01386	-.03170	-.26876	-.29863	-.29044	-.27585	-.26883	-.26245
.100	-.00422	-.00301	-.02148	-.19633	-.21158	-.20357	-.19827	-.21492	-.18868
.200	-.04036	-.02590	-.00460	-.02478	-.02605	-.02918	-.03183	-.05036	-.05745
.300	-.04398	-.03615	-.01534	-.07116	-.04575	-.05040	-.02321	-.03476	-.04256
.400	-.06446	-.07289	-.00920	-.10547	-.10801	-.09416	-.08952	-.08583	-.07164
.600	-.04880	-.03856	-.03119	-.08832	-.10611	-.09880	-.09085	-.07661	-.05958
.800	-.03313	-.03795	-.01381	-.03367	-.00953	-.00530	-.00066	-.03688	-.01631
1.000	-.05723	-.07591	-.08131	-.05909	-.10420	-.09748	-.09284	-.08228	-.04894

## P R E S S U R E M E A S U R E M E N T S

OUTER PANLL SWEEP= 15.0000 DEGREES

FUSELAGE OFF

ANGLE OF ATTACK= 4.75240 DEGREES

### S P A N W I S E L O C A T I O N

	2Y/B	2Y/B	2Y/B	2Y/B	2Y/B	2Y/B	2Y/B	2Y/B	2Y/B
	.04333	.12996	.21661	.33426	.43233	.48036	.57641	.67250	.86465
X/C	- CPU	- CPU	- CPU	- CPU	- CPU	- CPU	- CPU	- CPU	- CPU
0.000	-.01607	-.23449	-.48855	-.17992	-.86011	-.29555	-.15140	-.35205	-.49824
.025	-.16248	-.29460	-.48444	2.20682	1.91450	1.76477	1.71339	1.58491	1.42853
.050	-.15712	-.27615	-.43318	1.74011	1.31794	1.23514	1.28850	1.14941	-.82893
.075	-.14462	-.28092	-.39576	1.35809	1.05448	-.98021	-.96769	-.90747	-.71181
.100	-.13927	-.24521	-.34603	-.94913	-.94161	-.88469	-.88074	-.80719	-.70830
.200	-.15355	-.21604	-.29272	-.63004	-.70025	-.66665	-.67389	-.62275	-.52176
.300	-.15831	-.23866	-.28041	-.52033	-.59618	-.59418	-.57837	-.54000	-.44322
.400	-.18093	-.22438	-.28195	-.42764	-.52534	-.52199	-.49566	-.48179	-.36818
.600	-.19105	-.19402	-.21582	-.29778	-.32850	-.32585	-.31596	-.30156	-.23896
.800	-.13094	-.11189	-.09843	-.13040	-.11033	-.11256	-.11717	-.11142	-.08549
1.000	-.05595	-.08035	-.07792	-.05078	-.09780	-.08952	-.08821	-.07218	-.04485
X/C	- CPL	- CPL	- CPL	- CPL	- CPL	- CPL	- CPL	- CPL	- CPL
0.000	-.01607	-.23449	-.48855	-.17992	-.86011	-.29555	-.15140	-.35205	-.49824
.025	-.06904	-.05475	-.02307	-.69711	-.65323	-.64706	-.65232	-.64890	-.59495
.050	-.04940	-.04999	-.05280	-.43632	-.44635	-.42259	-.43708	-.42416	-.39102
.075	-.01666	-.02262	-.03486	-.30781	-.33727	-.32781	-.32254	-.32025	-.29782
.100	-.00298	-.01309	-.02512	-.24136	-.25578	-.24684	-.24421	-.23896	-.23195
.200	-.02678	0.00000	-.01230	-.00144	-.00645	-.07570	-.09084	-.09110	-.09951
.300	-.02321	-.04107	-.00871	-.02570	-.02538	-.00740	-.00592	-.00771	-.01682
.400	-.05297	-.05595	-.00308	-.08463	-.08212	-.06917	-.06582	-.05956	-.04765
.600	-.04583	-.03571	-.02307	-.07136	-.08400	-.08306	-.06977	-.06517	-.04835
.800	-.04107	-.02678	-.00359	-.02445	-.05185	0.00300	-.00263	-.01402	-.01892
1.000	-.05595	-.08035	-.07792	-.05078	-.09780	-.08952	-.08821	-.07218	-.04485

# APPENDIX A

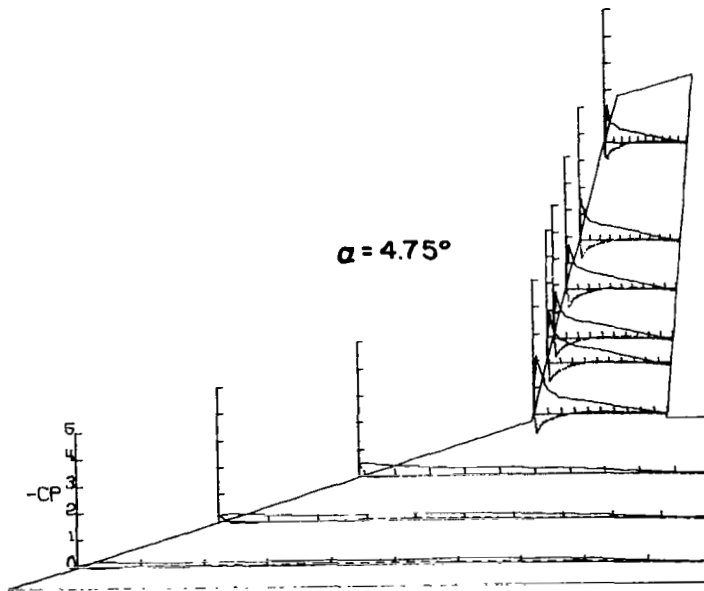
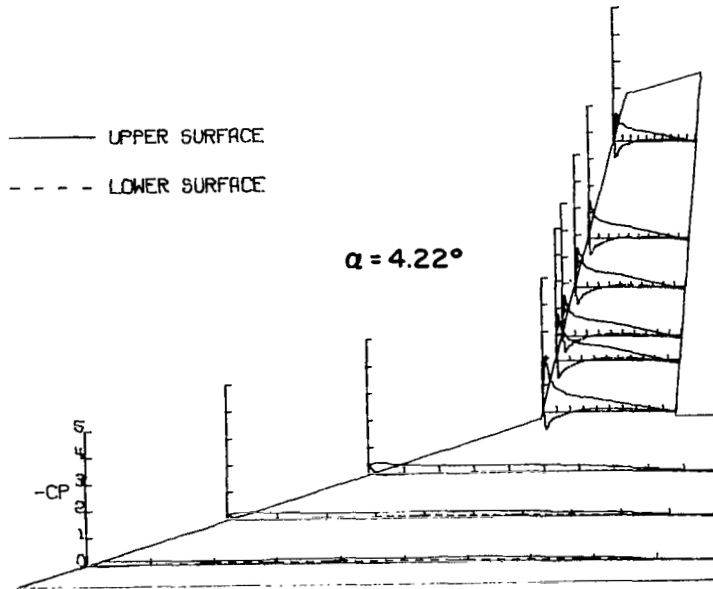

# APPENDIX A

## P R E S S U R E M E A S U R E M E N T S

WATER PANEL SWEEP= 15.00000 DEGREES

FUSELAGE OFF

ANGLE OF ATTACK= 5.26745 DEGREES

### S P A N W I S E L O C A T I O N

	2Y/B	2Y/B	2Y/B	2Y/B	2Y/B	2Y/B	2Y/B	2Y/B	2Y/B
	.04333	.12996	.21601	.33426	.43233	.43036	.57641	.67250	.86465
X/L	-CPL	-CPU	-CPU	-CPU	-CPU	-CPU	-CPU	-CPU	-CPU
0.000	.04653	.27980	.64892	.31210	1.16779	.66642	.43058	.63332	-.40977
.025	.17600	.34304	.54956	1.83970	2.12108	1.99596	1.89304	1.75650	1.86986
.050	.17304	.30665	.49678	1.94822	1.43529	1.32823	1.37757	1.25684	1.05740
.075	.15452	.26696	.42692	1.70074	1.12678	1.07166	1.03679	.98672	.77678
.100	.14915	.25357	.37873	1.20186	.99871	.95653	.91443	.85866	.72430
.200	.10297	.23974	.32291	.62168	.73895	.71115	.70326	.65782	.53885
.300	.17540	.26668	.31773	.55926	.63870	.62892	.61181	.57524	.45697
.400	.17719	.25534	.31043	.45901	.56935	.54102	.53970	.48427	.38280
.600	.19688	.20165	.23804	.30264	.33858	.33329	.32671	.30652	.24125
.800	.11937	.12648	.10575	.13178	.11917	.11175	.12490	.10699	.09160
1.000	-.06443	-.07756	-.06727	-.05044	-.08701	-.09729	-.07888	-.08391	-.04056

	CPL	CPL	CPL	CPL	CPL	CPL	CPL	CPL	CPL
	.04653	.27980	.64892	.31210	1.16779	.66642	.43058	.63332	-.40977
0.000	.04653	.27980	.64892	.31210	1.16779	.66642	.43058	.63332	-.40977
.025	-.07517	-.04713	-.00155	-.72697	-.72067	-.70010	-.71916	-.68738	-.60697
.050	-.06205	-.04534	-.03674	-.46910	-.49810	-.47199	-.49303	-.48669	-.43075
.075	-.02685	-.02446	-.02846	-.35056	-.37893	-.34062	-.36024	-.35733	-.33705
.100	-.00656	-.01909	-.01811	-.23057	-.28751	-.29976	-.27610	-.29649	-.26013
.200	-.02923	-.00418	-.00310	-.07881	-.10592	-.09598	-.11635	-.12587	-.11608
.300	.01847	.02364	-.00362	.00567	-.00441	-.01512	-.02629	-.02587	-.00909
.400	.04832	.04296	.00207	.07314	.06557	.05325	.04602	.03566	.03147
.600	.02744	.03291	.01604	.05738	.07251	.06574	.05922	.03986	.03496
.800	.03520	.02386	.00931	.01387	-.00820	-.00657	-.00526	-.00070	.00070
1.000	-.06443	-.07756	-.06727	-.05044	-.08701	-.09729	-.07888	-.08391	-.04056

## P R E S S U R E M E A S U R E M E N T S

WATER PANEL SWEEP= 15.00000 DEGREES

FUSELAGE OFF

ANGLE OF ATTACK= 5.80065 DEGREES

### S P A N W I S E L O C A T I O N

	2Y/B	2Y/B	2Y/B	2Y/B	2Y/B	2Y/B	2Y/B	2Y/B	2Y/B
	.04333	.12996	.21601	.33426	.43233	.48036	.57641	.67250	.86465
X/C	-CPU	-CPU	-CPU	-CPU	-CPU	-CPU	-CPU	-CPU	-CPU
0.000	.04968	.36238	.77164	.39533	1.53261	.93344	.69168	.73225	-.31500
.025	.20172	.38341	.62679	2.25584	2.33508	2.14289	2.06384	1.91544	2.01510
.050	.11930	.32331	.52415	1.89542	1.51626	1.44528	1.47558	1.36908	1.30052
.075	.16040	.31670	.46944	1.44425	1.20622	1.13962	1.11920	1.09060	1.00225
.100	.15685	.29267	.40588	1.62946	1.06169	1.02632	1.00788	.95772	.90118
.200	.16526	.24699	.33710	.70518	.77745	.74504	.74240	.71246	.59725
.300	.18089	.26803	.33294	.51600	.65992	.65150	.63832	.61139	.48205
.400	.18950	.25120	.33378	.48834	.56942	.56718	.54610	.52163	.39369
.600	.19110	.22235	.24176	.28948	.34819	.33439	.34821	.32372	.25638
.800	.13702	.12320	.11202	.13450	.09733	.11914	.11454	.12501	.09464
1.000	-.06133	-.07993	-.06669	-.04085	-.07861	-.08623	-.07767	-.06710	-.03108

	CPL	CPL	CPL	CPL	CPL	CPL	CPL	CPL	CPL
	.04968	.36238	.77164	.39533	1.53261	.93344	.69168	.73225	-.31500
0.000	.04968	.36238	.77164	.39533	1.53261	.93344	.69168	.73225	-.31500
.025	-.03293	-.05829	.00729	-.74540	-.70923	-.73450	-.76225	-.74465	-.66602
.050	-.07572	-.05529	-.03751	-.51788	-.54428	-.52133	-.53910	-.51699	-.47179
.075	-.03486	-.02885	-.02370	-.39533	-.42235	-.42720	-.40746	-.40581	-.35455
.100	-.01403	-.03055	-.03126	-.30905	-.34945	-.35019	-.33505	-.33554	-.28816
.200	.01567	-.01262	-.02032	-.11879	-.13635	-.13231	-.13955	-.15114	-.13914
.300	.02593	.01683	-.00729	-.00817	-.03268	-.02962	-.05793	-.03502	-.02189
.400	.03906	.04627	-.01074	.04902	.03703	.03094	.02041	.02401	.02543
.600	.02454	.01743	.01094	.00468	.05531	.05793	.04147	.03955	.03531
.800	.01367	.02874	.00938	.00754	-.00691	-.01343	-.00922	-.00848	.00353
1.000	-.06133	-.07993	-.06669	-.04085	-.07861	-.08623	-.07767	-.06710	-.03108

# APPENDIX A

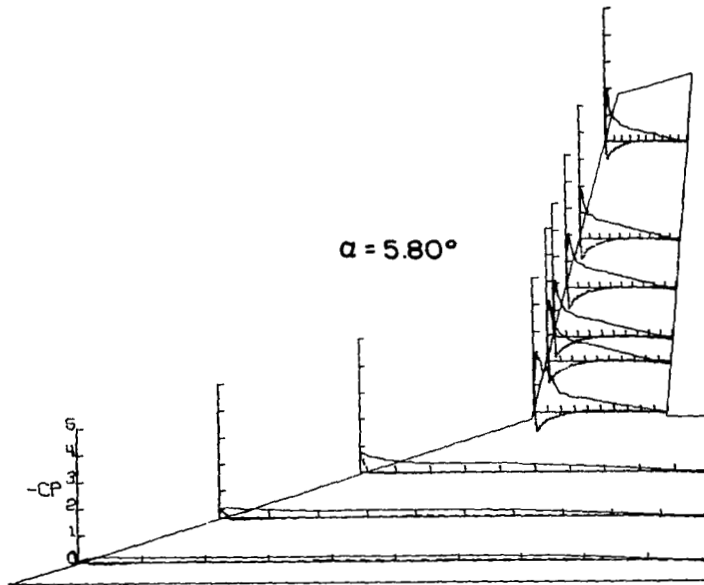
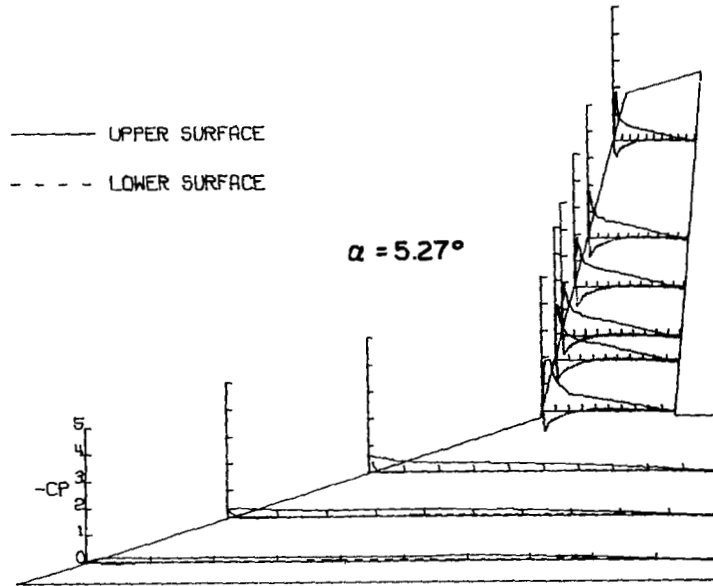

# APPENDIX A

## P R E S S U R E M E A S U R E M E N T S

OUTER PANEL SWEEP= 15.0000 DEGREES

FUSELAGE OFF

ANGLE OF ATTACK= 6.31149 DEGREES

### S P A N W I S E L O C A T I O N

	2Y/B .04333	2Y/B .12996	2Y/B .21661	2Y/B .33426	2Y/B .43233	2Y/B .48036	2Y/B .57641	2Y/B .67250	2Y/B .86465
X/C	-CPU	-CPU	-CPU	-CPU	-CPU	-CPU	-CPU	-CPU	-CPU
0.000	.06686	.41429	.85470	1.19690	1.57494	1.28879	1.00377	.94893	-.21118
.025	.22386	.41011	.69522	2.49515	2.30862	2.23255	2.24951	2.07980	2.10290
.050	.20356	.35758	.55845	2.07422	1.62406	1.53663	1.55163	1.49127	1.78939
.075	.17431	.32952	.48722	1.93556	1.35421	1.22344	1.19096	1.18056	1.25404
.100	.17670	.29370	.43200	1.38903	1.19560	1.08595	1.05399	1.06930	.99932
.200	.18327	.25908	.35613	.82705	.80344	.77354	.75332	.74809	.62143
.300	.19759	.27699	.34580	.57975	.65369	.67309	.65804	.63052	.48847
.400	.19461	.25848	.34735	.45298	.55054	.57070	.55113	.53325	.38420
.600	.19521	.22207	.27148	.28770	.33119	.32261	.33499	.31212	.24265
.800	.14327	.13014	.10942	.12800	.13298	.10754	.11796	.12377	.09021
1.000	-.05432	-.07164	-.06710	.00684	-.01491	-.04953	-.06191	-.06224	-.01818

	2Y/B .04333	2Y/B .12996	2Y/B .21661	2Y/B .33426	2Y/B .43233	2Y/B .48036	2Y/B .57641	2Y/B .67250	2Y/B .86465
X/C	-CPL	-CPL	-CPL	-CPL	-CPL	-CPL	-CPL	-CPL	-CPL
0.000	.06686	.41429	.85470	1.19690	1.57494	1.28879	1.00377	.94893	-.21118
.025	-.08775	-.04895	.01342	-.79101	-.76678	-.77165	-.79837	-.77759	-.69018
.050	-.07343	-.06029	-.03871	-.56235	-.56235	-.56114	-.57287	-.55802	-.49299
.075	-.03582	-.04238	-.04129	-.42067	-.44926	-.46142	-.45230	-.44753	-.38740
.100	-.02328	-.02627	-.03510	-.34052	-.36351	-.36692	-.36497	-.36712	-.31048
.200	-.02149	-.01612	-.03097	-.13360	-.14913	-.15055	-.17140	-.17272	-.14615
.300	.00836	.02268	-.02168	-.02796	-.03915	-.05735	-.06582	-.06433	-.03147
.400	.04597	.04776	-.01961	.03790	.02796	.01499	.01043	.00210	.01888
.600	.02149	.00478	-.00774	.05406	.04971	.05605	.02672	.03357	.02238
.800	.02268	.01433	-.00774	.01740	0.00000	-.00978	-.02151	-.01049	-.00350
1.000	-.05432	-.07164	-.06710	.00684	-.01491	-.04953	-.06191	-.06224	-.01818

## P R E S S U R E M E A S U R E M E N T S

OUTER PANEL SWEEP= 15.0000 DEGREES

FUSELAGE OFF

ANGLE OF ATTACK= 7.34351 DEGREES

### S P A N W I S E L O C A T I O N

	2Y/B .04333	2Y/B .12996	2Y/B .21661	2Y/B .33426	2Y/B .43233	2Y/B .48036	2Y/B .57641	2Y/B .67250	2Y/B .86465
X/C	-CPU	-CPU	-CPU	-CPU	-CPU	-CPU	-CPU	-CPU	-CPU
0.000	.12425	.57300	1.18554	1.04954	1.18153	1.53877	.53294	.41778	-.05842
.025	.26418	.49338	.84996	2.67208	1.40362	2.33911	1.69724	1.74311	2.05466
.050	.22196	.40351	.67378	1.73549	1.43979	2.11805	1.74651	1.79872	1.81297
.075	.19422	.37094	.56839	1.94552	1.51339	1.56873	1.80577	1.70033	1.52567
.100	.19000	.33294	.49917	1.74627	1.45184	1.25845	1.64131	1.47933	1.31963
.200	.19000	.28710	.40374	1.26782	1.15361	.84163	.90222	.90257	.76284
.300	.19844	.29917	.37753	.82059	.75020	.71445	.69315	.65946	.55039
.400	.20447	.27625	.36966	.54981	.57771	.56863	.54093	.52258	.42135
.600	.21412	.23463	.28472	.29361	.36717	.32269	.32935	.32011	.24649
.800	.14596	.14174	.13056	.18073	.18454	.15769	.13773	.13535	.11398
1.000	-.06755	-.08565	-.06816	.01649	.06532	.04125	-.02063	-.01852	-.01354

	2Y/B .04333	2Y/B .12996	2Y/B .21661	2Y/B .33426	2Y/B .43233	2Y/B .48036	2Y/B .57641	2Y/B .67250	2Y/B .86465
X/C	-CPL	-CPL	-CPL	-CPL	-CPL	-CPL	-CPL	-CPL	-CPL
0.000	.12425	.57300	1.18554	1.04954	1.18153	1.53877	.53294	.41778	-.05842
.025	-.10736	-.04644	.05453	-.83137	-.79966	-.80374	-.81372	-.77650	-.75015
.050	-.09771	-.07600	-.03985	-.61513	-.60688	-.60812	-.61079	-.58701	-.54640
.075	-.06816	-.06092	-.05191	-.47054	-.49844	-.49568	-.49102	-.46305	-.43171
.100	-.04825	-.05428	-.04719	-.38556	-.40586	-.40453	-.39788	-.38896	-.34765
.200	-.01930	-.03921	-.06659	-.17122	-.19151	-.18829	-.20493	-.20588	-.18522
.300	.00121	-.01075	-.03828	-.04946	-.06468	-.07119	-.08982	-.08406	-.05485
.400	.01086	.01689	-.05768	.01649	.00634	-.00200	-.00931	-.01496	-.00570
.600	-.00543	-.01086	-.02779	.03172	.05327	.04391	.03127	.02137	.02351
.800	.00121	.00603	-.00996	.01902	.01776	.00399	.00067	.00074	.00784
1.000	-.06755	-.08565	-.06816	.01649	.06532	.04125	-.02063	-.01852	-.01354



APPENDIX A

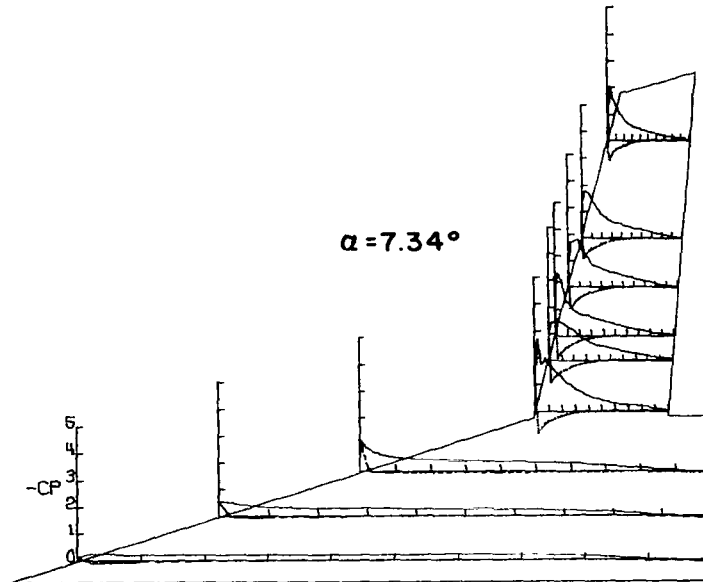
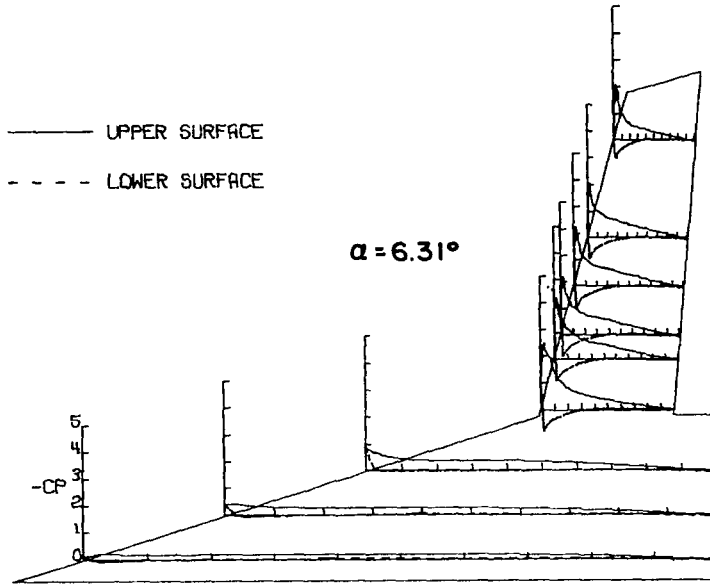

# APPENDIX A

## P R E S S U R E M E A S U R E M E N T S

OUTER PANEL SWEEP= 15.0000 DEGREES

FUSELAGE OFF

ANGLE OF ATTACK= 8.38860 DEGREES

### S P A N W I S E L O C A T I O N

	2Y/B	2Y/B	2Y/B	2Y/B	2Y/B	2Y/B	2Y/B	2Y/B	2Y/B
	.04333	.12996	.21661	.33426	.43233	.48036	.57641	.67250	.86465
X/C	-CPU	-CPU	-CPU	-CPU	-CPU	-CPU	-CPU	-CPU	-CPU
0.000	.17675	.76033	1.60409	.70165	1.08097	1.16765	.57053	.35718	.11897
.025	.23690	.57702	.94939	1.12461	1.26503	2.22492	1.60652	1.57058	2.11953
.050	.29451	.47052	.79836	1.43138	.96585	2.16308	1.64442	1.61264	1.11146
.075	.20939	.42419	.67605	1.38394	1.18154	1.73086	1.73352	1.60765	1.04088
.100	.21179	.37786	.54393	1.36117	1.11892	1.36447	1.64309	1.54206	1.19344
.200	.27937	.30506	.47117	1.31057	1.16256	.91630	1.22882	1.21126	.87548
.300	.21661	.31528	.43350	1.14232	1.04808	.74275	.74474	.76711	.71293
.400	.21661	.29362	.41929	.90785	.79647	.61774	.58383	.61954	.50832
.600	.22202	.25391	.39229	.47662	.35968	.48704	.36678	.35219	.31227
.800	.19339	.16426	.17200	.25526	.22251	.27309	.17076	.17810	.15815
1.000	-.09679	-.07341	-.05135	.11125	.13401	.12425	.03721	.04844	.08477

	2Y/B	2Y/B	2Y/B	2Y/B	2Y/B	2Y/B	2Y/B	2Y/B	2Y/B
	.04333	.12996	.21661	.33426	.43233	.48036	.57641	.67250	.86465
X/C	-CPL	-CPL	-CPL	-CPL	-CPL	-CPL	-CPL	-CPL	-CPL
0.000	.19675	.76033	1.60409	.70165	1.08097	1.16765	.57053	.35718	.11897
.025	-.11673	-.01925	-.10588	-.82618	-.77498	-.81794	-.81794	-.80073	-.75727
.050	-.13830	-.07040	-.00318	-.61442	-.02201	-.63388	-.63388	-.61479	-.54640
.075	-.04183	-.06679	-.03441	-.50633	-.52529	-.53754	-.51893	-.50580	-.44026
.100	-.06739	-.06077	-.04923	-.41088	-.42162	-.43521	-.42724	-.42530	-.37543
.200	-.02768	-.05897	-.05665	-.20291	-.21555	-.21462	-.21727	-.22725	-.20873
.300	-.02858	-.02768	-.05506	-.07965	-.08660	-.10100	-.11229	-.10401	-.06696
.400	-.00120	-.00662	-.05559	-.00126	-.00948	-.01462	-.02326	-.02208	-.01852
.600	-.01083	-.03189	-.03494	.03982	.04551	.05448	.02857	.03277	.02422
.800	-.00241	.00782	-.01588	.02402	.02718	.02259	.01329	.02351	.01567
1.000	-.00679	-.07341	-.05135	.11125	.13401	.12425	.03721	.04844	.08477

## P R E S S U R E M E A S U R E M E N T S

OUTER PANEL SWEEP= 15.0000 DEGREES

FUSELAGE OFF

ANGLE OF ATTACK= 9.46258 DEGREES

### S P A N W I S E L O C A T I O N

	2Y/B	2Y/B	2Y/B	2Y/B	2Y/B	2Y/B	2Y/B	2Y/B	2Y/B
	.04333	.12996	.21661	.33426	.43233	.48036	.57641	.67250	.86465
X/C	-CPU	-CPU	-CPU	-CPU	-CPU	-CPU	-CPU	-CPU	-CPU
0.000	.26402	.42392	2.01757	1.01670	.92188	1.35136	.39442	.37055	.09607
.025	.32494	.66780	1.14476	1.99415	1.11656	2.11195	1.31333	1.61481	1.24638
.050	.27775	.52982	.88798	1.23202	.87822	2.03983	1.42808	1.26462	1.39936
.075	.24012	.47308	.74260	1.37807	1.29755	1.79001	1.56446	1.31375	1.04777
.100	.22340	.40200	.63905	.94742	1.16586	1.29235	1.37497	1.23866	.96426
.200	.22101	.33649	.52296	1.23514	.98549	.81829	1.26153	1.30673	1.00847
.300	.22400	.33510	.47328	1.23389	1.12717	.87927	.98287	.96285	.83864
.400	.23359	.31847	.44347	.87373	.63273	.63273	.69240	.78741	.58529
.600	.23176	.28313	.41157	.97758	.58381	.55667	.40949	.43792	.41266
.800	.19577	.19353	.21337	.37923	.36676	.32432	.23980	.24334	.26297
1.000	-.09913	-.06939	-.04131	.14533	.19835	.11728	.13235	.11851	.13955

	2Y/B	2Y/B	2Y/B	2Y/B	2Y/B	2Y/B	2Y/B	2Y/B	2Y/B
	.04333	.12996	.21661	.33426	.43233	.48036	.57641	.67250	.86465
X/C	-CPL	-CPL	-CPL	-CPL	-CPL	-CPL	-CPL	-CPL	-CPL
0.000	.26402	.42392	2.01757	1.01670	.92188	1.35136	.39442	.37055	.09607
.025	-.12442	-.10115	-.17153	-.84391	-.83091	-.84454	-.84126	-.82959	-.72650
.050	-.11327	-.07705	.03347	-.05554	-.60178	-.65847	-.67419	-.61290	-.56662
.075	-.02356	-.07347	-.01935	-.54764	-.54889	-.55298	-.53660	-.50350	-.45792
.100	-.07944	-.07467	-.04079	-.44909	-.46909	-.46518	-.45667	-.43127	-.37517
.200	-.05077	-.07944	-.07854	-.23640	-.23078	-.25356	-.24832	-.24754	-.22090
.300	-.05310	-.04301	-.07583	-.09107	-.12288	-.11073	-.13628	-.10940	-.08415
.400	-.02150	-.02449	-.08367	-.01622	-.01123	-.03079	-.02555	-.03226	-.01192
.600	-.04002	-.04420	-.04654	.01060	.04553	.03014	.03669	.03086	.03506
.800	-.00396	-.01135	-.01935	.01372	.04241	.01441	.04193	.02244	.05610
1.000	-.09913	-.06939	-.04131	.14533	.19835	.11728	.13235	.11851	.13955

APPENDIX A

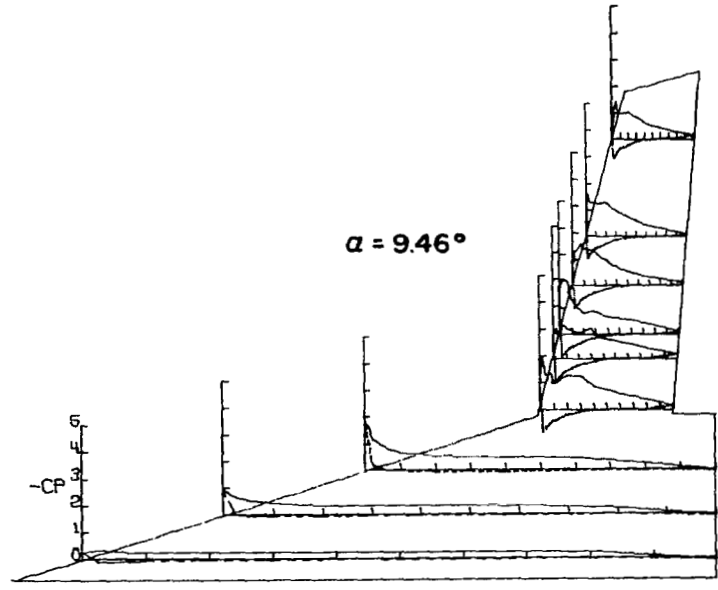
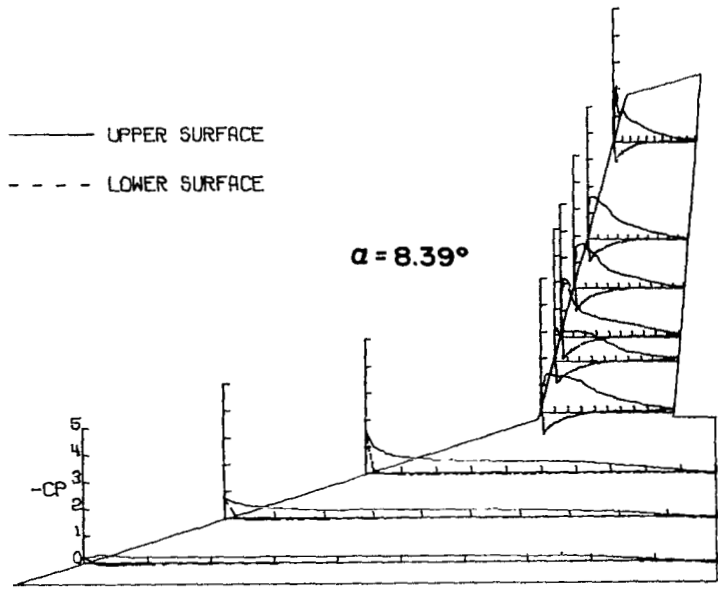

# APPENDIX A

## P R E S S U R E M E A S U R E M E N T S

OUTER PANEL SWEEP= 15.00000 DEGREES

FUSELAGE OFF

ANGLE OF ATTACK= 10.50945 DEGREES

### S P A N W I S E L O C A T I O N

	2Y/d	2Y/H	2Y/B	2Y/B	2Y/B	2Y/B	2Y/B	2Y/B	2Y/B
	.04333	.12996	.21661	.33426	.43233	.48036	.57641	.67250	.86465
X/C	-CPU	-CPU	-CPU	-CPU	-CPU	-CPU	-CPU	-CPU	-CPU
0.000	.35225	1.18412	2.37317	1.58066	1.37015	1.37033	.42598	-.23629	-.16808
.025	.36780	.75272	1.29090	1.70470	.98924	2.18543	1.17297	.86144	.92126
.050	.31397	.59206	.98213	1.50485	.95854	1.72624	1.28678	1.04794	.55529
.075	.25836	.50415	.79384	1.55810	.82270	1.76505	1.34007	.87903	.54333
.100	.24819	.44554	.70361	1.63203	1.18596	1.98075	1.20567	1.00783	.85511
.200	.24041	.36062	.61807	1.12895	1.00929	1.08548	1.23284	1.05428	.66297
.300	.24101	.34856	.49967	.97107	.93415	.93194	1.01180	.87200	.62426
.400	.23264	.32414	.41937	.74632	.71752	.86115	.68747	.86285	.71435
.600	.23982	.28407	.35102	.49324	.56537	.42400	.49040	.53911	.70801
.800	.18001	.20752	.21750	.38318	.53282	.43452	.36878	.41946	.43002
1.000	-.05323	-.06160	-.01930	.30992	.26735	.26921	.21627	.24051	.24755

	2Y/d	2Y/H	2Y/B	2Y/B	2Y/B	2Y/B	2Y/B	2Y/B	2Y/B
	.04333	.12996	.21661	.33426	.43233	.48036	.57641	.67250	.86465
X/C	-CPL	-CPL	-CPL	-CPL	-CPL	-CPL	-CPL	-CPL	-CPL
0.000	.35225	1.18412	2.37317	1.58066	1.37015	1.37033	.42598	-.23629	-.16808
.025	-.11841	-.02153	.23940	-.84963	-.84149	-.44472	-.84078	-.81578	-.73772
.050	-.13576	-.06279	.05268	-.69936	-.69999	-.69287	-.68498	-.64418	-.59566
.075	-.11363	-.08014	-.01721	-.57477	-.58291	-.59163	-.55219	-.55346	-.48454
.100	-.09608	-.07954	-.04746	-.50131	-.48899	-.49994	-.46936	-.46837	-.41492
.200	-.06459	-.07894	-.09910	-.26672	-.24856	-.27544	-.25572	-.26653	-.20746
.300	-.06399	-.05622	-.10548	-.12522	-.14025	-.13805	-.14462	-.12518	-.09072
.400	-.03229	-.03947	-.11214	-.03819	-.03882	-.04470	-.04602	-.01428	-.03094
.600	-.04426	-.04665	-.06363	.01252	.04696	.03944	.03944	.04079	.03657
.800	-.01136	-.01017	-.03182	.02817	.04320	.04470	.04602	.07173	.06822
1.000	-.05323	-.06160	-.01930	.30992	.26735	.26921	.21627	.24051	.24755

## P R E S S U R E M E A S U R E M E N T S

OUTER PANEL SWEEP= 15.00000 DEGREES

FUSELAGE OFF

ANGLE OF ATTACK= 11.53725 DEGREES

### S P A N W I S E L O C A T I O N

	2Y/d	2Y/H	2Y/B	2Y/B	2Y/B	2Y/B	2Y/B	2Y/B	2Y/B
	.04333	.12996	.21661	.33426	.43233	.48036	.57641	.67250	.86465
X/C	-CPU	-CPU	-CPU	-CPU	-CPU	-CPU	-CPU	-CPU	-CPU
0.000	.43518	1.34921	2.81236	1.73196	1.21005	1.42399	.52423	-.07601	-.29769
.025	.39579	.86603	1.43434	1.75203	.76733	2.16556	1.02822	.75148	.87684
.050	.33072	.64651	1.02751	1.63052	.82312	2.05446	.87964	.91276	.56555
.075	.27523	.55945	.84339	1.65100	.83127	2.21382	1.20769	.83381	.70147
.100	.26386	.47578	.79175	1.29536	.77297	1.54430	1.26686	.90853	.59865
.200	.25490	.39817	.82963	1.10740	.71028	.79220	1.10513	1.13672	.69725
.300	.24834	.37907	.39223	1.01057	.92468	.89304	1.09187	.92051	.85853
.400	.24416	.34206	.41257	.88519	.90149	.79514	.93381	.87966	.74021
.600	.23938	.30505	.33642	.64207	.69335	.62258	.54764	.72542	.56907
.800	.19938	.19938	.23002	.54102	.43444	.43358	.38956	.57329	.52188
1.000	-.06208	-.06387	-.00522	.44009	.36548	.38431	.26474	.39159	.35144

	2Y/d	2Y/H	2Y/B	2Y/B	2Y/B	2Y/B	2Y/B	2Y/B	2Y/B
	.04333	.12996	.21661	.33426	.43233	.48036	.57641	.67250	.86465
X/C	-CPL	-CPL	-CPL	-CPL	-CPL	-CPL	-CPL	-CPL	-CPL
0.000	.43518	1.34921	2.81236	1.73196	1.21005	1.42399	.52423	-.07601	-.29769
.025	-.13133	.05970	-.32964	-.05196	-.82676	-.83562	-.83395	-.72698	-.72698
.050	-.14984	-.06387	.04858	-.71724	-.70539	-.72798	-.69241	-.67701	-.57708
.075	-.13572	-.09133	-.00574	-.53681	-.60813	-.61883	-.57744	-.57427	-.50811
.100	-.10865	-.10327	-.03703	-.50591	-.41907	-.51504	-.48942	-.47011	-.40114
.200	-.08775	-.10924	-.10536	-.23023	-.30029	-.27985	-.29244	-.25054	-.24350
.300	-.08477	-.08417	-.11643	-.14231	-.15861	-.15701	-.16752	-.13090	-.10697
.400	-.05074	-.07343	-.12414	-.05286	-.04639	-.05124	-.04796	-.03515	-.02956
.600	-.06305	-.07104	-.06728	.03009	.04639	.03650	.04270	.03319	.06263
.800	-.02627	-.02865	-.02347	.33197	.07711	.05761	.06175	.09501	.08515
1.000	-.06208	-.06387	-.00522	.44009	.36548	.38431	.26474	.39159	.35144

# APPENDIX A

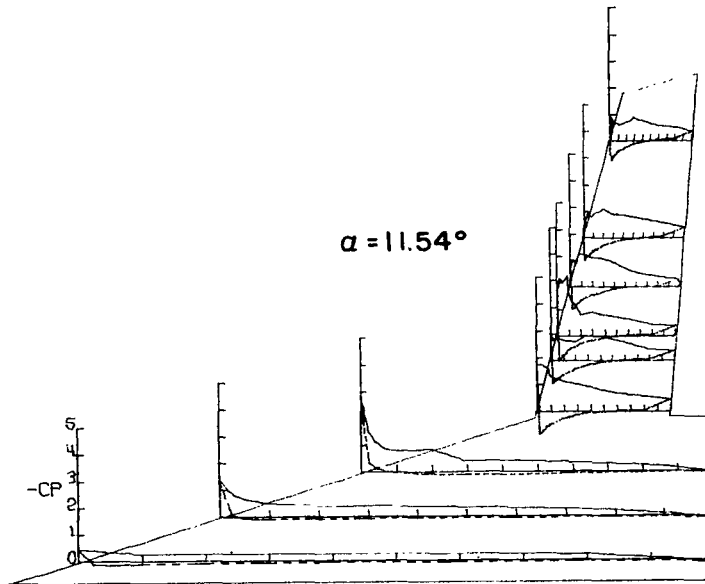
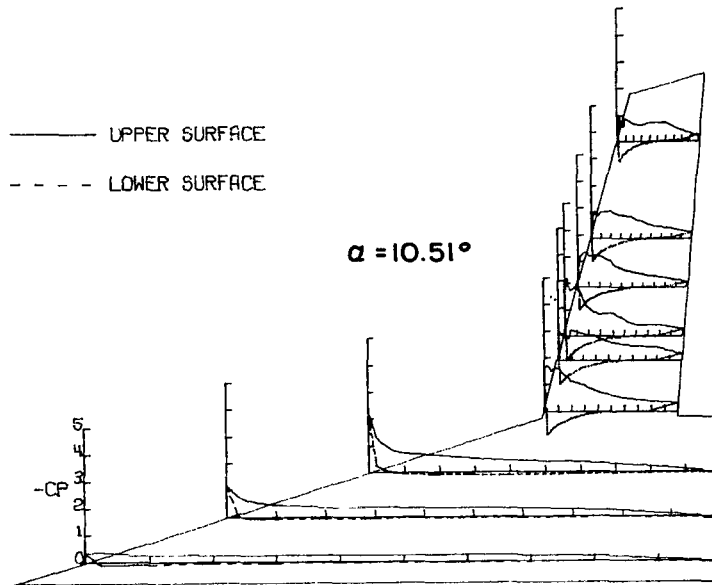

# APPENDIX A

## P R E S S U R E M E A S U R E M E N T S

UJTFR PANEL SWEEP= 15.00000 DEGREES

FUSELAGE OFF

ANGLE OF ATTACK= 12.54325 DEGREES

### S P A N W I S E L O C A T I O N

	2Y/a	2Y/a	2Y/d	2Y/B	2Y/d	2Y/B	2Y/B	2Y/B	2Y/B
	.04333	.12996	.21001	.33426	.43233	.48036	.57641	.67250	.86465
X/C	-CPU	-CPU	-CPU	-CPU	-CPU	-CPU	-CPU	-CPU	-CPU
0.000	.53671	1.69942	3.18595	1.84886	1.21831	1.42169	.59617	.16339	-.26973
.025	.45307	.95475	1.48882	2.42278	.77417	2.19434	1.03240	.82320	.54763
.050	.36823	.71697	.98934	2.00848	.81568	.67549	1.09783	1.44764	.58216
.075	.30024	.60349	.87903	1.48261	.81694	.54355	1.05355	1.32008	.69845
.100	.24980	.52648	.79943	1.55435	.86914	.62129	1.19697	1.31937	.68154
.200	.26655	.45247	1.27323	1.24096	.76789	.88606	1.16260	1.18405	.51803
.300	.26734	.40193	.36765	1.17678	.72323	.63186	1.01786	1.03675	.76188
.400	.25793	.36884	.41087	.95027	.67984	.69267	.90483	.78444	.86549
.600	.27136	.33394	.33328	.63519	.50941	.72440	.71911	.69140	.73299
.800	.20336	.23165	.21090	.50501	.54714	.48411	.60543	.63643	.56948
1.000	-.05954	-.05355	0.00000	.42136	.40941	.34938	.26352	.32280	.26691

	-CPL	-CPL	-CPL	-CPL	-CPL	-CPL	-CPL	-CPL	-CPL
0.000	.53671	1.69942	3.18595	1.84886	1.21831	1.42169	.59617	.16339	-.26973
.025	-.1341d	.10409	.41920	-.35404	-.80474	-.89689	-.87179	-.83173	-.79088
.050	-.16306	-.04152	.11501	-.75216	-.73141	-.75687	-.70074	-.66693	-.55566
.075	-.14140	-.07581	.01614	-.03645	-.63707	-.64394	-.60299	-.57186	-.50918
.100	-.13357	-.09326	-.04478	-.55469	-.55595	-.56336	-.53364	-.49862	-.44791
.200	-.13044	-.11613	-.13175	-.32074	-.31696	-.32560	-.29588	-.29084	-.23100
.300	-.09567	-.10048	-.14635	-.17609	-.19685	-.18691	-.19747	-.16480	-.13733
.400	-.09716	-.08724	-.14633	-.05409	-.08176	-.05482	-.07529	-.14287	-.03310
.600	-.07220	-.08935	-.10155	.00943	.04843	.04029	.04161	.04366	.02183
.800	-.03430	-.02764	-.03593	.06163	.09371	.09444	.08586	.09296	.15635
1.000	-.05954	-.05355	0.00000	.42136	.40941	.34938	.26352	.32280	.26691

## P R E S S U R E M E A S U R E M E N T S

UJTFR PANEL SWEEP= 15.00000 DEGREES

FUSELAGE OFF

ANGLE OF ATTACK= 13.56242 DEGREES

### S P A N W I S E L O C A T I O N

	2Y/a	2Y/B	2Y/B	2Y/B	2Y/B	2Y/B	2Y/B	2Y/B	2Y/B
	.04333	.12996	.21661	.33426	.43233	.48036	.57641	.67250	.86465
X/C	-CPU	-CPU	-CPU	-CPU	-CPU	-CPU	-CPU	-CPU	-CPU
0.000	.64524	1.92409	3.65957	2.98099	1.14309	.43317	.03878	-.03020	-.36096
.025	.48674	1.05152	1.44139	3.56924	.75272	.68155	.51735	.50039	.65149
.050	.39935	.70267	1.00435	2.11216	1.05860	.77957	.49500	1.48850	.59175
.075	.32477	.63404	1.00794	1.70602	1.06932	.77028	.53576	1.56299	.95087
.100	.30071	.55701	1.04912	1.39529	.99871	.75128	.52590	1.24534	.91222
.200	.24411	.51679	1.06509	1.19227	.88277	.76049	.47068	1.11321	.55099
.300	.27910	.30895	.80923	1.05734	.81031	.73631	.52984	.43995	.67960
.400	.26350	.38414	.41337	1.01006	.88277	.56642	.50749	.65570	.77869
.600	.27730	.32472	.24900	.75864	.56600	.52195	.46673	.46103	.58472
.800	.23880	.23879	.24040	.53451	.53622	.48120	.45753	.45330	.50531
1.000	-.05462	-.05162	-.03706	.47951	.51068	.43255	.44701	.47087	.38794

	-CPL	-CPL	-CPL	-CPL	-CPL	-CPL	-CPL	-CPL	-CPL
0.000	.64524	1.92409	3.65957	2.98099	1.14309	.43317	.03878	-.03020	-.36096
.025	-.14325	.15000	.49779	-.33552	-.39286	-.80379	-.81908	-.85043	-.78653
.050	-.16446	-.10022	.17533	-.70368	-.77503	-.71719	-.68827	-.62792	-.64607
.075	-.15366	-.07803	.03301	-.65531	-.66917	-.61135	-.56600	-.52880	-.54144
.100	-.15006	-.10504	-.03039	-.57654	-.56635	-.52918	-.49829	-.52458	-.43750
.200	-.12305	-.13545	-.13437	-.30049	-.33206	-.31488	-.27544	-.26996	-.27247
.300	-.11404	-.11404	-.14020	-.17895	-.18210	-.16697	-.16434	-.13273	-.10534
.400	-.09544	-.10344	-.15032	-.03131	-.00079	-.00442	-.03353	-.05829	-.04143
.600	-.07003	-.09364	-.10399	.01260	.06238	.07363	.09137	.08919	.05126
.800	-.03601	-.03741	.06301	.06301	.12539	.13936	.15908	.14958	.13273
1.000	-.05462	-.05162	-.03706	.47951	.51068	.43255	.44701	.47087	.38794

# APPENDIX A

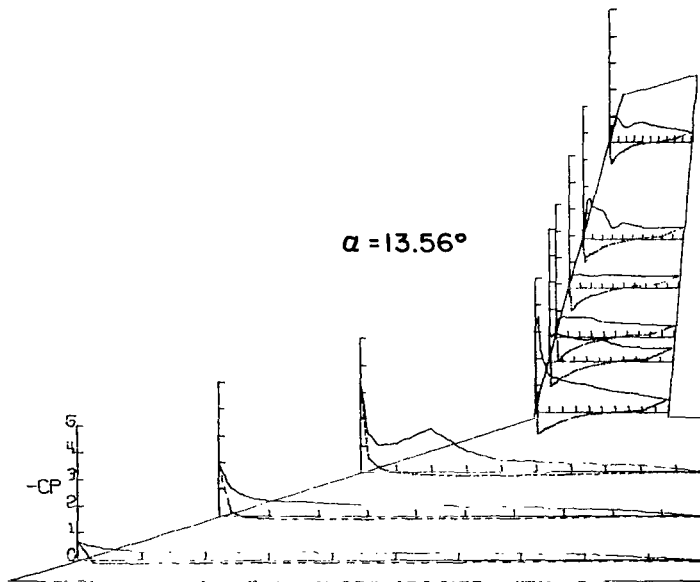
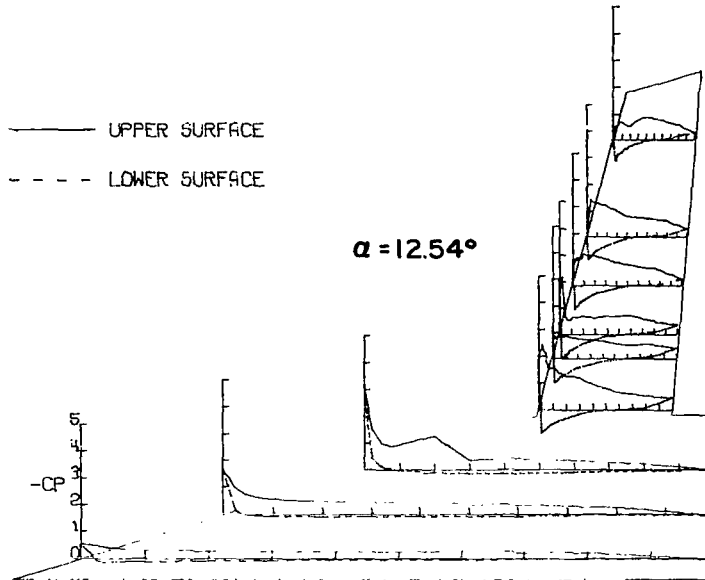

# APPENDIX A

## P R E S S U R E M E A S U R E M E N T S

OUTER PANEL SWEEP= 15.0000 DEGREES

FUSELAGE OFF

ANGLE OF ATTACK= 14.52711 DEGREES

### S P A N W I S E L O C A T I O N

	2Y/B .04333	2Y/B .12996	2Y/B .21601	2Y/B .33426	2Y/B .43233	2Y/B .48036	2Y/B .57641	2Y/B .67250	2Y/B .86465
X/C	-CPU	-CPU	-CPU	-CPU	-CPU	-CPU	-CPU	-CPU	-CPU
0.000	.74150	2.27751	4.06968	3.33525	1.46301	.59140	.19721	-.00706	-.06780
.025	.53884	1.18062	1.35656	4.37384	1.17643	.90904	.57745	.41702	.77466
.050	.42084	.80716	1.14930	1.60659	1.17205	.86385	.50663	.43822	.72801
.075	.35160	.68849	1.20398	1.42948	1.14422	.99343	.51195	.42409	1.06445
.100	.32330	.64540	1.22897	1.32385	1.23404	.85122	.56748	.45589	.89058
.200	.30584	.58640	1.78462	1.08856	1.19988	.92365	.54515	.42833	.83121
.300	.28477	.39916	1.15919	1.03100	1.00190	.81135	.57080	.40218	.80082
.400	.29681	.39013	.45305	1.06136	.88244	.72098	.53851	.45165	.74427
.600	.79982	.32692	.31766	.84009	.67700	.60602	.50265	.54919	.67995
.800	.21975	.26852	.25100	.79900	.56891	.51062	.50663	.46650	.57605
1.000	-.05780	-.04214	-.03333	.56322	.52403	.45019	.47078	.48841	.46296

	-CPL	-CPL	-CPL	-CPL	-CPL	-CPL	-CPL	-CPL	-CPL
X/C	-CPL	-CPL	-CPL	-CPL	-CPL	-CPL	-CPL	-CPL	-CPL
0.000	.74150	2.27751	4.06968	3.33525	1.46301	.59140	.19721	-.00706	-.06780
.025	-.13245	.19928	.59314	-.82681	-.90772	-.88246	-.85590	-.80727	-.82281
.050	-.17640	-.01264	.22809	-.78067	-.80785	-.75962	-.71046	-.67096	-.67661
.075	-.16858	-.08549	.06405	-.68395	-.69407	-.65670	-.59827	-.57491	-.55937
.100	-.16376	-.11018	-.03281	-.60178	-.61063	-.57635	-.52390	-.49369	-.48027
.200	-.14088	-.15834	-.15675	-.37421	-.37169	-.34395	-.31540	-.30511	-.29098
.300	-.14389	-.13366	-.17081	-.21492	-.21176	-.20385	-.17131	-.16809	-.13349
.400	-.11018	-.12463	-.17862	-.10683	-.09671	-.08101	-.05710	-.04661	-.05015
.600	-.12222	-.11800	-.11873	-.01138	.05183	.05710	.08300	.06680	.06427
.800	-.06382	-.03311	-.02708	.05436	.12769	.13214	.16069	.15397	.14196
1.000	-.05780	-.04214	-.03333	.56322	.52403	.45019	.47078	.48841	.46296

## P R E S S U R E M E A S U R E M E N T S

OUTER PANEL SWEEP= 15.0000 DEGREES

FUSELAGE OFF

ANGLE OF ATTACK= 15.55984 DEGREES

### S P A N W I S E L O C A T I O N

	2Y/B .04333	2Y/B .12996	2Y/B .21661	2Y/B .33426	2Y/B .43233	2Y/B .48036	2Y/B .57641	2Y/B .67250	2Y/B .86465
X/C	-CPU	-CPU	-CPU	-CPU	-CPU	-CPU	-CPU	-CPU	-CPU
0.000	.87022	2.58579	4.29647	3.44470	1.34869	.79448	.24335	.11960	-.04200
.025	.59460	1.27895	1.45610	4.23307	1.32658	1.43592	.61349	.46236	.76869
.050	.46005	.84960	1.45033	1.87048	1.39039	.94615	.61083	.44668	.89265
.075	.37458	.78774	1.40105	1.35754	1.21667	.94553	.56559	.42887	.99382
.100	.35216	.77440	1.40210	1.20656	1.28047	.91026	.63612	.44455	.84635
.200	.34246	.66673	1.93168	1.02021	1.26973	.87899	.58022	.50724	.77724
.300	.30367	.40792	1.10741	1.05053	1.19898	.82576	.63745	.48658	.79861
.400	.31033	.42065	.56157	1.04484	.91919	.86768	.57557	.48017	.77297
.600	.32185	.33882	.26846	.81692	.62942	.65541	.51264	.43742	.68392
.800	.24184	.24487	.32876	.84533	.62247	.61882	.47208	.50225	.63262
1.000	-.05637	-.04243	-.03146	.61616	.53283	.46942	.44814	.44882	.56566

	-CPL	-CPL	-CPL	-CPL	-CPL	-CPL	-CPL	-CPL	-CPL
X/C	-CPL	-CPL	-CPL	-CPL	-CPL	-CPL	-CPL	-CPL	-CPL
0.000	.87022	2.58579	4.29647	3.44470	1.34869	.79448	.24335	.11960	-.04200
.025	-.12001	.26669	.66592	-.78661	-.91603	-.89302	-.87766	-.81937	-.83788
.050	-.14335	.00546	.23858	-.78472	-.83838	-.78391	-.75798	-.71116	-.70404
.075	-.18244	-.07758	.05506	-.70644	-.73737	-.70213	-.65226	-.61079	-.60082
.100	-.18426	-.10789	-.05034	-.63826	-.65025	-.62434	-.56317	-.55041	-.50401
.200	-.16790	-.16911	-.17985	-.41035	-.41225	-.40027	-.35240	-.34526	-.31536
.300	-.16305	-.16426	-.19610	-.23864	-.24811	-.22939	-.20944	-.19221	-.15590
.400	-.13274	-.14426	-.19925	-.13131	-.12626	-.11037	-.08910	-.07404	-.06976
.600	-.13638	-.12789	-.13738	-.02399	.02967	.03391	.05984	.05481	.04912
.800	-.05879	-.07031	-.03828	.05429	.09722	.12700	.12965	.16017	.12244
1.000	-.05637	-.04243	-.03146	.61616	.53283	.46942	.44814	.44882	.56566



# APPENDIX A



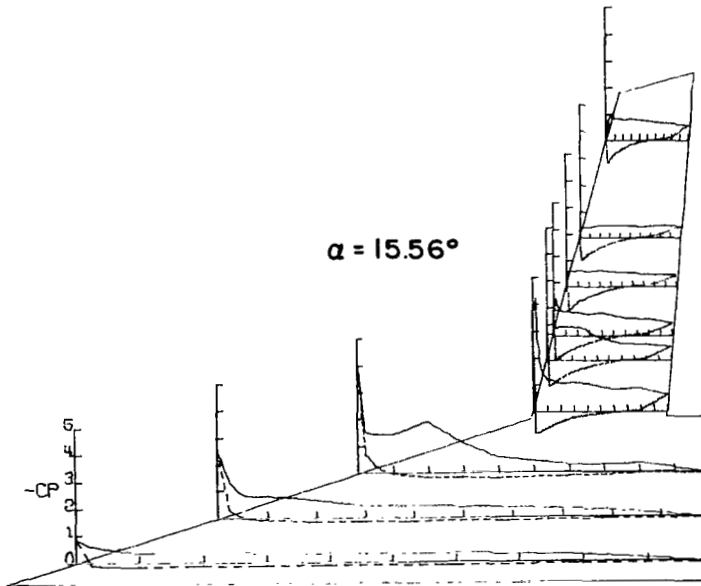
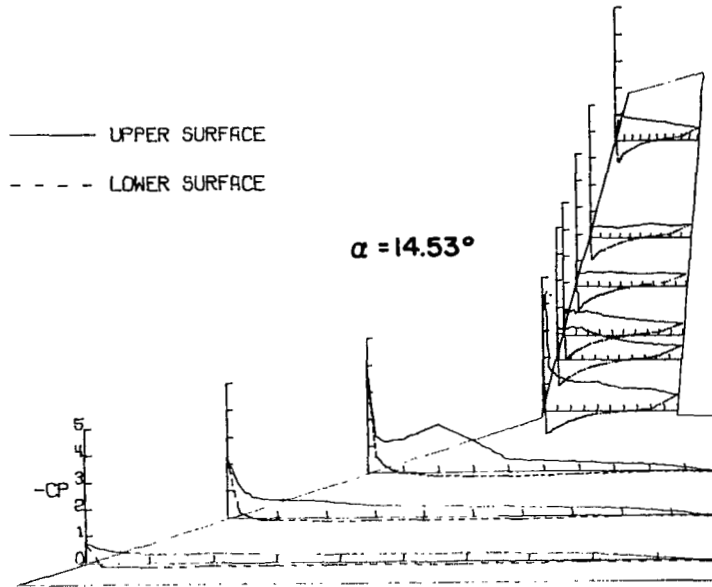

# APPENDIX A

## P R E S S U R E M E A S U R E M E N T S

OUTER PANEL SKEW= 15.0000 DEGREES

FUSELAGE OFF

ANGLE OF ATTACK= 16.55460 DEGREES

### S P A N W I S E L O C A T I O N

	2Y/B	2Y/B	2Y/B	2Y/B	2Y/B	2Y/B	2Y/B	2Y/B	2Y/B
	.74333	.12996	.21661	.33426	.43233	.48036	.57641	.67250	.86465
X/C	-CPU	-CPU	-CPU	-CPU	-CPU	-CPU	-CPU	-CPU	-CPU
0.000	.99530	2.94553	2.47360	3.69562	1.38040	.85570	.19747	.04330	-.36130
.025	.63637	1.32217	1.77659	3.82246	1.31014	1.08792	.69001	.49300	.47098
.050	.47803	.86920	1.48193	1.51648	1.34116	.81112	.57623	.47453	.44682
.075	.40037	.87703	2.11147	1.28793	1.19622	1.03802	.67538	.47808	.43262
.100	.34712	.94510	2.19535	1.17154	1.24179	.92889	.68336	.52780	.42764
.200	.39160	.91679	2.40443	1.06710	1.19875	.97747	.67538	.48660	.44327
.300	.31397	.42746	1.56330	.87984	1.26331	.94686	.64277	.47524	.42480
.400	.43173	.42325	.79668	.98989	1.01267	.92357	.63545	.48305	.41557
.600	.34016	.34739	.27933	.82987	.74701	.67671	.58754	.47027	.48518
.800	.26731	.23781	.41563	.92096	.62051	.65874	.51662	.44398	.50720
1.000	-.05117	-.03853	-.02306	.62999	.54777	.58089	.49535	.42551	.47311

X/C	-CPL	-CPL	-CPL	-CPL	-CPL	-CPL	-CPL	-CPL	-CPL
0.000	.99630	2.94553	2.47360	3.69562	1.38040	.85570	.19747	.04330	-.36130
.025	-.12764	.32270	.63045	-.76054	-.90261	-.90559	-.89030	-.85321	-.78720
.050	-.20048	.03191	.24055	-.79635	-.85454	-.81317	-.78458	-.71480	-.64807
.075	-.19338	-.07827	.07547	-.71349	-.76093	-.72939	-.68351	-.62536	-.55438
.100	-.19968	-.12041	-.04350	-.62810	-.67743	-.63764	-.59442	-.54941	-.47558
.200	-.17941	-.18965	-.16246	-.41557	-.43265	-.40559	-.38165	-.33291	-.29387
.300	-.19025	-.18062	-.19600	-.26187	-.26756	-.26064	-.23005	-.20514	-.12635
.400	-.15593	-.15834	-.19653	-.13726	-.12904	-.12833	-.09508	-.07453	-.03336
.600	-.14449	-.14630	-.13783	-.03226	.02340	.02327	.04854	.04614	.07950
.800	-.08248	-.06081	-.04979	.04175	.11196	.11370	.14428	.14693	.17675
1.000	-.05117	-.03853	-.02306	.62999	.54777	.58089	.49535	.42551	.47311

## P R E S S U R E M E A S U R E M E N T S

OUTER PANEL SKEW= 15.0000 DEGREES

FUSELAGE OFF

ANGLE OF ATTACK= 17.47723 DEGREES

### S P A N W I S E L O C A T I O N

	2Y/B	2Y/B	2Y/B	2Y/B	2Y/B	2Y/B	2Y/B	2Y/B	2Y/B
	.04333	.12996	.21661	.33426	.43233	.48036	.57641	.67250	.86465
X/C	-CPU	-CPU	-CPU	-CPU	-CPU	-CPU	-CPU	-CPU	-CPU
0.000	1.13464	3.26493	1.97366	3.41996	1.45152	.93285	.24914	.16092	-.28372
.025	.68773	1.34970	1.77130	4.11338	1.18647	1.01180	.68484	.50572	.41743
.050	.50536	.93455	1.73394	1.65565	1.31962	1.03416	.64076	.51207	.41884
.075	.43770	.98787	1.79935	1.29324	1.19840	1.03153	.64602	.50330	.46051
.100	.41854	1.06434	2.01267	1.17114	1.33909	.92233	.65063	.47605	.38918
.200	.36726	1.13943	2.42311	1.03572	1.59473	1.00324	.69799	.50642	.41390
.300	.33890	.42093	2.01579	1.05331	1.16071	.95719	.63155	.49018	.45486
.400	.35866	.43590	1.15433	.90200	.94783	1.06114	.55392	.51843	.45839
.600	.36285	.37004	.36154	.80283	.83421	.76707	.61247	.47111	.43862
.800	.27184	.26885	.42865	.99427	.71369	.65063	.57958	.51419	.44780
1.000	-.03593	-.03413	.00728	.64527	.58753	.55063	.54167	.48100	.50007

X/C	-CPL	-CPL	-CPL	-CPL	-CPL	-CPL	-CPL	-CPL	-CPL
0.000	1.13464	3.26493	1.97366	3.41996	1.45152	.93285	.24914	.16092	-.28372
.025	-.11436	.40297	.64765	-.75512	-.90451	-.90191	-.89600	-.86810	-.81305
.050	-.20897	.05988	.26478	-.79592	-.85806	-.83552	-.83506	-.79016	-.67260
.075	-.21196	-.06407	.07595	-.73252	-.77950	-.75795	-.69879	-.66201	-.57944
.100	-.22714	-.12574	-.04206	-.66724	-.71558	-.67972	-.63831	-.60273	-.51098
.200	-.19700	-.21256	-.17939	-.43939	-.46826	-.43912	-.41480	-.37476	-.32395
.300	-.20418	-.19580	-.21588	-.28686	-.29062	-.29122	-.25966	-.23008	-.15668
.400	-.17304	-.18322	-.22161	-.16383	-.16446	-.16040	-.13213	-.11010	-.06775
.600	-.16766	-.17364	-.15294	-.03641	-.05052	.01643	.02367	.04164	.05928
.800	-.09992	-.08063	-.04578	.05775	.09541	.12030	.12384	.14680	.14821
1.000	-.03593	-.03413	.00728	.64527	.58753	.55063	.54167	.48100	.50007

# APPENDIX A

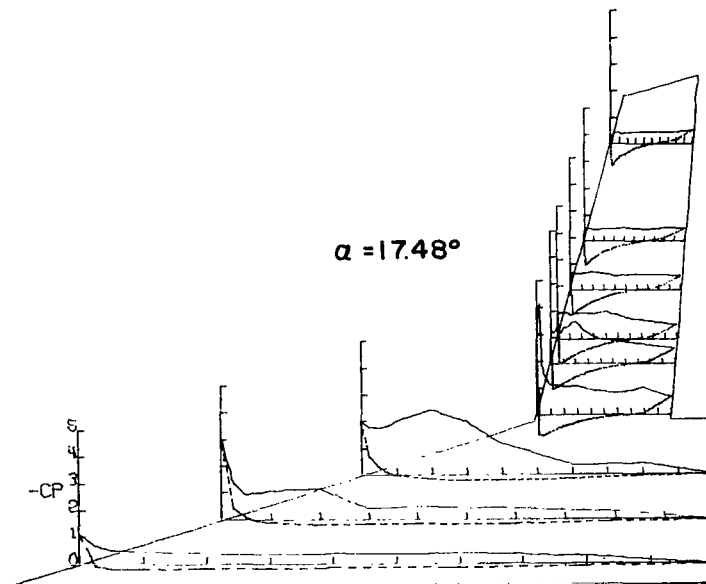
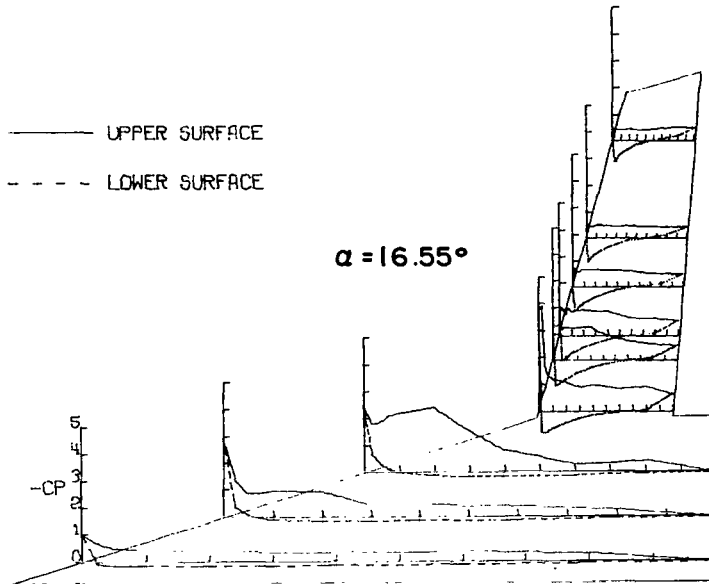

# APPENDIX A

## P R E S S U R E M E A S U R E M E N T S

OUTER PANEL SWEEP= 15.00000 DEGREES

FUSELAGE OFF

ANGLE OF ATTACK= 18.54192 DEGREES

### S P A N W I S E L O C A T I O N

	2Y/B .04333	2Y/B .12996	2Y/B .21661	2Y/B .33426	2Y/B .43233	2Y/B .48036	2Y/B .57641	2Y/B .67250	2Y/B .86465
X/C	-CPU	-CPU	-CPU	-CPU	-CPU	-CPU	-CPU	-CPU	-CPU
0.000	1.29345	3.59646	1.80579	4.02081	1.56726	1.16494	4.1758	3.2724	-24382
.025	.73713	1.36934	1.62594	3.77824	1.32911	1.15236	.70334	.52074	38415
.050	.53857	1.04091	1.71136	1.53631	1.26910	.94242	.65433	.52356	40336
.075	.45664	1.12288	1.79797	1.54937	1.29437	1.13713	.74109	.49726	39625
.100	.47411	1.28742	1.96052	1.21414	1.29563	1.08481	.68016	.43893	43253
.200	.38495	1.15482	2.56253	1.16613	1.50473	.98017	.67420	.54273	43395
.300	.37712	.44338	2.42822	1.02779	1.28616	1.10401	.74109	.54273	40976
.400	.39639	.45001	1.40282	.99241	1.03221	.99672	.72188	.53870	43110
.600	.39579	.36868	.44581	1.07074	.78283	.80400	.62916	.48873	41190
.800	.27952	.43675	.39150	1.13865	.65530	.58996	.53335	.45529	46027
1.000	-.04880	-.02289	-.01772	.72222	.62942	.57221	.52677	.46454	48019

	-CPL	-CPL	-CPL	-CPL	-CPL	-CPL	-CPL	-CPL	-CPL
0.000	1.29345	3.59646	1.80579	4.02081	1.56726	1.16494	4.1758	3.2724	-24382
.025	-.09518	.47591	.69437	-.72411	-.39836	-.88943	-.89869	-.88074	-.81961
.050	-.20904	.08856	.29766	-.73798	-.87689	-.84840	-.83318	-.77412	-.70587
.075	-.22772	-.05482	.08601	-.74053	-.79861	-.77825	-.73259	-.69237	-.60707
.100	-.23735	-.12651	-.03597	-.68813	-.72916	-.71273	-.66442	-.62839	-.53598
.200	-.22470	-.22290	-.19024	-.47159	-.48169	-.47846	-.43942	-.41300	-.34476
.300	-.23013	-.22470	-.23615	-.30619	-.35270	-.32030	-.30045	-.25875	-.19276
.400	-.18856	-.19880	-.24397	-.19381	-.18750	-.19277	-.16214	-.12937	-.08957
.600	-.18073	-.18494	-.17151	-.05934	-.02083	0.00000	.00953	.02914	.05047
.800	-.10422	-.09097	-.06203	.04167	.09091	.11316	.11846	.13577	.15639
1.000	-.04880	-.02289	-.01772	.72222	.62942	.57221	.52677	.46454	48019

## P R E S S U R E M E A S U R E M E N T S

OUTER PANEL SWEEP= 15.00000 DEGREES

FUSELAGE OFF

ANGLE OF ATTACK= 19.67211 DEGREES

### S P A N W I S E L O C A T I O N

	2Y/B .04333	2Y/B .12996	2Y/B .21661	2Y/B .33426	2Y/B .43233	2Y/B .48036	2Y/B .57641	2Y/B .67250	2Y/B .86465
X/C	-CPU	-CPU	-CPU	-CPU	-CPU	-CPU	-CPU	-CPU	-CPU
0.000	1.47454	4.03318	1.77847	4.18584	1.54425	1.23346	4.5648	3.1509	-19990
.025	.80083	1.38495	1.67775	4.05120	1.41024	1.17363	.71814	.53871	37081
.050	.56871	1.17339	1.82951	1.89380	1.53350	1.12509	.74940	.55158	36581
.075	.51365	1.27478	1.74320	1.37484	1.47851	1.10182	.73078	.53157	36295
.100	.52091	1.44245	1.93503	1.42099	1.27939	1.05128	.75139	.57801	40225
.200	.40354	1.39221	2.50395	1.14222	1.40898	1.12044	.73477	.54943	41868
.300	.39930	.49671	2.65988	1.16056	1.35019	1.01870	.79262	.57087	38082
.400	.40172	.48159	1.56973	1.10051	1.04367	1.03665	.73011	.49442	46370
.600	.42834	.40898	.55473	.94947	.84208	.90233	.69354	.51942	38796
.800	.31097	.34425	.53072	1.02085	.78706	.70152	.64832	.51585	39725
1.000	-.04175	-.04175	.05427	.77196	.65951	.56454	.59646	.50585	42154

	-CPL	-CPL	-CPL	-CPL	-CPL	-CPL	-CPL	-CPL	-CPL
0.000	1.47454	4.03318	1.77847	4.18584	1.54425	1.23346	4.5648	3.1509	-19990
.025	-.09660	.50387	.75086	-.70563	-.87308	-.90365	-.89701	-.89599	-.84244
.050	-.21962	.12584	.31468	-.81491	-.88124	-.87109	-.85349	-.80675	-.72821
.075	-.24079	-.04356	.12055	-.76248	-.82196	-.79933	-.77076	-.71822	-.63469
.100	-.25713	-.12645	-.07714	-.74212	-.74921	-.73555	-.68505	-.66039	-.55615
.200	-.25350	-.24200	-.20655	-.43958	-.50916	-.50166	-.46578	-.43336	-.37553
.300	-.26076	-.25168	-.25133	-.34365	-.36766	-.35415	-.33688	-.28988	-.22132
.400	-.22627	-.22869	-.26928	-.20341	-.21921	-.19867	-.19335	-.14993	-.12065
.600	-.19602	-.21296	-.19256	-.07075	-.03664	-.01794	.00159	.00071	.02070
.800	-.11798	-.10285	-.07567	.02401	.08781	.10764	.13023	.13136	.14493
1.000	-.04175	-.04175	.05427	.77196	.65951	.56454	.59646	.50585	42154

APPENDIX A

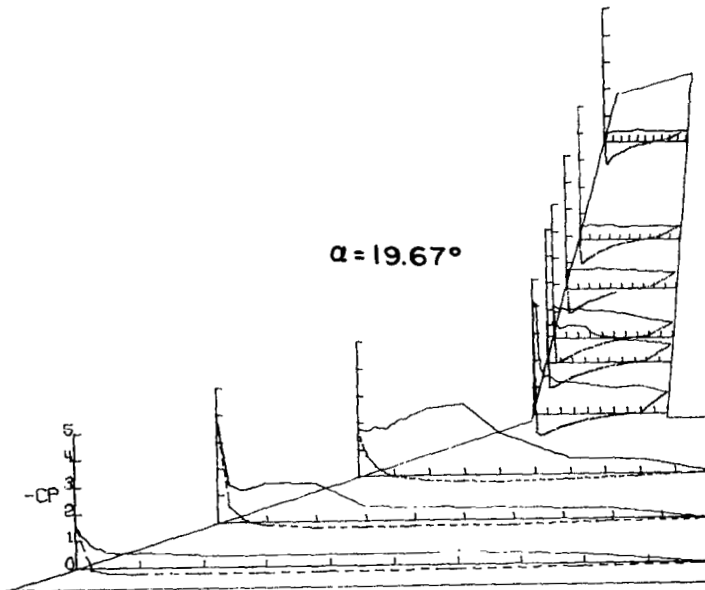
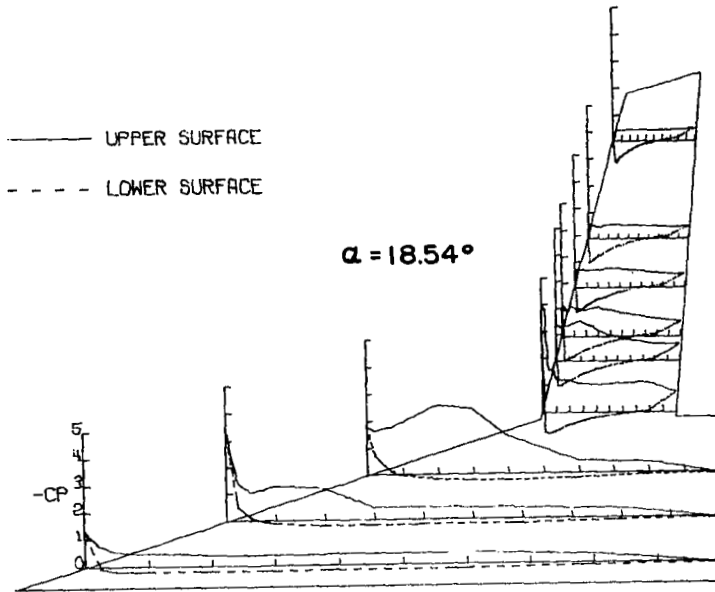

# APPENDIX A

## P R E S S U R E M E A S U R E M E N T S

WING PANEL SWEEP= 15.0000 DEGREES

FUSELAGE OFF

ANGLE OF ATTACK= 20.7047 DEGREES

### S P A N W I S E L O C A T I O N

	ZY/B	ZY/B	ZY/B	ZY/B	ZY/B	ZY/B	ZY/B	ZY/B	ZY/B
	.04333	.12796	.21661	.33426	.43233	.48036	.57641	.67250	.86465
X/C	-CPU	-CPU	-CPU	-CPU	-CPU	-CPU	-CPU	-CPU	-CPU
0.000	1.09152	4.47617	1.92747	4.54437	1.61736	1.35907	.49269	.41166	-.10408
.025	.77415	1.44919	1.73021	3.59829	1.25086	1.13623	.71390	.53937	-.39810
.050	.62303	1.34986	1.96104	2.01598	1.48389	1.18293	.78462	.63069	-.37884
.075	.59713	1.45408	1.61310	1.61450	1.52770	1.09152	.77528	.58146	-.36243
.100	.61399	1.57047	1.89704	1.37658	1.48706	1.20895	.78929	.55363	-.38170
.200	.41115	1.37667	2.63623	1.23896	1.41023	1.05617	.76927	.58074	-.38455
.300	.43373	.62308	2.67401	1.20768	1.30610	.95542	.78062	.54222	-.42522
.400	.42316	.51592	1.95790	1.14355	1.15625	.90605	.78395	.55363	-.43306
.600	.44404	.43125	.67024	.96323	.86554	.86068	.73725	.56719	-.41309
.800	.53314	.37521	.52833	1.03758	.73672	.68454	.62916	.52082	-.46802
1.000	-.12193	-.01706	.06033	.77797	.67136	.64251	.62249	.50369	-.44448

	ZY/B	ZY/B	ZY/B	ZY/B	ZY/B	ZY/B	ZY/B	ZY/B	ZY/B
	.14334	.12996	.21661	.33426	.43233	.48036	.57641	.67250	.86465
X/C	-CPL	-CPL	-CPL	-CPL	-CPL	-CPL	-CPL	-CPL	-CPL
0.000	1.09152	4.47617	1.92747	4.54437	1.61736	1.35907	.49269	.41166	-.10408
.025	.77553	.65723	.79743	-.72022	-.87950	-.90203	-.91070	-.90254	-.85834
.050	-.22419	.14131	.36381	-.82366	-.89917	-.90270	-.87803	-.85049	-.75853
.075	-.27991	-.03498	.13530	-.76591	-.85538	-.82003	-.79803	-.75496	-.67369
.100	-.27715	-.14070	-.02334	-.73672	-.78533	-.76603	-.73736	-.69437	-.60739
.200	-.27410	-.25278	-.21929	-.52288	-.53874	-.54535	-.49735	-.47978	-.40065
.300	-.27045	-.26677	-.27071	-.39852	-.38708	-.37735	-.35935	-.31867	-.24952
.400	-.27365	-.25481	-.28644	-.22971	-.24367	-.23068	-.21601	-.18678	-.14686
.600	-.22701	-.22476	-.21377	-.03201	-.05140	-.03667	-.02200	-.01426	-.00927
.800	-.13488	-.16111	-.08414	.01777	.09391	.09934	.12534	.13331	.14543
1.000	-.02193	-.01706	.06033	.77797	.67136	.64251	.62249	.50369	-.44448

## P R E S S U R E M E A S U R E M E N T S

WING PANEL SWEEP= 15.0000 DEGREES

FUSELAGE OFF

ANGLE OF ATTACK= 22.81037 DEGREES

### S P A N W I S E L O C A T I O N

	ZY/B	ZY/B	ZY/B	ZY/B	ZY/B	ZY/B	ZY/B	ZY/B	ZY/B
	.14334	.12996	.21661	.33426	.43233	.48036	.57641	.67250	.86465
X/C	-CPU	-CPU	-CPU	-CPU	-CPU	-CPU	-CPU	-CPU	-CPU
0.000	1.09261	5.04232	1.85121	4.19219	1.56783	1.21988	.70251	.57370	.08029
.025	.90398	1.67154	1.66967	3.63041	1.19364	1.09119	.77867	.64700	.44543
.050	.67017	1.48707	1.80348	1.95838	1.36973	1.29013	.78787	.59062	.44191
.075	.63334	1.61238	1.81645	1.43702	1.24143	.90145	.80691	.63432	.44755
.100	.75836	1.70919	1.46211	1.41186	1.50934	1.11220	.85483	.60612	.35451
.200	.43365	1.78449	2.13657	1.42947	1.32948	1.13124	.74782	.61317	.44896
.300	.46333	.42242	2.66060	1.17414	1.25590	1.10695	.81675	.58780	.39892
.400	.45994	.56233	1.84637	1.12572	1.03138	1.02029	.73140	.57370	.45600
.600	.46651	.43485	1.06258	1.02447	1.10245	.85746	.69660	.54904	.44120
.800	.43246	.51907	.64535	1.07729	.78814	.77030	.67297	.54622	.45671
1.000	-.01135	0.00000	-.10584	.82145	.70706	.73928	.71236	.59485	.43486

	ZY/B	ZY/B	ZY/B	ZY/B	ZY/B	ZY/B	ZY/B	ZY/B	ZY/B
	.14334	.12996	.21661	.33426	.43233	.48036	.57641	.67250	.86465
X/C	-CPL	-CPL	-CPL	-CPL	-CPL	-CPL	-CPL	-CPL	-CPL
0.000	1.09261	5.04232	1.85121	4.19219	1.56783	1.21988	.70251	.57370	.08029
.025	-.04438	.79982	.90902	-.66307	-.83213	-.87322	-.89290	-.89300	-.86342
.050	-.23534	.17800	.43167	-.80448	-.90139	-.83421	-.88699	-.85920	-.79440
.075	-.27714	-.03345	.15505	-.77494	-.84784	-.83713	-.81351	-.78736	-.70919
.100	-.33045	-.15791	.00156	-.72780	-.73877	-.77743	-.74397	-.72820	-.63947
.200	-.31713	-.29149	-.25236	-.53938	-.57759	-.56618	-.54387	-.51974	-.44791
.300	-.31300	-.29866	-.28380	-.36641	-.41795	-.38445	-.39823	-.34157	-.28663
.400	-.27300	-.28791	-.31390	-.27214	-.27654	-.27620	-.25127	-.22959	-.18311
.600	-.25035	-.26282	-.23637	-.12256	-.06725	-.07413	-.04330	-.05423	-.01409
.800	-.16724	-.13798	-.09910	.00363	.07605	.07813	.09710	.11620	.10775
1.000	-.01135	0.00000	.10584	.82145	.70706	.73928	.71236	.59485	.43486

# APPENDIX A

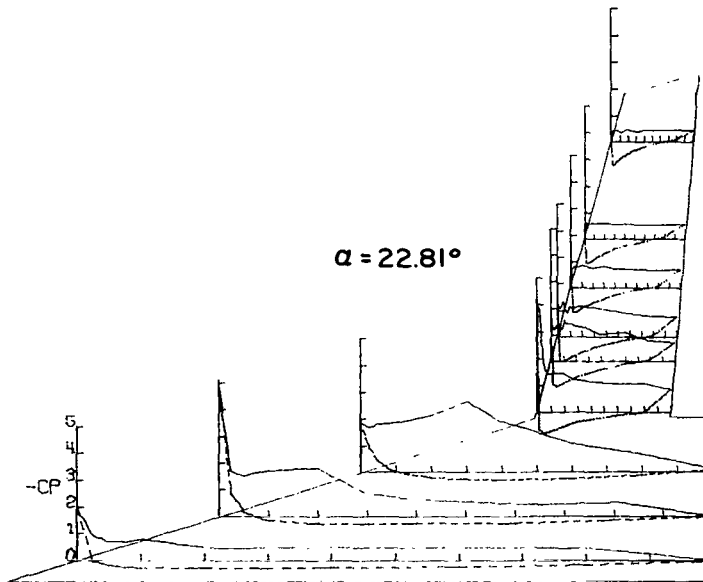
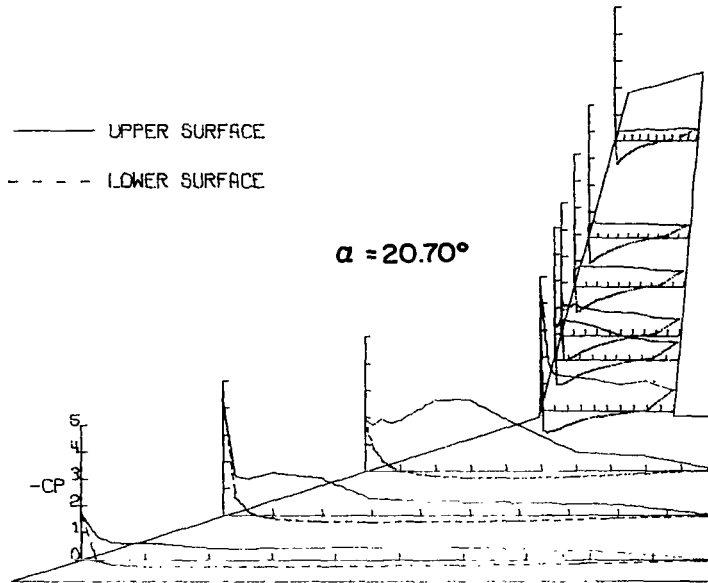

# APPENDIX A

## P R E S S U R E M E A S U R E M E N T S

OUTER PANEL SWEEP= 15.0000 DEGREES

FUSELAGE OFF

ANGLE OF ATTACK= 24.86540 DEGREES

		S P A N W I S E L O C A T I O N								
		2Y/B	2Y/B	2Y/B	2Y/B	2Y/B	2Y/B	2Y/B	2Y/B	2Y/B
		.04333	.12996	.21661	.33426	.43233	.48036	.57641	.67250	.86465
X/C	- CPU	- CPU	- CPU	- CPU	- CPU	- CPU	- CPU	- CPU	- CPU	- CPU
0.000	2.38855	5.48108	1.84100	4.17003	1.41403	1.39971	.88172	.62855	.31499	
.025	1.00118	1.87767	1.70523	3.23772	1.12452	1.19957	.73011	.63350	.47212	
.050	.78630	1.95636	1.85609	1.87358	1.31669	1.10448	.80126	.62572	.42045	
.075	.83654	1.88009	1.95649	1.70986	1.27434	.95287	.74075	.59457	.45867	
.100	.96910	2.75113	1.98074	1.50506	1.33944	1.12310	.85579	.58679	.44168	
.200	.55358	2.38250	1.74684	1.28445	1.37421	.94157	.82453	.62076	.45938	
.300	.50760	1.08774	1.91903	1.19406	1.24399	1.05328	.73144	.63067	.46504	
.400	.53059	.72940	2.07249	1.28887	1.07080	1.13241	.83584	.58608	.47354	
.600	.50095	.63949	.99567	1.02528	.93810	.95819	.72945	.63280	.51105	
.800	.53725	.49187	.73557	1.17952	.73154	.86377	.74873	.66748	.47000	
1.000	.00726	.00787	.13369	.93999	.73595	.75471	.68955	.68871	.49548	

		S P A N W I S E L O C A T I O N								
		2Y/B	2Y/B	2Y/B	2Y/B	2Y/B	2Y/B	2Y/B	2Y/B	2Y/B
		.04333	.12996	.21661	.33426	.43233	.48036	.57641	.67250	.86465
X/C	- CPL	- CPL	- CPL	- CPL	- CPL	- CPL	- CPL	- CPL	- CPL	- CPL
0.000	2.38855	5.48108	1.84100	4.17003	1.41403	1.39971	.88172	.62855	.31499	
.025	-.00121	.96607	1.01752	-.58434	-.78838	-.81927	-.85315	-.87562	-.86784	
.050	-.23111	.22990	.49315	-.80544	-.87682	-.88903	-.88571	-.87350	-.81692	
.075	-.29403	-.01815	.18779	-.78143	-.86545	-.85182	-.84186	-.81550	-.74336	
.100	-.33396	-.15065	.02185	-.74858	-.81049	-.79734	-.78339	-.75821	-.68041	
.200	-.36724	-.31037	-.25490	-.57549	-.62919	-.61063	-.59933	-.56795	-.50500	
.300	-.35514	-.33820	-.31160	-.41061	-.45041	-.43987	-.43389	-.39467	-.33667	
.400	-.32247	-.32852	-.34437	-.28111	-.31144	-.29435	-.29568	-.26240	-.22845	
.600	-.29987	-.28193	-.27103	-.13708	-.09223	-.09638	-.06046	-.06578	-.03678	
.800	-.17969	-.14883	-.10196	-.00821	.06380	.07907	.08970	.09902	.08134	
1.000	.00726	.00787	.13369	.93999	.73595	.75471	.68955	.68871	.49548	

## P R E S S U R E M E A S U R E M E N T S

OUTER PANEL SWEEP= 15.0000 DEGREES

FUSELAGE OFF

ANGLE OF ATTACK= 26.83861 DEGREES

		S P A N W I S E L O C A T I O N								
		2Y/B	2Y/B	2Y/B	2Y/B	2Y/B	2Y/B	2Y/B	2Y/B	2Y/B
		.04333	.12996	.21661	.33426	.43233	.48036	.57641	.67250	.86465
X/C	- CPU	- CPU	- CPU	- CPU	- CPU	- CPU	- CPU	- CPU	- CPU	- CPU
0.000	2.82533	3.50150	1.83966	4.85370	1.35262	1.26729	.77623	.60714	.49371	
.025	1.06791	2.79198	1.76227	3.33113	1.32535	1.14336	.83087	.67777	.53223	
.050	.92722	2.78167	1.86634	1.92778	1.33042	1.13403	.84486	.60143	.49656	
.075	1.00909	3.21041	1.93679	1.69315	1.36657	1.16801	.84753	.68847	.50655	
.100	1.25045	3.67797	1.96774	1.51623	1.14779	1.22198	.83153	.66992	.56077	
.200	.55460	2.62643	1.61390	1.22008	1.27145	1.12404	.84819	.64424	.50227	
.300	.55460	1.63107	1.54535	1.19218	1.46993	1.15735	.84686	.67135	.51654	
.400	.60309	1.05760	1.82525	1.28096	1.22579	1.06474	.85152	.75625	.49656	
.600	.56551	.83505	1.38334	1.13701	1.10721	1.00211	.82620	.71059	.47159	
.800	.49035	.44914	.91529	1.26257	.85619	.86435	.77290	.65708	.54721	
1.000	.01818	.01637	.20974	1.05965	.77950	.76024	.80355	.69061	.47159	

		S P A N W I S E L O C A T I O N								
		2Y/B	2Y/B	2Y/B	2Y/B	2Y/B	2Y/B	2Y/B	2Y/B	2Y/B
		.04333	.12996	.21661	.33426	.43233	.48036	.57641	.67250	.86465
X/C	- CPL	- CPL	- CPL	- CPL	- CPL	- CPL	- CPL	- CPL	- CPL	- CPL
0.000	2.82533	3.50150	1.83966	4.85370	1.35262	1.26729	.77623	.60714	.49371	
.025	-.05758	.95754	1.12770	-.57797	-.75415	-.82225	-.83357	-.88543	-.87473	
.050	-.24003	.25942	.59347	-.81246	-.88787	-.92745	-.90748	-.92179	-.84836	
.075	-.32376	-.01697	.28019	-.81943	-.86886	-.91081	-.86753	-.87687	-.79061	
.100	-.38357	-.15941	.04910	-.79281	-.86281	-.96287	-.82359	-.81128	-.72288	
.200	-.42065	-.35155	-.27058	-.62994	-.66290	-.67578	-.64715	-.63163	-.55606	
.300	-.41034	-.37155	-.32709	-.46897	-.49115	-.48270	-.48270	-.45911	-.37356	
.400	-.38246	-.37398	-.35438	-.34983	-.34919	-.36685	-.33955	-.32651	-.25950	
.600	-.33094	-.33215	-.29033	-.16604	-.13689	-.11318	-.11185	-.09339	-.08056	
.800	-.20548	-.19032	-.12595	-.01331	.05007	.06458	.07856	.09767	.06986	
1.000	.01818	.01637	.20974	1.05965	.77950	.76024	.80355	.69061	.47159	



# APPENDIX A

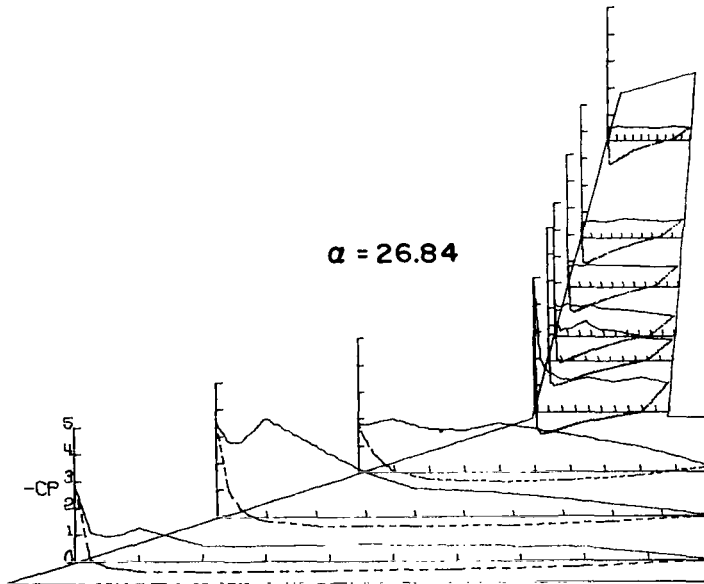
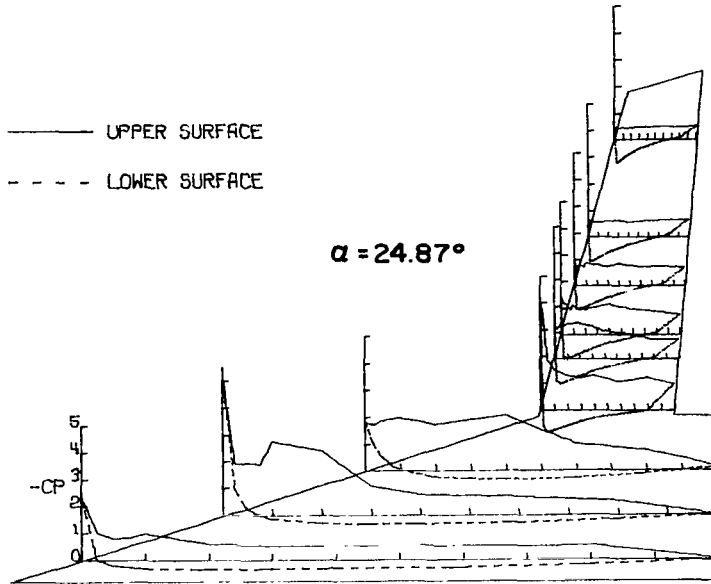

# APPENDIX A

## P R E S S U R E M E A S U R E M E N T S

OUTER PANEL SWEEP= 15.0000 DEGREES

FUSELAGE OFF

ANGLE OF ATTACK= 28.85530 DEGREES

### S P A N W I S E L O C A T I O N

	2Y/B .04333	2Y/B .12796	2Y/B .21661	2Y/B .33426	2Y/B .43233	2Y/B .48036	2Y/B .57641	2Y/B .67250	2Y/B .86465
X/C	-CPU	-CPU	-CPU	-CPU	-CPU	-CPU	-CPU	-CPU	-CPU
0.000	3.15756	2.75963	1.79237	4.64575	1.30540	1.07567	1.11083	.77589	.64692
.025	1.10757	2.36506	1.70925	2.33070	1.49925	1.18049	.85261	.68650	.51248
.050	1.02622	2.40139	1.60749	1.50409	1.37809	.95232	.74460	.74245	.54251
.075	1.15173	2.57019	1.92385	1.60404	1.26482	1.02902	.80020	.70356	.48382
.100	1.46578	3.33782	1.42615	1.30294	1.28178	1.02710	.76249	.71106	.46062
.200	.53704	2.99555	1.24478	1.26300	1.27693	1.03029	.86731	.75610	.51044
.300	.61333	1.90367	1.51832	1.24059	1.19213	1.10827	.83024	.72130	.48587
.400	.63831	1.14127	1.66240	1.14670	1.07825	.84686	.82002	.67626	.51385
.600	.69557	.83155	.98434	1.09460	.97042	.86156	.79573	.69332	.53364
.800	.55641	.58603	.80450	1.12125	.88809	.89581	.78039	.68854	.52954
1.000	.05924	.01568	.25490	.82210	.76277	.81618	.77847	.63122	.47632

	-CPL	-CPL	-CPL	-CPL	-CPL	-CPL	-CPL	-CPL	-CPL
X/C	3.16756	2.75963	1.79237	4.64675	1.30540	1.07567	1.11083	.77589	.64692
0.000	.10338	.73382	1.19642	-.43587	-.68831	-.70636	-.76512	-.79099	-.80599
.025	-.21374	.28692	.62264	-.74461	-.81847	-.85133	-.84750	-.85440	-.80735
.050	-.32177	.01162	.24483	-.75854	-.33845	-.84686	-.85070	-.82917	-.76848
.075	-.37610	-.13939	.06750	-.74401	-.80515	-.82004	-.79833	-.79712	-.71257
.100	-.43610	-.35429	-.27404	-.61627	-.66047	-.66868	-.65143	-.62256	-.56051
.200	-.41992	-.39146	-.35263	-.46130	-.52123	-.49879	-.51476	-.46982	-.39754
.300	-.34083	-.36972	-.38789	-.34930	-.38139	-.36659	-.36340	-.33140	-.28776
.400	-.35497	-.34035	-.31434	-.18525	-.15209	-.15200	-.13093	-.12547	-.09478
.600	-.22626	-.19864	-.14206	-.03693	.03814	.04726	.05173	.07910	.06955
.800	.05924	.01568	.25490	.82210	.76277	.81618	.77847	.63122	.47632

## P R E S S U R E M E A S U R E M E N T S

OUTER PANEL SWEEP= 15.0000 DEGREES

FUSELAGE OFF

ANGLE OF ATTACK= 30.79389 DEGREES

### S P A N W I S E L O C A T I O N

	2Y/B .04333	2Y/B .12796	2Y/B .21661	2Y/B .33426	2Y/B .43233	2Y/B .48036	2Y/B .57641	2Y/B .67250	2Y/B .86465
X/C	-CPU	-CPU	-CPU	-CPU	-CPU	-CPU	-CPU	-CPU	-CPU
0.000	3.80166	2.77348	1.75359	4.79244	1.36209	1.17293	.83036	.71600	.85241
.025	1.23032	2.49734	1.83983	2.73735	1.20329	1.03960	.92013	.73933	.58807
.050	1.23995	2.50335	1.59992	1.71298	1.15182	.93663	.83564	.79092	.55838
.075	1.53414	2.80657	1.57692	1.60470	1.47822	1.19471	.93267	.65309	.55414
.100	1.91015	3.19342	1.58895	1.47696	1.39536	1.11617	.86072	.74003	.56474
.200	.58504	3.44068	1.47137	1.15872	1.45625	1.06732	.86138	.80718	.61493
.300	.75895	2.18810	1.64121	1.32004	1.20203	1.13663	.88581	.77184	.58383
.400	.73393	1.45292	1.65324	1.15684	1.11102	1.05214	.87986	.73650	.55980
.600	.76300	1.00531	1.14362	1.09721	1.13168	1.00462	.86336	.75982	.58100
.800	.61036	.64341	.94030	1.24785	.93970	.94191	.83630	.76265	.57888
1.000	.02646	.07637	.26813	.91398	.79542	.76237	.84356	.71388	.57464

	-CPL	-CPL	-CPL	-CPL	-CPL	-CPL	-CPL	-CPL	-CPL
X/C	3.49166	2.77348	1.75359	4.79244	1.36209	1.17293	.83036	.71600	.85241
0.000	.17400	1.10518	1.12951	-.42534	-.67623	-.71431	-.74201	-.78820	-.81222
.025	-.20306	.33674	.60944	-.74837	-.84497	-.85678	-.87920	-.87790	-.84965
.050	-.34796	.02345	.28016	-.63162	-.87320	-.87924	-.88720	-.87013	-.81787
.100	-.42213	-.14952	.04286	-.76944	-.85250	-.83963	-.86007	-.83482	-.78185
.200	-.48827	-.39126	-.29166	-.65239	-.71512	-.71233	-.71761	-.67449	-.63141
.300	-.46767	-.44448	-.39462	-.51501	-.56583	-.56063	-.56393	-.53677	-.45908
.400	-.42453	-.43355	-.43435	-.33755	-.41715	-.41619	-.40695	-.38633	-.33195
.600	-.39447	-.39928	-.36588	-.21514	-.17815	-.18468	-.16489	-.16527	-.12925
.800	-.24382	-.22510	-.18137	-.03606	.02635	.00857	.05342	.05297	.07769
1.000	.02646	.07637	.26813	.91398	.79542	.76237	.84356	.71388	.57464

# APPENDIX A

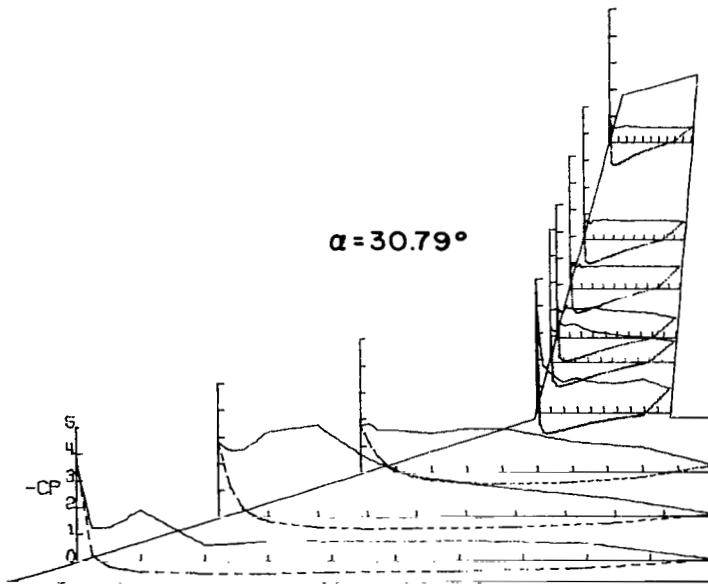
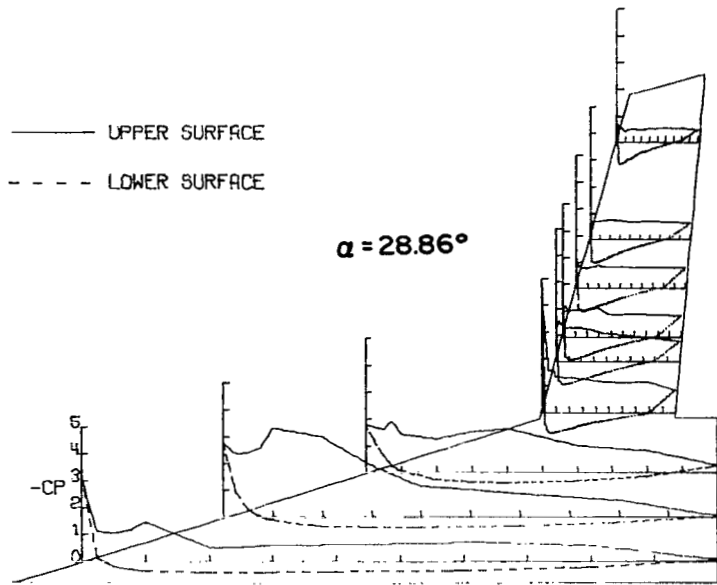

# APPENDIX A

## P R E S S U R E M E A S U R E M E N T S

OUTER PANEL SWEEP= 30.00000 DEGREES

FUSELAGE OFF

ANGLE OF ATTACK= -4.33276 DEGREES

### S P A N W I S E L O C A T I O N

	2Y/B .04707	2Y/B .14119	2Y/B .23533	2Y/B .37112	2Y/B .44999	2Y/B .49999	2Y/B .59999	2Y/B .69999	2Y/B .89997
X/C	-CPU	-CPU	-CPU	-CPU	-CPU	-CPU	-CPU	-CPU	-CPU
0.000	.01256	.14235	.40284	.71869	.11028	.13883	.12180	.01680	.13508
.025	-.05921	-.04665	-.02161	-.43171	-.47796	-.48263	-.49507	-.51943	-.47103
.050	-.02691	-.04127	-.02058	-.29073	-.31893	-.32022	-.32350	-.31706	-.32335
.075	-.02572	-.00419	-.01389	-.23371	-.23183	-.22789	-.23902	-.24917	-.25336
.100	-.01077	-.00538	-.00257	-.18171	-.17544	-.18401	-.19449	-.19177	-.19597
.200	.02153	.02811	.01646	-.03697	-.05326	-.05435	-.05632	-.06999	-.06019
.300	.04290	.06998	.03396	.03133	.02945	.02096	.01637	.00700	.01190
.400	.03708	.06041	.03550	.06579	.09211	.08055	.07596	.05529	.03779
.600	.04845	.05203	.02778	.05953	.08396	.07662	.07334	.06369	.04969
.800	.02392	.02751	.02006	.02318	.01692	.01048	.01499	.00280	.00280
1.000	-.05383	-.07936	-.05711	-.03384	-.03885	-.05108	-.03929	-.01540	-.01190

	-CPL	-CPL	-CPL	-CPL	-CPL	-CPL	-CPL	-CPL	-CPL
0.000	.01256	.14235	.40284	.71869	.11028	.13883	.12180	.01680	.13508
.025	.14474	.27273	.43062	1.36788	1.20762	1.24802	1.21072	1.20448	1.05130
.050	.13876	.25180	.39563	1.06175	.99977	.96792	.96138	.93798	.78970
.075	.15311	.24462	.37300	.85591	.80453	.80758	.79057	.78760	.68967
.100	.17046	.23326	.34624	.76255	.73686	.72512	.68389	.69387	.54978
.200	.18003	.21053	.30406	.55640	.56643	.57002	.54450	.53649	.44556
.300	.16926	.21831	.29274	.49374	.52655	.49572	.47608	.44766	.38051
.400	.20634	.24941	.28554	.41981	.43861	.43875	.42107	.39730	.32385
.600	.17285	.20455	.24901	.28071	.27945	.26849	.25015	.25266	.18967
.800	.12201	.12919	.12450	.11842	.10589	.08775	.08841	.07769	*****
1.000	-.05383	-.07936	-.05711	-.03384	-.03885	-.05108	-.03929	-.01540	-.01190

## P R E S S U R E M E A S U R E M E N T S

OUTER PANEL SWEEP= 30.00000 DEGREES

FUSELAGE OFF

ANGLE OF ATTACK= -3.76187 DEGREES

### S P A N W I S E L O C A T I O N

	2Y/B .04707	2Y/B .14119	2Y/B .23533	2Y/B .37112	2Y/B .44999	2Y/B .49999	2Y/B .59999	2Y/B .69999	2Y/B .89997
X/C	-CPU	-CPU	-CPU	-CPU	-CPU	-CPU	-CPU	-CPU	-CPU
0.000	-.00532	.09342	.30176	.30886	-.05096	-.05946	-.08725	-.16702	-.12752
.025	-.04198	-.02838	-.00928	-.40208	-.40954	-.41426	-.41491	-.44838	-.39364
.050	-.01596	-.02779	-.00309	-.26163	-.29084	-.24623	-.26562	-.26335	-.28414
.075	-.00710	.01183	.01135	-.17401	-.18146	-.17514	-.19647	-.19197	-.20167
.100	0.00000	.00650	.02218	-.12429	-.18706	-.13249	-.15058	-.15385	-.16494
.200	.02365	.04376	.03972	-.00994	-.01616	-.01874	-.02714	-.03742	-.03257
.300	.04849	.08160	.05932	.06401	.04474	.04653	.04847	.02287	.03534
.400	.04553	.06682	.05468	.08265	.10005	.10017	.08208	.06792	.04297
.600	.04967	.04908	.05003	.07333	.06960	.08466	.08078	.07346	.03604
.800	.04316	.03548	.03765	.03169	.01491	.02003	.01745	.01386	-.00139
1.000	-.05322	-.07214	-.05416	-.04039	-.04412	-.05346	-.05235	-.03673	-.02218

	-CPL	-CPL	-CPL	-CPL	-CPL	-CPL	-CPL	-CPL	-CPL
0.000	-.00532	.09342	.30176	.30886	-.05096	-.05946	-.08725	-.16702	-.12752
.025	.13363	.23770	.39254	1.19835	1.05554	1.08765	.99916	1.05966	.85604
.050	.13718	.23415	.37191	.93280	.86941	.85190	.83382	.84980	.67319
.075	.14308	.21700	.35635	.78427	.71405	.73177	.70723	.69397	.60601
.100	.15492	.21819	.33167	.64981	.66122	.54975	.62262	.60792	.50974
.200	.16911	.19749	.28938	.51083	.51705	.51961	.48923	.48619	.40862
.300	.16024	.21641	.27854	.45925	.48162	.45821	.43382	.41001	.35737
.400	.19572	.23179	.27906	.38965	.41699	.40134	.38583	.36915	.29920
.600	.17502	.20045	.23109	.27033	.26909	.24623	.23654	.23078	.19543
.800	.11648	.11589	.15114	.13627	.10192	.07820	.08337	.06792	*****
1.000	-.05322	-.07214	-.05416	-.04039	-.04412	-.05946	-.05235	-.03673	-.02218

# APPENDIX A

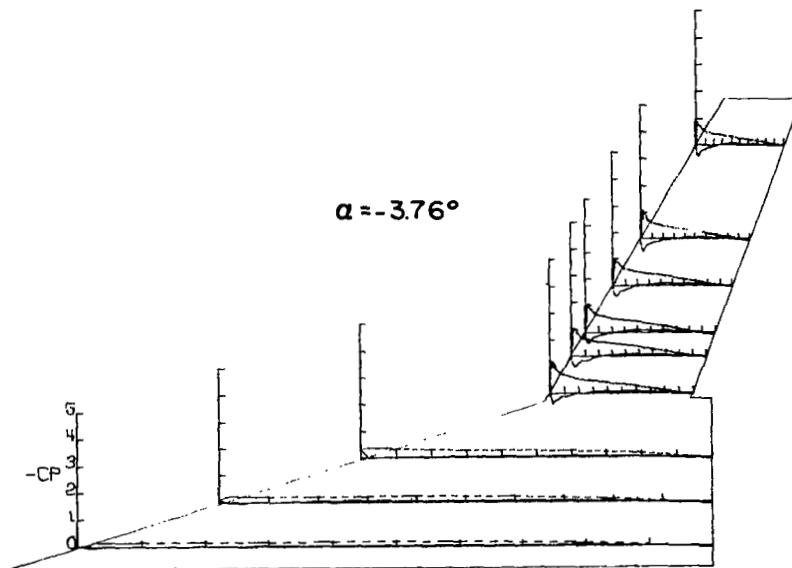
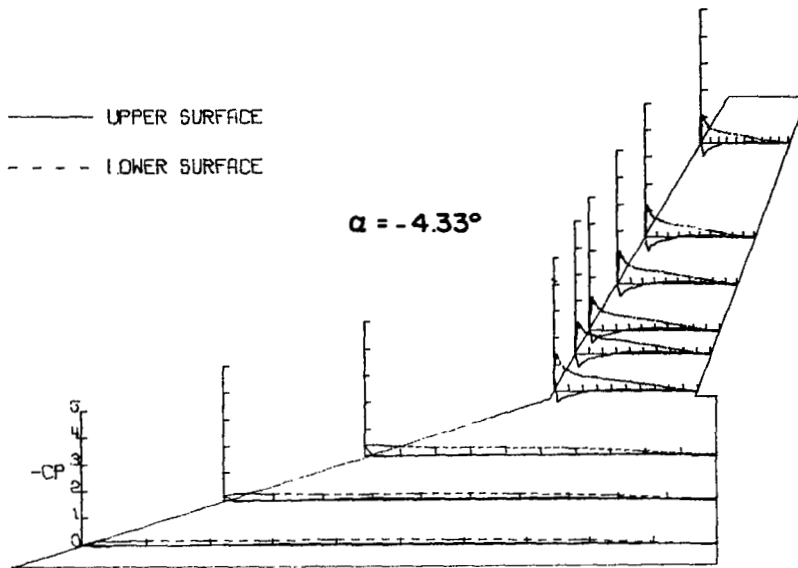

# APPENDIX A

## P R E S S U R E M E A S U R E M E N T S

OUTER PANEL SWEEP= 30.00000 DEGREES

FUSELAGE OFF

ANGLE OF ATTACK= -3.25175 DEGREES

### S P A N W I S E L O C A T I O N

	2Y/A .04707	2Y/B .14119	2Y/C .23533	2Y/D .37112	2Y/E .44999	2Y/F .49999	2Y/G .59999	2Y/H .69999	2Y/I .89997
X/C	-CPU	-CPU	-CPU	-CPU	-CPU	-CPU	-CPU	-CPU	-CPU
0.000	-.02572	-.04486	-.21510	-.05148	-.31138	-.26351	-.33928	-.31878	-.30387
.025	-.04386	-.03349	-.02642	-.38671	-.34842	-.36233	-.37419	-.39404	-.34860
.050	-.02093	-.01015	-.00413	-.29550	-.22349	-.20818	-.20818	-.21583	-.21370
.075	-.01734	.01974	.01135	-.13999	-.13183	-.14032	-.13637	-.14412	-.15548
.100	-.01317	.01445	.02155	-.09852	-.11426	-.09157	-.11858	-.10792	-.12212
.200	.07632	.04306	.03611	.02072	.00439	.00527	-.01383	0.00000	-.00355
.300	.04546	.07715	.04746	.06529	.03264	.07115	.06324	.06106	.05467
.400	.05233	.08254	.04233	.09568	.13246	.11595	.11463	.10011	.07668
.600	.09203	.06280	.04025	.08914	.08852	.08960	.10014	.09443	.07881
.800	.03407	.03428	.07632	.03076	.02574	.02767	.03492	.02840	.01207
1.000	-.00759	-.06998	-.04488	-.05713	-.04520	-.05495	-.04875	-.03266	-.01846

	-CPL	-CPL	-CPL	-CPL	-CPL	-CPL	-CPL	-CPL	-CPL
0.000	-.02572	.04486	.21510	.05148	-.31138	-.26351	-.33928	-.31878	-.30387
.025	.10706	.20345	.34406	1.00440	.92785	.96913	.89934	.96922	.80177
.050	.11702	.21532	.32394	.84436	.78535	.77886	.77030	.77410	.65916
.075	.13338	.19797	.33168	.70876	.64535	.66496	.64389	.65419	.57401
.100	.14534	.20276	.30073	.62652	.59827	.59649	.55369	.59317	.47823
.200	.16089	.19070	.26565	.46958	.49406	.48355	.47169	.46759	.39805
.300	.14952	.20575	.25791	.41810	.45011	.42674	.42558	.39309	.34626
.400	.14242	.21472	.26617	.37604	.39424	.39330	.37683	.36825	.30103
.600	.16268	.17345	.22077	.25362	.25174	.25824	.23519	.24210	.19524
.800	.11457	.11962	.10213	.10609	.08789	.08498	.06851	.08094	*****
1.000	-.05759	-.06998	-.04488	-.05713	-.04520	-.05995	-.04875	-.03266	-.01846

## P R E S S U R E M E A S U R E M E N T S

OUTER PANEL SWEEP= 30.00000 DEGREES

FUSELAGE OFF

ANGLE OF ATTACK= -2.66988 DEGREES

### S P A N W I S E L O C A T I O N

	2Y/B .04707	2Y/H .14119	2Y/C .23533	2Y/D .37112	2Y/E .44999	2Y/F .49999	2Y/G .59999	2Y/H .69999	2Y/I .89997
X/C	-CPU	-CPU	-CPU	-CPU	-CPU	-CPU	-CPU	-CPU	-CPU
0.000	-.03782	-.03959	-.14568	-.23061	-.45730	-.41217	-.45898	-.46207	-.46416
.025	-.03487	-.03132	-.03194	-.35014	-.28908	-.28995	-.27695	-.30177	-.30386
.050	-.00427	-.00473	-.00395	-.23239	-.15326	-.15147	-.14432	-.15472	-.17772
.075	-.00118	-.01773	.00812	-.04785	-.09470	-.08776	-.11182	-.10175	-.11360
.100	.01064	.03112	.01929	-.04673	-.05919	-.05266	-.06306	-.06969	-.08084
.200	.04727	.05118	.05076	.04610	.04112	.04226	.03511	.01951	.01603
.300	.06328	.09159	.05577	.09470	.07352	.10467	.09297	.08851	.06621
.400	.06146	.08056	.05634	.11152	.14641	.13977	.13457	.11081	.08084
.600	.07021	.07505	.04447	.09283	.10716	.10857	.10792	.10166	.08154
.800	.09696	.04255	.03046	.04486	.02804	.03576	.03706	.03624	.00836
1.000	-.04905	-.07328	-.06903	-.03364	-.05732	-.06241	-.06046	-.04669	-.03485

	-CPL	-CPL	-CPL	-CPL	-CPL	-CPL	-CPL	-CPL	-CPL
0.000	-.03782	.03959	.14568	.23061	-.45730	-.41217	-.45898	-.46207	-.46416
.025	.03273	.18555	.27413	.89279	.83858	.85696	.77704	.79401	.65750
.050	.13473	.18447	.26750	.74987	.71834	.70428	.66140	.67212	.54049
.075	.12764	.18310	.26649	.63446	.57255	.59903	.56784	.56556	.50218
.100	.14713	.18792	.24335	.55700	.53642	.51338	.49343	.50427	.40606
.200	.15653	.17432	.22335	.43477	.44359	.43667	.41997	.40815	.34129
.300	.15142	.15343	.24319	.39749	.44257	.40892	.39201	.36566	.31064
.400	.14355	.20801	.23959	.36447	.36260	.37056	.34521	.33989	.27320
.600	.15585	.18614	.19342	.24796	.24858	.23924	.22299	.21605	.17563
.800	.11378	.11405	.13051	.11277	.08722	.09036	.06891	.07597	*****
1.000	-.04905	-.07328	-.06903	-.03364	-.05732	-.06241	-.06046	-.04669	-.03485

# APPENDIX A

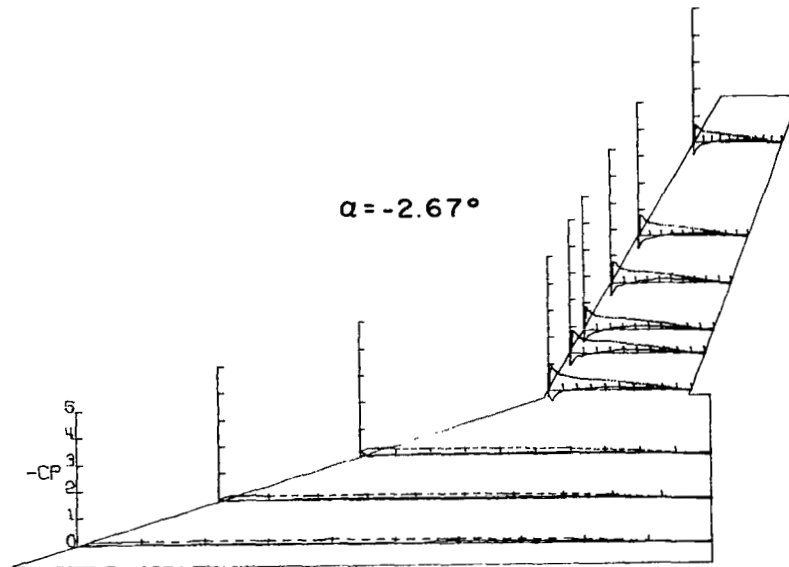
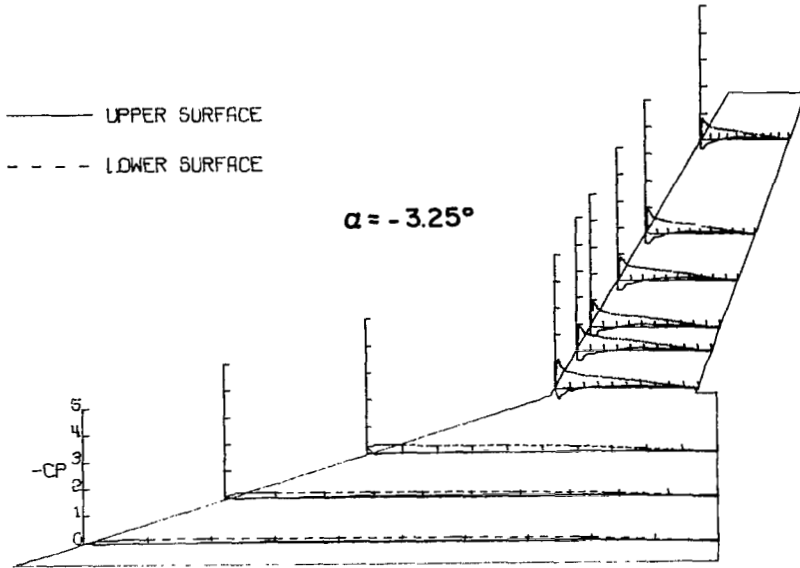

# APPENDIX A

## P R E S S U R E M E A S U R E M E N T S

OUTER PANEL SWEEP= 30.00000 DEGREES

FUSELAGE OFF

ANGLE OF ATTACK= -2.14378 DEGREES

### S P A N W I S E L O C A T I O N

	2Y/B .04707	2Y/B .14119	2Y/B .23533	2Y/B .37112	2Y/B .44999	2Y/B .49999	2Y/B .59999	2Y/B .69999	2Y/B .89997
X/C	-CPU	-CPU	-CPU	-CPU	-CPU	-CPU	-CPU	-CPU	-CPU
0.000	-.05357	.00060	.07839	-.45117	-.59535	-.54029	-.62689	-.55746	-.55815
.025	-.01607	-.01786	-.00512	-.32504	-.22934	-.20035	-.23718	-.22758	-.21227
.050	.00714	.00417	.01025	-.19886	-.10192	-.08143	-.08402	-.09465	-.11622
.075	.01309	.04762	.03731	-.03604	-.03045	-.03684	-.04524	-.05707	-.07586
.100	.01190	.04107	.03484	-.00497	-.00932	-.01034	-.01339	-.02853	-.03271
.200	.05119	.05714	.06660	.07892	.07209	.07368	.06269	.05776	.04872
.300	.06904	.09821	.08761	.12305	.09757	.12926	.10664	.10996	.08839
.400	.06845	.09345	.07275	.13113	.15785	.15769	.14676	.13501	.09117
.600	.07083	.08095	.05943	.09819	.14418	.11504	.11698	.11205	.08282
.800	.05416	.05000	.03834	.04412	.02921	.02844	.02779	.04037	.00974
1.000	-.05238	-.07381	-.06968	-.06214	-.03356	-.07174	-.06657	-.04663	-.03967

	-CPL	-CPL	-CPL	-CPL	-CPL	-CPL	-CPL	-CPL	-CPL
0.000	-.05357	.00060	.07839	-.45117	-.59535	-.54029	-.62689	-.55746	-.55815
.025	-.07976	.18452	.24080	.75568	.69292	.70142	.65750	.68509	.54737
.050	-.09702	.15714	.23773	.65314	.62704	.60131	.59614	.58632	.47365
.075	.10773	.16071	.23670	.52761	.51145	.51767	.50086	.50008	.43540
.100	.12797	.17678	.22902	.48597	.46857	.45692	.43430	.44374	.36098
.200	.14664	.17559	.21570	.39586	.40021	.39487	.37096	.37096	.31924
.300	.15178	.17916	.21877	.36541	.39711	.37161	.34576	.33315	.28882
.400	.17499	.20832	.22902	.33372	.34242	.34446	.32314	.32342	.25263
.600	.14583	.18987	.19981	.22807	.23615	.22684	.19453	.20948	.16564
.800	.10833	.11071	.09222	.09073	.08452	.07432	.07303	.06681	*****
1.000	-.05238	-.07381	-.06968	-.06214	-.03356	-.07174	-.06657	-.04663	-.03967

## P R E S S U R E M E A S U R E M E N T S

OUTER PANEL SWEEP= 30.00000 DEGREES

FUSELAGE OFF

ANGLE OF ATTACK= -1.64875 DEGREES

### S P A N W I S E L O C A T I O N

	2Y/B .04707	2Y/B .14119	2Y/B .23533	2Y/B .37112	2Y/B .44999	2Y/B .49999	2Y/B .59999	2Y/B .69999	2Y/B .89997
X/C	-CPU	-CPU	-CPU	-CPU	-CPU	-CPU	-CPU	-CPU	-CPU
0.000	-.05836	-.02240	.04290	-.53320	-.65465	-.61469	-.64759	-.64076	-.63729
.025	-.01828	-.01356	-.00715	-.25343	-.13801	-.14964	-.13287	-.17374	-.15359
.050	.01415	.01828	.03982	-.15511	-.04357	-.02516	-.01935	-.04726	-.05560
.075	.01710	.04598	.04495	.02992	.00550	.03225	-.01161	.00069	-.02363
.100	.02240	.04362	.05312	.05008	.02565	.04322	.02709	.02641	-.01251
.200	.04539	.07605	.06640	.09282	.09893	.09417	.09611	.08409	.07575
.300	.06721	.10729	.09142	.13069	.13313	.14384	.13674	.13204	.10494
.400	.07605	.10022	.08938	.14412	.17221	.17867	.17093	.15428	.10981
.600	.07723	.08725	.07202	.10992	.14046	.12255	.12965	.11384	.09035
.800	.05718	.04775	.04086	.04153	.02076	.02451	.02258	.02432	.00695
1.000	-.05070	-.07369	-.06435	-.05069	-.06656	-.07611	-.06386	-.05629	-.03544

	-CPL	-CPL	-CPL	-CPL	-CPL	-CPL	-CPL	-CPL	-CPL
0.000	-.05836	-.02240	.04290	-.53320	-.65465	-.61469	-.64759	-.64076	-.63729
.025	.06308	.14266	.19613	.61801	.55572	.57885	.56983	.56744	.40720
.050	.08430	.14090	.20532	.50085	.51725	.50246	.49601	.50424	.40770
.075	.09786	.15681	.20439	.44641	.44274	.45215	.45086	.43478	.38686
.100	.10494	.15387	.19562	.41343	.41343	.39603	.39732	.38616	.30560
.200	.13972	.15092	.20123	.34259	.35542	.35024	.34250	.33824	.28563
.300	.12321	.17450	.19562	.31878	.34870	.33605	.31476	.29397	.25714
.400	.15917	.18157	.20685	.30046	.30107	.31992	.29412	.29397	.22865
.600	.14208	.17714	.17825	.21152	.21496	.20576	.19286	.19459	.15845
.800	.08725	.09727	.07406	.07328	.06595	.05399	.05612	.05490	*****
1.000	-.05070	-.07369	-.06435	-.05069	-.06656	-.07611	-.06386	-.05629	-.03544



# APPENDIX A

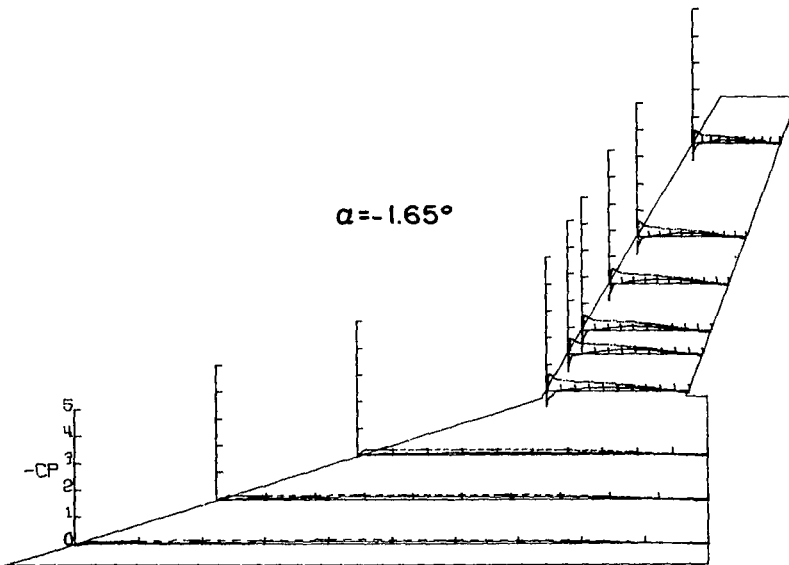
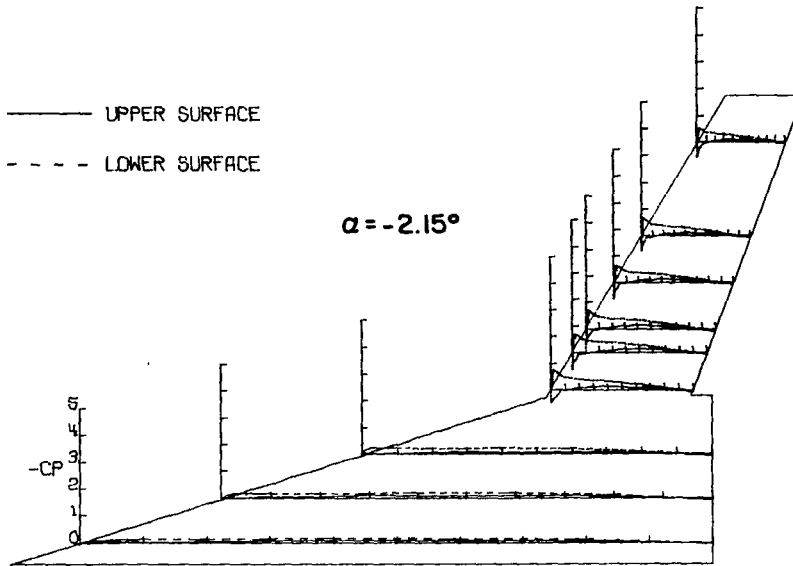

# APPENDIX A

## P R E S S U R E M E A S U R E M E N T S

INLET PANEL SWEEP= 30.0000 DEGREES

FUSELAGE OFF

ANGLE OF ATTACK= -1.1133 DEGREES

### S P A N W I S E L O C A T I O N

	2Y/1 .04707	2Y/2 .14119	2Y/3 .23533	2Y/4 .37112	2Y/5 .44999	2Y/6 .49999	2Y/7 .59999	2Y/8 .69999	2Y/9 .89997
X/C	-CPU	-CPU	-CPU	-CPU	-CPU	-CPU	-CPU	-CPU	-CPU
0.000	-.00373	-.03885	.00510	-.66565	-.72023	-.68756	-.69665	-.67961	-.67051
.025	-.00471	.01414	.02243	-.07222	-.04454	-.03766	-.06168	-.05319	-.06649
.050	.02160	.02121	.04383	-.04831	.04329	.04545	.03571	.05459	-.00840
.075	.02769	.07600	.05654	.08971	.10101	.06817	.07207	.06299	.02100
.100	.04247	.06245	.06677	.10226	.06407	.09349	.07661	.08609	.03709
.200	.06434	.08602	.08359	.15810	.16061	.13440	.13375	.13375	.10918
.300	.07306	.11725	.10143	.18570	.15958	.16296	.16101	.15538	.12948
.400	.03243	.10959	.09582	.18759	.21017	.20046	.18634	.17917	.13018
.600	.09449	.19486	.08614	.14942	.20264	.14024	.14154	.13928	.10210
.800	.05774	.06481	.05301	.06336	.05521	.02857	.03051	.01470	.02109
1.000	-.04546	-.07836	-.06524	-.02344	-.02133	-.07856	-.06382	-.05069	-.03779

	-CPL	-CPL	-CPL	-CPL	-CPL	-CPL	-CPL	-CPL	-CPL
0.000	-.00673	-.03885	.00510	-.06565	-.72023	-.68756	-.69665	-.67961	-.67051
.025	.04944	.10605	.10016	.50880	.41344	.46292	.40448	.43857	.35743
.050	.07247	.11666	.17330	.47994	.42737	.43045	.41877	.43647	.34904
.075	.04957	.13787	.19266	.41407	.38395	.38890	.36423	.39450	.32735
.100	.10787	.13610	.18859	.38097	.37580	.34805	.33047	.34834	.26106
.200	.13315	.14072	.18961	.35509	.34192	.33372	.30580	.32805	.26106
.300	.12726	.15849	.18859	.34568	.33816	.31229	.28827	.27926	.23867
.400	.15347	.10450	.19368	.30051	.30490	.28762	.27139	.26806	.21417
.600	.14494	.15790	.14718	.22523	.22272	.18179	.18244	.17588	.15328
.800	.09355	.04780	.08053	.09285	.08344	.05843	.05519	.05389	*****
1.000	-.04546	-.07836	-.06524	-.02344	-.02133	-.07856	-.06882	-.05669	-.03779

## P R E S S U R E M E A S U R E M E N T S

INLET PANEL SWEEP= 30.0000 DEGREES

FUSELAGE OFF

ANGLE OF ATTACK= -.58094 DEGREES

### S P A N W I S E L O C A T I O N

	2Y/1 .04707	2Y/2 .14119	2Y/3 .23533	2Y/4 .37112	2Y/5 .44999	2Y/6 .49999	2Y/7 .59999	2Y/8 .69999	2Y/9 .89997
X/C	-CPU	-CPU	-CPU	-CPU	-CPU	-CPU	-CPU	-CPU	-CPU
0.000	-.06373	-.04547	-.02605	-.70141	-.71709	-.70352	-.71320	-.68935	-.70807
.025	.00827	.02776	.03422	.02760	.09034	.07939	.06067	.02705	.01318
.050	.03012	.03957	.06180	.03200	.13426	.10198	.09811	.11859	.06034
.075	.03366	.08209	.08121	.15559	.15935	.12760	.11618	.10957	.06796
.100	.05020	.07676	.09174	.17002	.16312	.14329	.12199	.12830	.05964
.200	.06797	.09745	.10624	.17880	.19951	.15232	.15813	.13940	.11859
.300	.09036	.12579	.12513	.19449	.20954	.20460	.18588	.18170	.13593
.400	.10217	.12343	.12253	.21017	.24465	.21945	.21364	.19473	.14217
.600	.11162	.09686	.10777	.17692	.18633	.15232	.14974	.14980	.10333
.800	.07205	.07500	.06946	.08156	.07278	.04260	.04905	.01942	.02150
1.000	-.04546	-.07559	-.07610	-.04015	-.03011	-.08778	-.07422	-.07767	-.04716

	-CPL	-CPL	-CPL	-CPL	-CPL	-CPL	-CPL	-CPL	-CPL
0.000	-.06378	-.04547	-.02605	-.70141	-.71709	-.70352	-.71320	-.68935	-.70807
.025	.04725	.09272	.11594	.39776	.33941	.35563	.28270	.29751	.28226
.050	.07023	.10276	.13177	.40591	.32674	.33502	.30593	.34099	.26423
.075	.03445	.12520	.15220	.36200	.34380	.31820	.30012	.29335	.26215
.100	.04331	.12993	.14403	.33565	.33565	.29754	.27624	.27671	.19765
.200	.13052	.13052	.15476	.30930	.31956	.28463	.28399	.26900	.22470
.300	.12225	.15473	.15833	.29963	.32310	.28141	.25494	.26458	.21123
.400	.15296	.17549	.16446	.28459	.23926	.27560	.26140	.24758	.20875
.600	.12520	.16123	.14710	.22080	.22034	.17814	.16200	.16020	.13731
.800	.07154	.10099	.07510	.09411	.09057	.05873	.04905	.04924	*****
1.000	-.04546	-.07559	-.07610	-.04015	-.03011	-.08778	-.07422	-.07767	-.04716

# APPENDIX A

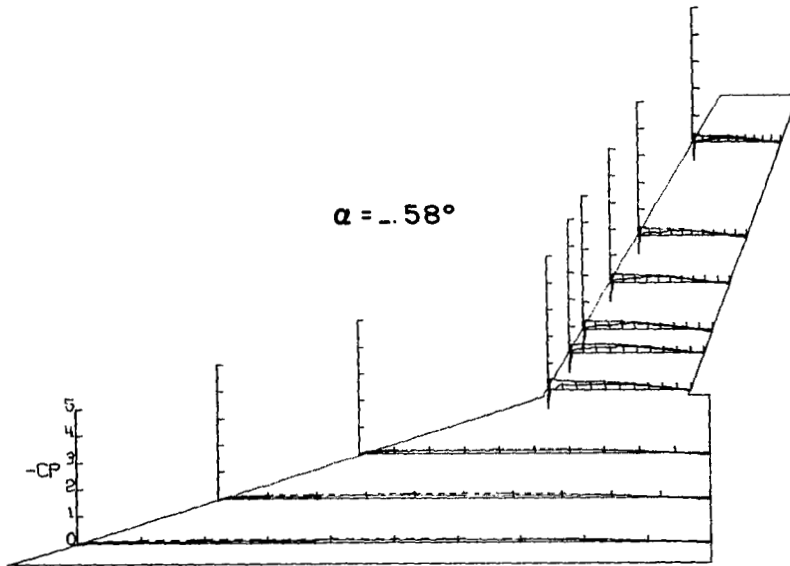
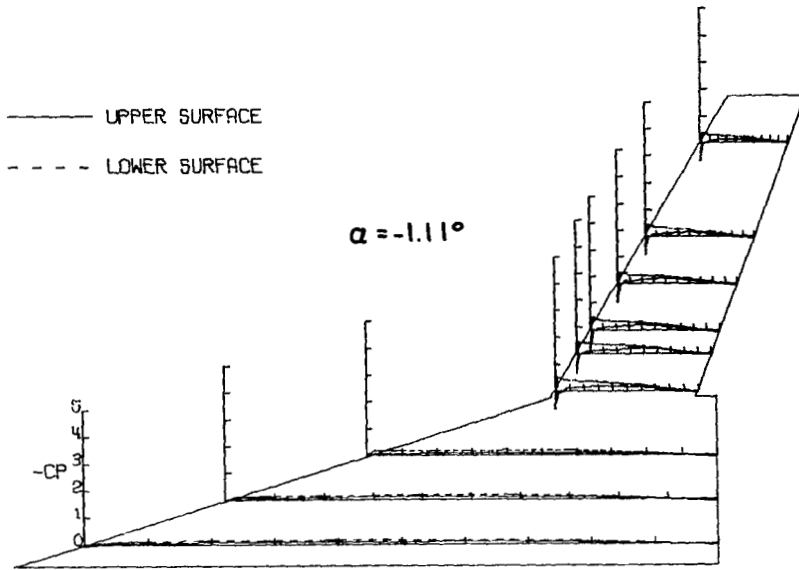

# APPENDIX A

## P R E S S U R E M E A S U R E M E N T S

OUTER PANEL SWEEP= 30.0000 DEGREES

FUSELAGE OFF

ANGLE OF ATTACK= -.04308 DEGREES

### S P A N W I S E L O C A T I O N

	2Y/B .04707	2Y/B .14119	2Y/B .23533	2Y/B .37112	2Y/B .44999	2Y/B .49999	2Y/B .59999	2Y/B .69999	2Y/B .89997
X/C	-CPU	-CPU	-CPU	-CPU	-CPU	-CPU	-CPU	-CPU	-CPU
0.000	-.07472	-.07173	-.04921	-.73251	-.78986	-.72248	-.73360	-.71195	-.77469
.025	.01494	.03766	.05075	.12344	.16645	.17538	.15641	.11278	.08388
.050	.04483	.06396	.08253	.10847	.20074	.20810	.20025	.20090	.13887
.075	.04065	.08667	.08663	.20697	.19638	.20025	.17866	.16495	.11913
.100	.04662	.09265	.09740	.20323	.18578	.19044	.18258	.17200	.12195
.200	.08428	.11835	.11072	.20386	.21819	.21465	.21530	.19244	.16918
.300	.09564	.14166	.12815	.21570	.22069	.23886	.21596	.21359	.16988
.400	.10221	.13210	.11893	.20448	.24749	.23297	.23886	.21077	.16001
.600	.10640	.11656	.10457	.15835	.17643	.16753	.16622	.16424	.11701
.800	.07292	.06754	.05639	.06671	.04738	.04974	.05104	.03525	.01551
1.000	-.04901	-.07830	-.06920	-.06733	-.07232	-.08442	-.07853	-.07683	-.04723

	-CPL	-CPL	-CPL	-CPL	-CPL	-CPL	-CPL	-CPL	-CPL
X/C	-CPL	-CPL	-CPL	-CPL	-CPL	-CPL	-CPL	-CPL	-CPL
0.000	-.07472	-.07173	-.04921	-.73251	-.78986	-.72248	-.73360	-.71195	-.77469
.025	.02451	.05499	.09381	.21258	.17580	.23624	.17931	.19173	.19526
.050	.04961	.09086	.09996	.25373	.20573	.26177	.25130	.25235	.21500
.075	.07890	.09504	.13840	.25747	.23253	.25784	.23494	.24460	.21006
.100	.09743	.11656	.14456	.25061	.23129	.24541	.23624	.24249	.15578
.200	.11716	.11835	.14917	.25124	.25622	.24410	.24868	.24108	.20442
.300	.12194	.14107	.16096	.24438	.25373	.26635	.23428	.23967	.19244
.400	.14764	.15900	.15942	.24438	.24313	.25391	.23952	.23685	.18680
.600	.12014	.14465	.14404	.17269	.18307	.18324	.15837	.16988	.13182
.800	.08727	.09086	.06049	.05985	.06296	.05366	.04319	.04582	*****
1.000	-.04901	-.07830	-.06920	-.06733	-.07232	-.08442	-.07853	-.07683	-.04723

## P R E S S U R E M E A S U R E M E N T S

OUTER PANEL SWEEP= 30.0000 DEGREES

FUSELAGE OFF

ANGLE OF ATTACK= .51412 DEGREES

### S P A N W I S E L O C A T I O N

	2Y/B .04707	2Y/B .14119	2Y/B .23533	2Y/B .37112	2Y/B .44999	2Y/B .49999	2Y/B .59999	2Y/B .69999	2Y/B .89997
X/C	-CPU	-CPU	-CPU	-CPU	-CPU	-CPU	-CPU	-CPU	-CPU
0.000	-.08354	-.07272	-.05047	-.73858	-.75429	-.72401	-.72071	-.70682	-.77454
.025	.03666	.05109	.09292	.27029	.30360	.30502	.28723	.26029	.17847
.050	.05710	.08234	.11108	.18103	.29794	.30370	.27471	.28922	.20934
.075	.05710	.10097	.11524	.27092	.27092	.26417	.24112	.23843	.17635
.100	.06311	.09316	.12977	.25080	.25017	.25034	.23782	.23067	.16365
.200	.09676	.12080	.14067	.25269	.22943	.25693	.22465	.23208	.18411
.300	.10337	.15566	.15313	.24954	.25017	.26747	.25561	.24478	.19399
.400	.11539	.14064	.14638	.23509	.27469	.26681	.26483	.23561	.17635
.600	.11299	.10938	.11783	.17412	.17852	.18314	.17260	.17706	.11921
.800	.07693	.08914	.06177	.06977	.06034	.05139	.06654	.03456	.02892
1.000	-.04808	-.07453	-.06852	-.06034	-.07669	-.08564	-.08564	-.07830	-.05432

	-CPL	-CPL	-CPL	-CPL	-CPL	-CPL	-CPL	-CPL	-CPL
X/C	-CPL	-CPL	-CPL	-CPL	-CPL	-CPL	-CPL	-CPL	-CPL
0.000	-.08354	-.07272	-.05047	-.73858	-.75429	-.72401	-.72071	-.70682	-.77454
.025	.01503	.04508	.07111	.13811	.05280	.12188	.05402	.10581	.08676
.050	.03846	.06551	.08669	.16783	.09869	.16997	.15350	.18270	.14743
.075	.05449	.08414	.10641	.17600	.17036	.16733	.17853	.15801	.14461
.100	.07993	.11179	.12769	.17977	.18920	.19764	.18907	.17424	.11145
.200	.10878	.11179	.13548	.21686	.22377	.21938	.21938	.21162	.17353
.300	.10277	.14965	.14379	.20360	.23634	.23123	.24436	.21444	.18623
.400	.13883	.16107	.14690	.21497	.23886	.22860	.22860	.21162	.18341
.600	.11660	.11960	.13081	.16154	.17600	.16009	.15350	.14886	.12697
.800	.09015	.08534	.07111	.06097	.05217	.04946	.04019	.03386	*****
1.000	-.04808	-.07453	-.06852	-.06034	-.07669	-.08564	-.08564	-.07830	-.05432

# APPENDIX A

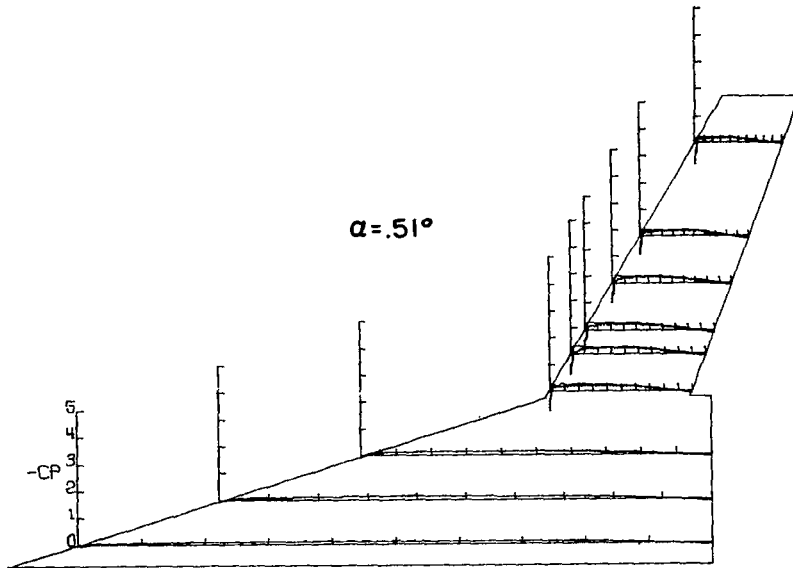
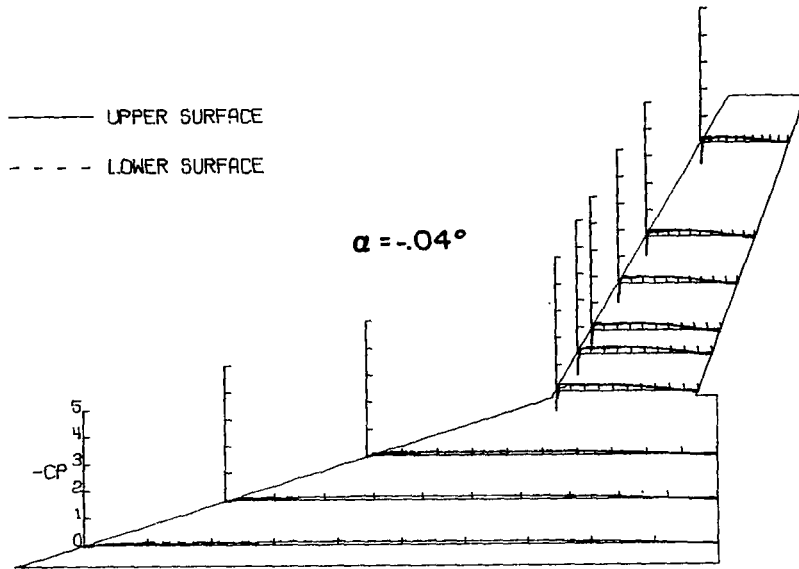

# APPENDIX A

## P R E S S U R E M E A S U R E M E N T S

OUTER PANEL SWEEP= 30.0000 DEGREES

FUSELAGE OFF

ANGLE OF ATTACK= 1.02602 DEGREES

### S P A N W I S E L O C A T I O N

	2Y/B .04707	2Y/B .14119	2Y/B .23533	2Y/B .37112	2Y/B .44999	2Y/B .49999	2Y/B .59999	2Y/B .69999	2Y/B .89997
X/C	-CPU	-CPU	-CPU	-CPU	-CPU	-CPU	-CPU	-CPU	-CPU
0.000	-.07482	-.05582	-.03291	-.64312	-.66874	-.64702	-.65224	-.62807	-.73228
.025	.03919	.07115	.10401	.34312	.35375	.44376	.40063	.39003	.31034
.050	.05502	.09322	.12958	.30062	.34750	.37383	.34704	.36556	.27277
.075	.05403	.11697	.13421	.34312	.34125	.33331	.31567	.30354	.23360
.100	.07482	.11044	.14132	.31250	.32125	.30063	.27580	.27906	.20702
.200	.08466	.12885	.13935	.27000	.27937	.27515	.26338	.25109	.21612
.300	.10337	.14904	.15375	.27187	.28187	.27711	.26273	.25109	.20912
.400	.10688	.13716	.14706	.24502	.28187	.27188	.26730	.24479	.18394
.600	.11816	.13835	.13524	.16375	.19437	.19672	.19280	.18534	.13848
.800	.08466	.07719	.08176	.09437	.05812	.06862	.05817	.05315	.01818
1.000	-.05522	-.07779	-.07148	-.06000	-.04625	-.09542	-.08104	-.08813	-.05106

	-CPL	-CPL	-CPL	-CPL	-CPL	-CPL	-CPL	-CPL	-CPL
0.000	-.07482	-.05582	-.03291	-.64312	-.66874	-.64702	-.65224	-.62807	-.73228
.025	.01009	.02375	.04217	-.00500	-.02687	.02549	-.05163	-.00140	-.00070
.050	.02731	.04869	.07250	.05250	.01750	.09999	.08627	.10002	.06155
.075	.04034	.06888	.08382	.12062	.11500	.11829	.11699	.10421	.09372
.100	.07125	.08432	.10233	.13375	.13375	.13071	.11764	.13079	.07484
.200	.10391	.09857	.12752	.19375	.18437	.19149	.18103	.18185	.13918
.300	.09357	.12885	.12958	.20375	.20750	.21567	.21567	.19024	.15247
.400	.12766	.14606	.13775	.20875	.21312	.20652	.19149	.18464	.15737
.600	.10926	.11401	.12341	.15750	.14937	.14640	.13921	.13988	.12100
.800	.06769	.09679	.06171	.04687	.06625	.03333	.04902	.02168	*****
1.000	-.05522	-.07779	-.07148	-.06000	-.04625	-.09542	-.08104	-.08813	-.05106

## P R E S S U R E M E A S U R E M E N T S

OUTER PANEL SWEEP= 30.0000 DEGREES

FUSELAGE OFF

ANGLE OF ATTACK= 1.52593 DEGREES

### S P A N W I S E L O C A T I O N

	2Y/B .04707	2Y/B .14119	2Y/B .23533	2Y/B .37112	2Y/B .44999	2Y/B .49999	2Y/B .59999	2Y/B .69999	2Y/B .89997
X/C	-CPU	-CPU	-CPU	-CPU	-CPU	-CPU	-CPU	-CPU	-CPU
0.000	-.07607	-.03016	-.03530	-.51693	-.57207	-.56578	-.59120	-.51613	-.73264
.025	-.05144	.09407	.12853	.53322	.55390	.53012	.55631	.50464	.39576
.050	.07214	.11294	.14976	.40540	.48623	.46345	.45563	.44182	.34760
.075	.06918	.13881	.14370	.41793	.42545	.40413	.37350	.36993	.31339
.100	.07629	.12713	.13816	.38347	.37783	.35524	.35981	.34062	.25073
.200	.10607	.14487	.14623	.32582	.34274	.31744	.31157	.30102	.26121
.300	.11530	.16142	.15530	.31266	.33334	.30636	.29071	.28495	.23676
.400	.12535	.15196	.15480	.29199	.32519	.31092	.29593	.28356	.20254
.600	.13422	.12594	.12656	.20426	.21304	.21380	.20076	.20324	.13898
.800	.08455	.08574	.05899	.08649	.08083	.07170	.07170	.04889	.02933
1.000	-.05499	-.08042	-.08269	-.05514	-.07143	-.08669	-.08213	-.08311	-.04889

	-CPL	-CPL	-CPL	-CPL	-CPL	-CPL	-CPL	-CPL	-CPL
0.000	-.07607	-.03016	-.03530	-.51693	-.57207	-.56578	-.59120	-.51613	-.73264
.025	-.00237	.01064	.01412	-.11965	-.08647	-.07431	-.11407	-.08381	-.09778
.050	.01247	.04316	.03277	-.04637	.01441	.01434	.02347	.01257	.00559
.075	.04316	.06741	.06404	.07519	.05827	.06909	.05827	.06076	.05378
.100	.07273	.07539	.08622	.09524	.07958	.08669	.07105	.08171	.02864
.200	.11464	.08928	.07563	.15038	.16730	.13297	.14014	.12781	.10756
.300	.04224	.11471	.10206	.16730	.17043	.18773	.17404	.15854	.13130
.400	.12299	.14622	.10639	.23176	.20614	.18968	.18186	.16902	.14248
.600	.04794	.11530	.09471	.15414	.15915	.12645	.11798	.11873	.09708
.800	.05313	.06445	.02874	.05953	.04762	.03129	.01955	.02025	*****
1.000	-.05499	-.08042	-.08269	-.05514	-.07143	-.08669	-.08213	-.08311	-.04889

# APPENDIX A

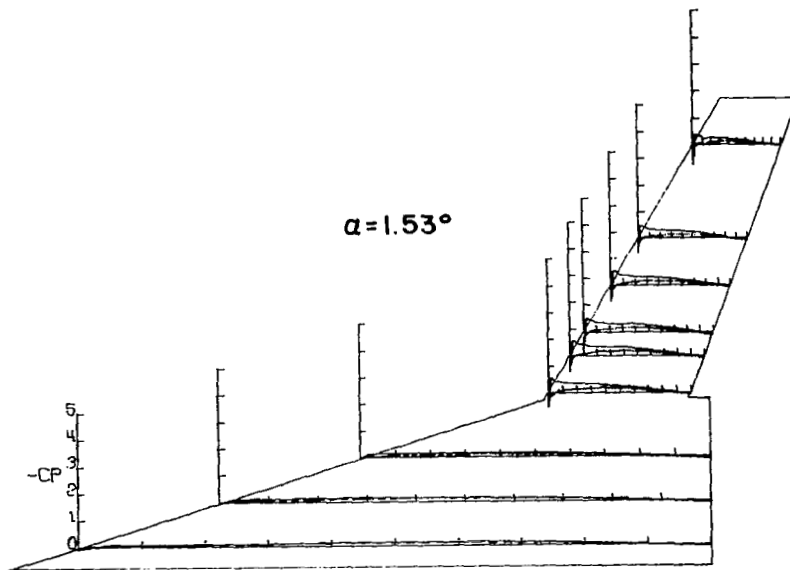
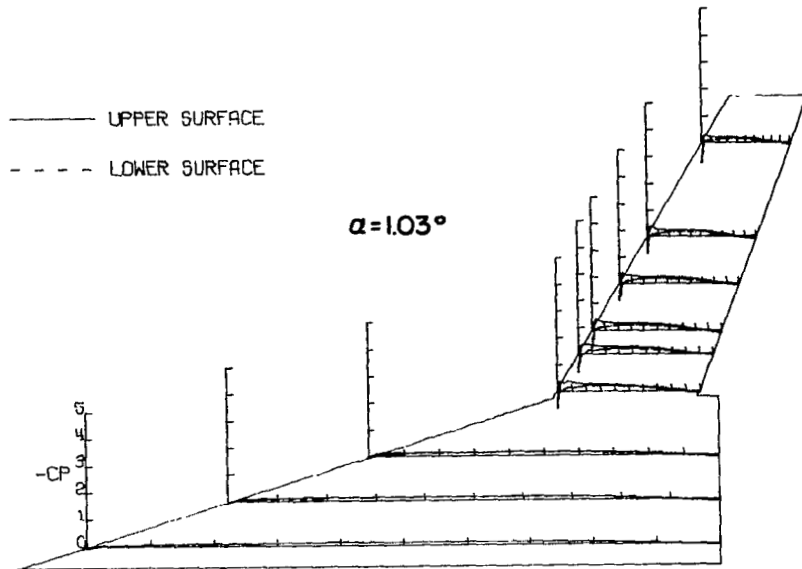

# APPENDIX A

## P R E S S U R E M E A S U R E M E N T S

OUTER PANEL SWEEP= 30.00000 DEGREES

FUSELAGE OFF

ANGLE OF ATTACK= 2.08463 DEGREES

### S P A N W I S E L O C A T I O N

	2Y/B .04707	2Y/B .14119	2Y/B .23533	2Y/B .37112	2Y/B .44999	2Y/B .49999	2Y/B .59999	2Y/B .69999	2Y/B .89997
X/C	-CPU	-CPU	-CPU	-CPU	-CPU	-CPU	-CPU	-CPU	-CPU
0.000	-.05994	-.01958	.02404	-.33185	-.42675	-.43969	-.46054	-.37784	-.72286
.025	-.06587	.11572	.19132	-.76356	.63827	.69460	.65359	.64005	.50185
.050	-.08249	.13055	.18313	-.48382	.54212	.56050	.53056	.54443	.42716
.075	-.09079	.14895	.19439	-.48134	.46211	.46510	.43709	.45508	.34271
.100	-.09435	.14895	.18518	-.42241	.41248	.41559	.40061	.39157	.29962
.200	-.11275	.14836	.18160	-.34922	.34860	.34719	.34980	.32526	.28076
.300	-.12046	.18277	.18467	-.32813	.32999	.33351	.32570	.31409	.26540
.400	-.13708	.17625	.18774	-.30146	.33619	.33547	.32505	.30711	.22629
.600	-.13293	.14836	.14374	.20345	.21462	.21757	.22082	.20494	.15365
.800	-.10207	.08961	.08747	.09118	.07133	.07347	.07426	.06565	.03422
1.000	-.05163	-.07714	-.06804	-.05086	-.07816	-.08924	-.08729	-.08171	-.05378
X/C	-CPL	-CPL	-CPL	-CPL	-CPL	-CPL	-CPL	-CPL	-CPL
0.000	-.05994	-.01958	.02404	-.33185	-.42675	-.43969	-.46054	-.37784	-.72286
.025	-.01662	.00415	.00870	-.20965	-.21027	-.15894	-.20128	-.17879	-.15295
.050	.01602	.03026	.03479	-.13956	-.07691	-.03908	-.05732	-.04121	-.03422
.075	.03976	.05578	.05678	.00620	.00434	.00847	-.00717	.00210	-.00489
.100	.05459	.06884	.07417	.04466	.00558	.04820	.02996	.03841	-.00349
.200	.08901	.07893	.09361	.12530	.11599	.11595	.12311	.10756	.08591
.300	.07893	.10326	.09975	.14204	.13336	.15764	.14787	.12951	.10756
.400	.11572	.12818	.11817	.17554	.17244	.17913	.16611	.15714	.12571
.600	.08189	.09376	.10026	.12716	.13088	.12963	.12051	.11733	.09359
.800	.06112	.06706	.04144	.03598	.02915	.02606	.02084	.00838	*****
1.000	-.05163	-.07714	-.06804	-.05086	-.07816	-.08924	-.08729	-.08171	-.05378

## P R E S S U R E M E A S U R E M E N T S

OUTER PANEL SWEEP= 30.00000 DEGREES

FUSELAGE OFF

ANGLE OF ATTACK= 2.58309 DEGREES

### S P A N W I S E L O C A T I O N

	2Y/B .04707	2Y/B .14119	2Y/B .23533	2Y/B .37112	2Y/B .44999	2Y/B .49999	2Y/B .59999	2Y/B .69999	2Y/B .89997
X/C	-CPU	-CPU	-CPU	-CPU	-CPU	-CPU	-CPU	-CPU	-CPU
0.000	-.06244	.00642	.05936	-.05693	-.24855	-.28837	-.30887	-.20054	-.66296
.025	-.07470	.14415	.21359	.89013	.77688	.77555	.77555	.72453	.59505
.050	-.08987	.15290	.21156	.61036	.63791	.61608	.62697	.60952	.50759
.075	-.08345	.16107	.21511	.52833	.53077	.52642	.50625	.49037	.41392
.100	-.08987	.15699	.20293	.45976	.47690	.46588	.44217	.43183	.35813
.200	-.10972	.16924	.19431	.38140	.38752	.37488	.37039	.35262	.30855
.300	-.12956	.17858	.20243	.34405	.35936	.35181	.34027	.32783	.27221
.400	-.13189	.17274	.19532	.31283	.35385	.34476	.33515	.31337	.23845
.600	-.12839	.15057	.15169	.20998	.23202	.21083	.22557	.20399	.15713
.800	-.09571	.09338	.08574	.09305	.07591	.07562	.08010	.05651	.03308
1.000	-.06828	-.08054	-.07001	-.06000	-.08081	-.09356	-.08715	-.09028	-.05582
X/C	-CPL	-CPL	-CPL	-CPL	-CPL	-CPL	-CPL	-CPL	-CPL
0.000	-.06244	.00642	.05936	-.05693	-.24855	-.28837	-.30887	-.20054	-.66296
.025	-.03093	-.01868	-.00101	-.29324	-.27916	-.24351	-.28773	-.24947	-.23500
.050	-.01517	.00233	.00660	-.13162	-.13346	-.11791	-.11919	-.11164	-.11233
.075	-.02568	.03677	.04465	-.05693	-.05877	-.05575	-.06152	-.05513	-.04962
.100	.03385	.04669	.05327	-.01530	-.05449	-.01858	-.02948	-.03101	-.03308
.200	.07353	.06595	.08219	.08510	.08571	.07498	.07882	.08623	.06065
.300	.06828	.09688	.08878	.12366	.10897	.12304	.12176	.09924	.08339
.400	.10155	.12431	.10045	.15060	.15060	.14995	.14034	.13369	.10820
.600	.08579	.09454	.09183	.11448	.11509	.10830	.10253	.10406	.08890
.800	.06069	.06069	.04769	.03490	.03673	.02243	.02435	.01861	*****
1.000	-.06828	-.08054	-.07001	-.06000	-.08081	-.09356	-.08715	-.09028	-.05582



# APPENDIX A

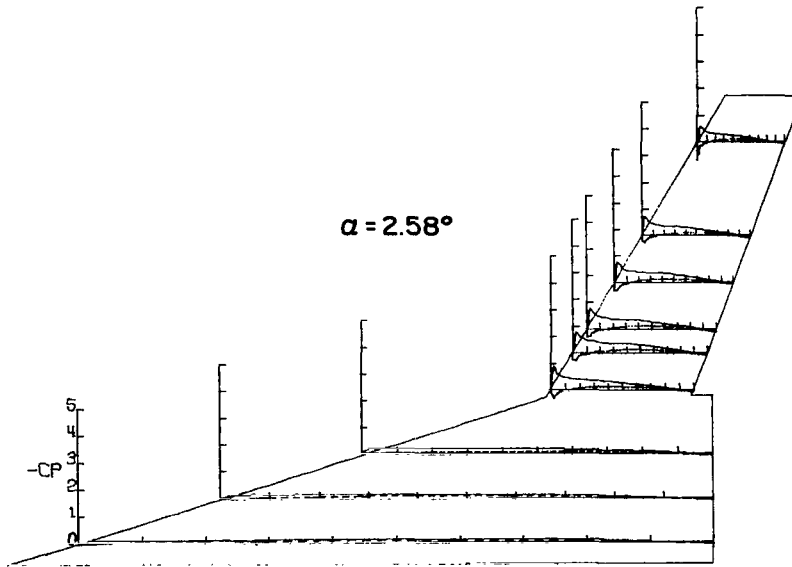
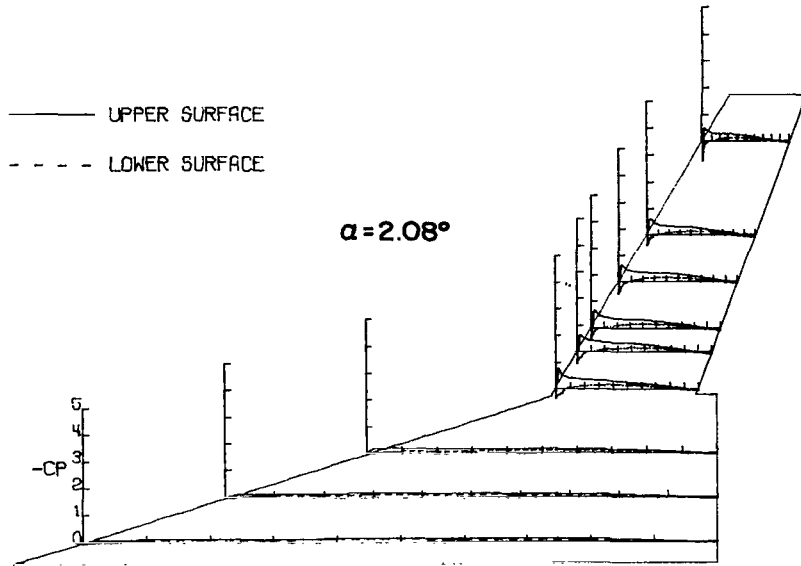

# APPENDIX A

## P R E S S U R E M E A S U R E M E N T S

OUTER PANEL SWEEP= 30.00000 DEGREES

FUSELAGE OFF

ANGLE OF ATTACK= 3.13960 DEGREES

### S P A N W I S E L O C A T I O N

	2Y/B .04707	2Y/H .14119	2Y/δ .23533	2Y/B .37112	2Y/B .44999	2Y/B .49999	2Y/B .59999	2Y/B .69999	2Y/B .89997
X/C	-CPU	-CPU	-CPU	-CPU	-CPU	-CPU	-CPU	-CPU	-CPU
0.000	-.04669	-.02685	-.11962	-.25221	-.05308	-.12431	-.10391	-.00275	-.57120
.025	.09746	.16574	.25237	1.06165	.93474	.95057	.95821	.86658	.74072
.050	.10155	.17450	.25237	.60503	.71999	.73395	.71802	.74209	.59147
.075	.09279	.19259	.23824	.58870	.59786	.60908	.54473	.57290	.44979
.100	.10096	.16510	.22900	.53740	.53557	.51606	.49598	.50206	.38308
.200	.12722	.16983	.21401	.41160	.41954	.41310	.40163	.39409	.34250
.300	.13189	.19784	.21199	.38045	.38229	.38378	.36720	.35695	.29867
.400	.14181	.18267	.20442	.32916	.37496	.36975	.35573	.34457	.25463
.600	.15524	.15057	.17212	.22534	.23511	.23269	.22631	.22366	.16104
.800	.09571	.11263	.09035	.09954	.08855	.08033	.08798	.06331	.04542
1.000	-.05486	-.07237	-.06511	-.05557	-.07328	-.08861	-.08415	-.08258	-.05574

	-CPL	-CPL	-CPL	-CPL	-CPL	-CPL	-CPL	-CPL	-CPL
X/C	-CPL	-CPL	-CPL	-CPL	-CPL	-CPL	-CPL	-CPL	-CPL
0.000	-.04669	-.02685	-.11962	-.25221	-.05008	-.12431	-.10391	-.00275	-.57120
.025	-.03618	-.03208	-.01060	-.36213	-.34748	-.32194	-.35445	-.31175	-.30418
.050	-.00233	-.00233	.00606	-.20946	-.20946	-.15810	-.16575	-.16035	-.14108
.075	.02101	.03443	.02372	-.09893	-.10809	-.10391	-.10965	-.11080	-.09703
.100	.03320	.04319	.04694	-.05496	-.09954	-.05993	-.06694	-.05987	-.08534
.200	.07762	.05953	.07218	.05740	.05069	.05483	.03698	.04336	.03785
.300	.06420	.07937	.07521	.10382	.10565	.10328	.09308	.08121	.07570
.400	.09454	.11088	.08833	.17458	.13069	.12113	.12559	.10873	.09979
.600	.08345	.08170	.07622	.10809	.10076	.10901	.10136	.09703	.08878
.800	.06595	.05486	.04543	.02931	.02321	.01913	.00574	.02615	*****
1.000	-.05486	-.07237	-.06511	-.05557	-.07328	-.08861	-.08415	-.08258	-.05574

## P R E S S U R E M E A S U R E M E N T S

OUTER PANEL SWEEP= 30.00000 DEGREES

FUSELAGE OFF

ANGLE OF ATTACK= 3.65333 DEGREES

### S P A N W I S E L O C A T I O N

	2Y/B .04707	2Y/H .14119	2Y/δ .23533	2Y/B .37112	2Y/B .44999	2Y/B .49999	2Y/B .59999	2Y/B .69999	2Y/B .89997
X/C	-CPU	-CPU	-CPU	-CPU	-CPU	-CPU	-CPU	-CPU	-CPU
0.000	-.03732	-.06160	-.15942	-.65420	-.23497	-.15994	-.16253	-.44455	-.38258
.025	.11610	.18718	.31474	1.16453	1.05889	1.05419	1.06325	1.04007	.85484
.050	.12439	.19074	.29936	.72407	.81249	.80698	.80828	.81080	.61859
.075	.13603	.20495	.26707	.68140	.68573	.65555	.62773	.63327	.52283
.100	.11373	.17593	.25682	.58618	.59607	.56560	.55330	.55638	.44874
.200	.12454	.18541	.23119	.45200	.44520	.46235	.43839	.43756	.39282
.300	.14094	.20140	.23375	.40686	.41057	.40795	.39177	.38863	.32432
.400	.15046	.19962	.21735	.34008	.38646	.38400	.36910	.36067	.27277
.600	.15046	.15105	.18146	.22817	.24548	.23894	.23765	.23990	.16786
.800	.10425	.10148	.09331	.10141	.07791	.08483	.08548	.07274	.04826
1.000	-.05746	-.07701	-.06613	-.05874	-.08595	-.09195	-.08807	-.07973	-.05945

	-CPL	-CPL	-CPL	-CPL	-CPL	-CPL	-CPL	-CPL	-CPL
X/C	-CPL	-CPL	-CPL	-CPL	-CPL	-CPL	-CPL	-CPL	-CPL
0.000	-.03732	-.06160	-.15942	-.65420	-.23497	-.15994	-.16253	-.44455	-.38258
.025	-.04976	-.03554	-.02614	-.44025	-.42974	-.38335	-.42285	-.39516	-.36369
.050	-.01955	-.00948	-.00320	-.27330	-.25290	-.23506	-.22794	-.22871	-.21682
.075	.00415	.00542	.01437	-.17066	-.16695	-.15541	-.15412	-.15597	-.13778
.100	.02547	.02547	.02614	-.13109	-.15582	-.11203	-.12692	-.10841	-.11540
.200	.06694	.04561	.06734	.02276	.01855	.01101	.01036	.01469	.00909
.300	.04739	.06174	.05537	.05503	.08286	.07188	.06864	.04896	.05875
.400	.08708	.10129	.07330	.10512	.10574	.10490	.09584	.09722	.08323
.600	.06575	.07957	.06409	.08038	.08966	.08677	.07576	.08183	.07624
.800	.04857	.04561	.03024	.01360	.00939	.00648	.00518	.01399	*****
1.000	-.05746	-.07701	-.06613	-.05874	-.08595	-.09195	-.08807	-.07973	-.05945

# APPENDIX A

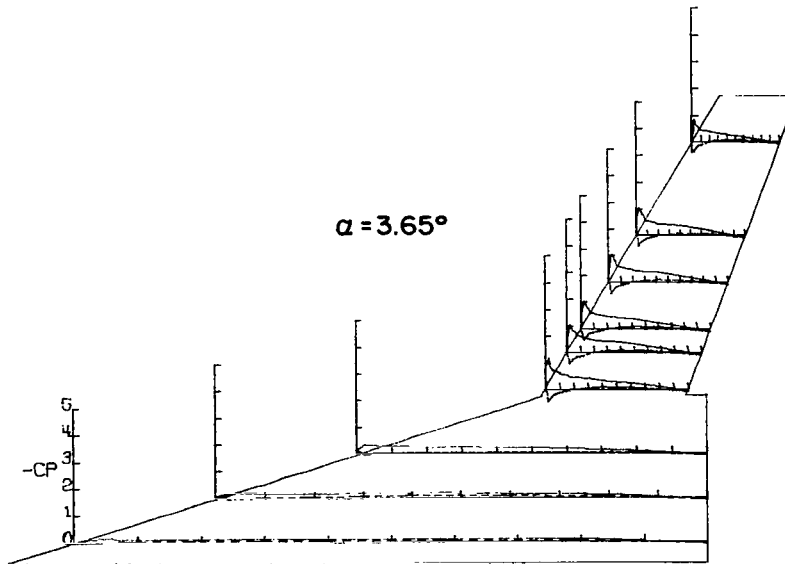
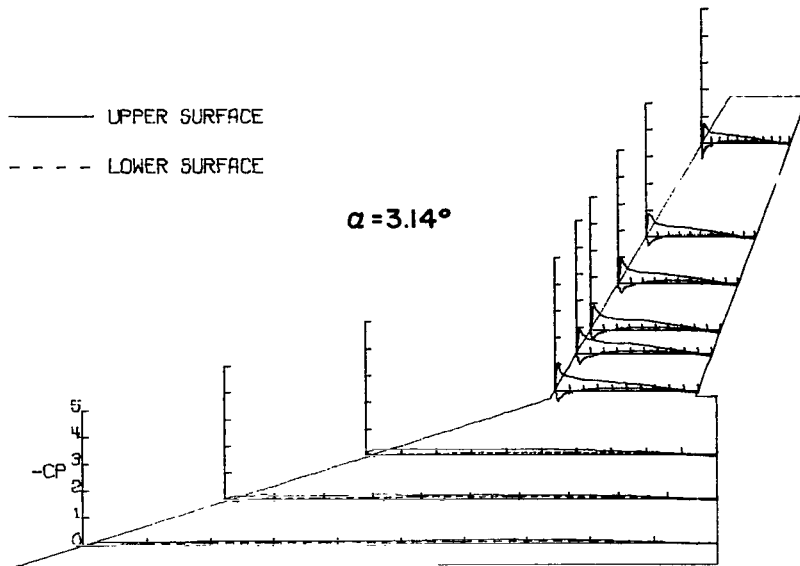

# APPENDIX A

## P R E S S U R E M E A S U R E M E N T S

OUTER PANEL SWEEP= 30.0000 DEGREES

FUSELAGE OFF

ANGLE OF ATTACK= 4.22433 DEGREES

### S P A N W I S E L O C A T I O N

	2Y/B .04707	2Y/B .14119	2Y/B .23533	2Y/B .37112	2Y/B .44999	2Y/B .49999	2Y/B .59999	2Y/B .69999	2Y/B .89997
X/C	-CPU	-CPU	-CPU	-CPU	-CPU	-CPU	-CPU	-CPU	-CPU
0.000	-.02086	.10141	.26825	1.15278	.55274	.50137	.48485	.79839	-.22884
.025	.12517	.23295	.36251	1.40447	1.22364	1.23645	1.25551	1.18907	.97399
.050	.14024	.20919	.33694	.83828	.95546	.89924	.86495	.92226	.70254
.075	.11706	.22368	.29783	.78570	.75390	.74111	.70174	.70038	.56969
.100	.11358	.19934	.26775	.67258	.67380	.67125	.62489	.63231	.48666
.200	.14024	.19876	.24769	.50688	.50627	.50201	.47850	.47508	.40634
.300	.15356	.20746	.25371	.44268	.44941	.44418	.42575	.41791	.34644
.400	.15878	.20456	.24117	.38398	.42617	.41177	.39779	.38184	.29081
.600	.16341	.17790	.18903	.26475	.26781	.24846	.25863	.24110	.18321
.800	.10141	.11590	.09827	.11740	.10456	.08134	.09341	.06811	.05653
1.000	-.05273	-.06954	-.06919	-.02996	-.07643	-.09278	-.08261	-.08377	-.05721
X/C	-CPL	-CPL	-CPL	-CPL	-CPL	-CPL	-CPL	-CPL	-CPL
0.000	-.02086	.10141	.26825	1.15278	.55274	.50137	.48485	.79839	-.22884
.025	-.04520	-.04288	-.02256	-.46775	-.47753	-.43211	-.47659	-.43179	-.41613
.050	-.03167	-.02260	-.02206	-.38765	-.30388	-.28341	-.30375	-.27174	-.26902
.075	.00232	.00464	.00100	-.20055	-.20605	-.19572	-.20462	-.20023	-.18389
.100	.01796	.02086	.01103	-.13024	-.18404	-.14870	-.16013	-.14983	-.15460
.200	.05621	.03767	.03610	.00734	-.00306	-.00826	-.02923	-.01035	-.02929
.300	.05273	.07301	.04513	.05870	.07398	.05211	.04575	.02724	.03746
.400	.08287	.08692	.05415	.08927	.09783	.08007	.08307	.06198	.06470
.600	.06432	.06664	.05265	.08071	.08988	.07753	.07435	.06130	.07083
.800	.04404	.04056	.01855	.01957	.01590	-.00127	.00508	-.00409	*****
1.000	-.05273	-.06954	-.06919	-.02996	-.07643	-.09278	-.08261	-.08377	-.05721

## P R E S S U R E M E A S U R E M E N T S

OUTER PANEL SWEEP= 30.0000 DEGREES

FUSELAGE OFF

ANGLE OF ATTACK= 4.69800 DEGREES

### S P A N W I S E L O C A T I O N

	2Y/B .04707	2Y/B .14119	2Y/B .23533	2Y/B .37112	2Y/B .44999	2Y/B .49999	2Y/B .59999	2Y/B .69999	2Y/B .89997
X/C	-CPU	-CPU	-CPU	-CPU	-CPU	-CPU	-CPU	-CPU	-CPU
0.000	-.01836	.14335	.34493	1.60093	.91951	.77046	.82619	1.12964	-.00700
.025	.13091	.26182	.40063	1.60958	1.38114	1.35755	1.44243	1.40243	1.12404
.050	.14098	.24287	.37508	.94299	1.05762	1.01022	1.03549	1.04710	.81767
.075	.12617	.23990	.34953	.85895	.83732	.83915	.79962	.79459	.68268
.100	.13802	.21266	.32756	.74154	.71249	.74519	.67197	.71695	.56377
.200	.15224	.19725	.29077	.54009	.53514	.55079	.52261	.53159	.44346
.300	.15638	.21680	.28003	.45790	.47953	.47981	.45518	.45745	.36792
.400	.16408	.20671	.26011	.39054	.43380	.43702	.41951	.40499	.31406
.600	.16171	.17711	.21156	.26448	.26386	.26195	.27036	.25266	.19737
.800	.11669	.10722	.14053	.11679	.09269	.09661	.09337	.08399	.05669
1.000	-.05983	-.07582	-.05570	-.04326	-.08095	-.07975	-.07586	-.07419	-.04969
X/C	-CPL	-CPL	-CPL	-CPL	-CPL	-CPL	-CPL	-CPL	-CPL
0.000	-.01836	.14335	.34493	1.60093	.91951	.77046	.82619	1.12964	-.00700
.025	-.06634	-.04620	-.02453	-.53205	-.52773	-.49667	-.52909	-.51583	-.46753
.050	-.03317	-.02666	-.01431	-.42886	-.35841	-.32874	-.34300	-.32195	-.30166
.075	-.00770	-.01362	0.00000	-.25274	-.26655	-.23991	-.25406	-.25406	-.23167
.100	.00355	.00415	.00971	-.19280	-.24285	-.18868	-.20230	-.20087	-.19177
.200	.05153	.02666	.03270	-.03399	-.03769	-.03890	-.04798	-.04479	-.05039
.300	.04443	.05746	.04293	.02657	.03213	.03307	.02723	.00770	.01750
.400	.07404	.07760	.04548	.06983	.07292	.07197	.06419	.05249	.05039
.600	.04620	.04976	.04446	.07106	.06303	.07521	.06160	.05599	.05949
.800	.03436	.03376	.03015	.00371	.00433	-.00065	-.00065	-.00420	*****
1.000	-.05983	-.07582	-.05570	-.04326	-.08095	-.07975	-.07586	-.07419	-.04969

# APPENDIX A

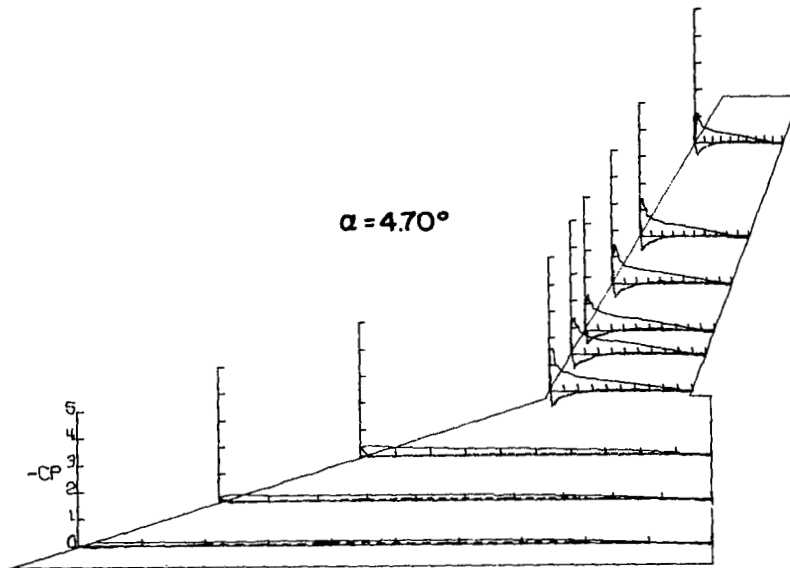
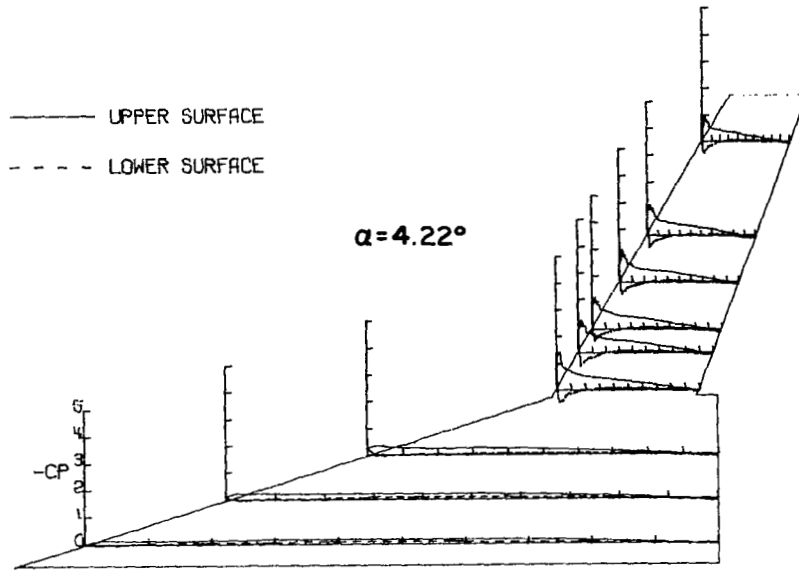

# APPENDIX A

## P R E S S U R E M E A S U R E M E N T S

OUTER PANEL SWEEP= 30.0000 DEGREES

FUSELAGE OFF

ANGLE OF ATTACK= 5.23475 DEGREES

### S P A N W I S E L O C A T I O N

	2Y/B .04707	2Y/B .14119	2Y/B .23533	2Y/B .37112	2Y/B .44999	2Y/B .49999	2Y/B .59999	2Y/B .69999	2Y/B .89997
X/C	-CPU	-CPU	-CPU	-CPU	-CPU	-CPU	-CPU	-CPU	-CPU
0.000	.00233	.17292	.44051	2.22230	1.23569	1.15211	1.13488	1.63417	.21201
.025	.15330	.27406	.44047	1.75336	1.48600	1.43981	1.45130	1.52823	1.21999
.050	.14905	.25618	.40436	1.06273	1.13338	1.10362	1.08066	1.09833	.89192
.075	.13749	.26549	.36815	.92164	.93240	.90331	.88545	.85092	.73063
.100	.13474	.22765	.34833	.78632	.80278	.77317	.76488	.74293	.62127
.200	.15487	.21950	.28315	.56261	.58700	.58307	.58307	.55566	.48253
.300	.16106	.23463	.26957	.47667	.51385	.49931	.48705	.47159	.40325
.400	.15710	.21309	.25000	.40962	.45411	.45449	.43917	.42648	.32055
.600	.16404	.16223	.20110	.27491	.28344	.28023	.27959	.26535	.19833
.800	.11586	.11935	.10059	.12069	.10058	.09447	.10660	.08685	.06292
1.000	-.05589	-.07627	-.04078	-.04815	-.07619	-.08490	-.07277	-.07386	-.04240

	-CPL	-CPL	-CPL	-CPL	-CPL	-CPL	-CPL	-CPL	-CPL
0.000	.00233	.17292	.44051	2.22230	1.23569	1.15211	1.13488	1.63417	.21201
.025	-.07605	-.05005	-.02103	-.50882	-.57359	-.54705	-.57705	-.56285	-.51224
.050	-.04032	-.03843	-.02716	-.51202	-.38828	-.39449	-.37853	-.37819	-.36178
.075	-.01688	-.01905	-.01509	-.28454	-.31148	-.27831	-.30512	-.29202	-.26535
.100	-.00733	-.00116	-.00704	-.22014	-.25296	-.23235	-.24065	-.22979	-.22842
.200	.02620	.01805	.01036	-.06156	-.07802	-.07468	-.08873	-.09711	-.08549
.300	.04317	.04425	.02716	.01280	-.05425	.00330	-.01021	-.01641	-.01436
.400	.06230	.07278	.03470	.05730	.05730	.05681	.04085	.02941	.03283
.600	.05350	.04774	.03118	.05913	.05547	.05745	.04468	.04514	.04856
.800	.03754	.02678	.01050	.03488	.01341	-.00191	.00064	.00752	*****
1.000	-.05589	-.07627	-.04878	-.04815	-.07619	-.08490	-.07277	-.07386	-.04240

## P R E S S U R E M E A S U R E M E N T S

OUTER PANEL SWEEP= 30.0000 DEGREES

FUSELAGE OFF

ANGLE OF ATTACK= 5.76022 DEGREES

### S P A N W I S E L O C A T I O N

	2Y/B .04707	2Y/B .14119	2Y/B .23533	2Y/B .37112	2Y/B .44999	2Y/B .49999	2Y/B .59999	2Y/B .69999	2Y/B .89997
X/C	-CPU	-CPU	-CPU	-CPU	-CPU	-CPU	-CPU	-CPU	-CPU
0.000	.03133	.24923	.55518	2.46438	1.59585	1.50910	1.60863	1.99738	.48897
.025	.18470	.31731	.52276	1.98001	1.68218	1.67649	1.64870	1.68823	1.30715
.050	.17246	.29600	.44273	1.17654	1.26965	1.23442	1.22925	1.22554	.96826
.075	.14741	.29126	.38650	1.00450	1.01128	.97461	.96686	.93852	.79605
.100	.15688	.25634	.36320	.85417	.87268	.84341	.83243	.80296	.69092
.200	.15510	.24331	.28671	.59125	.62026	.60105	.61139	.57888	.51663
.300	.17582	.24154	.29431	.51534	.53756	.53772	.51671	.50557	.41151
.400	.17701	.23325	.27101	.43079	.47522	.47920	.46498	.44125	.33751
.600	.19299	.19555	.22288	.28513	.29234	.30007	.28778	.28651	.20346
.800	.17491	.12314	.10840	.13578	.10430	.10412	.10477	.09550	.06782
1.000	-.05328	-.08051	-.06636	-.03518	-.07344	-.07372	-.07631	-.06436	-.04498

	-CPL	-CPL	-CPL	-CPL	-CPL	-CPL	-CPL	-CPL	-CPL
0.000	.03133	.24923	.55518	2.46438	1.59585	1.50910	1.60863	1.99738	.48897
.025	-.07163	-.04745	-.01210	-.62273	-.59249	-.58656	-.60725	-.60277	-.55779
.050	-.05520	-.04677	-.04350	-.46905	-.50176	-.42747	-.42553	-.43253	-.39516
.075	-.02034	-.01894	-.02735	-.33636	-.33952	-.33499	-.34464	-.34361	-.30381
.100	-.01104	-.01835	-.02583	-.29503	-.28945	-.27808	-.28584	-.28028	-.26713
.200	.01658	.01184	-.00912	-.09011	-.09319	-.10800	-.10606	-.12872	-.10588
.300	.04434	.04381	.01317	-.02439	-.06665	-.02009	-.02263	-.04083	-.02699
.400	.05216	.05920	.02026	.04259	.03209	.04074	.02005	.01730	.01523
.600	.04473	.04558	.01773	.03271	.04259	.03363	.03233	.02007	.03529
.800	.03197	.02960	-.00253	.00741	-.00247	-.00065	-.01811	-.01661	*****
1.000	-.05328	-.08051	-.06636	-.03518	-.07344	-.07372	-.07631	-.06436	-.04498

# APPENDIX A

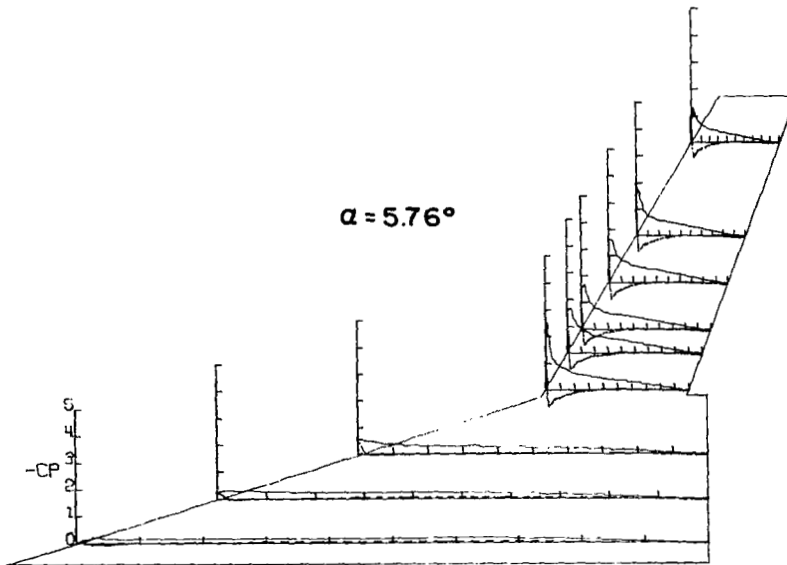
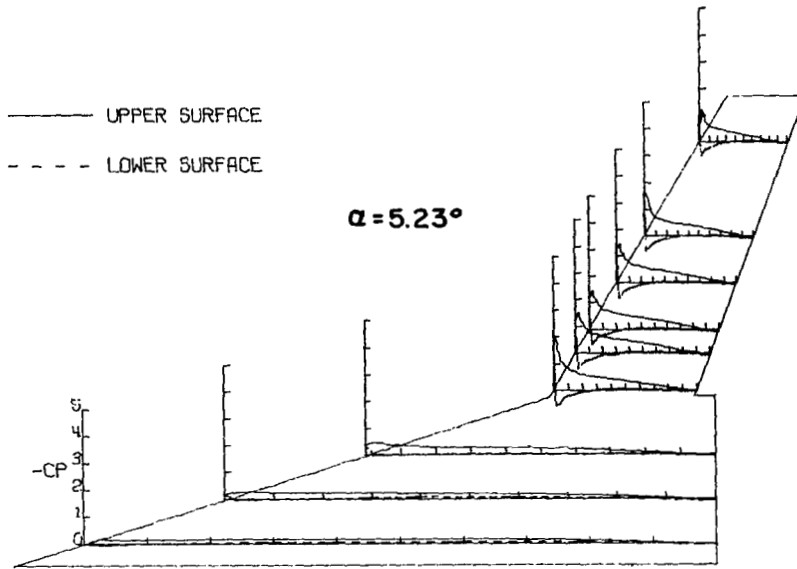

# APPENDIX A

## P R E S S U R E M E A S U R E M E N T S

OUTER PANEL SWEEP= 30.00000 DEGREES

FUSELAGE OFF

ANGLE OF ATTACK= 6.26179 DEGREES

### S P A N W I S E L O C A T I O N

	2Y/B .04707	2Y/B .14119	2Y/B .23533	2Y/B .37112	2Y/B .44999	2Y/B .49999	2Y/B .59999	2Y/B .69999	2Y/B .89997
X/C	-CPU	-CPU	-CPU	-CPU	-CPU	-CPU	-CPU	-CPU	-CPU
0.000	.04641	.33365	.05636	3.57803	2.04550	2.00236	1.96015	2.68200	.82742
.025	.18797	.34893	.57439	2.11356	1.47061	1.84508	1.83744	1.86776	1.44954
.050	.18562	.32132	.90948	1.27654	1.36494	1.36932	1.32127	1.33857	1.09375
.075	.16095	.30487	.43078	1.04120	1.09294	1.07779	1.03819	1.03271	.87805
.100	.16037	.26199	.39706	.92313	.93365	.91807	.89535	.87805	.74905
.200	.16505	.24613	.33063	.64656	.67317	.66356	.66356	.63045	.55762
.300	.17740	.25435	.31785	.53829	.56881	.57006	.54669	.52919	.44873
.400	.17857	.25759	.28872	.43682	.50550	.48726	.49700	.46399	.36551
.600	.19032	.20736	.23434	.28276	.30874	.29430	.30600	.28731	.22277
.800	.13158	.12864	.12315	.13921	.10890	.10720	.12149	.10202	.08050
1.000	-.05874	-.06579	-.05979	-.02908	-.06620	-.07146	-.06652	-.05552	-.02498

	2Y/B .04707	2Y/B .14119	2Y/B .23533	2Y/B .37112	2Y/B .44999	2Y/B .49999	2Y/B .59999	2Y/B .69999	2Y/B .89997
X/C	-CPL	-CPL	-CPL	-CPL	-CPL	-CPL	-CPL	-CPL	-CPL
0.000	.04641	.33365	.05636	3.57803	2.04550	2.00236	1.96015	2.68200	.82742
.025	-.08341	-.05346	-.00153	-.05151	-.65461	-.62309	-.65812	-.61904	-.58990
.050	-.08462	-.04934	-.03475	-.52035	-.53024	-.44791	-.48141	-.46498	-.42542
.075	-.03290	-.03701	-.02044	-.36028	-.37630	-.36057	-.37227	-.38100	-.34006
.100	-.02115	-.01292	-.01891	-.33535	-.31864	-.30990	-.30405	-.29287	-.28176
.200	.02526	.00176	.00460	-.12065	-.12808	-.13838	-.13838	-.14852	-.12214
.300	.02115	.03525	.00818	-.05507	-.10333	-.03313	-.05197	-.06062	-.05344
.400	.02528	.05287	.01278	.01299	.01609	.01293	.00650	-.00416	.00486
.600	.04112	.03994	.00869	.03898	.02908	.02428	.01754	.02082	.02568
.800	.01762	.02291	0.00000	-.01423	-.00247	-.01624	-.01689	-.02498	*****
1.000	-.05874	-.06579	-.05979	-.02908	-.06620	-.07146	-.06692	-.05552	-.02498

## P R E S S U R E M E A S U R E M E N T S

OUTER PANEL SWEEP= 30.00000 DEGREES

FUSELAGE OFF

ANGLE OF ATTACK= 7.31507 DEGREES

### S P A N W I S E L O C A T I O N

	2Y/B .04707	2Y/B .14119	2Y/B .23533	2Y/B .37112	2Y/B .44999	2Y/B .49999	2Y/B .59999	2Y/B .69999	2Y/B .89997
X/C	-CPU	-CPU	-CPU	-CPU	-CPU	-CPU	-CPU	-CPU	-CPU
0.000	.03174	.44604	.90701	4.91706	2.93891	2.96910	3.08574	3.81134	1.04610
.025	.22687	.43242	.09647	2.37513	2.15294	2.15134	2.16106	2.18964	1.44004
.050	.21388	.35837	.60311	1.50792	1.55993	1.56276	1.53529	1.53192	1.12962
.075	.18245	.34890	.50923	1.22911	1.23433	1.24350	1.19814	1.20758	.97093
.100	.18008	.29855	.46117	1.05433	1.04385	1.05104	1.02124	1.04123	.85539
.200	.17652	.26952	.36608	.71643	.72444	.73353	.72640	.71967	.67861
.300	.19429	.27544	.35125	.09091	.63062	.61609	.59162	.60344	.52061
.400	.19015	.25866	.32211	.47557	.52300	.52391	.52326	.50321	.40021
.600	.19607	.21394	.24899	.31602	.30463	.30799	.31318	.30555	.23331
.800	.13946	.14690	.13396	.14846	.10349	.11217	.11388	.11422	.10168
1.000	-.06457	-.08115	-.06180	-.02279	-.04497	-.05252	-.05447	-.04179	.01393

	2Y/B .04707	2Y/B .14119	2Y/B .23533	2Y/B .37112	2Y/B .44999	2Y/B .49999	2Y/B .59999	2Y/B .69999	2Y/B .89997
X/C	-CPL	-CPL	-CPL	-CPL	-CPL	-CPL	-CPL	-CPL	-CPL
0.000	.03174	.44604	.90701	4.91706	2.93891	2.96910	3.08574	3.81134	1.04610
.025	-.09055	-.05331	-.03917	-.63758	-.69364	-.67757	-.69508	-.67025	-.60173
.050	-.04056	-.05864	-.02606	-.51294	-.57844	-.56401	-.54725	-.53417	-.46522
.075	-.04502	-.03910	-.02965	-.43060	-.46000	-.43748	-.43961	-.44921	-.36912
.100	-.03554	-.03139	-.03308	-.37392	-.42675	-.37218	-.36894	-.36563	-.32315
.200	.09178	-.01955	-.02198	-.17495	-.19057	-.19257	-.20355	-.19640	-.16366
.300	-.00296	.01659	-.01637	-.12936	-.10657	-.09337	-.09985	-.10795	-.07591
.400	.03791	.03791	-.01023	-.02772	-.02549	-.02738	-.02983	-.04179	-.01114
.600	.02132	.02073	-.00655	.00246	-.01478	.01102	.00389	.00648	.02507
.800	.01185	-.00059	-.01432	-.02074	-.02094	-.02334	-.03112	-.02648	*****
1.000	-.06457	-.08115	-.06186	-.02279	-.04497	-.05252	-.05447	-.04179	.01393



APPENDIX A

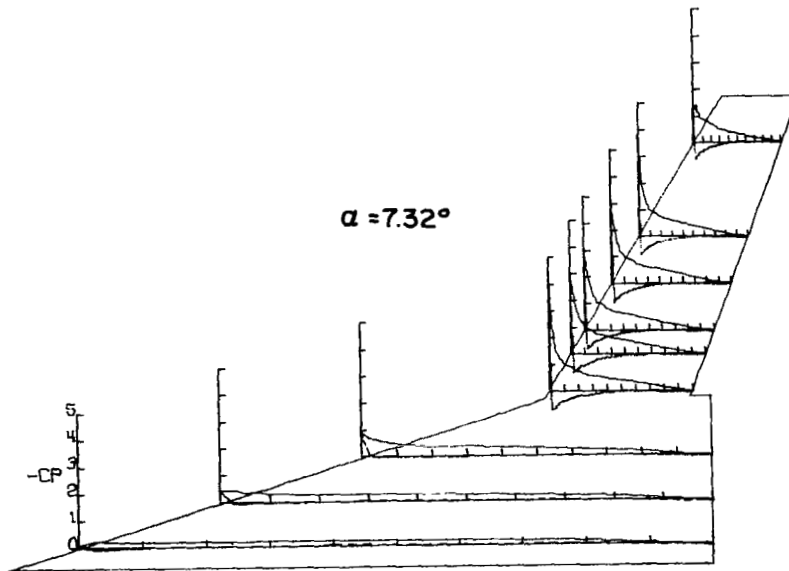
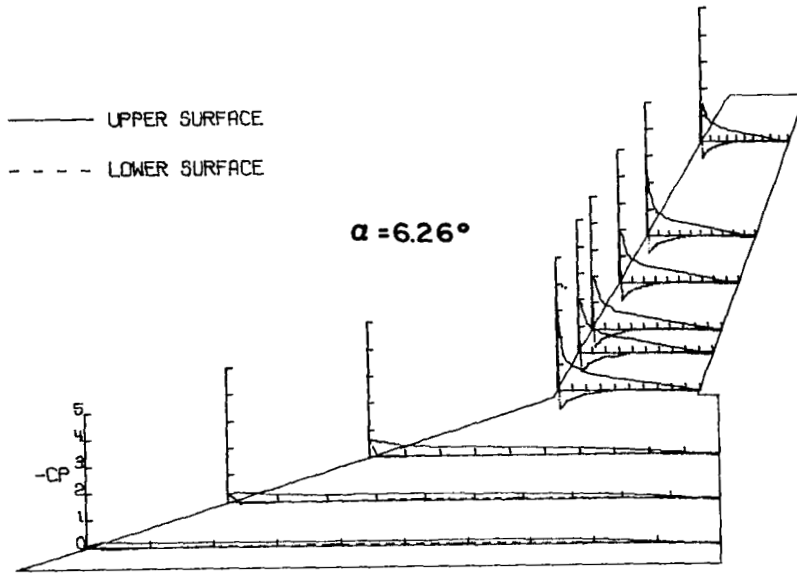

# APPENDIX A

## P R E S S U R E M E A S U R E M E N T S

OUTER PANEL SWEEP= 30.00000 DEGREES

FUSELAGE OFF

ANGLE OF ATTACK= 4.35939 DEGREES

### S P A N W I S E L O C A T I O N

	ZY/B .04707	ZY/B .14119	ZY/B .23533	ZY/B .37112	ZY/B .44999	ZY/B .49999	ZY/B .59999	ZY/B .69999	ZY/B .89997
X/C	-CPU	-CPU	-CPU	-CPU	-CPU	-CPU	-CPU	-CPU	-CPU
0.000	.61476	.61443	1.19133	5.01969	1.87983	3.73595	3.95275	3.45878	1.11229
.025	.26706	.52117	.83550	2.73036	1.71282	2.39378	2.52515	2.19273	1.34570
.050	.23568	.42733	.69932	1.99241	1.77344	1.67157	1.70910	1.77095	1.07490
.075	.27940	.39309	.57612	1.59220	1.70292	1.34735	1.34347	1.49876	.91006
.100	.27009	.34174	.52333	1.33487	1.49013	1.13379	1.14027	1.29583	.90383
.200	.20068	.28921	.41369	.85499	.89461	.79340	.80764	.83180	.77708
.300	.20127	.29925	.37664	.65316	.67916	.64391	.66332	.67596	.63233
.400	.21484	.26500	.30293	.52191	.55844	.55590	.54490	.53953	.46680
.600	.21720	.22498	.28070	.33308	.32937	.34126	.31924	.33106	.27097
.800	.14047	.15287	.13756	.16592	.15602	.15088	.11462	.13999	.15385
1.000	-.06493	-.08086	-.06396	-.00619	.00186	.00777	-.01295	-.00069	.06514

	-CPL	-CPL	-CPL	-CPL	-CPL	-CPL	-CPL	-CPL	-CPL
X/C	-CPL	-CPL	-CPL	-CPL	-CPL	-CPL	-CPL	-CPL	-CPL
0.000	.14750	.61443	1.19133	5.01969	1.87983	3.73595	3.95275	3.45878	1.11229
.025	-.10770	-.03541	.06497	-.69959	-.67607	-.69870	-.70129	-.67431	-.60362
.050	-.07457	-.06611	-.02436	-.65440	-.58877	-.58279	-.59445	-.56412	-.48234
.075	-.07024	-.05253	-.03046	-.49034	-.46857	-.48437	-.49408	-.47888	-.38878
.100	-.05594	-.04486	-.04670	-.43585	-.45009	-.42155	-.42544	-.41789	-.34027
.200	-.03054	-.03836	-.03299	-.17502	-.22288	-.22470	-.23959	-.22385	-.18019
.300	-.01417	.00354	-.03604	-.14301	-.12444	-.11856	-.11915	-.13653	-.07693
.400	.01987	.01299	-.03807	-.04581	-.04267	-.04921	-.05828	-.05544	-.02079
.600	.00531	.01062	-.02549	-.00433	-.02476	-.00907	-.00712	-.00554	.03049
.800	-.01062	-.00413	-.02843	-.02476	-.00743	-.01684	-.01748	-.02148	*****
1.000	-.05493	-.06086	-.06396	-.00619	.00186	.00777	-.01295	-.00069	.06514

## P R E S S U R E M E A S U R E M E N T S

OUTER PANEL SWEEP= 30.00000 DEGREES

FUSELAGE OFF

ANGLE OF ATTACK= 9.39904 DEGREES

### S P A N W I S E L O C A T I O N

	ZY/B .04707	ZY/B .14119	ZY/B .23533	ZY/B .37112	ZY/B .44999	ZY/B .49999	ZY/B .59999	ZY/B .69999	ZY/B .89997
X/C	-CPU	-CPU	-CPU	-CPU	-CPU	-CPU	-CPU	-CPU	-CPU
0.000	.22175	.77326	1.59212	5.36609	1.77639	3.04593	2.93419	3.55757	1.23176
.025	.30319	.59925	1.00722	2.84174	1.53712	2.41039	1.76387	1.33609	1.47867
.050	.26514	.47381	.74248	2.18789	1.75917	2.07389	1.50165	1.45085	.89374
.075	.22234	.43933	.67131	1.81391	1.58879	1.66828	1.35051	1.46128	.90000
.100	.21243	.37810	.58134	1.75548	1.48838	1.43706	1.34858	1.29578	.87983
.200	.20629	.32103	.45035	.99645	1.08872	.90809	1.06246	.93478	.78524
.300	.21461	.31330	.42743	.74122	.76154	.68333	.76223	.71708	.65031
.400	.22412	.29903	.34778	.59593	.61933	.56901	.55480	.55989	.51816
.600	.22597	.24434	.30012	.35768	.34906	.35028	.35545	.33941	.32759
.800	.15814	.16527	.16463	.20008	.19146	.19257	.16351	.16564	.23454
1.000	-.07253	-.07134	-.05164	.01478	-.04925	.05170	.05687	.05011	.09535

	-CPL	-CPL	-CPL	-CPL	-CPL	-CPL	-CPL	-CPL	-CPL
X/C	-CPL <td>-CPL <td>-CPL <td>-CPL <td>-CPL <td>-CPL <td>-CPL <td>-CPL <td>-CPL</td> </td></td></td></td></td></td></td>	-CPL <td>-CPL <td>-CPL <td>-CPL <td>-CPL <td>-CPL <td>-CPL <td>-CPL</td> </td></td></td></td></td></td>	-CPL <td>-CPL <td>-CPL <td>-CPL <td>-CPL <td>-CPL <td>-CPL</td> </td></td></td></td></td>	-CPL <td>-CPL <td>-CPL <td>-CPL <td>-CPL <td>-CPL</td> </td></td></td></td>	-CPL <td>-CPL <td>-CPL <td>-CPL <td>-CPL</td> </td></td></td>	-CPL <td>-CPL <td>-CPL <td>-CPL</td> </td></td>	-CPL <td>-CPL <td>-CPL</td> </td>	-CPL <td>-CPL</td>	-CPL
0.000	.22175	.77326	1.59212	5.36609	1.77639	3.04593	2.93419	3.55757	1.23176
.025	-.11593	-.31665	-.11904	-.70798	-.70182	-.71219	-.68805	-.68412	-.60966
.050	-.11177	-.05945	-.00031	-.63274	-.61994	-.61202	-.58359	-.57973	-.49065
.075	-.12225	-.07728	-.04550	-.55161	-.52329	-.53835	-.50603	-.51709	-.40852
.100	-.06956	-.06242	-.04244	-.43204	-.49743	-.44399	-.44334	-.42484	-.36607
.200	-.07972	-.05953	-.05420	-.24995	-.26595	-.25940	-.26368	-.26358	-.20391
.300	-.02550	-.32378	-.05471	-.20254	-.14960	-.14293	-.14864	-.14406	-.09813
.400	.00416	-.30238	-.04704	-.07572	-.07572	-.07432	-.07368	-.06820	-.03410
.600	-.01763	-.01343	-.05427	-.03448	-.03336	-.01640	-.02585	-.00696	.01949
.800	-.00535	-.00594	-.02301	-.02893	-.01478	.00259	-.01357	0.00000	*****
1.000	-.07253	-.07134	-.05164	.01478	-.04925	.05170	.05687	.05011	.09535

# APPENDIX A

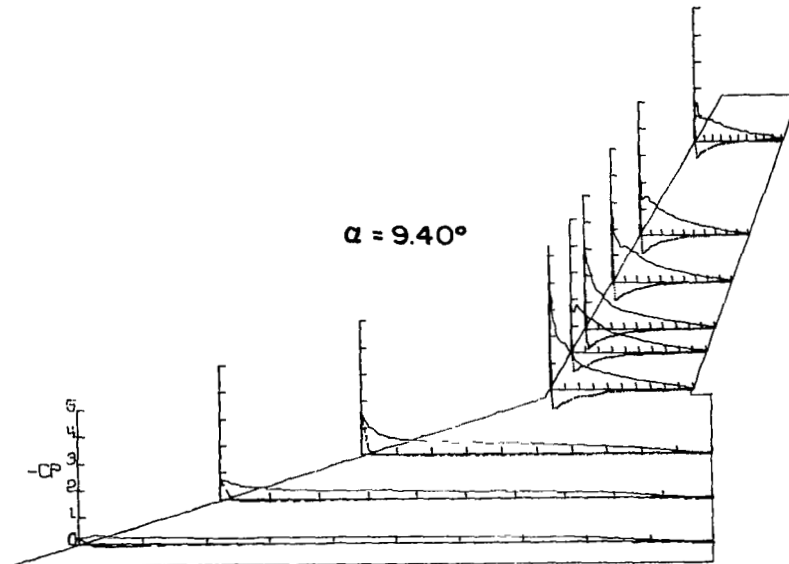
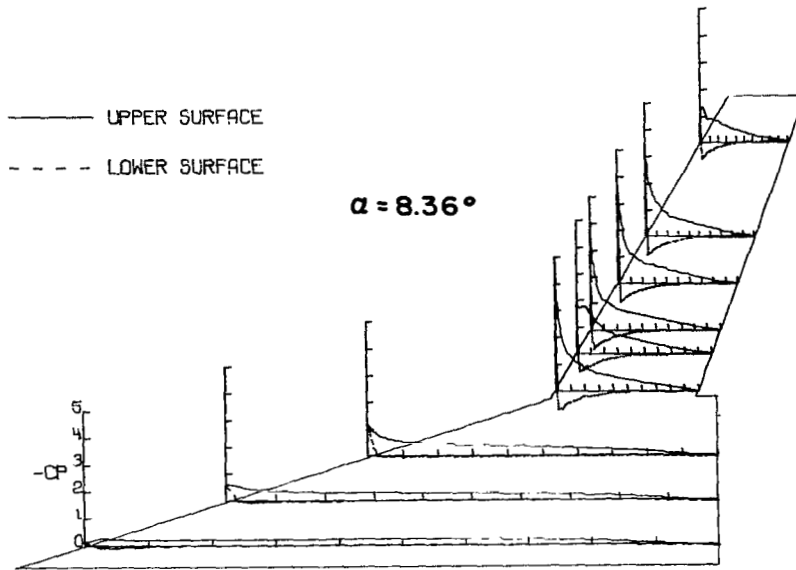

# APPENDIX A

## P R E S S U R E M E A S U R E M E N T S

OUTER PANEL SWEEP= 30.00000 DEGREES

FUSELAGE OFF

ANGLE OF ATTACK= 10.45391 DEGREES

### S P A N W I S E L O C A T I O N

	2Y/B .04707	2Y/B .14119	2Y/B .23533	2Y/B .37112	2Y/B .44999	2Y/B .49999	2Y/B .59999	2Y/B .69999	2Y/B .89997
X/C	-CPU	-CPU	-CPU	-CPU	-CPU	-CPU	-CPU	-CPU	-CPU
0.000	.30424	1.01351	2.03202	4.86192	1.43546	3.03877	2.59629	1.86874	1.15223
.025	.34072	.69135	1.15818	2.69800	1.29136	2.21647	1.59460	1.93652	1.28709
.050	.28753	.53433	.87842	2.48952	1.28768	2.02914	1.41692	1.56028	.89633
.075	.24833	.47725	.74516	2.17434	1.37169	1.73623	1.30877	1.41781	.88112
.100	.23598	.39780	.65106	1.88615	1.27358	1.50769	1.42593	1.37701	.85069
.200	.22950	.33190	.53407	1.34716	1.16566	.92702	1.09311	1.09068	.71928
.300	.23068	.33837	.47863	1.00746	.89112	.73067	.90706	.77945	.64043
.400	.23303	.31130	.41760	.77390	.68675	.58389	.63797	.60240	.57127
.600	.22650	.28011	.32146	.44863	.42715	.45205	.39036	.30942	.41220
.800	.16301	.18301	.18616	.27802	.23505	.27184	.21193	.20000	.25467
1.000	-.07474	-.07709	-.04120	.03375	-.13072	-.11208	-.07859	-.10450	.15502

	-CPL	-CPL	-CPL	-CPL	-CPL	-CPL	-CPL	-CPL	-CPL
0.000	.30424	1.01351	2.03202	4.86192	1.43546	3.03877	2.59629	1.86874	1.15223
.025	-.11769	.01000	.19634	-.70210	-.70148	-.68797	-.69699	-.67129	-.63115
.050	-.12770	-.06414	.02747	-.69166	-.62722	-.63064	-.62548	-.59170	-.52457
.075	-.09827	-.07120	-.01679	-.55910	-.53762	-.55141	-.53788	-.52180	-.43876
.100	-.09239	-.07532	-.04222	-.51737	-.51307	-.48248	-.47668	-.45260	-.39308
.200	-.05355	-.07062	-.07477	-.28170	-.28599	-.29438	-.29374	-.27751	-.22284
.300	-.04355	-.04649	-.07477	-.24426	-.17368	-.17199	-.17586	-.17163	-.12318
.400	-.01412	-.02825	-.07375	-.09206	-.09758	-.08825	-.08954	-.08651	-.04914
.600	-.03766	-.02942	-.06561	-.03621	-.02762	-.01739	-.02448	-.01453	.02422
.800	-.03472	-.01883	-.05086	-.04419	-.00552	-.00366	-.00773	-.00969	*****
1.000	-.07474	-.07709	-.04120	.03375	-.13072	-.11208	-.07859	-.10450	.15502

## P R E S S U R E M E A S U R E M E N T S

OUTER PANEL SWEEP= 30.00000 DEGREES

FUSELAGE OFF

ANGLE OF ATTACK= 11.47685 DEGREES

### S P A N W I S E L O C A T I O N

	2Y/B .04707	2Y/B .14119	2Y/B .23533	2Y/B .37112	2Y/B .44999	2Y/B .49999	2Y/B .59999	2Y/B .69999	2Y/B .89997
X/C	-CPU	-CPU	-CPU	-CPU	-CPU	-CPU	-CPU	-CPU	-CPU
0.000	.38336	1.24686	2.37966	6.21481	2.30231	1.59871	2.54651	2.00426	.95724
.025	.37572	.78940	1.30186	3.24077	1.54908	1.21978	1.37225	1.36955	.98348
.050	.31937	.59940	.97007	1.80530	1.67935	1.97377	1.43272	1.42688	.60915
.075	.26477	.53247	.80418	1.51141	1.36855	1.70055	1.28861	1.46072	.63885
.100	.24833	.44911	.71061	1.43918	1.71825	1.08210	1.25645	1.40823	.60432
.200	.23424	.38101	.62969	1.58797	1.31693	1.06023	1.09561	1.36403	.54906
.300	.24070	.34813	.51083	1.23358	.86760	.72440	.85693	1.17341	.53525
.400	.24187	.32876	.40462	.96254	.71805	.71154	.70768	.91304	.43373
.600	.24363	.28238	.33735	.57160	.43998	.40363	.41135	.45306	.40886
.800	.17671	.19608	.20534	.28117	.30403	.29934	.27359	.25224	.33773
1.000	-.07104	-.08336	-.03389	.08837	.19342	.16930	.15436	.12232	.21700

	-CPL	-CPL	-CPL	-CPL	-CPL	-CPL	-CPL	-CPL	-CPL
0.000	.38336	1.24686	2.37966	6.21481	2.30231	1.59871	2.54651	2.00426	.95724
.025	-.13092	.03699	.26502	-.66120	-.73968	-.69911	-.69911	-.71872	-.61161
.050	-.14031	-.36282	.06626	-.67171	-.67418	-.63409	-.63602	-.61782	-.51762
.075	-.12035	-.07925	-.00658	-.58396	-.58890	-.59031	-.56843	-.55148	-.43123
.100	-.10685	-.08747	-.04451	-.54627	-.54379	-.51500	-.49762	-.47270	-.37802
.200	-.06164	-.08278	-.07890	-.30588	-.30857	-.30707	-.30578	-.27159	-.20940
.300	-.07162	-.07338	-.09053	-.27499	-.27313	-.20020	-.20278	-.17830	-.11748
.400	-.03229	-.03464	-.09256	-.11556	-.10933	-.10236	-.09978	-.08500	-.02764
.600	-.06047	-.03757	-.08649	-.04326	-.02904	-.02704	-.02382	-.00415	.04630
.800	-.04579	-.03522	-.05867	-.02904	.00927	.00708	.00644	-.00069	*****
1.000	-.07104	-.08336	-.03389	.08837	.19342	.16930	.15836	.12232	.21700

# APPENDIX A

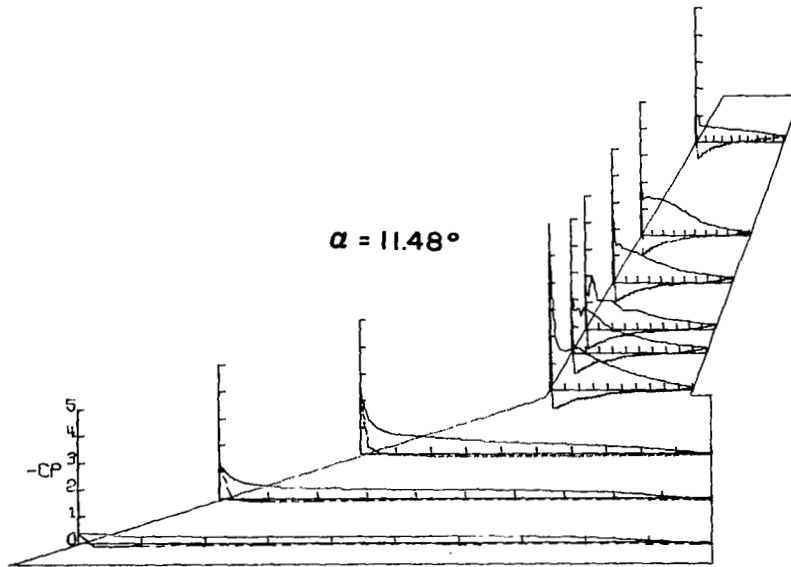
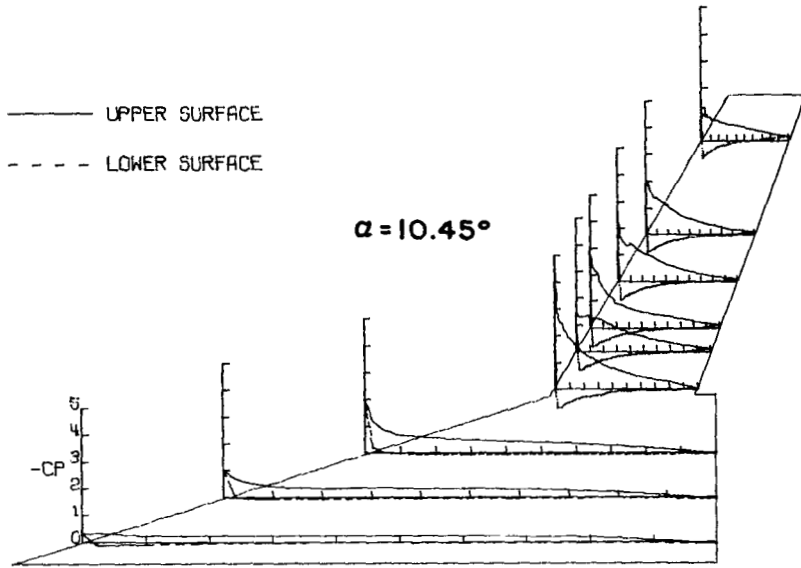

# APPENDIX A

## P R E S S U R E M E A S U R E M E N T S

INLET PANEL SWEEP= 30.0000 DEGREES

FUSELAGE OFF

ANGLE OF ATTACK= 12.51282 DEGREES

### S P A N W I S E L O C A T I O N

	2Y/A .04707	2Y/B .14119	2Y/C .23533	2Y/D .37112	2Y/E .44999	2Y/F .49999	2Y/G .59999	2Y/H .69999	2Y/I .89997
X/L	-CPU	-CPU	-CPU	-CPU	-CPU	-CPU	-CPU	-CPU	-CPU
0.000	.42067	1.40436	2.32554	6.41328	1.95544	1.56748	1.23104	2.23876	.53531
.025	.40553	.57847	1.42037	3.26581	1.67338	1.05097	.72414	1.50772	.93645
.050	.38000	.66375	1.01515	1.81441	1.48636	.97727	.66711	1.36594	.65773
.075	.27754	.55916	.35303	1.56607	1.45508	.98945	.66070	1.36525	.61900
.100	.27877	.47678	.82517	1.52621	1.36004	1.00867	.74273	1.44202	.72965
.200	.23799	.41543	.90521	1.55258	1.29198	.98240	.67287	1.37216	.70268
.300	.25300	.38057	.41588	1.35759	1.07491	.86384	.68569	.85760	.66395
.400	.25103	.34234	.42854	1.10128	.88253	.82796	.55112	.54345	.61830
.600	.25475	.30017	.32723	.71437	.66527	.64724	.45399	.38039	.47099
.800	.14288	.20333	.16084	.40812	.51491	.47836	.35268	.32575	.31468
1.000	-.07713	-.07946	-.03050	.14434	.34000	.35973	.25457	.25121	.22284

	2Y/A .04707	2Y/B .14119	2Y/C .23533	2Y/D .37112	2Y/E .44999	2Y/F .49999	2Y/G .59999	2Y/H .69999	2Y/I .89997
X/C	-CPL	-CPL	-CPL	-CPL	-CPL	-CPL	-CPL	-CPL	-CPL
0.000	.42067	1.43436	2.82554	6.41328	1.95544	1.56748	1.23104	2.23876	.53531
.025	-.12913	.07302	.35001	-.64563	-.73524	-.73614	-.66560	-.70587	-.64983
.050	-.15191	-.39317	.11453	-.66404	-.68859	-.66304	-.59635	-.62308	-.54257
.075	-.13497	-.06414	.02331	-.60635	-.60820	-.57647	-.53094	-.55779	-.43807
.100	-.12270	-.39407	-.07837	-.55480	-.56646	-.50914	-.47387	-.47405	-.39724
.200	-.06995	-.09694	-.04523	-.33693	-.33509	-.31356	-.30459	-.29827	-.22838
.300	-.04345	-.04423	-.10992	-.23751	-.21787	-.18788	-.18211	-.19270	-.12111
.400	-.05259	-.06193	-.11296	-.13809	-.12213	-.10901	-.09811	-.10173	-.04706
.600	-.06953	-.09317	-.04878	-.03592	-.04787	-.00769	-.01090	-.00415	.03875
.800	-.06257	-.03915	-.06231	-.02639	.04542	.04104	.06220	.04360	*****
1.000	-.07713	-.07946	-.03050	.14484	.34000	.35973	.25457	.25121	.22284

## P R E S S U R E M E A S U R E M E N T S

INLET PANEL SWEEP= 30.0000 DEGREES

FUSELAGE OFF

ANGLE OF ATTACK= 13.54378 DEGREES

### S P A N W I S E L O C A T I O N

	2Y/A .04707	2Y/B .14119	2Y/C .23533	2Y/D .37112	2Y/E .44999	2Y/F .49999	2Y/G .59999	2Y/H .69999	2Y/I .89997
X/L	-CPU	-CPU	-CPU	-CPU	-CPU	-CPU	-CPU	-CPU	-CPU
0.000	.57168	1.75935	3.35102	6.67624	2.01074	1.67758	1.54048	2.10735	.44263
.025	.47600	1.00389	1.53059	2.96291	1.49529	1.02310	.67776	1.74149	.67363
.050	.33211	.73454	1.07095	1.81330	1.45101	1.04260	.63766	1.67717	.63628
.075	.31473	.61834	.96526	1.67490	1.44301	1.03609	.65189	1.57896	.65703
.100	.23803	.55560	.93670	1.55354	1.47500	.99784	.65060	1.56645	.64113
.200	.23571	.48369	1.43331	1.27755	1.42394	.88365	.63995	1.56097	.61761
.300	.27757	.39620	.45575	1.24618	1.20497	.82715	.54518	.74763	.62107
.400	.27220	.36734	.44858	1.17914	.90868	.77929	.46916	.34304	.60378
.600	.24053	.33663	.29342	.85943	.69197	.65448	.41398	.40113	.53946
.800	.14489	.24037	.17001	.44880	.53437	.53289	.43163	.39214	.45992
1.000	-.07067	-.06910	-.02765	.25241	.45372	.42322	.29121	.28720	.43641

	2Y/A .04707	2Y/B .14119	2Y/C .23533	2Y/D .37112	2Y/E .44999	2Y/F .49999	2Y/G .59999	2Y/H .69999	2Y/I .89997
X/C	-CPL	-CPL	-CPL	-CPL	-CPL	-CPL	-CPL	-CPL	-CPL
0.000	.57168	1.75935	3.35102	6.67624	2.01074	1.67758	1.54048	2.10735	.44263
.025	-.13111	.11575	.45011	-.61687	-.74245	-.73772	-.68271	-.70035	-.66160
.050	-.15414	-.33780	.16447	-.68459	-.70859	-.67365	-.61606	-.64314	-.55225
.075	-.14664	-.30208	.04453	-.61071	-.63657	-.59147	-.55653	-.64970	-.46990
.100	-.13465	-.37626	-.01843	-.59239	-.57500	-.53338	-.49570	-.50450	-.42284
.200	-.10453	-.12334	-.10702	-.36322	-.36507	-.34166	-.32227	-.32042	-.28845
.300	-.10079	-.10335	-.12445	-.24933	-.23825	-.21873	-.20150	-.20000	-.13149
.400	-.07342	-.03622	-.13007	-.15514	-.13729	-.12295	-.10225	-.10796	-.04914
.600	-.04075	-.07914	-.11522	-.06218	-.10220	-.01100	.00861	-.00684	.05882
.800	-.05347	-.04311	-.06811	-.03263	.05110	.05695	.06859	.04291	*****
1.000	-.07067	-.06910	-.02765	.25241	.45372	.42322	.29121	.28720	.43641

# APPENDIX A

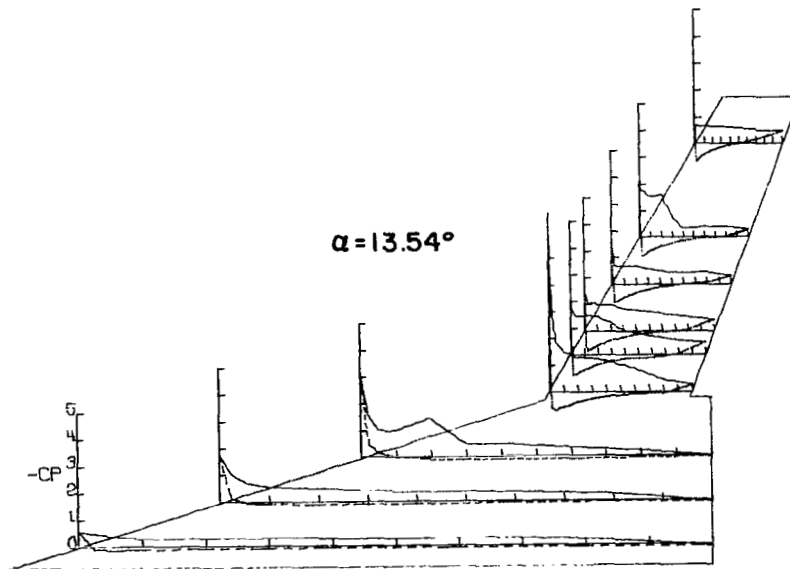
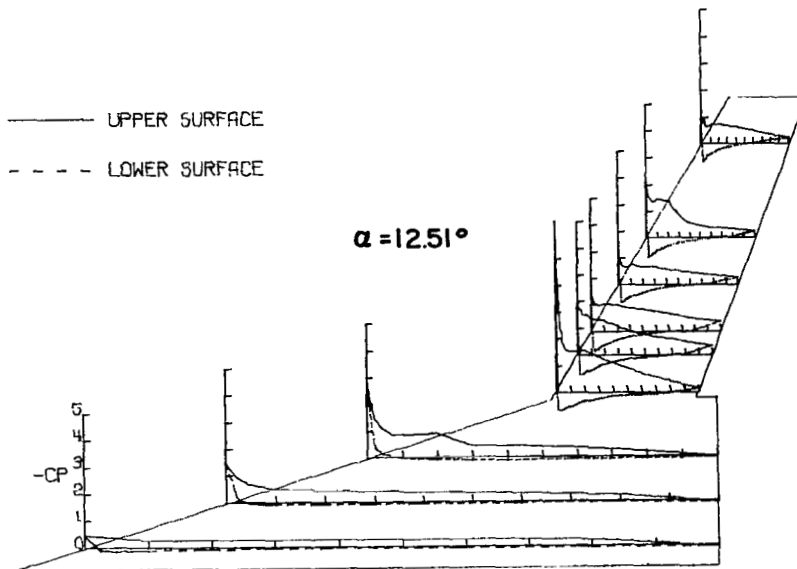

# APPENDIX A

## P R E S S U R E M E A S U R E M E N T S

OUTER PANEL SWEEP= 30.00000 DEGREES

FUSELAGE OFF

ANGLE OF ATTACK= 14.56188 DEGREES

### S P A N W I S E L O C A T I O N

	2Y/B .04707	2Y/B .14119	2Y/B .23533	2Y/B .37112	2Y/B .44999	2Y/B .49999	2Y/B .59999	2Y/B .69999	2Y/B .89997
X/C	-CPU	-CPU	-CPU	-CPU	-CPU	-CPU	-CPU	-CPU	-CPU
0.000	.66297	2.01322	3.74413	6.26554	2.03404	2.25226	1.24227	1.02196	.88940
.025	.51331	1.10560	1.42397	2.65390	1.87739	1.82555	.74177	.45397	.70878
.050	.40223	.78204	1.08291	2.06169	1.71828	1.59775	.74498	.48488	.74998
.075	.33149	.66180	1.08493	1.87616	1.91486	1.56824	.78733	.50411	.67512
.100	.31979	.59457	1.13604	1.70538	1.74900	1.36868	.69493	.60095	.77196
.200	.29407	.56300	1.70077	1.37426	1.37548	1.31927	.65771	.62842	.66688
.300	.28530	.39755	.95589	1.27043	1.09719	1.05041	.53002	.41002	.30494
.400	.28121	.38060	.40786	1.35521	.96511	.89128	.72894	.41071	.48007
.600	.28062	.33149	.31576	.91062	.76920	.72701	.53708	.39697	.54188
.800	.20345	.23327	.17762	.51526	.61979	.54478	.47385	.32966	.42650
1.000	-.05905	-.07717	-.04301	.27116	.47960	.46422	.45908	.36538	.30150

	-CPL	-CPL	-CPL	-CPL	-CPL	-CPL	-CPL	-CPL	-CPL
0.000	.66297	2.01322	3.74413	6.26554	2.03404	2.25226	1.24227	1.02196	.88940
.025	-.13388	.15727	.53589	-.58597	-.70771	-.72169	-.67867	-.69479	-.64187
.050	-.16311	-.02514	.20393	-.65791	-.71570	-.69279	-.65876	-.60201	-.57727
.075	-.16136	-.08068	.05971	-.61671	-.65422	-.63308	-.58300	-.51886	-.46388
.100	-.15317	-.10523	-.02328	-.56875	-.60195	-.56502	-.52586	-.45357	-.44189
.200	-.12394	-.13563	-.12803	-.38060	-.40397	-.36983	-.33965	-.32025	-.27214
.300	-.12453	-.11751	-.14219	-.27054	-.26870	-.23307	-.19262	-.19380	-.12576
.400	-.08886	-.09296	-.15586	-.17770	-.40397	-.14575	-.10209	-.09827	-.06804
.600	-.10523	-.10114	-.13106	-.08116	-.11375	-.02311	-.00257	-.00756	-.04398
.800	-.08594	-.07191	-.08805	-.04058	.05042	.05907	.09117	.06048	*****
1.000	-.05905	-.07717	-.04301	.27116	.47960	.46422	.45908	.36538	.30150

## P R E S S U R E M E A S U R E M E N T S

OUTER PANEL SWEEP= 30.00000 DEGREES

FUSELAGE OFF

ANGLE OF ATTACK= 15.56764 DEGREES

### S P A N W I S E L O C A T I O N

	2Y/B .04707	2Y/B .14119	2Y/B .23533	2Y/B .37112	2Y/B .44999	2Y/B .49999	2Y/B .59999	2Y/B .69999	2Y/B .89997
X/C	-CPU	-CPU	-CPU	-CPU	-CPU	-CPU	-CPU	-CPU	-CPU
0.000	.78458	2.36728	4.15940	6.10725	1.81602	2.38721	1.20008	.43887	.51558
.025	.54911	1.20718	1.34064	2.54515	1.71637	2.13384	.75426	.53010	.64206
.050	.43127	.83049	1.22353	1.96829	1.71018	1.67441	.68882	.46859	.41330
.075	.35645	.72749	1.26070	1.72380	1.82159	1.32709	.72640	.44094	.34073
.100	.33818	.68511	1.33911	1.60125	2.11003	1.28367	.73482	.40431	.35731
.200	.31874	.62511	1.75918	1.25030	1.73494	1.18842	.65123	.41675	.36768
.300	.29046	.40594	1.12374	1.11660	1.35366	1.27331	.73353	.42919	.33105
.400	.29635	.40771	.47149	1.18654	1.00828	1.08474	.74843	.42435	.32621
.600	.30460	.33229	.30194	.98910	.87597	.80934	.58449	.39671	.34211
.800	.22742	.22801	.22709	.65357	.69136	.63957	.53395	.40915	.33520
1.000	-.06599	-.06599	-.06466	.35373	.53029	.52650	.52455	.40777	.31792

	-CPL	-CPL	-CPL	-CPL	-CPL	-CPL	-CPL	-CPL	-CPL
0.000	.78458	2.36728	4.15940	6.10725	1.81602	2.38721	1.20008	.43887	.51558
.025	-.13610	.22094	.63137	-.56870	-.69879	-.72621	-.73853	-.70540	-.61480
.050	-.18146	-.01061	.24236	-.66348	-.73411	-.71907	-.68601	-.60650	-.53320
.075	-.18205	-.07600	.06212	-.63085	-.67649	-.65553	-.60625	-.54219	-.44468
.100	-.17204	-.10841	-.02953	-.57900	-.61640	-.59653	-.54854	-.47026	-.39903
.200	-.15377	-.14847	-.14257	-.40391	-.41630	-.40590	-.35792	-.30429	-.23721
.300	-.14199	-.13963	-.16039	-.36984	-.32524	-.25677	-.21138	-.18257	-.12517
.400	-.11135	-.11960	-.16344	-.18027	-.18275	-.14913	-.11736	-.07815	-.04288
.600	-.12490	-.11489	-.13646	-.07992	-.06133	-.01816	.01945	.03250	.07331
.800	-.09309	-.07600	-.07077	-.02354	.06319	.08429	.11606	.12172	*****
1.000	-.06599	-.06599	-.06466	.35373	.53029	.52650	.52455	.40777	.31792



# APPENDIX A

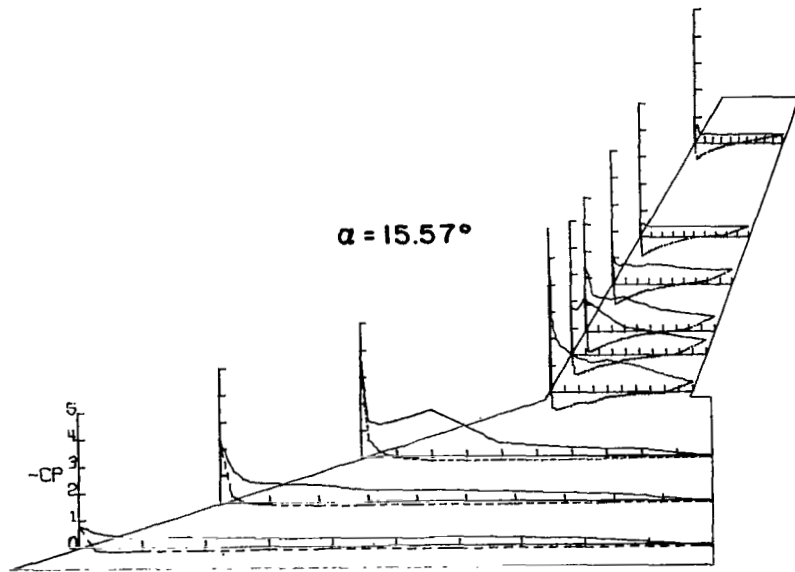
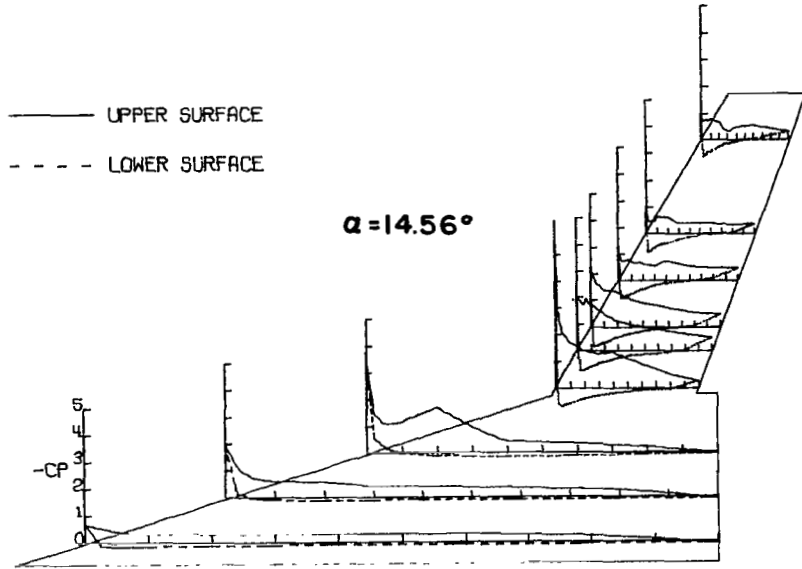

# APPENDIX A

## P R E S S U R E M E A S U R E M E N T S

OUTER PANEL SWEEP= 30.0000 DEGREES

FUSELAGE OFF

ANGLE OF ATTACK= 16.56606 DEGREES

### S P A N W I S E L O C A T I O N

	2Y/B .04707	2Y/B .14119	2Y/B .23543	2Y/B .37112	2Y/B .44999	2Y/B .49999	2Y/B .59999	2Y/B .69999	2Y/B .89997
X/C	-CPU	-CPU	-CPU	-CPU	-CPU	-CPU	-CPU	-CPU	-CPU
0.000	.44927	2.60840	3.30304	6.01194	1.80777	1.89970	.86643	.48306	.47681
.025	.59591	1.76505	1.41056	2.45739	1.70381	2.23403	.74532	.41851	.48236
.050	.45435	.84278	1.17602	1.95723	1.67675	1.74960	.83808	.45252	.39561
.075	.31550	.40131	1.22577	1.76060	1.77086	1.38564	.79170	.40671	.31926
.100	.36189	.82818	1.36527	1.50391	1.74072	1.26711	.70731	.48306	.35882
.200	.34201	.69794	2.03701	1.13977	2.19774	1.38242	.79314	.46709	.32690
.300	.30810	.42269	1.35245	1.17132	1.31446	1.43073	.71375	.45182	.36090
.400	.31404	.41860	.64037	1.08564	.87235	1.20462	.72084	.41643	.30746
.600	.32915	.33967	.31452	.92715	.87174	.84323	.67317	.43794	.31440
.800	.22491	.20345	.22310	.64703	.68520	.68734	.56237	.40741	.32828
1.000	-.07716	-.06489	-.05026	.40570	.59593	.52050	.55786	.40532	.30816

	-CPL	-CPL	-CPL	-CPL	-CPL	-CPL	-CPL	-CPL	-CPL
X/C	-CPL	-CPL	-CPL	-CPL	-CPL	-CPL	-CPL	-CPL	-CPL
0.000	.84427	2.60896	3.30804	6.01194	1.80777	1.89970	.86643	.48306	.47681
.025	-.17160	.28413	.66077	-.53560	-.68951	-.71807	-.73934	-.71254	-.64726
.050	-.19644	.01579	.26003	-.65750	-.72522	-.72451	-.68842	-.63545	-.55628
.075	-.19293	-.06723	.00052	-.63533	-.68643	-.67424	-.63621	-.57434	-.47433
.100	-.19451	-.11751	-.04206	-.59963	-.63780	-.62138	-.56917	-.50836	-.42989
.200	-.16774	-.17539	-.15643	-.42725	-.45126	-.43252	-.38546	-.33057	-.25557
.300	-.16194	-.16253	-.17540	-.33970	-.36753	-.29071	-.24945	-.21182	-.14376
.400	-.13680	-.14791	-.18463	-.21116	-.20316	-.18113	-.14761	-.10348	-.06042
.600	-.14148	-.13680	-.16309	-.06948	-.07203	-.03094	-.00387	.02570	.00442
.800	-.10565	-.09003	-.09237	-.03509	.05972	.06704	.10571	.11251	*****
1.000	-.07016	-.06489	-.05026	.40570	.59593	.52050	.55786	.40532	.30816

## P R E S S U R E M E A S U R E M E N T S

OUTER PANEL SWEEP= 30.0000 DEGREES

FUSELAGE OFF

ANGLE OF ATTACK= 17.47591 DEGREES

### S P A N W I S E L O C A T I O N

	2Y/B .04707	2Y/B .14119	2Y/B .23533	2Y/B .37112	2Y/B .44999	2Y/B .49799	2Y/B .59999	2Y/B .69999	2Y/B .89997
X/C	-CPU	-CPU	-CPU	-CPU	-CPU	-CPU	-CPU	-CPU	-CPU
0.000	1.02545	3.03383	2.95056	5.70202	1.55022	1.96277	.90071	.43995	.34682
.025	.66284	1.34738	2.22936	2.51402	1.68218	1.87464	.83073	.49416	.46219
.050	.44018	.89668	2.28741	1.90972	1.78022	1.73921	.83267	.42049	.35238
.075	.41390	.92503	2.24837	1.71856	1.82154	1.61156	.86183	.44273	.30164
.100	.39321	.97347	2.10907	1.44847	1.83510	1.47872	.84110	.46706	.33709
.200	.35556	.91795	2.33518	.92700	2.13849	1.30311	.87868	.47053	.32180
.300	.33290	.43105	1.67873	.65605	1.15866	1.49038	.82554	.47331	.30998
.400	.35004	.45992	.90253	.92700	.87762	1.13399	.82230	.42674	.34682
.600	.35536	.36542	.35137	.92206	.80356	.81906	.75556	.51015	.30998
.800	.24775	.23356	.30256	.73752	.76838	.61624	.66160	.46358	.30859
1.000	-.07214	-.04671	-.05137	.50300	.54553	.56440	.51807	.42466	.30511

	-CPL	-CPL	-CPL	-CPL	-CPL	-CPL	-CPL	-CPL	-CPL
X/C	-CPL	-CPL	-CPL	-CPL	-CPL	-CPL	-CPL	-CPL	-CPL
0.000	1.02545	3.03383	2.95056	5.70202	1.55022	1.96277	.90071	.43995	.34682
.025	-.12417	.35773	.67189	-.57151	-.66408	-.70546	-.73334	-.72885	-.65860
.050	-.20399	.04158	.27122	-.64988	-.72827	-.73010	-.71000	-.66139	-.57028
.075	-.20459	-.06741	.06893	-.63384	-.69309	-.68471	-.65099	-.60923	-.49517
.100	-.20399	-.11530	-.02928	-.60360	-.64433	-.62895	-.59977	-.52229	-.45344
.200	-.18389	-.18212	-.15256	-.44313	-.46220	-.44610	-.41238	-.35816	-.27819
.300	-.18507	-.19040	-.18544	-.34085	-.34315	-.31447	-.28530	-.25384	-.17526
.400	-.15019	-.17088	-.19006	-.23514	-.21478	-.20489	-.15626	-.13492	-.07233
.600	-.15787	-.14884	-.17260	-.17343	-.16479	-.05317	-.01810	.00278	.04242
.800	-.11412	-.09047	-.08733	-.03826	.05678	.07457	.09985	.10501	*****
1.000	-.07214	-.04671	-.05137	.50300	.54553	.56440	.51807	.42466	.30511

# APPENDIX A



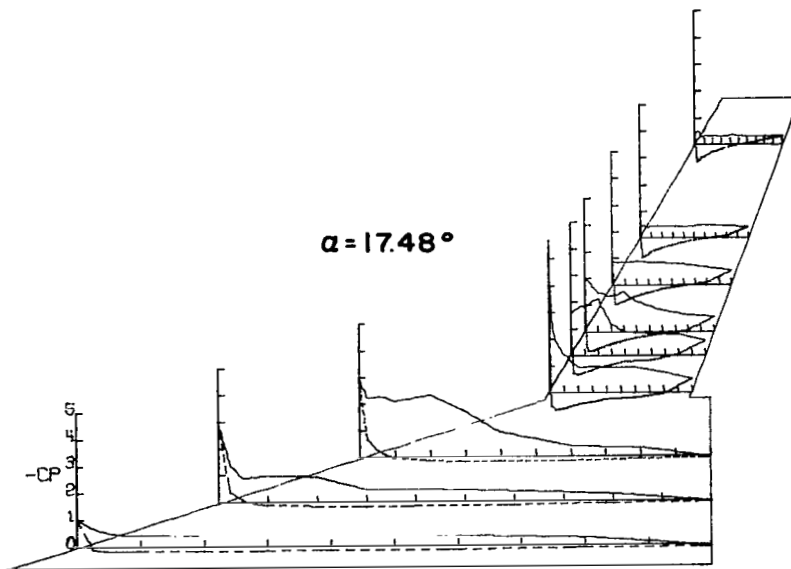
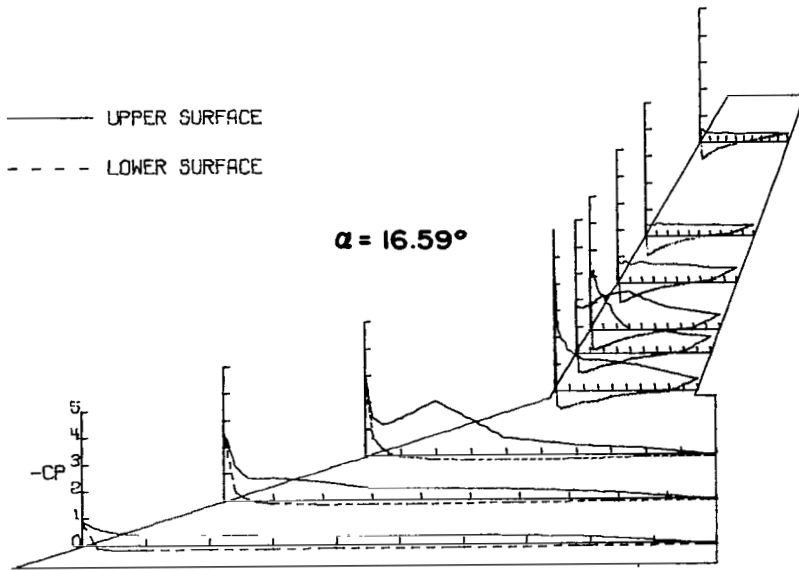

# APPENDIX A

## P R E S S U R E M E A S U R E M E N T S

OUTER PANEL SWEEP= 30.0000 DEGREES

FUSELAGE OFF

ANGLE OF ATTACK= 18.56174 DEGREES

### S P A N W I S E L O C A T I O N

	2Y/B .04707	2Y/B .14119	2Y/B .23533	2Y/B .37112	2Y/B .44999	2Y/B .49999	2Y/B .59999	2Y/B .69999	2Y/B .89997
X/C	- CPU	- CPU	- CPU	- CPU	- CPU	- CPU	- CPU	- CPU	- CPU
0.000	1.18814	3.41419	1.92031	5.26708	1.72673	2.01245	.79544	.54233	.34201
.025	.70614	1.38094	1.88774	2.30970	1.76309	2.29543	.82960	.53325	.37342
.050	.51800	.97464	1.79128	1.64230	1.70269	1.70498	.79995	.50254	.32456
.075	.44282	1.03437	1.93426	1.67804	1.88141	1.57090	.88762	.48998	.36365
.100	.43512	1.16271	2.06969	1.44264	2.11312	1.48774	.83025	.47532	.31200
.200	.37651	1.20647	2.63829	1.12958	1.99172	1.69466	.87537	.48370	.33922
.300	.35934	.44814	2.16687	1.01866	1.11972	1.54576	.85474	.52697	.30920
.400	.37178	.44992	1.12789	1.03715	.93690	1.21766	.86763	.50673	.31618
.600	.37178	.37533	.41404	.96320	.81046	.79351	.68134	.49347	.34340
.800	.29422	.31376	.38613	.70746	.63159	.62140	.63300	.46415	.29683
1.000	-.05446	-.03966	-.01499	.50885	.58842	.50053	.61753	.45229	.29194

	- CPL	- CPL	- CPL	- CPL	- CPL	- CPL	- CPL	- CPL	- CPL
0.000	1.18814	3.41419	1.92031	5.26708	1.72673	2.01245	.79544	.54233	.34201
.025	-.11366	.41973	.65750	-.49528	-.65688	-.67790	-.72886	-.72426	-.67048
.050	-.21016	.07104	.27189	-.65380	-.72473	-.73531	-.71402	-.71402	-.58807
.075	-.22082	-.06334	.08684	-.64331	-.70006	-.69661	-.67403	-.62369	-.51753
.100	-.21726	-.11899	-.02688	-.61494	-.65503	-.64823	-.61340	-.55105	-.46864
.200	-.21312	-.20542	-.17213	-.45889	-.47986	-.47537	-.43216	-.38692	-.29753
.300	-.21430	-.20898	-.21607	-.41201	-.36082	-.33992	-.30638	-.26749	-.19556
.400	-.18293	-.18648	-.21658	-.25165	-.23931	-.23027	-.18963	-.15505	-.09219
.600	-.17227	-.16043	-.19384	-.13199	-.17270	-.06773	-.03419	-.00419	.03911
.800	-.13320	-.09946	-.11269	-.05058	.04379	.05934	.09546	.09289	*****
1.000	-.05446	-.03966	-.01499	.50885	.58842	.50053	.61753	.45229	.29194

## P R E S S U R E M E A S U R E M E N T S

OUTER PANEL SWEEP= 30.0000 DEGREES

FUSELAGE OFF

ANGLE OF ATTACK= 19.63989 DEGREES

### S P A N W I S E L O C A T I O N

	2Y/B .04707	2Y/B .14119	2Y/B .23533	2Y/B .37112	2Y/B .44999	2Y/B .49999	2Y/B .59999	2Y/B .69999	2Y/B .89997
X/C	- CPU	- CPU	- CPU	- CPU	- CPU	- CPU	- CPU	- CPU	- CPU
0.000	1.35104	3.77373	1.83324	5.03182	1.72301	1.86847	.81266	.55017	.36818
.025	.75356	1.38440	1.72931	2.39608	1.77828	1.89057	.88678	.49837	.31918
.050	.54978	1.08476	1.80189	1.80994	1.94157	1.68058	.85492	.50957	.30728
.075	.48359	1.16042	1.83632	1.56717	2.00615	1.71959	.85037	.51027	.30047
.100	.48717	1.32006	1.87538	1.30018	2.37062	1.75210	.80486	.49207	.33388
.200	.39236	1.29862	2.49211	1.19711	1.99373	1.87562	.82306	.58447	.32548
.300	.39653	.46570	2.52295	.97482	1.06423	1.56551	.86062	.52637	.31918
.400	.39534	.49373	1.41848	1.06858	.92969	1.26515	.90628	.49137	.31358
.600	.40309	.39057	.51857	.98538	.81969	.89068	.79901	.56907	.35138
.800	.28980	.35300	.45535	.76376	.67738	.64103	.62477	.47947	.32058
1.000	-.04711	-.04472	.01490	.51207	.62829	.57471	.63453	.46827	.30327

	- CPL	- CPL	- CPL	- CPL	- CPL	- CPL	- CPL	- CPL	- CPL
0.000	1.35104	3.77373	1.83324	5.03182	1.72301	1.86847	.81266	.55017	.36818
.025	-.09958	.52175	.69331	-.47106	-.60591	-.67591	-.71429	-.71861	-.66678
.050	-.21347	.09898	.30580	-.63326	-.71529	-.73576	-.72535	-.68709	-.60514
.075	-.23255	-.04234	.10741	-.64009	-.70535	-.70778	-.68241	-.64367	-.53440
.100	-.24269	-.12403	-.01388	-.62331	-.66495	-.65964	-.62907	-.57223	-.49098
.200	-.22242	-.22063	-.17988	-.46857	-.49405	-.48985	-.44757	-.40273	-.32148
.300	-.23434	-.21168	-.21483	-.43129	-.37038	-.35714	-.31486	-.29207	-.20662
.400	-.19618	-.20214	-.22614	-.26039	-.25790	-.23940	-.21077	-.17160	-.12397
.600	-.18962	-.18127	-.19735	-.13299	-.16033	-.06831	-.04033	-.01331	.01821
.800	-.14013	-.10197	-.12129	-.04723	.04661	.06635	.08587	.09806	*****
1.000	-.04711	-.04472	.01490	.51207	.62829	.57471	.63453	.46827	.30327

# APPENDIX A

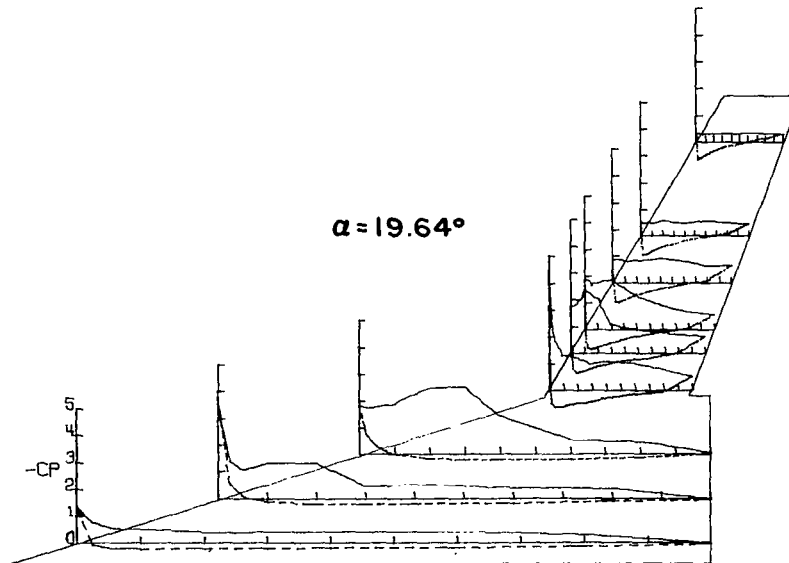
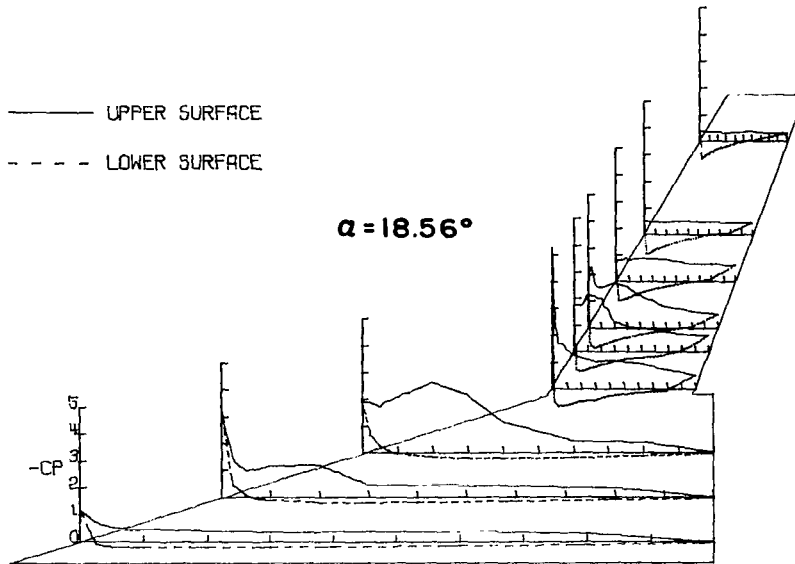

# APPENDIX A

## P R E S S U R E M E A S U R E M E N T S

OUTER PANEL SWEEP= 30.0000 DEGREES

FUSELAGE OFF

ANGLE OF ATTACK= 20.72936 DEGREES

### S P A N W I S E L O C A T I O N

	2Y/A	2Y/B	2Y/C	2Y/D	2Y/E	2Y/F	2Y/G	2Y/H	2Y/I
	.04707	.14119	.23533	.37112	.44999	.49999	.59999	.69999	.89997
X/C	-CPU	-CPU	-CPU	-CPU	-CPU	-CPU	-CPU	-CPU	-CPU
0.000	1.448239	4.15331	1.85983	5.05773	1.75807	1.50320	.90285	.54893	.39280
.025	.78500	1.39715	1.77661	2.39107	1.89209	1.75473	.96507	.51573	.31438
.050	.57875	1.18675	1.85259	1.86189	1.94620	1.81695	.89888	.53551	.30802
.075	.51750	1.33934	1.85724	1.58629	2.07834	1.61771	.91873	.51644	.31438
.100	.54713	1.44245	1.89704	1.46988	2.22558	1.69846	.97433	.51926	.27994
.200	.39737	1.31013	2.59900	1.15149	2.18720	1.90233	.91145	.58991	.32286
.300	.40632	.60978	2.64087	1.08102	1.19805	1.62168	.85982	.55741	.30256
.400	.43019	.50477	1.72440	1.15338	.95411	1.18747	.92668	.50584	.30590
.600	.41825	.42601	.63631	1.05774	.86783	.89821	.83666	.52209	.30256
.800	.32040	.32339	.59289	.75007	.73117	.70692	.71751	.50584	.28984
1.000	-.05131	-.04952	.02895	.55735	.74503	.59638	.68640	.45285	.28135

	-CPL	-CPL	-CPL	-CPL	-CPL	-CPL	-CPL	-CPL	-CPL
X/C	-CPL	-CPL	-CPL	-CPL	-CPL	-CPL	-CPL	-CPL	-CPL
0.000	1.44239	4.15331	1.85983	5.05773	1.75807	1.50320	.90285	.54893	.39280
.025	-.09248	.59546	.76244	-.43644	-.57373	-.64709	-.69875	-.71965	-.67511
.050	-.21181	.13007	.34684	-.62789	-.71417	-.73717	-.72922	-.69844	-.62492
.075	-.24284	-.03759	.13388	-.64678	-.71795	-.71796	-.70008	-.65320	-.55918
.100	-.25716	-.13425	-.00103	-.64300	-.67575	-.69610	-.64510	-.61502	-.50616
.200	-.25119	-.24164	-.1857	-.49564	-.51831	-.51860	-.47224	-.43900	-.34427
.300	-.26133	-.23806	-.21658	-.39676	-.37787	-.38613	-.34043	-.31811	-.22975
.400	-.22613	-.22374	-.23778	-.29096	-.27143	-.26559	-.21857	-.20289	-.13078
.600	-.22508	-.19153	-.21141	-.15241	-.14548	-.08279	-.05564	-.03323	-.00283
.800	-.14499	-.12828	-.12354	-.03716	.04660	.08345	.09206	.09402	*****
1.000	-.05131	-.04952	.02895	.55735	.74503	.59638	.68640	.45285	.28135

## P R E S S U R E M E A S U R E M E N T S

OUTER PANEL SWEEP= 30.0000 DEGREES

FUSELAGE OFF

ANGLE OF ATTACK= 22.80225 DEGREES

### S P A N W I S E L O C A T I O N

	2Y/B	2Y/B	2Y/C	2Y/D	2Y/E	2Y/F	2Y/G	2Y/H	2Y/I
	.04707	.14119	.23533	.37112	.44999	.49999	.59999	.69999	.89997
X/C	-CPU	-CPU	-CPU	-CPU	-CPU	-CPU	-CPU	-CPU	-CPU
0.000	1.85910	4.97170	1.89905	4.62489	1.78162	1.57474	.90162	.56337	.44536
.025	.91971	1.54617	1.83682	2.78498	2.04703	1.38465	.91464	.50858	.38986
.050	.66298	1.48358	1.91465	1.87154	2.08238	1.70493	.83782	.60130	.39408
.075	.64796	1.49252	1.93872	1.73015	2.18470	1.60729	.92115	.56618	.36949
.100	.69560	1.55213	1.94281	1.54969	2.47244	1.75962	1.02205	.59006	.38846
.200	.46121	1.59315	2.33865	1.30722	2.24485	1.71535	.91854	.54510	.30295
.300	.46181	.69977	2.73602	1.21606	1.29916	1.53698	.98104	.52473	.31400
.400	.49164	.58830	2.05752	1.20490	1.01390	1.35926	.90357	.58304	.30767
.600	.46778	.47732	.90330	1.05545	.90618	.94979	.82545	.53105	.34420
.800	.33293	.45047	.53922	.84535	.82921	.80332	.73627	.52614	.33296
1.000	-.03759	-.02327	.04865	.66287	.78701	.69525	.73822	.57742	.32313

	-CPL	-CPL	-CPL	-CPL	-CPL	-CPL	-CPL	-CPL	-CPL
X/C	-CPL	-CPL	-CPL	-CPL	-CPL	-CPL	-CPL	-CPL	-CPL
0.000	1.85910	4.97170	1.89905	4.62489	1.78162	1.57474	.90162	.56337	.44536
.025	-.05191	.77666	.86848	-.38419	-.52074	-.60905	-.68527	-.70781	-.70219
.050	-.23031	.19391	.41734	-.61694	-.70694	-.74194	-.73542	-.73171	-.65650
.075	-.27228	-.02446	.15823	-.64363	-.72556	-.73347	-.71914	-.69797	-.60027
.100	-.28699	-.13040	.02151	-.63681	-.69823	-.70025	-.67419	-.63752	-.55810
.200	-.30071	-.26790	-.20637	-.52571	-.55612	-.55238	-.51786	-.47516	-.38589
.300	-.29355	-.28878	-.25655	-.42454	-.42205	-.41233	-.38497	-.34723	-.27975
.400	-.26133	-.26909	-.27490	-.30971	-.31654	-.29313	-.26707	-.23406	-.18346
.600	-.24761	-.23985	-.25706	-.16944	-.16510	-.11139	-.08989	-.06467	-.02671
.800	-.18317	-.14320	-.13928	-.05462	-.05462	.05928	.09120	.07802	*****
1.000	-.03759	-.02327	.04865	.66287	.78701	.69525	.73822	.57742	.32313

# APPENDIX A

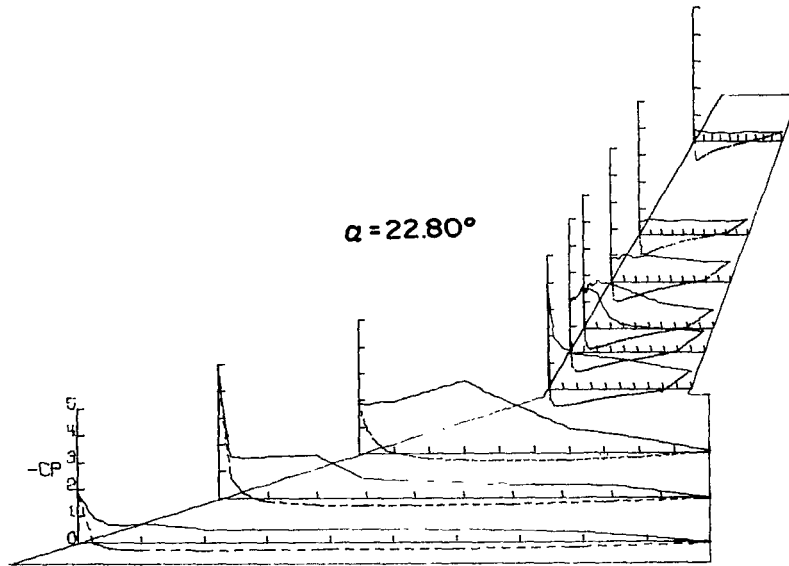
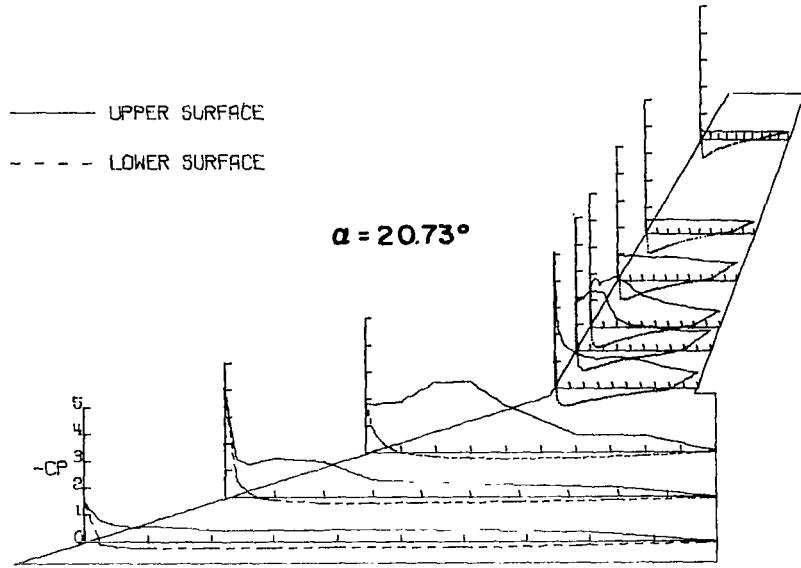

# APPENDIX A

## P R E S S U R E M E A S U R E M E N T S

OUTER PANEL SWEEP= 30.0000 DEGREES

FUSELAGE OFF

ANGLE OF ATTACK= 24.90131 DEGREES

### S P A N W I S E L O C A T I O N

	2Y/B .04707	2Y/B .14119	2Y/B .23533	2Y/B .37112	2Y/B .44999	2Y/B .49999	2Y/B .59999	2Y/B .69999	2Y/B .89997
X/C	-CPU	-CPU	-CPU	-CPU	-CPU	-CPU	-CPU	-CPU	-CPU
0.000	2.29677	5.45181	1.94584	4.44141	2.17222	1.40269	1.02260	.63578	.38444
.025	1.01296	1.92661	1.91080	2.97878	1.98963	1.48268	.89899	.59826	.35966
.050	.76439	1.70753	2.00911	2.03244	2.04630	1.58447	.85404	.62162	.34550
.075	.81013	1.96333	2.09906	1.89141	2.31452	1.77286	.99286	.57914	.37666
.100	.91426	2.13847	2.11736	1.62381	2.38315	1.84425	.99352	.61950	.35276
.200	.46933	1.93564	2.00702	1.46074	2.16089	1.71205	.87586	.61667	.38090
.300	.50367	1.05991	2.71351	1.36378	1.47711	1.68825	.83487	.61808	.38161
.400	.55428	.74994	2.22561	1.36000	1.17678	1.34915	1.03516	.56074	.33913
.600	.53621	.54826	1.10496	1.17489	1.02653	1.06887	.88379	.60463	.34621
.800	.43138	.56031	.92036	.97341	.90935	.90098	.76480	.56852	.32993
1.000	-.02832	-.01807	.11871	.64341	.88540	.83752	.73374	.62587	.33842

	-CPL	-CPL	-CPL	-CPL	-CPL	-CPL	-CPL	-CPL	-CPL
X/C	-CPL	-CPL	-CPL	-CPL	-CPL	-CPL	-CPL	-CPL	-CPL
0.000	2.29677	5.45181	1.94584	4.44141	2.17222	1.40269	1.02260	.63578	.38444
.025	-.01024	.92750	1.03959	-.30438	-.42096	-.56421	-.63101	-.70915	-.70278
.050	-.22774	.23858	.50882	-.60056	-.68690	-.74478	-.74478	-.74953	-.68507
.075	-.29883	-.01325	.23323	-.66043	-.72660	-.75801	-.73949	-.73041	-.62768
.100	-.33317	-.13737	.03974	-.66736	-.72534	-.74478	-.71303	-.68861	-.59297
.200	-.35727	-.30847	-.20917	-.57536	-.59993	-.61381	-.57082	-.53275	-.44632
.300	-.34763	-.32052	-.27088	-.53502	-.47327	-.46102	-.42861	-.40240	-.31880
.400	-.31389	-.30847	-.31010	-.37559	-.35857	-.35188	-.31154	-.29046	-.22599
.600	-.27533	-.28076	-.26722	-.21237	-.18086	-.14618	-.12104	-.09564	-.05738
.800	-.22412	-.17713	-.16577	-.08444	.03403	.05754	.07342	.05880	*****
1.000	-.02832	-.01807	.11871	.64341	.88540	.83752	.73374	.62587	.33842

## P R E S S U R E M E A S U R E M E N T S

OUTER PANEL SWEEP= 30.0000 DEGREES

FUSELAGE OFF

ANGLE OF ATTACK= 26.97070 DEGREES

### S P A N W I S E L O C A T I O N

	2Y/B .04707	2Y/B .14119	2Y/B .23533	2Y/B .37112	2Y/B .44999	2Y/B .49999	2Y/B .59999	2Y/B .69999	2Y/B .89997
X/C	-CPU	-CPU	-CPU	-CPU	-CPU	-CPU	-CPU	-CPU	-CPU
0.000	2.61740	3.60386	1.77517	4.46713	2.05587	1.44684	1.08123	.64746	.39478
.025	1.04189	3.20114	1.88459	3.07045	2.14099	1.52621	.95697	.61597	.41508
.050	.85261	3.07555	1.93060	2.02543	2.07327	1.53271	.91078	.74616	.39268
.075	.92160	3.15043	2.04973	1.84277	2.32489	1.46831	.93941	.62716	.40248
.100	1.14272	3.41695	2.02314	1.70670	2.41436	1.57825	1.04675	.62367	.41928
.200	.51822	2.52895	1.74910	1.52404	2.49761	1.73439	1.07862	.67966	.37938
.300	.53711	1.46544	2.35854	1.34324	1.50727	1.60232	.94851	.63206	.36188
.400	.59613	.89978	1.96844	1.31715	1.31218	1.31218	1.05390	.63416	.32408
.600	.54065	.62092	1.34621	1.17052	1.05869	1.04349	.82231	.58307	.35628
.800	.49402	.63981	.76999	.98041	.97482	.89192	.81580	.57467	.35278
1.000	-.03364	-.03305	.12782	.70703	.94396	.82165	.81515	.55437	.37168

	-CPL	-CPL	-CPL	-CPL	-CPL	-CPL	-CPL	-CPL	-CPL
X/C	-CPL	-CPL	-CPL	-CPL	-CPL	-CPL	-CPL	-CPL	-CPL
0.000	2.61740	3.60386	1.77517	4.46713	2.05587	1.44684	1.08123	.64746	.39478
.025	.03836	.91806	1.05631	-.20521	-.37124	-.49278	-.58261	-.64787	-.67028
.050	-.22429	.25203	.55781	-.52608	-.64609	-.68351	-.71281	-.72351	-.67448
.075	-.31273	-.01358	.24388	-.62619	-.70206	-.73038	-.73103	-.71721	-.63946
.100	-.35355	-.14165	.05777	-.65045	-.71450	-.72908	-.70499	-.68849	-.60795
.200	-.38188	-.32285	-.22701	-.57645	-.62122	-.61256	-.60214	-.54911	-.47627
.300	-.38601	-.34883	-.31904	-.57334	-.49996	-.49213	-.44721	-.43845	-.34179
.400	-.35237	-.34883	-.33949	-.33927	-.38430	-.36910	-.34631	-.31238	-.25705
.600	-.32463	-.30928	-.31802	-.22386	-.19153	-.15318	-.14061	-.12677	-.08405
.800	-.23432	-.20481	-.19531	-.09079	.01617	.04622	.06835	.02802	*****
1.000	-.03364	-.03305	.12782	.70703	.94396	.82165	.81515	.55437	.37168



# APPENDIX A

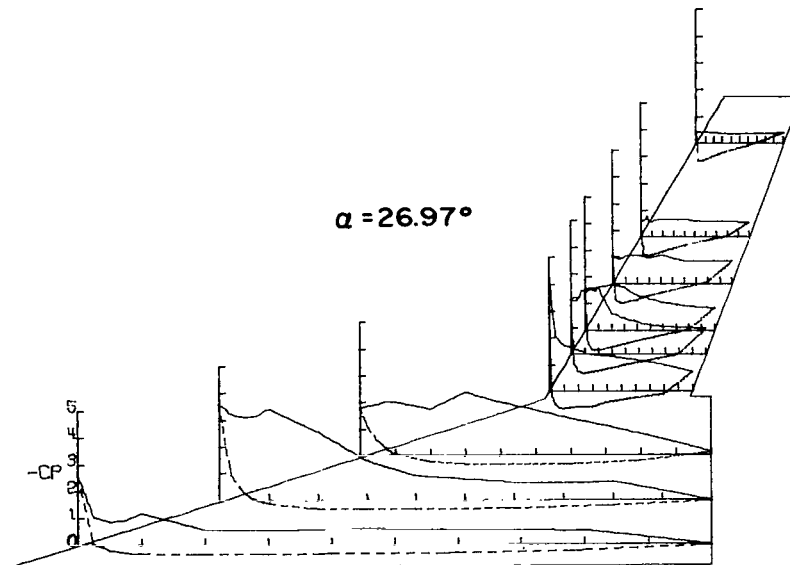
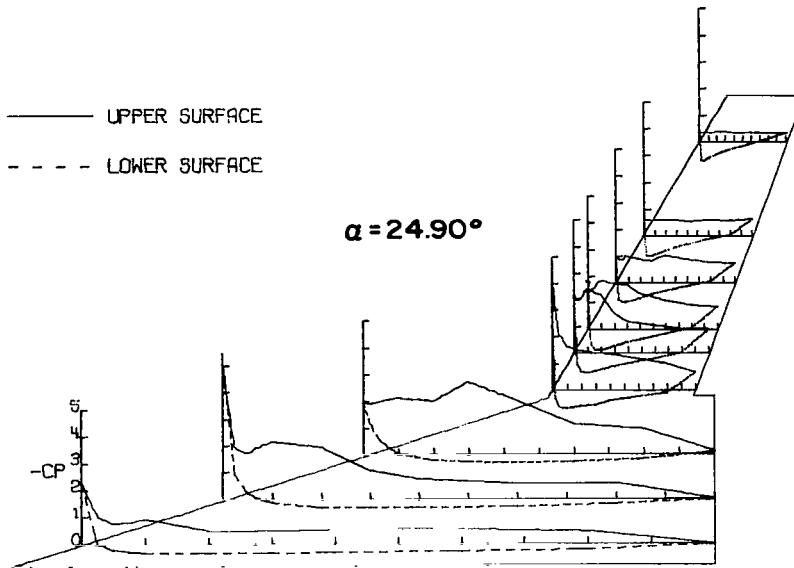

# APPENDIX A

## P R E S S U R E M E A S U R E M E N T S

OUTER PANEL SWEEP= 30.0000 DEGREES

FUSELAGE OFF

ANGLE OF ATTACK= 28.95970 DEGREES

### S P A N W I S E L O C A T I O N

	2Y/B .04707	2Y/B .14119	2Y/B .23533	2Y/B .37112	2Y/B .44999	2Y/B .49999	2Y/B .59999	2Y/B .69999	2Y/B .89997
X/C	-CPU	-CPU	-CPU	-CPU	-CPU	-CPU	-CPU	-CPU	-CPU
0.000	3.14983	2.87069	1.92201	4.59305	2.55218	1.55000	1.32932	.70476	-.39871
.025	1.14141	2.48154	2.06165	3.05107	2.26798	1.58515	1.25575	.66054	.40292
.050	1.03555	2.60337	2.06062	2.26178	2.40698	1.71014	.97583	.67879	.41485
.075	1.14555	2.98483	2.10081	2.01854	2.38402	1.67955	1.01554	.67668	.43240
.100	1.39572	3.52892	2.12194	1.85968	2.94993	1.56823	1.17438	.71529	.36923
.200	.53990	3.27225	1.81226	1.65119	2.22206	1.73032	.97648	.72793	.48154
.300	.63225	1.90965	2.01785	1.44828	1.61892	1.69647	.97257	.67598	.41696
.400	.69135	1.24668	1.97766	1.45138	1.37506	1.40353	.99926	.69283	.38748
.600	.64113	.89479	1.45619	1.23172	1.13306	1.19391	.98039	.72582	.39801
.800	.53754	.68721	.98316	.94711	1.06232	1.02140	.79355	.63878	.38537
1.000	-.00237	.00592	.19066	.72540	1.03750	.94458	.80136	.68791	.37204

	-CPL	-CPL	-CPL	-CPL	-CPL	-CPL	-CPL	-CPL	-CPL
X/C	-CPL	-CPL	-CPL	-CPL	-CPL	-CPL	-CPL	-CPL	-CPL
0.000	3.14983	2.87069	1.92201	4.59305	2.55218	1.55000	1.32932	.70476	-.39871
.025	.09235	.97818	1.24029	-.13166	-.30183	-.46054	-.52437	-.62934	-.68413
.050	-.21904	.28771	.67399	-.49498	-.60988	-.65791	-.71328	-.73119	-.70871
.075	-.32146	.01954	.32618	-.60740	-.71049	-.71849	-.74324	-.72768	-.67008
.100	-.38539	-.14208	.09327	-.65397	-.73161	-.73021	-.74064	-.70591	-.64550
.200	-.43571	-.35520	-.22260	-.62354	-.65956	-.65595	-.64358	-.59563	-.51696
.300	-.42979	-.38302	-.32669	-.59125	-.53163	-.51916	-.50288	-.46779	-.38913
.400	-.38592	-.40374	-.36688	-.42667	-.42046	-.41298	-.38432	-.35401	-.28517
.600	-.36230	-.35944	-.34009	-.25960	-.21737	-.18890	-.17783	-.15453	-.10747
.800	-.26877	-.23917	-.19735	-.10558	-.02236	.04299	.05341	.04214	*****
1.000	-.00237	.00592	.19066	.72540	1.03750	.94458	.80136	.68791	.37204

## P R E S S U R E M E A S U R E M E N T S

OUTER PANEL SWEEP= 30.0000 DEGREES

FUSELAGE OFF

ANGLE OF ATTACK= 30.95499 DEGREES

### S P A N W I S E L O C A T I O N

	2Y/B .04707	2Y/B .14119	2Y/B .23533	2Y/B .37112	2Y/B .44999	2Y/B .49999	2Y/B .59999	2Y/B .69999	2Y/B .89997
X/C	-CPU	-CPU	-CPU	-CPU	-CPU	-CPU	-CPU	-CPU	-CPU
0.000	3.64363	2.71190	2.03175	4.44515	2.50702	1.50301	1.37694	.67247	.38678
.025	1.22148	2.56137	2.10540	3.32116	2.49197	1.81687	1.11101	.75671	.43872
.050	1.18043	2.62920	2.01733	2.14072	2.52584	1.62711	1.12414	.84024	.40573
.075	1.41366	2.88861	2.13424	2.01716	2.68955	1.61989	1.13005	.72722	.37976
.100	1.87536	3.58056	2.05029	1.90614	2.44179	1.65338	1.05651	.78900	.36853
.200	.57949	3.61269	1.70935	1.68661	2.08553	1.87663	.99938	.76162	.46259
.300	.77644	2.31565	1.72892	1.55678	1.74745	1.65600	1.12874	.68862	.37835
.400	.72944	1.58144	1.86849	1.42882	1.47398	1.49579	1.12480	.72933	.42328
.600	.73658	1.00253	1.46884	1.25947	1.21243	1.22657	1.02105	.73916	.39871
.800	.56639	.79429	1.04034	1.01297	1.18985	1.06045	.96392	.62825	.38327
1.000	.01727	.04586	.23897	.77342	1.04120	.97509	.94685	.69634	.40082

	-CPL	-CPL	-CPL	-CPL	-CPL	-CPL	-CPL	-CPL	-CPL
X/C	-CPL	-CPL	-CPL	-CPL	-CPL	-CPL	-CPL	-CPL	-CPL
0.000	3.64363	2.71190	2.03175	4.44515	2.50702	1.50301	1.37694	.67247	.38678
.025	.16378	1.11141	1.30969	-.08036	-.16887	-.38305	-.41459	-.57877	-.64620
.050	-.19713	.36330	.74420	-.45325	-.57190	-.64126	-.68594	-.71644	-.68835
.075	-.33650	.04824	.35176	-.59388	-.68051	-.72076	-.72931	-.73962	-.67149
.100	-.41392	-.12924	.10661	-.63468	-.72006	-.73325	-.73916	-.72276	-.65323
.200	-.47705	-.37104	-.23948	-.63782	-.66105	-.67937	-.65046	-.62443	-.53382
.300	-.46097	-.42345	-.35639	-.59450	-.56814	-.55256	-.53942	-.50994	-.43548
.400	-.42583	-.42345	-.39965	-.44823	-.45639	-.43561	-.41393	-.38632	-.32029
.600	-.39010	-.39486	-.38008	-.28752	-.25111	-.20631	-.20499	-.17349	-.14540
.800	-.29123	-.26146	-.23433	-.12367	-.00251	.01314	.02957	.02388	*****
1.000	.01727	.04586	.23897	.77342	1.04120	.97509	.94685	.69634	.40082

# APPENDIX A

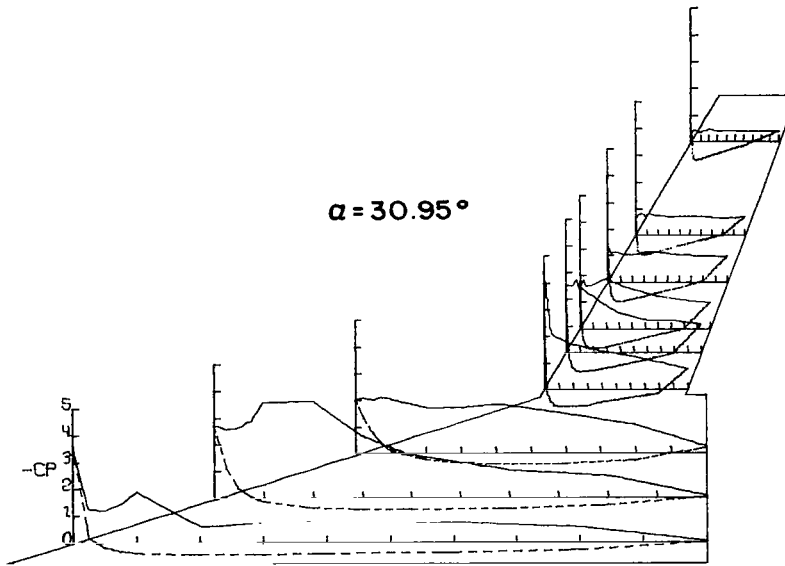
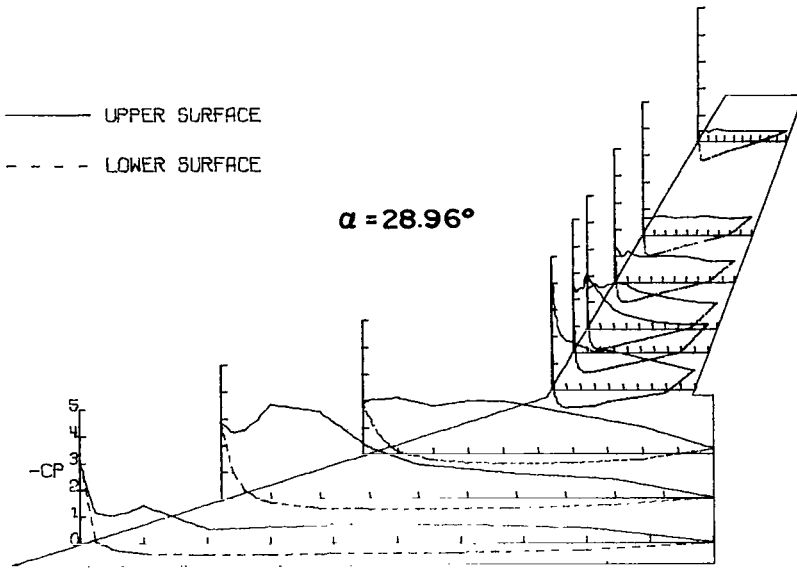

# APPENDIX A

## P R E S S U R E M E A S U R E M E N T S

OUTER PANEL SWEEP= 40.0000 DEGREES

FUSELAGE OFF

ANGLE OF ATTACK= -4.26082 DEGREES

### S P A N W I S E L O C A T I O N

	2Y/B .05001	2Y/B .14999	2Y/B .25001	2Y/B .40000	2Y/B .45001	2Y/B .50001	2Y/B .60000	2Y/B .70001	2Y/B .90001
X/C	-CPU	-CPU	-CPU	-CPU	-CPU	-CPU	-CPU	-CPU	-CPU
0.000	-.00177	.12957	.37786	.81365	.88824	.75258	.72985	-.63578	-.02151
.025	-.06153	-.09496	-.02162	-.42778	-.41472	-.40838	-.40838	-.43444	-.43167
.050	-.02956	-.02340	-.01236	-.28601	-.30389	-.29476	-.28307	-.30189	-.30744
.075	-.02603	.00828	-.00618	-.22745	-.22252	-.23308	-.23892	-.23943	-.22555
.100	-.02130	-.00118	-.00103	-.16581	-.17937	-.18244	-.16881	-.19224	-.19432
.200	.01657	.03136	.02420	-.05979	-.02527	-.04480	-.06233	-.06662	-.05274
.300	.03077	.06212	.04427	.01233	.01603	.01363	.00584	.00139	.01943
.400	.03787	.06094	.03851	.05850	.06411	.06233	.05454	.03539	.04164
.600	.05175	-.01657	.02940	.05071	.06226	.05843	.07012	.04233	.06246
.800	-.01242	-.00059	.01493	-.00925	-.00555	-.00584	.01363	-.01041	-.02776
1.000	-.05916	-.01302	-.06075	-.07212	-.05832	-.03960	-.06103	-.02845	-.03192

	-CPL	-CPL	-CPL	-CPL	-CPL	-CPL	-CPL	-CPL	-CPL
X/C	-CPL	-CPL	-CPL	-CPL	-CPL	-CPL	-CPL	-CPL	-CPL
0.000	-.00177	.12957	.37786	.81365	.88824	.75258	.72985	-.63578	-.02151
.025	.14318	.25796	.44891	1.31228	1.25006	1.21360	1.18049	1.05778	.89884
.050	.14909	.24672	.33970	.97892	.82352	.82205	.83699	.76835	.73781
.075	.15442	.23660	.37375	.73352	.70085	.73245	.70323	.65591	.65869
.100	.16744	.22355	.34904	.64168	.63859	.65178	.64154	.61774	.59483
.200	.17770	.21299	.29344	.47340	.48320	.48954	.48824	.47198	.43172
.300	.17158	.22060	.24571	.40083	.42533	.44279	.43370	.40812	.34774
.400	.13347	.23311	.27130	.35936	.37602	.38630	.37072	.34496	.28523
.600	.17453	.19051	.22457	.23362	.23423	.23698	.23842	.22832	.16587
.800	.12370	.12484	.12531	.09924	.08568	.09869	.09479	.09438	.05621
1.000	-.05916	-.01302	-.06075	-.07212	-.05832	-.03960	-.06103	-.02845	-.03192

## P R E S S U R E M E A S U R E M E N T S

OUTER PANEL SWEEP= 40.0000 DEGREES

FUSELAGE OFF

ANGLE OF ATTACK= -3.69236 DEGREES

### S P A N W I S E L O C A T I O N

	2Y/B .05001	2Y/B .14999	2Y/B .25001	2Y/B .40000	2Y/B .45001	2Y/B .50001	2Y/B .60000	2Y/B .70001	2Y/B .90001
X/C	-CPU	-CPU	-CPU	-CPU	-CPU	-CPU	-CPU	-CPU	-CPU
0.000	-.01732	.08540	.27913	.54244	.59238	.52181	.42313	.39834	-.05112
.025	-.04624	-.03688	-.01943	-.36614	-.35628	-.35217	-.36959	-.36564	-.39190
.050	-.02400	-.02400	-.01117	-.23423	-.25827	-.24510	-.23865	-.23003	-.26198
.075	-.01580	.00937	-.00233	-.18122	-.20095	-.13705	-.21479	-.17607	-.17891
.100	-.00519	.00176	.00966	-.12636	-.15040	-.14513	-.14577	-.13347	-.14554
.200	.02349	.03573	.02695	-.03390	-.00678	-.02129	-.03955	-.01704	-.00568
.300	.04507	.07067	.05034	.04085	.03457	.04709	.01484	.06035	.06461
.400	.05912	.06380	.05335	.08630	.08321	.08772	.07482	.08662	.08591
.600	.06372	.00117	.03651	.07039	.08137	.07934	.07031	.10721	.10011
.800	-.00527	.00000	.02745	.02247	.00925	.03452	.02387	.03621	.00568
1.000	-.05268	.00059	-.04118	-.07089	-.04022	-.05870	-.05483	-.01065	-.01136

	-CPL	-CPL	-CPL	-CPL	-CPL	-CPL	-CPL	-CPL	-CPL
X/C	-CPL	-CPL	-CPL	-CPL	-CPL	-CPL	-CPL	-CPL	-CPL
0.000	-.01732	.08540	.27913	.54244	.59238	.52181	.42313	.39834	-.05112
.025	.17819	.24350	.38031	1.16319	1.10589	1.08310	1.03795	.93941	.88829
.050	.12944	.22184	.35133	.82105	.75073	.74024	.73669	.73136	.62201
.075	.14672	.21433	.34014	.59832	.65763	.64444	.64573	.62059	.57018
.100	.15453	.20604	.32134	.53312	.57830	.57413	.58857	.50024	.51976
.200	.17032	.19667	.23828	.45306	.44566	.46054	.44506	.47787	.41183
.300	.15321	.20486	.23015	.34525	.39203	.31930	.39216	.41467	.35290
.400	.13374	.22008	.26439	.35258	.36060	.37281	.34830	.36568	.30103
.600	.16155	.18097	.22163	.21697	.22191	.21801	.22124	.24636	.18530
.800	.11982	.10987	.12253	.09801	.07643	.09611	.08450	.11644	.07242
1.000	-.05268	.00059	-.04118	-.07089	-.04022	-.05870	-.05483	-.01065	-.01136

# APPENDIX A

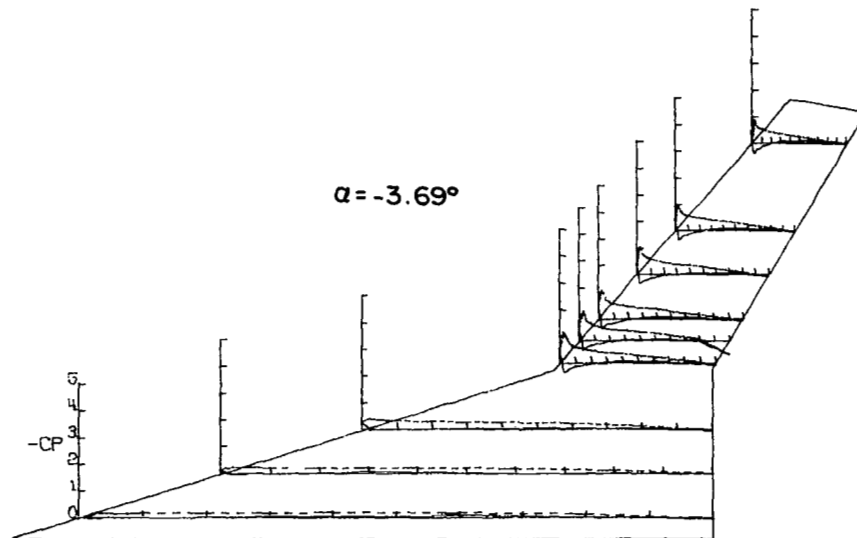
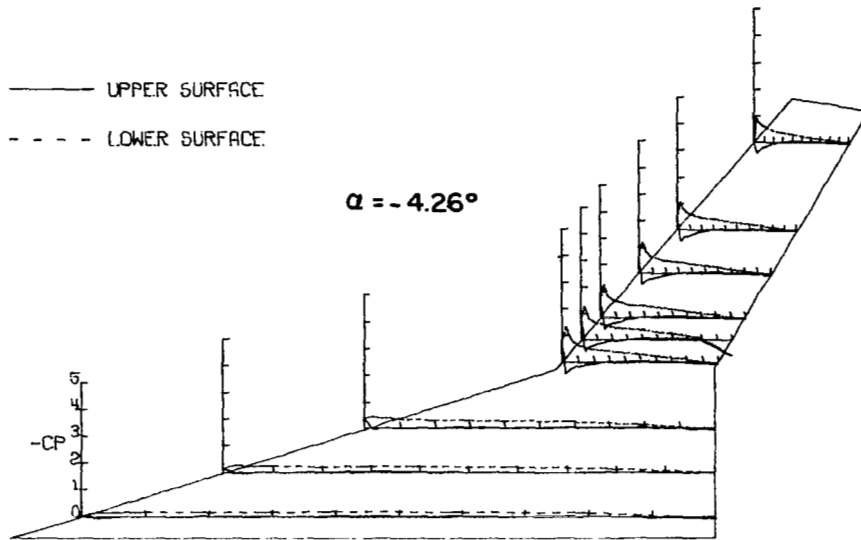

# APPENDIX A

## P R E S S U R E M E A S U R E M E N T S

OUTER PANEL SWEEP= 40.0000 DEGREES

FUSELAGE OFF

ANGLE OF ATTACK= -3.18388 DEGREES

### S P A N W I S E L O C A T I O N

	2Y/1 .05001	2Y/3 .14999	2Y/5 .25001	2Y/7 .40000	2Y/9 .45001	2Y/11 .50001	2Y/13 .60000	2Y/15 .70001	2Y/17 .90001
X/C	-CPU	-CPU	-CPU	-CPU	-CPU	-CPU	-CPU	-CPU	-CPU
0.000	-.02955	.06264	-.20683	.28293	-.30820	.24945	-.16308	-.15670	-.19570
.025	-.03363	-.02600	-.01880	-.32361	-.30759	-.31069	-.31778	-.32942	-.36912
.050	-.01182	-.01832	-.00661	-.19417	-.22006	-.21142	-.19789	-.21450	-.24097
.075	-.00768	.02186	-.00356	-.15102	-.16766	-.15857	-.16759	-.15182	-.16297
.100	.00827	.02600	.00966	-.09246	-.11342	-.10894	-.11022	-.10934	-.13372
.200	.03309	.04787	.03354	-.01418	.02281	-.00258	-.01096	-.01045	-.00627
.300	.05437	.08569	.05936	.06164	.06164	.05672	.04448	.05223	.05293
.400	.06264	.07505	.05590	.09924	.08753	.09475	.07864	.07870	.06059
.600	.06028	-.00591	.04116	.07582	.07952	.07735	.08380	.05711	.08009
.800	-.00355	.00177	.02287	-.00062	.00801	-.00451	.02063	.00766	-.01950
1.000	-.05909	-.00532	-.06038	-.09061	-.49004	-.07735	-.05995	-.05084	-.03413

	-CPL	-CPL	-CPL	-CPL	-CPL	-CPL	-CPL	-CPL	-CPL
X/C	-CPL	-CPL	-CPL	-CPL	-CPL	-CPL	-CPL	-CPL	-CPL
0.000	-.02955	.06264	.20683	.28293	.30820	.24945	.16308	.15670	-.19570
.025	.10814	.21333	.32625	1.000423	.96727	.96571	.91414	.77733	.70211
.050	.11701	.21865	.30694	.73907	.68791	.61630	.66078	.59136	.51195
.075	.13651	.20328	.30236	.57880	.57819	.56795	.57182	.52240	.47922
.100	.14655	.20505	.27950	.50792	.53504	.50278	.51309	.48966	.44926
.200	.16487	.19324	.25053	.40991	.41669	.40480	.40738	.39494	.35036
.300	.15836	.20624	.24138	.34765	.37292	.37193	.36484	.35732	.30787
.400	.17905	.21215	.23224	.32176	.33409	.33454	.32165	.30504	.25211
.600	.15836	.17669	.19361	.20341	.20218	.19660	.19595	.19918	.15113
.800	.10046	.12114	.12603	.09184	.07828	.08251	.07928	.08357	.04666
1.000	-.05909	-.00532	-.06098	-.09061	-.49004	-.07735	-.05995	-.05084	-.03413

## P R E S S U R E M E A S U R E M E N T S

OUTER PANEL SWEEP= 40.0000 DEGREES

FUSELAGE OFF

ANGLE OF ATTACK= -2.66004 DEGREES

### S P A N W I S E L O C A T I O N

	2Y/1 .05001	2Y/3 .14999	2Y/5 .25001	2Y/7 .40000	2Y/9 .45001	2Y/11 .50001	2Y/13 .60000	2Y/15 .70001	2Y/17 .90001
X/C	-CPU	-CPU	-CPU	-CPU	-CPU	-CPU	-CPU	-CPU	-CPU
0.000	-.04410	.02443	-.13094	-.00877	.15467	0.00000	-.03708	-.06743	-.41582
.025	-.03039	-.02384	-.01834	-.25924	-.24296	-.23549	-.25891	-.27183	-.30905
.050	-.01251	-.01073	-.00459	-.15655	-.16844	-.17499	-.14572	-.17279	-.21002
.075	-.00218	.03397	.01274	-.10395	-.12524	-.12881	-.12100	-.11941	-.13556
.100	.00656	.03516	.02191	-.04634	-.06951	-.07871	-.07611	-.09623	-.09412
.200	.03874	.06376	.04636	-.02943	.06324	.03318	.00846	.01967	.02950
.300	.06972	.08999	.08203	.08829	.09455	.08002	.07026	.07094	.06462
.400	.06074	.08879	.07134	-.11710	.11459	.10278	.09238	.09061	.07867
.600	.07151	-.00238	.03452	.09956	.08516	.07871	.06961	.07164	.08078
.800	-.00179	-.00060	.03108	.01565	.01691	-.00716	.02602	.01475	-.02458
1.000	-.05940	-.00179	-.07337	-.08266	-.46337	-.07416	-.06570	-.04987	-.04776

	-CPL	-CPL	-CPL	-CPL	-CPL	-CPL	-CPL	-CPL	-CPL
X/C	-CPL	-CPL	-CPL	-CPL	-CPL	-CPL	-CPL	-CPL	-CPL
0.000	-.04410	.02443	.13094	.00877	.15467	0.00000	.03708	-.06743	-.41582
.025	.09297	.17938	.26086	.88479	.85999	.81392	.80546	.66595	.60695
.050	.10488	.19189	.24150	.65060	.58611	.51913	.58035	.52616	.44538
.075	.11263	.19189	.24303	.50595	.52161	.46383	.50872	.44257	.42922
.100	.13647	.19427	.23631	.47277	.49155	.44757	.47034	.41657	.39761
.200	.15256	.18176	.21959	.38573	.38573	.37341	.36885	.36459	.31682
.300	.15717	.20381	.21755	.33689	.35649	.34674	.34674	.33438	.28306
.400	.17163	.20977	.21399	.31747	.34127	.32202	.31161	.28868	.24443
.600	.15256	.16209	.17323	.19725	.20664	.18150	.19516	.18052	.13907
.800	.10170	.10946	.08712	.09080	.07827	.07286	.07416	.07445	.04425
1.000	-.05940	-.00179	-.07337	-.08266	-.46337	-.07416	-.06570	-.04987	-.04776

APPENDIX A

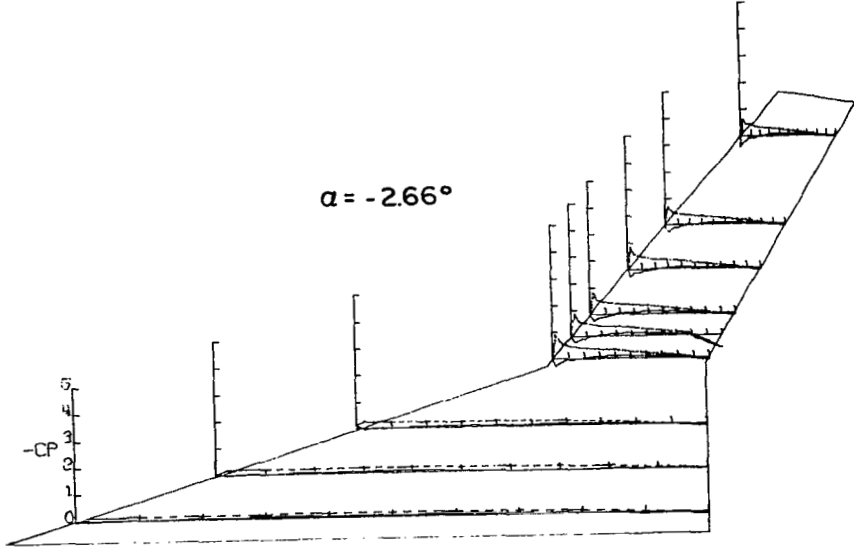
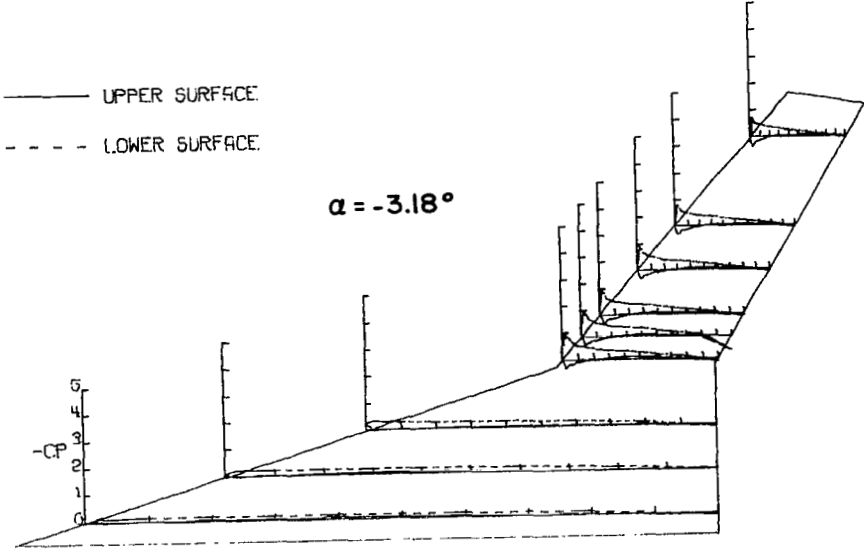

# APPENDIX A

## P R E S S U R E M E A S U R E M E N T S

OUTER PANEL SWEEP= 40.0000 DEGREES

FUSELAGE OFF

ANGLE OF ATTACK= -2.11575 DEGREES

### S P A N W I S E L O C A T I O N

	2Y/B .05001	2Y/B .14999	2Y/B .25001	2Y/B .40000	2Y/B .45001	2Y/B .50001	2Y/B .60000	2Y/B .70001	2Y/B .90001
X/C	-CPU	-CPU	-CPU	-CPU	-CPU	-CPU	-CPU	-CPU	-CPU
0.000	-.05988	-.00763	.05829	-.19343	-.08501	-.19200	-.19593	-.23799	-.55136
.025	-.02407	-.01174	.00614	-.18604	-.18542	-.16513	-.19134	-.21845	-.24497
.050	.00646	.00294	.02059	-.09240	-.11889	-.09698	-.10288	-.11376	-.17099
.075	.00470	.03111	.03784	-.05914	-.09117	-.06487	-.08388	-.07887	-.10469
.100	.01350	.04579	.04500	-.01786	-.02587	-.03407	-.03342	-.04606	-.06979
.200	.05107	.06458	.06647	.05975	.09302	.07077	.04718	.04397	.04048
.300	.06106	.10156	.07823	.09856	.10534	.10222	.09240	.07887	.08166
.400	.07456	.10156	.08181	.13244	.13429	.13302	.13695	.10748	.09771
.600	.08102	-.00998	.06443	.10349	.09980	.09829	.10550	.07607	.09282
.800	-.00704	-.00528	.04500	.00616	.02279	0.00000	.03473	.00907	-.01954
1.000	-.05342	-.00646	-.06443	-.08747	-.46263	-.07143	-.06422	-.05374	-.04676

	-CPL	-CPL	-CPL	-CPL	-CPL	-CPL	-CPL	-CPL	-CPL
0.000	-.05988	-.00763	.05829	-.19343	-.08501	-.19200	-.19593	-.23799	-.55136
.025	.07691	.15557	.24698	.74538	.75216	.71501	.69207	.56958	.56260
.050	.09804	.16614	.23931	.53717	.52423	.48884	.53471	.43207	.37204
.075	.11624	.16614	.24289	.44785	.43799	.43118	.44756	.38530	.35459
.100	.12328	.17436	.23879	.41951	.42567	.41807	.42856	.37414	.33156
.200	.15440	.17260	.22652	.35606	.36037	.36696	.36434	.34831	.29383
.300	.14912	.19021	.22601	.31171	.33450	.34992	.35189	.31550	.26730
.400	.17436	.20019	.22345	.28768	.31479	.31061	.31388	.26730	.23101
.600	.15327	.15440	.19431	.19343	.18850	.19396	.19003	.18076	.13889
.800	.09041	.11096	.09664	.08255	.06961	.08126	.07470	.07677	.03699
1.000	-.05342	-.00646	-.06443	-.08747	-.46263	-.07143	-.06422	-.05374	-.04676

## P R E S S U R E M E A S U R E M E N T S

OUTER PANEL SWEEP= 40.0000 DEGREES

FUSELAGE OFF

ANGLE OF ATTACK= -1.61905 DEGREES

### S P A N W I S E L O C A T I O N

	2Y/B .05001	2Y/B .14999	2Y/B .25001	2Y/B .40000	2Y/B .45001	2Y/B .50001	2Y/B .60000	2Y/B .70001	2Y/B .90001
X/C	-CPU	-CPU	-CPU	-CPU	-CPU	-CPU	-CPU	-CPU	-CPU
0.000	-.06421	-.02081	.03917	-.34469	-.27761	-.34034	-.37517	-.39600	-.60339
.025	-.00951	-.01011	.00515	-.12111	-.10931	-.11170	-.11958	-.15102	-.20879
.050	.02021	.01367	.03865	-.04099	-.06086	-.05913	-.03876	-.07586	-.11622
.075	.01605	.05707	.05102	-.00062	-.01739	-.01905	-.03285	-.03549	-.04176
.100	.02319	.04637	.05772	.02671	.00497	.00986	.00591	.00209	-.03480
.200	.05291	.08561	.07524	.03509	.12049	.09067	.06767	.05568	.06681
.300	.07610	.11295	.09946	.13104	.13850	.13272	.11235	.09952	.09604
.400	.07907	.10998	.10255	.15402	.16272	.14520	.15834	.12179	.10996
.600	.09393	-.01011	.07576	.12421	.10496	.10841	.11170	.08491	.09187
.800	-.00951	-.00713	.04638	.02422	.01739	.01117	.03154	.00835	-.03062
1.000	-.05945	-.00535	-.06854	-.08819	-.43847	-.08279	-.06965	-.05985	-.05428

	-CPL	-CPL	-CPL	-CPL	-CPL	-CPL	-CPL	-CPL	-CPL
0.000	-.06421	-.02081	.03917	-.34469	-.27761	-.34034	-.37517	-.39600	-.60339
.025	.07134	.13554	.20150	.69460	.63659	.57695	.56512	.44756	.46774
.050	.07788	.13673	.20047	.47263	.46207	.41919	.42247	.35359	.29160
.075	.10285	.15338	.21593	.39127	.39065	.37319	.38042	.29160	.27212
.100	.11830	.15338	.21232	.37450	.36518	.36005	.35611	.31183	.26585
.200	.14208	.13733	.20356	.31985	.30805	.31603	.31932	.28952	.24080
.300	.13495	.17775	.20098	.28507	.30494	.31538	.31012	.27977	.22966
.400	.15516	.18489	.19738	.26892	.27761	.28384	.27661	.24010	.19695
.600	.14327	.14565	.17264	.18321	.17638	.17280	.17083	.15450	.11901
.800	.09334	.11236	.08915	.07577	.07639	.06635	.08213	.06472	.03689
1.000	-.05945	-.00535	-.06854	-.08819	-.43847	-.08279	-.06965	-.05985	-.05428



# APPENDIX A

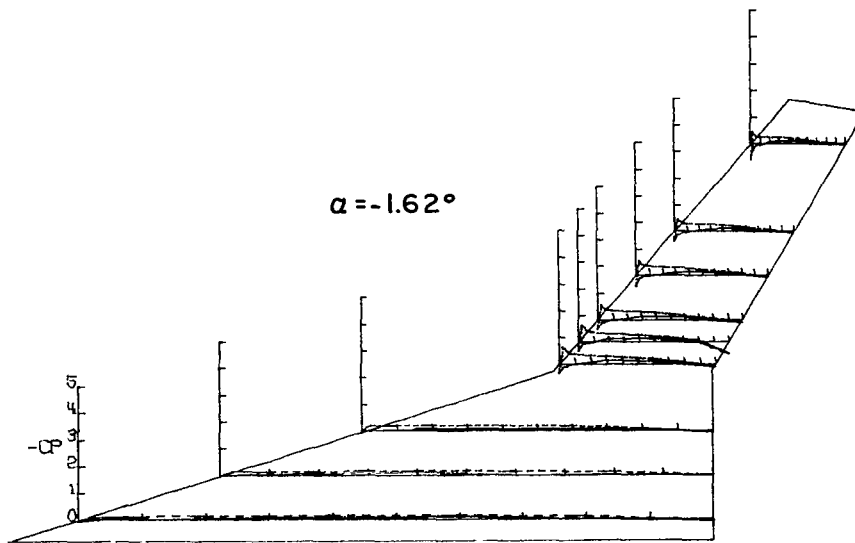
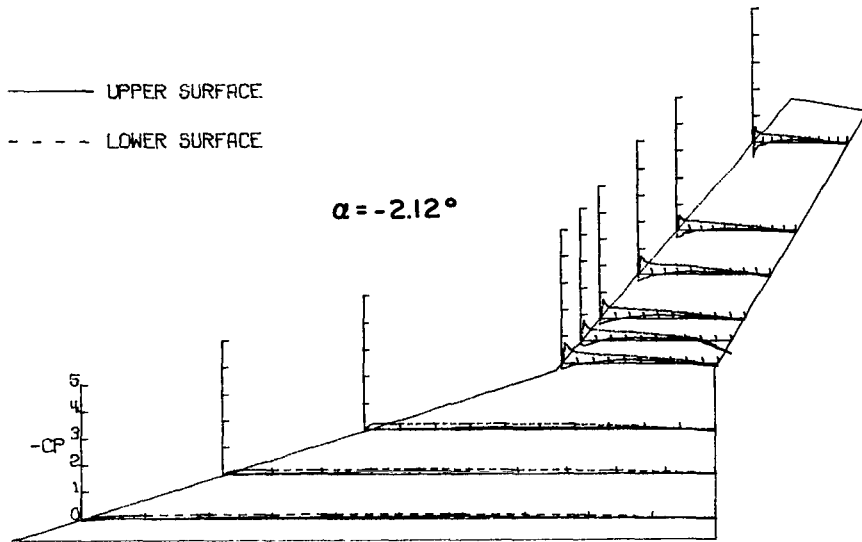

# APPENDIX A

## P R E S S U R E M E A S U R E M E N T S

OUTER PANEL SWEEP= 40.00000 DEGREES

FUSELAGE OFF

ANGLE OF ATTACK= -1.06149 DEGREES

### S P A N W I S E L O C A T I O N

	2Y/B .05001	2Y/B .14999	2Y/B .25001	2Y/B .40000	2Y/B .45001	2Y/B .50001	2Y/B .60000	2Y/B .70001	2Y/B .90001
X/C	-CPU	-CPU	-CPU	-CPU	-CPU	-CPU	-CPU	-CPU	-CPU
0.000	-.06072	-.03419	.00153	-.44751	-.38587	-.42128	-.44587	-.50146	-.63346
.025	-.00413	.00354	.02241	-.03760	-.00678	-.02524	-.03106	-.06914	-.11454
.050	-.02299	.02476	.04176	.00247	-.00678	-.01618	-.00388	-.01397	-.05448
.075	.01566	.06721	.06620	.03267	.01294	.00582	0.00000	.01886	-.00978
.100	.02883	.07015	.07435	.06596	.04808	.03689	.03947	.03422	.02375
.200	.06309	.09020	.10144	.11773	.13931	.12748	.09124	.10616	.09289
.300	.08135	.11790	.12425	.13807	.15348	.13331	.13266	.13549	.11873
.400	.08312	.11967	.12170	.17136	.17259	.15725	.16502	.14248	.12851
.600	.08961	.01061	.09522	.12260	.11897	.10354	.11778	.09778	.10127
.800	-.00766	-.00825	.05398	.02281	.02404	.00388	.02718	.00559	-.01537
1.000	-.06190	-.00354	-.07078	-.09924	-.41915	-.09383	-.06148	-.05657	-.05168
X/C	-CPL	-CPL	-CPL	-CPL	-CPL	-CPL	-CPL	-CPL	-CPL
0.000	-.06072	-.03419	.00153	-.44751	-.38587	-.42128	-.44587	-.50146	-.63346
.025	.05188	.10258	.15735	.52333	.46415	.46399	.44069	.36741	.35554
.050	.07782	.11849	.16499	.40066	.35443	.34103	.33586	.31223	.24305
.075	.10906	.13736	.19350	.34704	.32669	.31580	.31191	.27657	.25492
.100	.10376	.13913	.17212	.31868	.30820	.29768	.29574	.26051	.24026
.200	.14677	.14266	.18434	.28971	.27677	.28150	.26920	.27378	.23118
.300	.13500	.16919	.18485	.25766	.28355	.28020	.27179	.26400	.23537
.400	.14856	.17214	.18587	.25334	.25766	.26079	.25302	.23187	.18578
.600	.13745	.14797	.15633	.16273	.16026	.15013	.15272	.15784	.12083
.800	.09609	.09373	.08504	.07582	.05486	.06148	.05630	.07264	.03073
1.000	-.06190	-.00354	-.07078	-.09924	-.41915	-.09383	-.06148	-.05657	-.05168

## P R E S S U R E M E A S U R E M E N T S

OUTER PANEL SWEEP= 40.00000 DEGREES

FUSELAGE OFF

ANGLE OF ATTACK= -.51760 DEGREES

### S P A N W I S E L O C A T I O N

	2Y/B .05001	2Y/B .14999	2Y/B .25001	2Y/B .40000	2Y/B .45001	2Y/B .50001	2Y/B .60000	2Y/B .70001	2Y/B .90001
X/C	-CPU	-CPU	-CPU	-CPU	-CPU	-CPU	-CPU	-CPU	-CPU
0.000	-.07455	-.05206	-.03882	-.53576	-.46593	-.52495	-.47735	-.56910	-.66047
.025	.00114	.02307	.01942	.05685	.05747	.07913	.04503	.03627	-.04394
.050	.03017	.05088	.05721	.07663	.07230	.04825	.07720	.04743	.00139
.075	.03550	.08046	.06589	.08466	.06797	.06755	.06691	.05579	.03617
.100	.04319	.08106	.07458	.10938	.09516	.08492	.09007	.08648	.04254
.200	.07632	.09880	.09501	.14089	.17735	.15633	.12802	.14088	.14785
.300	.04461	.12188	.11033	.16808	.17488	.16147	.15440	.14925	.18412
.400	.09230	.12365	.10880	.19774	.18724	.18142	.17884	.16948	.13809
.600	.09585	-.00059	.08542	.13842	.13162	.12674	.12738	.10740	.09764
.800	-.00296	-.00828	.05517	.03337	.03090	.01673	.04310	.02092	-.02092
1.000	-.04911	-.00332	-.06641	-.08651	-.41341	-.07977	-.07141	-.04882	-.03975
X/C	-CPL	-CPL	-CPL	-CPL	-CPL	-CPL	-CPL	-CPL	-CPL
0.000	-.07455	-.05206	-.03882	-.53576	-.46593	-.52495	-.47735	-.56910	-.66047
.025	.04770	.09407	.10840	.41526	.39054	.34418	.35898	.26293	.24340
.050	.06331	.10590	.12923	.32937	.28055	.25990	.27534	.21969	.18831
.075	.04401	.12720	.14303	.27500	.25707	.25411	.25476	.19946	.20923
.100	.10176	.13776	.14916	.26019	.26819	.25218	.25540	.23224	.20156
.200	.12957	.13134	.15375	.25521	.24903	.24318	.24704	.22806	.19319
.300	.12247	.14614	.15988	.23544	.24471	.25920	.24961	.23434	.20295
.400	.15264	.18723	.16244	.23482	.26016	.23932	.23674	.20993	.18342
.600	.12740	.13844	.13337	.15078	.16252	.13703	.15182	.14158	.11577
.800	.07869	.09348	.06641	.06365	.05376	.05533	.05340	.05789	.03069
1.000	-.04911	-.00332	-.06641	-.04651	-.41341	-.07977	-.07141	-.04882	-.03975

# APPENDIX A

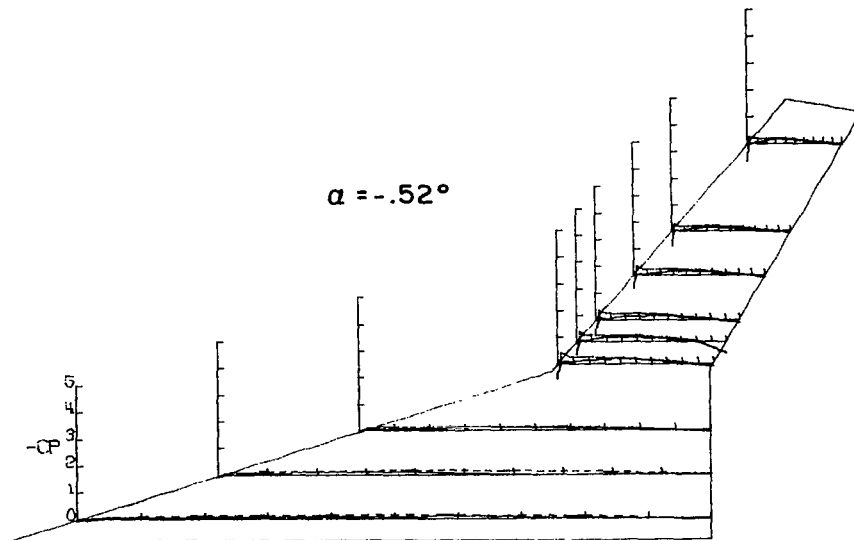
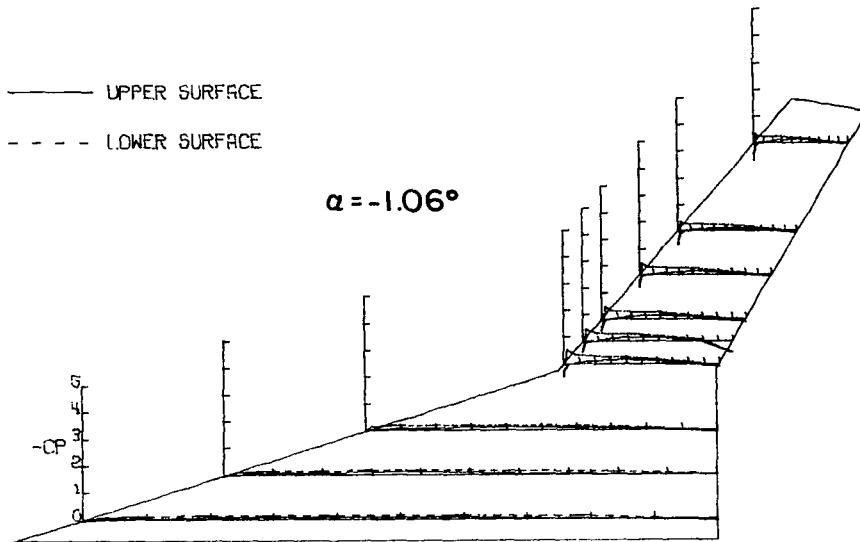

# APPENDIX A

## P R E S S U R E M E A S U R E M E N T S

OUTER PANEL SWEEP= 40.0000 DEGREES

FUSELAGE OFF

ANGLE OF ATTACK= .02840 DEGREES

### S P A N W I S E L O C A T I O N

	2Y/B .05001	2Y/B .14999	2Y/B .25001	2Y/B .40000	2Y/B .45001	2Y/B .50001	2Y/B .60000	2Y/B .70001	2Y/B .90001
X/C	- CPU	- CPU	- CPU	- CPU	- CPU	- CPU	- CPU	- CPU	- CPU
0.000	-.07610	-.05350	-.02480	-.56668	-.52242	-.55531	-.48598	-.60968	-.68694
.025	.01070	.04280	.06355	.15772	.18204	.15033	.16912	.12713	.03863
.050	.04399	.05350	.08990	.14276	.12032	.12571	.14320	.12222	.05268
.075	.03805	.09452	.10179	.13964	.12157	.11534	.12311	.12011	.08920
.100	.05350	.09393	.11161	.16707	.14276	.14385	.14903	.15101	.10325
.200	.06480	.11652	.11832	.16209	.21071	.16977	.17236	.16928	.16998
.300	.10344	.13019	.13951	.19326	.19762	.19504	.18467	.21142	.20018
.400	.10463	.13495	.13744	.21819	.21944	.20282	.20865	.19948	.16225
.600	.10939	-.01070	.11212	.15087	.14962	.13672	.15098	.15312	.11730
.800	-.00773	-.00297	.07595	.03740	.04115	.02203	.03953	.02810	-.01054
1.000	-.05350	.00119	-.05477	-.09725	-.39088	-.08942	-.07128	-.04636	-.04776
X/C	- CPL	- CPL	- CPL	- CPL	- CPL	- CPL	- CPL	- CPL	- CPL
0.000	-.07610	-.05350	-.02480	-.56668	-.52242	-.55531	-.48598	-.60968	-.68694
.025	.01902	.06539	.09249	.30485	.27617	.26049	.22485	.15804	.15804
.050	.04399	.07847	.11212	.23129	.20323	.18143	.19569	.15312	.13556
.075	.07610	.10106	.13899	.21258	.20573	.18791	.19958	.14820	.15172
.100	.09096	.10582	.14157	.21508	.20635	.18986	.20022	.17209	.16576
.200	.11830	.11771	.15501	.22443	.20199	.20800	.19828	.20299	.16155
.300	.11474	.14565	.16327	.21071	.22879	.22355	.21513	.20861	.19246
.400	.13733	.16230	.16172	.20947	.23066	.21059	.21513	.18613	.16506
.600	.11830	.11890	.14054	.13653	.13590	.12311	.14191	.13697	.10466
.800	.07847	.08145	.07905	.06234	.04613	.04925	.04925	.06111	.02950
1.000	-.05350	.00119	-.05477	-.09725	-.39088	-.08942	-.07128	-.04636	-.04776

## P R E S S U R E M E A S U R E M E N T S

OUTER PANEL SWEEP= 40.0000 DEGREES

FUSELAGE OFF

ANGLE OF ATTACK= .53836 DEGREES

### S P A N W I S E L O C A T I O N

	2Y/B .05001	2Y/B .14999	2Y/B .25001	2Y/B .40000	2Y/B .45001	2Y/B .50001	2Y/B .60000	2Y/B .70001	2Y/B .90001
X/C	- CPU	- CPU	- CPU	- CPU	- CPU	- CPU	- CPU	- CPU	- CPU
0.000	-.07528	-.06186	-.02326	-.56305	-.53007	-.55267	-.48927	-.62595	-.69717
.025	.03326	.05252	.07230	.24672	.24488	.26000	.23695	.20340	.13149
.050	.05544	.06828	.10516	.20641	.18504	.17483	.21389	.18422	.11916
.075	.05077	.10855	.11830	.19542	.17282	.17803	.17547	.16299	.14450
.100	.06478	.08987	.12437	.22290	.17893	.19917	.18764	.18148	.12464
.200	.08112	.12547	.12993	.19236	.23939	.21005	.20557	.19518	.19655
.300	.09571	.13948	.14257	.20580	.22412	.21389	.21518	.21984	.22326
.400	.10738	.13715	.14358	.22473	.22595	.22030	.23119	.21504	.16505
.600	.10505	-.01050	.11628	.16549	.16061	.15690	.17355	.16299	.11368
.800	-.00642	.00292	.06926	.03908	.04641	.02690	.05123	.02602	-.01370
1.000	-.05252	-.00584	-.05005	-.09038	-.37679	-.07941	-.07365	-.04451	-.04451
X/C	- CPL	- CPL	- CPL	- CPL	- CPL	- CPL	- CPL	- CPL	- CPL
0.000	-.07528	-.06186	-.02326	-.56305	-.53007	-.55267	-.48927	-.62595	-.69717
.025	.02509	.04552	.06522	.21618	.17221	.17739	.13448	.08013	.05890
.050	.03852	.07062	.08999	.17221	.15023	.13192	.13320	.09382	.06917
.075	.05836	.08637	.11628	.17160	.14717	.14665	.14409	.08971	.09382
.100	.08170	.09804	.12336	.16977	.16366	.16074	.14921	.12670	.10615
.200	.10913	.10038	.13398	.18565	.16916	.17931	.15626	.15135	.12738
.300	.10621	.13715	.14510	.18748	.20275	.19981	.19020	.18217	.15614
.400	.13364	.14181	.15066	.19908	.20458	.20237	.18508	.16710	.14108
.600	.11380	.11672	.12943	.13069	.12946	.13320	.13064	.12190	.09656
.800	.07995	.07762	.06775	.06168	.03542	.05315	.04547	.05273	.02055
1.000	-.05252	-.00584	-.05005	-.09038	-.37679	-.07941	-.07365	-.04451	-.04451

# APPENDIX A

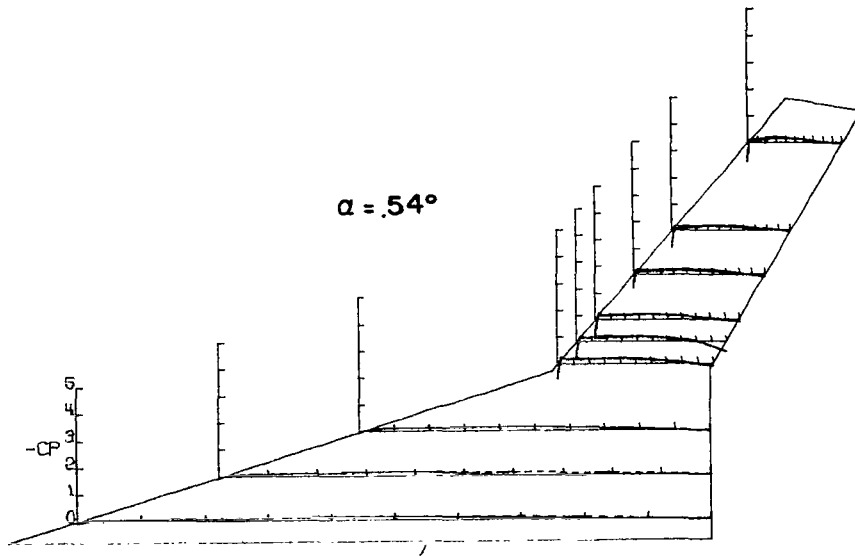
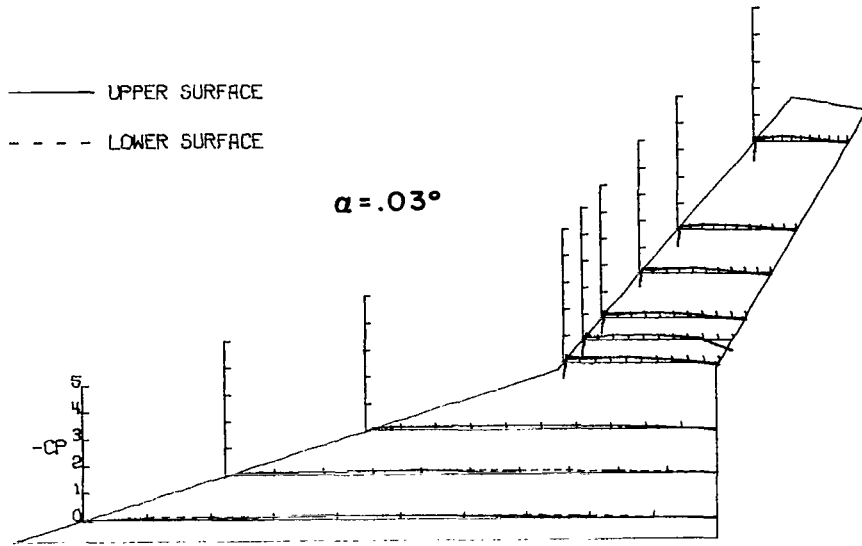

# APPENDIX A

## P R E S S U R E M E A S U R E M E N T S

OUTER PANEL SWEEP= 40.00000 DEGREES

FUSELAGE OFF

ANGLE OF ATTACK= 1.05085 DEGREES

### S P A N W I S E L O C A T I O N

	2Y/B .05001	2Y/B .14999	2Y/B .25001	2Y/B .40000	2Y/B .45001	2Y/B .50001	2Y/B .60000	2Y/B .70001	2Y/B .90001
X/C	-CPU	-CPU	-CPU	-CPU	-CPU	-CPU	-CPU	-CPU	-CPU
0.000	-.07447	-.04984	-.01924	-.55296	-.53148	-.55197	-.47735	-.61497	-.68838
.025	.04632	.07857	.12051	.37928	.38173	.37184	.36091	.34839	.22646
.050	.06626	.09558	.14684	.27986	.26635	.26119	.29014	.28602	.17383
.075	.05805	.12255	.14836	.23751	.22892	.21809	.22002	.23131	.17937
.100	.08033	.10731	.15545	.25960	.23567	.23867	.23031	.23546	.17036
.200	.09441	.12138	.15849	.26268	.26267	.25025	.22902	.23962	.22854
.300	.10731	.15949	.17520	.23444	.25592	.24382	.23288	.25624	.25208
.400	.11141	.14659	.16709	.24610	.25592	.24961	.24189	.24793	.18283
.600	.11370	-.02052	.13924	.16448	.18105	.16212	.18592	.17521	.13504
.800	-.00410	-.00176	-.08304	.04419	.05094	.03603	.05726	.03255	-.00346
1.000	-.05160	-.01231	-.04902	-.09083	-.38664	-.08170	-.07270	-.03740	-.04432

	-CPL	-CPL	-CPL	-CPL	-CPL	-CPL	-CPL	-CPL	-CPL
0.000	-.07447	-.04984	-.01924	-.55296	-.53148	-.55197	-.47735	-.61497	-.68838
.025	.00997	.02287	.05266	.10617	.06199	.07012	.05018	.01039	-.01731
.050	.03460	.05629	.07646	.10004	.07487	.05340	.07012	.03809	.00623
.075	.03453	.07095	.10279	.10986	.09267	.10100	.09393	.04501	.05956
.100	.07036	.09558	.10836	.11170	.11968	.09650	.11194	.08033	.06579
.200	.10848	.10027	.13064	.16079	.15098	.15504	.13767	.15097	.11496
.300	.09499	.12724	.14279	.16141	.16877	.17370	.15633	.16067	.14128
.400	.12900	.14307	.14887	.18718	.20007	.18978	.16469	.16621	.13851
.600	.09675	.10496	.12912	.11599	.12090	.11837	.12352	.11635	.09003
.800	.07709	.07036	.07241	.05646	.03621	.05211	.05661	.05817	.02701
1.000	-.05160	-.01231	-.04962	-.09083	-.38664	-.08170	-.07270	-.03740	-.04432

## P R E S S U R E M E A S U R E M E N T S

OUTER PANEL SWEEP= 40.00000 DEGREES

FUSELAGE OFF

ANGLE OF ATTACK= 1.58465 DEGREES

### S P A N W I S E L O C A T I O N

	2Y/B .05001	2Y/B .14999	2Y/B .25001	2Y/B .40000	2Y/B .45001	2Y/B .50001	2Y/B .60000	2Y/B .70001	2Y/B .90001
X/C	-CPU	-CPU	-CPU	-CPU	-CPU	-CPU	-CPU	-CPU	-CPU
0.000	-.06867	-.05032	.02044	-.49869	-.51540	-.53219	-.42927	-.56382	-.63979
.025	.06038	.08406	.13543	.50364	.48260	.50809	.50613	.45376	.34573
.050	.08051	.10123	.16559	.34463	.32854	.32244	.34719	.34015	.25368
.075	.06690	.15155	.17121	.30936	.29142	.28792	.27163	.28644	.23835
.100	.07814	.13024	.17223	.29822	.28152	.28140	.28531	.29550	.21884
.200	.11070	.14563	.17683	.28028	.33411	.28792	.26903	.29271	.27111
.300	.11840	.17523	.18939	.26605	.28399	.27554	.27098	.28853	.27599
.400	.10893	.14504	.18296	.25801	.26914	.27749	.27163	.25159	.19793
.600	.12906	-.00829	.15792	.18809	.18500	.22147	.17848	.19166	.12824
.800	-.00414	-.00710	.10631	.05445	.05507	.04951	.04560	.03554	-.01533
1.000	-.05446	-.00651	-.03526	-.09528	-.35205	-.06774	-.07556	-.04042	-.04321

	-CPL	-CPL	-CPL	-CPL	-CPL	-CPL	-CPL	-CPL	-CPL
0.000	-.06867	-.05032	.02044	-.49869	-.51540	-.53219	-.42927	-.56382	-.63979
.025	-.02572	.02013	.07964	.01423	-.00309	.00586	-.02801	-.05645	-.08363
.050	.01954	.05091	.05520	.03527	.02289	.00782	.01107	-.03276	-.01812
.075	.04618	.06926	.08075	.05507	.04269	.04234	.03778	-.00697	.00418
.100	.06270	.07696	.09250	.08353	.07115	.07556	.05146	.02439	.01254
.200	.03550	.09709	.10835	.12684	.12622	.12963	.11139	.10872	.09409
.300	.09235	.11349	.11550	.14787	.15159	.16415	.13614	.13730	.11918
.400	.12550	.14149	.12930	.17139	.17572	.17653	.14787	.14148	.12266
.600	.09709	.10419	.11550	.10840	.11199	.11204	.10097	.10106	.08363
.800	.07045	.06571	.07666	.05259	.02722	.05407	.02801	.04739	.01882
1.000	-.05446	-.00651	-.03526	-.09528	-.35205	-.06774	-.07556	-.04042	-.04321

# APPENDIX A

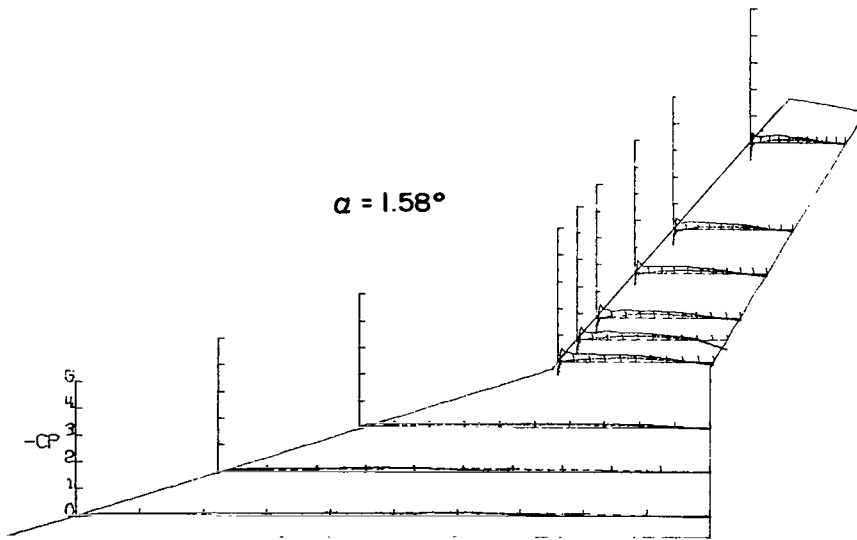
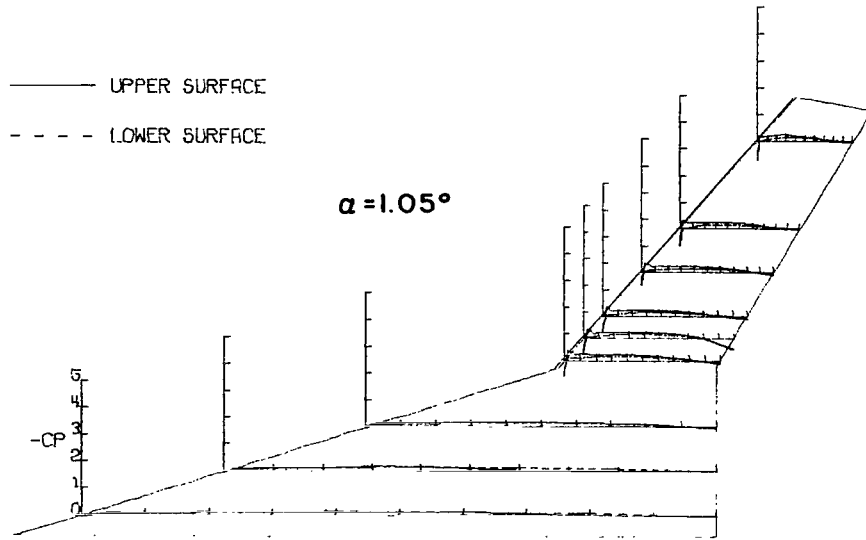

# APPENDIX A

## P R E S S U R E M E A S U R E M E N T S

OUTER PANEL SWEEP= 40.00000 DEGREES

FUSELAGE OFF

ANGLE OF ATTACK= 2.06877 DEGREES

### S P A N W I S E L O C A T I O N

	2Y/B .05001	2Y/B .14999	2Y/B .25001	2Y/B .40000	2Y/B .45001	2Y/B .50001	2Y/B .60000	2Y/B .70001	2Y/B .90001
X/C	- CPU	- CPU	- CPU	- CPU	- CPU	- CPU	- CPU	- CPU	- CPU
0.000	-.05868	-.02430	.03484	-.41233	-.47114	-.47297	-.44698	-.52539	-.56964
.025	.07231	.12269	.16653	.62221	.60797	.60038	.61272	.55988	.45451
.050	.09128	.12032	.19164	.44762	.41109	.42489	.42359	.44116	.31682
.075	.08239	.15173	.19471	.37518	.34856	.34693	.32679	.36880	.30343
.100	.09543	.13099	.19471	.37085	.32565	.32744	.33134	.34703	.26691
.200	.11143	.15588	.19881	.29717	.37270	.32094	.31509	.32736	.30414
.300	.12980	.17603	.19727	.29655	.29779	.29950	.29495	.32033	.30414
.400	.13099	.16122	.19727	.28665	.29098	.28911	.28781	.29711	.21704
.600	.12625	-.00652	.16397	.18202	.19997	.18646	.19101	.19175	.15382
.800	-.00415	-.01897	.10965	.05077	.05820	.03248	.05522	.04285	.00070
1.000	-.05690	-.01304	-.02511	-.08729	-.35599	-.07341	-.07731	-.03301	-.04214

	- CPL	- CPL	- CPL	- CPL	- CPL	- CPL	- CPL	- CPL	- CPL
0.000	-.05868	-.02430	.03484	-.41233	-.47114	-.47297	-.44698	-.52539	-.56964
.025	-.02252	-.00533	.01548	-.05139	-.08544	-.08901	-.09420	-.15312	-.15453
.050	.00711	.02904	.03433	-.02353	-.03900	-.05262	.02888	-.04237	-.08358
.075	.03793	.05334	.05534	.01424	-.00433	-.00260	-.01559	-.03442	-.02248
.100	.04860	.06638	.06764	.02662	.03529	.00975	.00780	-.00421	-.00702
.200	.08239	.07824	.09172	.09287	.09349	.07991	.07471	.07656	.06602
.300	.08416	.10847	.10607	.12566	.12754	.12994	.11434	.11941	.10466
.400	.10491	.12565	.11221	.13868	.15416	.13578	.12994	.12362	.11449
.600	.09306	.10254	.10145	.10649	.09968	.09810	.09485	.10044	.08780
.800	.05631	.06105	.06354	.03653	.02533	.02209	.03768	.04425	.02458
1.000	-.05690	-.01304	-.02511	-.08729	-.35599	-.07341	-.07731	-.03301	-.04214

## P R E S S U R E M E A S U R E M E N T S

OUTER PANEL SWEEP= 40.00000 DEGREES

FUSELAGE OFF

ANGLE OF ATTACK= 2.61405 DEGREES

### S P A N W I S E L O C A T I O N

	2Y/B .05001	2Y/B .14999	2Y/B .25001	2Y/B .40000	2Y/B .45001	2Y/B .50001	2Y/B .60000	2Y/B .70001	2Y/B .90001
X/C	- CPU	- CPU	- CPU	- CPU	- CPU	- CPU	- CPU	- CPU	- CPU
0.000	-.05456	-.00763	.07513	-.31206	-.39328	-.38742	-.43239	-.47823	-.47615
.025	.08273	.14492	.20738	.71450	.71450	.70361	.72482	.68495	.56745
.050	.10796	.14668	.22938	.51786	.48671	.48058	.49407	.48727	.37669
.075	.09388	.17954	.27385	.42870	.40061	.39320	.39449	.40710	.33867
.100	.09270	.16311	.21925	.41710	.37007	.37650	.37843	.38567	.30062
.200	.11793	.16252	.21567	.32671	.39328	.35016	.33474	.35181	.31448
.300	.13964	.18716	.21874	.32610	.32183	.32510	.31482	.34420	.30412
.400	.13553	.16252	.21618	.29313	.30168	.30904	.30582	.29716	.21700
.600	.13729	-.00763	.17990	.20030	.19542	.20688	.18247	.19903	.13960
.800	-.00117	-.00704	.11959	.06168	.05985	.03662	.06296	.04838	.00138
1.000	-.06043	-.01349	-.02249	-.09038	-.34259	-.07774	-.05911	-.03594	-.02626

	- CPL	- CPL	- CPL	- CPL	- CPL	- CPL	- CPL	- CPL	- CPL
0.000	-.05456	-.00763	.07513	-.31206	-.39328	-.38742	-.43239	-.47823	-.47615
.025	-.02758	-.01349	.02606	-.14778	-.17527	-.16769	-.17925	-.22460	-.21078
.050	0.00000	.01584	.04600	-.08000	-.09466	-.11244	-.10987	-.12854	-.14305
.075	.03403	.03344	.06644	-.03420	-.06534	-.04369	-.06296	-.07533	-.06980
.100	.03755	.05104	.07819	-.01466	-.01893	-.03020	-.03469	-.04354	-.04423
.200	.08683	.06395	.09097	.07450	.05618	.06625	.04112	.05736	.02972
.300	.07275	.09974	.10170	.09282	.10321	.09573	.08674	.09339	.08500
.400	.10796	.11441	.10631	.12336	.12519	.12593	.11179	.09952	.09606
.600	.08742	.08683	.10272	.09099	.08183	.08417	.08224	.08846	.07325
.800	.05691	.05104	.07155	.03847	.01649	.02698	.02763	.03663	.03179
1.000	-.06043	-.01349	-.02249	-.09038	-.34259	-.07774	-.05911	-.03594	-.02626



# APPENDIX A

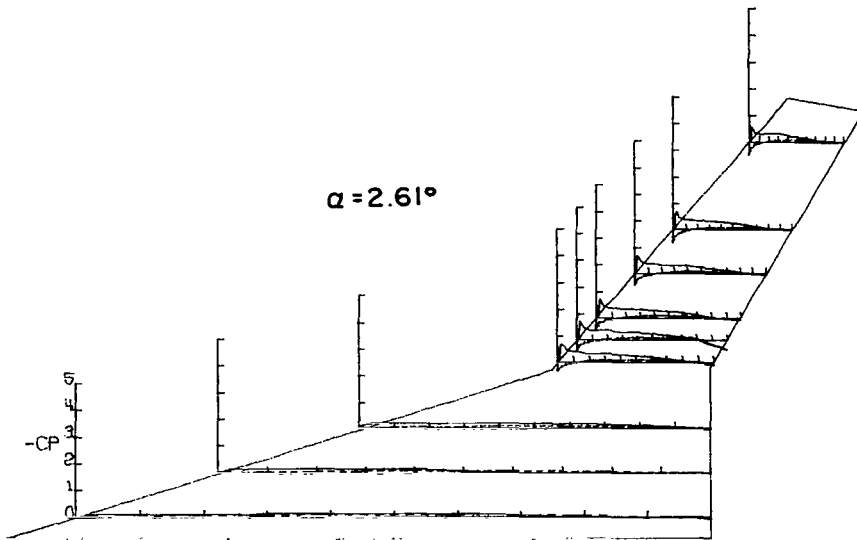
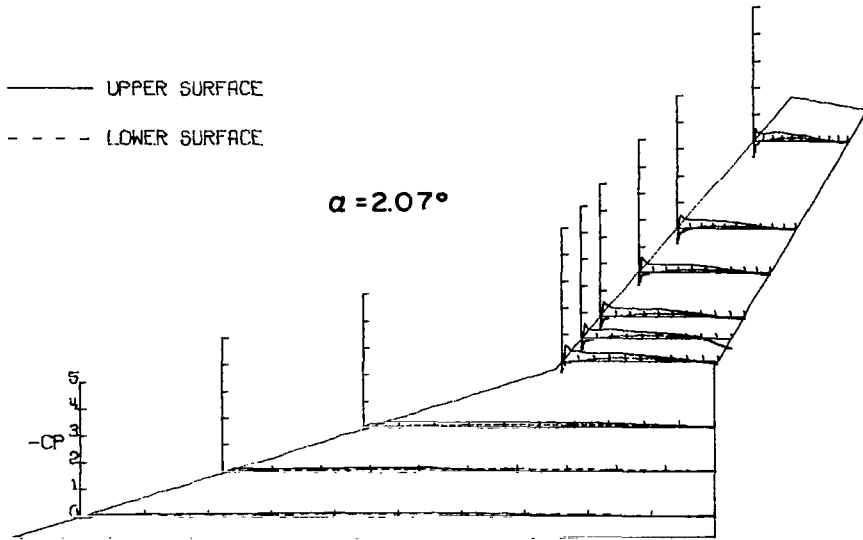

# APPENDIX A

## P R E S S U R E M E A S U R E M E N T S

OUTER PANEL SWEEP= 40.00000 DEGREES

FUSELAGE OFF

ANGLE OF ATTACK= 3.12603 DEGREES

### S P A N W I S E L O C A T I O N

	2Y/B .05001	2Y/B .14999	2Y/B .25001	2Y/B .40000	2Y/B .45001	2Y/B .50001	2Y/B .60000	2Y/B .70001	2Y/B .90001
X/C	- CPU	- CPU	- CPU	- CPU	- CPU	- CPU	- CPU	- CPU	- CPU
0.000	-.04427	.01889	.10093	-.12042	-.26308	-.22522	-.35034	-.41856	-.39976
.025	.10270	.16999	.21461	.86706	.87014	.83425	.85415	.83863	.67494
.050	.10506	.16822	.23143	.59039	.54901	.52686	.57114	.55723	.44021
.075	.09444	.19064	.21308	.48417	.47614	.44402	.45237	.45275	.39981
.100	.10388	.17058	.20798	.46749	.43106	.41387	.44017	.44091	.35105
.200	.11982	.16762	.19269	.35571	.43353	.37408	.36703	.37543	.34827
.300	.13929	.19419	.19320	.34151	.34954	.33751	.32339	.34827	.31762
.400	.14697	.18769	.18708	.32051	.33163	.31826	.31184	.31205	.24654
.600	.15936	-.01003	.15649	.21738	.21306	.20276	.19442	.21381	.14625
.800	-.00767	-.00485	.11062	.06423	.07534	.04492	.06160	.05014	.00488
1.000	-.05430	0.00000	-.04843	-.08152	-.32669	-.07251	-.06096	-.03413	-.02786

	- CPL	- CPL	- CPL	- CPL	- CPL	- CPL	- CPL	- CPL	- CPL
0.000	-.04427	-.01889	-.10093	-.12042	-.26308	-.22522	-.35034	-.41856	-.39976
.025	-.03955	-.01476	-.01325	-.20627	-.22170	-.23677	-.22907	-.26883	-.27510
.050	-.01417	-.00295	-.00102	-.13525	-.14760	-.16490	-.16426	-.18665	-.19013
.075	.02656	.02479	.02549	-.08152	-.09819	-.10266	-.11806	-.12606	-.11770
.100	.03305	.03423	.03721	-.04817	-.04817	-.07379	-.06930	-.08427	-.08984
.200	.07083	.06256	.06117	.04076	.02841	.02053	.01347	.01671	.01393
.300	.07260	.09090	.08054	.07658	.08584	.08021	.06802	.07452	.06895
.400	.08853	.10152	.08921	.10313	.10746	.09304	.08085	.07104	.07800
.600	.08440	.08027	.08156	.07905	.07967	.07187	.07058	.07173	.06825
.800	.05194	.05784	.04588	.02779	.02161	.01925	.02631	.03134	.02577
1.000	-.05430	0.00000	-.04843	-.08152	-.32669	-.07251	-.06096	-.03413	-.02786

## P R E S S U R E M E A S U R E M E N T S

OUTER PANEL SWEEP= 40.00000 DEGREES

FUSELAGE OFF

ANGLE OF ATTACK= 3.71867 DEGREES

### S P A N W I S E L O C A T I O N

	2Y/B .05001	2Y/B .14999	2Y/B .25001	2Y/B .40000	2Y/B .45001	2Y/B .50001	2Y/B .60000	2Y/B .70001	2Y/B .90001
X/C	- CPU	- CPU	- CPU	- CPU	- CPU	- CPU	- CPU	- CPU	- CPU
0.000	-.03848	.05446	.16543	.12996	-.12002	-.03562	-.28039	-.35519	-.28485
.025	.10774	.20246	.27983	1.06903	1.02118	.97727	.99411	.92987	.77176
.050	.11958	.18930	.27829	.67532	.63925	.62043	.68066	.65474	.52937
.075	.10715	.21075	.26798	.53727	.53292	.49796	.52451	.50499	.46668
.100	.10774	.18530	.25819	.53416	.48690	.48631	.49278	.48757	.41862
.200	.13971	.18470	.24118	.40171	.46203	.43515	.38594	.42907	.37613
.300	.14632	.19240	.24015	.36689	.37497	.36716	.35615	.37683	.34270
.400	.16339	.19122	.22778	.34326	.35010	.35291	.34320	.33991	.25142
.600	.15688	-.00770	.19480	.22511	.22884	.21952	.21887	.22077	.15949
.800	-.00651	-.00059	.13244	.07773	.07738	.05549	.06864	.05502	.00139
1.000	-.05979	-.00237	-.04844	-.08830	-.31776	-.07253	-.04533	-.03900	-.02577

	- CPL	- CPL	- CPL	- CPL	- CPL	- CPL	- CPL	- CPL	- CPL
0.000	-.03848	.05446	.16543	.12996	-.12002	-.03562	-.28039	-.35519	-.28485
.025	-.04326	-.03019	-.01546	-.26615	-.28916	-.29010	-.29010	-.33220	-.31967
.050	-.02072	-.01006	-.00155	-.17536	-.18842	-.20139	-.20333	-.22774	-.24306
.075	.01184	.01658	.01546	-.12686	-.14675	-.14505	-.15930	-.17341	-.16436
.100	.02309	.02427	.02422	-.09265	-.09328	-.11008	-.11397	-.13024	-.12954
.200	.06038	.05091	.04587	.00808	.00497	-.00453	-.00648	-.01463	-.01602
.300	.06275	.03762	.06334	.05783	.06654	.06281	.05051	.04248	.05502
.400	.08702	.10182	.08039	.09514	.10323	.09519	.07900	.06756	.06198
.600	.06926	.07518	.06787	.07400	.06840	.06734	.06022	.06268	.05920
.800	.03966	.05506	.02937	.02612	.00871	.02461	.02202	.03134	.01323
1.000	-.05979	-.00237	-.04844	-.01830	-.31776	-.07253	-.04533	-.03900	-.02577

# APPENDIX A

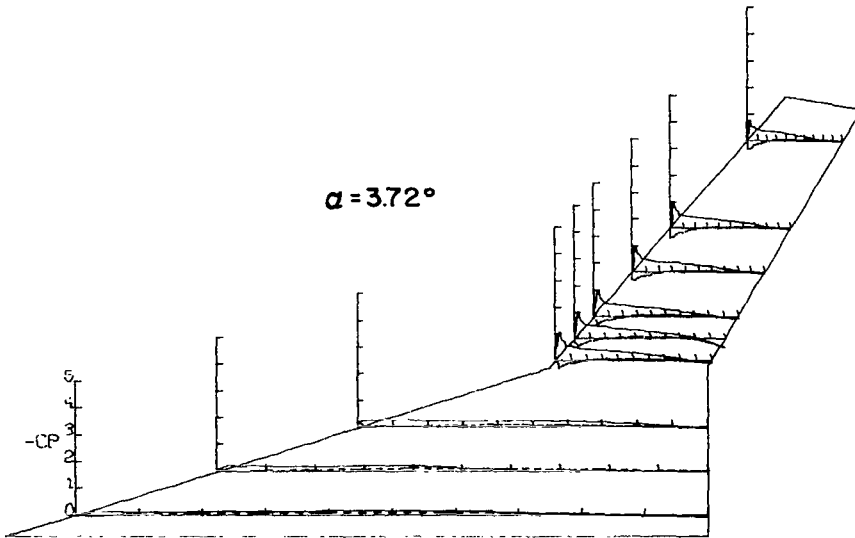
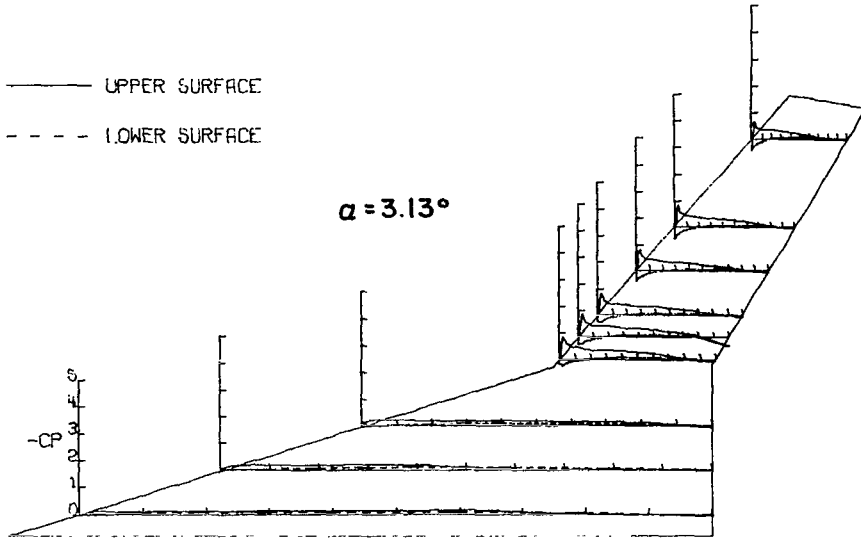

# APPENDIX A

## P R E S S U R E M E A S U R E M E N T S

OUTER PANEL SWEEP= 40.00000 DEGREES

FUSELAGE OFF

ANGLE OF ATTACK= 4.21907 DEGREES

### S P A N W I S E L O C A T I O N

	2Y/B .05001	2Y/B .14999	2Y/B .25001	2Y/B .40000	2Y/B .45001	2Y/B .50001	2Y/B .60000	2Y/B .70001	2Y/B .90001
X/C	-CPU	-CPU	-CPU	-CPU	-CPU	-CPU	-CPU	-CPU	-CPU
0.000	-.02350	.09751	.21045	.39265	.11034	.18782	-.18072	-.17497	-.16390
.025	.12747	.22792	.34682	1.25252	1.19769	1.14836	1.15224	1.09973	.89500
.050	.13452	.21499	.33764	.78776	.71996	.72491	.78881	.72693	.64324
.075	.11748	.23497	.31006	.61949	.61640	.58935	.59774	.60105	.52427
.100	.12571	.20383	.29422	.58558	.55045	.54417	.56095	.54641	.47655
.200	.13099	.20031	.25540	.42100	.50545	.45245	.43437	.44128	.40669
.300	.15155	.20795	.25540	.38957	.41299	.39758	.39565	.40323	.35897
.400	.15097	.19209	.23752	.35628	.36060	.35886	.34853	.34998	.25657
.600	.15567	.00176	.19513	.22930	.23608	.22590	.22267	.22338	.15906
.800	.00059	.00117	.10880	.08260	.07828	.06712	.07552	.05809	.01383
1.000	-.05757	-.00176	-.04648	-.07952	-.29156	-.06648	-.04518	-.02490	-.02075
X/C	-CPL	-CPL	-CPL	-CPL	-CPL	-CPL	-CPL	-CPL	-CPL
0.000	-.02350	.09751	.21045	.39265	.11034	.18782	-.18072	-.17497	-.16390
.025	-.05639	-.03525	-.00868	-.33286	-.33594	-.35305	-.34208	-.38105	-.37068
.050	-.02761	-.01057	-.00562	-.23362	-.23300	-.26011	-.24462	-.27732	-.27040
.075	-.00587	-.00117	.01379	-.17013	-.17752	-.18201	-.18330	-.21715	-.19364
.100	.02467	.01469	.02503	-.11403	-.12698	-.13425	-.13619	-.15699	-.15076
.200	.05346	.04699	.04750	-.00740	-.02157	-.02453	-.03163	-.03804	-.04080
.300	.05580	.06462	.05159	.03329	.03822	.04002	.02065	.01660	.02835
.400	.08283	.09457	.05772	.07212	.07397	.07293	.05680	.04149	.04910
.600	.06638	.06109	.05006	.05979	.05363	.04776	.04970	.05048	.04772
.800	.03642	.04699	.02758	.02219	.00678	.01549	.01936	.02282	.01314
1.000	-.05757	-.00176	-.04648	-.07952	-.29156	-.06648	-.04518	-.02490	-.02075

## P R E S S U R E M E A S U R E M E N T S

OUTER PANEL SWEEP= 40.00000 DEGREES

FUSELAGE OFF

ANGLE OF ATTACK= 4.70246 DEGREES

### S P A N W I S E L O C A T I O N

	2Y/B .05001	2Y/B .14999	2Y/B .25001	2Y/B .40000	2Y/B .45001	2Y/B .50001	2Y/B .60000	2Y/B .70001	2Y/B .90001
X/C	-CPU	-CPU	-CPU	-CPU	-CPU	-CPU	-CPU	-CPU	-CPU
0.000	-.00711	.12676	.33220	.72038	.32688	.54556	-.05239	.10366	.03502
.025	.13920	.24938	.37678	1.33922	1.42697	1.43955	1.29153	1.26998	1.02131
.050	.14335	.22273	.35728	.85424	.82436	.81343	.87041	.83358	.71590
.075	.12084	.23931	.31685	.70481	.66310	.67458	.66672	.64515	.61433
.100	.13032	.21206	.28921	.64691	.58776	.61171	.59272	.62624	.51276
.200	.13861	.20436	.25235	.46137	.53359	.50751	.47149	.48814	.43150
.300	.15460	.21502	.24877	.41467	.42525	.43024	.41845	.43430	.37616
.400	.16467	.20792	.23853	.38167	.39288	.39684	.40470	.38247	.28997
.600	.16408	-.00415	.18069	.24967	.24594	.24688	.23706	.24514	.17160
.800	-.01659	-.01303	.10033	.08530	.07472	.07465	.08579	.06724	.01401
1.000	-.05627	-.00533	-.07166	-.07658	-.28952	-.06025	-.05566	-.01961	-.02101
X/C	-CPL	-CPL	-CPL	-CPL	-CPL	-CPL	-CPL	-CPL	-CPL
0.000	-.00711	.12676	.33220	.72038	.32688	.54556	-.05239	.10366	.03502
.025	-.06812	-.05390	-.03481	-.37793	-.39475	-.39946	-.38636	-.42724	-.40763
.050	-.04739	-.02725	-.03634	-.28267	-.27645	-.29796	-.28159	-.31938	-.30187
.075	-.01777	-.01066	-.01792	-.21356	-.22415	-.21872	-.21676	-.24934	-.22693
.100	.00296	.00829	-.00102	-.16500	-.16624	-.17877	-.18074	-.19961	-.17720
.200	.03673	.02073	.01740	-.03985	-.05604	-.05173	-.06614	-.06724	-.07214
.300	.03317	.05213	.03071	.00374	.01183	.01637	.00065	-.00140	-.00350
.400	.06931	.07582	.04453	.05232	.05666	.05566	.04126	.02591	.03642
.600	.06812	.05687	.04607	.04794	.04109	.03796	.04126	.04342	.04132
.800	.02725	.04265	.00205	.01121	.00374	.01310	.01768	.02381	.01681
1.000	-.05627	-.00533	-.07166	-.07658	-.28952	-.06025	-.05566	-.01961	-.02101

# APPENDIX A

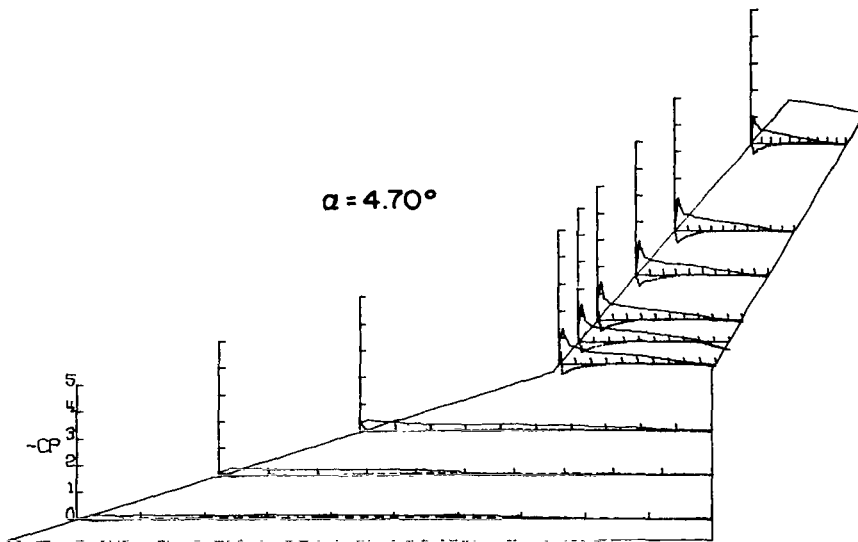
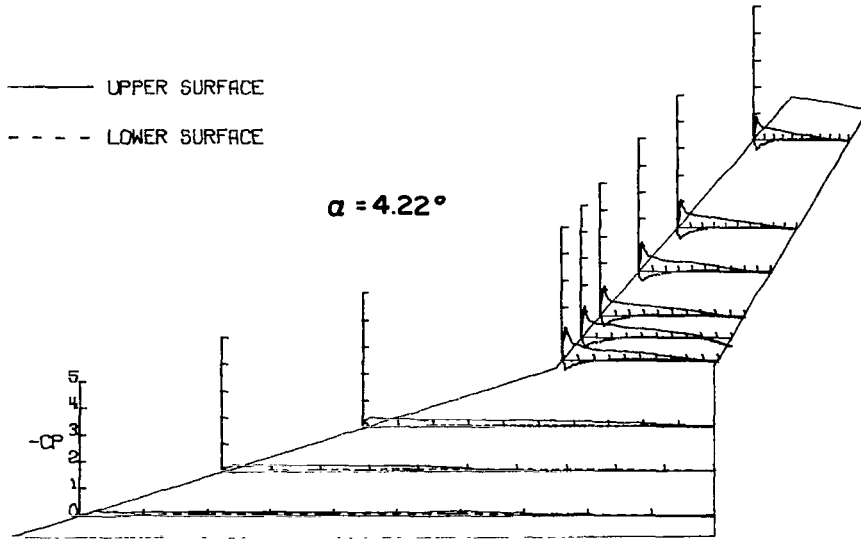

# APPENDIX A

## P R E S S U R E M E A S U R E M E N T S

OUTER PANEL SWEEP= 40.00000 DEGREES

FUSELAGE OFF

ANGLE OF ATTACK= 5.25136 DEGREES

### S P A N W I S E L O C A T I O N

	2Y/B .05001	2Y/B .14999	2Y/B .25001	2Y/B .40000	2Y/B .45001	2Y/B .50001	2Y/B .60000	2Y/B .70001	2Y/B .90001
X/C	- CPU	- CPU	- CPU	- CPU	- CPU	- CPU	- CPU	- CPU	- CPU
0.000	-.00413	.19076	-.40432	1.06005	-.64242	-.77725	-.02792	-.34663	-.09813
.025	-.16044	-.27462	-.44964	1.36531	1.59318	1.35646	1.25646	1.35241	1.15265
.050	-.16034	-.26281	-.39872	-.97089	-.92925	-.90647	-.94413	-.89789	-.80532
.075	-.13347	-.24982	-.35035	-.75393	-.73349	-.72401	-.73504	-.72388	-.71414
.100	-.13524	-.22442	-.37692	-.70065	-.65667	-.66946	-.66037	-.66054	-.62505
.200	-.14469	-.21202	-.26836	-.48445	-.56808	-.52849	-.50771	-.51298	-.46356
.300	-.15947	-.22501	-.26581	-.43489	-.45347	-.44733	-.44214	-.45034	-.39814
.400	-.16477	-.21202	-.24697	-.39028	-.40639	-.40254	-.41357	-.38630	-.30135
.600	-.16241	-.00059	-.19249	-.24842	-.25771	-.24866	-.26165	-.24010	-.17538
.800	-.03650	-.00118	-.11763	-.09416	-.08673	-.07791	-.10323	-.07168	-.02784
1.000	-.07315	-.01063	-.06355	-.05823	-.29178	-.04610	-.05259	-.00557	-.02993

	- CPL	- CPL	- CPL	- CPL	- CPL	- CPL	- CPL	- CPL	- CPL
X/C	- CPU	- CPU	- CPU	- CPU	- CPU	- CPU	- CPU	- CPU	- CPU
0.000	-.00413	.19076	-.40432	1.06005	-.64242	-.77725	-.02792	-.34663	-.09813
.025	-.06752	-.04784	-.01120	-.40267	-.41568	-.42071	-.41098	-.44959	-.45028
.050	-.04961	-.04311	-.03157	-.32276	-.32895	-.33956	-.32722	-.34519	-.34519
.075	-.02067	-.01654	-.01426	-.24284	-.25833	-.25581	-.25321	-.28882	-.25541
.100	-.00472	-.00118	-.00815	-.19514	-.19576	-.19525	-.20516	-.22966	-.21296
.200	-.04252	-.02067	-.02648	-.05823	-.08177	-.07272	-.09284	-.08282	-.09395
.300	-.03166	-.06083	-.02903	-.01487	-.00496	-.00260	-.00714	-.02088	-.00487
.400	-.07264	-.07323	-.05041	-.04832	-.04336	-.05064	-.02922	-.01601	-.02923
.600	-.05906	-.05256	-.04227	-.03717	-.03345	-.02402	-.03116	-.02923	-.03549
.800	-.03603	-.03662	-.00917	-.00867	0.00000	-.01169	-.01428	-.01114	-.02297
1.000	-.05315	-.01063	-.06365	-.05823	-.29178	-.04610	-.05259	-.00557	-.02993

## P R E S S U R E M E A S U R E M E N T S

OUTER PANEL SWEEP= 40.00000 DEGREES

FUSELAGE OFF

ANGLE OF ATTACK= 5.77208 DEGREES

### S P A N W I S E L O C A T I O N

	2Y/B .05001	2Y/B .14999	2Y/B .25001	2Y/B .40000	2Y/B .45001	2Y/B .50001	2Y/B .60000	2Y/B .70001	2Y/B .90001
X/C	- CPU	- CPU	- CPU	- CPU	- CPU	- CPU	- CPU	- CPU	- CPU
0.000	-.03303	-.24834	-.54543	1.51144	-.97584	1.12900	-.19169	-.69723	-.03830
.025	-.16988	-.32267	-.49293	1.61794	1.53188	1.47112	1.84422	1.54978	1.01485
.050	-.16988	-.27311	-.43849	1.04519	1.03343	-.98569	-.91275	1.01624	-.90967
.075	-.15042	-.28019	-.33302	-.83199	-.82393	-.78946	-.71458	-.80032	-.81703
.100	-.15219	-.25660	-.35733	-.75889	-.71180	-.71716	-.66810	-.72718	-.75922
.200	-.15632	-.22179	-.29413	-.53091	-.59286	-.56999	-.52480	-.56350	-.51613
.300	-.16988	-.23890	-.29311	-.46091	-.47825	-.47310	-.45890	-.48479	-.42071
.400	-.16634	-.22238	-.25997	-.40329	-.42312	-.41308	-.41178	-.40469	-.31135
.600	-.14227	-.00059	-.21002	-.25523	-.25895	-.25172	-.25688	-.25420	-.18247
.800	-.00531	-.01003	-.11316	-.08921	-.08549	-.07229	-.09230	-.07313	-.04318
1.000	-.05545	-.01121	-.05556	-.04956	-.27072	-.04324	-.03679	-.00557	-.02020

	- CPL	- CPL	- CPL	- CPL	- CPL	- CPL	- CPL	- CPL	- CPL
X/C	- CPU	- CPU	- CPU	- CPU	- CPU	- CPU	- CPU	- CPU	- CPU
0.000	-.03303	-.24834	-.54543	1.51144	-.97584	1.12900	-.19169	-.69723	-.03830
.025	-.07314	-.04955	-.01682	-.45161	-.45595	-.46923	-.45051	-.44957	-.44364
.050	-.05781	-.04070	-.02355	-.34568	-.35807	-.36596	-.35305	-.38653	-.35449
.075	-.02772	-.02065	-.01937	-.27816	-.29240	-.29173	-.29109	-.31758	-.27022
.100	-.02006	-.00649	-.01478	-.23231	-.22921	-.25107	-.23687	-.26465	-.23052
.200	-.02831	-.00985	-.00612	-.03540	-.10160	-.10972	-.10972	-.11143	-.10586
.300	-.03421	-.03834	-.02549	-.02850	-.02106	-.03034	-.03937	-.04388	-.02020
.400	-.05663	-.05840	-.03313	-.01735	-.02354	-.01614	-.00516	-.00070	-.01393
.600	-.04370	-.03843	-.02549	-.01858	-.01920	-.01097	-.01936	-.02159	-.03900
.800	-.02772	-.01652	-.00510	-.00558	-.01115	-.00710	-.00129	-.01880	-.02507
1.000	-.05545	-.01121	-.05556	-.04956	-.27072	-.04324	-.03679	-.00557	-.02020

# APPENDIX A

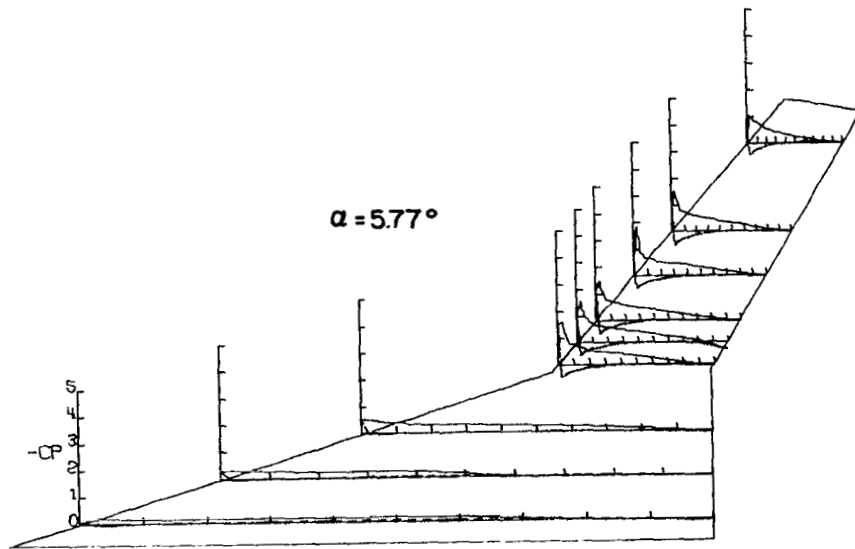
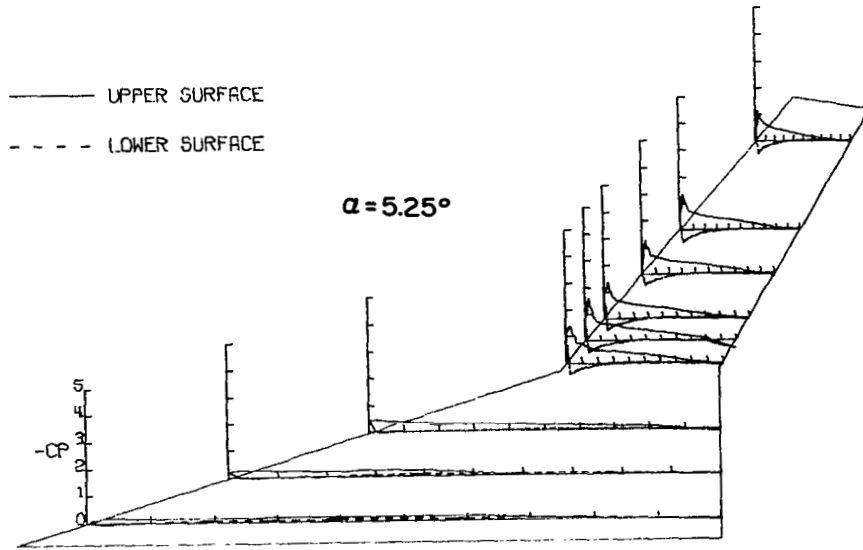

# APPENDIX A

## P R E S S U R E M E A S U R E M E N T S

INTEGRAL PANEL SWEEP= 40.0000 DEGREES

FUSELAGE OFF

ANGLE OF ATTACK= 6.29020 DEGREES

### S P A N W I S E L O C A T I O N

	2Y/B .05001	2Y/B .14999	2Y/B .25001	2Y/B .40000	2Y/B .45001	2Y/B .50001	2Y/B .60000	2Y/B .70001	2Y/B .90001
X/C	-CPU	-CPU	-CPU	-CPU	-CPU	-CPU	-CPU	-CPU	-CPU
0.000	.04090	.29280	.65246	1.93187	1.27925	1.49648	.37881	1.06312	.02864
.025	.14559	.35978	.67308	1.78884	1.68481	1.73098	2.20651	1.72321	.92901
.050	.18374	.30525	.49934	1.15479	1.11268	1.11893	1.08758	1.10573	.87173
.075	.15165	.30821	.42814	.99571	.90075	.89880	.80540	.88990	.82493
.100	.16655	.26316	.39383	.81526	.76158	.79103	.71917	.79839	.77953
.200	.16595	.24775	.34108	.56808	.63870	.61335	.58592	.59722	.57347
.300	.17663	.23945	.32623	.44631	.49374	.51009	.48919	.51270	.44704
.400	.17485	.23353	.29857	.41630	.44728	.43694	.45261	.42050	.33389
.600	.18374	-.00237	.22022	.26638	.26143	.27235	.27170	.25881	.18578
.800	-.00474	-.00356	.12291	.07664	.08859	.08425	.10581	.07892	.05797
1.000	-.05275	-.01067	-.05992	-.04522	-.27692	-.03788	-.03984	.00210	.00140

	-CPL	-CPL	-CPL	-CPL	-CPL	-CPL	-CPL	-CPL	-CPL
0.000	.04090	.29280	.65246	1.93187	1.27925	1.49648	.37881	1.06312	.02864
.025	-.08002	-.05334	.00717	-.46710	-.50303	-.49049	-.49180	-.50565	-.46026
.050	-.06461	-.04564	-.03329	-.33223	-.39462	-.39971	-.38795	-.41695	-.37086
.075	-.02364	-.02312	-.01792	-.30355	-.32586	-.32460	-.31807	-.34781	-.30172
.100	-.01541	-.01423	-.01639	-.25399	-.25709	-.26908	-.26908	-.29054	-.25422
.200	.01778	-.00563	-.00796	-.11647	-.12514	-.12671	-.12475	-.14457	-.11384
.300	.02371	.02964	.01844	-.05266	-.05390	-.04311	-.06139	-.06076	-.03771
.400	.05394	.05157	.02663	.00434	0.00000	.00849	-.01567	-.01956	-.00279
.600	.03675	.03912	.01690	.01115	.01053	.01110	.01633	.00978	.03213
.800	.02608	.02252	.00358	0.00000	-.01549	.00914	.00196	.01467	.01746
1.000	-.05275	-.01067	-.05992	-.04522	-.27692	-.03788	-.03984	.00210	.00140

## P R E S S U R E M E A S U R E M E N T S

INTEGRAL PANEL SWEEP= 40.0000 DEGREES

FUSELAGE OFF

ANGLE OF ATTACK= 7.35577 DEGREES

### S P A N W I S E L O C A T I O N

	2Y/B .05001	2Y/B .14999	2Y/B .25001	2Y/B .40000	2Y/B .45001	2Y/B .50001	2Y/B .60000	2Y/B .70001	2Y/B .90001
X/C	-CPU	-CPU	-CPU	-CPU	-CPU	-CPU	-CPU	-CPU	-CPU
0.000	.03162	.43136	.91385	2.77888	2.21689	2.29297	.67245	1.83972	.05479
.025	.21308	.43140	.66738	2.06772	2.05432	1.98290	2.44992	1.91712	.86986
.050	.23192	.35774	.57103	1.27202	1.29689	1.25303	1.82787	1.25685	.83082
.075	.16033	.33342	.49141	1.02107	1.02716	1.00868	1.08779	1.00753	.85343
.100	.17274	.30931	.43401	.93219	.89792	.88299	.86513	.88493	.81781
.200	.17560	.25737	.34435	.61831	.69263	.66224	.64119	.64726	.64932
.300	.14391	.26729	.32456	.51171	.54399	.53656	.52635	.53973	.48493
.400	.14200	.24569	.30123	.44043	.46541	.45806	.45739	.44521	.33973
.600	.13359	-.00525	.23531	.28327	.27352	.27813	.27686	.26709	.20408
.800	-.00917	-.01050	.12577	.11574	.09199	.08293	.10781	.08834	.07944
1.000	-.05711	-.01109	-.06745	-.02680	-.25890	-.02424	-.02871	.01844	.04041

	-CPL	-CPL	-CPL	-CPL	-CPL	-CPL	-CPL	-CPL	-CPL
0.000	.03162	.43136	.91385	2.77888	2.21689	2.29297	.67245	1.83972	.05479
.025	-.04777	-.04727	.02536	-.43917	-.52450	-.51799	-.50778	-.53349	-.47734
.050	-.04757	-.05773	-.12384	-.41850	-.44409	-.43697	-.43570	-.45542	-.39584
.075	-.00980	-.04377	-.03135	-.35819	-.36611	-.37701	-.35787	-.39516	-.32393
.100	-.03211	-.02860	-.03347	-.30732	-.30885	-.32406	-.30684	-.33705	-.27805
.200	.00525	-.00759	-.01876	-.15730	-.16630	-.17032	-.17479	-.19107	-.14382
.300	.01175	.02043	.01065	-.00777	-.07615	-.04421	-.08484	-.09999	-.05958
.400	.02233	.03385	.00051	-.02619	-.01949	-.03062	-.03891	-.05821	-.01301
.600	.02635	.00992	-.00335	-.00244	-.00305	-.00510	-.00957	-.00890	.01712
.800	.02332	.01109	-.01876	-.01279	-.01888	-.00319	.00093	0.00000	.02123
1.000	-.05711	-.01109	-.06745	-.02680	-.25890	-.02424	-.02871	.01644	.04041



# APPENDIX A

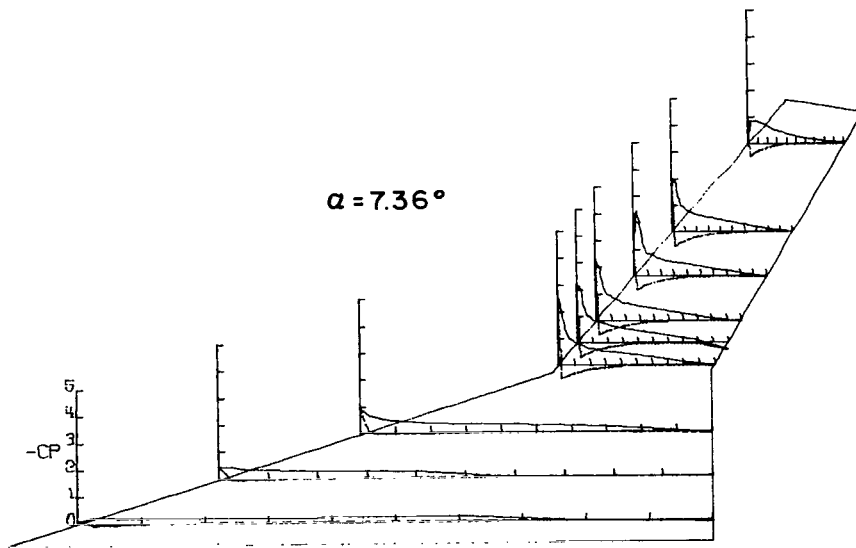
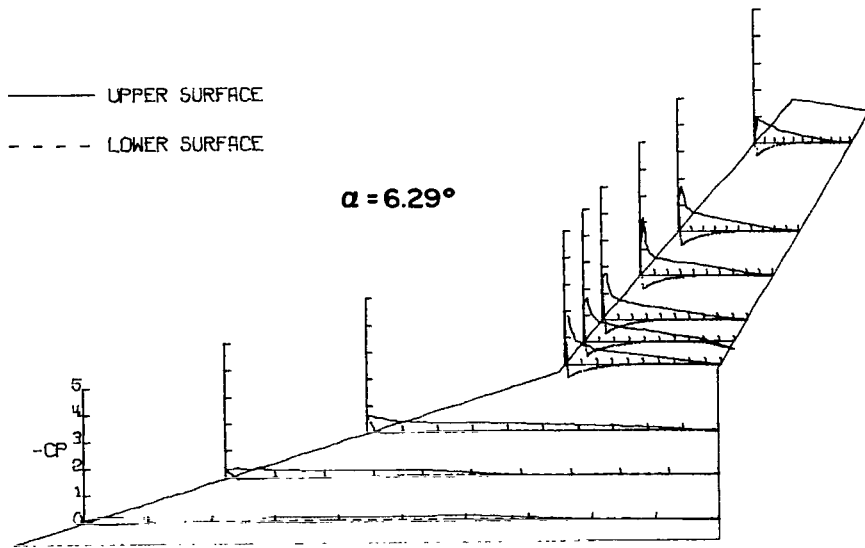

# APPENDIX A

## P R E S S U R E M E A S U R E M E N T S

OUTER PANEL SWEEP= 40.0000 DEGREES

FUSELAGE OFF

ANGLE OF ATTACK= 8.37406 DEGREES

### S P A N W I S E L O C A T I O N

	2Y/B .05001	2Y/B .14999	2Y/B .25001	2Y/B .40000	2Y/B .45001	2Y/B .50001	2Y/B .60000	2Y/B .70001	2Y/B .90001
X/C	- CPU	- CPU	- CPU	- CPU	- CPU	- CPU	- CPU	- CPU	- CPU
0.000	.15065	.60142	1.18047	3.77871	3.19751	3.20135	1.03259	2.27118	.07934
.025	.25657	.51020	.81941	2.35938	2.35814	2.36681	2.63587	2.01852	.79697
.050	.23715	.42370	.66936	1.49901	1.49468	1.51794	2.25932	1.50206	.82133
.075	.19949	.37672	.56591	1.20131	1.18092	1.19871	1.61696	1.33014	.83038
.100	.19431	.35778	.49677	1.04875	1.02651	1.04366	1.12054	1.17770	.82342
.200	.18596	.28603	.38052	.70446	.75822	.74724	.68405	.76147	.72180
.300	.19831	.28894	.35286	.56975	.58705	.59219	.58893	.58398	.53039
.400	.19595	.26659	.32316	.43323	.49003	.50092	.50027	.48305	.42668
.600	.20949	-.00942	.25197	.30650	.29414	.28596	.28987	.29369	.26237
.800	-.01236	-.02295	.12650	.13348	.11247	.08729	.11921	.10509	.11344
1.000	-.06414	-.00118	-.06248	-.00680	-.26077	.00912	.00391	.03410	.07377

	- CPL	- CPL	- CPL	- CPL	- CPL	- CPL	- CPL	- CPL	- CPL
X/C	- CPL	- CPL	- CPL	- CPL	- CPL	- CPL	- CPL	- CPL	- CPL
0.000	.15065	.60142	1.18047	3.77871	3.19751	3.20135	1.03259	2.27118	.07934
.025	-.10004	-.03707	.05582	-.51413	-.55368	-.54782	-.54978	-.54772	-.50178
.050	-.09239	-.06826	-.01895	-.47273	-.49621	-.49180	-.49441	-.49343	-.43567
.075	-.06297	-.06120	-.02970	-.40599	-.43318	-.42471	-.42992	-.43080	-.35911
.100	-.04767	-.04414	-.03995	-.35779	-.37139	-.37260	-.36022	-.37929	-.32014
.200	-.01353	-.03354	-.04291	-.21134	-.22061	-.22473	-.22082	-.23732	-.17260
.300	-.01765	.00530	-.03380	-.13286	-.11617	-.12051	-.12246	-.13989	-.08421
.400	.01824	.02295	-.02253	-.06488	-.05438	-.06188	-.06644	-.08212	-.03967
.600	-.00177	.01059	-.03636	-.02904	-.02595	-.03192	-.01954	-.02784	.01601
.800	-.01059	-.00235	-.04199	-.02904	-.02781	-.00847	-.01173	-.00139	-.02714
1.000	-.06414	-.00118	-.06248	-.00680	-.26077	.00912	.00391	.03410	.07377

## P R E S S U R E M E A S U R E M E N T S

OUTER PANEL SWEEP= 40.0000 DEGREES

FUSELAGE OFF

ANGLE OF ATTACK= 9.42907 DEGREES

### S P A N W I S E L O C A T I O N

	2Y/B .05001	2Y/B .14999	2Y/B .25001	2Y/B .40000	2Y/B .45001	2Y/B .50001	2Y/B .60000	2Y/B .70001	2Y/B .90001
X/C	- CPU	- CPU	- CPU	- CPU	- CPU	- CPU	- CPU	- CPU	- CPU
0.000	.21631	.40770	1.54330	4.51403	2.06531	3.25260	.70125	1.88579	.09594
.025	.29600	.59260	.96263	2.75708	1.85578	1.95366	1.57354	1.51047	.78945
.050	.26664	.47935	.78094	1.97274	1.79448	1.63121	1.58206	1.11186	.80356
.075	.22529	.43261	.63229	1.55117	1.67564	1.40249	1.50407	.97993	.79227
.100	.21751	.37949	.56106	1.29723	1.44922	1.24651	1.34875	1.08717	.74924
.200	.20617	.32116	.43450	.81853	.90113	.85395	1.36317	.76970	.66176
.300	.21451	.31096	.40054	.62453	.69712	.66192	1.16459	.64130	.51431
.400	.22350	.29180	.36905	.52691	.53880	.54658	.82445	.51713	.49032
.600	.21571	-.00479	.26995	.36043	.33667	.33354	.37417	.38167	.49385
.800	-.00300	.00300	.14814	.15770	.14956	.14744	.12713	.22996	.32312
1.000	-.06291	-.00339	-.06452	.00125	-.23592	.03670	-.01966	.14390	.20245

	- CPL	- CPL	- CPL	- CPL	- CPL	- CPL	- CPL	- CPL	- CPL
X/C	- CPL	- CPL	- CPL	- CPL	- CPL	- CPL	- CPL	- CPL	- CPL
0.000	.21631	.40770	1.54330	4.51403	2.06531	3.25260	.70125	1.88579	.09594
.025	-.11984	-.01917	.09962	-.53692	-.54318	-.56813	-.55372	-.53822	-.51706
.050	-.13785	-.06471	-.00103	-.51752	-.51064	-.52292	-.51440	-.48461	-.45428
.075	-.08149	-.16651	-.03923	-.45933	-.45495	-.46656	-.43970	-.42818	-.37528
.100	-.06791	-.06172	-.04749	-.33737	-.40426	-.41283	-.39383	-.37387	-.32308
.200	-.02696	-.04354	-.05626	-.23717	-.24906	-.25425	-.23852	-.24337	-.18975
.300	-.02337	-.02037	-.04955	-.16083	-.15457	-.15072	-.14351	-.13755	-.08676
.400	.01378	.00180	-.04749	-.09011	-.08636	-.08781	-.08912	-.09170	-.03739
.600	-.00339	-.01079	-.05213	-.04819	-.04005	-.04718	-.03276	-.02610	-.01693
.800	-.03653	-.01977	-.04078	-.02816	-.03442	-.01048	-.00786	.01764	.04303
1.000	-.06291	-.00339	-.06452	.00125	-.23592	.03670	-.01966	.14390	.20245

APPENDIX A

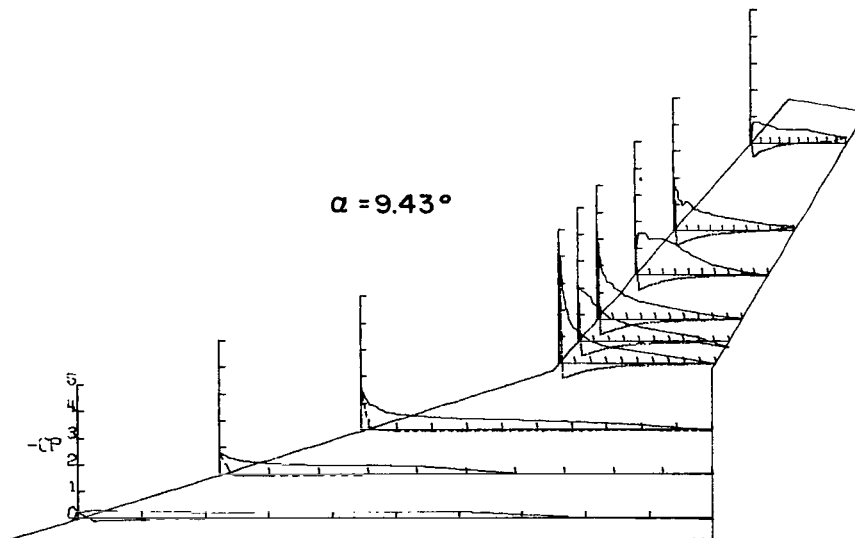
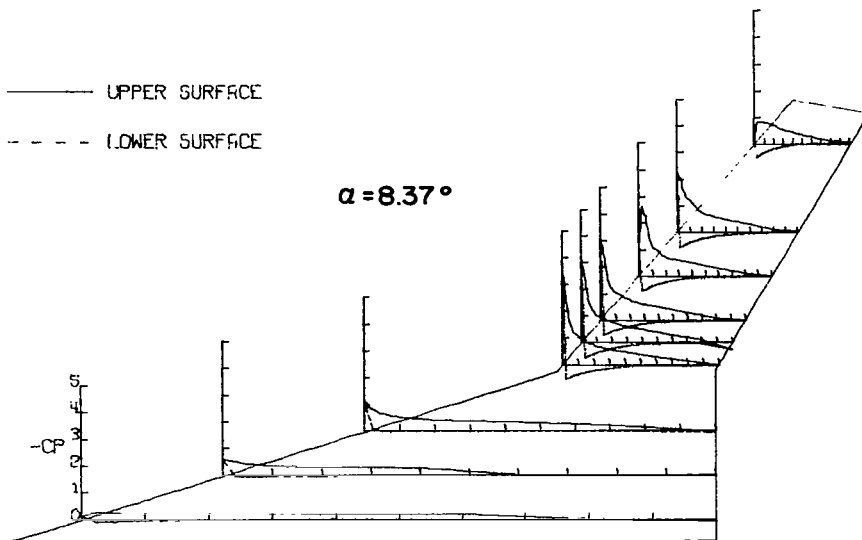

# APPENDIX A

## P R E S S U R E M E A S U R E M E N T S

OUTER PANEL SWEEP= 40.0000 DEGREES

FUSELAGE OFF

ANGLE OF ATTACK= 10.47229 DEGREES

### S P A N W I S E L O C A T I O N

	2Y/B .05001	2Y/B .14999	2Y/B .25001	2Y/B .40000	2Y/B .45001	2Y/B .50001	2Y/B .60000	2Y/B .70001	2Y/B .90001
X/C	- CPU	- CPU	- CPU	- CPU	- CPU	- CPU	- CPU	- CPU	- CPU
0.000	.28917	.96322	1.90309	4.10497	2.52065	3.46262	.98307	1.51450	.14308
.025	.33133	.68666	1.10007	3.49639	1.52177	1.16400	1.85052	1.76914	.77654
.050	.28086	.52965	.84605	2.65263	1.78572	1.57683	1.68199	1.29845	.78356
.075	.24286	.48274	.70009	2.27672	1.44547	1.42594	1.40830	.99681	.78777
.100	.22979	.41624	.62429	2.07657	1.31787	1.01834	1.39916	1.06555	.77514
.200	.21851	.33845	.48909	1.07394	.97511	.99091	1.51869	.77233	.74077
.300	.23157	.32658	.45170	.75970	.73905	.79625	1.18425	.64817	.69587
.400	.22326	.29155	.38615	.61765	.61389	.58265	.87725	.55698	.66851
.600	.22623	-.00534	.29397	.37359	.40989	.36444	.44151	.39003	.57662
.800	-.00297	-.00416	.17874	.17209	.23029	.22010	.20573	.28687	.38722
1.000	-.06888	-.00950	-.05173	.00626	-.23154	.10254	.05486	.24619	.29459

	- CPL	- CPL	- CPL	- CPL	- CPL	- CPL	- CPL	- CPL	- CPL
0.000	.28917	.96322	1.90309	4.10497	2.52065	3.46262	.98307	1.51450	.14308
.025	-.12469	.00238	.16491	-.55069	-.53755	-.55254	-.57213	-.54288	-.54569
.050	-.12648	-.06888	.01639	-.54944	-.52816	-.54927	-.52903	-.49378	-.48186
.075	-.09857	-.08254	-.03226	-.49625	-.48436	-.46306	-.46894	-.46573	-.41172
.100	-.09085	-.06591	-.05531	-.44431	-.42178	-.41930	-.41342	-.41102	-.34859
.200	-.05166	-.06947	-.07989	-.28473	-.27159	-.29194	-.25929	-.26022	-.20340
.300	-.04513	-.03325	-.07324	-.18398	-.17209	-.18091	-.16067	-.15992	-.10311
.400	-.01366	-.01247	-.07375	-.10638	-.09950	-.09797	-.09393	-.10872	-.05401
.600	-.02138	-.03385	-.06658	-.05945	-.04944	-.04966	-.03266	-.02174	.01964
.800	-.02731	-.01900	-.06248	-.03192	-.02628	.00131	.01110	.03367	.05611
1.000	-.06888	-.00950	-.05173	.00626	-.23154	.10254	.05486	.24619	.29459

## P R E S S U R E M E A S U R E M E N T S

OUTER PANEL SWEEP= 40.0000 DEGREES

FUSELAGE OFF

ANGLE OF ATTACK= 11.52776 DEGREES

### S P A N W I S E L O C A T I O N

	2Y/B .05001	2Y/B .14999	2Y/B .25001	2Y/B .40000	2Y/B .45001	2Y/B .50001	2Y/B .60000	2Y/B .70001	2Y/B .90001
X/C	- CPU	- CPU	- CPU	- CPU	- CPU	- CPU	- CPU	- CPU	- CPU
0.000	.38084	1.20965	2.36719	3.70887	2.48465	2.35403	1.35336	1.48996	-.04425
.025	.37549	.77556	1.29545	1.83727	1.80231	1.83381	1.84294	1.46327	.51422
.050	.31668	.60246	.97814	1.54448	1.73114	1.48178	1.71647	1.29186	.59992
.075	.25845	.50739	.77912	1.47456	1.57944	1.50460	1.73798	1.23637	.50228
.100	.24776	.44976	.69889	1.34970	1.42462	1.34162	1.74972	1.12327	.50157
.200	.23171	.37431	.61044	1.19738	1.10935	.87877	1.76993	.91885	.52967
.300	.24419	.35114	.48753	1.13245	.75639	.64408	1.16300	.88443	.44186
.400	.23766	.32678	.38622	.87506	.64708	.50973	.53000	.81348	.40814
.600	.23587	-.00059	.30856	.54527	.45720	.35916	.23987	.72426	.38004
.800	-.00891	.00475	.17794	.29481	.30753	.22423	.18316	.40393	.32244
1.000	-.07724	.00059	-.05246	.09431	-.20924	.17860	.07105	.24724	.30062

	- CPL	- CPL	- CPL	- CPL	- CPL	- CPL	- CPL	- CPL	- CPL
0.000	.38084	1.20965	2.36719	3.70887	2.48465	2.35403	1.35336	1.48996	-.04425
.025	-.13606	.03802	.24274	-.48094	-.53778	-.54688	-.56709	-.57947	-.52750
.050	-.13725	-.06001	.05606	-.52778	-.54028	-.55079	-.55144	-.53312	-.46007
.075	-.11705	-.07427	-.01234	-.48344	-.50093	-.49669	-.48496	-.48465	-.38491
.100	-.10813	-.08734	-.05348	-.45471	-.46033	-.46931	-.45041	-.43267	-.33996
.200	-.05941	-.08377	-.08074	-.29231	-.31292	-.30114	-.30245	-.27183	-.19807
.300	-.05288	-.05941	-.08383	-.20174	-.20299	-.18381	-.19381	-.16647	-.08920
.400	-.03684	-.04575	-.09463	-.12929	-.13179	-.12124	-.12254	-.11238	-.02669
.600	-.04931	-.04694	-.09257	-.06308	-.06371	-.05280	-.04172	-.02388	.06602
.800	-.04813	-.04159	-.07046	-.03248	-.01936	.01043	.00782	.02739	.11098
1.000	-.07724	.00059	-.05246	.09431	-.20924	.17860	.07105	.24724	.30062

# APPENDIX A

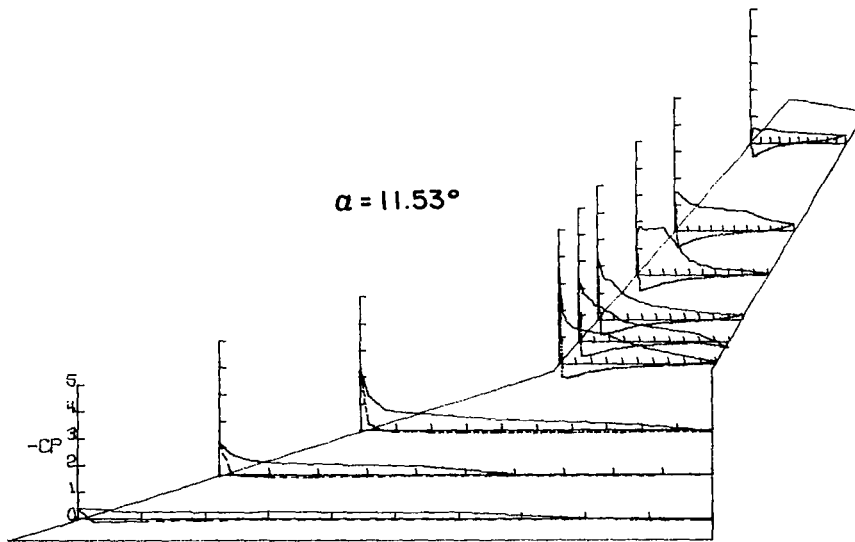
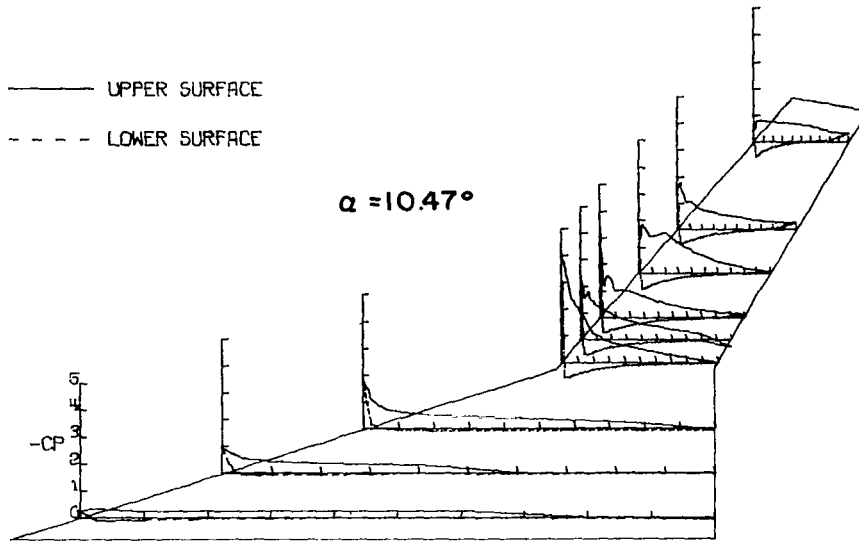

# APPENDIX A

## P R E S S U R E M E A S U R E M E N T S

OUTER PANEL SWEEP= 40.0000 DEGREES

FUSELAGE OFF

ANGLE OF ATTACK= 12.55527 DEGREES

### S P A N W I S E L O C A T I O N

	2Y/B .05001	2Y/B .14999	2Y/B .25001	2Y/B .40000	2Y/B .45001	2Y/B .50001	2Y/B .60000	2Y/B .70001	2Y/B .90001
X/C	-CPU	-CPU	-CPU	-CPU	-CPU	-CPU	-CPU	-CPU	-CPU
0.000	.46216	1.51259	2.78206	4.06885	2.46747	2.28955	1.38438	1.59781	-0.04342
.025	.41988	.88755	1.43697	1.91632	1.77869	1.43697	1.87527	1.36175	.49735
.050	.35377	.66942	1.02973	1.59022	1.65469	1.39412	1.82398	1.24197	.46863
.075	.28445	.58128	.83720	1.39121	1.66213	1.22334	1.79216	1.16351	.47423
.100	.27158	.49373	.79642	1.41477	1.61006	1.14412	1.85969	1.03602	.41959
.200	.25967	.41571	.84597	1.51210	1.17670	.86491	1.92397	1.05003	.46022
.300	.26086	.38950	.38608	1.19654	.88328	.64414	.86491	.97298	.40769
.400	.25312	.35437	.39589	1.04650	.79644	.54934	.37462	.97298	.42870
.600	.25193	.00119	.31950	.68789	.88182	.37267	.23373	.85320	.38177
.800	-.00357	.00179	.17188	.37961	.40814	.29801	.25710	.53868	.32083
1.000	-.07206	-.00060	-.04800	.15321	-.20035	.25516	.12660	.21082	.35025

	-CPL	-CPL	-CPL	-CPL	-CPL	-CPL	-CPL	-CPL	-CPL
X/C	-CPL	-CPL	-CPL	-CPL	-CPL	-CPL	-CPL	-CPL	-CPL
0.000	.46216	1.51259	2.78206	4.06885	2.46747	2.28955	1.38438	1.59781	-0.04342
.025	-.13281	.07564	.34634	-.45342	-.53158	-.54277	-.55641	-.58343	-.54351
.050	-.14691	-.05122	.10530	-.53902	-.56011	-.56810	-.56485	-.55892	-.47697
.075	-.13758	-.08100	.00568	-.50677	-.52724	-.52330	-.50901	-.51129	-.40133
.100	-.11554	-.08695	-.03510	-.47017	-.48444	-.48629	-.46551	-.45666	-.35090
.200	-.07742	-.09231	-.09084	-.32006	-.33495	-.32463	-.32852	-.30327	-.20942
.300	-.04100	-.08398	-.09652	-.23509	-.22888	-.21425	-.21620	-.18280	-.10856
.400	-.05062	-.05658	-.09652	-.16127	-.15383	-.14933	-.14284	-.12747	-.03992
.600	-.05658	-.06670	-.09704	-.08126	-.07505	-.06428	-.04545	-.03712	.05603
.800	-.05837	-.03514	-.07587	-.03598	-.00496	.02532	.02337	.02591	.12887
1.000	-.07206	-.00060	-.04800	.15321	-.20035	.25516	.12660	.21082	.35025

## P R E S S U R E M E A S U R E M E N T S

OUTER PANEL SWEEP= 40.0000 DEGREES

FUSELAGE OFF

ANGLE OF ATTACK= 13.59117 DEGREES

### S P A N W I S E L O C A T I O N

	2Y/B .05001	2Y/B .14999	2Y/B .25001	2Y/B .40000	2Y/B .45001	2Y/B .50001	2Y/B .60000	2Y/B .70001	2Y/B .90001
X/C	-CPU	-CPU	-CPU	-CPU	-CPU	-CPU	-CPU	-CPU	-CPU
0.000	.54019	1.75677	3.20530	3.73501	2.62789	2.12921	.97184	.78468	-1.13826
.025	.45132	.99972	1.46681	1.83589	1.72629	1.38203	1.23184	.76289	.30992
.050	.36303	.73499	.96638	1.48894	1.79350	1.29684	1.20028	.66889	.26221
.075	.29856	.62499	.91045	1.36905	1.79532	1.40096	1.06776	.62666	.28332
.100	.28752	.53264	.93392	1.32787	1.75536	1.37067	1.13655	.63619	.29354
.200	.27184	.47978	1.39139	1.21283	1.31516	.98383	1.16242	.69273	.26970
.300	.27242	.40020	.47046	1.23947	1.01422	.83868	1.12645	.70772	.26698
.400	.25732	.37407	.42801	1.30910	1.00090	.81092	.93082	.55991	.25131
.600	.26196	.00349	.30715	.88508	.74938	.63674	.72762	.51767	.26630
.800	-.00349	-.00697	.16930	.53250	.57370	.53325	.44926	.52789	.22407
1.000	-.07609	.00813	-.03696	.20234	-.16599	.39878	.34262	.49043	.25949

	-CPL	-CPL	-CPL	-CPL	-CPL	-CPL	-CPL	-CPL	-CPL
X/C	-CPL	-CPL	-CPL	-CPL	-CPL	-CPL	-CPL	-CPL	-CPL
0.000	.54019	1.75677	3.20530	3.73501	2.62789	2.12921	.97184	.78468	-1.13826
.025	-.13069	.11965	.42701	-.41195	-.48889	-.52687	-.54959	-.56392	-.48900
.050	-.16206	-.03834	.16731	-.51251	-.54947	-.56284	-.54517	-.51761	-.43316
.075	-.14115	-.08132	.04794	-.50282	-.52705	-.52182	-.49595	-.47402	-.37186
.100	-.13243	-.10223	-.01348	-.46647	-.48525	-.48586	-.45557	-.42566	-.32487
.200	-.10223	-.11210	-.09539	-.33804	-.34652	-.34199	-.30540	-.27583	-.18661
.300	-.09816	-.09584	-.11237	-.24596	-.24293	-.22084	-.19371	-.16073	-.08513
.400	-.07551	-.08829	-.11167	-.16363	-.16357	-.14891	-.12872	-.08786	-.03269
.600	-.04248	-.07958	-.10538	-.09451	-.07027	-.05426	-.00189	.02179	.07151
.800	-.07086	-.06796	-.07691	-.04301	-.00242	.04922	.10096	.13689	.12327
1.000	-.07609	.00813	-.03696	.20234	-.16599	.39878	.34262	.49043	.25949

# APPENDIX A

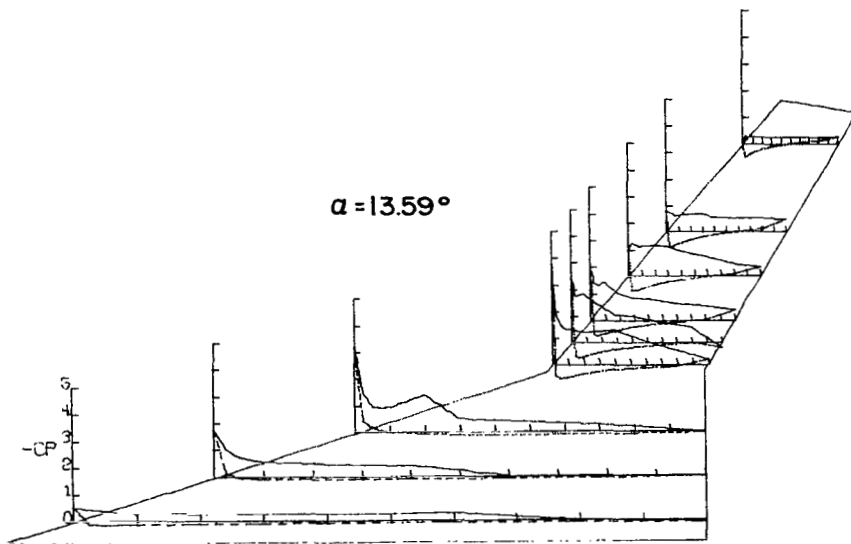
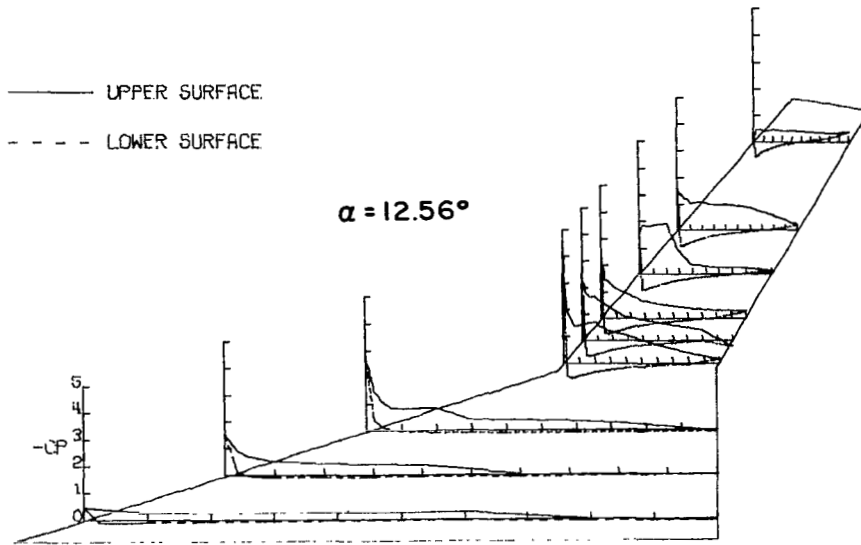

# APPENDIX A

## P R E S S U R E M E A S U R E M E N T S

OUTER PANEL SWEEP= 40.0000 DEGREES

FUSELAGE OFF

ANGLE OF ATTACK= 14.60549 DEGREES

### S P A N W I S E L O C A T I O N

	2Y/B .05001	2Y/B .14999	2Y/B .25001	2Y/B .40000	2Y/B .45001	2Y/B .50001	2Y/B .60000	2Y/B .70001	2Y/B .90001
X/C	-CPU	-CPU	-CPU	-CPU	-CPU	-CPU	-CPU	-CPU	-CPU
0.000	.67152	2.02123	3.71484	3.92687	2.66010	2.19583	.72999	.57178	-.16494
.025	.50941	1.09695	1.44356	2.02113	1.85549	1.55367	.88159	.44387	.26209
.050	.40646	.78945	1.07000	1.70288	1.71095	1.37020	.85816	.50188	.25999
.075	.33783	.66737	1.07254	1.56827	1.90326	1.63955	.82238	.51377	.26209
.100	.32126	.60170	1.11967	1.48390	2.01678	1.53806	.84840	.49280	.26489
.200	.30056	.57389	1.66811	1.31082	1.41380	1.44112	.90110	.44177	.26209
.300	.29878	.38871	.96964	1.29593	1.05337	1.13207	.87183	.43478	.26209
.400	.28754	.39522	.40195	1.67807	1.15449	1.13923	.87963	.46344	.26139
.600	.29819	-.00118	.32186	1.19543	.99816	.88809	.77228	.45086	.25510
.800	.00296	-.00769	.16828	.66225	.77087	.75276	.69095	.43688	.25301
1.000	-.08046	.00355	-.08211	.24454	-.15455	.64411	.46123	.48441	.30193

	-CPL	-CPL	-CPL	-CPL	-CPL	-CPL	-CPL	-CPL	-CPL
X/C	-CPL	-CPL	-CPL	-CPL	-CPL	-CPL	-CPL	-CPL	-CPL
0.000	.67152	2.02123	3.71484	3.92687	2.66010	2.19583	.72999	.57178	-.16494
.025	-.13075	.17513	.52968	-.39412	-.48847	-.55491	-.57702	-.58289	-.51510
.050	-.16980	-.02840	.20021	-.51702	-.58095	-.58808	-.57768	-.53257	-.45988
.075	-.15560	-.07987	.05677	-.51391	-.55550	-.56011	-.52368	-.47945	-.39768
.100	-.15383	-.10472	-.02332	-.49281	-.51515	-.51848	-.48335	-.43682	-.34666
.200	-.11655	-.12957	-.11962	-.36619	-.38047	-.37146	-.33633	-.27817	-.20618
.300	-.12129	-.11123	-.13584	-.27992	-.26068	-.25176	-.21012	-.17053	-.09296
.400	-.09230	-.09703	-.14395	-.19675	-.18372	-.17109	-.12555	-.09296	-.02796
.600	-.10945	-.09762	-.13635	-.11358	-.08255	-.06831	.00390	.03075	.06640
.800	-.08401	-.06745	-.09631	-.03538	.00310	.08977	.13661	.16005	.13140
1.000	-.08046	.00355	-.08211	.24454	-.15455	.64411	.46123	.48441	.30193

## P R E S S U R E M E A S U R E M E N T S

OUTER PANEL SWEEP= 40.0000 DEGREES

FUSELAGE OFF

ANGLE OF ATTACK= 15.62193 DEGREES

### S P A N W I S E L O C A T I O N

	2Y/B .05001	2Y/B .14999	2Y/B .25001	2Y/B .40000	2Y/B .45001	2Y/B .50001	2Y/B .60000	2Y/B .70001	2Y/B .90001
X/C	-CPU	-CPU	-CPU	-CPU	-CPU	-CPU	-CPU	-CPU	-CPU
0.000	.78674	2.34314	4.17411	3.77543	2.61902	2.21731	.75533	.72656	-.09903
.025	.54793	1.19542	1.33498	1.99060	1.86800	1.59696	.86304	.56310	.26940
.050	.43540	.83503	1.21809	1.62341	1.69796	1.63589	.82606	.49176	.27424
.075	.35822	.70960	1.26628	1.45337	1.90127	1.58463	.81762	.47029	.26109
.100	.33818	.70960	1.32011	1.41024	2.19145	1.55024	.80270	.44259	.26386
.200	.32463	.63866	1.78766	1.30427	1.39176	1.50157	.78063	.42458	.25624
.300	.29341	.40181	1.14170	1.19091	.91844	1.37373	.86694	.43566	.25693
.400	.29753	.39121	.46909	1.46631	.92276	1.12780	.86629	.43982	.25416
.600	.30931	.00589	.31939	1.14902	1.06831	.96298	.80918	.44120	.25139
.800	-.00471	.00569	.18353	.80872	.82352	.81827	.68005	.43566	.23823
1.000	-.08189	-.00295	-.08151	.34765	-.10664	.71639	.50414	.48830	.30199

	-CPL	-CPL	-CPL	-CPL	-CPL	-CPL	-CPL	-CPL	-CPL
X/C	-CPL	-CPL	-CPL	-CPL	-CPL	-CPL	-CPL	-CPL	-CPL
0.000	.78674	2.34314	4.17411	3.77543	2.61902	2.21731	.75533	.72656	-.09903
.025	-.12726	.23037	.63622	-.35566	-.47771	-.53398	-.57291	-.57827	-.52494
.050	-.18736	-.00589	.25223	-.52086	-.56709	-.59757	-.57680	-.55334	-.46815
.075	-.18146	-.07718	.06921	-.52826	-.55846	-.57680	-.52879	-.50347	-.41414
.100	-.17263	-.11018	-.02461	-.50237	-.52887	-.53723	-.49765	-.45569	-.36981
.200	-.14435	-.14435	-.14303	-.38833	-.42963	-.38410	-.34517	-.30333	-.22092
.300	-.14376	-.14494	-.15226	-.29341	-.37662	-.26732	-.23682	-.19114	-.12050
.400	-.11666	-.12019	-.15226	-.21821	-.19540	-.18102	-.13496	-.11011	-.05194
.600	-.12314	-.12078	-.14355	-.11958	-.09061	-.05969	0.00000	.01939	.04709
.800	-.09662	-.08307	-.11432	-.04192	.01294	.09148	.13690	.14405	.11011
1.000	-.08189	-.00295	-.08151	.34765	-.10664	.71639	.50414	.48830	.30199



# APPENDIX A

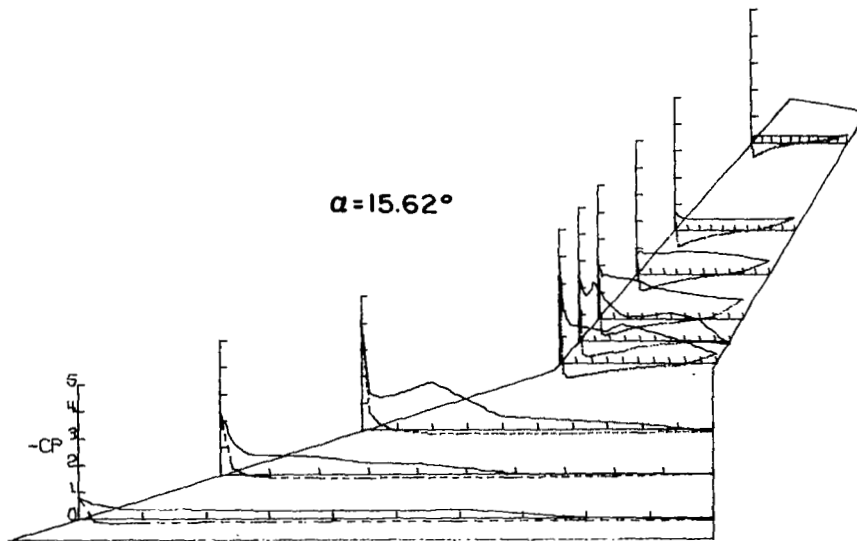
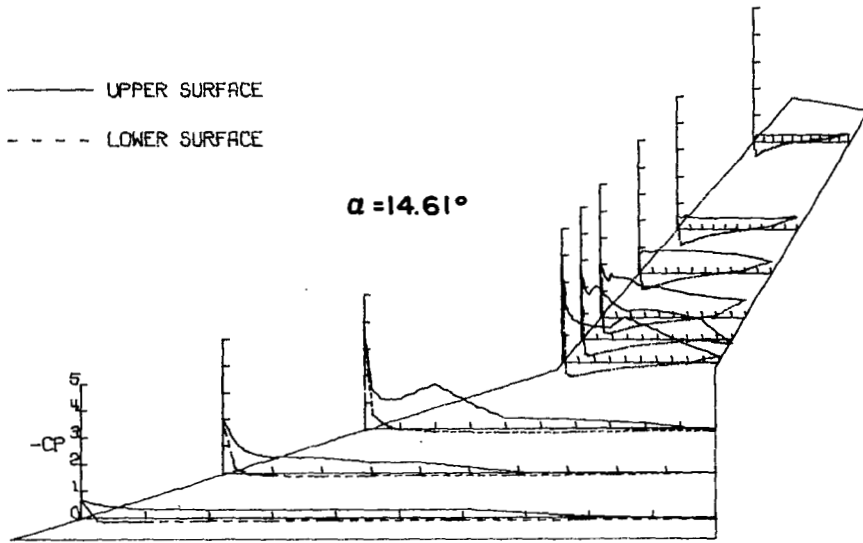

# APPENDIX A

## P R E S S U R E M E A S U R E M E N T S

OUTER PANEL SWEEP= 40.0000 DEGREES

FUSELAGE OFF

ANGLE OF ATTACK= 16.60336 DEGREES

### S P A N W I S E L O C A T I O N

	2Y/B .05001	2Y/B .14999	2Y/B .25001	2Y/B .40000	2Y/B .45001	2Y/B .50001	2Y/B .60000	2Y/B .70001	2Y/B .90001
X/C	-CPU	-CPU	-CPU	-CPU	-CPU	-CPU	-CPU	-CPU	-CPU
0.000	.88850	2.64250	3.15657	3.73658	2.60003	1.97074	.67694	.77649	.05785
.025	.60049	1.27821	1.39506	1.94616	1.88251	1.47079	.84876	.56668	.29550
.050	.45951	.85194	1.26680	1.62973	1.85222	1.48629	.88622	.49210	.26205
.075	.38519	.30301	1.21184	1.51787	2.15753	1.54766	.84553	.46980	.27808
.100	.35982	.82011	1.35282	1.36893	2.44800	1.57026	.78481	.44191	.26553
.200	.33328	.65063	1.78289	1.31330	1.29600	1.70074	.81646	.46561	.29480
.300	.31971	.43356	1.35231	1.09885	.98761	1.33256	.76349	.45516	.30809
.400	.31145	.42825	.66928	1.35842	.94867	1.08129	.86684	.46561	.29411
.600	.32915	.00059	.33032	1.27746	.99193	.94823	.90431	.49837	.31018
.800	0.00000	-.01121	.17865	.75746	.79827	.78158	.71440	.52138	.25229
1.000	-.08553	-.00885	-.07991	.47117	-.09893	.70342	.54517	.51510	.32830
X/C	-CPL	-CPL	-CPL	-CPL	-CPL	-CPL	-CPL	-CPL	-CPL
0.000	.88850	2.64250	3.15657	3.73658	2.60003	1.97074	.67694	.77649	.05785
.025	-.12682	.28727	.65452	-.33019	-.42851	-.51862	-.56964	-.58334	-.54013
.050	-.19879	.01534	.24735	-.50889	-.55341	-.58902	-.57933	-.56034	-.49064
.075	-.19584	-.07432	.06413	-.52311	-.56639	-.58062	-.55608	-.51922	-.43489
.100	-.18935	-.10972	-.03054	-.51013	-.54104	-.55414	-.51216	-.46486	-.38471
.200	-.16222	-.17519	-.14454	-.39635	-.42418	-.40430	-.37653	-.32059	-.25090
.300	-.16045	-.16222	-.15269	-.31411	-.37038	-.28288	-.25382	-.20769	-.14218
.400	-.14511	-.15101	-.15981	-.23373	-.24362	-.20280	-.16598	-.13102	-.07318
.600	-.14393	-.13685	-.15320	-.13232	-.19168	-.07556	-.01163	.00767	.04112
.800	-.10559	-.08907	-.11401	-.02412	.03710	.08719	.11690	.15054	.10106
1.000	-.08553	-.00885	-.07991	.47117	-.09893	.70342	.54517	.51510	.32830

## P R E S S U R E M E A S U R E M E N T S

OUTER PANEL SWEEP= 40.0000 DEGREES

FUSELAGE OFF

ANGLE OF ATTACK= 17.54326 DEGREES

### S P A N W I S E L O C A T I O N

	2Y/B .05001	2Y/B .14999	2Y/B .25001	2Y/B .40000	2Y/B .45001	2Y/B .50001	2Y/B .60000	2Y/B .70001	2Y/B .90001
X/C	-CPU	-CPU	-CPU	-CPU	-CPU	-CPU	-CPU	-CPU	-CPU
0.000	1.02884	3.04583	2.17355	3.63917	2.56060	1.83725	.91928	.97587	.16043
.025	.64807	1.34210	1.84071	1.86754	1.77348	1.40496	.94467	.54246	.28682
.050	.48576	.88903	1.93682	1.58289	1.77782	1.50457	.88347	.53760	.27154
.075	.40549	.91322	1.94188	1.49193	2.29761	1.60548	.87110	.53552	.27918
.100	.38719	.98224	2.29596	1.30072	2.65775	1.78191	.89974	.49940	.26668
.200	.36122	.92325	2.39409	1.16644	1.17201	2.13283	.99545	.49106	.25210
.300	.33584	.42201	1.62118	.94924	.87295	1.44727	.96290	.55496	.27293
.400	.34646	.42024	.83361	.98884	.90947	.97982	1.04102	.49245	.27154
.600	.34764	-.00118	.35661	1.07548	.93671	.78776	.92058	.49593	.26599
.800	0.00000	0.00000	.22762	.82280	.76894	.73308	.76368	.51398	.25349
1.000	-.08027	.00059	-.05665	.55163	-.07615	.60091	.50645	.52510	.29863
X/C	-CPL	-CPL	-CPL	-CPL	-CPL	-CPL	-CPL	-CPL	-CPL
0.000	1.02884	3.04583	2.17355	3.63917	2.56060	1.83725	.91928	.97587	.16043
.025	-.11923	.35650	.60801	-.33184	-.41852	-.51426	-.54876	-.57434	-.54239
.050	-.20009	.03718	.23774	-.49219	-.54482	-.58912	-.59238	-.56184	-.50420
.075	-.20776	-.07201	.06475	-.52624	-.56215	-.58131	-.56178	-.52781	-.46044
.100	-.20894	-.11273	-.01619	-.52067	-.54420	-.55527	-.52142	-.48822	-.40558
.200	-.18061	-.18297	-.15327	-.40861	-.46805	-.41271	-.38342	-.34585	-.26877
.300	-.18474	-.17707	-.18210	-.33742	-.41728	-.29879	-.26104	-.22501	-.14515
.400	-.14756	-.16999	-.18311	-.23960	-.22907	-.20701	-.17641	-.15140	-.08403
.600	-.15477	-.15818	-.17046	-.13125	-.16097	-.06965	-.02343	.00069	.02847
.800	-.12101	-.10624	-.12292	-.01672	.02415	.10676	.11782	.14376	.10487
1.000	-.08027	.00059	-.05665	.55163	-.07615	.60091	.50645	.52510	.29863

# APPENDIX A

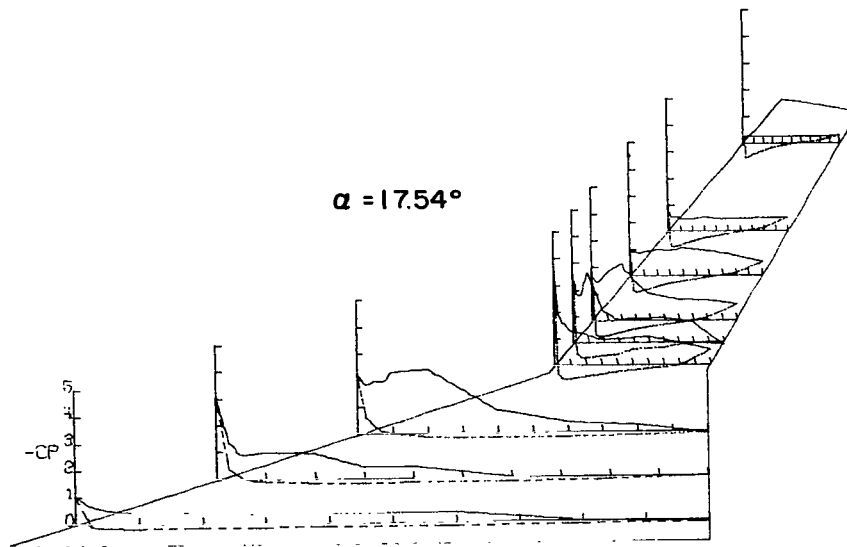
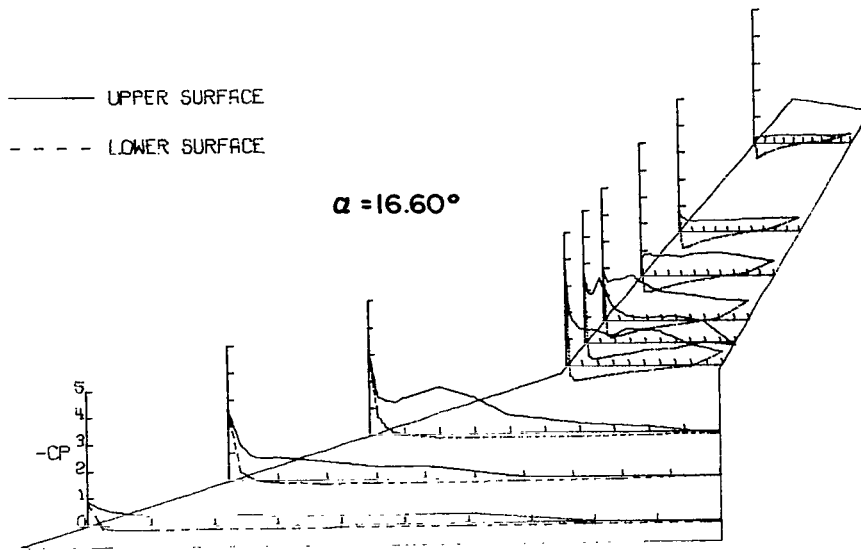

# APPENDIX A

## P R E S S U R E M E A S U R E M E N T S

OUTER PANEL SWEEP= 40.00000 DEGREES

FUSELAGE OFF

ANGLE OF ATTACK= 18.60395 DEGREES

### S P A N W I S E L O C A T I O N

	2Y/B .05001	2Y/B .14999	2Y/B .25001	2Y/B .40000	2Y/B .45001	2Y/B .50001	2Y/B .60000	2Y/B .70001	2Y/B .90001
X/C	- CPU	- CPU	- CPU	- CPU	- CPU	- CPU	- CPU	- CPU	- CPU
0.000	1.18971	3.38957	1.88659	3.30917	2.25464	1.62106	.94915	.97788	.23270
.025	.70574	1.37878	1.68218	2.24287	1.94052	1.50429	.97329	.55588	.29788
.050	.52526	.98756	1.76833	1.83457	2.39157	1.62693	.89566	.51733	.28947
.075	.44019	1.05950	1.77954	1.66295	2.81784	1.60279	1.00982	.50751	.23270
.100	.43246	1.14095	1.92686	1.42627	2.97645	1.83568	.96415	.47807	.22429
.200	.37476	1.24262	2.44222	1.10161	1.48761	1.98637	.88587	.51593	.30068
.300	.35453	.45625	2.09814	1.02602	.93975	1.28967	.89174	.48368	.28106
.400	.38190	.44436	1.20556	1.00248	.92053	1.03265	.99481	.56149	.29788
.600	.37059	-.00357	.40168	1.02912	.95353	.86043	.86826	.52644	.27896
.800	-.00119	.00654	.26762	.87838	.80771	.83303	.75345	.51733	.27055
1.000	-.07019	.00059	-.04078	.62361	-.05269	.71692	.54601	.54817	.32526

	- CPL	- CPL	- CPL	- CPL	- CPL	- CPL	- CPL	- CPL	- CPL
X/C	- CPL <td>- CPL <td>- CPL <td>- CPL <td>- CPL <td>- CPL <td>- CPL <td>- CPL <td>- CPL</td> </td></td></td></td></td></td></td>	- CPL <td>- CPL <td>- CPL <td>- CPL <td>- CPL <td>- CPL <td>- CPL <td>- CPL</td> </td></td></td></td></td></td>	- CPL <td>- CPL <td>- CPL <td>- CPL <td>- CPL <td>- CPL <td>- CPL</td> </td></td></td></td></td>	- CPL <td>- CPL <td>- CPL <td>- CPL <td>- CPL <td>- CPL</td> </td></td></td></td>	- CPL <td>- CPL <td>- CPL <td>- CPL <td>- CPL</td> </td></td></td>	- CPL <td>- CPL <td>- CPL <td>- CPL</td> </td></td>	- CPL <td>- CPL <td>- CPL</td> </td>	- CPL <td>- CPL</td>	- CPL
0.000	1.18971	3.38957	1.88659	3.30917	2.25464	1.62106	.94915	.97788	.23270
.025	-.11183	.43424	.64331	-.28515	-.40913	-.50419	-.52702	-.57684	-.55301
.050	-.20166	.06781	.26660	-.49033	-.54612	-.60268	-.59160	-.58104	-.52077
.075	-.22129	-.05235	.08054	-.53434	-.56658	-.59290	-.56746	-.56740	-.46119
.100	-.22010	-.11838	-.00867	-.53930	-.54984	-.57333	-.53876	-.51236	-.43035
.200	-.20106	-.19214	-.16873	-.43144	-.48599	-.43636	-.39657	-.37007	-.28526
.300	-.20582	-.18916	-.19982	-.40603	-.42400	-.31373	-.26677	-.24321	-.16541
.400	-.18321	-.18262	-.21104	-.28577	-.24362	-.22177	-.19111	-.16471	-.10654
.600	-.17608	-.16180	-.20084	-.15063	-.15187	-.07892	-.02805	-.01472	.01542
.800	-.12908	-.11183	-.13814	-.03223	.01736	.08675	.12197	.14158	.09883
1.000	-.07019	.00059	-.04078	.62361	-.05269	.71692	.54601	.54817	.32526

## P R E S S U R E M E A S U R E M E N T S

OUTER PANEL SWEEP= 40.00000 DEGREES

FUSELAGE OFF

ANGLE OF ATTACK= 19.67862 DEGREES

### S P A N W I S E L O C A T I O N

	2Y/B .05001	2Y/B .14999	2Y/B .25001	2Y/B .40000	2Y/B .45001	2Y/B .50001	2Y/B .60000	2Y/B .70001	2Y/B .90001
X/C	- CPU	- CPU	- CPU	- CPU	- CPU	- CPU	- CPU	- CPU	- CPU
0.000	1.34970	3.77647	1.79867	3.27388	1.98978	1.57620	.98440	1.10103	.27367
.025	.75612	1.35147	1.71266	2.48905	2.03362	1.51864	.86086	.51907	.28196
.050	.54204	1.06763	1.78900	1.64630	2.25038	1.55421	.89773	.47898	.27021
.075	.48017	1.16244	1.81852	1.45519	2.63640	1.67063	.89514	.56123	.27574
.100	.48489	1.33145	1.87960	1.36691	2.55481	1.77088	1.02385	.49211	.31656
.200	.38473	1.33145	2.41401	1.16598	1.44241	2.06646	.93848	.50317	.30619
.300	.38826	.45072	2.50715	1.06917	1.10509	1.48177	.95594	.49833	.30131
.400	.39416	.47075	1.36453	1.07526	1.02777	1.23664	.93848	.51907	.26883
.600	.39416	-.00648	.52372	1.02594	.97358	.81623	.95465	.54810	.30481
.800	.00412	0.00000	.33490	.71152	.81812	.86604	.76191	.51699	.27229
1.000	-.07718	-.00177	-.03563	.64633	-.04081	.66748	.54976	.55155	.30131

	- CPL	- CPL	- CPL	- CPL	- CPL	- CPL	- CPL	- CPL	- CPL
X/C	- CPL <td>- CPL <td>- CPL <td>- CPL <td>- CPL <td>- CPL <td>- CPL <td>- CPL <td>- CPL</td> </td></td></td></td></td></td></td>	- CPL <td>- CPL <td>- CPL <td>- CPL <td>- CPL <td>- CPL <td>- CPL <td>- CPL</td> </td></td></td></td></td></td>	- CPL <td>- CPL <td>- CPL <td>- CPL <td>- CPL <td>- CPL <td>- CPL</td> </td></td></td></td></td>	- CPL <td>- CPL <td>- CPL <td>- CPL <td>- CPL <td>- CPL</td> </td></td></td></td>	- CPL <td>- CPL <td>- CPL <td>- CPL <td>- CPL</td> </td></td></td>	- CPL <td>- CPL <td>- CPL <td>- CPL</td> </td></td>	- CPL <td>- CPL <td>- CPL</td> </td>	- CPL <td>- CPL</td>	- CPL
0.000	1.34970	3.77647	1.79867	3.27388	1.98978	1.57620	.98440	1.10103	.27367
.025	-.09780	.51494	.63150	-.25890	-.40084	-.47662	-.52706	-.55770	-.55425
.050	-.21151	.10252	.29265	-.48490	-.50927	-.58074	-.58656	-.57912	-.52937
.075	-.23096	-.04713	.09518	-.53425	-.57201	-.58268	-.56974	-.55148	-.47546
.100	-.24510	-.11960	-.02901	-.53485	-.55496	-.56845	-.53999	-.51831	-.44091
.200	-.22683	-.22153	-.17915	-.44470	-.47516	-.44234	-.41971	-.38148	-.30615
.300	-.23331	-.21623	-.21478	-.40387	-.41424	-.33046	-.29619	-.26123	-.19419
.400	-.20385	-.19502	-.22700	-.27413	-.30885	-.22893	-.19789	-.18265	-.12509
.600	-.18382	-.19030	-.21529	-.24306	-.15473	-.08278	-.04010	-.02350	.00484
.800	-.14906	-.12962	-.14455	-.03046	.02254	.10671	.13645	.12992	.09122
1.000	-.07718	-.00177	-.03563	.64633	-.04081	.66748	.54976	.55155	.30131

# APPENDIX A

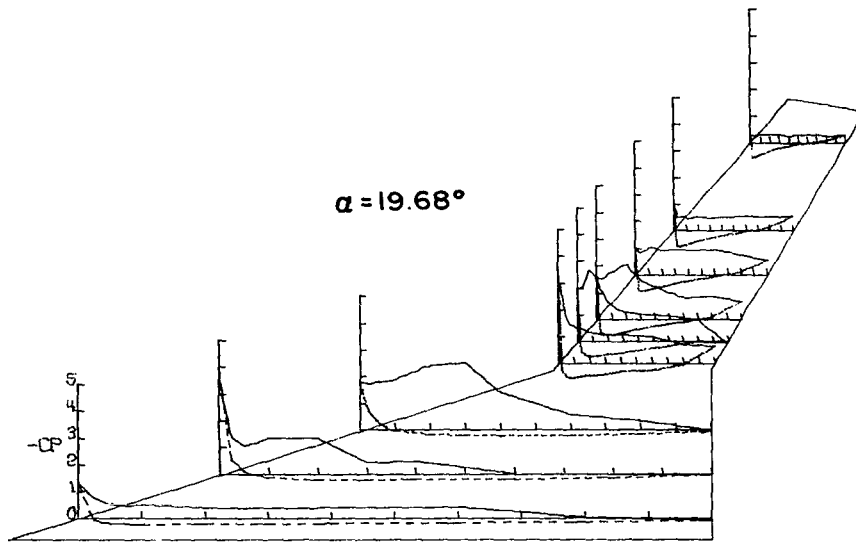
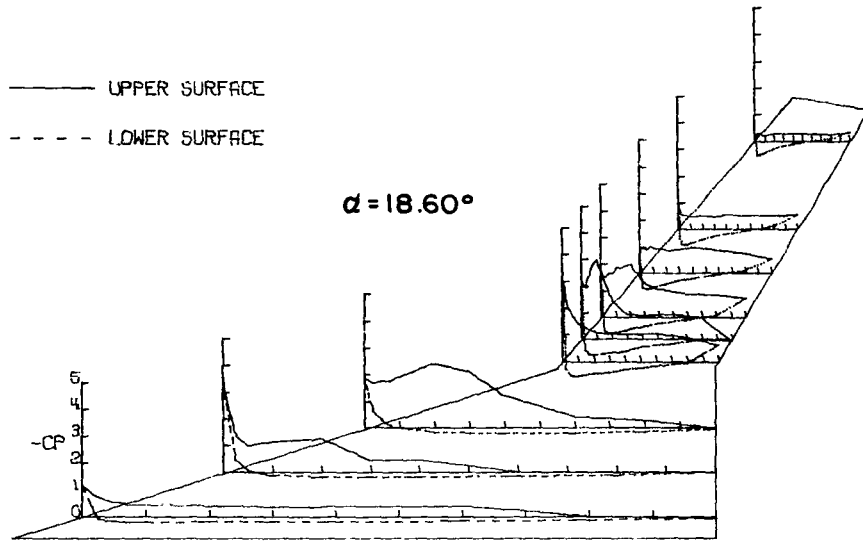

# APPENDIX A

## P R E S S U R E M E A S U R E M E N T S

OUTER PANEL SWEEP= 40.0000 DEGREES

FUSELAGE OFF

ANGLE OF ATTACK= 20.77925 DEGREES

### S P A N W I S E L O C A T I O N

	2Y/B .05001	2Y/B .14999	2Y/B .25001	2Y/B .40000	2Y/B .45001	2Y/B .50001	2Y/B .60000	2Y/B .70001	2Y/B .90001
X/C	-CPU	-CPU	-CPU	-CPU	-CPU	-CPU	-CPU	-CPU	-CPU
0.000	1.48192	4.11756	1.85323	3.35822	1.85245	1.43632	.98958	1.14892	.31474
.025	.80305	1.37902	1.77700	2.28117	1.99679	1.54606	.84348	.55027	.29297
.050	.57389	1.19689	1.84859	1.76670	2.20900	1.59346	.84738	.53696	.34138
.075	.53189	1.33349	1.86559	1.46444	2.81723	1.70645	.89218	.52995	.30139
.100	.54254	1.46654	1.90216	1.38178	2.60749	1.64346	.88050	.52434	.33577
.200	.40528	1.38908	2.68455	1.20659	1.38486	2.02592	.94608	.52924	.28526
.300	.40587	.59105	2.68661	1.05792	1.18870	1.34282	.89153	.64491	.30068
.400	.42539	.51118	1.70592	1.20412	1.10789	1.28048	.98634	.54116	.27615
.600	.40942	.00177	.67320	1.11591	1.00056	1.02270	.89153	.56289	.30139
.800	-.00118	.00118	.44605	.83565	.88873	.87400	.75388	.56570	.25372
1.000	-.05857	0.00000	.02266	.79184	-.00309	.74414	.54739	.55027	.32035

	-CPL	-CPL	-CPL	-CPL	-CPL	-CPL	-CPL	-CPL	-CPL
X/C	-CPL	-CPL	-CPL	-CPL	-CPL	-CPL	-CPL	-CPL	-CPL
0.000	1.48192	4.11756	1.85323	3.35822	1.85245	1.43632	.98958	1.14892	.31474
.025	-.08579	.58987	.77673	-.22403	-.35611	-.47136	-.52005	-.56492	-.55791
.050	-.20944	.12780	.35952	-.48078	-.53386	-.58627	-.59861	-.58525	-.53689
.075	-.23962	-.04437	.13958	-.52892	-.57150	-.59407	-.58627	-.56072	-.49483
.100	-.25500	-.12957	.00052	-.53077	-.56410	-.58173	-.56355	-.52918	-.45909
.200	-.25618	-.23902	-.16894	-.45733	-.47831	-.46421	-.43889	-.39811	-.33012
.300	-.25737	-.24080	-.21478	-.43079	-.42647	-.35384	-.32657	-.28456	-.22148
.400	-.22660	-.21950	-.23024	-.29563	-.27958	-.25451	-.21295	-.19205	-.13107
.600	-.20234	-.20175	-.21530	-.16664	-.19935	-.09674	-.05324	-.03294	-.01192
.800	-.15501	-.13904	-.13701	-.02037	.02160	.10648	.13050	.12826	.08271
1.000	-.05857	0.00000	.02266	-.79184	-.00309	.74414	.54739	.55027	.32035

## P R E S S U R E M E A S U R E M E N T S

OUTER PANEL SWEEP= 40.0000 DEGREES

FUSELAGE OFF

ANGLE OF ATTACK= 22.89898 DEGREES

### S P A N W I S E L O C A T I O N

	2Y/B .05001	2Y/B .14999	2Y/B .25001	2Y/B .40000	2Y/B .45001	2Y/B .50001	2Y/B .60000	2Y/B .70001	2Y/B .90001
X/C	-CPU	-CPU	-CPU	-CPU	-CPU	-CPU	-CPU	-CPU	-CPU
0.000	1.83116	4.86135	1.90172	3.04624	1.86446	1.45553	1.01550	1.29677	.30280
.025	.90001	1.50687	1.83685	2.51789	1.88188	1.54237	.91505	.57997	.32437
.050	.63890	1.44812	1.92981	1.72755	2.09472	1.40044	1.02846	.51051	.27571
.075	.63126	1.48278	1.93952	1.47178	2.21731	1.54561	.99152	.52579	.34520
.100	.68499	1.58853	1.93390	1.53961	2.47371	1.65513	.85997	.60636	.36535
.200	.43906	1.76830	2.60458	1.25646	1.50850	1.94805	.86126	.51676	.31881
.300	.45963	.93056	2.84977	1.24775	1.33923	1.63763	.99865	.55080	.32853
.400	.48726	.58013	2.16580	1.22036	1.23343	1.46525	.83404	.61053	.31464
.600	.44259	-.00705	.87194	1.23032	1.13262	1.15483	.89755	.62512	.31812
.800	.00705	.00999	.59917	.98637	.99073	1.07318	.76276	.52857	.29863
1.000	-.05878	-.00176	.06998	.93767	.02366	.95717	.63250	.57858	.32645

	-CPL	-CPL	-CPL	-CPL	-CPL	-CPL	-CPL	-CPL	-CPL
X/C	-CPL	-CPL	-CPL	-CPL	-CPL	-CPL	-CPL	-CPL	-CPL
0.000	1.83116	4.86135	1.90172	3.04624	1.86446	1.45553	1.01550	1.29677	.30280
.025	-.05525	.75608	.86990	-.15379	-.28143	-.41341	-.49699	-.52850	-.55628
.050	-.21395	.18456	.43010	-.42899	-.50370	-.56179	-.58253	-.57295	-.55628
.075	-.26214	-.02391	.19359	-.50993	-.56534	-.57994	-.58706	-.56600	-.51947
.100	-.28272	-.12519	.03065	-.51242	-.56783	-.57605	-.57670	-.54795	-.48267
.200	-.29217	-.26626	-.17316	-.49250	-.48752	-.48922	-.46524	-.43405	-.35349
.300	-.29506	-.27331	-.22731	-.44455	-.44518	-.37906	-.34796	-.32016	-.25279
.400	-.26450	-.25627	-.24774	-.30695	-.29637	-.27992	-.24688	-.22501	-.16390
.600	-.23463	-.23276	-.23293	-.18367	-.17558	-.11923	-.06998	-.06181	-.02222
.800	-.18397	-.16222	-.15733	-.00125	.06289	.13348	.13413	.11876	.07709
1.000	-.05878	-.00176	.06998	.93767	.02366	.95717	.63250	.57858	.32645

# APPENDIX A

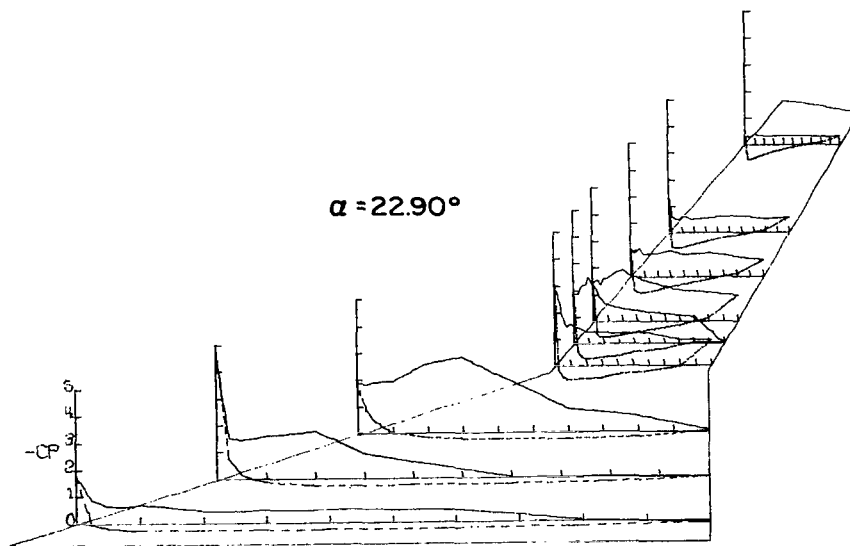
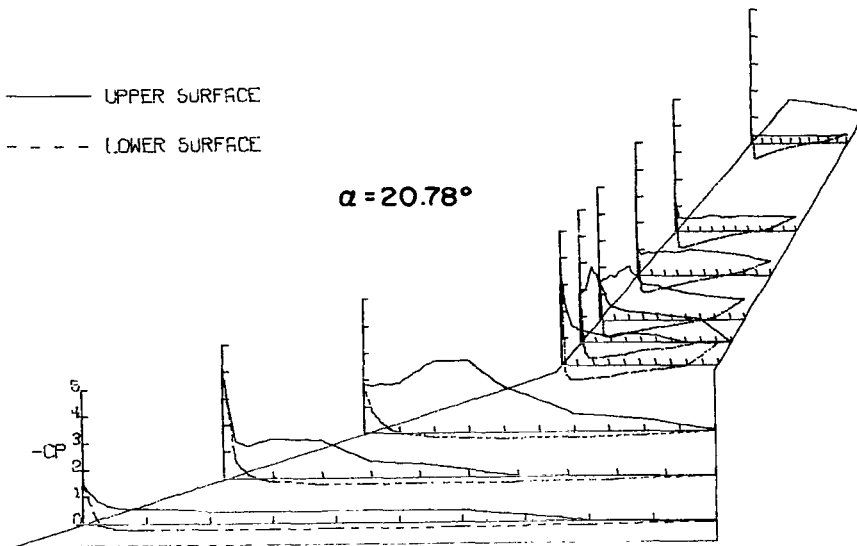

# APPENDIX A

## P R E S S U R E M E A S U R E M E N T S

OUTER PANEL SWEEP= 40.0000 DEGREES

FUSELAGE OFF

ANGLE OF ATTACK= 24.97543 DEGREES

### S P A N W I S E L O C A T I O N

	2Y/B .05001	2Y/B .14999	2Y/B .25001	2Y/B .40000	2Y/B .45001	2Y/B .50001	2Y/B .60000	2Y/B .70001	2Y/B .90001
X/C	-CPU	-CPU	-CPU	-CPU	-CPU	-CPU	-CPU	-CPU	-CPU
0.000	2.29772	5.34168	1.82939	2.94365	1.79907	1.50231	.97111	1.39924	.32427
.025	1.01947	1.90052	1.82111	2.06543	1.91896	1.85821	1.12392	.64569	.32214
.050	.76490	1.75127	2.01621	1.59141	2.03268	1.49636	.97508	.58042	.31575
.075	.80944	1.84335	2.04157	1.64827	2.29596	1.49040	.95986	.57687	.37465
.100	.89730	2.19722	2.00896	1.43628	2.62228	1.89856	1.05777	.65421	.33349
.200	.49975	2.30013	2.28686	1.32937	1.51354	2.01168	.91290	.61305	.33491
.300	.52564	1.05257	2.83697	1.18907	1.39240	1.62535	.97971	.70743	.38387
.400	.55515	.69208	2.35052	1.36830	1.27869	1.39117	1.05711	.63434	.32923
.600	.50036	.00843	1.07848	1.20638	1.18969	1.23572	1.02072	.64144	.33349
.800	.01264	.00843	.82077	1.02468	.93568	1.02403	.85468	.61093	.32498
1.000	-.04516	.01144	.09988	.90030	.01855	.98169	.68136	.61518	.34059

	-CPL	-CPL	-CPL	-CPL	-CPL	-CPL	-CPL	-CPL	-CPL
0.000	2.29772	5.34168	1.82939	2.94365	1.79907	1.50231	.97111	1.39924	.32427
.025	-.01204	.90212	.98844	-.14345	-.29804	-.32278	-.47491	-.51578	-.57254
.050	-.22338	.23904	.50146	-.44582	-.51013	-.56751	-.59199	-.58176	-.56544
.075	-.28962	0.00000	.20286	-.57196	-.57196	-.59199	-.61051	-.59169	-.53706
.100	-.32032	-.12644	.03778	-.56269	-.59051	-.60521	-.60058	-.58034	-.51791
.200	-.34983	-.29925	-.21114	-.52620	-.53486	-.52518	-.50397	-.47960	-.39446
.300	-.35163	-.31972	-.26910	-.51631	-.50394	-.42663	-.39157	-.36963	-.29301
.400	-.31310	-.30106	-.28825	-.36544	-.33823	-.32278	-.27714	-.26889	-.20220
.600	-.28600	-.27697	-.27997	-.25475	-.26650	-.13229	-.09789	-.09578	-.06030
.800	-.21014	-.19147	-.18889	-.103401	-.04885	.11906	.13559	.10074	.06385
1.000	-.04516	.01144	.09988	.90030	.01855	.98169	.68136	.61518	.34059

## P R E S S U R E M E A S U R E M E N T S

OUTER PANEL SWEEP= 40.0000 DEGREES

FUSELAGE OFF

ANGLE OF ATTACK= 26.99766 DEGREES

### S P A N W I S E L O C A T I O N

	2Y/B .05001	2Y/B .14999	2Y/B .25001	2Y/B .40000	2Y/B .45001	2Y/B .50001	2Y/B .60000	2Y/B .70001	2Y/B .90001
X/C	-CPU	-CPU	-CPU	-CPU	-CPU	-CPU	-CPU	-CPU	-CPU
0.000	2.60307	3.53079	1.89621	2.74270	2.23143	1.63997	1.16638	1.14589	.37660
.025	1.06161	2.95081	1.87760	2.14070	2.31725	1.95505	1.02482	.68599	.37870
.050	.86374	2.77487	2.02183	1.71832	2.82117	1.52125	1.02873	.70559	.32620
.075	.95675	2.96088	2.13401	1.66928	2.47603	1.74500	.98307	.66079	.36610
.100	1.06516	2.94667	2.11385	1.50499	2.76048	1.82720	.91719	.65939	.34510
.200	.56782	2.50473	1.98047	1.43020	1.90223	2.05160	.99677	.69299	.33110
.300	.56307	1.61196	2.47778	1.36215	1.47617	1.76131	1.05548	.69159	.33250
.400	.60279	.91706	2.23585	1.29778	1.36522	1.47950	1.18073	.69859	.35560
.600	.54826	.01363	1.19521	1.26897	1.21809	1.14746	1.06070	.69509	.39690
.800	.01719	.02015	.94448	1.12552	.97471	1.08875	.96611	.66779	.27576
1.000	-.03556	.00889	.15664	.88566	.04600	1.02352	.66147	.63419	.34090

	-CPL	-CPL	-CPL	-CPL	-CPL	-CPL	-CPL	-CPL	-CPL
0.000	2.60307	3.53079	1.89621	2.74270	2.23143	1.63997	1.16638	1.14589	.37660
.025	.06149	.92654	1.09750	-.07728	-.06624	-.25438	-.37896	-.47863	-.54522
.050	-.22049	.25605	.57434	-.38395	-.44614	-.47941	-.56224	-.58022	-.56412
.075	-.29695	.00119	.26572	-.50478	-.54894	-.56355	-.60138	-.59842	-.55782
.100	-.34555	-.12091	.08542	-.51766	-.56366	-.59747	-.58964	-.58932	-.51793
.200	-.38645	-.31473	-.20782	-.52502	-.54912	-.53615	-.52311	-.49483	-.41854
.300	-.37874	-.33844	-.28588	-.51398	-.51398	-.44092	-.40636	-.38635	-.30866
.400	-.33784	-.33844	-.31648	-.37720	-.36678	-.33526	-.31439	-.29256	-.23307
.600	-.30584	-.30702	-.28950	-.24411	-.23798	-.15654	-.11414	-.10709	-.07559
.800	-.24597	-.20804	-.19076	-.05827	.00429	.09653	.10371	.09939	.04199
1.000	-.03556	.00889	.15664	.88566	.04600	1.02352	.66147	.63419	.34090



# APPENDIX A

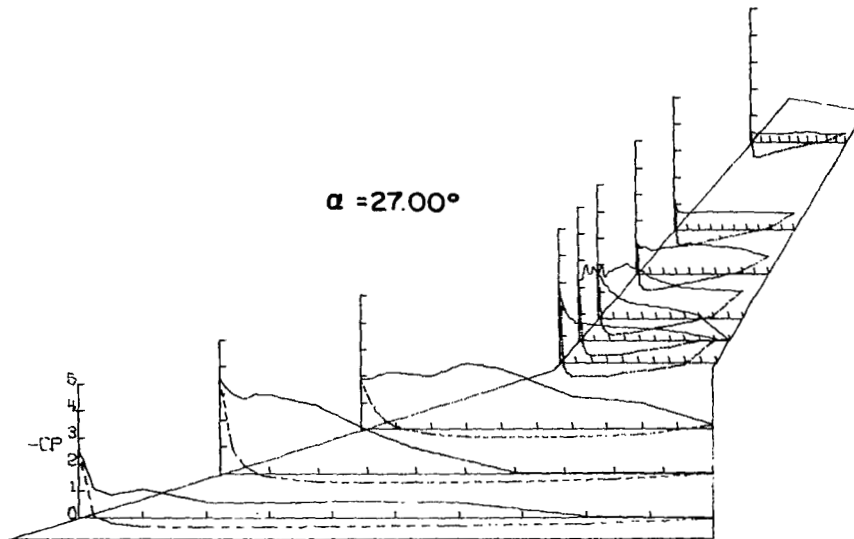
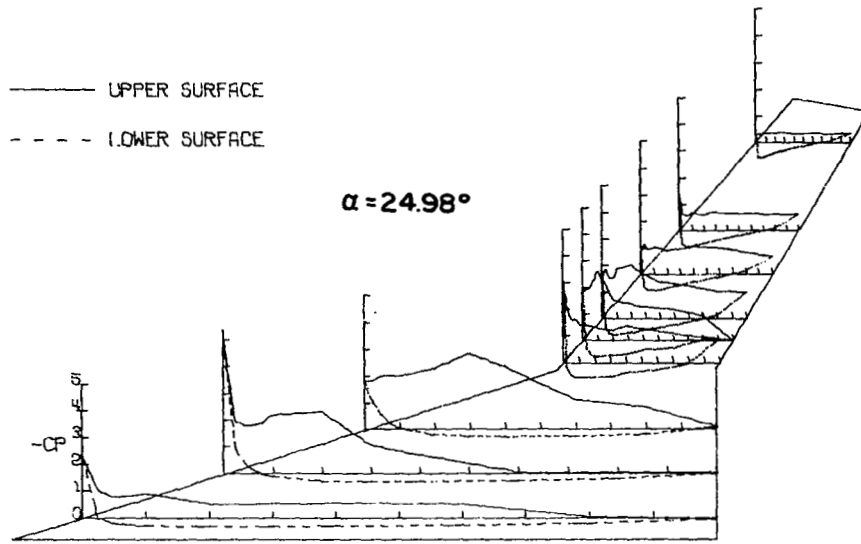

# APPENDIX A

## P R E S S U R E M E A S U R E M E N T S

OUTER PANEL SWEEP= 40.0000 DEGREES

FUSELAGE OFF

ANGLE OF ATTACK= 28.98640 DEGREES

### S P A N W I S E L O C A T I O N

	2Y/B .05001	2Y/B .14999	2Y/B .25001	2Y/B .40000	2Y/B .45001	2Y/B .50001	2Y/B .60000	2Y/B .70001	2Y/B .90001
X/C	-CPU	-CPU	-CPU	-CPU	-CPU	-CPU	-CPU	-CPU	-CPU
0.000	3.08549	2.77218	1.76259	2.95972	2.43655	1.72113	1.09480	.71718	.40471
.025	1.19387	2.31720	1.82437	2.53568	2.44756	1.96819	1.02356	.66350	.37993
.050	.98931	2.30427	1.90791	1.80753	3.05994	1.69840	1.06207	.69103	.36961
.075	1.12451	2.52470	2.13223	1.82405	2.92178	1.93354	1.11148	.73439	.35791
.100	1.47495	2.66407	2.11306	1.69494	2.85141	2.13248	.98057	.61257	.37029
.200	.52695	3.05727	1.75297	1.54135	1.96765	2.32821	1.06784	.71374	.37718
.300	.53046	2.09442	2.00361	1.44016	1.67352	1.79749	1.07169	.69994	.35859
.400	.67776	1.14332	2.10895	1.44590	1.39939	1.44326	1.05244	.78051	.33382
.600	.70411	.01059	1.42081	1.23480	1.16158	1.21929	.94591	.70824	.34070
.800	.01411	.01411	.98079	.99310	1.10875	1.15384	1.00945	.73301	.30560
1.000	.01176	.00470	.16760	1.05612	.07857	1.21223	.60858	.67726	.32831

	-CPL	-CPL	-CPL	-CPL	-CPL	-CPL	-CPL	-CPL	-CPL
X/C	-CPL	-CPL	-CPL	-CPL	-CPL	-CPL	-CPL	-CPL	-CPL
0.000	3.08549	2.77218	1.76259	2.95972	2.43655	1.72113	1.09480	.71718	.40471
.025	.09645	.88637	1.18890	.05081	-.04224	-.13667	-.36574	-.45352	-.53197
.050	-.20819	.32170	.64705	-.32875	-.40466	-.47482	-.55439	-.57945	-.57464
.075	-.31405	.03705	.30583	-.46527	-.52894	-.56273	-.60187	-.59528	-.57395
.100	-.36851	-.12233	.10380	-.47323	-.55587	-.59160	-.61470	-.59528	-.56776
.200	-.41580	-.34581	-.21824	-.53077	-.56628	-.55631	-.56145	-.51408	-.46177
.300	-.41051	-.38051	-.31090	-.52037	-.53628	-.45750	-.44402	-.41360	-.34685
.400	-.37640	-.38404	-.34634	-.39670	-.39609	-.36831	-.35098	-.32895	-.26358
.600	-.34728	-.34581	-.33773	-.26080	-.32263	-.19121	-.15207	-.14653	-.10667
.800	-.26583	-.23575	-.22593	-.05265	-.01837	.08983	.09368	.08189	.02271
1.000	.01176	.00470	.16760	1.05612	.07857	1.21223	.60858	.67726	.32831

## P R E S S U R E M E A S U R E M E N T S

OUTER PANEL SWEEP= 40.0000 DEGREES

FUSELAGE OFF

ANGLE OF ATTACK= 30.94351 DEGREES

### S P A N W I S E L O C A T I O N

	2Y/B .05001	2Y/B .14999	2Y/B .25001	2Y/B .40000	2Y/B .45001	2Y/B .50001	2Y/B .60000	2Y/B .70001	2Y/B .90001
X/C	-CPU	-CPU	-CPU	-CPU	-CPU	-CPU	-CPU	-CPU	-CPU
0.000	3.56712	2.66348	1.88347	3.35075	2.47317	1.74659	1.08733	.84804	.45380
.025	1.19174	2.35166	1.92784	2.74212	2.68713	1.86981	1.11020	.68993	.42573
.050	1.16629	2.30133	1.95407	2.07125	2.89927	1.90792	1.13370	.73237	.40246
.075	1.37866	2.41819	2.07106	1.92257	3.13377	1.98477	1.09559	.76933	.41204
.100	1.83563	2.74679	2.02113	1.79202	2.78625	1.94729	1.08543	.75701	.40178
.200	.59559	3.45547	1.65705	1.64274	2.06521	2.02795	.97365	.70431	.41547
.300	.75033	2.44480	1.80228	1.50856	1.64274	1.71738	.94253	.75427	.46201
.400	.71504	1.46943	1.74076	1.42878	1.46444	1.45888	1.00540	.73716	.39493
.600	.62742	.02547	1.51938	1.23598	1.22027	1.26009	.97238	.73579	.37987
.800	.02084	.01679	1.03175	1.07340	1.08126	1.18070	.98635	.74948	.33470
1.000	-.00347	.02142	.21583	1.07400	.12094	1.20293	.76660	.69541	.33196

	-CPL	-CPL	-CPL	-CPL	-CPL	-CPL	-CPL	-CPL	-CPL
X/C	-CPL	-CPL	-CPL	-CPL	-CPL	-CPL	-CPL	-CPL	-CPL
0.000	3.56712	2.66348	1.88347	3.35075	2.47317	1.74659	1.08733	.84804	.45380
.025	.16264	1.05579	1.28792	.18806	-.08647	-.10288	-.27815	-.41199	-.49001
.050	-.19795	.36523	.71254	-.28300	-.35496	-.43247	-.50931	-.54476	-.56118
.075	-.32124	.06714	.35955	-.45050	-.44920	-.54741	-.55757	-.58787	-.54886
.100	-.39069	-.10650	.13868	-.50976	-.53455	-.57599	-.57599	-.59540	-.53860
.200	-.46131	-.35902	-.23197	-.55209	-.55571	-.58043	-.55312	-.54886	-.45237
.300	-.44336	-.40516	-.32727	-.55269	-.55390	-.48771	-.46485	-.44210	-.36888
.400	-.40921	-.41095	-.36056	-.42329	-.41966	-.39500	-.37595	-.34971	-.29017
.600	-.37564	-.37970	-.36207	-.29509	-.26969	-.21084	-.17146	-.16151	-.14098
.800	-.30040	-.26220	-.25768	-.08647	.00605	.04763	.07557	.06844	.01779
1.000	-.00347	.02142	.21583	1.07400	.12094	1.20293	.76660	.69541	.33196

# APPENDIX A

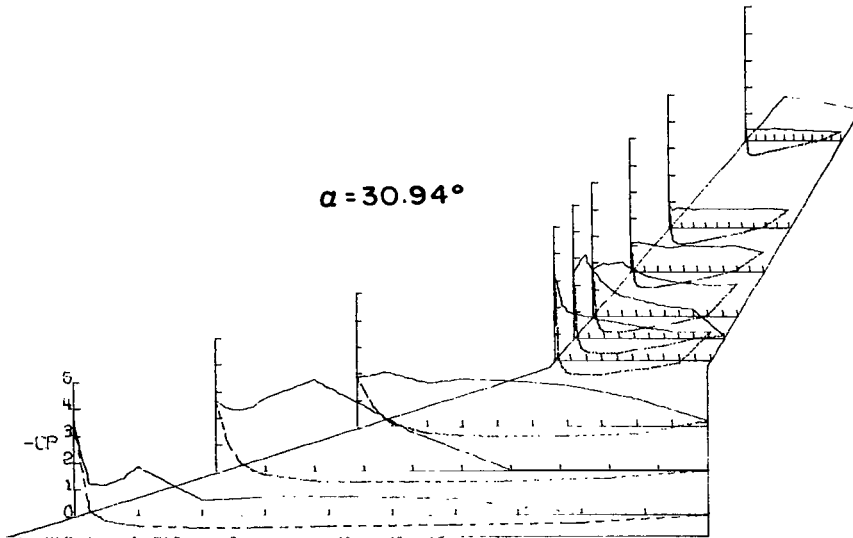
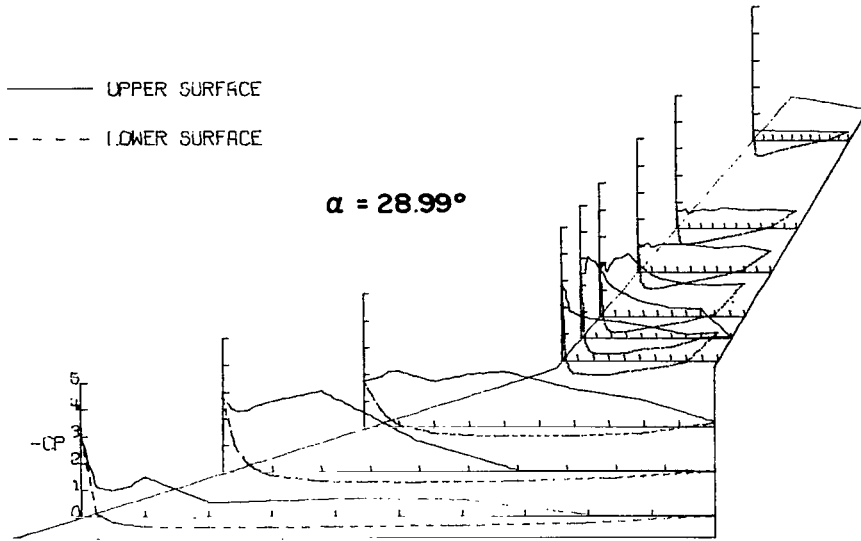

**THIS PAGE IS BLANK**

## APPENDIX B

### VARIABLE-SWEEP-WING PRESSURE DATA FOR FUSELAGE ON

The pressure measurements made on the variable-sweep wings with fuselage on (fig. 1 and bottom photographs of figs. 3(a), 3(b), and 3(c)) are presented in this appendix in coefficient form in tables and graphs on facing pages. The data for the three sweep-back angles are arranged in order of increasing angle of attack. These data begin on page 138 for  $\Lambda = 15^\circ$ , page 176 for  $\Lambda = 30^\circ$ , and page 214 for  $\Lambda = 40^\circ$ .

# APPENDIX B

## P R E S S U R E M E A S U R E M E N T S

OUTER PANEL SWEEP= 15.0000 DEGREES

FUSELAGE ON

ANGLE OF ATTACK= -4.37771 DEGREES

### S P A N W I S E L O C A T I O N

	2Y/B .12996	2Y/B .21661	2Y/B .33426	2Y/B .43233	2Y/B .48036	2Y/B .57641	2Y/B .67250	2Y/B .86465
X/C	-CPU	-CPU	-CPU	-CPU	-PU	-CPU	-CPU	-CPU
0.000	.08628	.28978	1.81033	.03767	.39301	.38722	-.13826	-.45922
.025	-.05213	-.02686	-.56625	-.45576	-.46639	-.45517	-.45710	-.44511
.050	-.03895	-.02376	-.31200	-.28501	-.28554	-.25925	-.27652	-.30050
.075	-.01438	-.02118	-.21156	-.20528	-.20384	-.19658	-.19892	-.20809
.100	-.00240	.00413	-.13999	-.13246	-.12732	-.12732	-.13191	-.12909
.200	.01798	.00413	.00377	.00377	-.00264	.00198	-.00917	-.01905
.300	.05333	.03771	.08852	.09668	.39829	.09103	.07407	.05643
.400	.05153	.03771	1.3811	1.5004	1.3985	1.2600	.10793	.08324
.600	.04734	.04649	1.1614	1.2556	1.3193	1.1478	1.1145	.07407
.800	.02636	.03099	.04394	.02637	.03760	.03694	.03598	.00282
1.000	-.04134	-.05217	-.04666	-.10044	-.05871	-.09367	-.04162	-.02610
X/C	-CPL	-CPL	-CPL	-CPL	-CPL	-CPL	-CPL	-CPL
0.000	.08628	.28978	1.81033	.03767	.09301	.38722	-.13826	-.45922
.025	.22889	.37139	1.50892	1.23765	1.21358	1.10536	1.22701	1.14093
.050	.21990	.33833	1.15414	1.04111	1.05774	1.00175	1.01181	.78179
.075	.20912	.31767	.91027	.82050	.80510	.81433	.77896	.64631
.100	.20672	.29236	.76086	.74454	.73514	.72327	.68935	.58211
.200	.16897	.25827	.56876	.60266	.50315	.57413	.54612	.43534
.300	.20013	.25982	.48464	.53863	.51652	.49871	.47768	.43182
.400	.21091	.26705	.44321	.47836	.47358	.45055	.44452	.36408
.600	.19114	.22470	.27057	.32142	.30081	.30477	.27581	.24195
.800	.13362	.10537	.12367	.10421	.10027	.10027	.10440	.09452
1.000	-.04134	-.05217	-.04666	-.10044	-.05871	-.09367	-.04162	-.02610

## P R E S S U R E M E A S U R E M E N T S

OUTER PANEL SWEEP= 15.0000 DEGREES

FUSELAGE ON

ANGLE OF ATTACK= -3.76327 DEGREES

### S P A N W I S E L O C A T I O N

	2Y/B .12996	2Y/B .21661	2Y/B .33426	2Y/B .43233	2Y/B .48036	2Y/B .57641	2Y/B .67250	2Y/B .86465
X/C	-CPU	-CPU	-CPU	-CPU	-CPU	-CPU	-CPU	-CPU
0.000	.03347	.21596	1.26941	-.24655	-.15485	.10630	-.42284	-.57105
.025	-.05380	-.02434	-.48498	-.36296	-.37926	-.35564	-.37929	-.38983
.050	-.03527	-.01554	-.24781	-.21965	-.22572	-.19816	-.22477	-.22758
.075	.01136	-.00673	-.15269	-.13955	-.14698	-.13845	-.15225	-.14399
.100	.00120	.00880	-.08323	-.09199	-.09974	-.09383	-.09974	-.10185
.200	.03706	.03418	.04756	.05131	.04358	.04134	.03231	.01405
.300	.04961	.04402	.10701	.11952	.12139	.10105	.08780	.05338
.400	.05918	.05697	.15770	.17084	.16076	.14567	.13275	.09272
.600	.05320	.05593	.12078	.13392	.13517	.11811	.11519	.08358
.800	.03885	.03418	.04819	.03254	.02953	.03150	.03582	.01194
1.000	-.04662	-.05852	-.05882	-.10576	-.07874	-.09842	-.05689	-.03512
X/C	-CPL	-CPL	-CPL	-CPL	-CPL	-CPL	-CPL	-CPL
0.000	.03347	.21596	1.26941	-.24656	-.15485	.10630	-.42284	-.57105
.025	.19486	.32524	1.33638	1.08037	1.07979	.98920	1.03910	.98992
.050	.18590	.29209	1.01090	.96645	.94982	.88746	.92599	.88220
.075	.19068	.29520	.82541	.74093	.72598	.72664	.70257	.56697
.100	.18948	.27604	.70839	.67898	.67938	.64984	.62740	.51217
.200	.16976	.23875	.52941	.57072	.56138	.53346	.50515	.40257
.300	.18829	.24548	.46183	.50501	.48818	.46587	.45175	.40538
.400	.20263	.25532	.42115	.46058	.45378	.43372	.42365	.34567
.600	.17215	.22787	.27096	.29537	.29658	.28280	.26831	.22055
.800	.13569	.11031	.12265	.11076	.10039	.10630	.10395	.09131
1.000	-.04662	-.05852	-.05882	-.10576	-.07874	-.09842	-.05689	-.03512

# APPENDIX B

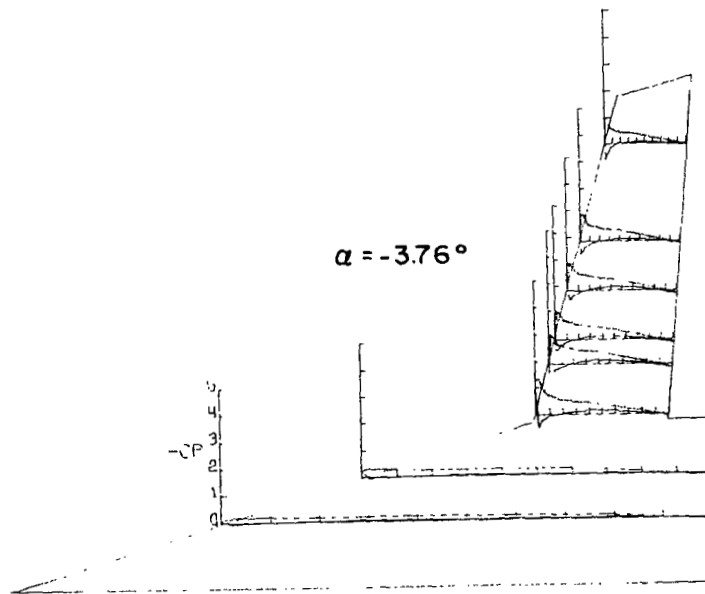
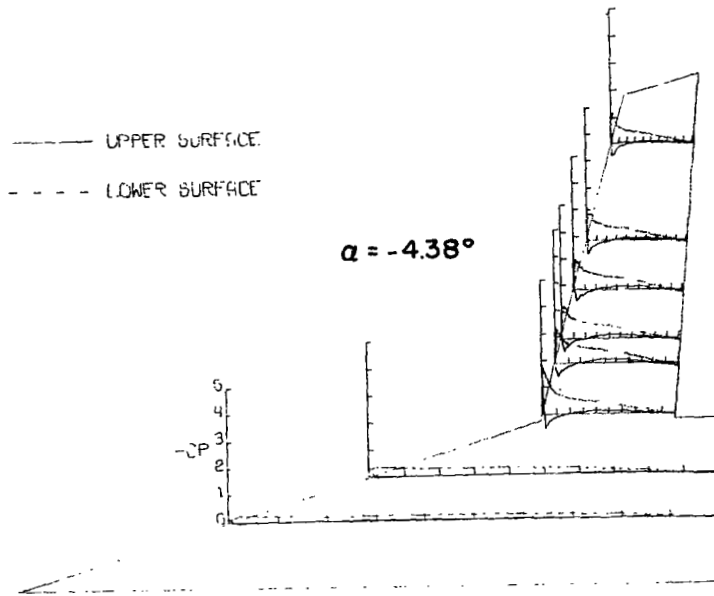

# APPENDIX B

## P R E S S U R E M E A S U R E M E N T S

OUTER PANEL SWEEP= 15.0000 DEGREES

FUSELAGE ON

ANGLE OF ATTACK= -3.21667 DEGREES

### S P A N W I S E L O C A T I J N

	2Y/B .12996	2Y/B .21661	2Y/B .33426	2Y/B .43233	2Y/B .48036	2Y/B .57641	2Y/B .67250	2Y/B .86465
X/C	- CPU	- CPU	- CPU	- CPU	- CPU	- CPU	- CPU	- CPU
0.000	.01374	.12788	.70802	-.47846	-.38254	-.18241	-.69220	-.73490
.025	-.02927	-.02003	-.41109	-.28757	-.28905	-.28215	-.29256	-.30796
.050	-.02031	-.00976	-.19088	-.16157	-.17126	-.12795	-.14628	-.18967
.075	.01912	.00822	-.09856	-.08983	-.10827	-.10105	-.10709	-.10149
.100	.02628	.02260	-.02620	-.02932	-.03543	-.02690	-.05179	-.05949
.200	.04600	.03646	.08109	.07548	.07808	.07611	.06299	.04129
.300	.07467	.05341	.12850	.15408	.14698	.14107	.12108	.09449
.400	.07587	.06831	.18090	.20087	.18756	.17716	.14838	.11898
.600	.06691	.05855	.12726	.14847	.14501	.13582	.11898	.10149
.800	.05556	.03492	.04554	.04741	.02559	.04659	.02450	.02170
1.000	-.03823	-.06163	-.06238	-.11104	-.08071	-.10302	-.06019	-.03570
X/C	- CPL	- CPL	- CPL	- CPL	- CPL	- CPL	- CPL	- CPL
0.000	.01374	.12788	.70802	-.47846	-.38254	-.18241	-.69220	-.73490
.025	.16667	.27579	1.12563	.92511	.91175	.86645	.89050	.88140
.050	.16249	.25525	.89828	.82904	.83954	.78900	.78269	.60417
.075	.17025	.24857	.72362	.64502	.67084	.63802	.60137	.49216
.100	.17563	.23779	.60073	.60322	.59011	.59470	.55376	.43965
.200	.15114	.22649	.48096	.50653	.51508	.47703	.45015	.35354
.300	.17503	.23265	.44166	.45787	.46325	.41863	.42355	.36754
.400	.20012	.23676	.40048	.43292	.42847	.40813	.39274	.32484
.600	.18698	.21622	.26262	.29880	.29396	.28609	.26036	.22117
.800	.13560	.11042	.12476	.10917	.10433	.10761	.10639	.08749
1.000	-.03823	-.06163	-.06238	-.11104	-.08071	-.10302	-.06019	-.03570

## P R E S S U R E M E A S U R E M E N T S

OUTER PANEL SWEEP= 15.0000 DEGREES

FUSELAGE ON

ANGLE OF ATTACK= -2.62514 DEGREES

### S P A N W I S E L O C A T I J N

	2Y/B .12996	2Y/B .21661	2Y/B .33426	2Y/B .43233	2Y/B .48036	2Y/B .57641	2Y/B .67250	2Y/B .86465
X/C	- CPU	- CPU	- CPU	- CPU	- CPU	- CPU	- CPU	- CPU
0.000	-.01441	.08452	.27754	-.66887	-.54835	-.43072	-.85783	-.83089
.025	-.02761	-.02087	-.29524	-.16943	-.21503	-.20175	-.22687	-.23325
.050	-.00720	.00522	-.11569	-.07397	-.09026	-.05774	-.08082	-.12974
.075	.02701	.03183	-.01897	-.02529	-.04181	-.02920	-.04892	-.06593
.100	.01801	.04748	.03414	.00632	.01726	-.00332	.00496	-.02552
.200	.04562	.05217	.11632	.11253	.11415	.10486	.09146	.07373
.300	.08104	.07461	.15805	.17765	.17786	.16392	.14959	.12052
.400	.07804	.08348	.20673	.21811	.21436	.19644	.17440	.13895
.600	.07564	.07826	.14857	.16121	.16658	.14667	.14604	.10705
.800	.05643	.04226	.05627	.04678	.02854	.04447	.02198	.02552
1.000	-.04502	-.05426	-.06512	-.11569	-.08027	-.10884	-.06026	-.03828
X/C	- CPL	- CPL	- CPL	- CPL	- CPL	- CPL	- CPL	- CPL
0.000	-.01441	.08452	.27754	-.66887	-.54835	-.43072	-.85783	-.83089
.025	.13446	.23321	.97193	.78962	.79337	.77345	.78359	.76444
.050	.14347	.22121	.80036	.73335	.74225	.69711	.71339	.52972
.075	.15487	.23060	.63979	.61450	.50157	.59756	.55738	.45243
.100	.15307	.21600	.56076	.54115	.54757	.53026	.50277	.40137
.200	.13506	.21130	.46087	.47857	.49738	.44930	.44179	.32904
.300	.15607	.22591	.42673	.43306	.44353	.39421	.41059	.35173
.400	.18189	.23217	.38880	.42957	.41346	.38426	.39357	.30280
.600	.16148	.19982	.24150	.28070	.27741	.26812	.24747	.20985
.800	.11525	.10174	.10937	.09230	.09159	.08827	.09429	.07231
1.000	-.04502	-.05426	-.06512	-.11569	-.08027	-.10884	-.06026	-.03828



# APPENDIX B

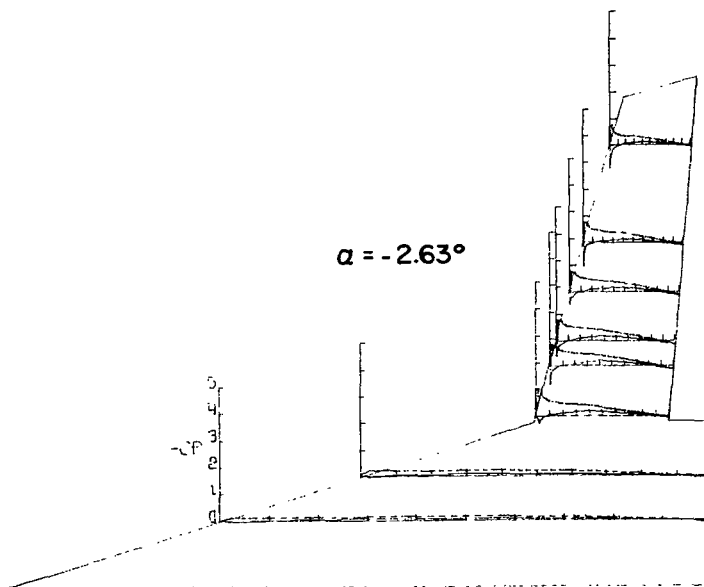
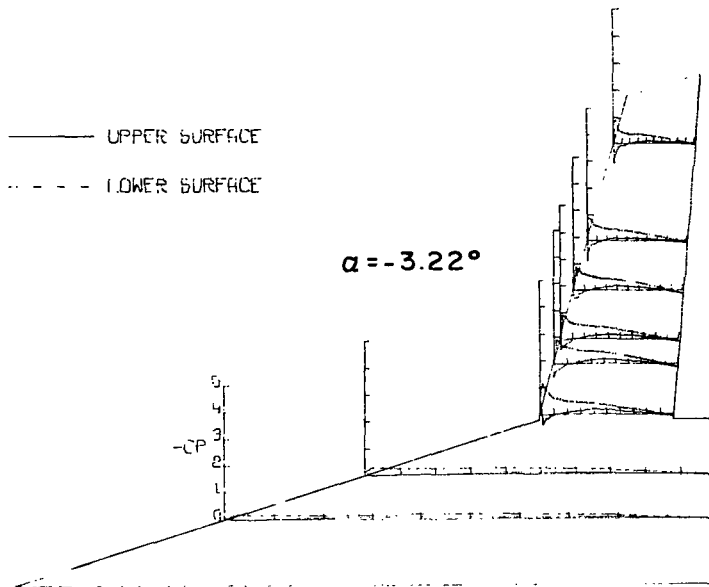

# APPENDIX B

## P R E S S U R E M E A S U R E M E N T S

OUTER PANEL SWEEP= 15.0000 DEGREES

FUSELAGE ON

ANGLE OF ATTACK= -2.12202 DEGREES

### S P A N W I S E L O C A T I O N

	2Y/B .12996	2Y/B .21661	2Y/B .33426	2Y/B .43233	2Y/B .48336	2Y/B .57641	2Y/B .67250	2Y/B .86465
X/C	-CPU	-CPU	-CPU	-CPU	-CPU	-CPU	-CPU	-CPU
0.000	-.03520	-.04192	-.16278	-.80628	-.74716	-.63165	-.96262	-.88561
.025	-.01639	-.00995	-.20984	-.08966	-.39815	-.09415	-.11837	-.14546
.050	.00303	.01362	-.03370	-.02289	-.32938	-.00067	-.03280	-.07701
.075	.04855	.03930	.03815	.03752	.02273	.01602	.00357	-.01212
.100	.03156	.04244	.06231	.07312	.35275	.05208	.04991	.02496
.200	.06312	.06392	.14561	.15642	.13955	.14556	.12764	.10054
.300	.09104	.09117	.19012	.20920	.21166	.19163	.17826	.13762
.400	.09043	.10007	.23209	.24608	.24037	.21433	.20465	.15188
.600	.07951	.08959	.16024	.17677	.17494	.15758	.15545	.11266
.800	.07405	.05239	.06804	.05786	.33373	.05008	.02995	.03066
1.000	-.05220	-.05397	-.06677	-.11730	-.39815	-.11818	-.06560	-.04991
X/C	-CPL	-CPL	-CPL	-CPL	-CPL	-CPL	-CPL	-CPL
0.000	-.03520	.04192	-.16278	-.80628	-.74715	-.63165	-.96262	-.88561
.025	.13413	.19700	.82726	.65621	.57463	.63122	.61267	.63264
.050	.12260	.18705	.69882	.65113	.56395	.61585	.64476	.44648
.075	.14566	.20958	.58436	.53158	.52348	.52214	.50425	.38729
.100	.13474	.19700	.49343	.49216	.48475	.46472	.45219	.35733
.200	.13534	.19648	.42539	.46100	.45404	.42866	.39798	.31454
.300	.16508	.21063	.40314	.43557	.40863	.38927	.37587	.35448
.400	.18451	.20801	.36944	.40759	.38059	.38059	.36232	.30740
.600	.16994	.19595	.23209	.28741	.26040	.26975	.23531	.21178
.800	.13110	.09431	.10683	.10174	.38079	.09415	.08699	.07986
1.000	-.05220	-.05397	-.06677	-.11700	-.09815	-.11818	-.06560	-.04991

## P R E S S U R E M E A S U R E M E N T S

OUTER PANEL SWEEP= 15.0000 DEGREES

FUSELAGE ON

ANGLE OF ATTACK= -1.59888 DEGREES

### S P A N W I S E L O C A T I O N

	2Y/B .12996	2Y/B .21661	2Y/B .33426	2Y/B .43233	2Y/B .48336	2Y/B .57641	2Y/B .67250	2Y/B .86465
X/C	-CPU	-CPU	-CPU	-CPU	-CPJ	-CPU	-CPU	-CPU
0.000	-.06498	-.00473	-.42348	-.87545	-.81239	-.75361	-.99615	-.94545
.025	-.00850	.01840	-.06014	.01709	-.01263	.00133	-.03570	-.04999
.050	.01700	.03206	.05317	.07786	.35649	.09902	.04356	-.00928
.075	.04798	.05992	.10445	.08925	.08772	.08108	.07926	.04356
.100	.05344	.07043	.13546	.12534	.11952	.11098	.10568	.07141
.200	.07288	.08305	.18484	.18800	.18608	.17544	.15567	.13353
.300	.10081	.10723	.21143	.24308	.24130	.22994	.21351	.16995
.400	.09595	.10617	.23738	.26207	.24921	.23525	.21922	.15853
.600	.08867	.10144	.16142	.18421	.18475	.16747	.16852	.13139
.800	.06498	.05782	.06900	.04558	.34535	.03987	.04213	.02285
1.000	-.04433	-.05677	-.07659	-.11964	-.09902	-.11297	-.06641	-.03927
X/C	-CPL	-CPL	-CPL	-CPL	-CPL	-CPL	-CPL	-CPL
0.000	-.06498	-.00473	-.42348	-.87545	-.81239	-.75361	-.99615	-.94545
.025	.08624	.15453	.63807	.52350	.52035	.48978	.51356	.50070
.050	.11660	.16662	.58490	.51654	.55644	.51636	.53213	.38927
.075	.12207	.18029	.48742	.42918	.45123	.41535	.42499	.33499
.100	.12936	.17766	.43994	.42538	.42332	.39674	.40427	.28992
.200	.13361	.17976	.38297	.41209	.40870	.39475	.36642	.27992
.300	.15000	.19185	.36715	.38297	.36316	.35221	.34856	.31928
.400	.17369	.20552	.35702	.36335	.37348	.33959	.35642	.27635
.600	.13846	.18712	.22788	.24814	.25386	.24057	.23208	.18923
.800	.11599	.09829	.10445	.08546	.08307	.08108	.09283	.06784
1.000	-.04433	-.05677	-.07659	-.11964	-.09902	-.11297	-.06641	-.03927

# APPENDIX B

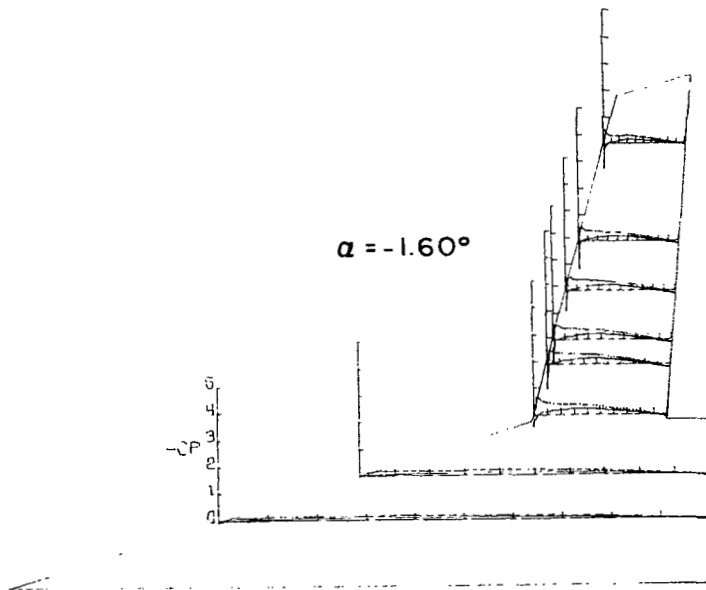
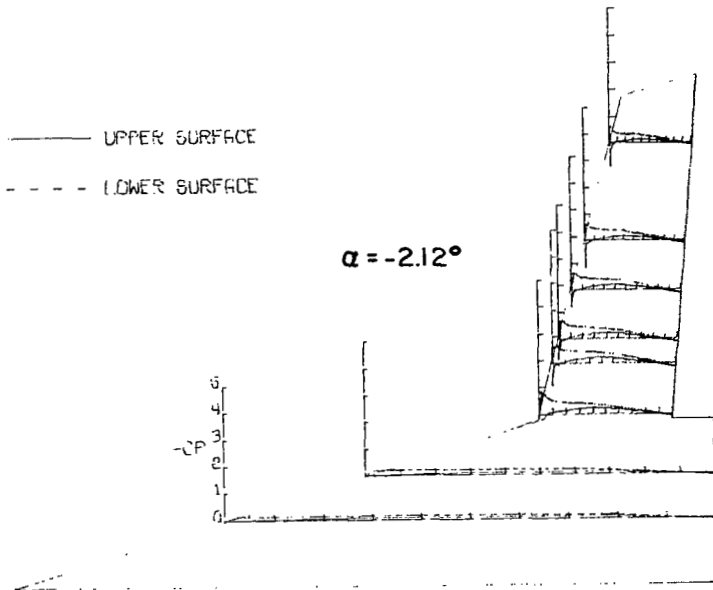

# APPENDIX B

## P R E S S U R E M E A S U R E M E N T S

OUTER PANEL SWEEP= 15.00000 DEGREES

FUSELAGE ON

ANGLE OF ATTACK= -1.07230 DEGREES

### S P A N W I S E L O C A T I O N

	2Y/B .12996	2Y/B .21661	2Y/B .33426	2Y/B .43233	2Y/B .48036	2Y/B .57641	2Y/B .67250	2Y/B .86465
X/C	-CPU	-CPU	-CPU	-CPU	-CPU	-CPU	-CPU	-CPU
0.000	-.07108	-.03216	-.66495	-.91664	-.85119	-.87141	-.96108	-.96595
.025	.02251	.03318	.06028	.15785	.13045	.13958	.10454	.05227
.050	.03376	.06584	.15598	.15350	.14023	.17154	.13381	.07039
.075	.07464	.07707	.17587	.16593	.15132	.14154	.12754	.08224
.100	.06101	.08115	.19700	.18768	.18057	.16959	.15402	.11778
.200	.07938	.09749	.22061	.22372	.23025	.21264	.21047	.15960
.300	.11373	.11484	.23242	.26971	.26090	.25568	.23138	.18748
.400	.11432	.12556	.26287	.29270	.27786	.26808	.23556	.18260
.600	.10248	.10361	.17028	.19576	.19698	.18067	.17702	.13381
.800	.07464	.06584	.07395	.06277	.05740	.06001	.05227	.03415
1.000	-.04324	-.04951	-.06587	-.11994	-.09252	-.11154	-.06203	-.04739
X/C	-CPL	-CPL	-CPL	-CPL	-CPL	-CPL	-CPL	-CPL
0.000	-.07108	-.03216	-.66495	-.91664	-.85119	-.87141	-.96108	-.96595
.025	.07641	.12096	.45490	.38095	.37309	.33526	.37226	.34437
.050	.08708	.12199	.45304	.42818	.44745	.40570	.41896	.29836
.075	.10959	.15210	.40394	.37163	.36370	.36200	.34298	.29418
.100	.10959	.15210	.36603	.35174	.34339	.34374	.32346	.26275
.200	.11077	.14495	.32875	.36293	.35678	.33982	.30324	.23487
.300	.13802	.16333	.32875	.35050	.33135	.31830	.31091	.28644
.400	.15046	.17251	.32253	.33310	.33461	.31504	.31649	.25508
.600	.13920	.17200	.20881	.24050	.23286	.23090	.21047	.17981
.800	.10603	.08524	.09570	.07706	.07370	.07305	.07806	.06621
1.000	-.04324	-.04951	-.06587	-.11994	-.09252	-.11154	-.06203	-.04739

## P R E S S U R E M E A S U R E M E N T S

OUTER PANEL SWEEP= 15.00000 DEGREES

FUSELAGE ON

ANGLE OF ATTACK= -.51469 DEGREES

### S P A N W I S E L O C A T I O N

	2Y/B .12996	2Y/B .21661	2Y/B .33426	2Y/B .43233	2Y/B .48036	2Y/B .57641	2Y/B .67250	2Y/B .86465
X/C	-CPU	-CPU	-CPU	-CPU	-CPU	-CPU	-CPU	-CPU
0.000	-.08029	-.04285	-.85343	-.92330	-.91792	-.90873	-.90187	-.97843
.025	.02936	.05318	.22909	.28385	.25148	.24557	.22477	.11730
.050	.05333	.08364	.25490	.23916	.23643	.26329	.21072	.12994
.075	.08868	.08983	.26686	.25364	.20945	.23112	.19175	.13837
.100	.07969	.10171	.26308	.26182	.24951	.23966	.21283	.18052
.200	.09707	.10738	.27063	.27944	.27117	.26264	.24092	.20369
.300	.12763	.13320	.27063	.31595	.29547	.28431	.26270	.20650
.400	.12223	.13733	.29014	.32035	.30072	.28496	.25427	.19105
.600	.10905	.11823	.19511	.21651	.22127	.19370	.19035	.14399
.800	.07730	.07951	.09189	.07049	.06874	.05909	.06673	.03723
1.000	-.04614	-.05885	-.07175	-.12273	-.10243	-.11884	-.08148	-.05057
X/C	-CPL	-CPL	-CPL	-CPL	-CPL	-CPL	-CPL	-CPL
0.000	-.08029	-.04285	-.85343	-.92330	-.91792	-.90873	-.90187	-.97843
.025	.04254	.08983	.31469	.24294	.27511	.24031	.24031	.28377
.050	.07250	.10325	.33986	.32224	.33486	.31517	.32248	.22547
.075	.08568	.13062	.33798	.28070	.28431	.26329	.26340	.21072
.100	.09407	.13062	.30902	.29832	.28956	.27643	.26691	.20159
.200	.09887	.14146	.30777	.32098	.32239	.29218	.27885	.19737
.300	.13182	.15075	.30902	.32728	.30203	.28759	.28096	.26550
.400	.16418	.16830	.31784	.33105	.31548	.30663	.30140	.24443
.600	.12463	.16417	.21210	.24168	.23046	.21208	.20510	.16436
.800	.10905	.08260	.09755	.08308	.06632	.07223	.07305	.06673
1.000	-.04614	-.05885	-.07175	-.12273	-.10243	-.11884	-.08148	-.05057

# APPENDIX B

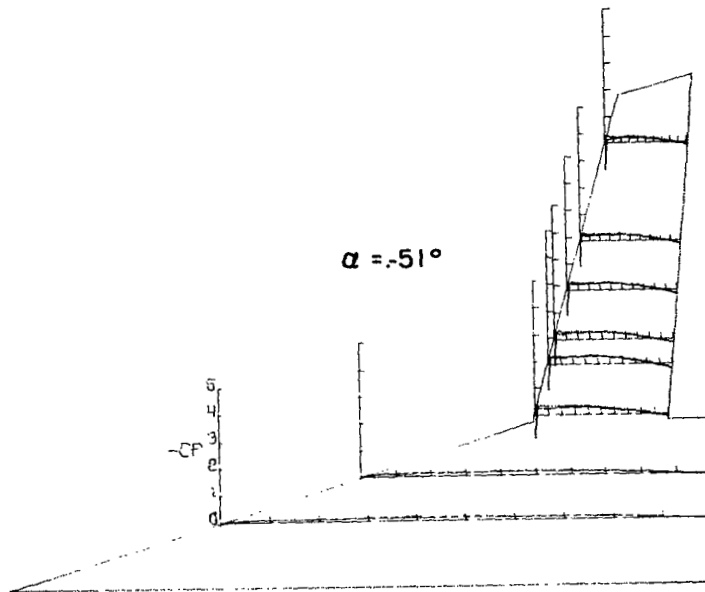
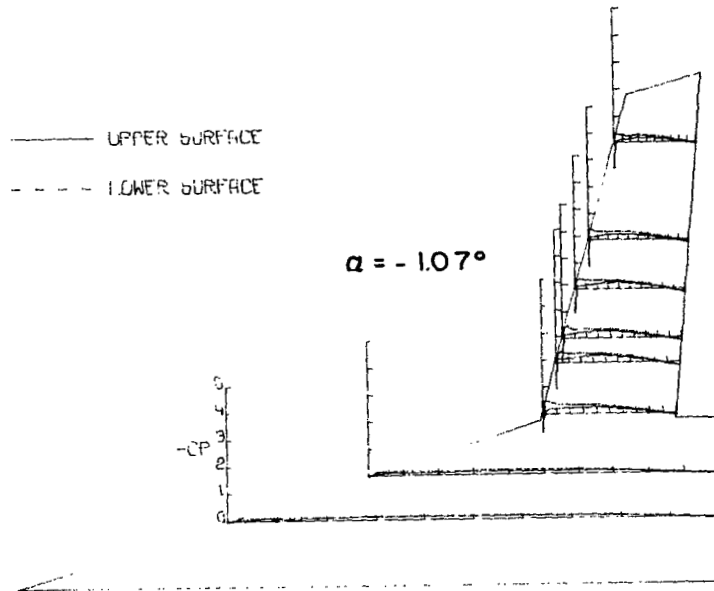

# APPENDIX B

## P R E S S U R E M E A S U R E M E N T S

OUTER PANEL SWEEP= 15.0000 DEGREES

FUSELAGE ON

ANGLE OF ATTACK= .01211 DEGREES

### S P A N W I S E L O C A T I O N

	2Y/B .12996	2Y/B .21661	2Y/B .33426	2Y/B .43233	2Y/B .48036	2Y/B .57641	2Y/B .67250	2Y/B .86465
X/C	-CPU	-CPU	-CPU	-CPU	-CPU	-CPU	-CPU	-CPU
0.000	-.07221	-.03994	-.89811	-.89999	-.90091	-.89697	-.95644	-.94583
.025	.04694	.08403	.37500	.40625	.35629	.33727	.36229	.32774
.050	.07702	.10063	.33812	.33625	.28871	.35695	.28085	.20091
.075	.10892	.12864	.32187	.32552	.28871	.28805	.26316	.20303
.100	.09568	.12449	.31750	.30875	.29452	.28937	.27307	.24548
.200	.10230	.13435	.30375	.30500	.31102	.29133	.28863	.22638
.300	.14683	.14368	.28750	.33562	.31339	.31364	.28368	.24336
.400	.13359	.15458	.30687	.33250	.32414	.30052	.28651	.20940
.600	.11674	.13487	.20250	.22437	.22244	.20866	.20515	.16342
.800	.08906	.07729	.08312	.07062	.05693	.06365	.07145	.04245
1.000	-.04092	-.05758	-.08125	-.12312	-.11089	-.11286	-.07994	-.04457
X/C	-CPL	-CPL	-CPL	-CPL	-CPL	-CPL	-CPL	-CPL
0.000	-.07221	-.03994	-.89811	-.89999	-.90091	-.89697	-.95644	-.94583
.025	.02467	.04824	.12562	.12687	.12533	.08333	.12026	.13512
.050	.05897	.08662	.25875	.24312	.24081	.21981	.25397	.14785
.075	.07101	.10271	.24562	.21312	.20210	.20013	.18605	.16483
.100	.09387	.10737	.22875	.23625	.21053	.23490	.21930	.18393
.200	.09327	.11930	.24875	.28187	.27099	.25525	.23062	.18322
.300	.12215	.14472	.27812	.29812	.27362	.26443	.25397	.23982
.400	.14442	.15146	.27875	.29687	.28412	.27690	.27024	.22425
.600	.11253	.14472	.18437	.21375	.20538	.19094	.18605	.15422
.800	.09568	.07884	.08125	.06000	.05643	.05184	.07145	.05447
1.000	-.04092	-.05758	-.08125	-.12312	-.11089	-.11286	-.07994	-.04457

## P R E S S U R E M E A S U R E M E N T S

OUTER PANEL SWEEP= 15.0000 DEGREES

FUSELAGE ON

ANGLE OF ATTACK= .51336 DEGREES

### S P A N W I S E L O C A T I O N

	2Y/B .12996	2Y/B .21661	2Y/B .33426	2Y/B .43233	2Y/B .48036	2Y/B .57641	2Y/B .67250	2Y/B .86465
X/C	-CPU	-CPU	-CPU	-CPU	-CPU	-CPU	-CPU	-CPU
0.000	-.06933	-.02764	-.91835	-.88692	-.89391	-.90182	-.93184	-.95583
.025	.07475	.11472	.55252	.57515	.51552	.49376	.44664	.31822
.050	.07777	.13558	.45823	.43246	.39158	.44564	.36690	.23631
.075	.12298	.14496	.41109	.40103	.36785	.36126	.32175	.26876
.100	.10851	.13558	.37400	.39852	.34741	.36060	.29564	.28287
.200	.12660	.14966	.33754	.37086	.34873	.35796	.31399	.26241
.300	.14288	.15956	.32497	.35955	.35664	.33621	.31822	.25324
.400	.14288	.17208	.32874	.36835	.34873	.33621	.30270	.22996
.600	.12841	.14653	.21183	.23823	.22941	.22282	.20951	.16365
.800	.09646	.07717	.08863	.08171	.07383	.08108	.06419	.04797
1.000	-.05184	-.04902	-.06537	-.12634	-.09838	-.11800	-.08042	-.05502
X/C	-CPL	-CPL	-CPL	-CPL	-CPL	-CPL	-CPL	-CPL
0.000	-.06933	-.02764	-.91835	-.88692	-.89391	-.90182	-.93184	-.95583
.025	.01628	.04015	.00314	.00314	.02175	-.04285	.02116	.02116
.050	.04220	.05684	.15966	.15714	.15921	.14767	.15660	.07618
.075	.06270	.09230	.18417	.14457	.15624	.15426	.14672	.10511
.100	.06692	.09490	.17789	.17160	.15283	.16283	.15237	.12062
.200	.08078	.10585	.21874	.23446	.23600	.20634	.19187	.14531
.300	.10670	.11785	.24200	.25709	.23556	.21754	.21797	.20386
.400	.12901	.13193	.26337	.26965	.26303	.24391	.24125	.19681
.600	.10248	.13193	.16909	.19172	.18920	.17470	.16577	.13614
.800	.08982	.06779	.07920	.05909	.05340	.05076	.05714	.04515
1.000	-.05184	-.04902	-.06537	-.12634	-.09838	-.11800	-.08042	-.05502

# APPENDIX B

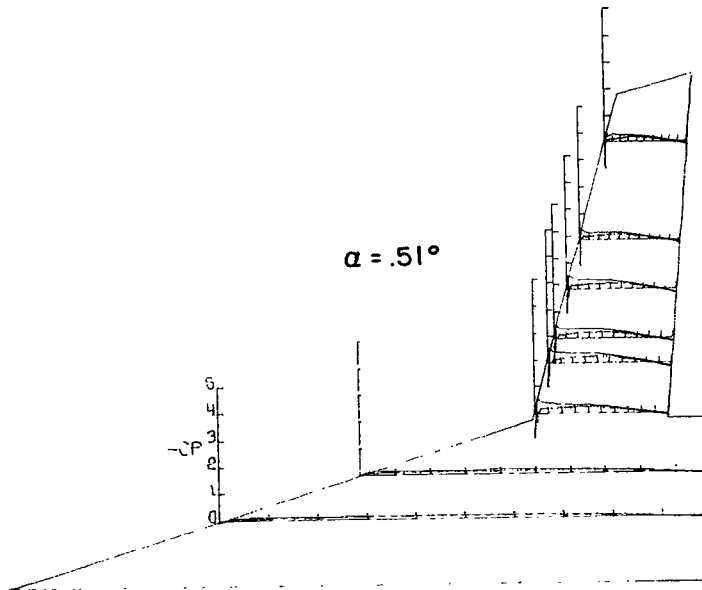
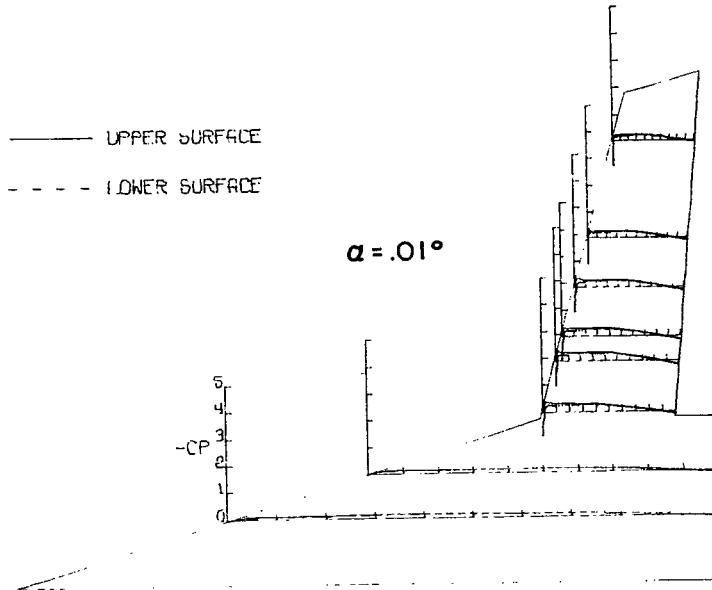

# APPENDIX B

## P R E S S U R E M E A S U R E M E N T S

OUTER PANEL SWEEP= 15.0000 DEGREES

FUSELAGE ON

ANGLE OF ATTACK= 1.07369 DEGREES

### S P A N W I S E L O C A T I O N

	2Y/B .12996	2Y/B .21661	2Y/B .33426	2Y/B .43233	2Y/B .48036	2Y/B .57641	2Y/B .67250	2Y/B .86465
X/C	- CPU	-CPU	-CPU	-CPU	- CPU	- CPU	- CPU	- CPU
0.000	-.06092	-.02133	-.90779	-.80467	-.85935	-.89322	-.89935	-.95556
.025	.08928	.14830	.73825	.70346	.63130	.61652	.60066	.46046
.050	.10737	.18264	.59844	.54151	.49874	.54125	.49035	.34375
.075	.13029	.16391	.49786	.48078	.44233	.43897	.40851	.30247
.100	.13029	.16027	.44915	.46307	.43499	.43831	.37648	.34375
.200	.12547	.17016	.39285	.39348	.40178	.37456	.37150	.28958
.300	.15080	.18525	.36944	.40107	.41042	.37788	.36083	.27535
.400	.14477	.19201	.36501	.39221	.38850	.35729	.33876	.25187
.600	.14538	.15663	.22394	.26506	.24735	.24904	.22911	.18855
.800	.09832	.08482	.10944	.09932	.09155	.09298	.07755	.06048
1.000	-.04524	-.04787	-.07212	-.12083	-.10692	-.11157	-.07969	-.05123

	- CPL	-CPL	-CPL	- CPL	- CPL	-CPL	-CPL	-CPL
X/C	- CPU	-CPU	-CPU	-CPU	- CPU	- CPU	- CPU	- CPU
0.000	-.06092	-.02133	-.90779	-.80467	-.85935	-.89322	-.89935	-.95556
.025	-.00362	.02550	-.09616	-.10122	-.07335	-.11290	-.06332	-.05550
.050	.01267	.03955	.06642	.05251	.39238	.03985	.05906	.01210
.075	.04223	.05932	.09932	.07781	.36176	.07239	.06332	.03415
.100	.05127	.06921	.11956	.10248	.11157	.10227	.09748	.06973
.200	.06273	.08846	.18535	.20307	.20255	.17267	.15724	.11455
.300	.09953	.10147	.22015	.23406	.21915	.19326	.19068	.19567
.400	.12426	.11344	.24292	.24988	.23974	.22248	.22839	.18428
.600	.10013	.11552	.15878	.19358	.17854	.17732	.15582	.14657
.800	.08143	.06869	.07401	.05314	.34649	.04715	.05479	.04625
1.000	-.04524	-.04787	-.07212	-.12083	-.10692	-.11157	-.07969	-.05123

## P R E S S U R E M E A S U R E M E N T S

OUTER PANEL SWEEP= 15.0000 DEGREES

FUSELAGE ON

ANGLE OF ATTACK= 1.58919 DEGREES

### S P A N W I S E L O C A T I O N

	2Y/B .12996	2Y/B .21661	2Y/B .33426	2Y/B .43233	2Y/B .48036	2Y/B .57641	2Y/B .67250	2Y/B .86465
X/C	- CPU	-CPU	-CPU	-CPU	- CPU	- CPU	- CPU	- CPU
0.000	-.03943	.04341	-.84321	-.66457	-.78659	-.84786	-.81841	-.94124
.025	.12127	.19174	.91628	.86632	.77538	.80204	.74279	.54621
.050	.12545	.19019	.67269	.62585	.58456	.62740	.55885	.38614
.075	.15591	.19019	.55839	.55339	.51335	.50792	.46056	.37420
.100	.12903	.18915	.50592	.51467	.48816	.48157	.43177	.37210
.200	.13501	.17727	.40974	.43347	.42228	.42162	.39386	.32225
.300	.16547	.19019	.37476	.42285	.42395	.40581	.37771	.30329
.400	.15830	.20259	.37101	.40474	.40334	.37551	.35735	.26181
.600	.14516	.16435	.23297	.26920	.25930	.25956	.23303	.19162
.800	.10514	.08734	.10556	.09182	.09421	.09355	.08493	.06177
1.000	-.04062	-.05788	-.08245	-.11368	-.11792	-.10804	-.09125	-.05264

	- CPL	-CPL	-CPL	-CPL	-CPL	-CPL	-CPL	-CPL
X/C	- CPU	-CPU	-CPU	-CPU	- CPU	- CPU	- CPU	- CPU
0.000	-.03943	.04341	-.84321	-.66457	-.78659	-.84786	-.81841	-.94124
.025	-.02509	.09155	-.21861	-.19487	-.17721	-.22992	-.17126	-.14950
.050	.00836	.01654	-.03935	-.02686	.30056	-.02701	-.00772	-.05896
.075	.03286	.05013	.03748	.30562	.01252	.02174	.01614	-.00070
.100	.04361	.06512	.06746	.04550	.35534	.05073	.03690	.03369
.200	.05376	.08217	.15303	.15615	.17128	.17912	.12634	.09054
.300	.08772	.10026	.20050	.20174	.20159	.16799	.17056	.15284
.400	.10992	.11008	.22236	.22485	.22536	.20027	.20636	.15933
.600	.08961	.11215	.15490	.17551	.17524	.16074	.14810	.12564
.800	.07646	.06719	.07120	.09335	.04348	.03887	.05479	.03018
1.000	-.04062	-.05788	-.08245	-.11368	-.11792	-.10804	-.09125	-.05264



# APPENDIX B

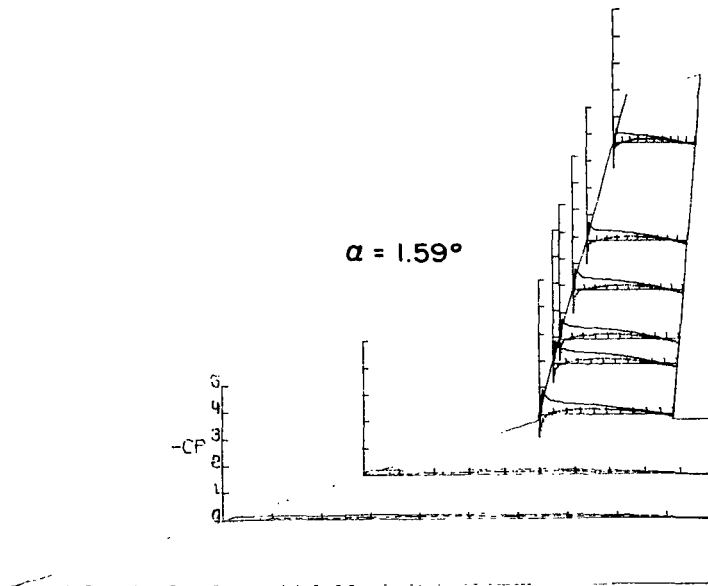
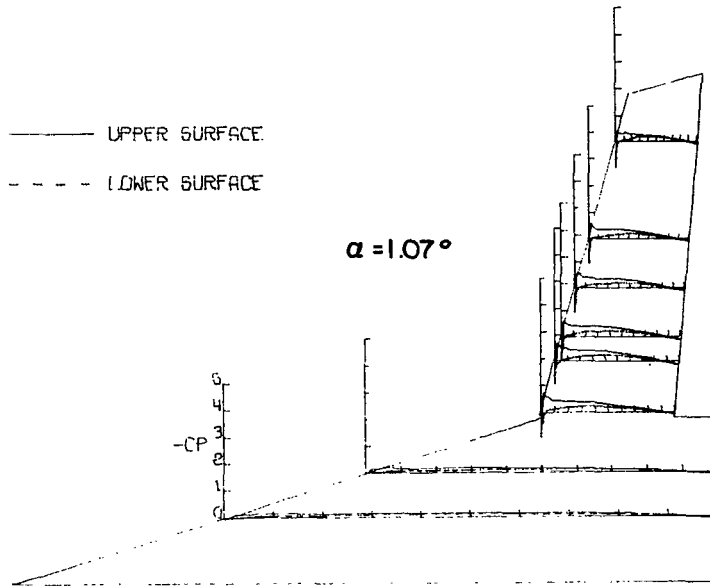

# APPENDIX B

## P R E S S U R E M E A S U R E M E N T S

OUTER PANEL SWEEP= 15.00000 DEGREES

FUSELAGE ON

ANGLE OF ATTACK= 2.13532 DEGREES

### S P A N W I S E L O C A T I O N

	2Y/B .12996	2Y/B .21661	2Y/B .33426	2Y/B .43233	2Y/B .48036	2Y/B .57641	2Y/B .67250	2Y/B .86465
X/C	- CPU	- CPU	- CPU	- CPU	- CPU	- CPU	- CPU	- CPU
0.000	-.01025	.07569	-.73983	-.51560	-.70945	-.76321	-.71029	-.90368
.025	-.14348	.24064	1.14867	1.03273	.92234	.92881	.86337	.64504
.050	-.15011	.23020	.80064	.72463	.71635	.73628	.64575	.44733
.075	-.16639	.21768	.65179	.62772	.58424	.55702	.54405	.41746
.100	-.15553	.21924	.59224	.57641	.56233	.54221	.50280	.42671
.200	-.15252	.18844	.45353	.47253	.46191	.45195	.42671	.34634
.300	-.17302	.21611	.41299	.45226	.45733	.42474	.41319	.32999
.400	-.16880	.21507	.38892	.43389	.42010	.39952	.37550	.28938
.600	-.15071	.18009	.25527	.27554	.28036	.26148	.25667	.19695
.800	-.11454	.09500	.10768	.10135	.09159	.09490	.08603	.06470
1.000	-.04099	-.06003	-.07348	-.10895	-.10818	-.10552	-.09314	-.04550

	- CPL	- CPL	- CPL	- CPL	- CPL	- CPL	- CPL	- CPL
X/C	- CPU	- CPU	- CPU	- CPU	- CPU	- CPU	- CPU	- CPU
0.000	-.01025	.07569	-.73983	-.51560	-.70945	-.76321	-.71029	-.90368
.025	-.03135	-.01148	-.34078	-.29644	-.27210	-.29997	-.28298	-.21259
.050	-.00663	.00157	-.10705	-.11211	-.07566	-.10353	-.07252	-.09030
.075	.02231	.04750	-.01394	-.05574	-.03733	-.04845	-.02844	-.04266
.100	.02833	.04124	.00443	-.00380	-.00465	-.00465	-.01777	-.02275
.200	.04642	.05794	.11972	.12985	.12410	.10552	.09101	.06683
.300	.07777	.08248	.16532	.17989	.16392	.14401	.14149	.14007
.400	.10188	.09187	.20839	.19953	.20374	.17720	.17704	.14860
.600	.07294	.09605	.13682	.15392	.15530	.14269	.13651	.10594
.800	.08259	.05116	.05511	.04751	.02555	.04579	.02773	.04266
1.000	-.04099	-.06003	-.07348	-.10895	-.10818	-.10552	-.09314	-.04550

## P R E S S U R E M E A S U R E M E N T S

OUTER PANEL SWEEP= 15.00000 DEGREES

FUSELAGE ON

ANGLE OF ATTACK= 2.64654 DEGREES

### S P A N W I S E L O C A T I O N

	2Y/B .12996	2Y/B .21661	2Y/B .33426	2Y/B .43233	2Y/B .48036	2Y/B .57641	2Y/B .67250	2Y/B .86465
X/C	- CPU	- CPU	- CPU	- CPU	- CPU	- CPU	- CPU	- CPU
0.000	.01448	.14721	-.54854	-.34711	-.59225	-.65658	-.58276	-.85004
.025	.16347	.27666	1.37042	1.18225	1.11197	1.05690	.98569	.75452
.050	.16227	.27457	.91402	.82914	.80478	.82270	.75168	.52050
.075	.19122	.25630	.75250	.69359	.55749	.63494	.59638	.47228
.100	.16528	.23386	.64989	.63785	.50972	.57390	.56092	.47512
.200	.15804	.21298	.48963	.52384	.49940	.49476	.46164	.38222
.300	.18338	.21768	.43389	.48963	.47486	.46491	.43115	.35173
.400	.17916	.22968	.40349	.45796	.43838	.41981	.38577	.30422
.600	.16106	.18479	.25970	.29074	.28187	.27258	.26019	.20347
.800	.11883	.09866	.11718	.11085	.09816	.10280	.09500	.07373
1.000	-.03740	-.04594	-.06271	-.10071	-.10230	-.09484	-.08153	-.04466

	- CPL	- CPL	- CPL	- CPL	- CPL	- CPL	- CPL	- CPL
X/C	- CPU	- CPU	- CPU	- CPU	- CPU	- CPU	- CPU	- CPU
0.000	.01448	.14721	-.54854	-.34711	-.59225	-.65658	-.58276	-.85004
.025	-.04584	-.02297	-.43199	-.39652	-.35814	-.38599	-.34951	-.30910
.050	-.00905	-.00940	-.17736	-.16976	-.13928	-.18504	-.15448	-.18433
.075	.00362	.01775	-.08995	-.11211	-.10943	-.09285	-.07940	-.10634
.100	.01749	.03706	-.04054	-.05574	-.04543	-.04576	-.05317	-.05530
.200	.04223	.05481	.08868	.08995	.38953	.06566	.06168	.03757
.300	.06877	.06316	.14379	.15202	.13530	.11407	.11910	.11272
.400	.09832	.07882	.17989	.18559	.17310	.15851	.15668	.13116
.600	.06997	.07778	.12162	.15519	.13331	.14325	.11272	.09925
.800	.06937	.04855	.05891	.03040	.02587	.02918	.02198	.02269
1.000	-.03740	-.04594	-.06271	-.10071	-.10230	-.09484	-.08153	-.04466

# APPENDIX B

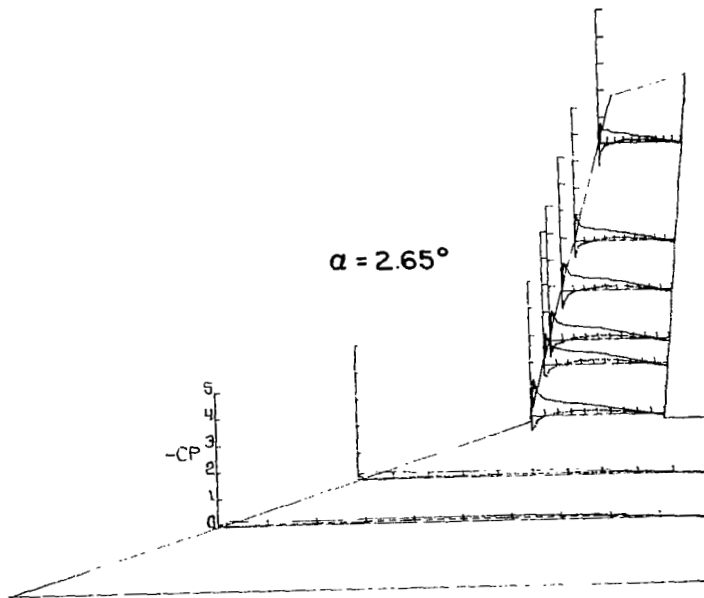
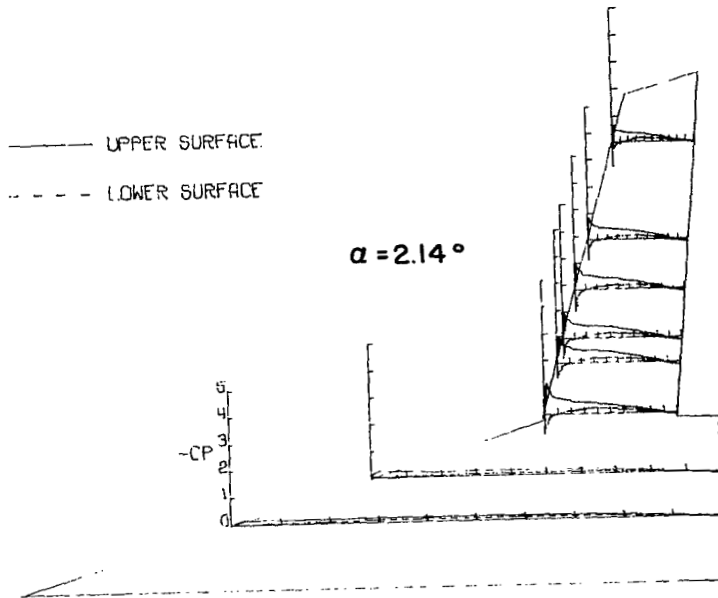

# APPENDIX B

## P R E S S U R E M E A S U R E M E N T S

OUTER PANEL SWEEP= 15.0000 DEGREES

FUSELAGE ON

ANGLE OF ATTACK= 3.18126 DEGREES

### S P A N W I S E L O C A T I O N

	2Y/B .12996	2Y/B .21661	2Y/B .33426	2Y/B .43233	2Y/B .48036	2Y/B .57641	2Y/B .67250	2Y/B .86465
X/C	- CPU	- CPU	- CPU	- CPU	- CPU	- CPU	- CPU	- CPU
0.000	.06674	.20051	-.26943	-.10640	-.43474	-.52327	-.40718	-.81435
.025	.20262	.30641	1.49685	1.39228	1.24044	1.25224	1.13661	.84809
.050	.19010	.29973	1.00267	.94914	.86260	.94919	.80478	.59869
.075	.19904	.27557	.80517	.77717	.72419	.72025	.66157	.52883
.100	.18176	.25552	.70872	.70250	.68221	.65794	.60428	.52674
.200	.16984	.23392	.53263	.55441	.55551	.52917	.50229	.42265
.300	.19487	.23958	.45547	.50774	.50622	.48720	.45758	.37025
.400	.17997	.24523	.42312	.46730	.46819	.43737	.41357	.31716
.600	.16209	.19074	.26756	.29369	.29770	.28267	.27029	.21162
.800	.12038	.11054	.12756	.10765	.11147	.10492	.10337	.07333
1.000	-.04350	-.04576	-.05413	-.09956	-.09442	-.09049	-.08311	-.04330
X/C	- CPL	- CPL	- CPL	- CPL	- CPL	- CPL	- CPL	- CPL
0.000	.06674	.20051	-.26943	-.10640	-.43474	-.52327	-.40718	-.81435
.025	-.05423	-.02468	-.51708	-.47414	-.42753	-.46294	-.43162	-.37086
.050	-.02860	-.01799	-.25200	-.25325	-.22032	-.24196	-.21162	-.23187
.075	-.00834	-.00154	-.15743	-.17360	-.17049	-.15934	-.15714	-.17321
.100	.01132	.01851	-.10578	-.10516	-.10492	-.09442	-.11245	-.10686
.200	.01728	.02879	.04480	.04045	.04524	.02295	.01467	-.00908
.300	.06138	.05347	.11760	.11698	.11344	.09115	.09429	.08311
.400	.07330	.05810	.14747	.14685	.14754	.13049	.13060	.09498
.600	.06079	.07198	.11822	.13378	.13311	.12393	.10965	.08800
.800	.05542	.04781	.05600	.03111	.02638	.02688	.02864	.02165
1.000	-.04350	-.04576	-.05413	-.09956	-.09442	-.09049	-.08311	-.04330

## P R E S S U R E M E A S U R E M E N T S

OUTER PANEL SWEEP= 15.0000 DEGREES

FUSELAGE ON

ANGLE OF ATTACK= 3.70683 DEGREES

### S P A N W I S E L O C A T I O N

	2Y/B .12996	2Y/B .21661	2Y/B .33426	2Y/B .43233	2Y/B .48036	2Y/B .57641	2Y/B .67250	2Y/B .86465
X/C	- CPU	- CPU	- CPU	- CPU	- CPU	- CPU	- CPU	- CPU
0.000	.10712	.28706	.02691	.15394	-.15547	-.31819	-.14118	-.71152
.025	.22861	.38448	1.72635	1.55672	1.39056	1.39056	1.30959	.99273
.050	.21964	.35443	1.15173	1.06786	.99910	1.04325	.94285	.72505
.075	.23041	.30986	.91302	.86483	.83632	.80798	.75245	.61756
.100	.19630	.29069	.79037	.77785	.75196	.72230	.68571	.57681
.200	.18133	.26582	.56759	.60138	.58852	.58325	.54238	.45667
.300	.19630	.26323	.49187	.54068	.54730	.52176	.49531	.39695
.400	.19749	.26686	.43617	.50501	.48618	.47499	.43278	.34566
.600	.17774	.22592	.28098	.31039	.30755	.29843	.28447	.22547
.800	.13406	.12488	.12891	.11577	.10936	.11397	.10395	.08218
1.000	-.04429	-.04353	-.05695	-.10075	-.09882	-.09618	-.07726	-.04987
X/C	- CPL	- CPL	- CPL	- CPL	- CPL	- CPL	- CPL	- CPL
0.000	.10712	.28706	.02691	.15394	-.15547	-.31819	-.14118	-.71152
.025	-.06284	-.02384	-.60138	-.53442	-.51385	-.54284	-.50783	-.46288
.050	-.04848	-.02176	-.33792	-.32165	-.28450	-.31029	-.29430	-.30976
.075	-.02095	-.01192	-.22716	-.23905	-.23189	-.21740	-.22617	-.21147
.100	-.00180	.00933	-.16458	-.16708	-.16272	-.15943	-.15312	-.16225
.200	.01736	.02539	.00814	.00563	.01120	-.00725	-.00632	-.03723
.300	.04788	.03627	.08323	.08135	.07642	.05402	.05689	.06502
.400	.06463	.05337	.13079	.12703	.12715	.11463	.11238	.08850
.600	.06164	.05441	.10075	.11577	.11255	.10409	.08780	.07867
.800	.06104	.03420	.04005	.02190	.01186	.01252	.03301	.02107
1.000	-.04429	-.04353	-.05695	-.10075	-.09882	-.09618	-.07726	-.04987

# APPENDIX B

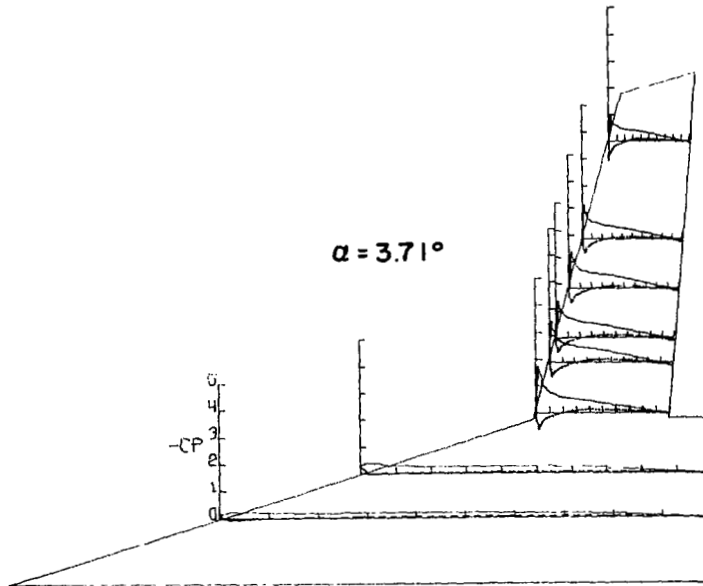
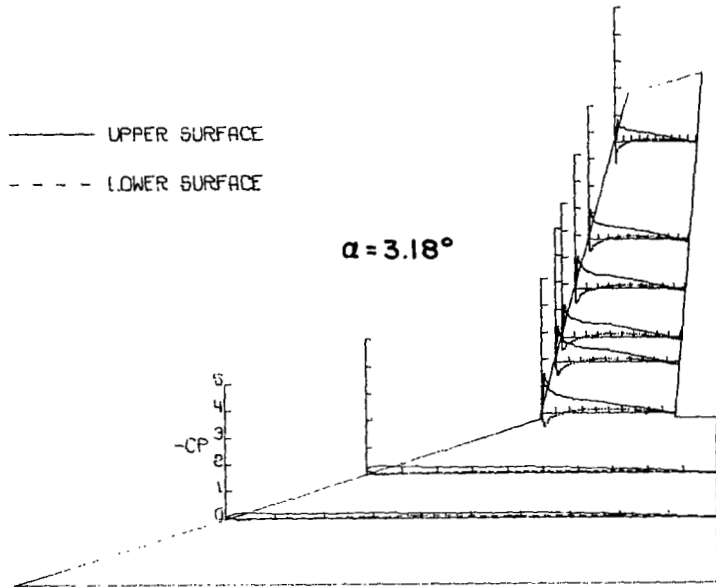

# APPENDIX B

## P R E S S U R E M E A S U R E M E N T S

OUTER PANEL SWEEP= 15.00000 DEGREES

FUSELAGE ON

ANGLE OF ATTACK= 4.24699 DEGREES

### S P A N W I S E L O C A T I O N

	2Y/B .12996	2Y/B .21661	2Y/B .33426	2Y/B .43233	2Y/B .48036	2Y/B .57641	2Y/B .67250	2Y/B .86465
X/C	- CPU	- CPU	- CPU	- CPU	- CPU	- CPU	- CPU	- CPU
0.000	.15256	.38049	.19536	.45605	.39097	-.10350	-.12441	-.61925
.025	.27472	.41973	2.06156	1.74111	1.57812	1.55702	1.42864	1.09046
.050	.23301	.38772	1.46778	1.21394	1.12243	1.16463	1.04336	.78955
.075	.24970	.33816	1.10524	.97454	.30942	.90084	.83947	.68549
.100	.22228	.30821	.88698	.87379	.32962	.83226	.74807	.66581
.200	.19010	.27156	.61059	.66272	.63376	.63376	.59269	.50480
.300	.20440	.27414	.51762	.58043	.57440	.55198	.52098	.42044
.400	.20262	.28188	.46548	.52453	.51222	.48783	.45418	.35435
.600	.18593	.22251	.29901	.32163	.32332	.30324	.29459	.23406
.800	.13528	.11410	.13694	.12563	.11800	.11866	.11106	.08786
1.000	-.05125	-.04182	-.04397	-.09800	-.08900	-.09691	-.07310	-.04991

	- CPL	- CPL	- CPL	- CPL	- CPL	- CPL	- CPL	- CPL
X/C	.15256	.38049	.19536	.45605	.39097	-.10350	-.12441	-.61925
0.000	-.06794	-.02736	-.65330	-.62566	-.59199	-.62495	-.59605	-.53209
.025	-.04887	-.04182	-.39512	-.39512	-.36521	-.38960	-.35215	-.34723
.050	-.03218	-.02117	-.26132	-.29775	-.28083	-.28149	-.27483	-.27202
.075	-.01549	-.00723	-.20039	-.21107	-.20238	-.20568	-.20665	-.18556
.100	-.00060	.00620	-.02576	-.03267	-.02703	-.04812	-.04920	-.05764
.200	.04291	.03356	.07036	.06282	.05538	.03428	.03796	.04639
.300	.05602	.02220	.11056	.10805	.09888	.08570	.08083	.06677
.400	.04291	.05524	.09674	.11056	.10284	.09691	.08294	.06888
.600	.05363	.03046	.03518	.02010	.00132	.00593	.02320	.02320
.800	-.05125	-.04182	-.04397	-.09800	-.08900	-.09691	-.07310	-.04991

## P R E S S U R E M E A S U R E M E N T S

OUTER PANEL SWEEP= 15.00000 DEGREES

FUSELAGE ON

ANGLE OF ATTACK= 4.77147 DEGREES

### S P A N W I S E L O C A T I O N

	2Y/B .12996	2Y/B .21661	2Y/B .33426	2Y/B .43233	2Y/B .48036	2Y/B .57641	2Y/B .67250	2Y/B .86465
X/C	- CPU	- CPU	- CPU	- CPU	- CPU	- CPU	- CPU	- CPU
0.000	.20831	.52277	.27456	.82623	.35691	.13552	.34692	-.49629
.025	.31339	.49329	2.28469	1.98574	1.80870	1.73823	1.67237	1.54147
.050	.27959	.43907	1.88204	1.32063	1.25435	1.29797	1.16021	.85121
.075	.28082	.38800	1.38528	1.08441	1.02352	.99260	.92703	.71530
.100	.23658	.34272	1.00119	.95614	.90737	.89932	.83833	.71458
.200	.20401	.30377	.66175	.69247	.59596	.66509	.64234	.53147
.300	.23105	.30482	.54719	.60863	.62281	.58657	.56723	.44349
.400	.21630	.30008	.48383	.54783	.54543	.51188	.48640	.36766
.600	.19786	.23322	.31040	.33087	.33812	.31800	.31473	.23813
.800	.14133	.12161	.14656	.12352	.12277	.12478	.11871	.09225
1.000	-.04609	-.05317	-.05120	-.08768	-.09525	-.08051	-.07938	-.03933

	- CPL	- CPL	- CPL	- CPL	- CPL	- CPL	- CPL	- CPL
X/C	.20831	.52277	.27456	.82623	.35691	.13552	.34692	-.49629
0.000	-.06022	-.02001	-.70975	-.65791	-.55746	-.67692	-.65290	-.59212
.025	-.06145	-.04264	-.45247	-.46527	-.42735	-.44211	-.41548	-.40404
.050	-.03011	-.02422	-.32127	-.34367	-.34282	-.32538	-.31108	-.29749
.100	-.02765	-.02053	-.24704	-.25920	-.25829	-.25225	-.25300	-.23027
.200	-.00307	-.00526	-.05952	-.05824	-.06739	-.07313	-.08939	-.08724
.300	.03318	.00526	.03392	.02752	.01878	.00872	.00358	.02646
.400	.04977	.01737	.10176	.08576	.09057	.06575	.06865	.04791
.600	.03748	.04054	.08960	.09792	.09258	.08319	.07008	.05649
.800	.04547	.02896	.03648	.00192	-.00258	-.00268	.01788	.01001
1.000	-.04609	-.05317	-.05120	-.08768	-.09526	-.08051	-.07938	-.03933

# APPENDIX B

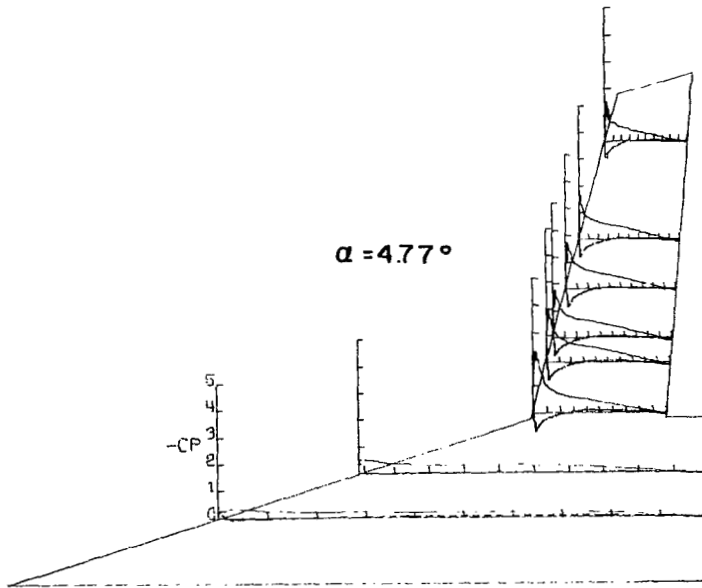
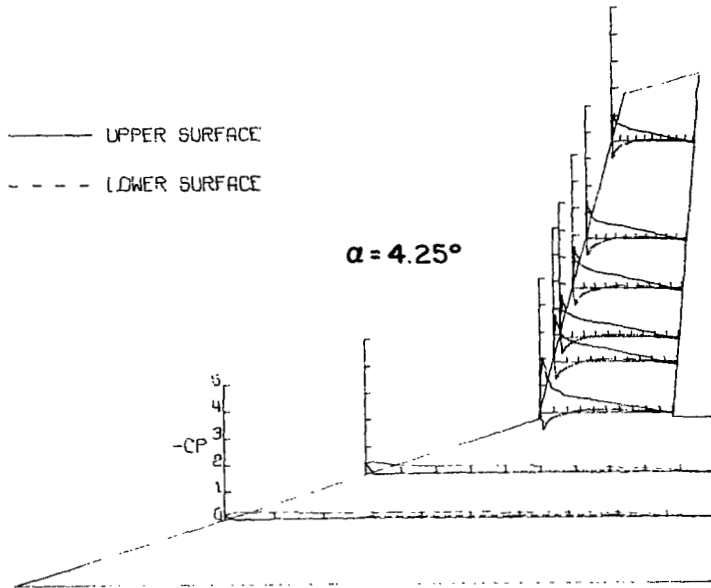

# APPENDIX B

## P R E S S U R E M E A S U R E M E N T S

OUTER PANEL SWEEP= 15.0000 DEGREES

FUSFLAGE DN

ANGLE OF ATTACK= 5.28039 DEGREES

### S P A N W I S E L O C A T I O N

	2Y/B .12996	2Y/B .21661	2Y/B .33426	2Y/B .43233	2Y/B .48036	2Y/B .57641	2Y/B .67250	2Y/B .86465
X/C	- CPU	- CPU	- CPU	- CPU	- CPU	- CPU	- CPU	- CPU
0.000	.26021	.63554	.51071	1.19949	.64230	.46437	.63884	-.43220
.025	.32855	.56689	1.97359	2.12062	1.96390	1.94011	1.82537	1.89303
.050	.29378	.47847	1.98050	1.42505	1.34671	1.39363	1.26060	1.05904
.075	.27699	.42594	1.75933	1.13791	1.09154	1.05992	1.02486	.85535
.100	.24702	.37238	1.22462	1.01162	.98327	.95618	.90307	.78413
.200	.22064	.31673	.59802	.74753	.72358	.71499	.69012	.56691
.300	.22243	.31205	.55531	.62755	.63371	.61124	.59326	.46435
.400	.22183	.31621	.48809	.56096	.56631	.53439	.51563	.39385
.600	.20385	.24236	.31409	.34361	.34018	.33292	.32405	.25633
.800	.14089	.12118	.14197	.12187	.12550	.12484	.12816	.09897
1.000	-.05456	-.04317	-.03895	-.08166	-.08653	-.08389	-.06479	-.03703
X/C	- CPL	- CPL	- CPL	- CPL	- CPL	- CPL	- CPL	- CPL
0.000	.26021	.63554	.51071	1.19949	.64230	.46437	.63884	-.43220
.025	-.07195	-.06624	-.71926	-.71172	-.63556	-.72661	-.68639	-.63370
.050	-.07915	-.03953	-.48055	-.50442	-.47031	-.49343	-.48418	-.43718
.075	-.04497	-.03953	-.35932	-.39575	-.38180	-.37453	-.35028	-.33679
.100	-.03477	-.02080	-.27954	-.30341	-.28856	-.28536	-.28410	-.24921
.200	-.01319	-.01352	-.09171	-.09800	-.09908	-.10635	-.11392	-.11250
.300	.01499	.00312	.01319	-.00063	-.00733	-.02378	-.02278	.00071
.400	.05156	.00832	.07161	.07036	.05549	.04888	.04557	.04486
.600	.02218	.01872	.06721	.07538	.07338	.06143	.05340	.04984
.800	.03417	.01924	.02764	.00063	-.00727	-.00066	.01068	.01353
1.000	-.05456	-.04317	-.03895	-.08166	-.08653	-.08389	-.06479	-.03703

## P R E S S U R E M E A S U R E M E N T S

OUTER PANEL SWEEP= 15.0000 DEGREES

FUSELAGE DN

ANGLE OF ATTACK= 5.79867 DEGREES

### S P A N W I S E L O C A T I O N

	2Y/B .12996	2Y/B .21661	2Y/B .33426	2Y/B .43233	2Y/B .48036	2Y/B .57641	2Y/B .67250	2Y/B .86465
X/C	- CPU	- CPU	- CPU	- CPU	- CPU	- CPU	- CPU	- CPU
0.000	.31351	.78770	.58870	1.63801	.98990	.80889	.75046	-.33819
.025	.36105	.63173	1.89761	2.33196	2.18153	2.14747	1.96996	2.02255
.050	.32675	.52496	1.91660	1.55570	1.43085	1.50890	1.37727	1.35950
.075	.29907	.46634	1.90014	1.21948	1.19497	1.15756	1.09969	.98214
.100	.26236	.40720	1.67726	1.08778	1.05232	1.01996	.96437	.85848
.200	.23288	.34073	.73303	.79569	.77883	.76948	.73127	.60406
.300	.24250	.33445	.53869	.66973	.68338	.65593	.62183	.48041
.400	.22565	.34020	.49122	.57984	.59982	.56308	.53797	.39371
.600	.21543	.26693	.32600	.35765	.35989	.35655	.33614	.25791
.800	.14502	.12300	.14433	.13167	.13020	.13755	.12576	.10302
1.000	-.05055	-.03978	-.03735	-.06204	-.07946	-.06009	-.06608	-.01776
X/C	- CPL	- CPL	- CPL	- CPL	- CPL	- CPL	- CPL	- CPL
0.000	.31351	.78770	.58870	1.63801	.98990	.80889	.75046	-.33819
.025	-.07943	.00209	-.75898	-.76721	-.75384	-.76452	-.74885	-.67141
.050	-.07883	-.03664	-.51654	-.55452	-.52748	-.53884	-.51226	-.46892
.075	-.06017	-.02774	-.38107	-.44627	-.41130	-.42666	-.40995	-.36661
.100	-.04513	-.03193	-.31904	-.34246	-.33452	-.32384	-.33393	-.28490
.200	-.03310	-.01937	-.11837	-.12913	-.13154	-.13621	-.14423	-.13783
.300	.00842	-.00994	-.00570	-.02532	-.02634	-.04273	-.05258	-.01208
.400	.02166	0.00000	.06900	.04621	.04674	.02938	.03268	.02060
.600	.01143	.02094	.06330	.07026	.07345	.05542	.04618	.04050
.800	.02467	.01361	.02342	-.00253	.00067	.00534	.00071	-.00071
1.000	-.05055	-.03978	-.03735	-.06204	-.07946	-.06009	-.06608	-.01776



# APPENDIX B

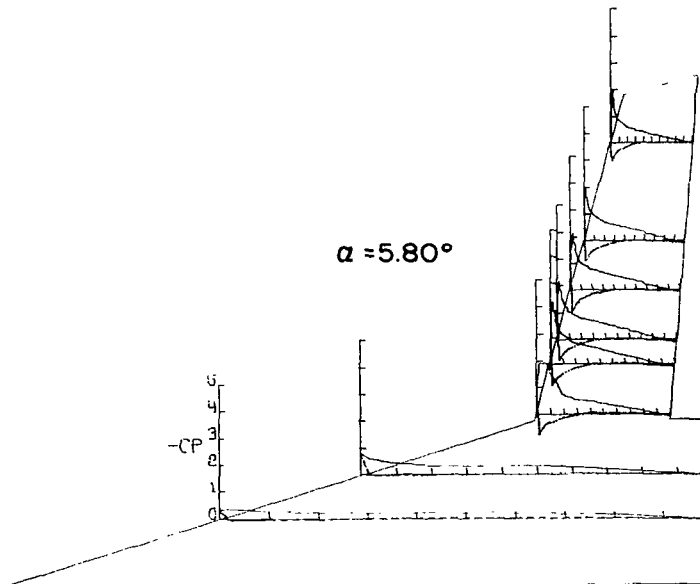
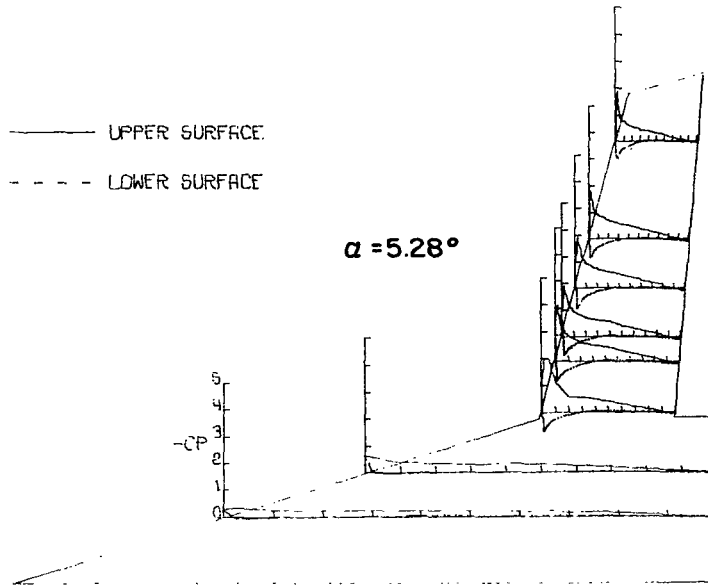

# APPENDIX B

## P R E S S U R E M E A S U R E M E N T S

OUTER PANEL SWEEP= 15.00000 DFGREES

FUSELAGE ON

ANGLE OF ATTACK= 6.30711 DEGREES

### S P A N W I S E L O C A T I O N

	2Y/B .12996	2Y/B .21661	2Y/B .33426	2Y/B .43233	2Y/B .48035	2Y/B .57641	2Y/B .67250	2Y/B .86465
X/C	-CPU	-CPU	-CPU	-CPU	-CPU	-CPU	-CPU	-CPU
0.000	.39329	.92385	1.01689	1.54149	1.29054	1.03456	1.00139	-.19052
.025	.42303	.71367	2.62744	2.28467	2.32710	2.29844	2.18192	2.15337
.050	.34595	.58296	2.18837	1.67201	1.57184	1.57451	1.49958	1.79008
.075	.37410	.49565	1.96218	1.39070	1.26321	1.21921	1.20480	1.33970
.100	.28708	.43970	1.65617	1.24561	1.11455	1.07989	1.04849	1.08561
.200	.25612	.36651	.88108	.84941	.81525	.80325	.77441	.62310
.300	.26098	.34036	.58591	.68282	.68393	.68793	.65022	.50605
.400	.24884	.34193	.47570	.55994	.59327	.57994	.54744	.39827
.600	.22881	.27135	.31101	.35661	.34717	.35916	.34474	.25403
.800	.15659	.12809	.14885	.14632	.12594	.13127	.13058	.10418
1.000	-.05462	-.03346	.01203	.00443	-.03865	-.05864	-.05066	-.01213
X/C	-CPL	-CPL	-CPL	-CPL	-CPL	-CPL	-CPL	-CPL
0.000	.39329	.92385	1.01689	1.54149	1.29054	1.03456	1.00139	-.19052
.025	-.06737	.01255	-.80887	-.76643	-.79152	-.79895	-.79135	-.69858
.050	-.07769	-.03451	-.56311	-.56818	-.55640	-.57773	-.56229	-.49450
.075	-.05705	-.03555	-.42502	-.46113	-.46511	-.45378	-.44955	-.38176
.100	-.04188	-.03451	-.33001	-.36041	-.35317	-.36050	-.36107	-.30398
.200	-.03035	-.03398	-.13555	-.13872	-.15126	-.15659	-.16983	-.14842
.300	.00121	-.01882	-.01520	-.04054	-.04598	-.06863	-.05994	-.02640
.400	.02610	-.01882	.05067	.03674	.02732	.01599	.01213	.01927
.600	.00728	.00209	.05574	.06017	.06054	.04131	.03354	.02997
.800	.03520	.00680	.02597	.01774	.00800	.00200	0.00000	.01356
1.000	-.05462	-.03346	.01203	.00443	-.03865	-.05864	-.05066	-.01213

## P R E S S U R E M E A S U R E M E N T S

OUTER PANEL SWEEP= 15.00000 DEGREES

FUSELAGE ON

ANGLE OF ATTACK= 7.37033 DEGREES

### S P A N W I S E L O C A T I O N

	2Y/B .12996	2Y/B .21661	2Y/B .33426	2Y/B .43233	2Y/B .48036	2Y/B .57641	2Y/B .67250	2Y/B .86465
X/C	-CPU	-CPU	-CPU	-CPU	-CPU	-CPU	-CPU	-CPU
0.000	.56281	1.19744	1.02304	1.42772	1.02162	.55875	.48577	-.03327
.025	.47631	.82572	2.54152	1.40376	2.33286	1.67146	1.75187	2.09602
.050	.39282	.66640	1.69813	1.50462	2.27203	1.78932	1.81914	1.83543
.075	.36639	.56072	1.77892	1.41637	1.73245	1.78866	1.74408	1.51395
.100	.31594	.50657	1.71263	1.36720	1.31190	1.60351	1.62300	1.29585
.200	.26489	.40453	1.31993	1.04636	.85697	.90260	.93825	.77963
.300	.26368	.38683	.80537	.78773	.70356	.66257	.64509	.54808
.400	.25648	.37745	.57346	.61443	.56536	.54334	.51976	.43407
.600	.23786	.30144	.33084	.35605	.33777	.33380	.33706	.25344
.800	.16638	.14213	.17393	.20670	.15996	.14740	.14088	.11681
1.000	-.05466	-.04269	.03151	.08444	.05354	.00066	-.00425	.02053
X/C	-CPL	-CPL	-CPL	-CPL	-CPL	-CPL	-CPL	-CPL
0.000	.56281	1.19744	1.02304	1.42772	1.02162	.55875	.48577	-.03327
.025	-.06847	.06820	-.83058	-.78331	-.79518	-.80311	-.76811	-.74121
.050	-.08469	-.02655	-.60686	-.58922	-.60217	-.59622	-.57626	-.53024
.075	-.07688	-.03644	-.46948	-.48650	-.48867	-.47592	-.45803	-.42405
.100	-.06547	-.04373	-.39008	-.39386	-.40519	-.39197	-.39290	-.34193
.200	-.05586	-.04842	-.16322	-.18464	-.18177	-.19367	-.19397	-.17486
.300	-.01922	-.04686	-.05609	-.06428	-.07856	-.08791	-.08424	-.05380
.400	.00541	-.03853	.03592	.01575	.01586	-.00066	0.00000	.00496
.600	-.01862	-.01406	.03907	.06365	.04495	.04495	.02549	.03469
.800	.01742	.00833	.02458	.02647	.01322	.00529	.00283	.01203
1.000	-.05466	-.04269	.03151	.08444	.05354	.00066	-.00425	.02053

# APPENDIX B

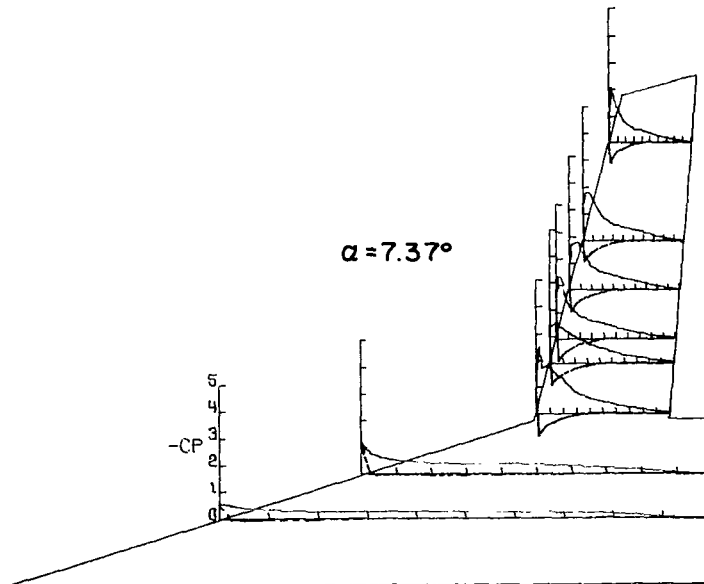
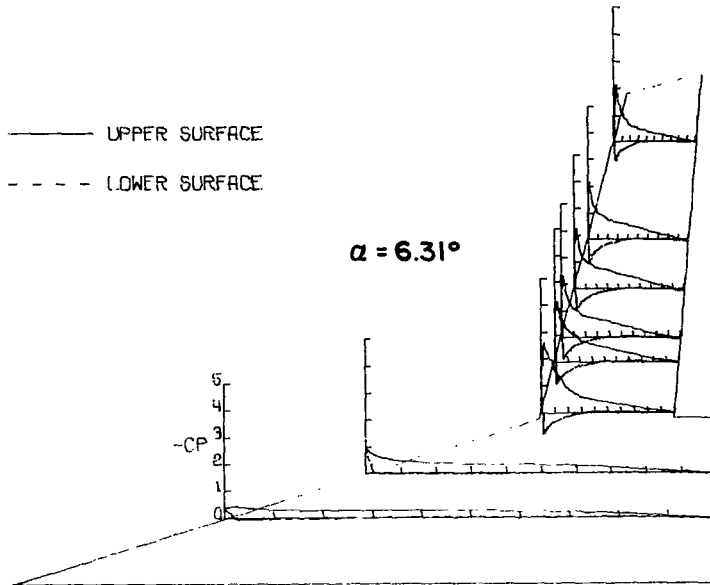

# APPENDIX B

## P R E S S U R E M E A S U R E M E N T S

OUTER PANEL SWEEP= 15.00000 DEGREES

FUSELAGE ON

ANGLE OF ATTACK= 8.39515 DEGREES

### S P A N W I S E L O C A T I O N

	2Y/B .12996	2Y/B .21661	2Y/B .33426	2Y/B .43233	2Y/B .48036	2Y/B .57641	2Y/B .67250	2Y/B .86465
X/C	- CPU	- CPU	- CPU	- CPU	- CPU	- CPU	- CPU	- CPU
0.000	.73052	1.57197	1.29103	.98141	1.24051	.62788	.40311	-.09470
.025	.55711	.98085	1.88748	1.13084	2.22177	1.55345	1.51770	2.09173
.050	.45691	.77633	1.43223	1.34548	2.19260	1.60517	1.57895	1.68649
.075	.42372	.65529	1.32586	1.47655	1.92474	1.60174	1.73991	1.39734
.100	.34525	.57755	1.39994	1.32965	1.60119	1.62174	1.62097	1.78980
.200	.29636	.45025	1.41323	1.10551	.97199	1.29885	1.17442	.92230
.300	.28670	.42573	1.08082	.99661	.63517	.76247	.83968	.67873
.400	.28067	.42312	.87292	.67479	.76247	.56423	.62887	.59398
.600	.26980	.36364	.43298	.41272	.43014	.36983	.38103	.35254
.800	.19315	.18000	.23485	.24751	.32211	.17895	.18584	.15949
1.000	-.06398	-.03809	.08356	.13736	.12394	.03115	.06835	.08473
X/C	- CPL	- CPL	- CPL	- CPL	- CPL	- CPL	- CPL	- CPL
0.000	.73052	1.57197	1.29103	.98141	1.24051	.62788	.40311	-.09470
.025	-.05010	.12104	-.85267	-.80202	-.83774	-.82316	-.82096	-.76115
.050	-.09356	-.00470	-.64440	-.63354	-.53550	-.64487	-.61661	-.57603
.075	-.08631	-.04174	-.50704	-.51147	-.54082	-.51100	-.50696	-.46068
.100	-.07907	-.05374	-.42918	-.44311	-.43345	-.44008	-.42579	-.37452
.200	-.06700	-.07096	-.19813	-.20699	-.22136	-.22600	-.22785	-.19865
.300	-.03682	-.06365	-.07026	-.09179	-.09743	-.11068	-.10609	-.06693
.400	-.02294	-.06313	.01139	-.01456	-.00199	-.02651	-.00712	-.01566
.600	-.02294	-.02870	.02912	.06710	.04109	.04573	.02706	.03275
.800	.00483	.00052	.04115	.02975	.03844	.01723	.02848	.02207
1.000	-.06398	-.03809	.08356	.13736	.12394	.03115	.06835	.08473

## P R E S S U R E M E A S U R E M E N T S

OUTER PANEL SWEEP= 15.00000 DEGREES

FUSELAGE ON

ANGLE OF ATTACK= 9.49628 DEGREES

### S P A N W I S E L O C A T I O N

	2Y/B .12996	2Y/B .21661	2Y/B .33426	2Y/B .43233	2Y/B .48036	2Y/B .57641	2Y/B .67250	2Y/B .86465
X/C	- CPU	- CPU	- CPU	- CPU	- CPU	- CPU	- CPU	- CPU
0.000	.93959	1.88906	1.34046	1.02798	1.22530	.39883	.21907	-.10777
.025	.66392	1.12212	2.02263	.96322	2.11691	1.27279	1.45270	1.77694
.050	.51658	.86041	1.35366	.88943	2.07932	1.39809	1.23935	1.38872
.075	.46005	.71710	1.77051	.98460	1.89259	1.29917	1.27176	1.04911
.100	.37827	.62311	1.45426	.94286	1.53130	1.40138	1.04207	1.02586
.200	.30310	.51199	1.23735	1.05753	.90215	1.23849	1.00613	.96381
.300	.30249	.46526	.99654	1.15121	.80918	.89161	1.02516	.67060
.400	.29287	.43046	.79200	.90578	.70300	.68454	.83492	.65526
.600	.27844	.35102	.52863	.53177	.44498	.42850	.45022	.41006
.800	.20266	.23730	.32057	.45132	.45619	.27688	.29310	.32551
1.000	-.06134	-.02389	.21937	.20240	.21425	.13250	.13524	.16553
X/C	- CPL	- CPL	- CPL	- CPL	- CPL	- CPL	- CPL	- CPL
0.000	.93959	1.88906	1.34046	1.02798	1.22530	.39883	.21907	-.10777
.025	-.03247	.17603	-.84795	-.80520	-.83854	-.83129	-.81358	-.77202
.050	-.09382	.02700	-.67823	-.64869	-.65857	-.64604	-.62198	-.56493
.075	-.09502	-.02181	-.55176	-.55503	-.56825	-.52540	-.51351	-.44941
.100	-.09021	-.05296	-.46703	-.46452	-.46805	-.44630	-.44659	-.37967
.200	-.09382	-.08048	-.23949	-.24954	-.24787	-.24325	-.23668	-.20568
.300	-.06495	-.09243	-.11754	-.11817	-.12355	-.12591	-.12257	-.06974
.400	-.04270	-.08724	-.01069	-.03206	-.02373	-.03428	-.02113	-.01691
.600	-.04631	-.05037	.02011	.03583	.04021	.03494	.03381	.03099
.800	.01383	-.00208	.03646	.05594	.04021	.04746	.04579	.04931
1.000	-.06134	-.02389	.21937	.20240	.21425	.13250	.13524	.16553

# APPENDIX B

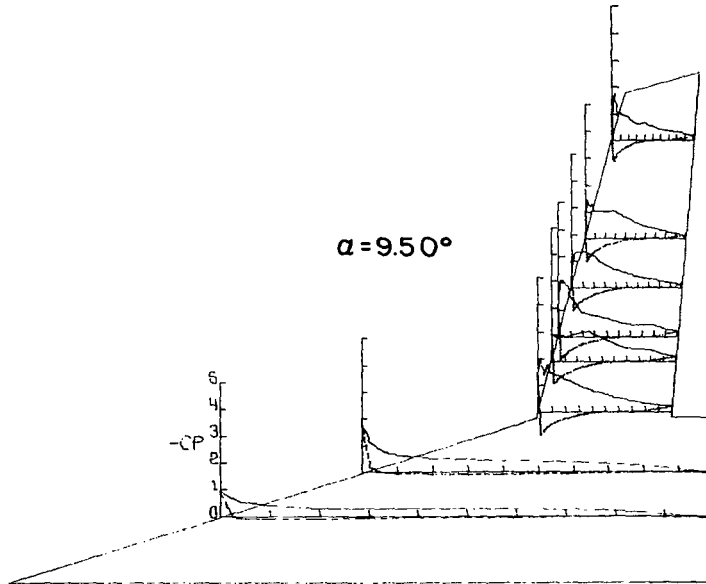
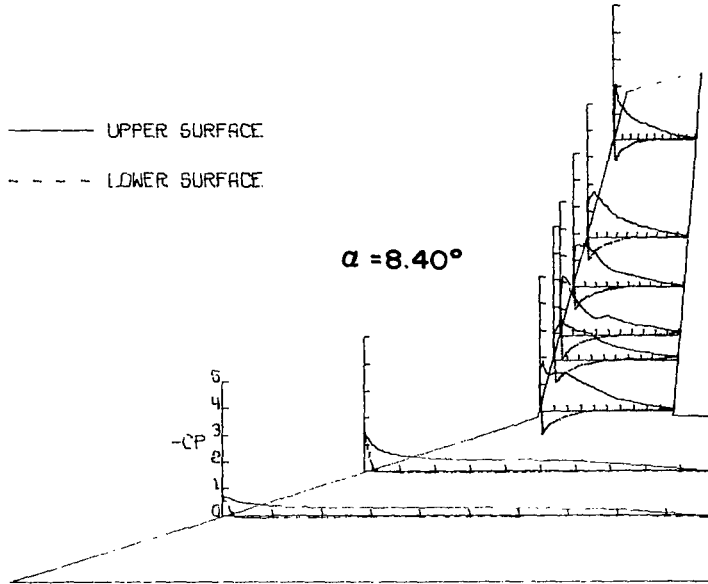

# APPENDIX B

## P R E S S U R E M E A S U R E M E N T S

OUTER PANEL SWEEP= 15.0000 DEGREES

FUSELAGE ON

ANGLE OF ATTACK= 10.50730 DEGREES

### S P A N W I S E L O C A T I O N

	2Y/B .12996	2Y/B .21661	2Y/B .33426	2Y/B .43233	2Y/B .48036	2Y/B .57641	2Y/B .67250	2Y/B .86465
X/C	- CPU	- CPU	- CPU	- CPU	- CPU	- CPU	- CPU	- CPU
0.000	1.15274	2.35557	1.48606	1.25499	1.36094	.54870	.25778	-.20637
.025	.74955	1.26384	2.08595	1.06709	2.41613	1.19108	.88426	1.26996
.050	.57471	.92591	1.63270	.87199	2.12732	1.33563	.79569	.99997
.075	.49434	.77525	1.85107	.92403	1.92850	1.18175	1.16496	.89711
.100	.42121	.69783	1.69237	1.18136	2.04575	1.32497	1.08068	.78640
.200	.34567	.64761	1.26388	1.20294	1.14578	1.26169	.92068	.77783
.300	.33782	.49329	1.12994	.86438	.90853	1.02787	.87283	.72283
.400	.32936	.40646	.91578	1.02583	.78606	.80404	.91140	.80497
.600	.28524	.36304	.72222	.49758	.59237	.47812	.72855	.65569
.800	.21756	.22285	.35096	.47154	.35325	.28567	.45070	.45713
1.000	-.05802	-.01726	.25830	.29384	.24935	.20909	.26493	.23065

	- CPL	- CPL	- CPL	- CPL	- CPL	- CPL	- CPL	- CPL
0.100	1.15274	2.35557	1.48606	1.25499	1.36094	.54870	.25778	-.20637
.025	-.02665	.24691	-.87072	-.84851	-.86567	-.86234	-.83762	-.73622
.050	-.09488	-.05807	-.71524	-.71524	-.69986	-.68854	-.64268	-.56056
.075	-.09790	-.01569	-.60354	-.59910	-.50254	-.56535	-.52557	-.45701
.100	-.11240	-.04970	-.50898	-.52548	-.50941	-.49277	-.46201	-.38346
.200	-.10213	-.09102	-.27163	-.28178	-.26359	-.27835	-.24065	-.23779
.300	-.08400	-.10201	-.12947	-.15422	-.14184	-.16048	-.12496	-.09354
.400	-.05016	-.10148	-.03173	-.03427	-.03736	-.04062	-.01785	-.01928
.600	-.06950	-.06644	.01904	.05331	.04328	.04395	.04642	.03570
.800	-.01088	-.01569	.02856	.05141	.04734	.04528	.07926	.05784
1.000	-.05802	-.01726	.25830	.29384	.24935	.20909	.26493	.23065

## P R E S S U R E M E A S U R E M E N T S

OUTER PANEL SWEEP= 15.0000 DEGREES

FUSELAGE ON

ANGLE OF ATTACK= 11.54436 DEGREES

### S P A N W I S E L O C A T I O N

	2Y/B .12996	2Y/B .21661	2Y/B .33426	2Y/B .43233	2Y/B .48036	2Y/B .57641	2Y/B .67250	2Y/B .86465
X/C	- CPU	- CPU	- CPU	- CPU	- CPU	- CPU	- CPU	- CPU
0.000	1.40783	2.84147	2.13018	1.30474	1.46286	.52207	.23838	-.31074
.025	.83599	1.35819	2.62595	.86263	2.12235	1.08716	.66706	.62803
.050	.62427	.96774	2.21006	.94059	1.80327	1.04252	.71461	.82247
.075	.54087	.79712	1.76627	1.01691	1.75530	1.15444	.71745	.72242
.100	.45989	.78247	1.58305	.95898	1.36248	1.26036	.73448	.63300
.200	.40006	.97926	1.31044	.78150	.78139	1.20573	.80544	.77706
.300	.35655	.36742	1.20393	.62368	.54483	1.12713	.85938	.98782
.400	.32996	.40720	.94250	.64396	.79472	.93394	.88563	.66919
.600	.29854	.32084	.65601	.53305	.54471	.65616	.69758	.65429
.800	.21816	.22872	.49819	.46459	.61219	.44216	.58687	.64081
1.000	-.05439	-.00733	.35431	.37015	.35491	.26902	.39669	.39882

	- CPL	- CPL	- CPL	- CPL	- CPL	- CPL	- CPL	- CPL
0.000	1.40783	2.84147	2.13018	1.30474	1.46286	.52207	.23838	-.31074
.025	.03142	.33549	-.85630	-.86073	-.88298	-.86301	-.82794	-.73217
.050	-.09642	.09787	-.74601	-.72446	-.72849	-.69720	-.65483	-.59595
.075	-.10515	.00314	-.62051	-.62558	-.52461	-.57933	-.54274	-.50656
.100	-.10636	-.04972	-.54382	-.53431	-.54337	-.49010	-.49733	-.39446
.200	-.12087	-.11358	-.30360	-.30424	-.30831	-.28567	-.26534	-.24122
.300	-.09427	-.11619	-.15719	-.14705	-.16581	-.14517	-.14189	-.08868
.400	-.07010	-.12143	-.04690	-.05261	-.04595	-.04794	-.02128	-.01774
.600	-.06829	-.07432	.01331	.05704	.05327	.06193	.06527	.06101
.800	-.02236	-.01099	.05768	.07669	.08524	.06925	.08159	.09507
1.000	-.05439	-.00733	.35431	.37015	.36491	.26902	.39669	.39882

# APPENDIX B

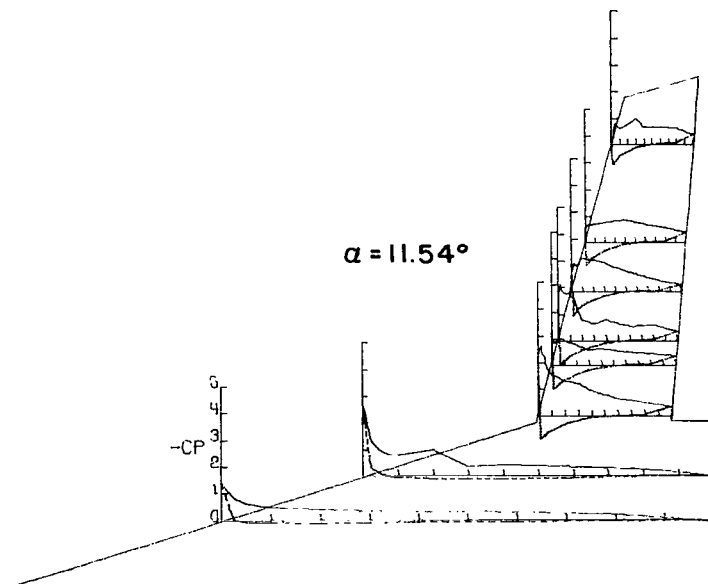
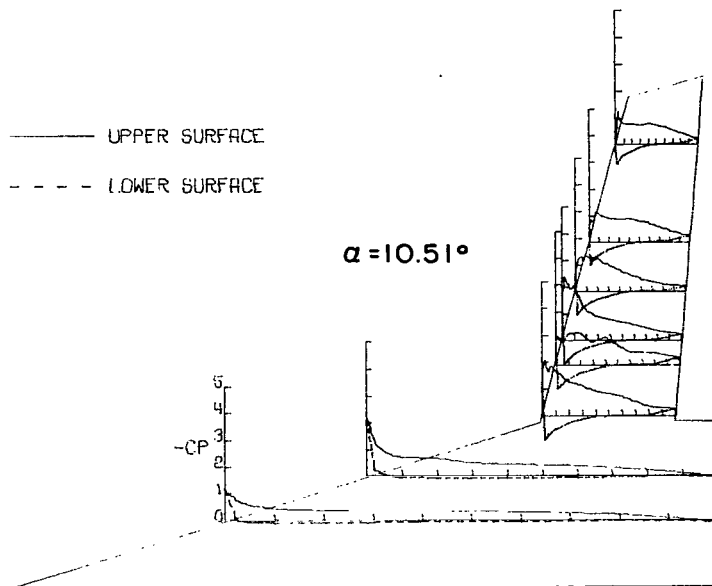

# APPENDIX B

## P R E S S U R E M E A S U R E M E N T S

OUTER PANEL SWEEP= 15.00000 DEGREES

FUSELAGE ON

ANGLE OF ATTACK= 12.55856 DEGREES

### S P A N W I S E L O C A T I O N

	2Y/B .12996	2Y/B .21661	2Y/B .33426	2Y/B .43233	2Y/B .48036	2Y/B .57641	2Y/B .67250	2Y/B .86465
X/C	- CPU	- CPU	- CPU	- CPU	- CPU	- CPU	- CPU	- CPU
0.000	1.65244	3.22940	2.23093	1.40403	1.49906	.70715	.08165	-.36919
.025	.93630	1.41874	3.03387	.97639	2.11295	.99452	.78472	.55960
.050	.68650	.92284	2.31293	.92570	2.33870	.99452	.66967	.80176
.075	.57990	.89200	1.80392	1.03883	2.11583	.99319	.70660	.68743
.100	.49525	.93329	1.62037	1.03505	2.35525	.55420	.72649	.85076
.200	.46864	1.46055	1.32203	.80084	.55617	1.10642	.85999	.74779
.300	.36282	.52047	1.07731	.79517	.61843	1.14217	.83656	.81667
.400	.34710	.43059	.98017	.66148	.81905	.99849	.83301	.77052
.600	.31988	.29733	.65833	.48744	.51445	.74887	.70660	.75418
.800	.22495	.19648	.51456	.43069	.39978	.51296	.54114	.45024
1.000	-.04414	-.00470	.41366	.42123	.40639	.37793	.45805	.37993

	- CPL	- CPL	- CPL	- CPL	- CPL	- CPL	- CPL	- CPL
X/C	1.65244	3.22940	2.23093	1.40403	1.49906	.70715	.08165	-.36919
0.000	.07861	.40812	-.84561	-.87840	-.86177	-.81544	-.85765	-.76748
.025	-.07014	.13796	-.74976	-.74220	-.75190	-.66056	-.66880	-.58573
.050	-.11066	.01097	-.65139	-.63752	-.66337	-.55797	-.57082	-.48633
.075	-.17033	-.03344	-.54861	-.54293	-.55257	-.48582	-.48278	-.41604
.100	-.13606	-.11862	-.31592	-.31529	-.31836	-.27799	-.26908	-.23216
.200	-.11852	-.14214	-.17972	-.17026	-.18539	-.15422	-.14412	-.11360
.300	-.09736	-.13952	-.07189	-.08198	-.07281	-.06486	-.05609	-.01633
.400	-.09494	-.09727	.01135	.05549	.04756	.06089	.03976	.08591
.600	-.01149	-.02090	.04666	.10405	.07744	.09862	.08733	.15122
.800	-.04414	-.00470	.41366	.42123	.40639	.37793	.45805	.37993
1.000								

## P R E S S U R E M E A S U R E M E N T S

OUTER PANEL SWEEP= 15.00000 DEGREES

FUSELAGE ON

ANGLE OF ATTACK= 13.58435 DEGREES

### S P A N W I S E L O C A T I O N

	2Y/B .12996	2Y/B .21661	2Y/B .33426	2Y/B .43233	2Y/B .48036	2Y/B .57641	2Y/B .67250	2Y/B .86465
X/C	- CPU	- CPU	- CPU	- CPU	- CPU	- CPU	- CPU	- CPU
0.000	1.93483	3.63328	3.38411	1.32972	.51871	.07354	-.08493	-.19092
.025	1.04440	1.33260	4.50588	1.17752	.35915	.52790	.44581	.90075
.050	.75495	1.01436	1.66794	1.28587	.93337	.52659	.43318	.84599
.075	.61813	1.02618	1.61908	1.10611	1.01351	.54978	.40650	.87267
.100	.58114	1.07657	1.53202	1.22136	.89396	.48260	.43528	.86214
.200	.53460	1.68117	1.22637	1.04849	1.00168	.58065	.43528	.86214
.300	.36396	.89045	1.19756	1.12115	.76062	.49770	.45845	.81651
.400	.36575	.40924	1.09797	.96769	.77113	.51149	.43599	.82353
.600	.33293	.27300	.72136	.70195	.59262	.50952	.43107	.75192
.800	.24880	.24472	.70696	.56231	.50886	.47800	.47039	.67188
1.000	-.04057	-.01697	.52662	.52787	.47603	.40906	.47951	.41843

	- CPL	- CPL	- CPL	- CPL	- CPL	- CPL	- CPL	- CPL
X/C	1.93483	3.63328	3.38411	1.32972	.51871	.07354	-.08493	-.19092
0.000	.12291	.51772	-.81967	-.89920	-.36277	-.84176	-.77910	-.80016
.025	-.06146	.18200	-.76958	-.77521	-.73342	-.67367	-.63521	-.64083
.050	-.10561	.04319	-.66501	-.67690	-.53624	-.56664	-.53905	-.52712
.075	-.12470	-.03599	-.57296	-.57922	-.53972	-.48851	-.46957	-.44289
.100	-.14200	-.13778	-.33816	-.33501	-.31057	-.27314	-.26953	-.26742
.200	-.12709	-.15578	-.18848	-.18410	-.17137	-.14182	-.13266	-.10248
.300	-.10983	-.14909	-.07264	-.06074	-.04924	-.02561	-.02527	-.02457
.400	-.10740	-.09203	.01065	.05885	.07617	.08798	.08423	.05966
.600	-.02208	-.01851	.06324	.11710	.13985	.15561	.16424	.11581
.800	-.04057	-.01697	.52662	.52787	.47603	.40906	.47951	.41843
1.000								



# APPENDIX B



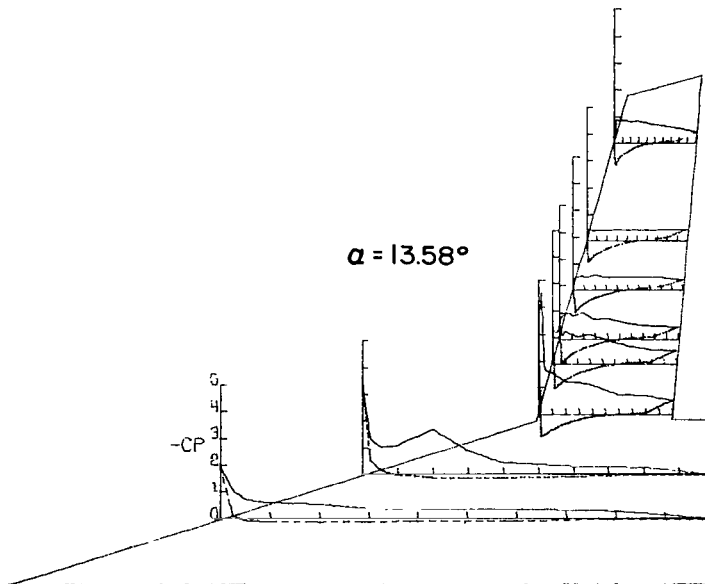
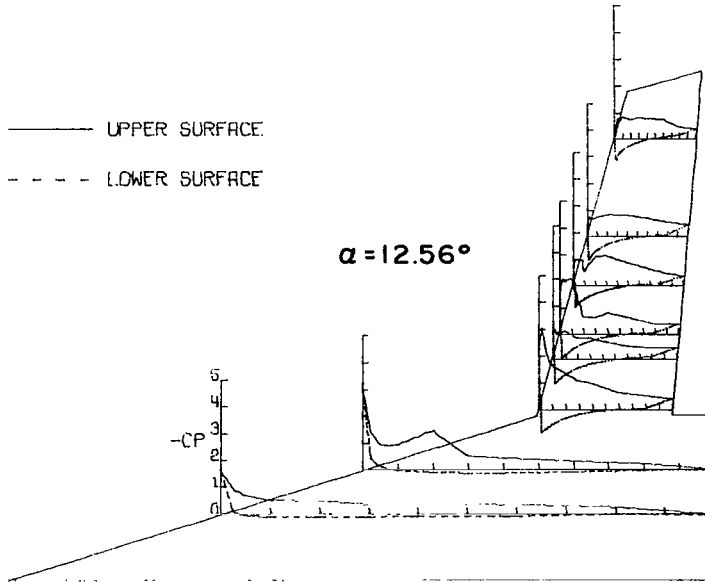

APPENDIX B

P R E S S U R E M E A S U R E M E N T S

OUTER PANEL SWEEP= 15.0000 DEGREES

FUSELAGF ON

ANGLE OF ATTACK= 14.56521 DEGREES

S P A N W I S E L O C A T I J N

	2Y/B .12996	2Y/B .21661	2Y/R .33426	2Y/B .43233	2Y/B .48036	2Y/R .57641	2Y/R .67250	2Y/B .86465
X/C	-CPU	-CPU	-CPU	-CPU	-CPU	-CPU	-CPU	-CPU
0.000	2.22703	4.09065	3.73773	1.45789	.75951	.03916	.03188	-.00213
.025	1.12709	1.27413	4.52172	1.15163	.95271	.58291	.42659	.83051
.050	.79282	1.16370	1.65721	1.34715	.94474	.60349	.38337	.82200
.075	.68422	1.23975	1.40347	1.22883	.93545	.62341	.42021	.93113
.100	.67138	1.28454	1.20984	1.26859	.86338	.60084	.43226	.67886
.200	.53324	1.77315	1.21870	1.33829	.91155	.59885	.40250	.76390
.300	.39571	1.03972	.94005	1.18200	.87334	.56964	.46982	.81279
.400	.37219	.51778	1.25034	.93752	.81395	.58955	.40675	.75539
.600	.32453	.27347	.79139	.70029	.68250	.55105	.40675	.66611
.800	.25637	.30942	.82302	.57061	.54885	.46788	.45423	.55343
1.000	-.03137	-.01354	.48204	.52569	.47452	.42872	.46486	.47336
X/C	-CPL	-CPL	-CPL	-CPL	-CPL	-CPL	-CPL	-CPL
0.000	2.22703	4.09065	3.73773	1.45789	.75951	.03916	.03188	-.00213
.025	.18217	.60737	-.81037	-.91032	-.88466	-.86475	-.81188	-.82605
.050	-.04886	.23180	-.78506	-.82175	-.76719	-.72870	-.68436	-.68082
.075	-.10798	.05938	-.69523	-.71927	-.67152	-.62583	-.57809	-.56817
.100	-.12969	-.03698	-.61173	-.62122	-.58658	-.53226	-.51150	-.48316
.200	-.16649	-.15210	-.36818	-.38462	-.35041	-.32320	-.30321	-.29330
.300	-.14839	-.16669	-.21445	-.22015	-.20507	-.18383	-.17003	-.13248
.400	-.13271	-.18700	-.10564	-.10122	-.09026	-.06968	-.06163	-.05668
.600	-.12125	-.10835	-.00822	.04175	.05575	.06968	.07226	.05242
.800	-.03076	-.02292	.06516	.11703	.13340	.15131	.15373	.12539
1.000	-.03137	-.01354	.48204	.52569	.47452	.42872	.46486	.47336

P R E S S U R E M E A S U R E M E N T S

OUTER PANEL SWEEP= 15.0000 DEGREES

FUSELAGE ON

ANGLE OF ATTACK= 15.60510 DEGREES

S P A N W I S E L O C A T I J N

	2Y/B .12996	2Y/B .21661	2Y/B .33426	2Y/B .43233	2Y/R .48036	2Y/R .57641	2Y/B .67250	2Y/B .86465
X/C	-CPU	-CPU	-CPU	-CPU	-CPU	-CPU	-CPU	-CPU
0.000	2.53811	3.36097	3.43416	1.38082	.82501	.12377	.14383	.02919
.025	1.22981	1.38936	4.29129	1.30359	1.32365	.59393	.49213	.93156
.050	.82712	1.28084	1.76638	1.33938	1.34881	.62240	.48715	.70223
.075	.76373	1.35336	1.58365	1.22447	.95214	.58930	.48358	.48287
.100	.79271	1.57353	1.37266	1.41034	1.05742	.75218	.49071	.45082
.200	.46536	2.20795	1.06560	1.43608	.95545	.68729	.49712	.42803
.300	.41768	1.03876	.97204	1.21631	.94420	.64160	.47076	.78983
.400	.40742	.60155	1.01474	.98020	.89785	.60783	.45937	.79339
.600	.35672	.30730	.90462	.78284	.71907	.61909	.45367	.68158
.800	.25471	.33547	.83180	.56625	.64822	.50104	.45438	.61748
1.000	-.02716	.02139	.61396	.55056	.52421	.40904	.40595	.46293
X/C	-CPL	-CPL	-CPL	-CPL	-CPL	-CPL	-CPL	-CPL
0.000	2.53811	3.36097	3.43416	1.38082	.82501	.12377	.14383	.02919
.025	.24143	.65268	-.79037	-.90085	-.89486	-.86772	-.83805	-.83235
.050	-.02354	.23321	-.79351	-.81799	-.80418	-.74528	-.71701	-.69422
.075	-.10442	.05582	-.71629	-.73010	-.72079	-.64004	-.51875	-.59667
.100	-.13822	-.04330	-.64159	-.66105	-.63210	-.57319	-.56250	-.51906
.200	-.18289	-.15756	-.40366	-.40805	-.39051	-.35609	-.34319	-.31756
.300	-.17202	-.17739	-.23981	-.25048	-.23166	-.21246	-.19087	-.15736
.400	-.15935	-.19304	-.13497	-.13058	-.11848	-.09862	-.08544	-.06978
.600	-.14064	-.13200	-.02009	.02951	.04633	.05295	.07690	.04343
.800	-.04648	-.03756	.05148	.10421	.12245	.13238	.15664	.13386
1.000	-.02716	.02139	.61396	.55056	.52421	.40904	.40595	.46293

# APPENDIX B

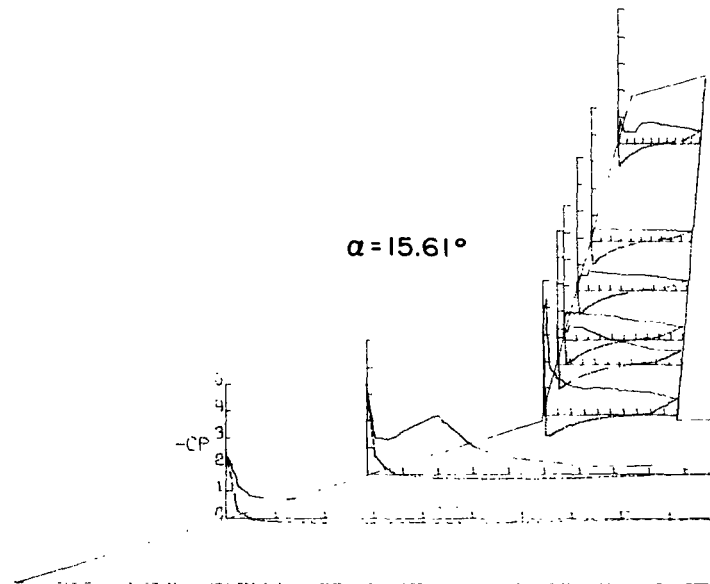
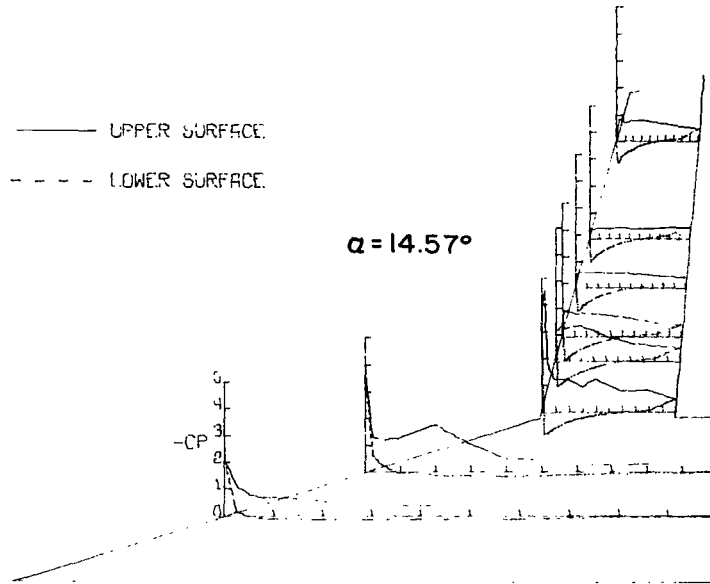

# APPENDIX B

## P R E S S U R E M E A S U R E M E N T S

OUTER PANEL SWEEP= 15.0000 DEGREES

FUSELAGE ON

ANGLE OF ATTACK= 16.58821 DEGREES

### S P A N W I S E L O C A T I O N

	2Y/B .12996	2Y/B .21661	2Y/B .33426	2Y/B .43233	2Y/B .48036	2Y/B .57641	2Y/B .67250	2Y/B .86465
X/C	-CPU	-CPU	-CPU	-CPU	-CPU	-CPU	-CPU	-CPU
0.000	2.89693	2.19671	3.78172	1.48413	.84630	.25730	.17061	-.37733
.025	1.31575	1.92460	4.52850	1.32307	1.12950	.73712	.45178	.40717
.050	.86192	1.88961	1.59800	1.44072	.86879	.74307	.58065	.37459
.075	.86312	2.07606	1.35012	1.23184	.93033	.68087	.47302	.42841
.100	.97447	2.31318	1.45896	1.41555	1.01833	.75167	.46027	.40008
.200	.42664	2.44636	1.15006	1.35138	1.03421	.76425	.50064	.39513
.300	.44108	1.39867	.97327	1.22178	.92636	.72124	.53533	.40929
.400	.42303	.77350	1.05757	1.02612	.95150	.70337	.52046	.44186
.600	.35804	.32434	.94724	.82207	.79458	.62000	.49285	.49214
.800	.30749	.31859	.96572	.62520	.62529	.57236	.44965	.50630
1.000	-.02106	.01201	.68558	.59250	.54238	.52187	.46665	.46169
X/C	-CPL	-CPL	-CPL	-CPL	-CPL	-CPL	-CPL	-CPL
0.000	2.89693	2.19671	3.78172	1.48413	.84630	.25730	.17061	-.37733
.025	.29726	.62674	-.77301	-.90384	-.89757	-.89294	-.85519	-.79076
.050	-.00181	.23920	-.79628	-.82962	-.82084	-.77057	-.73625	-.64139
.075	-.09568	.04387	-.71829	-.75854	-.73419	-.67599	-.62865	-.55077
.100	-.14021	-.04230	-.65980	-.67552	-.66210	-.59662	-.55927	-.47149
.200	-.19316	-.16974	-.41387	-.43336	-.41141	-.37702	-.34264	-.28459
.300	-.19376	-.20108	-.25977	-.27989	-.25654	-.24473	-.19751	-.12884
.400	-.16849	-.21727	-.14341	-.14404	-.13030	-.10980	-.07575	-.04672
.600	-.16006	-.15146	-.03711	.02201	.01786	.05159	.05026	.08849
.800	-.06258	-.02611	.05661	.12202	.12832	.14485	.16353	.17344
1.000	-.02106	.01201	.68558	.59250	.54238	.52187	.46665	.46169

## P R E S S U R E M E A S U R E M E N T S

OUTER PANEL SWEEP= 15.0000 DEGREES

FUSELAGE ON

ANGLE OF ATTACK= 17.48685 DEGREES

### S P A N W I S E L O C A T I O N

	2Y/B .12996	2Y/B .21661	2Y/B .33426	2Y/B .43233	2Y/B .48036	2Y/B .57641	2Y/B .67250	2Y/B .86465
X/C	-CPU	-CPU	-CPU	-CPU	-CPU	-CPU	-CPU	-CPU
0.000	3.27716	1.98409	4.33965	1.35767	1.37477	.34606	.29240	-.32402
.025	1.40501	1.72251	4.57626	1.35078	1.39230	.70423	.54957	.42768
.050	.96369	1.82008	1.65499	1.37457	.99974	.78518	.47982	.34947
.075	1.00933	1.84914	1.39084	1.14735	1.06490	.71371	.50236	.39315
.100	1.13301	2.12213	1.50038	1.41212	1.07740	.74569	.51293	.38681
.200	.39499	2.74180	1.13608	1.43779	1.11159	.81019	.46925	.36568
.300	.47182	1.89585	1.13108	1.19367	1.08332	.67922	.58973	.40795
.400	.45982	.99334	1.18428	1.12732	1.01553	.74832	.49814	.39245
.600	.37638	.38405	.94556	.84856	.81151	.65750	.48404	.43261
.800	.35597	.40688	1.09477	.69337	.70883	.57325	.50166	.46361
1.000	-.02401	.03010	.74656	.62078	.59432	.50001	.43966	.40090
X/C	-CPL	-CPL	-CPL	-CPL	-CPL	-CPL	-CPL	-CPL
0.000	3.27716	1.98409	4.33965	1.35767	1.37477	.34606	.29240	-.32402
.025	.36257	.65911	-.74406	-.90363	-.90462	-.90133	-.87768	-.80372
.050	-.02341	.26468	-.79913	-.86358	-.84212	-.80462	-.75441	-.67904
.075	-.09124	.07525	-.72466	-.77159	-.75067	-.70659	-.65580	-.58395
.100	-.15007	-.03425	-.68085	-.70088	-.59015	-.64080	-.59803	-.49731
.200	-.22511	-.18009	-.45182	-.46746	-.45396	-.42106	-.38390	-.32191
.300	-.19239	-.21797	-.28786	-.30038	-.28882	-.26251	-.22470	-.15779
.400	-.19269	-.22991	-.16959	-.15832	-.16053	-.12500	-.10989	-.05847
.600	-.18489	-.15414	-.03442	-.01252	-.02237	.02566	.04719	.05776
.800	-.06723	-.03737	.04881	.11139	.12835	.15000	.15074	.17610
1.000	-.02401	.03010	.74656	.62078	.59432	.50001	.43966	.40090

APPENDIX B

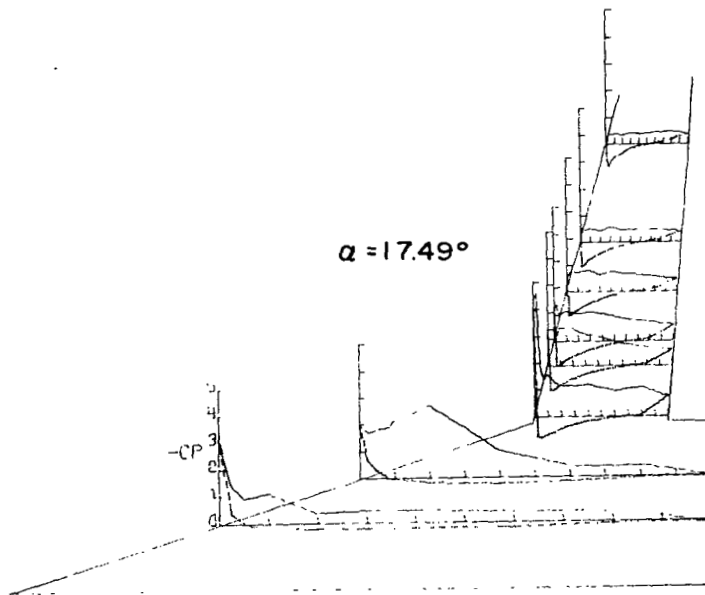
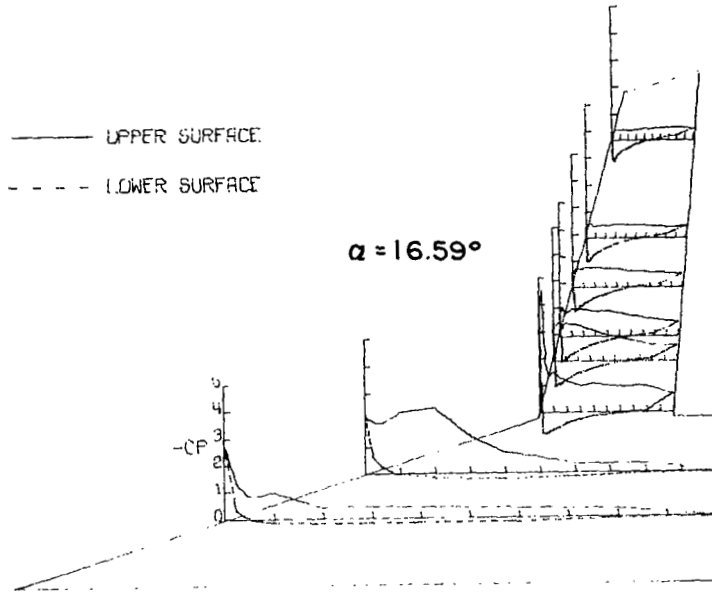

# APPENDIX B

## P R E S S U R E M E A S U R E M E N T S

OUTER PANEL SWEEP= 15.0000 DEGREES

FUSELAGE ON

ANGLE OF ATTACK= 18.56155 DEGREES

### S P A N W I S E L O C A T I O N

	2Y/B .12996	2Y/B .21661	2Y/B .33426	2Y/B .43233	2Y/B .48036	2Y/B .57641	2Y/B .67250	2Y/B .86465
X/C	-CPU	-CPU	-CPU	-CPU	-CPU	-CPU	-CPU	-CPU
0.000	3.64864	1.88759	4.37310	1.66217	1.12883	.46282	.34760	-.26011
.025	1.45273	1.65158	4.20324	1.60806	1.19469	.81073	.64162	-.36382
.050	1.04118	1.86633	1.87922	1.43065	1.09590	.67967	.60073	-.35677
.075	1.11688	1.85077	1.61310	1.47720	1.07812	.69613	.54644	-.39343
.100	1.33617	1.94102	1.32936	1.31237	1.00502	.76858	.52740	-.38638
.200	.53037	2.95303	1.27336	1.48790	1.03202	.80810	.55772	-.41106
.300	.47271	2.27715	1.14188	1.26519	1.10315	.85551	.54362	-.41952
.400	.49193	1.22831	1.29601	1.16704	1.11698	.77912	.55137	-.40401
.600	.42286	.55554	1.08274	.83968	.85420	.72643	.50836	-.40613
.800	.31714	.47981	1.14754	.71200	.81205	.62567	.48086	-.43362
1.000	-.01502	.01971	.72018	.68055	.58615	.60393	.47452	-.38779
X/C	-CPL	-CPL	-CPL	-CPL	-CPL	-CPL	-CPL	-CPL
0.000	3.64864	1.88759	4.37310	1.66217	1.12883	.46282	.34760	-.26011
.025	.43787	.72257	-.72395	-.87755	-.89404	-.91379	-.88113	-.83037
.050	.05586	.31071	-.80132	-.87742	-.85124	-.83478	-.78103	-.70067
.075	-.07568	.09441	-.75540	-.79754	-.78936	-.73077	-.69926	-.60199
.100	-.14476	-.02594	-.67741	-.74093	-.69719	-.67151	-.61679	-.53432
.200	-.24747	-.19192	-.46796	-.49941	-.47457	-.45097	-.40955	-.34752
.300	-.24026	-.23186	-.30631	-.33399	-.31074	-.30547	-.25729	-.18891
.400	-.21984	-.24743	-.17548	-.19498	-.17315	-.16261	-.11772	-.09234
.600	-.19581	-.17636	-.05975	-.01258	-.00461	.01843	.00692	.04370
.800	-.08169	-.06328	.03019	.11636	.11333	.13430	.14662	.16213
1.000	-.01502	.01971	.72018	.68055	.58615	.60393	.47452	.38779

## P R E S S U R E M E A S U R E M E N T S

OUTER PANEL SWEEP= 15.0000 DEGREES

FUSELAGE ON

ANGLE OF ATTACK= 19.67951 DEGREES

### S P A N W I S E L O C A T I O N

	2Y/B .12996	2Y/B .21661	2Y/B .33426	2Y/B .43233	2Y/B .48036	2Y/B .57641	2Y/B .67250	2Y/B .86465
X/C	-CPU	-CPU	-CPU	-CPU	-CPU	-CPU	-CPU	-CPU
0.000	4.05049	1.86551	4.23466	1.74911	1.17970	.54186	.36349	-.14480
.025	1.48842	1.71559	4.06629	1.22219	1.07038	.75221	.61870	-.41762
.050	1.14108	1.86654	1.72541	1.34254	1.01015	.81113	.55050	-.37403
.075	1.27894	1.91394	1.55456	1.59696	1.07758	.80458	.55613	-.35575
.100	1.55168	1.95464	1.38183	1.55331	1.02782	.78691	.57652	-.38950
.200	.54415	2.68776	1.29827	1.42735	.96366	.72864	.50621	-.40216
.300	.56682	2.36834	1.11931	1.28330	1.08674	.78822	.55894	-.40919
.400	.52207	1.63986	1.26460	1.15048	1.12013	.75745	.59198	-.40708
.600	.43496	.62647	1.13677	.95780	.92242	.73191	.55683	-.42606
.800	.35381	.44822	1.19912	.70072	.73584	.67823	.55261	-.41692
1.000	.00358	.05822	.71318	.69386	.58396	.57676	.46613	-.41270
X/C	-CPL	-CPL	-CPL	-CPL	-CPL	-CPL	-CPL	-CPL
0.000	4.05049	1.86551	4.23466	1.74911	1.17970	.54186	.36349	-.14480
.025	.53400	.78567	-.68388	-.88088	-.89031	-.90179	-.89057	-.83715
.050	.09188	.34260	-.79984	-.87901	-.86645	-.84027	-.80762	-.71906
.075	-.06861	.12210	-.74435	-.82103	-.78988	-.76109	-.71484	-.63190
.100	-.15453	-.00824	-.69760	-.73553	-.72117	-.67929	-.64104	-.54826
.200	-.25119	-.19320	-.48813	-.50559	-.50325	-.45482	-.43509	-.36340
.300	-.25716	-.24008	-.33415	-.35472	-.34422	-.31608	-.28608	-.20243
.400	-.23090	-.26069	-.21009	-.22069	-.20948	-.18716	-.15323	-.11527
.600	-.21002	-.18856	-.07169	-.03179	-.01243	.00196	.01476	.02390
.800	-.09845	-.05976	.03117	.09538	.10863	.12369	.14769	.13566
1.000	.00358	.05822	.71318	.69386	.58396	.57676	.46613	.41270

# APPENDIX B

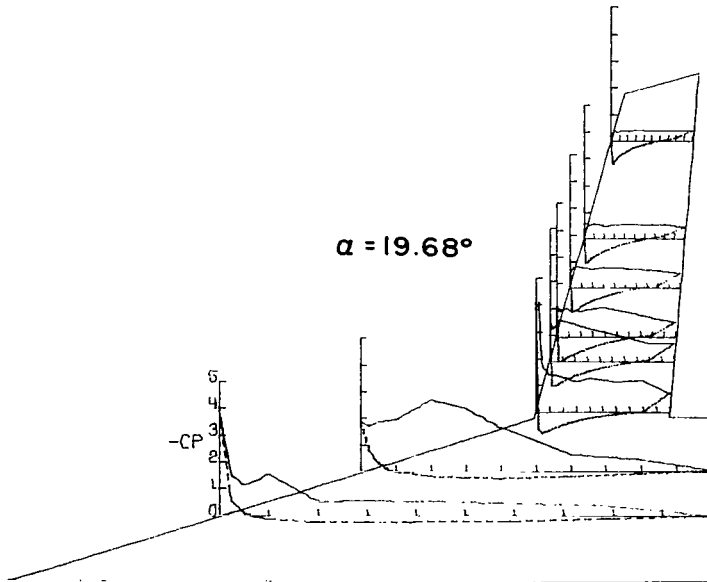
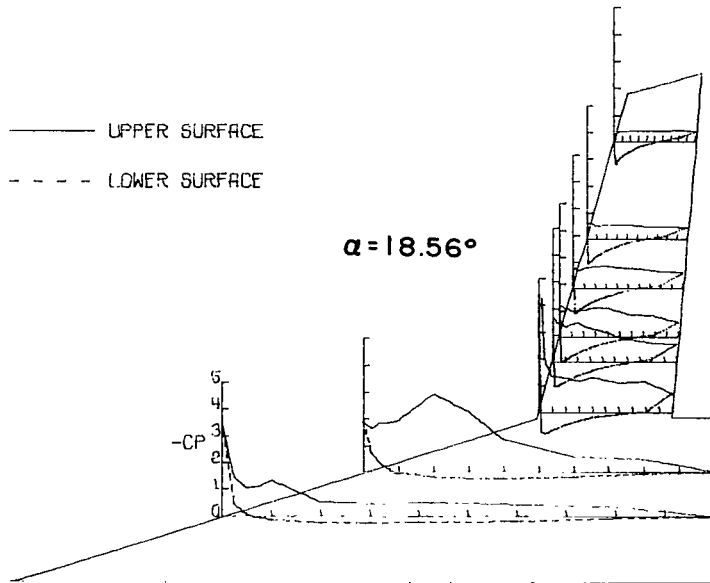

# APPENDIX B

## P R E S S U R E M E A S U R E M E N T S

OUTER PANEL SWEEP= 15.00000 DEGREES

FUSELAGE ON

ANGLE OF ATTACK= 20.73855 DEGREES

### S P A N W I S E L O C A T I O N

	2Y/B	2Y/B	2Y/B	2Y/B	2Y/B	2Y/B	2Y/B	2Y/B
	.12996	.21661	.33426	.43233	.48036	.57641	.67250	.86465
X/C	-CPU	-CPU	-CPU	-CPU	-CPU	-CPU	-CPU	-CPU
0.000	4.49369	1.85310	4.38124	1.68548	1.25050	.52304	.48613	-.06013
.025	1.52635	1.69820	3.76304	1.54330	1.30632	.79176	.55406	.39131
.050	1.28649	1.81568	1.80323	1.46375	1.12545	.78715	.61137	.42952
.075	1.44339	1.92172	1.46313	1.46313	.91747	.75951	.63897	.38989
.100	1.79447	1.92224	1.47753	1.56084	1.08925	.80624	.55547	.34248
.200	.67193	2.51326	1.32408	1.41365	1.10833	.74108	.63331	.40051
.300	.58899	2.55796	1.24328	1.26959	1.18468	.78715	.55193	.40334
.400	.54512	1.81828	1.14620	1.04098	1.30171	.77794	.55476	.41395
.500	.47901	.78543	1.13618	.90671	.88259	.71015	.57245	.40475
.600	.42371	.56503	1.22575	.77897	.76609	.68909	.59156	.41324
1.000	.06190	.11020	.80026	.71197	.51735	.60485	.60076	.41537

	-CPL	-CPL	-CPL	-CPL	-CPL	-CPL	-CPL	-CPL
X/C	-CPL	-CPL	-CPL	-CPL	-CPL	-CPL	-CPL	-CPL
0.000	4.49369	1.85310	4.38124	1.68548	1.25050	.52304	.48613	-.06013
.025	.61123	.82857	-.68755	-.86351	-.88883	-.89607	-.89914	-.85953
.050	1.22611	.37946	-.80464	-.87415	-.87765	-.85265	-.83052	-.74068
.075	-.06190	.13463	-.75705	-.83846	-.81054	-.78554	-.73148	-.66428
.100	-.16348	.00156	-.70884	-.77459	-.74935	-.71778	-.67913	-.59707
.200	-.27406	-.19701	-.49719	-.54666	-.51120	-.50396	-.46549	-.40111
.300	-.27166	-.26354	-.36131	-.37634	-.37557	-.34869	-.31764	-.24619
.400	-.25423	-.28069	-.23482	-.22981	-.23224	-.20527	-.18393	-.14361
.600	-.23920	-.20584	-.08328	-.05323	-.02961	-.02566	-.00495	-.00212
.800	-.10999	-.07641	.01127	.08015	.09277	.11842	.13229	.12804
1.000	.06190	.11020	.80026	.71197	.51735	.60485	.60076	.41537

## P R E S S U R E M E A S U R E M E N T S

OUTER PANEL SWEEP= 15.00000 DEGREES

FUSELAGE ON

ANGLE OF ATTACK= 22.84658 DEGREES

### S P A N W I S E L O C A T I O N

	2Y/B	2Y/B	2Y/B	2Y/B	2Y/B	2Y/B	2Y/B	2Y/B
	.12996	.21661	.33426	.43233	.48036	.57641	.67250	.86465
X/C	-CPU	-CPU	-CPU	-CPU	-CPU	-CPU	-CPU	-CPU
0.000	5.42113	1.77327	4.47032	1.48759	1.35130	.67237	.59071	.10879
.025	1.68549	1.70940	3.78350	1.34594	1.19059	.81931	.69175	.41336
.050	1.59082	1.83610	1.86720	1.40449	1.26078	.87179	.63735	.41548
.075	1.59766	1.98980	1.67267	1.35224	.97740	.84358	.69882	.46776
.100	1.90083	1.46985	1.44730	1.47374	1.02791	.81800	.67480	.41618
.200	1.05268	2.04380	1.42401	1.45922	1.30464	.81800	.71790	.45787
.300	.73146	2.41507	1.26473	1.27355	1.08498	.84227	.65148	.41830
.400	.68394	1.91554	1.22381	1.20997	.99133	.83768	.67126	.42113
.600	.59356	1.04631	.98585	.93966	.86523	.79632	.62110	.45929
.800	.54665	.67192	1.15583	.83833	.80750	.76158	.63452	.43314
1.000	-.03789	.27053	.80057	.72064	.59457	.69599	.64865	.42184

	-CPL	-CPL	-CPL	-CPL	-CPL	-CPL	-CPL	-CPL
X/C	-CPL	-CPL	-CPL	-CPL	-CPL	-CPL	-CPL	-CPL
0.000	5.42113	1.77327	4.47032	1.48759	1.35130	.67237	.59071	.10879
.025	.80244	.93570	-.64322	-.82322	-.84392	-.88391	-.88373	-.86819
.050	.19272	.45124	-.79364	-.88616	-.88654	-.87801	-.85688	-.78765
.075	-.05473	.16616	-.76029	-.84840	-.82424	-.81375	-.77353	-.71348
.100	-.17199	.01973	-.71497	-.80120	-.76916	-.76326	-.72478	-.63719
.200	-.29768	-.21705	-.53245	-.58029	-.56327	-.55146	-.50791	-.45988
.300	-.32174	-.28819	-.37322	-.40595	-.39802	-.38688	-.35533	-.27974
.400	-.29889	-.31623	-.26308	-.27818	-.27147	-.25901	-.22323	-.18508
.600	-.26280	-.23886	-.11014	-.07301	-.06426	-.05180	-.03532	-.02684
.800	-.12449	-.08412	.02077	.07804	.10885	.10885	.13563	.11444
1.000	-.03789	.27053	.80057	.72064	.69457	.69599	.64865	.42184



# APPENDIX B

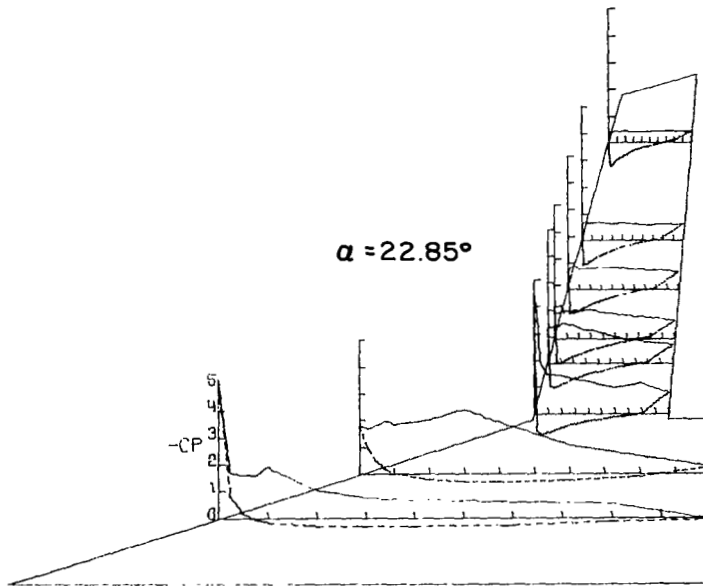
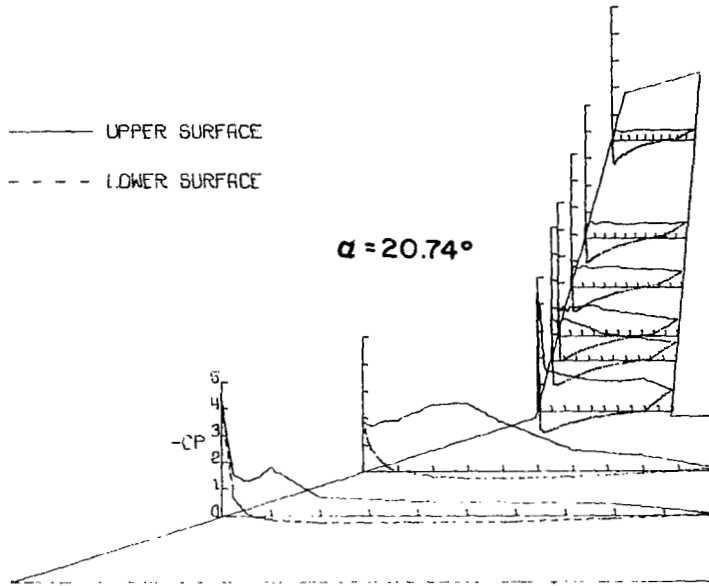

# APPENDIX B

## P R E S S U R E M E A S U R E M E N T S

OUTER PANEL SWEEP= 15.0000 DEGREES

FUSELAGE ON

ANGLE OF ATTACK= 24.94760 DEGREES

### S P A N W I S E L O C A T I O N

	2Y/B .12996	2Y/B .21661	2Y/B .33426	2Y/B .43233	2Y/B .48036	2Y/B .57641	2Y/B .67250	2Y/B .86465
X/C	- CPU	- CPU	- CPU	- CPU	- CPU	- CPU	- CPU	- CPU
0.000	6.24661	1.85024	5.31135	1.51863	1.48853	.86642	.63365	.34915
.025	2.09952	1.79959	3.62026	1.41246	1.15278	.88578	.72489	.48637
.050	1.69368	1.90511	1.91180	1.38865	1.12608	.77163	.72130	.46554
.075	1.78658	2.02382	1.73806	1.36612	1.23038	.83905	.72992	.50792
.100	2.24744	2.00007	1.63317	1.70846	1.18415	.83905	.75362	.45045
.200	1.16559	1.99005	1.49611	1.60808	1.16813	.96254	.71770	.44686
.300	.93944	1.96578	1.34103	1.39444	1.14054	.88845	.68609	.48134
.400	.83186	1.95417	1.26252	1.18144	1.08002	.89445	.65807	.55821
.600	.80864	1.18443	1.04116	1.05468	.97122	.85040	.66238	.48996
.800	.54079	.90006	1.37256	.93154	.80835	.82370	.67532	.50864
1.000	-.02017	.20154	1.02057	.82346	.75027	.73676	.66382	.49930
X/C	- CPL	- CPL	- CPL	- CPL	- CPL	- CPL	- CPL	- CPL
0.000	6.24661	1.85024	5.31135	1.51863	1.48853	.86642	.63365	.34915
.025	.99322	1.07891	-.56034	-.80223	-.31938	-.88144	-.88703	-.88775
.050	.24259	.54922	-.80223	-.89873	-.91145	-.90746	-.89780	-.82526
.075	-.04033	.22317	-.79322	-.87493	-.37677	-.85675	-.82598	-.76636
.100	-.16254	.04590	-.75720	-.83311	-.82072	-.87737	-.76924	-.69239
.200	-.33425	-.24111	-.58092	-.63368	-.53055	-.60720	-.57531	-.50708
.300	-.36419	-.32024	-.42974	-.46127	-.46708	-.44906	-.42161	-.33901
.400	-.34403	-.36351	-.30944	-.31330	-.32767	-.30360	-.27868	-.23558
.600	-.31286	-.28701	-.14990	-.09007	-.11277	-.08341	-.08188	-.05387
.800	-.15643	-.12082	.01158	.08106	.08941	.10543	.10343	.09193
1.000	-.02017	.20154	1.02057	.82346	.75027	.73676	.66382	.49930

# APPENDIX B

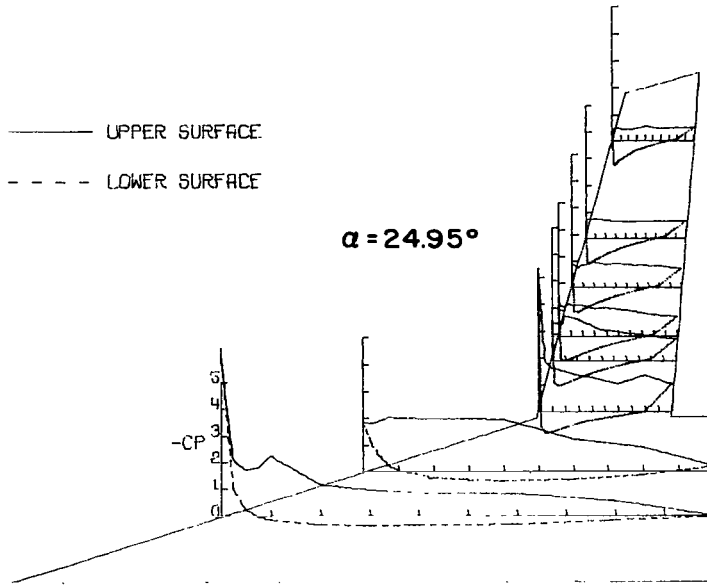

# APPENDIX B

## P R E S S U R E M E A S U R E M E N T S

OUTER PANEL SWEEP= 30.00000 DEGREES

FUSELAGE ON

ANGLE OF ATTACK= -4.28016 DEGREES

### S P A N W I S E L O C A T I O N

	2Y/B .14119	2Y/B .23533	2Y/B .37112	2Y/B .44999	2Y/B .49999	2Y/B .59999	2Y/B .69999	2Y/B .89997
X/C	-CPU	-CPU	-CPU	-CPU	-CPU	-CPU	-CPU	-CPU
0.000	.12506	.37825	.73754	.11945	.17396	.14745	.06019	.10709
.025	-.06046	-.02961	-.51395	-.47720	-.47791	-.48632	-.50253	-.44613
.050	-.05809	-.03165	-.35529	-.32895	-.31882	-.31882	-.31776	-.32545
.075	-.01660	-.01429	-.23462	-.23891	-.23346	-.23604	-.24777	-.24077
.100	-.01837	-.00919	-.17826	-.19480	-.18496	-.19918	-.19737	-.19807
.200	.02549	.01123	-.05329	-.05023	-.05626	-.05368	-.06999	-.05319
.300	.04979	.03165	.01776	.01654	.02845	.01811	.01400	.01610
.400	.04445	.02603	.06003	.07902	.08655	.08278	.06019	.04269
.600	.03438	.03114	.06065	.06616	.07372	.07308	.07069	.05319
.800	.03616	.03114	.02818	.00551	.02910	.01487	.02170	.00210
1.000	-.04623	-.04951	-.04104	-.03798	-.04592	-.03880	-.01330	-.01400

	CPL	CPL	CPL	CPL	CPL	CPL	CPL	CPL
X/C	-CPL	-CPL	-CPL	-CPL	-CPL	-CPL	-CPL	-CPL
0.000	.12506	.37825	.73754	.11945	.17396	.14745	.06019	.10709
.025	.25724	.41858	1.36828	1.19050	1.29841	1.17543	1.27229	1.06281
.050	.24005	.37519	1.05870	.98820	.99032	.98643	.99555	.78888
.075	.22049	.36549	.86067	.81044	.83691	.81102	.82811	.71601
.100	.22227	.33282	.74612	.70753	.72623	.69452	.71461	.58920
.200	.19797	.28586	.54213	.55683	.57801	.54759	.55067	.45679
.300	.20448	.27463	.46678	.50231	.49666	.47338	.45679	.38042
.400	.22286	.26901	.42390	.42268	.43523	.42100	.40845	.33068
.600	.20804	.24400	.27137	.27811	.28002	.26127	.26036	.20577
.800	.15292	.12864	.12252	.09556	.10218	.09312	.09309	*****
1.000	-.04623	-.04951	-.04104	-.03798	-.04592	-.03880	-.01330	-.01400

## P R E S S U R E M E A S U R E M E N T S

OUTER PANEL SWEEP= 30.00000 DEGREES

FUSELAGE ON

ANGLE OF ATTACK= -3.81071 DEGREES

### S P A N W I S E L O C A T I O N

	2Y/B .14119	2Y/B .23533	2Y/B .37112	2Y/B .44999	2Y/B .49999	2Y/B .59999	2Y/B .69999	2Y/B .89997
X/C	-CPU	-CPU	-CPU	-CPU	-CPU	-CPU	-CPU	-CPU
0.000	.09732	.28979	.39192	-.10181	-.03231	-.10470	-.14316	-.05699
.025	-.06112	-.03469	-.44712	-.42504	-.42450	-.43236	-.44061	-.40864
.050	-.03917	-.02194	-.29563	-.26742	-.26045	-.27144	-.26200	-.27590
.075	-.00534	-.01378	-.18216	-.19320	-.17579	-.19453	-.19251	-.20988
.100	.00178	-.00153	-.13555	-.14536	-.13766	-.14218	-.14803	-.15637
.200	.02670	.01888	-.01963	-.02576	-.02973	-.02714	-.03961	-.02780
.300	.05934	.04235	.04784	.04661	.05106	.04072	.04239	.03266
.400	.05341	.04490	.08219	.10059	.11051	.09112	.08479	.05699
.600	.05638	.03214	.07299	.09507	.08531	.08595	.08131	.06741
.800	.04391	.03418	.03005	.02085	.02391	.02650	.02293	.00764
1.000	-.04273	-.05561	-.03803	-.04416	-.05493	-.04589	-.02710	-.01668

	CPL	CPL	CPL	CPL	CPL	CPL	CPL	CPL
X/C	-CPL	-CPL	-CPL	-CPL	-CPL	-CPL	-CPL	-CPL
0.000	.09732	.28979	.39192	-.10181	-.03231	-.10470	-.14316	-.05699
.025	.23500	.38469	1.21714	1.04712	1.13793	1.01360	1.11029	.95098
.050	.22728	.33928	.94768	.87891	.87712	.86677	.88489	.72419
.075	.21541	.33673	.77097	.72681	.74128	.72770	.72419	.66767
.100	.20117	.29796	.67161	.65689	.64878	.63132	.64071	.50853
.200	.17862	.26632	.50355	.51643	.52588	.50474	.49810	.42575
.300	.19642	.25714	.44590	.47043	.45885	.44011	.42157	.35479
.400	.21007	.25663	.40542	.40542	.40974	.39100	.38262	.31027
.600	.20779	.22245	.26067	.27048	.25722	.24623	.24255	.19529
.800	.14717	.11581	.10917	.09997	.09112	.08402	.08062	*****
1.000	-.04273	-.05561	-.03803	-.04416	-.05493	-.04589	-.02710	-.01668

# APPENDIX B

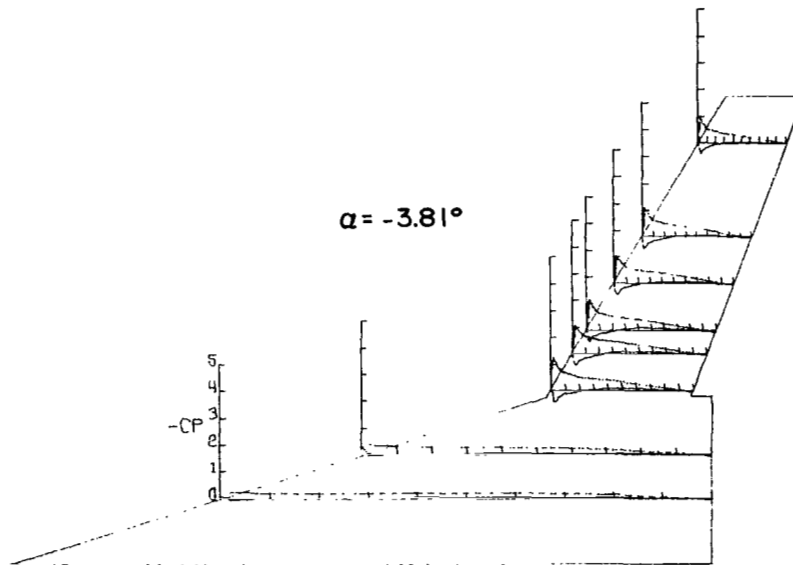
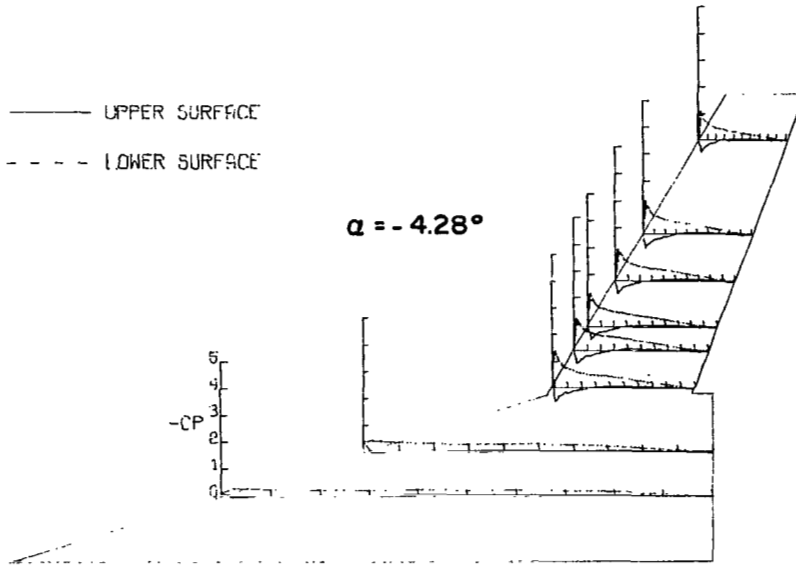

# APPENDIX B

## P R E S S U R E M E A S U R E M E N T S

OUTFR PANFL SWEEP= 30.0000 DEGREES

FUSELAGE ON

ANGLE OF ATTACK= -3.19704 DEGREES

### S P A N W I S E L O C A T I O N

	2Y/B .14119	2Y/B .23533	2Y/B .37112	2Y/B .44999	2Y/B .49999	2Y/B .59999	2Y/B .69999	2Y/B .89997
X/C	-CPU	-CPU	-CPU	-CPU	-CPU	-CPU	-CPU	-CPU
0.000	.03624	.21631	.02649	-.27228	-.24136	-.30689	-.33919	-.25265
.025	-.04337	-.02870	-.38316	-.36653	-.34372	-.36788	-.37897	-.34268
.050	-.03921	-.02204	-.24518	-.21314	-.20827	-.21346	-.19961	-.23171
.075	.00951	.00513	-.14846	-.14230	-.13820	-.14599	-.14307	-.15982
.100	.00238	.00615	-.09671	-.11828	-.09732	-.10576	-.11865	-.12912
.200	.03684	.03742	.01725	.00431	.01363	.00519	.00070	-.00349
.300	.06060	.05792	.07515	.04497	.07916	.05645	.06909	.04188
.400	.06654	.05228	.09179	.12444	.12133	.11549	.10050	.07189
.600	.05882	.04152	.08131	.09671	.09539	.09667	.09352	.06909
.800	.04456	.03947	.03696	.01725	.03569	.03179	.03071	.00140
1.000	-.04753	-.05331	-.03943	-.00616	-.05839	-.05450	-.03280	-.03210

	-CPL	-CPL	-CPL	-CPL	-CPL	-CPL	-CPL	-CPL
0.000	.03624	.21631	.02649	-.27228	-.24136	-.30689	-.33919	-.25265
.025	.19309	.32805	1.06341	.88460	.97149	.87603	.92917	.76848
.050	.19012	.29935	.83779	.77064	.79486	.75979	.77407	.61269
.075	.18953	.29063	.69487	.64251	.56238	.65069	.65880	.56169
.100	.18418	.27116	.60185	.57906	.56432	.57985	.57985	.45620
.200	.16398	.26090	.48419	.47865	.49830	.46326	.46388	.39193
.300	.18478	.24194	.40842	.44292	.43566	.41914	.39053	.33394
.400	.20319	.23886	.36900	.38563	.38929	.37567	.36049	.29243
.600	.18359	.22092	.24764	.25626	.25334	.23682	.23729	.19053
.800	.14735	.11584	.11027	.09671	.09148	.08629	.08026	*****
1.000	-.04753	-.05331	-.03943	-.00616	-.05839	-.05450	-.03280	-.03210

## P R E S S U R E M E A S U R E M E N T S

OUTER PANEL SWEEP= 30.0000 DEGREES

FUSELAGE ON

ANGLE OF ATTACK= -2.64018 DEGREES

### S P A N W I S E L O C A T I O N

	2Y/B .14119	2Y/B .23533	2Y/B .37112	2Y/B .44999	2Y/B .49999	2Y/B .59999	2Y/B .69999	2Y/B .89997
X/C	-CPU	-CPU	-CPU	-CPU	-CPU	-CPU	-CPU	-CPU
0.000	.01891	.13891	-.20477	-.44470	-.37727	-.46010	-.44579	-.41380
.025	-.04077	-.01179	-.30038	-.29359	-.28150	-.28409	-.32409	-.28584
.050	-.01891	.00461	-.17455	-.18072	-.13137	-.15207	-.14813	-.15231
.075	.01477	.01435	-.08758	-.08943	-.08283	-.09707	-.09111	-.11753
.100	.02127	.02563	-.04996	-.08635	-.05759	-.05436	-.07094	-.08137
.200	.04491	.04818	.05736	.04688	.04918	.03494	.03269	.02225
.300	.08391	.07432	.10855	.06415	.10289	.09448	.08971	.07302
.400	.07150	.07279	.12644	.15358	.15272	.14366	.12797	.09041
.600	.07623	.05997	.09930	.11287	.11001	.11519	.10362	.08346
.800	.05259	.04921	.04996	.02652	.03494	.03624	.03547	.00904
1.000	-.03841	-.03844	-.04132	-.04441	-.05436	-.04983	-.03616	-.02712

	-CPL	-CPL	-CPL	-CPL	-CPL	-CPL	-CPL	-CPL
0.000	.01891	.13891	-.20477	-.44470	-.37727	-.46010	-.44579	-.41380
.025	.17492	.28141	.88509	.78270	.83034	.78047	.78179	.67458
.050	.17728	.26142	.73521	.69574	.58785	.66842	.67249	.57155
.075	.17255	.27013	.62419	.58472	.50883	.58681	.59034	.49706
.100	.18378	.25783	.54709	.52427	.51511	.51964	.51168	.43719
.200	.15719	.24040	.44039	.44717	.44457	.43228	.41978	.35713
.300	.17433	.23169	.39474	.42435	.43833	.39474	.36200	.30770
.400	.19442	.23220	.35712	.36452	.36951	.35074	.34460	.27054
.600	.18378	.21682	.24425	.25165	.23879	.22714	.22116	.17943
.800	.12882	.14045	.10917	.08573	.08671	.06924	.07372	*****
1.000	-.03841	-.03844	-.04132	-.04441	-.05436	-.04983	-.03616	-.02712

# APPENDIX B

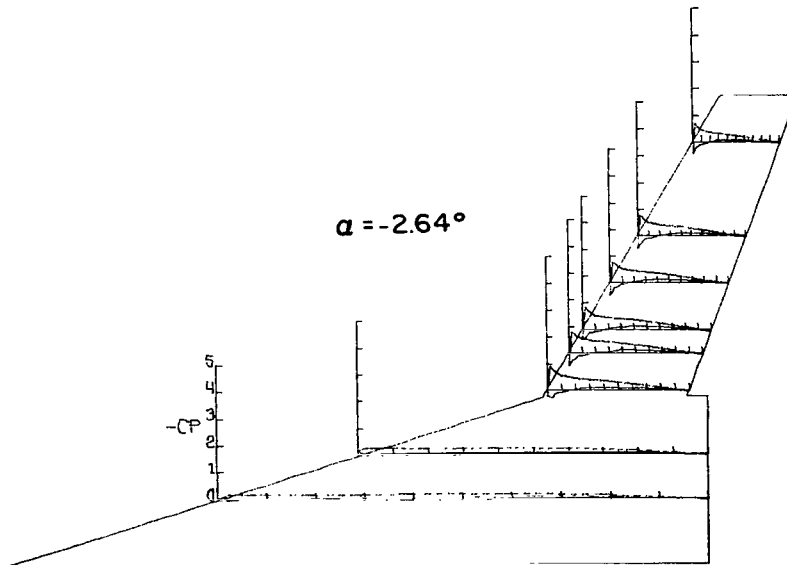
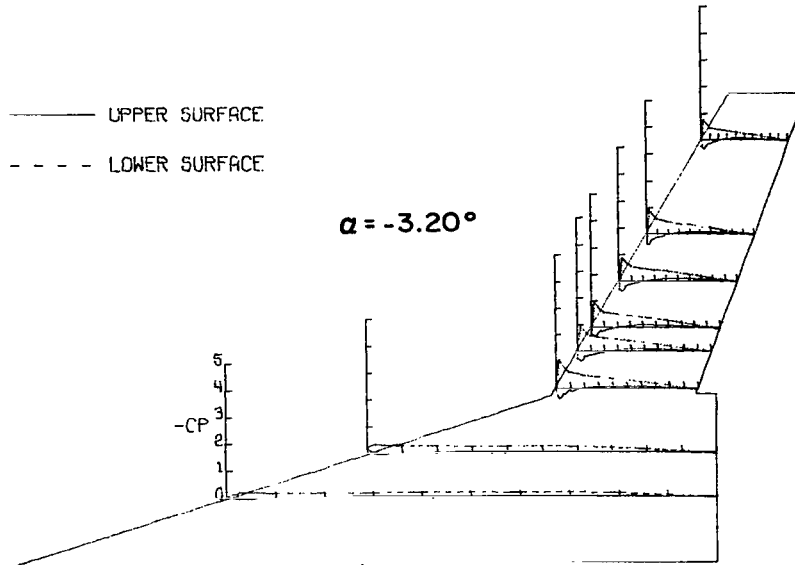

# APPENDIX B

## P R E S S U R E M E A S U R E M E N T S

OUTER PANEL SWEEP= 30.0000 DEGREES

FUSELAGE ON

ANGLE OF ATTACK= -2.10790 DEGREES

### S P A N W I S E L O C A T I O N

	2Y/B .14119	2Y/B .23533	2Y/B .37112	2Y/B .44999	2Y/B .49999	2Y/B .59999	2Y/B .69999	2Y/B .89997
X/C	-CPU	-CPU	-CPU	-CPU	-CPU	-CPU	-CPU	-CPU
0.000	-.01629	.08714	-.43175	-.53722	-.52641	-.58222	-.54598	-.54189
.025	-.02909	-.01561	-.21032	-.19614	-.19978	-.22008	-.24706	-.20816
.050	-.01397	.00907	-.08697	-.08512	-.08055	-.09069	-.07917	-.10237
.075	.02968	.03022	-.01789	-.00185	-.02537	-.03742	-.05050	-.07098
.100	.02153	.03979	.02961	-.01419	-.00444	-.02220	-.02866	-.04777
.200	.05644	.05541	.09807	.10239	.06377	.06659	.05528	.06142
.300	.07739	.07858	.15358	.10609	.12431	.10718	.10715	.09077
.400	.08263	.08009	.15790	.19614	.16490	.15729	.13854	.10237
.600	.07564	.06951	.13816	.15666	.12177	.12494	.11124	.08872
.800	.06633	.05389	.07710	.05243	.03425	.03742	.03685	.01297
1.000	-.03084	-.05087	-.02591	-.02159	-.06850	-.04820	-.04777	-.02662
X/C	-CPL	-CPL	-CPL	-CPL	-CPL	-CPL	-CPL	-CPL
0.000	-.01629	.08714	-.43175	-.53722	-.52641	-.58222	-.54598	-.54189
.025	.14489	.23220	.77592	.72658	.57986	.66208	.67496	.54584
.050	.15769	.23875	.65565	.66366	.50495	.60495	.57454	.47138
.075	.15885	.24127	.56436	.54524	.52370	.50358	.50554	.44405
.100	.15827	.21457	.51317	.50207	.46345	.44269	.45362	.35524
.200	.15245	.20651	.40585	.43422	.38551	.38878	.36754	.32245
.300	.16467	.21155	.37686	.42558	.37156	.35961	.35961	.28459
.400	.18736	.22213	.35897	.37809	.33931	.33487	.31494	.25525
.600	.15362	.19493	.25720	.26213	.22325	.21056	.20474	.16448
.800	.11521	.11635	.12706	.10609	.08562	.06786	.07575	*****
1.000	-.03084	-.05087	-.02591	-.02159	-.06850	-.04820	-.04777	-.02662

## P R E S S U R E M E A S U R E M E N T S

OUTER PANEL SWEEP= 30.0000 DEGREES

FUSELAGE ON

ANGLE OF ATTACK= -1.59833 DEGREES

### S P A N W I S E L O C A T I O N

	2Y/B .14119	2Y/B .23533	2Y/B .37112	2Y/B .44999	2Y/B .49999	2Y/B .59999	2Y/B .69999	2Y/B .89997
X/C	-CPU	-CPU	-CPU	-CPU	-CPU	-CPU	-CPU	-CPU
0.000	-.03754	.03710	-.57671	-.63574	-.61516	-.65617	-.64251	-.59352
.025	-.02026	-.00927	-.13734	-.12367	-.12564	-.13996	-.17008	-.15328
.050	.00477	.02370	-.04661	-.02362	-.01332	-.02213	-.02100	-.05249
.075	.04291	.04019	.02486	.02921	.02734	.00911	.00980	-.02940
.100	.04350	.05256	.05344	.02610	.05208	.03710	.02730	-.00420
.200	.07330	.07162	.11186	.11186	.10806	.10075	.09239	.08819
.300	.09356	.09120	.15474	.11062	.15353	.13735	.13998	.10778
.400	.09237	.09532	.16158	.19079	.19269	.17316	.16518	.11268
.600	.08164	.08965	.13299	.13113	.14517	.13280	.13788	.09659
.800	.07270	.05462	.06028	.04350	.03320	.03841	.02940	.01680
1.000	-.04231	-.05771	-.03791	-.06090	-.07616	-.06379	-.05809	-.03849
X/C	-CPL	-CPL	-CPL	-CPL	-CPL	-CPL	-CPL	-CPL
0.000	-.03754	.03710	-.57671	-.63574	-.61516	-.65617	-.64251	-.59352
.025	.12932	.18755	.61710	.52761	.59615	.57661	.58640	.45960
.050	.13408	.20353	.55495	.53258	.52272	.51231	.51634	.39864
.075	.15196	.21641	.48411	.46795	.46859	.45828	.45749	.40775
.100	.14958	.19734	.43812	.42321	.42183	.40815	.40285	.31177
.200	.14839	.20507	.37722	.38654	.39472	.36649	.36641	.30096
.300	.16329	.21023	.35423	.37846	.36194	.33850	.32368	.27156
.400	.17938	.21332	.33061	.33061	.33655	.31442	.30826	.24427
.600	.16746	.19013	.24112	.22931	.22068	.20180	.19947	.16588
.800	.12515	.10408	.09446	.08514	.07291	.07161	.06229	*****
1.000	-.04231	-.05771	-.03791	-.06090	-.07616	-.06379	-.05809	-.03849



# APPENDIX B

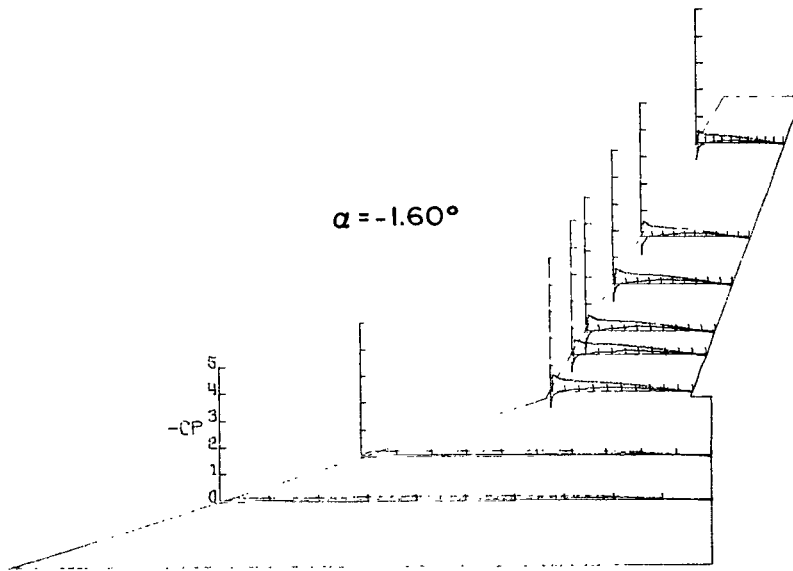
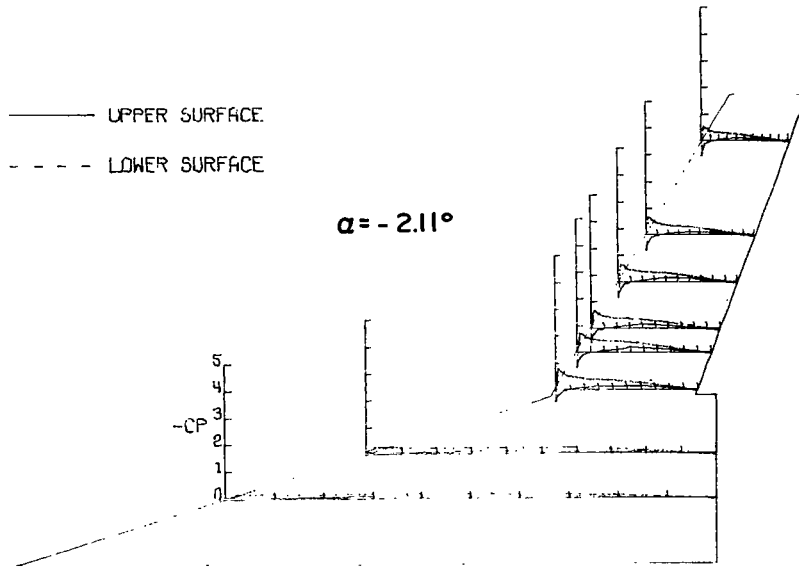

# APPENDIX B

P R E S S U R E M E A S U R E M E N T S

OUTER PANEL SWEEP= 30.0000 DEGREES

FUSELAGE ON

ANGLE OF ATTACK= -1.04169 DEGREES

S P A N W I S E L O C A T I O N

	2Y/B .14119	2Y/B .23533	2Y/B .37112	2Y/B .44999	2Y/B .49999	2Y/B .59999	2Y/B .69999	2Y/B .89997
X/C	- CPU	- CPU	- CPU	- CPU	- CPU	- CPU	- CPU	- CPU
0.000	-.06965	-.01076	-.66700	-.69551	-.58467	-.69968	-.68551	-.68412
.025	-.01239	.01025	-.03657	-.03347	-.04308	-.03981	-.07725	-.07029
.050	.01417	.03740	.03409	.04215	.05352	.05221	.04245	-.00070
.075	.05135	.04867	.06819	.09360	.08289	.08485	.05359	.01601
.100	.04486	.05994	.08492	.09980	.08485	.09138	.05637	.03897
.200	.06729	.07685	.13947	.15187	.14359	.14490	.12666	.10787
.300	.09267	.11220	.18411	.16861	.19189	.16382	.16703	.13084
.400	.08558	.10605	.19279	.20518	.22844	.19646	.18721	.12458
.500	.08558	.09580	.15001	.16861	.15664	.15664	.14337	.10578
.600	.07496	.05994	.06819	.05517	.04395	.04830	.02436	.02575
.800	-.04663	-.04406	-.03595	-.05765	-.06723	-.05678	-.05150	-.03967
1.000								

	- CPL	- CPL	- CPL	- CPL	- CPL	- CPL	- CPL	- CPL
X/C	- CPL	- CPL	- CPL	- CPL	- CPL	- CPL	- CPL	- CPL
0.000	-.06965	-.01076	-.66700	-.69551	-.68457	-.69968	-.68551	-.68412
.025	.08912	.15882	.48165	.49851	.46657	.44970	.44376	.36156
.050	.10565	.16702	.45748	.43082	.43926	.44383	.42983	.34414
.075	.11923	.18495	.39983	.37937	.39357	.38965	.37131	.35947
.100	.12277	.18187	.37751	.38495	.36420	.35898	.36226	.26237
.200	.12808	.17982	.33660	.33970	.34035	.33744	.32115	.27351
.300	.14047	.19468	.32792	.35892	.33548	.31329	.29160	.24846
.400	.15877	.19929	.30437	.31428	.31459	.30089	.28464	.22897
.500	.14461	.18597	.21944	.22440	.21996	.20103	.19835	.15798
.600	.10683	.09990	.09546	.08183	.08093	.06788	.06124	*****
.800	-.04663	-.04406	-.03595	-.05765	-.06723	-.05678	-.05150	-.03967
1.000								

P R E S S U R E M E A S U R E M E N T S

OUTER PANEL SWEEP= 30.0000 DEGREES

FUSELAGE ON

ANGLE OF ATTACK= -.49451 DEGREES

S P A N W I S E L O C A T I O N

	2Y/R .14119	2Y/R .23533	2Y/R .37112	2Y/R .44999	2Y/R .49999	2Y/R .59999	2Y/R .69999	2Y/R .89997
X/C	- CPU	- CPU	- CPU	- CPU	- CPU	- CPU	- CPU	- CPU
0.000	-.07463	-.02908	-.71879	-.73055	-.71422	-.71487	-.71663	-.71944
.025	-.01493	.02752	-.07120	-.06967	-.06523	-.06262	-.01404	-.00912
.050	.02448	.07219	.08668	.08668	.13823	.12849	.12845	.06106
.075	.06806	.07634	.13063	.13744	.14415	.13632	.11932	.08563
.100	.05254	.08465	.13682	.12630	.13557	.12654	.12424	.06317
.200	.08537	.10438	.17645	.17149	.17937	.16698	.15793	.13336
.300	.11104	.12516	.17830	.17768	.22177	.18850	.19653	.15091
.400	.11343	.12048	.19254	.22288	.22959	.22177	.21127	.13968
.500	.09433	.10958	.17397	.19750	.15850	.15654	.15161	.10879
.600	.08478	.07219	.06686	.04024	.05283	.05218	.01965	.02106
.800	-.04418	-.04778	-.04705	-.06563	-.08414	-.06457	-.06528	-.04071
1.000								

	- CPL	- CPL	- CPL	- CPL	- CPL	- CPL	- CPL	- CPL
X/C	- CPL	- CPL	- CPL	- CPL	- CPL	- CPL	- CPL	- CPL
0.000	-.07463	-.02908	-.71879	-.73055	-.71422	-.71487	-.71663	-.71944
.025	.07442	.13970	.36404	.30460	.35326	.29156	.32109	.26391
.050	.10209	.12568	.35661	.35599	.33722	.34309	.35411	.27795
.075	.10746	.16255	.31884	.31884	.31243	.31895	.31125	.27374
.100	.11701	.16047	.30708	.30213	.30526	.29743	.30041	.21267
.200	.11104	.17034	.30708	.29160	.29547	.29678	.28567	.23022
.300	.14985	.17761	.28046	.29717	.29156	.27525	.25900	.22812
.400	.15761	.18280	.26931	.27612	.28373	.26742	.25900	.20636
.500	.13612	.17293	.19254	.19502	.20024	.18263	.18039	.15231
.600	.10985	.09296	.07367	.06686	.06196	.05544	.05264	*****
.800	-.04418	-.04778	-.04705	-.06563	-.08414	-.06457	-.06528	-.04071
1.000								

APPENDIX B

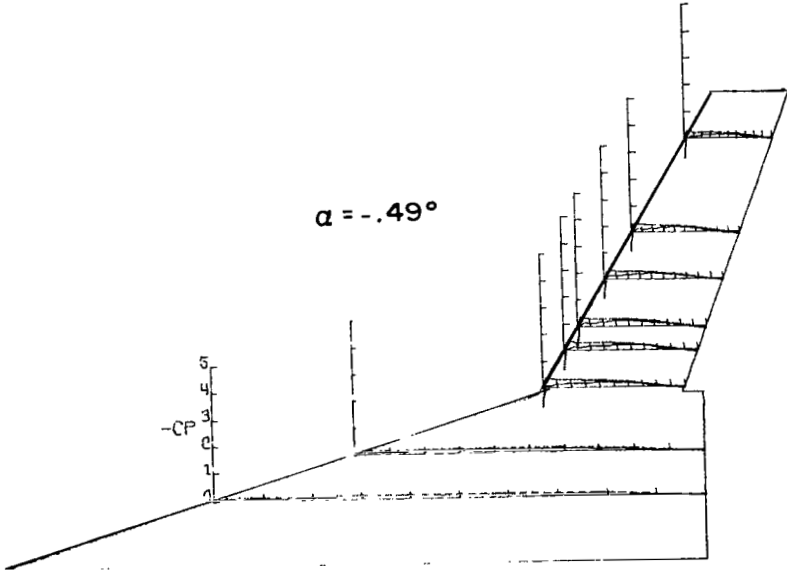
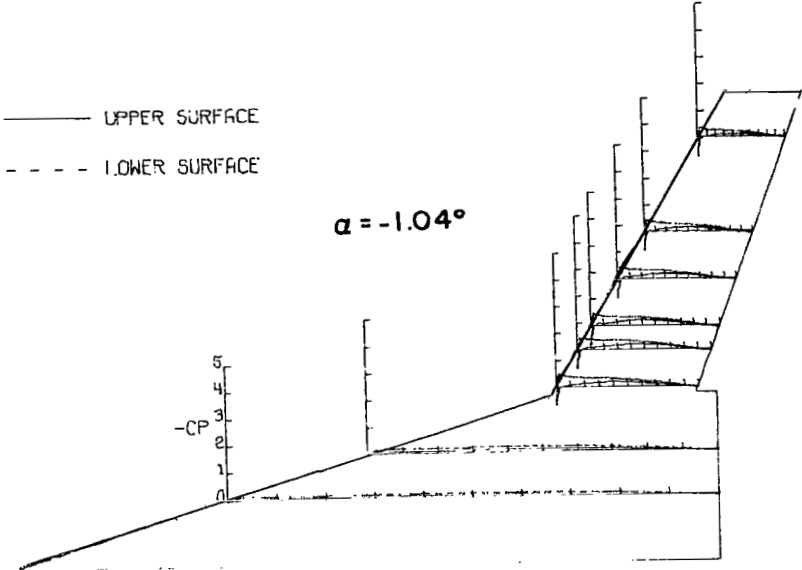

# APPENDIX B

## P R E S S U R E M E A S U R E M E N T S

OUTER PANEL SWEEP= 30.0000 DEGREES

FUSELAGE ON

ANGLE OF ATTACK= .05174 DEGREES

### S P A N W I S E L O C A T I O N

	2Y/B .14119	2Y/B .23533	2Y/B .37112	2Y/B .44999	2Y/B .49999	2Y/B .59999	2Y/B .69999	2Y/B .89997
X/C	-CPU	-CPU	-CPU	-CPU	-CPU	-CPU	-CPU	-CPU
0.000	-.08239	-.04694	-.72615	-.73112	-.72199	-.72174	-.71328	-.76213
.025	.02074	.04898	.21280	.16963	.17457	.19216	.12772	.10888
.050	.05097	.08061	.20845	.19165	.21541	.21170	.21915	.15564
.075	.08950	.09439	.20720	.22089	.20323	.20389	.18565	.14098
.100	.07824	.09847	.20720	.20223	.20339	.18695	.18635	.11865
.200	.09483	.10204	.20720	.21467	.21235	.20714	.18944	.15913
.300	.12032	.12959	.20471	.23520	.23776	.22343	.22194	.17378
.400	.12269	.12806	.22649	.25947	.25535	.24362	.22613	.16890
.600	.10906	.10918	.16489	.18854	.17262	.17262	.16262	.12283
.800	.09068	.07755	.08276	.06907	.36123	.06384	.04467	.02931
1.000	-.03971	-.05714	-.04542	-.06658	-.08142	-.06905	-.07468	-.03559

	-CPL	-CPL	-CPL	-CPL	-CPL	-CPL	-CPL	-CPL
X/C	-CPL	-CPL	-CPL	-CPL	-CPL	-CPL	-CPL	-CPL
0.000	-.08239	-.04694	-.72615	-.73112	-.72109	-.72174	-.71328	-.76213
.025	.05631	.09745	.23645	.18978	.21525	.17457	.21217	.20170
.050	.07409	.11173	.27378	.22835	.27945	.26121	.26312	.21217
.075	.09720	.13112	.26943	.27005	.27359	.25470	.25265	.23241
.100	.10254	.13673	.25947	.27129	.24352	.24515	.24637	.17657
.200	.10906	.14490	.26694	.26320	.26958	.25600	.25614	.21147
.300	.12447	.15153	.25325	.27689	.26837	.23711	.24218	.19891
.400	.15885	.16581	.26507	.27440	.26933	.25860	.24637	.20728
.600	.12506	.13928	.20036	.19414	.17848	.17132	.16820	.14238
.800	.10847	.08316	.07840	.08213	.06123	.06058	.05025	*****
1.000	-.03971	-.05714	-.04542	-.06658	-.08142	-.06905	-.07468	-.03559

## P R E S S U R E M E A S U R E M E N T S

OUTER PANEL SWEEP= 30.0000 DEGREES

FUSELAGE ON

ANGLE OF ATTACK= .57582 DEGREES

### S P A N W I S E L O C A T I O N

	2Y/B .14119	2Y/B .23533	2Y/B .37112	2Y/B .44999	2Y/B .49999	2Y/B .59999	2Y/B .69999	2Y/B .89997
X/C	-CPU	-CPU	-CPU	-CPU	-CPU	-CPU	-CPU	-CPU
0.000	-.07893	-.04797	-.71029	-.71462	-.70277	-.69756	-.68633	-.77020
.025	.03976	.08098	.31307	.28337	.30555	.28605	.25720	.21317
.050	.07418	.11193	.26358	.28276	.29305	.28995	.29005	.21177
.075	.09376	.11451	.27100	.27224	.27545	.25484	.24602	.18381
.100	.08189	.12121	.25615	.24996	.25419	.24119	.24532	.15516
.200	.10029	.12843	.24996	.24501	.25939	.24704	.23064	.18661
.300	.13411	.14545	.24068	.25368	.26734	.25484	.23903	.19639
.400	.13471	.14597	.23945	.27348	.27565	.26719	.24741	.18102
.600	.11394	.13153	.17634	.18933	.19438	.18918	.18172	.13349
.800	.09079	.08769	.08724	.06002	.06355	.06501	.04962	.02376
1.000	-.04095	-.04642	-.04393	-.07239	-.08126	-.06696	-.07758	-.04124

	-CPL	-CPL	-CPL	-CPL	-CPL	-CPL	-CPL	-CPL
X/C	-CPL	-CPL	-CPL	-CPL	-CPL	-CPL	-CPL	-CPL
0.000	-.07893	-.04797	-.71029	-.71462	-.70277	-.69756	-.68633	-.77020
.025	.02730	.06912	.11261	.05445	.11442	.07411	.12161	.08946
.050	.06409	.09336	.16149	.10828	.18788	.19243	.17403	.12930
.075	.07358	.11709	.19923	.17695	.20389	.19568	.18172	.18172
.100	.09139	.12328	.20047	.18995	.19828	.19243	.18940	.13559
.200	.09495	.13772	.22398	.22335	.22884	.21584	.21736	.18102
.300	.10682	.13772	.22398	.24378	.23469	.22819	.21317	.17473
.400	.14301	.16557	.23697	.24749	.24444	.22144	.22365	.18172
.600	.12462	.14700	.18005	.18067	.17553	.16058	.16075	.12930
.800	.10741	.07582	.06497	.06744	.05721	.05071	.04543	*****
1.000	-.04095	-.04642	-.04393	-.07239	-.08126	-.06696	-.07758	-.04124

# APPENDIX B

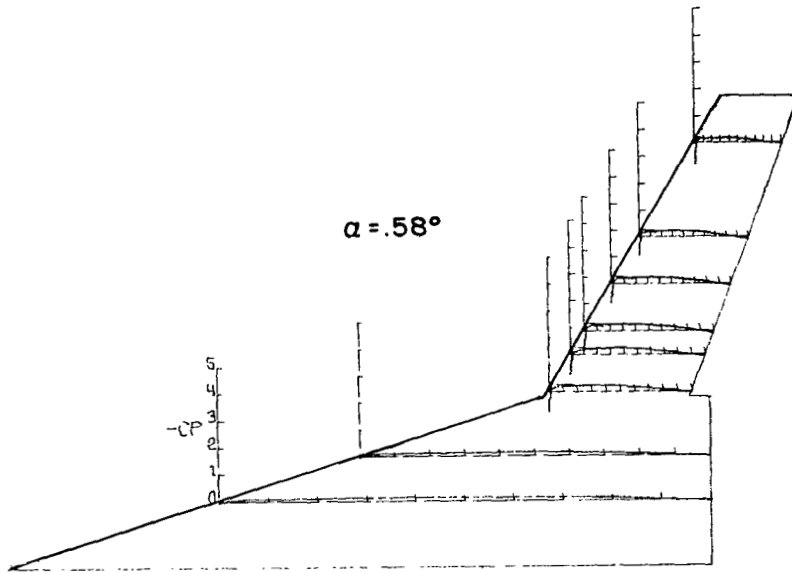
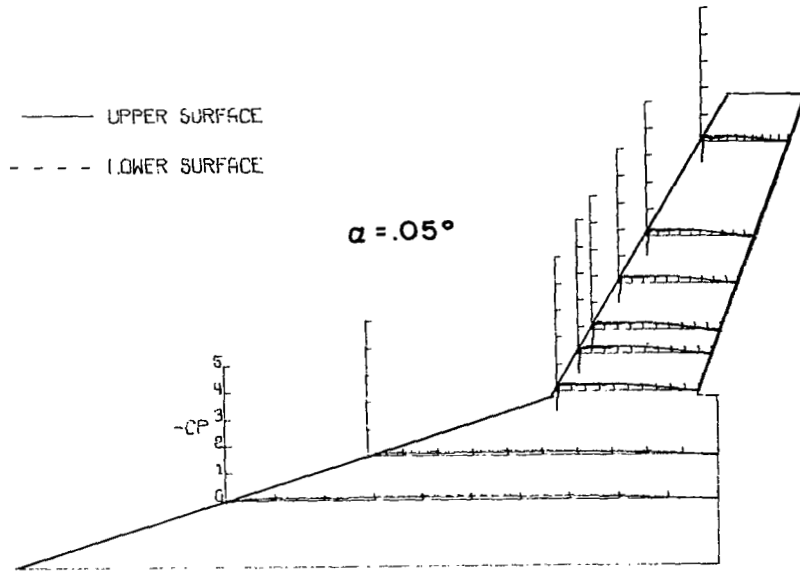

# APPENDIX B

P R E S S U R E M E A S U R E M E N T S

OUTLR PANEL SWEEP= 30.0000 DEGREES

FUSELAGE ON

ANGLE OF ATTACK= 1.07366 DEGREES

S P A N W I S E L O C A T I O N

	2Y/B .14119	2Y/B .23523	2Y/B .37112	2Y/B .44999	2Y/B .49999	2Y/B .59999	2Y/B .69999	2Y/B .89997
X/C	-CPU	-CPU	-CPU	-CPU	-CPU	-CPU	-CPU	-CPU
0.000	-.07810	-.03990	-.63779	-.66019	-.64369	-.66502	-.61670	-.72921
.025	.05916	.09054	.46730	.40819	.41879	.39229	.37192	.33577
.050	.08815	.12174	.36338	.37707	.36062	.37096	.36288	.28266
.075	.10590	.12635	.35094	.35405	.33412	.31474	.31283	.24099
.100	.10058	.12890	.31547	.31983	.30504	.29987	.27918	.20209
.200	.10768	.13964	.29369	.29805	.28178	.27273	.26668	.22223
.300	.14554	.15243	.28312	.29121	.28307	.27661	.26251	.22571
.400	.13726	.15243	.26880	.30614	.29276	.27467	.27015	.19723
.600	.12602	.13351	.19476	.20845	.19841	.19776	.18404	.15348
.800	.09230	.09156	.10702	.08276	.08203	.07174	.06736	.02917
1.000	-.04142	-.04655	-.03547	-.05787	-.08725	-.07561	-.08264	-.04445

	-CPL	-CPL	-CPL	-CPL	-CPL	-CPL	-CPL	-CPL
0.000	-.07810	-.03990	-.63779	-.66019	-.64369	-.66502	-.61670	-.72921
.025	.01124	.03939	-.00373	-.02178	.03102	-.01616	.01389	.01458
.050	.05621	.06292	.08151	.11387	.09953	.10987	.10903	.11528
.075	.05916	.08389	.14747	.13938	.14477	.12279	.12223	.11876
.100	.07691	.09872	.15245	.15120	.15123	.12861	.14654	.07917
.200	.08283	.11151	.20907	.19476	.19259	.18096	.18126	.14931
.300	.11123	.12276	.20409	.22712	.21521	.21198	.19098	.16112
.400	.14140	.13555	.22649	.23396	.22620	.20681	.20418	.16529
.600	.12839	.12993	.17547	.16863	.15834	.13766	.15140	.11598
.800	.09230	.07161	.06845	.06782	.04330	.04330	.03542	*****
1.000	-.04142	-.04655	-.03547	-.05787	-.08725	-.07561	-.08264	-.04445

P R E S S U R E M E A S U R E M E N T S

OUTLR PANFL SWEEP= 30.0000 DEGREES

FUSELAGE ON

ANGLE OF ATTACK= 1.63330 DEGREES

S P A N W I S E L O C A T I O N

	2Y/B .14119	2Y/B .23533	2Y/B .37112	2Y/B .44999	2Y/B .49999	2Y/B .59999	2Y/B .69999	2Y/B .89997
X/C	-CPU	-CPU	-CPU	-CPU	-CPU	-CPU	-CPU	-CPU
0.000	-.05929	-.00355	-.51378	-.58472	-.56667	-.59816	-.50513	-.73498
.025	.08395	.13183	.60754	.56621	.54915	.53630	.48703	.41401
.050	.10509	.15719	.47431	.50823	.44332	.47223	.46086	.35408
.075	.13268	.15668	.41572	.43299	.38805	.39256	.35959	.31550
.100	.12035	.16023	.38179	.39351	.36686	.34502	.33548	.25050
.200	.12035	.15871	.32381	.32690	.31739	.30647	.29523	.24844
.300	.14912	.17291	.30284	.32566	.31546	.30454	.28973	.23949
.400	.14383	.17138	.29297	.33307	.32124	.30711	.28835	.21540
.600	.12457	.14958	.21032	.21834	.21523	.20560	.19957	.14452
.800	.09863	.10090	.11226	.09005	.09138	.08545	.06469	.03234
1.000	-.03229	-.03600	-.03577	-.06230	-.07903	-.06425	-.07845	-.03372

	-CPL	-CPL	-CPL	-CPL	-CPL	-CPL	-CPL	-CPL
0.000	-.05929	-.00355	-.51378	-.58472	-.56667	-.59816	-.50513	-.73498
.025	-.00235	.02637	-.10670	-.10855	-.05339	-.10730	-.08189	-.07226
.050	.02759	.05628	-.01357	.02467	.01799	.06104	.02890	.02684
.075	.05107	.08164	.08882	.06661	.08288	.06168	.06538	.05918
.100	.07104	.08924	.12151	.08388	.09573	.08674	.07983	.03166
.200	.07338	.10699	.16653	.16407	.15677	.15163	.14383	.12181
.300	.10509	.11612	.17517	.19429	.18696	.18953	.16172	.13695
.400	.12563	.12778	.20416	.20662	.20113	.19082	.17618	.14245
.600	.11976	.12271	.16160	.15913	.14006	.14006	.12731	.11355
.800	.08865	.07961	.06353	.06045	.04175	.03662	.02615	*****
1.000	-.03229	-.03600	-.03577	-.06230	-.07903	-.06425	-.07845	-.03372

APPENDIX B

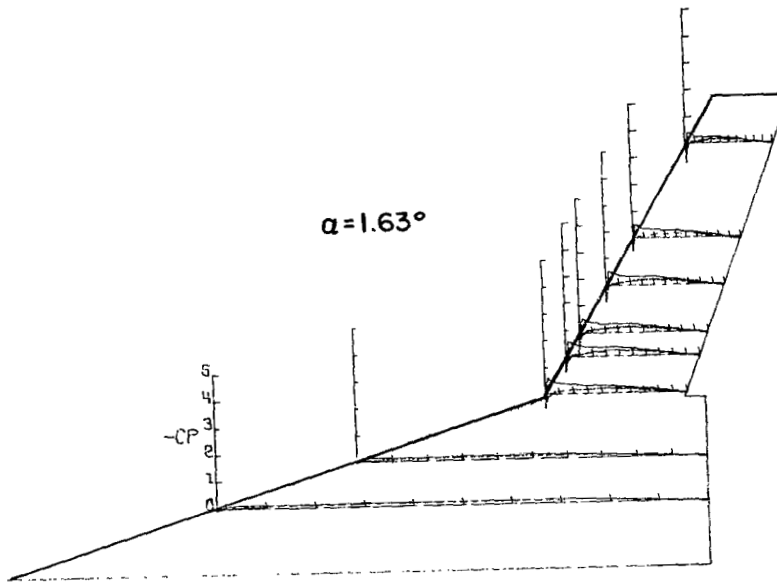
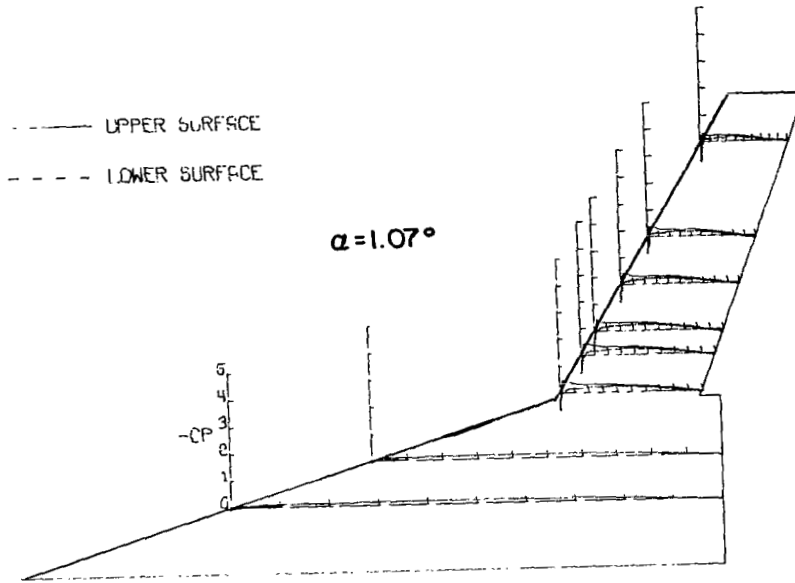

# APPENDIX B

## P R E S S U R E M E A S U R E M E N T S

OUTER PANEL SWEEP= 30.0000 DEGREES

FUSELAGE ON

ANGLE OF ATTACK= 2.14471 DEGREES

### S P A N W I S E L O C A T I O N

	2Y/B .14119	2Y/B .23533	2Y/B .37112	2Y/B .44999	2Y/B .49999	2Y/B .59999	2Y/B .69999	2Y/B .89997
X/C	- CPU	- CPU	- CPU	- CPU	- CPU	- CPU	- CPU	- CPU
0.000	-.03742	.02076	-.29134	-.39254	-.46391	-.46071	-.35073	-.70146
.025	-.11459	.18681	.77403	.66425	.56534	.67047	.60717	.53006
.050	.11050	.17770	.58880	.56427	.55102	.54909	.52112	.41923
.075	.14382	.18378	.46675	.46798	.45236	.44659	.43438	.36623
.100	.12102	.18428	.41707	.42382	.42542	.38563	.39032	.30152
.200	.13213	.18580	.35880	.37046	.35419	.34328	.33456	.28402
.300	.15493	.19289	.33243	.34899	.34549	.32468	.32286	.26339
.400	.15551	.18681	.30115	.35083	.33430	.32724	.30053	.23588
.600	.13973	.16859	.21651	.23368	.21816	.21945	.20562	.15680
.800	.10757	.10581	.10733	.09384	.08149	.08341	.06464	.03851
1.000	-.04443	-.02329	-.03803	-.06072	-.08341	-.08021	-.08115	-.04951

	- CPL	- CPL	- CPL	- CPL	- CPL	- CPL	- CPL	- CPL
X/C	- CPL	- CPL	- CPL	- CPL	- CPL	- CPL	- CPL	- CPL
0.000	-.03742	.02076	-.29134	-.39254	-.46391	-.46071	-.35073	-.70146
.025	-.02397	.01823	-.18829	-.19075	-.16298	-.18672	-.19050	-.15817
.050	.02105	.03696	-.10243	-.05397	-.03080	-.03529	-.02751	-.04057
.075	.02865	.05923	.02944	.02085	.02310	0.00000	.01169	.00894
.100	.04969	.06632	.06072	.02821	.04427	.03657	.03439	-.00413
.200	.05788	.08759	.12757	.11347	.12512	.10780	.11210	.07771
.300	.08886	.10227	.14965	.13371	.15271	.15207	.12860	.11553
.400	.10816	.11391	.18277	.18461	.17389	.16490	.15955	.12654
.600	.09588	.10328	.14659	.14781	.12448	.12191	.11347	.09765
.800	.07951	.06733	.05704	.05213	.03850	.02887	.02613	*****
1.000	-.04443	-.02329	-.03803	-.06072	-.08341	-.08021	-.08115	-.04951

## P R E S S U R E M E A S U R E M E N T S

OUTER PANEL SWEEP= 30.0000 DEGREES

FUSELAGE ON

ANGLE OF ATTACK= 2.66838 DEGREES

### S P A N W I S E L O C A T I O N

	2Y/B .14119	2Y/B .23533	2Y/B .37112	2Y/B .44999	2Y/B .49999	2Y/B .59999	2Y/B .69999	2Y/B .89997
X/C	- CPU	- CPU	- CPU	- CPU	- CPU	- CPU	- CPU	- CPU
0.000	-.02234	.06889	0.00000	-.25679	-.27948	-.33345	-.14852	-.65791
.025	.14106	.20109	.95275	.77907	.81732	.78838	.75930	.60438
.050	.14224	.20616	.72572	.65998	.54370	.62826	.66760	.51685
.075	.16164	.19957	.56259	.56507	.54016	.52345	.50643	.42376
.100	.14224	.19704	.49498	.50180	.48701	.45745	.45155	.35846
.200	.15223	.18539	.41062	.41186	.39063	.38035	.37930	.31886
.300	.16928	.19096	.37961	.39140	.36108	.34694	.33623	.28037
.400	.16869	.18184	.32937	.38023	.34823	.34951	.32164	.25261
.600	.14400	.16462	.23819	.25928	.23515	.22808	.22485	.15962
.800	.11109	.10738	.12468	.09986	.09316	.08738	.06940	.04303
1.000	-.04173	-.04660	-.03784	-.05831	-.07967	-.07774	-.07703	-.04858

	- CPL	- CPL	- CPL	- CPL	- CPL	- CPL	- CPL	- CPL
X/C	- CPL	- CPL	- CPL	- CPL	- CPL	- CPL	- CPL	- CPL
0.000	-.02234	.06889	0.00000	-.25679	-.27948	-.33345	-.14852	-.65791
.025	-.02821	-.01013	-.26982	-.26548	-.22551	-.26984	-.25192	-.22069
.050	-.00118	.01520	-.17740	-.11537	-.10537	-.10087	-.09716	-.09785
.075	.01998	.04761	-.02791	-.04280	-.02331	-.04433	-.04164	-.04580
.100	.03585	.05876	.01799	-.02977	-.00578	-.01670	0.00000	-.02082
.200	.05349	.08104	.10545	.09738	.08417	.07774	.07495	.06038
.300	.08170	.08763	.13832	.11227	.12786	.13364	.11104	.10132
.400	.10110	.09725	.16437	.16561	.15291	.14649	.14019	.11659
.600	.09169	.09421	.14080	.13460	.11950	.11629	.11173	.09716
.800	.08170	.06636	.06203	.05085	.03534	.02377	.03123	*****
1.000	-.04173	-.04660	-.03784	-.05831	-.07967	-.07774	-.07703	-.04858



# APPENDIX B

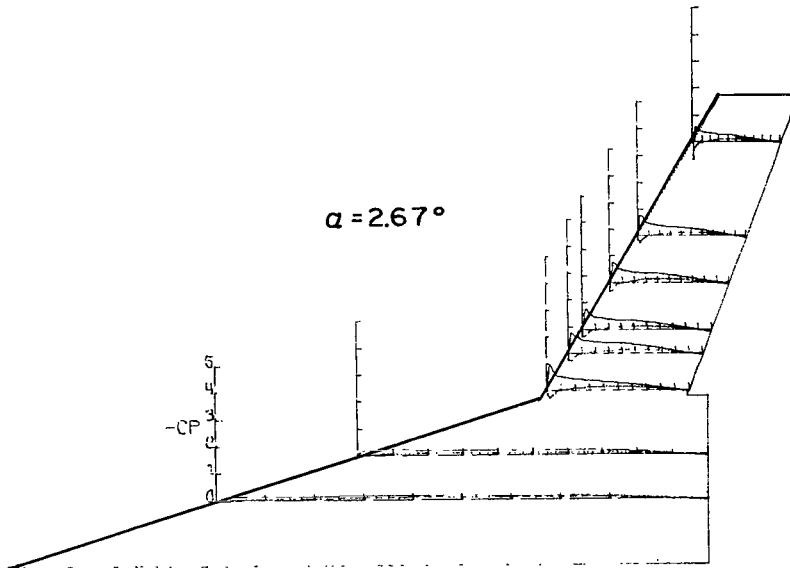
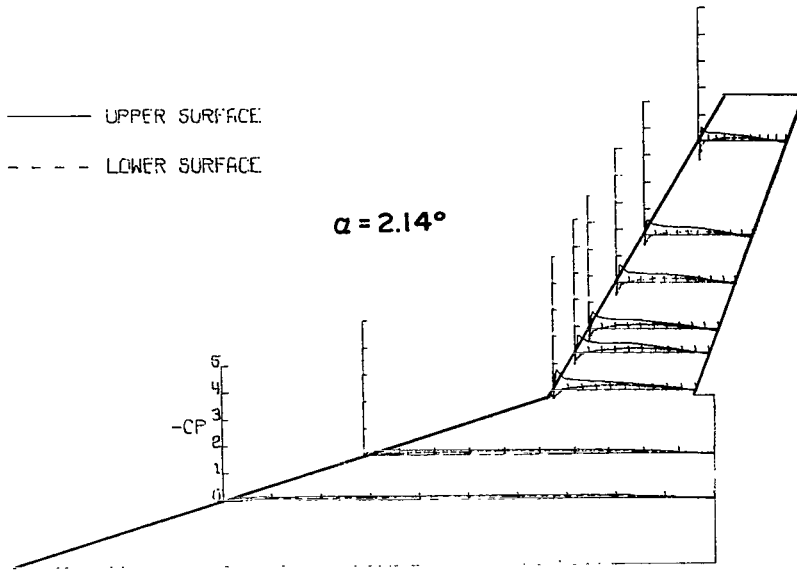

# APPENDIX B

## P R E S S U R E M E A S U R E M E N T S

OUTER PANEL SWEEP= 30.0000 DEGREES

FUSELAGE ON

ANGLE OF ATTACK= 3.21525 DEGREES

### S P A N W I S E L O C A T I O N

	2Y/A	2Y/B	2Y/R	2Y/R	2Y/S	2Y/B	2Y/R	2Y/B
	.14119	.23533	.37112	.44999	.49939	.59999	.69999	.89997
X/C	- CPU	- CPU	- CPU	- CPU	- CPU	- CPU	- CPU	- CPU
0.000	.02252	.09747	.29662	-.05659	-.34749	-.10474	.07424	-.56382
.025	.17307	.23067	1.09088	.96890	.96639	.98056	.92334	.74246
.050	.15114	.22458	.79036	.75740	.75529	.75789	.76630	.59453
.075	.18789	.21252	.61065	.64112	.63027	.59250	.59733	.49217
.100	.15588	.20247	.55593	.53152	.53411	.51587	.50479	.40032
.200	.16300	.18890	.43591	.44959	.43846	.43391	.41224	.36807
.300	.17129	.19694	.38492	.41415	.39437	.38317	.37368	.31339
.400	.17129	.19091	.35134	.39549	.39032	.37536	.36736	.26265
.500	.16477	.16780	.24197	.26553	.24570	.25111	.23884	.17720
.600	.10787	.09294	.12002	.09390	.09303	.08782	.07634	.04413
1.000	-.04208	-.04622	-.04539	-.06965	-.08057	-.08002	-.07564	-.05463
X/C	- CPL	- CPL	- CPL	- CPL	- CPL	- CPL	- CPL	- CPL
0.000	.02252	.09747	.29662	-.05659	-.34749	-.10474	.07424	-.56382
.025	-.04030	-.02261	-.35942	-.35694	-.31291	-.34218	-.33339	-.29277
.050	-.02015	-.01407	-.21578	-.18717	-.16524	-.17239	-.15899	-.14358
.075	.01126	.01195	-.10012	-.10758	-.10018	-.11059	-.09525	-.10506
.100	.03082	.02110	-.05099	-.08333	-.35337	-.05920	-.06654	-.07214
.200	.03438	.04471	.07151	.05659	.06535	.04636	.05743	.03012
.300	.07113	.05627	.10447	.09017	.11254	.10994	.09245	.09035
.400	.09009	.06732	.14551	.13307	.13921	.12685	.12817	.10436
.500	.07365	.06582	.12188	.11566	.11447	.10864	.10856	.10226
.600	.07527	.03014	.04042	.03669	.02657	.01952	.03012	*****
1.000	-.04208	-.04622	-.04539	-.06965	-.08057	-.08002	-.07564	-.05463

## P R E S S U R E M E A S U R E M E N T S

OUTER PANEL SWEEP= 30.0000 DEGREES

FUSELAGE ON

ANGLE OF ATTACK= 3.71500 DEGREES

### S P A N W I S E L O C A T I O N

	2Y/A	2Y/B	2Y/R	2Y/R	2Y/S	2Y/B	2Y/R	2Y/B
	.14119	.23533	.37112	.44999	.49939	.59999	.69999	.89997
X/C	- CPU	- CPU	- CPU	- CPU	- CPU	- CPU	- CPU	- CPU
0.000	.04178	.17246	.71878	.25824	.15612	.15677	.38047	-.44575
.025	.19361	.29688	1.23063	1.08541	1.11312	1.10219	1.06256	.86333
.050	.18654	.27963	.79748	.84544	.82825	.84368	.83704	.64404
.075	.21244	.26147	.69726	.70156	.67777	.65077	.66894	.54442
.100	.18478	.24681	.61671	.62348	.53382	.56781	.56794	.45172
.200	.17242	.22051	.47529	.47714	.47223	.45103	.45380	.38116
.300	.19831	.22455	.41381	.44086	.42340	.41890	.40676	.33896
.400	.18949	.21798	.36523	.40950	.43155	.39256	.37009	.28887
.500	.16830	.18409	.25455	.26193	.25328	.25443	.24533	.18106
.600	.12945	.12492	.13158	.10699	.10473	.09959	.08638	.05390
1.000	-.03295	-.04249	-.03013	-.06764	-.07195	-.06682	-.06634	-.04492
X/C	- CPL	- CPL	- CPL	- CPL	- CPL	- CPL	- CPL	- CPL
0.000	.04178	.17246	.71878	.25824	.15612	.15677	.38047	-.44575
.025	-.03943	-.02276	-.43041	-.41811	-.37971	-.47862	-.38424	-.34969
.050	-.02707	-.02023	-.32403	-.30895	-.24093	-.22216	-.21769	-.21285
.075	.00647	.00708	-.14941	-.14947	-.14456	-.16126	-.14444	-.13683
.100	.01530	.02782	-.09284	-.09469	-.09123	-.11179	-.08708	-.10919
.200	.02530	.05664	.03320	.01906	.02313	.01156	.01866	.00138
.300	.06473	.07485	.08916	.08916	.09812	.07710	.06565	.06773
.400	.08886	.08345	.12051	.11621	.11759	.10794	.10643	.08777
.500	.07532	.08757	.09653	.10699	.09959	.09059	.09606	.08708
.600	.06709	.05108	.03751	.02705	.02313	.01092	.02357	*****
1.000	-.03295	-.04249	-.03013	-.06764	-.07195	-.06682	-.06634	-.04492

# APPENDIX B

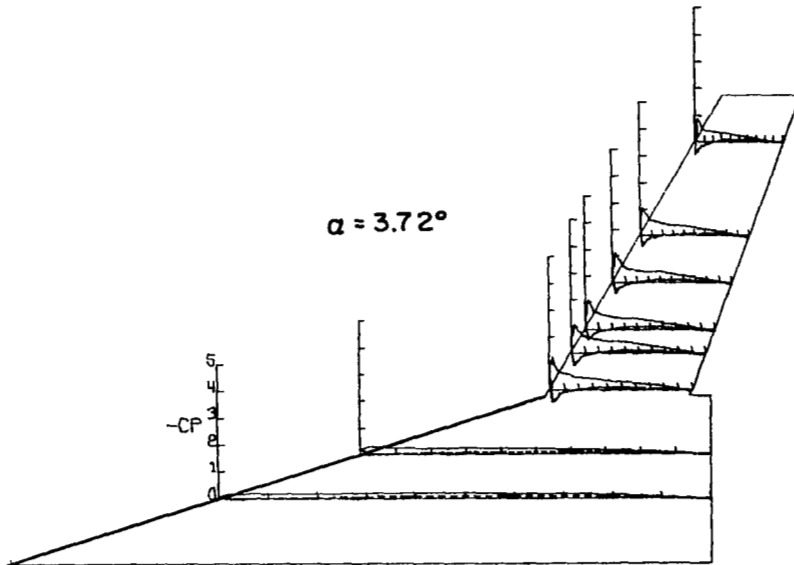
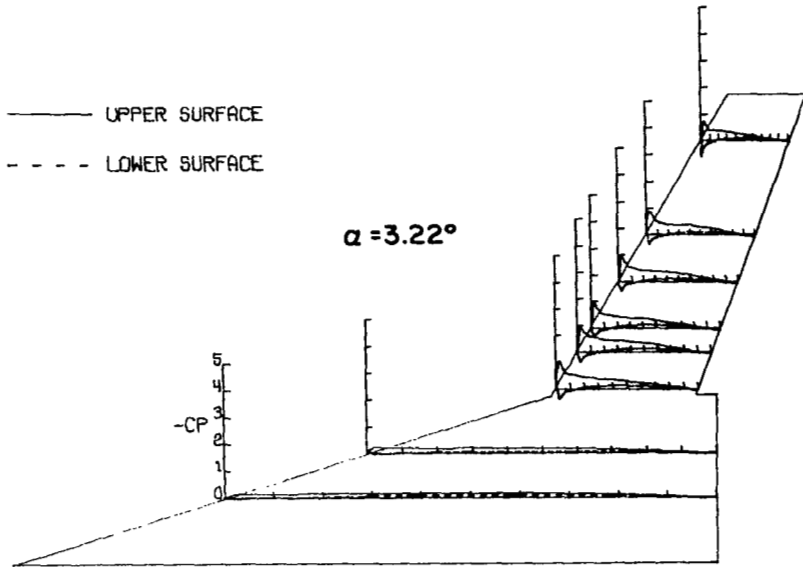

# APPENDIX B

## P R E S S U R E M E A S U R E M E N T S

OUTER PANEL SWEEP= 30.0000 DEGREES

FUSELAGE ON

ANGLE OF ATTACK= 4.25991 DEGREES

### S P A N W I S E L O C A T I O N

	2Y/B .14119	2Y/B .23533	2Y/B .37112	2Y/B .44999	2Y/B .49999	2Y/B .59999	2Y/B .69999	2Y/B .89997
X/C	-CPU	-CPU	-CPU	-CPU	-CPU	-CPU	-CPU	-CPU
0.000	.09688	.25754	1.10510	.54742	.47156	.46902	.73256	-.26212
.025	.22024	.34856	1.42988	1.21947	1.29210	1.27031	1.16727	.99211
.050	.20941	.32528	.91362	.94077	.90850	.89925	.92899	.75383
.075	.22024	.28133	.77661	.78292	.75004	.71571	.71770	.59498
.100	.18714	.27047	.68380	.69769	.67015	.65364	.63895	.50634
.200	.18534	.23478	.50196	.52153	.50794	.50860	.48790	.42975
.300	.19196	.24306	.45208	.45271	.45639	.42483	.43967	.35316
.400	.19196	.23582	.38578	.43440	.42944	.41163	.39287	.30321
.600	.16247	.19186	.26582	.27276	.27310	.26651	.25858	.18632
.800	.13299	.11015	.12565	.10607	.10357	.10357	.07864	.05880
1.000	-.04754	-.05999	-.04041	-.06882	-.08510	-.07322	-.08076	-.04959
X/C	-CPL	-CPL	-CPL	-CPL	-CPL	-CPL	-CPL	-CPL
0.000	.09688	.25754	1.10510	.54742	.47156	.46902	.73256	-.26212
.025	-.05356	-.02793	-.48806	-.46786	-.44660	-.48486	-.44278	-.39956
.050	-.02949	-.02431	-.33022	-.27339	-.28300	-.27178	-.28054	-.27558
.075	-.00842	0.00000	-.19005	-.19573	-.18669	-.18669	-.19978	-.17853
.100	.00241	.00879	-.15974	-.14206	-.13721	-.16294	-.13956	-.13815
.200	.02708	.03258	-.00189	-.00884	-.01121	-.01847	-.01204	-.02338
.300	.06318	.04809	.04862	.06945	.06257	.05211	.03471	.03896
.400	.06920	.06464	.11365	.08776	.11148	.08114	.09068	.06518
.600	.08184	.06413	.09155	.08524	.09301	.07454	.08218	.06872
.800	.06619	.03982	.04167	.03220	.02837	.02309	.02196	*****
1.000	-.04754	-.05999	-.04041	-.06882	-.08510	-.07322	-.08076	-.04959

## P R E S S U R E M E A S U R E M E N T S

OUTER PANEL SWEEP= 30.0000 DEGREES

FUSELAGE ON

ANGLE OF ATTACK= 4.77195 DEGREES

### S P A N W I S E L O C A T I O N

	2Y/B .14119	2Y/B .23533	2Y/B .37112	2Y/B .44999	2Y/B .49999	2Y/B .59999	2Y/B .69999	2Y/B .89997
X/C	-CPU	-CPU	-CPU	-CPU	-CPU	-CPU	-CPU	-CPU
0.000	.13554	.32180	1.66097	.86889	.75109	.77201	1.11247	.03007
.025	.25444	.38626	1.66971	1.40798	1.37657	1.43289	1.37291	1.08446
.050	.22829	.34972	1.04567	1.06315	1.04067	1.02956	1.07116	.83523
.075	.23185	.31419	.86639	.87138	.84457	.82038	.79112	.70151
.100	.20213	.29033	.74779	.76090	.73736	.71840	.70011	.58389
.200	.18786	.25886	.53619	.56241	.54583	.54256	.52648	.45507
.300	.20510	.25886	.47751	.49811	.49506	.47482	.46137	.38156
.400	.18786	.24668	.41072	.45879	.45055	.44216	.41866	.32135
.600	.17359	.21267	.26903	.28963	.28019	.28084	.26577	.20283
.800	.13198	.11014	.13483	.10924	.10189	.10776	.08533	.06504
1.000	-.04697	-.06751	-.03558	-.07178	-.08491	-.07119	-.07903	-.04686
X/C	-CPL	-CPL	-CPL	-CPL	-CPL	-CPL	-CPL	-CPL
0.000	.13554	.32180	1.66097	.86889	.75109	.77201	1.11247	.03007
.025	-.07074	-.03401	-.53993	-.53619	-.49732	-.54666	-.50427	-.47769
.050	-.04399	-.04111	-.39450	-.41072	-.34681	-.33766	-.32662	-.31613
.075	-.02319	-.02741	-.24656	-.24157	-.23969	-.24688	-.25948	-.22171
.100	-.00297	-.01421	-.18039	-.18289	-.18353	-.18940	-.17485	-.18464
.200	.01943	.00355	-.03308	-.02559	-.04433	-.03723	-.05595	-.04476
.300	.04161	.02538	.03558	.04806	.04180	.02808	.01259	.01399
.400	.06480	.03045	.08427	.08614	.07737	.07511	.05246	.05385
.600	.06599	.03553	.07553	.08614	.07315	.06923	.06365	.06854
.800	.05826	.02284	.03183	.02372	.01633	.01045	.01399	*****
1.000	-.04697	-.06751	-.03558	-.07178	-.08491	-.07119	-.07903	-.04686

# APPENDIX B

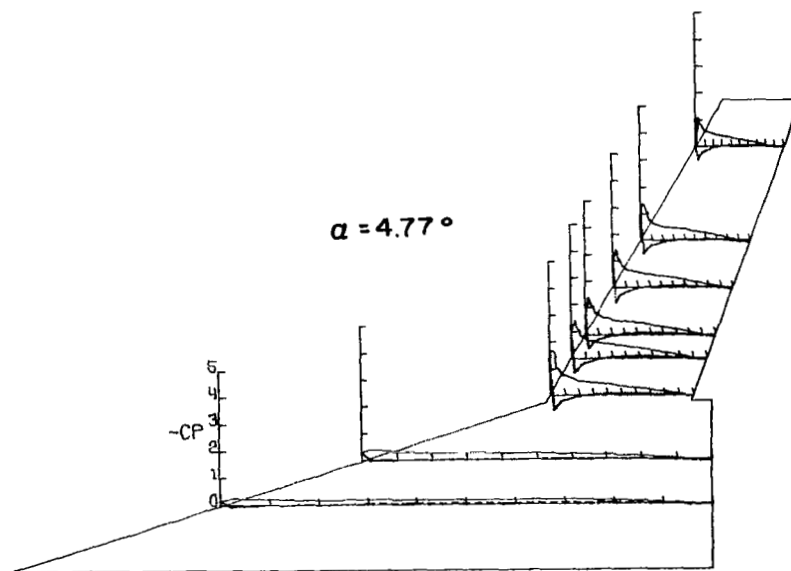
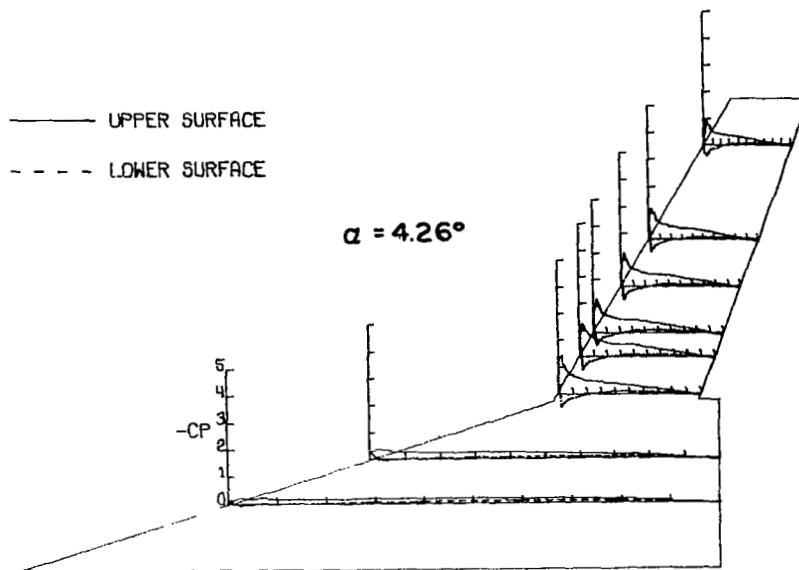

# APPENDIX B

## P R E S S U R E M E A S U R E M E N T S

OUTER PANEL SWEEP= 30.0000 DEGREES

FUSELAGE ON

ANGLE OF ATTACK= 5.29285 DEGREES

### S P A N W I S E L O C A T I O N

	2Y/B .14119	2Y/B .23533	2Y/B .37112	2Y/B .44999	2Y/B .49999	2Y/B .59999	2Y/B .69999	2Y/B .89997
X/C	-CPU	-CPU	-CPU	-CPU	-CPU	-CPU	-CPU	-CPU
0.000	.17665	.40951	2.24447	1.26181	1.34790	1.18826	1.59405	.31144
.025	.28617	.45706	1.78248	1.55518	1.47770	1.57439	1.56693	1.23186
.050	.24259	.40747	1.14878	1.14631	1.15127	1.09675	1.14913	.90721
.075	.26026	.36350	.94366	.96163	.92737	.91374	.87871	.74732
.100	.21198	.33998	.79122	.80541	.79044	.76383	.75914	.63331
.200	.20844	.30164	.58014	.60421	.60029	.59121	.57561	.49914
.300	.20609	.29090	.50053	.51102	.52391	.48954	.49080	.39695
.400	.20903	.27557	.41844	.47461	.46814	.46166	.43657	.33647
.600	.17841	.23415	.28081	.30303	.30086	.28919	.28404	.20835
.800	.13837	.12168	.13208	.11418	.10180	.11412	.09237	.07084
1.000	-.05240	-.05726	-.03580	-.06048	-.08105	-.07327	-.07292	-.04306
X/C	-CPL	-CPL	-CPL	-CPL	-CPL	-CPL	-CPL	-CPL
0.000	.17665	.40951	2.24447	1.26181	1.34790	1.18826	1.59405	.31144
.025	-.06713	-.02812	-.58632	-.57459	-.54790	-.57578	-.55767	-.50836
.050	-.06241	-.03579	-.43819	-.45301	-.38580	-.39228	-.37502	-.35905
.075	-.03297	-.02607	-.29686	-.29933	-.28789	-.29308	-.29654	-.26390
.100	-.01472	-.01329	-.23576	-.22527	-.22554	-.23537	-.22918	-.21668
.200	.00883	.00256	-.06172	-.05863	-.07003	-.07197	-.08125	-.08806
.300	.02473	.02607	.00432	.02345	.01880	-.00519	-.00694	-.01181
.400	.05535	.03477	.06048	.05678	.05771	.04604	.03611	.03681
.600	.04063	.03528	.05987	.06295	.05511	.04733	.04722	.04514
.800	.03827	.01841	.01543	.01666	.00519	.00454	-.00486	*****
1.000	-.05240	-.05726	-.03580	-.06048	-.08105	-.07327	-.07292	-.04306

## P R E S S U R E M E A S U R E M E N T S

OUTER PANEL SWEEP= 30.0000 DEGREES

FUSELAGE ON

ANGLE OF ATTACK= 5.79496 DEGREES

### S P A N W I S E L O C A T I O N

	2Y/B .14119	2Y/B .23533	2Y/B .37112	2Y/B .44999	2Y/B .49999	2Y/B .59999	2Y/B .69999	2Y/B .89997
X/C	-CPU	-CPU	-CPU	-CPU	-CPU	-CPU	-CPU	-CPU
0.000	.23897	.54290	3.04555	1.68675	1.74610	1.69155	2.16694	.57373
.025	.32836	.52123	1.96592	1.68181	1.70667	1.71784	1.73665	1.39705
.050	.27890	.44640	1.23526	1.24267	1.26242	1.21905	1.27331	1.01175
.075	.26817	.38705	.99252	1.00426	.99692	.99232	.93441	.82403
.100	.23539	.36228	.84553	.86034	.87798	.84117	.83879	.70099
.200	.22169	.29467	.60421	.62582	.65059	.64008	.61099	.53646
.300	.22228	.27868	.50855	.53571	.55202	.53447	.52170	.43662
.400	.21394	.27609	.42894	.48263	.49901	.48785	.46264	.35436
.600	.18712	.23378	.28452	.29810	.31254	.31385	.29430	.22898
.800	.14183	.13211	.13578	.11233	.11430	.12475	.10536	.08078
1.000	-.05781	-.05109	-.02469	-.06912	-.06303	-.06697	-.06251	-.03652
X/C	-CPL	-CPL	-CPL	-CPL	-CPL	-CPL	-CPL	-CPL
0.000	.23897	.54290	3.04555	1.68675	1.74610	1.69155	2.16694	.57373
.025	-.06972	-.02167	-.62335	-.62211	-.58700	-.61260	-.60260	-.55349
.050	-.06317	-.03612	-.53077	-.45547	-.42022	-.42285	-.41090	-.38983
.075	-.04469	-.02632	-.33451	-.34438	-.32698	-.34012	-.33364	-.29711
.100	-.02563	-.02477	-.27526	-.27341	-.26526	-.26855	-.27464	-.25848
.200	-.01549	.00722	-.08640	-.10554	-.08733	-.10703	-.09553	-.09834
.300	.03099	.01393	-.02284	-.01234	-.00328	-.01838	-.03723	-.01896
.400	.05423	.03354	.03826	.03271	.04727	.02955	.02669	.02739
.600	.03099	.02787	.04999	.04259	.05121	.04859	.04074	.04776
.800	.03337	.01909	.00185	0.00000	.00394	-.00525	-.00773	*****
1.000	-.05781	-.05109	-.02469	-.06912	-.06303	-.06697	-.06251	-.03652

# APPENDIX B

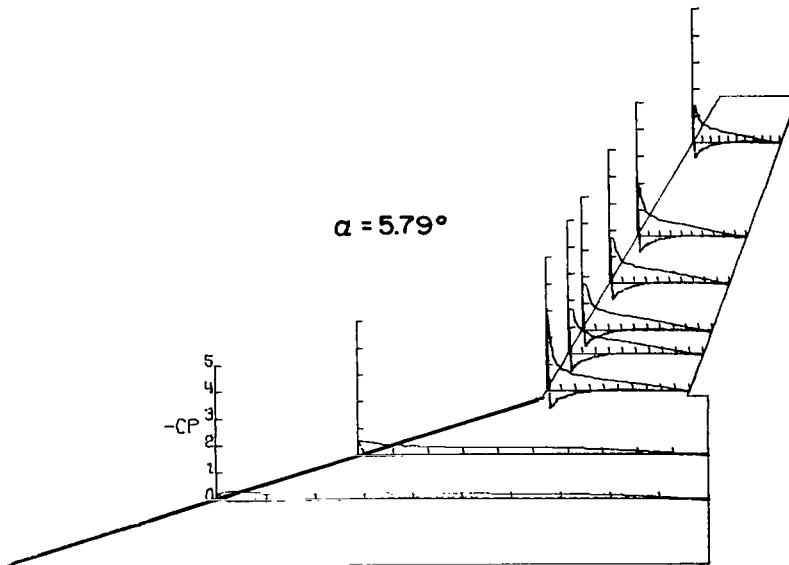
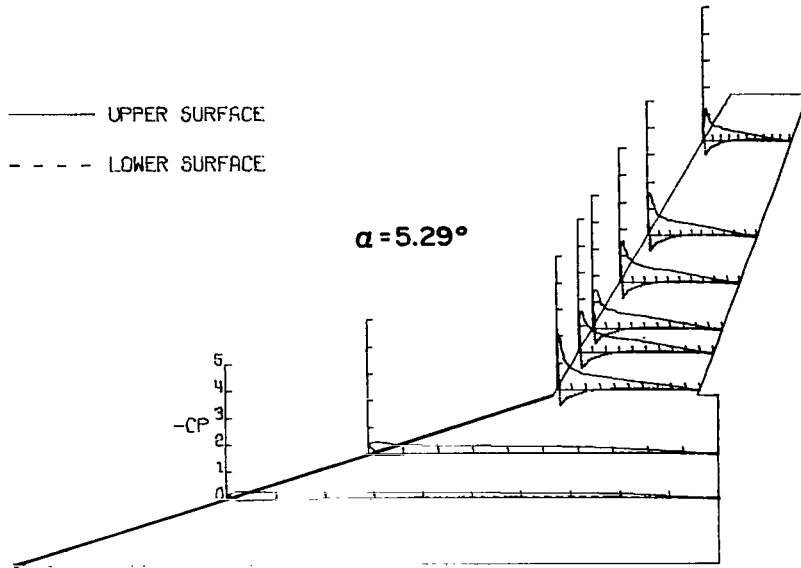

# APPENDIX B

## P R E S S U R E M E A S U R E M E N T S

OUTER PANEL SWEEP= 30.00000 DEGREES

FUSELAGE ON

ANGLE OF ATTACK= 6.33770 DEGREES

### S P A N W I S E L O C A T I O N

	2Y/B .14119	2Y/B .23533	2Y/B .37112	2Y/B .44999	2Y/B .49999	2Y/B .59999	2Y/B .69999	2Y/B .89997
X/C	- CPU	- CPU	- CPU	- CPU	- CPU	- CPU	- CPU	- CPU
0.000	.31251	.65612	3.47192	2.11075	1.98641	2.03860	2.70603	.80786
.025	.34834	.56813	2.11381	1.84575	1.86236	1.82597	1.87947	1.47035
.050	.29430	.48268	1.36974	1.35317	1.36014	1.30666	1.34298	1.11799
.075	.29195	.43283	1.09370	1.09493	1.08244	1.04572	1.04807	.86532
.100	.26023	.37841	.93108	.93047	.91943	.89495	.89785	.75871
.200	.22557	.31585	.67490	.67425	.57308	.65784	.65972	.55588
.300	.23732	.30212	.54369	.57618	.56506	.55926	.54480	.45896
.400	.22263	.28788	.45052	.50998	.49955	.49955	.47489	.38143
.600	.19561	.23549	.30096	.30709	.30771	.31157	.30083	.22960
.800	.14627	.13122	.15140	.11278	.11587	.11845	.11134	.07746
1.000	-.05639	-.04527	-.01900	-.04475	-.06180	-.06952	-.05187	-.03181
X/C	- CPL	- CPL	- CPL	- CPL	- CPL	- CPL	- CPL	- CPL
0.000	.31251	.65612	3.47192	2.11075	1.98641	2.03860	2.70603	.80786
.025	-.07401	-.00712	-.63870	-.64606	-.51220	-.64954	-.61618	-.58368
.050	-.06403	-.03764	-.57128	-.52714	-.46929	-.46478	-.44952	-.42116
.075	-.04641	-.02543	-.36226	-.37758	-.35728	-.37337	-.36515	-.32503
.100	-.03113	-.02543	-.29728	-.30648	-.29741	-.30835	-.29461	-.28562
.200	-.01234	-.00814	-.11646	-.11830	-.12911	-.12875	-.13555	-.11480
.300	.01351	.00458	-.03984	-.03065	-.02897	-.04892	-.05256	-.03942
.400	.03759	.01424	.02697	.02329	.02382	.00837	.00761	.00830
.600	.03936	.00610	.04107	.03555	.03347	.02317	.02420	.04149
.800	.02820	.01068	.00061	0.00000	-.00644	-.01931	-.01591	*****
1.000	-.05639	-.04527	-.01900	-.04475	-.06180	-.06952	-.05187	-.03181

## P R E S S U R E M E A S U R E M E N T S

OUTER PANEL SWEEP= 30.00000 DEGREES

FUSELAGE ON

ANGLE OF ATTACK= 7.37269 DEGREES

### S P A N W I S E L O C A T I O N

	2Y/B .14119	2Y/B .23533	2Y/B .37112	2Y/B .44999	2Y/B .49999	2Y/B .59999	2Y/B .69999	2Y/B .89997
X/C	- CPU	- CPU	- CPU	- CPU	- CPU	- CPU	- CPU	- CPU
0.000	.44098	.96983	5.03139	3.09542	3.02572	3.08371	3.95699	1.07104
.025	.42023	.71496	2.43784	2.22301	2.18459	2.25431	2.18264	1.45136
.050	.35622	.57883	1.57478	1.61028	1.58714	1.56694	1.57930	1.17241
.075	.34377	.50871	1.30079	1.29519	1.27595	1.22684	1.22764	1.00043
.100	.29517	.44730	1.12021	1.12395	1.08024	1.07959	1.05776	.91864
.200	.24775	.35006	.73672	.75601	.75838	.75057	.74595	.68933
.300	.24775	.33624	.59797	.63281	.63329	.61439	.61662	.52503
.400	.24183	.32140	.51085	.55005	.56358	.54403	.53202	.43135
.600	.23116	.25845	.33601	.33601	.33134	.34241	.32998	.26260
.800	.16952	.14023	.16925	.12382	.12043	.12954	.12013	.11454
1.000	-.06105	-.04708	0.00000	-.02240	-.03710	-.04817	-.03562	.01397
X/C	- CPL	- CPL	- CPL	- CPL	- CPL	- CPL	- CPL	- CPL
0.000	.44098	.96983	5.03139	3.09542	3.02572	3.08371	3.95699	1.07104
.025	-.06638	.02968	-.68695	-.68570	-.57951	-.68612	-.68165	-.60343
.050	-.08002	-.03224	-.64028	-.58303	-.54290	-.54095	-.54476	-.46375
.075	-.06723	-.03941	-.43556	-.43930	-.43550	-.44070	-.44489	-.36876
.100	-.04860	-.03531	-.35156	-.41316	-.35638	-.37691	-.35480	-.32407
.200	-.03912	-.02354	-.16489	-.18418	-.18357	-.19073	-.18019	-.15086
.300	-.00237	-.01382	-.07031	-.07965	-.07746	-.09179	-.10197	-.06356
.400	.02371	-.02098	-.00871	-.00996	-.01237	-.01823	-.02654	-.01117
.600	.00711	-.00563	.01991	.01929	.01823	.01107	.01467	.03702
.800	.02786	-.01638	-.00684	-.00124	-.00846	-.02018	-.02235	*****
1.000	-.06105	-.04708	0.00000	-.02240	-.03710	-.04817	-.03562	.01397



# APPENDIX B

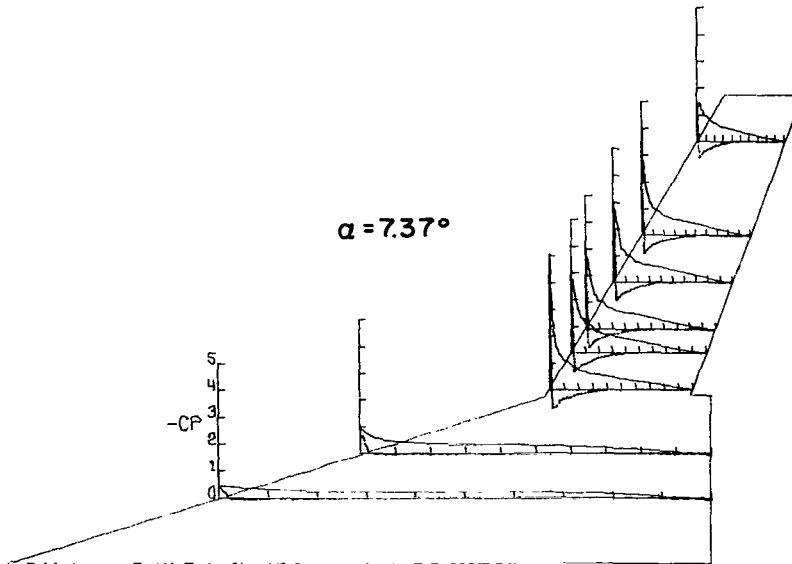
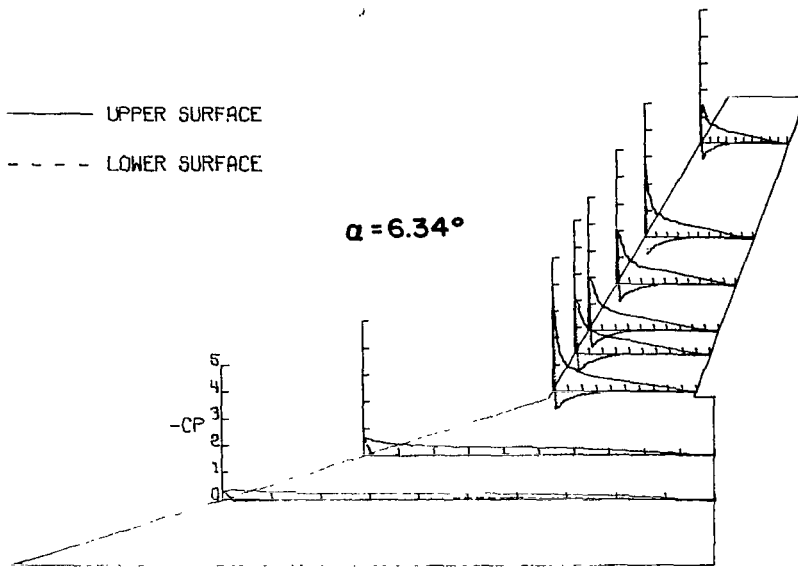

# APPENDIX B

## P R E S S U R E M E A S U R E M E N T S

OUTER PANEL SWEEP= 30.00070 DEGREES

FUSELAGE ON

ANGLF OF ATTACK= 8.38805 DEGREES

### S P A N W I S E L O C A T I O N

	2Y/B .14119	2Y/B .23533	2Y/B .37112	2Y/B .44999	2Y/B .49999	2Y/B .59999	2Y/B .69999	2Y/B .89997
X/C	-CPU	-CPU	-CPU	-CPU	-CPU	-CPU	-CPU	-CPU
0.000	.60453	1.27783	5.17840	1.93006	3.72431	4.01546	3.67653	1.12947
.025	.48989	.84780	2.72855	1.76258	2.41757	2.52161	2.22406	1.38271
.050	.40302	.68080	2.07159	1.78112	1.72820	1.71529	1.73222	1.09389
.075	.37347	.57354	1.59138	1.60684	1.33559	1.32149	1.49991	.95855
.100	.32442	.50051	1.35036	1.53144	1.11491	1.14460	1.25504	.88530
.200	.26888	.41011	.85223	.97154	.79406	.81601	.84693	.75903
.300	.27242	.38560	.64597	.69723	.65461	.65655	.68787	.62787
.400	.26178	.35598	.52801	.55827	.56100	.55326	.54834	.47648
.600	.24760	.28498	.33781	.35077	.34259	.32508	.34747	.28993
.800	.17905	.16037	.17600	.15686	.15545	.12062	.14636	.16308
1.000	-.05791	-.03064	.01420	.00679	.00581	-.01226	.00348	.06342

	-CPL	-CPL	-CPL	-CPL	-CPL	-CPL	-CPL	-CPL
0.000	.60453	1.27783	5.17840	1.93006	3.72431	4.01546	3.67653	1.12947
.025	-.05437	.05312	-.69167	-.68302	-.68822	-.70693	-.67951	-.60912
.050	-.08982	-.01021	-.66388	-.58174	-.58896	-.58567	-.55476	-.48298
.075	-.07919	-.03269	-.48973	-.48170	-.49035	-.49537	-.47880	-.39238
.100	-.07037	-.03213	-.40944	-.44711	-.40635	-.47184	-.40562	-.33941
.200	-.05378	-.03320	-.20379	-.20997	-.22759	-.22898	-.22023	-.17702
.300	-.01891	-.03013	-.10746	-.11487	-.11481	-.11997	-.12893	-.07875
.400	-.00532	-.02400	-.03520	-.03735	-.04133	-.05096	-.04739	-.01742
.600	.00355	-.02043	-.00556	-.00062	.00065	-.01032	0.00000	.03276
.800	.01005	-.00613	-.01112	-.00185	-.00710	-.01677	-.01115	*****
1.000	-.05791	-.03064	.01420	.00679	.00581	-.01226	.00348	.06342

## P R E S S U R E M E A S U R E M E N T S

OUTER PANEL SWEEP= 30.00000 DEGREES

FUSELAGE ON

ANGLE OF ATTACK= 9.46745 DEGREES

### S P A N W I S E L O C A T I O N

	2Y/B .14119	2Y/B .23533	2Y/B .37112	2Y/B .44999	2Y/B .49999	2Y/B .59999	2Y/B .69999	2Y/B .89997
X/C	-CPU	-CPU	-CPU	-CPU	-CPU	-CPU	-CPU	-CPU
0.000	.80478	1.65552	4.93359	2.00845	3.06936	3.02414	3.73188	1.12716
.025	.59821	.98929	2.73425	1.77678	2.42311	1.81225	2.12346	1.38327
.050	.45492	.78525	2.37072	1.84145	2.15373	1.47012	1.46981	.92382
.075	.42627	.65386	2.03608	1.70458	1.74933	1.44390	1.57817	.88935
.100	.36239	.56936	1.75292	1.60349	1.42621	1.36591	1.39523	.90271
.200	.29791	.45343	1.04848	1.08112	.93529	1.04409	1.07932	.77185
.300	.30149	.42560	.76728	.77795	.70458	.76292	.73878	.65786
.400	.27283	.38902	.61546	.58346	.57284	.57743	.59735	.56217
.600	.25134	.32204	.38584	.38772	.36382	.36475	.35954	.33913
.800	.18627	.19889	.21582	.20390	.19711	.18598	.20032	.17572
1.000	-.05910	-.02576	.03890	.06462	.06810	.06876	.08505	.11035

	-CPL	-CPL	-CPL	-CPL	-CPL	-CPL	-CPL	-CPL
0.000	.80478	1.65552	4.93359	2.00845	3.06936	3.02414	3.73188	1.12716
.025	-.04657	.12830	-.71835	-.70203	-.72230	-.67480	-.69868	-.61855
.050	-.09433	.00361	-.68635	-.62675	-.52538	-.59657	-.57708	-.50257
.075	-.08657	-.02319	-.53892	-.52951	-.52917	-.51406	-.49484	-.41400
.100	-.08478	-.03864	-.46175	-.51901	-.45774	-.44203	-.41541	-.37183
.200	-.06985	-.05101	-.25283	-.25597	-.26325	-.25343	-.24531	-.19470
.300	-.03642	-.05565	-.14116	-.13990	-.14014	-.14472	-.15183	-.09348
.400	-.00776	-.04998	-.06399	-.06274	-.06287	-.06287	-.06256	-.02812
.600	-.00776	-.04019	-.01506	-.00565	-.00655	-.00458	0.00000	.03514
.800	-.00119	-.03504	-.02259	-.00690	-.00587	-.01179	-.00492	*****
1.000	-.05910	-.02576	.03890	.06462	.06810	.06876	.08505	.11035

# APPENDIX B

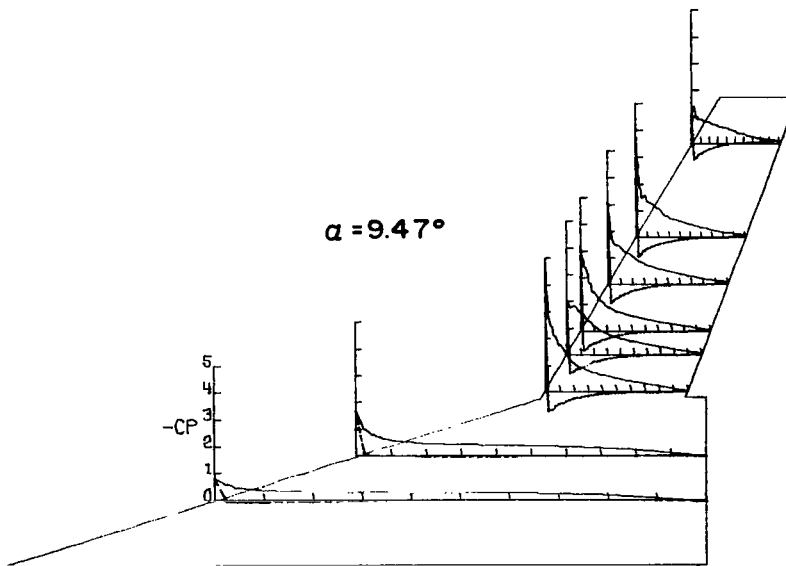
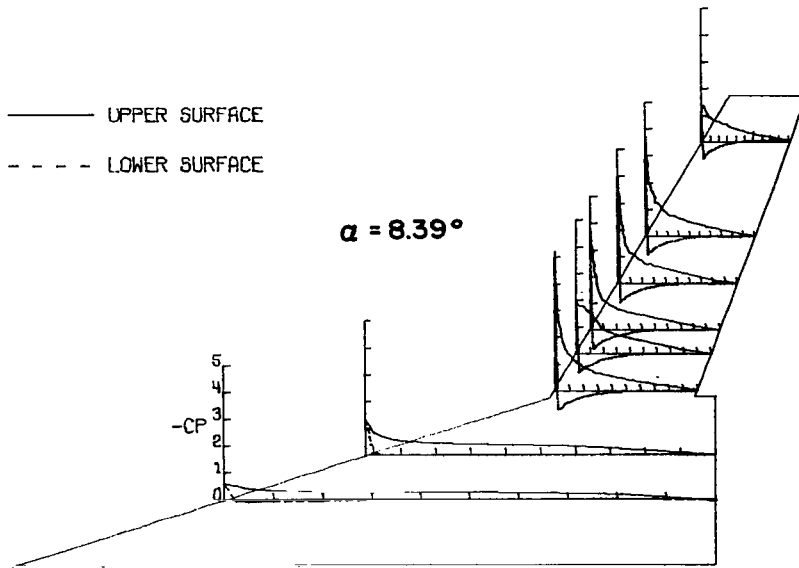

# APPENDIX B

## P R F S S U R F M E A S U R E M E N T S

OUTER PANFL SWEEP= 30.0000 DEGREES

FUSELAGE ON

ANGLE OF ATTACK= 10.48769 DEGREES

### S P A N W I S E L O C A T I O N

	2Y/R .14119	2Y/R .23533	2Y/R .37112	2Y/R .44999	2Y/R .49999	2Y/R .59999	2Y/R .69999	2Y/R .89997
X/C	-CPU	-CPU	-CPU	-CPU	-CPU	-CPU	-CPU	-CPU
0.000	.96382	2.04014	5.75937	1.63889	3.16151	3.05125	3.92280	1.23202
.025	.69209	1.14373	3.02216	1.30198	2.23972	1.67600	1.30946	1.32551
.050	.53116	.85844	2.56524	1.67640	1.87499	1.43136	1.37434	.87414
.075	.45630	.72657	1.96893	1.57076	1.73733	1.31393	1.33179	.83995
.100	.39391	.63934	1.67452	1.24260	1.56118	1.37395	1.34085	.87553
.125	.31727	.53005	1.25760	1.24948	.97433	1.13452	1.12947	.71717
.150	.33093	.46957	.97382	.88818	.72431	.88269	.82600	.67880
.175	.37836	.40278	.82697	.65895	.60347	.72807	.61741	.55183
.200	.26558	.33357	.48469	.39912	.41521	.39892	.40602	.39137
.225	.20676	.23501	.28482	.22923	.23725	.22749	.20908	.29132
1.000	-.05882	-.03027	.08370	.12055	.13232	.11081	.11848	.17354

	-CPL	-CPL	-CPL	-CPL	-CPL	-CPL	-CPL	-CPL
X/C	-CPL	-CPL	-CPL	-CPL	-CPL	-CPL	-CPL	-CPL
0.000	.96382	2.04014	5.75937	1.63889	3.16151	3.05125	3.92280	1.23202
.025	-.01307	.20371	-.70517	-.71329	-.72513	-.69680	-.68509	-.62736
.050	-.08437	.03284	-.68893	-.65645	-.54791	-.61793	-.60633	-.51295
.075	-.10457	-.01488	-.56214	-.55152	-.54753	-.55340	-.51991	-.45161
.100	-.09347	-.03951	-.52341	-.52216	-.48431	-.48365	-.44375	-.39377
.125	-.08912	-.06722	-.28419	-.29481	-.29332	-.29071	-.26623	-.22441
.150	-.05525	-.07235	-.20612	-.24859	-.17078	-.16296	-.17423	-.11290
.175	-.04278	-.07594	-.09182	-.09556	-.08734	-.08930	-.08363	-.04391
.200	-.03387	-.06978	-.03310	-.00999	-.01434	-.00913	-.00976	.03345
.225	-.01723	-.03540	-.03195	.00062	.00466	.00717	-.00209	*****
1.000	-.05982	-.03027	.08370	.12055	.13232	.11081	.11848	.17354

## P R F S S U R F M E A S U R E M E N T S

OUTER PANFL SWEEP= 30.0000 DEGREES

FUSELAGE ON

ANGLE OF ATTACK= 11.55564 DEGREES

### S P A N W I S E L O C A T I O N

	2Y/R .14119	2Y/R .23533	2Y/R .37112	2Y/R .44999	2Y/R .49999	2Y/R .59999	2Y/R .69999	2Y/R .89997
X/C	-CPU	-CPU	-CPU	-CPU	-CPU	-CPU	-CPU	-CPU
0.000	1.21824	2.46604	6.30090	2.41066	3.22055	2.88730	2.06772	.95020
.025	.77116	1.28401	3.20472	1.84552	2.33577	1.58827	1.51628	1.00319
.050	.57321	.94440	1.76798	1.51239	1.27638	1.37880	1.45354	.70132
.075	.50584	.76541	1.56140	1.42306	1.24779	1.23158	1.44239	.64346
.100	.42193	.69861	1.54403	1.42744	1.20706	1.25168	1.44099	.66786
.125	.37524	.72207	1.54093	1.17432	1.31043	1.06166	1.41241	.58211
.150	.35456	.44517	1.25681	.85978	.77241	.81197	1.26252	.65601
.175	.31711	.37582	.98013	.67754	.56358	.64984	.98506	.56887
.200	.27774	.33503	.60563	.43702	.44451	.40822	.50473	.40365
.225	.20801	.21621	.33040	.33908	.29677	.29548	.20824	.30605
1.000	-.05850	-.03111	.12150	.22440	.17550	.18597	.13511	.25908

	-CPL	-CPL	-CPL	-CPL	-CPL	-CPL	-CPL	-CPL
X/C	-CPL <td>-CPL <td>-CPL <td>-CPL <td>-CPL <td>-CPL <td>-CPL <td>-CPL</td> </td></td></td></td></td></td>	-CPL <td>-CPL <td>-CPL <td>-CPL <td>-CPL <td>-CPL <td>-CPL</td> </td></td></td></td></td>	-CPL <td>-CPL <td>-CPL <td>-CPL <td>-CPL <td>-CPL</td> </td></td></td></td>	-CPL <td>-CPL <td>-CPL <td>-CPL <td>-CPL</td> </td></td></td>	-CPL <td>-CPL <td>-CPL <td>-CPL</td> </td></td>	-CPL <td>-CPL <td>-CPL</td> </td>	-CPL <td>-CPL</td>	-CPL
0.000	1.21824	2.46604	6.30090	2.41066	3.22055	2.88730	2.06772	.95020
.025	.01123	.28913	-.66328	-.71225	-.70370	-.69727	-.72430	-.61357
.050	-.08569	.07139	-.68064	-.67382	-.54737	-.64279	-.63728	-.51607
.075	-.09337	-.00510	-.59013	-.57464	-.57336	-.54883	-.55019	-.42483
.100	-.10164	-.03570	-.53744	-.55108	-.51643	-.51319	-.46801	-.38792
.125	-.09514	-.08567	-.30684	-.31242	-.31167	-.30066	-.27579	-.21033
.150	-.07446	-.08312	-.25229	-.26965	-.18378	-.17690	-.16575	-.10029
.175	-.04568	-.09281	-.10476	-.10352	-.09655	-.09525	-.08009	-.01950
.200	-.05496	-.07445	-.05905	-.01860	-.01751	-.00907	.00139	.05502
.225	-.03073	-.04191	-.02170	.01984	.02721	.01685	.01532	*****
1.000	-.05850	-.03111	.12150	.22440	.17550	.18597	.13511	.25908

APPENDIX B

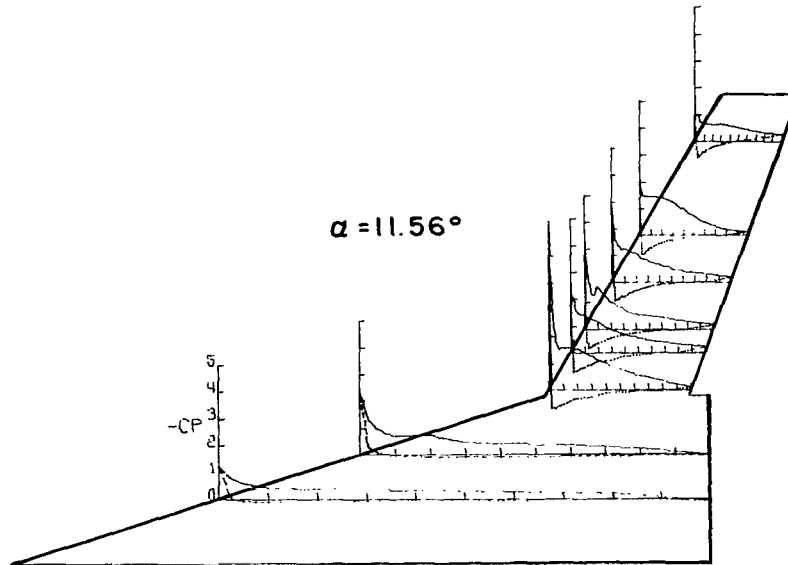
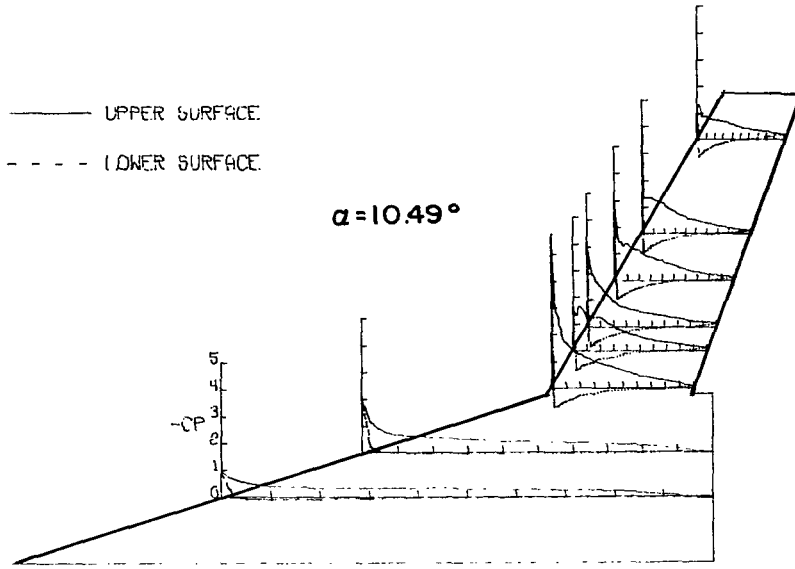

# APPENDIX B

## P R E S S U R E M E A S U R E M E N T S

OUTER PANEL SWEEP= 30.00000 DFGREES

FUSELAGE ON

ANGLE OF ATTACK= 12.59404 DEGREES

### S P A N W I S E L O C A T I O N

	2Y/B .14119	2Y/B .23533	2Y/B .37112	2Y/B .44999	2Y/B .49999	2Y/R .59999	2Y/B .69999	2Y/B .89997
X/C	-CPU	-CPU	-CPU	-CPU	-CPU	-CPU	-CPU	-CPU
0.000	1.47330	2.97874	6.56782	2.54366	2.06189	1.70230	2.26118	.46990
.025	.88014	1.39927	3.12287	1.76593	1.34600	.77725	1.57081	.69885
.050	.65271	.93870	1.81383	1.71551	1.33017	.74624	1.39062	.71298
.075	.54292	.84318	1.55480	1.75018	1.24769	.76867	1.51994	.62960
.100	.47873	.85970	1.51636	1.71614	1.26089	.80232	1.56728	.69814
.200	.44694	1.22733	1.33736	1.48925	1.09660	.73370	1.23658	.75114
.300	.38275	.49310	1.33484	1.09976	1.04513	.69873	.93556	.68401
.400	.33715	.39603	1.27371	.82050	.92307	.61032	.55470	.65786
.600	.32156	.30722	.83257	.60585	.57630	.47662	.33918	.48050
.800	.23277	.18588	.45659	.48934	.49244	.36587	.30637	.43810
1.000	-.06599	-.03408	.21601	.35268	.35335	.28083	.22448	.36956

	-CPL	-CPL	-CPL	-CPL	-CPL	-CPL	-CPL	-CPL
0.000	1.47330	2.97874	6.56782	2.54366	2.06189	1.70230	2.26118	.46990
.025	.04919	.36505	-.65875	-.74818	-.76965	-.67483	-.71368	-.66638
.050	-.07679	.11204	-.69150	-.71732	-.68889	-.61967	-.54873	-.54355
.075	-.10439	.01033	-.61718	-.63041	-.53187	-.55045	-.56402	-.45814
.100	-.11038	-.03614	-.56428	-.67310	-.52343	-.49781	-.49414	-.41931
.200	-.10439	-.10637	-.34638	-.34008	-.33291	-.29665	-.30566	-.22166
.300	-.09239	-.12186	-.28655	-.22420	-.20172	-.18195	-.19624	-.11506
.400	-.07439	-.11514	-.13036	-.12029	-.11075	-.09361	-.09459	-.04306
.600	-.07679	-.09501	-.03968	-.05416	-.00461	.00857	.01059	.04518
.800	-.02940	-.04647	-.01260	.04912	.05406	.05669	.04235	*****
1.000	-.06599	-.03408	.21601	.35268	.35335	.28083	.22448	.36956

## P R E S S U R E M E A S U R E M E N T S

OUTER PANEL SWEEP= 30.00000 DEGREES

FUSELAGE ON

ANGLE OF ATTACK= 13.60142 DEGREES

### S P A N W I S E L O C A T I O N

	2Y/B .14119	2Y/B .23533	2Y/B .37112	2Y/B .44999	2Y/B .49999	2Y/R .59999	2Y/B .69999	2Y/B .89997
X/C	-CPU	-CPU	-CPU	-CPU	-CPU	-CPU	-CPU	-CPU
0.000	1.78754	3.31802	6.04850	1.71757	2.30709	1.94092	1.95055	.38983
.025	.97216	1.31459	2.62199	1.66977	1.71289	.85025	1.57330	.66998
.050	.68651	.94431	1.89945	1.46989	1.67510	.96949	1.66831	.57008
.075	.56375	.94586	1.66729	1.49534	1.56272	.70822	1.71721	.67417
.100	.51628	.98413	1.61639	1.42023	1.45553	.73298	1.69416	.71120
.200	.54773	1.47284	1.34823	1.35195	1.18580	.69584	1.58378	.59942
.300	.35427	1.00327	1.27312	1.09434	.97861	.56879	.74543	.59663
.400	.34359	.39769	1.24953	.83551	.78835	.52970	.29731	.54213
.600	.31273	.31184	.98696	.68789	.52873	.37365	.26242	.50580
.800	.23856	.19238	.43109	.55205	.49929	.33850	.36468	.44642
1.000	-.05222	-.03568	.26734	.42613	.40230	.29098	.28196	.45900

	-CPL	-CPL	-CPL	-CPL	-CPL	-CPL	-CPL	-CPL
0.000	1.78754	3.31802	6.04850	1.71757	2.30709	1.94092	1.95055	.38983
.025	.09376	.45561	-.61470	-.71022	-.72192	-.68091	-.71467	-.65605
.050	-.06884	.17273	-.66990	-.68665	-.58481	-.62818	-.64558	-.54857
.075	-.10682	.03879	-.60973	-.63082	-.61777	-.57936	-.58416	-.47249
.100	-.11868	-.01500	-.55949	-.58864	-.54551	-.50124	-.49901	-.42085
.200	-.13293	-.09826	-.35542	-.35728	-.35543	-.32723	-.32453	-.23450
.300	-.11750	-.11998	-.31758	-.30083	-.22588	-.20570	-.20100	-.13051
.400	-.09376	-.11481	-.15507	-.13708	-.13149	-.11522	-.11586	-.04606
.600	-.09198	-.09774	-.04838	-.02791	-.00911	-.00586	0.00000	.04676
.800	-.04273	-.05171	-.02419	.05396	.06510	.06054	.04048	*****
1.000	-.05222	-.03568	.26734	.42613	.40230	.29098	.28196	.45900

# APPENDIX B

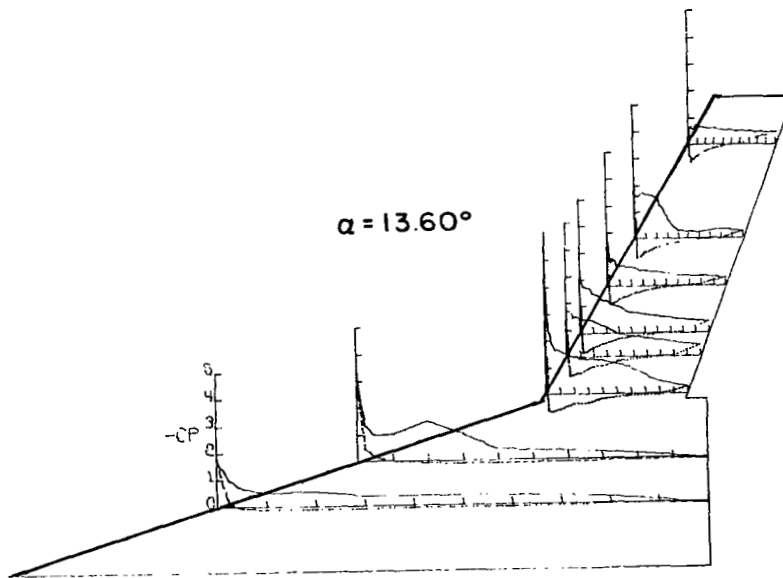
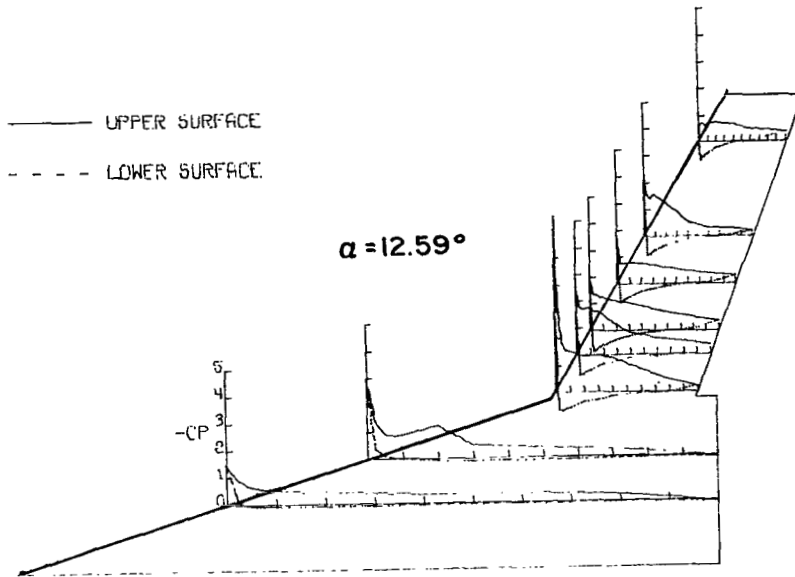

# APPENDIX B

## P R E S S U R E M E A S U R E M E N T S

OUTER PANFL SWEEP= 30.0000 DEGREES

FUSELAGE ON

ANGLE OF ATTACK= 14.65124 DEGREES

### S P A N W I S E L O C A T I O N

	2Y/B .14119	2Y/B .23533	2Y/B .37112	2Y/B .44999	2Y/B .49999	2Y/B .59999	2Y/B .69999	2Y/B .89997
X/C	-CPU	-CPU	-CPU	-CPU	-CPU	-CPU	-CPU	-CPU
0.000	2.05095	3.67122	5.98539	2.07320	2.16640	1.07770	1.65342	.60042
.025	1.06157	1.24358	2.58426	1.93942	1.96953	.74565	.75525	.78748
.050	.73375	1.06658	1.92894	1.78222	1.86355	.89387	.59831	.72863
.075	.62618	1.09099	1.78715	1.83647	1.41881	.77348	1.30242	.67258
.100	.60193	1.12202	1.64475	1.85065	1.45834	.90682	1.93927	.52475
.200	.60666	1.64182	1.31123	1.40247	1.29194	.60584	1.58266	.66978
.300	.35123	1.15508	1.22492	1.12135	1.08417	.46368	.60042	.61373
.400	.36778	.44199	1.32356	.91417	.89711	.47338	.20367	.58150
.600	.33585	.32399	.91048	.80144	.55955	.55600	.32158	.53946
.800	.23770	.18361	.52916	.67269	.57801	.40871	.37692	.44698
1.000	-.05499	-.04272	.35914	.51058	.44622	.44170	.31807	.40845

	-CPL	-CPL	-CPL	-CPL	-CPL	-CPL	-CPL	-CPL
X/C	-CPL	-CPL	-CPL	-CPL	-CPL	-CPL	-CPL	-CPL
0.000	2.05095	3.67122	5.98539	2.07320	2.16640	1.07770	1.65342	.60042
.025	-.14191	.53202	-.57475	-.79165	-.71525	-.72042	-.67821	-.61381
.050	-.05440	.19938	-.66530	-.71027	-.71256	-.66481	-.61311	-.51723
.075	-.10170	-.04832	-.61910	-.65175	-.64152	-.57556	-.53612	-.47663
.100	-.12181	-.04018	-.56859	-.58953	-.57750	-.52512	-.47803	-.43394
.200	-.14841	-.13885	-.38871	-.39364	-.38091	-.34469	-.34085	-.26596
.300	-.13541	-.15513	-.33265	-.32341	-.24445	-.20177	-.17917	-.11968
.400	-.11353	-.14547	-.16756	-.15893	-.13387	-.10929	-.11618	-.04829
.600	-.10466	-.12665	-.06530	-.03388	-.03995	.00905	.02450	.04689
.800	-.05736	-.06205	-.02033	.05975	.07825	.11576	.07279	*****
1.000	-.05499	-.04272	.35914	.51058	.44622	.44170	.31807	.40845

## P R E S S U R E M E A S U R E M E N T S

OUTER PANEL SWEEP= 30.0000 DEGREES

FUSELAGE ON

ANGLE OF ATTACK= 15.63807 DEGREES

### S P A N W I S E L O C A T I O N

	2Y/B .14119	2Y/B .23533	2Y/B .37112	2Y/B .44999	2Y/B .49999	2Y/B .59999	2Y/B .69999	2Y/B .89997
X/C	-CPU	-CPU	-CPU	-CPU	-CPU	-CPU	-CPU	-CPU
0.000	2.31946	4.00473	5.92008	2.02474	2.65817	1.34549	.67438	.49702
.025	1.14243	1.25915	2.44450	2.01311	2.22511	.89571	.66613	.49633
.050	.76416	1.24241	1.95682	2.01311	2.00119	1.01539	.54308	.32860
.075	.71431	1.22313	1.67229	2.26522	1.34356	1.00510	.64070	.37328
.100	.72643	1.27894	1.43793	2.24808	1.28694	.91244	.54996	.32241
.200	.69027	1.86083	1.16013	1.90664	1.39302	.99673	.65995	.31004
.300	.38324	1.01463	1.01083	1.24151	1.38281	.89120	.60633	.34785
.400	.37795	.52000	.98146	.78448	1.16210	.90021	.54446	.31760
.600	.34986	.31048	.93923	.71294	.95933	.71489	.46952	.34441
.800	.24027	.31301	.64446	.66341	.59456	.69044	.45303	.27333
1.000	-.04278	-.04363	.42984	.54846	.47897	.57719	.44959	.28225

	-CPL	-CPL	-CPL	-CPL	-CPL	-CPL	-CPL	-CPL
X/C	-CPL <td>-CPL <td>-CPL <td>-CPL <td>-CPL <td>-CPL <td>-CPL <td>-CPL</td> </td></td></td></td></td></td>	-CPL <td>-CPL <td>-CPL <td>-CPL <td>-CPL <td>-CPL <td>-CPL</td> </td></td></td></td></td>	-CPL <td>-CPL <td>-CPL <td>-CPL <td>-CPL <td>-CPL</td> </td></td></td></td>	-CPL <td>-CPL <td>-CPL <td>-CPL <td>-CPL</td> </td></td></td>	-CPL <td>-CPL <td>-CPL <td>-CPL</td> </td></td>	-CPL <td>-CPL <td>-CPL</td> </td>	-CPL <td>-CPL</td>	-CPL
0.000	2.31946	4.00473	5.92008	2.02474	2.65817	1.34549	.67438	.49702
.025	.19446	.60522	-.55580	-.69337	-.59438	-.72006	-.70598	-.62906
.050	-.03751	.21409	-.64384	-.71783	-.70591	-.69241	-.62357	-.53841
.075	-.10255	-.05073	-.61388	-.65791	-.65834	-.61205	-.55833	-.45257
.100	-.13420	-.04312	-.56803	-.61205	-.58559	-.56447	-.49034	-.42167
.200	-.17405	-.14957	-.39988	-.42189	-.41210	-.37353	-.32006	-.24792
.300	-.14944	-.16133	-.35647	-.33323	-.25845	-.22887	-.20603	-.13048
.400	-.13068	-.16995	-.19505	-.17793	-.16780	-.12665	-.10164	-.04945
.600	-.12131	-.13495	-.07460	-.05197	-.02379	.00771	.02678	.06043
.800	-.07384	-.07458	-.02262	.05931	.07908	.10737	.12155	*****
1.000	-.04278	-.04363	.42984	.54846	.47897	.57719	.44959	.28225



# APPENDIX B

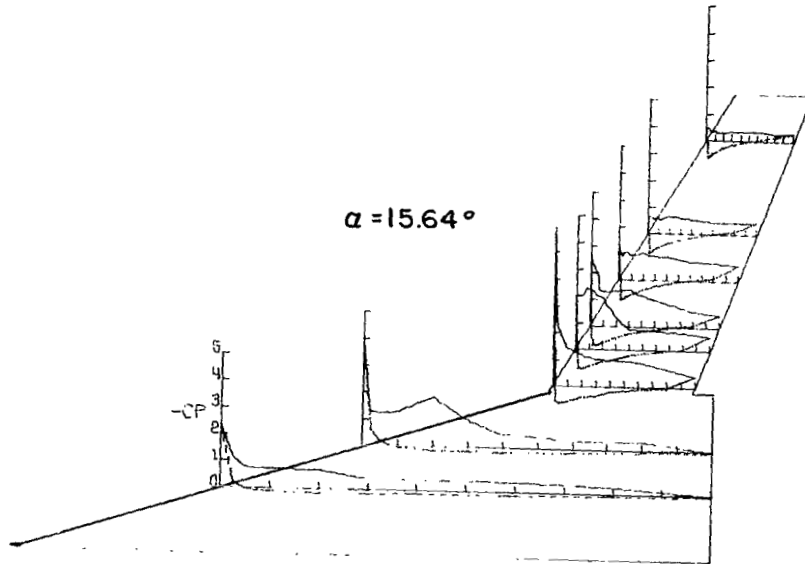
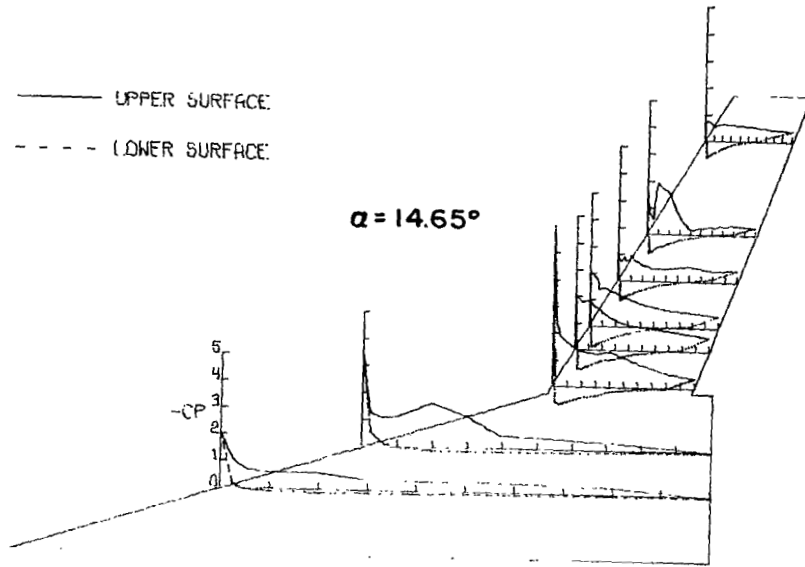

# APPENDIX B

## P R E S S U R E M E A S U R E M E N T S

OUTER PANEL SWEEP= 30.00000 DEGREES

FUSELAGE ON

ANGLE OF ATTACK= 16.63844 DEGREES

### S P A N W I S E L O C A T I O N

	2Y/B .14119	2Y/B .23533	2Y/B .37112	2Y/B .44999	2Y/B .49999	2Y/B .59999	2Y/B .69999	2Y/B .89997
X/C	-CPU	-CPU	-CPU	-CPU	-CPU	-CPU	-CPU	-CPU
0.000	2.64881	2.68630	5.87055	1.87376	2.12200	1.26726	.57173	.28246
.025	1.21925	1.53188	2.53731	1.89726	2.13328	1.05164	.58354	.51199
.050	.80513	1.69548	1.89726	1.89056	1.86377	1.01226	.53422	.39320
.075	.80098	1.77548	1.71112	1.82367	1.64879	1.05999	.63287	.37583
.100	.86615	1.79343	1.50704	2.22502	1.61945	1.02259	.56479	.31470
.200	.79506	2.31807	1.20278	2.24295	1.63459	.95028	.59813	.31539
.300	.39190	1.20673	.90838	1.08096	1.48095	.96513	.55715	.30289
.400	.40197	.70465	.92012	.73350	1.25370	1.06455	.56618	.29911
.600	.34987	.36105	.92136	.70137	.56107	.88250	.57868	.30984
.800	.24213	.20770	.62474	.65626	.51035	.75726	.51477	.30775
1.000	-.03789	-.01180	.47397	.59199	.39990	.59070	.54047	.30011
X/C	-CPL	-CPL	-CPL	-CPL	-CPL	-CPL	-CPL	-CPL
0.000	2.64881	2.68630	5.87055	1.87376	2.12200	1.26726	.57173	.28246
.025	.25752	.61901	-.51722	-.66059	-.69854	-.72370	-.71898	-.65166
.050	-.01184	.23591	-.65193	-.72114	-.71273	-.70112	-.64611	-.54964
.075	-.09886	-.04769	-.62165	-.68098	-.55371	-.64501	-.59267	-.47678
.100	-.14267	-.03744	-.59323	-.63092	-.61534	-.58373	-.52535	-.43444
.200	-.18766	-.15129	-.42206	-.45048	-.43409	-.43248	-.34492	-.26649
.300	-.17997	-.17334	-.37633	-.34481	-.28767	-.26058	-.22138	-.14921
.400	-.15214	-.17950	-.20948	-.19960	-.18383	-.14964	-.11590	-.05691
.600	-.13557	-.14514	-.08651	-.06365	-.03935	-.01935	.02568	.05413
.800	-.07518	-.06513	-.02657	.05376	.05835	.09804	.13047	*****
1.000	-.03789	-.01180	.47397	.59199	.39990	.59070	.54947	.30011

## P R E S S U R E M E A S U R E M E N T S

OUTER PANEL SWEEP= 30.00000 DEGREES

FUSELAGE ON

ANGLE OF ATTACK= 17.58236 DEGREES

### S P A N W I S E L O C A T I O N

	2Y/B .14119	2Y/B .23533	2Y/B .37112	2Y/B .44999	2Y/B .49999	2Y/B .59999	2Y/B .69999	2Y/B .89997
X/C	-CPU	-CPU	-CPU	-CPU	-CPU	-CPU	-CPU	-CPU
0.000	2.98376	2.26374	6.13236	1.70719	1.83437	.99754	.61330	.33745
.025	1.28807	2.02851	2.55924	1.86836	2.00294	1.00736	.58389	.39276
.050	.88465	1.97292	2.09824	1.97455	1.82818	1.04991	.59439	.34936
.075	.94031	1.91836	1.73593	2.09636	1.67436	.97922	.57199	.28046
.100	1.01453	2.00072	1.51792	2.10261	1.57421	.96567	.59019	.29935
.200	.75836	2.70434	1.21995	2.25815	1.75749	1.05172	.63700	.32345
.300	.43661	1.72843	.98008	1.23307	1.74439	.99362	.55869	.30385
.400	.43661	.89355	.92444	.86232	1.29799	1.04925	.55999	.33115
.600	.38218	.38758	.92694	.75965	.80576	.95631	.57969	.31715
.800	.26615	.20795	.71970	.74467	.61201	.77696	.61260	.31995
1.000	-.04486	-.02728	.45816	.71159	.52319	.63361	.53348	.29725
X/C	-CPL	-CPL	-CPL	-CPL	-CPL	-CPL	-CPL	-CPL
0.000	2.98376	2.26374	6.13236	1.70719	1.83437	.99754	.61330	.33745
.025	.33135	.61406	-.51809	-.65666	-.69780	-.73115	-.72459	-.66583
.050	.01854	.24346	-.63918	-.71284	-.73377	-.71807	-.67283	-.57421
.075	-.09151	.06537	-.62795	-.69286	-.68799	-.65922	-.60569	-.50707
.100	-.13876	-.03809	-.61109	-.63544	-.54325	-.60886	-.54694	-.46231
.200	-.19737	-.15750	-.43694	-.45692	-.45387	-.41266	-.36509	-.27766
.300	-.18541	-.18890	-.40573	-.34269	-.30214	-.27271	-.24199	-.16646
.400	-.17106	-.19920	-.22471	-.21909	-.20797	-.17004	-.13429	-.08043
.600	-.15909	-.17295	-.10112	-.06929	-.05335	-.01967	.01329	.04616
.800	-.08015	-.09625	-.03433	.06617	.05559	.10856	.11191	*****
1.000	-.04486	-.02728	.45816	.71159	.52319	.63361	.53348	.29725

# APPENDIX B

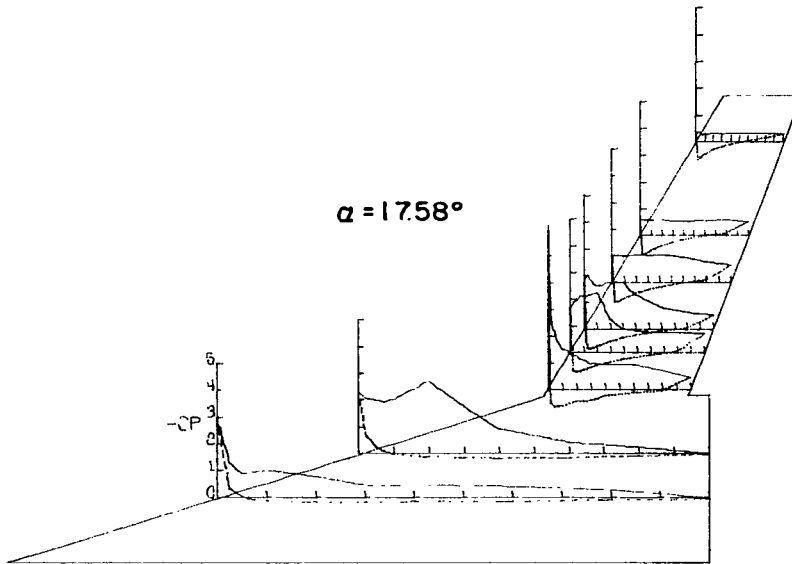
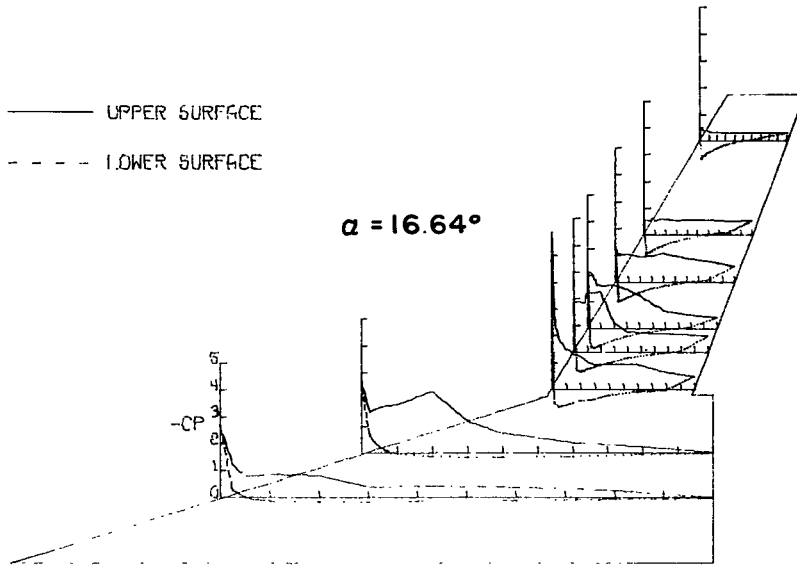

# APPENDIX B

## P R E S S U R E M E A S U R E M E N T S

OUTER PANEL SWFFP= 30.0000 DEGREES

FUSELAGE ON

ANGLE OF ATTACK= 18.64907 DEGREES

### S P A N W I S E L O C A T I O N

	2Y/B .14119	2Y/B .23533	2Y/B .37112	2Y/B .44999	2Y/B .49999	2Y/B .59999	2Y/B .69999	2Y/B .89997
X/C	- CPU	-CPU	-CPU	-CPU	- CPU	- CPU	- CPU	- CPU
0.000	3.33756	1.83564	5.87901	1.80963	1.49144	.92600	.65880	.37475
.025	1.34505	1.68549	2.62351	1.95063	2.03325	.87214	.64404	.32694
.050	.96194	1.75028	2.06456	1.87635	1.33491	.93256	.57443	.31077
.075	1.03236	1.71377	1.82474	1.94937	1.55515	.89316	.62716	.37897
.100	1.19885	1.79861	1.51757	2.25528	1.70150	.92403	.59271	.33960
.200	.61180	2.82801	1.15060	2.33711	1.83294	.94176	.53154	.31921
.300	.45974	2.20842	1.01653	1.22110	1.75135	1.02451	.63349	.30273
.400	.46093	1.09470	1.08199	.89818	1.32989	.89382	.55826	.32131
.600	.39117	.48745	1.02660	.78685	.83885	.99627	.57232	.29149
.800	.30769	.34759	.72081	.71955	.65017	.81566	.53506	.29501
1.000	-.03220	-.00051	.56671	.74219	.59121	.65608	.54068	.28166

	- CPL	-CPL	- CPL	-CPL	- CPL	- CPL	- CPL	- CPL
X/C	3.33756	1.83564	5.87901	1.80963	1.49144	.92600	.65880	.37475
0.000	.39653	.64324	-.46733	-.62394	-.56994	-.72506	-.71855	-.67149
.025	.03637	.27355	-.63652	-.73401	-.73030	-.72768	-.67500	-.59001
.050	-.07931	.07456	-.64407	-.69628	-.71128	-.67781	-.63075	-.52609
.075	-.14430	-.02160	-.61703	-.66042	-.56141	-.62663	-.57105	-.47622
.100	-.21765	-.17379	-.46104	-.48557	-.48293	-.44619	-.39264	-.30414
.200	-.22182	-.20773	-.35160	-.35977	-.33923	-.30708	-.26550	-.19035
.300	-.19499	-.22007	-.23775	-.23146	-.21981	-.18307	-.14750	-.09553
.400	-.16696	-.18459	-.10755	-.15473	-.06132	-.02756	.00070	.02177
.600	-.10495	-.10489	-.02264	.06730	.08858	.10892	.10676	*****
.800	-.03220	-.00051	.56671	.74219	.58121	.65608	.54068	.28166
1.000								

## P R E S S U R E M E A S U R E M E N T S

OUTER PANEL SWFFP= 30.0000 DEGREES

FUSELAGE ON

ANGLE OF ATTACK= 19.70949 DEGREES

### S P A N W I S E L O C A T I O N

	2Y/B .14119	2Y/B .23533	2Y/B .37112	2Y/B .44999	2Y/B .49999	2Y/B .59999	2Y/B .69999	2Y/B .89997
X/C	- CPU	-CPU	-CPU	-CPU	- CPU	- CPU	- CPU	- CPU
0.000	3.78921	1.81717	5.77226	1.89757	1.47340	.97920	.57952	.39009
.025	1.37593	1.77766	2.68553	1.86315	1.72442	.92415	.55707	.32554
.050	1.05832	1.76181	2.06155	1.88944	1.39746	.97593	.54585	.31923
.075	1.19495	1.79855	1.77803	2.00272	1.72901	.87434	.54444	.30450
.100	1.35256	1.87668	1.47512	2.27622	1.81094	.98707	.58654	.30590
.200	.72392	2.73870	1.12652	2.39012	2.01871	1.06375	.57672	.30730
.300	.48145	2.42825	1.07269	1.18722	1.90598	.97331	.57601	.31993
.400	.49882	1.48499	.98883	.92933	1.32134	1.08735	.58163	.30520
.600	.43415	.60900	.98757	.92489	.90252	.82911	.58654	.32905
.800	.32636	.49362	.94496	.75609	.69147	.72555	.55847	.29858
1.000	-.01677	.02225	.56785	.60788	.64559	.69803	.51217	.30068

	- CPL	-CPL	- CPL	-CPL	- CPL	- CPL	- CPL	- CPL
X/C	3.78921	1.81717	5.77226	1.89757	1.47340	.97920	.57952	.39009
0.000	.49625	.73078	-.43840	-.60287	-.69420	-.71051	-.72122	-.68267
.025	.07485	.32028	-.63665	-.71982	-.74391	-.73278	-.70290	-.61188
.050	-.08784	.11435	-.63665	-.71232	-.71182	-.69152	-.64062	-.55161
.075	-.14791	.00103	-.62789	-.67567	-.66337	-.64503	-.58945	-.50535
.100	-.24312	-.16868	-.48030	-.50969	-.49900	-.45905	-.41073	-.32872
.200	-.23294	-.20852	-.42839	-.37398	-.35297	-.31760	-.28597	-.21658
.300	-.22097	-.22146	-.26454	-.25453	-.24301	-.20038	-.17242	-.11915
.400	-.19102	-.20024	-.12320	-.10757	-.06614	-.03274	-.01121	.02313
.600	-.11318	-.10400	-.02627	.05941	.08971	.10347	.10794	*****
.800	-.01677	.02225	.56785	.60788	.64559	.69803	.51217	.30068
1.000								

# APPENDIX B

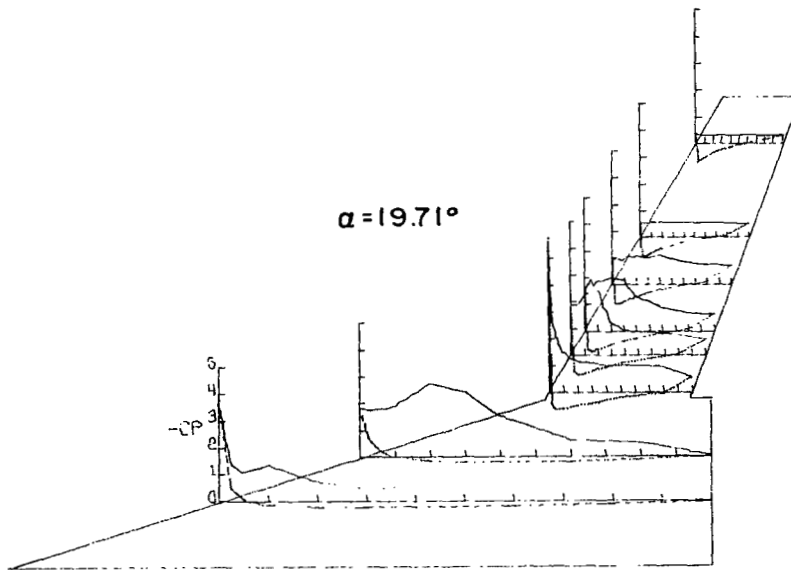
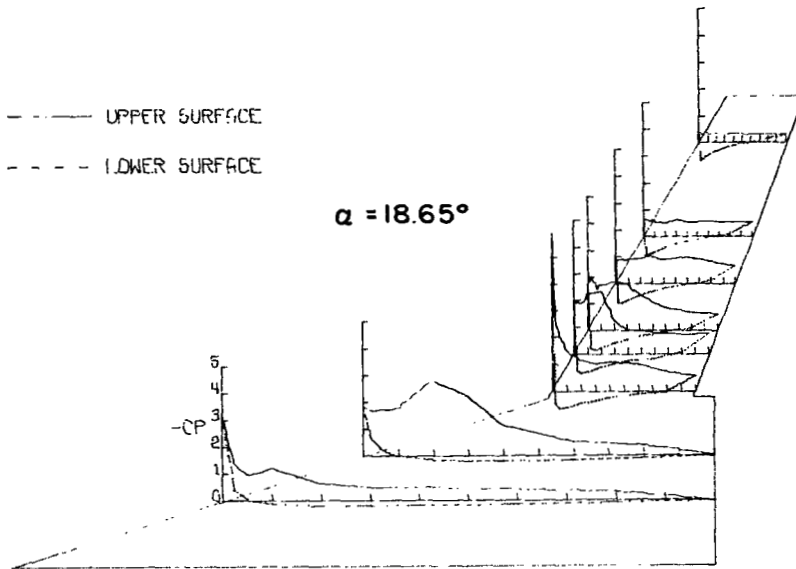

# APPENDIX B

## P R E S S U R E M E A S U R E M E N T S

OUTER PANEL SWEEP= 30.0000 DEGREES

FUSELAGE ON

ANGLE OF ATTACK= 20.81155 DEGREES

### S P A N W I S E L O C A T I O N

	2Y/B .14119	2Y/B .23533	2Y/B .37112	2Y/B .44999	2Y/B .49999	2Y/R .59999	2Y/B .69999	2Y/B .89997
X/C	-CPU	-CPU	-CPU	-CPU	-CPU	-CPU	-CPU	-CPU
0.000	4.15234	1.84236	5.24786	1.82990	1.75132	.96362	.58532	.37672
.025	1.39920	1.69232	2.66039	1.74449	1.52003	.88413	.54067	.32859
.050	1.18298	1.77016	1.91033	2.05623	1.79433	.96557	.58881	.35440
.075	1.31104	1.84594	1.74885	1.85173	1.67119	.91085	.56997	.27947
.100	1.52608	1.84952	1.54559	2.20462	1.72266	.96753	.58532	.31533
.200	.95365	2.48907	1.20455	2.38543	1.91615	1.07829	.58532	.29899
.300	.55355	2.44453	1.11165	1.19582	1.91616	1.03008	.56160	.31812
.400	.54105	1.67901	1.08047	1.03246	1.32327	.99359	.58532	.29968
.600	.46546	.67437	1.01937	.81740	.93430	.85025	.53718	.30278
.800	.36189	.56274	.92394	.76133	.70691	.71473	.59718	.28296
1.000	.01429	.04967	.55199	.76756	.63459	.67434	.55462	.29202
X/C	-CPL	-CPL	-CPL	-CPL	-CPL	-CPL	-CPL	-CPL
0.000	4.15234	1.84236	5.24786	1.82990	1.75132	.96362	.58532	.37672
.025	.57200	.76756	-.40621	-.56757	-.52818	-.68677	-.70669	-.68091
.050	.10059	.35895	-.61243	-.71024	-.72908	-.73234	-.70669	-.62864
.075	-.07083	.12238	-.63112	-.71086	-.70434	-.69523	-.66070	-.56034
.100	-.15773	-.00461	-.62364	-.67411	-.67570	-.65162	-.60355	-.51713
.200	-.25177	-.18383	-.48969	-.51835	-.52012	-.47781	-.43698	-.35056
.300	-.25237	-.23042	-.43674	-.38129	-.36845	-.34045	-.30874	-.23069
.400	-.23630	-.24374	-.27600	-.27226	-.25778	-.22068	-.19166	-.13590
.600	-.20237	-.21916	-.14080	-.11713	-.07942	-.04947	-.02370	-.00558
.800	-.12202	-.10651	-.03364	.06791	.08137	.08853	.10106	*****
1.000	.01429	.04967	.55199	.76756	.63459	.67434	.55462	.29202

## P R E S S U R E M E A S U R E M E N T S

OUTER PANEL SWEEP= 30.0000 DEGREES

FUSELAGE ON

ANGLE OF ATTACK= 22.93074 DEGREES

### S P A N W I S E L O C A T I O N

	2Y/B .14119	2Y/B .23533	2Y/B .37112	2Y/B .44999	2Y/B .49999	2Y/R .59999	2Y/B .69999	2Y/B .89997
X/C	-CPU	-CPU	-CPU	-CPU	-CPU	-CPU	-CPU	-CPU
0.000	5.00005	1.85845	4.74440	2.00239	1.63914	1.10315	.62747	.36609
.025	1.54587	1.80096	2.86219	1.98910	1.59536	.97513	.64528	.33475
.050	1.50208	1.88614	1.93279	2.08463	1.59270	.94395	.59471	.33404
.075	1.52093	1.99171	1.69744	2.45791	1.72670	1.01957	.64029	.37549
.100	1.53431	1.95147	1.51586	2.64645	1.79931	1.05141	.62462	.33689
.200	1.23633	2.07429	1.39122	2.30670	2.12338	1.01294	.68089	.31979
.300	.72915	2.54935	1.22356	1.38110	1.79105	1.13101	.66451	.34686
.400	.67209	1.93109	1.25963	1.09323	1.38936	.97247	.67804	.39030
.600	.56271	.96424	1.11032	.92301	1.02952	.91012	.58455	.31481
.800	.65993	.65380	.84715	.82123	.79601	.81924	.58972	.30097
1.000	-.00304	.19285	.70490	.85031	.75321	.78076	.57263	.35184
X/C	-CPL	-CPL	-CPL	-CPL	-CPL	-CPL	-CPL	-CPL
0.000	5.00005	1.85845	4.74440	2.00239	1.63914	1.10315	.62747	.36609
.025	.76746	.89839	-.35087	-.49564	-.59732	-.66675	-.70937	-.71436
.050	.16772	.41601	-.59300	-.69289	-.73833	-.74098	-.73784	-.66099
.075	-.05287	.17821	-.64548	-.72324	-.73700	-.72441	-.70368	-.59909
.100	-.16225	.01307	-.63852	-.70806	-.70794	-.69392	-.65174	-.57703
.200	-.28804	-.19755	-.52536	-.55317	-.55673	-.52160	-.48525	-.40343
.300	-.30262	-.26183	-.48679	-.42926	-.41953	-.39567	-.36358	-.28745
.400	-.28135	-.28326	-.30978	-.30346	-.29550	-.25782	-.23622	-.18072
.600	-.24246	-.25661	-.17069	-.11822	-.10803	-.08621	-.06119	-.03273
.800	-.14523	-.13588	-.04046	.06259	.07489	.08417	.09748	*****
1.000	-.00304	.19285	.70490	.85031	.75821	.78076	.57263	.35184

# APPENDIX B

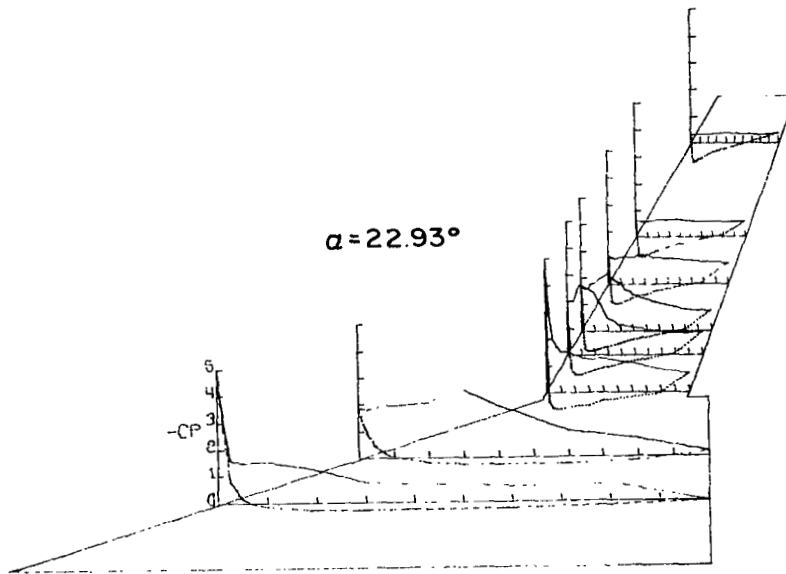
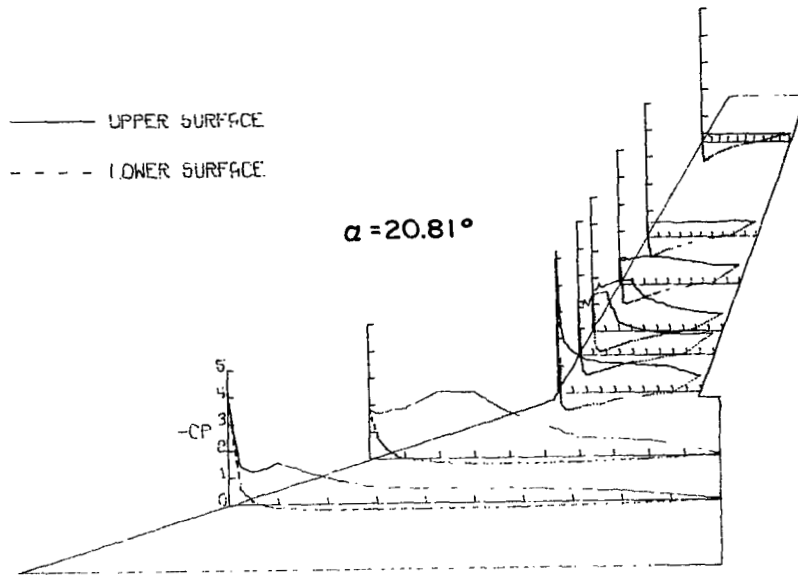

# APPENDIX B

## P R E S S U R E M E A S U R E M E N T S

OUTER PANEL SWFEP= 30.0000 DEGREES

FUSELAGE ON

ANGLE OF ATTACK= 24.98539 DEGREES

### S P A N W I S E L O C A T I O N

	2Y/B .14119	2Y/B .23533	2Y/B .37112	2Y/B .44999	2Y/B .49999	2Y/B .59999	2Y/B .69999	2Y/B .89997
X/C	- CPU	- CPU	- CPU	- CPU	- CPU	- CPU	- CPU	- CPU
0.000	5.82927	1.86951	4.75860	1.92955	1.54033	1.01005	.72636	.36141
.025	1.95052	1.85964	3.07905	2.02644	1.59218	.92145	.58959	.37700
.050	1.64942	1.97187	2.09457	2.09770	1.63418	.95820	.65550	.32244
.075	1.63075	2.06176	1.80829	2.26709	1.61843	.97395	.59101	.34724
.100	1.84995	1.97343	1.66890	2.18083	1.45552	.96607	.63282	.37417
.200	1.21403	1.92458	1.40012	2.28834	1.93411	.94704	.67818	.38125
.300	.90871	2.45509	1.31636	1.49513	1.70310	.95557	.62857	.36779
.400	.79490	2.01396	1.24323	1.29886	1.36051	.93326	.64770	.32314
.600	.69118	1.28912	1.09822	1.03071	1.07335	.88929	.59810	.34369
.800	.56143	.88747	.92378	.98758	.89848	.82694	.61369	.28955
1.000	-.02046	.10912	.77263	.96883	.81775	.75475	.60802	.33519
X/C	- CPL	- CPL	- CPL	- CPL	- CPL	- CPL	- CPL	- CPL
0.000	5.82927	1.86951	4.75860	1.92955	1.54033	1.01005	.72636	.36141
.025	.89848	.99970	-.27295	-.42847	-.54397	-.62949	-.67254	-.68599
.050	.21904	.50193	-.55152	-.65895	-.71330	-.72130	-.72563	-.67042
.075	-.03430	.20732	-.62460	-.70579	-.73179	-.72064	-.71502	-.62652
.100	-.15706	.05144	-.63147	-.70392	-.72556	-.69703	-.66050	-.58546
.200	-.32133	-.21148	-.55464	-.58150	-.58359	-.55933	-.51750	-.43538
.300	-.32374	-.28682	-.51092	-.45658	-.44458	-.41311	-.38936	-.31432
.400	-.31652	-.31384	-.35602	-.34540	-.34038	-.30360	-.28247	-.20813
.600	-.27139	-.29097	-.21361	-.14803	-.12524	-.10623	-.08283	-.06088
.800	-.19436	-.18004	-.05684	.06245	.06557	.07606	.06301	*****
1.000	-.02046	.10912	.77263	.96883	.81775	.75475	.60902	.33519



# APPENDIX B

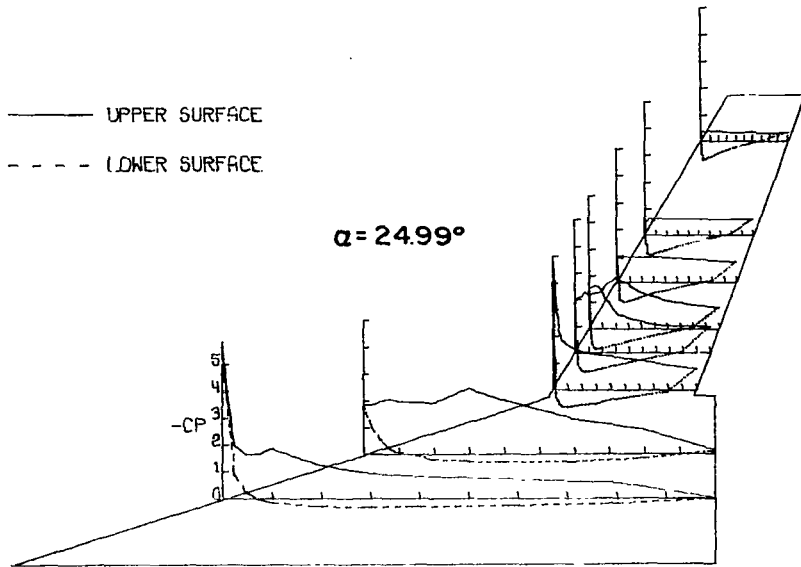

# APPENDIX B

## P R F S S U R E M E A S U R E M E N T S

OUTER PANEL SWEEP= 40.0000 DEGREES

FUSELAGE ON

ANGLE OF ATTACK= -4.28514 DEGREES

### S P A N W I S E L O C A T I O N

	2Y/B .14999	2Y/B .25001	2Y/B .40000	2Y/B .45001	2Y/B .50001	2Y/B .60000	2Y/B .70001	2Y/B .90001
X/C	-CPU	-CPU	-CPU	-CPU	-CPU	-CPU	-CPU	-CPU
0.000	.11828	.39644	.88781	.94016	.85545	1.13757	.69416	.02017
.025	-.07003	-.02359	-.42006	-.40844	-.39423	-.41238	-.42284	-.42423
.050	-.05649	-.01744	-.35953	-.30022	-.28854	-.28335	-.29140	-.30322
.075	-.01118	-.00821	-.21645	-.23235	-.21916	-.24056	-.23228	-.27394
.100	-.01707	.00615	-.15836	-.18221	-.16275	-.17118	-.17317	-.19125
.200	.02177	.02308	-.05992	-.02018	-.33826	-.04993	-.06051	-.04381
.300	.05590	.04513	.00978	.00978	.02658	.00778	.01252	.02086
.400	.05708	.04923	.06726	.07093	.07457	.06873	.04938	.04938
.600	-.01295	.04103	.05625	.05870	-.07252	.07457	.05077	.07441
.800	-.01118	.03846	.00367	.00306	.03843	.02464	.00904	-.02295
1.000	-.00706	-.02667	-.06237	-.05564	-.04733	-.04479	-.02434	-.02225

	-CPL	-CPL	-CPL	-CPL	-CPL	-CPL	-CPL	-CPL
X/C								
0.000	.11828	.39644	.88781	.94016	.35545	1.13757	.69416	.02017
.025	.26069	.42567	1.28615	1.26475	1.22542	1.21280	1.05167	.91952
.050	.23951	.40054	.90799	.94623	.84248	.84507	.76163	.75328
.075	.22303	.37233	.72893	.71171	.73028	.73546	.66495	.64547
.100	.21479	.33336	.65057	.64323	.64207	.64207	.60096	.60443
.200	.18537	.29335	.48243	.48243	.50705	.49278	.47715	.43889
.300	.19890	.28002	.40661	.42984	.45647	.43183	.42568	.35821
.400	.21303	.27181	.40737	.38215	.40330	.38191	.36516	.29349
.600	.17713	.23335	.28921	.30083	.24185	.23407	.22463	.16343
.800	.14535	.14616	.11801	.10211	.11412	.10828	.10641	.05911
1.000	-.00706	-.02667	-.06237	-.05564	-.04733	-.04409	-.02434	-.02225

## P R F S S U R E M E A S U R E M E N T S

OUTER PANEL SWEEP= 40.0000 DEGREES

FUSELAGE ON

ANGLE OF ATTACK= -3.70968 DEGREES

### S P A N W I S E L O C A T I O N

	2Y/B .14999	2Y/B .25001	2Y/B .40000	2Y/B .45001	2Y/B .50001	2Y/B .60000	2Y/B .70001	2Y/B .90001
X/C	-CPU	-CPU	-CPU	-CPU	-CPU	-CPU	-CPU	-CPU
0.000	.09217	.28265	.53374	.59358	.54419	.64675	.40210	-.02138
.025	-.05753	-.02847	-.38778	-.36641	-.37168	-.36463	-.39171	-.39792
.050	-.04403	-.00915	-.26809	-.34381	-.24992	-.24159	-.25930	-.28413
.075	-.00763	-.00508	-.18687	-.18870	-.19594	-.18520	-.19797	-.19723
.100	-.00411	.00813	-.17771	-.15817	-.14226	-.13970	-.15724	-.16068
.200	.03053	.02084	-.04214	.00122	-.01858	-.03204	-.03724	-.02000
.300	.06458	.05745	.02443	.05130	.04101	.03204	.03379	.04207
.400	.05518	.05338	.08244	.05618	.08202	.06729	.06689	.05172
.600	-.00235	.04423	.07328	.06351	.08971	.07690	.10620	.06965
.800	-.00411	.03254	.00122	.02015	.00320	.02435	.00828	-.02000
1.000	-.00939	-.04474	-.06595	-.01466	-.05319	-.04678	-.03034	-.03793

	-CPL	-CPL	-CPL	-CPL	-CPL	-CPL	-CPL	-CPL
X/C								
0.000	.09217	.28265	.53374	.59358	.54419	.64675	.40210	-.02138
.025	.23776	.37314	1.15390	1.10017	1.09607	1.06787	.90767	.88146
.050	.21252	.33654	.82564	.77618	.73456	.75251	.68075	.59247
.075	.20754	.31824	.65282	.65221	.64739	.64931	.59040	.54695
.100	.19843	.29129	.63938	.63022	.59038	.57944	.54005	.49108
.200	.17671	.27248	.45862	.45007	.46552	.44729	.45245	.37659
.300	.18375	.24452	.41343	.42992	.41235	.39410	.38762	.32899
.400	.19843	.25622	.35542	.36213	.37360	.34732	.34003	.27378
.600	.17612	.21199	.25282	.21557	.22044	.23134	.21379	.16551
.800	.13737	.12506	.11542	.10137	.09675	.10189	.09172	.05586
1.000	-.00939	-.04474	-.06595	-.01466	-.05319	-.04678	-.03034	-.03793

# APPENDIX B

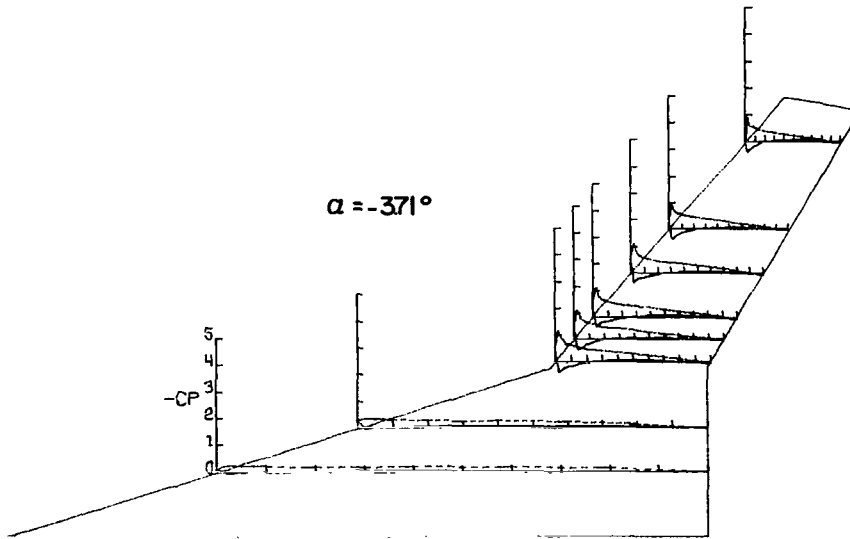
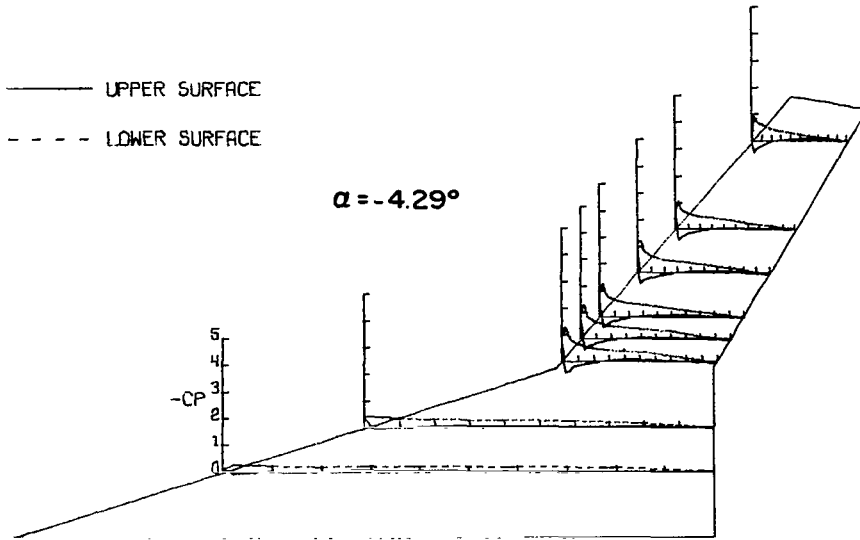

# APPENDIX B

## P R E S S U R E M E A S U R E M E N T S

OUTER PANEL SWEEP= 40.0000 DEGREES

FUSELAGE ON

ANGLE OF ATTACK= -3.16323 DEGREES

### S P A N W I S E L O C A T I O N

	2Y/B .14999	2Y/B .25001	2Y/B .40000	2Y/B .45001	2Y/B .50001	2Y/B .60000	2Y/B .70001	2Y/B .90001
X/C	-CPU	-CPU	-CPU	-CPU	-CPU	-CPU	-CPU	-CPU
0.000	.05058	.20904	.29680	.29989	.32139	.37745	.16837	-.18110
.025	-.05118	-.04191	-.34998	-.31411	-.32139	-.31978	-.33886	-.36999
.050	-.03372	-.01914	-.30608	-.29927	-.19986	-.19134	-.21152	-.23911
.075	.00903	-.00207	-.16200	-.16448	-.14678	-.14613	-.14715	-.15776
.100	.01144	.01294	-.14778	-.11996	-.39829	-.09960	-.10753	-.12451
.200	.03793	.03001	-.01917	.01546	.01573	-.00459	.00212	.00495
.300	.07406	.05174	-.01360	.04081	.36291	.04784	.05164	.06508
.400	.06683	.05692	.09646	.08409	.11039	.09043	.08206	.07287
.600	-.01505	.03726	.08471	.07173	.09138	.09698	.07357	.08701
.800	-.01204	.03156	0.00000	.00495	.30655	.02687	.01627	-.02335
1.000	-.01084	-.05226	-.00804	-.01546	-.05701	-.06291	-.03325	-.04528

	-CPL	-CPL	-CPL	-CPL	-CPL	-CPL	-CPL	-CPL
0.000	.05058	.20904	.29680	.29989	.32139	.37745	.16837	-.18110
.025	.20652	.30994	1.00331	.97920	1.01529	.95499	.83133	.72237
.050	.19930	.28148	.74200	.67708	.64037	.69281	.61837	.53488
.075	.19569	.28562	.59360	.57876	.59056	.60170	.53771	.50021
.100	.18786	.26544	.57629	.52805	.52751	.52816	.50163	.45635
.200	.17521	.22922	.41676	.40563	.41873	.42266	.40824	.35517
.300	.19388	.22767	.39512	.39388	.40235	.38990	.38135	.32687
.400	.20231	.22922	.33699	.34689	.35320	.34665	.32263	.27519
.600	.17341	.18886	.24362	.28258	.20576	.21821	.20798	.16271
.800	.13909	.10400	.12119	.08533	.09436	.09305	.08914	.04811
1.000	-.01084	-.05226	-.00804	-.01546	-.05701	-.06291	-.03325	-.04528

## P R E S S U R E M E A S U R E M E N T S

OUTER PANEL SWEEP= 40.0000 DEGREES

FUSELAGE ON

ANGLE OF ATTACK= -2.64412 DEGREES

### S P A N W I S E L O C A T I O N

	2Y/B .14999	2Y/B .25001	2Y/B .40000	2Y/B .45001	2Y/B .50001	2Y/B .60000	2Y/B .70001	2Y/B .90001
X/C	-CPU	-CPU	-CPU	-CPU	-CPU	-CPU	-CPU	-CPU
0.000	0.00000	.12902	-.00425	.12192	.02033	.14623	-.03782	-.37051
.025	-.04685	-.02426	-.27113	-.26082	-.23540	-.25770	-.27246	-.32288
.050	-.02076	-.00774	-.24808	-.24505	-.16327	-.13049	-.15689	-.20592
.075	.00771	.00361	-.13284	-.14193	-.11410	-.11606	-.11557	-.13168
.100	.01483	.01858	-.12010	-.09280	-.05639	-.06951	-.07564	-.08825
.200	.05100	.04077	-.00364	.03761	.04197	.03410	.02241	.02732
.300	.07591	.06296	.00607	.05277	.09115	.07344	.07004	.05533
.400	.08006	.06812	.09220	.09220	.13130	.11147	.11276	.08545
.600	-.00534	.05109	.08674	.07279	.09508	.08065	.07144	.08335
.800	-.01008	.04129	0.00000	0.00000	.30525	.04328	.01191	-.01821
1.000	-.00830	-.03509	-.02851	-.01152	-.05164	-.04065	-.03572	-.02872

	-CPL	-CPL	-CPL	-CPL	-CPL	-CPL	-CPL	-CPL
0.000	0.00000	.12902	-.00425	.12192	.02033	.14623	-.03782	-.37051
.025	.15776	.28797	.86009	.83522	.86380	.82051	.68998	.62623
.050	.18385	.26733	.63264	.56227	.55356	.60276	.53447	.45672
.075	.17555	.26268	.49434	.48524	.52130	.52720	.46722	.42379
.100	.16487	.25236	.44400	.45431	.47343	.47540	.44061	.38247
.200	.15657	.23894	.38395	.36515	.39999	.39081	.37756	.32573
.300	.18029	.23533	.34392	.35605	.38037	.36765	.34884	.29487
.400	.19037	.23585	.29842	.31359	.34350	.33114	.30467	.25144
.600	.16428	.21108	.18561	.21533	.21311	.21639	.20662	.14848
.800	.12573	.12076	.07218	.08795	.09442	.09180	.08475	.06763
1.000	-.00830	-.03509	-.02851	-.01152	-.06164	-.04065	-.03572	-.02872

# APPENDIX B

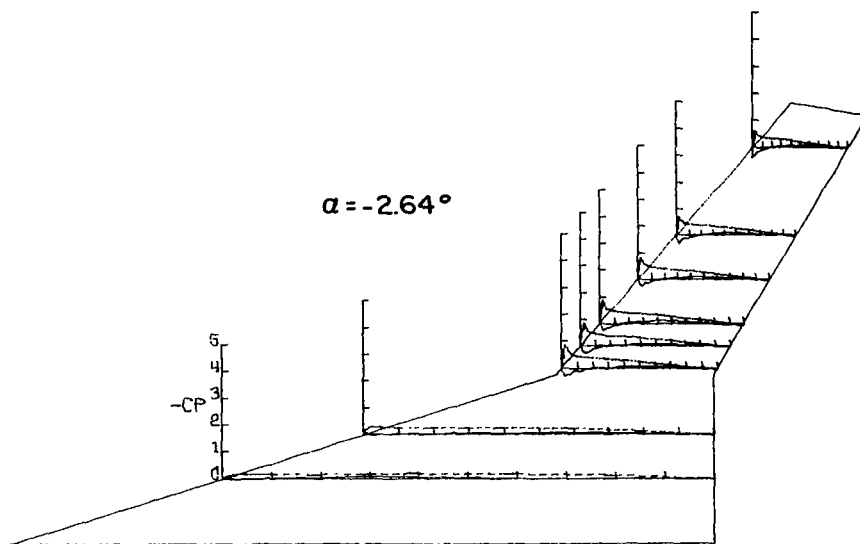
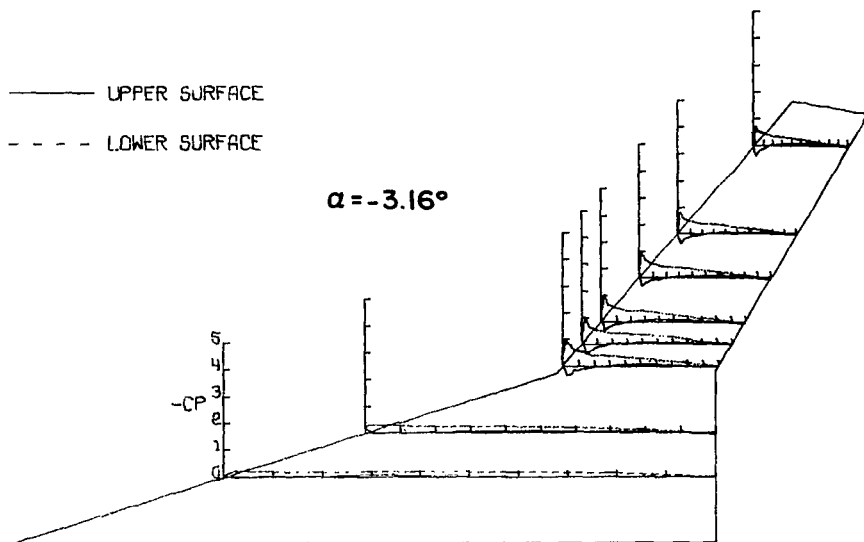

# APPENDIX B

## P R E S S U R E M E A S U R E M E N T S

OUTER PANEL SWEEP= 40.0000 DEGREES

FUSELAGE ON

ANGLE OF ATTACK= -2.11267 DEGREES

### S P A N W I S E L O C A T I O N

	2Y/B .14999	2Y/B .25001	2Y/B .40000	2Y/B .45001	2Y/B .50001	2Y/B .60000	2Y/B .70001	2Y/B .90001
X/C	-CPU	-CPU	-CPU	-CPU	-CPU	-CPU	-CPU	-CPU
0.000	-.02196	.08069	-.16275	-.13044	-.14247	-.13921	-.20577	-.52003
.025	-.03739	-.01079	-.19140	-.17921	-.17554	-.18215	-.21417	-.26736
.050	-.01009	.01542	-.17067	-.15824	-.10659	-.10083	-.11198	-.14978
.075	.02967	.03649	-.08717	-.09631	-.36635	-.07091	-.06859	-.09239
.100	.02967	.04060	-.07132	-.08899	-.31551	-.02082	-.02520	-.05809
.125	.06231	.05859	.02865	.06156	.36895	.05790	.04689	.04689
.150	.08130	.08737	.03413	.06095	.11449	.09563	.10079	.08469
.175	.08130	.08942	.11216	.11033	.14537	.12946	.11758	.09169
.200	-.00297	.06013	.10362	.10179	.39953	.09498	.08189	.07979
.225	-.01128	.04985	.00792	.00122	.01236	.04228	.02450	-.02520
.250	.00059	-.04471	-.01951	-.00914	-.36310	-.04814	-.04129	-.03360
.275								
.300								
.325								
.350								
.375								
.400								
.425								
.450								
.475								
.500								
.525								
.550								
.575								
.600								
.625								
.650								
.675								
.700								
.725								
.750								
.775								
.800								
.825								
.850								
.875								
.900								
.925								
.950								
.975								
1.000								

## P R E S S U R E M E A S U R E M E N T S

OUTER PANEL SWEEP= 40.0000 DEGREES

FUSELAGE ON

ANGLE OF ATTACK= -1.59300 DEGREES

### S P A N W I S E L O C A T I O N

	2Y/B .14999	2Y/B .25001	2Y/B .40000	2Y/B .45001	2Y/B .50001	2Y/B .60000	2Y/B .70001	2Y/B .90001
X/C	-CPU	-CPU	-CPU	-CPU	-CPU	-CPU	-CPU	-CPU
0.000	-.04100	.02568	-.34425	-.31076	-.35320	-.25818	-.39573	-.59184
.025	-.01545	.00205	-.12095	-.10049	-.09950	-.09764	-.15199	-.19961
.050	.00416	.02825	-.08870	-.07816	-.04587	-.03145	-.05113	-.09455
.075	.03981	.03736	-.02605	-.02667	-.01704	-.02490	-.02451	-.03432
.100	.03565	.04520	.01613	-.02543	.01245	.01769	.00840	-.02171
.125	.06773	.06883	.07595	.12033	.09895	.08846	.07214	.05953
.150	.09684	.09708	.08188	.10545	.14039	.11795	.11977	.10436
.175	.08971	.09194	.14949	.15011	.15596	.14744	.13027	.10856
.200	-.00416	.07397	.13398	.13956	.11458	.11271	.09245	.10226
.225	-.00654	.05650	.03101	.02295	.01734	.04194	.02101	-.02311
.250	-.00059	-.04777	.00806	.01799	-.36815	-.05111	-.04132	-.03852
.275								
.300								
.325								
.350								
.375								
.400								
.425								
.450								
.475								
.500								
.525								
.550								
.575								
.600								
.625								
.650								
.675								
.700								
.725								
.750								
.775								
.800								
.825								
.850								
.875								
.900								
.925								
.950								
.975								
1.000								

# APPENDIX B

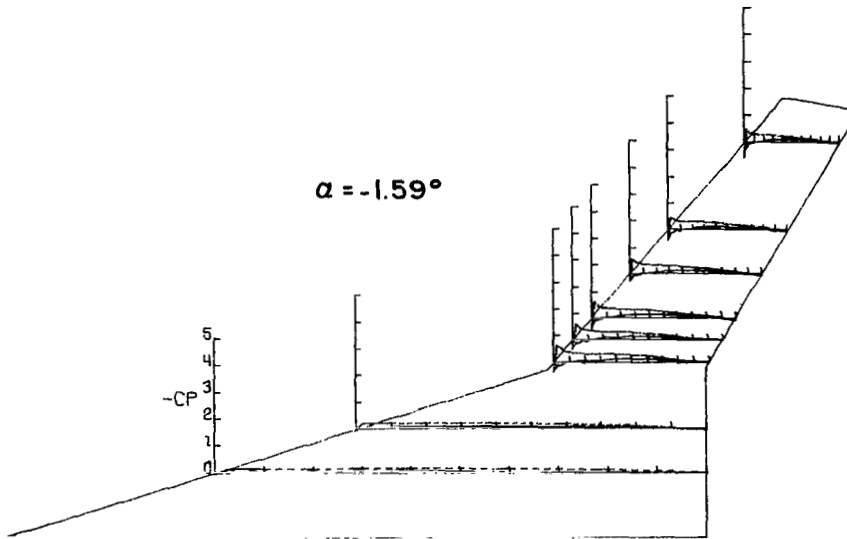
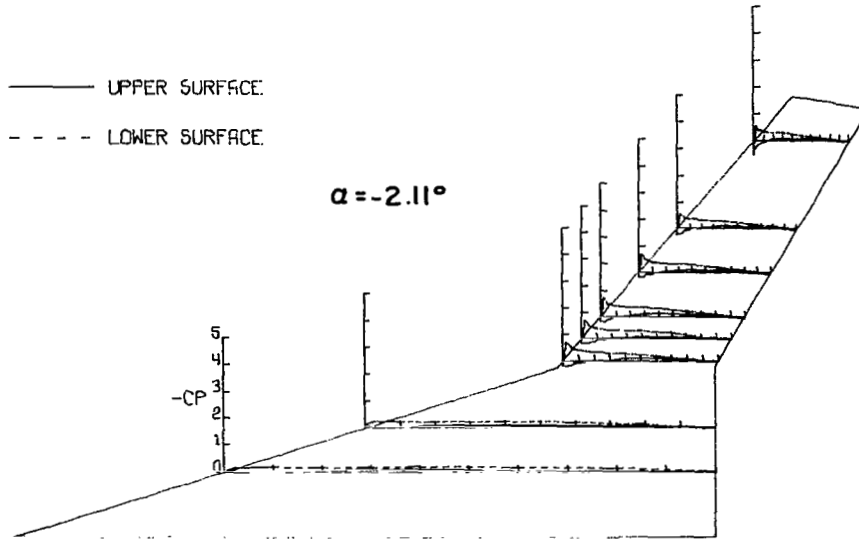

# APPENDIX B

## P R E S S U R E M E A S U R E M E N T S

OUTER PANEL SWEEP= 40.0000 DEGREES

FUSELAG ON

ANGLE OF ATTACK= -1.03632 DEGREES

### S P A N W I S E L O C A T I O N

	2Y/B .14999	2Y/B .25001	2Y/B .40000	2Y/B .45001	2Y/B .50001	2Y/B .60000	2Y/B .70001	2Y/B .90001
X/C	-CPU	-CPU	-CPU	-CPU	-CPU	-CPU	-CPU	-CPU
0.000	-.05600	-.00662	-.43751	-.40661	-.43276	-.41735	-.47785	-.63228
.025	-.01061	-.01885	-.04758	-.02410	-.02761	-.04494	-.05471	-.11219
.050	.01828	.04585	-.04635	-.03028	-.00385	.02119	0.00000	-.05817
.075	.05542	.04839	.01668	.01730	.02183	.01990	.02424	-.00069
.100	.04834	.06215	.02781	.00989	.05393	.04944	.03878	.01524
.200	.08430	.08711	.10382	.14954	.13227	.11300	.11219	.09695
.300	.10140	.10596	.09825	.14027	.15281	.13548	.14405	.11496
.400	.10081	.10596	.16746	.14893	.17237	.17464	.15305	.12189
.600	.00177	.08253	.15263	.15696	.11814	.12585	.10111	.10319
.800	.00354	.05553	.04264	.04573	.02376	.04816	.01801	-.01108
1.000	-.00531	-.03973	-.03831	.02225	-.06742	-.05714	-.03463	-.04155

	-CPL	-CPL	-CPL	-CPL	-CPL	-CPL	-CPL	-CPL
X/C	-CPL	-CPL	-CPL	-CPL	-CPL	-CPL	-CPL	-CPL
0.000	-.05600	-.00662	-.43751	-.40661	-.43276	-.41735	-.47785	-.63228
.025	.08902	.15384	.53020	.47953	.48412	.43597	.37124	.34700
.050	.11142	.16047	.44245	.38375	.34415	.35314	.30614	.25762
.075	.12616	.17524	.37880	.34172	.32158	.31975	.27978	.28048
.100	.11496	.18084	.34481	.33678	.31333	.30306	.27494	.24031
.200	.12852	.17779	.30465	.31083	.29095	.28123	.27424	.23477
.300	.14443	.18033	.29538	.30465	.29343	.26967	.27632	.22507
.400	.16801	.18237	.26695	.29909	.26453	.25298	.23269	.19460
.600	.13736	.15894	.22926	.17673	.16822	.16951	.16621	.12258
.800	.11319	.07947	.09022	.07477	.06742	.07512	.06579	.03947
1.000	-.00531	-.03973	-.03831	.02225	-.06742	-.05714	-.03463	-.04155

## P R E S S U R E M E A S U R E M E N T S

OUTER PANEL SWEEP= 40.0000 DEGREES

FUSELAGE ON

ANGLE OF ATTACK= -.50089 DEGREES

### S P A N W I S E L O C A T I O N

	2Y/B .14999	2Y/B .25001	2Y/B .40000	2Y/B .45001	2Y/B .50001	2Y/B .60000	2Y/B .70001	2Y/B .90001
X/C	-CPU	-CPU	-CPU	-CPU	-CPU	-CPU	-CPU	-CPU
0.000	-.06414	-.02795	-.53468	-.49250	-.50705	-.49408	-.55867	-.66138
.025	.01295	.02286	.02481	.04962	.06354	.07132	.03748	-.06246
.050	.03354	.06910	.04962	.04652	.07332	.09791	.08050	.01527
.075	.06591	.07622	.10049	.04714	.08170	.07068	.05552	.04095
.100	.05944	.08079	.10297	.06017	.10569	.10245	.10341	.05136
.200	.08415	.09806	.13460	.16748	.16794	.14200	.13811	.15476
.300	.11299	.11788	.12902	.16499	.18674	.17896	.16448	.19362
.400	.10769	.12195	.18794	.16189	.20425	.19906	.17142	.14088
.600	-.00942	.08943	.18050	.15507	.14035	.14913	.11659	.10896
.800	-.00118	.07520	.05893	.05520	.03437	.05771	.02845	-.01180
1.000	-.00942	-.04675	-.07195	-.00124	-.06808	-.06484	-.04233	-.04719

	-CPL	-CPL	-CPL	-CPL	-CPL	-CPL	-CPL	-CPL
X/C	-CPL	-CPL	-CPL	-CPL	-CPL	-CPL	-CPL	-CPL
0.000	-.06414	-.02795	-.53468	-.49250	-.50705	-.49408	-.55867	-.66138
.025	.07532	.12144	.41807	.36907	.36894	.34041	.29778	.27413
.050	.09180	.13363	.38519	.29153	.28455	.28465	.22208	.19848
.075	.10946	.15142	.28967	.27168	.27038	.25547	.21791	.22000
.100	.11887	.14989	.27664	.27168	.25482	.25482	.21514	.20542
.200	.10651	.16209	.26858	.26548	.26649	.23861	.23735	.19779
.300	.13594	.16615	.25680	.27416	.27751	.26390	.24706	.27612
.400	.15182	.17377	.24129	.25990	.26130	.23926	.21930	.18321
.600	.14241	.14989	.18732	.19353	.15951	.16469	.15476	.11937
.800	.10769	.08638	.07878	.06637	.07781	.07521	.07079	.04025
1.000	-.00942	-.04675	-.07195	-.00124	-.06808	-.06484	-.04233	-.04719



# APPENDIX B

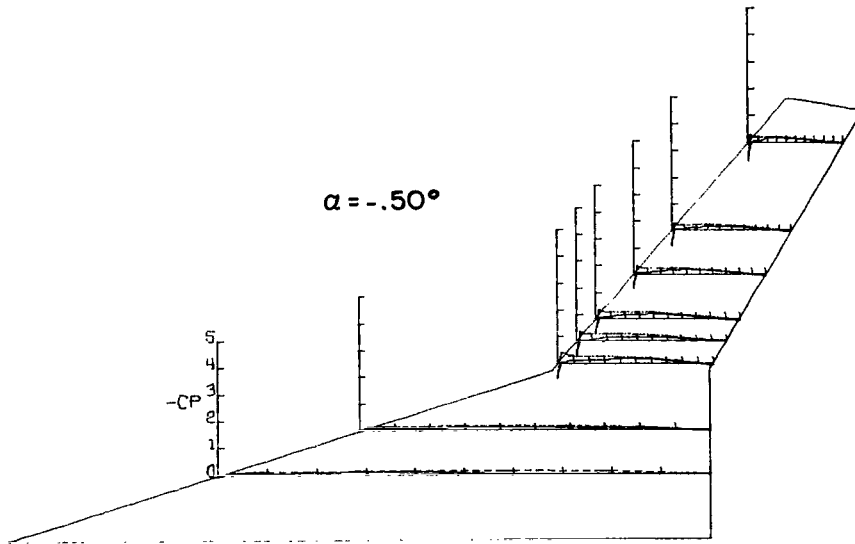
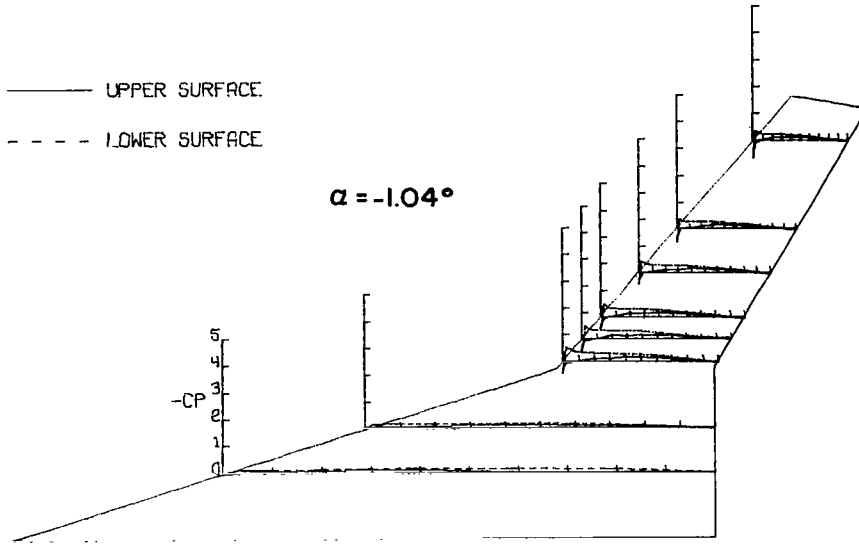

# APPENDIX B

## P R E S S U R E M E A S U R E M E N T S

OUTER PANEL SWEEP= 40.00000 DEGREES

FUSELAGE ON

ANGLE OF ATTACK= .02280 DEGREES

### S P A N W I S E L O C A T I O N

	2Y/B .14999	2Y/B .25001	2Y/B .40000	2Y/B .45001	2Y/B .50001	2Y/B .60000	2Y/B .70001	2Y/B .90001
X/C	-CPU	-CPU	-CPU	-CPU	-CPU	-CPU	-CPU	-CPU
0.000	-.07596	-.03730	-.55595	-.58292	-.53485	-.53420	-.60328	-.67581
.025	.01708	.05621	.15263	.15447	.17546	.16633	.13739	.04254
.050	.04534	.08176	.13669	.11217	.11936	.15328	.12205	.07114
.075	.08126	.09492	.13362	.12627	.13697	.13241	.11996	.08718
.100	.06889	.09862	.15140	.10788	.15328	.13893	.15204	.09346
.200	.09244	.11702	.17347	.19982	.20481	.17546	.19528	.18482
.300	.12542	.13439	.16305	.18082	.20024	.20155	.19807	.22387
.400	.11541	.13235	.21024	.19982	.22046	.21785	.20574	.16180
.600	.00589	.11293	.15508	.16305	.15458	.16502	.15901	.11996
.800	-.01590	.08483	.03494	.03800	.04109	.05805	.03696	-.00558
1.000	0.00000	-.03935	-.08643	-.03310	-.07110	-.05218	-.03557	-.03417

	-CPL	-CPL	-CPL	-CPL	-CPL	-CPL	-CPL	-CPL
X/C	-CPL	-CPL	-CPL	-CPL	-CPL	-CPL	-CPL	-CPL
0.000	-.07596	-.03730	-.55595	-.58292	-.53485	-.53420	-.60328	-.67581
.025	.05535	.09351	.29177	.28503	.26742	.26416	.17784	.15762
.050	.07655	.10731	.23476	.23109	.21785	.22372	.17017	.15622
.075	.09068	.13082	.19982	.20411	.20481	.22438	.16669	.15483
.100	.10422	.13593	.19369	.21208	.20481	.22111	.17017	.17854
.200	.10187	.14512	.21637	.20657	.22829	.20807	.20853	.17575
.300	.12660	.15074	.22054	.22005	.25699	.22438	.23294	.18691
.400	.14191	.15534	.21760	.22312	.24329	.22111	.20574	.16738
.600	.12012	.14563	.15140	.15569	.15654	.15654	.15553	.11717
.800	.10834	.09453	.07049	.05088	.07501	.06979	.07253	.03836
1.000	0.00000	-.03935	-.08643	-.03310	-.07110	-.05218	-.03557	-.03417

## P R E S S U R E M E A S U R E M E N T S

OUTER PANEL SWEEP= 40.00000 DEGREES

FUSELAGE ON

ANGLE OF ATTACK= .54447 DEGREES

### S P A N W I S E L O C A T I O N

	2Y/B .14999	2Y/B .25001	2Y/B .40000	2Y/B .45001	2Y/B .50001	2Y/B .60000	2Y/B .70001	2Y/B .90001
X/C	-CPU	-CPU	-CPU	-CPU	-CPU	-CPU	-CPU	-CPU
0.000	-.07788	-.04312	-.57577	-.56153	-.56420	-.54594	-.65091	-.69150
.025	.05529	.07444	.28727	.27984	.29678	.28960	.23587	.12458
.050	.06242	.09857	.21607	.24764	.19894	.23807	.20297	.11898
.075	.10047	.10627	.19131	.18016	.18067	.18067	.15888	.15118
.100	.09096	.11346	.21607	.16840	.18915	.19959	.17778	.13648
.200	.11890	.12527	.20802	.25198	.23090	.21655	.21277	.22467
.300	.13436	.14170	.21235	.21978	.23351	.22372	.24007	.23587
.400	.13971	.14221	.23402	.24953	.23546	.25568	.23097	.18757
.600	-.00297	.11859	.17521	.17149	.16959	.16045	.17078	.11618
.800	-.00059	.08420	.05201	.03467	.04957	.05088	.03989	-.02100
1.000	-.00594	-.03594	-.07863	.00743	-.07370	-.05936	-.03919	-.04409

	-CPL	-CPL	-CPL	-CPL	-CPL	-CPL	-CPL	-CPL
X/C	-CPL	-CPL	-CPL	-CPL	-CPL	-CPL	-CPL	-CPL
0.000	-.07788	-.04312	-.57577	-.56153	-.56420	-.54594	-.65091	-.69150
.025	.03864	.06623	.21421	.17273	.17220	.16241	.07699	.06089
.050	.05945	.07958	.20740	.15540	.14219	.15002	.08399	.08959
.075	.07074	.10987	.17335	.14735	.16328	.15328	.11968	.10079
.100	.08977	.11603	.16406	.16468	.16828	.16567	.13928	.11478
.200	.09750	.12886	.19131	.18511	.19046	.17611	.17918	.14348
.300	.12544	.13759	.19069	.19131	.21745	.20546	.19037	.16938
.400	.13852	.14888	.20740	.20802	.21655	.19829	.17568	.15328
.600	.12187	.13040	.14611	.13435	.15132	.14350	.13438	.10499
.800	.10463	.08317	.06748	.05572	.06783	.06523	.06299	.03220
1.000	-.00594	-.03594	-.07863	.00743	-.07370	-.05936	-.03919	-.04409

# APPENDIX B

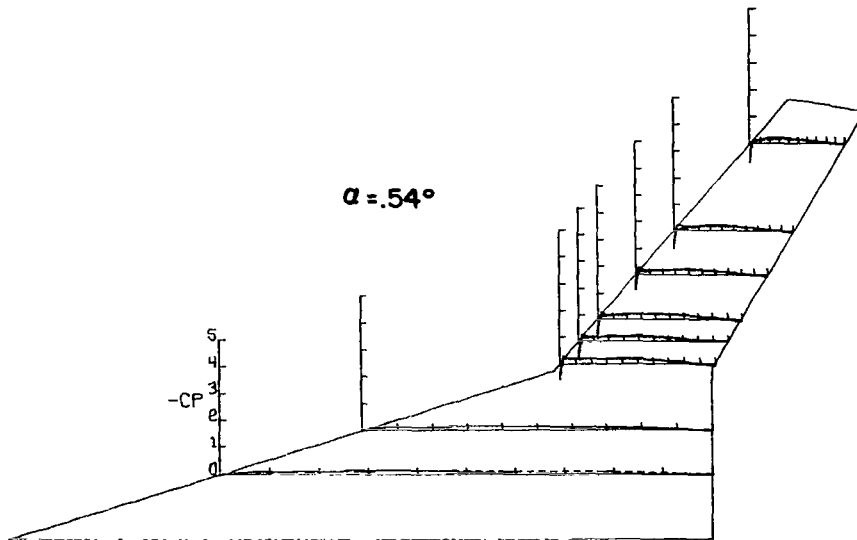
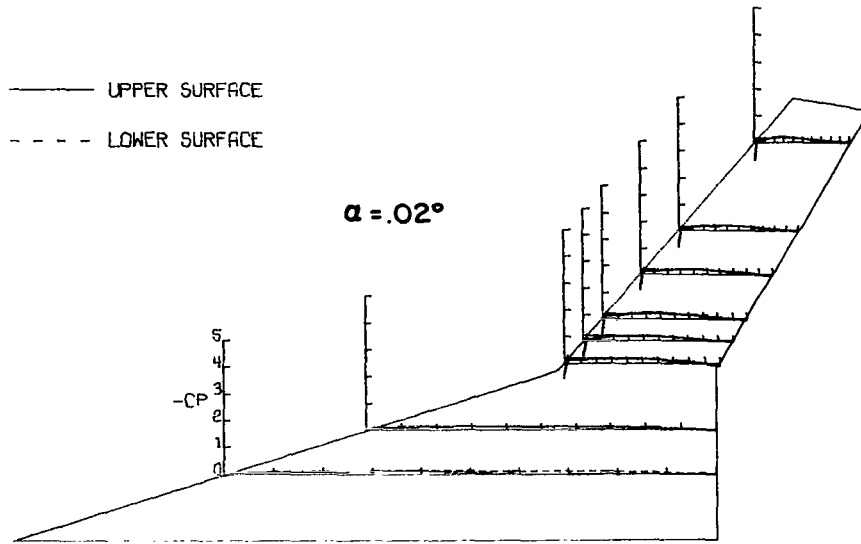

# APPENDIX B

## P R E S S U R E M E A S U R E M E N T S

OUTER PANEL SWEEP= 40.00000 DEGREES

FUSFLAGE ON

ANGLE OF ATTACK= 1.07492 DEGREES

### S P A N W I S E L O C A T I O N

	2Y/B .14999	2Y/B .25001	2Y/B .40000	2Y/B .45001	2Y/B .50001	2Y/B .60000	2Y/B .70001	2Y/B .90001
X/C	- CPU	- CPU	- CPU	- CPU	- CPU	- CPU	- CPU	- CPU
0.000	-.07427	-.02892	-.54627	-.55492	-.54630	-.52280	-.62698	-.69868
.025	.07011	.11050	.38066	.37139	.39357	.38117	.34446	.27483
.050	.07843	.13064	.29229	.27622	.24857	.29697	.28889	.20314
.075	.11051	.14251	.24903	.23729	.24737	.23105	.24109	.19119
.100	.10338	.14303	.25768	.23235	.23823	.25259	.22914	.18346
.200	.12596	.15335	.23729	.27931	.25303	.24737	.24812	.24953
.300	.14913	.16626	.23976	.25521	.26042	.25651	.27061	.26569
.400	.13428	.16833	.26448	.24903	.27935	.26042	.26991	.19259
.600	-.00772	.14509	.26718	.21752	.18993	.19189	.18838	.14128
.800	.00594	.09811	.05685	.05932	.05155	.06462	.04288	-.00281
1.000	-.00594	-.03666	-.07230	-.03213	-.07506	-.05026	-.03374	-.03444
X/C	- CPL	- CPL	- CPL	- CPL	- CPL	- CPL	- CPL	- CPL
0.000	-.07427	-.02892	-.54627	-.55492	-.54630	-.52280	-.62698	-.69868
.025	.02079	.04647	.11494	.10011	.10132	.07245	.03374	-.00281
.050	.03684	.07435	.10134	.08775	.07441	.08224	.03093	.03936
.075	.06298	.09759	.12297	.08466	.11879	.10182	.06326	.05201
.100	.07308	.10740	.13471	.09825	.12662	.11487	.09770	.06959
.200	.08496	.12444	.15572	.12977	.15795	.15795	.14901	.11527
.300	.10754	.13838	.15634	.13718	.19776	.17296	.17432	.14761
.400	.12833	.14922	.19280	.19713	.20133	.18471	.17221	.13847
.600	.11407	.13786	.14213	.14089	.14294	.12793	.12863	.10051
.800	.09863	.08830	.06921	.05253	.06452	.06527	.06467	.03585
1.000	-.00594	-.03666	-.07230	-.03213	-.07506	-.05026	-.03374	-.03444

## P R E S S U R E M E A S U R E M E N T S

OUTER PANEL SWEEP= 40.00000 DEGREES

FUSELAGE ON

ANGLE OF ATTACK= 1.59749 DEGREES

### S P A N W I S E L O C A T I O N

	2Y/B .14999	2Y/B .25001	2Y/B .40000	2Y/B .45001	2Y/B .50001	2Y/B .60000	2Y/B .70001	2Y/B .90001
X/C	- CPU	- CPU	- CPU	- CPU	- CPU	- CPU	- CPU	- CPU
0.000	-.06050	-.01219	-.51491	-.53271	-.51831	-.49505	-.55955	-.63053
.025	.08400	.14735	.49650	.50939	.49753	.54106	.46843	.33549
.050	.09516	.15751	.36885	.35350	.33219	.37161	.35359	.26168
.075	.12629	.16209	.31852	.30134	.30440	.28695	.30065	.24358
.100	.12336	.15599	.31913	.26758	.29406	.30246	.28604	.23662
.200	.13099	.16158	.27740	.33755	.30181	.26627	.29369	.28395
.300	.14979	.17428	.27065	.29397	.28888	.27337	.30204	.28534
.400	.14744	.17428	.28354	.29581	.29276	.28888	.28888	.21783
.600	-.00117	.14074	.22830	.20007	.19259	.19711	.19835	.15033
.800	-.01116	.08943	.06383	.06321	.05299	.07174	.04593	-.00557
1.000	-.01175	-.04065	-.08162	-.00982	-.06851	-.05493	-.02784	-.03897
X/C	- CPL	- CPL	- CPL	- CPL	- CPL	- CPL	- CPL	- CPL
0.000	-.06050	-.01219	-.51491	-.53271	-.51831	-.49505	-.55955	-.63053
.025	-.00059	.02642	.01780	-.01105	.00194	-.01293	-.05637	-.07655
.050	.02820	.04929	.03191	.00982	.00711	.01939	-.01601	-.02993
.075	.04523	.07418	.05646	.03560	.05041	.04782	.00278	.00070
.100	.06285	.08536	.05953	.05585	.07691	.07626	.04663	.02923
.200	.07166	.09959	.12336	.10740	.12215	.11762	.11622	.09883
.300	.09810	.11534	.14054	.11906	.17256	.14606	.14476	.11970
.400	.12277	.12245	.17061	.14852	.17708	.16609	.15520	.12527
.600	.10574	.11229	.13502	.14545	.12344	.11698	.11622	.09256
.800	.09105	.07977	.06444	.04971	.06075	.05429	.06472	.03341
1.000	-.01175	-.04065	-.08162	-.00982	-.06851	-.05493	-.02784	-.03897

# APPENDIX B

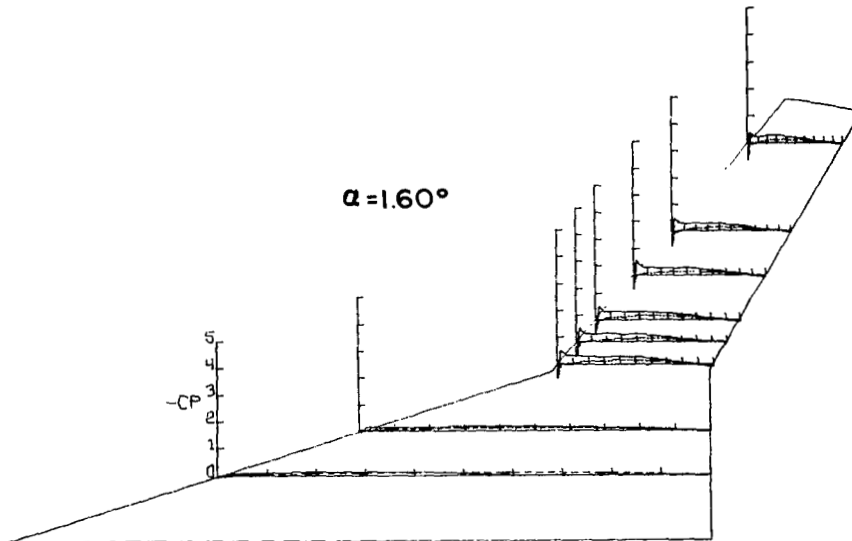
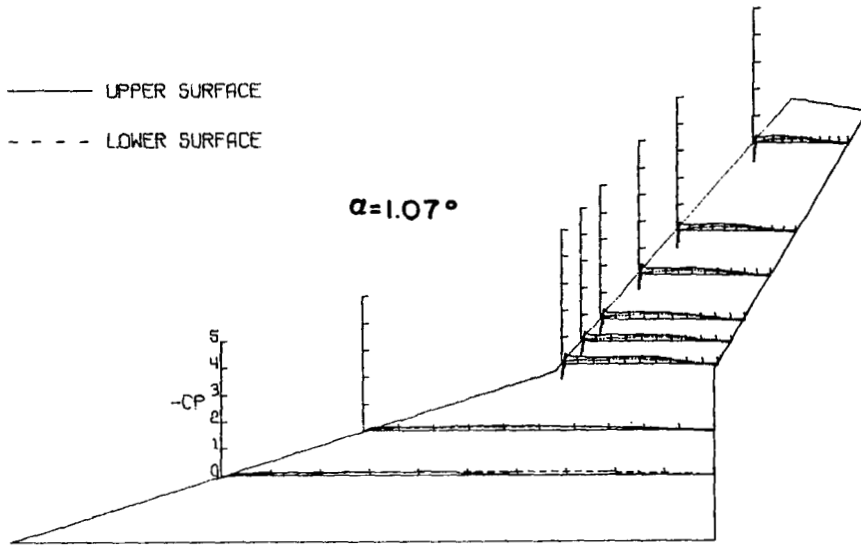

# APPENDIX B

## P R E S S U R E M E A S U R E M E N T S

OUTER PANEL SWEEP= 40.0000 DEGREES

FUSELAGE ON

ANGLE OF ATTACK= 2.12149 DEGREES

### S P A N W I S E L O C A T I O N

	2Y/B .14999	2Y/B .25001	2Y/B .40000	2Y/B .45001	2Y/B .50001	2Y/B .60000	2Y/B .70001	2Y/B .90001
X/C	-CPU	-CPU	-CPU	-CPU	-CPU	-CPU	-CPU	-CPU
0.000	-.03850	.01170	-.40321	-.51062	-.45849	-.43824	-.54298	-.58137
.025	.10307	.15971	.61249	.58488	.61569	.62911	.59470	.49279
.050	.11432	.17802	.44249	.42347	.42453	.44086	.42439	.32806
.075	.14453	.17243	.35903	.34859	.34877	.34419	.35040	.31410
.100	.11847	.17090	.36394	.31852	.33622	.35072	.33504	.26870
.200	.13861	.16785	.28599	.36025	.33374	.31415	.32318	.30852
.300	.14513	.17751	.28415	.33632	.31154	.28084	.32178	.28545
.400	.15224	.17039	.27986	.29029	.30239	.29652	.29103	.22334
.600	-.00652	.14140	.22339	.22033	.19985	.19920	.19402	.13958
.800	-.00770	.09308	.05708	.06444	.05225	.07772	.04397	.00209
1.000	.00296	-.03916	-.08715	-.01780	-.05943	-.04572	-.02582	-.02722

	-CPL	-CPL	-CPL	-CPL	-CPL	-CPL	-CPL	-CPL
X/C	-CPL	-CPL	-CPL	-CPL	-CPL	-CPL	-CPL	-CPL
0.000	-.03850	.01170	-.40321	-.51062	-.45849	-.43824	-.54298	-.58137
.025	-.01599	.00254	-.06444	-.09635	-.08099	-.09013	-.15494	-.15145
.050	.01303	.02187	-.02700	-.05401	-.03319	-.03070	-.06351	-.07747
.075	.04028	.05239	.01043	.00184	.01176	.01176	-.02303	-.01815
.100	.05272	.06307	.01841	.02394	.03853	.03396	.01117	.00907
.200	.06042	.08240	.10126	.07978	.10646	.08686	.09213	.05932
.300	.09952	.09359	.10065	.10310	.14760	.13715	.12563	.11097
.400	.10366	.10427	.15404	.11968	.16981	.14042	.13400	.10678
.600	.09122	.10071	.11292	.11538	.11756	.10646	.10818	.08445
.800	.08234	.06307	.05401	.03682	.05485	.05421	.05374	.03280
1.000	.00296	-.03916	-.08715	-.01780	-.05943	-.04572	-.02582	-.02722

## P R E S S U R E M E A S U R E M E N T S

OUTER PANFL SWEEP= 40.0000 DEGREES

FUSELAGE ON

ANGLE OF ATTACK= 2.65289 DEGREES

### S P A N W I S E L O C A T I O N

	2Y/B .14999	2Y/B .25001	2Y/B .40000	2Y/B .45001	2Y/B .50001	2Y/B .60000	2Y/B .70001	2Y/B .90001
X/C	-CPU	-CPU	-CPU	-CPU	-CPU	-CPU	-CPU	-CPU
0.000	-.01475	.05051	-.28474	-.40582	-.35035	-.36814	-.50073	-.48821
.025	.12918	.20867	.73193	.72220	.73710	.74808	.69903	.58635
.050	.13744	.21378	.49282	.49221	.47018	.51668	.49593	.39159
.075	.16458	.20663	.41129	.39122	.40301	.40237	.41594	.35403
.100	.14747	.19388	.40095	.36019	.37653	.40430	.40203	.33108
.200	.14688	.19031	.30847	.38574	.45134	.33132	.34638	.31995
.300	.15573	.20000	.30482	.33159	.33435	.31453	.34499	.31022
.400	.16517	.19286	.30239	.29691	.32745	.30355	.31300	.22672
.600	.00413	.16684	.29869	.20504	.20667	.20667	.21351	.15092
.800	-.00826	.10714	.06145	.06510	.05877	.07686	.05425	.01043
1.000	-.00059	-.03316	-.08822	-.01460	-.06717	-.05296	-.02712	-.02225

	-CPL	-CPL	-CPL	-CPL	-CPL	-CPL	-CPL	-CPL
X/C	-CPL <td>-CPL <td>-CPL <td>-CPL <td>-CPL <td>-CPL <td>-CPL <td>-CPL</td> </td></td></td></td></td></td>	-CPL <td>-CPL <td>-CPL <td>-CPL <td>-CPL <td>-CPL <td>-CPL</td> </td></td></td></td></td>	-CPL <td>-CPL <td>-CPL <td>-CPL <td>-CPL <td>-CPL</td> </td></td></td></td>	-CPL <td>-CPL <td>-CPL <td>-CPL <td>-CPL</td> </td></td></td>	-CPL <td>-CPL <td>-CPL <td>-CPL</td> </td></td>	-CPL <td>-CPL <td>-CPL</td> </td>	-CPL <td>-CPL</td>	-CPL
0.000	-.01475	.05051	-.28474	-.40582	-.35035	-.36814	-.50073	-.48821
.025	-.03480	-.00306	-.14967	-.17766	-.15146	-.16792	-.20168	-.20933
.050	-.00649	.01582	-.10465	-.15332	-.10786	-.11109	-.13701	-.13214
.075	.01711	.03980	-.03346	-.06632	-.04034	-.04779	-.07302	-.06468
.100	.03362	.04898	-.01643	-.04259	-.01615	-.01679	-.04868	-.03825
.200	.05368	.07194	.05902	.05476	.06717	.05425	.05564	.04034
.300	.08848	.08878	.09248	.06023	.11819	.10398	.09945	.09319
.400	.09674	.10306	.11195	.12594	.14467	.12530	.11266	.10293
.600	.08789	.09592	.10830	.11743	.09882	.09752	.09736	.08763
.800	.07491	.05663	.04137	.01034	.04715	.04069	.05077	.04034
1.000	-.00059	-.03316	-.08822	-.01460	-.06717	-.05296	-.02712	-.02225

APPENDIX B

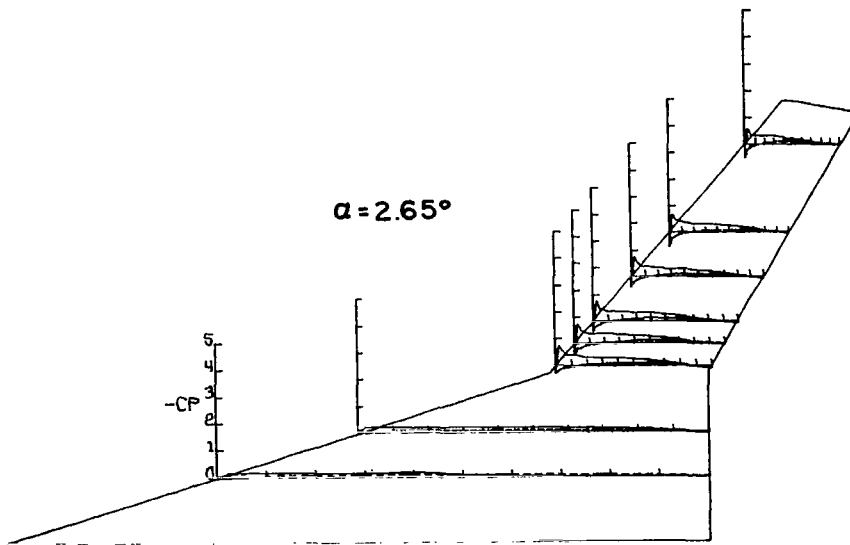
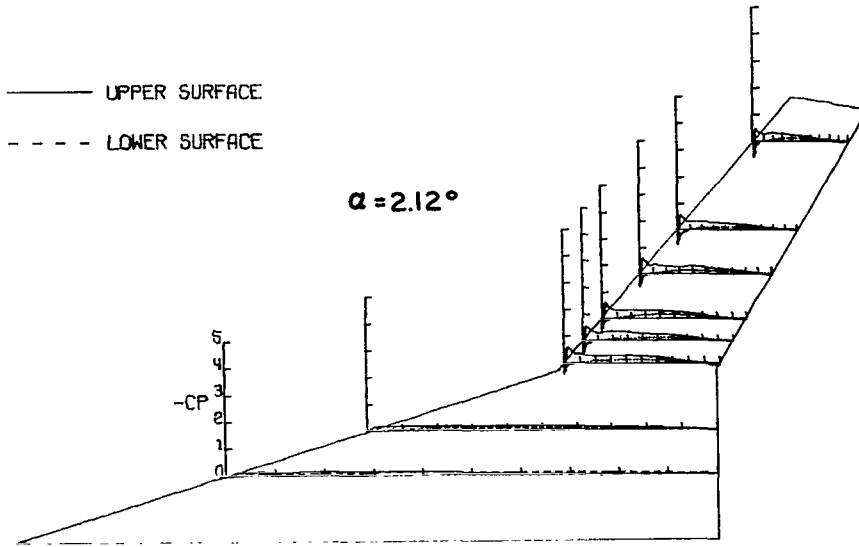

# APPENDIX B

## P R E S S U R E M E A S U R E M E N T S

OUTER PANEL SWEEP= 40.0000 DEGREES

FUSFLAGE ON

ANGLE OF ATTACK= 3.18925 DEGREES

### S P A N W I S E L O C A T I O N

	2Y/B .14999	2Y/B .25001	2Y/B .40000	2Y/B .45001	2Y/B .50001	2Y/B .60000	2Y/B .70001	2Y/B .90001
X/C	-CPU	-CPU	-CPU	-CPU	-CPU	-CPU	-CPU	-CPU
0.000	-.00951	.08487	-.13199	-.24548	-.22449	-.27705	-.43620	-.37758
.025	.16636	.25256	.88879	.82156	.36575	.86834	.82644	.68196
.050	.16636	.24592	.59520	.53969	.54774	.59382	.58493	.46069
.075	.18359	.23774	.48171	.45396	.46586	.47559	.48791	.42160
.100	.15566	.21780	.47493	.45827	.45093	.45223	.46836	.37134
.200	.17289	.20911	.35712	.43052	.39708	.38086	.39507	.36576
.300	.17349	.21524	.33430	.40153	.37048	.34582	.38111	.33365
.400	.16933	.20962	.32381	.33985	.34517	.33544	.33644	.25474
.600	-.00951	.17434	.21094	.24363	.22958	.21671	.23171	.15913
.800	.00356	.11657	.06168	.06600	.05839	.07007	.05583	.00209
1.000	.00059	-.02301	-.08450	-.01480	-.05710	-.04282	-.01954	-.01954

	-CPL	-CPL	-CPL	-CPL	-CPL	-CPL	-CPL	-CPL
X/C	-CPL	-CPL	-CPL	-CPL	-CPL	-CPL	-CPL	-CPL
0.000	-.00951	.08487	-.13199	-.24548	-.22449	-.27705	-.43620	-.37758
.025	-.03684	-.00460	-.21341	-.23253	-.21541	-.23487	-.26940	-.26591
.050	-.01961	.00665	-.17332	-.16160	-.15247	-.14793	-.17308	-.18076
.075	.01188	.02659	-.09314	-.10855	-.08899	-.10122	-.11586	-.12353
.100	.02436	.03834	-.06600	-.08080	-.06229	-.05126	-.07817	-.07049
.200	.04813	.06544	.03947	.02714	.04347	.02920	.02861	.02024
.300	.07843	.07771	.06353	.03701	.09538	.09019	.07817	.07607
.400	.09625	.08691	.10547	.10855	.11744	.10251	.08794	.07887
.600	.08080	.08334	.07401	.09622	.08759	.08694	.08445	.07747
.800	.07843	.05573	.03886	.02097	.05126	.04152	.05025	.02792

## P R E S S U R E M E A S U R E M E N T S

OUTFR PANEL SWEEP= 40.0000 DEGREES

FUSELAGE ON

ANGLE OF ATTACK= 3.72351 DEGREES

### S P A N W I S E L O C A T I O N

	2Y/B .14999	2Y/B .25001	2Y/B .40000	2Y/B .45001	2Y/B .50001	2Y/B .60000	2Y/B .70001	2Y/B .90001
X/C	-CPU	-CPU	-CPU	-CPU	-CPU	-CPU	-CPU	-CPU
0.000	.04744	.15130	.11639	-.07535	-.01087	-.12919	-.34822	-.28009
.025	.17687	.28033	1.10543	1.00377	1.03317	.99542	.97115	.80803
.050	.17629	.27679	.70140	.61380	.53909	.66724	.66694	.53341
.075	.19620	.26768	.55806	.53723	.52202	.52842	.53479	.44944
.100	.17629	.25605	.53662	.52253	.50654	.50910	.50588	.43086
.200	.17687	.23176	.38960	.47168	.41700	.41061	.41159	.38268
.300	.18683	.23226	.37428	.39511	.38374	.35839	.38268	.35308
.400	.17863	.22265	.35101	.35591	.35624	.34537	.34414	.25738
.600	-.01054	.19279	.23584	.23829	.22577	.22321	.22573	.16172
.800	-.00644	.13612	.08637	.07780	.07035	.07355	.05987	.00963
1.000	-.00117	-.01417	-.06493	-.00858	-.05436	-.03837	-.00963	-.02615

	-CPL	-CPL	-CPL	-CPL	-CPL	-CPL	-CPL	-CPL
X/C	-CPL	-CPL	-CPL	-CPL	-CPL	-CPL	-CPL	-CPL
0.000	.04744	.15130	.11639	-.07535	-.01087	-.12919	-.34822	-.28009
.025	-.05095	-.01113	-.25177	-.27872	-.27246	-.28077	-.32689	-.32895
.050	-.02401	-.00455	-.20031	-.22849	-.18935	-.19187	-.21747	-.23123
.075	.00410	.00860	-.12497	-.13293	-.13239	-.13175	-.16104	-.15553
.100	.01406	.01822	-.10965	-.12558	-.09145	-.10681	-.12731	-.10873
.200	.03573	.04301	.01776	.01348	.00704	.00320	-.00206	-.00893
.300	.06560	.05617	.02634	.01899	.07355	.05564	.05299	.05093
.400	.09371	.06831	.09617	.10291	.09785	.08187	.07088	.06744
.600	.06911	.06629	.07351	.08209	.07675	.06907	.06813	.06400
.800	.06325	.04959	.03859	.02634	.03646	.03582	.03923	.01789
1.000	-.00117	-.01417	-.06493	-.00858	-.05436	-.03837	-.00963	-.02615



# APPENDIX B

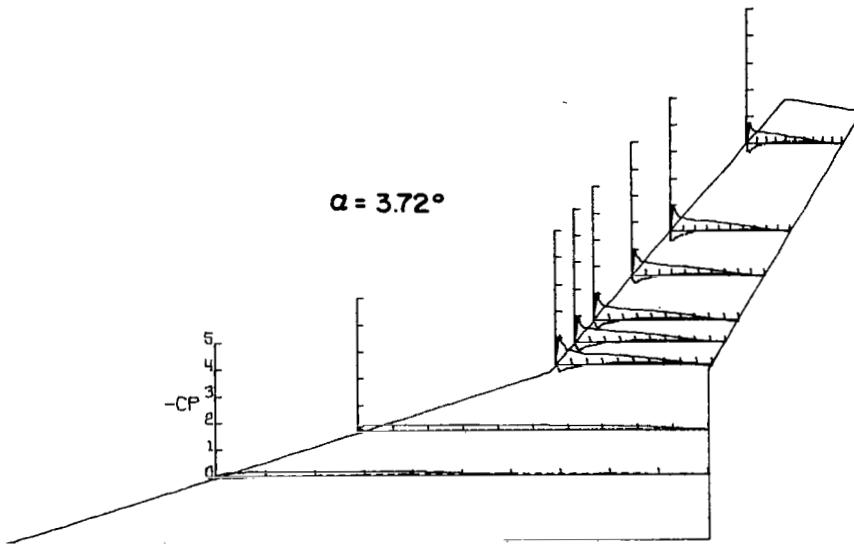
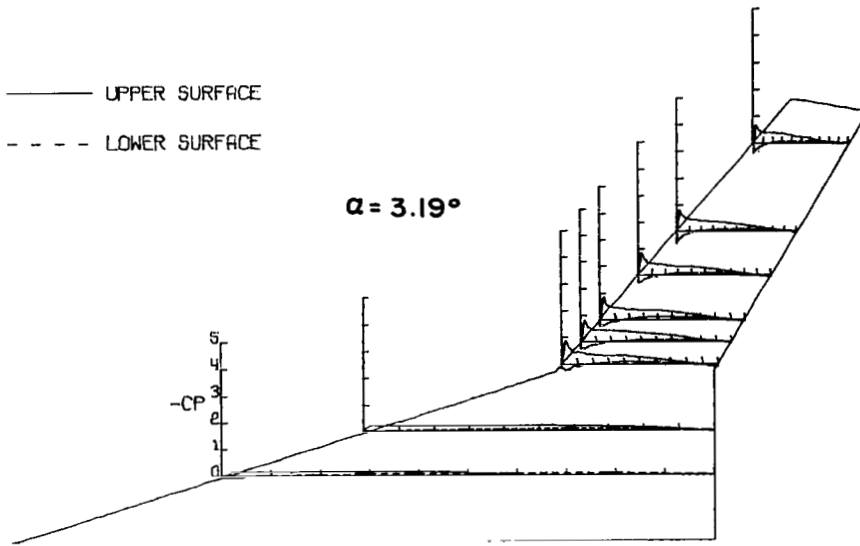

# APPENDIX B

## P R E S S U R E M E A S U R E M E N T S

OUTER PANEL SWEEP= 40.0000 DEGREES

FUSELAGE ON

ANGLE OF ATTACK= 4.25778 DEGREES

### S P A N W I S E L O C A T I O N

	2Y/B .14999	2Y/B .25001	2Y/B .40000	2Y/B .45001	2Y/B .50001	2Y/B .60000	2Y/B .70001	2Y/B .90001
X/C	- CPU	- CPU	- CPU	- CPU	- CPU	- CPU	- CPU	- CPU
0.000	.08204	.26548	.39789	.11880	.19517	-.01102	-.20015	-.10842
.025	.20717	.34989	1.35488	1.20783	1.22902	1.14081	1.14337	.93208
.050	.20717	.32942	.81275	.73732	.72509	.77178	.74232	.63459
.075	.20776	.30487	.66503	.63297	.60575	.61159	.60123	.53589
.100	.17707	.28646	.62103	.61349	.55378	.56230	.57203	.47959
.200	.18474	.25474	.45760	.53555	.47009	.44869	.46430	.41217
.300	.18887	.25372	.42680	.45446	.40849	.39682	.41148	.37116
.400	.18828	.24451	.39600	.41612	.38774	.37802	.37255	.28841
.600	-.01830	.20615	.28349	.27469	.25352	.23861	.24811	.17513
.800	-.00118	.13300	.11880	.11000	.08494	.09272	.07714	.02363
1.000	-.00590	-.01893	-.04400	.02011	-.04963	-.03242	-.00903	-.01459
X/C	- CPL	- CPL	- CPL	- CPL	- CPL	- CPL	- CPL	- CPL
0.000	.08204	.26548	.39789	.11880	.19517	-.01102	-.20015	-.10842
.025	-.06315	-.00767	-.31114	-.32874	-.34365	-.34300	-.39266	-.36486
.050	-.03896	-.00767	-.26400	-.23257	-.25871	-.23731	-.27173	-.26617
.075	-.00708	.01432	-.15400	-.15903	-.18155	-.16988	-.20571	-.18973
.100	.00590	.02711	-.11314	-.11443	-.12334	-.12644	-.15081	-.14108
.200	.01771	.04604	.01760	-.01823	-.00973	-.03112	-.01737	-.03753
.300	.05253	.06189	.01697	.00817	.05706	.04085	.03822	.03614
.400	.07201	.07008	.09806	.09491	.08364	.06419	.05143	.05282
.600	.07142	.06854	.08989	.10434	.06354	.06808	.07158	.06185
.800	.04368	.04655	.04589	.04400	.02383	.02075	.03614	.01529
1.000	-.00590	-.01893	-.04400	.02011	-.04963	-.03242	-.00903	-.01459

## P R E S S U R E M E A S U R E M E N T S

OUTER PANEL SWEEP= 40.0000 DEGREES

FUSELAGE ON

ANGLE OF ATTACK= 4.79014 DEGREES

### S P A N W I S E L O C A T I O N

	2Y/B .14999	2Y/B .25001	2Y/B .40000	2Y/B .45001	2Y/B .50001	2Y/B .60000	2Y/B .70001	2Y/B .90001
X/C	- CPU	- CPU	- CPU	- CPU	- CPU	- CPU	- CPU	- CPU
0.000	.11534	.32148	.74338	.32361	.51835	.15531	.09896	-.00484
.025	.25128	.38790	1.29598	1.43525	1.41690	1.31916	1.25484	1.08873
.050	.23480	.36559	.86728	.81797	.82334	.86995	.82779	.74058
.075	.22950	.32452	.71071	.69345	.69194	.70295	.67829	.61323
.100	.20832	.30069	.65832	.61147	.62234	.61427	.63400	.52879
.200	.18478	.26215	.46662	.53565	.50476	.47434	.48380	.43258
.300	.19949	.25708	.42162	.44011	.44198	.42775	.44089	.38690
.400	.19243	.25150	.38402	.39388	.39604	.38633	.38344	.29066
.600	-.00765	.21499	.25519	.25704	.25302	.24526	.24775	.17855
.800	-.00765	.14451	.09554	.08753	.08154	.08801	.07405	.02215
1.000	-.00353	-.03397	-.06102	.00678	-.04789	-.03559	-.00415	-.01107
X/C	- CPL	- CPL	- CPL	- CPL	- CPL	- CPL	- CPL	- CPL
0.000	.11534	.32148	.74338	.32361	.51835	.15531	.09896	-.00484
.025	-.06120	-.01775	-.35628	-.38340	-.37145	-.37857	-.40485	-.40208
.050	-.04943	-.02738	-.31252	-.32608	-.29509	-.28862	-.30589	-.30865
.075	-.02413	-.00203	-.19910	-.21512	-.21614	-.21614	-.24360	-.22699
.100	-.00235	.01470	-.16889	-.15150	-.16760	-.16437	-.18893	-.17855
.200	.01471	.02840	-.03452	-.03883	-.04336	-.05436	-.05260	-.06298
.300	.05179	.03702	-.00308	-.02342	.02330	.02200	.00761	.02284
.400	.06826	.05273	.06102	.06534	.05630	.04853	.03391	.03737
.600	.06297	.04564	.05671	.05116	.04336	.05371	.04498	.05329
.800	.05061	.03347	.03082	.02034	.02653	.02912	.03114	.02630
1.000	-.00353	-.03397	-.06102	.00678	-.04789	-.03559	-.00415	-.01107

# APPENDIX B

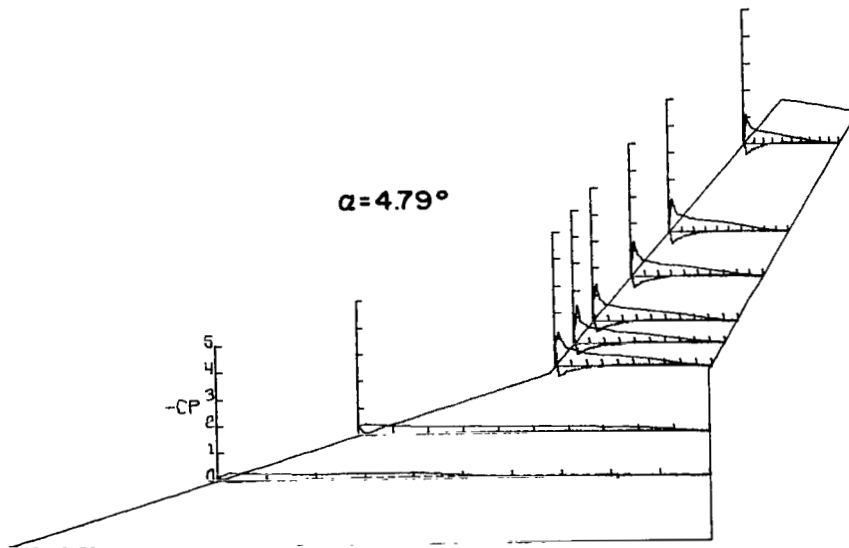
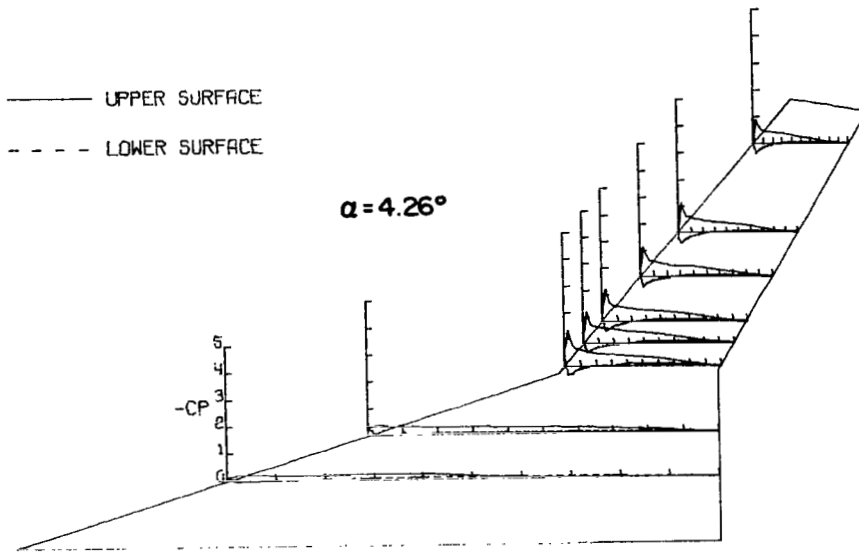

# APPENDIX B

## P R E S S U R E M E A S U R E M E N T S

OUTER PANEL SWEEP= 40.0000 DEGREES

FUSELAGE ON

ANGLE OF ATTACK= 5.31320 DEGREES

### S P A N W I S E L O C A T I O N

	2Y/B .14999	2Y/B .25001	2Y/B .40000	2Y/B .45001	2Y/B .50001	2Y/B .60000	2Y/B .70001	2Y/B .90001
X/C	-CPU	-CPU	-CPU	-CPU	-CPU	-CPU	-CPU	-CPU
0.000	.18271	.42186	1.06038	.58658	.75976	.34746	.36238	.10154
.025	.28737	.43775	1.42737	1.59949	1.37646	1.50124	1.39388	1.18383
.050	.25012	.39931	.96387	.92353	.93027	.98515	.92995	.84022
.075	.25425	.36343	.77104	.75506	.76172	.78132	.75259	.72685
.100	.20754	.34139	.70095	.66344	.59052	.68725	.69207	.62252
.200	.20163	.28090	.49312	.57552	.55463	.53503	.53696	.47437
.300	.21286	.27936	.43963	.46054	.47220	.45130	.47158	.40898
.400	.20340	.26142	.39597	.40950	.42714	.41473	.40968	.30535
.600	-.00177	.20094	.26316	.25886	.26321	.26255	.25245	.18638
.800	-.01774	.12661	.09469	.08178	.08882	.09013	.07928	.02573
1.000	-.00473	-.04101	-.06026	-.00123	-.04537	-.02874	0.00000	-.01669
X/C	-CPL	-CPL	-CPL	-CPL	-CPL	-CPL	-CPL	-CPL
0.000	.18271	.42186	1.06038	.58658	.75976	.34746	.36238	.10154
.025	-.06977	-.01845	-.40889	-.44209	-.42322	-.43302	-.45275	-.44579
.050	-.05144	-.03383	-.36154	-.38491	-.33570	-.32199	-.35260	-.34356
.075	-.02779	-.02460	-.25271	-.26378	-.26385	-.24819	-.29766	-.26567
.100	-.01064	-.01487	-.21213	-.20352	-.20955	-.19724	-.23228	-.19682
.200	.01064	.01025	-.06026	-.07071	-.36662	-.08360	-.09180	-.08346
.300	.03962	.02153	-.03197	-.04857	.00457	-.00522	-.01252	-.00487
.400	.05262	.04101	.04243	.03505	.05160	.02417	.02086	.02156
.600	.04967	.03434	.04058	.02828	.34115	.04049	.03964	.04103
.800	.03962	.01692	.02152	.00307	.02743	.01763	.02573	.01878
1.000	-.00473	-.04101	-.06026	-.00123	-.04537	-.02874	0.00000	-.01669

## P R E S S U R E M E A S U R E M E N T S

OUTER PANEL SWEEP= 40.0000 DEGREES

FUSELAGE ON

ANGLE OF ATTACK= 5.78845 DEGREES

### S P A N W I S E L O C A T I O N

	2Y/B .14999	2Y/B .25001	2Y/B .40000	2Y/B .45001	2Y/B .50001	2Y/B .60000	2Y/B .70001	2Y/B .90001
X/C	-CPU	-CPU	-CPU	-CPU	-CPU	-CPU	-CPU	-CPU
0.000	.23931	.54281	1.42354	1.03284	1.18984	.68139	.79697	.06403
.025	.31809	.51783	1.63861	1.53077	1.46512	1.60567	1.55913	.99603
.050	.27841	.43934	1.08337	1.02174	1.02532	1.08232	1.01135	.90624
.075	.27426	.37869	.84940	.87845	.83101	.84591	.81994	.81437
.100	.24109	.34913	.76311	.71688	.73709	.74357	.75868	.74128
.200	.21443	.29154	.53319	.61702	.57775	.56545	.56310	.53038
.300	.22391	.28185	.46477	.48634	.48890	.47271	.49210	.42319
.400	.21147	.26605	.41854	.43210	.43774	.42414	.42598	.30974
.600	-.00889	.21254	.27430	.26814	.27197	.25643	.26377	.18095
.800	-.00533	.12589	.09678	.08753	.08030	.08612	.07934	.03619
1.000	-.01007	-.04434	-.04192	.00555	-.04274	-.02720	.00487	-.02993
X/C	-CPL	-CPL	-CPL	-CPL	-CPL	-CPL	-CPL	-CPL
0.000	.23931	.54281	1.42354	1.03284	1.18984	.68139	.79697	.06403
.025	-.06220	-.01631	-.43950	-.45306	-.45523	-.44875	-.48895	-.44819
.050	-.05864	-.03364	-.39573	-.42593	-.35522	-.36068	-.37581	-.35842
.075	-.03080	-.02243	-.27060	-.29108	-.28622	-.28363	-.30900	-.26794
.100	-.02369	-.01121	-.23423	-.22006	-.23830	-.23053	-.25053	-.22827
.200	-.00415	.00663	-.07890	-.09986	-.09454	-.11203	-.11205	-.10022
.300	.03495	.02905	-.05116	-.05979	-.01748	-.03626	-.03549	-.02088
.400	.05568	.03721	.03267	.02651	.02849	.00842	.00139	.01392
.600	.04798	.03313	.03267	.03390	.02137	.02914	.02575	.04245
.800	.04620	.02039	.02342	.00925	.02072	.01748	.02575	.02575
1.000	-.01007	-.04434	-.04192	.00555	-.04274	-.02720	.00487	-.02993

APPENDIX B

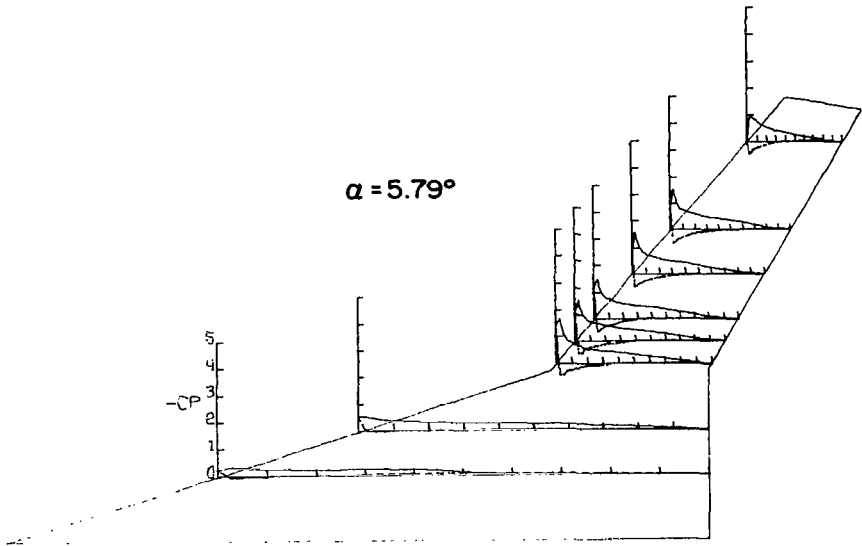
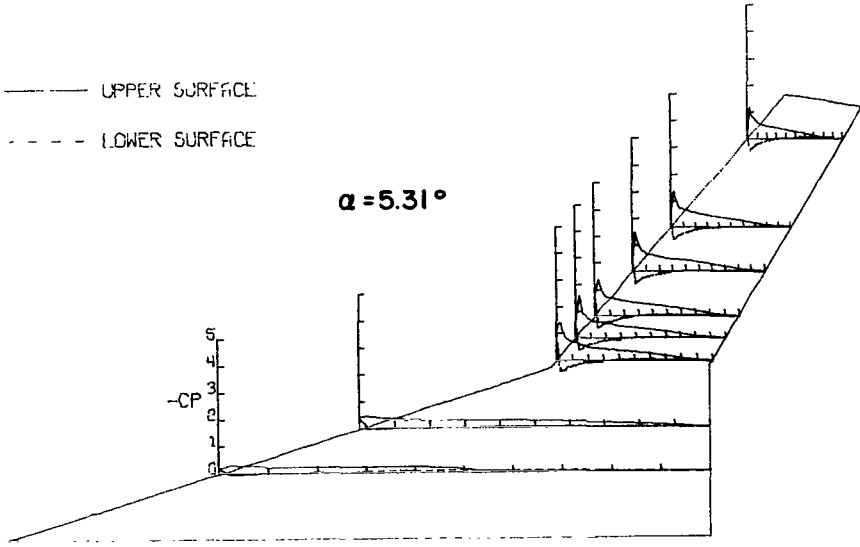

# APPENDIX B

## P R E S S U R E M E A S U R E M E N T S

OUTER PANEL SWEEP= 40.0000 DEGREES

FUSELAGE ON

ANGLE OF ATTACK= 6.32044 DEGREES

### S P A N W I S E L O C A T I O N

	2Y/B .14999	2Y/B .25001	2Y/B .40000	2Y/B .45001	2Y/B .50001	2Y/B .60000	2Y/B .70001	2Y/B .90001
X/C	-CPU	-CPU	-CPU	-CPU	-CPU	-CPU	-CPU	-CPU
0.000	.29600	.67017	1.94047	1.37545	1.50462	.81870	1.16242	.05179
.025	.33896	.56110	1.84094	1.72720	1.77437	1.79804	1.74259	.94485
.050	.29835	.48703	1.17269	1.12695	1.13284	1.21445	1.13272	.86404
.075	.29600	.41651	.92503	.89968	.90161	.93075	.88062	.82537
.100	.25010	.38100	.83970	.79951	.81935	.83101	.80672	.76528
.200	.21832	.30947	.57752	.64307	.62439	.60820	.60158	.58915
.300	.23068	.29932	.50703	.50271	.52516	.50573	.51663	.43927
.400	.21479	.27395	.44025	.45757	.45846	.45652	.43651	.32600
.600	-.00412	.22728	.28876	.27825	.29010	.27521	.27486	.18508
.800	-.00942	.13647	.11058	.10388	.09519	.11462	.08218	.05801
1.000	-.00294	-.03602	-.02968	.00618	-.02914	-.01295	.00691	-.01174
X/C	-CPL	-CPL	-CPL	-CPL	-CPL	-CPL	-CPL	-CPL
0.000	.29600	.67017	1.94047	1.37545	1.50462	.81870	1.16242	.05179
.025	-.06944	-.01065	-.47426	-.49034	-.49149	-.47854	-.52002	-.45787
.050	-.06297	-.03653	-.42109	-.45324	-.38400	-.39177	-.40745	-.36118
.075	-.04002	-.03044	-.30484	-.31164	-.31924	-.30758	-.34392	-.29558
.100	-.02825	-.02486	-.26403	-.25475	-.26355	-.25902	-.28591	-.23480
.200	-.01353	-.00203	-.10326	-.12181	-.11462	-.13598	-.13467	-.12362
.300	.03295	.00913	-.06802	-.06987	-.33825	-.03367	-.05663	-.02072
.400	.04472	.02638	.01422	.01855	.01425	.00777	-.01381	-.01312
.600	.03531	.02486	.02473	.01855	.02720	.02590	.02072	.04075
.800	.03472	.00812	.01237	.00618	.01554	.01554	.01588	.02555
1.000	-.00294	-.03602	-.02968	.00618	-.02914	-.01295	.00691	-.01174

## P R E S S U R E M E A S U R E M E N T S

OUTER PANEL SWEEP= 40.0000 DEGREES

FUSELAGE ON

ANGLE OF ATTACK= 7.33740 DEGREES

### S P A N W I S E L O C A T I O N

	2Y/B .14999	2Y/B .25001	2Y/B .40000	2Y/B .45001	2Y/B .50001	2Y/B .60000	2Y/B .70001	2Y/B .90001
X/C	-CPU	-CPU	-CPU	-CPU	-CPU	-CPU	-CPU	-CPU
0.000	.39533	.90565	2.92039	2.18659	2.41558	1.35115	1.91660	.08431
.025	.42881	.67708	2.15761	2.08916	2.06700	2.14560	1.98019	.89437
.050	.35363	.56711	1.34550	1.32885	1.29703	1.46842	1.29041	.91994
.075	.33424	.48855	1.05753	1.06925	1.03543	1.13917	1.05126	.91165
.100	.27844	.42825	.94307	.91778	.90914	.96327	.92409	.86258
.200	.25083	.34361	.64331	.72596	.68234	.68492	.67112	.69047
.300	.23908	.32841	.53784	.56745	.56765	.55605	.56606	.51215
.400	.22204	.30155	.47308	.48295	.48506	.47862	.47345	.40018
.600	-.00235	.24174	.30408	.30038	.28408	.28859	.28196	.22460
.800	.00235	.15559	.14865	.10794	.09920	.10951	.10021	.08984
1.000	-.00822	-.03497	.00062	.06476	-.01031	-.00322	.02142	.05045
X/C	-CPL	-CPL	-CPL	-CPL	-CPL	-CPL	-CPL	-CPL
0.000	.39533	.90565	2.92039	2.18659	2.41558	1.35115	1.91660	.08431
.025	-.07343	.02281	-.49281	-.51995	-.52986	-.51791	-.54872	-.47823
.050	-.07813	-.02990	-.46444	-.45581	-.45156	-.44061	-.45957	-.40497
.075	-.06285	-.03193	-.35034	-.38179	-.37168	-.37426	-.39253	-.32619
.100	-.04171	-.03142	-.30963	-.34664	-.31564	-.31951	-.32273	-.27712
.200	-.03055	-.01520	-.14865	-.16098	-.17070	-.17135	-.19074	-.14236
.300	0.00000	.00355	-.09869	-.13631	-.06699	-.09212	-.08915	-.05667
.400	.03113	.00304	-.01974	-.00802	-.02190	-.03607	-.04354	-.01728
.600	.01175	-.00101	.00493	.00555	-.00133	-.00129	-.00138	.02833
.800	.02408	-.00608	.00308	-.00123	.00515	.00258	.00829	.02695
1.000	-.00822	-.03497	.00062	.06476	-.01031	-.00322	.02142	.05045

# APPENDIX B

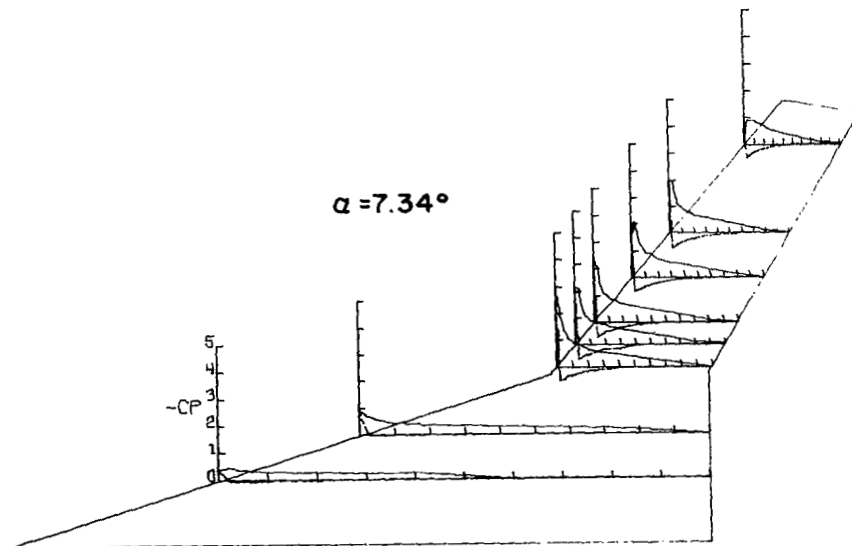
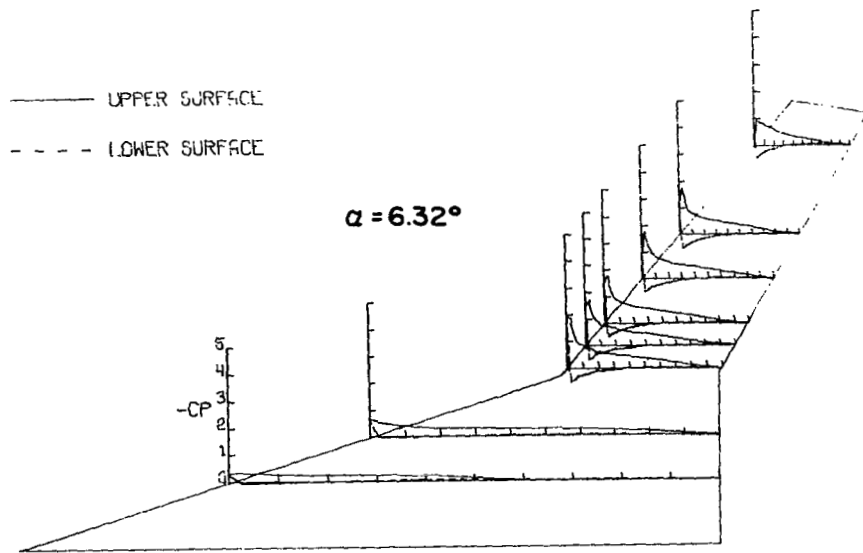

# APPENDIX B

## P R E S S U R E M E A S U R E M E N T S

OUTER PANEL SWEEP= 40.00000 DFGRS

FUSELAGE ON

ANGLE OF ATTACK= 8.40370 DEGREES

### S P A N W I S E L O C A T I O N

	2Y/B .14999	2Y/B .25001	2Y/B .40000	2Y/B .45001	2Y/B .50001	2Y/B .60000	2Y/B .70001	2Y/B .90001
X/C	- CPU	- CPU	- CPU	- CPU	- CPU	- CPU	- CPU	- CPU
0.000	.56828	1.20562	3.81269	3.21874	3.28432	1.49199	2.78188	.11243
.025	.49372	.81837	2.37395	2.39996	2.40984	2.71536	1.89207	.81624
.050	.40332	.65664	1.49262	1.51926	1.49254	1.88424	1.50685	.80167
.075	.36750	.56531	1.22569	1.20711	1.18936	1.48228	1.23338	.79889
.100	.30997	.48776	1.06837	1.01944	1.03112	1.11721	1.09040	.83082
.200	.26770	.38776	.73163	.77623	.75797	.74567	.74753	.71838
.300	.26007	.35867	.59410	.59926	.60456	.59679	.60871	.58095
.400	.24187	.32959	.50056	.50179	.50476	.49117	.49627	.43866
.600	-.00822	.26072	.32214	.29860	.28797	.28991	.29634	.22971
.800	-.00763	.15612	.15673	.13257	.38995	.12036	.11035	.12353
1.000	-.00646	-.04184	.00558	.03036	.01553	.02136	.03886	.07703
X/C	- CPL	- CPL	- CPL	- CPL	- CPL	- CPL	- CPL	- CPL
0.000	.56828	1.20562	3.81269	3.21874	3.28432	1.49199	2.78188	.11243
.025	-.05695	.06888	-.50241	-.53649	-.54517	-.53323	-.56352	-.50384
.050	-.08865	-.01224	-.49560	-.50551	-.48922	-.48599	-.49968	-.43375
.075	-.07162	-.03265	-.40267	-.41073	-.42322	-.41028	-.43375	-.35047
.100	-.06458	-.03265	-.37046	-.39958	-.35851	-.35980	-.37962	-.30119
.200	-.04873	-.03929	-.19452	-.21497	-.21293	-.22455	-.22694	-.17489
.300	-.01115	-.02908	-.14372	-.18089	-.11001	-.12360	-.13047	-.08536
.400	.00176	-.01327	-.05204	-.04089	-.05436	-.05759	-.07079	-.03262
.600	-.00235	-.01327	-.01425	-.02354	-.02394	-.02136	-.02087	.01319
.800	.00646	-.02602	-.01239	-.01239	-.30055	-.00259	0.00000	.02776
1.000	-.00646	-.04184	.00558	.03036	.01553	.02136	.03886	.07703

## P R E S S U R E M E A S U R E M E N T S

OUTER PANEL SWEEP= 40.00000 DFGRS

FUSELAGE ON

ANGLE OF ATTACK= 9.47055 DEGREES

### S P A N W I S E L O C A T I O N

	2Y/B .14999	2Y/B .25001	2Y/B .40000	2Y/B .45001	2Y/B .50001	2Y/B .60000	2Y/B .70001	2Y/B .90001
X/C	- CPU	- CPU	- CPU	- CPU	- CPU	- CPU	- CPU	- CPU
0.000	.78917	1.61005	3.85138	2.03559	3.28227	1.14659	2.24090	.12106
.025	.60151	.99968	2.66720	1.85963	1.97328	1.32643	1.98884	.79582
.050	.47326	.77811	1.88000	1.81394	1.60799	1.26605	1.45924	.79936
.075	.41666	.63315	1.42930	1.57686	1.52529	1.21091	1.26312	.75051
.100	.36127	.56222	1.20827	1.33854	1.34415	1.18729	1.11160	.74555
.200	.29985	.44005	.81950	.90905	.90966	.94051	.83405	.70024
.300	.28841	.40743	.63424	.65585	.70686	.75411	.68537	.66059
.400	.26914	.37171	.51196	.54160	.56247	.60119	.56217	.60111
.600	-.00421	.28940	.33410	.33101	.33136	.34842	.33631	.52323
.800	.00482	.18896	.15810	.15501	.14531	.18766	.19397	.33490
1.000	-.00060	-.03676	.00741	.02408	.04265	.04790	.14867	.24282
X/C	- CPL	- CPL	- CPL	- CPL	- CPL	- CPL	- CPL	- CPL
0.000	.78917	1.61005	3.85138	2.03559	3.28227	1.14659	2.24090	.12106
.025	-.03613	.11234	-.54160	-.54345	-.57395	-.51902	-.56210	-.53662
.050	-.09092	.00052	-.54963	-.53172	-.53237	-.48949	-.51113	-.44883
.075	-.08068	-.03158	-.47367	-.44711	-.47447	-.42125	-.46441	-.37237
.100	-.07767	-.04349	-.44094	-.44279	-.42519	-.38320	-.40211	-.32777
.200	-.05238	-.05281	-.25135	-.25011	-.25459	-.23490	-.24070	-.17557
.300	-.02529	-.03674	-.20997	-.20380	-.14042	-.14304	-.14088	-.08212
.400	-.00120	-.03883	-.09819	-.08522	-.07874	-.08071	-.08354	-.03257
.600	-.01505	-.03831	-.05188	-.04817	-.04265	-.02100	-.01841	.03398
.800	-.00181	-.02640	-.02656	-.03150	.00394	.00656	.02336	.07150
1.000	-.00060	-.03676	.00741	.02408	.04265	.04790	.14867	.24282



# APPENDIX B

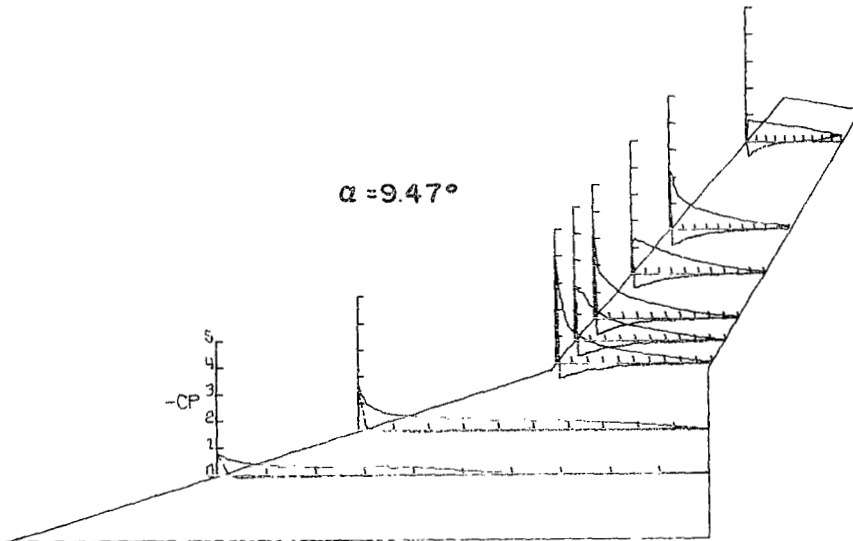
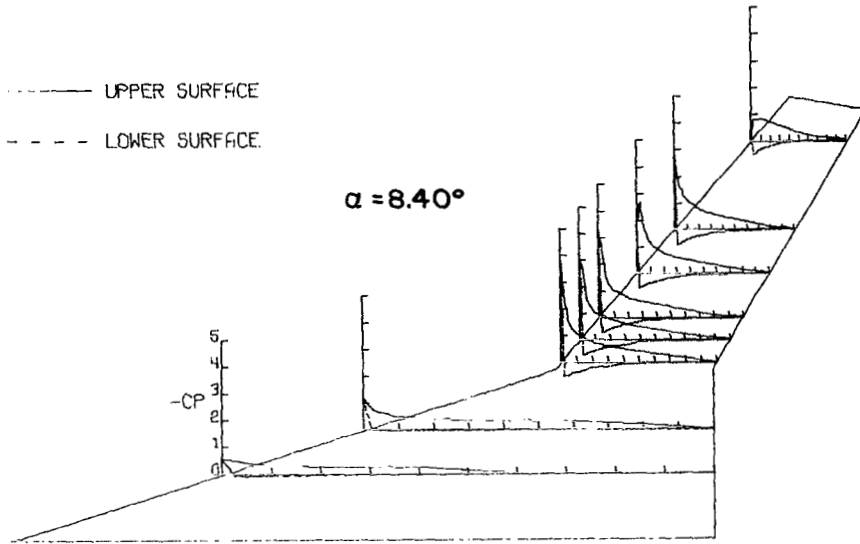

# APPENDIX B

## P R E S S U R E M E A S U R E M E N T S

OUTER PANEL SWEEP= 40.0000 DEGREES

FUSELAGE ON

ANGLE OF ATTACK= 10.48599 DEGREES

### S P A N W I S E L O C A T I O N

	2Y/B .14999	2Y/B .25001	2Y/B .40000	2Y/B .45001	2Y/B .50001	2Y/B .60000	2Y/B .70001	2Y/B .90001
X/C	- CPU	- CPU	- CPU	- CPU	- CPU	- CPU	- CPU	- CPU
0.000	.96204	1.93259	3.93222	2.13488	2.30047	1.41464	1.65965	.06877
.025	.66259	1.10484	2.29467	1.83636	1.97557	1.38580	1.64658	.68367
.050	.51509	.84542	1.80168	1.69143	1.75756	1.33324	1.54272	.59769
.075	.45831	.69400	1.52359	1.54898	1.50630	1.29478	1.34533	.70774
.100	.38983	.61677	1.42078	1.22321	1.37746	1.15761	1.31231	.71118
.200	.32544	.49009	1.07704	1.05413	.99800	1.10248	.93746	.62245
.300	.30788	.45425	.87783	.75207	.66213	.82302	.70843	.55643
.400	.28622	.37653	.78119	.58109	.52945	.60701	.57843	.55849
.600	-.00644	.29930	.47330	.40515	.35694	.36719	.43331	.42850
.800	-.00995	.21552	.23727	.23045	.18775	.18584	.21869	.36316
1.000	-.00351	-.03382	.07186	.03779	.11599	.09420	.14717	.29228

	- CPL	- CPL	- CPL	- CPL	- CPL	- CPL	- CPL	- CPL
X/C	- CPU	- CPU	- CPU	- CPU	- CPU	- CPU	- CPU	- CPU
0.000	.96204	1.93259	3.93222	2.13488	2.30047	1.41464	1.65965	.06877
.025	-.02341	.19381	-.49498	-.54330	-.53893	-.53508	-.54398	-.53641
.050	-.08938	.03281	-.52905	-.52843	-.53148	-.52035	-.51097	-.44426
.075	-.09365	-.02069	-.47330	-.49126	-.47933	-.45690	-.45939	-.38924
.100	-.08780	-.04187	-.44480	-.45657	-.42935	-.40692	-.41194	-.33698
.200	-.08078	-.06561	-.25523	-.26700	-.27299	-.26594	-.24689	-.18568
.300	-.04858	-.05653	-.22798	-.23541	-.17110	-.16149	-.15405	-.10041
.400	-.03161	-.06006	-.09602	-.09107	-.09164	-.10317	-.09353	-.04057
.600	-.03512	-.05401	-.03841	-.02974	-.03845	-.02948	-.01444	.03714
.800	-.00702	-.03483	-.00991	.00496	.01474	.01922	.02613	.09765
1.000	-.00351	-.03382	.07186	.03779	.11599	.09420	.14717	.29228

## P R E S S U R E M E A S U R E M E N T S

OUTER PANEL SWEEP= 40.0000 DEGREES

FUSELAGE ON

ANGLE OF ATTACK= 11.54549 DEGREES

### S P A N W I S E L O C A T I O N

	2Y/B .14999	2Y/B .25001	2Y/B .40000	2Y/B .45001	2Y/B .50001	2Y/B .60000	2Y/B .70001	2Y/B .90001
X/C	- CPU	- CPU	- CPU	- CPU	- CPU	- CPU	- CPU	- CPU
0.000	1.19248	2.36889	3.87520	2.37255	2.19191	1.59536	1.46654	-.03136
.025	.76710	1.26633	1.93637	1.63474	1.70583	1.52647	1.55297	.51371
.050	.57147	.93674	1.52907	1.64641	1.58326	1.45759	1.39126	.48861
.075	.49373	.75766	1.40068	1.56532	1.48229	1.39391	1.34944	.48373
.100	.42786	.69031	1.38962	1.48730	1.33677	1.45564	1.24837	.48861
.200	.35190	.67551	1.34354	1.07201	.91367	1.45499	1.09433	.49210
.300	.34537	.45919	1.24894	.89006	.57648	1.11318	1.01626	.47328
.400	.30958	.36735	.98355	.68515	.55301	.75576	.80576	.40149
.600	-.01899	.31480	.51371	.50019	.37681	.35278	.66217	.40149
.800	-.01128	.22653	.25255	.34595	.26637	.16957	.43215	.31227
1.000	0.00000	-.03469	.07067	.04363	.19880	.09940	.25159	.31575

	- CPL	- CPL	- CPL	- CPL	- CPL	- CPL	- CPL	- CPL
X/C	- CPU	- CPU	- CPU	- CPU	- CPU	- CPU	- CPU	- CPU
0.000	1.19248	2.36889	3.87520	2.37255	2.19191	1.59536	1.46654	-.03136
.025	.01306	.27398	-.46086	-.52723	-.53144	-.54118	-.56940	-.52549
.050	-.08367	.06276	-.51985	-.54935	-.53599	-.53534	-.53734	-.45580
.075	-.09732	-.00765	-.48729	-.50818	-.49505	-.48726	-.48019	-.37844
.100	-.09910	-.03980	-.45841	-.48483	-.45478	-.43528	-.43140	-.32686
.200	-.08664	-.07092	-.28819	-.29372	-.29885	-.27027	-.26693	-.18817
.300	-.06468	-.08061	-.26239	-.27898	-.17931	-.18451	-.15866	-.07597
.400	-.03739	-.08214	-.13396	-.11860	-.11824	-.10655	-.10942	-.01324
.600	-.04866	-.07296	-.07005	-.05469	-.05003	-.02079	-.02300	.06830
.800	-.02314	-.04286	-.02151	-.00614	.03248	.03248	.04182	.12684
1.000	0.00000	-.03469	.07067	.04363	.19880	.09940	.25159	.31575

APPENDIX B

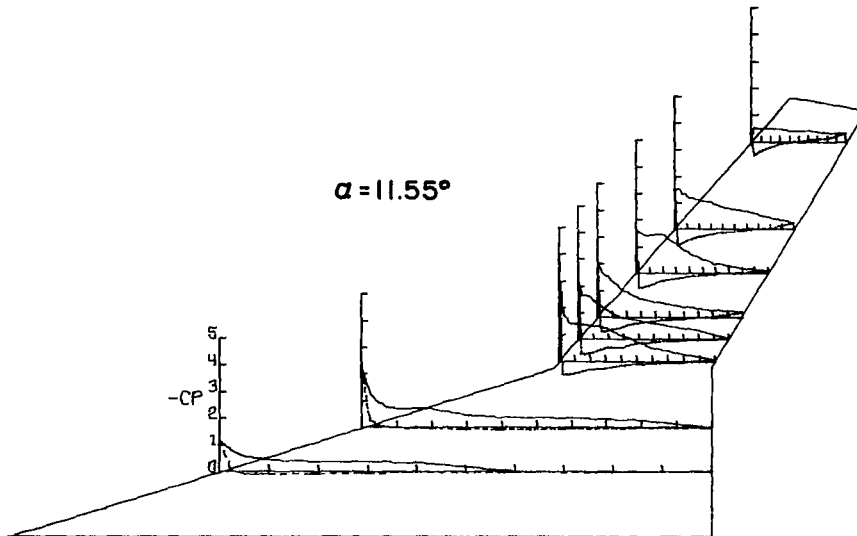
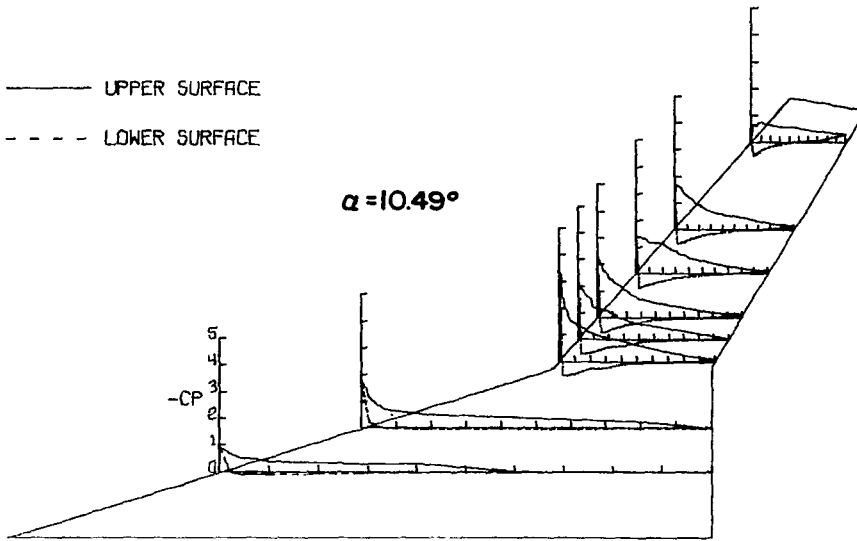

# APPENDIX B

## P R E S S U R E M E A S U R E M E N T S

OUTER PANEL SWEEP= 40.00000 DEGREES

FUSELAGE ON

ANGLE OF ATTACK= 12.60333 DEGREES

### S P A N W I S E L O C A T I O N

	2Y/B .14999	2Y/B .25001	2Y/B .40000	2Y/B .45001	2Y/B .50001	2Y/B .60000	2Y/B .70001	2Y/B .90001
X/C	- CPU	- CPU	- CPU	- CPU	- CPU	- CPU	- CPU	- CPU
0.000	1.44735	2.82330	3.56479	2.46654	2.21640	1.59486	1.49735	-.02882
.025	.85337	1.36661	1.79737	1.77928	1.47935	1.63096	1.23795	.45272
.050	.62849	.92755	1.37328	1.76244	1.38418	1.53842	1.32161	.46116
.075	.53075	.81945	1.27849	1.80797	1.46622	1.62111	1.18382	.47667
.100	.44900	.80401	1.23421	1.66702	1.25670	1.71891	1.27179	.50052
.200	.40991	1.17410	1.17995	1.07268	.84009	1.68675	.98628	.41546
.300	.36074	.37061	1.25479	.80471	.57601	1.16825	1.17257	.38734
.400	.31750	.37781	1.22111	.77414	.58639	.48818	1.15289	.41476
.600	-.00355	.29803	.84214	.65091	.46357	.25984	.88084	.36696
.800	-.00829	.17089	.49156	.49967	.36811	.19422	.50615	.34235
1.000	-.00355	-.03037	.17591	.07236	.33454	.14370	.15323	.36696
X/C	- CPL	- CPL	- CPL	- CPL	- CPL	- CPL	- CPL	- CPL
0.000	1.44735	2.82330	3.56479	2.46654	2.21640	1.59486	1.49735	-.02882
.025	.04146	.35156	-.45039	-.52150	-.54139	-.55642	-.58902	-.54474
.050	-.08115	.10758	-.52150	-.54708	-.55430	-.54461	-.54966	-.46602
.075	-.10544	.00824	-.50653	-.51776	-.52335	-.49146	-.51241	-.40206
.100	-.11669	-.02882	-.45288	-.50965	-.46850	-.46522	-.44282	-.35496
.200	-.11847	-.09780	-.32188	-.32313	-.32742	-.31158	-.30154	-.20173
.300	-.09122	-.09831	-.26948	-.30567	-.20275	-.19619	-.18556	-.09981
.400	-.07227	-.09574	-.15034	-.14036	-.12861	-.12664	-.11387	-.07866
.600	-.07641	-.09214	-.07361	-.06987	-.04793	-.02953	-.02460	.05904
.800	-.03376	-.06692	-.02682	-.01248	.05315	.04659	.04077	.14128
1.000	-.00355	-.03037	.17591	.07236	.33464	.14370	.15323	.36696

## P R E S S U R E M E A S U R E M E N T S

OUTER PANEL SWEEP= 40.00000 DEGREES

FUSELAGE ON

ANGLE OF ATTACK= 13.59268 DEGREES

### S P A N W I S E L O C A T I O N

	2Y/B .14999	2Y/B .25001	2Y/B .40000	2Y/B .45001	2Y/B .50001	2Y/B .60000	2Y/B .70001	2Y/B .90001
X/C	- CPU	- CPU	- CPU	- CPU	- CPU	- CPU	- CPU	- CPU
0.000	1.72044	3.30616	3.79538	2.65646	2.22772	1.16988	.70306	-.18453
.025	.93469	1.38183	1.92491	1.88393	1.58112	1.09602	.68210	.30286
.050	.68019	.93958	1.56709	1.77139	1.46308	1.09602	.60977	.27713
.075	.57305	.91427	1.43130	1.83867	1.43090	1.16237	.65168	.26834
.100	.49885	.96936	1.39399	1.76405	1.21432	1.05533	.63275	.24807
.200	.47431	1.47266	1.21049	1.27655	1.08748	1.22684	.63072	.28862
.300	.35730	.79068	1.34628	1.07516	.98085	1.13357	.56515	.26834
.400	.35554	.37573	1.62031	1.01292	.81938	.95330	.60368	.25418
.600	-.00114	.31319	1.20132	-.97317	.78430	.70481	.58746	.25753
.800	-.00400	.19209	.58000	-.77517	.62156	.58963	.51174	.21765
1.000	0.00000	-.04666	.21046	.08933	.55082	.44618	.53405	.29538
X/C	- CPL	- CPL	- CPL	- CPL	- CPL	- CPL	- CPL	- CPL
0.000	1.72044	3.30616	3.79538	2.65646	2.22772	1.16988	.70306	-.18453
.025	.08790	.44026	-.39217	-.48150	-.54819	-.56696	-.57725	-.49343
.050	-.05993	.15833	-.49007	-.54023	-.56258	-.55194	-.51505	-.42178
.075	-.10103	.03276	-.48089	-.51025	-.53504	-.50198	-.47518	-.36838
.100	-.11872	-.03276	-.44051	-.50658	-.49137	-.46433	-.42746	-.32747
.200	-.12329	-.10374	-.30468	-.32304	-.32916	-.30726	-.25685	-.17845
.300	-.10217	-.11912	-.23677	-.23249	-.22273	-.19712	-.15344	-.07773
.400	-.08790	-.11217	-.13766	-.13032	-.13830	-.10763	-.07908	-.01960
.600	-.09189	-.09480	-.10279	-.04895	-.04443	.00688	.03988	.07097
.800	-.05479	-.06254	-.00673	.03977	.06758	.11765	.14600	.12032
1.000	0.00000	-.04666	.21046	.08933	.55032	.44618	.53405	.29538

# APPENDIX B

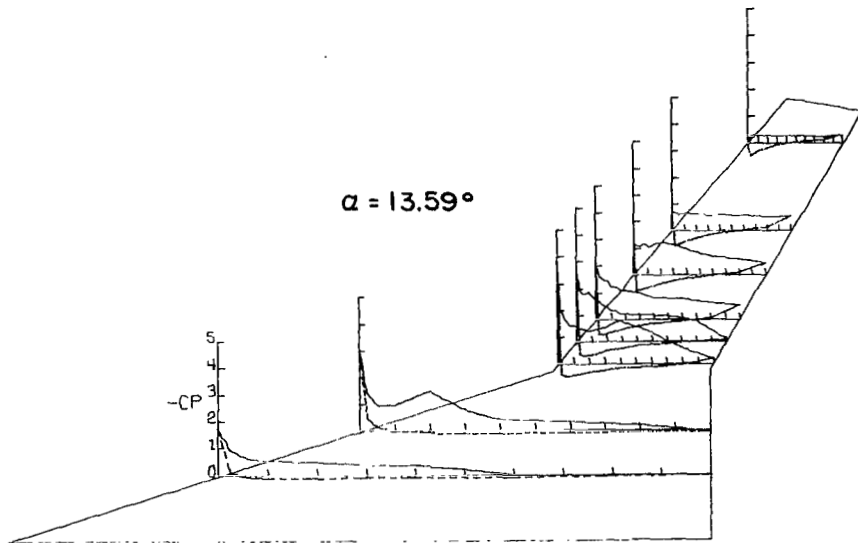
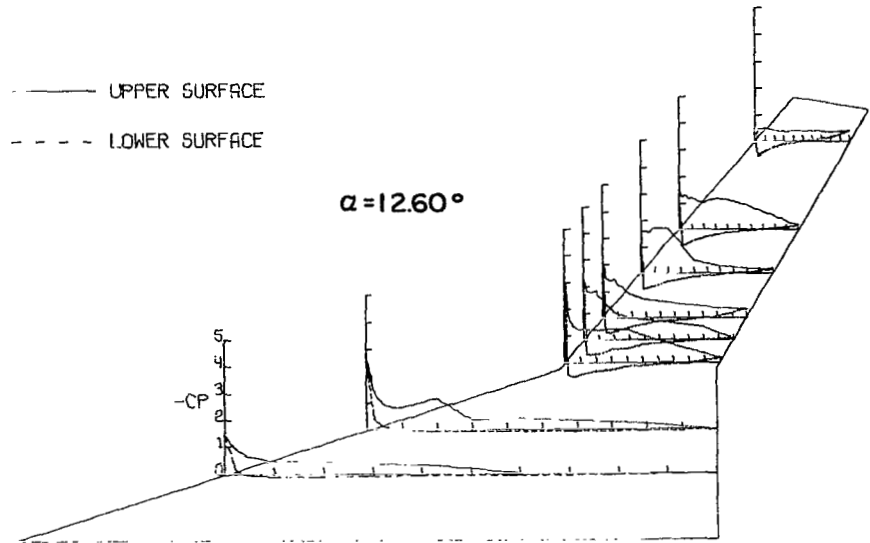

# APPENDIX B

## P R E S S U R E M E A S U R E M E N T S

OUTER PANEL SWEEP= 40.0000 DEGREES

FUSELAGE ON

ANGLE OF ATTACK= 14.62674 DEGREES

### S P A N W I S E L O C A T I O N

	2Y/B .14999	2Y/B .25001	2Y/B .40000	2Y/B .45001	2Y/B .50001	2Y/B .60000	2Y/B .70001	2Y/B .90001
X/C	-CPU	-CPU	-CPU	-CPU	-CPU	-CPU	-CPU	-CPU
0.000	2.00496	3.70762	3.82099	2.70952	2.23942	1.06476	.62039	-.14662
.025	1.06564	1.30706	1.99117	1.91498	1.53058	1.02659	.52874	.25306
.050	.73877	1.06256	1.71394	1.78821	1.70243	.92985	.49420	.24531
.075	.63475	1.07443	1.56285	1.98541	1.59846	.94038	.51182	.24108
.100	.59942	1.15592	1.54172	2.09809	1.72341	.94170	.52945	.26081
.200	.55331	1.66606	1.35413	1.41943	1.45637	.96078	.45190	.25729
.300	.36468	1.08784	1.35605	1.09483	1.14504	1.07200	.48151	.26504
.400	.37786	.41677	1.68449	1.08394	.97532	.96671	.48433	.24954
.600	-.00120	.32960	1.39126	1.12620	.97329	.86668	.48574	.24249
.800	-.00240	.19601	.70701	.92731	.80548	.69032	.51182	.26222
1.000	.00659	-.05932	.30483	.14473	.69229	.52238	.51464	.30240
X/C	-CPL	-CPL	-CPL	-CPL	-CPL	-CPL	-CPL	-CPL
0.000	2.00496	3.70762	3.82099	2.70952	2.23942	1.06476	.62039	-.14662
.025	.13474	.56017	-.37015	-.46429	-.54606	-.56975	-.59564	-.50894
.050	-.04970	.20168	-.50272	-.54883	-.59541	-.56514	-.54489	-.44902
.075	-.09881	.05829	-.51232	-.52897	-.56975	-.51580	-.49907	-.38417
.100	-.12875	-.02940	-.47966	-.53154	-.52370	-.48554	-.44620	-.34047
.200	-.14432	-.12586	-.34774	-.34838	-.36309	-.32238	-.28267	-.19808
.300	-.13533	-.13824	-.26961	-.33941	-.25056	-.21711	-.16918	-.09657
.400	-.11018	-.13720	-.16394	-.15754	-.14737	-.12303	-.07895	-.03877
.600	-.11018	-.12895	-.11783	-.05251	-.05137	.01908	.03454	.07120
.800	-.05689	-.09285	-.00384	.04419	.10461	.14935	.16918	.11349
1.000	.00659	-.05932	.30483	.14473	.69229	.52238	.51464	.30240

## P R E S S U R E M E A S U R E M E N T S

OUTER PANEL SWEEP= 40.0000 DEGREES

FUSELAGE ON

ANGLE OF ATTACK= 15.63743 DEGREES

### S P A N W I S E L O C A T I O N

	2Y/B .14999	2Y/B .25001	2Y/B .40000	2Y/B .45001	2Y/B .50001	2Y/B .60000	2Y/B .70001	2Y/B .90001
X/C	-CPU	-CPU	-CPU	-CPU	-CPU	-CPU	-CPU	-CPU
0.000	2.30506	4.01569	3.48737	2.58070	2.30843	1.05188	.71965	-.08026
.025	1.15992	1.27085	1.91630	1.83635	1.53835	.96508	.56190	.28754
.050	.76539	1.26423	1.57289	1.66313	1.64453	1.00654	.56469	.26940
.075	.68791	1.26677	1.37947	1.66919	1.56785	.85562	.49279	.26172
.100	.69264	1.28612	1.37908	2.13676	1.81154	.88542	.49140	.27359
.200	.62063	1.81258	1.17134	1.21071	1.52406	.90096	.45789	.25614
.300	.38694	1.02085	1.07383	.88327	1.40876	.96703	.52211	.26172
.400	.36800	.47504	1.20162	.84147	1.02995	1.02079	.47046	.27498
.600	.00118	.32840	1.16528	.95451	.87117	.95083	.48232	.26730
.800	-.00296	.19093	.72273	.78634	.83036	.75652	.45318	.24148
1.000	-.00177	-.05397	.34410	.11874	.56221	.52982	.51094	.30220
X/C	-CPL	-CPL	-CPL	-CPL	-CPL	-CPL	-CPL	-CPL
0.000	2.30506	4.01569	3.48737	2.58070	2.30843	1.05188	.71965	-.08026
.025	.18696	.61964	-.36833	-.46284	-.52322	-.56596	-.57997	-.52554
.050	-.04023	.23828	-.05524	-.56340	-.57891	-.57826	-.54438	-.46970
.075	-.10886	.06364	-.51918	-.55916	-.56531	-.53164	-.49413	-.41387
.100	-.13489	-.03870	-.51009	-.54947	-.53359	-.50120	-.45574	-.35524
.200	-.16152	-.13900	-.39438	-.41680	-.39112	-.34514	-.30499	-.22054
.300	-.15324	-.15173	-.30775	-.34228	-.26355	-.23053	-.18844	-.11655
.400	-.13371	-.16038	-.22294	-.20779	-.18326	-.14311	-.11237	-.04816
.600	-.13134	-.14205	-.13812	-.09996	-.06087	-.00583	.02233	.05234
.800	-.07277	-.08656	-.03574	.01939	.08742	.14505	.16611	.11097
1.000	-.00177	-.05397	.34410	.11874	.56221	.52982	.51094	.30220

# APPENDIX B

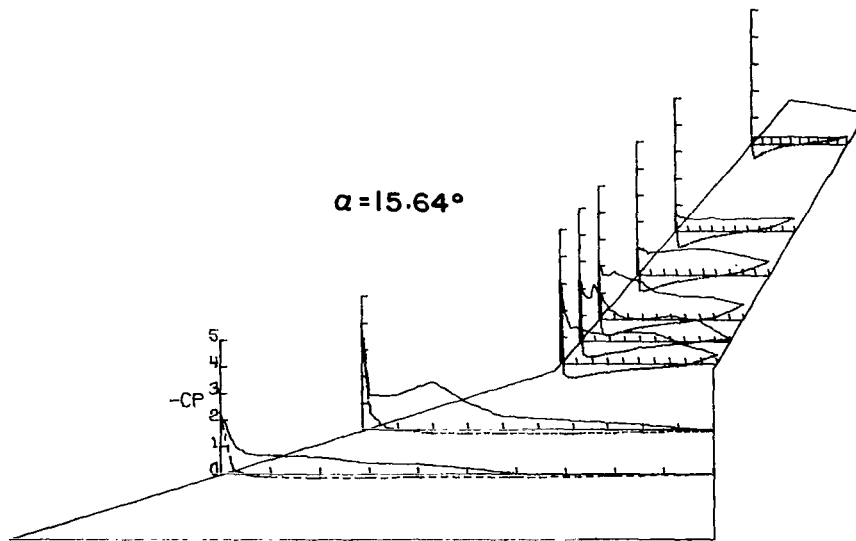
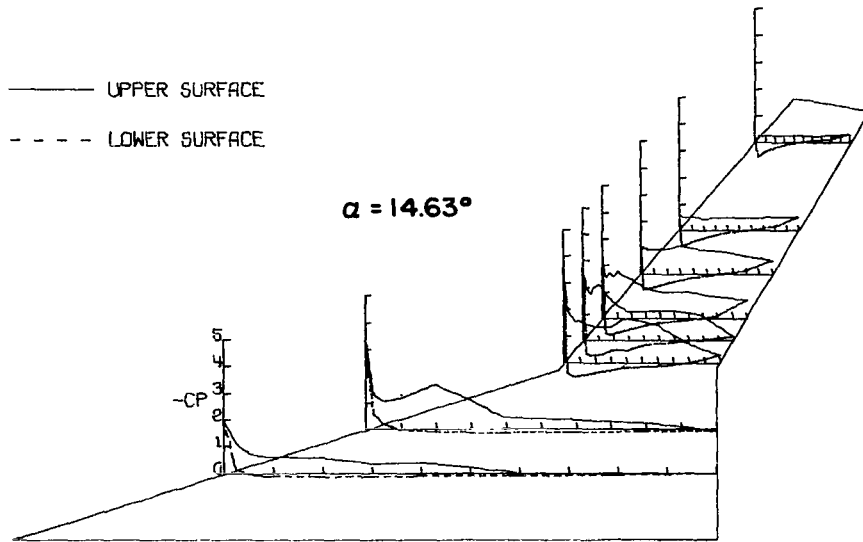

# APPENDIX B

## P R E S S U R E M E A S U R E M E N T S

OUTER PANEL SWEEP= 40.0000 DEGREES

FUSELAGE ON

ANGLE OF ATTACK= 16.66450 DEGREES

### S P A N W I S E L O C A T I O N

	2Y/B .14999	2Y/B .25001	2Y/B .40000	2Y/B .45001	2Y/B .50001	2Y/B .60000	2Y/B .70001	2Y/B .90001
X/C	-CPU	-CPU	-CPU	-CPU	-CPU	-CPU	-CPU	-CPU
0.000	2.67863	2.70481	3.75148	2.64000	2.38174	1.13608	.89024	.06055
.025	1.24410	1.57806	2.07657	1.90557	1.59142	.95537	.59372	.31391
.050	.81457	1.94271	1.65523	1.87819	1.62540	.92363	.59581	.24219
.075	.80923	1.68782	1.50945	2.12455	1.59142	.92946	.52551	.29926
.100	.84957	2.17965	1.48362	2.55511	1.79480	.96768	.51298	.26585
.200	.60351	2.38735	1.16746	1.25480	2.11865	.93987	.55474	.27629
.300	.40531	1.11341	.98416	.82567	1.48001	.99035	.53734	.28952
.400	.40946	.61851	1.00322	.85212	1.00459	1.12118	.56101	.29439
.600	.00297	.36054	1.19760	.82751	.76235	1.02014	.64036	.28952
.800	.00593	.20566	.68416	.79736	.72673	.78632	.56170	.22758
1.000	-.00059	-.04257	.46021	.14889	.62439	.49732	.58259	.31739

	-CPL	-CPL	-CPL	-CPL	-CPL	-CPL	-CPL	-CPL
0.000	2.67863	2.70481	3.75148	2.64000	2.38174	1.13608	.89024	.06055
.025	.25577	.60722	-.31378	-.43314	-.50509	-.55495	-.56790	-.54911
.050	-.01780	.22002	-.49282	-.54942	-.59186	-.58020	-.56163	-.49065
.075	-.10088	.05744	-.51620	-.55926	-.56337	-.54459	-.51501	-.43428
.100	-.12937	-.03744	-.50758	-.54880	-.54200	-.50832	-.47882	-.38417
.200	-.18752	-.14411	-.39684	-.43191	-.40407	-.37299	-.32292	-.25054
.300	-.17565	-.15642	-.31685	-.37346	-.27974	-.25384	-.20670	-.14058
.400	-.15607	-.16258	-.22580	-.21042	-.19038	-.15865	-.13362	-.06472
.600	-.14480	-.15591	-.12551	-.10090	-.06475	-.02072	-.01322	.03410
.800	-.08071	-.10257	-.02092	.02584	.38612	1.0879	.15079	.10509
1.000	-.00059	-.04257	.46021	.14889	.62439	.49732	.58259	.31739

## P R E S S U R E M E A S U R E M E N T S

OUTER PANEL SWEEP= 40.0000 DEGREES

FUSELAGE ON

ANGLE OF ATTACK= 17.55453 DEGREES

### S P A N W I S E L O C A T I O N

	2Y/B .14999	2Y/B .25001	2Y/B .40000	2Y/B .45001	2Y/B .50001	2Y/B .60000	2Y/B .70001	2Y/B .90001
X/C	-CPU	-CPU	-CPU	-CPU	-CPU	-CPU	-CPU	-CPU
0.000	2.98659	1.99802	3.70304	2.31440	1.85526	1.03056	1.07475	.23261
.025	1.33074	1.76744	2.13367	1.90500	1.56303	.89566	.61016	.29111
.050	.89093	1.75824	1.69415	1.89824	1.71739	.97543	.57116	.28624
.075	.92540	1.85742	1.54170	2.51602	1.69459	.96506	.58439	.28206
.100	1.01336	2.13862	1.41876	2.69675	1.78678	.89566	.55723	.30156
.200	.63968	2.52206	1.07698	1.31733	2.38151	.98581	.57325	.27858
.300	.43220	1.55629	.99891	.88971	1.29128	1.05585	.57951	.26256
.400	.42863	.79246	.98600	.88295	1.00916	1.04483	.63106	.27370
.600	.00416	.40390	1.08374	.91000	.83340	.96116	.55305	.28485
.800	.00773	.33897	.67266	.74153	.62067	.72379	.54956	.24167
1.000	.00238	-.02505	.52264	.17401	.53201	.55387	.54260	.31831

	-CPL	-CPL	-CPL	-CPL	-CPL	-CPL	-CPL	-CPL
0.000	2.98659	1.99802	3.70304	2.31440	1.85526	1.03056	1.07475	.23261
.025	.32519	.61454	-.30866	-.41196	-.49857	-.52974	-.54323	-.54323
.050	.01308	.25154	-.50050	-.54908	-.58356	-.58421	-.56412	-.50632
.075	-.09096	.06851	-.52510	-.57490	-.58032	-.55827	-.53766	-.45687
.100	-.12425	-.02505	-.51833	-.54785	-.55114	-.51807	-.48542	-.41090
.200	-.19559	-.14980	-.41504	-.43656	-.41358	-.38126	-.34753	-.25838
.300	-.19559	-.17792	-.33510	-.39106	-.29243	-.26519	-.22565	-.16018
.400	-.16349	-.18763	-.25210	-.22443	-.21138	-.17053	-.15531	-.08148
.600	-.14862	-.17076	-.13343	-.12051	-.26614	-.01816	.00627	.02995
.800	-.09096	-.10941	-.01045	.02951	.39457	.11995	.15531	.11143
1.000	.00238	-.02505	.52264	.17401	.59201	.55387	.54260	.31831



APPENDIX B

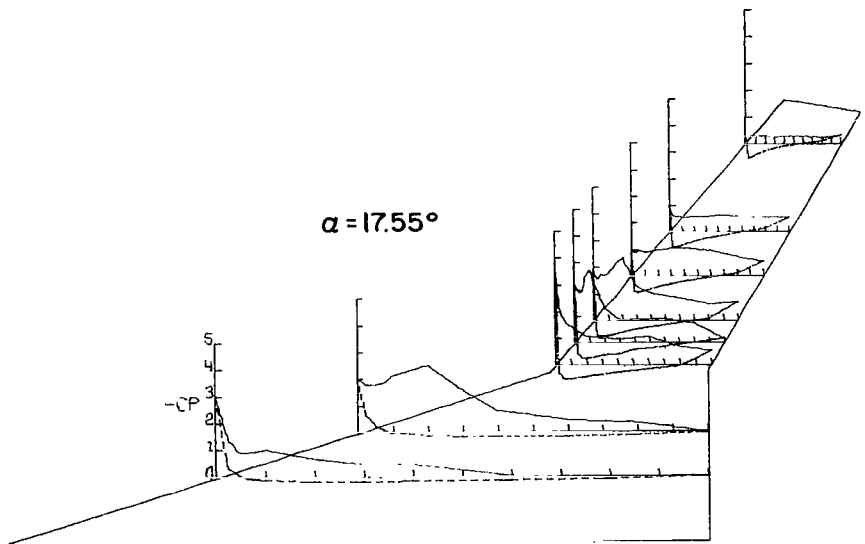
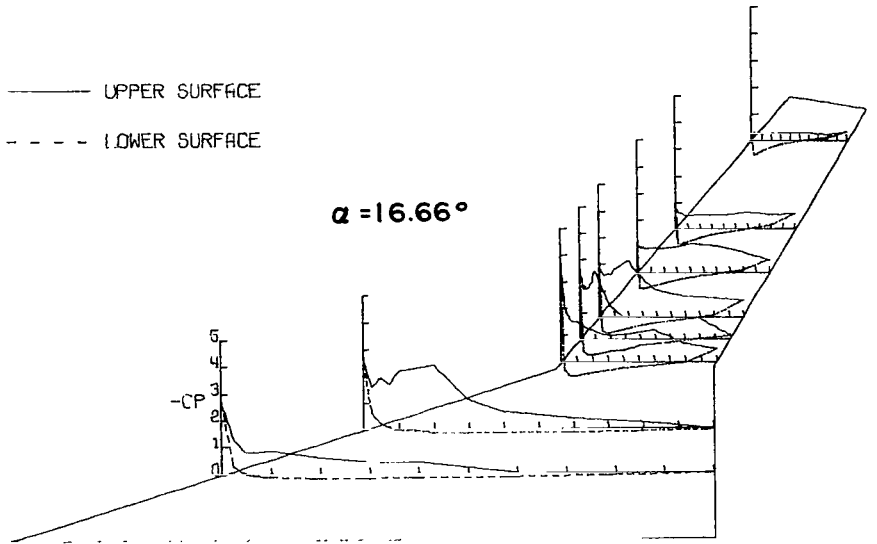

# APPENDIX B

## P R E S S U R E M E A S U R E M E N T S

OUTER PANFL SWEEP= 40.0000 DEGREES

FUSELAGE ON

ANGLE OF ATTACK= 18.63519 DEGREES

### S P A N W I S E L O C A T I O N

	2Y/B .14999	2Y/B .25001	2Y/B .40000	2Y/B .45001	2Y/B .50001	2Y/B .60000	2Y/B .70001	2Y/B .90001
X/C	- CPU	- CPU	- CPU	- CPU	- CPU	- CPU	- CPU	- CPU
0.000	3.37621	1.85380	3.75503	2.20284	1.60215	1.07450	1.21329	.26152
.025	1.36480	1.71511	2.30920	1.97949	1.51078	.89574	.67256	.29324
.050	.97349	1.84404	1.87063	2.44746	1.71271	.95003	.56470	.25306
.075	1.03016	1.79935	1.65729	3.07309	1.71138	.91163	.54425	.25376
.100	1.19420	1.88667	1.53279	3.10625	1.76898	.92818	.55835	.26998
.200	.53042	2.77017	1.23437	1.44020	2.39925	.91362	.53086	.33135
.300	.47673	2.09881	1.10924	.94494	1.51740	.99968	.52522	.28337
.400	.47016	1.02989	1.01540	.90050	1.14931	1.12680	.60700	.28619
.600	-.00060	.51520	1.15554	1.00664	1.30432	.98181	.60770	.26011
.800	.01253	.30460	.81477	.98099	.91153	.83484	.60700	.29676
1.000	.00537	-.01901	.70213	.20776	.71103	.59849	.58373	.31443

	- CPL	- CPL	- CPL	- CPL	- CPL	- CPL	- CPL	- CPL
0.000	3.37621	1.85380	3.75503	2.20284	1.60215	1.07450	1.21329	.26152
.025	.38961	.65697	-.27159	-.40175	-.50766	-.53083	-.58013	-.54982
.050	.04117	.27532	-.48686	-.56258	-.59172	-.58974	-.58295	-.51740
.075	-.08174	.08784	-.53567	-.56759	-.59503	-.56194	-.54841	-.46876
.100	-.13484	-.02209	-.53129	-.56508	-.57120	-.54009	-.52022	-.42224
.200	-.22016	-.16232	-.42553	-.44431	-.43221	-.40838	-.36373	-.28760
.300	-.21360	-.19314	-.35857	-.41865	-.31505	-.28130	-.24460	-.17623
.400	-.18616	-.20033	-.25720	-.23217	-.21643	-.18003	-.15719	-.10080
.600	-.18079	-.18492	-.15081	-.10638	-.07479	-.02515	-.00775	.00916
.800	-.10203	-.12071	-.00876	.04443	.13238	.13238	.16142	.09657
1.000	.00537	-.01901	.70213	.20776	.71103	.59849	.58373	.31443

## P R E S S U R E M E A S U R E M E N T S

OUTER PANEL SWEEP= 40.0000 DEGREES

FUSELAGE ON

ANGLE OF ATTACK= 19.69664 DEGREES

### S P A N W I S E L O C A T I O N

	2Y/B .14999	2Y/B .25001	2Y/B .40000	2Y/B .45001	2Y/B .50001	2Y/B .60000	2Y/B .70001	2Y/B .90001
X/C	- CPU	- CPU	- CPU	- CPU	- CPU	- CPU	- CPU	- CPU
0.000	3.72629	1.78631	3.23126	2.00502	1.71359	1.13631	1.21067	.27327
.025	1.41447	1.74055	2.31861	1.94267	1.52920	.89849	.57877	.23274
.050	1.05386	1.80071	1.93839	2.06187	1.77484	.89328	.58995	.27258
.075	1.16930	1.79659	1.52821	2.96901	1.75855	.91153	.55221	.25440
.100	1.39721	1.87578	1.43530	2.84370	1.57351	1.02685	.53124	.29005
.200	.63688	2.82498	1.12904	1.45180	2.19314	.90957	.55850	.29494
.300	.50355	2.32159	1.06608	1.02940	1.62217	.83985	.52425	.30616
.400	.49522	1.31531	.96216	1.00556	1.18323	1.01382	.58995	.29774
.600	.00417	.62423	1.10398	.98417	.92977	1.02490	.62770	.27887
.800	.00952	.35839	.95360	.90248	.92847	.81510	.58227	.26838
1.000	.01131	.01080	.66280	.19872	.73330	.58966	.56759	.30686

	- CPL	- CPL	- CPL	- CPL	- CPL	- CPL	- CPL	- CPL
0.000	3.72629	1.78631	3.23126	2.00502	1.71359	1.13631	1.21067	.27327
.025	.47379	.72193	-.23235	-.35035	-.46575	-.51330	-.55633	-.55633
.050	.07083	.32651	-.48243	-.55763	-.58134	-.57518	-.57241	-.53257
.075	-.06904	.10078	-.54051	-.57781	-.59342	-.54978	-.55983	-.48015
.100	-.13987	-.00257	-.53317	-.56619	-.56802	-.53479	-.51859	-.43752
.200	-.23332	-.16300	-.45246	-.46897	-.44490	-.41885	-.38230	-.30193
.300	-.23392	-.20516	-.37237	-.44085	-.33351	-.29508	-.26768	-.19639
.400	-.20594	-.22110	-.28982	-.26108	-.23971	-.19868	-.18102	-.11183
.600	-.18928	-.19385	-.16937	-.13085	-.08729	-.03452	-.01398	.00419
.800	-.11369	-.12135	-.01651	.03669	.13158	.13549	.14607	.08247
1.000	.01131	.01080	.66280	.19872	.73330	.58966	.56759	.30686

# APPENDIX B

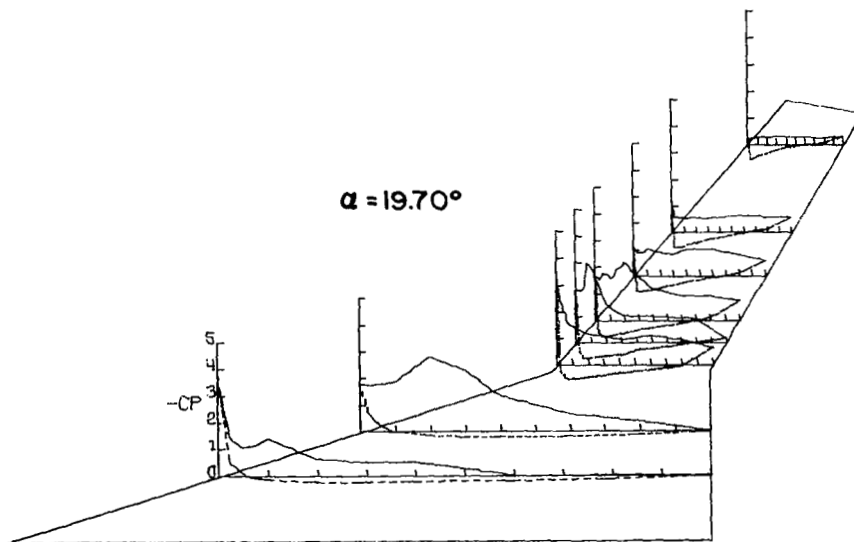
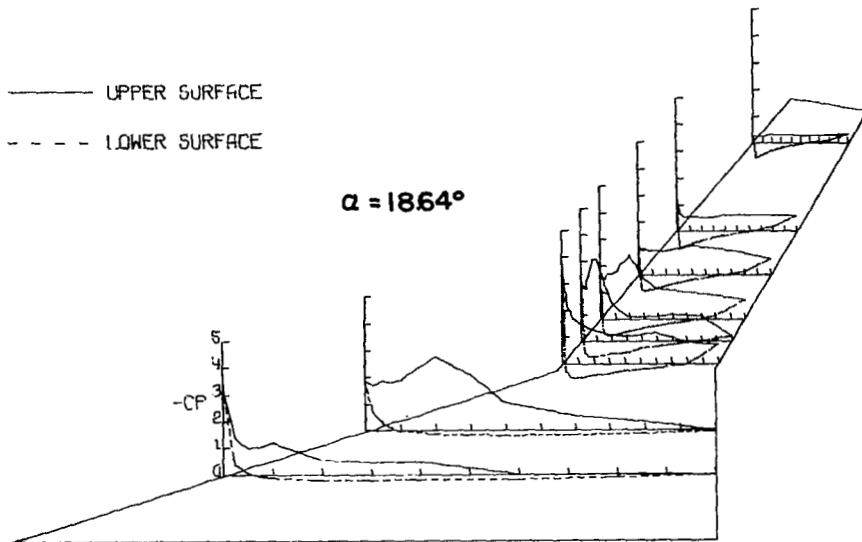

# APPENDIX B

## P R E S S U R E M E A S U R E M E N T S

OUTER PANEL SWEEP= 40.00000 DEGREES

FUSELAGE ON

ANGLE OF ATTACK= 20.76925 DEGREES

### S P A N W I S E L O C A T I O N

	2Y/B .14999	2Y/B .25001	2Y/B .40000	2Y/B .45001	2Y/B .50001	2Y/B .60000	2Y/B .70001	2Y/B .90001
X/C	- CPU	- CPU	- CPU	- CPU	- CPU	- CPU	- CPU	- CPU
0.000	4.14367	1.87836	3.41253	1.97140	1.54150	1.15022	1.26899	.30700
.025	1.45446	1.73951	2.38682	1.91031	1.57261	.90653	.60914	.28960
.050	1.17020	1.79800	1.77957	2.26097	1.52915	.92082	.48273	.27015
.075	1.32536	1.85802	1.45701	2.54993	1.71233	.97736	.60497	.27779
.100	1.58534	1.89617	1.42341	2.90181	1.78706	.95786	.55496	.25835
.200	.80659	2.67996	1.15278	1.41059	2.39141	.92732	.61886	.32298
.300	.54023	2.44854	1.03671	1.16317	1.64734	.81555	.63067	.29863
.400	.53430	1.61642	1.11124	1.03427	1.31373	1.05794	.59247	.30561
.600	.00118	.71920	1.12835	.92430	.99685	1.08978	.58552	.27363
.800	.00829	.55034	.86526	.87443	.85259	.77396	.61678	.27085
1.000	.01659	.05239	.74794	.22365	.70118	.63099	.58830	.31186

	- CPL	- CPL	- CPL	- CPL	- CPL	- CPL	- CPL	- CPL
X/C	4.14367	1.87836	3.41253	1.97140	1.54150	1.15022	1.26898	.30700
0.000	.56984	.76752	-.21265	-.33914	-.45323	-.49700	-.54448	-.55420
.025	-.11018	.35706	-.46991	-.53407	-.57237	-.57302	-.58059	-.52850
.050	-.06694	.11953	-.52490	-.57379	-.53535	-.58731	-.56600	-.50211
.075	-.14987	.00407	-.52429	-.54156	-.56652	-.55418	-.53197	-.45419
.100	-.25353	-.16988	-.44852	-.46746	-.45932	-.44048	-.40558	-.33057
.200	-.25175	-.21261	-.36908	-.44363	-.34108	-.32029	-.27849	-.22015
.300	-.22628	-.22939	-.28353	-.26337	-.24428	-.21439	-.19237	-.13542
.400	-.21088	-.21464	-.15888	-.12527	-.09940	-.04743	-.03056	-.01389
.600	-.13091	-.13021	-.01161	.02994	.10305	.12084	.14029	.07639
.800	.01659	.05239	.74794	.22365	.70118	.63099	.58830	.31186
1.000								

## P R E S S U R E M E A S U R E M E N T S

OUTER PANEL SWEEP= 40.00000 DEGREES

FUSELAGE ON

ANGLE OF ATTACK= 22.87919 DEGREES

### S P A N W I S E L O C A T I O N

	2Y/B .14999	2Y/B .25001	2Y/B .40000	2Y/B .45001	2Y/B .50001	2Y/B .60000	2Y/B .70001	2Y/B .90001
X/C	- CPU	- CPU	- CPU	- CPU	- CPU	- CPU	- CPU	- CPU
0.000	4.91448	1.84748	2.83323	1.97595	1.83133	1.24601	1.33752	.33930
.025	1.51713	1.87289	2.30414	1.93103	1.51343	.98055	.58868	.27604
.050	1.43551	1.94652	1.68819	2.21606	1.70351	1.01791	.57182	.28798
.075	1.49313	1.93614	1.48145	2.82773	1.70614	.96154	.62099	.29641
.100	1.68577	1.92992	1.38664	3.06872	1.73956	1.00743	.58095	.28236
.200	1.37850	2.71859	1.23006	1.46127	2.35700	.95302	.63996	.30343
.300	.75016	2.79274	1.10161	1.22149	1.63535	.98121	.76360	.29922
.400	.60028	1.99940	1.10650	1.18908	1.34629	1.00480	.59500	.28096
.600	.00660	.87837	1.08815	1.02637	.98973	1.05003	.64207	.25286
.800	.00900	.71400	.82045	.95725	.98530	.86388	.63504	.24303
1.000	.01141	.15296	.83697	.25146	1.05658	.63841	.62240	.31401

	- CPL	- CPL	- CPL	- CPL	- CPL	- CPL	- CPL	- CPL
X/C	4.91448	1.84748	2.83323	1.97595	1.83133	1.24601	1.33752	.33930
0.000	.72016	.90015	-.17009	-.28021	-.37679	-.45936	-.53031	-.56543
.025	.15727	.43296	-.44540	-.52005	-.54848	-.58910	-.59142	-.55911
.050	-.04622	.17681	-.53106	-.56716	-.59061	-.59710	-.58158	-.51977
.075	-.13987	.02852	-.55125	-.56532	-.58336	-.56355	-.55559	-.48184
.100	-.27913	-.18874	-.48395	-.49313	-.49031	-.45215	-.44110	-.34839
.200	-.28573	-.24007	-.40747	-.48089	-.37548	-.34599	-.32591	-.25005
.300	-.27253	-.25770	-.32549	-.29612	-.27915	-.24442	-.23600	-.16647
.400	-.24311	-.24318	-.19150	-.16091	-.11147	-.07732	-.06251	-.04074
.600	-.14407	-.14415	-.02080	.04283	.12123	.14023	.13275	.06532
.800	.01141	.15296	.83697	.25146	1.05658	.63841	.62240	.31401
1.000								

APPENDIX B

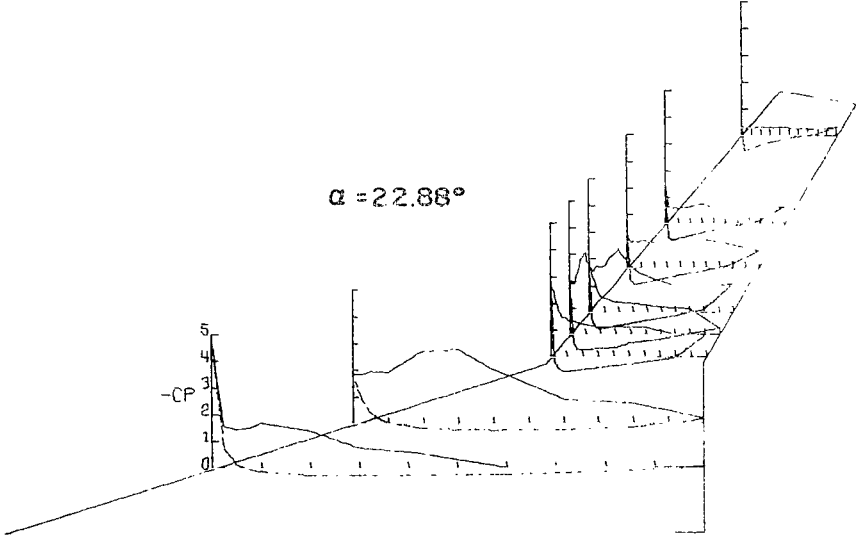
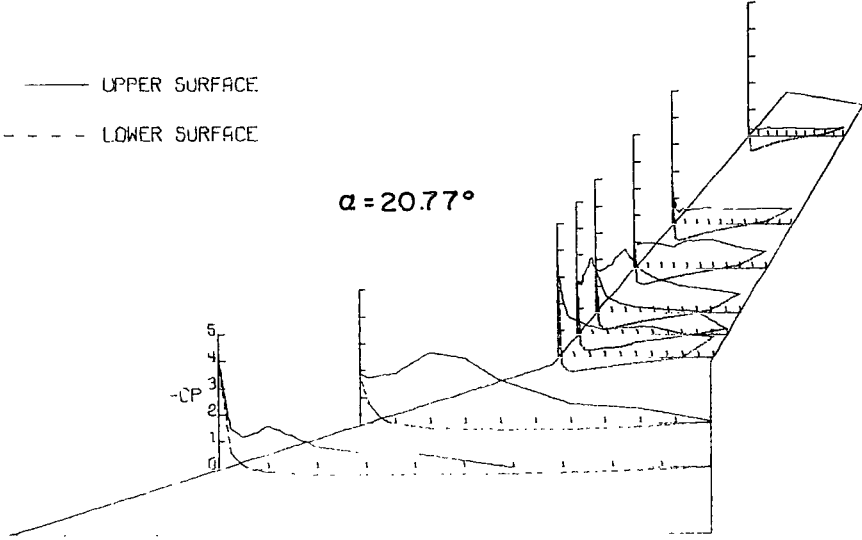

# APPENDIX B

## P P E S S U R E M E A S U R E M E N T S

OUTER PANEL SWEEP= 40.0000 DEGREES

FUSELAGE ON

ANGLE OF ATTACK= 25.00777 DEGREES

### S P A N W I S E L O C A T I O N

	2Y/B .14999	2Y/B .25001	2Y/B .40000	2Y/B .45001	2Y/B .50001	2Y/B .60000	2Y/B .70001	2Y/B .90001
X/C	-CPU	-CPU	-CPU	-CPU	-CPU	-CPU	-CPU	-CPU
0.000	5.77737	1.92825	2.80321	2.14441	1.86733	1.20947	1.07213	.32214
.025	1.88905	1.90330	2.30800	2.13936	1.63908	.94092	.59177	.33704
.050	1.56744	2.05250	1.88923	2.36738	1.93057	1.01416	.64782	.31717
.075	1.64678	2.05874	1.46793	2.91501	1.56145	1.04187	.58325	.32568
.100	2.15675	1.96776	1.43129	2.95543	1.94255	.93366	.62299	.34200
.200	1.57592	2.40551	1.47551	1.83049	1.89900	.81687	.59531	.33420
.300	.86064	2.65245	1.36750	1.52920	1.74987	.82413	.58680	.29585
.400	.79523	2.31972	1.40982	1.27528	1.51629	.89869	.64356	.31717
.600	.01272	1.15258	1.31128	1.13695	1.12897	1.02010	.67266	.30152
.800	.01151	.81258	1.19064	1.09842	1.17780	.87164	.64144	.29868
1.000	.00727	.12685	1.23612	.31337	.97051	.71922	.66911	.30578
X/C	-CPL	-CPL	-CPL	-CPL	-CPL	-CPL	-CPL	-CPL
0.000	5.77737	1.92825	2.80321	2.14441	1.86733	1.20947	1.07213	.32214
.025	.89395	1.01325	-.11120	-.18954	-.32554	-.43274	-.53423	-.54061
.050	.21446	.50481	-.41572	-.48459	-.54291	-.57457	-.60659	-.56402
.075	-.01757	.22199	-.51681	-.52755	-.59040	-.57193	-.59950	-.52287
.100	-.13752	-.05563	-.54713	-.56167	-.59558	-.57457	-.58105	-.50017
.200	-.30775	-.20639	-.51112	-.50480	-.52773	-.48222	-.47108	-.37814
.300	-.32411	-.28438	-.45110	-.49217	-.41889	-.37403	-.36041	-.28449
.400	-.31987	-.31557	-.35886	-.32727	-.32324	-.27244	-.27243	-.19085
.600	-.28049	-.29425	-.20533	-.17311	-.14183	-.08840	-.08585	-.04895
.800	-.19204	-.18560	-.01327	.09287	.12995	.14843	.11210	.06598
1.000	.00727	.12685	1.23612	.31337	.97051	.71922	.66911	.30578

APPENDIX B

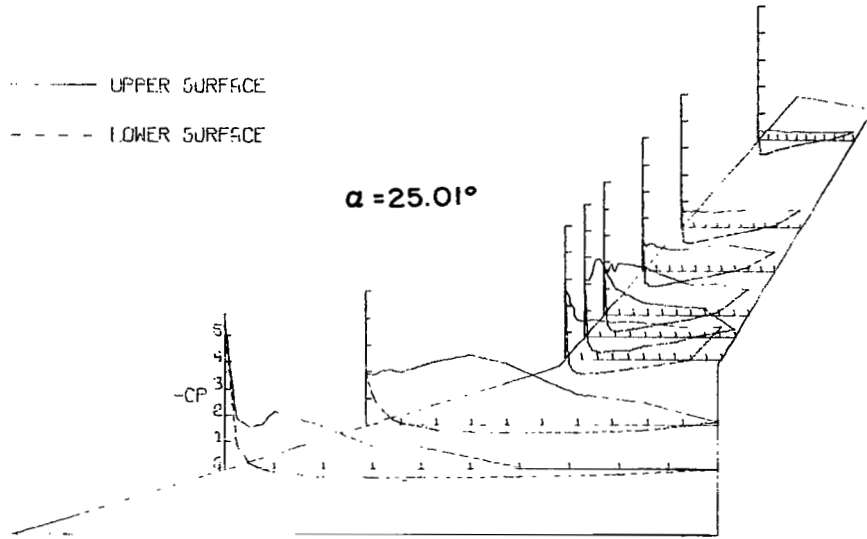

THIS PAGE IS BLANK



## APPENDIX C

### FORWARD-FACING CUBIC-CURVE-FIT METHOD WITH

### ARBITRARY SPACING AND FLOATING ORIGIN<sup>b</sup>

#### INTRODUCTION

A method of representing the chordwise pressure-distribution envelope of a wing which is based on a series of cubic curves that face forward, have a floating origin, and can have an arbitrary spacing between data points is developed in this appendix and is hereinafter called the present method. The forward-facing feature of the present method (that is, of always taking positive displacements in the upstream direction) was chosen to better define the pressure-coefficient distribution near the leading edge. In this region, the character of the pressure distribution on the upper surface for positive angles of attack is to have a negative peak accompanied by a sharp increase at the leading edge. The arbitrary spacing allowed between data points is a useful feature of the present method, since generally more definition of the pressure distribution is required near the leading edge than elsewhere.

The mathematical development of the present method is given first and then integrated results obtained with this representation of the pressure envelope and those of equivalent rectangles and hand-fairing procedures are compared at three angles of attack.

#### SYMBOLS

In addition to the symbols defined in the body of the report, the following symbols are used in this appendix:

$\bar{A}, \bar{B}, \bar{C}, \bar{D}$  coefficients of arbitrary cubic equation in order of increasing powers of  $x$

$h_i$  distance of independent variable from local origin forward to  $i$ th data point

$R_{i,j}$  element of geometric matrix

---

<sup>b</sup>This method was originally formulated in 1966. Since then, the author has become aware of a method using third-degree spline functions (ref. 8) which has recently been used with good success in representing the pressure-distribution envelope.

## APPENDIX C

$x$	general independent variable
$\bar{x}$	distance along local chord measured from local leading edge
$y$	value of cubic equation at $x$
$x_i, y_i$	$i$ th value of independent variable and of dependent variable associated with known data
$\bar{Y}$	spanwise coordinate axis
$\bar{y}$	distance along $\bar{Y}$
$\Delta\bar{x}$	chordwise distance between adjacent pressure ports (downstream)
$\Delta x_j$	chordwise distance between adjacent pressure ports (upstream)

Matrix notation:

$[ ]$	square matrix
$[ ]^{-1}$	inverse matrix
$[ ]$	row matrix
$\{ \}$	column matrix

## DEVELOPMENT

Figure 19 shows five arbitrary points  $(x_{n+1}, y_{n+1})$ ,  $(x_n, y_n)$ ,  $(x_{n-1}, y_{n-1})$ ,  $(x_{n-2}, y_{n-2})$ , and  $(x_{n-3}, y_{n-3})$ , where the ordinate  $y_i$  corresponds to the pressure magnitude. Note that the  $x$ -spacing between adjacent points is variable and is given by either  $\Delta x_1$ ,  $\Delta x_2$ , or  $\Delta x_3$ . It is possible to pass through four of these points a cubic equation which is of the form

$$y = \bar{A} + \bar{B}x + \bar{C}x^2 + \bar{D}x^3 \quad (1)$$

APPENDIX C

or

$$y = \begin{bmatrix} 1, x, x^2, x^3 \end{bmatrix} \begin{Bmatrix} \bar{A} \\ \bar{B} \\ \bar{C} \\ \bar{D} \end{Bmatrix} \quad (2)$$

where  $\bar{A}$ ,  $\bar{B}$ ,  $\bar{C}$ , and  $\bar{D}$  are unknown coefficients. Because of the floating-origin concept employed herein (that is, of fixing the origin of each cubic equation at the rightmost end point in each set of four data points to be curve fitted), the  $x$ -values always begin at zero in each interval. In figure 19,  $x_n$  and  $x_{n+1}$  are two such floating origins so that when

$$x = 0, \quad y = y_n = \bar{A} \quad (3a)$$

$$x = \Delta x_1 = h_1, \quad \left. \begin{aligned} y = y_{n-1} &= \bar{A} + \bar{B} \Delta x_1 + \bar{C} \Delta x_1^2 + \bar{D} \Delta x_1^3 \\ \text{or} \\ y = y_{n-1} &= \bar{A} + \bar{B}h_1 + \bar{C}h_1^2 + \bar{D}h_1^3 \end{aligned} \right\} \quad (3b)$$

$$x = \Delta x_1 + \Delta x_2 = h_2, \quad y = y_{n-2} = \bar{A} + \bar{B}h_2 + \bar{C}h_2^2 + \bar{D}h_2^3 \quad (3c)$$

$$x = \Delta x_1 + \Delta x_2 + \Delta x_3 = h_3, \quad y = y_{n-3} = \bar{A} + \bar{B}h_3 + \bar{C}h_3^2 + \bar{D}h_3^3 \quad (3d)$$

Equations (3) can also be expressed as the following matrix equation:

$$\begin{Bmatrix} y_n \\ y_{n-1} \\ y_{n-2} \\ y_{n-3} \end{Bmatrix} = \begin{bmatrix} 1 & 0 & 0 & 0 \\ 1 & h_1 & h_1^2 & h_1^3 \\ 1 & h_2 & h_2^2 & h_2^3 \\ 1 & h_3 & h_3^2 & h_3^3 \end{bmatrix} \begin{Bmatrix} \bar{A} \\ \bar{B} \\ \bar{C} \\ \bar{D} \end{Bmatrix} \quad (4)$$

However, because  $\bar{A}$  is equal to  $y_n$  (a consequence of the floating-origin feature), the matrix equation can be written as

APPENDIX C

$$\begin{Bmatrix} y_{n-1} \\ y_{n-2} \\ y_{n-3} \end{Bmatrix} = \begin{Bmatrix} \bar{A} \\ \bar{A} \\ \bar{A} \end{Bmatrix} + \begin{bmatrix} h_1 & h_1^2 & h_1^3 \\ h_2 & h_2^2 & h_2^3 \\ h_3 & h_3^2 & h_3^3 \end{bmatrix} \begin{Bmatrix} \bar{B} \\ \bar{C} \\ \bar{D} \end{Bmatrix} = \begin{Bmatrix} y_n \\ y_n \\ y_n \end{Bmatrix} + \begin{bmatrix} \bar{B} \\ \bar{C} \\ \bar{D} \end{bmatrix} \quad (5)$$

Then, by matrix inversion  $\bar{B}$ ,  $\bar{C}$ , and  $\bar{D}$  are found to be

$$\begin{Bmatrix} \bar{B} \\ \bar{C} \\ \bar{D} \end{Bmatrix} = \begin{bmatrix} \bar{B} \\ \bar{C} \\ \bar{D} \end{bmatrix} = [\mathbf{R}]^{-1} \begin{Bmatrix} y_{n-1} - y_n \\ y_{n-2} - y_n \\ y_{n-3} - y_n \end{Bmatrix} \quad (6)$$

Substitution of equation (6) into equation (2) results in

$$y = y_n + [x, x^2, x^3] [\mathbf{R}]^{-1} \begin{Bmatrix} y_{n-1} - y_n \\ y_{n-2} - y_n \\ y_{n-3} - y_n \end{Bmatrix} \quad (7)$$

which shows the cubic equation that can pass through four arbitrary data points. In practice, the cubic equations which are generated to fit each set of four data points overlap in the region from the second data point in from the beginning of the full interval until the second point in from the end is reached. It has been found that the curves obtained from the equations give the best fit over the two points in the middle of their range. (See fig. 19.) Thus, the equations were considered valid only in a particular range along the chord. However, at the beginning and end of the full interval where those points did not lie in the middle of some range, the equation selection technique was not used. In particular, near the leading edge the first cubic equation was used and near the trailing edge the last one was used.

## APPENDIX C

### APPLICATION

The pressure data presented in the body of this report were the first data to which this method was applied. Selected upper- and lower-surface pressure data for the wing model shown in figure 20 are plotted in figure 21 with the series of curve fits which result from the present method. From figure 21 it can be seen that the resultant curves are a good representation of the data at and in between data points. These pressure-distribution curves are integrated to give the section normal-force and pitching-moment coefficients as follows.

The section normal-force coefficient  $c_n$  is determined by (1) integrating the equations used to represent the pressure distribution over the chord in the range where they are considered valid for both the upper and lower surfaces at each spanwise station and (2) subtracting the value obtained on the upper surface from that obtained on the lower surface. In equation form

$$c_n = \int_0^1 C_{p,l} d(x/c) - \int_0^1 C_{p,u} d(x/c) \quad (8)$$

By using the cubic-curve-fit representation of the pressure-coefficient envelope associated with the present method, the integrations can be performed analytically and the  $c_n$  result can be written as a sum of integrated parts. Individual contributions to the normal-force coefficient  $c_n$  were obtained for both the upper and lower wing surfaces at the tipmost spanwise station ( $\bar{Y} = 0.865b/2$ ) by employing an equivalent rectangles procedure between data points and by using the present method. These results are compared with those obtained by mechanical integration of the hand fairing in table I at  $\alpha = -4.387^\circ$ ,  $2.621^\circ$ , and  $30.793^\circ$ . (The individual contributions to  $c_n$  are presented rather than the total so that more numerical comparisons between each of the methods and the hand-faired results can be made.) From table I it can be seen that, in general, integrations under the curves predicted by the present method give the best agreement with the values found by integrating under the hand-faired curves. As a point of interest, a forward-facing quadratic-curve-fit method was also tried and the results were not as good as those obtained by the cubic fit.

APPENDIX C

TABLE I.- SURFACE  $c_n$  CONTRIBUTIONS AT  $\bar{Y} = 0.865b/2$

$\alpha$ , deg	Wing surface	Hand fairing	Present method	Equivalent rectangles procedure
-4.387	Upper	-0.0055	-0.00682	-0.00896
	Lower	-.2928	-.30724	-.30461
2.621	Upper	.2408	.23773	.23126
	Lower	-.0248	-.02363	-.02033
30.793	Upper	.5804	.58037	.58174
	Lower	.2280	.22750	.21194

The section pitching-moment coefficient  $c_m$  is determined about the local leading edge by (1) integrating the product of each pressure equation on the upper and lower surfaces by its own variable distance to the leading edge (taking into account the variable origin) and (2) subtracting the result obtained for the upper surface from that found for the lower surface. In equation form

$$c_m = \int_0^1 (x/c)C_{p,l} d(x/c) - \int_0^1 (x/c)C_{p,u} d(x/c) \quad (9)$$

This equation (like eq. (8)) can be integrated analytically by making use of the cubic-curve-fit representation of the pressure-coefficient envelope and the result can be expressed in terms of a sum of the integrated parts.

Individual contributions to the pitching-moment coefficient  $c_m$  were obtained for both upper and lower surfaces at the same three angles of attack and spanwise station as for  $c_n$  are presented in table II for the same approximating methods. (Again, individual contributions are presented rather than the total result so that more comparisons can be made.) From table II, the present method is seen to give slightly better agreement with the hand-fairing results than the equivalent rectangles method.

APPENDIX C

TABLE II.- SURFACE  $c_m$  CONTRIBUTIONS AT  $\bar{Y} = 0.865b/2$

$\alpha$ , deg	Wing surface	Hand fairing	Present method	Equivalent rectangles procedure
-4.387	Upper	-0.0157	-0.01274	-0.01274
	Lower	.09584	.09423	.09603
2.621	Upper	-.07456	-.07394	-.07532
	Lower	.02016	.02145	.02147
30.793	Upper	-.29184	-.28846	-.28870
	Lower	-.01248	-.01450	-.00958

In general, the normal-force coefficient is easier to predict than the pitching-moment coefficient because only the area, not the distribution, under the represented curve has to be approximately the same. Hence, the spread in the normal-force-coefficient predictions is not as great as that found in the pitching-moment-coefficient predictions.

From tables I and II, it is seen that the present method gives results which are generally as good as or better than those found by the equivalent rectangles procedure when both are compared with the hand-faired values.

## LISTINGS OF SAMPLE CASES AND FORTRAN COMPUTER PROGRAM

The pressure data plotted in figures 21(a) to 21(c) serve as sample cases for the present FORTRAN computer program. These data are preceded by a parameter card containing the run number, sweepback angle in degrees, span location, and angle of attack in degrees. All data are keypunched according to a 6F12.5 format and examples follow for the sample cases.

## C O L U M N N U M B E R S F O R I N P U T D A T A

00000000011111111122222222223333333333444444444455555555566666666677777777778  
 1234567890123456789012345678901234567890123456789012345678901234567890

1.	15.0	.865	-4.39				Parameter Card
-.4842	-.4406	-.3019	-.2147	-.1316	-.0232	}	$C_{p,u}$
+.0472	+.0753	+.0746	+.0099	-.0141			
-.4842	1.1614	+.7642	+.6550	+.5656	+.4493	}	$C_{p,l}$
+.4388	+.3676	+.2393	+.0929	-.0141			
1.	15.0	.865	2.62				Parameter Card
-.8715	+.7696	+.5440	+.4842	+.4660	+.3781	}	$C_{p,u}$
+.3430	+.3036	+.2037	+.0681	-.0456			
-.8715	-.3223	-.1861	-.0962	-.0681	+.0218	}	$C_{p,l}$
+.1067	+.1215	+.1011	+.0190	-.0456			
1.	15.0	.865	30.79				Parameter Card
+.8524	+.5881	+.5584	+.5541	+.5647	+.6149	}	$C_{p,u}$
+.5838	+.5598	+.5810	+.5789	+.5746			
+.8524	-.8122	-.8497	-.8179	-.7819	-.6314	}	$C_{p,l}$
-.4591	-.3320	-.1293	+.0777	+.5746			

The  $c_n$  and  $c_m$  results for the preceding data are given in the following listing:

RUN	LAMBDA	YSPAN	ALPHA	CNL	CML
1.0000	15.0000	.86500	-4.39000	-.31404	.08144
1.0000	15.0000	.86500	2.62000	.21410	-.05251
1.0000	15.0000	.86500	30.79000	.80788	-.30294



A FORTRAN computer program which represents the best version of the present method is listed as follows:

```

PROGRAM CUBCURV (INPUT,OUTPUT,TAPE5=INPUT,TAPE6=OUTPUT)      CUBC0001
DIMENSION DELTX(10),A(4,4),Y(11),CPU(11),CPL(11)              CUBC0002
REAL LAMBDA                                                    CUBC0003
500 FORMAT(1H15X3HRUN8X6HLAMBDA6X5HYPAN7X5HALPHA8X3HCNL9X3HCML) CUBC0004
505 FORMAT(6F12.5)                                             CUBC0005
C                                                                CUBC0006
C                                                                CUBC0007
C   THERE ARE A TOTAL OF ELEVEN PRESSURE PORTS IN THIS EXAMPLE CUBC0008
C                                                                CUBC0009
C                                                                CUBC0010
C                                                                CUBC0011
C                                                                CUBC0012
C   FRACTIONAL CHORDWISE DISTANCE BETWEEN ADJACENT PRESSURE PORTS IN CUBC0013
C   TERMS OF X/C AND IN ORDER OF INCREASING X/C                CUBC0014
C                                                                CUBC0015
C   DELTX(1)=0.025                                             CUBC0016
C   DELTX(2)=0.025                                             CUBC0017
C   DELTX(3)=0.025                                             CUBC0018
C   DELTX(4)=0.025                                             CUBC0019
C   DELTX(5)=0.1                                               CUBC0020
C   DELTX(6)=0.1                                               CUBC0021
C   DELTX(7)=0.1                                               CUBC0022
C   DELTX(8)=0.2                                               CUBC0023
C   DELTX(9)=0.2                                               CUBC0024
C   DELTX(10)=0.2                                              CUBC0025
C   WRITE(6,500)                                               CUBC0026
1  READ(5,505) RUN,LAMBDA,YSPAN,ALPHA                          CUBC0027
   IF(EOF,5) 12,11                                            CUBC0028
C                                                                CUBC0029
C                                                                CUBC0030
C   CPU(L) AND CPL(L) VALUES ARE TO BE READ IN ORDER OF INCREASING X/C CUBC0031
C                                                                CUBC0032
C   SUCTION PRESSURES ARE SPECIFIED TO BE POSITIVE IN THIS PROGRAM CUBC0033
C                                                                CUBC0034
C                                                                CUBC0035
11 READ(5,505)(CPU(L),L=1,11)                                  CUBC0036
    READ(5,505)(CPL(L),L=1,11)                                  CUBC0037
    SUCODE=1.                                                   CUBC0038
2  CNL=n.                                                       CUBC0039
   CML=n.                                                       CUBC0040
   DO 3 L=1,11                                                 CUBC0041
     IF(SUCODE.EQ.1.) Y(L)=CPU(L)                               CUBC0042
     IF(SUCODE.EQ.2.) Y(L)=CPL(L)                               CUBC0043
3  CONTINUE                                                    CUBC0044

```

C		CUBC0045
C	CUBIC CURVE FIT SCHEME, USED IN DETERMINING THE LOCAL NORMAL	CUBC0046
C	FORCE COEFFICIENT AND THE LOCAL PITCHING MOMENT COEFFICIENT ABOUT	CUBC0047
C	THE LOCAL LEADING EDGE	CUBC0048
C		CUBC0049
	DO 5 I=4,11	CUBC0050
	H1= DELTX(I-1)	CUBC0051
	H2=H1+DELT(X(I-2)	CUBC0052
	H3=H2+DELT(X(I-3)	CUBC0053
C		CUBC0054
	DETERM=H1*H2*H3*(H2*H3**2+H1*H2**2+H1**2*H3	CUBC0055
	I-H1**2*H2-H2**2*H3-H3**2*H1)	CUBC0056
	A(1,1)=H2**2*H3**3-H3**2*H2**3	CUBC0057
	A(2,1)=H3*H2**3-H2*H3**3	CUBC0058
	A(3,1)=H2*H3**2-H3*H2**2	CUBC0059
	A(1,2)=H3**2*H1**3-H1**2*H3**3	CUBC0060
	A(2,2)=H1*H3**3-H3*H1**3	CUBC0061
	A(3,2)=H3*H1**2-H1*H3**2	CUBC0062
	A(1,3)=H1**2*H2**3-H2**2*H1**3	CUBC0063
	A(2,3)=H2*H1**3-H1*H2**3	CUBC0064
	A(3,3)=H1*H2**2-H2*H1**2	CUBC0065
C		CUBC0066
	YOIM1P=Y(I-1)-Y(I)	CUBC0067
	YOIM2P=Y(I-2)-Y(I)	CUBC0068
	YOIM3P=Y(I-3)-Y(I)	CUBC0069
	ABAR=Y(I)	CUBC0070
	BBAR=(1./DETERM)*(A(1,1)*YOIM1P+A(1,2)*YOIM2P+A(1,3)*YOIM3P)	CUBC0071
	CBAR=(1./DETERM)*(A(2,1)*YOIM1P+A(2,2)*YOIM2P+A(2,3)*YOIM3P)	CUBC0072
	DBAR=(1./DETERM)*(A(3,1)*YOIM1P+A(3,2)*YOIM2P+A(3,3)*YOIM3P)	CUBC0073
C		CUBC0074
	IF(I.EQ.4) GO TO 6	CUBC0075
	IF(I.GT.4.AND.I.LE.10) GO TO 7	CUBC0076
	IF(I.EQ.11) B=0.	CUBC0077
	C=H2	CUBC0078
	GO TO 8	CUBC0079
6	B=H1	CUBC0080
	C=H3	CUBC0081
	GO TO 8	CUBC0082
7	B=H1	CUBC0083
	C=H2	CUBC0084

8	SUM1=ABAR*(C-B)+BBAR/2.*(C**2-B**2)+CBAR/3.*(C**3-B**3)+DBAR/4.*	CUBC0085
	1(C**4-B**4)	CUBC0086
	CNL=CNL+SUM1	CUBC0087
	IF(I.EQ.4) E=-.075	CUBC0088
	IF(I.EQ.5) E=-.100	CUBC0089
	IF(I.EQ.6) E=-.200	CUBC0090
	IF(I.EQ.7) E=-.300	CUBC0091
	IF(I.EQ.8) E=-.400	CUBC0092
	IF(I.EQ.9) E=-.600	CUBC0093
	IF(I.EQ.10) E=-.800	CUBC0094
	IF(I.EQ.11) E=-1.000	CUBC0095
	SUM2=ABAR/2.*(C**2-B**2)+BBAR/3.*(C**3-B**3)+CBAR/4.*(C**4-B**4)+	CUBC0096
	1DBAR/5.*(C**5-B**5) + E*SUM1	CUBC0097
	CML=CML+SUM2	CUBC0098
5	CONTINUE	CUBC0099
	IF(SUCODE.EQ.1.) GO TO 9	CUBC0100
	CNLO=CNL	CUBC0101
	CML0=CML	CUBC0102
	CNLOP=CNUP-CNLO	CUBC0103
	CML0P=CMUP-CML0	CUBC0104
	WRITE(6,505) RUN,LAMBDA,YSPAN, ALPHA,CNLOP,CML0P	CUBC0105
	GO TO 1	CUBC0106
9	CNUP=CNL	CUBC0107
	CMUP=CML	CUBC0108
	SUCODE=2.	CUBC0109
	GO TO 2	CUBC0110
12	STOP	CUBC0111
	END	CUBC0112

## REFERENCES

1. Ray, Edward J.: NASA Supersonic Commercial Air Transport (SCAT) Configurations: A Summary and Index of Experimental Characteristics. NASA TM X-1329, 1967.
2. Spearman, M. Leroy; and Foster, Gerald V.: A Summary of Research on Variable-Sweep Fighter Airplanes. NASA TM X-1185, 1965.
3. Lamar, John E.: A Modified Multhopp Approach for Predicting Lifting Pressures and Camber Shape for Composite Planforms in Subsonic Flow. NASA TN D-4427, 1968.
4. Swanson, Robert S.; and Toll, Thomas A.: Jet-Boundary Corrections for Reflection-Plane Models in Rectangular Wind Tunnels. NACA Rep. 770, 1943. (Supersedes NACA WR L-458.)
5. McCullough, George B.; and Gault, Donald E.: Examples of Three Representative Types of Airfoil-Section Stall at Low Speed. NACA TN 2502, 1951.
6. Multhopp, H.: Methods for Calculating the Lift Distribution of Wings (Subsonic Lifting-Surface Theory). R. & M. No. 2884, Brit. A.R.C., Jan. 1950.
7. Polhamus, Edward C.: A Concept of the Vortex Lift of Sharp-Edge Delta Wings Based on a Leading-Edge-Suction Analogy. NASA TN D-3767, 1966.
8. Greville, T. N. E.: Spline Functions, Interpolation, and Numerical Quadrature. Mathematical Methods for Digital Computers, Vol. II, Anthony Ralston and Herbert S. Wilf, eds., John Wiley & Sons, Inc., c.1967, pp. 156-168.

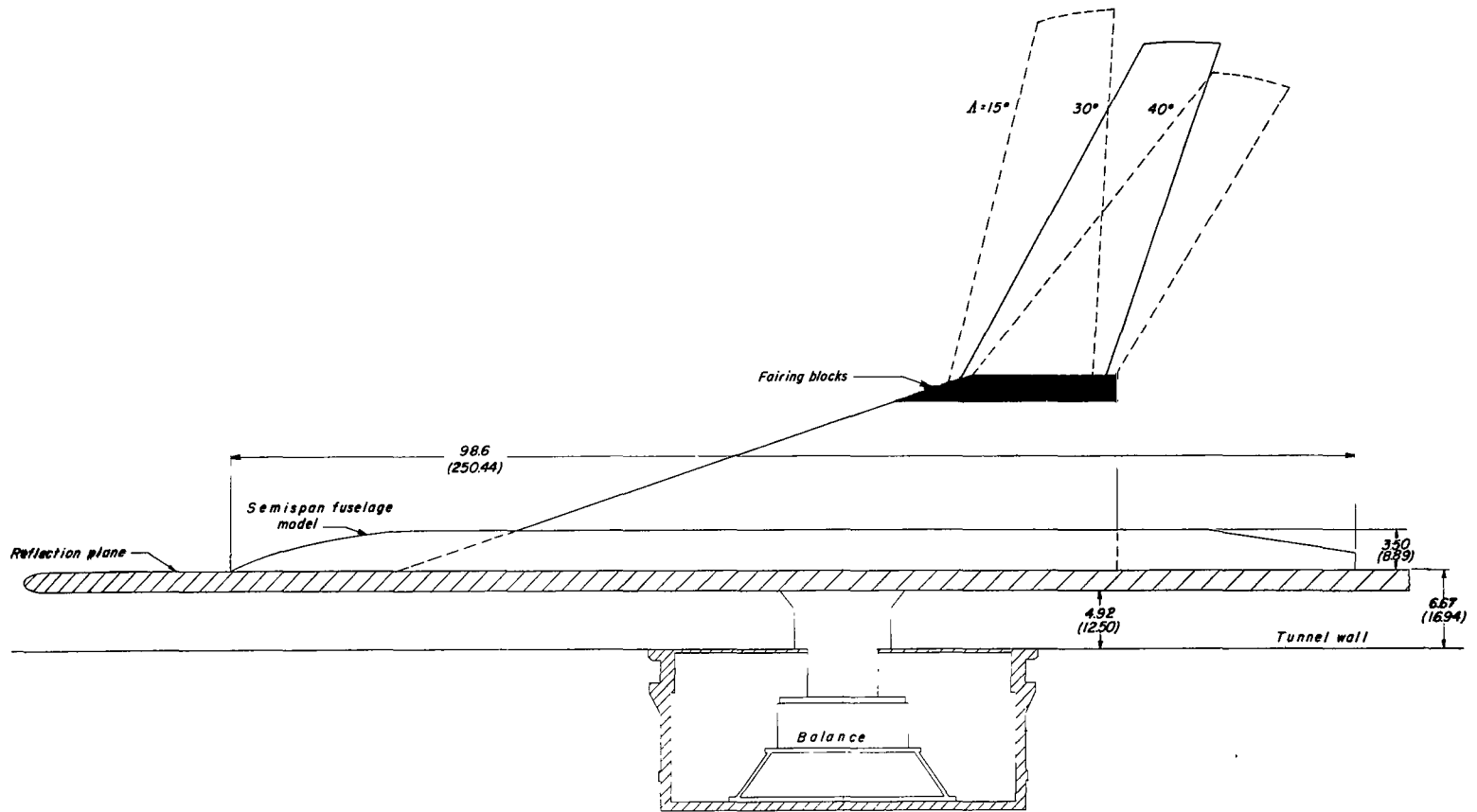
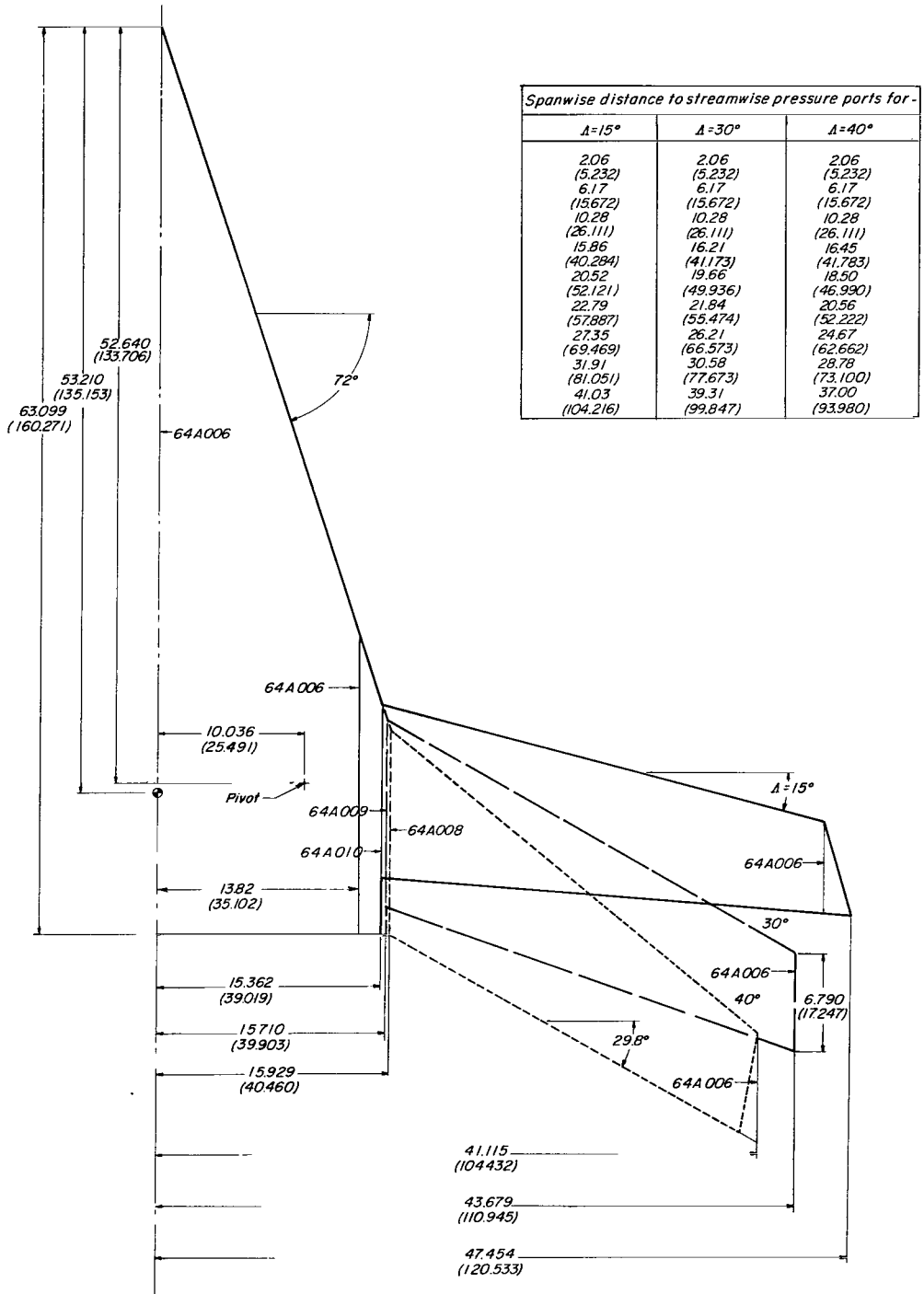
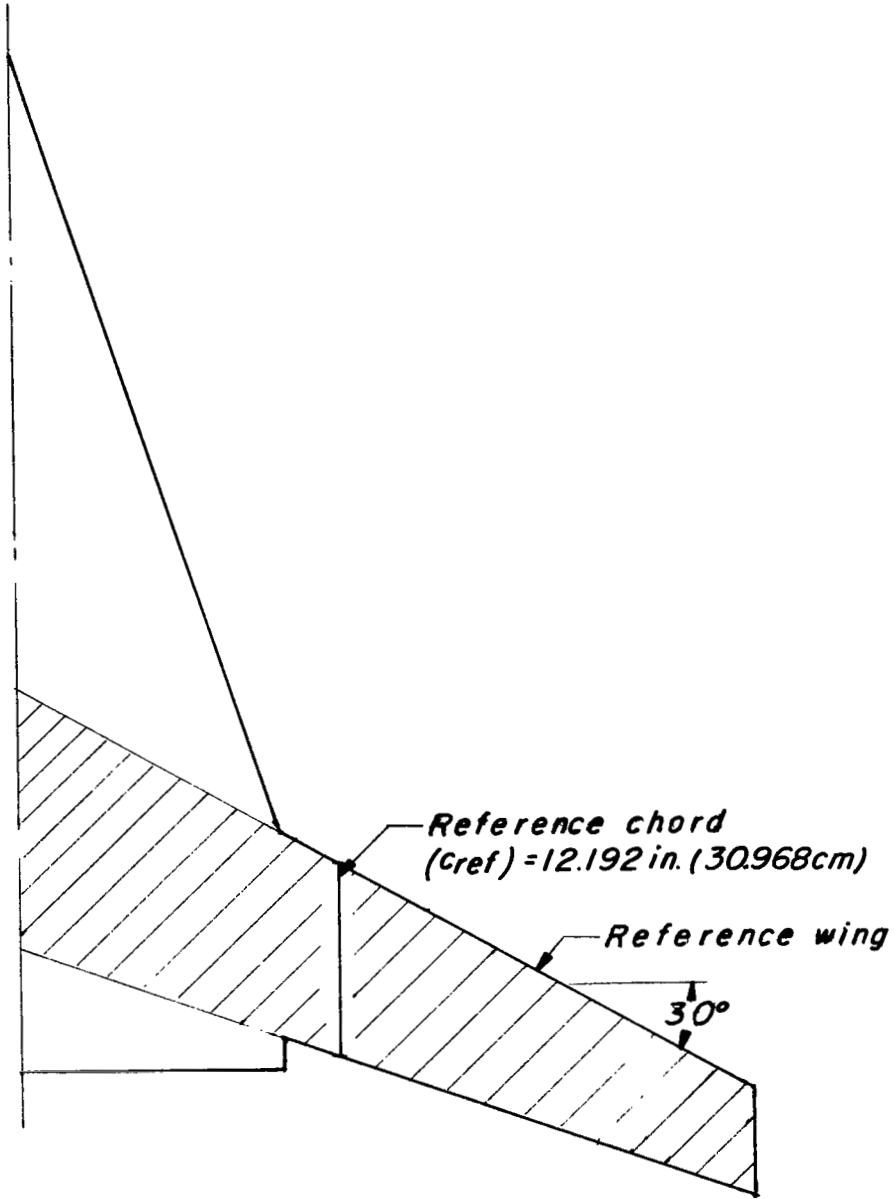

Figure 1.- General layout of model and support and balance systems. All linear dimensions are in inches (centimeters).



(a) Planform dimensions and spanwise locations of pressure ports. All linear dimensions are in inches (centimeters).

Figure 2.- Variable-sweep-wing configurations.



$$S_{ref} = 3.503 \text{ ft}^2 (0.326 \text{ m}^2)$$

(b) Reference wing and chord.

Figure 2.- Concluded.



L-66-1363

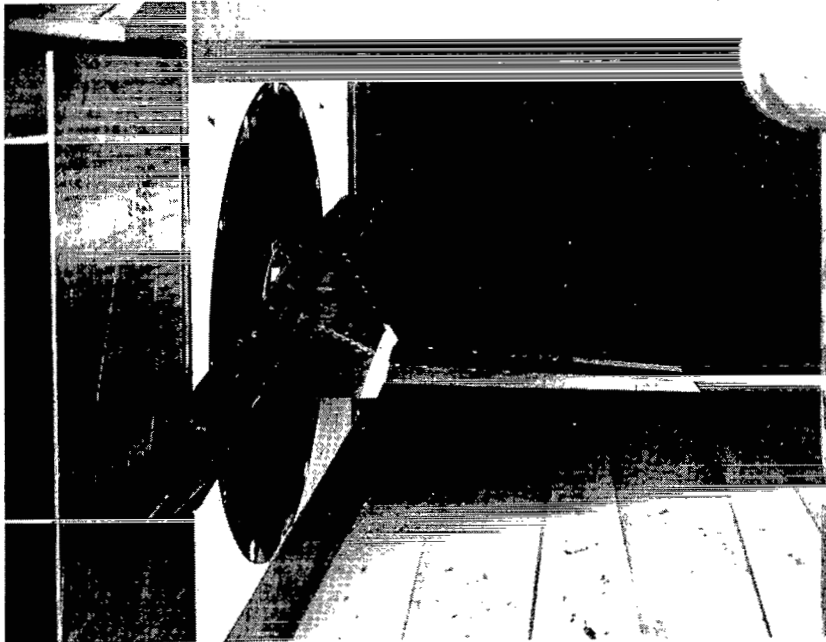

L-66-1362

(a)  $\Lambda = 15^\circ$ .

Figure 3.- Half-span fuselage and variable-sweep pressure wing models mounted in the Langley high-speed 7- by 10-foot tunnel.





L-66-1280

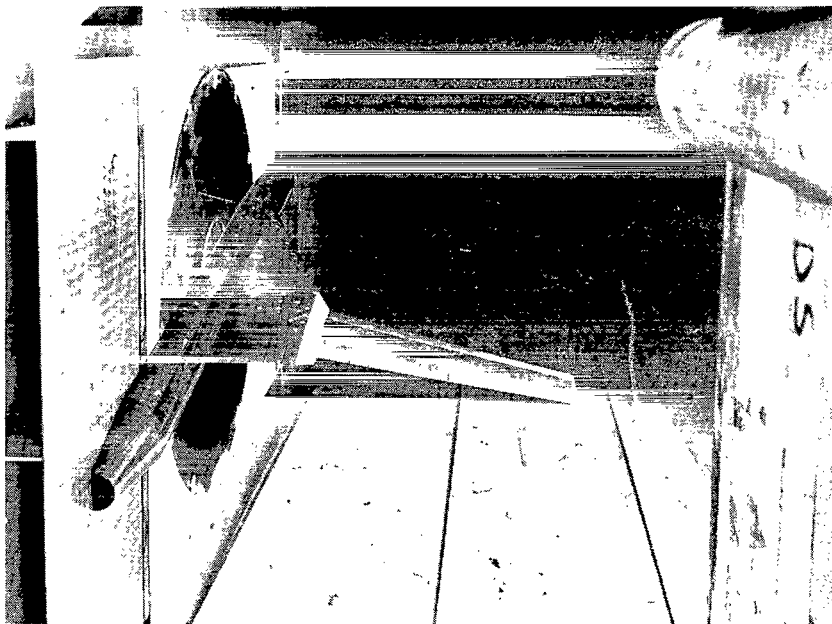

L-66-1279

(b)  $\Lambda = 30^\circ$ .

Figure 3.- Continued.



L-66-1208

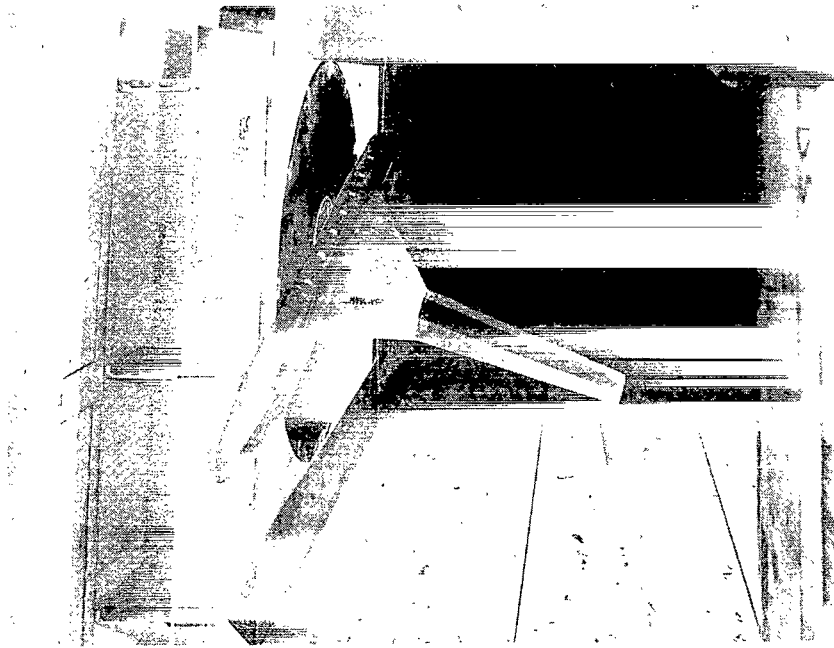

L-66-1209

(c)  $\Lambda = 40^\circ$ .

Figure 3.- Concluded.

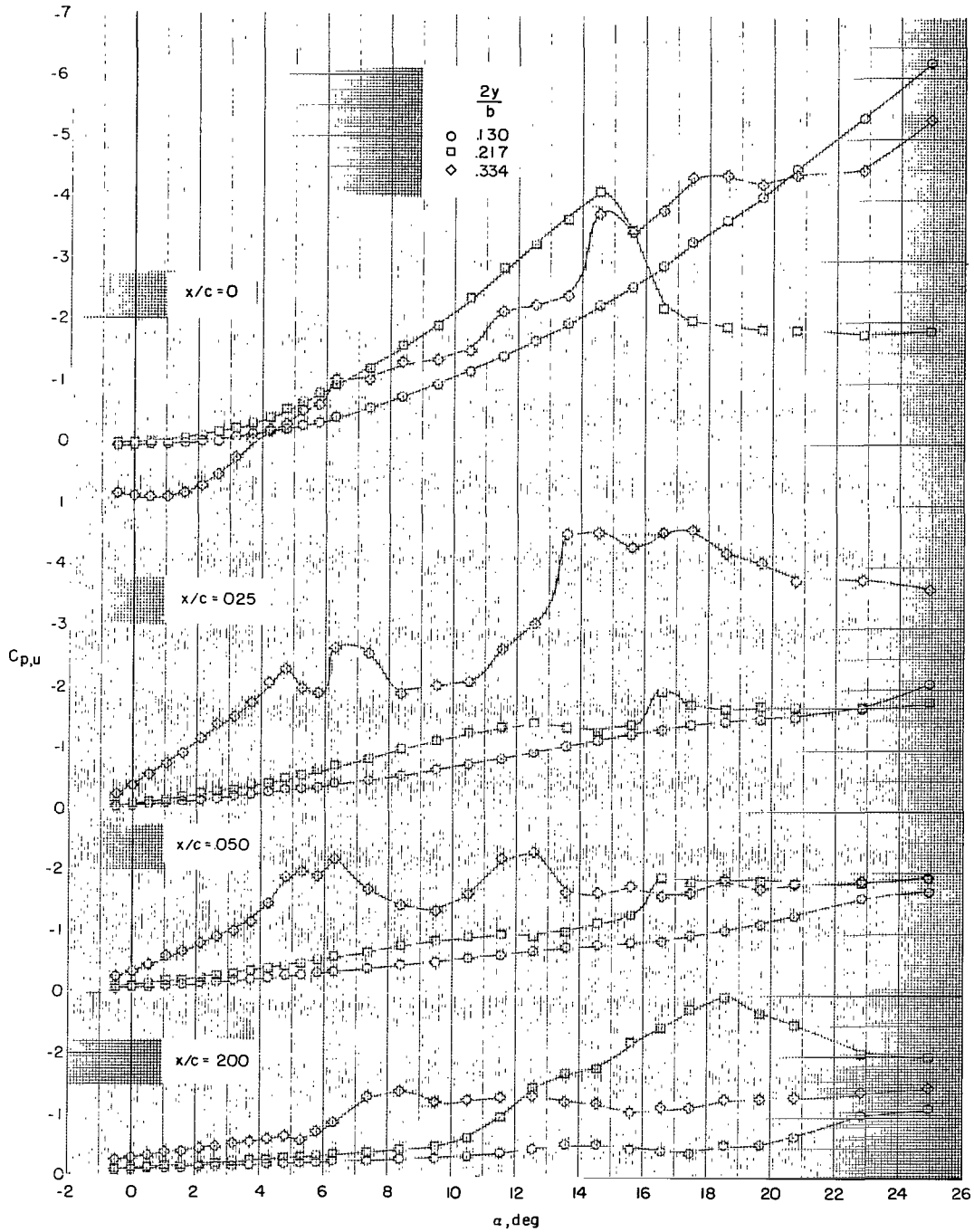
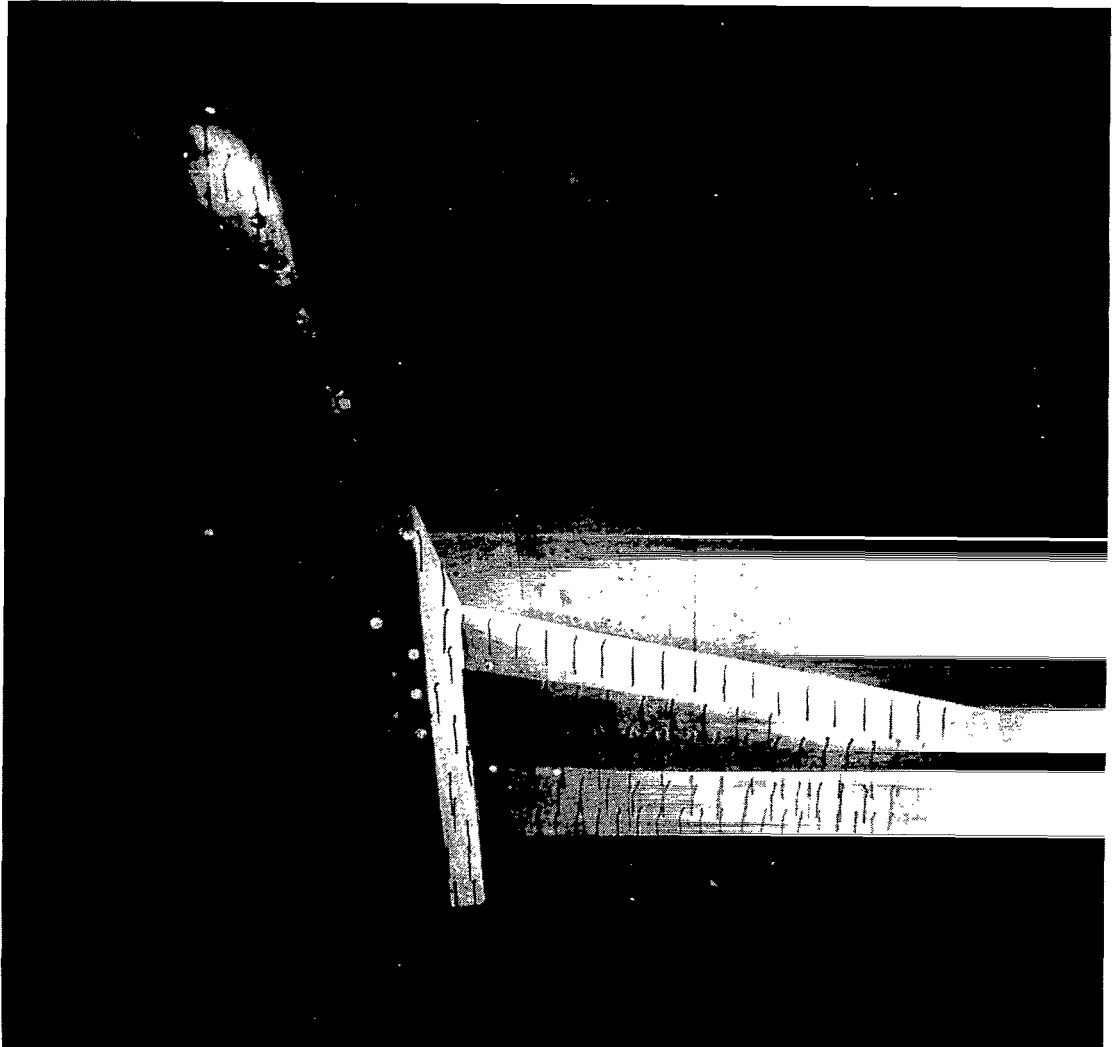

Figure 4.- Effect of spanwise location on the flow separation near the leading edge of a variable-sweep wing at  $\Lambda = 15^\circ$ . Fuselage on.



L-71-587

(a)  $\alpha = 0^\circ$ .

Figure 5.- Tuft patterns on a variable-sweep wing at  $\Lambda = 15^\circ$ . Fuselage on.

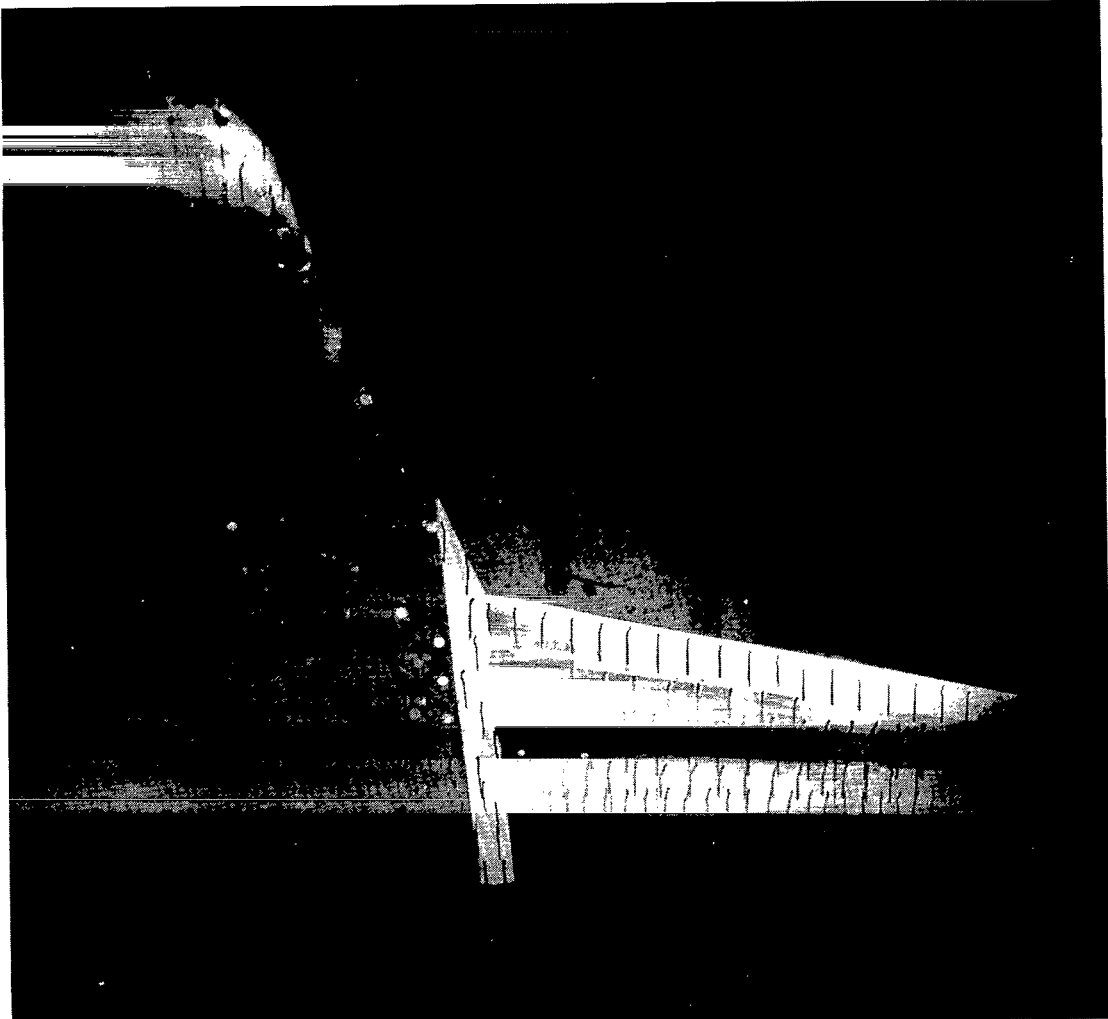

L-71-588

(b)  $\alpha = 1^\circ$ .

Figure 5.- Continued.

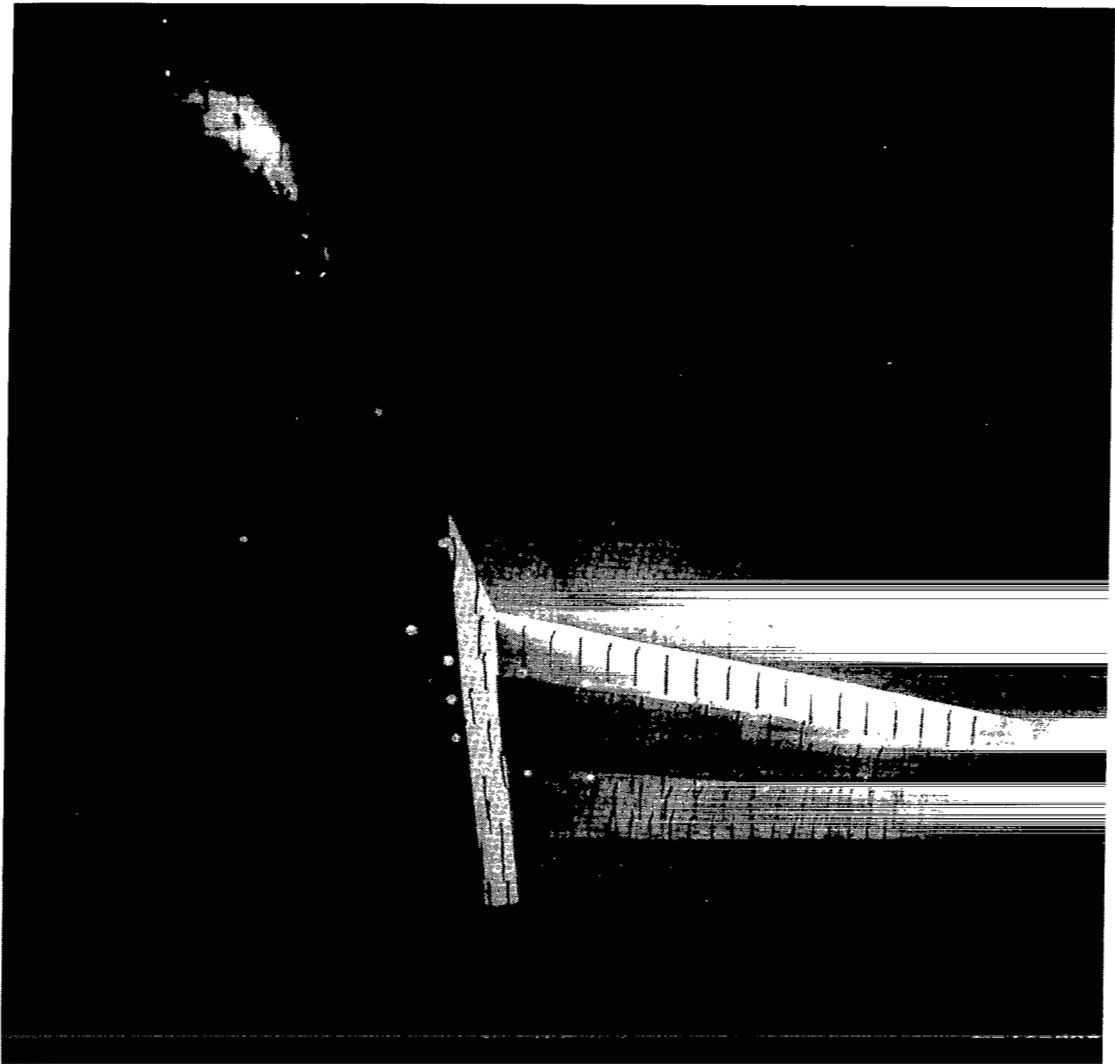

L-71-589

(c)  $\alpha = 2^\circ$ .

Figure 5.- Continued.

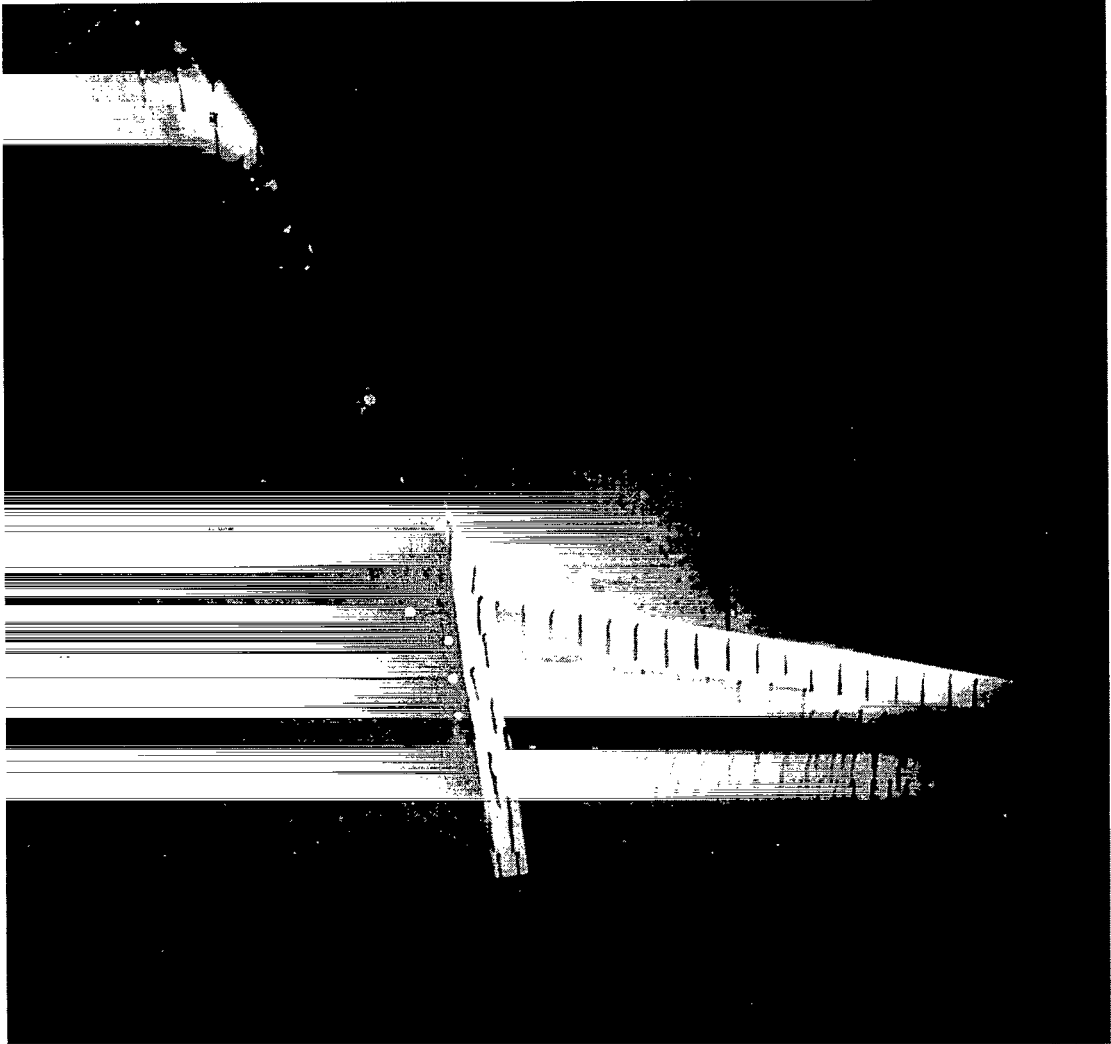

L-71-590

(d)  $\alpha = 3^\circ$ .

Figure 5.- Continued.

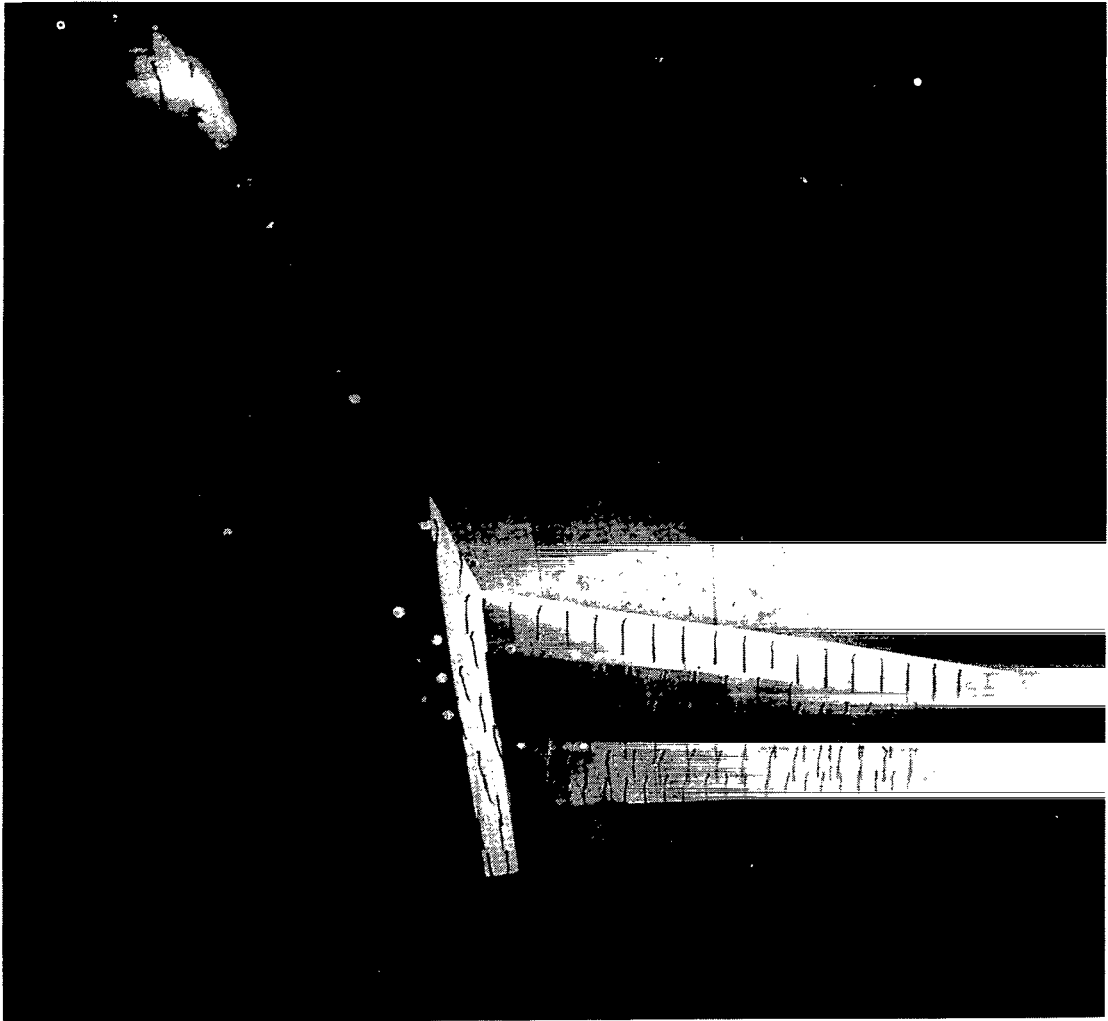

L-71-591

(e)  $\alpha = 4^\circ$ .

Figure 5.- Continued.



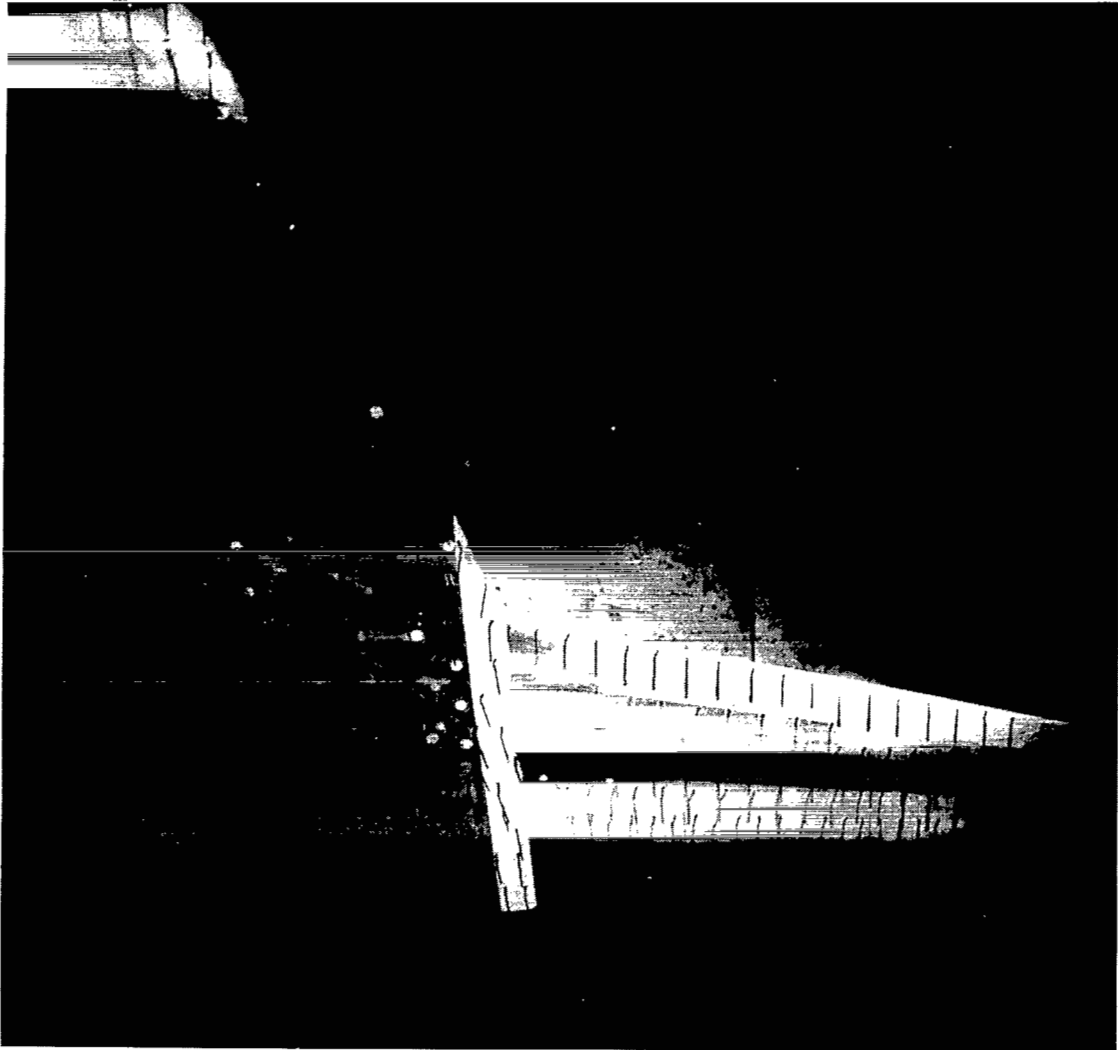

L-71-592

(f)  $\alpha = 5^\circ$ .

Figure 5.- Continued.

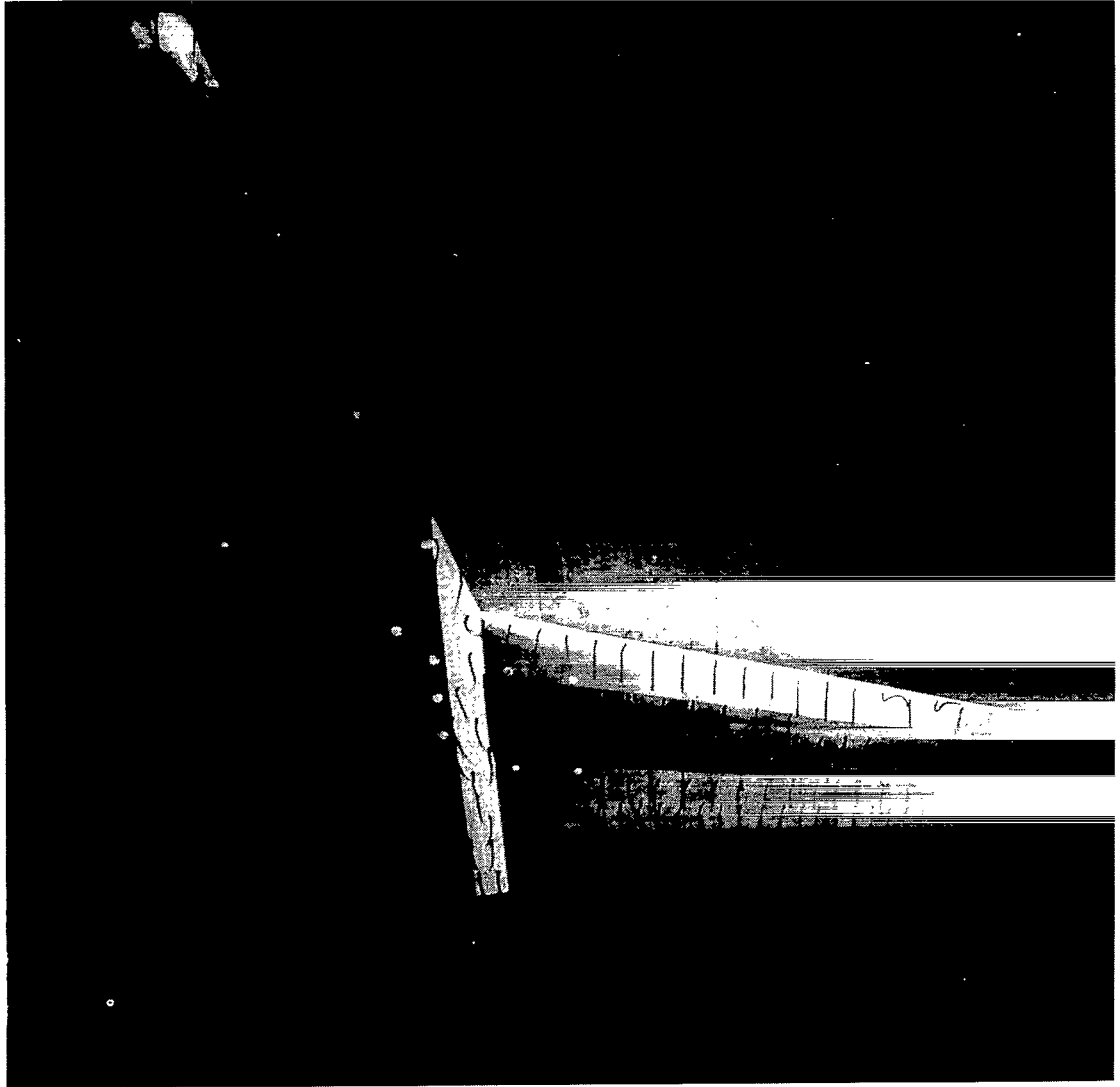

L-71-593

(g)  $\alpha = 6^\circ$ .

Figure 5.- Continued.

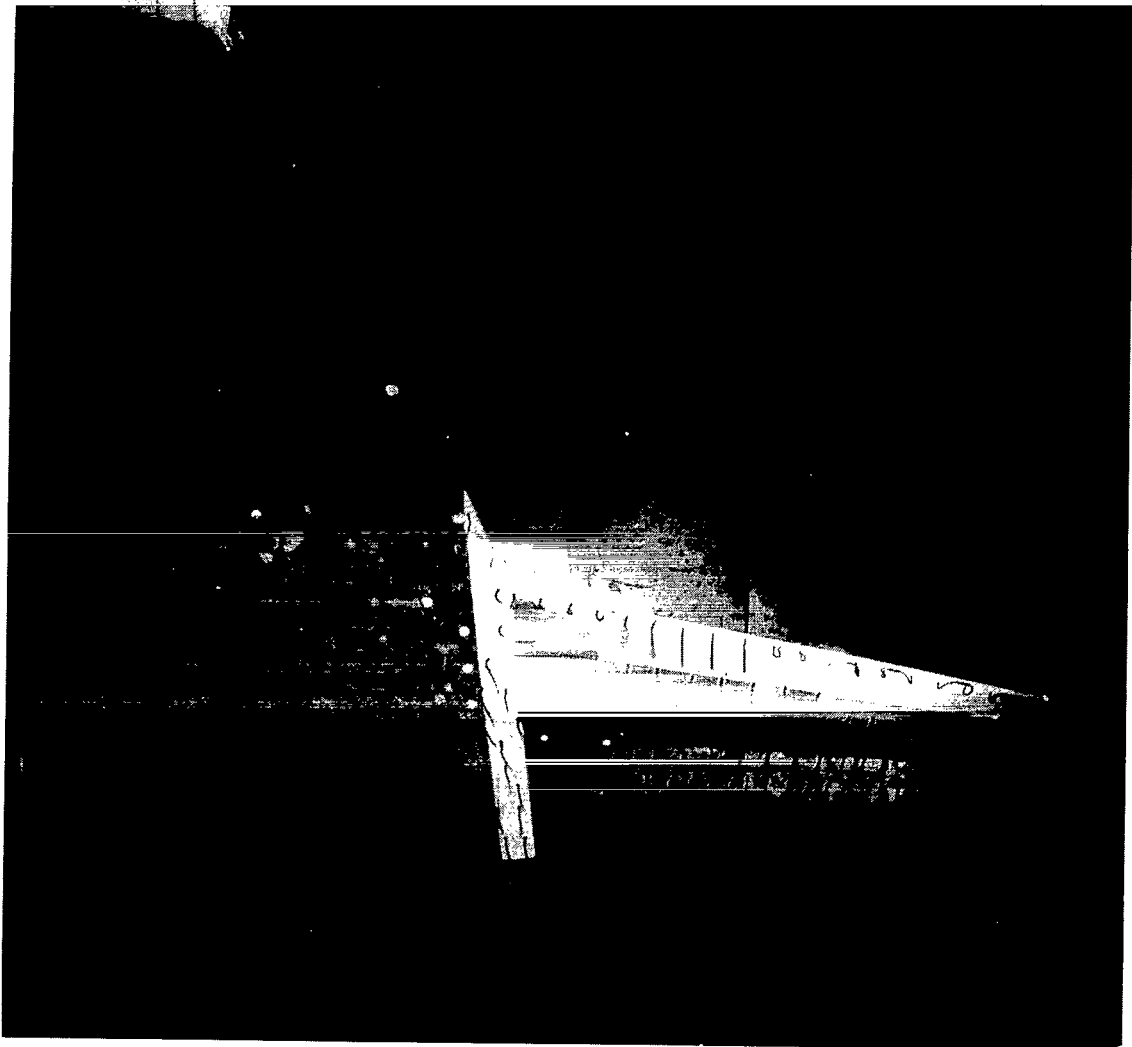

L-71-594

(h)  $\alpha = 7^\circ$ .

Figure 5.- Continued.

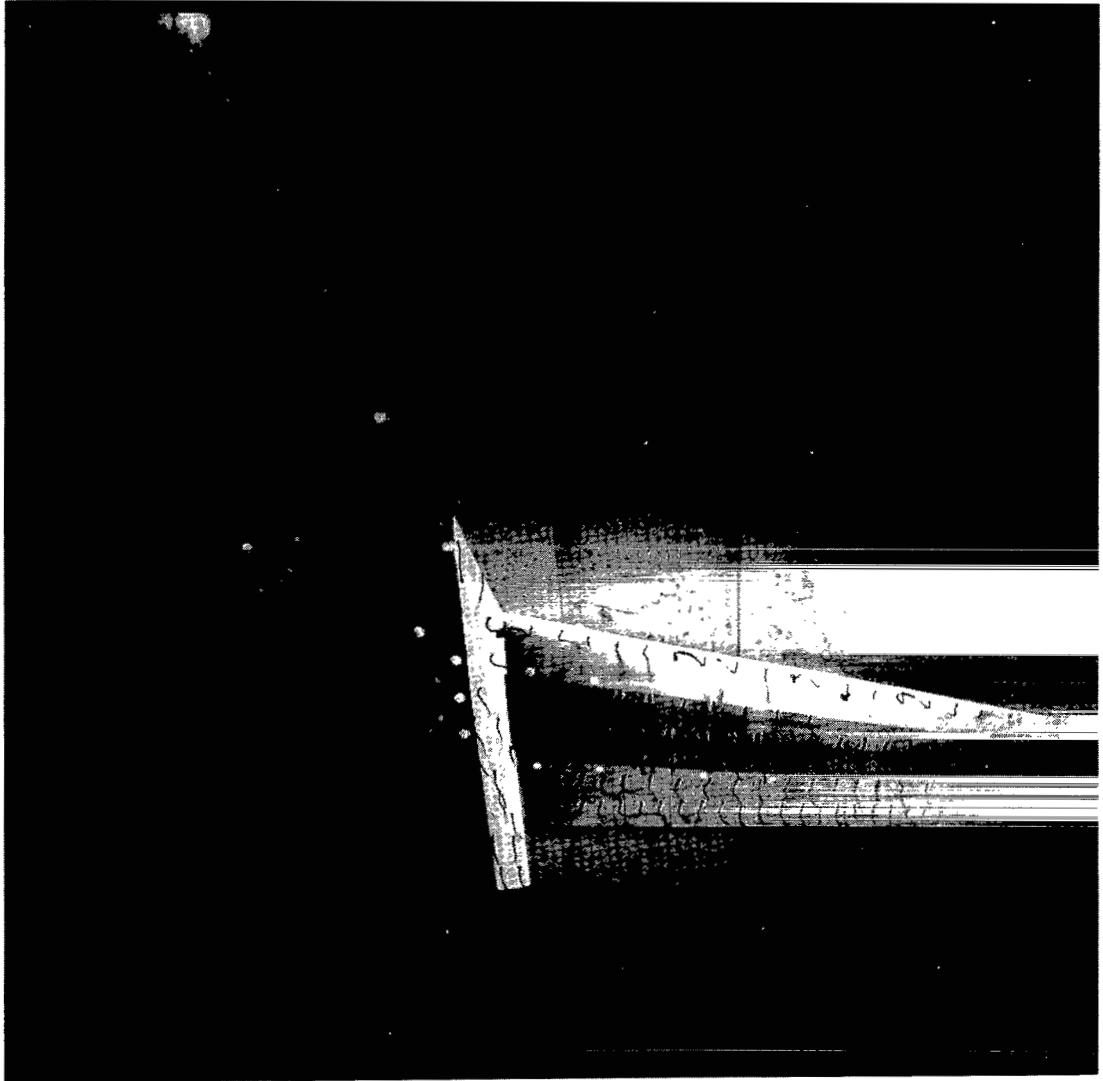

L-71-595

(i)  $\alpha = 8^\circ$ .

Figure 5.- Continued.

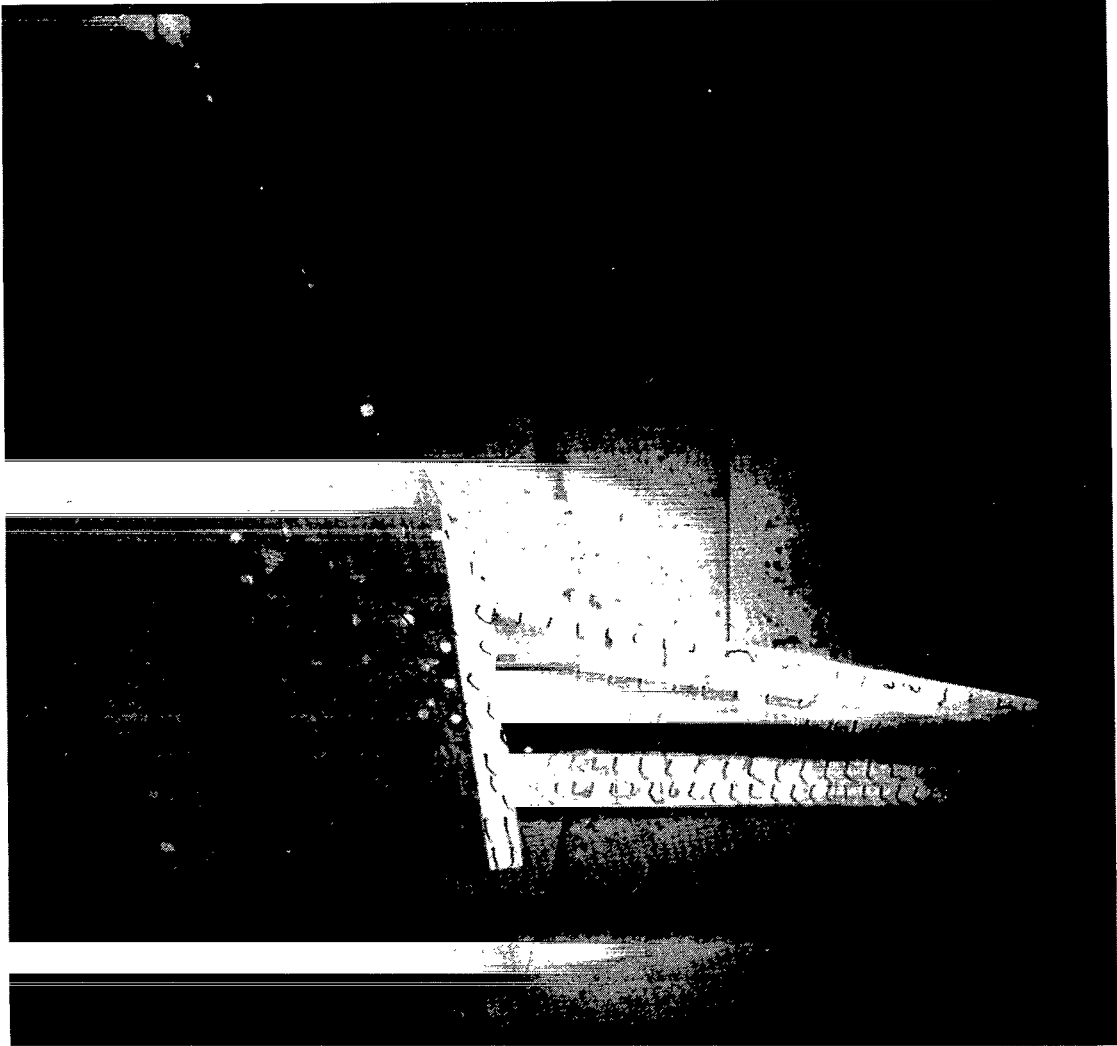

L-71-596

(j)  $\alpha = 9^\circ$ .

Figure 5.- Continued.

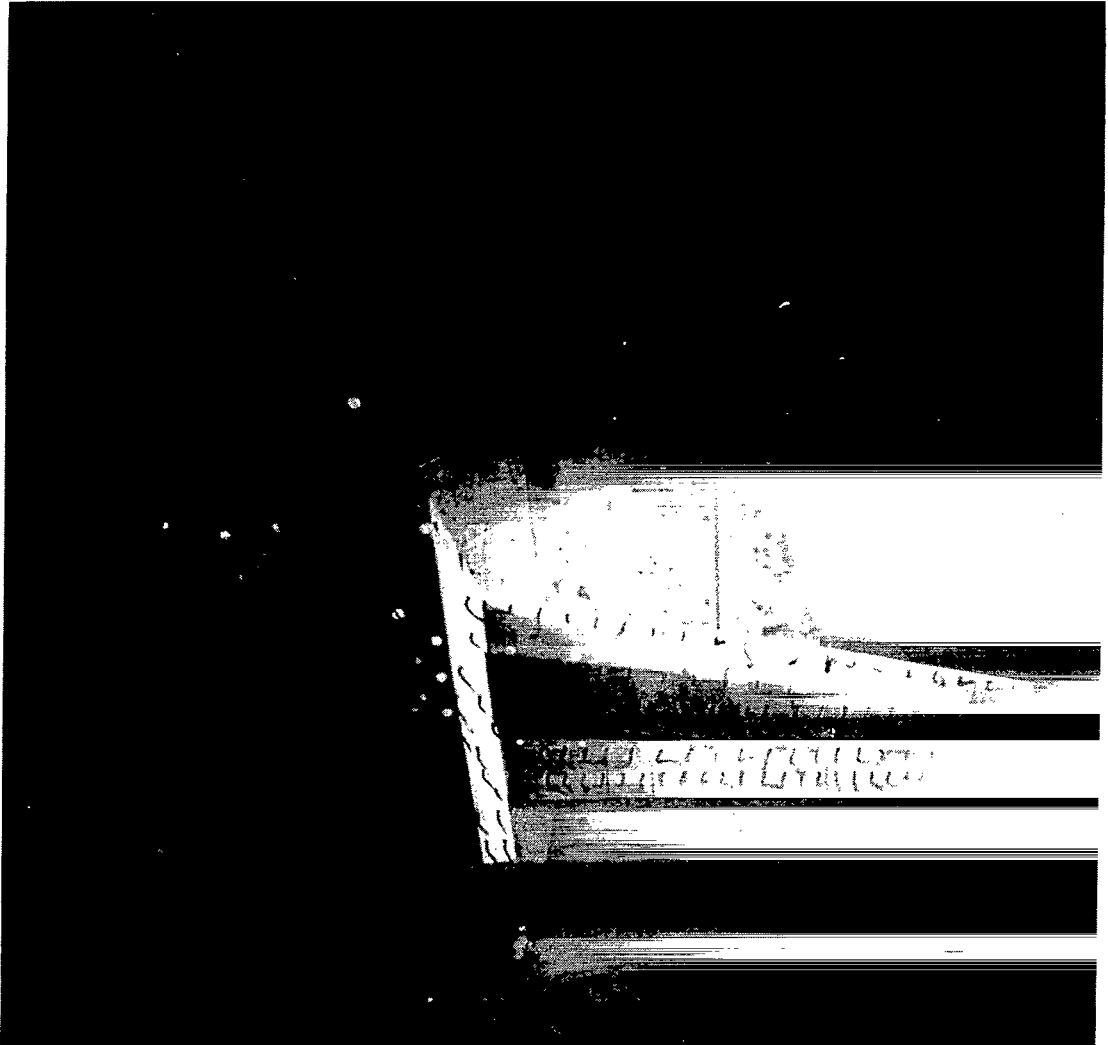

L-71-597

(k)  $\alpha = 10^\circ$ .

Figure 5.- Continued.

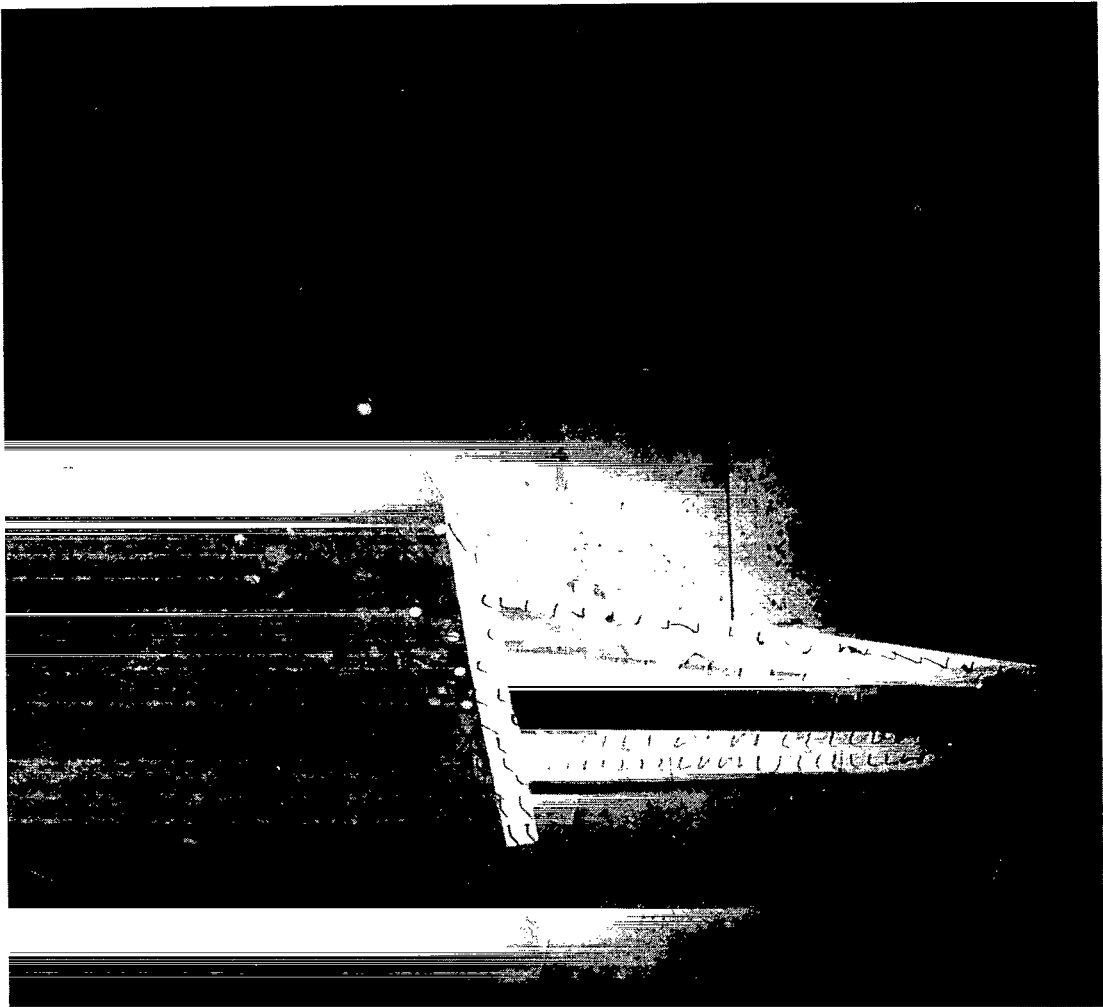

L-71-598

(1)  $\alpha = 12^{\circ}$ .

Figure 5.- Continued.

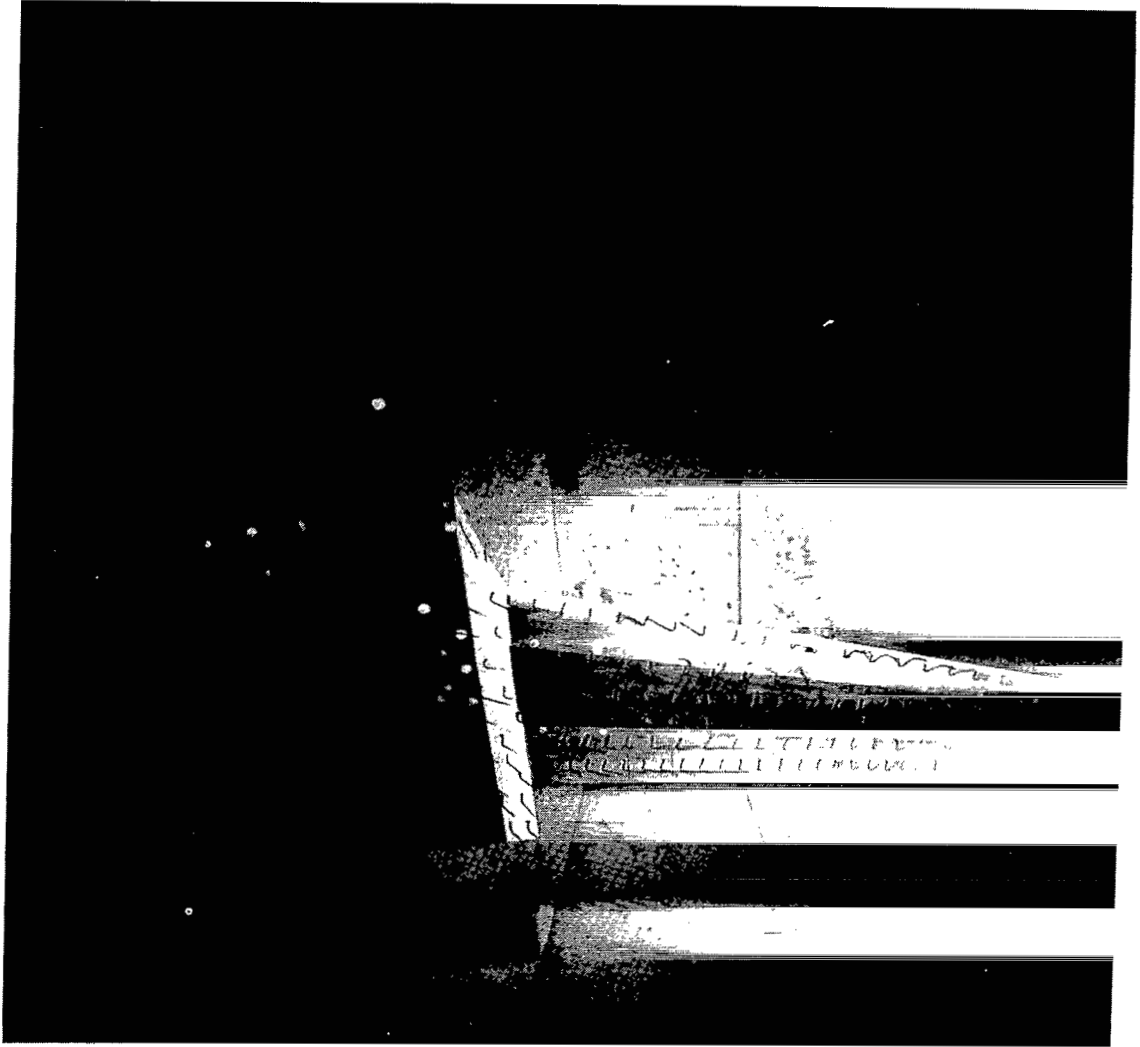

L-71-599

(m)  $\alpha = 14^\circ$ .

Figure 5.- Continued.



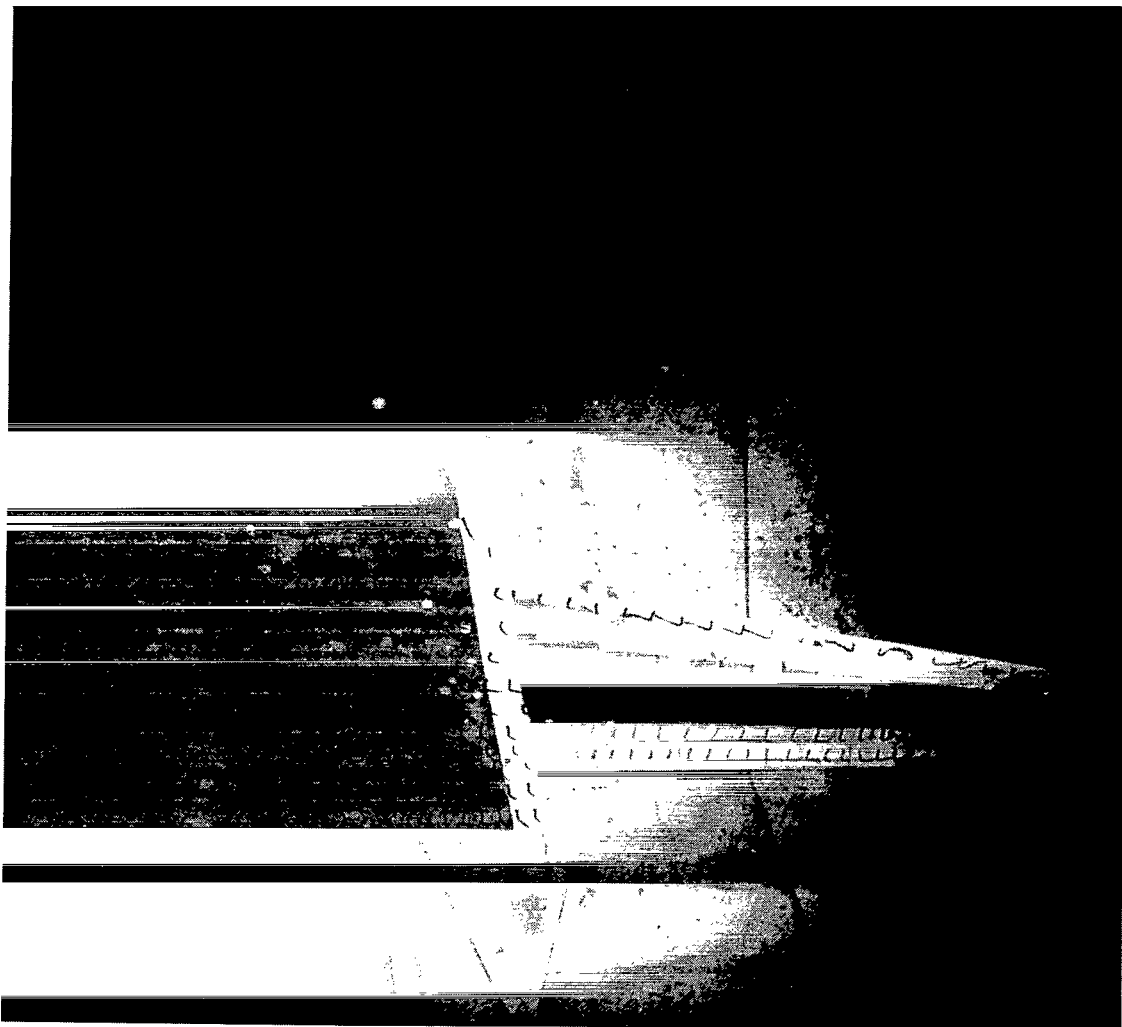

L-71-600

(n)  $\alpha = 16^\circ$ .

Figure 5.- Continued.

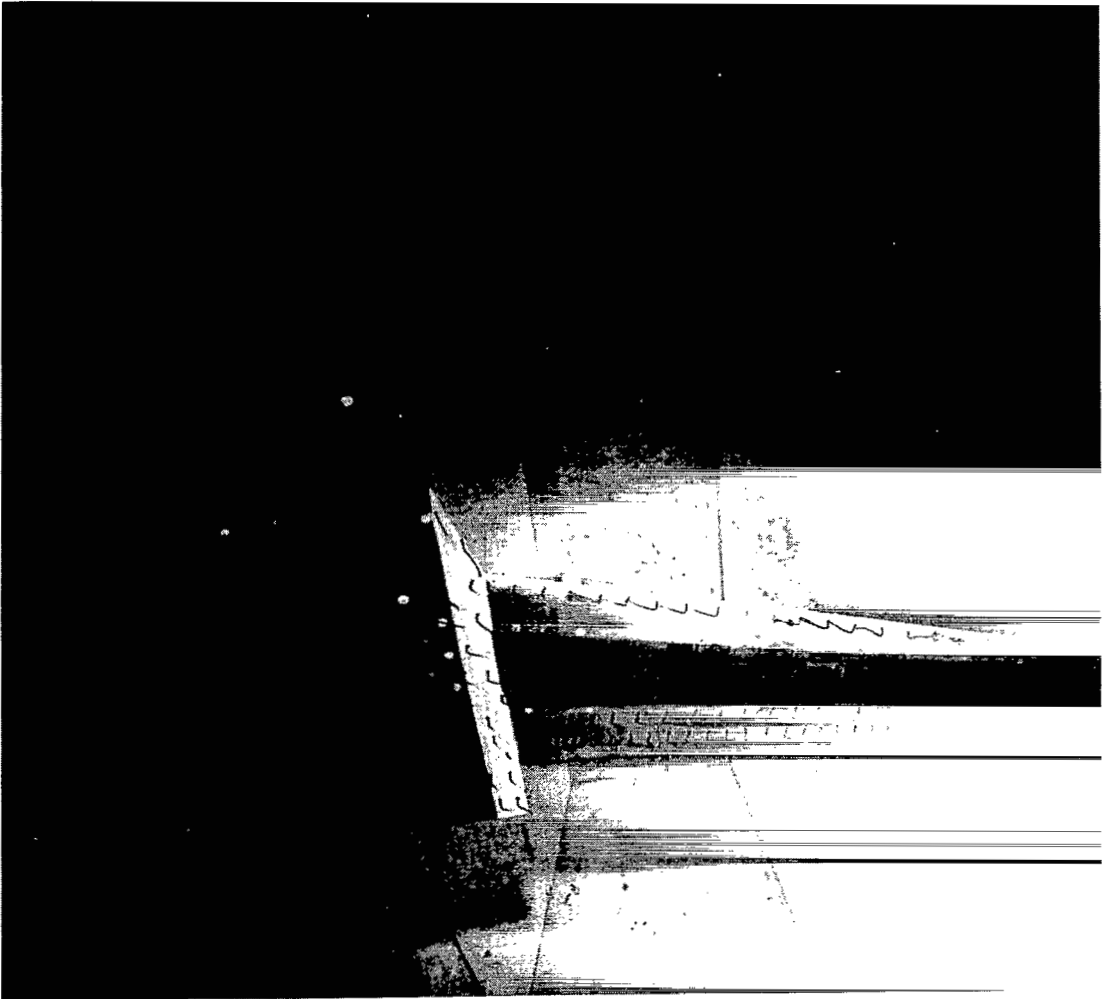

L-71-601

(o)  $\alpha = 18^\circ$ .

Figure 5.- Continued.

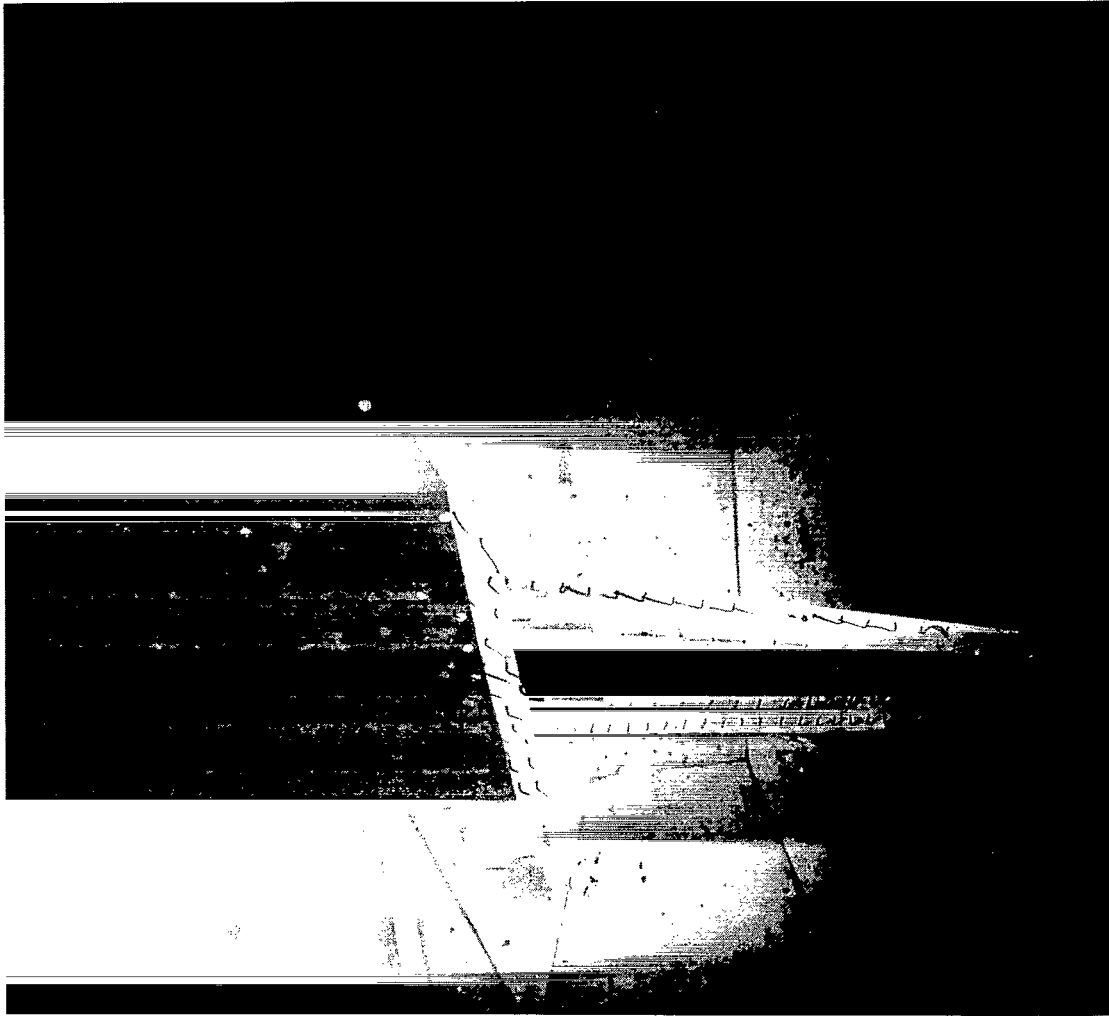

L-71-602

(p)  $\alpha = 20^\circ$ .

Figure 5.- Concluded.

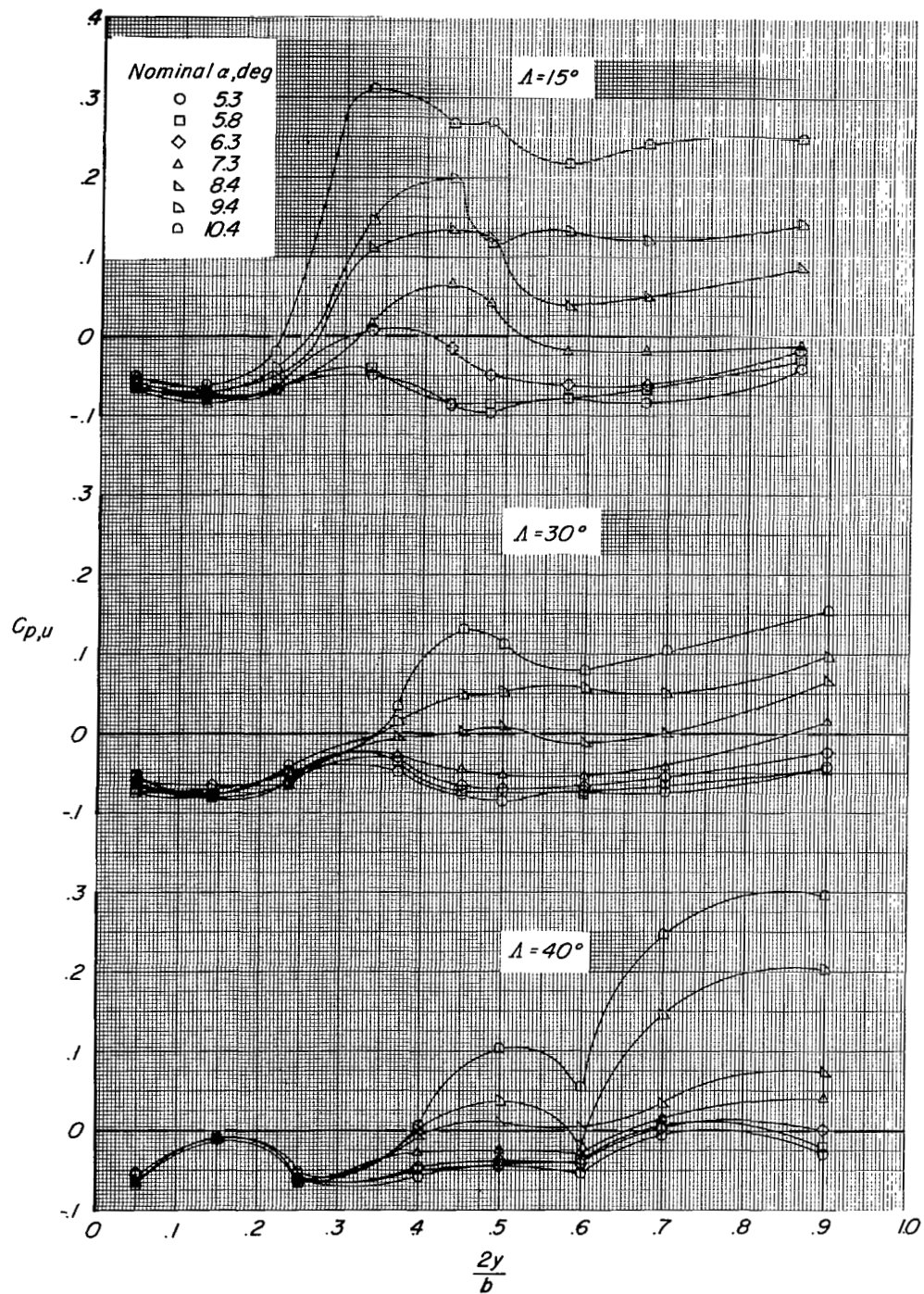

Figure 6.- Effect of angles of attack and sweepback on the trailing-edge flow separation at  $x/c = 1.00$  of a variable-sweep wing. Fuselage off.

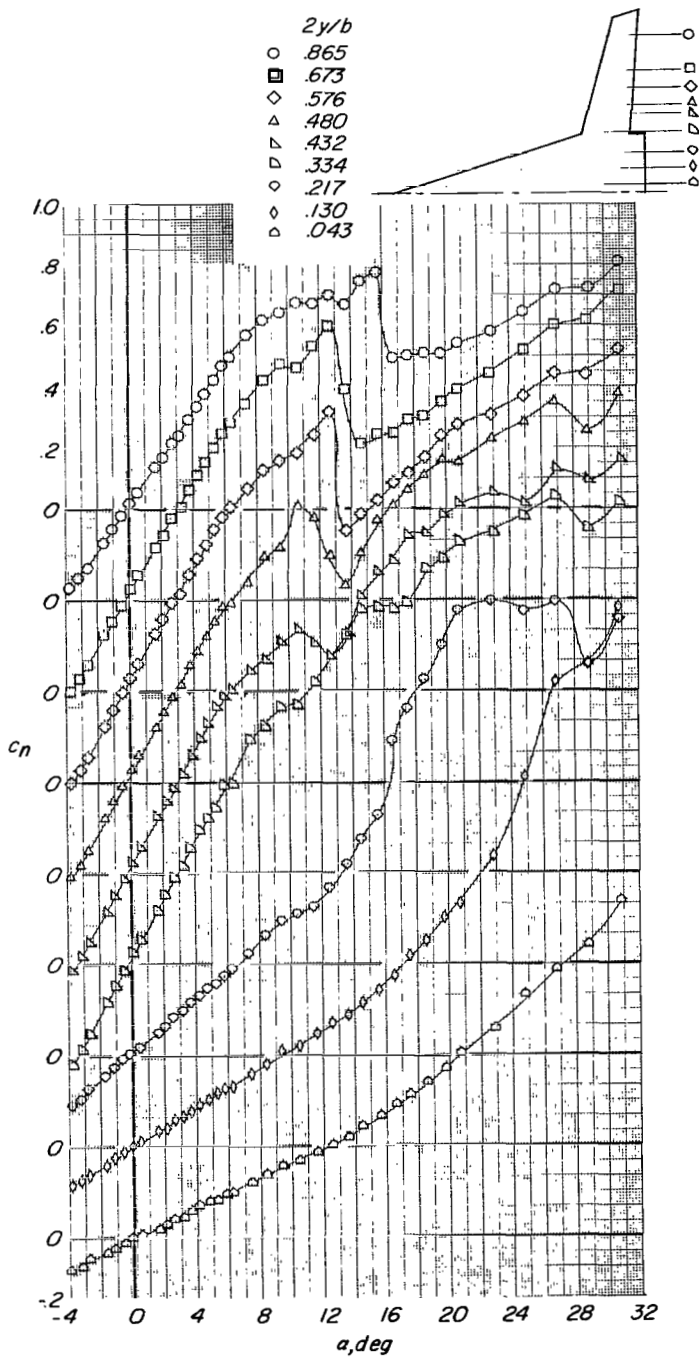
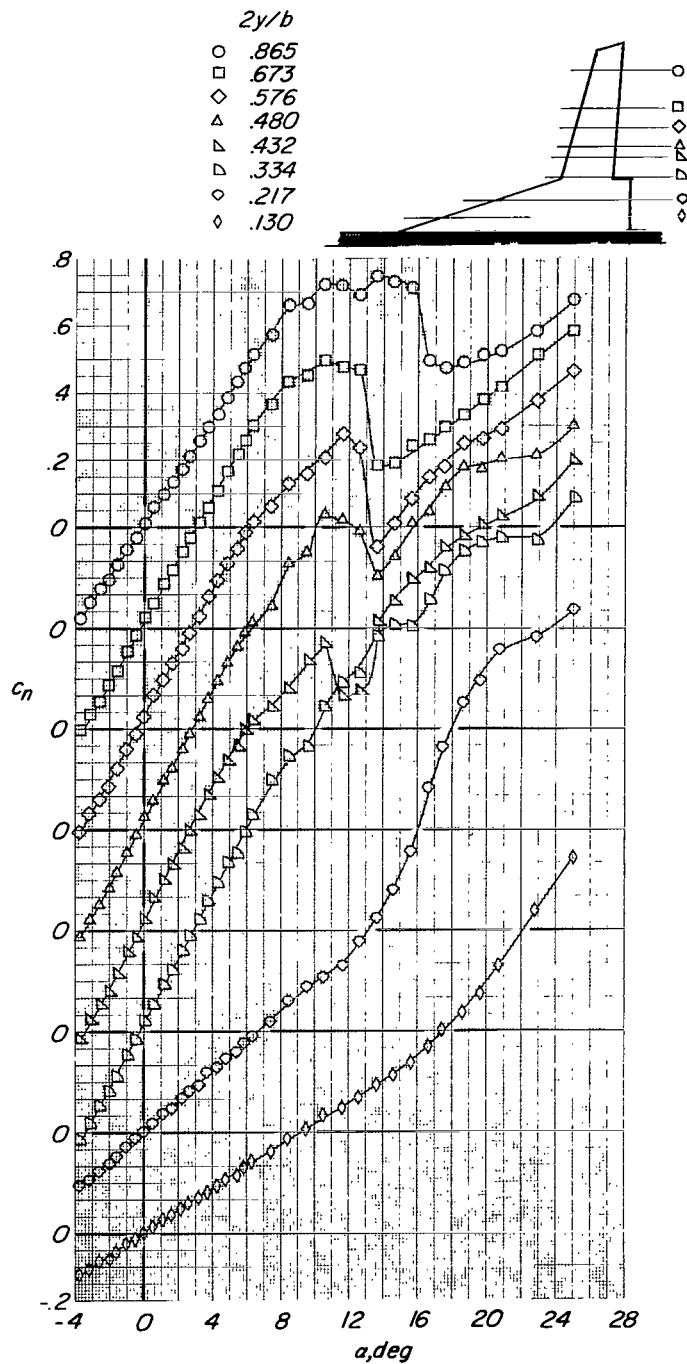
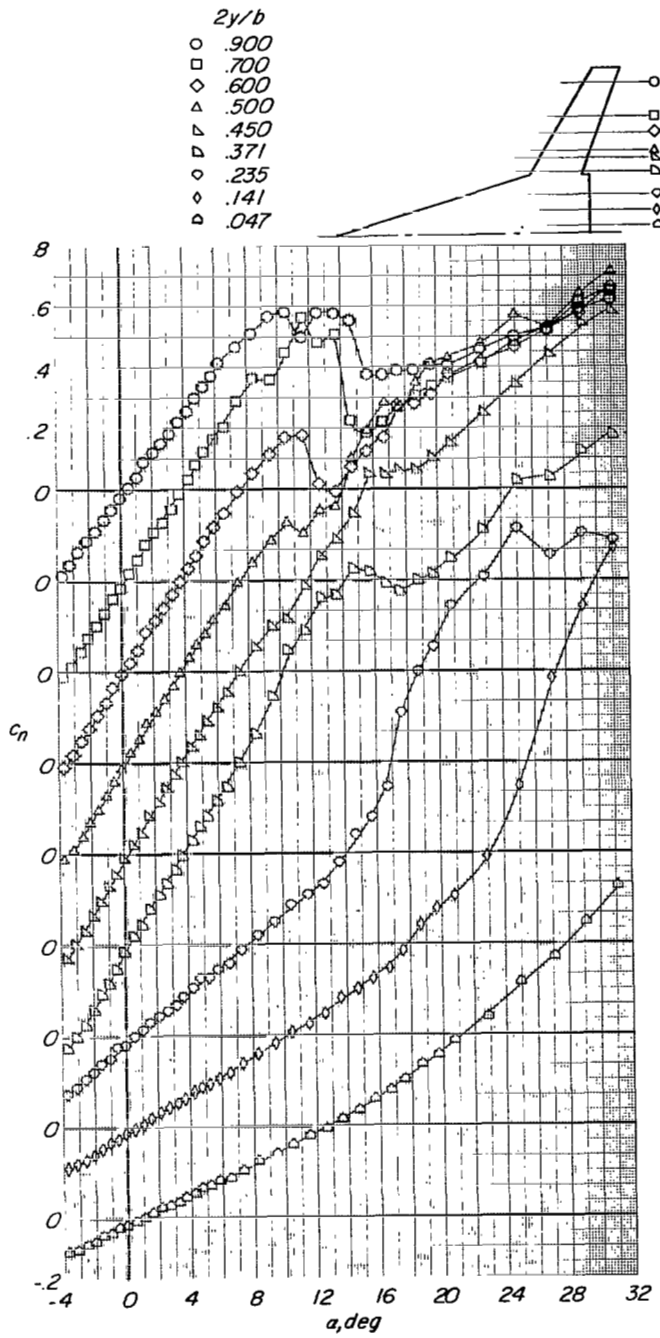

Figure 7.- Effect of spanwise location on section normal-force coefficients.



(b)  $\Lambda = 15^\circ$ ; fuselage on.

Figure 7.- Continued.



(c)  $\Lambda = 30^\circ$ ; fuselage off.

Figure 7.- Continued.

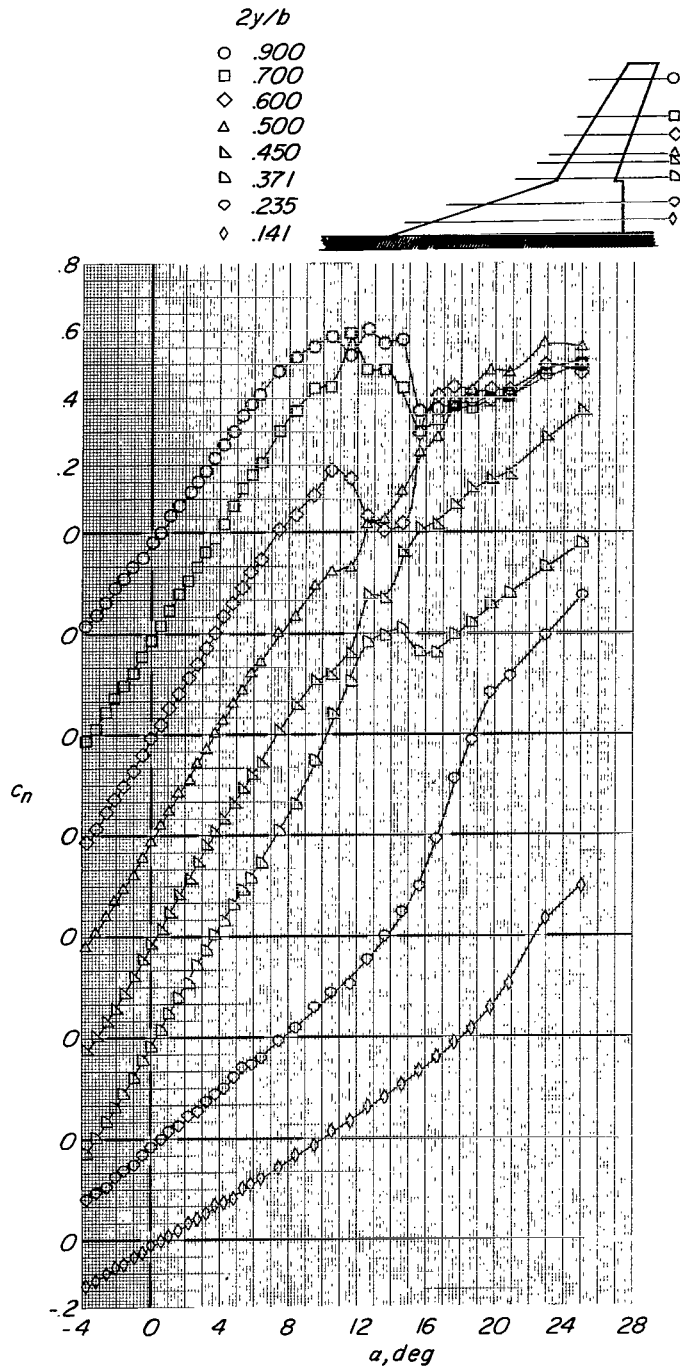

(d)  $\Lambda = 30^\circ$ ; fuselage on.

Figure 7.- Continued.



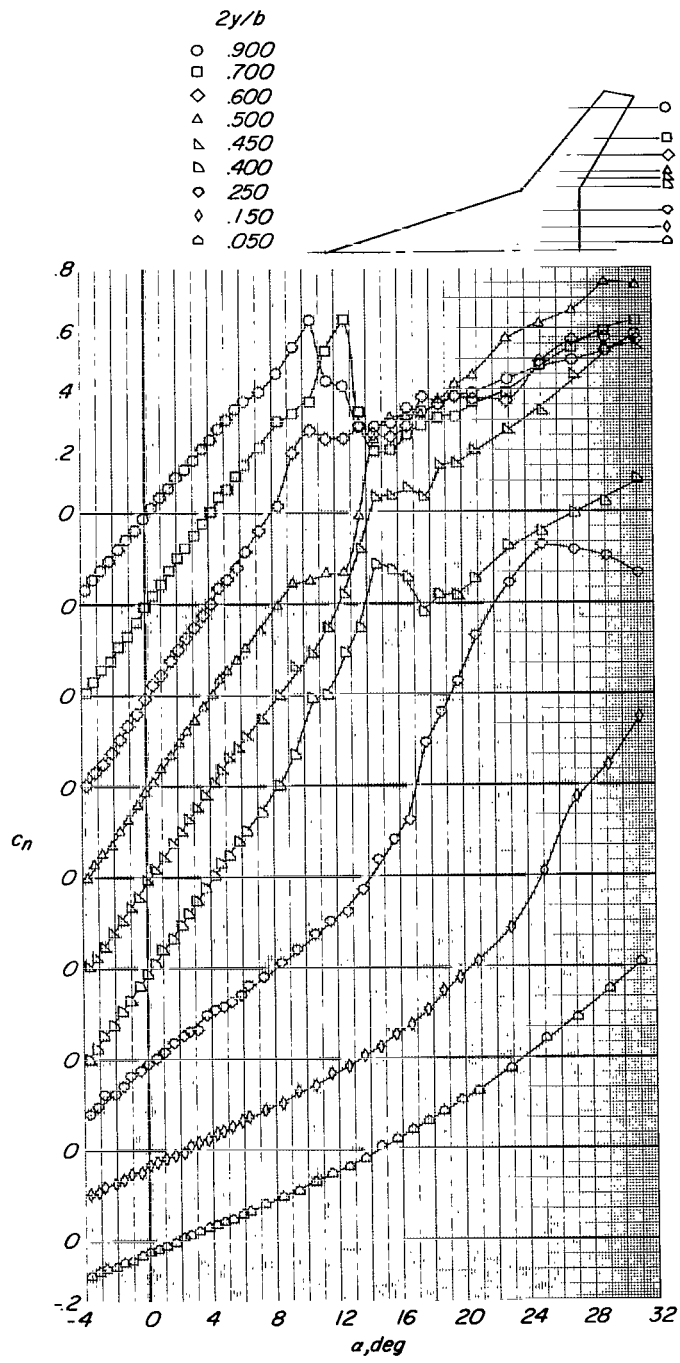

(e)  $\Lambda = 40^\circ$ ; fuselage off.

Figure 7.- Continued.

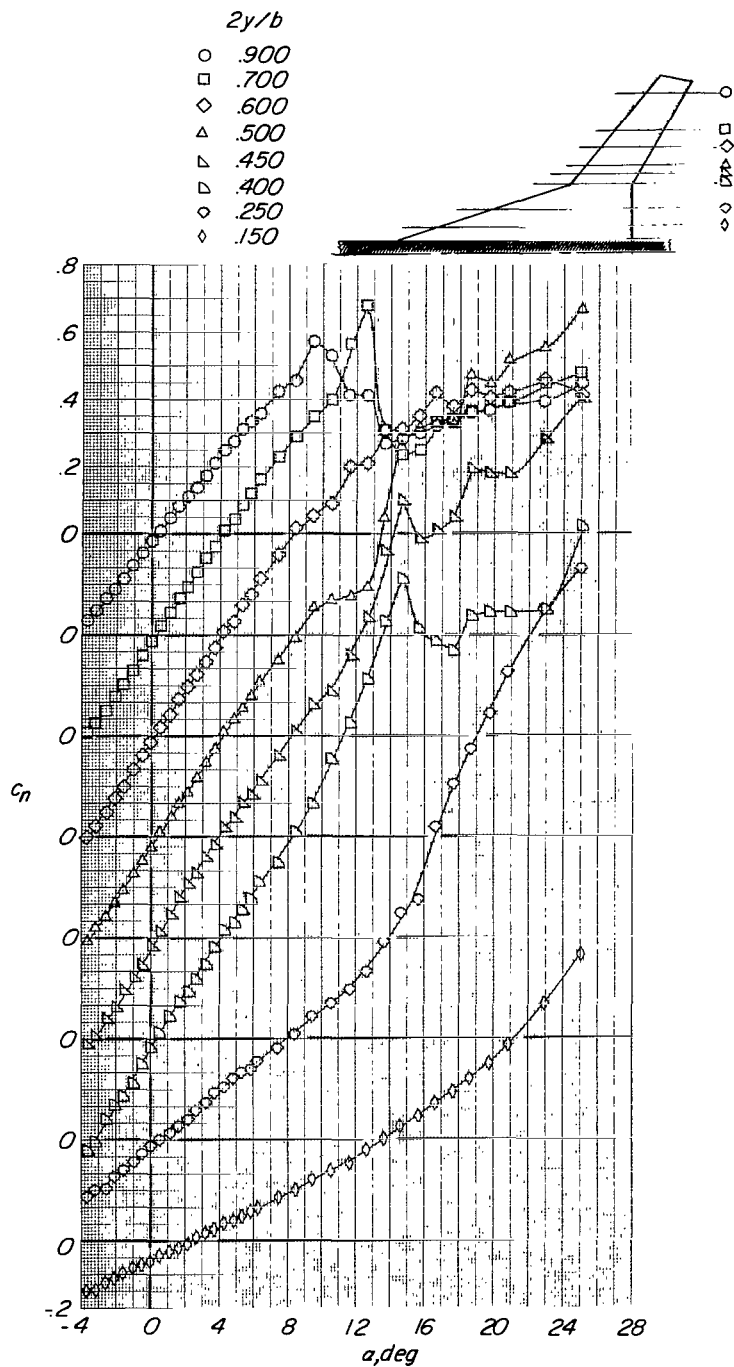

(f)  $\Lambda = 40^\circ$ ; fuselage on.

Figure 7.- Concluded.

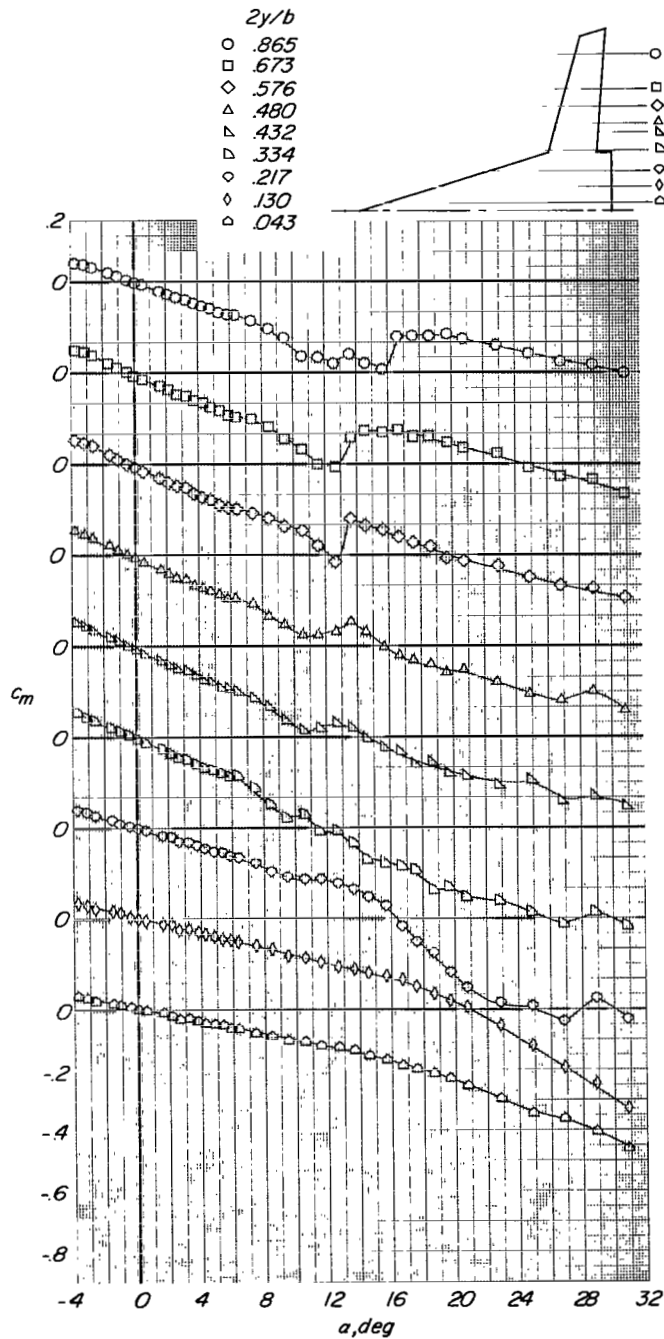

(a)  $\Lambda = 15^\circ$ ; fuselage off.

Figure 8.- Effect of spanwise location on section pitching-moment coefficients.

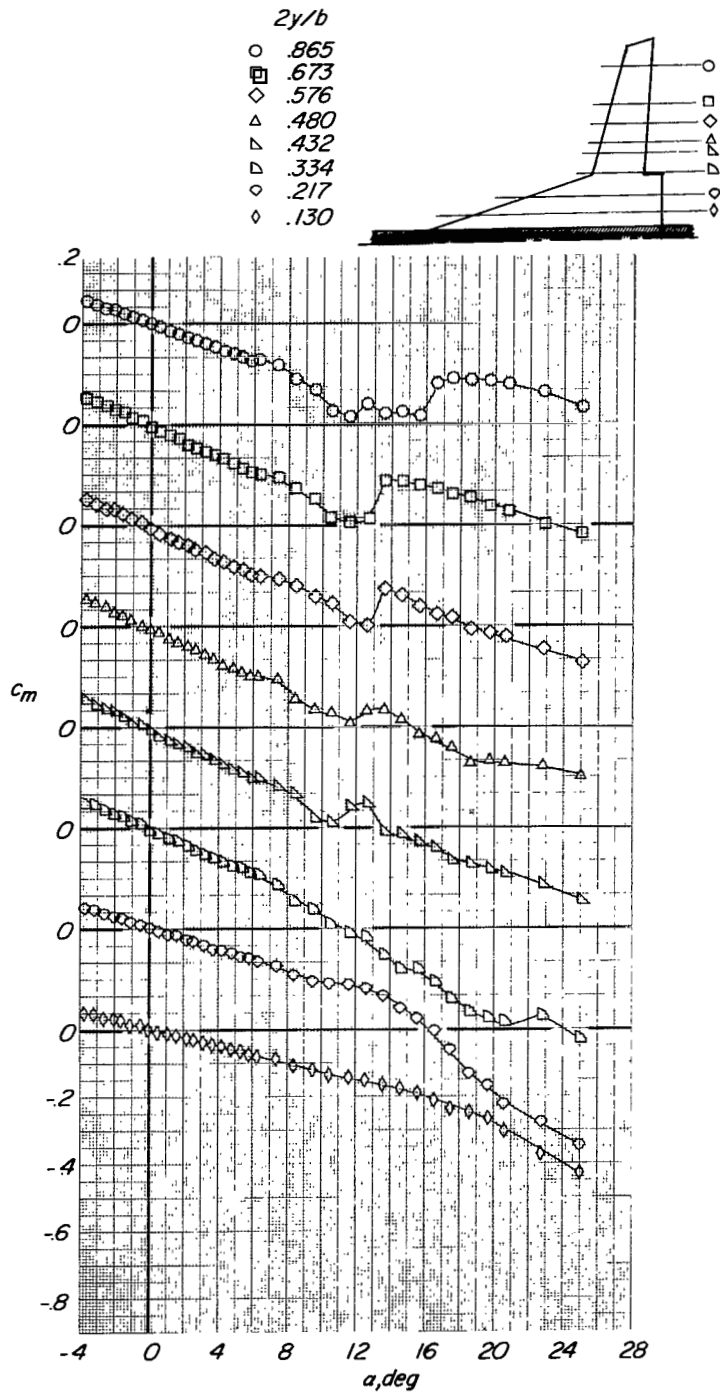

(b)  $\Lambda = 15^\circ$ ; fuselage on.

Figure 8.- Continued.

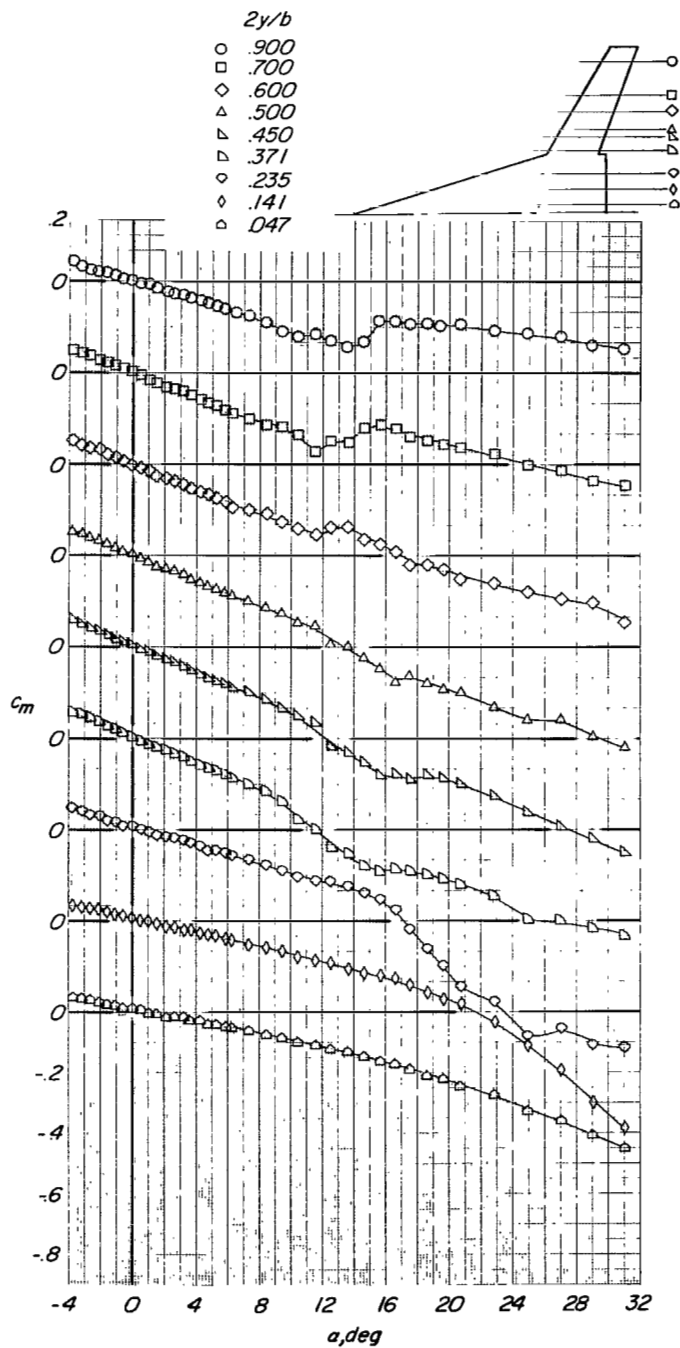

(c)  $\Lambda = 30^\circ$ ; fuselage off.

Figure 8.- Continued.

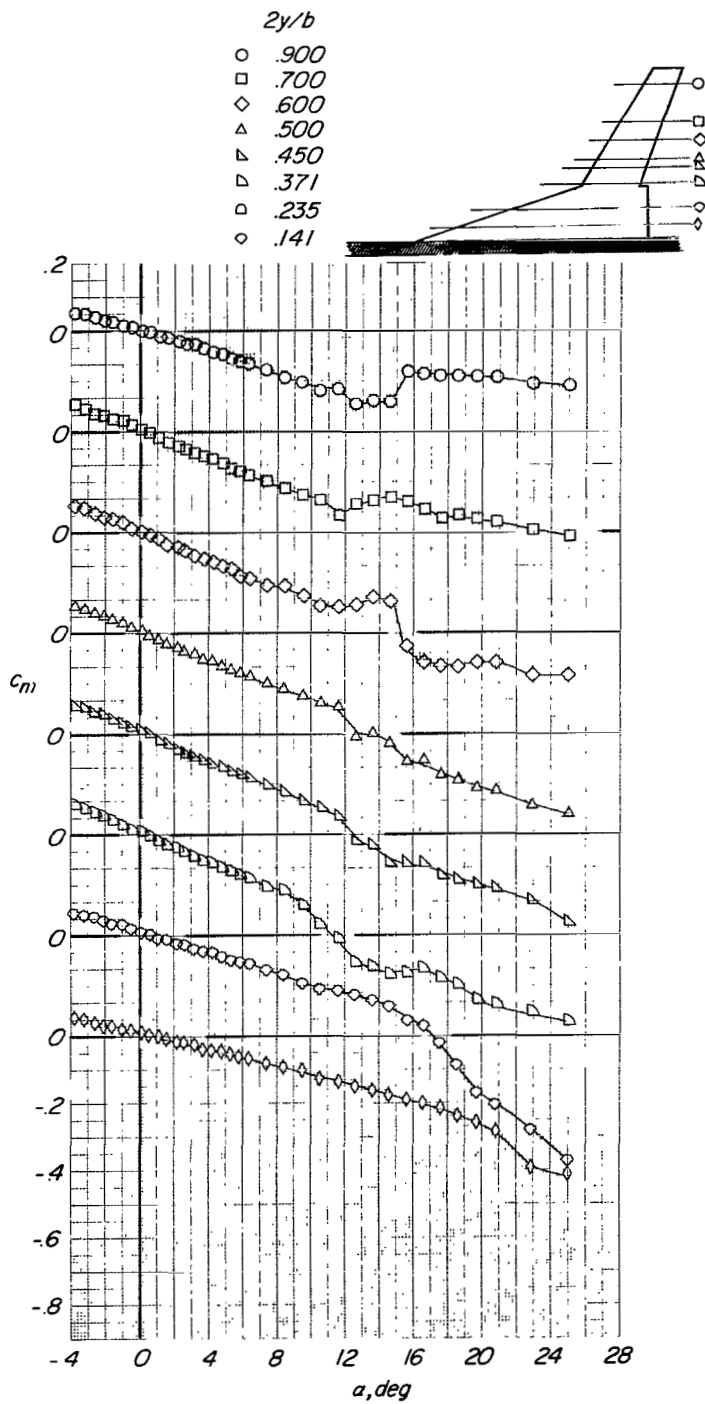

(d)  $\Lambda = 30^\circ$ ; fuselage on.

Figure 8.- Continued.

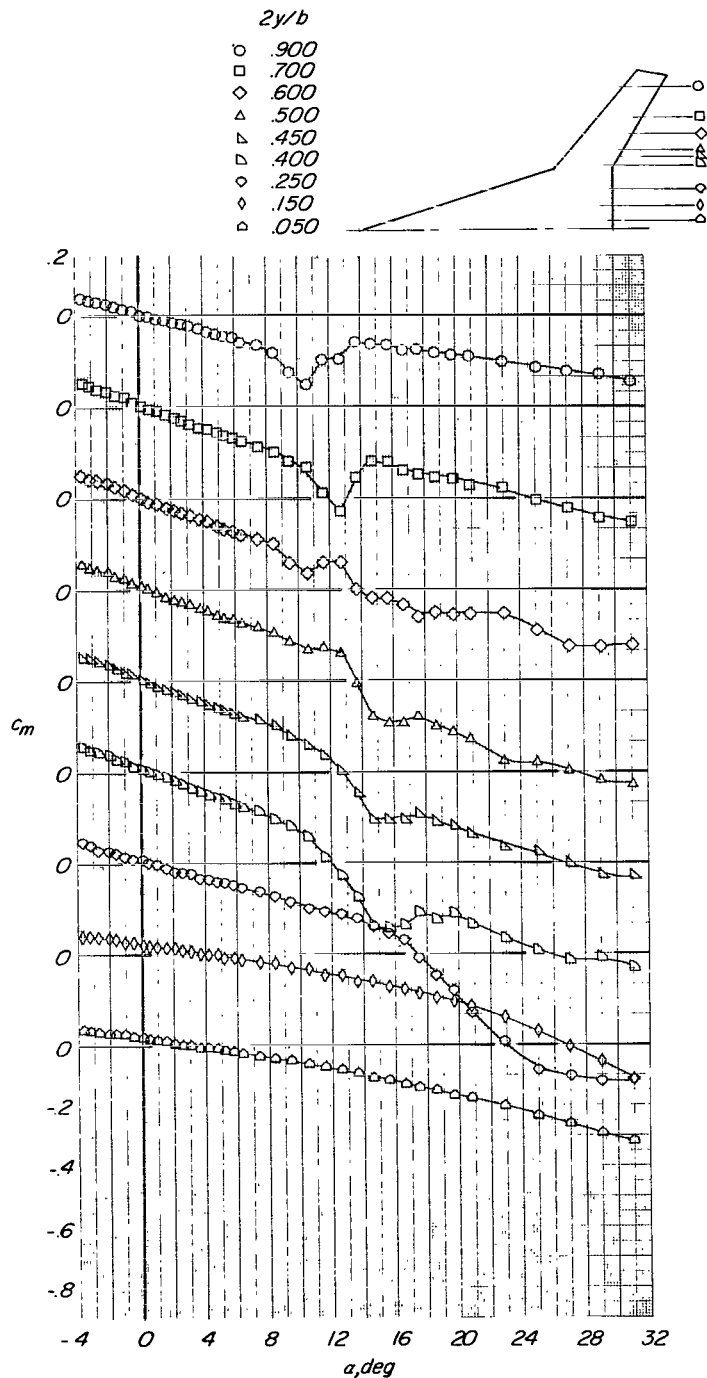

(e)  $\Lambda = 40^\circ$ ; fuselage off.

Figure 8.- Continued.

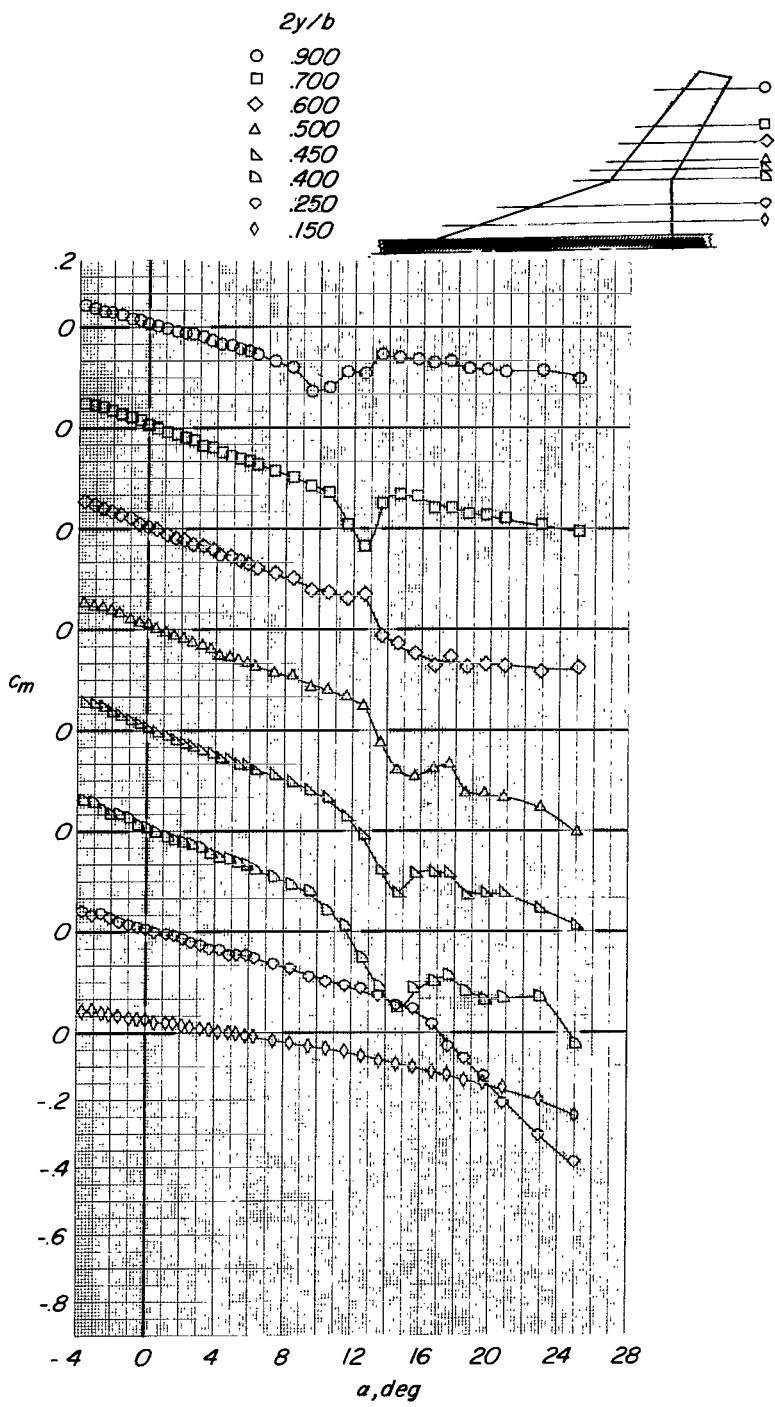

(f)  $\Lambda = 40^\circ$ ; fuselage on.

Figure 8.- Concluded.



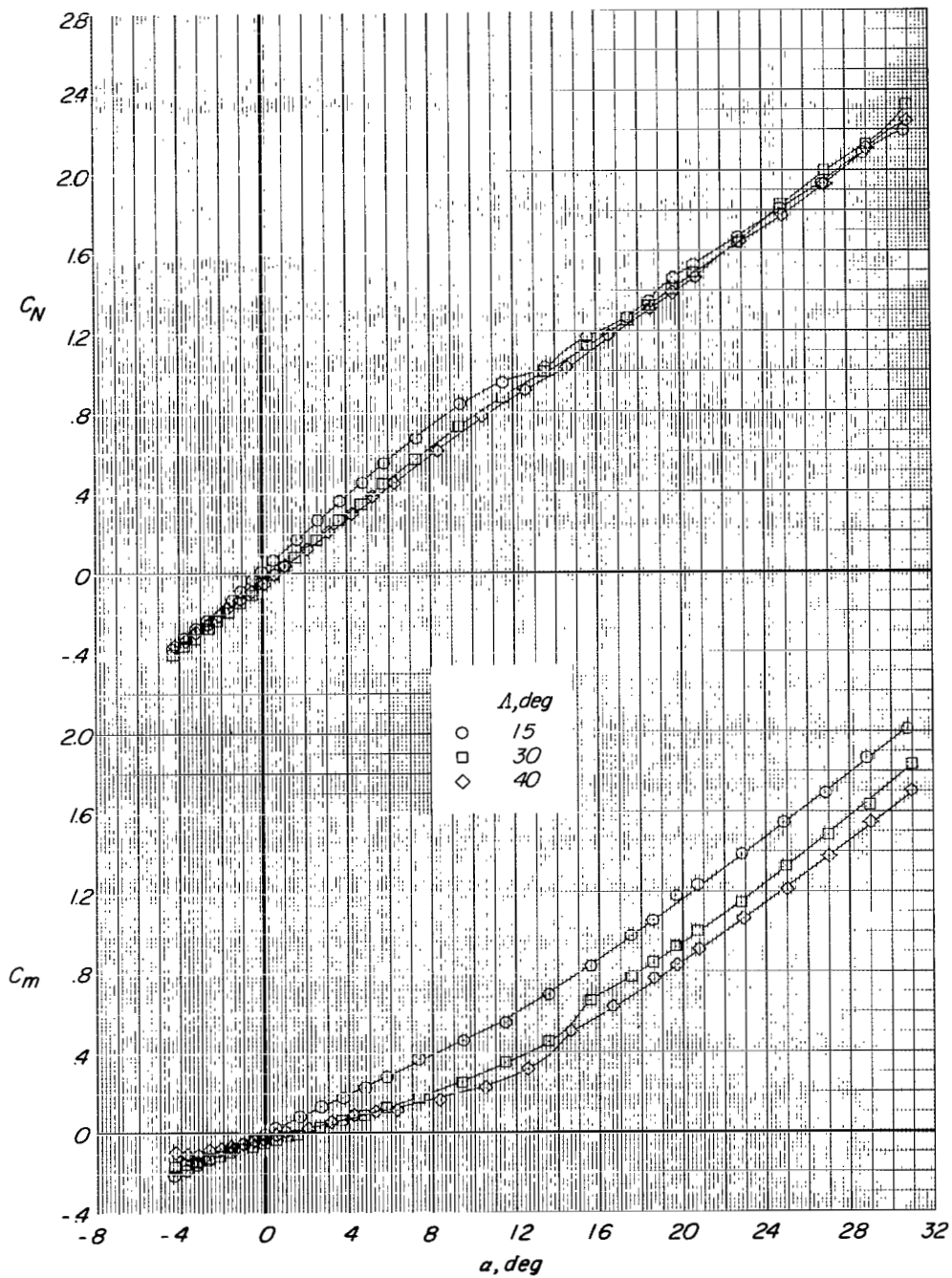

(a) Fuselage off.

Figure 9.- Effect of sweep on total normal-force and pitching-moment coefficients as determined from force balance data.

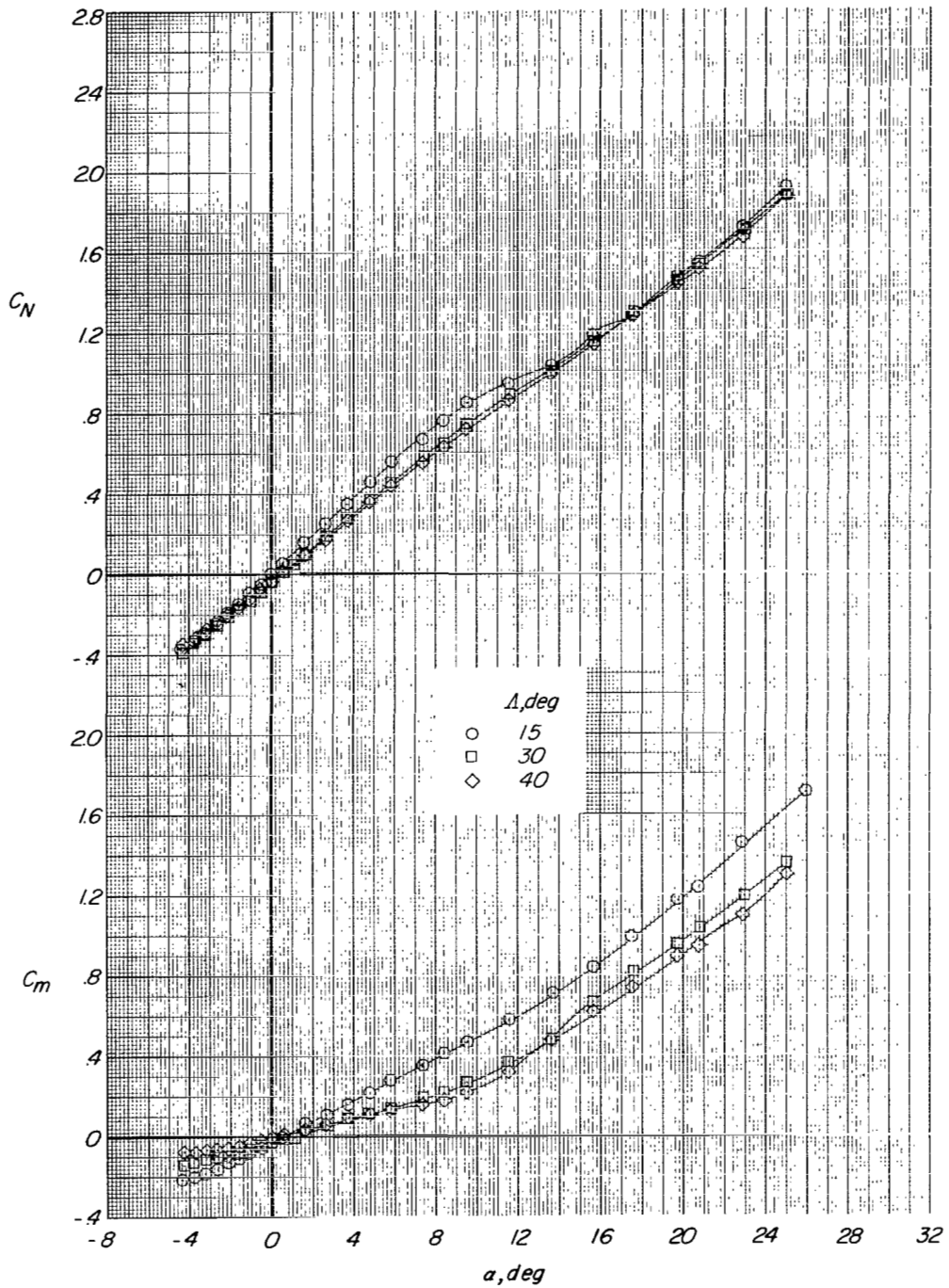

(b) Fuselage on.

Figure 9.- Concluded.

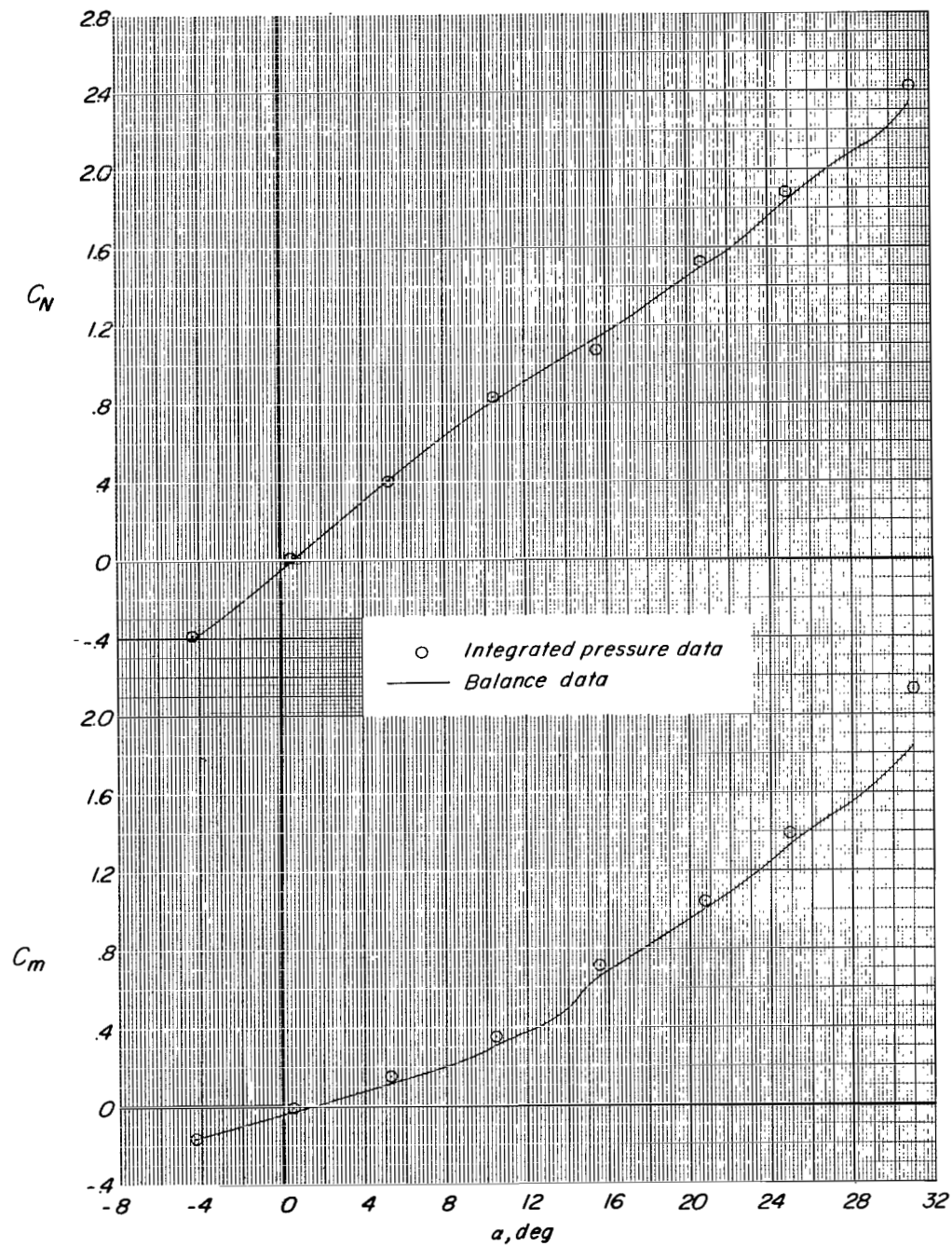
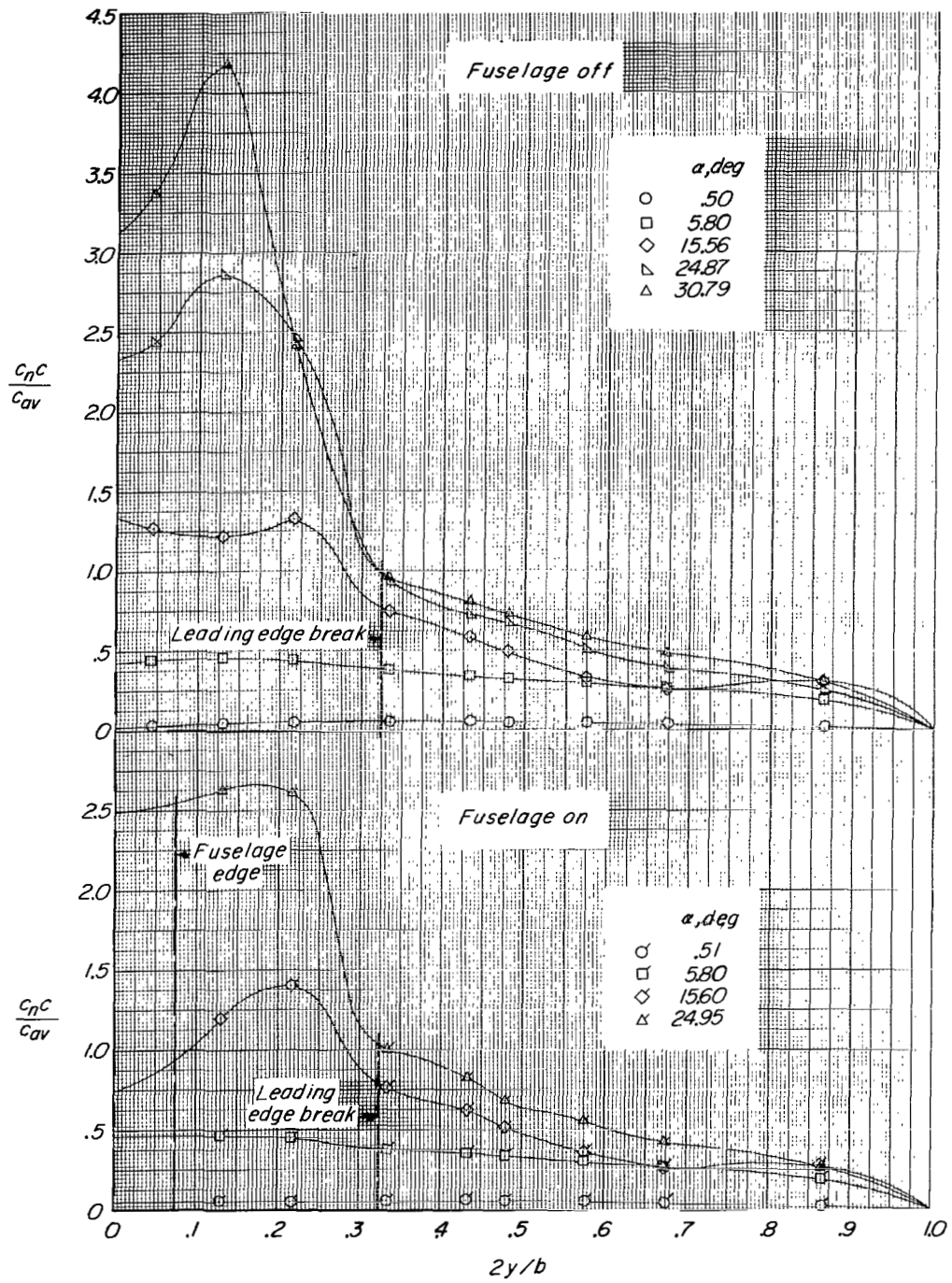
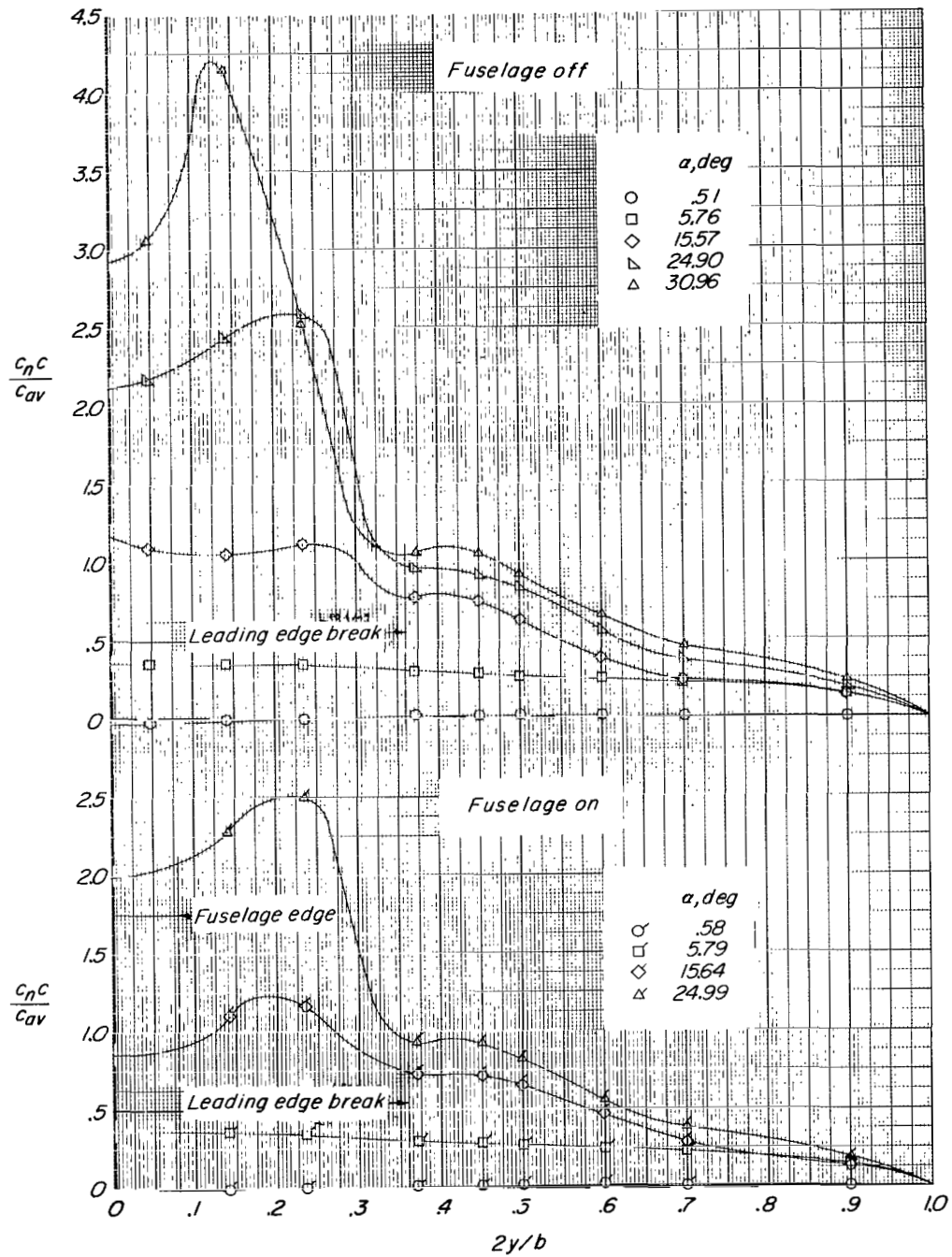

Figure 10.- Correlation of integrated pressure data with force balance data.  
 $\Lambda = 30^\circ$ ; fuselage off.



(a)  $\Lambda = 15^\circ$ .

Figure 11.- Effect of angle of attack and fuselage on span load distribution.



(b)  $\Lambda = 30^\circ$ .

Figure 11.- Continued.

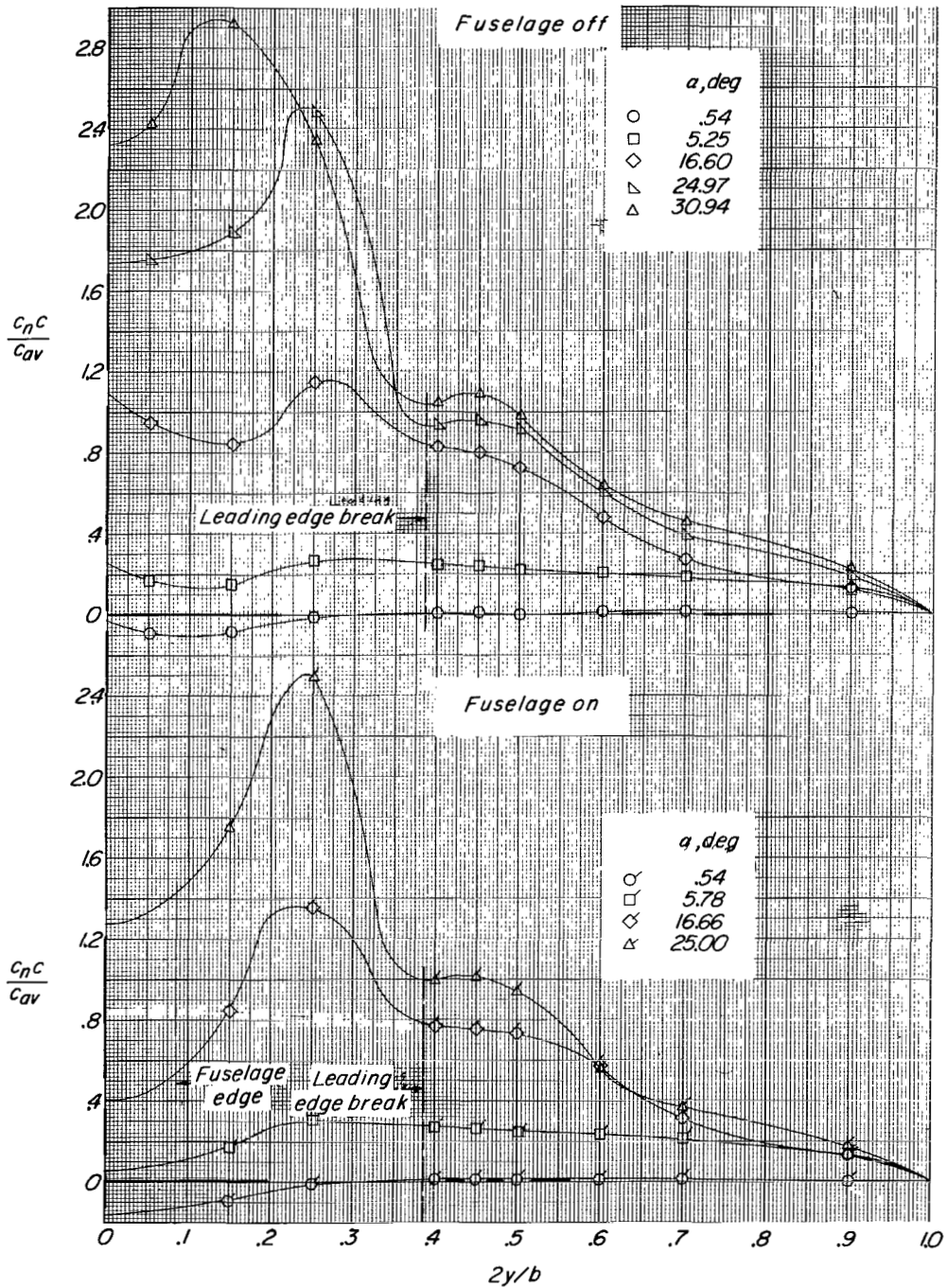

(c)  $\Lambda = 40^\circ$ .

Figure 11.- Concluded.

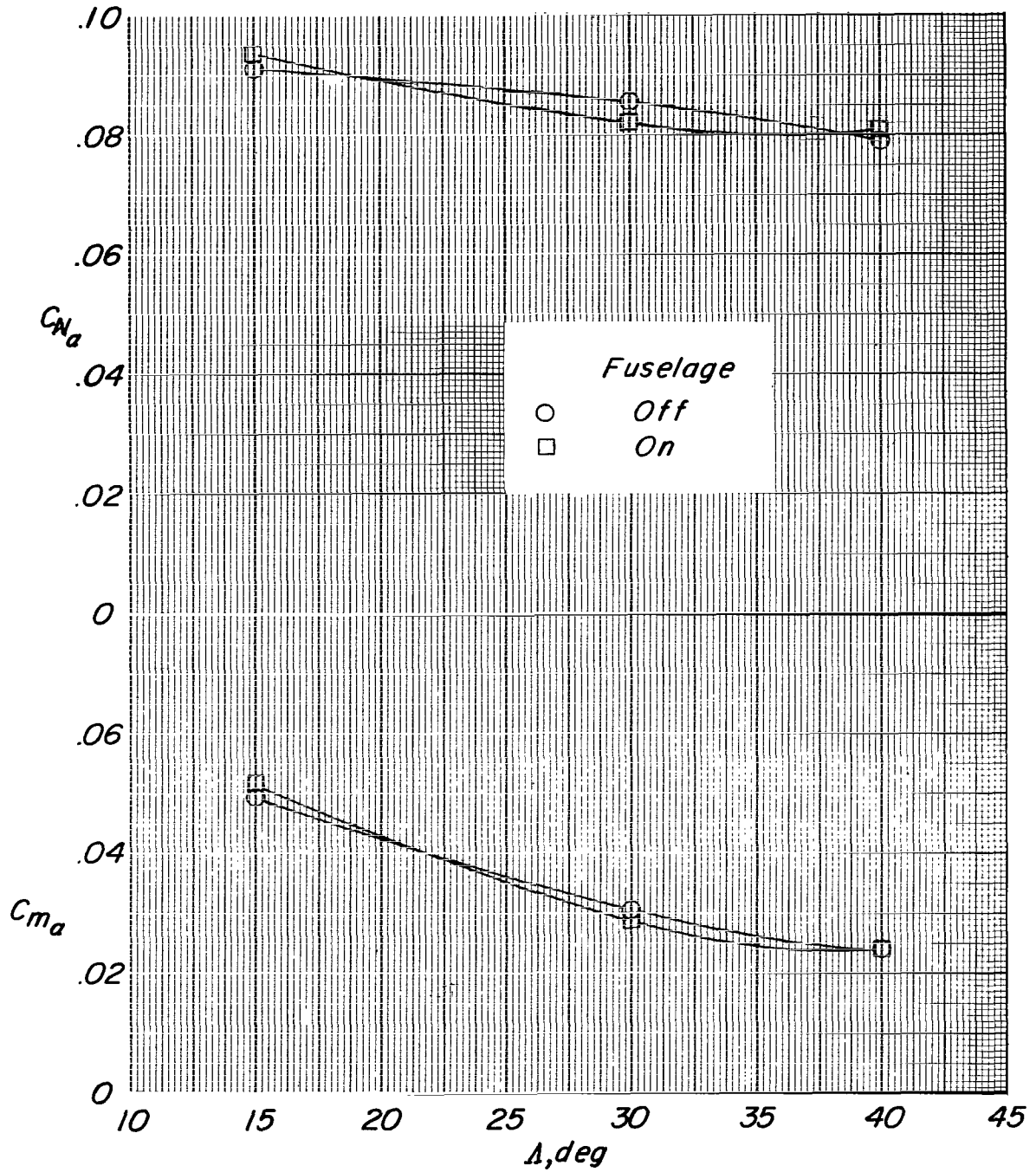

Figure 12.- Effect of fuselage on  $C_{N\alpha}$  and  $C_{m\alpha}$ .

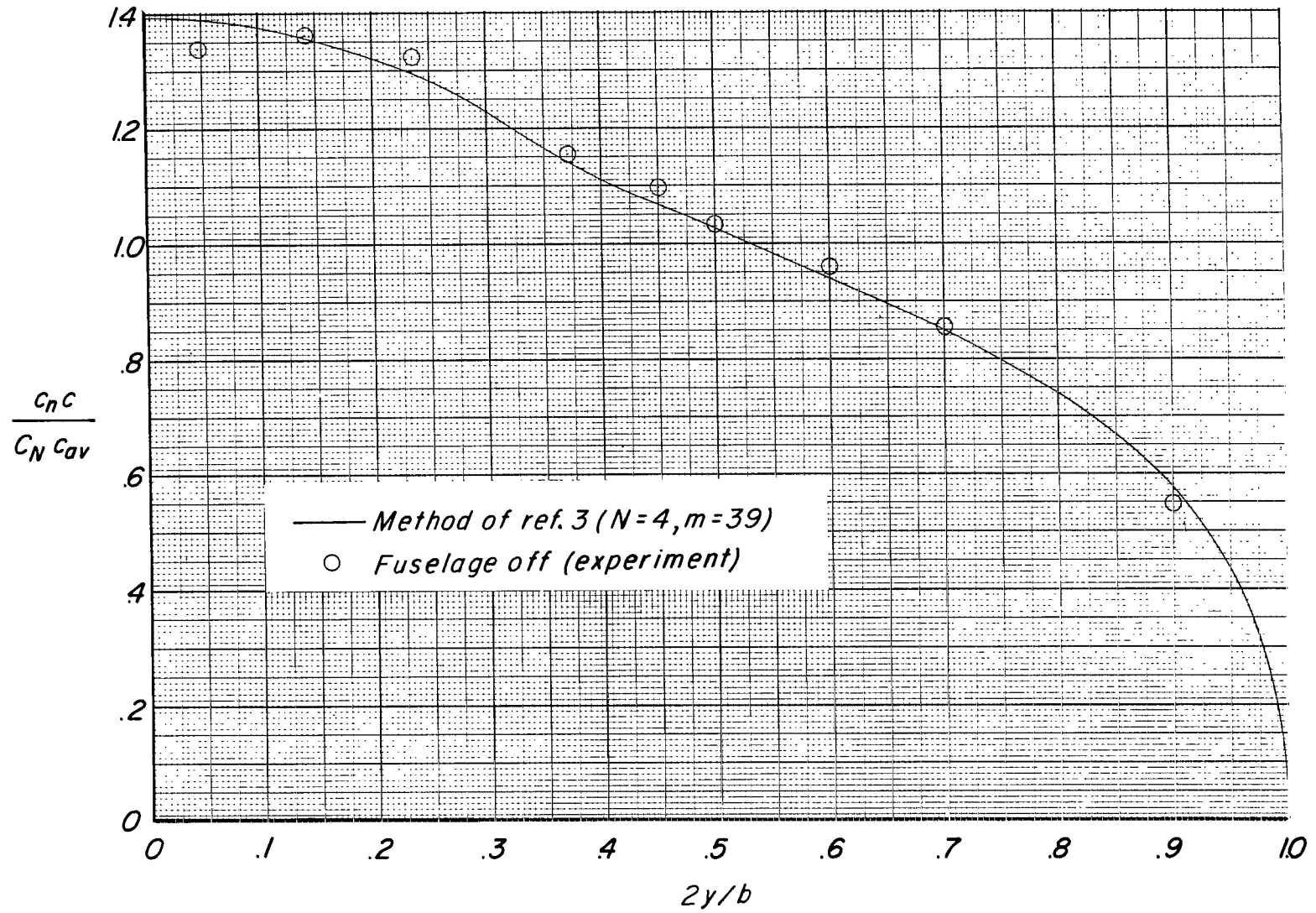

Figure 13.- Experimental and theoretical wing-alone span load distribution at  $\Lambda = 30^\circ$  and  $\alpha = 5.76^\circ$ .



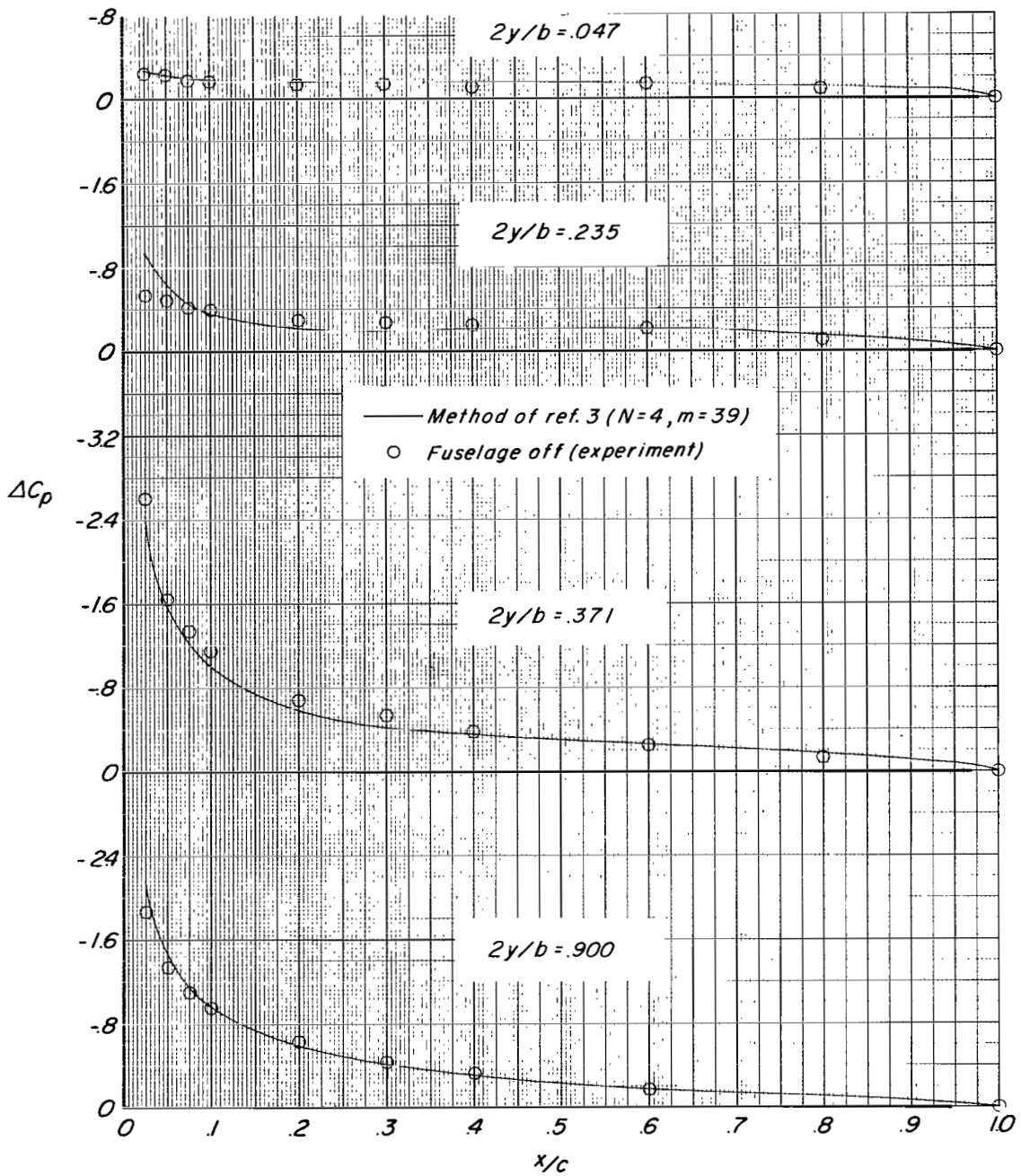
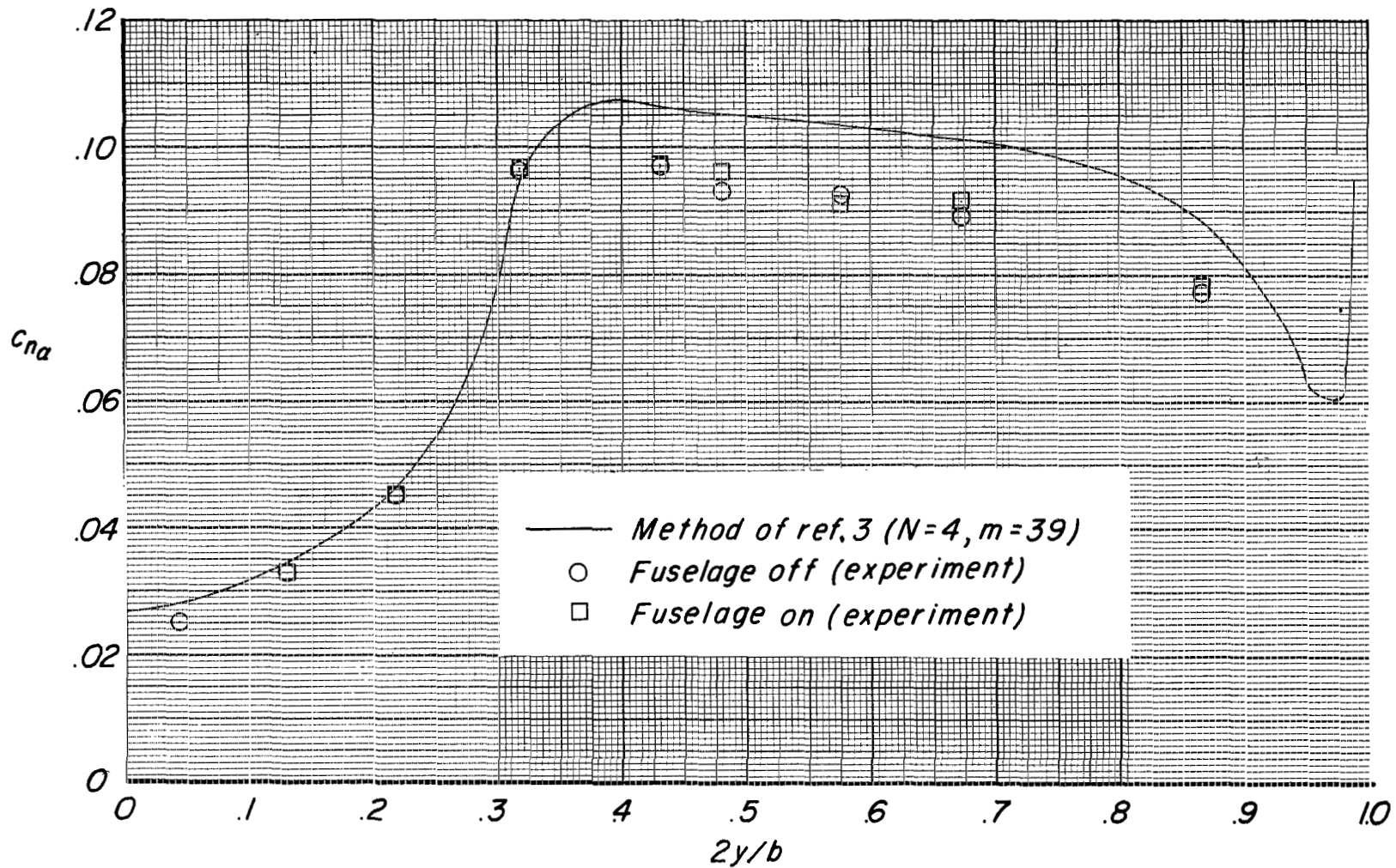
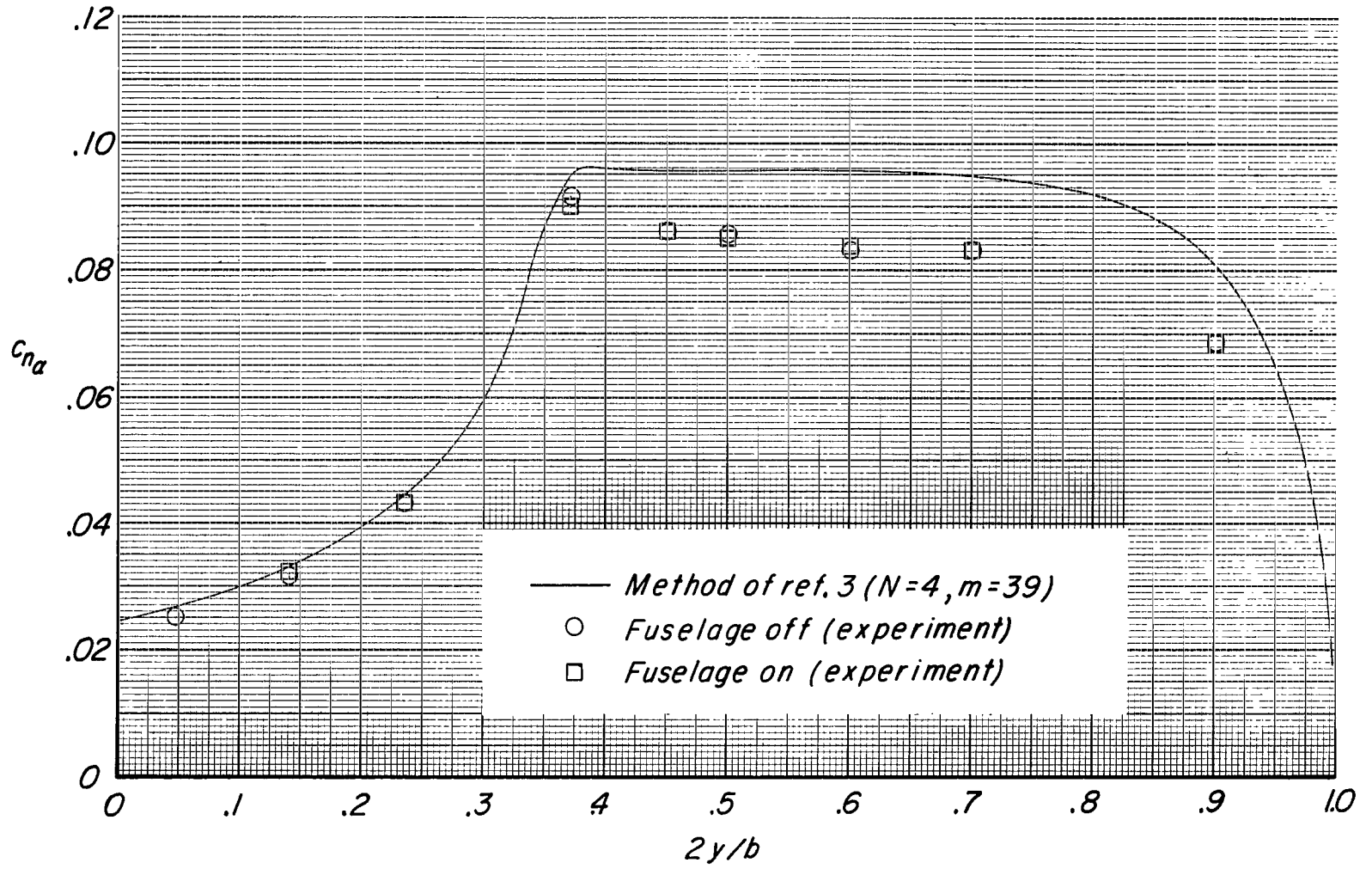

Figure 14.- Effect of spanwise location on the experimental and theoretical wing-alone chordwise pressure distributions at  $\Lambda = 30^\circ$  and  $\alpha = 5.76^\circ$ .



(a)  $\Lambda = 15^\circ$ .

Figure 15.- Experimental and theoretical section normal-force-coefficient-curve slopes.



(b)  $\Lambda = 30^\circ$ .

Figure 15.- Continued.

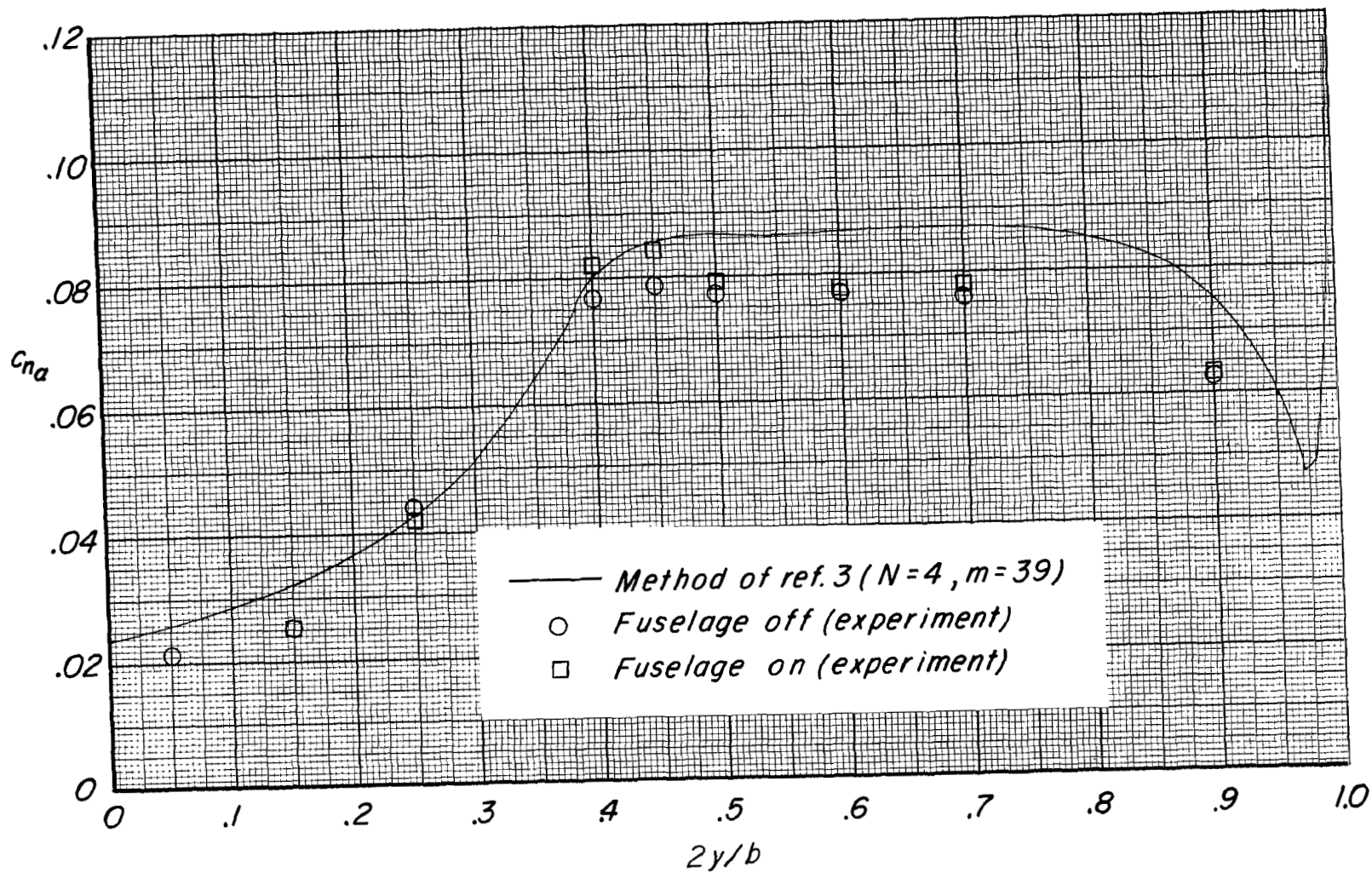

(c)  $\Lambda = 40^\circ$ .

Figure 15.- Concluded.

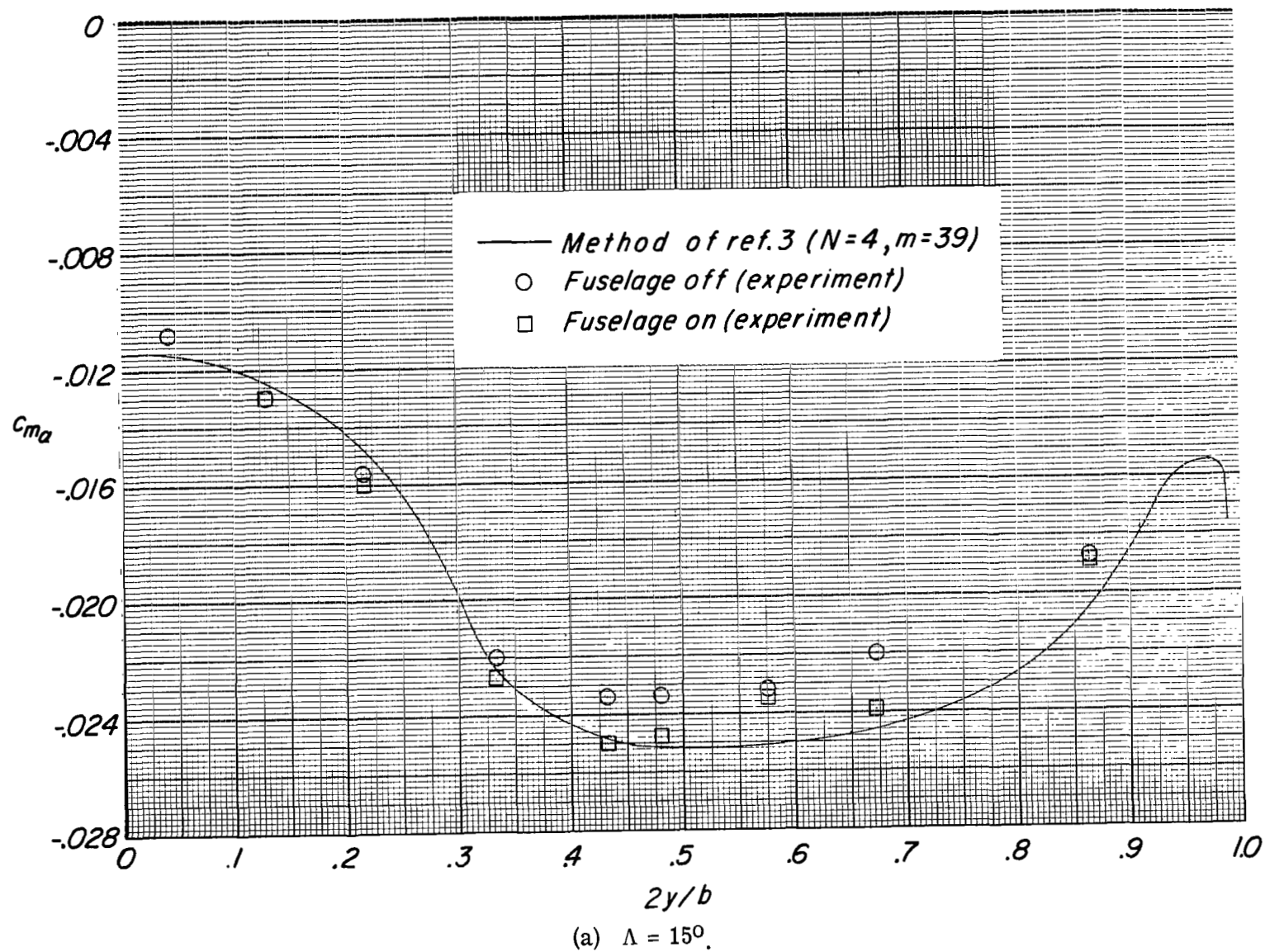
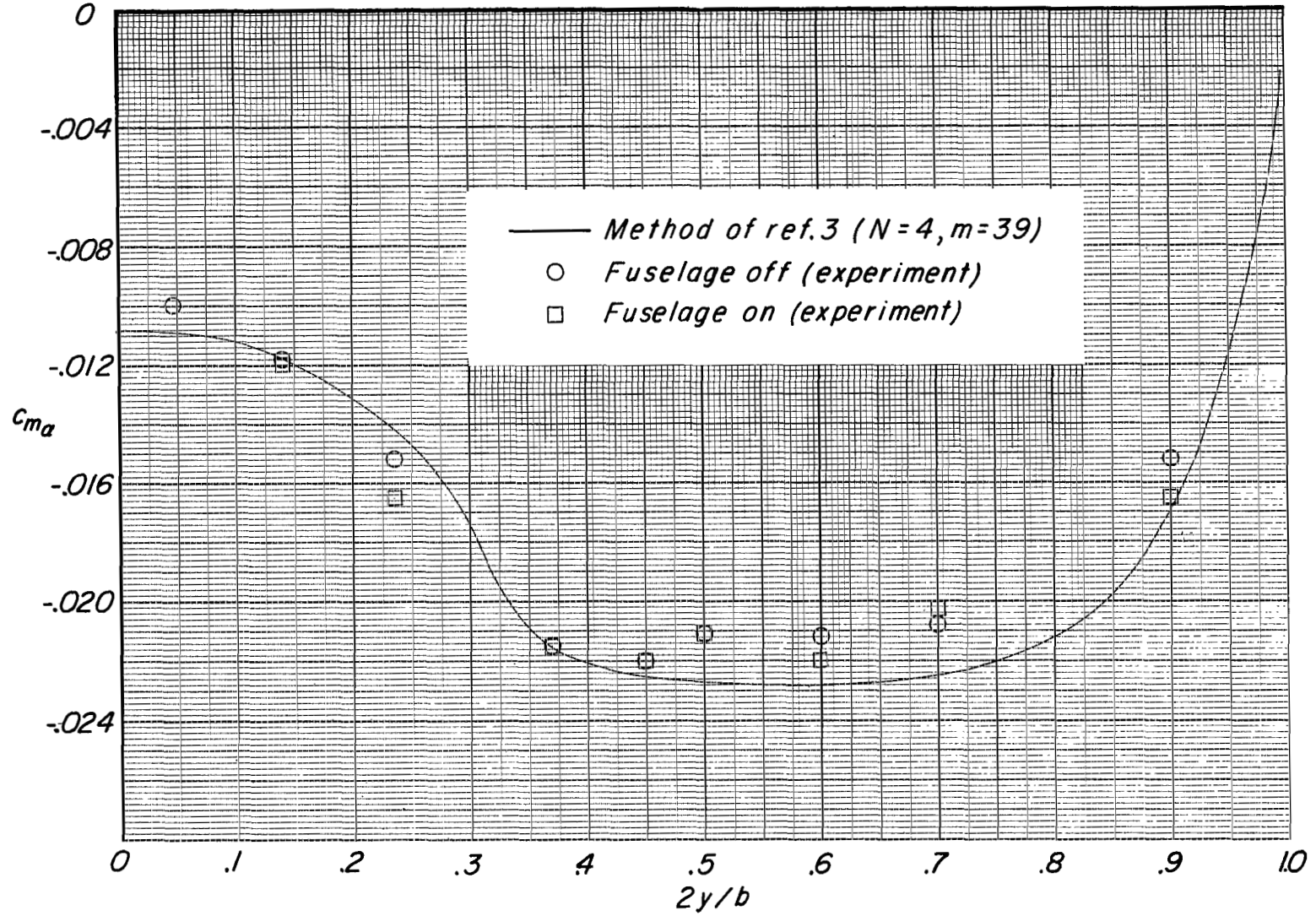
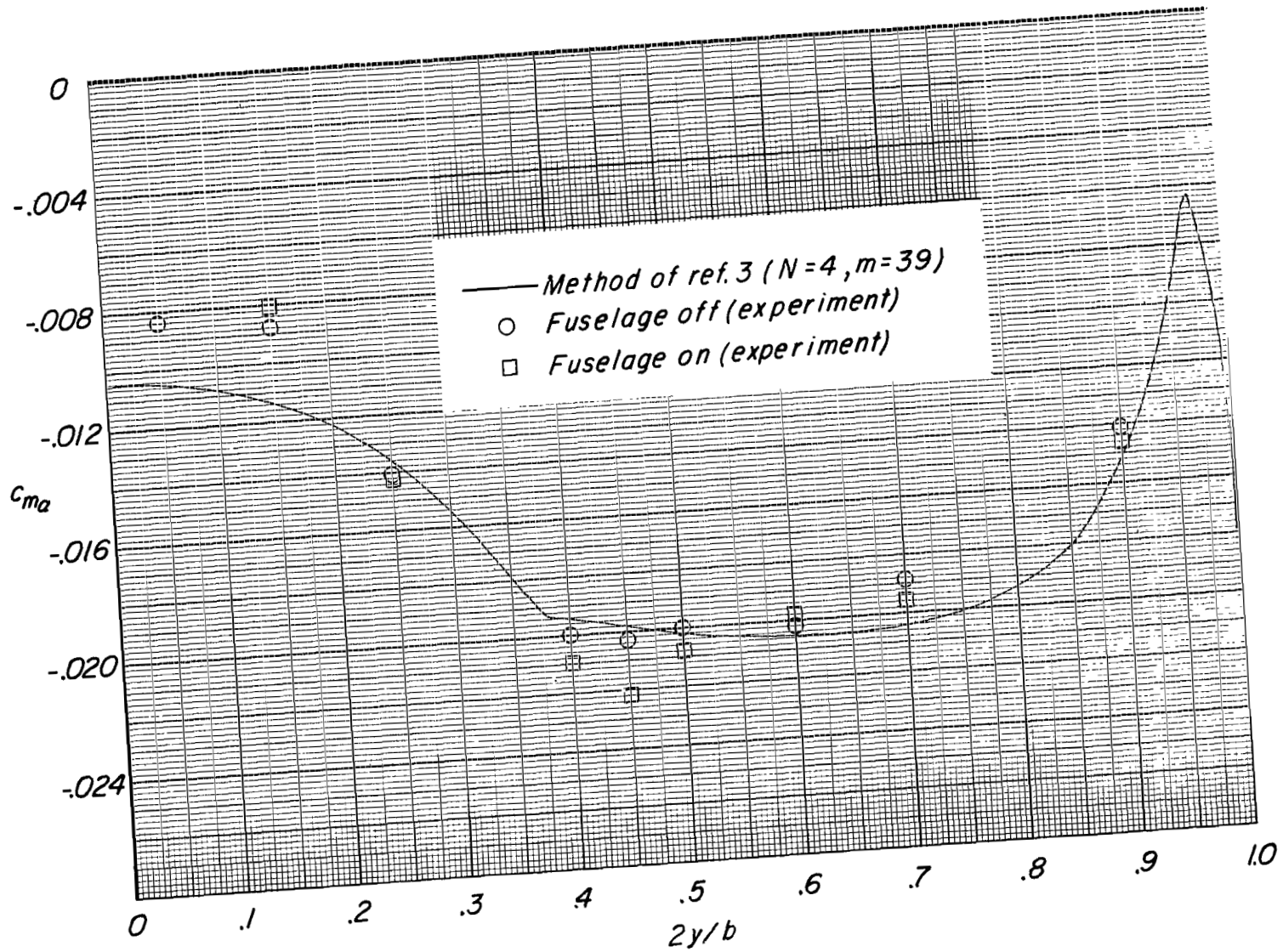

Figure 16.- Experimental and theoretical section pitching-moment-coefficient-curve slopes.



(b)  $\Lambda = 30^\circ$ .

Figure 16.- Continued.



(c)  $\Lambda = 40^\circ$ .

Figure 16.- Concluded.

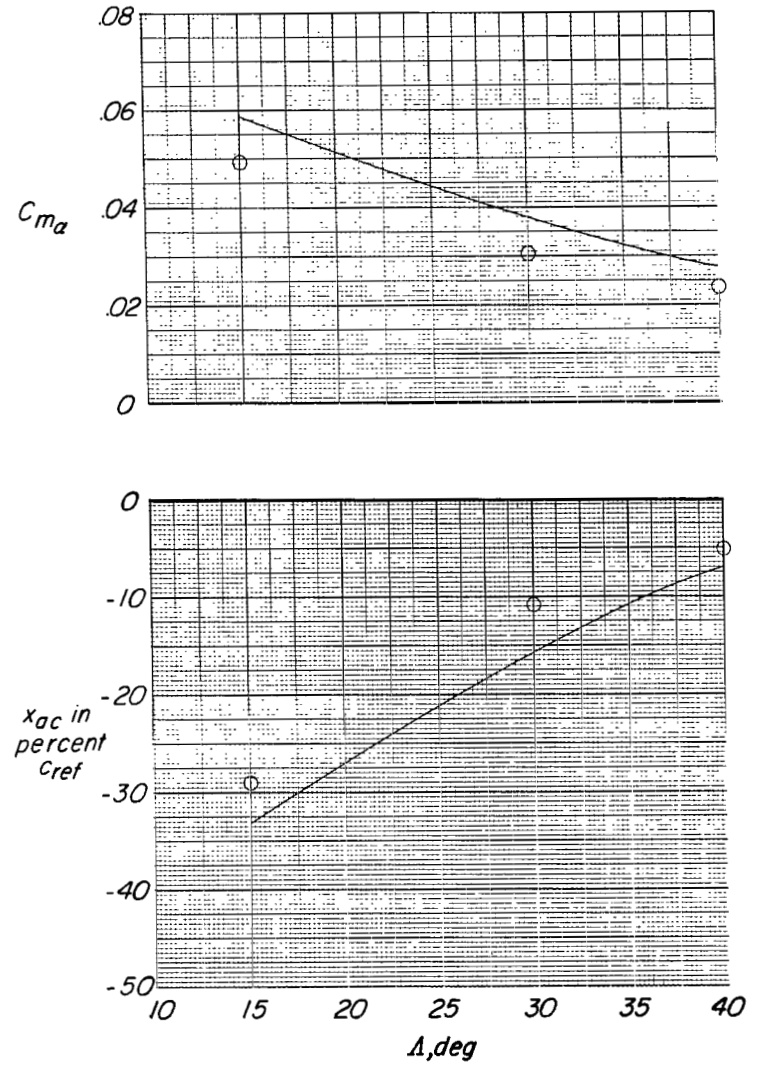
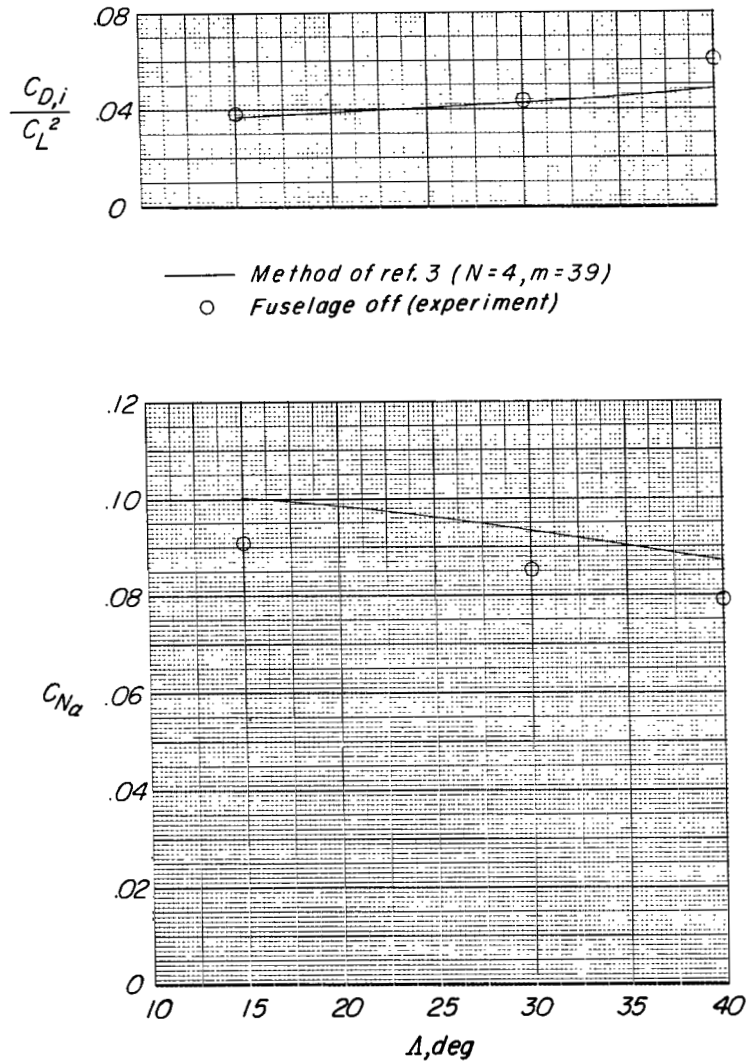

Figure 17.- Effect of sweepback angle on wing-alone longitudinal aerodynamic characteristics.



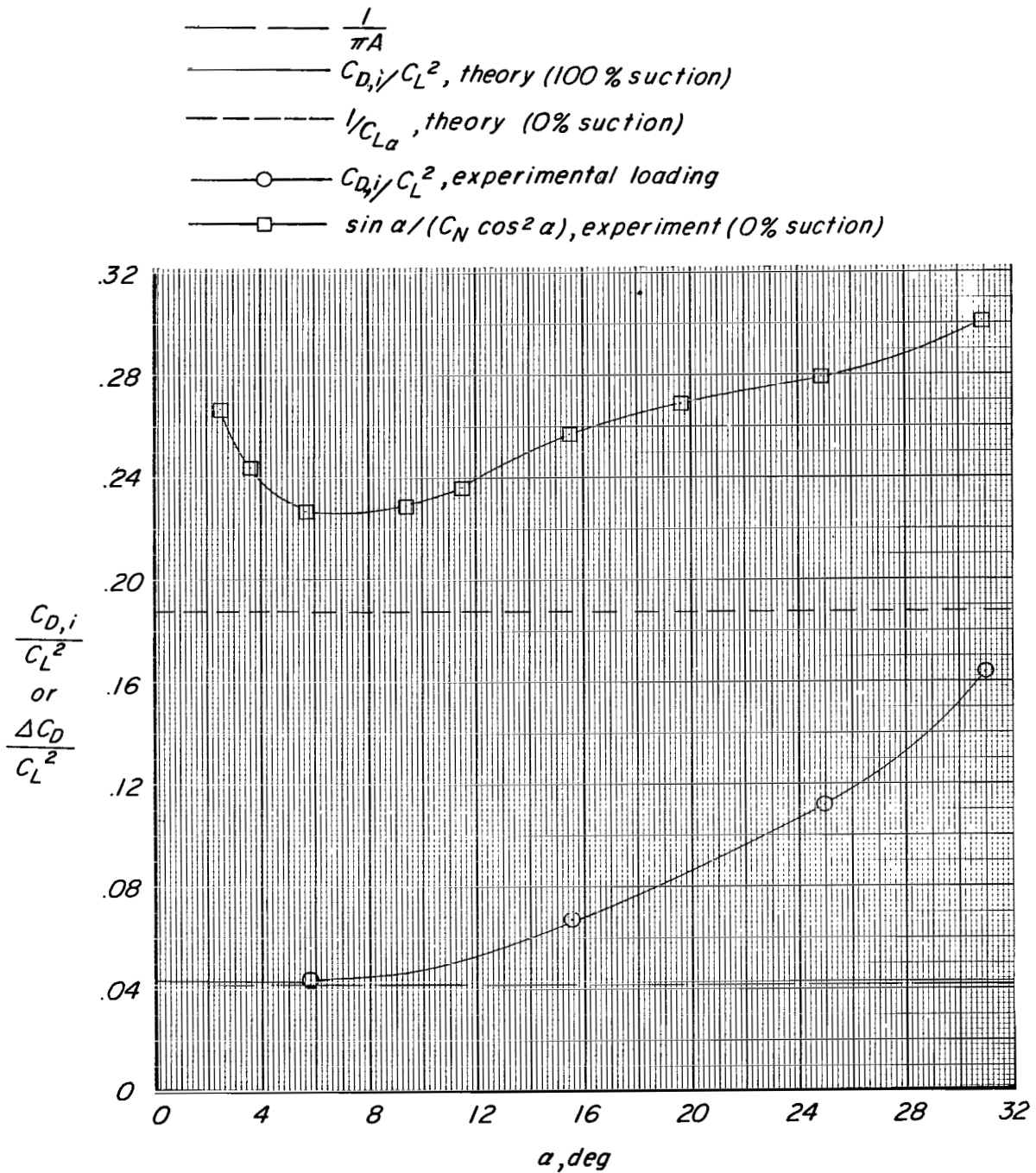

Figure 18.- Experimental and theoretical drag-due-to-lift variations as effected by span loading and loss of leading-edge suction.  $\Lambda = 30^\circ$ ; fuselage off.

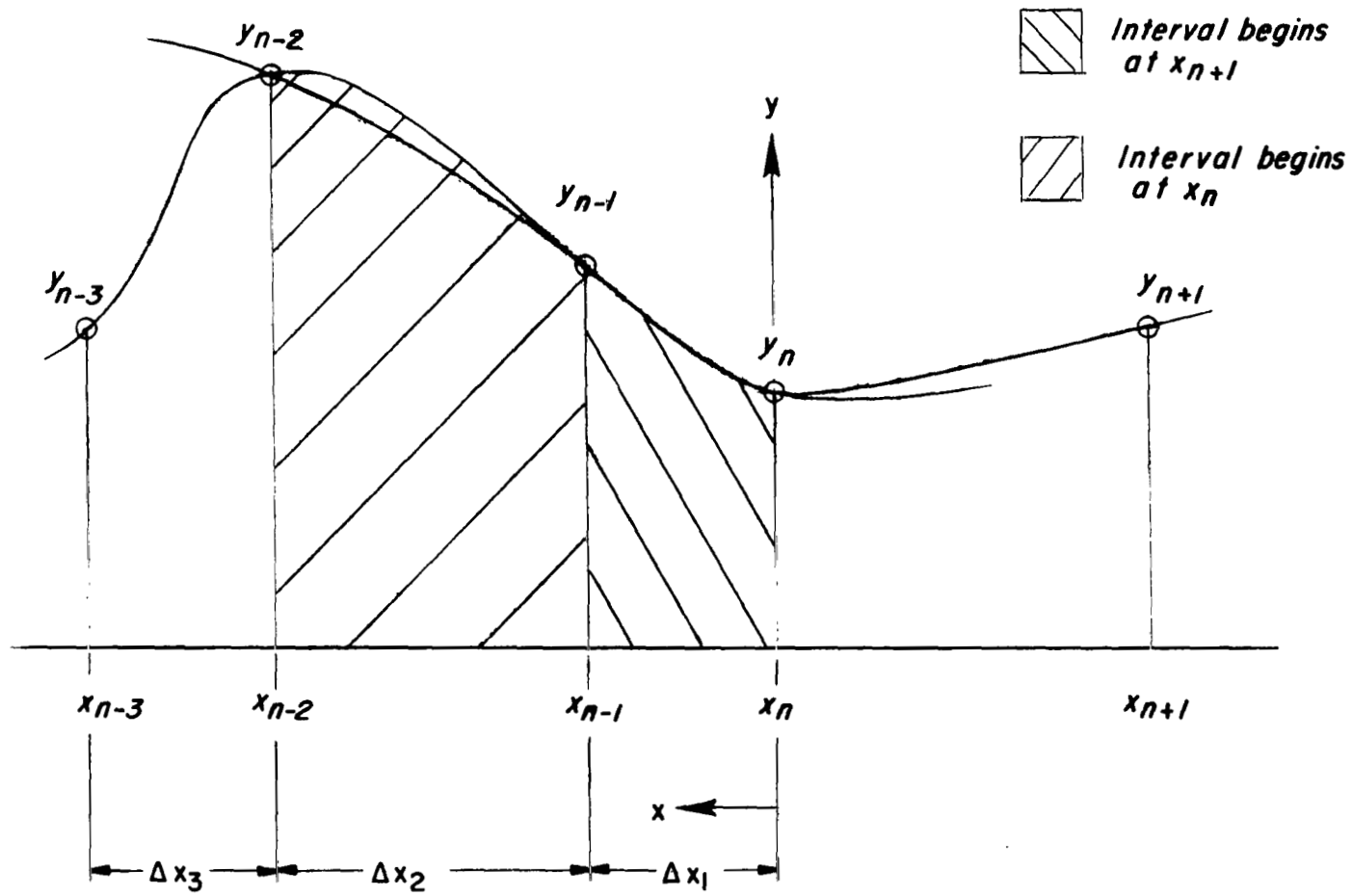
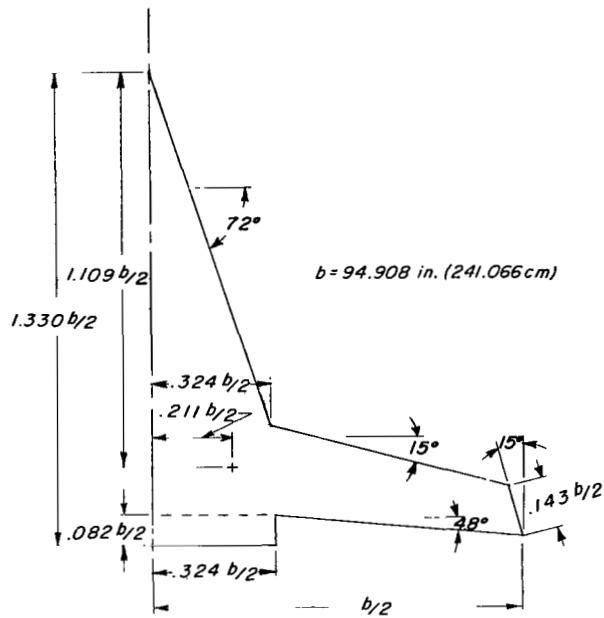
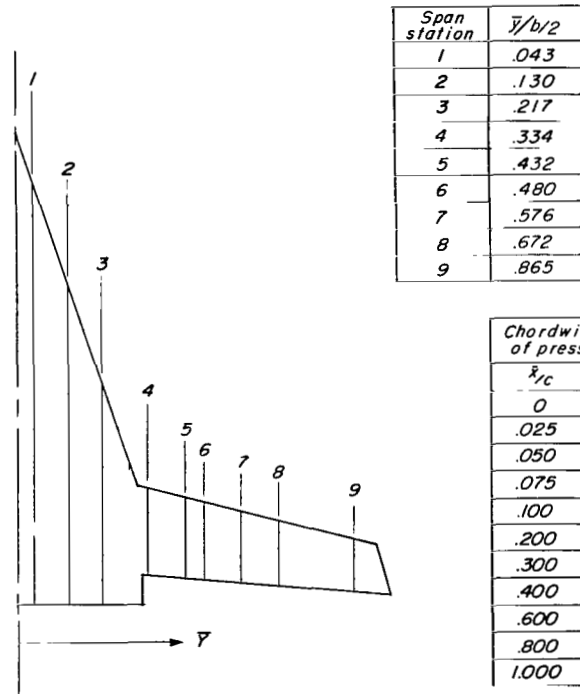

Figure 19.- General set of  $x$  and  $y$  points that are to be fitted with a series of forward-facing cubic curves. The regions where the curves are considered valid are indicated by hatching.



(a) Geometry details.



Chordwise location of pressure ports	
$\bar{x}/c$	$\Delta \bar{x}/c$
0	
.025	.025
.050	.025
.075	.025
.100	.025
.200	.100
.300	.100
.400	.100
.600	.200
.800	.200
1.000	.200

(b) Spanwise locations of chordwise rows of pressure ports.

Figure 20.- Forward sweep position and locations of pressure ports of variable-sweep wing.

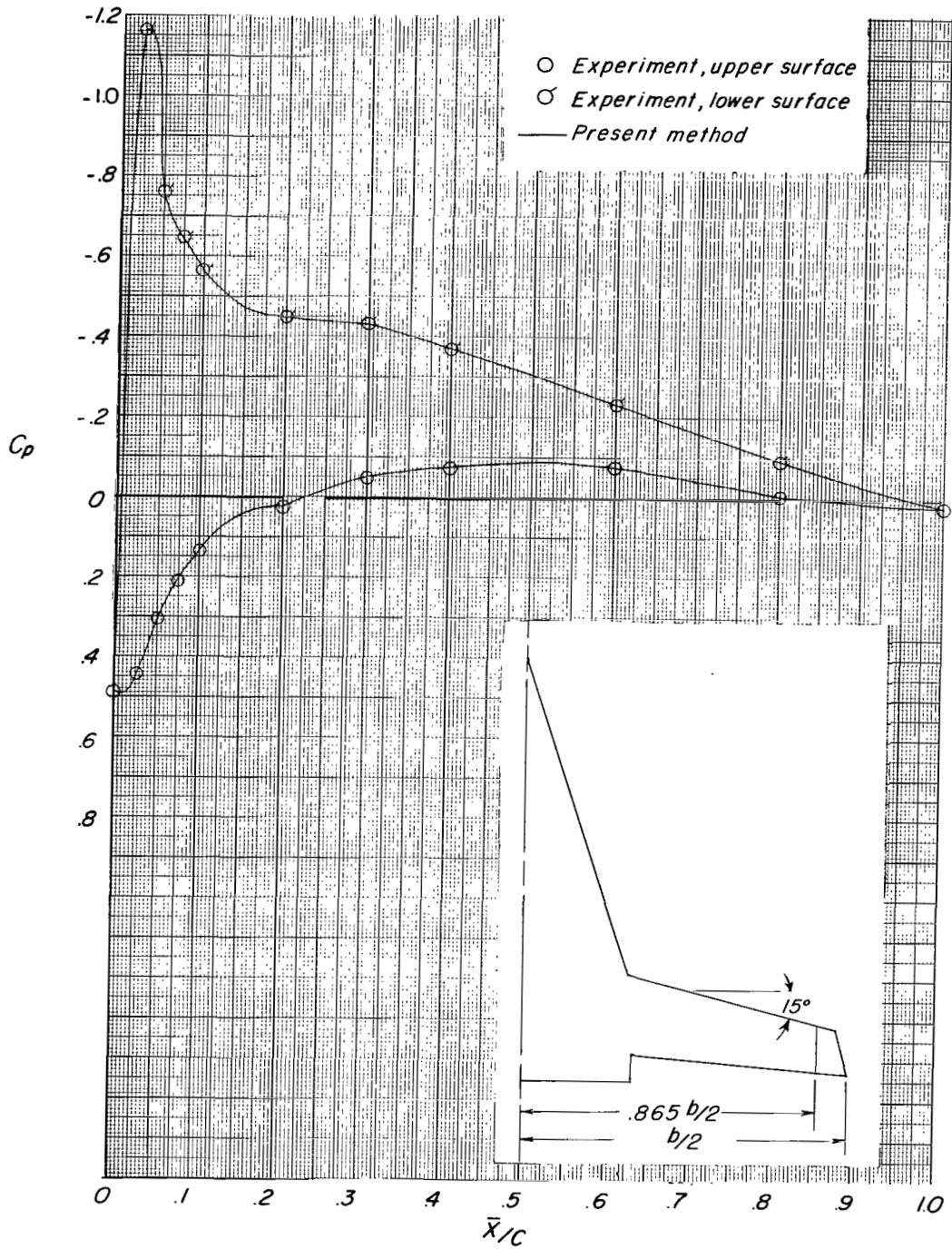

(a)  $\alpha = -4.387^\circ$ .

Figure 21.- Representation of a prescribed set of pressure-coefficient data by the present method at several angles of attack for the variable-sweep planform shown at  $\bar{Y} = 0.865b/2$ .

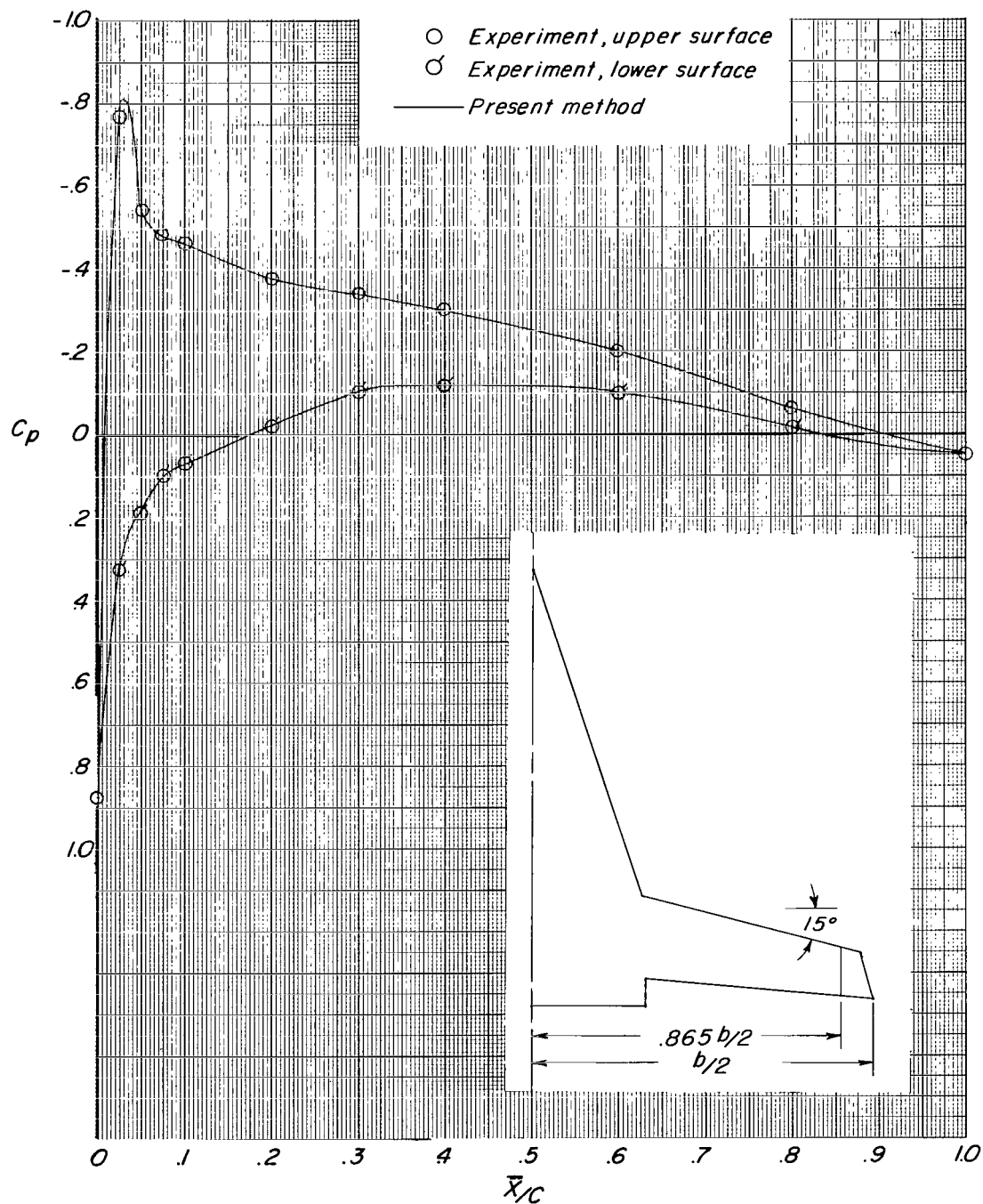

(b)  $\alpha = 2.621^\circ$ .

Figure 21.- Continued.

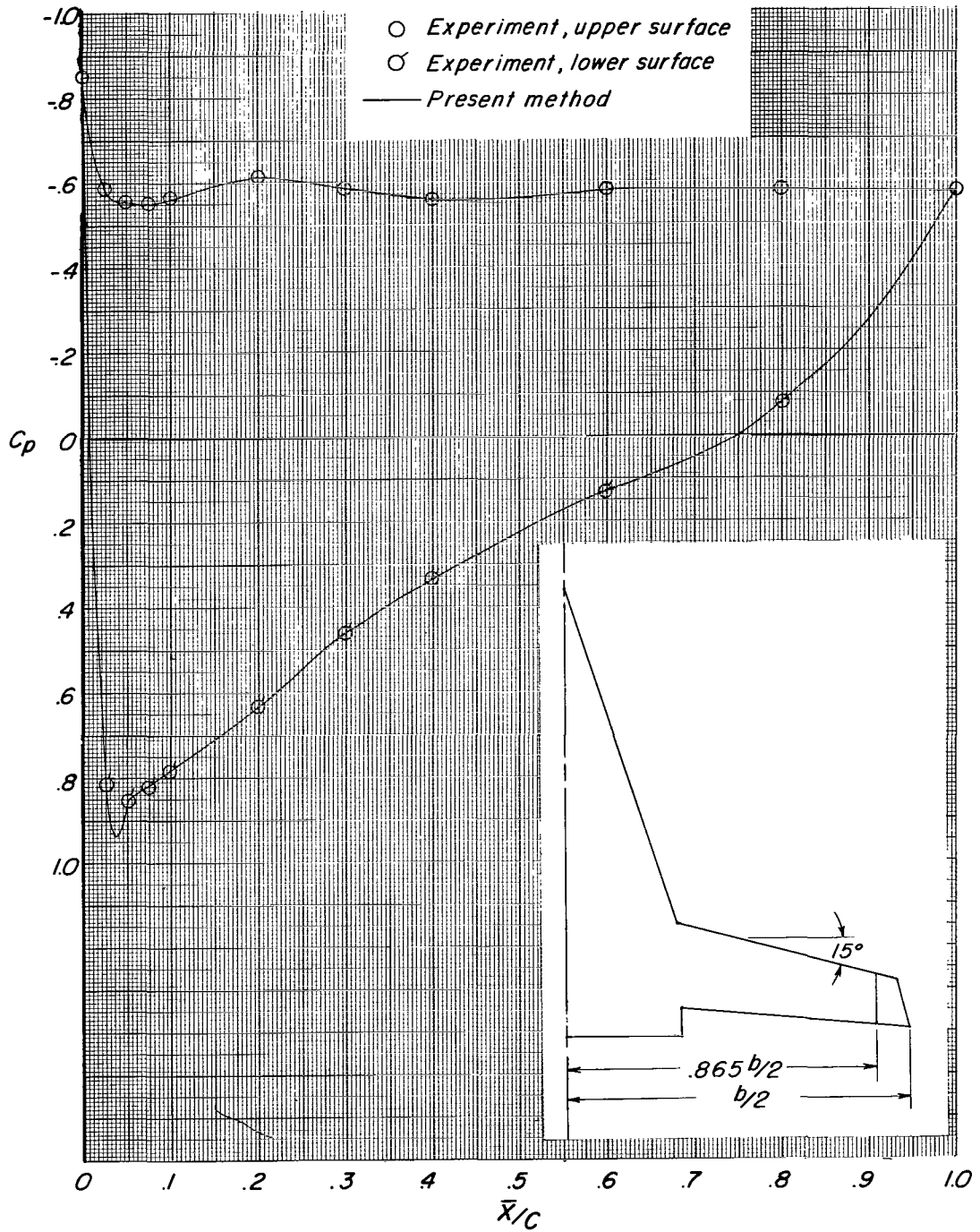

(c)  $\alpha = 30.793^\circ$ .

Figure 21.- Concluded.



NATIONAL AERONAUTICS AND SPACE ADMINISTRATION  
 WASHINGTON, D. C. 20546  
 OFFICIAL BUSINESS  
 PENALTY FOR PRIVATE USE \$300

FIRST CLASS MAIL



POSTAGE AND FEES PAID  
 NATIONAL AERONAUTICS &  
 SPACE ADMINISTRATION

001 001 C1 U 01 710809 S00903DS  
 DEPT OF THE AIR FORCE  
 AF SYSTEMS COMMAND  
 AF WEAPONS LAB (WLOL)  
 ATTN: E LOU BOWMAN, CHIEF TECH LIBRARY  
 KIRTLAND APB NM 87117

POSTMASTER: If Undeliverable (Section 115  
 Postal Manual) Do Not Ret

*"The aeronautical and space activities of the United States shall be conducted so as to contribute . . . to the expansion of human knowledge of phenomena in the atmosphere and space. The Administration shall provide for the widest practicable and appropriate dissemination of information concerning its activities and the results thereof."*

— NATIONAL AERONAUTICS AND SPACE ACT OF 1958

## NASA SCIENTIFIC AND TECHNICAL PUBLICATIONS

**TECHNICAL REPORTS:** Scientific and technical information considered important, complete, and a lasting contribution to existing knowledge.

**TECHNICAL NOTES:** Information less broad in scope but nevertheless of importance as a contribution to existing knowledge.

**TECHNICAL MEMORANDUMS:** Information receiving limited distribution because of preliminary data, security classification, or other reasons.

**CONTRACTOR REPORTS:** Scientific and technical information generated under a NASA contract or grant and considered an important contribution to existing knowledge.

**TECHNICAL TRANSLATIONS:** Information published in a foreign language considered to merit NASA distribution in English.

**SPECIAL PUBLICATIONS:** Information derived from or of value to NASA activities. Publications include conference proceedings, monographs, data compilations, handbooks, sourcebooks, and special bibliographies.

**TECHNOLOGY UTILIZATION PUBLICATIONS:** Information on technology used by NASA that may be of particular interest in commercial and other non-aerospace applications. Publications include Tech Briefs, Technology Utilization Reports and Technology Surveys.

*Details on the availability of these publications may be obtained from:*

**SCIENTIFIC AND TECHNICAL INFORMATION OFFICE**

**NATIONAL AERONAUTICS AND SPACE ADMINISTRATION**

**Washington, D.C. 20546**