

**NASA CONTRACTOR  
REPORT**

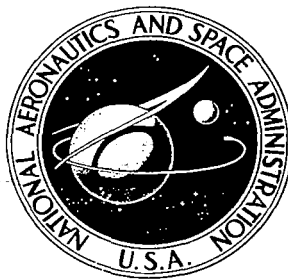

NASA CR  
C.1

0060833



NASA CR-1674

LOAN COPY: RETURN TO  
AFWL (DOGL)  
KIRTLAND AFB, N. M.

# AN EXPLORATORY AERODYNAMIC AND STRUCTURAL INVESTIGATION OF ALL-FLEXIBLE PARAWINGS

*by J. N. Nielsen, S. B. Spangler, S. S. Stahara,  
and A. L. Lee*

*Prepared by*  
NIELSEN ENGINEERING & RESEARCH, INC.  
Mountain View, Calif. 94022  
*for*

NATIONAL AERONAUTICS AND SPACE ADMINISTRATION • WASHINGTON, D. C. • DECEMBER 1970



0060833

1. Report No. NASA CR-1674	2. Government Accession No.	3. Recipient's Catalog No.	
4. Title and Subtitle AN EXPLORATORY AERODYNAMIC AND STRUCTURAL INVESTIGATION OF ALL-FLEXIBLE PARAWINGS		5. Report Date December 1970	
		6. Performing Organization Code	
7. Author(s) J. N. Nielsen, S. B. Spangler, S. S. Stahara, and A. L. Lee		8. Performing Organization Report No. NEAR TR 20	
		10. Work Unit No. 124-07-19-04	
9. Performing Organization Name and Address Nielsen Engineering & Research, Inc. Mountain View, California.		11. Contract or Grant No. NAS 1-8477	
		13. Type of Report and Period Covered Contractor Report	
12. Sponsoring Agency Name and Address National Aeronautics and Space Administration Washington, D.C. 20546		14. Sponsoring Agency Code	
		15. Supplementary Notes	
16. Abstract  A theoretical investigation was made of the aerodynamic and structural aspects of all-flexible parawings. These wings are characterized by large amounts of spanwise camber. Consequently, planar lifting surface theory is inadequate for predicting the aerodynamic load distribution on the canopy. An aerodynamic method was developed through the use of slender-body theory to account for the principal nonplanar effects. The method considers sections in the plane normal to the root chord to be circular arcs which may translate and dilate with distance along the root chord. The method yields spanwise and chordwise distributions of loading, the distribution of suction along the leading edge and the induced drag. Various static equilibrium models were examined for the purpose of determining the canopy tension distribution and rigging line loads. The methods were applied to a single- and a twin-keel parawing for which data on inflated shape, overall aerodynamic loads, and line loads were obtained by the Langley Research Center, NASA. Comparisons with these load data were made using the measured canopy shapes.			
17. Key Words (Suggested by Author(s))  <u>All-flexible parawing</u>  Slender-body theory to account for nonplanar effects		18. Distribution Statement <i>1. Wings</i>  Unclassified - Unlimited	
19. Security Classif. (of this report) Unclassified	20. Security Classif. (of this page) Unclassified	21. No. of Pages 158	22. Price* \$3.00



TABLE OF CONTENTS

	<u>Page</u> <u>No.</u>
SUMMARY . . . . .	1
INTRODUCTION . . . . .	2
LIST OF SYMBOLS . . . . .	3
AERODYNAMIC THEORY . . . . .	9
Preliminary Considerations . . . . .	9
Boundary Conditions . . . . .	.10
Pressure Coefficient . . . . .	.13
Solution for Translating Circular Arc . . . . .	.15
Complex potential . . . . .	.15
Velocity components . . . . .	.16
Solution for Dilating Circular Arc . . . . .	.19
Complex potential . . . . .	.19
Velocity components . . . . .	.21
Normal Force and Moment Distributions . . . . .	.25
Leading-Edge Suction and Vortex Lift . . . . .	.32
Leading-edge suction . . . . .	.32
Vortex lift . . . . .	.36
Theory for Conical Parawings . . . . .	.37
RESULTS AND DISCUSSION . . . . .	.42
Theoretical Results for Conical Canopies . . . . .	.42
Measured Shapes and Aerodynamic Coefficients . . . . .	.45
Single-keel parawing . . . . .	.46
Twin-keel parawing . . . . .	.47
Aerodynamic Performance Comparisons . . . . .	.48
Single-keel parawing . . . . .	.49
Twin-keel parawing . . . . .	.53
Structural Characteristics . . . . .	.54
Methods of approach . . . . .	.54
Theoretical results . . . . .	.59
Single-keel parawing results . . . . .	.61
Twin-keel parawing . . . . .	.62
CONCLUDING REMARKS . . . . .	.63

	<u>Page</u> <u>No.</u>
APPENDIX A - EVALUATION OF AN INTEGRAL OCCURRING IN THE INDUCED-DRAG CALCULATION . . . . .	.66
APPENDIX B - DETERMINATION OF CERTAIN DIRECTION COSINES . . . . .	.68
APPENDIX C - TABULATION OF CANOPY COORDINATES FOR SINGLE- KEEL PARAWING. . . . .	.71
APPENDIX D - TABULATION OF CANOPY COORDINATES FOR TWIN- KEEL PARAWING. . . . .	.93
REFERENCES . . . . .	110
TABLES I AND II. . . . .	111
FIGURES 1 THROUGH 30 . . . . .	113

AN EXPLORATORY AERODYNAMIC AND STRUCTURAL  
INVESTIGATION OF ALL-FLEXIBLE PARAWINGS

By J. N. Nielsen, S. B. Spangler,  
S. S. Stahara, and A. L. Lee  
Nielsen Engineering & Research, Inc.

SUMMARY

A theoretical investigation was made of the aerodynamic and structural aspects of all-flexible parawings. These wings are characterized by large amounts of spanwise camber. Consequently, planar lifting surface theory is inadequate for predicting the aerodynamic load distribution on the canopy. An aerodynamic method was developed through the use of slender-body theory to account for the principal nonplanar effects. The method considers sections in the plane normal to the root chord to be circular arcs which may translate and dilate with distance along the root chord. The method yields spanwise and chordwise distributions of loading, the distribution of suction along the leading edge and the induced drag. Various static equilibrium models were examined for the purpose of determining the canopy tension distribution and rigging line loads. The methods were applied to a single- and a twin-keel parawing for which data on inflated shape, overall aerodynamic loads, and line loads were obtained by the Langley Research Center, NASA. Comparisons with these load data were made using the measured canopy shapes.

Systematic calculations on conical parawings indicate that spanwise camber increases the lift-curve slope considerably and has a favorable effect on the ratio of normal force to induced drag. These calculations indicate that if a parawing could be rigged closer to a conical shape so that the entire leading edge could be operated close to luffing, a significant increase in lift-drag ratio could be achieved. Comparisons with lift and drag data for single- and twin-keel parawings indicate reasonably good agreement and show that the induced drag constitutes most of the total drag. Line load comparisons illustrate the proper behavior for the analytical structural models, but indicate that the models are not sufficiently detailed to be predictive in nature.

## INTRODUCTION

Because the all-flexible parawing is completely stowable, it has received much attention for applications such as aerial delivery schemes, parachute jumping, and space capsule recovery where this property is of prime importance (refs. 1-3). In contrast to the rigid boom parawing, however, its stowability feature has made it more difficult to specify the aerodynamic shape of the inflated parawing and to develop rational aerodynamic and structural theories of the device. Accordingly, almost all progress to date in developing all-flexible parawings has been through experimental means. It is the purpose of this report to present some exploratory work aimed at obtaining insight into the aerodynamic and structural problems of all-flexible parawings.

It was recognized before the present investigation started that no substantial theoretical progress could be made unless good measurements of all-flexible parawing shapes were made to guide the analysis. Accordingly, measurements were made at Langley Research Center in the 7- by 10-Foot Wind Tunnel using stereoscopic photography to determine the inflated shapes of a single-keel and a twin-keel all-flexible parawing. These measured shapes have been utilized together with a specially developed nonplanar slender-wing lifting-surface theory to obtain approximate aerodynamic loadings on the parawings. In this manner the necessary aerodynamic loadings for a preliminary structural analysis have been obtained.

In the present report, the aerodynamic theory developed for all-flexible parawings is presented first. Next, the theory is utilized to describe the aerodynamic characteristics of idealized all-flexible parawings and to assess the importance of various factors in their aerodynamic efficiency. The measured shapes are presented, and are then used together with the theory to estimate the lift and drag characteristics of the single-keel and twin-keel parawings. Finally, results on predicted and measured line loads are presented.

## LIST OF SYMBOLS

$a$	radius of circle in $\zeta_3$ or $\zeta_4$ plane
$a_n$	complex coefficients in Laurent series for $W_2(\zeta_4)$
$R$	aspect ratio
$A_n$	real part of $C_n$
$B_n$	imaginary part of $C_n$
$c_r$	root chord of inflated parawing
$C_D$	drag coefficient, $D/qS_R$
$C_{D_i}$	induced-drag coefficient, $D_i/qS_R$
$C_{D_o}$	friction drag coefficient, nondimensionalized by $qS_R$
$C_L$	lift coefficient, $L/qS_R$
$C_s$	suction-force coefficient, $S/qS_R$
$C_{T_k}$	keel-line tension coefficient, $T_k/qS_R$
$C_{T_\ell}$	leading-edge line tension coefficient, $T_\ell/qS_R$
$C_X$	chord-force coefficient, $X/qS_R$
$C_Y$	lateral-force coefficient on half of the canopy, $Y/qS_R$
$C_Z$	normal-force coefficient, $Z/qS_R$
$C'_X, C'_Y, C'_Z$	components of $C_X, C_Y,$ and $C_Z$ due to differential pressure loading on canopy



$(\Delta C_X)_s$	}	components of $C_X$ , $C_Y$ , $C_Z$ , and $C_{D_i}$ , respectively, due to leading-edge suction
$(\Delta C_Y)_s$		
$(\Delta C_Z)_s$		
$(\Delta C_{D_i})_s$		
$(\Delta C_X)_v$	}	components of $C_X$ , $C_Z$ , and $C_{D_i}$ , respectively, associated with vortex lift
$(\Delta C_Z)_v$		
$(\Delta C_{D_i})_v$		
$C_{11}$	coefficient of $\zeta^{-1}$ term in Laurent series for $W_1(\zeta)$	
$C_{12}$	coefficient of $\zeta^{-1}$ term in Laurent series for $W_2(\zeta)$	
$d\ell$	element of length lying in canopy surface cut out by plane parallel to x-axis, fig. 2(a)	
$D_o, C_o, C_1, \dots$	complex coefficients in Laurent series for $W(\zeta)$ , eq. (72)	
$D$	total drag	
$D_i$	induced drag of canopy	
$e$	distance between top of canopy and $x_1$ -axis, measured parallel to z-axis, positive downward	
$e'$	distance between top of canopy and x-axis, measured parallel to z-axis, positive downward	
$\vec{e}_x$	unit vector along x-axis	
$e_1, e_2$	values of $e$ associated with contours $C_1$ and $C_2$ , respectively, fig. 2(b)	
$e'_1, e'_2$	values of $e'$ associated with contours $C_1$ and $C_2$ , respectively, fig. 2(b)	
$f$	circular arc camber in crossflow plane, defined in fig. 1	
$h$	rigging line length, figs. 14 and 17	
$h_k$	keel length of theoretical wing canopy flat pattern, measured from theoretical apex to trailing edge of the plane of symmetry	

$I_1, I_2, I_3, I_4$	definite integrals given by eq. (93)
$J(k)$	definite integral given by eq. (99)
$k$	$\sqrt{f/2r}$
$K$	ratio of lift-curve slope of segment of circular cone to that of the uncambered wing corresponding to its chord plane, eq. (139) or eq. (140)
$l$	$s/2$
$L$	lift of canopy
$M_y$	moment of canopy about y-axis
$M_z$	moment of canopy about z-axis
$n$	summation index
$\vec{n}$	unit vector normal to canopy
$\vec{n}_1$	unit upward vector perpendicular to canopy at right-hand leading edge
$\vec{n}_2$	unit normal tangent to canopy and normal to right-hand leading edge, directed away from canopy
$p$	local static pressure
$p_\infty$	free-stream static pressure
$\Delta p$	pressure difference across the canopy
$P$	pressure coefficient, $(p - p_\infty)/q$
$\Delta P$	$P_\ell - P_u$ , wing loading
$P_\ell$	pressure coefficient for lower wing surface
$P_n, Q_n$	coefficients in a Laurent series, eq. (50)
$P_u$	pressure coefficient for upper wing surface
$q$	free-stream dynamic pressure
$\vec{q}$	vector flow velocity
$r$	radius of curvature of circular arc in $\zeta_1$ and $\zeta_2$ planes

$r_1, r_2$	values of $r$ associated with contours $C_1$ and $C_2$ , respectively, fig. 2(b)
$s$	parawing local semispan
$s_m$	maximum semispan of conical parawing formed from surface of circular cone
$S$	leading-edge suction force associated with both leading edges
$S_R$	reference area, taken as flat canopy area unless otherwise indicated
$T_k$	keel rigging line tension
$T_\ell$	leading-edge rigging line tension
$u, v, w$	perturbation velocities along $x, y,$ and $z$ axes, respectively
$u_\ell, w_\ell$	values of $u$ and $w$ on lower surface, respectively
$u_u, w_u$	values of $u$ and $w$ on upper surface, respectively
$(u_u)_{\text{odd}}$	$(u_u - u_\ell)/2$
$v_r, v_\phi$	radial and tangential perturbation velocity components in $yz$ plane
$v_{r_1}, v_{\phi_1}$	radial and tangential perturbation velocity components on circular arc in $\zeta_1$ plane associated with $\phi_1$
$v_{r_2}, v_{\phi_2}$	radial and tangential perturbation velocity components on circular arc in $\zeta_2$ plane associated with $\phi_2$
$V_\infty$	free-stream velocity
$(w_u)_{\text{odd}}$	$(w_u - w_\ell)/2$
$w_1$	velocity component along $z$ -axis associated with $\phi_1$
$w_2$	velocity component along $z$ -axis associated with $\phi_2$
$W(\zeta)$	complex potential for total flow
$W_1(\zeta_1)$	complex potential for circular arc translating upward at unit velocity with fluid stationary at infinity

$W_1(\zeta_4)$	complex potential for flow about a fixed circle with center at the origin with unit free-stream directed along the negative $z$ -axis
$W_2(\zeta_4)$	complex potential in $\zeta_4$ plane for flow which in the $\zeta_1$ plane yields a circular arc dilating at unit velocity with the flow velocity zero at infinity
$x, y, z$	axis system with origin at leading edge of parawing with positive $x$ rearward along the root chord, positive $y$ laterally to the right facing forward, and positive $z$ vertically up
$x', y', z'$	axis system used in canopy shape measurement tests, with origin at the rigging line confluence point. $x'$ is parallel to the keel chord, positive aft; $z'$ is positive up; and $y'$ is positive to right facing forward in tunnel
$x_1, y_1, z_1$	axis system with origin at leading edge of parawing with positive $x_1$ rearward in streamwise direction, positive $y_1$ laterally to right facing forward, and positive $z_1$ vertical upward
$X$	chordwise force directed along $x$ -axis
$Y$	lateral force on half of the canopy, directed along $y$ -axis
$Z$	normal force on canopy in direction of $z$ -axis
$\alpha$	angle between free-stream velocity and root chord direction
$\alpha_{ideal}$	angle of attack for conical parawing at which the leading-edge suction is zero
$\alpha_k, \beta_k, \gamma_k$	direction cosines of vectors representing the keel line tension, positive downward
$\alpha_\ell, \beta_\ell, \gamma_\ell$	direction cosines of vectors representing the leading-edge line tension, positive downward
$\alpha_0$	angle of zero lift of segment of a circular cone
$\alpha_7$	"angle of attack" for a single-keel parawing, defined as the angle between the number 7 keel line and the vertical direction
$\alpha_8$	"angle of attack" for twin-keel parawing, defined as the angle between the projection of number 8 keel line onto vertical plane of symmetry and the vertical direction
$\beta$	polar angle in $\zeta_3$ plane, fig. 4

$\zeta$	complex variable, $y + iz$
$\zeta_1$	$y_1 + iz_1$
$\zeta_2$	$\zeta_1 + i(e + f)$
$\zeta_3$	$\frac{\zeta_2}{2} + \frac{1}{2} (\zeta_2^2 - 4l^2)^{1/2}$
$\zeta_4$	$\zeta_3 - \frac{if}{2}$
$\eta$	fraction of semispan
$\theta$	polar angle in $\zeta_4$ plane, fig. 4
$\lambda_1$	$-\left(\frac{dr}{dx} + \frac{de}{dx}\right)$
$\lambda_2$	$+\frac{dr}{dx}$
$\lambda_3$	$xV_\infty \cos \alpha + zV_\infty \sin \alpha$
$v$	coordinate in $\vec{v}$ direction
$\vec{v}$	unit vector normal to canopy contour lying in crossflow plane
$\sigma_x, \sigma_y, \sigma_z$	components in the x, y, and z directions, respectively, of canopy tension per unit width
$\vec{\tau}$	unit vector tangent to canopy contour lying in crossflow plane
$\phi$	polar angle of points on canopy surface in yz plane, fig. 2(b)
$\phi_0$	$\Phi/V_\infty \cos \alpha$
$\phi_1$	velocity potential for circular arc translating upward at unit velocity
$(\phi_1)_{\text{odd}}$	$(\phi_{1u} - \phi_{1l})/2$
$\phi_2$	velocity potential for expanding circular arc with unit radial velocity
$(\phi_2)_{\text{odd}}$	$(\phi_{2u} - \phi_{2l})/2$
$\Phi$	velocity potential for complete flow past parawing

## Subscripts

ee	associated with	$(de/dx)^2$
ef	associated with	$\frac{de}{dx} \frac{df}{dx}$
er	associated with	$\frac{de}{dx} \frac{dr}{dx}$
ze	associated with	$d^2e/dx^2$
rf	associated with	$\frac{dr}{dx} \frac{df}{dx}$
rr	associated with	$(dr/dx)^2$
zr	associated with	$d^2r/dx^2$

## AERODYNAMIC THEORY

### Preliminary Considerations

As part of a general investigation of the structural and aerodynamic characteristics of all-flexible parawings, it is desired to develop an aerodynamic theory that will predict the detailed load distribution on such wings. None of the existing planar lifting-surface theories is applicable to all-flexible parawings because the canopies of such wings are not even approximately planar. Since the rigging lines from the wing tips slant inward toward the vertical plane of symmetry, the canopy must be nearly vertical near the tips. Accordingly, the rigging method of all-flexible parawings effectively provides the wing with end plates which preclude the use of planar lifting-surface theory if accurate predictions are desired.

No nonplanar lifting-surface theory exists which is applicable to all-flexible parawings with the accuracy of linearized wing theory. However, it appears possible to develop a slender-wing nonplanar lifting-surface theory that will account for the principal nonplanar effects of canopy shape. The principal assumption used in the analysis is that the shape of the canopy in any crossflow plane can be approximated in the mean by a circular arc. The circular arcs will vary chordwise in span, camber ratio, and vertical location of the center of

curvature. The variation of these quantities with chordwise distance in the cases considered in this report is obtained from measurement, but in other cases may have to be obtained by other means. The aerodynamic theory will be complete in that loading distributions as well as gross forces and moments will be obtained.

A line joining the wing leading edge and trailing edge in the vertical plane of symmetry is defined as the root chord of the parawing (fig. 1). The apex of the wing is taken as the origin of the wing axis system with  $x$  taken positive rearward, along the root chord, and  $y$  and  $z$  as shown in the figure. The free-stream velocity  $V_\infty$  is in the vertical plane of symmetry for the present analysis, and the  $x$ -axis is inclined at the angle  $\alpha$  to  $V_\infty$ . For the purposes of the analysis, crossflow planes are considered perpendicular to the  $x$ -axis. In these crossflow planes, the canopy shape is assumed to be representable by a circular arc. The circular arc is described by three quantities which vary with  $x$ . Besides the camber,  $f$ , and the local semispan,  $s$ , there is the distance  $e$  between the top of the canopy and the  $x_1$ -axis, measured in the  $z$  direction.

The crossflow planes have been set up normal to the root chord rather than normal to the free-stream direction so that the canopy shape for a rigid canopy will not change with angle of attack. Also, the local crossflow section of maximum span will be farther aft than if the crossflow planes are taken normal to the free-stream direction. Since slender-body theory usually predicts negative lift on sections of decreasing span in the downstream direction, the present choice of crossflow planes will tend to reduce the extent of regions of negative lift on the rear of the parawing.

#### Boundary Conditions

Consider the two contours  $C_1$  and  $C_2$  lying in the canopy in crossflow planes  $dx$  apart as shown in figure 2(a). Let  $\vec{\tau}$  and  $\vec{\nu}$  be unit vectors tangent to and perpendicular to the contour  $C_1$ , respectively at some point. Consider a plane parallel to the  $x$ -axis and containing  $\vec{\nu}$ . This plane intersects the body surface between  $C_1$  and  $C_2$  along an element  $d\ell$ . Let  $\vec{n}$  be normal to  $\vec{\tau}$  and  $d\ell$  so that it is the unit normal to the surface. If  $\phi$  is the entire velocity

potential and if the unit vector along the x-axis is  $\vec{e}_x$ , then the velocity vector  $\vec{q}$  is

$$\vec{q} = \frac{\partial \Phi}{\partial x} \vec{e}_x + \frac{\partial \Phi}{\partial v} \vec{v} + \frac{\partial \Phi}{\partial \tau} \vec{\tau} \quad (1)$$

The tangency condition is

$$\vec{q} \cdot \vec{n} = 0 \quad (2)$$

or

$$\frac{\partial \Phi}{\partial x} \cos(\vec{e}_x, \vec{n}) + \frac{\partial \Phi}{\partial v} \cos(\vec{v}, \vec{n}) = 0 \quad (3)$$

It is noted that  $\vec{v}$ ,  $d\ell$ , and  $dx$  are coplanar by construction, lying in a plane normal to  $\vec{\tau}$ . Since  $\vec{n}$  also lies in this plane,  $\vec{n}$ ,  $\vec{v}$ ,  $d\ell$ , and  $dx$  are coplanar, with  $\vec{n}$  and  $\vec{v}$  perpendicular to  $d\ell$  and  $dx$ , respectively. If we make the small angle assumption for  $dv/dx$ , we have

$$\left. \begin{aligned} \cos(\vec{e}_x, \vec{n}) &= -\frac{dv}{dx} \\ \cos(\vec{v}, \vec{n}) &= 1 \end{aligned} \right\} \quad (4)$$

Thus the boundary condition becomes

$$\frac{\partial \Phi / \partial v}{\partial \Phi / \partial x} = \frac{dv}{dx} \quad (5)$$

We can write on the basis of small perturbation velocities

$$\frac{\partial \Phi}{\partial v} = (V_\infty \cos \alpha) \frac{dv}{dx} \quad (6)$$

It is desirable to relate the tangency condition to the geometric parameters of the canopy shape. For this purpose consider a fixed crossflow plane through which the wing is passing. Let the contours  $C_1$  and  $C_2$  as seen in the fixed crossflow plane be circular arcs as shown in figure 2(b) where the traces of the x- and  $x_1$ -axes are shown. Then

$$-\Delta v = OA + AB \quad (7)$$



$$\left. \begin{aligned} OA &= r_1 - r_2 \\ AB &= [(r_2 + e_2') - (r_1 + e_1')] \sin \phi \end{aligned} \right\} \quad (8)$$

$$-\Delta v = +(r_2 - r_1)(-1 + \sin \phi) + (e_2' - e_1') \sin \phi$$

or with  $dr = r_2 - r_1$  and  $de' = e_2' - e_1'$ , we obtain

$$\frac{dv}{dx} = + \frac{dr}{dx} - \sin \phi \left( \frac{dr}{dx} + \frac{de'}{dx} \right) = \frac{dr}{dx} - \sin \phi \left( \frac{dr}{dx} + \frac{de}{dx} - \tan \alpha \right) \quad (9)$$

The change from  $e'$  to  $e$  is desirable for computational purposes because of the way the canopy shape is measured in the wind tunnel.

This boundary condition suggests two potential problems that must be solved. The first term  $dr/dx$  is the boundary condition for an expanding circular arc. For a translating arc the velocity normal to the arc varies as  $\sin \phi$  so that the second term of equation (9) describes the boundary condition of a translating arc. Let  $\phi_1$  be the potential function for a translating arc with the normal velocity equal to  $\sin \phi$  and no velocity at infinity. Let  $\phi_2$  be the crossflow potential function for an expanding arc with unit normal velocity and no velocity at infinity. Thus, the boundary conditions are, from figure 3,

$$\left. \begin{aligned} \frac{\partial \phi_1}{\partial v} &= \sin \phi \quad \text{on the arc} \\ \frac{\partial \phi_1}{\partial y}, \frac{\partial \phi_1}{\partial z} &\rightarrow 0 \quad \text{as } y, z \rightarrow \infty \end{aligned} \right\} \quad (10)$$

$$\left. \begin{aligned} \frac{\partial \phi_2}{\partial v} &= 1 \quad \text{on the arc} \\ \frac{\partial \phi_2}{\partial y}, \frac{\partial \phi_2}{\partial z} &\rightarrow 0 \quad \text{as } y, z \rightarrow \infty \end{aligned} \right\} \quad (11)$$

We can construct the total potential function as follows.

$$\Phi = xV_{\infty}\cos \alpha + zV_{\infty}\sin \alpha - \left( \frac{dr}{dx} + \frac{de}{dx} \right) V_{\infty}\cos \alpha \phi_1 + V_{\infty}\cos \alpha \frac{dr}{dx} \phi_2 \quad (12)$$

To verify the boundary condition on the body, differentiate equation (12) with respect to  $v$ .

$$\frac{\partial \Phi}{\partial v} = \frac{\partial z}{\partial v} V_{\infty}\sin \alpha - V_{\infty}\cos \alpha \left( \frac{dr}{dx} + \frac{de}{dx} \right) \sin \phi + V_{\infty}\cos \alpha \frac{dr}{dx} \quad (13)$$

On the body  $\partial z/\partial v$  is  $\sin \phi$  so that

$$\frac{\partial \Phi}{\partial v} = V_{\infty}\cos \alpha \left[ \frac{dr}{dx} - \left( \frac{dr}{dx} + \frac{de}{dx} - \tan \alpha \right) \sin \phi \right] \quad (14)$$

Using equation (9), we obtain

$$\frac{\partial \Phi}{\partial v} = V_{\infty}\cos \alpha \frac{dv}{dx} \quad (15)$$

a result fulfilling the boundary condition, equation (6). The only other condition that the potential must fulfill is that it must give the parallel flow at infinity. Since  $\phi_1$  and  $\phi_2$  yield no velocities at infinity, it can be seen from equation (12) that  $\partial \Phi/\partial x$  and  $\partial \Phi/\partial z$  have the proper behavior at infinity.

#### Pressure Coefficient

Let  $u$ ,  $v$ , and  $w$  be the perturbation velocities along the  $x$ ,  $y$ , and  $z$  axes, respectively, such that

$$\left. \begin{aligned} \frac{\partial \Phi}{\partial x} &= V_{\infty}\cos \alpha + u \\ \frac{\partial \Phi}{\partial y} &= v \\ \frac{\partial \Phi}{\partial z} &= V_{\infty}\sin \alpha + w \end{aligned} \right\} \quad (16)$$

Then from reference 4, p. 48, the pressure coefficient for zero yaw angle is given by

$$P = \frac{-2(u + \alpha w)}{V_\infty} - \frac{(v^2 + w^2)}{V_\infty^2} \quad (17)$$

With regard to the square terms, it is easier to evaluate the sum by means of the following equality

$$(v^2 + w^2) = (v_r^2 + v_\phi^2) \quad (18)$$

where

$$\left. \begin{aligned} v_r &= \frac{\partial}{\partial r} (\Phi - xV_\infty \cos \alpha - zV_\infty \sin \alpha) \\ v_\phi &= \frac{1}{r} \frac{\partial}{\partial \phi} (\Phi - xV_\infty \cos \alpha - zV_\infty \sin \alpha) \end{aligned} \right\} \quad (19)$$

Carrying out the operation to obtain the velocity components, we find that

$$\frac{u}{V_\infty \cos \alpha} = -\phi_1 \frac{d}{dx} \left( \frac{dr}{dx} + \frac{de}{dx} \right) - \left( \frac{dr}{dx} + \frac{de}{dx} \right) \frac{\partial \phi_1}{\partial x} + \phi_2 \frac{d^2 r}{dx^2} + \frac{dr}{dx} \frac{\partial \phi_2}{\partial x} \quad (20)$$

$$\frac{w}{V_\infty \cos \alpha} = - \left( \frac{dr}{dx} + \frac{de}{dx} \right) \frac{\partial \phi_1}{\partial z} + \frac{dr}{dx} \frac{\partial \phi_2}{\partial z} \quad (21)$$

and on the canopy

$$\frac{v_r}{V_\infty \cos \alpha} = - \left( \frac{dr}{dx} + \frac{de}{dx} \right) \sin \phi + \frac{dr}{dx} \quad (22)$$

$$\frac{v_\phi}{V_\infty \cos \alpha} = - \frac{1}{r} \left( \frac{dr}{dx} + \frac{de}{dx} \right) \frac{\partial \phi_1}{\partial \phi} + \frac{1}{r} \frac{dr}{dx} \frac{\partial \phi_2}{\partial \phi} \quad (23)$$

It is noted that the pressure coefficient depends not only on  $dr/dx$  and  $de/dx$ , but also on  $d^2(r + e)/dx^2$ .

## Solution for Translating Circular Arc

Complex potential.- It is desired to obtain the potential for a translating arc with unit upward velocity with the flow stationary at infinity. The arc is shown in figure 1(a), together with its dimensions and its position with respect to the  $x, y, z$  coordinate system. The potential is obtained in several steps, as illustrated in figure 4. We start with the known potential for a circle with its center at the origin with downward flow parallel to the  $z$ -axis at unit speed in the far field (fig. 4(d)).

$$W'_1(\zeta_4) = i \left( \zeta_4 - \frac{a^2}{\zeta_4} \right) \quad (24)$$

This potential can be transformed through the planes  $\zeta_4 \rightarrow \zeta_3 \rightarrow \zeta_2 \rightarrow \zeta_1$  to obtain a flow past the translating arc in the  $\zeta_1$  plane with the velocity at infinity unchanging. The first transformation simply shifts the origin of the circle up onto the imaginary axis.

$$\zeta_3 = \zeta_4 + \frac{if}{2} \quad (25)$$

The second transformation is the Joukowski transformation which carries a circle with the center offset on the imaginary axis into a circular arc.

$$\zeta_2 = \zeta_3 + \frac{l^2}{\zeta_3} \quad (26)$$

or

$$\zeta_3 = \frac{\zeta_2}{2} + \frac{1}{2} \sqrt{\zeta_2^2 - 4l^2} \quad (27)$$

where we have used the positive sign on the square root. The last transformation merely changes the vertical position of the circular arc.

$$\zeta_1 = \zeta_2 - i(e + f) \quad (28)$$

By simply making the appropriate transformations in the complex potential, we obtain the flows in the several planes since the contours

are streamlines and the flow velocity at infinity is unaltered. Accordingly,

$$W_1'(\zeta_3) = i \left[ \zeta_3 - \frac{if}{2} - \frac{a^2}{\zeta_3 - \frac{if}{2}} \right] \quad (29)$$

$$W_1'(\zeta_2) = i \left[ \frac{\zeta_2}{2} - \frac{if}{2} + \frac{1}{2} \sqrt{\zeta_2^2 - 4l^2} - \frac{a^2}{\frac{\zeta_2}{2} - \frac{if}{2} + \frac{1}{2} \sqrt{\zeta_2^2 - 4l^2}} \right] \quad (30)$$

$$W_1'(\zeta_1) = i \left[ \frac{\zeta_1}{2} + \frac{ie}{2} + \frac{1}{2} \sqrt{[\zeta_1 + i(e+f)]^2 - 4l^2} - \frac{a^2}{\frac{\zeta_1}{2} + \frac{ie}{2} + \frac{1}{2} \sqrt{[\zeta_1 + i(e+f)]^2 - 4l^2}} \right] \quad (31)$$

The complex potential for the upward moving arc is now obtained by imposing a flow given by  $-i\zeta_1$  which makes the velocity at infinity zero and imparts a uniform upward velocity to the circular arc. The final complex potential in the  $\zeta_1$  plane is thus

$$W_1(\zeta_1) = W_1'(\zeta_1) - i\zeta_1 \quad (32)$$

This complex function  $W_1(\zeta_1)$  is now transformed back to the  $\zeta_4$  plane, resulting in the following simple form, correct except for a constant.

$$W_1(\zeta_4) = -i \left[ \frac{a^2}{\zeta_4} + \frac{l^2}{\zeta_4 + \frac{if}{2}} \right] \quad (33)$$

Velocity components.- With the complex potential for the terms known, it is possible to obtain the velocity components. The following scheme is used.

$$\left( v_{r_1} - iv_{\phi_1} \right) e^{-i\phi} = \frac{dW_1}{d\zeta_1} = \frac{dW_1}{d\zeta_4} \frac{d\zeta_4}{d\zeta_3} \frac{d\zeta_3}{d\zeta_2} \frac{d\zeta_2}{d\zeta_1} \quad (34)$$

Carrying out the operations yields the following results on the contour

$$\left. \begin{aligned}
 \frac{dw_1}{d\zeta_4} &= i \left[ e^{-2i\theta} + \frac{(1 - k^2)}{(e^{i\theta} + ik)^2} \right]; \quad k^2 = \frac{f}{2r} \\
 \frac{d\zeta_4}{d\zeta_3} &= 1 \\
 \frac{d\zeta_3}{d\zeta_2} &= \frac{(e^{i\theta} + ik)^2}{2ie^{i\theta}(\sin \theta + k)} \\
 \frac{d\zeta_2}{d\zeta_1} &= 1
 \end{aligned} \right\} \quad (35)$$

where  $\theta$  is the polar angle in the  $\zeta_3$  plane (fig. 4). In order to separate the velocity components into components which are symmetric and antisymmetric with respect to the top and bottom surfaces of the wing, we must express the results in terms of some angle other than  $\theta$ . An appropriate angle is  $\beta$ , the polar angle in the  $\zeta_3$  plane (fig. 4). Use of equation (25) yields the following relationships

$$\left. \begin{aligned}
 \sin \theta &= -k \cos^2 \beta + \sin \beta \sqrt{1 - k^2 \cos^2 \beta} \\
 \cos \theta &= \cos \beta \left[ k \sin \beta + \sqrt{1 - k^2 \cos^2 \beta} \right]
 \end{aligned} \right\} \quad (36)$$

between  $\theta$  and  $\beta$ . The equation of the circular arc in the  $\zeta_2$  plane in terms of  $\beta$  is

$$\zeta_2 = 2a \cos \beta \sqrt{1 - k^2 \cos^2 \beta} + 2aik \sin^2 \beta \quad (37)$$

Accordingly,  $\beta$  and  $-\beta$  yield corresponding points on the top and bottom of the circular arc.

With the use of equations (34), (35), and the following relationship

$$e^{i\phi} = \frac{ke^{2i\theta} + ie^{i\theta}}{e^{i\theta} + ik} \quad (38)$$

it can be shown that in terms of  $\theta$  and  $\phi$

$$\left. \begin{aligned} v_{r_1} &= \sin \phi \\ v_{\phi_1} &= \frac{-\cos \theta}{\sin \theta + k} (1 + k^2 + 2k \sin \theta) + \cos \phi \end{aligned} \right\} \quad (39)$$

It is seen that  $v_{r_1}$  satisfies the boundary condition for the arc translating upward at unit velocity.

In order to bring out the symmetry properties of the velocity components, both velocities are given in terms of  $\beta$  with the help of equation (36) as follows:

$$\left. \begin{aligned} v_{r_1} &= 1 - 2k^2 \cos^2 \beta \\ v_{\phi_1} &= -\frac{\cos \beta}{\sin \beta} [1 + k^2 (\sin^2 \beta - \cos^2 \beta)] \end{aligned} \right\} \quad (40)$$

It is seen that  $v_{r_1}$  is an even function of  $\beta$  and  $v_{\phi_1}$  is an odd function of  $\beta$ .

The vertical velocity  $w_1$  is also used in the loading equation

$$w_1 = v_{r_1} \sin \phi + v_{\phi_1} \cos \phi \quad (41)$$

Equation (41) can be expressed entirely in terms of  $\beta$  by use of equation (40) and the relationships

$$\left. \begin{aligned} \sin \phi &= 1 - 2k^2 \cos^2 \beta \\ \cos \phi &= 2k \cos \beta \sqrt{1 - k^2 \cos^2 \beta} \end{aligned} \right\} \quad (42)$$

with the result that

$$w_1 = 1 - \frac{2k \cos^2 \beta}{\sin \beta} \left( k \sin \beta + \sqrt{1 - k^2 \cos^2 \beta} \right)^2 \quad (43)$$

### Solution for Dilating Circular Arc

Complex potential.— The complex potential and velocities for a dilating arc can be obtained in a manner similar to that for a translating arc. The boundary conditions in the  $\zeta_1$  plane, figure 5(a), are that  $\partial\phi/\partial v$  be unity on the arc and the velocity at infinity be zero. The flow external to a circular arc with an as yet undetermined normal velocity distribution in the  $\zeta_4$  plane can be transformed as before to a circular arc with a uniform normal velocity distribution. The specification of the normal velocity distribution in the  $\zeta_4$  plane is determined by the boundary conditions in the  $\zeta_1$  plane.

The flow due to any distribution of normal velocity on the circle in the  $\zeta_4$  plane can be represented by a Laurent series

$$W_2(\zeta_4) = \sum_{n=1}^{\infty} \frac{a_n}{\zeta_4^n} \quad (44)$$

The problem is to determine the coefficients  $a_n$  which will satisfy the normal boundary condition in the  $\zeta_1$  plane; that is, unit normal velocity on the circular arc. We satisfy the boundary condition in the following way

$$\begin{aligned} (v_{r_2} - iv_{\phi_2}) e^{-i\phi} &= \frac{dW_2}{d\zeta_1} = \frac{dW_2}{d\zeta_4} \frac{d\zeta_4}{d\zeta_3} \frac{d\zeta_3}{d\zeta_2} \frac{d\zeta_2}{d\zeta_1} \\ &= \frac{-1}{1 - \frac{l^2}{\zeta_3^2}} \sum_{n=1}^{\infty} \frac{na_n}{\zeta_4^{n+1}} \end{aligned} \quad (45)$$

Equation (45) is a Laurent series in  $\zeta_4$  valid over the complete interval  $0 \leq \theta \leq 2\pi$ . On the circle, we find that

$$\frac{e^{i\phi} \zeta_3^2}{\zeta_3^2 - l^2} = \frac{(ke^{i\theta} + i)(e^{i\theta} + ik)}{2i(\sin \theta + k)} \quad (46)$$



so that equation (45) becomes

$$\left( v_{r_2} - i v_{\phi_2} \right)_{\zeta_1 \text{ arc}} = - \sum_{n=1}^{\infty} \frac{n a_n}{a^{n+1}} e^{-i(n+1)\theta} \frac{(k e^{i\theta} + i)(e^{i\theta} + i k)}{2i(\sin \theta + k)} \quad (47)$$

or

$$\left( v_{r_2} - i v_{\phi_2} \right)_{\zeta_1 \text{ arc}} (\sin \theta + k) = - \frac{1}{2} \sum_{n=1}^{\infty} \frac{n a_n}{a^{n+1}} e^{-in\theta} (1 + 2k \sin \theta + k^2) \quad (48)$$

Defining

$$\frac{n a_n}{a^{n+1}} = P_n + i Q_n \quad (49)$$

we get

$$\left( v_{r_2} - i v_{\phi_2} \right)_{\zeta_1 \text{ arc}} (\sin \theta + k) = - \frac{1}{2} \sum_{n=1}^{\infty} (P_n + i Q_n) e^{-in\theta} (1 + 2k \sin \theta + k^2) \quad (50)$$

Since  $v_{r_2}$  is unity on the arc in the  $\zeta_1$  plane, we obtain for the real part of equation (50) after some manipulation

$$\frac{\sin \theta + k}{1 + 2k \sin \theta + k^2} = - \frac{1}{2} \sum_{n=1}^{\infty} (P_n \cos n\theta + Q_n \sin n\theta) \quad (51)$$

We have the known Fourier series

$$\frac{\sin \theta + k}{1 + 2k \sin \theta + k^2} = - \sum_{n=1}^{\infty} (-1)^n k^{2n-2} \left[ k \cos 2n\theta + \sin (2n-1)\theta \right]$$

$$0 \leq \theta \leq \pi; k < 1 \quad (52)$$

from which

$$\left. \begin{aligned} P_{2n} &= (2) (-1)^n k^{2n-1} \\ P_{2n-1} &= 0 \end{aligned} \right\} n = 1, 2, 3, \dots \quad (53)$$

$$\left. \begin{aligned} Q_{2n-1} &= (2) (-1)^n k^{2n-2} \\ Q_{2n} &= 0 \end{aligned} \right\} \quad (54)$$

Accordingly, the complex potential is

$$W_2(\zeta_4) = 2 \sum_{n=1}^{\infty} \frac{(-1)^n k^{2n-1} a^{2n+1}}{2n \zeta_4^{2n}} + 2i \sum_{n=1}^{\infty} \frac{(-1)^n k^{2n-1} a^{2n}}{(2n-1) \zeta_4^{2n-1}} \quad (55)$$

The series can be rewritten as follows

$$W_2(\zeta_4) = -\frac{a}{k} \sum_{n=1}^{\infty} \frac{(-1)^{n+1}}{n} \left( \frac{k^2 a^2}{\zeta_4^2} \right)^n - 2i \frac{a}{k} \sum_{n=0}^{\infty} \frac{(-1)^n}{(2n+1)} \left( \frac{ka}{\zeta_4} \right)^{2n+1} \quad (56)$$

From the known expansions for  $\ln(1+x)$  and  $\tan^{-1} x$ , we can sum the series

$$W_2(\zeta_4) = -\frac{2a}{k} \left\{ \frac{1}{2} \ln \left( 1 + \frac{k^2 a^2}{\zeta_4^2} \right) + i \tan^{-1} \left( \frac{ka}{\zeta_4} \right) \right\} \quad (57)$$

The expression for  $W_2$  can be further simplified to

$$W_2(\zeta_4) = -\frac{2a}{k} \ln \left( 1 + \frac{ika}{\zeta_4} \right) \quad (58)$$

Velocity components.— The velocity components have been evaluated in the same manner as for the previous case. The results for the radial and tangential velocities on the arc are

$$\left. \begin{aligned} v_{r_2} &= \frac{\partial \phi_2}{\partial r} = 1 \\ v_{\phi_2} &= \frac{1}{r} \frac{\partial \phi_2}{\partial \phi} = -\frac{\cos \beta}{\sin \beta} \end{aligned} \right\} \quad (59)$$

It is noted that  $v_{r_2}$  is an even function of  $\beta$  while  $v_{\phi_2}$  is an odd function analogous to the  $v_{r_1}$  and  $v_{\phi_1}$  velocity components. We are also interested in  $w_2$  for determining the wing loading

$$\begin{aligned} w_2 &= v_{r_2} \sin \phi + v_{\phi_2} \cos \phi \\ &= \sin \phi - \frac{\cos \beta}{\sin \beta} \cos \phi \end{aligned} \quad (60)$$

With the help of equation (42) the result for  $w_2$  becomes

$$w_2 = 1 - \frac{2k^2 \cos^2 \beta}{\sin \beta} \left( k \sin \beta + \sqrt{1 - k^2 \cos^2 \beta} \right) \quad (61)$$

#### Wing Loading

The wing loading equations will now be determined with the help of equation (17). The loading is considerably simpler to obtain than the pressure distribution because the even terms in  $\beta$  do not contribute to the loading. Consider, for instance, the squares term,  $v^2 + w^2$ , in equation (17), or its equal,  $v_r^2 + v_\phi^2$ . From equations (40) and (59), it is clear that  $v_{r_1}$  and  $v_{r_2}$  are even in  $\beta$ . The quantities  $v_{\phi_1}$  and  $v_{\phi_2}$  are both odd in  $\beta$  by the same equations. Accordingly, the square term contributes nothing to the loading.

The loading is given with the help of equation (17) as

$$\Delta P = P_\ell - P_u = \frac{2(u_u - u_\ell)}{V_\infty} + \frac{2\alpha(w_u - w_\ell)}{V_\infty} \quad (62)$$

where the subscripts  $u$  and  $\ell$  refer to corresponding points on the upper and lower surfaces respectively. Considering now only the parts of  $u$  and  $w$  odd in  $\beta$ , we have

$$\Delta P = 4 \left( \frac{u_u}{V_\infty} + \frac{\alpha w_u}{V_\infty} \right)_{\text{odd}} \quad (63)$$

where the subscript odd applies to quantities of the upper surface. From equations (20) and (21) taking  $\cos \alpha$  equal to unity

$$\begin{aligned} \frac{(u_u)_{\text{odd}}}{V_\infty} = & - \frac{d^2}{dx^2} (e + r) (\phi_1)_{\text{odd}} - \frac{d}{dx} (e + r) \left. \frac{\partial \phi_1}{\partial x} \right|_{\text{odd}} \\ & + \frac{d^2 r}{dx^2} \phi_2 \Big|_{\text{odd}} + \frac{dr}{dx} \left. \frac{\partial \phi_2}{\partial x} \right|_{\text{odd}} \end{aligned} \quad (64)$$

$$\frac{(w_u)_{\text{odd}}}{V_\infty} = - \frac{d}{dx} (e + r) \left. \frac{\partial \phi_1}{\partial z} \right|_{\text{odd}} + \frac{dr}{dx} \left. \frac{\partial \phi_2}{\partial z} \right|_{\text{odd}} \quad (65)$$

At the wing surface, we find the following results from equations (33) and (58) for the velocity potentials, from which the odd and even parts can readily be separated.

$$\phi_1 = rk \left[ k - 2 \sin \beta \sqrt{1 - k^2 \cos^2 \beta} \right] \quad (66)$$

$$\begin{aligned} \phi_2 = & -r \ln \left( \sqrt{1 - k^2 \cos^2 \beta} + k \sin \beta \right) \\ = & -2r \tanh^{-1} \left( \frac{k \sin \beta}{\sqrt{1 - k^2 \cos^2 \beta}} \right) - r \ln (1 - k^2) \end{aligned} \quad (67)$$

The odd parts of the derivatives are found first by taking the derivatives of  $W_1(\zeta)$  and  $W_2(\zeta)$  with respect to  $x$ , determining the value of the resulting complex expressions at the canopy surface, and then extracting the real parts. These processes, which are quite lengthy, yield the following results.

$$\begin{aligned} \left. \frac{\partial \phi_1}{\partial x} \right|_{\text{odd}} = & - \frac{k \sqrt{1 - k^2 \cos^2 \beta}}{\sin \beta} \left[ 2 \cos^2 \beta (1 + k^2 - 2k^2 \cos^2 \beta) \left( \frac{de'}{dx} \right) \right. \\ & \left. + (1 + 2k^2 \cos^2 \beta - 4k^4 \cos^4 \beta) \left( \frac{dr}{dx} \right) + \frac{1}{2k^2} \left( \frac{df}{dx} \right) \right] \end{aligned} \quad (68)$$

$$\left. \frac{\partial \phi_2}{\partial x} \right|_{\text{odd}} = \frac{k \sqrt{1 - k^2 \cos^2 \beta}}{2 \sin \beta} \left[ -4 \cos^2 \beta \left( \frac{de'}{dx} \right) + \frac{2}{1 - k^2} (1 - 2 \cos^2 \beta + 2k^2 \cos^2 \beta) \left( \frac{dr}{dx} \right) - \frac{1}{k^2(1 - k^2)} \left( \frac{df}{dx} \right) \right] \quad (69)$$

It is noted that the three independent parameters specifying the shape have been taken to be  $r$ ,  $e$ , and  $f$  together with their  $x$  derivatives. The total loading can then be written

$$\begin{aligned} \Delta P = & + 8r \frac{d^2 e}{dx^2} k \sin \beta \sqrt{1 - k^2 \cos^2 \beta} \\ & + 4r \frac{d^2 r}{dx^2} \left[ 2k \sin \beta \sqrt{1 - k^2 \cos^2 \beta} - \ln \left( \frac{\sqrt{1 - k^2 \cos^2 \beta} + k \sin \beta}{\sqrt{1 - k^2 \cos^2 \beta} - k \sin \beta} \right) \right] \\ & + 8 \left( \frac{de}{dx} \right)^2 \frac{k \cos^2 \beta}{\sin \beta} \sqrt{1 - k^2 \cos^2 \beta} (1 + k^2 - 2k^2 \cos^2 \beta) \\ & + 4 \left( \frac{dr}{dx} \right)^2 \frac{k \sqrt{1 - k^2 \cos^2 \beta}}{\sin \beta} \left[ 1 + \frac{1}{1 - k^2} - 2(1 - k^2) \cos^2 \beta - 4k^2 \cos^4 \beta \right. \\ & \quad \left. - \frac{\sin \beta}{k \sqrt{1 - k^2 \cos^2 \beta}} \ln \left( \frac{\sqrt{1 - k^2 \cos^2 \beta} + k \sin \beta}{\sqrt{1 - k^2 \cos^2 \beta} - k \sin \beta} \right) \right] \\ & + 2 \left( \frac{de}{dx} \right) \left( \frac{df}{dx} \right) \frac{\sqrt{1 - k^2 \cos^2 \beta}}{k \sin \beta} \\ & - 2 \left( \frac{dr}{dx} \right) \left( \frac{df}{dx} \right) \frac{k}{(1 - k^2)} \frac{\sqrt{1 - k^2 \cos^2 \beta}}{\sin \beta} \\ & + 4 \left( \frac{dr}{dx} \right) \left( \frac{de}{dx} \right) \frac{k \sqrt{1 - k^2 \cos^2 \beta}}{\sin \beta} (1 + 4k^2 \cos^2 \beta - 8k^2 \cos^4 \beta); \end{aligned} \quad (70)$$

$$0 \leq \beta \leq \pi$$

It is noted that the loading depends on the shape parameters  $dr/dx$ ,  $de/dx$ , and  $df/dx$  as well as  $d^2r/dx^2$ ,  $d^2e/dx^2$ , and  $\alpha$ . There are a number of distinct types of loading associated with the seven characteristic terms in the foregoing result. All but those associated with  $d^2e/dx^2$  and  $d^2r/dx^2$  exhibit the usual square-root singularity at the edges of the wing. Integration of these pressure distributions spanwise across the canopy will yield the chordwise load distribution without any effects of leading-edge suction.

### Normal Force and Moment Distributions

Quite simple results can be obtained for the chordwise normal-force and pitching-moment distributions despite the complicated wing loading equations. The complex potential for the total flow can be found by combining perturbation complex potentials with the free-stream complex potential. Thus

$$W(\zeta) = xV_{\infty}\cos \alpha - i\zeta \sin \alpha - V_{\infty}\cos \alpha \left( \frac{dr}{dx} + \frac{de}{dx} \right) W_1(\zeta) + V_{\infty}\cos \alpha \left( \frac{dr}{dx} \right) W_2(\zeta) \quad (71)$$

The quantity  $W(\zeta)$  can be expanded in a Laurent series

$$W(\zeta) = V_{\infty}\cos \alpha \left[ D_0 \ln \zeta + C_0 + \sum_{n=1}^{\infty} \frac{C_n}{\zeta^n} \right] \quad (72)$$

Herein  $\zeta$  is the complex variable in the  $y, z$  coordinate system.

$$\zeta = y + iz = \zeta_1 - ix \tan \alpha \quad (73)$$

The coefficients  $D_0$  and  $C_n$  are generally complex, and  $D_0$  is zero for the present case wherein the wing has no volume. If we express  $C_n$  as follows

$$C_n = A_n + iB_n \quad (74)$$

then from equations (3-64) and (3-66), reference 4, we have for the normal force ( $Z$ ) and the pitching-moment coefficient  $M_Y$

$$\frac{Z}{q} = 4\pi B_1(x) \quad (75)$$

$$M_Y + iM_Z = 4\pi ix C_1(x) - 4\pi i \int_0^x C_1 dx \quad (76)$$

where the values of  $Z$  and  $M_Y$  are those for the wing canopy from its leading edge up to some chordwise distance  $x$ . A result of this nature

yields the chordwise load distribution by differentiation. The chordwise loading includes the effects of leading-edge suction.

The coefficient  $C_1$  for  $W(\zeta)$  can be written from equation (71) as

$$C_1 = -V_\infty \cos \alpha \left( \frac{dr}{dx} + \frac{de}{dx} \right) C_{11} + V_\infty \cos \alpha \left( \frac{dr}{dx} \right) C_{12}$$

where  $C_{11}$  and  $C_{12}$  are the coefficients of  $\zeta^{-1}$  in the Laurent expansions for  $W_1(\zeta)$  and  $W_2(\zeta)$ , respectively. Since the series of transformations  $\zeta_4 \rightarrow \zeta_3 \rightarrow \zeta_2 \rightarrow \zeta_1 \rightarrow \zeta$  are the identity transformations at infinity, the coefficients  $C_{11}$  and  $C_{12}$  are the same in all planes. Collecting together previous results from equations (33) and (58)

$$W_1(\zeta_4) = -i \left( \frac{a^2}{\zeta_4} + \frac{\ell^2}{\zeta_4 + \frac{if}{2}} \right) \quad (77)$$

$$W_2(\zeta_4) = -\frac{2a}{k} \ln \left( 1 + \frac{ika}{\zeta_4} \right) \quad (78)$$

we can see by inspection that

$$C_{11} = -i(a^2 + \ell^2) \quad (79)$$

and

$$C_{12} = -2ia^2 \quad (80)$$

The assumption is now made that  $\cos \alpha$  does not differ significantly from unity. These results lead directly to the equation for the normal force

$$\frac{Z}{q} = 4\pi \left[ (a^2 + \ell^2) \left( \frac{dr}{dx} + \frac{de}{dx} \right) - 2a^2 \left( \frac{dr}{dx} \right) \right] \quad (81)$$

or

$$\frac{Z}{q} = \pi s^2 \left( 1 + \frac{1}{1 - k^2} \right) \left( \frac{dr}{dx} + \frac{de}{dx} \right) - \frac{2\pi s^2}{1 - k^2} \left( \frac{dr}{dx} \right) \quad (82)$$

and for the pitching moment about the apex

$$\begin{aligned} \frac{M_y}{q} &= 4\pi x \left[ (a^2 + l^2) \left( \frac{dr}{dx} + \frac{de}{dx} \right) - 2a^2 \left( \frac{dr}{dx} \right) \right] \\ &\quad - 4\pi \int_0^x \left[ (a^2 + l^2) \left( \frac{dr}{dx} + \frac{de}{dx} \right) - 2a^2 \left( \frac{dr}{dx} \right) \right] dx \end{aligned} \quad (83)$$

or

$$\begin{aligned} \frac{M_y}{q} &= \pi s^2 x \left( 1 + \frac{1}{1 - k^2} \right) \left( \frac{dr}{dx} + \frac{de}{dx} \right) - \frac{2\pi s^2 x}{1 - k^2} \left( \frac{dr}{dx} \right) \\ &\quad - \pi \int_0^x \left[ s^2 \left( 1 + \frac{1}{1 - k^2} \right) \left( \frac{dr}{dx} + \frac{de}{dx} \right) - \frac{2s^2}{1 - k^2} \left( \frac{dr}{dx} \right) \right] dx \end{aligned} \quad (84)$$

#### Induced Drag

For the present lifting surface which has no volume, the induced drag is given by equation (3-74) of reference 4, as

$$\frac{D_i}{q} = - \oint_C \phi_o \frac{\partial \phi_o}{\partial v} d\tau \quad (85)$$

where  $C$  is a contour enclosing the base of the lifting surface in the rearmost crossflow plane,  $\vec{v}$  is the outward normal in the crossflow plane, and  $\vec{\tau}$  is the tangent. Now repeating equation (12)

$$\begin{aligned} \phi &= -V_\infty \cos \alpha \left( \frac{dr}{dx} + \frac{de}{dx} \right) \phi_1 + V_\infty \cos \alpha \frac{dr}{dx} \phi_2 \\ &\quad + xV_\infty \cos \alpha + zV_\infty \sin \alpha \end{aligned} \quad (86)$$

and making the assumption that  $\cos \alpha$  is unity, we define the following quantities

$$\phi_o \equiv \frac{\phi}{V_\infty \cos \alpha} \equiv \lambda_1 \phi_1 + \lambda_2 \phi_2 + \lambda_3 \quad (87)$$



wherein

$$\lambda_1 \equiv - \left( \frac{dr}{dx} + \frac{de}{dx} \right)$$

$$\lambda_2 \equiv \frac{dr}{dx}$$

$$\lambda_3 \equiv x + z \tan \alpha$$

The values of  $\phi_1$  and  $\phi_2$  on the surface have odd and even parts, and since  $\partial\phi/\partial v$  is an odd function of  $\beta$ , only the odd parts of  $\phi_1$  and  $\phi_2$  at the surface contribute to the induced drag. From equations (66) and (67), we find

$$(\phi_1)_{\text{odd}} = -2a \sin \beta \sqrt{1 - k^2 \cos^2 \beta} \quad (88)$$

$$(\phi_2)_{\text{odd}} = -\frac{a}{k} \ln \left( \frac{k \sin \beta + \sqrt{1 - k^2 \cos^2 \beta}}{-k \sin \beta + \sqrt{1 - k^2 \cos^2 \beta}} \right) \quad (89)$$

or

$$= -\frac{2a}{k} \tanh^{-1} \left( \frac{k \sin \beta}{\sqrt{1 - k^2 \cos^2 \beta}} \right)$$

On the wing surface

$$\frac{\partial \phi_1}{\partial r} = \sin \phi \quad (90)$$

$$\frac{\partial \phi_2}{\partial r} = 1 \quad (91)$$

Equation (85) for the drag can be written

$$\frac{D_i}{q} = \lambda_1^2 I_1 + \lambda_1 \lambda_2 (I_2 + I_3) + \lambda_2^2 I_4 \quad (92)$$

where

$$\left. \begin{aligned}
 I_1 &= - \oint_c \phi_1 \frac{\partial \phi_1}{\partial v} d\tau \\
 I_2 &= - \oint_c \phi_1 \frac{\partial \phi_2}{\partial v} d\tau \\
 I_3 &= I_2 = - \oint_c \phi_2 \frac{\partial \phi_1}{\partial v} d\tau \\
 I_4 &= - \oint_c \phi_2 \frac{\partial \phi_2}{\partial v} d\tau
 \end{aligned} \right\} \quad (93)$$

$$\left. \begin{aligned}
 \sin \phi &= 1 - 2k^2 \cos^2 \beta \\
 \cos \phi &= 2k \cos \beta \sqrt{1 - k^2 \cos^2 \beta} \\
 d\tau = r d\phi &= \frac{4rk^2 \cos \beta \sin \beta d\beta}{\cos \phi} = \frac{2rk \sin \beta d\beta}{\sqrt{1 - k^2 \cos^2 \beta}}
 \end{aligned} \right\} \quad (94)$$

The integrals can be evaluated as follows.

$$\begin{aligned}
 I_1 &= -2 \int_0^\pi (-2a \sin \beta \sqrt{1 - k^2 \cos^2 \beta}) \sin \phi \frac{(2rk \sin \beta) d\beta}{\sqrt{1 - k^2 \cos^2 \beta}} \\
 &= + 8ark \int_0^\pi \sin^2 \beta (1 - 2k^2 \cos^2 \beta) d\beta
 \end{aligned}$$

Now

$$\int_0^\pi \sin^2 \beta d\beta = \frac{\pi}{2}$$

and

$$\int_0^{\pi} \sin^2 \beta \cos^2 \beta = \int_0^{\pi} \sin^2 \beta \, d\beta - \int_0^{\pi} \sin^4 \beta \, d\beta = \frac{\pi}{2} - \frac{3\pi}{8} = \frac{\pi}{8}$$

Therefore,

$$I_1 = +8ark \left( \frac{\pi}{2} - k^2 \frac{\pi}{4} \right) = +2\pi ark (2 - k^2) \quad (95)$$

Also,

$$\begin{aligned} I_2 &= -2 \int_0^{\pi} (-2a \sin \beta \sqrt{1 - k^2 \cos^2 \beta}) \frac{(2rk \sin \beta) d\beta}{\sqrt{1 - k^2 \cos^2 \beta}} \\ &= 8ark \int_0^{\pi} \sin^2 \beta \, d\beta \\ &= 4\pi ark \end{aligned} \quad (96)$$

Also

$$\begin{aligned} I_3 &= -2 \int_0^{\pi} \left[ -\frac{2a}{k} \tanh^{-1} \left( \frac{k \sin \beta}{\sqrt{1 - k^2 \cos^2 \beta}} \right) \right] (1 - 2k^2 \cos^2 \beta) \frac{2rk \sin \beta \, d\beta}{\sqrt{1 - k^2 \cos^2 \beta}} \\ &= +8ar \int_0^{\pi} \tanh^{-1} \left( \frac{k \sin \beta}{\sqrt{1 - k^2 \cos^2 \beta}} \right) \frac{(1 - 2k^2 \cos^2 \beta) \sin \beta \, d\beta}{\sqrt{1 - k^2 \cos^2 \beta}} \\ &= 4\pi ark \end{aligned} \quad (97)$$

Finally,

$$\begin{aligned} I_4 &= -2 \int_0^{\pi} \left[ -\frac{2a}{k} \tanh^{-1} \left( \frac{k \sin \beta}{\sqrt{1 - k^2 \cos^2 \beta}} \right) \right] \frac{2rk \sin \beta \, d\beta}{\sqrt{1 - k^2 \cos^2 \beta}} \\ &= +\frac{8ar}{k} \int_0^{\pi} \tanh^{-1} \left( \frac{k \sin \beta}{\sqrt{1 - k^2 \cos^2 \beta}} \right) \frac{k \sin \beta}{\sqrt{1 - k^2 \cos^2 \beta}} \, d\beta \end{aligned} \quad (98)$$

The value of this integral is worked out in appendix A. With the notation

$$\begin{aligned} J(k) &= \frac{1}{k^2} \int_0^\pi \tanh^{-1} \left( \frac{k \sin \beta}{\sqrt{1 - k^2 \cos^2 \beta}} \right) \frac{k \sin \beta}{\sqrt{1 - k^2 \cos^2 \beta}} d\beta \\ &= \frac{-\pi}{2k^2} \ln (1 - k^2) \end{aligned} \quad (99)$$

we have

$$I_4 = 8\pi k J(k) \quad (100)$$

From equation (92) the induced drag is found to be

$$\frac{D_i}{q} = 2\pi \text{ark} \left[ \left( \frac{dr}{dx} + \frac{de}{dx} \right)^2 (2 - k^2) - 4 \frac{dr}{dx} \left( \frac{dr}{dx} + \frac{de}{dx} \right) + \frac{4J}{\pi} \left( \frac{dr}{dx} \right)^2 \right] \quad (101)$$

This result can be applied to the trailing edge of the nonplanar lifting surface to determine the induced drag. Such induced drag includes components associated with lift and with zero lift. For a cylindrical parawing  $dr/dx$  is zero, and if it is further at zero angle of attack, then  $de/dx$  is also zero. Accordingly, the induced drag given by equation (101) is zero, as it should be.

It is of interest to consider the ratio of normal force to induced drag as given by equations (82) and (101). From these results it is readily shown that

$$\frac{Z}{D_i} = \frac{2 \left[ \left( \frac{dr}{dx} + \frac{de}{dx} \right) (2 - k^2) - 2 \frac{dr}{dx} \right]}{\left( \frac{dr}{dx} + \frac{de}{dx} \right)^2 (2 - k^2) - 4 \frac{dr}{dx} \left( \frac{dr}{dx} + \frac{de}{dx} \right) + \frac{4J}{\pi} \left( \frac{dr}{dx} \right)^2} \quad (102)$$

For a flat plate at angle of attack  $\alpha$ , it can be shown from equation (102) that

$$\frac{Z}{D_i} = \frac{2}{\alpha} \quad (103)$$

This is the well-known result of slender-body theory that the induced drag due to lift corresponds to a rearward inclination of the resultant force vector due to lift of  $\alpha/2$ .

#### Leading-Edge Suction and Vortex Lift

In the present case of a nonplanar lifting surface, the leading-edge suction forces can change the magnitude of the lift and drag as well as the side force of either panel. It is of interest to know how important the effect of leading-edge suction is on these aerodynamic quantities for nonplanar lifting-surface shapes typical of all-flexible parawings.

Leading-edge suction.— Usually an evaluation of the leading-edge suction is made by the method of Jones and Cohen, reference 5, which utilizes complex integration around a contour partially surrounding the edge. In the present case, a different method is utilized. The normal force as obtained from equation (82) includes the leading-edge suction force. We may determine the normal force without leading-edge suction by integrating the pressure distributions given by equation (70) over the lifting surface exclusive of contours around the leading edges. The difference in normal force for the two calculations is the component of leading-edge suction force in the normal-force direction. The leading-edge suction force is normal to the leading edge in a plane tangent to the lifting surface. Knowing the direction and the one component of the leading-edge suction, we can therefore determine its other components.

The integration of equation (70) to obtain the normal-force chordwise distribution without suction has been carried out for all seven terms of that equation. Introducing the following subscript notation

$$\left. \begin{array}{l} \frac{d^2e}{dx^2} \sim ze \quad \frac{d^2r}{dx^2} \sim zr \quad \left(\frac{de}{dx}\right)^2 \sim ee \quad \left(\frac{dr}{dx}\right)^2 \sim rr \\ \frac{de}{dx} \frac{df}{dx} \sim ef \quad \frac{dr}{dx} \frac{df}{dx} \sim rf \quad \frac{de}{dx} \frac{dr}{dx} \sim er \end{array} \right\} (104)$$

we find the following result for the first component

$$\begin{aligned}
 \frac{dC_{z_{2e}}}{dx} &= \frac{1}{S_R} \int_{\phi_l}^{\phi_r} \Delta P_{2e} \sin \phi r \, d\phi \\
 &= \frac{16 k^2 r^2}{S_R} \frac{d^2 e}{dx^2} \int_0^\pi \sin^2 \beta (1 - 2k^2 \cos^2 \beta) d\beta \\
 &= \frac{4\pi r^2}{S_R} \frac{d^2 e}{dx^2} k^2 (2 - k^2) \tag{105}
 \end{aligned}$$

The results for all seven components of the loading without suction are:

$$\frac{dC_{z_{2e}}}{dx} = \frac{4\pi r^2}{S_R} \frac{d^2 e}{dx^2} k^2 (2 - k^2) \tag{106}$$

$$\frac{dC_{z_{2r}}}{dx} = - \frac{4\pi r^2}{S_R} \frac{d^2 r}{dx^2} k^4 \tag{107}$$

$$\frac{dC_{z_{ee}}}{dx} = \frac{8\pi r}{S_R} \left( \frac{de}{dx} \right)^2 k^2 (1 - k^2)^2 \tag{108}$$

$$\frac{dC_{z_{rr}}}{dx} = \frac{8\pi r}{S_R} \left( \frac{dr}{dx} \right)^2 k^6 \tag{109}$$

$$\frac{dC_{z_{ef}}}{dx} = \frac{4\pi r}{S_R} \left( \frac{de}{dx} \right) \left( \frac{df}{dx} \right) (1 - k^2) \tag{110}$$

$$\frac{dC_{z_{rf}}}{dx} = - \frac{4\pi r}{S_R} \left( \frac{dr}{dx} \right) \left( \frac{df}{dx} \right) k^2 \tag{111}$$

$$\frac{dC_{z_{re}}}{dx} = \frac{8\pi r}{S_R} \left( \frac{dr}{dx} \right) \left( \frac{de}{dx} \right) k^2 (1 - 2k^2 + 2k^4) \tag{112}$$

where the induced drag associated with vortex lift  $(\Delta C_{D_i})_v$  by analogy with equation (126) is

$$\begin{aligned}
 (\Delta C_{D_i})_v &= (\Delta C_z)_v \sin \alpha + (\Delta C_x)_v \cos \alpha \\
 &= C_s \left[ \alpha \cos(n_1, z) + \cos(n_1, x) \right] \\
 &= \frac{(\Delta C_z)_s}{\cos(n_2, z)} \left[ \alpha \cos(n_1, z) + \cos(n_1, x) \right] \quad (132)
 \end{aligned}$$

### Theory for Conical Parawings

While an all-flexible parawing is not conical, the qualitative effects of spanwise camber for a conical parawing are of interest to the extent they lead to an understanding of all-flexible parawings with large spanwise camber. Therefore, the foregoing theoretical results will be applied to a conical parawing to obtain closed algebraic results for the effects of spanwise camber.

The configuration type is illustrated in figure 6 with the straight leading edges lying in the x-y plane and all sections of the canopy in planes parallel to the y-z plane being circular arcs of uniform k. The canopy is thus part of a circular cone. For a canopy which is half of a right circular cone in particular, the cross sections are semi-circular and  $k = 0.707$ .

For a conical canopy, the angle of attack of the chord plane is

$$\alpha = \frac{de}{dx} + \frac{df}{dx} \quad (133)$$

so that

$$\frac{dr}{dx} + \frac{de}{dx} = \alpha + \frac{(1 - 2k^2)}{2k\sqrt{1 - k^2}} \frac{ds}{dx} \quad (134)$$

where s is the local semispan.

Also,

$$\frac{dr}{dx} = \frac{1}{2k\sqrt{1-k^2}} \frac{ds}{dx} \quad (135)$$

Writing equation (82) in the following form

$$\frac{Z}{q} = \pi s^2 \left(1 + \frac{1}{1-k^2}\right) \alpha + \pi s^2 \left(1 + \frac{1}{1-k^2}\right) \left(\frac{dr}{dx} - \frac{df}{dx}\right) - \frac{2\pi s^2}{1-k^2} \frac{dr}{dx} \quad (136)$$

and utilizing equations (133) to (135), we obtain the normal-force coefficient

$$C_Z = \frac{\pi s^2}{S_R} \left\{ \frac{2-k^2}{1-k^2} \left[ \alpha + \frac{1-2k^2}{2k\sqrt{1-k^2}} \frac{ds}{dx} \right] - \frac{1}{k(1-k^2)^{3/2}} \frac{ds}{dx} \right\} \quad (137)$$

Alternately, it is convenient to form a normal-force parameter

$$\frac{S_R}{s_m^2} \frac{C_Z}{\alpha} = \left( \frac{4}{R} \frac{C_Z}{\alpha} \right) = \frac{\pi(2-k^2)}{(1-k^2)} \left[ 1 - \frac{k(5-2k^2)}{2(2-k^2)\sqrt{1-k^2}} \left( \frac{ds/dx}{\alpha} \right) \right] \quad (138)$$

which depends only on  $k$  and  $\alpha/(ds/dx)$ . From equation (137), the term proportional to  $\alpha$  is associated with the slope of the normal-force curve. For fixed values of  $ds/dx$  and  $\alpha$ , the ratio of normal force due to  $\alpha$  with and without spanwise camber is given by

$$K \equiv \frac{(Z)_{k \neq 0}}{(Z)_{k=0}} = \frac{(2-k^2)}{2(1-k^2)} ; \quad \beta \leq 90^\circ \quad (139)$$

The quantity  $K$  can be thought of as an apparent mass ratio which indicates the extent to which spanwise camber increases the lift-curve slope. If  $\beta > 90^\circ$ , we can form a similar ratio. The ratio chosen is that of the normal force due to  $\alpha$  for the cambered surface to that of the flat surface having the same maximum span, which is now the cone diameter. In this case, we have

$$K \equiv \frac{(Z)_{k \neq 0}}{(Z)_{k=0}} = \frac{4 \left(\frac{f}{s}\right)^2 \left(1 + \frac{1}{2} \frac{f^2}{s^2}\right)}{\left(1 + \frac{f^2}{s^2}\right)^2} = 2k^2(2-k^2) ; \quad 90^\circ \leq \beta \leq 180^\circ \quad (140)$$



With regard to the angle of zero normal force, the analysis yields

$$\frac{\alpha_0}{df/dx} = \frac{1}{2} \frac{5 - 2k^2}{2 - k^2} = \frac{5 + 3 \frac{f^2}{s^2}}{2 \left(2 + \frac{f^2}{s^2}\right)}; \quad 0 \leq \beta < 180^\circ \quad (141)$$

or in terms of the parameter  $ds/dx$

$$\frac{\alpha_0}{(ds/dx)} = \frac{k(5 - 2k^2)}{2(2 - k^2) \sqrt{1 - k^2}} \quad (142)$$

Results similar to those for normal force can also be obtained for induced drag. From equation (101) and equations (133) and (134) we find

$$\begin{aligned} \frac{4}{R} \frac{C_{D_i}}{\alpha^2} = & \frac{\pi}{2} \left( \frac{2 - k^2}{1 - k^2} \right) \left\{ 1 - \frac{k(5 - k^2)}{\sqrt{1 - k^2} (2 - k^2)} \left( \frac{ds/dx}{\alpha} \right) \right. \\ & \left. + \frac{[4J/\pi - (1 - 2k^2)(2 + 5k^2 - 2k^4)]}{4k^2(1 - k^2)(2 - k^2)} \left( \frac{ds/dx}{\alpha} \right)^2 \right\} \quad (143) \end{aligned}$$

To obtain the part of the normal force due to leading-edge suction, we write equation (123) as

$$\frac{d(\Delta C_Z)}{dx} = - \frac{8\pi k^2 r}{S_R} \left\{ (1 - k^2) \left[ \alpha + \frac{1 - 2k^2}{2k \sqrt{1 - k^2}} \frac{ds}{dx} \right] - \frac{1}{2k \sqrt{1 - k^2}} \frac{ds}{dx} \right\}^2 \quad (144)$$

Integration of the foregoing equation over the root chord yields the normal-force coefficient

$$\begin{aligned} (\Delta C_Z)_s = & - \frac{8\pi k^2}{S_R} \left\{ (1 - k^2) \left[ \alpha + \frac{1 - 2k^2}{2k \sqrt{1 - k^2}} \frac{ds}{dx} \right] \right. \\ & \left. - \frac{1}{2k \sqrt{1 - k^2}} \frac{ds}{dx} \right\}^2 \int_0^{c_r} r \, dx \quad (145) \end{aligned}$$

Since

$$\frac{ds}{dx} = \frac{s}{c_r} ; \quad \frac{r}{s} = \frac{1}{2k\sqrt{1-k^2}} \quad (146)$$

it can easily be shown that

$$\frac{4}{R} \frac{(\Delta C_z)}{\alpha} s = -2\pi k(1-k^2)^{3/2} \left( \frac{\alpha}{ds/dx} \right) \left[ 1 - \frac{k(3-2k^2)}{2(1-k^2)^{3/2}} \frac{ds/dx}{\alpha} \right]^2 \quad (147)$$

It is seen that the fractional part of the total normal force due to leading-edge suction thus depends only on the parameters  $k$  and  $\alpha/(ds/dx)$ . If  $k$  is zero as for a flat plate, no normal force is associated with leading-edge suction. However, if  $k$  is greater than zero, a negative normal force is associated with such suction, and loss of suction results in an increase in normal force.

The induced drag associated with leading-edge suction can be readily obtained from  $(\Delta C_z)_s$  with the help of equation (127). Using the direction cosines derived in Appendix B, we find

$$\frac{4}{R} \frac{(\Delta C_{Di})}{\alpha^2} s = \frac{4}{R} \frac{(\Delta C_z)_s}{\alpha} s \left[ 1 + \frac{(1-2k^2)(ds/dx)/\alpha}{2k\sqrt{1-k^2} \left( 1 + \frac{R^2}{16} \right)} \right] \quad (148)$$

From equations (143) and (148), the induced drag with and without leading-edge suction can be readily calculated.

An additional item is of interest. It is noted in equation (147) that the leading-edge suction is zero at a certain angle of attack. By analogy with airfoil practice, we term this angle of attack the ideal angle of attack,  $\alpha_{ideal}$ . From equation (147), this angle is given by

$$\frac{\alpha_{ideal}}{(ds/dx)} = \frac{k(3-2k^2)}{2(1-k^2)^{3/2}} \quad (149)$$

Using the direction cosines we find

$$(\Delta C_{D_i})_s = (\Delta C_Z)_s \left[ \alpha + \frac{\cos(n_2, x)}{\cos(n_2, z)} \right] \quad (127)$$

Vortex lift.- It is of interest to determine the probable importance of the vortex-lift concept of Polhamus, reference 6, for all-flexible parawing applications. In this concept, the force of leading-edge suction is no longer assumed to act normal to the leading edge in a plane tangent to the canopy. It is assumed that a separation bubble occurs on the upper surface of the wing extending from the leading edge inward and that the suction force is changed only in direction but not in magnitude. For the present purpose, it is assumed that this bubble is of such a small extent that the force is rotated  $90^\circ$  on the average to a direction along  $\vec{n}_1$  normal to the canopy and the leading edge.

To obtain the vortex normal force,  $(\Delta C_Z)_v$ , we have

$$(\Delta C_Z)_v = C_s \cos(n_1, z) \quad (128)$$

and from equation (125)

$$(\Delta C_Z)_v = (\Delta C_Z)_s \frac{\cos(n_1, z)}{\cos(n_2, z)} \quad (129)$$

The total normal force with vortex lift is then

$$(C_Z)_v = (C_Z) - (\Delta C_Z)_s + (\Delta C_Z)_v \quad (130)$$

In order to obtain the total induced drag with vortex lift,  $(C_{D_i})_v$ , we have

$$(C_{D_i})_v = (C_{D_i}) - (\Delta C_{D_i})_s + (\Delta C_{D_i})_v \quad (131)$$

Let us turn now to evaluating the increments in normal force and drag associated with vortex lift. From the direction cosines given in Appendix B, we find using equation (129) that

$$\frac{4}{R} \frac{(\Delta C_Z)_v}{\alpha} = - \frac{4}{R} \frac{(\Delta C_Z)_s}{\alpha} \frac{(1 - 2k^2)}{2k \sqrt{1 - k^2} \sqrt{1 + \left(\frac{R}{4}\right)^2}} \quad (150)$$

The induced drag associated with vortex lift becomes, using equation (132),

$$(\Delta C_{D_i})_v = - \frac{\alpha (\Delta C_Z)_s (1 - 2k^2)}{2k \sqrt{1 - k^2} \sqrt{1 + \left(\frac{R}{4}\right)^2}} \left[ 1 - \frac{2k \sqrt{1 - k^2}}{1 - 2k^2} \left( \frac{ds/dx}{\alpha} \right) \right] \quad (151)$$

For purposes of later comparison, it is desired to obtain specific results for  $k = 0$ . In this case, the results of equations (138) and (143) yield the following nondimensional results for lift, induced drag, and drag-rise factor with full suction

$$\left. \begin{aligned} \left(\frac{4}{R}\right)^2 C_Z &= 2\pi \left(\frac{\alpha}{ds/dx}\right) \\ \left(\frac{4}{R}\right)^3 C_{D_i} &= \pi \left(\frac{\alpha}{ds/dx}\right)^2 \\ \frac{C_{D_i}}{C_Z^2} &= \frac{1}{\pi R} \end{aligned} \right\} \quad (152)$$

With no leading-edge suction, we find the same result for  $C_Z$ , but for the other quantities we have

$$\left. \begin{aligned} \left(\frac{4}{R}\right)^3 C_{D_i} &= 2\pi \left(\frac{\alpha}{ds/dx}\right)^2 \\ \frac{C_{D_i}}{C_Z^2} &= \frac{2}{\pi R} \end{aligned} \right\} \quad (153)$$

With vortex lift the corresponding results are

$$\left. \begin{aligned} \left(\frac{4}{\mathcal{R}}\right)^2 c_Z &= 2\pi \left(\frac{\alpha}{ds/dx}\right) + \pi \left(\frac{\alpha}{ds/dx}\right)^2 \\ \left(\frac{4}{\mathcal{R}}\right)^3 c_{D_i} &= 2\pi \left(\frac{\alpha}{ds/dx}\right)^2 + \pi \left(\frac{\alpha}{ds/dx}\right)^3 \end{aligned} \right\} \quad (154)$$

$$\frac{c_{D_i}}{c_Z^2} = \frac{2}{\pi \mathcal{R}} \left[ \frac{1}{1 + \frac{1}{2} \left(\frac{\alpha}{ds/dx}\right)} \right] \quad (155)$$

## RESULTS AND DISCUSSION

### Theoretical Results for Conical Canopies

The nonplanar slender-body theory described in the preceding section of the report has been used to make a systematic set of calculations for conical canopies formed by segments of circular cones. These calculations illustrate a number of significant qualitative effects which have bearing on the aerodynamics of real parawings. Let us then consider the results for conical parawings and their implications for all-flexible parawings.

It is of interest to have a knowledge of the shape parameters of an all-flexible parawing in order to assess the probable applicability of the theoretical results for conical parawings to those of the all-flexible type. The variation of  $s$  and  $k$  with chordwise distance are shown in figure 7 as obtained from shape measurements on a twin-keel all-flexible parawing. Examination of the variation of  $s$  with  $x$  near the trailing edge of the root chord shows that it is not possible to characterize the parawing by a single value of  $ds/dx$  as for a conical one. However, figure 7(b) shows that a value of  $k = 0.5$  is a good average value for the parawing.

Considering first normal-force results, the apparent mass factor  $K$  given by equations (139) and (140) is shown as a function of the spanwise camber parameter  $k$  in figure 8(a). It is noted that a surface of semicircular cross section has a normal-force curve slope 50 percent greater than that for a triangular flat wing of the same span. For the

limiting case of  $k = 1$ , the slope is doubled. The limiting configuration for  $k = 1$  is not a solid circle because there is still a slit in the bottom meridian, and pressures exist on both sides of the wing surface. Corresponding results for the angle of zero normal force are shown in figure 8(b). The angle is greater than  $df/dx$  because the wing has geometric washout.

There exists an ideal angle of attack, calculable from equation (149), for which the leading-edge suction becomes zero at all points along the leading edges. The ratio of ideal angle of attack to  $ds/dx$  is shown as a function of  $k$  in figure 9 together with corresponding results for  $\alpha_0$ . The ideal angle of attack varies from  $1.2 \alpha_0$  at  $k = 0$  to  $1.5 \alpha_0$  at  $k = 0.707$ . For a wing of aspect ratio 2,  $ds/dx = 0.5$ . For  $k = 0.5$ , this wing would have an ideal angle of attack close to 0.5 radian. If the wing were operated at an angle less than the ideal angle of attack, the stagnation point would move to the upper canopy surface, and luffing would occur.

It is of interest to examine the effects of leading-edge suction and vortex lift on normal-force and drag characteristics of conical canopies. The effects are functions of the amount of spanwise camber. As a basis of comparison for the effect of spanwise camber, let us examine the effects of leading-edge suction and vortex lift first for  $k = 0$ . Figure 10 has been prepared for this purpose, based on the simple results given by equations (152) to (155) in a form independent of aspect ratio. Figure 10(a) shows no effect of leading-edge suction on normal force, but a large effect of vortex lift is exhibited at the larger values of  $\alpha/(ds/dx)$  attainable with low-aspect-ratio wings. The drag curves in a non-dimensional form are shown in figure 10(b). At small normal-force coefficients the induced drag associated with vortex lift can exceed that with no suction, but at high normal-force coefficients the induced drag with vortex lift approaches that with full suction. The ratio  $Z/D_i$  is plotted in figure 10(c) to show the approximate magnitude of the ratio of normal force to induced drag. It is clear the vortex-lift effects on this ratio are important only for smaller values of the ratio. At large values of  $C_z$ , the ratio  $Z/D_i$  with vortex lift can be greater than that for full suction.

For comparison with the foregoing results in figure 10 for  $k = 0$ , a corresponding set is shown in figure 11 for  $k = 0.5$ . This value of  $k$  was chosen because it is the average value measured for a twin-keel all-flexible parawing. In figure 11(a), it is noted that the loss of leading-edge suction now causes an increase in normal force where none was manifest previously. The difference in normal force between the full-suction and no-suction cases is almost as great as that between the vortex-lift and full-suction cases. One important effect of spanwise camber is thus that leading-edge suction can have significant effects on normal force where none occurred for  $k = 0$ .

For  $k = 0.5$ , the strength of the leading-edge suction is zero along the entire lengths of the leading edges at a value of  $\alpha/(ds/dx)$  equal to 0.96 regardless of aspect ratio. Hence, all three normal-force curves for all three cases have the same normal force at the ideal angle of attack. At the ideal angle of attack, the leading-edge streamline is tangent to the camberline, and small changes in the angle of attack can put a stagnation point on either the lower surface or upper surface of the canopy.

In figure 11(b), the low ranges of the drag curves are presented for the cases of full suction, no suction, and vortex lift. At the normal-force coefficient corresponding to the ideal angle of attack, all drag curves are tangent. The point of maximum  $Z/D_i$  for any drag curve corresponds to the point of tangency to the curve of a straight line from the origin. It can thus be seen that the points of maximum  $Z/D_i$  ratio occur for values of normal force less than that corresponding to the ideal angle of attack. However, a conical parawing must operate above the ideal angle of attack so that it cannot attain the maximum value of  $Z/D_i$ . In figure 11(c), the ratio of  $Z/D_i$  is shown versus the  $C_Z$  parameter for the three cases. The results of this figure for  $k = 0.5$  are qualitatively the same as those in figure 10(c) for  $k = 0$ .

Direct comparisons of  $Z/D_i$  ratios for two values of  $k$  are given in figure 12 for the full-suction case and the vortex-lift cases. In this figure it is seen that spanwise camber has a favorable effect on the  $Z/D_i$  ratio for both cases.

It appears that appreciable gains in the ratio of lift to induced drag could be realized if an all-flexible parawing could be rigged into

a conical shape. For example, the twin-keel all-flexible parawing on which the shape data were taken has a  $Z/D_i$  ratio of 2.90 and an  $L/D_i$  ratio of 2.76 based on the present theory using measured geometric quantities. Assume that the all-flexible parawing could be rigged into a conical shape with  $k = 0.5$ . At the point of maximum  $Z/D_i$  corresponding to the luffing boundary, figure 11(b) gives the following values

$$\left(\frac{4}{R}\right)^2 \frac{C_Z}{\pi} = 0.5 \qquad \left(\frac{4}{R}\right)^3 \frac{C_{D_i}}{\pi} = 0.065$$

The ratio  $Z/D_i$  is thus

$$\frac{Z}{D_i} = \frac{0.5}{0.065} \left(\frac{4}{R}\right) \approx \frac{30}{R}$$

It thus appears that for any small or moderate aspect ratio all-flexible parawing, substantial gains would result if the parawing could be rigged closer to the conical shape. The gain would result principally from operating closer to the luffing condition which corresponds to the highest useful  $Z/D_i$  ratio. This point cannot be attained with present all-flexible parawings because of nose collapse. As long as the ideal angle of attack cannot be attained, vortex lift will be a factor in improved performance.

#### Measured Shapes and Aerodynamic Coefficients

During the course of this investigation, the Langley Research Center conducted a wind-tunnel program to obtain data on the inflated shapes of both a single-keel and a twin-keel all-flexible parawing. Prior attempts to find the inflated shapes had involved measuring, photographing, or rigidizing the models. These methods were not generally satisfactory, and the method finally adopted by Langley was the use of stereo photography. The experimental arrangement is shown in figure 13. The wing is marked with 1-inch squares. From the stereo pair of photographs, data are obtained on the line intersection points on the wing and read directly into punch cards for use in a computer program which calculates the coordinates of the points in a tunnel axis system. The crosses on the tunnel ceiling are used as control points in setting up



the stereo model. In addition to obtaining the stereo photographs, aerodynamic performance was measured.

The measurements described above were made on a single-keel and a twin-keel all-flexible parawing, for both of which considerable prior aerodynamic data had been obtained at the Langley Research Center. The major part of the analysis and data comparisons of the present investigation was conducted using these two configurations. In the following sections of this report, the single-keel and twin-keel parawings referred to are those described below.

Single-keel parawing.- The single-keel parawing configuration used during this investigation is the basic wing configuration of reference 7. The flat canopy arrangement, line attachment locations, and line lengths are shown in figure 14. The inflated configuration is shown mounted in the tunnel in figure 13.

This configuration was tested in the wind tunnel over a range of angles of attack,  $\alpha_7$ , from  $26^\circ$  to  $35^\circ$ . The angle at which the highest L/D ratio occurred is  $27^\circ$ , which is the angle at which the inflated shape data were obtained. At this angle the following aerodynamic data were obtained:

$$C_L = 0.95$$

$$C_D = 0.39$$

$$L/D = 2.43$$

The canopy coordinates of the inflated shape, as obtained from the stereo photography, are listed in Appendix C. In order to use these data, it is necessary to know something of the coordinate system set up in the stereo model and the order in which the points were read. This information is contained on the first page of Appendix C.

For purposes of applying aerodynamic theories to the known canopy shape, the data of Appendix C were used to construct chordwise sections at various spanwise stations. These sections are shown in figure 15. The sections were obtained for a given spanwise station by locating those points in the tabular data having  $y'$  values within  $\pm 0.10$  inch of the nominal  $y'$  value of the desired semispan station and plotting the

points on an  $x'-z'$  graph. This procedure gives acceptable results over most of the canopy. Near the maximum span and near the line attachment points along the leading edge, however, the canopy surface is nearly vertical, and small differences in  $y'$  give large differences in the  $z'$  coordinate. This difficulty can be most easily visualized by examining figures 16(a) and 16(b), which are photographs showing the side and rear views of a single-keel parawing having the same configuration and rigging characteristics as that used in the shape determination tests. Consequently, it is difficult to obtain an accurate section near the tip, as indicated by the sections having  $\eta$  values near 1 in figure 15(b). The most forward points for a given span station are close to, but do not necessarily indicate, the section leading edges, because the high curvature at the leading edge sometimes prevented the first one or two points from being seen properly in the photographs.

Twin-keel parawing.- The twin-keel parawing configuration used in the present investigation is that described in reference 8. The canopy shape data, however, were obtained on a wing having an  $h_k$  of 75 inches rather than the 15-foot size used in the investigation reported in reference 8. The flat canopy arrangement, line attachment locations, and line lengths are shown in figure 17.

The configuration described in figure 17 was tested in the wind tunnel over a range of angles of attack,  $\alpha_B$ , from  $24.2^\circ$  to  $31.8^\circ$ . The shape data were obtained at an angle of  $24.8^\circ$  which is near the maximum L/D ratio condition. At this angle, the following aerodynamic data were obtained:

$$C_L = 0.840$$

$$C_D = 0.329$$

$$L/D = 2.56$$

The canopy coordinates of the inflated configuration, as obtained from the stereo photography, are listed in Appendix D. As for the single-keel data of Appendix C, an explanation of the data is included in the appendix.

Chordwise sections of the canopy were plotted for purposes of predicting the aerodynamic performance of the parawing. The sections are shown in figure 18. The comments given in the preceding section concerning the methods of obtaining these sections and the accuracy of the section shapes apply equally to the twin-keel data. Generally, however, the twin-keel parawing tends to have a more regular and smoother shape than the single-keel parawing because of the absence of leading-edge lines in the center lobe and the fact that the inflation of the forward portion of the outer lobes is assisted by the presence of the center lobe. These characteristics can be seen by comparing figures 19(a) and 19(b) with figures 16(a) and 16(b).

#### Aerodynamic Performance Comparisons

The slender-wing analysis was applied to the two parawings just described in order to evaluate the method. To apply the method, it is necessary to obtain spanwise canopy sections in planes normal to the root chord and fit circular arcs to these sections. Using the chordwise variation of the circular-arc section properties, the detailed aerodynamic load distribution on the parawing can be computed, from which the gross aerodynamic performance and the rigging line load distributions can be obtained and compared with measured results. A computer program was written to perform the calculations. The canopy fitting procedure and the aerodynamic load calculations are described below. The aerodynamic calculations and comparisons with data were made assuming full leading-edge suction.

As an additional standard of comparison, a planar lifting-surface method was also applied to the two parawing configurations. The method used is that of Multhopp, as modified and programmed by Lamar (ref. 9). An arrangement of 21 spanwise and 10 chordwise control points was used. The predicted angles of attack at which the measured lift coefficients are obtained were compared with measured angles. The predicted angles were low by 10 and 27 percent for the single- and twin-keel parawings, respectively. The differences are due both to an overprediction of the effect of chordwise camber and the inability of the method to account for spanwise camber. The slender-wing results, which follow, illustrate

better agreement, which is felt to be the result of accounting for the large amount of spanwise camber.

Single-keel parawing.- The first task in applying the theory to the known parawing shape is to determine spanwise sections in planes normal to the root chord. The procedure adopted was to use the chordwise shape data of figure 15 to obtain a  $y-z$  crossplot at regular intervals of  $x$ . Some typical  $y-z$  plots are shown in figure 20 for several stations along the chord.

It is evident from figure 20 that these spanwise sections do not resemble circular arcs, and fitting circular arcs to the shapes is a somewhat arbitrary process. In order to fit the arcs in a consistent manner, the following approach was used. The circular arc was first made to pass through and terminate at the tip of the section. Then, an attempt was made to adjust the circular arc radius and the center of curvature so that the area ( $A_1$  in the sketch below) between the circular arc and canopy sections outboard of the point where these two lines cross is equal to the area ( $A_2$ ) between the arc and canopy inboard of the point.

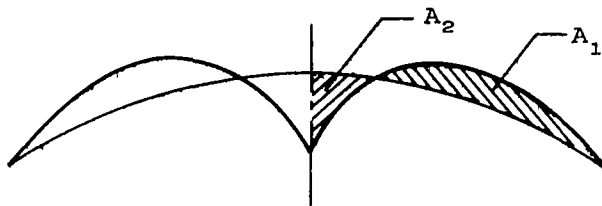

Circular-arc sections were fitted in this manner at 2-inch intervals (intervals in  $x/c_r$  of 0.051 where  $c_r = 38.9$  inches) along the root chord, and the quantities  $r$ ,  $f$ , and  $e$  were measured. These quantities were then plotted versus  $x$  and the resulting curves smoothed. Finally, the semispan values,  $s$ , were computed using equation (114) and compared with the planform deduced directly from the photogrammetric data. Any sizable discrepancies in span were eliminated by modifying the values of  $r$  and  $f$ , and the  $r$  and  $f$  curves were again smoothed. The resulting circular-arc fits to several spanwise sections are shown in figure 20. The planform fit that was obtained using this procedure is compared with

the actual planform obtained from the photogrammetric data (as viewed normal to the root chord) in figure 21. The two planforms are in reasonable agreement, considering the complexity of the leading-edge shape. A table of the circular-arc properties used in the single-keel parawing calculations is given in table I. Since only three quantities may be independently specified, the  $s$  values in table I are calculated from the  $e$ ,  $f$ , and  $r$  values.

After a satisfactory planform fit was obtained, the slopes of the curves of  $r$ ,  $e$ , and  $f$  versus  $x$  were obtained graphically to determine  $dr/dx$ ,  $de/dx$ , and  $df/dx$ . These values were then plotted versus  $x$  to obtain the second derivatives  $d^2r/dx^2$  and  $d^2e/dx^2$ . The resulting values were then used as tabular input to the computer program to compute the loading distribution. The pressure distribution was computed using equation (70). From a knowledge of the circular-arc canopy shape, the direction cosines of the local normal to the canopy were obtained and used with the pressure distribution to obtain force distributions in the normal, axial, and side directions. The normal force per unit chordwise length was checked with the analytically integrated values for no suction represented by equations (106)-(112). Finally, the chordwise integrated loadings using 19 stations along the root chord were checked with the analytically integrated normal-force coefficient with and without leading-edge suction using equations (113) and (123). The differences between the numerically and analytically integrated values were generally less than 2 percent.

The normal-force results for the single-keel parawing are shown in figure 22. The ordinate represents the total normal force with leading-edge suction up to the chord station of interest, as predicted from equation (113). The irregular shape of the curve near the nose is caused by the difficulty in fitting circular arcs to the actual canopy spanwise sections. The canopy span begins to decrease rapidly near the 87-percent chord station, which causes the loading to become negative in the slender-wing analysis. Consequently, the total wing normal force is taken as the maximum value, which occurs at  $x/c_r = 0.85$ .

For purposes of applying the theory as a predictive method, the normal force and induced drag coefficients predicted by the theory should be modified according to the following comments. In the development of

the expressions for normal force (eq. (81)) and induced drag (eq. (101)), the factor  $\cos \alpha$  was assumed nearly unity and dropped from the force expressions. The angle  $\alpha$  is in fact not small, and the  $\cos \alpha$  factor should probably be retained. Accordingly, the normal-force coefficient presented in figure 22 should be interpreted as  $C_Z/\cos \alpha$  and the values indicated should be multiplied by  $\cos \alpha$  to obtain  $C_Z$ . For induced drag, equations (87) and (85) indicate that a correction of  $\cos^2 \alpha$  is applicable to the induced-drag coefficient. Consequently, the induced-drag coefficient computed from equation (101) should be interpreted as  $C_{D_i}/\cos^2 \alpha$ . Secondly, it is well known that slender-wing theory tends to overpredict aerodynamic force coefficients, with the difference increasing with increasing aspect ratio. Thus, a slenderness correction should be applied to the predicted force coefficients. Finally, since normal and drag forces represent a mixed set, the lift force should be determined according to the following equations.

$$C_L = C_Z \cos \alpha - C_X \sin \alpha$$

$$C_{D_i} = C_Z \sin \alpha + C_X \cos \alpha$$

Therefore,

$$C_L = \frac{1}{\cos \alpha} \left[ C_Z - C_{D_i} \sin \alpha \right] \quad (156)$$

With the above noted corrections, the predicted results can be compared with the measured results given in the previous section. The predicted normal-force coefficient from figure 22 is 1.53 and the induced-drag coefficient is 0.727. The photogrammetric data (fig. 15) indicate that the root chord makes an angle with the wind vector of  $41^\circ$ . Thus, the normal-force and induced-drag coefficients corrected for the  $\cos \alpha$  effect are 1.154 and 0.413, respectively. Using equation (156), the predicted lift coefficient is 1.17. The slenderness correction is based on the aspect ratio of the planform shown in figure 21, which is 1.56. Figure 6-10 of reference 10 illustrates some results for lift-curve slope for triangular wings having aspect ratios up to 4 and indicates for an aspect ratio of 1.56 that slender-wing theory overpredicts measured

values by about 32 percent. This correction was applied to the lift and induced-drag coefficients noted above in order to obtain the final predicted values.

The measured drag includes the effect of frictional effects as well as induced drag. In order to make a comparison with measured drag, rough estimates of the canopy skin friction and line drag were made using a flat plate, turbulent-boundary-layer skin-friction coefficient, and a two-dimensional drag coefficient for a cylinder. This calculation indicates a frictional drag coefficient  $C_{D_o}$  of 0.06 based on flat canopy area.

The predicted results are compared with the measured values in the following table.

	<u>Predicted</u>	<u>Measured</u>
$C_L$	0.89	0.95
$C_{D_i}$	.31	----
$C_D$	.37	.39
$L/D_i$	2.83	----
$L/D$	2.40	2.43

The predicted lift coefficient is somewhat lower than the measured value. This quantity is dependent only on the cross section properties at the last station developing positive lift, according to equation (113). In order to determine the sensitivity of the predicted lift to the circular-arc fits to the sections near the trailing edge, the actual sections at four chordwise stations were refit, keeping the same semispan but varying the radius and spanwise camber of the circular arc. These changes cause a change in  $C_Z$  principally through  $dr/dx$ . It was found that the predicted  $C_Z$  could be increased about 20 percent through changes in  $r$ ,  $e$ , and  $f$  that did not appear unreasonably large. Thus, for the single-keel parawing, additional work is required to develop a rational approach for obtaining a unique circular-arc fit to a given spanwise section.

The measured and predicted drag coefficients agree reasonably well. From the relative sizes of the induced drag and estimated frictional drag, it is apparent that the induced drag is a major part of the total

drag of a single-keel parawing. The lift-drag ratios agree very well as a result of the underprediction of both lift and drag coefficients.

Twin-keel parawing.- The approach to calculating the aerodynamic performance of the twin-keel parawing is similar to that described above for the single-keel parawing. The first step is to obtain spanwise sections by crossplotting the chordwise section data of figure 18. The results for several chordwise stations are shown in figure 23. The fitting of circular arcs to these sections can be made on a more rational basis than was the case with the single-keel parawing. The procedure followed is to pass the circular arc through the actual canopy points at the vertical plane of symmetry and at the maximum span station (the leading edge). Towards the center, chordwise, of the parawing, the tips of the canopy are reentrant, as shown in figure 23. In this case, the maximum span station does not correspond to the leading edge, and the maximum span station is used. The circular-arc fits are also shown in figure 23. The tabulation of the circular-arc parameters is shown in table II. The nondimensional chordwise values are based on a root chord length  $c_r$  of 51.4 inches. The resulting fit of the circular-arc planform to the actual planform obtained from the photogrammetric data is shown in figure 24.

The normal force results obtained using the circular-arc fit properties described above are shown in figure 25. The local span begins to decrease rapidly beyond  $x/c_r = 0.86$  and a negative normal force is predicted aft of this point. Thus the total normal force is taken as that at  $x/c_r = 0.86$ . The dip in the curve at  $x/c_r = 0.6$  occurs in the region where the canopy tip is reentrant (see fig. 23), and could possibly be smoothed by a somewhat different approach to the circular-arc fit for this type of spanwise section.

For purposes of comparing predicted and measured performance of the twin-keel parawing, the same corrections were made to the theoretical results as were discussed in the previous section. The predicted normal force (from fig. 25) and induced-drag coefficients are 1.385 and 0.551, respectively. When these values are corrected for the  $\cos \alpha$  and slender-wing effects and the wing lift coefficient is computed, the following results are obtained.



	<u>Predicted</u>	<u>Measured</u>
$C_L$	0.86	0.84
$C_{D_i}$	.31	----
$C_D$	.36	.33
$L/D_i$	2.76	----
$L/D$	2.38	2.55

In these calculations, the aspect ratio is that of the planform illustrated in figure 24, which is 1.76. The slenderness correction is then 0.745, based on the values shown in reference 10. The total frictional drag coefficient is estimated to be 0.05, based on the same approach as noted for the single-keel parawing. The predicted total drag coefficient is somewhat larger than the measured value, which gives a lower lift-drag ratio than is measured.

#### Structural Characteristics

One of the principal advantages of a capability for predicting the detailed load distribution on the canopy is the potential for determining line loads. Using the slender-wing theory, an investigation was made for both the single- and twin-keel parawings to attempt to obtain an understanding of the manner in which the distributed loading on the canopy is led into the discrete support loads represented by the rigging line tensions. In order to make a detailed stress analysis of this problem, it would be necessary to know the shape of the "scalloped" leading edge and the resulting canopy aerodynamic load distribution near the leading edge. It would then be possible to predict the canopy stresses and to solve the static force equilibrium problem at the line attachment points. Since the canopy shape along the leading edge is imperfectly known, and the theory does not model the "scalloped" shape, a simplified approach was taken.

Methods of approach.- It was assumed first that the canopy was made up of circular-arc sections of chordwise width  $dx$ , on each of which the spanwise load distribution was known. Further, it was assumed that each section was supported at the leading edge by a "distributed" line tension  $dT_\ell/dx$  and at the keel(s) by a line tension  $dT_k/dx$ . The

static equilibrium equations were then solved for the distributed line tensions on each section to obtain the chordwise variation of the distributed line tensions. These tension distributions were then apportioned to the discrete lines by assigning a chordwise length of influence to each line and integrating the distributed tension to obtain the line load. In this process, a single confluence point for all lines was assumed known. Thus, in the static equilibrium equations where the distributed line tension is used, direction cosines were assigned to the line tension force as if a discrete line existed between the leading edge (or keel) at that chordwise station and the confluence point.

Four approaches to the static equilibrium equations were examined. These are described briefly below (as applied to the twin-keel parawing) together with comments on the difficulties with the approach.

Method (a): The  $x$  and  $z$  equilibrium equations on a section were considered, as indicated below.

$$\frac{d(\Delta C_X)_s}{dx} + \frac{dC'_X}{dx} + 2 \frac{dC_{T_\ell}}{dx} \cos \alpha_\ell + 2 \frac{dC_{T_k}}{dx} \cos \alpha_k = 0$$

$$\frac{d(\Delta C_Z)_s}{dx} - \frac{dC'_Z}{dx} + 2 \frac{dC_{T_\ell}}{dx} \cos \gamma_\ell + 2 \frac{dC_{T_k}}{dx} \cos \gamma_k = 0$$

where the leading-edge suction coefficient is taken as positive down and  $C'_X$  and  $C'_Z$  are the aerodynamic force coefficients due to the pressure difference loading. The assumption is made in these equations that there is no chordwise variation in the canopy stress. However, near the nose and trailing edge of the parawing, the canopy loads are taken only by the keel lines. At these sections, a differential chordwise canopy tension force  $d\sigma_x/dx$  (assumed uniform over the section span) was used in the  $x$  equation, with the value thus computed being high at the leading and trailing edges and dropping to zero (uniform chordwise canopy tension) over the central (chordwise) portion of the canopy where the leading-edge lines exist. A major problem with this approach is that the axial canopy tension force is not constant over most of the chord but varies considerably. As a result, the  $C'_X$  and  $(\Delta C_X)_s$  forces, which are weakly coupled into the line tension because  $\cos \alpha_\ell$  and

$\cos \alpha_k$  are small, tend to cause unreasonably large variations in line tension to create equilibrium in the  $x$  direction.

Method (b): The  $y$  and  $z$  equilibrium equations were applied to a strip of width  $dx$  extending over only the semispan, using the fact that on the vertical plane of symmetry, a knowledge of the principal radii of curvature of the canopy and the  $\Delta p$  value will yield the canopy stress components. Thus, in the plane of symmetry

$$\frac{\sigma_x}{r_x} + \frac{\sigma_y}{r} = \Delta p$$

where  $r_x$  is the radius of curvature of the canopy in the  $y = 0$  plane, and  $r$  is the radius of curvature in a constant  $x$  plane. The shape data indicate that  $r_x$  is generally larger than  $r$ , and the assumption was made that  $\sigma_x/r_x$  could be ignored over the entire canopy. The resulting force equilibrium equations neglecting higher-order terms are then

$$\begin{aligned} \frac{dC'_y}{dx} + \frac{d(\Delta C_y)}{dx} s + \frac{dC_{T_\ell}}{dx} \cos \beta_\ell + \frac{dC_{T_k}}{dx} \cos \beta_k + \frac{\sigma_y}{qS_R} &= 0 \\ - \frac{dC'_z}{dx} + \frac{d(\Delta C_{T_z})}{dx} s + 2 \frac{dC_{T_\ell}}{dx} \cos \gamma_\ell + 2 \frac{dC_{T_k}}{dx} \cos \gamma_k &= 0 \end{aligned}$$

Because of the weak coupling of the line tension into the  $y$  force balance equation (small  $\cos \beta$ ), this set of equations is not well conditioned. Consequently, one difficulty with this approach is that if the assumption of  $r_x \gg r$  is not sufficiently good over the chord, the computed values of line tension tend to vary widely along the chord.

Method (c): It is evident from considerations of two-dimensional static equilibrium that the canopy tension (say,  $\sigma_1$ ) in a  $y$ - $z$  plane must be constant from the plane of symmetry out to the keel line attachment point and must also be constant over the outer lobe (say, at  $\sigma_2$ ), as shown below.

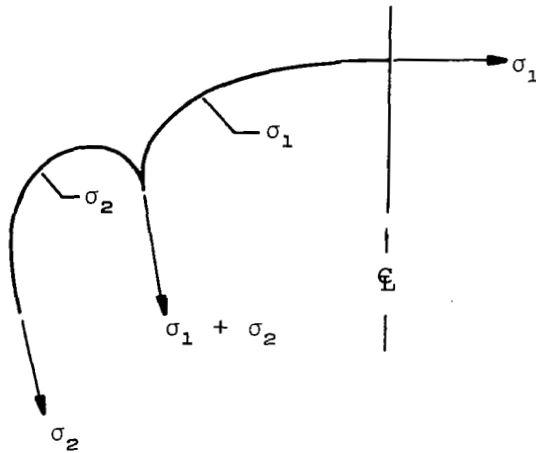

The line tensions must then be  $\sigma_1 + \sigma_2$  and  $\sigma_2$  for the keel and leading-edge lines, respectively, from considerations of force equilibrium at the line attachment points, assuming the cusp angle at the keel line is zero. Thus,  $y$  and  $z$  equilibrium equations can be written as follows.

$$\frac{dC'_y}{dx} + \frac{d(\Delta C_y)}{dx} s + \frac{\sigma_2}{qS_R} \cos \beta_\ell + \frac{(\sigma_1 + \sigma_2)}{qS_R} \cos \beta_k + \frac{\sigma_1}{qS_R} = 0$$

$$-\frac{dC'_z}{dx} + \frac{d(\Delta C_z)}{dx} s + \frac{\sigma_2}{qS_R} \cos \gamma_\ell + \frac{(\sigma_1 + \sigma_2)}{qS_R} \cos \gamma_k = 0$$

This set of equations tends to have the poor conditioning of those of the previous two approaches, but the assumptions used in the derivation are not so restrictive.

Method (d): The chordwise section of width  $dx$  was divided spanwise into portions, as shown in the following sketch.

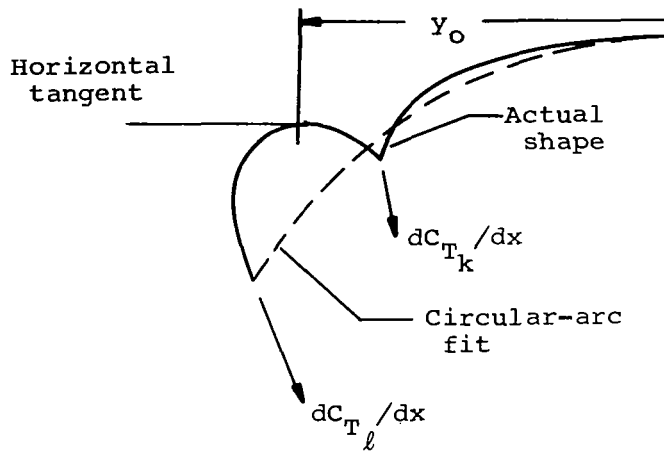

The inner portion is that part between the span stations (noted  $y_0$ ) on the actual canopy section where the tangent to the canopy shape in a  $y-z$  plane is horizontal. The two outer portions are those parts outboard of  $\pm y_0$ . For each portion of the canopy, the lateral component ( $\sigma_y$ ) of the canopy stress at  $\pm y_0$  is horizontal and does not enter into a  $z$  equilibrium equation. Thus, the following two equations can be written for the inner and outer portions of the canopy, respectively, assuming that the chordwise canopy stress  $\sigma_x$  is uniform over the section ( $d\sigma_x/dx = 0$ ).

$$-\left. \frac{dC'_z}{dx} \right|_i + 2 \frac{dC_{T_k}}{dx} \cos \gamma_k = 0$$

$$-\left. \frac{dC'_z}{dx} \right|_o + \frac{d(\Delta C_z)}{dx} s + 2 \frac{dC_{T_l}}{dx} \cos \gamma_l = 0$$

The division of normal force between the inner and outer portions of the canopy section can be approximated by integrating the loading equations from 0 to  $y_0$  and from  $y_0$  to  $s$ , respectively. The assumption is made in so doing that the load out to the span station  $y_0$  on the circular-arc section is the same as that on the actual section. This approach has the advantage over the other three of employing only the  $z$

direction equations, into which the line tension forces are strongly coupled.

Theoretical results.- A preliminary investigation of the first two methods described above indicated that unreasonable results would be obtained, in accordance with the comments already noted. Consequently, calculations were made only for the latter two methods. The methods were applied first to the twin-keel parawing, since there is less uncertainty in the circular-arc fits for the twin-keel parawing than for the single-keel parawing.

The distributed line tension results for the canopy tension approach (method (c)) are shown in figure 26. The chordwise variation for both the keel and leading edge is large. Near the 65-percent chord station, the loadings for both the keel and leading edge become negative, as a result of the properties of the circular-arc fits in this region. (This result is also illustrated in figure 25.)

Similar results for the  $z$  equilibrium approach (method (d)) are shown in figure 27. Again, the chordwise variation is large, and a region of very small loading is indicated near the 0.60 chord station.

These two sets of results were used to construct discrete line load predictions in the following way. The line attachment points for the twin-keel parawing are shown in figure 24. The  $x/c_r$  value of the midpoint of the line joining two adjacent line attachment points was located for all points along the keel and leading edge. Each line was then considered to take the distributed load over an  $x/c_r$  range from the midpoint forward of the line attachment point to the midpoint aft of the point. The appropriate distributed loads from figures 26 and 27 were integrated for each line and are shown in figure 28. The large chordwise variation in distributed loading from figures 25 and 26 is carried over into the discrete line loads and is particularly evident near  $x/c_r = 0.6$  for both the keel and leading-edge lines. The measured values obtained from unpublished Langley Research Center data are shown in figure 28 to indicate that there is not the degree of chordwise variation in the actual case that is indicated by the predicted values, particularly for the keel lines.

It is possible that some refitting of the circular arc sections would provide a more even chordwise variation of the predicted line loads, particularly since the detailed load distribution is affected by the second derivatives of  $r$  and  $e$  as well as the first derivatives. A more detailed examination of the structural aspects of all-flexible parawings should include such a study. However, an alternate approach was examined, based on attempting to derive a simple engineering method for estimating line loads.

It was noted previously that the predicted total forces on the parawing are determined by the circular-arc section properties near the maximum span station toward the trailing edge. First, it is assumed that the total normal force is distributed uniformly chordwise over the planform, so that  $dC_z/dx$  is constant. This assumption appears reasonable based on the results of figures 22 and 25. Method (d) was then adopted for computing the distributed line loads. The further assumption is made that the division of load spanwise between the inner and outer portions of any section is determined in part by the  $y_0/s$  value at the maximum span station. A further assumption must now be made as to the form of the span load distribution curve. The two alternatives examined were a rectangular span load distribution and a distribution given by the slender-body solution for a flat wing ( $1/\sqrt{1 - (y^2/s^2)}$ ), both illustrated in the sketch below.

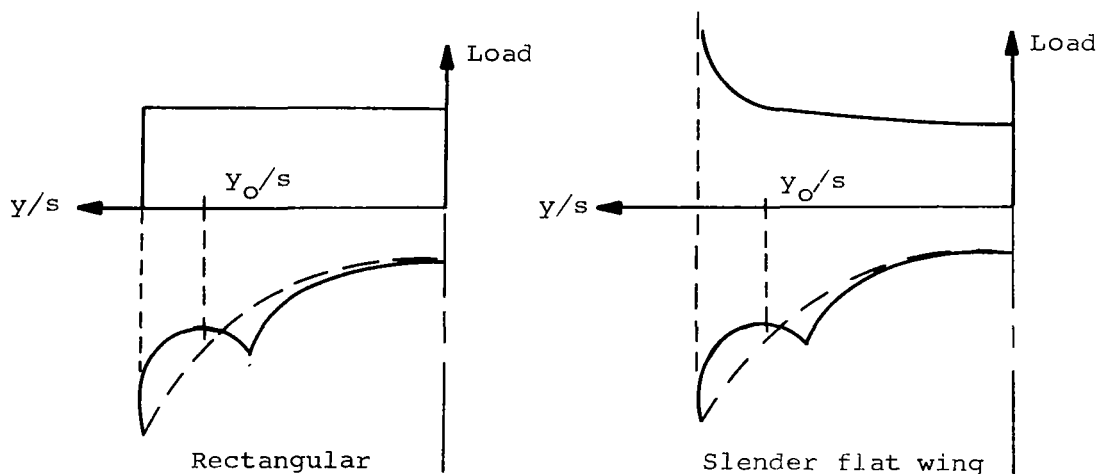

The goal with this approach is to derive a method based on knowledge only of the parawing section properties at the chord station near the trailing edge where the loading just goes negative according to the slender-wing method. This approach was applied to both the single- and twin-keel parawings, and the predictions were compared with measured values. The results are described in the following sections.

Single-keel parawing results.- The approach described above was applied to the single-keel parawing defined in configuration by figures 14 and 21 and table I. The discrete line loads were predicted using the aerodynamic loads predicted by the slender-wing theory, as corrected for the  $\cos \alpha$  and slender-wing factors discussed previously.

The measured line loads were obtained from reference 7. The values for  $q = 2$  psf were used. An initial check was made on the force balance on the parawing by comparing the measured normal force obtained from the lift and drag with the sum of the  $z$  components of the line tensions obtained from the measured line tensions and the direction cosines of the lines. The  $C_z$  value obtained from the measured  $C_L$  and  $C_D$  is 0.973, and the sum of the line tension components in the normal-force direction is 1.1, which is 13 percent greater. Although the line tension and aerodynamic data were obtained in different tests, the only known difference between the tests is the  $q$  value, which should not account for the 13-percent difference.

The comparison of discrete line loads is shown in figure 29. For the keel lines (fig. 29(a)), the predicted values generally tend to follow the chordwise variations shown by the data. The two predicted curves bracket the data, with the rectangular span load results being higher, as would be expected. For the leading-edge lines (fig. 29(b)), both predicted curves are generally lower than the measured values, with the slender-wing solution giving the higher values.

It is apparent from these results first that both span load distributions place relatively too much lift on the inner part of the canopy and too little on the outer part. One possible reason is an overestimation of leading-edge suction. All of the line load calculations were carried out assuming full suction. Since suction acts in the same general direction as the line tension, loss of suction would require additional line loading to balance the lift due to pressure difference.



Secondly, the sum of the keel and leading-edge line tensions appears low compared to the measured values. The reasons for this are first that the total predicted lift is lower than the measured value by about 7 percent and secondly that the measured line loads exceed the measured lift by 13 percent, as indicated above.

Twin-keel parawing.- The twin-keel parawing to which the line load method was applied is defined by figures 17 and 24 and table II. As in the single-keel parawing case, the aerodynamic loading was corrected for the  $\cos \alpha$  and slender-wing factors discussed previously.

The measured line loads were obtained from unpublished NASA data obtained at the Langley Research Center. The data were obtained at  $q = 2$  psf. The force balance check between the line loads and the canopy aerodynamic loads indicate that the sum of the  $z$  components of the line tension is 14 percent greater than the normal force obtained from the measured lift and drag coefficients.

The comparison of discrete line loads is shown in figure 30. For the keel lines (fig. 30(a)), the predicted values generally tend to follow the chordwise variation indicated by the data, except at the leading and trailing edges. At these two stations (keel lines 1 and 12), the keel lines were considered to carry the entire span load rather than having the load divided between the keel and leading-edge lines; this assumption then accounts for the high predicted loads. The rectangular span load curve tends to agree well with the data, whereas the slender-wing span load results are generally low. For the leading-edge lines (fig. 30(b)), the chordwise variation of the predicted line loads follows the variation shown by the data. The slender-wing span load results tend to agree well with the data, whereas the rectangular span load results are generally low.

These results indicate first that the sum of the keel and leading-edge loads is somewhat lower than that indicated by the data. The comparison on overall aerodynamic loads indicates that the theory predicts reasonably well the measured lift and drag on this parawing. However, the measured line loads exceed the measured normal force, which would tend to account for the line load data being generally higher than predicted loads. Secondly, the actual division of load between the keel

and leading-edge lines seems to fall about halfway between the rectangular and slender-wing span load results.

#### CONCLUDING REMARKS

All-flexible parawings are characterized by large amounts of spanwise camber. Consequently, planar lifting-surface theory is inadequate for predicting the canopy aerodynamic load distribution and a new aerodynamic theory was developed specifically adapted to the all-flexible parawing. The method is based on the use of slender-body theory and considers spanwise sections in the crossflow plane to consist of circular arcs which, from section to adjacent section, may translate and dilate. The theory yields the spanwise and chordwise distribution of loading, the distribution of suction along the leading edge, and the induced drag.

Since the circular-arc fits to all-flexible parawings tend to yield nearly conical wings, systematic calculations were made for conical parawings to assess the importance of spanwise camber. The lift-curve slope increases with increasing camber, such that a parawing having a semicircular cross section has a 50-percent higher slope than a flat wing of the same aspect ratio. Spanwise camber also affects the role that leading-edge suction plays in the overall forces, in that loss of suction causes an increase in normal force with camber but no change in normal force without camber. In addition, spanwise camber has a favorable effect on the ratio of normal force to induced drag for both the full-suction and the vortex-lift cases.

The slender-wing, circular-arc method was applied to two specific parawings for which both aerodynamic, line tension, and shape data exist. For both the single- and twin-keel parawings, the measured shape data were used to obtain spanwise sections normal to the root chord, which were then fit with circular arcs. Application of the aerodynamic theory to the two circular-arc parawing models resulted in predicted lift coefficients that are within 3 and 6 percent of the measured values. In making the comparisons, a correction was made to account for the tendency of slender-wing theory to overpredict lift at moderate aspect ratios. The predicted induced drag was within 20 percent of the measured

total drag, which tends to indicate that most of the drag for a parawing is induced drag. With the addition of rough estimates of the line and canopy frictional drag, the predicted total drag coefficients were within 6 and 9 percent of the measured values. It is felt on the basis of these comparisons that the slender-wing, circular-arc method does account properly for the chordwise and spanwise camber present in all-flexible parawings.

The manner in which the predicted canopy aerodynamic loading is transmitted by stresses in the canopy to the rigging lines was investigated. An approach was evolved in which "distributed" line tensions were computed using section span-load distributions, and discrete line loads were then calculated by allotting portions of the continuous line loads to each line. Use of the predicted chord load distributions for both the single- and twin-keel parawings resulted in considerably greater variations chordwise between the line loads than are indicated by the measured values. The probable cause is the circular-arc fits, since there is no way of assessing how accurately the distribution of loading over the canopy is predicted. An engineering method was evolved in which the total normal force was distributed uniformly over the chord, and the division of load spanwise between the keel and leading-edge lines was governed by either a rectangular or a slender flat-wing span-load distribution. This approach was found to give reasonable agreement with measured line loads, with the comparisons indicating that for the twin-keel parawing the actual span load distribution is probably between the rectangular and slender-wing loadings on the average. It is felt that this approach would be useful in assessing the general distribution of aerodynamic loads between lines, but a much more complex canopy stress analysis considering the local canopy shape in the line attachment regions would be necessary to obtain accurate predictions of each line load. Such an investigation should probably await the verification of the capability of the slender-wing method to predict accurately the detailed aerodynamic load distribution on the canopy.

Finally, several comments are in order with regard to basic limitations and growth potential of the slender-body method developed. One basic deficiency of slender-body theory is that the Kutta condition is not imposed at the trailing edge. In the present application, this

limitation does not permit calculation of canopy loads aft of approximately the maximum span station, which occurs near the 85-percent chord point. Thus, the tension distribution in the canopy cannot be completely determined, and the line tensions for the most rearward lines cannot be predicted. Secondly, a shape determination method starting with the flat canopy and rigging line characteristics has not been developed. Such a method is necessary to provide a complete capability for predicting aerodynamic load distributions and canopy and line structural loadings. It is felt that some additional work should be done to verify, and perhaps improve, the methods described herein before a shape determination method is evolved.

With regard to growth potential, one important feature of the slender-body method is its potential for handling both deliberate canopy shape changes and bumps. The sorts of deliberate canopy shape changes that might be considered are aspect ratio changes, changes in the size and shape of the center panel of a twin-keel parawing, or changes due to shortening lines for control purposes. The present method could be employed to predict the relative changes in the aerodynamic performance due to these types of shape changes. For bumps, it is felt that the present method could be extended to consider deviations of the canopy spanwise sections from circular arcs by including higher harmonics in the spanwise shape specification. Such an extension would provide a capability, in particular, for examining the aerodynamic and tension loadings due to the local bumps near line attachment points. However, it is probable that many Fourier harmonics would be required, and the calculations would be lengthy.

Nielsen Engineering & Research, Inc.  
Mountain View, California  
February 27, 1970

APPENDIX A

EVALUATION OF AN INTEGRAL OCCURRING  
IN THE INDUCED-DRAG CALCULATION

It is required in the derivation of the expression for induced drag that the following integral be evaluated.

$$\begin{aligned}
 J(k) &= \frac{1}{k^2} \int_0^{\pi} \tanh^{-1} \left( \frac{k \sin \beta}{\sqrt{1 - k^2 \cos^2 \beta}} \right) \frac{k \sin \beta}{\sqrt{1 - k^2 \cos^2 \beta}} d\beta \\
 &= \frac{1}{2k^2} \int_0^{\pi} \ln \left[ \frac{k \sin \beta + \sqrt{1 - k^2 \cos^2 \beta}}{-k \sin \beta + \sqrt{1 - k^2 \cos^2 \beta}} \right] \frac{k \sin \beta}{\sqrt{1 - k^2 \cos^2 \beta}} d\beta \\
 &= \frac{1}{k^2} \int_0^{\pi/2} \ln \left[ \frac{k \sin \beta + \sqrt{1 - k^2 \cos^2 \beta}}{-k \sin \beta + \sqrt{1 - k^2 \cos^2 \beta}} \right] \frac{k \sin \beta}{\sqrt{1 - k^2 \cos^2 \beta}} d\beta
 \end{aligned} \tag{A-1}$$

If

$$I(k) = \int_0^{\pi} \ln \left[ k \sin \beta + \sqrt{1 - k^2 \cos^2 \beta} \right] \frac{k \sin \beta}{\sqrt{1 - k^2 \cos^2 \beta}} d\beta \tag{A-2}$$

then

$$J(k) = \frac{1}{k^2} [I(k) + I(-k)] \tag{A-3}$$

Integration by parts yields

$$\begin{aligned}
 I(k) &= - \ln \left[ k \sin \beta + \sqrt{1 - k^2 \cos^2 \beta} \right] \sin^{-1}(k \cos \beta) \Big|_0^{\pi/2} \\
 &\quad + \int_0^{\pi/2} \frac{\sin^{-1}(k \cos \beta)}{\sqrt{1 - k^2 \cos^2 \beta}} k \cos \beta d\beta
 \end{aligned} \tag{A-4}$$

$$= \sin^{-1} k \ln \sqrt{1 - k^2} + \int_0^1 \frac{kx \sin^{-1}(kx) dx}{\sqrt{(1 - x^2)(1 - k^2x^2)}} \quad (\text{A-5})$$

The integral is to be found in reference 11, p. 607.

$$I(k) = \sin^{-1}(k) \ln \sqrt{1 - k^2} - \frac{\pi}{2} \sqrt{1 - k^2} \quad (\text{A-6})$$

The final result is from equation (A-3)

$$J(k) = -\frac{\pi}{2k^2} \ln(1 - k^2) \quad (\text{A-7})$$

## APPENDIX B

### DETERMINATION OF CERTAIN DIRECTION COSINES

In determining the effect of leading-edge suction and vortex lift on normal force and induced drag, it is necessary to know the direction cosines of certain directions associated with the lifting surface. For surfaces formed from the segments of circular cones, such as that shown in figure 6, the cross sections parallel to the y-z plane are all circular arcs, and the x-y plane is the chord plane. Plane OAC is tangent to the lifting surface at its left edge. The unit vector  $\vec{n}_2$  is in the plane OAC and lies normal to the leading edge. It is the direction in which the leading-edge suction is usually directed. Under the assumption used herein to evaluate vortex-lift effects, it is assumed that the leading-edge suction force is rotated  $90^\circ$  from  $\vec{n}_2$  to  $\vec{n}_1$ , where it is perpendicular to the leading edge and the lifting surface.

Let us first determine the direction cosines of  $\vec{n}_1$ . If the plane OAC has the equation

$$Ax + By + Cz = 0 \tag{B-1}$$

then

$$\left. \begin{aligned} \cos(n_1, x) &= \frac{A}{\sqrt{A^2 + B^2 + C^2}} \\ \cos(n_1, y) &= \frac{B}{\sqrt{A^2 + B^2 + C^2}} \\ \cos(n_1, z) &= \frac{C}{\sqrt{A^2 + B^2 + C^2}} \end{aligned} \right\} \tag{B-2}$$

From the equation of OA

$$s_x + c_r y = 0 \tag{B-3}$$

and that for OC

$$\frac{s_m}{c_r} x - z \tan \phi = 0 \quad (B-4)$$

we can write the equation of plane OAC as

$$\frac{s_m}{c_r} x + y - z \tan \phi = 0 \quad (B-5)$$

With the definitions

$$k = \frac{f}{\sqrt{f^2 + s^2}} \quad (B-6)$$

$$\tan \phi = \frac{1 - 2k^2}{2k\sqrt{1 - k^2}} \quad (B-7)$$

the direction cosines for  $\vec{n}_1$  are

$$\left. \begin{aligned} \cos(n_1, x) &= \frac{-2k\sqrt{1 - k^2} (s_m/c_r)}{R} \\ \cos(n_1, y) &= \frac{-2k\sqrt{1 - k^2}}{R} \\ \cos(n_1, z) &= \frac{(1 - 2k^2)}{R} \\ R^2 &= 1 + 4k^2(1 - k^2) \frac{s_m^2}{c_r^2} \end{aligned} \right\} \quad (B-8)$$

The direction cosines of  $\vec{n}_2$  are obtainable from the coordinates of the line CD lying in the plane OAC and normal to OA. The coordinates of C are

$$C \sim (c_r, 0, s_m/\tan \phi) \quad (B-9)$$



Appendix B

and the coordinates of D are

$$D \sim \left( \frac{c_r}{1 + \frac{s_m^2}{c_r^2}}, \frac{-s}{1 + \frac{s_m^2}{c_r^2}}, 0 \right) \quad (\text{B-10})$$

From the coordinates of these points, the direction cosines of  $\vec{n}_2$  are found to be

$$\left. \begin{aligned} \cos(n_2, x) &= \frac{-(1 - 2k^2)(s_m/c_r)}{\sqrt{1 + \frac{s_m^2}{c_r^2}} R} \\ \cos(n_2, y) &= \frac{-(1 - 2k^2)}{\sqrt{1 + \frac{s_m^2}{c_r^2}} R} \\ \cos(n_2, z) &= \frac{-2k\sqrt{1 - k^2}\sqrt{1 + \frac{s_m^2}{c_r^2}}}{R} \end{aligned} \right\} \quad (\text{B-11})$$

## APPENDIX C

### TABULATION OF CANOPY COORDINATES FOR SINGLE-KEEL PARAWING

The following pages are a reproduction of the printed computer output for the canopy coordinates obtained photogrammetrically at the Langley Research Center from the stereo photographs of the single-keel parawing in the wind tunnel. The coordinate system used in the data presentation is illustrated in the sketch below.

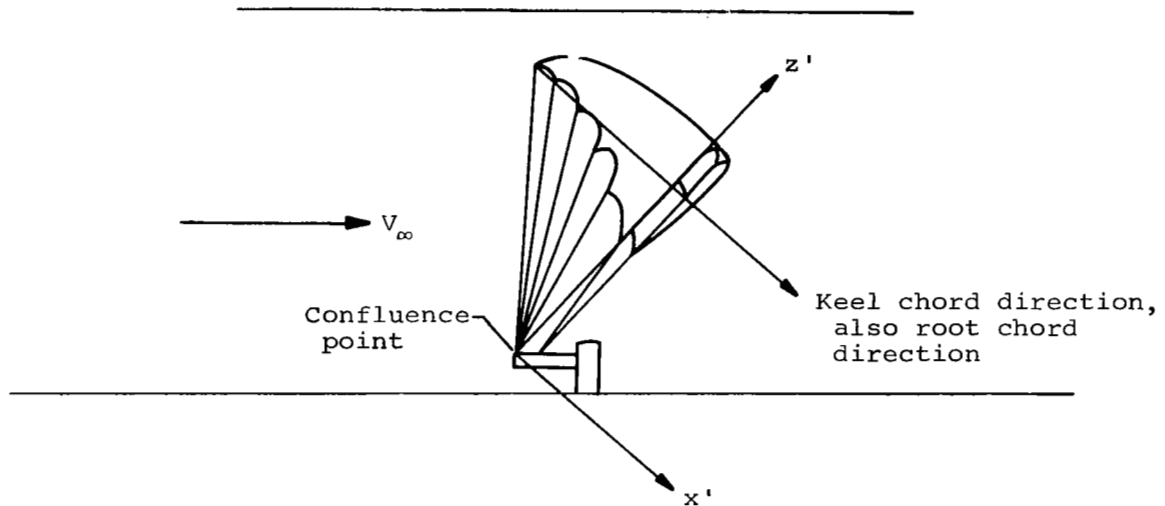

The origin of the axis system is on the sting at the confluence point of all the rigging lines except the two tip lines and the last keel line. The  $x'$ -axis is parallel to the keel chord, positive downstream. The positive  $z'$  direction is upwards towards the canopy, and the positive  $y'$  direction is in accordance with a right-hand system.

The data consist of a point identification number, followed by the  $x'$ ,  $y'$ , and  $z'$  coordinates of the point, nondimensionalized by the characteristic length  $h_k$ . For the parawing tested,  $h_k = 60$  inches. Points 1-11 are the canopy line attachment point coordinates for the keel lines 1-11, respectively. Points 12-17 are the canopy line attachment point coordinates of the leading-edge lines 1-6, respectively. For the remainder of the coordinates, generally a single streamwise set of points having about the same  $y'$  coordinate was read starting at the leading edge and working aft. The sets start at the keel and move out towards the tip.

Point No.	x'/h <sub>k</sub>	y'/h <sub>k</sub>	z'/h <sub>k</sub>		Point No.	x'/h <sub>k</sub>	y'/h <sub>k</sub>	z'/h <sub>k</sub>
1	-.77271	.00000	1.12923	K1	51	-.71767	.00388	1.14019
2	-.67370	.00901	1.16419	K2	52	-.71481	.00456	1.14723
3	-.60197	.00503	1.17326	K3	53	-.71514	.00127	1.16528
4	-.54556	.00280	1.18731	K4	54	-.69457	.00155	1.17567
5	-.48154	.00570	1.20354	K5	55	-.68571	.00464	1.17270
6	-.40316	.00220	1.20334	K6	56	-.68115	.00120	1.17640
7	-.32587	.00946	1.22515	K7	57	-.67815	.00345	1.18254
8	-.23689	.01045	1.21868	K8	58	-.67261	.00337	1.18569
9	-.16808	.00401	1.20567	K9	59	-.66707	.00934	1.19345
10	-.10847	.00775	1.17831	K10	60	-.65945	.00714	1.19560
11	-.05536	.00000	1.12923	K11	61	-.62511	.00378	1.20756
12	-.68955	.09298	1.14844	LE1	62	-.61420	.00322	1.21054
13	-.60195	.15424	1.11181	LE2	63	-.60865	.00335	1.20851
14	-.52192	.22916	1.11502	LE3	64	-.60224	.00375	1.21117
15	-.40689	.31746	1.07370	LE4	65	-.55339	.00376	1.21870
16	-.28448	.36787	1.02747	LE5	66	-.54513	.00173	1.22006
17	-.17171	.38207	.96742	LE6	67	-.53701	.00198	1.22253
18	-.71220	.02126	1.15514		68	-.52936	.00106	1.22429
19	-.67498	.01873	1.17712		69	-.51503	.00164	1.22847
20	-.66029	.00662	1.18125		70	-.50759	.00280	1.22957
21	-.64875	.01174	1.19542		71	-.49445	.00393	1.22779
22	-.62377	.00211	1.19047		72	-.48716	.00042	1.22484
23	-.59538	.00576	1.19733		73	-.48082	.00277	1.22851
24	-.59403	.00384	1.22543		74	-.47439	.00370	1.23200
25	-.57215	.00901	1.21395		75	-.46657	.00381	1.23452
26	-.54445	.01183	1.21886		76	-.45860	.00090	1.23543
27	-.53927	.00916	1.22680		77	-.45241	.00428	1.23828
28	-.51403	.00783	1.22549		78	-.44432	.00293	1.23637
29	-.49935	.00754	1.22061		79	-.43577	.00169	1.23449
30	-.47032	.00746	1.22048		80	-.42771	.00964	1.23372
31	-.45765	.00326	1.22953		81	-.41551	.00081	1.23305
32	-.44271	.00480	1.22696		82	-.41141	.00293	1.23697
33	-.42794	.00553	1.22353		83	-.40487	.00178	1.24064
34	-.40104	.00035	1.22787		84	-.39694	.00168	1.24293
35	-.38451	.00337	1.23600		85	-.39036	.00374	1.24341
36	-.38905	.00630	1.24192		86	-.28329	.00797	1.25436
37	-.37351	.00730	1.24646		87	-.37586	.00552	1.25534
38	-.37217	.01165	1.23782		88	-.36790	.00739	1.25700
39	-.35601	.00596	1.23261		89	-.35969	.00582	1.25487
40	-.34010	.00271	1.22567		90	-.35106	.00365	1.25182
41	-.31591	.00019	1.23744		91	-.33738	.00169	1.24294
42	-.30486	.001781	1.25132		92	-.32927	.00370	1.23958
43	-.28718	.000974	1.23620		93	-.32488	.00306	1.24709
44	-.27495	.00537	1.24022		94	-.31457	.00272	1.24359
45	-.25763	.011459	1.23861		95	-.31057	.00170	1.24974
46	-.23532	.01044	1.23499		96	-.30339	.00314	1.25432
47	-.21496	.02062	1.23165		97	-.29714	.00601	1.25918
48	-.20258	.01787	1.22742		98	-.28933	.00231	1.25776
49	-.18475	.01316	1.22446		99	-.28215	.00403	1.25861
50	-.16707	.02035	1.23372		100	-.27428	.00299	1.25496

Suspension line  
attachment points

101	-25770	.00317	1.25320	151	-35746	.00432	1.25523	201	-51036	.00948	1.23907
102	-26340	.00567	1.25264	152	-33762	.00467	1.24608	202	-53358	.01076	1.23661
103	-25151	.00769	1.24362	153	-32178	.00194	1.25930	203	-49063	.01757	1.23592
104	-24584	.00384	1.24371	154	-30554	.00717	1.26120	204	-48556	.00436	1.24569
105	-23914	.00754	1.24390	155	-28353	.00100	1.26101	205	-47712	.00931	1.24290
106	-23325	.00282	1.24370	156	-27372	.00497	1.25717	206	-46888	.00854	1.24476
107	-22607	.00454	1.24402	157	-25848	.00348	1.25398	207	-46121	.00426	1.24703
108	-21395	.00527	1.24561	158	-24661	.00410	1.24942	208	-45404	.00759	1.24865
109	-21170	.01225	1.25135	159	-23166	.00516	1.24641	209	-44504	.00743	1.24618
110	-20327	.00346	1.24517	16	-21752	.00748	1.24444	210	-43700	.01151	1.24474
111	-19524	.00407	1.24325	161	-20132	.00128	1.24931	211	-42973	.01246	1.24262
112	-18753	.00530	1.23852	162	-18684	.00110	1.24350	212	-41917	.01254	1.24200
113	-18766	.00368	1.23458	163	-17481	.00139	1.24126	213	-41335	.01293	1.24446
114	-17380	.00360	1.22869	164	-16037	.00352	1.23611	214	-40687	.01144	1.24961
115	-16778	.00234	1.22861	165	-14442	.00518	1.23586	215	-39943	.01195	1.25278
116	-16153	.00785	1.23233	166	-13074	.00308	1.22631	216	-39214	.00922	1.25766
117	-15433	.01160	1.23438	167	-11085	.00351	1.21247	217	-38369	.01780	1.25862
118	-14650	.00623	1.23024	168	-09283	.00312	1.20354	218	-37648	.00834	1.26197
119	-12602	.00702	1.21757	169	-07969	.00929	1.20051	219	-36850	.00767	1.26101
120	-11978	.00556	1.21248	170	-72478	.00914	1.14208	220	-36014	.01317	1.25760
121	-11092	.00195	1.20147	171	-72422	.01590	1.15175	221	-34580	.01155	1.25571
122	-10296	.00530	1.20013	172	-72211	.01597	1.15830	222	-33226	.01236	1.25423
123	-09596	.00657	1.19691	173	-72058	.01107	1.17292	223	-32597	.01216	1.25611
124	-08833	.00809	1.19323	174	-71489	.00952	1.17878	224	-31777	.01236	1.25847
125	-08138	.01131	1.19168	175	-70366	.00714	1.18533	225	-31261	.00970	1.26241
126	-07549	.00438	1.18092	176	-70039	.01058	1.18499	226	-30537	.00816	1.26593
127	-05613	.00362	1.15582	177	-69553	.01734	1.18641	227	-29756	.00708	1.26725
128	-72100	.00305	1.17402	178	-69378	.00716	1.19102	228	-28859	.00915	1.26519
129	-69184	.00607	1.18107	179	-68247	.00947	1.19078	229	-28228	.00631	1.26770
130	-68153	.00122	1.18799	180	-68045	.00157	1.20038	230	-27312	.00680	1.26514
131	-66747	.00133	1.19291	181	-67376	.00729	1.20500	231	-25842	.00955	1.25991
132	-65451	.00438	1.20565	182	-65633	.00129	1.20981	232	-24529	.01210	1.25394
133	-63993	.00303	1.21227	183	-65324	.00765	1.21454	233	-23843	.01071	1.25456
134	-62750	.00012	1.21487	184	-65114	.00747	1.21508	234	-23134	.00896	1.25481
135	-60538	.00385	1.21677	185	-64267	.00205	1.21792	235	-22490	.00812	1.25602
136	-59448	.00725	1.22959	186	-63593	.00238	1.22024	236	-21745	.00792	1.25555
137	-57881	.00201	1.23117	187	-62810	.00773	1.21867	237	-20947	.00456	1.25793
138	-54734	.00325	1.22578	188	-62112	.01067	1.21941	238	-20125	.00215	1.25781
139	-53293	.00083	1.23454	189	-60757	.01109	1.22535	239	-19386	.00287	1.25607
140	-51658	.00326	1.23435	190	-60327	.00318	1.23032	240	-18531	.00738	1.24918
141	-50208	.00484	1.23046	191	-59545	.00436	1.23320	241	-17715	.00871	1.24325
142	-48454	.00548	1.22956	192	-58834	.00789	1.23506	242	-16582	.00664	1.24290
143	-47456	.00554	1.23439	193	-58737	.00383	1.23543	243	-15792	.00425	1.24267
144	-45966	.00784	1.24103	194	-57733	.01001	1.23275	244	-14969	.00189	1.24263
145	-44431	.00362	1.24091	195	-55531	.00994	1.22536	245	-14230	.00322	1.24262
146	-42367	.00557	1.23448	196	-54950	.00768	1.23281	246	-13467	.00138	1.23706
147	-41530	.00485	1.23304	197	-54111	.00718	1.23501	247	-12413	.00285	1.23293
148	-40587	.00433	1.24471	198	-53510	.00422	1.24082	248	-12129	.00499	1.22695
149	-39791	.00394	1.25127	199	-52411	.00335	1.24365	249	-10375	.00799	1.21191
150	-37569	.00158	1.25813	200	-51010	.00475	1.24302	250	-09600	.00446	1.21027

251	-.08941	.00174	1.20921	301	-.06769	.01248	1.19136	351	-.37741	.02506	1.26793
252	-.08288	.00134	1.20519	302	-.73319	.03387	1.14924	352	-.37009	.02392	1.26904
253	-.06482	.01191	1.17740	303	-.73012	.03313	1.15600	353	-.36259	.02565	1.26656
254	-.05927	.01027	1.17295	304	-.72879	.03140	1.16387	354	-.35433	.02658	1.26579
255	-.05475	.01707	1.16137	305	-.72302	.02741	1.17370	355	-.34633	.02736	1.26379
256	-.02767	.02015	1.16361	306	-.72285	.02904	1.17743	356	-.33401	.02755	1.26303
257	-.02317	.01703	1.17726	307	-.71694	.02376	1.18196	357	-.32759	.02501	1.26776
258	-.01082	.01438	1.18897	308	-.71123	.02537	1.18941	358	-.31989	.02504	1.26853
259	-.069732	.01980	1.14822	309	-.70485	.02879	1.18910	359	-.31272	.02489	1.27078
260	-.068679	.01130	1.19934	310	-.69859	.02829	1.19105	360	-.30489	.02285	1.27330
261	-.067676	.00409	1.21127	311	-.69487	.02329	1.20061	361	-.29797	.02044	1.27706
262	-.065272	.00107	1.22079	312	-.68985	.01740	1.20598	362	-.28942	.01931	1.27794
263	-.054554	.00711	1.22303	313	-.68290	.01434	1.21123	363	-.28197	.01777	1.27925
264	-.063159	.01316	1.22475	314	-.67567	.01472	1.21382	364	-.27453	.01620	1.27942
265	-.061056	.01396	1.22810	315	-.67242	.00491	1.22249	365	-.26602	.02197	1.27280
266	-.059638	.01504	1.23698	316	-.06543	.00733	1.22650	366	-.25850	.02303	1.26965
267	-.058111	.01733	1.23704	317	-.05944	.01366	1.22473	367	-.25193	.02511	1.26534
268	-.054983	.01690	1.23509	318	-.06484	.01430	1.22809	368	-.24551	.02468	1.26582
269	-.053526	.01167	1.24455	319	-.06002	.00313	1.22584	369	-.23705	.02284	1.26646
270	-.051913	.01545	1.24374	320	-.06354	.02375	1.22876	370	-.22976	.02318	1.26518
271	-.050407	.01485	1.24344	321	-.062512	.02490	1.22985	371	-.22385	.02034	1.26745
272	-.049146	.01984	1.24311	322	-.061196	.02751	1.23259	372	-.21584	.01902	1.26859
273	-.047702	.01943	1.24524	323	-.060494	.02475	1.23198	373	-.20791	.01678	1.26857
274	-.046702	.01514	1.245125	324	-.059788	.02246	1.24201	374	-.19921	.01780	1.26675
275	-.045565	.01793	1.24904	325	-.059132	.02232	1.24404	375	-.19143	.01979	1.26256
276	-.043072	.01811	1.24812	326	-.058190	.02685	1.24503	376	-.18471	.01785	1.26250
277	-.042034	.02022	1.24563	327	-.056466	.02358	1.23346	377	-.17796	.01924	1.25912
278	-.040741	.01964	1.25216	328	-.055782	.02046	1.23614	378	-.17000	.01690	1.25899
279	-.039353	.01581	1.26183	329	-.055136	.02307	1.24096	379	-.16249	.01725	1.25598
280	-.037750	.01491	1.26620	330	-.054433	.02095	1.24666	380	-.15408	.01478	1.25578
281	-.036148	.01743	1.26316	331	-.053676	.02025	1.24840	381	-.14597	.01513	1.25354
282	-.034636	.01406	1.26060	332	-.052827	.02279	1.24756	382	-.13927	.01249	1.25260
283	-.033294	.02017	1.25773	333	-.052061	.02193	1.24314	383	-.13133	.01213	1.24937
284	-.031952	.01968	1.26173	334	-.051209	.02496	1.24651	384	-.12542	.01055	1.24763
285	-.030531	.01531	1.26445	335	-.050515	.02501	1.24604	385	-.11396	.00936	1.24164
286	-.028941	.01320	1.27219	336	-.049325	.02615	1.24520	386	-.10573	.01410	1.23208
287	-.027439	.01040	1.27393	337	-.048484	.02585	1.24771	387	-.09981	.01374	1.22859
288	-.025777	.01339	1.26191	338	-.047845	.02391	1.25136	388	-.09145	.01417	1.22405
289	-.024511	.01731	1.25930	339	-.047011	.02335	1.25353	389	-.08578	.01200	1.22248
290	-.023025	.01623	1.25934	340	-.046296	.02273	1.25521	390	-.07035	.01965	1.20040
291	-.021733	.01010	1.26476	341	-.045419	.02465	1.25280	391	-.06461	.02199	1.19267
292	-.019957	.01194	1.25903	342	-.044509	.02588	1.25227	392	-.05716	.02450	1.18201
293	-.017247	.01025	1.25296	343	-.043858	.02347	1.25121	393	-.05402	.02252	1.18055
294	-.015646	.00734	1.25061	344	-.043091	.02753	1.25087	394	-.04709	.03597	1.16823
295	-.014089	.01437	1.24862	345	-.042178	.02792	1.24967	395	-.04233	.03529	1.18944
296	-.012491	.01264	1.24394	346	-.041565	.02429	1.25220	396	-.041280	.03363	1.19163
297	-.011544	.00981	1.22992	347	-.040782	.02384	1.25553	397	-.040018	.03315	1.19536
298	-.010124	.01007	1.22046	348	-.040184	.02517	1.25175	398	-.038839	.02650	1.20683
299	-.008404	.00959	1.21404	349	-.039435	.02271	1.25648	399	-.037696	.02023	1.21731
300	-.007514	.00814	1.20420	350	-.038578	.02447	1.26074	400	-.036939	.01086	1.23261

471	-.55122	.02329	1.24103	451	-.65446	.02584	1.23492	501	-.22733	.03427	1.27640
492	-.63602	.02576	1.23300	452	-.63304	.03513	1.23438	502	-.22237	.03218	1.27408
493	-.61575	.02792	1.24254	453	-.63258	.03268	1.24106	503	-.21444	.03351	1.27875
404	-.59405	.03159	1.24221	454	-.62572	.03546	1.23968	504	-.20605	.02367	1.27328
405	-.58274	.03270	1.24295	455	-.61547	.03421	1.24333	505	-.19714	.03324	1.27553
406	-.56153	.03147	1.24336	456	-.61765	.03783	1.24553	506	-.18970	.02921	1.27451
407	-.53326	.02549	1.25349	457	-.60325	.02577	1.25825	507	-.18284	.03766	1.27077
408	-.52234	.02547	1.25353	458	-.57722	.03316	1.24707	508	-.17552	.02923	1.26969
409	-.49444	.03248	1.25457	459	-.58455	.03307	1.24708	509	-.16757	.02716	1.26989
410	-.47972	.03151	1.25443	460	-.55114	.03620	1.24725	510	-.16023	.02540	1.26934
411	-.46344	.03041	1.25310	461	-.55338	.03595	1.24957	511	-.15163	.02350	1.26309
412	-.44629	.03452	1.25404	462	-.54341	.03300	1.25554	512	-.14348	.02722	1.26312
413	-.43152	.03459	1.25398	463	-.53924	.03261	1.25767	513	-.13646	.02448	1.26263
414	-.42214	.03559	1.25219	464	-.53757	.03441	1.25691	514	-.12967	.02442	1.25884
415	-.40965	.03377	1.26088	465	-.52229	.03542	1.25540	515	-.12351	.02312	1.25199
416	-.39412	.03254	1.26751	466	-.51437	.03765	1.25428	516	-.11516	.02518	1.24790
417	-.37903	.03126	1.27145	467	-.50225	.04030	1.25060	517	-.10403	.02583	1.24548
418	-.36362	.02907	1.27366	468	-.49487	.04107	1.25213	518	-.10148	.02309	1.24439
419	-.34610	.03634	1.25479	469	-.48748	.03799	1.25664	519	-.09449	.02884	1.24651
420	-.33383	.03441	1.26564	470	-.47984	.03782	1.25902	520	-.08761	.02748	1.23174
421	-.31985	.03353	1.27033	471	-.47230	.03735	1.26103	521	-.08266	.02413	1.22717
422	-.30451	.03233	1.27413	472	-.46392	.03799	1.26083	522	-.07686	.03086	1.21931
423	-.28999	.02420	1.28383	473	-.45613	.03855	1.26382	523	-.07089	.03277	1.21230
424	-.27404	.02423	1.27174	474	-.44487	.03770	1.26227	524	-.06598	.03094	1.20955
425	-.25753	.03212	1.27122	475	-.43716	.04259	1.25725	525	-.06122	.03343	1.20253
426	-.24419	.03081	1.25994	476	-.43119	.04355	1.25589	526	-.05738	.03546	1.19644
427	-.22952	.02772	1.27120	477	-.42348	.04300	1.25645	527	-.05405	.03838	1.19089
428	-.21497	.02747	1.25981	478	-.41869	.04046	1.26207	528	-.05021	.04571	1.20555
429	-.19795	.02330	1.27053	479	-.41150	.03860	1.26749	529	-.04909	.03661	1.21865
430	-.18371	.02549	1.26516	480	-.40367	.03917	1.26990	530	-.047854	.03494	1.22573
431	-.16899	.02337	1.26255	481	-.39573	.03889	1.27275	531	-.045929	.03172	1.23948
432	-.15364	.01930	1.26190	482	-.38874	.03918	1.27331	532	-.044201	.03392	1.23978
433	-.13752	.01919	1.25586	483	-.37914	.03864	1.27523	533	-.042833	.04493	1.24125
434	-.11036	.01663	1.24383	484	-.37179	.03741	1.27685	534	-.041832	.04177	1.25005
435	-.09691	.02070	1.23237	485	-.36444	.03884	1.27464	535	-.040377	.04547	1.24933
436	-.07312	.02523	1.22332	486	-.35459	.03785	1.27308	536	-.038468	.04814	1.24831
437	-.06275	.02624	1.19384	487	-.34105	.04319	1.26782	537	-.036609	.04696	1.24456
438	-.04364	.04865	1.15250	488	-.33556	.03368	1.27337	538	-.035360	.04395	1.25285
439	-.03151	.04714	1.15917	489	-.32387	.03934	1.27527	539	-.033923	.04150	1.25962
440	-.02377	.04522	1.16748	490	-.32324	.03984	1.27543	540	-.032440	.04215	1.25969
441	-.01589	.04365	1.17544	491	-.31316	.03924	1.27814	541	-.030704	.04446	1.25927
442	-.01237	.04238	1.18312	492	-.30513	.03861	1.28011	542	-.028117	.04367	1.26373
443	-.01157	.03804	1.19204	493	-.29788	.03424	1.28432	543	-.026395	.04722	1.26242
444	-.01153	.03391	1.19524	494	-.28984	.03336	1.28599	544	-.024493	.04516	1.26481
445	-.01058	.03847	1.20170	495	-.28105	.03531	1.28362	545	-.022466	.05012	1.26040
446	-.009676	.03360	1.20910	496	-.26950	.03632	1.28005	546	-.021122	.04817	1.26826
447	-.009125	.02840	1.21596	497	-.25431	.03753	1.27745	547	-.019558	.04708	1.27416
448	-.008363	.02358	1.21329	498	-.24588	.03536	1.27748	548	-.017967	.04466	1.27945
449	-.007741	.02748	1.22153	499	-.24426	.03347	1.27595	549	-.016307	.04361	1.27461
450	-.007054	.02356	1.22457	500	-.23656	.03389	1.27756	550	-.014657	.04675	1.27784

551	-.32113	.04567	1.28181	601	-.41295	.05473	1.27420	651	-.07693	.05123	1.23477
552	-.30596	.04251	1.28689	602	-.40559	.05353	1.27855	652	-.08871	.05268	1.24255
553	-.28881	.04477	1.28513	603	-.39633	.05533	1.27725	653	-.10241	.04719	1.25587
554	-.25840	.04514	1.28009	604	-.38785	.05414	1.28058	654	-.11597	.04926	1.26174
555	-.24457	.03997	1.28411	605	-.38043	.05352	1.28235	655	-.13067	.04914	1.27004
556	-.22930	.03816	1.28388	606	-.37201	.05534	1.28085	656	-.14689	.04958	1.27496
557	-.21341	.03952	1.28076	607	-.36397	.05685	1.27979	657	-.16248	.04842	1.28135
558	-.19608	.03552	1.28181	608	-.35556	.05519	1.28064	658	-.17821	.04892	1.28619
559	-.18133	.03826	1.27455	609	-.34169	.06033	1.27339	659	-.19355	.05314	1.28608
560	-.16567	.03625	1.27238	610	-.33567	.05680	1.27951	660	-.21149	.05142	1.29071
561	-.15041	.03291	1.27033	611	-.32893	.05321	1.28541	661	-.22668	.05319	1.29086
562	-.13434	.03283	1.26528	612	-.32151	.05243	1.28703	662	-.24254	.05523	1.29121
563	-.12059	.03066	1.26355	613	-.31343	.05191	1.28901	663	-.25703	.06173	1.28591
564	-.10584	.03332	1.24949	614	-.30569	.05093	1.29059	664	-.28872	.05671	1.29449
565	-.09214	.03417	1.24093	615	-.29734	.04954	1.29173	665	-.30512	.05933	1.29208
566	-.08000	.03799	1.22725	616	-.28935	.04859	1.29329	666	-.32109	.06081	1.28842
567	-.06876	.04037	1.21615	617	-.28190	.04765	1.29377	667	-.33579	.06274	1.28388
568	-.05952	.04333	1.20352	618	-.26470	.05204	1.28721	668	-.34993	.06346	1.27994
569	-.070876	.05188	1.20636	619	-.25805	.05247	1.28586	669	-.36433	.06293	1.28281
570	-.070083	.05290	1.20836	620	-.25092	.04841	1.28843	670	-.38015	.06183	1.28307
571	-.69677	.04706	1.21763	621	-.24285	.05132	1.28549	671	-.39703	.06110	1.28117
572	-.68903	.04729	1.22055	622	-.23510	.04983	1.28633	672	-.41299	.06153	1.27626
573	-.68505	.04123	1.22914	623	-.22782	.04819	1.28680	673	-.42704	.06438	1.26838
574	-.64429	.04997	1.23894	624	-.22043	.04648	1.28724	674	-.44815	.06713	1.26452
575	-.63084	.05492	1.24275	625	-.21249	.04455	1.28802	675	-.46477	.06423	1.26662
576	-.62643	.05168	1.24951	626	-.20454	.04276	1.28813	676	-.48263	.05909	1.26993
577	-.61992	.05024	1.25292	627	-.19485	.04455	1.28534	677	-.49895	.05843	1.26788
578	-.60953	.05442	1.24939	628	-.18791	.04252	1.28524	678	-.51255	.06343	1.25885
579	-.60206	.05406	1.25147	629	-.18017	.04237	1.28306	679	-.52558	.06028	1.26196
580	-.59402	.05534	1.25095	630	-.17271	.04025	1.28306	680	-.54078	.06016	1.26000
581	-.58651	.05563	1.25194	631	-.16431	.04174	1.27952	681	-.55424	.05957	1.25999
582	-.56847	.05212	1.25096	632	-.15725	.03952	1.27922	682	-.56808	.05127	1.25210
583	-.56042	.05417	1.25137	633	-.14932	.04027	1.27600	683	-.57634	.06014	1.24792
584	-.55524	.04974	1.25928	634	-.14054	.04039	1.27233	684	-.58499	.05822	1.24933
585	-.54724	.04926	1.26094	635	-.13270	.04034	1.26949	685	-.59358	.05692	1.25012
586	-.54051	.04885	1.26275	636	-.12547	.03735	1.26833	686	-.60282	.06137	1.25282
587	-.53414	.04815	1.26407	637	-.11869	.03950	1.26244	687	-.61815	.06228	1.24827
588	-.52509	.05209	1.26088	638	-.11151	.04105	1.25691	688	-.63465	.05879	1.24759
589	-.51779	.05112	1.26220	639	-.10414	.03971	1.25421	689	-.64607	.05855	1.23910
590	-.50611	.05231	1.26188	640	-.09739	.04065	1.24967	690	-.66850	.05493	1.222097
591	-.49668	.05540	1.26023	641	-.09079	.04075	1.24542	691	-.69983	.05968	1.21117
592	-.48992	.05141	1.26676	642	-.08429	.04391	1.23693	692	-.70439	.06720	1.20822
593	-.48116	.05293	1.26634	643	-.07905	.04282	1.23389	693	-.69763	.06710	1.21182
594	-.47309	.05446	1.26571	644	-.07336	.04384	1.22840	694	-.69252	.06255	1.21953
595	-.46535	.05373	1.26747	645	-.06763	.04346	1.22374	695	-.68574	.06009	1.22364
596	-.45829	.05291	1.26888	646	-.06256	.04853	1.21522	696	-.67732	.05888	1.22358
597	-.44865	.05772	1.26430	647	-.05796	.04842	1.20980	697	-.64953	.06231	1.24196
598	-.44058	.05070	1.26582	648	-.05366	.05287	1.20174	698	-.64157	.06634	1.24374
599	-.42551	.05996	1.26314	649	-.05575	.05903	1.20851	699	-.63514	.06724	1.24702
600	-.42085	.05425	1.27093	650	-.06500	.05735	1.21997	700	-.63024	.06399	1.25389

701	-.62365	.24830	1.25134	751	-.15409	.75506	1.28496	801	-.53771	-.27208	1.24864
702	-.51275	.08361	1.25364	752	-.14349	.05541	1.28169	802	-.64469	.27408	1.23594
703	-.70315	.07128	1.25177	753	-.13766	.25586	1.27852	803	-.68274	.08733	1.22170
704	-.54500	.06873	1.25555	754	-.13711	.25534	1.27431	804	-.69551	.07325	1.21193
705	-.58740	.07392	1.25221	755	-.12282	.75539	1.27151	805	-.70533	.08337	1.19928
706	-.50587	.07275	1.25258	756	-.11544	.25523	1.26739	806	-.73128	.07775	1.15196
707	-.56357	.07017	1.25775	757	-.10850	.25357	1.25598	807	-.72441	.07460	1.15569
708	-.54345	.08544	1.26209	758	-.10135	.05471	1.26092	808	-.72518	.07108	1.16202
709	-.53617	.06552	1.26549	759	-.09439	.05607	1.25524	809	-.72543	.07574	1.17531
710	-.52872	.25502	1.26741	760	-.08376	.25478	1.25252	810	-.72185	.07257	1.18034
711	-.51524	.26785	1.26659	761	-.28162	.25391	1.24329	811	-.71917	.07371	1.18919
712	-.50822	.06801	1.26870	762	-.27560	.25307	1.23910	812	-.71501	.07449	1.19779
713	-.49915	.06885	1.26903	763	-.06983	.05716	1.23699	813	-.70903	.07260	1.20230
714	-.49159	.06520	1.27360	764	-.06385	.26260	1.22633	814	-.70361	.07229	1.20869
715	-.48750	.06950	1.27072	765	-.35890	.05346	1.27093	815	-.68929	.26784	1.21631
716	-.47478	.06383	1.27253	766	-.05439	.06527	1.21535	816	-.69064	.08084	1.22223
717	-.46653	.06398	1.27200	767	-.06276	.06888	1.22935	817	-.58687	.08564	1.21384
718	-.45787	.07276	1.26987	768	-.07423	.06505	1.24297	818	-.69402	.08775	1.21387
719	-.45354	.07394	1.27204	769	-.08531	.06783	1.24841	819	-.59906	.08712	1.20712
720	-.42468	.07155	1.27467	770	-.29974	.06195	1.26279	820	-.70596	.08493	1.22259
721	-.42247	.07135	1.27758	771	-.11402	.26225	1.26974	821	-.71118	.27300	1.19690
722	-.41359	.07174	1.27906	772	-.12910	.05302	1.27665	822	-.71475	.29849	1.18807
723	-.40537	.07154	1.28159	773	-.14471	.05247	1.28407	823	-.71916	.29347	1.18194
724	-.39710	.07103	1.28378	774	-.16361	.06178	1.29003	824	-.71721	.28653	1.16471
725	-.38896	.07030	1.28567	775	-.17542	.06630	1.29047	825	-.71887	.08892	1.15817
726	-.38094	.06970	1.28767	776	-.19212	.06713	1.29440	826	-.71948	.08900	1.15067
727	-.37298	.06970	1.28903	777	-.20949	.06708	1.29755	827	-.70393	.09531	1.14839
728	-.36487	.07069	1.28685	778	-.22542	.06749	1.29995	828	-.70555	.09916	1.16154
729	-.35554	.07052	1.28502	779	-.24170	.07065	1.29824	829	-.70720	.09396	1.16809
730	-.34397	.07169	1.28543	780	-.25655	.07367	1.29699	830	-.70775	.10153	1.17630
731	-.33676	.06836	1.29081	781	-.30514	.07223	1.30072	831	-.70841	.10419	1.18492
732	-.32957	.06787	1.29267	782	-.32115	.07556	1.29558	832	-.70597	.10622	1.19495
733	-.32165	.06708	1.29442	783	-.33521	.07694	1.29209	833	-.69926	.10230	1.19772
734	-.31358	.06618	1.29606	784	-.35092	.07987	1.28606	834	-.69328	.10210	1.20427
735	-.30554	.06519	1.29757	785	-.36490	.07464	1.28762	835	-.68697	.10315	1.20876
736	-.29767	.06203	1.30203	786	-.38149	.07607	1.29003	836	-.67948	.09878	1.21296
737	-.28691	.26456	1.29627	787	-.39918	.07369	1.29091	837	-.67266	.09767	1.21663
738	-.28737	.26775	1.29288	788	-.41359	.07827	1.28087	838	-.66650	.09682	1.21974
739	-.28476	.26512	1.29475	789	-.42922	.07851	1.27584	839	-.64966	.10044	1.22964
740	-.28232	.26352	1.29535	790	-.44732	.08380	1.27143	840	-.64157	.10098	1.23070
741	-.28472	.26178	1.29583	791	-.46587	.07559	1.27378	841	-.63464	.10044	1.23374
742	-.22585	.06323	1.29373	792	-.48284	.07650	1.27200	842	-.62700	.10057	1.23616
743	-.21835	.06172	1.29445	793	-.49964	.07473	1.27216	843	-.62025	.10322	1.24166
744	-.21764	.06012	1.29512	794	-.51691	.07377	1.27034	844	-.61340	.10505	1.24607
745	-.20239	.05798	1.29534	795	-.52304	.07772	1.26344	845	-.59479	.11076	1.25626
746	-.19345	.25748	1.29457	796	-.54406	.07415	1.26296	846	-.57692	.10763	1.25753
747	-.18582	.05572	1.29503	797	-.56806	.07637	1.25749	847	-.56845	.10634	1.25819
748	-.17767	.05636	1.29130	798	-.58793	.08251	1.25163	848	-.56188	.10959	1.26297
749	-.16994	.25549	1.28910	799	-.60322	.07888	1.25092	849	-.55341	.10799	1.26403
750	-.16114	.25363	1.28835	800	-.62294	.07214	1.25374	850	-.54532	.10974	1.26702



851	-.53953	.11284	1.27151	901	-.05470	.07674	1.22662	951	-.15621	.10460	1.29842
852	-.51611	.11240	1.27305	902	-.05852	.08378	1.23723	952	-.14858	.10298	1.29724
853	-.50672	.11047	1.27161	903	-.07066	.08515	1.24536	953	-.14084	.10387	1.29482
854	-.49905	.11231	1.27469	904	-.08406	.08169	1.25678	954	-.13239	.10185	1.29304
855	-.49065	.11135	1.27391	905	-.09726	.07912	1.26736	955	-.12464	.10043	1.29131
856	-.48216	.11286	1.27499	906	-.11213	.07915	1.27589	956	-.11747	.09786	1.29063
857	-.47383	.11273	1.27477	907	-.12659	.08378	1.27789	957	-.10969	.10126	1.28391
858	-.46582	.11384	1.27617	908	-.14288	.08094	1.28795	958	-.10167	.10414	1.27766
859	-.45845	.11741	1.27864	909	-.15864	.08221	1.29167	959	-.09459	.10140	1.27674
860	-.42714	.11504	1.27886	910	-.17350	.08545	1.29367	960	-.08688	.10253	1.27124
861	-.42009	.11494	1.28137	911	-.19000	.08499	1.29871	961	-.08020	.10502	1.26454
862	-.41178	.11500	1.28414	912	-.22334	.08428	1.30453	962	-.07341	.10232	1.26358
863	-.40329	.11558	1.28634	913	-.24003	.08718	1.30554	963	-.06661	.10517	1.25664
864	-.39600	.11580	1.28856	914	-.25567	.08999	1.30368	964	-.06054	.10649	1.25107
865	-.38865	.11636	1.29041	915	-.24814	.09364	1.31019	965	-.05593	.10844	1.24707
866	-.37948	.11521	1.29014	916	-.23953	.09577	1.30754	966	-.06546	.11193	1.26020
867	-.37192	.11419	1.29025	917	-.23197	.09363	1.30753	967	-.07896	.11157	1.26781
868	-.36330	.11504	1.29217	918	-.19905	.09044	1.30536	968	-.09324	.10996	1.27810
869	-.33551	.11389	1.29511	919	-.19007	.09059	1.30369	969	-.10780	.10957	1.28556
870	-.32009	.11406	1.30018	920	-.18248	.08828	1.30347	970	-.12314	.11107	1.29038
871	-.30399	.11124	1.30072	921	-.17354	.08875	1.30034	971	-.13942	.11262	1.29497
872	-.29537	.11203	1.30264	922	-.16613	.08661	1.30026	972	-.15497	.11235	1.30034
873	-.28663	.10886	1.30006	923	-.15755	.09053	1.29367	973	-.17156	.11107	1.30542
874	-.25542	.08263	1.29890	924	-.15029	.08838	1.29353	974	-.18736	.11548	1.30539
875	-.24880	.07819	1.30305	925	-.14236	.08810	1.29059	975	-.18631	.12254	1.30724
876	-.24199	.07690	1.30383	926	-.13405	.08907	1.28621	976	-.17927	.12072	1.30787
877	-.23297	.07923	1.30061	927	-.12621	.08826	1.28439	977	-.17044	.12366	1.30309
878	-.22437	.07758	1.30157	928	-.11865	.08643	1.28203	978	-.16293	.11767	1.30667
879	-.21683	.07548	1.30158	929	-.11177	.08416	1.28165	979	-.15445	.11949	1.30259
880	-.20874	.07618	1.29968	930	-.10385	.08620	1.27542	980	-.14723	.11748	1.30261
881	-.20069	.07257	1.30213	931	-.09689	.08482	1.27355	981	-.13923	.11835	1.29986
882	-.19102	.07525	1.29783	932	-.08983	.08761	1.26634	982	-.13109	.11522	1.30012
883	-.18363	.07212	1.29925	933	-.08309	.08768	1.26265	983	-.13109	.11522	1.30012
884	-.17503	.07318	1.29533	934	-.07628	.08634	1.25900	984	-.12287	.11868	1.29366
885	-.16734	.07083	1.29507	935	-.06969	.08929	1.25201	985	-.11503	.11578	1.29281
886	-.15939	.07373	1.28962	936	-.06410	.08867	1.24847	986	-.10713	.11795	1.28778
887	-.15241	.07128	1.28903	937	-.05639	.08990	1.24158	987	-.09963	.11885	1.28373
888	-.14413	.07121	1.28590	938	-.06773	.09618	1.25464	988	-.09238	.11511	1.28421
889	-.13620	.06835	1.28603	939	-.08172	.09198	1.26834	989	-.08504	.11517	1.27995
890	-.12854	.06840	1.28244	940	-.09520	.07415	1.27372	990	-.07805	.11682	1.27500
891	-.12137	.06747	1.28023	941	-.10911	.07952	1.27551	991	-.07097	.11362	1.27352
892	-.11382	.06789	1.27533	942	-.12503	.09600	1.28630	992	-.06369	.11952	1.26371
893	-.10666	.06916	1.27048	943	-.14193	.09369	1.29439	993	-.05903	.11975	1.26097
894	-.09902	.07066	1.26524	944	-.15647	.09811	1.29481	994	-.06276	.12662	1.26805
895	-.09209	.07204	1.25961	945	-.17318	.09446	1.30333	995	-.07636	.12322	1.27908
896	-.08565	.07305	1.25481	946	-.18904	.09865	1.30392	996	-.09143	.12174	1.28789
897	-.07954	.06987	1.25303	947	-.18793	.10582	1.30584	997	-.10601	.12674	1.28902
898	-.07339	.07000	1.24878	948	-.18094	.10253	1.30782	998	-.12121	.12874	1.29312
899	-.06737	.07140	1.24219	949	-.17220	.10510	1.30183	999	-.13808	.12724	1.30063
900	-.06136	.07381	1.23608	950	-.16455	.10399	1.30187	1000	-.15391	.12567	1.30676

1001	-.17002	.12864	1.30793	1051	-.18362	.16363	1.31087	1101	-.62280	.12180	1.24055
1002	-.18667	.12877	1.31120	1052	-.18330	.17012	1.31337	1102	-.61668	.12381	1.24510
1003	-.18549	.13827	1.31005	1053	-.17506	.16994	1.31171	1103	-.60929	.12155	1.24547
1004	-.17798	.13834	1.30338	1054	-.16699	.17019	1.31051	1104	-.60119	.12218	1.24749
1005	-.16867	.14014	1.30506	1055	-.15887	.16846	1.31116	1105	-.59328	.12248	1.24982
1006	-.16143	.13594	1.30758	1056	-.15086	.16767	1.31038	1106	-.58630	.12452	1.25462
1007	-.15346	.13370	1.30756	1057	-.14232	.16872	1.30735	1107	-.57812	.12464	1.25724
1008	-.14608	.13319	1.30598	1058	-.13474	.16758	1.30726	1108	-.56938	.12134	1.25656
1009	-.13788	.13505	1.30244	1059	-.12595	.16557	1.30651	1109	-.56274	.12455	1.26255
1010	-.12947	.13266	1.30196	1060	-.11788	.16747	1.30279	1110	-.55545	.12565	1.26589
1011	-.12142	.13409	1.29826	1061	-.10997	.16582	1.30222	1111	-.54648	.12387	1.26621
1012	-.11374	.13150	1.29772	1062	-.10221	.16549	1.30073	1112	-.54013	.12700	1.27057
1013	-.10548	.13241	1.29394	1063	-.09354	.16626	1.29664	1113	-.53248	.12943	1.27353
1014	-.09731	.13494	1.28745	1064	-.08571	.16852	1.29169	1114	-.51631	.12947	1.27518
1015	-.09000	.13261	1.28713	1065	-.07816	.16500	1.29164	1115	-.50757	.12663	1.27339
1016	-.08260	.13306	1.28302	1066	-.07070	.16501	1.29093	1116	-.50017	.13744	1.27732
1017	-.07500	.13416	1.27767	1067	-.06905	.16454	1.29092	1117	-.49179	.12928	1.27617
1018	-.06840	.13155	1.27674	1068	-.08434	.17380	1.29523	1118	-.48291	.12744	1.27440
1019	-.06156	.13612	1.26960	1069	-.10098	.17451	1.30044	1119	-.47443	.12825	1.27632
1020	-.07382	.14080	1.28114	1070	-.11710	.17427	1.30506	1120	-.46630	.12944	1.27767
1021	-.08865	.14134	1.28766	1071	-.13452	.17437	1.30973	1121	-.42881	.13534	1.28656
1022	-.10433	.13964	1.29588	1072	-.14942	.17778	1.30882	1122	-.42083	.13330	1.28800
1023	-.11979	.14287	1.29837	1073	-.16608	.18062	1.30831	1123	-.41260	.13399	1.28998
1024	-.13638	.14341	1.30236	1074	-.18173	.18371	1.30760	1124	-.40446	.13421	1.29249
1025	-.15178	.14755	1.30215	1075	-.17426	.18584	1.31274	1125	-.39637	.13537	1.29386
1026	-.16836	.14487	1.30913	1076	-.16603	.18379	1.31303	1126	-.38022	.13265	1.29513
1027	-.18497	.14536	1.31188	1077	-.15797	.18230	1.31394	1127	-.36474	.13381	1.29902
1028	-.18467	.15367	1.31263	1078	-.14952	.18442	1.31061	1128	-.35049	.12434	1.29343
1029	-.17635	.15351	1.31089	1079	-.14170	.18329	1.30978	1129	-.33384	.12974	1.29879
1030	-.16832	.15201	1.31182	1080	-.13347	.18441	1.30728	1130	-.32720	.13326	1.30488
1031	-.16023	.15157	1.30975	1081	-.12493	.18198	1.30806	1131	-.31907	.13220	1.30467
1032	-.15195	.15166	1.30840	1082	-.11709	.18383	1.30425	1132	-.31057	.13085	1.30598
1033	-.14430	.14940	1.30823	1083	-.10877	.18288	1.30387	1133	-.30265	.12987	1.30562
1034	-.13583	.15232	1.30358	1084	-.10036	.18237	1.30194	1134	-.29432	.13022	1.30806
1035	-.12704	.14992	1.30365	1085	-.09250	.18035	1.30218	1135	-.28617	.12564	1.30525
1036	-.11987	.14798	1.30372	1086	-.08403	.18020	1.29949	1136	-.27063	.12727	1.30860
1037	-.11188	.14935	1.29923	1087	-.07623	.17783	1.29883	1137	-.23958	.12850	1.31138
1038	-.10382	.15026	1.29589	1088	-.07271	.17680	1.29875	1138	-.70237	.12616	1.17395
1039	-.09564	.14966	1.29243	1089	-.69714	.10795	1.15326	1139	-.69569	.12664	1.18786
1040	-.08917	.14758	1.29245	1090	-.70442	.11912	1.17577	1140	-.68331	.12555	1.19759
1041	-.08035	.15036	1.28638	1091	-.69946	.11933	1.18998	1141	-.66948	.12012	1.20351
1042	-.07313	.14905	1.28432	1092	-.69267	.11790	1.19402	1142	-.64687	.11867	1.21511
1043	-.06499	.15019	1.27853	1093	-.68616	.11608	1.19842	1143	-.63468	.12485	1.22579
1044	-.07155	.15527	1.28824	1094	-.67914	.11472	1.20245	1144	-.62117	.12657	1.23534
1045	-.08672	.15512	1.29542	1095	-.67254	.11310	1.20664	1145	-.60758	.12616	1.24048
1046	-.10214	.15880	1.29716	1096	-.66644	.11204	1.20946	1146	-.59160	.12674	1.24523
1047	-.11803	.15984	1.30101	1097	-.64894	.11501	1.22147	1147	-.57608	.12801	1.25222
1048	-.13579	.15731	1.30880	1098	-.64234	.11672	1.22650	1148	-.56286	.13230	1.26186
1049	-.15793	.15087	1.30798	1099	-.63333	.11423	1.22668	1149	-.54699	.13279	1.26670
1050	-.16629	.16433	1.30697	1100	-.62811	.11701	1.23317	1150	-.53183	.13401	1.27041

1151	-.51671	.13943	1.27662	1201	-.68786	.14116	1.18330	1251	-.29127	.15916	1.30928
1152	-.69670	.12633	1.15920	1202	-.67433	.13631	1.18831	1252	-.26814	.16000	1.31396
1153	-.69922	.13333	1.17063	1203	-.64435	.13471	1.20743	1253	-.26085	.16062	1.31571
1154	-.69598	.13275	1.17722	1204	-.63335	.13900	1.21898	1254	-.25141	.15589	1.31166
1155	-.69064	.13347	1.18404	1205	-.61957	.14171	1.22802	1255	-.23499	.15370	1.31027
1156	-.68534	.13269	1.18947	1206	-.60781	.14624	1.23805	1256	-.21913	.15961	1.31555
1157	-.67845	.12995	1.19244	1207	-.59249	.14581	1.24380	1257	-.20314	.15369	1.30999
1158	-.67047	.12507	1.19302	1208	-.57607	.14525	1.25007	1258	-.18543	.15275	1.30700
1159	-.66320	.12171	1.19420	1209	-.56272	.14825	1.25812	1259	-.16909	.15119	1.30391
1160	-.64508	.12578	1.21040	1210	-.54694	.14795	1.26387	1260	-.15295	.14878	1.29916
1161	-.64094	.13039	1.21863	1211	-.50001	.15261	1.27432	1261	-.66698	.14797	1.18008
1162	-.63430	.13153	1.22279	1212	-.48411	.15482	1.27708	1262	-.64016	.14762	1.19877
1163	-.62671	.13140	1.22554	1213	-.69516	.16004	1.18247	1263	-.63043	.15324	1.21159
1164	-.62070	.13387	1.23164	1214	-.68450	.14906	1.17976	1264	-.61757	.15522	1.22015
1165	-.61698	.14071	1.24103	1215	-.67762	.14659	1.18237	1265	-.60583	.16012	1.23088
1166	-.60796	.13730	1.24002	1216	-.67041	.14281	1.18401	1266	-.59268	.16510	1.24206
1167	-.60082	.13744	1.24228	1217	-.66302	.13781	1.18450	1267	-.57671	.16443	1.24832
1168	-.59256	.13717	1.24543	1218	-.64118	.13848	1.20079	1268	-.56282	.16583	1.25579
1169	-.58273	.15203	1.26418	1219	-.63870	.14682	1.21159	1269	-.50138	.17178	1.27463
1170	-.57016	.14240	1.25817	1220	-.63164	.14628	1.21465	1270	-.48522	.17350	1.27808
1171	-.56335	.14198	1.26099	1221	-.62585	.14758	1.21997	1271	-.46951	.17182	1.27712
1172	-.55572	.14310	1.26443	1222	-.61977	.15037	1.22579	1272	-.44332	.17306	1.28792
1173	-.54780	.14304	1.26721	1223	-.61473	.15515	1.23327	1273	-.41187	.17567	1.29547
1174	-.53167	.14144	1.26919	1224	-.60753	.15476	1.23620	1274	-.39596	.17487	1.29855
1175	-.51567	.14312	1.27264	1225	-.59998	.15499	1.23843	1275	-.37943	.17254	1.29981
1176	-.50888	.14591	1.27489	1226	-.59196	.15468	1.24155	1276	-.66626	.15262	1.16994
1177	-.50031	.14689	1.27664	1227	-.58566	.15825	1.24878	1277	-.66165	.15153	1.17279
1178	-.48472	.14898	1.27945	1228	-.57705	.15677	1.25020	1278	-.65537	.14825	1.17405
1179	-.46826	.14960	1.28212	1229	-.56942	.15655	1.25304	1279	-.63731	.15341	1.19339
1180	-.45450	.15089	1.28421	1230	-.56357	.15859	1.25865	1280	-.63390	.15829	1.20114
1181	-.42860	.14984	1.28828	1231	-.54873	.16080	1.26604	1281	-.63074	.16619	1.21126
1182	-.41143	.14677	1.28968	1232	-.53298	.16244	1.26945	1282	-.62288	.16311	1.21272
1183	-.39581	.14772	1.29388	1233	-.51758	.16372	1.27319	1283	-.61674	.16536	1.21812
1184	-.38762	.14832	1.29590	1234	-.50079	.15184	1.27393	1284	-.61068	.16740	1.22323
1185	-.38039	.14883	1.29775	1235	-.48469	.16384	1.27705	1285	-.60479	.16875	1.22805
1186	-.37231	.14901	1.30030	1236	-.46940	.15568	1.28009	1286	-.59796	.17002	1.23210
1187	-.36385	.14802	1.30003	1237	-.44236	.15201	1.28378	1287	-.59053	.17057	1.23623
1188	-.35062	.14293	1.30041	1238	-.42718	.16357	1.28708	1288	-.58413	.17352	1.24264
1189	-.31775	.14519	1.30616	1239	-.41212	.16688	1.29486	1289	-.57574	.17136	1.24480
1190	-.30144	.14470	1.30803	1240	-.40337	.15548	1.29343	1290	-.56883	.17257	1.24902
1191	-.28559	.14522	1.31122	1241	-.39583	.16521	1.29635	1291	-.56210	.17371	1.25327
1192	-.26921	.14131	1.31026	1242	-.38724	.16046	1.29404	1292	-.55572	.17674	1.25961
1193	-.25310	.14162	1.31325	1243	-.37924	.16378	1.29825	1293	-.54848	.17585	1.26149
1194	-.23704	.13946	1.31070	1244	-.37171	.15407	1.30047	1294	-.53316	.17765	1.26508
1195	-.22788	.13909	1.31000	1245	-.36276	.16177	1.29912	1295	-.51804	.17905	1.27023
1196	-.21913	.13788	1.30805	1246	-.33279	.15483	1.30786	1296	-.51013	.18004	1.27175
1197	-.20472	.13635	1.30745	1247	-.32463	.16528	1.30956	1297	-.50068	.17714	1.27119
1198	-.18787	.14009	1.30869	1248	-.31713	.16611	1.31112	1298	-.49258	.17796	1.27298
1199	-.17081	.13466	1.30172	1249	-.30947	.16271	1.30998	1299	-.48547	.18217	1.27763
1200	-.15501	.13563	1.29939	1250	-.30046	.16196	1.31039	1300	-.47052	.18095	1.27698

1301	-.45736	.18127	1.28327	1351	-.61205	.17550	1.20693	1401	-.13369	.18357	1.30355
1302	-.44381	.13487	1.29084	1352	-.61767	.17281	1.20119	1402	-.11768	.17597	1.29590
1303	-.42762	.18275	1.29165	1353	-.62451	.17375	1.19773	1403	-.10205	.18082	1.29541
1304	-.41962	.18151	1.29139	1354	-.62942	.17062	1.19221	1404	-.63386	.15471	1.15389
1305	-.41119	.18265	1.29459	1355	-.63319	.16785	1.19664	1405	-.60480	.13223	1.20192
1306	-.39562	.18229	1.29757	1356	-.60712	.18022	1.21460	1406	-.52192	.17931	1.19255
1307	-.38739	.18277	1.29980	1357	-.60735	.17951	1.21776	1407	-.59825	.18749	1.21336
1308	-.37853	.17819	1.29722	1358	-.58736	.18388	1.22858	1408	-.58591	.19232	1.22458
1309	-.36407	.18265	1.30513	1359	-.57192	.18307	1.23403	1409	-.55400	.19493	1.24157
1310	-.34861	.18299	1.30830	1360	-.56677	.18993	1.24336	1410	-.54789	.20108	1.25167
1311	-.33204	.18003	1.30810	1361	-.56174	.19323	1.25011	1411	-.53245	.19924	1.25463
1312	-.31606	.18069	1.31167	1362	-.54749	.19094	1.25318	1412	-.51943	.20606	1.26421
1313	-.29995	.18114	1.31388	1363	-.54114	.19171	1.25673	1413	-.50022	.19994	1.26310
1314	-.28345	.17959	1.31476	1364	-.53347	.19362	1.26042	1414	-.47104	.20270	1.27200
1315	-.26718	.17690	1.31476	1365	-.52528	.19267	1.26155	1415	-.45817	.20375	1.28119
1316	-.25048	.17576	1.31528	1366	-.51705	.19314	1.26376	1416	-.44320	.20940	1.28763
1317	-.23365	.17439	1.31448	1367	-.50957	.19362	1.26574	1417	-.42756	.20799	1.29173
1318	-.21644	.17091	1.31206	1368	-.50146	.19409	1.26800	1418	-.41929	.20653	1.29154
1319	-.20124	.17271	1.31293	1369	-.49489	.19944	1.27449	1419	-.37411	.20753	1.29587
1320	-.18372	.16980	1.30891	1370	-.48575	.19584	1.27283	1420	-.37320	.20816	1.29940
1321	-.16706	.16726	1.30594	1371	-.47804	.19463	1.27332	1421	-.36304	.20890	1.30428
1322	-.15108	.16663	1.30312	1372	-.47115	.19657	1.27479	1422	-.34632	.20638	1.30511
1323	-.13542	.16644	1.30076	1373	-.46527	.19749	1.27962	1423	-.33015	.20667	1.30804
1324	-.11964	.16450	1.29530	1374	-.45969	.19998	1.28590	1424	-.31355	.20396	1.30859
1325	-.10372	.16282	1.28971	1375	-.44414	.20206	1.29099	1425	-.29695	.20193	1.30883
1326	-.08921	.15211	1.28412	1376	-.43054	.20327	1.29214	1426	-.28067	.20200	1.31038
1327	-.65828	.15757	1.16832	1377	-.42742	.20080	1.29257	1427	-.26497	.20152	1.31245
1328	-.61408	.17039	1.21244	1378	-.41187	.20199	1.29646	1428	-.24852	.20189	1.31427
1329	-.62646	.16767	1.20273	1379	-.39426	.19735	1.29562	1429	-.23196	.19865	1.31277
1330	-.63651	.16393	1.19238	1380	-.37819	.19528	1.29803	1430	-.21455	.19880	1.31413
1331	-.60217	.17373	1.22127	1381	-.36246	.19532	1.30109	1431	-.19870	.19565	1.31121
1332	-.58854	.17534	1.23121	1382	-.34703	.19596	1.30559	1432	-.18153	.19339	1.30944
1333	-.57385	.17630	1.23951	1383	-.33077	.19752	1.30926	1433	-.16471	.19127	1.30693
1334	-.56156	.18204	1.25072	1384	-.32243	.19547	1.30842	1434	-.63168	.15689	1.14901
1335	-.54785	.18155	1.25599	1385	-.31385	.19354	1.30752	1435	-.61993	.18703	1.18840
1336	-.53223	.18087	1.25821	1386	-.30551	.19435	1.30937	1436	-.61344	.19627	1.19152
1337	-.51800	.18748	1.26802	1387	-.29740	.19153	1.30891	1437	-.60930	.19254	1.20083
1338	-.50712	.18465	1.27207	1388	-.28957	.19472	1.31278	1438	-.60616	.20088	1.21076
1339	-.48478	.18698	1.27266	1389	-.28088	.19086	1.30981	1439	-.59455	.19064	1.20531
1340	-.47172	.19135	1.27749	1390	-.26561	.19226	1.31338	1440	-.58723	.19695	1.21860
1341	-.45874	.18963	1.28398	1391	-.25776	.19286	1.31478	1441	-.56724	.19558	1.22480
1342	-.44327	.19043	1.28831	1392	-.24914	.19193	1.31499	1442	-.55578	.20106	1.23665
1343	-.42771	.19148	1.29238	1393	-.24052	.19161	1.31440	1443	-.54426	.19451	1.23963
1344	-.41168	.19213	1.29598	1394	-.23209	.18875	1.31249	1444	-.53180	.20655	1.25124
1345	-.39576	.19146	1.29827	1395	-.22319	.19006	1.31393	1445	-.51713	.21090	1.25891
1346	-.37898	.18919	1.29942	1396	-.21474	.18916	1.31355	1446	-.50921	.20642	1.25715
1347	-.31473	.18577	1.30822	1397	-.19937	.18673	1.31190	1447	-.50098	.21117	1.26293
1348	-.29814	.18478	1.30955	1398	-.18197	.18580	1.30971	1448	-.49228	.20807	1.26229
1349	-.64713	.15388	1.15950	1399	-.16557	.18297	1.30799	1449	-.48530	.21218	1.26708
1350	-.64297	.15275	1.16227	1400	-.14986	.18418	1.30699	1450	-.47193	.21261	1.27232

1451	-.45710	.21224	1.27780	1501	-.31199	.21956	1.30503	1551	-.31091	.22604	1.30216
1452	-.44276	.21794	1.28723	1502	-.29575	.21835	1.30637	1552	-.29523	.22719	1.30613
1453	-.42600	.21514	1.28720	1503	-.27943	.21888	1.30904	1553	-.28641	.22557	1.30544
1454	-.41089	.22039	1.29518	1504	-.26326	.21606	1.30899	1554	-.27863	.22702	1.30803
1455	-.39419	.21803	1.29630	1505	-.24672	.21541	1.31095	1555	-.26219	.22263	1.30711
1456	-.37802	.21431	1.29782	1506	-.23044	.21507	1.31249	1556	-.25376	.22074	1.30607
1457	-.37104	.21802	1.30197	1507	-.21277	.21253	1.31101	1557	-.24620	.22330	1.31006
1458	-.36198	.21538	1.30140	1508	-.19761	.21249	1.31182	1558	-.23775	.22465	1.31135
1459	-.35426	.21589	1.30343	1509	-.17971	.20875	1.30916	1559	-.22903	.22013	1.30855
1460	-.34447	.20867	1.29907	1510	-.14637	.20466	1.30466	1560	-.22092	.22015	1.30964
1461	-.32862	.21008	1.30279	1511	-.13137	.20659	1.30528	1561	-.21227	.22142	1.31107
1462	-.32055	.21238	1.30616	1512	-.11490	.20555	1.30297	1562	-.19640	.21899	1.30996
1463	-.31246	.20982	1.30528	1513	-.09866	.20403	1.29901	1563	-.18854	.22104	1.31183
1464	-.30422	.21119	1.30696	1514	-.08170	.14517	1.12398	1564	-.17936	.21746	1.30987
1465	-.29621	.20890	1.30632	1515	-.061520	.20047	1.18048	1565	-.16980	.21253	1.30527
1466	-.28772	.20967	1.30828	1516	-.060908	.19964	1.18358	1566	-.15474	.21657	1.30880
1467	-.28026	.21027	1.31013	1517	-.060354	.20297	1.18974	1567	-.14595	.21389	1.30630
1468	-.27190	.21106	1.31148	1518	-.059574	.20266	1.19277	1568	-.13035	.21184	1.30427
1469	-.26370	.20906	1.31050	1519	-.058459	.20940	1.20569	1569	-.12181	.21407	1.30445
1470	-.25628	.20966	1.31232	1520	-.057661	.20643	1.20641	1570	-.11377	.21392	1.30413
1471	-.24673	.20482	1.30918	1521	-.056911	.20674	1.21139	1571	-.09751	.21071	1.29943
1472	-.23071	.20466	1.31100	1522	-.056140	.20666	1.21467	1572	-.08193	.20823	1.29433
1473	-.22150	.20626	1.31218	1523	-.054325	.21638	1.23328	1573	-.07024	.21204	1.29430
1474	-.21341	.20444	1.31161	1524	-.053690	.21867	1.23776	1574	-.08073	.21783	1.29667
1475	-.19795	.20270	1.31017	1525	-.052903	.21905	1.24056	1575	-.09602	.21844	1.29930
1476	-.18033	.19962	1.30839	1526	-.052315	.22403	1.24796	1576	-.12965	.22131	1.30514
1477	-.16372	.20003	1.30871	1527	-.050800	.22452	1.25256	1577	-.14501	.22487	1.30826
1478	-.14745	.19965	1.30648	1528	-.49947	.22502	1.25484	1578	-.16077	.22254	1.30737
1479	-.13187	.19663	1.30356	1529	-.49303	.22698	1.25987	1579	-.17810	.22778	1.31007
1480	-.11610	.19824	1.30273	1530	-.48540	.22725	1.26214	1580	-.19557	.22870	1.31026
1481	-.10012	.19735	1.29853	1531	-.47743	.22513	1.26109	1581	-.21098	.22998	1.31017
1482	-.06909	.19604	1.28836	1532	-.47150	.22870	1.26853	1582	-.22815	.22972	1.30855
1483	-.061677	.19123	1.18276	1533	-.46448	.22884	1.27076	1583	-.24499	.23034	1.30713
1484	-.060617	.19728	1.19453	1534	-.45630	.22897	1.27342	1584	-.26219	.23749	1.31014
1485	-.057978	.20120	1.21270	1535	-.44830	.22898	1.27614	1585	-.27777	.23517	1.30592
1486	-.056637	.20575	1.22352	1536	-.44083	.22924	1.27840	1586	-.29383	.23478	1.30316
1487	-.054540	.21080	1.23920	1537	-.43353	.23197	1.28278	1587	-.30954	.23349	1.29934
1488	-.051657	.21834	1.25471	1538	-.42419	.22855	1.28148	1588	-.32605	.23377	1.29679
1489	-.050073	.21869	1.25973	1539	-.41674	.22980	1.28420	1589	-.34310	.23677	1.29648
1490	-.048594	.22120	1.26632	1540	-.40789	.22798	1.28483	1590	-.35959	.23826	1.29479
1491	-.047180	.22136	1.27096	1541	-.39257	.23177	1.27128	1591	-.37536	.23827	1.29167
1492	-.045689	.22114	1.27632	1542	-.38517	.23202	1.29350	1592	-.39177	.23920	1.28837
1493	-.044107	.22150	1.28128	1543	-.37663	.23252	1.29583	1593	-.40779	.23803	1.28434
1494	-.042506	.22284	1.28515	1544	-.36743	.22732	1.29260	1594	-.42375	.23744	1.27957
1495	-.040965	.22332	1.28983	1545	-.36070	.23117	1.29773	1595	-.43943	.23695	1.27479
1496	-.039360	.22461	1.29380	1546	-.35205	.22819	1.29687	1596	-.45502	.23669	1.26974
1497	-.037765	.22509	1.29864	1547	-.34424	.22897	1.29916	1597	-.47013	.23663	1.26466
1498	-.036181	.22486	1.30151	1548	-.33652	.23023	1.30201	1598	-.48472	.23385	1.25729
1499	-.034498	.22235	1.30229	1549	-.32700	.22670	1.29983	1599	-.49923	.23410	1.25205
1500	-.032866	.22230	1.30508	1550	-.31962	.23075	1.30543	1600	-.52806	.22605	1.23595

1601	-.54052	.22002	1.22591	1651	-.24381	.23706	1.30397	1701	-.60395	.21463	1.16235
1602	-.55705	.20826	1.20584	1652	-.23570	.23790	1.30573	1702	-.61025	.23572	1.14960
1603	-.57286	.21125	1.20019	1653	-.22780	.23859	1.30763	1703	-.60637	-.19272	1.12410
1604	-.58580	.29767	1.19071	1654	-.21933	.23946	1.30947	1704	-.60704	.21030	1.14361
1605	-.58684	.21000	1.19257	1655	-.71040	.23672	1.30790	1705	-.60434	.21500	1.14974
1606	-.60123	.21100	1.18642	1656	-.20338	.23715	1.30922	1706	-.59991	.21894	1.15637
1607	-.61076	.20283	1.17258	1657	-.19507	.23585	1.30856	1707	-.59447	.22160	1.16219
1608	-.60815	.17799	1.12814	1658	-.18686	.23666	1.31043	1708	-.58753	.22138	1.16647
1609	-.61200	.19811	1.15326	1659	-.17751	.23369	1.30824	1709	-.57583	.22245	1.17414
1610	-.61108	.20590	1.16109	1660	-.16885	.23223	1.30739	1710	-.56882	.22185	1.17671
1611	-.60617	.20754	1.16573	1661	-.15313	.23303	1.30844	1711	-.56237	.22354	1.18187
1612	-.60984	.20923	1.17045	1662	-.14455	.23429	1.30987	1712	-.54745	.22256	1.18979
1613	-.59687	.21580	1.17993	1663	-.12911	.23246	1.30792	1713	-.53308	.23574	1.20906
1614	-.59009	.21460	1.18258	1664	-.12034	.23013	1.30544	1714	-.52105	.24032	1.21670
1615	-.58301	.21414	1.18554	1665	-.11233	.22957	1.30499	1715	-.50408	.25233	1.23433
1616	-.57638	.21561	1.19048	1666	-.09636	.23096	1.30441	1716	-.49578	.25017	1.23520
1617	-.56854	.21399	1.19289	1667	-.08006	.23029	1.30145	1717	-.48802	.25069	1.23778
1618	-.55532	.21827	1.20393	1668	-.07527	.22769	1.29861	1718	-.48184	.25442	1.24402
1619	-.53918	.22757	1.22185	1669	-.09466	.23134	1.30011	1719	-.46733	.25732	1.25244
1620	-.53215	.22752	1.22433	1670	-.11141	.23816	1.30545	1720	-.46016	.25788	1.25479
1621	-.52605	.23217	1.23047	1671	-.12801	.23974	1.30732	1721	-.45215	.25778	1.25765
1622	-.51995	.23643	1.23650	1672	-.14337	.23756	1.30523	1722	-.44457	.25857	1.26100
1623	-.49879	.23952	1.24691	1673	-.15988	.24150	1.30825	1723	-.43721	.26023	1.26499
1624	-.49118	.23975	1.24923	1674	-.17666	.24352	1.30902	1724	-.42998	.26342	1.27001
1625	-.48528	.24487	1.25599	1675	-.19427	.24467	1.30840	1725	-.42213	.26303	1.27201
1626	-.47017	.24476	1.26188	1676	-.20975	.24562	1.30762	1726	-.41441	.26168	1.27340
1627	-.45471	.24507	1.26676	1677	-.22716	.24896	1.30783	1727	-.40569	.26223	1.27569
1628	-.44678	.24517	1.26934	1678	-.24439	.24985	1.30662	1728	-.39770	.26473	1.28005
1629	-.43999	.24788	1.27419	1679	-.25979	.24894	1.30238	1729	-.38916	.26060	1.27866
1630	-.43169	.24631	1.27546	1680	-.27539	.24778	1.29842	1730	-.38104	.26154	1.28029
1631	-.42313	.24560	1.27692	1681	-.29285	.25122	1.29862	1731	-.37356	.26300	1.28400
1632	-.41575	.24532	1.27924	1682	-.30881	.24926	1.29443	1732	-.36591	.26362	1.28587
1633	-.40702	.24607	1.28189	1683	-.32473	.25151	1.29370	1733	-.35670	.25960	1.28400
1634	-.39108	.24696	1.28625	1684	-.34090	.25055	1.28929	1734	-.34918	.26062	1.28651
1635	-.38333	.24769	1.28799	1685	-.35788	.25264	1.28848	1735	-.34078	.26141	1.28841
1636	-.37510	.24686	1.28950	1686	-.37367	.25363	1.28533	1736	-.33225	.25916	1.28828
1637	-.35850	.24441	1.29065	1687	-.38963	.25283	1.28141	1737	-.32445	.25976	1.29023
1638	-.35070	.24514	1.29244	1688	-.40694	.25595	1.28046	1738	-.31566	.26047	1.29238
1639	-.34762	.24556	1.29470	1689	-.42271	.25544	1.27569	1739	-.30750	.25737	1.29144
1640	-.33445	.24651	1.29634	1690	-.43877	.25523	1.27042	1740	-.29955	.26122	1.29641
1641	-.32527	.24218	1.29494	1691	-.45477	.25484	1.26543	1741	-.29167	.25903	1.29601
1642	-.31700	.24304	1.29675	1692	-.46924	.25318	1.25845	1742	-.27614	.26100	1.30185
1643	-.30874	.24023	1.29552	1693	-.48491	.25296	1.25279	1743	-.26005	.25808	1.30226
1644	-.30920	.24385	1.29714	1694	-.49960	.25333	1.24733	1744	-.25223	.25993	1.30497
1645	-.29299	.24330	1.30059	1695	-.52427	.23791	1.22528	1745	-.24324	.25442	1.30154
1646	-.28474	.24079	1.30023	1696	-.53516	.22862	1.21292	1746	-.23410	.25245	1.30073
1647	-.27612	.23820	1.29888	1697	-.55153	.22014	1.19683	1747	-.22645	.25458	1.30421
1648	-.26843	.24149	1.30383	1698	-.56700	.22127	1.19023	1748	-.21708	.25293	1.30369
1649	-.26048	.24041	1.30388	1699	-.57972	.21815	1.17961	1749	-.20927	.25320	1.30548
1650	-.25266	.24239	1.30699	1700	-.59256	.21708	1.17325	1750	-.20169	.25278	1.30632

1751	-.19330	.24931	1.30498	1801	-.60423	.21594	1.13786	1851	-.21543	.26893	1.29935
1752	-.18497	.25754	1.30625	1802	-.60470	.22151	1.12825	1852	-.20741	.27166	1.30336
1753	-.17594	.24754	1.30451	1803	-.60050	.22042	1.13098	1853	-.20008	.26929	1.30303
1754	-.16762	.24880	1.30580	1804	-.59734	.22633	1.13911	1854	-.19235	.26834	1.30341
1755	-.15976	.24944	1.30716	1805	-.59201	.22831	1.14460	1855	-.18386	.26702	1.30333
1756	-.15204	.25034	1.30873	1806	-.58430	.22744	1.14827	1856	-.17492	.26586	1.30324
1757	-.14314	.24754	1.30615	1807	-.57836	.22846	1.15346	1857	-.16618	.26684	1.30502
1758	-.13622	.24905	1.30838	1808	-.56084	.22972	1.16397	1858	-.15891	.26958	1.30820
1759	-.12831	.24856	1.30837	1809	-.55306	.22605	1.16498	1859	-.15097	.26810	1.30754
1760	-.11964	.25018	1.30935	1810	-.54714	.22974	1.17194	1860	-.14248	.26634	1.30749
1761	-.11093	.24486	1.30482	1811	-.53857	.22565	1.17315	1861	-.13487	.26456	1.30601
1762	-.10284	.24630	1.30581	1812	-.53591	.23683	1.18503	1862	-.12666	.26230	1.30476
1763	-.09479	.24710	1.30595	1813	-.53170	.24140	1.19104	1863	-.11743	.26084	1.30404
1764	-.08707	.24468	1.30320	1814	-.52578	.24173	1.19265	1864	-.10973	.26204	1.30523
1765	-.08102	.24412	1.30212	1815	-.52282	.25063	1.20155	1865	-.10173	.26325	1.30651
1766	-.09409	.25502	1.30612	1816	-.51712	.25422	1.20712	1866	-.09343	.26503	1.30721
1767	-.11055	.25522	1.30696	1817	-.51265	.26068	1.21459	1867	-.08596	.26211	1.30432
1768	-.12697	.25533	1.30625	1818	-.49869	.26057	1.21950	1868	-.09267	.26898	1.30446
1769	-.14259	.25501	1.30579	1819	-.49083	.26055	1.22222	1869	-.10925	.27374	1.30770
1770	-.15880	.25592	1.30536	1820	-.48442	.26490	1.22832	1870	-.12607	.27340	1.30688
1771	-.17529	.25760	1.30504	1821	-.47833	.26858	1.23408	1871	-.14078	.27429	1.30587
1772	-.19273	.25918	1.30454	1822	-.47153	.27067	1.23911	1872	-.15758	.27472	1.30477
1773	-.19273	.25918	1.30454	1823	-.46410	.27091	1.24193	1873	-.17403	.27537	1.30293
1774	-.20779	.26014	1.30277	1824	-.44932	.27200	1.24800	1874	-.19099	.27648	1.30152
1775	-.22519	.26069	1.30016	1825	-.44141	.27189	1.25082	1875	-.20629	.27601	1.29856
1776	-.24256	.26395	1.30062	1826	-.43477	.27557	1.25679	1876	-.22445	.28021	1.29883
1777	-.25829	.26444	1.29809	1827	-.42672	.27363	1.25779	1877	-.24046	.28078	1.29500
1778	-.27428	.26794	1.29701	1828	-.42045	.27934	1.26536	1878	-.25673	.27931	1.29175
1779	-.29063	.26523	1.29176	1829	-.41199	.27682	1.26543	1879	-.27322	.28140	1.29059
1780	-.30618	.26275	1.28717	1830	-.40288	.27365	1.26535	1880	-.28903	.28053	1.28618
1781	-.32405	.26889	1.28866	1831	-.39556	.27631	1.27050	1881	-.30548	.28334	1.28410
1782	-.33970	.26786	1.28455	1832	-.38759	.27770	1.27272	1882	-.32188	.28329	1.28151
1783	-.35668	.26840	1.28280	1833	-.37966	.27642	1.27347	1883	-.33792	.28239	1.27712
1784	-.37293	.27083	1.28128	1834	-.37167	.27620	1.27532	1884	-.35386	.28190	1.27283
1785	-.38886	.27097	1.27800	1835	-.35581	.27712	1.27962	1885	-.36928	.28073	1.26893
1786	-.40482	.26924	1.27226	1836	-.34767	.27813	1.28119	1886	-.38597	.28320	1.26729
1787	-.42075	.26877	1.26738	1837	-.33889	.27567	1.28133	1887	-.40226	.28324	1.26342
1788	-.43645	.26891	1.26185	1838	-.33092	.27646	1.28308	1888	-.44743	.27649	1.24154
1789	-.45111	.26630	1.25417	1839	-.32304	.27668	1.28554	1889	-.48997	.27054	1.21973
1790	-.46591	.26621	1.24923	1840	-.31418	.27560	1.28639	1890	-.51275	.25663	1.19836
1791	-.48106	.26391	1.24162	1841	-.31418	.27560	1.28639	1891	-.52225	.24449	1.18494
1792	-.49568	.26458	1.23582	1842	-.30750	.27723	1.28903	1892	-.53200	.23948	1.17760
1793	-.50941	.25936	1.22702	1843	-.29780	.27544	1.28985	1893	-.53615	.23242	1.16971
1794	-.52011	.24905	1.21399	1844	-.29053	.27425	1.29030	1894	-.55060	.23371	1.16267
1795	-.52923	.23842	1.19988	1845	-.27403	.27467	1.29430	1895	-.57172	.22799	1.14422
1796	-.54249	.22319	1.18133	1846	-.26559	.27323	1.29425	1896	-.58547	.23036	1.13668
1797	-.55877	.22783	1.17632	1847	-.25807	.27358	1.29644	1897	-.58730	.23561	1.12762
1798	-.57257	.22740	1.16881	1848	-.23301	.27253	1.29933	1898	-.58384	.23882	1.13479
1799	-.58233	.22429	1.15927	1849	-.24177	.27385	1.29940	1899	-.57710	.23936	1.13974
1800	-.59575	.22293	1.14977	1850	-.22459	.27147	1.30302	1900	-.57014	.23808	1.14364

1901	-0.55688	.23147	1.14733	1951	-0.10858	.28039	1.30664	2001	-0.43505	.30078	1.21273
1902	-0.54505	.23244	1.15349	1952	-0.09978	.27788	1.30427	2002	-0.42874	.30485	1.21871
1903	-0.53715	.23091	1.15584	1953	-0.09197	.27755	1.30401	2003	-0.42149	.30501	1.22100
1904	-0.52986	.24483	1.17253	1954	-0.09099	.28001	1.30593	2004	-0.41441	.30625	1.22484
1905	-0.51993	.25076	1.18106	1955	-0.10737	.28925	1.30569	2005	-0.40783	.31028	1.23098
1906	-0.51475	.25306	1.18455	1956	-0.12407	.28582	1.30733	2006	-0.39756	.32050	1.24350
1907	-0.51147	.26247	1.19410	1957	-0.13972	.29250	1.30442	2007	-0.38826	.31821	1.24290
1908	-0.50720	.26996	1.20432	1958	-0.15571	.29097	1.30081	2008	-0.38061	.31858	1.24503
1909	-0.49421	.27133	1.20815	1959	-0.17223	.29053	1.29799	2009	-0.37216	.31541	1.24465
1910	-0.48720	.27377	1.21279	1960	-0.18928	.29307	1.29602	2010	-0.36459	.31806	1.24879
1911	-0.48058	.27663	1.21796	1961	-0.20547	.29510	1.29617	2011	-0.35697	.31864	1.25129
1912	-0.47307	.27666	1.22049	1962	-0.22248	.29384	1.29189	2012	-0.34941	.32022	1.25494
1913	-0.45929	.27815	1.22803	1963	-0.23874	.29619	1.28983	2013	-0.34039	.31747	1.25424
1914	-0.44566	.28208	1.23666	1964	-0.25561	.29760	1.28824	2014	-0.33264	.31763	1.25677
1915	-0.43162	.28603	1.24545	1965	-0.27185	.29813	1.28498	2015	-0.32504	.31792	1.25899
1916	-0.40943	.28974	1.25558	1966	-0.28755	.29637	1.27999	2016	-0.31665	.31871	1.26091
1917	-0.40304	.29584	1.26333	1967	-0.30380	.29676	1.27629	2017	-0.30794	.31792	1.26244
1918	-0.39269	.28938	1.26052	1968	-0.31929	.29577	1.27217	2018	-0.30053	.31922	1.26578
1919	-0.38602	.29294	1.26560	1969	-0.33617	.29834	1.27031	2019	-0.29268	.32157	1.26918
1920	-0.37831	.29328	1.26782	1970	-0.35293	.30024	1.26814	2020	-0.28476	.31797	1.26859
1921	-0.37036	.29352	1.26966	1971	-0.36884	.29958	1.26360	2021	-0.26861	.32069	1.27495
1922	-0.36183	.29476	1.27163	1972	-0.38406	.29831	1.25923	2022	-0.25955	.31834	1.27377
1923	-0.35373	.29155	1.27123	1973	-0.38406	.29831	1.25923	2023	-0.25318	.32040	1.27822
1924	-0.34641	.29482	1.27629	1974	-0.40128	.30121	1.25693	2024	-0.24429	.31671	1.27689
1925	-0.33867	.29522	1.27847	1975	-0.45830	.29123	1.22714	2025	-0.23637	.31670	1.27903
1926	-0.32978	.29275	1.27742	1976	-0.47144	.28461	1.21671	2026	-0.22745	.31362	1.27817
1927	-0.32093	.28942	1.27686	1977	-0.48496	.28022	1.20758	2027	-0.21958	.31536	1.28167
1928	-0.31237	.28982	1.27932	1978	-0.49834	.27784	1.20013	2028	-0.20291	.31551	1.28545
1929	-0.30592	.29513	1.28506	1979	-0.50833	.26693	1.18700	2029	-0.19539	.31606	1.28737
1930	-0.29681	.29415	1.28585	1980	-0.51940	.26231	1.17974	2030	-0.18732	.31639	1.28974
1931	-0.28901	.29138	1.28544	1981	-0.52700	.25077	1.16748	2031	-0.17854	.31401	1.28920
1932	-0.27177	.28715	1.28591	1982	-0.54018	.23413	1.14603	2032	-0.17004	.31419	1.29189
1933	-0.26357	.29015	1.28973	1983	-0.55148	.23419	1.14210	2033	-0.16180	.31392	1.29271
1934	-0.25678	.28931	1.29078	1984	-0.56520	.23375	1.13583	2034	-0.15372	.31433	1.29498
1935	-0.24888	.28977	1.29294	1985	-0.54222	.23889	1.11575	2035	-0.14650	.31519	1.29642
1936	-0.24017	.28300	1.29283	1986	-0.53782	.24080	1.12199	2036	-0.13745	.31253	1.29630
1937	-0.23157	.28866	1.29498	1987	-0.53146	.23995	1.12517	2037	-0.13072	.31282	1.29768
1938	-0.22332	.28628	1.29545	1988	-0.51649	.26427	1.15158	2038	-0.12225	.31409	1.29963
1939	-0.21465	.28752	1.29807	1989	-0.50813	.26867	1.15697	2039	-0.11379	.31489	1.30156
1940	-0.20642	.28463	1.29745	1990	-0.50468	.27418	1.16273	2040	-0.10500	.31099	1.29943
1941	-0.19836	.28539	1.29930	1991	-0.49923	.27726	1.16709	2041	-0.10080	.31156	1.30018
1942	-0.19055	.28573	1.30035	1992	-0.49404	.28257	1.17320	2042	-0.10408	.31508	1.29486
1943	-0.18200	.28338	1.29977	1993	-0.48946	.28825	1.18049	2043	-0.12114	.31752	1.29415
1944	-0.17360	.28526	1.30270	1994	-0.48228	.28844	1.18267	2044	-0.13643	.31864	1.29223
1945	-0.16464	.28327	1.30242	1995	-0.47630	.29216	1.18826	2045	-0.15215	.32082	1.29001
1946	-0.15656	.28170	1.30189	1996	-0.46944	.29403	1.19296	2046	-0.16927	.32488	1.29039
1947	-0.14029	.28014	1.30307	1997	-0.46175	.29401	1.19562	2047	-0.18631	.32386	1.28577
1948	-0.13361	.28303	1.30644	1998	-0.45483	.29553	1.19959	2048	-0.20195	.32365	1.28247
1949	-0.12528	.28077	1.30515	1999	-0.44850	.29973	1.20542	2049	-0.21857	.32283	1.27777
1950	-0.11599	.28001	1.30528	2000	-0.44148	.29844	1.20816	2050	-0.23488	.32194	1.27325



2051	-.25147	.32493	1.27221	2101	-.22555	.32950	1.27157	2151	-.49127	.28955	1.13606
2052	-.26705	.32416	1.26780	2102	-.21712	.32747	1.27160	2152	-.48559	.29261	1.14105
2053	-.28322	.32353	1.26302	2103	-.20890	.33173	1.27745	2153	-.47412	.30039	1.15137
2054	-.29881	.32291	1.25843	2104	-.20119	.33273	1.27948	2154	-.46845	.30367	1.15672
2055	-.31492	.32208	1.25393	2105	-.19333	.33293	1.28194	2155	-.46115	.30556	1.16149
2056	-.33043	.32216	1.24970	2106	-.18541	.33189	1.28238	2156	-.45405	.30547	1.16401
2057	-.34773	.32440	1.24758	2107	-.17654	.32875	1.28217	2157	-.44697	.30582	1.16771
2058	-.36265	.32381	1.24321	2108	-.16836	.33029	1.28546	2158	-.43977	.30561	1.17043
2059	-.37898	.32384	1.23933	2109	-.15967	.33085	1.28777	2159	-.43290	.30708	1.17499
2060	-.39452	.32109	1.23257	2110	-.15222	.33111	1.28998	2160	-.42026	.31148	1.18373
2061	-.41866	.31056	1.21589	2111	-.14456	.33184	1.29173	2161	-.41344	.31342	1.18774
2062	-.43238	.30751	1.20790	2112	-.13614	.32883	1.29121	2162	-.40761	.31960	1.19617
2063	-.44571	.30422	1.19979	2113	-.12917	.33217	1.29481	2163	-.39955	.32422	1.20151
2064	-.45908	.29919	1.18978	2114	-.12130	.33089	1.29614	2164	-.38758	.33178	1.21054
2065	-.47249	.29530	1.18124	2115	-.11122	.32986	1.29610	2165	-.37973	.33291	1.21305
2066	-.49628	.28291	1.16187	2116	-.10676	.33226	1.29886	2166	-.37427	.34081	1.22069
2067	-.51781	.23908	1.10823	2117	-.11944	.33608	1.28996	2167	-.35898	.34382	1.22704
2068	-.51286	.25607	1.12519	2118	-.13423	.33485	1.28639	2168	-.35215	.34716	1.23127
2069	-.50765	.26503	1.13322	2119	-.15054	.33795	1.28526	2169	-.34298	.34174	1.22906
2070	-.50171	.27821	1.14546	2120	-.16751	.34100	1.28404	2170	-.33497	.34151	1.23212
2071	-.49243	.28599	1.15445	2121	-.18396	.33839	1.27804	2171	-.32697	.34214	1.23469
2072	-.48094	.29245	1.16359	2122	-.19974	.33762	1.27356	2172	-.31909	.34284	1.23656
2073	-.47552	.29664	1.16948	2123	-.21620	.33711	1.26855	2173	-.31114	.34302	1.23906
2074	-.46790	.29643	1.17233	2124	-.23251	.33691	1.26497	2174	-.29529	.34393	1.24339
2075	-.46145	.29908	1.17707	2125	-.24894	.33794	1.26167	2175	-.28678	.34380	1.24524
2076	-.45514	.30211	1.18245	2126	-.26384	.33755	1.25698	2176	-.27882	.34123	1.24577
2077	-.44860	.30575	1.18836	2127	-.28063	.33723	1.25342	2177	-.27064	.34169	1.24803
2078	-.44211	.30731	1.19273	2128	-.29668	.33754	1.24936	2178	-.26320	.34506	1.25238
2079	-.43417	.30571	1.19446	2129	-.31260	.33660	1.24507	2179	-.25496	.34492	1.25537
2080	-.42819	.30857	1.19884	2130	-.32870	.33858	1.24247	2180	-.24804	.34542	1.25715
2081	-.42136	.31009	1.20283	2131	-.34432	.33560	1.23540	2181	-.23969	.34569	1.25968
2082	-.41407	.31133	1.20673	2132	-.35993	.33470	1.23115	2182	-.23179	.34616	1.26182
2083	-.40763	.31434	1.21285	2133	-.39104	.33366	1.22171	2183	-.22362	.34632	1.26443
2084	-.39046	.31859	1.22060	2134	-.40224	.32053	1.20846	2184	-.21550	.34363	1.26457
2085	-.37759	.32960	1.23292	2135	-.41113	.31646	1.20215	2185	-.20669	.34409	1.26704
2086	-.36205	.33024	1.23748	2136	-.42508	.31361	1.19388	2186	-.19882	.34451	1.26923
2087	-.35434	.33059	1.23969	2137	-.43750	.30771	1.18403	2187	-.19081	.34303	1.26963
2088	-.34643	.33082	1.24215	2138	-.45083	.30184	1.17396	2188	-.18295	.34350	1.27174
2089	-.33788	.32915	1.24293	2139	-.46408	.30004	1.16589	2189	-.17495	.34638	1.27627
2090	-.32986	.33008	1.24637	2140	-.47667	.29442	1.15532	2190	-.16592	.34371	1.27667
2091	-.32251	.33165	1.24936	2141	-.48830	.28627	1.14609	2191	-.15760	.34620	1.28005
2092	-.31426	.33238	1.25131	2142	-.49832	.28012	1.13770	2192	-.14969	.34062	1.27772
2093	-.29802	.32936	1.25338	2143	-.50636	.27309	1.12952	2193	-.14202	.34090	1.28002
2094	-.29014	.33243	1.25829	2144	-.51141	.26151	1.12031	2194	-.13412	.34125	1.28234
2095	-.28271	.33289	1.26029	2145	-.51141	.26436	1.11038	2195	-.12680	.34329	1.28469
2096	-.26618	.33368	1.26501	2146	-.50891	.26603	1.11304	2196	-.11924	.34339	1.28717
2097	-.25730	.33193	1.26477	2147	-.50585	.26901	1.11597	2197	-.11212	.34465	1.28869
2098	-.25040	.33398	1.26880	2148	-.50374	.27668	1.12285	2198	-.11771	.34956	1.28208
2099	-.24252	.33103	1.26797	2149	-.49966	.28006	1.12627	2199	-.13242	.34866	1.27870
2100	-.23368	.32843	1.26832	2150	-.49605	.28546	1.13172	2200	-.14847	.34766	1.27385

2201	-.16485	.35154	1.27299	2251	-.33100	.34877	1.21660	2301	-.47751	.30355	1.10896
2202	-.18196	.35303	1.26948	2252	-.32349	.35319	1.22209	2302	-.46526	.31174	1.12113
2203	-.19729	.35136	1.26450	2253	-.31617	.35436	1.22556	2303	-.45750	.31066	1.12398
2204	-.21404	.35074	1.25951	2254	-.30784	.35256	1.22585	2304	-.45175	.31300	1.12872
2205	-.23006	.34924	1.25407	2255	-.29219	.35310	1.23056	2305	-.44384	.31233	1.13223
2206	-.24559	.34640	1.24803	2256	-.28307	.35310	1.23309	2306	-.43033	.31250	1.13940
2207	-.26169	.35093	1.24766	2257	-.27621	.35579	1.23692	2307	-.41834	.31866	1.15024
2208	-.27750	.34836	1.24121	2258	-.26050	.35629	1.24174	2308	-.41079	.31733	1.15216
2209	-.29416	.35012	1.23873	2259	-.25086	.35200	1.24012	2309	-.40371	.31689	1.15511
2210	-.30979	.34963	1.23397	2260	-.24446	.35517	1.24437	2310	-.39844	.32991	1.16574
2211	-.32557	.34866	1.22980	2261	-.23591	.35295	1.24469	2311	-.38898	.34048	1.17529
2212	-.34089	.34842	1.22476	2262	-.22901	.35680	1.25009	2312	-.38342	.34186	1.17729
2213	-.35724	.34800	1.21966	2263	-.21913	.34829	1.24544	2313	-.37862	.34953	1.18427
2214	-.37225	.34446	1.21349	2264	-.21213	.35476	1.25239	2314	-.36645	.35818	1.19327
2215	-.38648	.34132	1.20769	2265	-.20361	.35663	1.25662	2315	-.35846	.35641	1.19463
2216	-.39742	.33017	1.19625	2266	-.19590	.35722	1.25856	2316	-.35072	.35698	1.19659
2217	-.41764	.31807	1.18017	2267	-.18033	.35802	1.26285	2317	-.34298	.35736	1.19879
2218	-.42972	.31238	1.16968	2268	-.17174	.35555	1.26347	2318	-.33598	.36100	1.20386
2219	-.44397	.31068	1.16289	2269	-.16384	.35748	1.26742	2319	-.32796	.36148	1.20661
2220	-.45711	.30742	1.15439	2270	-.15539	.35622	1.26890	2320	-.32001	.36352	1.20983
2221	-.47089	.30594	1.14638	2271	-.14775	.35670	1.27094	2321	-.31210	.36377	1.21224
2222	-.48174	.29572	1.13356	2272	-.14010	.35695	1.27326	2322	-.30424	.36441	1.21474
2223	-.49279	.28895	1.12455	2273	-.13155	.35748	1.27555	2323	-.29748	.37034	1.22113
2224	-.50224	.28383	1.11808	2274	-.12510	.36080	1.27966	2324	-.29034	.37053	1.22341
2225	-.50933	.27555	1.11078	2275	-.11659	.36105	1.28168	2325	-.28148	.37081	1.22614
2226	-.50290	.28507	1.10757	2276	-.14600	.36035	1.26365	2326	-.27356	.36882	1.22646
2227	-.49907	.28544	1.10953	2277	-.16205	.36253	1.26142	2327	-.26454	.36636	1.22657
2228	-.49435	.28910	1.11336	2278	-.21113	.36196	1.24827	2328	-.25734	.36641	1.22900
2229	-.48943	.29173	1.11685	2279	-.22737	.36238	1.24399	2329	-.24866	.36683	1.23147
2230	-.48439	.29633	1.12302	2280	-.24310	.36182	1.23929	2330	-.24189	.37055	1.23580
2231	-.47840	.29981	1.12816	2281	-.25866	.36137	1.23509	2331	-.23380	.37086	1.23820
2232	-.47194	.30102	1.13169	2282	-.27485	.36067	1.23038	2332	-.22620	.36896	1.23894
2233	-.46508	.30204	1.13506	2283	-.29084	.36063	1.22615	2333	-.21783	.36770	1.24037
2234	-.45933	.30419	1.13948	2284	-.30706	.36340	1.22437	2334	-.20999	.37141	1.24511
2235	-.45221	.30660	1.14577	2285	-.32228	.35935	1.21696	2335	-.20156	.37097	1.24794
2236	-.44692	.31054	1.15134	2286	-.33805	.35655	1.21080	2336	-.19327	.37033	1.24917
2237	-.43926	.31013	1.15445	2287	-.35330	.35615	1.20606	2337	-.18530	.36825	1.24907
2238	-.43225	.30980	1.15723	2288	-.36751	.35174	1.19880	2338	-.17803	.37284	1.25431
2239	-.42482	.30966	1.15992	2289	-.38069	.34369	1.18877	2339	-.16997	.37301	1.25680
2240	-.41900	.31384	1.16596	2290	-.39172	.33651	1.18139	2340	-.16034	.36898	1.25670
2241	-.41238	.31531	1.16987	2291	-.40141	.32673	1.17194	2341	-.14522	.37375	1.26382
2242	-.40630	.31823	1.17531	2292	-.40776	.31548	1.16097	2342	-.13756	.37164	1.26422
2243	-.39825	.32209	1.18033	2293	-.42198	.31555	1.15609	2343	-.12927	.37285	1.26739
2244	-.39347	.32947	1.18634	2294	-.43476	.31260	1.14738	2344	-.12314	.37287	1.26948
2245	-.38287	.33884	1.19611	2295	-.44902	.31353	1.14139	2345	-.12030	.37402	1.26967
2246	-.37551	.33910	1.19838	2296	-.46180	.30908	1.13112	2346	-.12770	.37498	1.25833
2247	-.37013	.34879	1.20729	2297	-.48763	.30146	1.11410	2347	-.15850	.37432	1.24975
2248	-.35518	.35152	1.21326	2298	-.49809	.29052	1.10488	2348	-.17565	.37573	1.24632
2249	-.34732	.35147	1.21544	2299	-.48857	.30757	1.10650	2349	-.19091	.37536	1.24151
2250	-.34003	.35173	1.21765	2300	-.48315	.30006	1.10292	2350	-.20764	.37482	1.23643

2351	-.22370	.37441	1.23143	2401	-.19733	.37970	1.23360	2451	-.32838	.37950	1.17793
2352	-.23929	.37097	1.22607	2402	-.18972	.38195	1.23765	2452	-.32046	.38037	1.17956
2353	-.25511	.37062	1.22119	2403	-.18254	.38228	1.23973	2453	-.31215	.38035	1.18240
2354	-.27155	.37170	1.21778	2404	-.17479	.38205	1.24145	2454	-.30457	.38081	1.18444
2355	-.28815	.37405	1.21581	2405	-.16617	.37934	1.24171	2455	-.29733	.38301	1.18842
2356	-.30362	.37186	1.21019	2406	-.15734	.38012	1.24439	2456	-.28994	.38705	1.19379
2357	-.31894	.37052	1.20540	2407	-.14240	.38579	1.25339	2457	-.28226	.38502	1.19415
2358	-.33538	.36980	1.20064	2408	-.13457	.38193	1.25180	2458	-.27331	.38667	1.19759
2359	-.35013	.36613	1.19289	2409	-.12675	.38531	1.25697	2459	-.26598	.38693	1.19976
2360	-.36341	.35852	1.18397	2410	-.12323	.38292	1.25504	2460	-.25762	.38742	1.20260
2361	-.37615	.35237	1.17649	2411	-.14052	.38726	1.24399	2461	-.25032	.38785	1.20461
2362	-.38604	.34347	1.16811	2412	-.15618	.38912	1.24115	2462	-.24198	.38752	1.20667
2363	-.39539	.33240	1.15810	2413	-.17324	.38626	1.23461	2463	-.23448	.38736	1.20882
2364	-.41382	.31904	1.14225	2414	-.18762	.38319	1.22805	2464	-.22685	.38765	1.21109
2365	-.42759	.31810	1.13538	2415	-.20468	.38482	1.22497	2465	-.21874	.38662	1.21213
2366	-.43955	.31335	1.12524	2416	-.22038	.38161	1.21814	2466	-.21063	.38687	1.21461
2367	-.45272	.30969	1.11456	2417	-.23589	.37901	1.21177	2467	-.20296	.38681	1.21672
2368	-.46726	.31248	1.10951	2418	-.25211	.38172	1.21009	2468	-.19403	.38704	1.21952
2369	-.47084	.32214	1.10402	2419	-.26818	.38154	1.20605	2469	-.18638	.39073	1.22420
2370	-.45869	.32028	1.11040	2420	-.28359	.37963	1.20008	2470	-.17853	.38730	1.22393
2371	-.44937	.31538	1.11106	2421	-.29947	.38024	1.19630	2471	-.17113	.39022	1.22765
2372	-.44329	.31637	1.11528	2422	-.31503	.37925	1.19156	2472	-.16250	.38960	1.22953
2373	-.43488	.31563	1.11903	2423	-.33078	.37772	1.18564	2473	-.15411	.39015	1.23237
2374	-.42205	.31735	1.12694	2424	-.34639	.37737	1.18191	2474	-.14593	.39005	1.23471
2375	-.41597	.31698	1.12946	2425	-.35991	.37033	1.17278	2475	-.13833	.39239	1.23867
2376	-.40894	.31785	1.13415	2426	-.37238	.36195	1.16339	2476	-.13134	.39209	1.24022
2377	-.39177	.33436	1.15072	2427	-.38143	.35028	1.15345	2477	-.12677	.39226	1.24158
2378	-.38886	.34494	1.15563	2428	-.38925	.34039	1.14551	2478	-.13603	.39286	1.22887
2379	-.38298	.34443	1.16001	2429	-.39848	.33208	1.13754	2479	-.15172	.39512	1.22602
2380	-.37342	.35367	1.16834	2430	-.40473	.31792	1.12659	2480	-.16929	.39487	1.22213
2381	-.36961	.36667	1.17854	2431	-.41809	.31921	1.12050	2481	-.18460	.39445	1.21741
2382	-.36192	.36646	1.17965	2432	-.43034	.31521	1.11114	2482	-.20135	.39320	1.21145
2383	-.34824	.37366	1.18923	2433	-.44236	.31984	1.09537	2483	-.21653	.38975	1.20447
2384	-.34012	.37166	1.18972	2434	-.44012	.31929	1.09788	2484	-.23235	.38864	1.19977
2385	-.33251	.37202	1.19187	2435	-.43281	.31496	1.09842	2485	-.24776	.38895	1.19588
2386	-.32413	.37003	1.19242	2436	-.42584	.31677	1.10414	2486	-.26468	.39188	1.19429
2387	-.31621	.37127	1.19601	2437	-.41392	.32105	1.11414	2487	-.28043	.39188	1.18949
2388	-.30872	.37159	1.19817	2438	-.40216	.32352	1.12248	2488	-.29482	.38376	1.17958
2389	-.30125	.37563	1.20293	2439	-.39855	.32776	1.12532	2489	-.31040	.38458	1.17621
2390	-.29448	.38107	1.20942	2440	-.39447	.33259	1.12989	2490	-.32629	.38405	1.17142
2391	-.28628	.37856	1.20930	2441	-.39049	.33861	1.13533	2491	-.34233	.38659	1.16997
2392	-.27749	.37872	1.21212	2442	-.38409	.35026	1.14467	2492	-.35577	.37899	1.15979
2393	-.27014	.37923	1.21399	2443	-.37888	.35201	1.14607	2493	-.36816	.36993	1.15069
2394	-.26165	.37983	1.21618	2444	-.37354	.35347	1.14786	2494	-.37510	.35392	1.13814
2395	-.25363	.37661	1.21628	2445	-.36952	.36282	1.15527	2495	-.39129	.33475	1.12219
2396	-.24558	.37966	1.22069	2446	-.36379	.36854	1.16024	2496	-.39918	.32502	1.11382
2397	-.23872	.37992	1.22273	2447	-.35712	.37179	1.16383	2497	-.40874	.32053	1.10651
2398	-.23064	.38029	1.22506	2448	-.35058	.37512	1.16852	2498	-.42270	.32159	1.10053
2399	-.22278	.38076	1.22716	2449	-.34242	.37591	1.17034	2499	-.42300	.32116	1.08942
2400	-.20657	.37932	1.23089	2450	-.33583	.37920	1.17512	2500	-.41656	.31676	1.09030

2501	-.41039	.31977	1.09592	2551	-.33642	.38805	1.15033	2601	-.28674	.40259	1.15346
2502	-.40401	.31908	1.09892	2552	-.35058	.38376	1.14360	2602	-.30088	.39724	1.14685
2503	-.39865	.32051	1.10234	2553	-.37207	.36473	1.12678	2603	-.31539	.39149	1.13833
2504	-.39482	.32607	1.10692	2554	-.38473	.33716	1.10705	2604	-.33078	.39249	1.13535
2505	-.39153	.33153	1.11147	2555	-.40273	.32929	1.08824	2605	-.34607	.39109	1.13010
2506	-.38790	.33684	1.11528	2556	-.38899	.33068	1.09345	2606	-.36906	.37282	1.11306
2507	-.37440	.35953	1.13340	2557	-.38330	.34140	1.10078	2607	-.38282	.34595	1.09386
2508	-.37080	.36868	1.14029	2558	-.38119	.35027	1.10706	2608	-.38637	.33221	1.08368
2509	-.36616	.37425	1.14509	2559	-.37364	.35901	1.11386	2609	-.39093	.33492	1.07498
2510	-.35936	.37529	1.14613	2560	-.36931	.36348	1.11677	2610	-.38649	.33535	1.07655
2511	-.35270	.37762	1.14970	2561	-.36511	.37020	1.12151	2611	-.38396	.34603	1.08392
2512	-.34547	.37844	1.15175	2562	-.35542	.38697	1.13585	2612	-.38124	.35055	1.08723
2513	-.33857	.38308	1.15728	2563	-.34861	.38756	1.13747	2613	-.37922	.35905	1.09332
2514	-.33076	.38384	1.15962	2564	-.34090	.38808	1.13950	2614	-.37508	.36328	1.09582
2515	-.32375	.38537	1.16252	2565	-.33357	.38829	1.14177	2615	-.37117	.37032	1.10113
2516	-.31662	.38969	1.16738	2566	-.32574	.38863	1.14405	2616	-.36705	.37691	1.10599
2517	-.30837	.39009	1.16973	2567	-.31957	.39495	1.15020	2617	-.36072	.37557	1.10636
2518	-.30097	.39014	1.17218	2568	-.31177	.39525	1.15248	2618	-.34289	.39261	1.12181
2519	-.29300	.39058	1.17439	2569	-.30419	.39536	1.15499	2619	-.33545	.39356	1.12436
2520	-.28500	.39087	1.17678	2570	-.29656	.39591	1.15691	2620	-.32776	.39337	1.12726
2521	-.27774	.39233	1.17930	2571	-.28885	.39883	1.16071	2621	-.32043	.39457	1.13008
2522	-.26202	.39270	1.18424	2572	-.28044	.39737	1.16183	2622	-.31310	.39486	1.13225
2523	-.25369	.39536	1.18861	2573	-.27443	.40463	1.16929	2623	-.30679	.40168	1.13957
2524	-.24574	.39190	1.18780	2574	-.26510	.40204	1.16911	2624	-.29748	.39626	1.13705
2525	-.23738	.39203	1.19050	2575	-.25804	.40183	1.17119	2625	-.28493	.40655	1.14700
2526	-.22961	.39309	1.19242	2576	-.24932	.40062	1.17209	2626	-.27637	.40547	1.14774
2527	-.22305	.39686	1.19782	2577	-.24175	.40066	1.17463	2627	-.26891	.40560	1.15013
2528	-.21499	.39619	1.19961	2578	-.23369	.40120	1.17731	2628	-.25314	.40637	1.15460
2529	-.19921	.39753	1.20522	2579	-.22577	.39696	1.17635	2629	-.24465	.40696	1.15737
2530	-.19050	.39787	1.20780	2580	-.21867	.40262	1.18247	2630	-.23659	.40718	1.15986
2531	-.18266	.39752	1.20972	2581	-.21034	.40312	1.18473	2631	-.22916	.40979	1.16391
2532	-.17437	.39496	1.20974	2582	-.20253	.40304	1.18749	2632	-.22250	.41284	1.16779
2533	-.16681	.39541	1.21175	2583	-.19520	.40552	1.19115	2633	-.21403	.40978	1.16791
2534	-.15894	.39911	1.21769	2584	-.18597	.40296	1.19150	2634	-.20634	.41068	1.17122
2535	-.15011	.39916	1.21946	2585	-.17760	.39916	1.19132	2635	-.19866	.41107	1.17339
2536	-.14230	.39455	1.21825	2586	-.17038	.40101	1.19451	2636	-.19046	.41097	1.17632
2537	-.13404	.39479	1.22076	2587	-.16270	.40117	1.19694	2637	-.18164	.40663	1.17523
2538	-.12923	.39454	1.22096	2588	-.15411	.40233	1.20023	2638	-.17351	.40817	1.17849
2539	-.14765	.39987	1.20945	2589	-.14612	.40550	1.20445	2639	-.16652	.40829	1.18075
2540	-.16459	.39996	1.20533	2590	-.13760	.40462	1.20604	2640	-.15847	.40837	1.18340
2541	-.17999	.40019	1.20154	2591	-.13156	.40963	1.21151	2641	-.14144	.40748	1.18797
2542	-.19629	.40022	1.19651	2592	-.14389	.40853	1.19750	2642	-.13401	.40558	1.18696
2543	-.21251	.39707	1.19004	2593	-.16050	.40579	1.19042	2643	-.13908	.40973	1.18086
2544	-.22817	.39862	1.18633	2594	-.17573	.40524	1.18585	2644	-.15552	.40502	1.17215
2545	-.24383	.39994	1.18354	2595	-.19193	.40486	1.18077	2645	-.17090	.40842	1.17036
2546	-.25966	.39672	1.17671	2596	-.20837	.40644	1.17795	2646	-.18792	.40858	1.16610
2547	-.27536	.39612	1.17204	2597	-.22391	.40628	1.17283	2647	-.20394	.41027	1.16268
2548	-.29110	.39534	1.16760	2598	-.23919	.40341	1.16637	2648	-.21970	.41029	1.15778
2549	-.30585	.39187	1.16142	2599	-.25546	.40537	1.16312	2649	-.23486	.41110	1.15402
2550	-.32219	.39257	1.15798	2600	-.27134	.40361	1.15806	2650	-.25125	.41316	1.14836

2651	-.26670	.40946	1.14391	2701	-.27590	.40542	1.11787	2751	-.28563	.40893	1.10063
2652	-.28243	.40810	1.13899	2702	-.29755	.40384	1.11474	2752	-.29827	.39889	1.09300
2653	-.29640	.40101	1.13291	2703	-.30492	.40235	1.11164	2753	-.31160	.39701	1.08616
2654	-.30966	.39277	1.12262	2704	-.31964	.40247	1.10648	2754	-.32573	.39687	1.08208
2655	-.32574	.39806	1.12235	2705	-.33263	.39424	1.09646	2755	-.34022	.39601	1.07478
2656	-.34009	.39384	1.11500	2706	-.34708	.39194	1.08973	2756	-.35551	.39541	1.07026
2657	-.36506	.37778	1.09770	2707	-.36079	.38648	1.08314	2757	-.35682	.39509	1.05900
2658	-.37432	.36763	1.08976	2708	-.37064	.37481	1.07289	2758	-.35227	.39530	1.06198
2659	-.38089	.35660	1.08230	2709	-.37511	.38183	1.06805	2759	-.34545	.39776	1.06529
2660	-.38463	.35500	1.06964	2710	-.36941	.38039	1.06838	2760	-.33701	.39536	1.06655
2661	-.38149	.36226	1.07531	2711	-.36365	.38043	1.06918	2761	-.33084	.40428	1.07601
2662	-.37765	.36770	1.07959	2712	-.35876	.39008	1.07726	2762	-.32363	.40168	1.07762
2663	-.37293	.37145	1.08229	2713	-.35189	.39254	1.08062	2763	-.31718	.40093	1.08072
2664	-.36925	.38092	1.08909	2714	-.34440	.39296	1.08268	2764	-.30941	.39882	1.08079
2665	-.36298	.38158	1.09048	2715	-.33631	.39291	1.08551	2765	-.30237	.39914	1.08339
2666	-.35757	.38693	1.09560	2716	-.32917	.39340	1.08903	2766	-.29402	.39564	1.08305
2667	-.34226	.38899	1.10002	2717	-.32232	.39315	1.09166	2767	-.28943	.40446	1.08929
2668	-.33726	.39751	1.10868	2718	-.31488	.39418	1.09351	2768	-.28297	.40867	1.09219
2669	-.32253	.39845	1.11376	2719	-.30124	.39593	1.10006	2769	-.27626	.41172	1.09419
2670	-.31484	.39891	1.11584	2720	-.29398	.40005	1.10443	2770	-.26856	.41115	1.09530
2671	-.30749	.39897	1.11829	2721	-.28842	.40677	1.10854	2771	-.26188	.41805	1.10072
2672	-.29942	.39916	1.12077	2722	-.28164	.40755	1.10993	2772	-.25441	.42052	1.10431
2673	-.29399	.40348	1.12497	2723	-.27444	.41070	1.11321	2773	-.24625	.42112	1.10695
2674	-.28679	.40666	1.12705	2724	-.26698	.41532	1.11771	2774	-.23892	.42154	1.10895
2675	-.27914	.40733	1.12887	2725	-.25978	.41607	1.11988	2775	-.23061	.42172	1.11157
2676	-.27116	.40778	1.13106	2726	-.25086	.41701	1.12293	2776	-.22311	.42171	1.11416
2677	-.26351	.40931	1.13358	2727	-.24360	.41503	1.12317	2777	-.21413	.41410	1.11147
2678	-.25549	.40959	1.13598	2728	-.23561	.41742	1.12765	2778	-.20736	.41823	1.11682
2679	-.24826	.41243	1.14026	2729	-.22791	.41505	1.12853	2779	-.20091	.42009	1.12139
2680	-.23998	.41273	1.14273	2730	-.21946	.41486	1.13049	2780	-.19267	.41777	1.12241
2681	-.23251	.41309	1.14486	2731	-.21212	.41511	1.13269	2781	-.18502	.41765	1.12517
2682	-.22405	.41334	1.14802	2732	-.20494	.41480	1.13551	2782	-.17662	.41799	1.12765
2683	-.21696	.41375	1.14995	2733	-.19707	.41752	1.13954	2783	-.16772	.41491	1.12865
2684	-.20955	.41349	1.15222	2734	-.18928	.41509	1.14050	2784	-.16089	.41408	1.13202
2685	-.20147	.41213	1.15374	2735	-.18085	.41316	1.14169	2785	-.15351	.41250	1.13299
2686	-.18542	.41219	1.15917	2736	-.17272	.41488	1.14587	2786	-.14530	.41246	1.13469
2687	-.17722	.41262	1.16146	2737	-.16441	.41140	1.14599	2787	-.14024	.41092	1.13487
2688	-.16949	.41277	1.16392	2738	-.15733	.41175	1.14856	2788	-.15878	.41256	1.12310
2689	-.16186	.41048	1.16464	2739	-.15003	.41127	1.15166	2789	-.17449	.42008	1.12130
2690	-.15399	.41069	1.16707	2740	-.14141	.41230	1.15448	2790	-.18927	.41162	1.10933
2691	-.14552	.41082	1.16980	2741	-.13916	.41273	1.15474	2791	-.20539	.42049	1.11021
2692	-.13537	.41404	1.17524	2742	-.14752	.41261	1.14343	2792	-.22141	.42503	1.10793
2693	-.15154	.41022	1.15808	2743	-.16245	.41272	1.13819	2793	-.23682	.42284	1.10126
2694	-.16645	.41039	1.15280	2744	-.17821	.41587	1.13477	2794	-.25245	.42221	1.09668
2695	-.18282	.41188	1.14885	2745	-.19465	.41859	1.13106	2795	-.26663	.41709	1.08992
2696	-.19886	.41214	1.14423	2746	-.20979	.41878	1.12565	2796	-.28046	.40998	1.08467
2697	-.21451	.41325	1.14043	2747	-.22505	.41848	1.12078	2797	-.29207	.40027	1.07821
2698	-.22991	.41302	1.13542	2748	-.24123	.41835	1.11542	2798	-.30567	.40012	1.07371
2699	-.24572	.41273	1.13035	2749	-.25695	.41787	1.11063	2799	-.31934	.40130	1.06935
2700	-.26177	.41246	1.12581	2750	-.27184	.41378	1.10530	2800	-.33487	.40253	1.06261

2801	-.33751	.40712	1.05569	2851	-.23676	.42840	1.07757	2901	-.25171	.42572	1.04473
2802	-.33154	.40149	1.05492	2852	-.22922	.42555	1.07790	2902	-.26454	.41491	1.03776
2803	-.31620	.40009	1.06124	2853	-.22112	.42606	1.08062	2903	-.28056	.41650	1.03094
2804	-.30853	.39399	1.06109	2854	-.21406	.42543	1.08319	2904	-.27447	.40598	1.02415
2805	-.30229	.39551	1.06476	2855	-.20598	.42547	1.08591	2905	-.26907	.41354	1.02906
2806	-.29502	.39589	1.06679	2856	-.19846	.42090	1.08548	2906	-.26329	.42090	1.03268
2807	-.28938	.39744	1.06966	2857	-.18360	.42071	1.09075	2907	-.25611	.42223	1.03353
2808	-.28489	.40721	1.07522	2858	-.17658	.41982	1.09424	2908	-.24847	.42339	1.03475
2809	-.27786	.40847	1.07611	2859	-.16742	.41339	1.09325	2909	-.24060	.42528	1.03683
2810	-.27198	.41754	1.08135	2860	-.15973	.41246	1.09701	2910	-.23337	.42672	1.04036
2811	-.26514	.41909	1.08356	2861	-.15973	.41246	1.09701	2911	-.22530	.42771	1.04414
2812	-.25837	.42792	1.09010	2862	-.15234	.40845	1.09651	2912	-.21863	.42455	1.04518
2813	-.24984	.42275	1.08896	2863	-.14547	.40861	1.09866	2913	-.21141	.42465	1.04697
2814	-.24138	.42350	1.09152	2864	-.15085	.41269	1.09198	2914	-.20438	.42433	1.04976
2815	-.23458	.42619	1.09513	2865	-.16577	.41333	1.08609	2915	-.19684	.42419	1.05306
2816	-.22618	.42586	1.09786	2866	-.18126	.41766	1.08177	2916	-.19004	.42419	1.05537
2817	-.21825	.42268	1.09754	2867	-.19600	.42127	1.07742	2917	-.18278	.41824	1.05556
2818	-.21065	.42239	1.10048	2868	-.21114	.42339	1.07305	2918	-.17486	.41514	1.05758
2819	-.20339	.42729	1.10308	2869	-.22731	.42867	1.07196	2919	-.16833	.41465	1.06039
2820	-.19586	.41823	1.10371	2870	-.24195	.42547	1.06461	2920	-.15988	.40660	1.05920
2821	-.18786	.41706	1.10501	2871	-.25701	.42394	1.06013	2921	-.15111	.40681	1.06246
2822	-.18061	.41890	1.10917	2872	-.26984	.41614	1.05506	2922	-.14909	.40965	1.06467
2823	-.17154	.41327	1.10883	2873	-.28167	.40621	1.04949	2923	-.15957	.41806	1.05980
2824	-.16375	.41257	1.11234	2874	-.29290	.39682	1.04480	2924	-.17304	.41439	1.04976
2825	-.15668	.41233	1.11505	2875	-.29236	.39062	1.03103	2925	-.18716	.41559	1.04294
2826	-.14948	.41276	1.11700	2876	-.28290	.39895	1.03957	2926	-.20180	.42223	1.04153
2827	-.14326	.41293	1.11836	2877	-.27880	.40728	1.04370	2927	-.21588	.42278	1.03605
2828	-.15457	.41082	1.10575	2878	-.27322	.41197	1.04439	2928	-.24590	.42274	1.02585
2829	-.16984	.41597	1.10283	2879	-.26662	.41307	1.04531	2929	-.26078	.42027	1.02373
2830	-.18488	.41626	1.09621	2880	-.26088	.42000	1.04952	2930	-.26538	.42499	1.01709
2831	-.20026	.41852	1.09161	2881	-.25452	.42439	1.05263	2931	-.25810	.41832	1.01444
2832	-.21560	.42186	1.08858	2882	-.23952	.42739	1.05755	2932	-.25154	.42332	1.01778
2833	-.23174	.42457	1.08498	2883	-.23084	.42774	1.06007	2933	-.24401	.42413	1.01938
2834	-.24735	.42651	1.08189	2884	-.22422	.42312	1.06060	2934	-.23624	.42793	1.02351
2835	-.26300	.42490	1.07849	2885	-.21541	.42136	1.06068	2935	-.22000	.42416	1.02642
2836	-.27541	.41398	1.07034	2886	-.20899	.42195	1.06439	2936	-.21299	.42396	1.02904
2837	-.29920	.39841	1.05957	2887	-.20121	.42328	1.06765	2937	-.20048	.42302	1.03444
2838	-.31203	.39741	1.05194	2888	-.19391	.42287	1.07064	2938	-.19352	.42234	1.03763
2839	-.31562	.41074	1.04984	2889	-.18655	.41730	1.07092	2939	-.17833	.41589	1.04013
2840	-.30911	.39898	1.04605	2890	-.17851	.41735	1.07359	2940	-.17089	.41521	1.04345
2841	-.30176	.39454	1.04613	2891	-.17181	.41701	1.07741	2941	-.16462	.41153	1.04512
2842	-.29545	.39564	1.05027	2892	-.16400	.41277	1.07849	2942	-.15618	.41123	1.04833
2843	-.29042	.39956	1.05452	2893	-.15599	.41245	1.08162	2943	-.15216	.41104	1.04994
2844	-.28489	.40398	1.05668	2894	-.14912	.41174	1.08262	2944	-.14690	.41377	1.03459
2845	-.27923	.40833	1.05897	2895	-.16189	.41203	1.07122	2945	-.19771	.41898	1.02435
2846	-.27242	.41161	1.06127	2896	-.17676	.41705	1.06626	2946	-.21032	.42556	1.02254
2847	-.26639	.41844	1.06523	2897	-.19138	.41841	1.05957	2947	-.22380	.42015	1.01236
2848	-.26005	.42122	1.06804	2898	-.20741	.42610	1.05940	2948	-.24042	.42212	1.00929
2849	-.25240	.42806	1.07263	2899	-.22211	.42612	1.05436	2949	-.24264	.42224	.99968
2850	-.24509	.42848	1.07463	2900	-.23661	.42675	1.04865	2950	-.23871	.42666	1.00504

2951	-.23032	.42721	1.00725
2952	-.22329	.42940	1.01083
2953	-.21528	.42800	1.01360
2954	-.20831	.42403	1.01471
2955	-.19557	.41837	1.01709
2956	-.18846	.41759	1.02045
2957	-.17548	.41704	1.02554
2958	-.16751	.41061	1.02564
2959	-.16046	.40970	1.02913
2960	-.15487	.40758	1.02872
2961	-.16517	.40709	1.01723
2962	-.19375	.41580	1.00887
2963	-.20572	.42299	1.00700
2964	-.21971	.42397	.99998
2965	-.22141	.42518	.99098
2966	-.21771	.42962	.99610
2967	-.21000	.42540	.99615
2968	-.20289	.42150	.99841
2969	-.19116	.41399	1.00010
2970	-.18401	.41566	1.00483
2971	-.17769	.41531	1.00741
2972	-.16370	.40965	1.01195
2973	-.15715	.40813	1.01341
2974	-.16094	.40365	1.00040
2975	-.20025	.42187	.99132
2976	-.21582	.42784	.98963
2977	-.20114	.42261	.98056
2978	-.19735	.42185	.98262
2979	-.18593	.41332	.98613
2980	-.17351	.40800	.98988
2981	-.16677	.40372	.99043
2982	-.15819	.40001	.99148
2983	-.16268	.40388	.97897
2984	-.17007	.40460	.97559
2985	-.18044	.40674	.96952
2986	-.18514	.42096	.97347
2987	-.17983	.41531	.96839
2988	-.16583	.40209	.95869

APPENDIX D

TABULATION OF CANOPY COORDINATES  
FOR TWIN-KEEL PARAWING

The following pages are a reproduction of the printed computer output for the canopy coordinates obtained photogrammetrically at the Langley Research Center from the stereo photographs of the twin-keel parawing in the wind tunnel. The coordinate system used in the data presentation is illustrated in the sketch below.

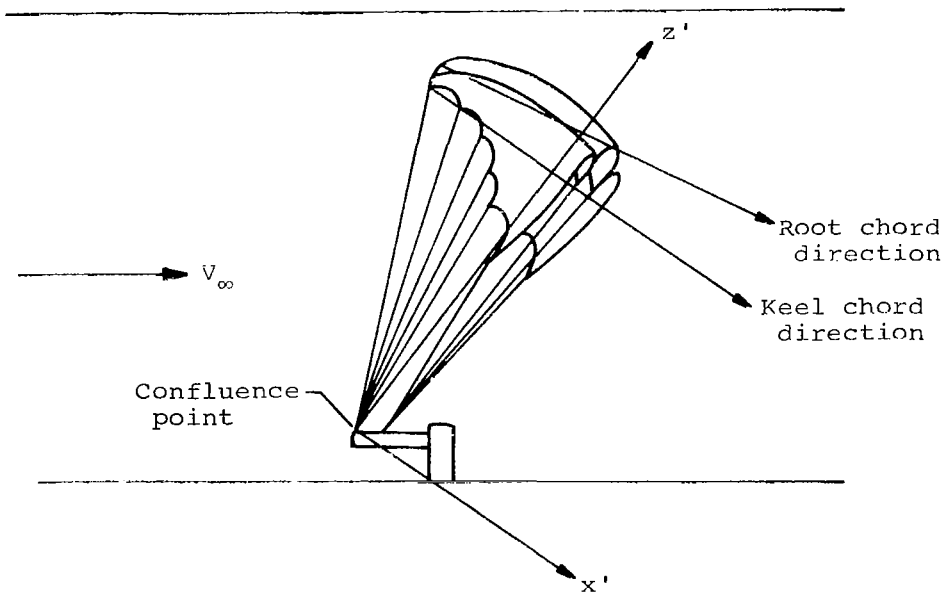

The origin of the axis system is on the sting at the confluence point of all the rigging lines except those on the trailing edge. The positive  $x'$  direction is parallel to the keel chord direction, which differs slightly from the root chord direction, with positive  $x'$  downstream. The positive  $z'$  direction is upward towards the canopy, and the positive  $y'$  direction is consistent with a right-hand system.

The data consist of a point identification number, followed by the  $x'$ ,  $y'$ , and  $z'$  coordinates of the point, nondimensionalized by the characteristic length  $h_k$ , which is 75 inches for the parawing tested. Points 1-12 are the canopy line attachment points for keel lines 1-12, respectively. The six leading-edge line attachment points are listed as



#### Appendix D

points 13-18. For the remainder of the coordinates, generally, a single streamwise set of points having about the same  $y'$  coordinate was read, with the sets starting near the vertical plane of symmetry and moving out toward the tip.

Point No.	$x'/h_k$	$y'/h_k$	$z'/h_k$		Point No.	$x'/h_k$	$y'/h_k$	$z'/h_k$
1	-.41920	.10703	.86478	K1	51	-.28740	.00437	1.00346
2	-.38668	.13789	.88237	K2	52	-.27411	.00299	1.00242
3	-.33674	.14857	.89325	K3	53	-.25087	.00136	1.00887
4	-.27954	.16197	.90401	K4	54	-.23919	.00293	1.00656
5	-.22207	.17916	.93441	K5	55	-.22581	.00244	1.00863
6	-.16443	.17318	.93674	K6	56	-.21177	.00110	1.01179
7	-.11003	.16909	.94245	K7	57	-.19864	.00031	1.01490
8	-.04790	.17185	.94557	K8	58	-.18583	.00225	1.01271
9	.00896	.16517	.93223	K9	59	-.17361	.00460	1.01164
10	.06727	.15954	.92205	K10	60	-.16136	.00512	1.01643
11	.11607	.15628	.89836	K11	61	-.14768	.00319	1.01989
12	.15994	.15061	.86478	K12	62	-.13398	.00240	1.02091
13	-.38303	.17650	.82932	LE1	63	-.12140	.00425	1.01930
14	-.30536	.26011	.81751	LE2	64	-.10768	.00199	1.02255
15	-.23315	.34008	.78933	LE3	65	-.09430	.00199	1.02322
16	-.14934	.40491	.72147	LE4	66	-.08042	.00072	1.02562
17	-.06162	.42228	.65039	LE5	67	-.06704	.00001	1.02658
18	.02084	.36495	.57049	LE6	68	-.05550	.00395	1.02203
19	-.48273	.01552	.94830		69	-.04057	.00040	1.02698
20	-.48610	.00622	.94999		70	-.02732	.00113	1.02598
21	-.48780	.01687	.96861		71	-.01524	.00274	1.02308
22	-.48478	.02689	.96133		72	-.00063	.00007	1.02568
23	-.48155	.03106	.94659		73	.01087	.00377	1.02023
24	-.47942	.04186	.93856		74	.02540	.00113	1.02320
25	-.47577	.05374	.93150		75	.03814	.00232	1.02095
26	-.47534	.06436	.92592		76	.05237	.00065	1.02125
27	-.47477	.07617	.92056		77	.06560	.00081	1.01918
28	-.47222	.08537	.91757		78	.07885	.00001	1.01744
29	-.47014	.09019	.90510		79	.09098	.00001	1.01429
30	-.46633	.09701	.89360		80	.10396	.00093	1.00930
31	-.46470	.10282	.87967		81	.11815	.00136	1.00878
32	-.45754	.10845	.87026		82	.12988	.00021	1.00315
33	-.44772	.11461	.86722		83	.14116	.00227	.99656
34	-.43404	.11591	.85867		84	.15412	.00087	.99407
35	-.49393	.01736	.94905		85	.16727	.00049	.99093
36	-.50335	.02229	.94390		86	.18203	.00232	.99978
37	-.47140	.00116	.98910		87	.19267	.00000	.98237
38	-.45855	.00000	.99241		88	.20505	.00102	.97733
39	-.44503	.00050	.99417		89	.21737	.00027	.97407
40	-.43236	.00187	.99482		90	-.49483	.00333	.95219
41	-.41910	.00211	.99619		91	-.50400	.00697	.94845
42	-.40589	.00102	.99912		92	-.48346	.01185	.98245
43	-.39253	.00228	.99897		93	-.47150	.01277	.98814
44	-.37979	.00417	.99737		94	-.45852	.01186	.98962
45	-.36690	.00381	.99918		95	-.44519	.01156	.99211
46	-.35326	.00237	1.00206		96	-.43229	.01212	.99479
47	-.34029	.00241	1.00205		97	-.41878	.01125	.99589
48	-.32659	.00147	1.00348		98	-.40579	.01167	.99762
49	-.31418	.00310	1.00200		99	-.39265	.01281	.99981
50	-.30098	.00485	1.00127		100	-.37938	.01291	1.00127

Suspension line  
attachment points

101	-.36634	.00978	.99848	151	-.49506	.00749	.95082	201	.16906	.02831	.99133
102	-.35237	.01279	1.00329	152	-.48262	.02267	.97847	202	.17996	.02570	.98336
103	-.33968	.01116	1.00146	153	-.47057	.02407	.98349	203	.19260	.02619	.97992
104	-.32675	.00932	.99976	154	-.45779	.02550	.98784	204	.20397	.02440	.97240
105	-.31352	.01124	1.00303	155	-.44466	.02489	.98989	205	.21528	.02415	.96723
106	-.29992	.01155	1.00486	156	-.43132	.02756	.99557	206	-.49383	.02047	.94927
107	-.28705	.01033	1.00544	157	-.41839	.02294	.99196	207	-.49370	.01849	.94713
108	-.27341	.01271	1.00490	158	-.40504	.02419	.99538	208	-.49370	.01849	.94713
109	-.26405	.01267	.99518	159	-.39186	.02460	.99658	209	-.49370	.01849	.94713
110	-.25100	.01324	1.00747	160	-.37884	.02424	.99744	210	-.46967	.03638	.97962
111	-.25082	.01374	1.00783	161	-.36571	.02437	.99923	211	-.45763	.03520	.98028
112	-.23904	.01052	1.00708	162	-.35174	.02513	1.00082	212	-.44381	.03710	.98511
113	-.22507	.01189	1.01057	163	-.33930	.02419	.99986	213	-.43096	.03492	.98482
114	-.21141	.01219	1.01226	164	-.32616	.02224	.99820	214	-.41769	.03697	.98977
115	-.19903	.01024	1.01078	165	-.31340	.02266	.99931	215	-.40473	.03497	.98905
116	-.18576	.01076	1.01298	166	-.29948	.02348	1.00121	216	-.39128	.03717	.99278
117	-.17282	.01043	1.01430	167	-.28689	.02309	1.00256	217	-.37823	.03519	.99172
118	-.16081	.01052	1.01901	168	-.27407	.02403	1.00127	218	-.36522	.03634	.99462
119	-.14719	.01088	1.02106	169	-.25129	.02384	1.00299	219	-.35130	.03590	.99479
120	-.13396	.01080	1.02124	170	-.23803	.02546	1.00850	220	-.33875	.03564	.99517
121	-.12108	.00908	1.01943	171	-.22471	.02502	1.00893	221	-.32539	.03578	.99584
122	-.10747	.01075	1.02183	172	-.21126	.02501	1.01070	222	-.31281	.03615	.99652
123	-.09479	.01104	1.02288	173	-.19809	.02461	1.01115	223	-.29909	.03562	.99715
124	-.08216	.00814	1.01999	174	-.18600	.02164	1.00891	224	-.28752	.03465	.99817
125	-.06842	.00947	1.02213	175	-.17268	.02266	1.01247	225	-.27475	.03587	.99861
126	-.05485	.01053	1.02368	176	-.16025	.02290	1.01611	226	-.26504	.03775	.99246
127	-.04063	.01190	1.02541	177	-.14763	.02213	1.01738	227	-.25134	.03334	.99686
128	-.02825	.01035	1.02327	178	-.13429	.02287	1.01862	228	-.25134	.03334	.99686
129	-.01471	.01084	1.02327	179	-.12055	.02357	1.01981	229	-.23844	.03560	1.00220
130	-.00132	.01134	1.02331	180	-.10734	.02400	1.02080	230	-.22543	.03491	1.00323
131	.01208	.01203	1.02349	181	-.09436	.02285	1.02027	231	-.21153	.03627	1.00572
132	.02585	.01250	1.02317	182	-.08050	.02504	1.02379	232	-.19839	.03714	1.00831
133	.03864	.01235	1.02245	183	-.06782	.02313	1.02127	233	-.18523	.03643	1.00871
134	.05208	.01161	1.01992	184	-.05533	.02267	1.02088	234	-.17237	.03624	1.00970
135	.06523	.01247	1.01850	185	-.04099	.02395	1.02271	235	-.16073	.03285	1.00827
136	.07810	.01215	1.01544	186	-.02762	.02405	1.02281	236	-.14801	.03459	1.01353
137	.09230	.01416	1.01521	187	-.01497	.02312	1.02127	237	-.13487	.03464	1.01427
138	.10545	.01414	1.01180	188	-.00155	.02421	1.02142	238	-.12087	.03612	1.01654
139	.11671	.01168	1.00520	189	.01228	.02499	1.02176	239	-.10838	.03552	1.01655
140	.13022	.01202	1.00167	190	.02640	.02614	1.02263	240	-.09607	.03350	1.01515
141	.14228	.01229	.99800	191	.03974	.02644	1.02263	241	-.08123	.03672	1.01966
142	.15554	.01367	.99578	192	.05169	.02391	1.01710	242	-.06867	.03551	1.01778
143	.16642	.01126	.98834	193	.06463	.02380	1.01507	243	-.05571	.03504	1.01758
144	.18064	.01297	.98619	194	.07832	.02492	1.01393	244	-.04301	.03324	1.01588
145	.19302	.01283	.98155	195	.09128	.02481	1.01065	245	-.02919	.03527	1.01815
146	.20535	.01254	.97708	196	.10463	.02545	1.00784	246	-.01619	.03393	1.01551
147	.21575	.01077	.96983	197	.11747	.02555	1.00441	247	-.00322	.03453	1.01564
148	-.49506	.00749	.95082	198	.13028	.02583	1.00083	248	.00940	.03222	1.01267
149	-.49506	.00749	.95082	199	.14350	.02727	.99860	249	.02523	.03698	1.01731
150	-.49506	.00749	.95082	200	.15391	.02442	.99127	250	.03647	.03373	1.01294

251	.05103	.03633	1.01399	301	-.06820	.05031	1.01961	351	-.18354	.06237	1.00374
252	.06458	.03772	1.01359	302	-.05658	.04659	1.01428	352	-.17051	.06251	1.00504
253	.07864	.03942	1.01344	303	-.04178	.04937	1.01690	353	-.15991	.06663	1.00518
254	.09069	.03772	1.00805	304	-.02960	.04791	1.01537	354	-.14727	.06084	1.00805
255	.10422	.03830	1.00526	305	-.01524	.04983	1.01674	355	-.13385	.06214	1.01104
256	.11683	.03836	1.00192	306	-.00159	.05030	1.01650	356	-.12094	.06153	1.01096
257	.12979	.03887	.99840	307	.00959	.04630	1.01092	357	-.10833	.06121	1.01133
258	.14233	.03925	.99448	308	.02373	.04784	1.01210	358	-.09498	.06214	1.01350
259	.15402	.03866	.98884	309	.03733	.04831	1.01199	359	-.08195	.06133	1.01299
260	.16617	.03791	.98353	310	.05136	.04951	1.01157	360	-.06868	.06122	1.01304
261	.17900	.03815	.97974	311	.06440	.05006	1.01051	361	-.05544	.06181	1.01342
262	.19166	.03872	.97399	312	.07837	.05177	1.01008	362	-.04224	.06142	1.01313
263	.20291	.03720	.96683	313	.09027	.05043	1.00501	363	-.02932	.06119	1.01248
264	.21372	.03679	.96191	314	.10278	.04932	1.00022	364	-.01568	.06200	1.01289
265	-.49188	.03048	.94221	315	.11588	.04381	.99668	365	-.00350	.06084	1.01075
266	-.49188	.03048	.94221	316	.12866	.05006	.99312	366	.01155	.06302	1.01210
267	-.49188	.03048	.94221	317	.14095	.05006	.98867	367	.02292	.05916	1.00693
268	-.48184	.05719	.98230	318	.15299	.05082	.98486	368	.03722	.06186	1.00929
269	-.46873	.04646	.97208	319	.16608	.05053	.97982	369	.05015	.06082	1.00653
270	-.45567	.04759	.97584	320	.17692	.04946	.97294	370	.06512	.06451	1.00918
271	-.44336	.04590	.97719	321	.18827	.04819	.96581	371	.07786	.06407	1.00623
272	-.42997	.04928	.98367	322	.20058	.04853	.96075	372	.08913	.06146	.99991
273	-.41688	.04679	.98306	323	.21110	.04851	.95588	373	.10242	.06214	.99711
274	-.40342	.04945	.98779	324	-.49011	.03970	.93437	374	.11523	.06197	.99297
275	-.39087	.04811	.98799	325	-.49011	.03970	.93437	375	.12787	.06260	.98911
276	-.37731	.04840	.98956	326	-.49011	.03970	.93437	376	.13994	.06268	.98431
277	-.36411	.04868	.99059	327	-.46699	.05886	.96687	377	.15205	.06281	.97977
278	-.35081	.04751	.99028	328	-.47931	.06333	.96881	378	.16360	.06112	.97291
279	-.33811	.04861	.99227	329	-.45444	.06049	.97121	379	.17559	.06161	.96809
280	-.32434	.04664	.99046	330	-.44146	.06061	.97380	380	.18589	.05924	.96940
281	-.31223	.04618	.98973	331	-.42898	.06051	.97676	381	.19771	.05918	.96358
282	-.29819	.04723	.99260	332	-.41550	.06154	.98129	382	.20789	.05929	.94865
283	-.28728	.04546	.99136	333	-.40263	.06062	.98159	383	-.48839	.05333	.93066
284	-.27495	.04984	.99521	334	-.38969	.05975	.98183	384	-.48839	.05333	.93066
285	-.26251	.05113	.99724	335	-.37648	.06262	.98689	385	-.48839	.05333	.93066
286	-.26251	.05113	.99724	336	-.36377	.05945	.98472	386	-.46484	.07136	.96205
287	-.24964	.05107	1.00039	337	-.34969	.06292	.98939	387	-.45284	.07061	.96318
288	-.23735	.04839	.99958	338	-.33703	.06023	.98679	388	-.43982	.07008	.96553
289	-.22397	.04883	1.00218	339	-.32343	.06086	.98816	389	-.42676	.07221	.97109
290	-.21056	.05053	1.00545	340	-.31088	.05919	.98611	390	-.41396	.07262	.97441
291	-.19810	.04866	1.00449	341	-.29730	.06006	.98787	391	-.40105	.07364	.97749
292	-.18392	.05114	1.00872	342	-.28635	.05702	.98429	392	-.38871	.07157	.97642
293	-.17192	.04790	1.00610	343	-.27675	.06153	.98993	393	-.37531	.07199	.97826
294	-.16012	.04687	1.00754	344	-.26194	.06278	.99316	394	-.36201	.07336	.98158
295	-.14854	.04541	1.00885	345	-.24883	.06370	.99717	395	-.34830	.07273	.98174
296	-.13409	.04871	1.01331	346	-.26175	.06308	.99283	396	-.33534	.07507	.98493
297	-.12137	.04813	1.01354	347	-.23734	.05953	.99437	397	-.32222	.07333	.98310
298	-.10882	.04737	1.01309	348	-.22308	.06279	1.00047	398	-.30977	.07150	.98150
299	-.09633	.04526	1.01173	349	-.21023	.06181	1.00069	399	-.29615	.07272	.98355
300	-.08212	.04821	1.01547	350	-.19713	.06268	1.00279	400	-.27809	.07360	.98537

401	-.27889	.07360	.99537	451	.08907	.08735	.99376	501	-.46464	.07952	.92399
402	-.26172	.17432	.98845	452	.07594	.19781	.99678	502	-.45906	.08380	.93700
403	-.26077	.07432	.98845	453	.06297	.08689	.99907	503	-.44776	.08827	.94429
404	-.24774	.07625	.99311	454	.04920	.08522	.99805	504	-.43561	.09225	.95141
405	-.23574	.07572	.99494	455	.03568	.08548	.99944	505	-.42321	.09299	.95508
406	-.22225	.07508	.99678	456	.02363	.08658	1.07161	506	-.40992	.09413	.95934
407	-.20952	.07410	.99735	457	.00949	.08442	1.00023	507	-.39818	.09692	.96514
408	-.19716	.07197	.99603	458	-.00408	.08459	1.00171	508	-.38533	.09802	.96799
409	-.18347	.07167	.99635	459	-.01655	.08583	1.00386	509	-.37223	.09678	.96742
410	-.17005	.07371	.99949	460	-.02988	.08659	1.00476	510	-.35969	.09550	.96790
411	-.15832	.07186	.99961	461	-.04271	.08409	1.00277	511	-.34667	.09429	.96763
412	-.14754	.07269	1.00244	462	-.05571	.08567	1.00475	512	-.33396	.09599	.97063
413	-.13352	.07517	1.00792	463	-.06858	.08692	1.00699	513	-.32042	.09637	.97143
414	-.12098	.07452	1.00801	464	-.08203	.08597	1.00601	514	-.30763	.09600	.97137
415	-.10790	.07503	1.00971	465	-.09501	.08599	1.00539	515	-.29480	.09516	.96938
416	-.09512	.07363	1.00949	466	-.10868	.08480	1.00245	516	-.28338	.09031	.96463
417	-.08203	.07454	1.01150	467	-.12113	.08631	1.00373	517	-.28367	.09026	.96474
418	-.06799	.07535	1.01243	468	-.13356	.08613	1.00156	518	-.25842	.09861	.97926
419	-.05482	.07554	1.01228	469	-.14645	.08615	.99996	519	-.24555	.09756	.98044
420	-.04210	.07434	1.01004	470	-.16645	.08615	.99996	520	-.23322	.09772	.98248
421	-.02908	.07518	1.01062	471	-.16967	.08313	.99162	521	-.22091	.09742	.98436
422	-.01637	.07312	1.00818	472	-.18184	.08608	.99427	522	-.20783	.09857	.98779
423	-.00355	.07324	1.00695	473	-.19590	.08616	.99392	523	-.19486	.09843	.98879
424	.00956	.07214	1.00482	474	-.20871	.08495	.99138	524	-.18117	.09806	.98860
425	.02404	.07462	1.00707	475	-.22206	.08394	.98825	525	-.16833	.09693	.98841
426	.03645	.07319	1.00446	476	-.23442	.08688	.98884	526	-.16829	.09695	.98838
427	.05094	.07613	1.00635	477	-.24662	.08674	.98736	527	-.14664	.09743	.99336
428	.06441	.07629	1.00492	478	-.25953	.08731	.98605	528	-.13436	.09696	.99491
429	.07833	.07835	1.00491	479	-.25953	.08731	.98605	529	-.12193	.09598	.99532
430	.09002	.07571	.99908	480	-.27949	.08172	.97591	530	-.10810	.09952	1.00041
431	.10260	.07507	.99412	481	-.27949	.08172	.97591	531	-.09413	.10100	1.00331
432	.11569	.07634	.99150	482	-.29534	.08163	.97455	532	-.08178	.09882	1.00171
433	.12783	.07578	.98628	483	-.30797	.08551	.97873	533	-.06874	.09837	1.00124
434	.13953	.07536	.98073	484	-.32097	.08435	.97760	534	-.05536	.09965	1.00167
435	.15162	.07565	.97605	485	-.33483	.08449	.97760	535	-.04291	.09737	.99792
436	.16295	.07378	.96842	486	-.34720	.08499	.97689	536	-.03128	.09673	.99736
437	.17540	.07426	.96381	487	-.36066	.08284	.97366	537	-.01724	.09832	.99927
438	.18440	.07105	.95489	488	-.37379	.08443	.97392	538	-.00373	.10028	1.00103
439	.19499	.06961	.94686	489	-.38719	.08386	.97135	539	.00883	.09704	.99594
440	.20379	.06762	.93983	490	-.39995	.08513	.97182	540	.02353	.10037	.99799
441	.19906	.07740	.93212	491	-.41229	.08392	.96873	541	.03554	.09807	.99467
442	.19071	.07842	.93796	492	-.42507	.08288	.96454	542	.04867	.09941	.99550
443	.18033	.08019	.94563	493	-.43752	.08233	.96043	543	.06119	.09862	.99293
444	.17113	.08244	.95417	494	-.45075	.08024	.95465	544	.07407	.09807	.99705
445	.16084	.08425	.96123	495	-.46204	.07715	.94800	545	.08710	.09858	.99749
446	.14802	.08332	.96539	496	-.46204	.07715	.94800	546	.10003	.09854	.99833
447	.13774	.08640	.97423	497	-.46637	.06384	.92359	547	.11475	.10117	.99247
448	.12874	.09064	.98401	498	-.48697	.06384	.92359	548	.12514	.09882	.97476
449	.11388	.08625	.98442	499	-.49038	.08620	.91467	549	.13577	.09715	.96739
450	.10379	.08948	.99239	500	-.46464	.07952	.92399	550	.14661	.09593	.96055

551	.15988	.09631	.95575	601	-.35760	.10696	.96034	651	.00916	.12296	.98606
552	.16976	.09420	.94877	602	-.37067	.10741	.95900	652	.01921	.11802	.97827
553	.17750	.09136	.93985	603	-.38445	.10588	.95649	653	-.03315	.12123	.98172
554	.18590	.08714	.92930	604	-.39630	.10841	.95730	654	.00432	.12430	.98549
555	.19520	.08635	.92355	605	-.40858	.10303	.94969	655	.00589	.12355	.98309
556	.19130	.09639	.91562	606	-.42772	.10274	.94605	656	.007153	.12324	.97992
557	.18121	.09676	.92100	607	-.43341	.10014	.94251	657	.008366	.12240	.97588
558	.17244	.10033	.93162	608	-.44527	.09713	.93492	658	-.009777	.12434	.97437
559	.16492	.10259	.93816	609	-.45463	.08963	.92420	659	.11065	.12422	.96981
560	.15525	.10552	.94658	610	-.45463	.08963	.92420	660	.12149	.12303	.96414
561	.14489	.10830	.95572	611	-.46690	.09267	.91237	661	.13111	.12077	.95623
562	.13371	.10899	.96121	612	-.46012	.10297	.90683	662	.14152	.11934	.94868
563	.12406	.11237	.97038	613	-.44178	.10075	.92049	663	.15291	.11707	.94042
564	.11091	.11007	.97297	614	-.44178	.10075	.92049	664	.16162	.11351	.93149
565	.09931	.11200	.97977	615	-.43099	.10492	.92683	665	-.16976	.11007	.92396
566	.08624	.11202	.98316	616	-.41909	.10626	.93112	666	.17676	.10698	.91462
567	.07407	.11348	.98861	617	-.40627	.10815	.93614	667	.18390	.10201	.90333
568	.05848	.10825	.98473	618	-.39442	.11293	.94372	668	.18027	.11364	.89821
569	.04622	.10921	.98708	619	-.38245	.11651	.94853	669	.17165	.11560	.90641
570	.03485	.10979	.98824	620	-.36975	.11419	.94731	670	.16518	.11814	.91266
571	.02192	.11020	.98933	621	-.35668	.11565	.95065	671	.15731	.12172	.92153
572	.00710	.10742	.98800	622	-.34467	.11360	.94937	672	.14961	.12741	.93268
573	-.00542	.11039	.99245	623	-.33306	.11422	.95072	673	.13893	.13059	.94190
574	-.01966	.10728	.98970	624	-.31955	.11648	.95391	674	-.12720	.13003	.94642
575	-.03255	.10738	.98979	625	-.30634	.11878	.95691	675	.11904	.13274	.95482
576	-.04353	.10899	.99121	626	-.29387	.11556	.95304	676	.10804	.13506	.96246
577	-.05598	.11091	.99466	627	-.28197	.11196	.94790	677	.09471	.13273	.96314
578	-.06899	.11038	.99566	628	-.26864	.12258	.96476	678	.08229	.13343	.96771
579	-.08279	.10963	.99518	629	-.26962	.12259	.96475	679	.06932	.13361	.97126
580	-.09609	.10957	.99398	630	-.25584	.12482	.97055	680	.05602	.13305	.97361
581	-.10804	.11221	.99569	631	-.24396	.11999	.96636	681	.04470	.13537	.97743
582	-.12188	.10900	.99119	632	-.23085	.12025	.96784	682	.03030	.13054	.97256
583	-.13528	.10728	.98750	633	-.21986	.11906	.96966	683	.01922	.13199	.97416
584	-.14696	.10871	.98649	634	-.20679	.12212	.97569	684	.00645	.13302	.97656
585	-.16775	.10842	.98108	635	-.19418	.12140	.97549	685	-.00676	.13439	.98042
586	-.16775	.10842	.98108	636	-.18050	.12113	.97523	686	-.01876	.13558	.98216
587	-.18100	.10865	.98097	637	-.16733	.11917	.97355	687	-.03206	.13357	.97971
588	-.19399	.11068	.98254	638	-.16731	.11919	.97354	688	-.04403	.13234	.97722
589	-.20609	.11275	.98352	639	-.14733	.11988	.98005	689	-.05609	.13431	.98115
590	-.21926	.11177	.99113	640	-.13523	.12038	.98328	690	-.06918	.13509	.98387
591	-.23085	.11293	.97977	641	-.12205	.12153	.98579	691	-.08284	.13399	.98332
592	-.24481	.10800	.97216	642	-.10884	.12257	.98729	692	-.09499	.13523	.98315
593	-.25726	.11042	.97323	643	-.09506	.12434	.99097	693	-.10739	.13604	.98314
594	-.26980	.11290	.97427	644	-.08197	.12507	.99295	694	-.12021	.13663	.98310
595	-.28224	.10435	.96029	645	-.06845	.12421	.99146	695	-.13347	.13482	.97934
596	-.29456	.10412	.96018	646	-.05552	.12390	.98965	696	-.14683	.13184	.97361
597	-.30674	.10591	.96173	647	-.04504	.11771	.98163	697	-.14683	.13184	.97361
598	-.31974	.10734	.96393	648	-.03345	.11936	.98380	698	-.16591	.12966	.96471
599	-.33309	.10858	.96472	649	-.01898	.12263	.98733	699	-.18056	.13012	.96510
600	-.34539	.10531	.95922	650	-.00684	.12110	.98552	700	-.19243	.13618	.97170

701	-.20513	.13356	.96750	751	-.15730	.14028	.95969	801	-.04623	.15057	.95899
702	-.21435	.12945	.96762	752	-.14648	.14151	.96553	802	-.05711	.15505	.96550
703	-.22958	.12954	.95682	753	-.13232	.14933	.97654	803	-.06988	.15503	.96725
704	-.24223	.13042	.95814	754	-.12106	.14408	.97289	804	-.08284	.15551	.96861
705	-.25516	.13283	.95934	755	-.10908	.14223	.97080	805	-.09463	.15614	.96925
706	-.26692	.13437	.95832	756	-.09497	.14547	.97561	806	-.10625	.15720	.96715
707	-.27826	.13041	.95049	757	-.08248	.14578	.97718	807	-.11978	.15553	.96488
708	-.27826	.13041	.95049	758	-.06969	.14414	.97528	808	-.13266	.15644	.96490
709	-.28262	.12325	.94125	759	-.05733	.14272	.97207	809	-.14576	.15370	.95946
710	-.29303	.12750	.94631	760	-.04422	.14353	.97079	810	-.15728	.15218	.95418
711	-.30615	.12628	.94465	761	-.03187	.14305	.97108	811	-.16535	.15167	.94994
712	-.31825	.13025	.94951	762	-.01942	.14714	.97623	812	-.17730	.15551	.95488
713	-.33166	.12650	.94437	763	-.00733	.14492	.97376	813	-.19211	.15179	.95066
714	-.34273	.12345	.94041	764	.00616	.14424	.97085	814	-.20414	.15384	.95227
715	-.35491	.12247	.93783	765	.01849	.14235	.96705	815	-.21603	.15286	.94559
716	-.36847	.12264	.93749	766	.02974	.14356	.96820	816	-.22604	.15119	.94388
717	-.38112	.12266	.93562	767	.04223	.14467	.96927	817	-.23491	.15074	.94098
718	-.39183	.12172	.93327	768	.05635	.14692	.96995	818	-.25133	.15282	.94297
719	-.40303	.11616	.92679	769	.06904	.14404	.96490	819	-.26341	.15277	.94014
720	-.41542	.11719	.92324	770	.07919	.14067	.95785	820	-.27495	.14990	.93438
721	-.42752	.11508	.91912	771	.09336	.14403	.95798	821	-.27493	.14991	.93437
722	-.43749	.11032	.91307	772	.10541	.14271	.95210	822	-.28099	.14651	.92835
723	-.46679	.09699	.91706	773	.11571	.14055	.94583	823	-.29264	.14381	.92499
724	-.45179	.10773	.89566	774	.12404	.13899	.93958	824	-.30424	.14824	.93048
725	-.43241	.11186	.89771	775	.13334	.13601	.93054	825	-.31683	.14691	.92907
726	-.43241	.11186	.89771	776	.14610	.13731	.92604	826	-.32906	.14225	.92420
727	-.42430	.11837	.90498	777	.15673	.13578	.91925	827	-.33919	.13899	.92053
728	-.41219	.12057	.91031	778	.16349	.12943	.90709	828	-.35124	.13941	.91870
729	-.39902	.12031	.91403	779	.16715	.12420	.89930	829	-.36477	.13978	.91732
730	-.38978	.12506	.91911	780	.17419	.12069	.88892	830	-.37681	.13743	.91460
731	-.37983	.13100	.92591	781	.17013	.13044	.88098	831	-.38655	.13239	.90981
732	-.36613	.13380	.92952	782	.16216	.13204	.88839	832	-.39522	.12406	.90146
733	-.35306	.13107	.92436	783	.15843	.13888	.89907	833	-.40724	.12682	.89963
734	-.34138	.12846	.92759	784	.15027	.14117	.90604	834	-.42043	.12466	.89405
735	-.33097	.13296	.93206	785	.14073	.14447	.91441	835	-.42044	.12468	.89404
736	-.31834	.13512	.93529	786	.13056	.14717	.92355	836	-.43605	.11129	.89406
737	-.30485	.13710	.93761	787	.11789	.14415	.92700	837	-.44472	.11440	.89740
738	-.29299	.13561	.93587	788	.11157	.14813	.93404	838	-.45222	.11185	.89798
739	-.28204	.13237	.93193	789	.10253	.15244	.94288	839	-.46038	.10843	.88825
740	-.27740	.13237	.93193	790	.09035	.15341	.94877	840	-.40356	.12725	.88445
741	-.26540	.13626	.93900	791	.07653	.14976	.94786	841	-.40356	.12725	.88445
742	-.25377	.13996	.94546	792	.06591	.15276	.95446	842	-.40356	.12725	.88445
743	-.24299	.14296	.95117	793	.05338	.15462	.95931	843	-.39211	.12794	.88985
744	-.23271	.14420	.95395	794	.04210	.15702	.96337	844	-.38422	.13362	.89482
745	-.22248	.14049	.95116	795	.02766	.15235	.95865	845	-.37546	.14194	.90239
746	-.21249	.14180	.95516	796	.01529	.14680	.95173	846	-.36301	.14595	.90656
747	-.20484	.14337	.95930	797	.00542	.15375	.96062	847	-.34091	.14603	.90850
748	-.19257	.14289	.96085	798	-.00811	.15438	.96359	848	-.33777	.14372	.90771
749	-.17840	.14432	.96267	799	-.02078	.15500	.96505	849	-.32406	.14593	.90921
750	-.16705	.13920	.95658	800	-.03442	.15419	.96316	850	-.31651	.15314	.91706

851	-.30346	.15561	.91963	901	.10815	.15692	.90363	951	-.39583	.15152	.83060
852	-.29207	.15446	.91771	902	.10061	.16007	.91097	952	-.40646	.14422	.84426
853	-.28100	.15320	.91597	903	.09184	.16551	.92053	953	-.42153	.13079	.85505
854	-.28100	.15320	.91597	904	.08183	.16633	.92754	954	-.42153	.13079	.85505
855	-.27335	.15515	.92074	905	.07153	.16614	.93038	955	-.42153	.13079	.85505
856	-.26231	.15940	.92800	906	.05955	.16541	.93416	956	-.40744	.13832	.83979
857	-.25009	.16059	.93213	907	.04942	.16896	.94205	957	-.40744	.13832	.83979
858	-.23734	.16055	.93487	908	.03928	.17177	.94667	958	-.39613	.15150	.83044
859	-.22479	.16061	.93579	909	.02609	.17135	.94405	959	-.39613	.15150	.83044
860	-.21625	.16011	.93704	910	.01276	.17066	.94040	960	-.38987	.16506	.89061
861	-.20212	.16638	.94580	911	.00323	.17297	.94437	961	-.38987	.16506	.89061
862	-.18980	.16657	.94766	912	-.00876	.17626	.94941	962	-.38987	.16506	.89061
863	-.17752	.16207	.94292	913	-.02070	.17757	.95136	963	-.36264	.15606	.89666
864	-.16559	.16045	.94034	914	-.03356	.17815	.95259	964	-.34922	.16112	.89861
865	-.15629	.16156	.94557	915	-.04540	.17666	.95089	965	-.34922	.16120	.89855
866	-.14538	.16463	.95246	916	-.05756	.17306	.94893	966	-.34922	.16120	.89855
867	-.13304	.16480	.95474	917	-.06945	.17544	.95311	967	-.29173	.17284	.91213
868	-.11902	.16753	.95812	918	-.08298	.17418	.95137	968	-.29173	.17284	.91213
869	-.10715	.16465	.95569	919	-.09399	.17712	.95354	969	-.29173	.17284	.91213
870	-.09504	.16644	.96015	920	-.10537	.17747	.95205	970	-.26215	.17046	.91694
871	-.08365	.16469	.95873	921	-.11758	.17680	.95042	971	-.24924	.17685	.92527
872	-.06982	.16601	.96001	922	-.13053	.17676	.95130	972	-.23795	.17342	.91997
873	-.05565	.16882	.96152	923	-.14223	.17618	.94698	973	-.22444	.18170	.92725
874	-.04562	.16444	.95446	924	-.15497	.17106	.93800	974	-.21432	.18411	.93289
875	-.03465	.16644	.95719	925	-.16428	.17119	.93506	975	-.20256	.18391	.93772
876	-.02133	.16783	.95958	926	-.17873	.16779	.93172	976	-.19065	.18209	.93625
877	-.00956	.16402	.95472	927	-.19123	.16763	.93053	977	-.17725	.18407	.93626
878	.00358	.16318	.95174	928	-.20197	.17216	.93295	978	-.16415	.18500	.93576
879	.01468	.16188	.94806	929	-.21403	.16798	.92613	979	-.15570	.18424	.93955
880	.02800	.16587	.95330	930	-.22392	.16953	.92611	980	-.14411	.18558	.94636
881	.03934	.16559	.95287	931	-.23511	.17077	.92610	981	-.13181	.18425	.94720
882	.04994	.16120	.94687	932	-.24776	.16750	.92179	982	-.11713	.18879	.95270
883	.06287	.16084	.94381	933	-.25863	.16953	.92101	983	-.10595	.18665	.94977
884	.07453	.16063	.94063	934	-.26993	.17148	.91924	984	-.09527	.18430	.95067
885	.08758	.16390	.94045	935	-.27838	.16634	.91210	985	-.08226	.18752	.95665
886	.10253	.16852	.94156	936	-.29051	.16681	.91276	986	-.06873	.18840	.95525
887	.11172	.16319	.93185	937	-.30228	.16349	.91203	987	-.05636	.18746	.95123
888	.11725	.15547	.91962	938	-.31487	.16156	.90974	988	-.04512	.18524	.94736
889	.12410	.15313	.91229	939	-.32681	.15532	.90225	989	-.03421	.18441	.94912
890	.13540	.15280	.90552	940	-.33643	.14898	.89505	990	-.02151	.18482	.95065
891	.14693	.15336	.90171	941	-.34820	.15020	.89447	991	-.00910	.18378	.94808
892	.15622	.15120	.89461	942	-.36185	.15096	.89481	992	.00332	.18216	.94198
893	.16065	.14268	.88022	943	-.37253	.15194	.89568	993	.01366	.17830	.93722
894	.16461	.13973	.87202	944	-.38143	.14778	.89294	994	.02721	.18286	.94784
895	.16069	.14989	.86400	945	-.38757	.13701	.88390	995	.04018	.18502	.95305
896	.15266	.14765	.86808	946	-.39985	.12610	.87323	996	.05206	.18031	.94557
897	.14492	.14687	.87355	947	-.41155	.12726	.87467	997	.06285	.17872	.93795
898	.13976	.15383	.88657	948	-.42155	.12726	.87467	998	.07870	.18855	.94441
899	.12876	.15540	.89335	949	-.42967	.12662	.86739	999	.16534	.17778	.88891
900	.11759	.15730	.89988	950	-.43573	.09888	.84281	1000	.16411	.17869	.87626



1001	.15794	.16659	.87515	1051	-.27373	.19098	.92148	1101	.06633	.20455	.94307
1002	.15191	.17440	.88011	1052	-.29420	.18350	.91098	1102	.08133	.20600	.94622
1003	.15191	.17440	.88011	1053	-.30782	.17827	.91000	1103	.09414	.20529	.94349
1004	.14979	.17912	.89646	1054	-.32002	.17857	.91143	1104	.11352	.20278	.92461
1005	.14240	.18204	.90706	1055	-.33121	.17925	.90990	1105	.11352	.20278	.92461
1006	.13012	.18062	.91153	1056	-.34201	.17193	.90003	1106	.12176	.19248	.91648
1007	.11676	.18165	.91152	1057	-.35277	.17002	.89247	1107	.13694	.19863	.91887
1008	.15112	.16882	.88226	1058	-.36621	.16571	.89239	1108	.14676	.19630	.91047
1009	.14439	.16873	.89300	1059	-.37841	.16613	.89404	1109	.15184	.19308	.89766
1010	.13259	.17238	.89875	1060	-.38952	.16350	.89023	1110	.15939	.19203	.88693
1011	.12346	.17330	.90720	1061	-.39991	.15545	.87895	1111	.16393	.19106	.87956
1012	.10941	.17964	.90724	1062	-.39593	.15547	.87894	1112	.16546	.20571	.88609
1013	.10433	.18352	.91486	1063	-.39224	.17266	.88279	1113	.16211	.20295	.88586
1014	.09654	.18181	.92864	1064	-.38018	.18001	.89068	1114	.15509	.20512	.89780
1015	.08645	.18208	.93561	1065	-.36846	.18285	.89515	1115	.14813	.20786	.90838
1016	.07166	.18595	.93501	1066	-.34593	.18393	.90022	1116	.13862	.20817	.91656
1017	.06285	.18655	.93778	1067	-.34593	.18393	.90022	1117	.12835	.20917	.92167
1018	.11168	.18884	.92368	1068	-.33567	.18660	.90542	1118	.11390	.20699	.92275
1019	.09963	.18783	.93069	1069	-.32302	.18918	.90956	1119	.10489	.21445	.93149
1020	.08996	.18075	.93952	1070	-.30989	.19307	.91189	1120	.10489	.21445	.93149
1021	.07675	.19038	.94034	1071	-.29745	.19454	.91124	1121	.08214	.21430	.94129
1022	.06417	.19161	.93824	1072	-.28558	.19838	.91134	1122	.06722	.21397	.94246
1023	.05078	.18823	.94213	1073	-.27660	.19874	.91773	1123	.05499	.21537	.94440
1024	.03997	.19320	.94844	1074	-.26527	.20011	.92270	1124	.04367	.21937	.94987
1025	.02802	.19441	.94882	1075	-.25324	.20156	.92472	1125	.03237	.22475	.95415
1026	.01623	.19375	.94097	1076	-.23999	.20485	.92790	1126	.02009	.22323	.94756
1027	.00370	.19340	.94064	1077	-.22742	.20549	.92932	1127	.00800	.22575	.95050
1028	-.00714	.19778	.94941	1078	-.21671	.20787	.93472	1128	-.00545	.22404	.94949
1029	-.02127	.19606	.95037	1079	-.20437	.20731	.93641	1129	-.01897	.22368	.95034
1030	-.03349	.19746	.95067	1080	-.19194	.20624	.93413	1130	-.03154	.22379	.95085
1031	-.04506	.19813	.94787	1081	-.17923	.20682	.93281	1131	-.04363	.22362	.94950
1032	-.05960	.19372	.94229	1082	-.16568	.21141	.93756	1132	-.05705	.22314	.94680
1033	-.06985	.19936	.95293	1083	-.15697	.21088	.94215	1133	-.06730	.22744	.94996
1034	-.08243	.19900	.95524	1084	-.14594	.20962	.94457	1134	-.07926	.22976	.95503
1035	-.09350	.20131	.95607	1085	-.13188	.21164	.94942	1135	-.09293	.22823	.95531
1036	-.10573	.19916	.95143	1086	-.11930	.21041	.94723	1136	-.10648	.22416	.94925
1037	-.11891	.19729	.94657	1087	-.10634	.21326	.95270	1137	-.11834	.22696	.95317
1038	-.13229	.19671	.94801	1088	-.09452	.21317	.95527	1138	-.13163	.22590	.94837
1039	-.14399	.19887	.94722	1089	-.08106	.21450	.95649	1139	-.14528	.22422	.94463
1040	-.15527	.19829	.94303	1090	-.06887	.21163	.95091	1140	-.15639	.22583	.94318
1041	-.16491	.19735	.93570	1091	-.05650	.21468	.95089	1141	-.16477	.22945	.94149
1042	-.17770	.19479	.93307	1092	-.04540	.21115	.94916	1142	-.17827	.22465	.93736
1043	-.19084	.19489	.93641	1093	-.03196	.21508	.95473	1143	-.19149	.22119	.93429
1044	-.20380	.19342	.93548	1094	-.01935	.21250	.95373	1144	-.20484	.21932	.93310
1045	-.21442	.19628	.93601	1095	-.00748	.20865	.94707	1145	-.21557	.22458	.93820
1046	-.22440	.19758	.93341	1096	.00518	.20777	.94454	1146	-.22841	.22095	.93210
1047	-.23754	.19170	.92696	1097	.01698	.20624	.94150	1147	-.24075	.21908	.92975
1048	-.25107	.19042	.92702	1098	.02919	.20794	.95043	1148	-.25324	.21715	.92691
1049	-.26346	.18725	.92212	1099	.04212	.20767	.95230	1149	-.26632	.21636	.92536
1050	-.27373	.19098	.92148	1100	.05380	.20419	.94633	1150	-.27789	.21319	.92016

1151	-.28750	.20790	.91030	1201	.04620	.23477	.95181	1251	-.29135	.23951	.91631
1152	-.20978	.20856	.91321	1202	.05940	.23438	.95136	1252	-.30274	.23693	.91351
1153	-.31147	.20470	.91003	1203	.07136	.23037	.94639	1253	-.31449	.23265	.90837
1154	-.32380	.20497	.91057	1204	.08438	.22880	.94303	1254	-.32672	.23084	.90492
1155	-.33669	.20253	.90715	1205	.09556	.22568	.93607	1255	-.33800	.22808	.89971
1156	-.34791	.20026	.90261	1206	.09556	.22568	.93607	1256	-.34816	.22680	.89509
1157	-.35948	.19462	.89364	1207	.12078	.22577	.93038	1257	-.35942	.22136	.88593
1158	-.37045	.19637	.89318	1208	.13089	.22179	.92283	1258	-.36988	.22030	.88078
1159	-.38187	.19241	.88726	1209	.14186	.22102	.91626	1259	-.37932	.21747	.87499
1160	-.38187	.19241	.88726	1210	.15101	.22049	.90831	1260	-.37932	.21747	.87499
1161	-.38187	.19241	.88726	1211	.15948	.22066	.89960	1261	-.38142	.21836	.87201
1162	-.40786	.15052	.83431	1212	.16692	.22030	.89236	1262	-.36688	.22751	.87039
1163	-.40786	.15052	.83431	1213	.16546	.23081	.89532	1263	-.36688	.22751	.87039
1164	-.38118	.20549	.88206	1214	.16274	.23392	.90063	1264	-.36688	.22751	.87039
1165	-.38118	.20549	.88206	1215	.15122	.22955	.90396	1265	-.35670	.22941	.87601
1166	-.38118	.20549	.88206	1216	.14484	.23462	.91618	1266	-.34620	.23207	.88274
1167	-.37206	.20703	.88674	1217	.13533	.23719	.92489	1267	-.33657	.23502	.89837
1168	-.36146	.20799	.89072	1218	.12093	.23322	.92540	1268	-.32653	.24181	.89754
1169	-.34952	.21070	.89699	1219	.10958	.23800	.93299	1269	-.31552	.24325	.90166
1170	-.33858	.21305	.90216	1220	.09560	.23666	.93306	1270	-.30366	.24821	.90803
1171	-.32625	.21524	.90599	1221	.08672	.24306	.94165	1271	-.29227	.25101	.91224
1172	-.31281	.22083	.91234	1222	.07510	.24727	.94856	1272	-.28101	.24917	.91094
1173	-.30124	.22125	.91262	1223	.05979	.24534	.94775	1273	-.26827	.25314	.91604
1174	-.28995	.22323	.91406	1224	.04850	.24895	.95095	1274	-.25549	.25719	.92148
1175	-.27968	.22577	.91836	1225	.03500	.24754	.94884	1275	-.24343	.25491	.92037
1176	-.26744	.22702	.92121	1226	.02166	.24855	.94904	1276	-.23051	.26002	.92625
1177	-.25516	.22794	.92374	1227	.00808	.24730	.94550	1277	-.21758	.26082	.92865
1178	-.24187	.23254	.92940	1228	-.00286	.25126	.94826	1278	-.20386	.26295	.93097
1179	-.22968	.23484	.93211	1229	-.01615	.25137	.94892	1279	-.19134	.26389	.93144
1180	-.21754	.23244	.93140	1230	-.02897	.25206	.94961	1280	-.18035	.26185	.93038
1181	-.20419	.23487	.93438	1231	-.04165	.25124	.94822	1281	-.16811	.26578	.93554
1182	-.19084	.23805	.93675	1232	-.05501	.25121	.94702	1282	-.15574	.26660	.93869
1183	-.17989	.23675	.93570	1233	-.06732	.25096	.94271	1283	-.14317	.26626	.94056
1184	-.16732	.23588	.93546	1234	-.07843	.25502	.94976	1284	-.12921	.26840	.94472
1185	-.15636	.23991	.94367	1235	-.09127	.25706	.95233	1285	-.11741	.26564	.94342
1186	-.14494	.23707	.94321	1236	-.10412	.25515	.95031	1286	-.10338	.26725	.94573
1187	-.13133	.24037	.94856	1237	-.11740	.25522	.94867	1287	-.09113	.26745	.94574
1188	-.11808	.24113	.95073	1238	-.13034	.25502	.94722	1288	-.07832	.26497	.94356
1189	-.10457	.24305	.95440	1239	-.14311	.25437	.94480	1289	-.06746	.26402	.94157
1190	-.09151	.24357	.95531	1240	-.15596	.25307	.94137	1290	-.05332	.26723	.94761
1191	-.07865	.24233	.95304	1241	-.16717	.25354	.93894	1291	-.03968	.26866	.94997
1192	-.06540	.24410	.95068	1242	-.17915	.25153	.93599	1292	-.02873	.26404	.94640
1193	-.05611	.23765	.94726	1243	-.19147	.24929	.93338	1293	-.01584	.26272	.94419
1194	-.04303	.23836	.94992	1244	-.20389	.24859	.93206	1294	-.00219	.26422	.94511
1195	-.03219	.23492	.94714	1245	-.21719	.24937	.93258	1295	.01049	.26386	.94763
1196	-.02193	.23723	.94977	1246	-.22952	.24901	.93193	1296	.02360	.26316	.94862
1197	-.00385	.23945	.95086	1247	-.24237	.24562	.92741	1297	.03722	.26396	.95093
1198	.00725	.23496	.94721	1248	-.25410	.24516	.92579	1298	.04924	.26183	.94968
1199	.02089	.23698	.94931	1249	-.26683	.24329	.92223	1299	.06363	.26269	.95002
1200	.03300	.23330	.94941	1250	-.28011	.23912	.91747	1300	.07442	.25629	.94383

1301	.08767	.25708	.94242	1351	-.34015	.24383	.87697	1401	.15085	.26915	.91296
1302	.09970	.25394	.93753	1352	-.35079	.24142	.87028	1402	.16170	.26909	.90600
1303	.11101	.24933	.93005	1353	-.36090	.23869	.86416	1403	.16075	.28043	.90760
1304	.12541	.25051	.92867	1354	-.36994	.23252	.85427	1404	.15594	.28616	.91638
1305	.13592	.24707	.92140	1355	-.37838	.19989	.82110	1405	.14417	.28637	.92104
1306	.14671	.24751	.91577	1356	-.37709	.21912	.82095	1406	.13271	.29449	.92730
1307	.15555	.24696	.90889	1357	-.37292	.23361	.83637	1407	.11827	.28970	.92843
1308	.16525	.24329	.89970	1358	-.36454	.23949	.84496	1408	.10663	.29319	.93229
1309	.16276	.25175	.89855	1359	-.35539	.23999	.85082	1409	.09325	.29453	.93462
1310	.15889	.25566	.90633	1360	-.34646	.24339	.85654	1410	.08095	.29864	.93918
1311	.14930	.26036	.91567	1361	-.33531	.24594	.86345	1411	.06896	.30290	.94284
1312	.13953	.26158	.92164	1362	-.32861	.24961	.86854	1412	.05364	.30089	.94045
1313	.12620	.26098	.92569	1363	-.32061	.25920	.87932	1413	.04095	.30140	.93941
1314	.11268	.26165	.92862	1364	-.31209	.26797	.88891	1414	.02796	.30320	.94088
1315	.10000	.26254	.93151	1365	-.30238	.27362	.89598	1415	.01429	.30312	.93958
1316	.08850	.26670	.93710	1366	-.29135	.27818	.90260	1416	.00133	.30395	.93871
1317	.07627	.26924	.94084	1367	-.27955	.27904	.90543	1417	-.01054	.30629	.93975
1318	.06396	.27289	.94434	1368	-.26677	.28204	.91029	1418	-.02459	.30451	.93730
1319	.05103	.27437	.94641	1369	-.25554	.28222	.91204	1419	-.03646	.30659	.93822
1320	.03751	.27385	.94518	1370	-.24313	.28282	.91376	1420	-.05036	.30521	.93540
1321	.02486	.27605	.94654	1371	-.23068	.28258	.91494	1421	-.06352	.30542	.93484
1322	.01028	.27441	.94277	1372	-.21598	.28948	.92297	1422	-.07572	.30808	.93603
1323	-.00285	.27276	.93869	1373	-.20413	.28727	.92185	1423	-.08806	.30598	.93350
1324	-.01434	.27737	.94313	1374	-.19126	.28939	.92453	1424	-.10065	.30599	.93231
1325	-.02591	.28111	.94700	1375	-.17937	.29216	.92861	1425	-.11376	.30679	.93194
1326	-.03924	.27913	.94430	1376	-.16654	.29287	.93100	1426	-.12698	.30574	.92983
1327	-.05279	.27934	.94353	1377	-.15387	.29256	.93200	1427	-.14082	.30310	.92593
1328	-.06634	.27884	.94100	1378	-.14139	.29272	.93399	1428	-.15356	.30339	.92495
1329	-.07900	.27740	.93981	1379	-.12786	.29348	.93520	1429	-.16517	.30655	.92654
1330	-.09060	.27964	.94118	1380	-.11464	.29404	.93738	1430	-.17849	.30688	.92569
1331	-.10216	.28252	.94404	1381	-.10199	.29278	.93724	1431	-.19059	.30399	.92168
1332	-.11528	.28395	.94382	1382	-.08898	.29398	.93893	1432	-.20329	.30079	.91718
1333	-.12908	.27825	.93759	1383	-.07563	.29548	.94030	1433	-.21663	.29894	.91404
1334	-.14194	.28075	.93805	1384	-.06473	.29289	.93976	1434	-.22942	.29878	.91292
1335	-.15549	.27817	.93383	1385	-.05112	.29425	.94155	1435	-.24191	.29683	.90974
1336	-.16819	.27757	.93168	1386	-.03753	.29461	.94359	1436	-.25537	.29199	.90328
1337	-.17894	.27982	.93249	1387	-.02549	.29254	.94227	1437	-.26638	.29369	.90336
1338	-.19079	.27786	.92903	1388	-.01267	.29033	.94086	1438	-.27815	.29451	.90216
1339	-.20403	.27556	.92633	1389	.00019	.29155	.94235	1439	-.28967	.28861	.89445
1340	-.21663	.27654	.92645	1390	.01227	.28900	.94144	1440	-.30024	.28412	.88764
1341	-.23023	.27530	.92489	1391	.02577	.28952	.94376	1441	-.30841	.27630	.87931
1342	-.24252	.27514	.92369	1392	.03996	.28944	.94504	1442	-.31530	.26872	.87099
1343	-.25487	.27111	.91821	1393	.05117	.28540	.94146	1443	-.32134	.26093	.86316
1344	-.26755	.26836	.91372	1394	.06613	.28709	.94344	1444	-.32916	.25353	.85515
1345	-.28047	.26682	.91148	1395	.07878	.28462	.94125	1445	-.33981	.25077	.84796
1346	-.29211	.26530	.90794	1396	.09212	.28305	.93913	1446	-.34855	.24581	.84069
1347	-.30365	.26277	.90410	1397	.10421	.28002	.93441	1447	-.35792	.24621	.83555
1348	-.31415	.25760	.89683	1398	.11711	.27886	.93169	1448	-.36768	.24283	.82738
1349	-.32338	.25407	.89130	1399	.12951	.27412	.92562	1449	-.37359	.24154	.82355
1350	-.33292	.24631	.88127	1400	.14075	.27182	.91948	1450	-.36268	.25063	.81860

1451	-.35264	.25036	.22527	1501	.02654	.32113	.22786	1551	-.25397	.32534	.38015
1452	-.36273	.25322	.33271	1502	.02839	.32557	.23163	1552	-.23952	.32674	.38409
1453	-.36172	.25325	.33265	1503	.02602	.32342	.22703	1553	-.22707	.33222	.39041
1454	-.37370	.25676	.34434	1504	.05776	.32920	.23271	1554	-.21439	.33362	.39315
1455	-.31763	.26527	.35268	1505	.04391	.32525	.23171	1555	-.20767	.33667	.39639
1456	-.31714	.27342	.36070	1506	.02976	.32522	.22940	1556	-.19915	.33504	.39775
1457	-.30459	.28158	.36877	1507	.01654	.32710	.22848	1557	-.17434	.34001	.40100
1458	-.27742	.29159	.37813	1508	.00378	.32656	.22638	1558	-.16250	.33933	.40375
1459	-.22770	.29519	.38308	1509	-.00101	.32507	.22784	1559	-.14977	.34037	.40598
1460	-.27705	.30022	.39041	1510	-.02220	.32514	.22577	1560	-.13710	.33989	.40723
1461	-.26538	.30344	.39505	1511	-.03621	.32668	.22597	1561	-.12328	.34109	.40937
1462	-.25467	.30665	.39982	1512	-.04744	.32775	.22428	1562	-.11384	.34205	.41110
1463	-.24124	.30883	.40320	1513	-.04145	.32753	.22334	1563	-.09983	.33955	.41095
1464	-.22974	.30958	.40616	1514	-.07335	.32990	.22176	1564	-.08542	.33837	.41122
1465	-.21559	.31083	.40849	1515	-.08889	.32864	.21956	1565	-.07719	.34175	.41445
1466	-.21259	.31436	.41289	1516	-.09890	.32725	.21941	1566	-.06952	.34167	.41512
1467	-.19034	.31520	.41497	1517	-.11271	.32732	.21645	1567	-.06423	.34322	.41419
1468	-.17847	.31609	.41572	1518	-.12458	.32703	.21744	1568	-.05415	.34447	.41575
1469	-.16441	.31774	.41978	1519	-.13938	.32705	.21322	1569	-.04251	.34431	.41943
1470	-.15174	.31863	.42246	1520	-.15042	.32718	.21439	1570	-.03713	.34284	.42185
1471	-.13226	.31842	.42321	1521	-.16371	.32711	.21253	1571	-.03327	.33561	.41595
1472	-.12598	.31840	.42446	1522	-.17717	.32729	.21224	1572	-.03112	.33813	.41986
1473	-.11308	.31579	.42333	1523	-.18386	.32340	.20510	1573	-.03368	.33573	.41980
1474	-.10027	.31741	.42261	1524	-.20154	.32662	.20573	1574	-.04362	.33592	.42075
1475	-.09763	.31796	.42755	1525	-.21443	.32357	.20251	1575	-.05752	.33717	.42316
1476	-.07464	.31783	.42842	1526	-.22702	.32265	.20094	1576	-.07205	.33906	.42432
1477	-.06154	.31915	.43046	1527	-.23381	.32357	.20133	1577	-.08220	.33239	.42000
1478	-.04872	.31905	.43016	1528	-.25347	.32227	.20035	1578	-.09527	.33024	.41853
1479	-.03652	.31507	.42322	1529	-.26391	.32075	.20073	1579	-.11125	.33393	.42260
1480	-.02193	.32026	.43452	1530	-.27520	.32012	.20070	1580	-.12464	.33149	.42138
1481	-.01074	.31573	.43278	1531	-.28485	.32561	.20455	1581	-.13838	.33315	.42097
1482	.00284	.31650	.43411	1532	-.29322	.32283	.20281	1582	-.15073	.32791	.41732
1483	.01570	.31573	.43477	1533	-.29975	.32388	.20304	1583	-.15632	.32731	.41603
1484	.02918	.31531	.43587	1534	-.30595	.32325	.20351	1584	-.15469	.34096	.41520
1485	.04301	.31547	.43664	1535	-.31671	.26426	.20345	1585	-.13962	.34297	.41628
1486	.05510	.31326	.43581	1536	-.31671	.26426	.20345	1586	-.12493	.34110	.41370
1487	.06841	.31154	.43455	1537	-.32442	.26731	.20386	1587	-.11217	.34300	.41504
1488	.08133	.30934	.43310	1538	-.32442	.26731	.20386	1588	-.10390	.34883	.41872
1489	.09530	.30852	.43230	1539	-.33337	.26605	.20215	1589	-.09253	.34545	.41435
1490	.10824	.30692	.43132	1540	-.34479	.26681	.20156	1590	-.07256	.34722	.41600
1491	.12124	.30512	.42980	1541	-.34561	.26764	.20150	1591	-.05880	.34763	.41489
1492	.13478	.30337	.42813	1542	-.32739	.26592	.20140	1592	-.04692	.34987	.41607
1493	.14830	.30273	.42824	1543	-.31182	.26643	.201325	1593	-.03248	.34725	.41211
1494	.15967	.30087	.42729	1544	-.31782	.26643	.201325	1594	-.01927	.34978	.41333
1495	.16251	.29953	.42639	1545	-.31782	.26643	.201325	1595	-.00726	.35241	.41416
1496	.15372	.31647	.42536	1546	-.29222	.30187	.20187	1596	-.00617	.35137	.41187
1497	.14707	.31019	.42151	1547	-.29222	.30187	.20187	1597	-.01091	.34917	.40952
1498	.13656	.31585	.42351	1548	-.28232	.31017	.20198	1598	-.03099	.35360	.41101
1499	.12251	.31647	.42456	1549	-.27215	.31823	.20181	1599	-.04425	.35288	.40914
1500	.10939	.31906	.42637	1550	-.26221	.31798	.20260	1600	-.05880	.35055	.40553

1601	-.07199	.34846	.90317	1651	.02136	.36161	.90580	1701	-.29099	.31741	.79980
1602	-.08314	.35319	.90572	1652	.03442	.36039	.90633	1702	-.28161	.32416	.80533
1603	-.09581	.35313	.90457	1653	.04832	.36088	.90800	1703	-.27282	.32998	.81276
1604	-.11000	.34975	.90090	1654	.06082	.35890	.90756	1704	-.26162	.33399	.82012
1605	-.12320	.34897	.89852	1655	.07332	.35719	.90723	1705	-.25231	.33651	.82570
1606	-.13595	.35149	.89937	1656	.08564	.35498	.90596	1706	-.25231	.33651	.82570
1607	-.14777	.35225	.89928	1657	.10088	.35787	.90992	1707	-.23576	.35265	.83928
1608	-.16087	.35042	.89614	1658	.11392	.35520	.90888	1708	-.22793	.36231	.84673
1609	-.17460	.35069	.89473	1659	.12758	.35744	.91131	1709	-.22001	.36607	.84982
1610	-.18696	.34754	.89061	1660	.14123	.35619	.91138	1710	-.20861	.37095	.85435
1611	-.20062	.34313	.88538	1661	.14910	.35526	.91013	1711	-.19621	.37355	.85843
1612	-.21339	.34286	.88331	1662	.14396	.36170	.89948	1712	-.18432	.37312	.85972
1613	-.22530	.34178	.88076	1663	.13953	.36044	.89812	1713	-.17121	.37548	.86359
1614	-.23752	.33718	.87556	1664	.12936	.36598	.90199	1714	-.15794	.37677	.86573
1615	-.24737	.33793	.87418	1665	.11475	.36537	.90027	1715	-.14375	.38175	.87086
1616	-.25721	.33118	.86723	1666	.10276	.36696	.90055	1716	-.13111	.38000	.87082
1617	-.26830	.32498	.85997	1667	.09333	.36728	.89933	1717	-.11827	.38037	.87229
1618	-.27830	.31961	.85378	1668	.07573	.36666	.89796	1718	-.10488	.38180	.87440
1619	-.28738	.31497	.84840	1669	.06226	.36807	.89790	1719	-.09237	.37944	.87356
1620	-.29423	.30406	.83833	1670	.05015	.36992	.89835	1720	-.08017	.37693	.87261
1621	-.29406	.30414	.83821	1671	.03479	.37103	.89799	1721	-.06732	.37899	.87539
1622	-.30424	.27945	.81646	1672	.02172	.36767	.89383	1722	-.05426	.38052	.87827
1623	-.30355	.27819	.80083	1673	.01018	.37205	.89655	1723	-.04039	.38129	.88026
1624	-.29019	.31138	.82865	1674	-.00395	.36920	.89281	1724	-.02764	.38116	.88197
1625	-.29019	.31138	.82865	1675	-.01556	.37206	.89331	1725	-.01551	.38014	.88181
1626	-.28353	.31747	.83466	1676	-.02940	.36976	.89049	1726	-.00169	.37932	.88281
1627	-.27440	.32152	.83951	1677	-.04273	.37010	.88912	1727	.01126	.38036	.88525
1628	-.26389	.32952	.84814	1678	-.05453	.37559	.89263	1728	.02454	.38071	.88718
1629	-.25295	.33445	.85423	1679	-.06883	.36810	.88480	1729	.03775	.38065	.88843
1630	-.24470	.33977	.85953	1680	-.08022	.37390	.88923	1730	.05072	.37814	.88724
1631	-.23478	.34733	.86678	1681	-.09366	.37252	.88601	1731	.06513	.38203	.89260
1632	-.22351	.35254	.87235	1682	-.10735	.37070	.88359	1732	.07766	.37555	.89155
1633	-.21190	.35421	.87578	1683	-.11968	.36946	.88137	1733	.08978	.37814	.89108
1634	-.19846	.35829	.88033	1684	-.13384	.36807	.87842	1734	.10266	.37549	.89013
1635	-.18522	.36164	.88502	1685	-.14643	.36906	.87811	1735	.11674	.37764	.89317
1636	-.17345	.35941	.88426	1686	-.15916	.37049	.87786	1736	.13058	.37785	.89446
1637	-.16102	.35674	.88407	1687	-.17141	.36863	.87517	1737	.14121	.37554	.89371
1638	-.14758	.35950	.88762	1688	-.18448	.36679	.87178	1738	.15176	.37889	.89582
1639	-.13445	.36049	.89015	1689	-.19705	.36544	.86923	1739	.13122	.38532	.88320
1640	-.12003	.36393	.89469	1690	-.21003	.36394	.86629	1740	.11865	.38585	.88239
1641	-.10890	.35939	.89134	1691	-.22198	.36011	.86124	1741	.10552	.38778	.88230
1642	-.09574	.36028	.89365	1692	-.23111	.35615	.85763	1742	.09215	.38779	.88181
1643	-.08242	.36310	.89738	1693	-.24050	.34809	.85038	1743	.07967	.38931	.88230
1644	-.06918	.36283	.89900	1694	-.24729	.34002	.84364	1744	.06713	.38991	.88143
1645	-.05745	.36014	.89732	1695	-.25775	.33298	.83589	1745	.05284	.38745	.87835
1646	-.04390	.36103	.89859	1696	-.26823	.32813	.83044	1746	.03935	.38526	.87515
1647	-.03143	.35992	.89912	1697	-.27793	.32712	.82677	1747	.02614	.38854	.87652
1648	-.01785	.36215	.90007	1698	-.28590	.32172	.82046	1748	.01310	.38784	.87521
1649	-.00483	.36095	.90291	1699	-.29147	.31413	.81411	1749	-.00058	.38776	.87320
1650	.00884	.36226	.90529	1700	-.29813	.30236	.80423	1750	-.01359	.38681	.87110

1751	-.72492	.39062	.87209	1901	.05713	.37559	.96918	1851	-.05841	.41018	.82981
1752	-.03949	.39887	.86951	1902	.08129	.39559	.96970	1852	-.04497	.40748	.82920
1753	-.05171	.39960	.86951	1903	.09307	.39411	.86974	1853	-.07305	.40877	.83161
1754	-.06533	.39762	.86645	1904	.10634	.39375	.87055	1854	-.05990	.40997	.83362
1755	-.07909	.39703	.86403	1905	.12011	.39510	.87336	1855	-.04706	.40980	.83525
1756	-.09270	.39772	.86401	1906	.13231	.39247	.87257	1856	-.03359	.40867	.83653
1757	-.10347	.39017	.86414	1907	.12993	.40259	.86610	1857	-.02175	.40796	.83753
1758	-.11638	.39884	.86216	1908	.12242	.40149	.86229	1858	-.00874	.40760	.83803
1759	-.12756	.39859	.86103	1909	.10919	.40141	.86077	1859	.00412	.40624	.83888
1760	-.14277	.39629	.85759	1910	.09616	.40279	.86006	1860	.01681	.40632	.84003
1761	-.15474	.39877	.85933	1911	.08230	.40160	.85793	1861	.03106	.40839	.84298
1762	-.16876	.39609	.85450	1912	.06934	.40120	.85713	1862	.04354	.40578	.84193
1763	-.18123	.39509	.85225	1913	.05595	.39983	.85501	1863	.05709	.40594	.84362
1764	-.19397	.39132	.84791	1914	.04261	.40135	.85455	1864	.06922	.40332	.84267
1765	-.20646	.39018	.84556	1915	.02921	.40133	.85323	1865	.08299	.40367	.84371
1766	-.21726	.37545	.84140	1916	.01588	.40000	.85395	1866	.09656	.40588	.84673
1767	-.22173	.37535	.84146	1917	.00224	.39962	.84914	1867	.11110	.40516	.84776
1768	-.24646	.33711	.81310	1918	-.01076	.40063	.84937	1868	.12241	.40225	.84712
1769	-.24646	.33711	.81310	1919	-.02262	.40223	.84912	1869	.10036	.40748	.83590
1770	-.25577	.33667	.80951	1920	-.03611	.40099	.84614	1870	.11091	.40658	.83378
1771	-.26616	.33351	.80209	1921	-.04930	.40397	.84671	1871	.09952	.40887	.83426
1772	-.27401	.33012	.79527	1922	-.06144	.40360	.84491	1872	.08438	.40795	.83170
1773	-.26039	.33908	.79351	1923	-.07327	.40555	.84558	1873	.07035	.40532	.82891
1774	-.24900	.33858	.79737	1924	-.08656	.40902	.84402	1874	.05967	.41111	.83184
1775	-.24890	.33859	.79797	1925	-.09944	.40662	.84355	1875	.04632	.41052	.82989
1776	-.21505	.37850	.82429	1926	-.11283	.40288	.84378	1876	.03341	.41338	.83074
1777	-.25372	.34259	.79426	1927	-.12525	.40540	.84079	1877	.02185	.41044	.82704
1778	-.21505	.37850	.82429	1928	-.13841	.40199	.83639	1878	.00533	.40908	.82454
1779	-.21505	.37850	.82429	1929	-.15126	.40068	.83452	1879	-.00690	.41183	.82529
1780	-.20374	.38452	.83239	1930	-.16440	.39874	.83230	1880	-.02051	.41096	.82308
1781	-.19102	.38915	.83816	1931	-.17534	.39927	.83002	1881	-.03200	.41361	.82373
1782	-.17919	.39045	.84056	1932	-.18837	.39342	.82538	1882	-.04511	.41462	.82283
1783	-.16642	.39259	.84336	1933	-.20089	.39118	.82174	1883	-.05799	.41561	.82223
1784	-.15364	.39408	.84576	1934	-.21266	.38340	.81616	1884	-.07105	.41477	.82024
1785	-.14099	.39363	.84691	1935	-.22072	.37147	.80773	1885	-.08383	.41534	.81899
1786	-.12964	.39477	.84977	1936	-.22072	.37147	.80773	1886	-.09649	.41629	.81880
1787	-.11473	.37558	.85021	1937	-.22072	.37147	.80773	1887	-.10924	.41603	.81723
1788	-.10239	.39620	.85191	1938	-.24110	.33808	.78576	1888	-.12351	.41263	.81355
1789	-.09347	.39511	.85225	1939	-.23150	.35544	.78364	1889	-.13534	.41152	.81329
1790	-.07595	.39702	.85529	1940	-.21865	.37900	.79701	1890	-.14701	.40883	.81174
1791	-.06268	.39863	.85932	1941	-.20909	.39080	.80659	1891	-.15919	.40411	.80754
1792	-.05094	.39620	.85711	1942	-.19912	.38749	.80255	1892	-.16916	.40131	.80575
1793	-.03767	.39426	.85474	1943	-.18624	.39484	.81108	1893	-.18148	.40182	.80328
1794	-.02515	.39459	.85873	1944	-.17283	.39680	.81632	1894	-.19472	.39863	.79790
1795	-.01219	.39463	.86221	1945	-.16182	.40144	.81955	1895	-.20773	.39241	.79199
1796	.00065	.39344	.86701	1946	-.14907	.40206	.82055	1896	-.21646	.38685	.78755
1797	.01333	.39285	.86144	1947	-.13926	.40430	.82276	1897	-.22404	.37631	.78071
1798	.02672	.39357	.86295	1948	-.12574	.40749	.82536	1898	-.22903	.37053	.77785
1799	.03097	.39387	.86495	1949	-.11141	.40861	.82749	1899	-.22443	.36883	.77177
1800	.03591	.39318	.86541					1900	-.21559	.36929	.77288

1901	-.20356	.39779	.77992	1951	-.17400	.30803	.77293	2001	-.13737	.41348	.75593
1902	-.19143	.39936	.78257	1952	-.18812	.39814	.77899	2002	-.15500	.39667	.75021
1903	-.17879	.39933	.78672	1953	-.20746	.39708	.76481	2003	-.16644	.40282	.75212
1904	-.16636	.40140	.79158	1954	-.21146	.40029	.76482	2004	-.18251	.39771	.74126
1905	-.15597	.40608	.79412	1955	-.19819	.40248	.75380	2005	-.16710	.39948	.73599
1906	-.14497	.40895	.79589	1956	-.18550	.39775	.75474	2006	-.16411	.39801	.73552
1907	-.13293	.41617	.80051	1957	-.17102	.40077	.76077	2007	-.15339	.39476	.73725
1908	-.12203	.41751	.80079	1958	-.16074	.39918	.76426	2008	-.15339	.39406	.73725
1909	-.10758	.42174	.80393	1959	-.14955	.40504	.76722	2009	-.13685	.41089	.74466
1910	-.09463	.42205	.80566	1960	-.14105	.40705	.76609	2010	-.12551	.42083	.74560
1911	-.08147	.42231	.80735	1961	-.12872	.42167	.77446	2011	-.11468	.42990	.74976
1912	-.06918	.41954	.80630	1962	-.11831	.42604	.77565	2012	-.10385	.43517	.75312
1913	-.05572	.42140	.80961	1963	-.10441	.43031	.77910	2013	-.09291	.43711	.75519
1914	-.04276	.42106	.81097	1964	-.09111	.43203	.78169	2014	-.08395	.43464	.75476
1915	-.02984	.42038	.81230	1965	-.07761	.43355	.78420	2015	-.06221	.43526	.75758
1916	-.01702	.41780	.81147	1966	-.06593	.42901	.78252	2016	-.04837	.43533	.75993
1917	-.00552	.41475	.81003	1967	-.05305	.42608	.78174	2017	-.03575	.43222	.75975
1918	.00918	.41661	.81395	1968	-.04052	.42793	.78529	2018	-.02334	.42869	.75964
1919	.02040	.41602	.81507	1969	-.02734	.42386	.78429	2019	-.01115	.42697	.76031
1920	.03463	.41705	.81733	1970	-.01637	.41894	.78251	2020	-.00009	.42371	.75931
1921	.04848	.41717	.81717	1971	.00306	.41886	.78391	2021	.01332	.42399	.76086
1922	.06145	.41592	.82039	1972	.01647	.42120	.78696	2022	.02503	.42032	.76106
1923	.07393	.41354	.81922	1973	.02238	.42035	.78842	2023	.03847	.41015	.76262
1924	.08685	.41336	.82091	1974	.03274	.42108	.79085	2024	.05181	.41691	.76353
1925	.10040	.41319	.82245	1975	.04511	.42213	.79184	2025	.06623	.41314	.76352
1926	.11126	.40679	.81964	1976	.06457	.42066	.79443	2026	.07622	.41052	.76425
1927	.11483	.40653	.82001	1977	.07619	.41463	.79278	2027	.08936	.40540	.76385
1928	.11124	.40607	.80699	1978	.08924	.41407	.79417	2028	.09557	.40403	.76410
1929	.10076	.41015	.80609	1979	.09915	.40521	.79070	2029	-.07337	.41241	.73217
1930	.08925	.41499	.80758	1980	.10352	.40437	.79327	2030	-.12347	.42205	.73256
1931	.07520	.41391	.80490	1981	.09709	.39720	.77325	2031	-.12342	.42205	.73256
1932	.06288	.41584	.80471	1982	.08752	.40603	.77483	2032	-.11273	.43045	.73522
1933	.04992	.41920	.80546	1983	.07540	.41126	.77645	2033	-.09953	.43445	.73788
1934	.03456	.41892	.80403	1984	.06623	.41490	.77640	2034	-.08639	.43875	.74225
1935	.02412	.42188	.80470	1985	.05193	.41816	.77702	2035	-.07381	.43673	.74207
1936	.01049	.42173	.80270	1986	.03877	.42150	.77738	2036	-.05857	.43879	.74547
1937	-.00274	.41969	.79963	1987	.02421	.42045	.77489	2037	-.04579	.43775	.74638
1938	-.01692	.41789	.79643	1988	.01106	.41942	.77155	2038	-.03408	.43303	.74573
1939	-.02735	.42403	.79914	1989	-.00112	.42231	.77217	2039	-.02194	.42831	.74511
1940	-.04055	.42506	.79917	1990	-.01337	.42538	.77262	2040	-.01543	.42536	.74549
1941	-.05411	.42516	.79699	1991	-.02576	.42472	.77046	2041	.00020	.42170	.74422
1942	-.06606	.42495	.79514	1992	-.03693	.43182	.77374	2042	.01217	.41915	.74350
1943	-.08039	.42381	.79267	1993	-.04931	.43330	.77222	2043	.02635	.42120	.74867
1944	-.09232	.42900	.79540	1994	-.06324	.43351	.77044	2044	.03925	.41783	.74937
1945	-.10516	.42789	.79312	1995	-.07671	.43556	.77335	2045	.05131	.41292	.74739
1946	-.11980	.42155	.78797	1996	-.08784	.43927	.77175	2046	.06350	.40672	.74531
1947	-.12961	.42244	.78971	1997	-.10161	.43621	.76980	2047	.07353	.40002	.74404
1948	-.14152	.41261	.78452	1998	-.11587	.42965	.76393	2048	.08627	.39606	.74423
1949	-.15346	.40513	.78735	1999	-.12490	.42124	.75995	2049	.09752	.39576	.74418
1950	-.16244	.40370	.77910	2000	-.13737	.41348	.75683	2050	.08368	.39051	.73146

2051	.07220	.39228	.72707	2101	-.06872	.43862	.70260	2151	.03628	.38323	.64803
2052	.06294	.40294	.73155	2102	-.08167	.43757	.70033	2152	.02773	.39541	.65120
2053	.05071	.40832	.73224	2103	-.09374	.44058	.70047	2153	.01926	.40548	.65486
2054	.03870	.41266	.73150	2104	-.10832	.43550	.69634	2154	.01115	.41415	.65738
2055	.02635	.41655	.73190	2105	-.12003	.43543	.69760	2155	-.00184	.41560	.65586
2056	.01319	.41856	.73065	2106	-.10684	.43532	.69197	2156	-.01425	.41673	.65178
2057	.00168	.42147	.73106	2107	-.09156	.44224	.68815	2157	-.02653	.42143	.65079
2058	-.00734	.42796	.73314	2108	-.07960	.43826	.68765	2158	-.02749	.41936	.64961
2059	-.01094	.42999	.73268	2109	-.06833	.43484	.68715	2159	-.05099	.42578	.65055
2060	-.03162	.43619	.73443	2110	-.05528	.43445	.68844	2160	-.05598	.42728	.65114
2061	-.04558	.43584	.73158	2111	-.04221	.43226	.68916	2161	-.04759	.42182	.63663
2062	-.05818	.43809	.73029	2112	-.02865	.43164	.69211	2162	-.03562	.42213	.64093
2063	-.07202	.43684	.72760	2113	-.01520	.42994	.69544	2163	-.03562	.42213	.64093
2064	-.08342	.44241	.72948	2114	-.00168	.43005	.69811	2164	-.01383	.41297	.63898
2065	-.09685	.43985	.72693	2115	.00030	.42054	.69637	2165	-.00237	.40828	.64017
2066	-.11034	.43438	.72417	2116	.01670	.41449	.69305	2166	.00931	.40666	.64213
2067	-.12194	.42722	.72065	2117	.02576	.40333	.68761	2167	.02041	.40172	.64364
2068	-.13237	.41643	.71679	2118	.03716	.39709	.68713	2168	.02852	.39263	.64020
2069	-.13930	.40593	.71166	2119	.04863	.39150	.68666	2169	.03883	.38385	.63921
2070	-.13517	.41494	.70075	2120	.05954	.38272	.68461	2170	.04788	.37336	.63509
2071	-.12206	.42841	.70685	2121	.06803	.38838	.69055	2171	.04393	.37576	.62487
2072	-.10945	.43765	.71188	2122	.06274	.38435	.67594	2172	.03991	.37969	.62609
2073	-.09641	.43919	.71247	2123	.04919	.38949	.67551	2173	.02708	.38358	.62543
2074	-.08251	.44207	.71514	2124	.03786	.39505	.67593	2174	.02012	.39525	.63041
2075	-.06890	.44240	.71735	2125	.02760	.40253	.67618	2175	.01109	.40491	.63175
2076	-.05664	.43930	.71691	2126	.01681	.40925	.67759	2176	-.00133	.40445	.62693
2077	-.04405	.43522	.71695	2127	.01010	.42210	.68518	2177	-.01291	.40908	.62580
2078	-.03044	.43551	.72019	2128	-.00229	.42446	.68259	2178	-.01291	.40908	.62580
2079	-.01844	.43062	.71949	2129	-.01635	.42361	.67867	2179	-.02403	.41108	.62661
2080	-.00511	.43092	.72281	2130	-.02809	.42616	.67662	2180	-.03058	.41535	.62599
2081	.00679	.42643	.72322	2131	-.04058	.43093	.67630	2181	-.01391	.42010	.62271
2082	.01489	.41852	.71834	2132	-.05262	.43595	.67897	2182	-.00034	.40254	.61768
2083	.02576	.41084	.71566	2133	-.06700	.43177	.67601	2183	-.00034	.40254	.61768
2084	.03658	.40564	.71429	2134	-.07794	.43691	.67610	2184	.00981	.39751	.61779
2085	.05010	.40385	.71649	2135	-.08981	.43889	.67466	2185	.01933	.39009	.61792
2086	.06023	.39319	.71355	2136	-.07535	.43470	.66428	2186	.02797	.38010	.61402
2087	.07111	.38643	.71135	2137	-.06461	.43130	.66483	2187	.04036	.37643	.61410
2088	.07544	.38517	.71135	2138	-.05206	.42845	.66350	2188	.03699	.37418	.60316
2089	.06750	.37617	.69354	2139	-.03982	.42713	.66150	2189	.02768	.37365	.60075
2090	.06014	.38894	.69022	2140	-.02824	.42298	.66218	2190	.01900	.38291	.60313
2091	.04915	.39694	.70117	2141	-.01397	.42336	.66633	2191	-.00748	.38516	.60047
2092	.03749	.40225	.70135	2142	-.00243	.42039	.66872	2192	-.00104	.39410	.60342
2093	.02635	.40776	.70121	2143	.01075	.41906	.67137	2193	-.00740	.40118	.60217
2094	.01691	.41719	.70564	2144	.01842	.40886	.66683	2194	.00547	.39931	.59770
2095	.00502	.41915	.70700	2145	.02622	.39569	.66308	2195	.00908	.38669	.59369
2096	-.00389	.42707	.70766	2146	.03807	.39078	.66219	2196	.01866	.37842	.59189
2097	-.01618	.43100	.70738	2147	.04906	.38424	.66157	2197	.02954	.37467	.59241
2098	-.02822	.43640	.70825	2148	.05494	.37534	.65947	2198	.03206	.37420	.59218
2099	-.04158	.43722	.70593	2149	.05271	.37551	.64771	2199	.02906	.37629	.58393
2100	-.05611	.43646	.70250	2150	.04892	.37922	.64891	2200	.02064	.37865	.58291
								2201	.02071	.37880	.58302



## REFERENCES

1. Rogallo, F. M.: Flexible Wings. *Astronautics and Aeronautics*, vol. 16, no. 8, Aug. 1968, pp. 50-54.
2. Sleeman, W. C., Jr. and Gainer, T. G.: Status of Research on Parawing Lifting Decelerators. AIAA Paper No. 68-967, presented at AIAA 2nd Aerodynamic Decelerator Systems Conference, El Centro, Calif., Sept. 22-25, 1968.
3. Naeseth, R. L.: Recent Flexible-Wing Research, NASA Langley Research Center. Presented at the course on Aerodynamic Deceleration at the Center for Continuation Study, University of Minnesota, Minneapolis, Minnesota, July 17, 1969.
4. Nielsen, J. N.: *Missile Aerodynamics*. McGraw-Hill Book Co., New York, N. Y., 1960.
5. Jones, R. T. and Cohen, D.: *High Speed Wing Theory*. Princeton University Press, 1960.
6. Polhamus, E. D.: A Concept of the Vortex Lift of Sharp-Edge Delta Wings Based on a Leading-Edge-Suction Analogy. NASA TN D-3767, Dec. 1966.
7. Naeseth, R. L. and Fournier, P. G.: Low-Speed Wind Tunnel Investigation of Tension Structure Parawings. NASA TN D-3940, June 1967.
8. Ware, G. M.: Wind-Tunnel Investigation of the Aerodynamic Characteristics of a Twin-Keel Parawing. NASA TN D-5199, May 1969.
9. Lamar, J. E.: A Modified Multhopp Approach for Predicting Lifting Pressures and Camber Shape for Composite Planforms in Subsonic Flow. NASA TN D-4427, July 1968.
10. Ashley, H. and Landahl, M.: *Aerodynamics of Wings and Bodies*. Addison-Wesley, Reading, Mass., 1965.
11. Gradshteyn, I. S. and Ryzhik, I. M.: *Table of Integrals, Series, and Products*. Fourth Edition, Academic Press, New York and London, 1965.

TABLE I  
 PROPERTIES OF THE CIRCULAR-ARC FITS  
 TO THE SINGLE-KEEL PARAWING

x (in.)	$x/c_r$	e (in.)	f (in.)	r (in.)	s (in.)
2	0.052	0.60	5.40	8.60	7.98
4	.103	.50	6.50	9.50	9.01
6	.154	1.65	7.60	13.30	12.02
8	.206	3.05	8.60	15.50	13.88
10	.256	4.50	9.50	16.50	14.94
12	.308	5.95	10.30	17.80	16.14
14	.360	7.40	11.00	19.10	17.30
16	.411	8.80	11.60	20.60	18.53
18	.462	10.30	12.10	22.40	19.89
20	.514	11.85	12.50	24.20	21.18
22	.575	13.45	12.85	25.60	22.20
24	.616	15.15	13.15	26.00	22.60
26	.668	16.90	13.40	26.00	22.74
28	.720	18.70	13.50	26.20	22.92
30	.771	20.50	13.50	27.00	23.38
32	.822	22.00	13.50	27.00	23.38
34	.874	23.75	13.50	27.00	23.38
36	.925	25.00	10.00	18.00	16.12
38	.977	27.00	6.00	17.00	12.96

TABLE II  
 PROPERTIES OF THE CIRCULAR-ARC FITS  
 TO THE TWIN-KEEL PARAWING

$x$ (in.)	$x/c_r$	$e$ (in.)	$f$ (in.)	$r$ (in.)	$s$ (in.)
2	0.039	-0.9	4.0	11.4	8.67
4	.078	.1	9.6	13.6	13.00
6	.117	1.1	10.5	18.0	16.36
8	.156	2.1	11.2	23.7	20.14
10	.194	3.2	11.9	25.5	21.57
12	.234	4.2	12.5	28.5	23.58
14	.272	5.2	13.1	31.2	25.41
16	.312	6.2	13.8	33.4	27.04
18	.350	7.3	14.5	34.3	28.01
20	.389	8.3	15.4	35.5	29.26
22	.429	9.3	16.5	35.9	30.21
24	.466	10.3	18.4	36.0	31.40
26	.505	11.3	21.4	36.0	32.91
28	.545	12.3	24.0	36.0	33.94
30	.585	13.4	25.4	36.1	34.48
32	.622	14.6	25.6	36.3	34.69
34	.662	15.8	23.7	36.9	34.46
36	.700	17.1	20.4	37.7	33.50
38	.740	18.4	18.5	38.8	33.07
40	.780	19.9	17.0	40.0	32.73
42	.818	21.4	16.1	41.4	32.77
44	.856	23.2	15.4	43.0	32.97
46	.895	24.9	10.0	24.5	19.75
48	.934	26.7	5.8	12.0	10.27
50	.973	28.5	2.2	4.5	3.87

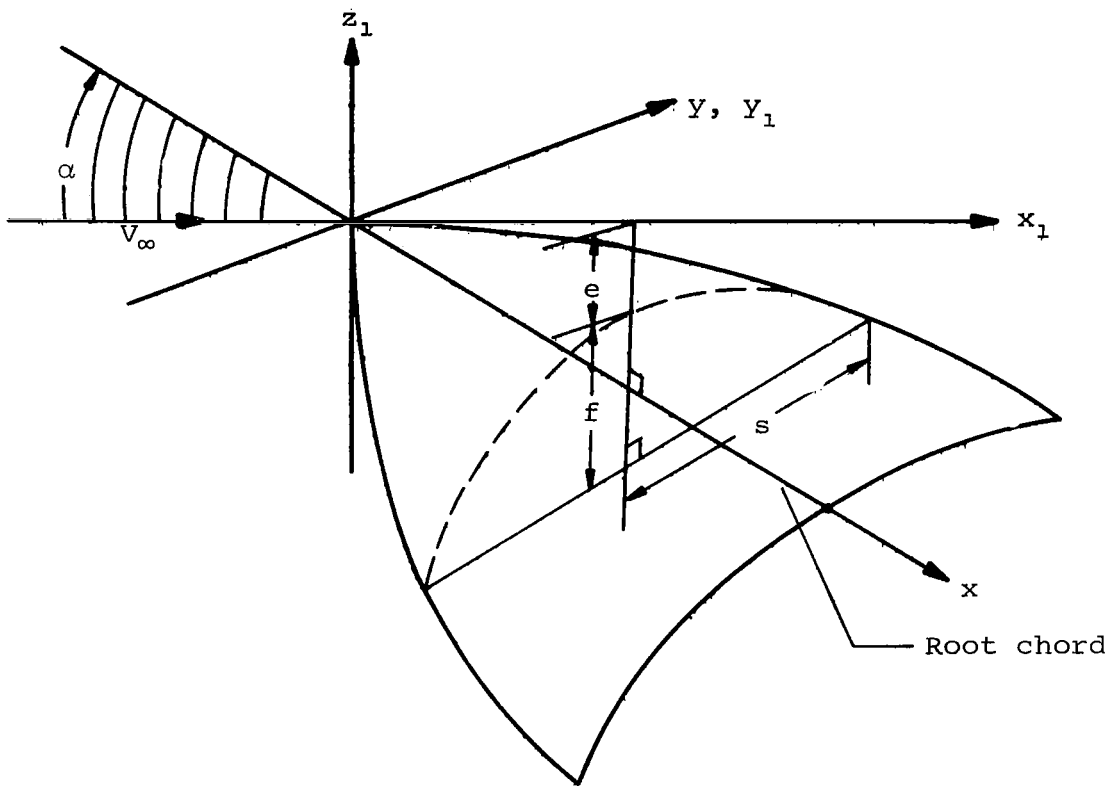
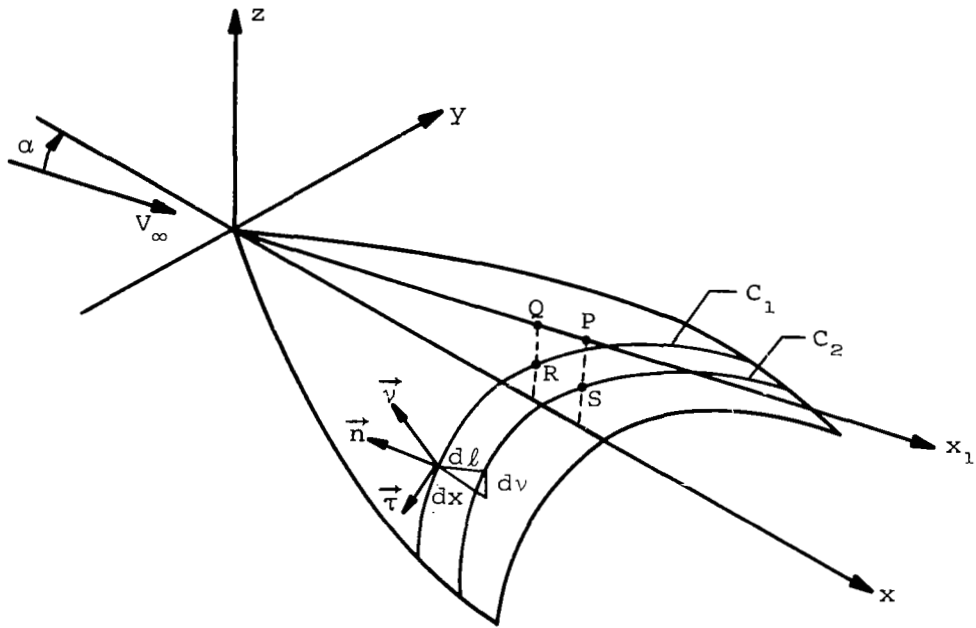
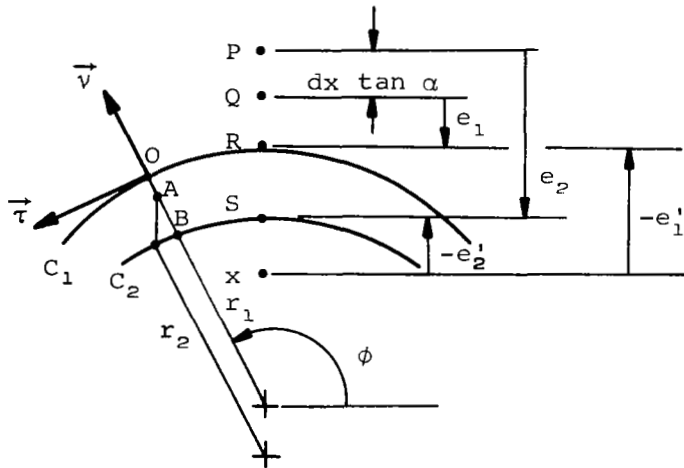

Figure 1.- Axes and crossflow plane used in theory.



(a) Boundary condition for stationary parawing.



(b) Boundary condition in fixed crossflow plane through which parawing is moving.

Figure 2.- Boundary conditions for all-flexible slender parawing.

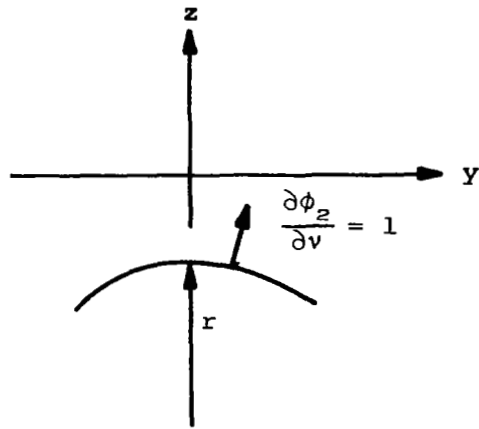

(a)  $\phi_2$  boundary condition for an expanding circular arc.

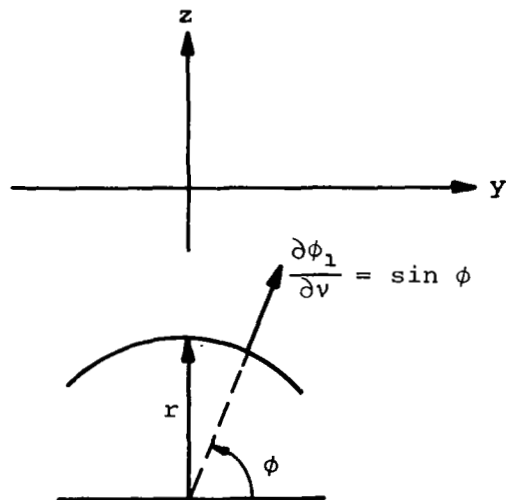

(b)  $\phi_1$  boundary condition for a translating circular arc.

Figure 3.- Unit potential solutions arising in all-flexible slender parawing theory.

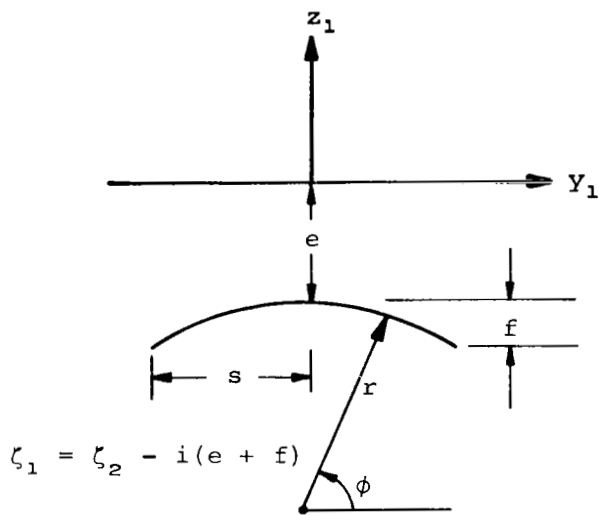

(a)  $\zeta_1$  plane.

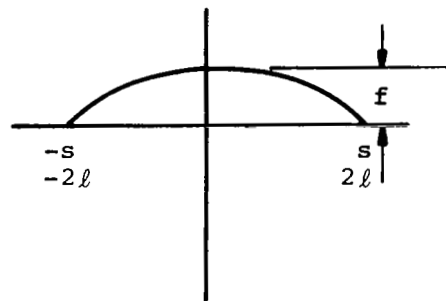

$$\zeta_2 = \zeta_3 + \frac{l^2}{\zeta_3}$$

(b)  $\zeta_2$  plane.

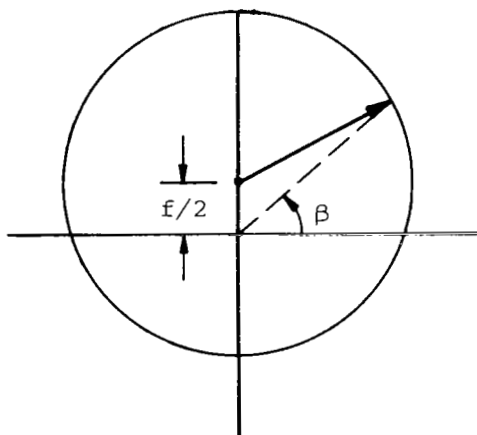

$$\zeta_3 = \zeta_4 + \frac{if}{2}$$

(c)  $\zeta_3$  plane.

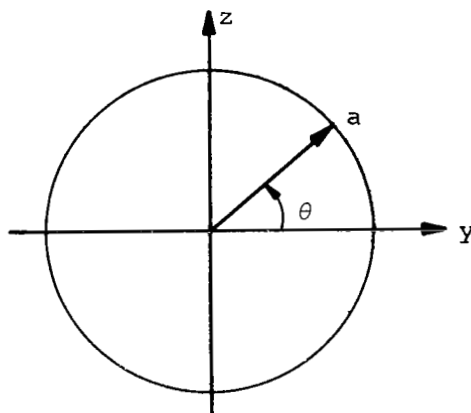

1  
↓

(d)  $\zeta_4$  plane.

Figure 4.- Transformations used in obtaining complex potential for translating arc.

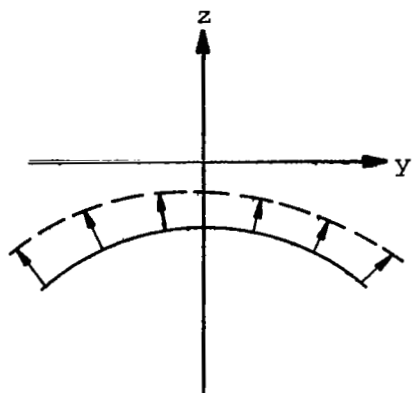

(a)  $\zeta_1$  plane.

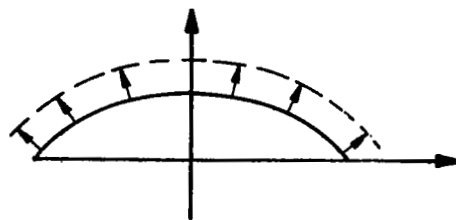

(b)  $\zeta_2$  plane.

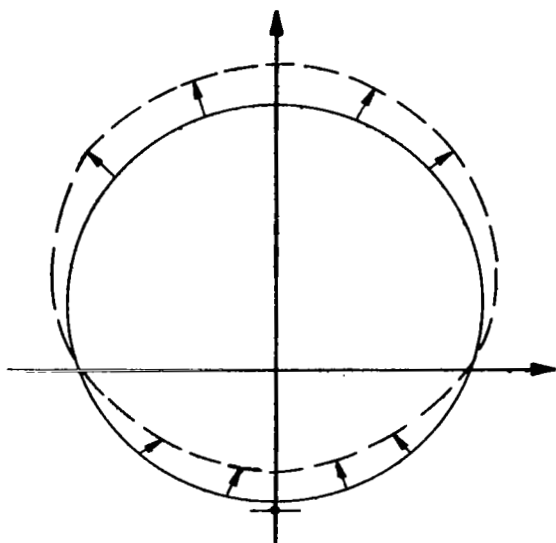

(c)  $\zeta_3$  plane.

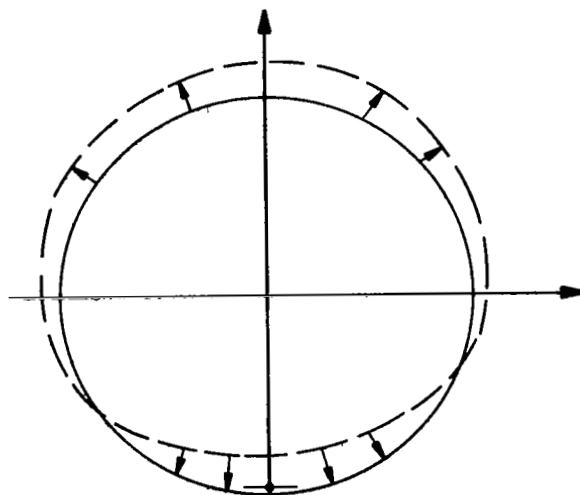

(d)  $\zeta_4$  plane.

Figure 5.- Transformations and flows used in obtaining complex potential for dilating arc.



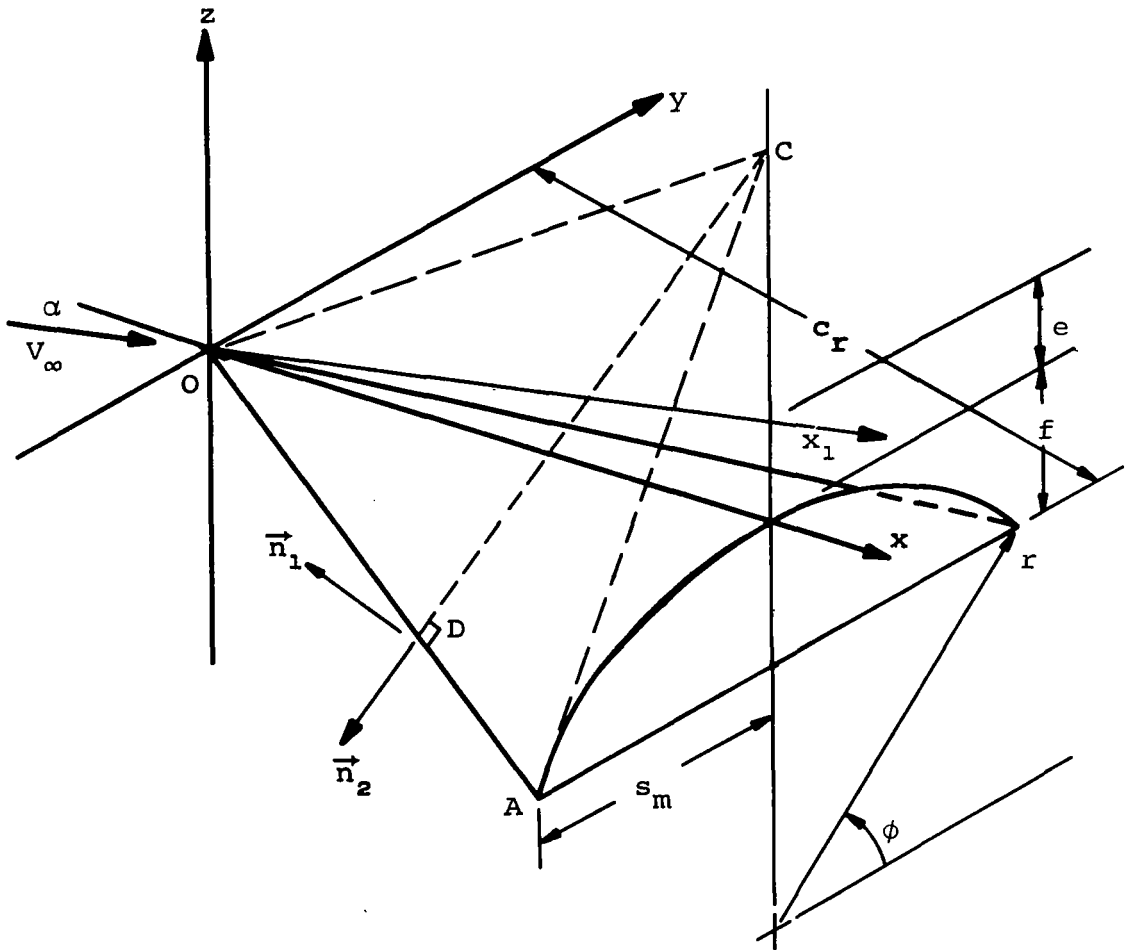
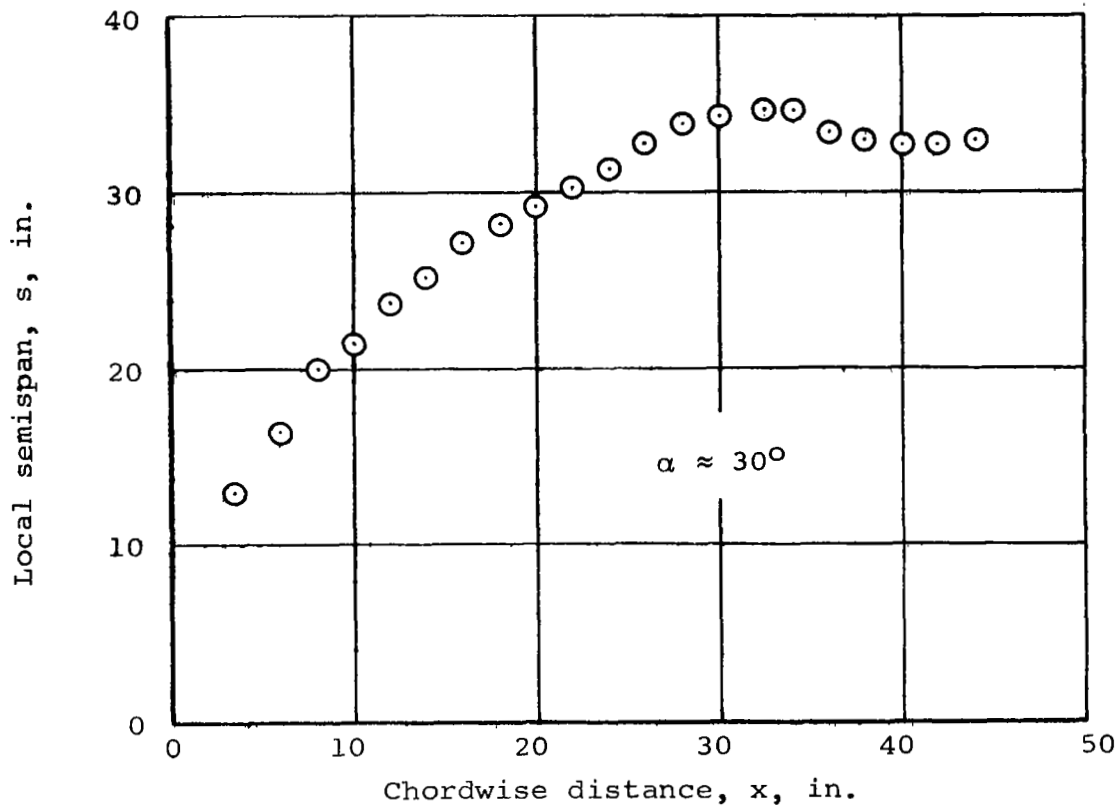
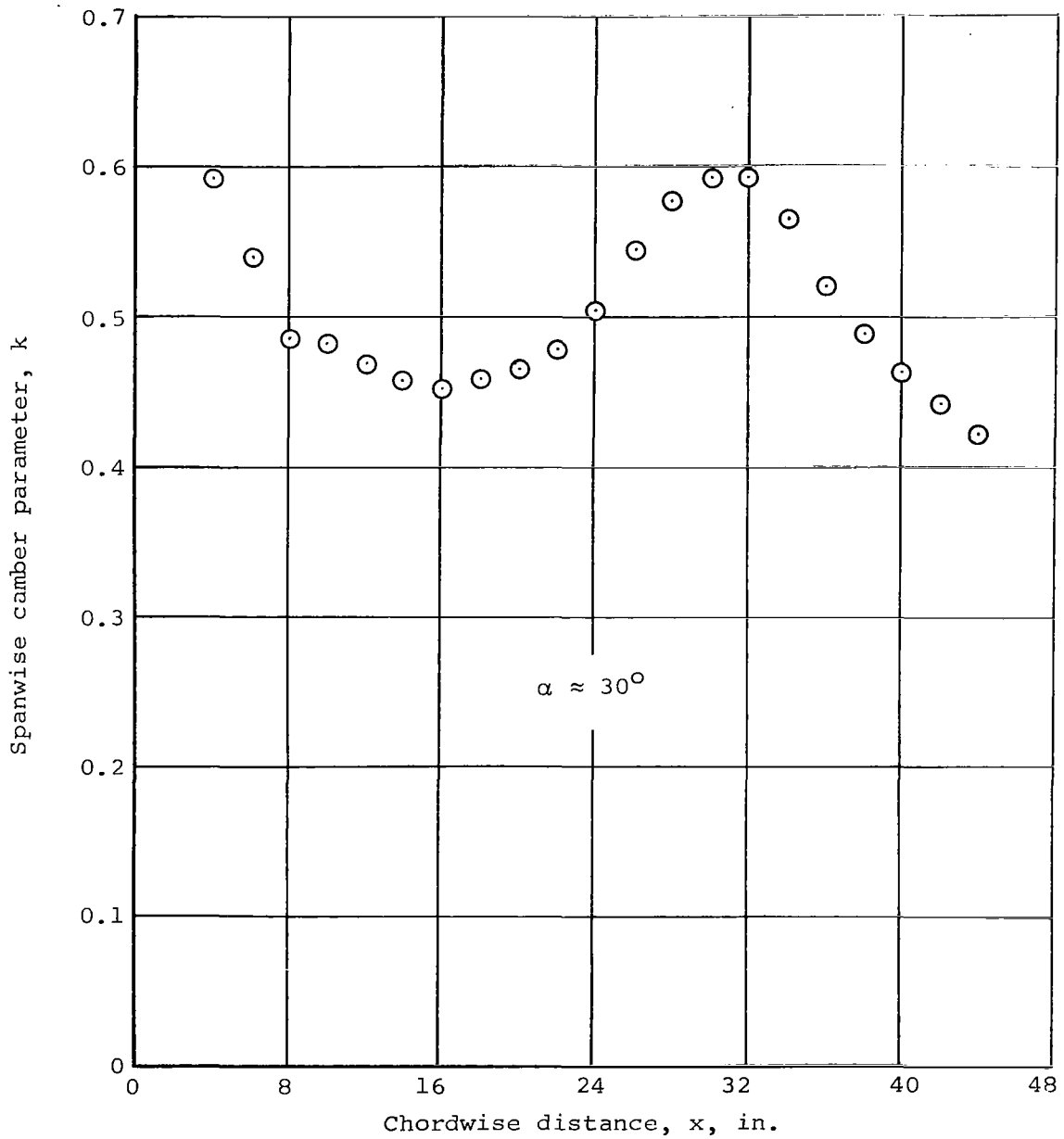

Figure 6.- Normal directions associated with surface formed from segment of a circular cone.



(a) Local semispan.

Figure 7.- Geometric characteristics of twin-keel, all-flexible parawing based on wing tunnel shape measurements.



(b) Spanwise camber parameter, k.

Figure 7.- Concluded.

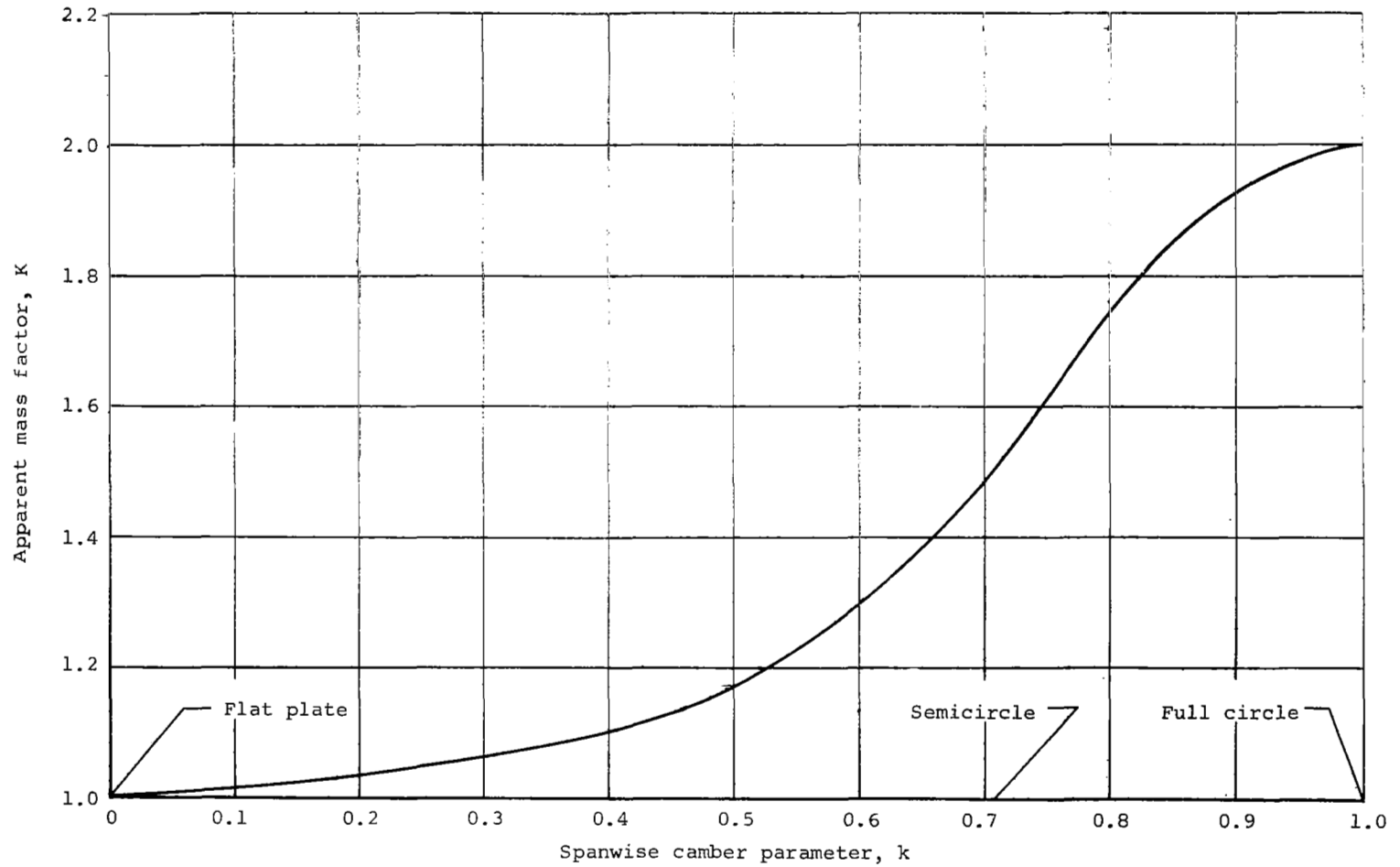

(a) Apparent mass factor.

Figure 8.- Effect of spanwise camber on normal-force curve slope and angle of zero normal force for conical parawing.

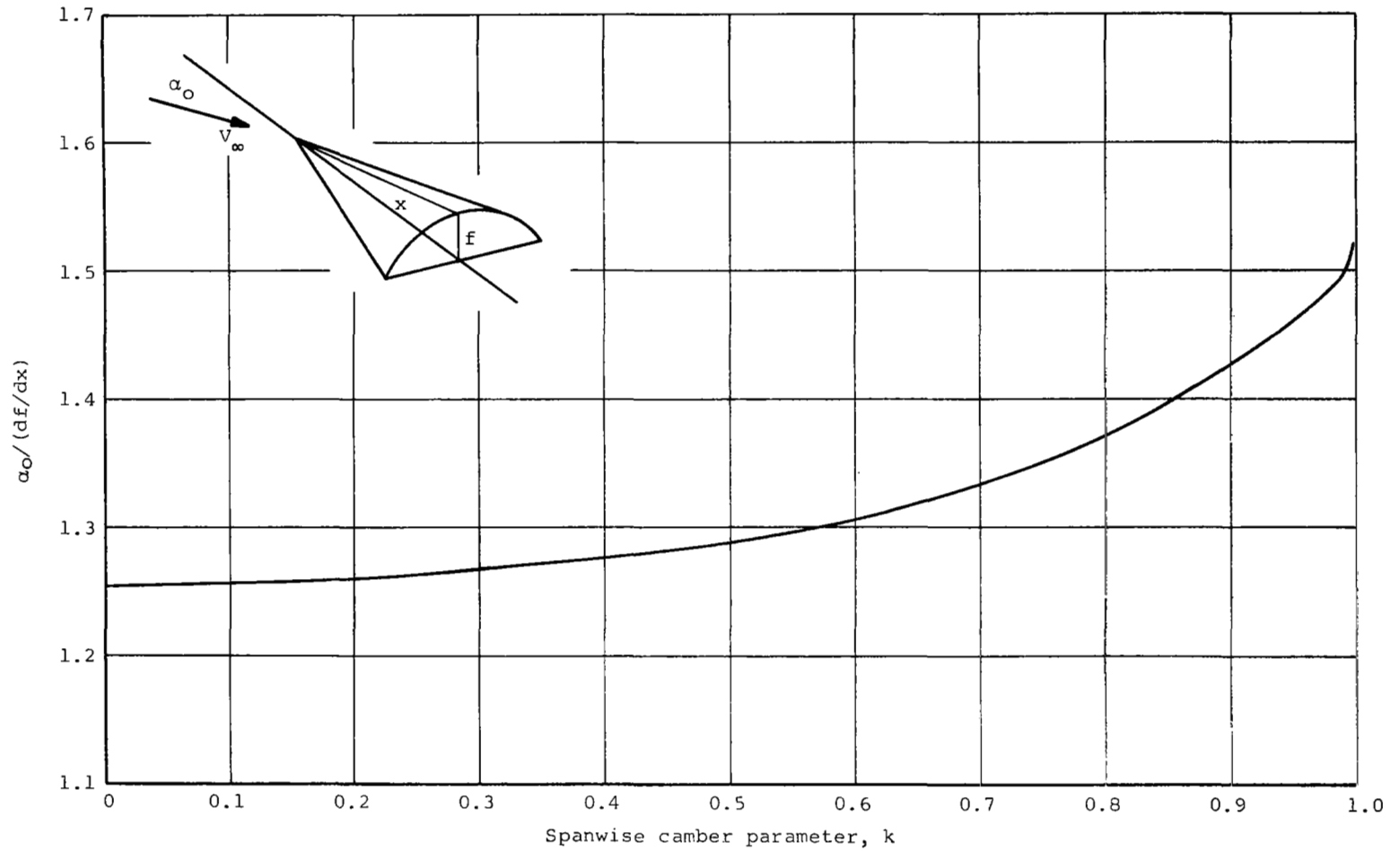

(b) Angle of zero normal force.

Figure 8.- Concluded.

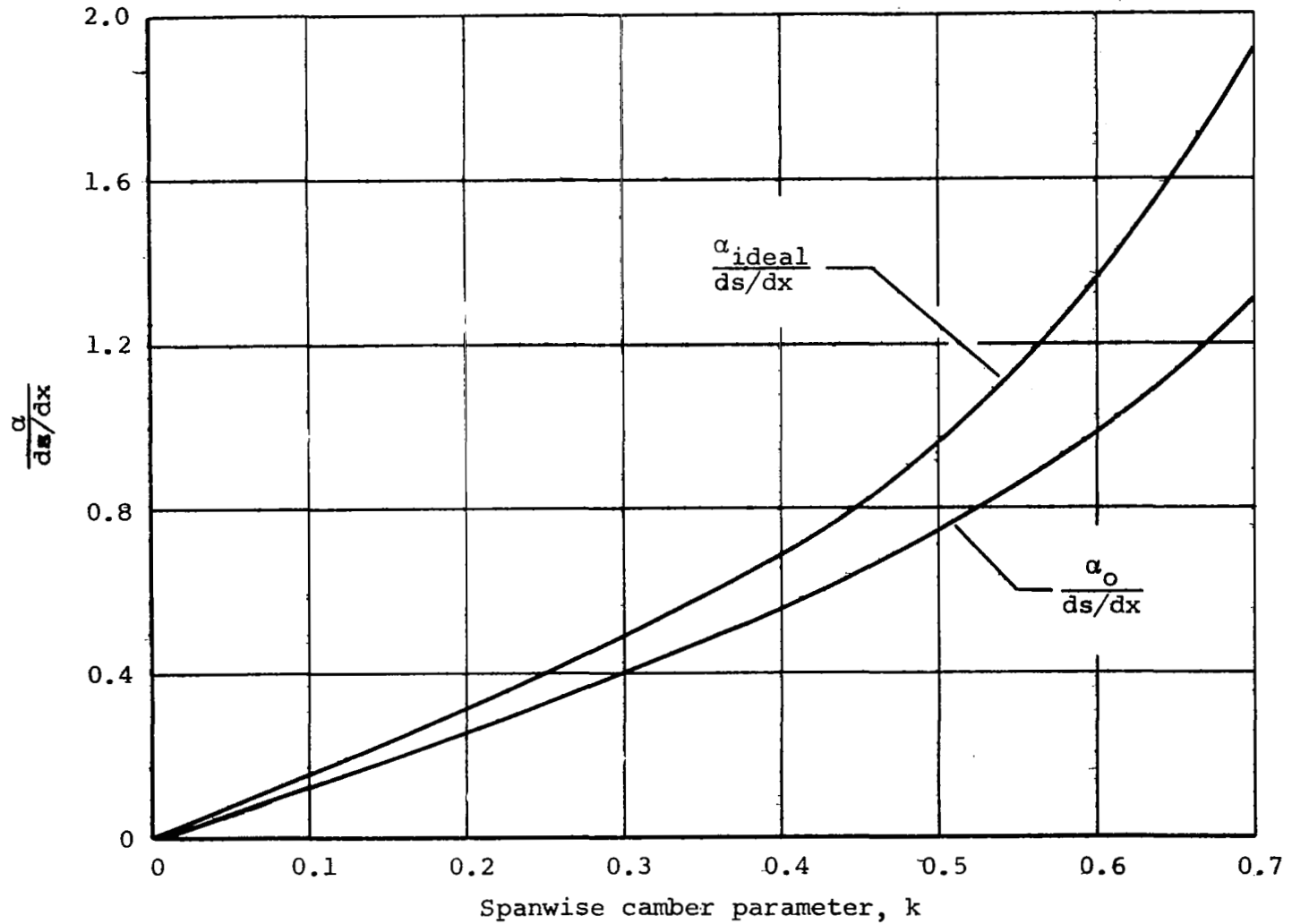
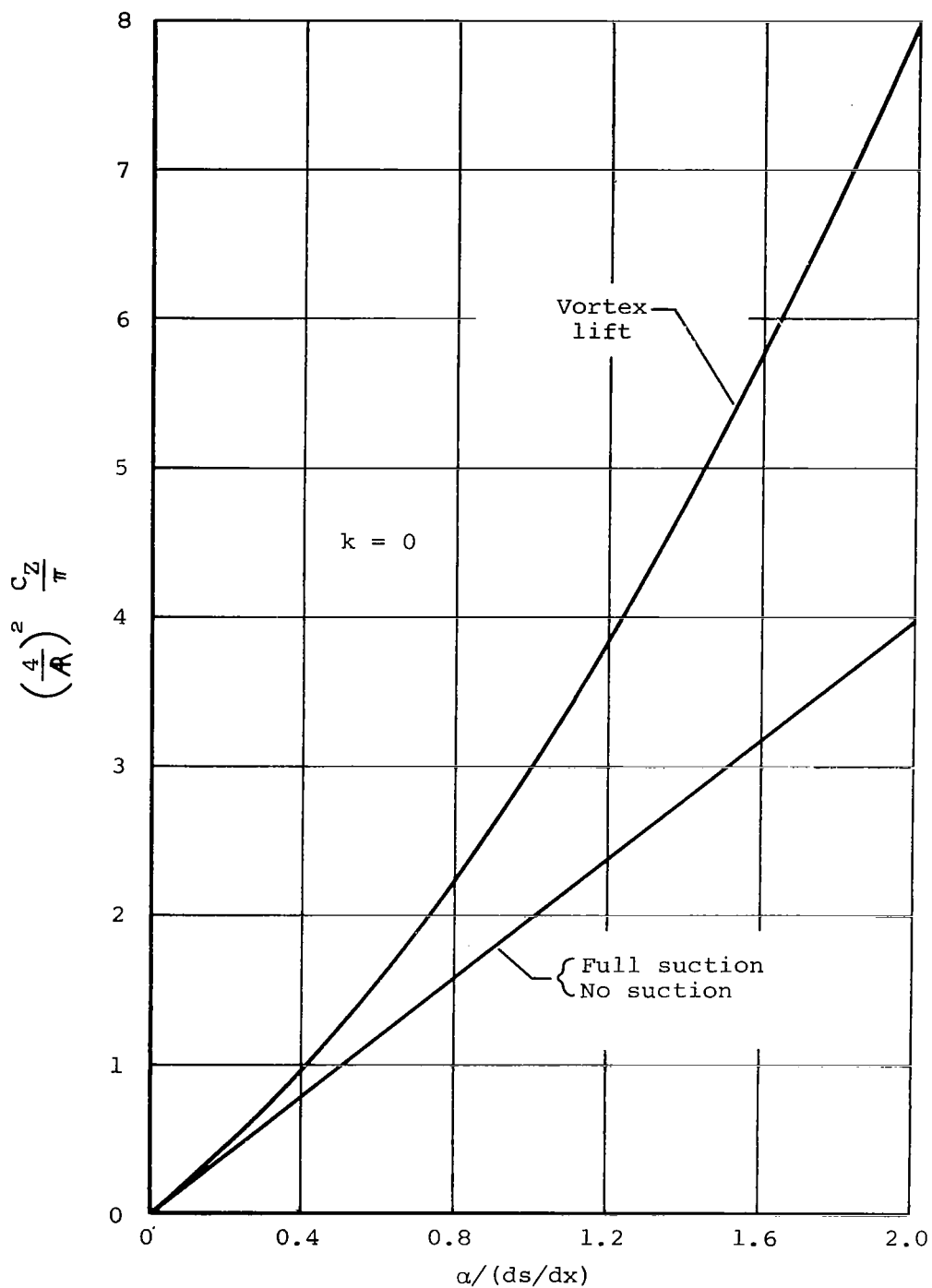
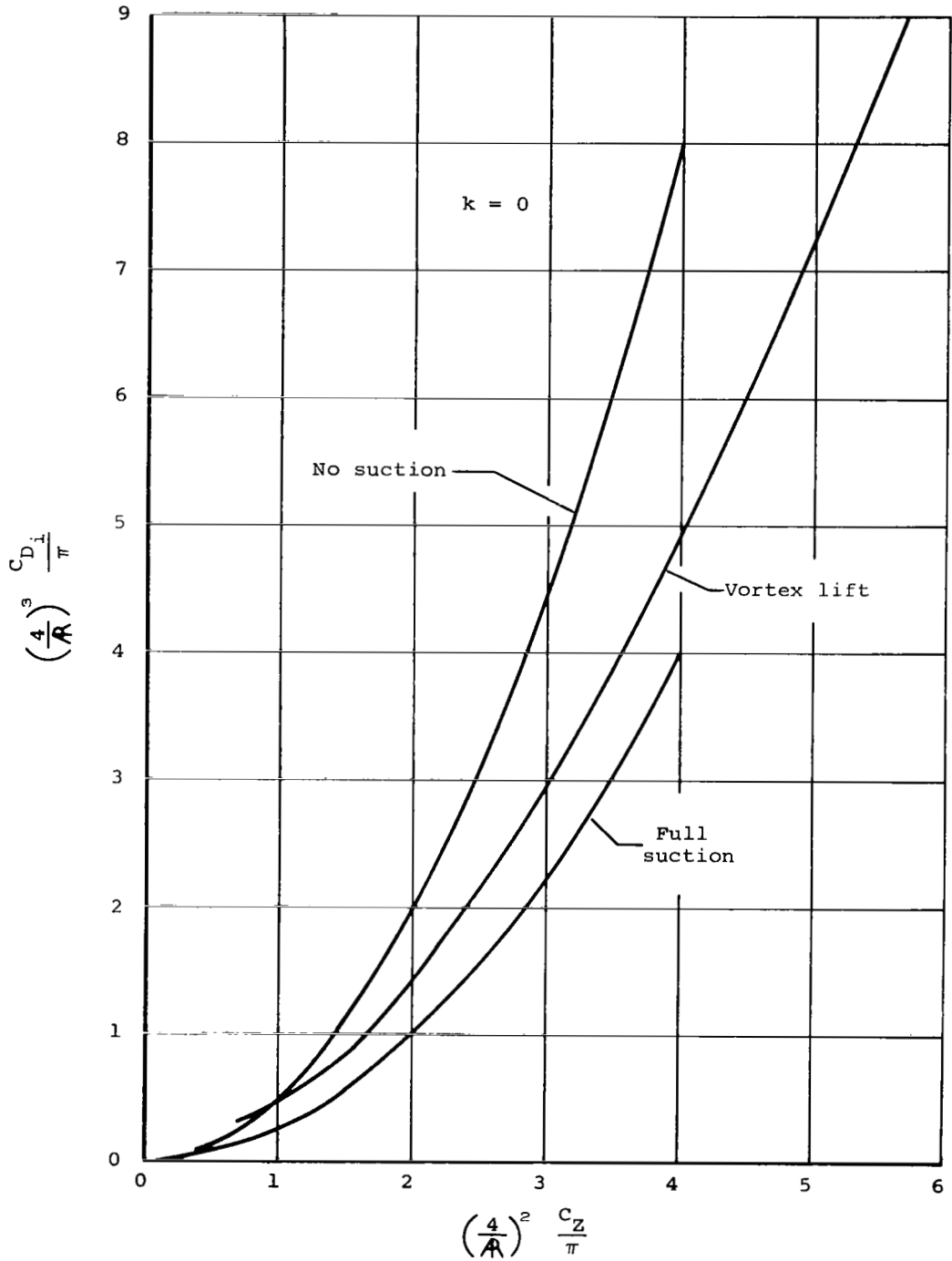

Figure 9.- Effect of spanwise camber on angle of zero normal force and ideal angle of attack.



(a) Normal-force curves.

Figure 10.- Effect of leading-edge suction and vortex lift on aerodynamic characteristics of flat delta wings of low aspect ratio.



(b) Drag curves.

Figure 10.- Continued.



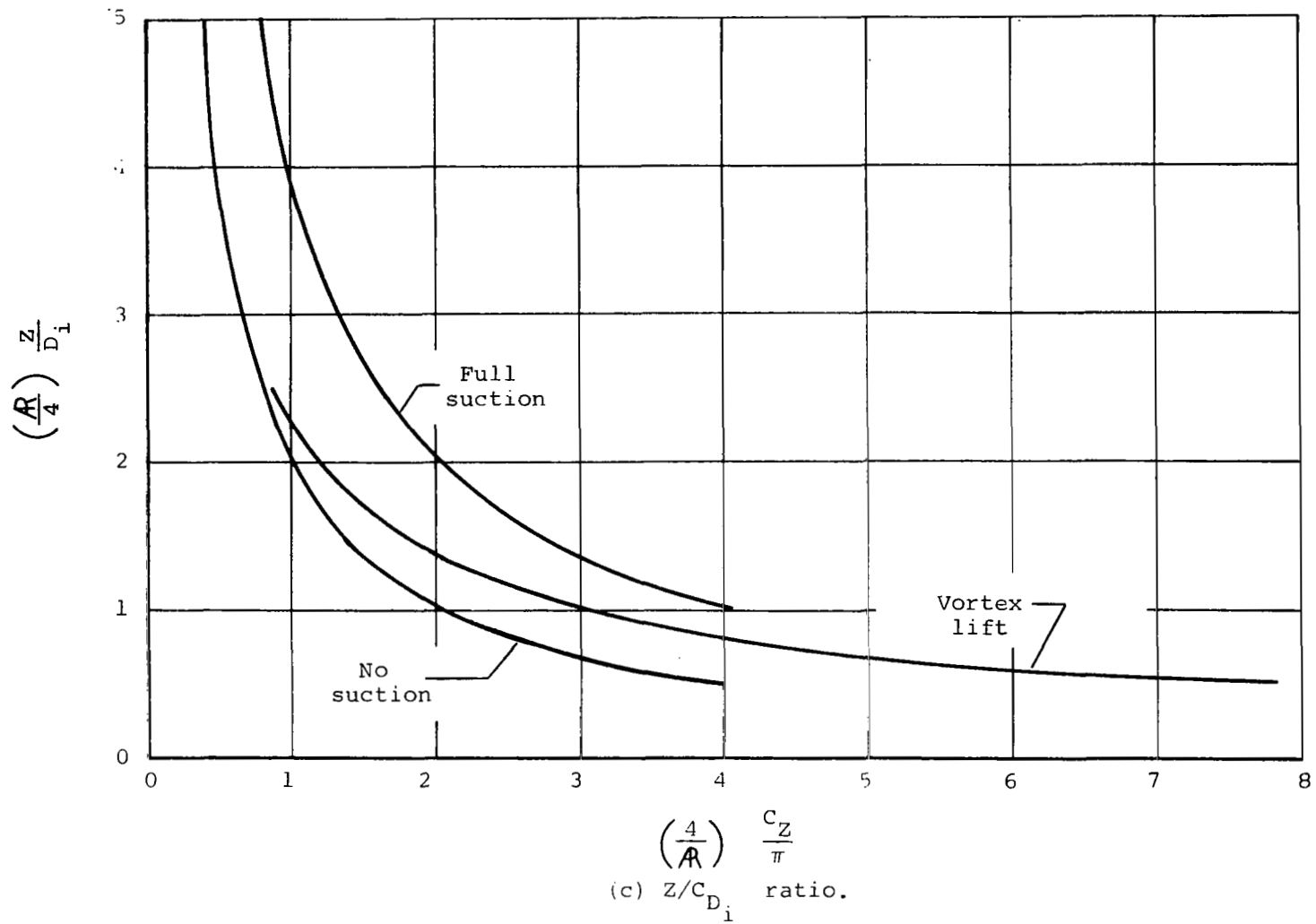
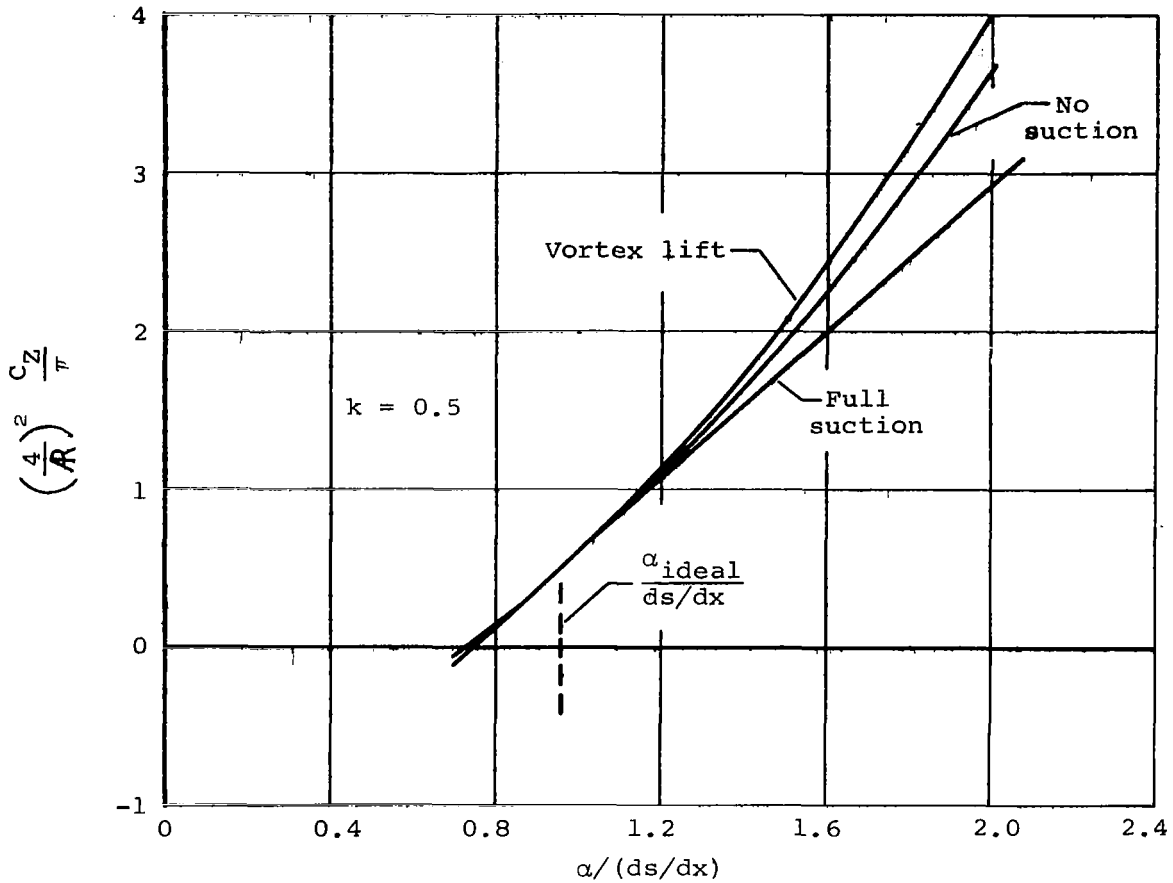
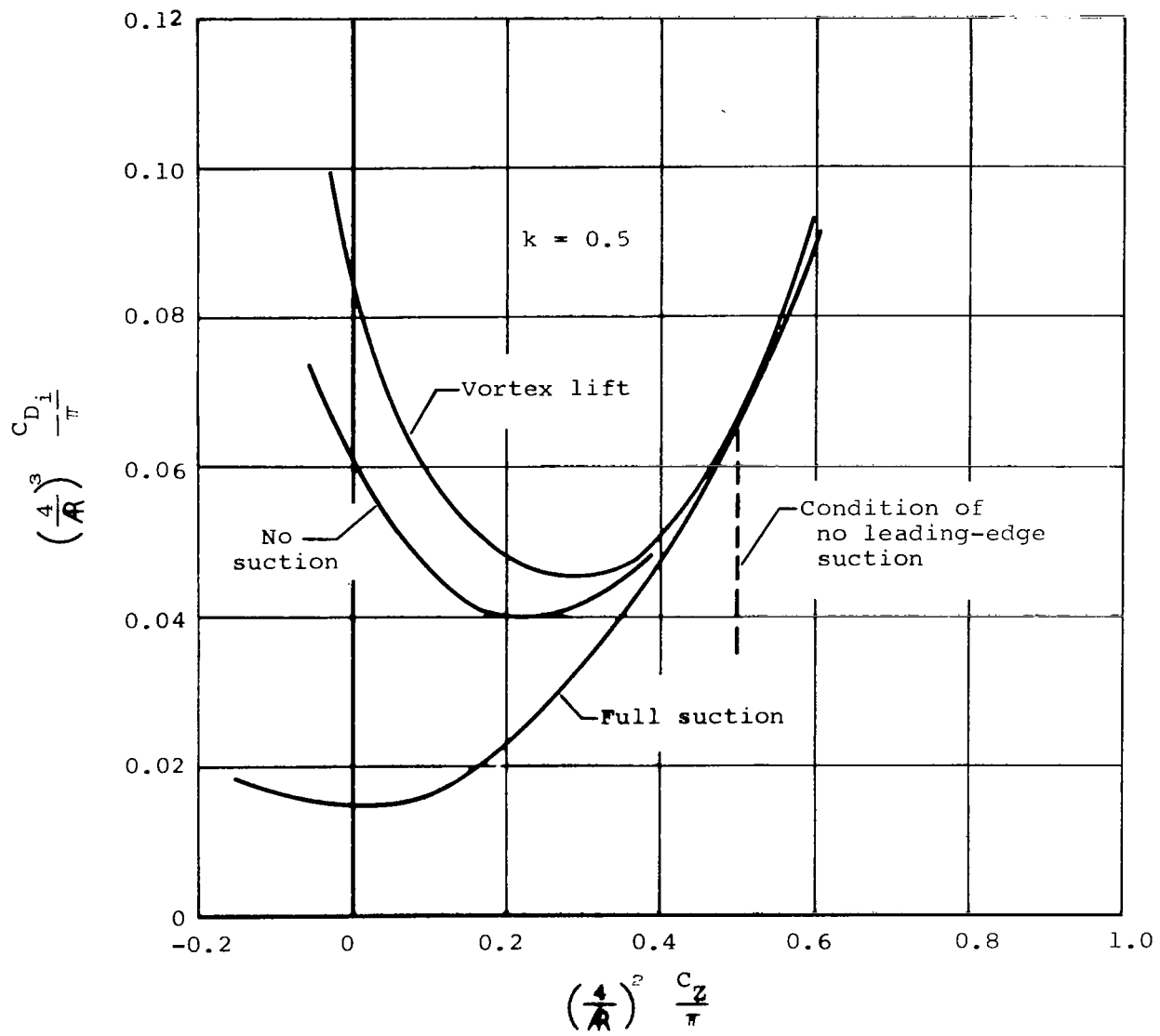

Figure 10.- Concluded.



(a) Normal-force curves.

Figure 11.- Effect of leading-edge suction and vortex lift on aerodynamic characteristics of parawing formed by segments of circular cones.



(b) Drag curves.

Figure 11.- Continued.

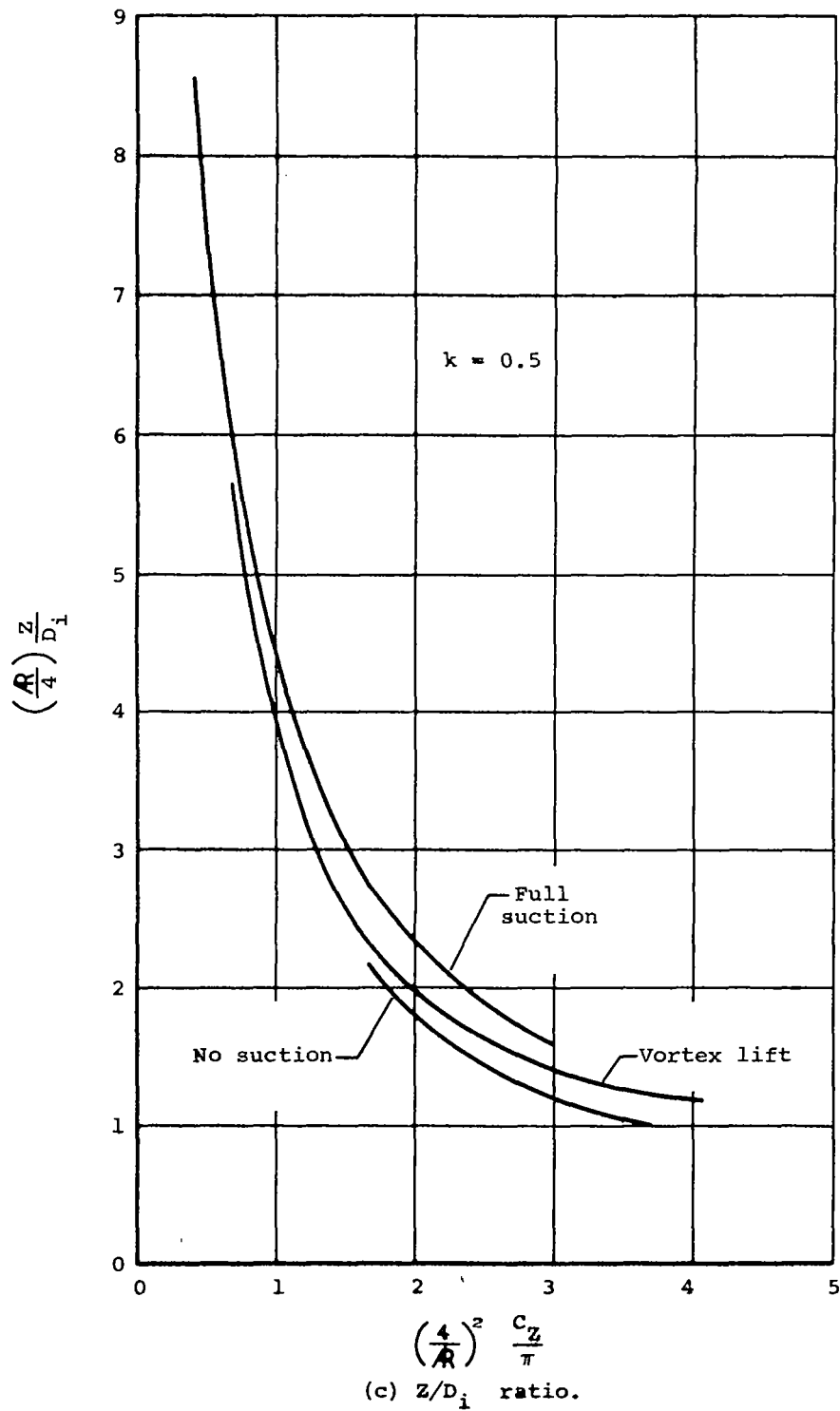
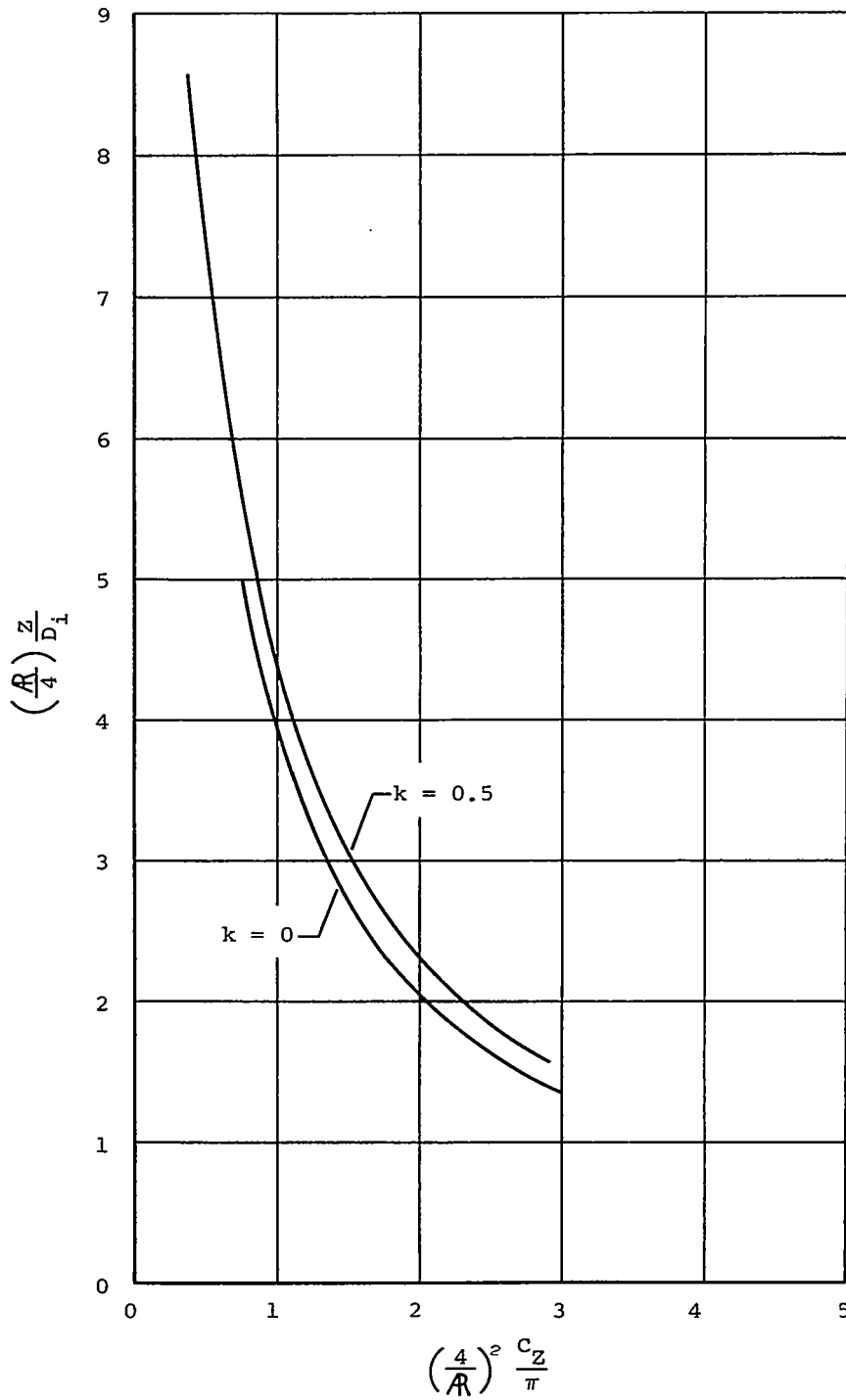
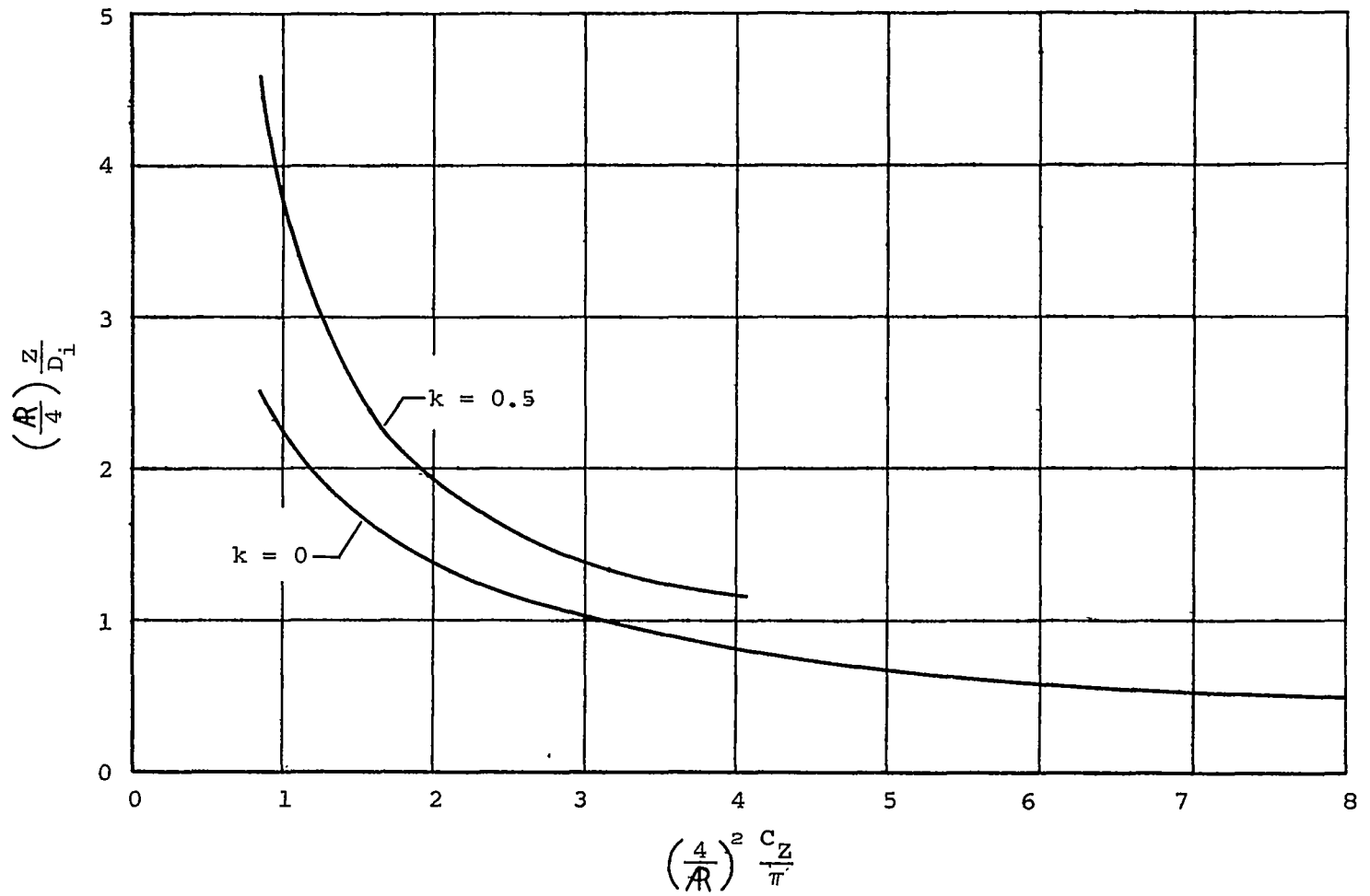

Figure 11.- Concluded.



(a) Full suction.

Figure 12.- Effect of  $k$  on ratio of normal force to induced drag for conical lifting surfaces.



(b) Vortex lift.

Figure 12.- Concluded.



Figure 13.- Equipment setup for photogrammetric test.

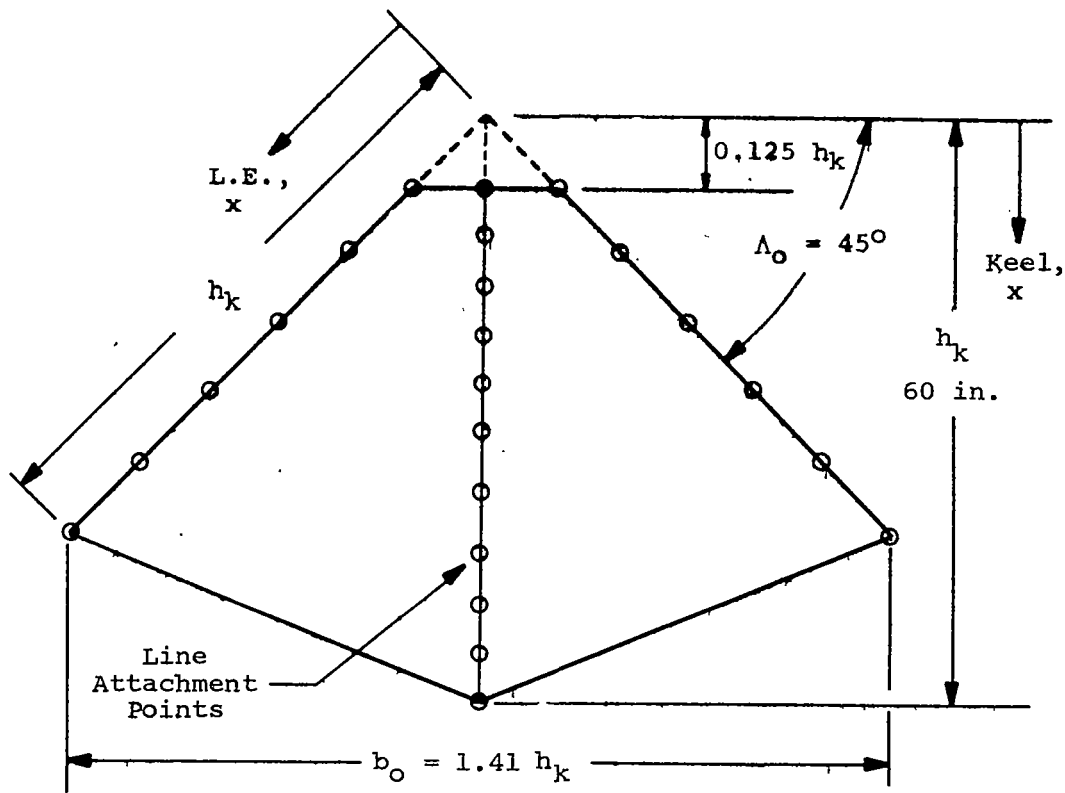

Keel	$h/h_k$		$x/h_k$	
	Leading Edge Right	Leading Edge Left	Keel	Leading Edge
1.35	1.368	1.365	0.125	0.177
1.36	1.304	1.317	.208	.333
1.352	1.309	1.26	.292	.500
1.34	1.202	1.216	.375	.667
1.322	1.168	1.162	.459	.833
1.308	.994	.985	.542	1.000
1.292			.645	
1.270			.750	
1.242			.833	
1.205			.917	
1.092			1.000	

Line Lengths                      Line Attachment Location

Figure 14.- Single-keel parawing configuration.



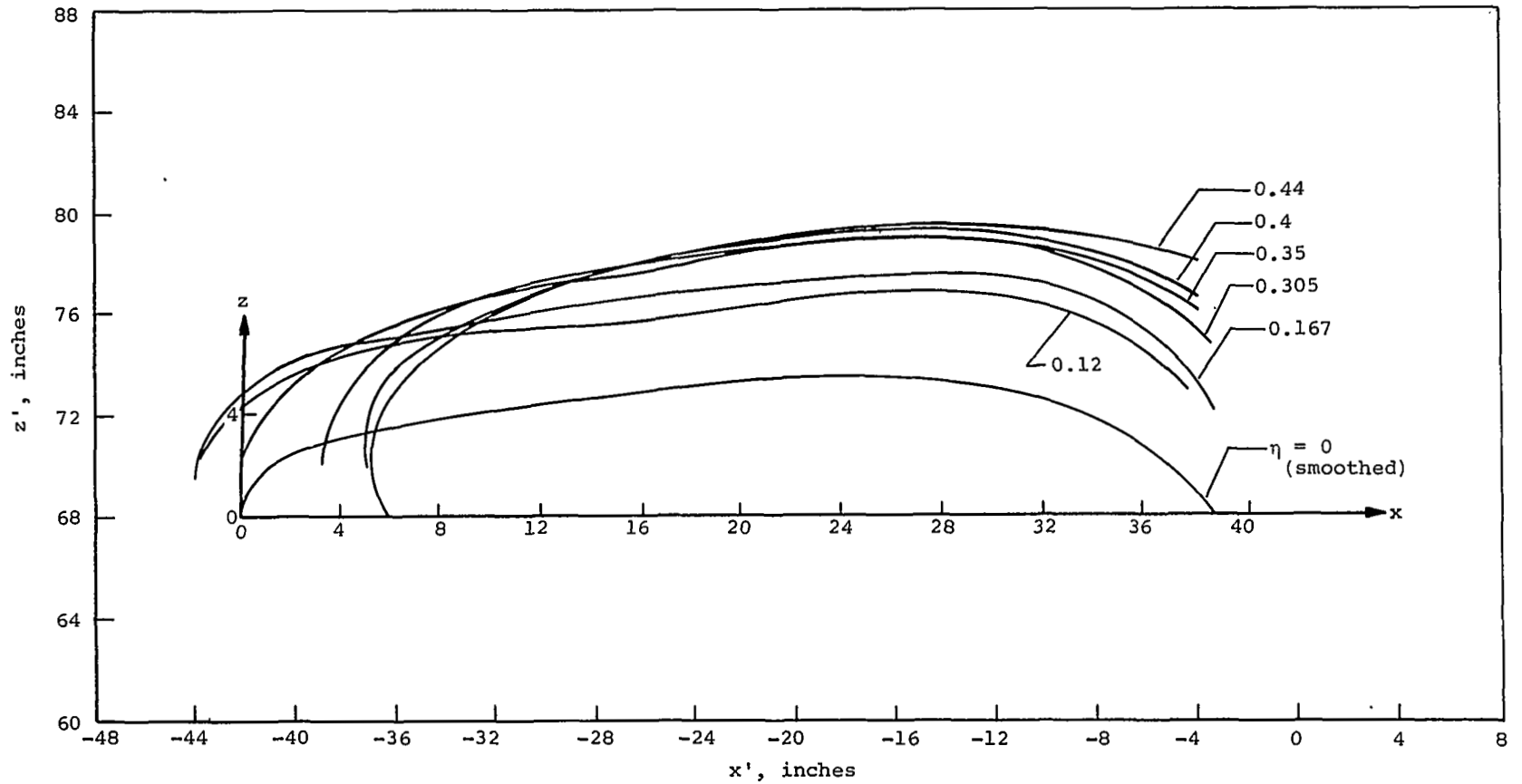

(a) Sections for  $0 < \eta < 0.44$ .

Figure 15.- Chordwise sections of single-keel parawing obtained from measured canopy shape data.

(b) Sections for  $0.56 < \eta < 0.925$ .

Figure 15.- Concluded.



(a) Side view.

Figure 16.- Photographs of single-keel parawing  
in Langley Research Center wind tunnel.

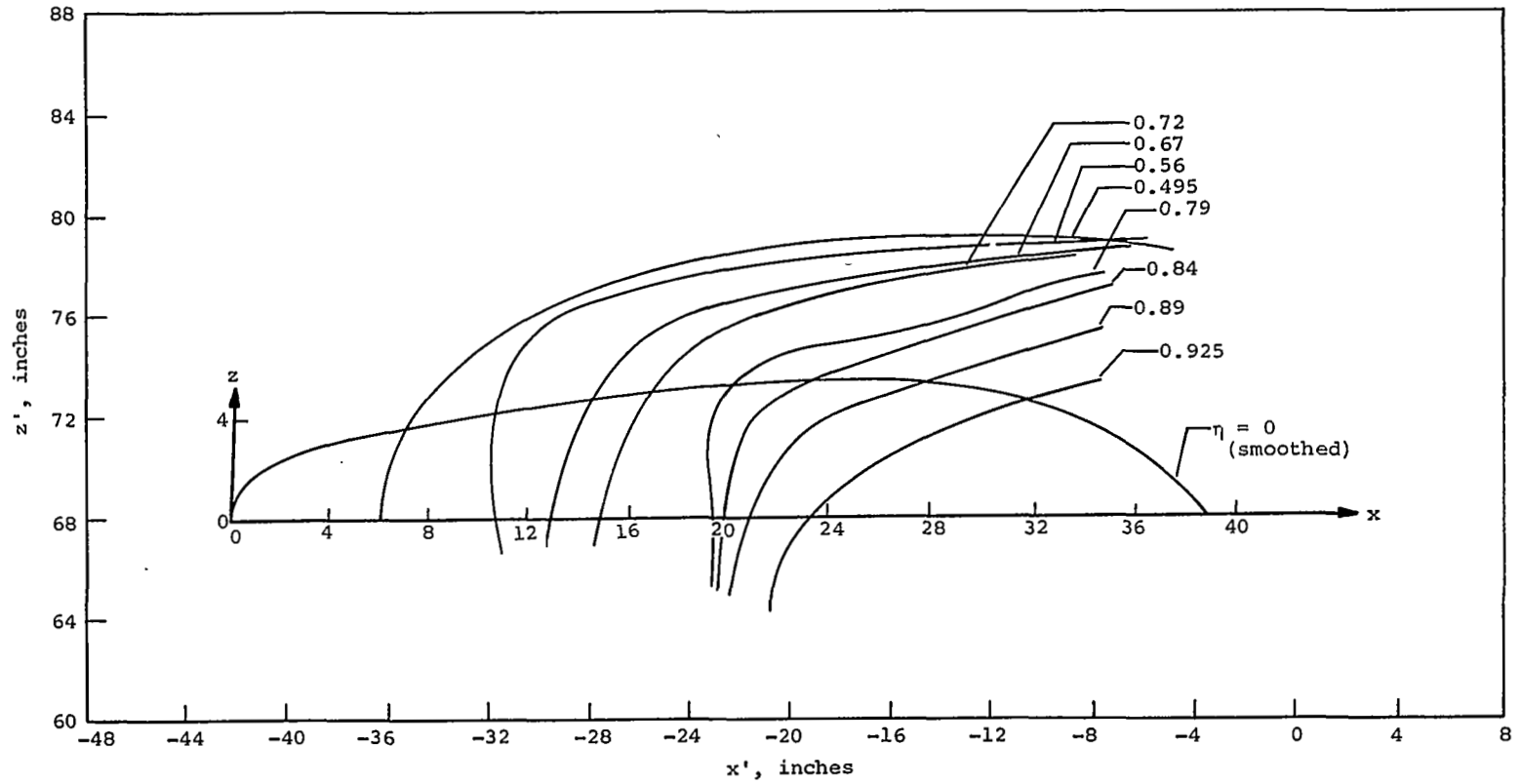
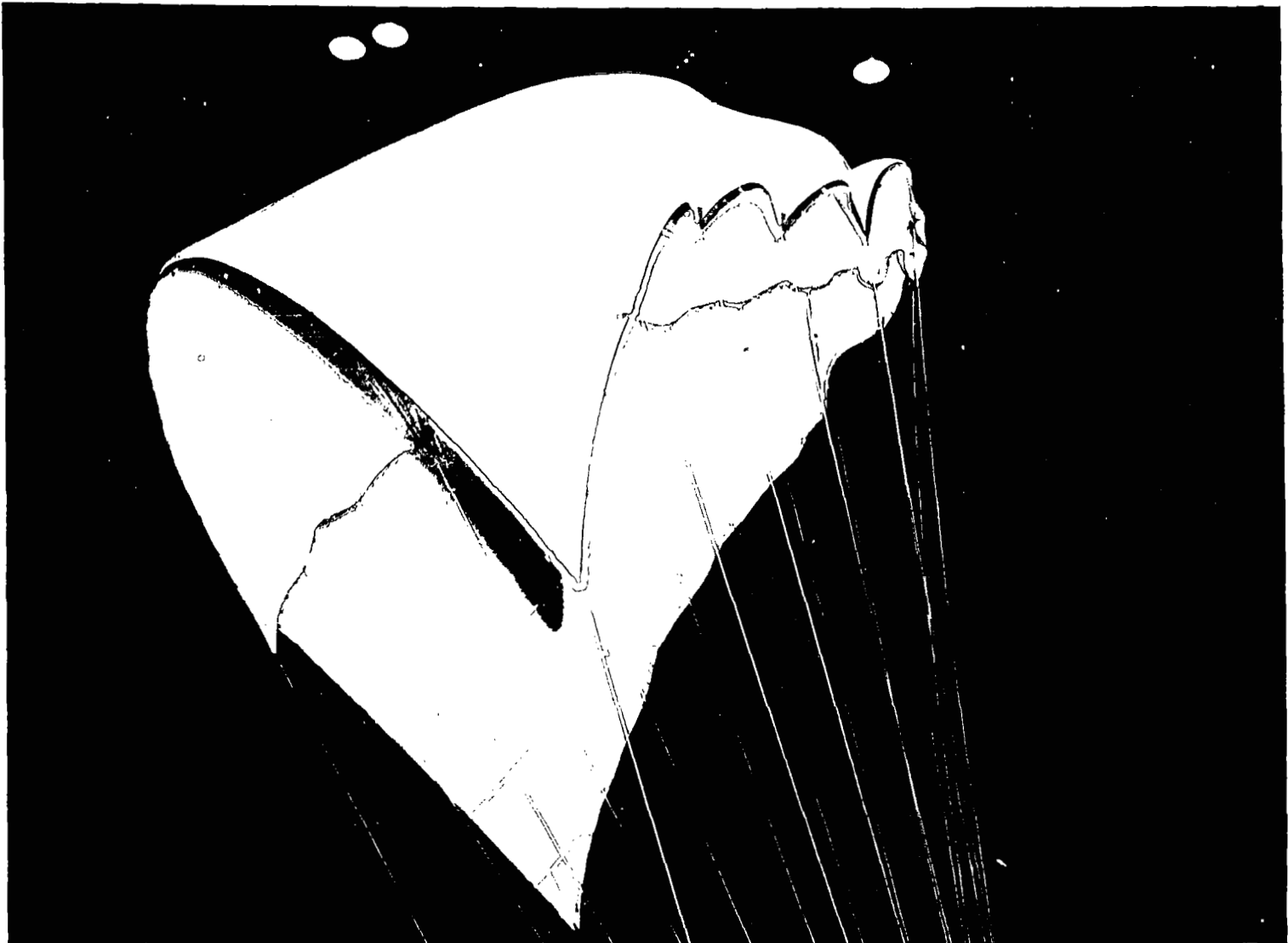

(b) Rear view.  
Figure 16.- Concluded.



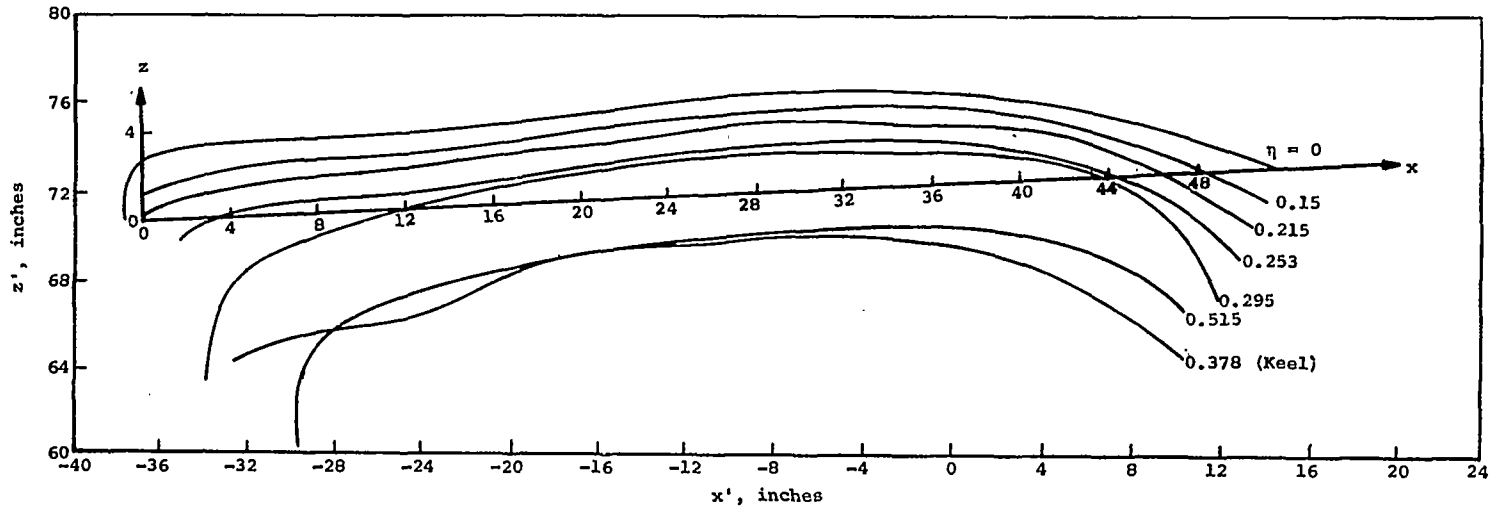

(a) Sections for  $0 < \eta < 0.515$ .

Figure 18.- Chordwise sections of twin-keel parawing  
obtained from measured canopy shape data.

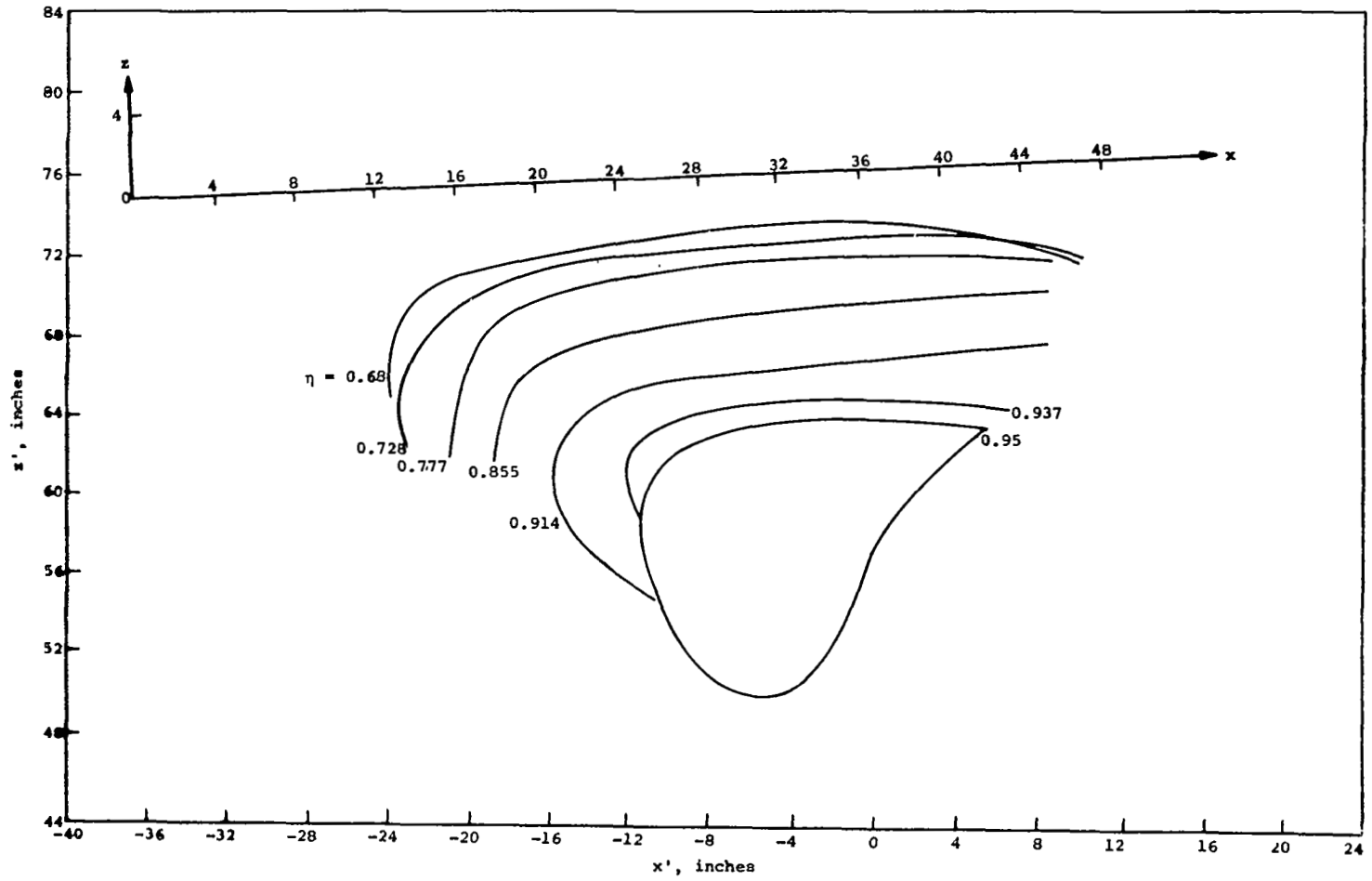

(b) Sections for  $0.68 < \eta < 0.95$ .

Figure 18.- Concluded.

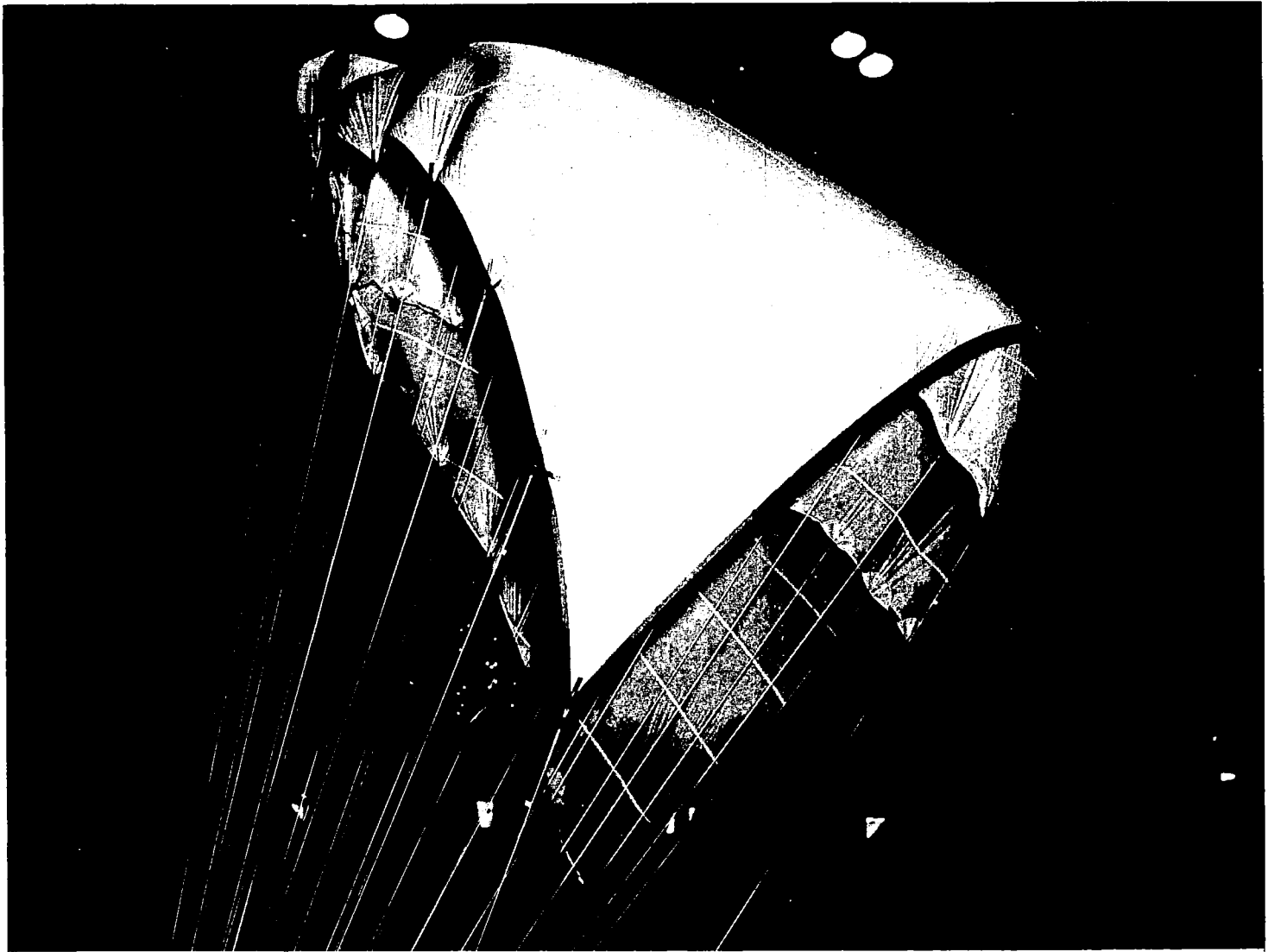

(a) Side view.

Figure 19.- Photographs of twin-keel parawing  
in Langley Research Center tunnel.



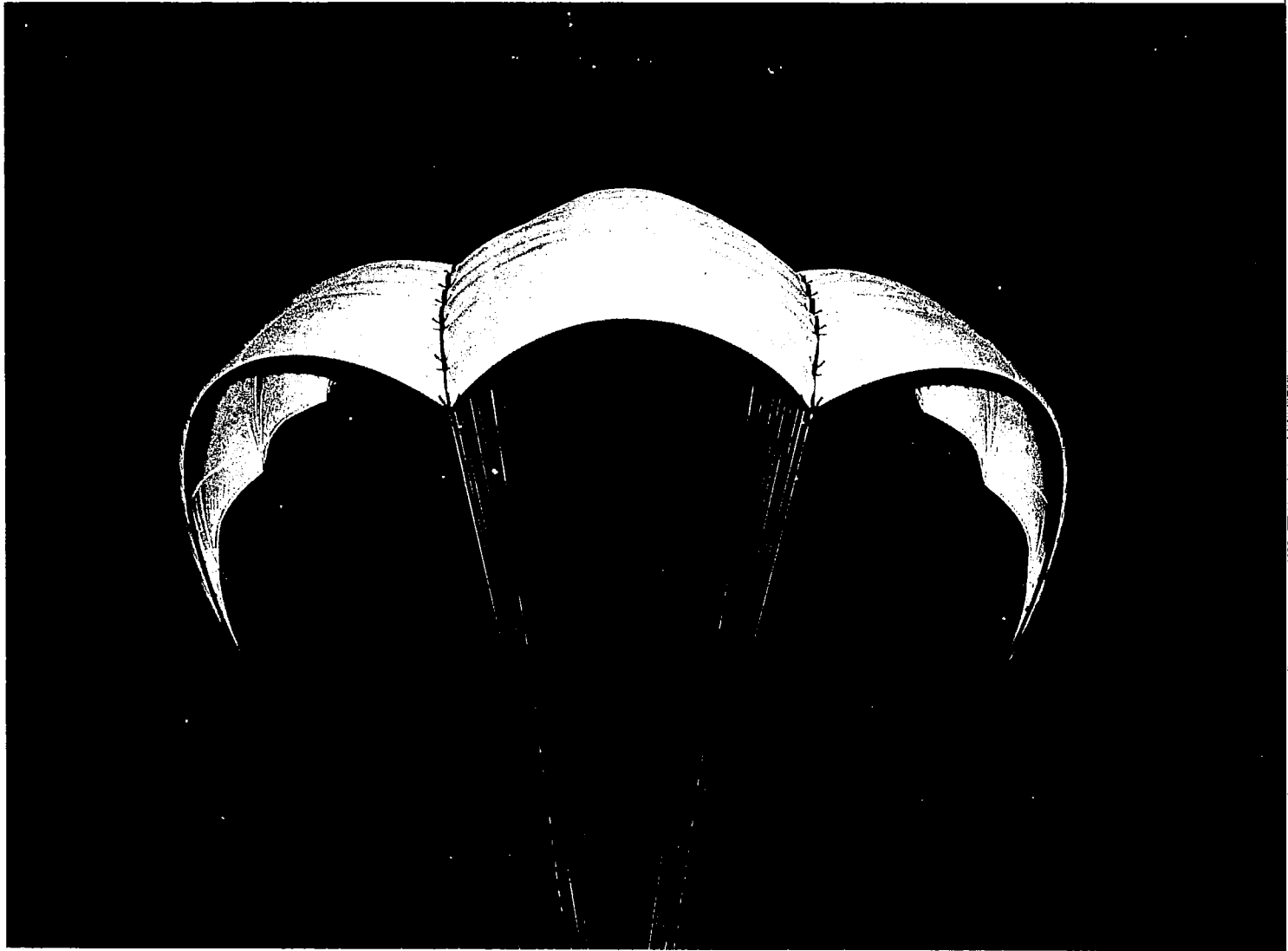

(b) Rear view.  
Figure 19.- Concluded.

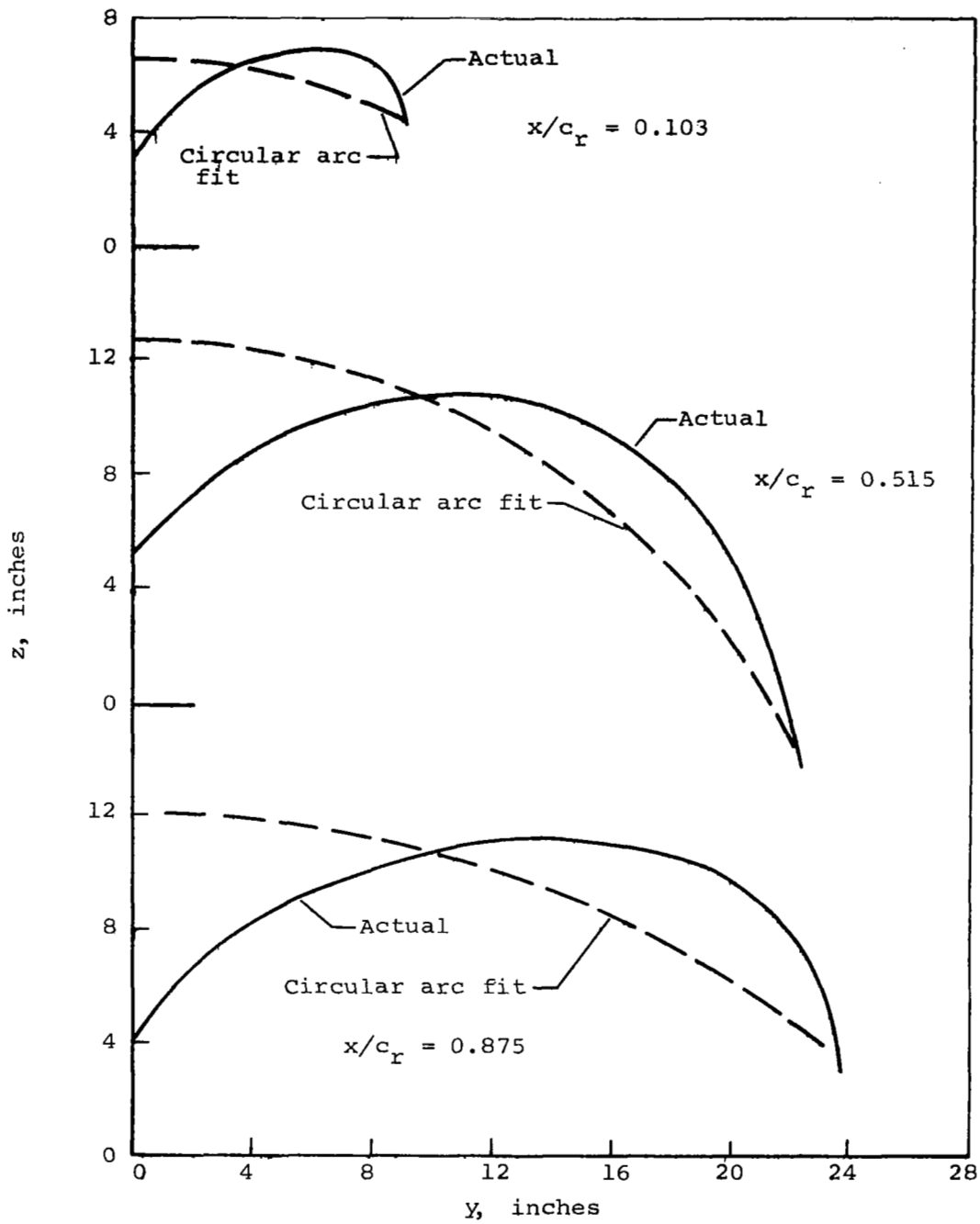

Figure 20.- Spanwise sections for single-keel parawing.

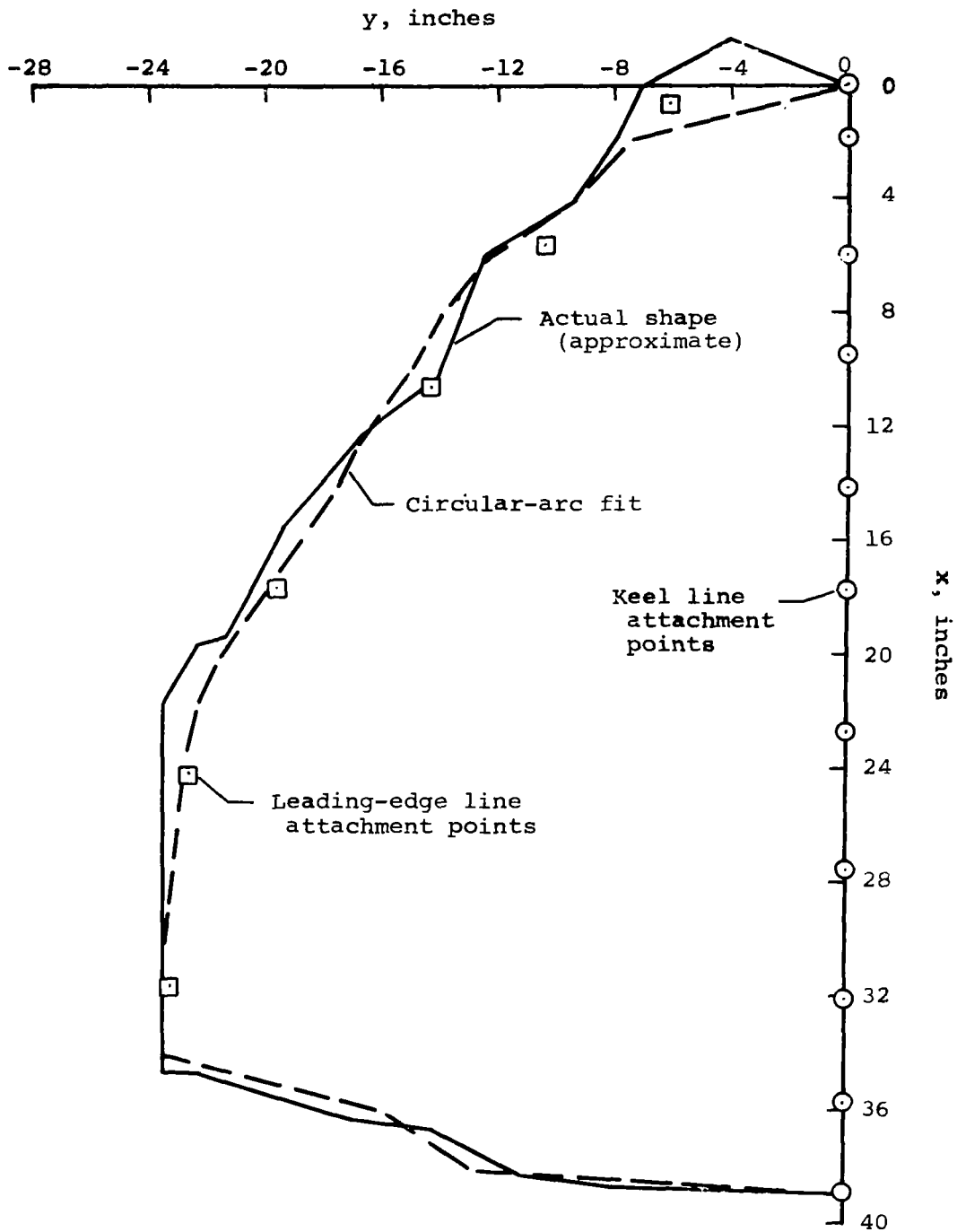

Figure 21.- Comparison of actual planform with circular-arc planform for single-keel parawing.

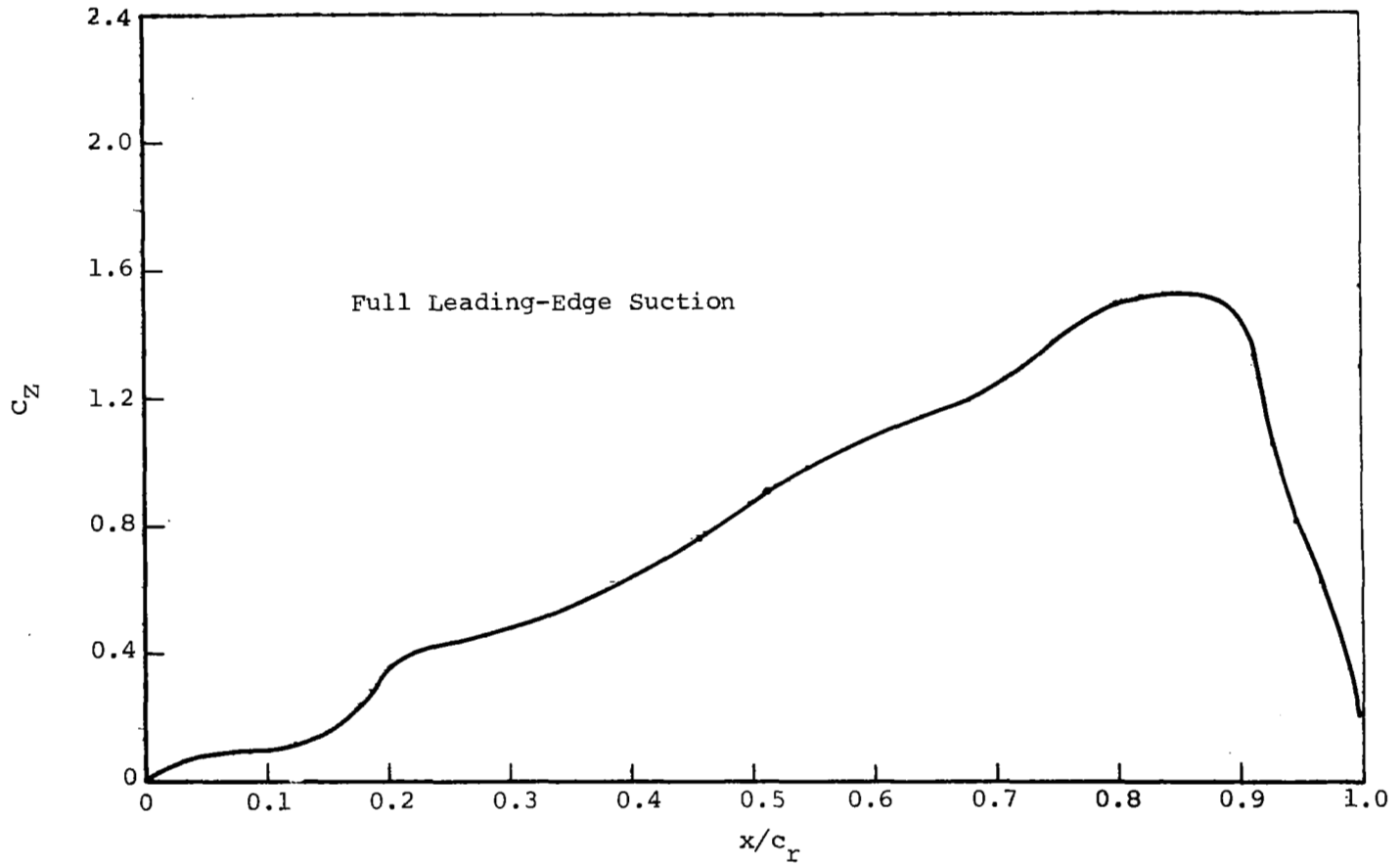

Figure 22.- Predicted chordwise buildup of normal force on single-keel parawing.

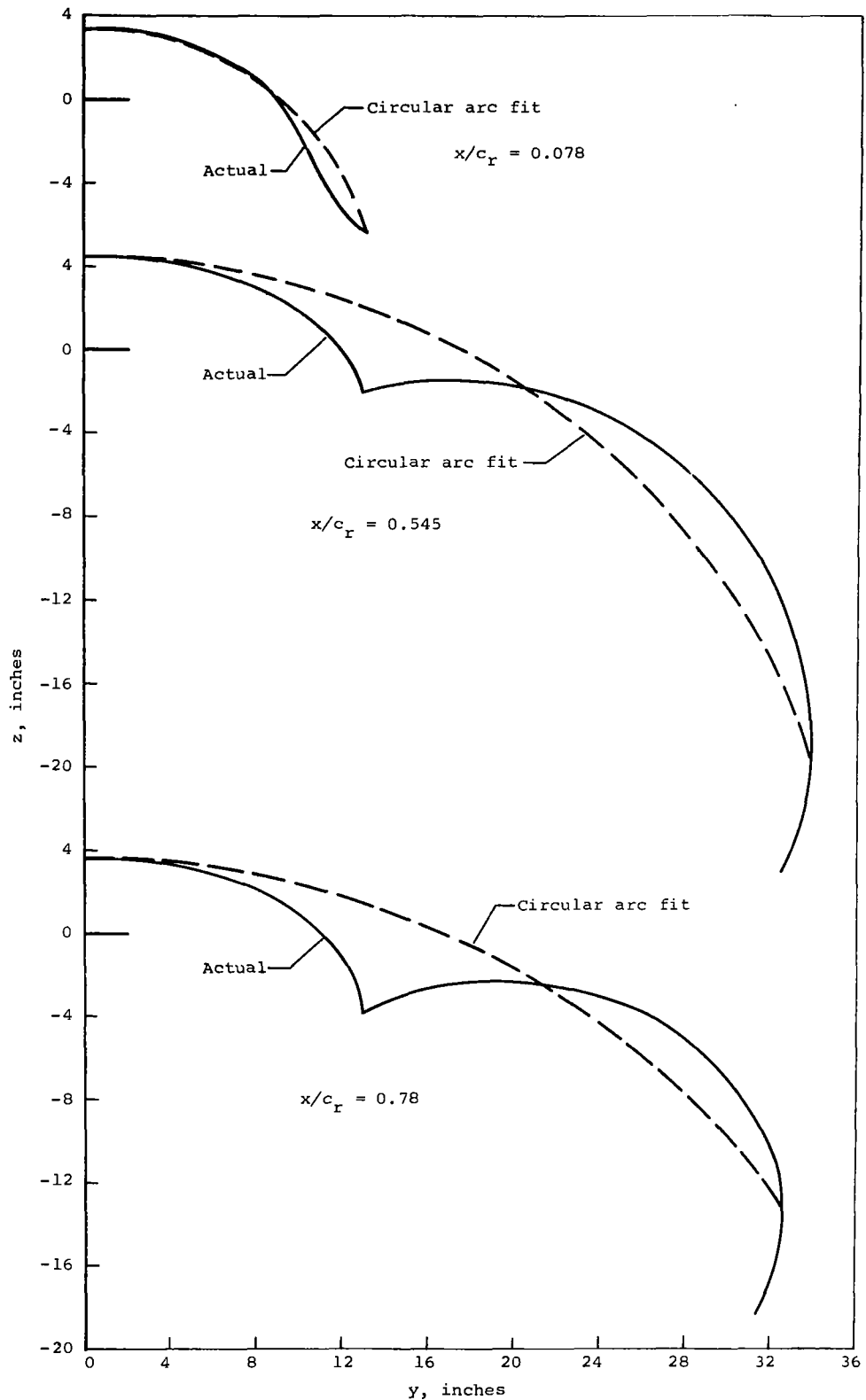

Figure 23.- Spanwise sections for twin-keel parawing.

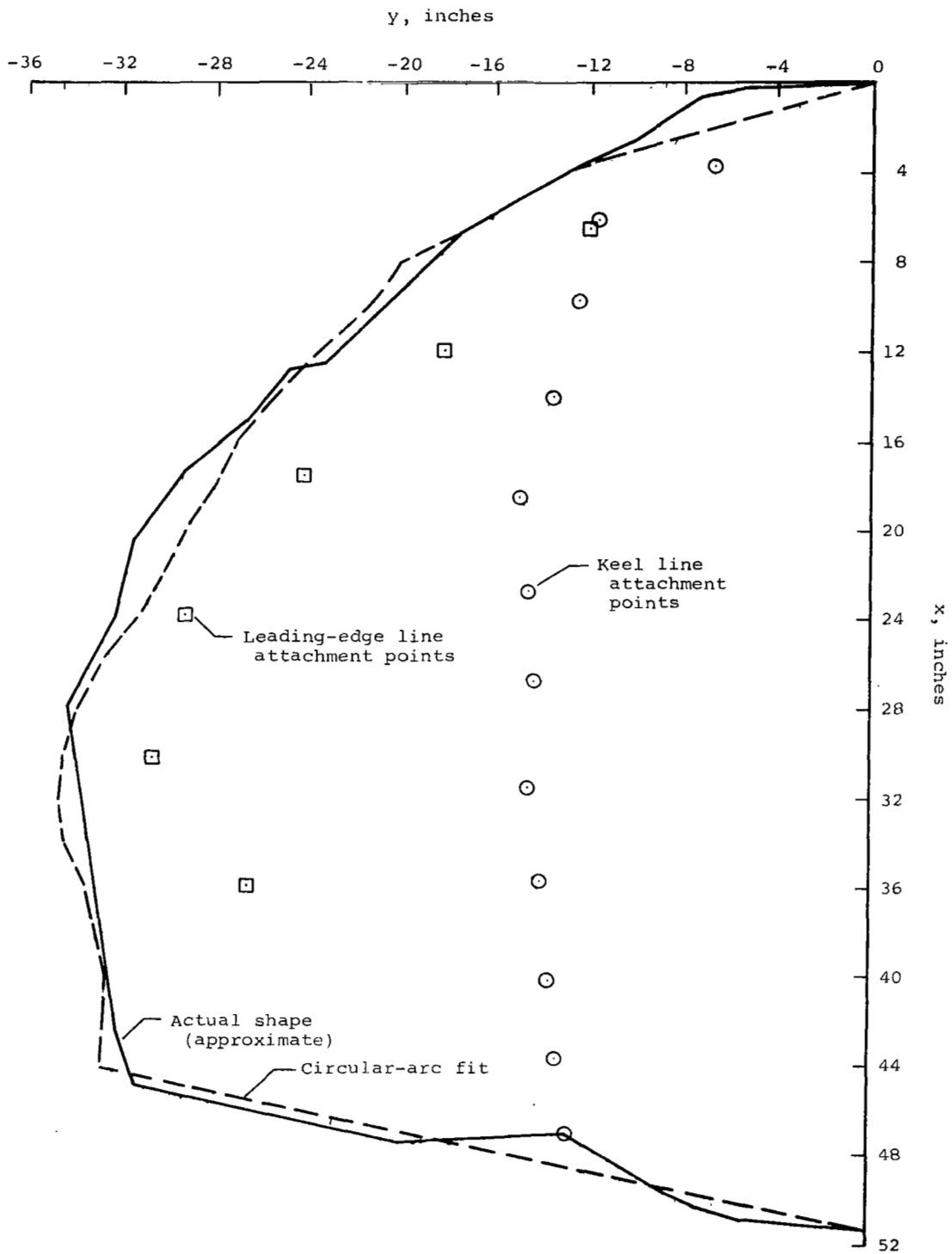

Figure 24.- Comparison of actual planform with circular-arc fit planform for twin-keel parawing.

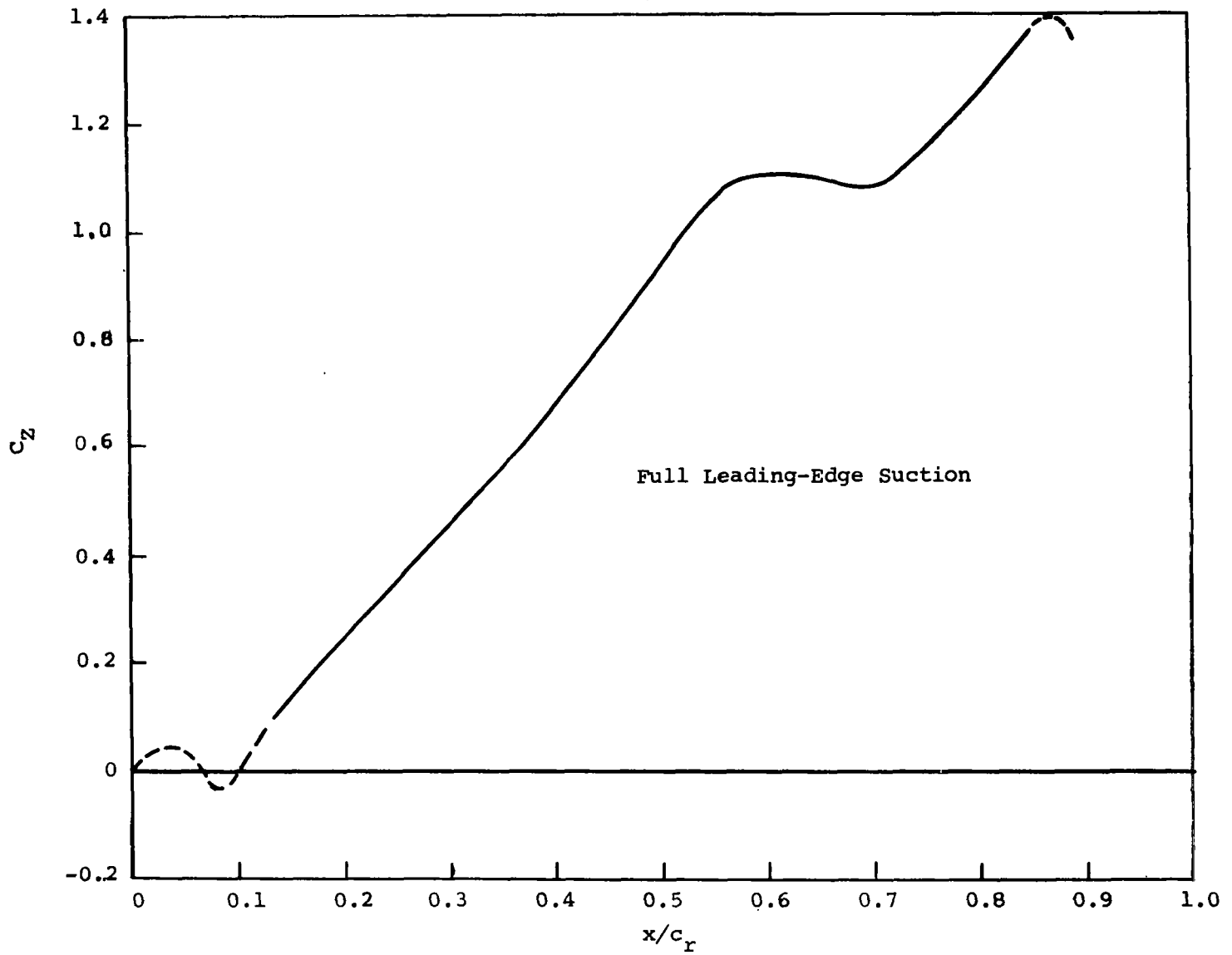

Figure 25.- Predicted chordwise buildup of normal force on twin-keel parawing.

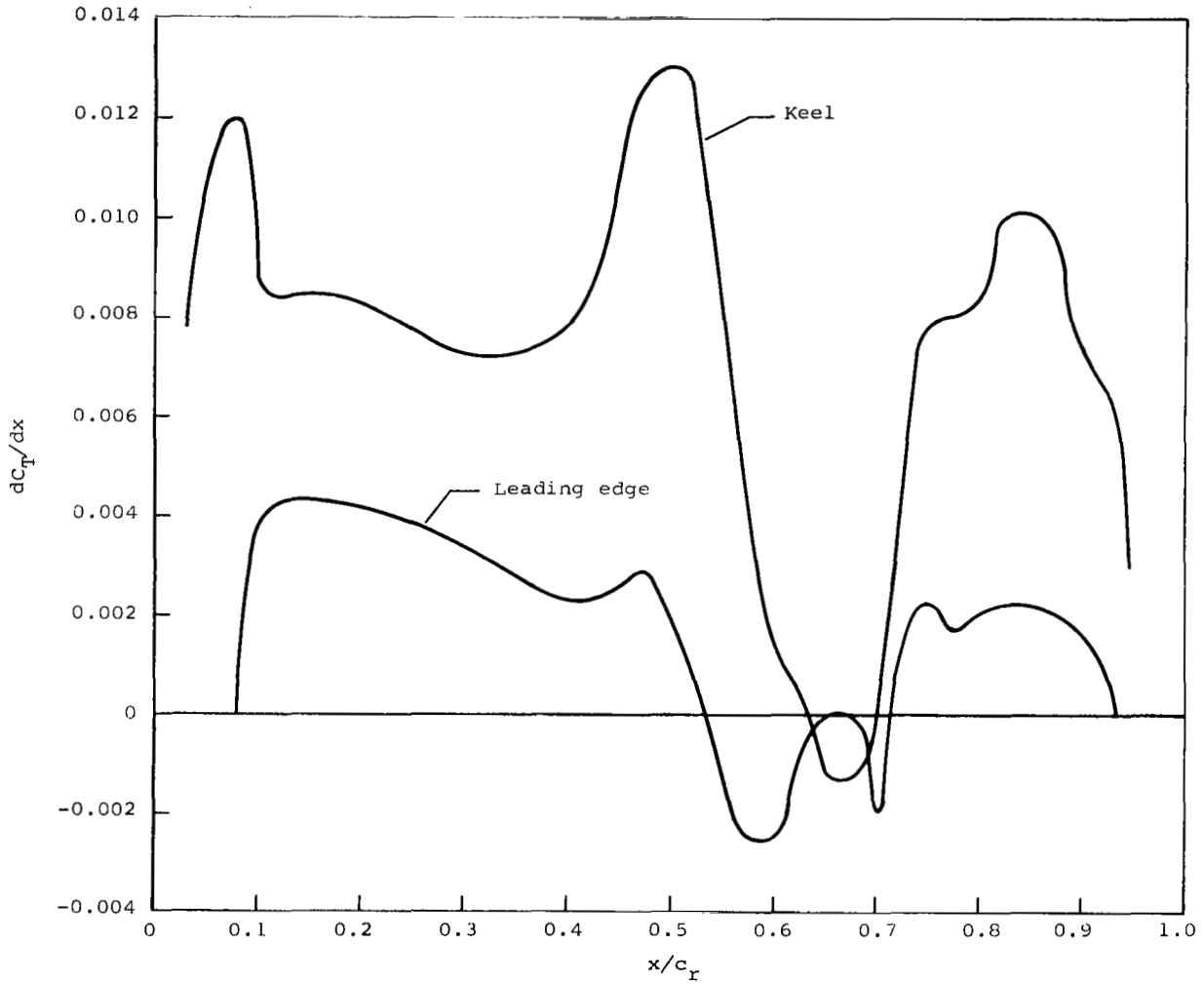

Figure 26.- Predicted distributed line tension load on twin-keel parawing obtained from Canopy Tension Approach (method c).



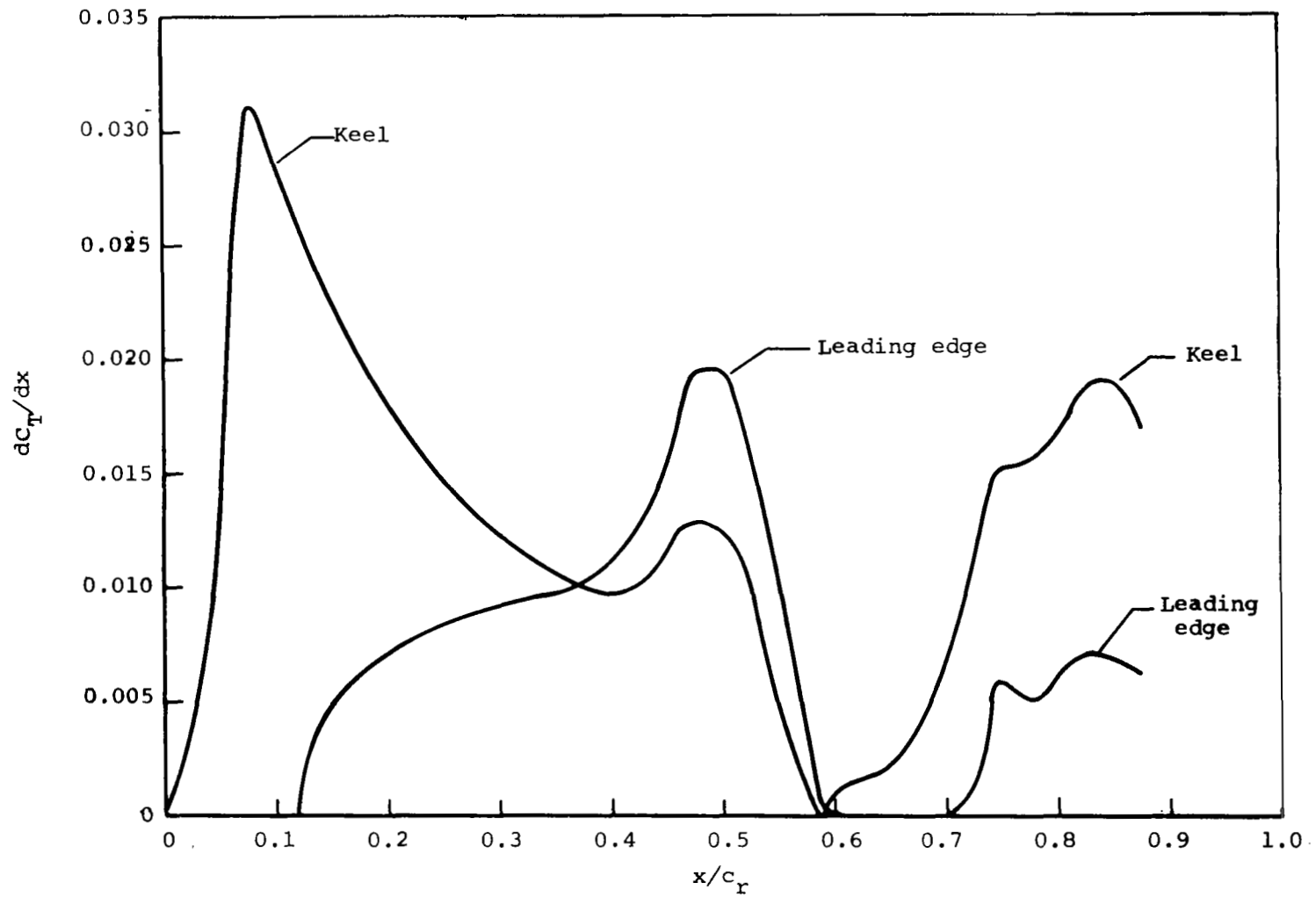
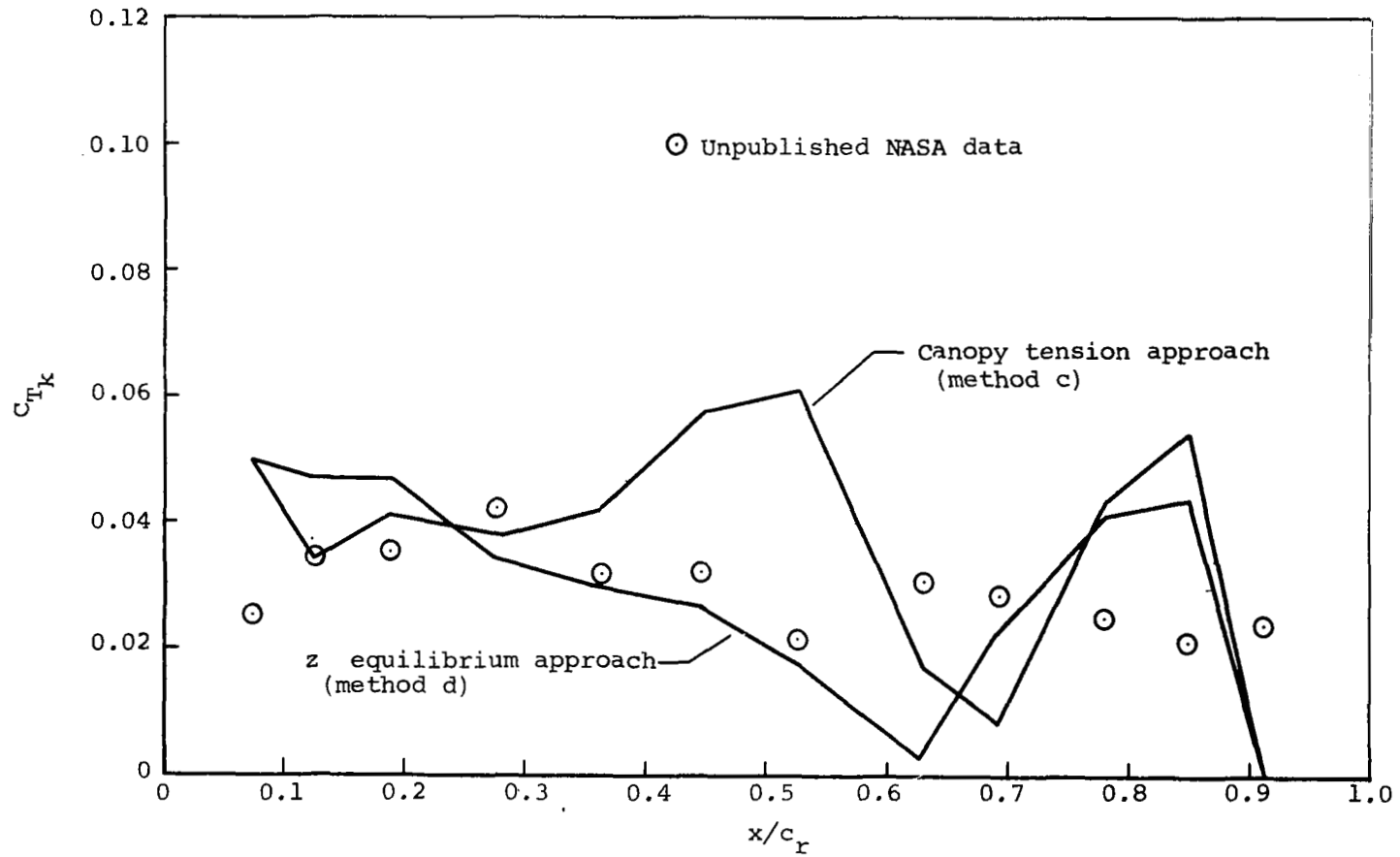
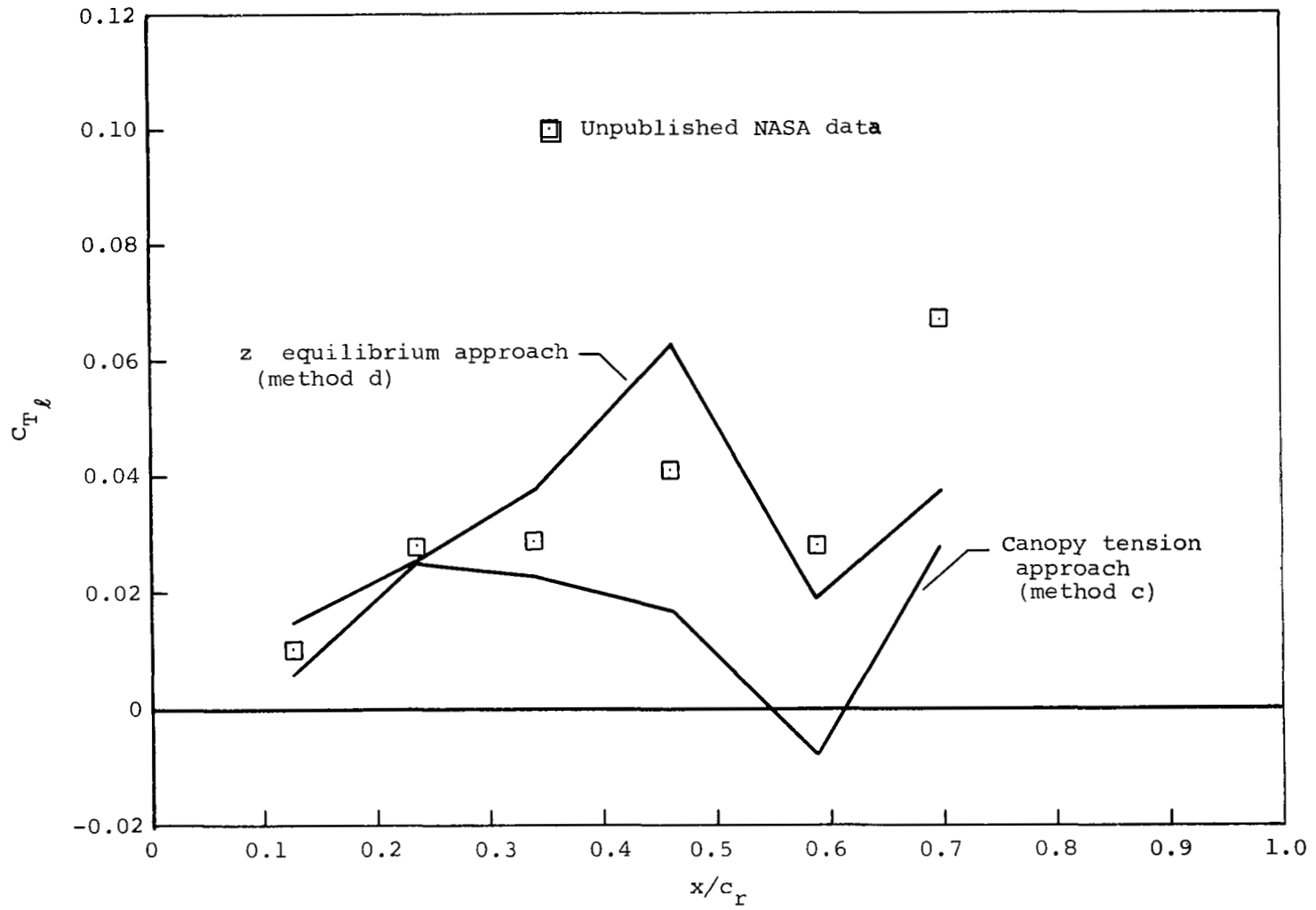

Figure 27.- Predicted distributed line tension load on twin-keel parawing obtained from z Equilibrium Approach (method d).



(a) Keel line loads.

Figure 28.- Comparison of line loads for two theoretical load distribution models for twin-keel parawing.



(b) Leading-edge line loads.  
Figure 28.- Concluded.

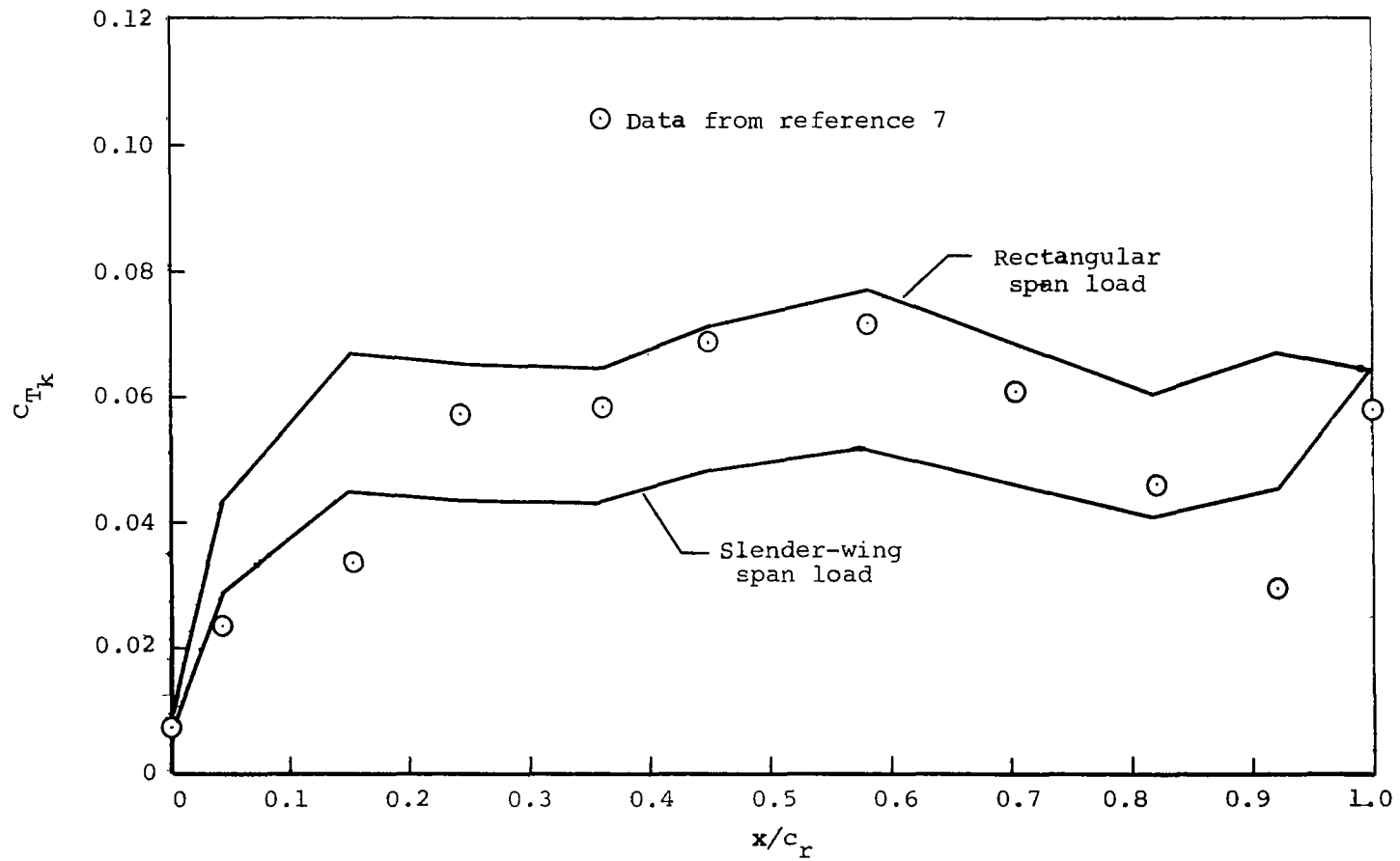

(a) Keel line loads.

Figure 29.- Comparison of predicted and measured line loads for the single-keel parawing.

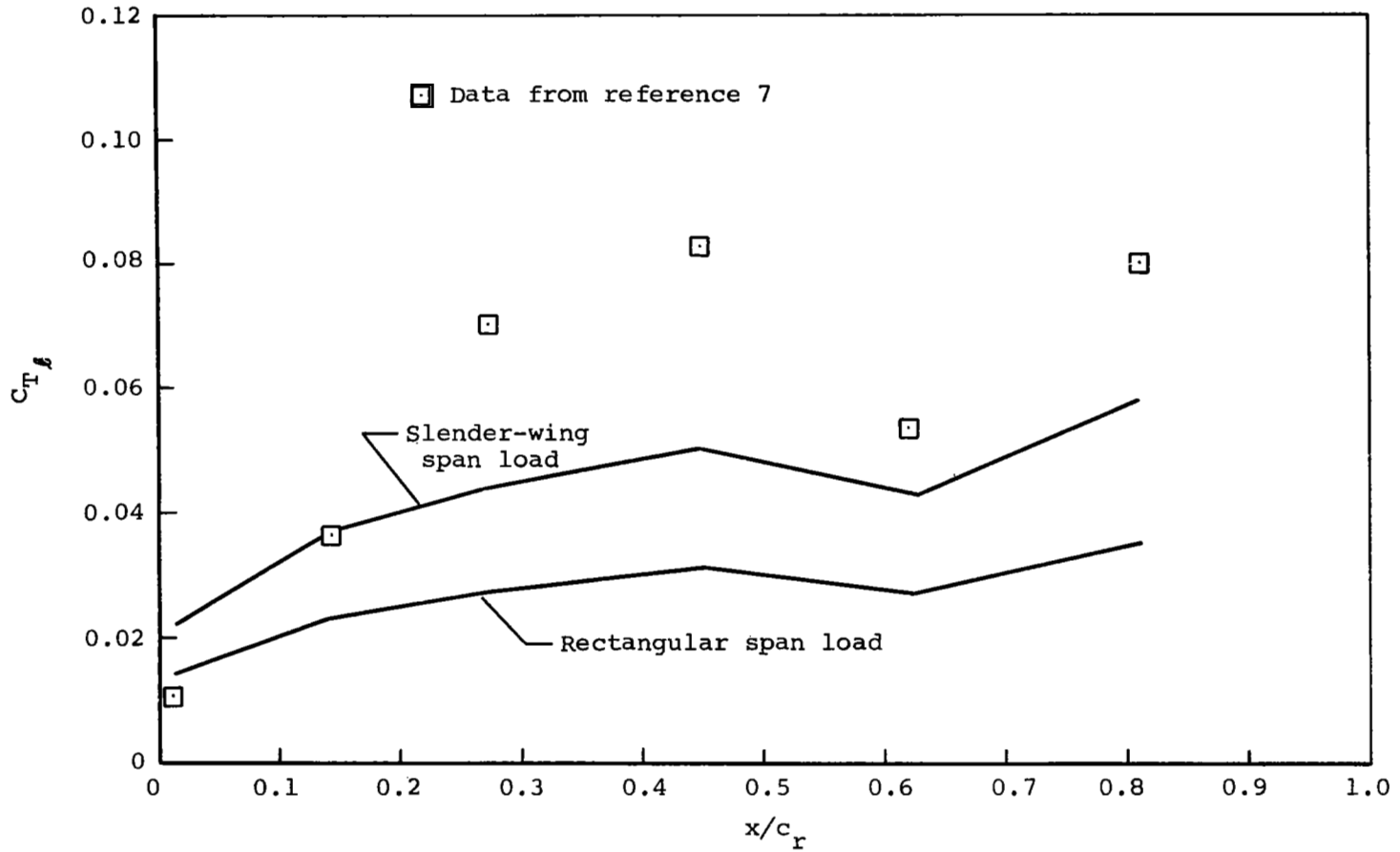

(b) Leading-edge line loads.

Figure 29.- Concluded.

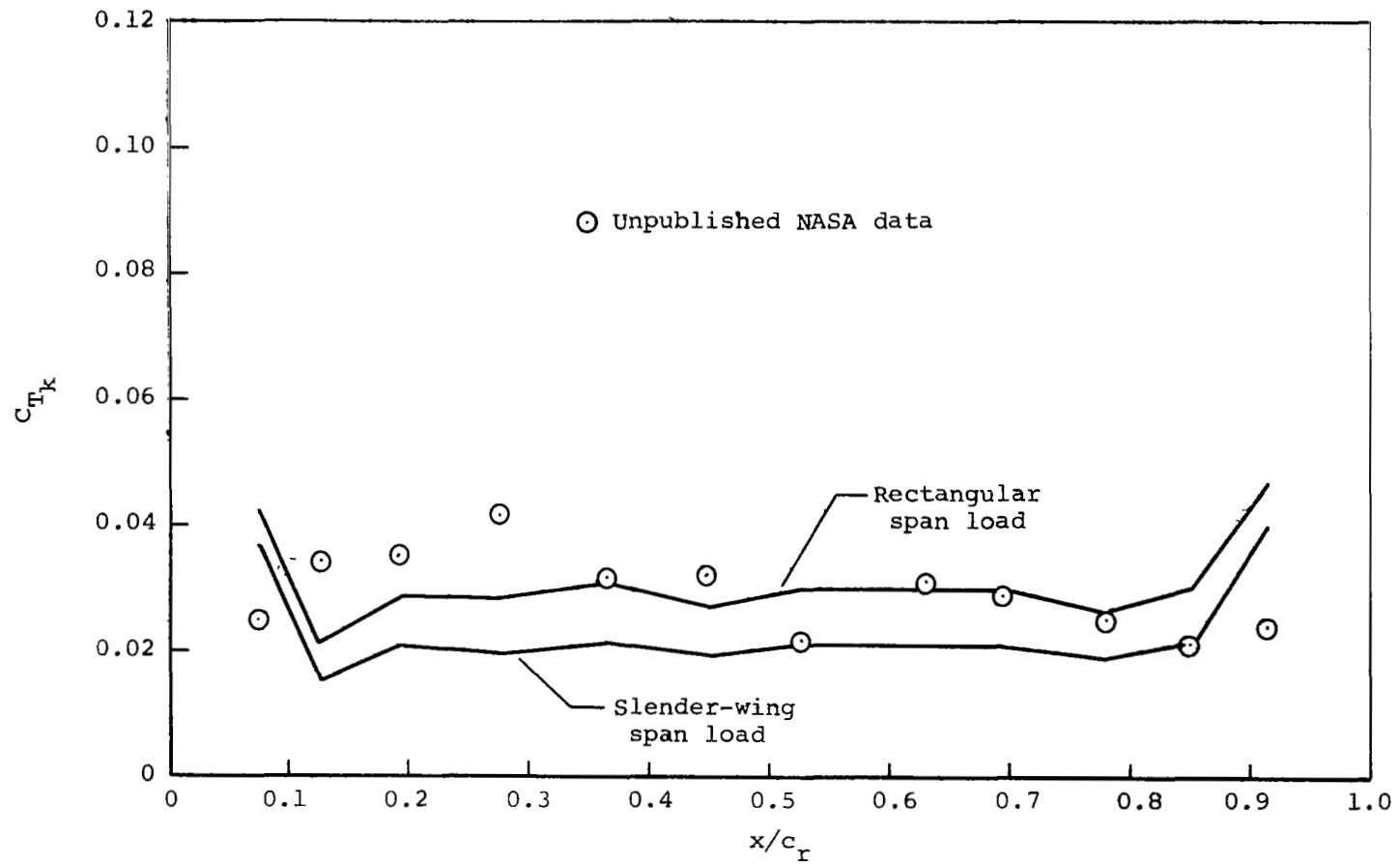

(a) Keel line loads.

Figure 30.- Comparison of predicted and measured line loads for the twin-keel parawing.

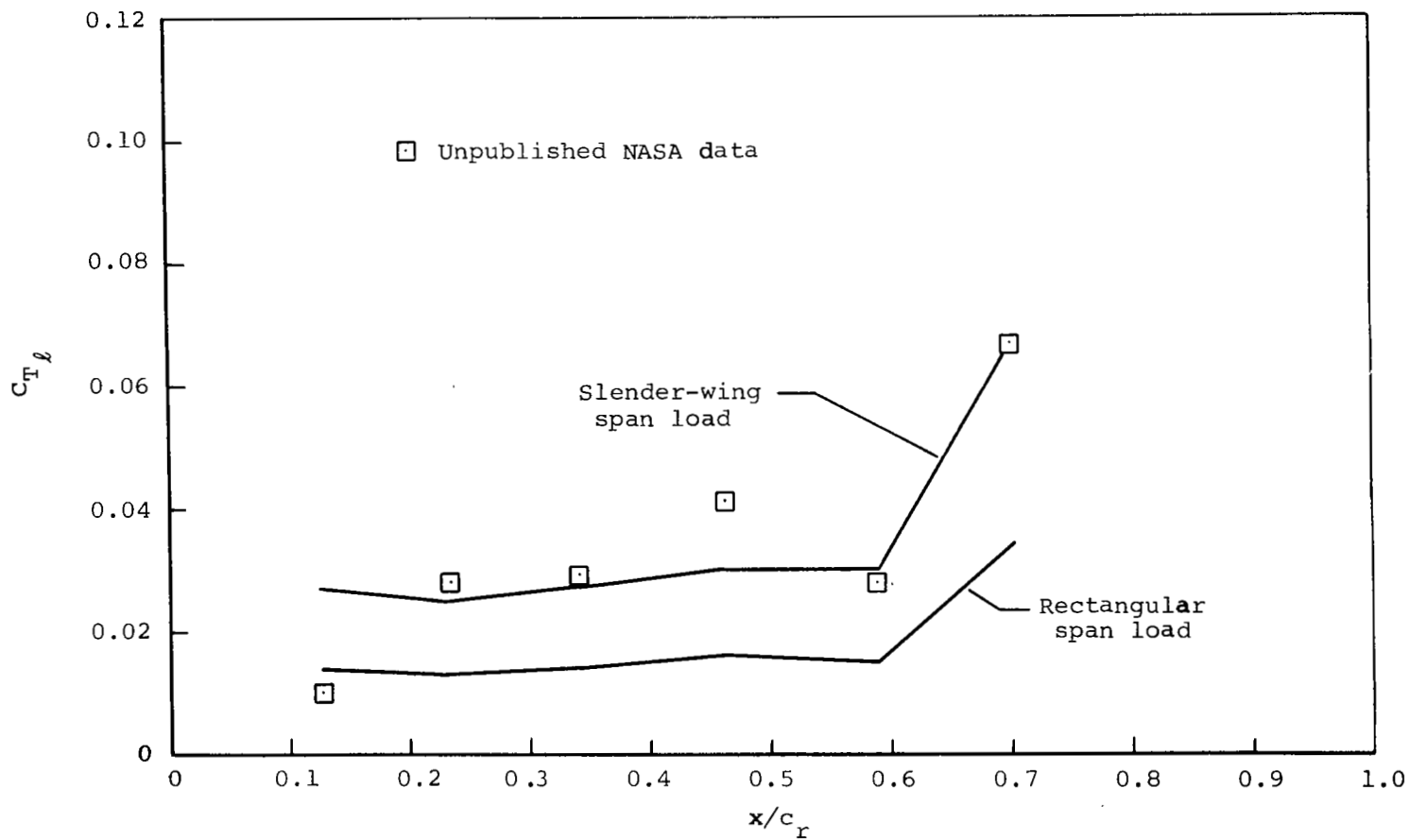

(b) Leading-edge line loads.

Figure 30.- Concluded.